

AR047 NEUTRON ACER TENDL-2023 LIBRARY; T=0.K  
Principal cross sections

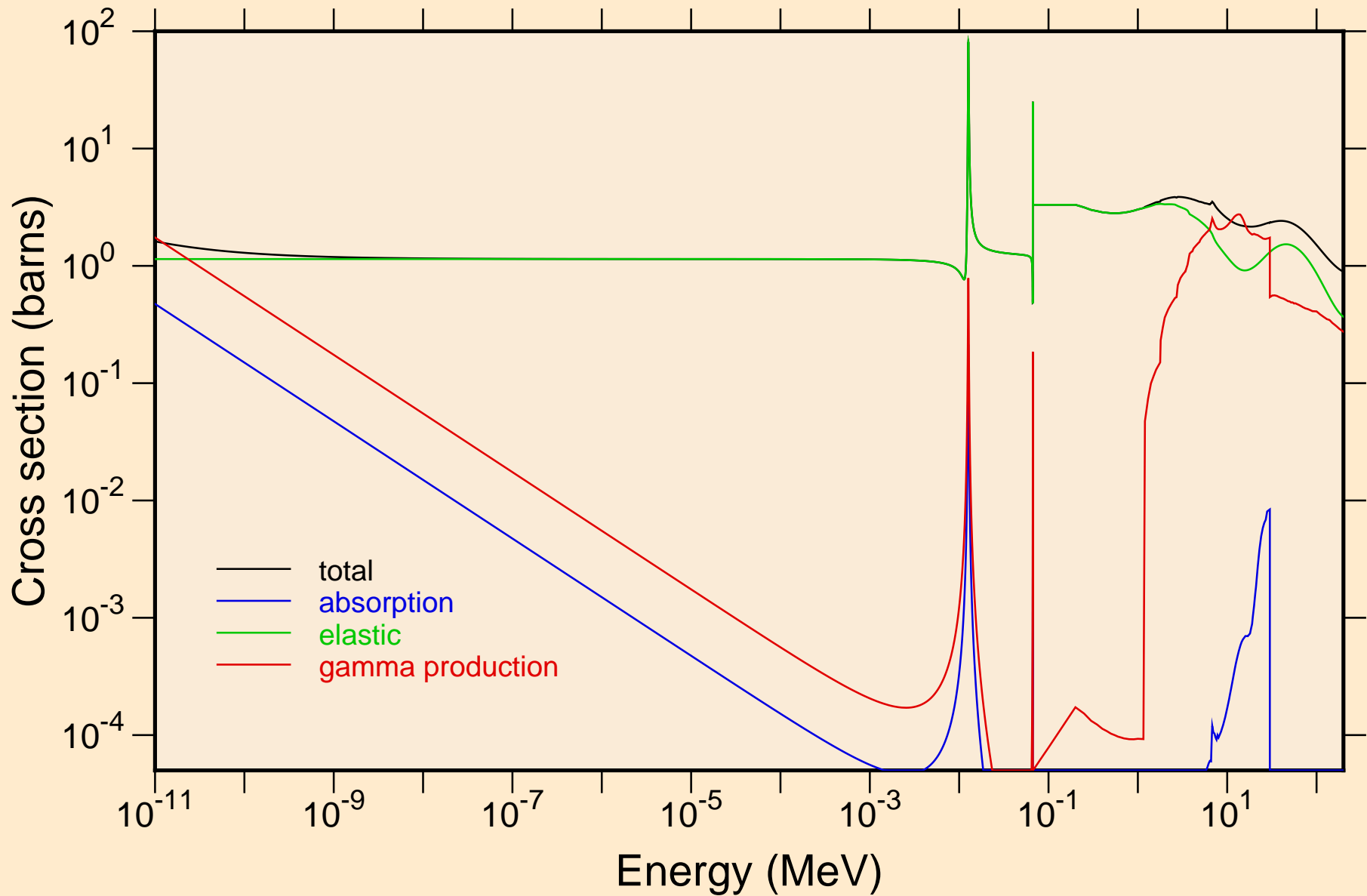

AR047 NEUTRON ACER TENDL-2023 LIBRARY; T=0.K  
Heating

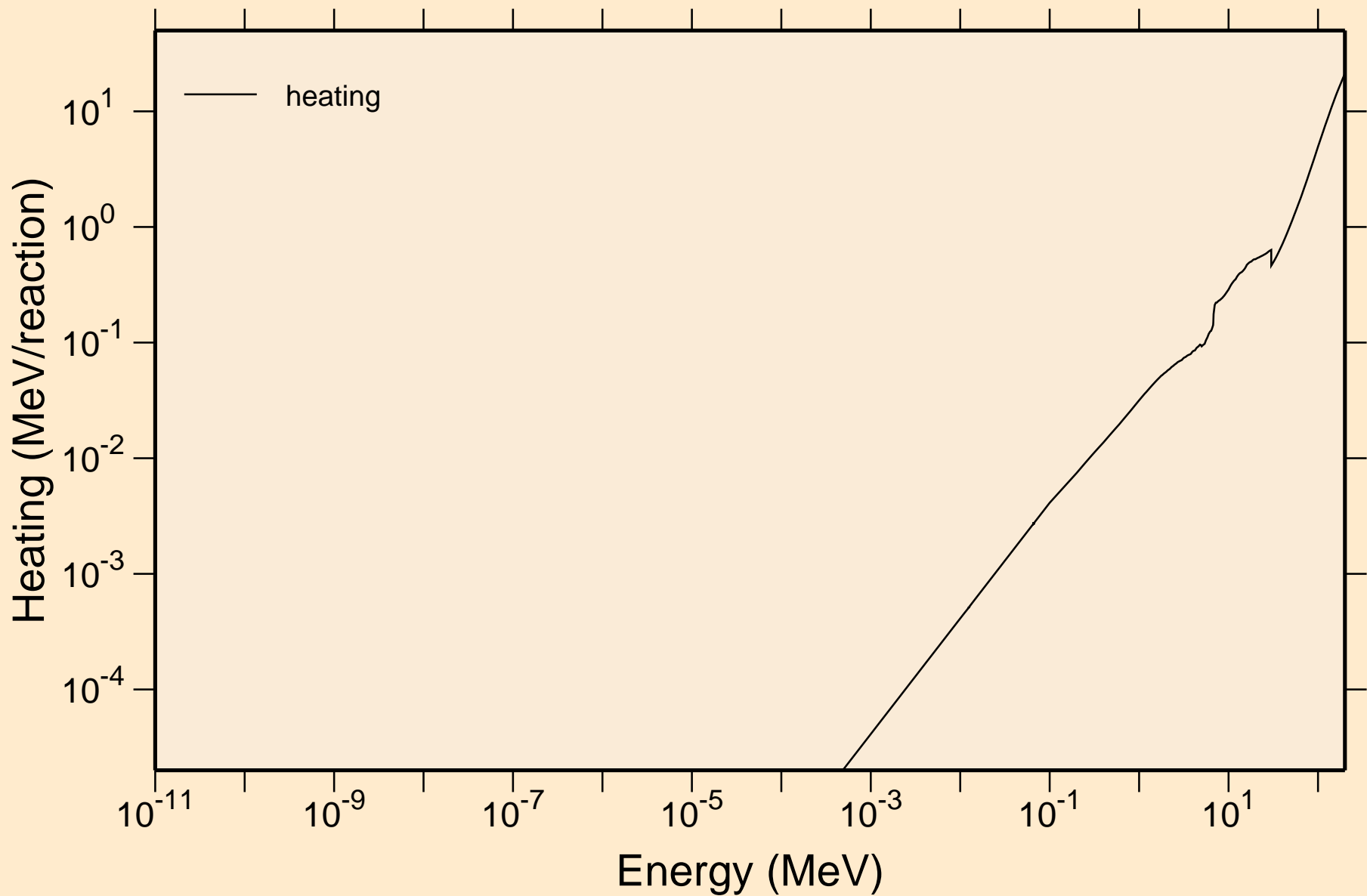

AR047 NEUTRON ACER TENDL-2023 LIBRARY; T=0.K  
Damage

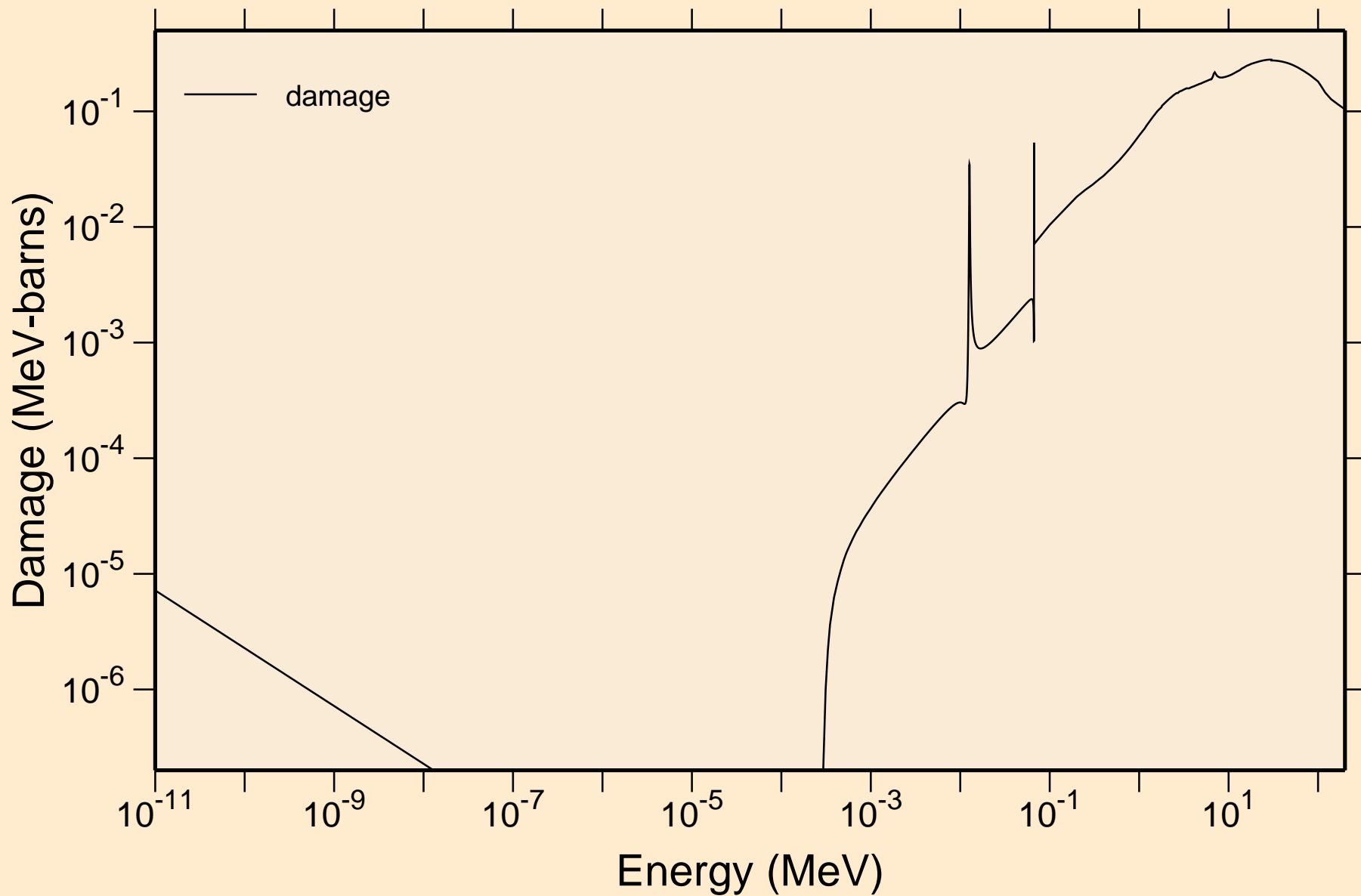

AR047 NEUTRON ACER TENDL-2023 LIBRARY; T=0.K  
Non-threshold reactions

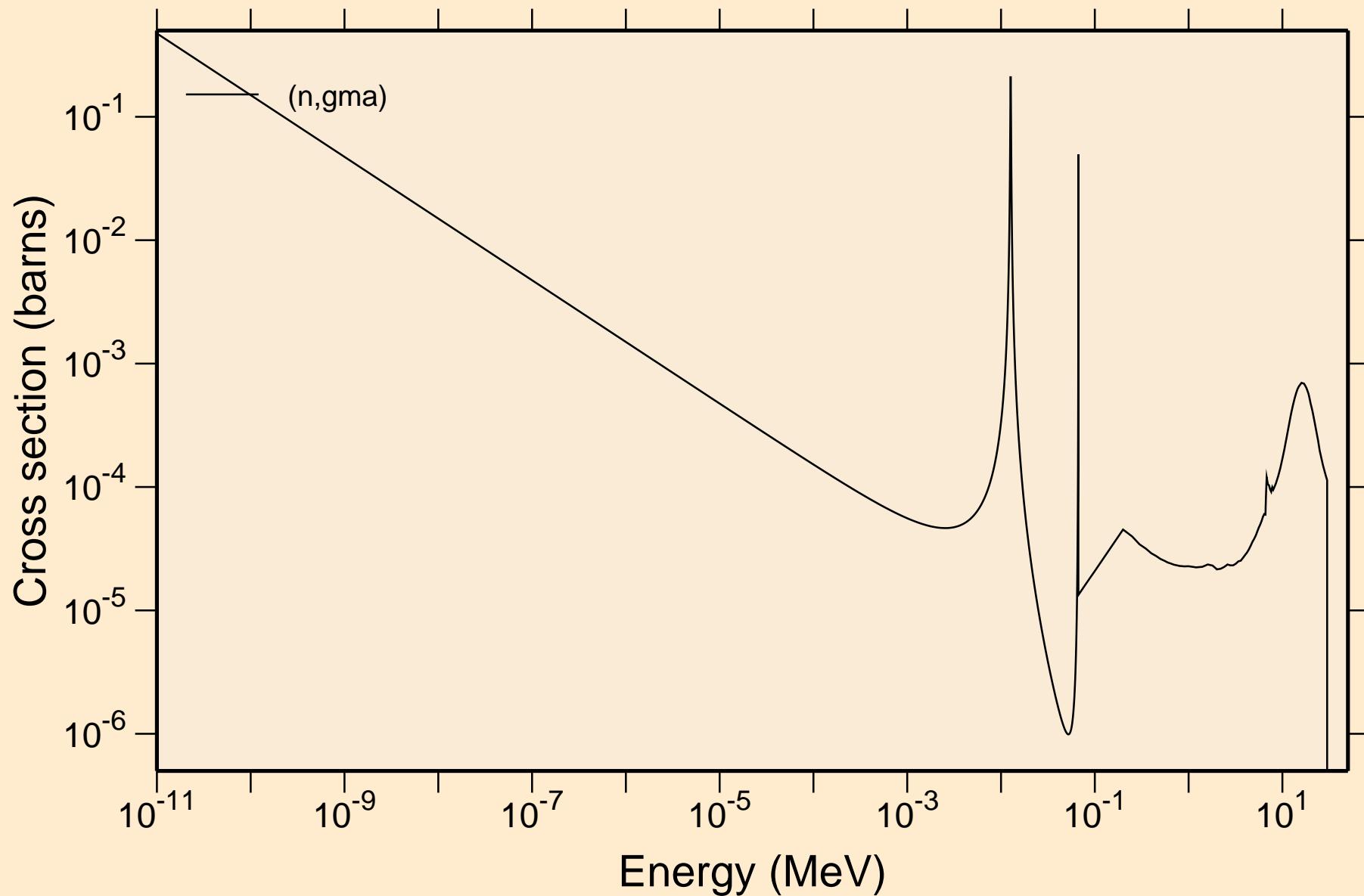

AR047 NEUTRON ACER TENDL-2023 LIBRARY; T=0.K  
Principal cross sections

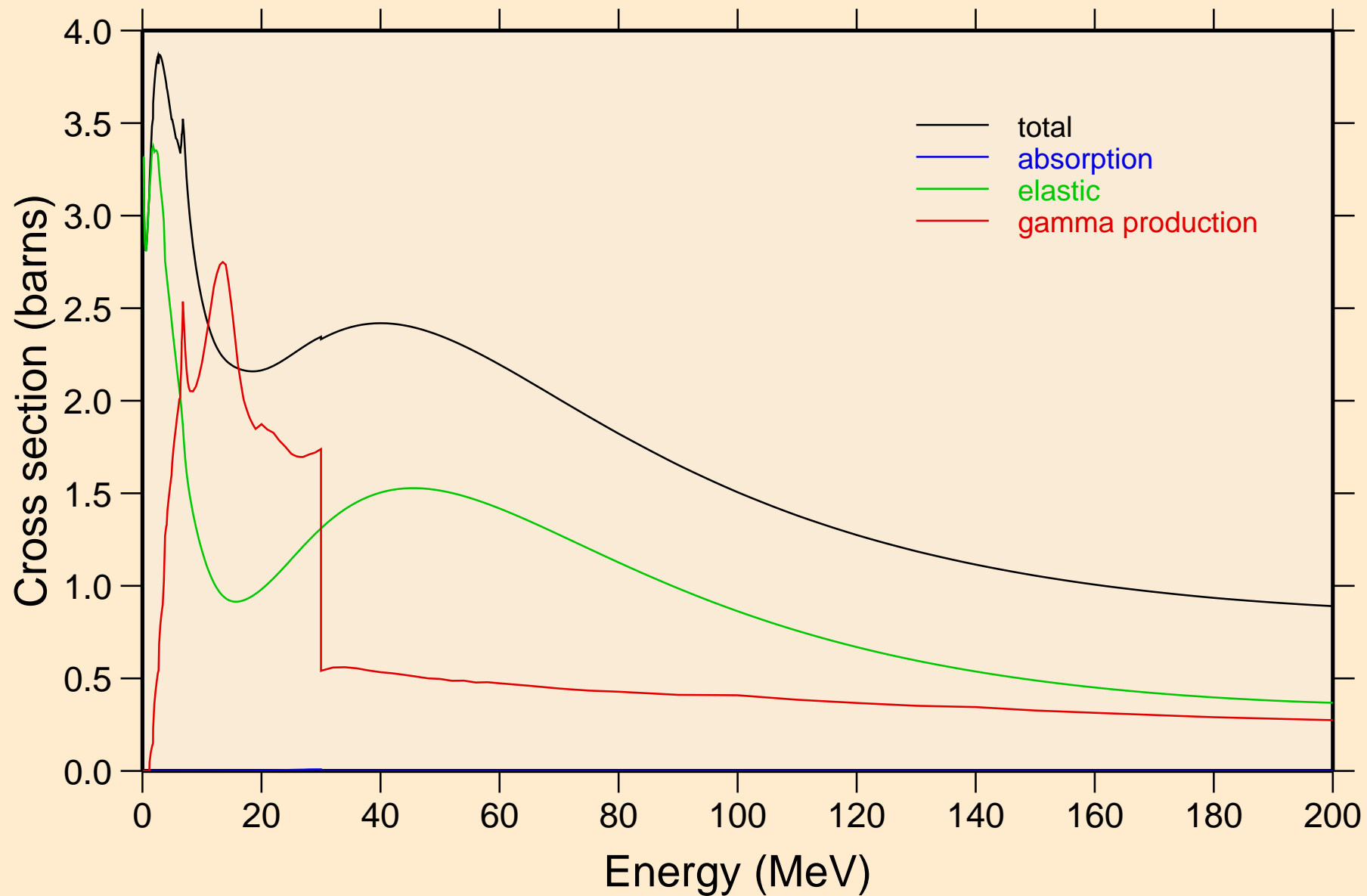

AR047 NEUTRON ACER TENDL-2023 LIBRARY; T=0.K  
Heating

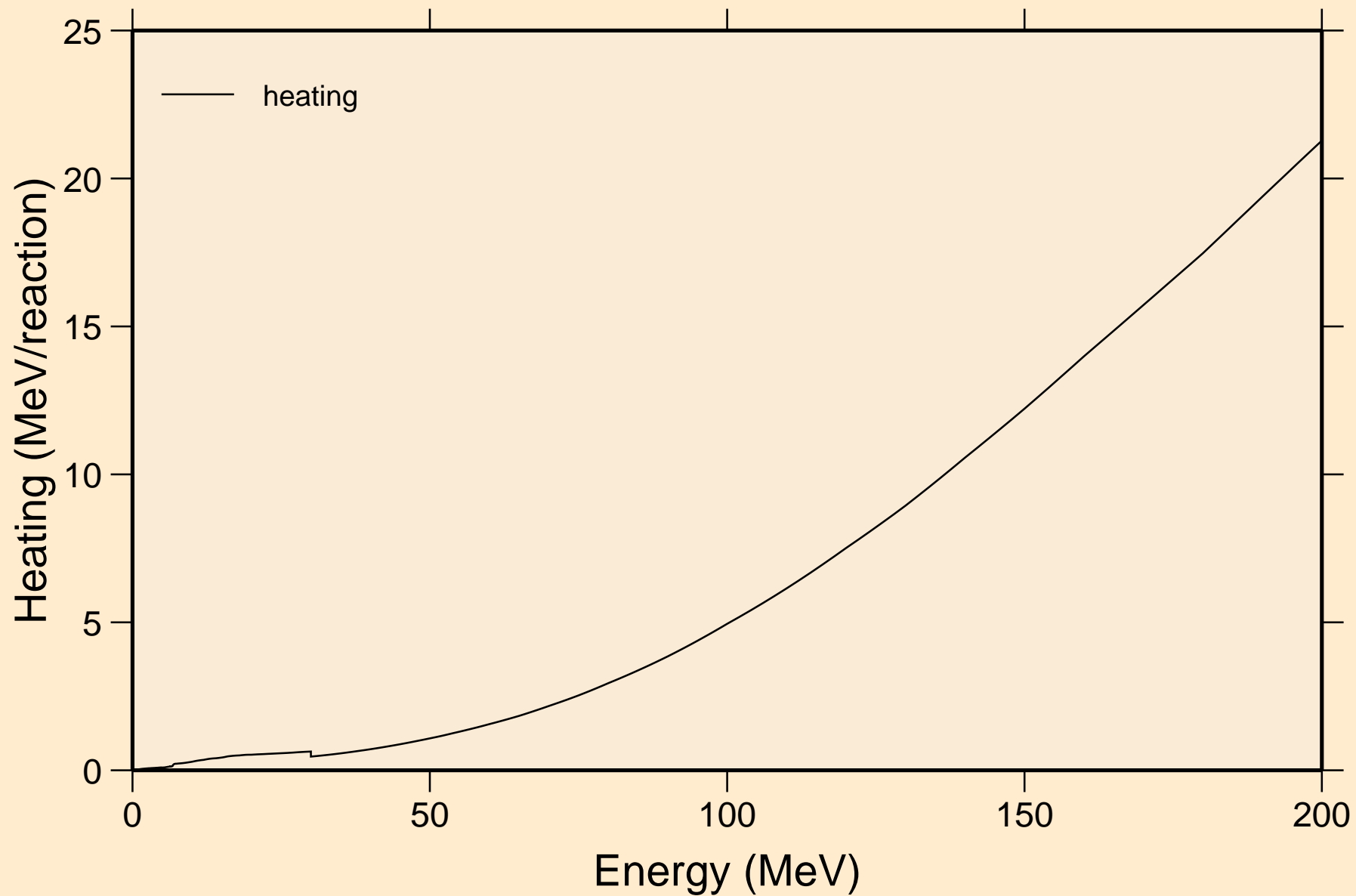

AR047 NEUTRON ACER TENDL-2023 LIBRARY; T=0.K  
Damage

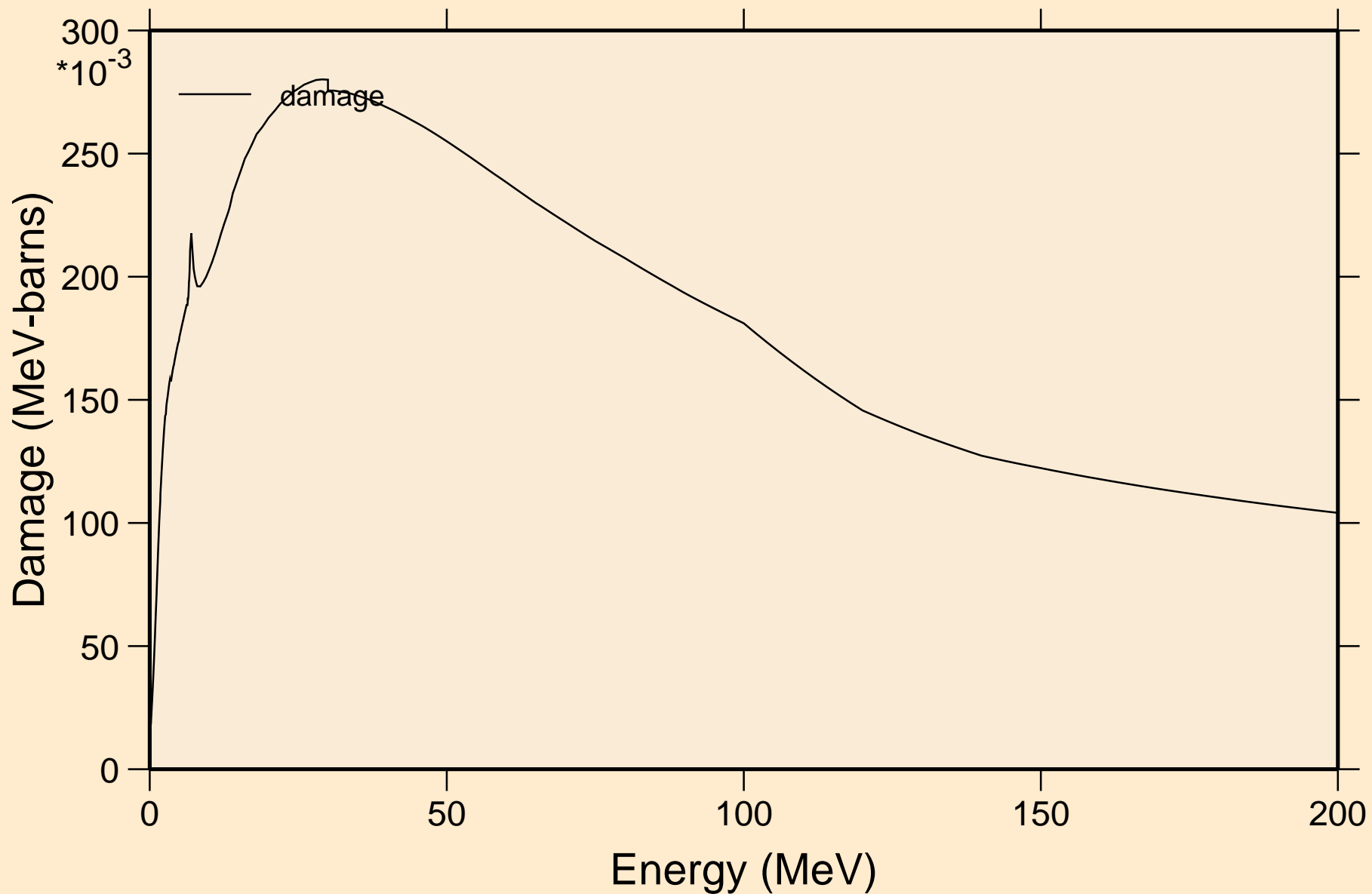

AR047 NEUTRON ACER TENDL-2023 LIBRARY; T=0.K  
Non-threshold reactions

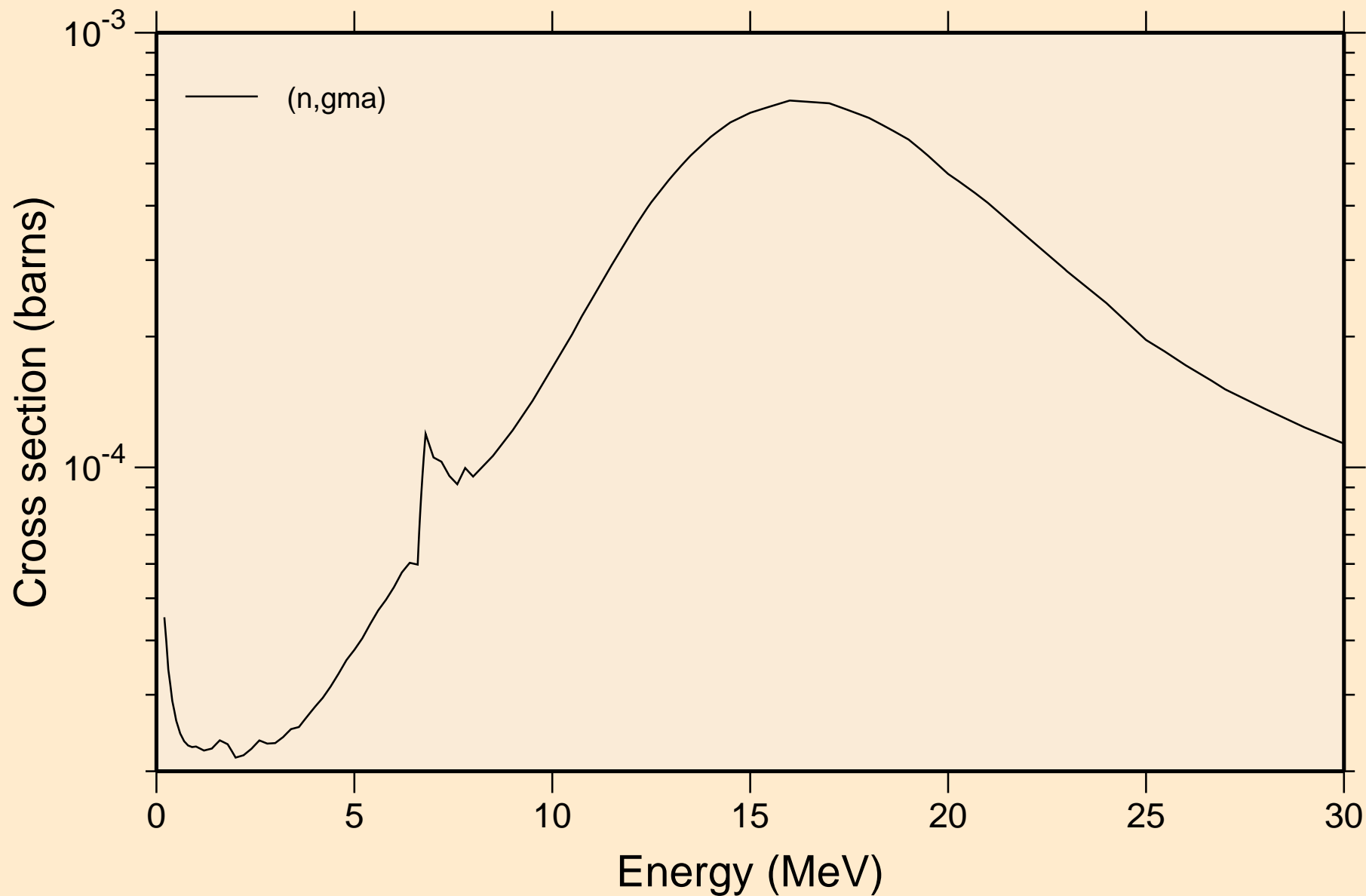



AR047 NEUTRON ACER TENDL-2023 LIBRARY; T=0.K  
Inelastic levels

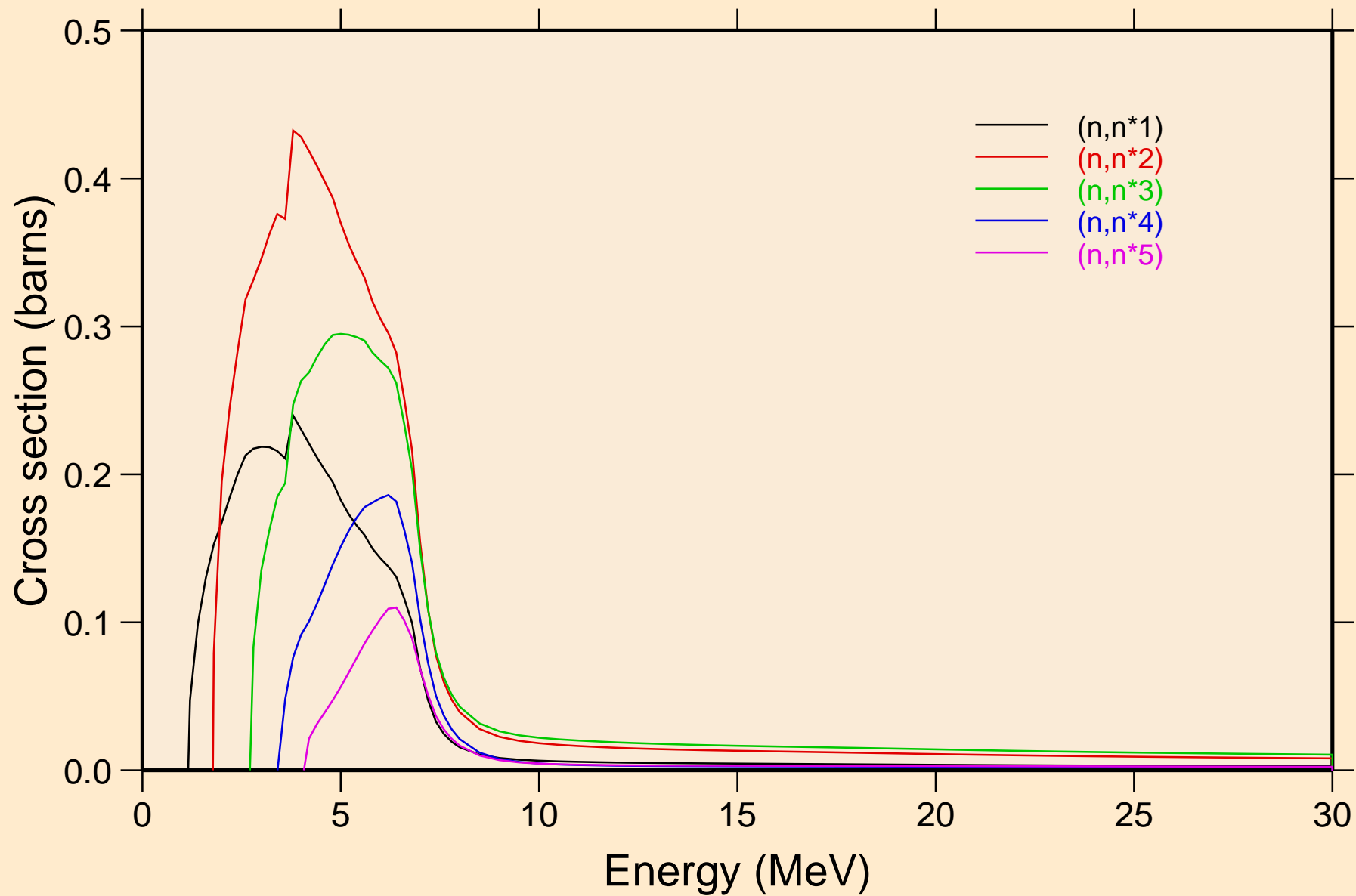

AR047 NEUTRON ACER TENDL-2023 LIBRARY; T=0.K  
Inelastic levels

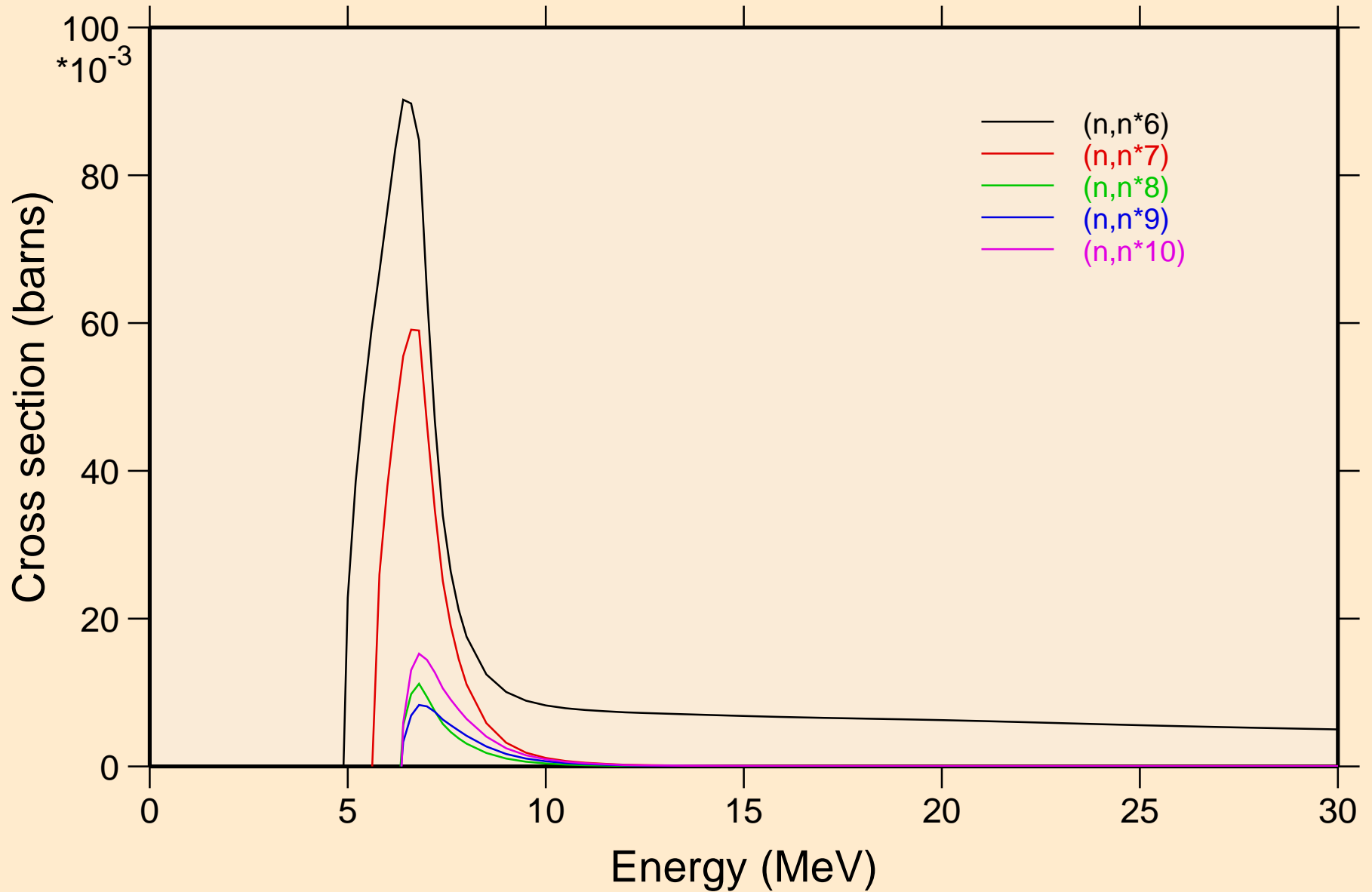

AR047 NEUTRON ACER TENDL-2023 LIBRARY; T=0.K  
Inelastic levels

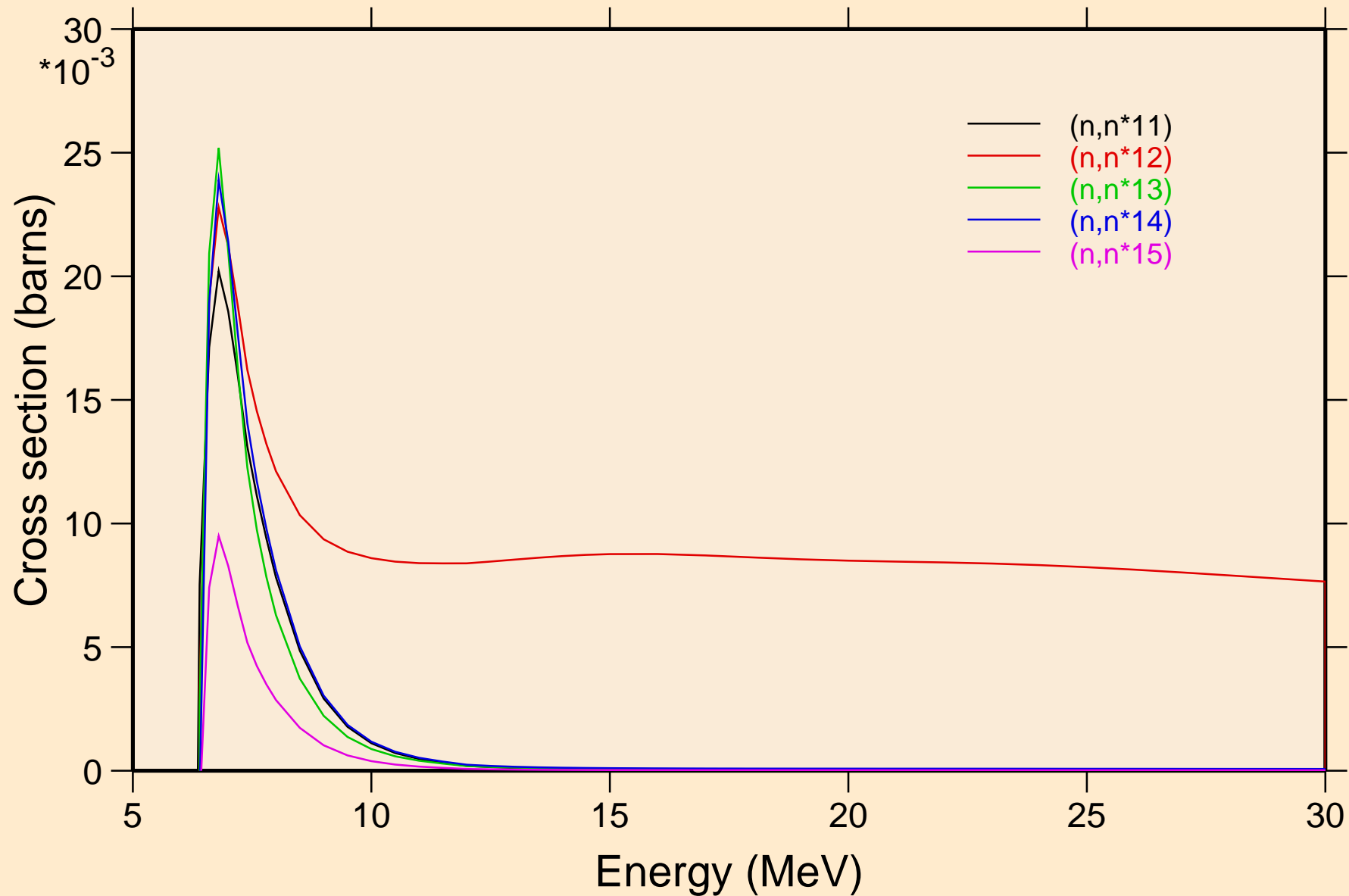

AR047 NEUTRON ACER TENDL-2023 LIBRARY; T=0.K  
Inelastic levels

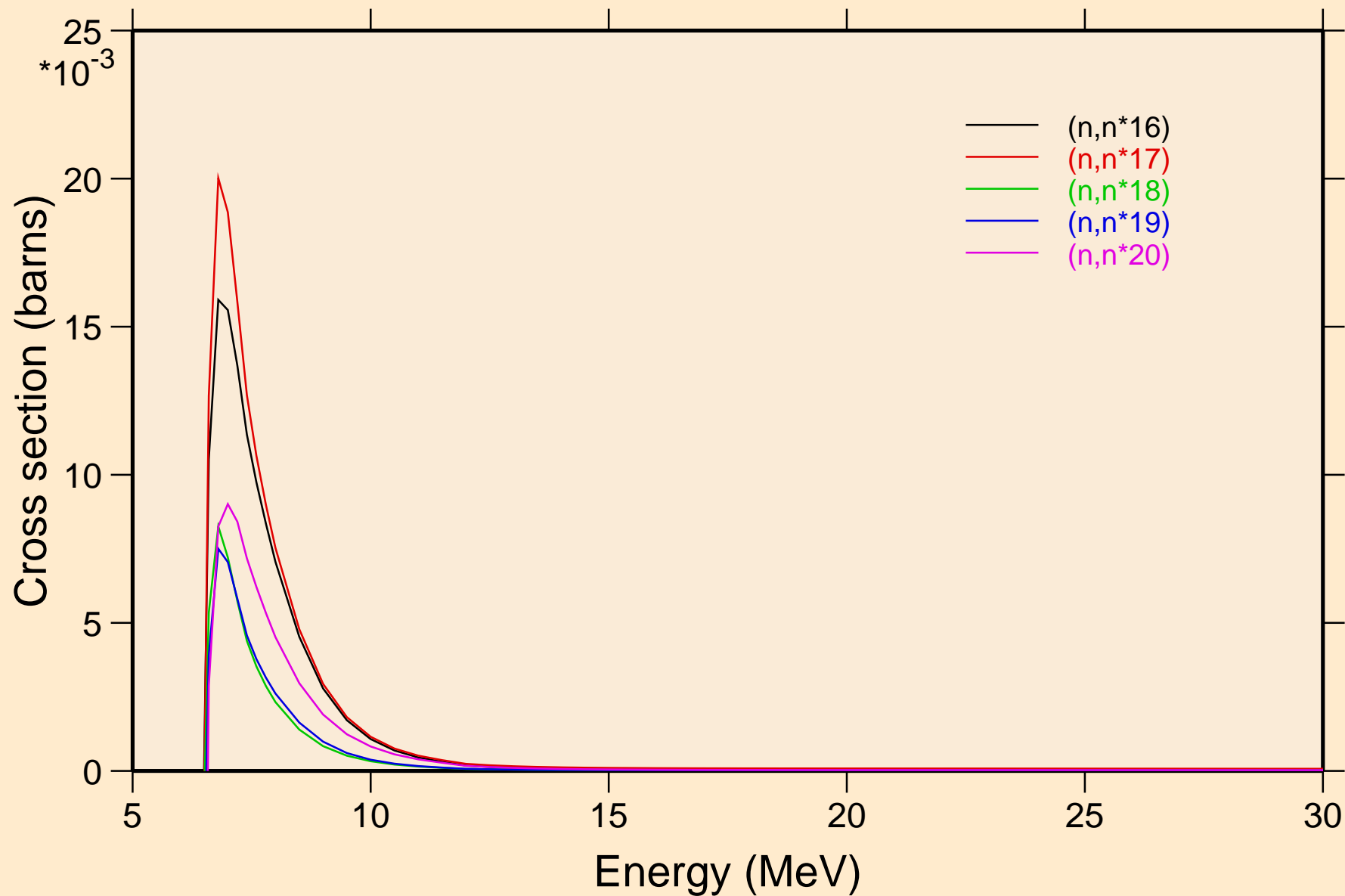

AR047 NEUTRON ACER TENDL-2023 LIBRARY; T=0.K  
Inelastic levels

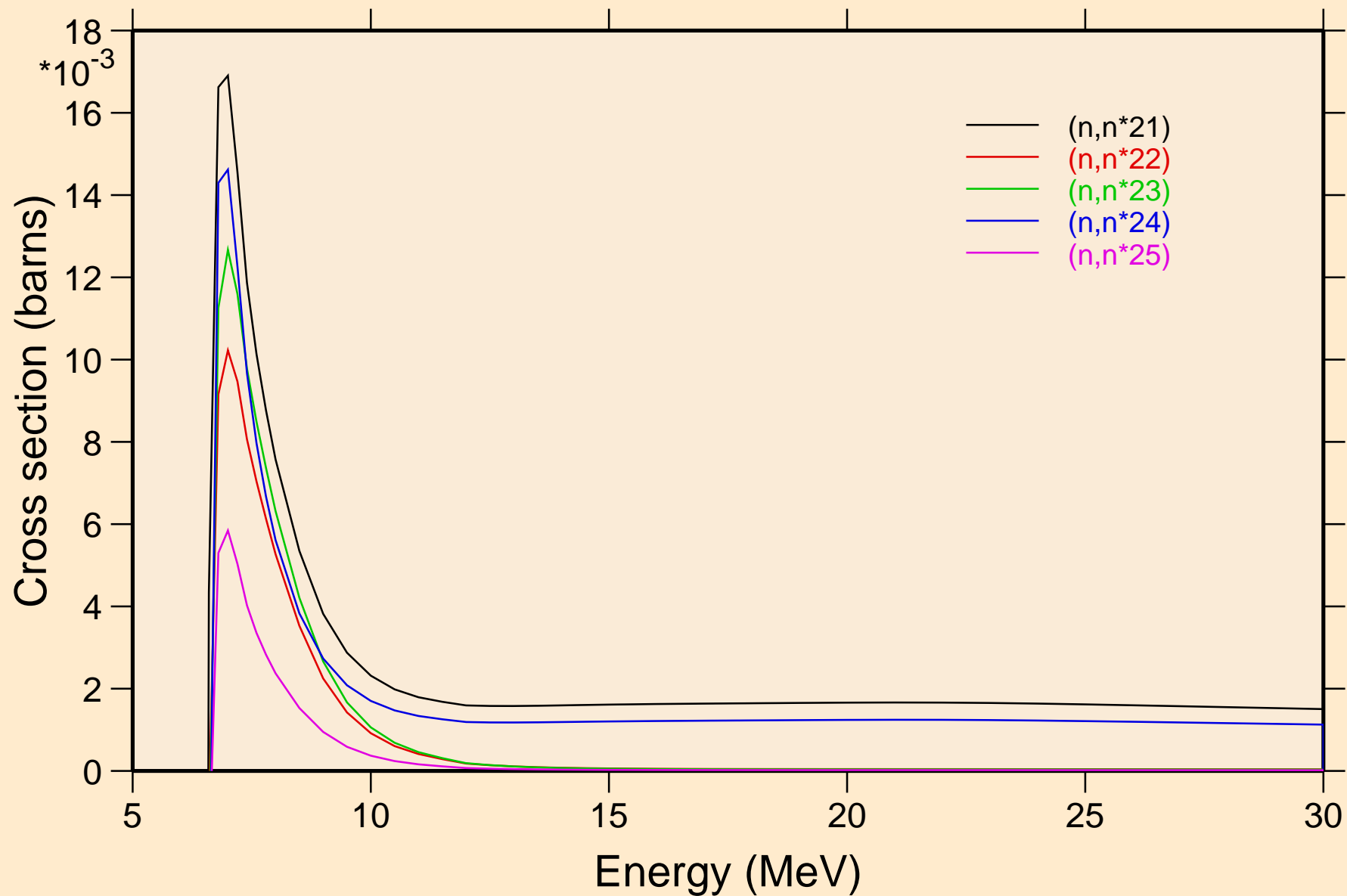

AR047 NEUTRON ACER TENDL-2023 LIBRARY; T=0.K  
Inelastic levels

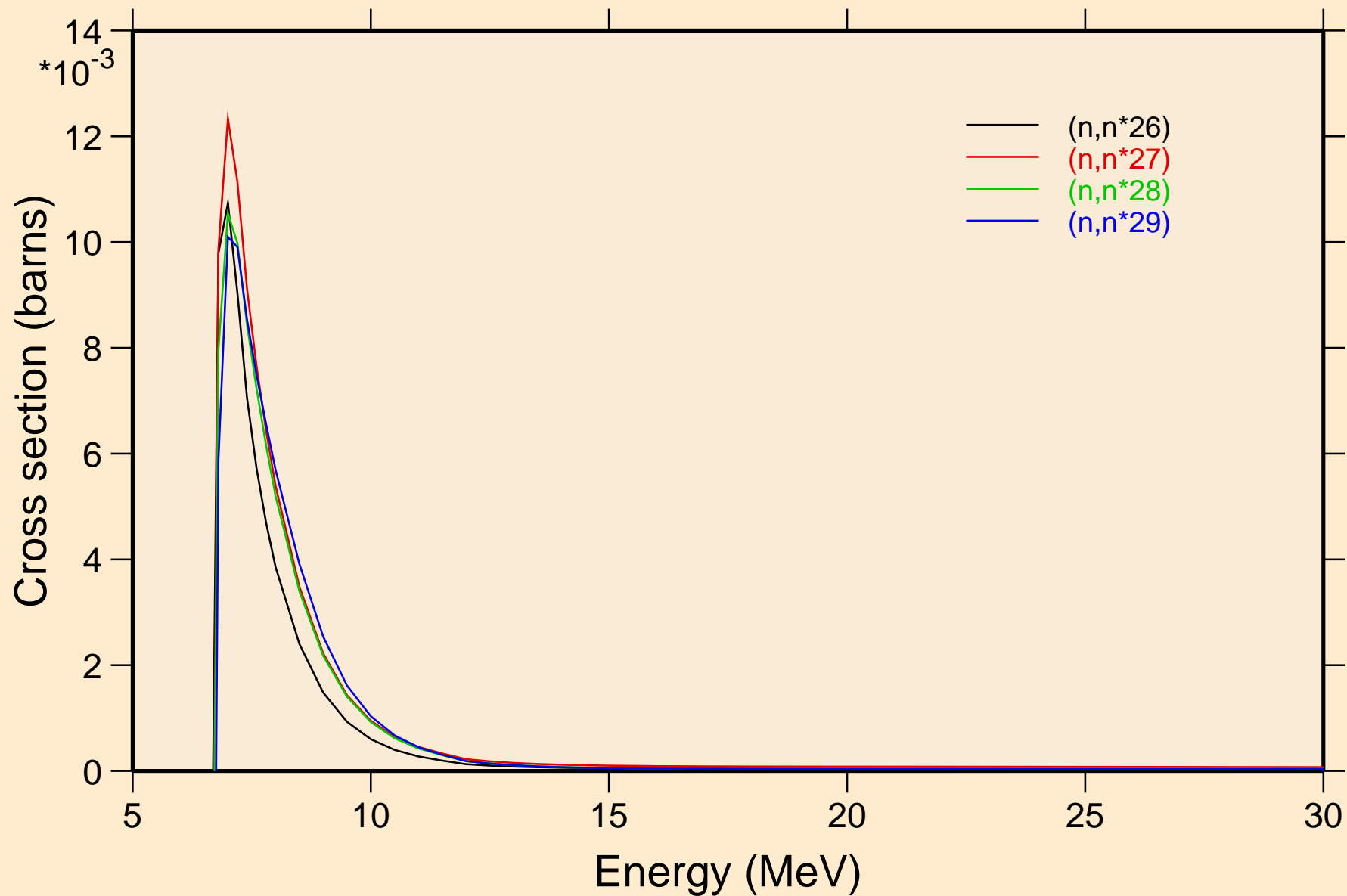

AR047 NEUTRON ACER TENDL-2023 LIBRARY; T=0.K  
Threshold reactions

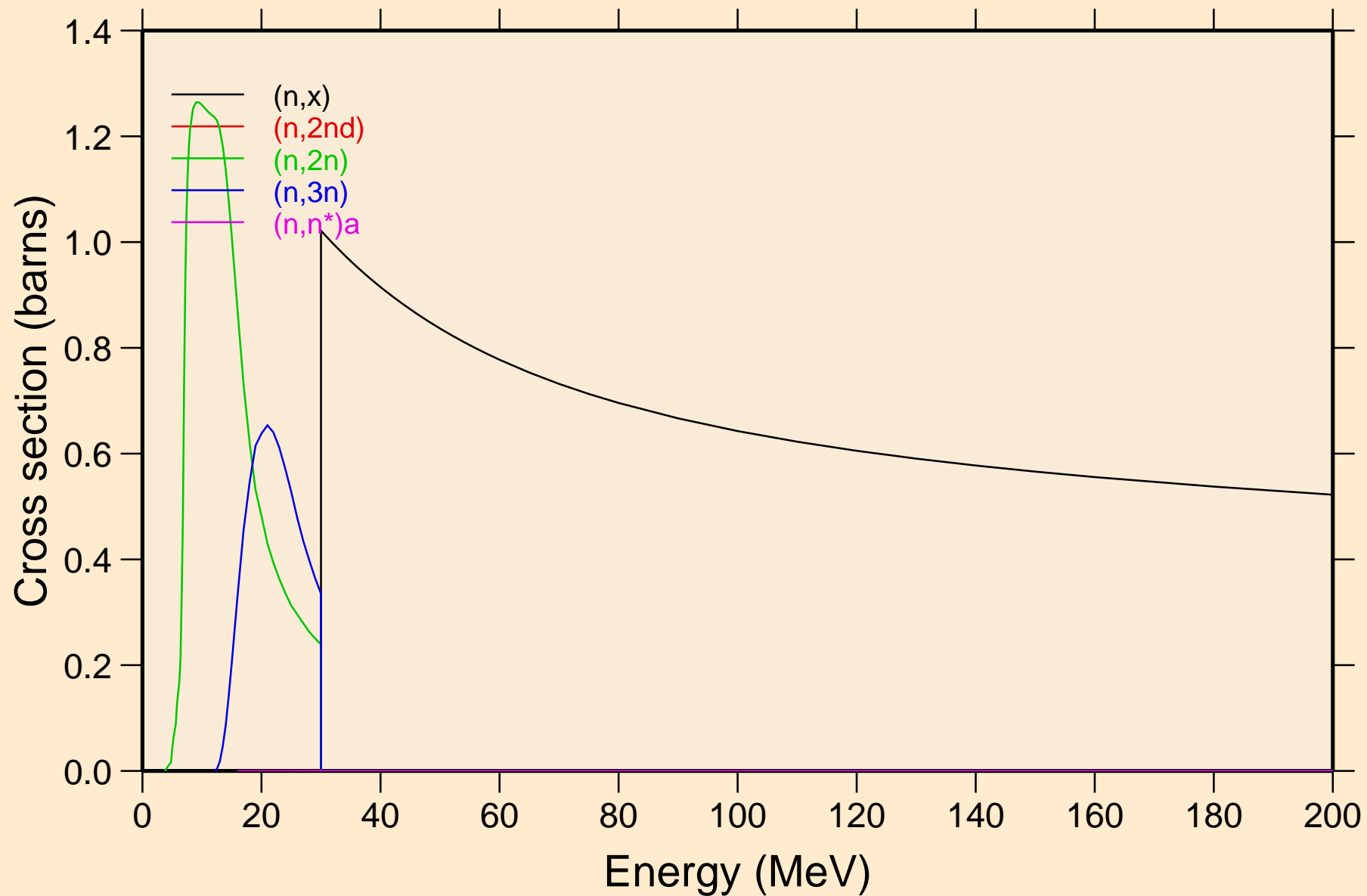

AR047 NEUTRON ACER TENDL-2023 LIBRARY; T=0.K  
Threshold reactions

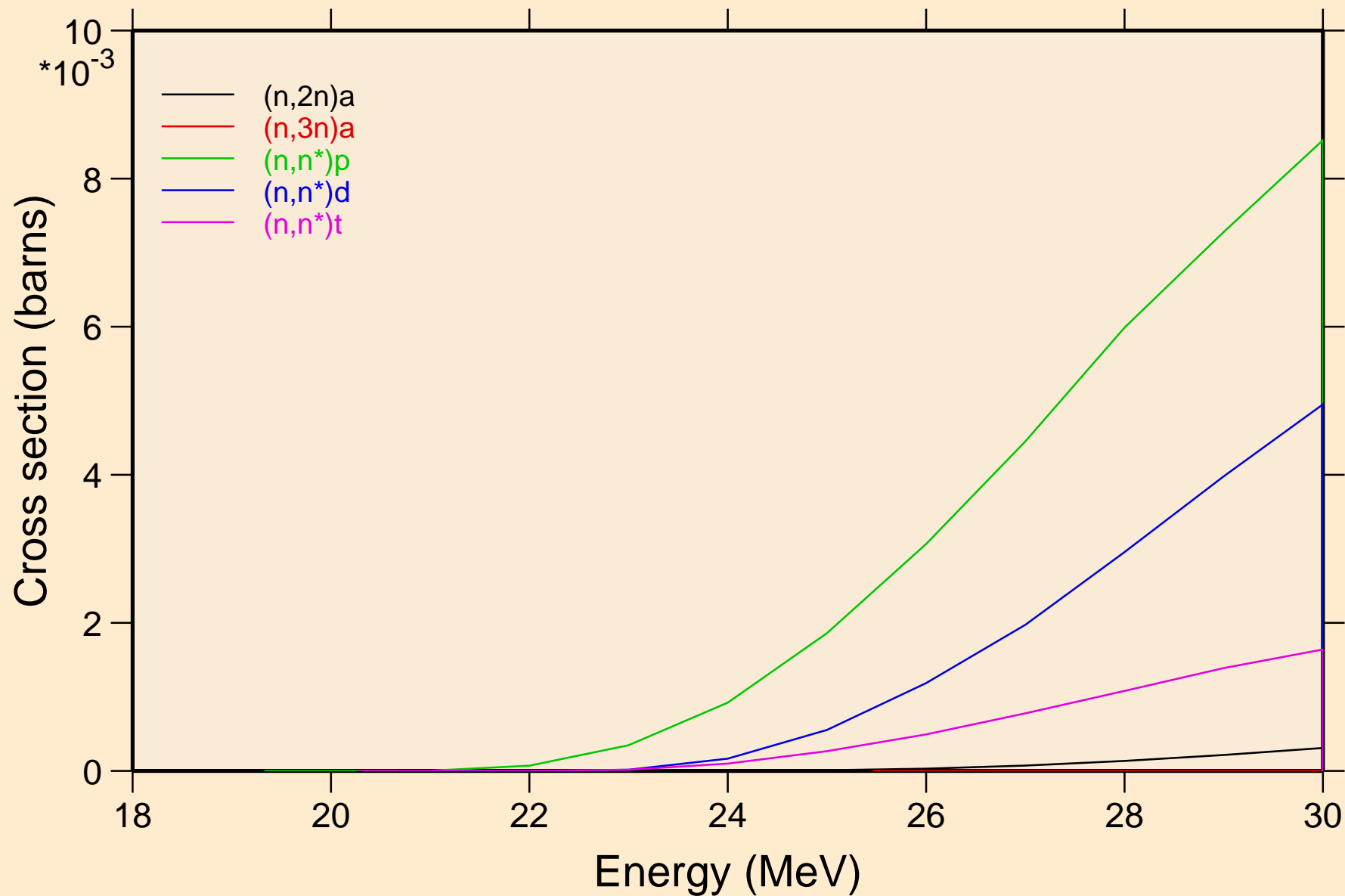



# AR047 NEUTRON ACER TENDL-2023 LIBRARY; T=0.K

## Threshold reactions

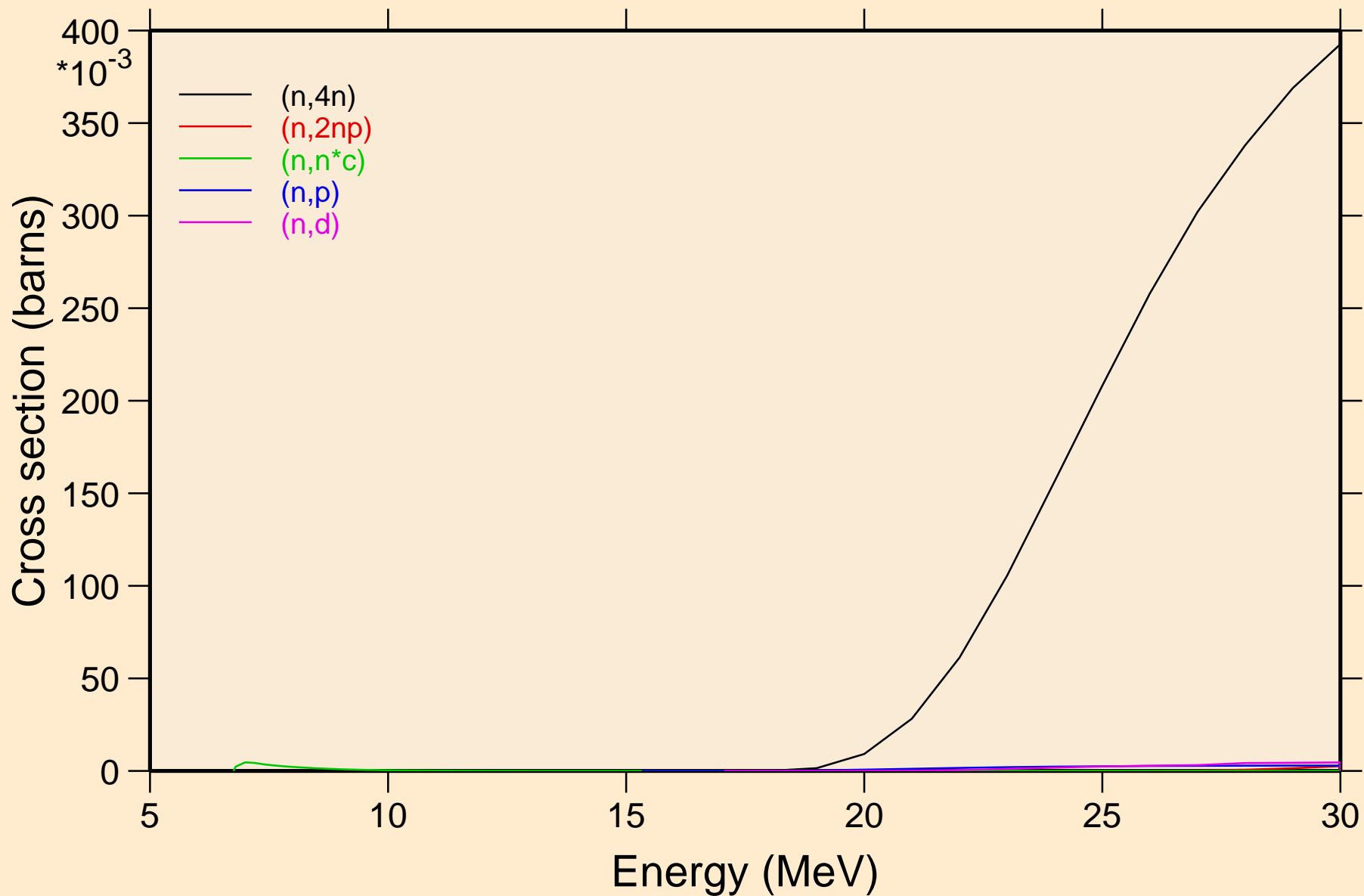

AR047 NEUTRON ACER TENDL-2023 LIBRARY; T=0.K  
Threshold reactions

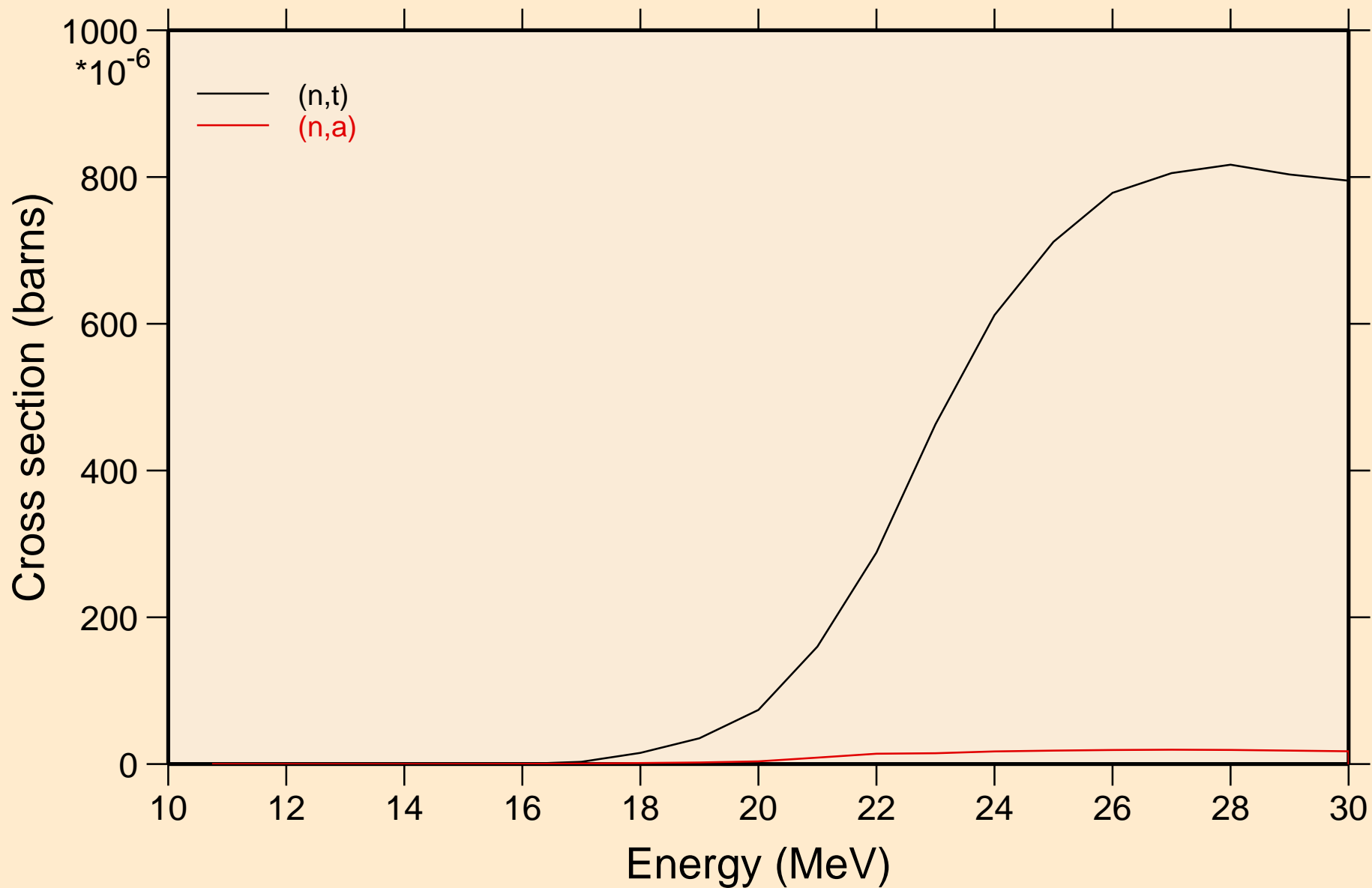

# AR047 NEUTRON ACER TENDL-2023 LIBRARY; T=0.K

## Threshold reactions

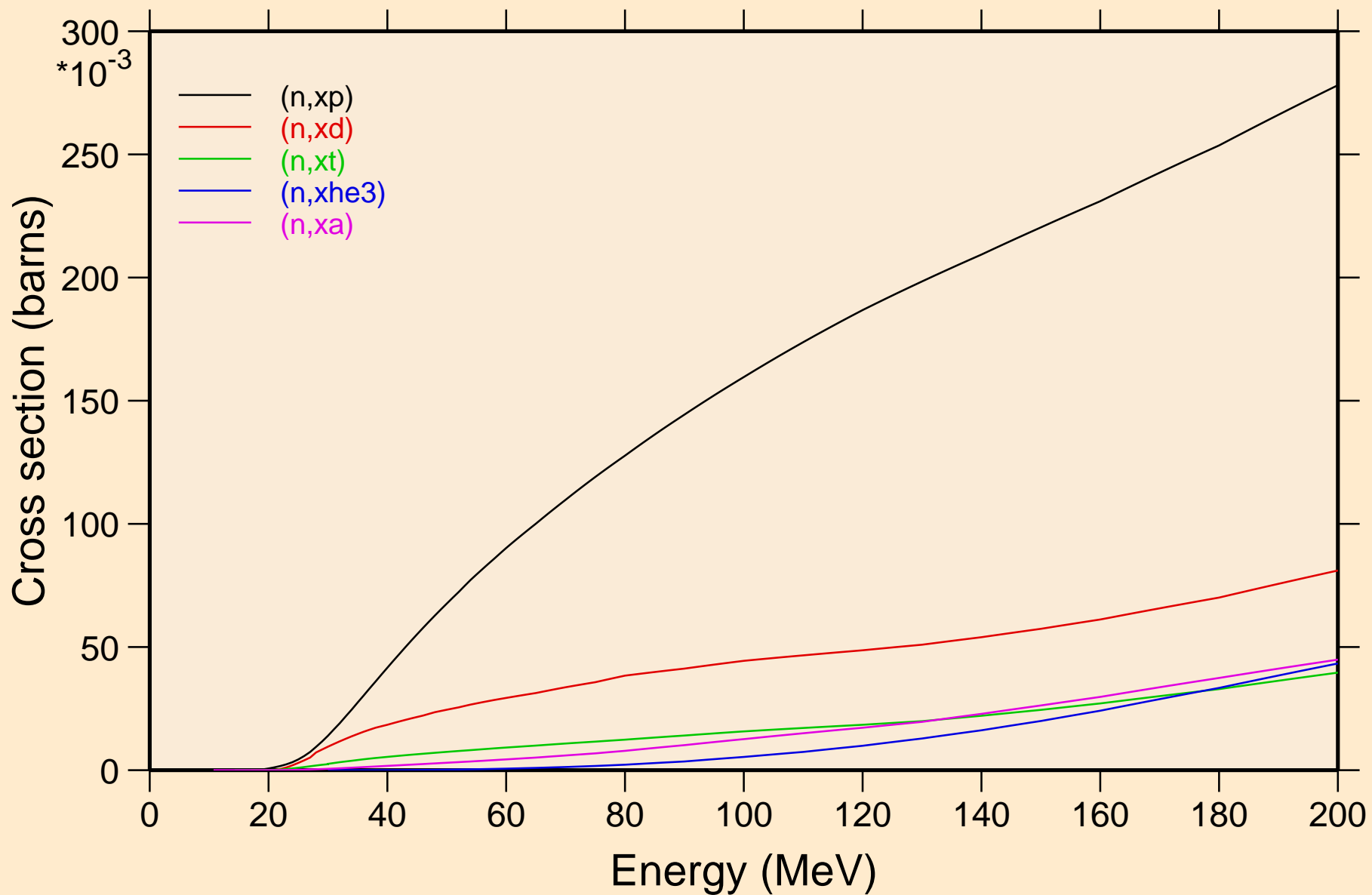

AR047 NEUTRON ACER TENDL-2023 LIBRARY; T=0.K  
angular distribution for elastic

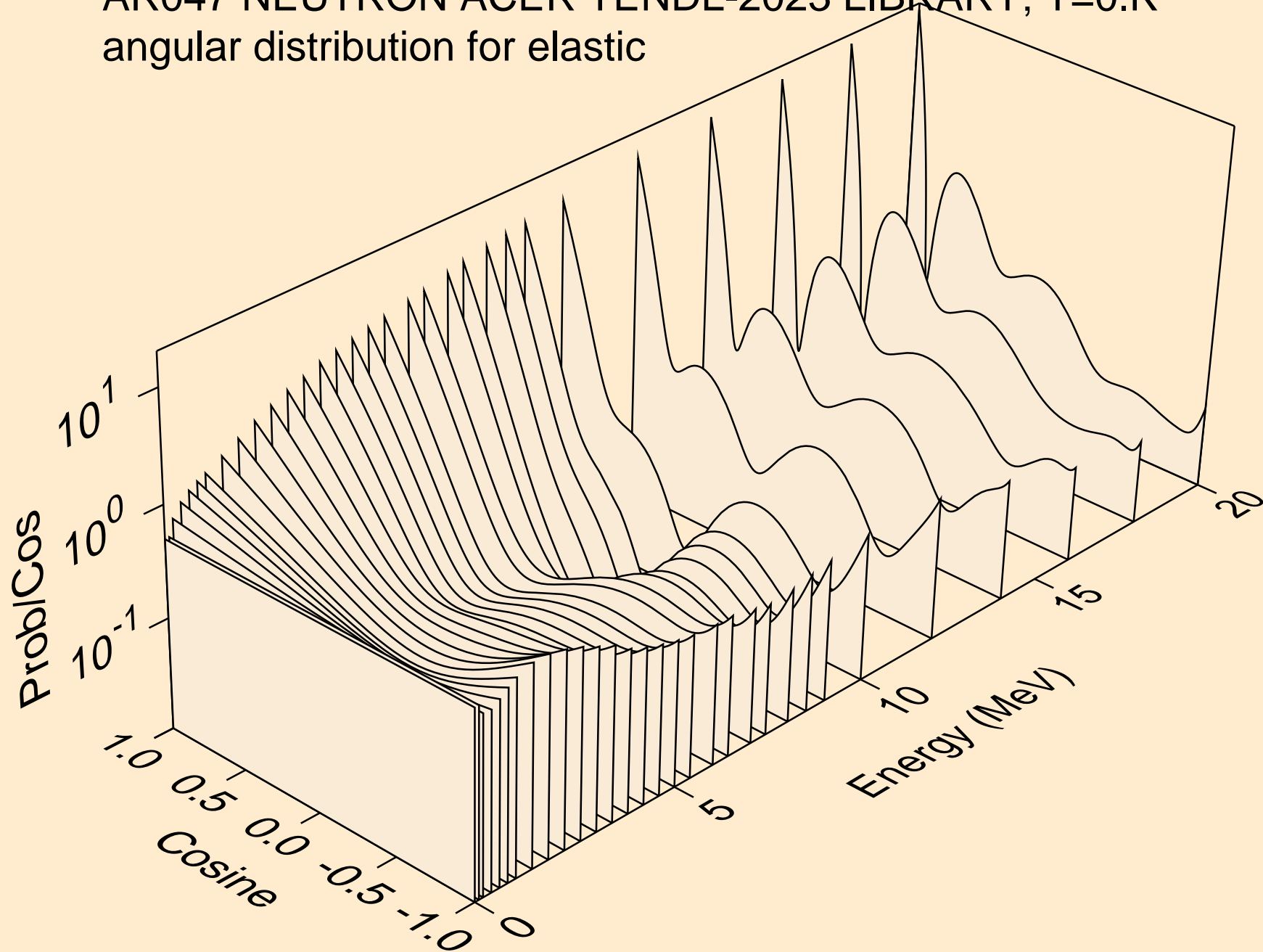

AR047 NEUTRON ACER TENDL-2023 LIBRARY; T=0.K  
angular distribution for elastic

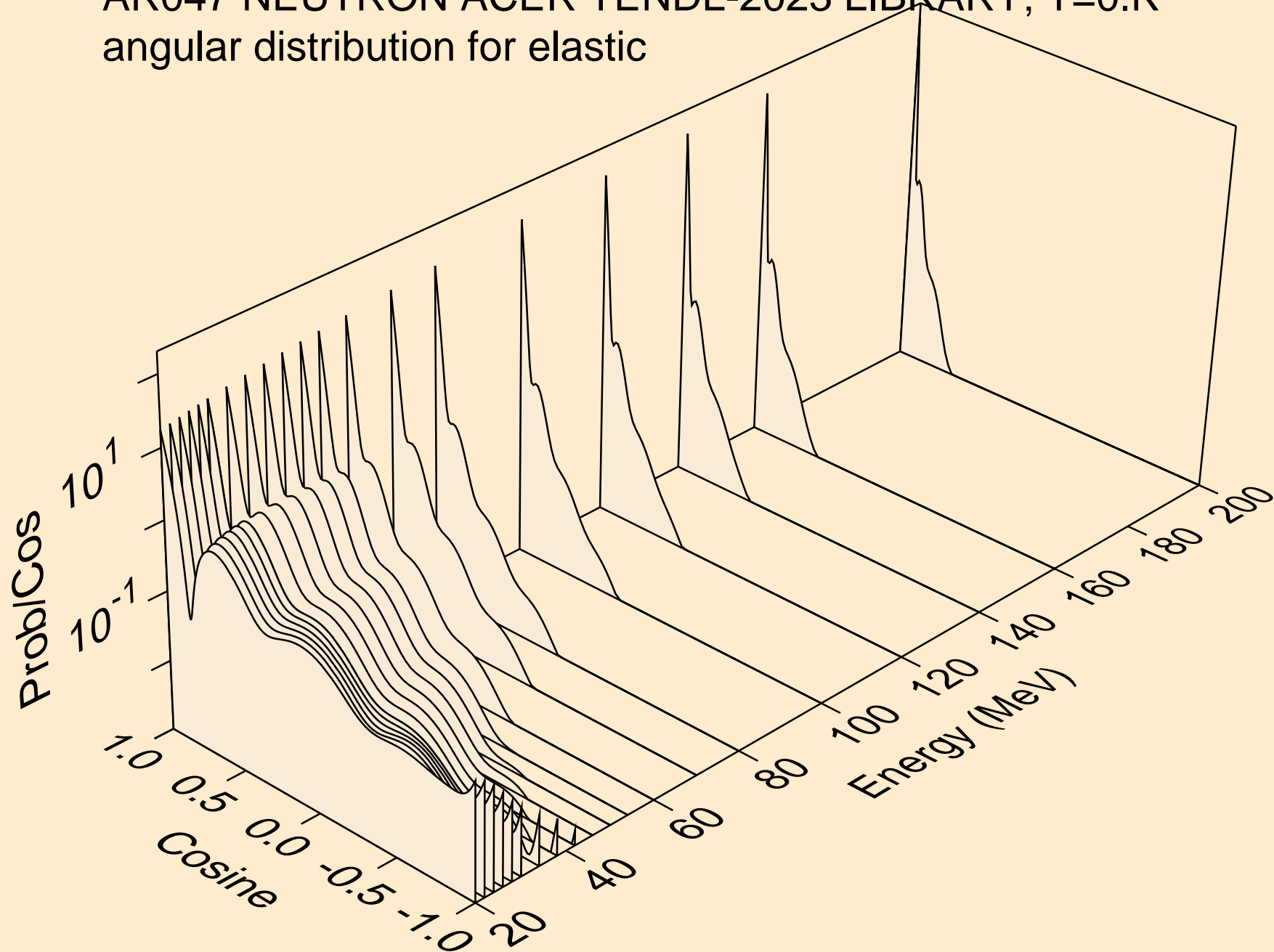

AR047 NEUTRON ACER TENDL-2023 LIBRARY; T=0.K  
angular distribution for (n,n\*1)

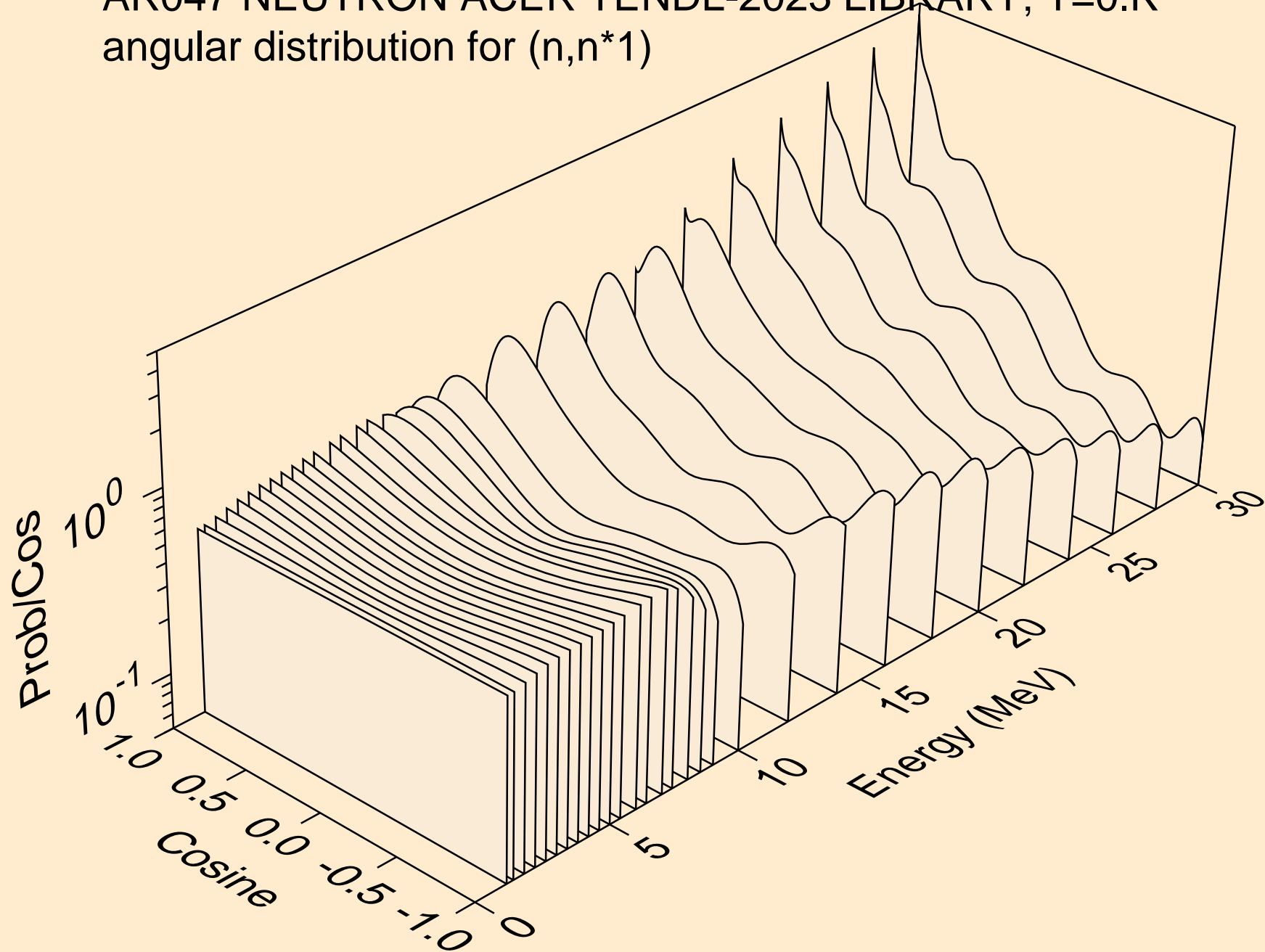

AR047 NEUTRON ACER TENDL-2023 LIBRARY; T=0.K  
angular distribution for (n,n\*2)

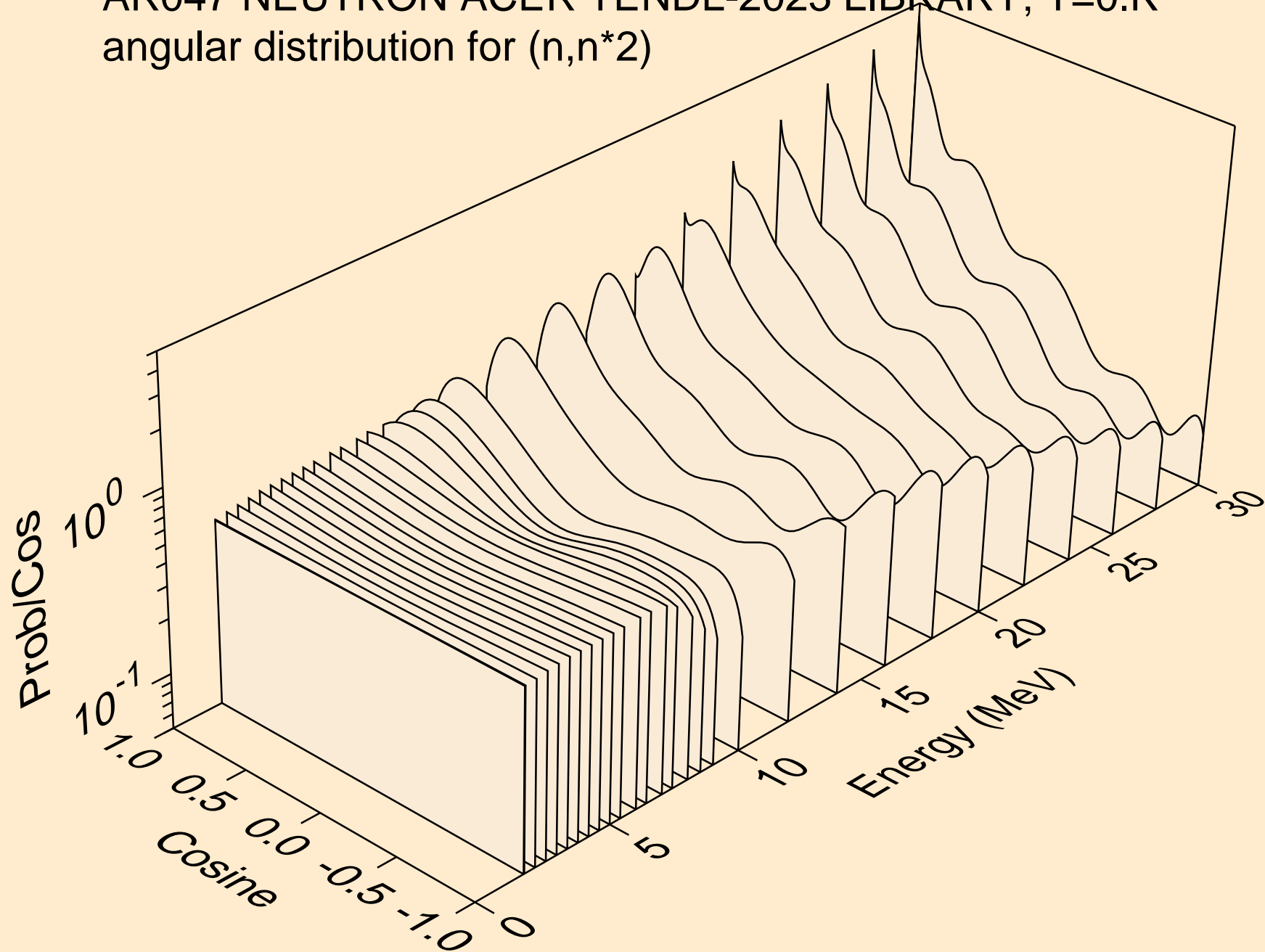

AR047 NEUTRON ACER TENDL-2023 LIBRARY; T=0.K  
angular distribution for (n,n\*3)

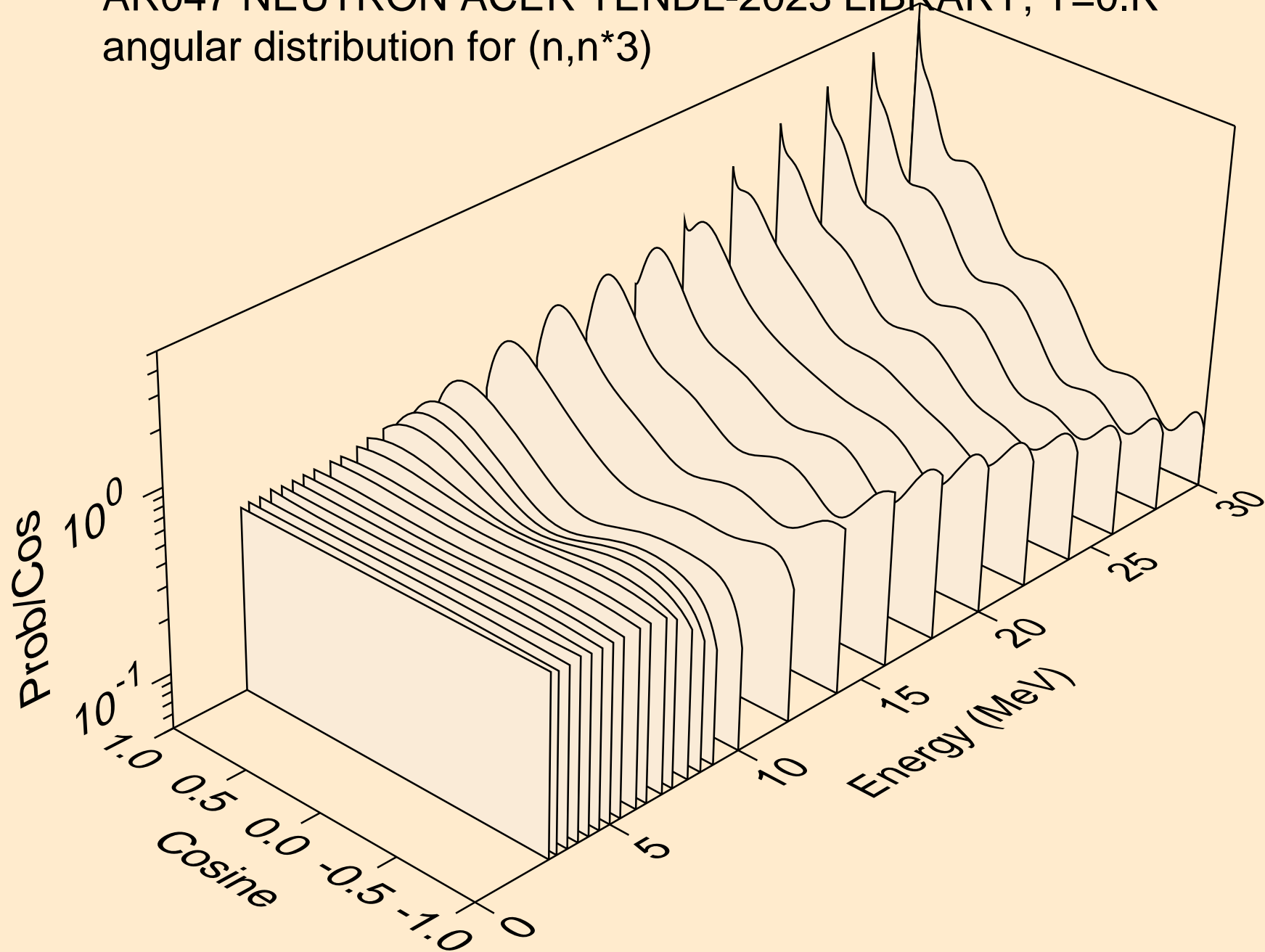



AR047 NEUTRON ACER TENDL-2023 LIBRARY; T=0.K  
angular distribution for (n,n\*4)

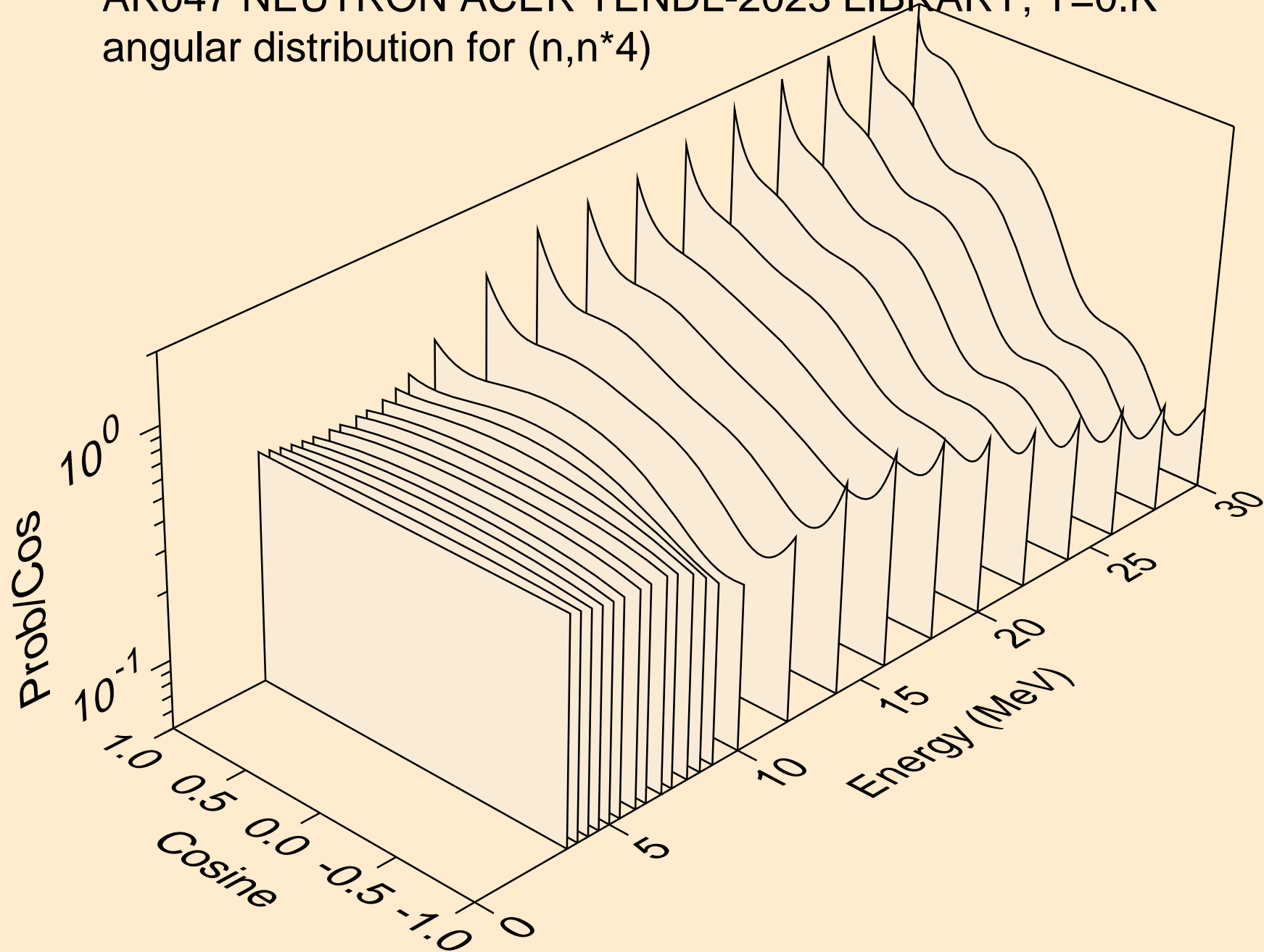

AR047 NEUTRON ACER TENDL-2023 LIBRARY; T=0.K  
angular distribution for (n,n\*5)

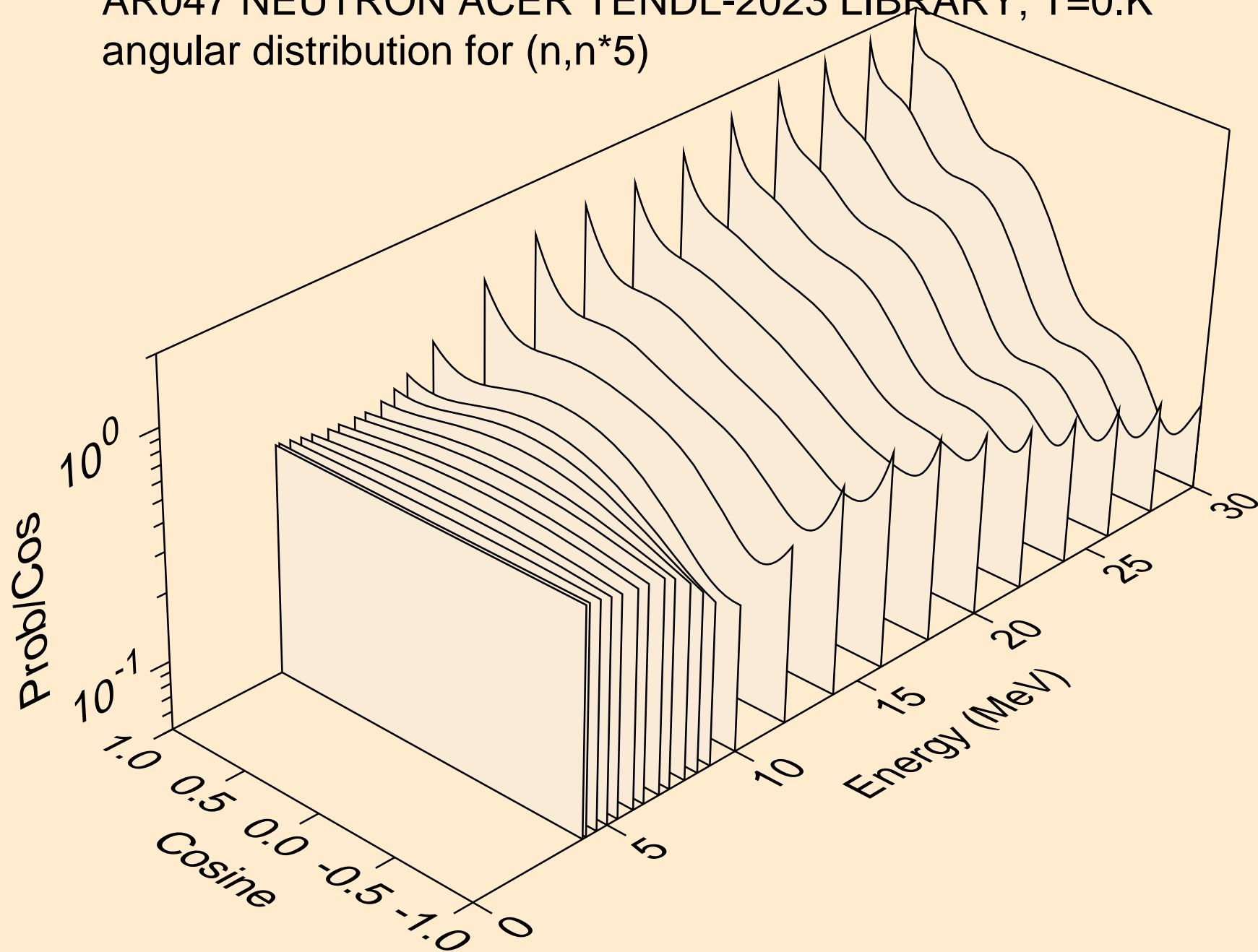

AR047 NEUTRON ACER TENDL-2023 LIBRARY; T=0.K  
angular distribution for (n,n\*6)

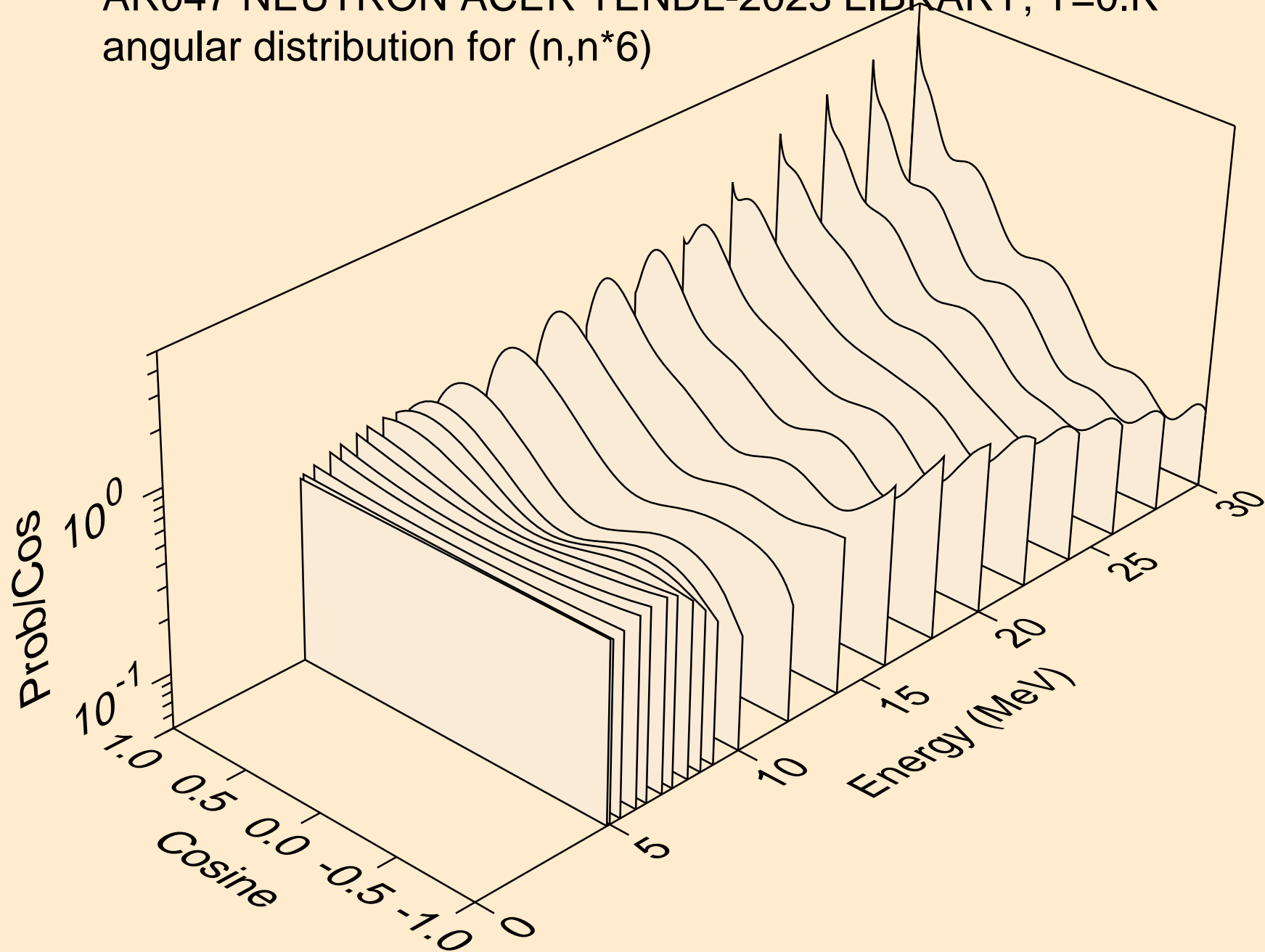

AR047 NEUTRON ACER TENDL-2023 LIBRARY; T=0.K  
angular distribution for (n,n\*7)

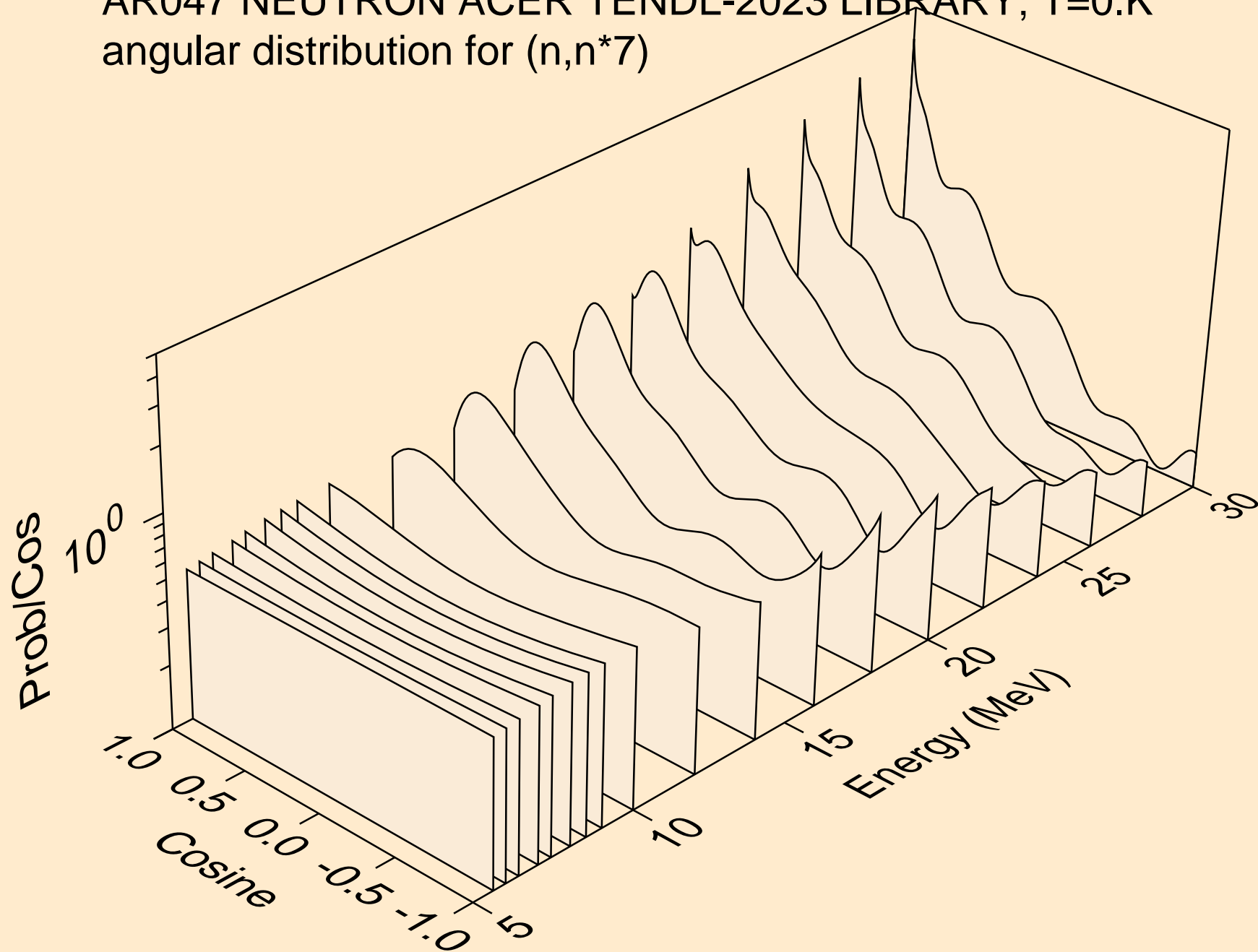

AR047 NEUTRON ACER TENDL-2023 LIBRARY; T=0.K  
angular distribution for (n,n\*8)

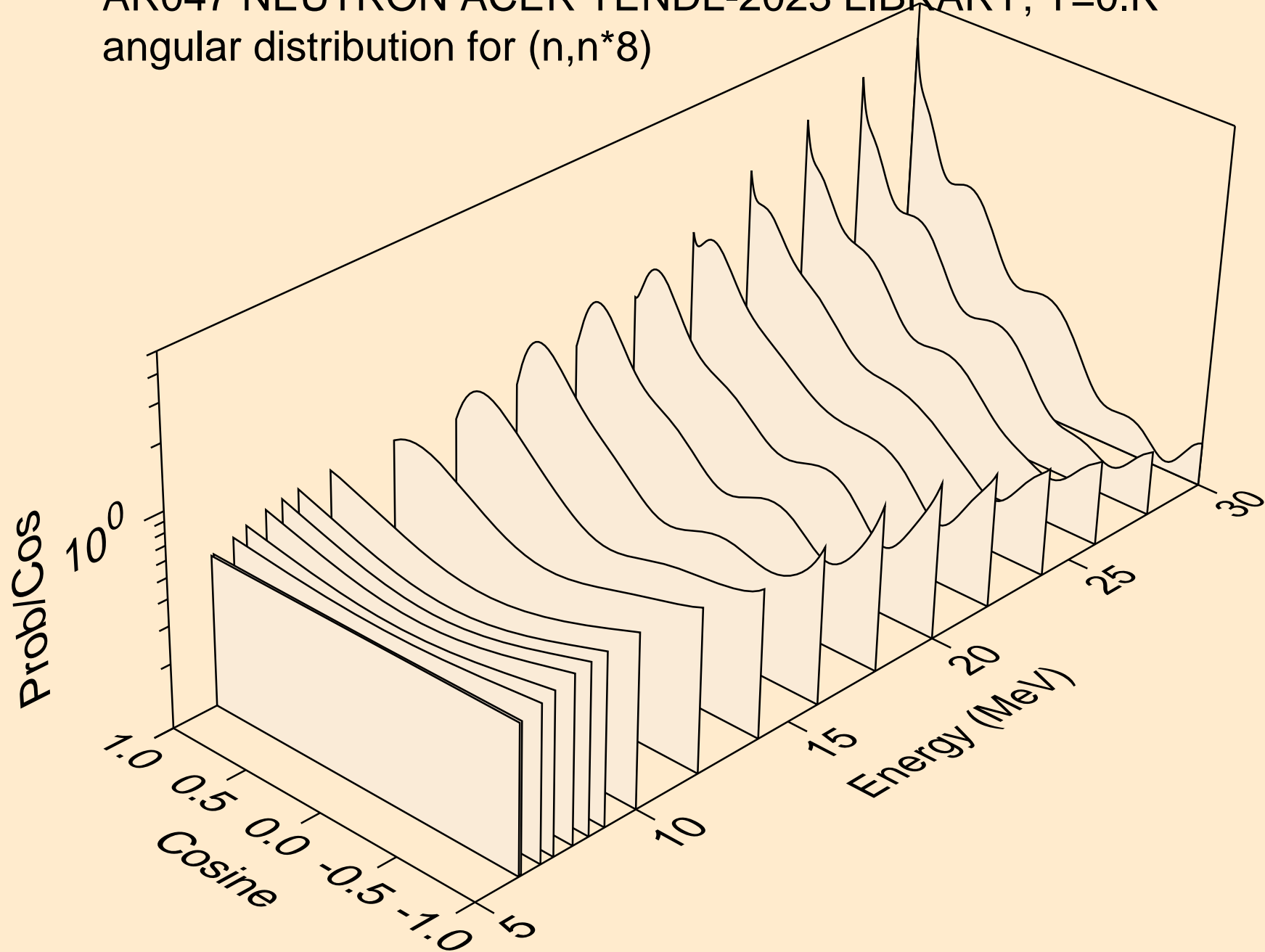

AR047 NEUTRON ACER TENDL-2023 LIBRARY; T=0.K  
angular distribution for (n,n\*9)

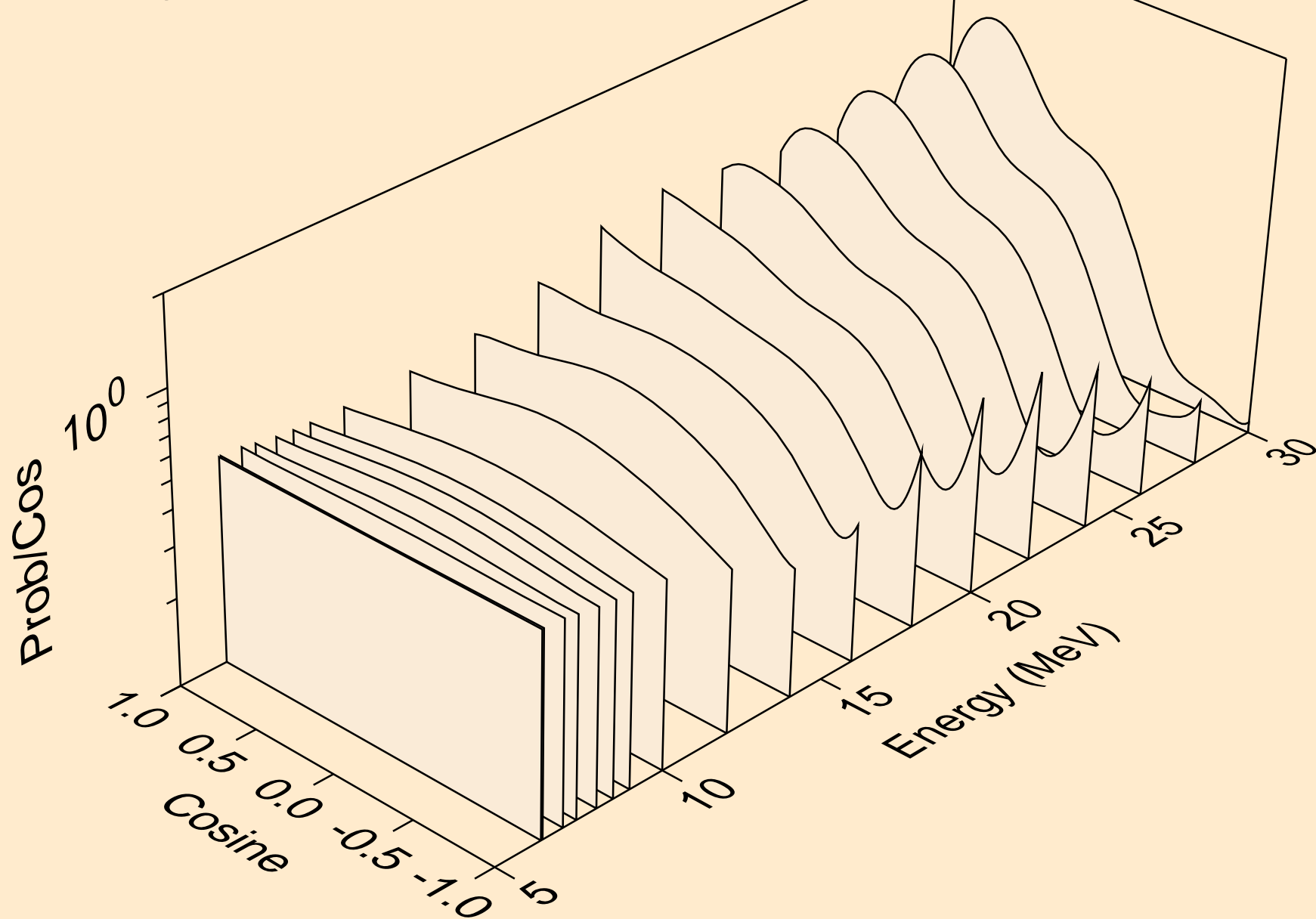

AR047 NEUTRON ACER TENDL-2023 LIBRARY; T=0.K  
angular distribution for (n,n\*10)

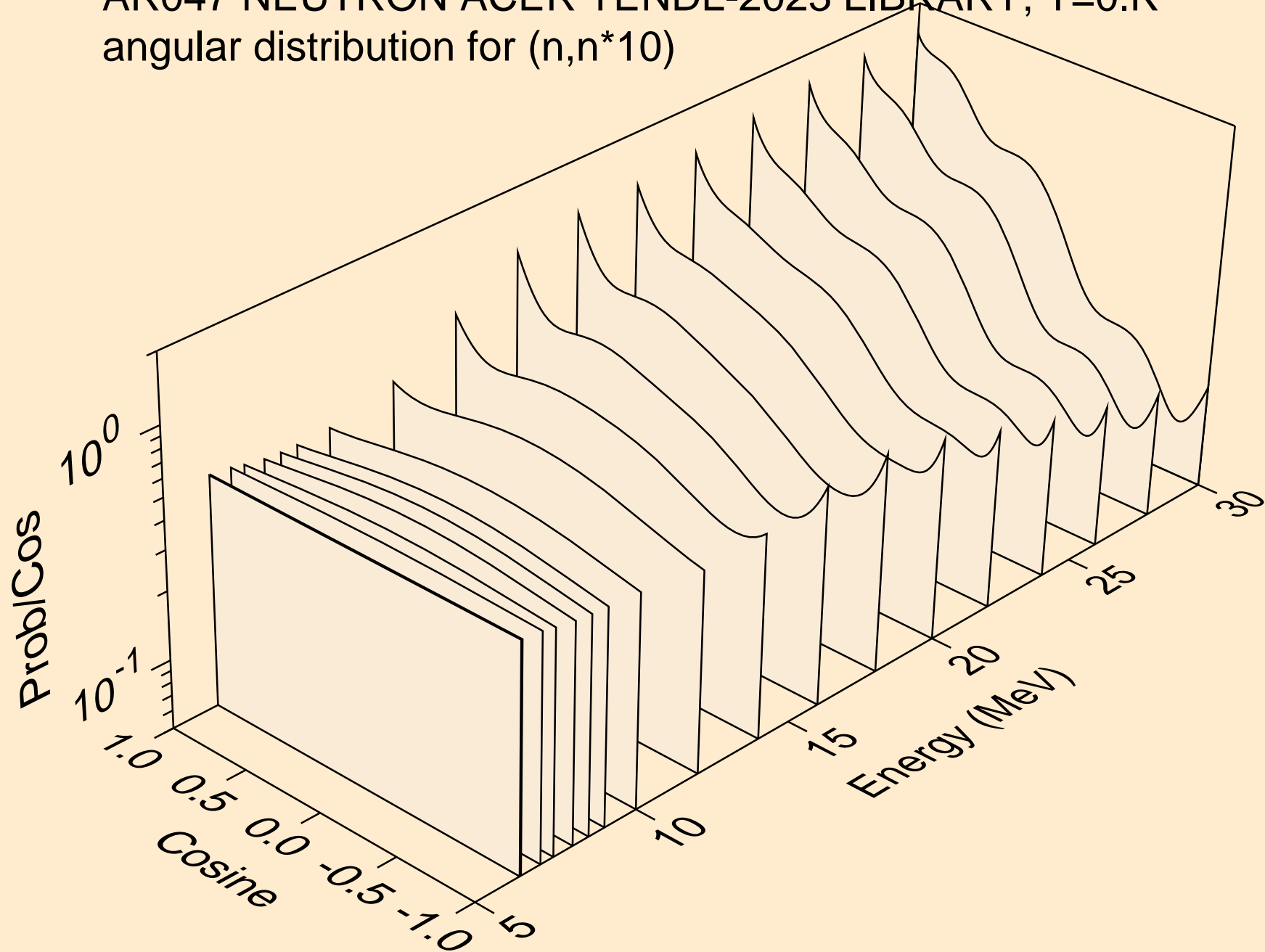

AR047 NEUTRON ACER TENDL-2023 LIBRARY; T=0.K  
angular distribution for (n,n\*11)

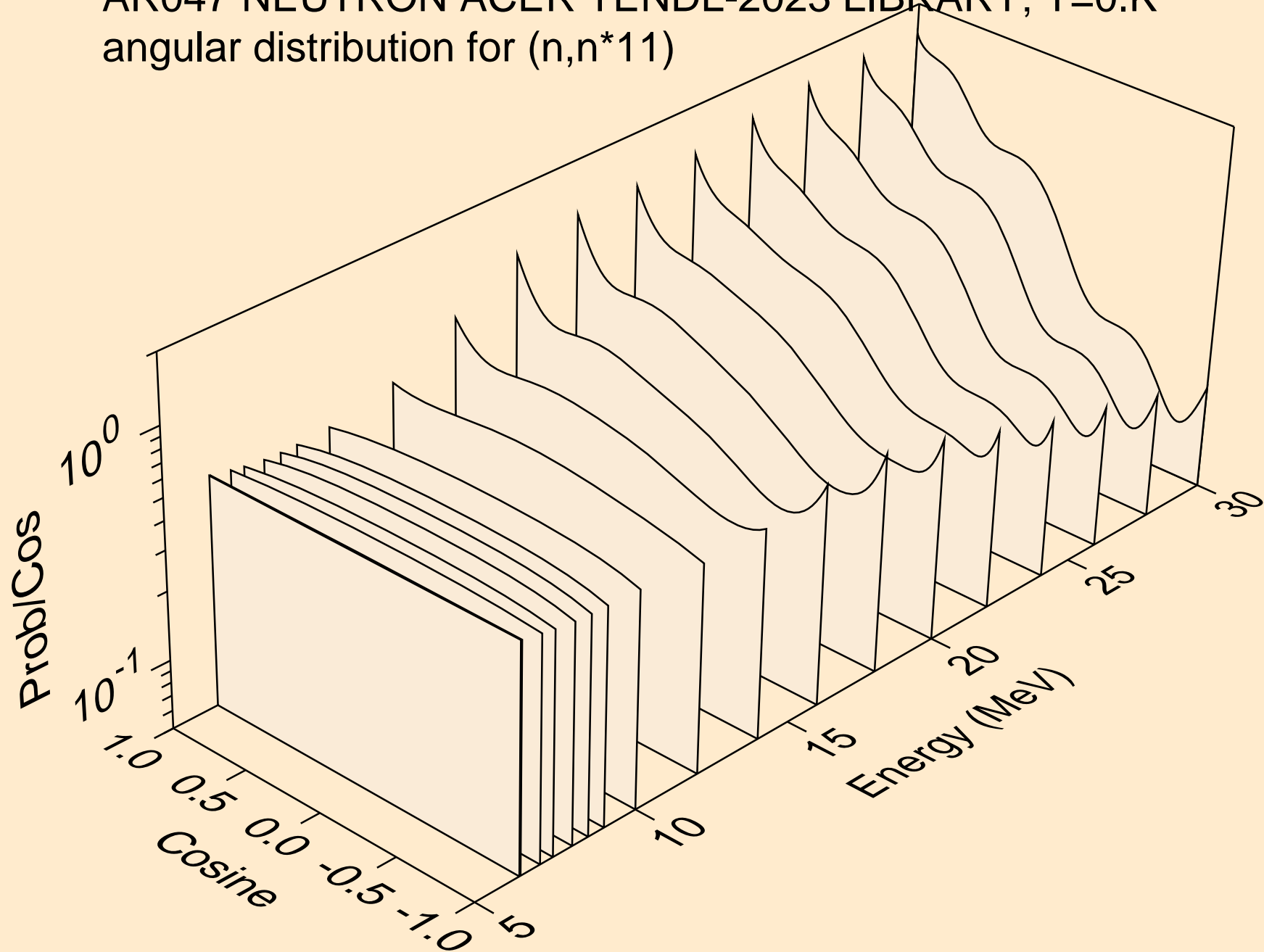



AR047 NEUTRON ACER TENDL-2023 LIBRARY; T=0.K  
angular distribution for (n,n\*12)

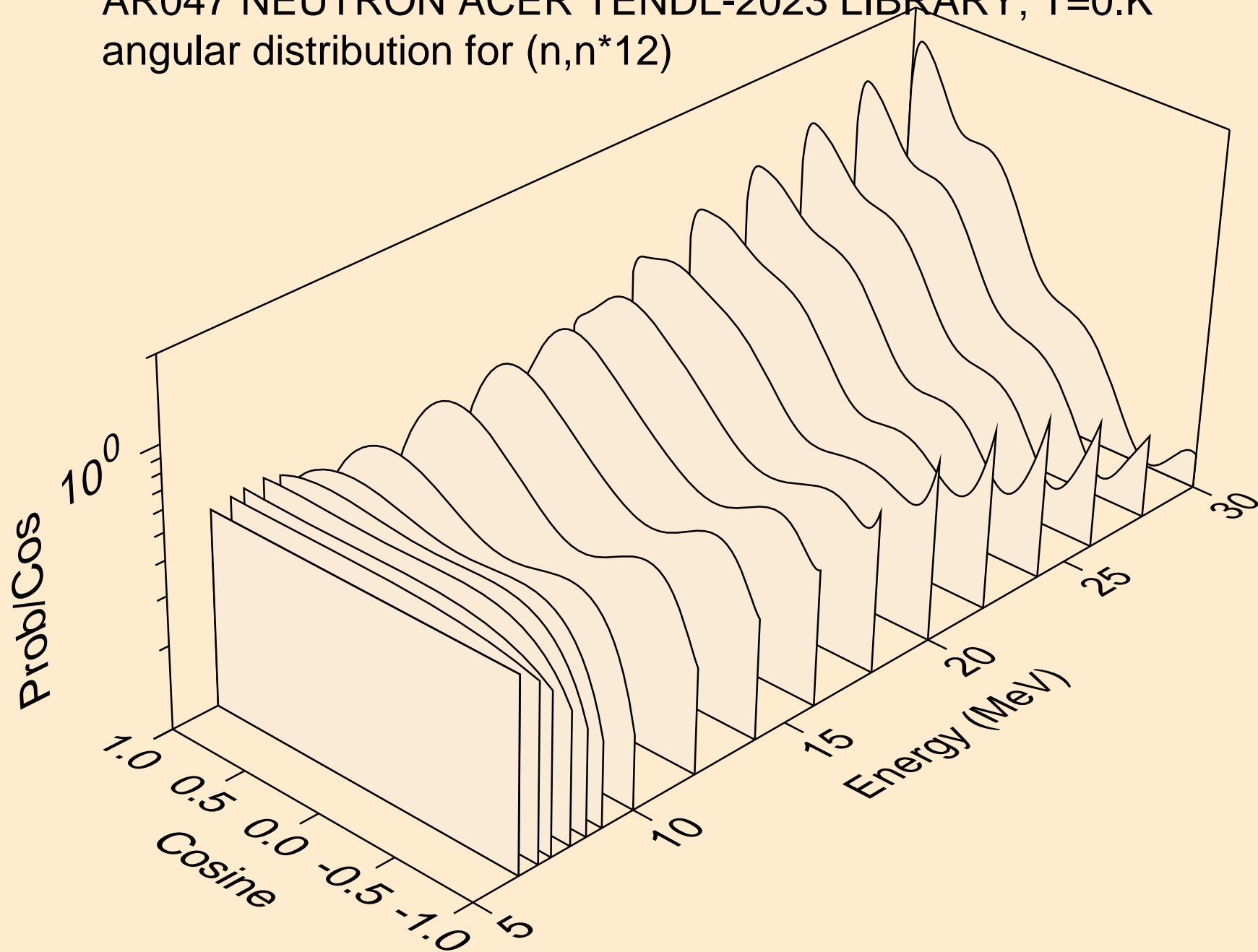

AR047 NEUTRON ACER TENDL-2023 LIBRARY; T=0.K  
angular distribution for (n,n\*13)

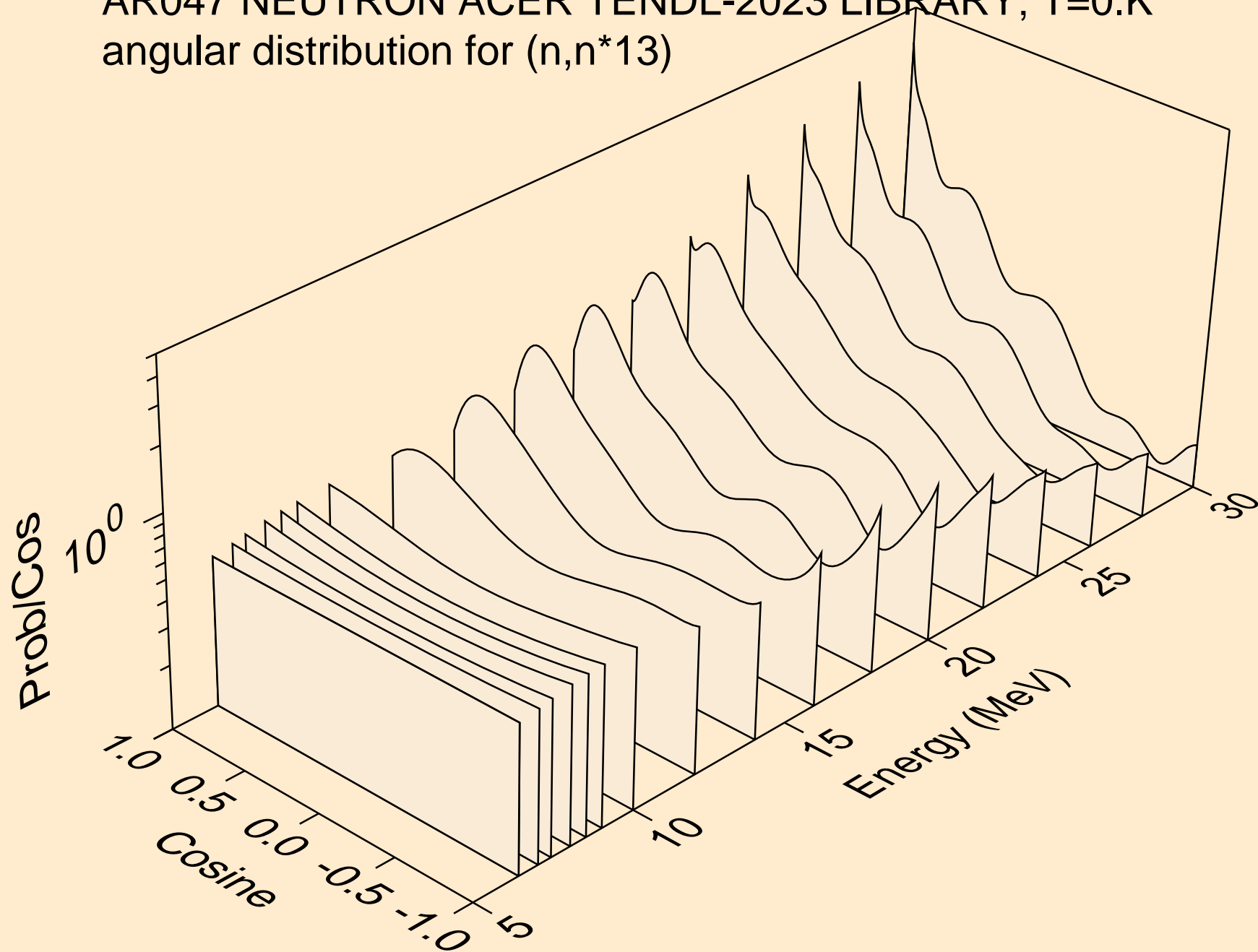

AR047 NEUTRON ACER TENDL-2023 LIBRARY; T=0.K  
angular distribution for (n,n\*14)

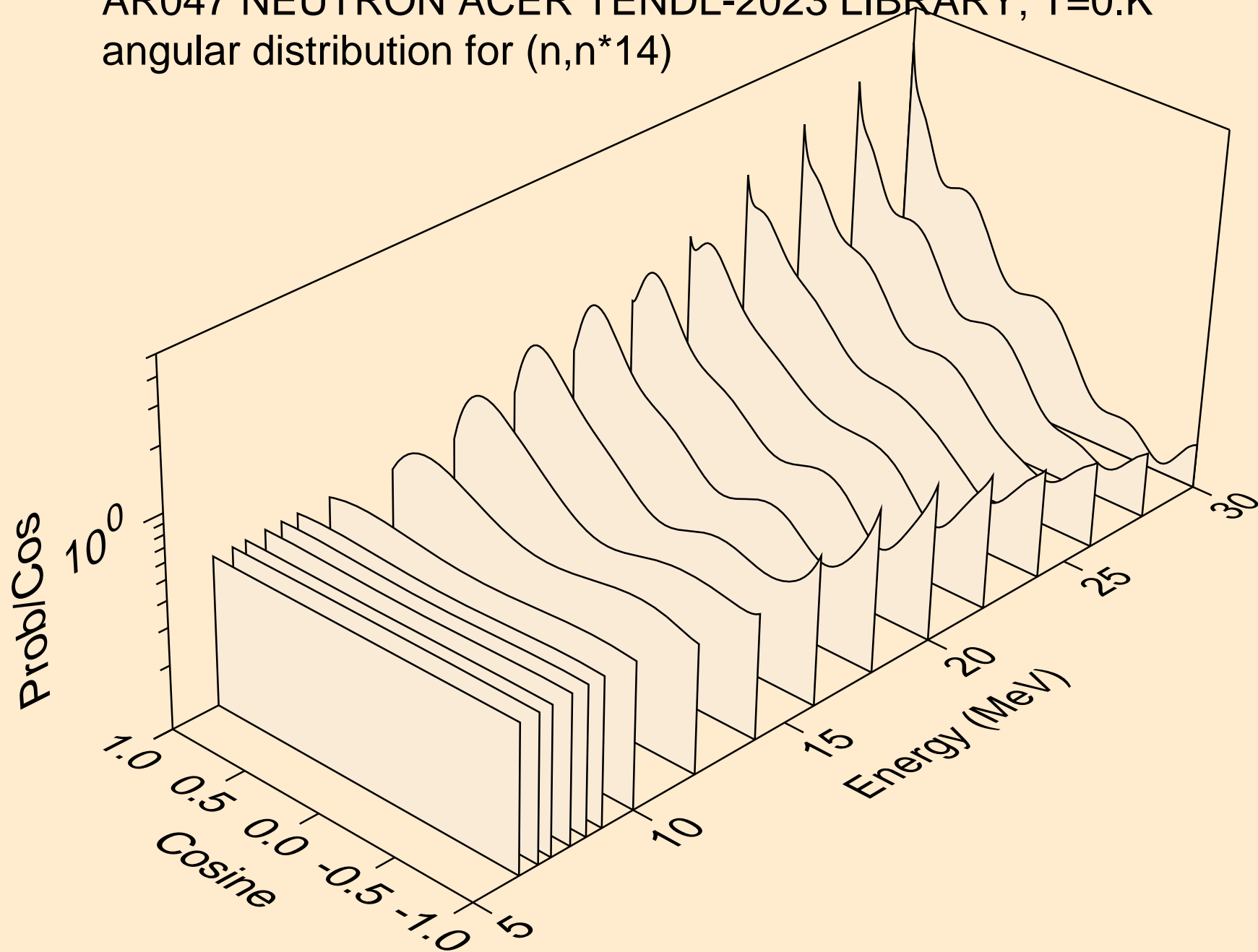

AR047 NEUTRON ACER TENDL-2023 LIBRARY; T=0.K  
angular distribution for (n,n\*15)

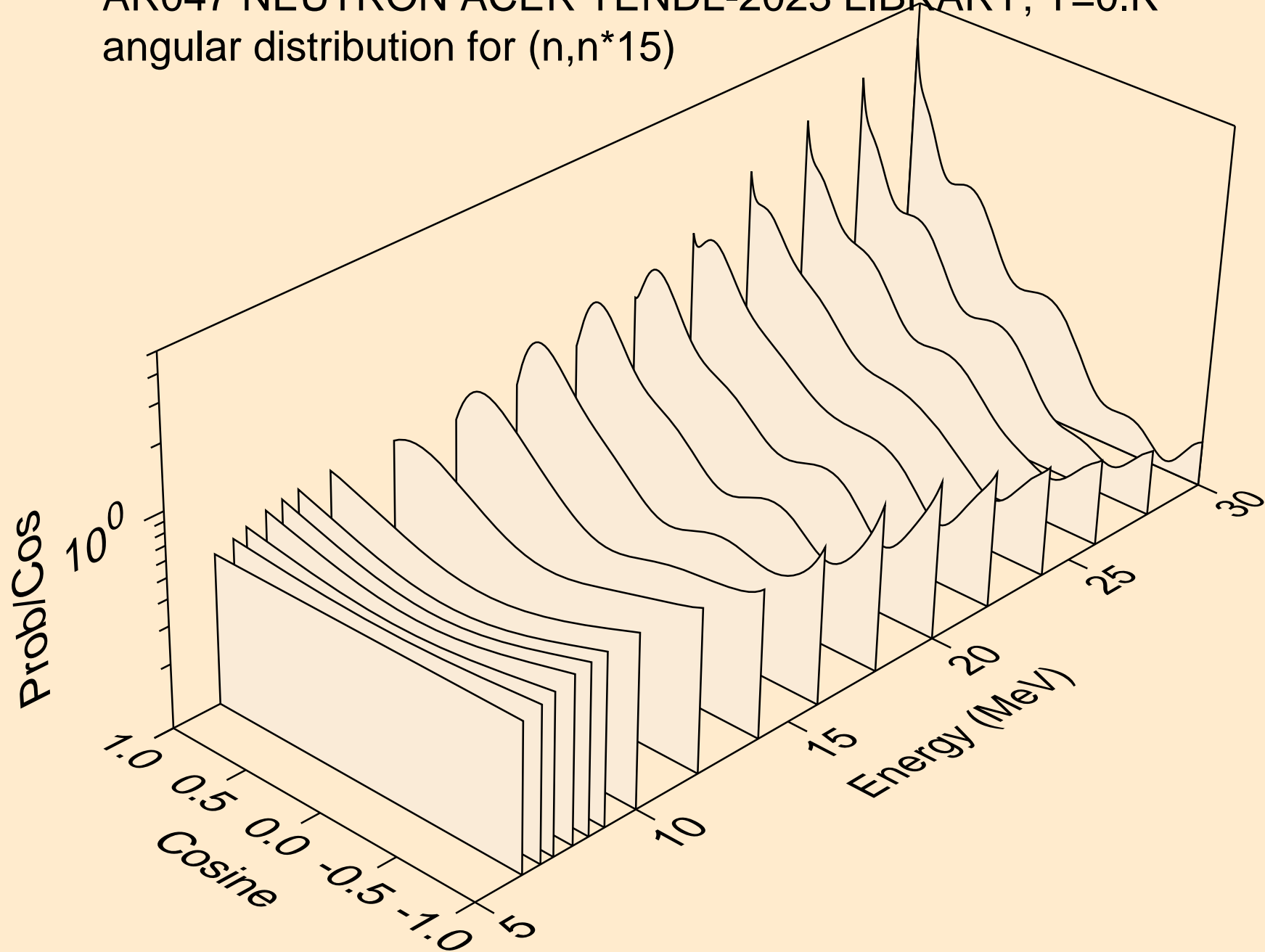

AR047 NEUTRON ACER TENDL-2023 LIBRARY; T=0.K  
angular distribution for (n,n\*16)

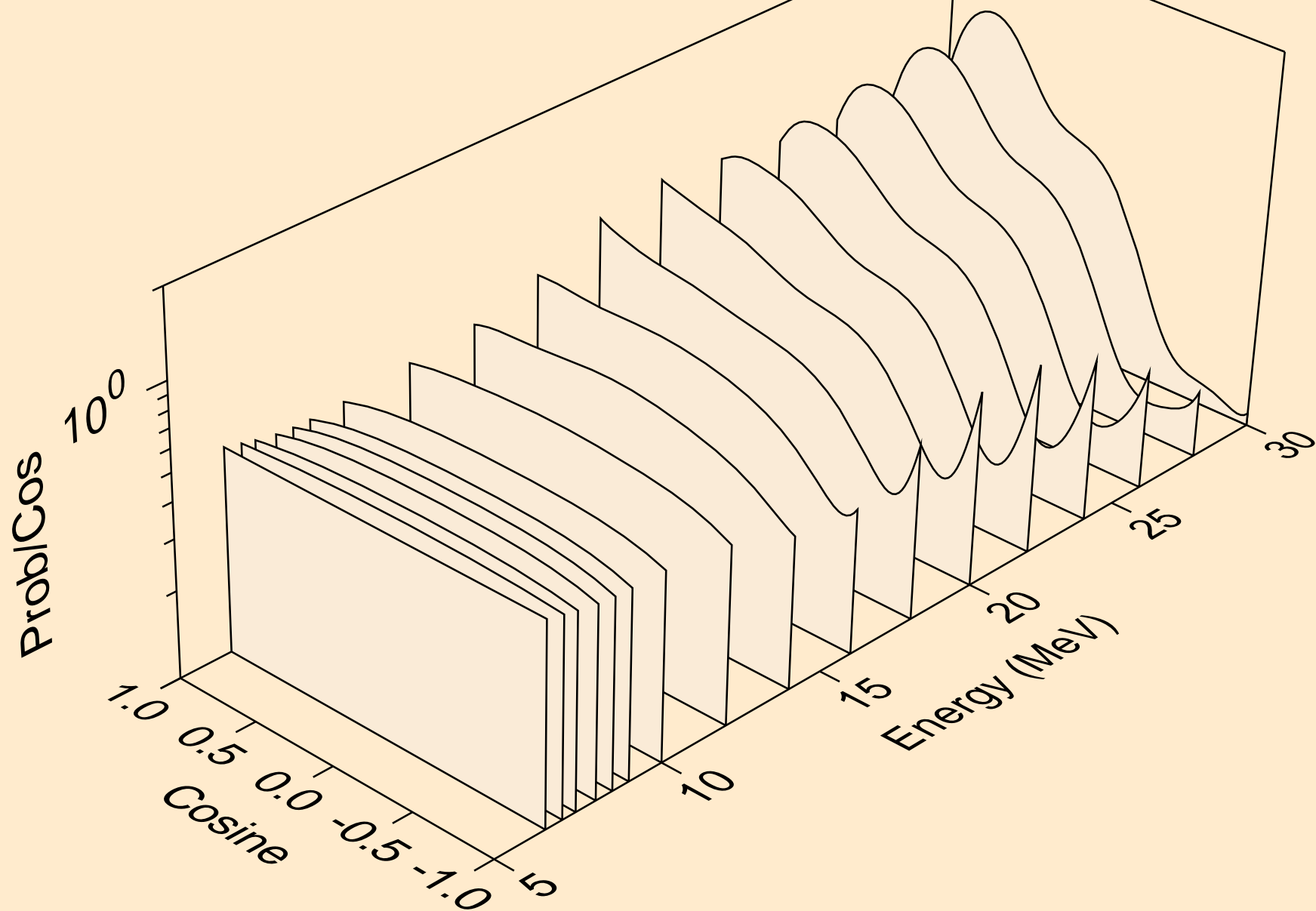

AR047 NEUTRON ACER TENDL-2023 LIBRARY; T=0.K  
angular distribution for (n,n\*17)

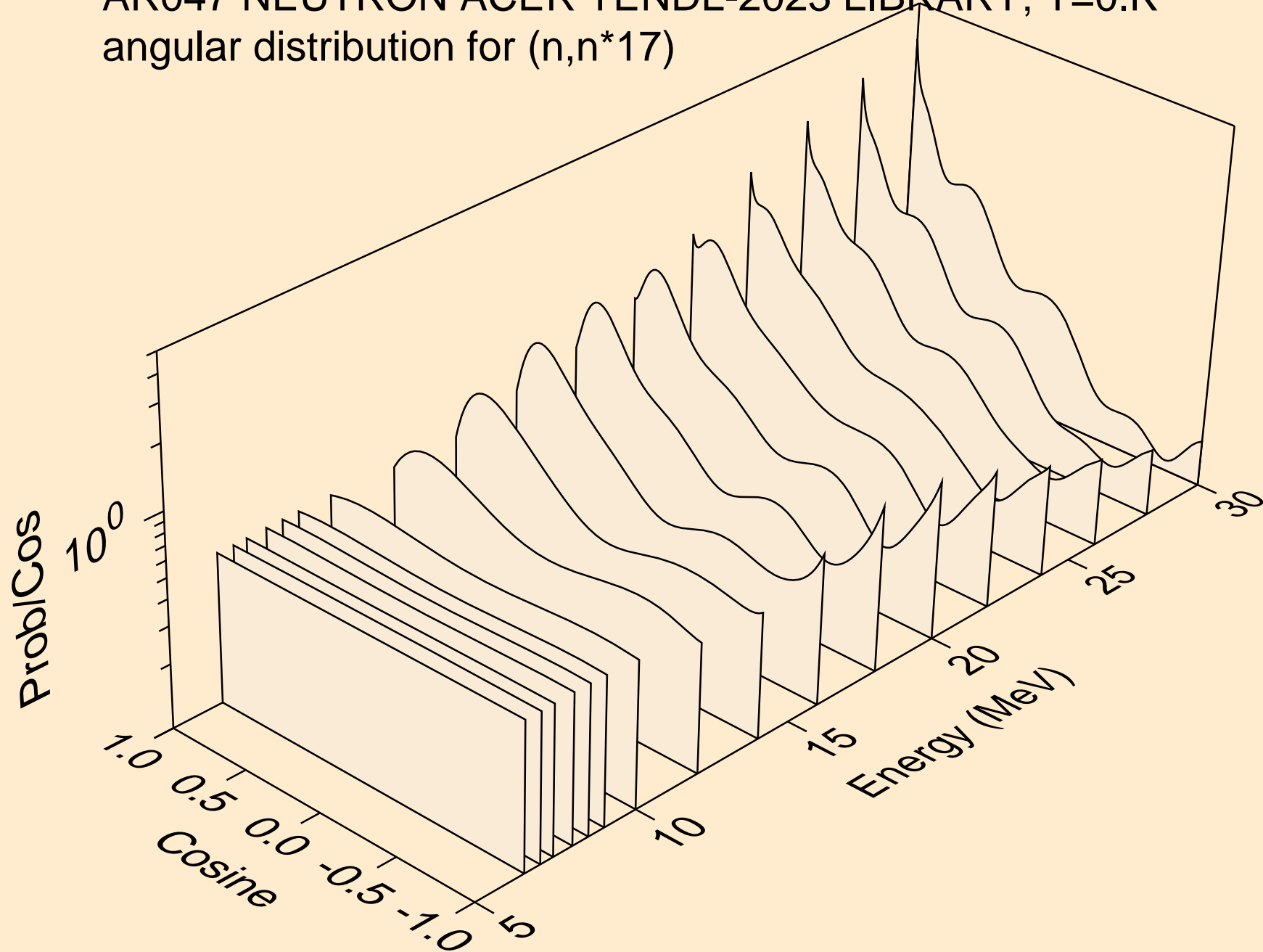

AR047 NEUTRON ACER TENDL-2023 LIBRARY; T=0.K  
angular distribution for (n,n\*18)

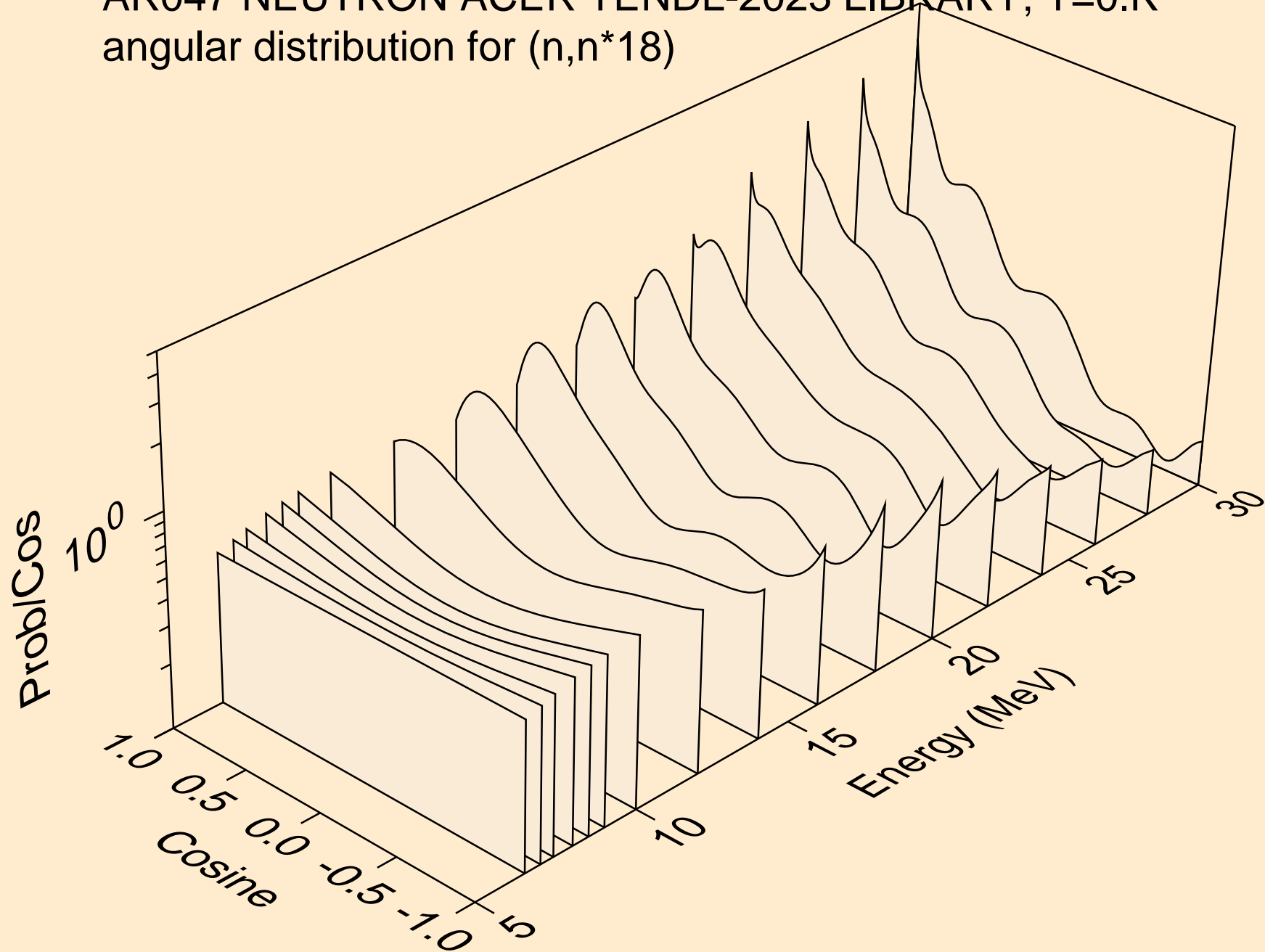

AR047 NEUTRON ACER TENDL-2023 LIBRARY; T=0.K  
angular distribution for (n,n\*19)

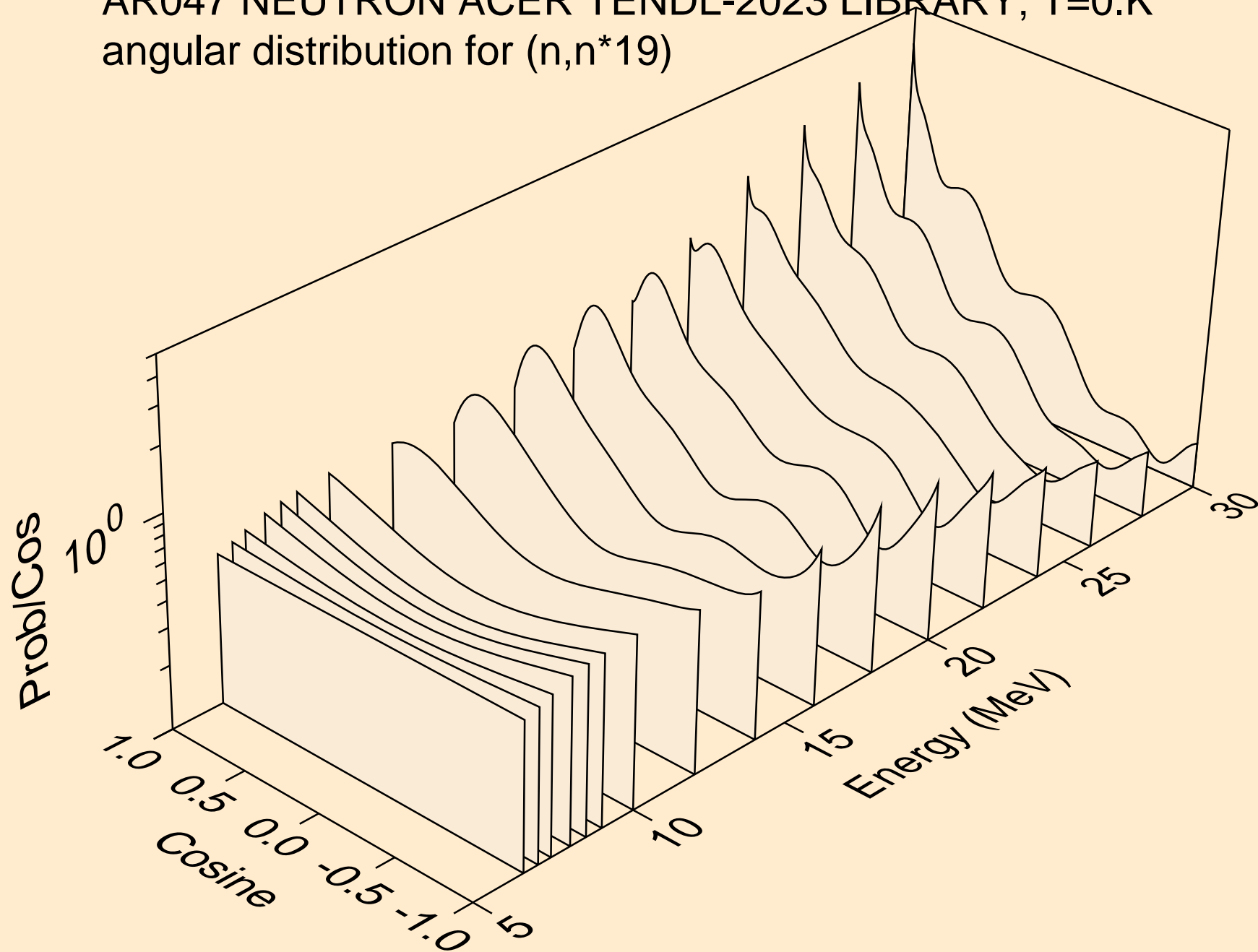



AR047 NEUTRON ACER TENDL-2023 LIBRARY; T=0.K  
angular distribution for (n,n\*20)

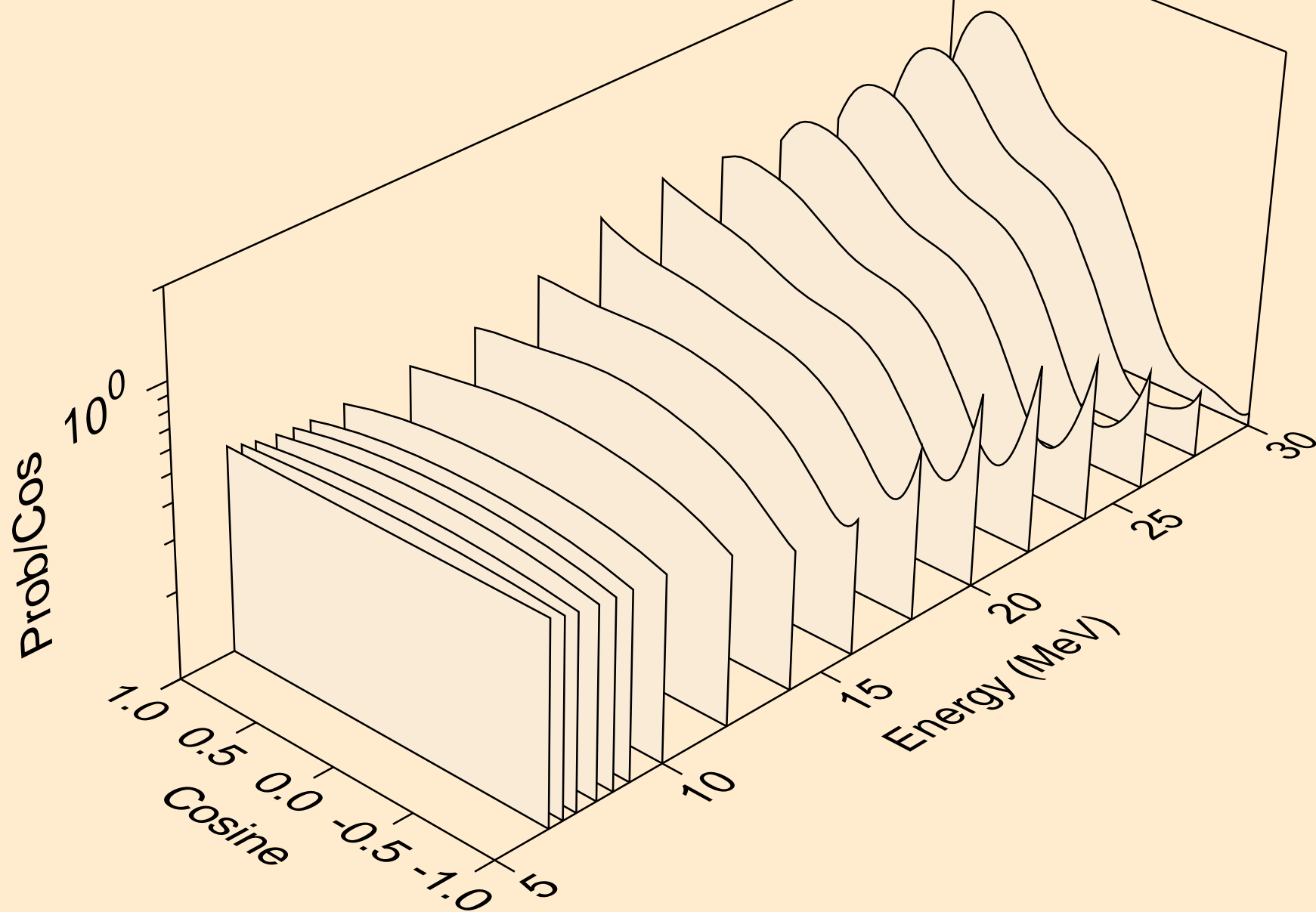

AR047 NEUTRON ACER TENDL-2023 LIBRARY; T=0.K  
angular distribution for (n,n\*21)

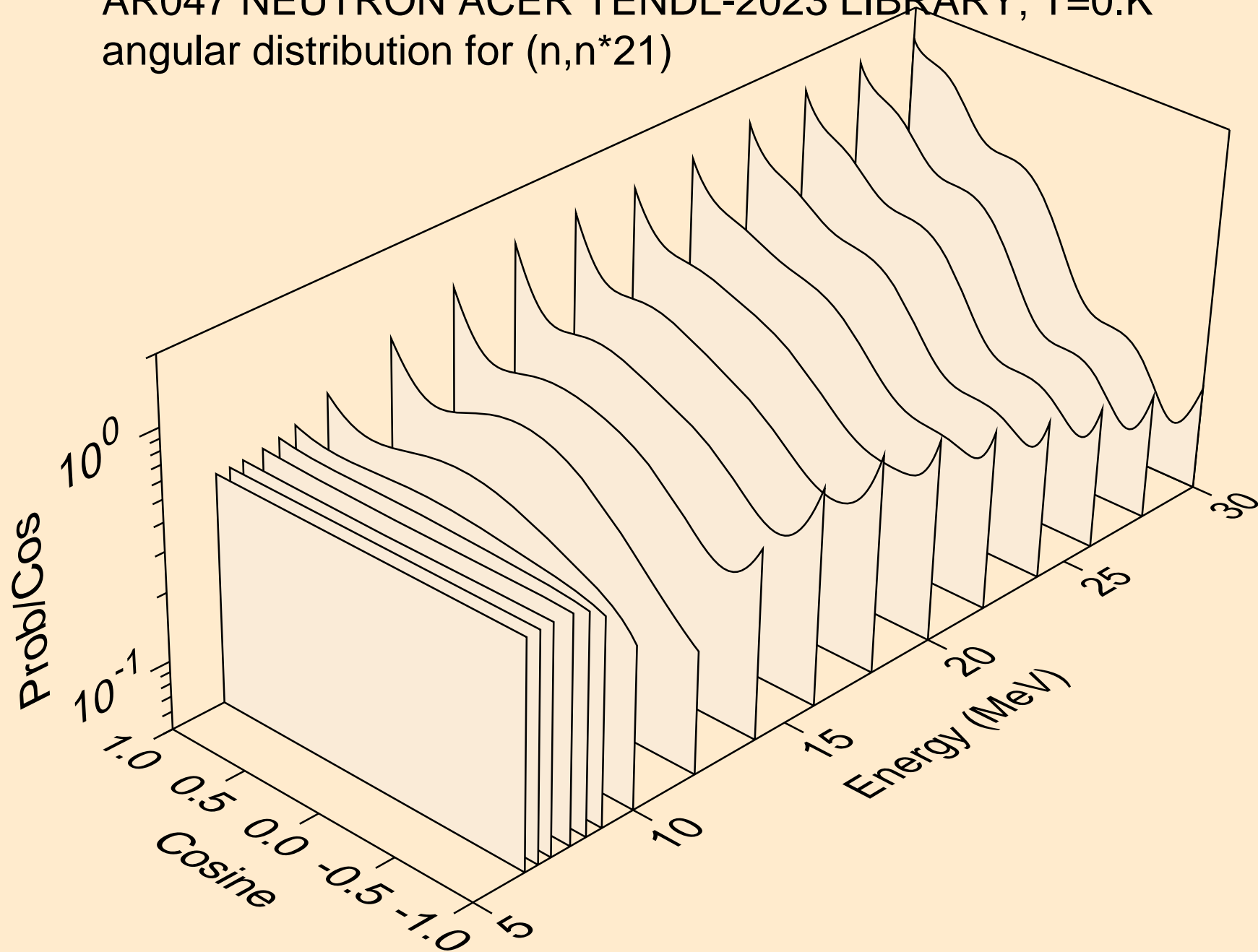

AR047 NEUTRON ACER TENDL-2023 LIBRARY; T=0.K  
angular distribution for (n,n\*22)

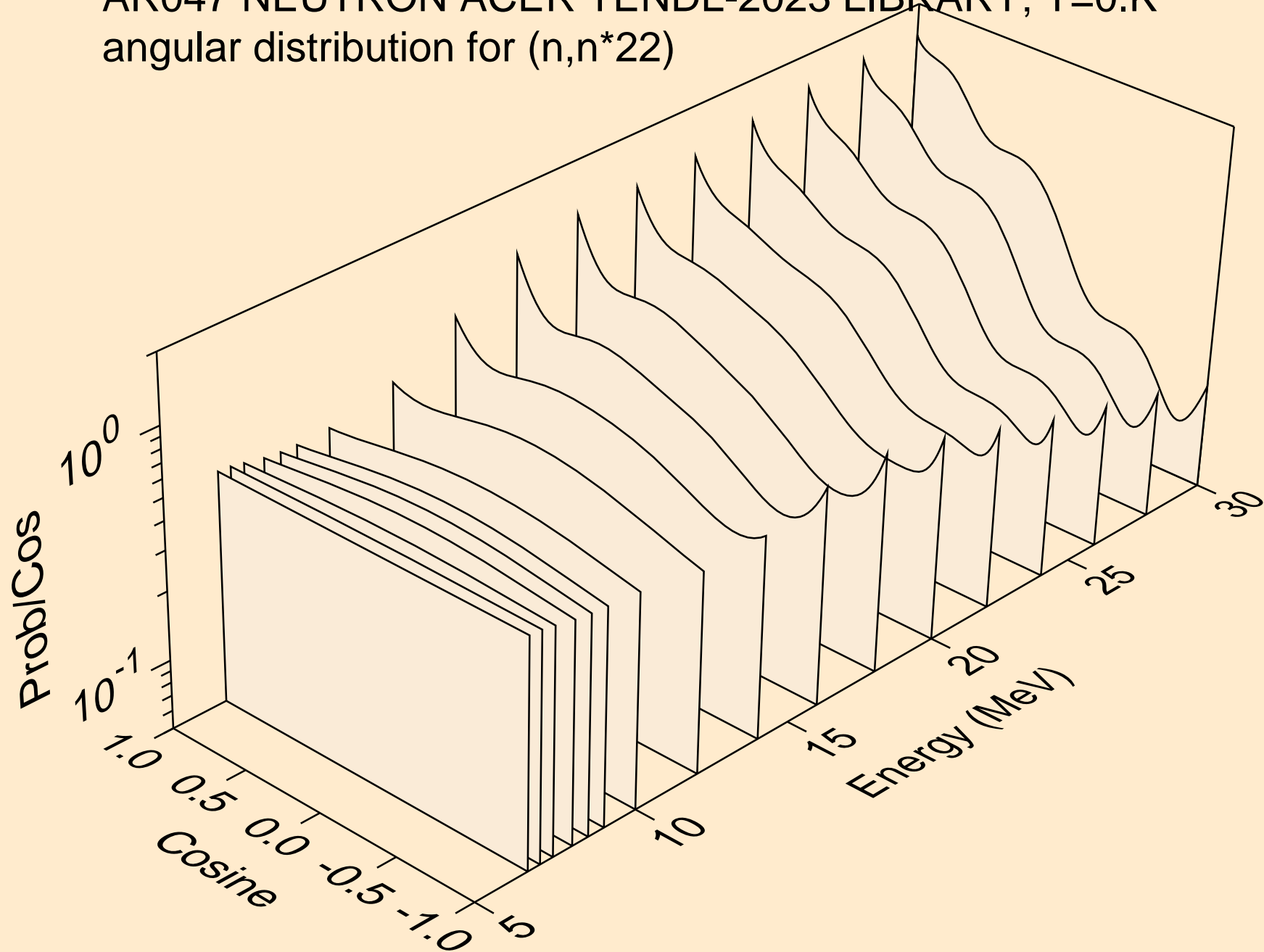

AR047 NEUTRON ACER TENDL-2023 LIBRARY; T=0.K  
angular distribution for (n,n\*23)

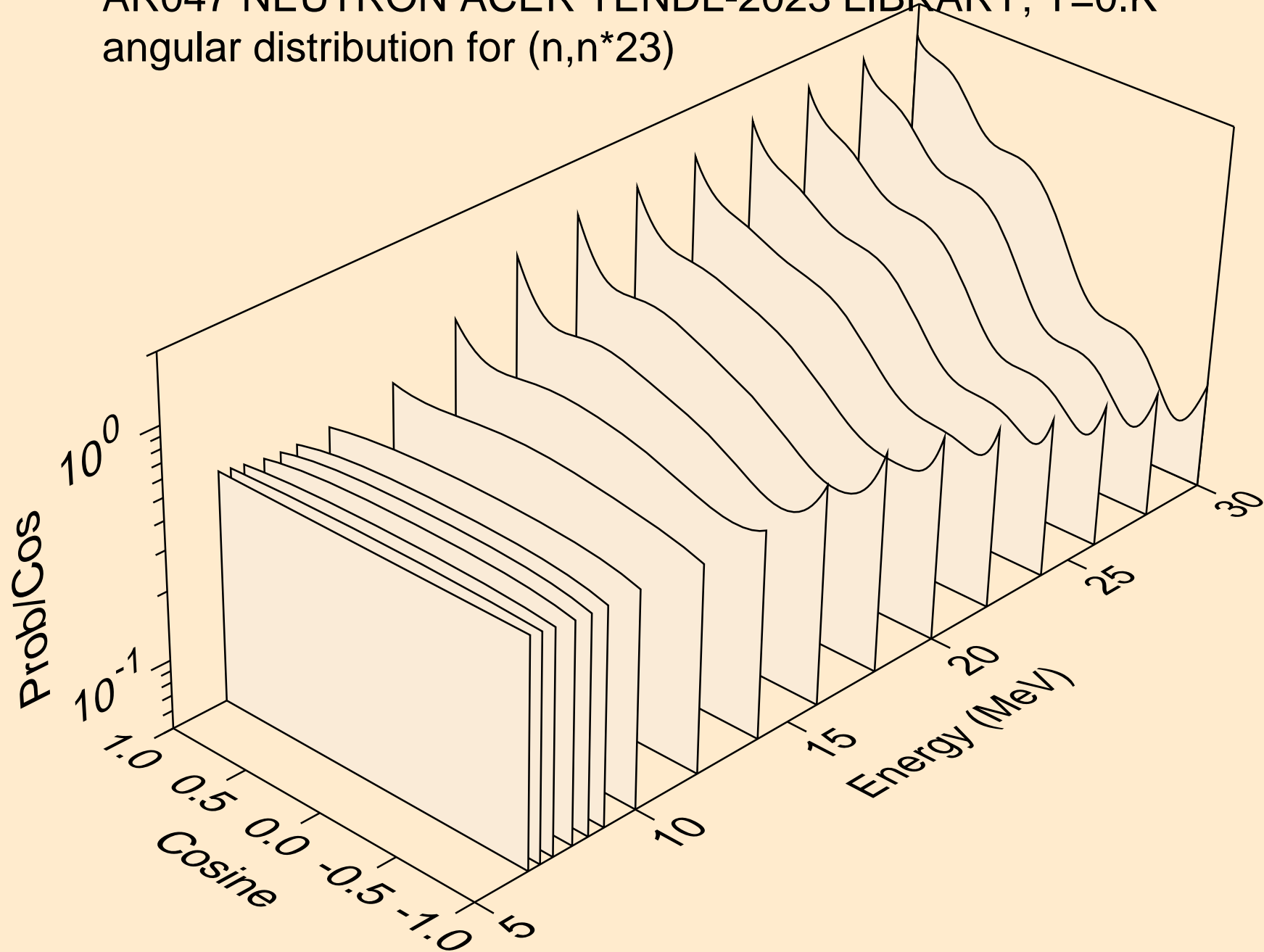

AR047 NEUTRON ACER TENDL-2023 LIBRARY; T=0.K  
angular distribution for (n,n\*24)

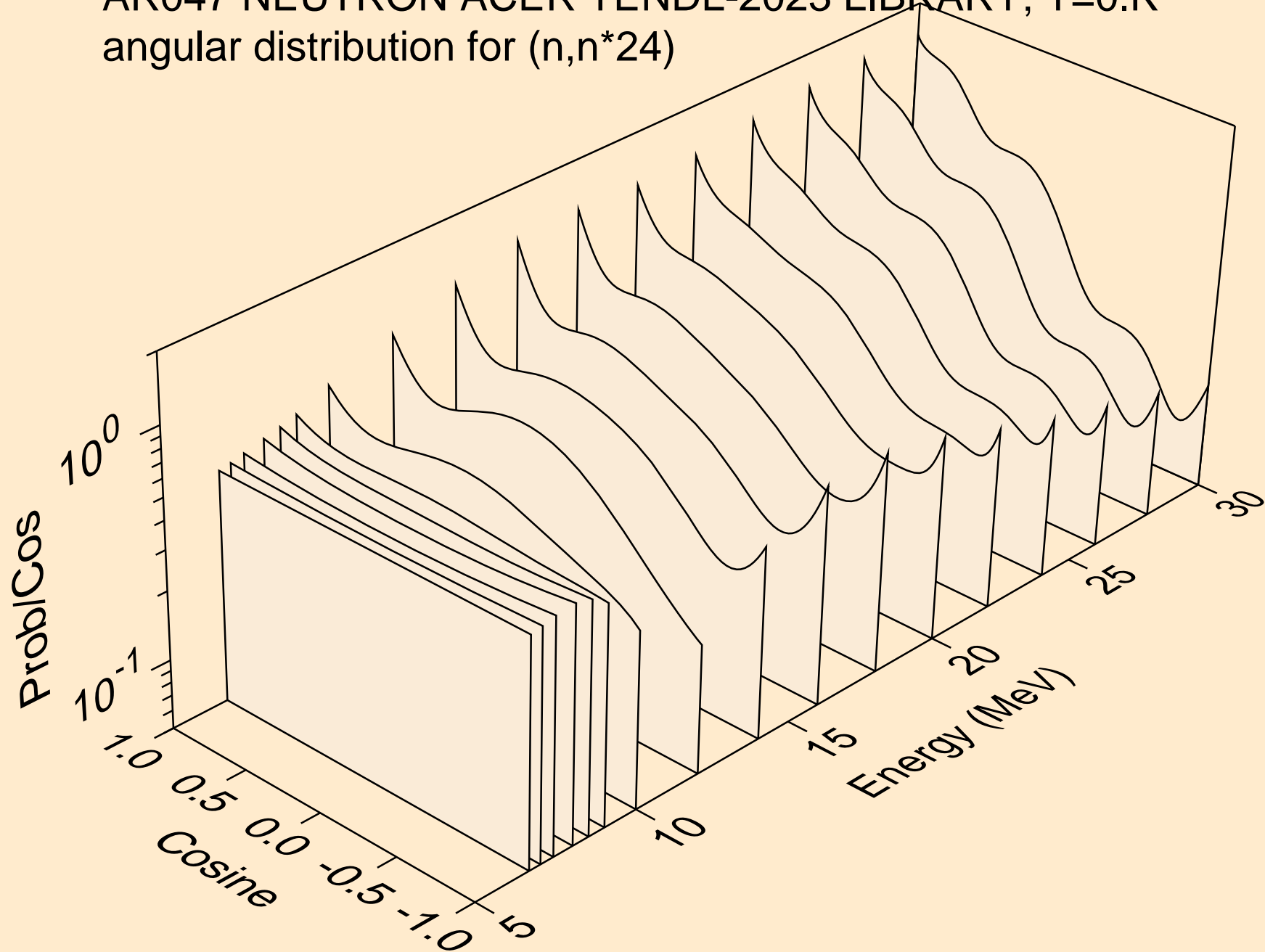

AR047 NEUTRON ACER TENDL-2023 LIBRARY; T=0.K  
angular distribution for (n,n\*25)

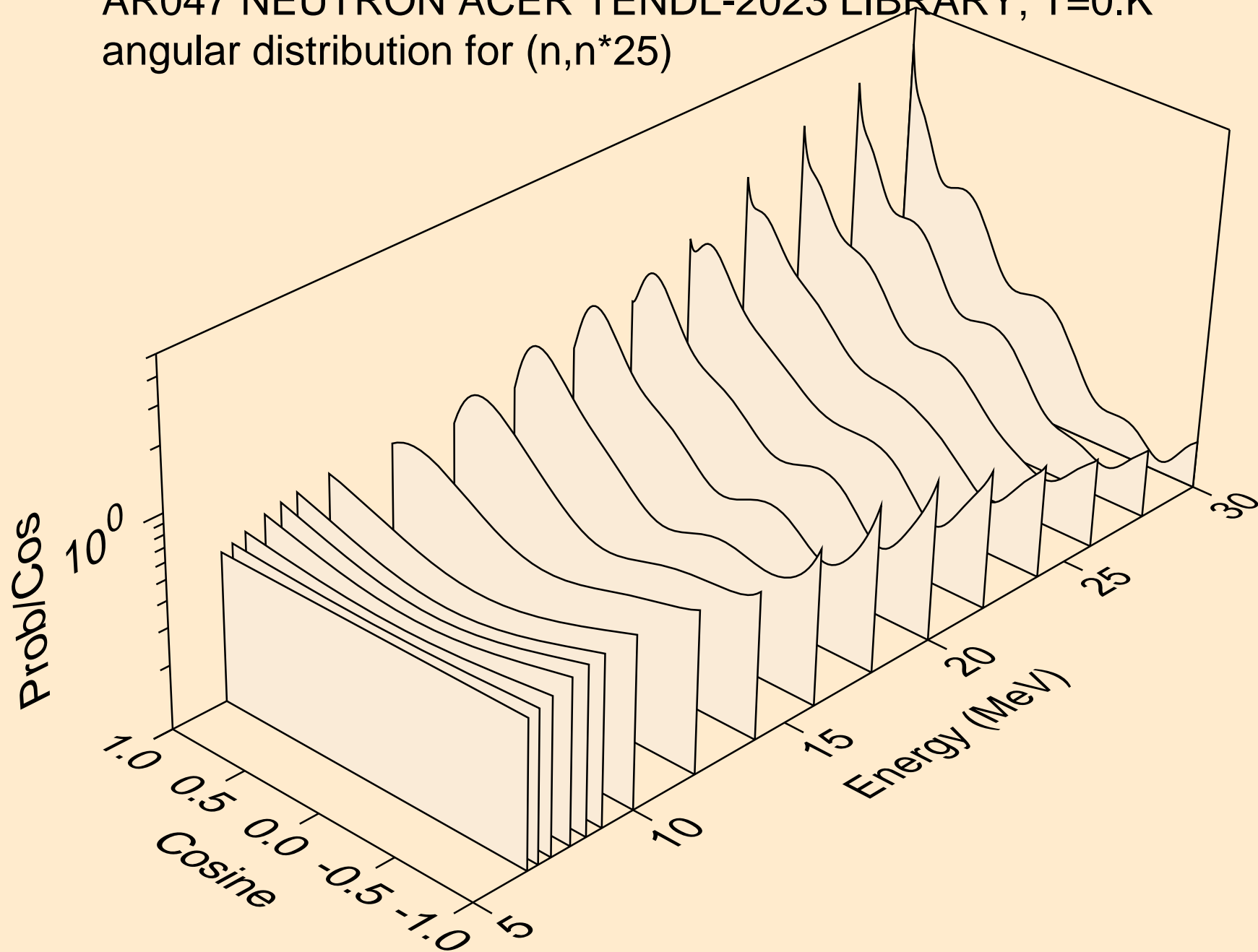

AR047 NEUTRON ACER TENDL-2023 LIBRARY; T=0.K  
angular distribution for (n,n\*26)

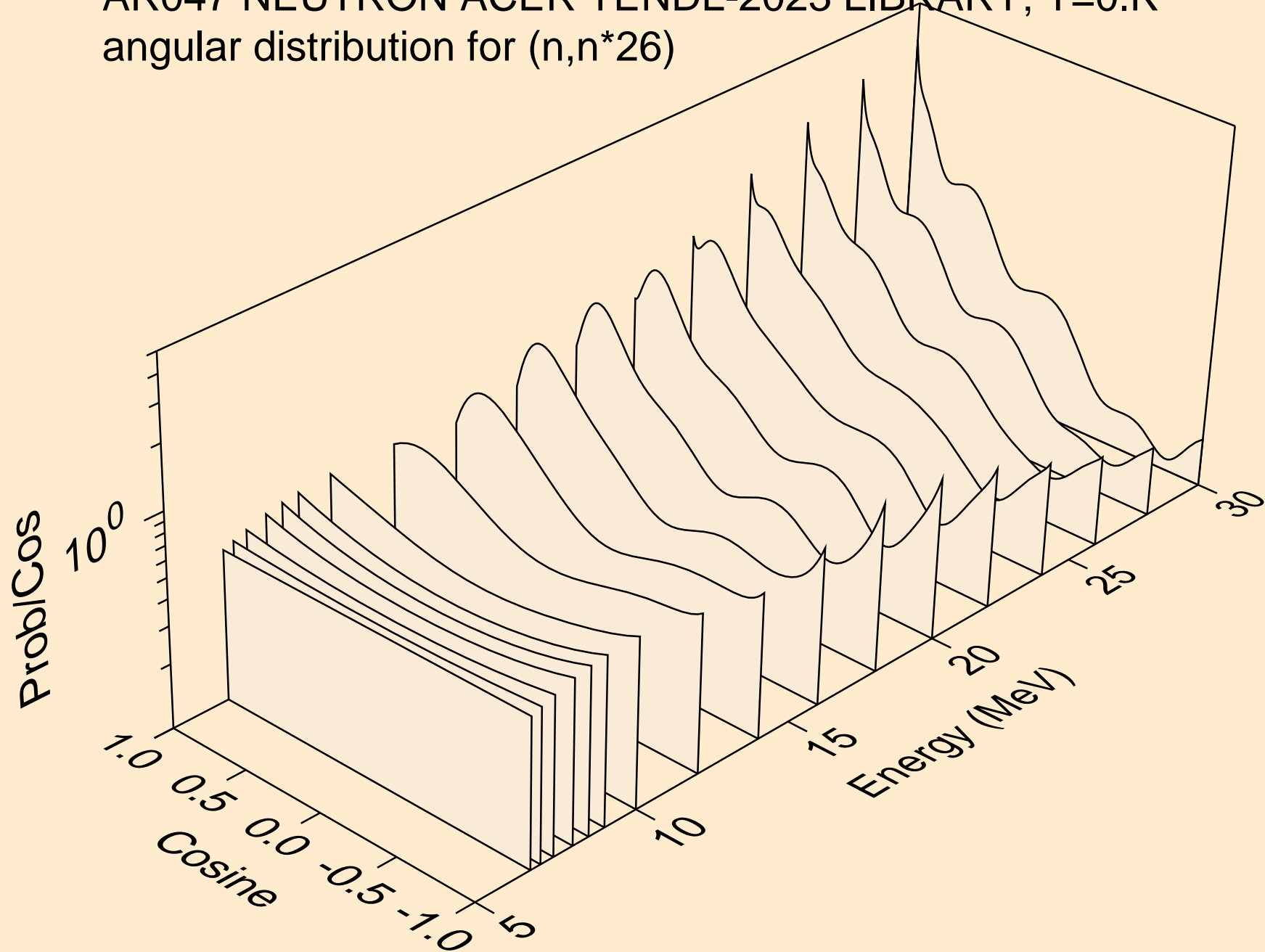

AR047 NEUTRON ACER TENDL-2023 LIBRARY; T=0.K  
angular distribution for (n,n\*27)

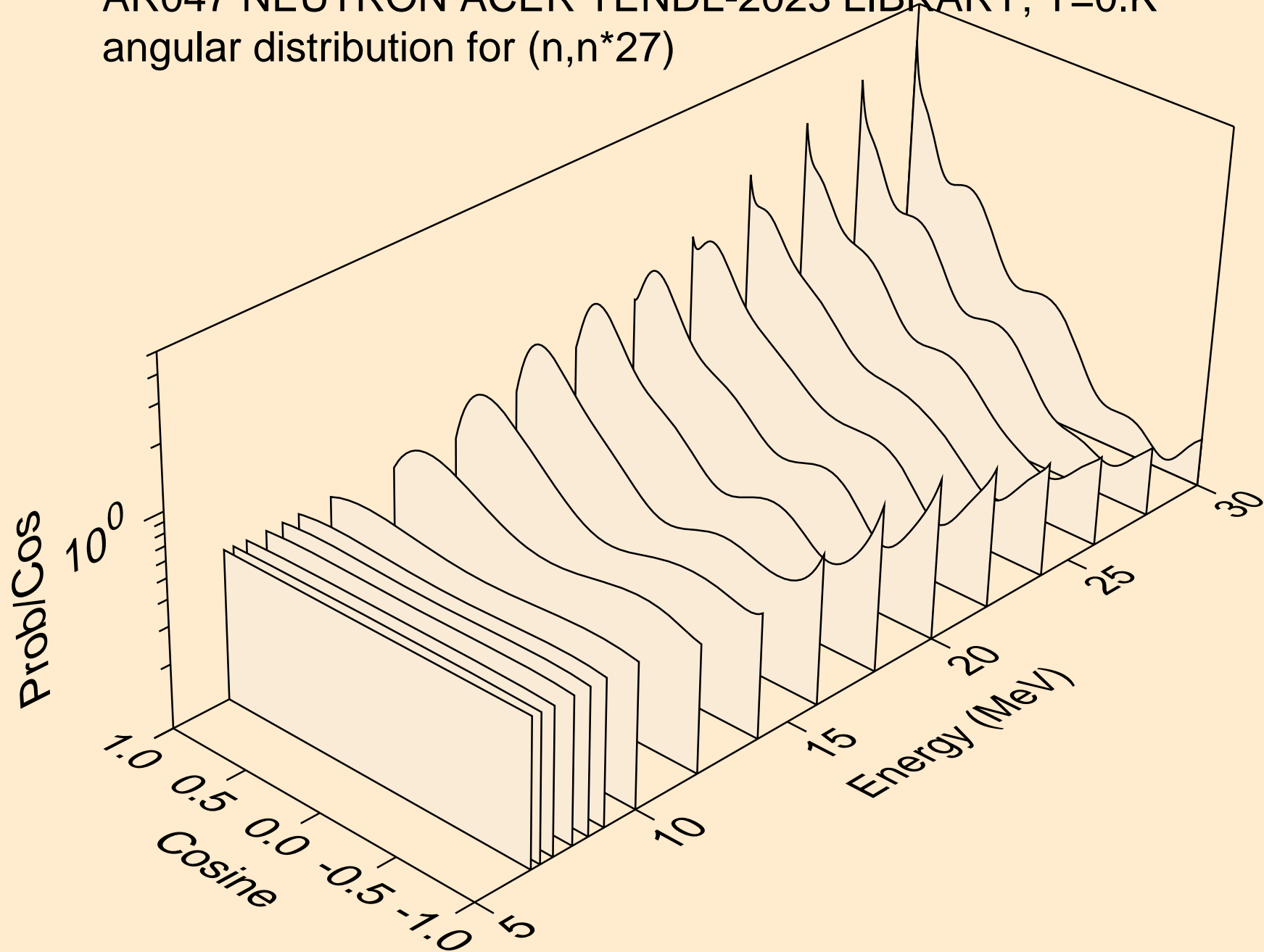



AR047 NEUTRON ACER TENDL-2023 LIBRARY; T=0.K  
angular distribution for (n,n\*28)

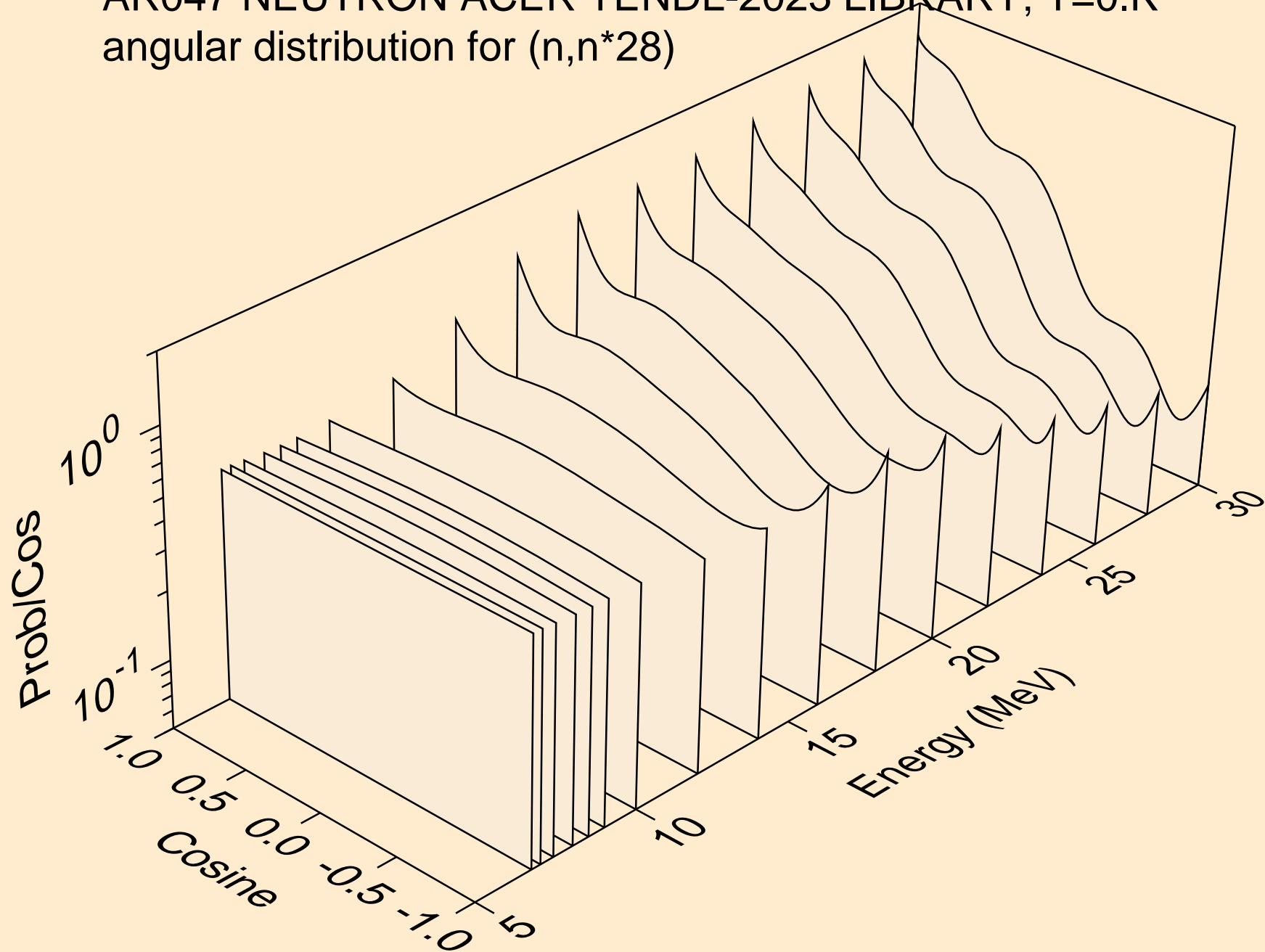

AR047 NEUTRON ACER TENDL-2023 LIBRARY; T=0.K  
angular distribution for (n,n\*29)

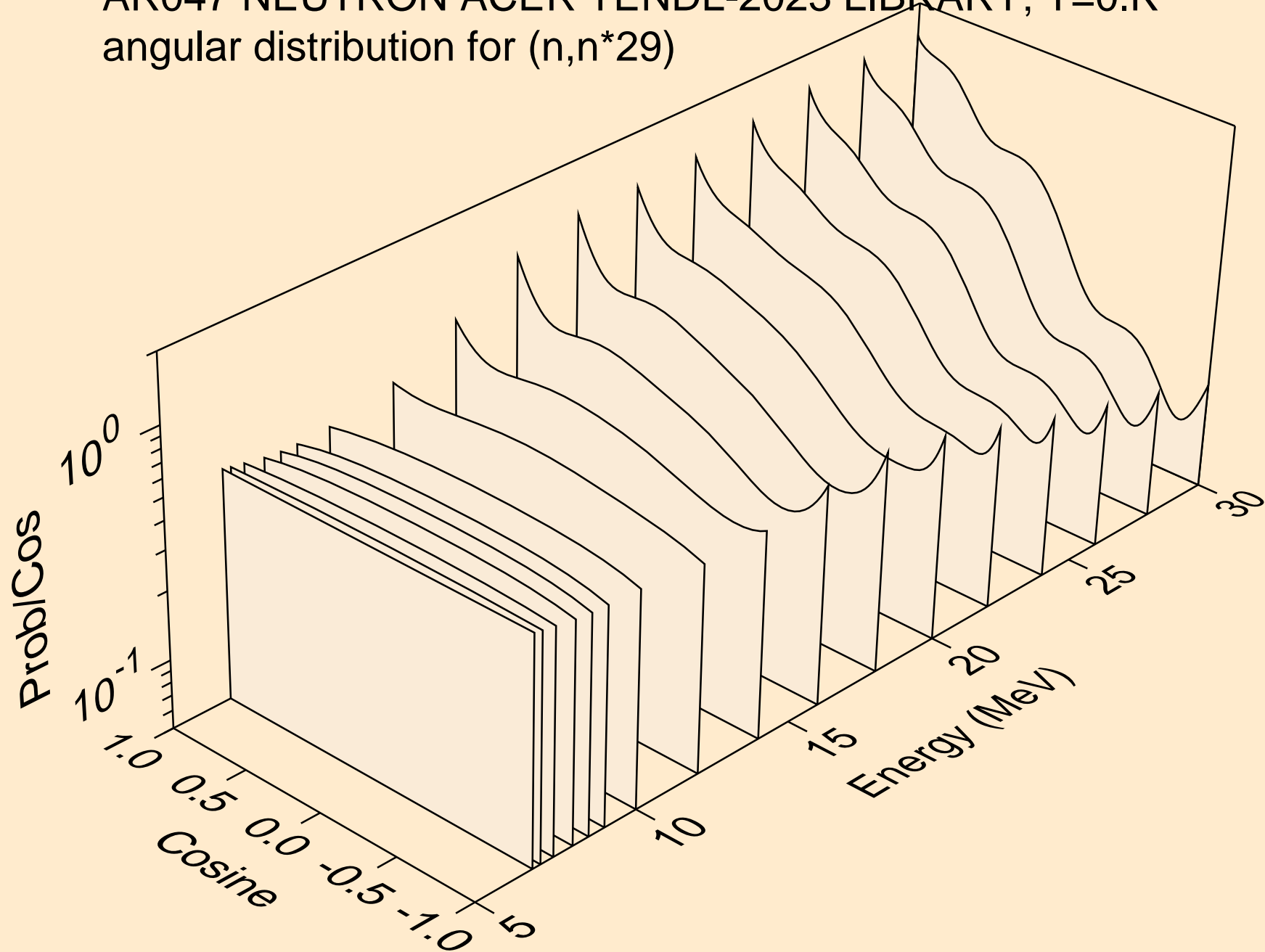

AR047 NEUTRON ACER TENDL-2023 LIBRARY; T=0.K  
Neutron emission for (n,x)

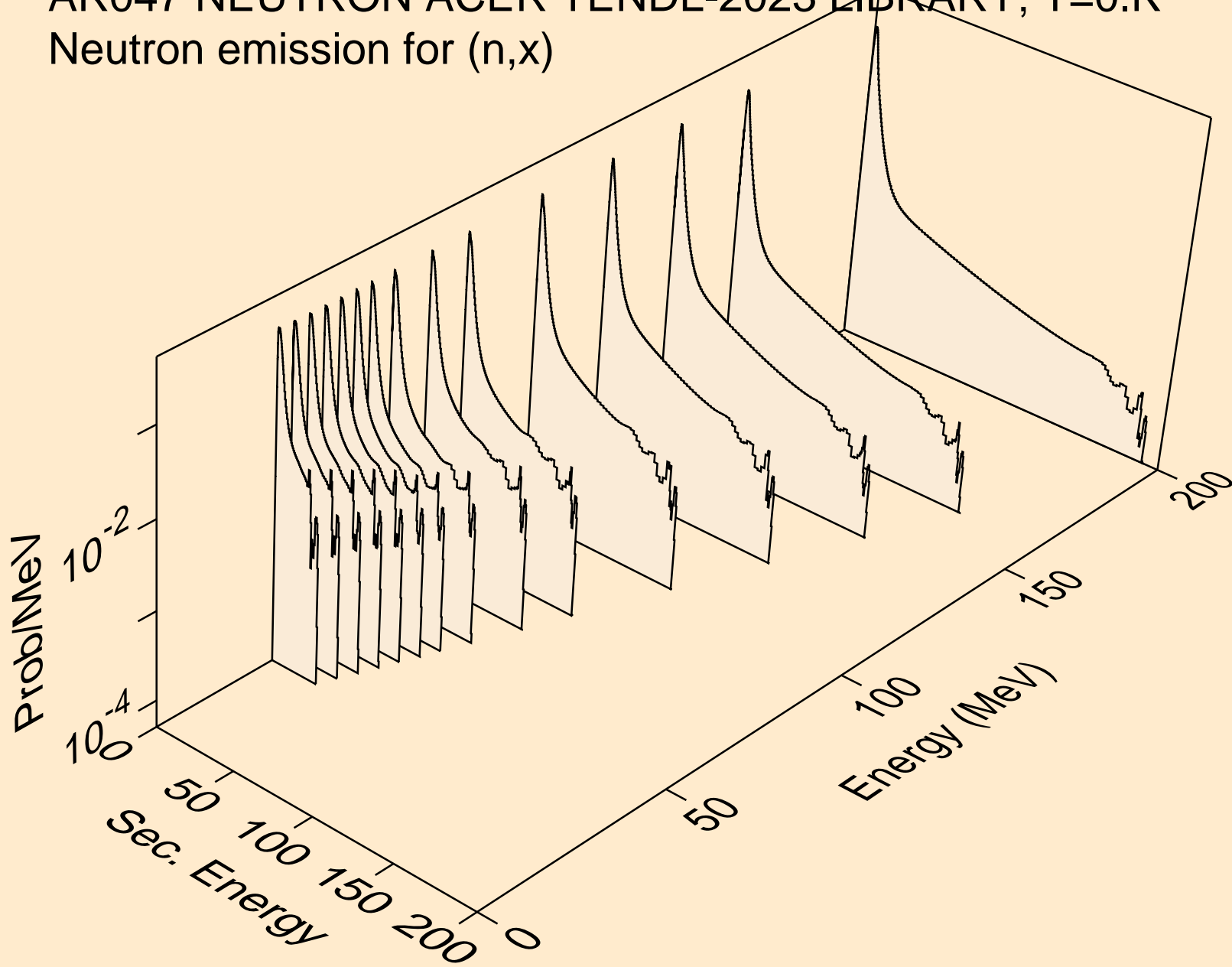

AR047 NEUTRON ACER TENDL-2023 LIBRARY; T=0.K  
Neutron emission for (n,2nd)

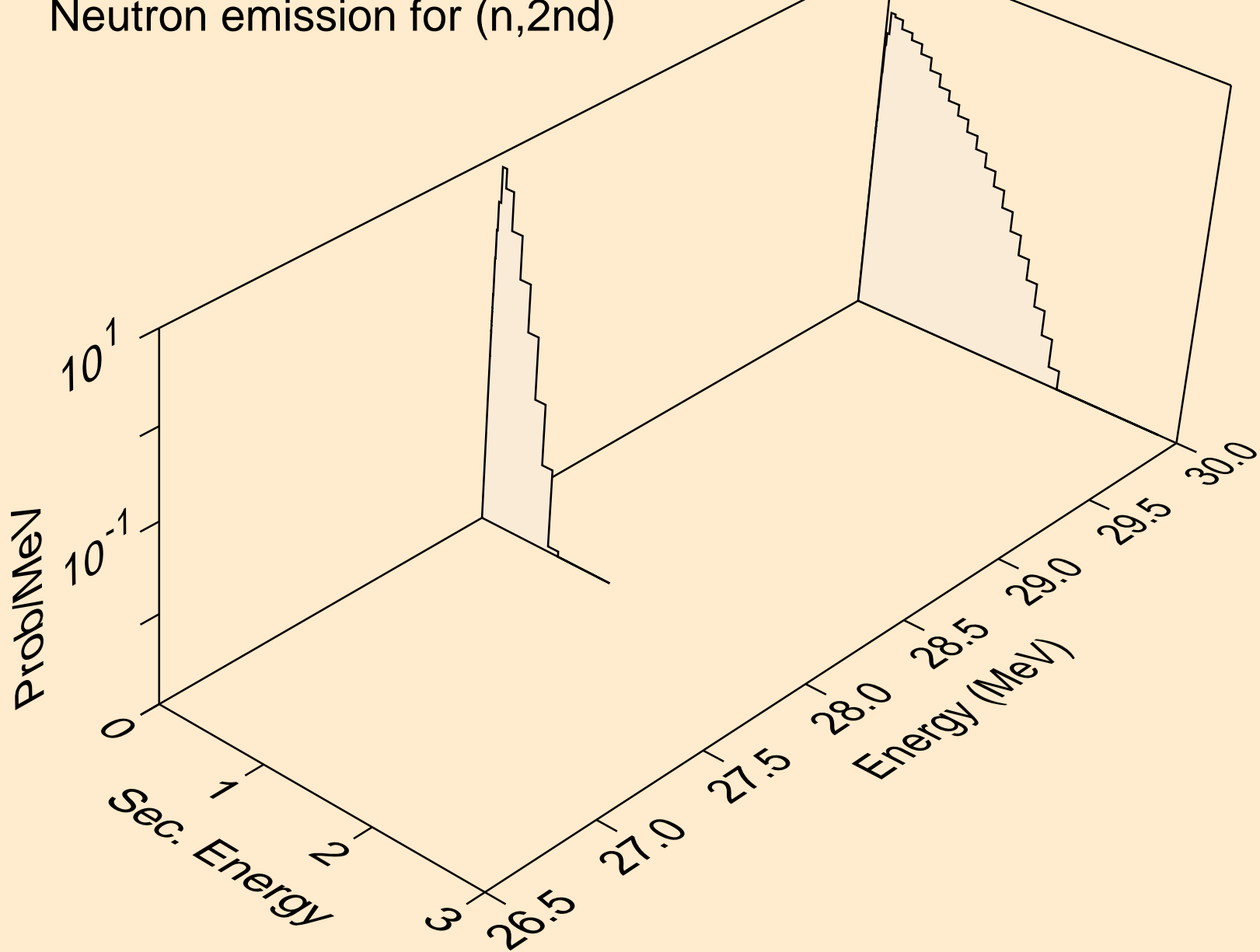

AR047 NEUTRON ACER TENDL-2023 LIBRARY; T=0.K  
Neutron emission for (n,2n)

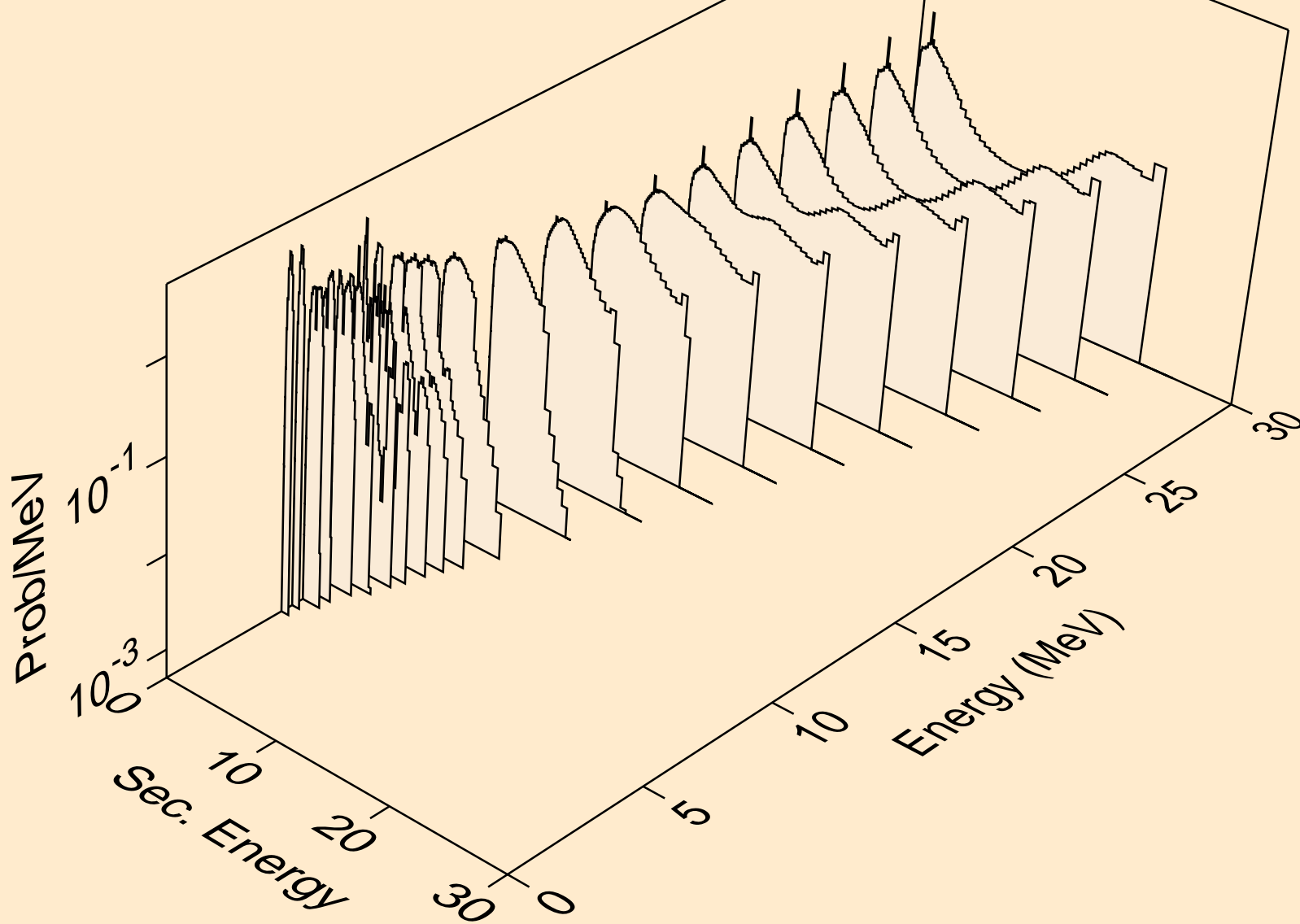

AR047 NEUTRON ACER TENDL-2023 LIBRARY; T=0.K  
Neutron emission for (n,3n)

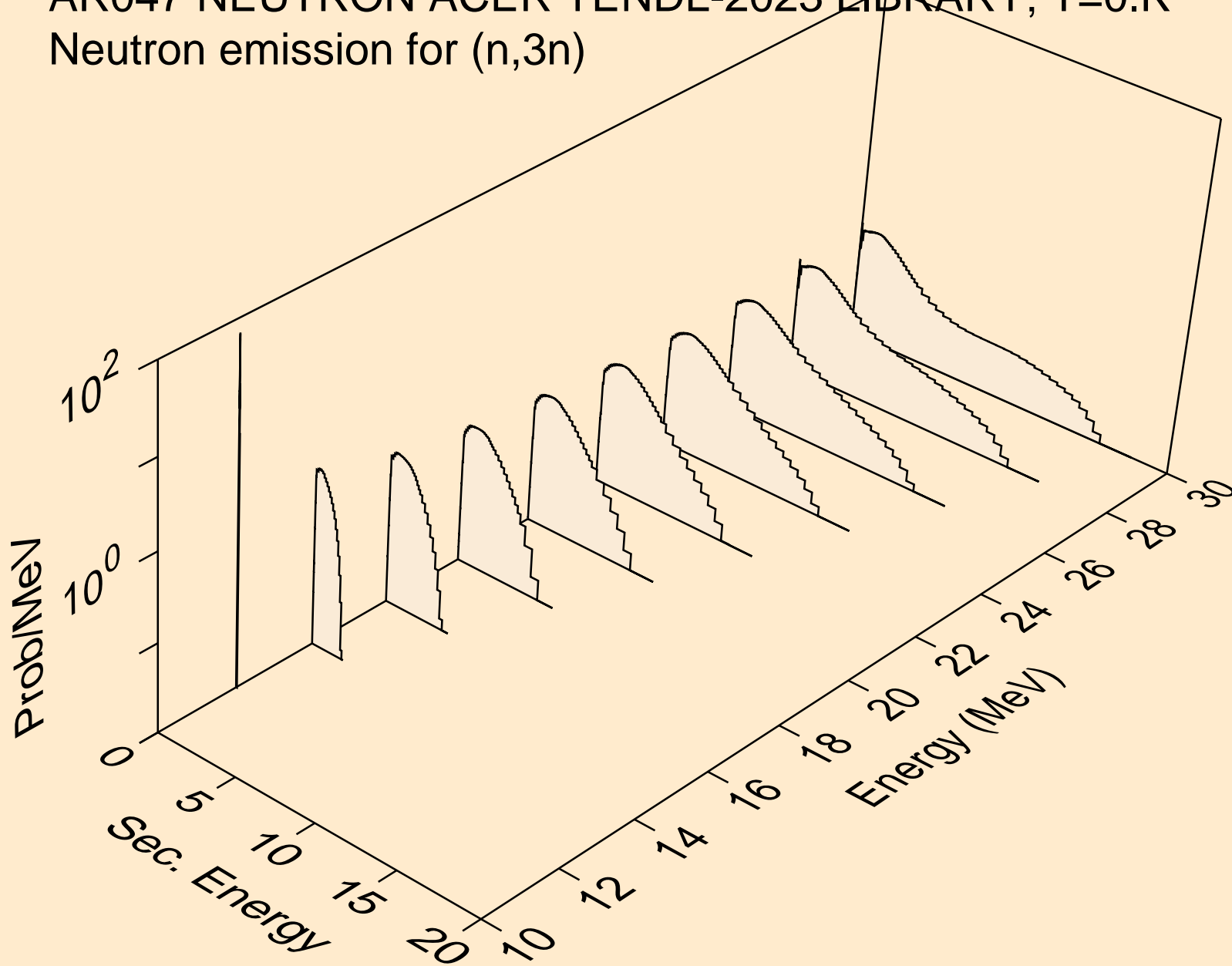

AR047 NEUTRON ACER TENDL-2023 LIBRARY; T=0.K  
Neutron emission for (n,n\*)a

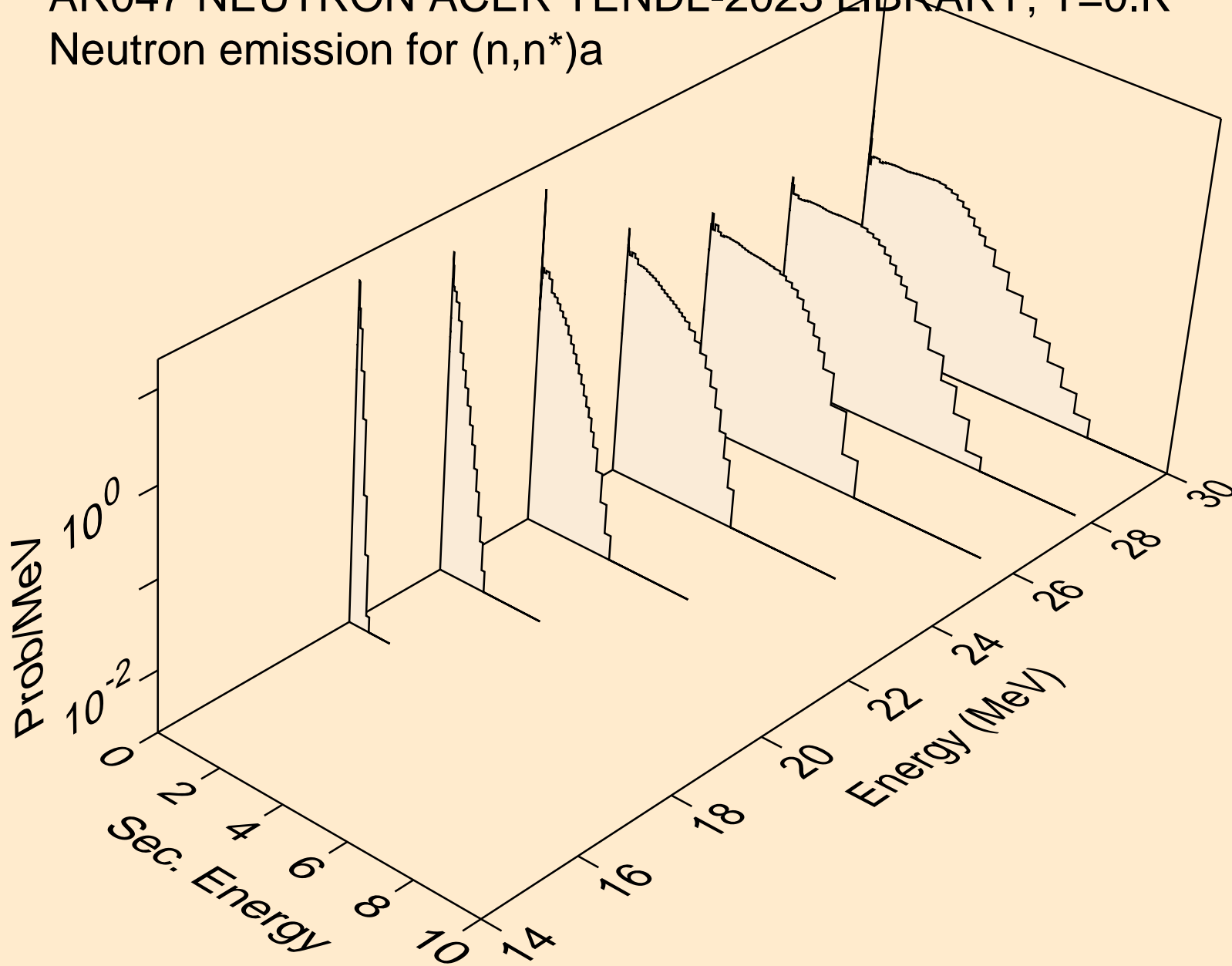

AR047 NEUTRON ACER TENDL-2023 LIBRARY; T=0.K  
Neutron emission for (n,2n)a

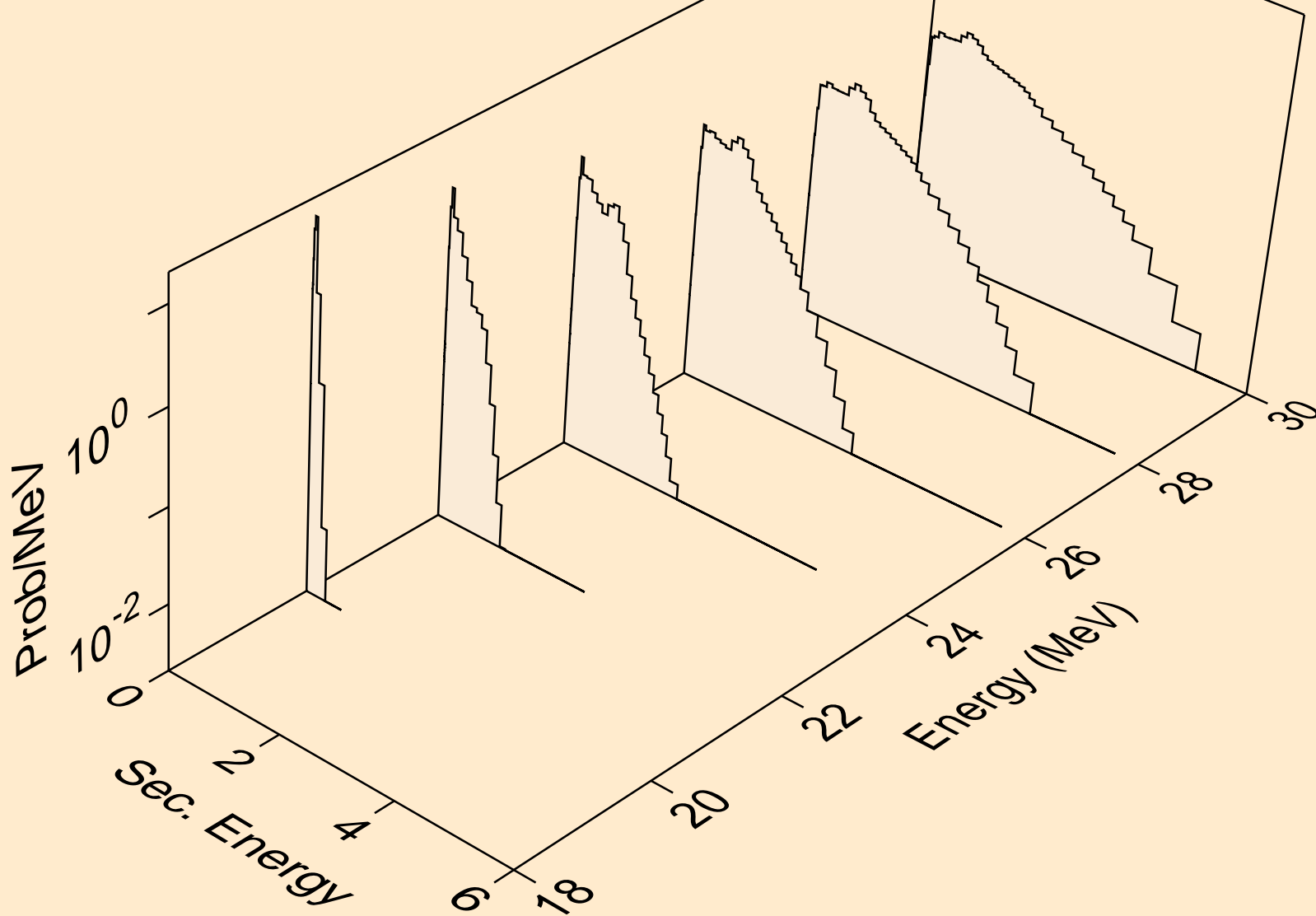



AR047 NEUTRON ACER TENDL-2023 LIBRARY; T=0.K  
Neutron emission for (n,3n)a

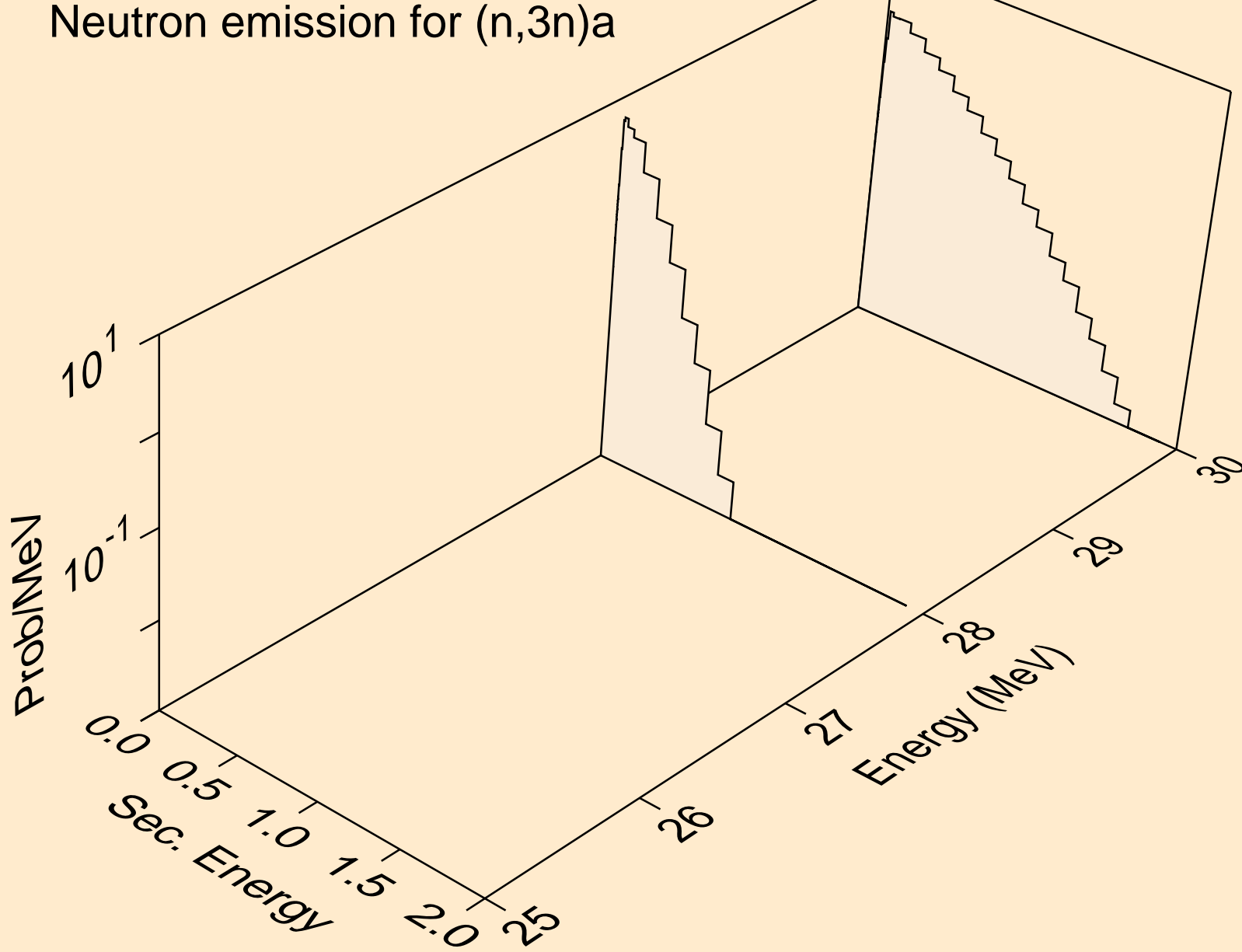

AR047 NEUTRON ACER TENDL-2023 LIBRARY; T=0.K  
Neutron emission for (n,n\*)p

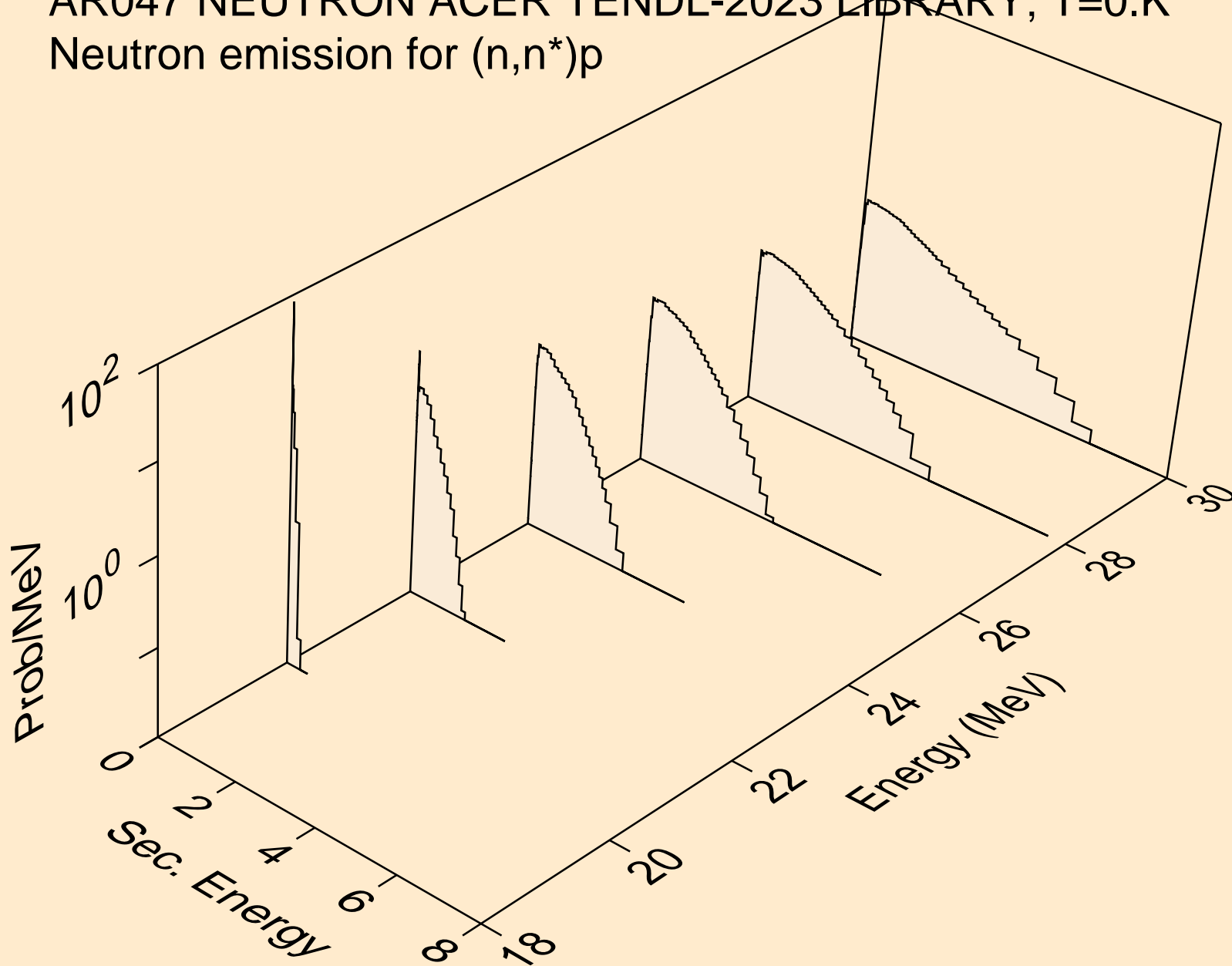

AR047 NEUTRON ACER TENDL-2023 LIBRARY; T=0.K  
Neutron emission for (n,n\*)d

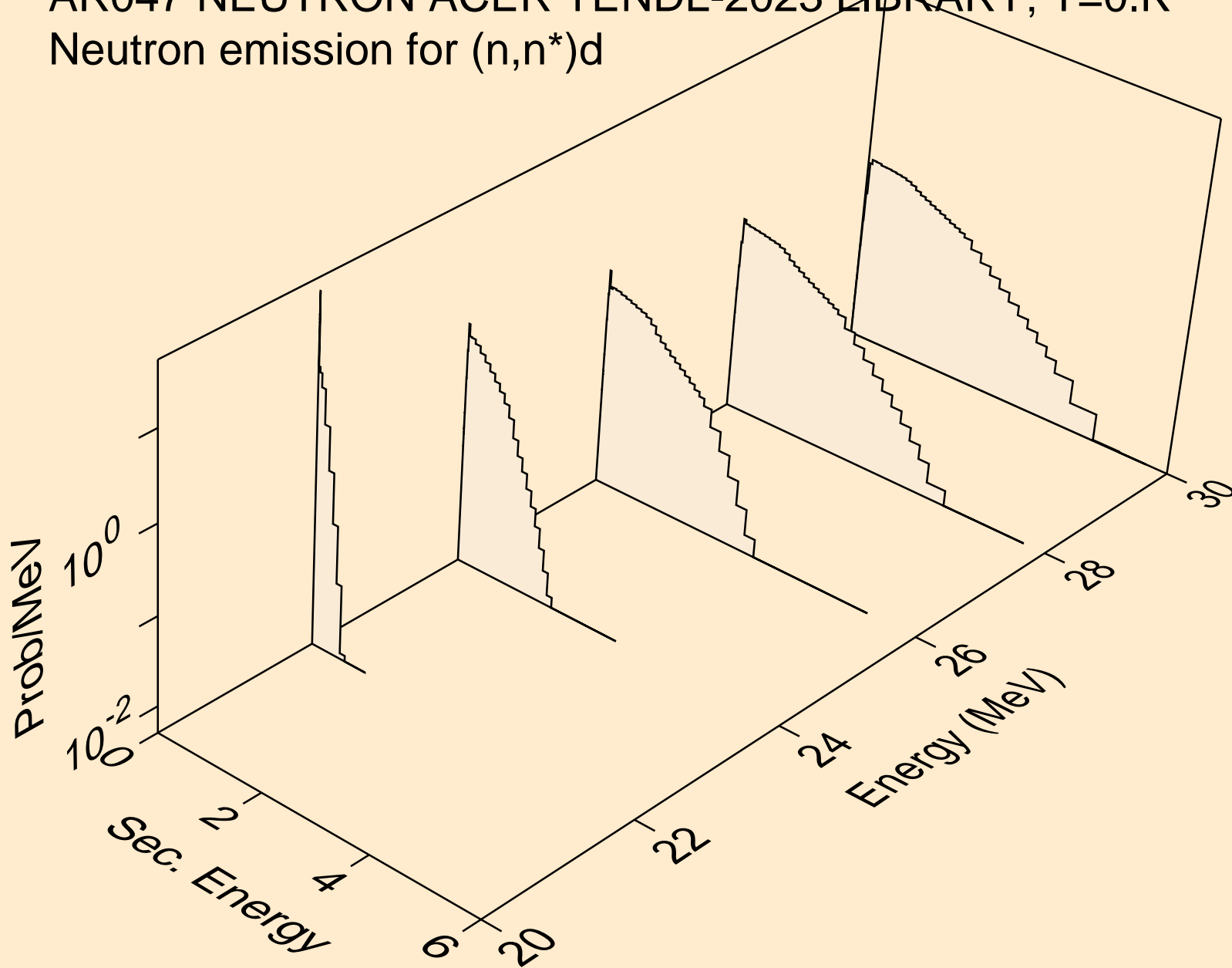

AR047 NEUTRON ACER TENDL-2023 LIBRARY; T=0.K  
Neutron emission for (n,n\*)t

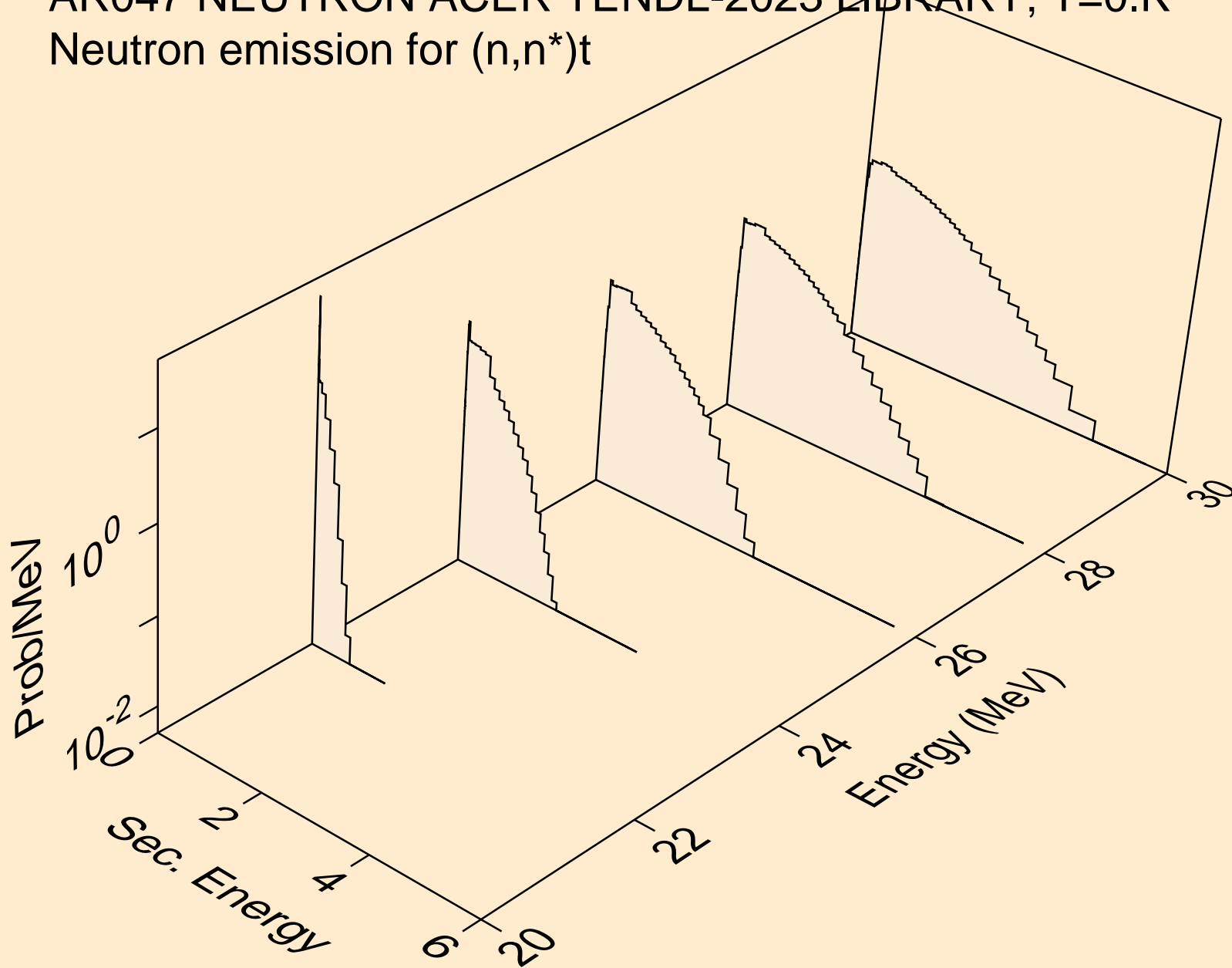

AR047 NEUTRON ACER TENDL-2023 LIBRARY; T=0.K  
Neutron emission for (n,4n)

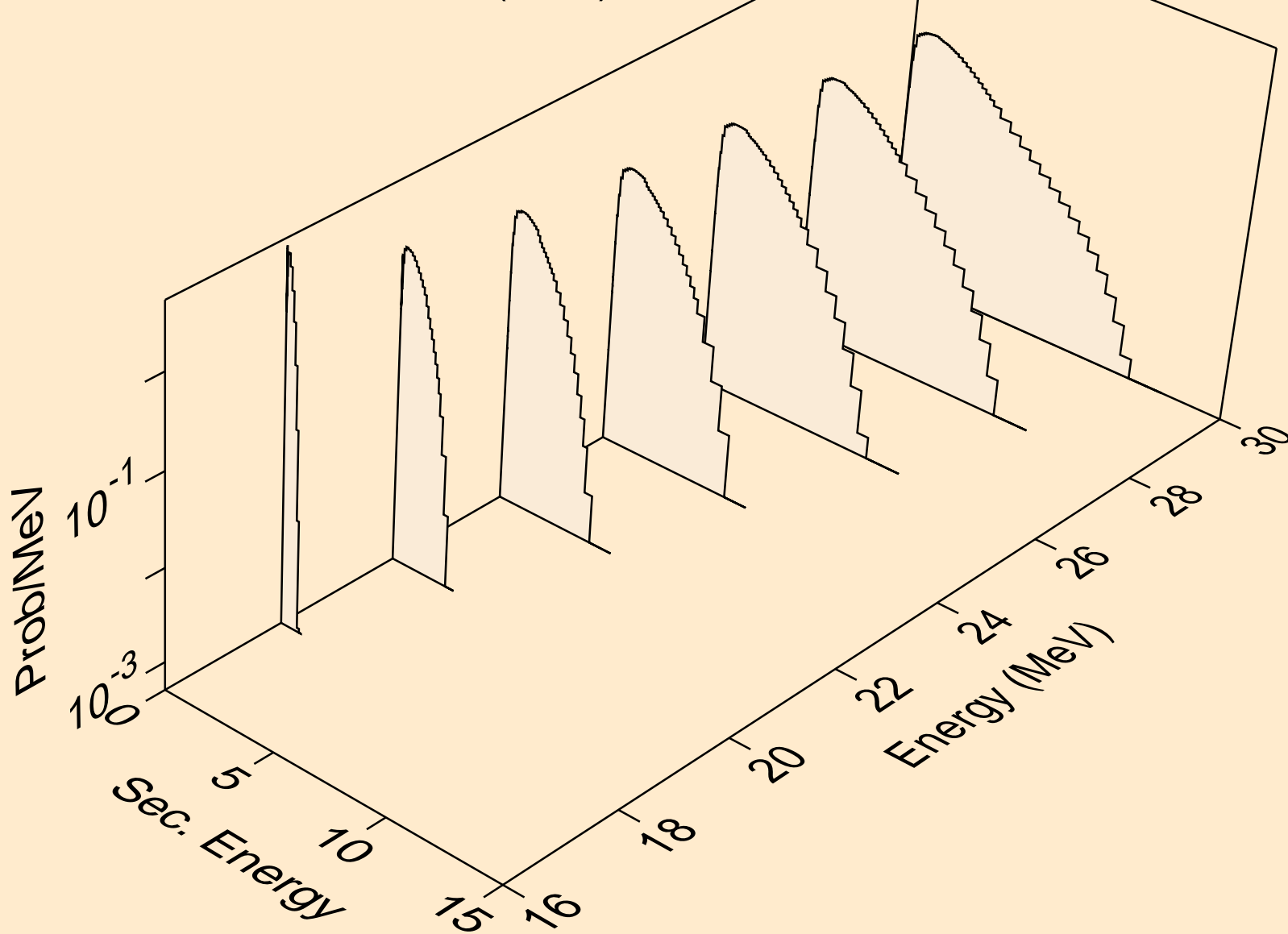

AR047 NEUTRON ACER TENDL-2023 LIBRARY; T=0.K  
Neutron emission for (n,2np)

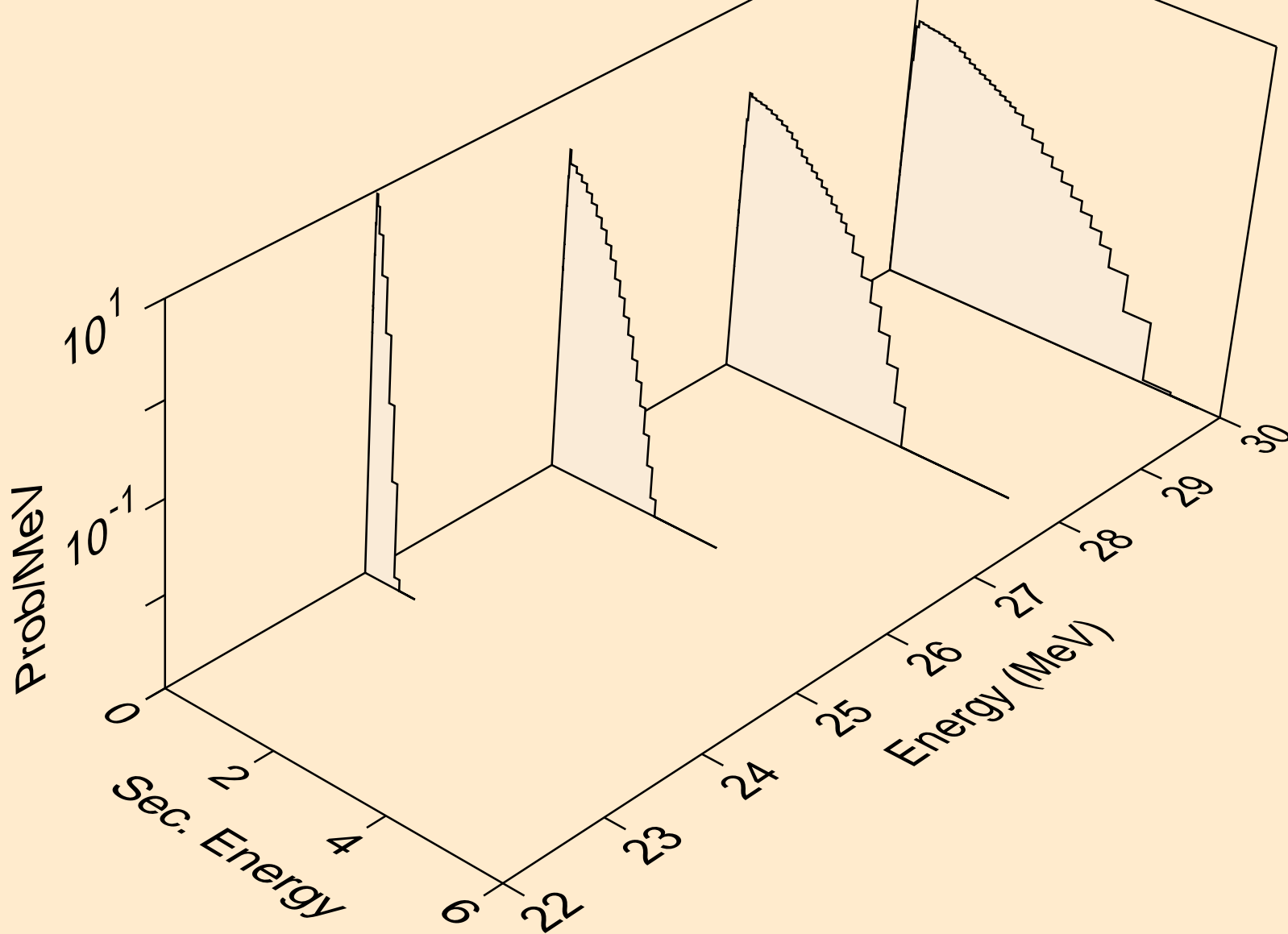

AR047 NEUTRON ACER TENDL-2023 LIBRARY; T=0.K  
Photon emission for (n,x)

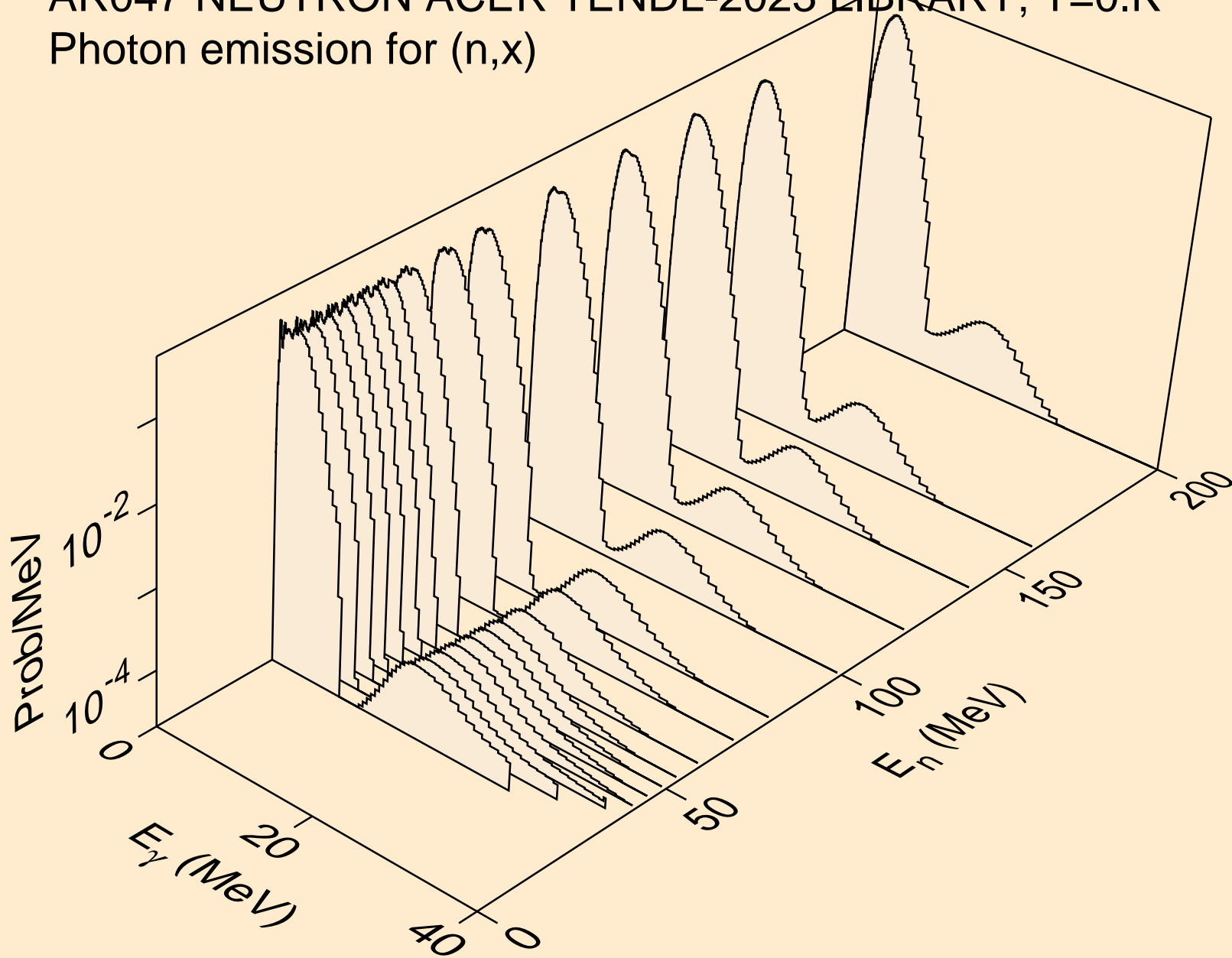

AR047 NEUTRON ACER TENDL-2023 LIBRARY; T=0.K  
Photon emission for (n,2nd)

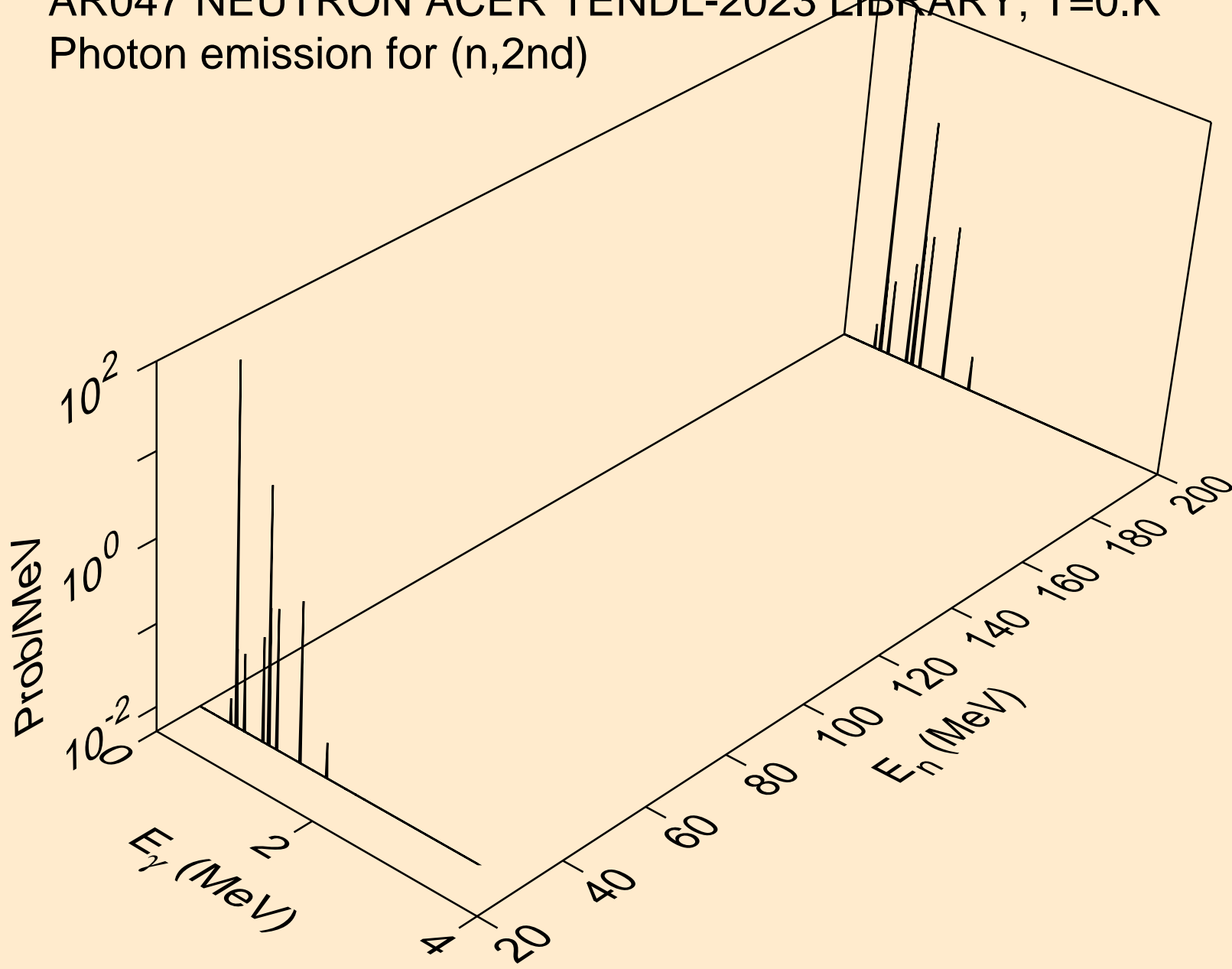



AR047 NEUTRON ACER TENDL-2023 LIBRARY; T=0.K  
Photon emission for (n,2n)

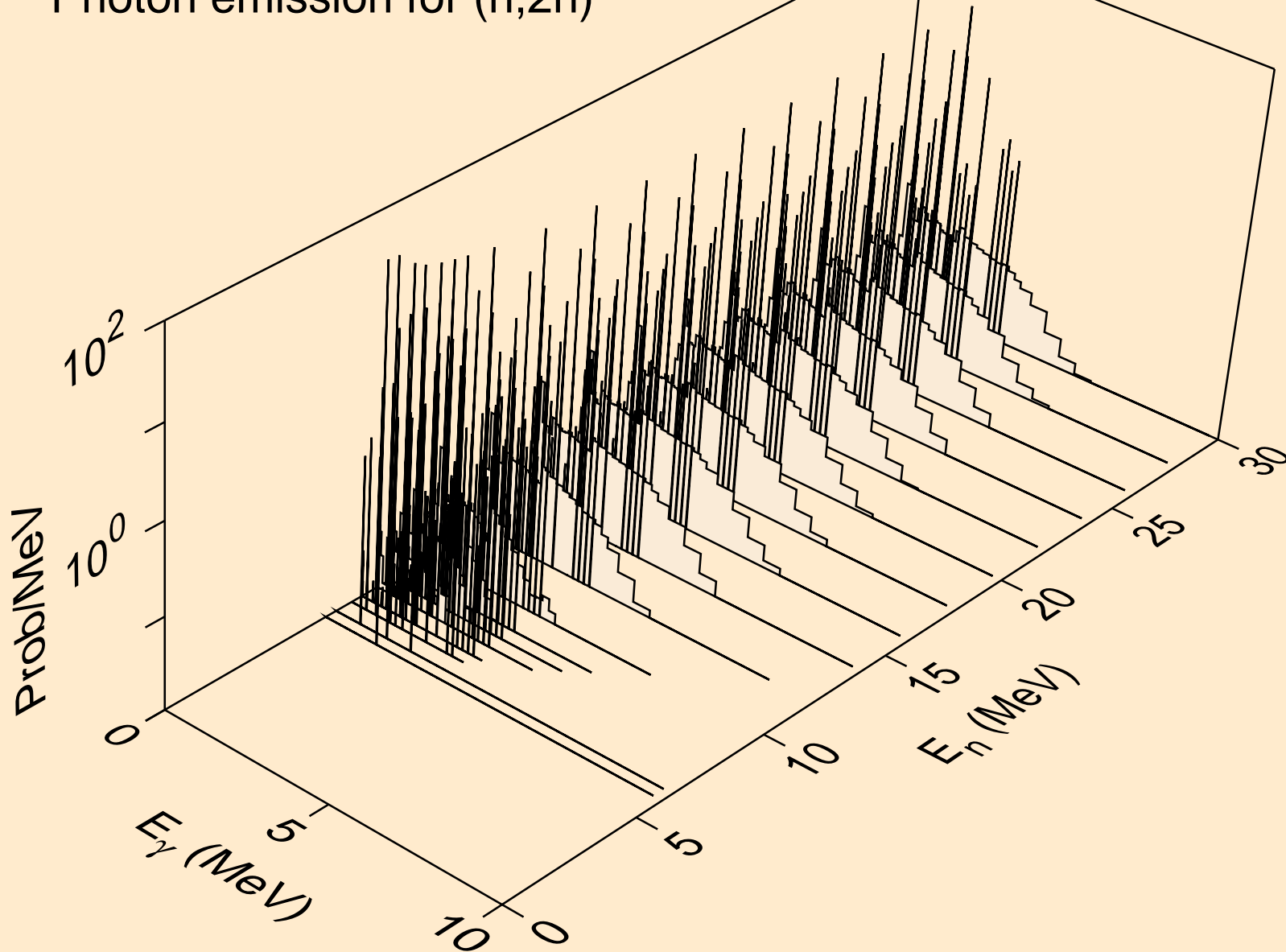

AR047 NEUTRON ACER TENDL-2023 LIBRARY; T=0.K  
Photon emission for (n,3n)

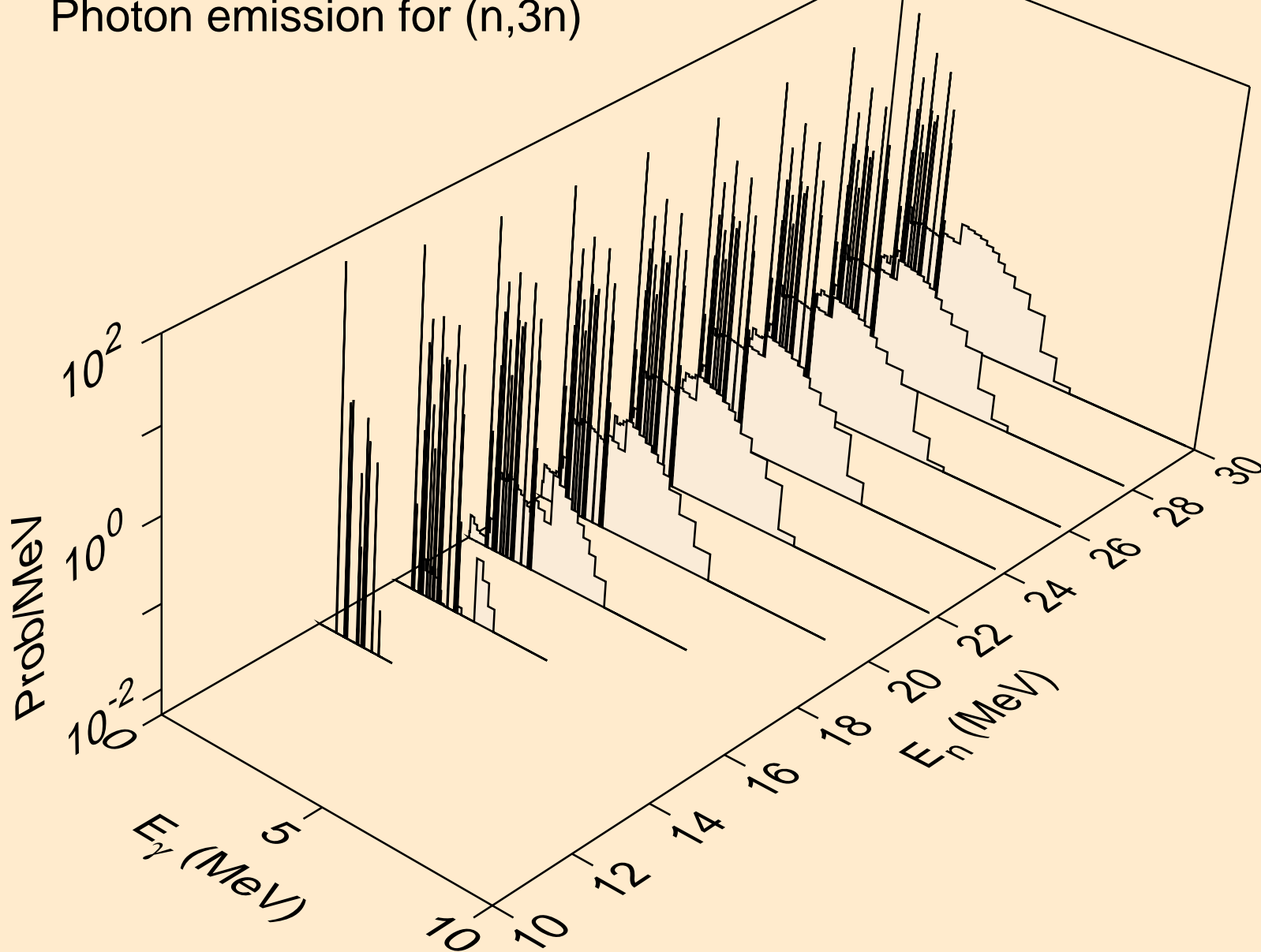

AR047 NEUTRON ACER TENDL-2023 LIBRARY; T=0.K  
Photon emission for (n,n\*)a

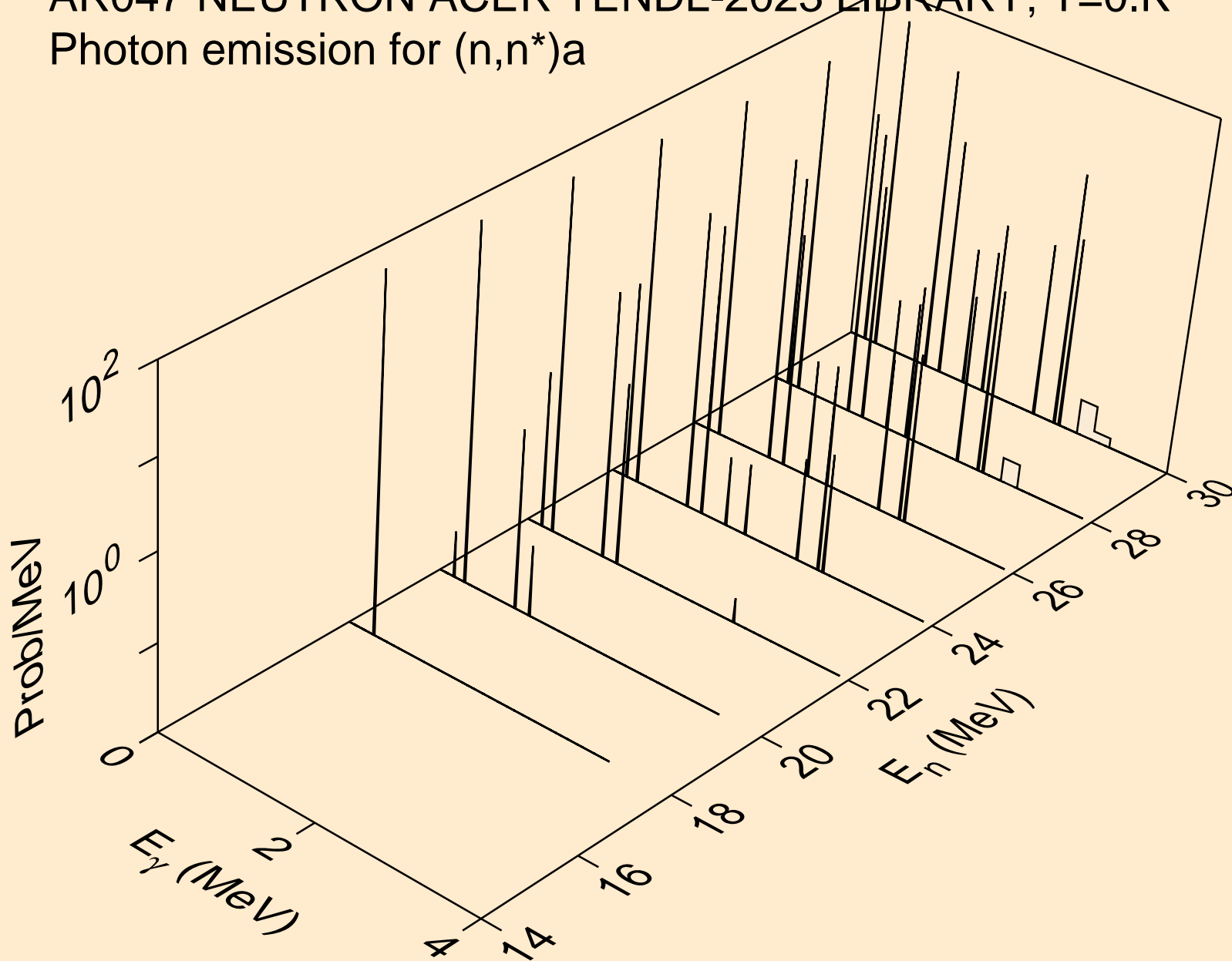

AR047 NEUTRON ACER TENDL-2023 LIBRARY; T=0.K  
Photon emission for (n,2n)a

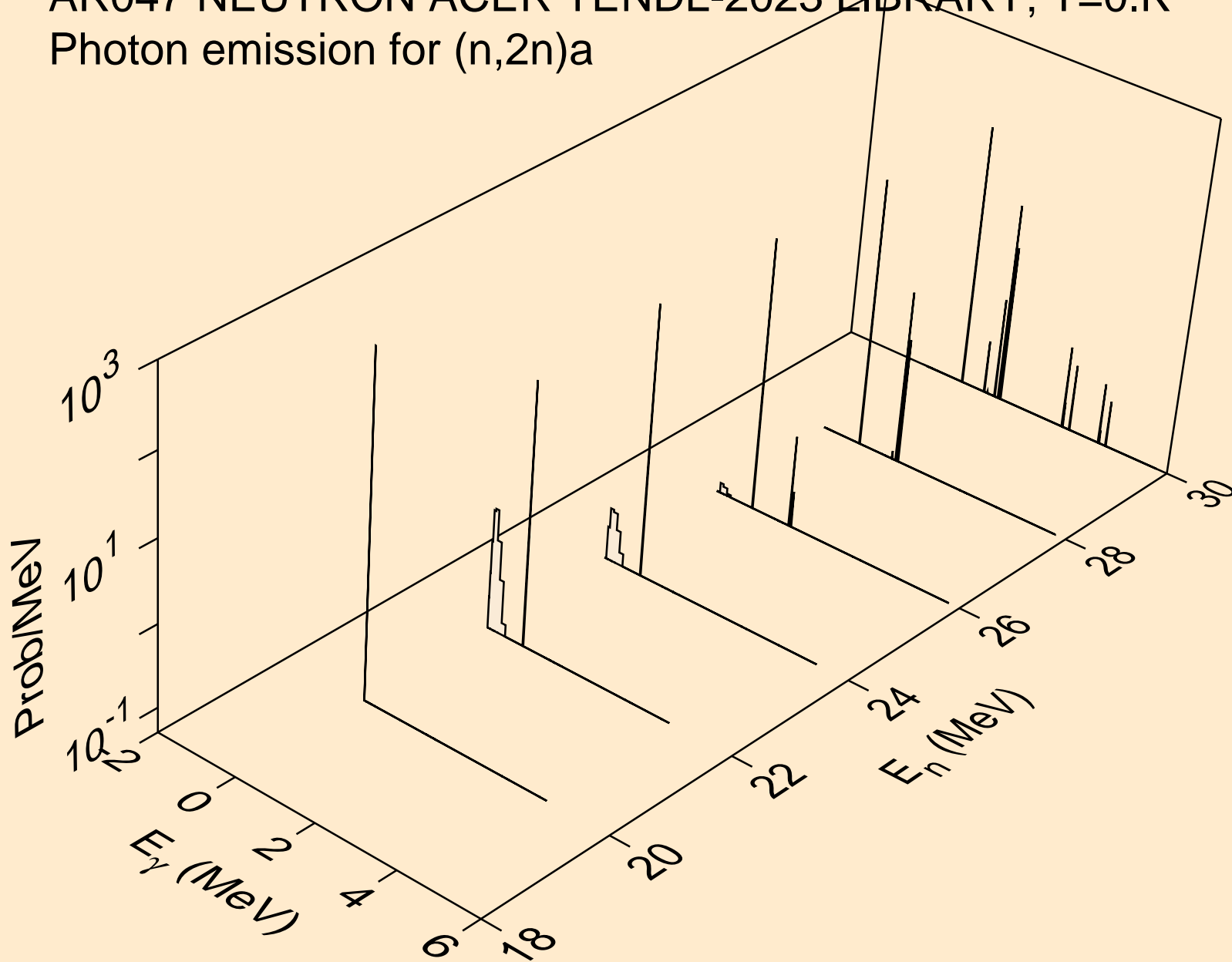

AR047 NEUTRON ACER TENDL-2023 LIBRARY; T=0.K  
Photon emission for (n,3n)a

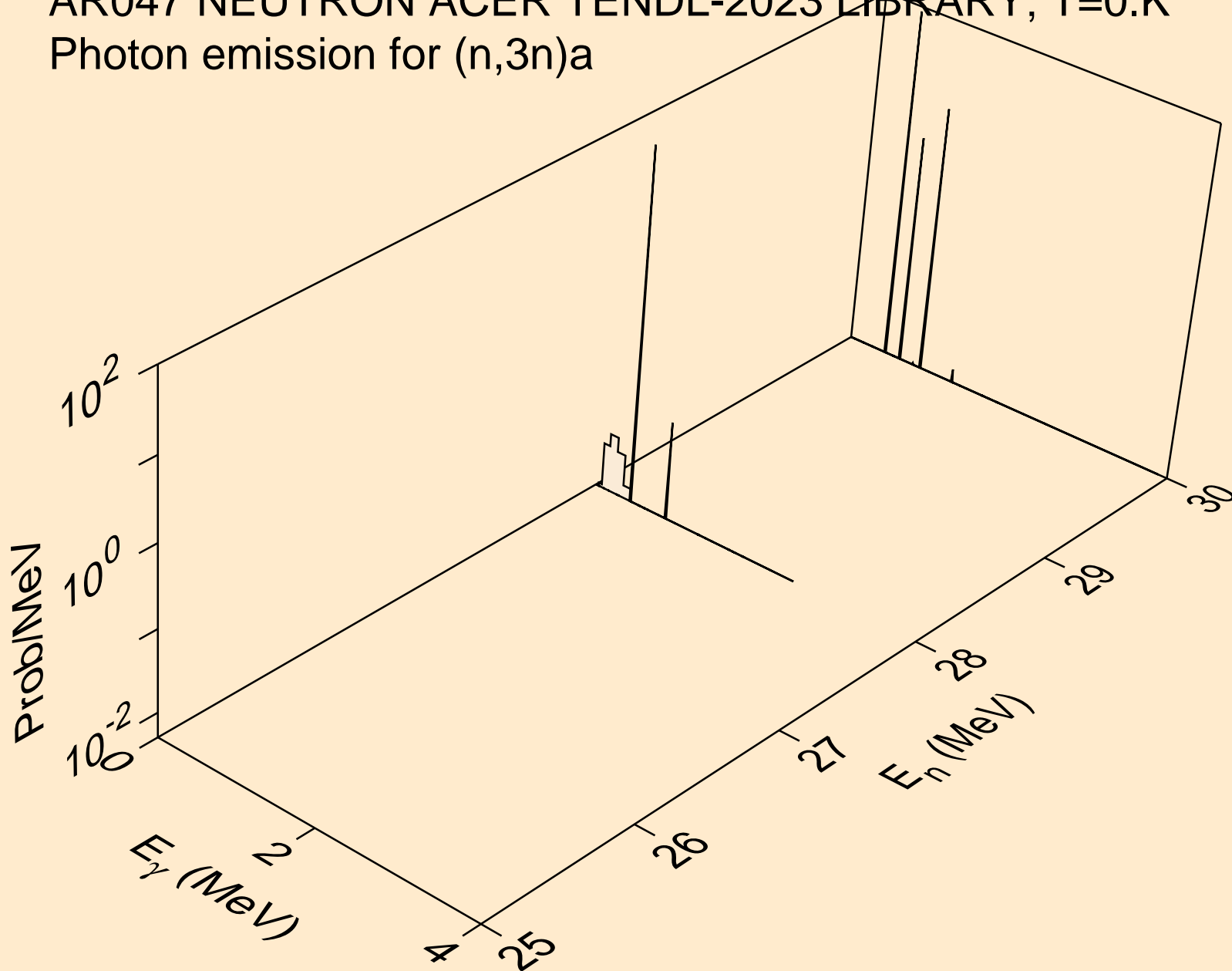

AR047 NEUTRON ACER TENDL-2023 LIBRARY; T=0.K  
Photon emission for (n,n\*)p

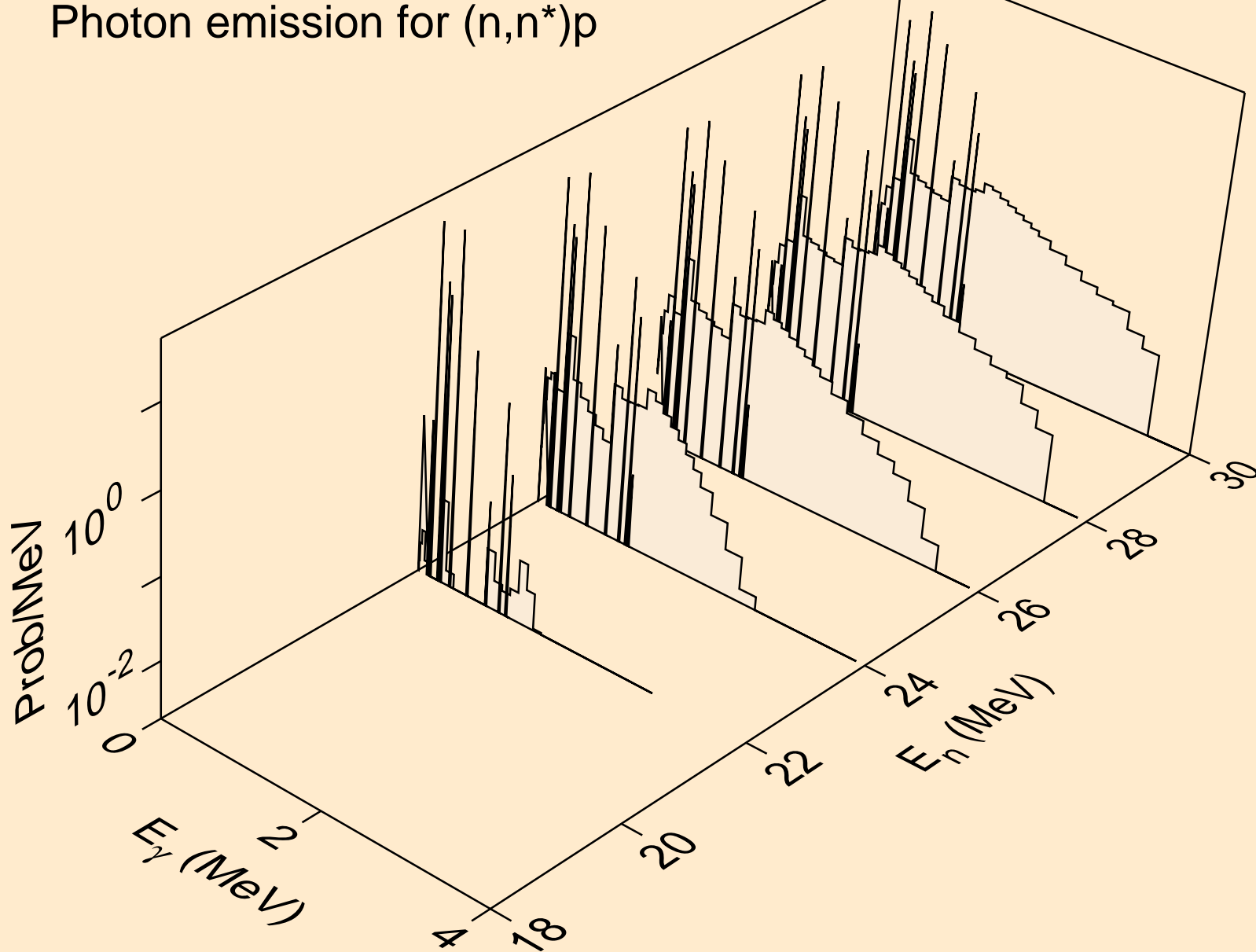

AR047 NEUTRON ACER TENDL-2023 LIBRARY; T=0.K  
Photon emission for (n,n\*)d

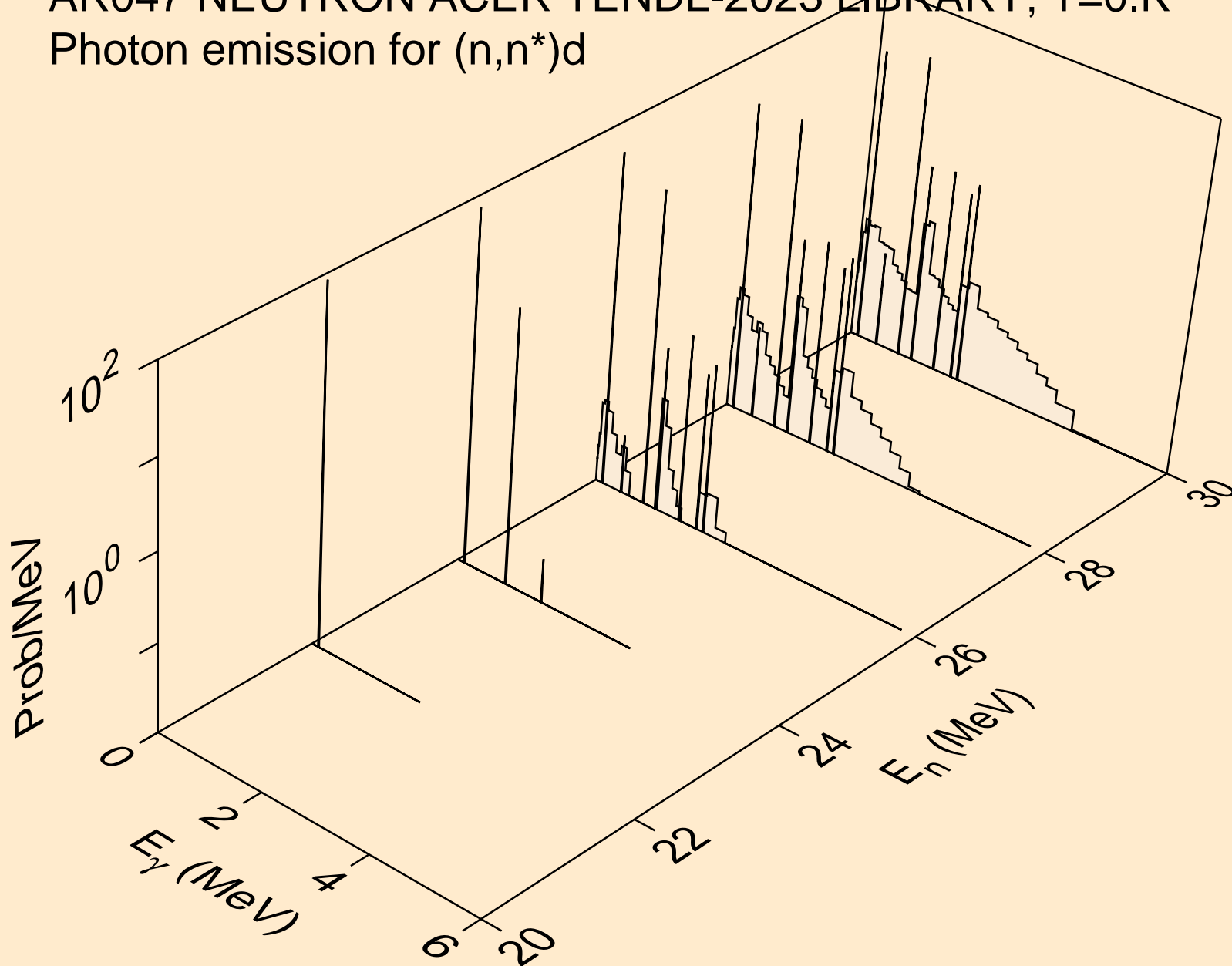

AR047 NEUTRON ACER TENDL-2023 LIBRARY; T=0.K  
Photon emission for (n,n\*)t

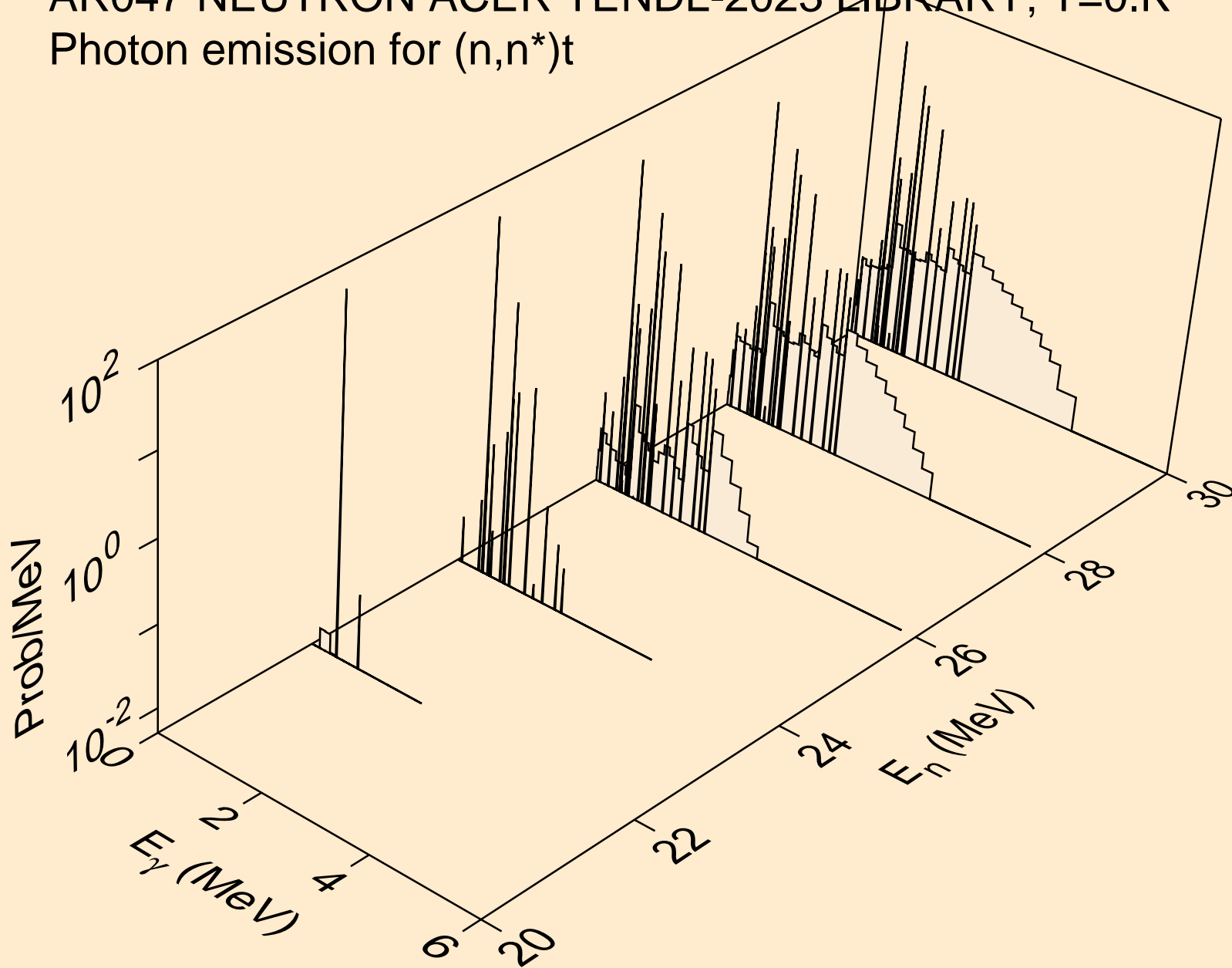



AR047 NEUTRON ACER TENDL-2023 LIBRARY; T=0.K  
Photon emission for (n,4n)

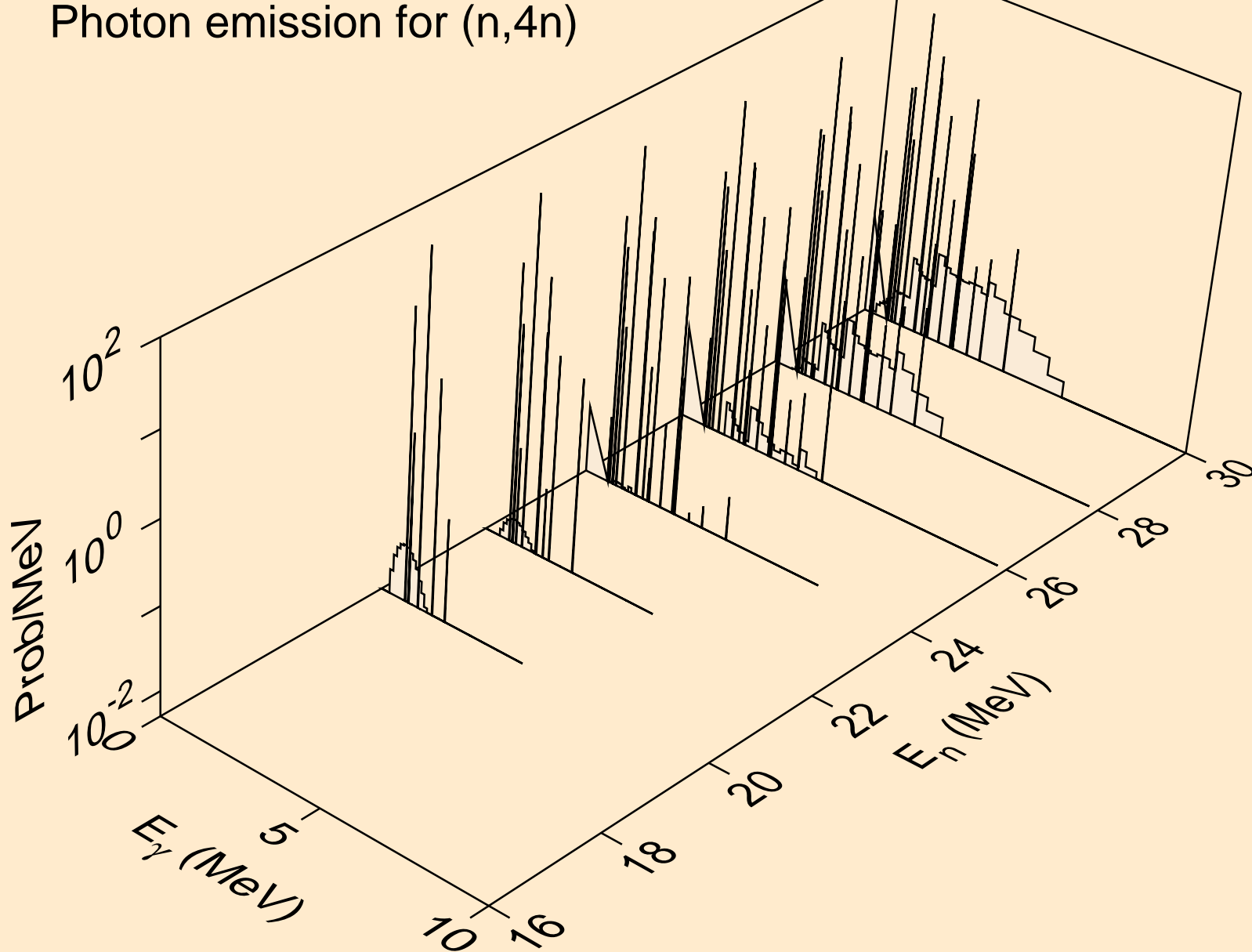

AR047 NEUTRON ACER TENDL-2023 LIBRARY; T=0.K  
Photon emission for (n,2np)

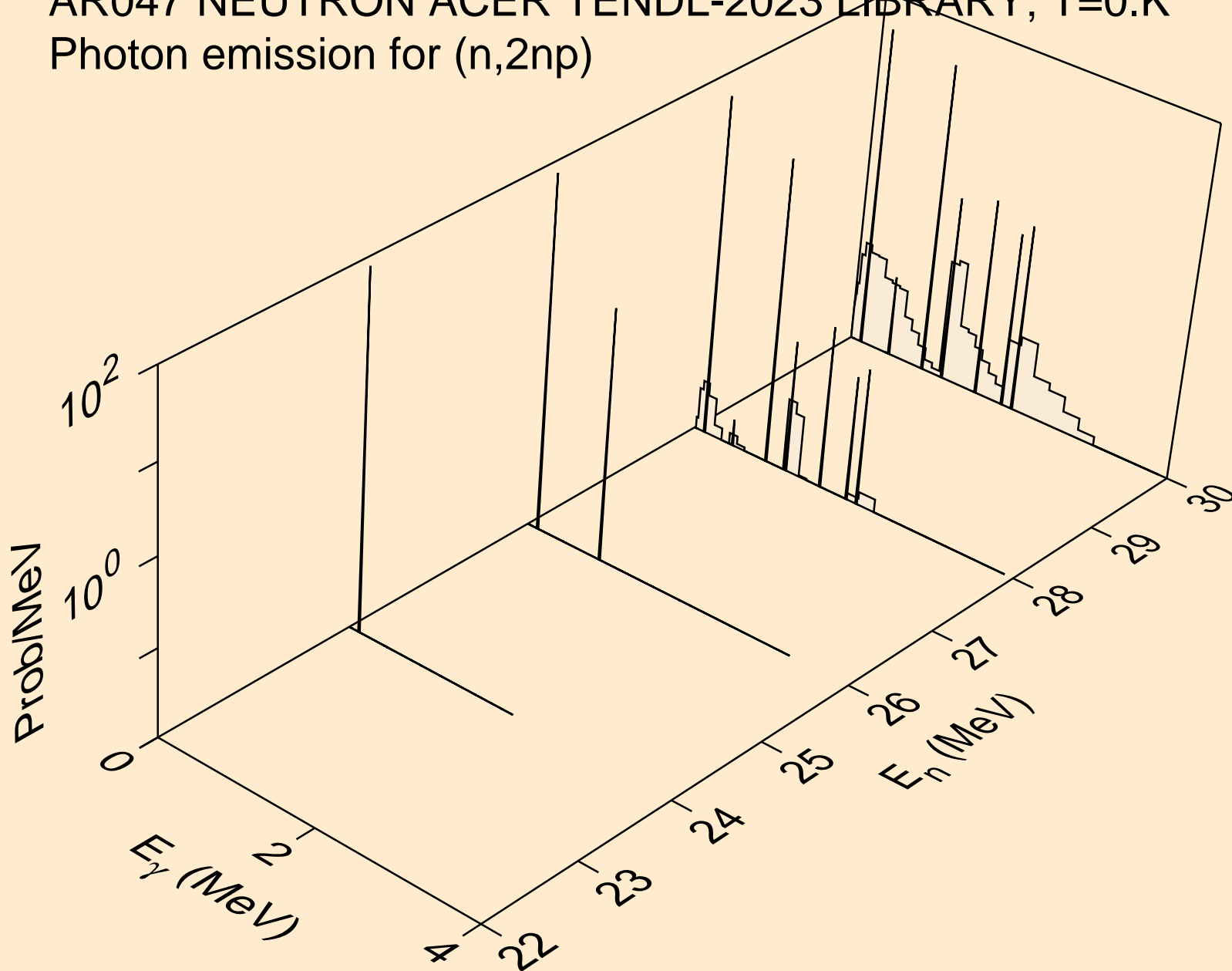

AR047 NEUTRON ACER TENDL-2023 LIBRARY; T=0.K  
Photon emission for (n,n\*c)

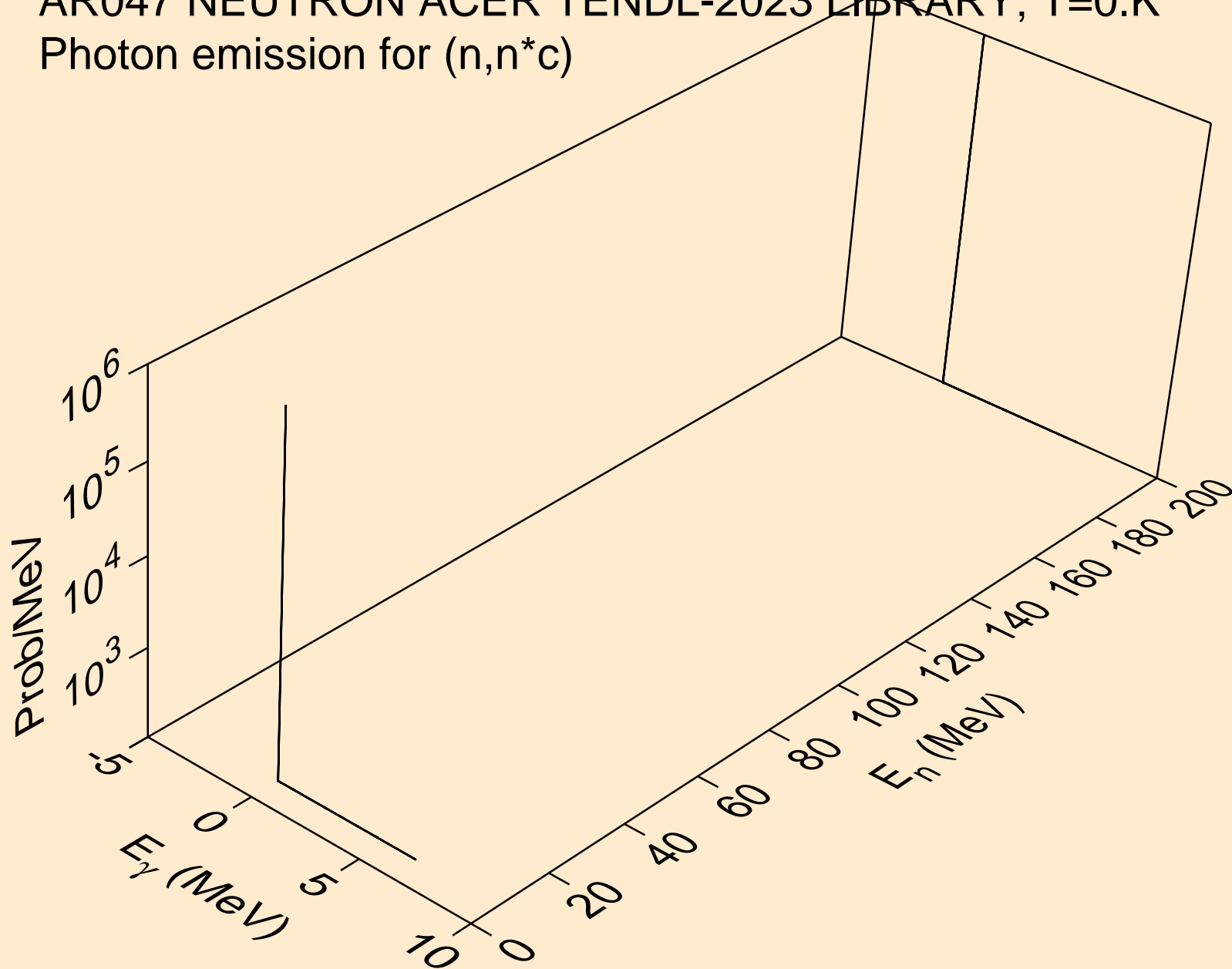

AR047 NEUTRON ACER TENDL-2023 LIBRARY; T=0.K  
Photon emission for (n,gma)

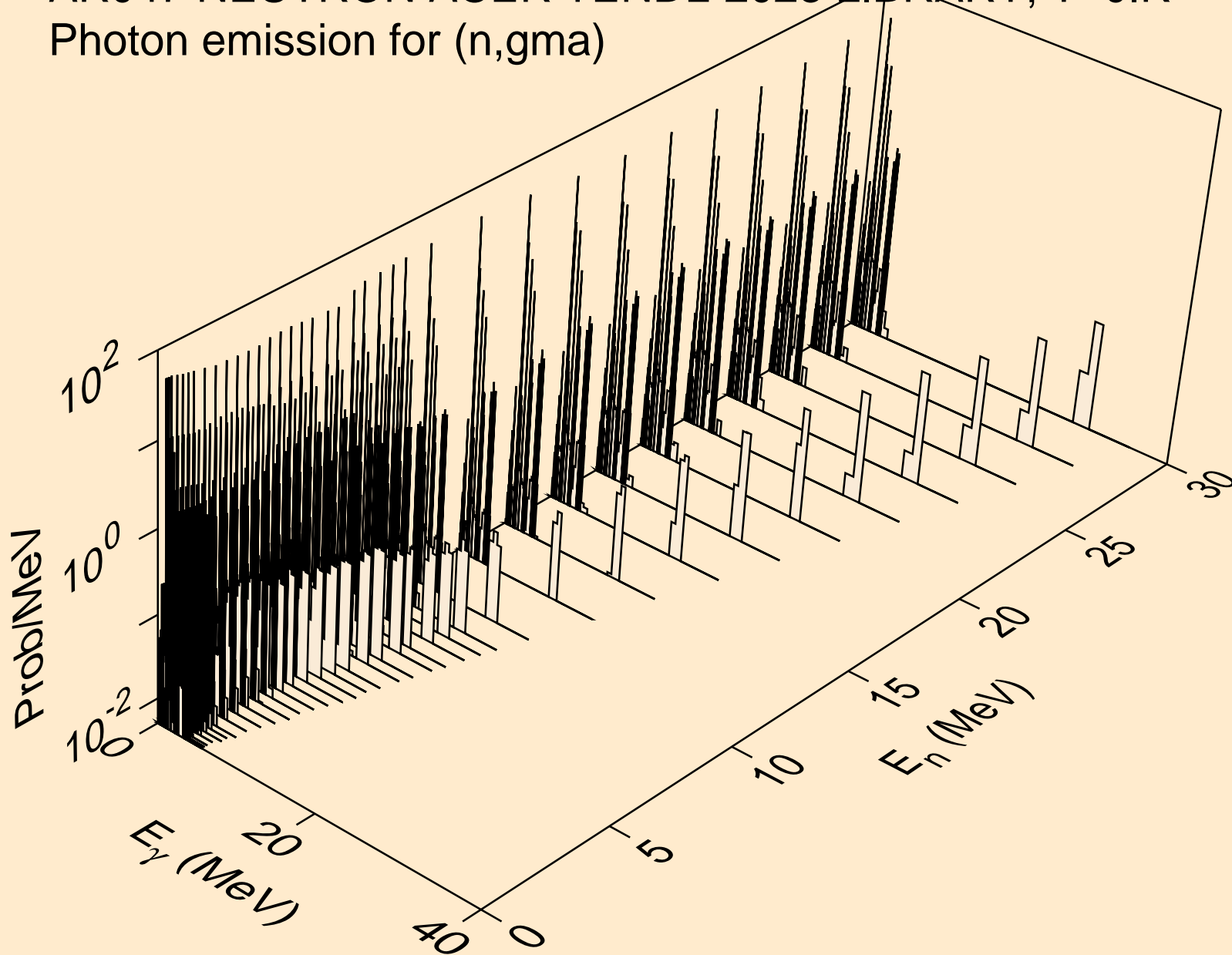

AR047 NEUTRON ACER TENDL-2023 LIBRARY; T=0.K  
Photon emission for (n,p)

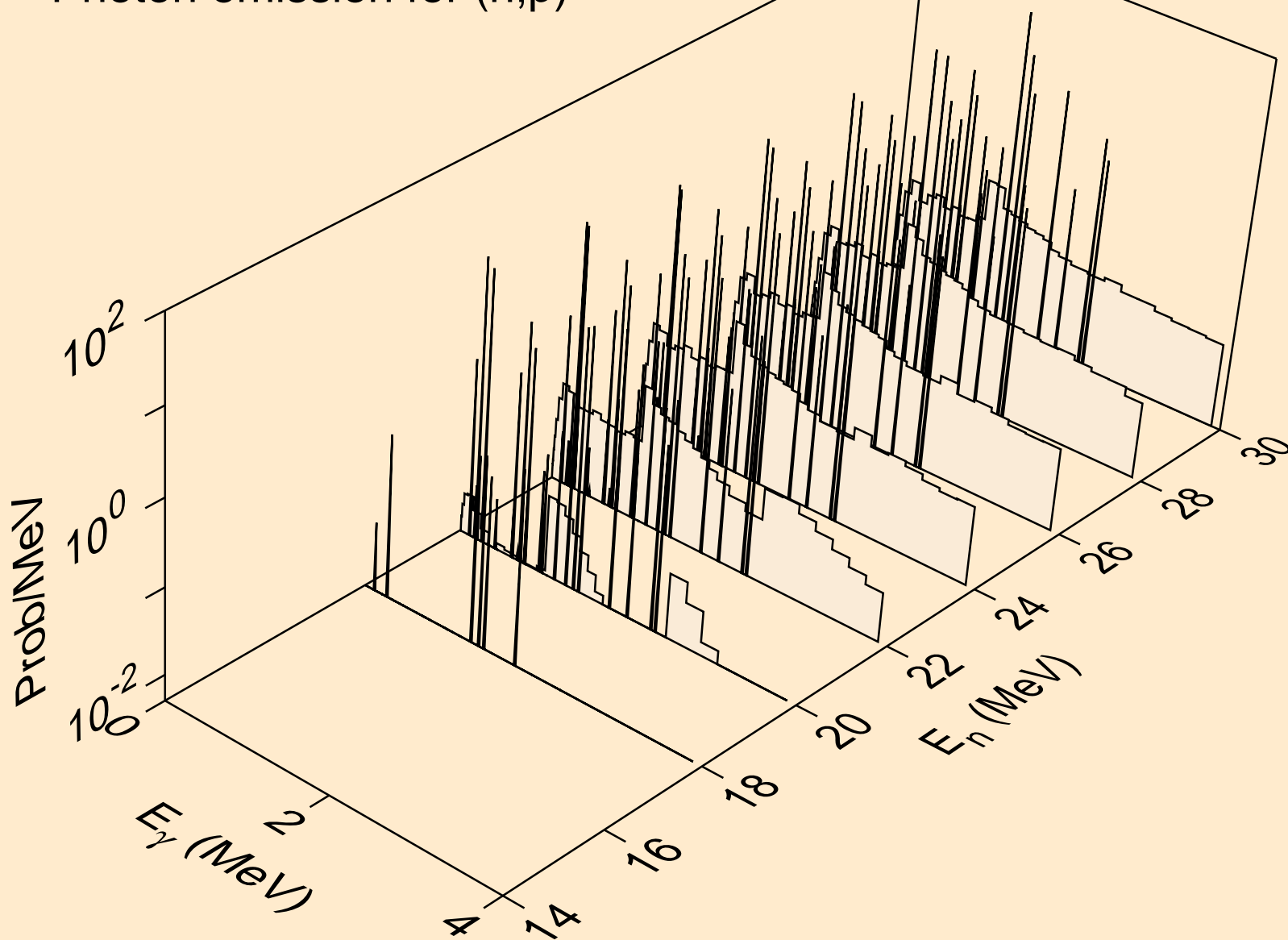

AR047 NEUTRON ACER TENDL-2023 LIBRARY; T=0.K  
Photon emission for (n,d)

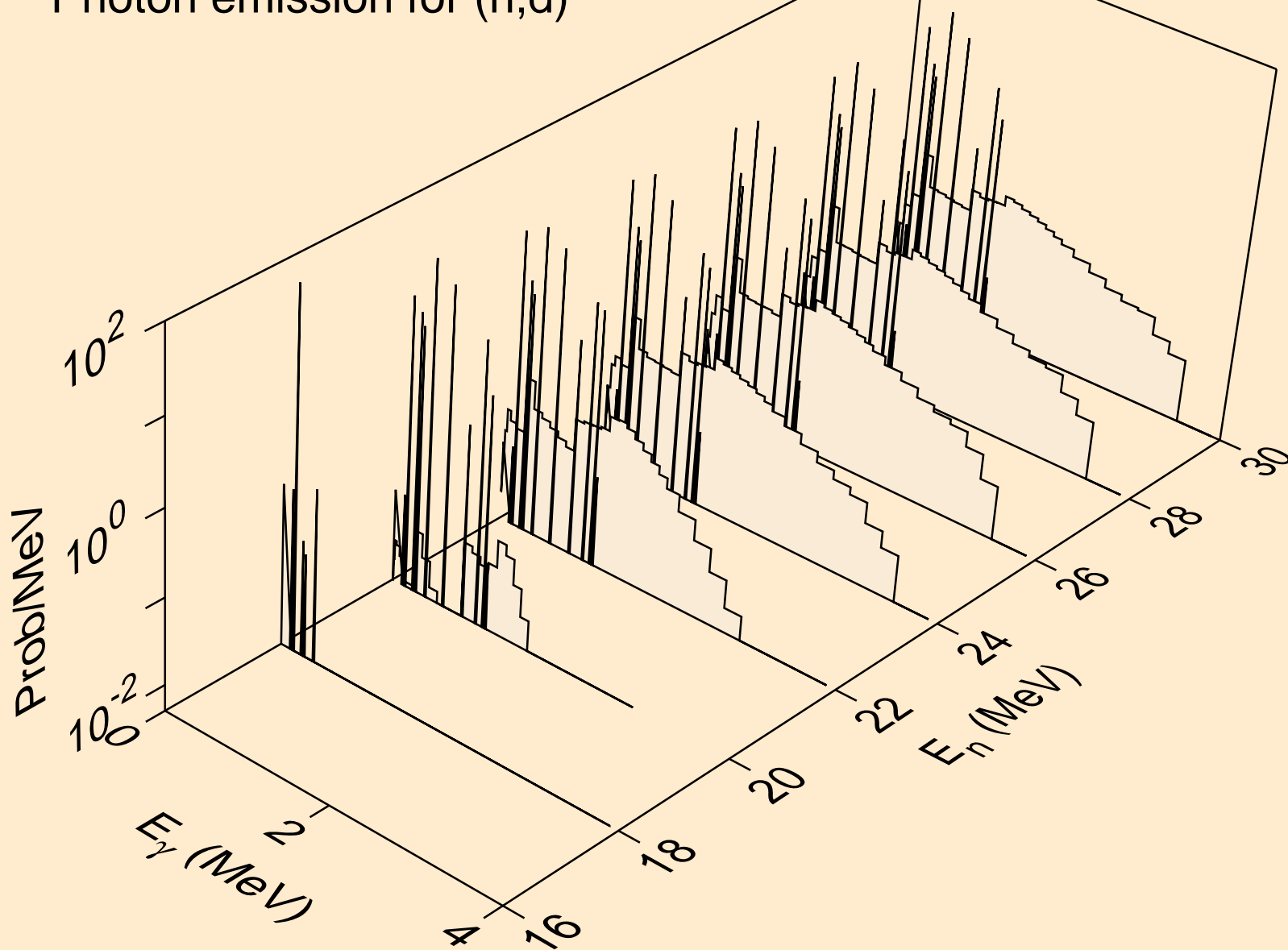

AR047 NEUTRON ACER TENDL-2023 LIBRARY; T=0.K  
Photon emission for (n,t)

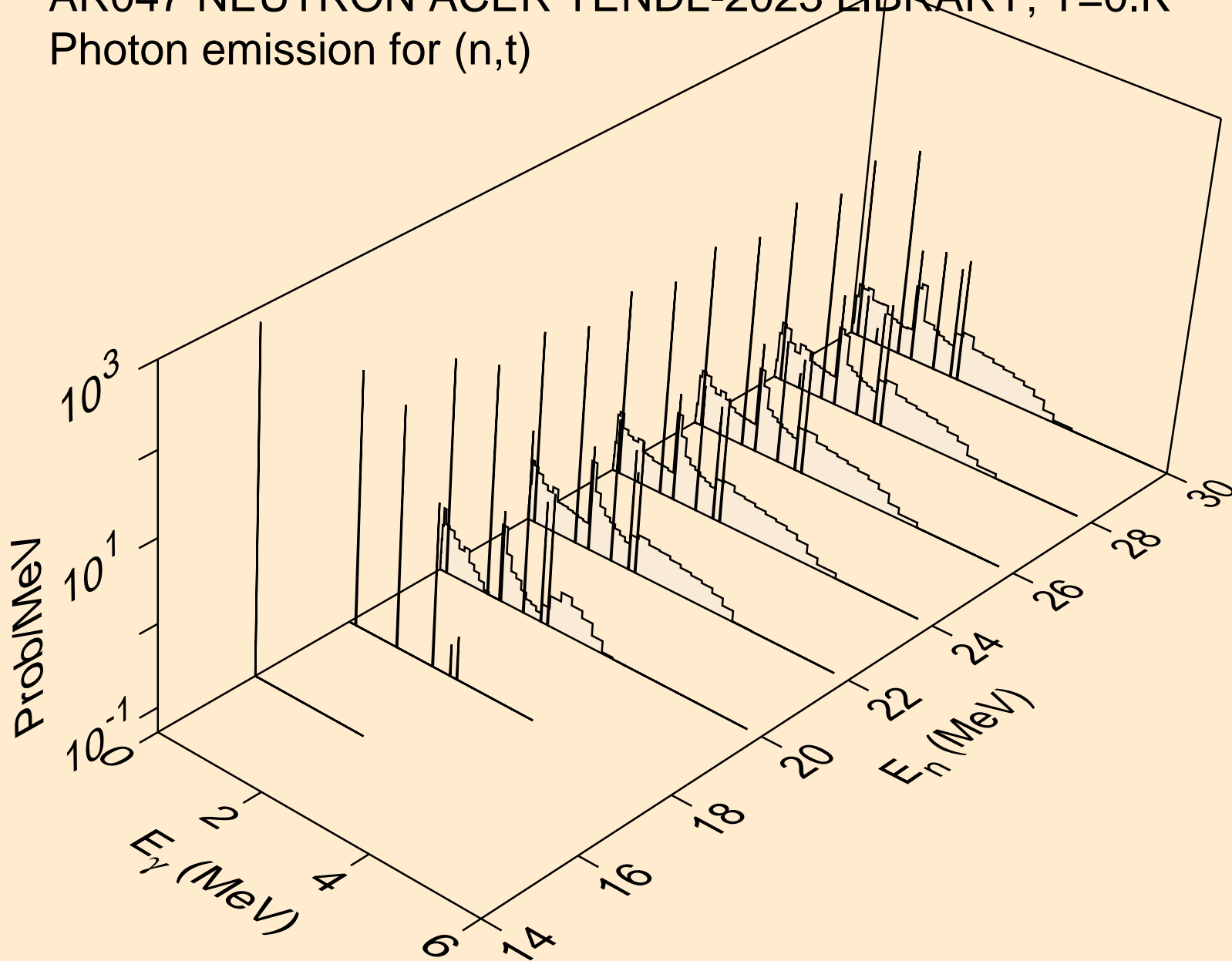

AR047 NEUTRON ACER TENDL-2023 LIBRARY; T=0.K  
Photon emission for (n,a)

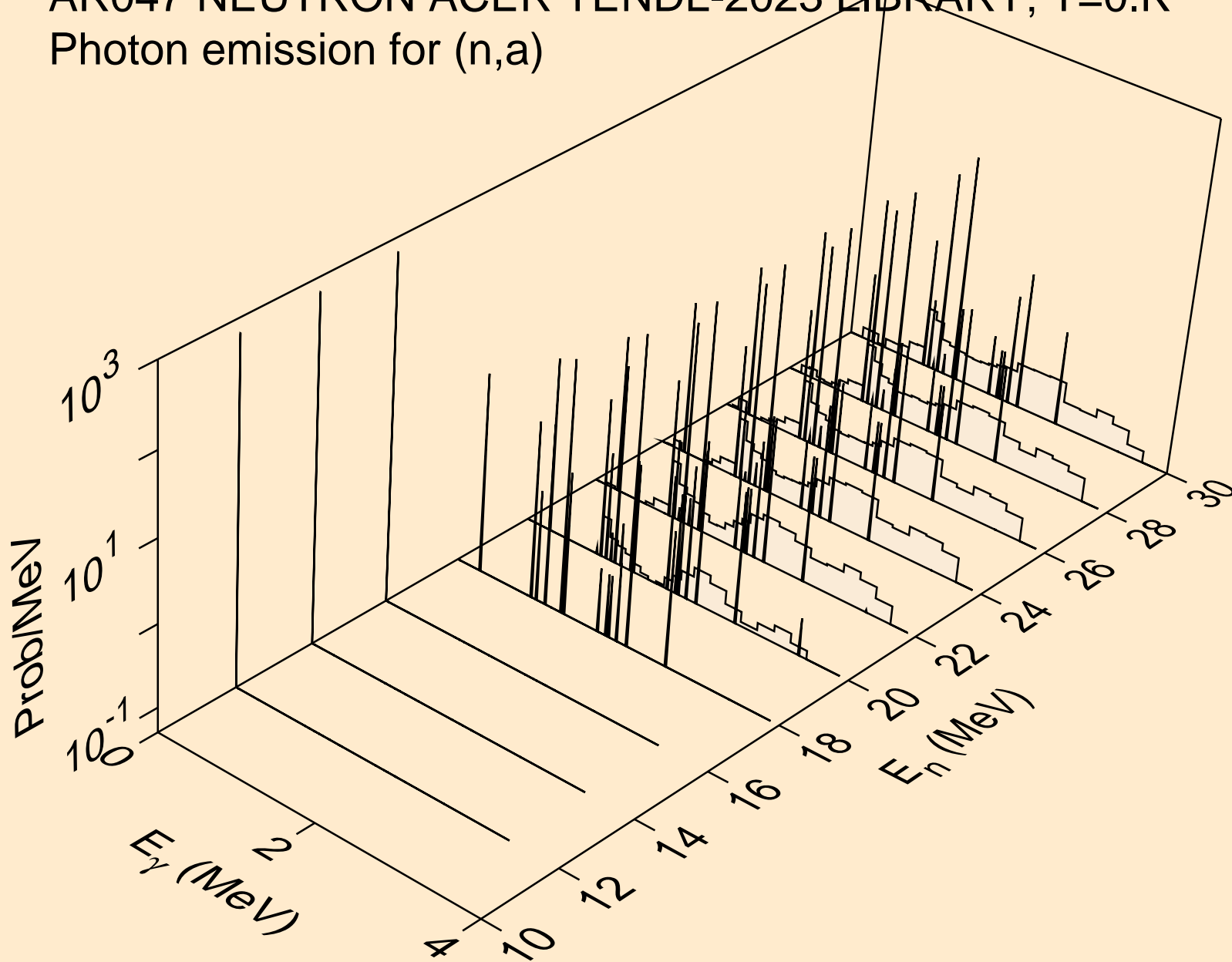



AR047 NEUTRON ACER TENDL-2023 LIBRARY; T=0.K  
thermal capture photon spectrum

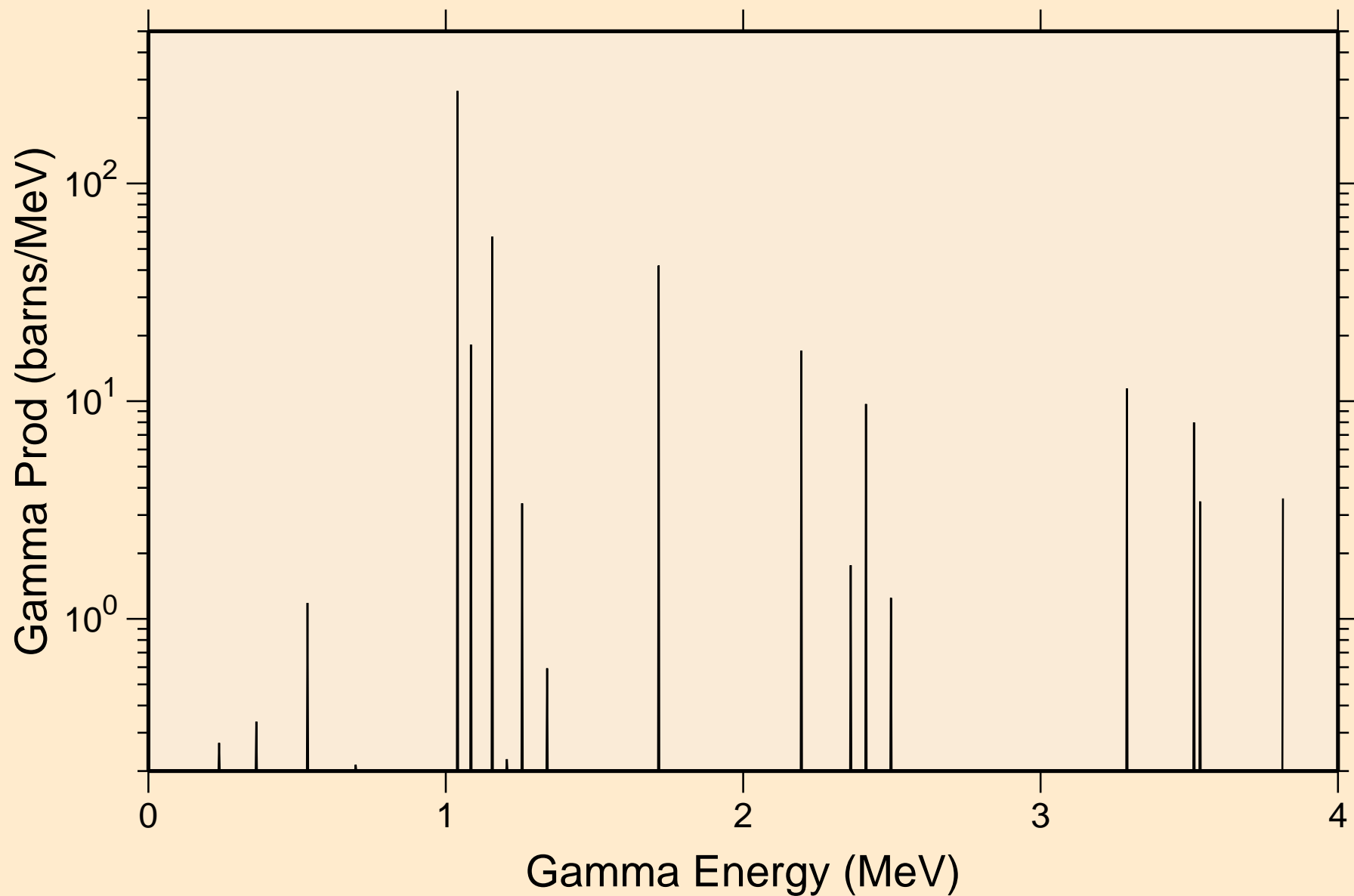

AR047 NEUTRON ACER TENDL-2023 LIBRARY; T=0.K  
14 MeV photon spectrum

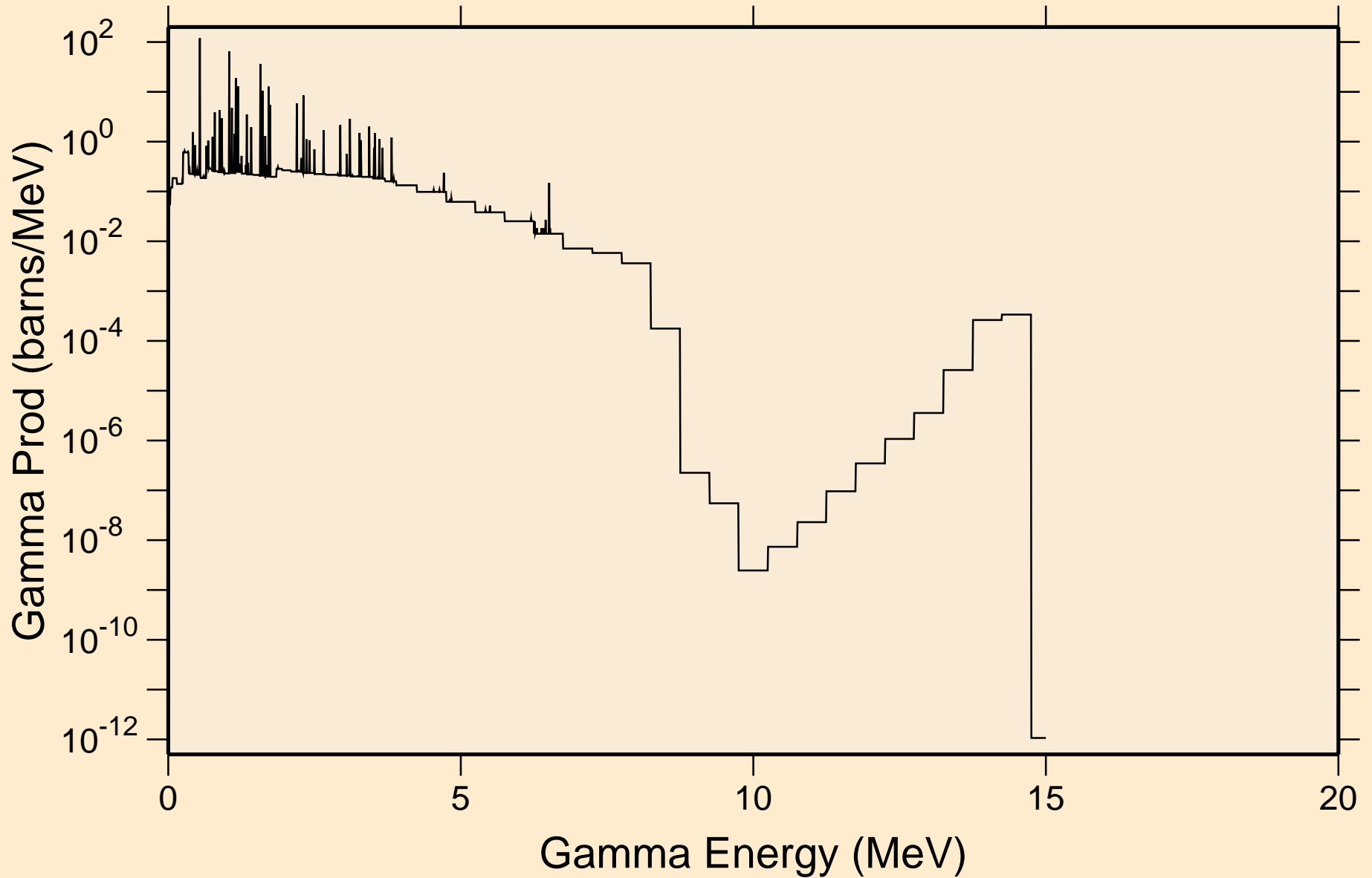

# AR047 NEUTRON ACER TENDL-2023 LIBRARY; T=0.K

## Particle heating contributions

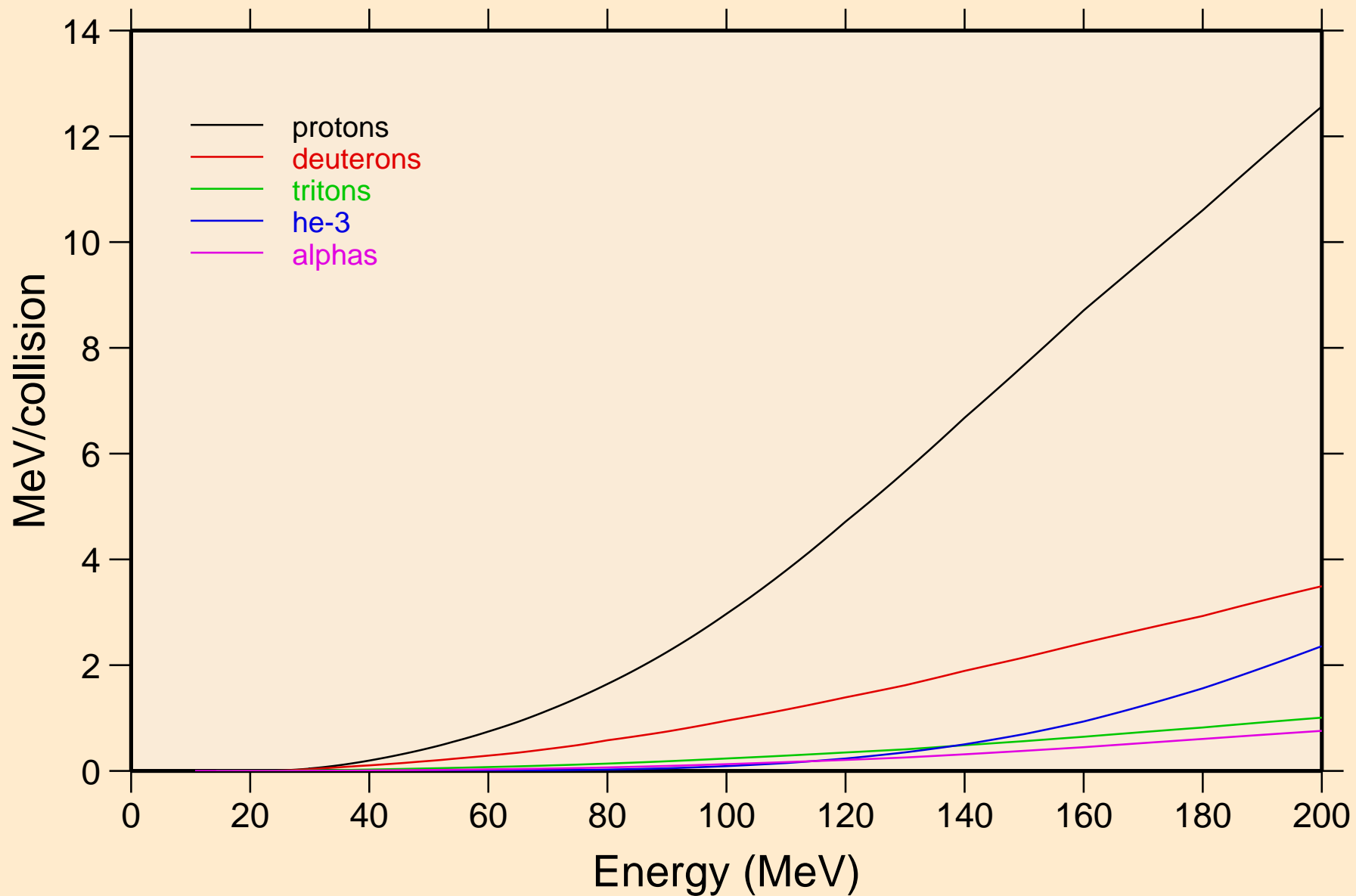

AR047 NEUTRON ACER TENDL-2023 LIBRARY; T=0.K  
Recoil Heating

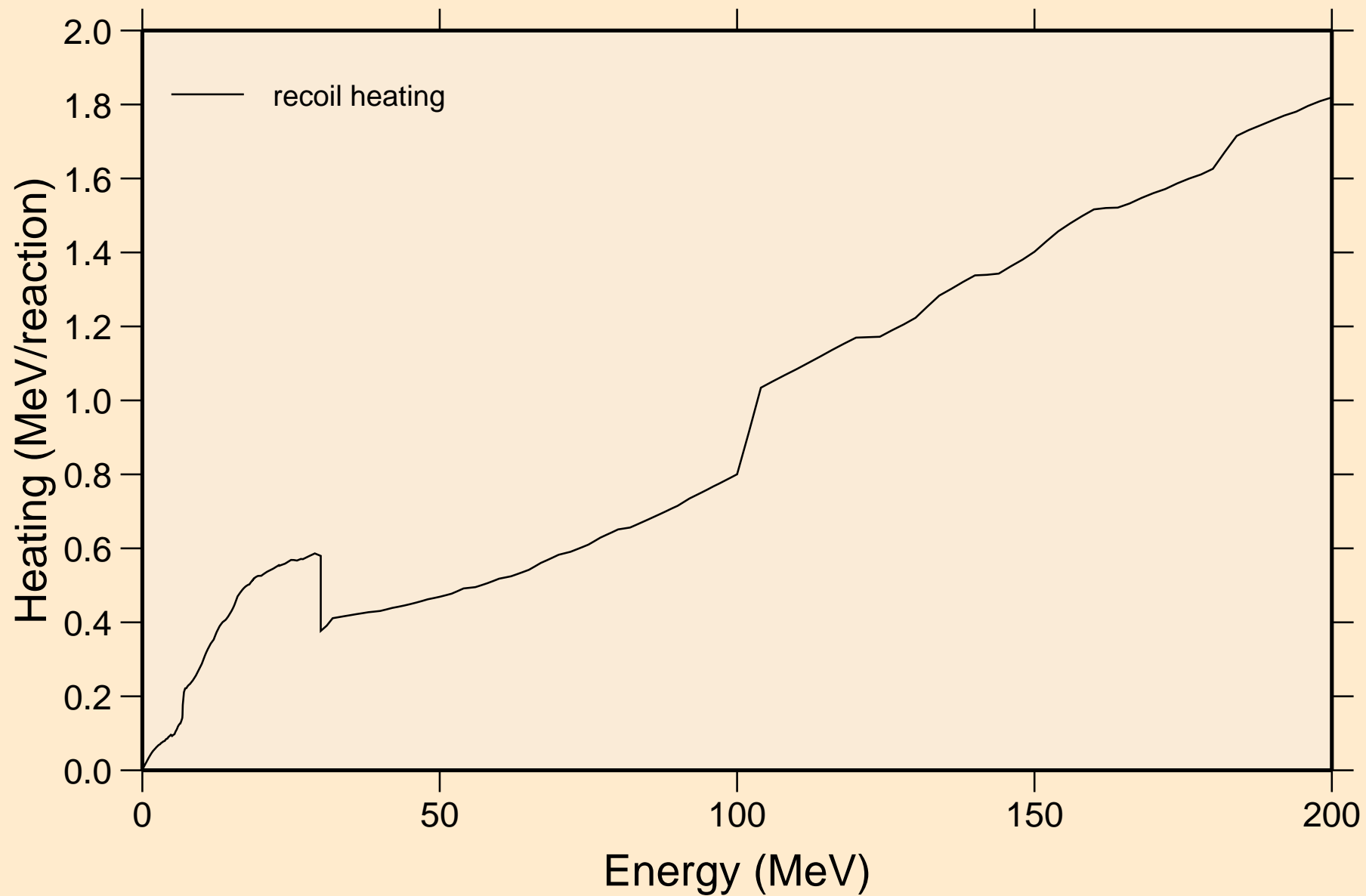

AR047 NEUTRON ACER TENDL-2023 LIBRARY; T=0.K  
Particle production cross sections

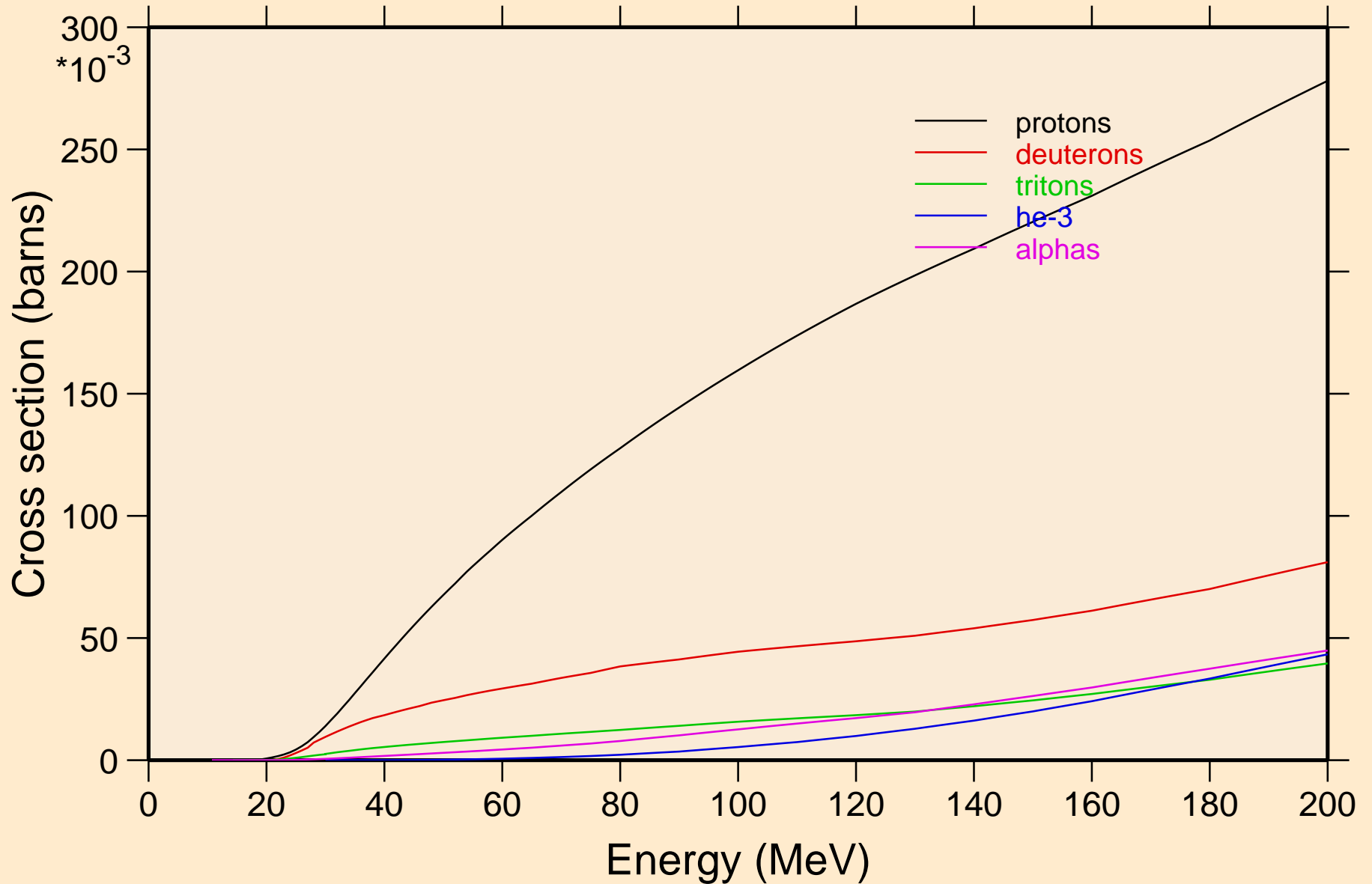

AR047 NEUTRON ACER TENDL-2023 LIBRARY; T=0.K  
protons from (n,x)

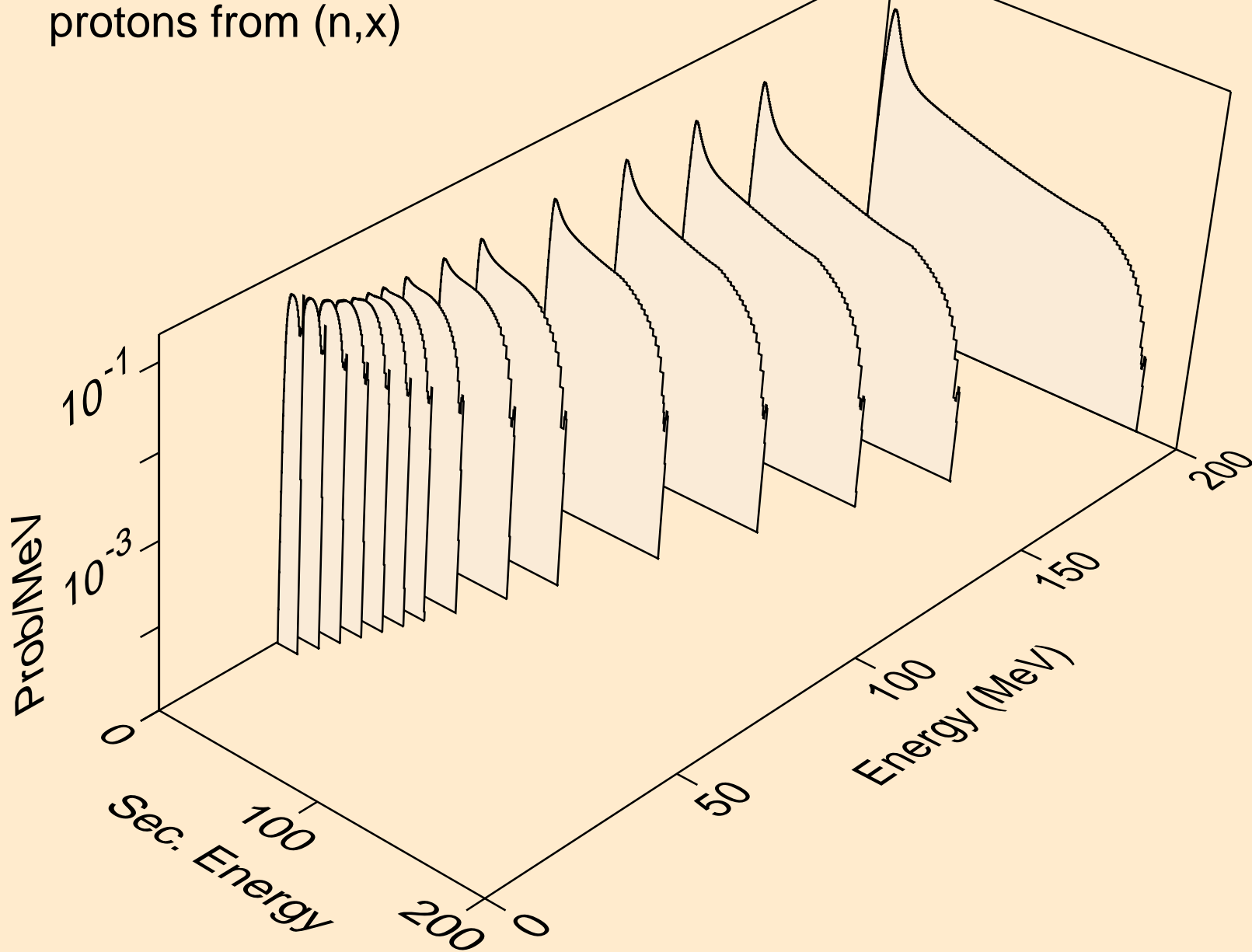

AR047 NEUTRON ACER TENDL-2023 LIBRARY; T=0.K  
protons from (n,n\*)p

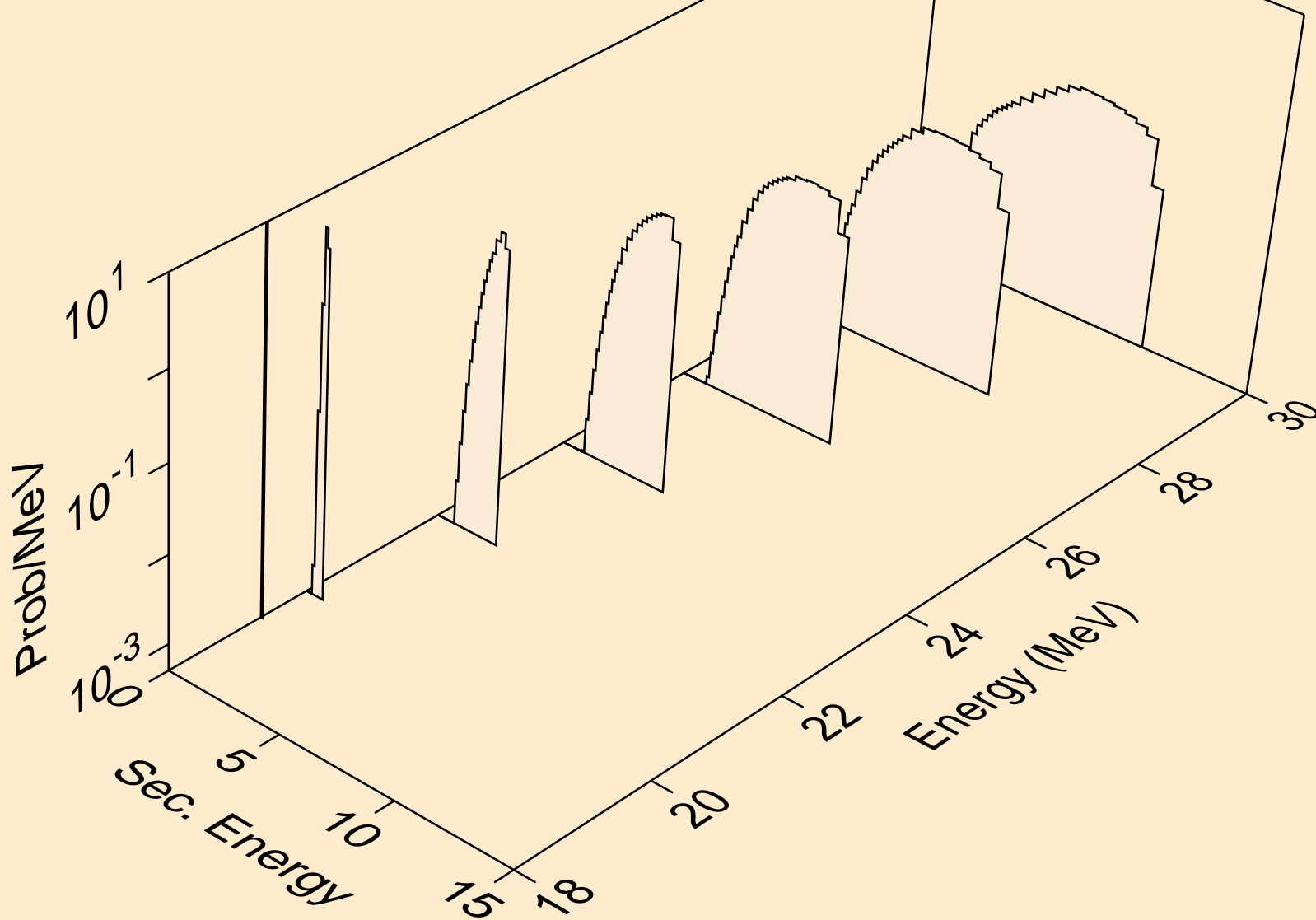

AR047 NEUTRON ACER TENDL-2023 LIBRARY; T=0.K  
protons from (n,2np)

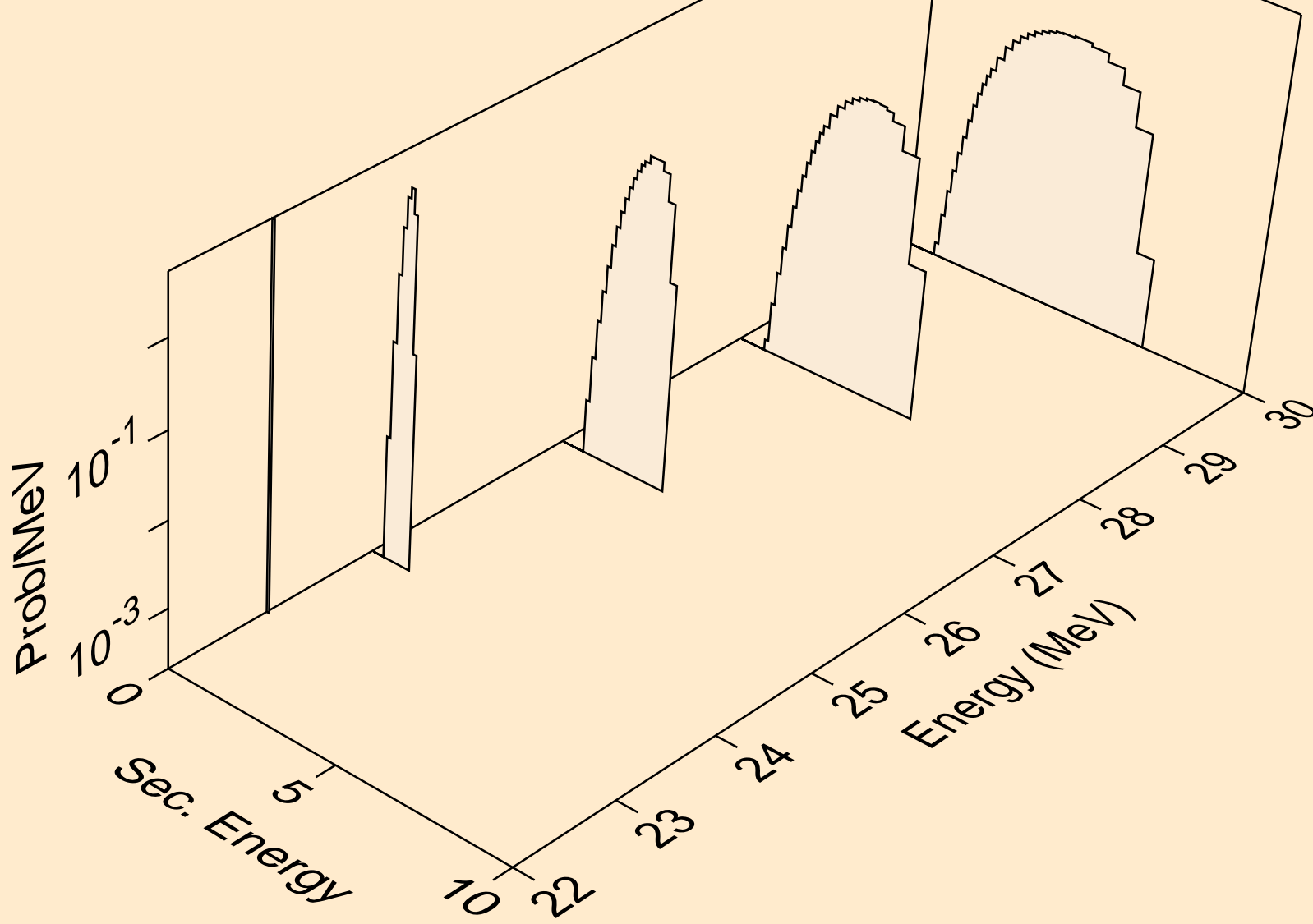



AR047 NEUTRON ACER TENDL-2023 LIBRARY; T=0.K  
protons from (n,p)

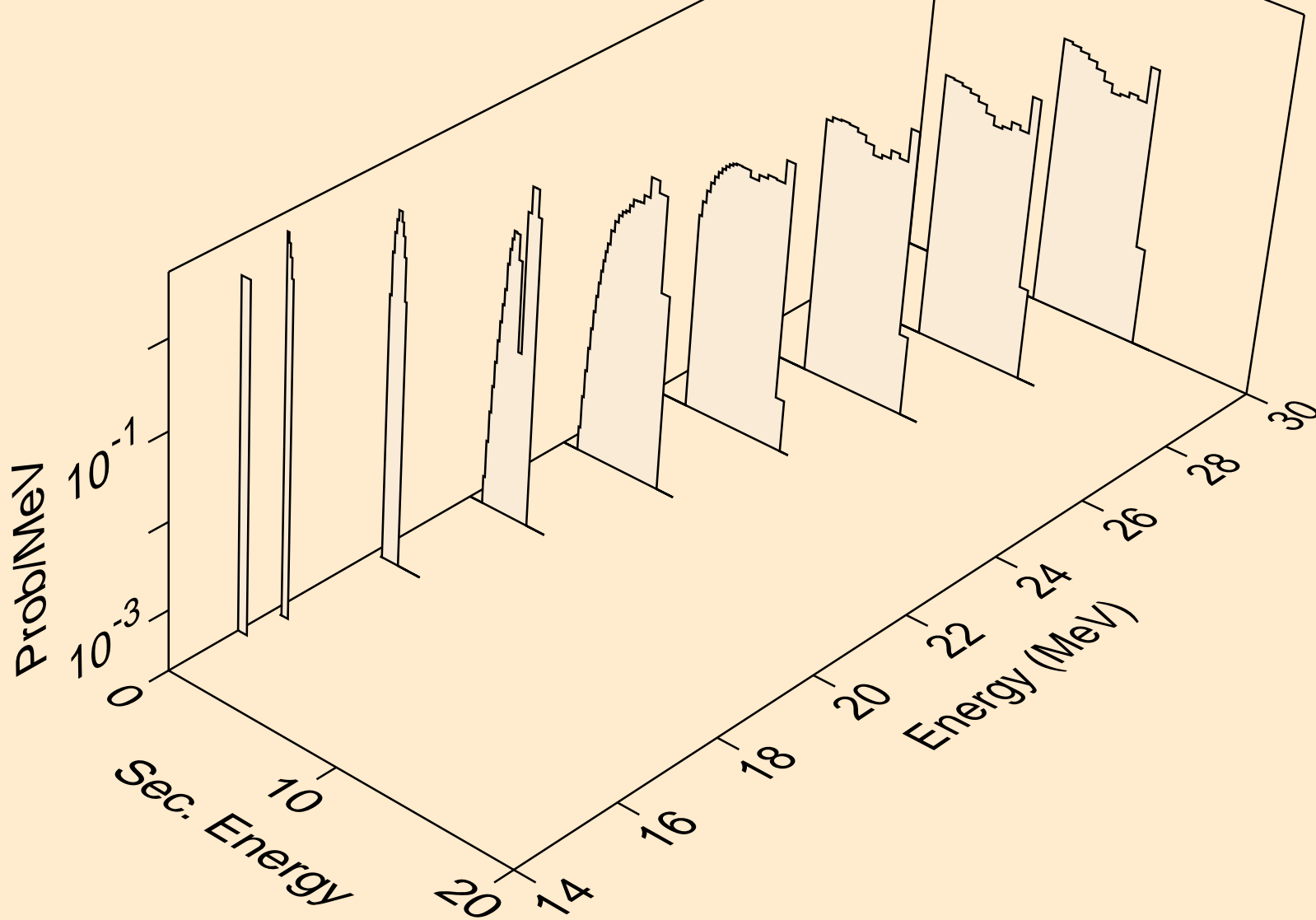

AR047 NEUTRON ACER TENDL-2023 LIBRARY; T=0.K  
deuterons from (n,x)

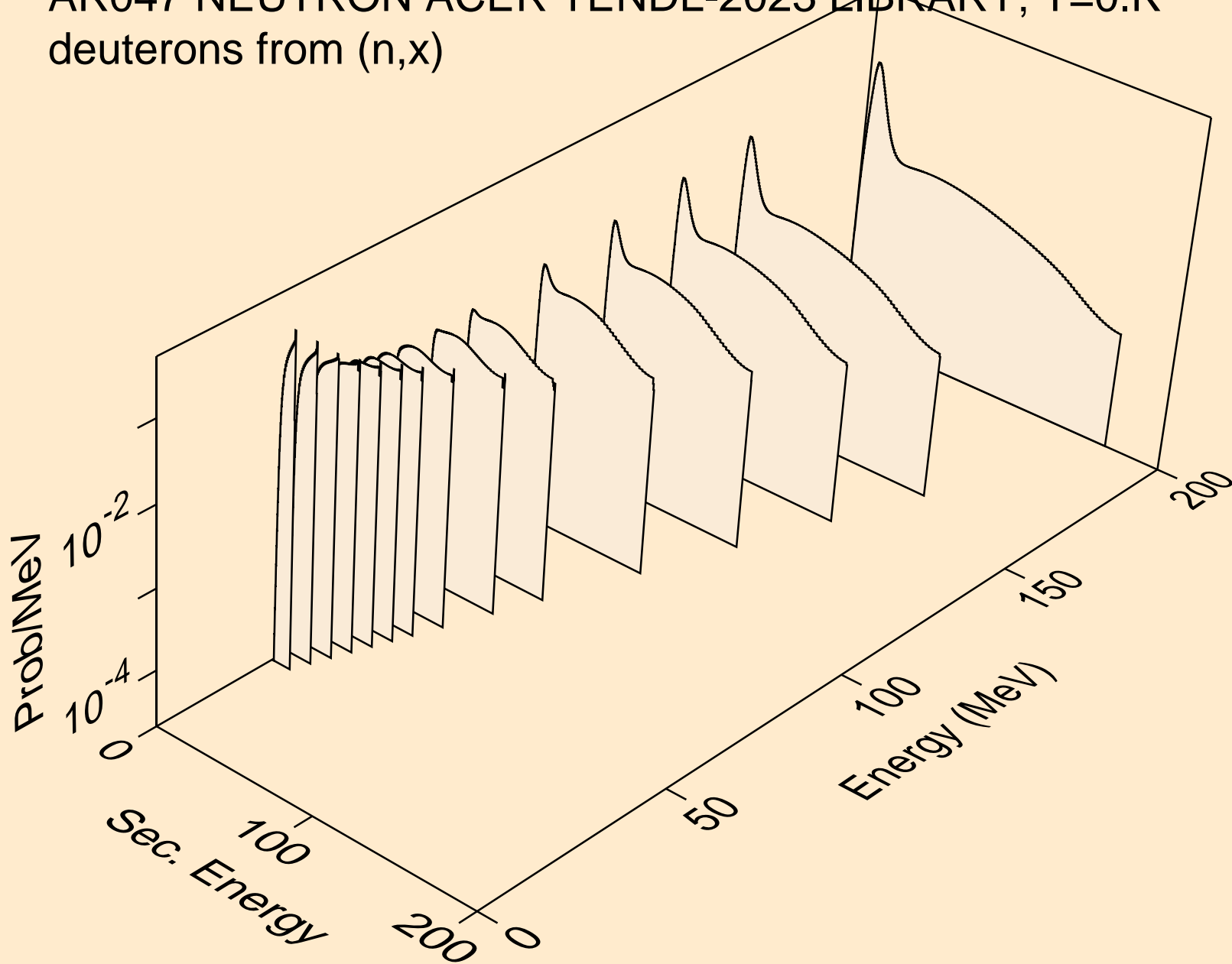

AR047 NEUTRON ACER TENDL-2023 LIBRARY; T=0.K  
deuterons from (n,2nd)

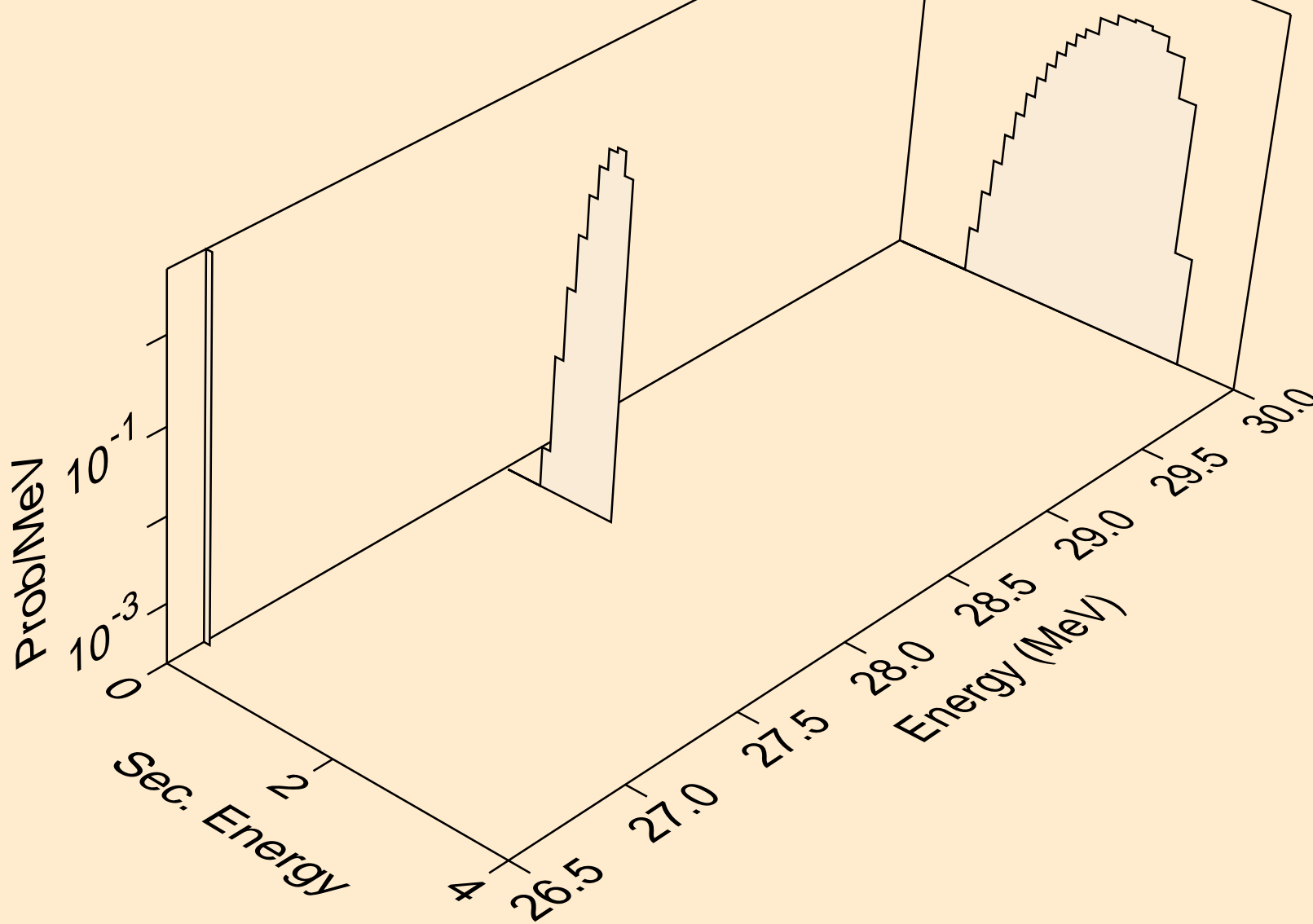

AR047 NEUTRON ACER TENDL-2023 LIBRARY; T=0.K  
deuterons from (n,n\*)d

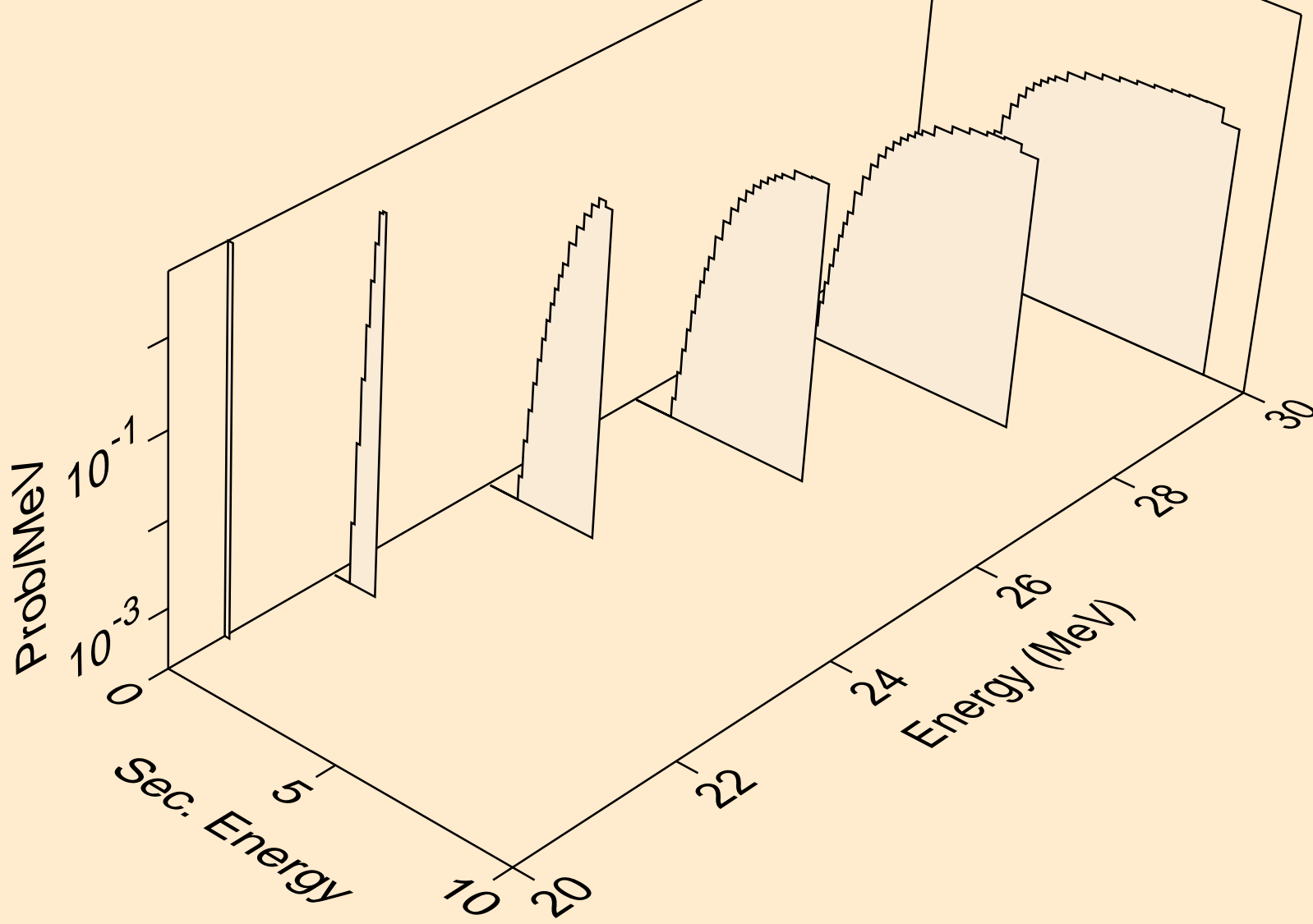

AR047 NEUTRON ACER TENDL-2023 LIBRARY; T=0.K  
deuterons from (n,d)

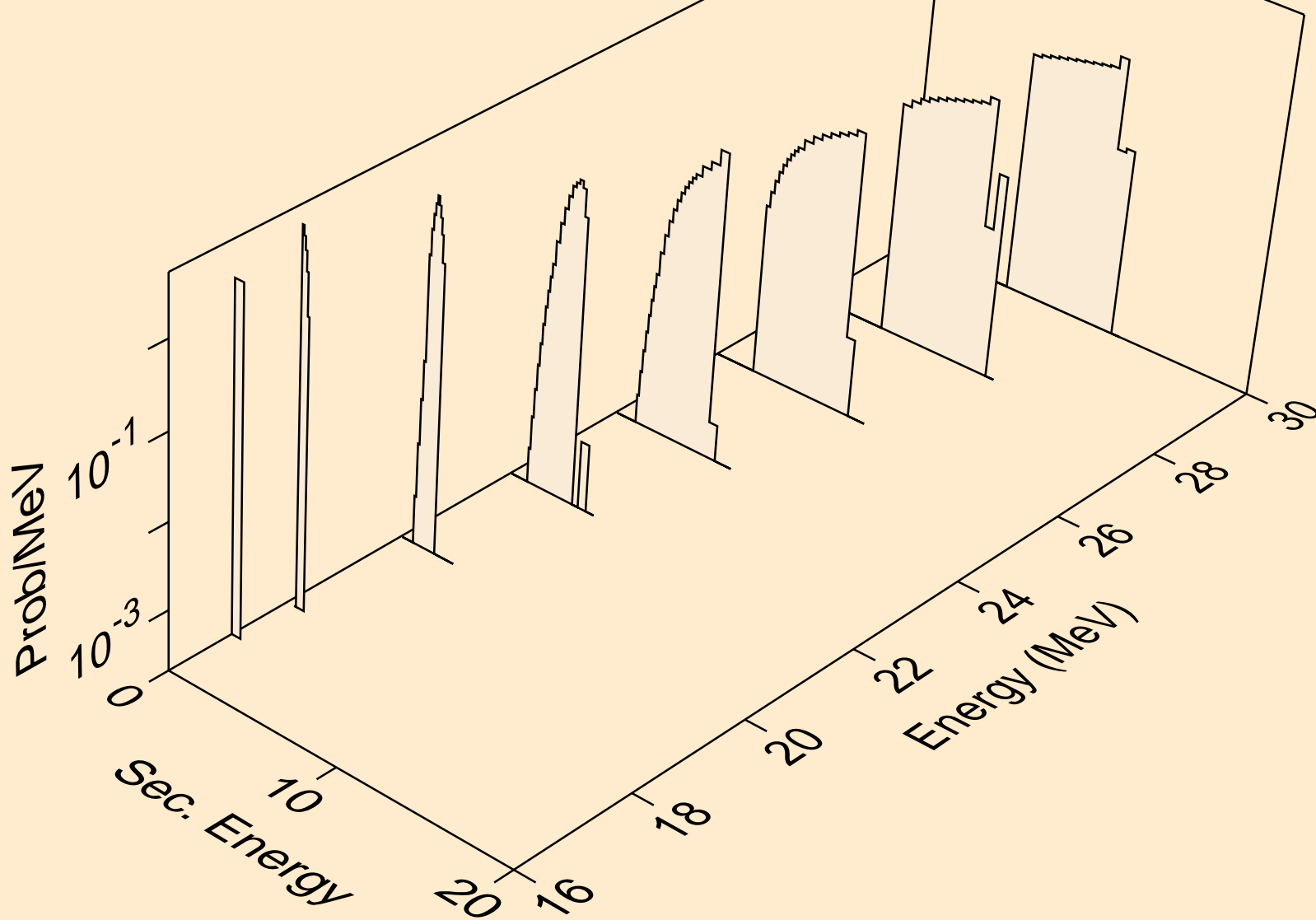

AR047 NEUTRON ACER TENDL-2023 LIBRARY; T=0.K  
tritons from (n,x)

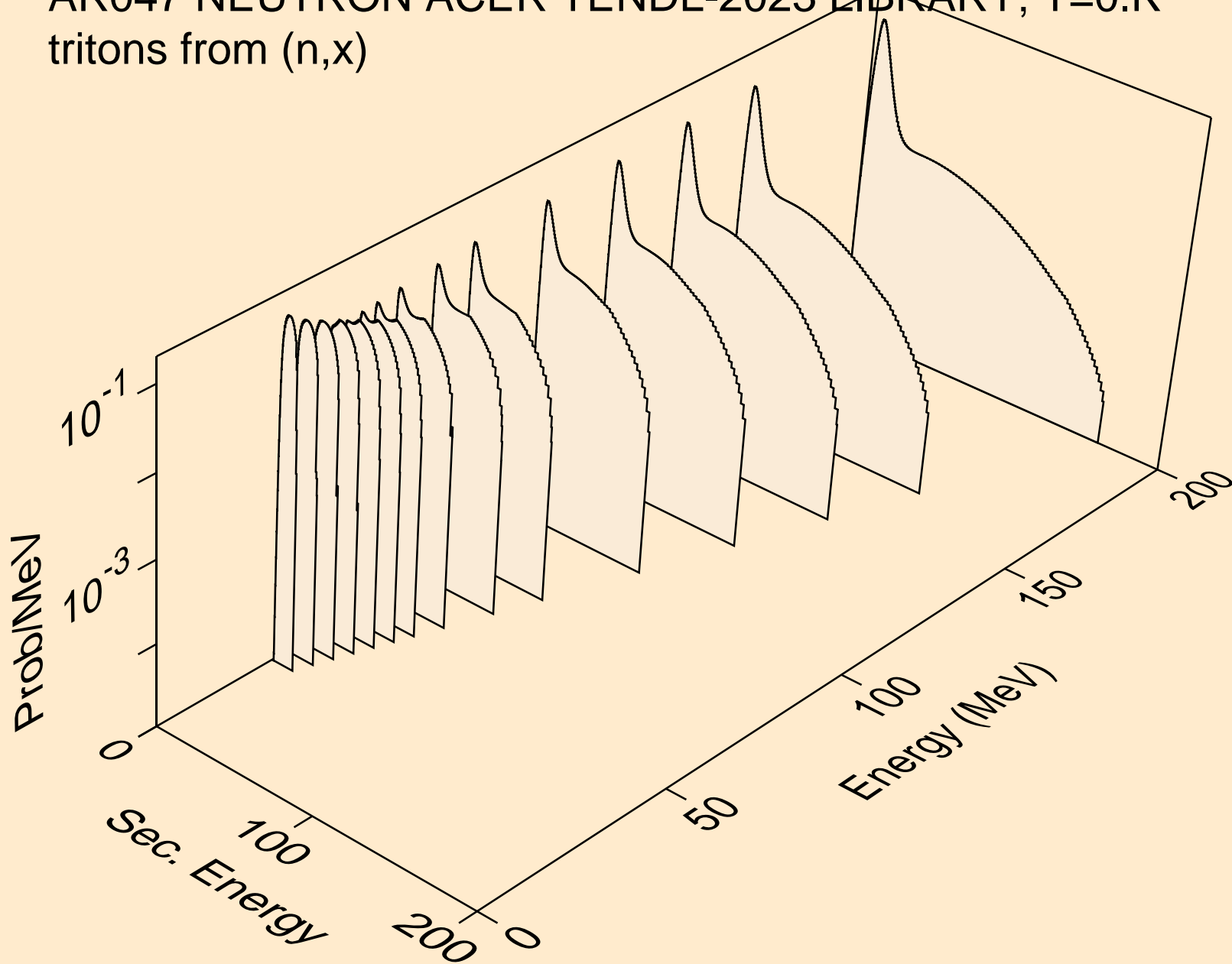

AR047 NEUTRON ACER TENDL-2023 LIBRARY; T=0.K  
tritons from (n,n\*)t

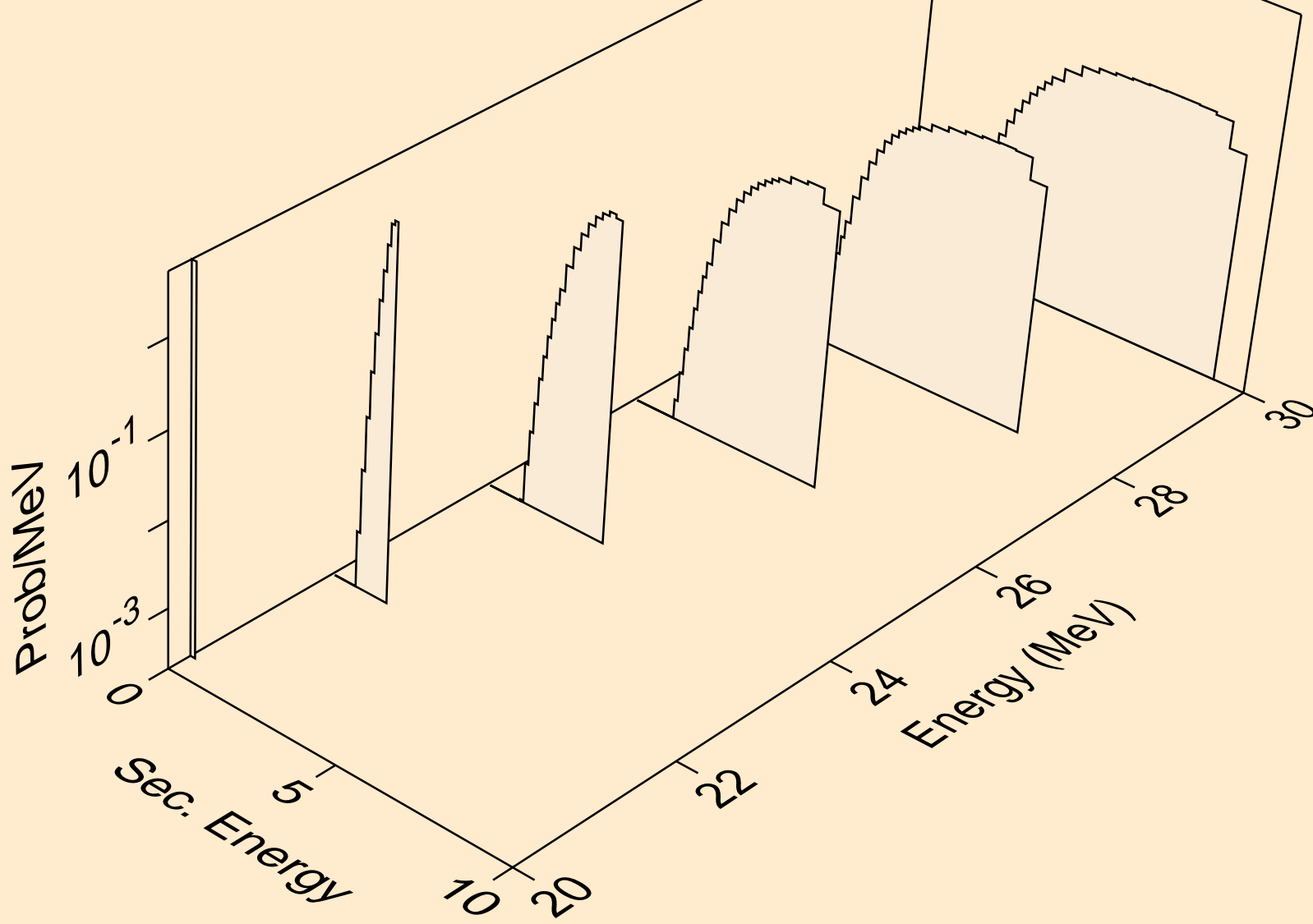

AR047 NEUTRON ACER TENDL-2023 LIBRARY; T=0.K  
tritons from (n,t)

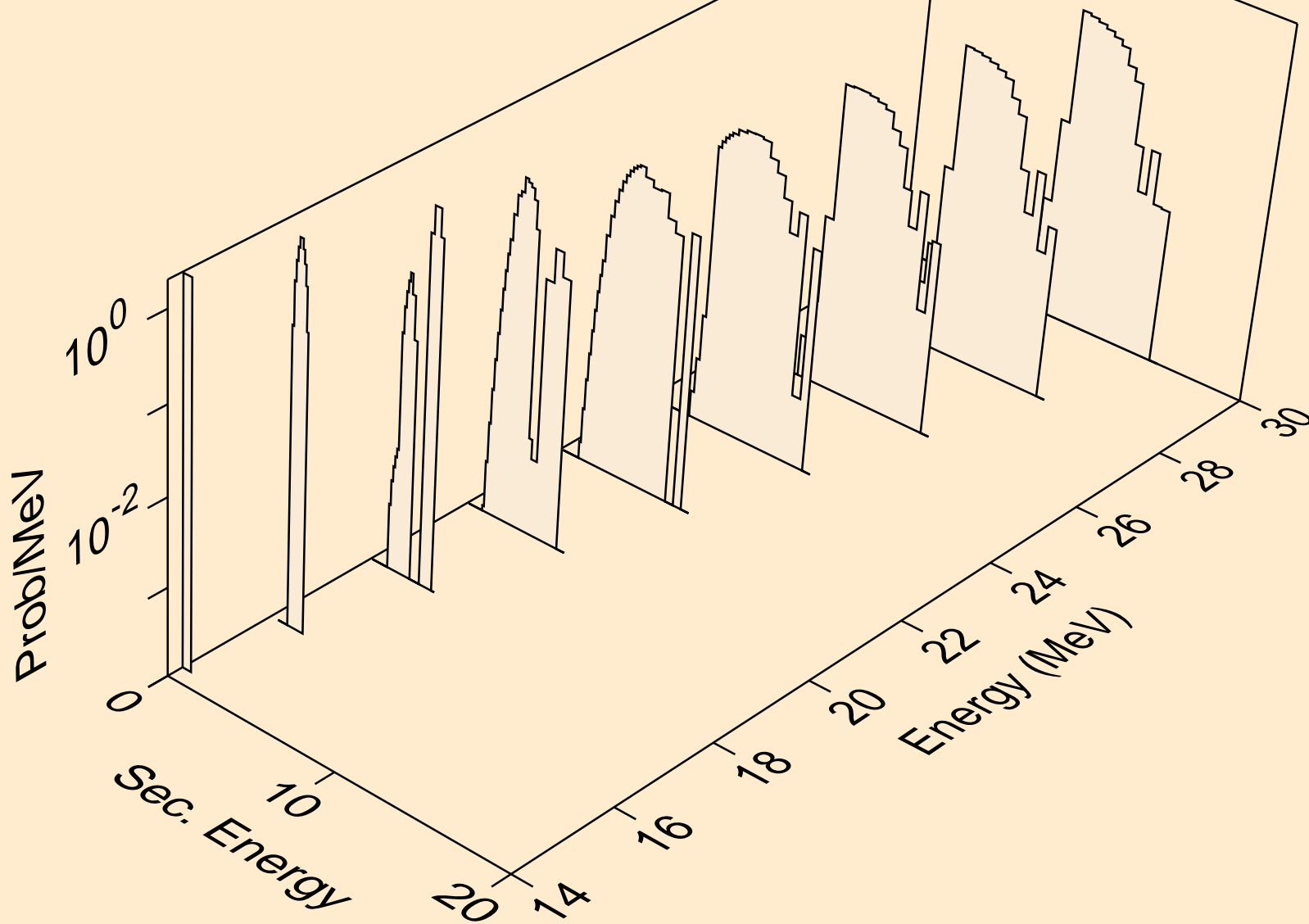



AR047 NEUTRON ACER TENDL-2023 LIBRARY; T=0.K  
he3s from (n,x)

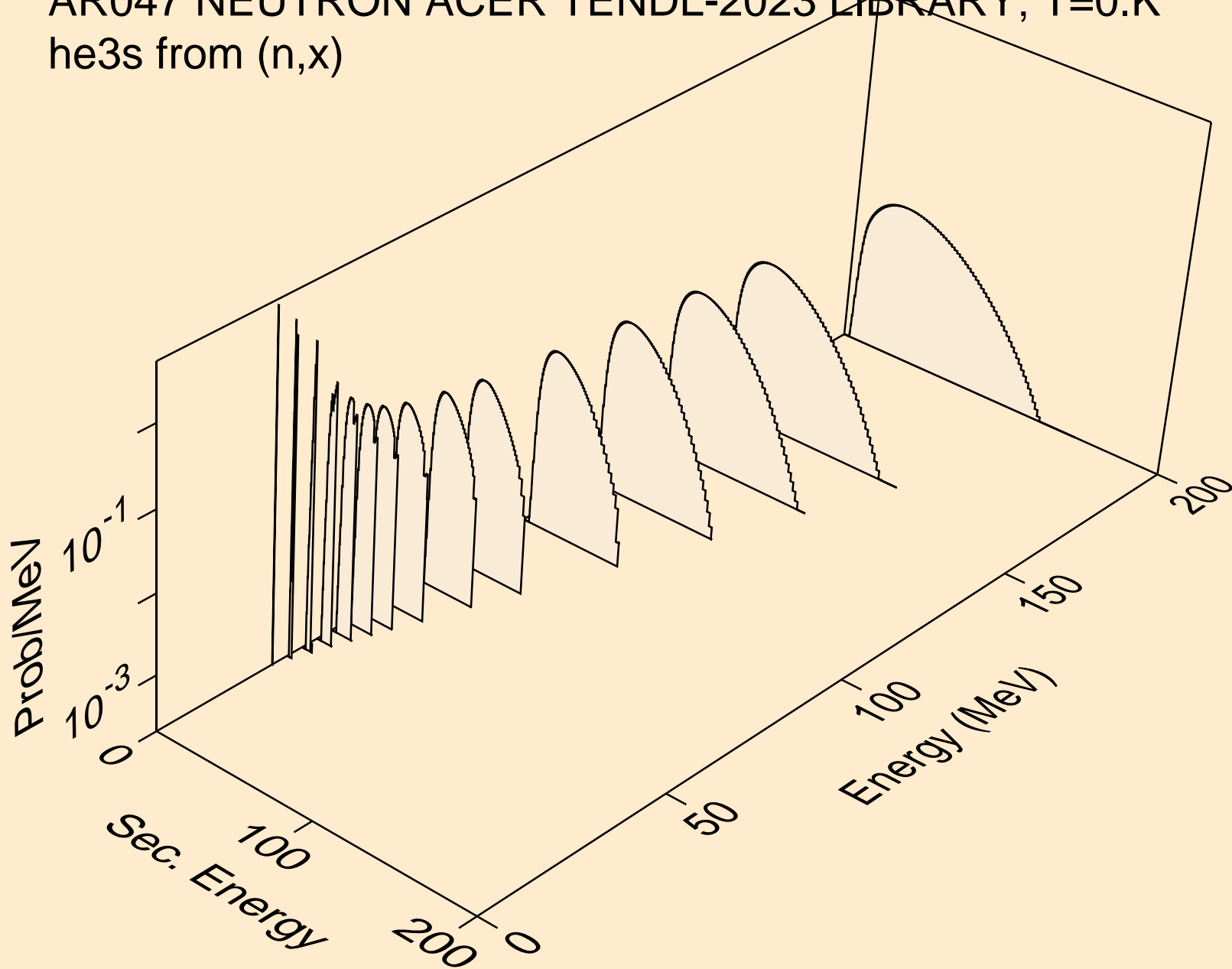

AR047 NEUTRON ACER TENDL-2023 LIBRARY; T=0.K  
alphas from (n,x)

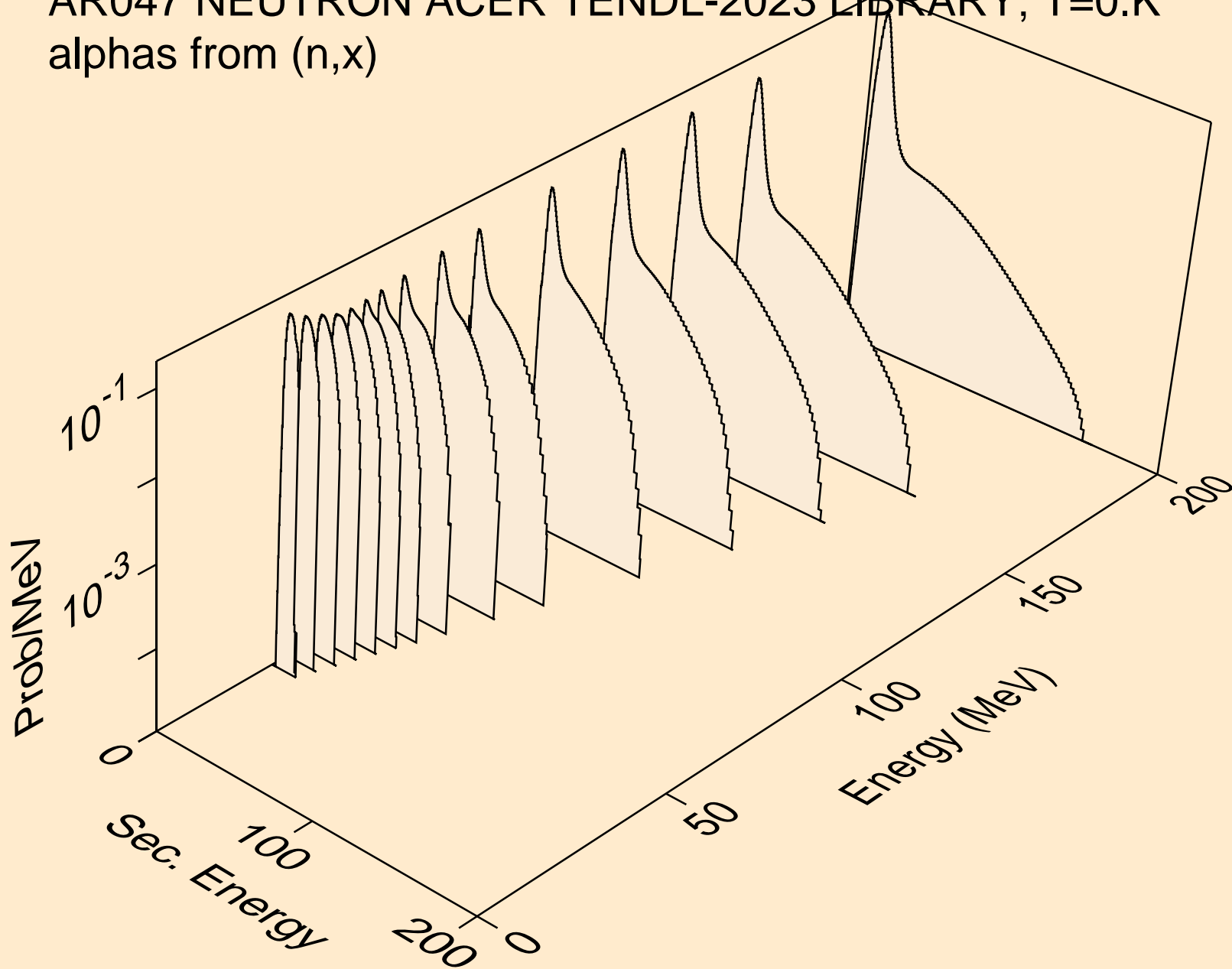

AR047 NEUTRON ACER TENDL-2023 LIBRARY; T=0.K  
alphas from (n,n\*)a

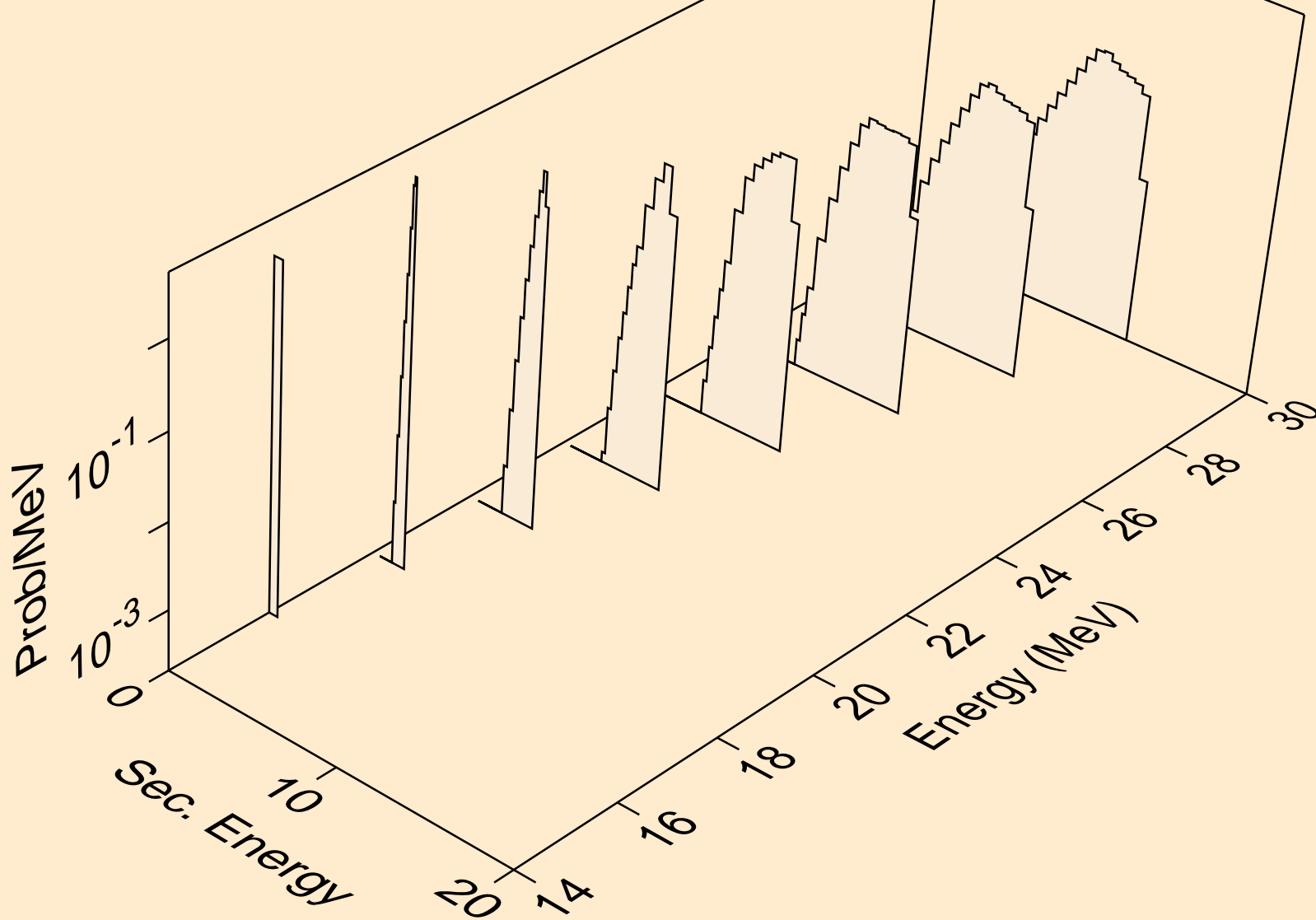

AR047 NEUTRON ACER TENDL-2023 LIBRARY; T=0.K  
alphas from (n,2n)a

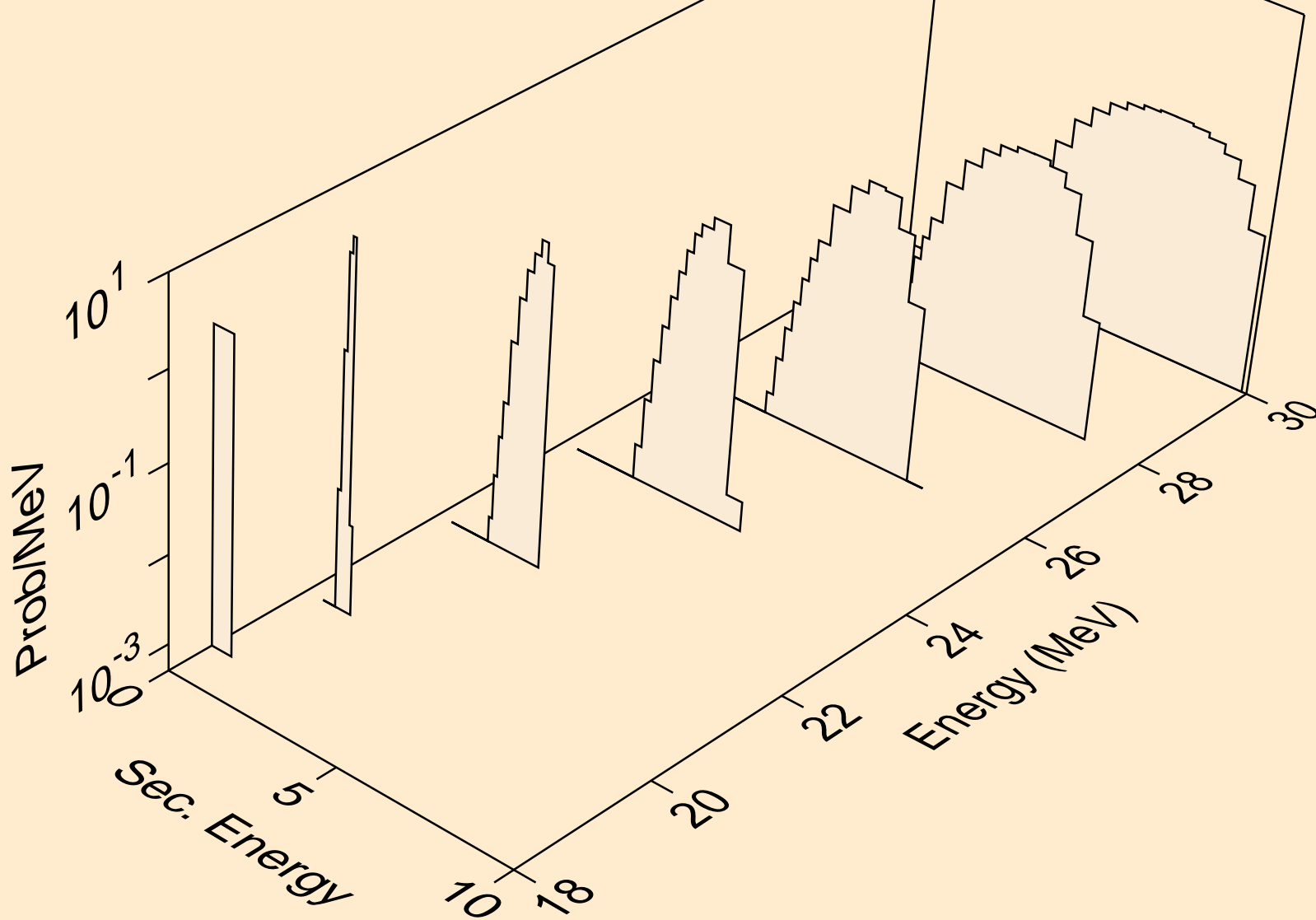

AR047 NEUTRON ACER TENDL-2023 LIBRARY; T=0.K  
alphas from (n,3n)a

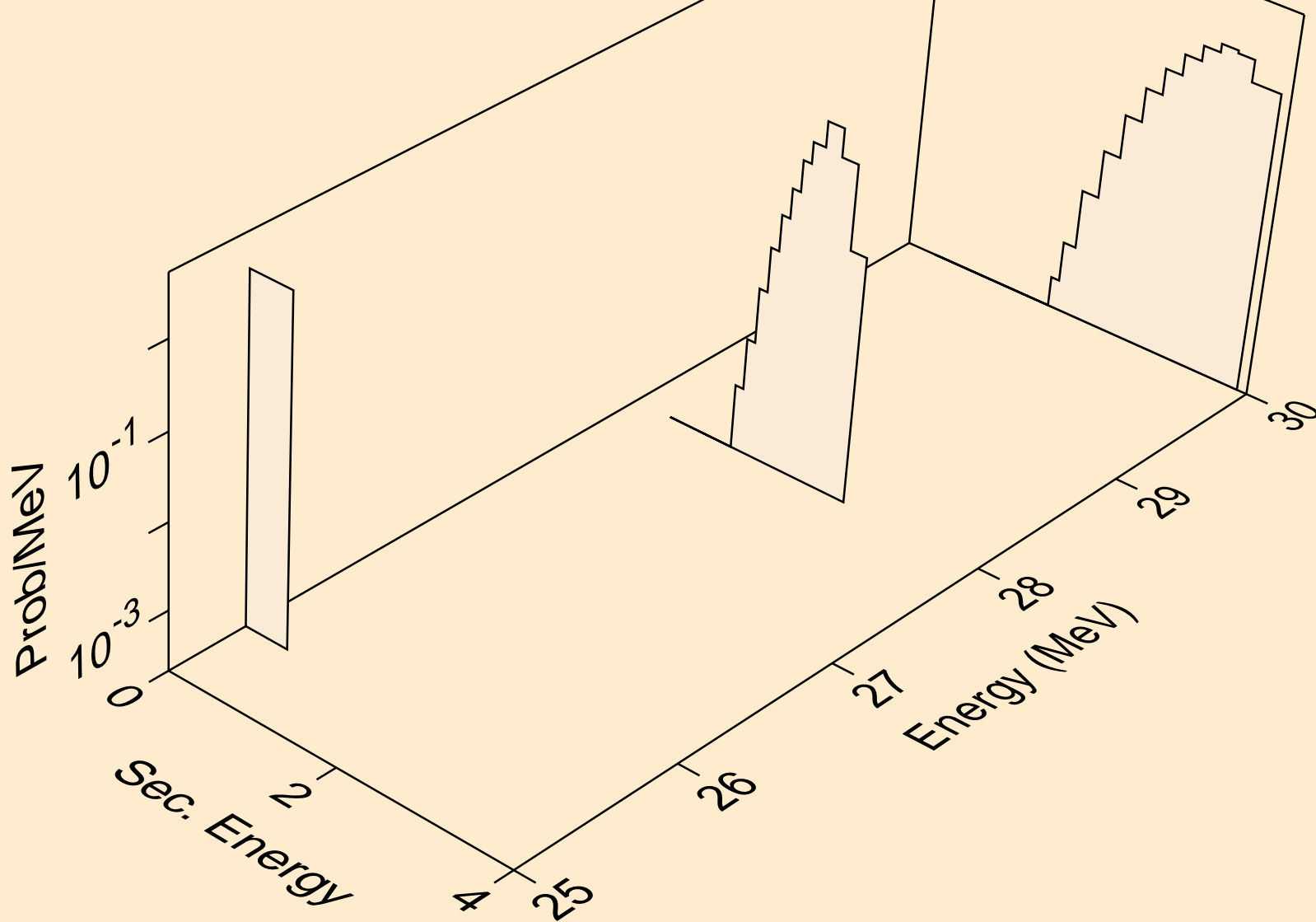

AR047 NEUTRON ACER TENDL-2023 LIBRARY; T=0.K  
alphas from (n,a)

