

AS067 NEUTRON ACER TENDL-2023 LIBRARY; T=0.K

Principal cross sections

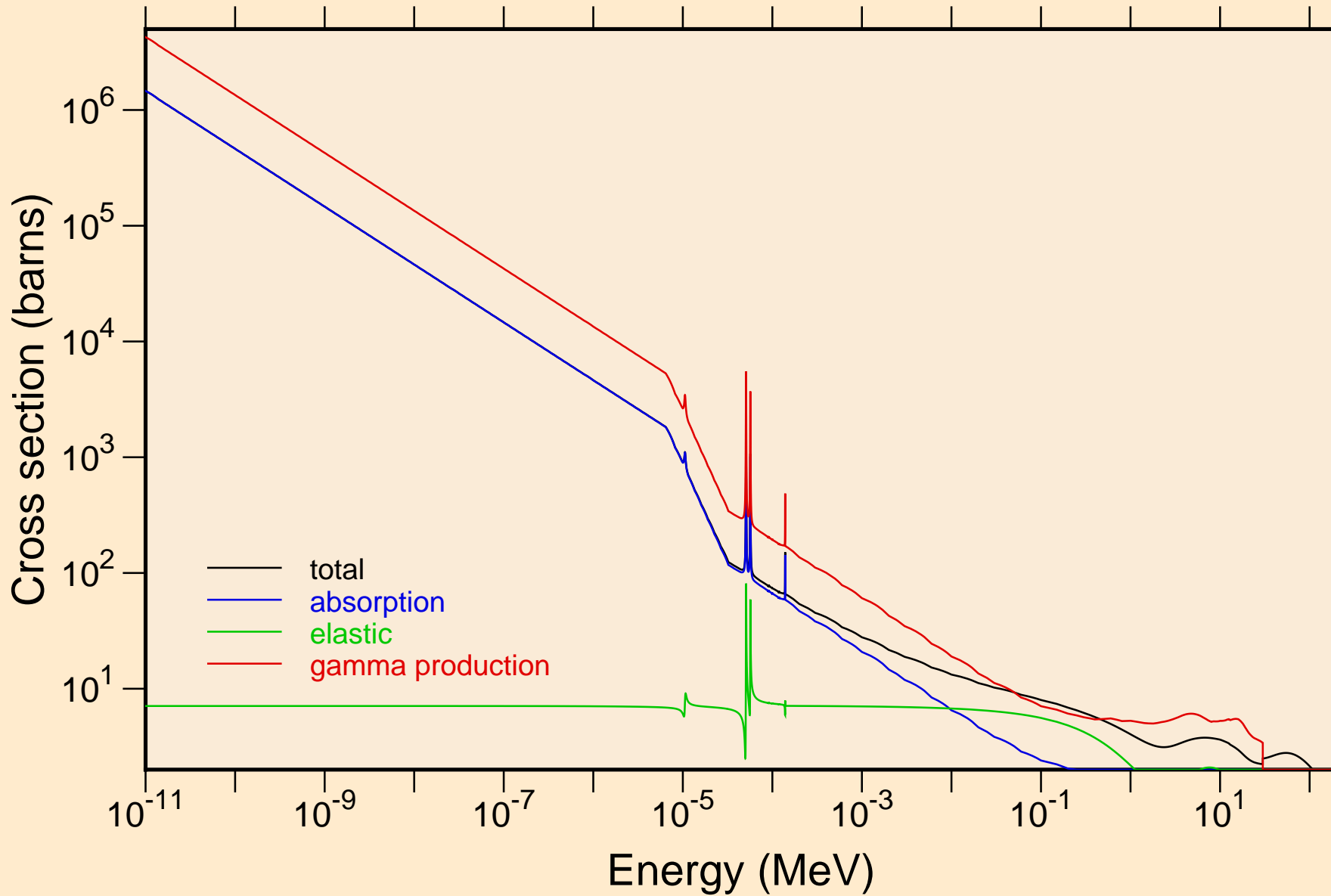

AS067 NEUTRON ACER TENDL-2023 LIBRARY; T=0.K
resonance total cross section

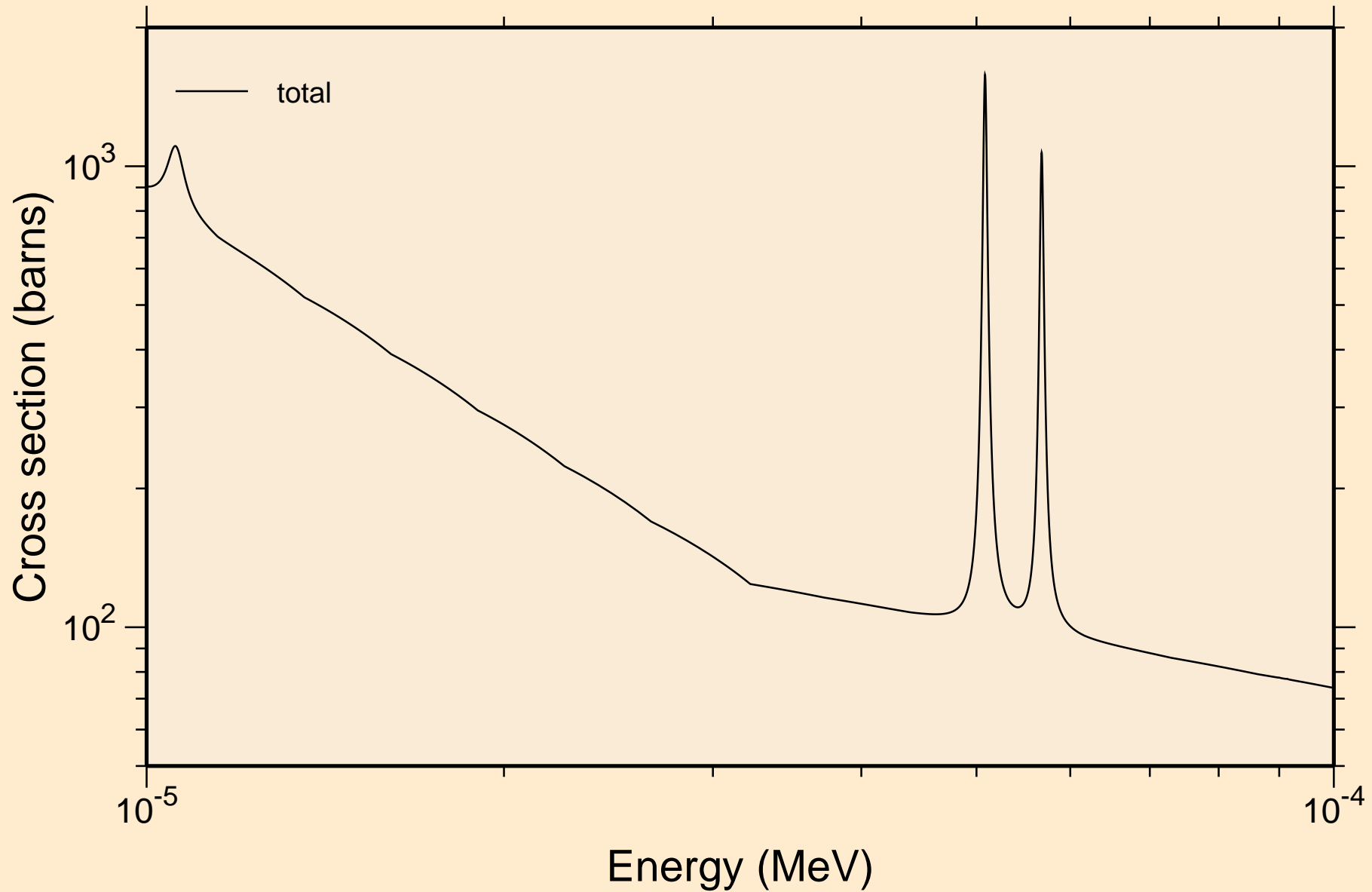

AS067 NEUTRON ACER TENDL-2023 LIBRARY; T=0.K
resonance total cross section

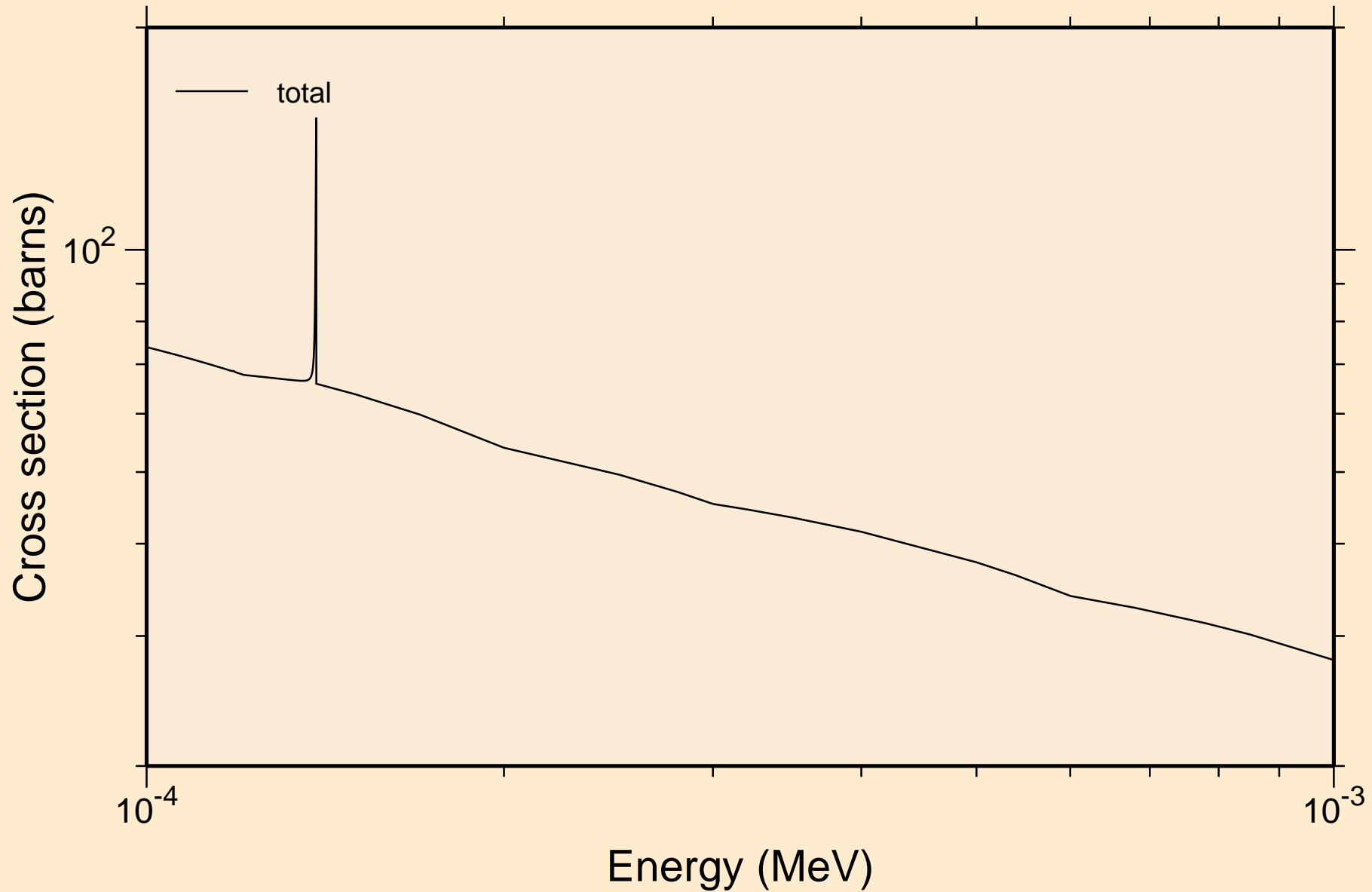

A5067 NEUTRON ACER TENDL-2023 LIBRARY; T=0.K
resonance total cross section

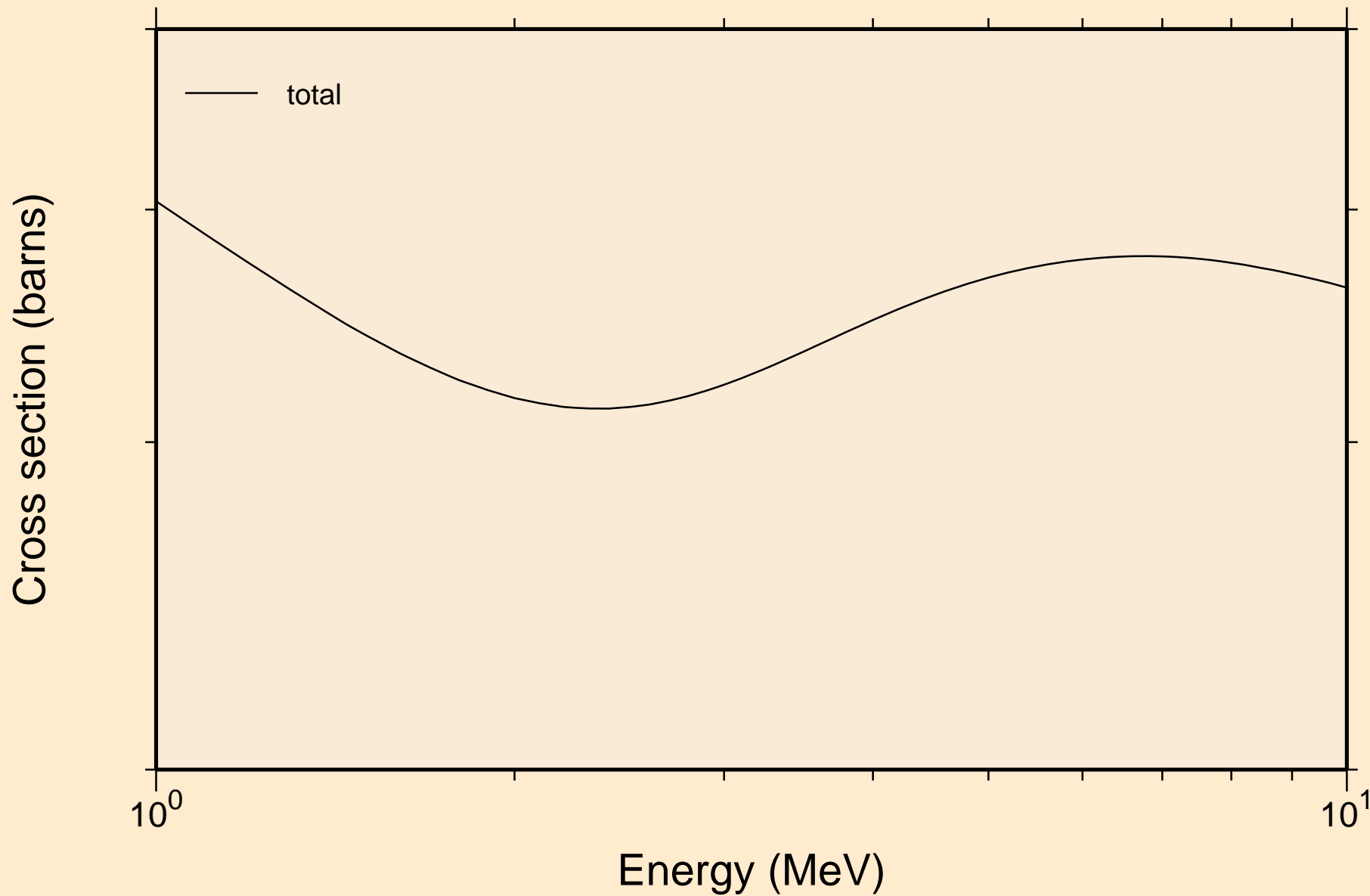

AS067 NEUTRON ACER TENDL-2023 LIBRARY; T=0.K
resonance absorption cross sections

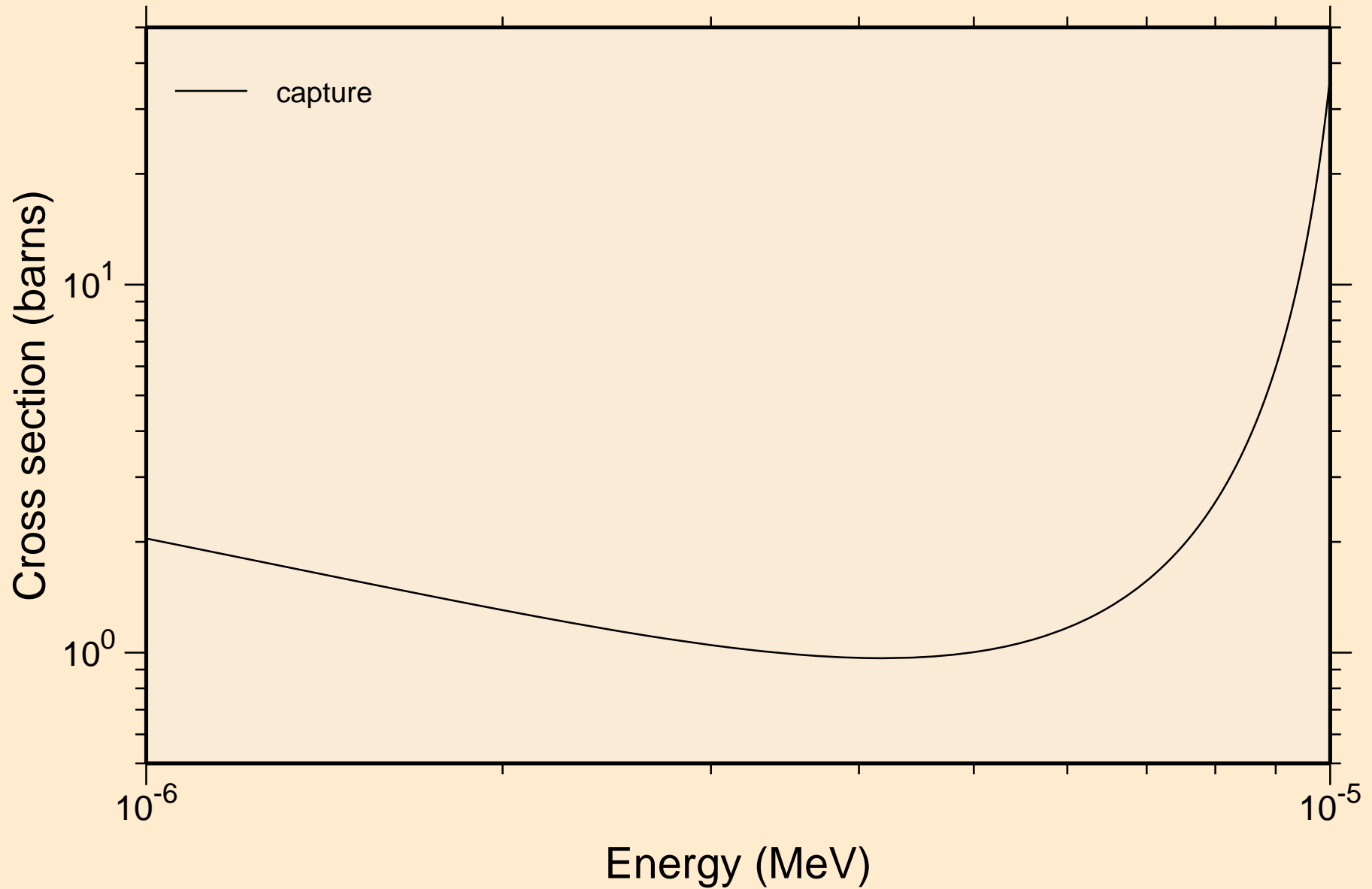

AS067 NEUTRON ACER TENDL-2023 LIBRARY; T=0.K
resonance absorption cross sections

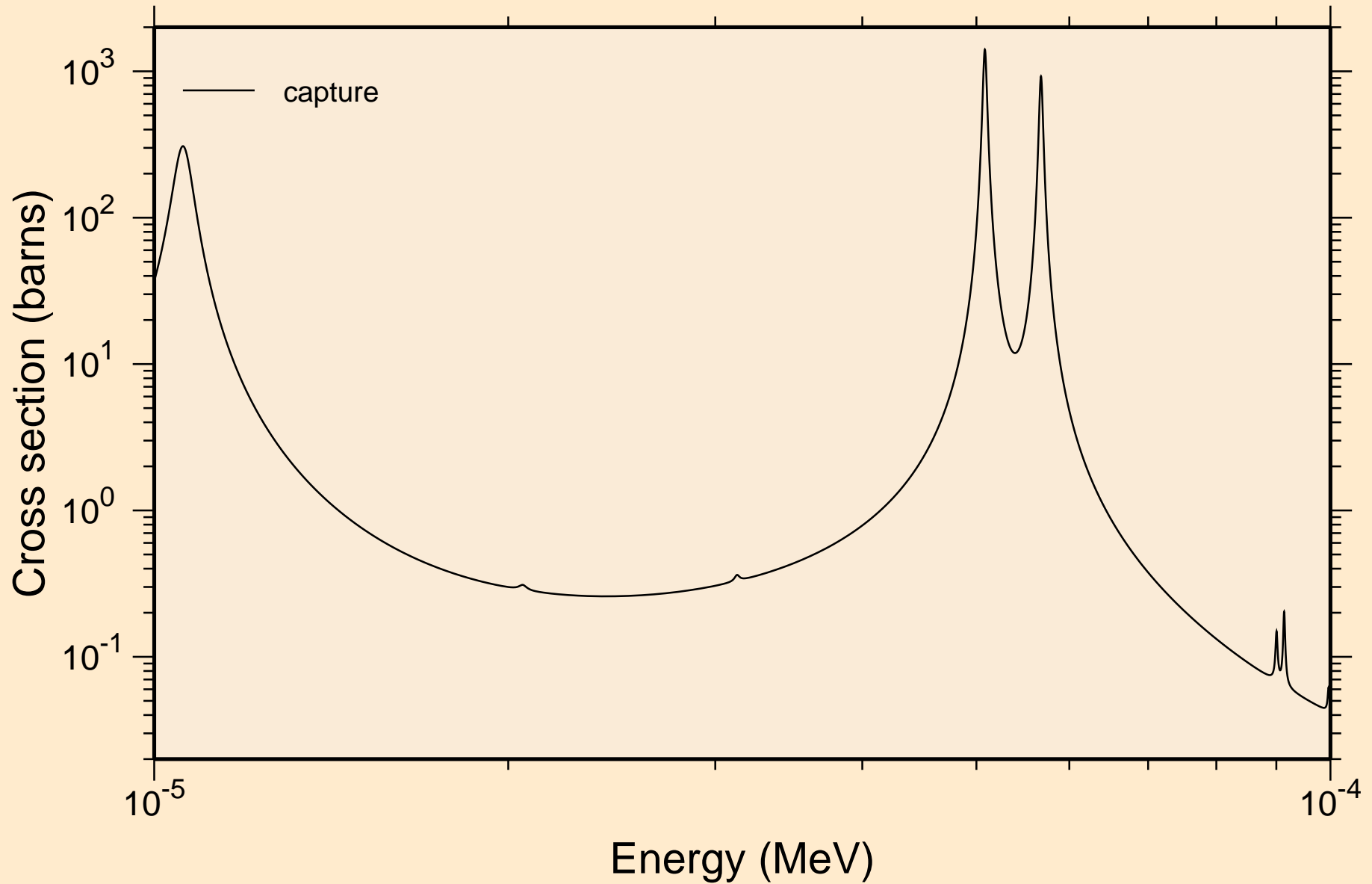

AS067 NEUTRON ACER TENDL-2023 LIBRARY; T=0.K
resonance absorption cross sections

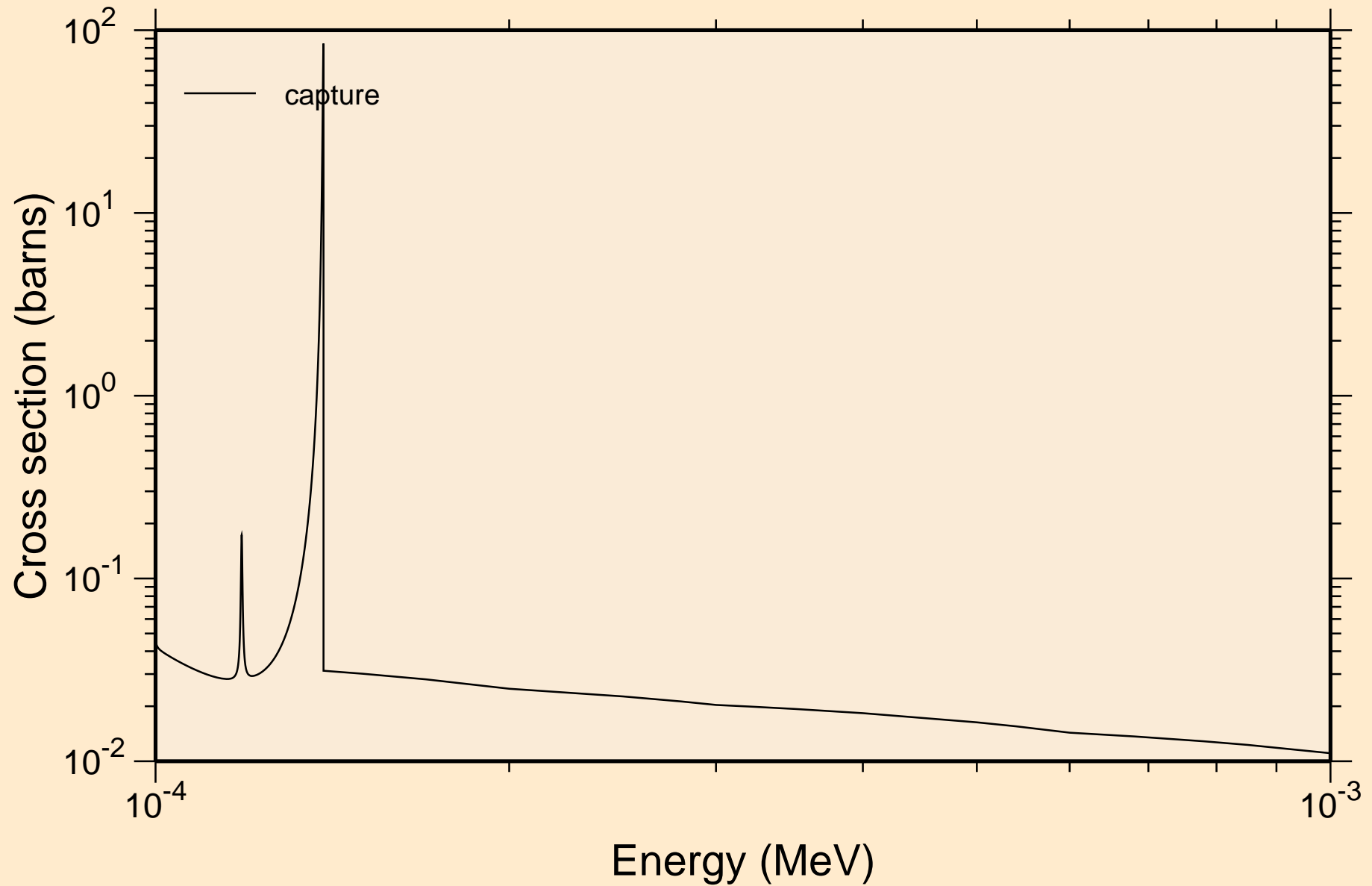

AS067 NEUTRON ACER TENDL-2023 LIBRARY; T=0.K
resonance absorption cross sections

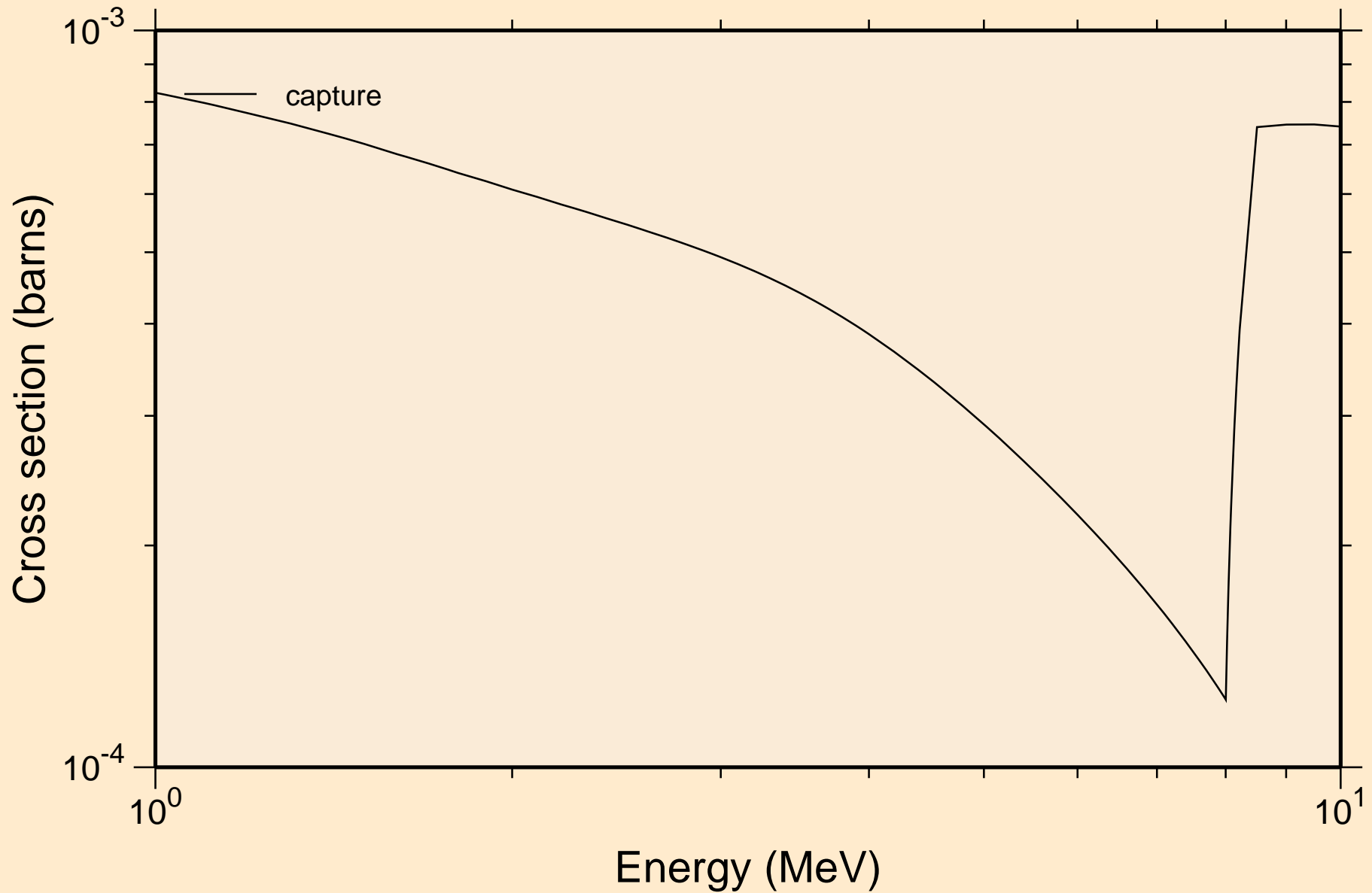

AS067 NEUTRON ACER TENDL-2023 LIBRARY; T=0.K

Heating

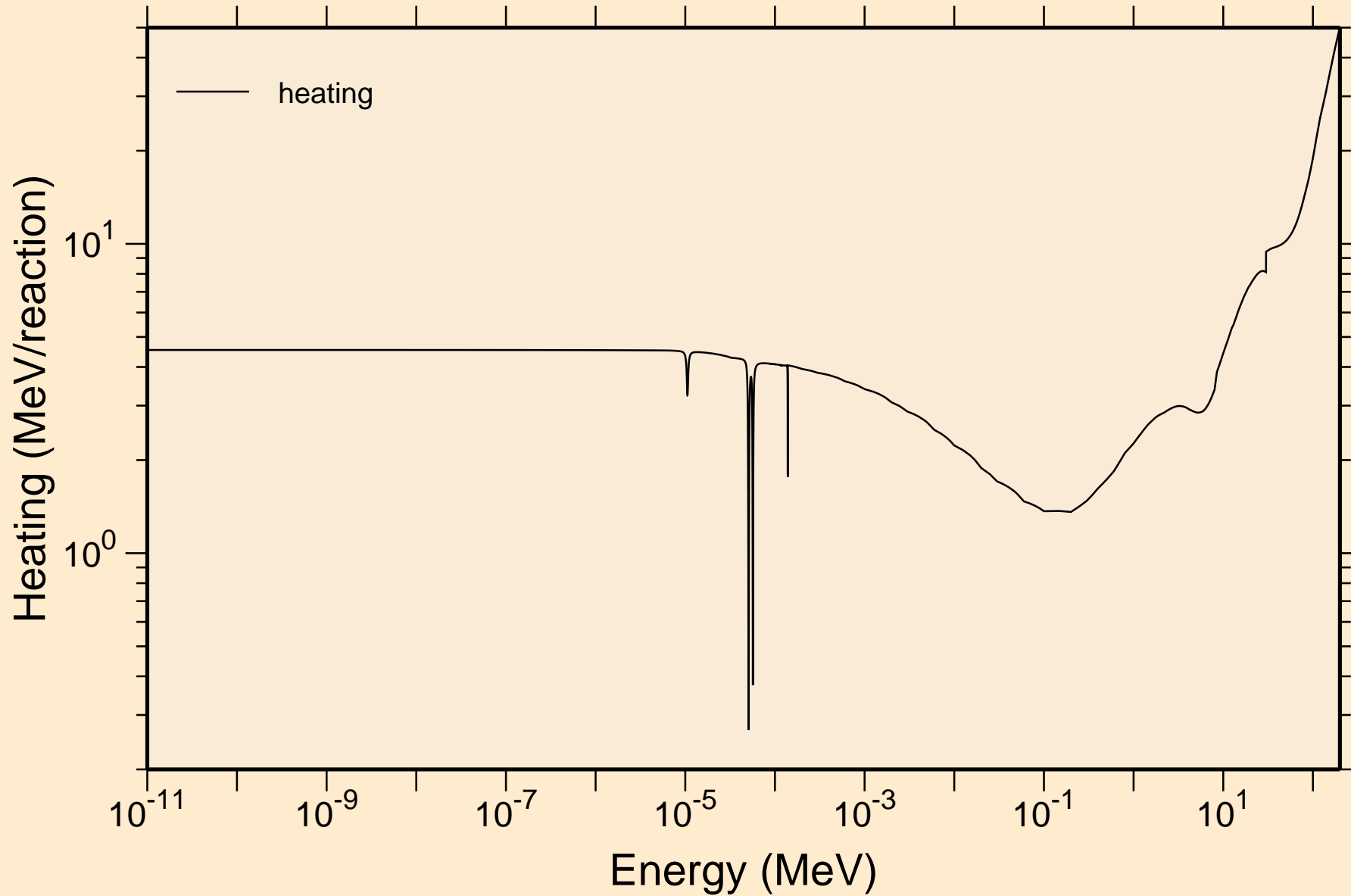

AS067 NEUTRON ACER TENDL-2023 LIBRARY; T=0.K
Damage

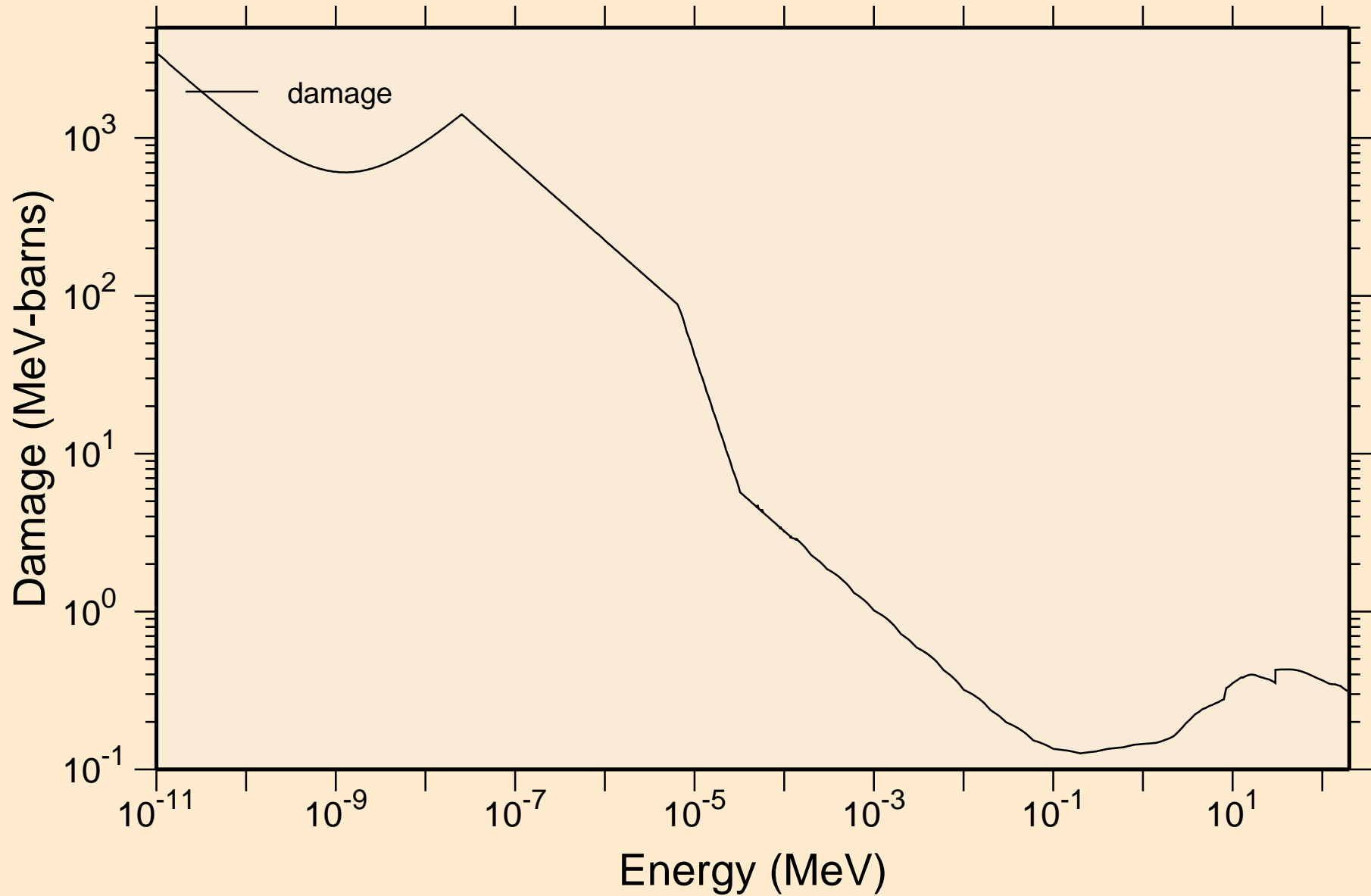

AS067 NEUTRON ACER TENDL-2023 LIBRARY; T=0.K
Non-threshold reactions

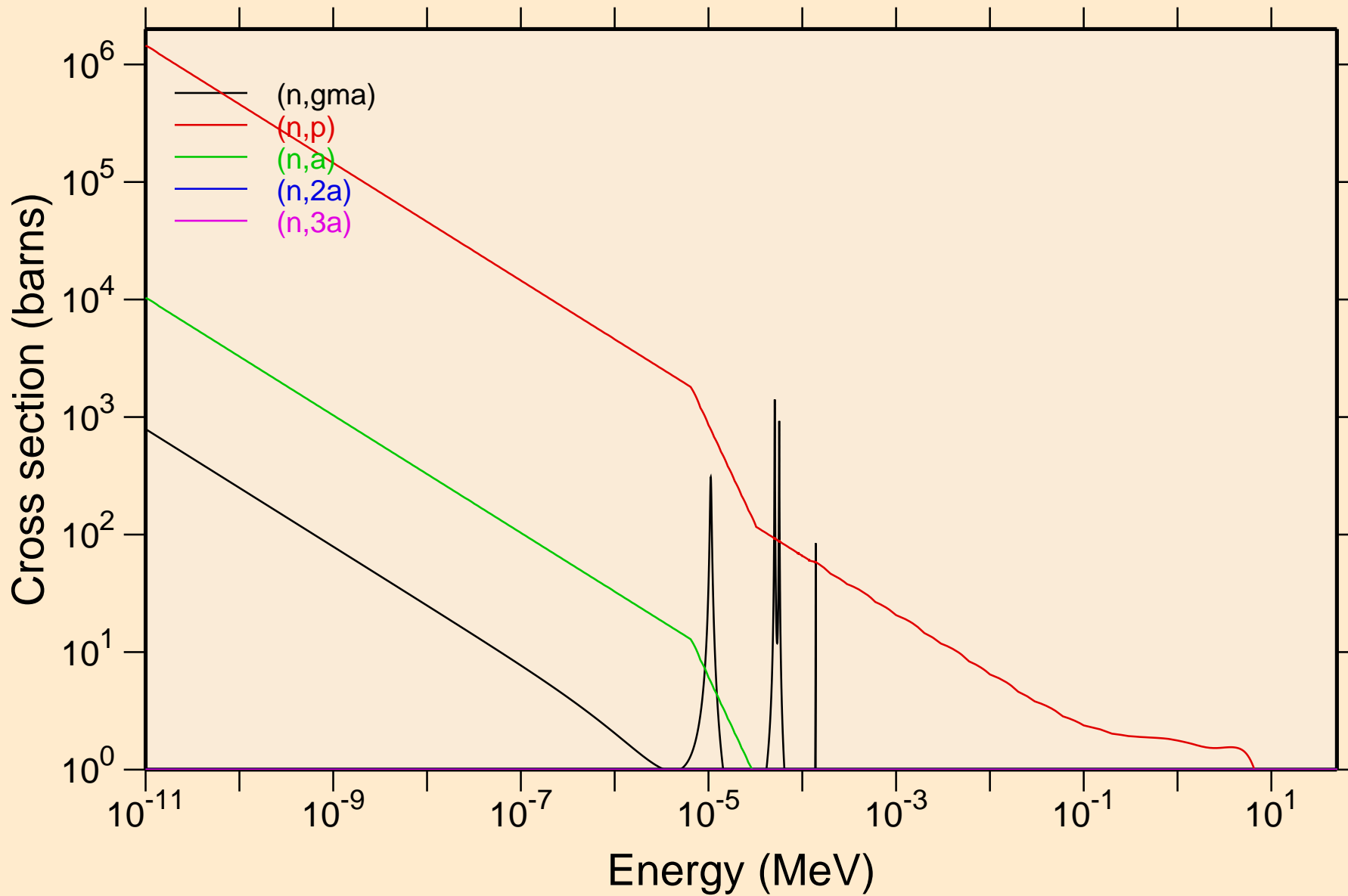

AS067 NEUTRON ACER TENDL-2023 LIBRARY; T=0.K
Non-threshold reactions

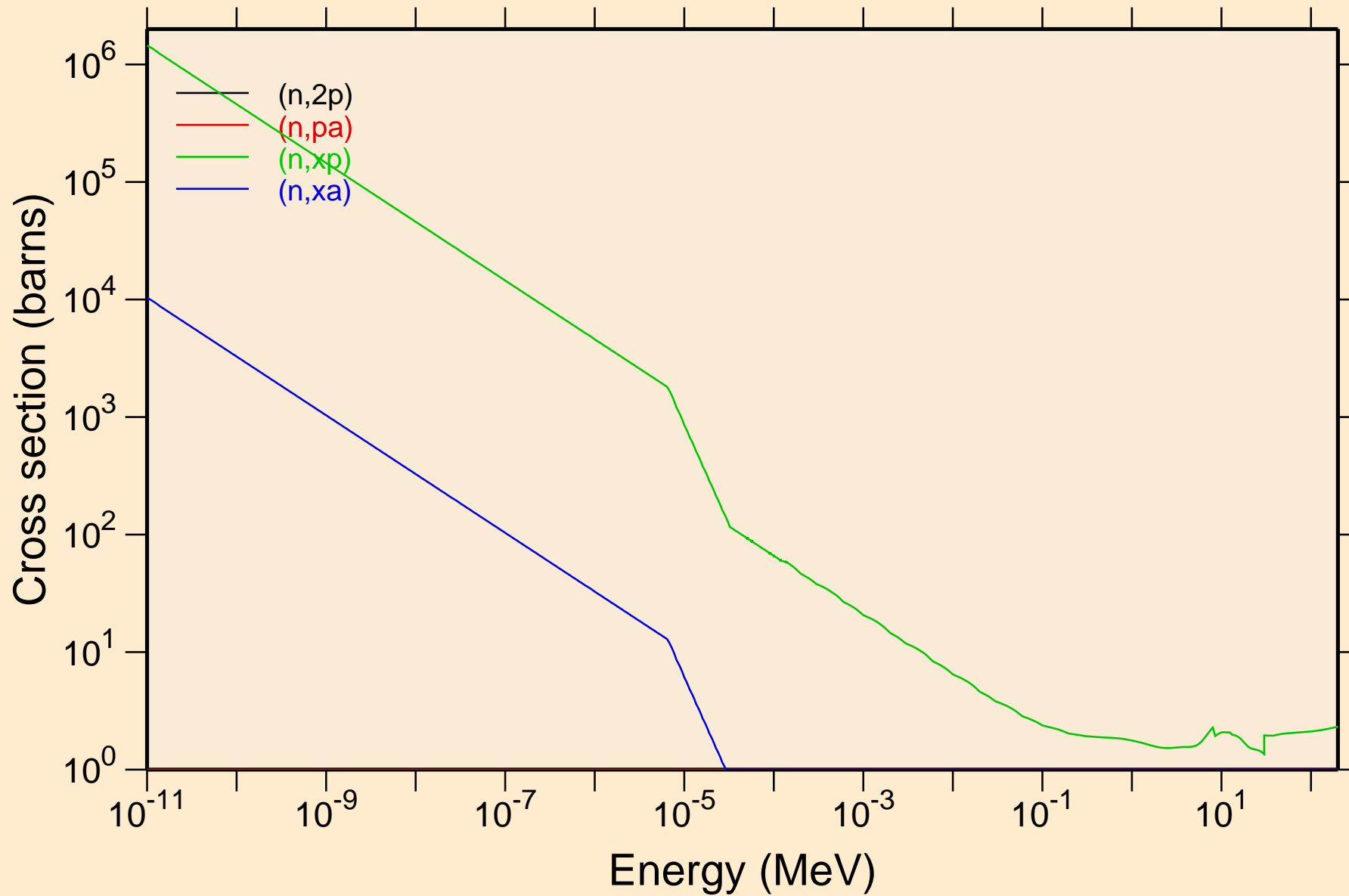

AS067 NEUTRON ACER TENDL-2023 LIBRARY; T=0.K

Principal cross sections

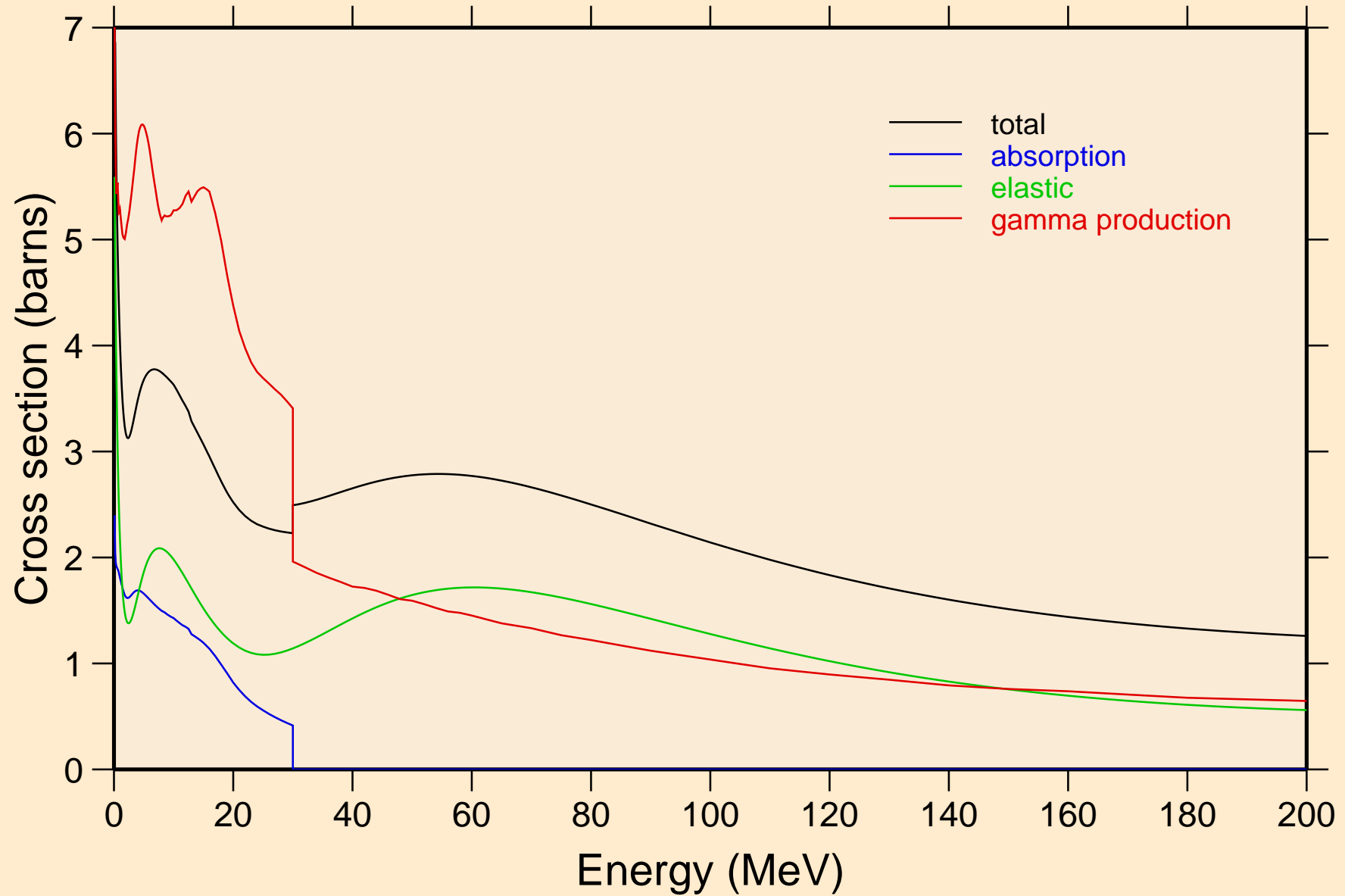

AS067 NEUTRON ACER TENDL-2023 LIBRARY; T=0.K

Heating

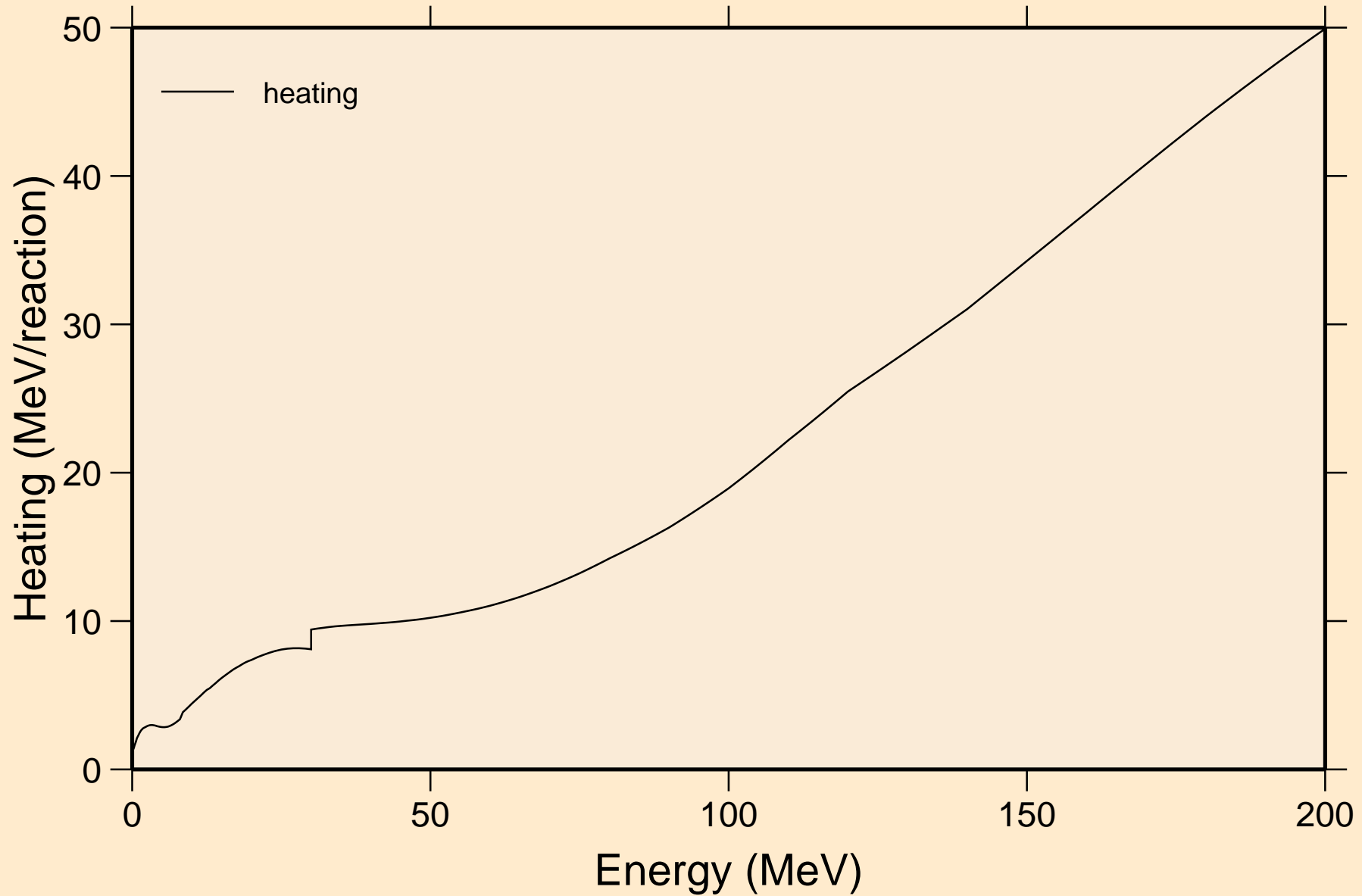

AS067 NEUTRON ACER TENDL-2023 LIBRARY; T=0.K

Damage

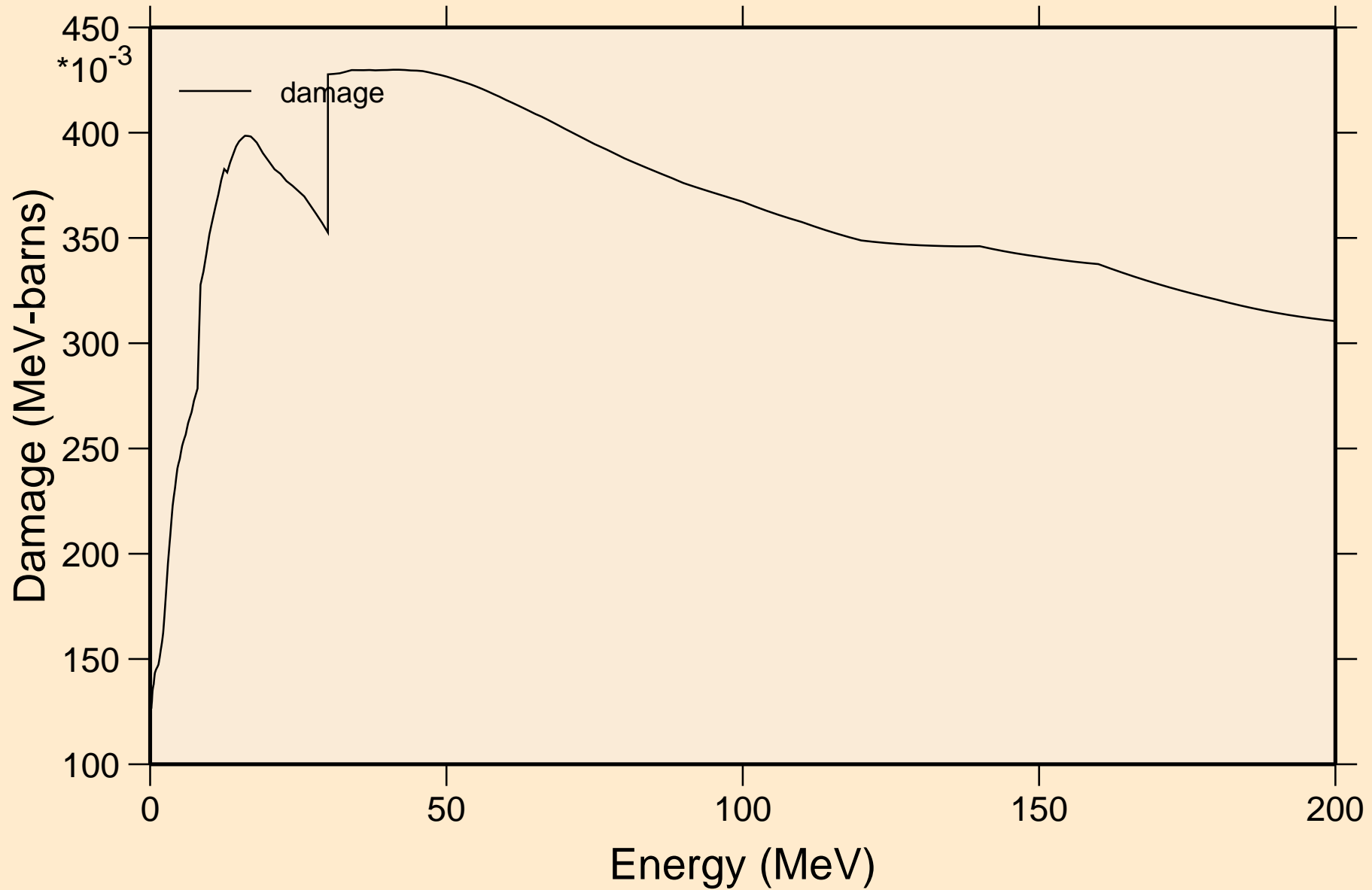

AS067 NEUTRON ACER TENDL-2023 LIBRARY; T=0.K
Non-threshold reactions

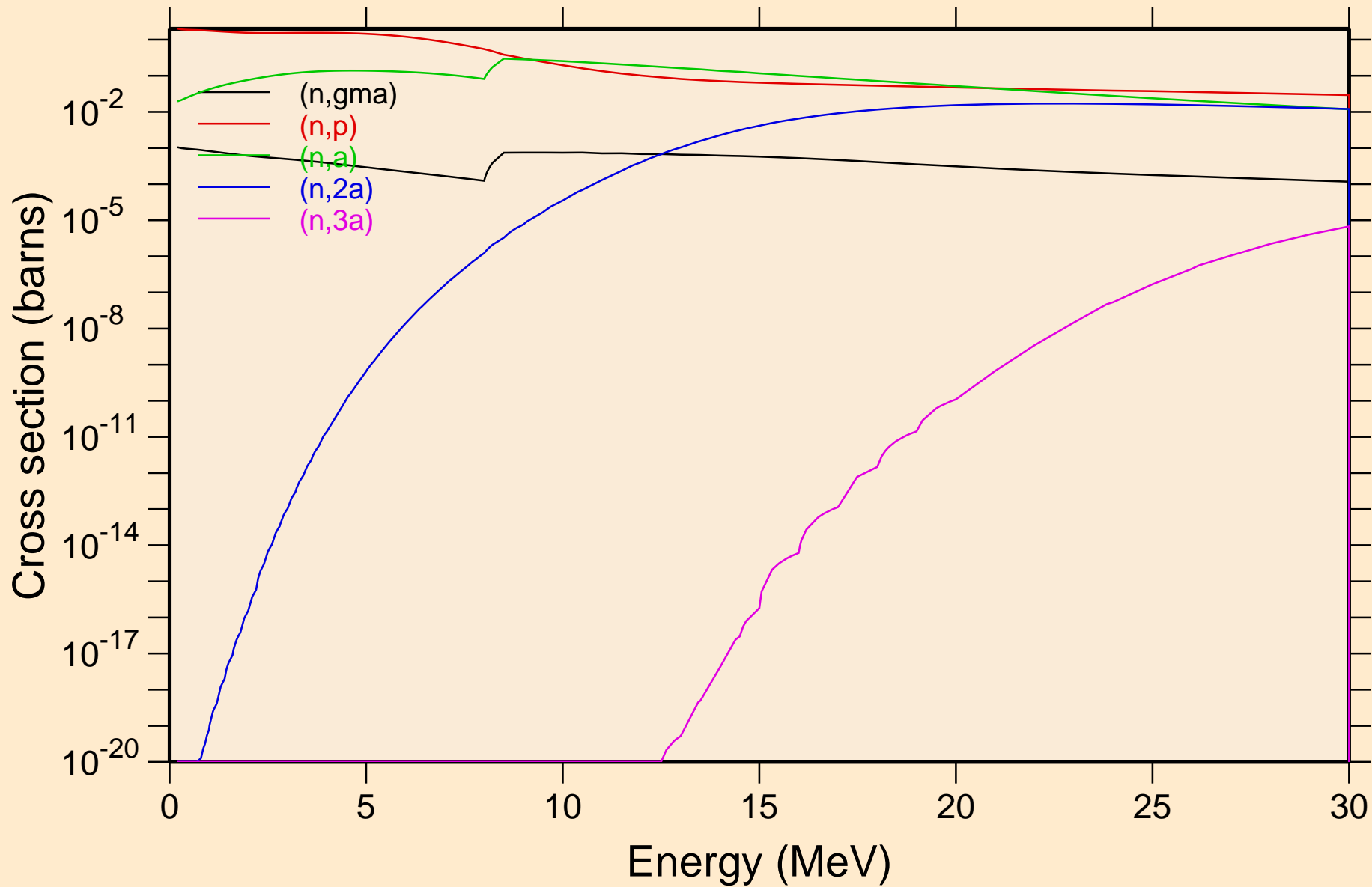

AS067 NEUTRON ACER TENDL-2023 LIBRARY; T=0.K
Non-threshold reactions

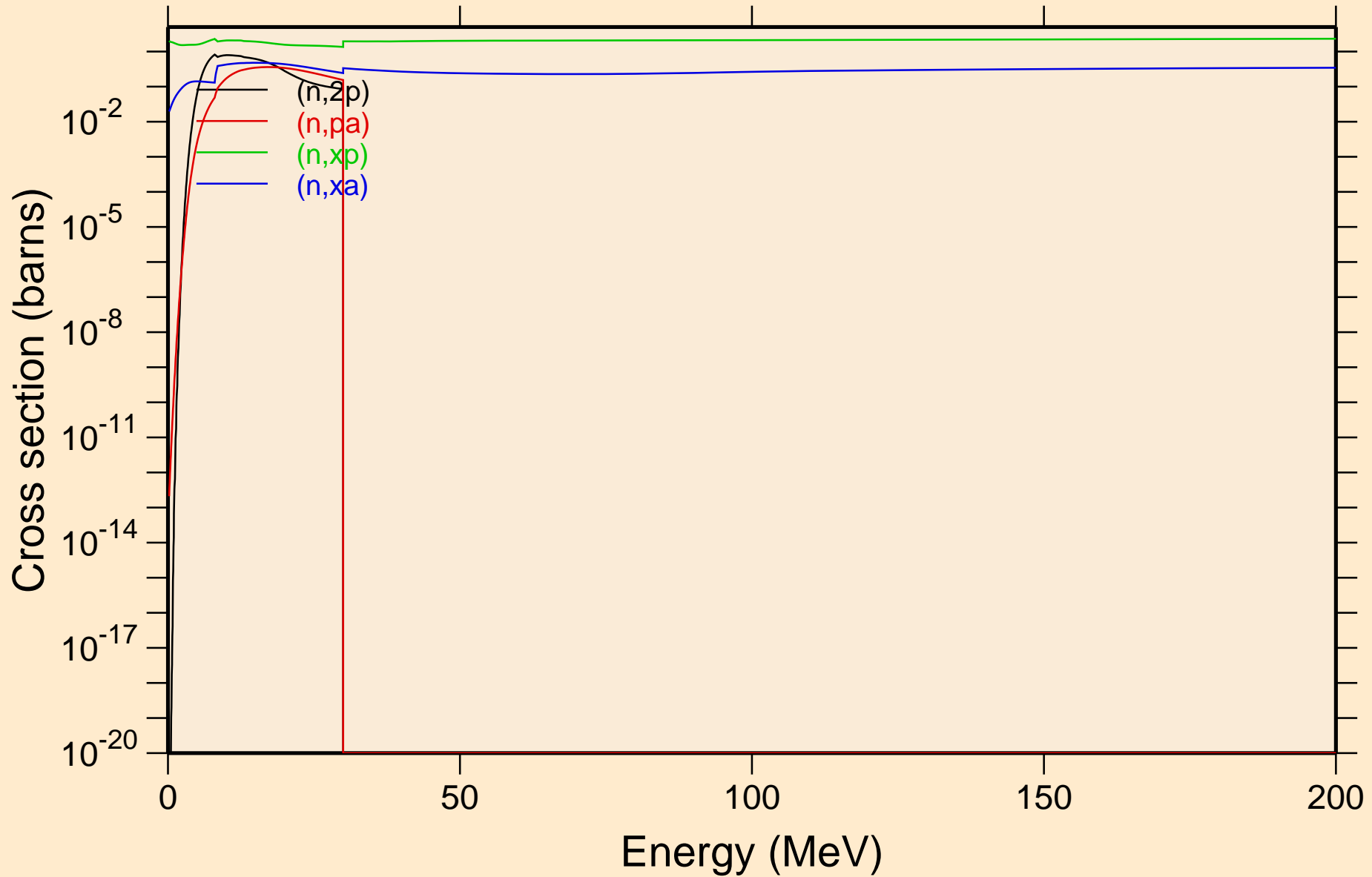

AS067 NEUTRON ACER TENDL-2023 LIBRARY; T=0.K
Inelastic levels

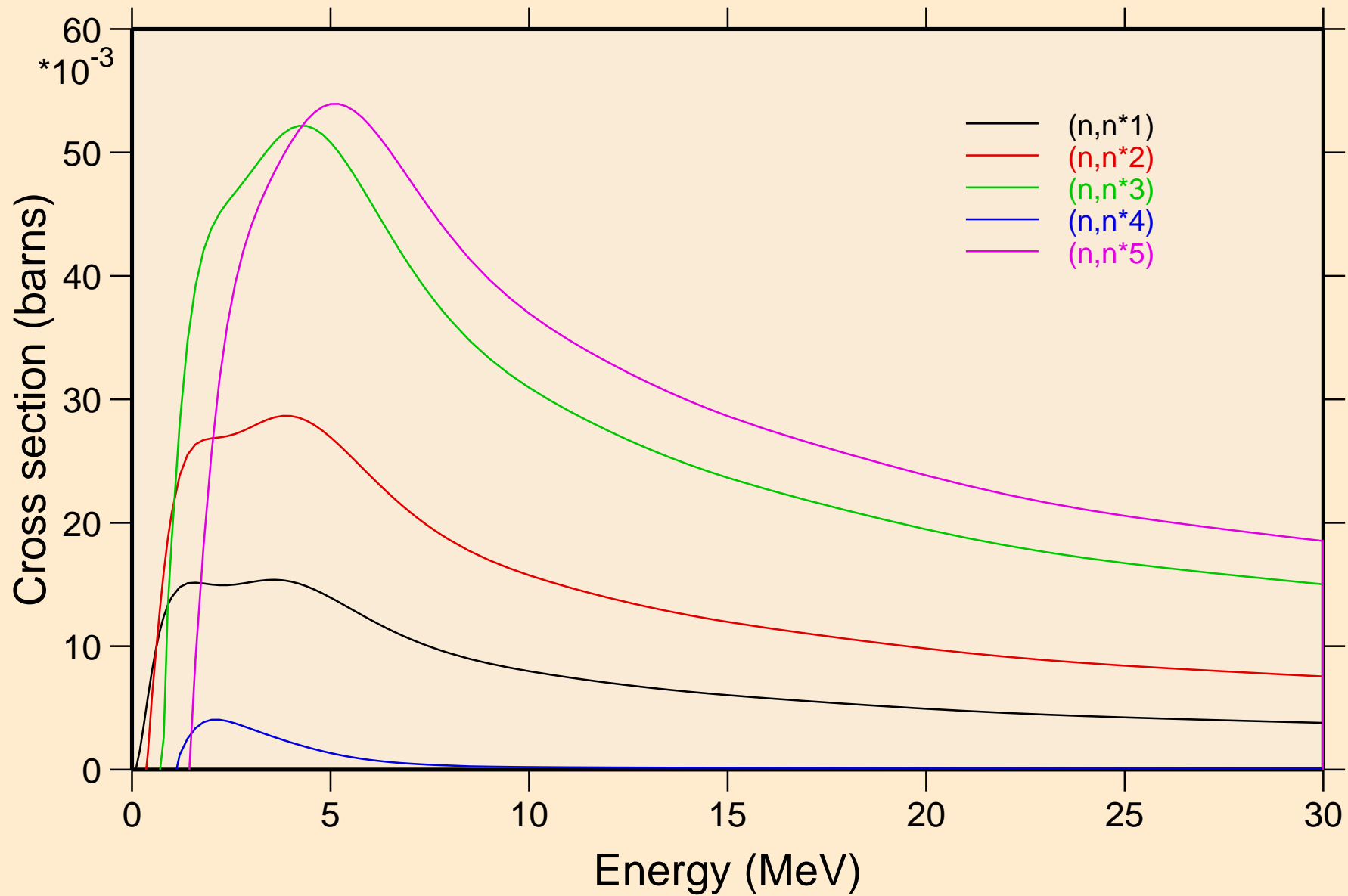

AS067 NEUTRON ACER TENDL-2023 LIBRARY; T=0.K
Threshold reactions

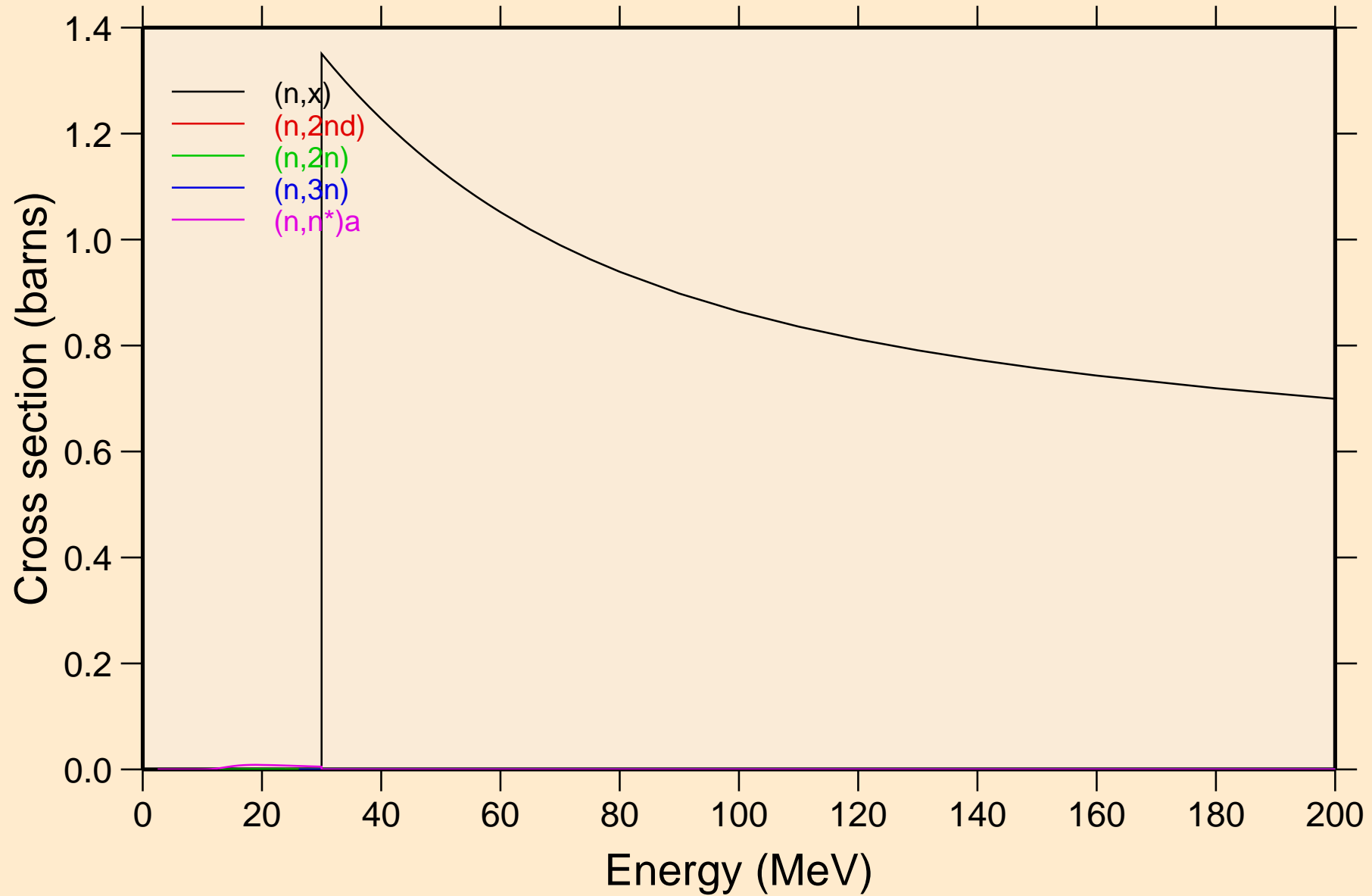

AS067 NEUTRON ACER TENDL-2023 LIBRARY; T=0.K
Threshold reactions

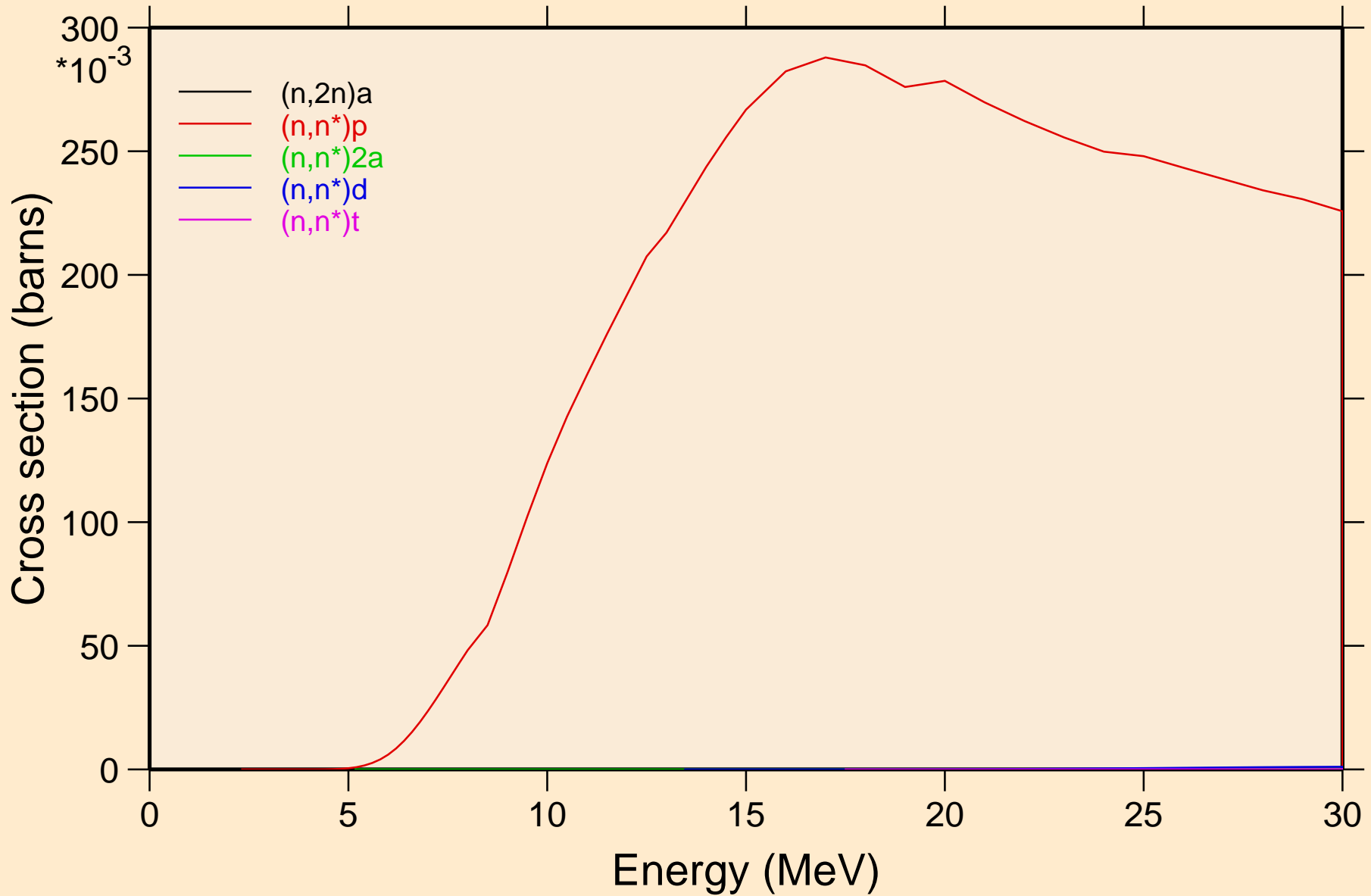

AS067 NEUTRON ACER TENDL-2023 LIBRARY; T=0.K

Threshold reactions

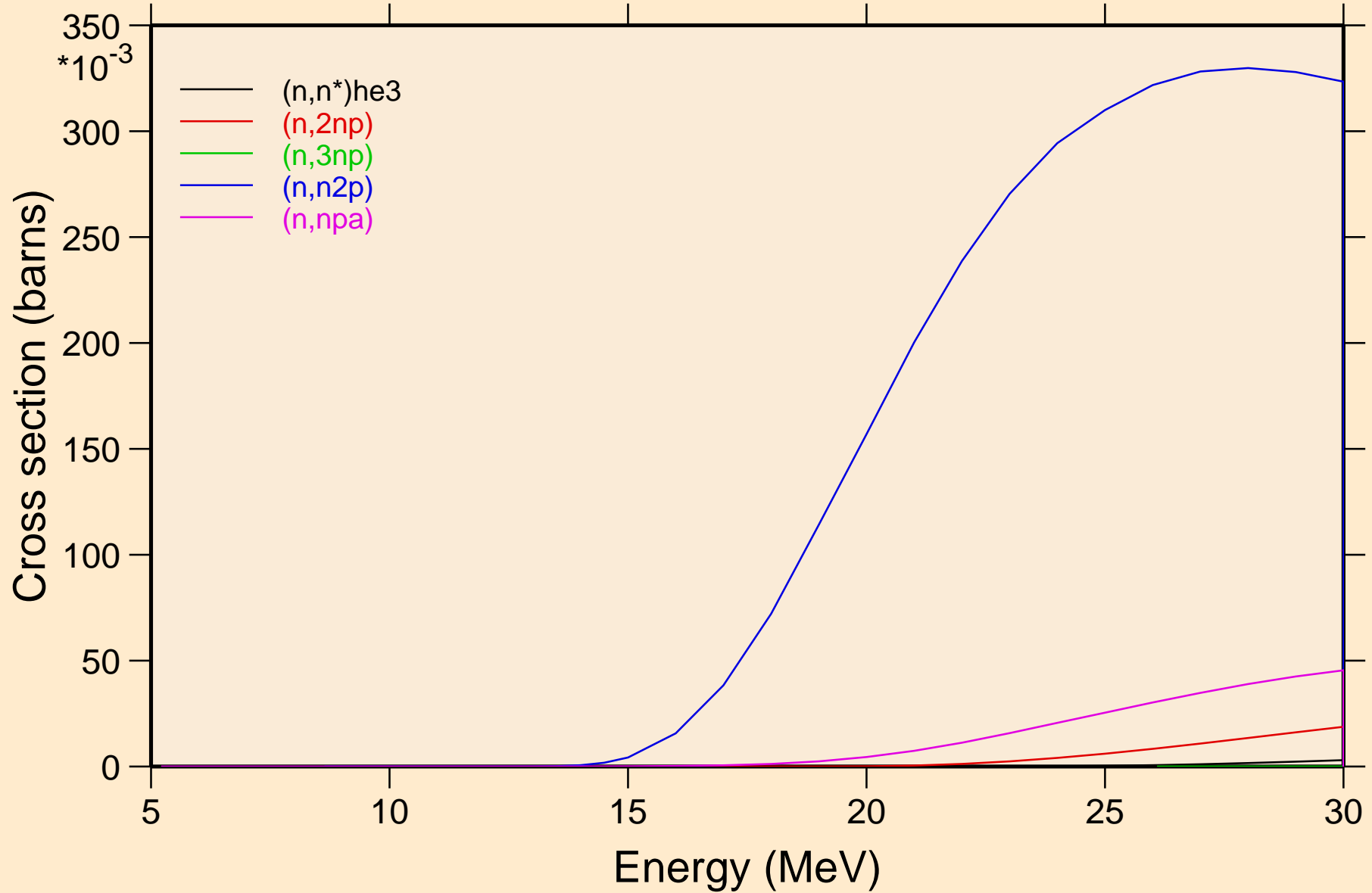

AS067 NEUTRON ACER TENDL-2023 LIBRARY; T=0.K
Threshold reactions

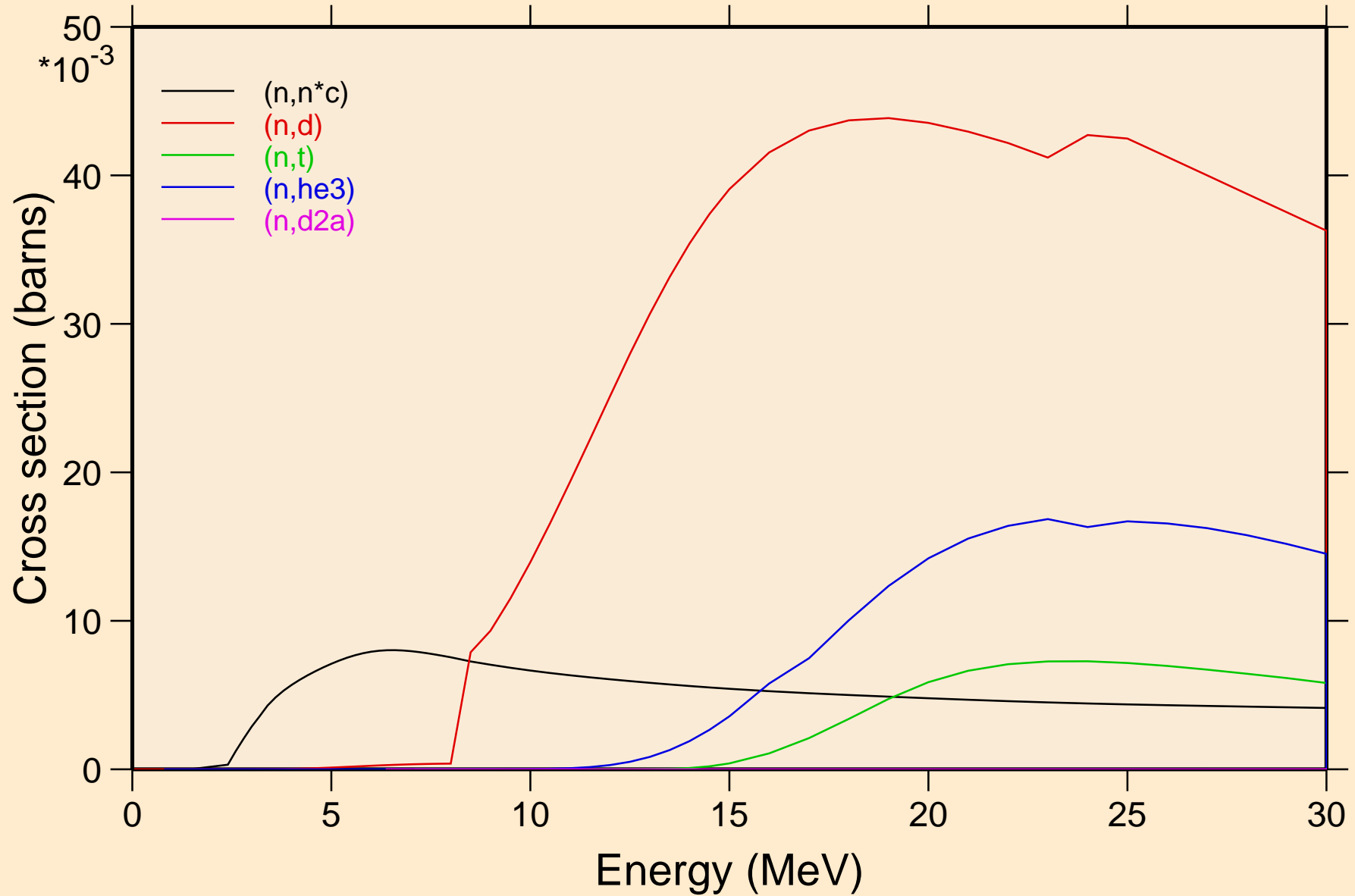

AS067 NEUTRON ACER TENDL-2023 LIBRARY; T=0.K
Threshold reactions

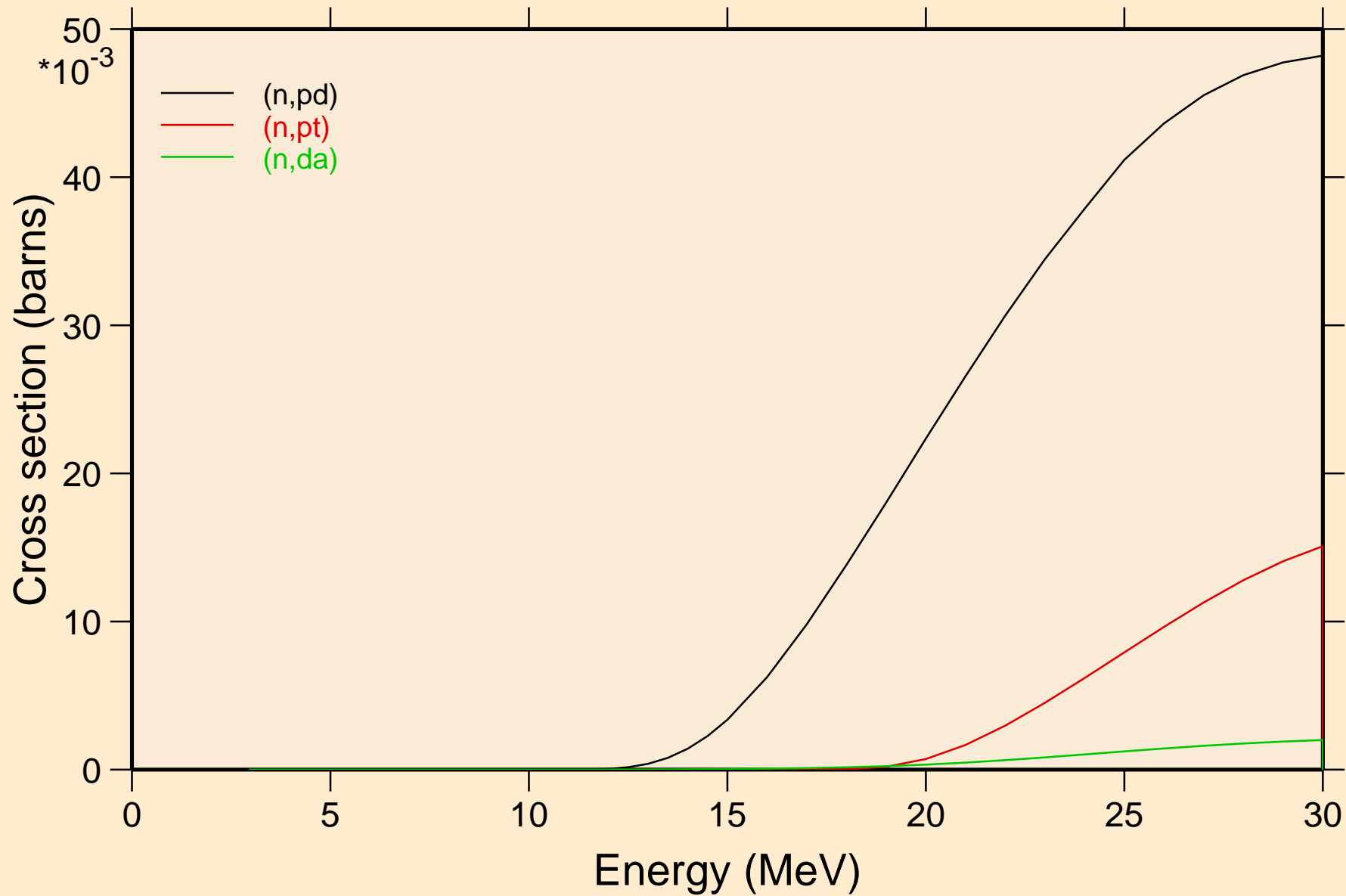

AS067 NEUTRON ACER TENDL-2023 LIBRARY; T=0.K

Threshold reactions

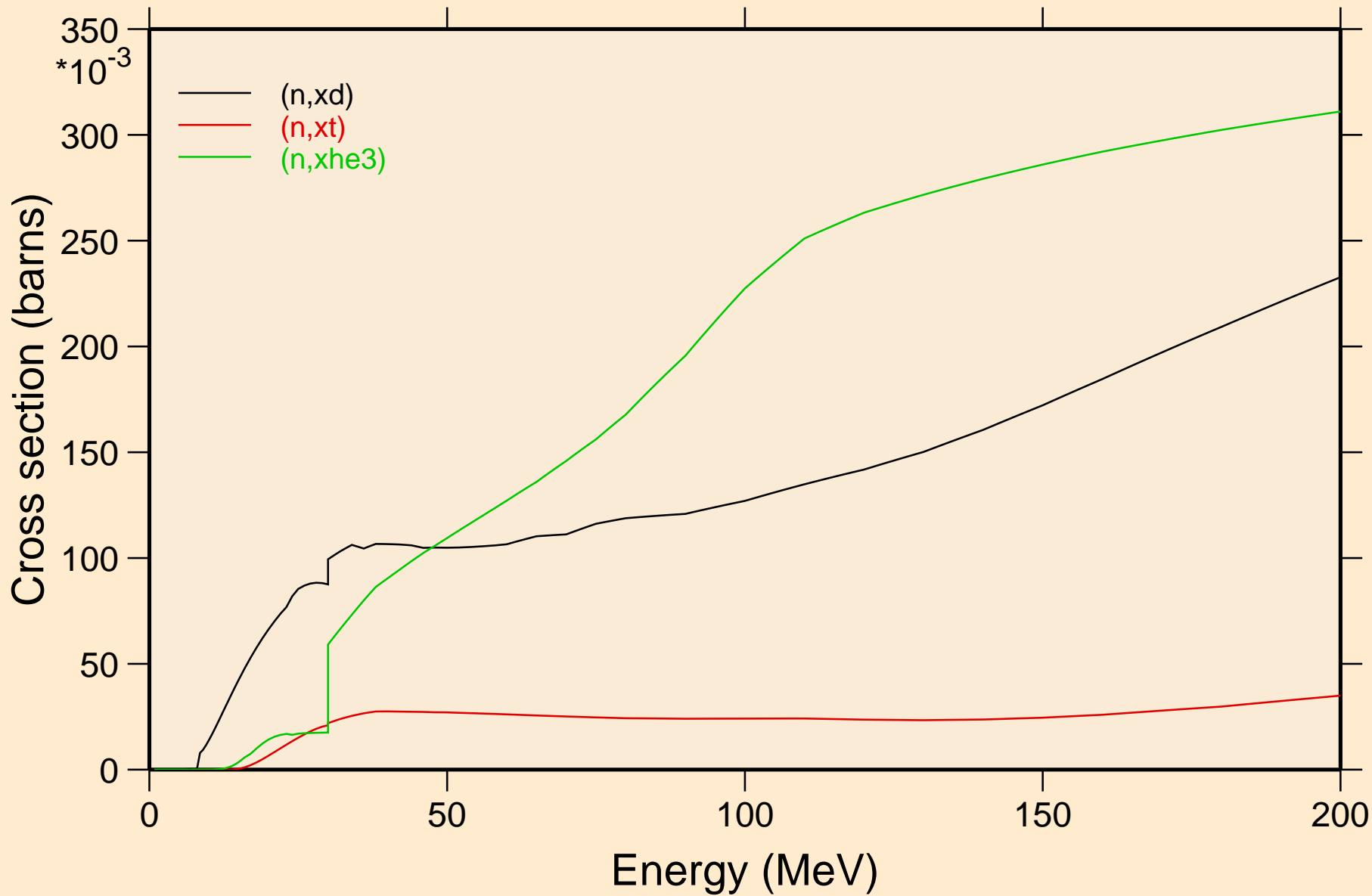

AS067 NEUTRON ACER TENDL-2023 LIBRARY; T=0.K
angular distribution for elastic

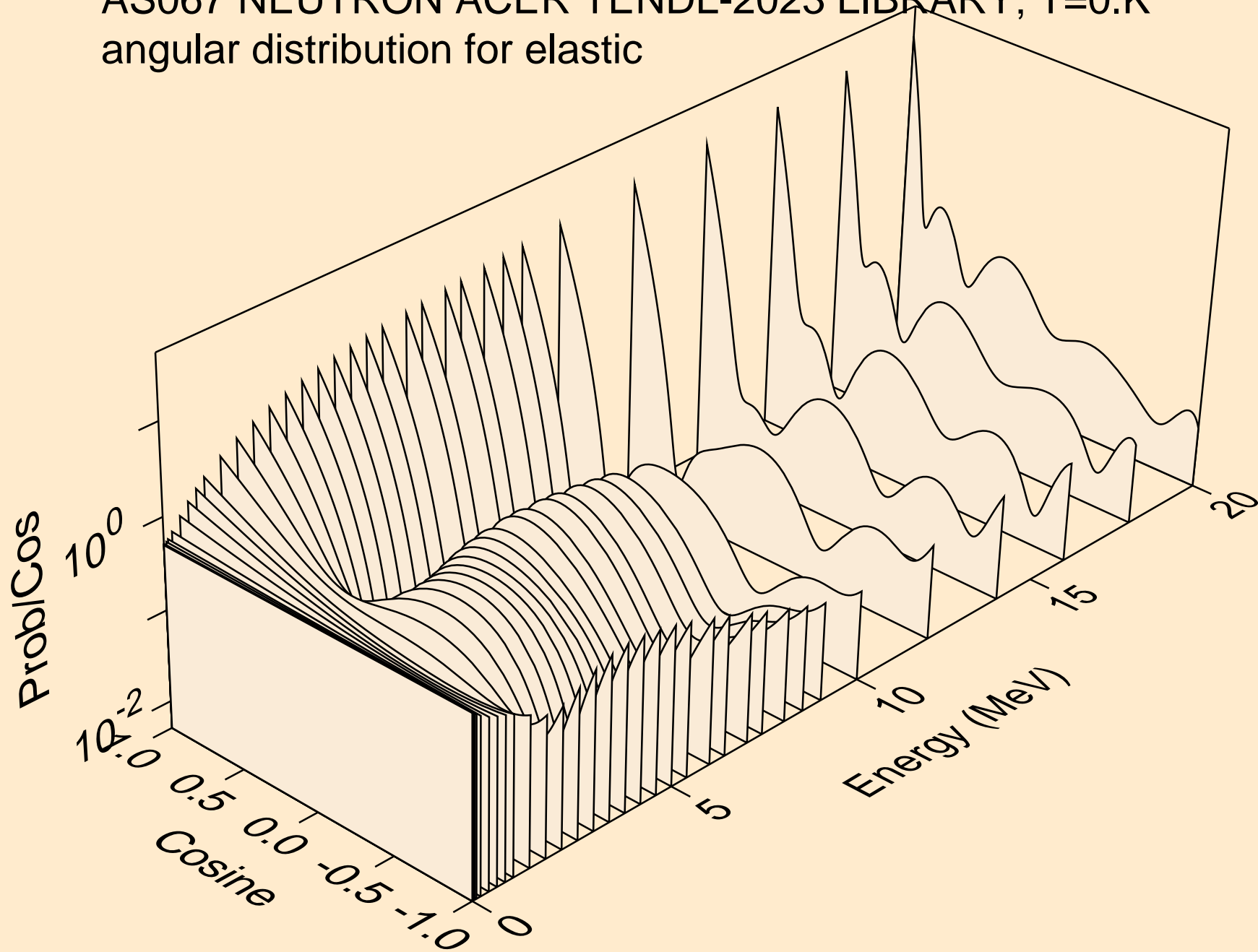

AS067 NEUTRON ACER TENDL-2023 LIBRARY; T=0.K
angular distribution for elastic

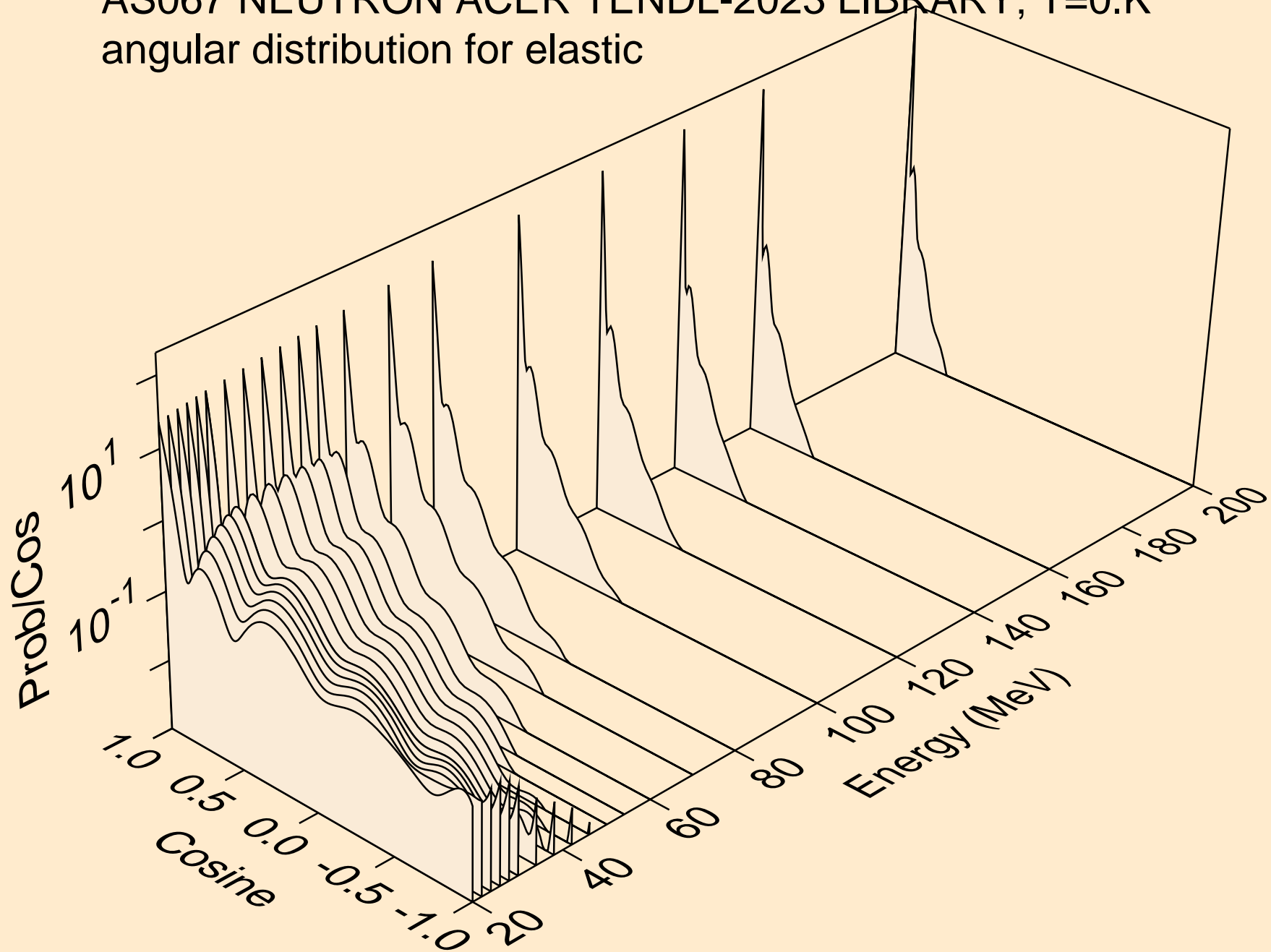

AS067 NEUTRON ACER TENDL-2023 LIBRARY; T=0.K
angular distribution for (n,n*1)

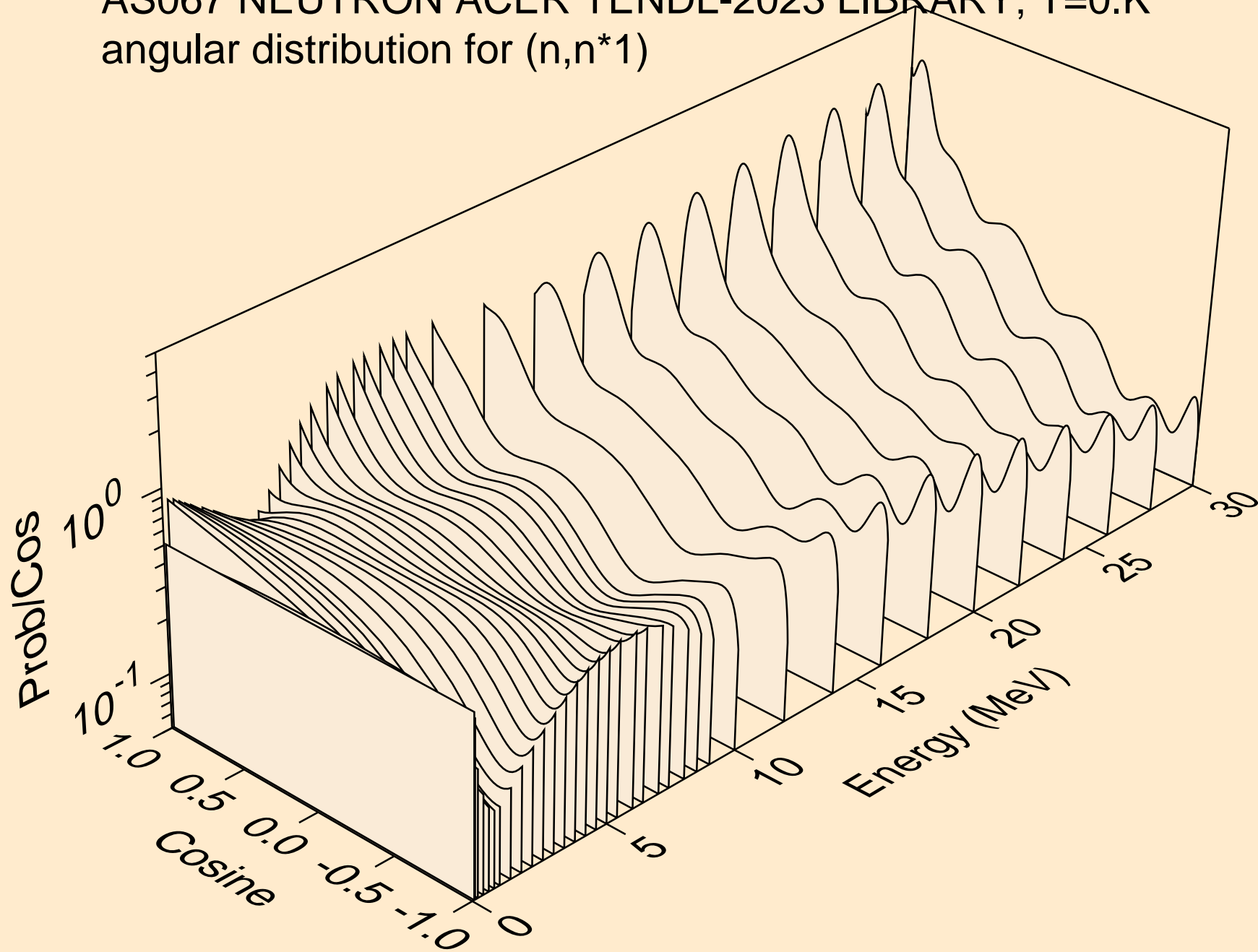

AS067 NEUTRON ACER TENDL-2023 LIBRARY; T=0.K
angular distribution for (n,n*2)

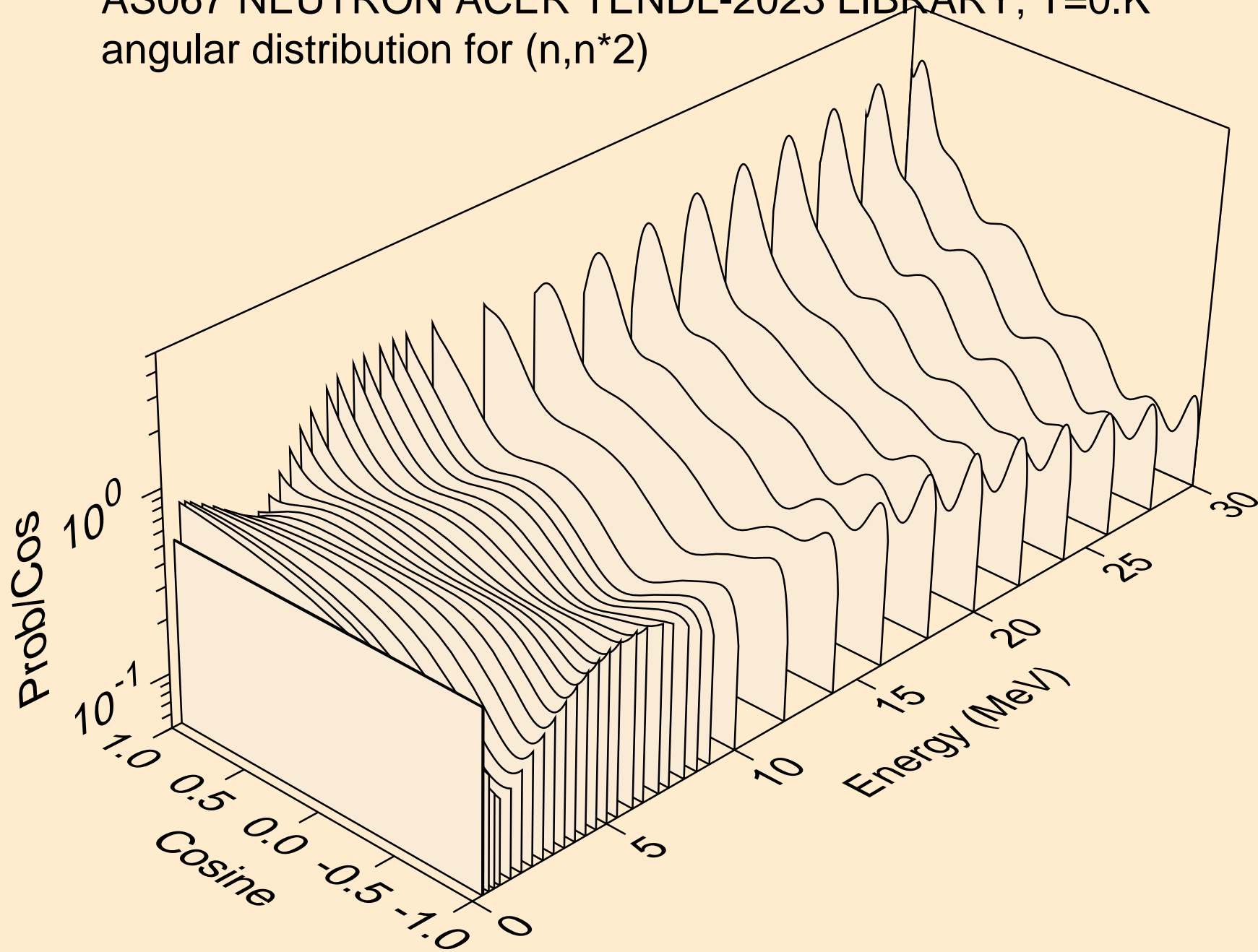

AS067 NEUTRON ACER TENDL-2023 LIBRARY; T=0.K
angular distribution for (n,n*3)

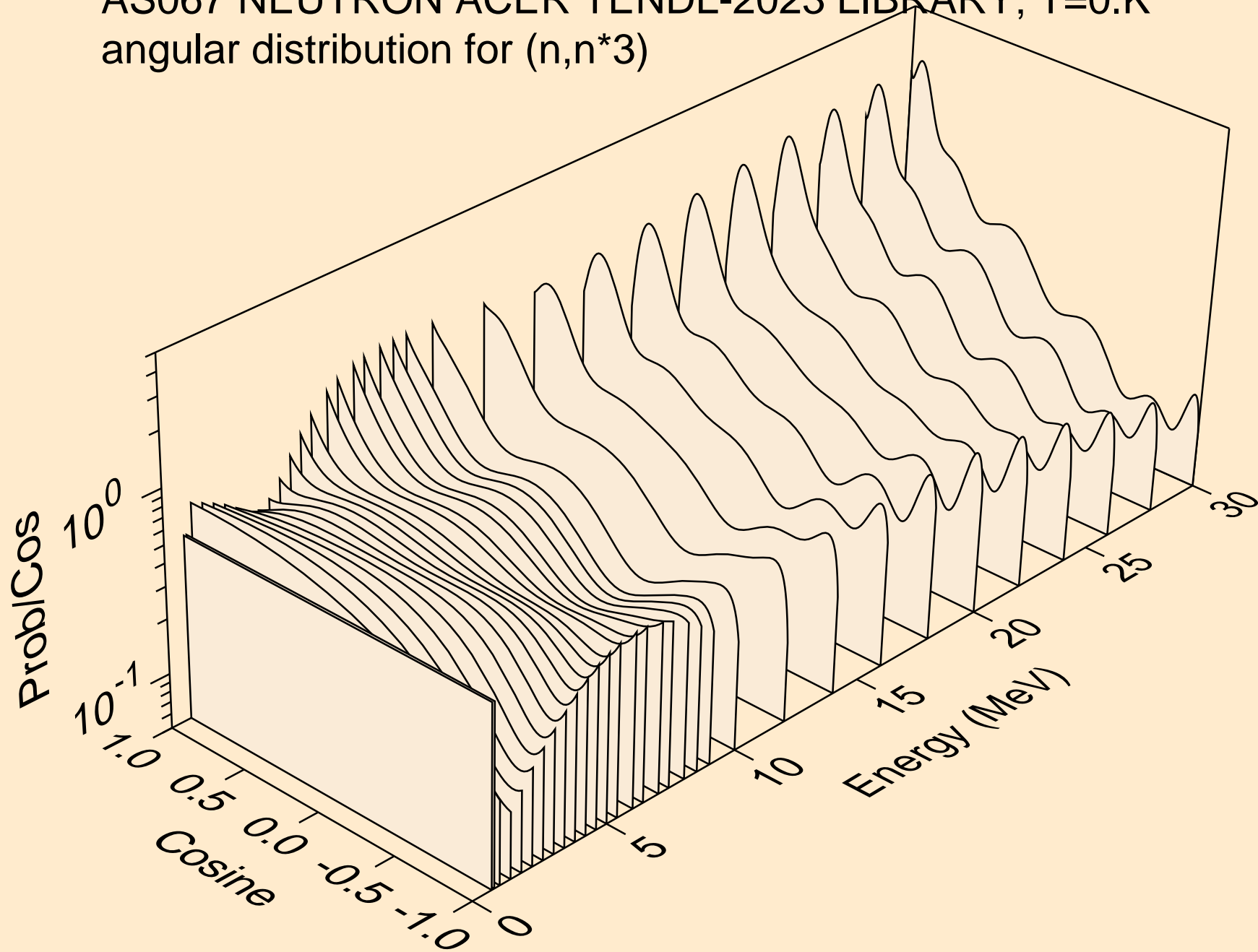

AS067 NEUTRON ACER TENDL-2023 LIBRARY; T=0.K
angular distribution for (n,n*4)

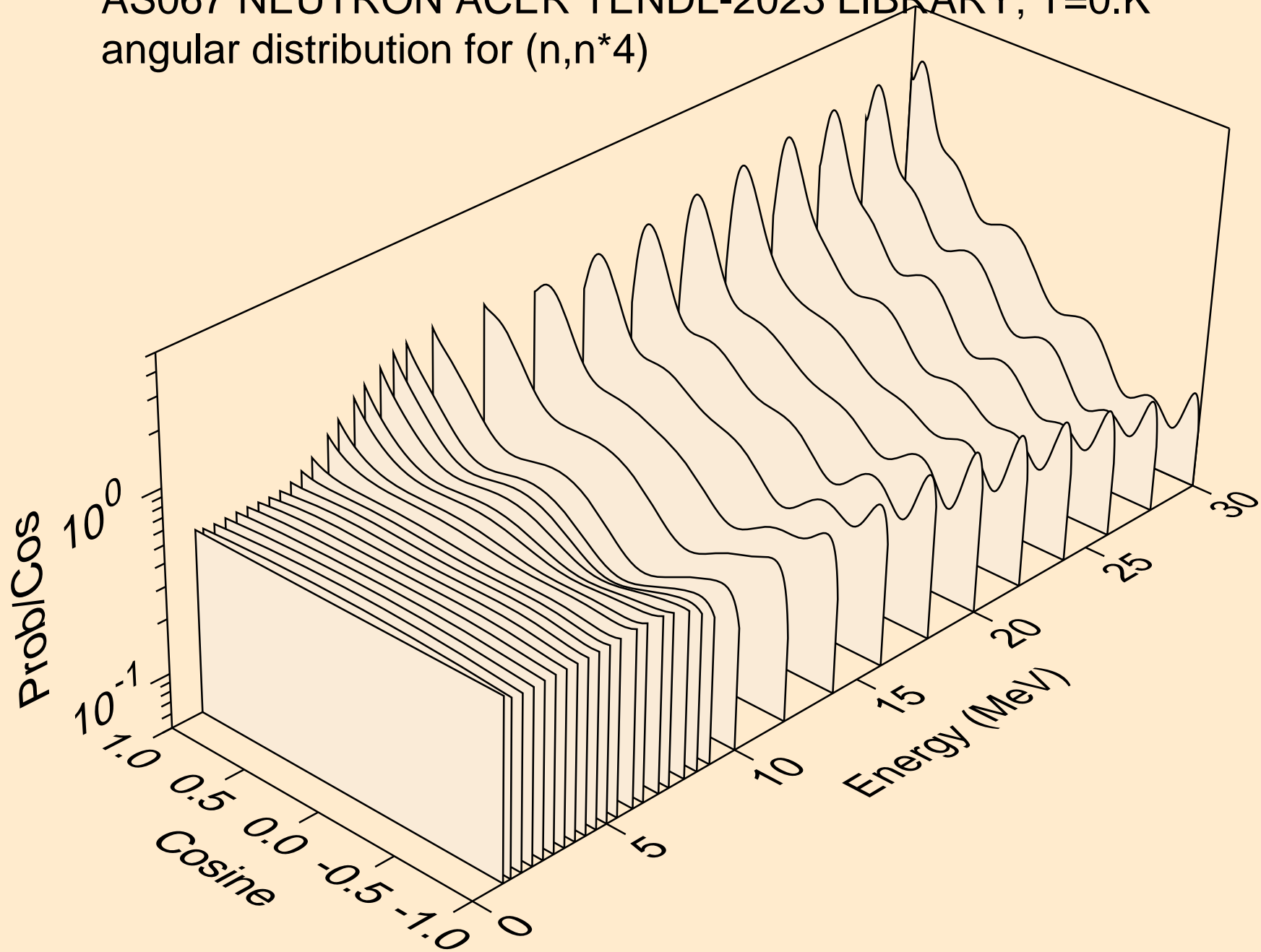

AS067 NEUTRON ACER TENDL-2023 LIBRARY; T=0.K
angular distribution for (n,n*5)

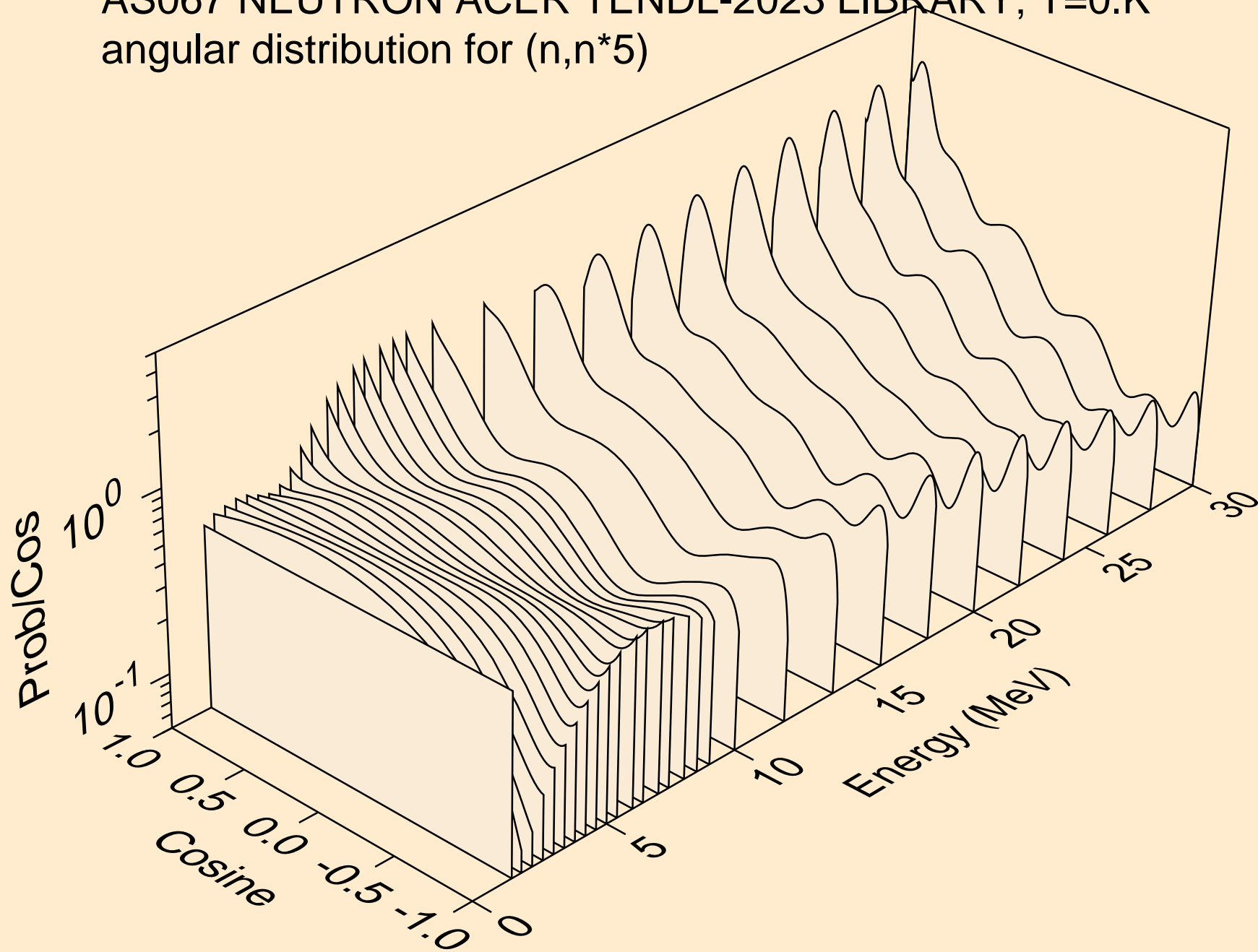

AS067 NEUTRON ACER TENDL-2023 LIBRARY; T=0.K
Neutron emission for (n,x)

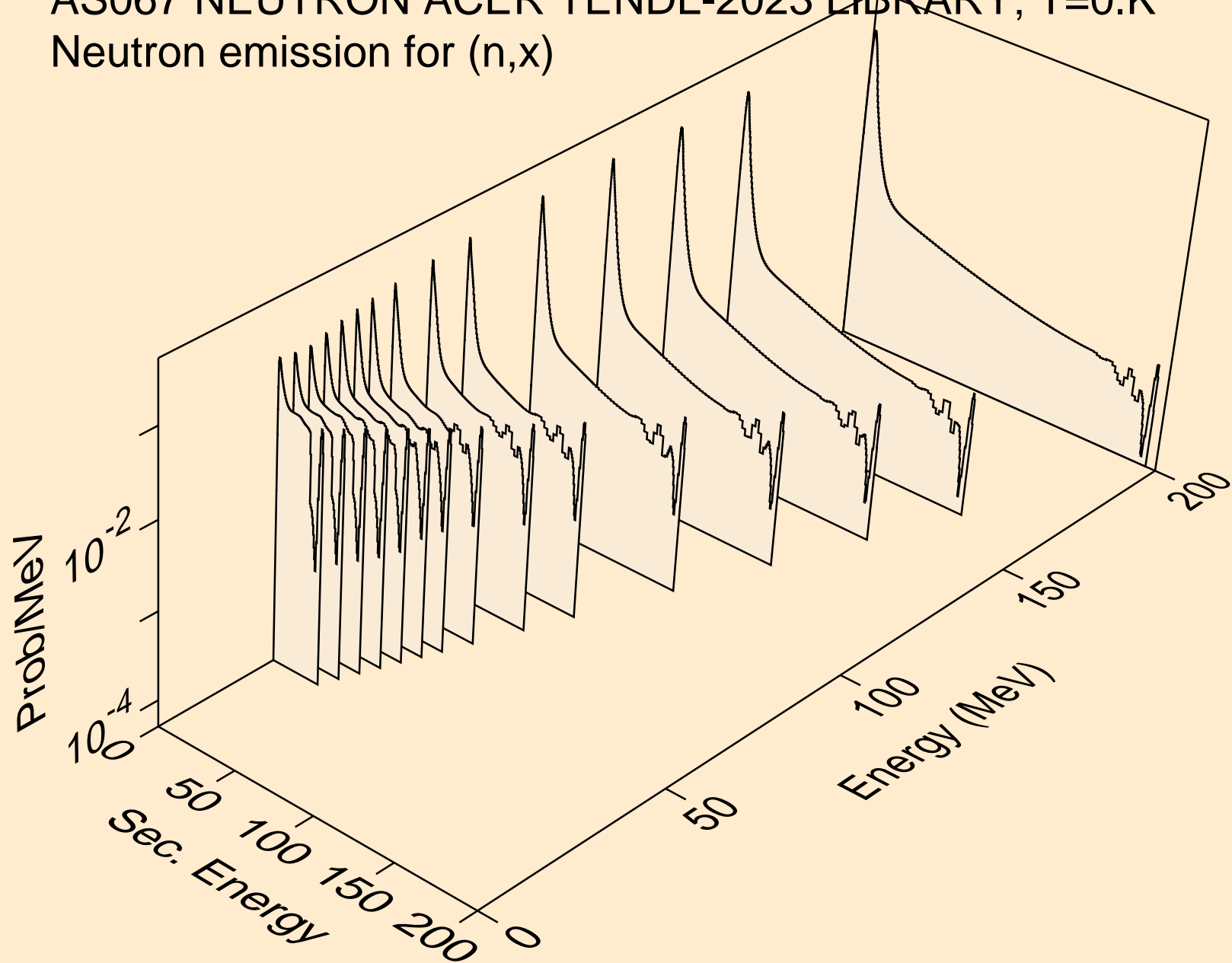

AS067 NEUTRON ACER TENDL-2023 LIBRARY; T=0.K
Neutron emission for (n,2nd)

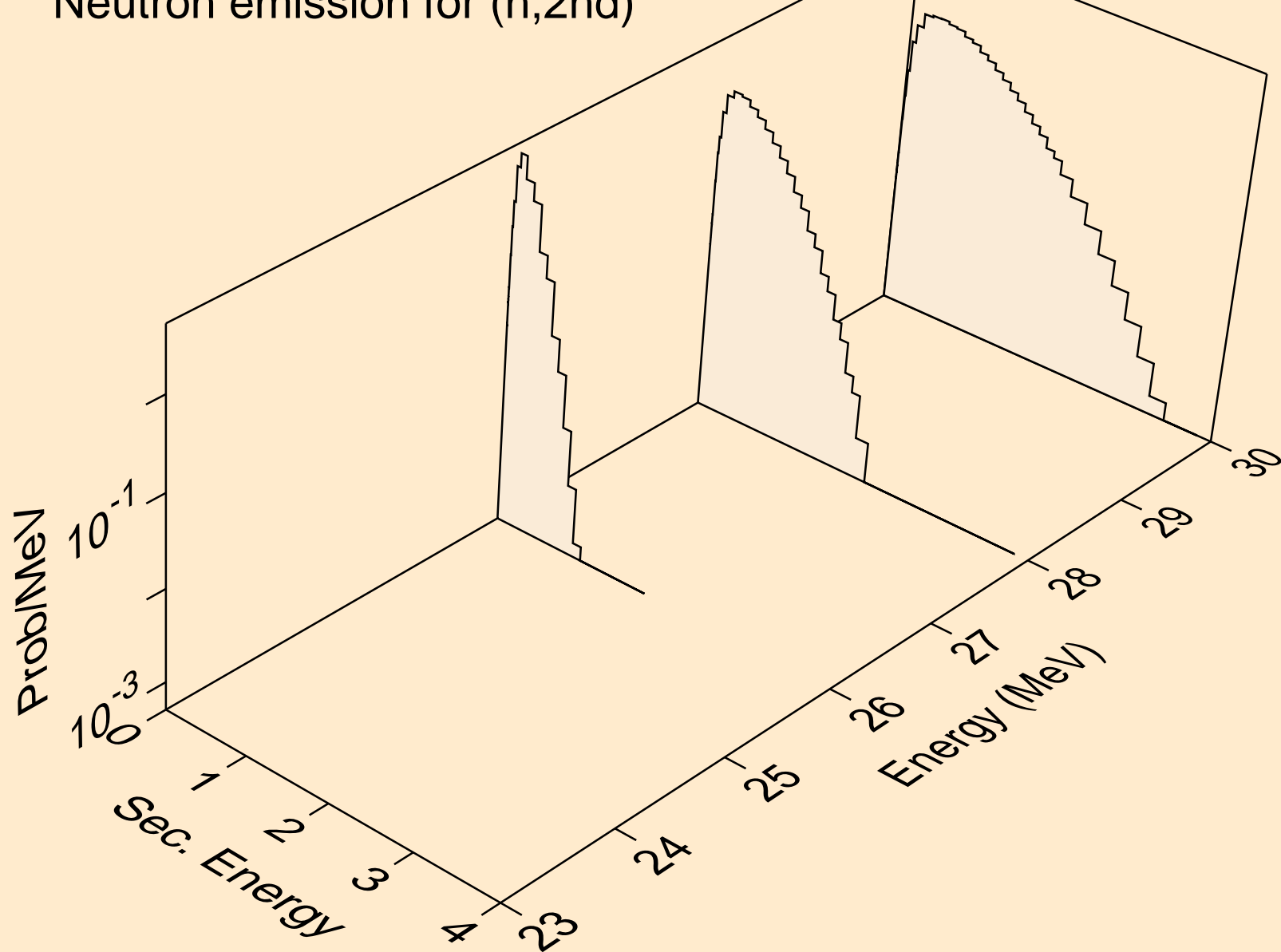

AS067 NEUTRON ACER TENDL-2023 LIBRARY; T=0.K
Neutron emission for (n,2n)

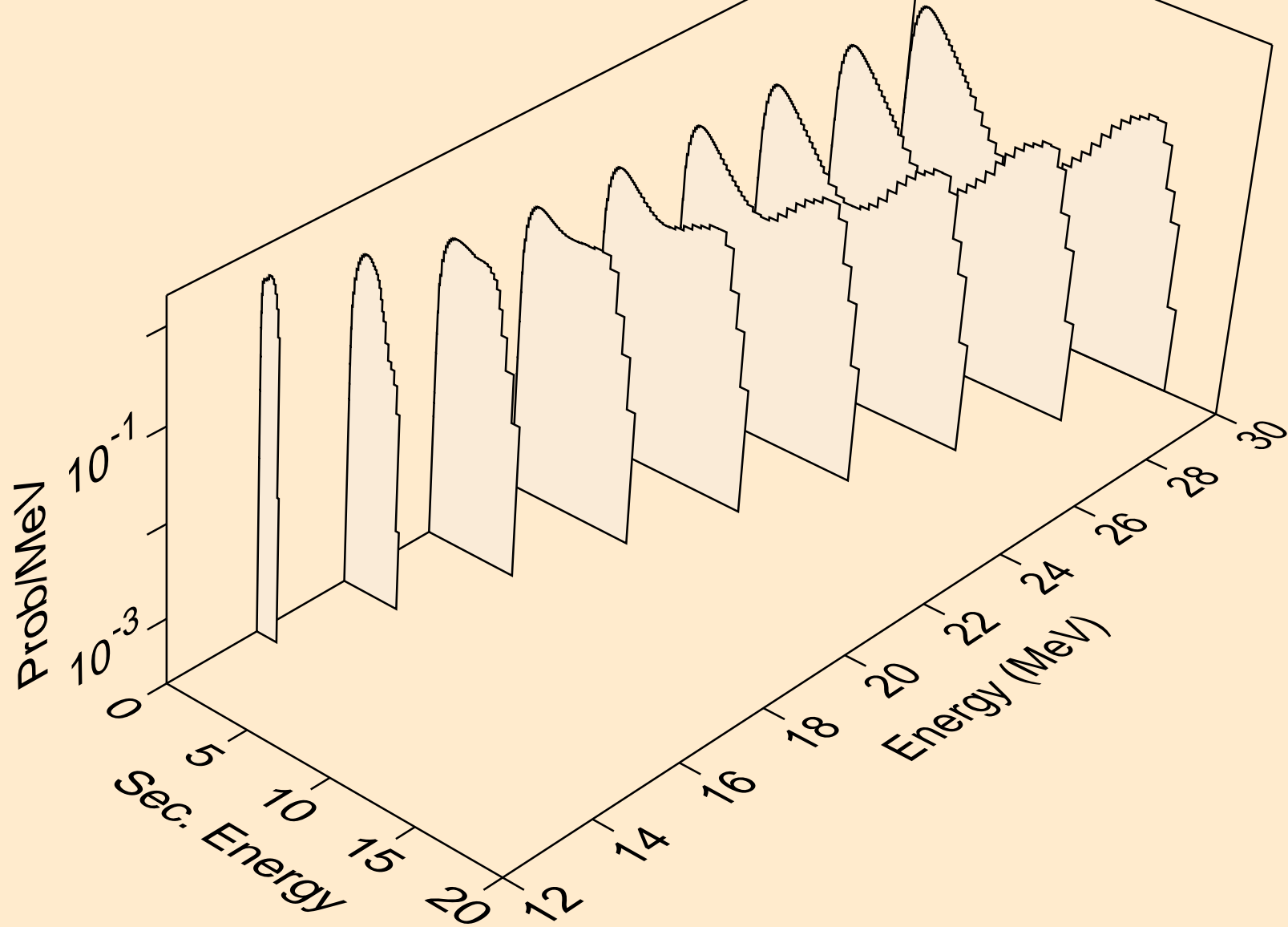

AS067 NEUTRON ACER TENDL-2023 LIBRARY; T=0.K
Neutron emission for (n,3n)

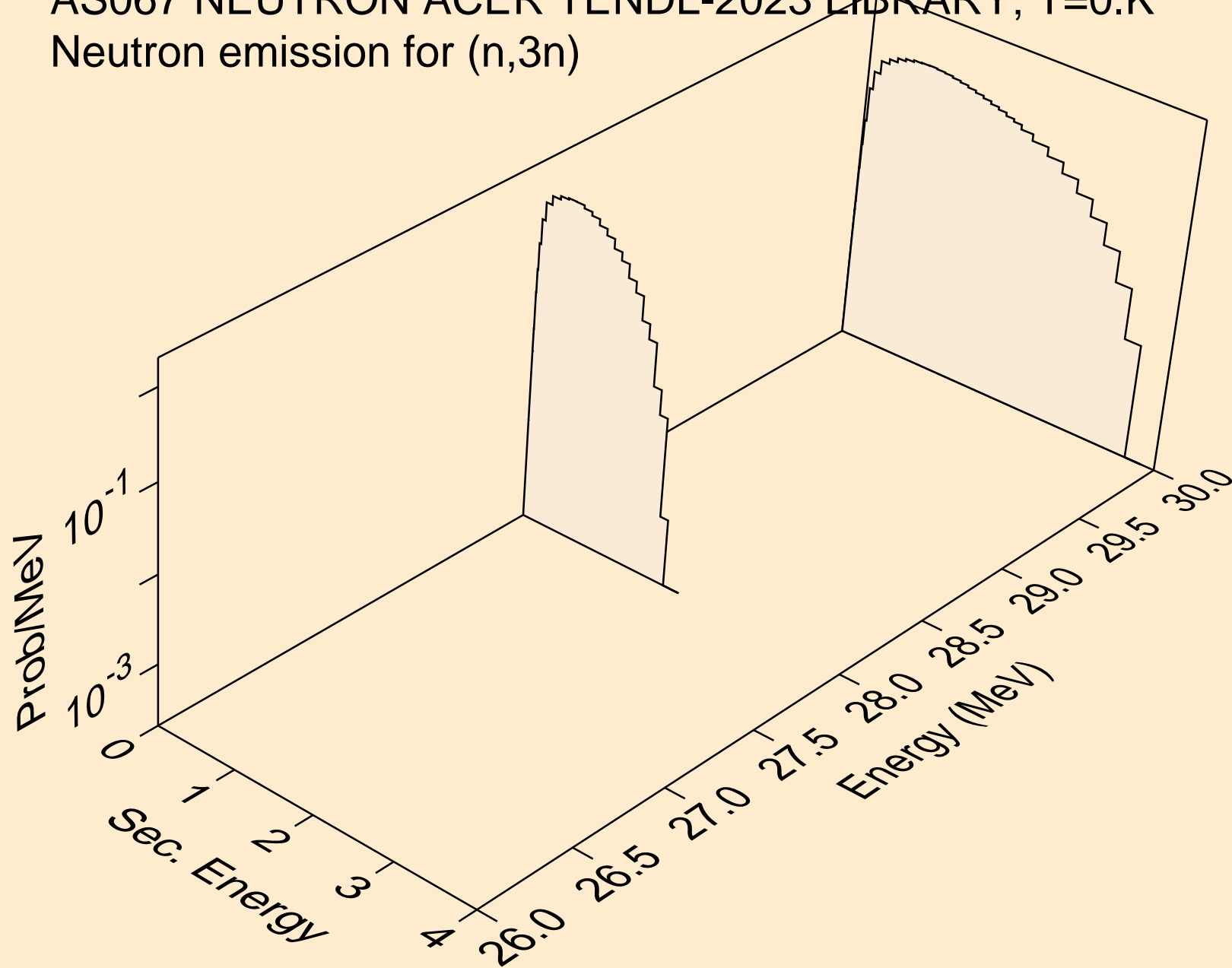

AS067 NEUTRON ACER TENDL-2023 LIBRARY; T=0.K
Neutron emission for (n,n*)a

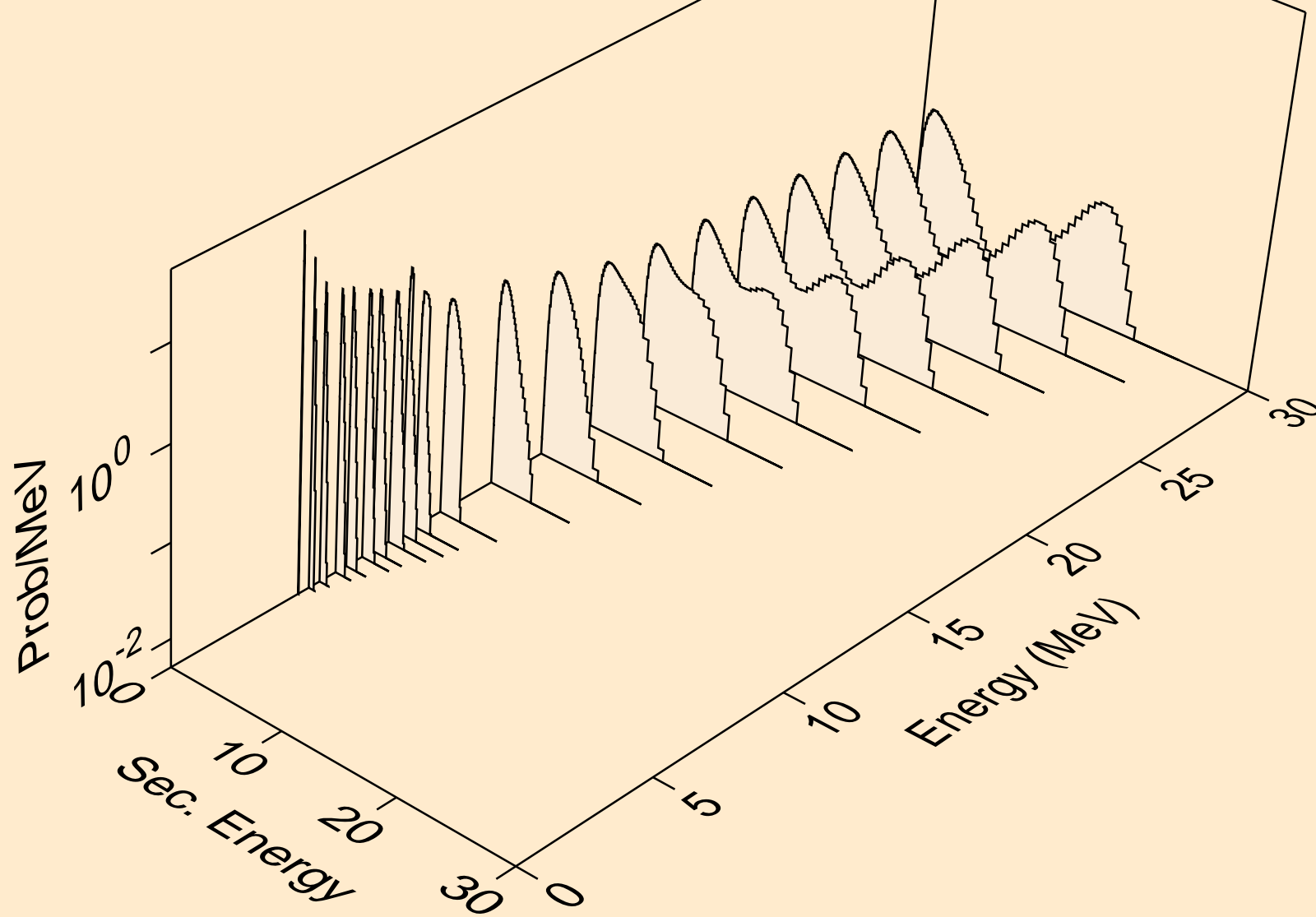

AS067 NEUTRON ACER TENDL-2023 LIBRARY; T=0.K
Neutron emission for (n,2n)a

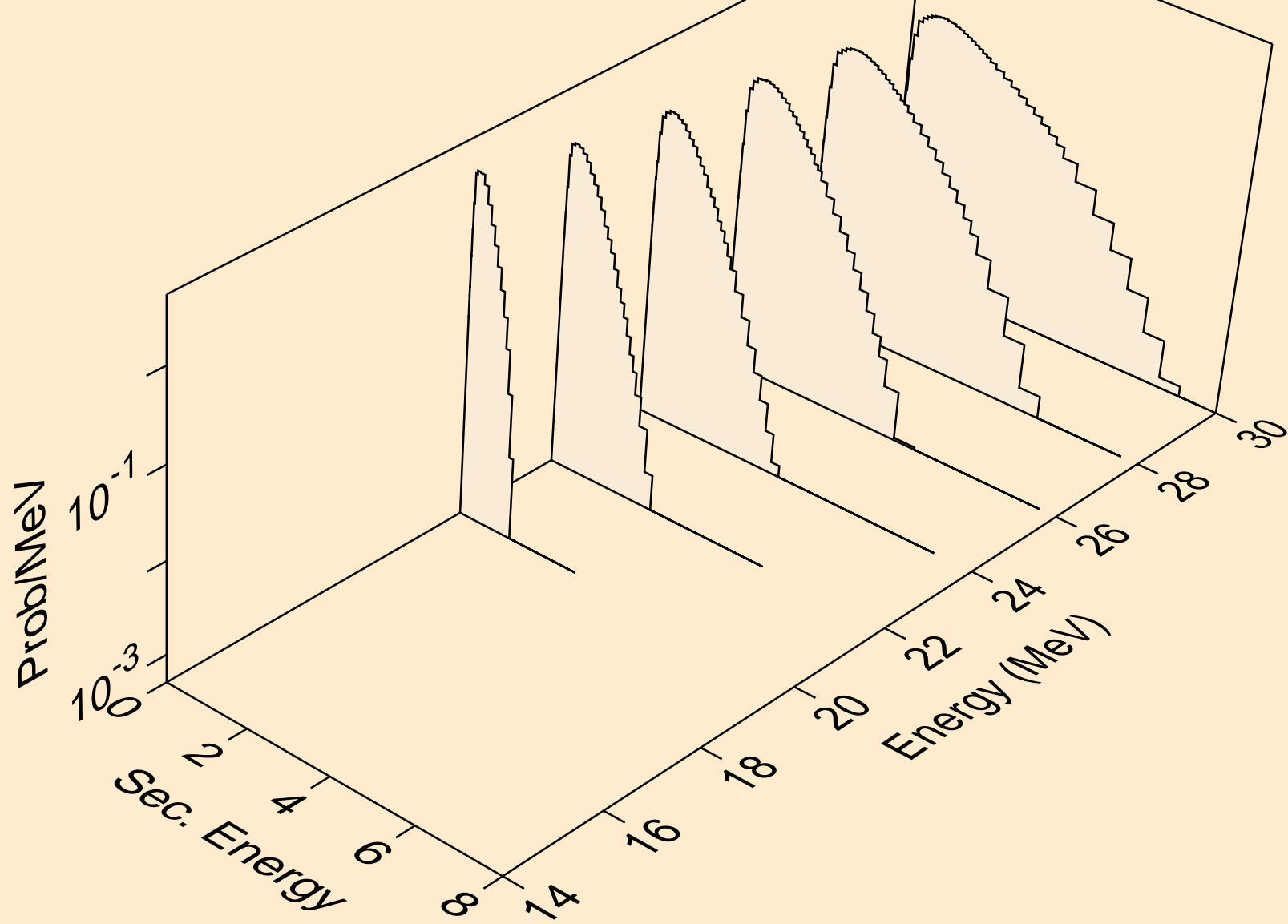

AS067 NEUTRON ACER TENDL-2023 LIBRARY; T=0.K
Neutron emission for (n,n*)p

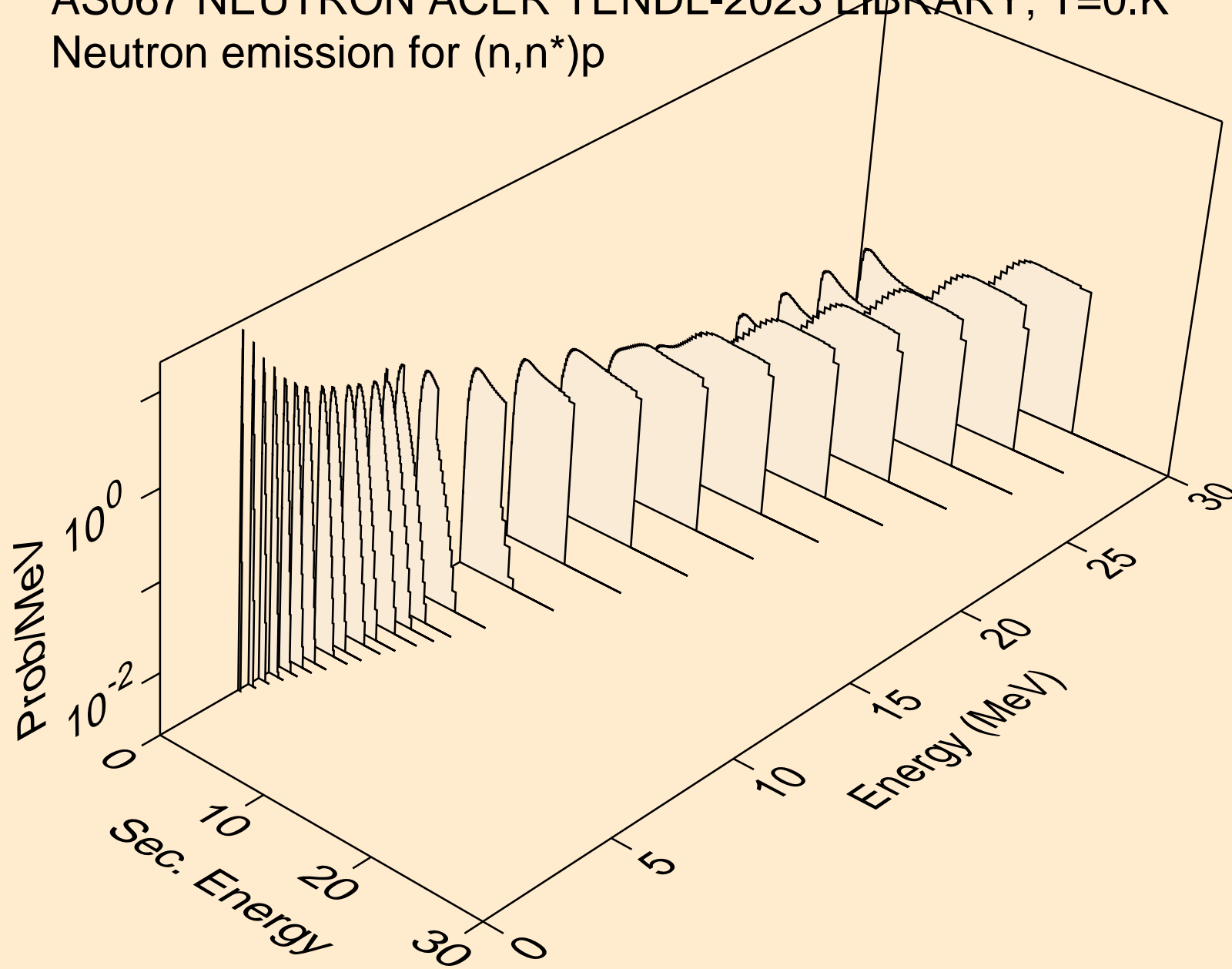

AS067 NEUTRON ACER TENDL-2023 LIBRARY; T=0.K
Neutron emission for (n,n*)2a

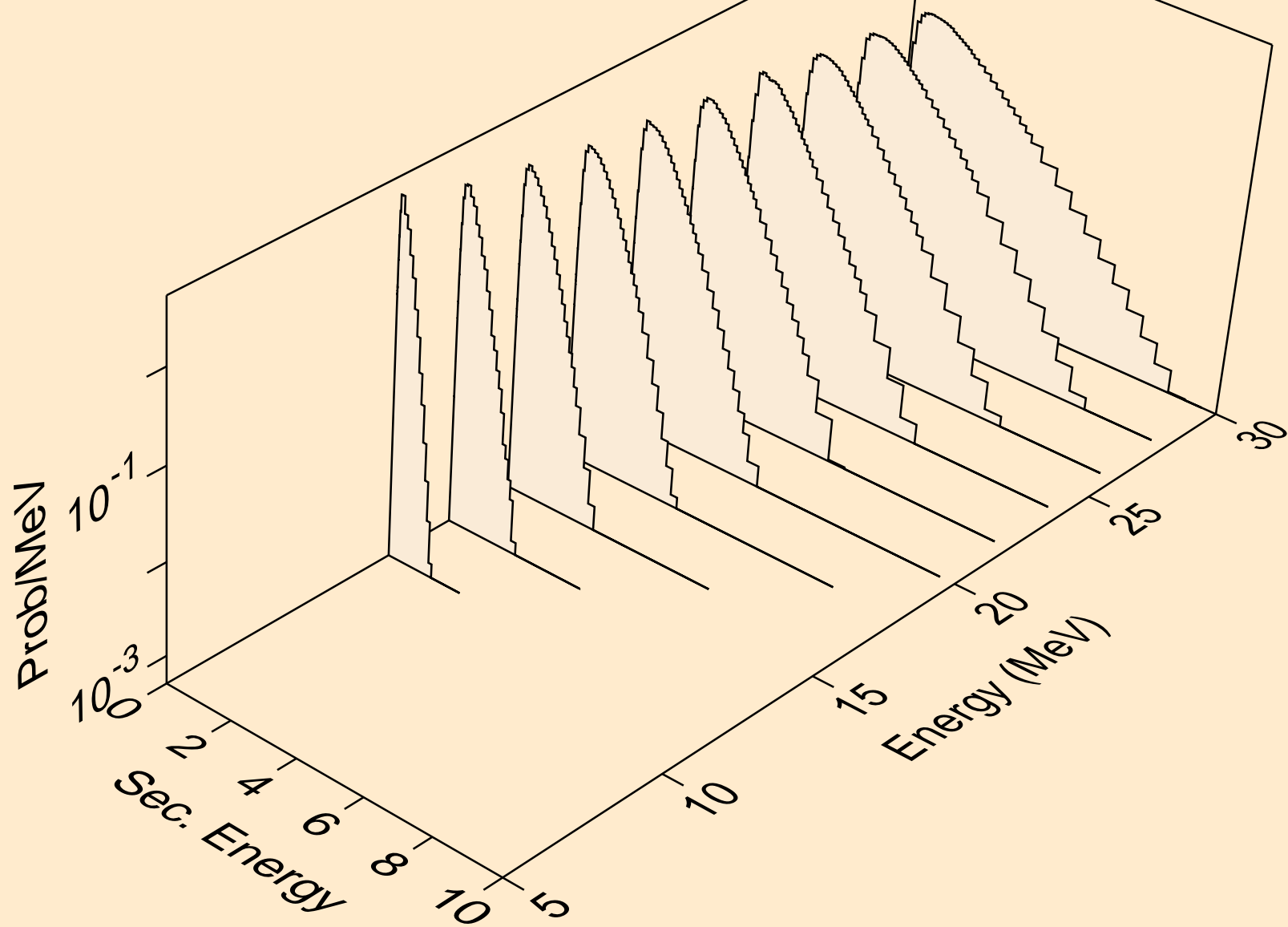

AS067 NEUTRON ACER TENDL-2023 LIBRARY; T=0.K
Neutron emission for (n,n*)d

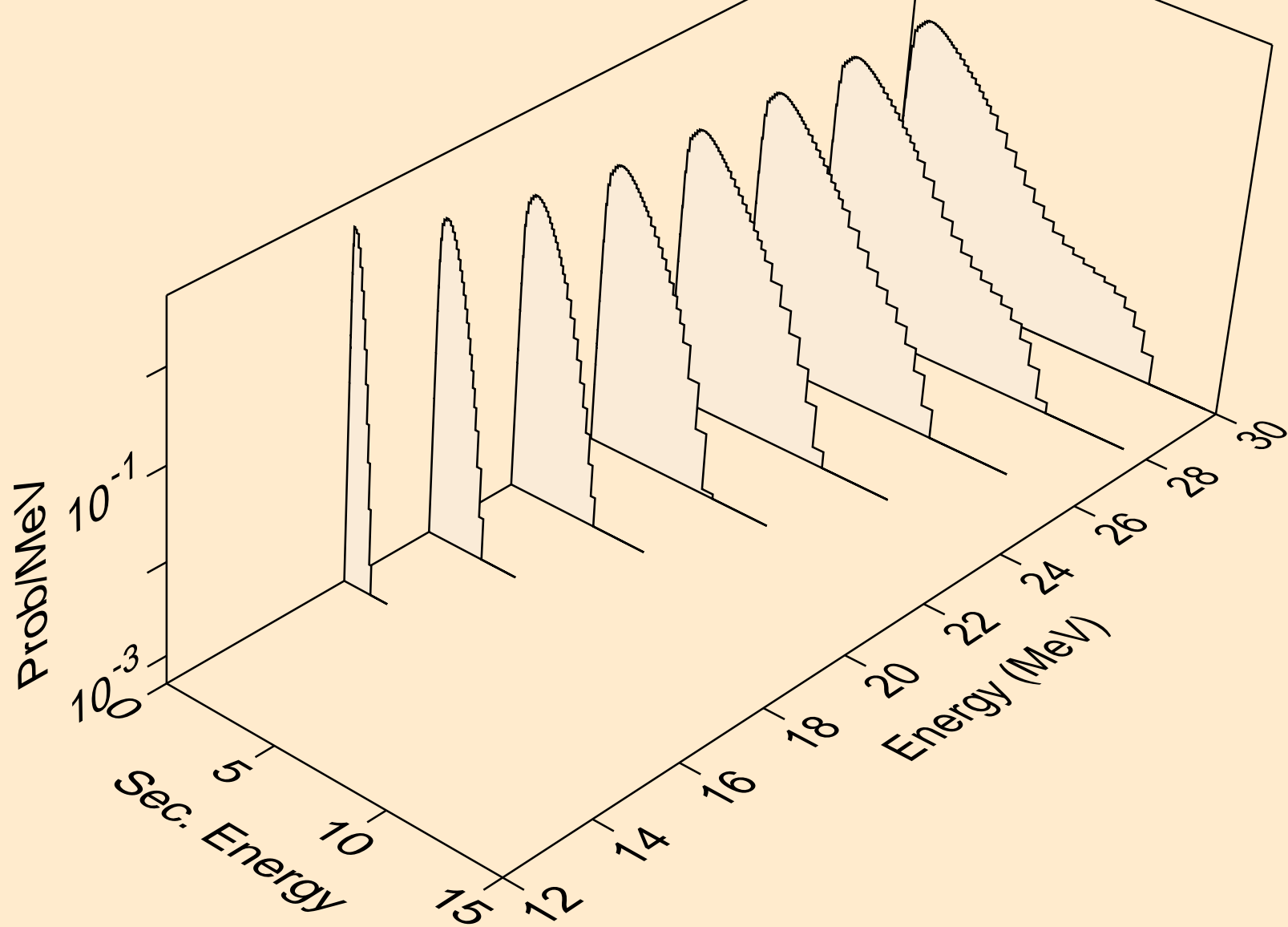

AS067 NEUTRON ACER TENDL-2023 LIBRARY; T=0.K
Neutron emission for (n,n*)t

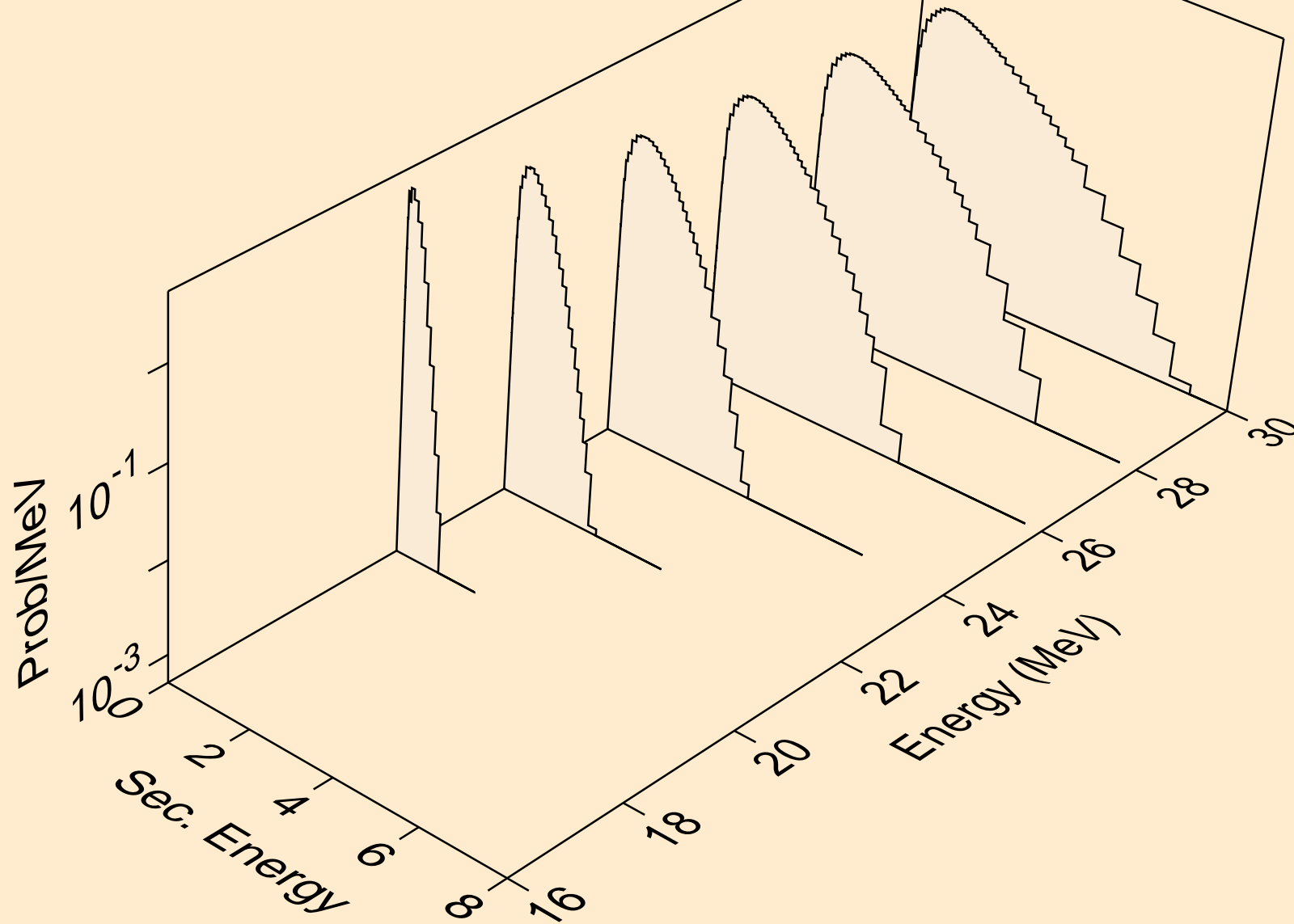

AS067 NEUTRON ACER TENDL-2023 LIBRARY; T=0.K
Neutron emission for (n,n*)he3

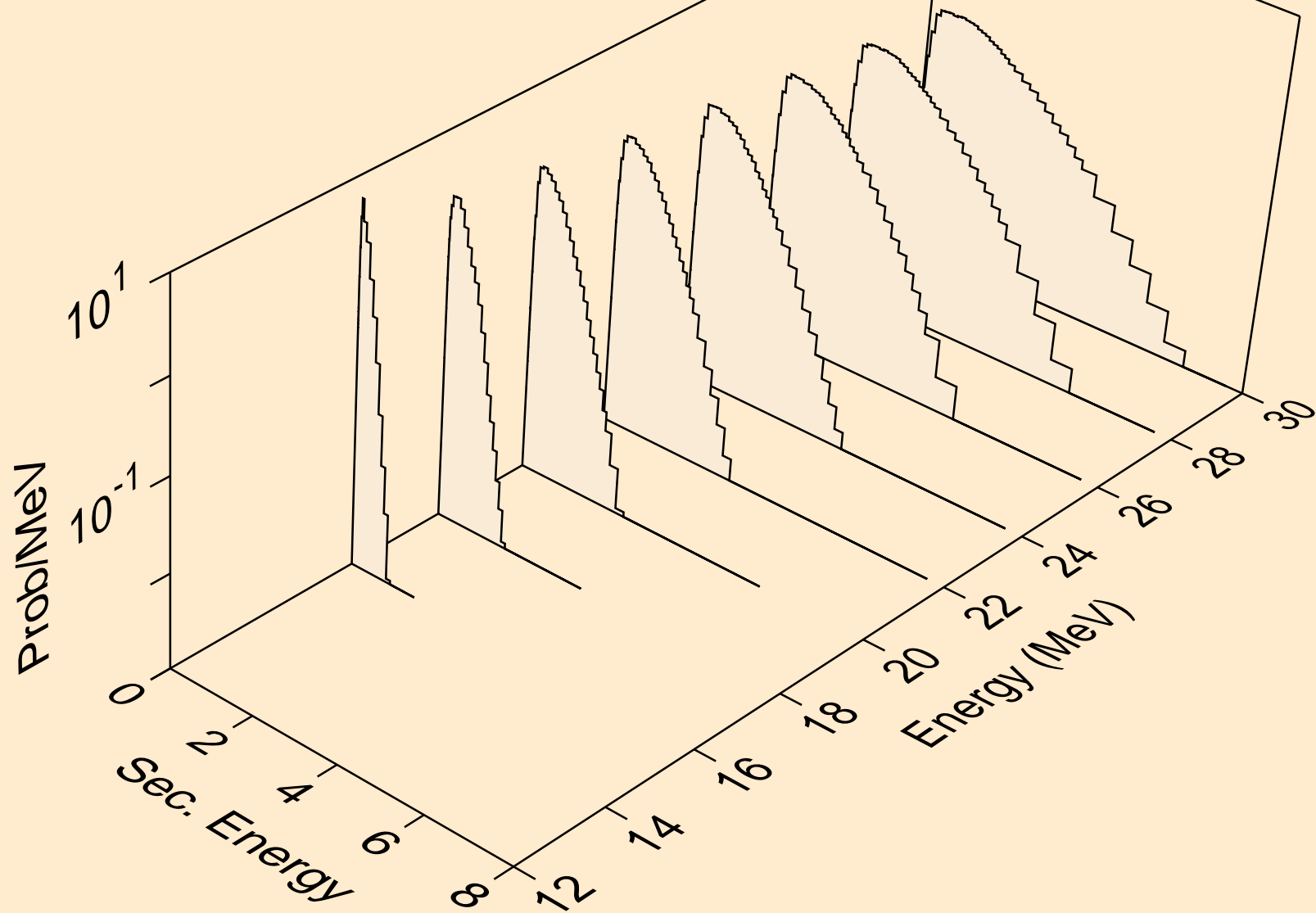

AS067 NEUTRON ACER TENDL-2023 LIBRARY; T=0.K
Neutron emission for (n,2np)

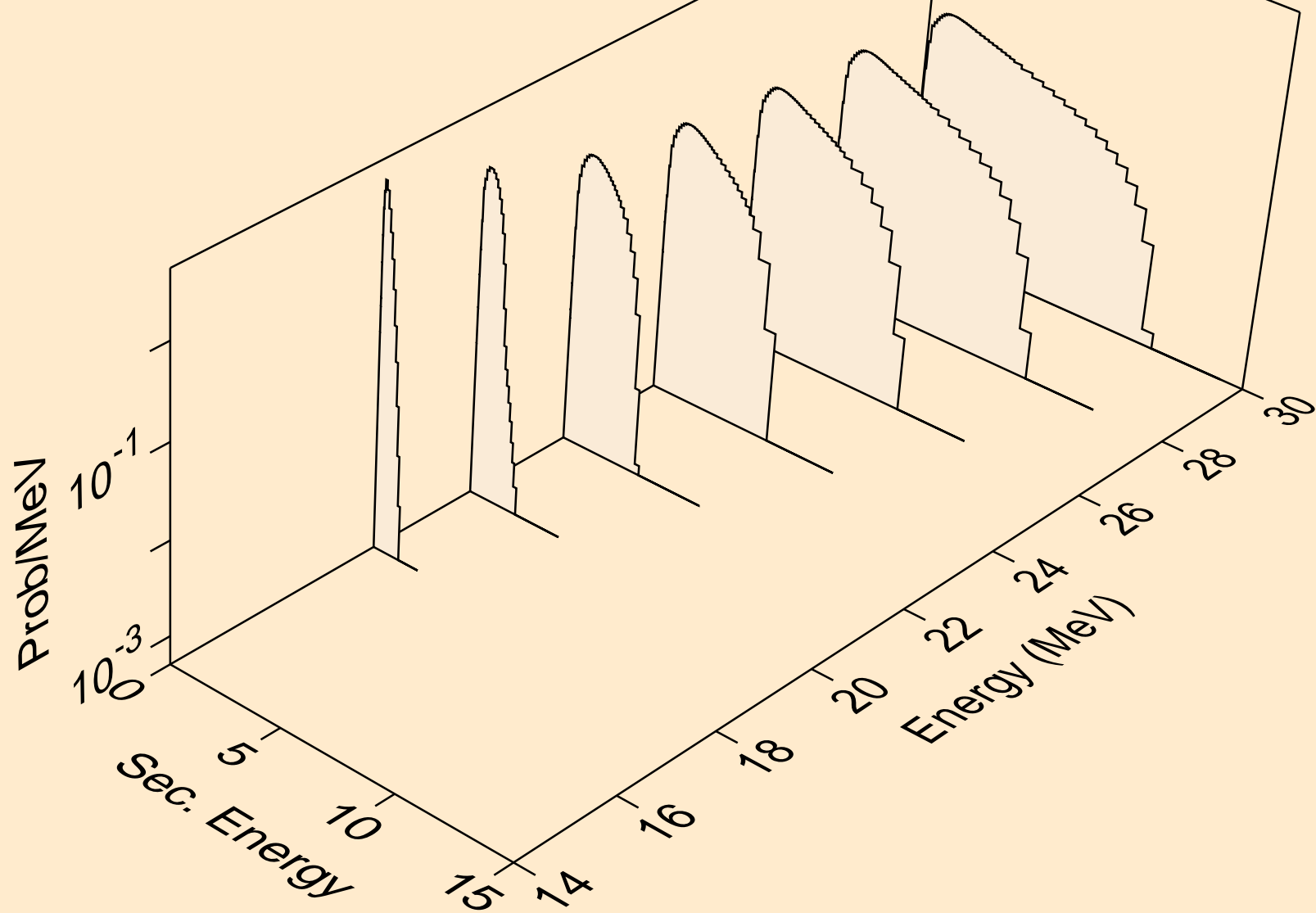

AS067 NEUTRON ACER TENDL-2023 LIBRARY; T=0.K
Neutron emission for (n,3np)

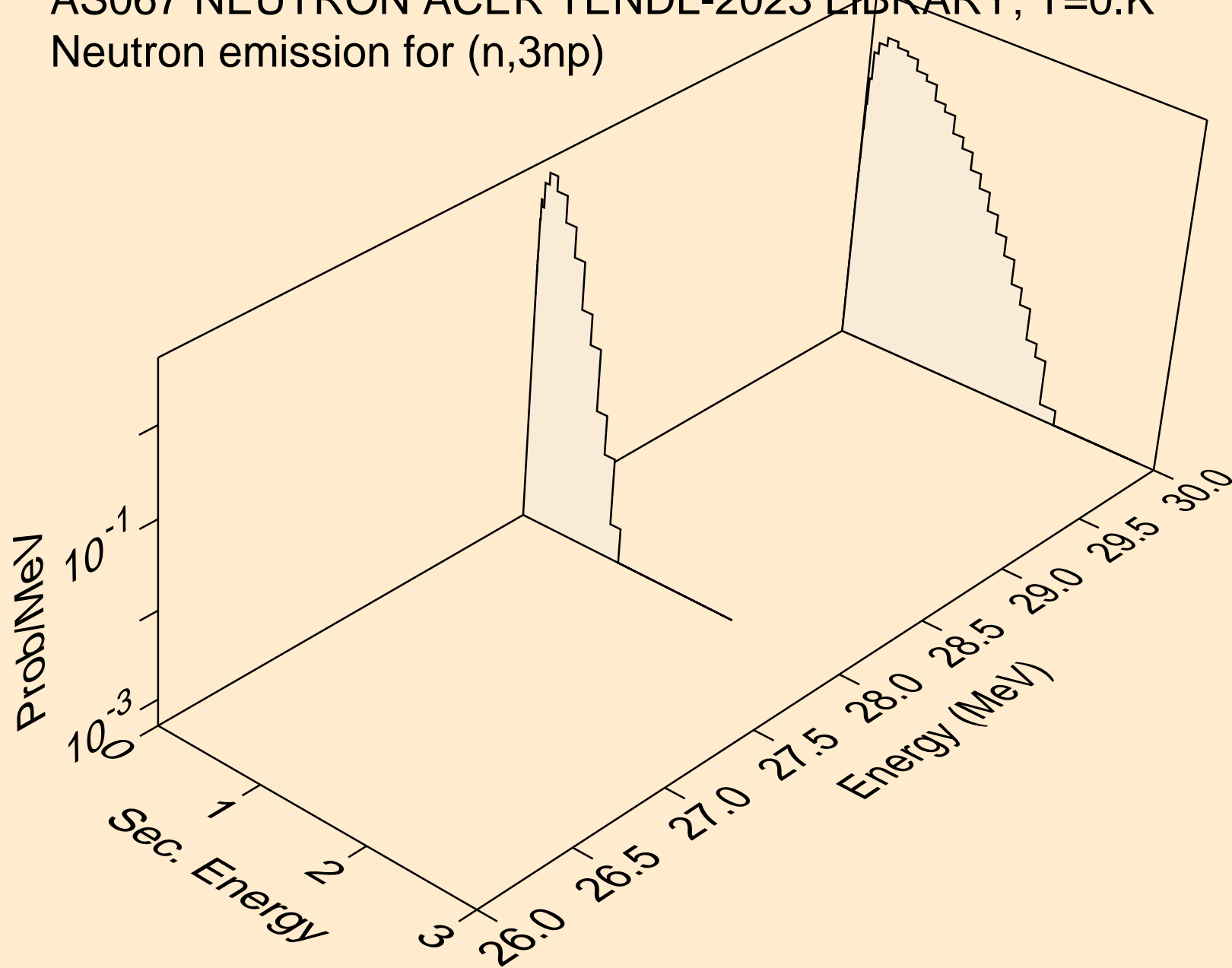

AS067 NEUTRON ACER TENDL-2023 LIBRARY; T=0.K
Neutron emission for (n,n2p)

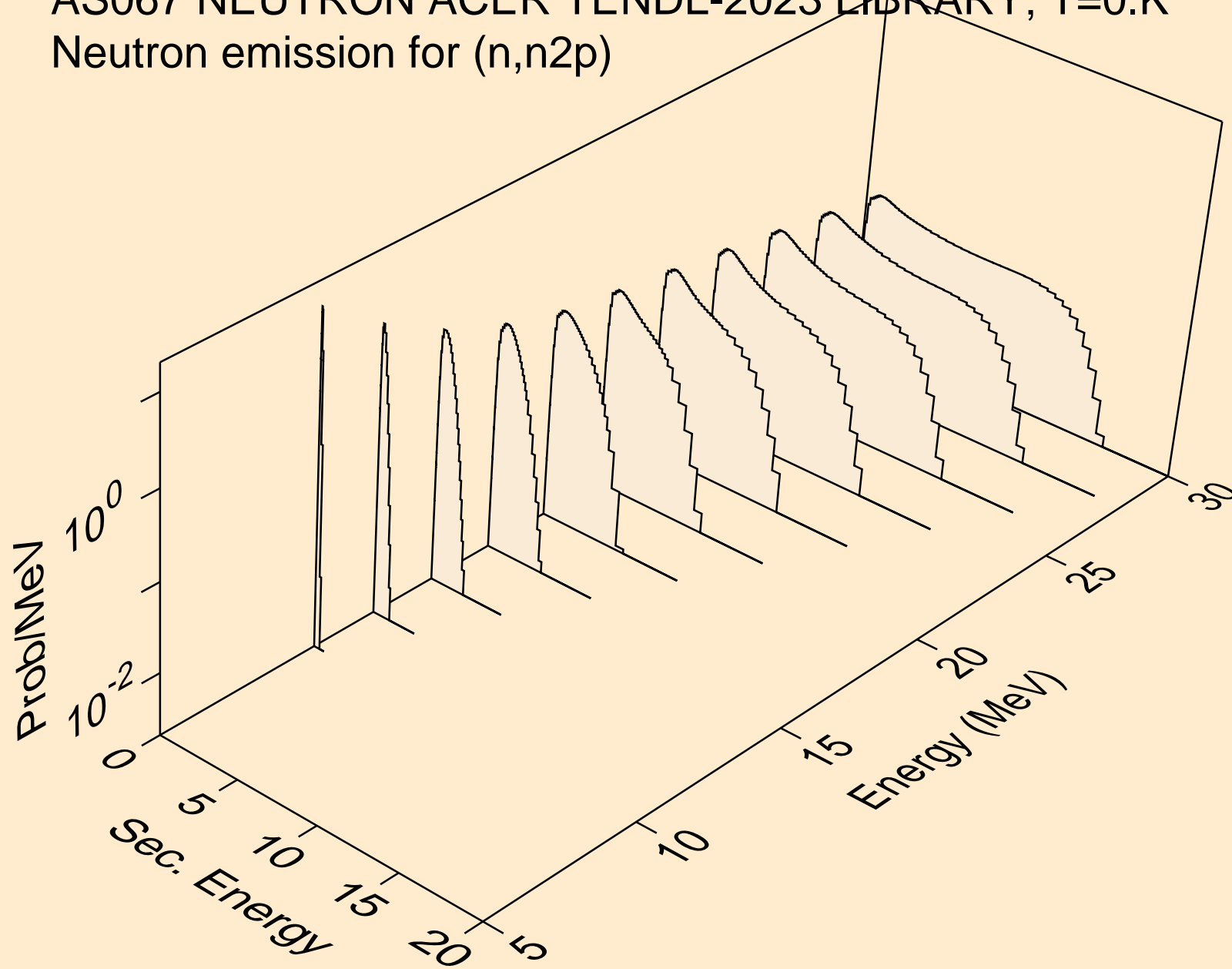

AS067 NEUTRON ACER TENDL-2023 LIBRARY; T=0.K
Neutron emission for (n,npa)

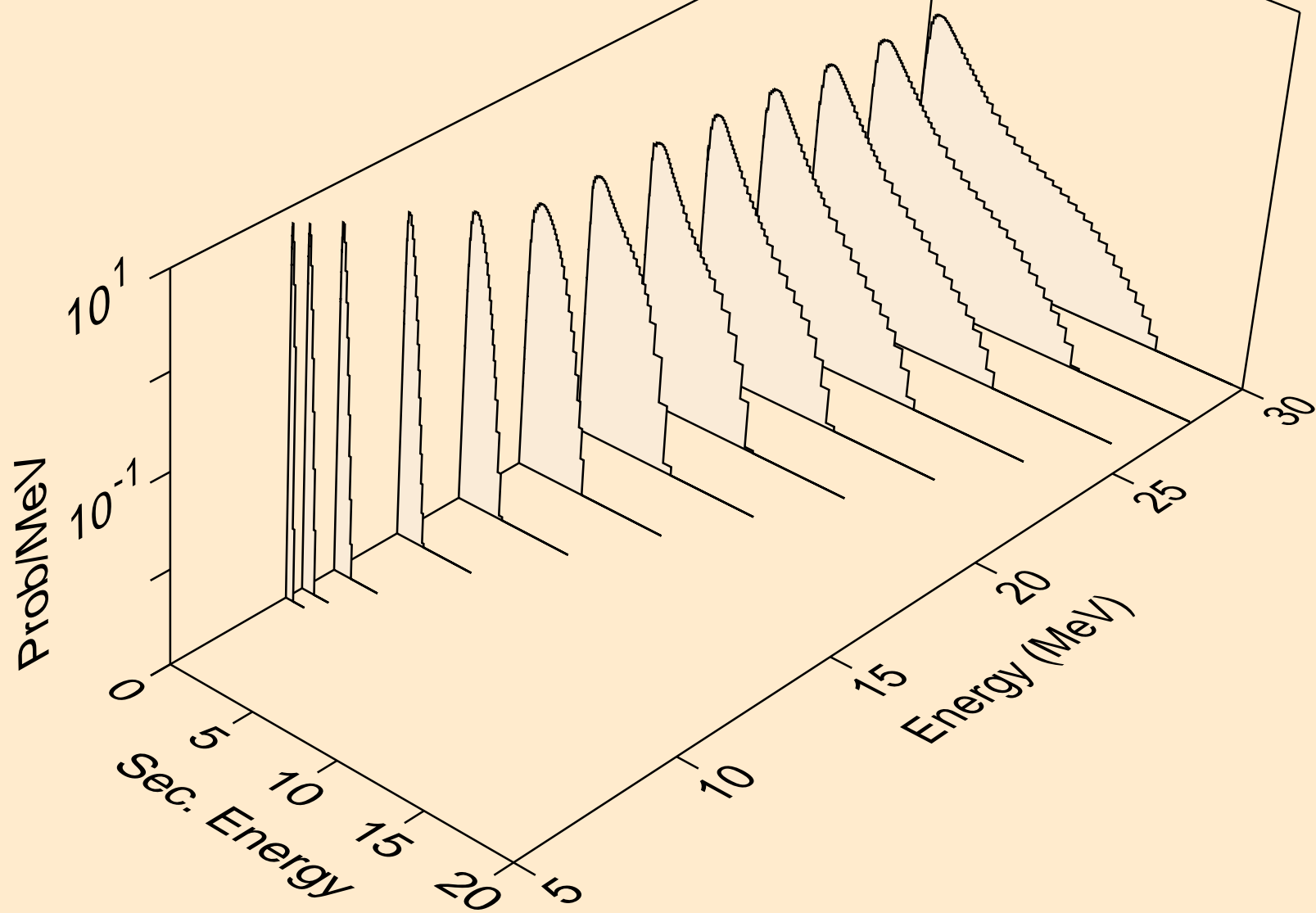

AS067 NEUTRON ACER TENDL-2023 LIBRARY; T=0.K
Neutron emission for (n,n*c)

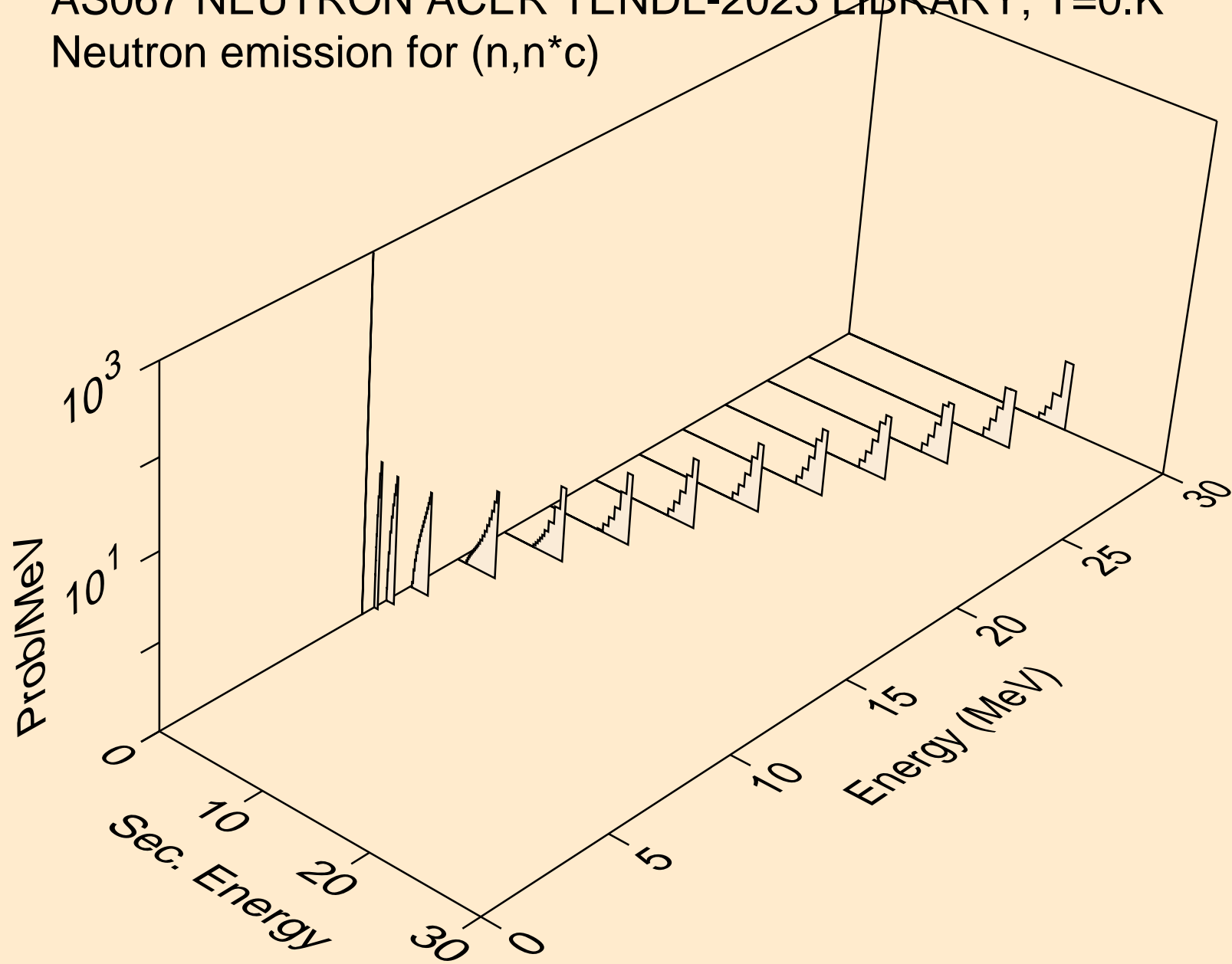

AS067 NEUTRON ACER TENDL-2023 LIBRARY; T=0.K
Photon emission for (n,x)

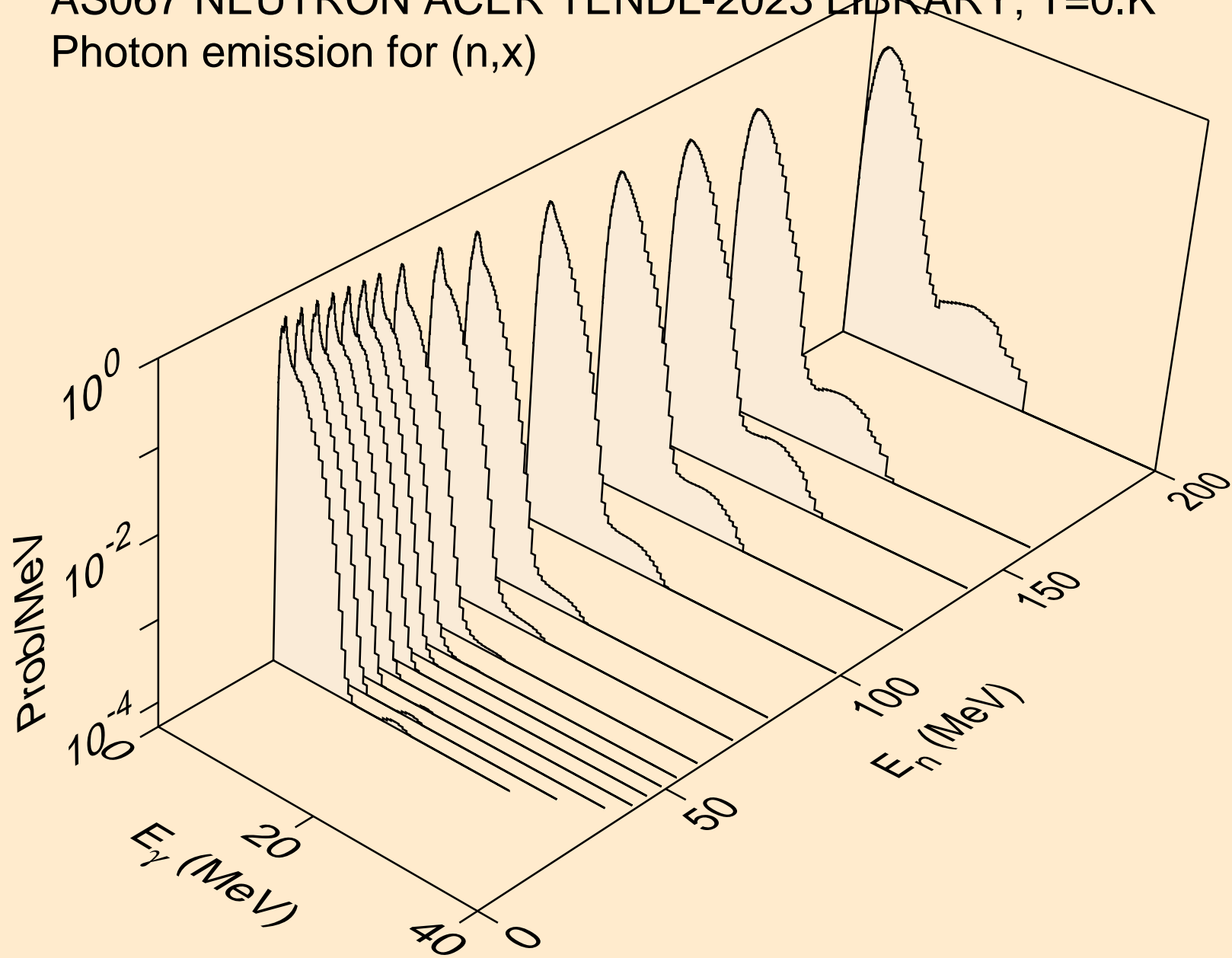

AS067 NEUTRON ACER TENDL-2023 LIBRARY; T=0.K
Photon emission for (n,2nd)

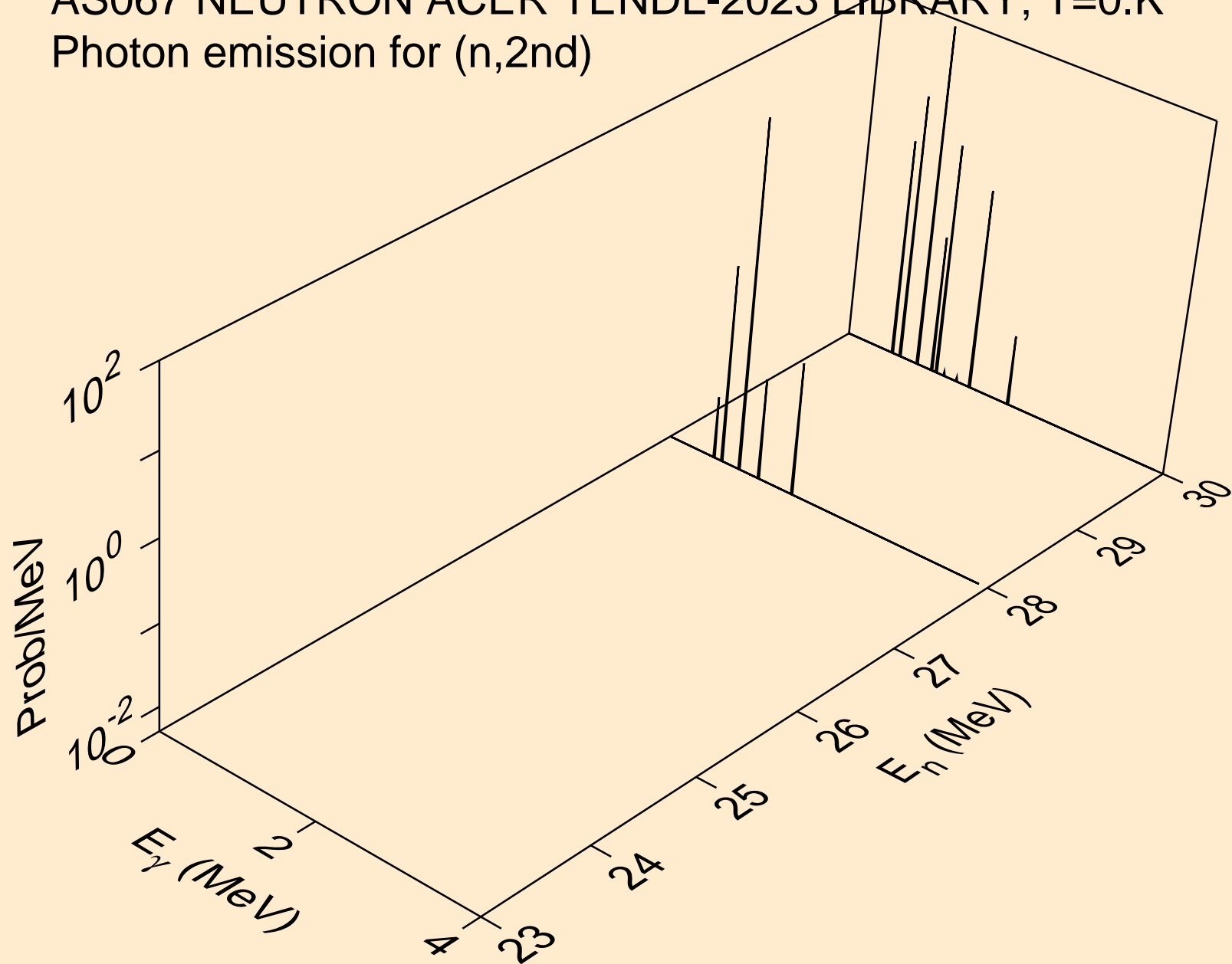

AS067 NEUTRON ACER TENDL-2023 LIBRARY; T=0.K
Photon emission for (n,2n)

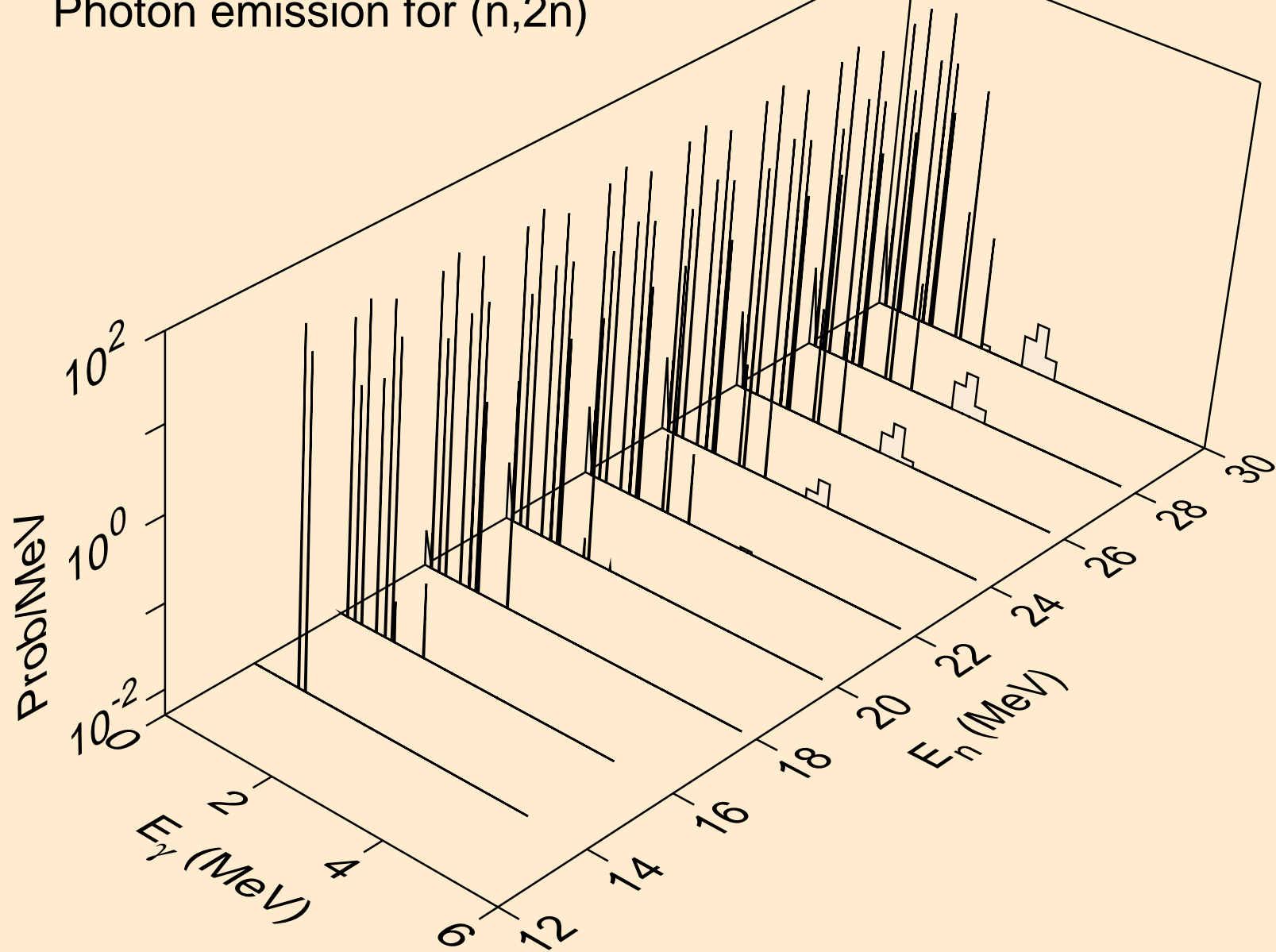

AS067 NEUTRON ACER TENDL-2023 LIBRARY; T=0.K
Photon emission for (n,3n)

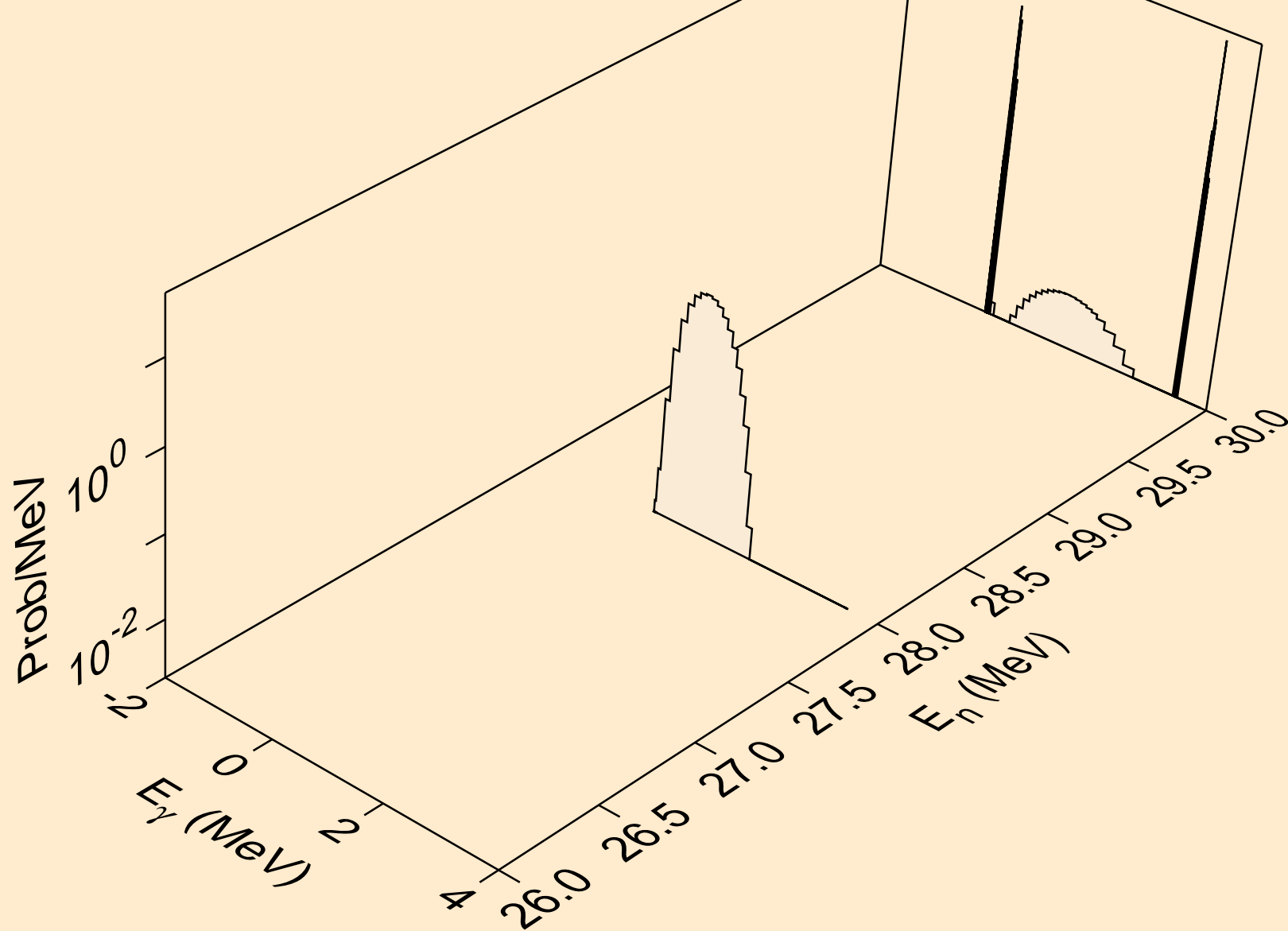

AS067 NEUTRON ACER TENDL-2023 LIBRARY; T=0.K
Photon emission for (n,n*)a

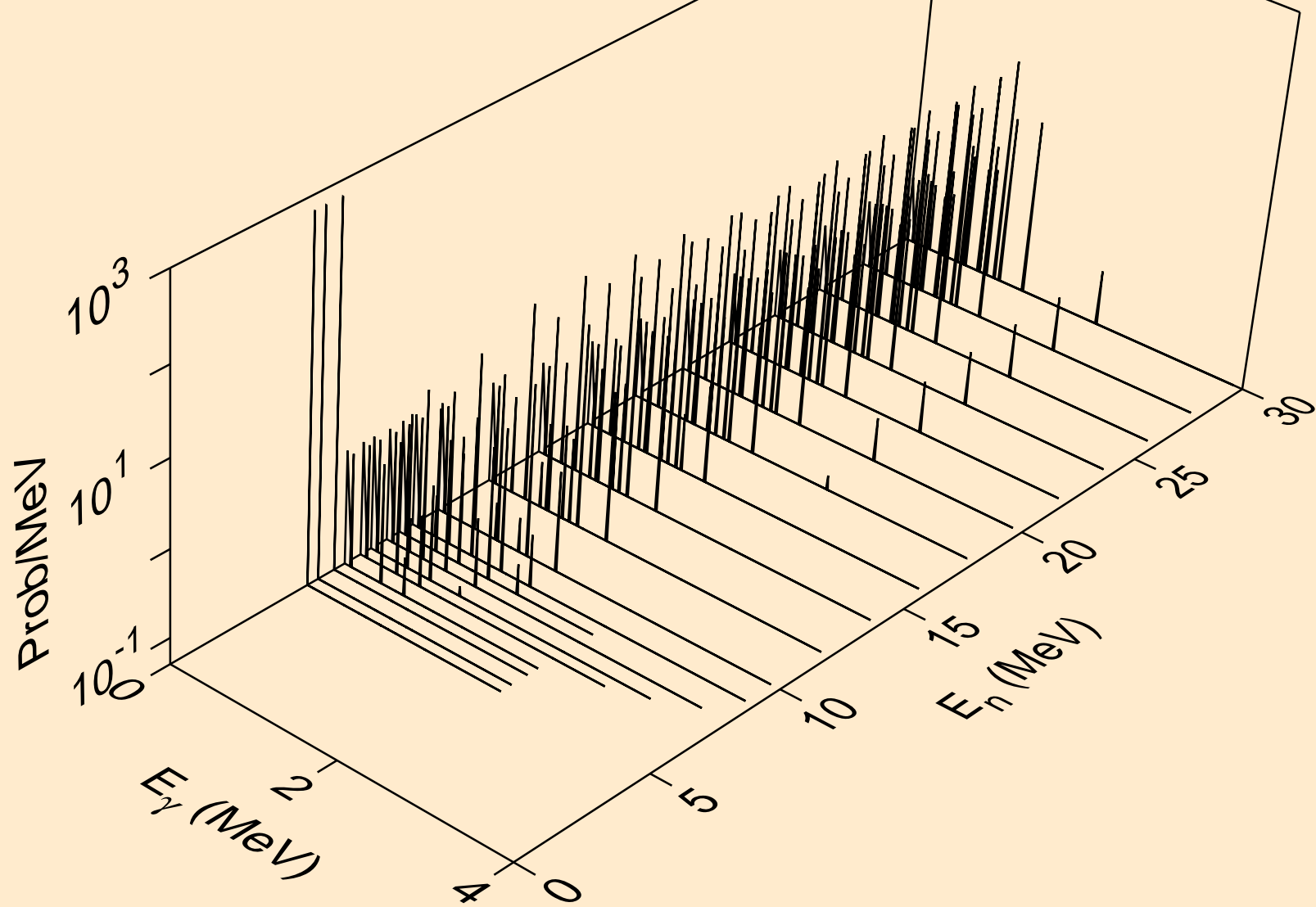

AS067 NEUTRON ACER TENDL-2023 LIBRARY; T=0.K
Photon emission for (n,2n)a

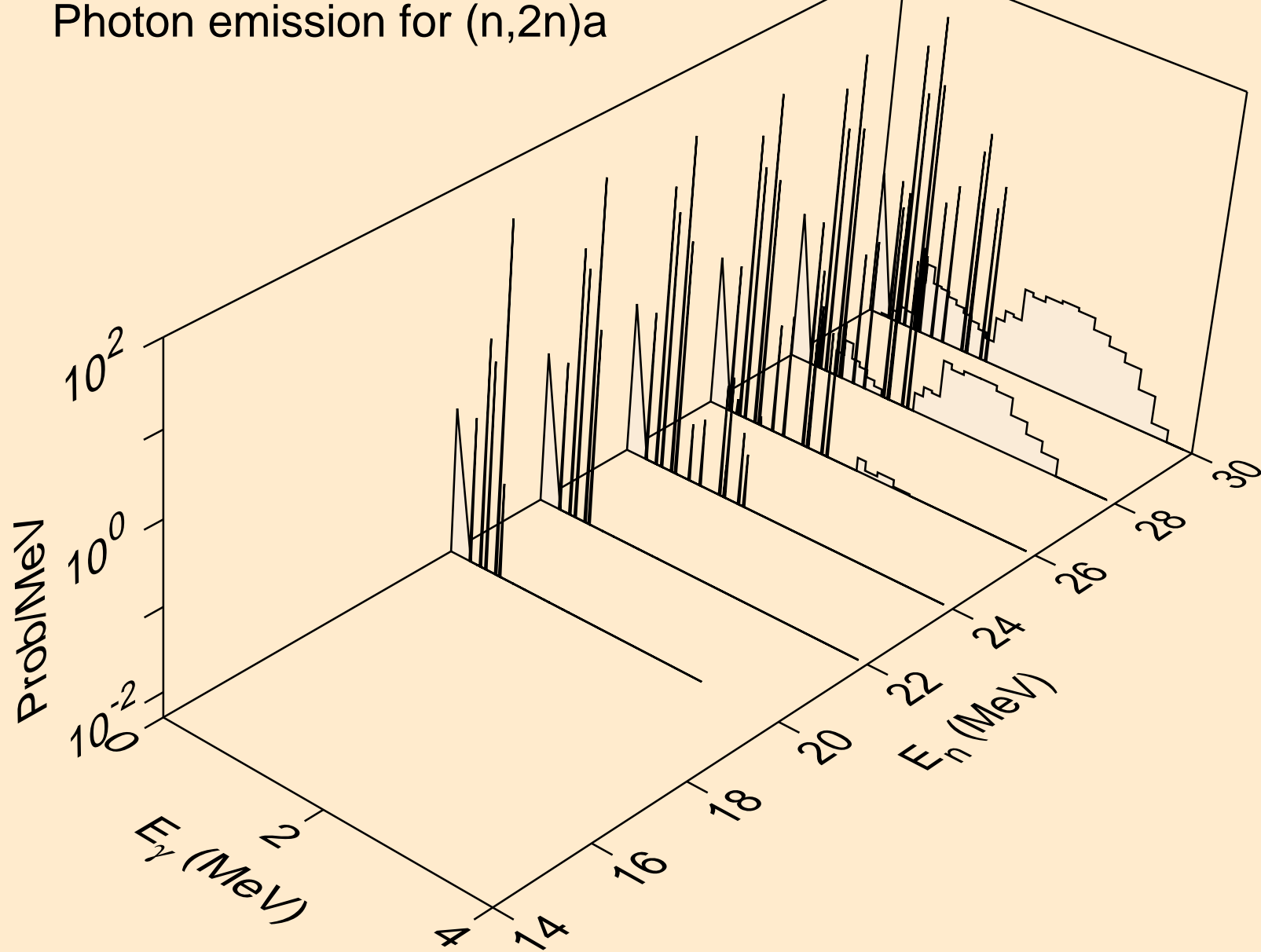

AS067 NEUTRON ACER TENDL-2023 LIBRARY; T=0.K
Photon emission for (n,n*)p

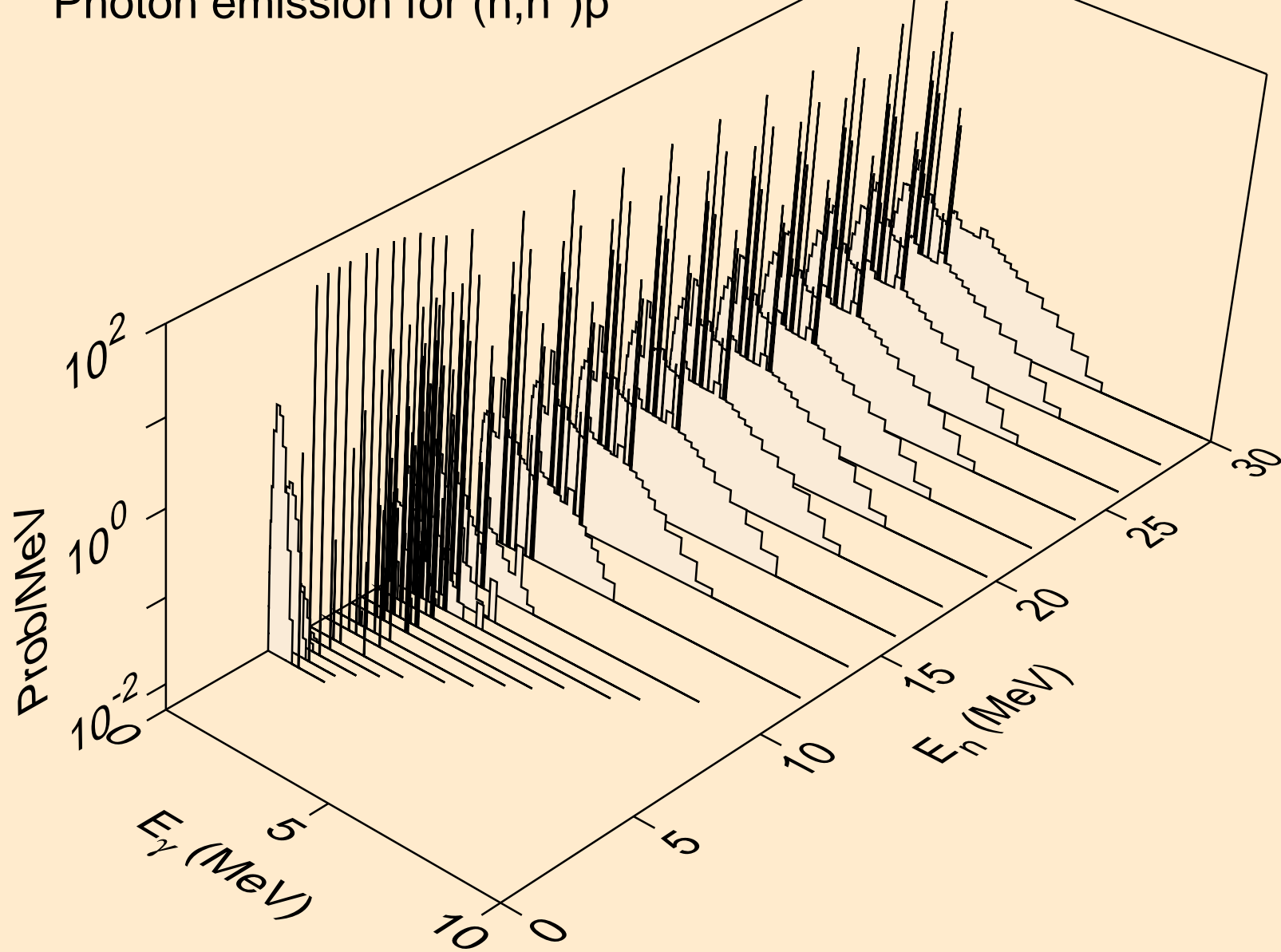

AS067 NEUTRON ACER TENDL-2023 LIBRARY; T=0.K
Photon emission for (n,n*)2a

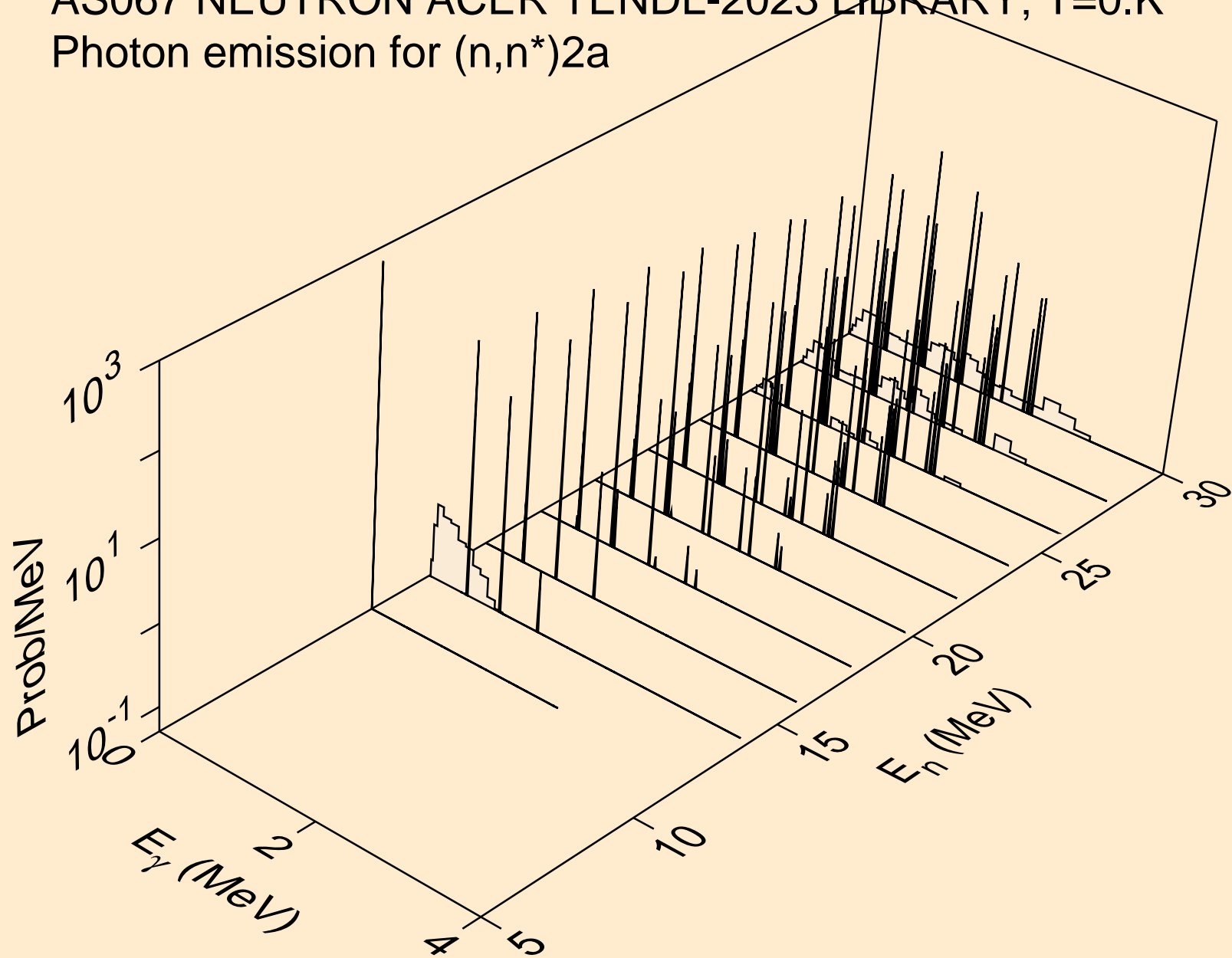

AS067 NEUTRON ACER TENDL-2023 LIBRARY; T=0.K
Photon emission for (n,n*)d

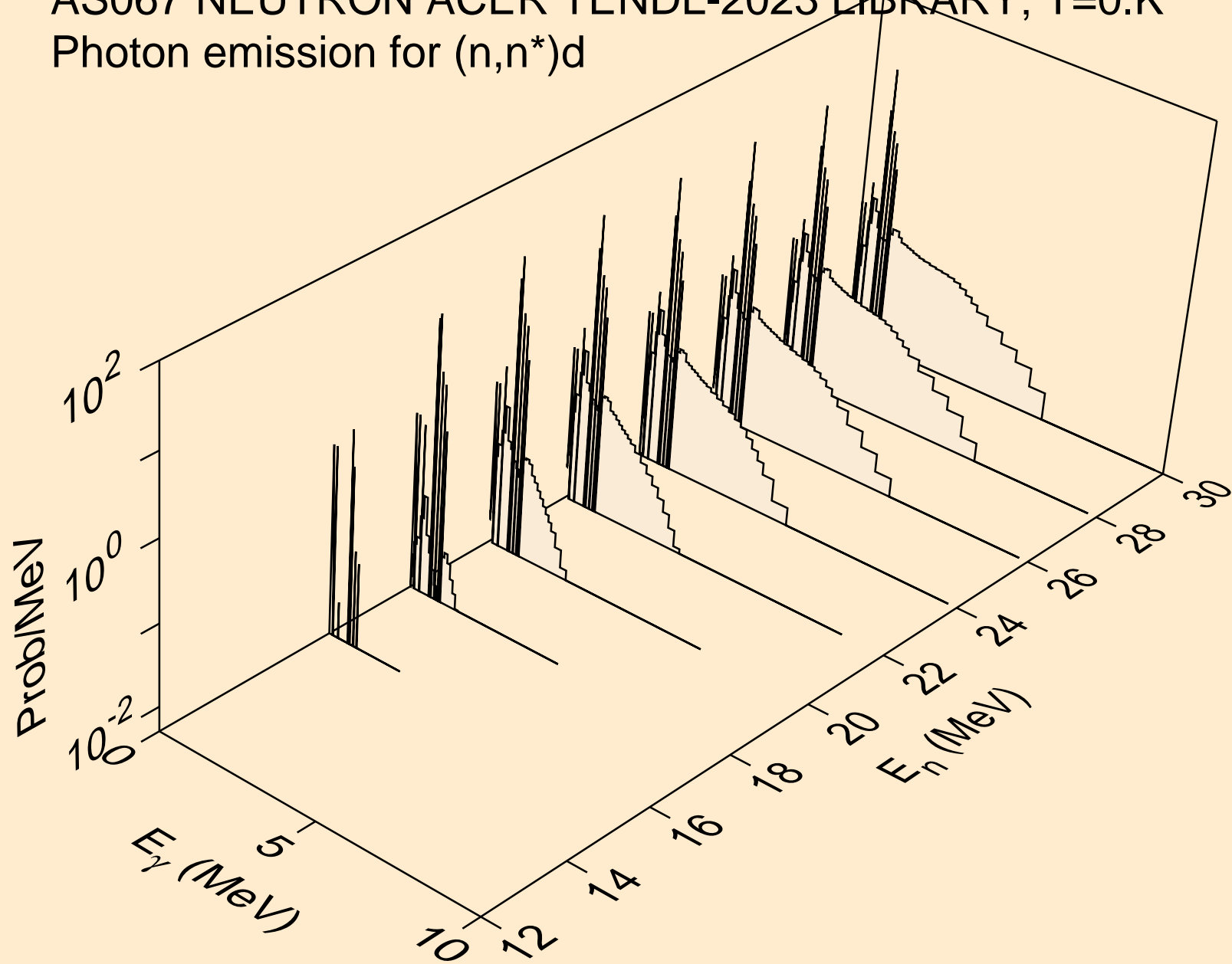

AS067 NEUTRON ACER TENDL-2023 LIBRARY; T=0.K
Photon emission for (n,n*)t

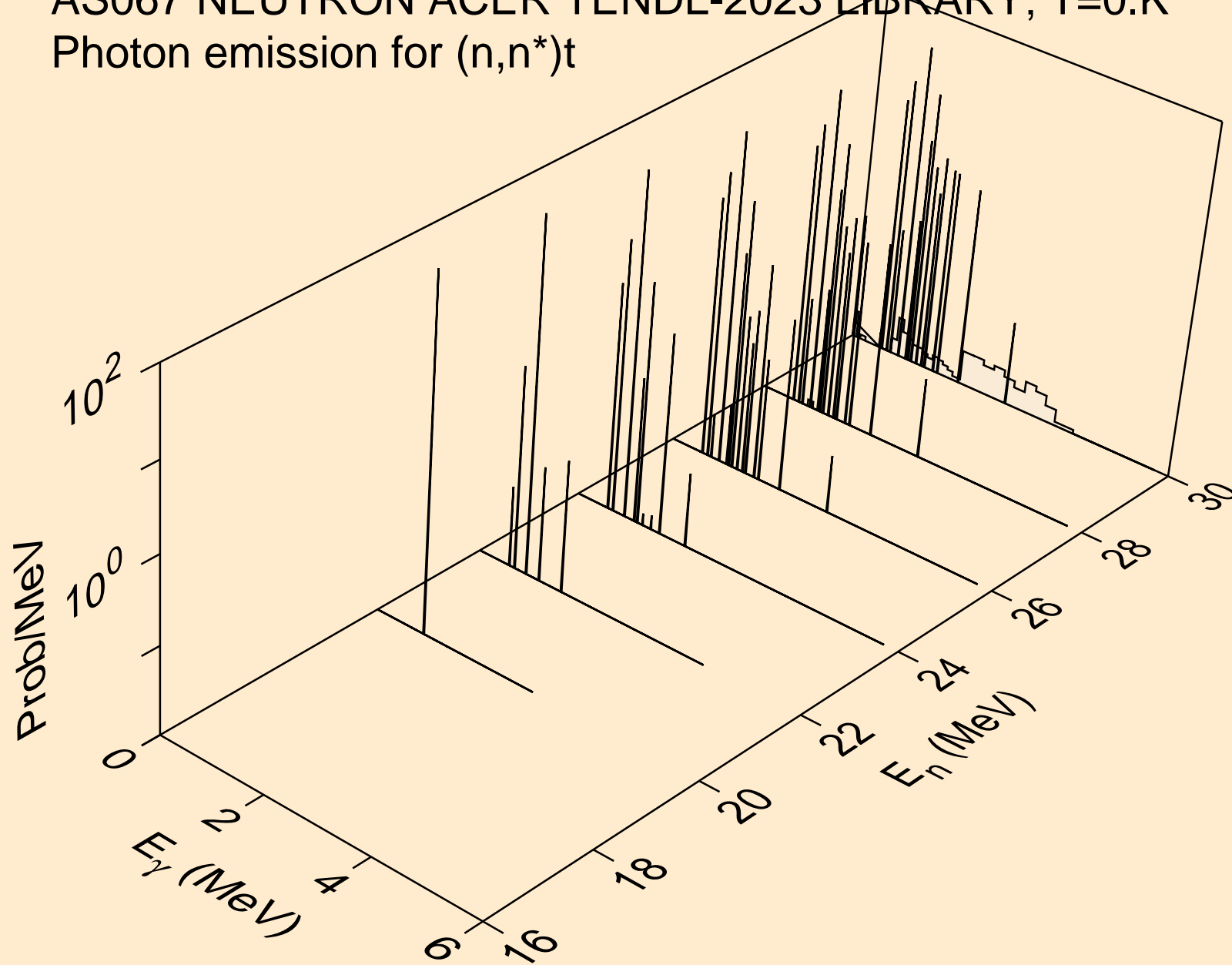

AS067 NEUTRON ACER TENDL-2023 LIBRARY; T=0.K
Photon emission for (n,n*)he3

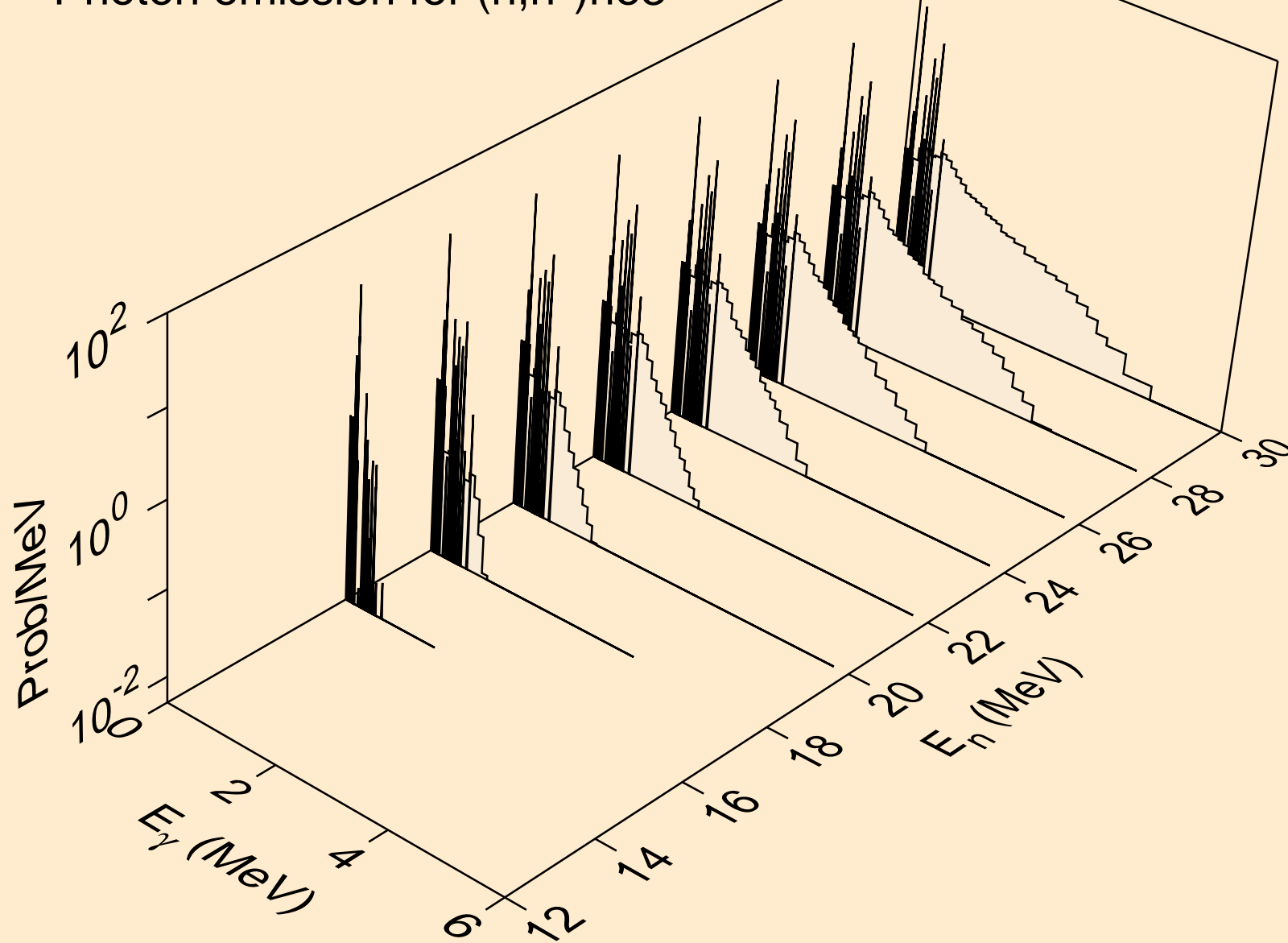

AS067 NEUTRON ACER TENDL-2023 LIBRARY; T=0.K
Photon emission for (n,2np)

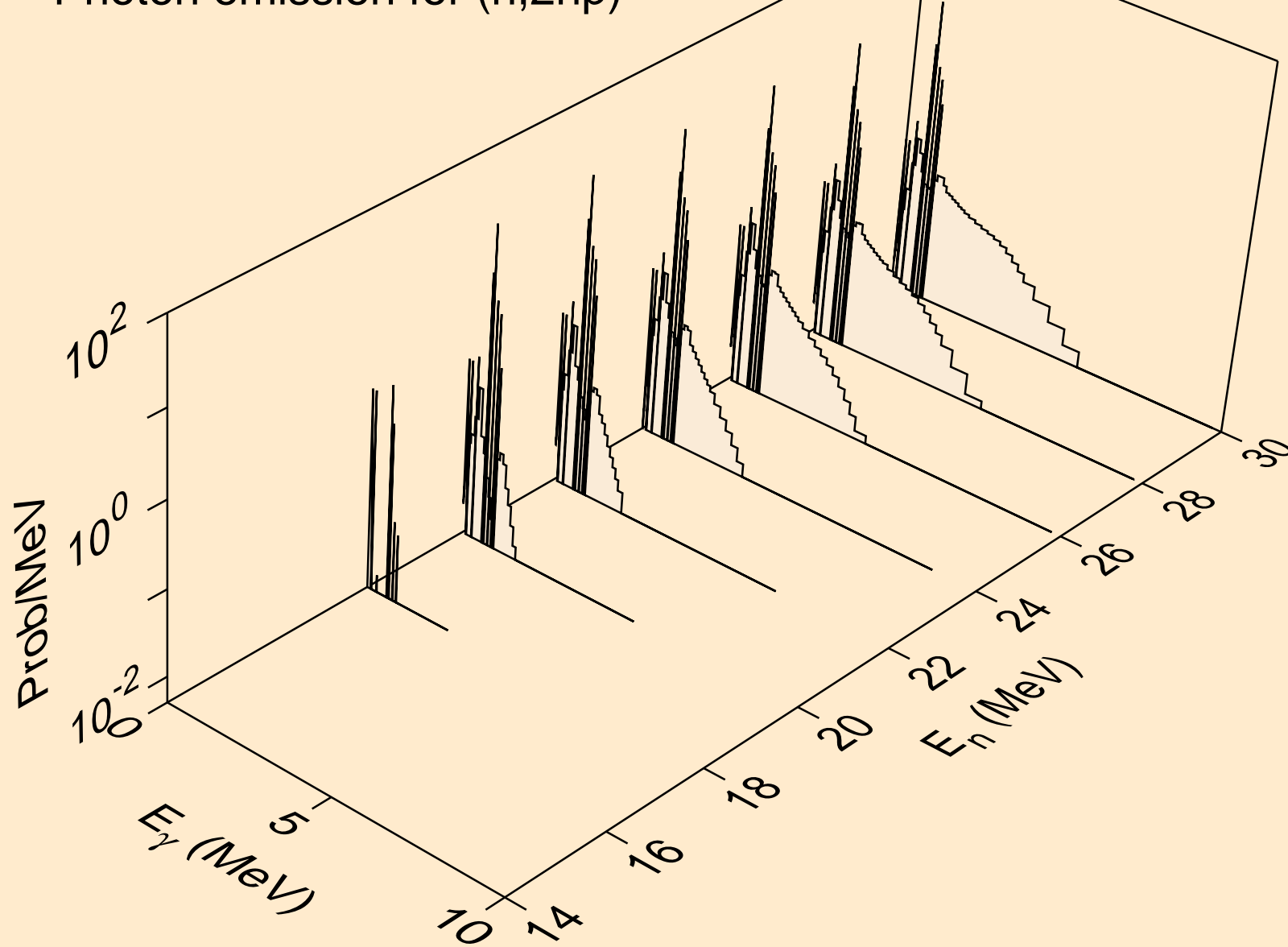

AS067 NEUTRON ACER TENDL-2023 LIBRARY; T=0.K
Photon emission for (n,3np)

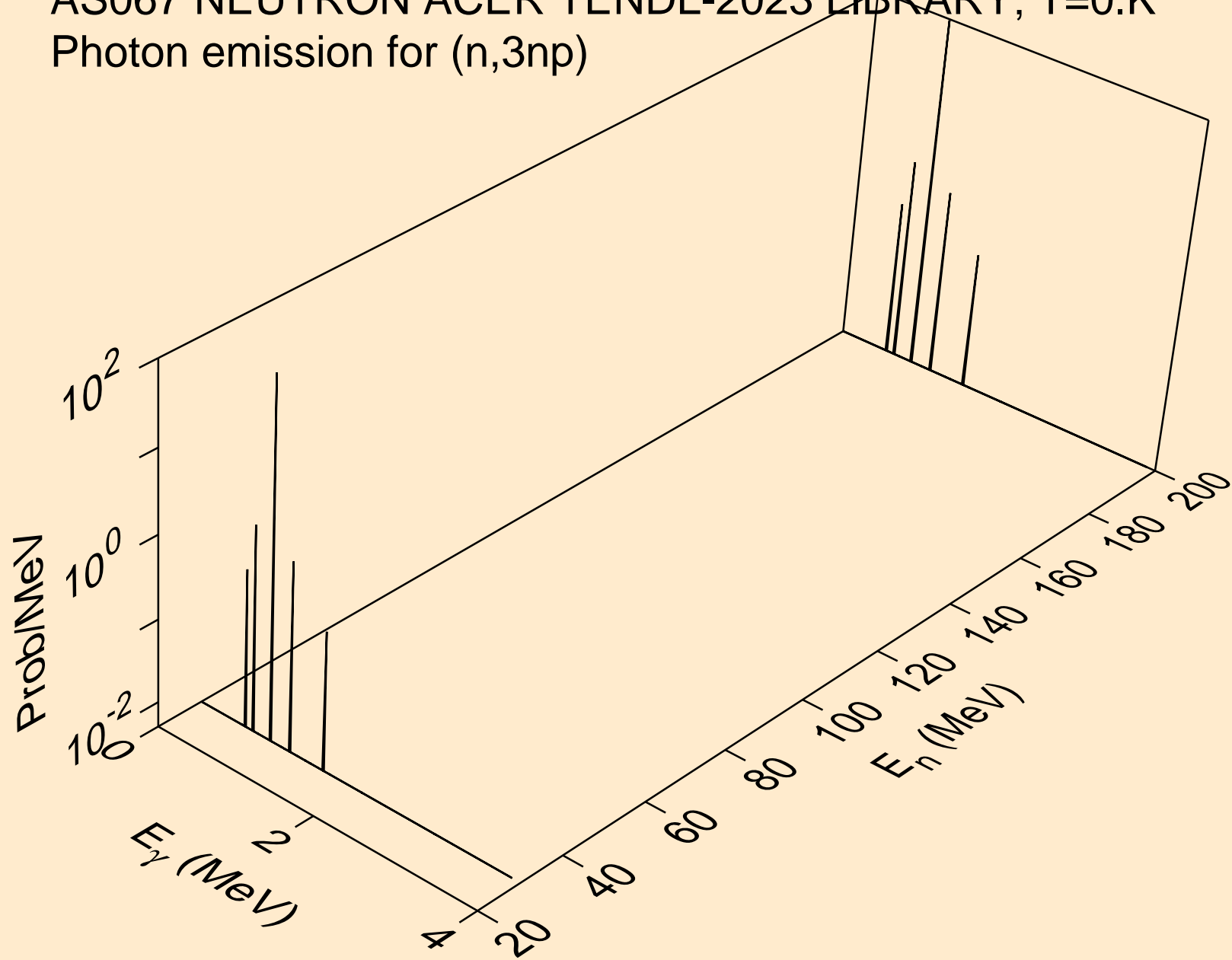

AS067 NEUTRON ACER TENDL-2023 LIBRARY; T=0.K
Photon emission for (n,n2p)

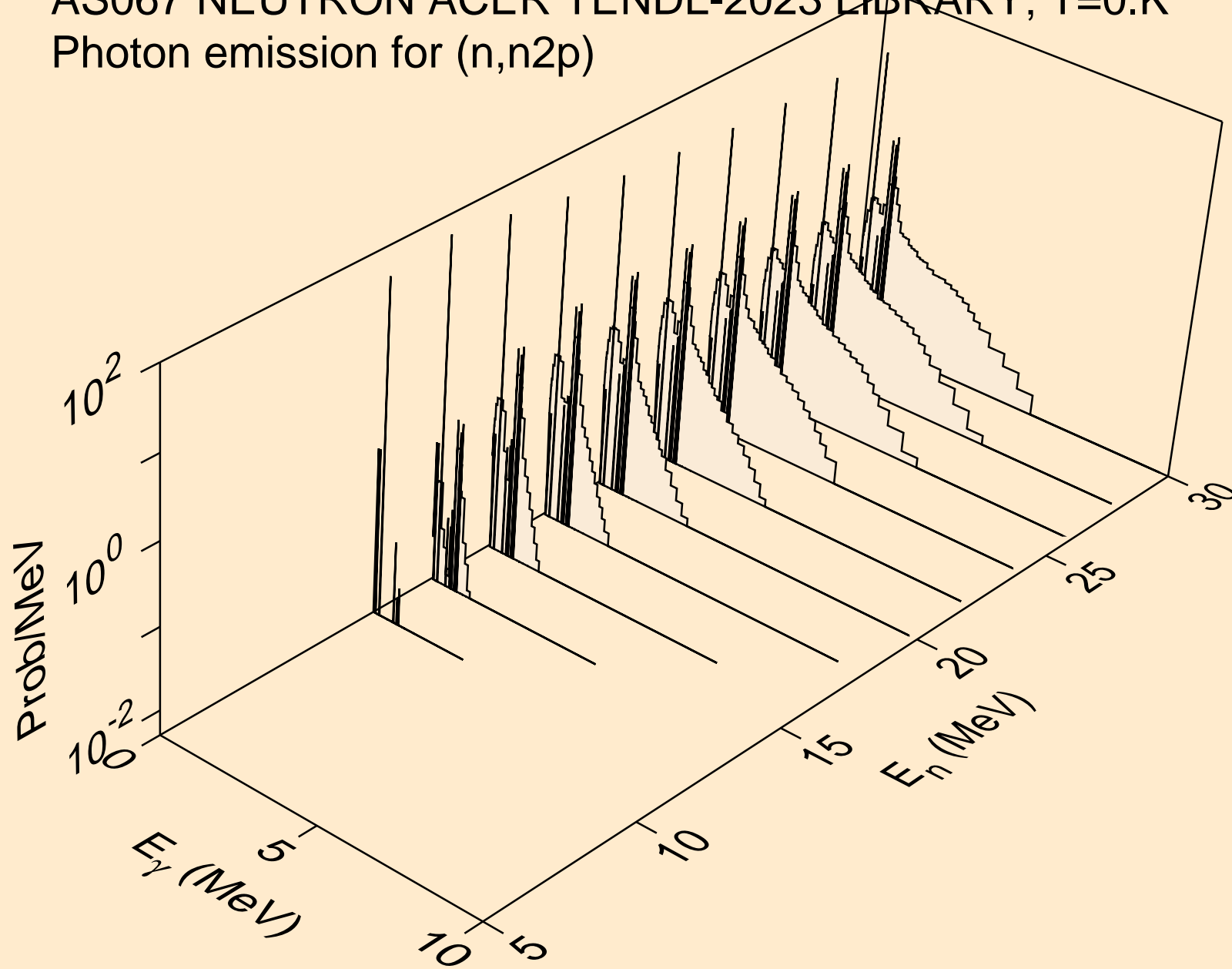

AS067 NEUTRON ACER TENDL-2023 LIBRARY; T=0.K
Photon emission for (n,npa)

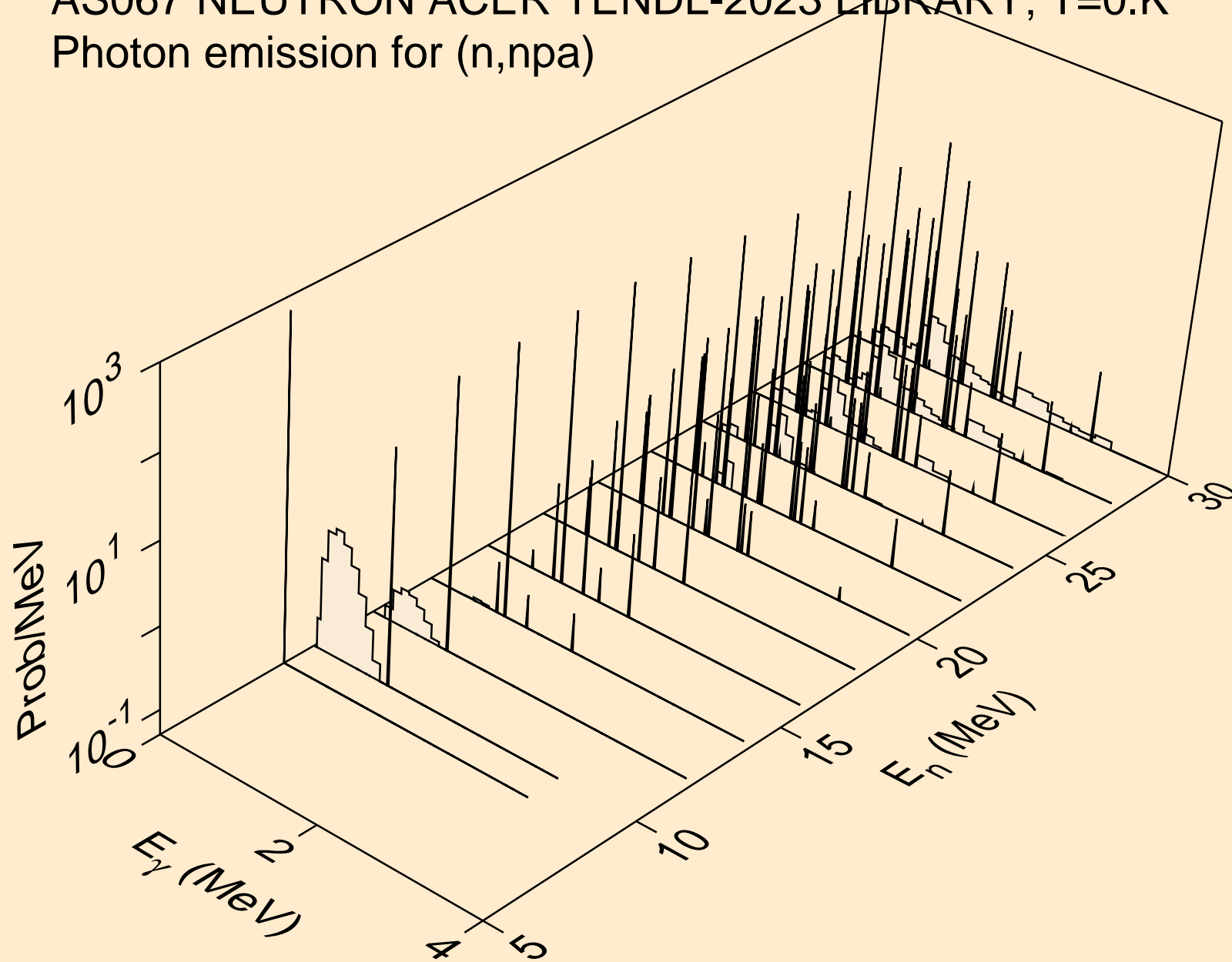

AS067 NEUTRON ACER TENDL-2023 LIBRARY; T=0.K
Photon emission for (n,n*c)

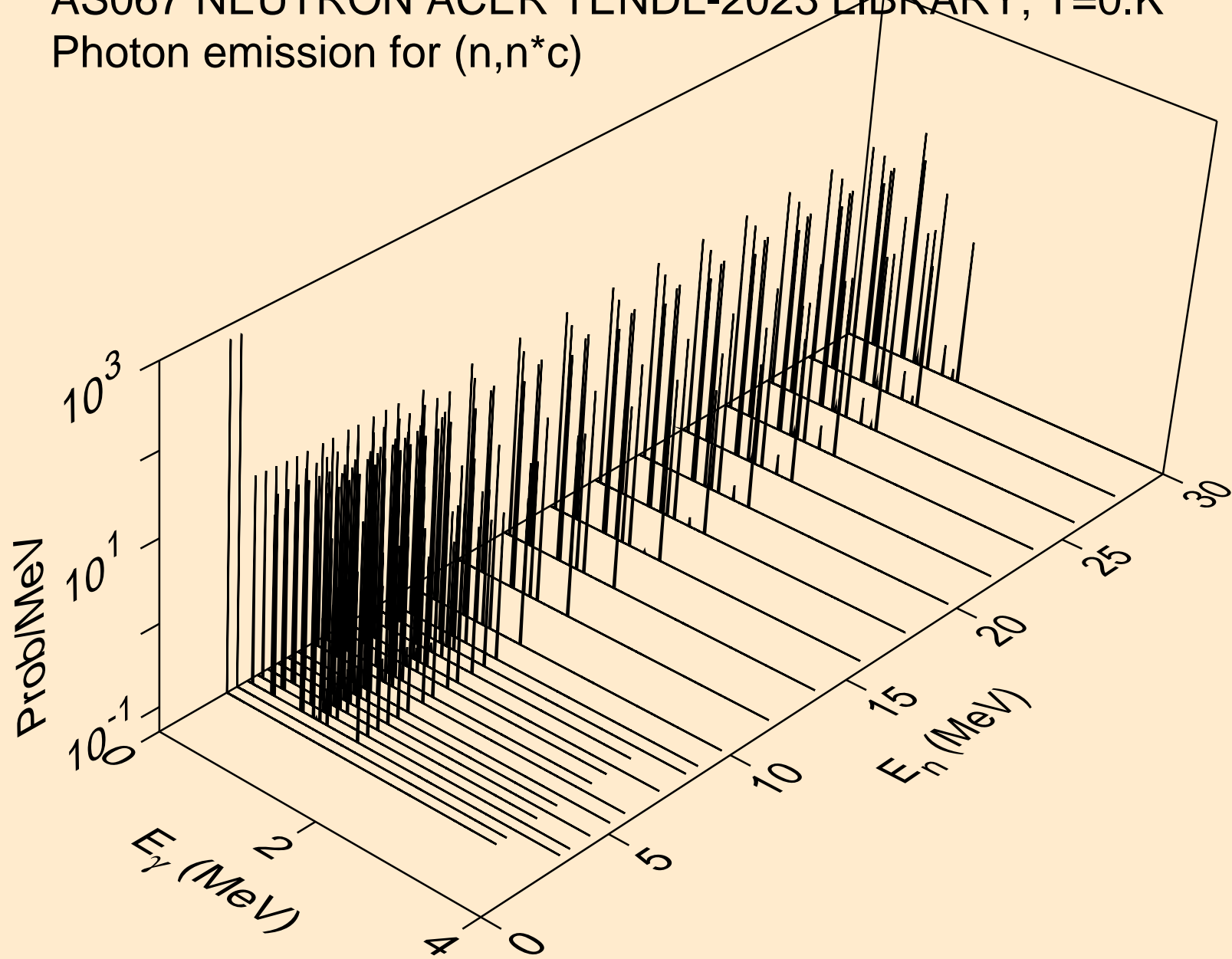

AS067 NEUTRON ACER TENDL-2023 LIBRARY; T=0.K
Photon emission for (n,gma)

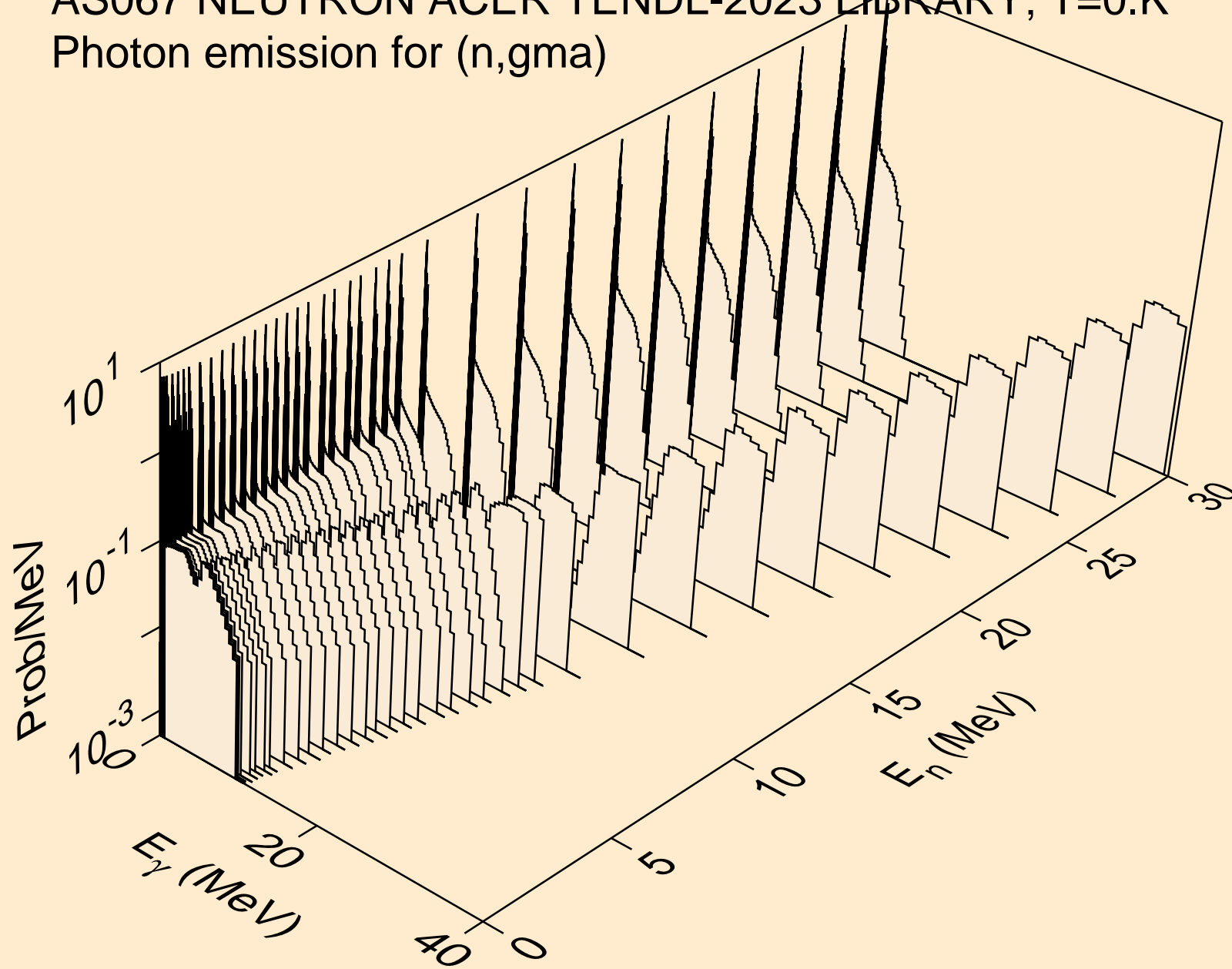

AS067 NEUTRON ACER TENDL-2023 LIBRARY; T=0.K
Photon emission for (n,p)

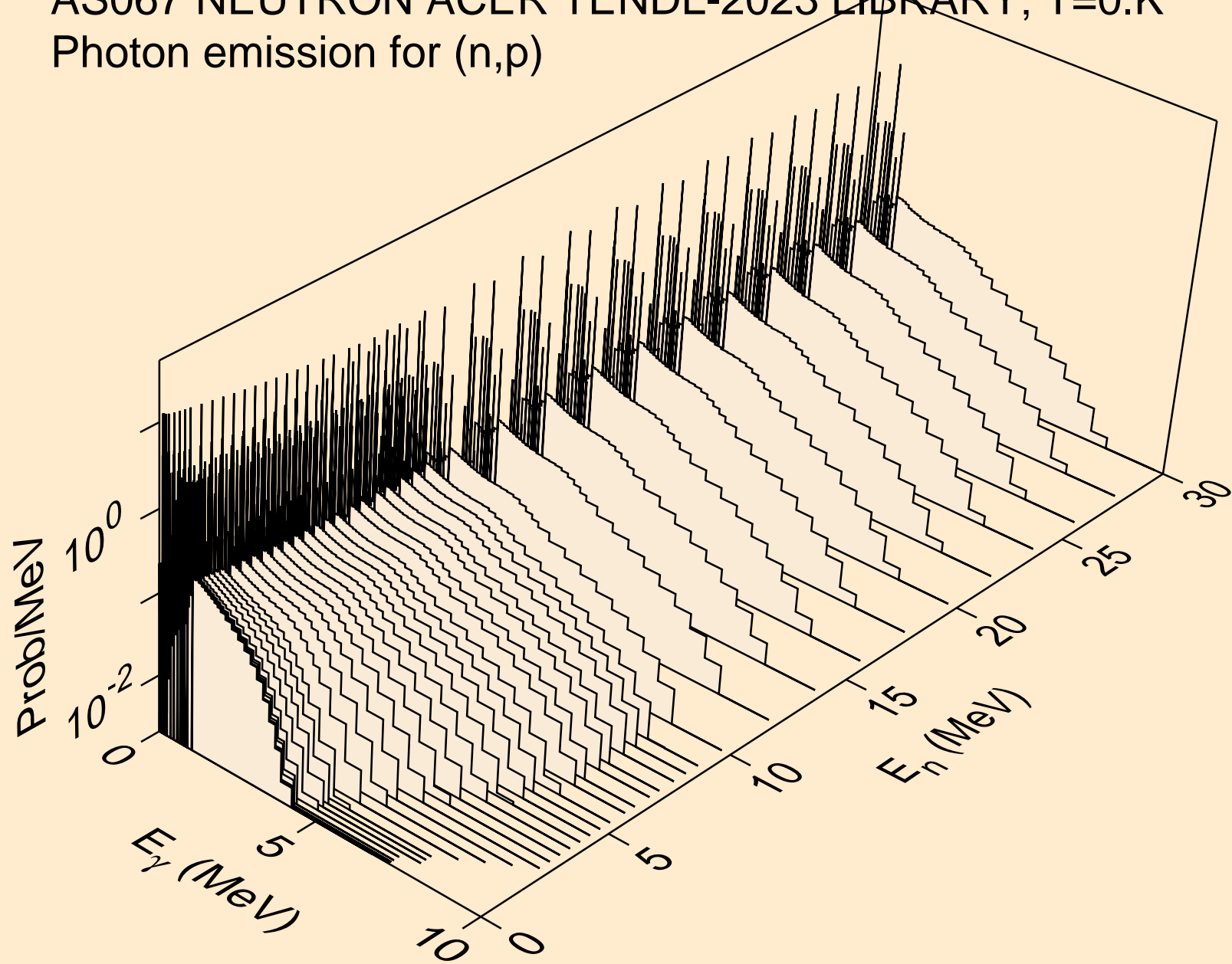

AS067 NEUTRON ACER TENDL-2023 LIBRARY; T=0.K
Photon emission for (n,d)

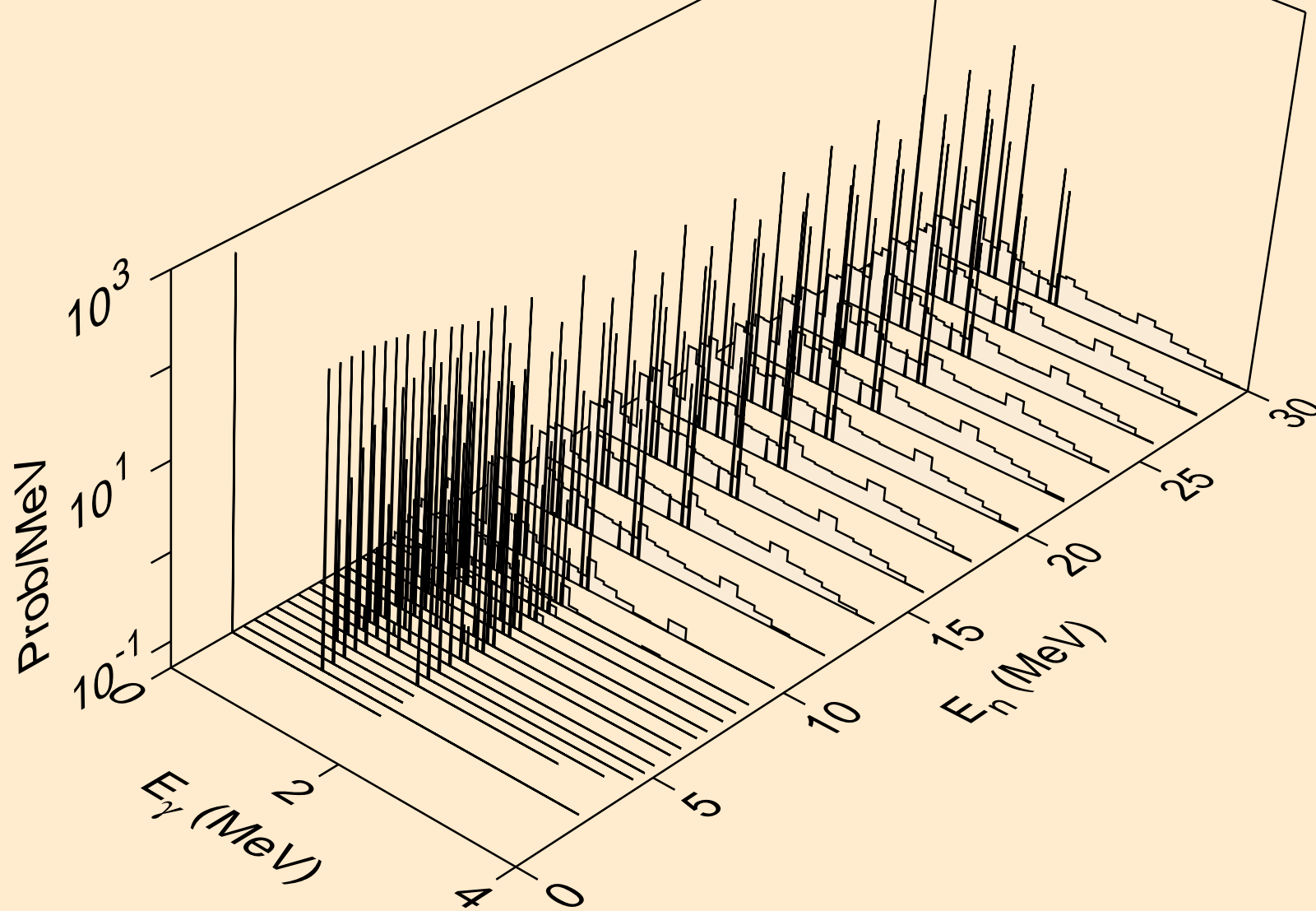

AS067 NEUTRON ACER TENDL-2023 LIBRARY; T=0.K
Photon emission for (n,t)

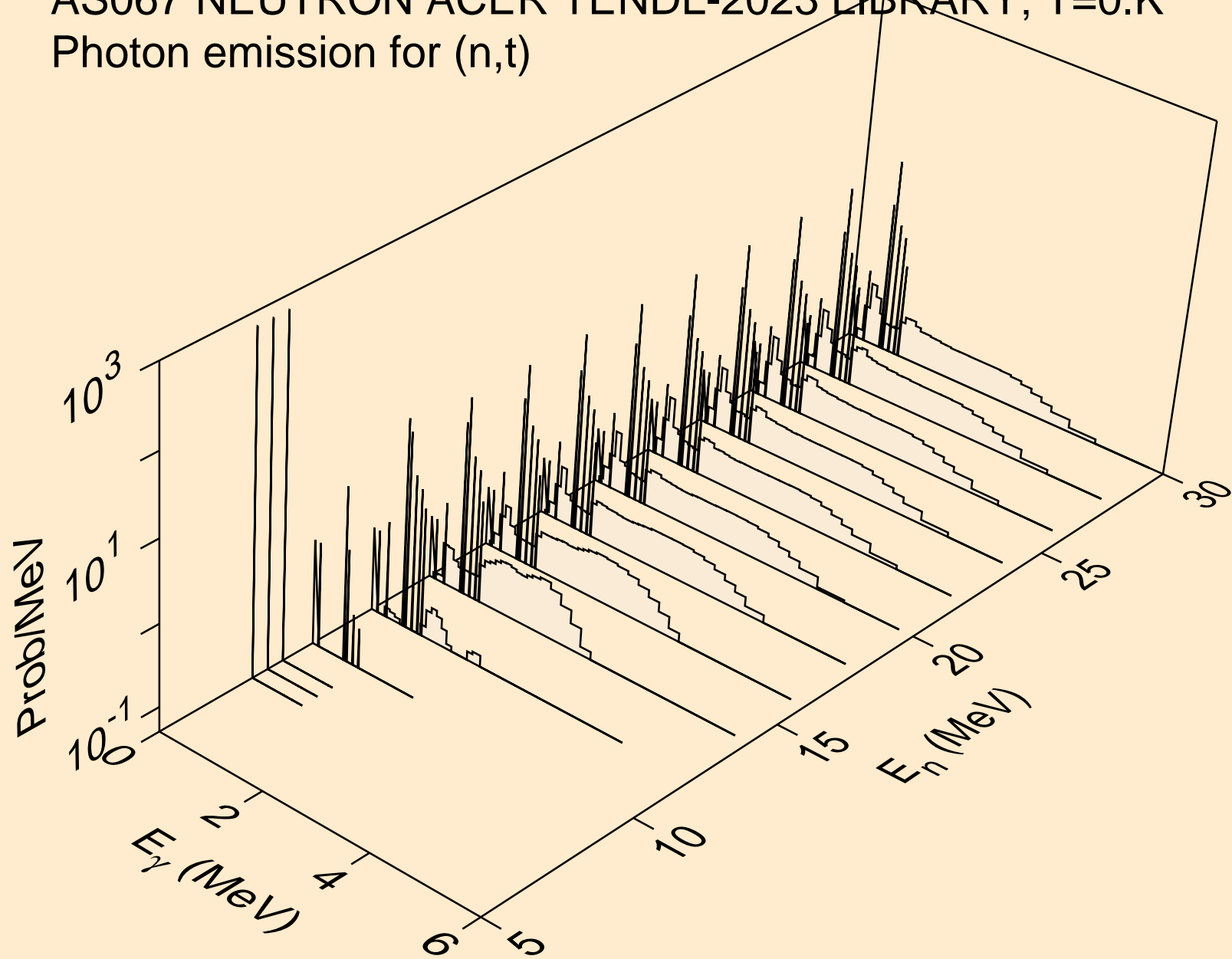

AS067 NEUTRON ACER TENDL-2023 LIBRARY; T=0.K
Photon emission for (n,he3)

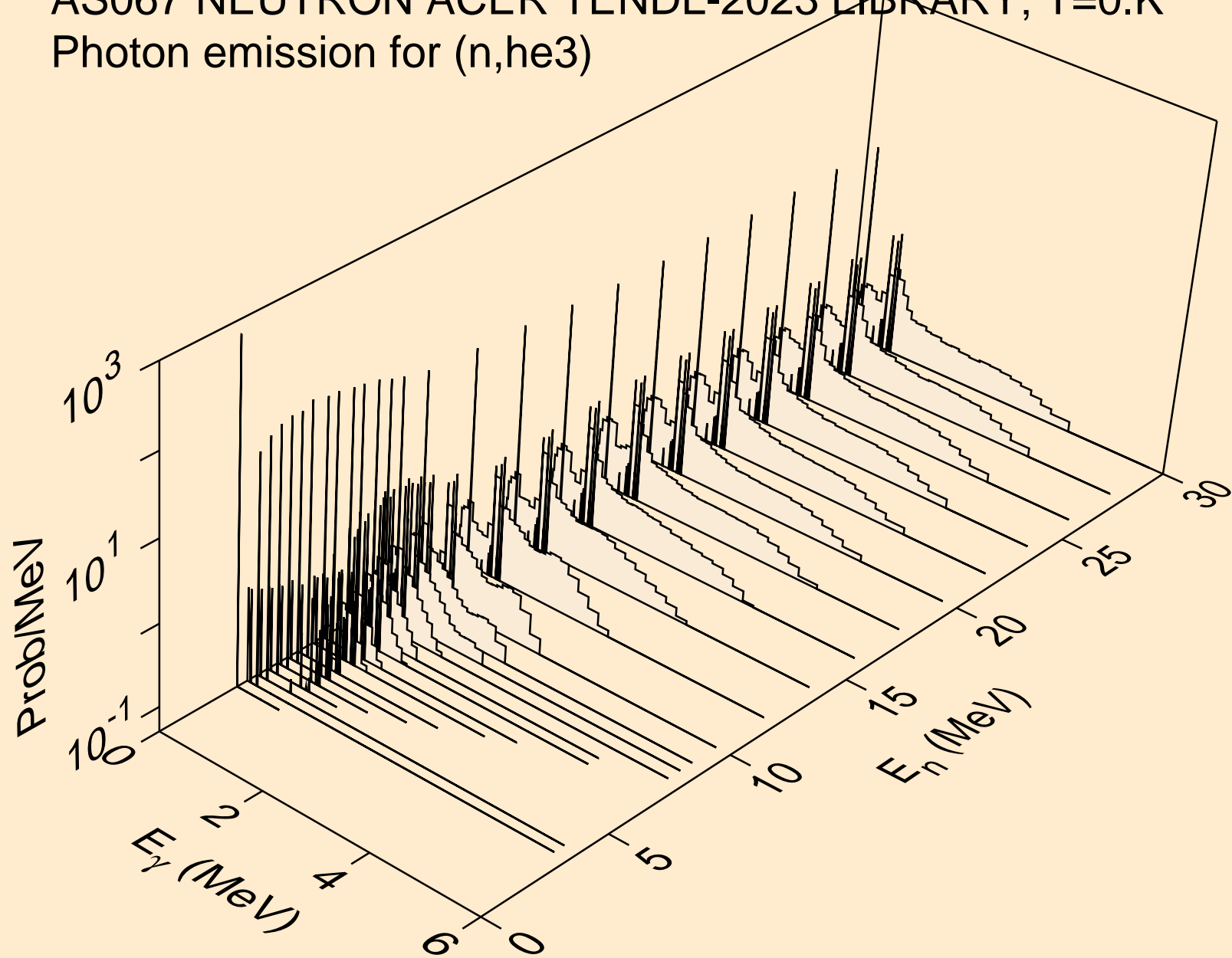

AS067 NEUTRON ACER TENDL-2023 LIBRARY; T=0.K
Photon emission for (n,a)

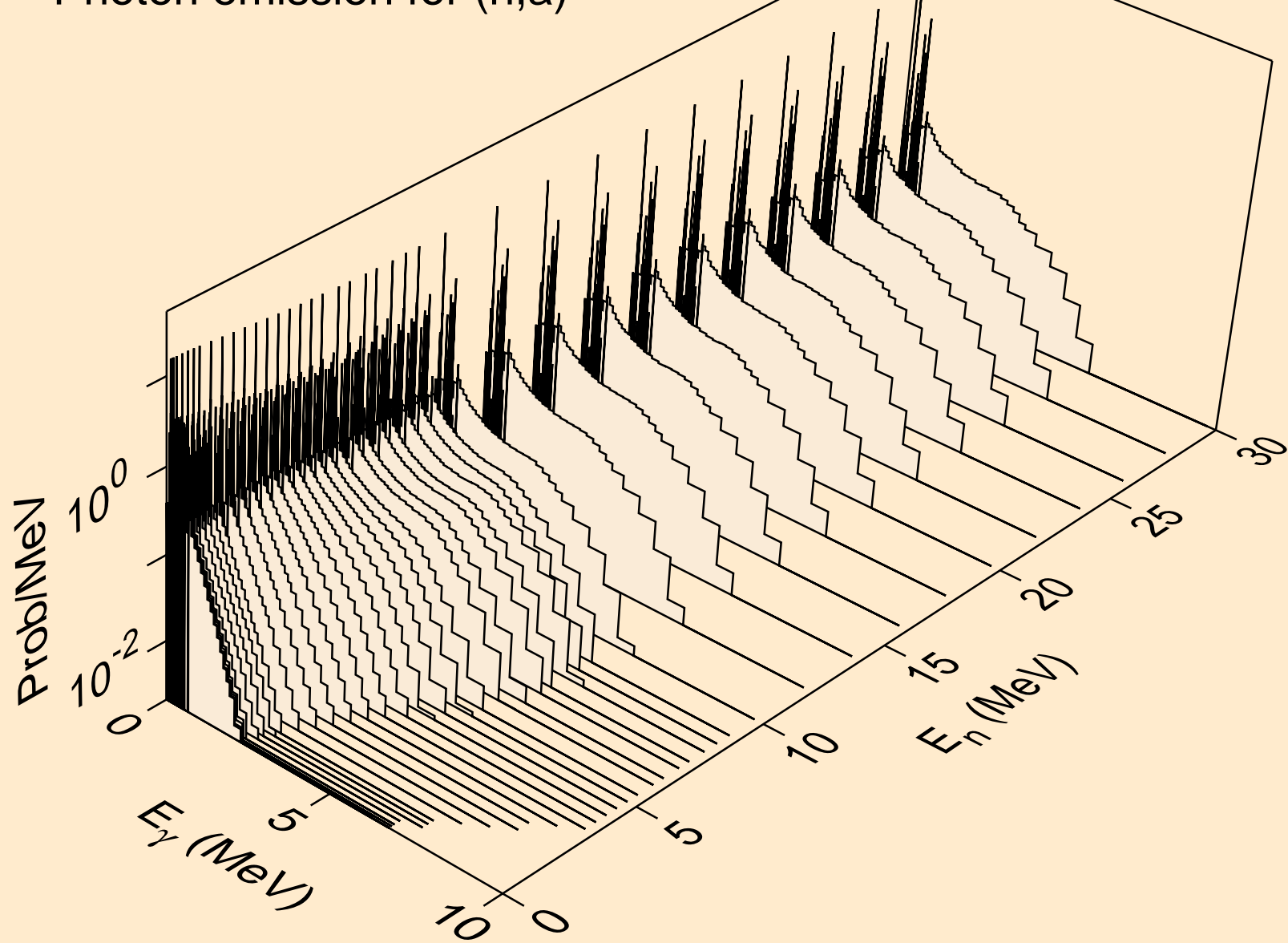

AS067 NEUTRON ACER TENDL-2023 LIBRARY; T=0.K
Photon emission for (n,2a)

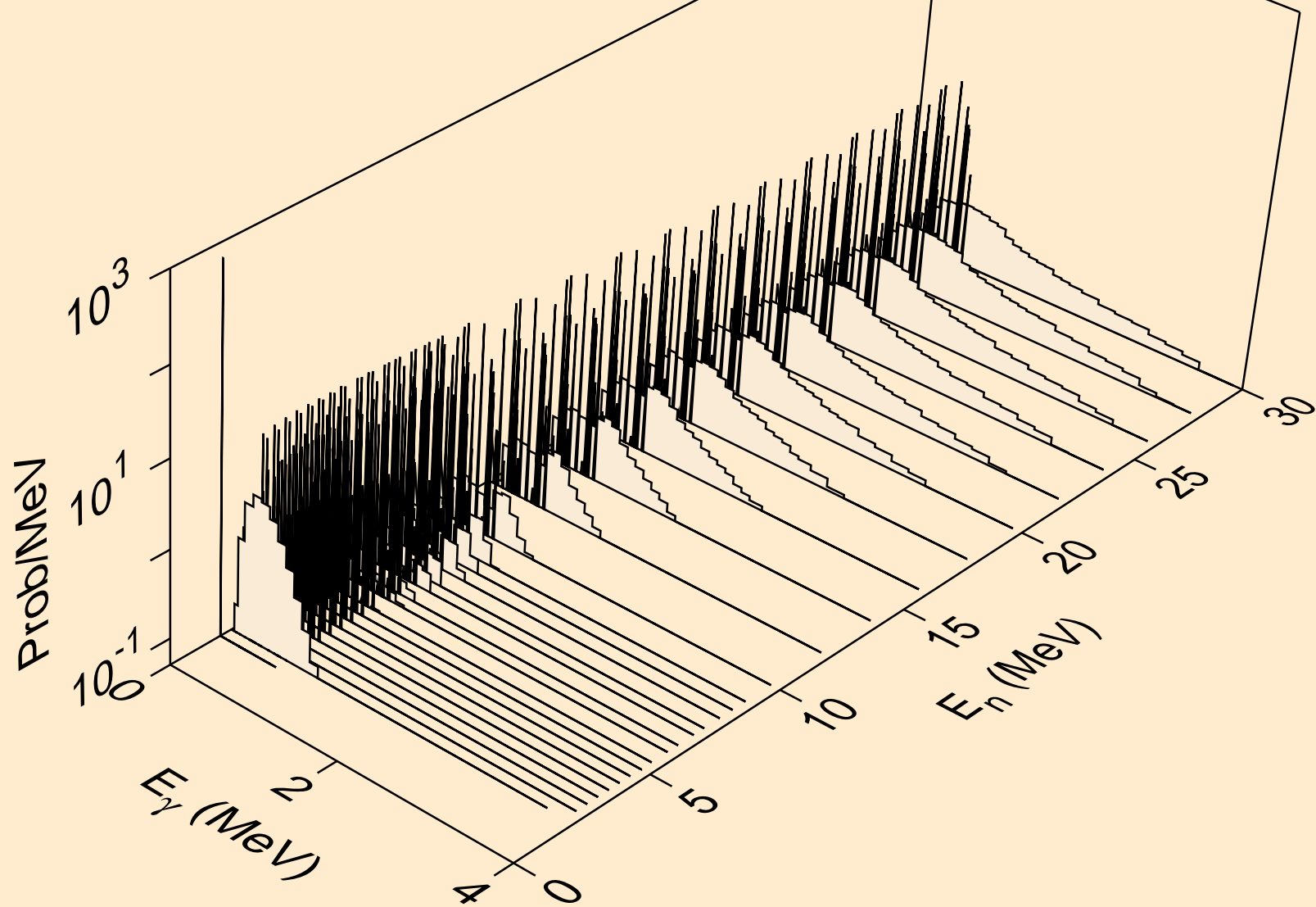

AS067 NEUTRON ACER TENDL-2023 LIBRARY; T=0.K
Photon emission for (n,3a)

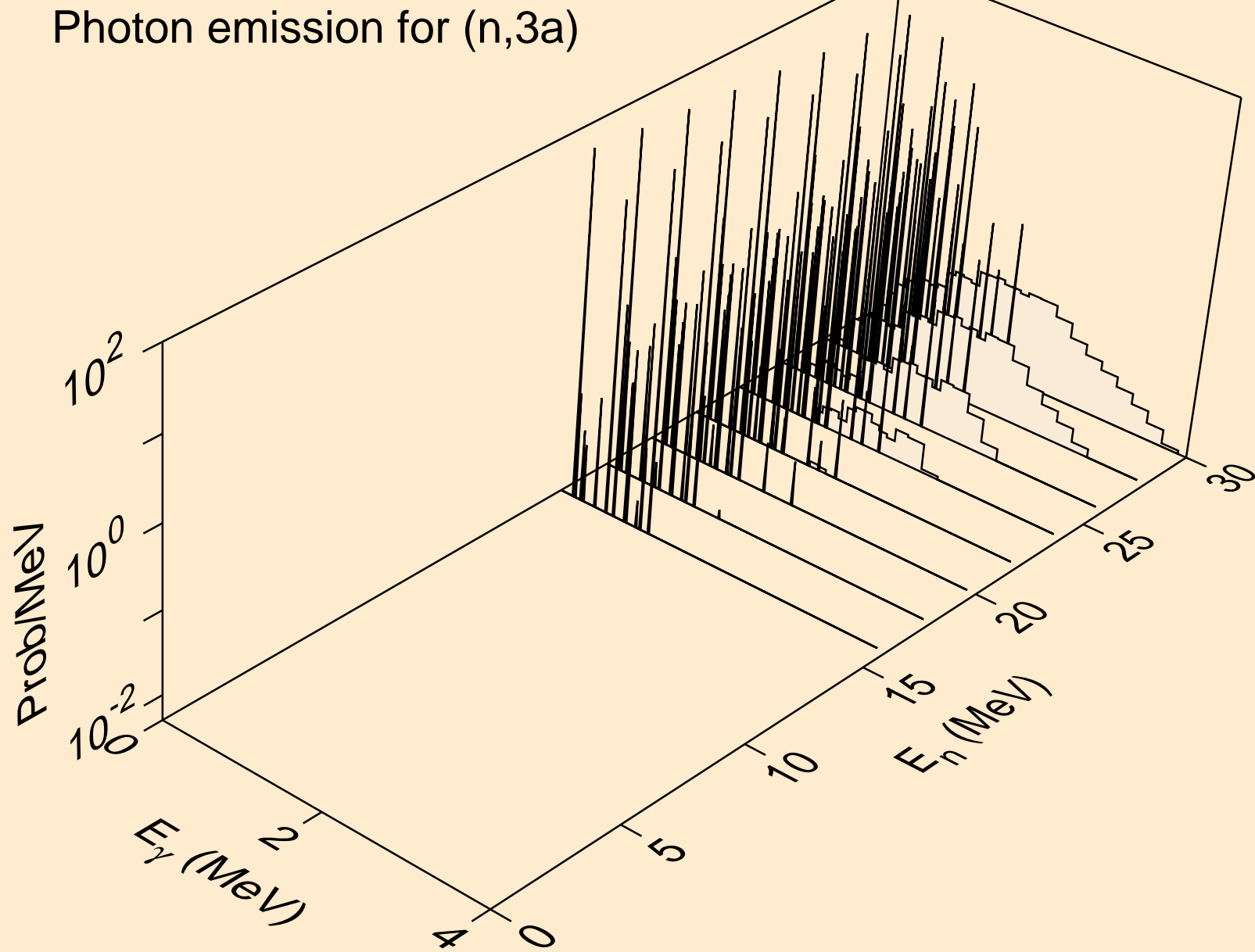

AS067 NEUTRON ACER TENDL-2023 LIBRARY; T=0.K
Photon emission for (n,2p)

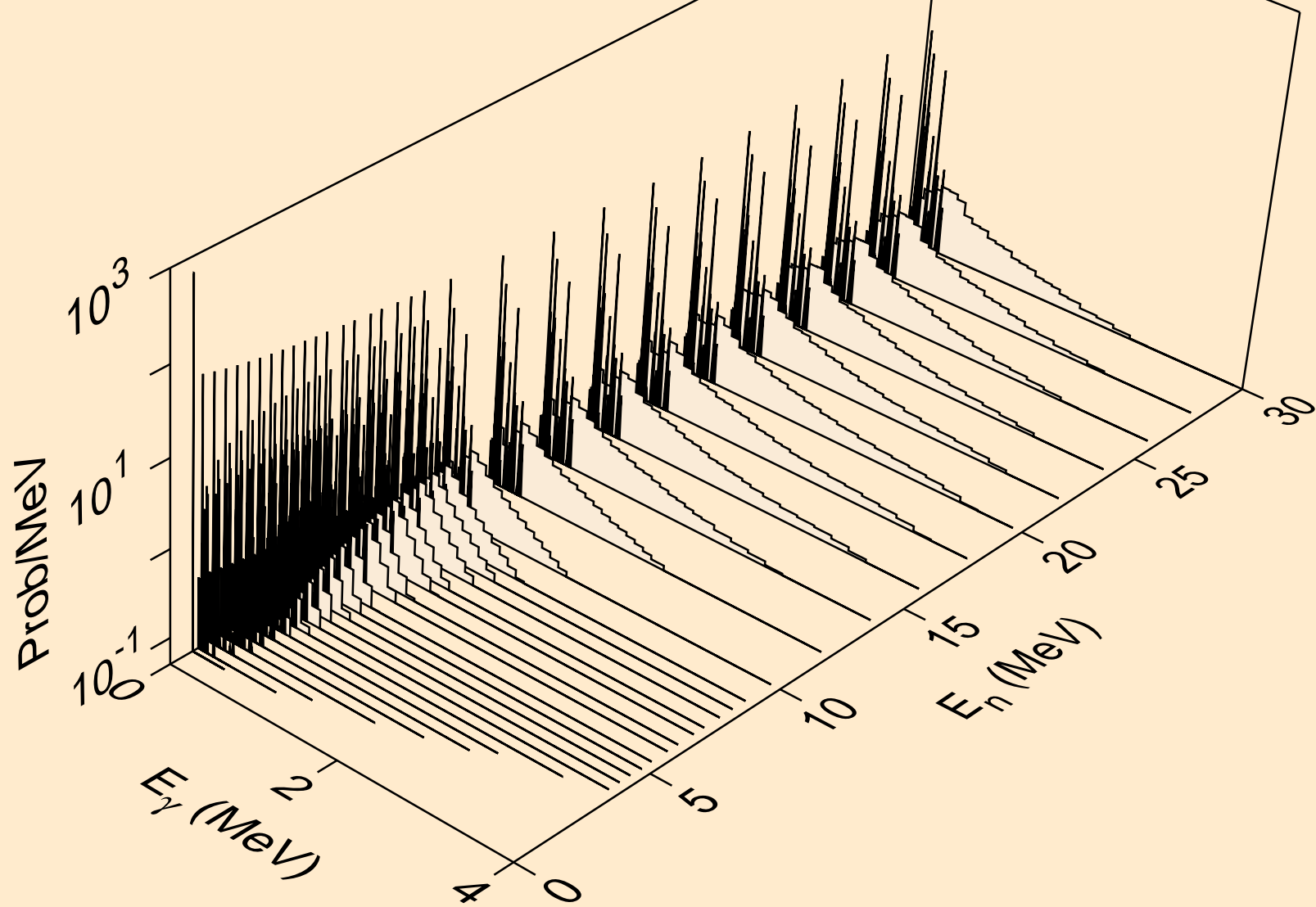

AS067 NEUTRON ACER TENDL-2023 LIBRARY; T=0.K
Photon emission for (n,p α)

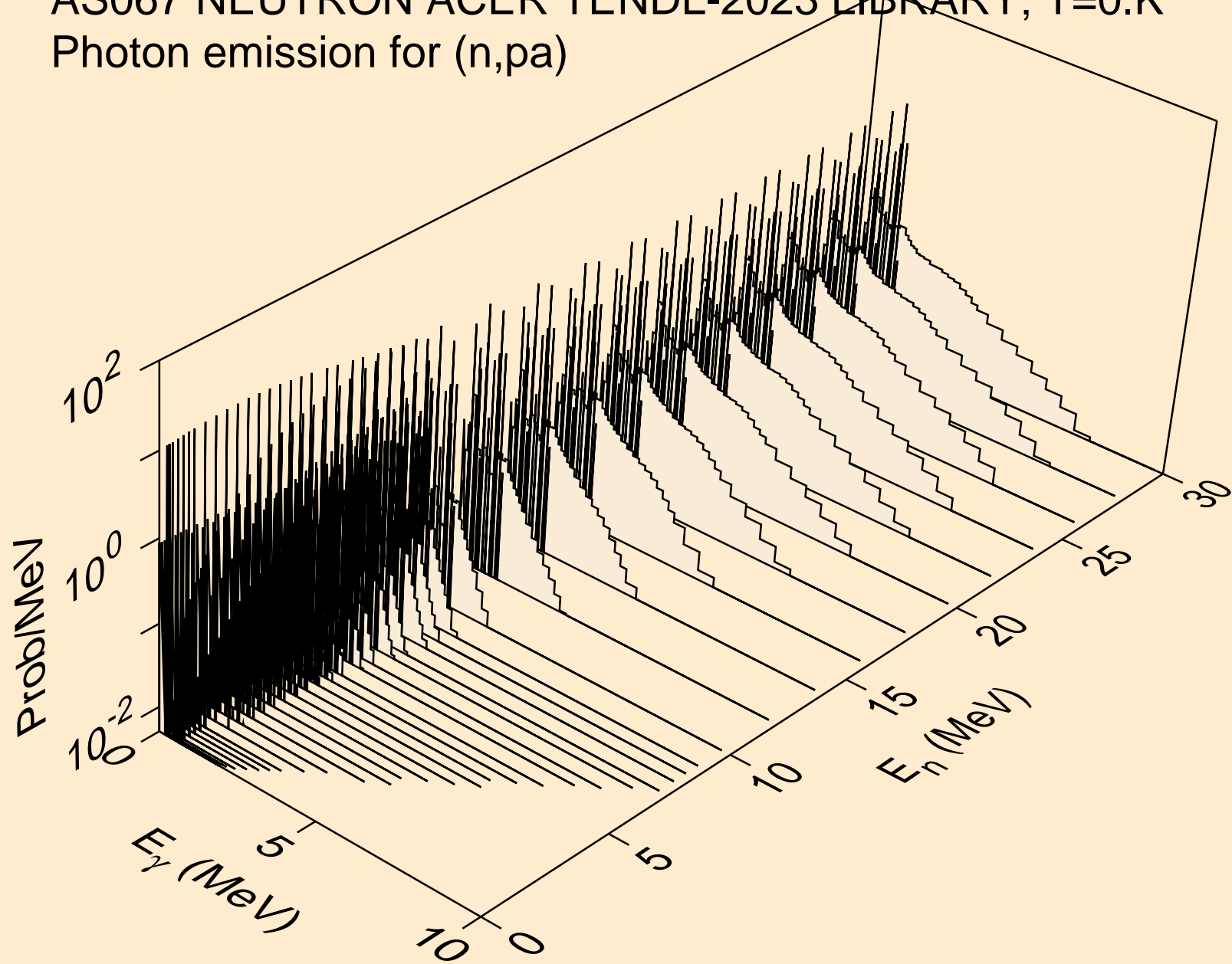

AS067 NEUTRON ACER TENDL-2023 LIBRARY; T=0.K
Photon emission for (n,d2a)

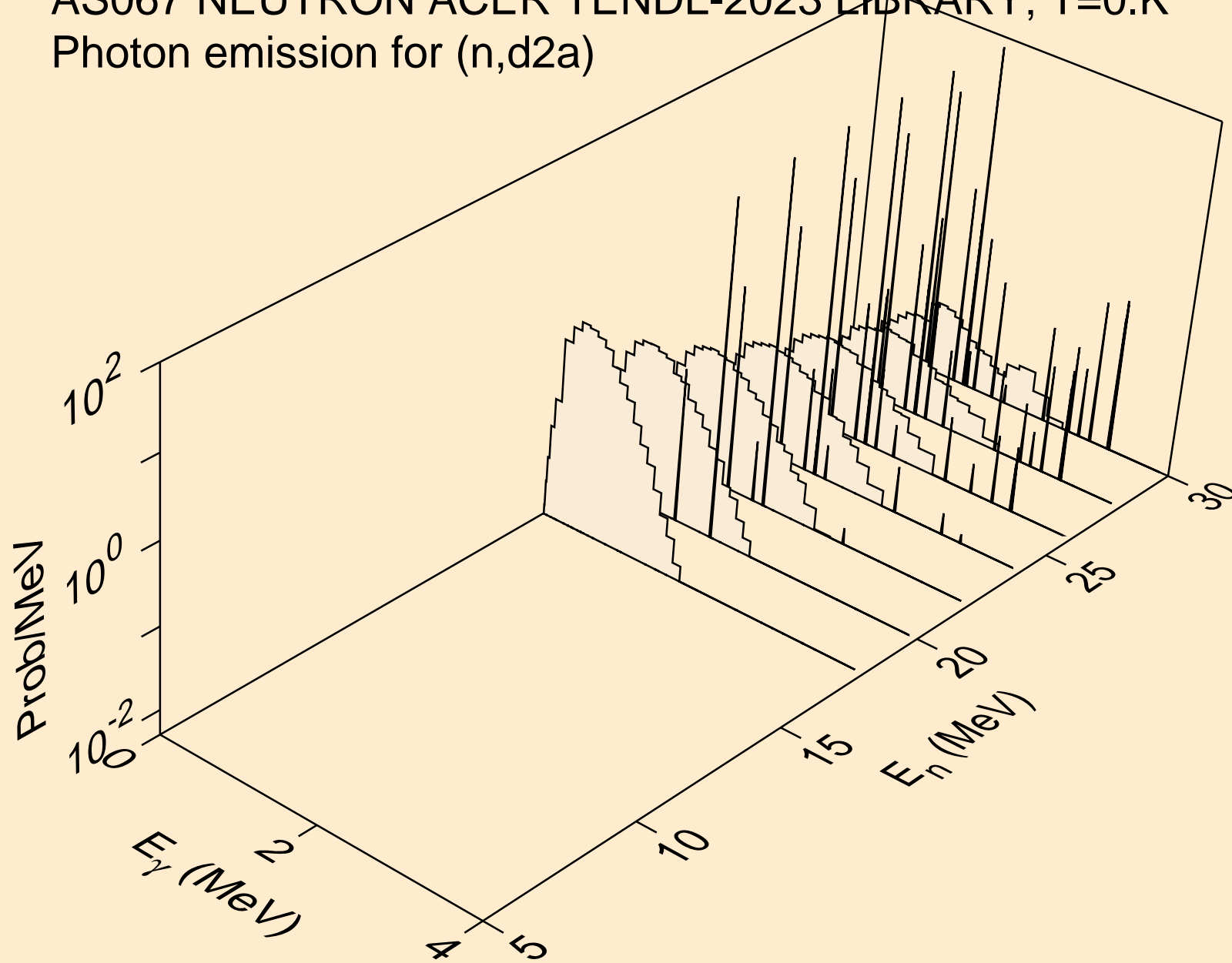

AS067 NEUTRON ACER TENDL-2023 LIBRARY; T=0.K
Photon emission for (n,pd)

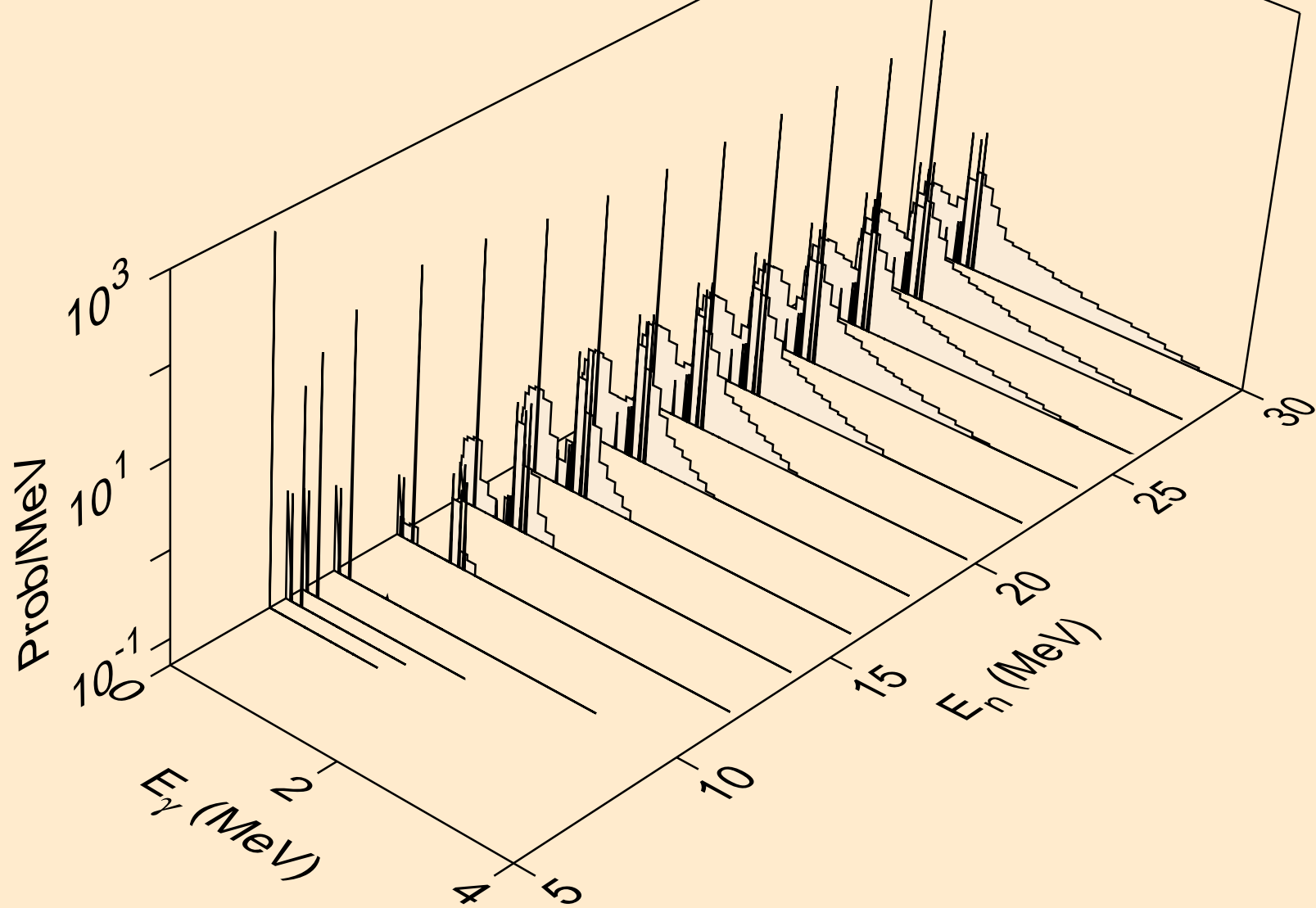

AS067 NEUTRON ACER TENDL-2023 LIBRARY; T=0.K
Photon emission for (n,pt)

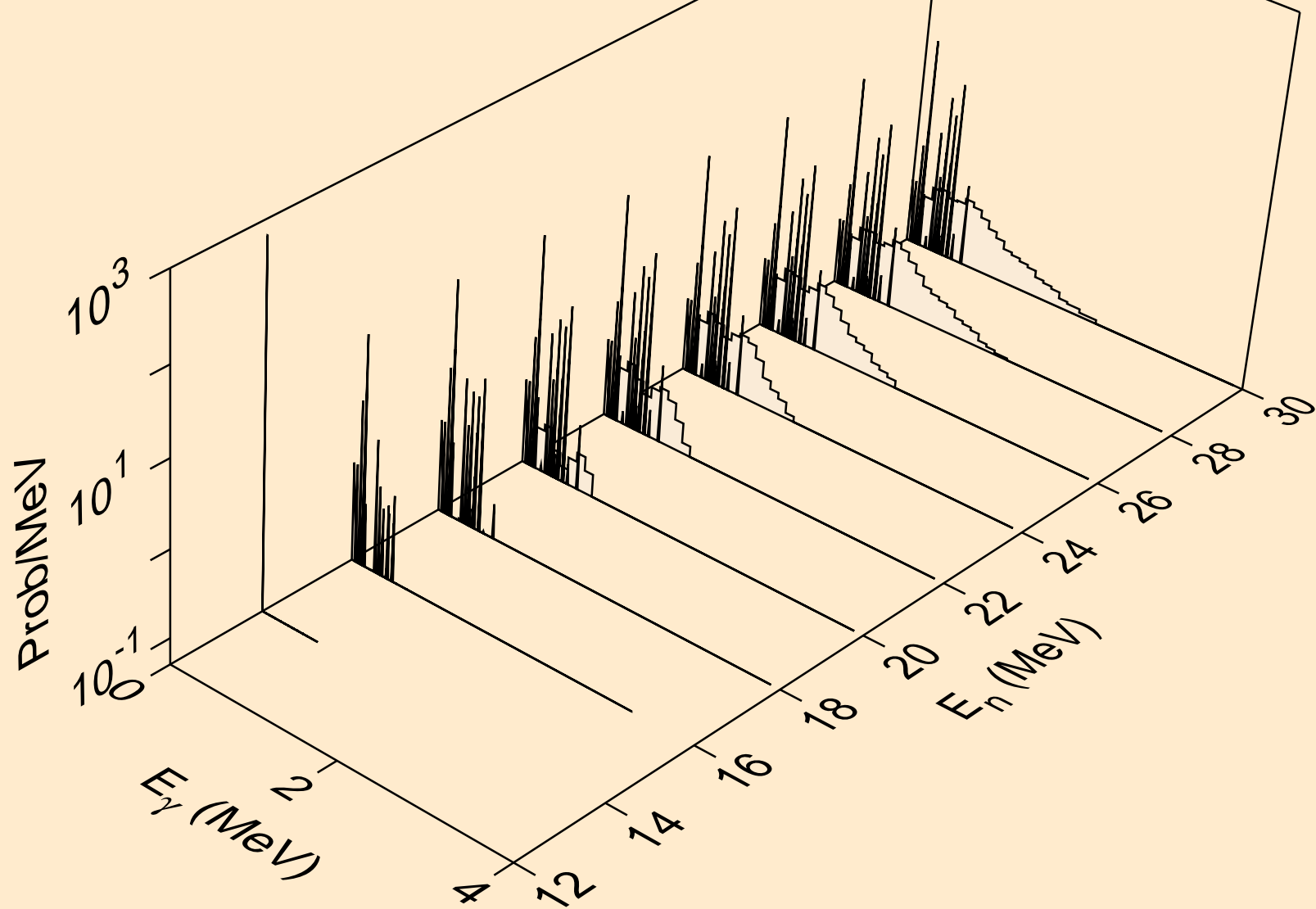

AS067 NEUTRON ACER TENDL-2023 LIBRARY; T=0.K
Photon emission for (n,da)

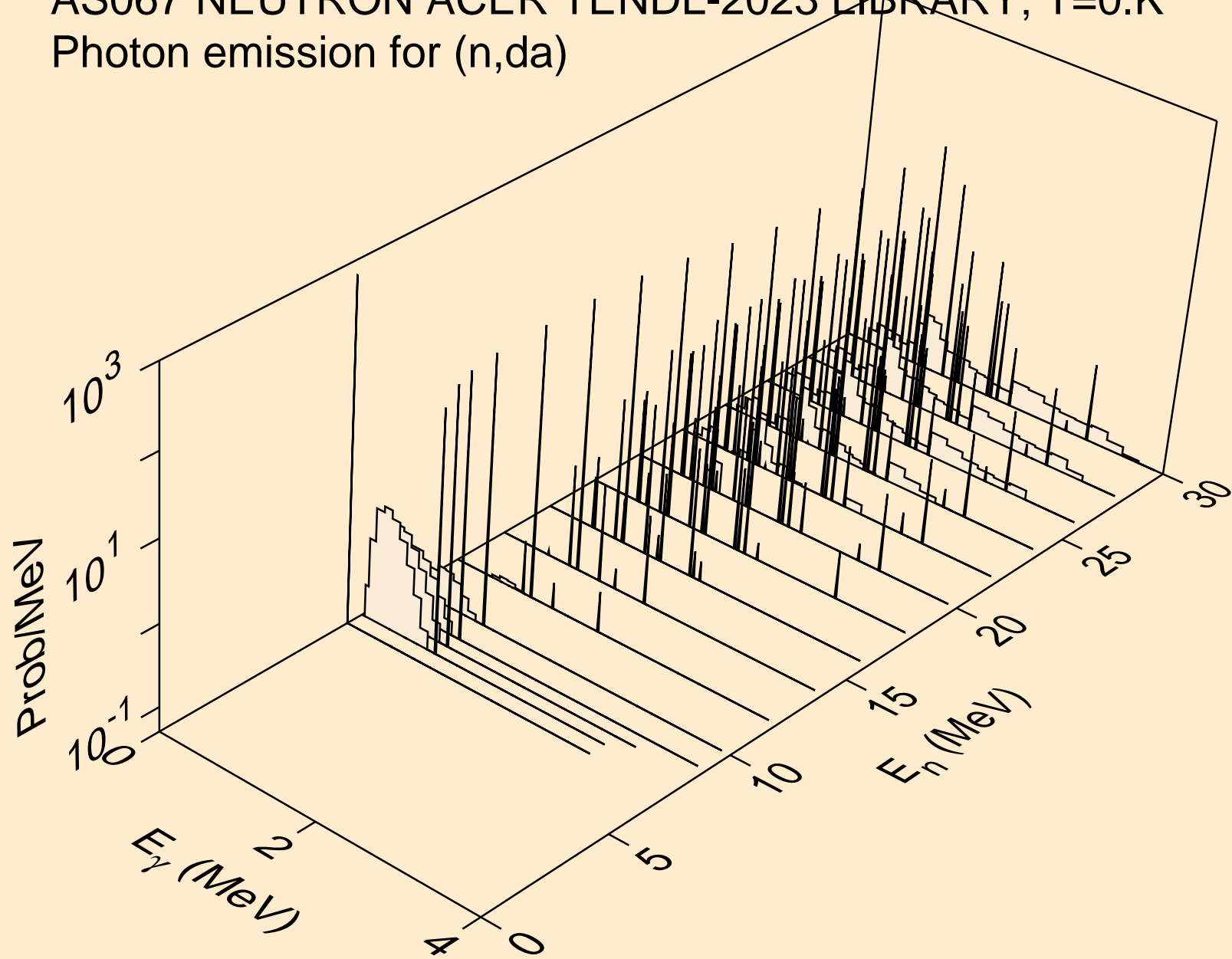

AS067 NEUTRON ACER TENDL-2023 LIBRARY; T=0.K
thermal capture photon spectrum

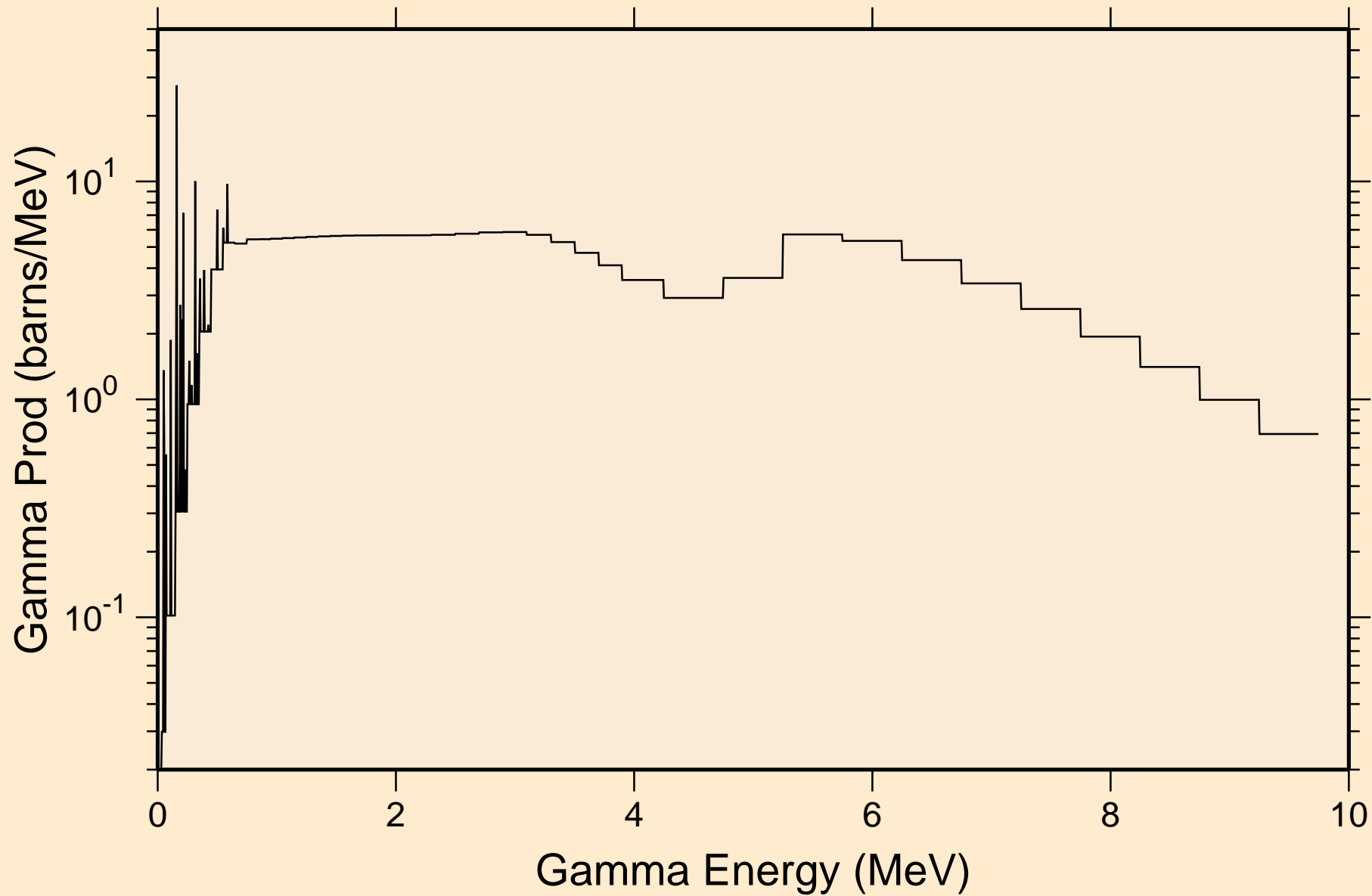

AS067 NEUTRON ACER TENDL-2023 LIBRARY; T=0.K
14 MeV photon spectrum

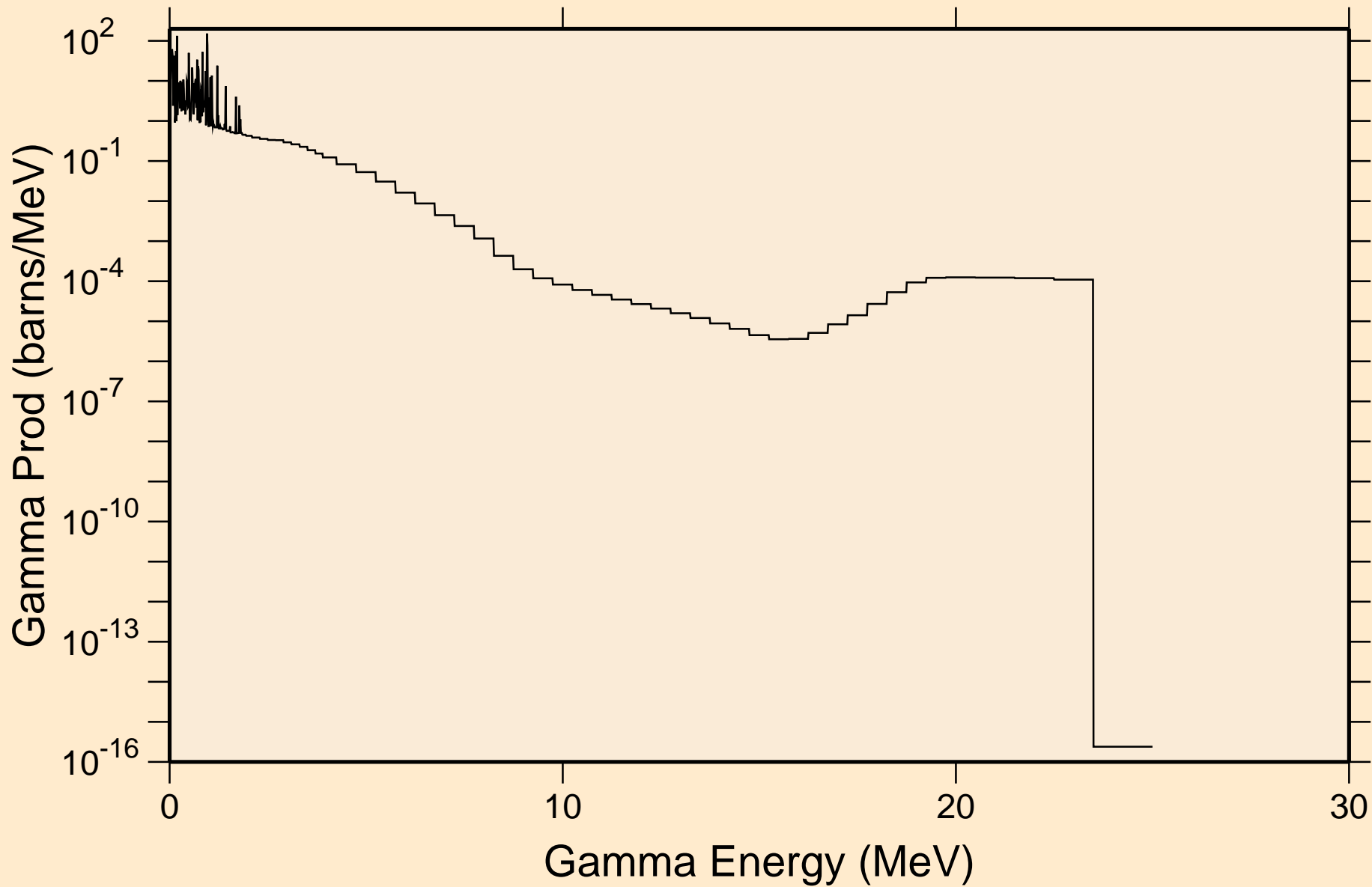

AS067 NEUTRON ACER TENDL-2023 LIBRARY; T=0.K
Particle heating contributions

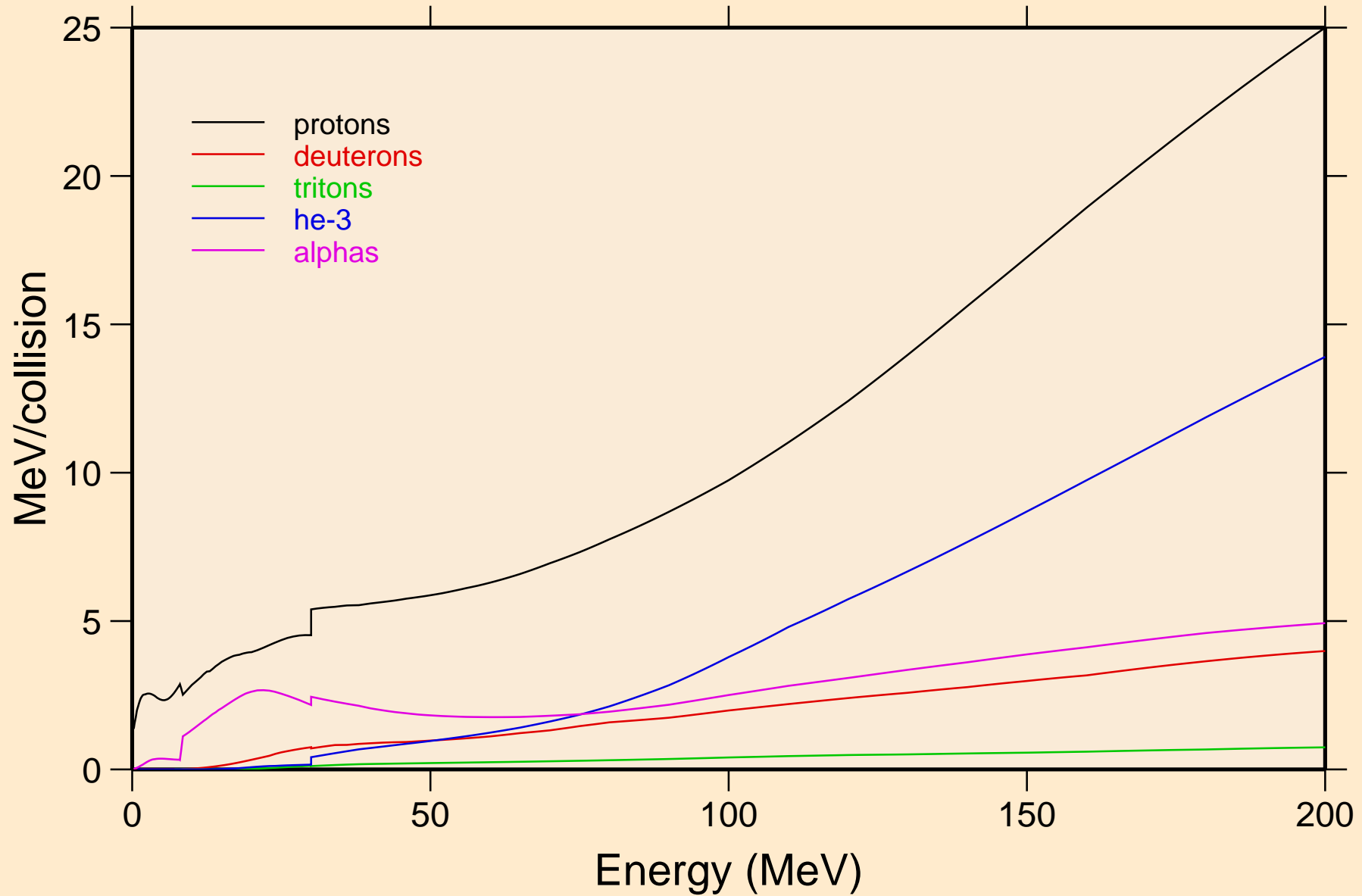

AS067 NEUTRON ACER TENDL-2023 LIBRARY; T=0.K
Recoil Heating

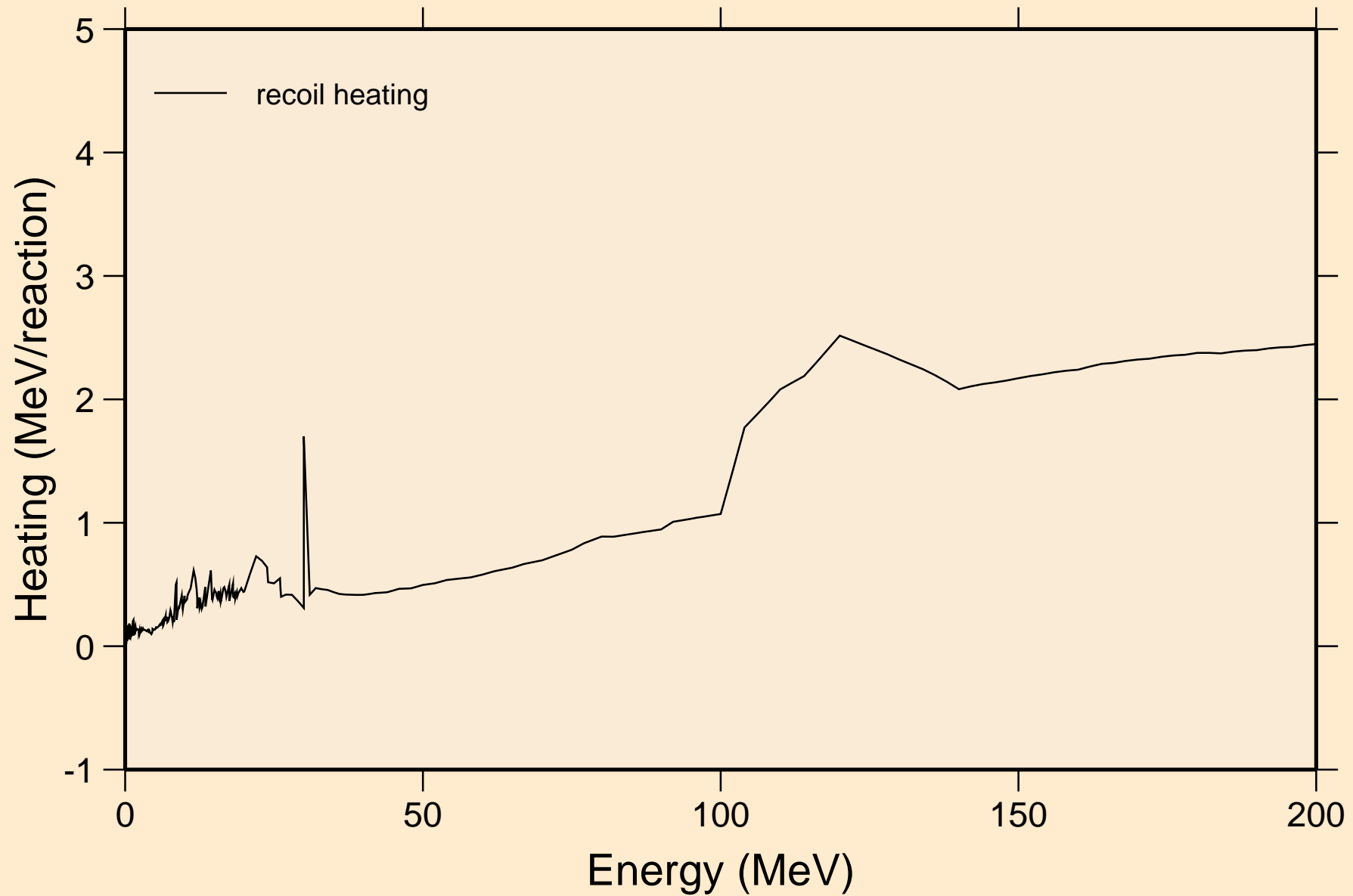

AS067 NEUTRON ACER TENDL-2023 LIBRARY; T=0.K

Particle production cross sections

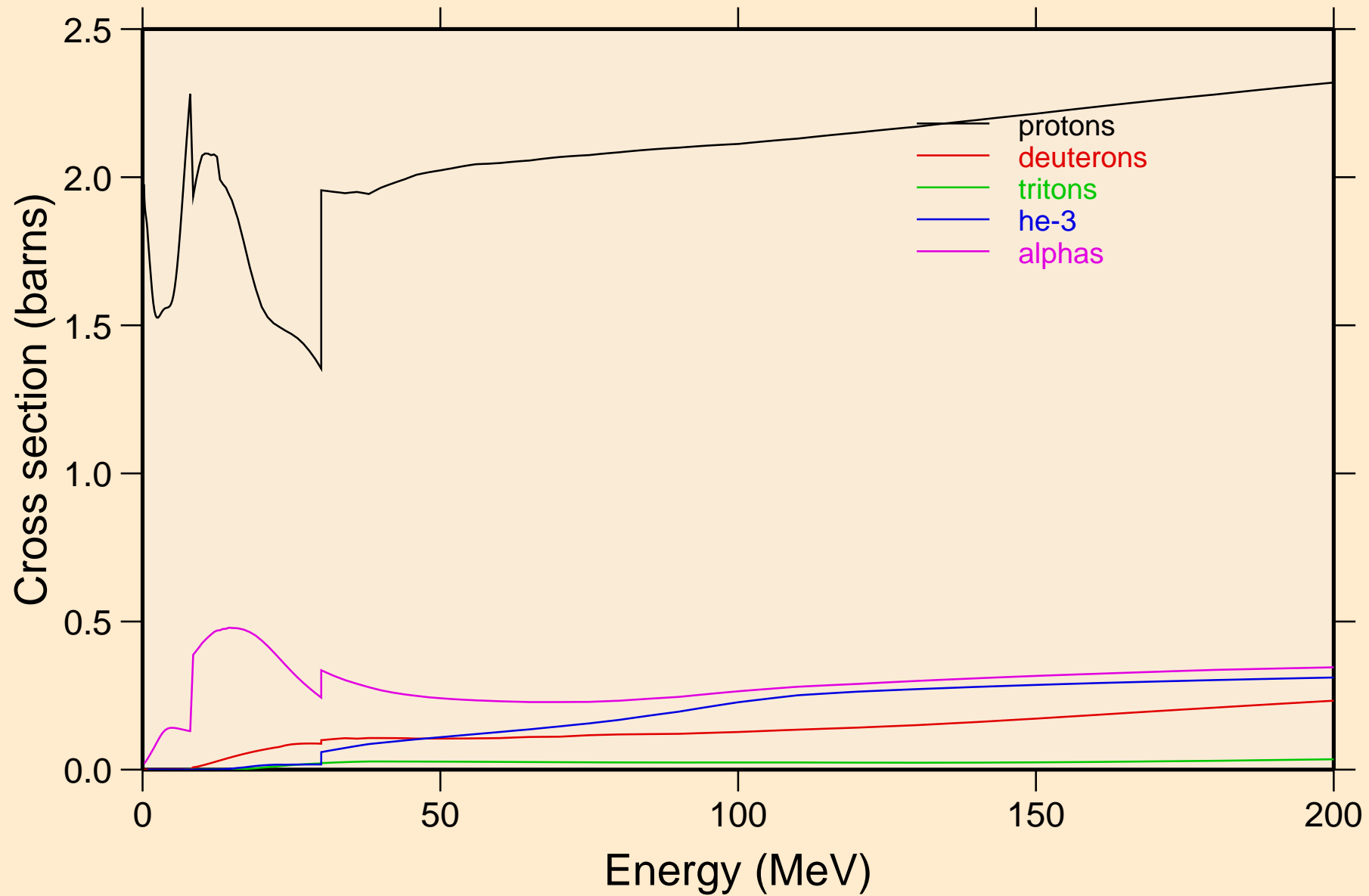

AS067 NEUTRON ACER TENDL-2023 LIBRARY; T=0.K
protons from (n,x)

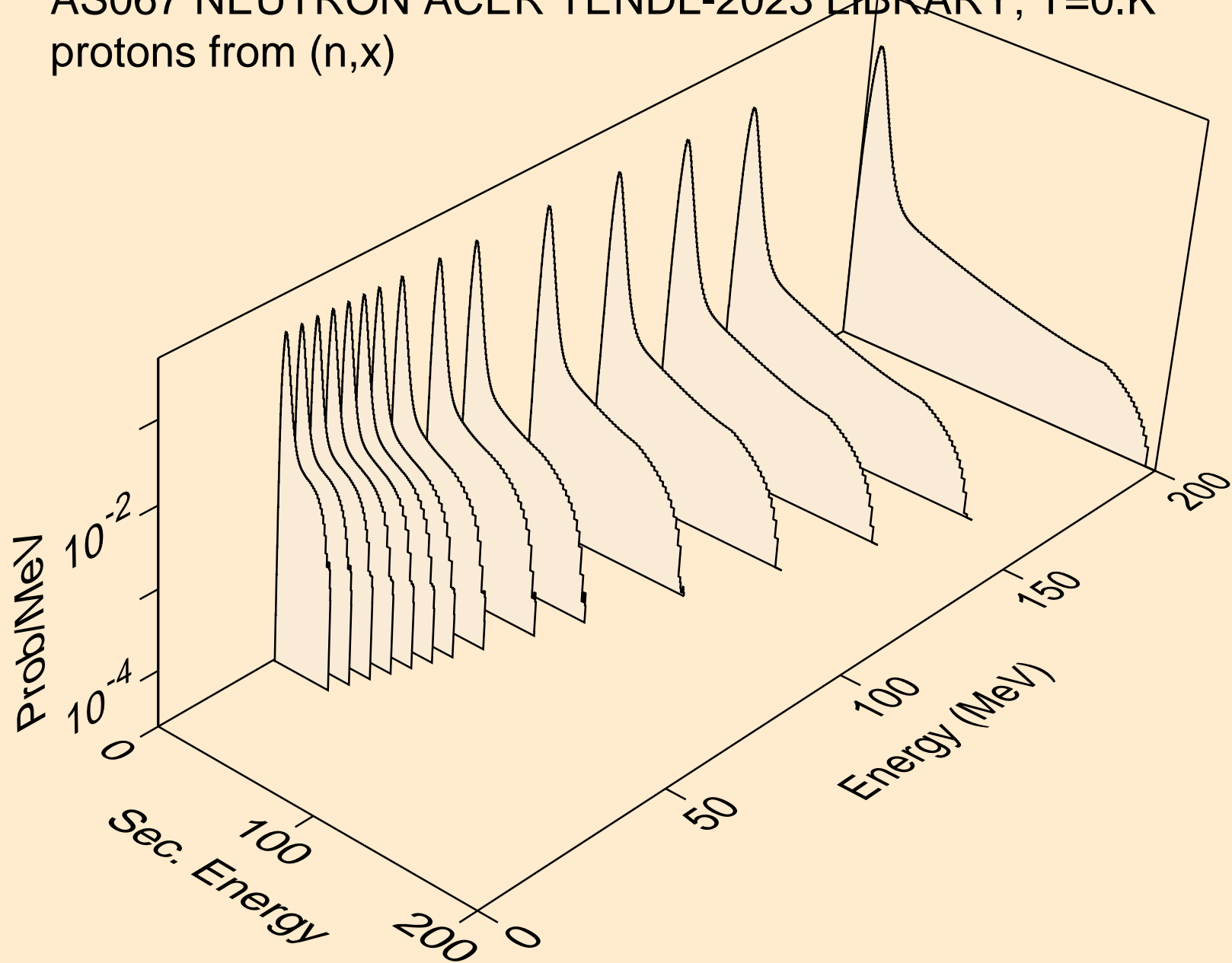

AS067 NEUTRON ACER TENDL-2023 LIBRARY; T=0.K
protons from (n,n*)p

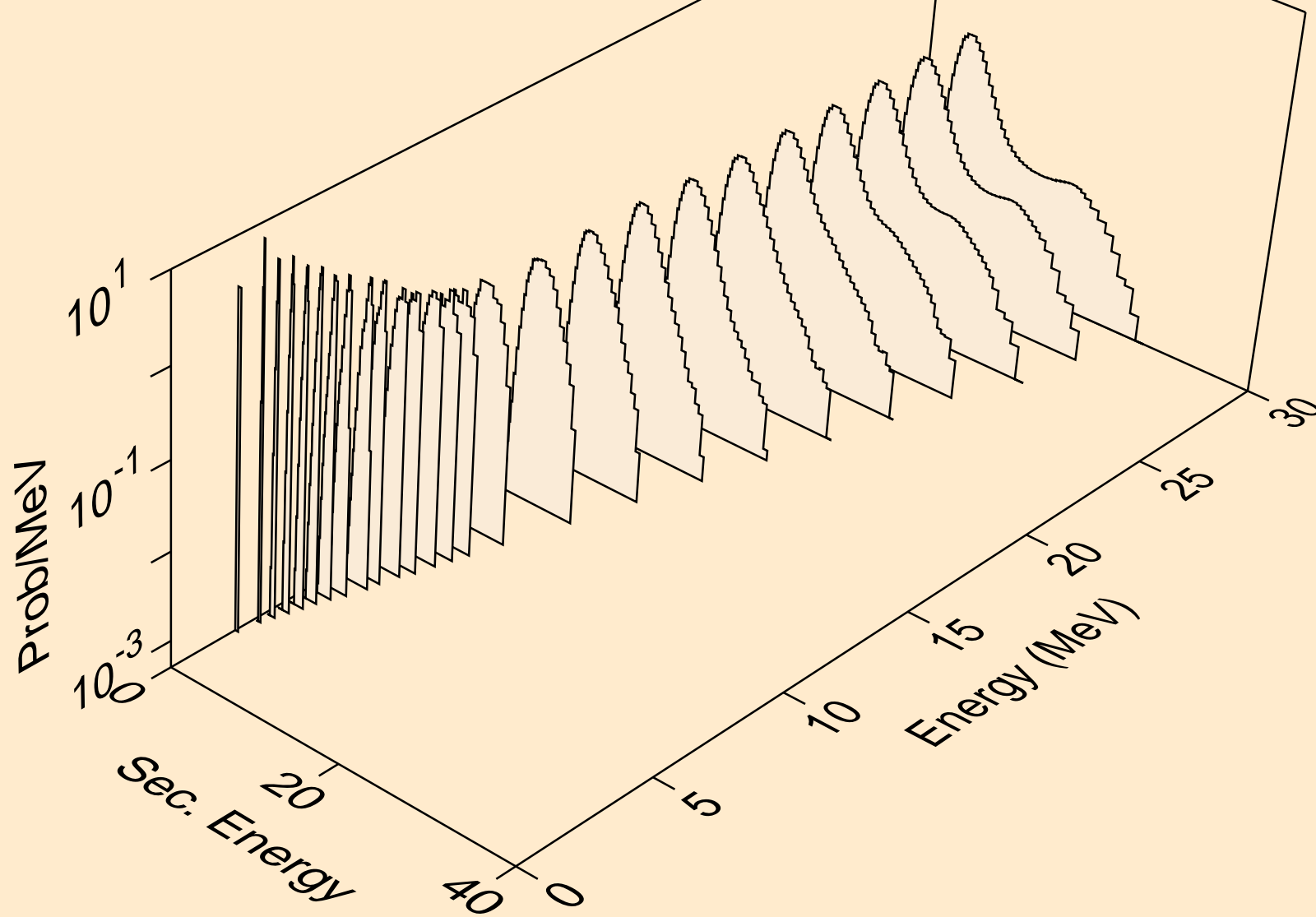

AS067 NEUTRON ACER TENDL-2023 LIBRARY; T=0.K
protons from (n,2np)

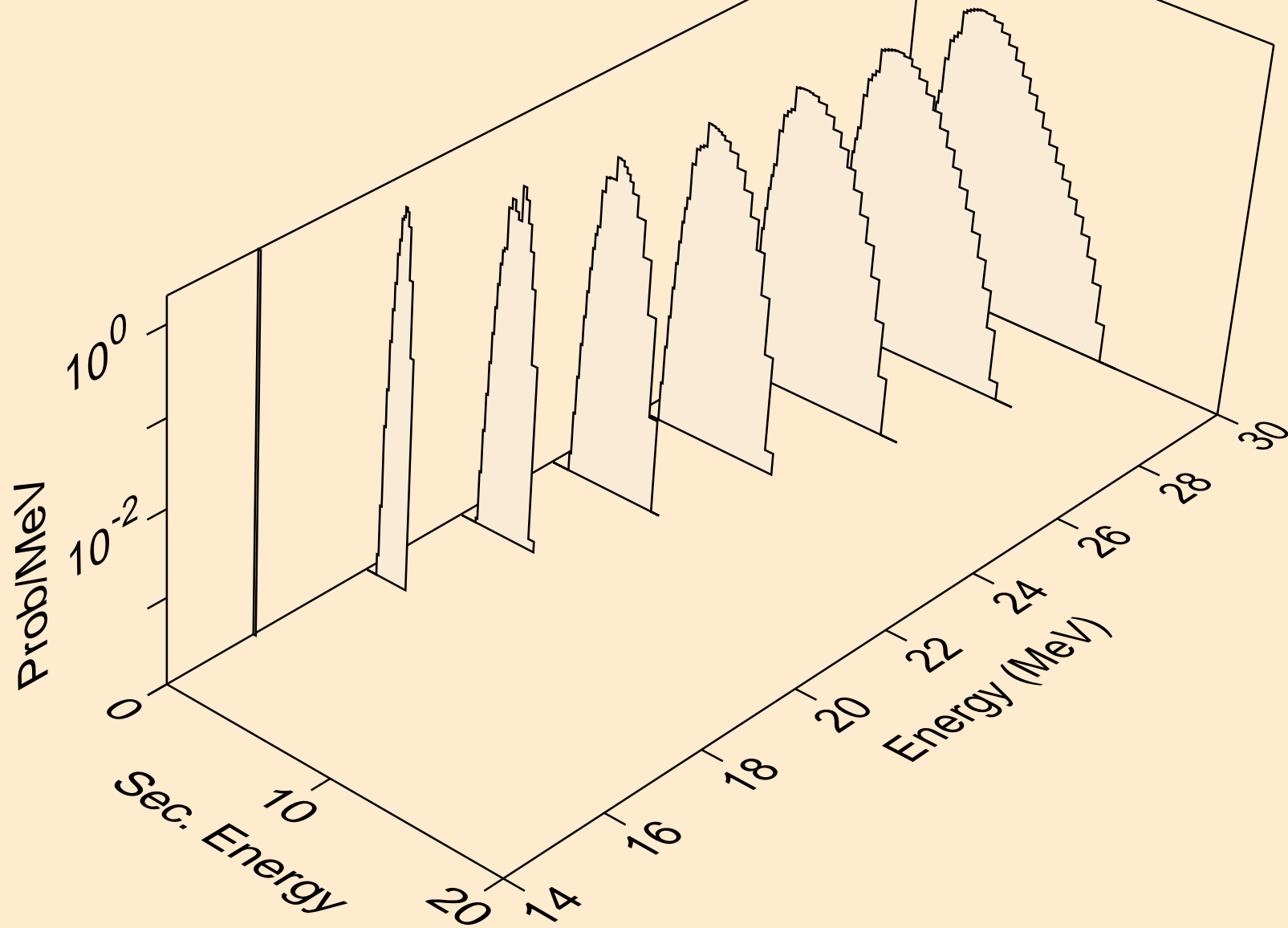

AS067 NEUTRON ACER TENDL-2023 LIBRARY; T=0.K
protons from (n,3np)

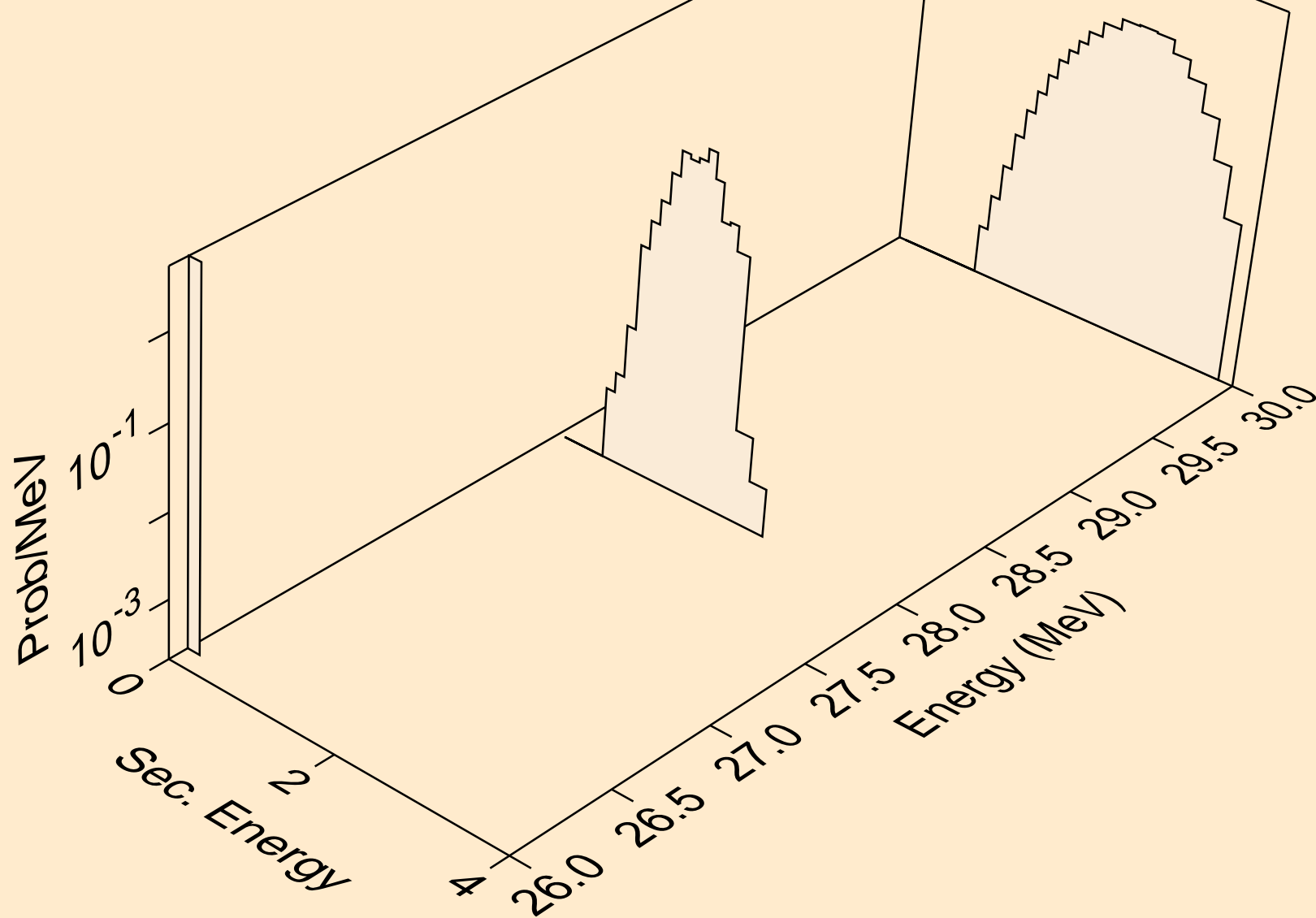

AS067 NEUTRON ACER TENDL-2023 LIBRARY; T=0.K
protons from (n,n2p)

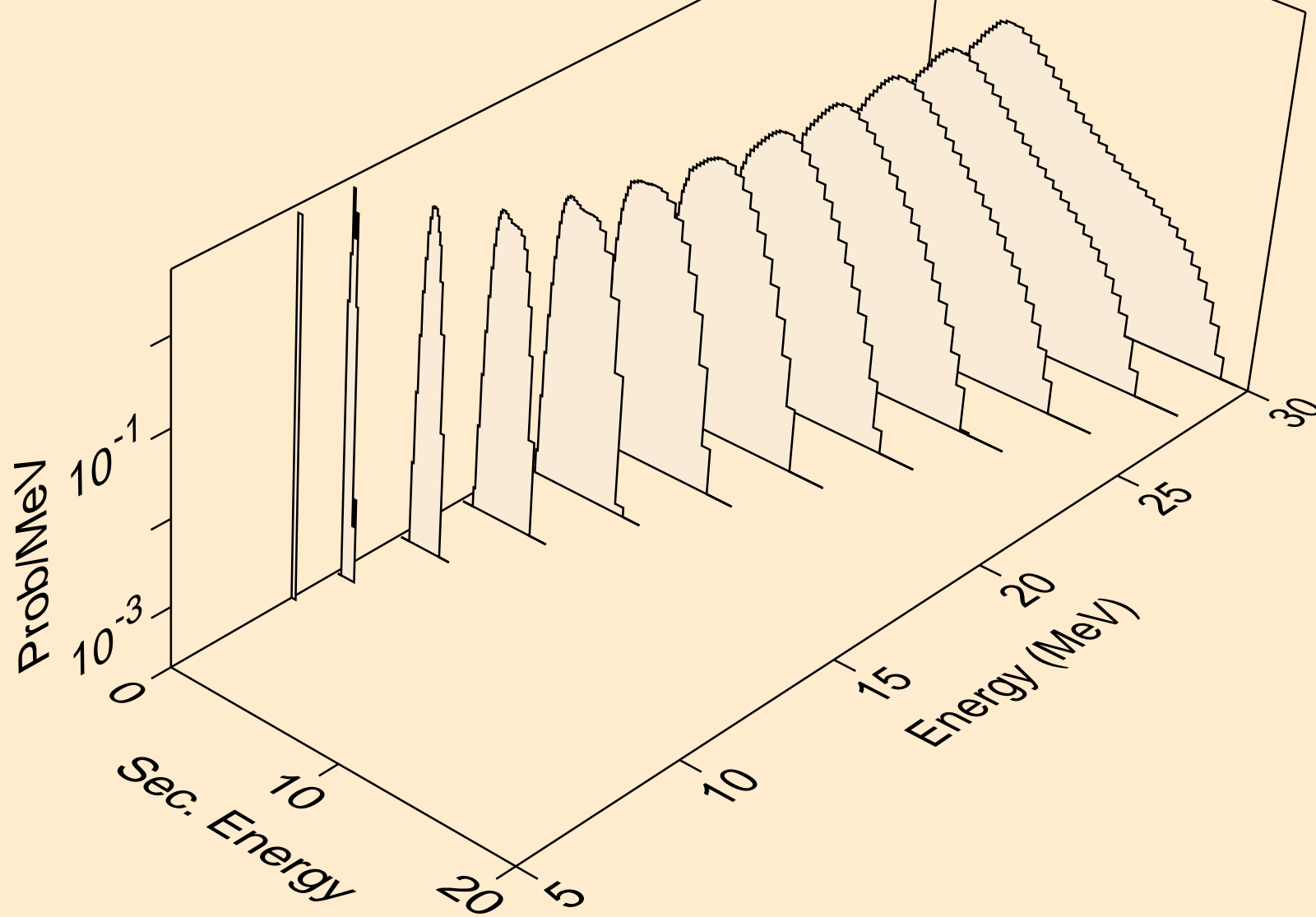

AS067 NEUTRON ACER TENDL-2023 LIBRARY; T=0.K
protons from (n,npa)

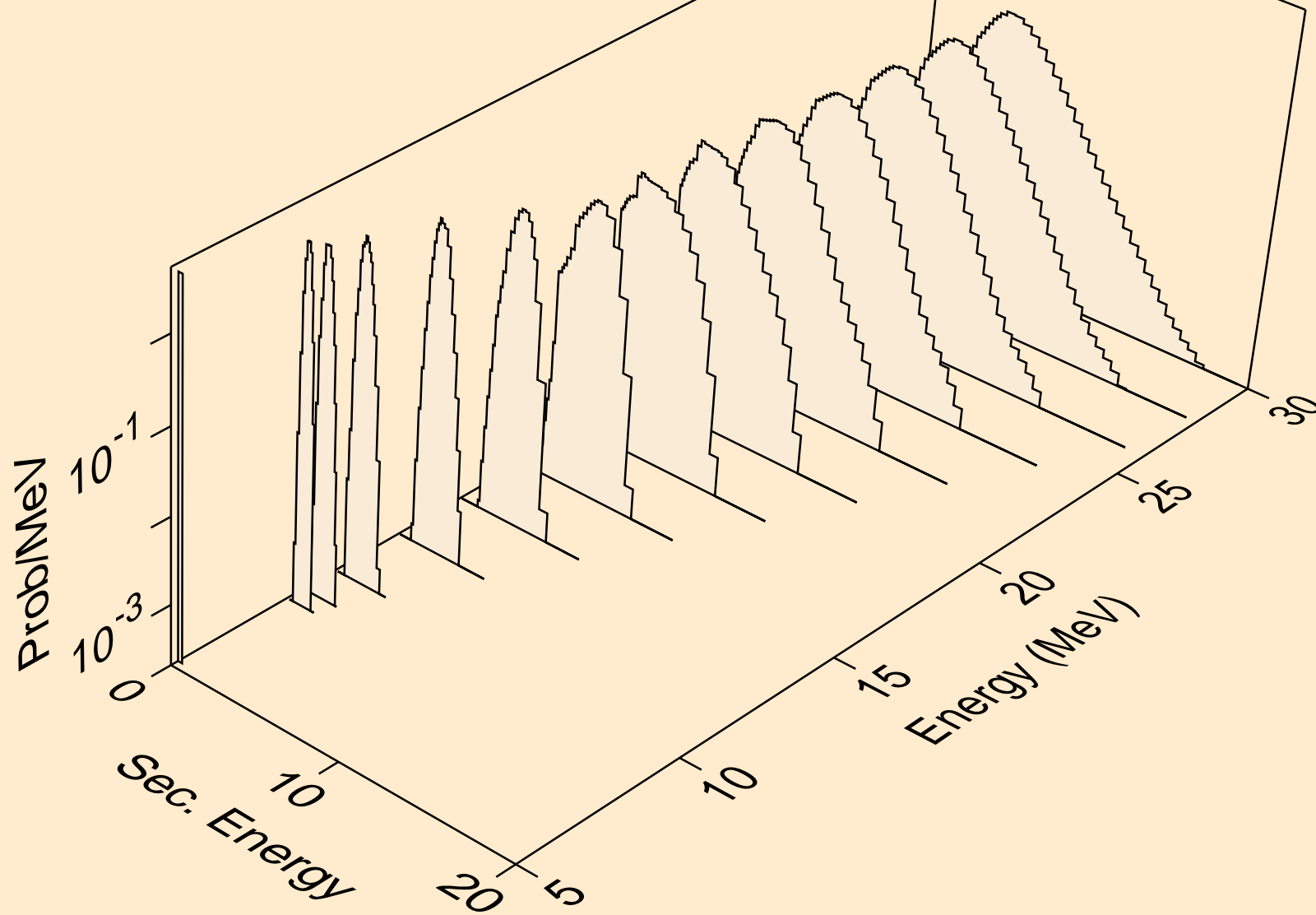

AS067 NEUTRON ACER TENDL-2023 LIBRARY; T=0.K
protons from (n,p)

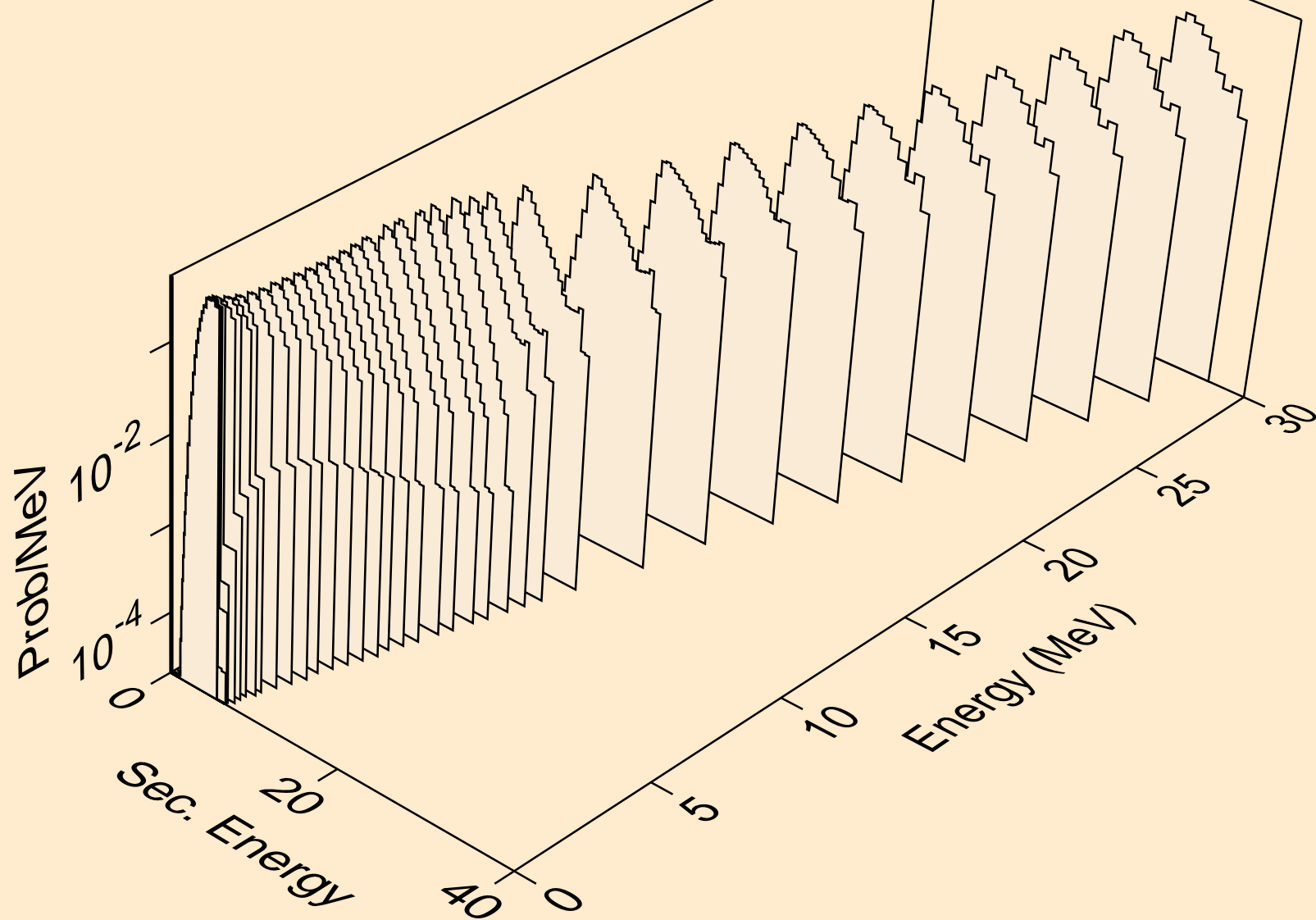

AS067 NEUTRON ACER TENDL-2023 LIBRARY; T=0.K
protons from (n,2p)

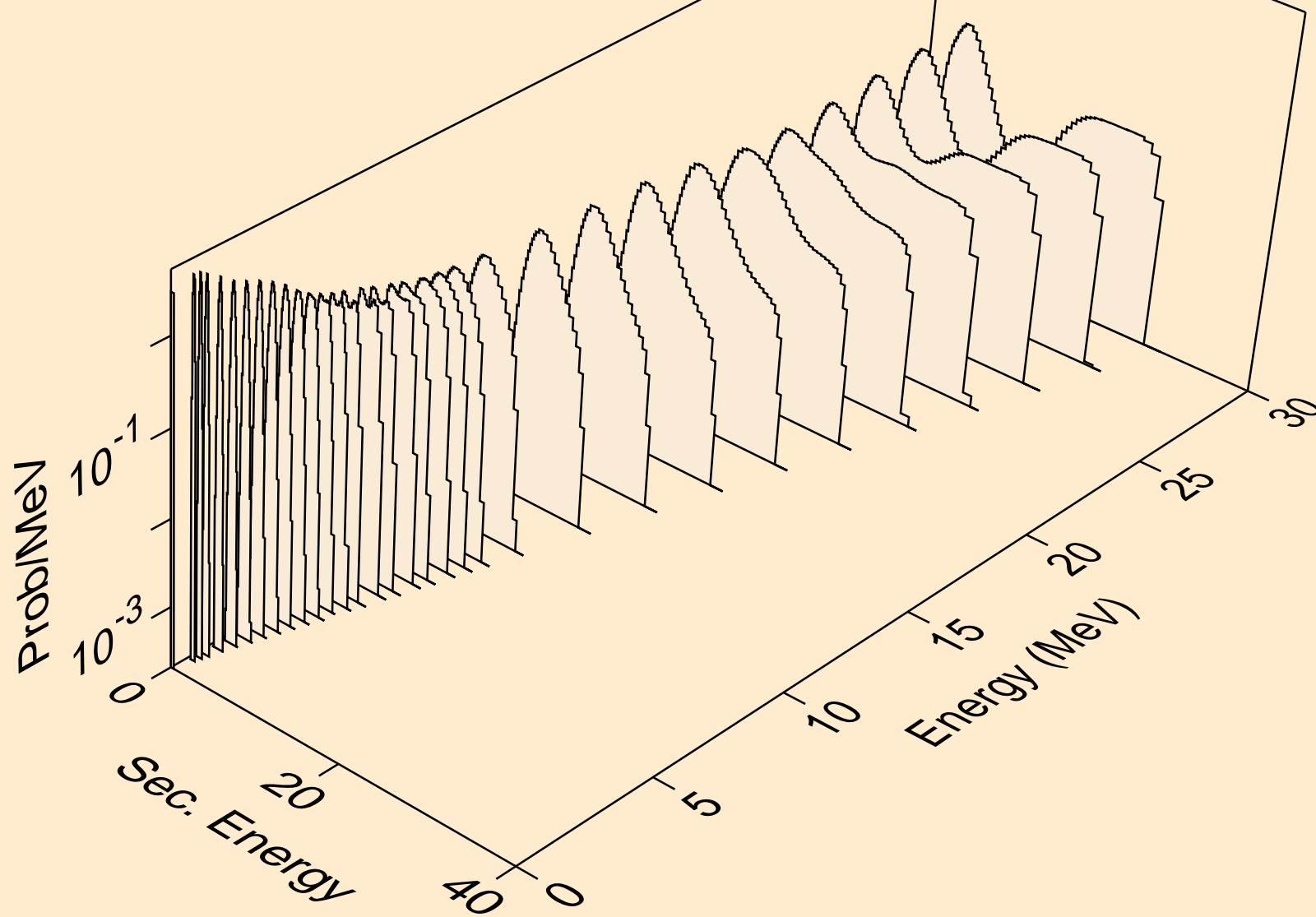

AS067 NEUTRON ACER TENDL-2023 LIBRARY; T=0.K
protons from (n,p)

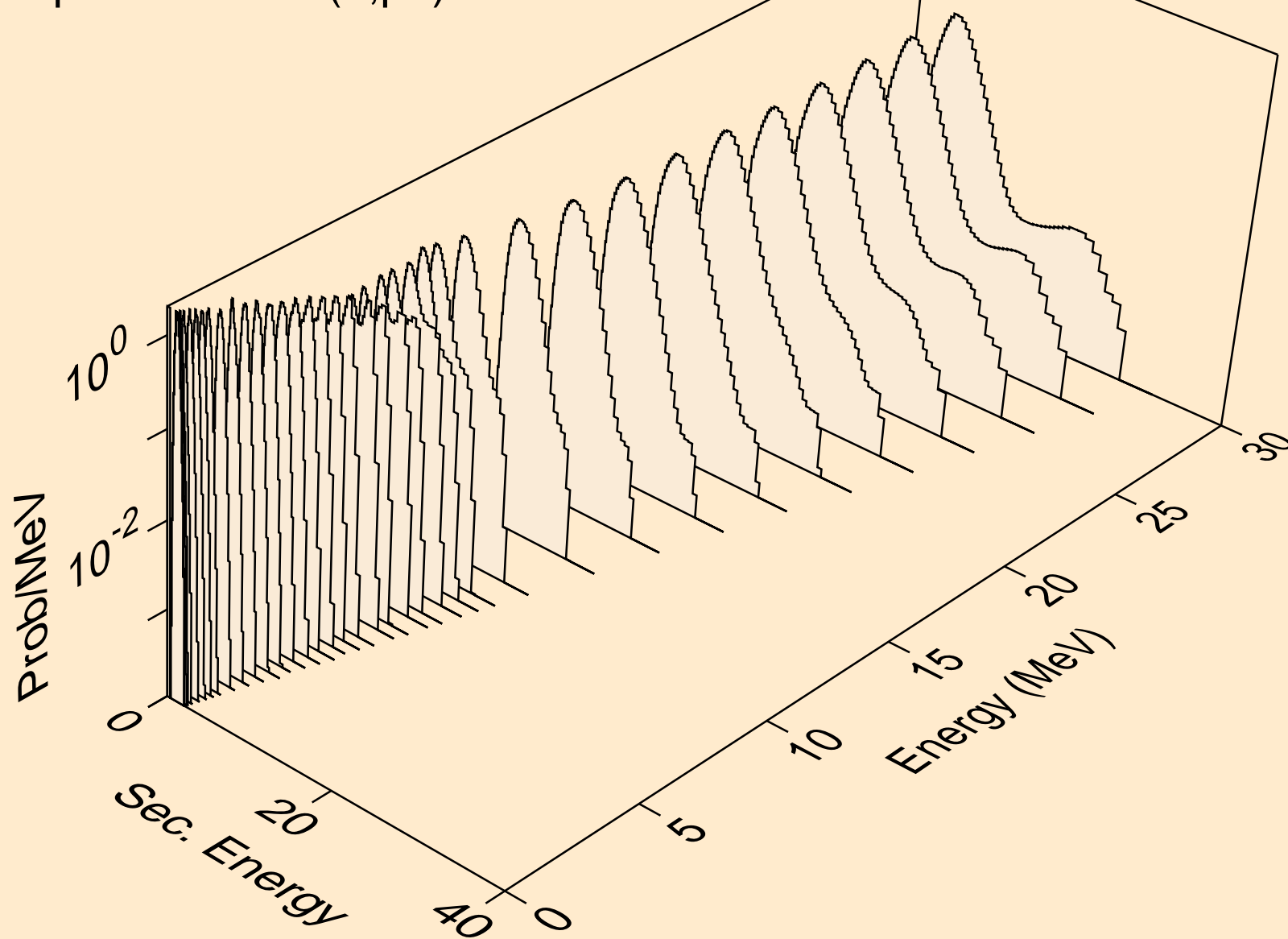

AS067 NEUTRON ACER TENDL-2023 LIBRARY; T=0.K
protons from (n,pd)

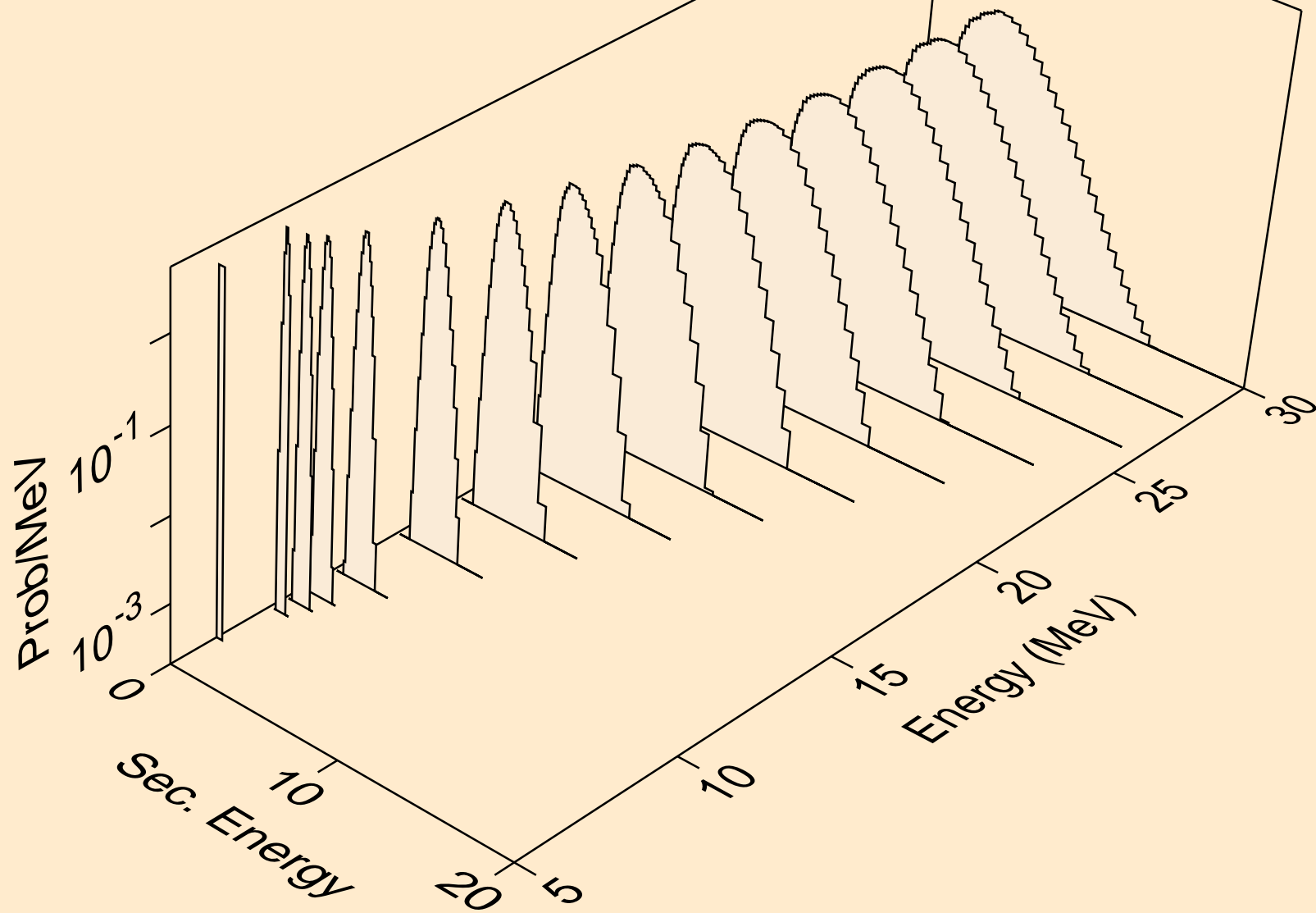

AS067 NEUTRON ACER TENDL-2023 LIBRARY; T=0.K
protons from (n,pt)

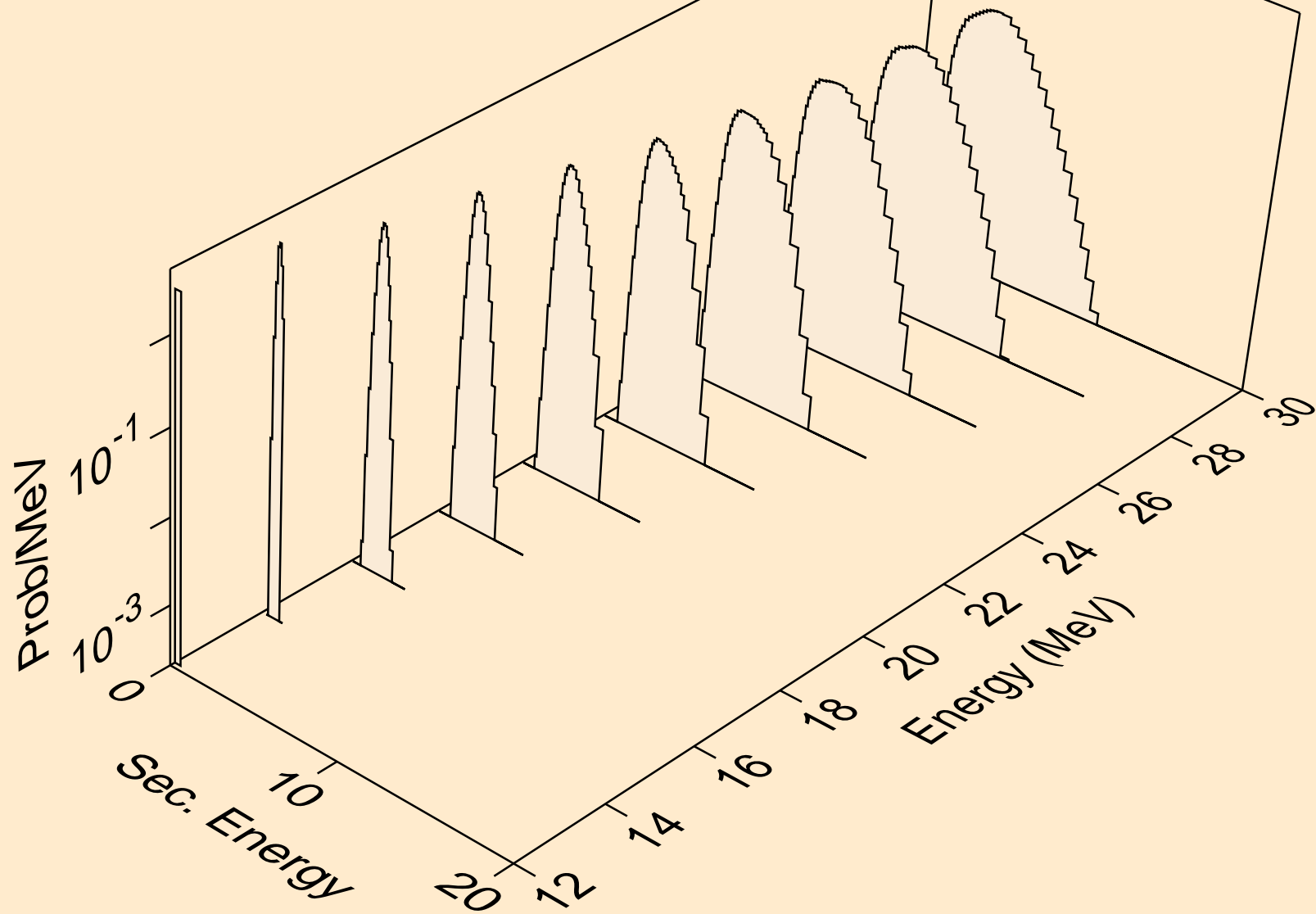

AS067 NEUTRON ACER TENDL-2023 LIBRARY; T=0.K
deuterons from (n,x)

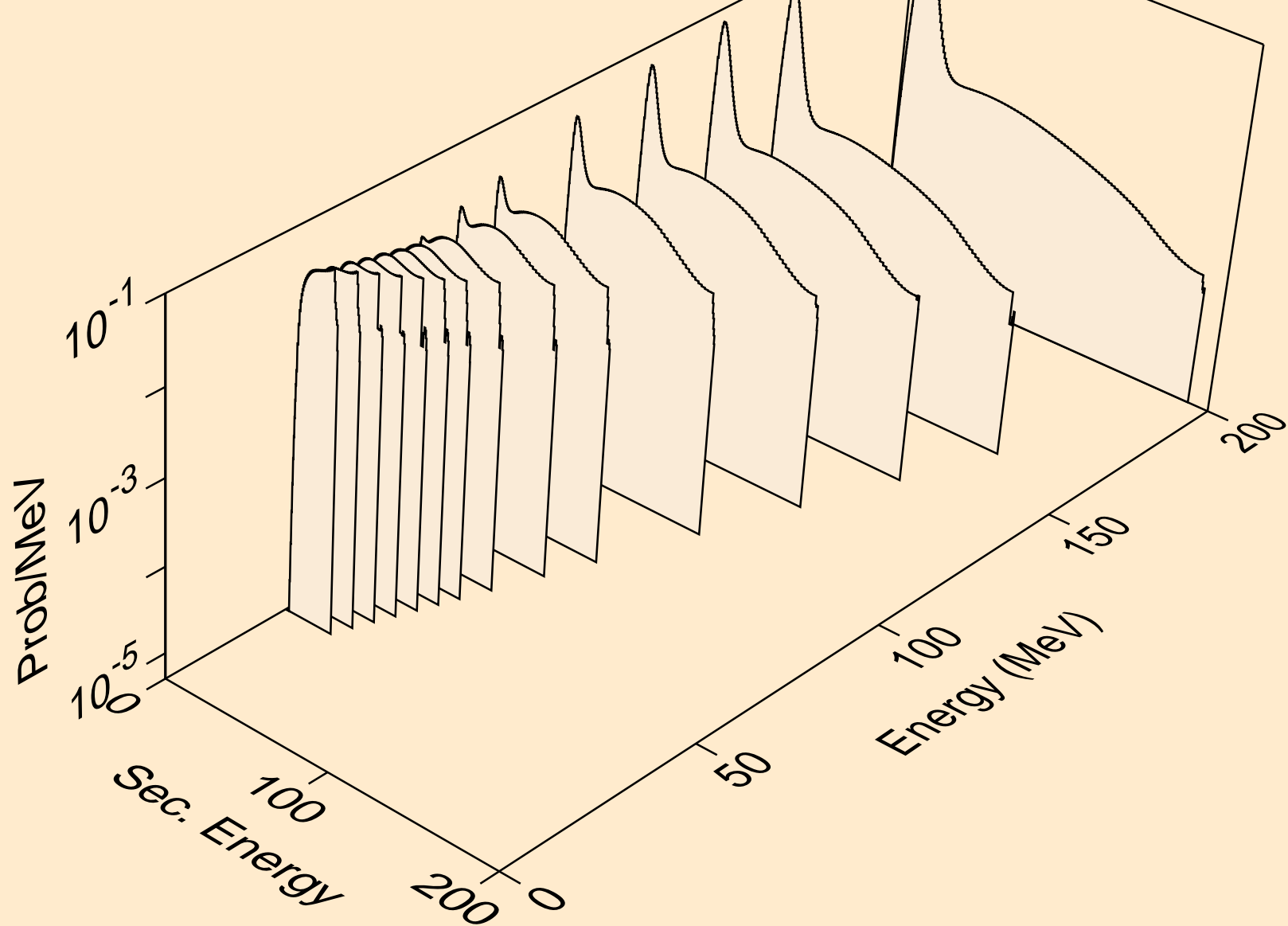

AS067 NEUTRON ACER TENDL-2023 LIBRARY; T=0.K
deuterons from (n,2nd)

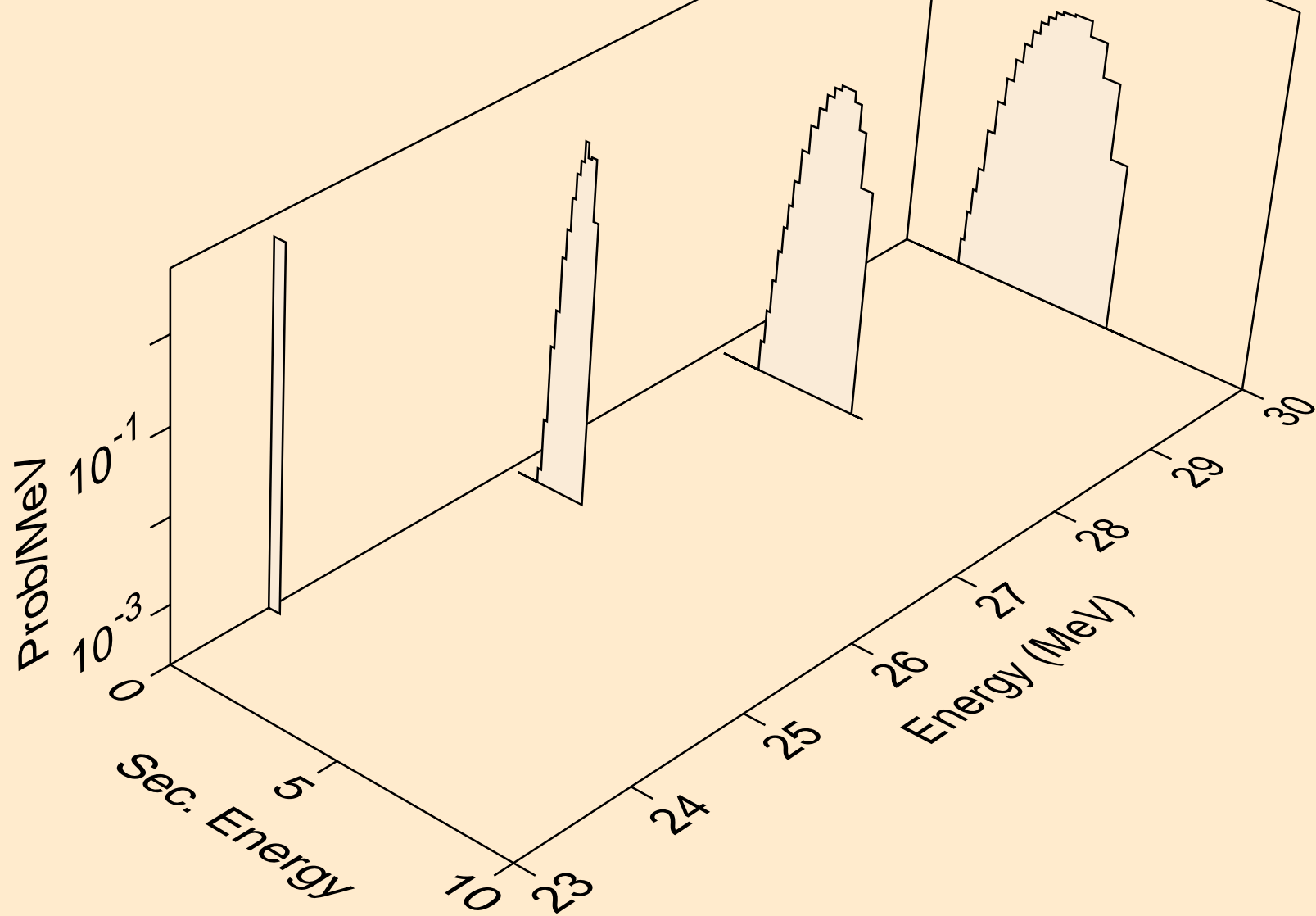

AS067 NEUTRON ACER TENDL-2023 LIBRARY; T=0.K
deuterons from (n,n*)d

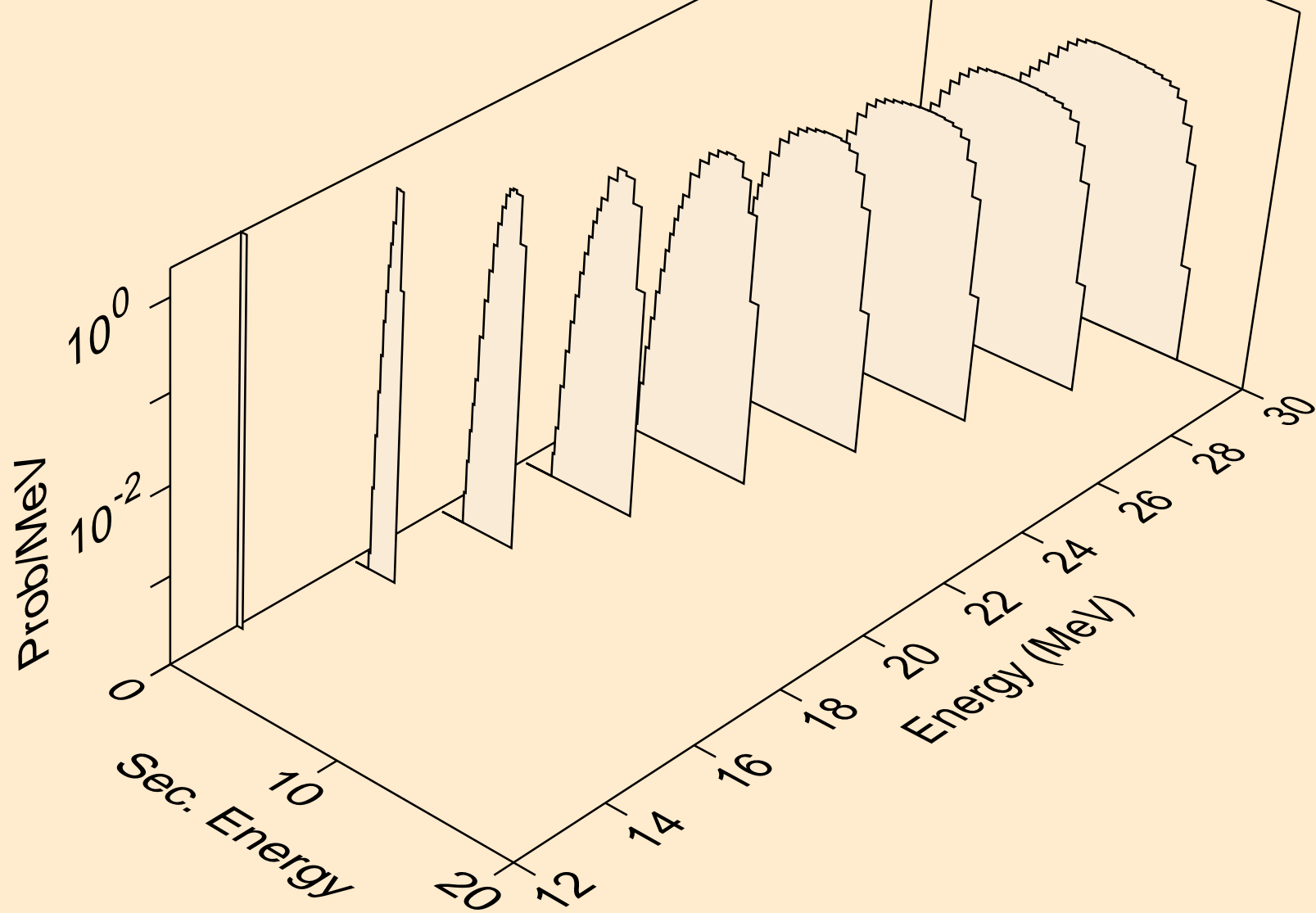

AS067 NEUTRON ACER TENDL-2023 LIBRARY; T=0.K
deuterons from (n,d)

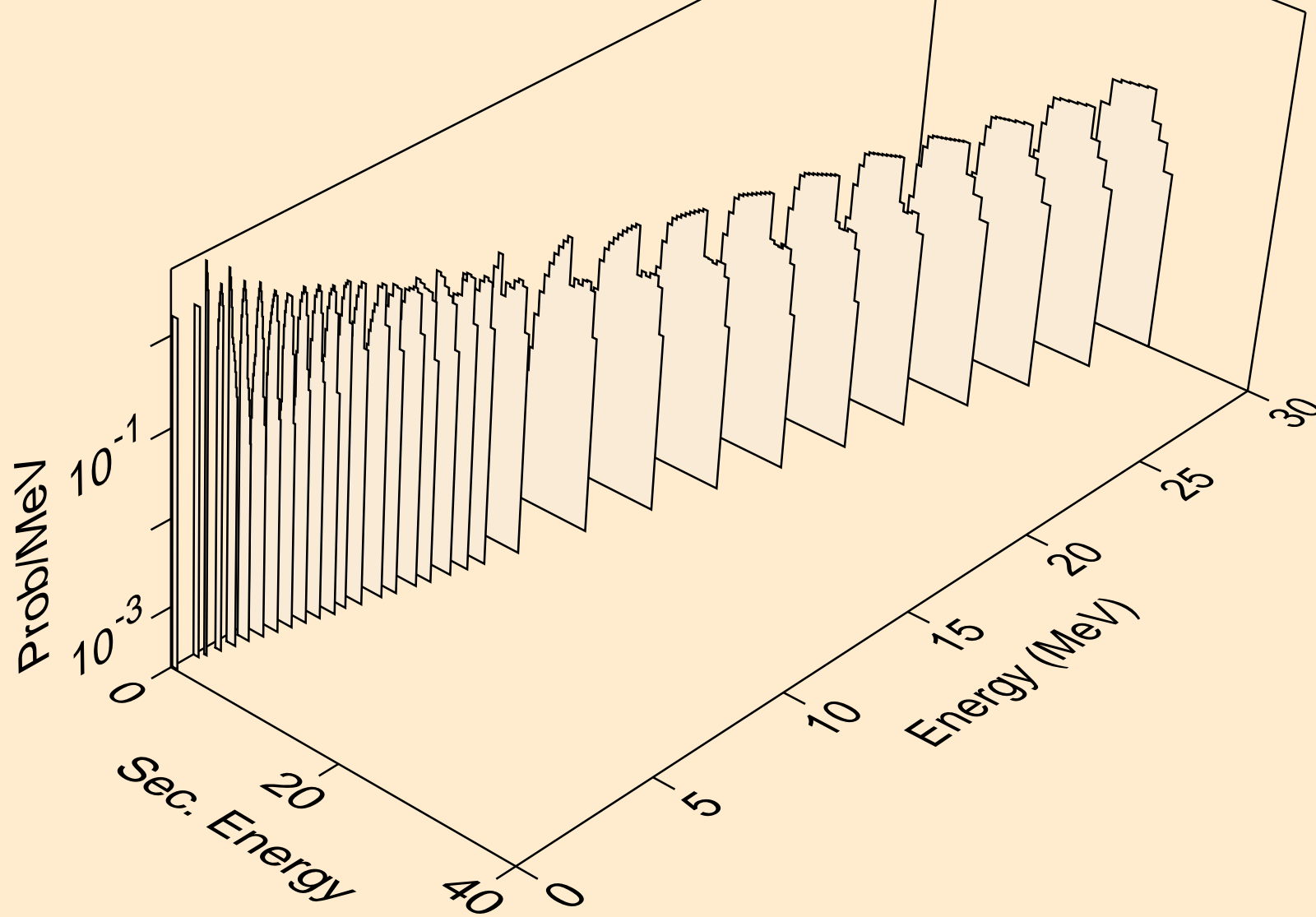

AS067 NEUTRON ACER TENDL-2023 LIBRARY; T=0.K
deuterons from (n,d2a)

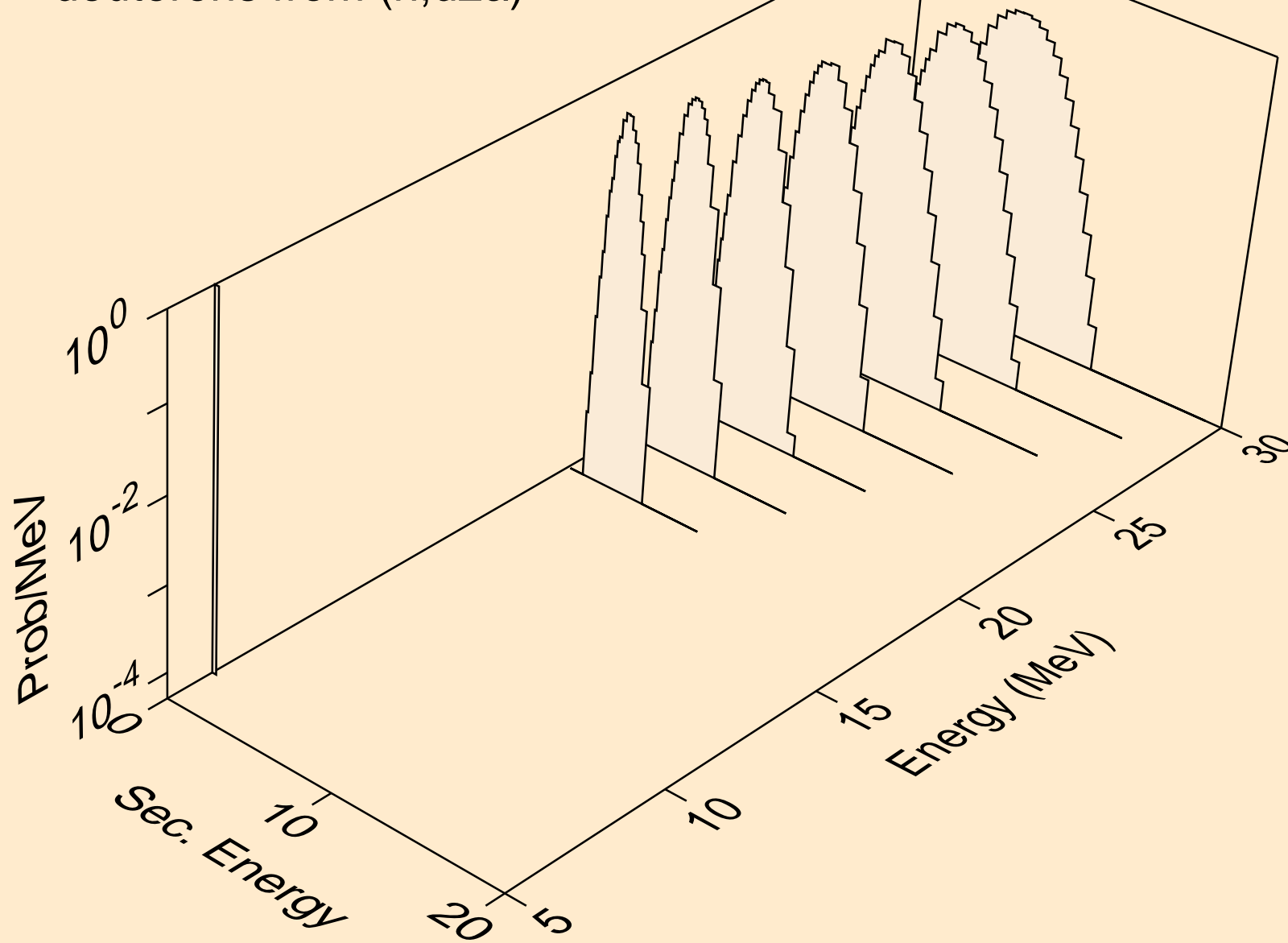

AS067 NEUTRON ACER TENDL-2023 LIBRARY; T=0.K
deuterons from (n,pd)

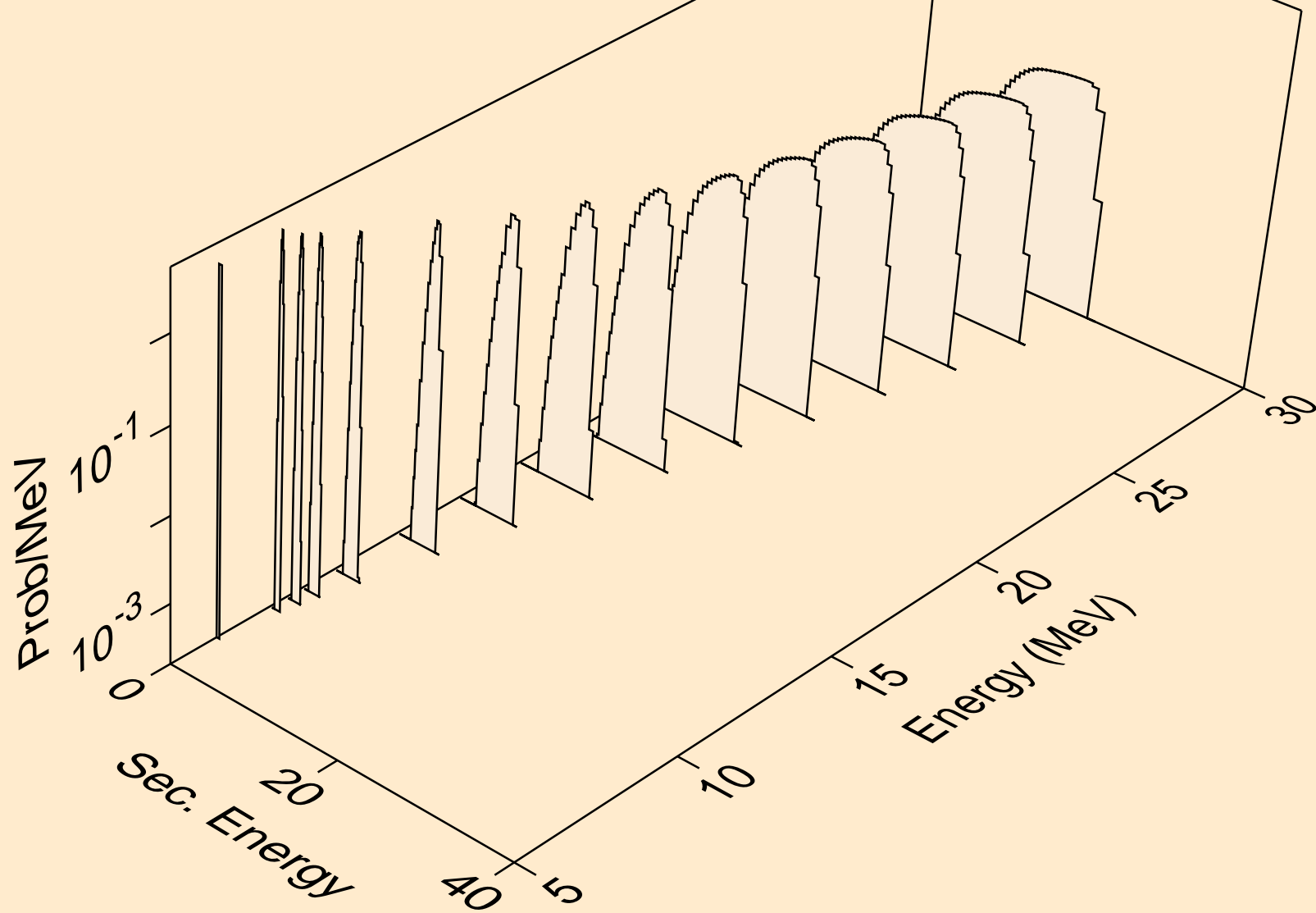

AS067 NEUTRON ACER TENDL-2023 LIBRARY; T=0.K
deuterons from (n,da)

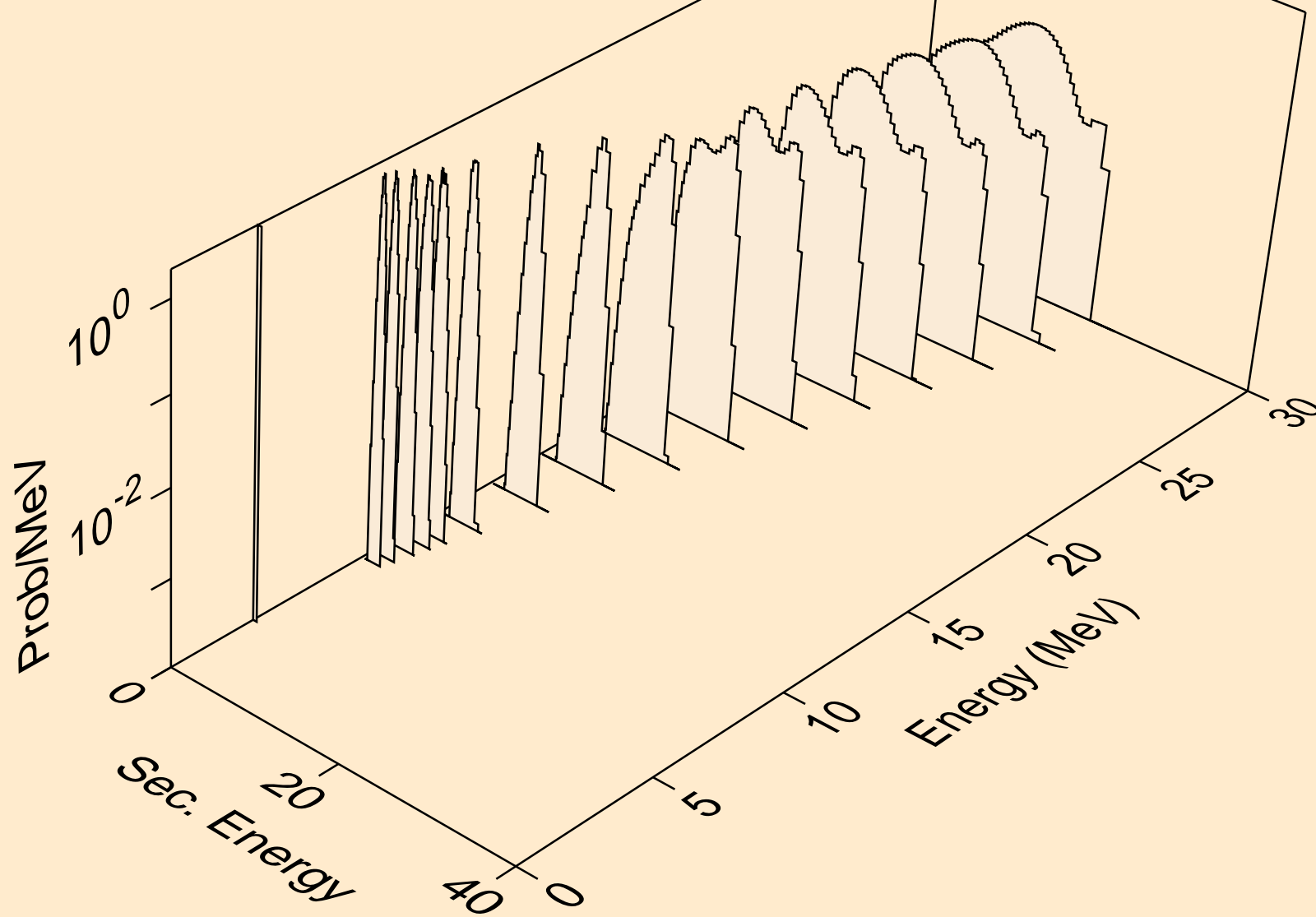

AS067 NEUTRON ACER TENDL-2023 LIBRARY; T=0.K
tritons from (n,x)

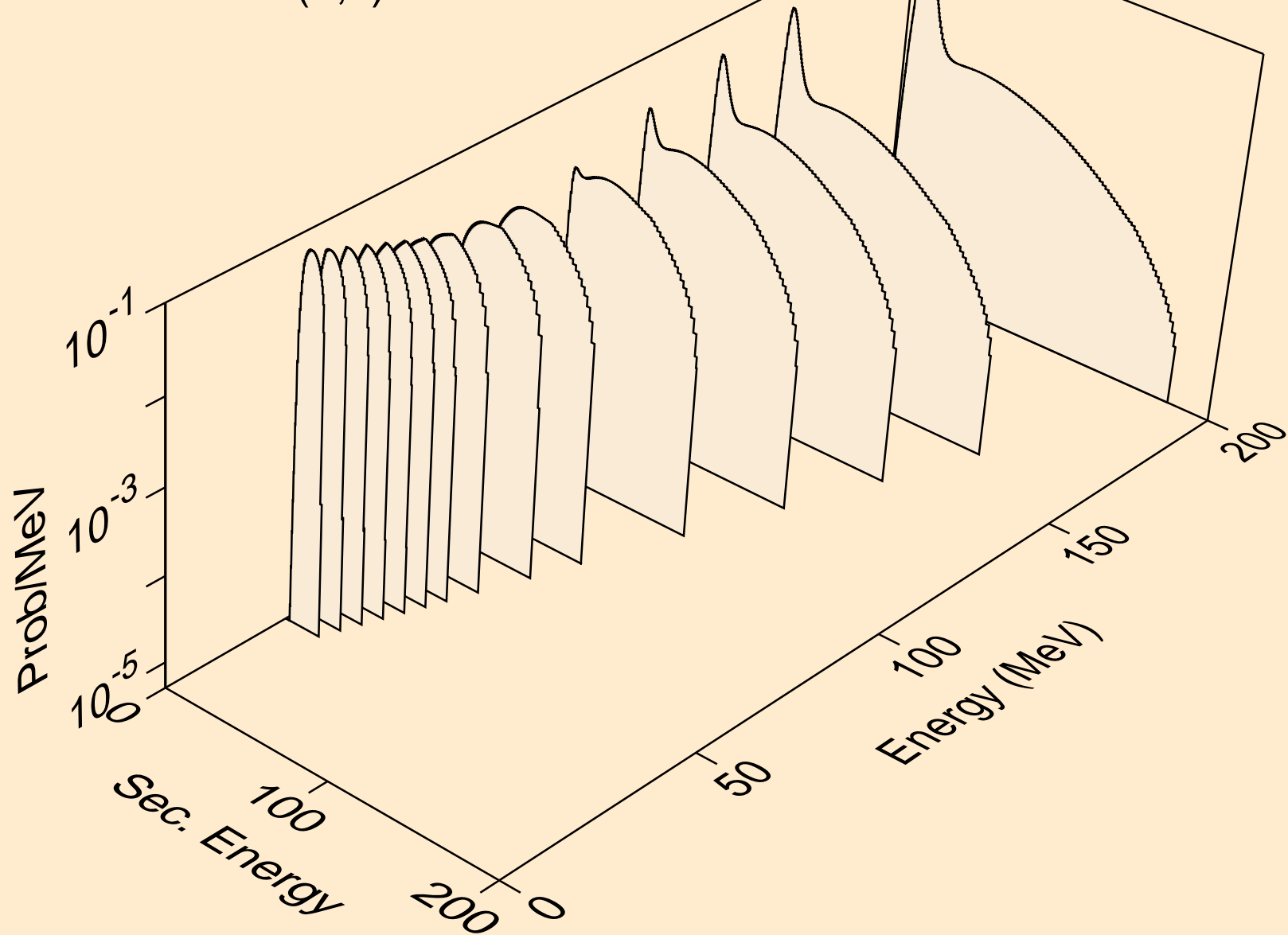

AS067 NEUTRON ACER TENDL-2023 LIBRARY; T=0.K
tritons from (n,n*)t

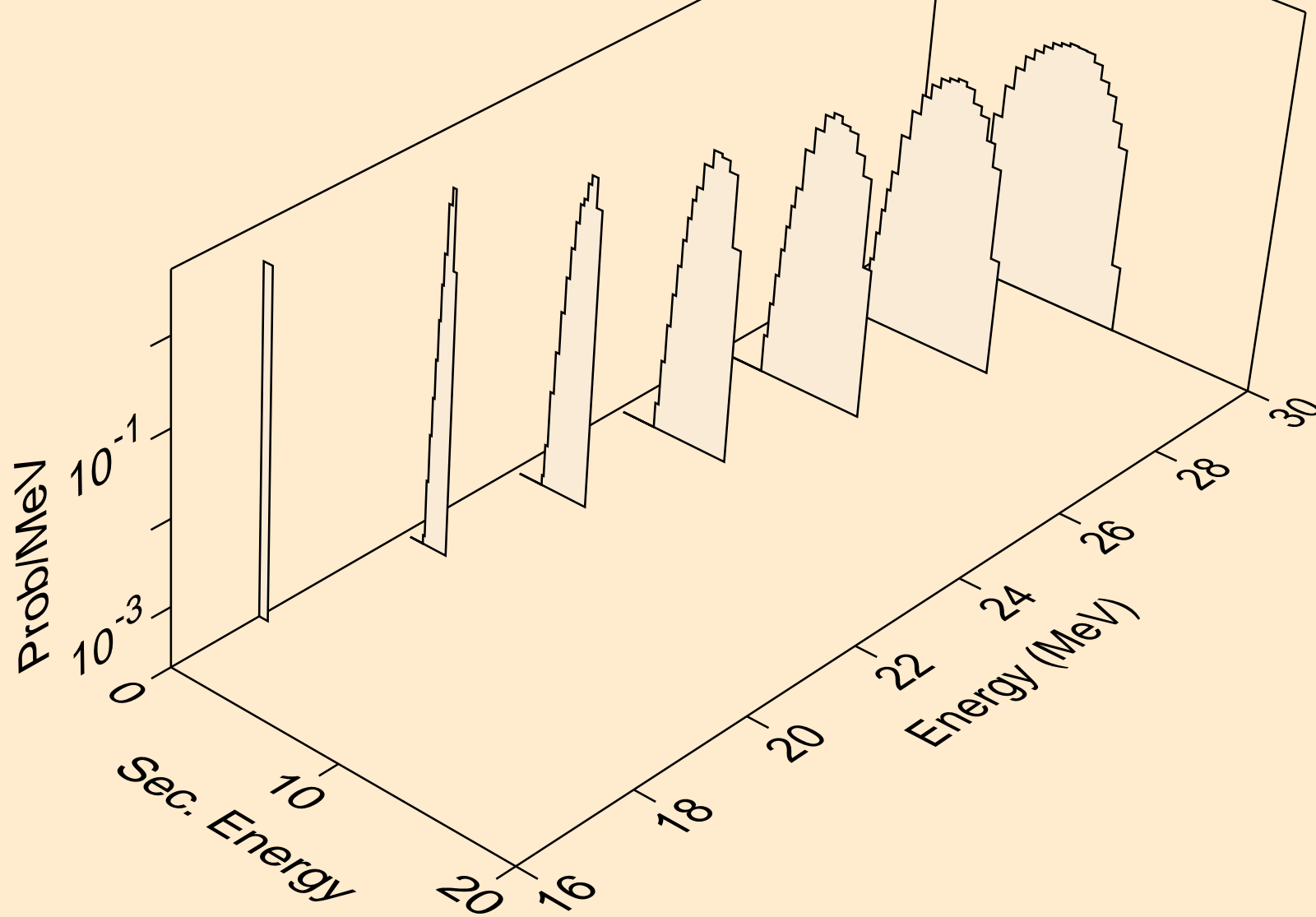

AS067 NEUTRON ACER TENDL-2023 LIBRARY; T=0.K
tritons from (n,t)

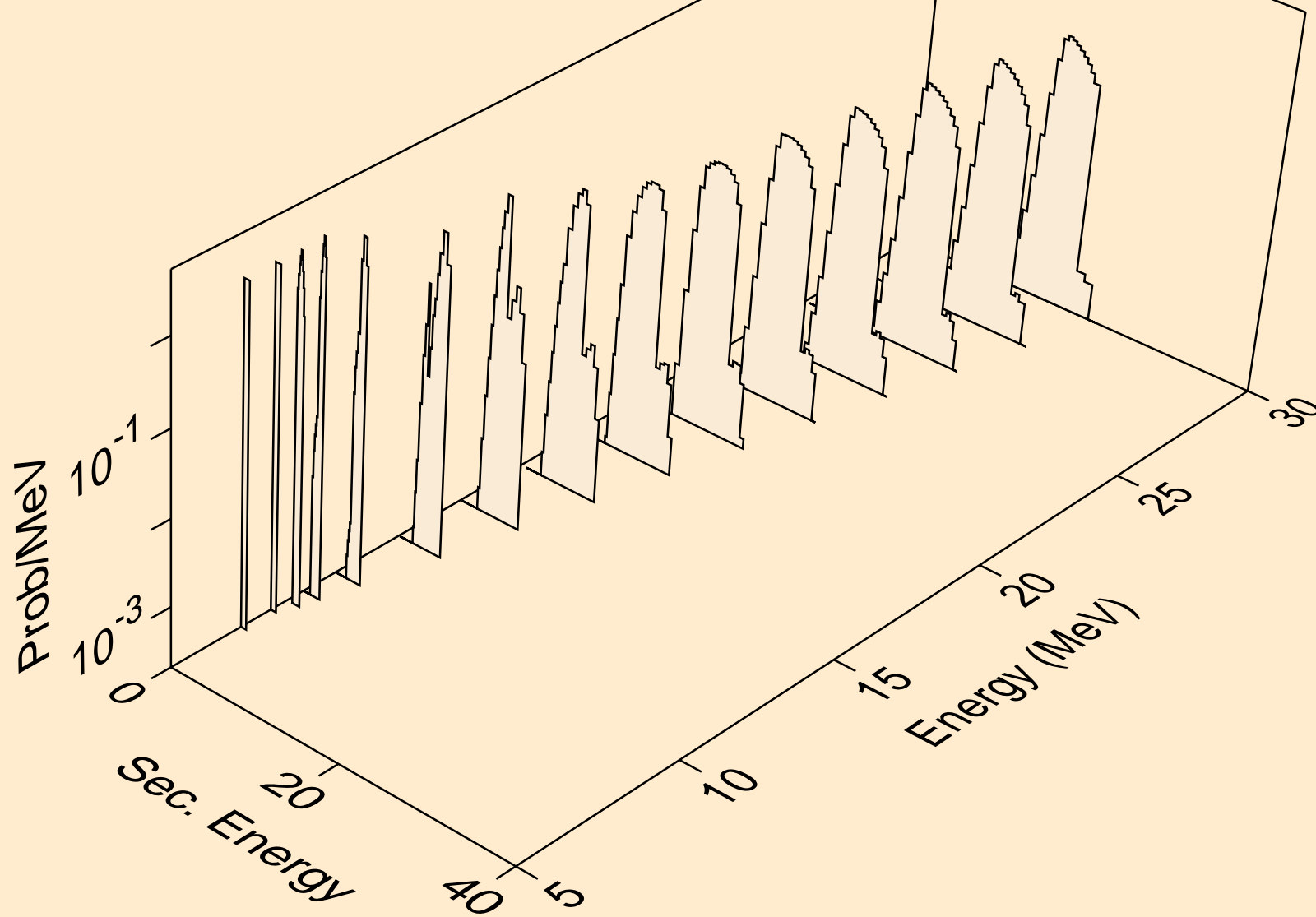

AS067 NEUTRON ACER TENDL-2023 LIBRARY; T=0.K
tritons from (n,pt)

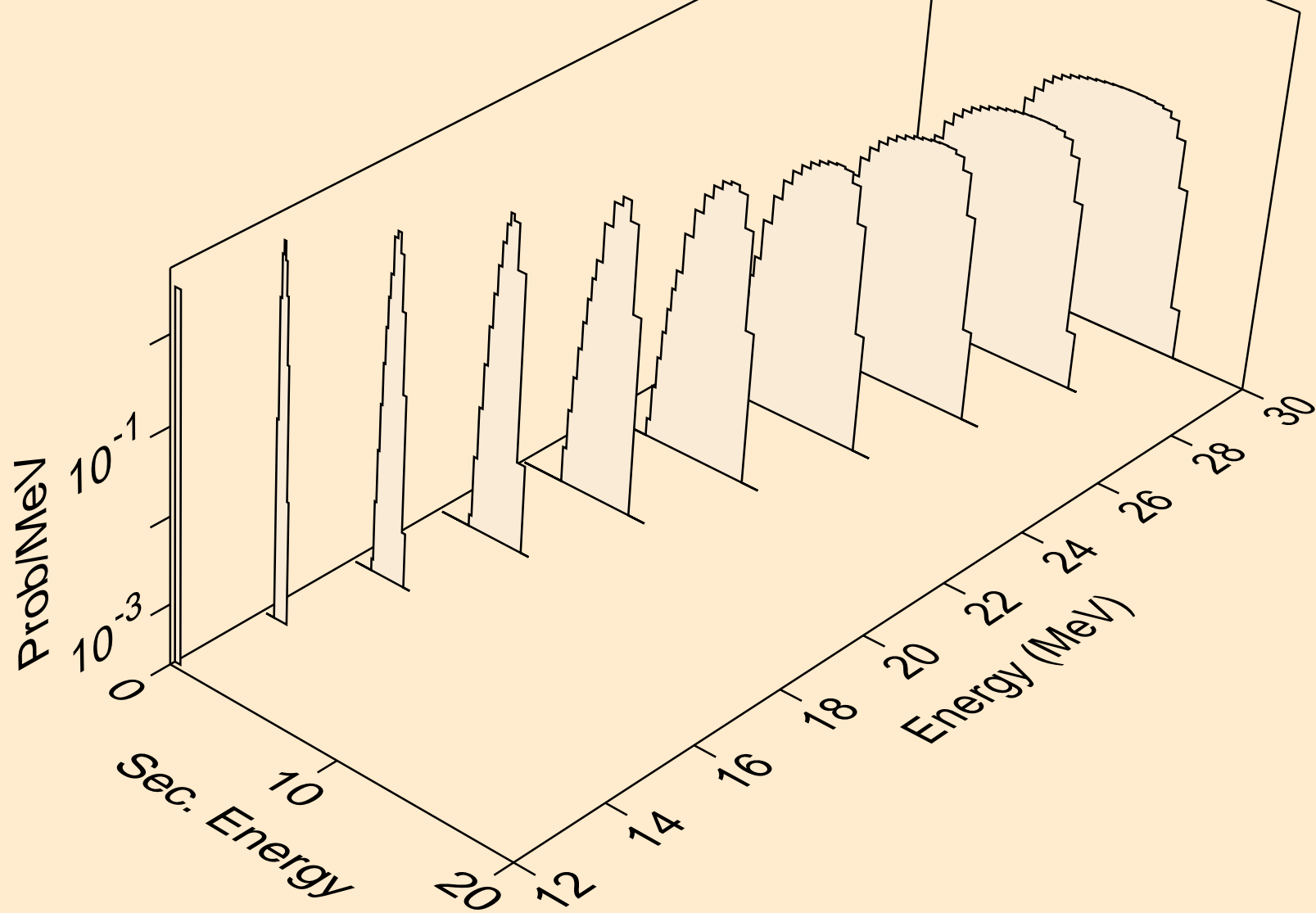

AS067 NEUTRON ACER TENDL-2023 LIBRARY; T=0.K
he3s from (n,x)

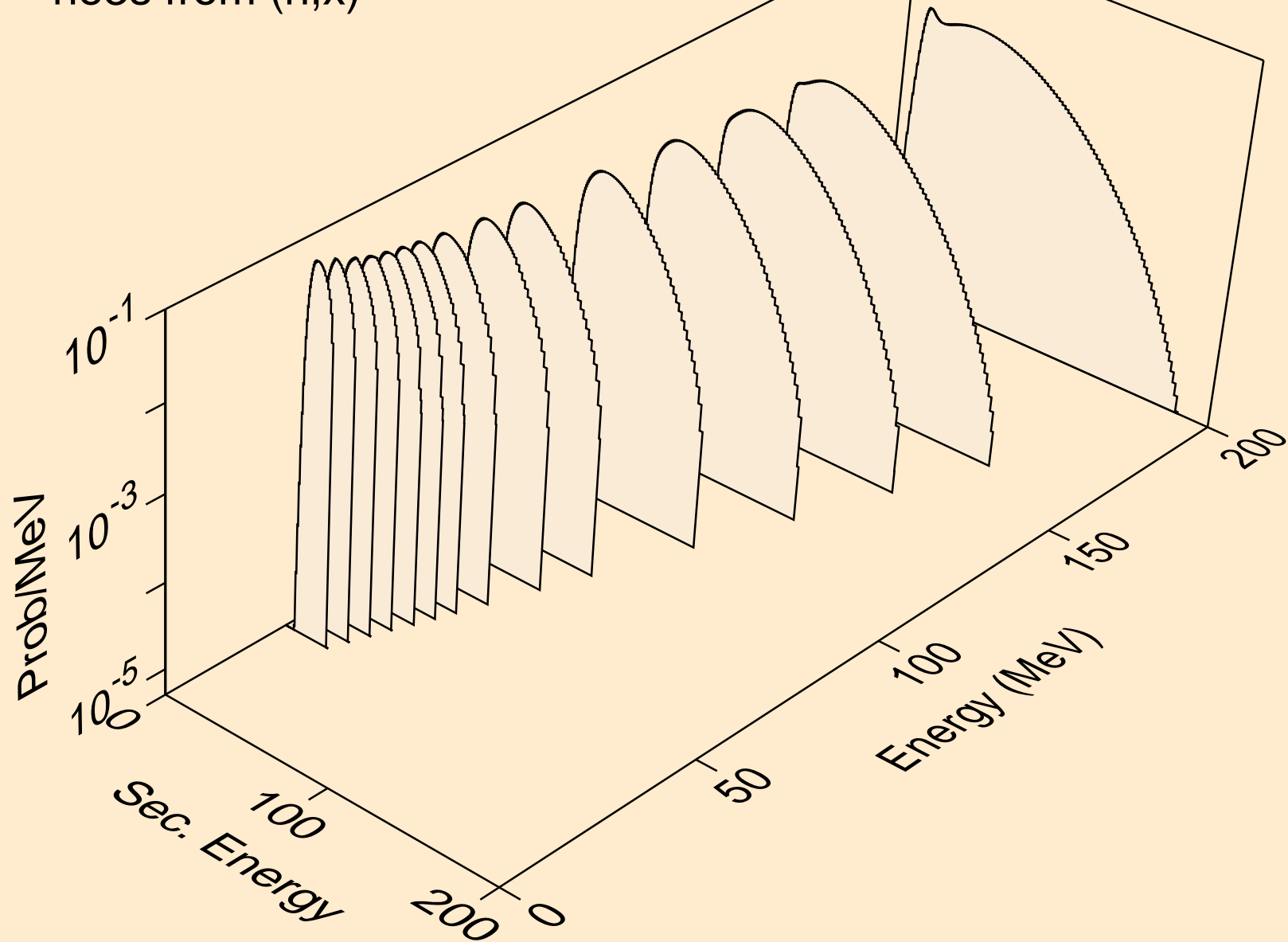

AS067 NEUTRON ACER TENDL-2023 LIBRARY; T=0.K
he3s from (n,n*)he3

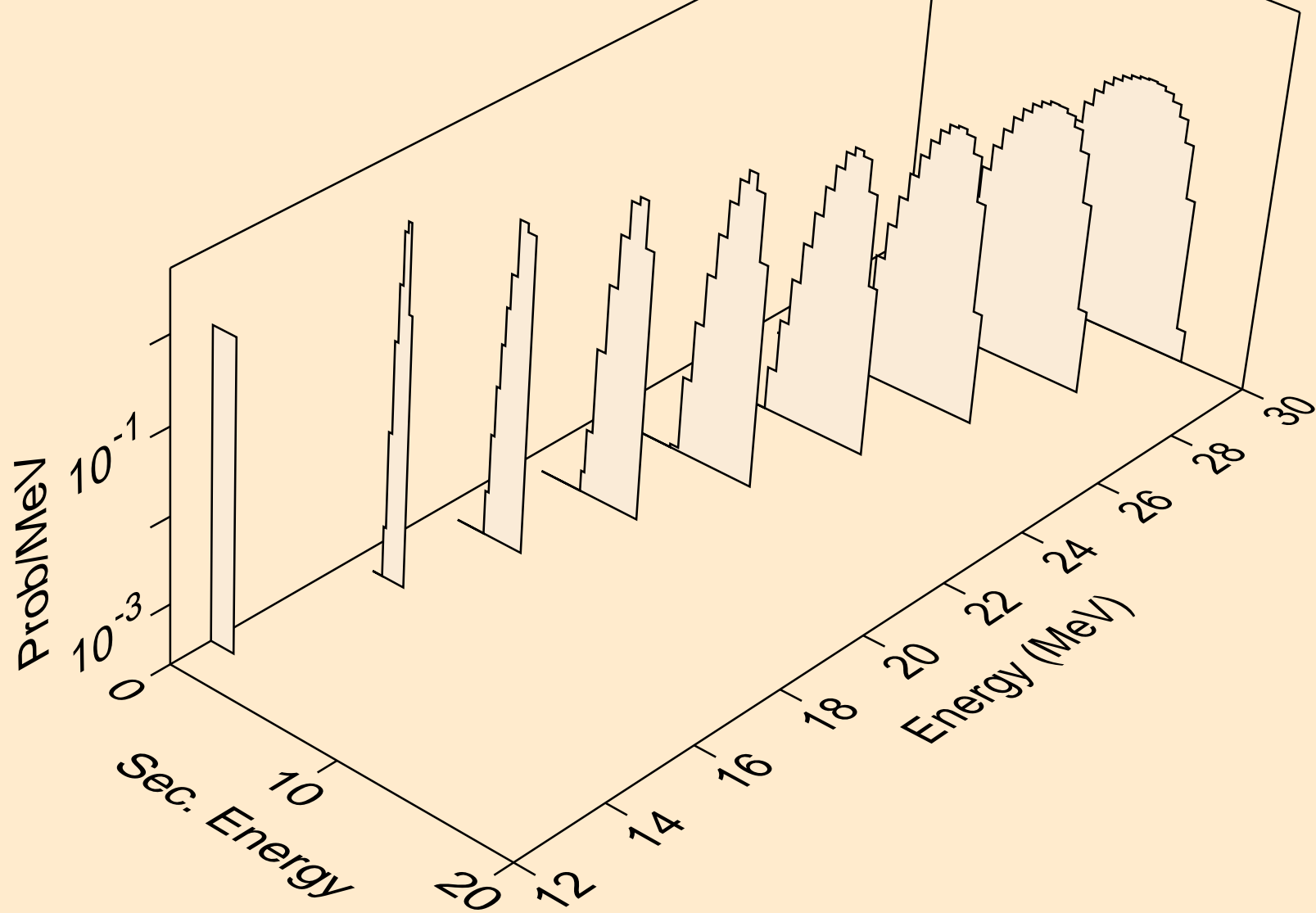

AS067 NEUTRON ACER TENDL-2023 LIBRARY; T=0.K
he3s from (n,he3)

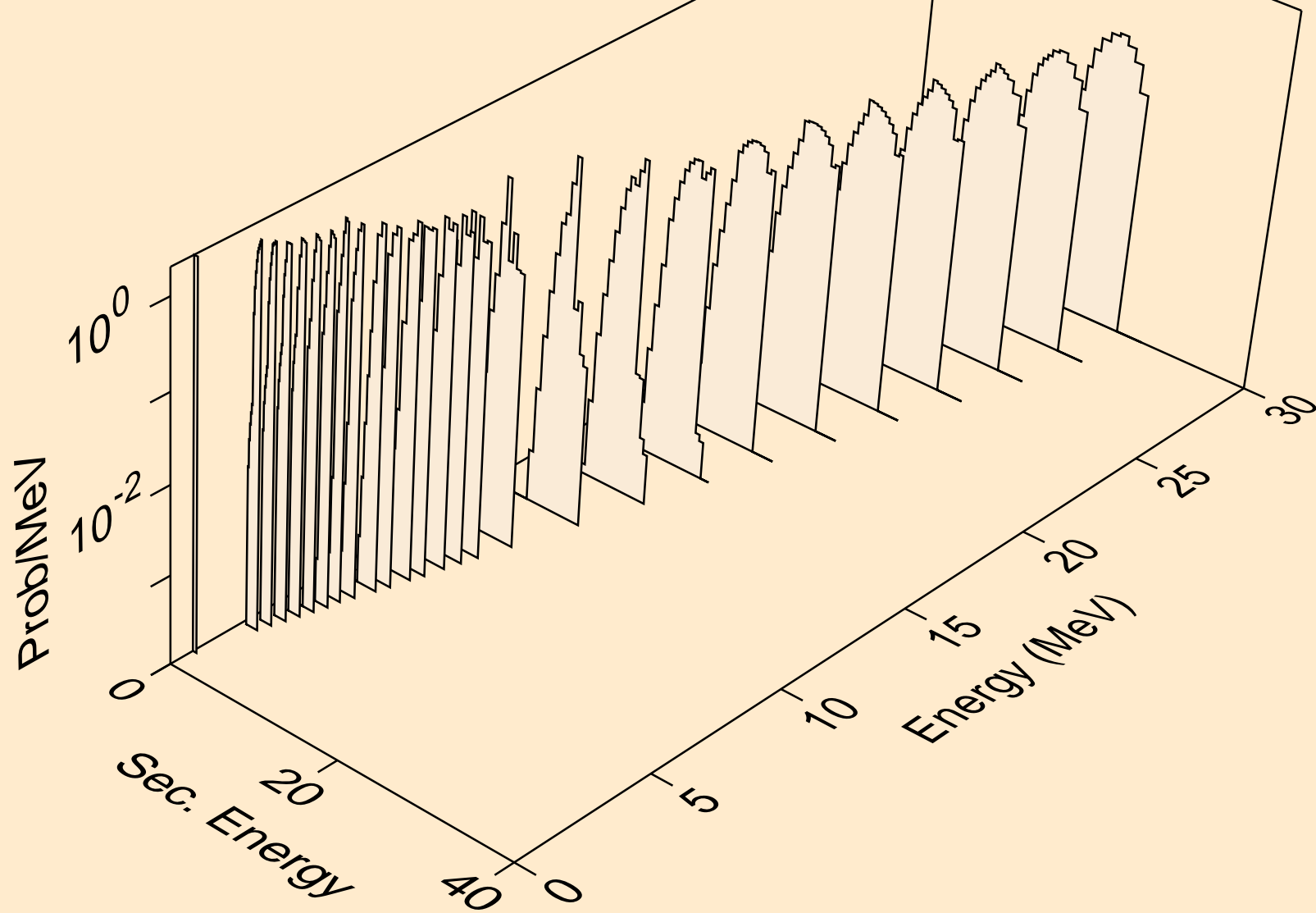

AS067 NEUTRON ACER TENDL-2023 LIBRARY; T=0.K
alphas from (n,x)

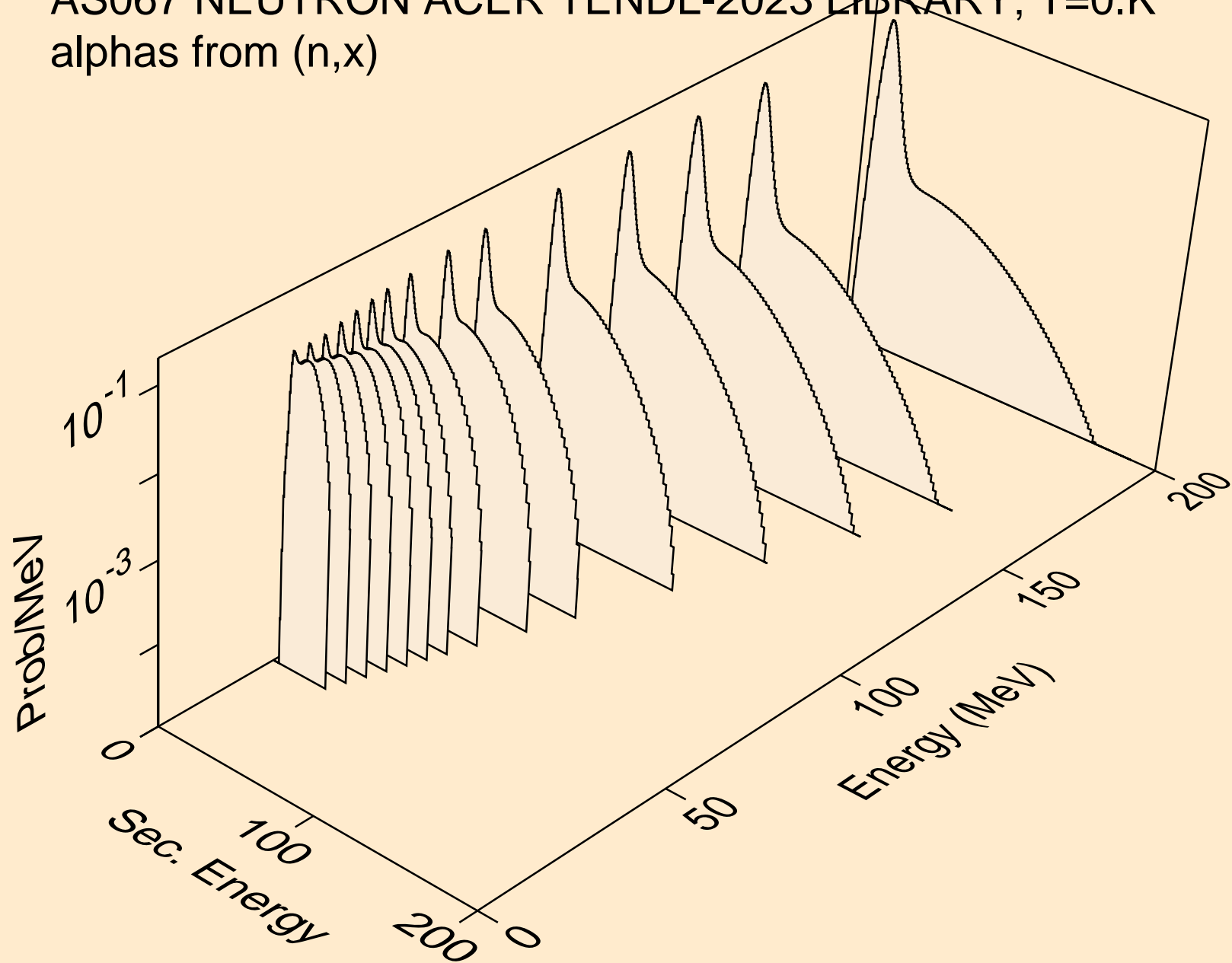

AS067 NEUTRON ACER TENDL-2023 LIBRARY; T=0.K
alphas from (n,n*)a

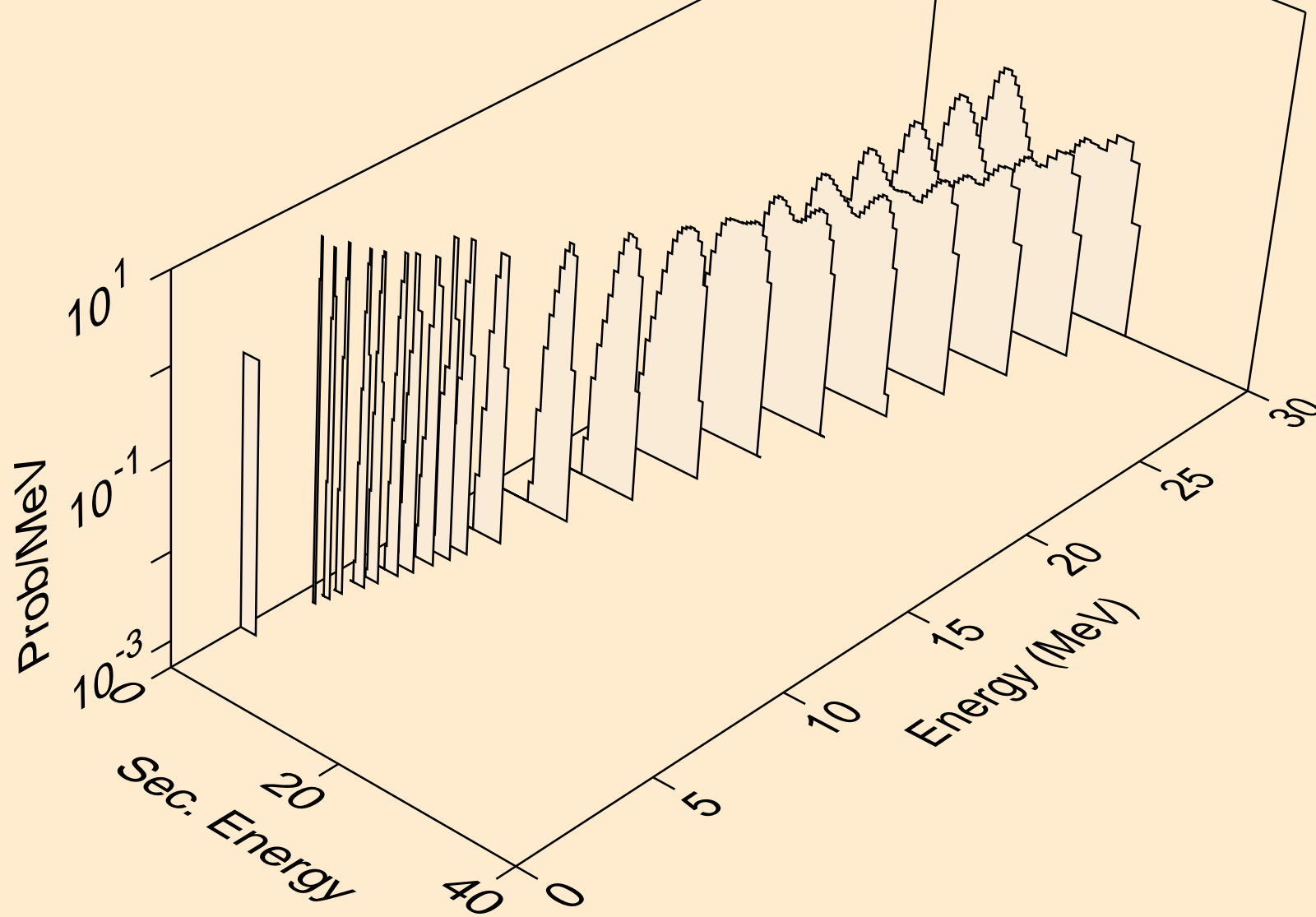

AS067 NEUTRON ACER TENDL-2023 LIBRARY; T=0.K
alphas from (n,2n)a

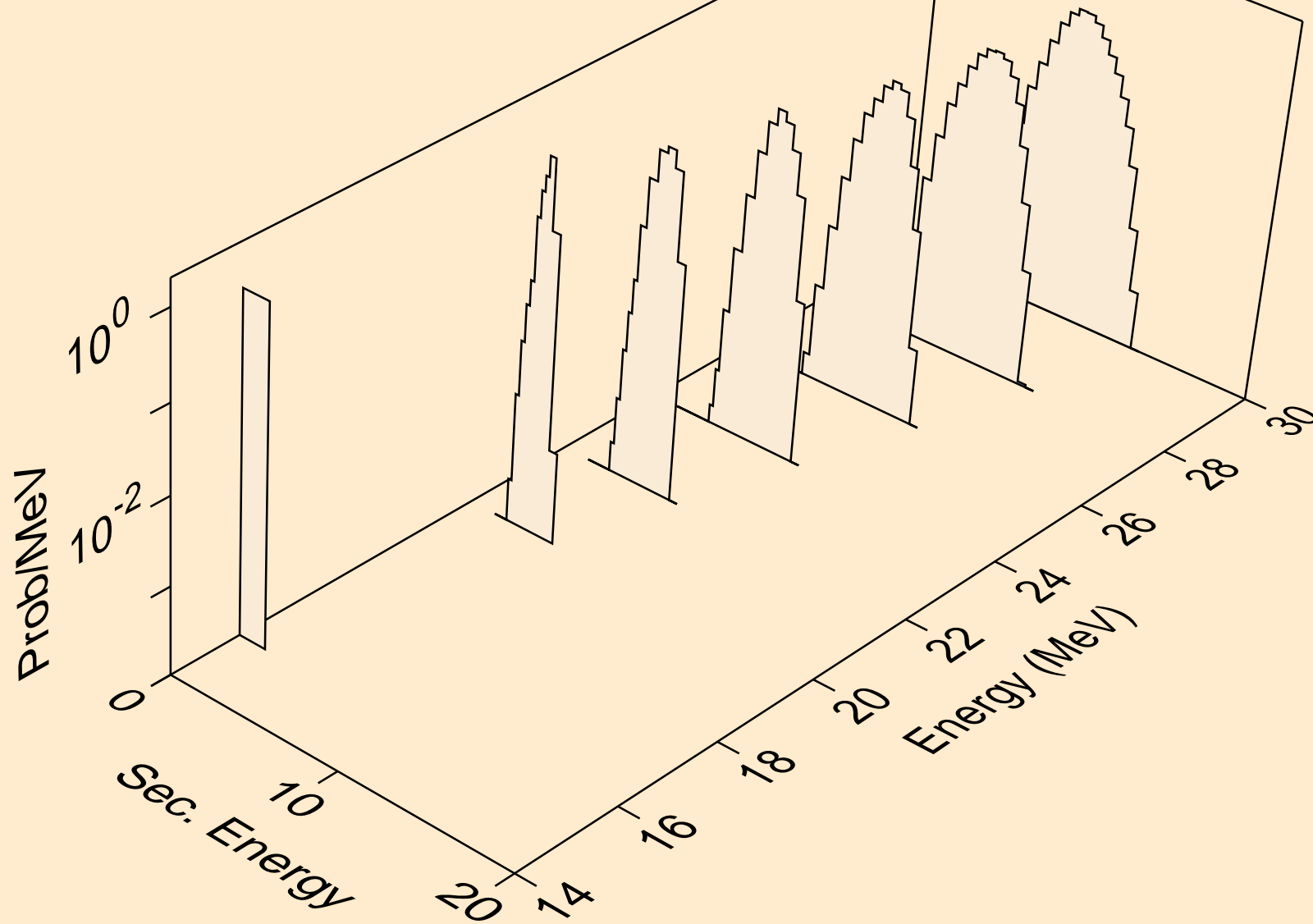

AS067 NEUTRON ACER TENDL-2023 LIBRARY; T=0.K
alphas from (n,n*)2a

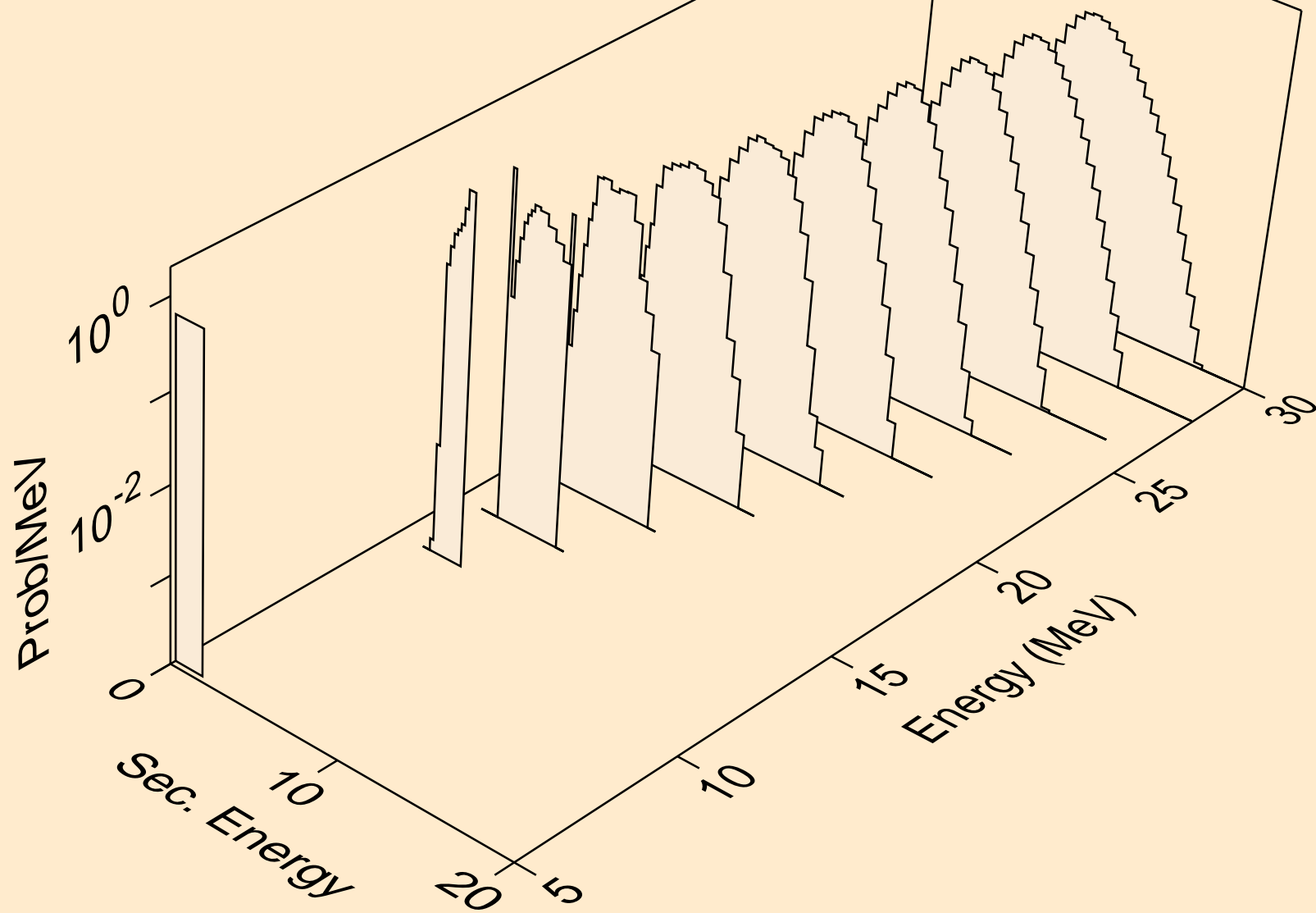

AS067 NEUTRON ACER TENDL-2023 LIBRARY; T=0.K
alphas from (n,npa)

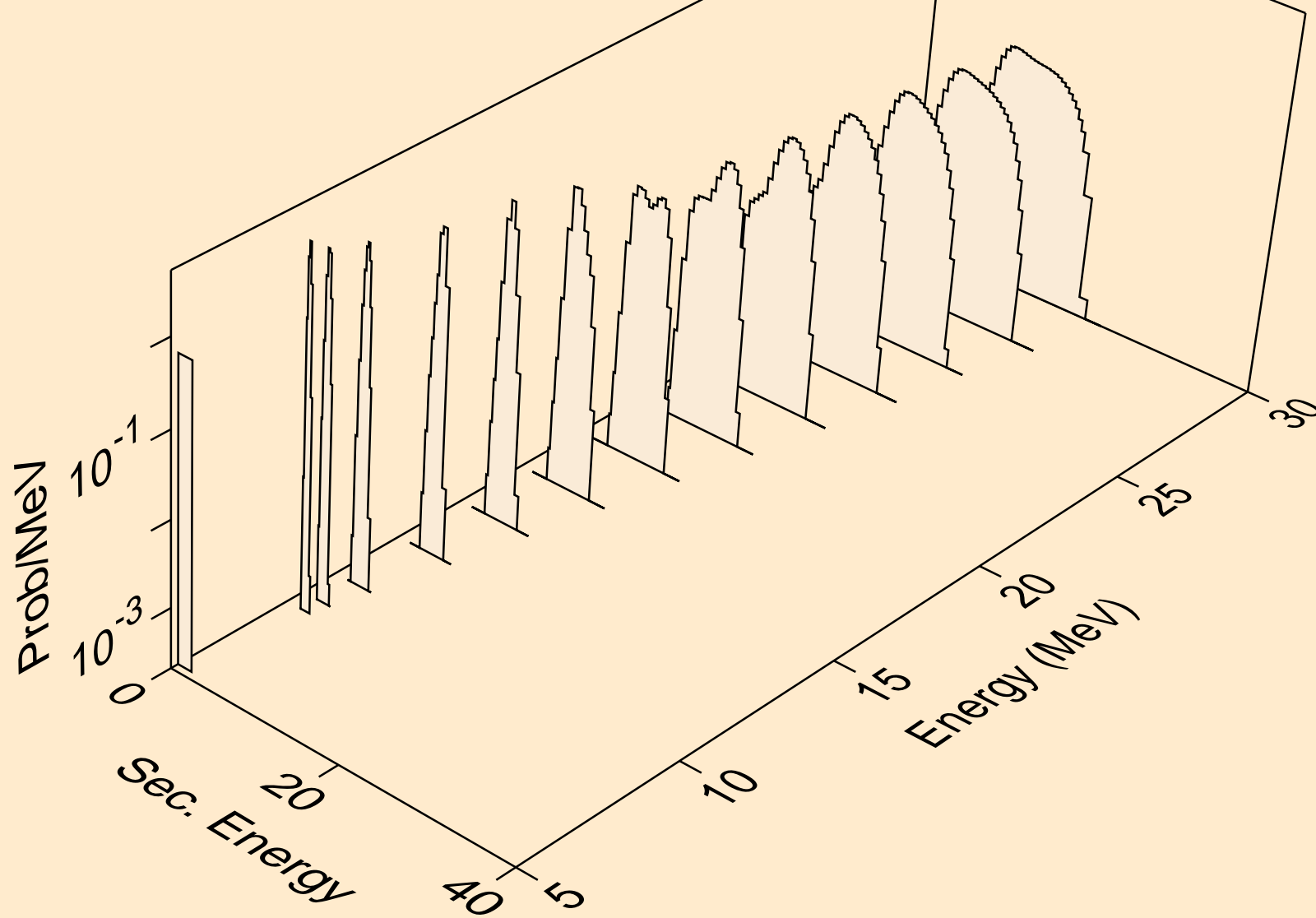

AS067 NEUTRON ACER TENDL-2023 LIBRARY; T=0.K
alphas from (n,a)

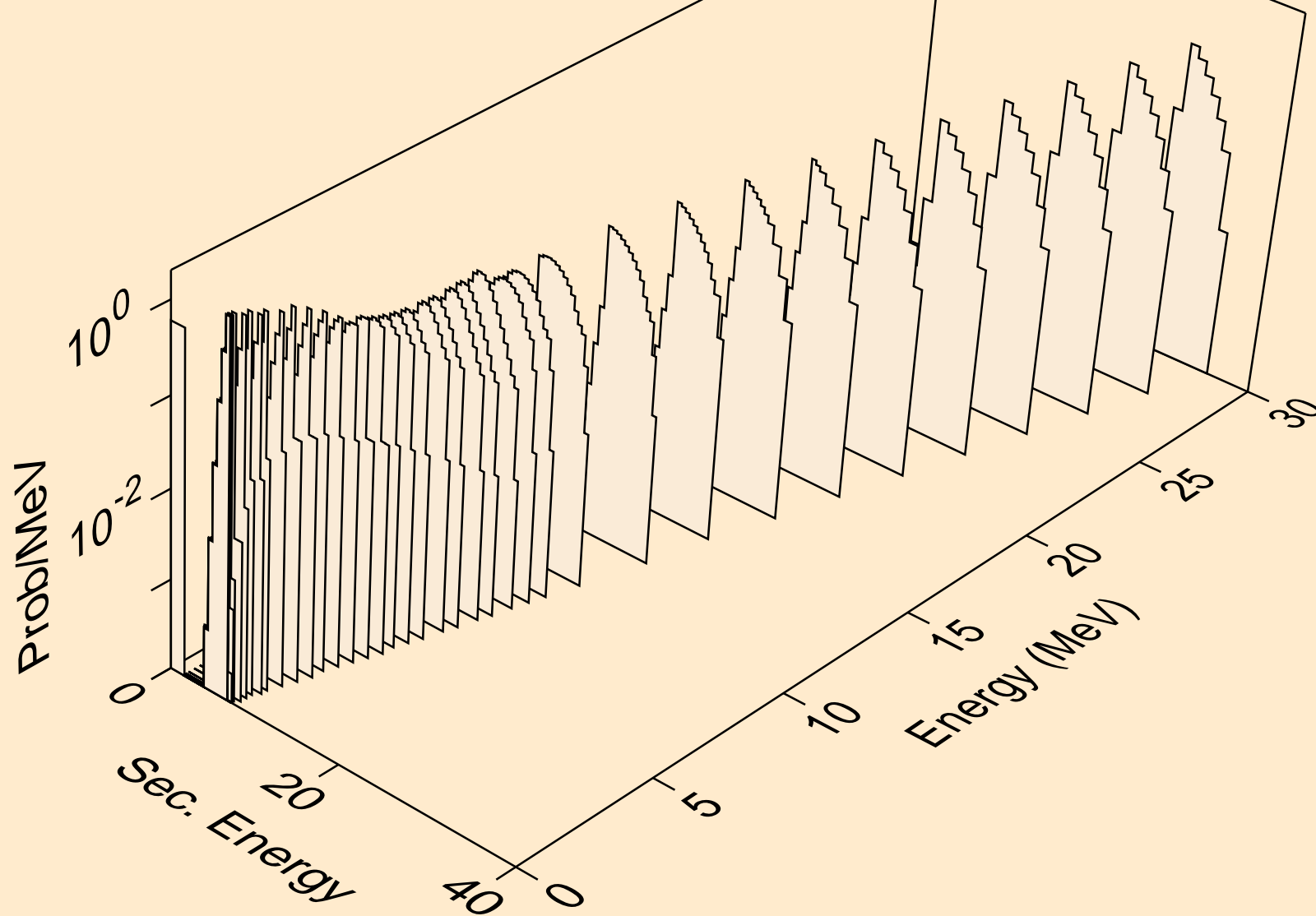

AS067 NEUTRON ACER TENDL-2023 LIBRARY; T=0.K
alphas from (n,2a)

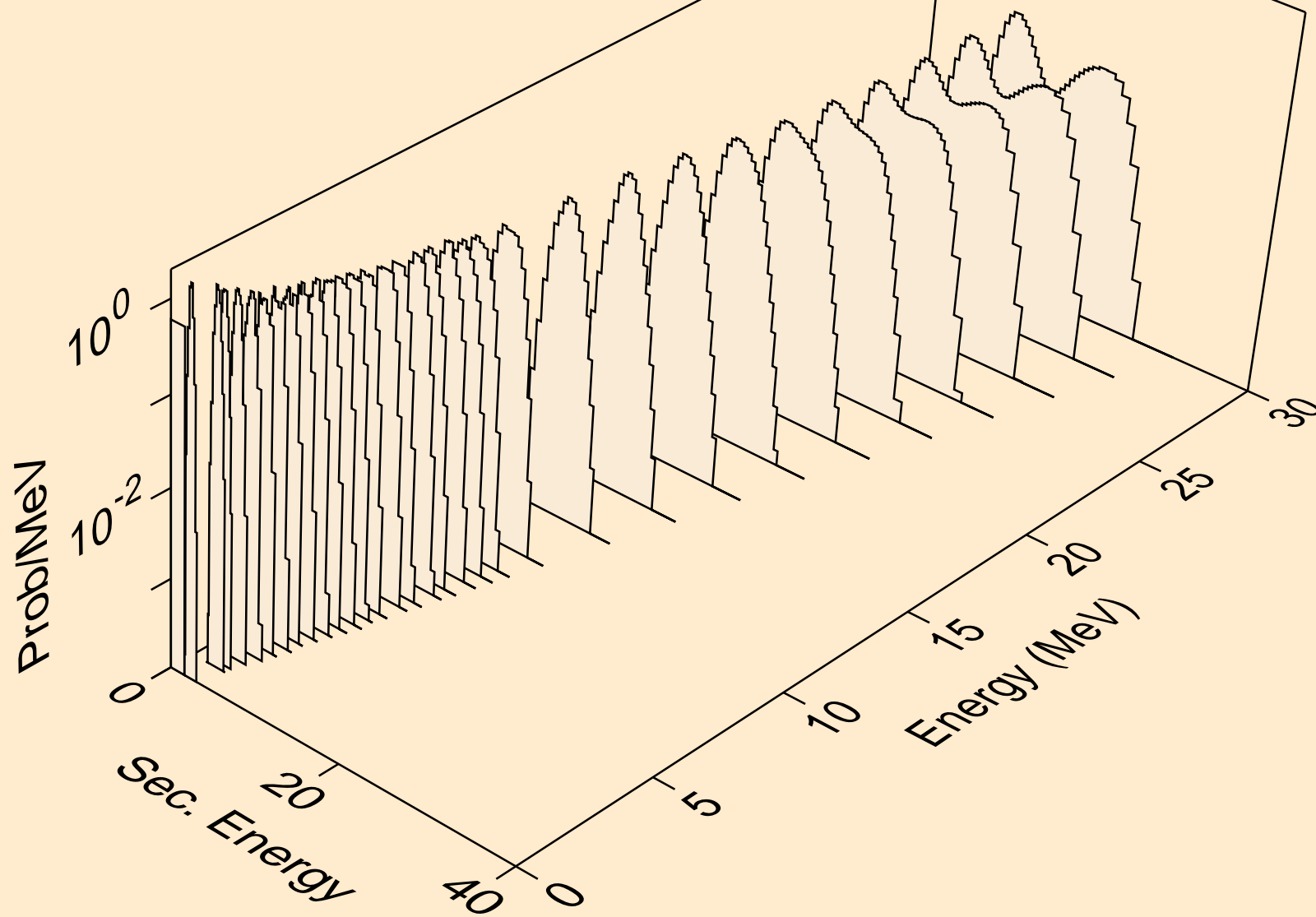

AS067 NEUTRON ACER TENDL-2023 LIBRARY; T=0.K
alphas from (n,3a)

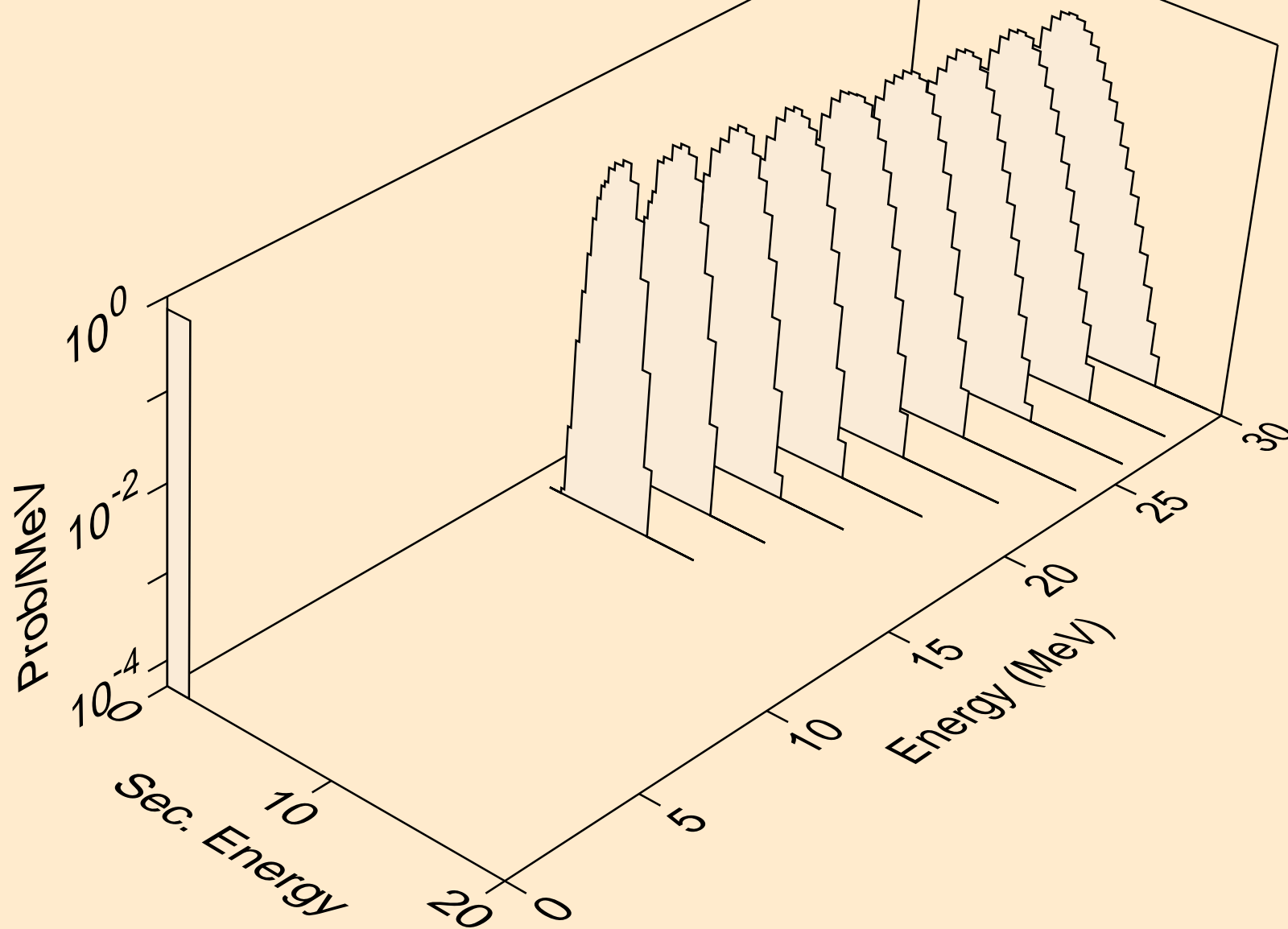

AS067 NEUTRON ACER TENDL-2023 LIBRARY; T=0.K
alphas from (n,pa)

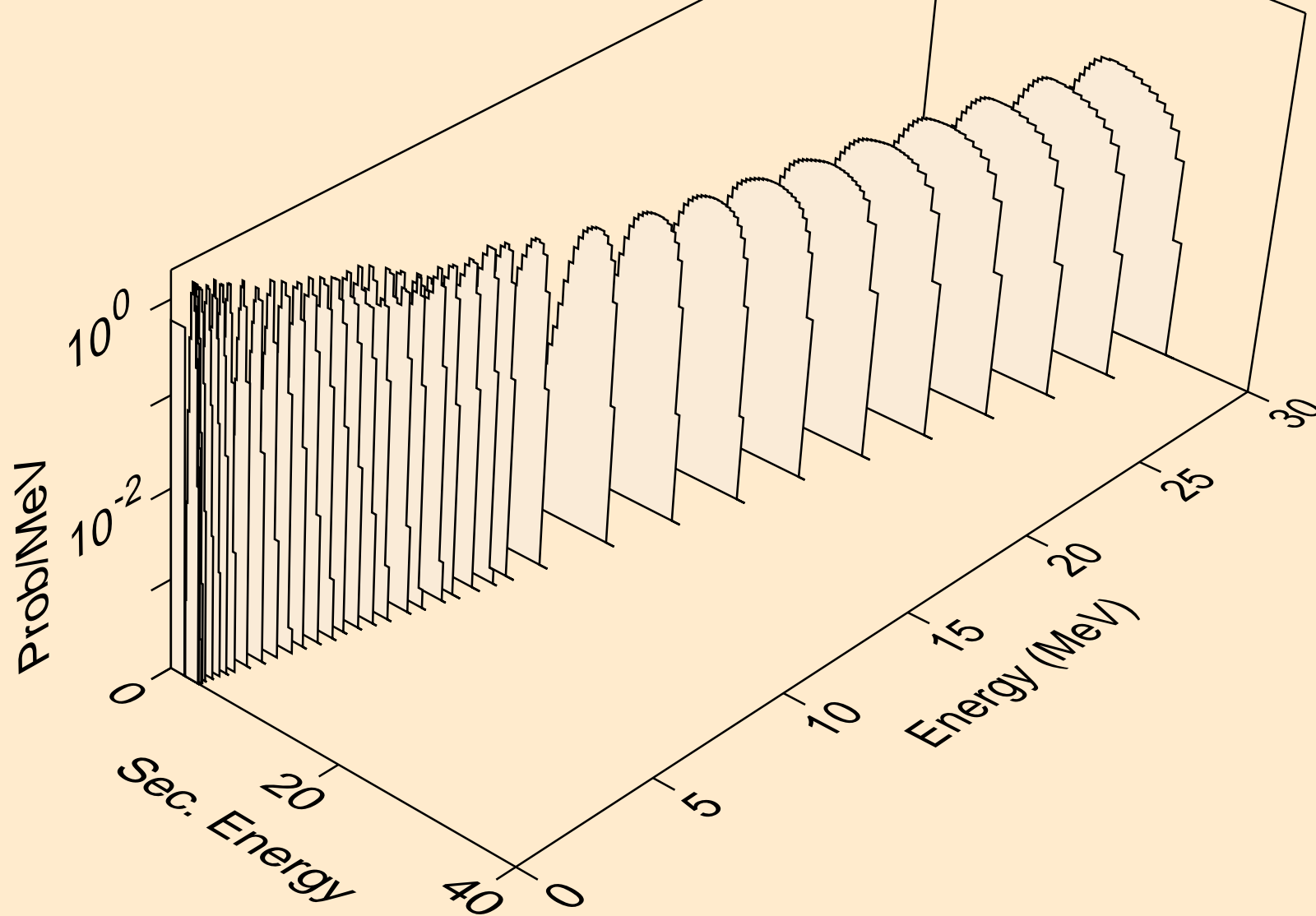

AS067 NEUTRON ACER TENDL-2023 LIBRARY; T=0.K
alphas from (n,d2a)

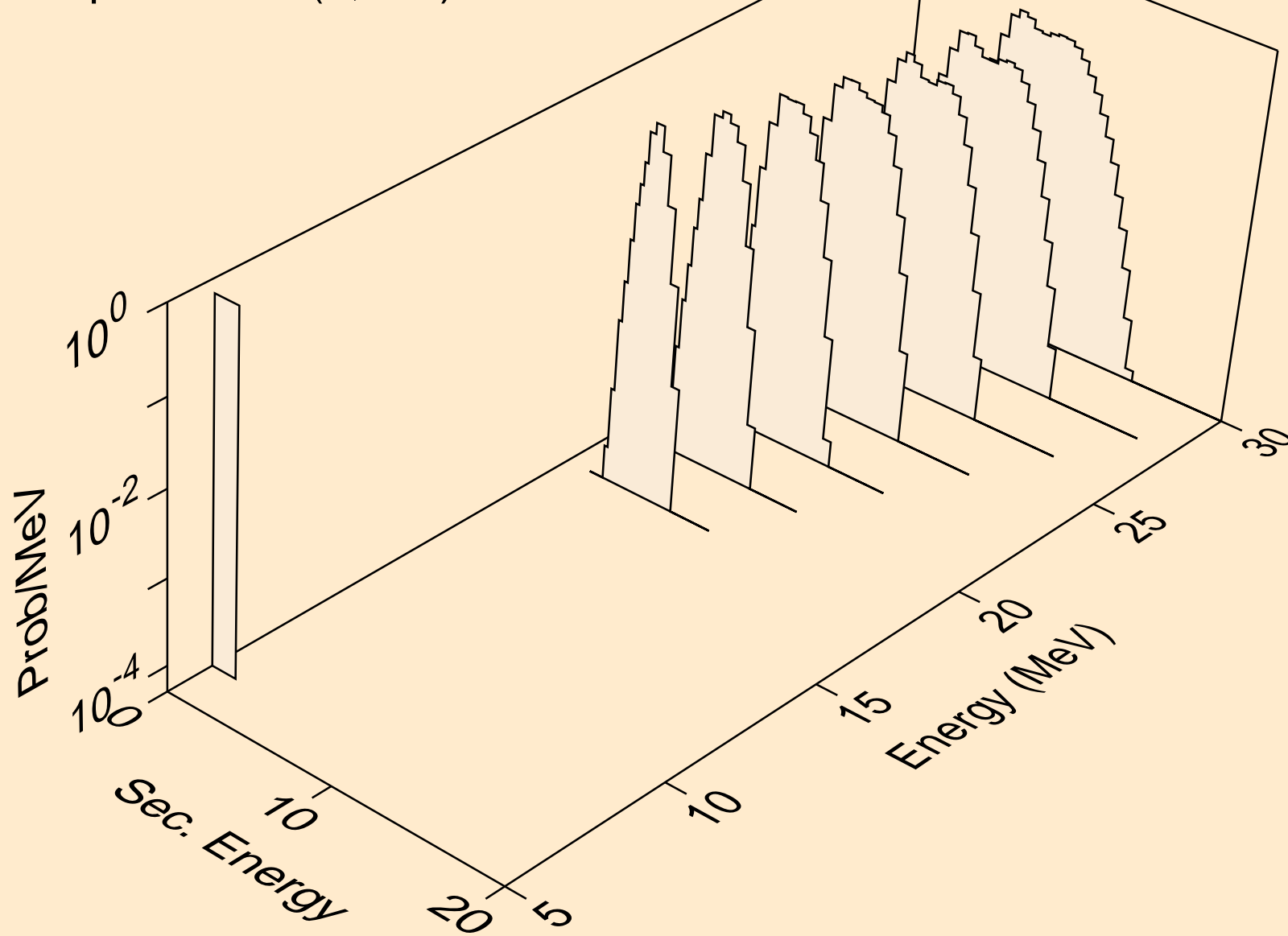

AS067 NEUTRON ACER TENDL-2023 LIBRARY; T=0.K
alphas from (n,da)

