

AT202 NEUTRON ACER TENDL-2023 LIBRARY; T=0.K

Principal cross sections

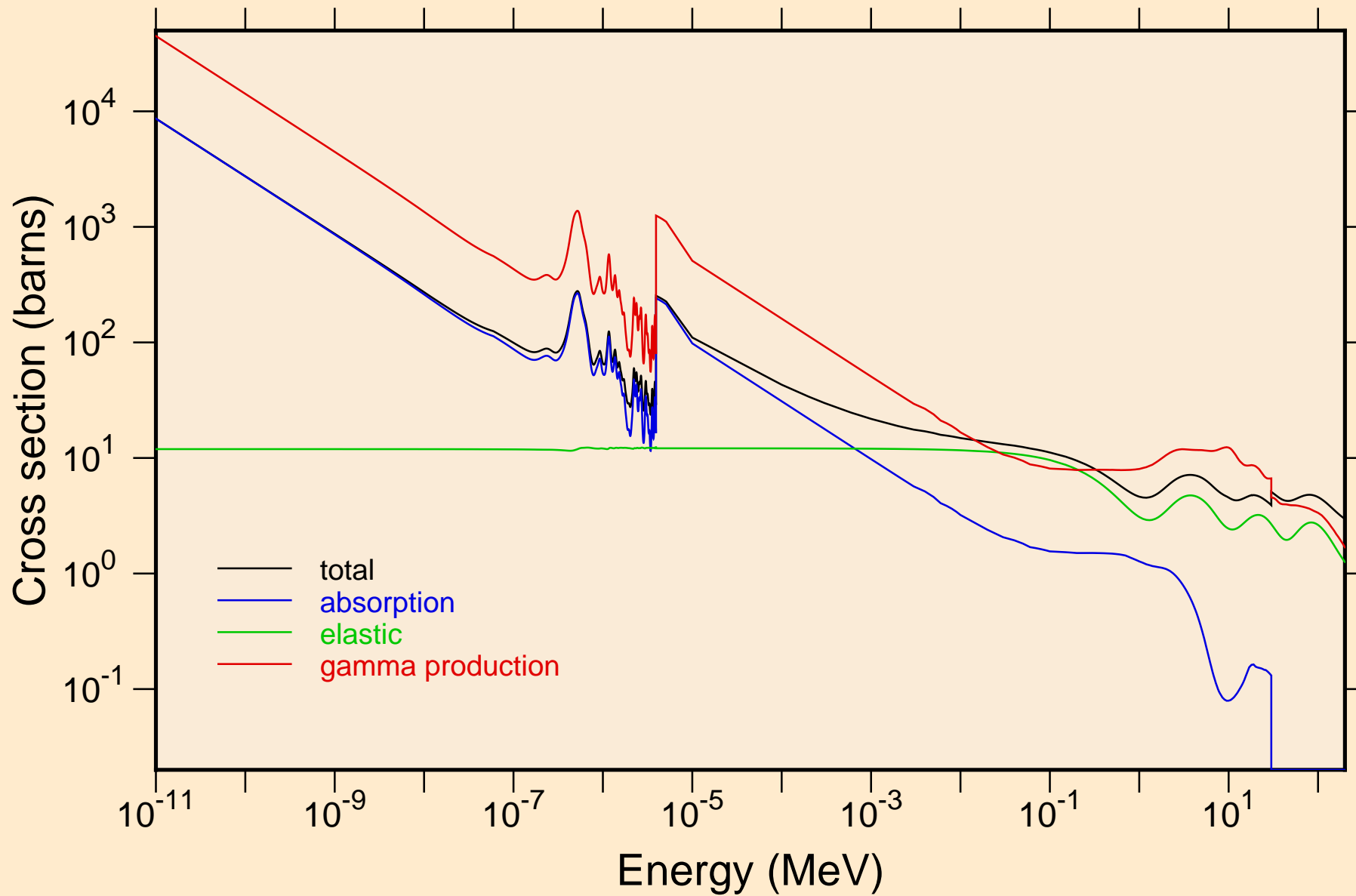

AT202 NEUTRON ACER TENDL-2023 LIBRARY; T=0.K

Heating

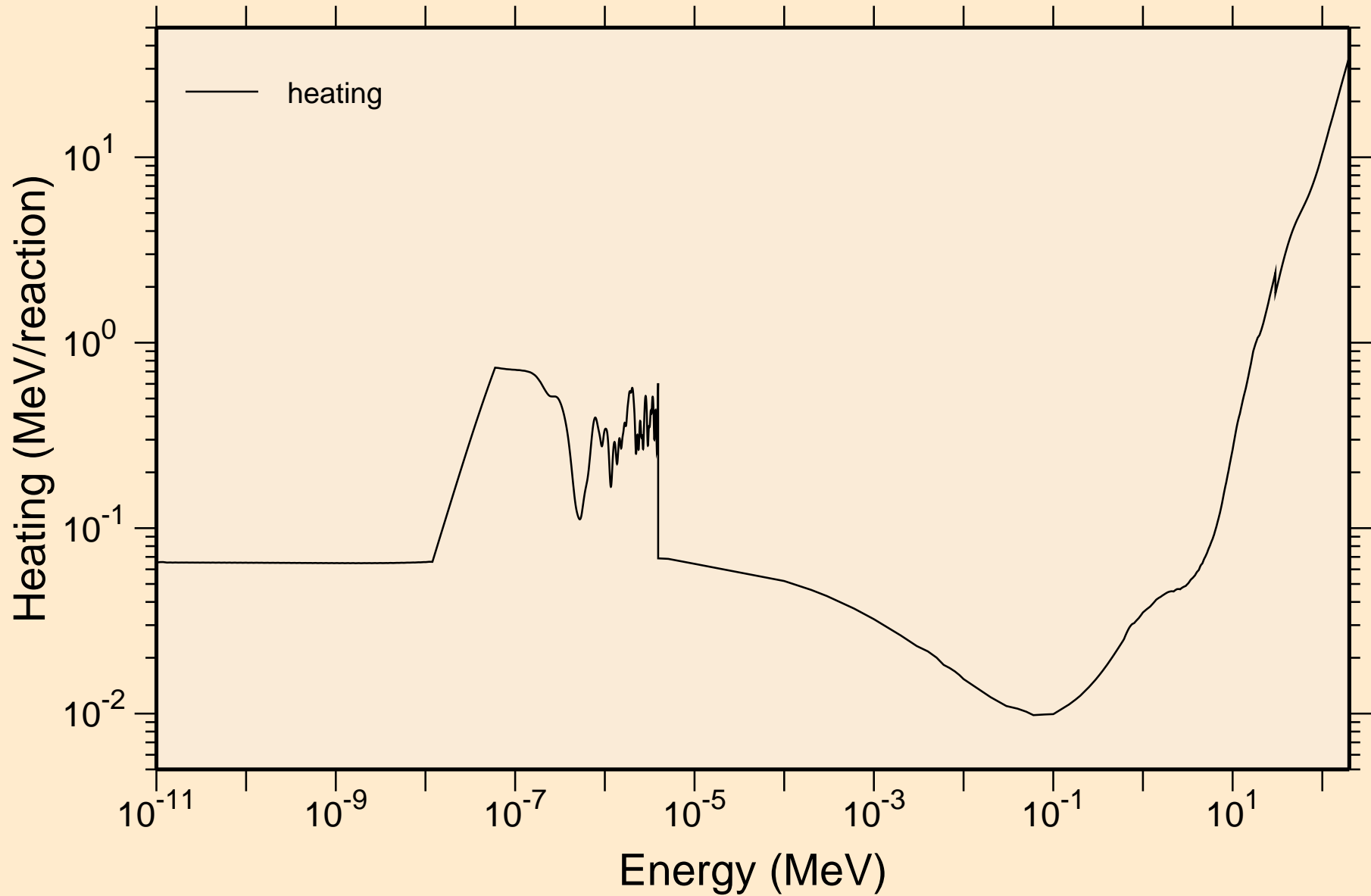

AT202 NEUTRON ACER TENDL-2023 LIBRARY; T=0.K

Damage

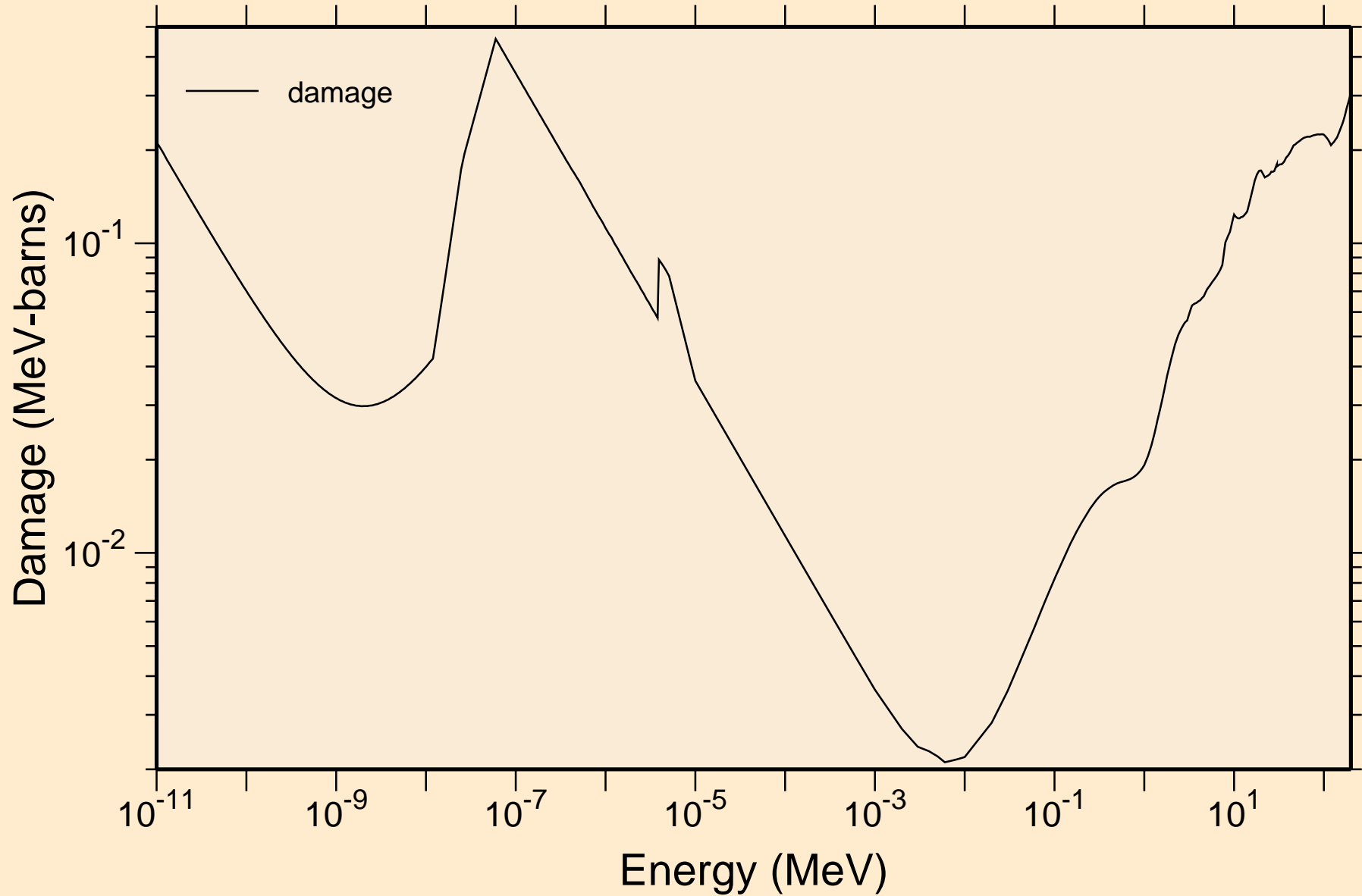

AT202 NEUTRON ACER TENDL-2023 LIBRARY; T=0.K
Non-threshold reactions

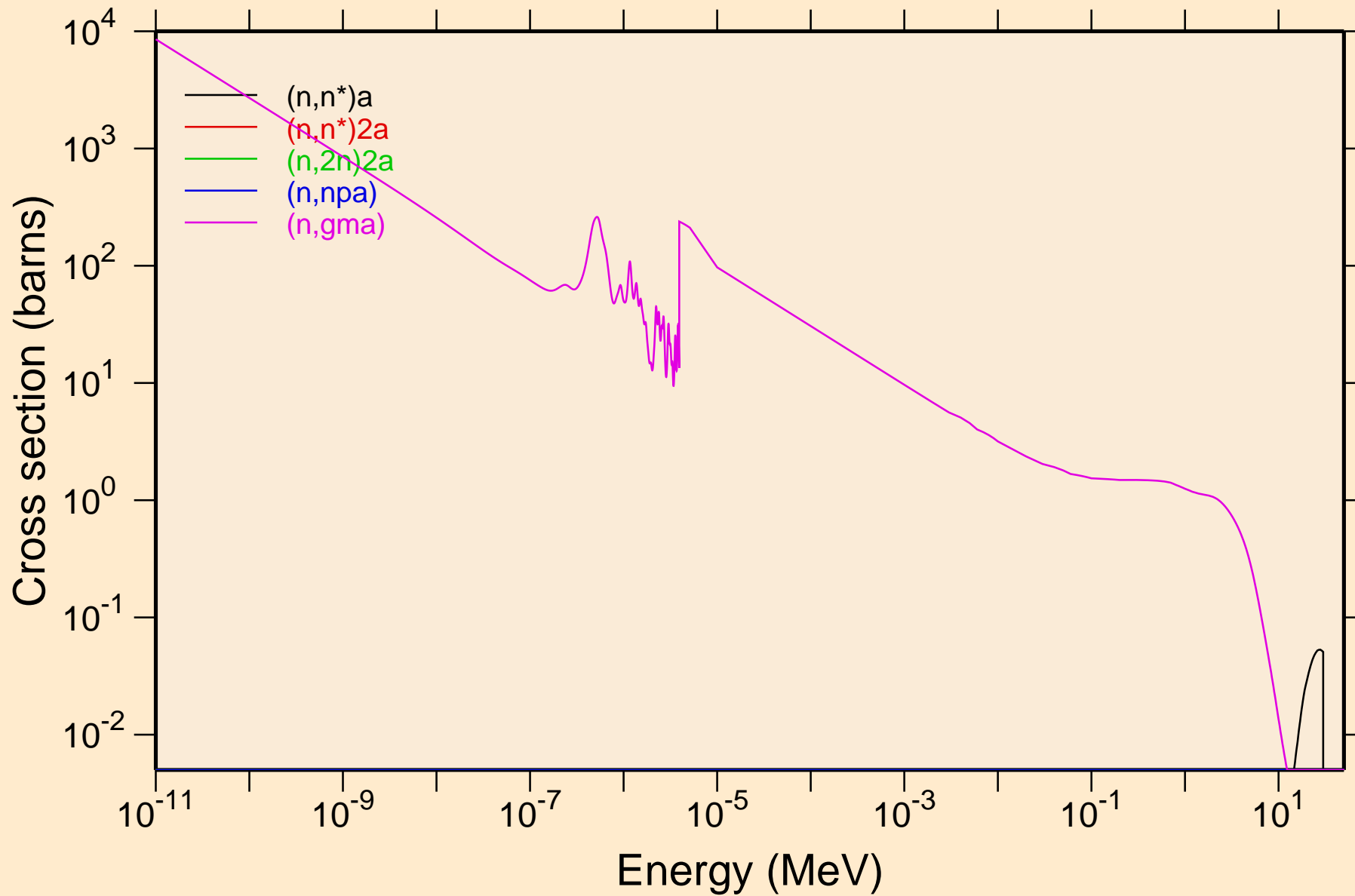

AT202 NEUTRON ACER TENDL-2023 LIBRARY; T=0.K
Non-threshold reactions

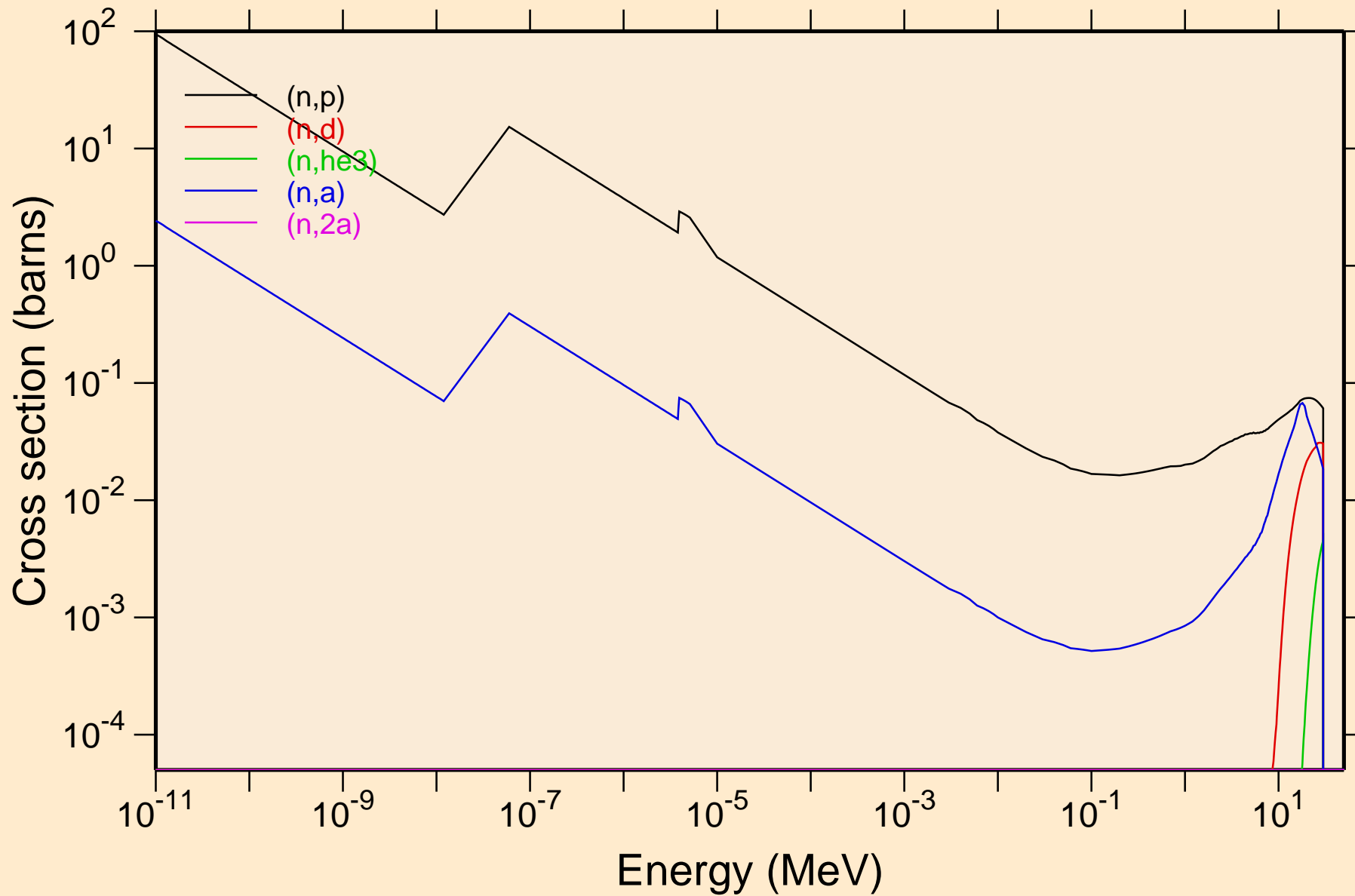

AT202 NEUTRON ACER TENDL-2023 LIBRARY; T=0.K
Non-threshold reactions

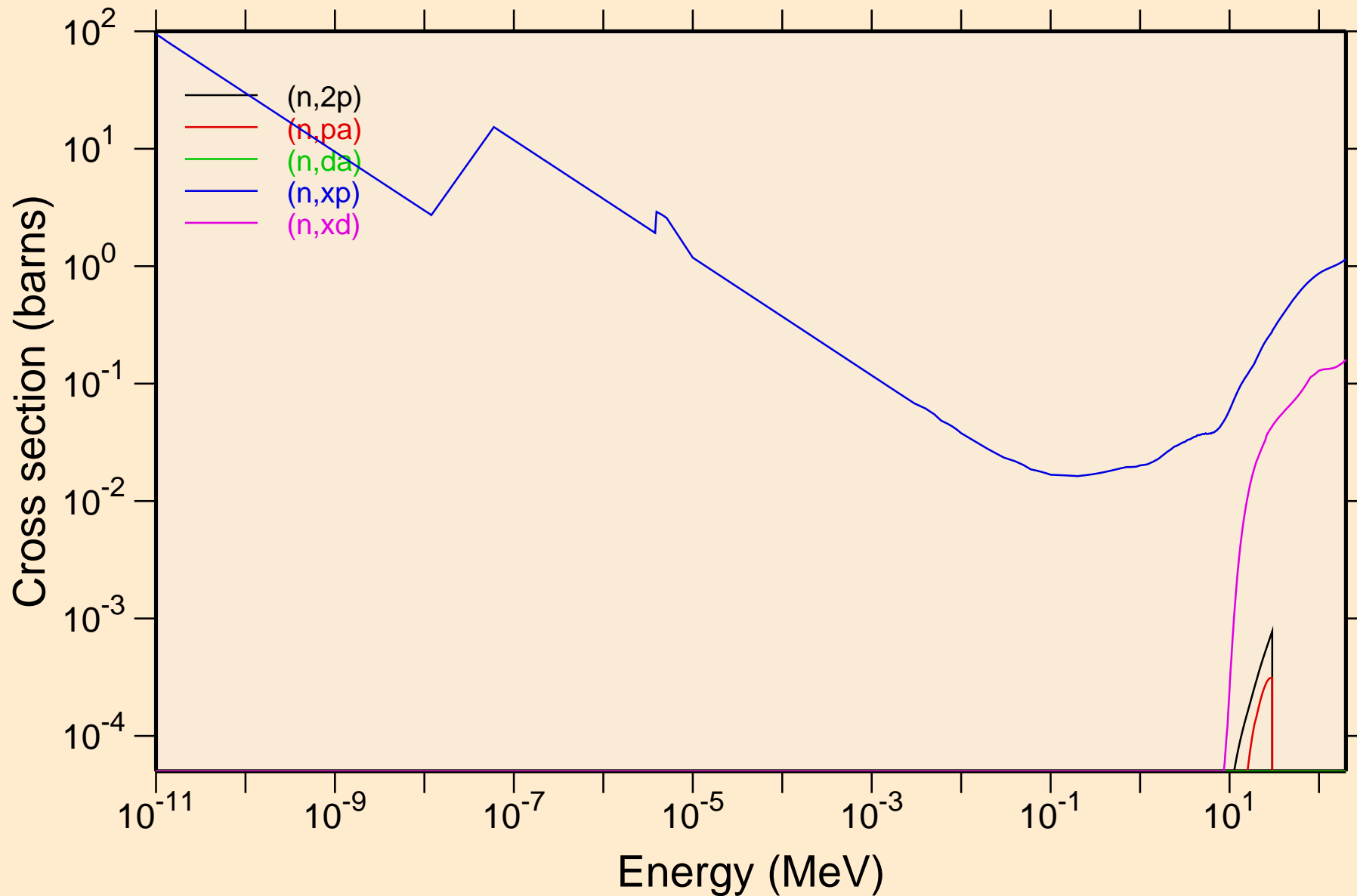

AT202 NEUTRON ACER TENDL-2023 LIBRARY; T=0.K
Non-threshold reactions

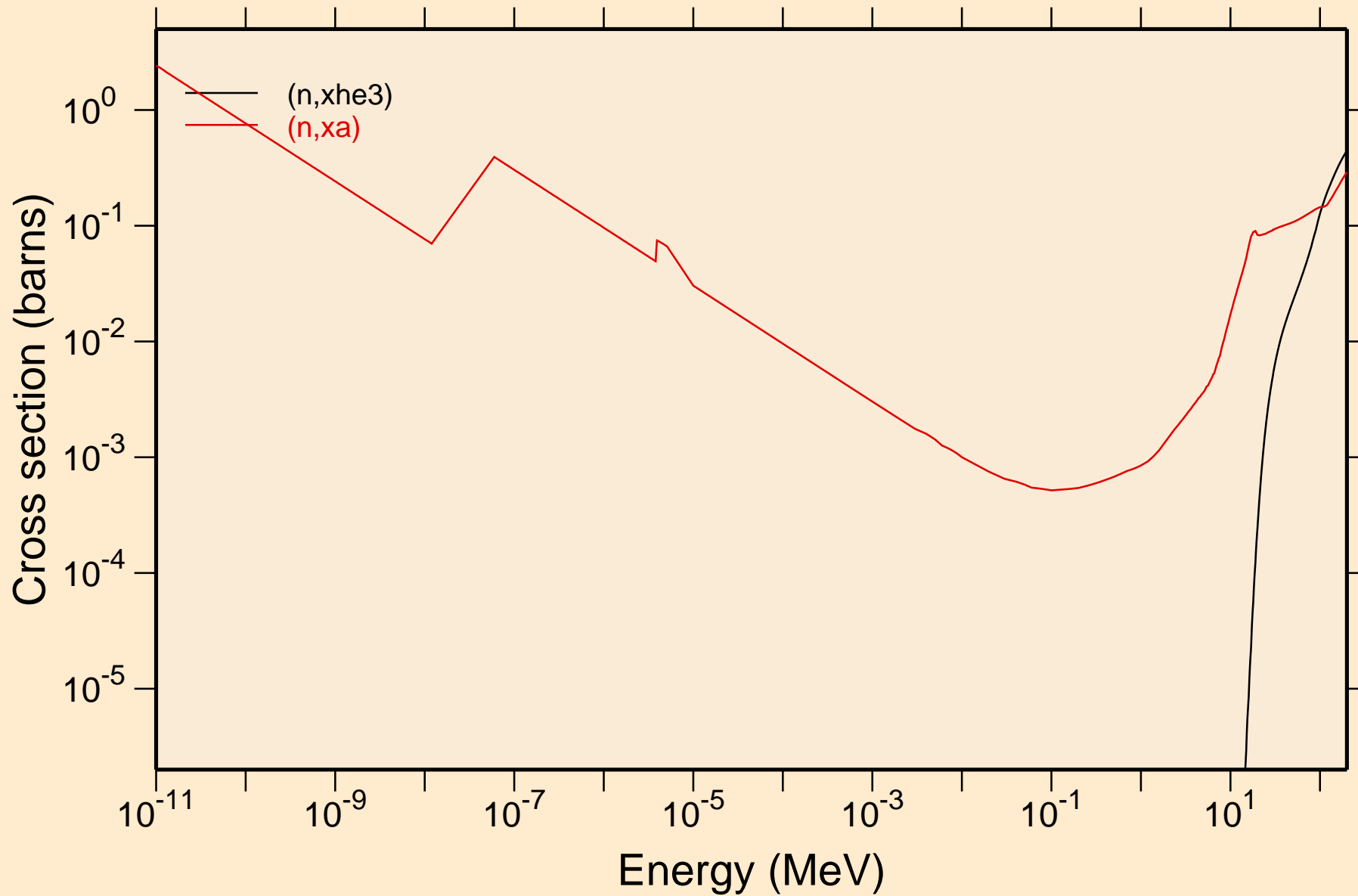

AT202 NEUTRON ACER TENDL-2023 LIBRARY; T=0.K
Principal cross sections

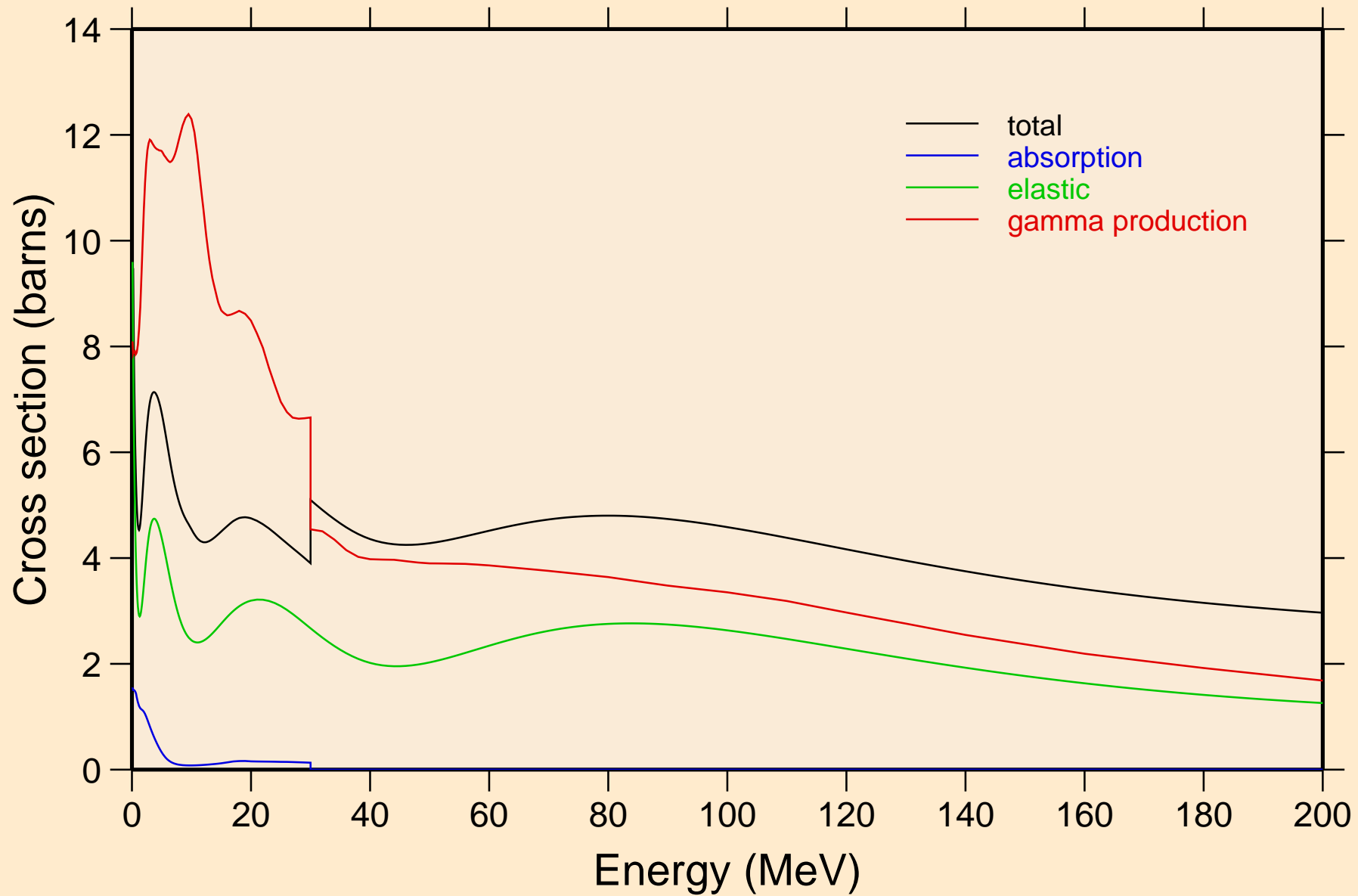

AT202 NEUTRON ACER TENDL-2023 LIBRARY; T=0.K

Heating

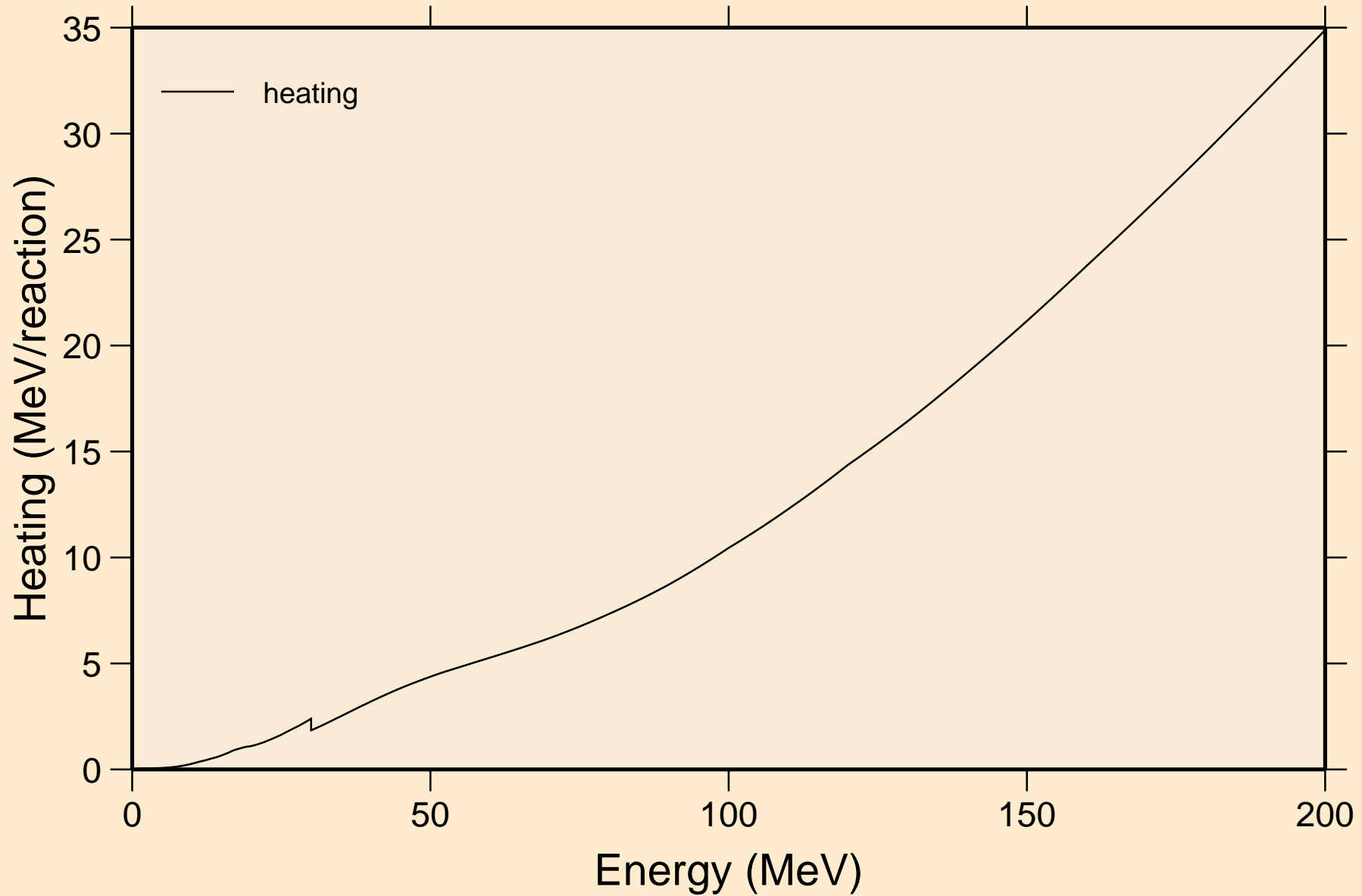

AT202 NEUTRON ACER TENDL-2023 LIBRARY; T=0.K

Damage

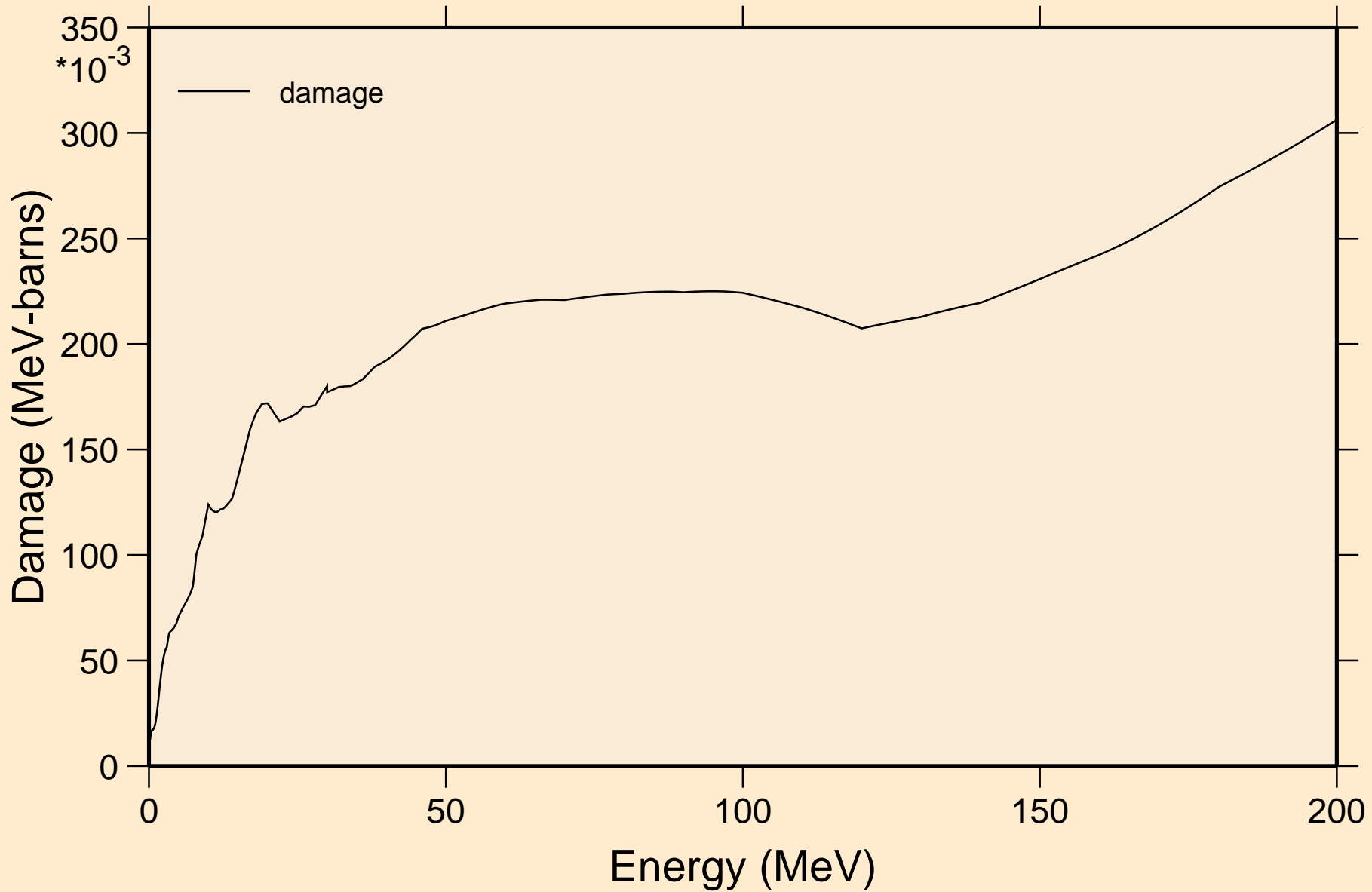

AT202 NEUTRON ACER TENDL-2023 LIBRARY; T=0.K
Non-threshold reactions

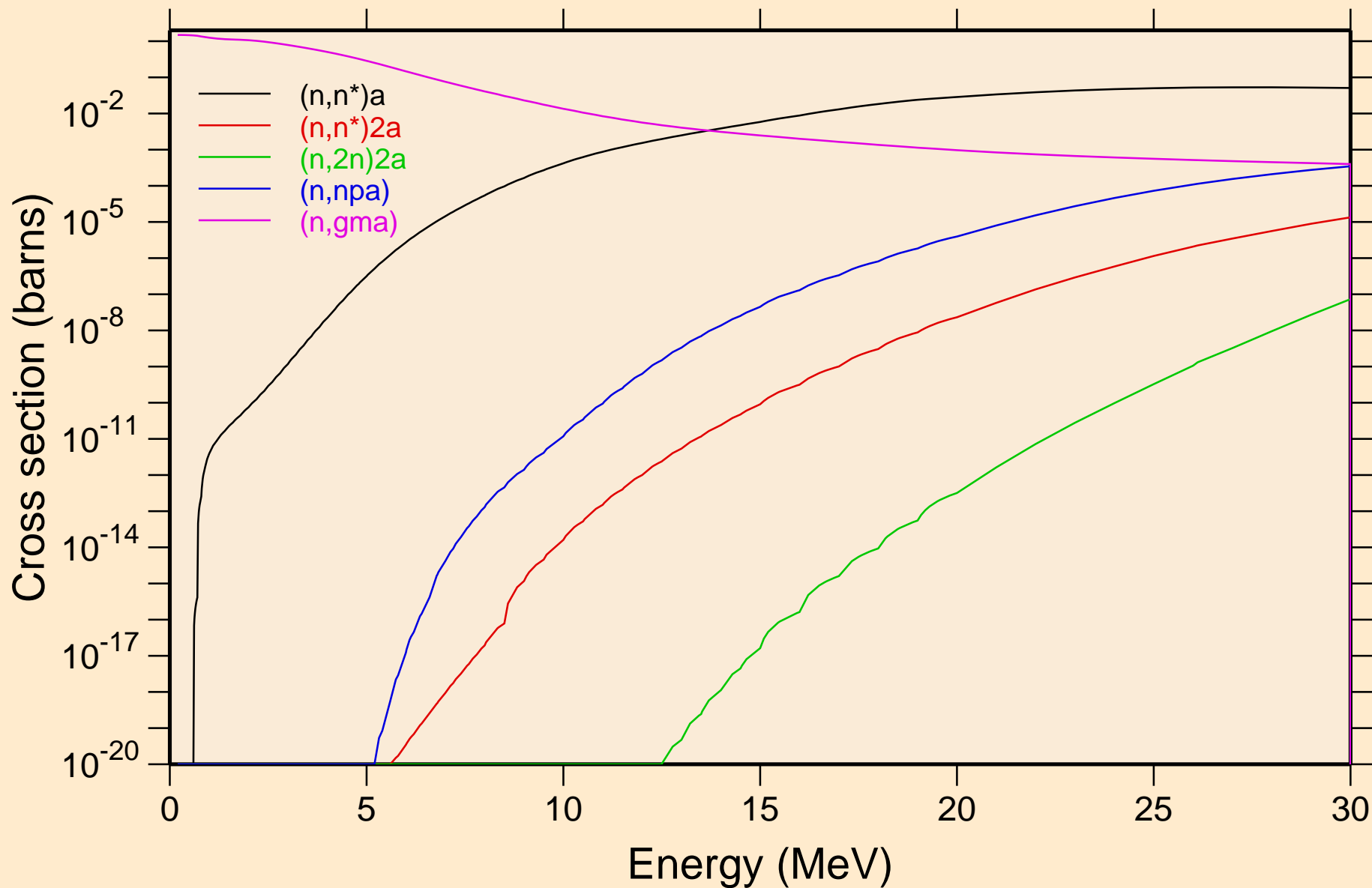

AT202 NEUTRON ACER TENDL-2023 LIBRARY; T=0.K
Non-threshold reactions

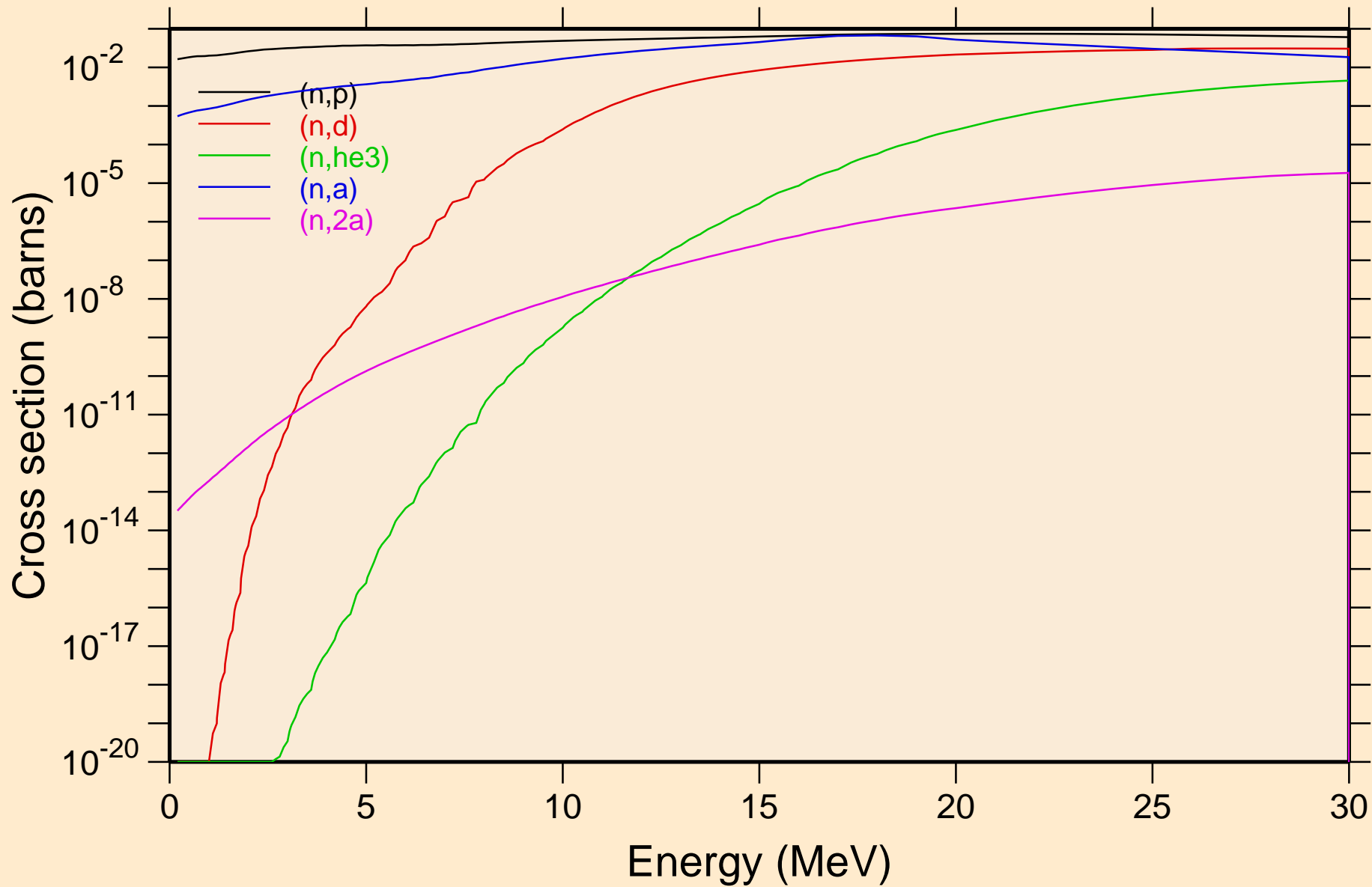

AT202 NEUTRON ACER TENDL-2023 LIBRARY; T=0.K
Non-threshold reactions

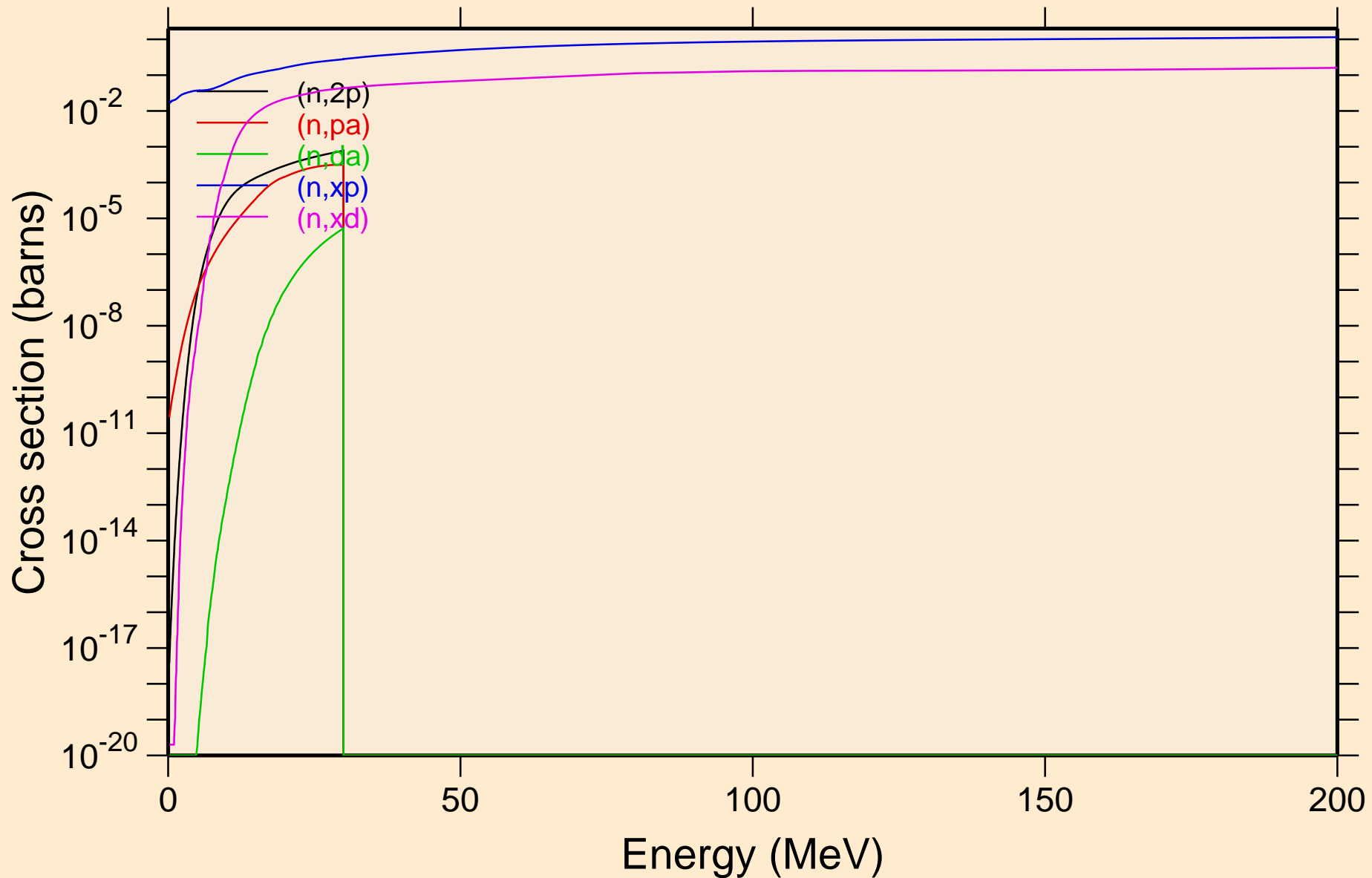

AT202 NEUTRON ACER TENDL-2023 LIBRARY; T=0.K
Non-threshold reactions

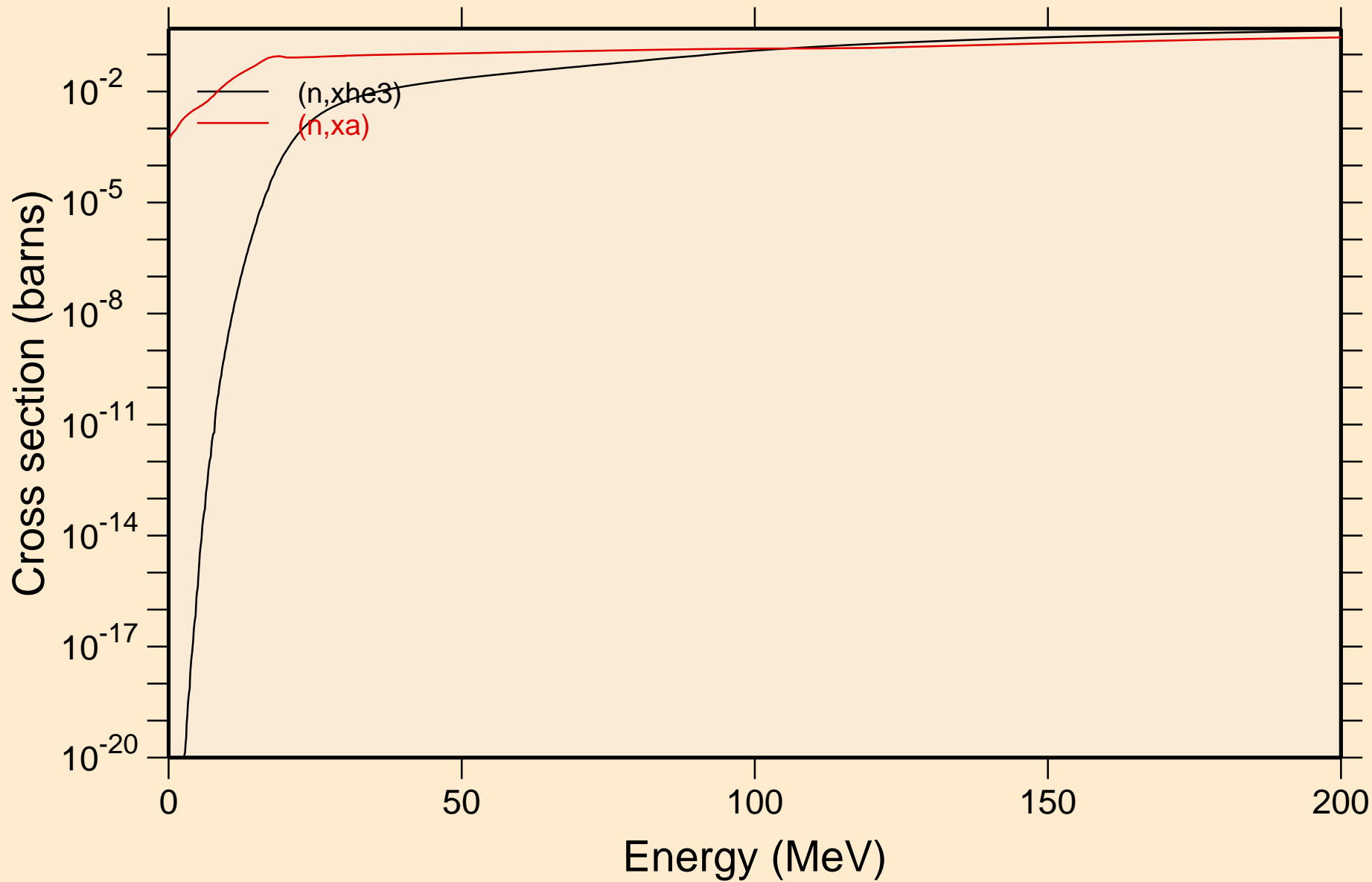

AT202 NEUTRON ACER TENDL-2023 LIBRARY; T=0.K
Inelastic levels

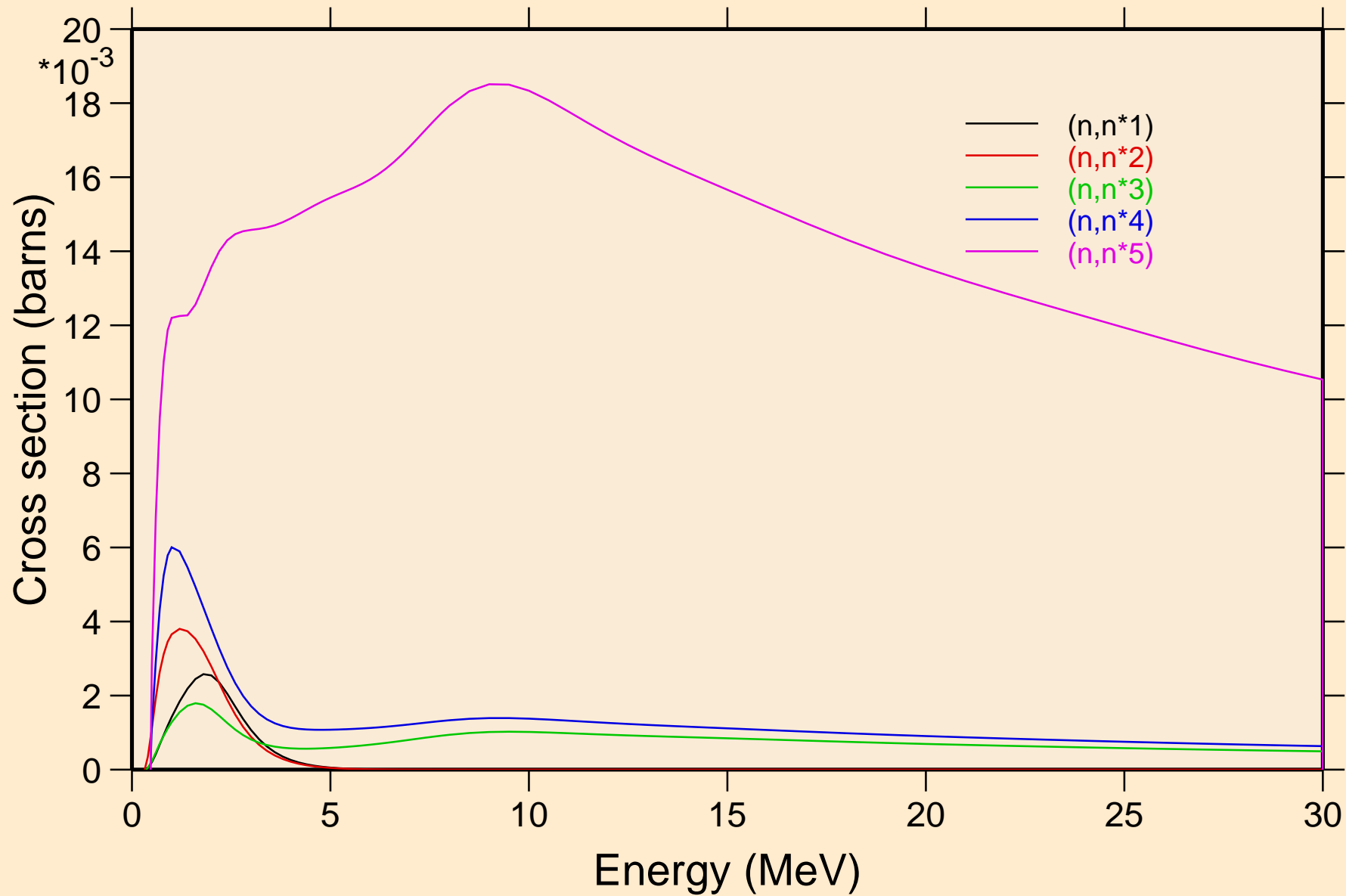

AT202 NEUTRON ACER TENDL-2023 LIBRARY; T=0.K
Inelastic levels

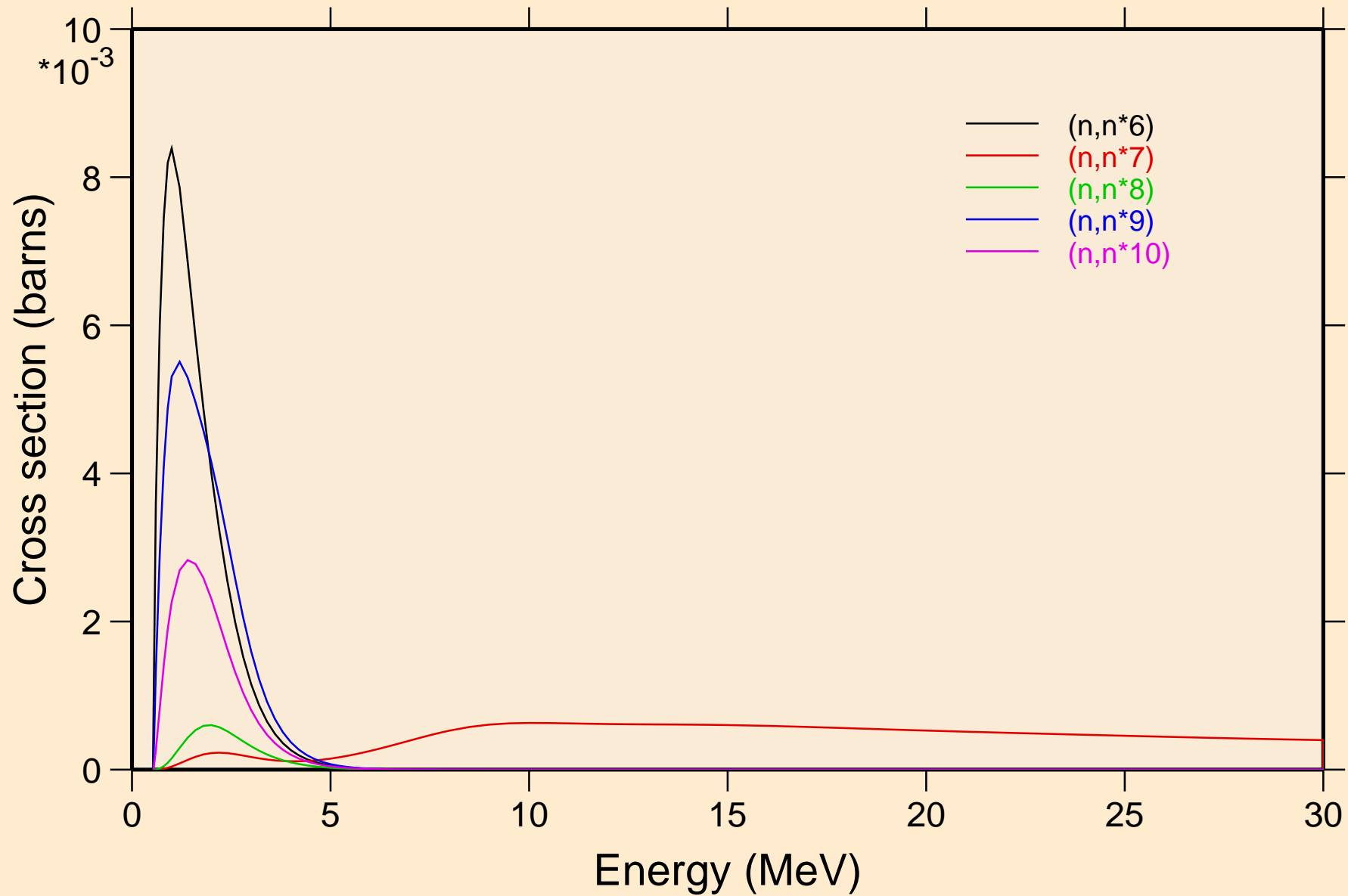

AT202 NEUTRON ACER TENDL-2023 LIBRARY; T=0.K
Inelastic levels

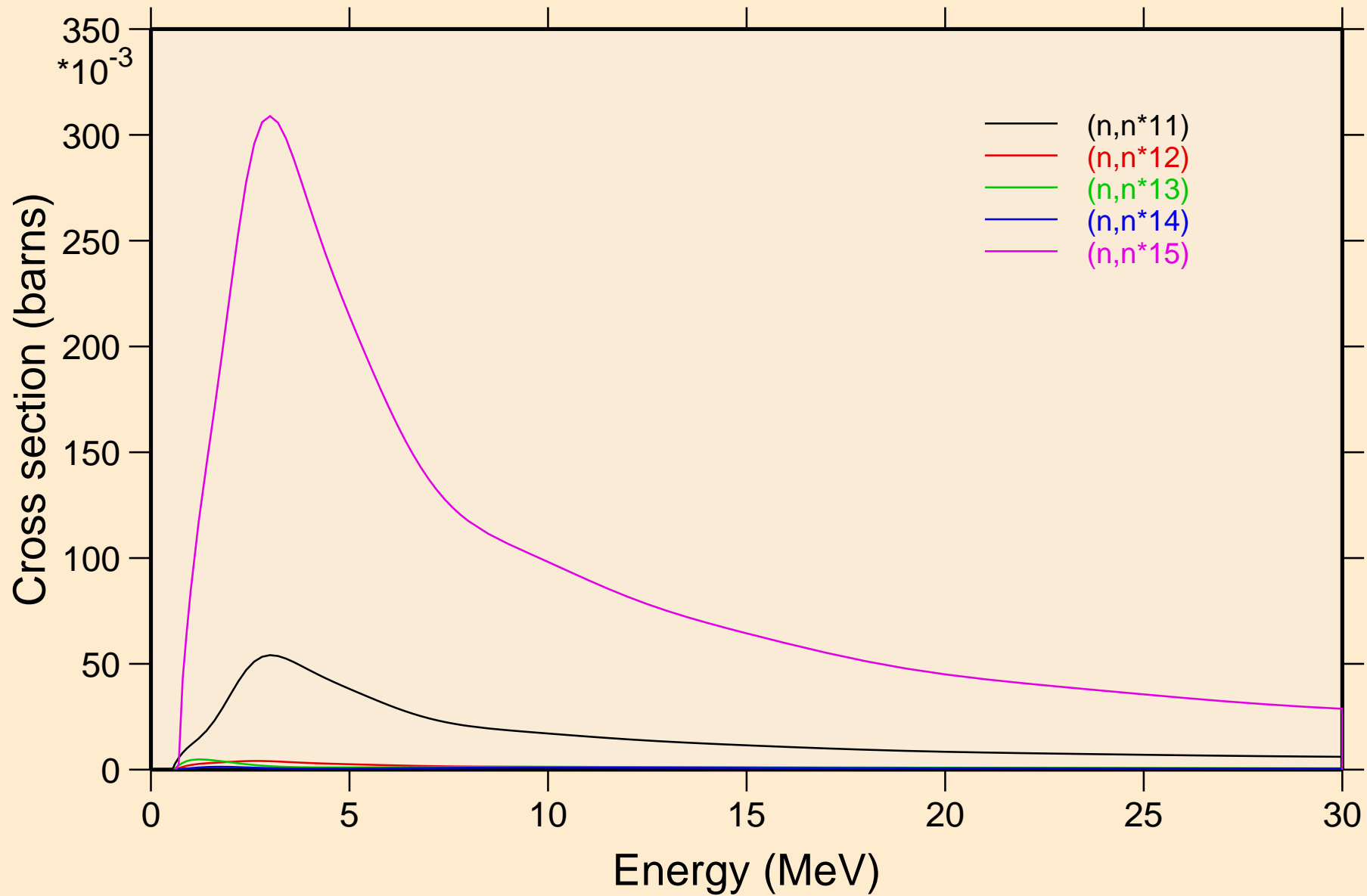

AT202 NEUTRON ACER TENDL-2023 LIBRARY; T=0.K

Threshold reactions

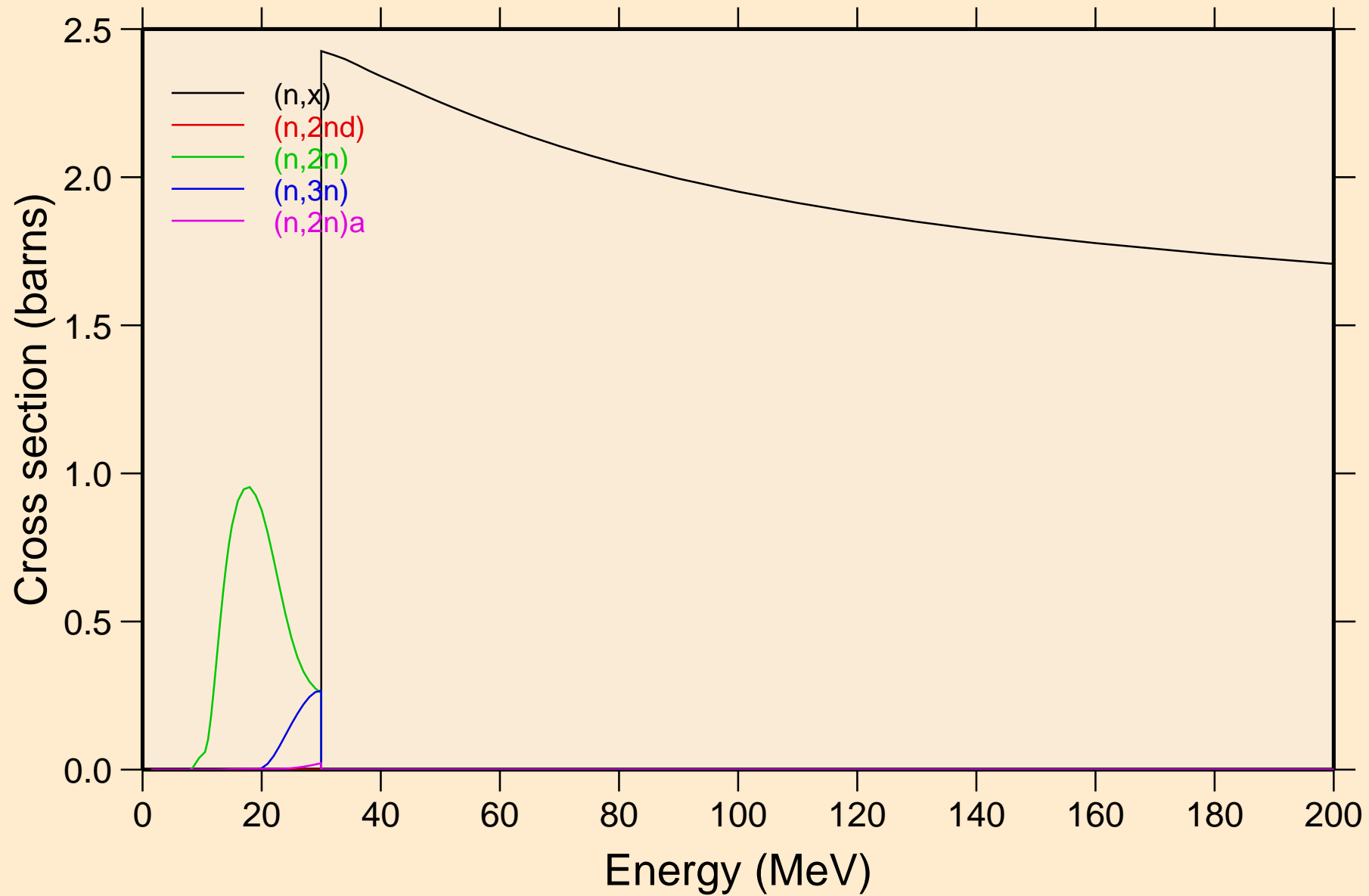

AT202 NEUTRON ACER TENDL-2023 LIBRARY; T=0.K
Threshold reactions

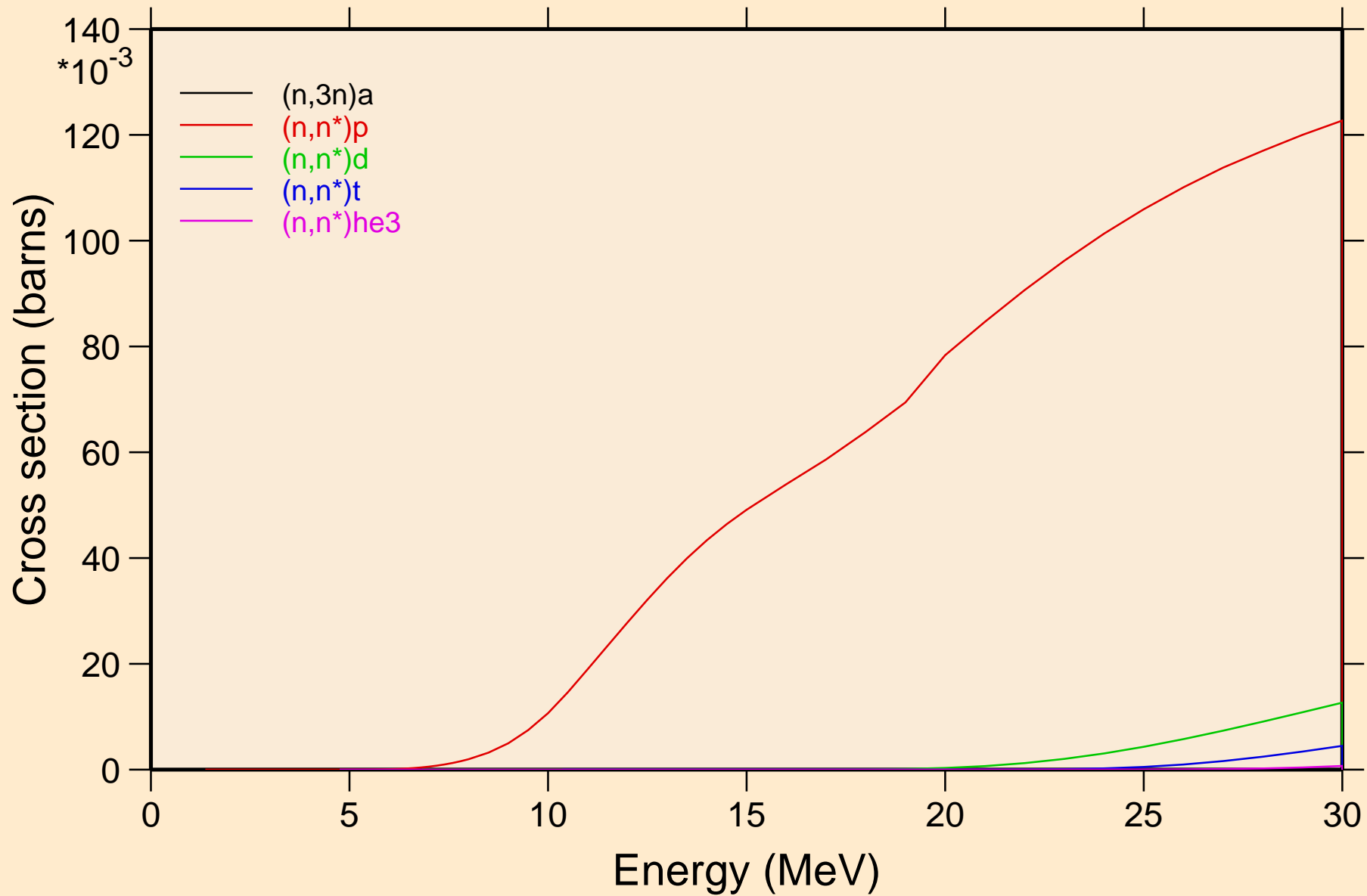

AT202 NEUTRON ACER TENDL-2023 LIBRARY; T=0.K
Threshold reactions

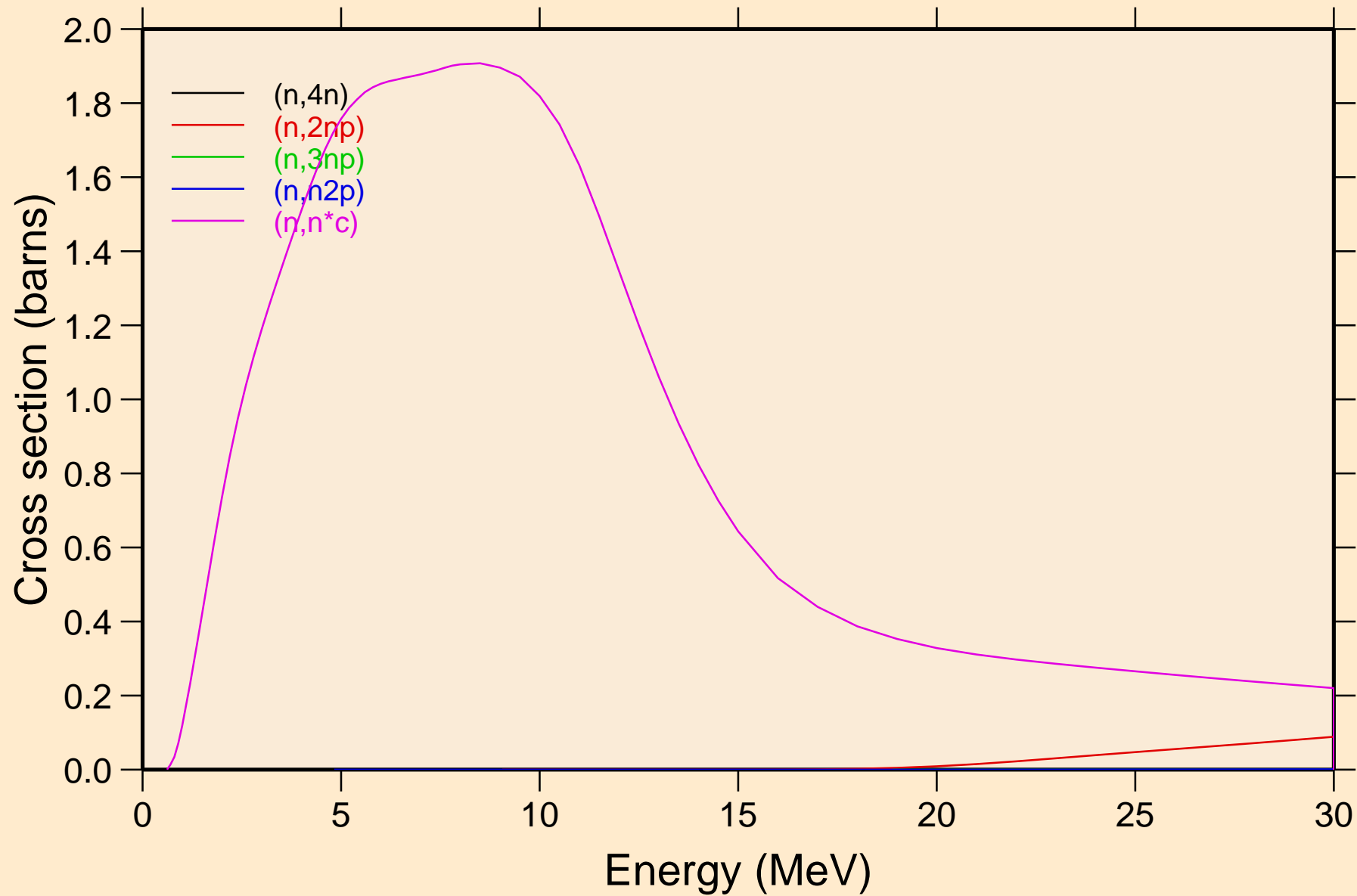

AT202 NEUTRON ACER TENDL-2023 LIBRARY; T=0.K
Threshold reactions

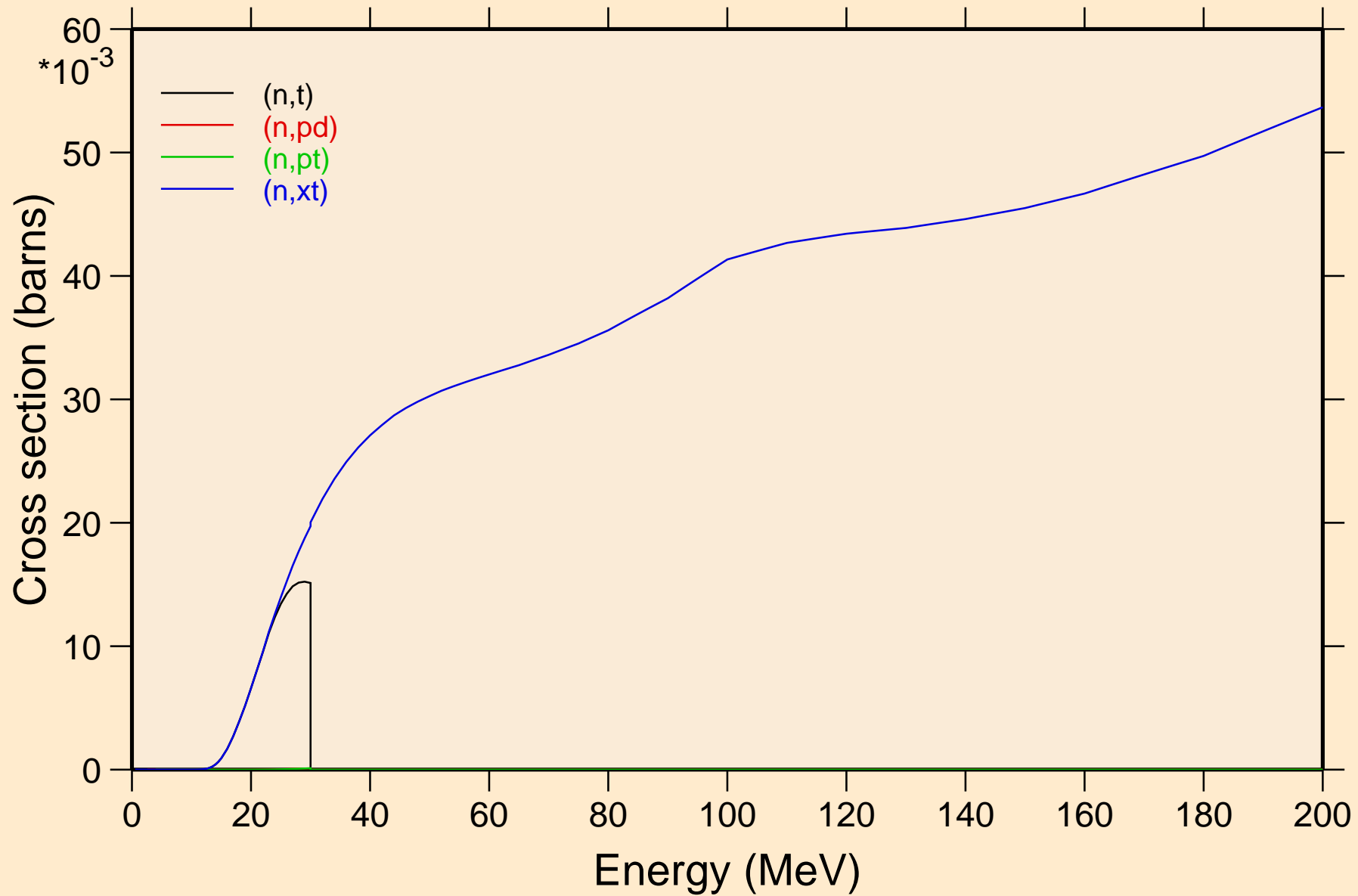

AT202 NEUTRON ACER TENDL-2023 LIBRARY; T=0.K
angular distribution for elastic

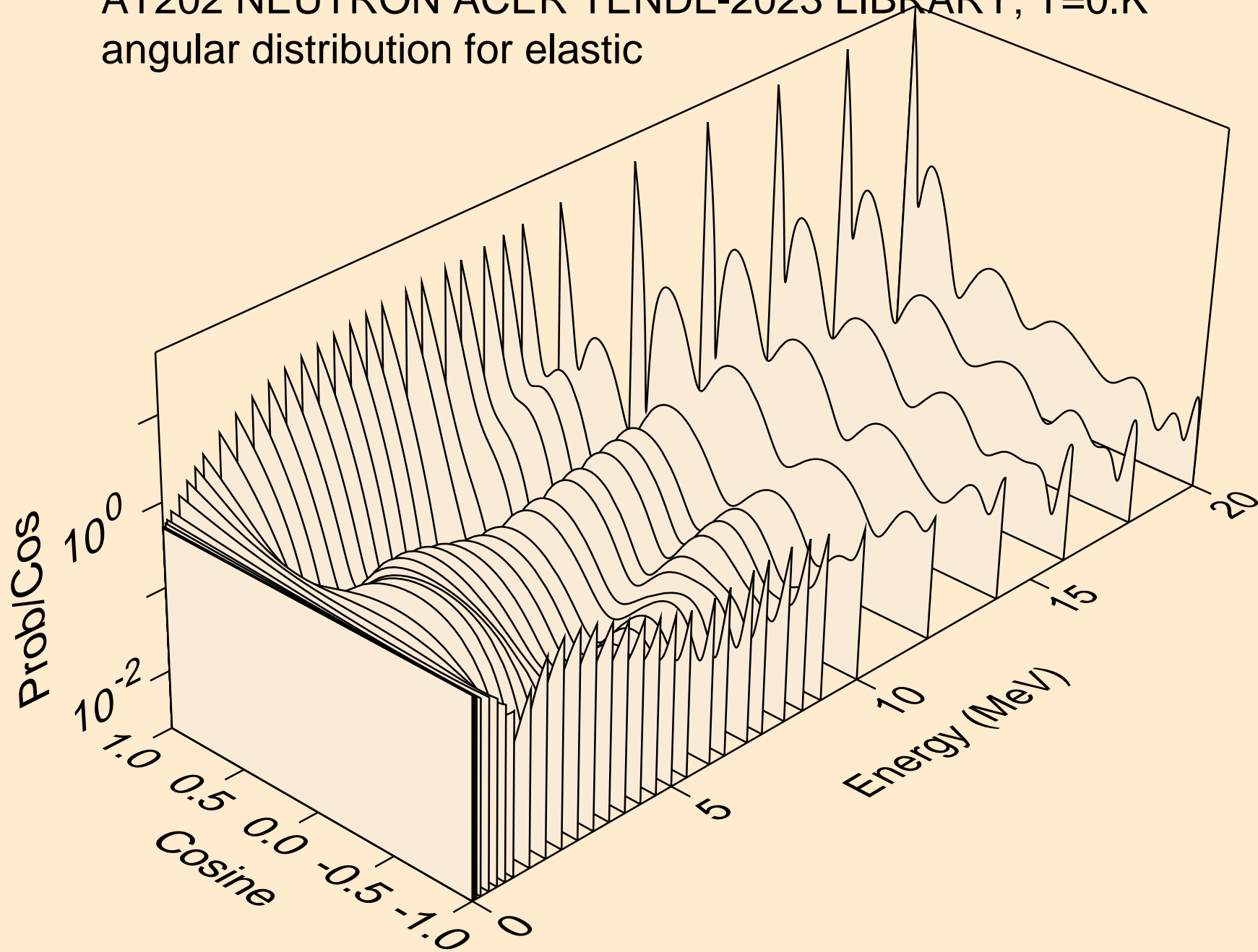

AT202 NEUTRON ACER TENDL-2023 LIBRARY; T=0.K
angular distribution for elastic

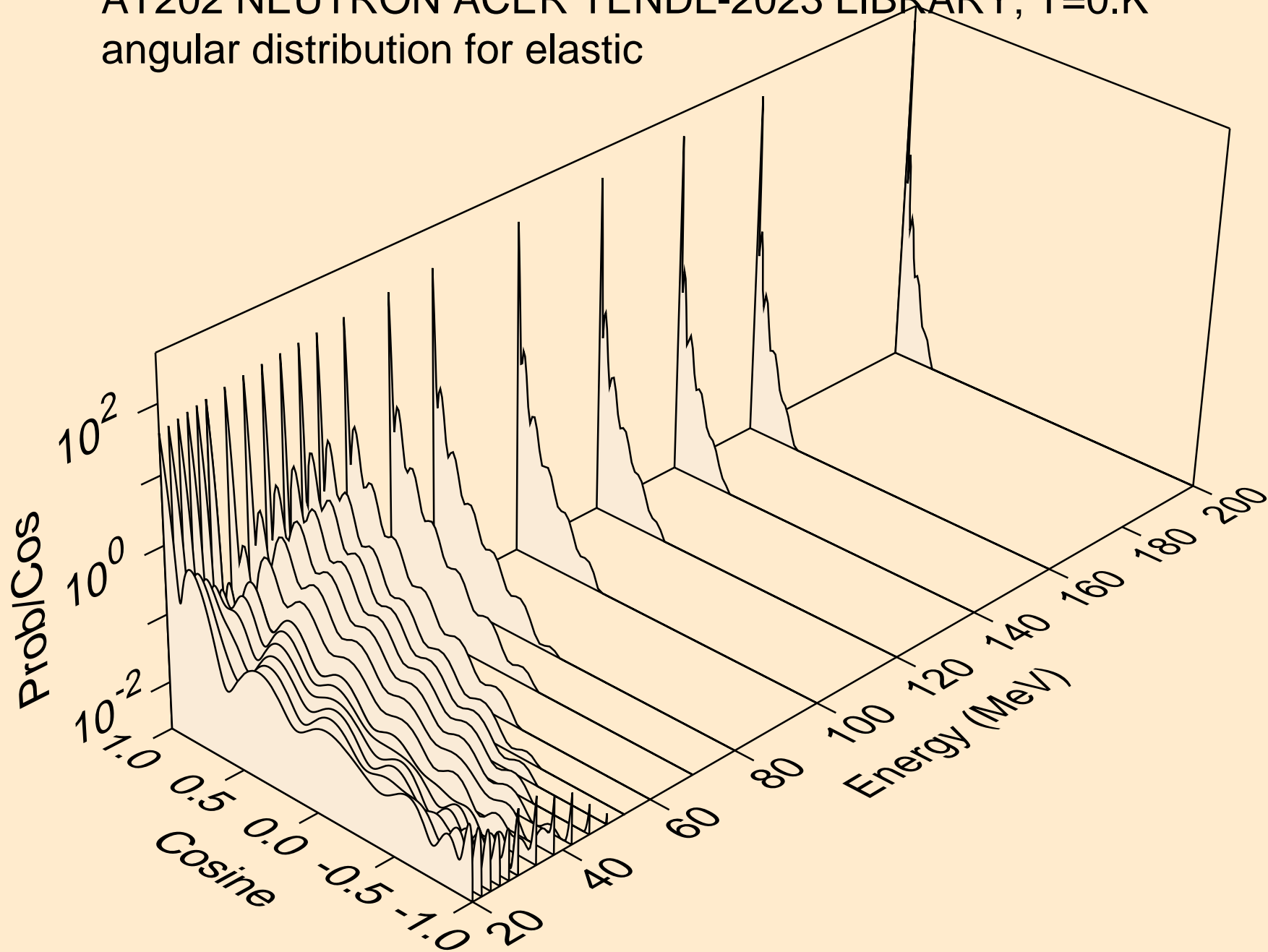

AT202 NEUTRON ACER TENDL-2023 LIBRARY; T=0.K
angular distribution for (n,n*1)

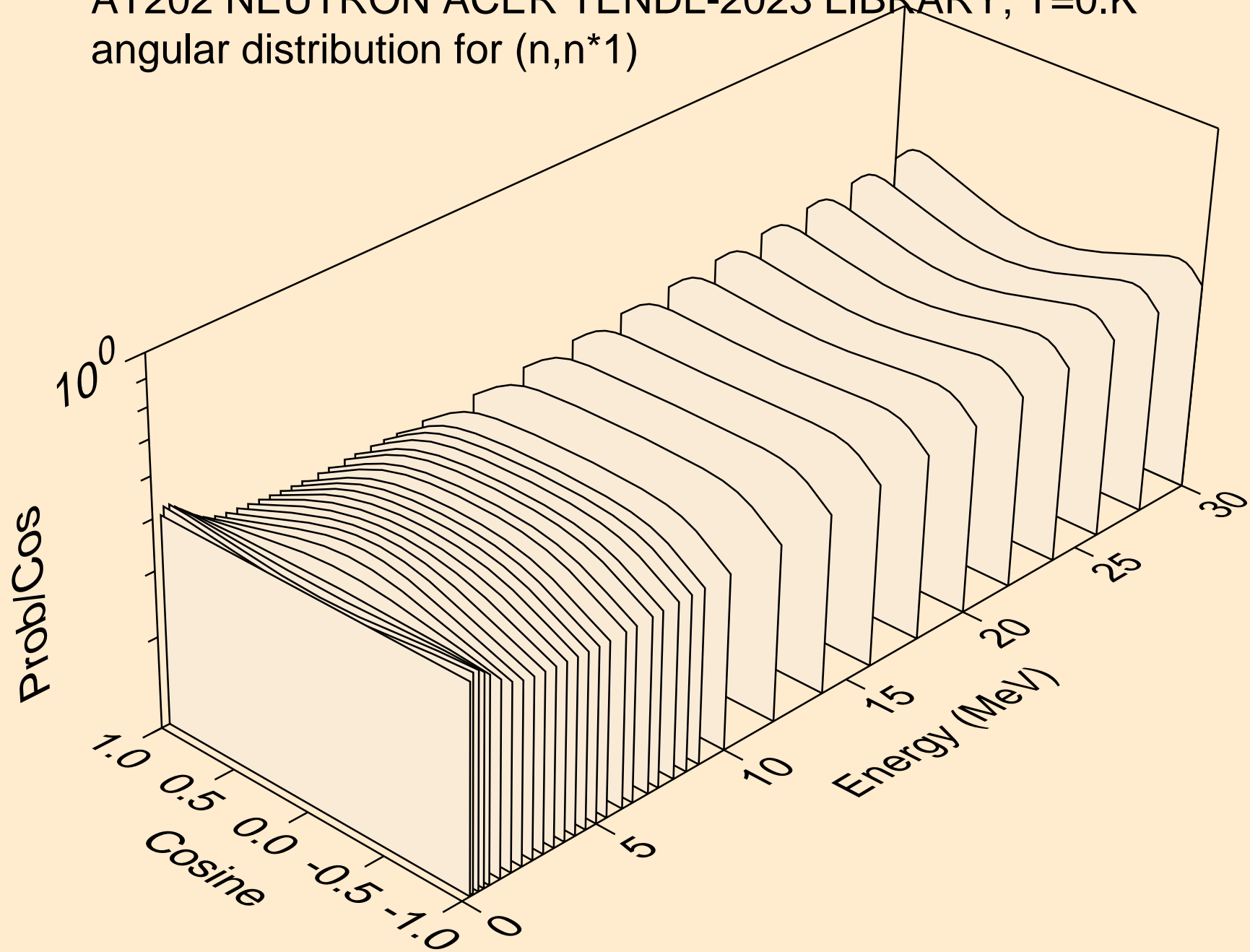

AT202 NEUTRON ACER TENDL-2023 LIBRARY; T=0.K
angular distribution for (n,n*2)

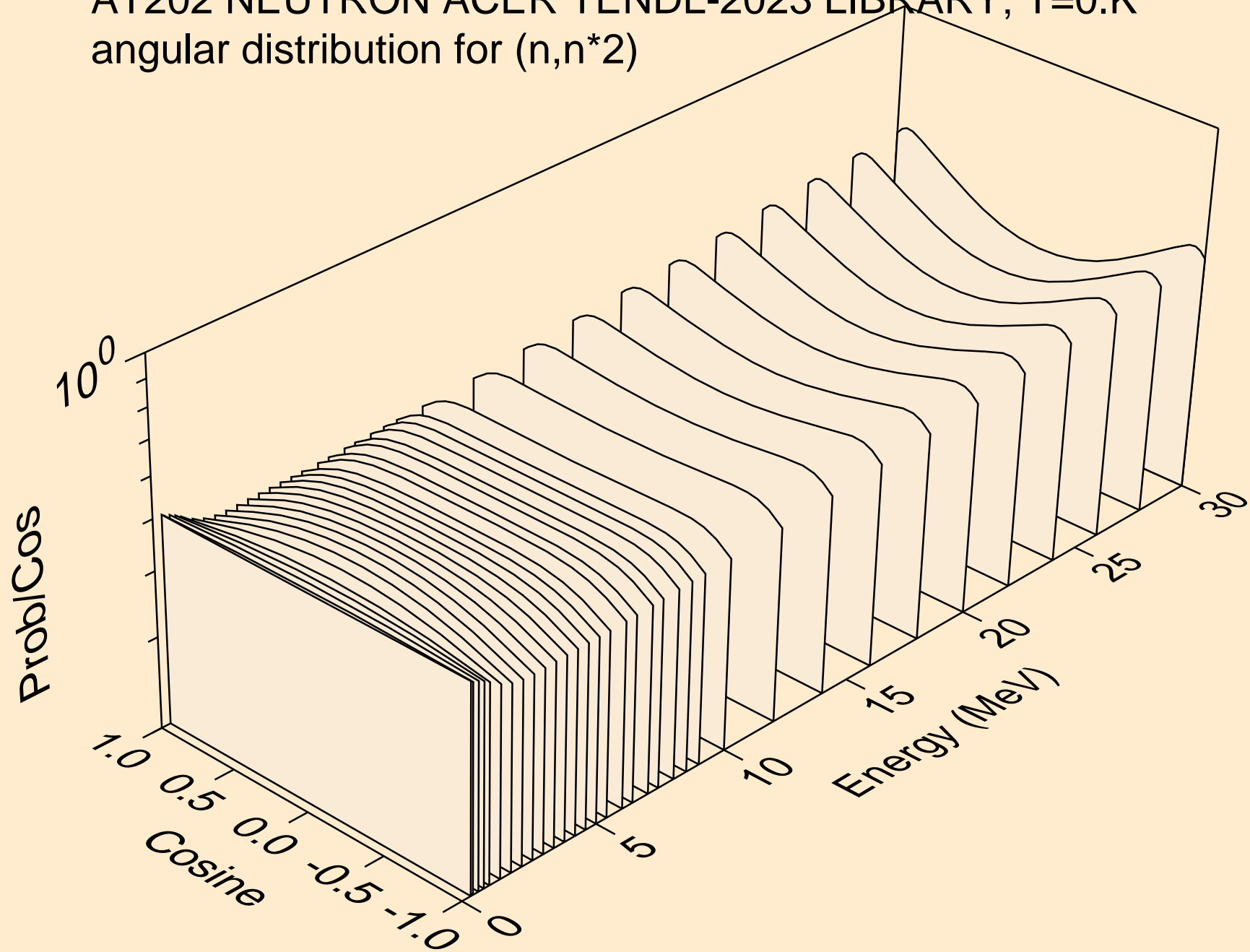

AT202 NEUTRON ACER TENDL-2023 LIBRARY; T=0.K
angular distribution for (n,n*3)

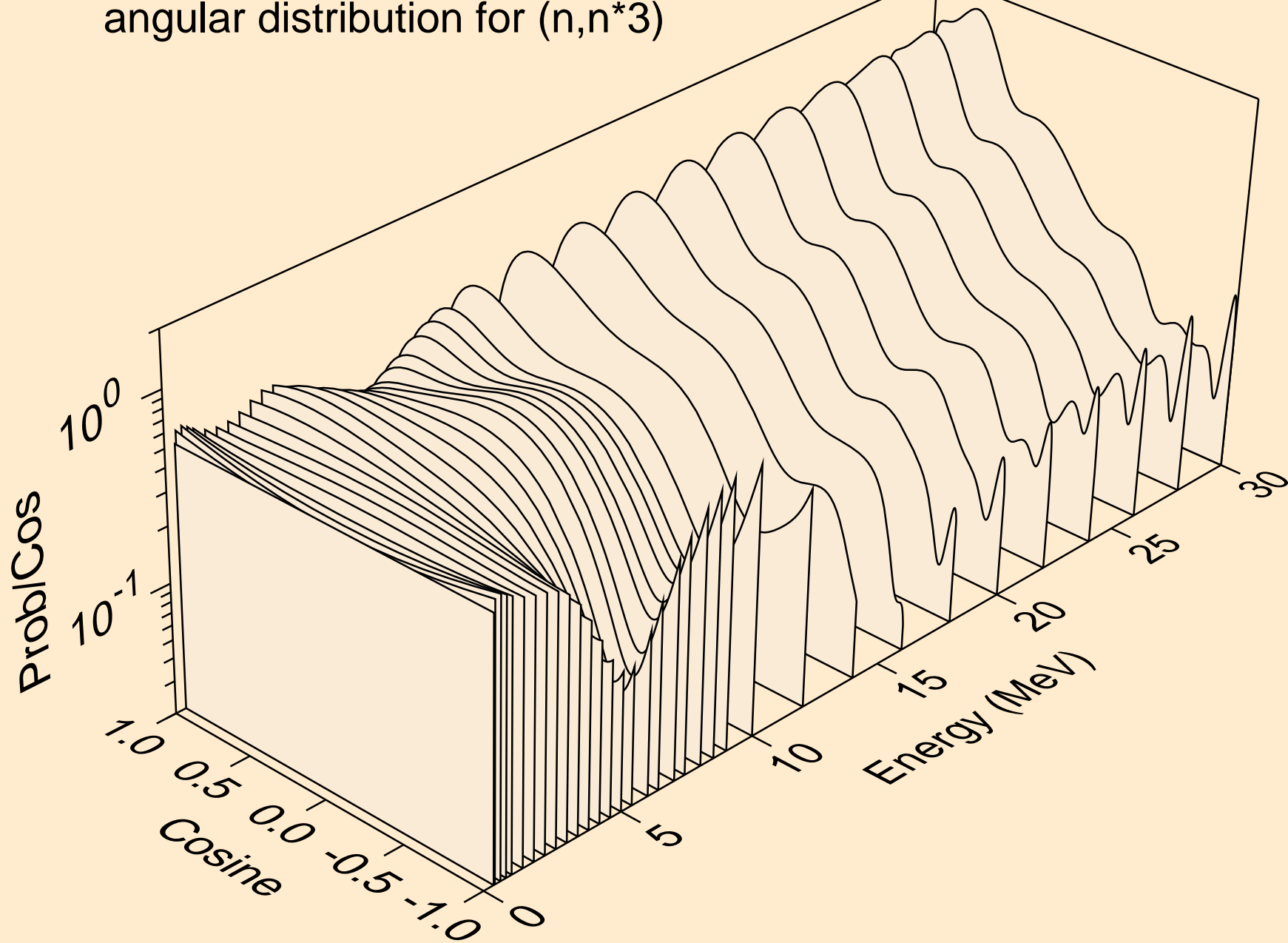

AT202 NEUTRON ACER TENDL-2023 LIBRARY; T=0.K
angular distribution for (n,n*4)

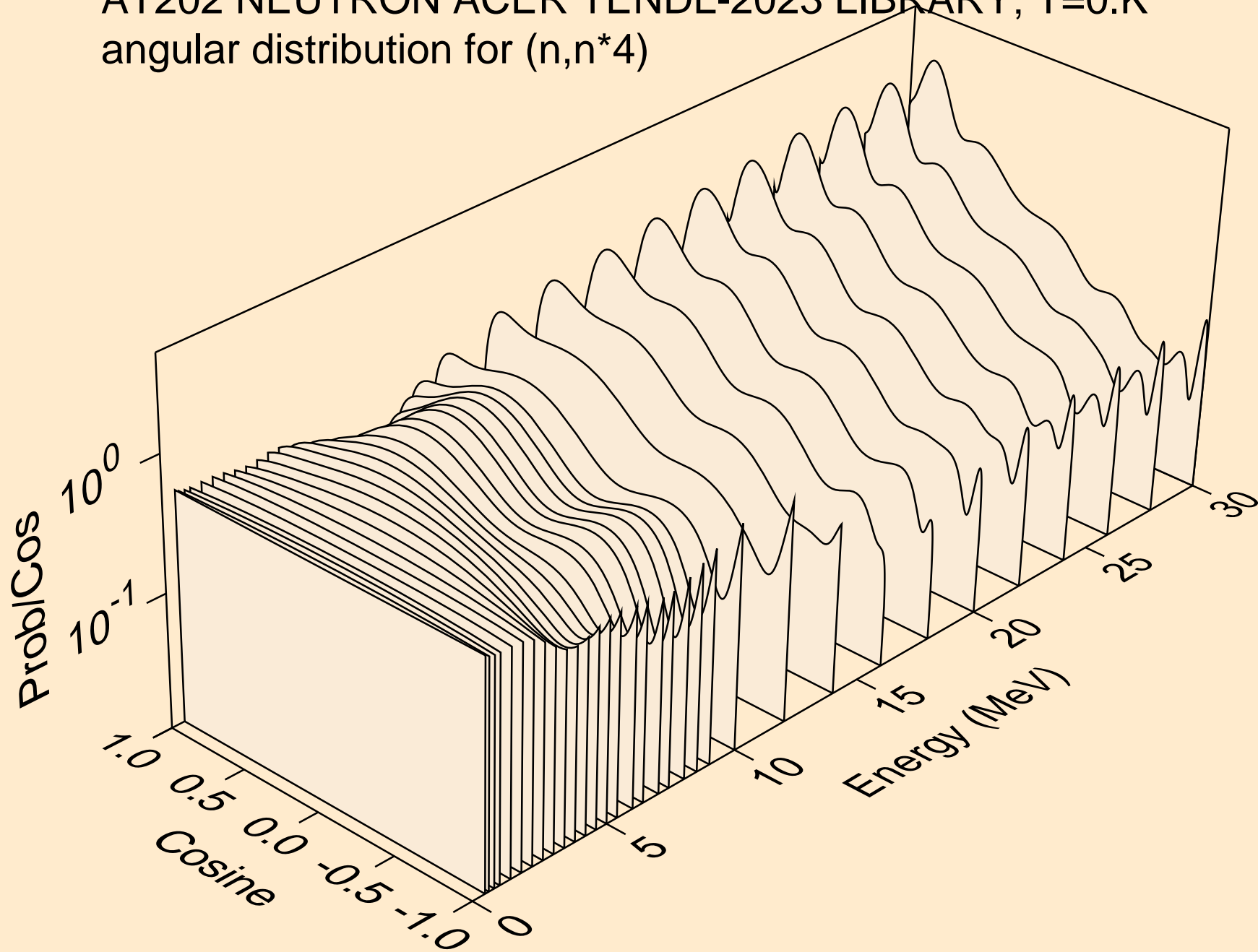

AT202 NEUTRON ACER TENDL-2023 LIBRARY; T=0.K
angular distribution for (n,n*5)

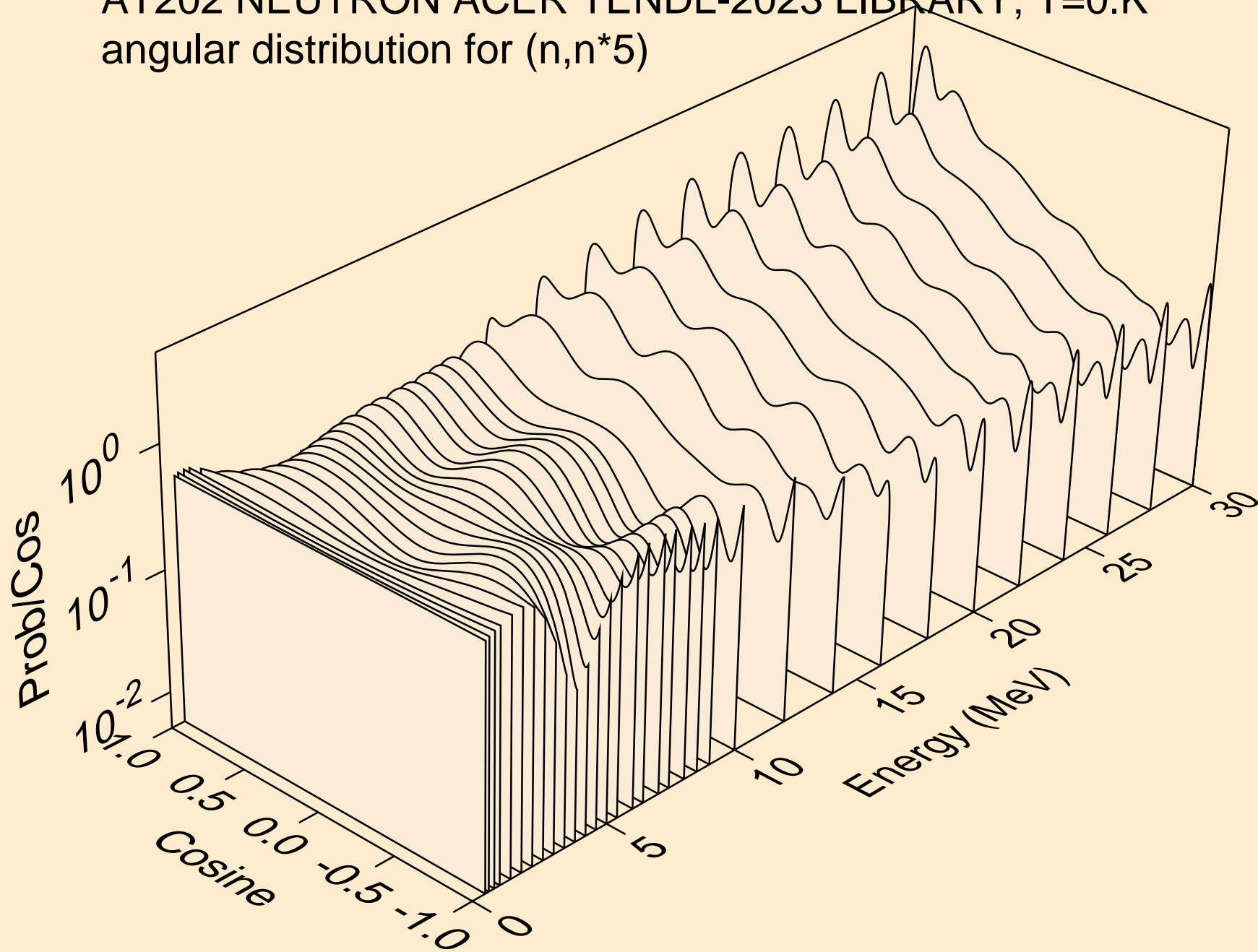

AT202 NEUTRON ACER TENDL-2023 LIBRARY; T=0.K
angular distribution for (n,n*6)

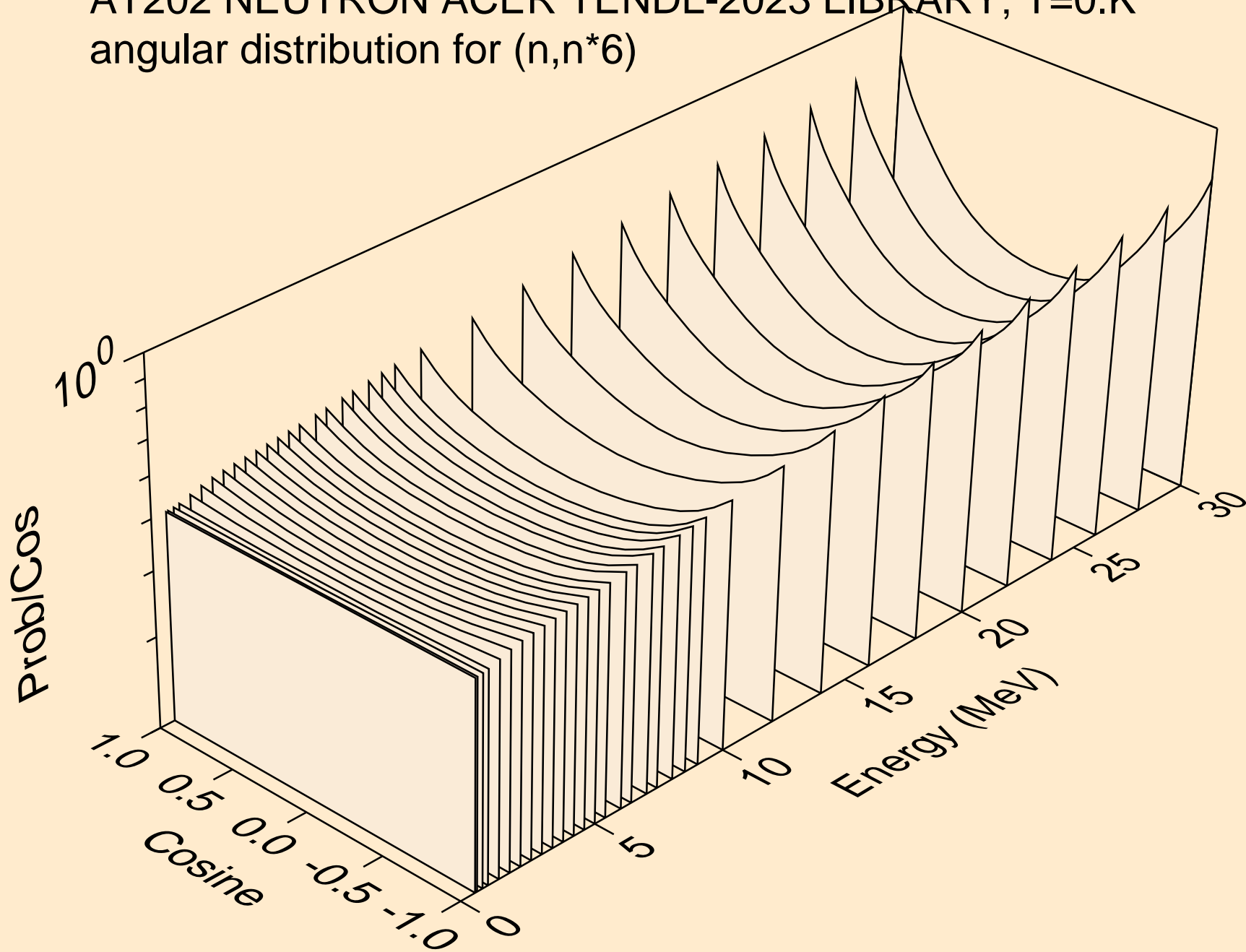

AT202 NEUTRON ACER TENDL-2023 LIBRARY; T=0.K
angular distribution for (n,n*7)

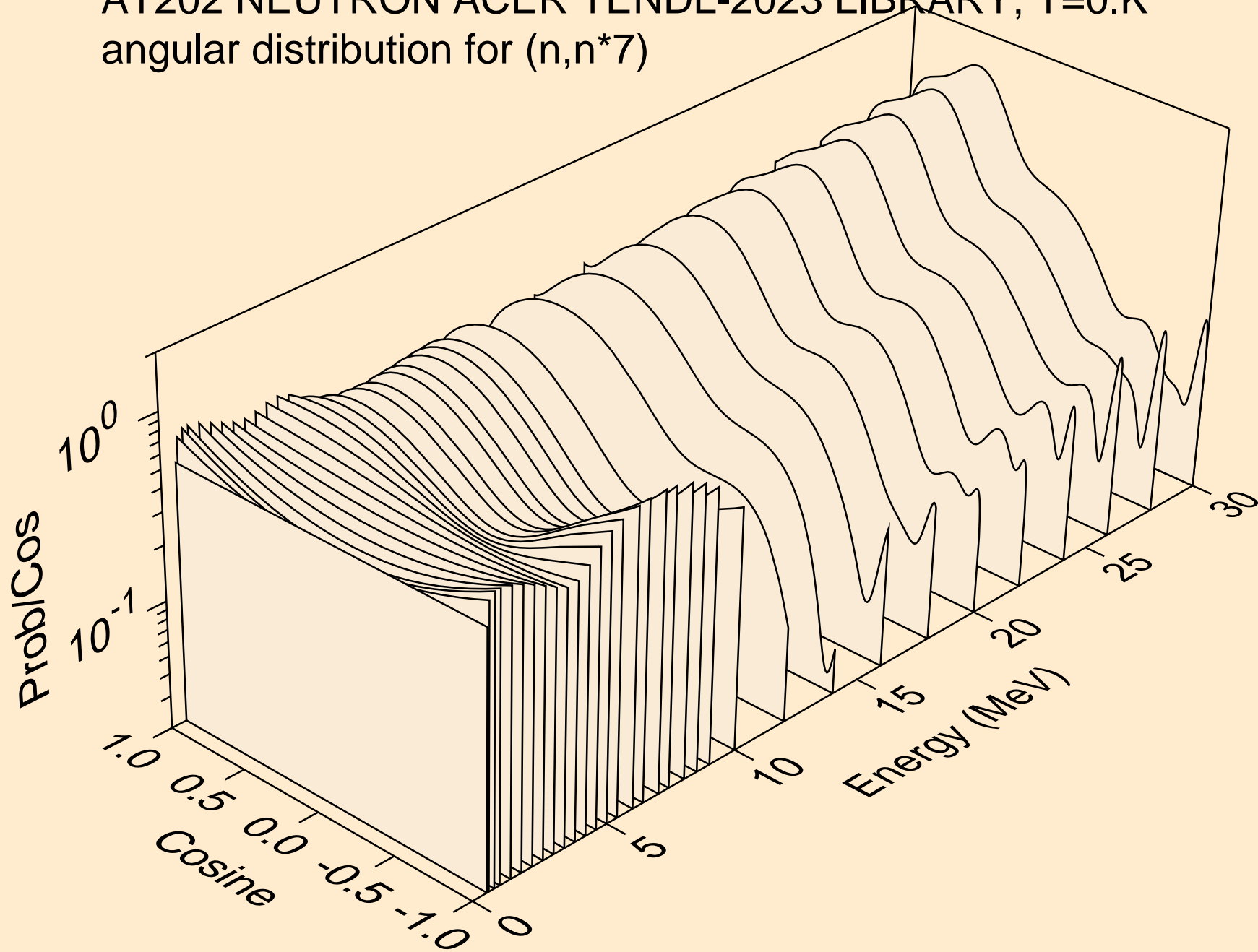

AT202 NEUTRON ACER TENDL-2023 LIBRARY; T=0.K
angular distribution for (n,n*8)

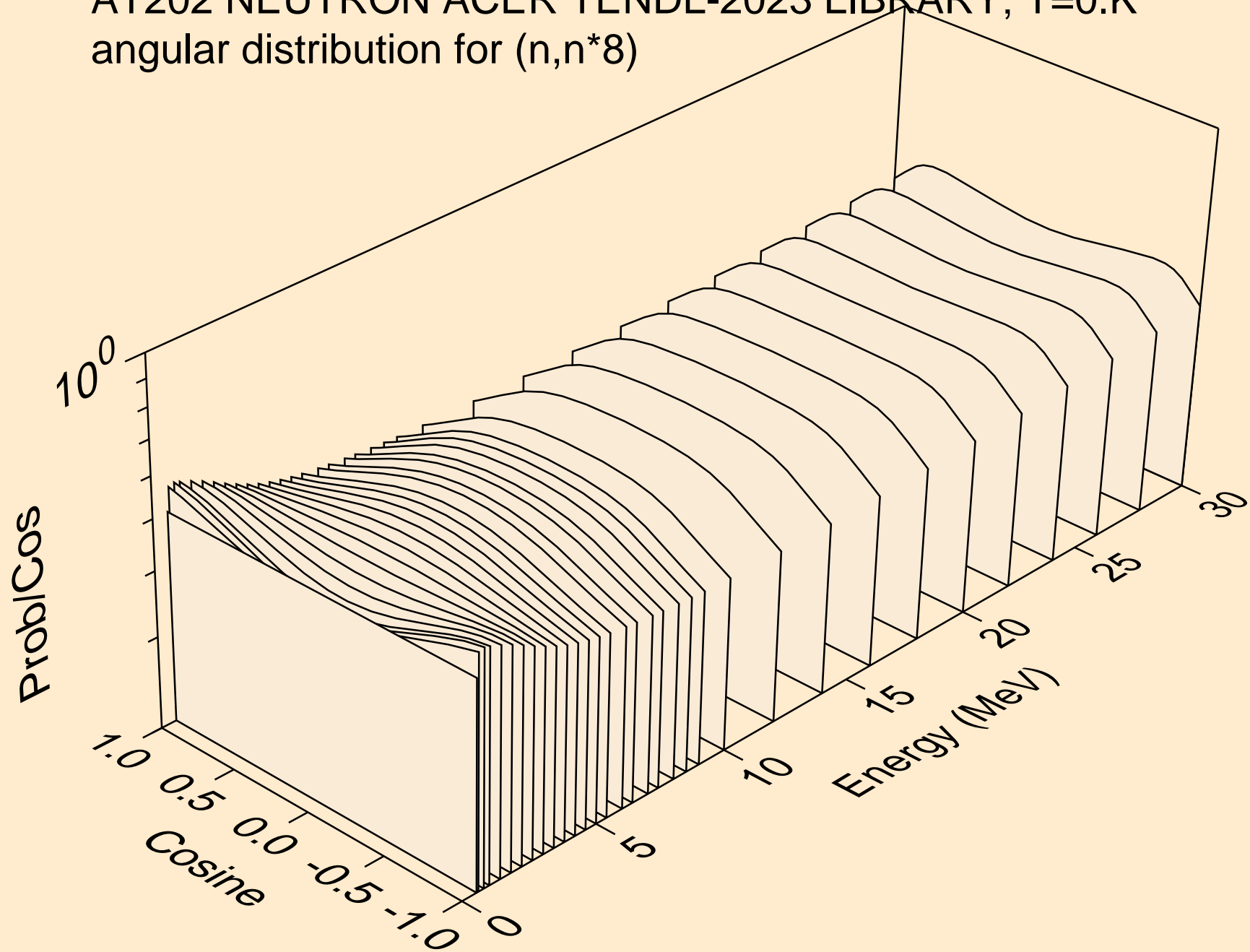

AT202 NEUTRON ACER TENDL-2023 LIBRARY; T=0.K
angular distribution for (n,n*9)

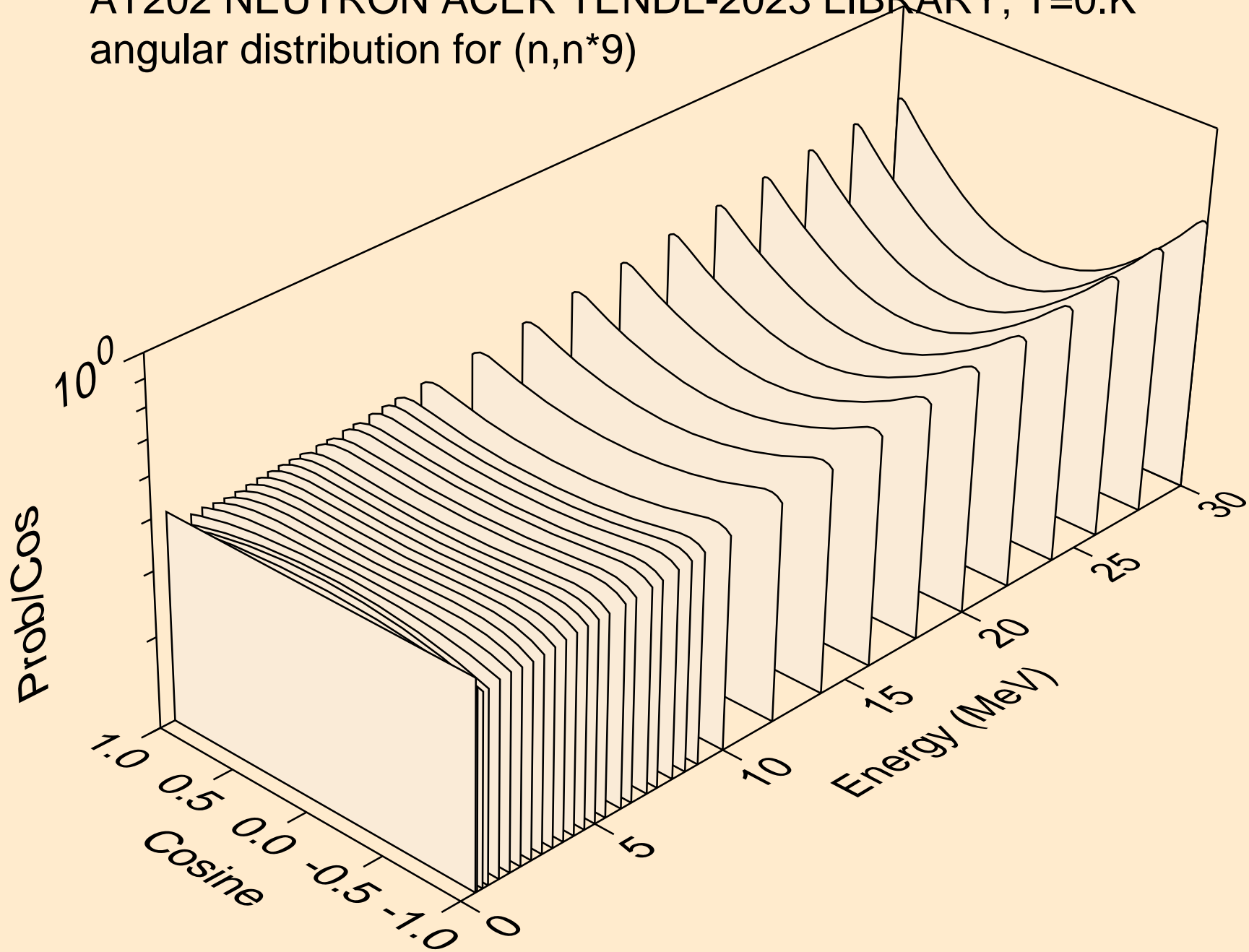

AT202 NEUTRON ACER TENDL-2023 LIBRARY; T=0.K
angular distribution for (n,n*10)

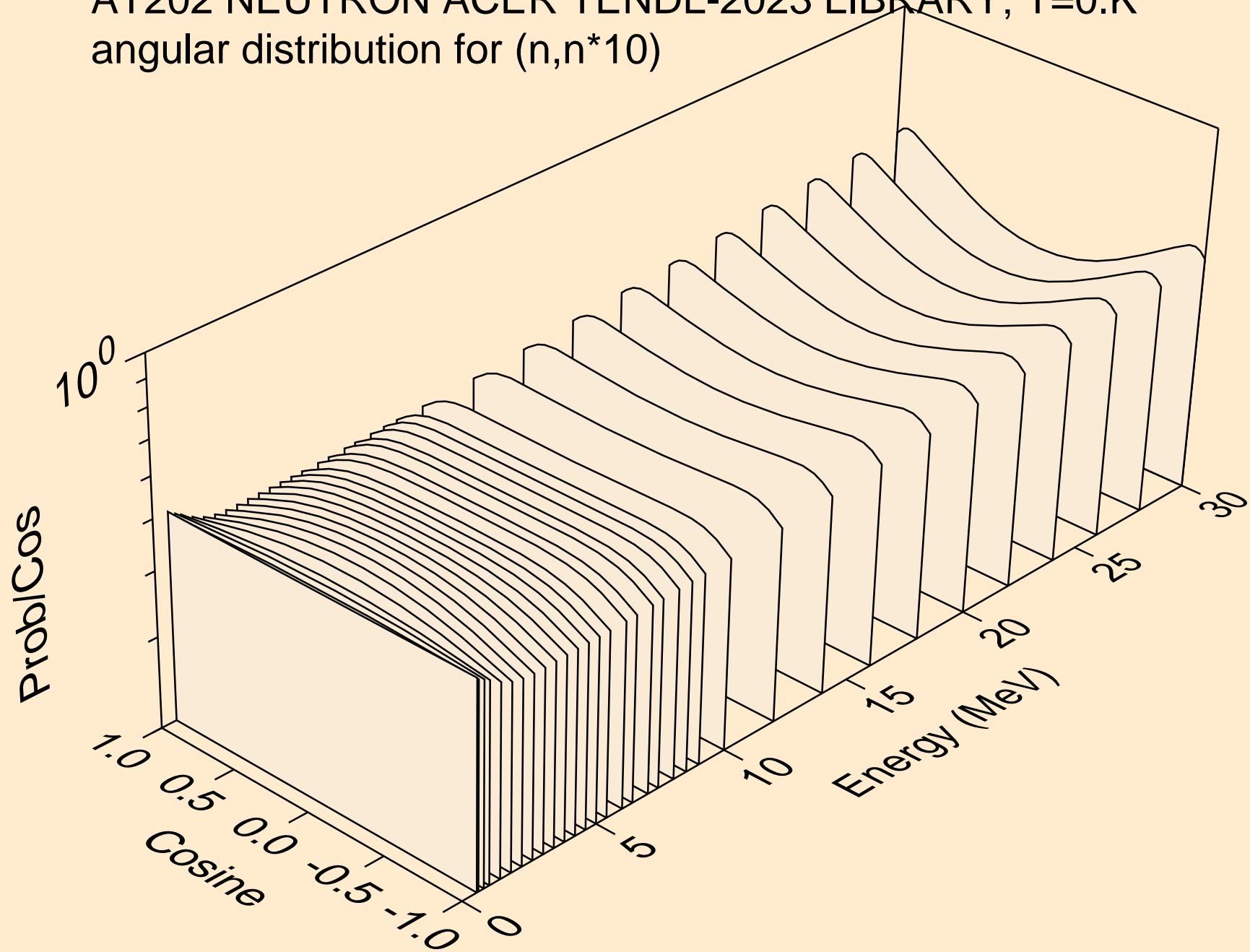

AT202 NEUTRON ACER TENDL-2023 LIBRARY; T=0.K
angular distribution for (n,n*11)

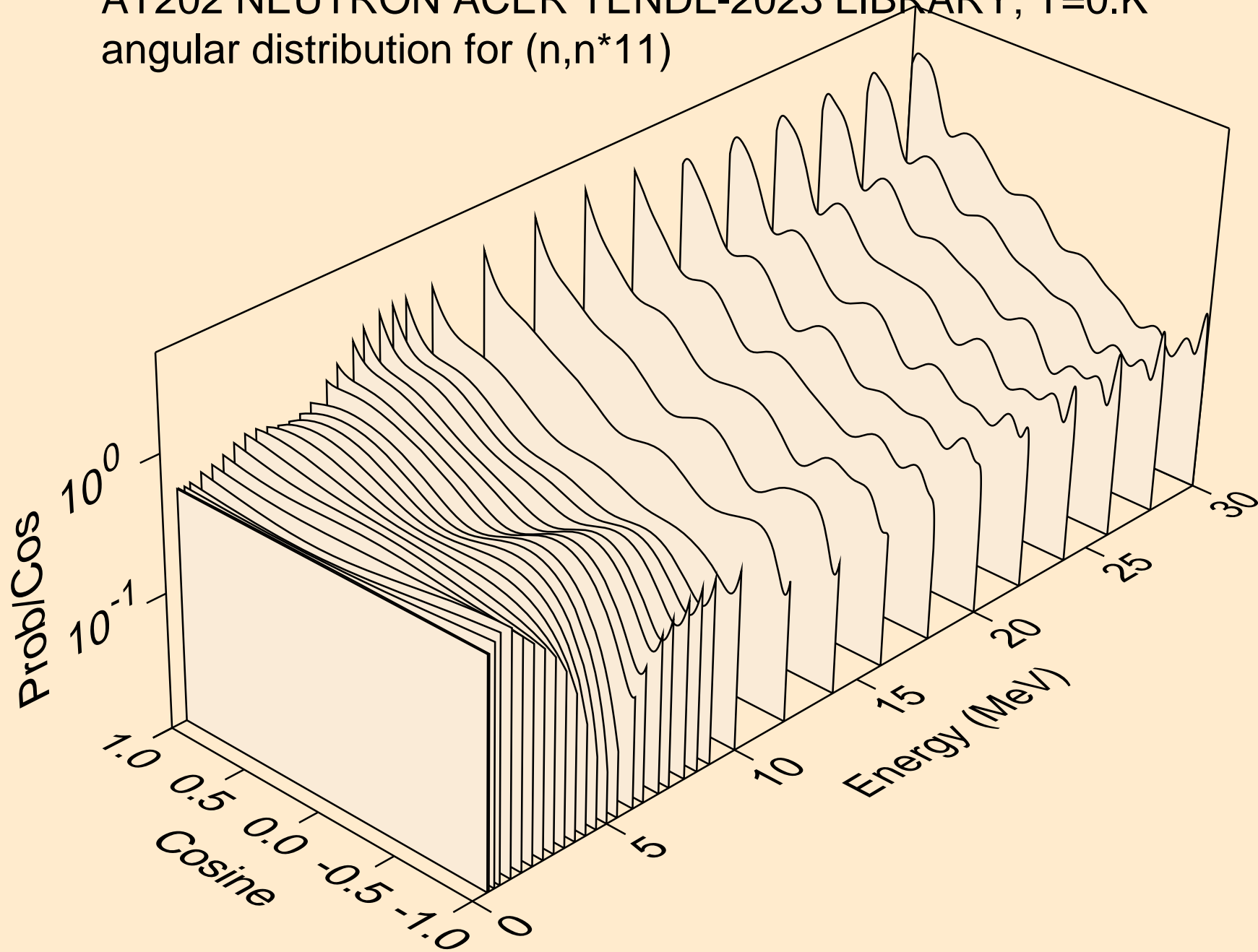

AT202 NEUTRON ACER TENDL-2023 LIBRARY; T=0.K
angular distribution for (n,n*12)

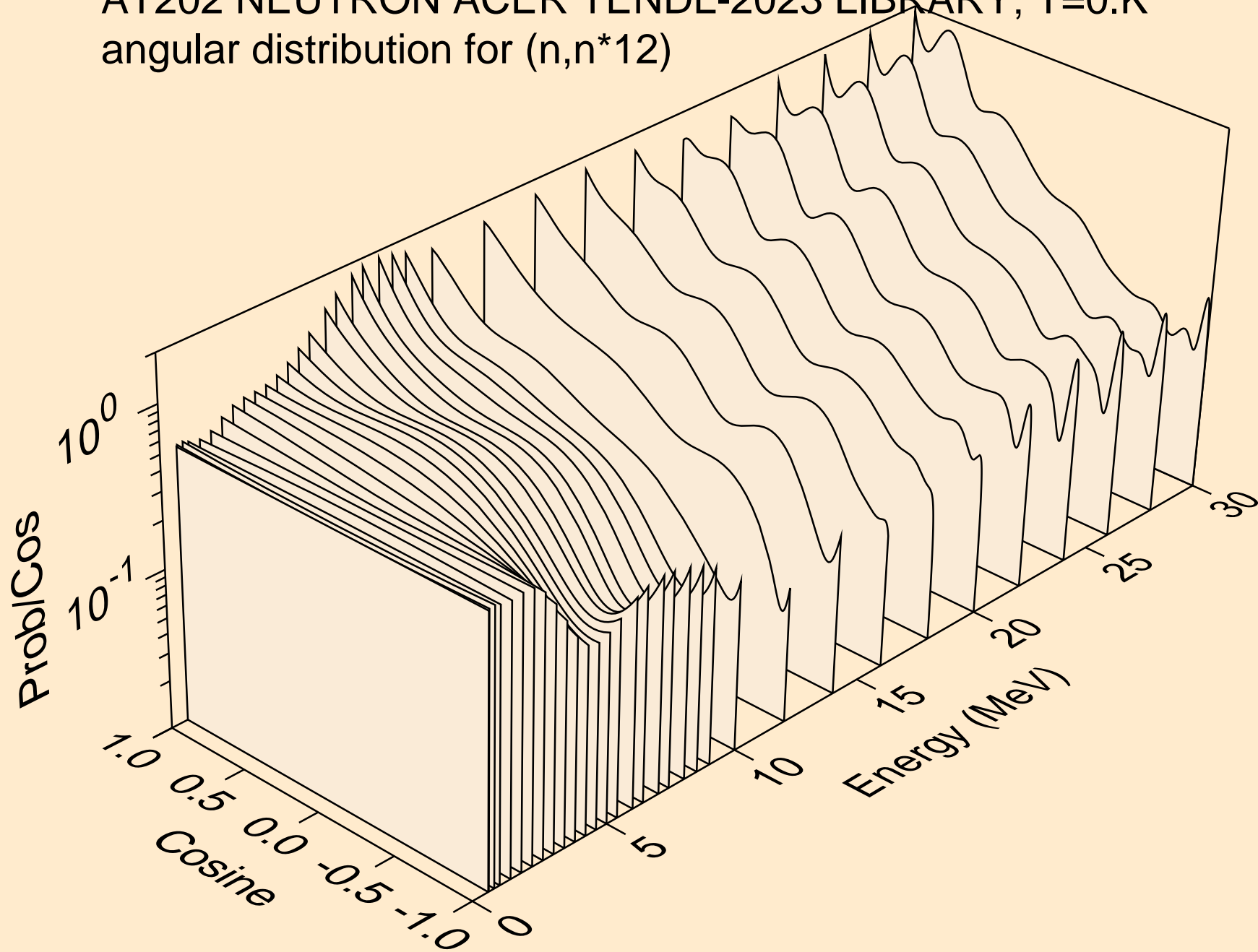

AT202 NEUTRON ACER TENDL-2023 LIBRARY; T=0.K
angular distribution for (n,n*13)

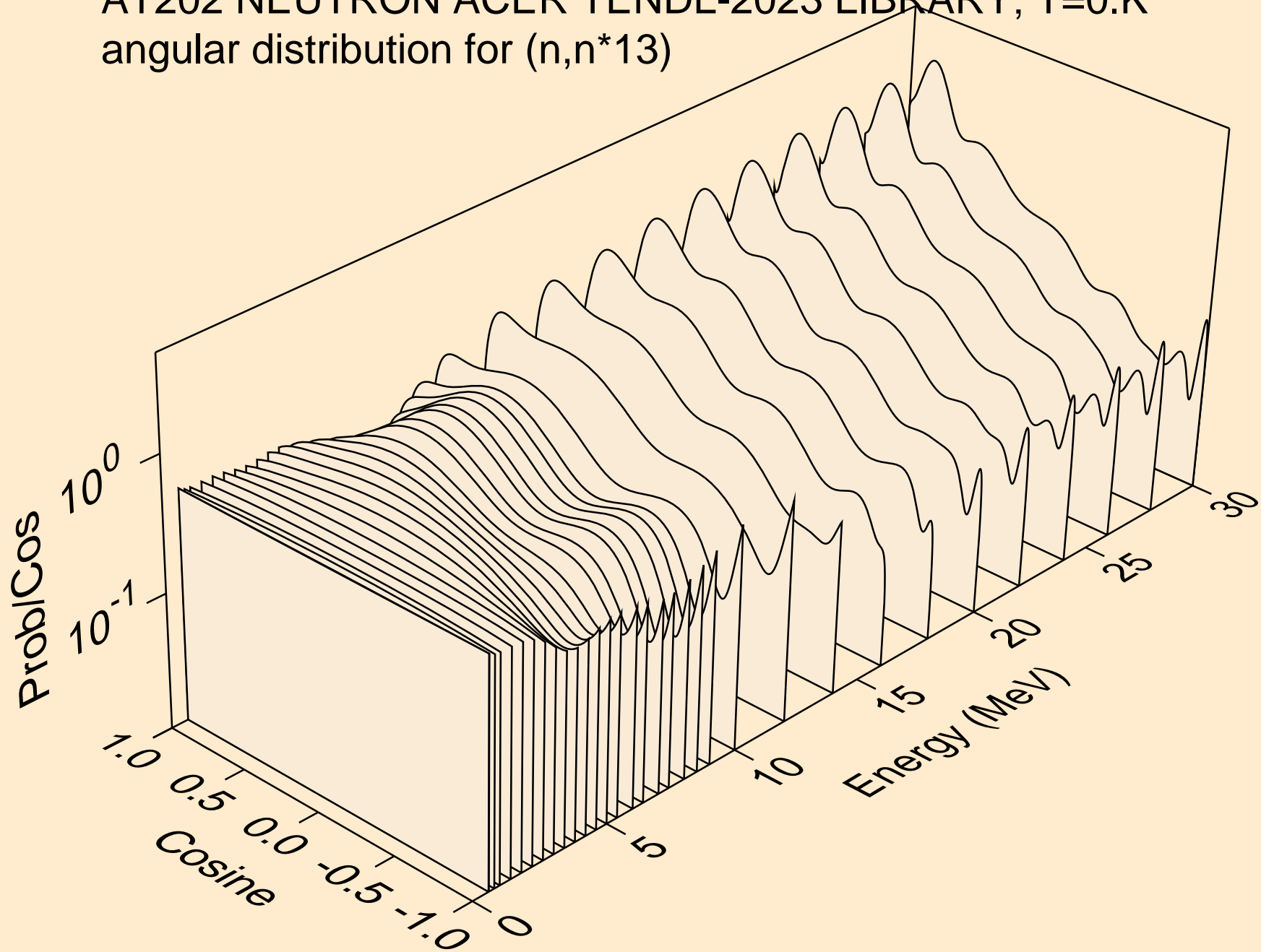

AT202 NEUTRON ACER TENDL-2023 LIBRARY; T=0.K
angular distribution for (n,n*14)

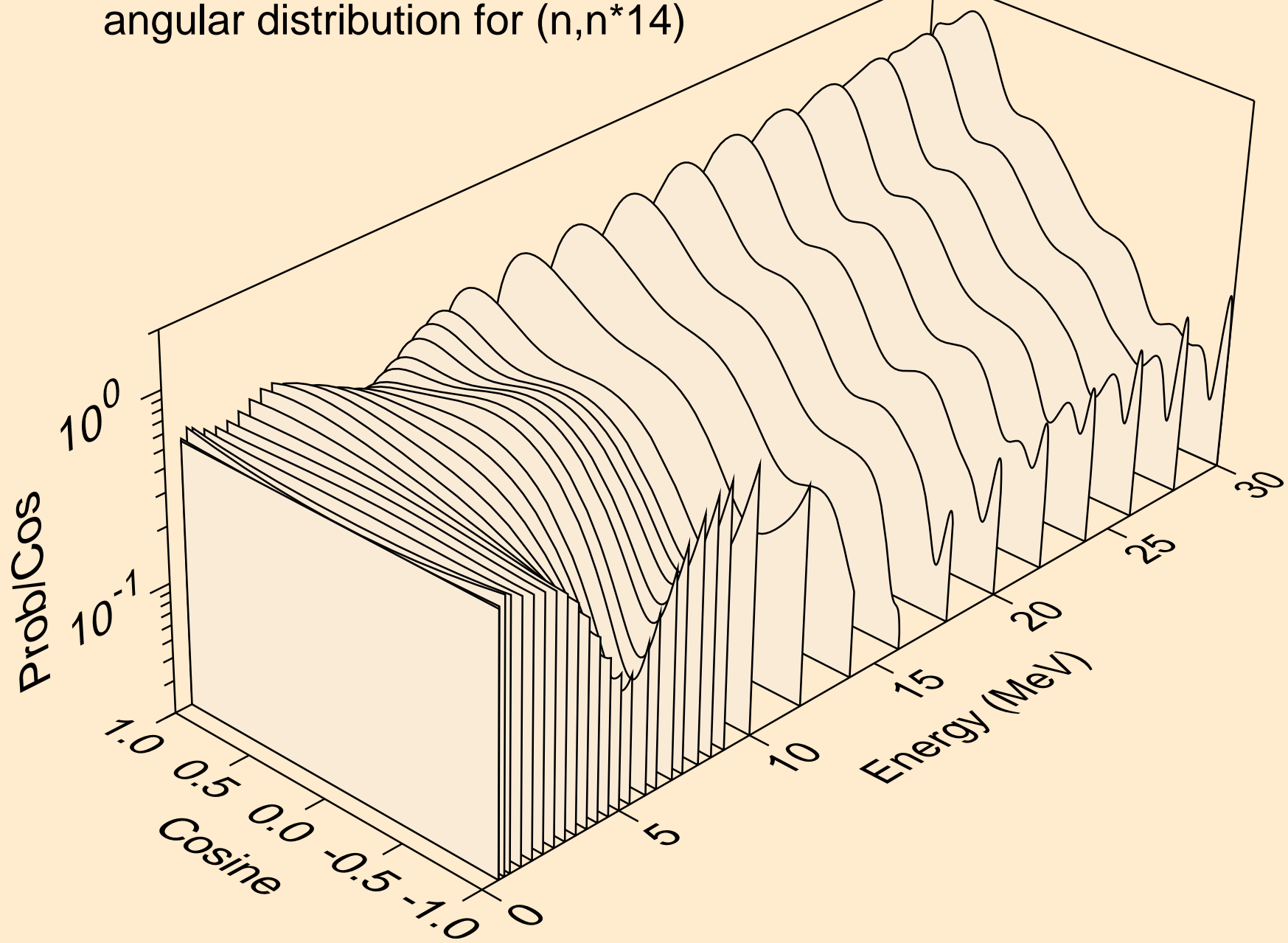

AT202 NEUTRON ACER TENDL-2023 LIBRARY; T=0.K
angular distribution for (n,n*15)

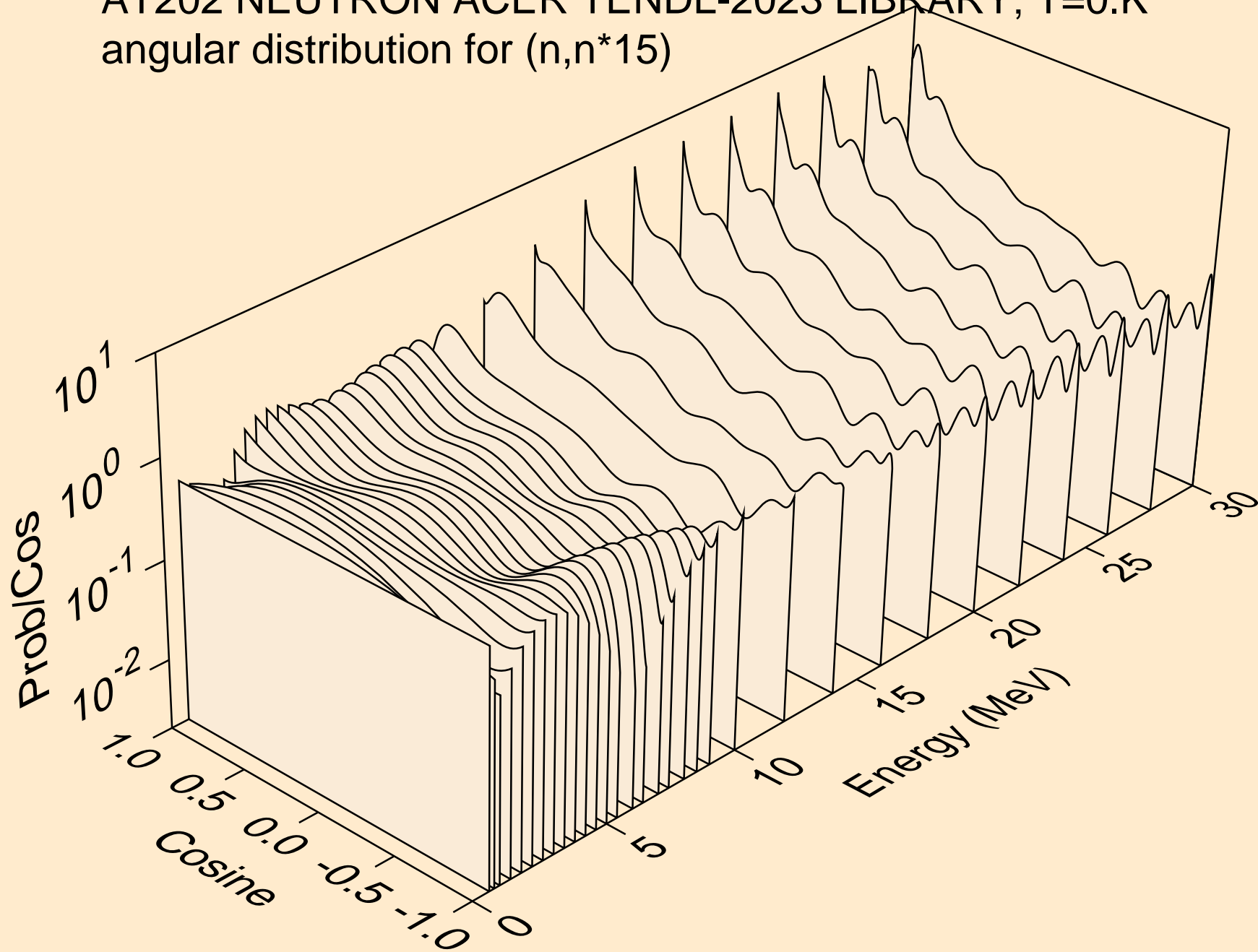

AT202 NEUTRON ACER TENDL-2023 LIBRARY; T=0.K
Neutron emission for (n,x)

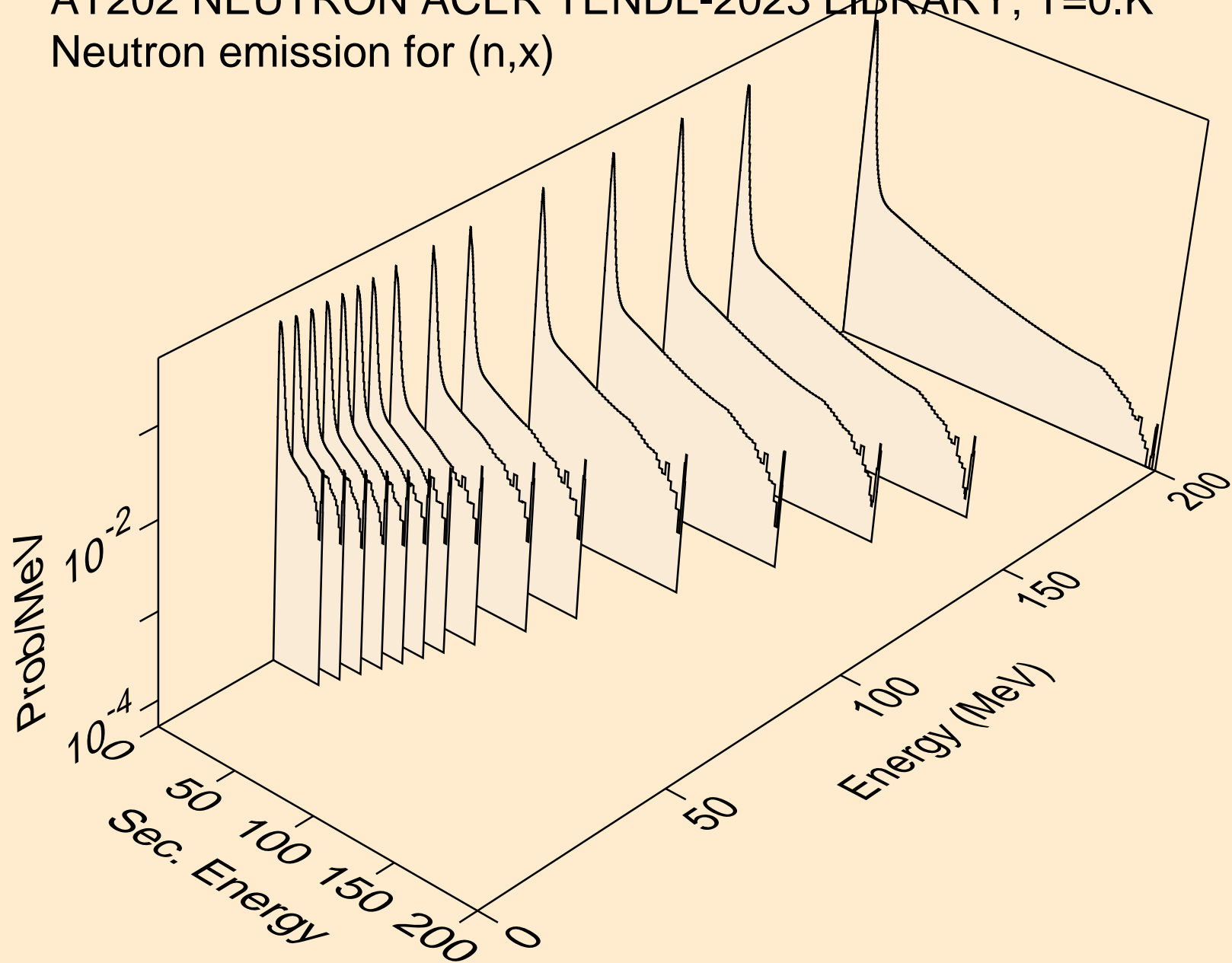

AT202 NEUTRON ACER TENDL-2023 LIBRARY; T=0.K
Neutron emission for (n,2nd)

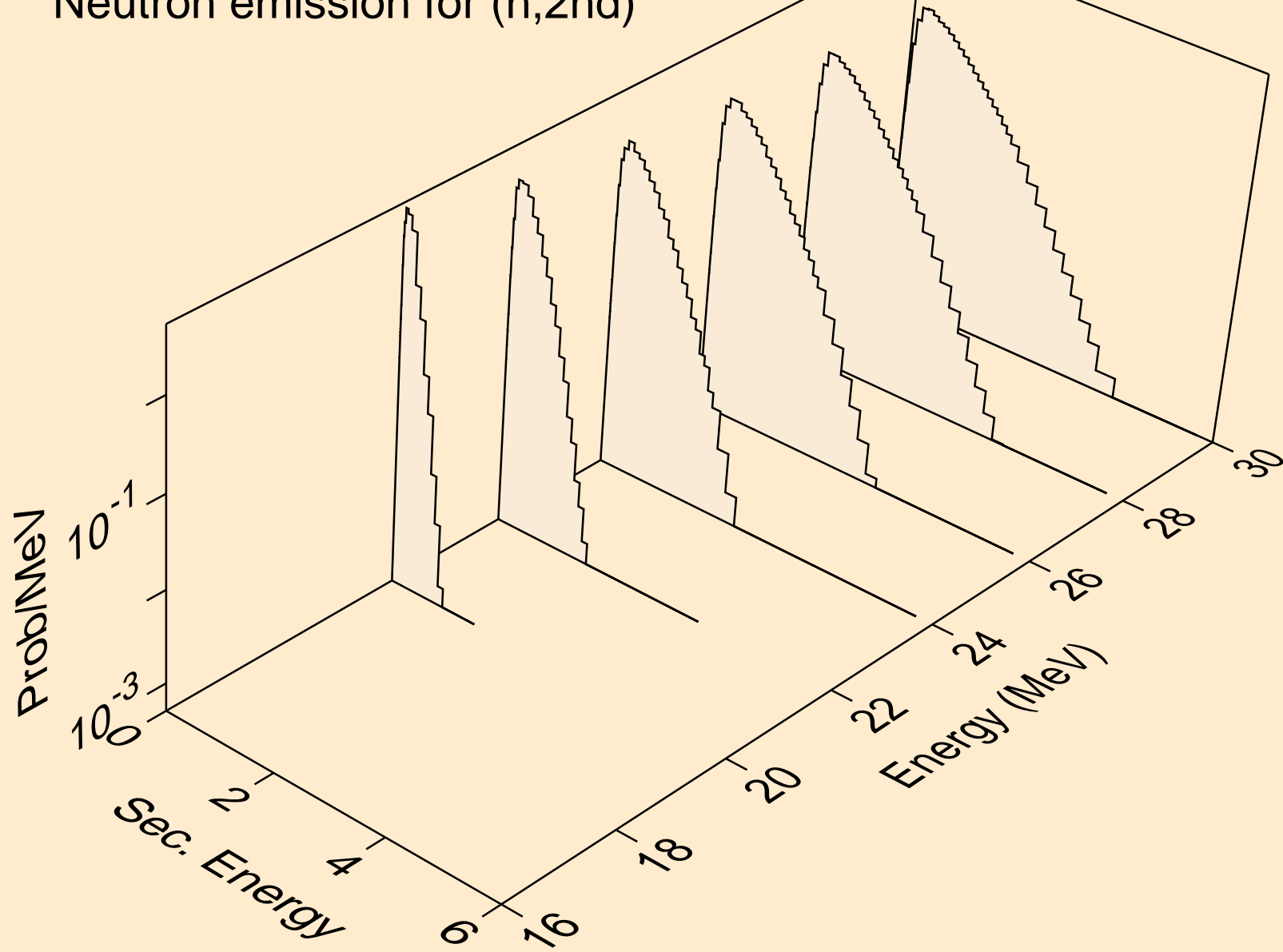

AT202 NEUTRON ACER TENDL-2023 LIBRARY; T=0.K
Neutron emission for (n,2n)

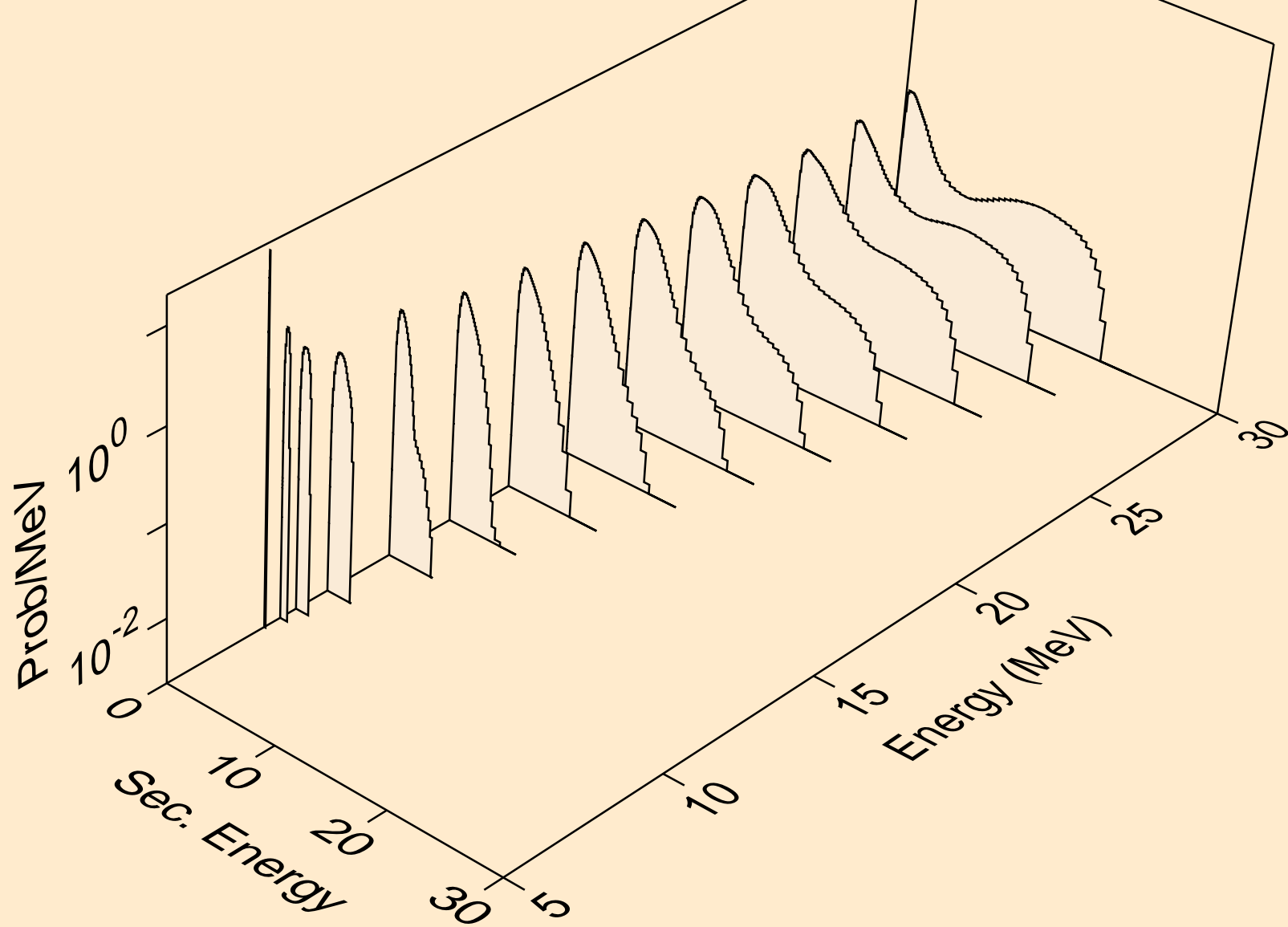

AT202 NEUTRON ACER TENDL-2023 LIBRARY; T=0.K
Neutron emission for (n,3n)

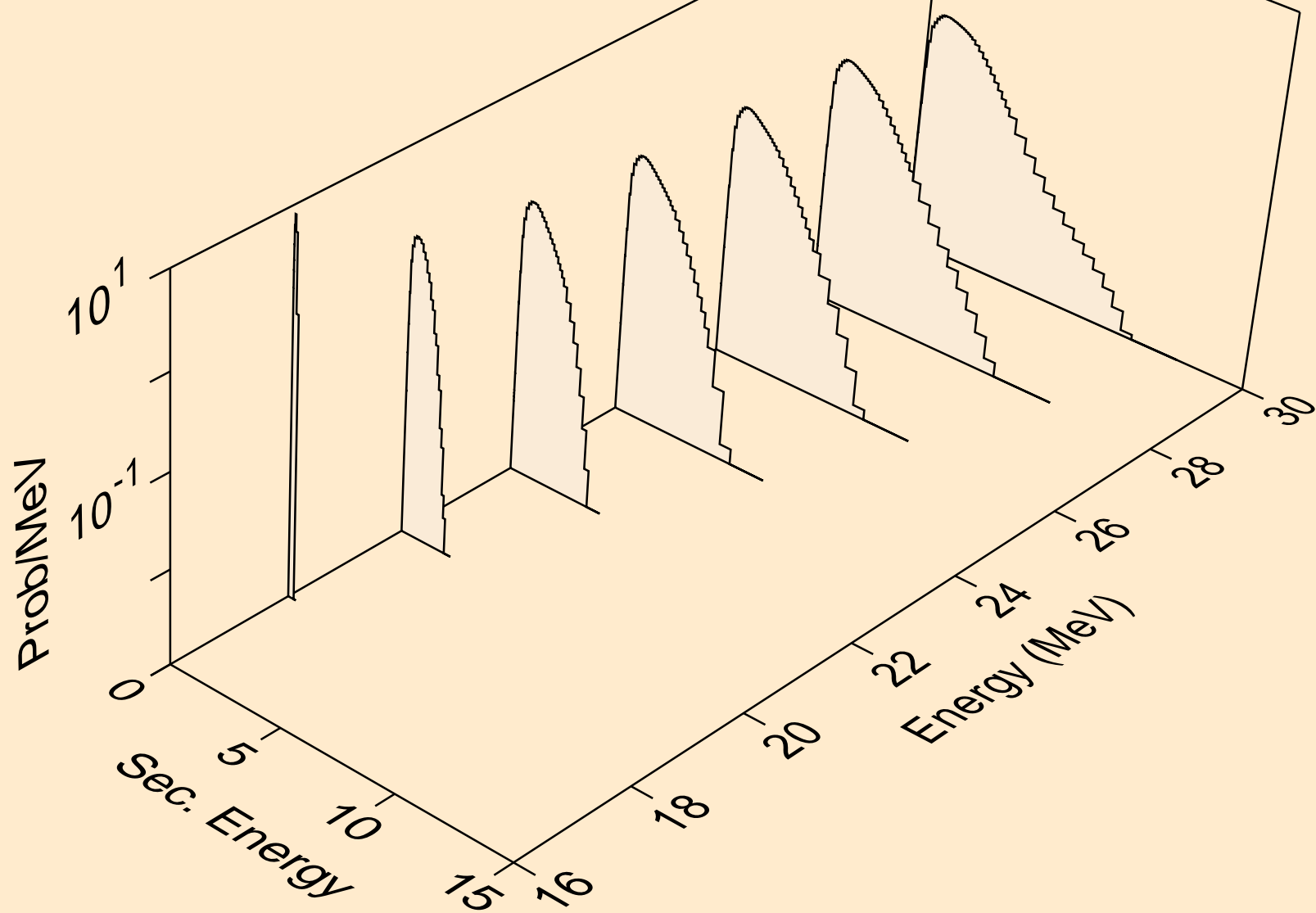

AT202 NEUTRON ACER TENDL-2023 LIBRARY; T=0.K
Neutron emission for (n,n*)a

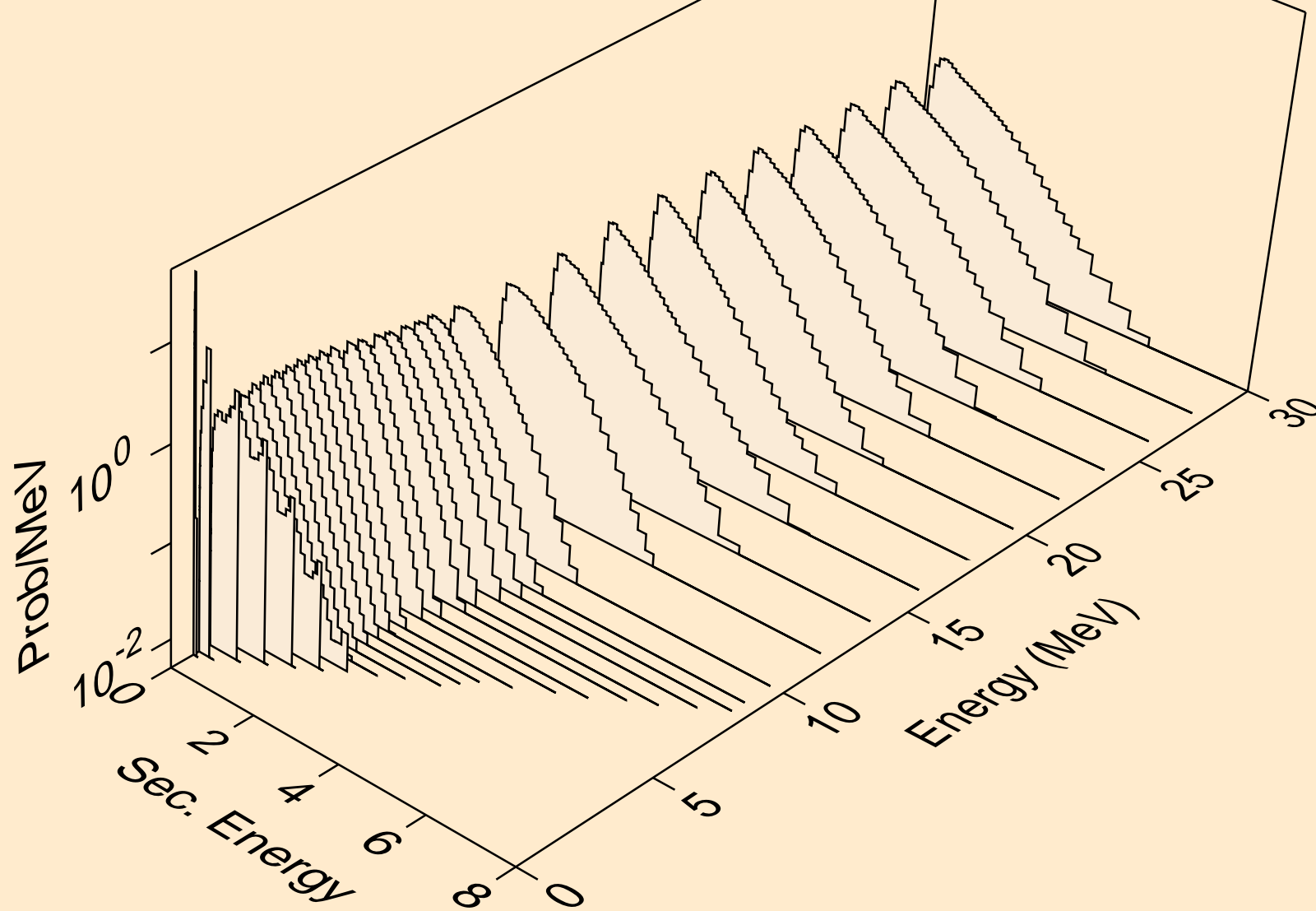

AT202 NEUTRON ACER TENDL-2023 LIBRARY; T=0.K
Neutron emission for (n,2n)a

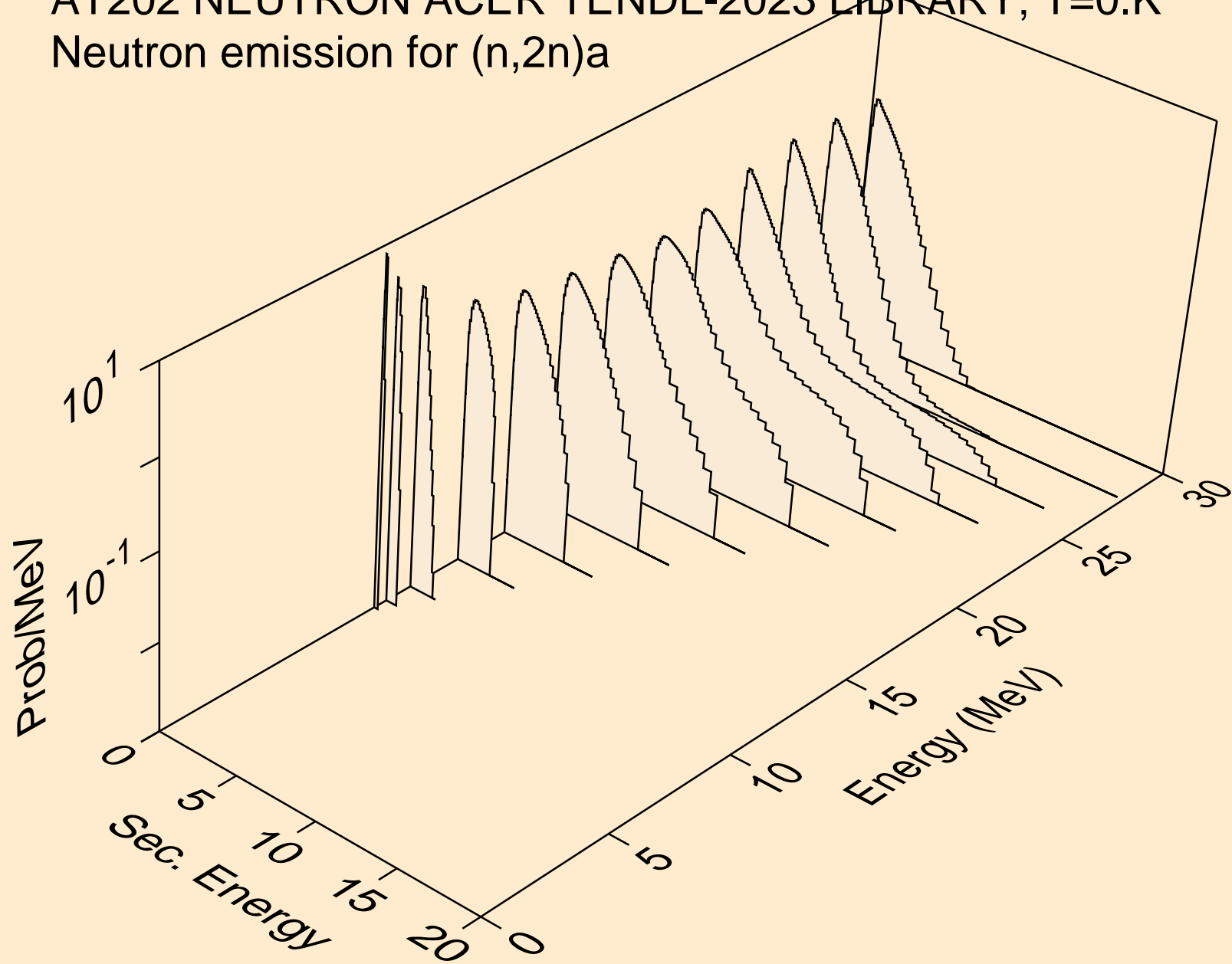

AT202 NEUTRON ACER TENDL-2023 LIBRARY; T=0.K
Neutron emission for (n,3n)a

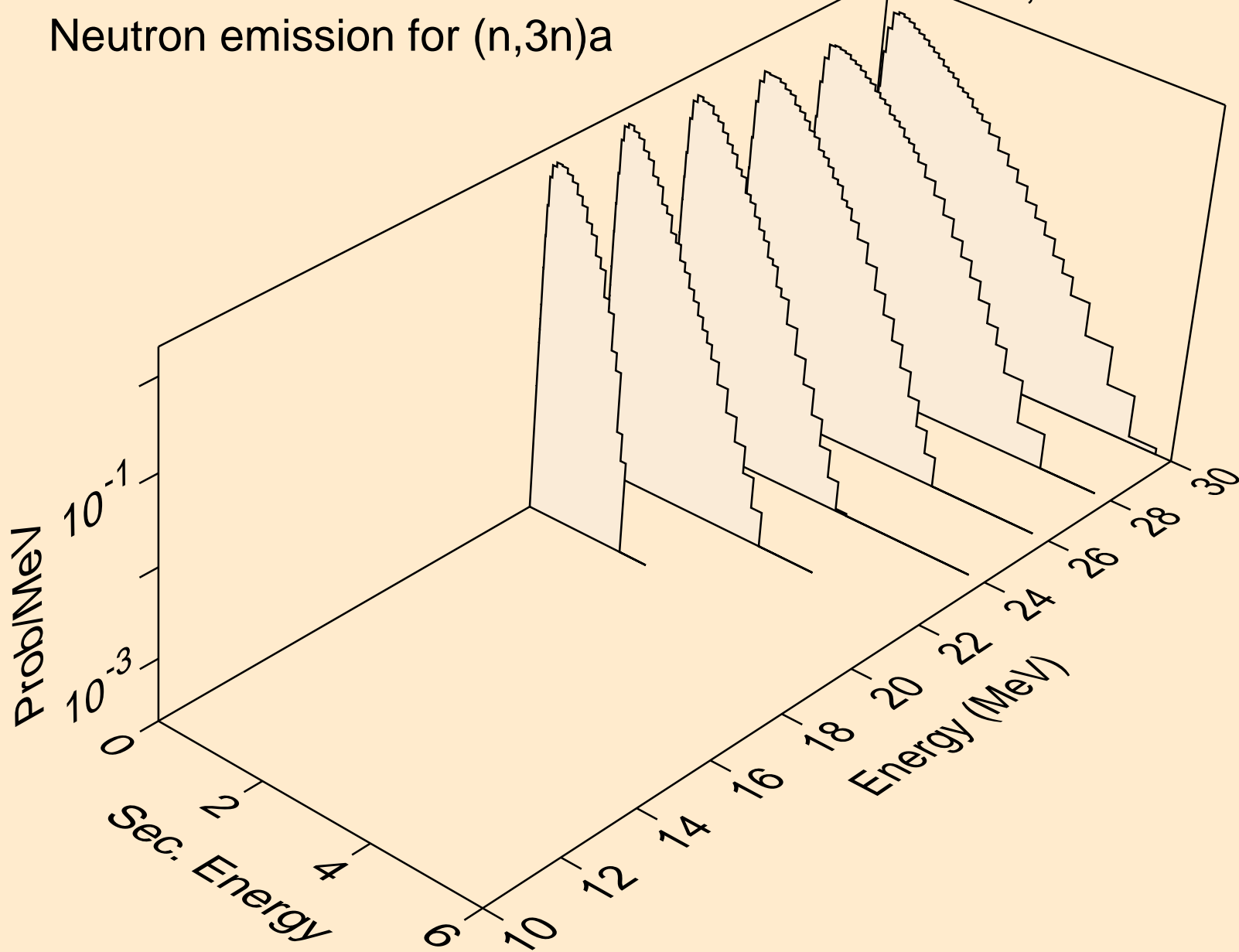

AT202 NEUTRON ACER TENDL-2023 LIBRARY; T=0.K
Neutron emission for (n,n*)p

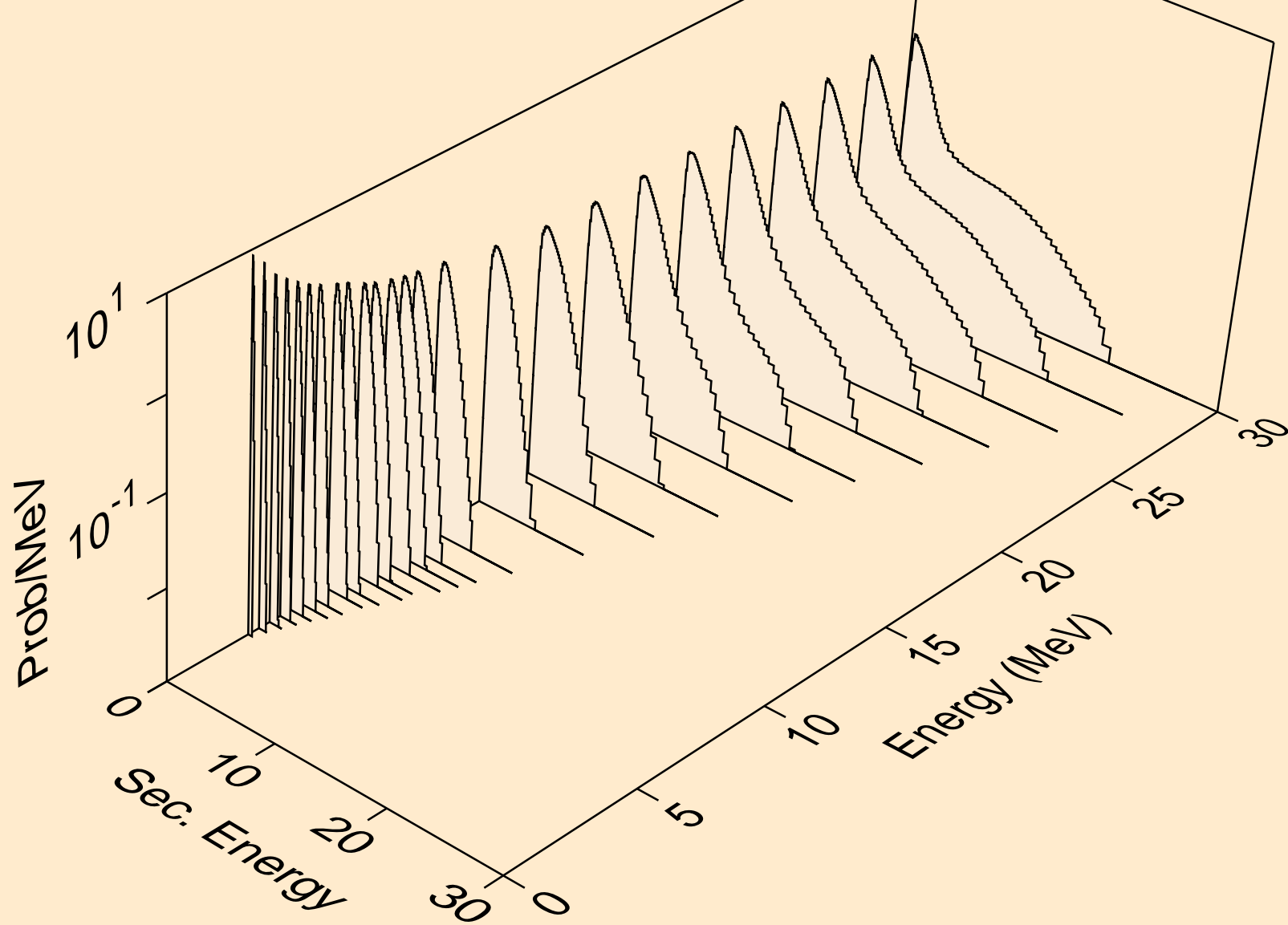

AT202 NEUTRON ACER TENDL-2023 LIBRARY; T=0.K
Neutron emission for (n,n*)2a

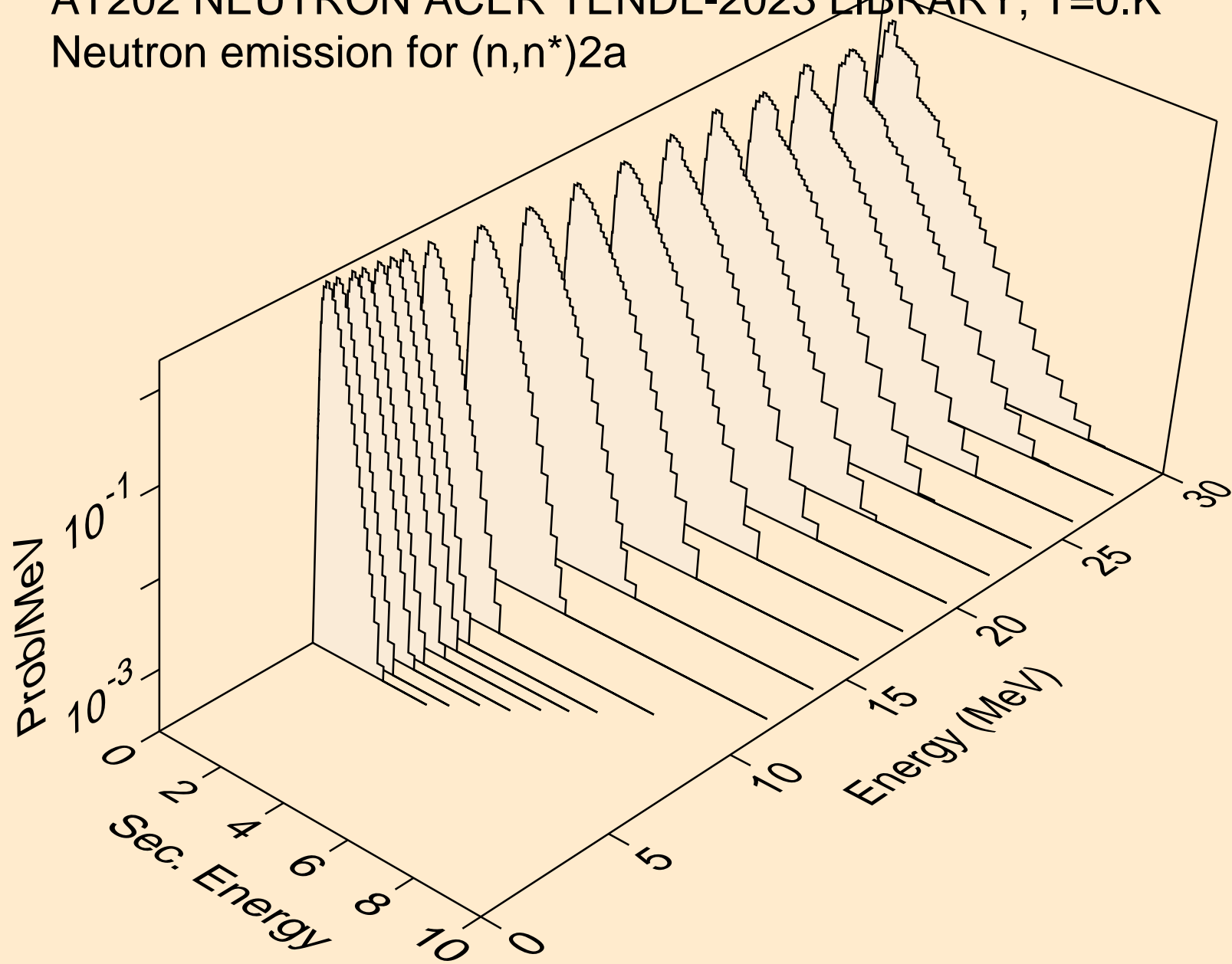

AT202 NEUTRON ACER TENDL-2023 LIBRARY; T=0.K
Neutron emission for (n,2n)_{2a}

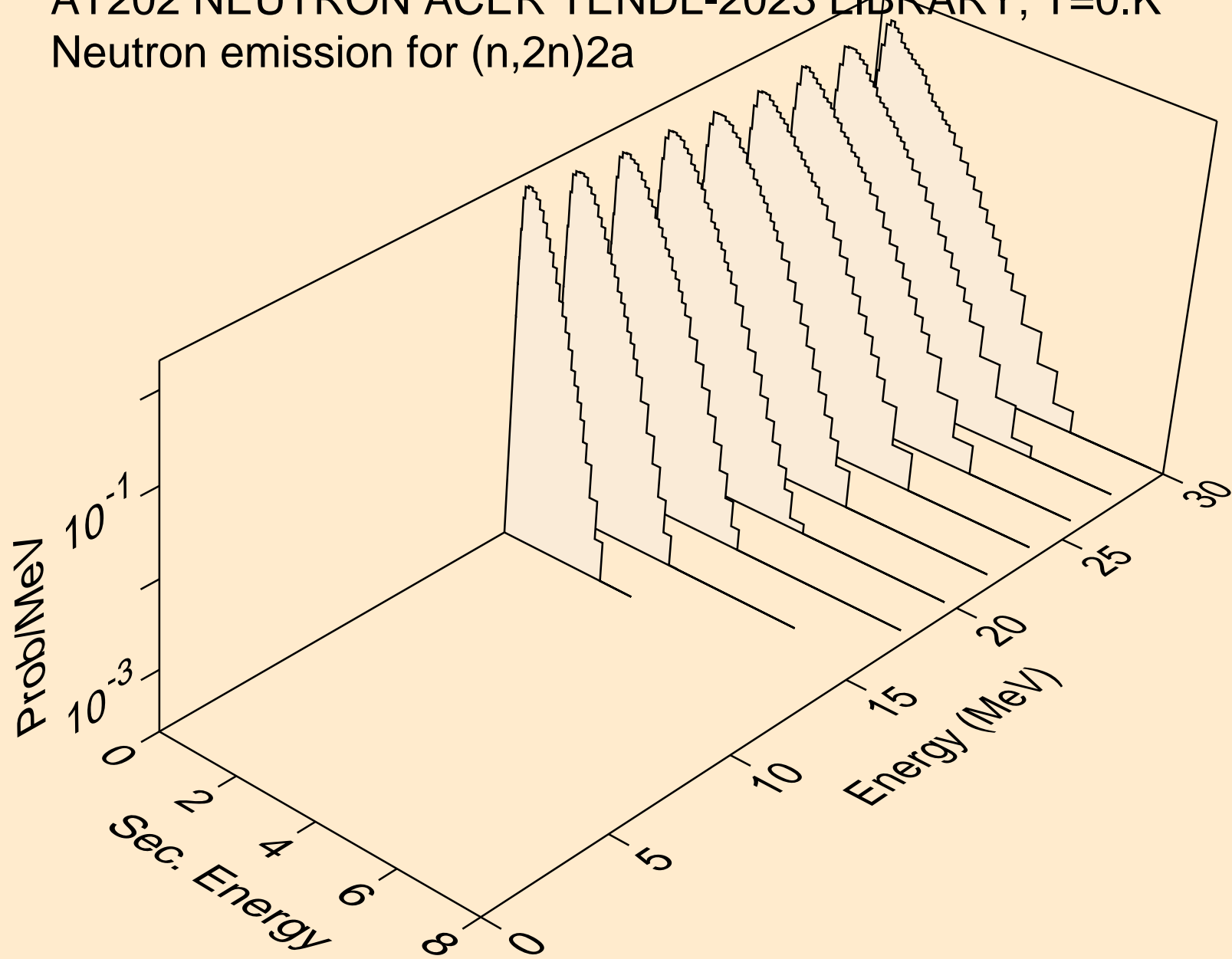

AT202 NEUTRON ACER TENDL-2023 LIBRARY; T=0.K
Neutron emission for (n,n*)d

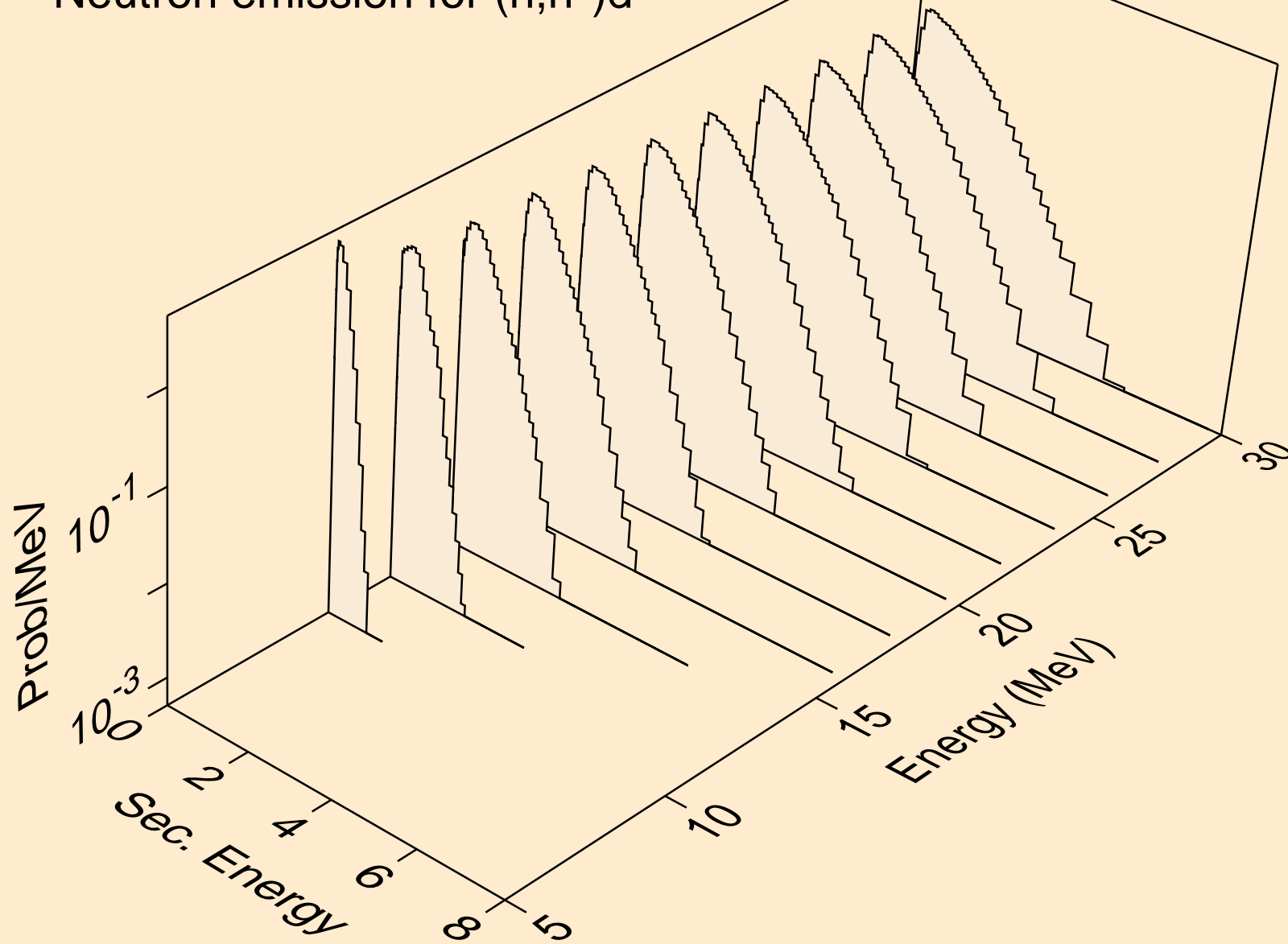

AT202 NEUTRON ACER TENDL-2023 LIBRARY; T=0.K
Neutron emission for (n,n*)t

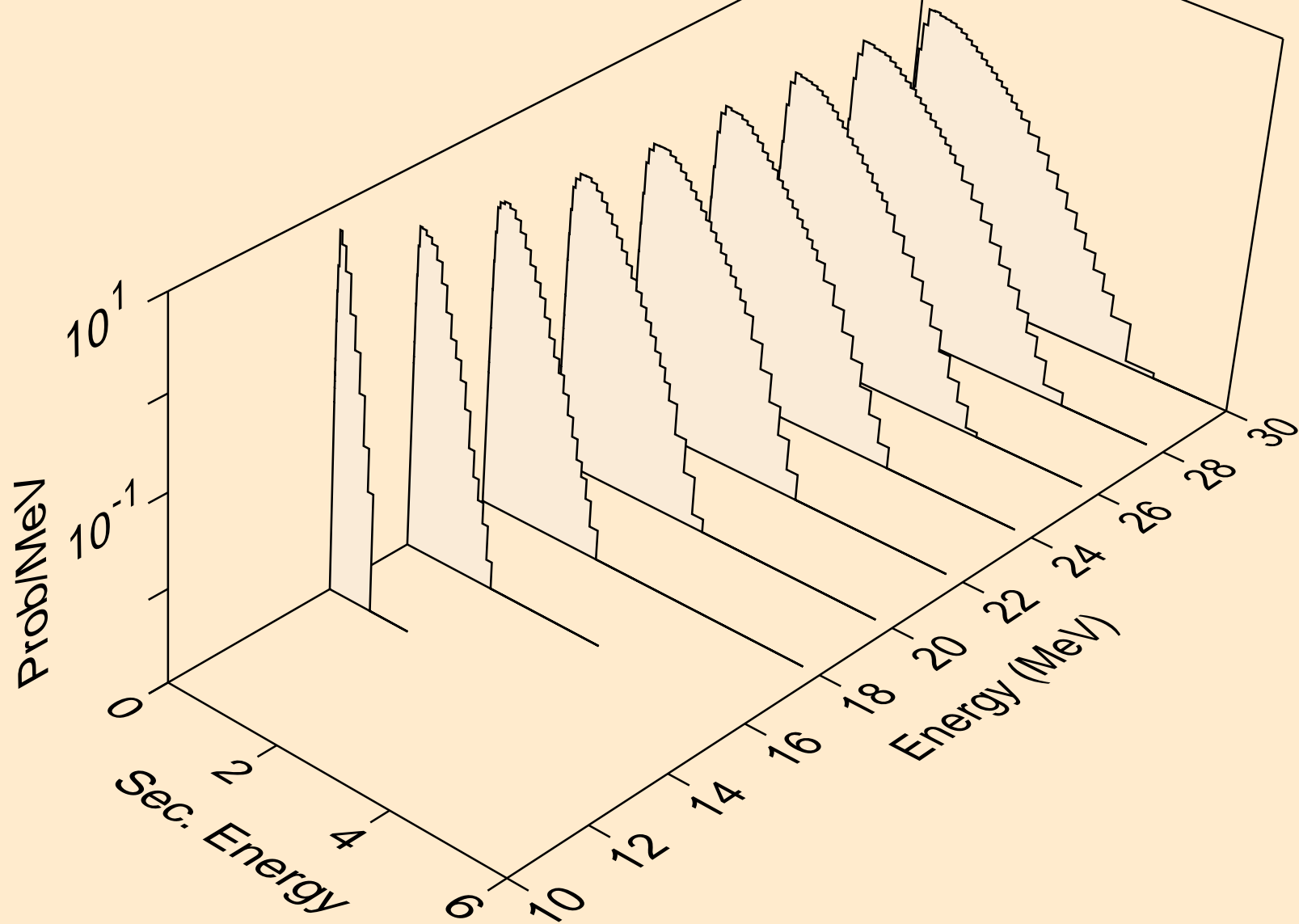

AT202 NEUTRON ACER TENDL-2023 LIBRARY; T=0.K
Neutron emission for (n,n*)he3

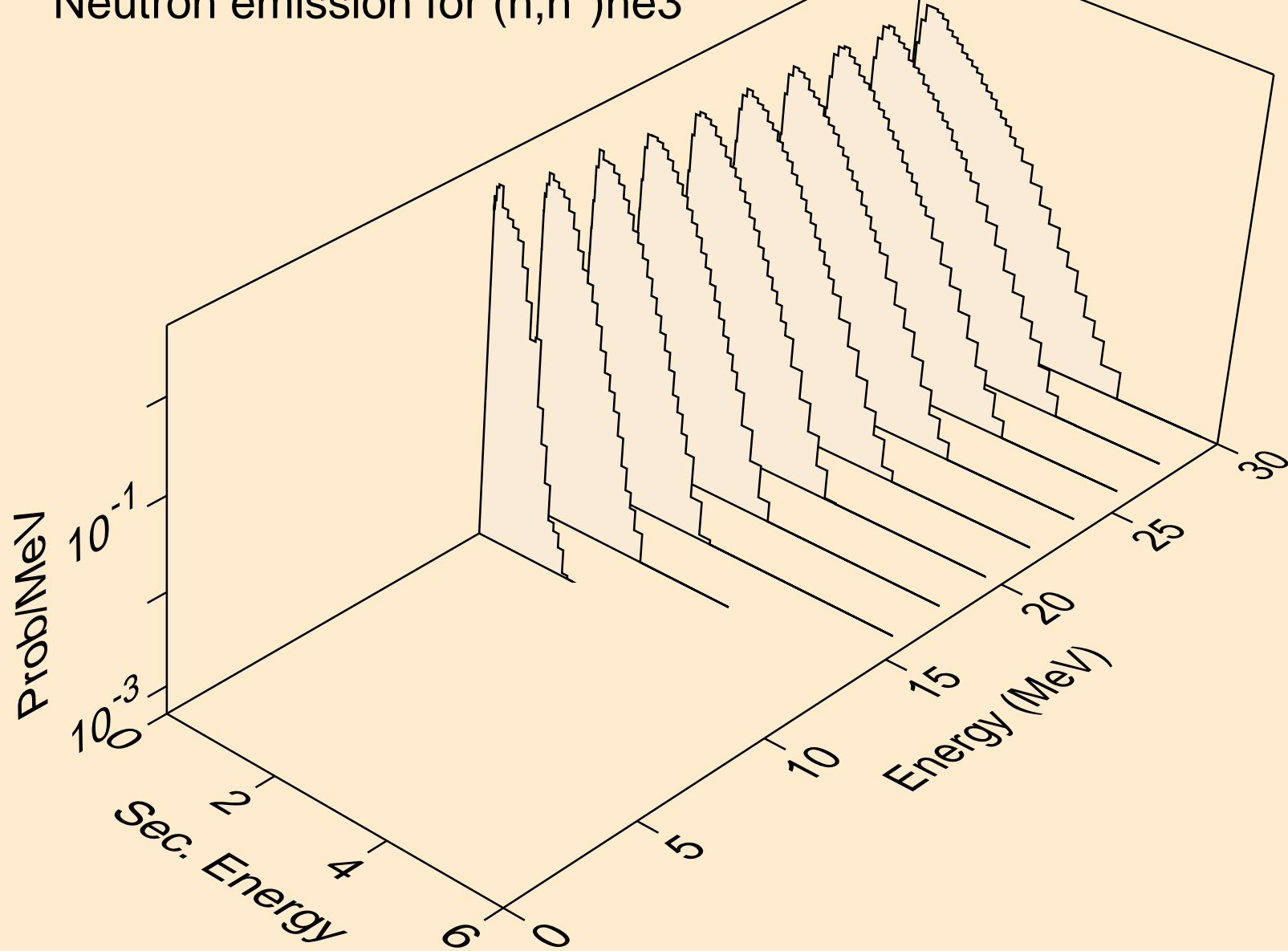

AT202 NEUTRON ACER TENDL-2023 LIBRARY; T=0.K
Neutron emission for (n,4n)

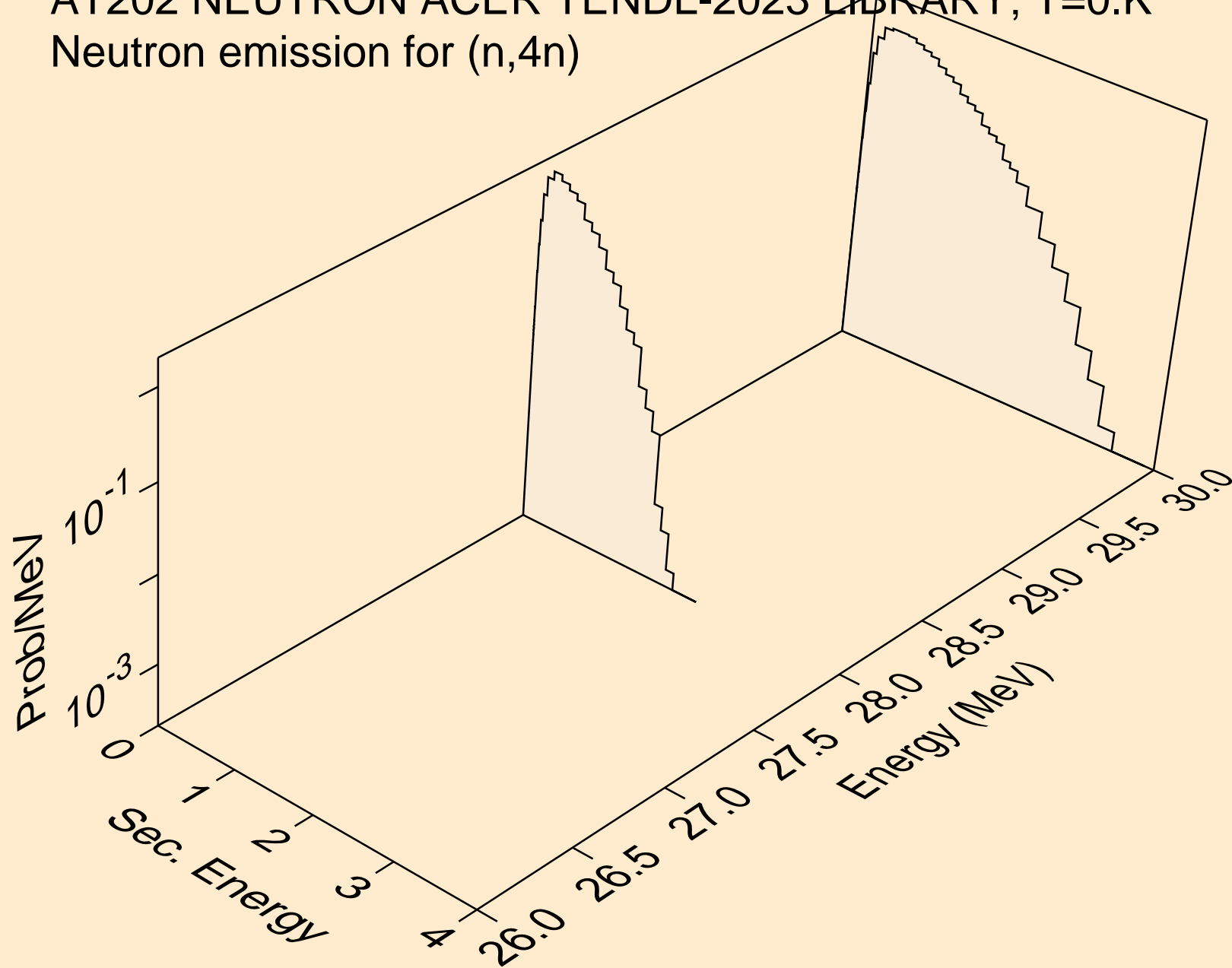

AT202 NEUTRON ACER TENDL-2023 LIBRARY; T=0.K
Neutron emission for (n,2np)

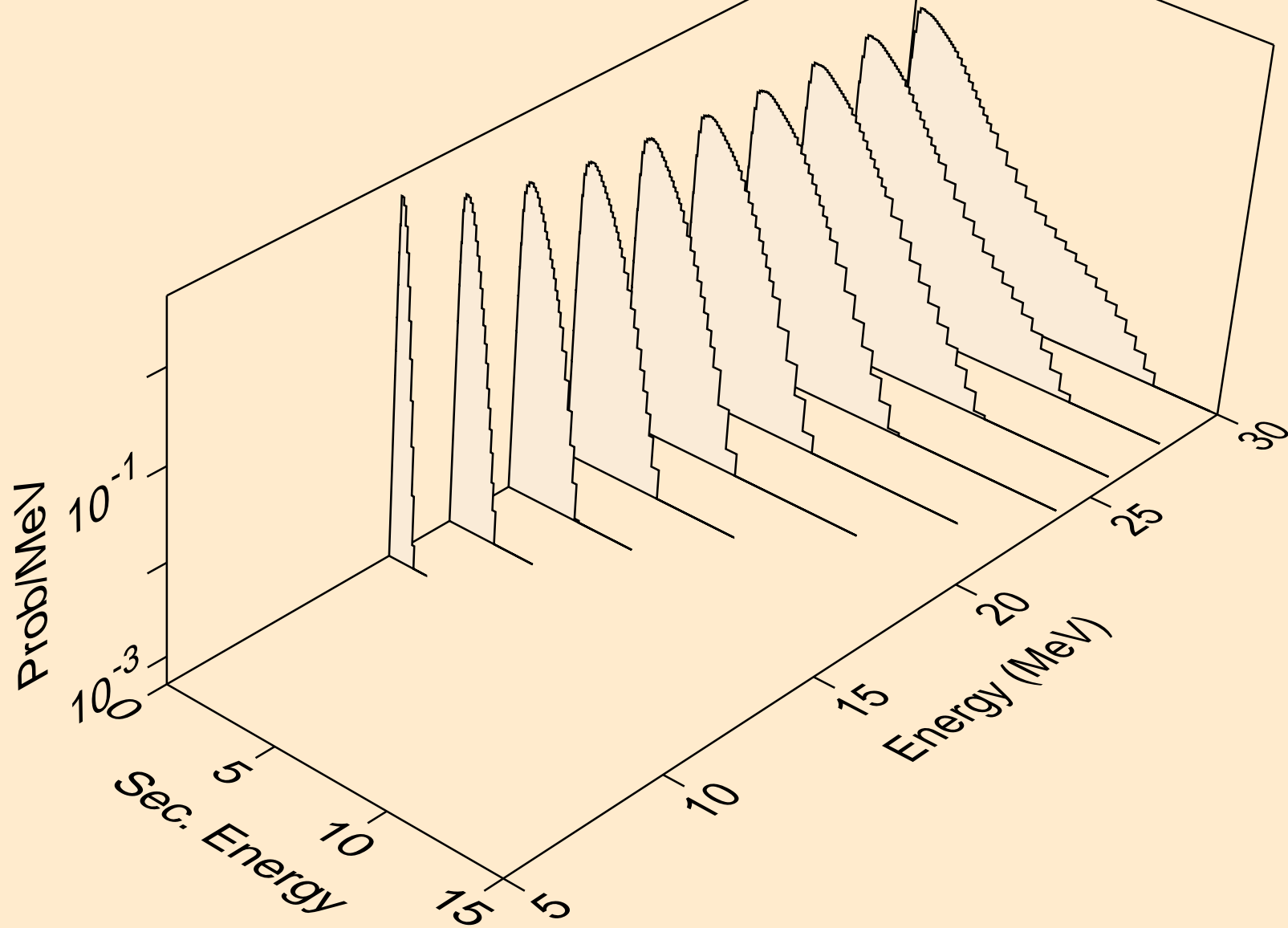

AT202 NEUTRON ACER TENDL-2023 LIBRARY; T=0.K
Neutron emission for (n,3np)

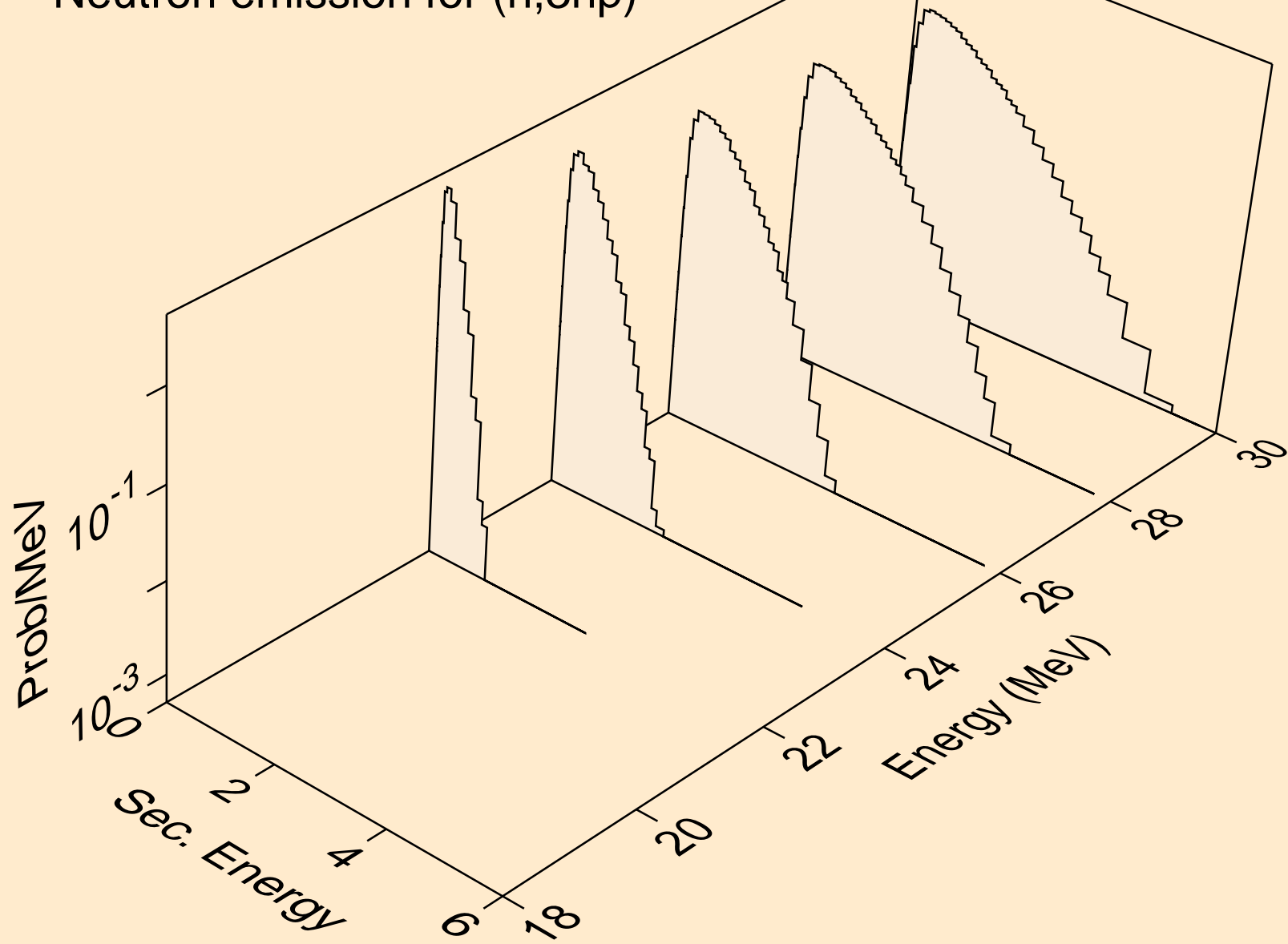

AT202 NEUTRON ACER TENDL-2023 LIBRARY; T=0.K
Neutron emission for (n,n2p)

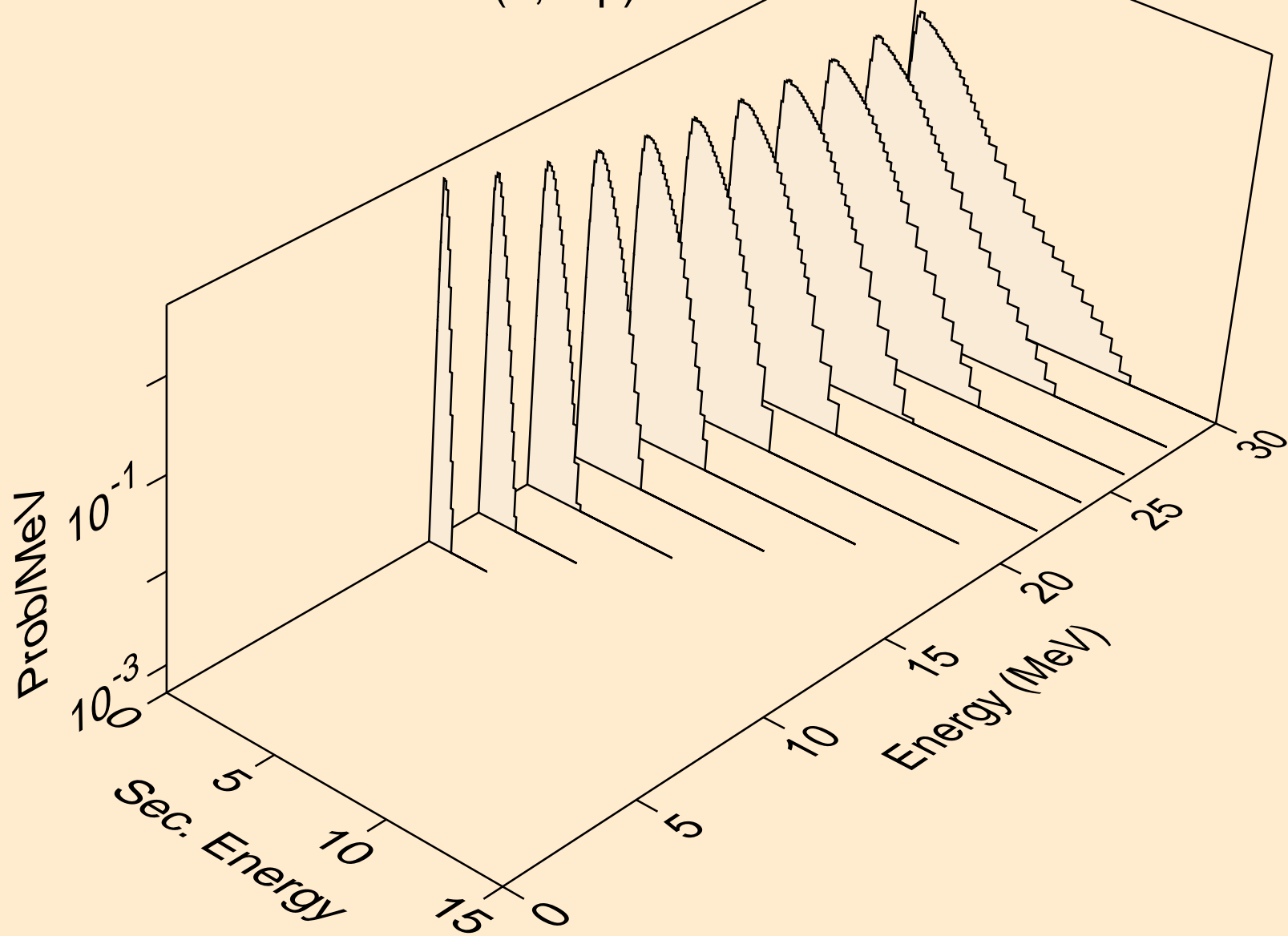

AT202 NEUTRON ACER TENDL-2023 LIBRARY; T=0.K
Neutron emission for (n,npa)

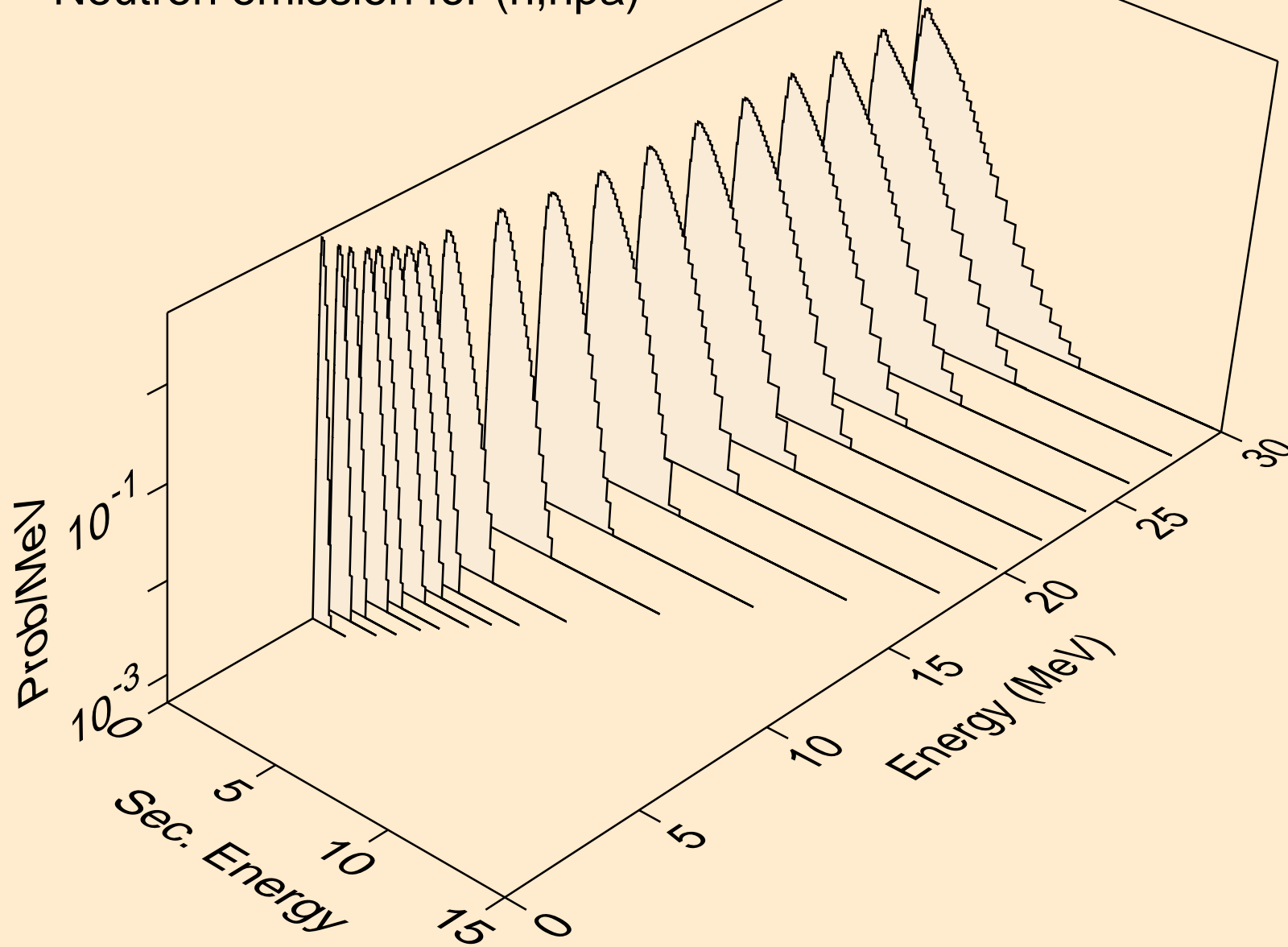

AT202 NEUTRON ACER TENDL-2023 LIBRARY; T=0.K
Neutron emission for (n,n*c)

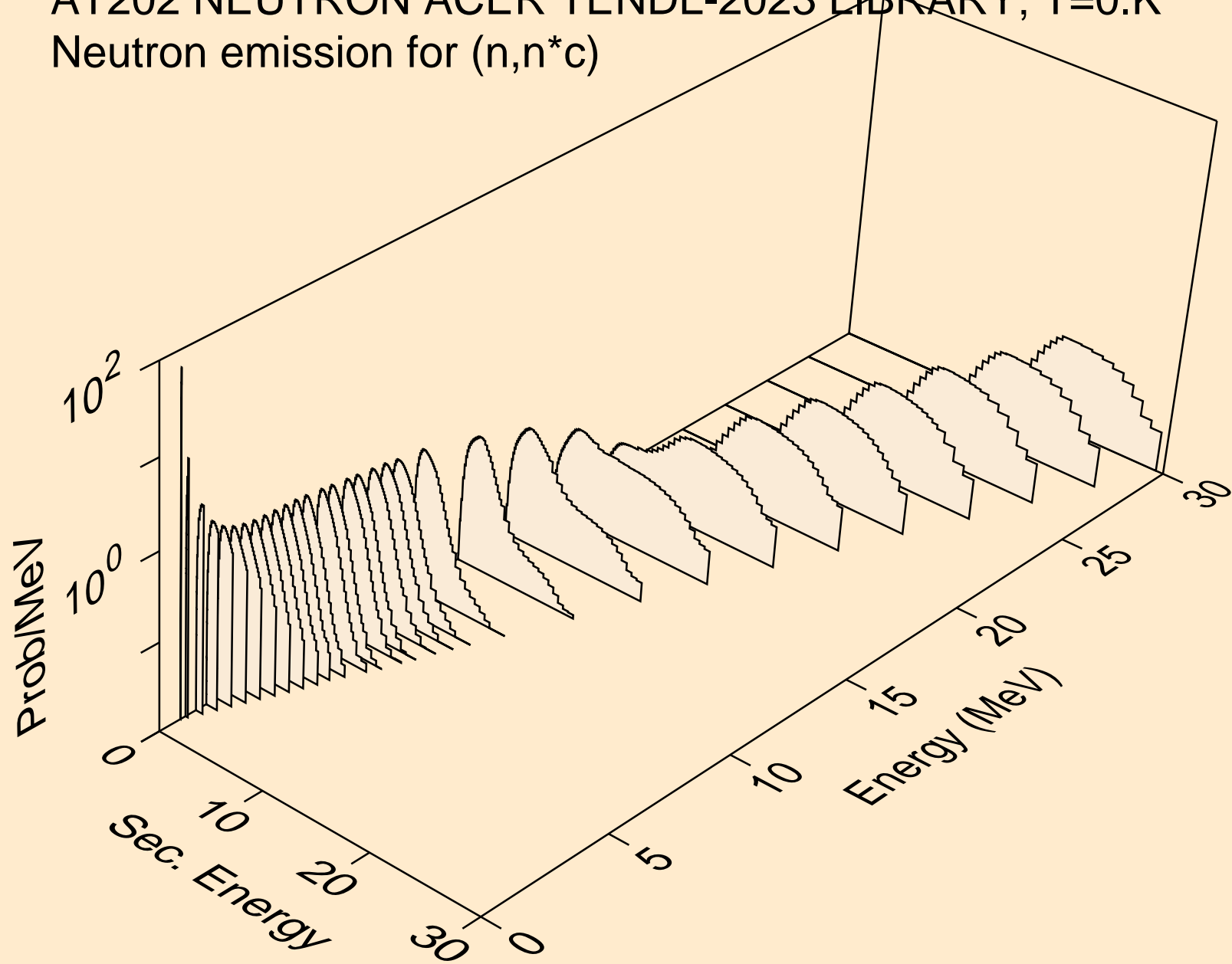

AT202 NEUTRON ACER TENDL-2023 LIBRARY; T=0.K
Photon emission for (n,x)

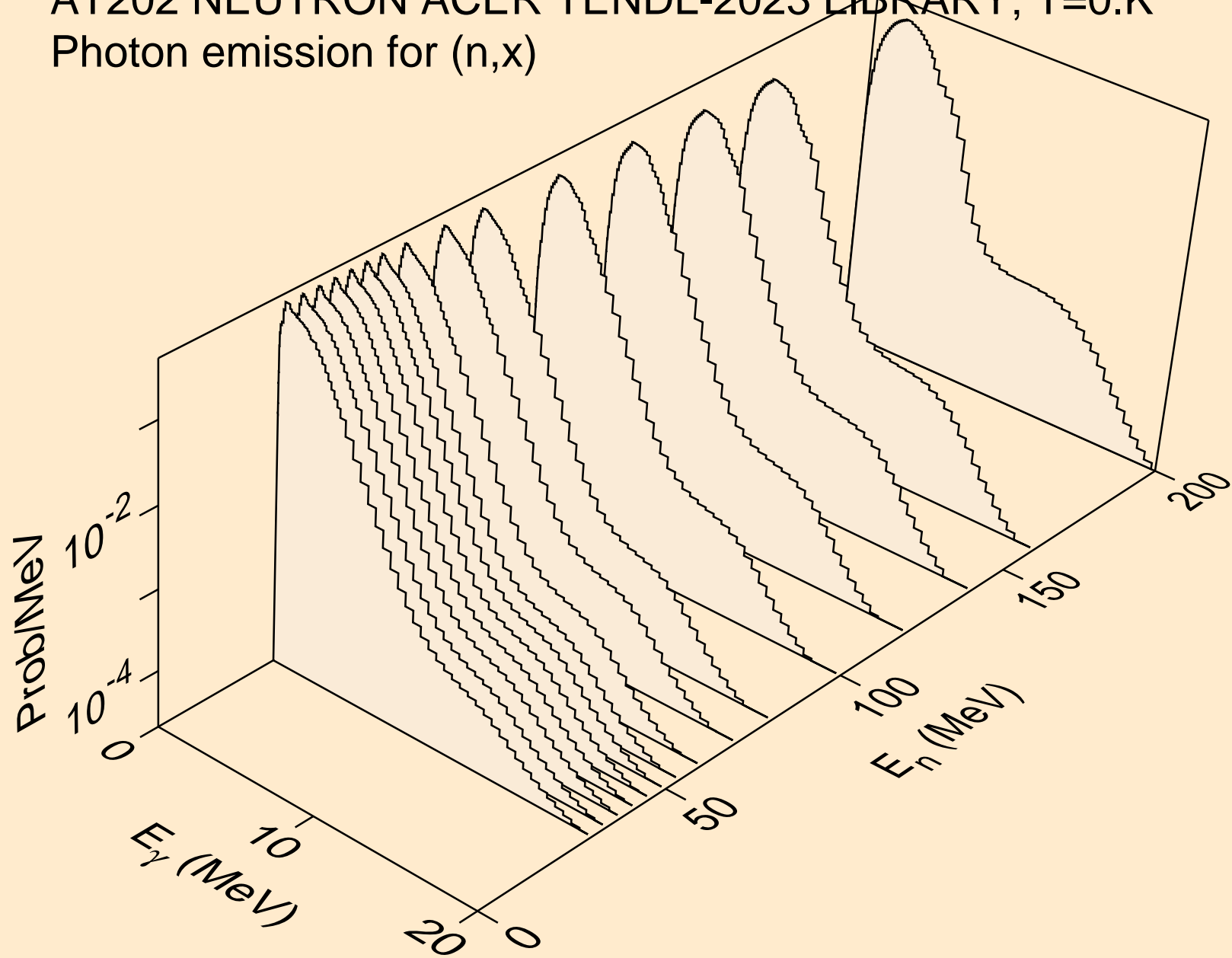

AT202 NEUTRON ACER TENDL-2023 LIBRARY; T=0.K
Photon emission for (n,2nd)

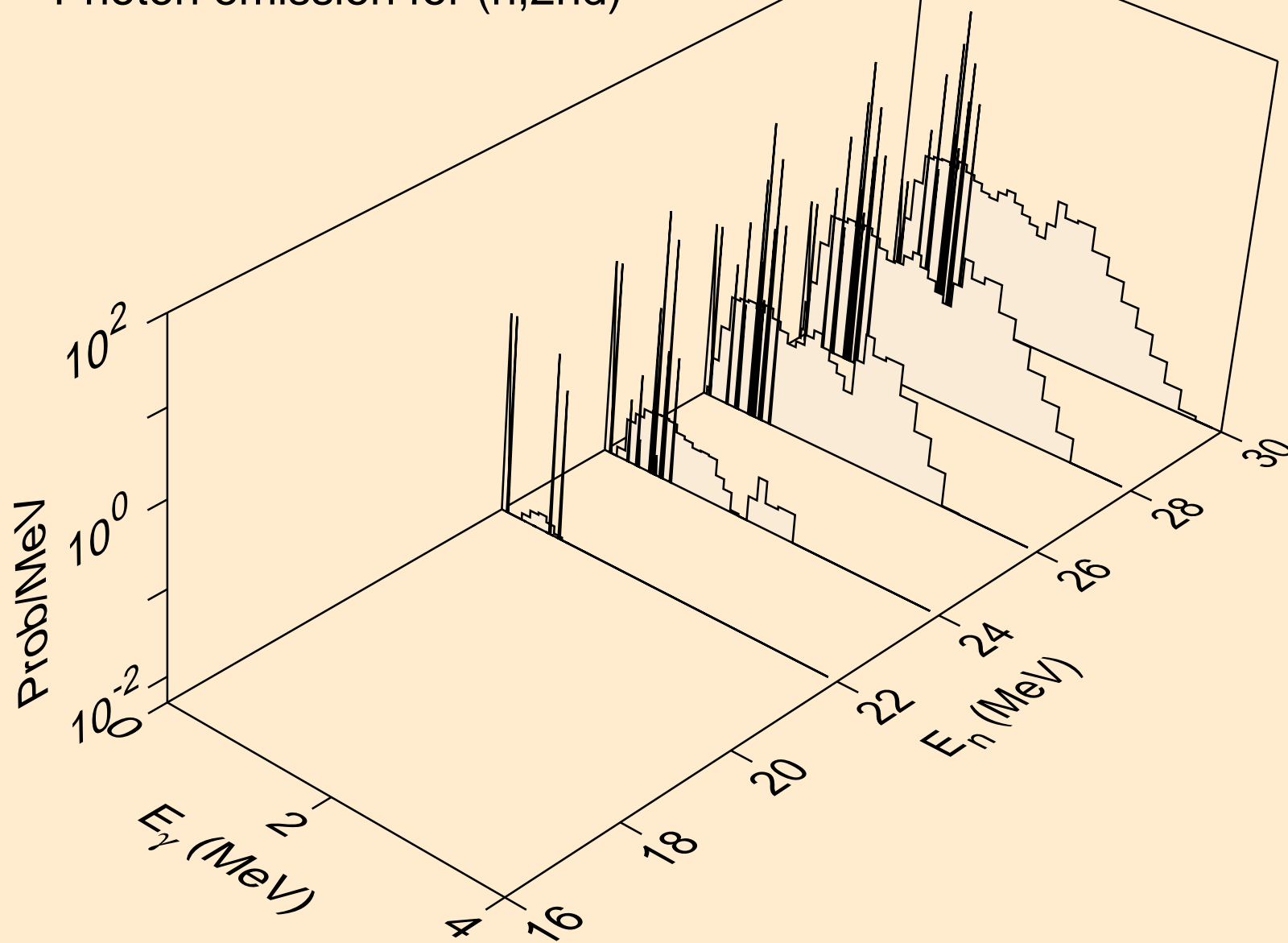

AT202 NEUTRON ACER TENDL-2023 LIBRARY; T=0.K
Photon emission for (n,2n)

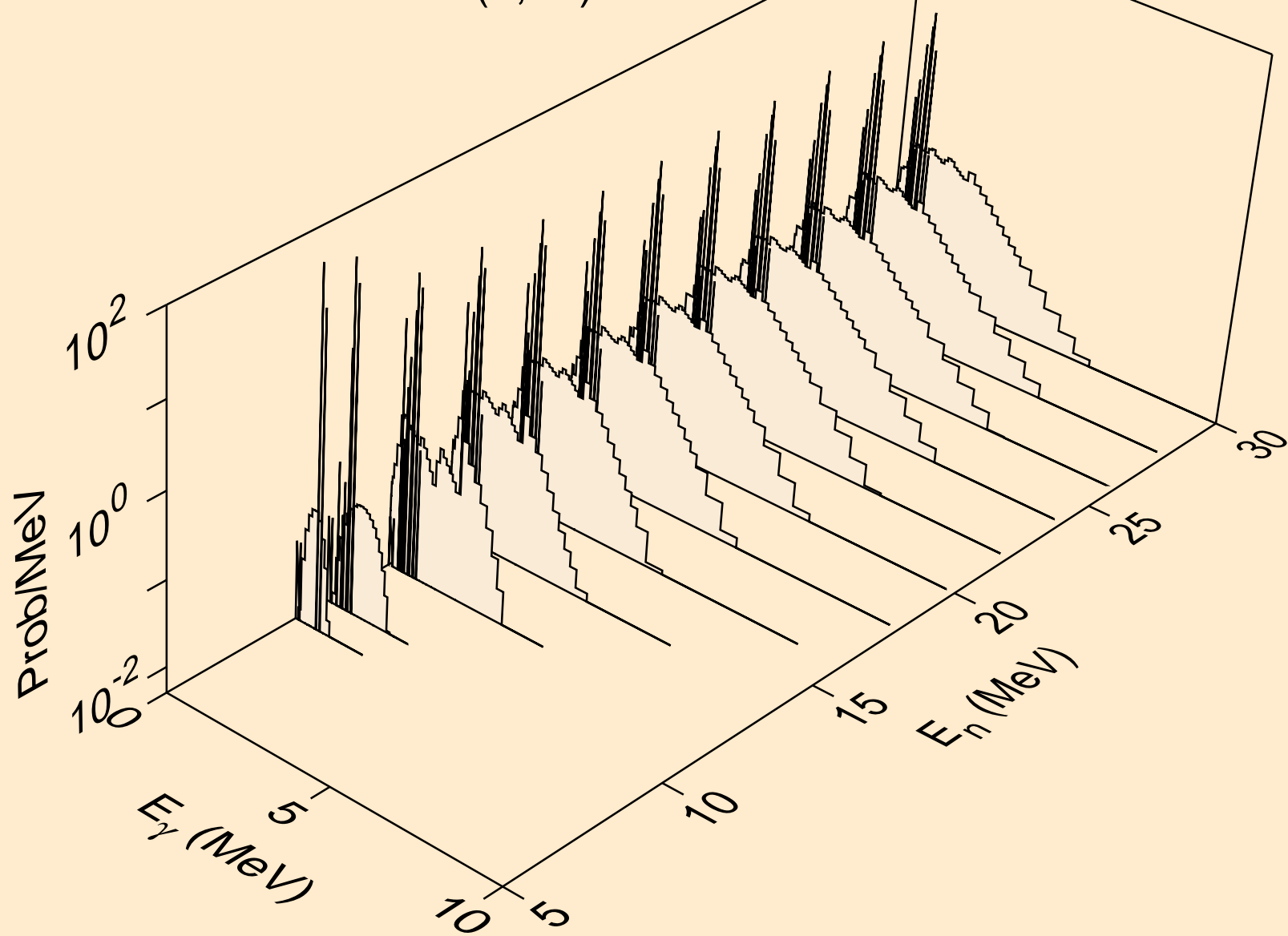

AT202 NEUTRON ACER TENDL-2023 LIBRARY; T=0.K
Photon emission for (n,3n)

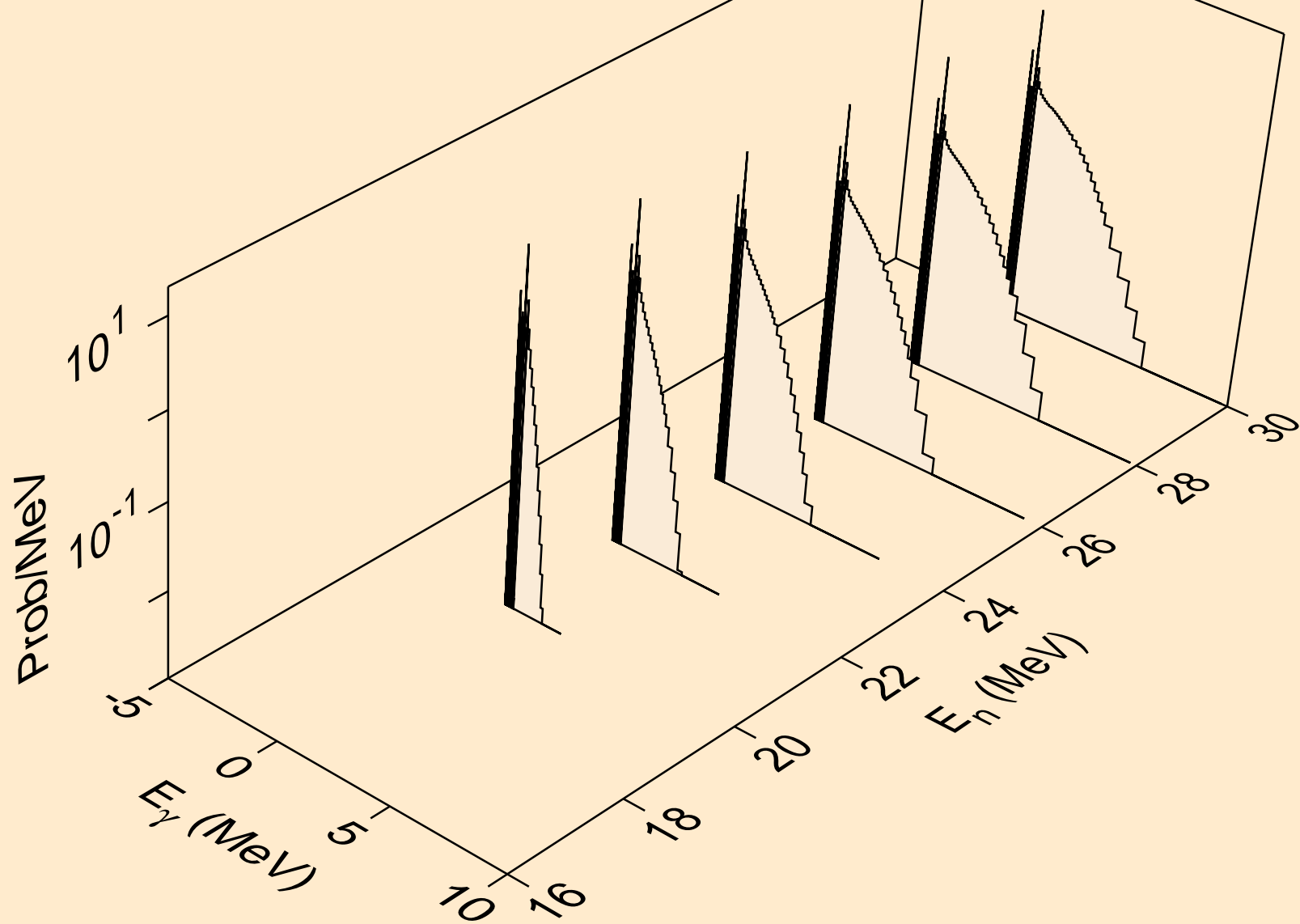

AT202 NEUTRON ACER TENDL-2023 LIBRARY; T=0.K
Photon emission for (n,n*)a

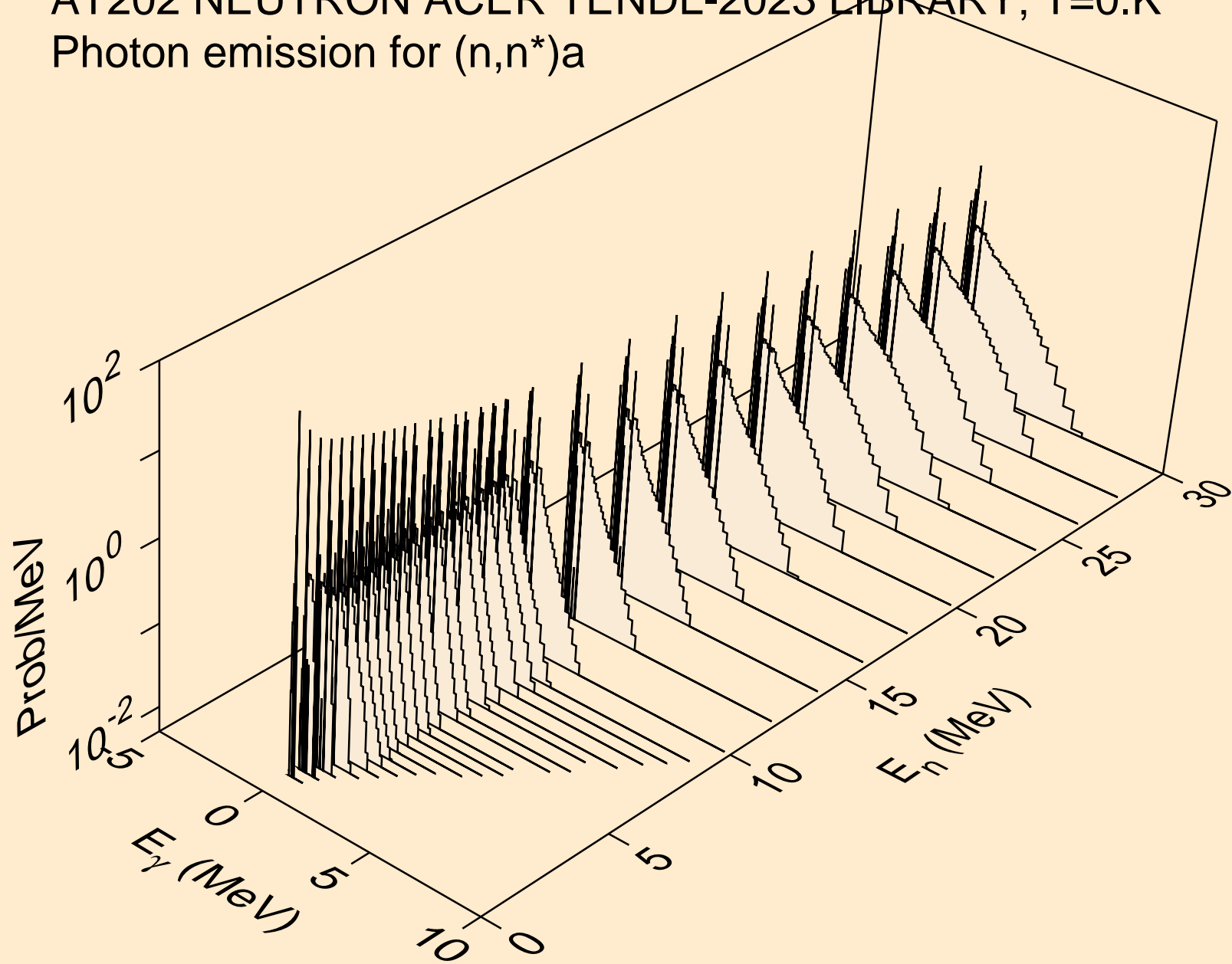

AT202 NEUTRON ACER TENDL-2023 LIBRARY; T=0.K
Photon emission for (n,2n)a

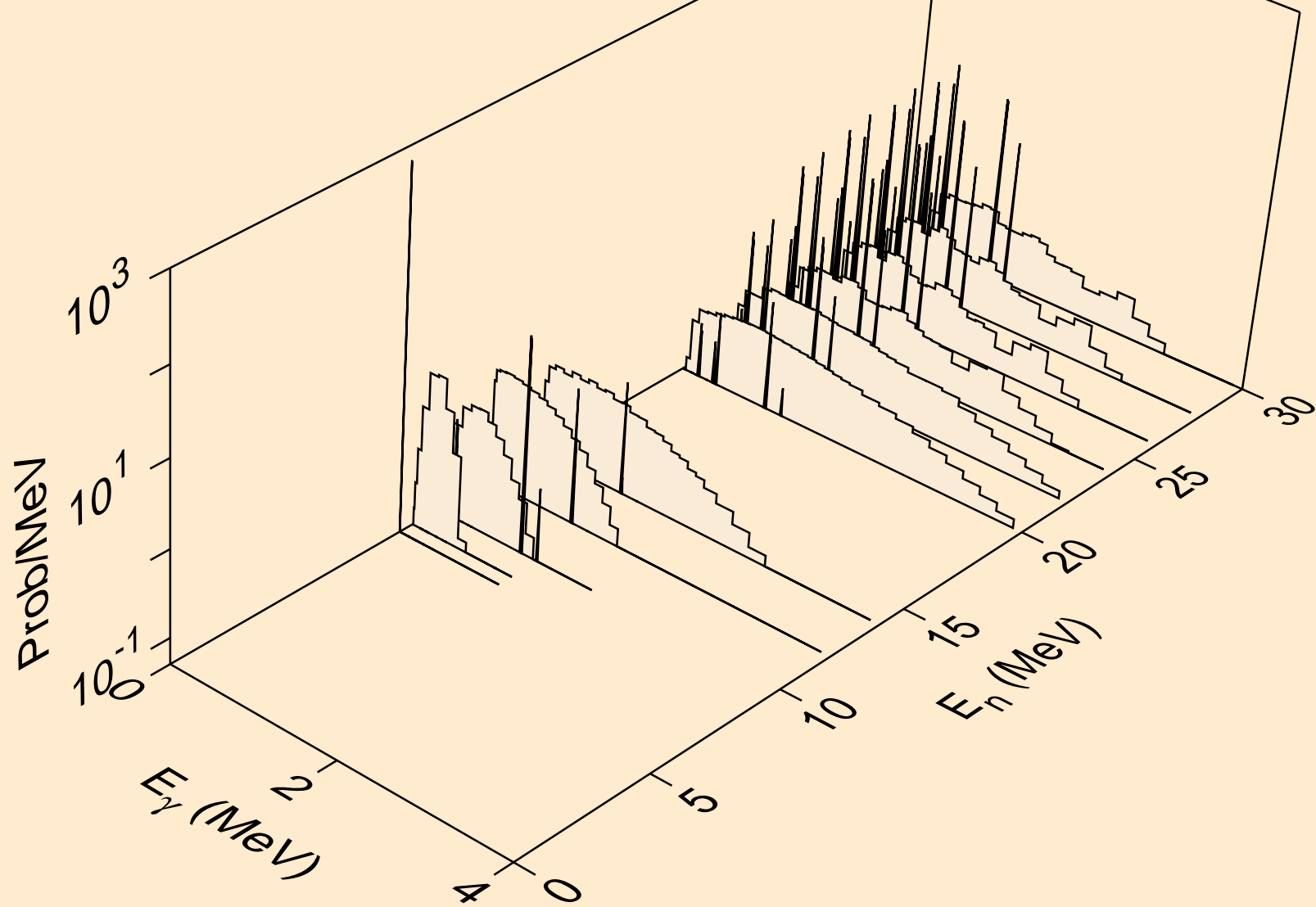

AT202 NEUTRON ACER TENDL-2023 LIBRARY; T=0.K
Photon emission for (n,3n)a

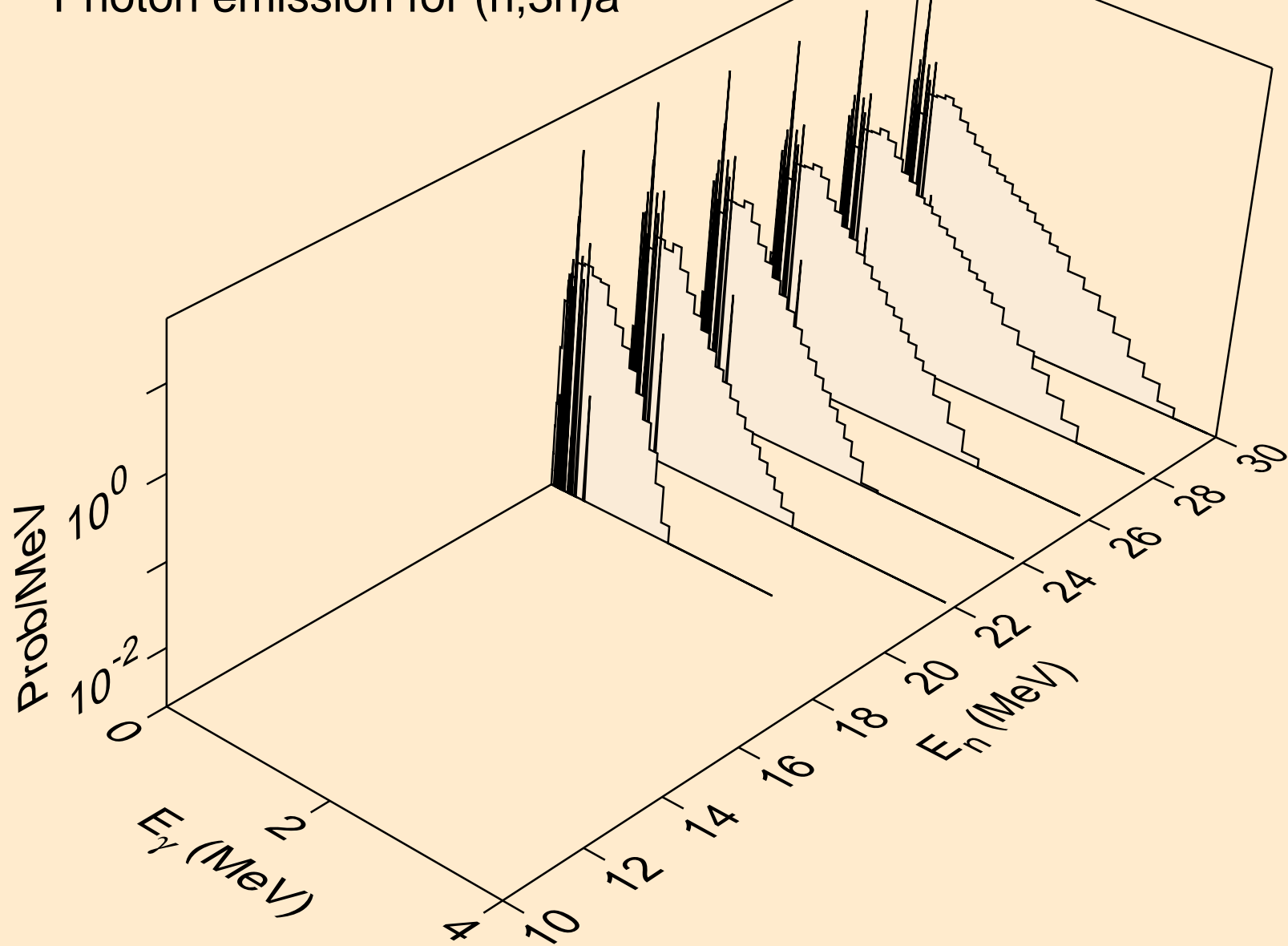

AT202 NEUTRON ACER TENDL-2023 LIBRARY; T=0.K
Photon emission for (n,n*)p

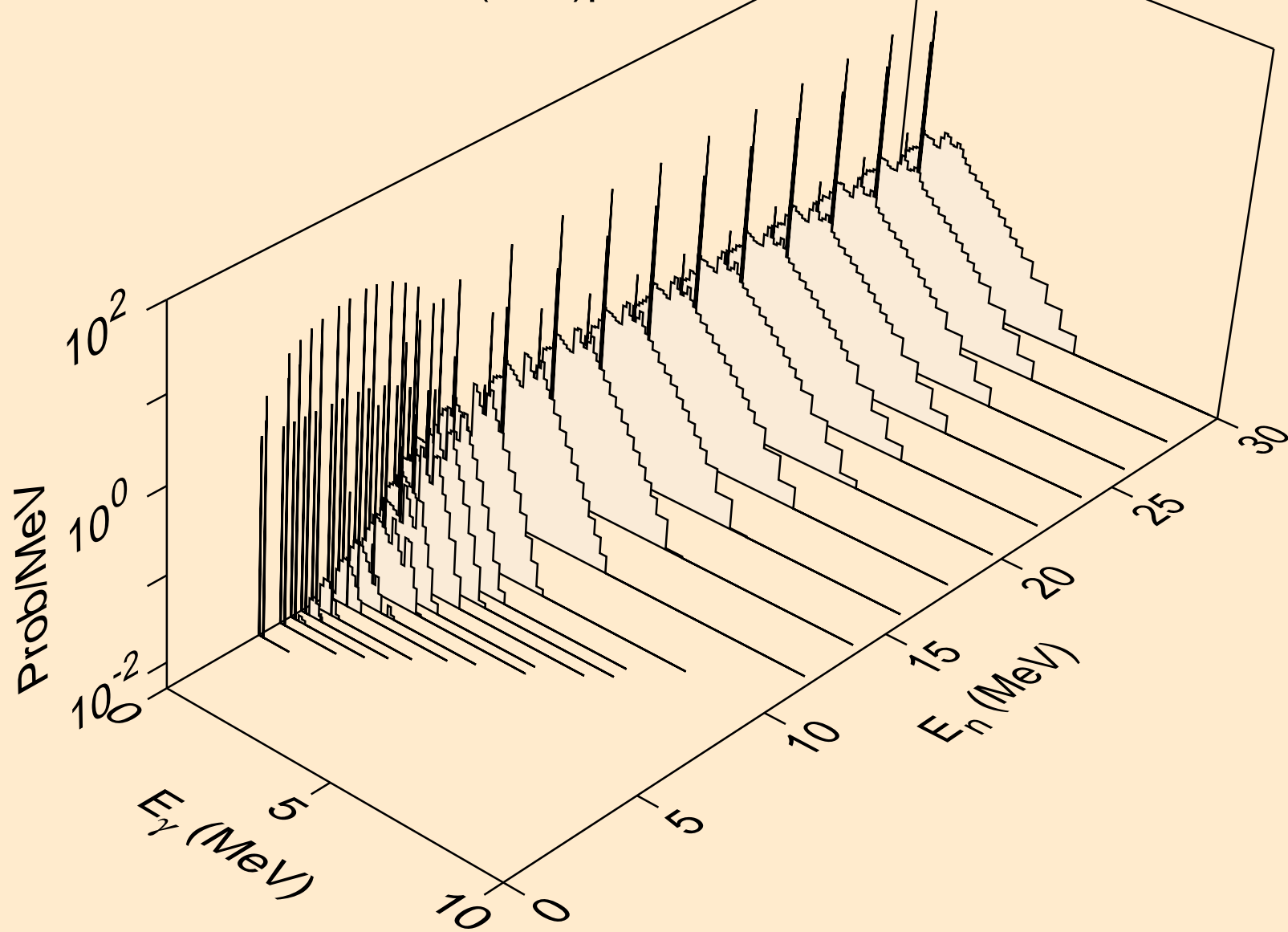

AT202 NEUTRON ACER TENDL-2023 LIBRARY; T=0.K
Photon emission for (n,n*)2a

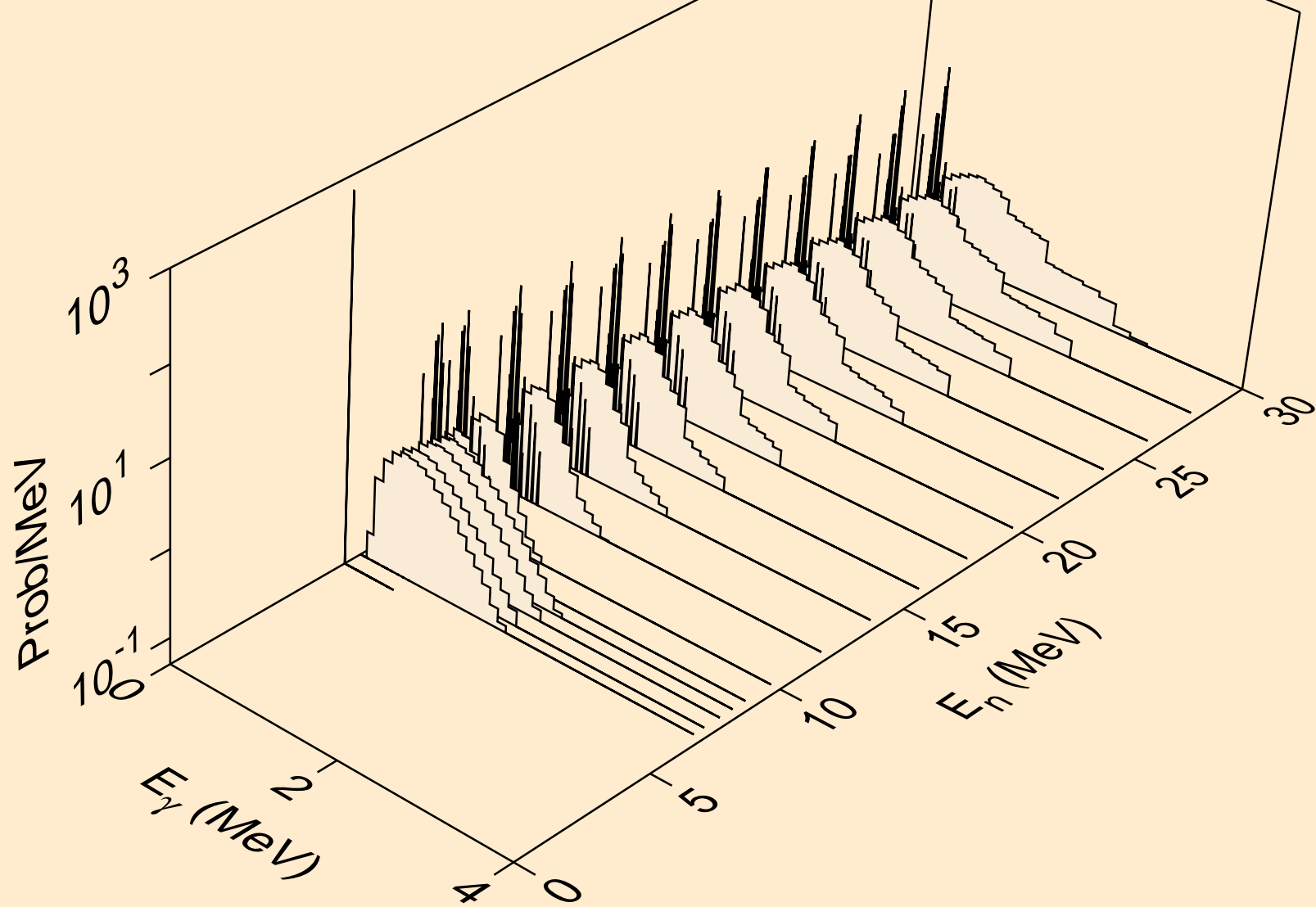

AT202 NEUTRON ACER TENDL-2023 LIBRARY; T=0.K
Photon emission for (n,2n)2a

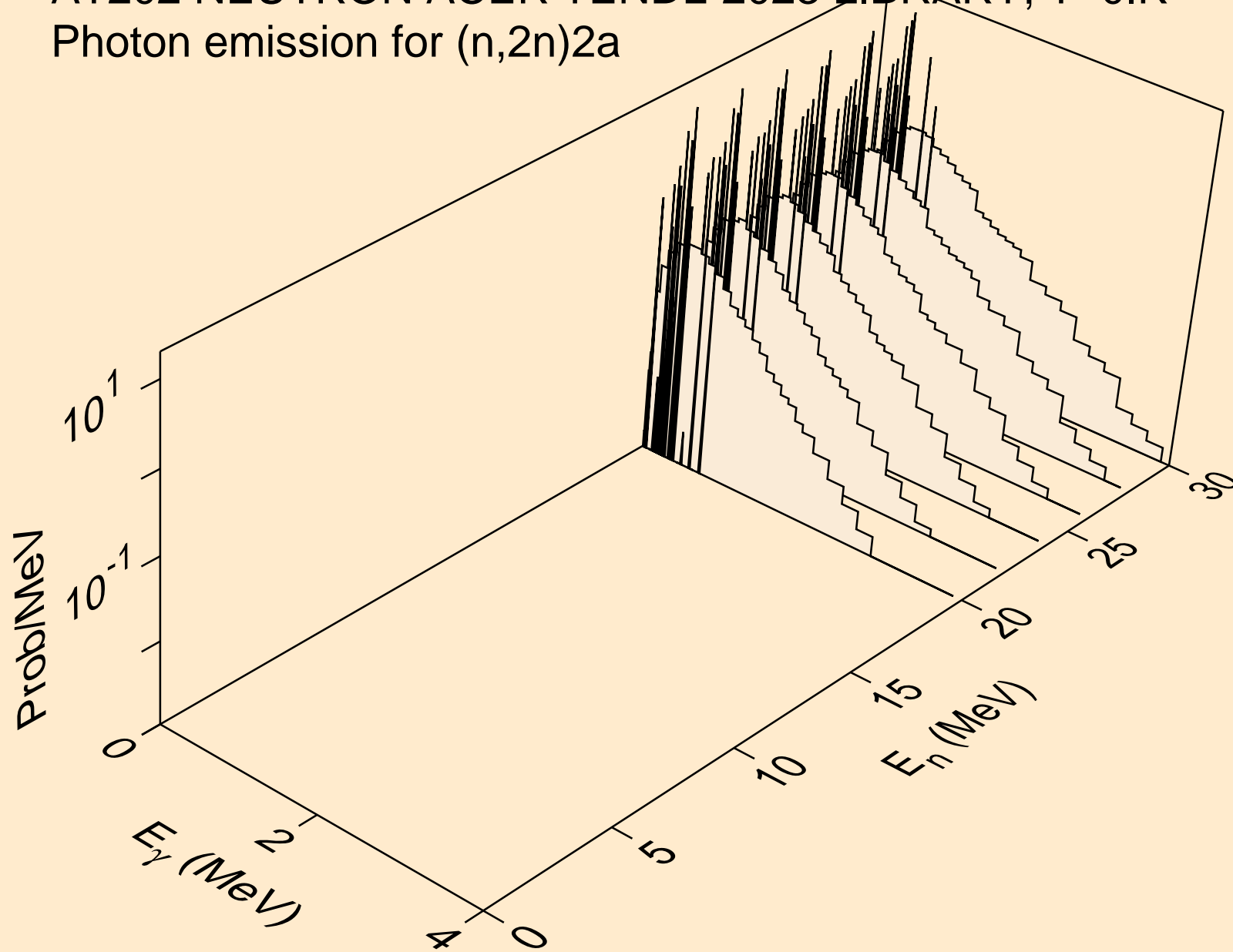

AT202 NEUTRON ACER TENDL-2023 LIBRARY; T=0.K
Photon emission for (n,n*)d

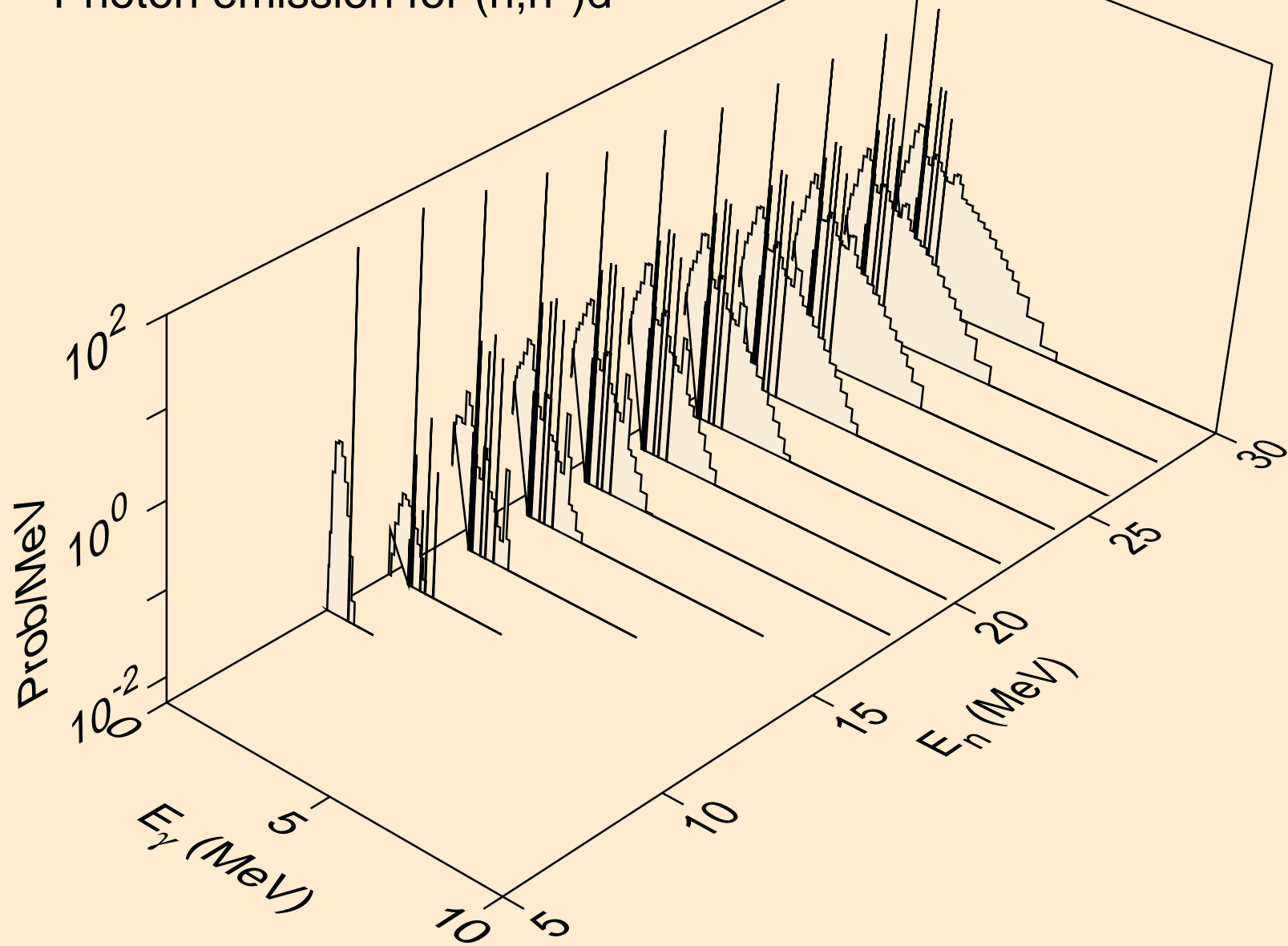

AT202 NEUTRON ACER TENDL-2023 LIBRARY; T=0.K
Photon emission for (n,n*)t

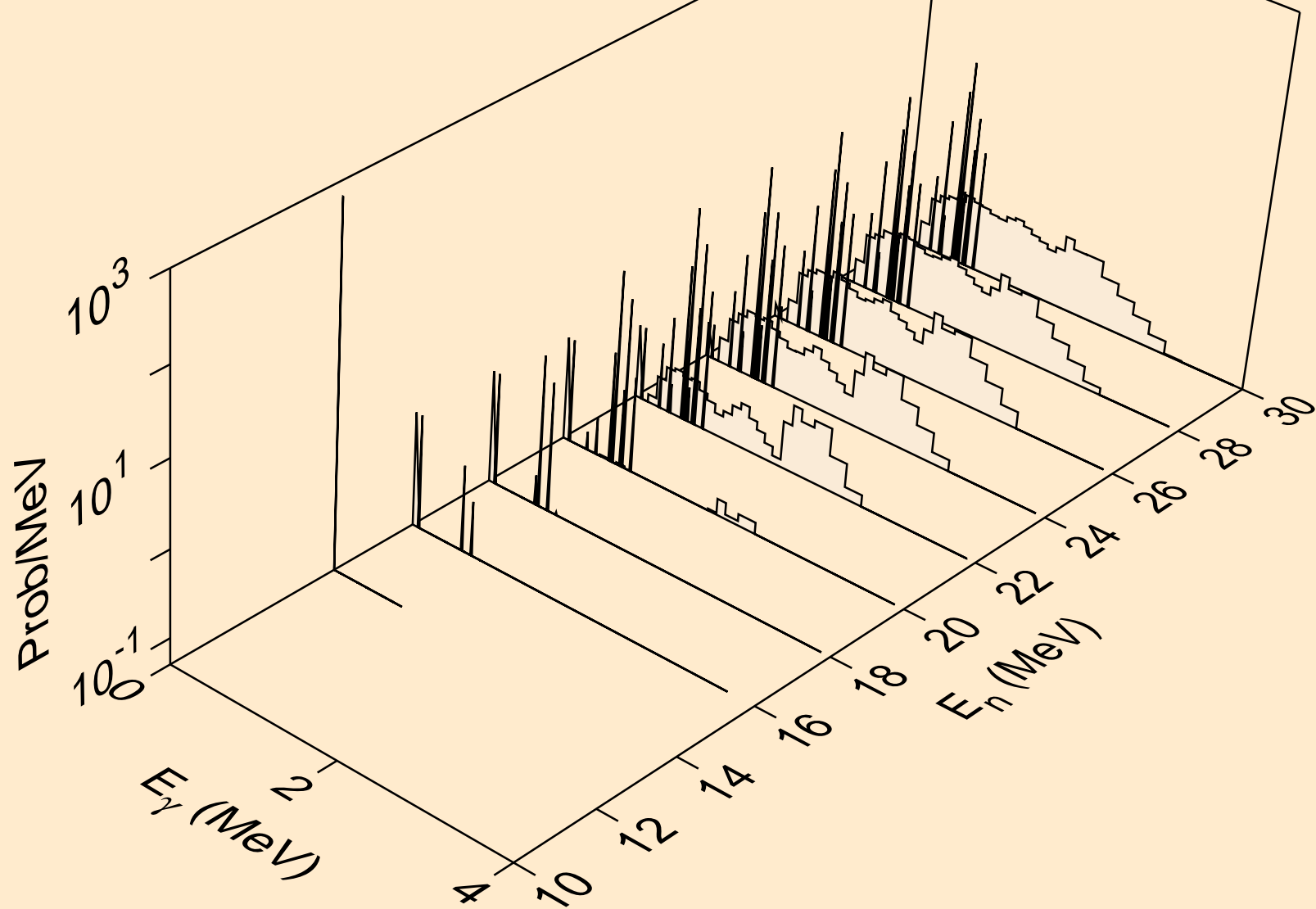

AT202 NEUTRON ACER TENDL-2023 LIBRARY; T=0.K
Photon emission for (n,n*)he3

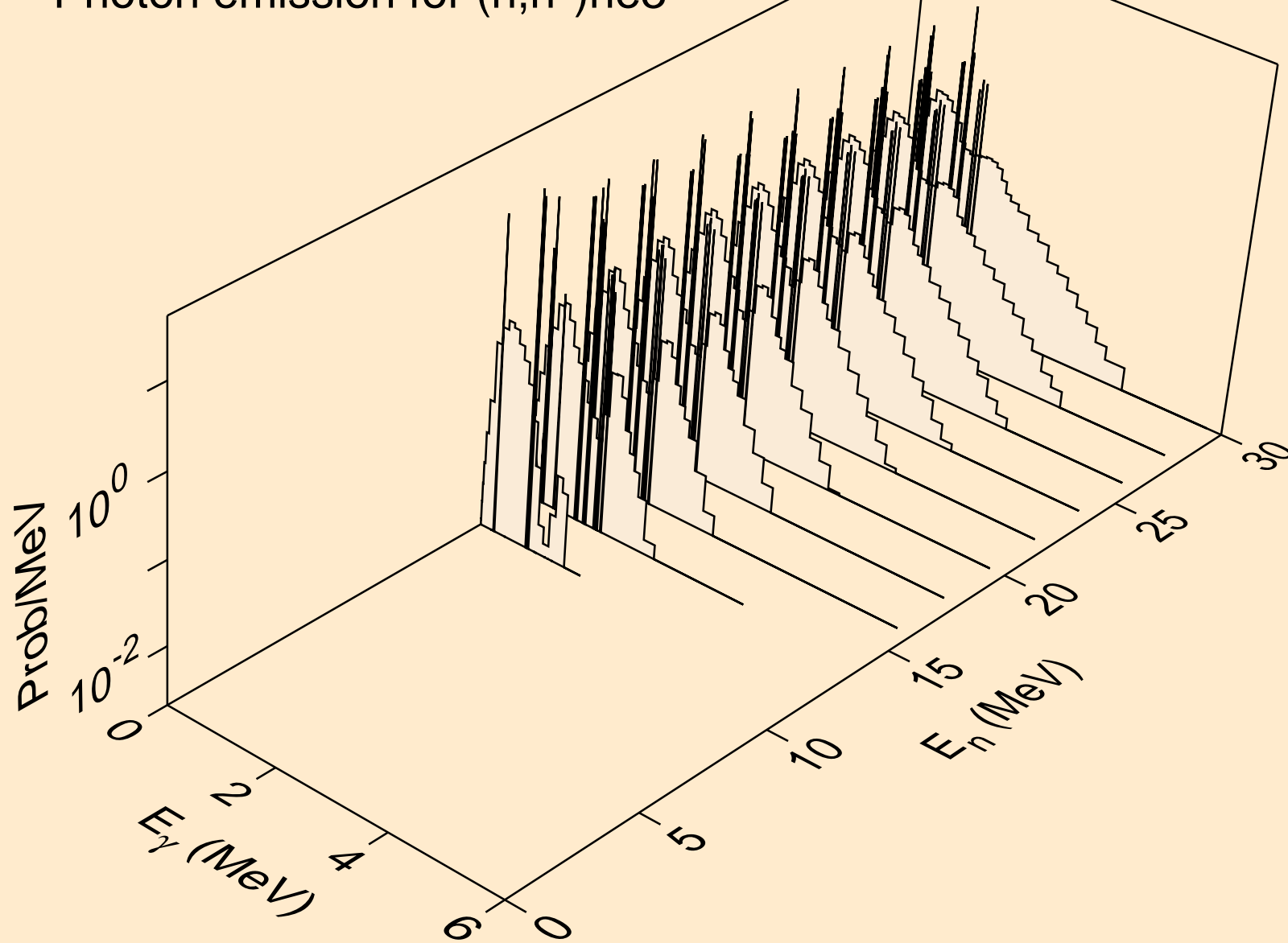

AT202 NEUTRON ACER TENDL-2023 LIBRARY; T=0.K
Photon emission for (n,4n)

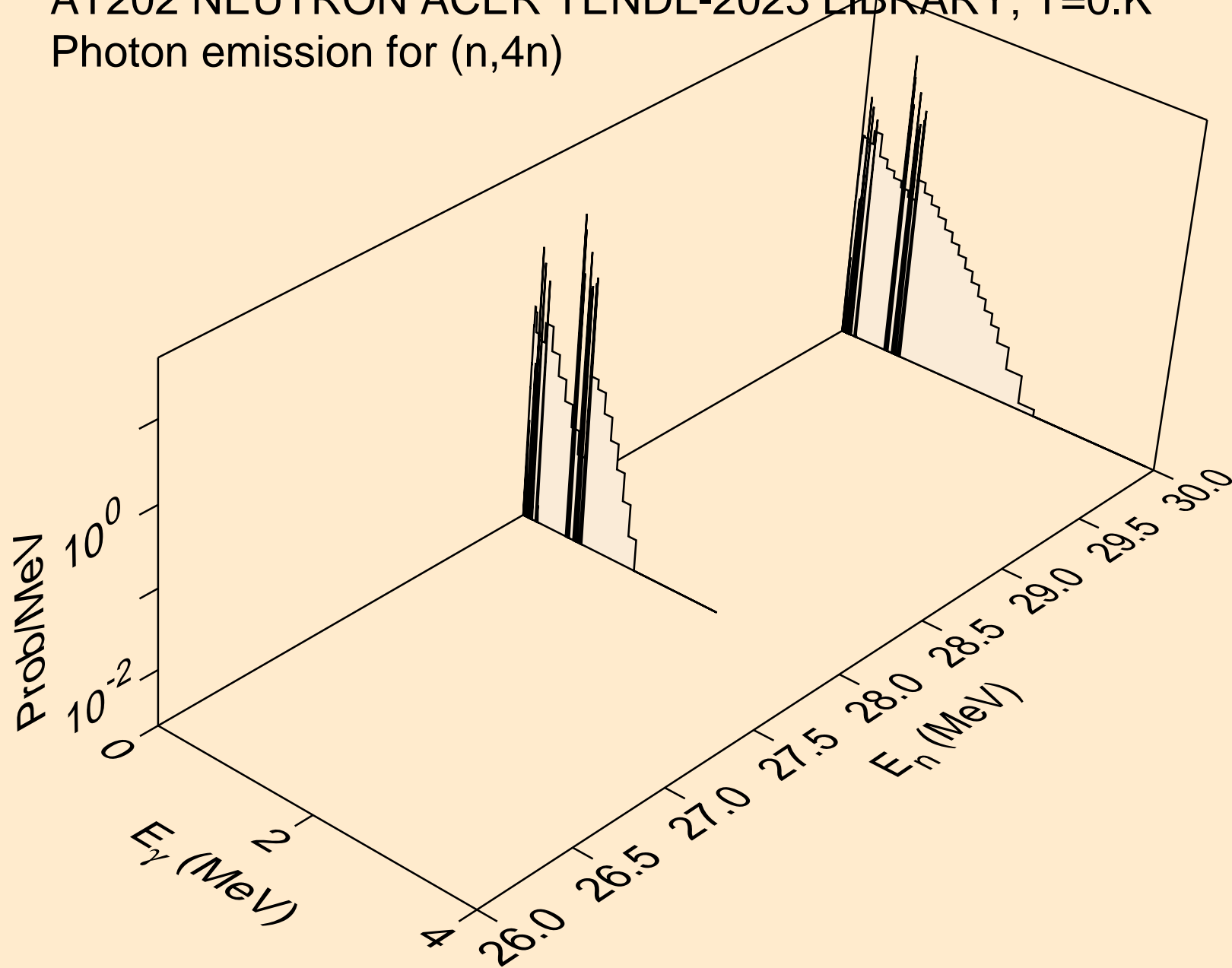

AT202 NEUTRON ACER TENDL-2023 LIBRARY; T=0.K
Photon emission for (n,2np)

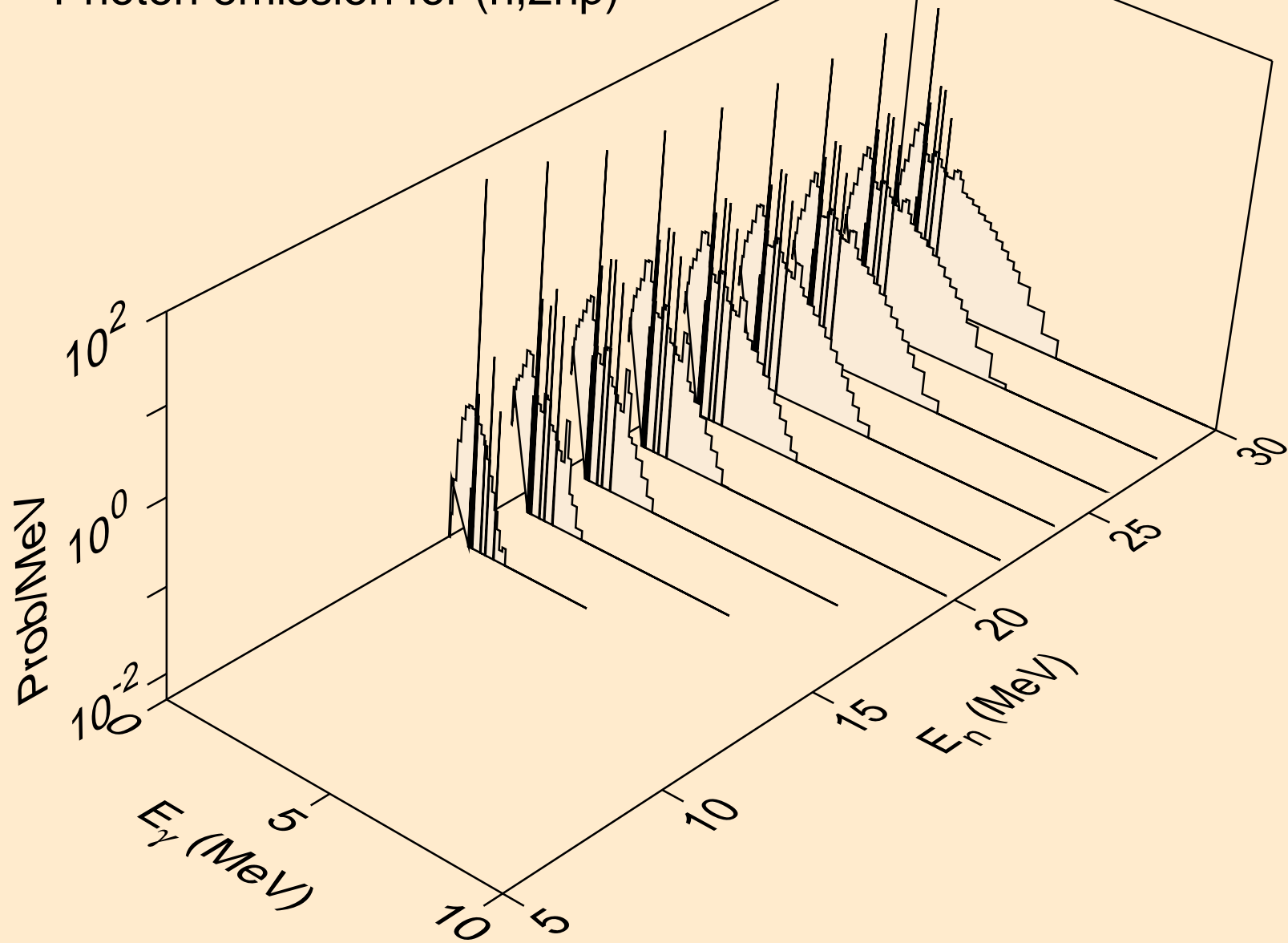

AT202 NEUTRON ACER TENDL-2023 LIBRARY; T=0.K
Photon emission for (n,3np)

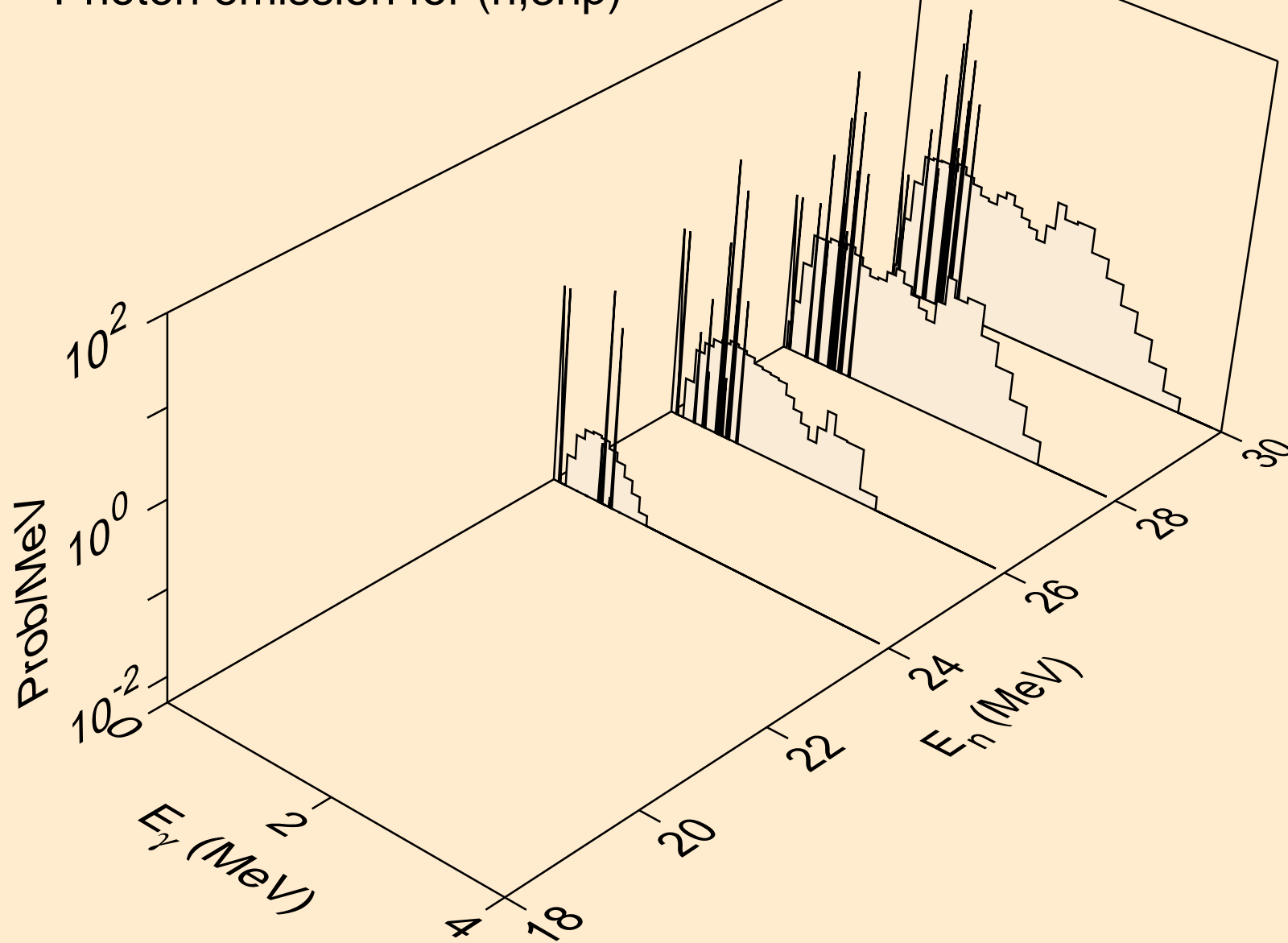

AT202 NEUTRON ACER TENDL-2023 LIBRARY; T=0.K
Photon emission for (n,n2p)

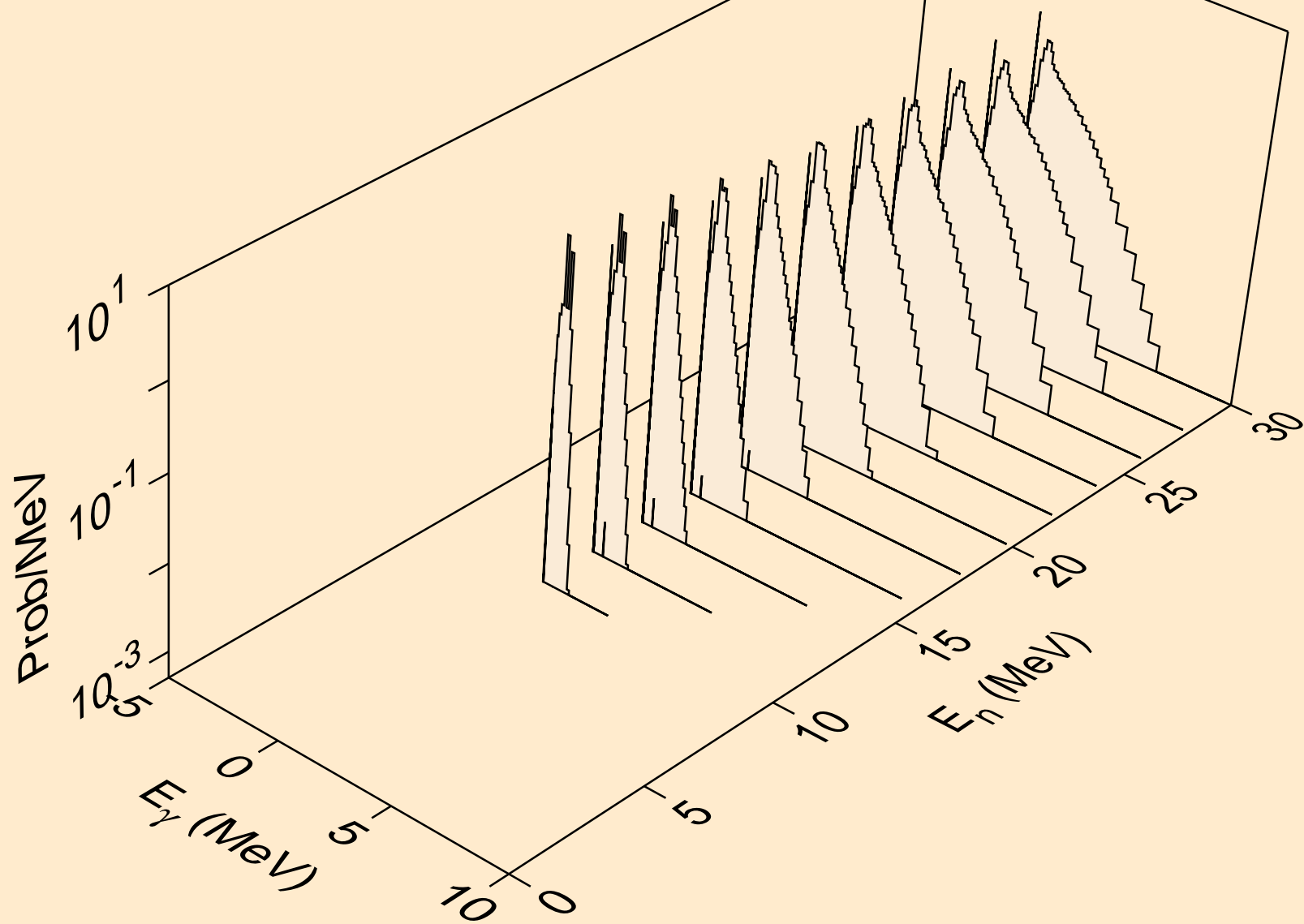

AT202 NEUTRON ACER TENDL-2023 LIBRARY; T=0.K
Photon emission for (n,npa)

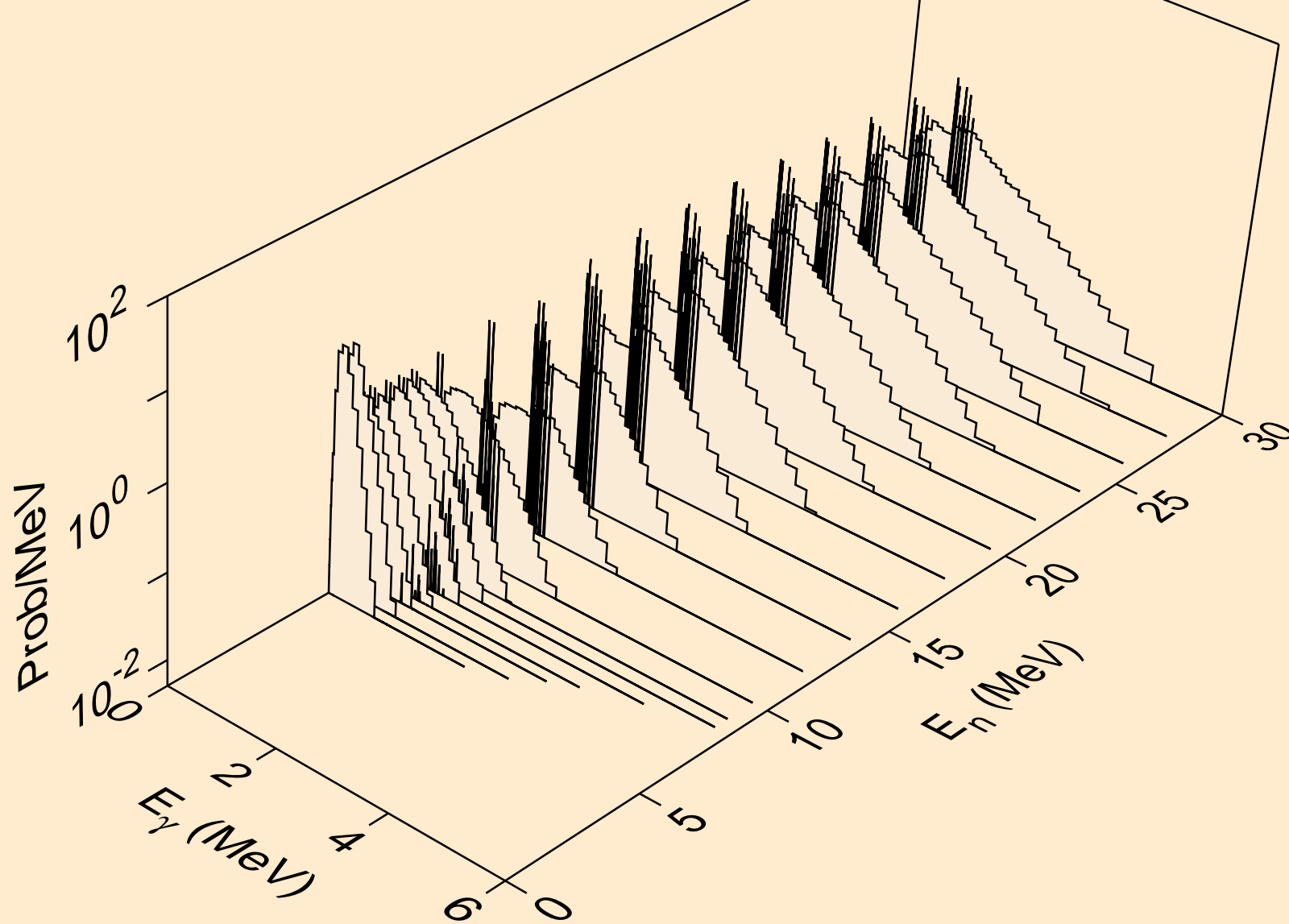

AT202 NEUTRON ACER TENDL-2023 LIBRARY; T=0.K
Photon emission for (n,n*c)

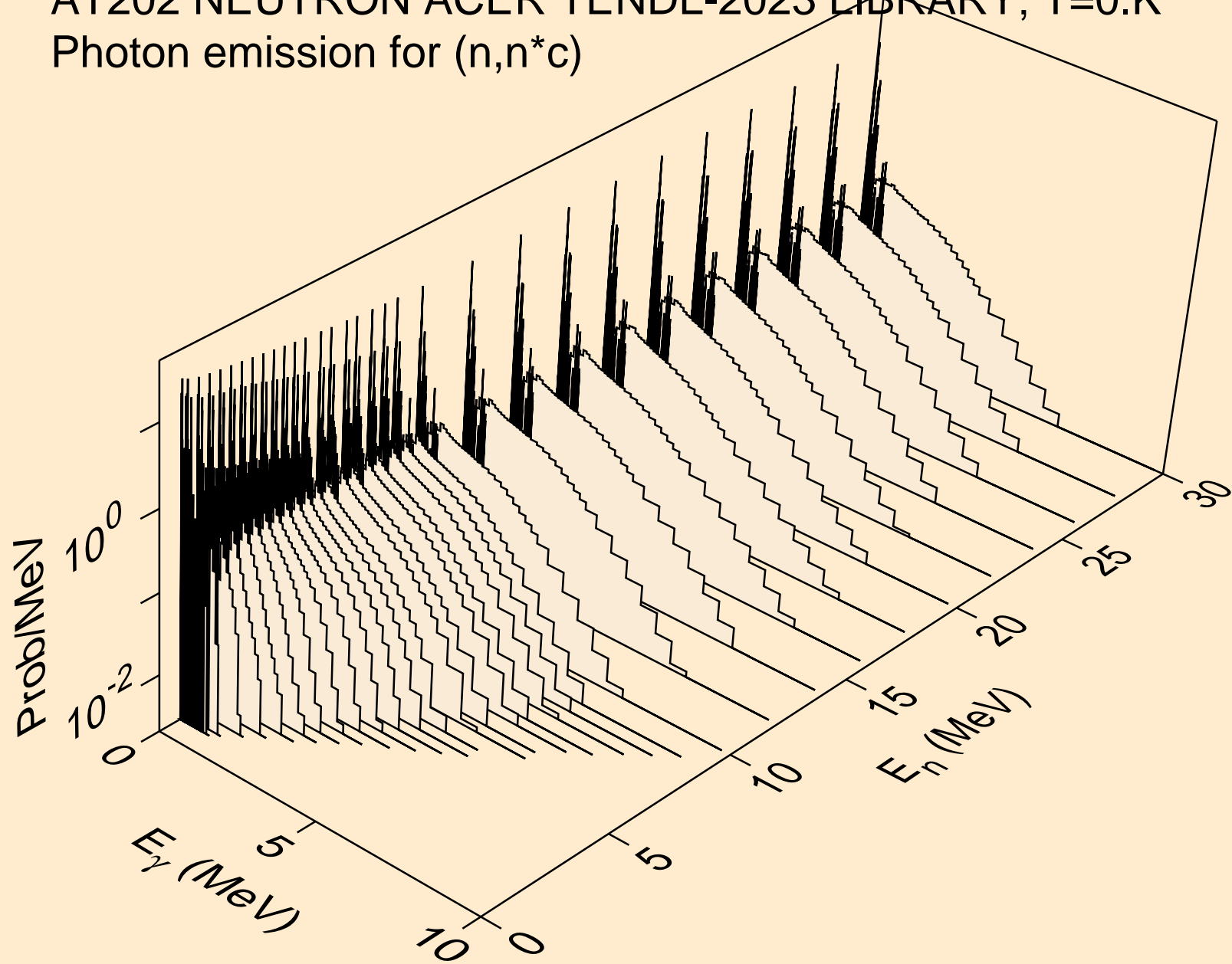

AT202 NEUTRON ACER TENDL-2023 LIBRARY; T=0.K
Photon emission for (n,gma)

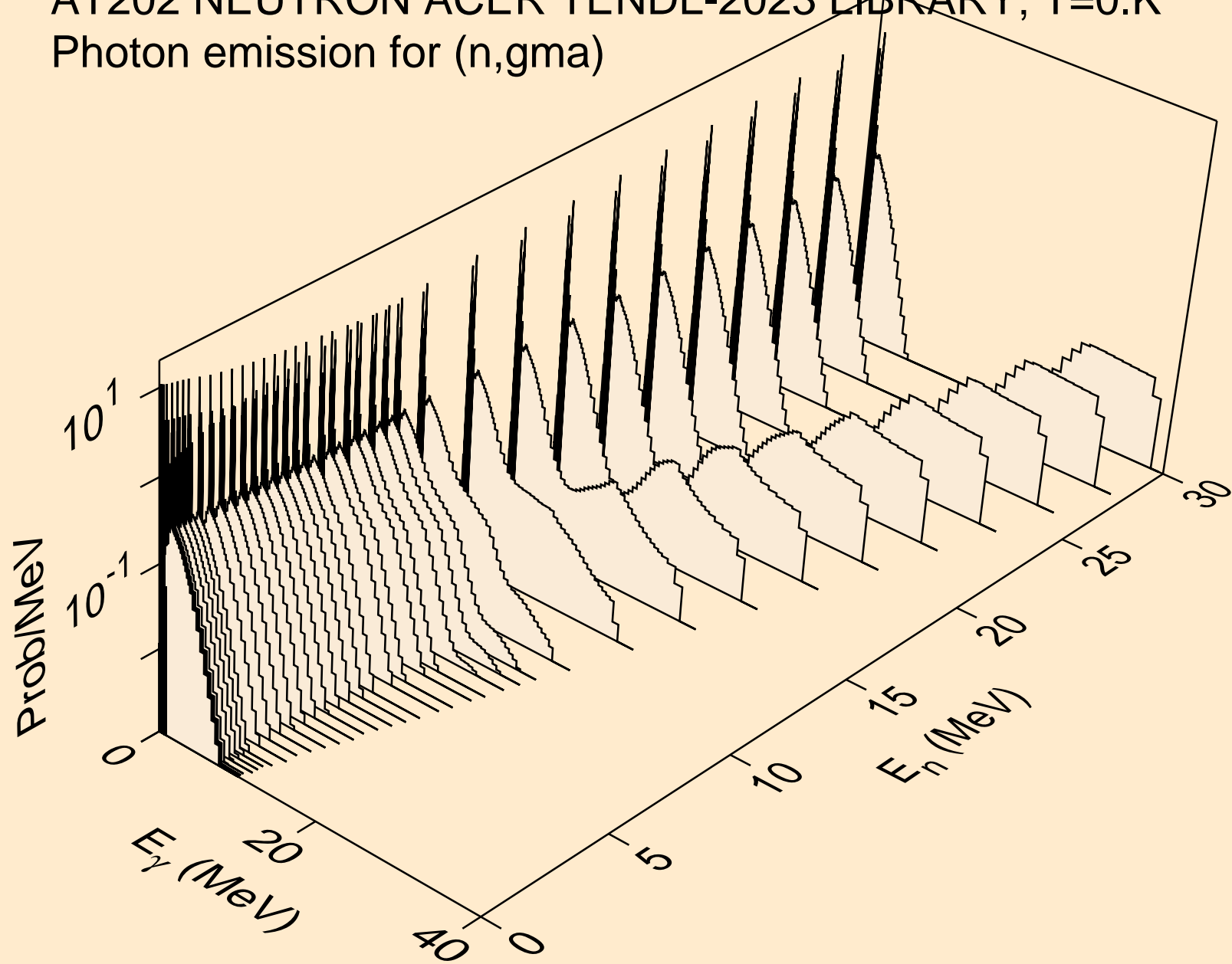

AT202 NEUTRON ACER TENDL-2023 LIBRARY; T=0.K
Photon emission for (n,p)

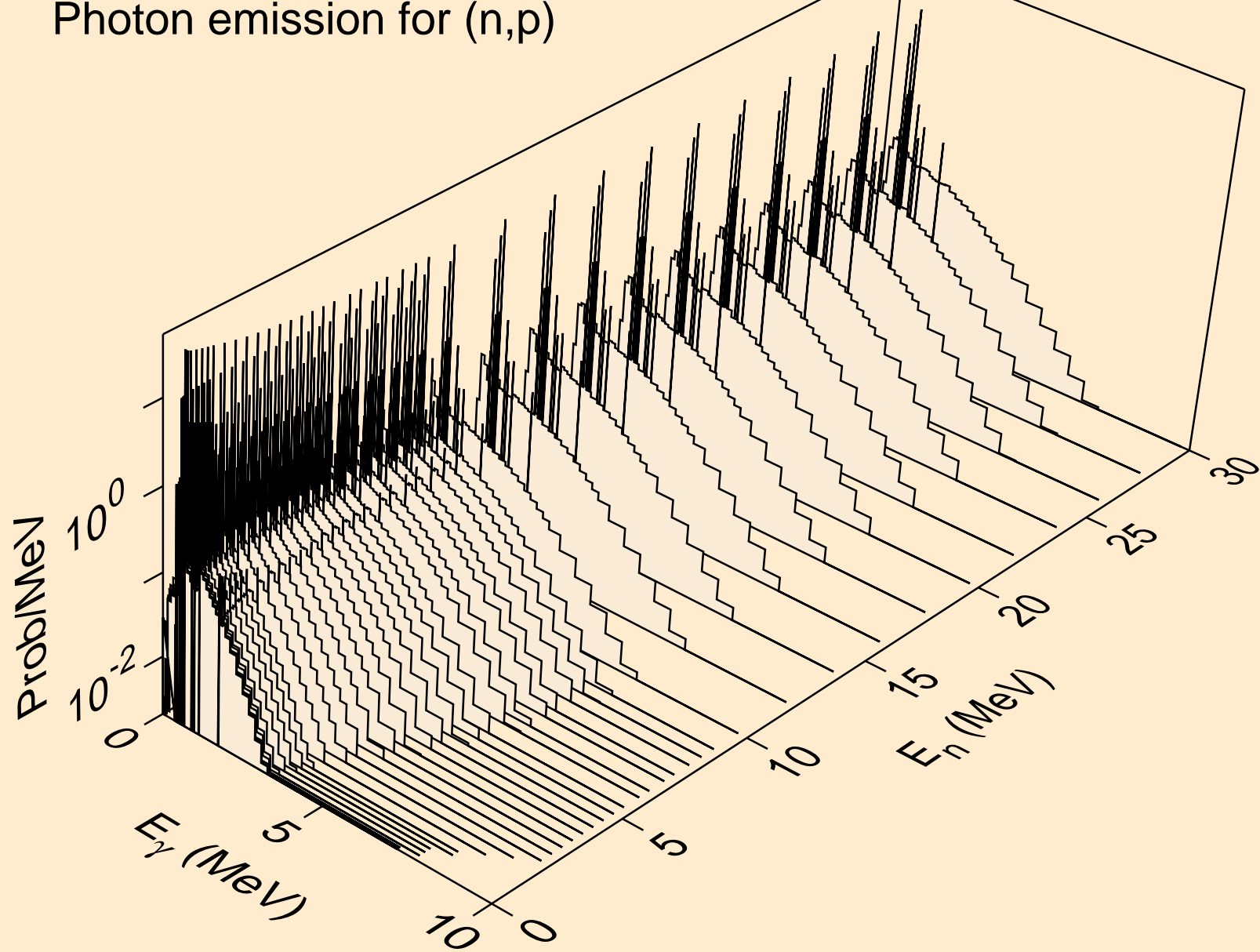

AT202 NEUTRON ACER TENDL-2023 LIBRARY; T=0.K
Photon emission for (n,d)

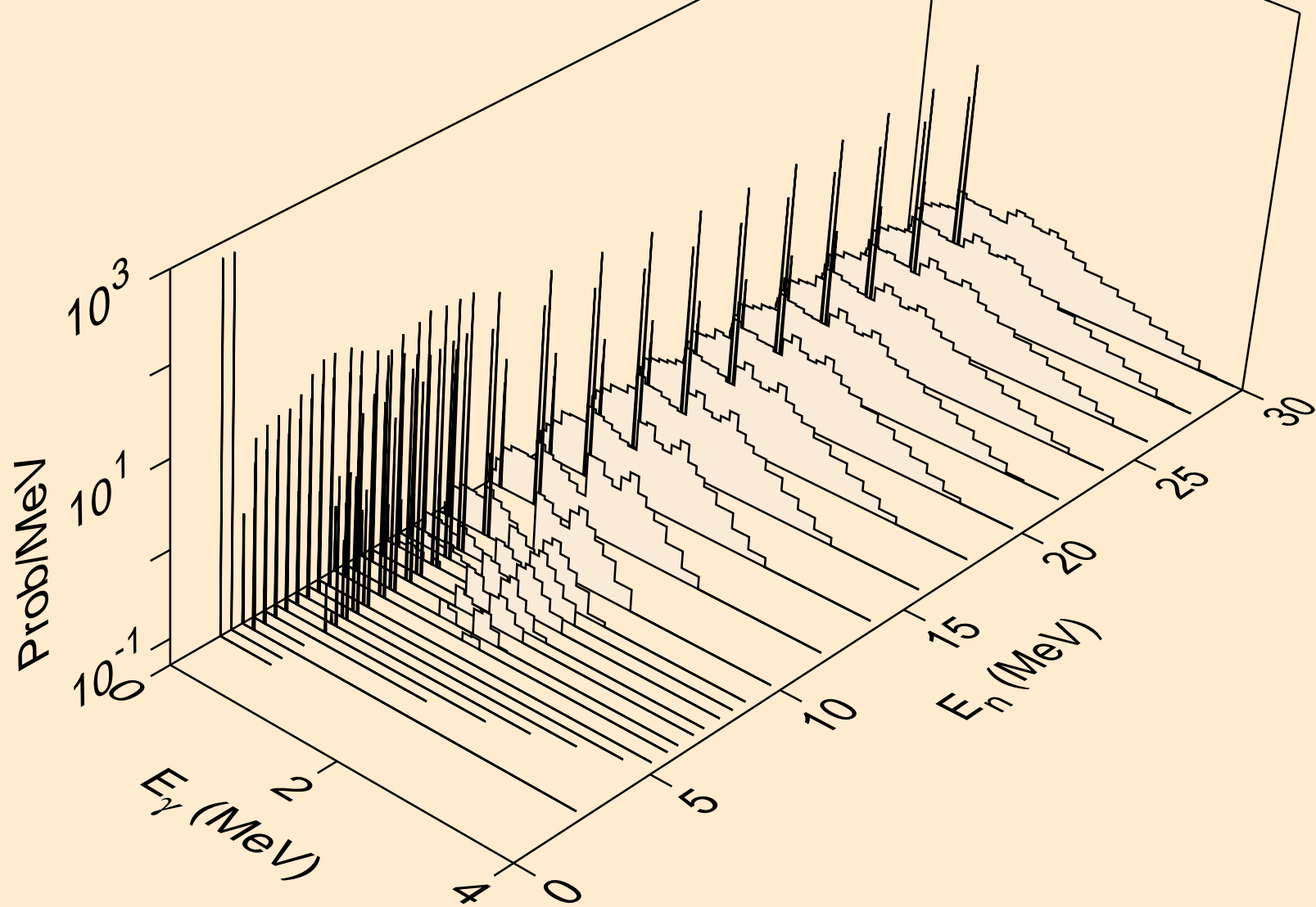

AT202 NEUTRON ACER TENDL-2023 LIBRARY; T=0.K
Photon emission for (n,t)

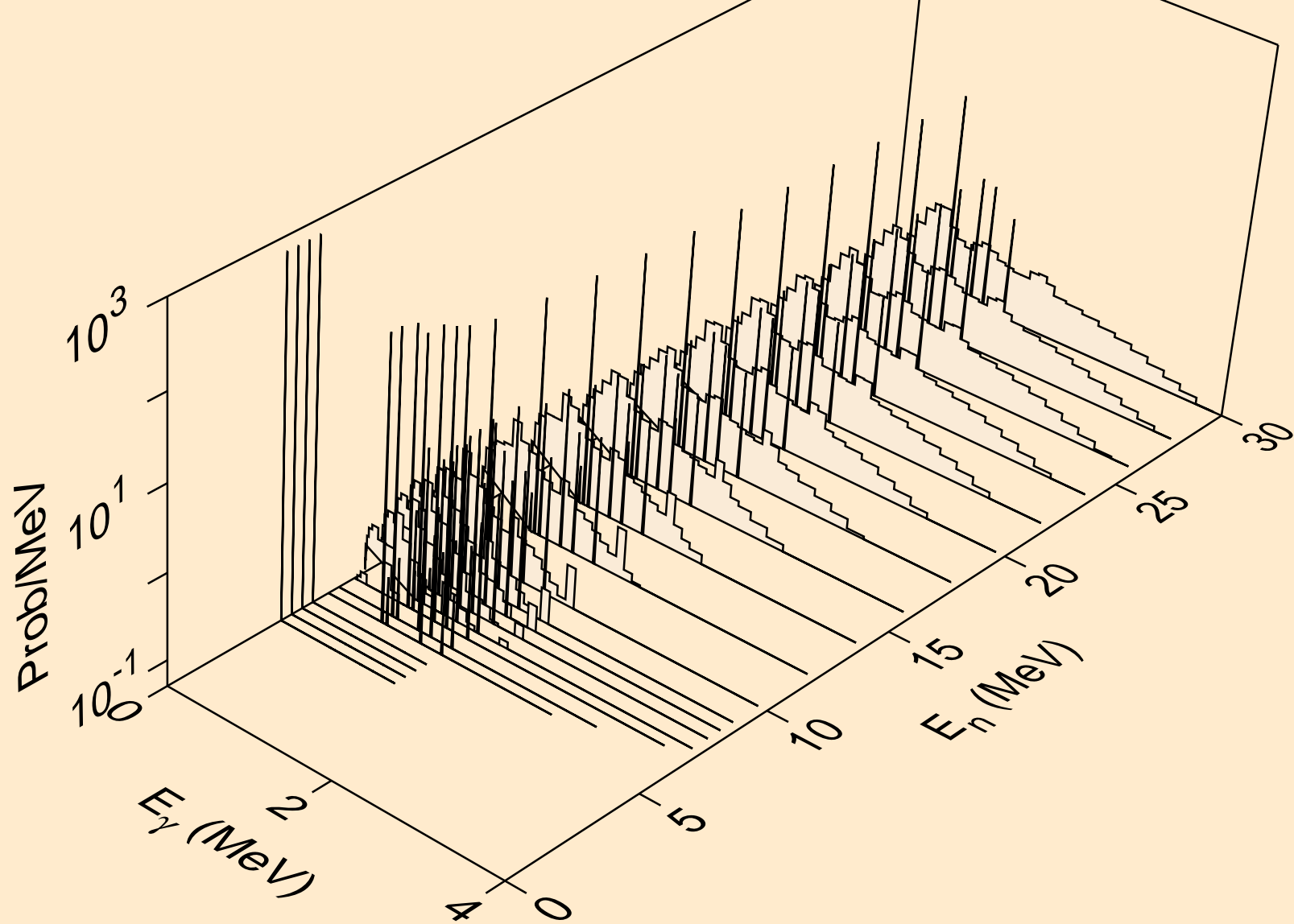

AT202 NEUTRON ACER TENDL-2023 LIBRARY; T=0.K
Photon emission for (n,he3)

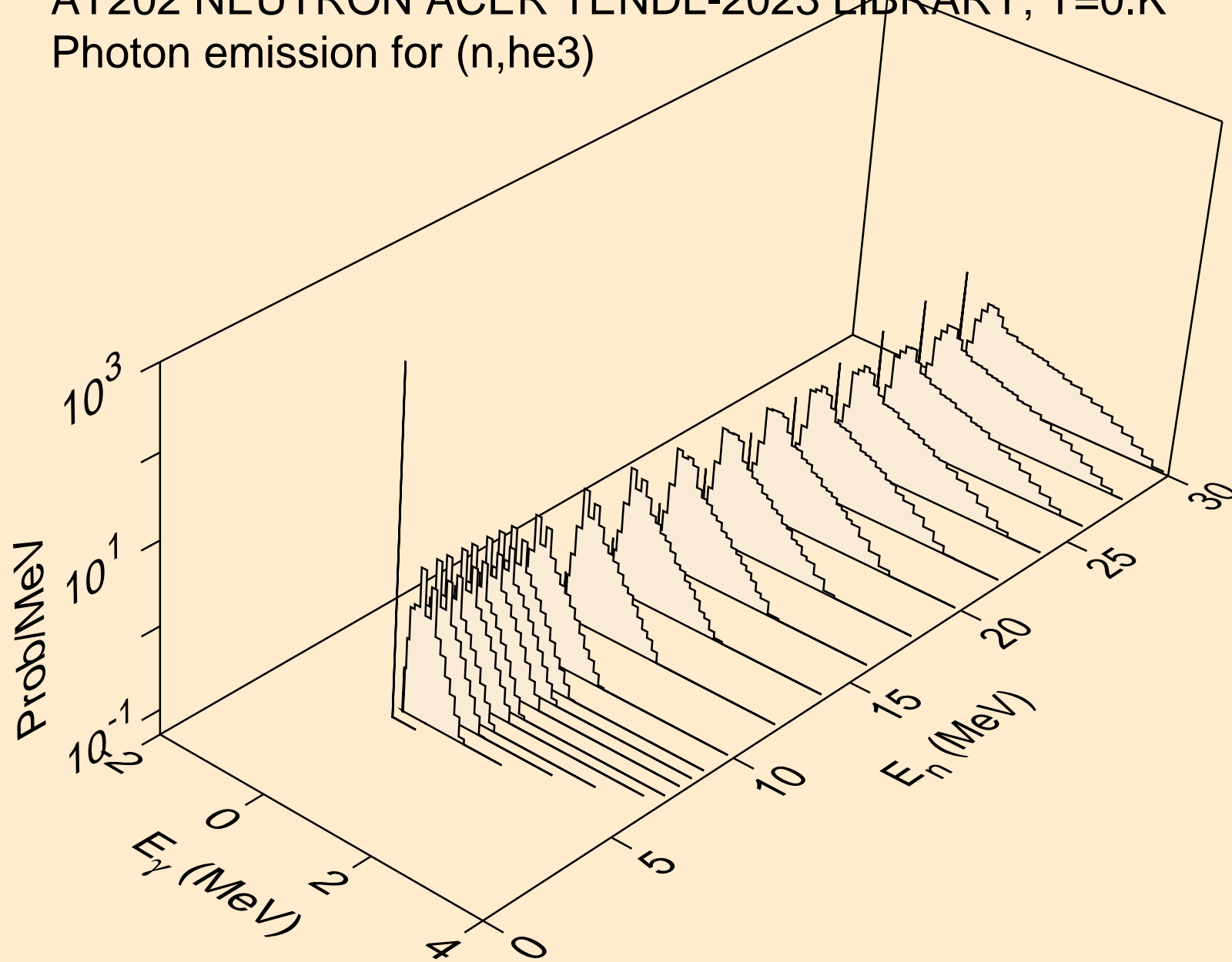

AT202 NEUTRON ACER TENDL-2023 LIBRARY; T=0.K
Photon emission for (n,a)

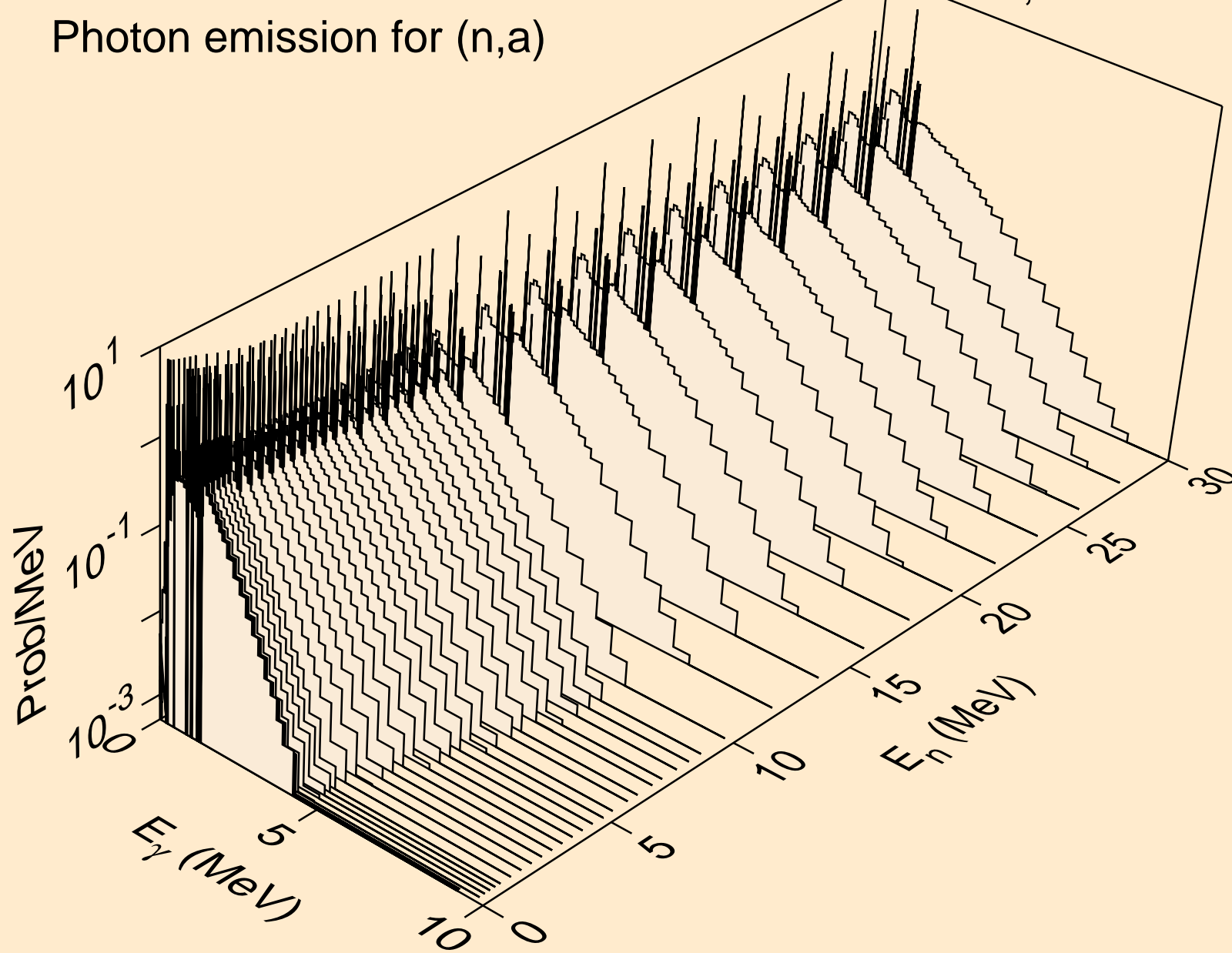

AT202 NEUTRON ACER TENDL-2023 LIBRARY; T=0.K
Photon emission for (n,2a)

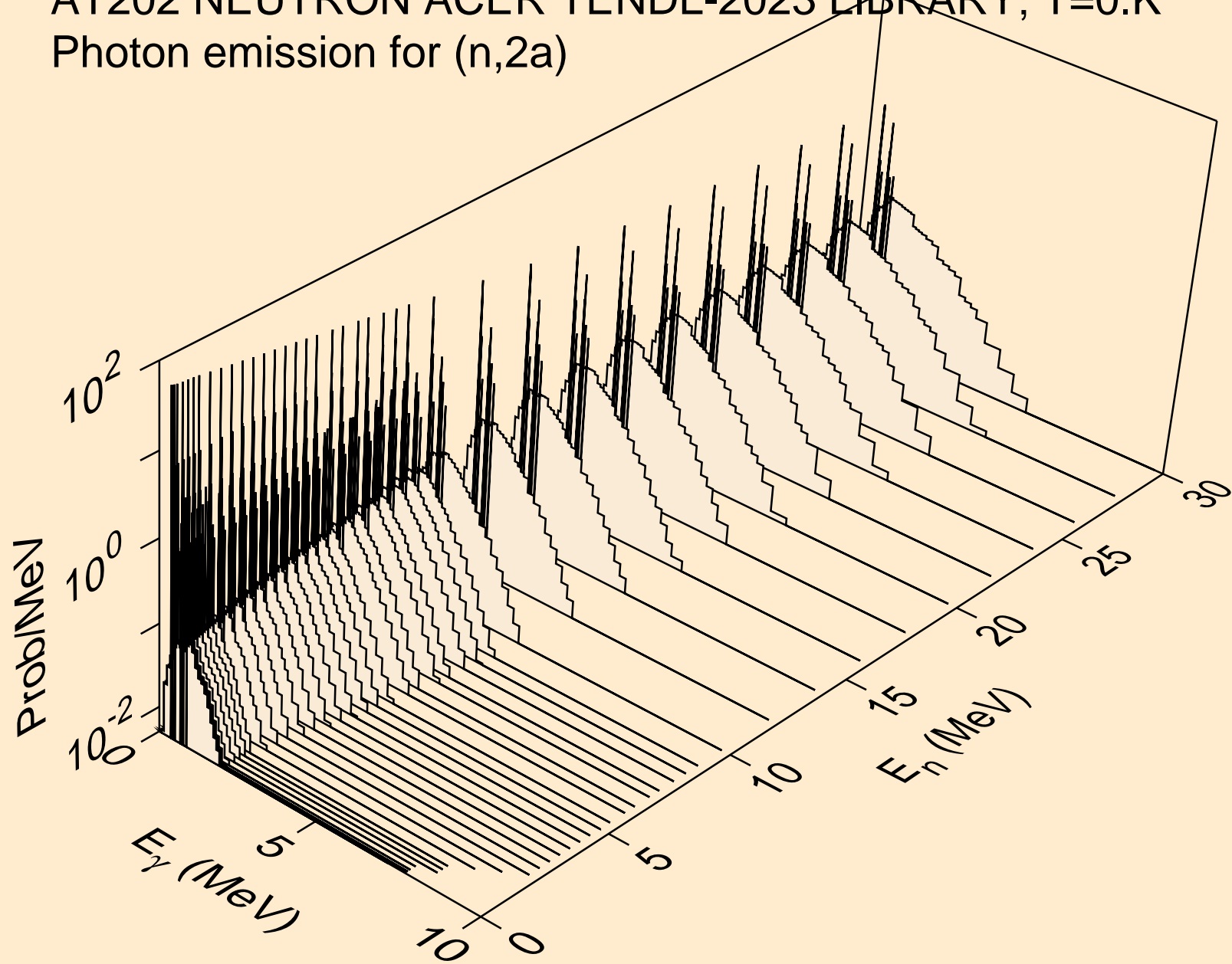

AT202 NEUTRON ACER TENDL-2023 LIBRARY; T=0.K
Photon emission for (n,2p)

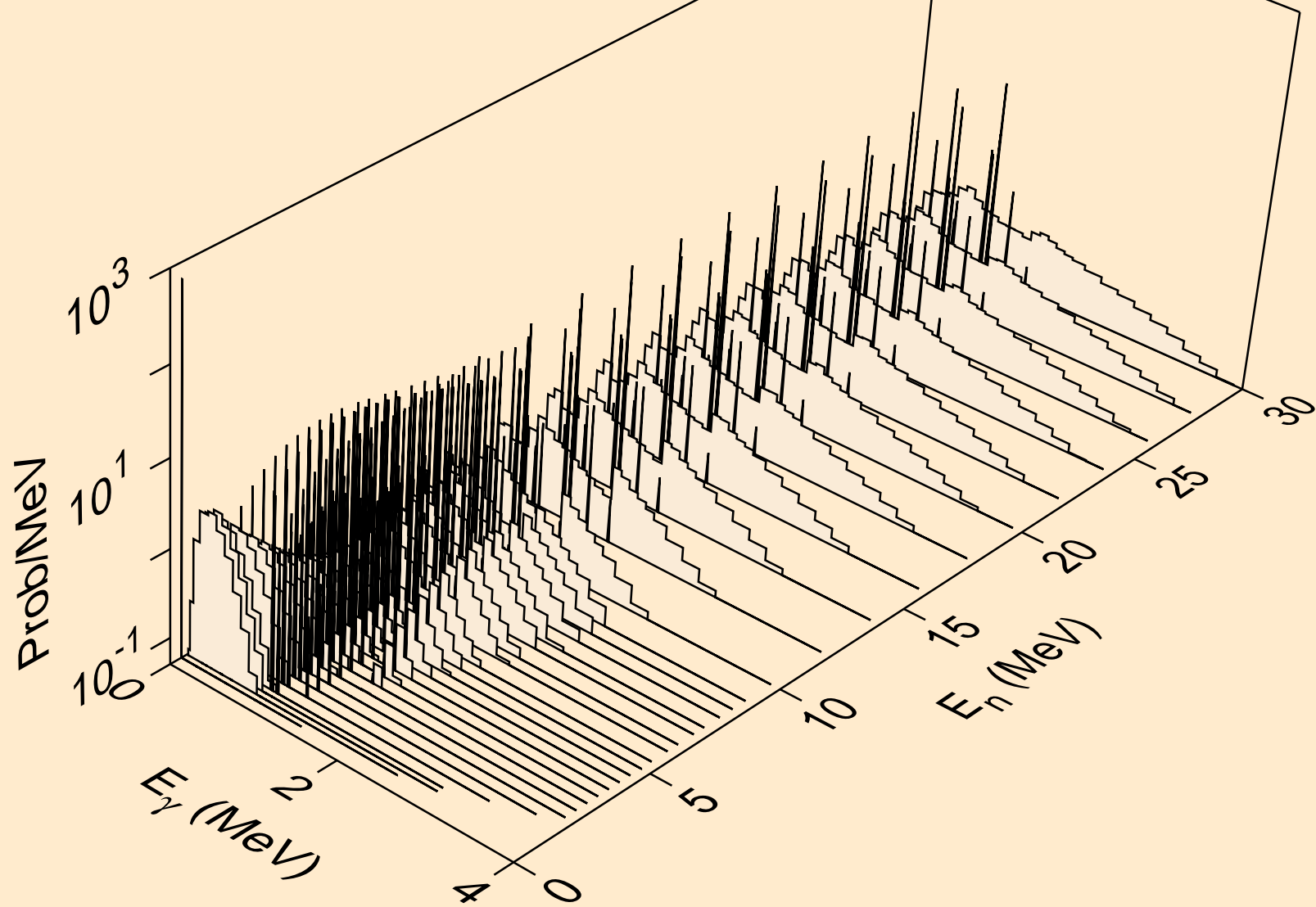

AT202 NEUTRON ACER TENDL-2023 LIBRARY; T=0.K
Photon emission for (n,p α)

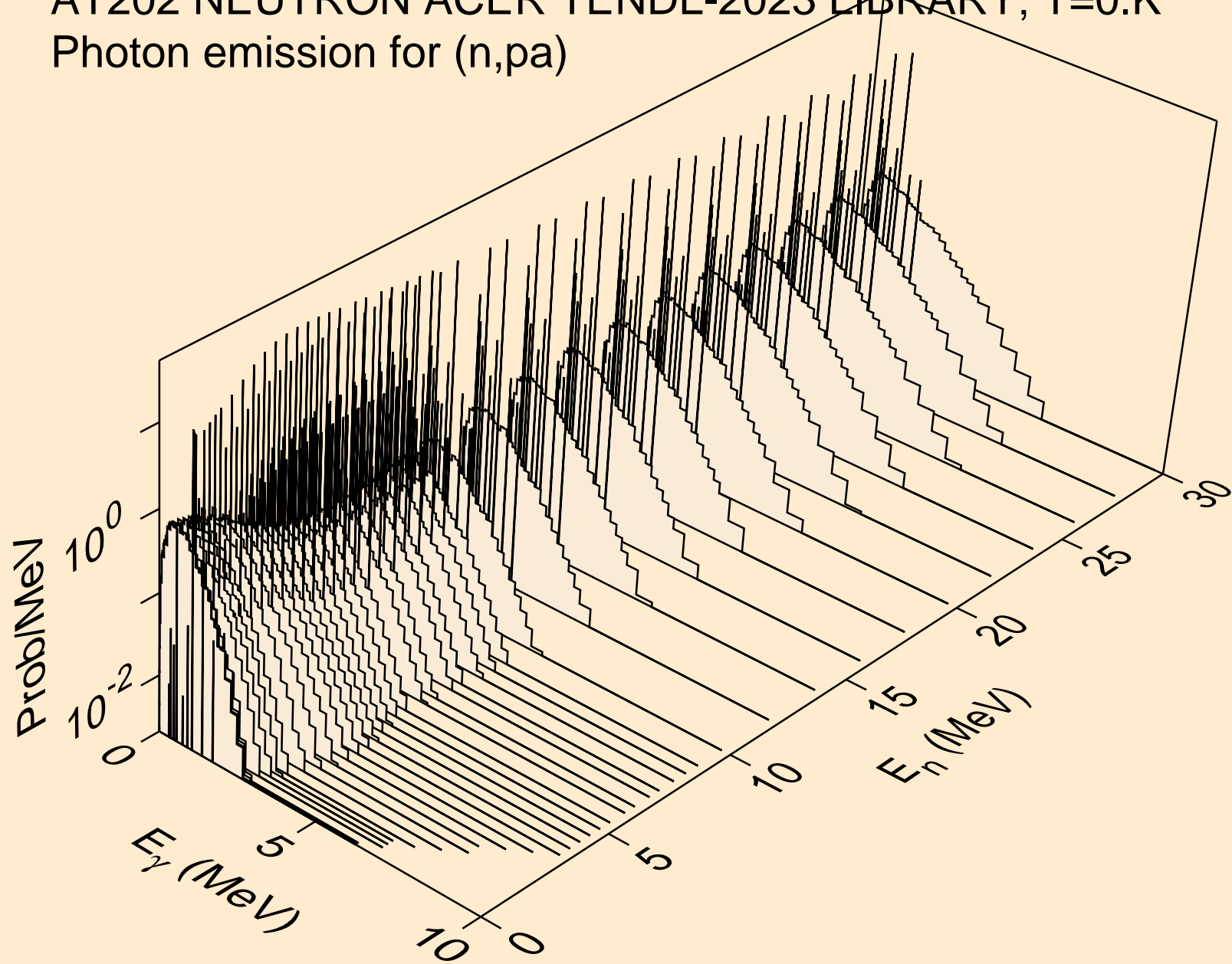

AT202 NEUTRON ACER TENDL-2023 LIBRARY; T=0.K
Photon emission for (n,pd)

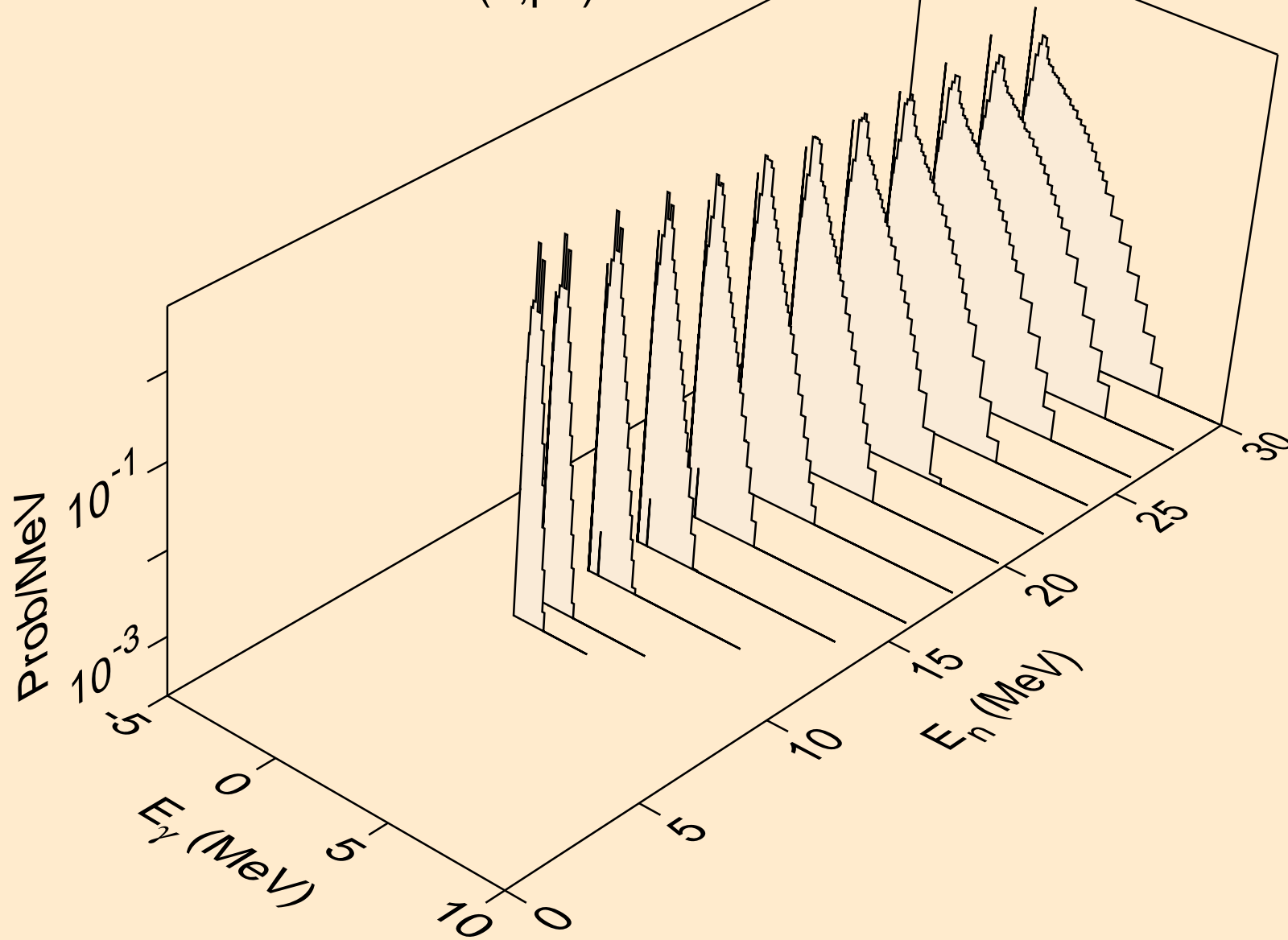

AT202 NEUTRON ACER TENDL-2023 LIBRARY; T=0.K
Photon emission for (n,pt)

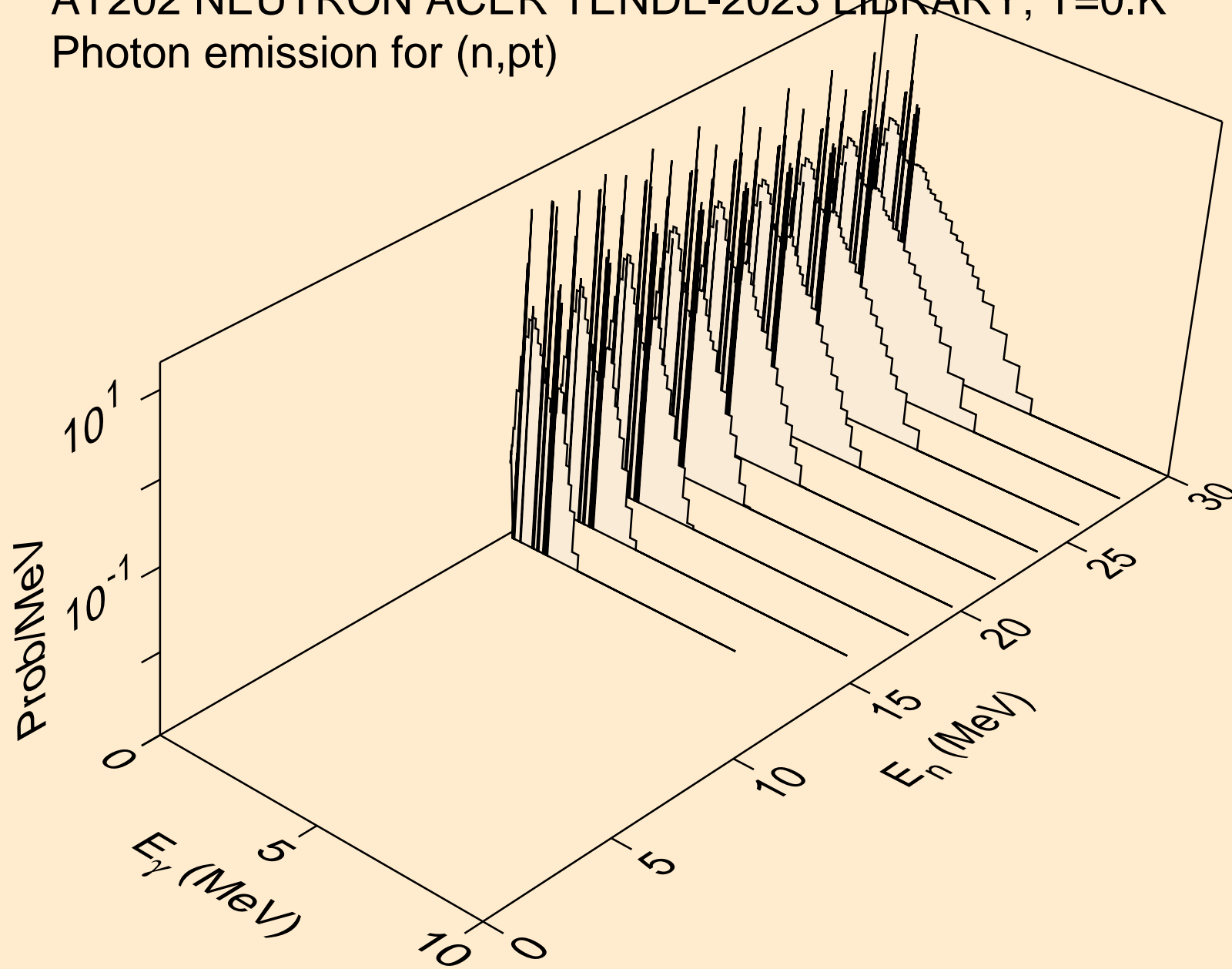

AT202 NEUTRON ACER TENDL-2023 LIBRARY; T=0.K
Photon emission for (n,da)

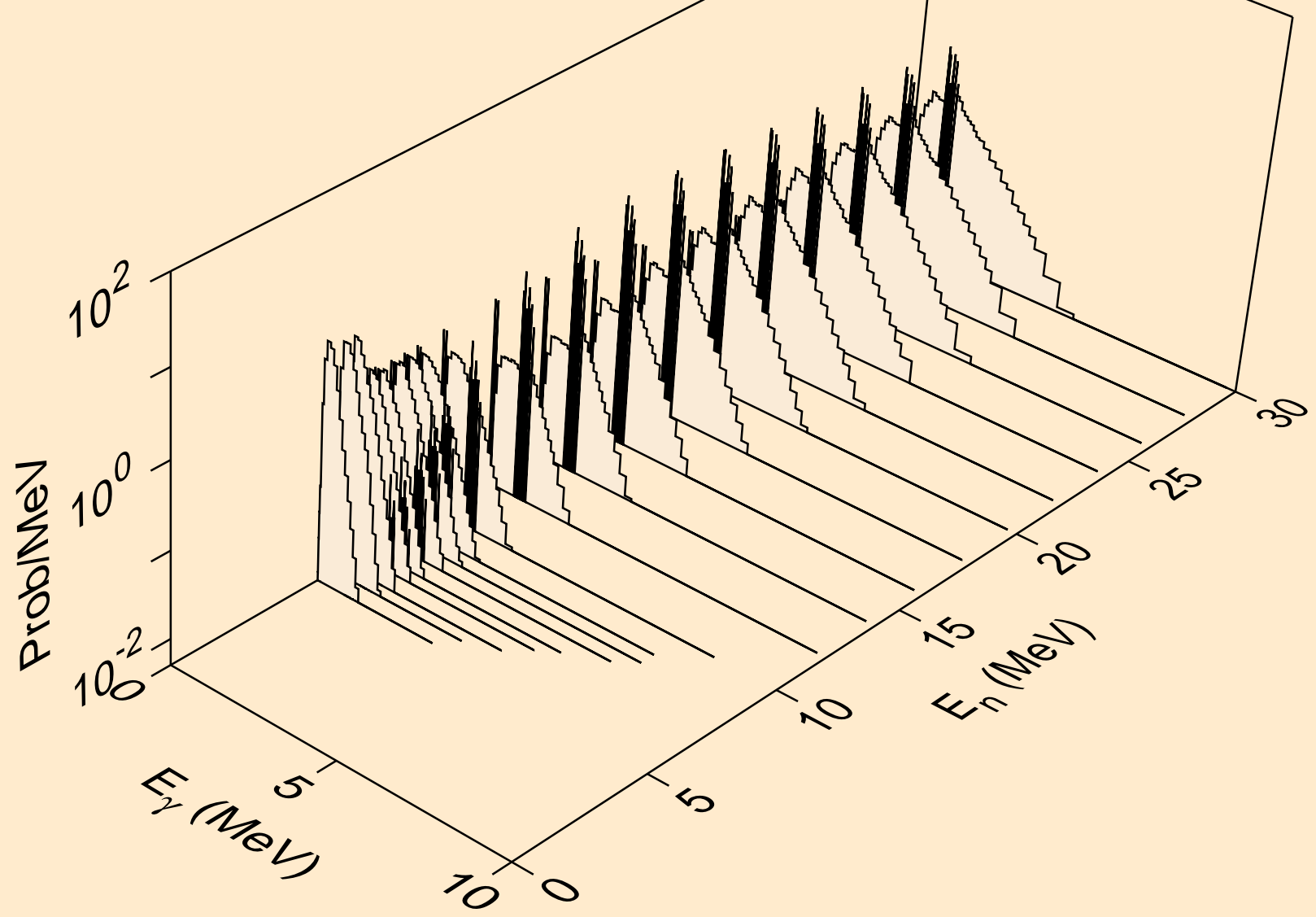

AT202 NEUTRON ACER TENDL-2023 LIBRARY; T=0.K
thermal capture photon spectrum

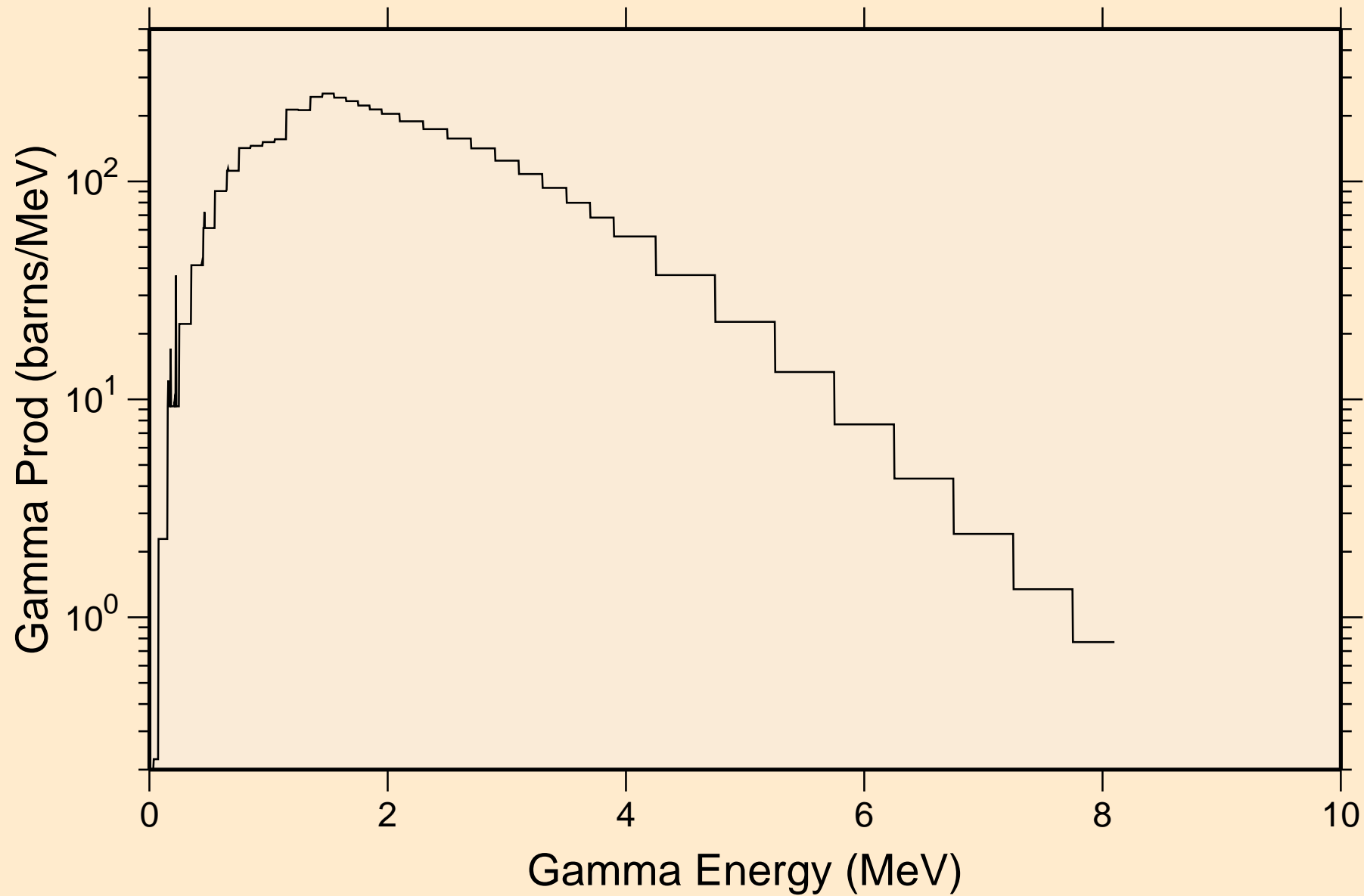

AT202 NEUTRON ACER TENDL-2023 LIBRARY; T=0.K
14 MeV photon spectrum

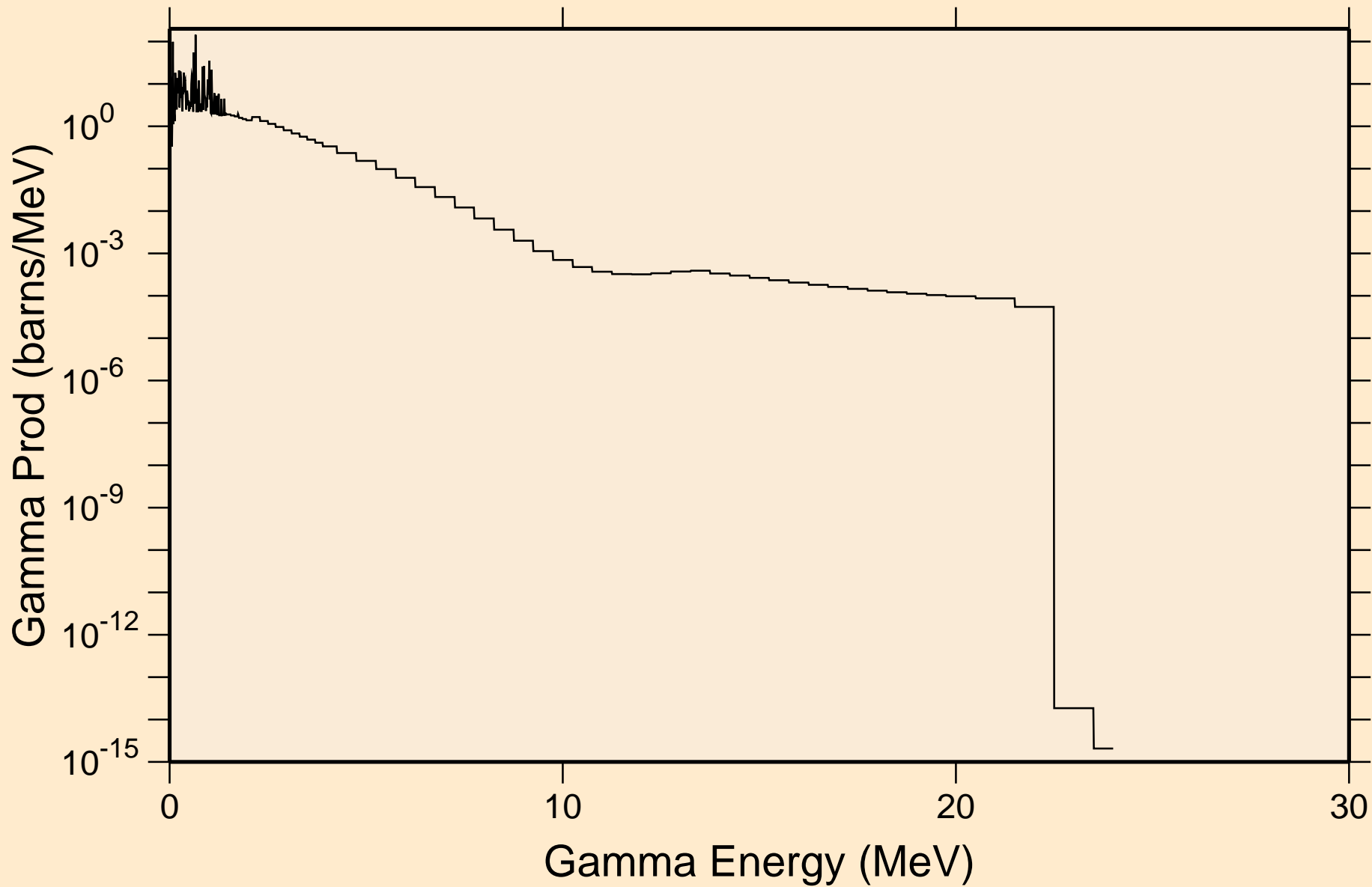

AT202 NEUTRON ACER TENDL-2023 LIBRARY; T=0.K
Particle heating contributions

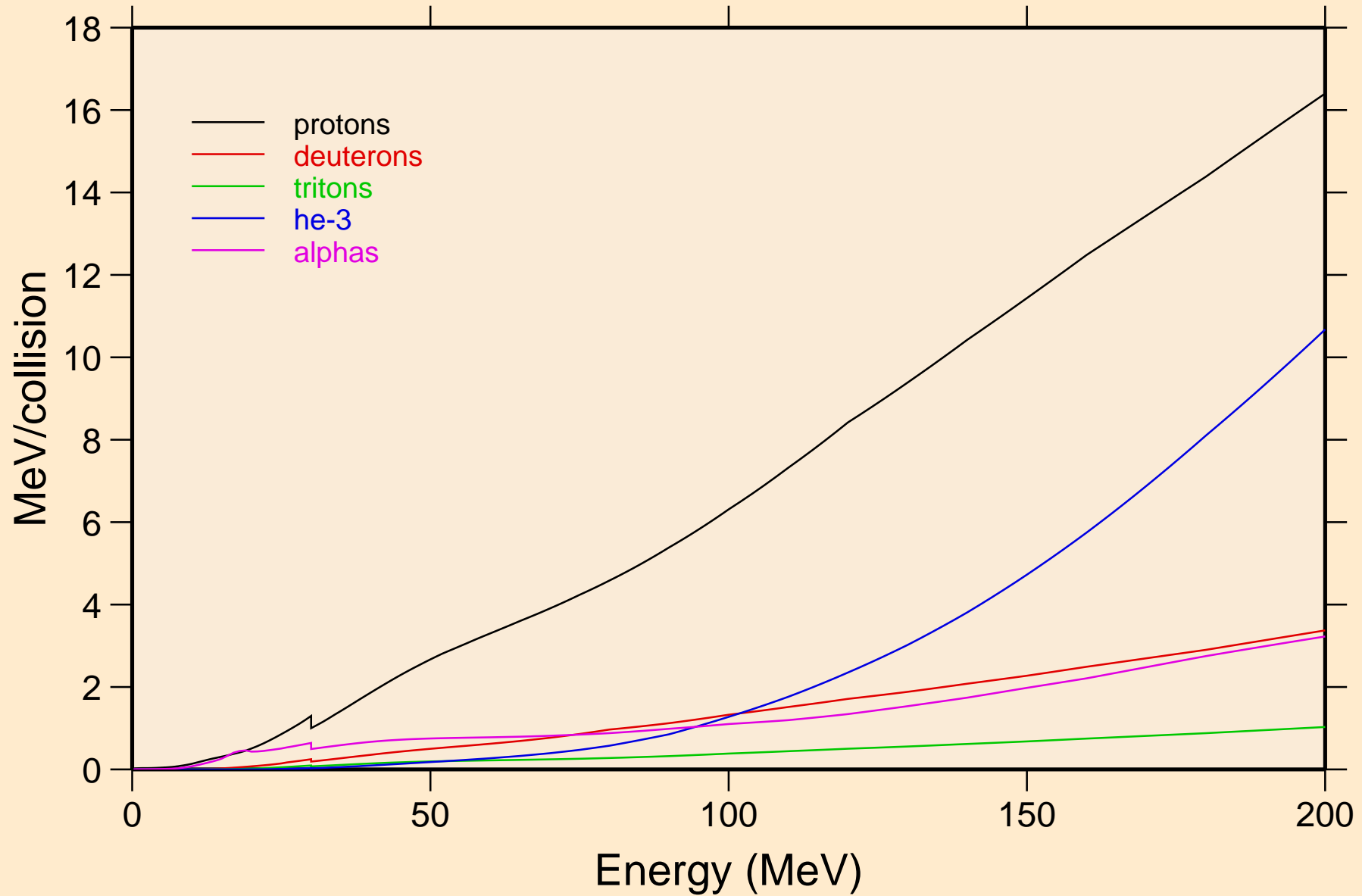

AT202 NEUTRON ACER TENDL-2023 LIBRARY; T=0.K
Recoil Heating

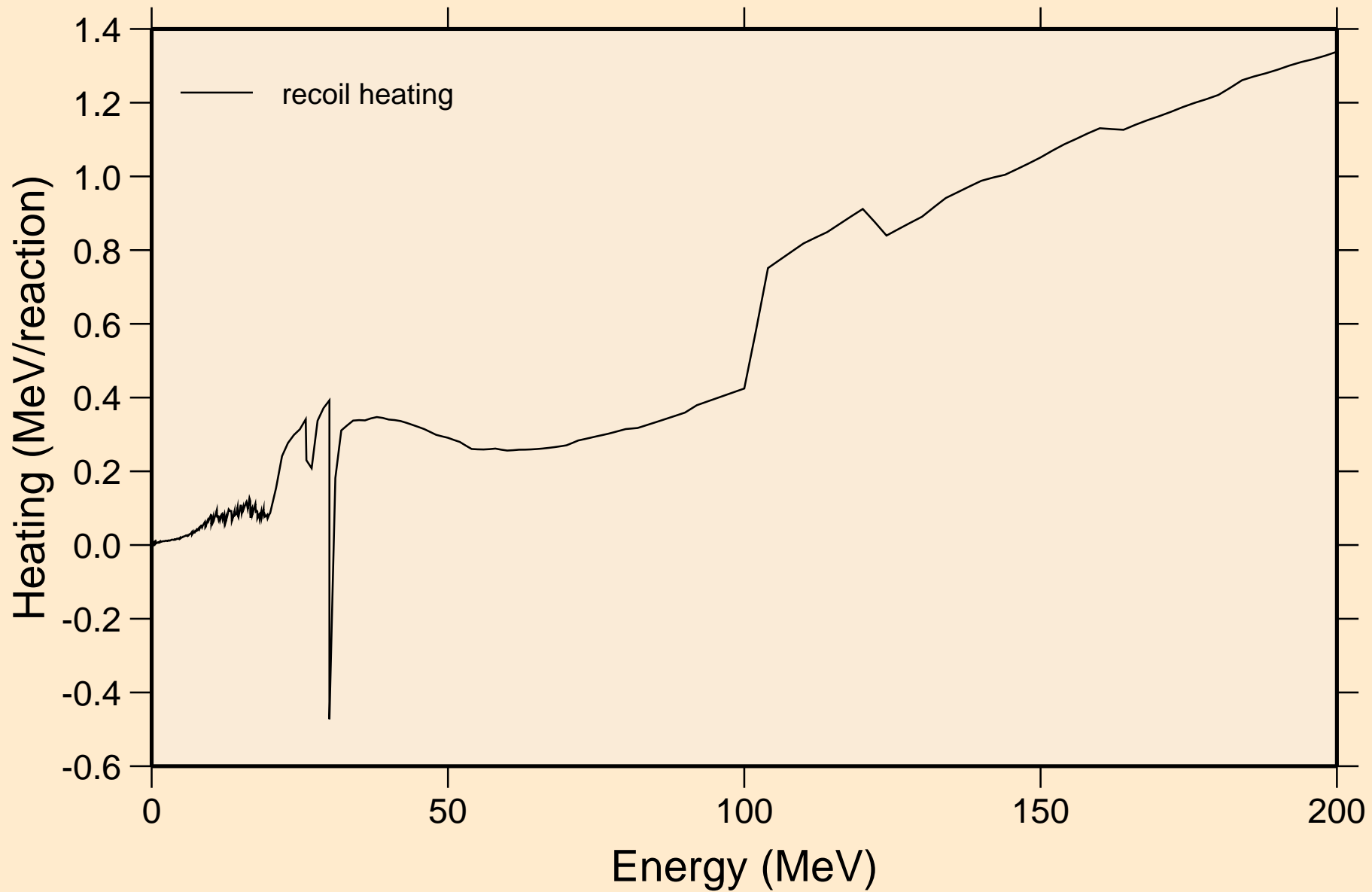

AT202 NEUTRON ACER TENDL-2023 LIBRARY; T=0.K
Particle production cross sections

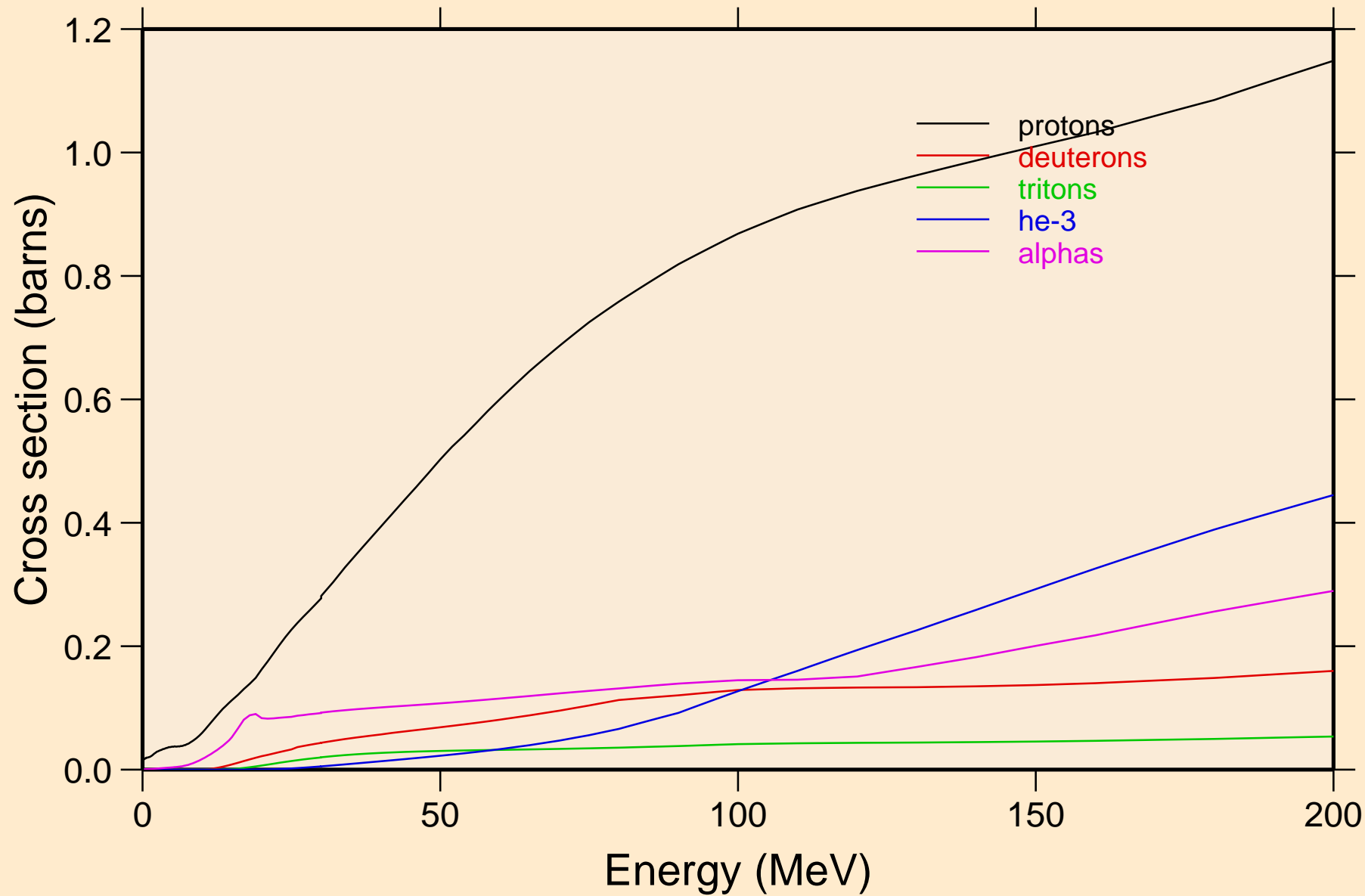

AT202 NEUTRON ACER TENDL-2023 LIBRARY; T=0.K
protons from (n,x)

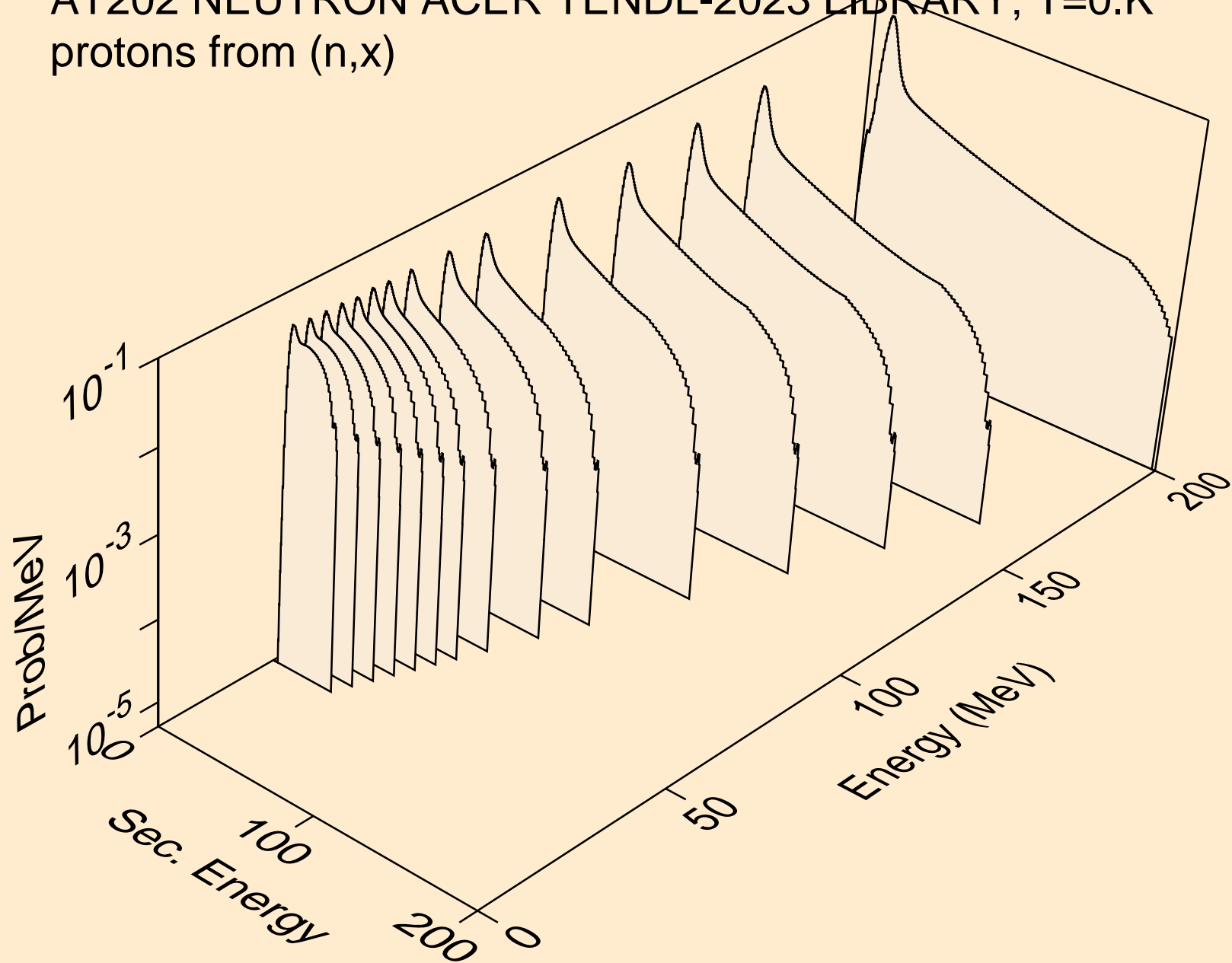

AT202 NEUTRON ACER TENDL-2023 LIBRARY; T=0.K
protons from (n,n*)p

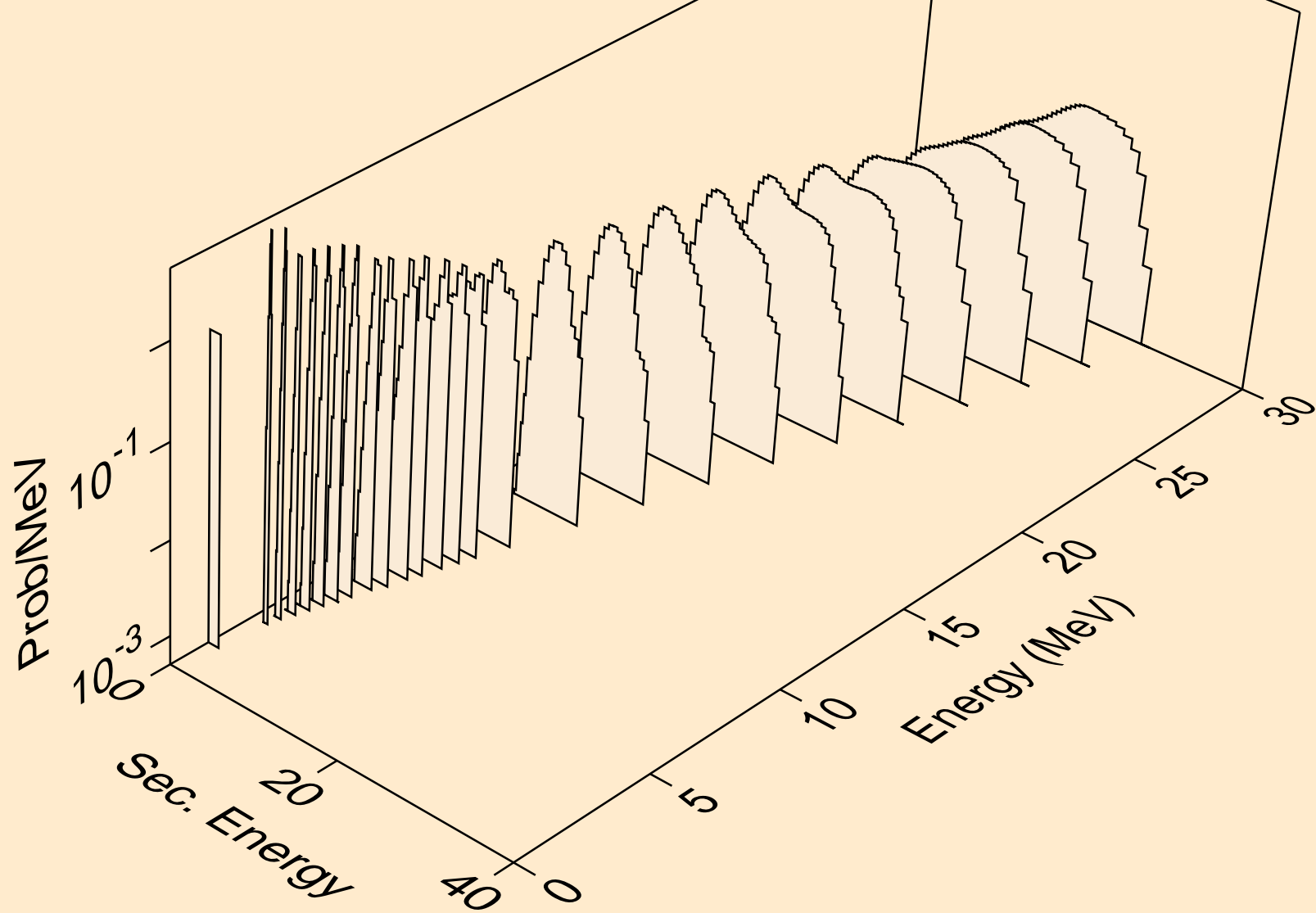

AT202 NEUTRON ACER TENDL-2023 LIBRARY; T=0.K
protons from (n,2np)

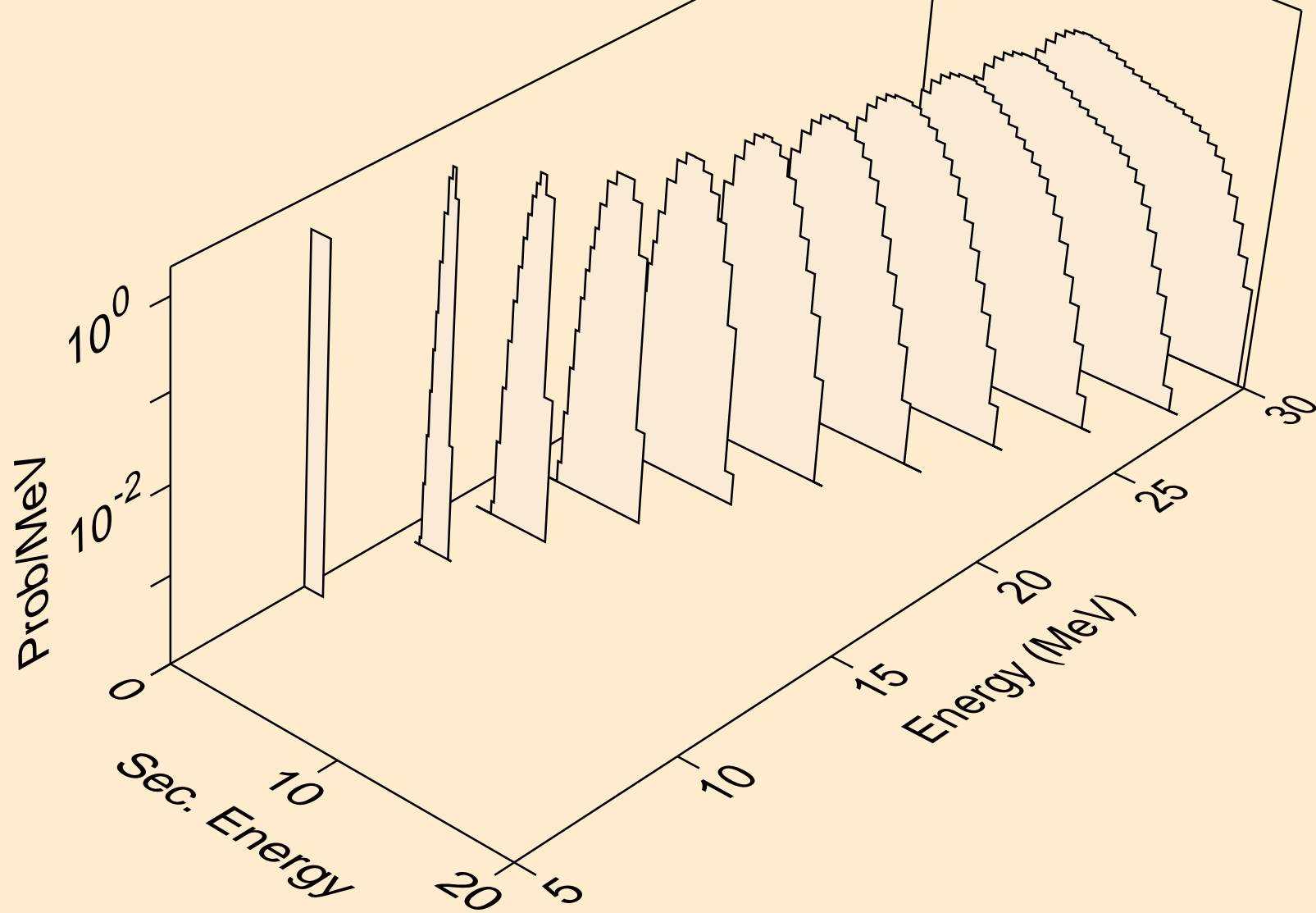

AT202 NEUTRON ACER TENDL-2023 LIBRARY; T=0.K
protons from (n,3np)

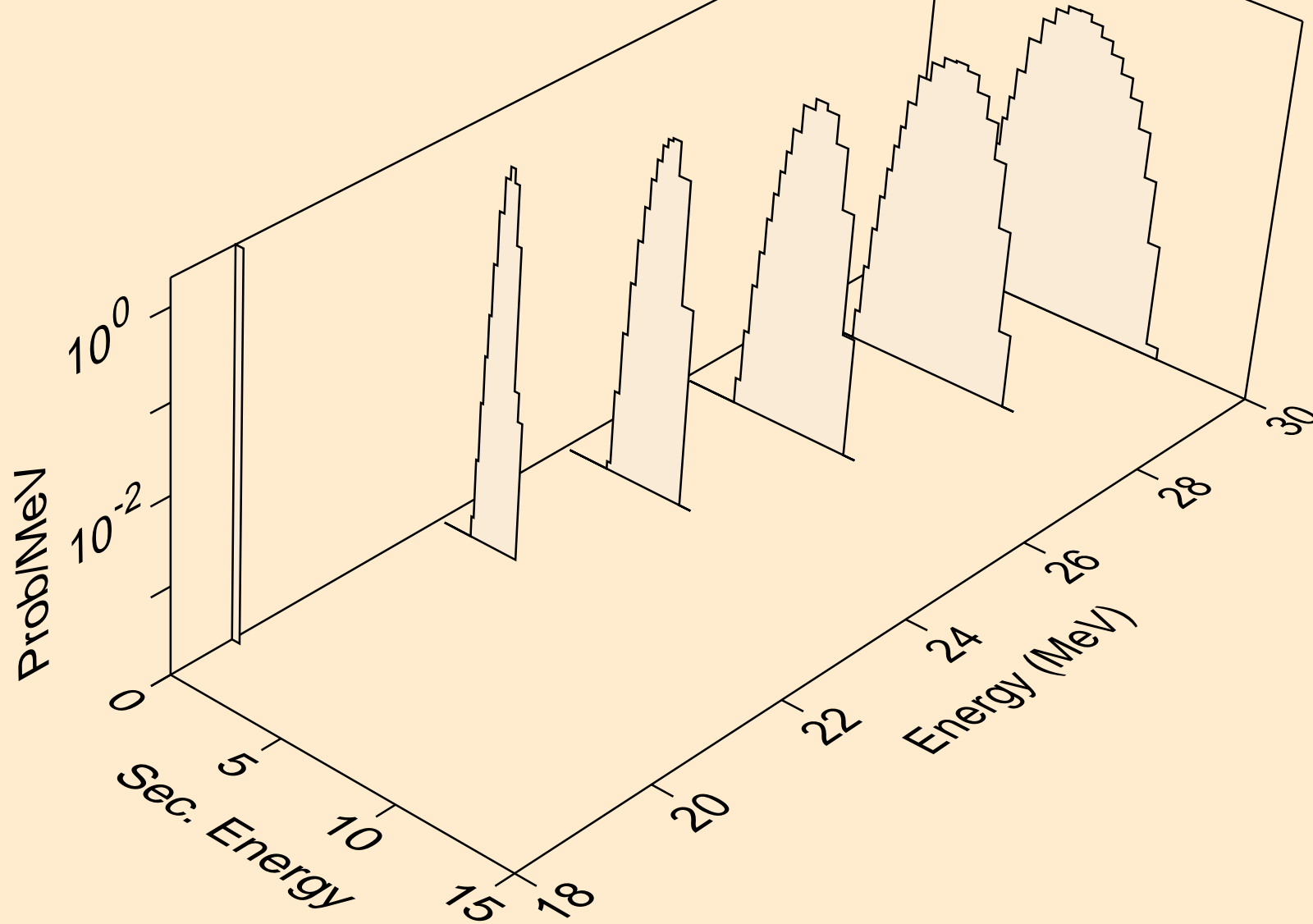

AT202 NEUTRON ACER TENDL-2023 LIBRARY; T=0.K
protons from (n,n2p)

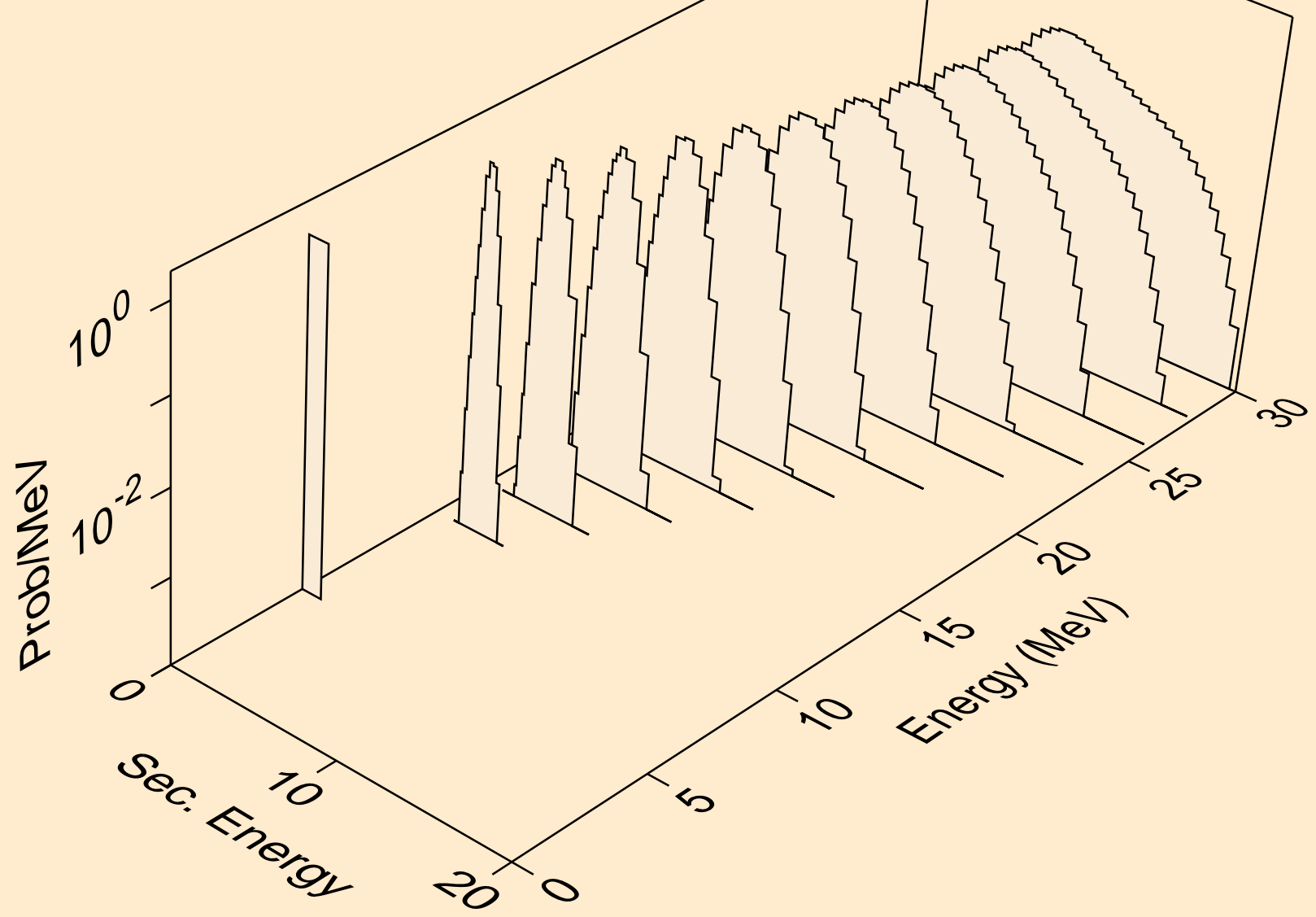

AT202 NEUTRON ACER TENDL-2023 LIBRARY; T=0.K
protons from (n,npa)

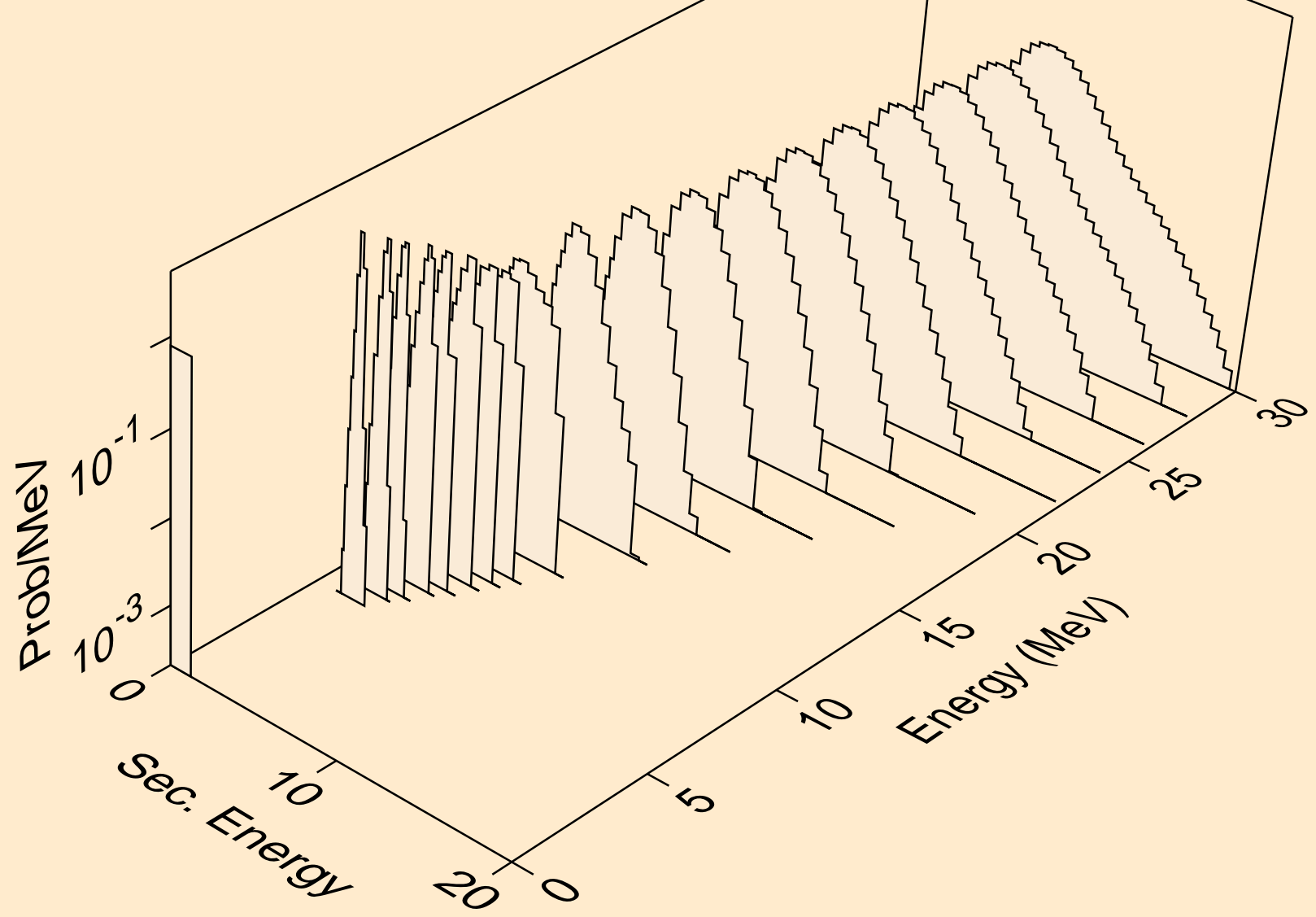

AT202 NEUTRON ACER TENDL-2023 LIBRARY; T=0.K
protons from (n,p)

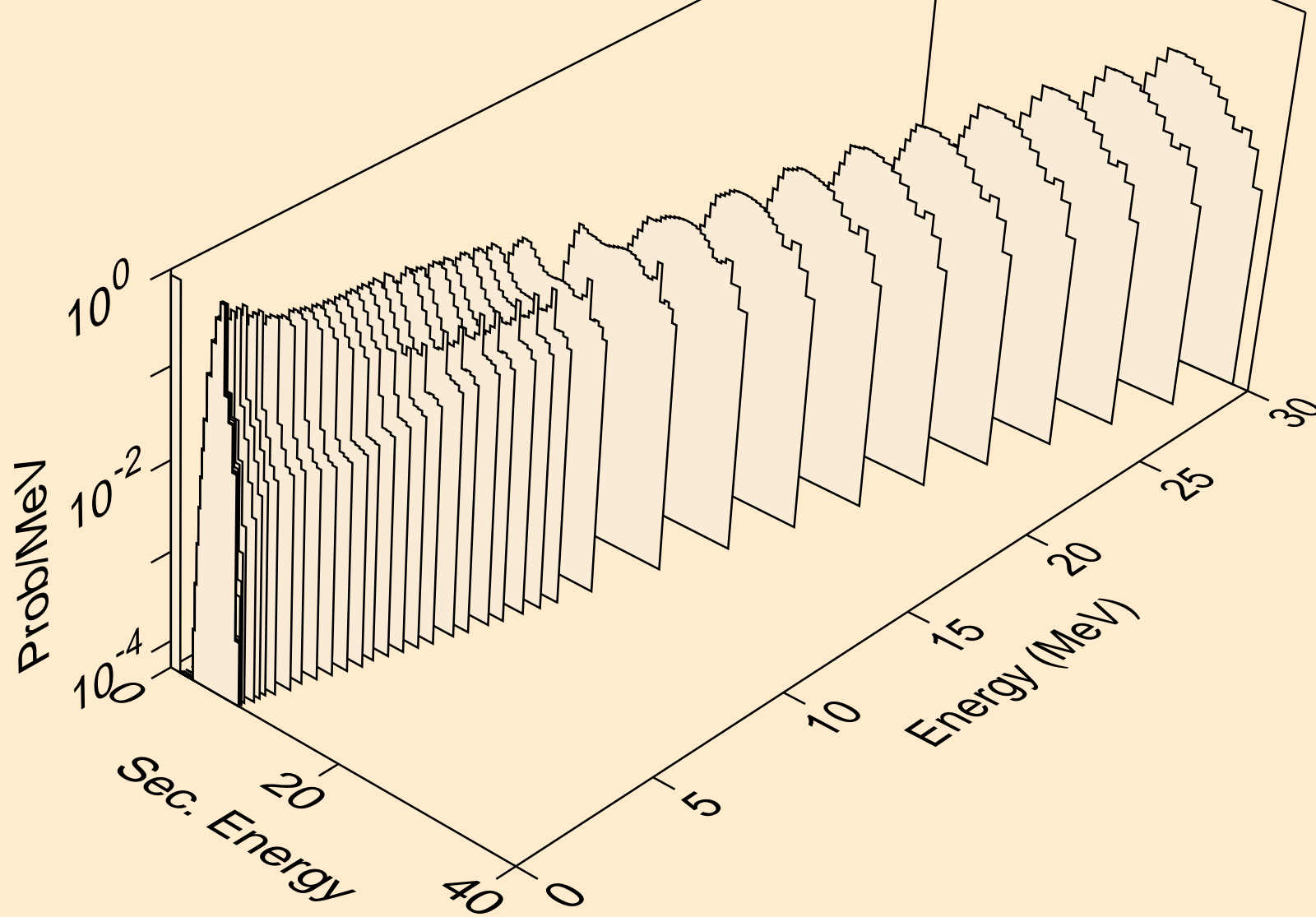

AT202 NEUTRON ACER TENDL-2023 LIBRARY; T=0.K
protons from (n,2p)

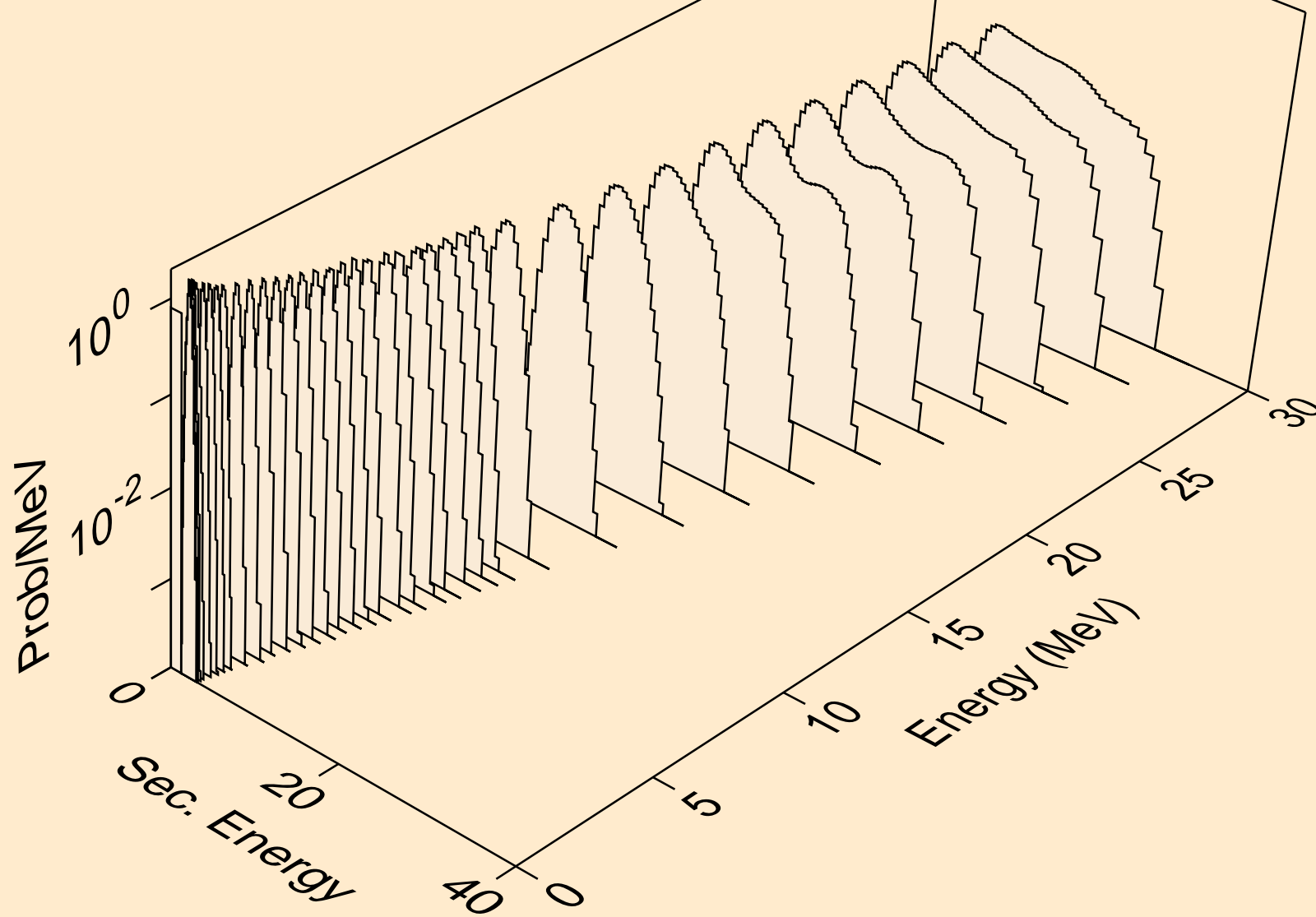

AT202 NEUTRON ACER TENDL-2023 LIBRARY; T=0.K
protons from (n,p)

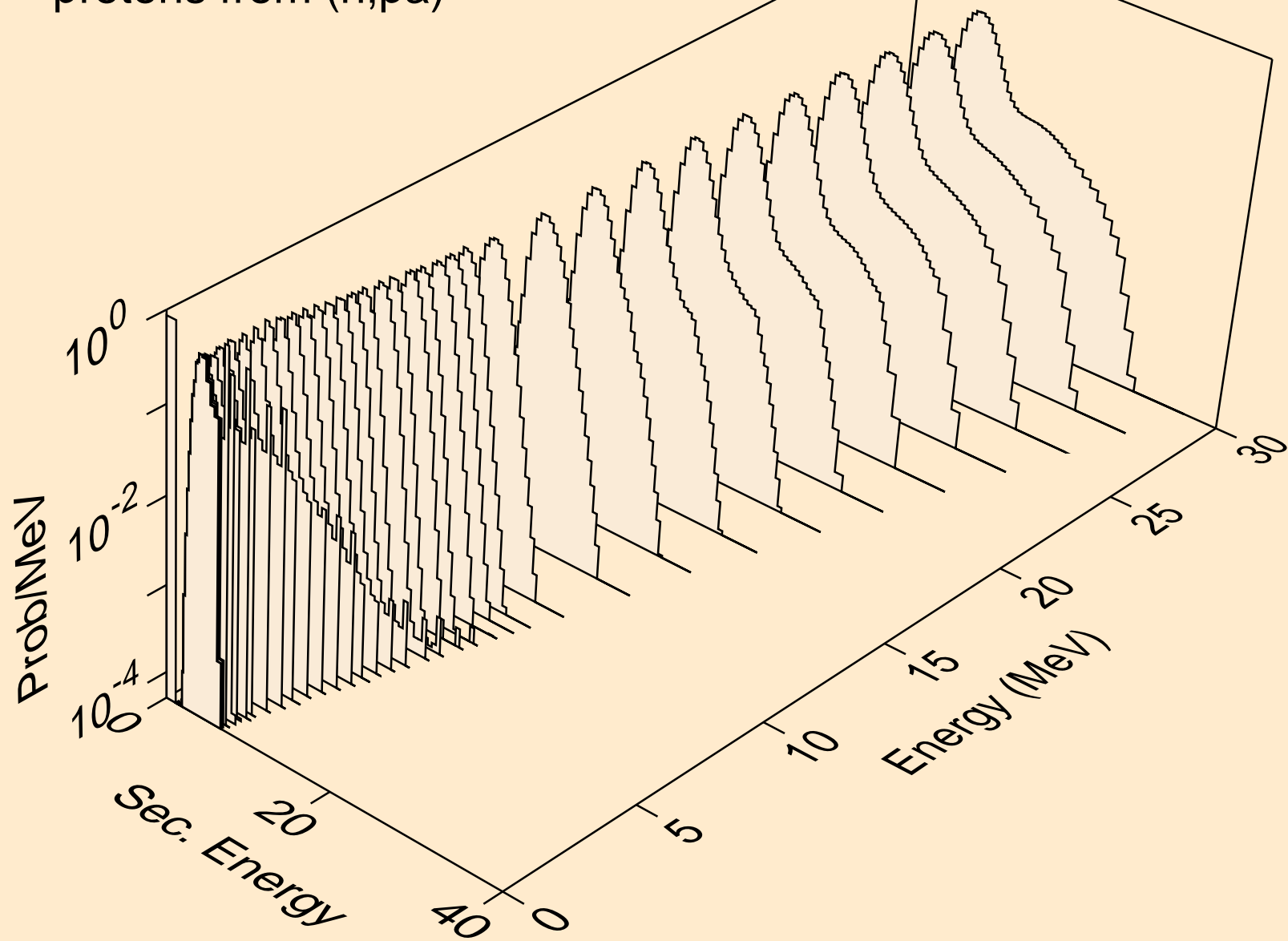

AT202 NEUTRON ACER TENDL-2023 LIBRARY; T=0.K
protons from (n,pd)

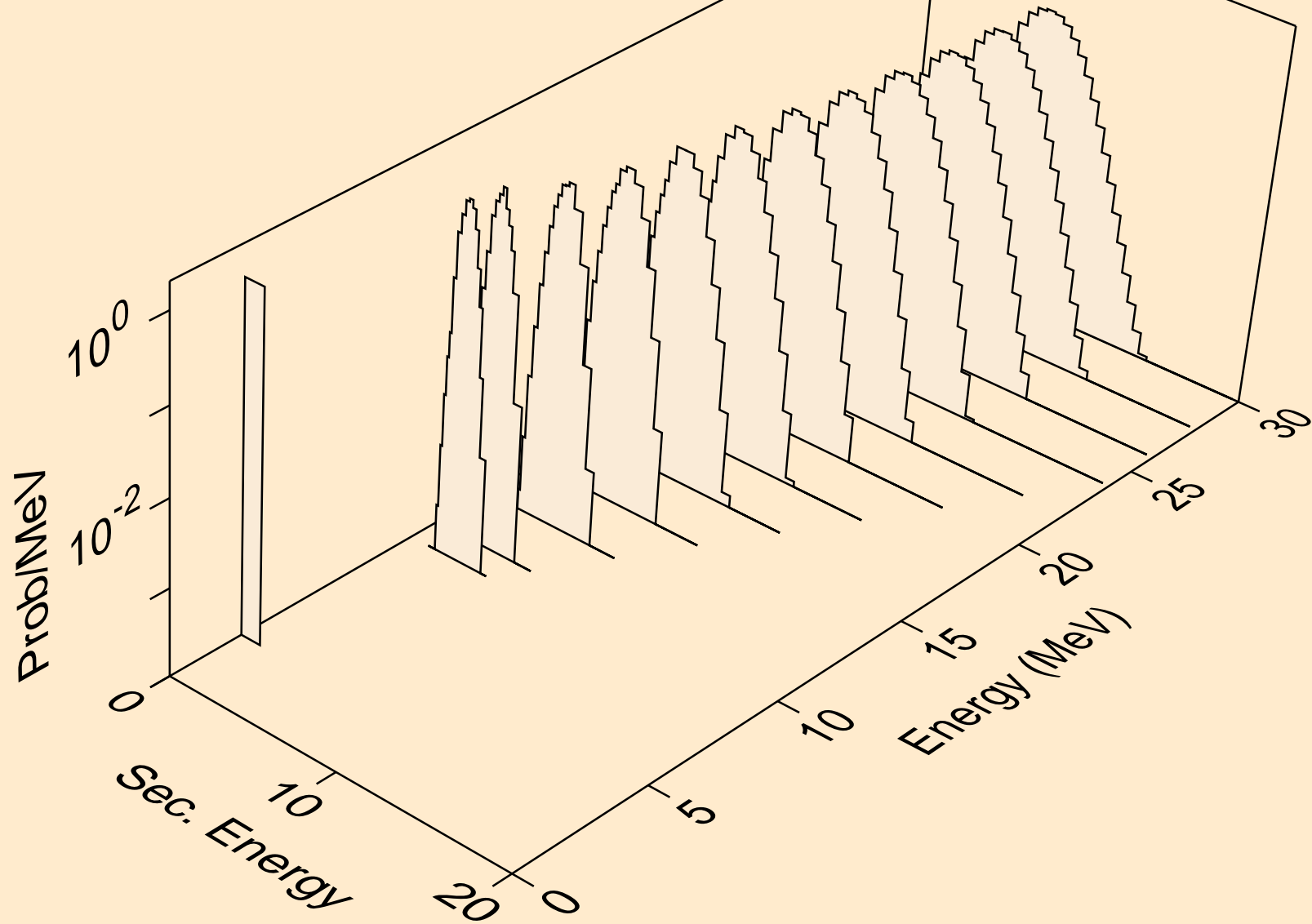

AT202 NEUTRON ACER TENDL-2023 LIBRARY; T=0.K
protons from (n,pt)

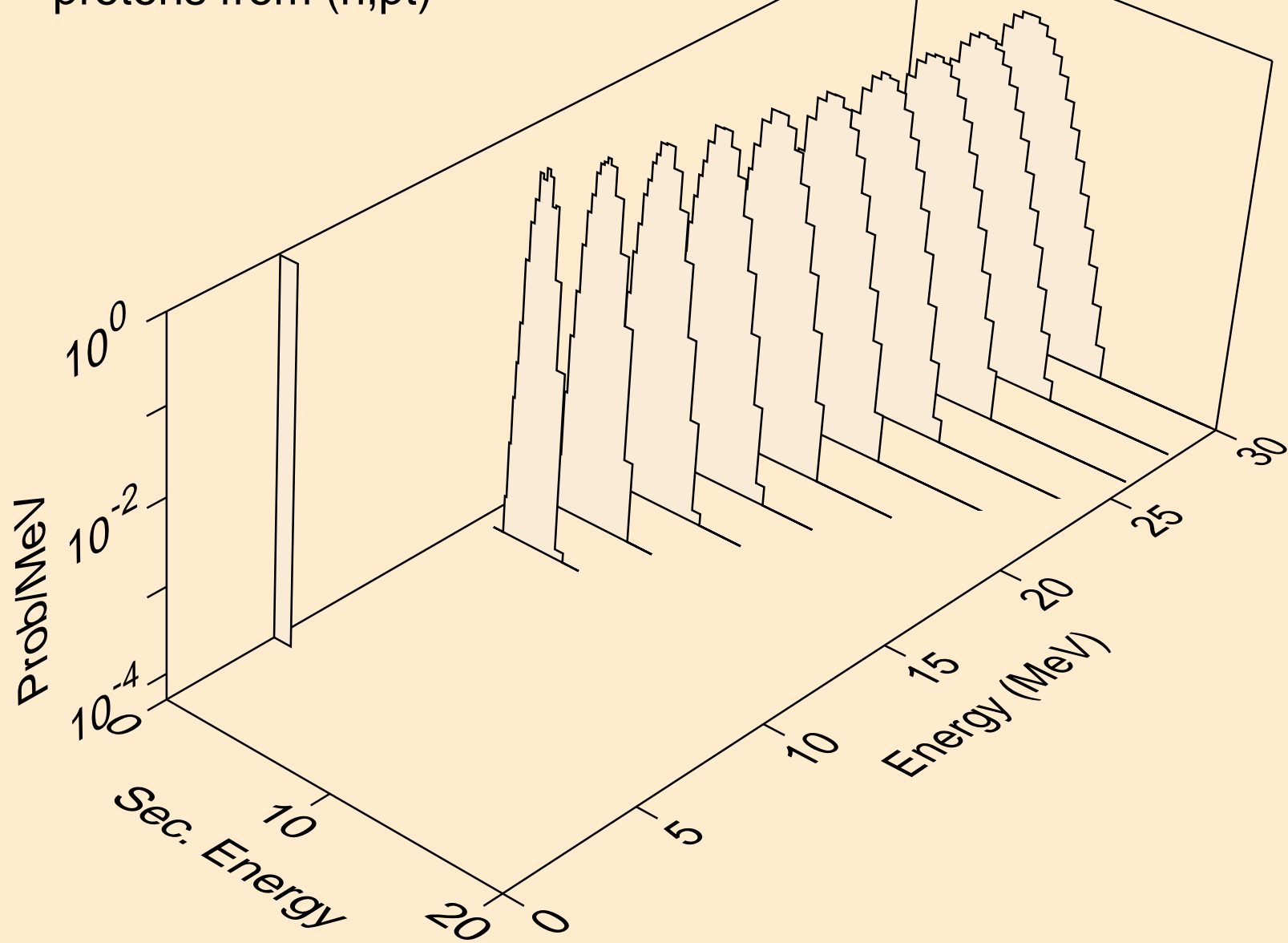

AT202 NEUTRON ACER TENDL-2023 LIBRARY; T=0.K
deuterons from (n,x)

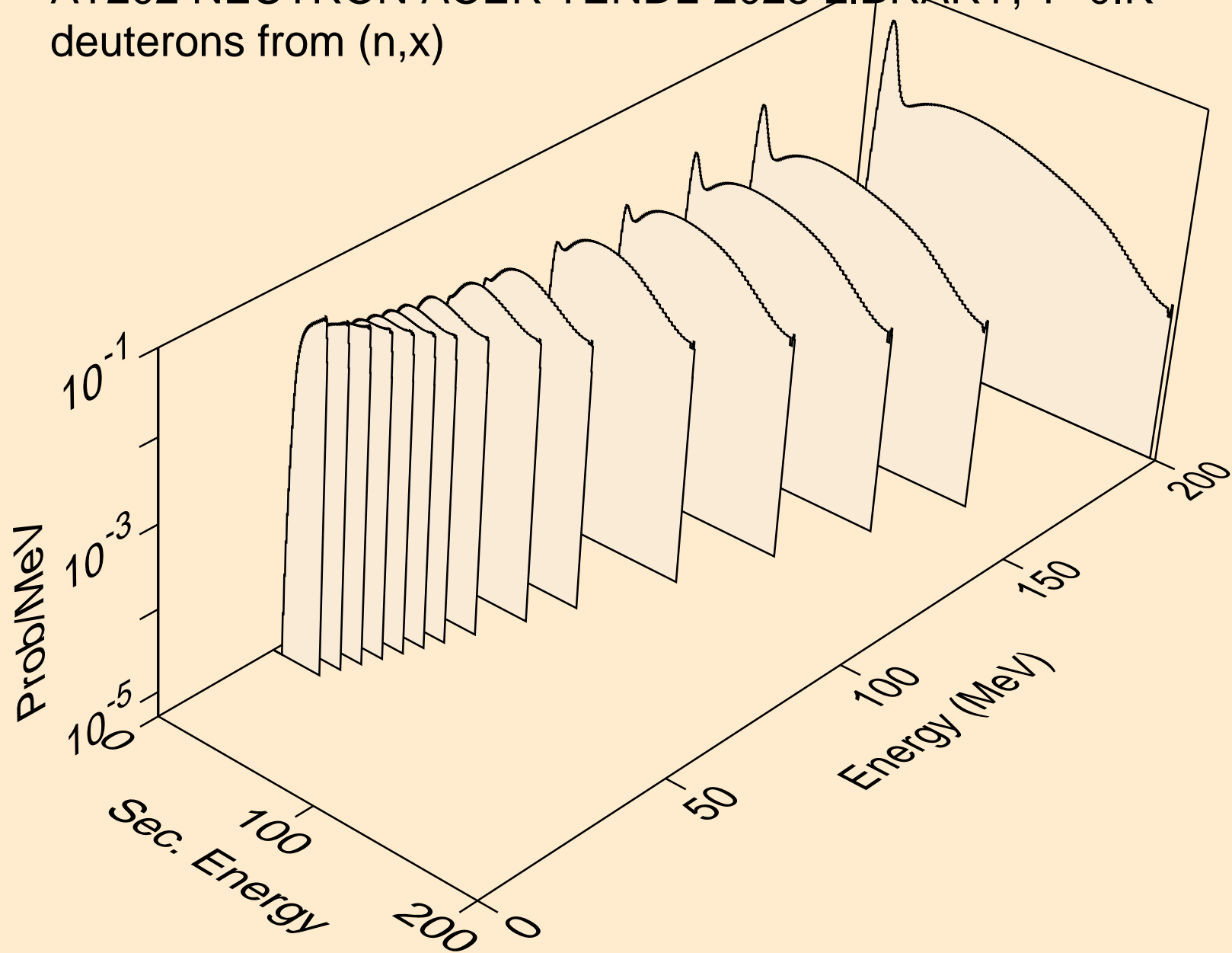

AT202 NEUTRON ACER TENDL-2023 LIBRARY; T=0.K
deuterons from (n,2nd)

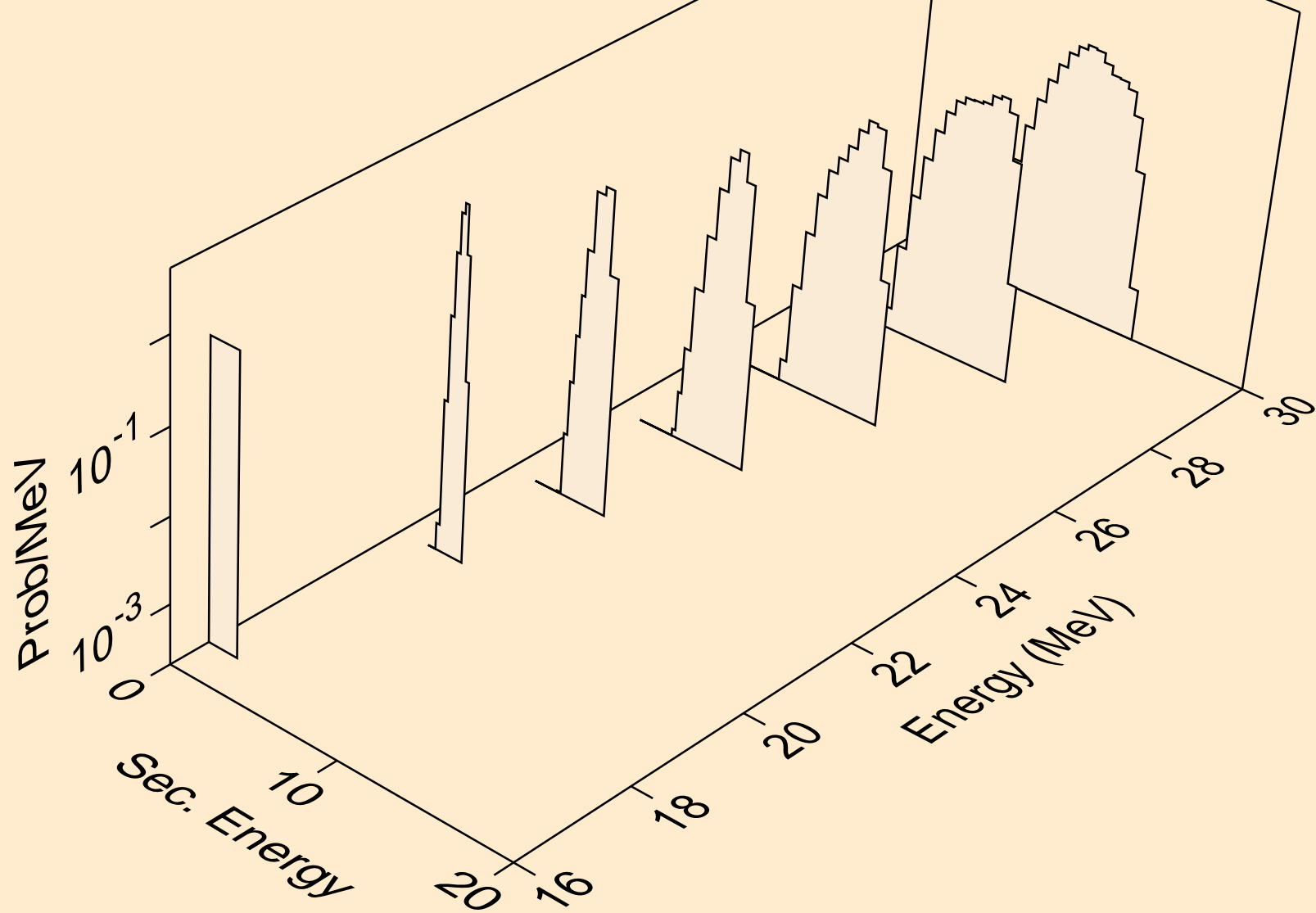

AT202 NEUTRON ACER TENDL-2023 LIBRARY; T=0.K
deuterons from (n,n*)d

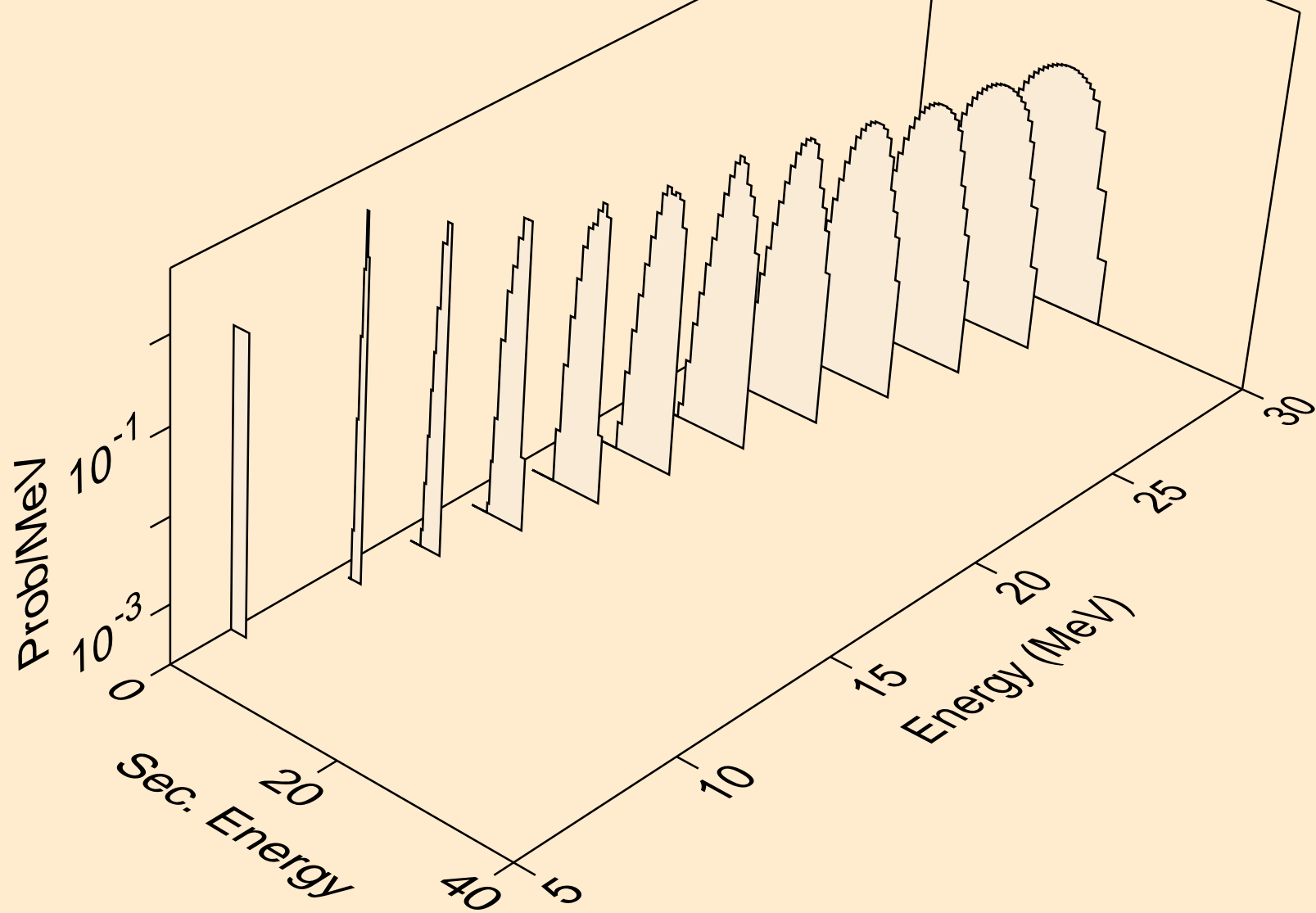

AT202 NEUTRON ACER TENDL-2023 LIBRARY; T=0.K
deuterons from (n,d)

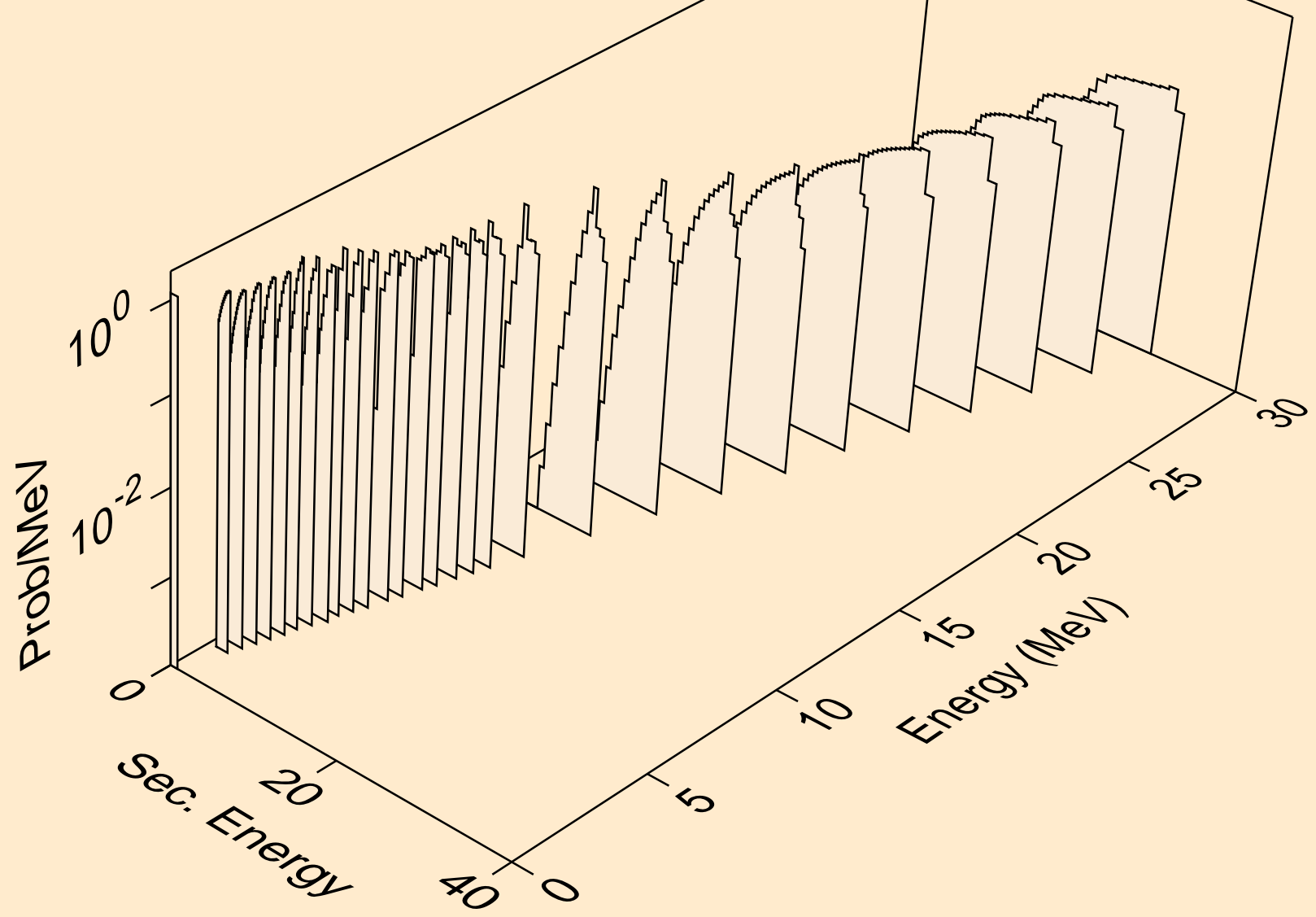

AT202 NEUTRON ACER TENDL-2023 LIBRARY; T=0.K
deuterons from (n,pd)

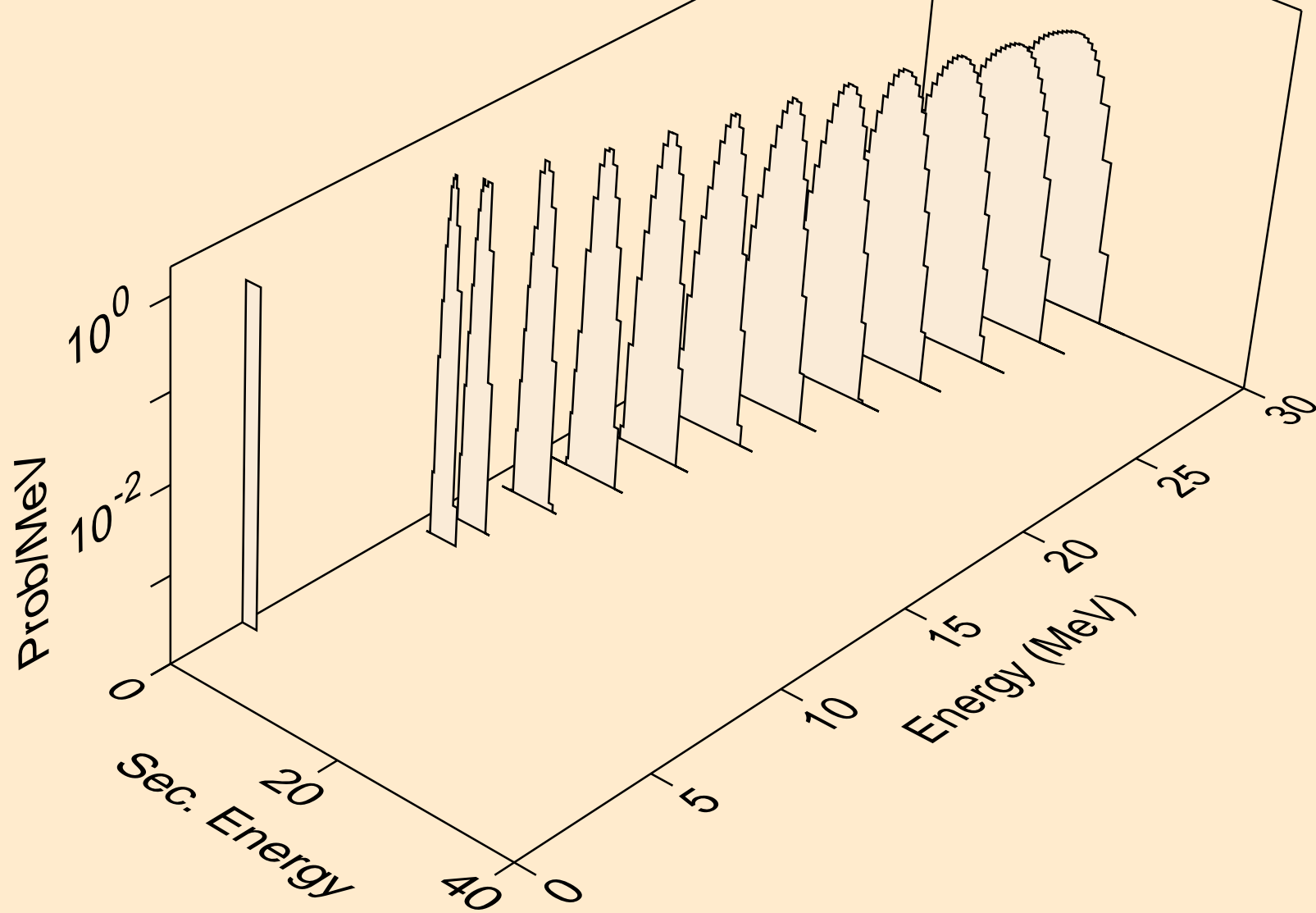

AT202 NEUTRON ACER TENDL-2023 LIBRARY; T=0.K
deuterons from (n,da)

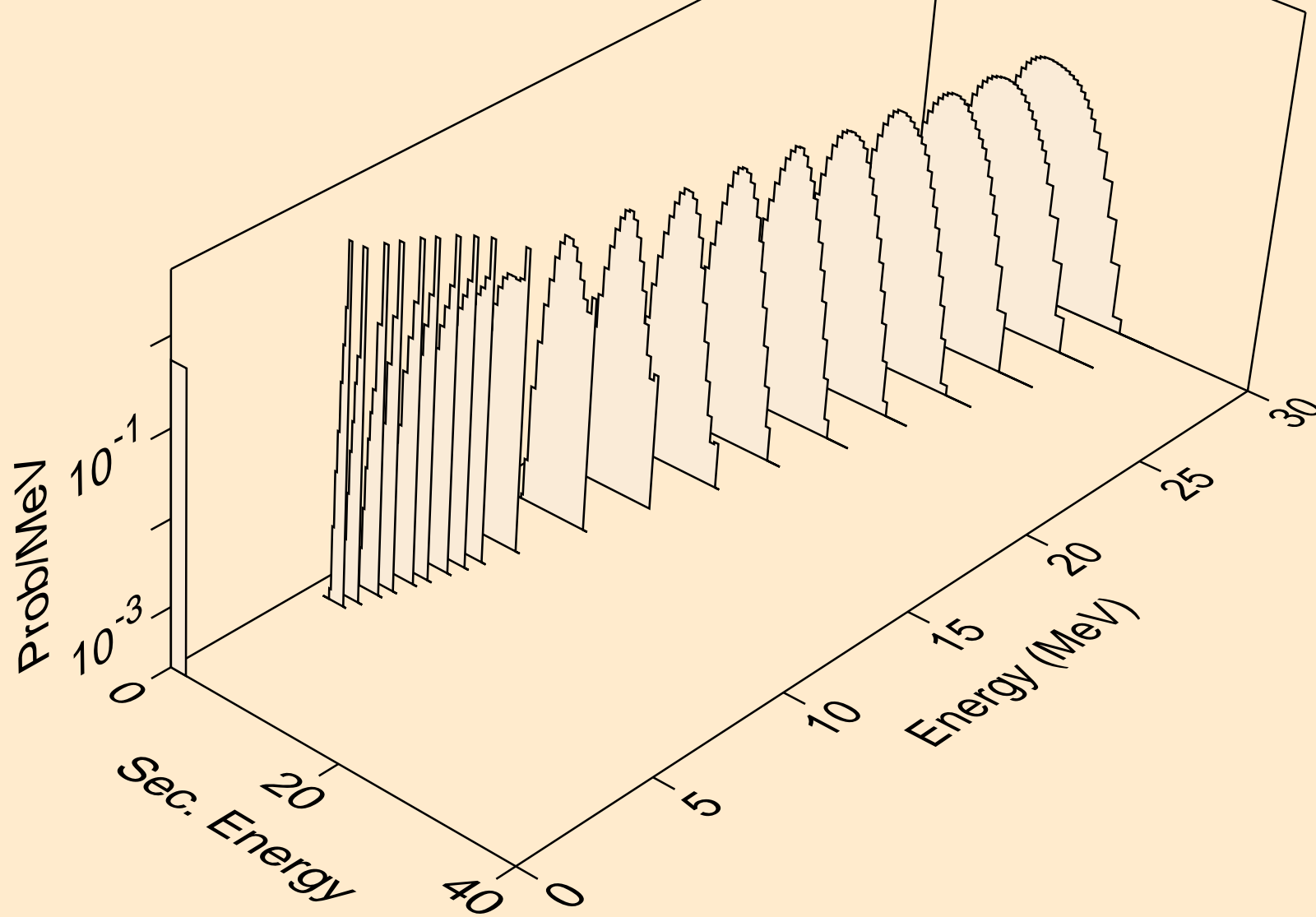

AT202 NEUTRON ACER TENDL-2023 LIBRARY; T=0.K
tritons from (n,x)

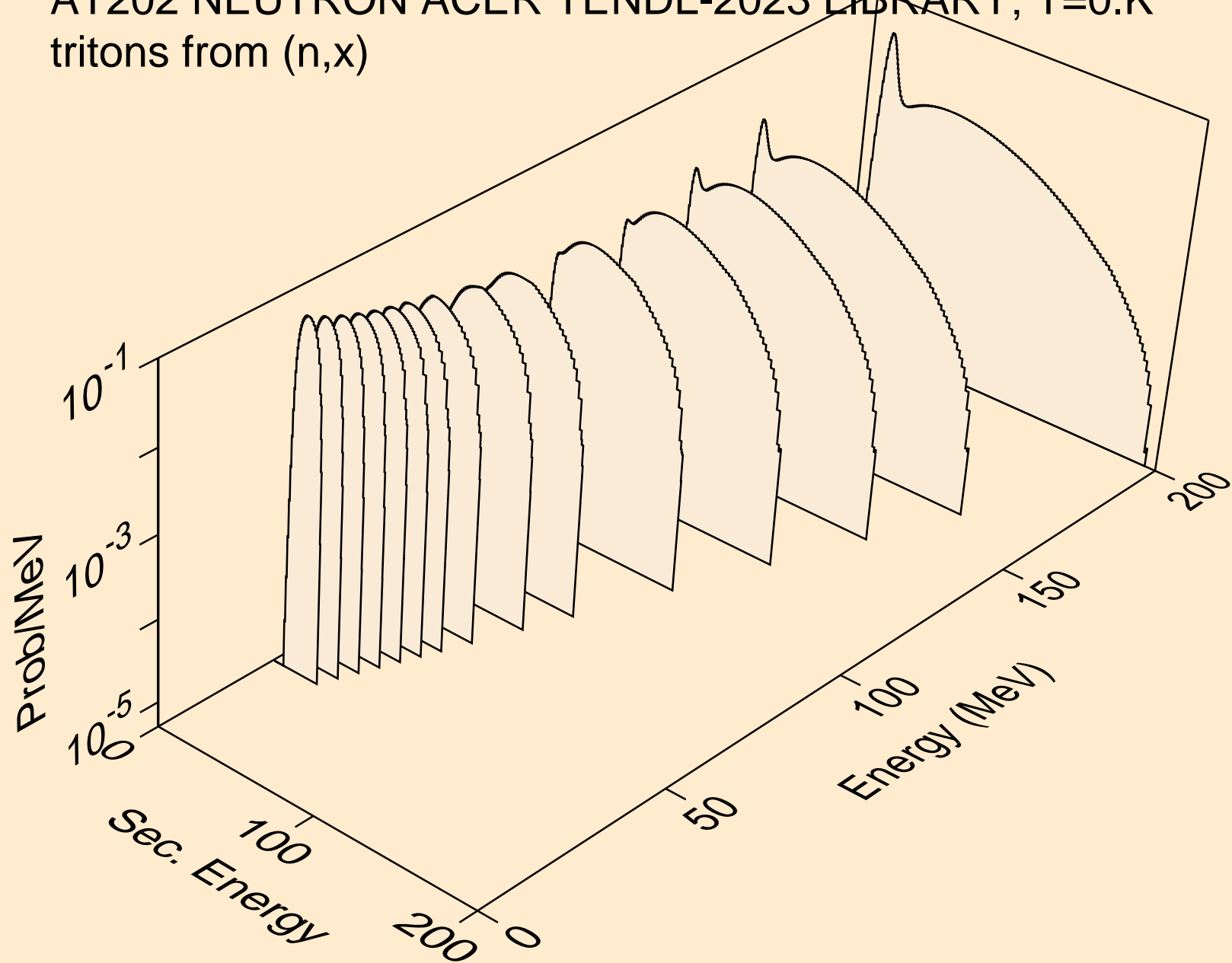

AT202 NEUTRON ACER TENDL-2023 LIBRARY; T=0.K
tritons from (n,n*)t

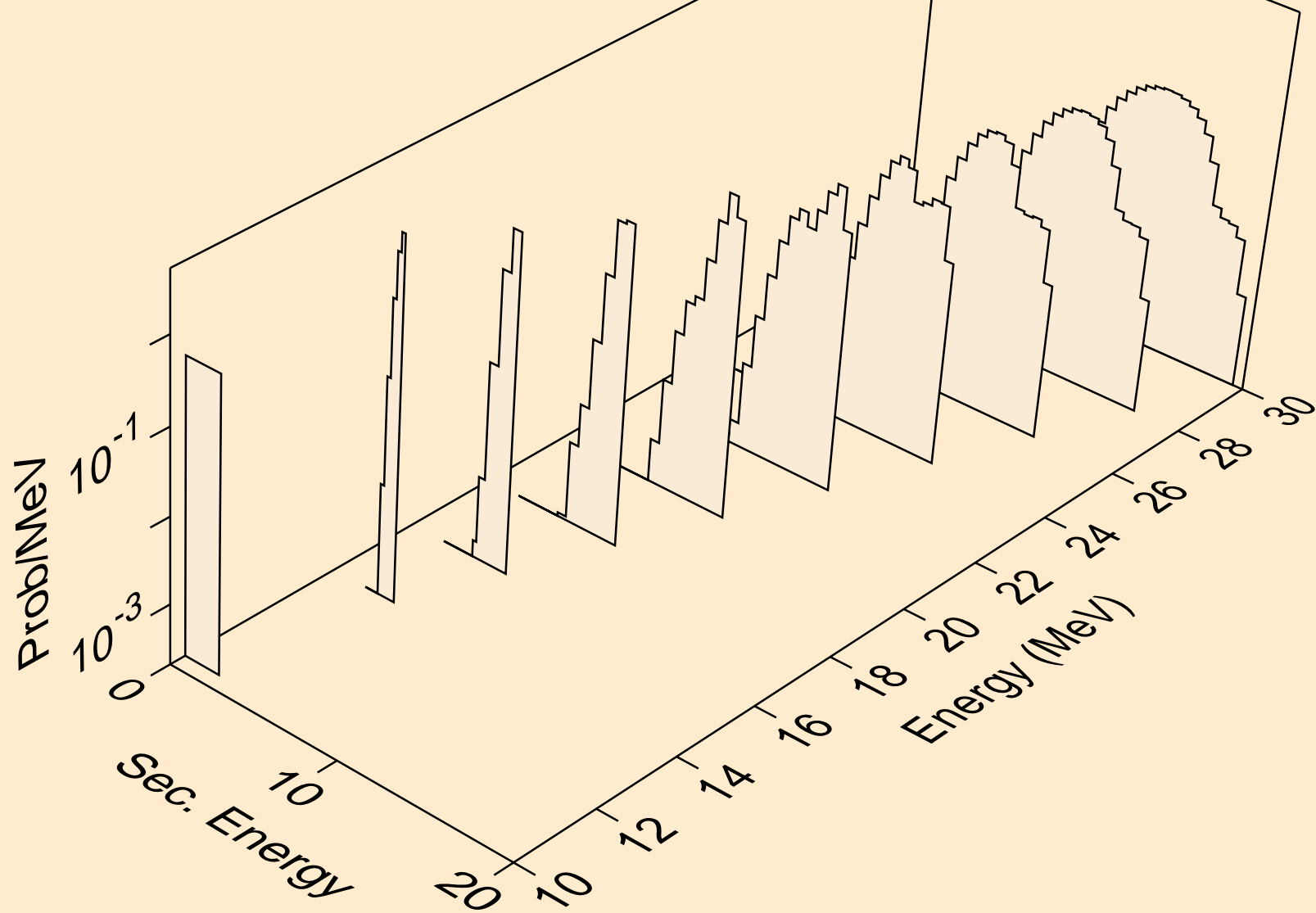

AT202 NEUTRON ACER TENDL-2023 LIBRARY; T=0.K
tritons from (n,t)

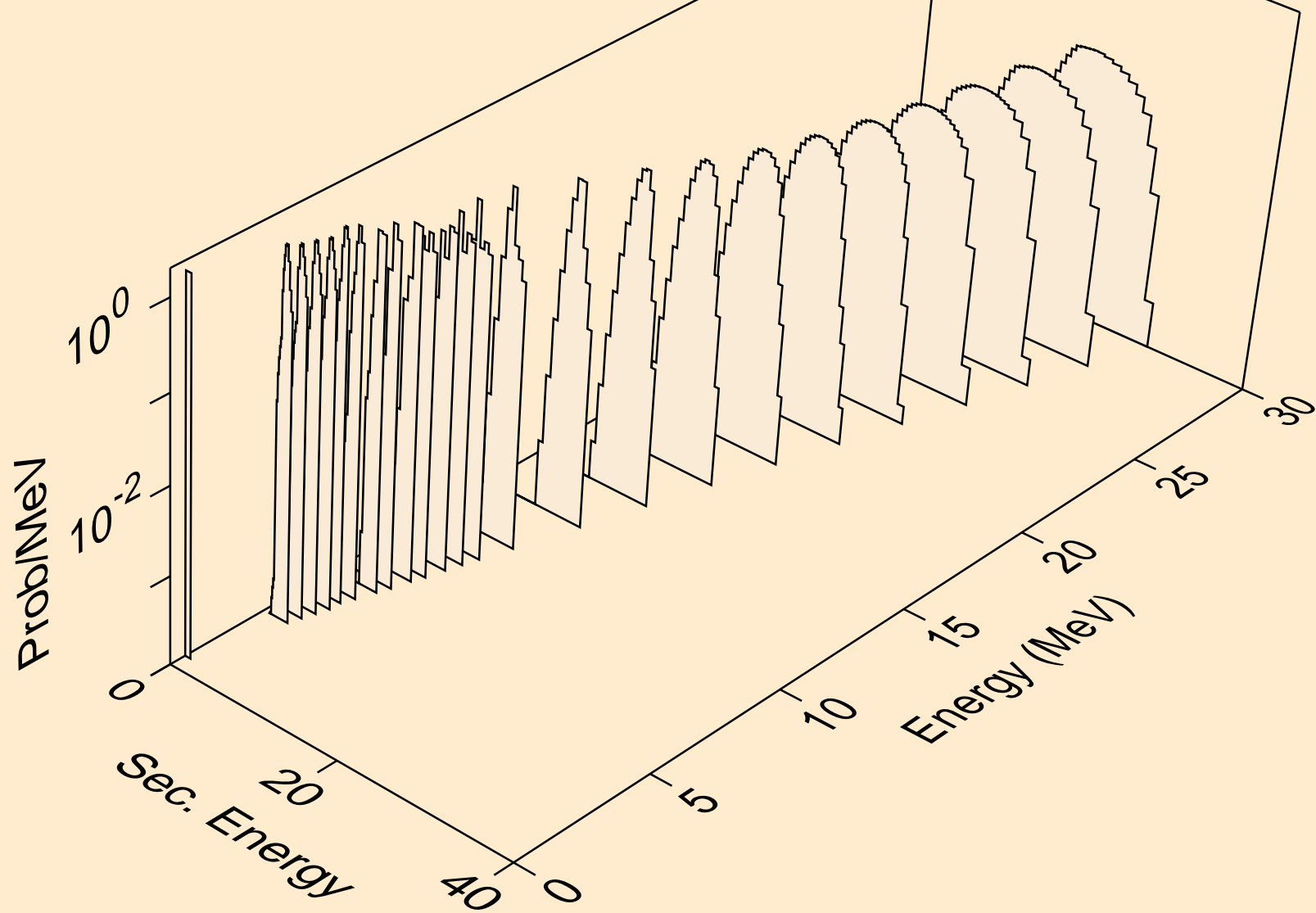

AT202 NEUTRON ACER TENDL-2023 LIBRARY; T=0.K
tritons from (n,pt)

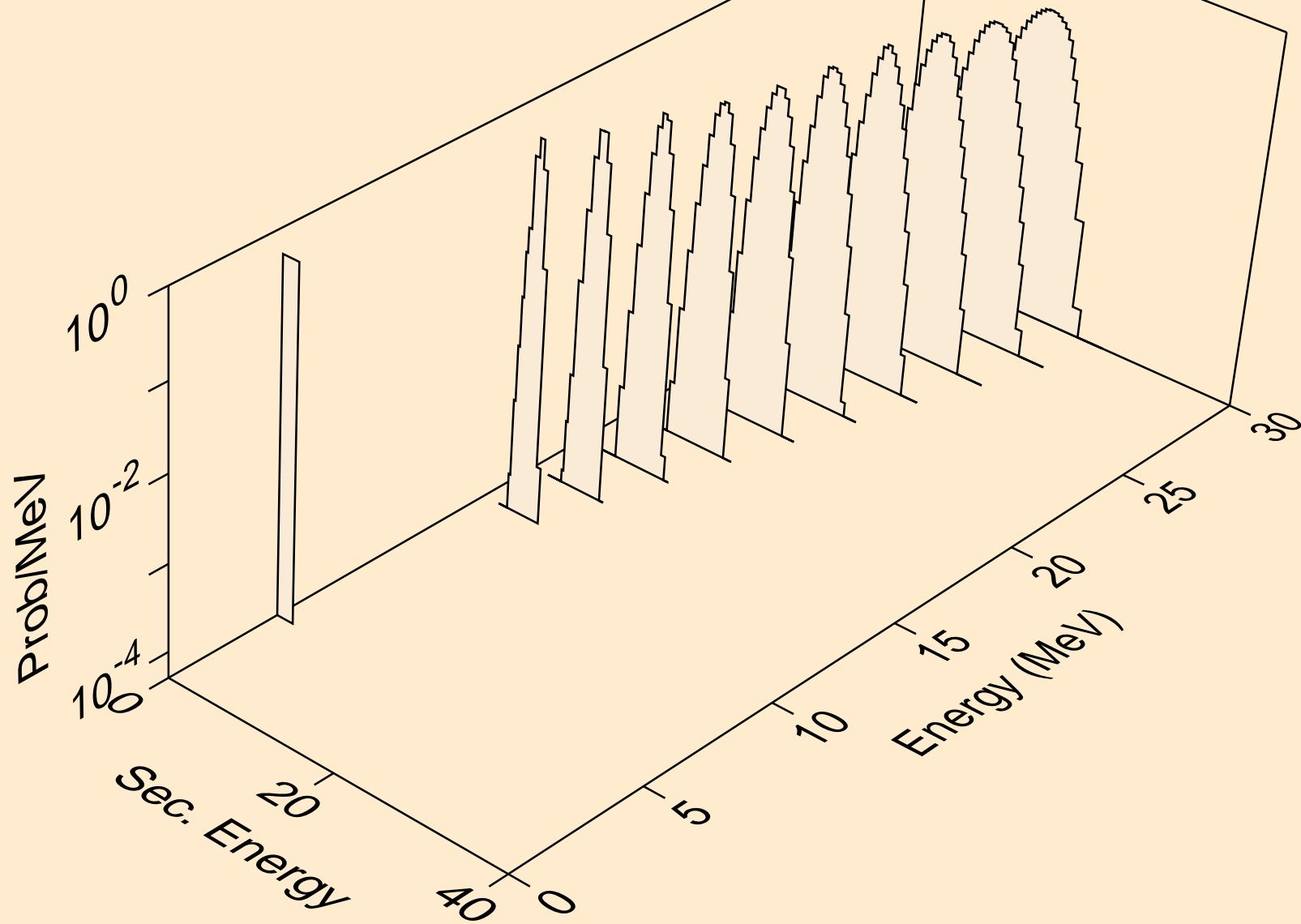

AT202 NEUTRON ACER TENDL-2023 LIBRARY; T=0.K
he3s from (n,x)

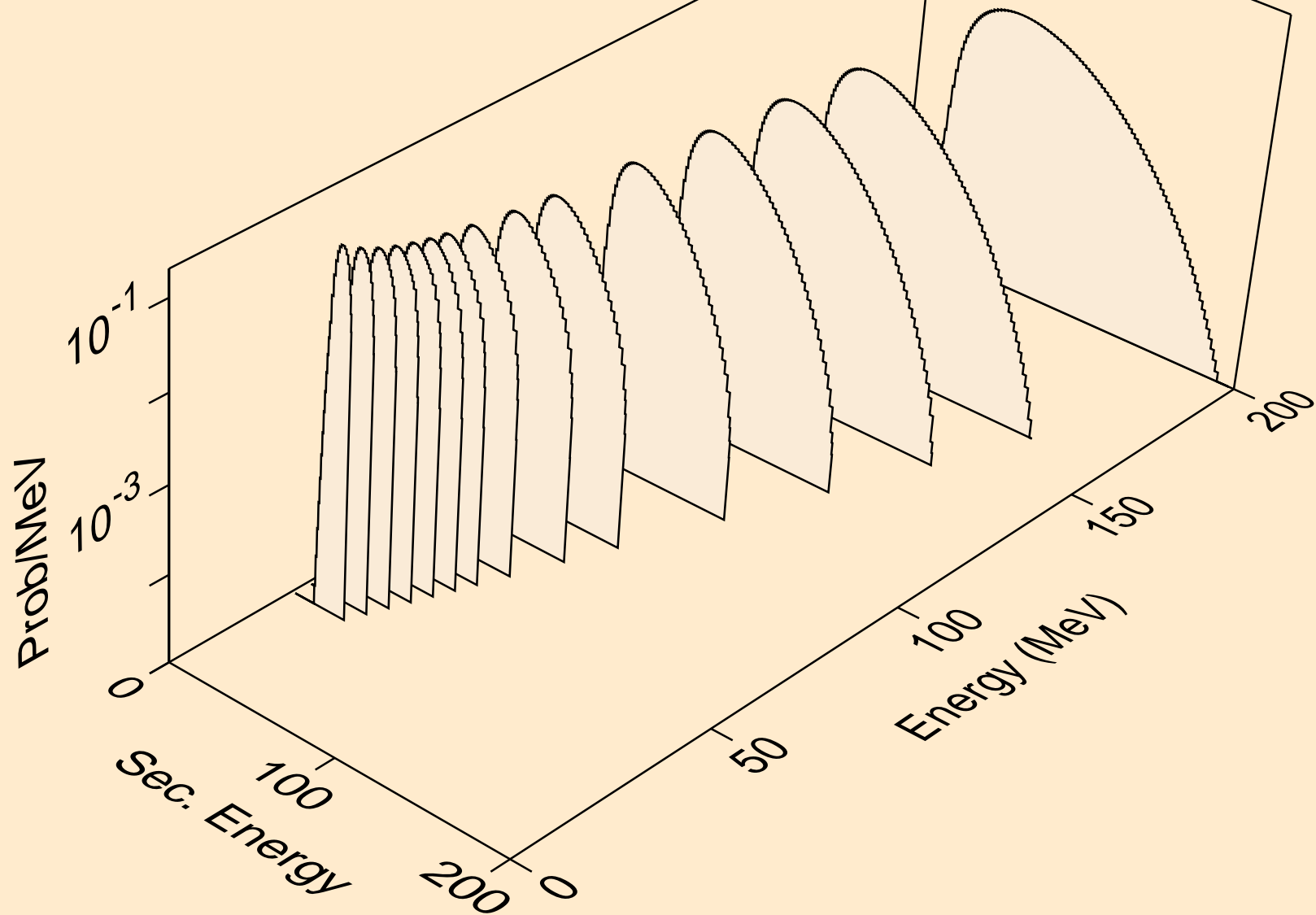

AT202 NEUTRON ACER TENDL-2023 LIBRARY; T=0.K
he3s from (n,n*)he3

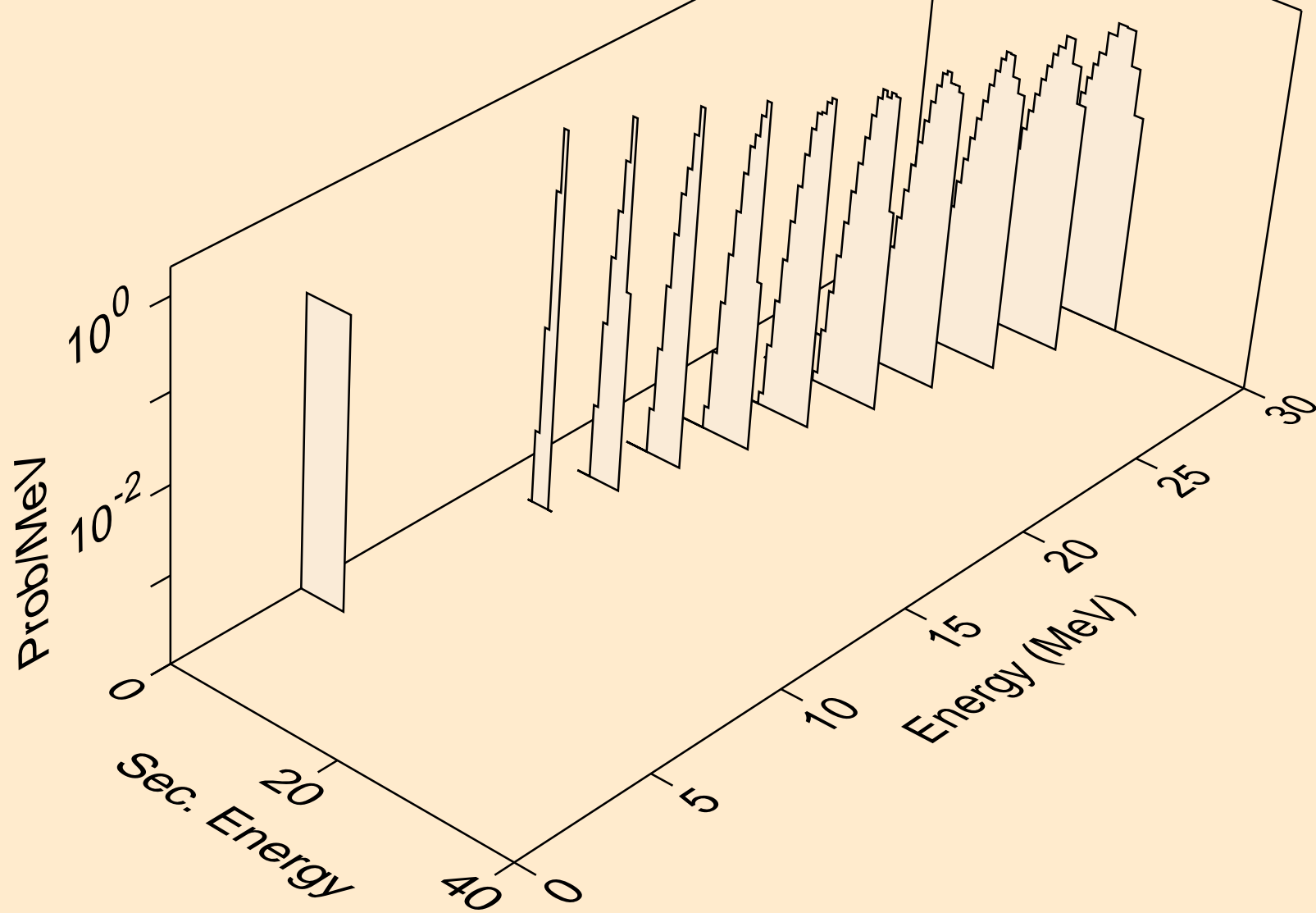

AT202 NEUTRON ACER TENDL-2023 LIBRARY; T=0.K
he3s from (n,he3)

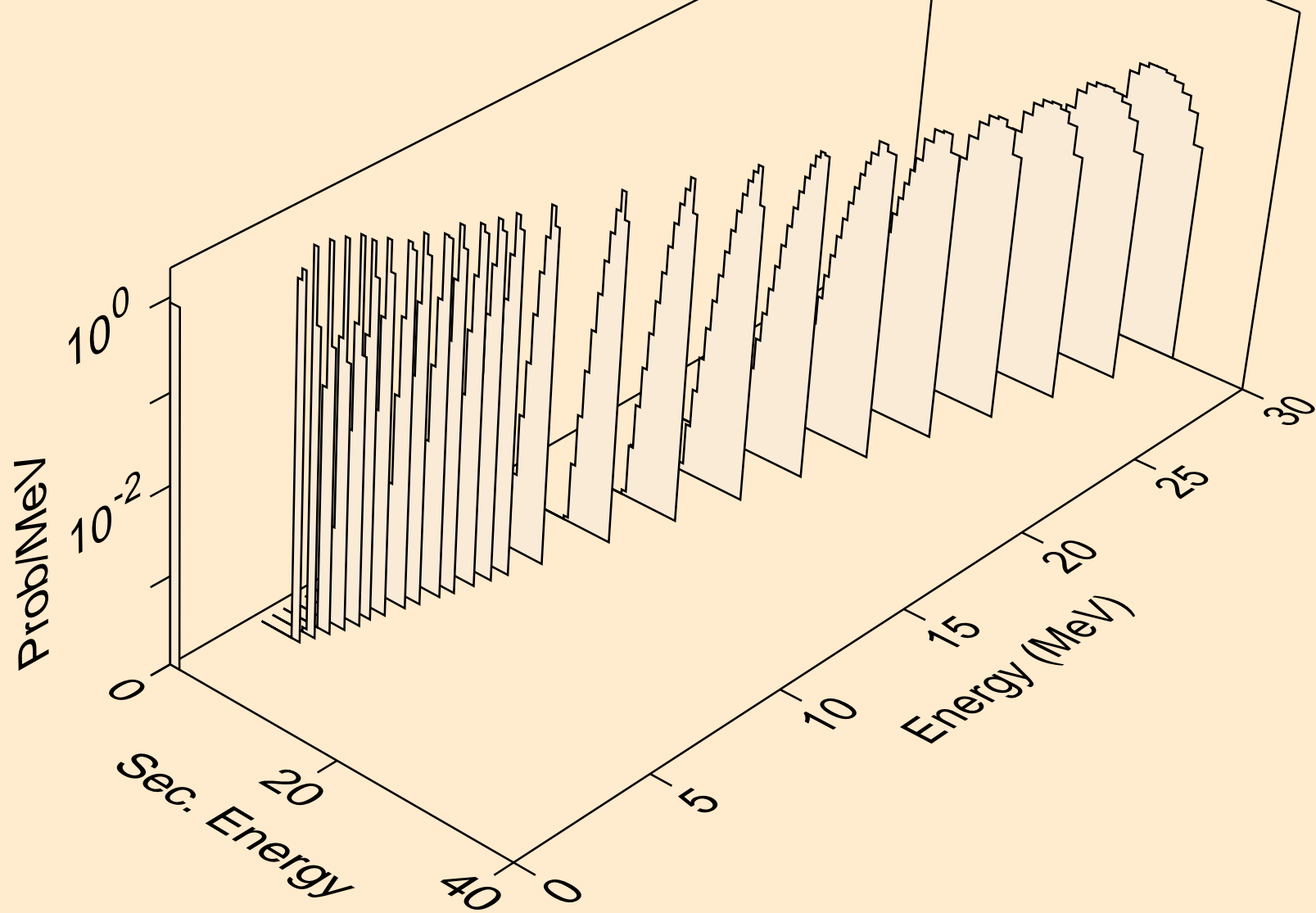

AT202 NEUTRON ACER TENDL-2023 LIBRARY; T=0.K
alphas from (n,x)

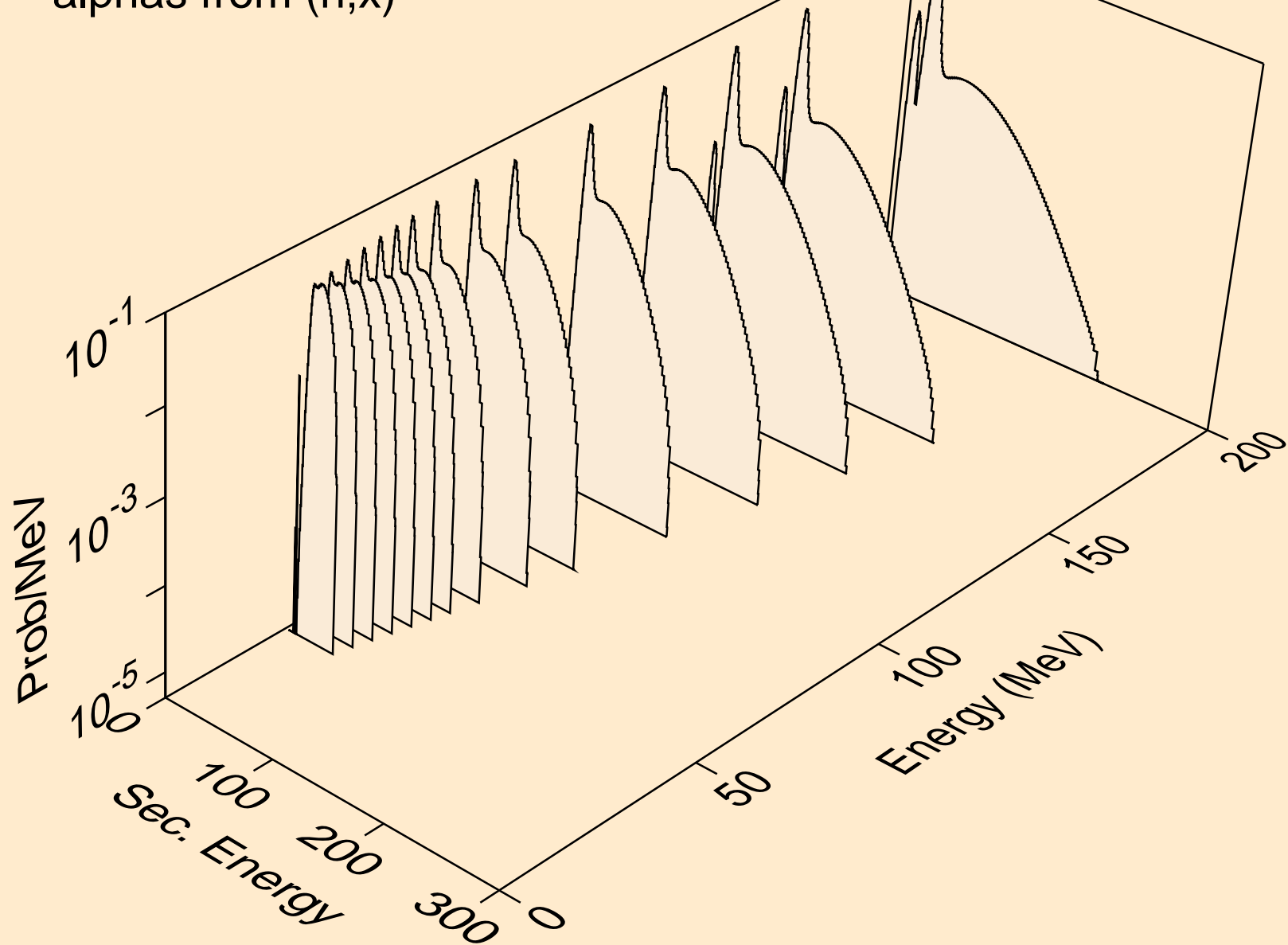

AT202 NEUTRON ACER TENDL-2023 LIBRARY; T=0.K
alphas from (n,n*)a

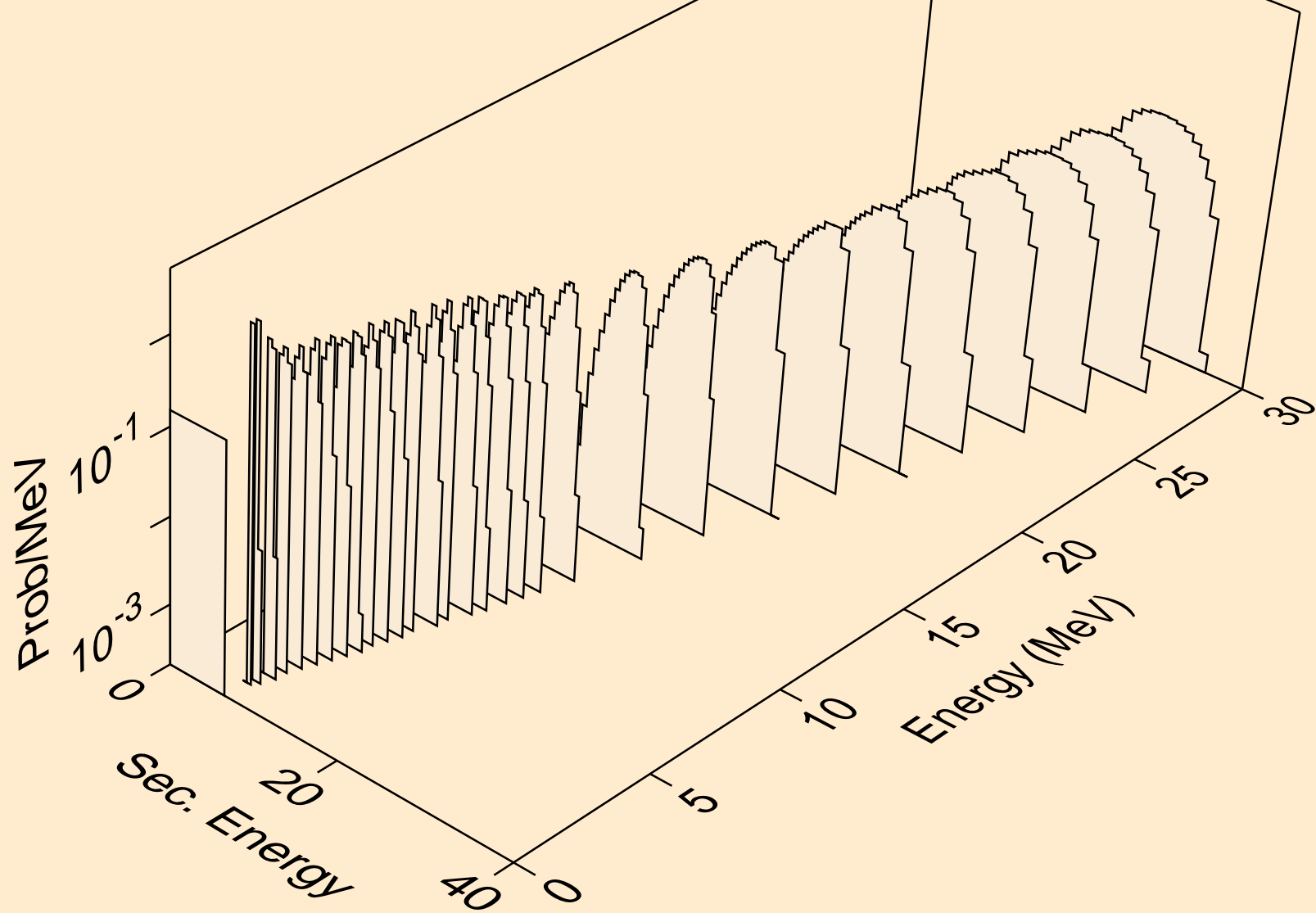

AT202 NEUTRON ACER TENDL-2023 LIBRARY; T=0.K
alphas from (n,2n)a

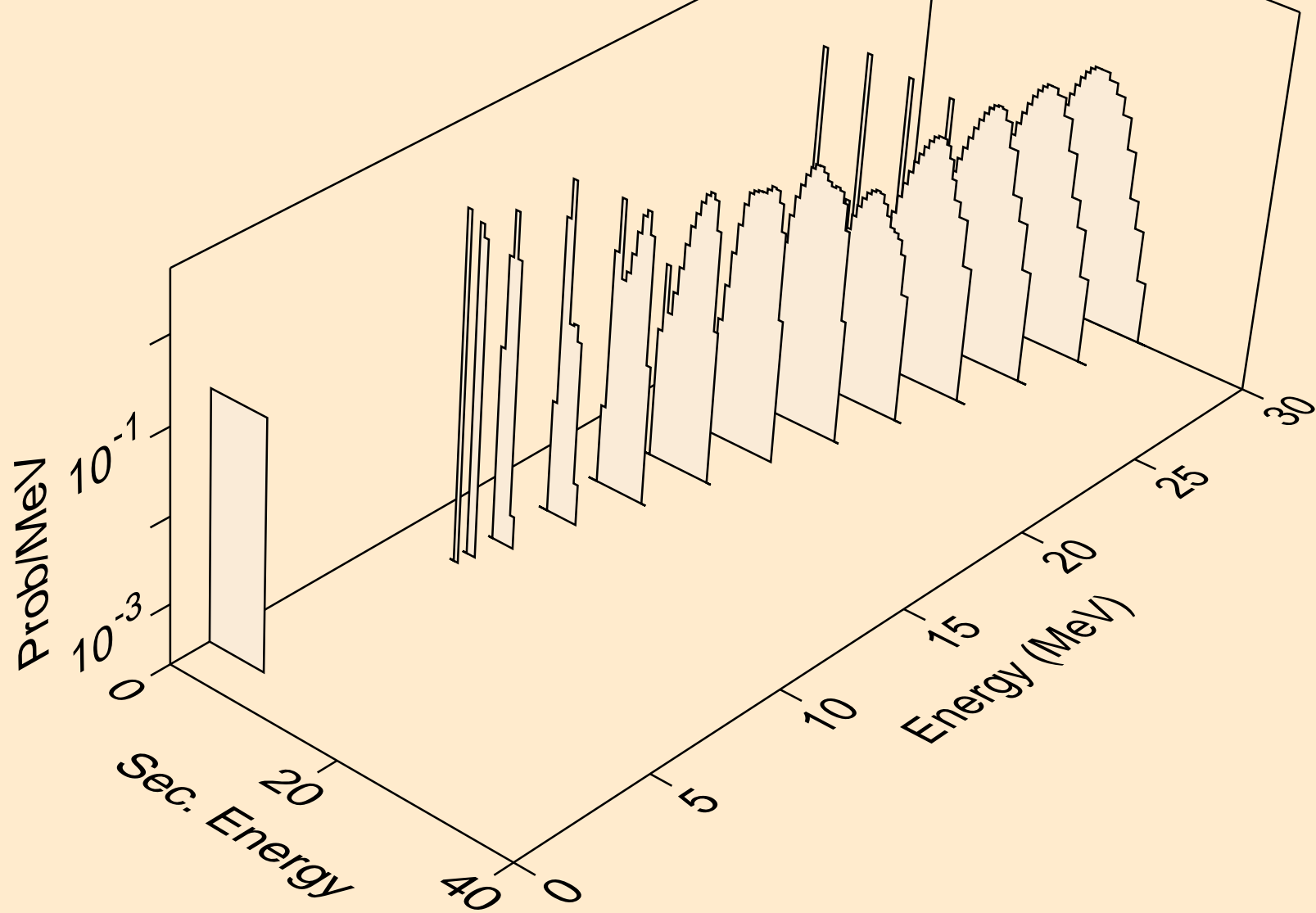

AT202 NEUTRON ACER TENDL-2023 LIBRARY; T=0.K
alphas from (n,3n)a

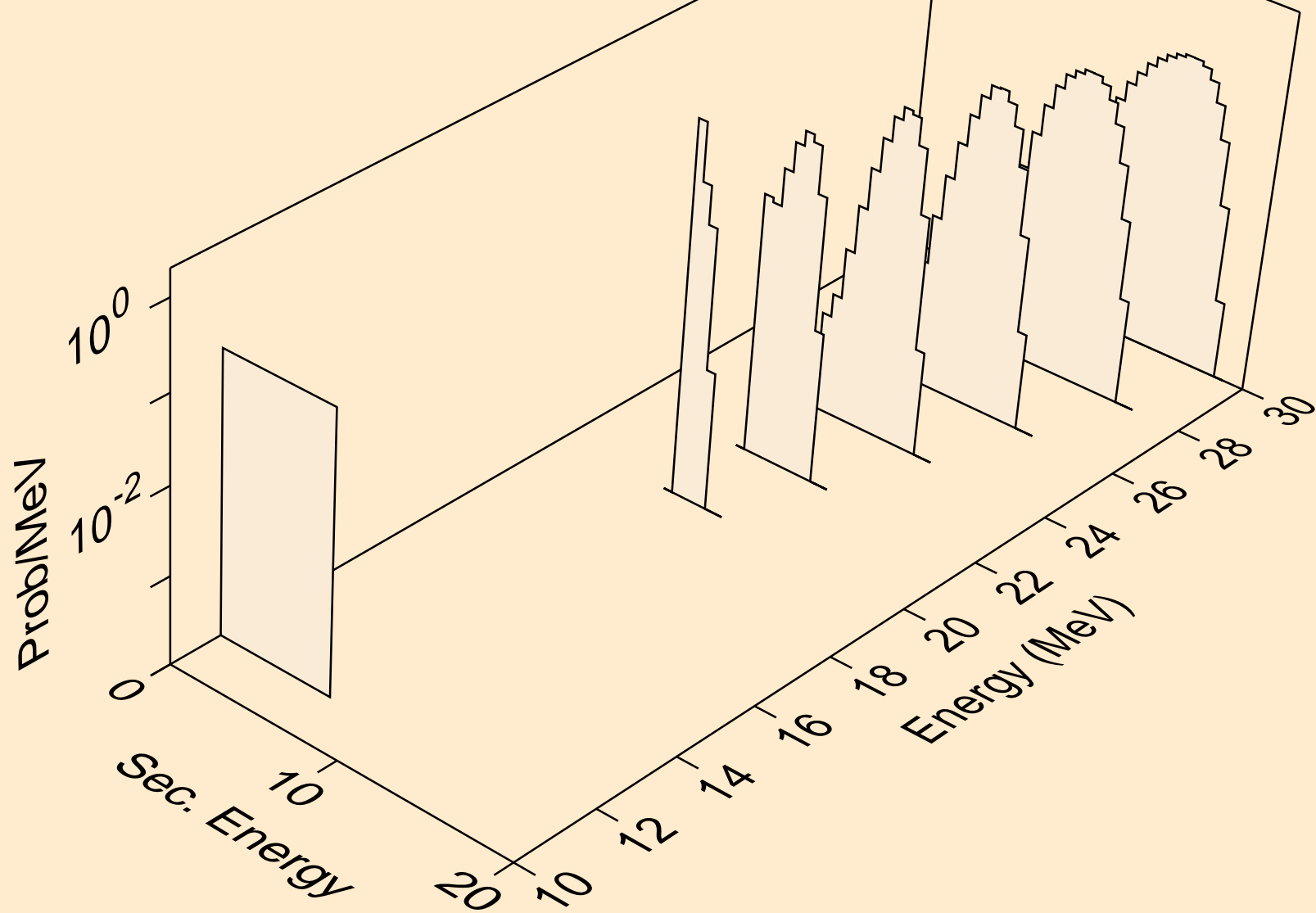

AT202 NEUTRON ACER TENDL-2023 LIBRARY; T=0.K
alphas from (n,n*)2a

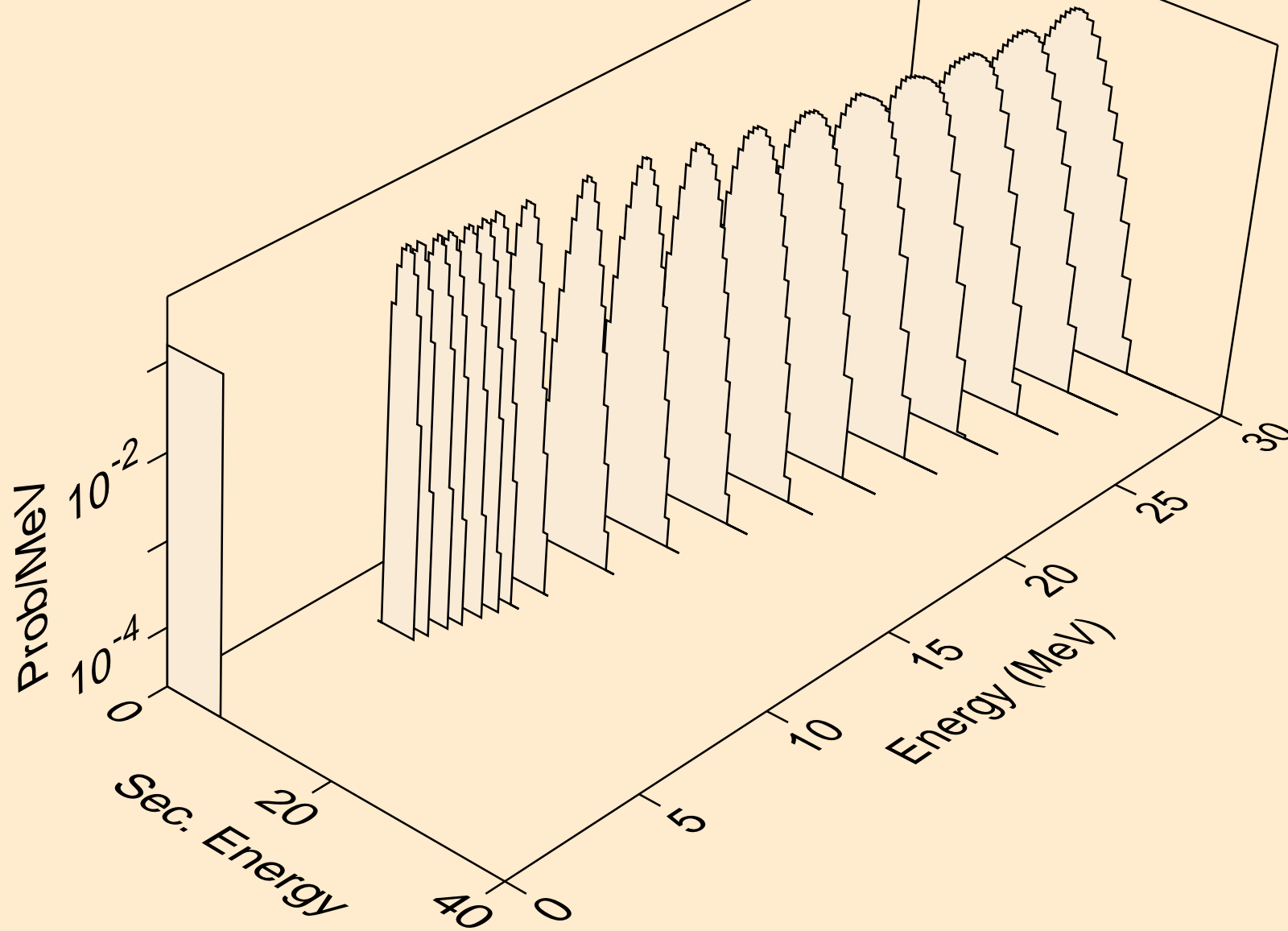

AT202 NEUTRON ACER TENDL-2023 LIBRARY; T=0.K
alphas from (n,2n)2a

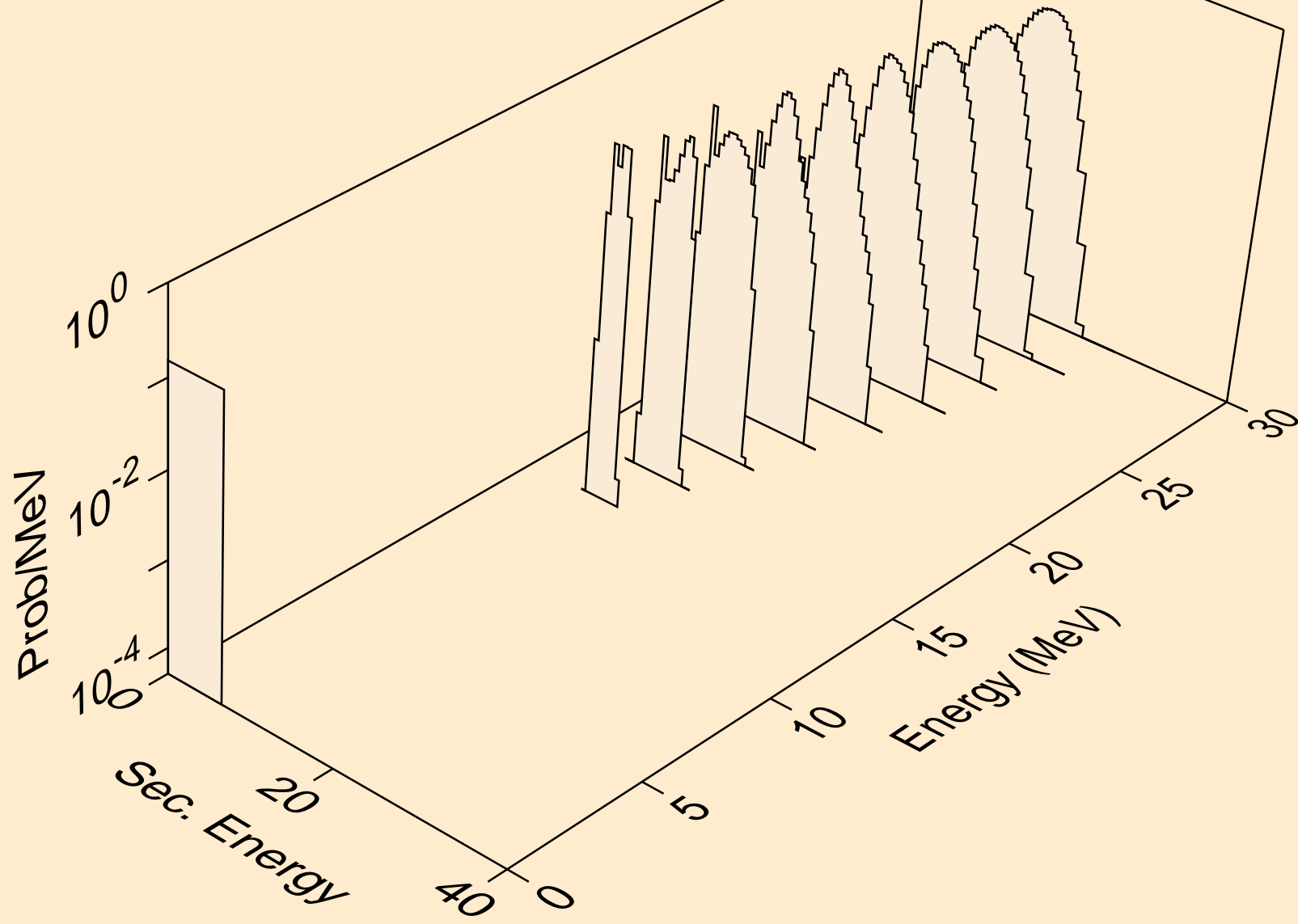

AT202 NEUTRON ACER TENDL-2023 LIBRARY; T=0.K
alphas from (n,npa)

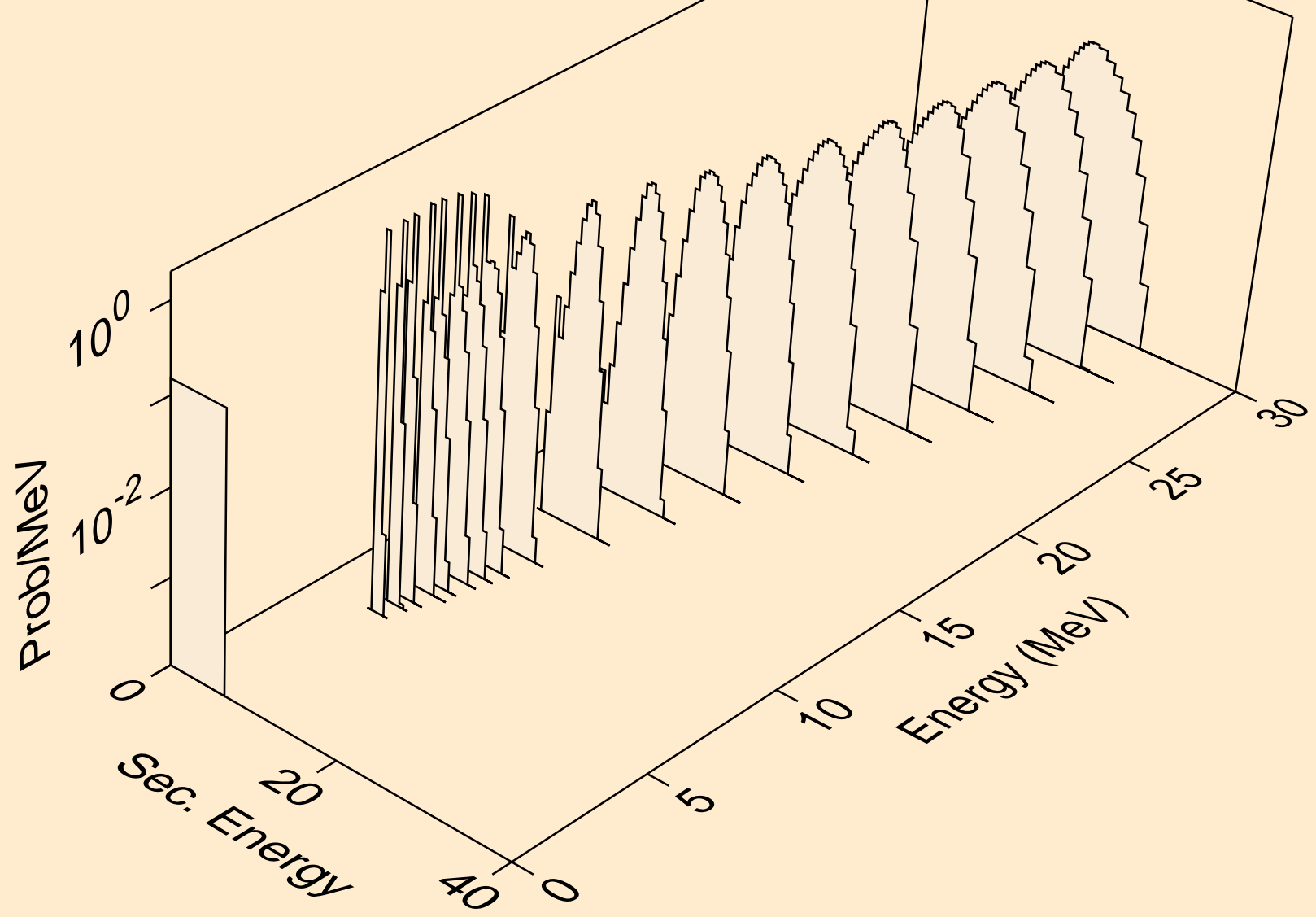

AT202 NEUTRON ACER TENDL-2023 LIBRARY; T=0.K
alphas from (n,a)

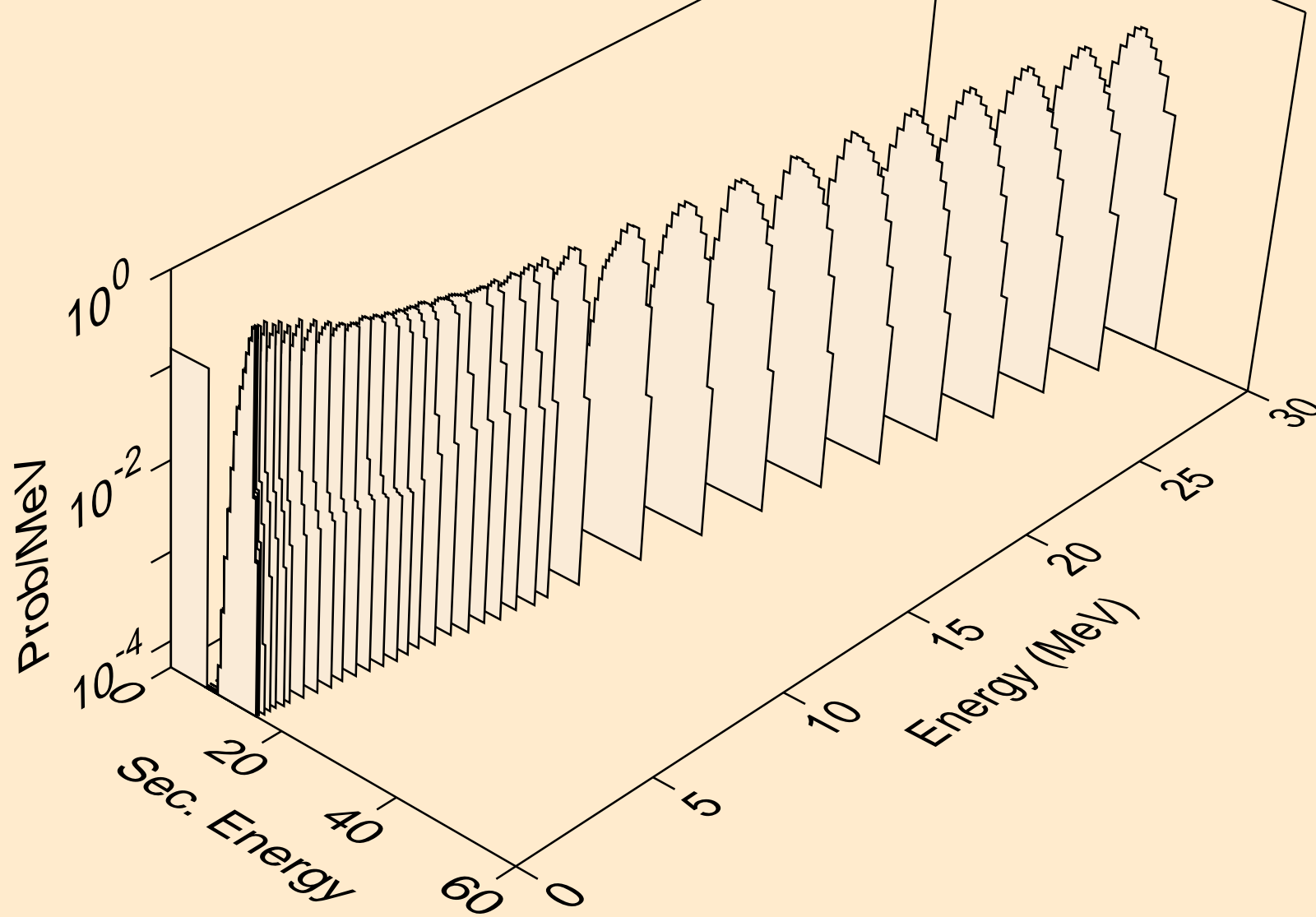

AT202 NEUTRON ACER TENDL-2023 LIBRARY; T=0.K
alphas from (n,2a)

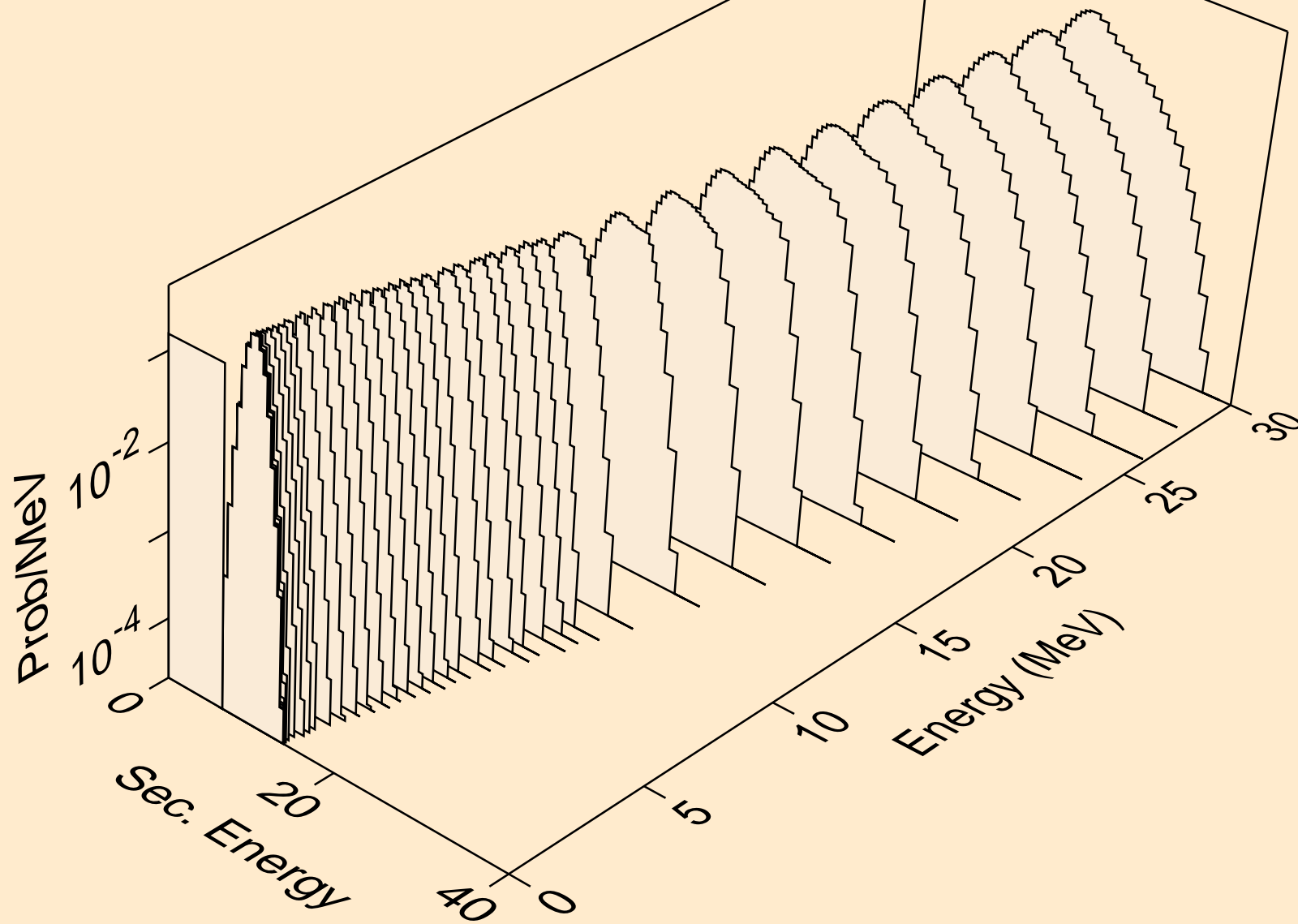

AT202 NEUTRON ACER TENDL-2023 LIBRARY; T=0.K
alphas from (n,pa)

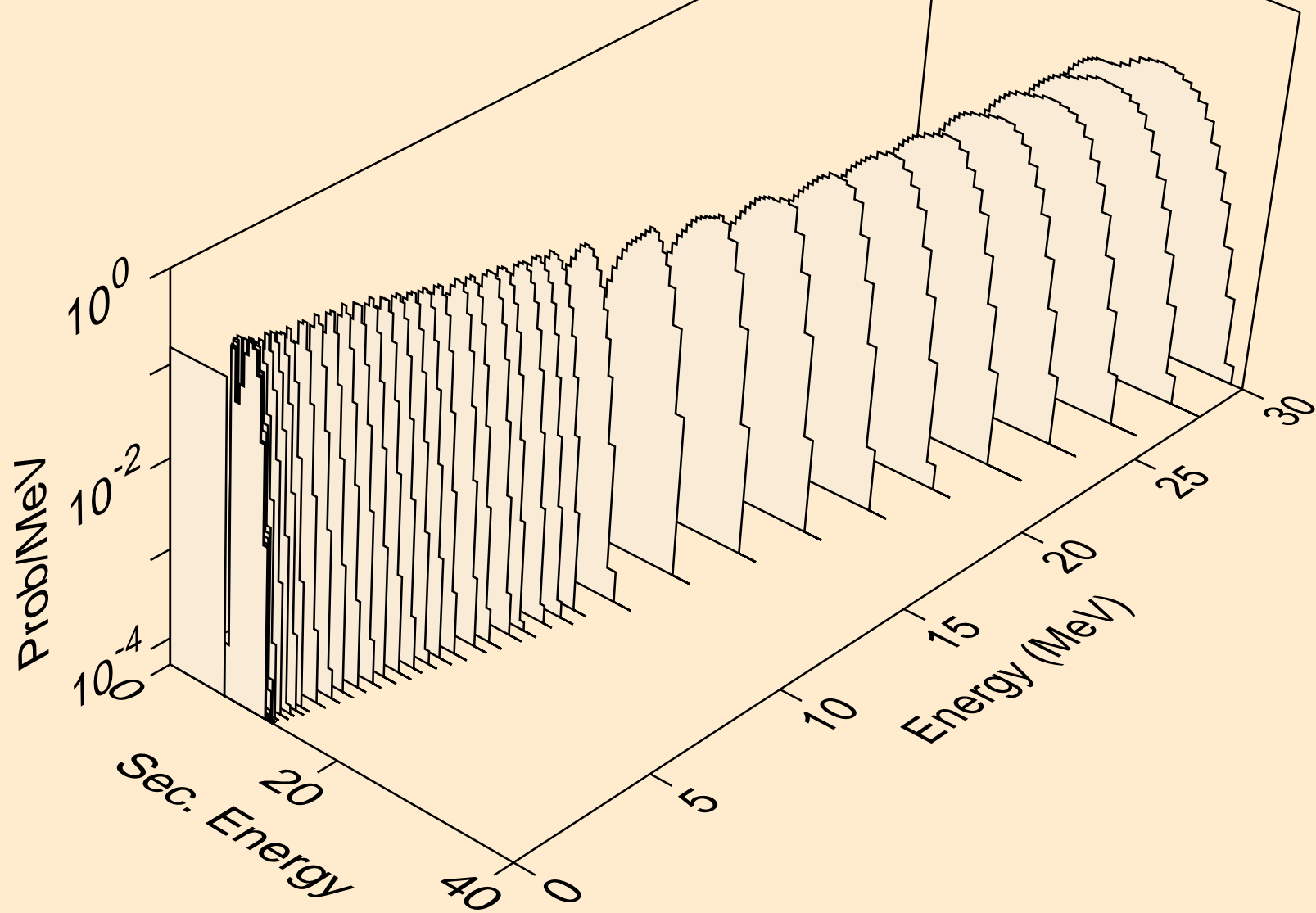

AT202 NEUTRON ACER TENDL-2023 LIBRARY; T=0.K
alphas from (n,da)

