

# AU194 NEUTRON ACER TENDL-2023 LIBRARY; T=0.K

## Principal cross sections

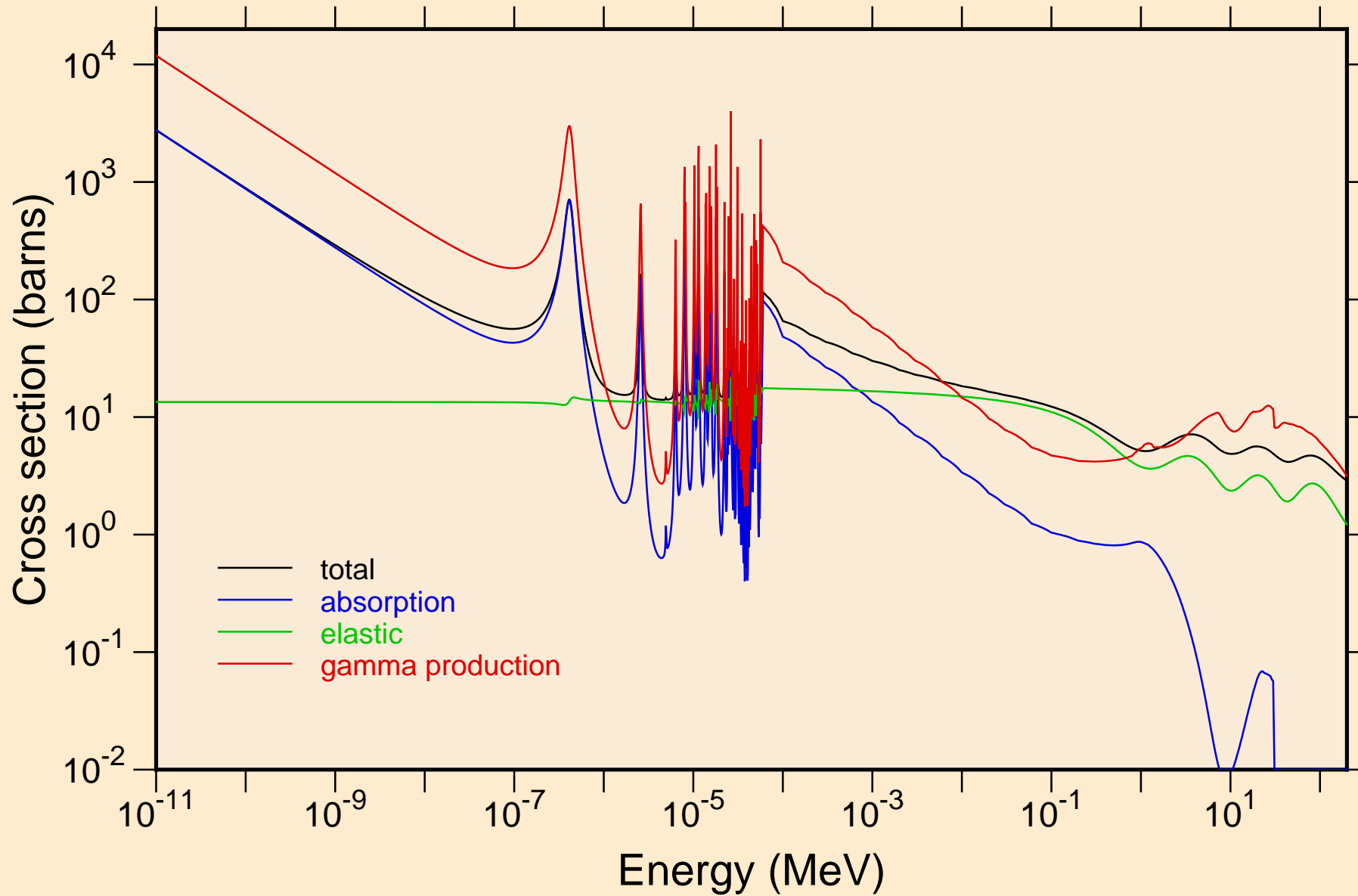

AU194 NEUTRON ACER TENDL-2023 LIBRARY; T=0.K  
resonance total cross section

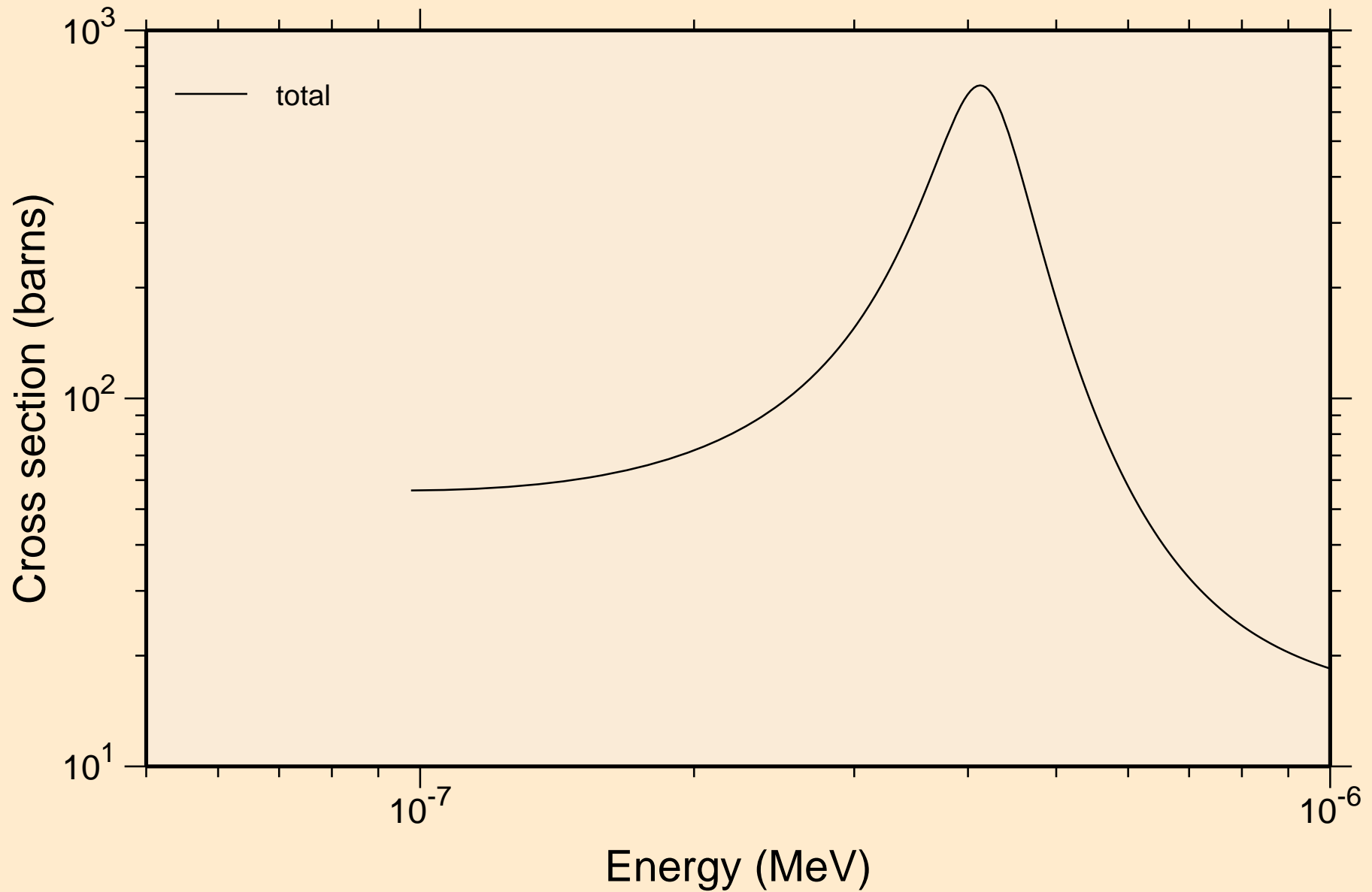

AU194 NEUTRON ACER TENDL-2023 LIBRARY; T=0.K  
resonance total cross section

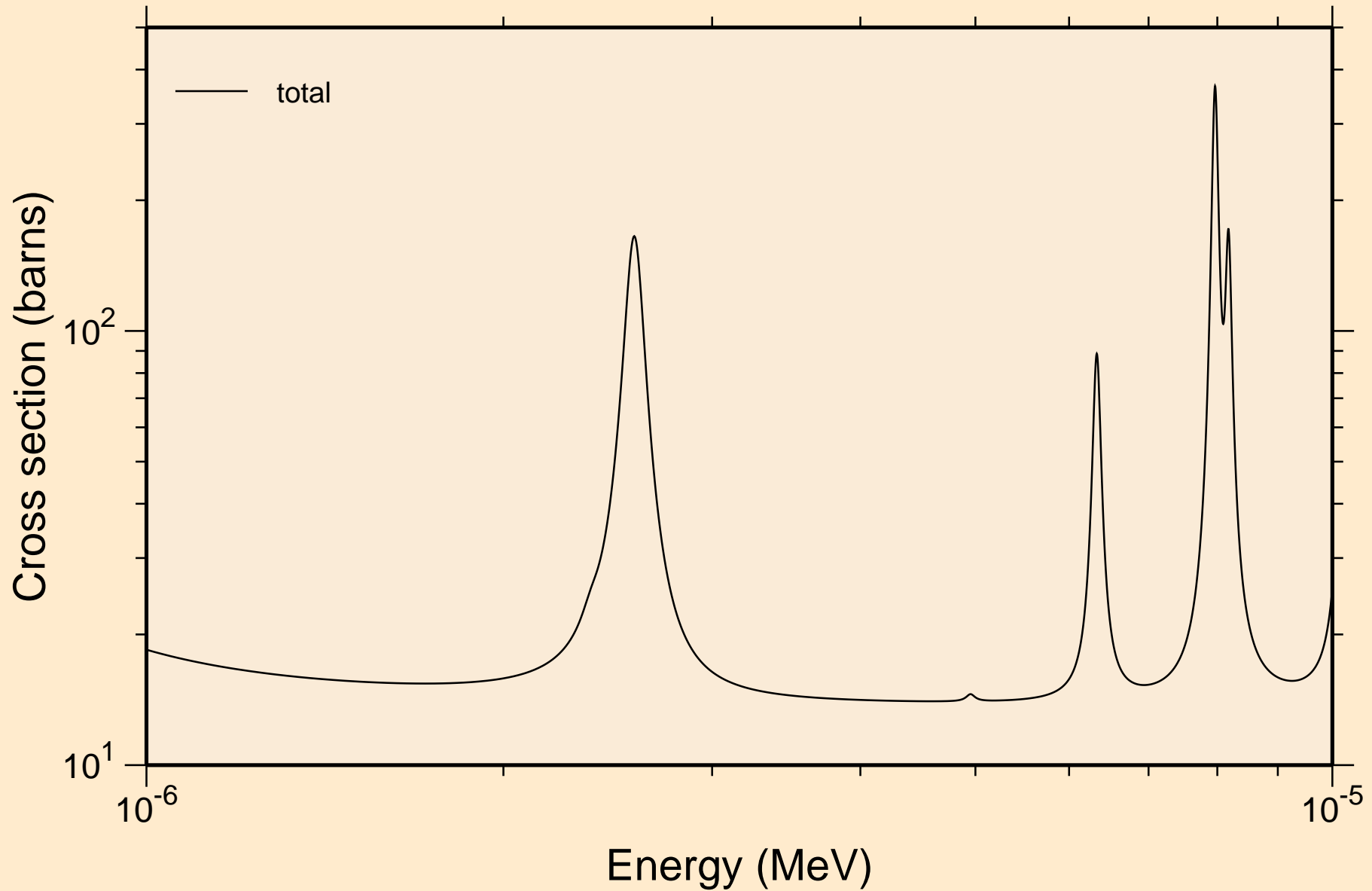

AU194 NEUTRON ACER TENDL-2023 LIBRARY; T=0.K  
resonance total cross section

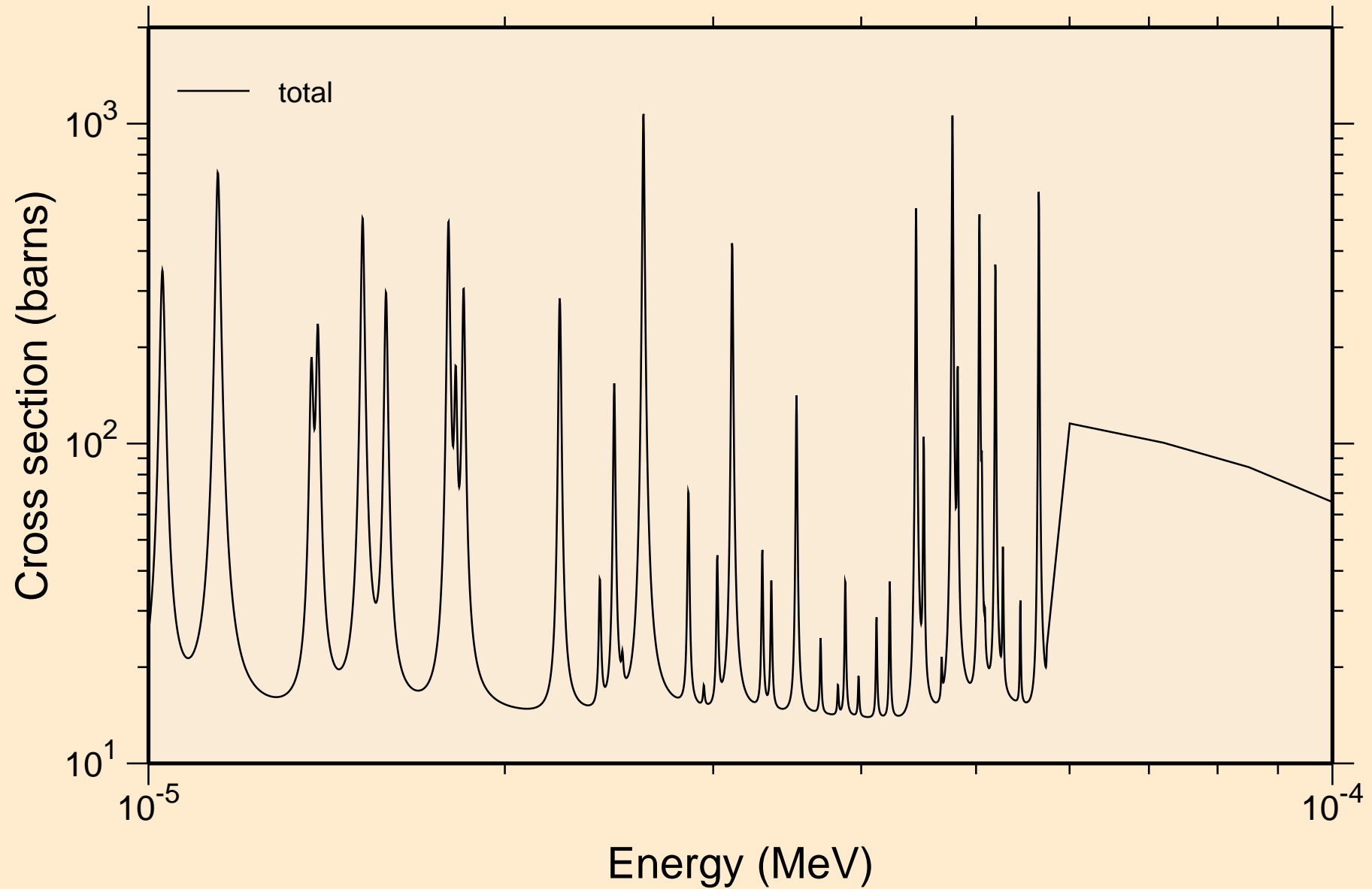

AU194 NEUTRON ACER TENDL-2023 LIBRARY; T=0.K  
resonance total cross section

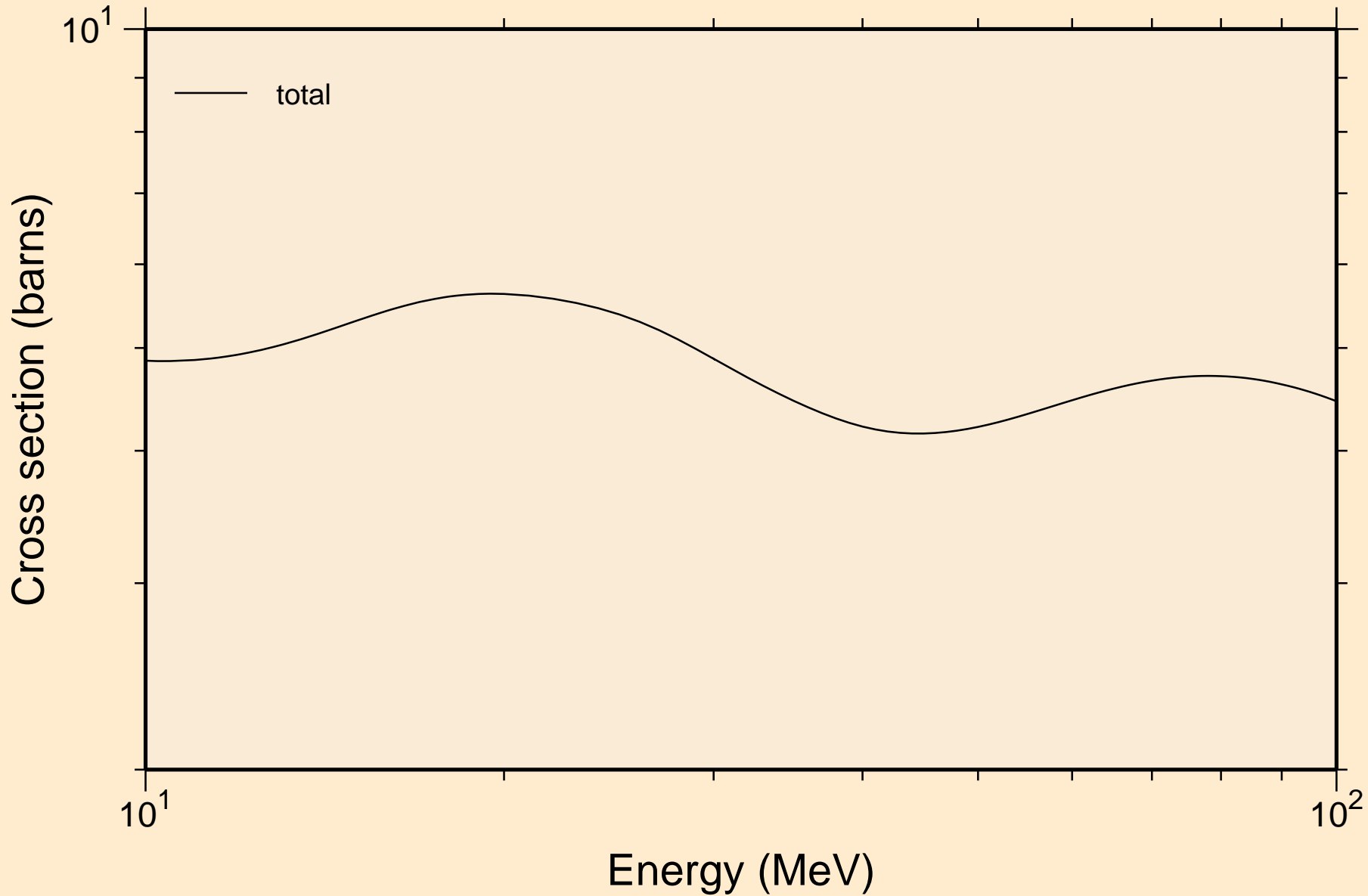

AU194 NEUTRON ACER TENDL-2023 LIBRARY; T=0.K  
resonance absorption cross sections

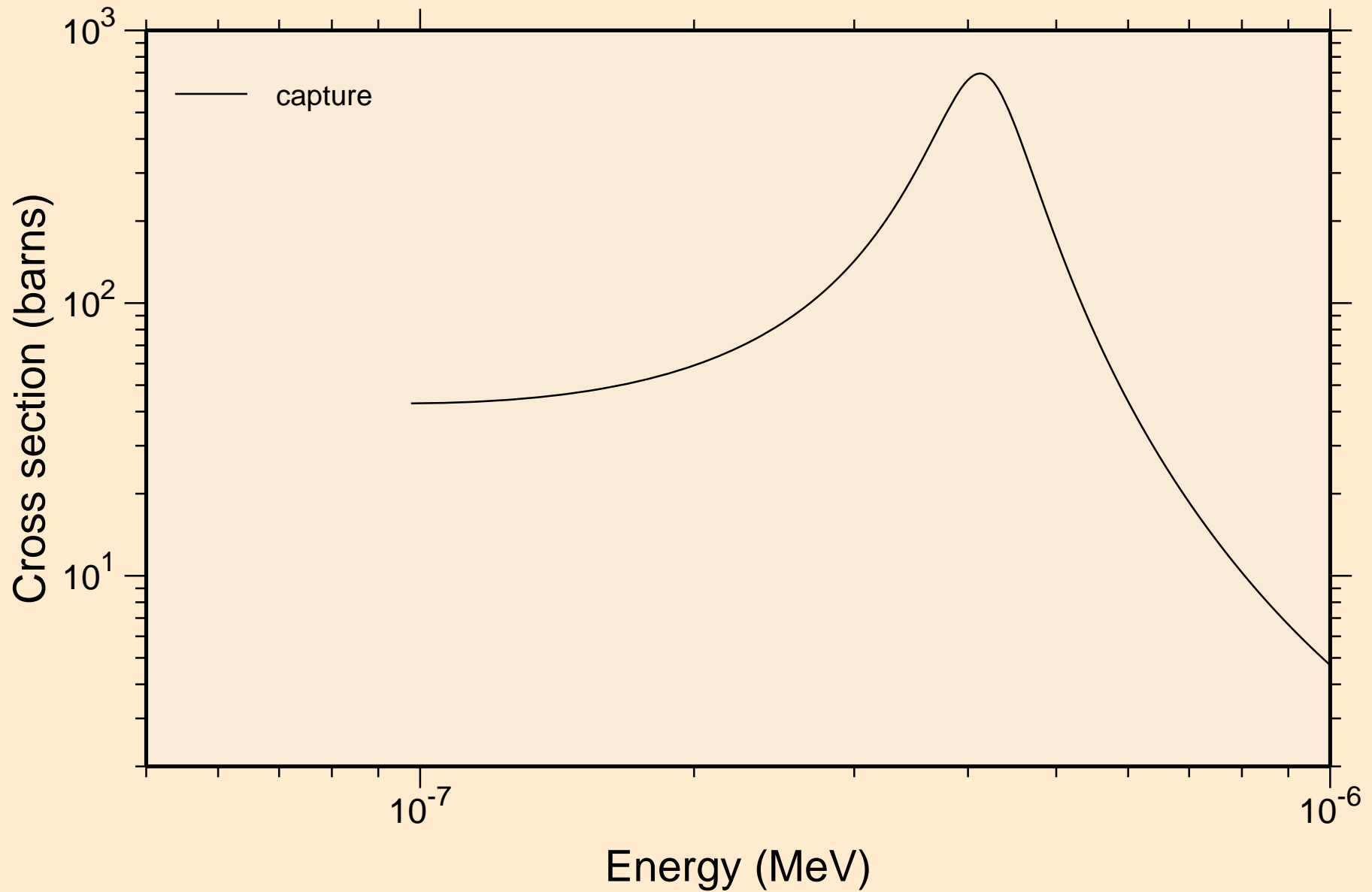

AU194 NEUTRON ACER TENDL-2023 LIBRARY; T=0.K  
resonance absorption cross sections

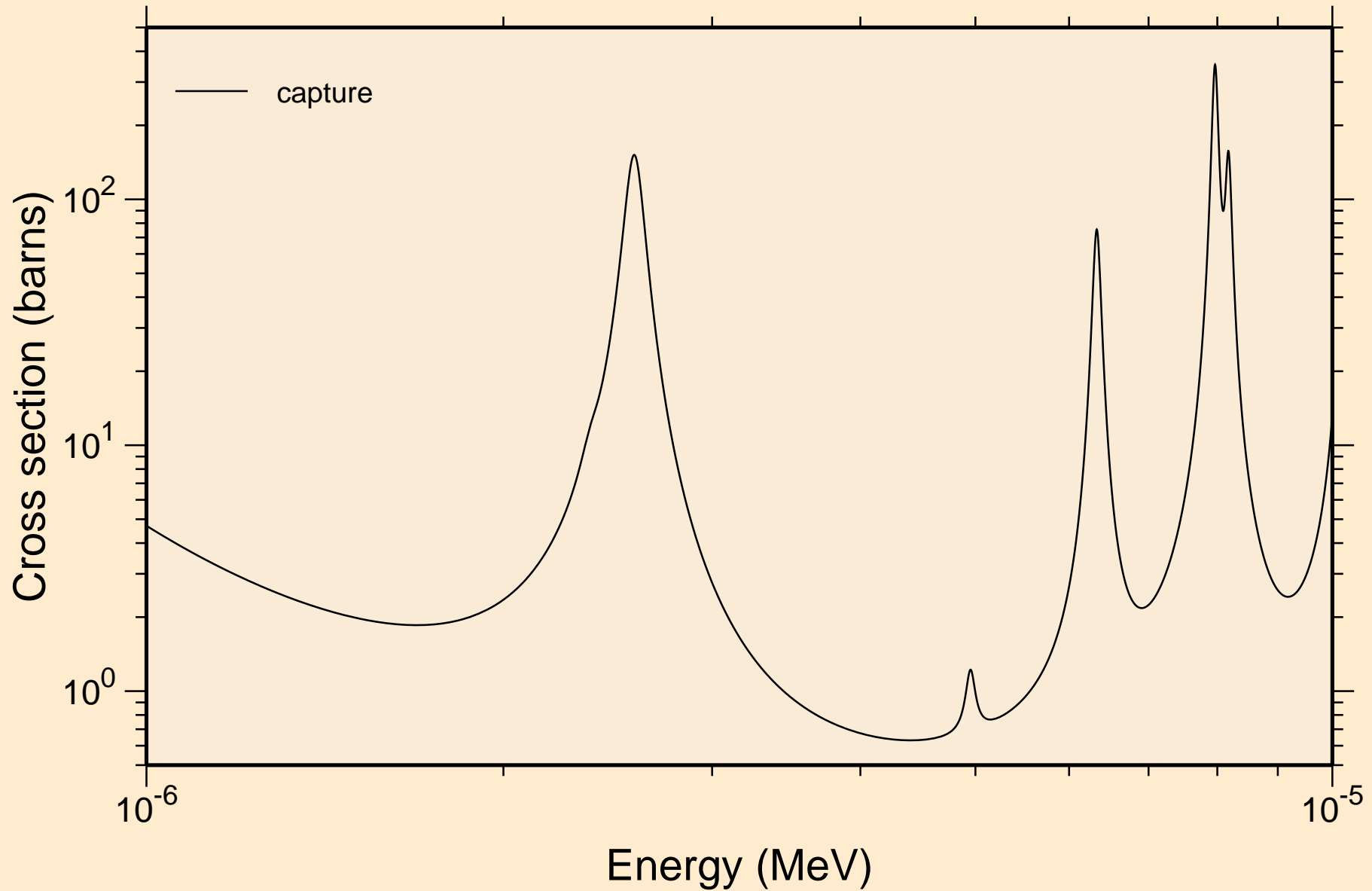

AU194 NEUTRON ACER TENDL-2023 LIBRARY; T=0.K  
resonance absorption cross sections

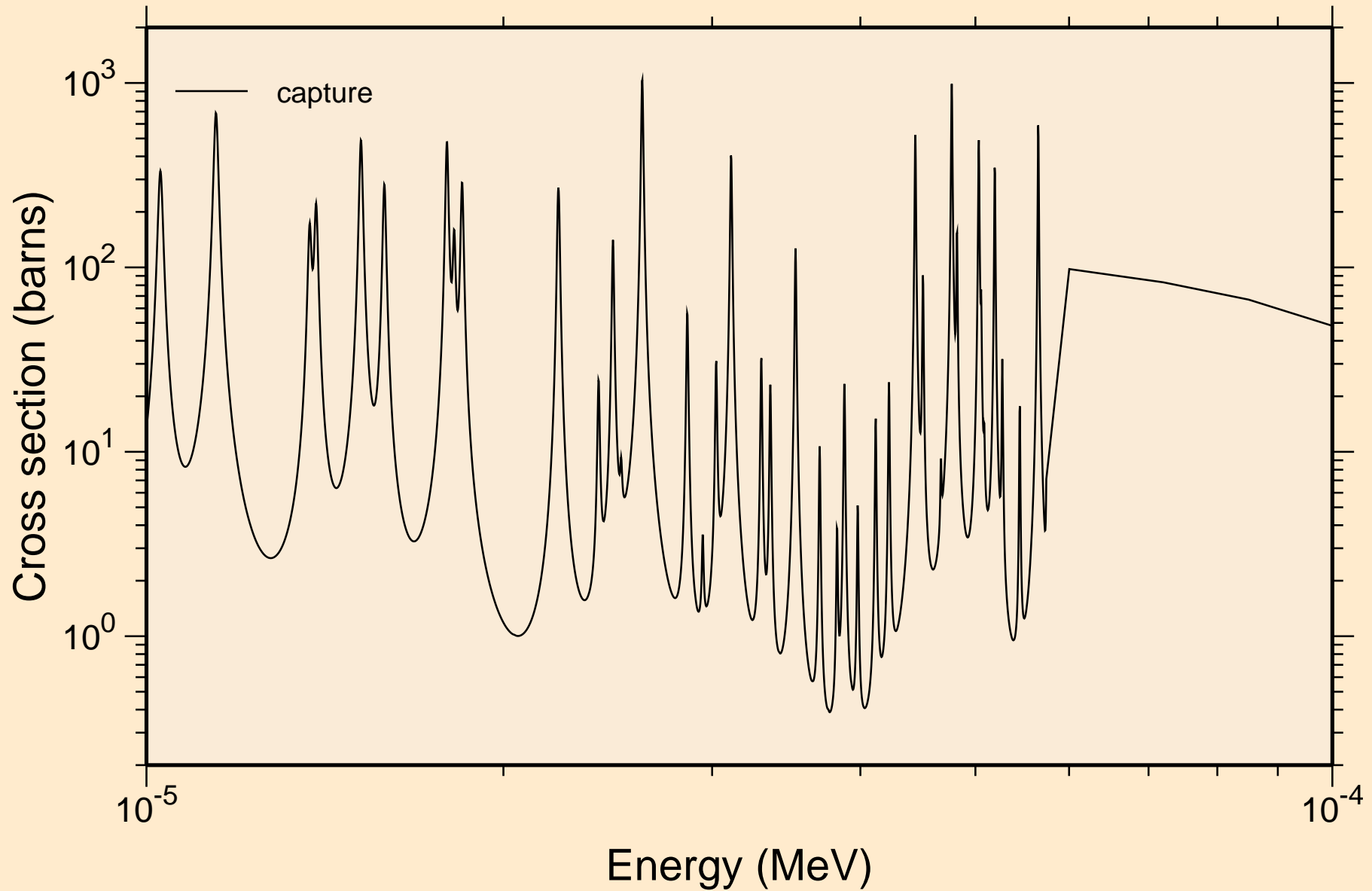



AU194 NEUTRON ACER TENDL-2023 LIBRARY; T=0.K  
resonance absorption cross sections

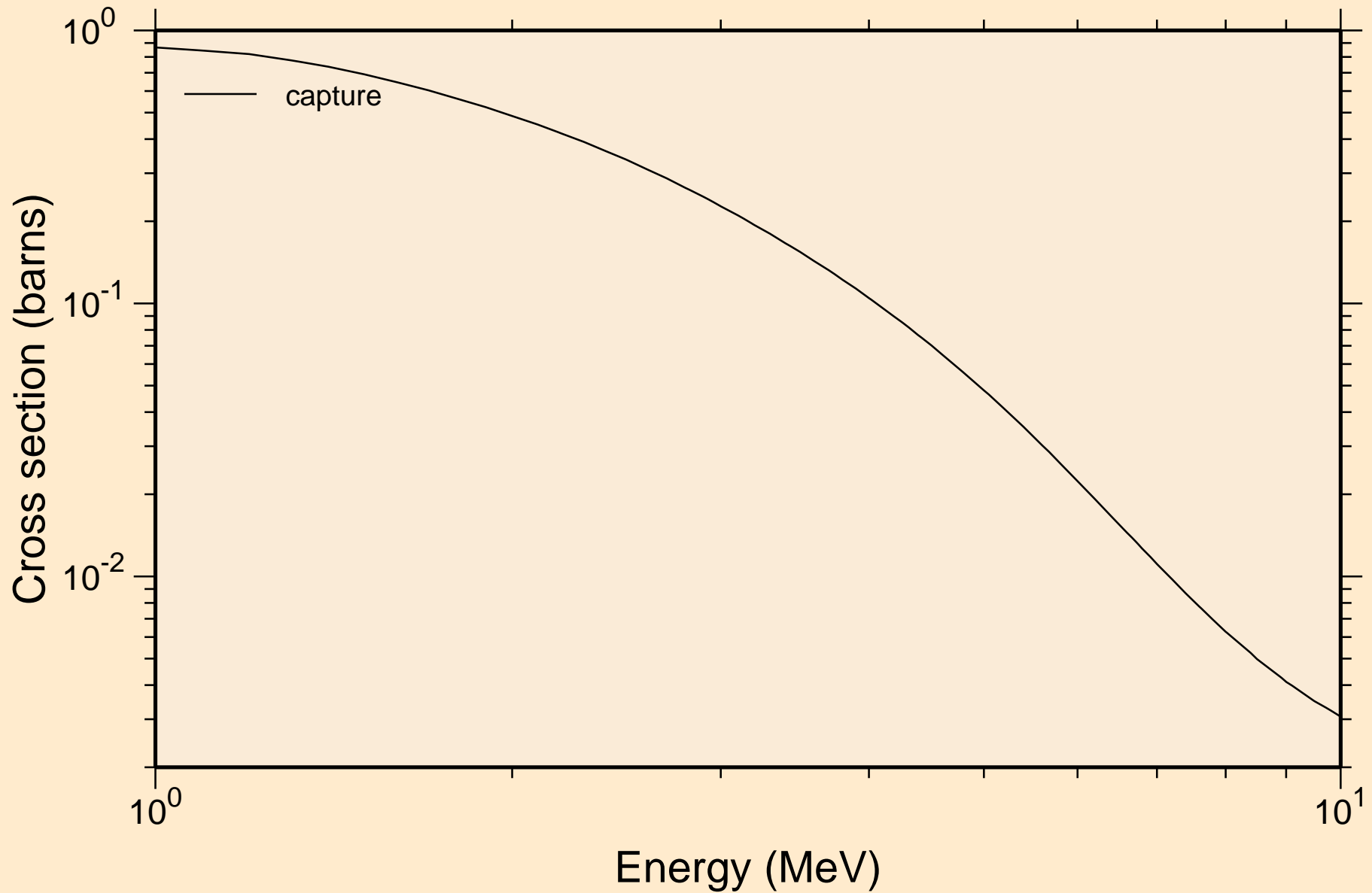

AU194 NEUTRON ACER TENDL-2023 LIBRARY; T=0.K  
Heating

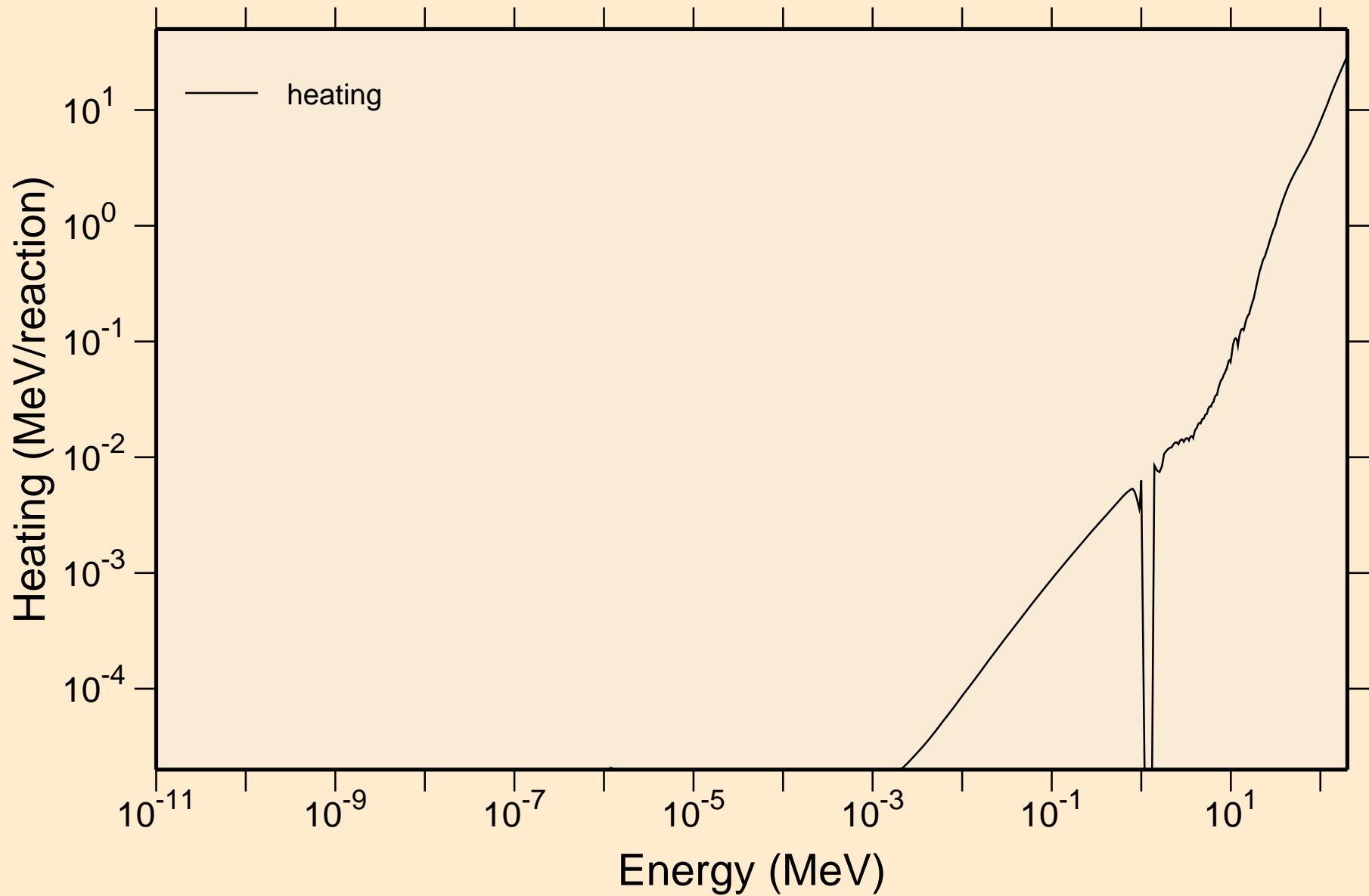

# AU194 NEUTRON ACER TENDL-2023 LIBRARY; T=0.K

## Damage

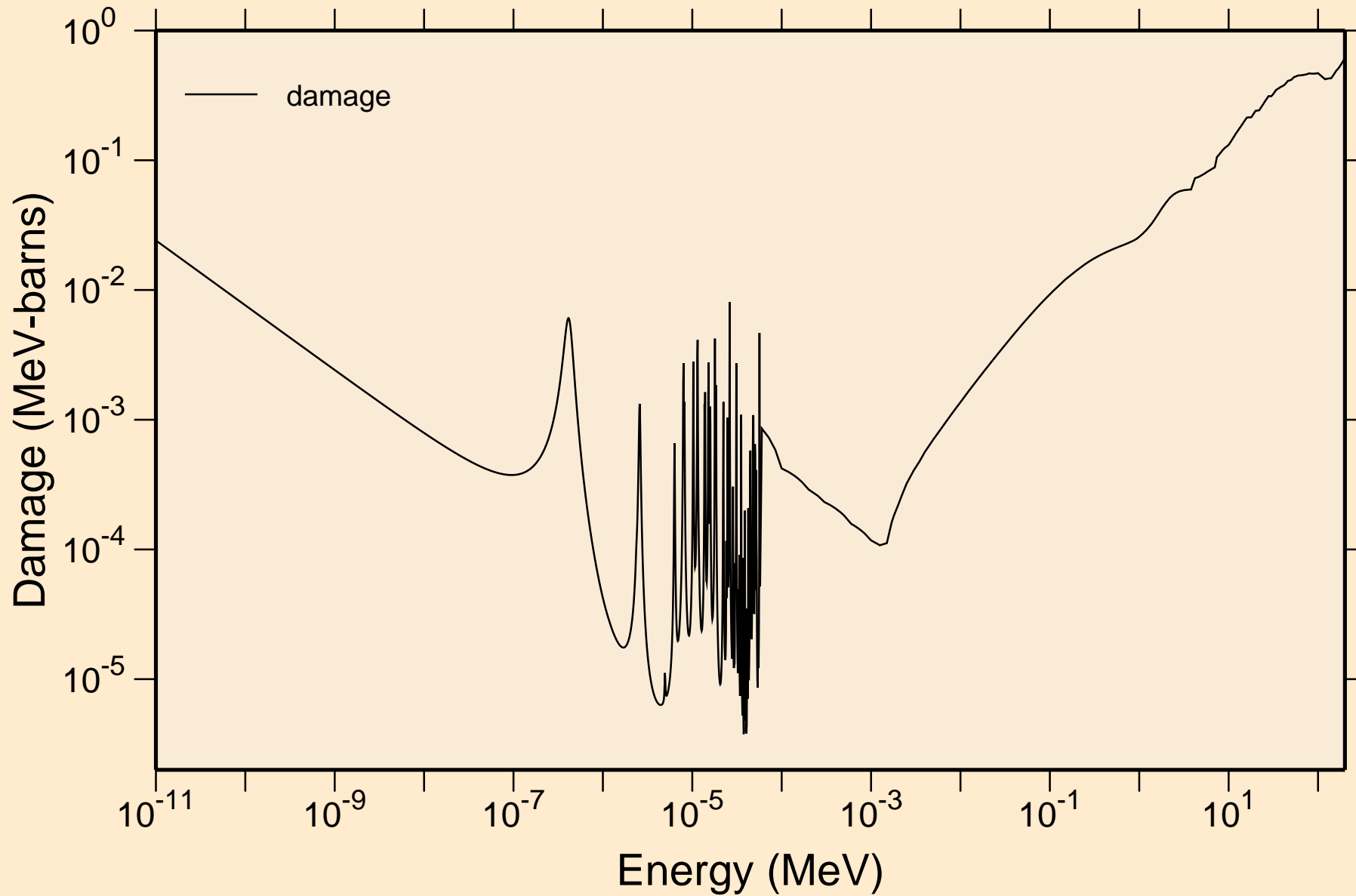

# AU194 NEUTRON ACER TENDL-2023 LIBRARY; T=0.K

## Non-threshold reactions

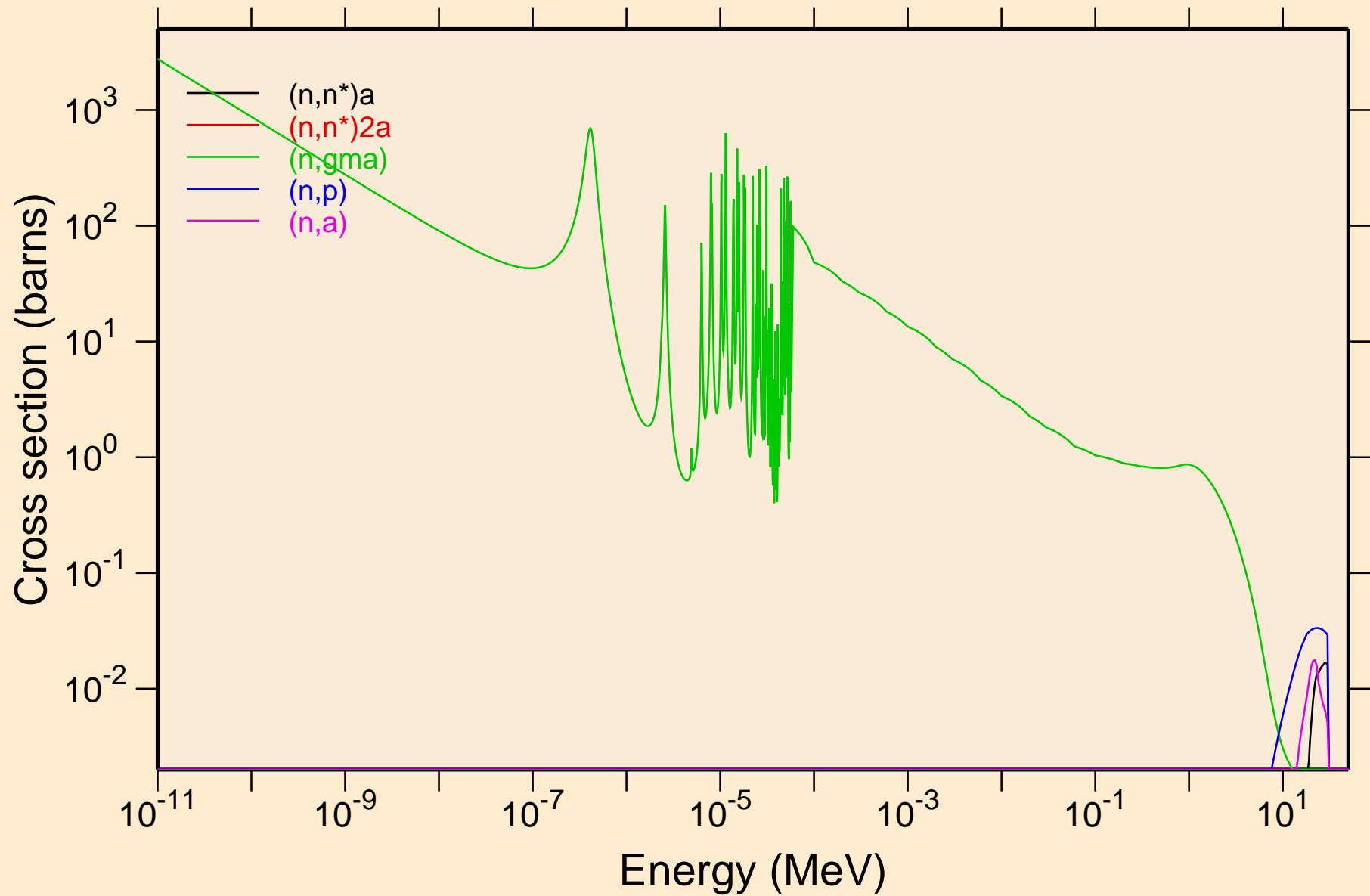

AU194 NEUTRON ACER TENDL-2023 LIBRARY; T=0.K  
Non-threshold reactions

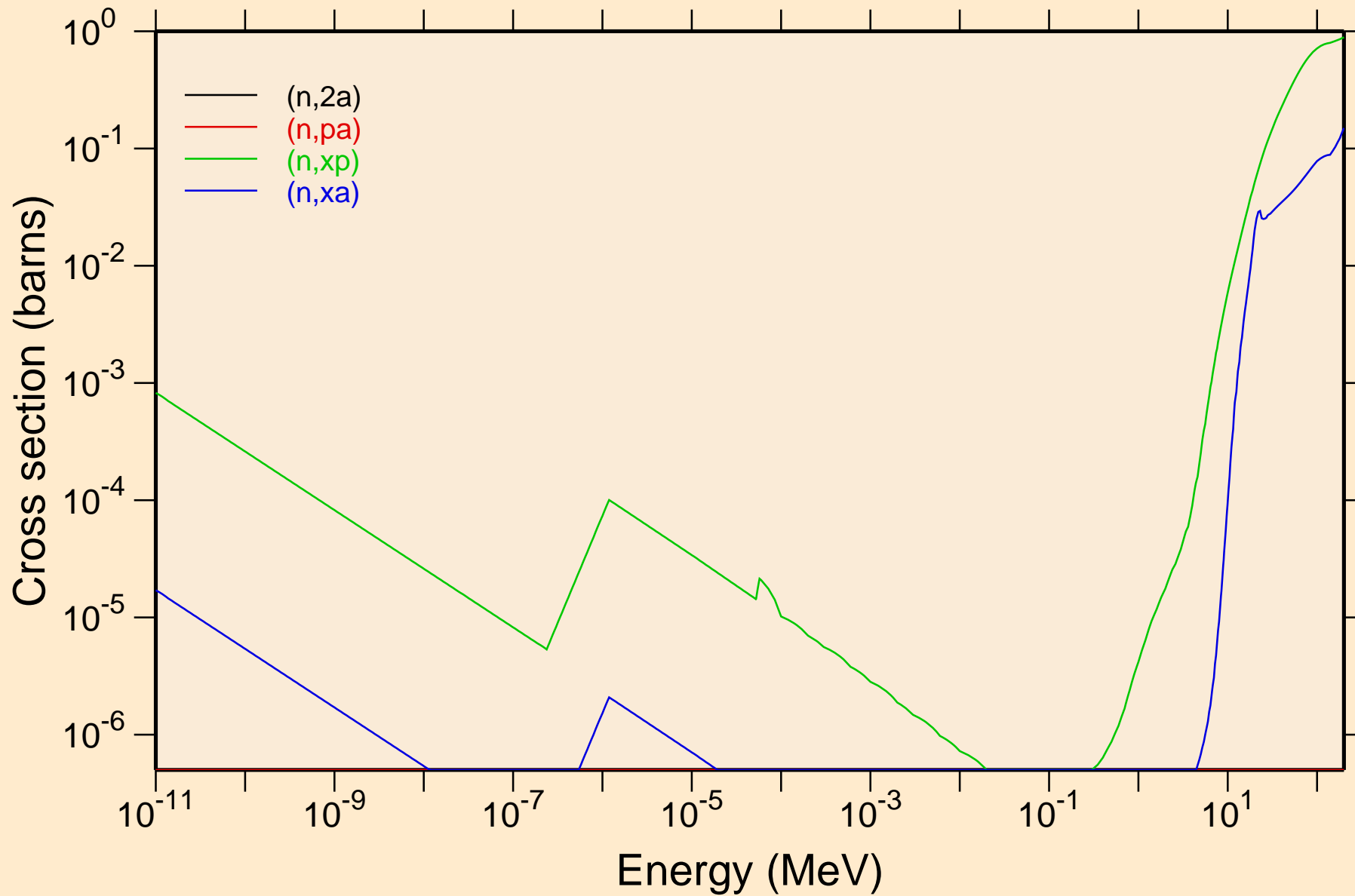

# AU194 NEUTRON ACER TENDL-2023 LIBRARY; T=0.K

## Principal cross sections

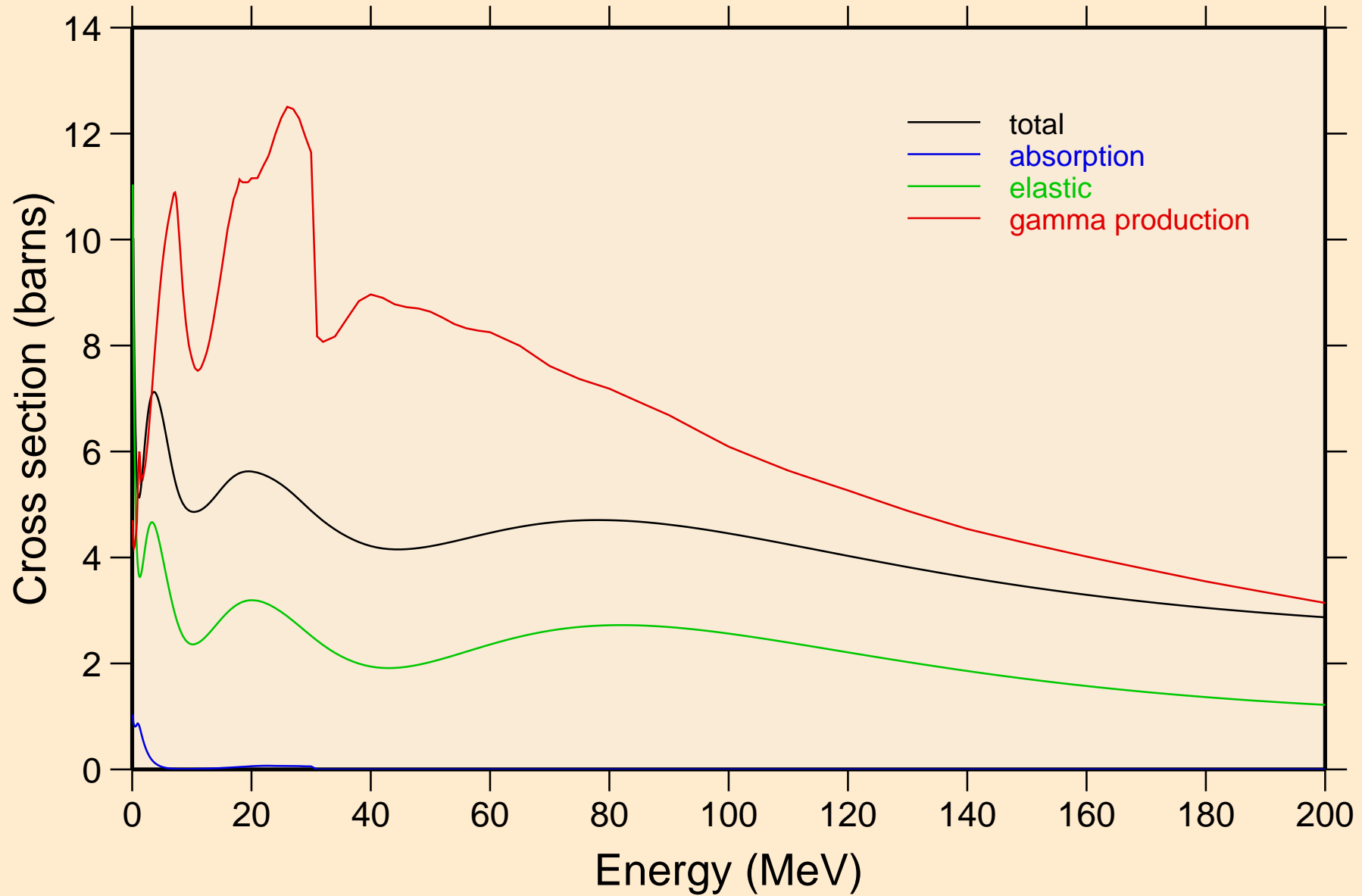

# AU194 NEUTRON ACER TENDL-2023 LIBRARY; T=0.K

## Heating

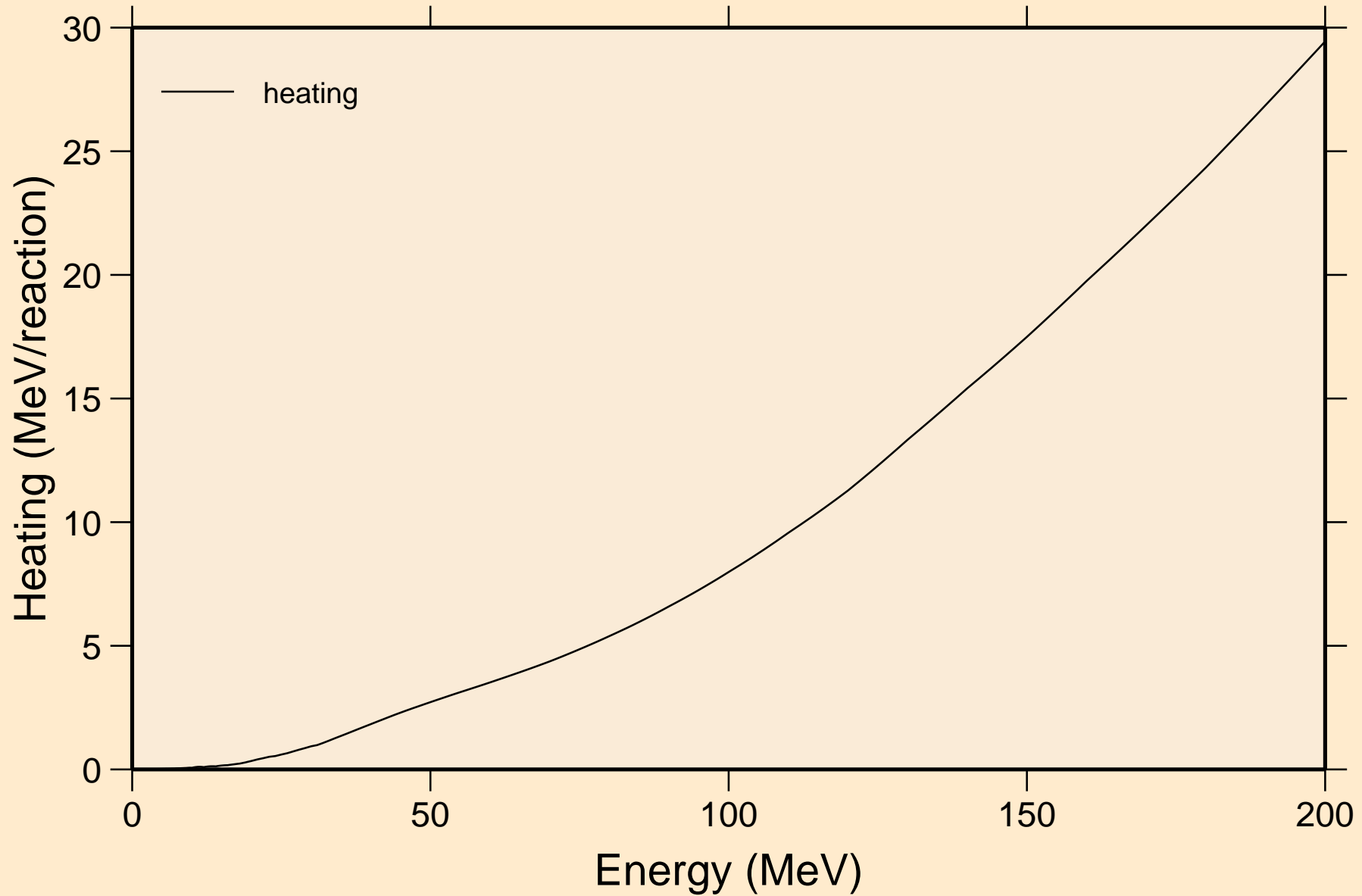

# AU194 NEUTRON ACER TENDL-2023 LIBRARY; T=0.K

## Damage

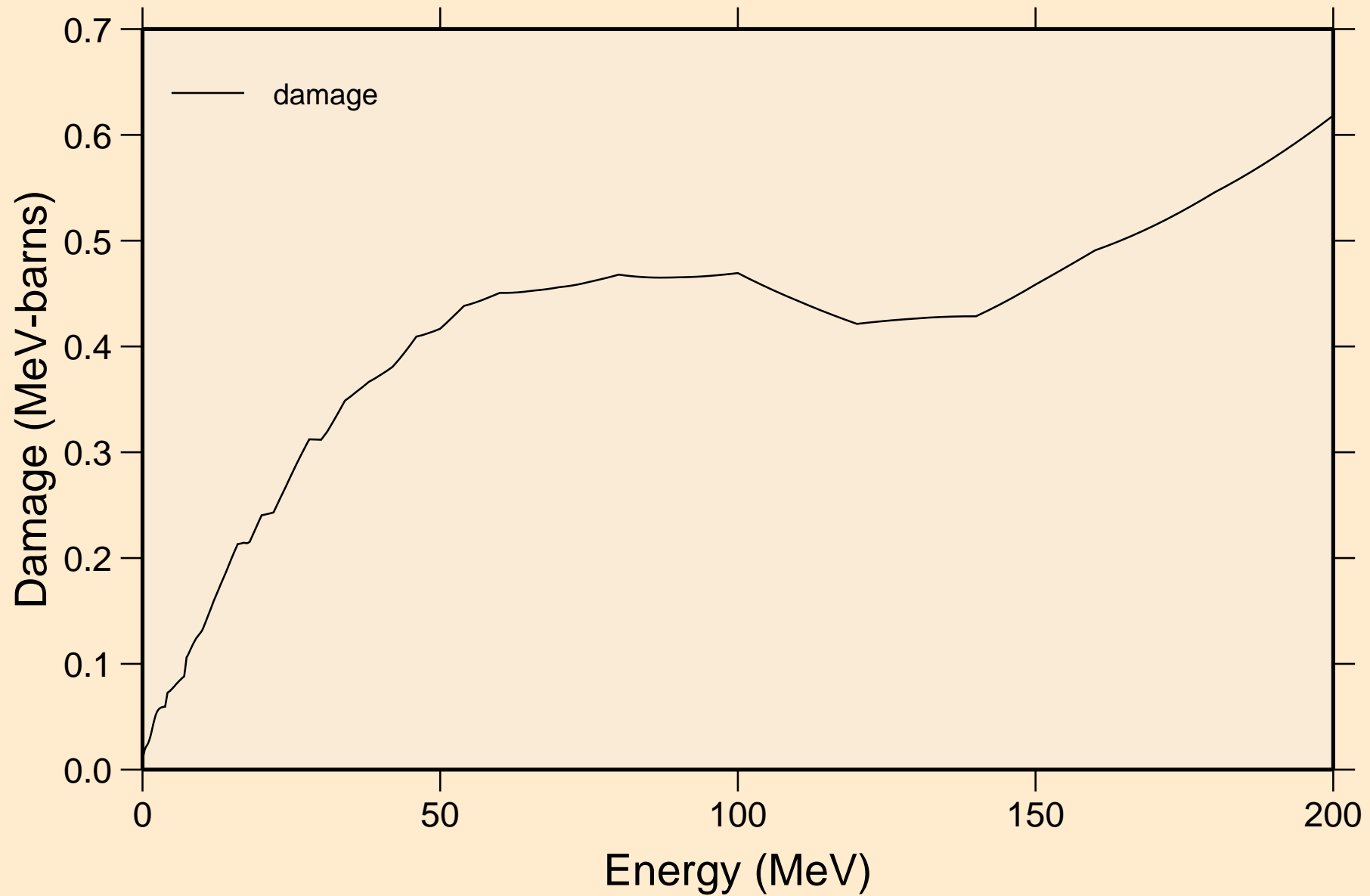



AU194 NEUTRON ACER TENDL-2023 LIBRARY; T=0.K  
Non-threshold reactions

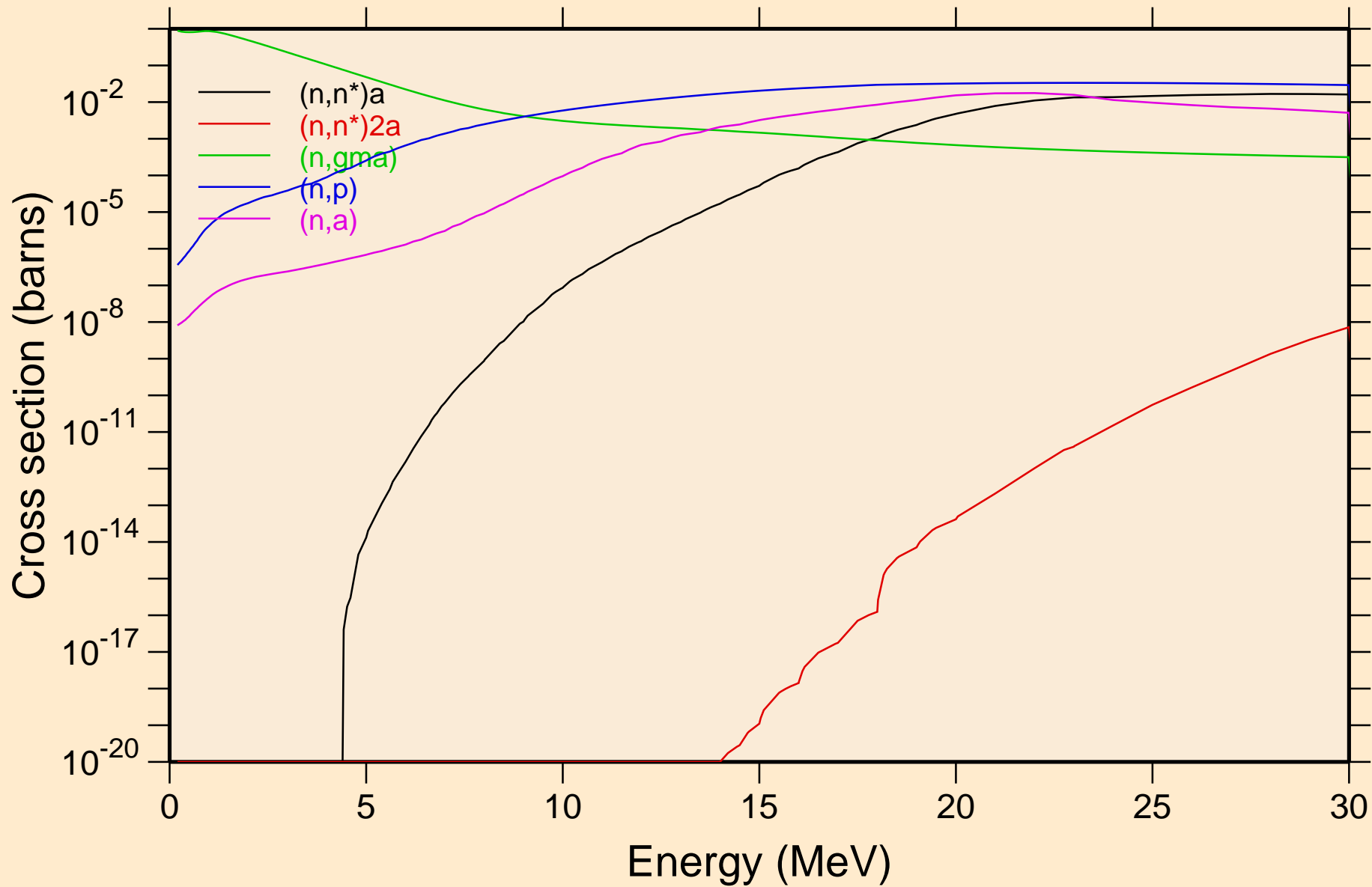

AU194 NEUTRON ACER TENDL-2023 LIBRARY; T=0.K  
Non-threshold reactions

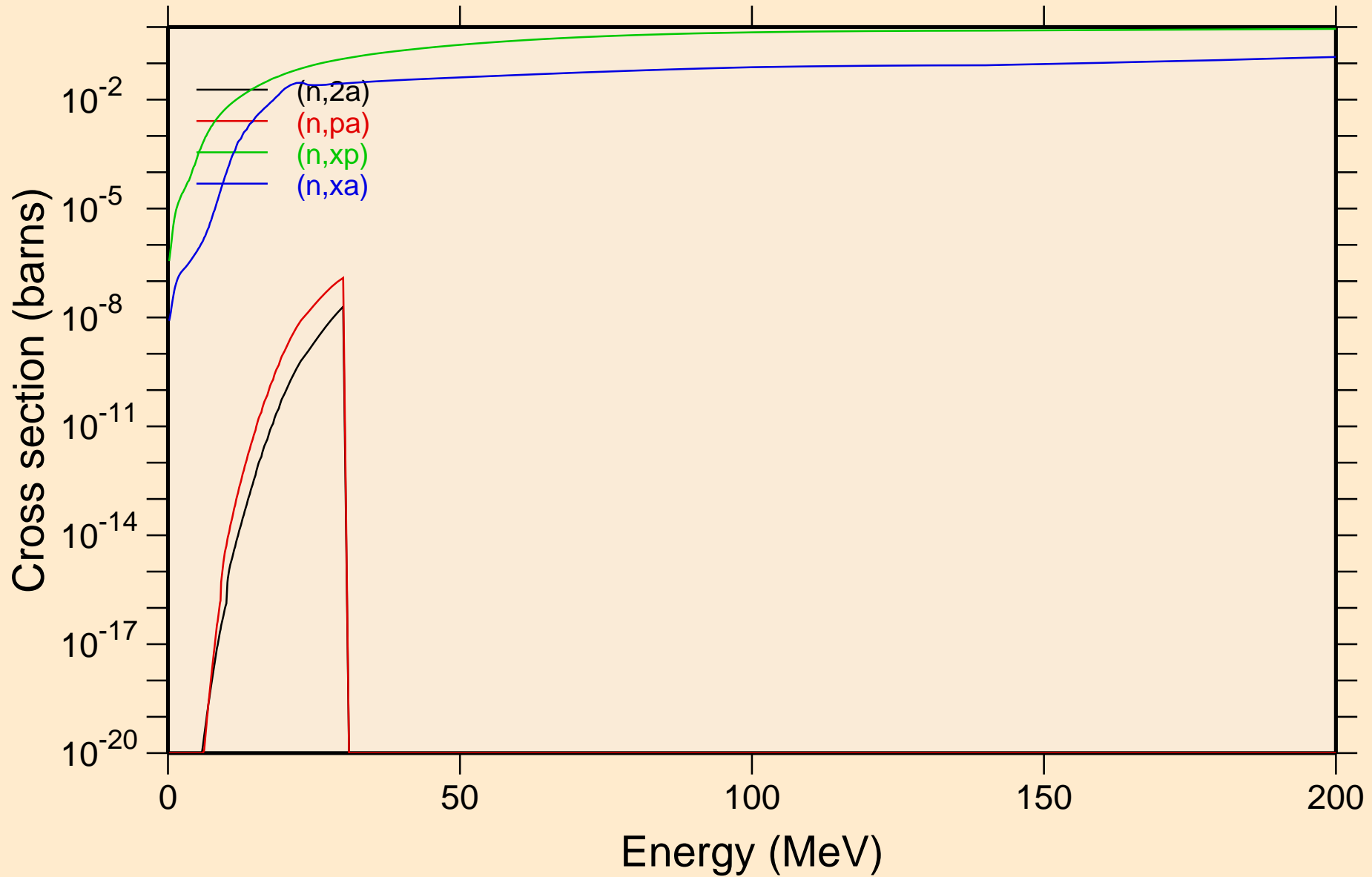

AU194 NEUTRON ACER TENDL-2023 LIBRARY; T=0.K  
Inelastic levels

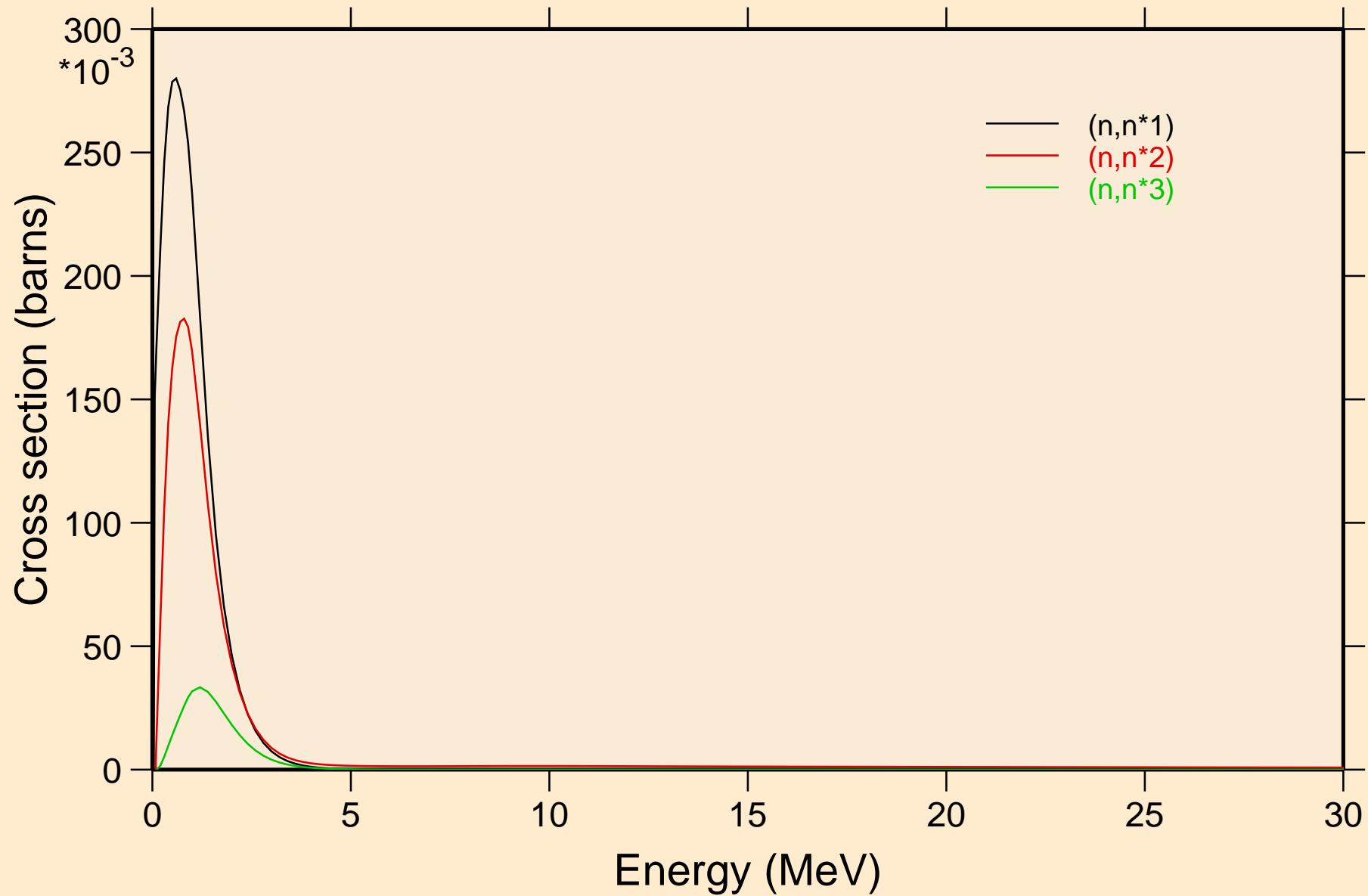

AU194 NEUTRON ACER TENDL-2023 LIBRARY; T=0.K  
Threshold reactions

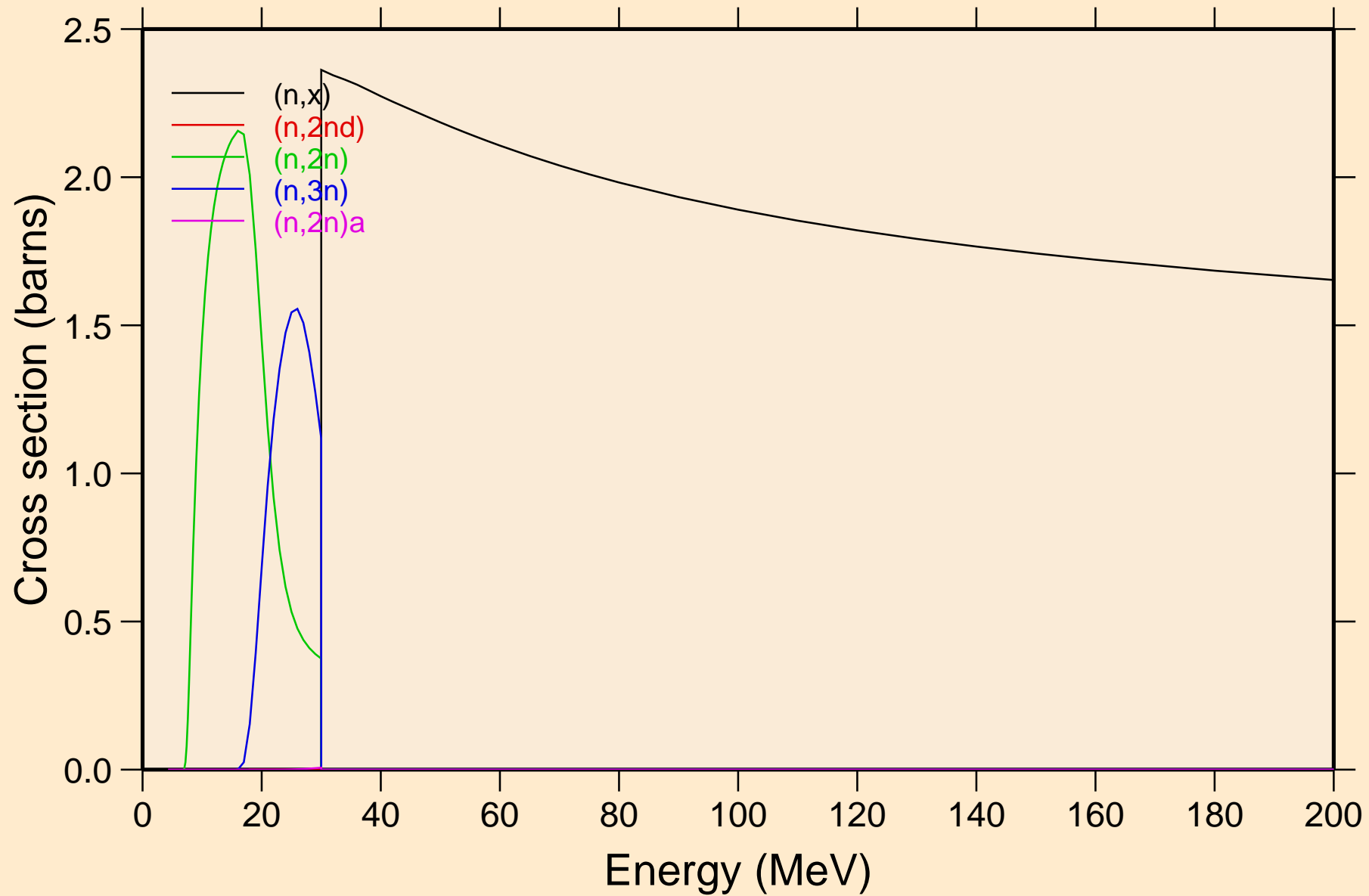

# AU194 NEUTRON ACER TENDL-2023 LIBRARY; T=0.K

## Threshold reactions

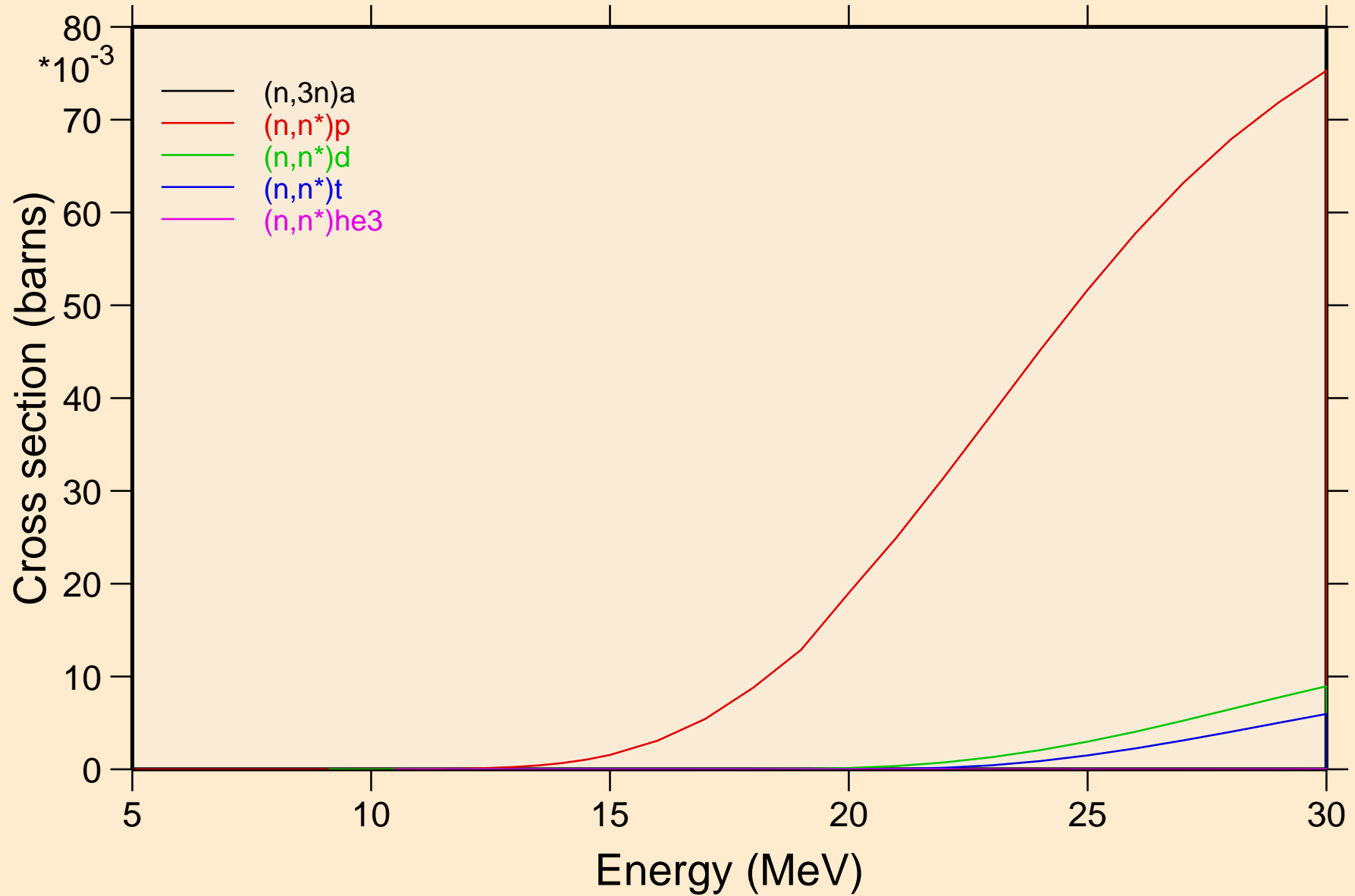

AU194 NEUTRON ACER TENDL-2023 LIBRARY; T=0.K  
Threshold reactions

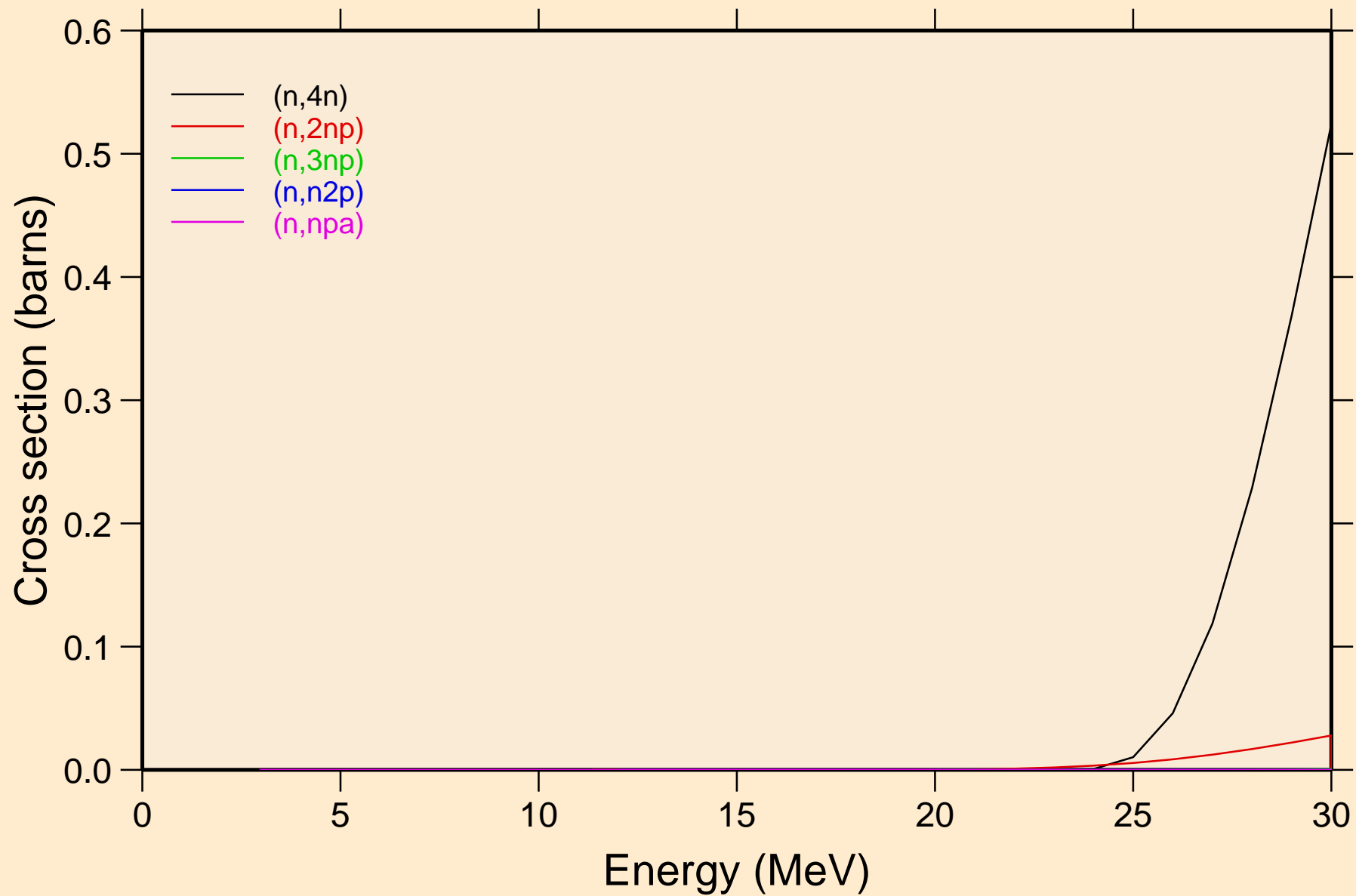

# AU194 NEUTRON ACER TENDL-2023 LIBRARY; T=0.K

## Threshold reactions

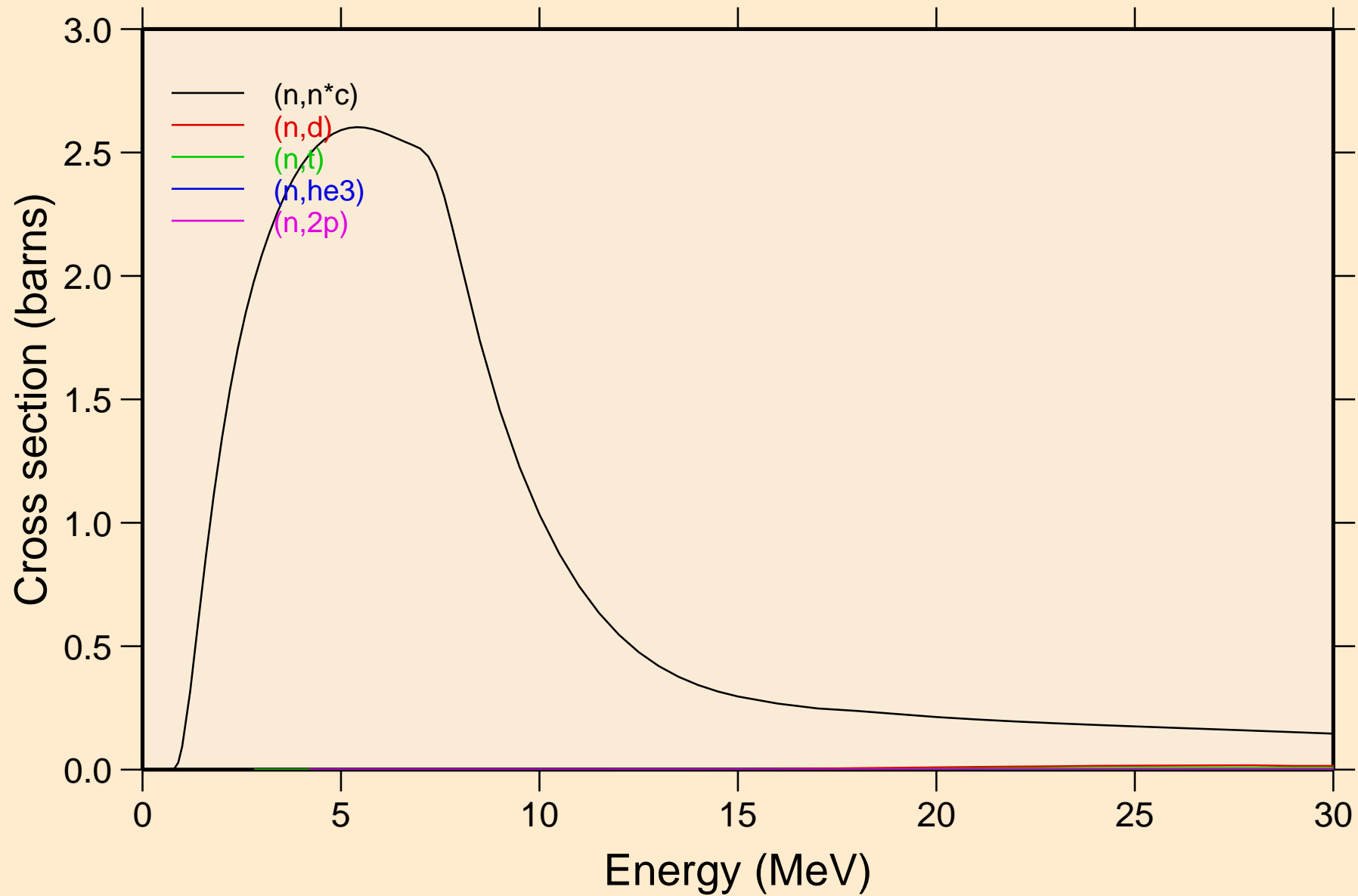

# AU194 NEUTRON ACER TENDL-2023 LIBRARY; T=0.K

## Threshold reactions

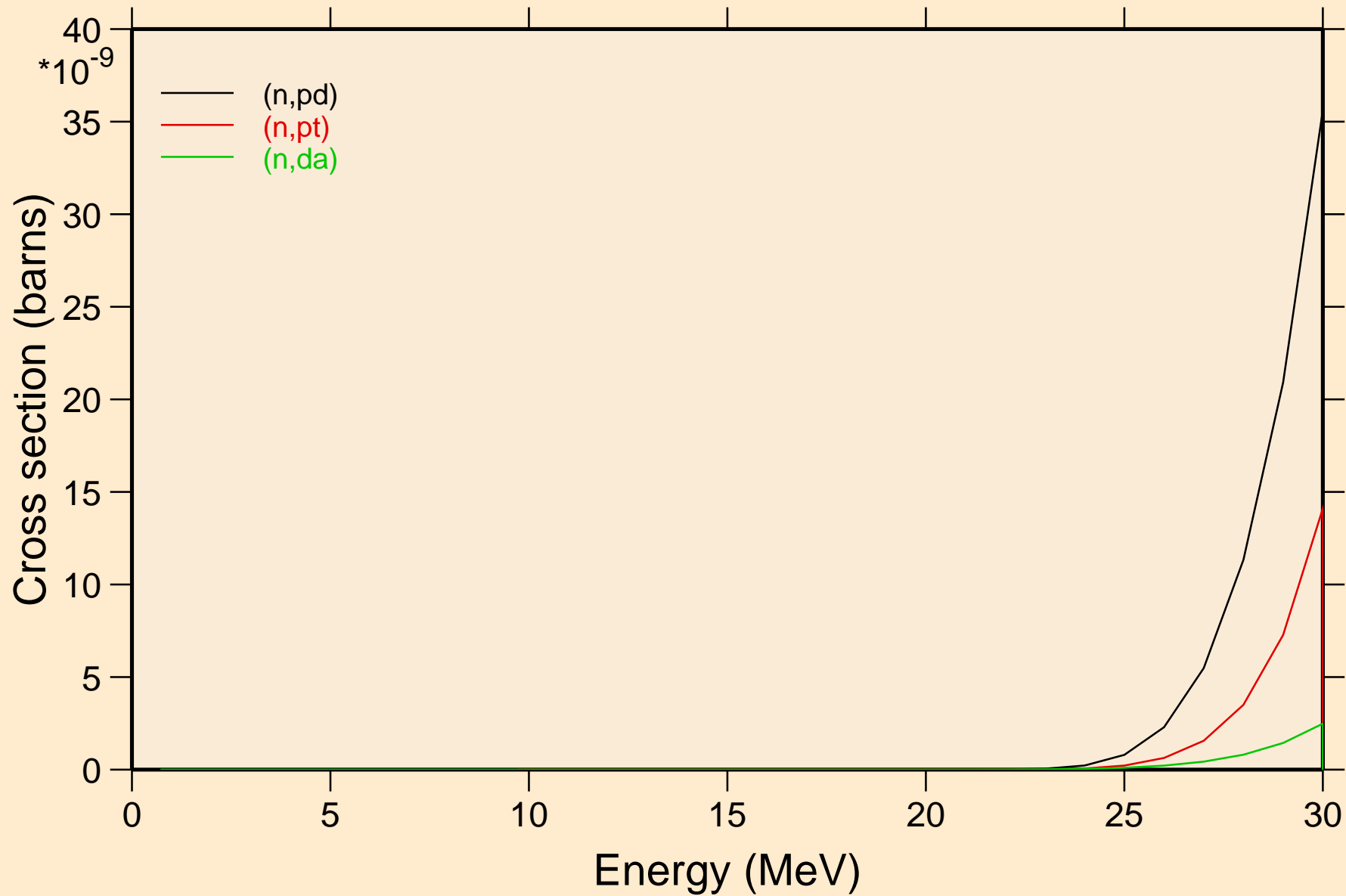



# AU194 NEUTRON ACER TENDL-2023 LIBRARY; T=0.K

## Threshold reactions

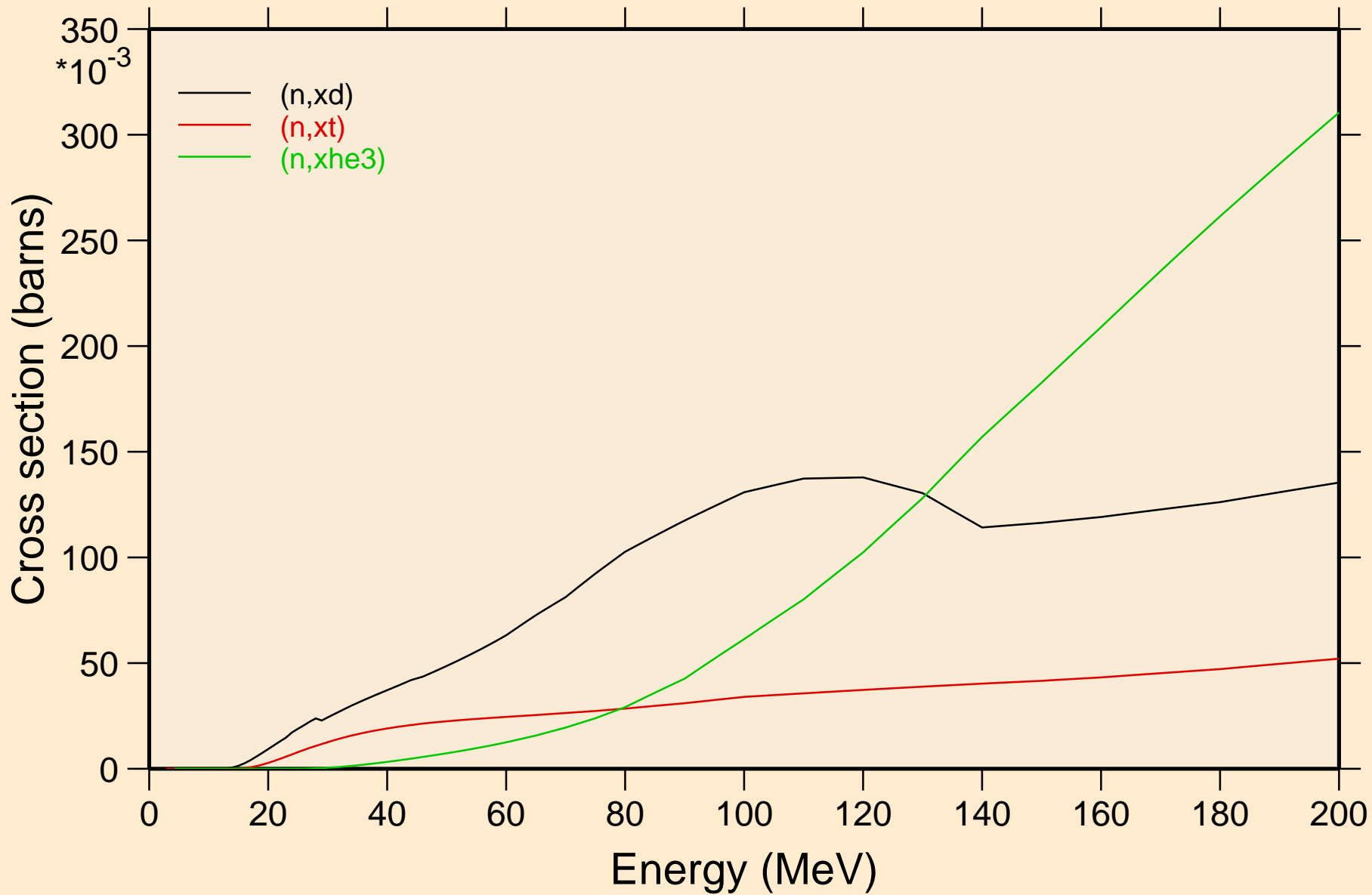

AU194 NEUTRON ACER TENDL-2023 LIBRARY; T=0.K  
angular distribution for elastic

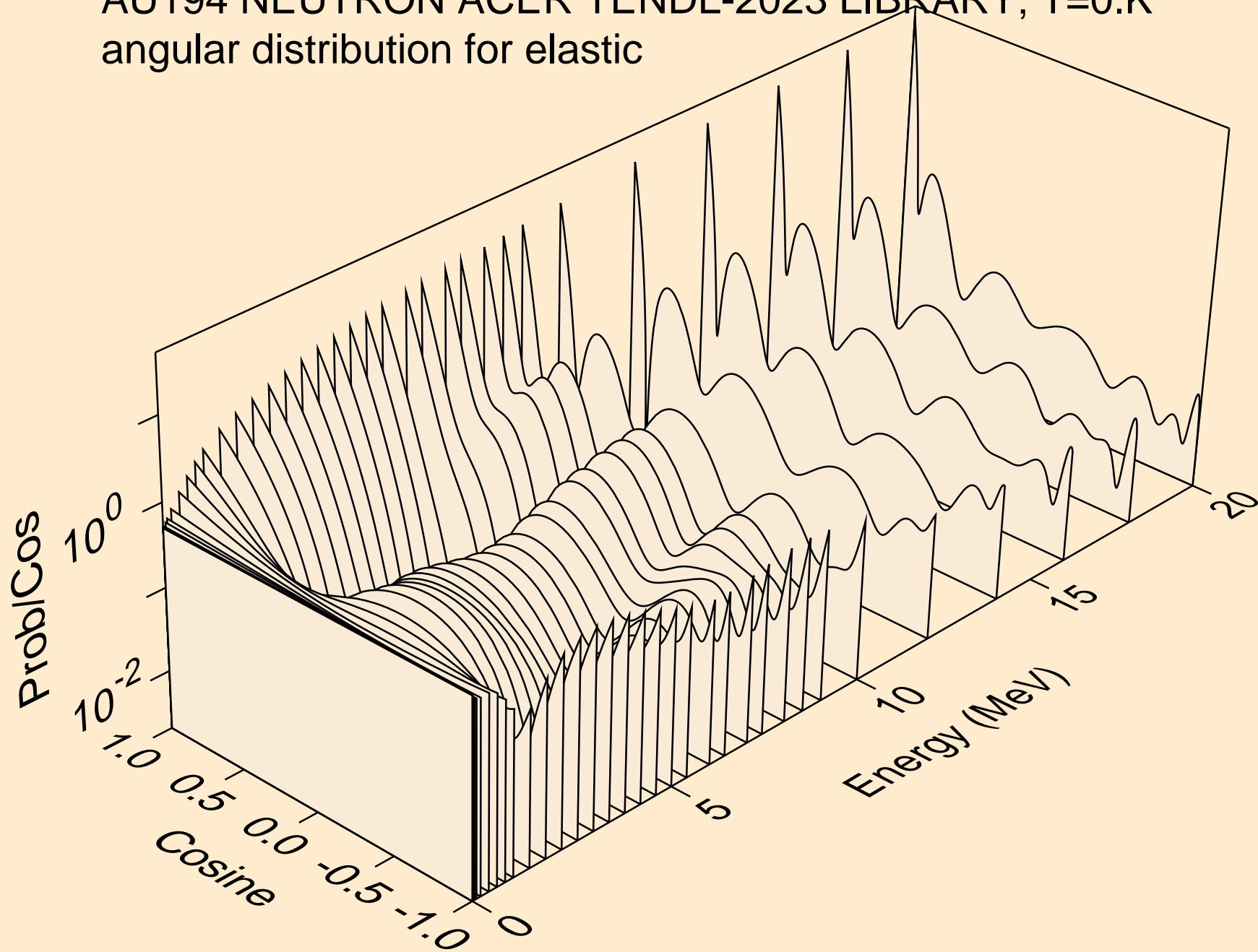

AU194 NEUTRON ACER TENDL-2023 LIBRARY; T=0.K  
angular distribution for elastic

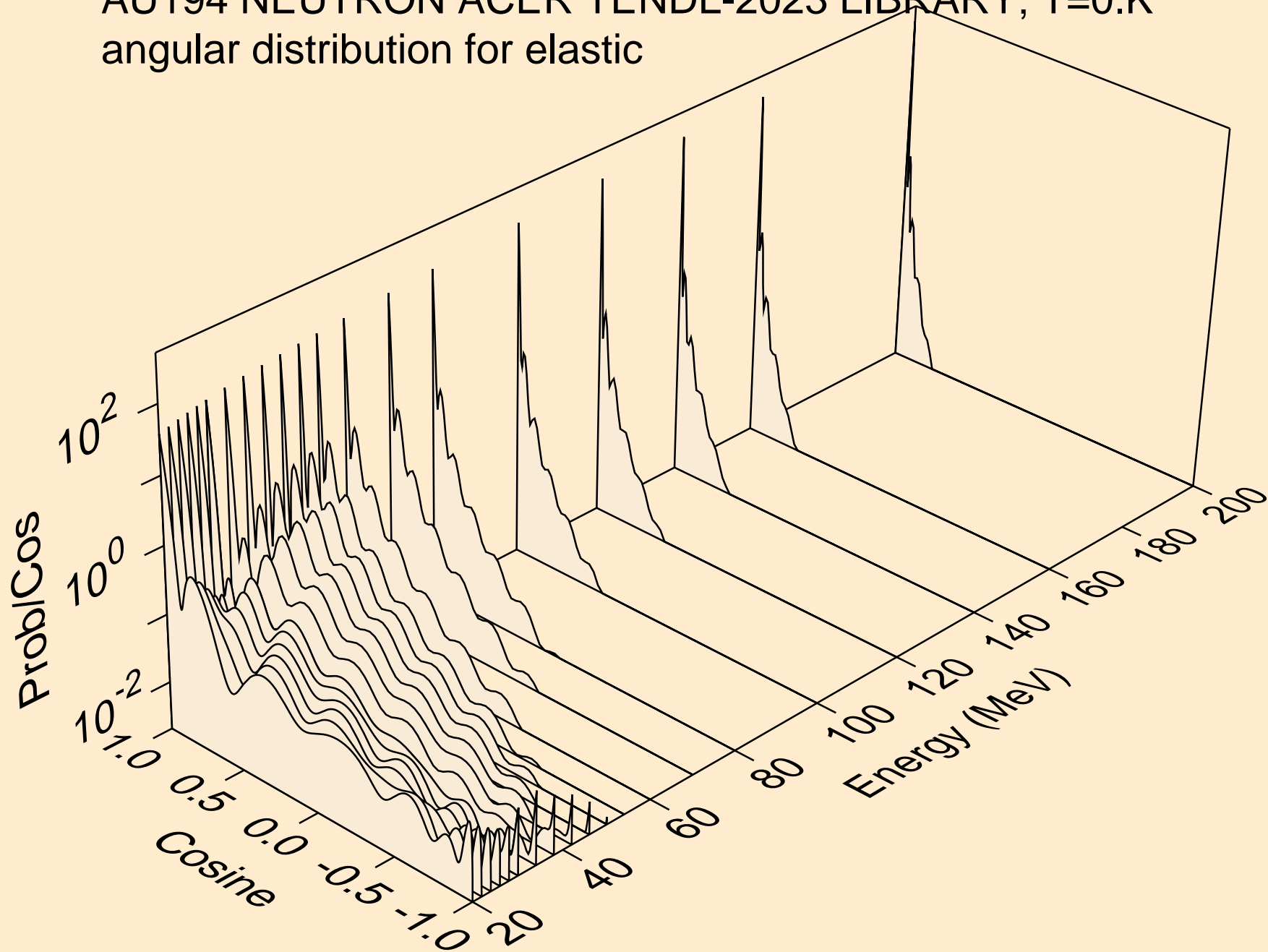

AU194 NEUTRON ACER TENDL-2023 LIBRARY; T=0.K  
angular distribution for (n,n\*1)

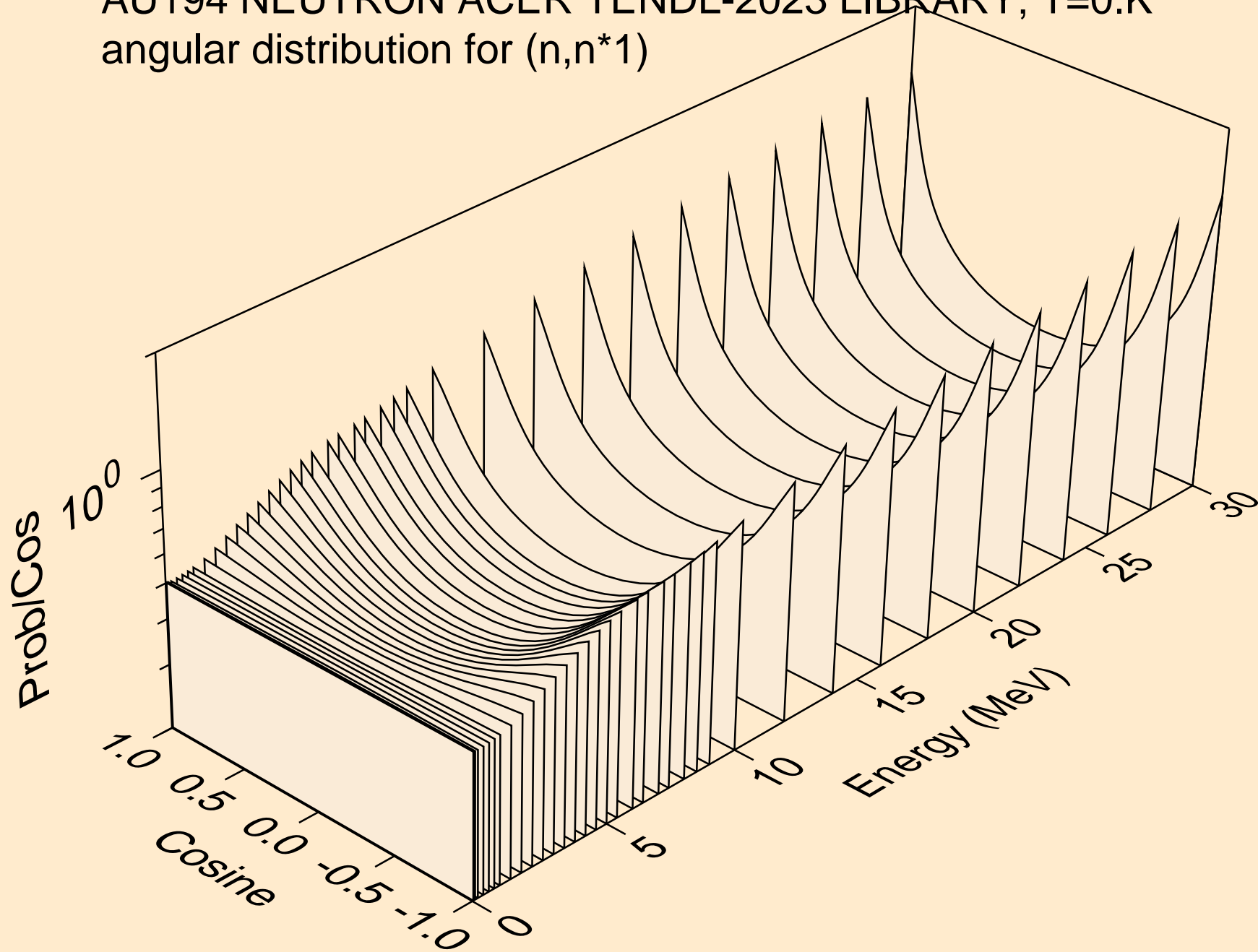

AU194 NEUTRON ACER TENDL-2023 LIBRARY; T=0.K  
angular distribution for (n,n\*2)

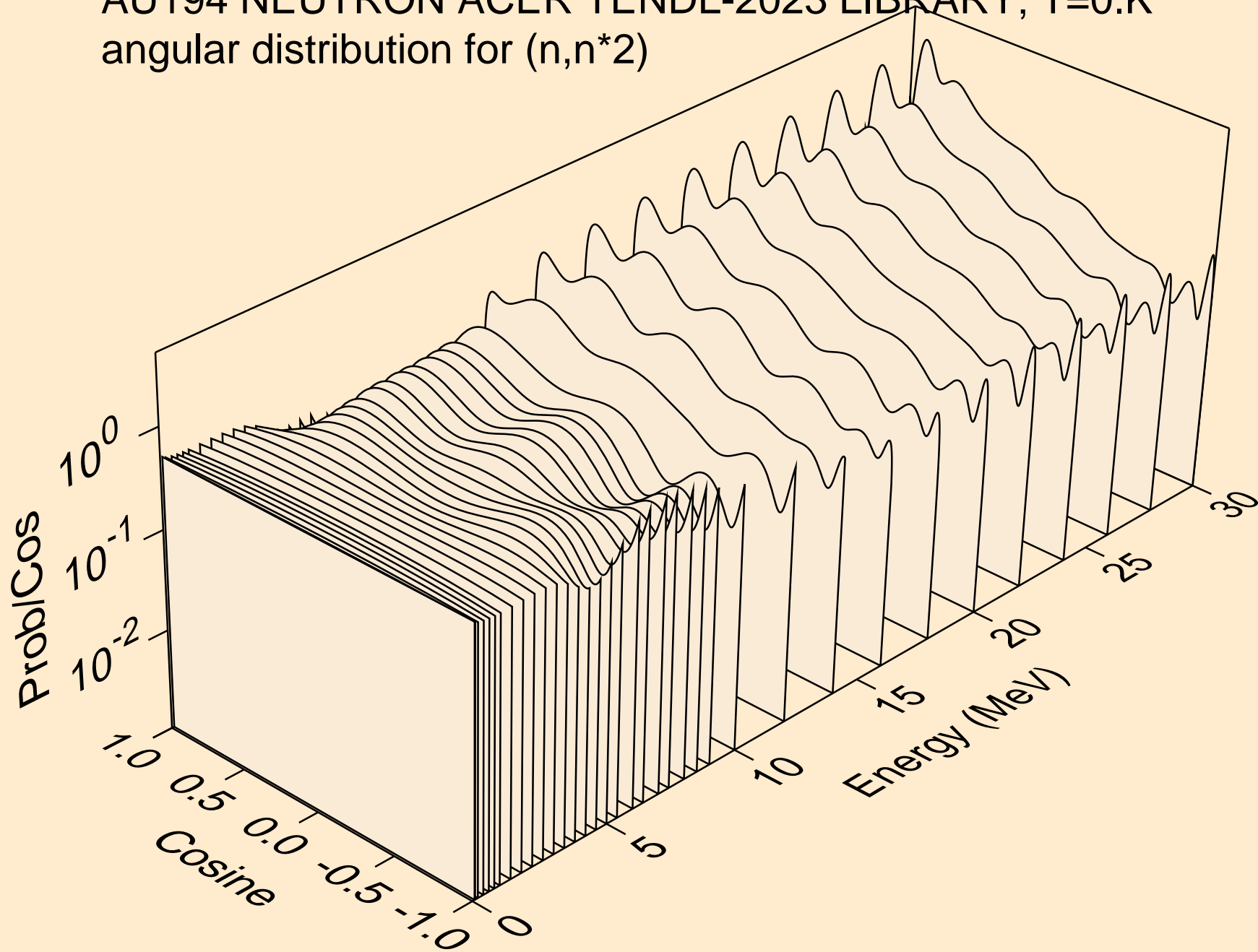

AU194 NEUTRON ACER TENDL-2023 LIBRARY; T=0.K  
angular distribution for (n,n\*3)

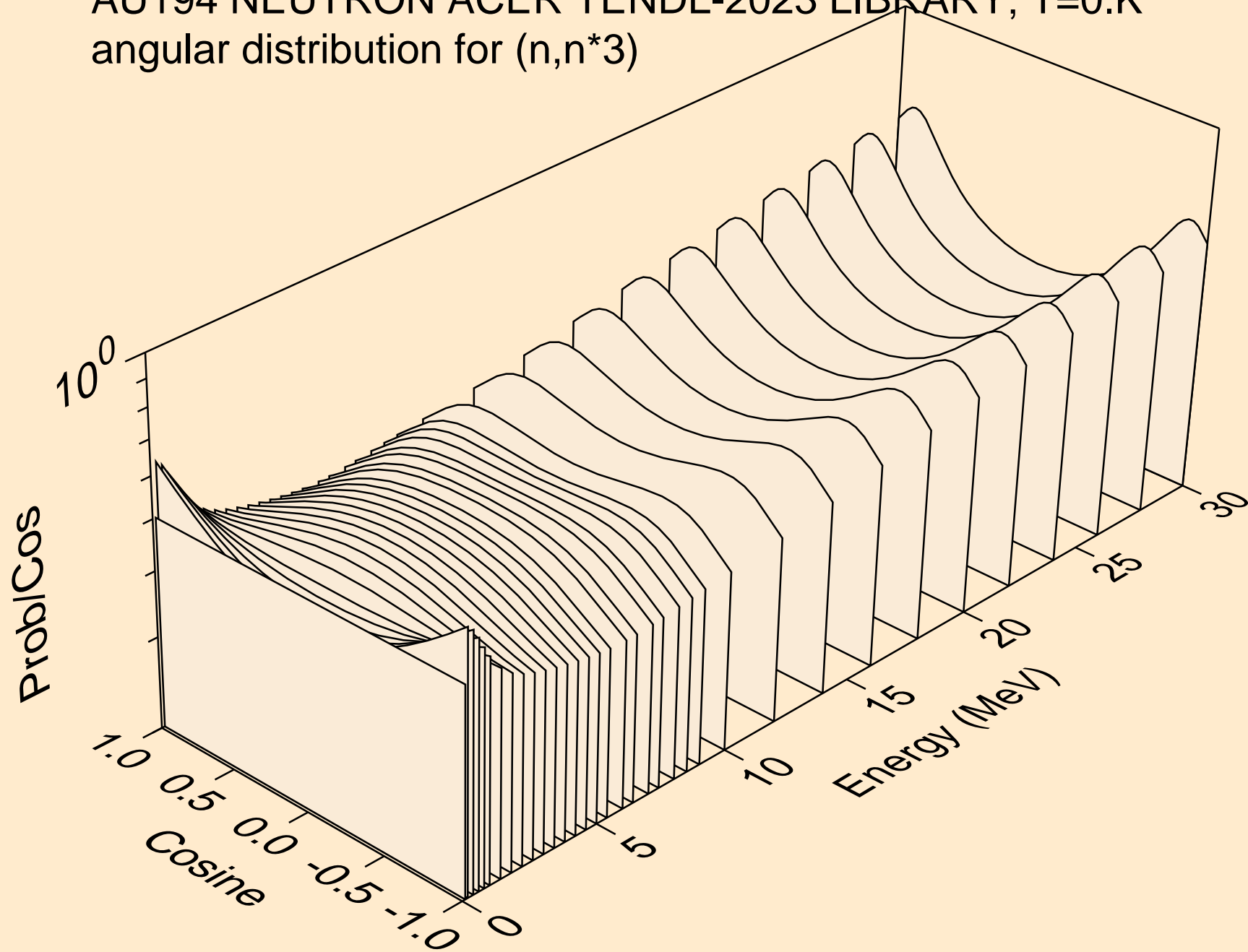

AU194 NEUTRON ACER TENDL-2023 LIBRARY; T=0.K  
Neutron emission for (n,x)

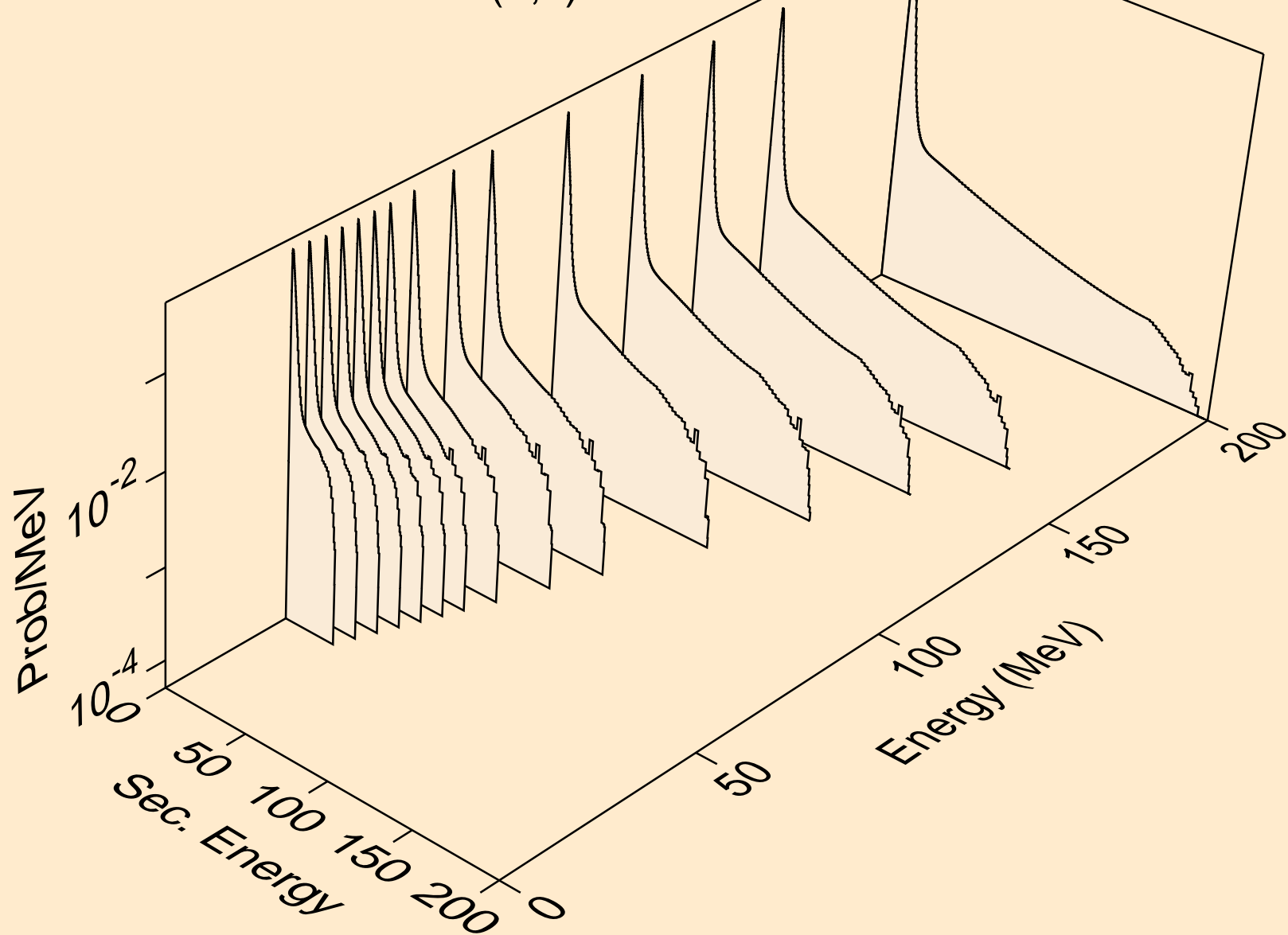

AU194 NEUTRON ACER TENDL-2023 LIBRARY; T=0.K  
Neutron emission for (n,2nd)

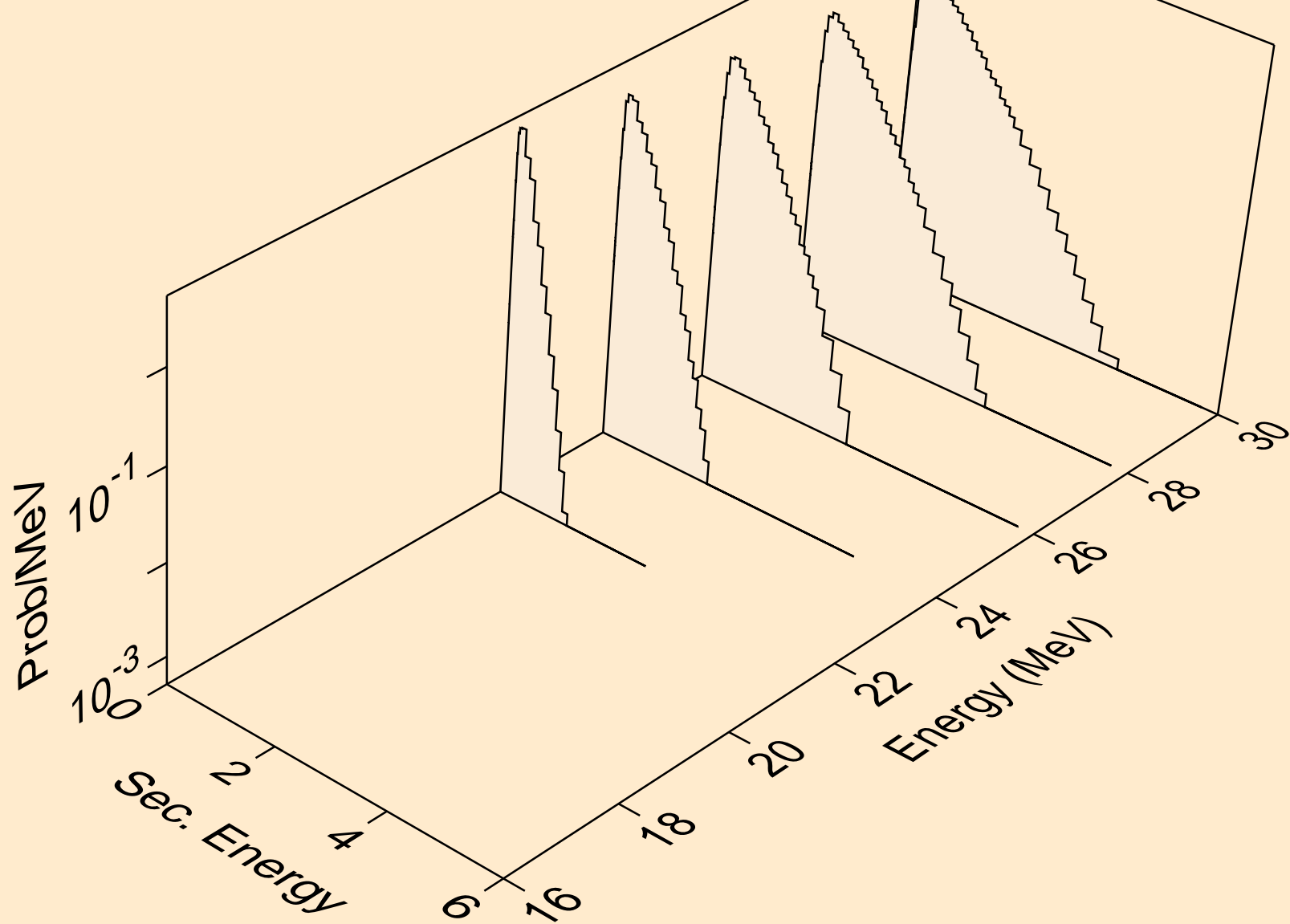



AU194 NEUTRON ACER TENDL-2023 LIBRARY; T=0.K  
Neutron emission for (n,2n)

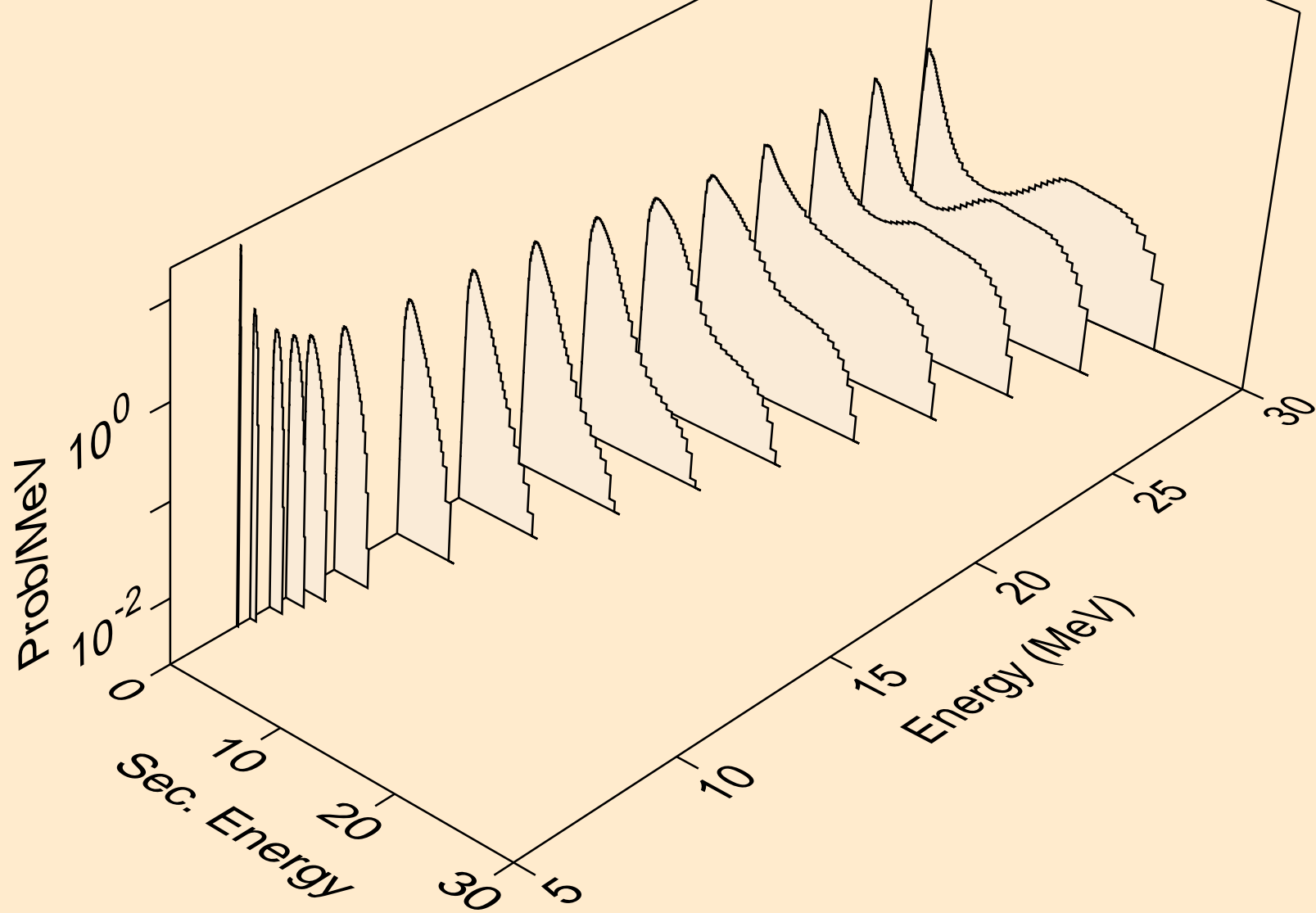

AU194 NEUTRON ACER TENDL-2023 LIBRARY; T=0.K  
Neutron emission for (n,3n)

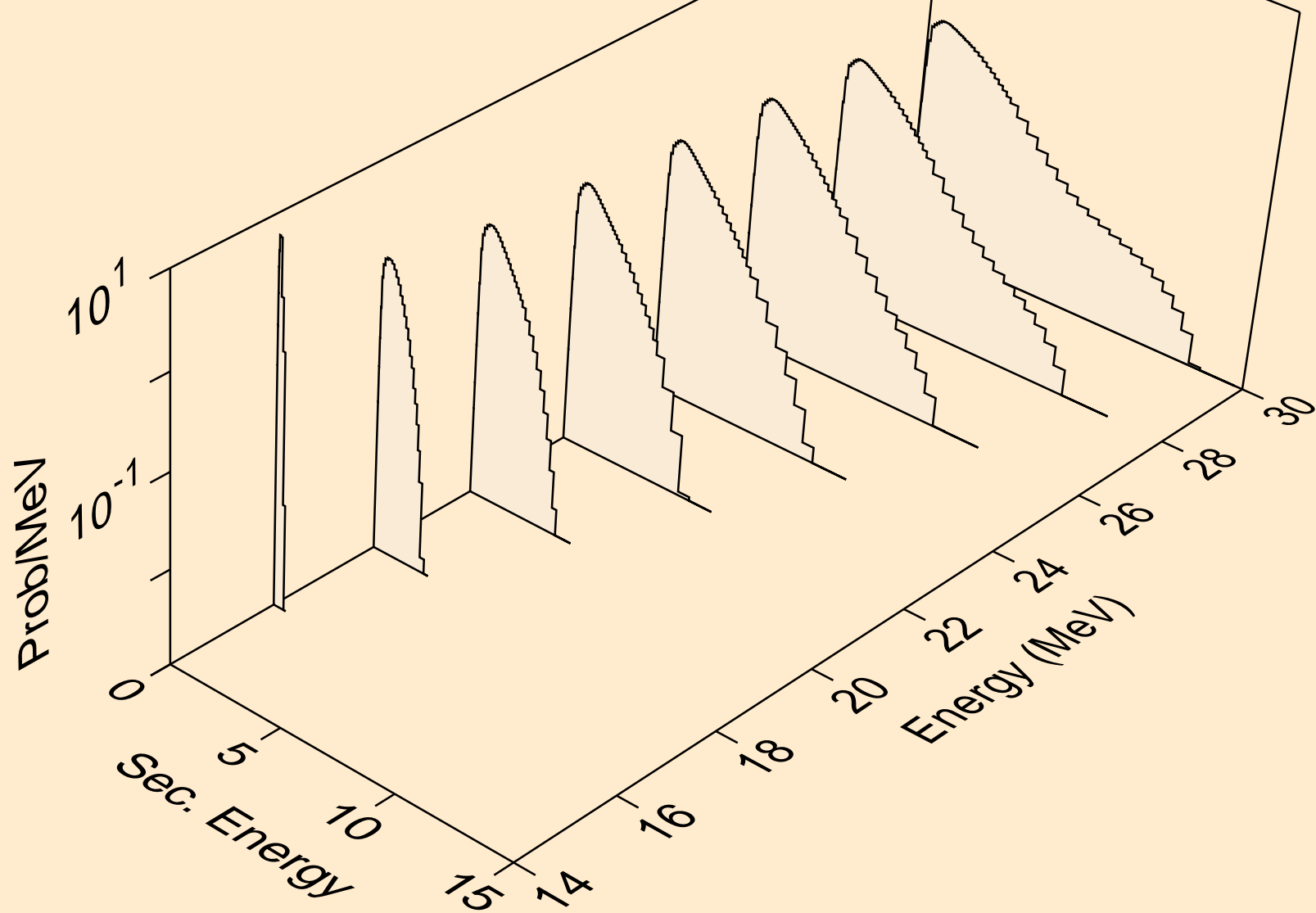

AU194 NEUTRON ACER TENDL-2023 LIBRARY; T=0.K  
Neutron emission for (n,n\*)a

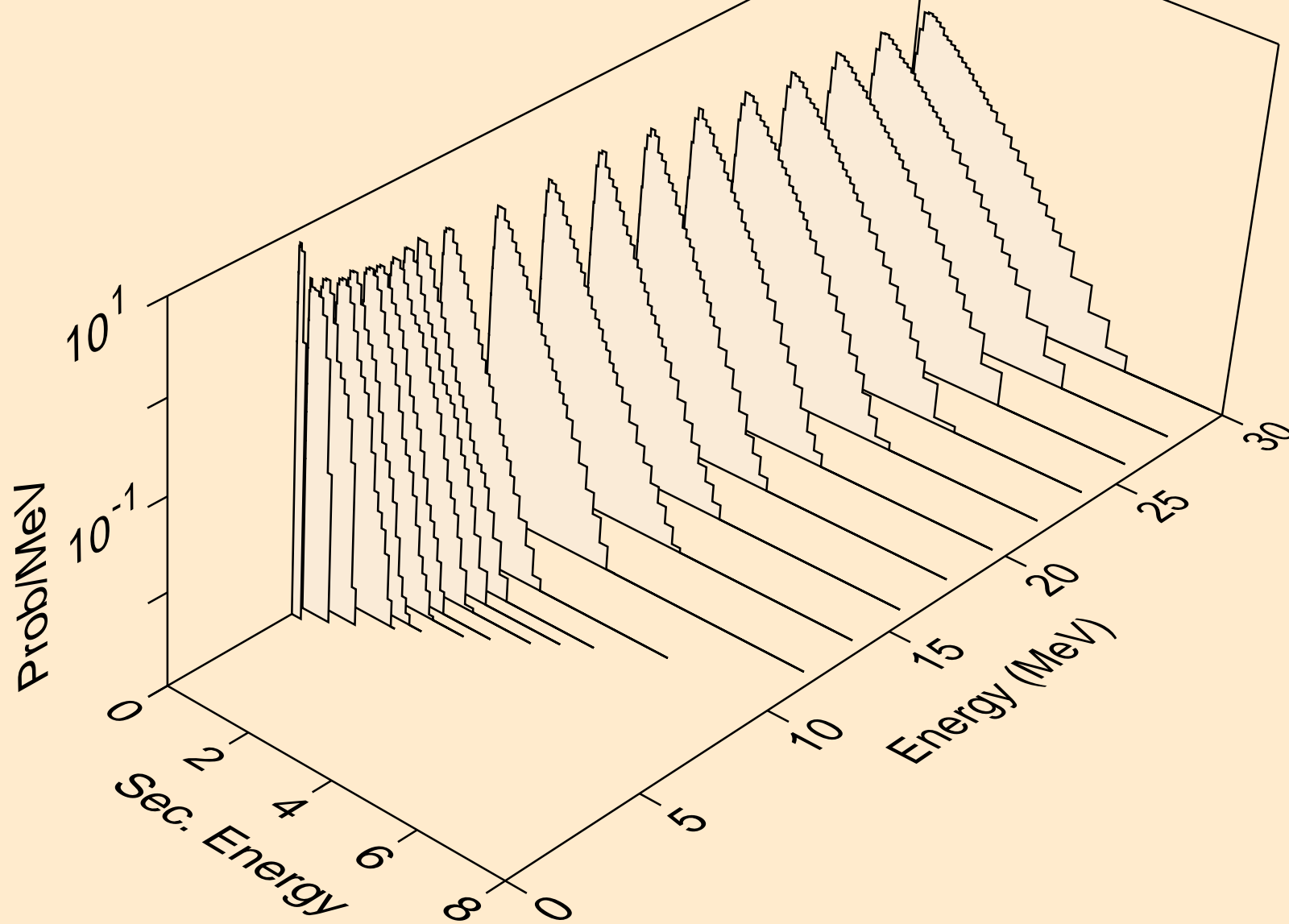

AU194 NEUTRON ACER TENDL-2023 LIBRARY; T=0.K  
Neutron emission for (n,2n)a

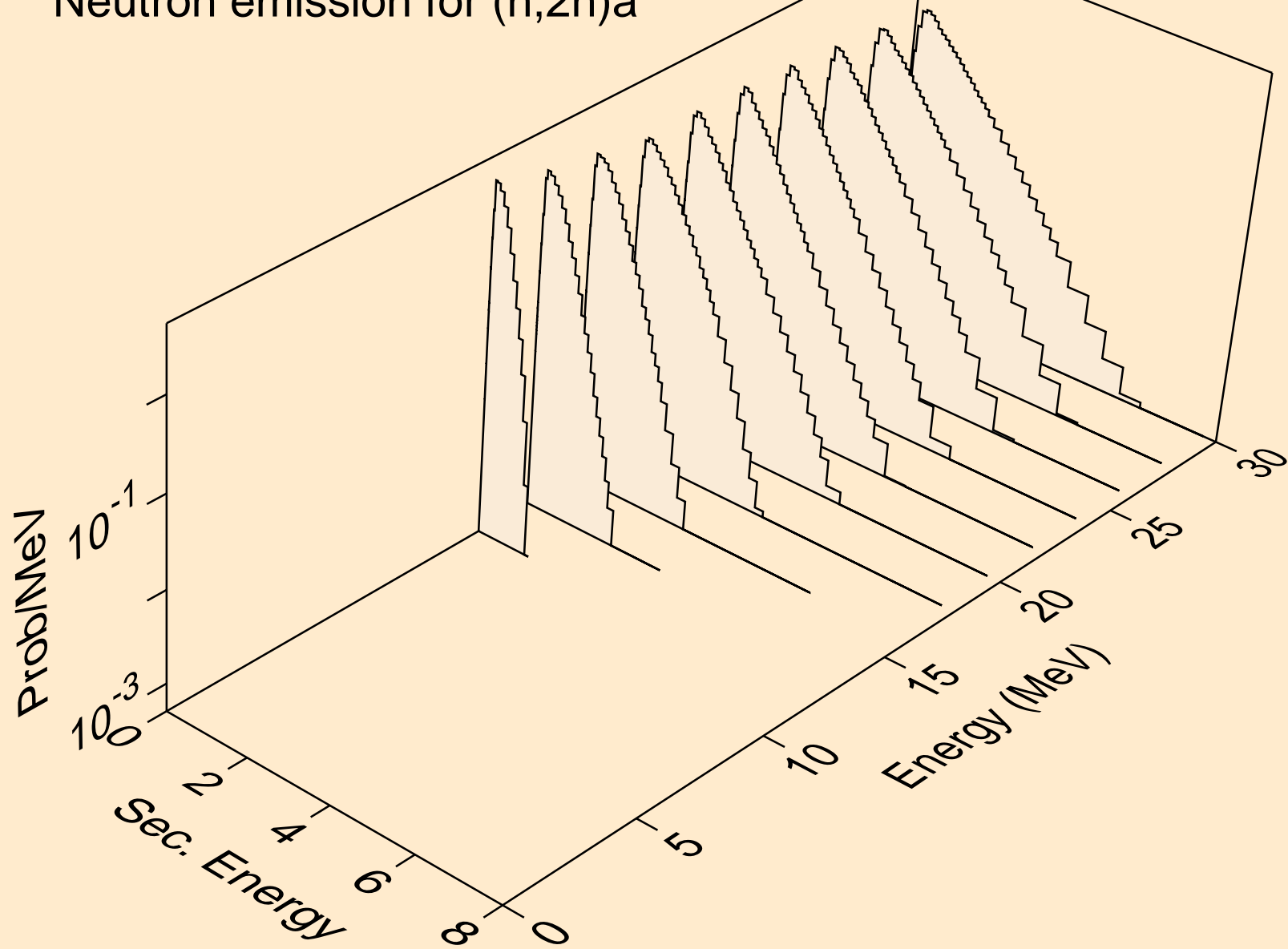

AU194 NEUTRON ACER TENDL-2023 LIBRARY; T=0.K  
Neutron emission for (n,3n)a

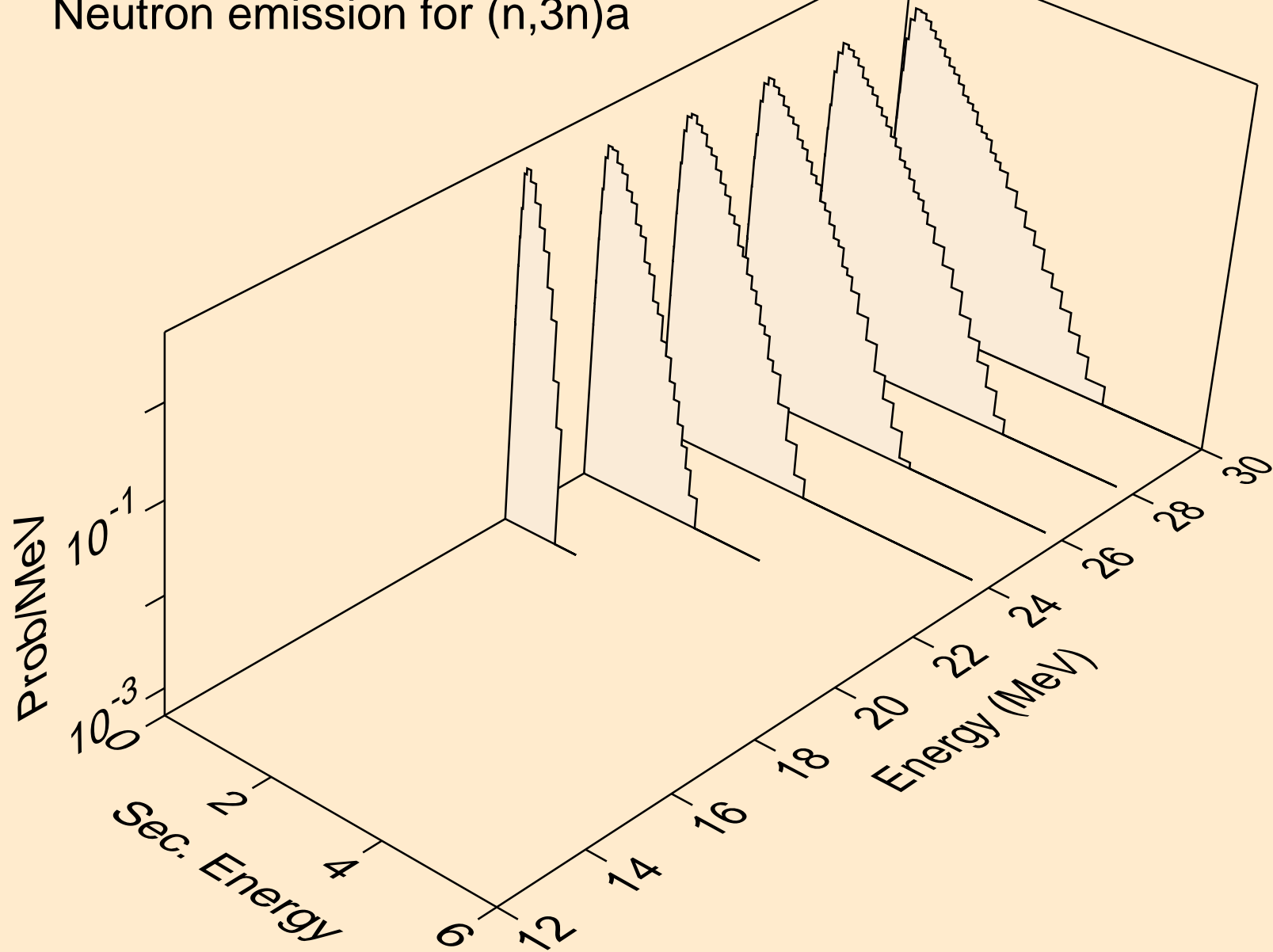

AU194 NEUTRON ACER TENDL-2023 LIBRARY; T=0.K  
Neutron emission for (n,n\*)p

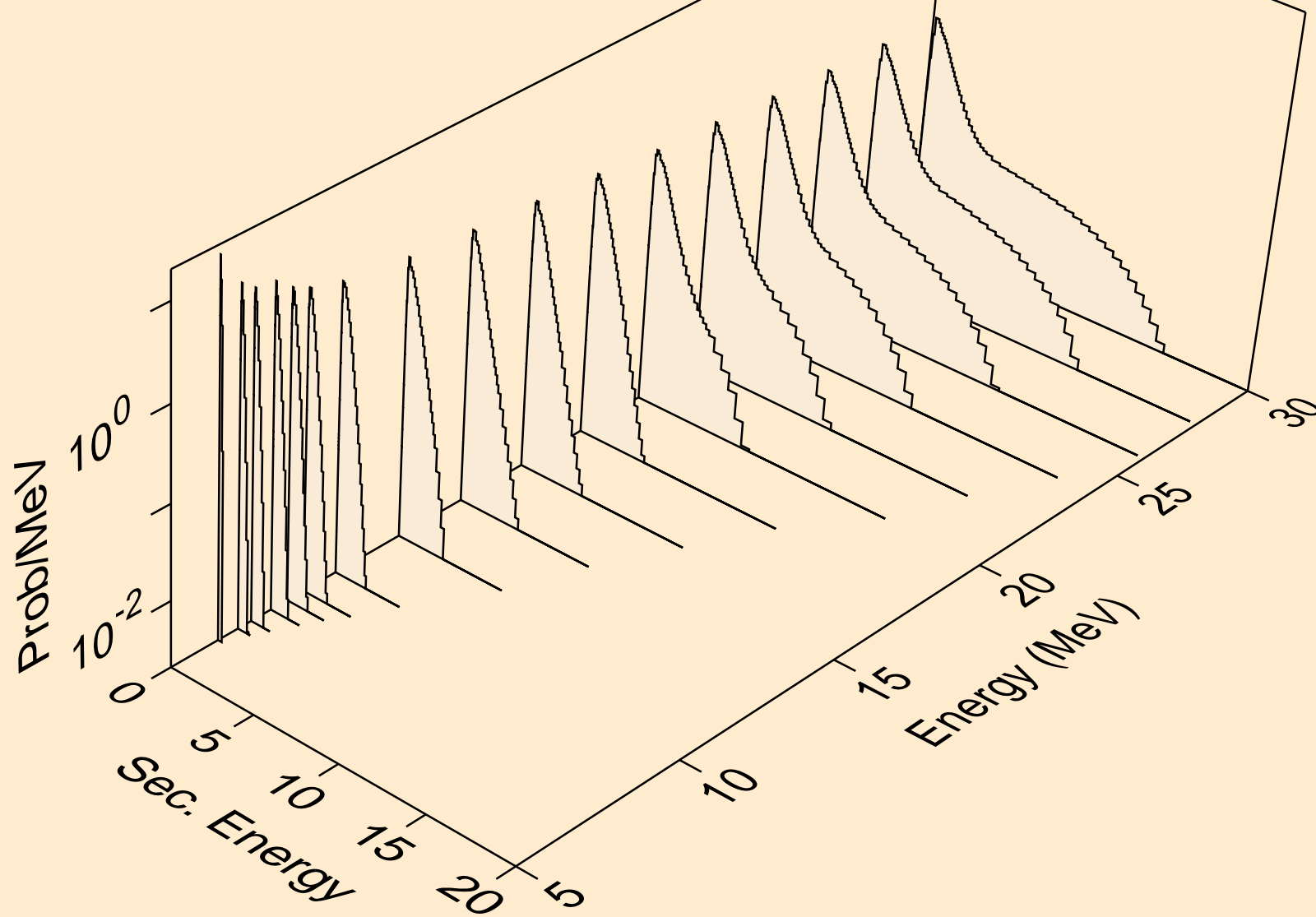

AU194 NEUTRON ACER TENDL-2023 LIBRARY; T=0.K  
Neutron emission for (n,n\*)2a

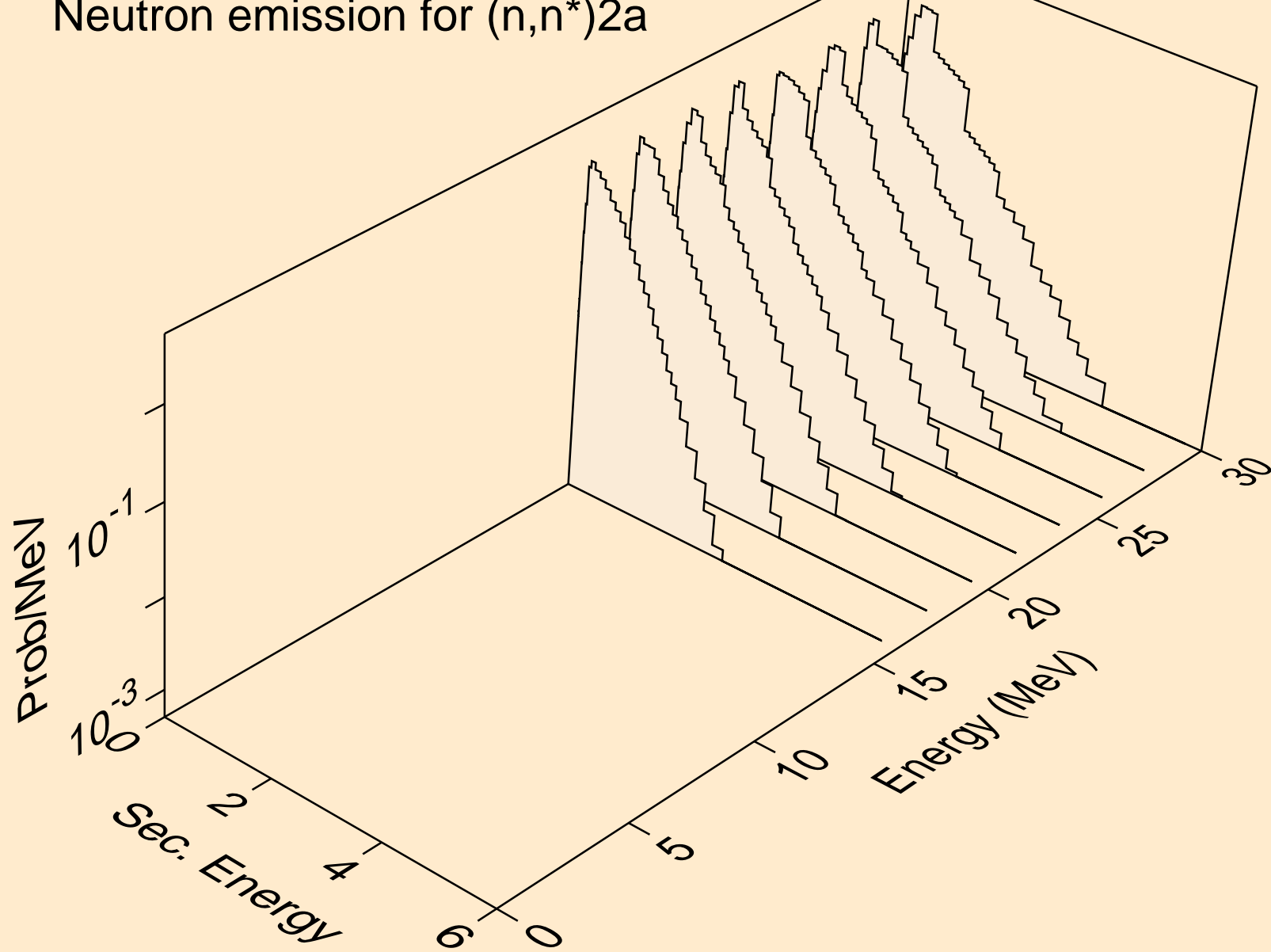

AU194 NEUTRON ACER TENDL-2023 LIBRARY; T=0.K  
Neutron emission for (n,n\*)d

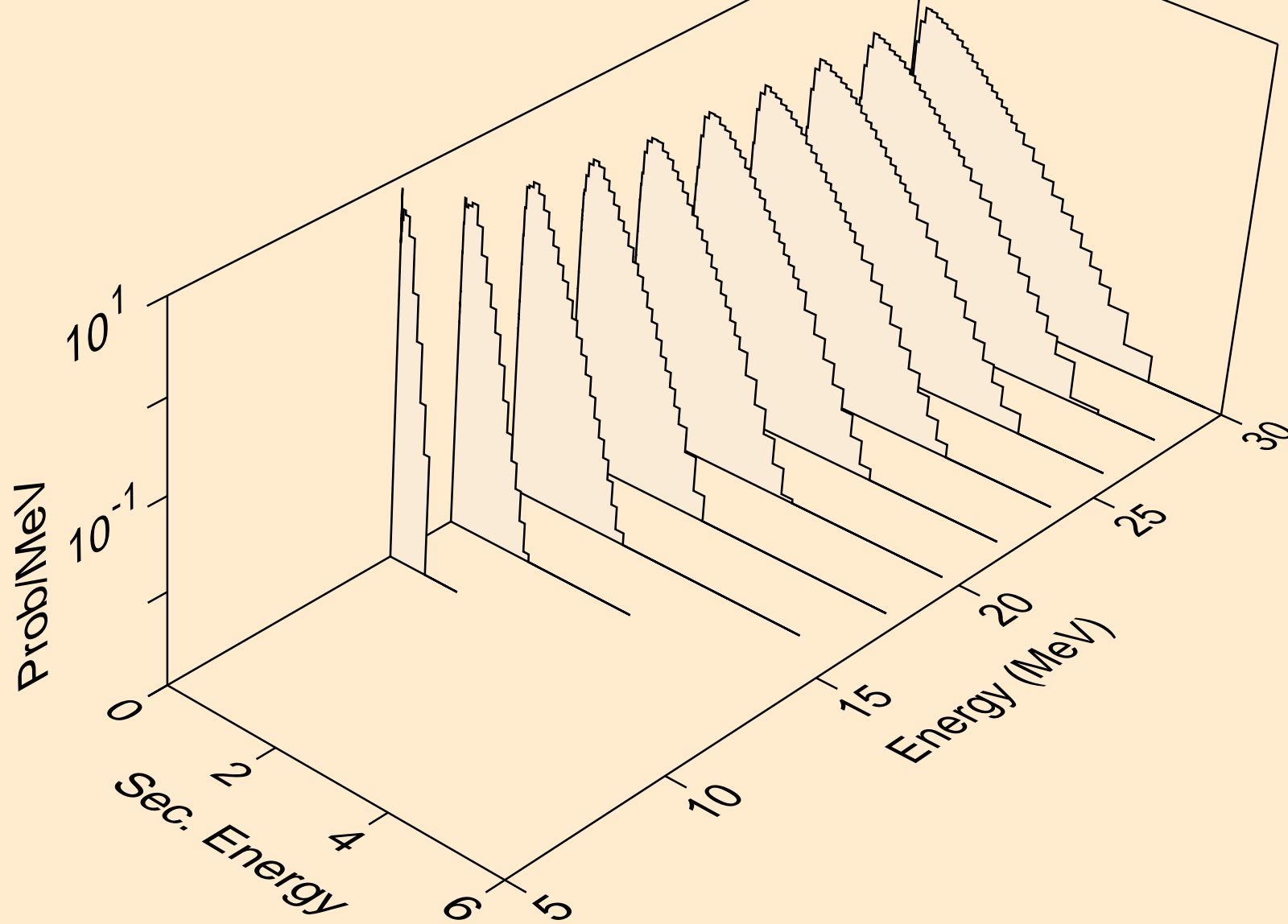



AU194 NEUTRON ACER TENDL-2023 LIBRARY; T=0.K  
Neutron emission for (n,n\*)t

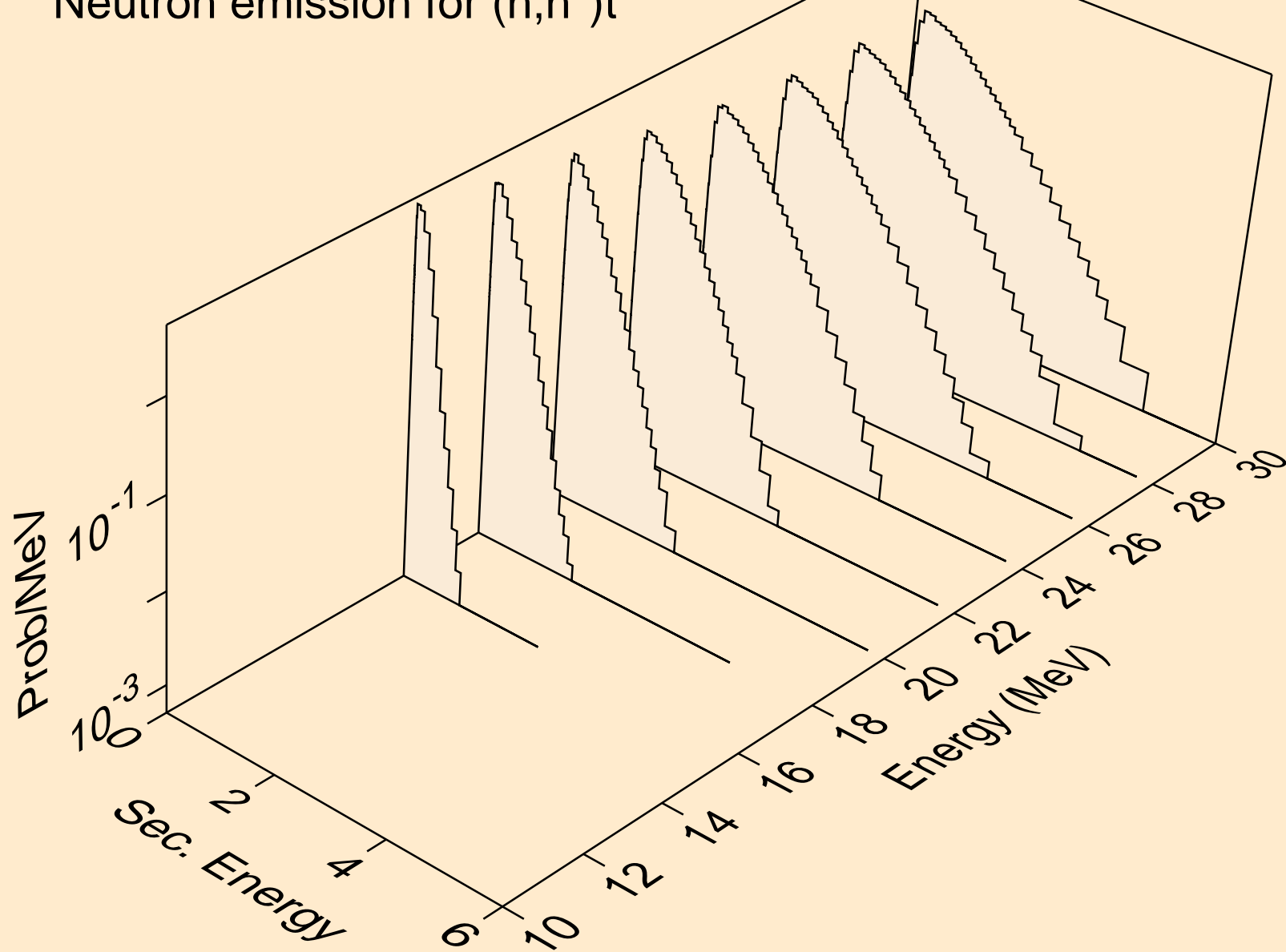

AU194 NEUTRON ACER TENDL-2023 LIBRARY; T=0.K  
Neutron emission for (n,n\*)he3

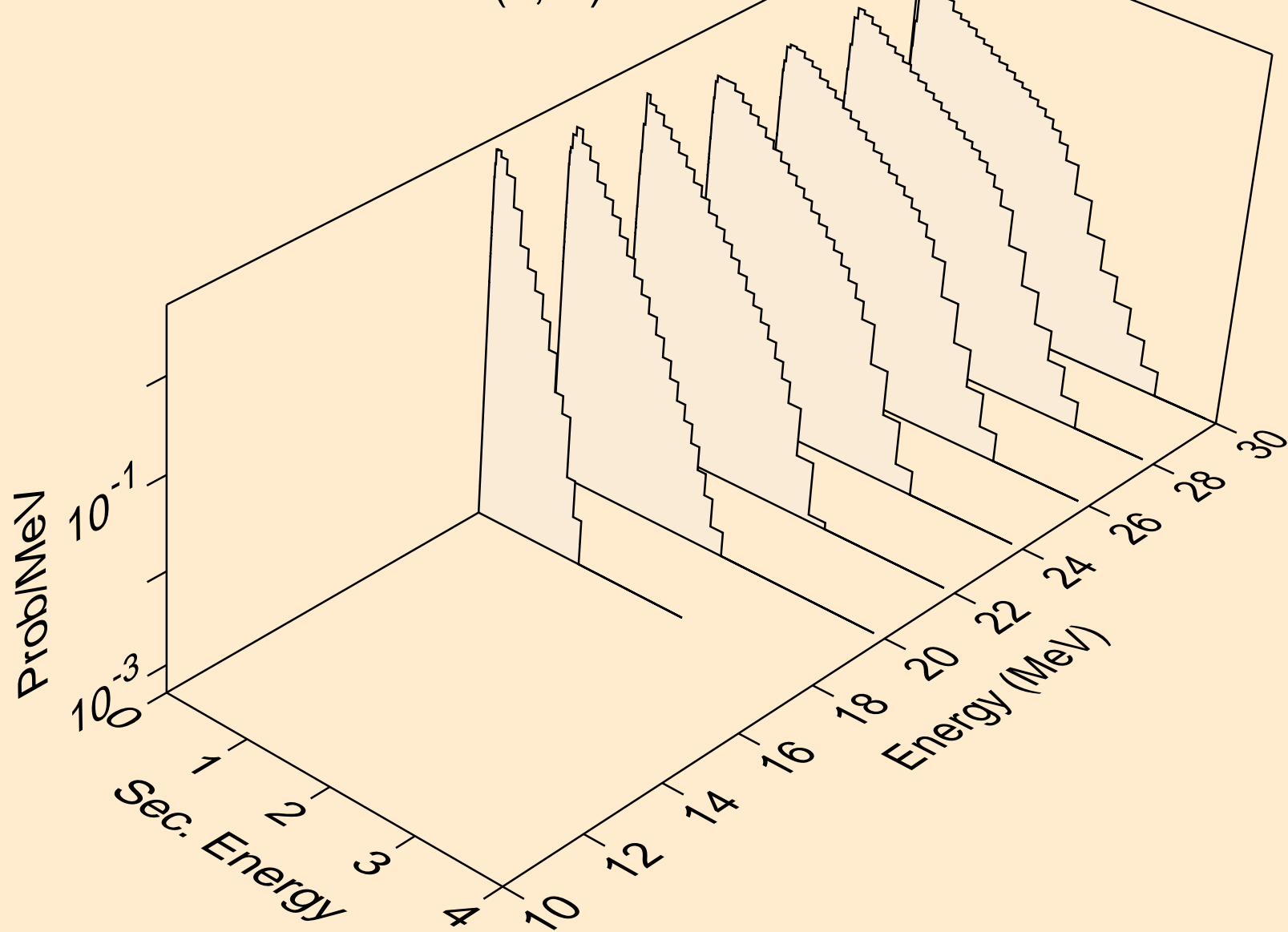

AU194 NEUTRON ACER TENDL-2023 LIBRARY; T=0.K  
Neutron emission for (n,4n)

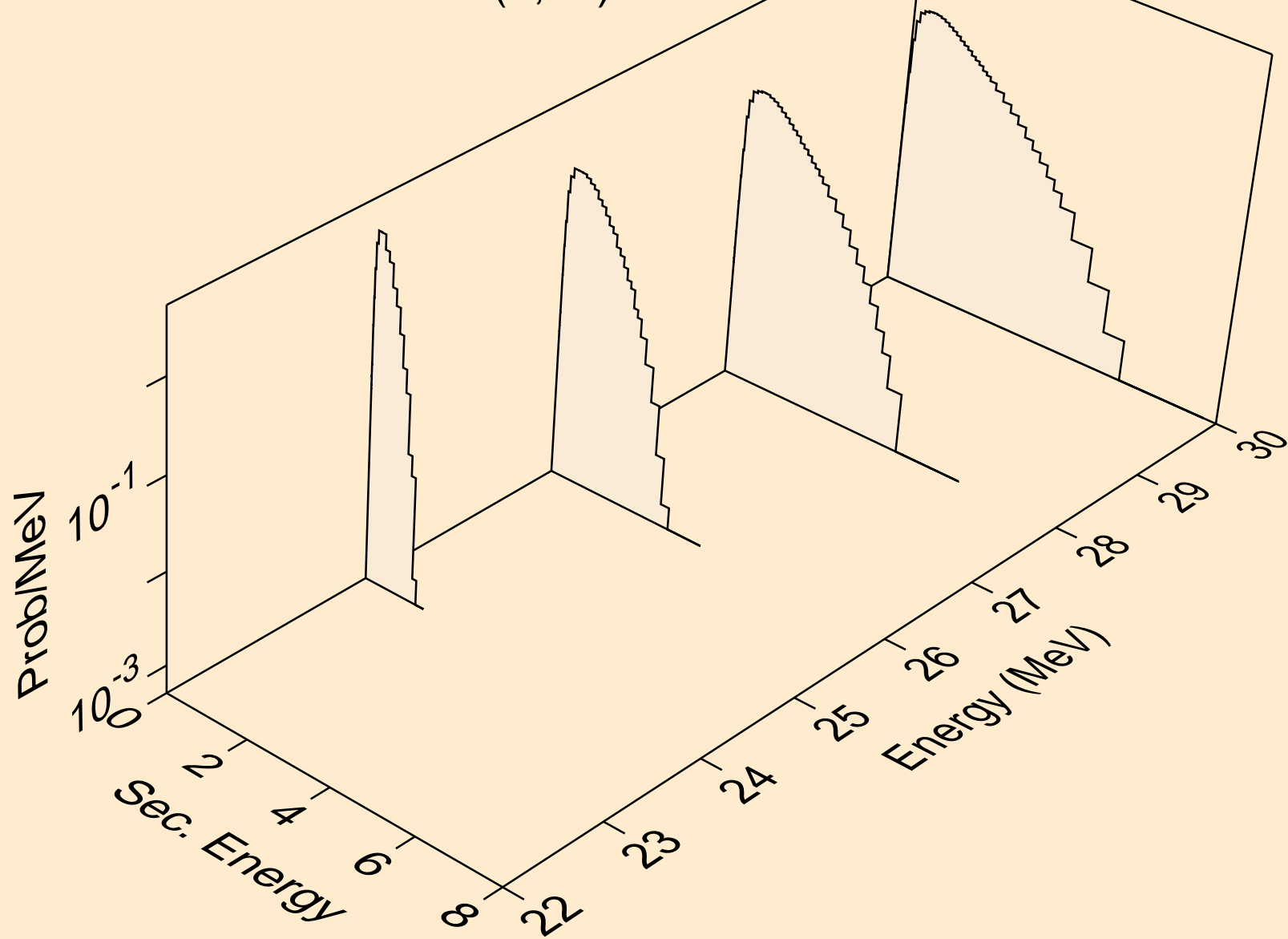

AU194 NEUTRON ACER TENDL-2023 LIBRARY; T=0.K  
Neutron emission for (n,2np)

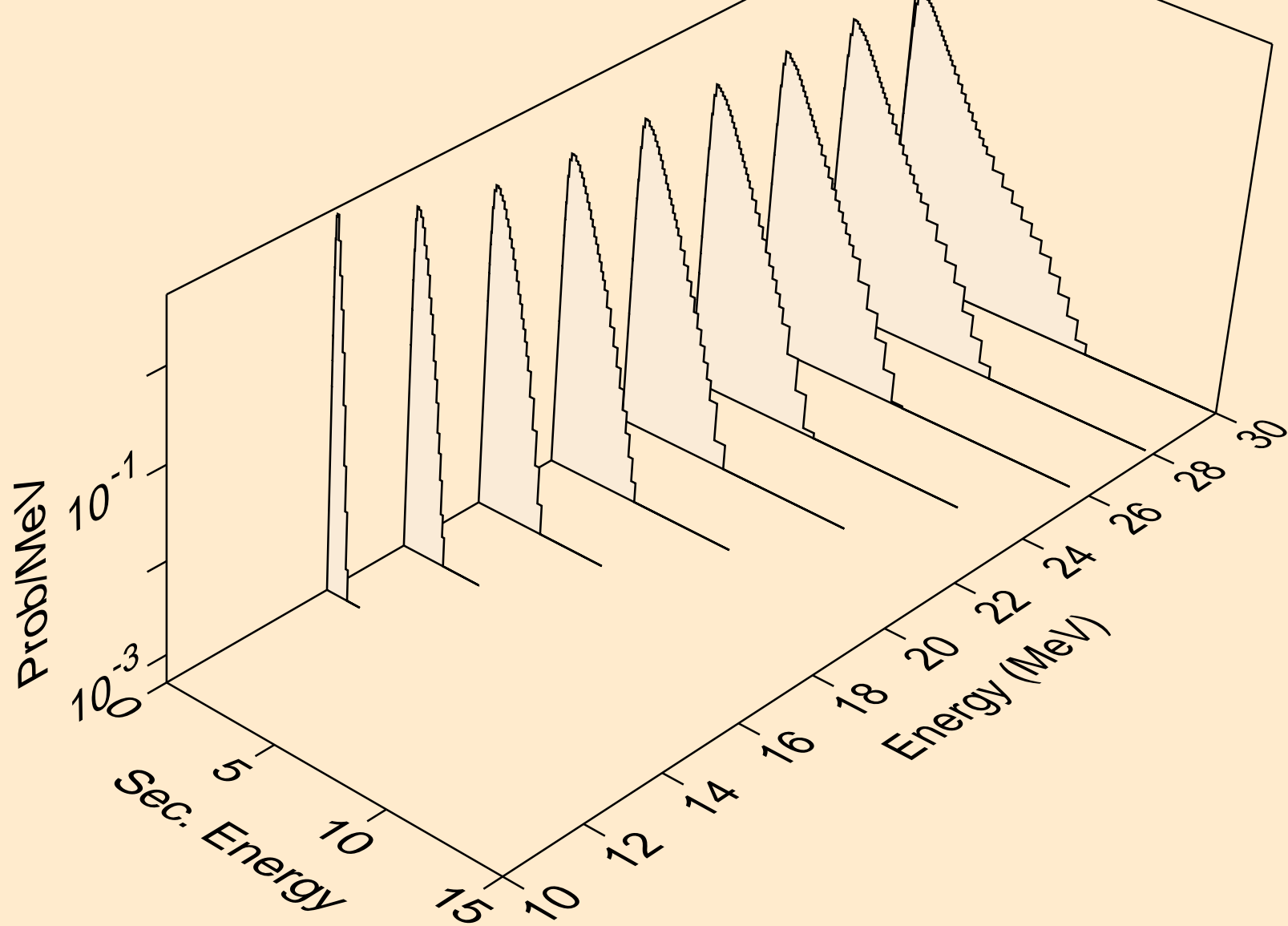

AU194 NEUTRON ACER TENDL-2023 LIBRARY; T=0.K  
Neutron emission for (n,3np)

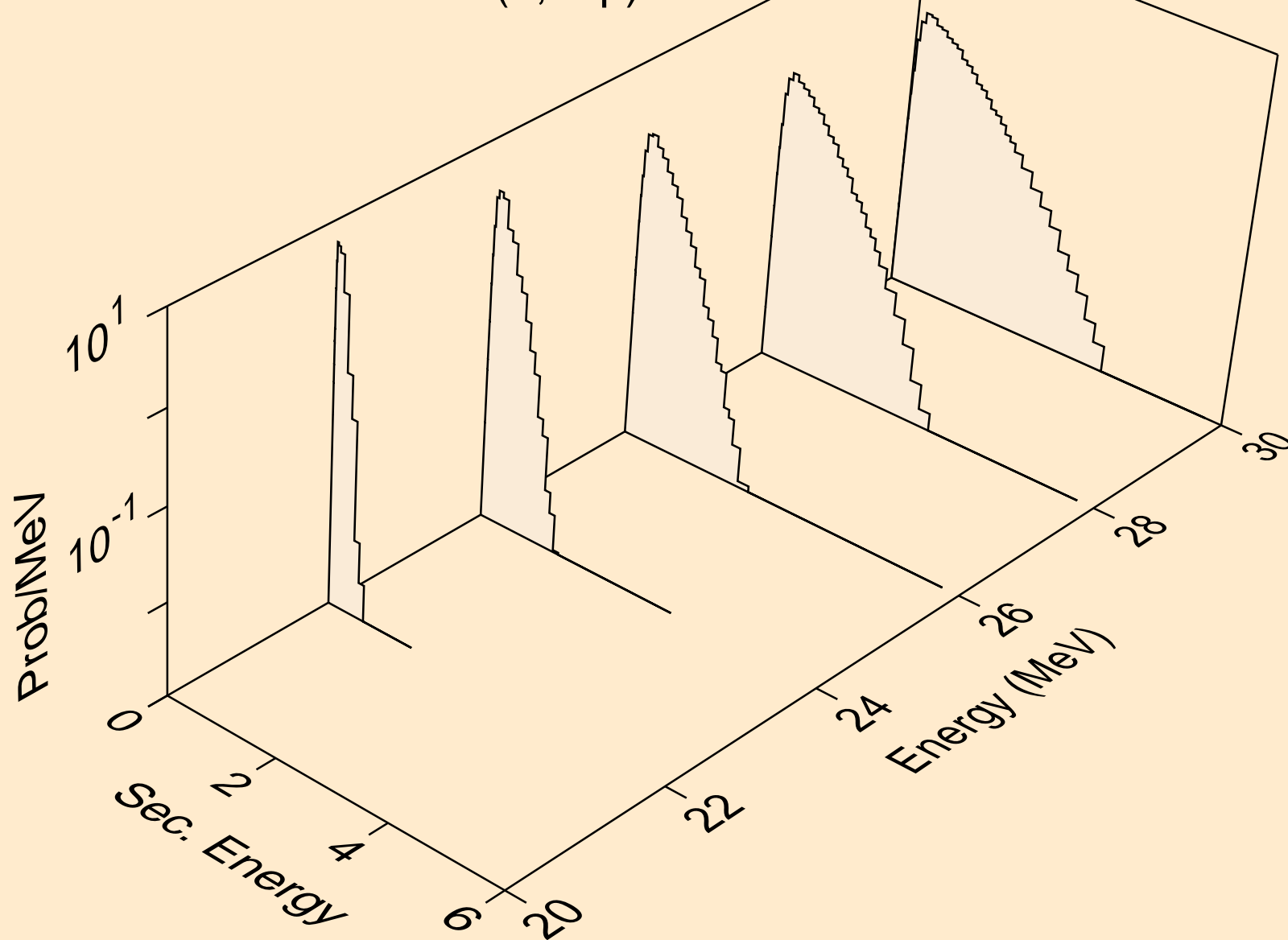

AU194 NEUTRON ACER TENDL-2023 LIBRARY; T=0.K  
Neutron emission for (n,n2p)

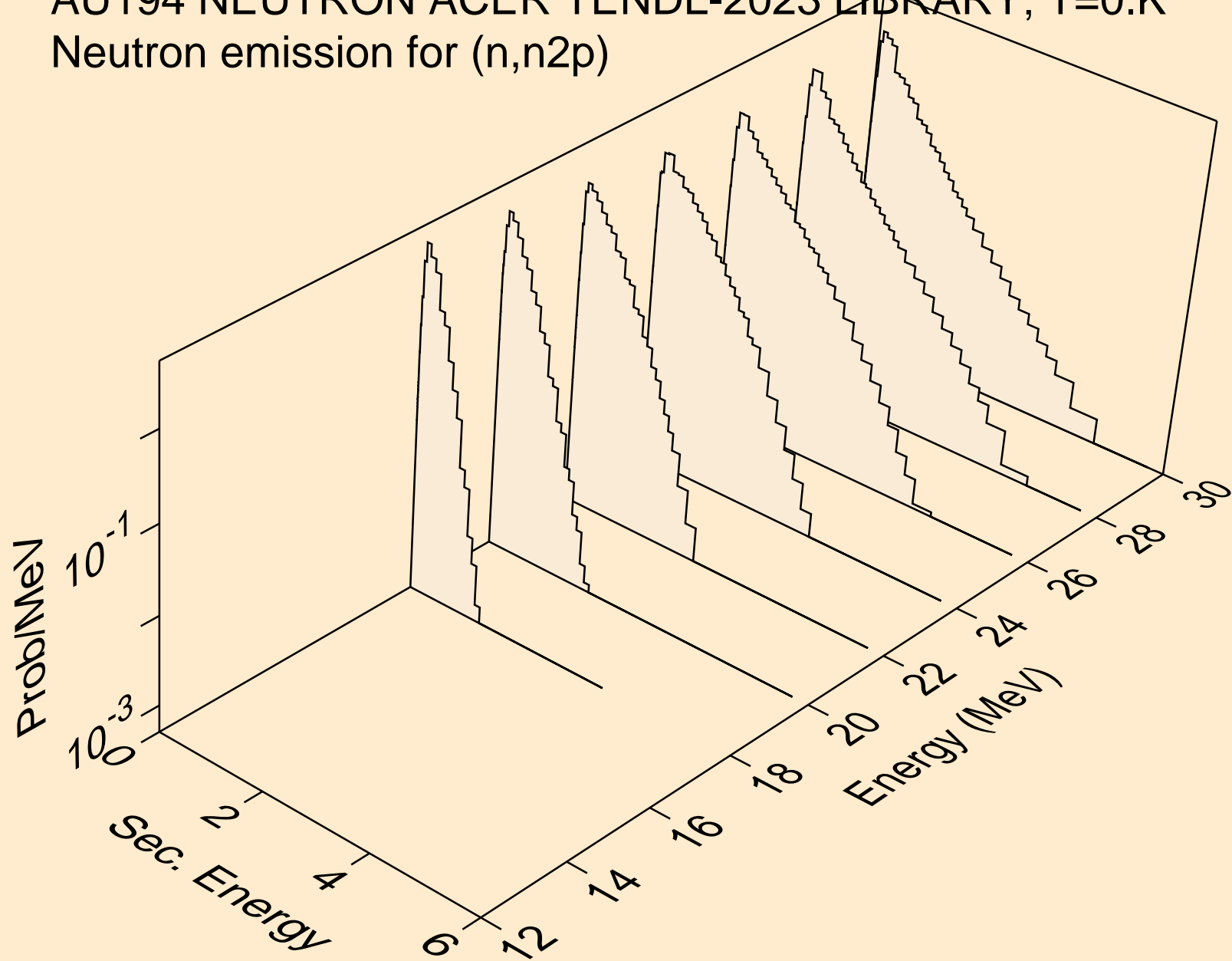

AU194 NEUTRON ACER TENDL-2023 LIBRARY; T=0.K  
Neutron emission for (n,npa)

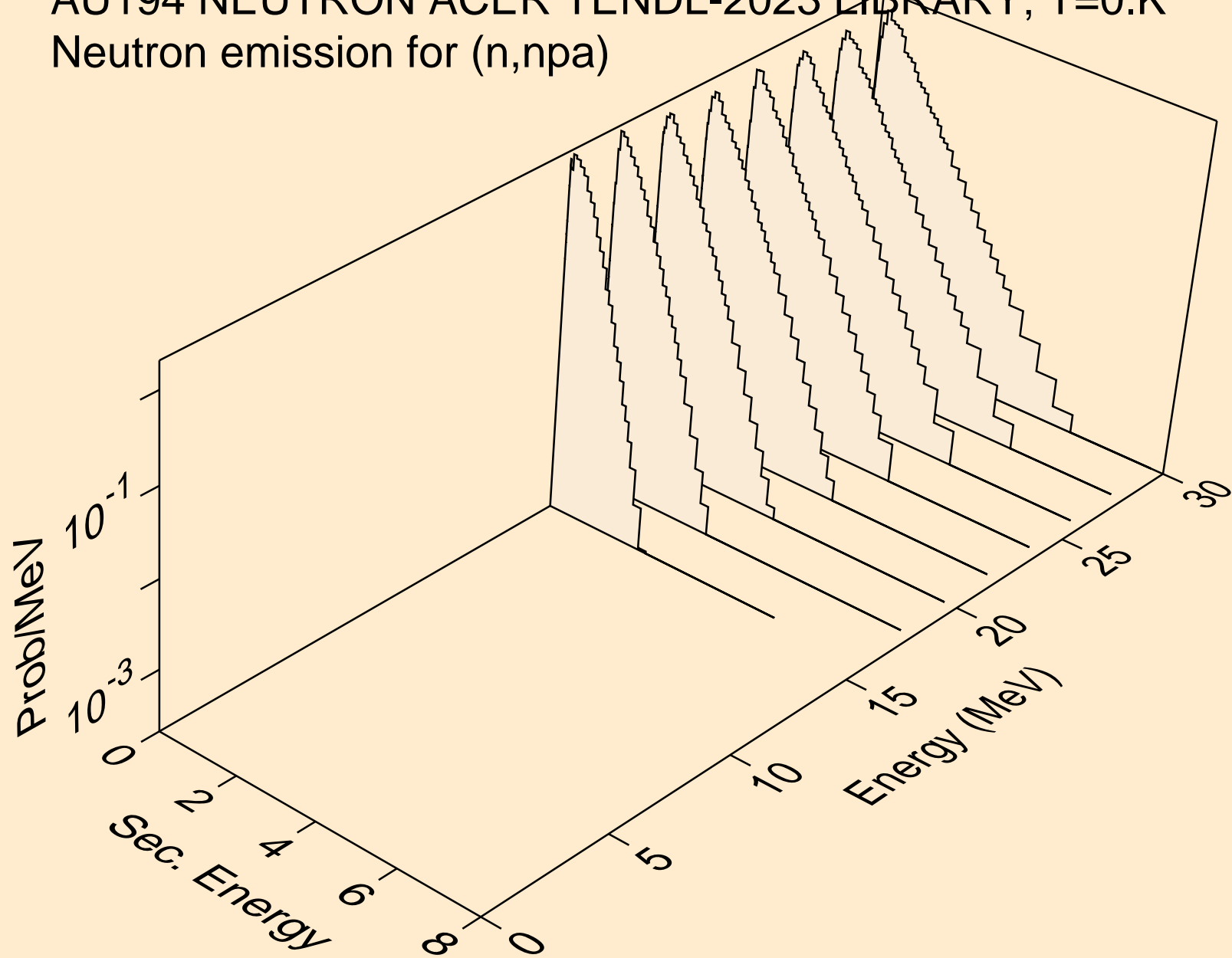

AU194 NEUTRON ACER TENDL-2023 LIBRARY; T=0.K  
Neutron emission for (n,n\*c)

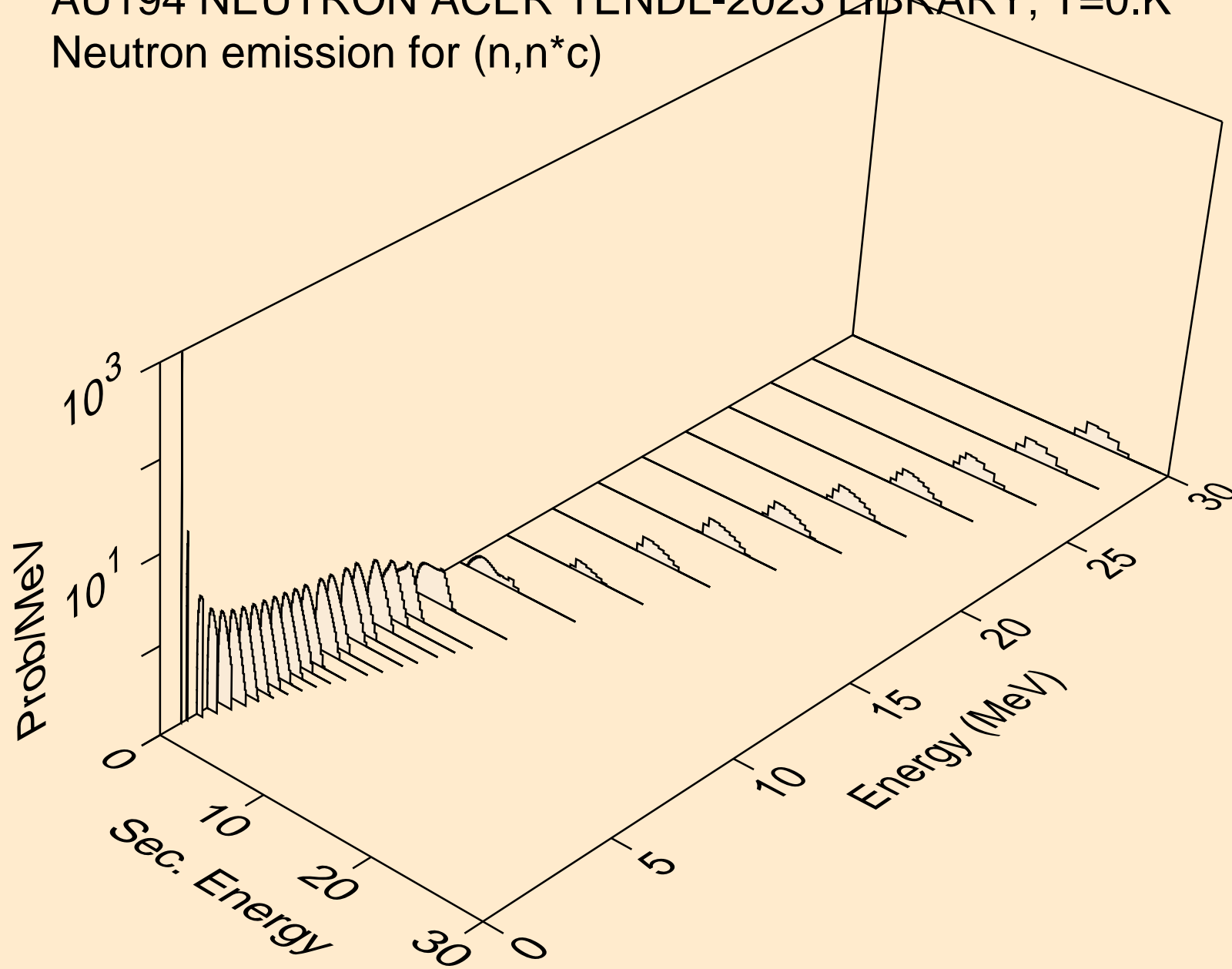



AU194 NEUTRON ACER TENDL-2023 LIBRARY; T=0.K  
Photon emission for (n,x)

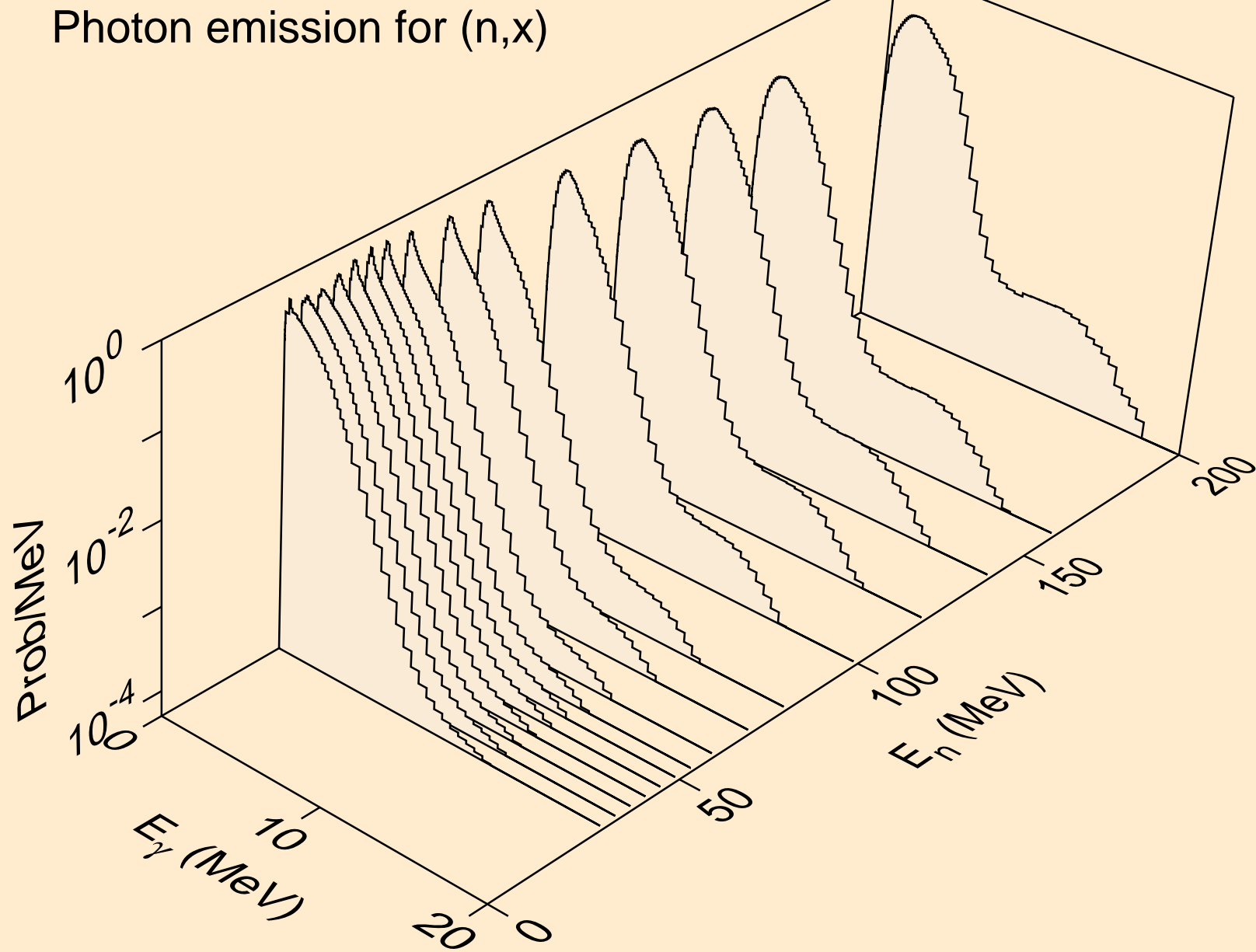

AU194 NEUTRON ACER TENDL-2023 LIBRARY; T=0.K  
Photon emission for (n,2nd)

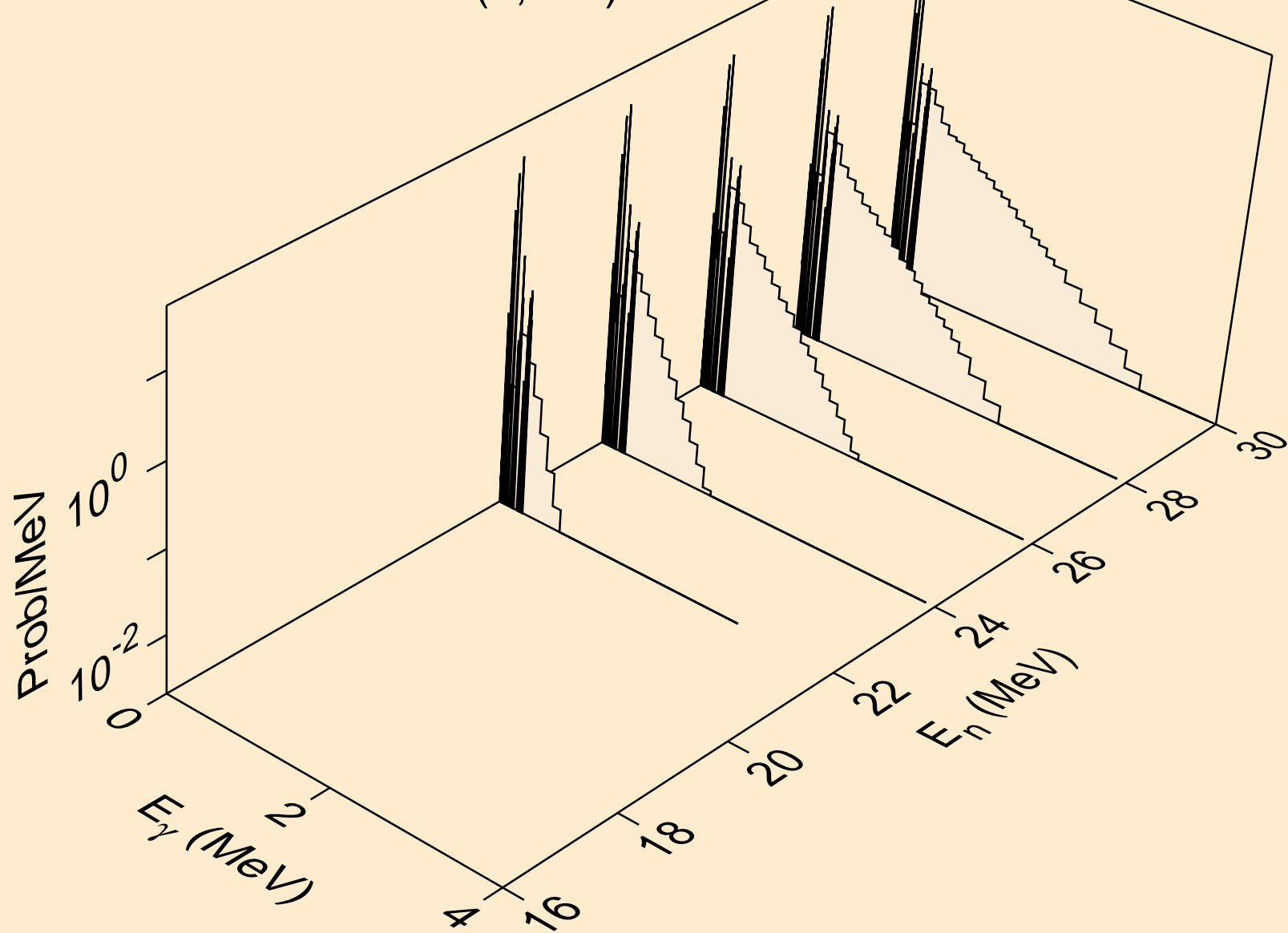

AU194 NEUTRON ACER TENDL-2023 LIBRARY; T=0.K  
Photon emission for (n,2n)

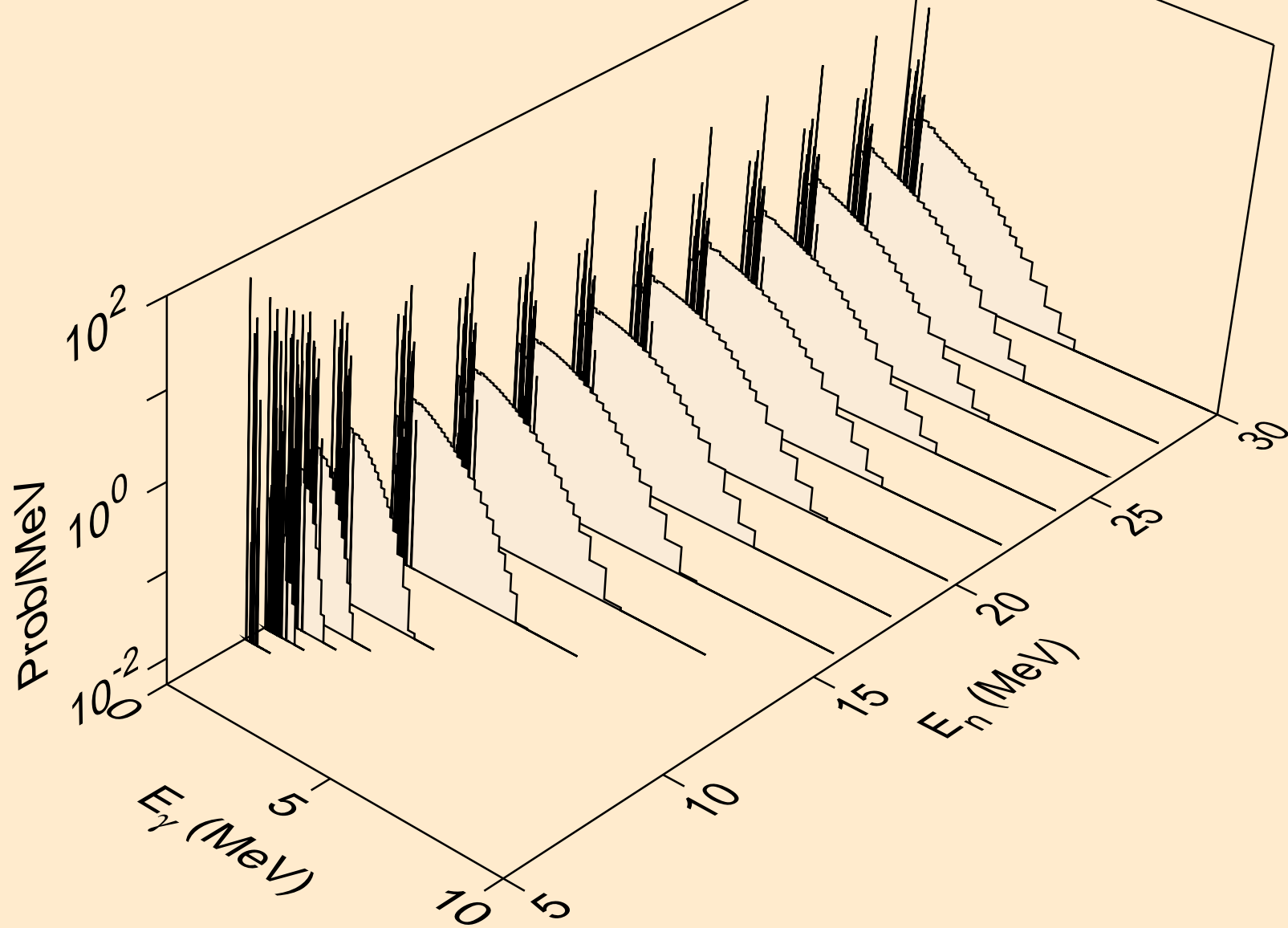

AU194 NEUTRON ACER TENDL-2023 LIBRARY; T=0.K  
Photon emission for (n,3n)

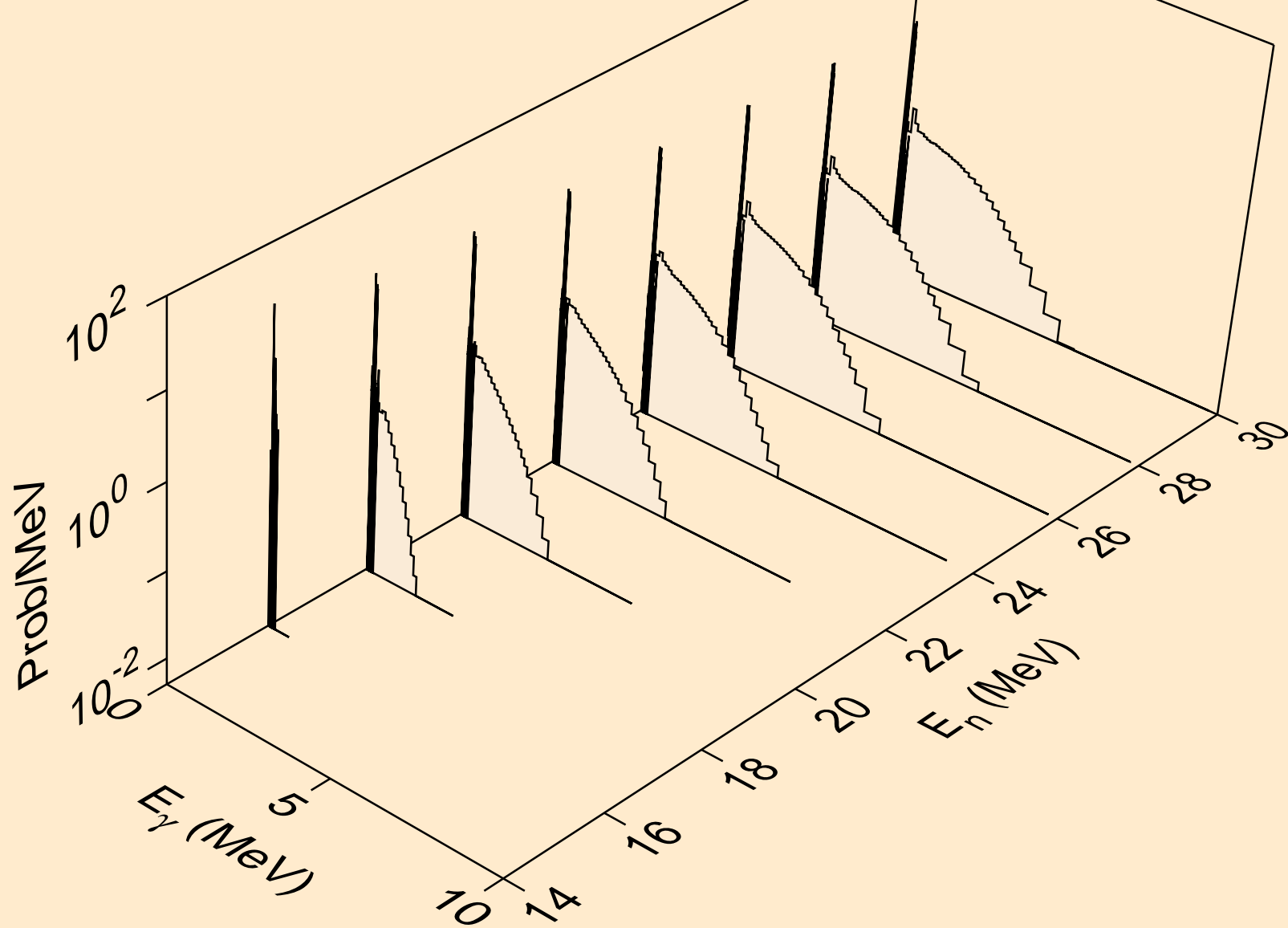

AU194 NEUTRON ACER TENDL-2023 LIBRARY; T=0.K  
Photon emission for (n,n\*)a

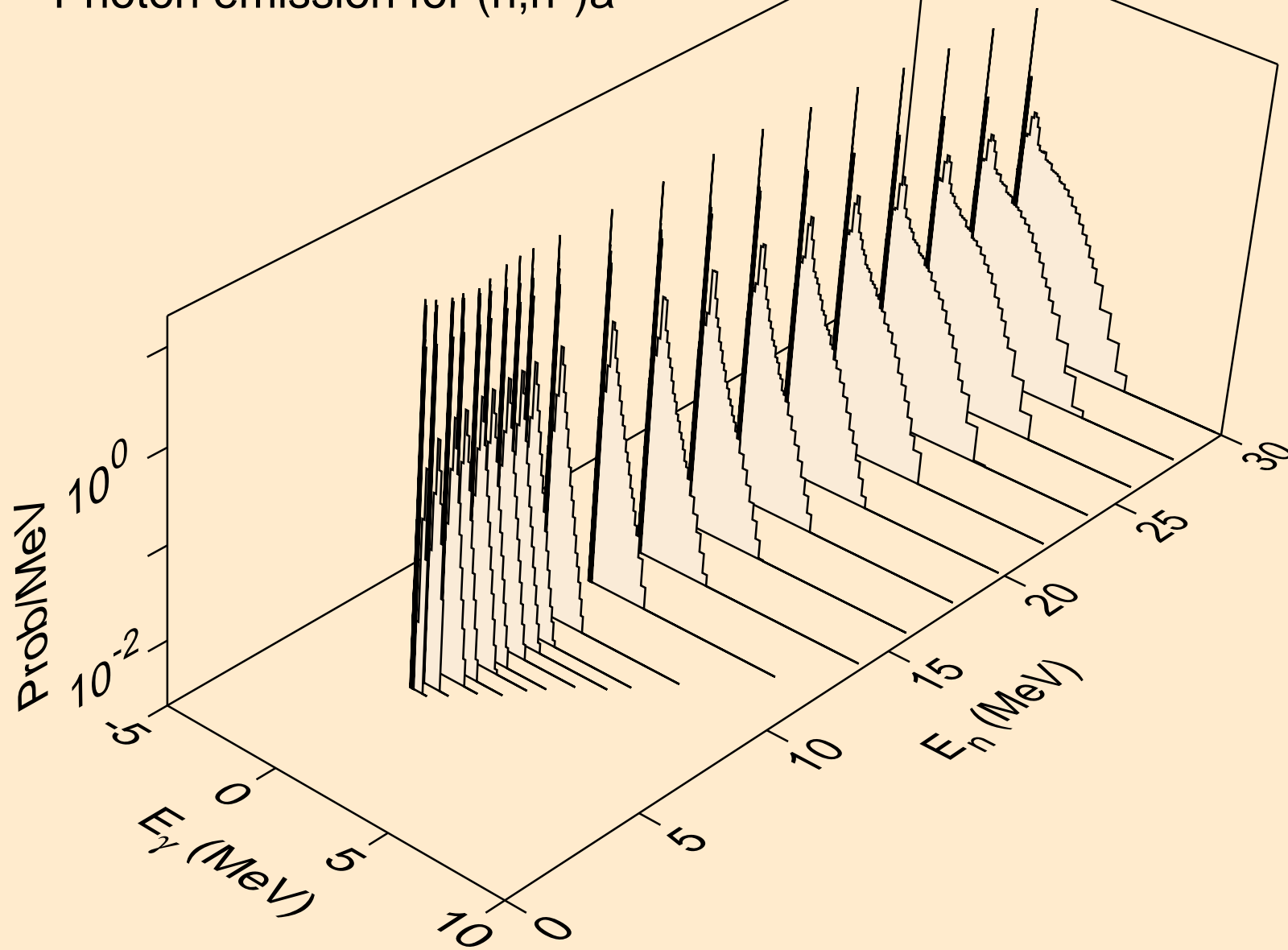

AU194 NEUTRON ACER TENDL-2023 LIBRARY; T=0.K  
Photon emission for (n,2n)a

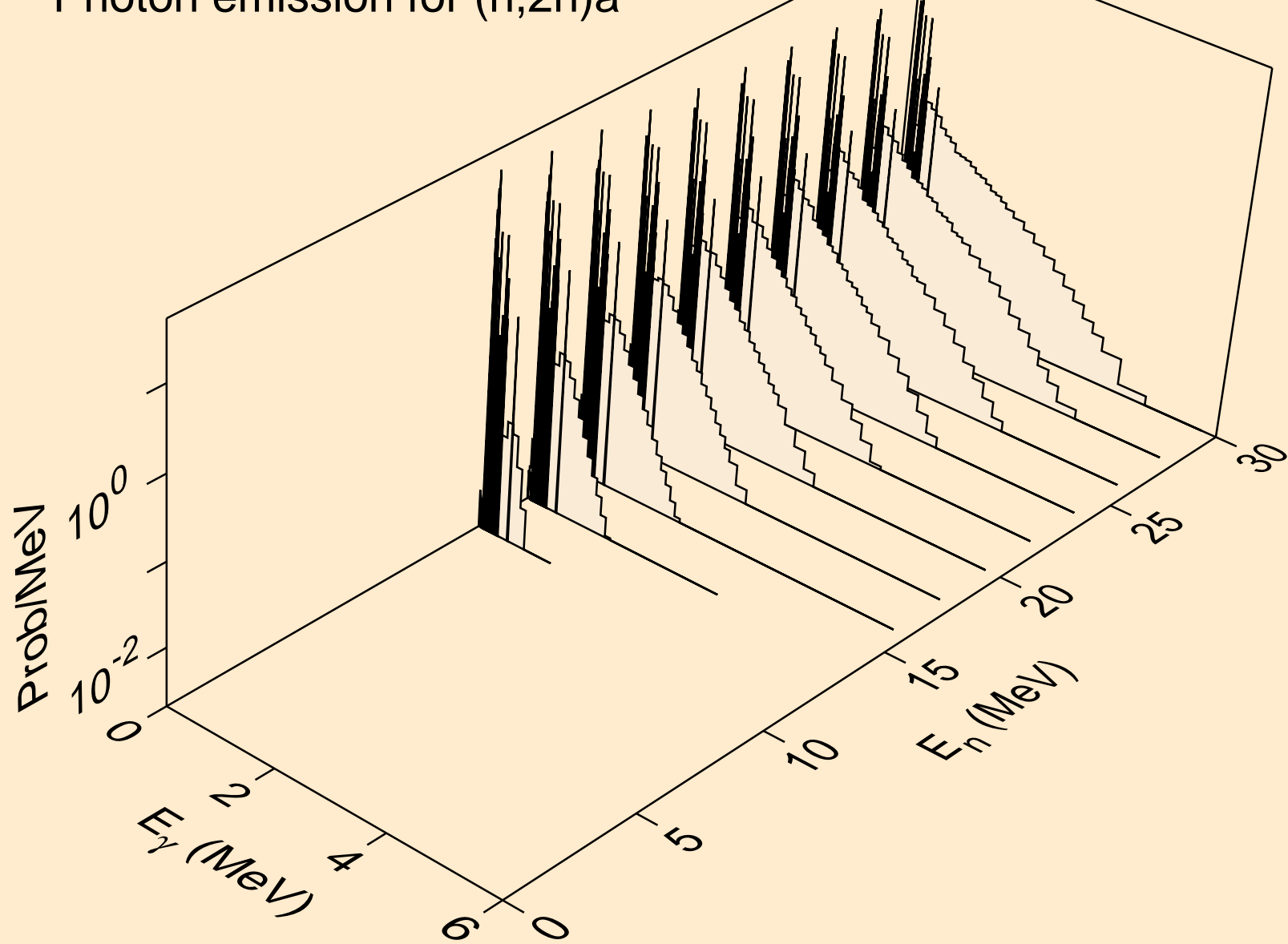

AU194 NEUTRON ACER TENDL-2023 LIBRARY; T=0.K  
Photon emission for (n,3n)a

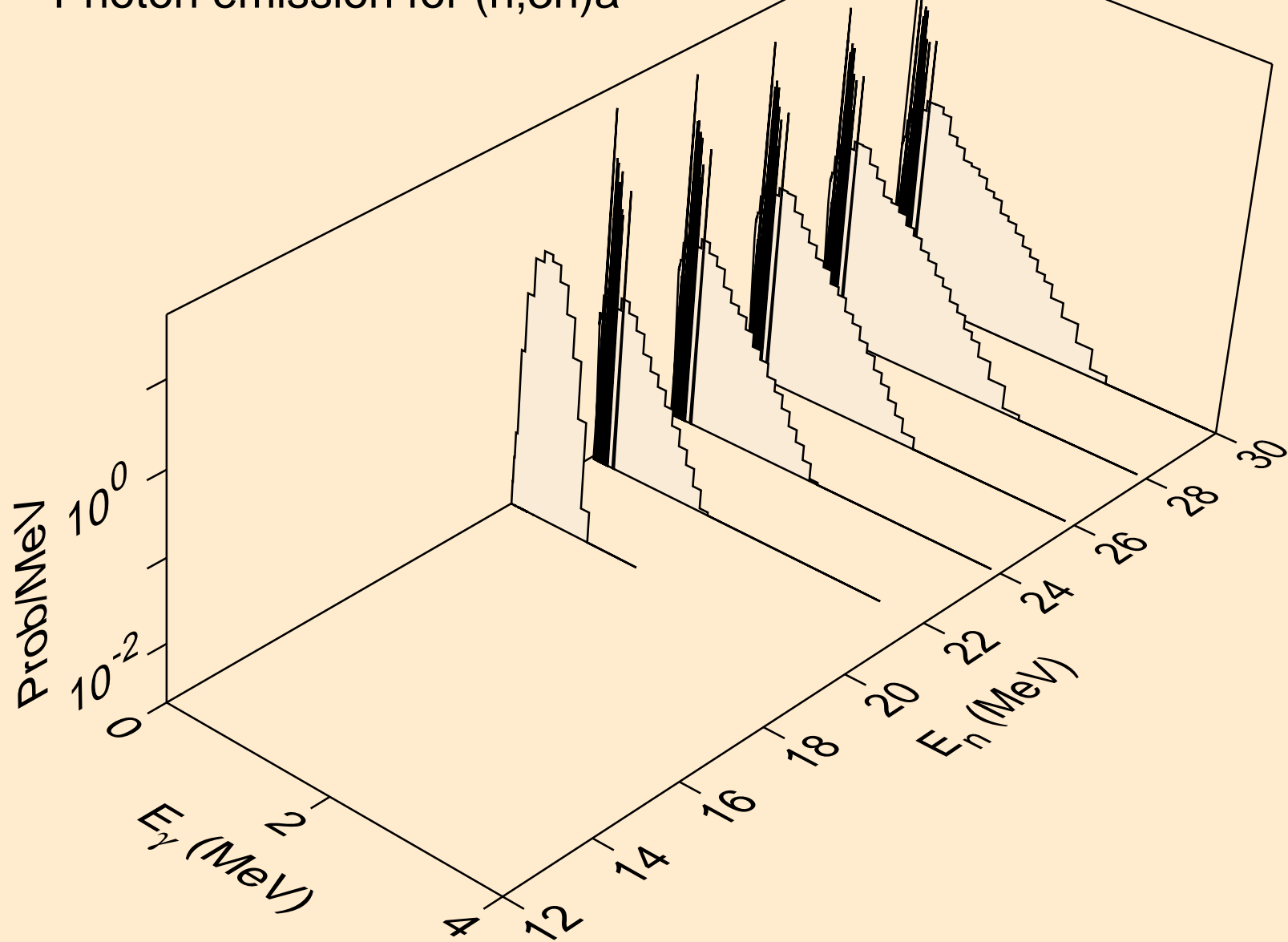

AU194 NEUTRON ACER TENDL-2023 LIBRARY; T=0.K  
Photon emission for (n,n\*)p

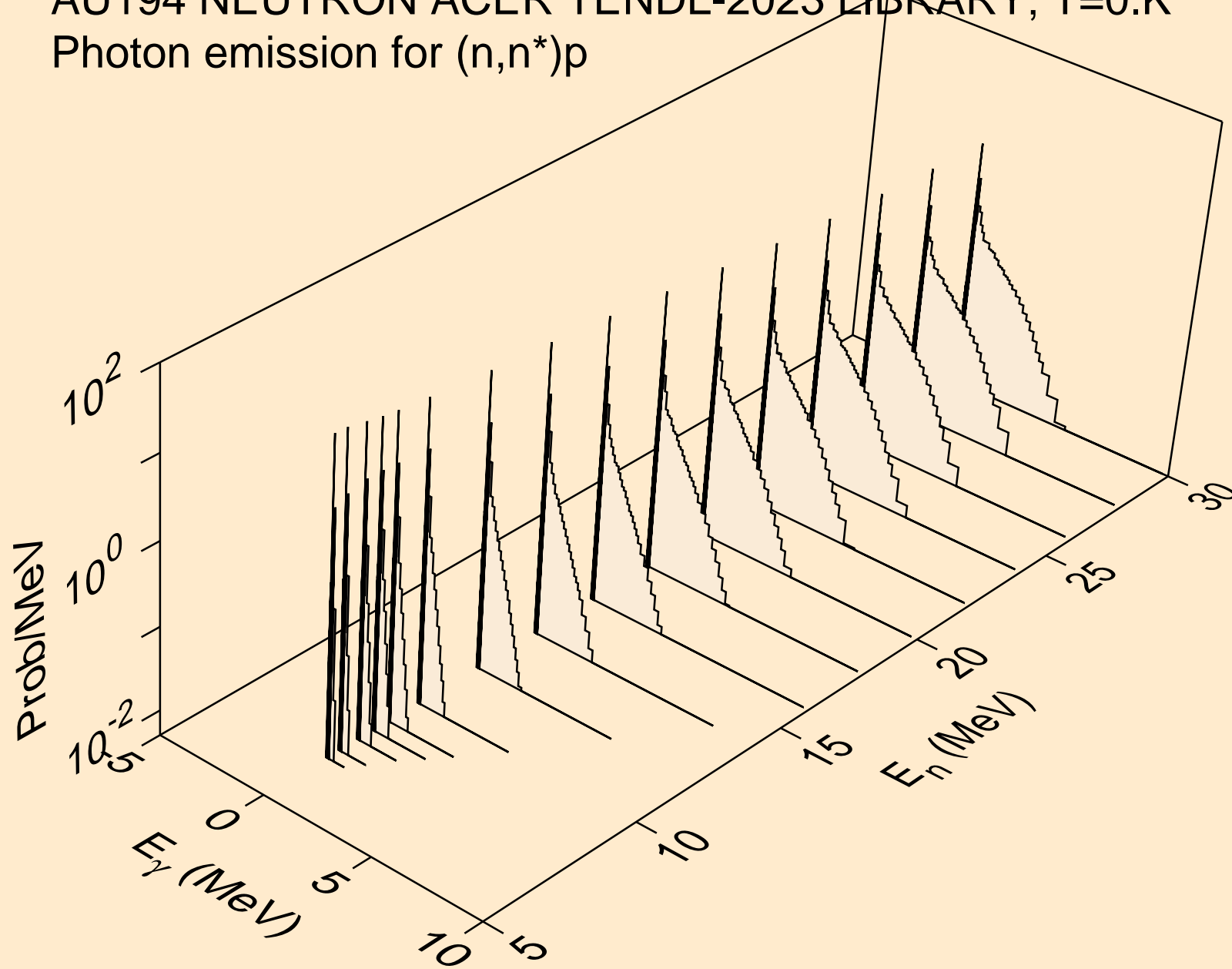



AU194 NEUTRON ACER TENDL-2023 LIBRARY; T=0.K  
Photon emission for (n,n\*)2a

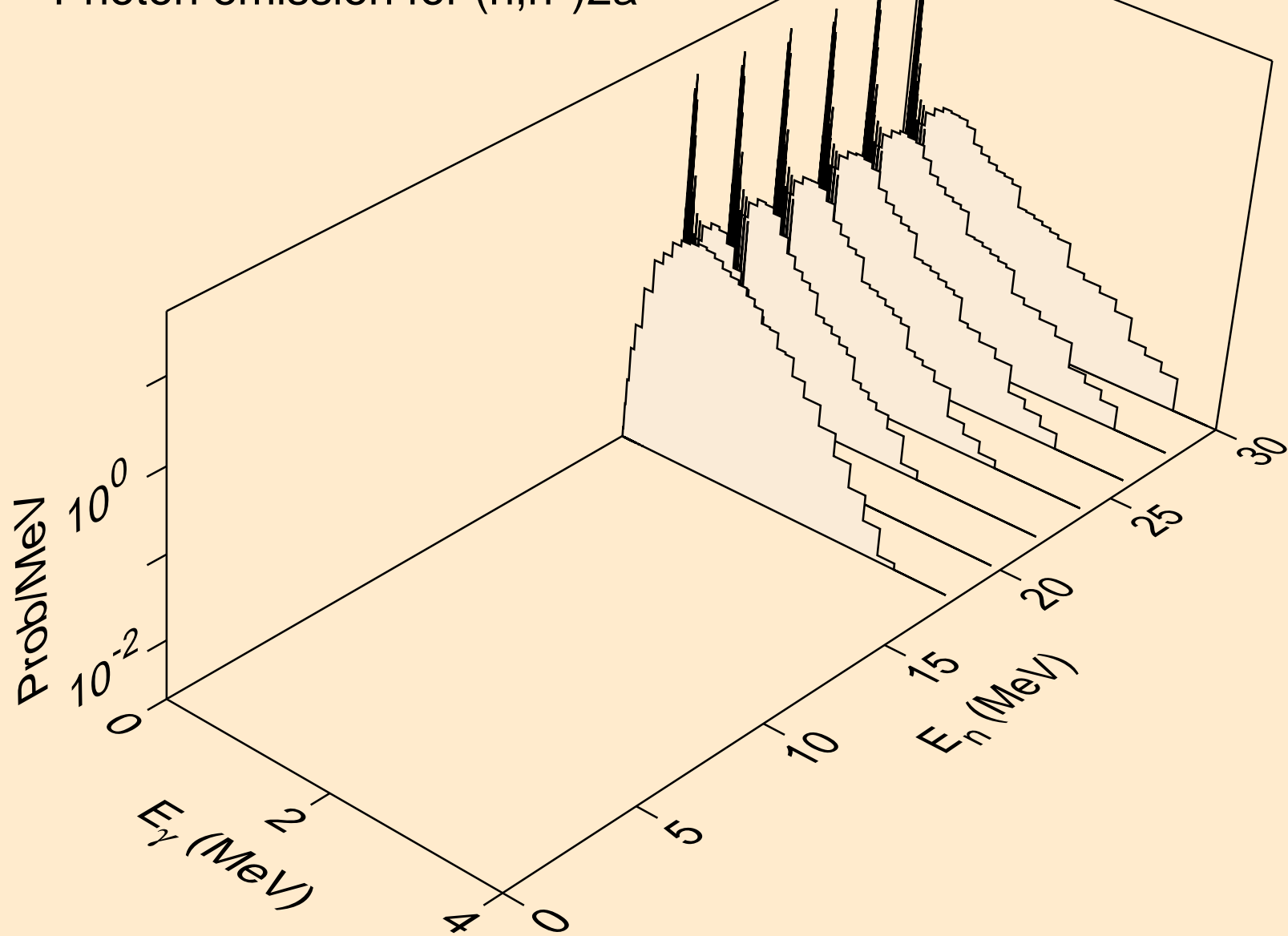

AU194 NEUTRON ACER TENDL-2023 LIBRARY; T=0.K  
Photon emission for (n,n\*)d

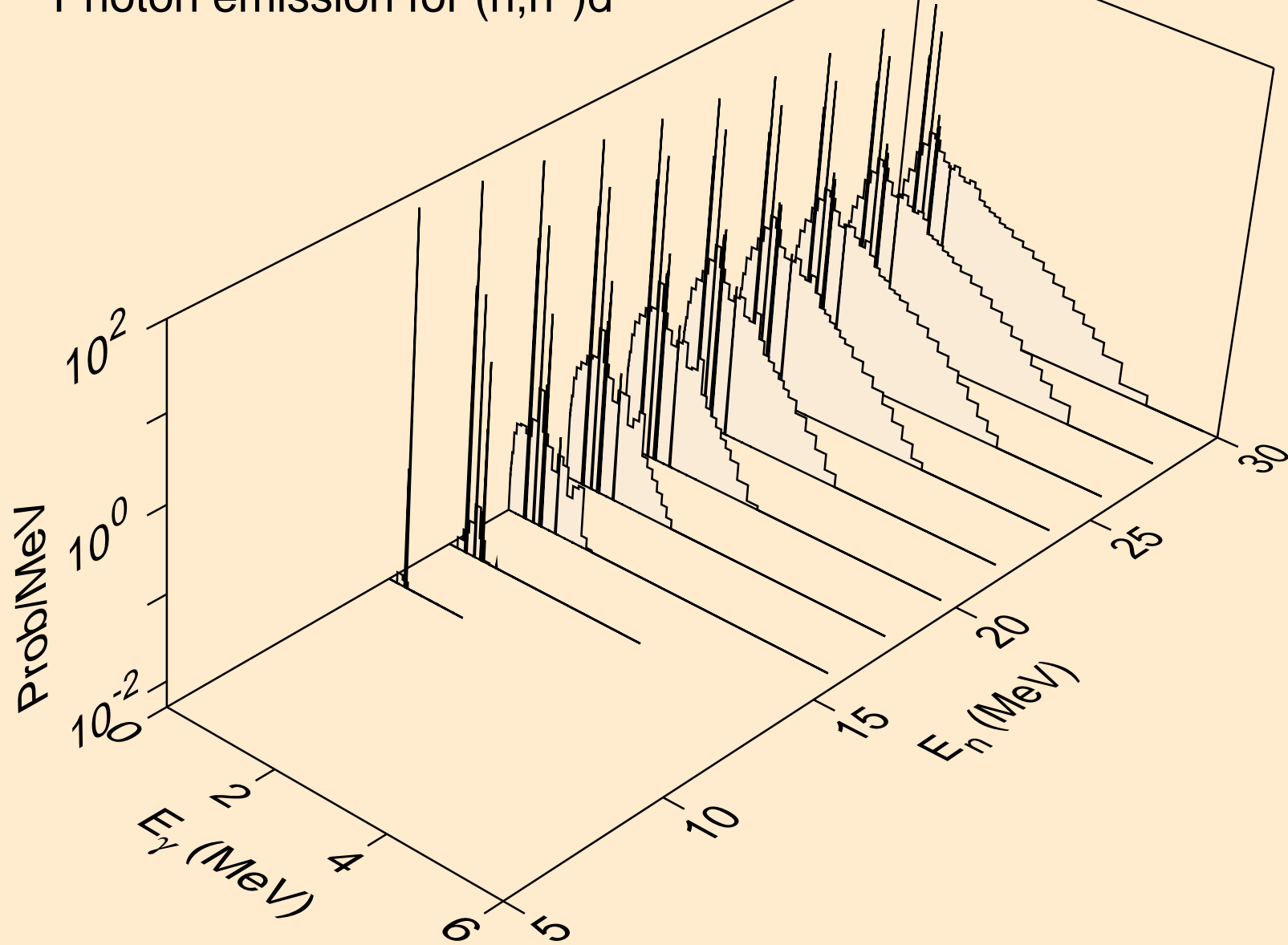

AU194 NEUTRON ACER TENDL-2023 LIBRARY; T=0.K  
Photon emission for (n,n\*)t

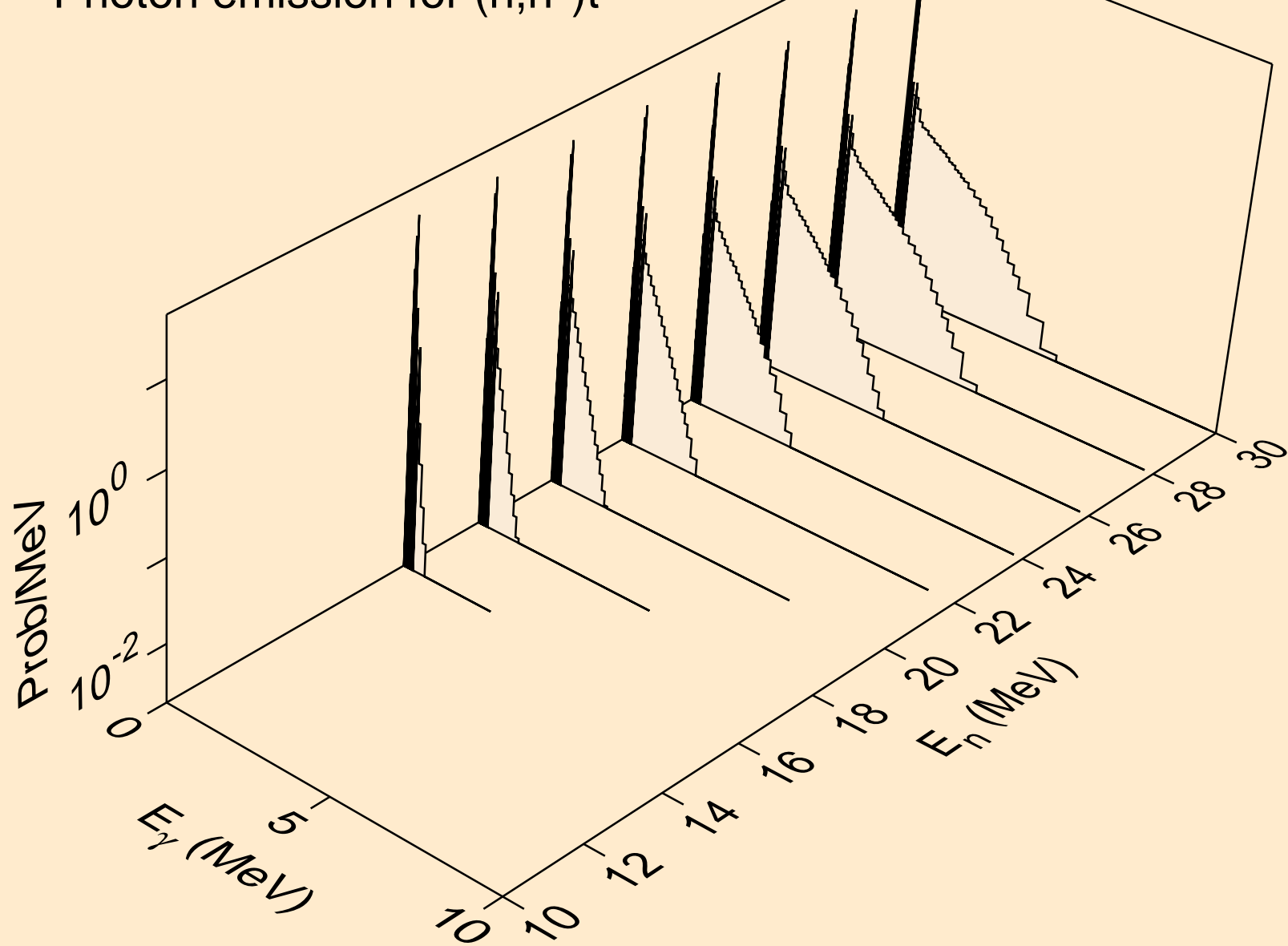

AU194 NEUTRON ACER TENDL-2023 LIBRARY; T=0.K  
Photon emission for (n,n\*)he3

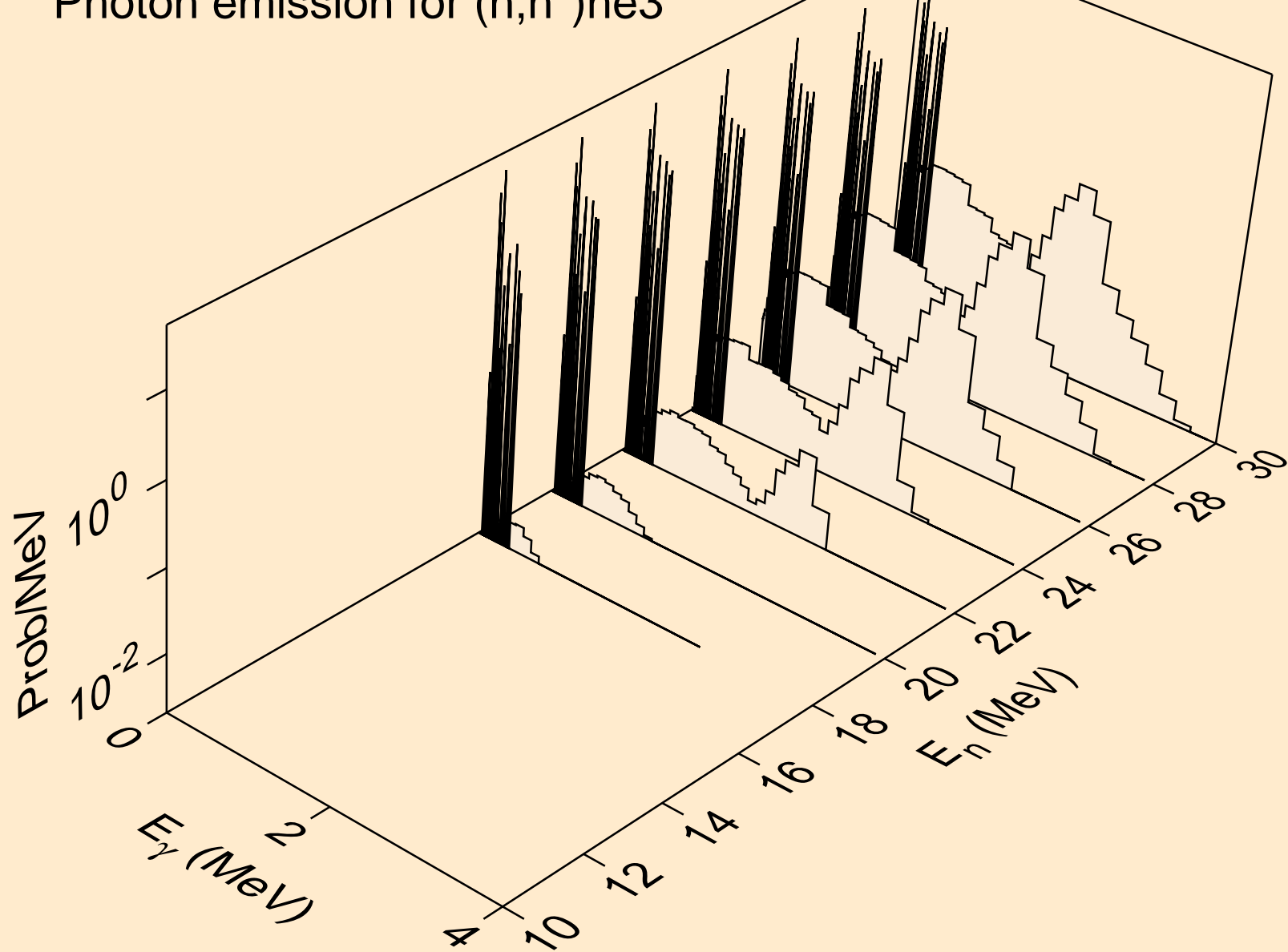

AU194 NEUTRON ACER TENDL-2023 LIBRARY; T=0.K  
Photon emission for (n,4n)

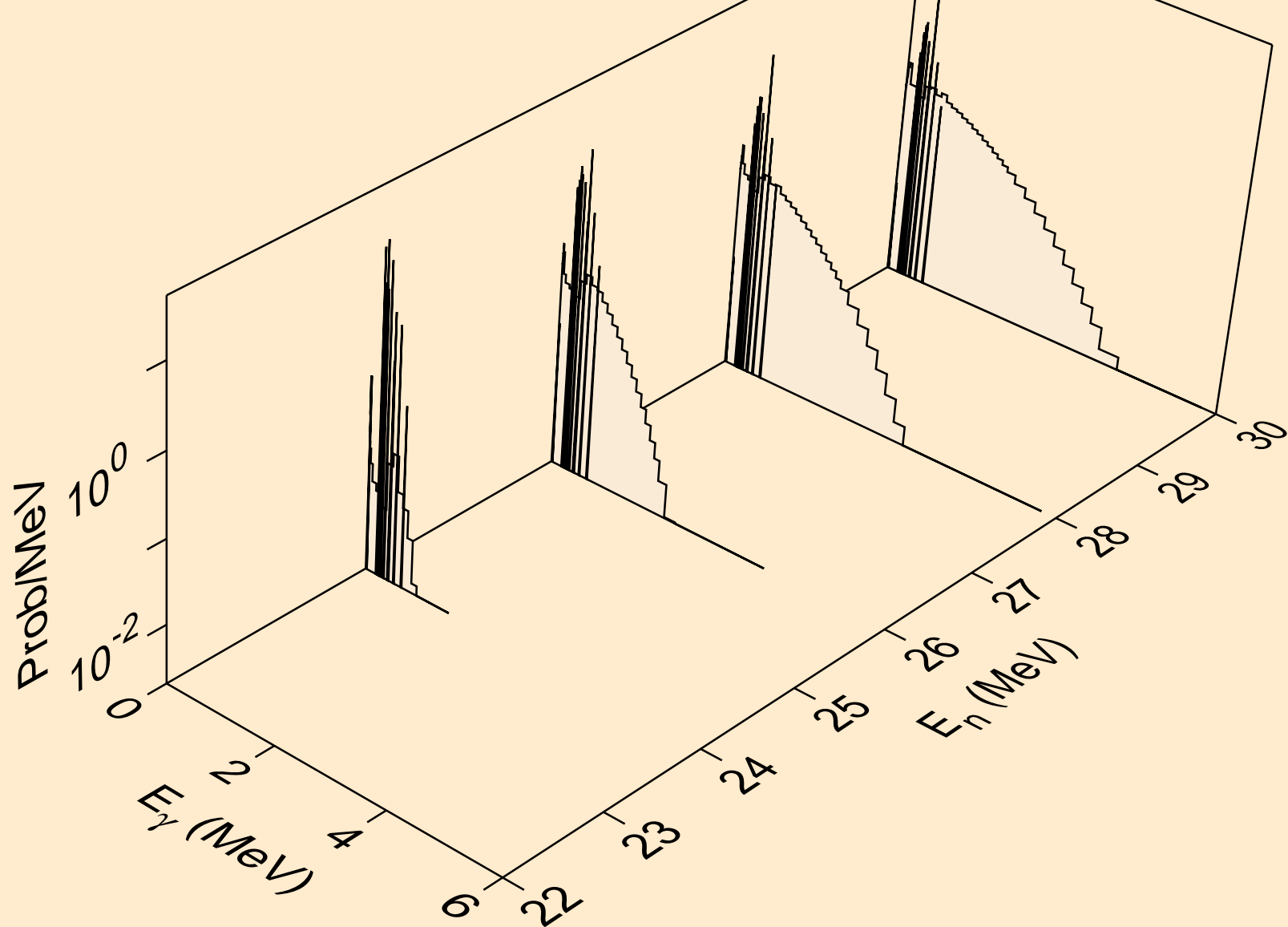

AU194 NEUTRON ACER TENDL-2023 LIBRARY; T=0.K  
Photon emission for (n,2np)

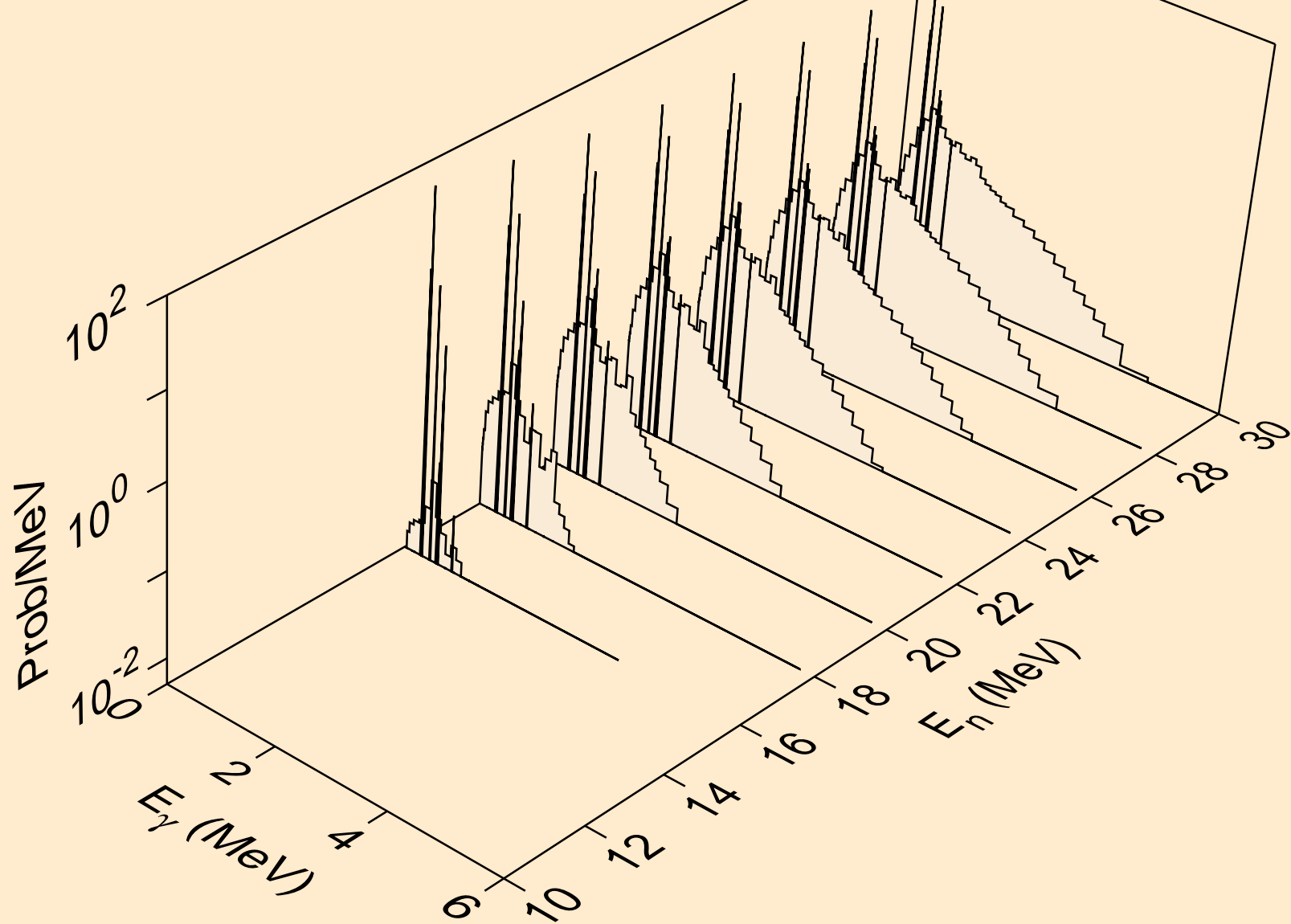

AU194 NEUTRON ACER TENDL-2023 LIBRARY; T=0.K  
Photon emission for (n,3np)

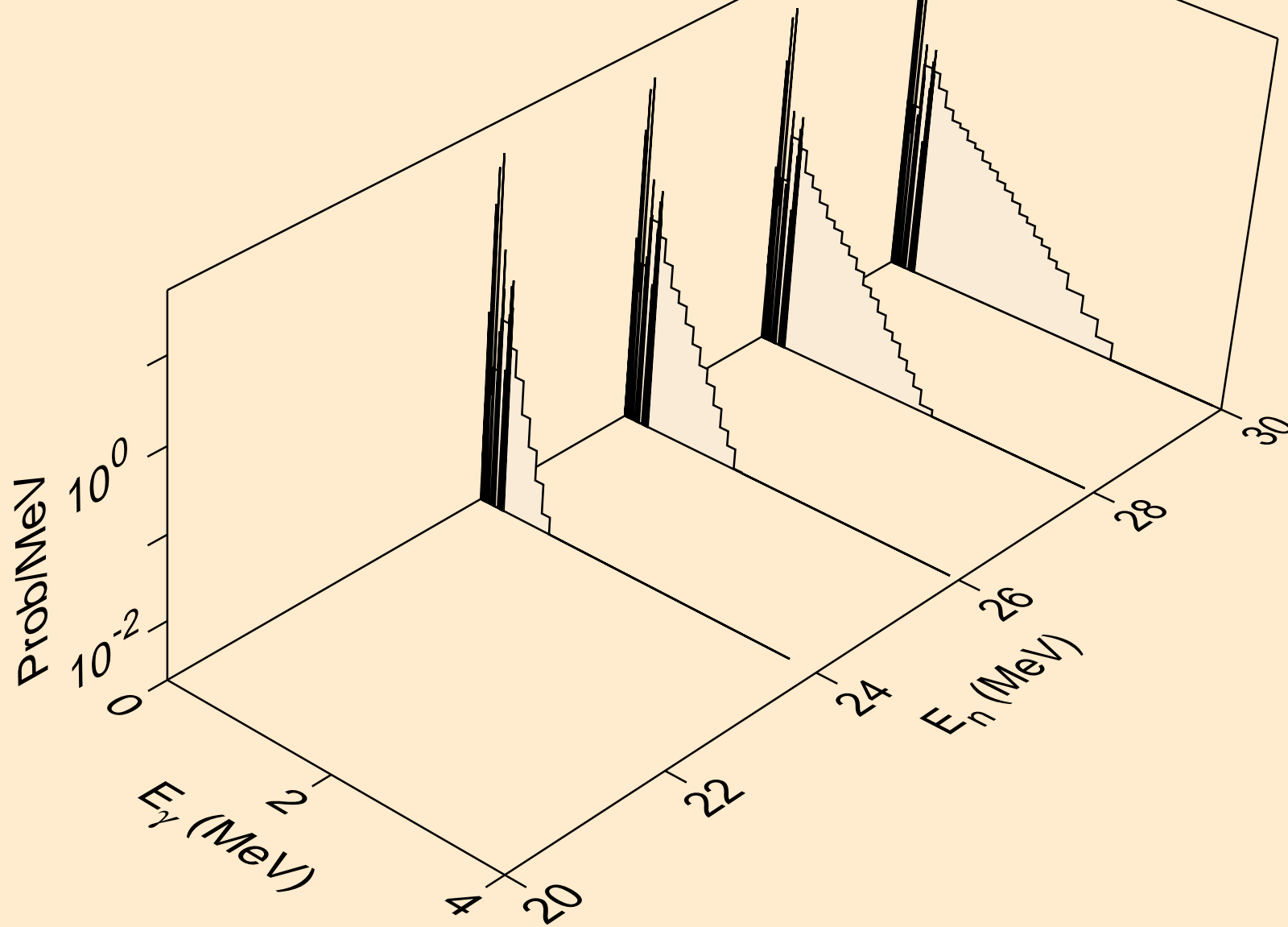

AU194 NEUTRON ACER TENDL-2023 LIBRARY; T=0.K  
Photon emission for (n,n2p)

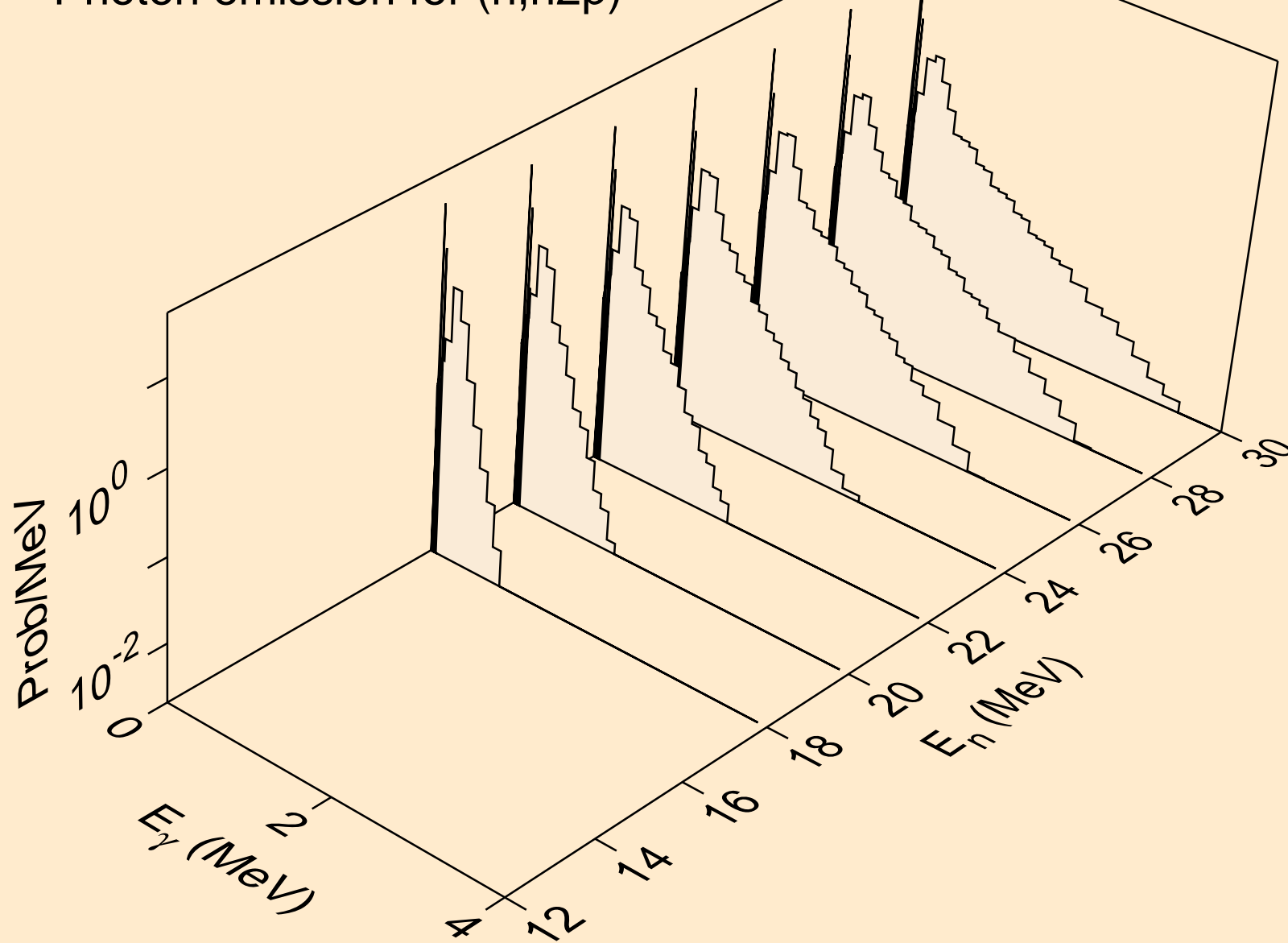



AU194 NEUTRON ACER TENDL-2023 LIBRARY; T=0.K  
Photon emission for (n,npa)

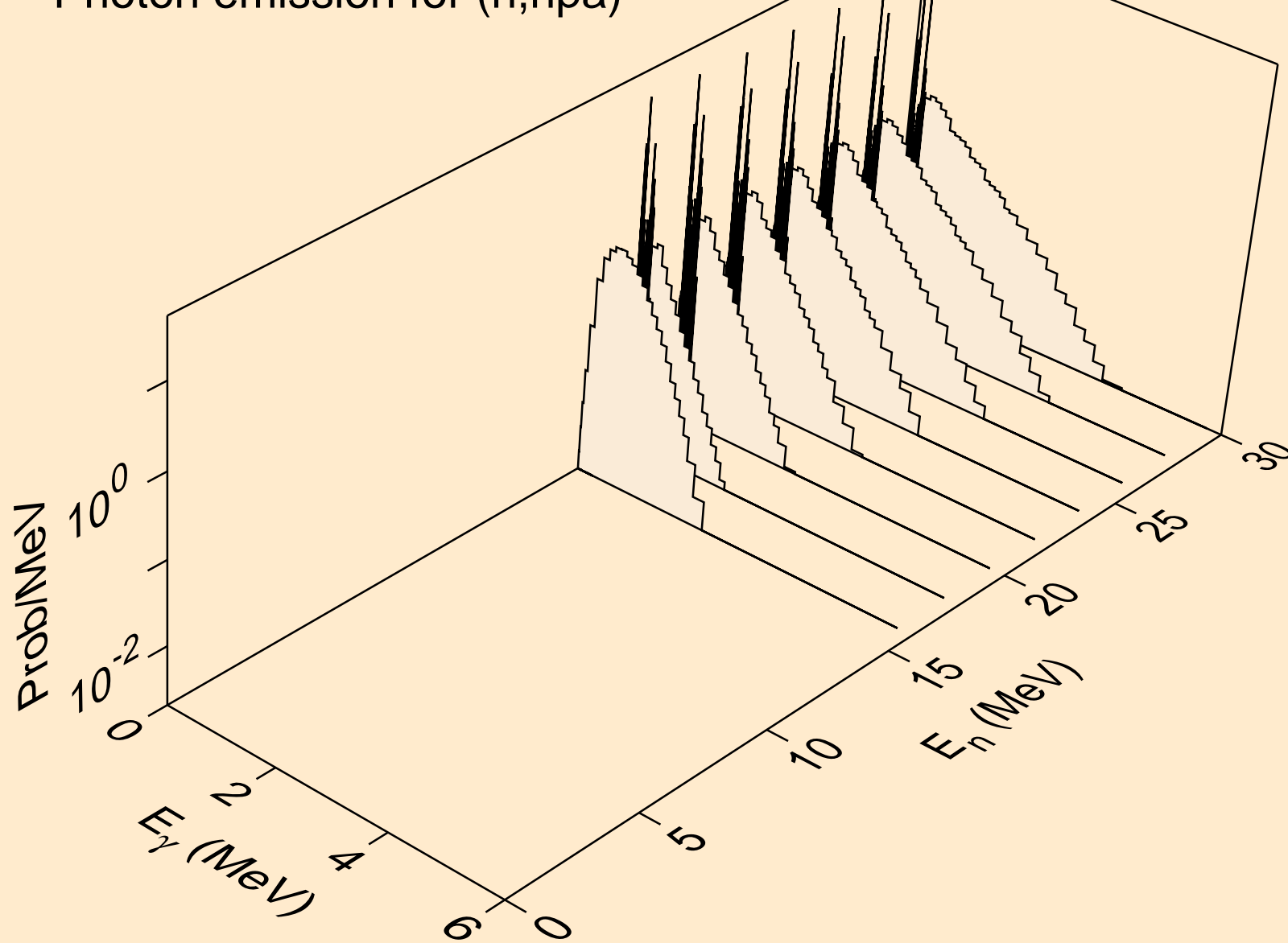

AU194 NEUTRON ACER TENDL-2023 LIBRARY; T=0.K  
Photon emission for (n,n\*c)

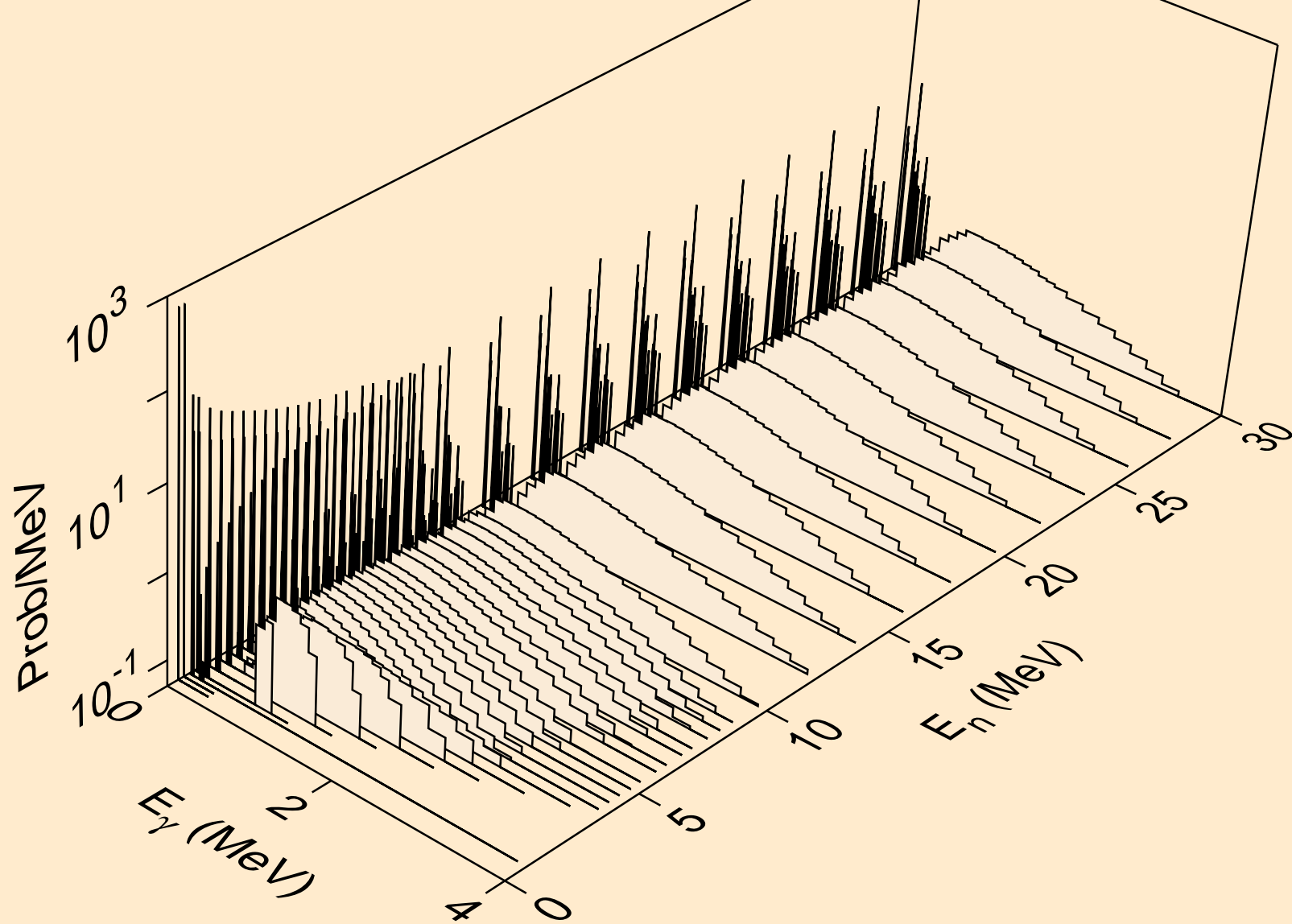

AU194 NEUTRON ACER TENDL-2023 LIBRARY; T=0.K  
Photon emission for (n,gma)

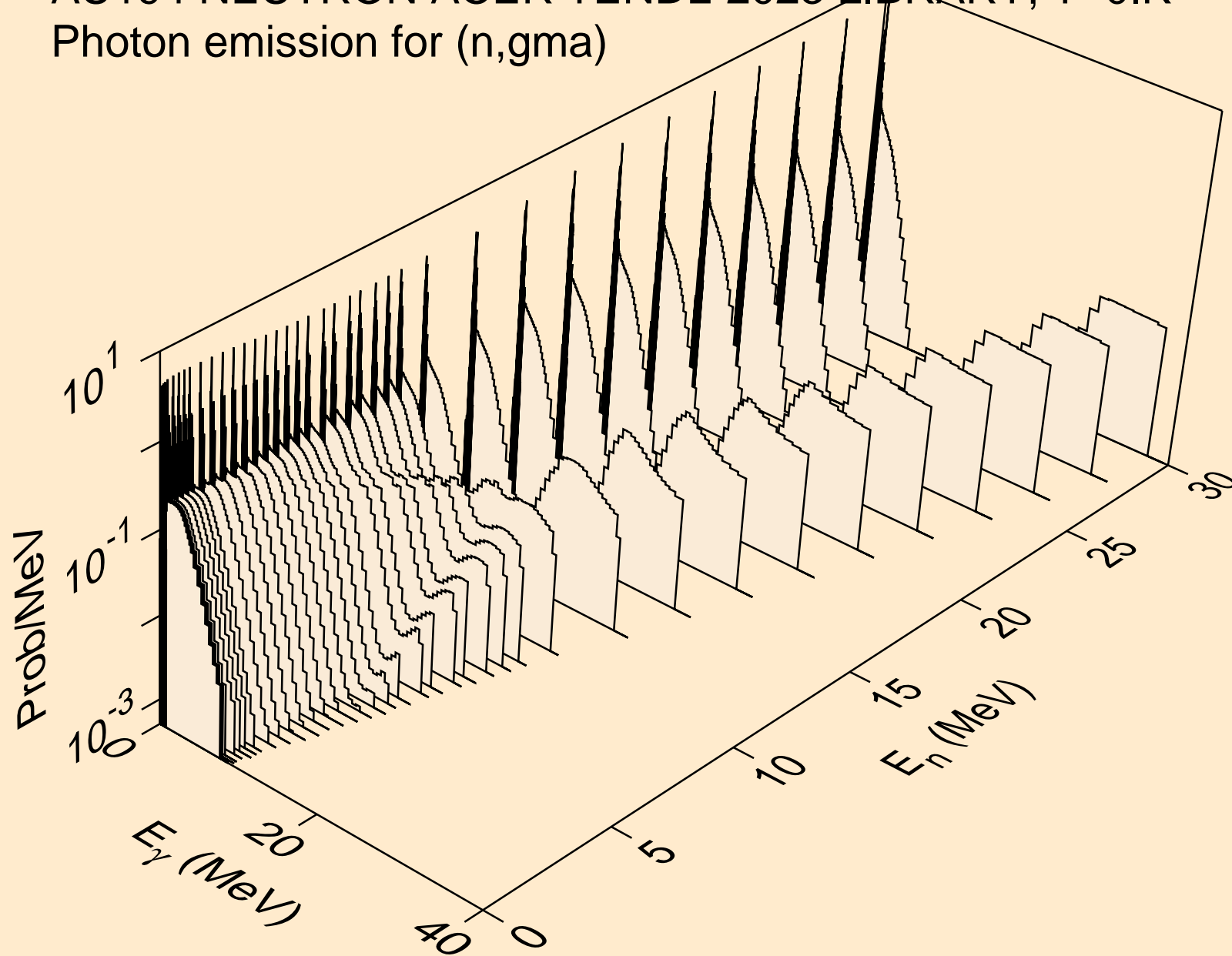

AU194 NEUTRON ACER TENDL-2023 LIBRARY; T=0.K  
Photon emission for (n,p)

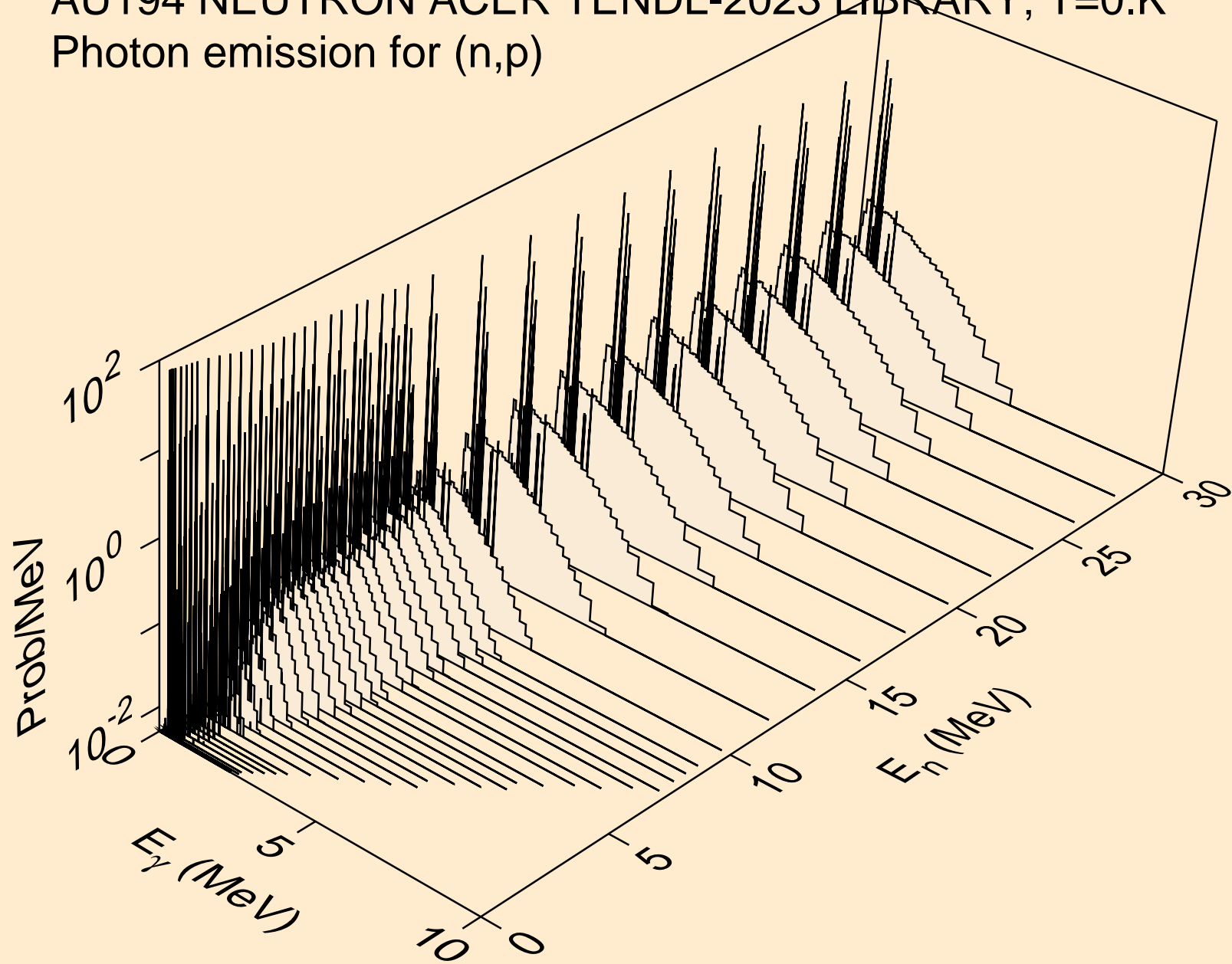

AU194 NEUTRON ACER TENDL-2023 LIBRARY; T=0.K  
Photon emission for (n,d)

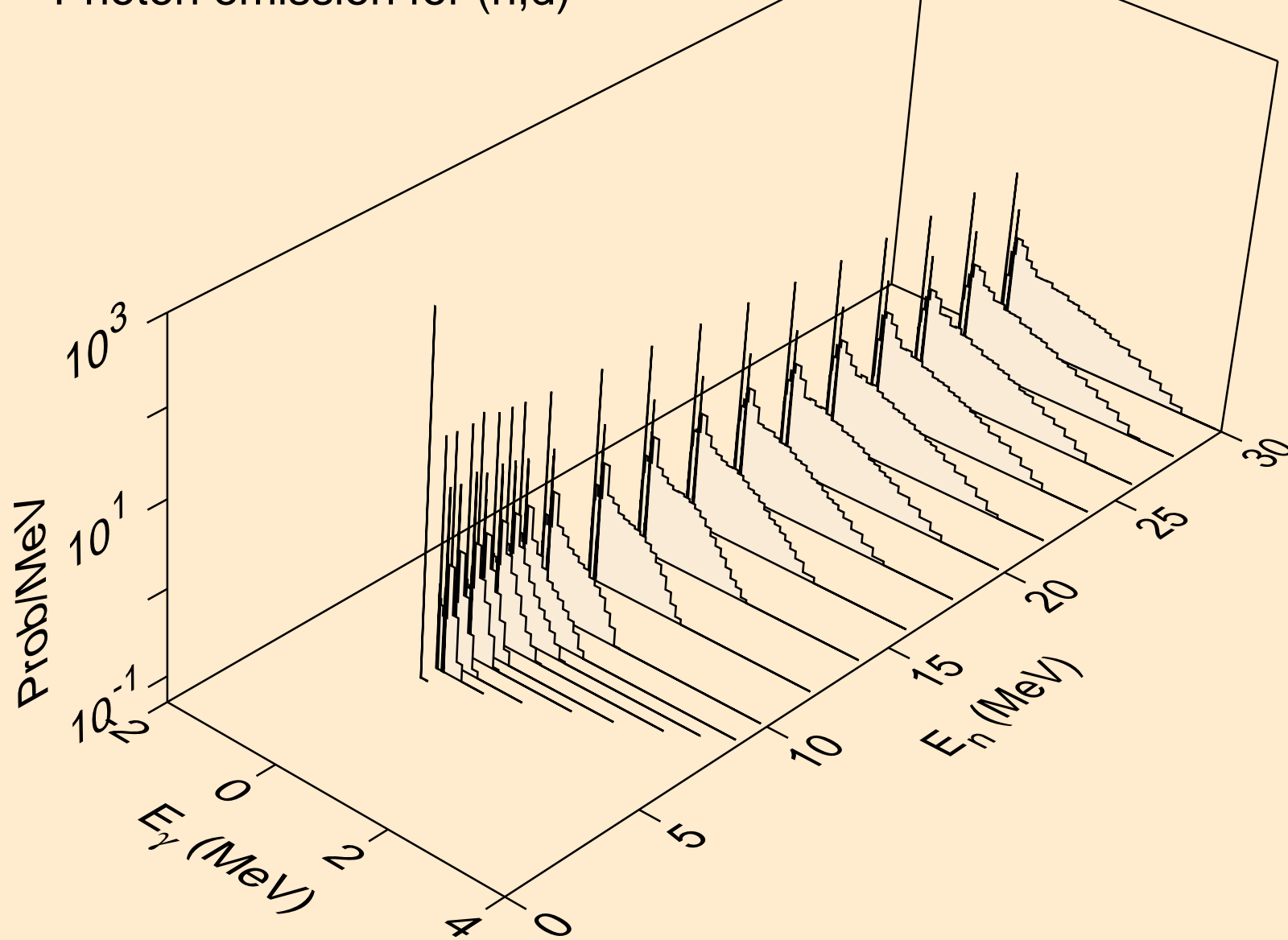

AU194 NEUTRON ACER TENDL-2023 LIBRARY; T=0.K  
Photon emission for (n,t)

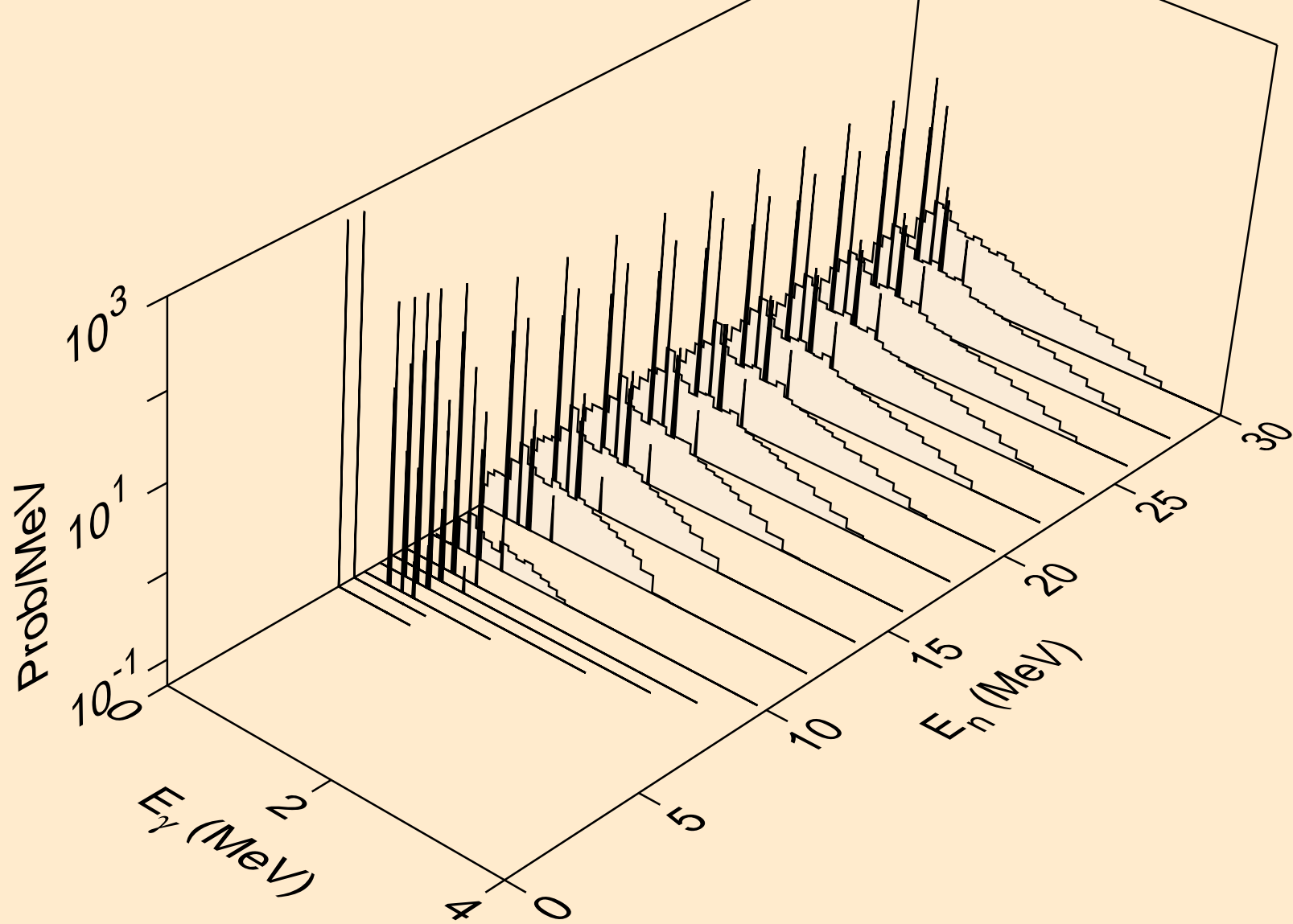

AU194 NEUTRON ACER TENDL-2023 LIBRARY; T=0.K  
Photon emission for (n,he3)

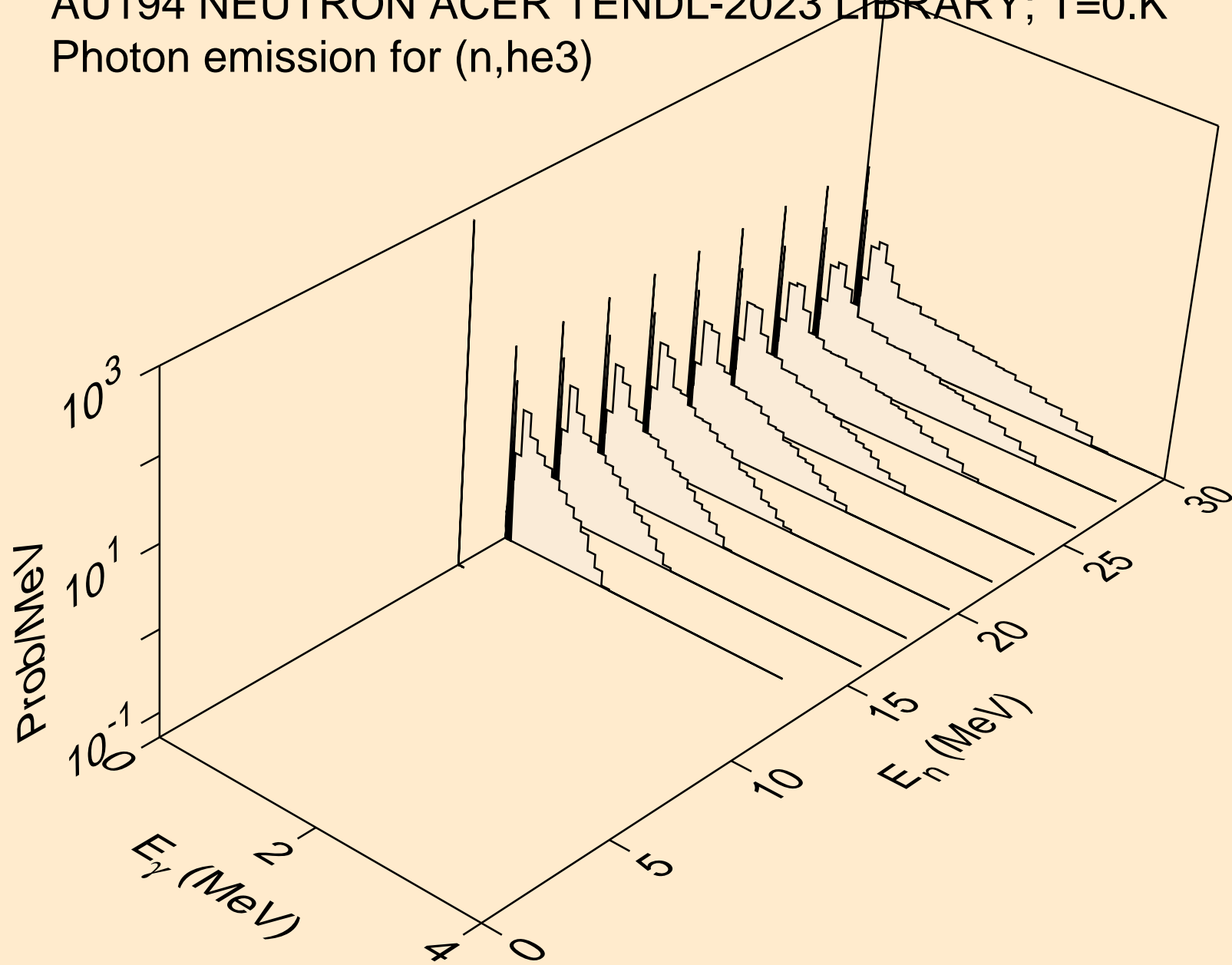

AU194 NEUTRON ACER TENDL-2023 LIBRARY; T=0.K  
Photon emission for (n,a)

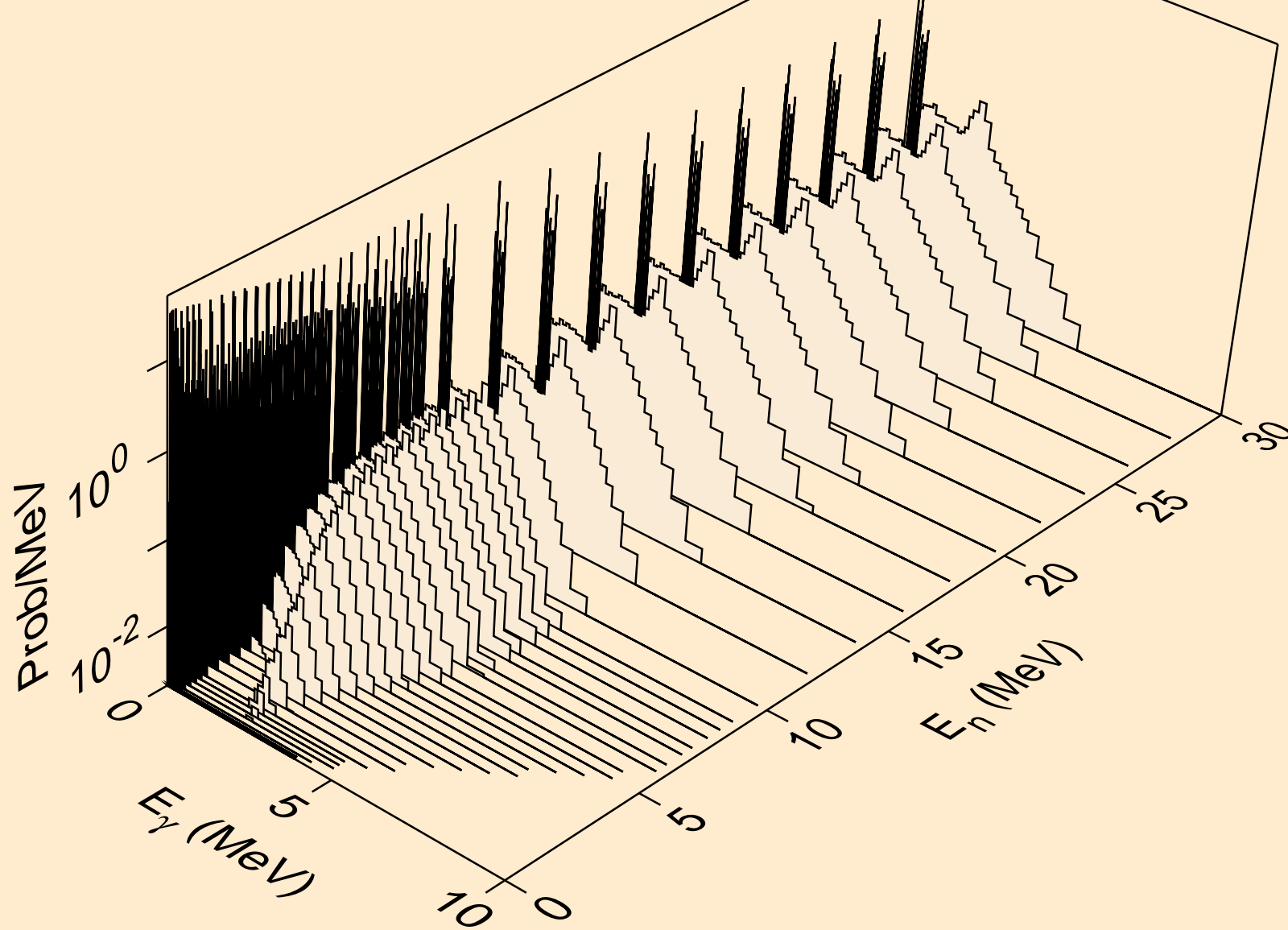



AU194 NEUTRON ACER TENDL-2023 LIBRARY; T=0.K  
Photon emission for (n,2a)

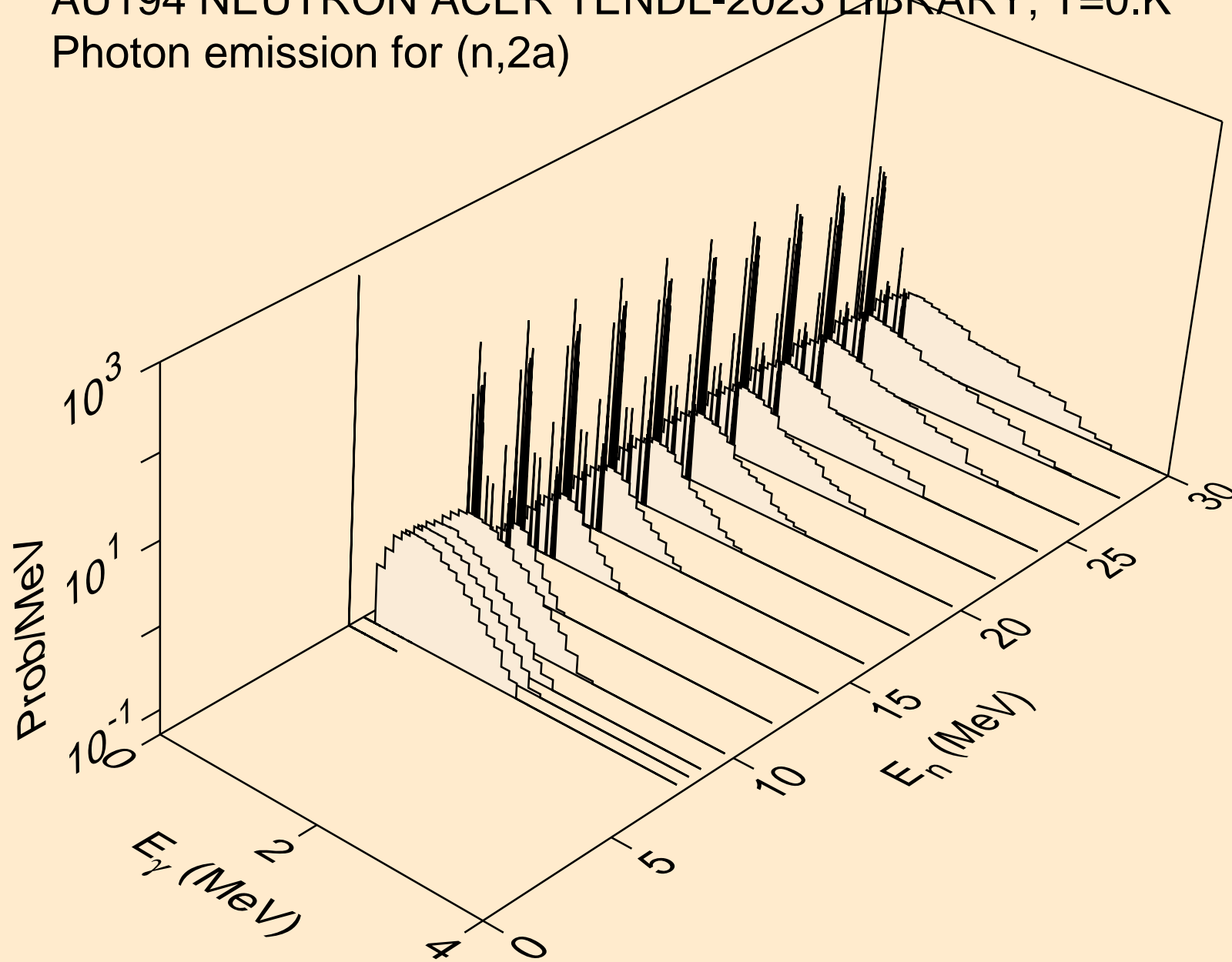

AU194 NEUTRON ACER TENDL-2023 LIBRARY; T=0.K  
Photon emission for (n,2p)

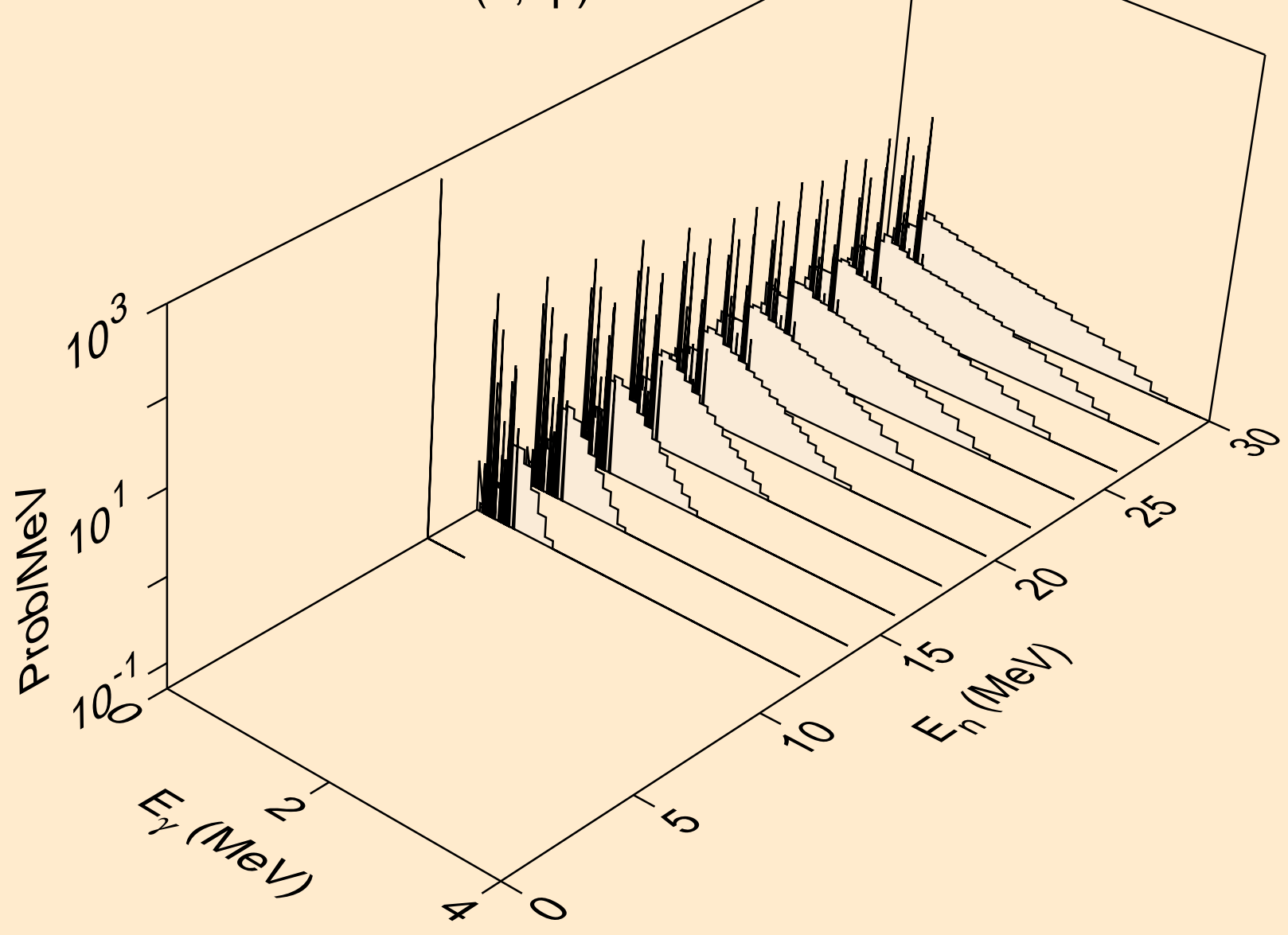

AU194 NEUTRON ACER TENDL-2023 LIBRARY; T=0.K  
Photon emission for (n,p $\alpha$ )

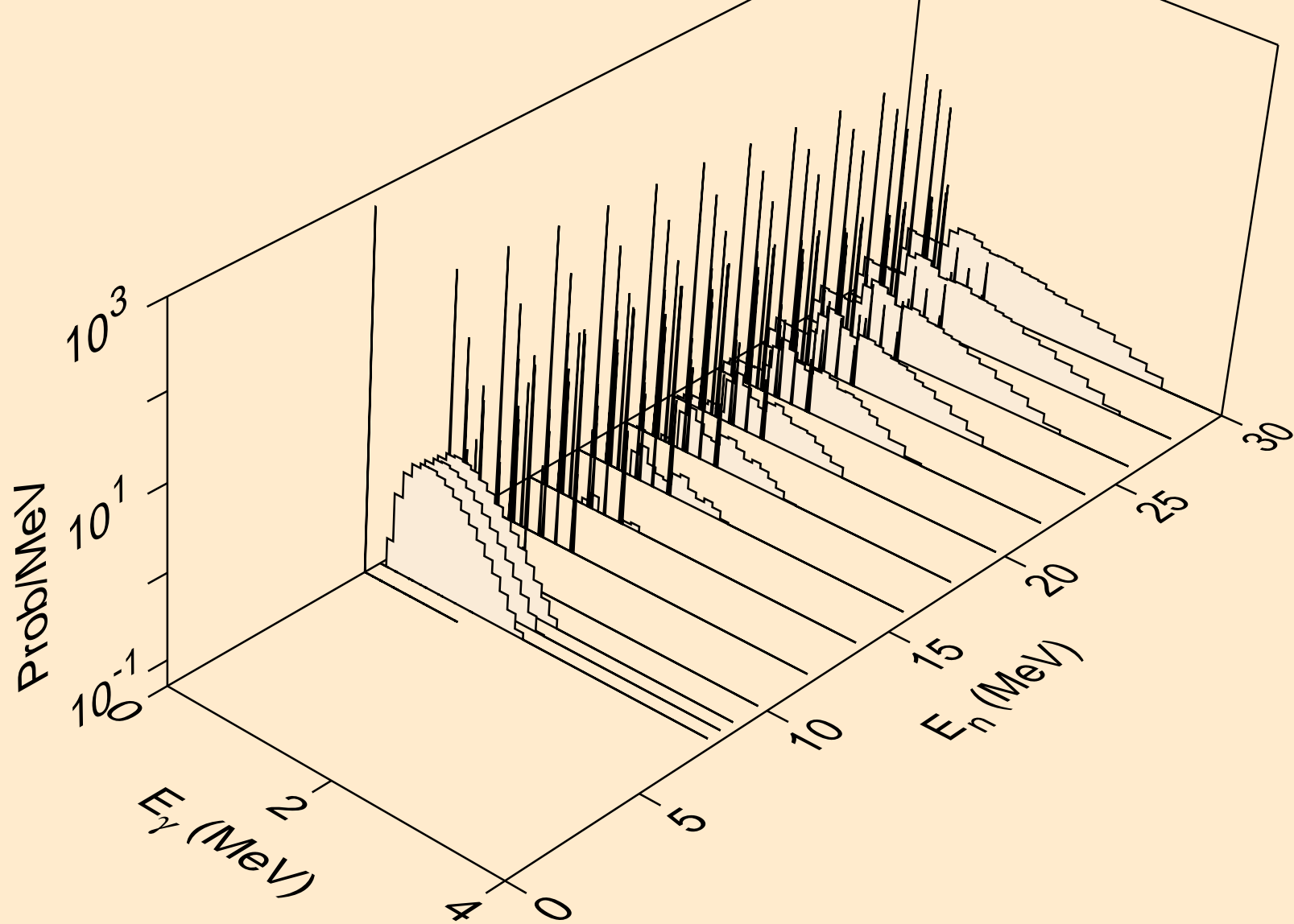

AU194 NEUTRON ACER TENDL-2023 LIBRARY; T=0.K  
Photon emission for (n,pd)

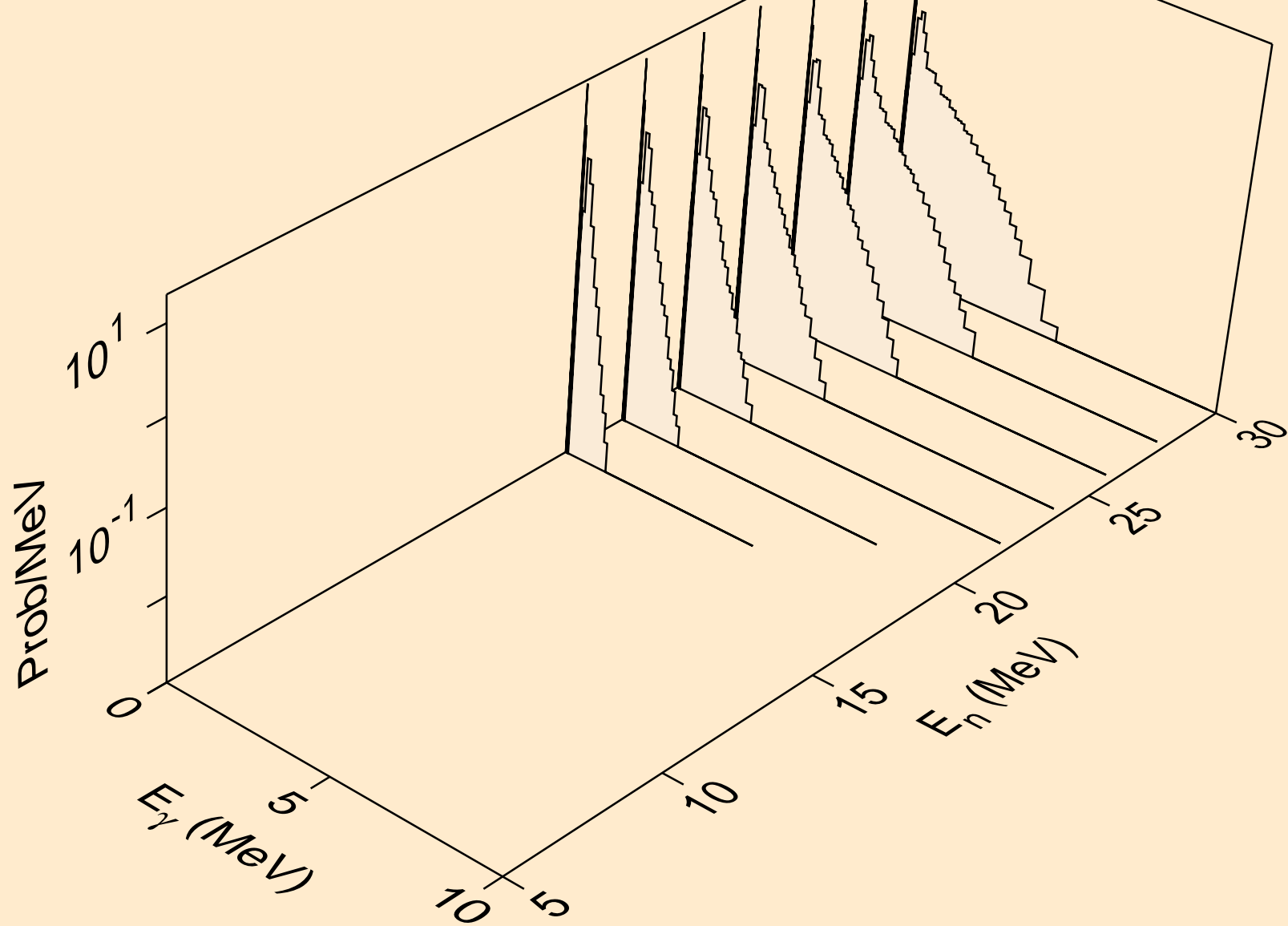

AU194 NEUTRON ACER TENDL-2023 LIBRARY; T=0.K  
Photon emission for (n,pt)

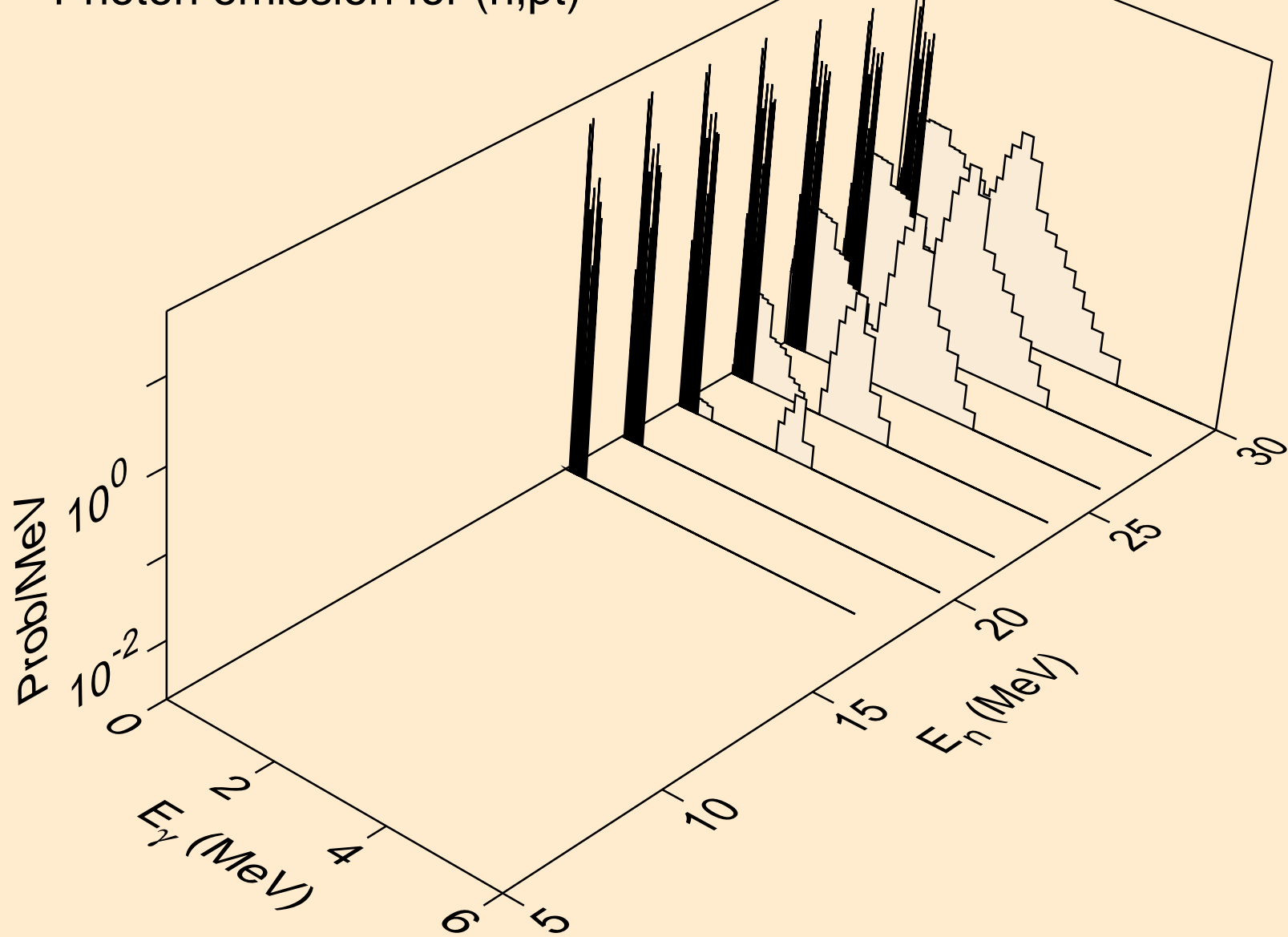

AU194 NEUTRON ACER TENDL-2023 LIBRARY; T=0.K  
Photon emission for (n,da)

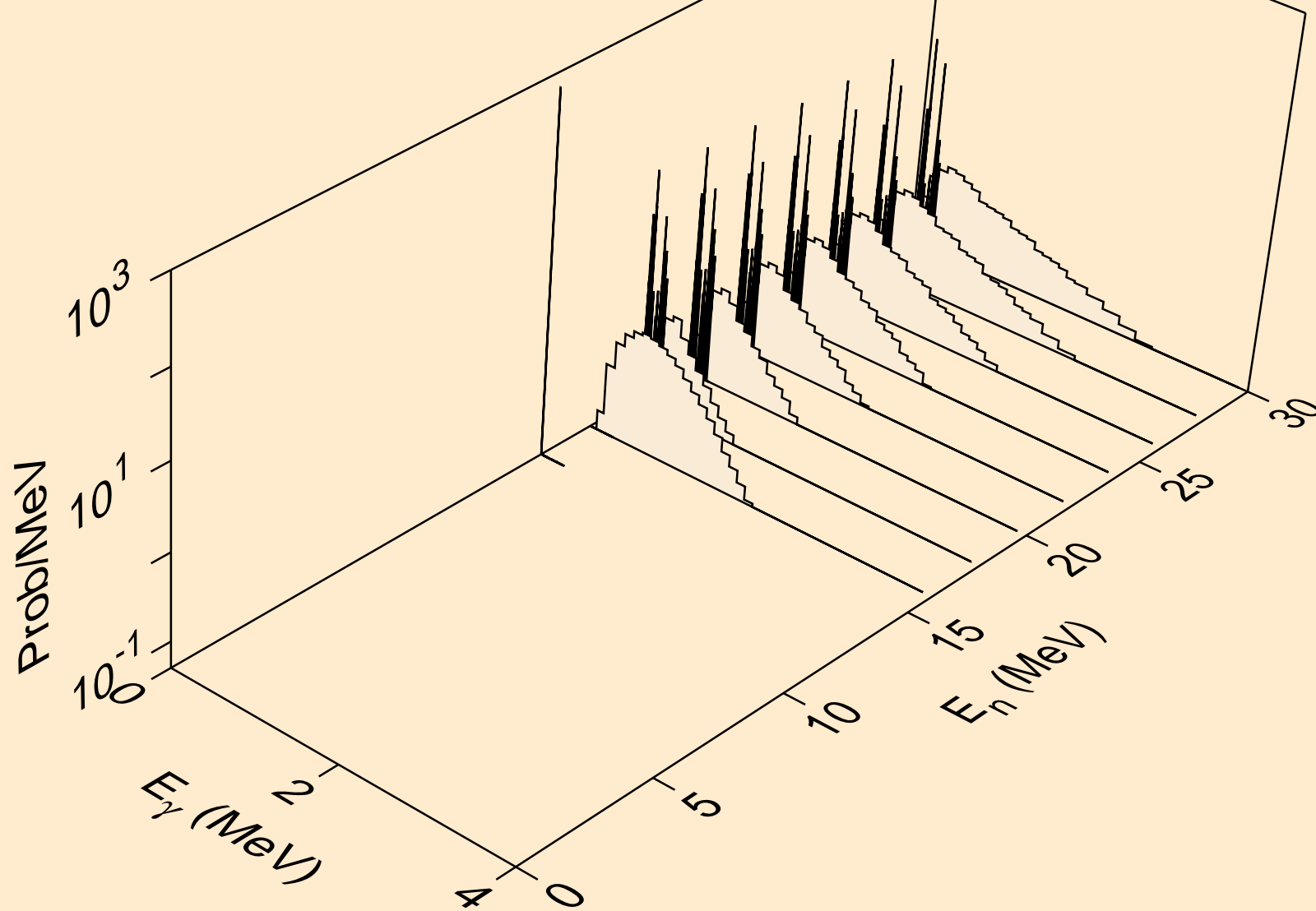

AU194 NEUTRON ACER TENDL-2023 LIBRARY; T=0.K  
thermal capture photon spectrum

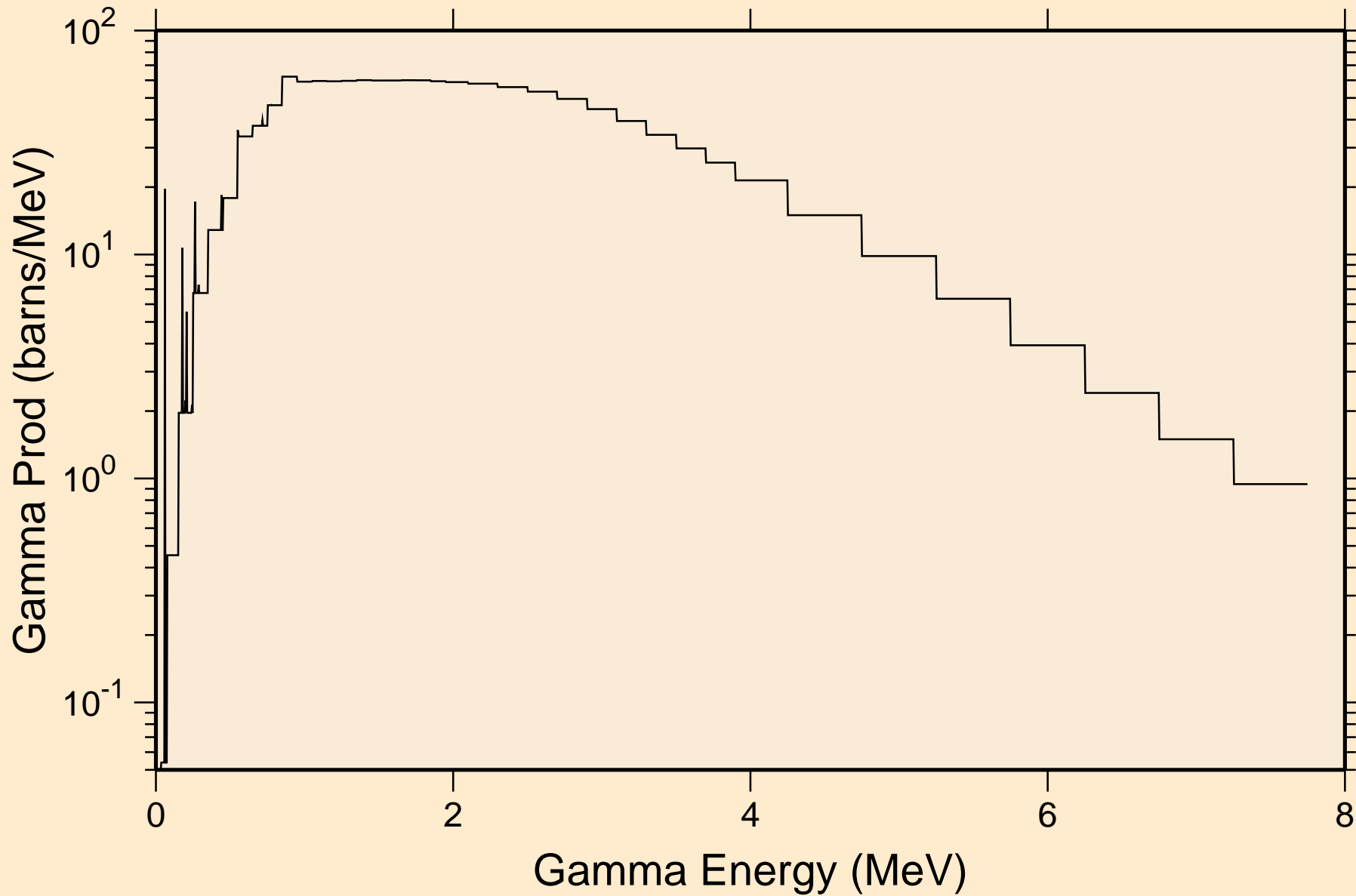

AU194 NEUTRON ACER TENDL-2023 LIBRARY; T=0.K  
14 MeV photon spectrum

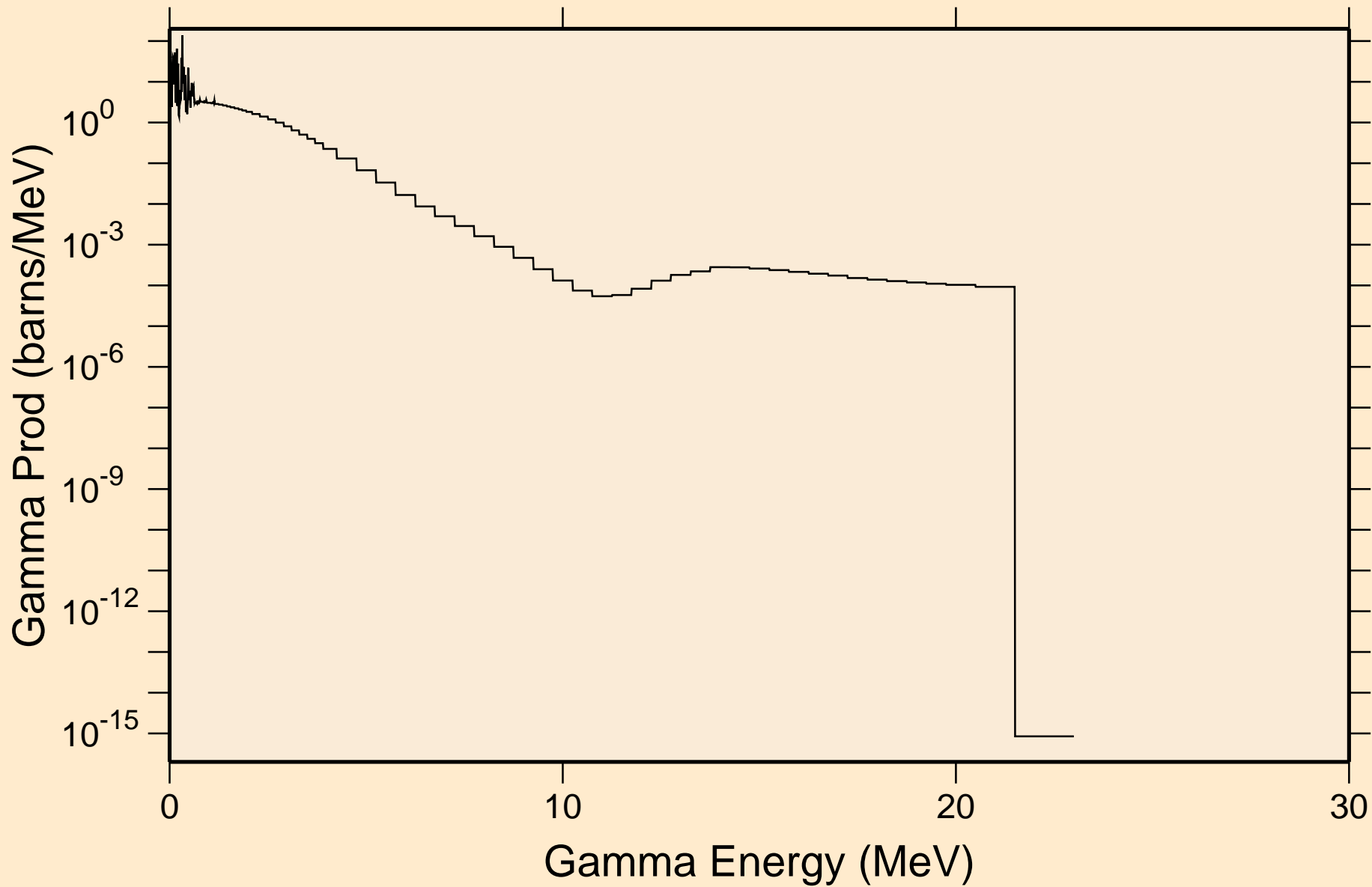



# AU194 NEUTRON ACER TENDL-2023 LIBRARY; T=0.K

## Particle heating contributions

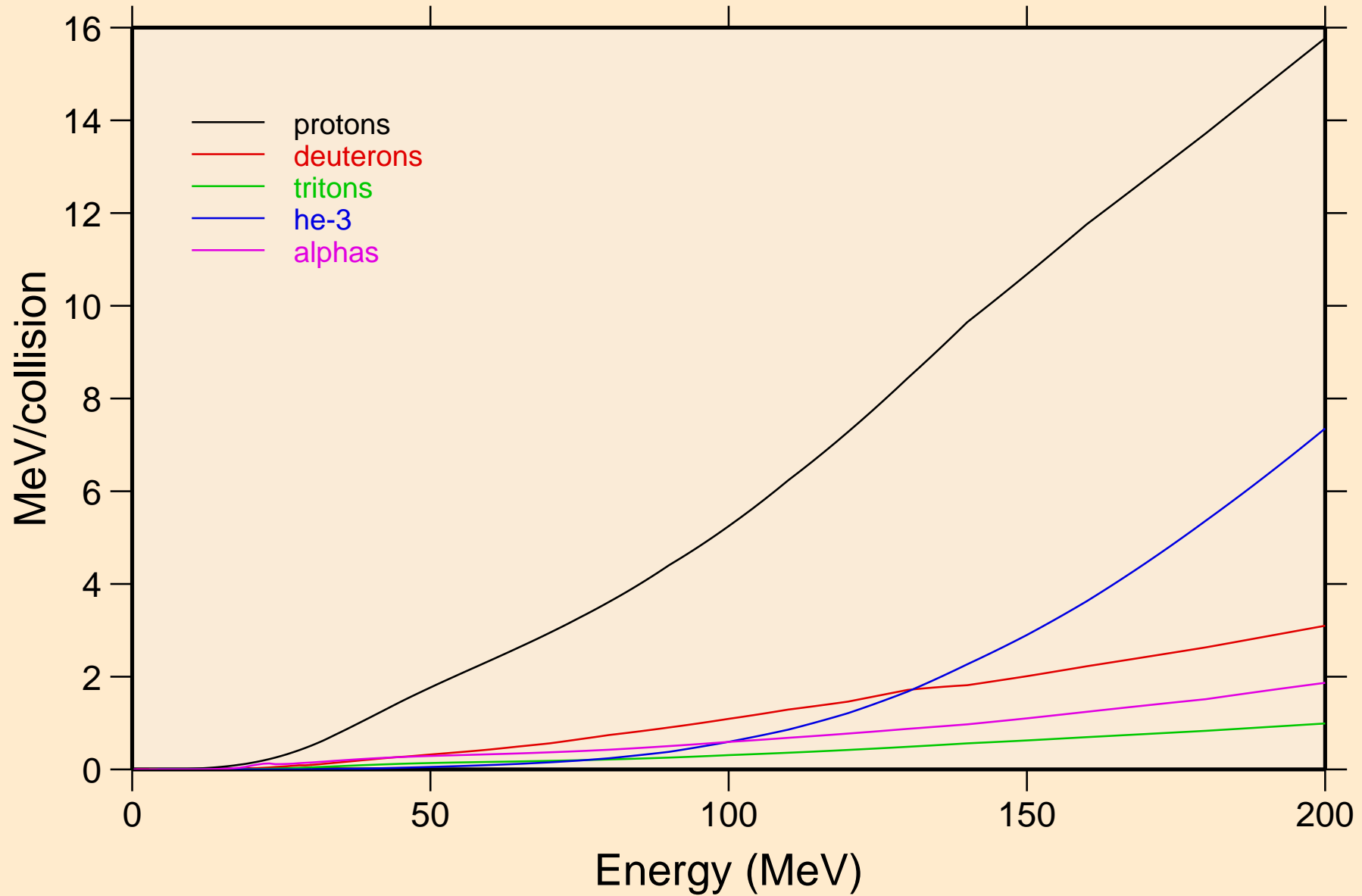

AU194 NEUTRON ACER TENDL-2023 LIBRARY; T=0.K  
Recoil Heating

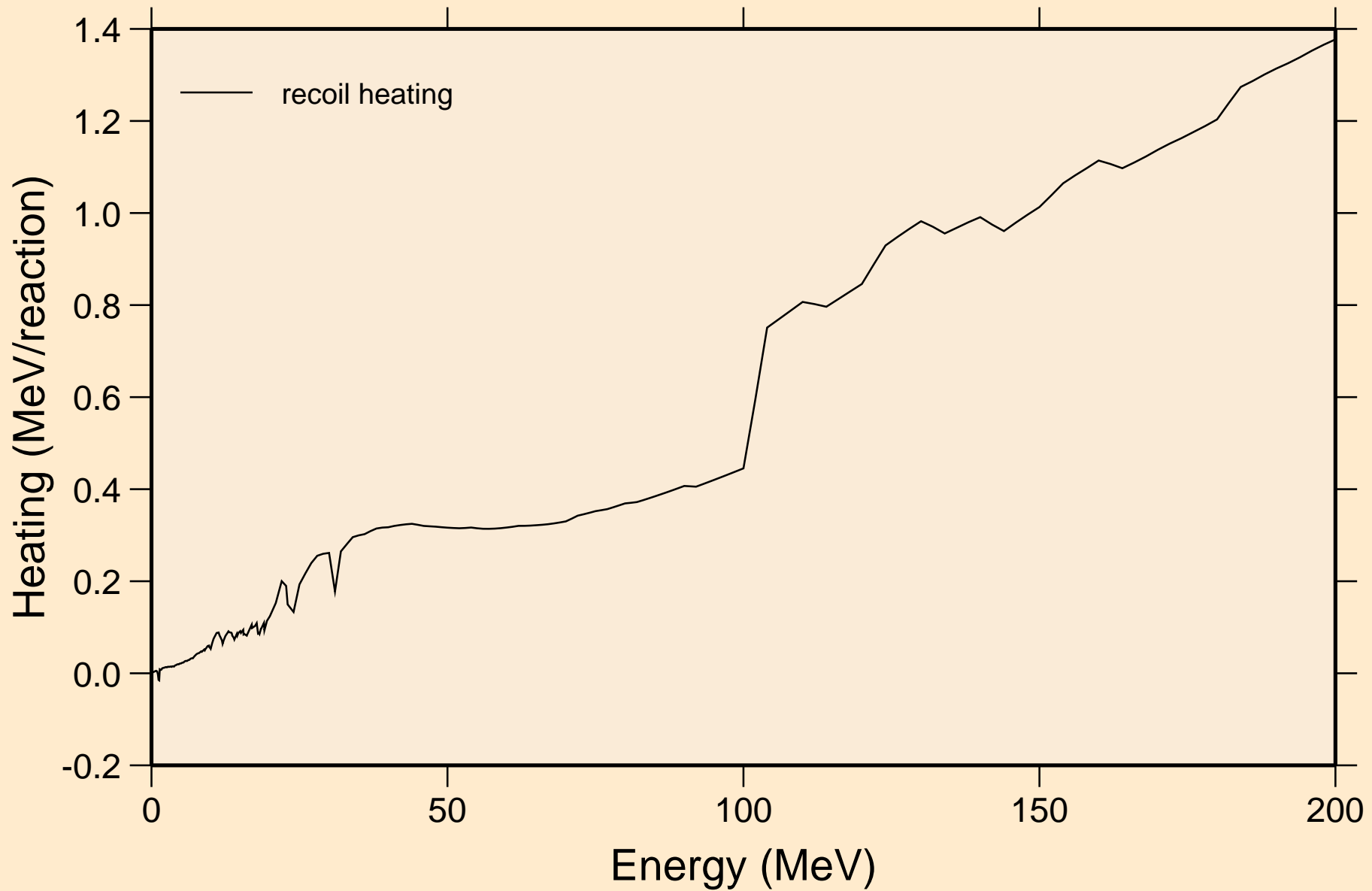

AU194 NEUTRON ACER TENDL-2023 LIBRARY; T=0.K  
Particle production cross sections

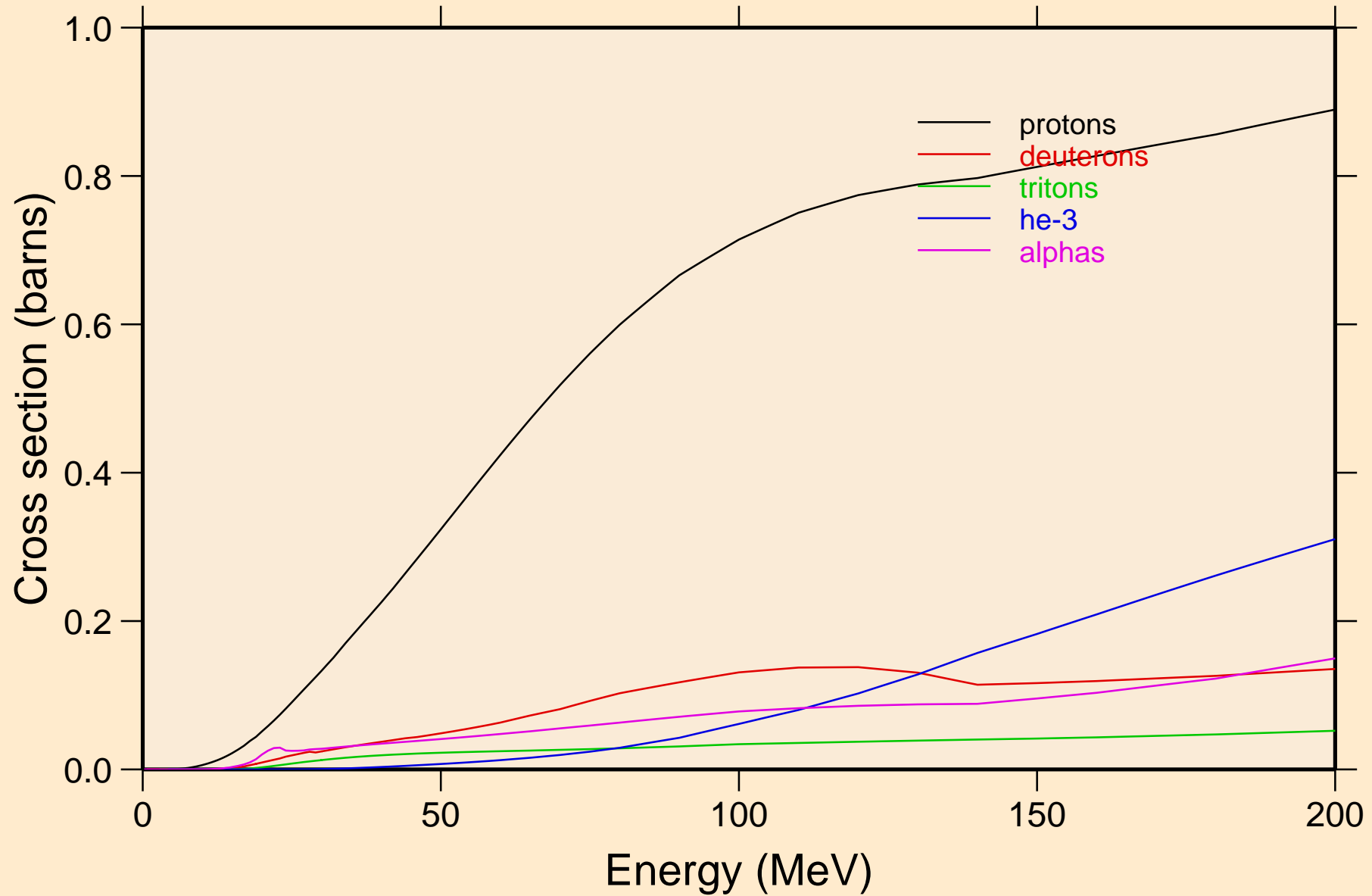

AU194 NEUTRON ACER TENDL-2023 LIBRARY; T=0.K  
protons from (n,x)

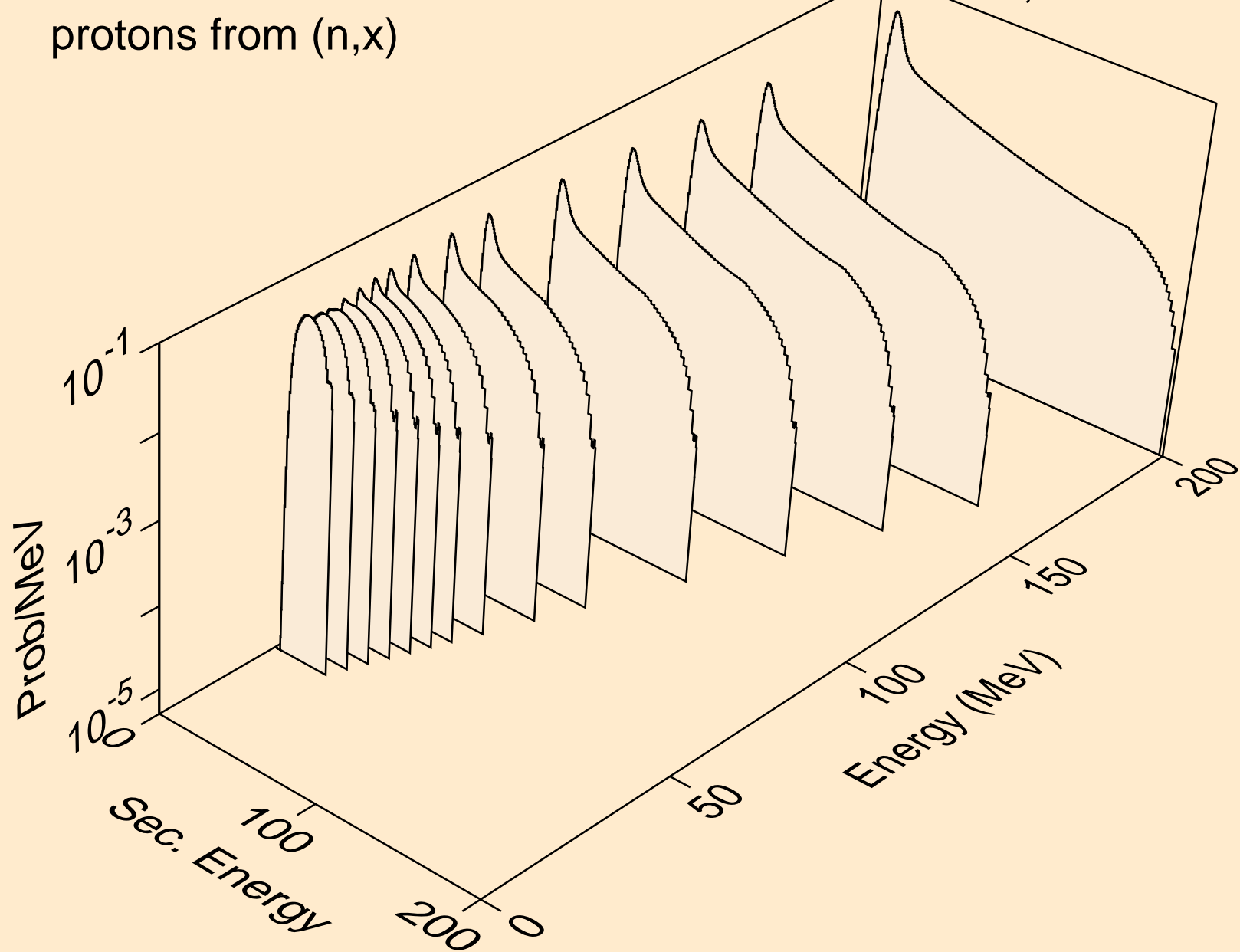

AU194 NEUTRON ACER TENDL-2023 LIBRARY; T=0.K  
protons from (n,n\*)p

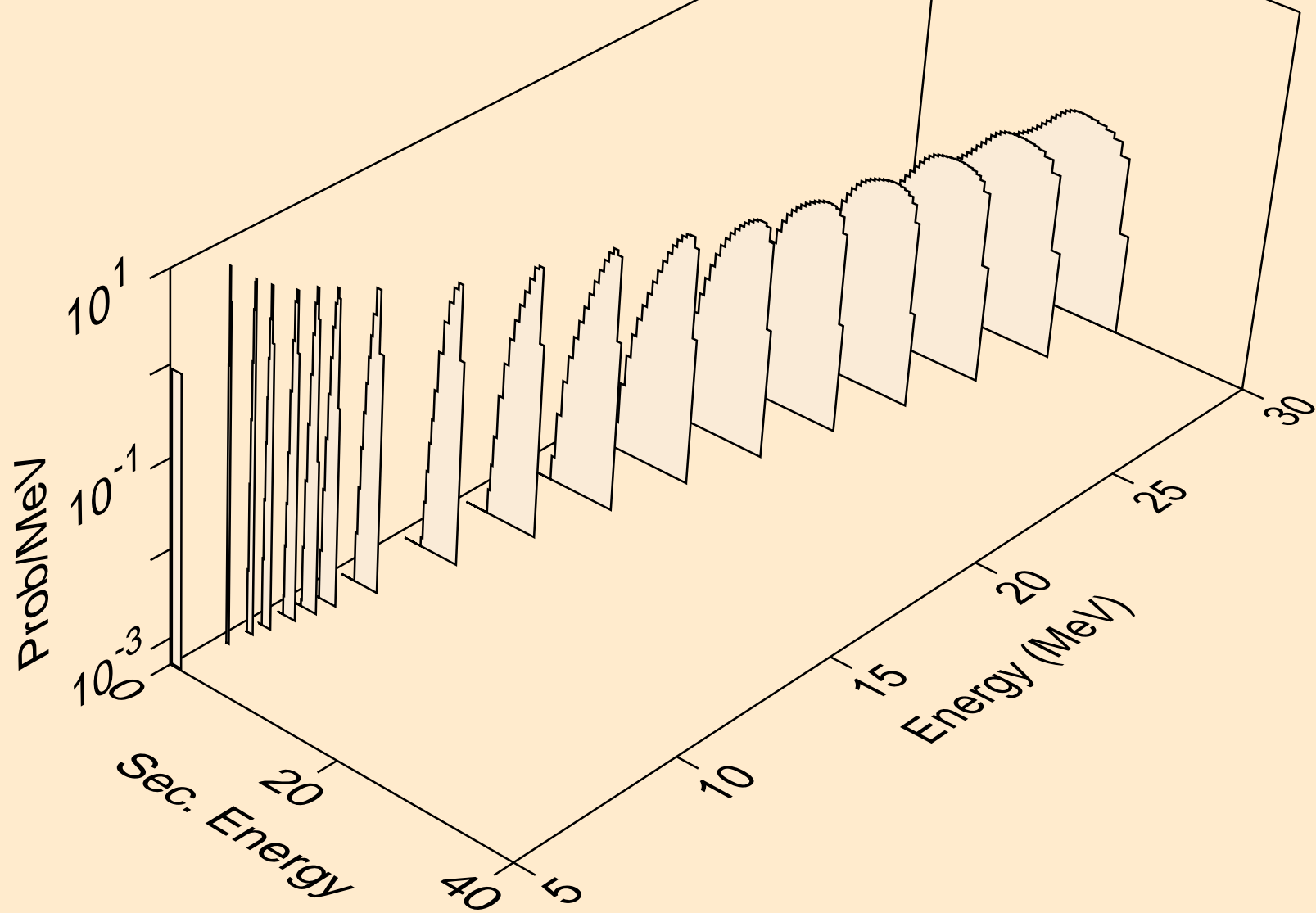

AU194 NEUTRON ACER TENDL-2023 LIBRARY; T=0.K  
protons from (n,2np)

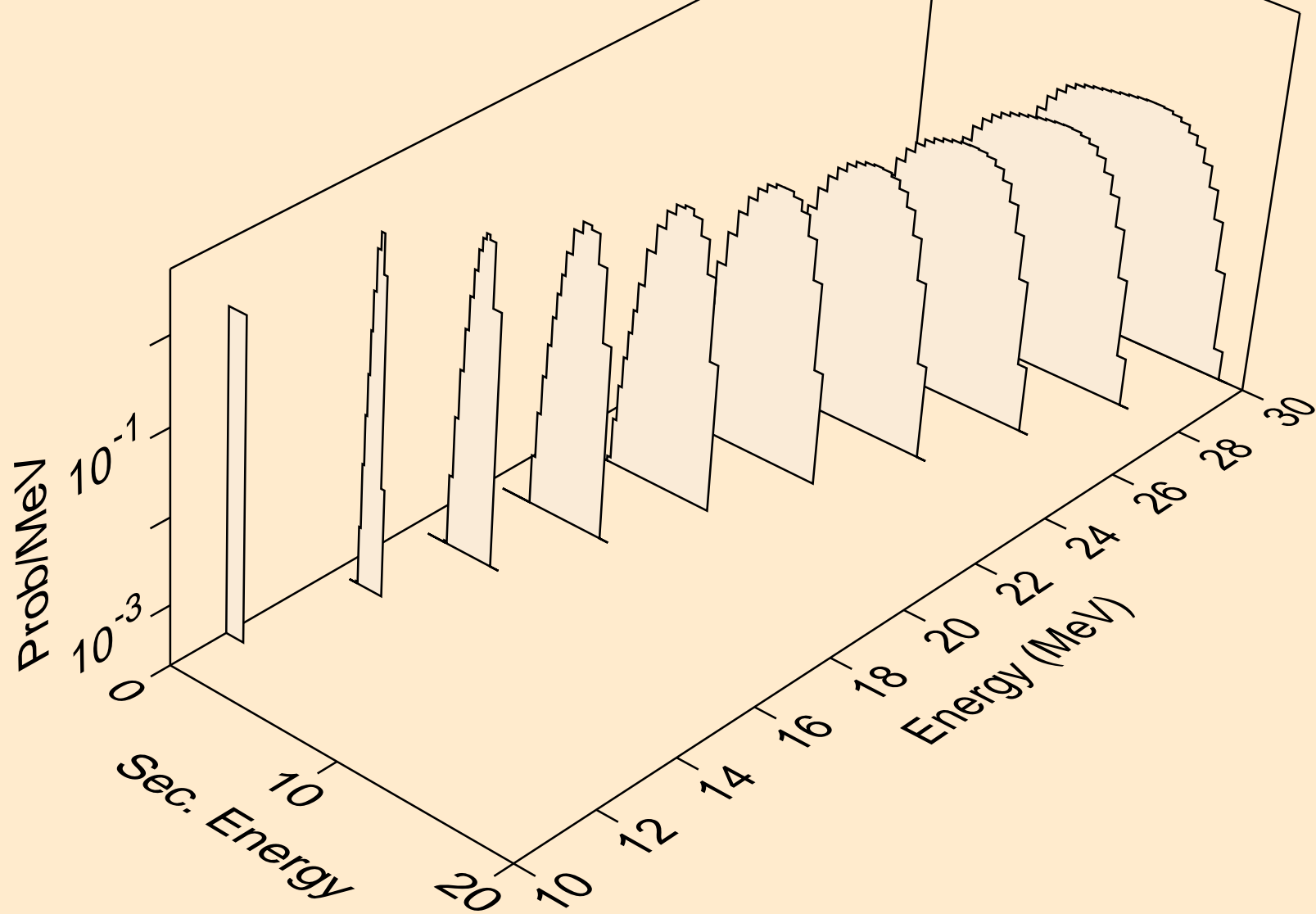

AU194 NEUTRON ACER TENDL-2023 LIBRARY; T=0.K  
protons from (n,3np)

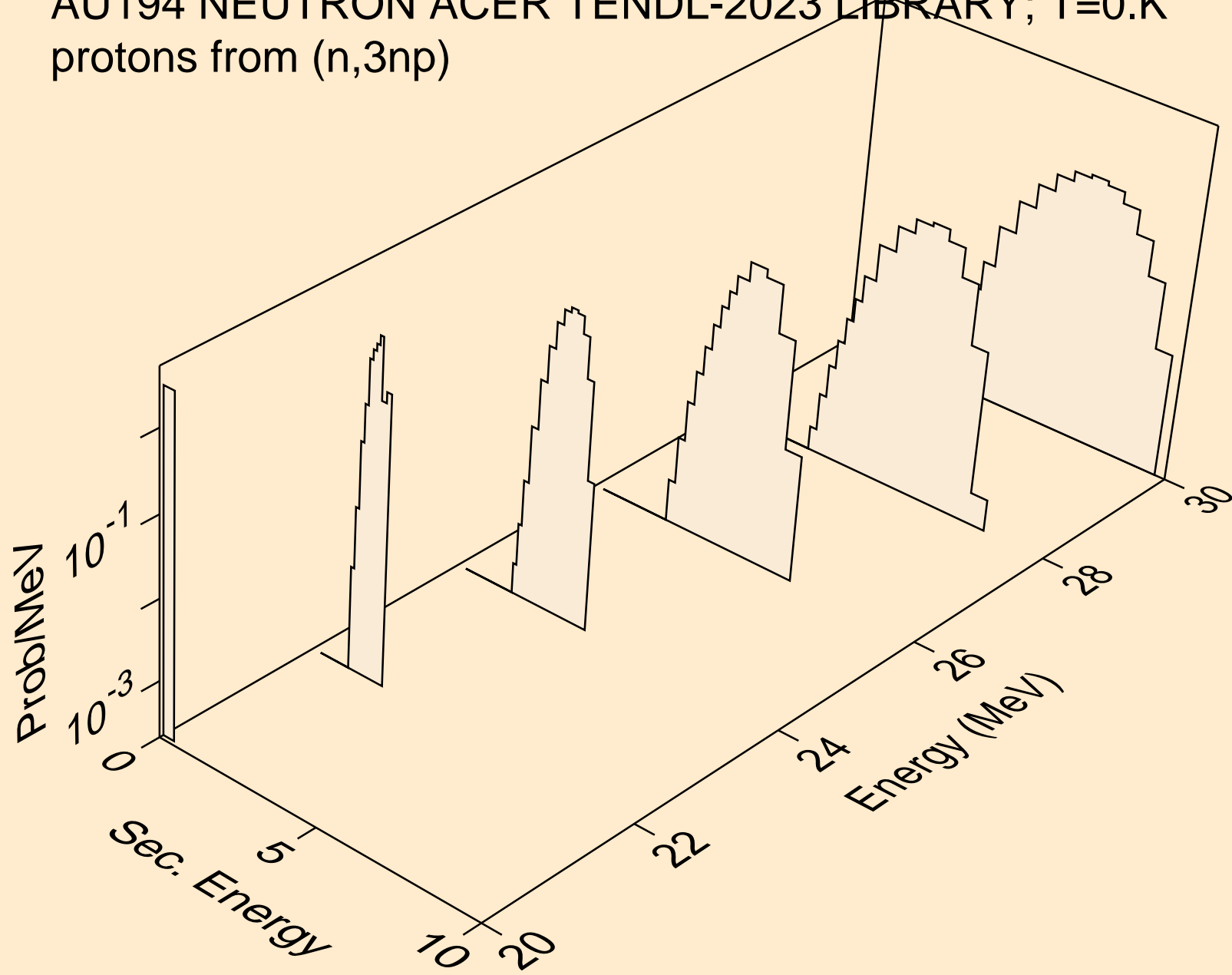

AU194 NEUTRON ACER TENDL-2023 LIBRARY; T=0.K  
protons from (n,n2p)

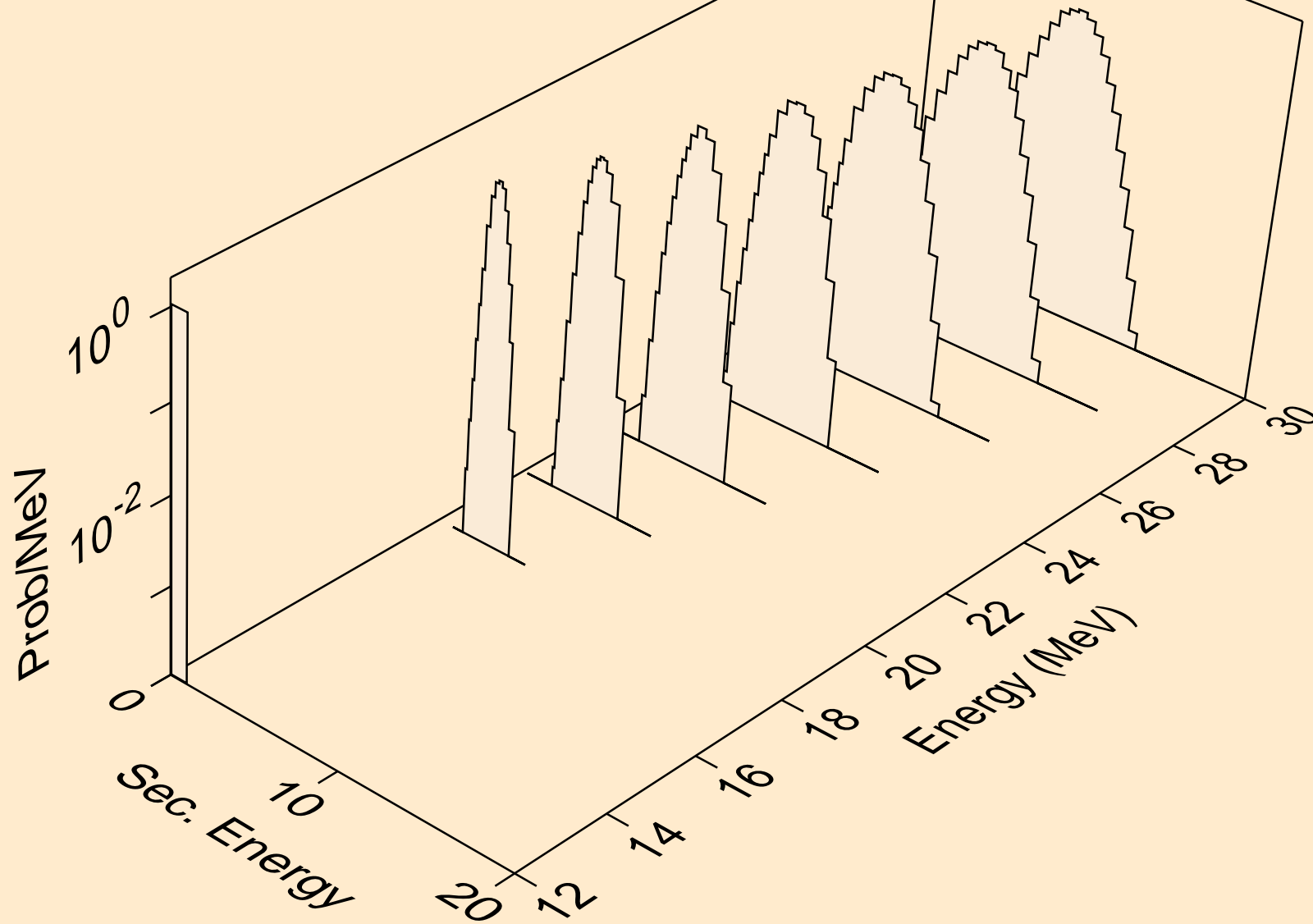



AU194 NEUTRON ACER TENDL-2023 LIBRARY; T=0.K  
protons from (n,npa)

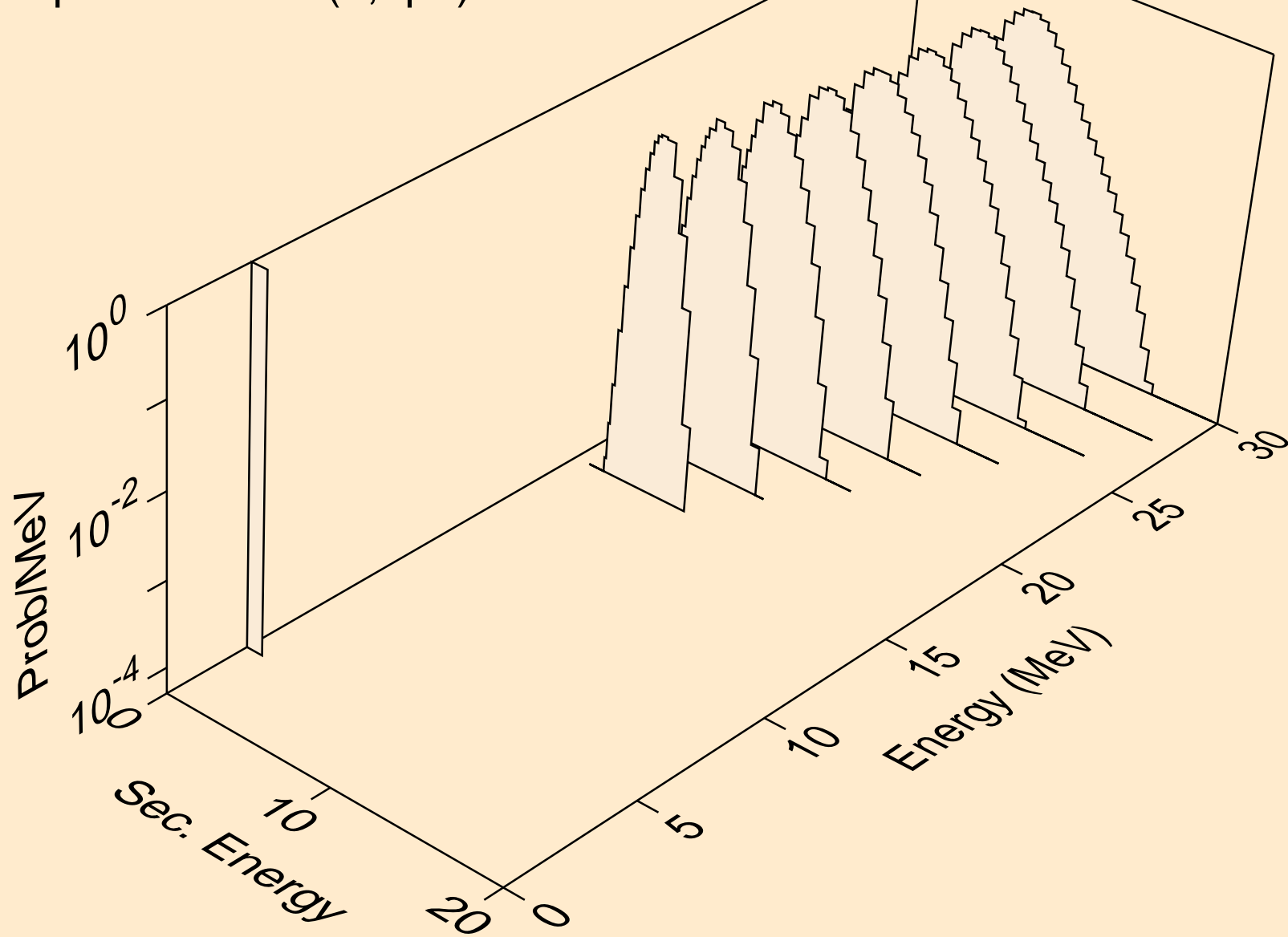

AU194 NEUTRON ACER TENDL-2023 LIBRARY; T=0.K  
protons from (n,p)

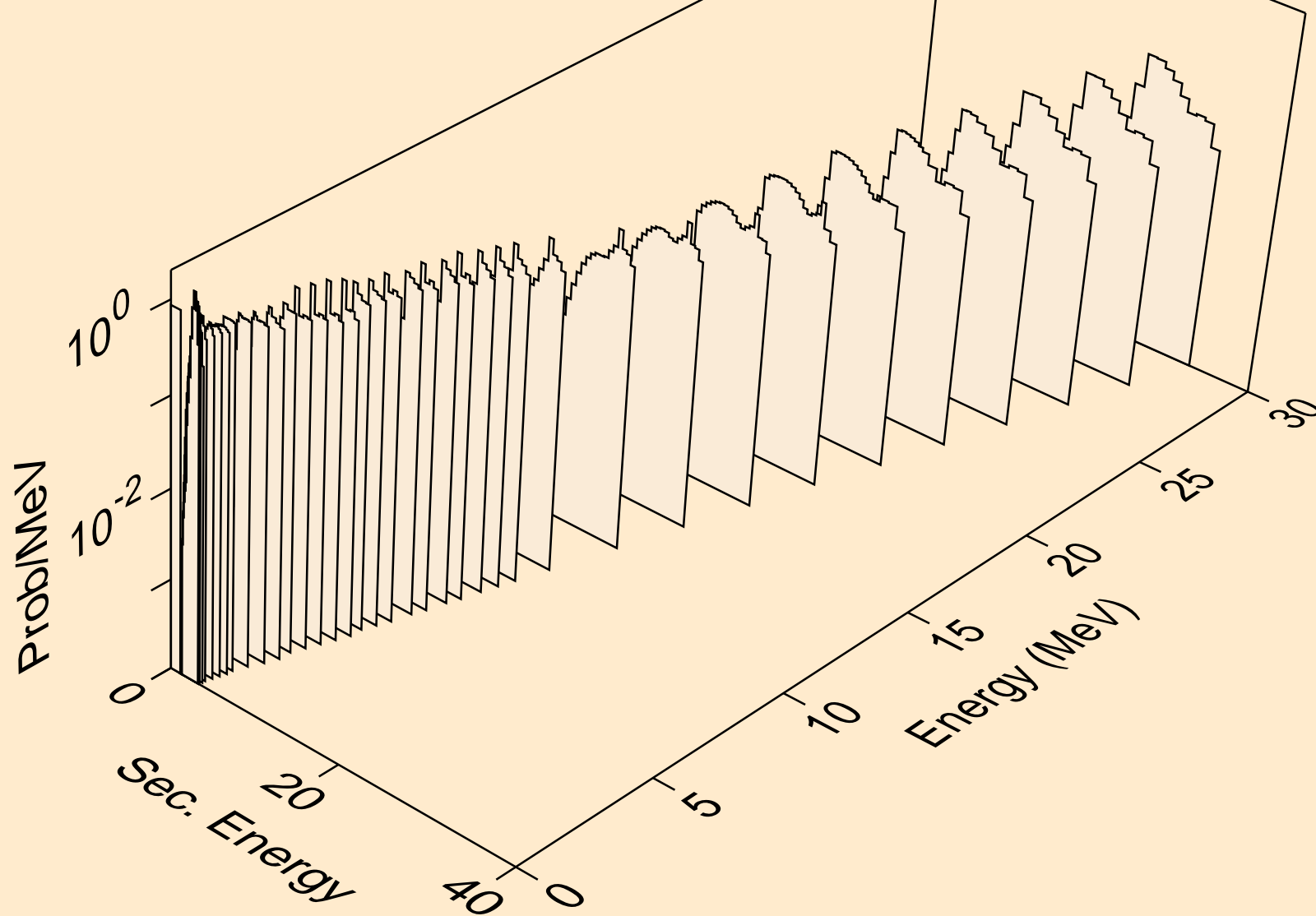

AU194 NEUTRON ACER TENDL-2023 LIBRARY; T=0.K  
protons from (n,2p)

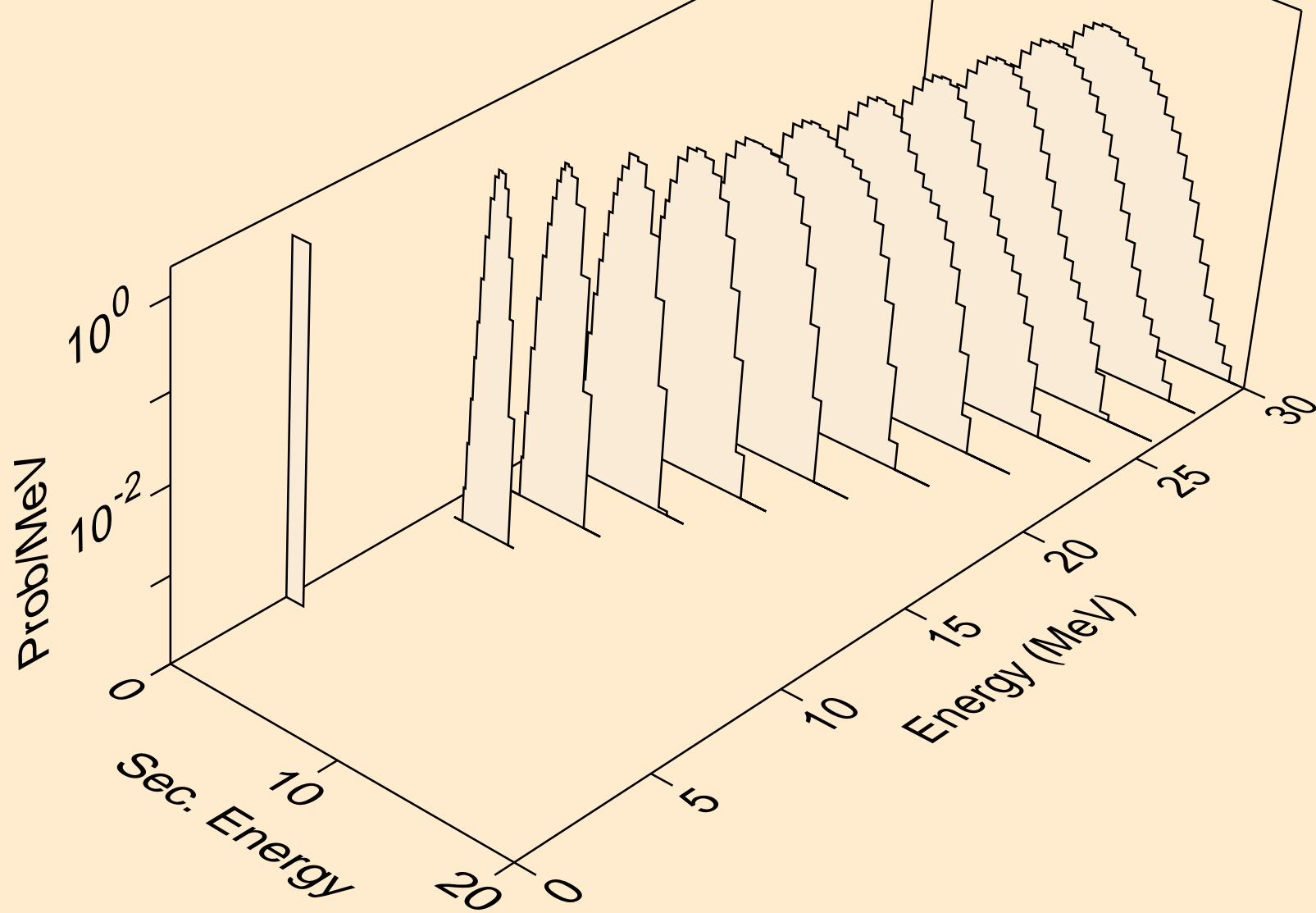

AU194 NEUTRON ACER TENDL-2023 LIBRARY; T=0.K  
protons from (n,p)

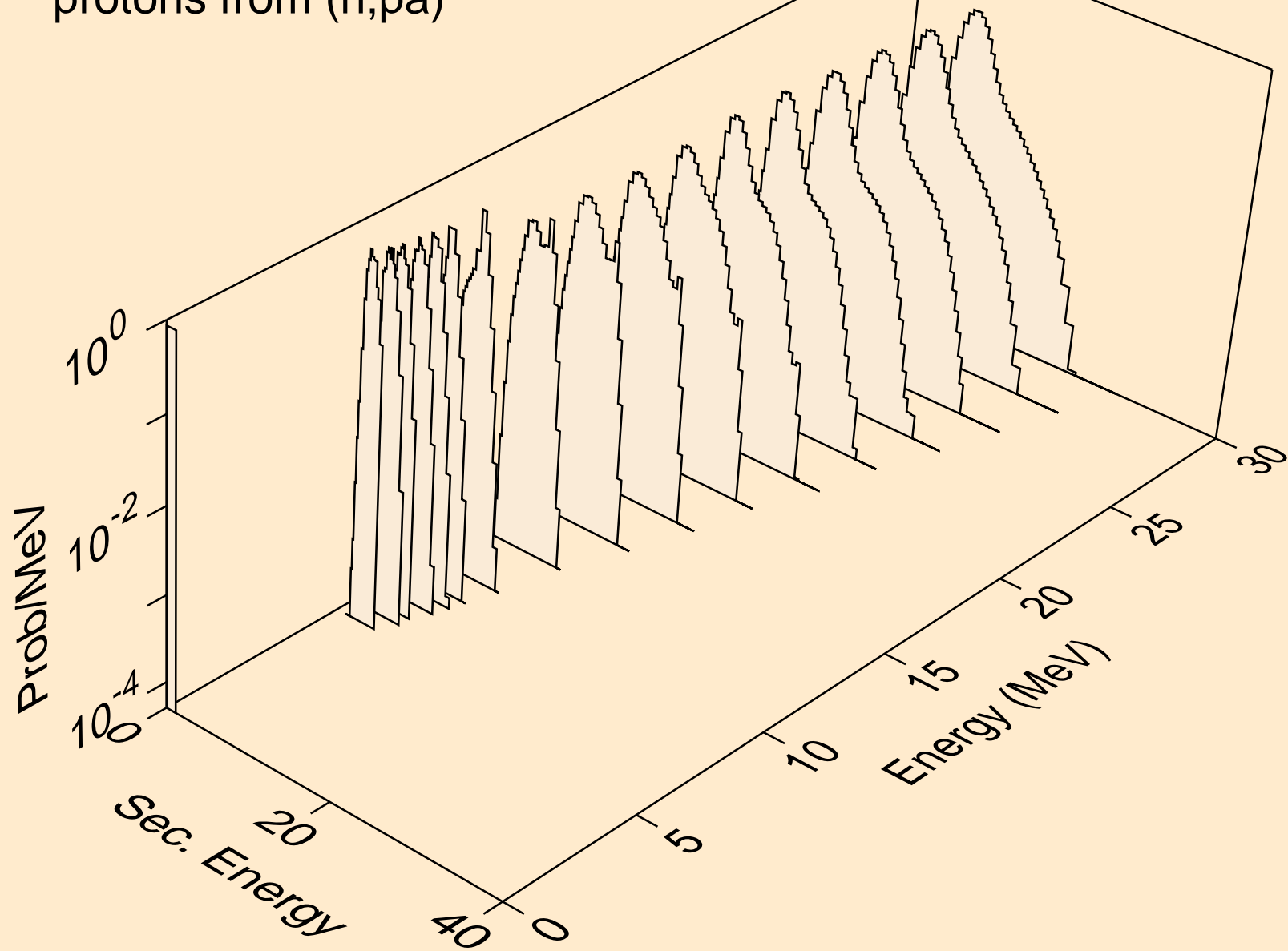

AU194 NEUTRON ACER TENDL-2023 LIBRARY; T=0.K  
protons from (n,pd)

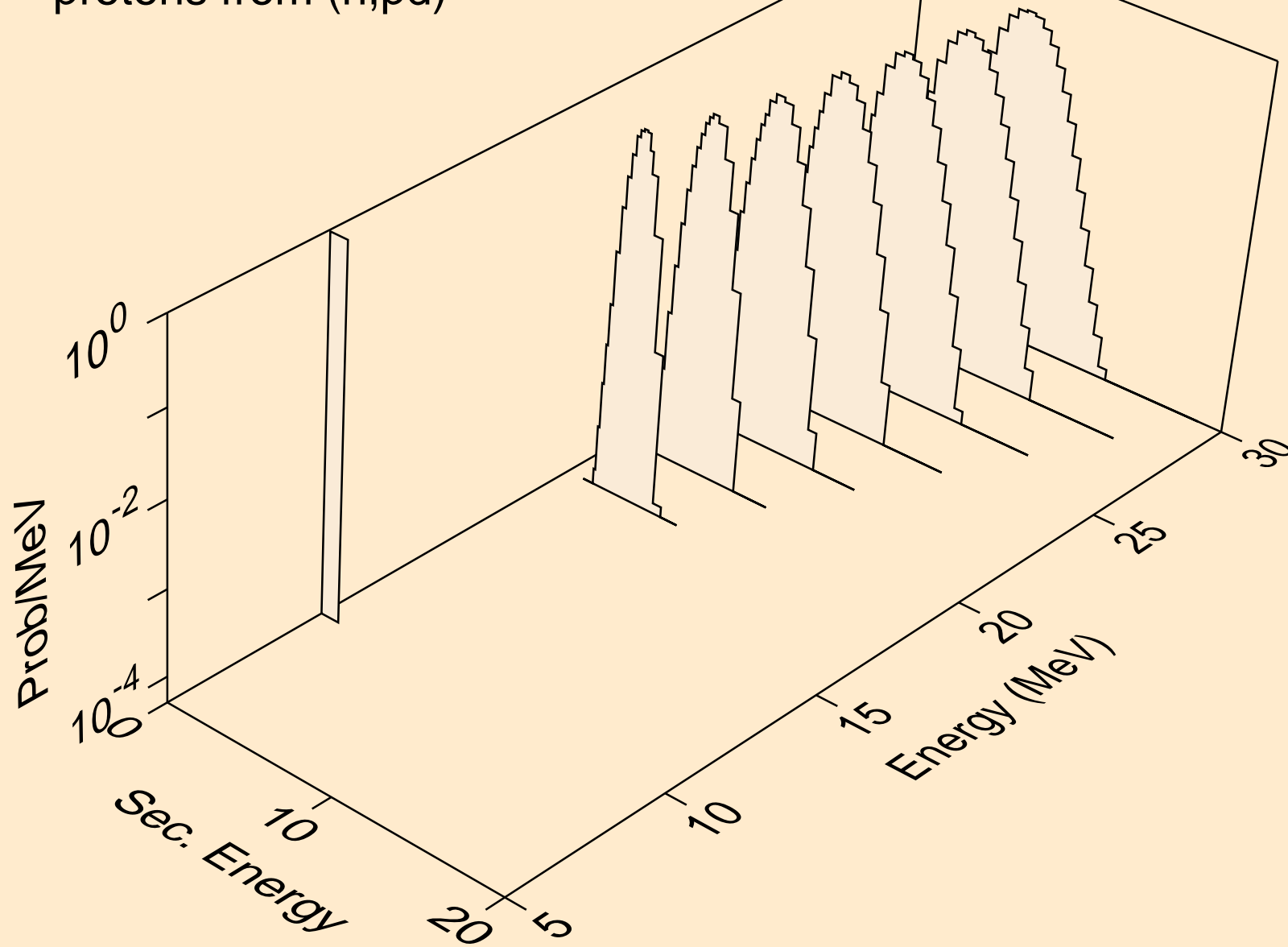

AU194 NEUTRON ACER TENDL-2023 LIBRARY; T=0.K  
protons from (n,pt)

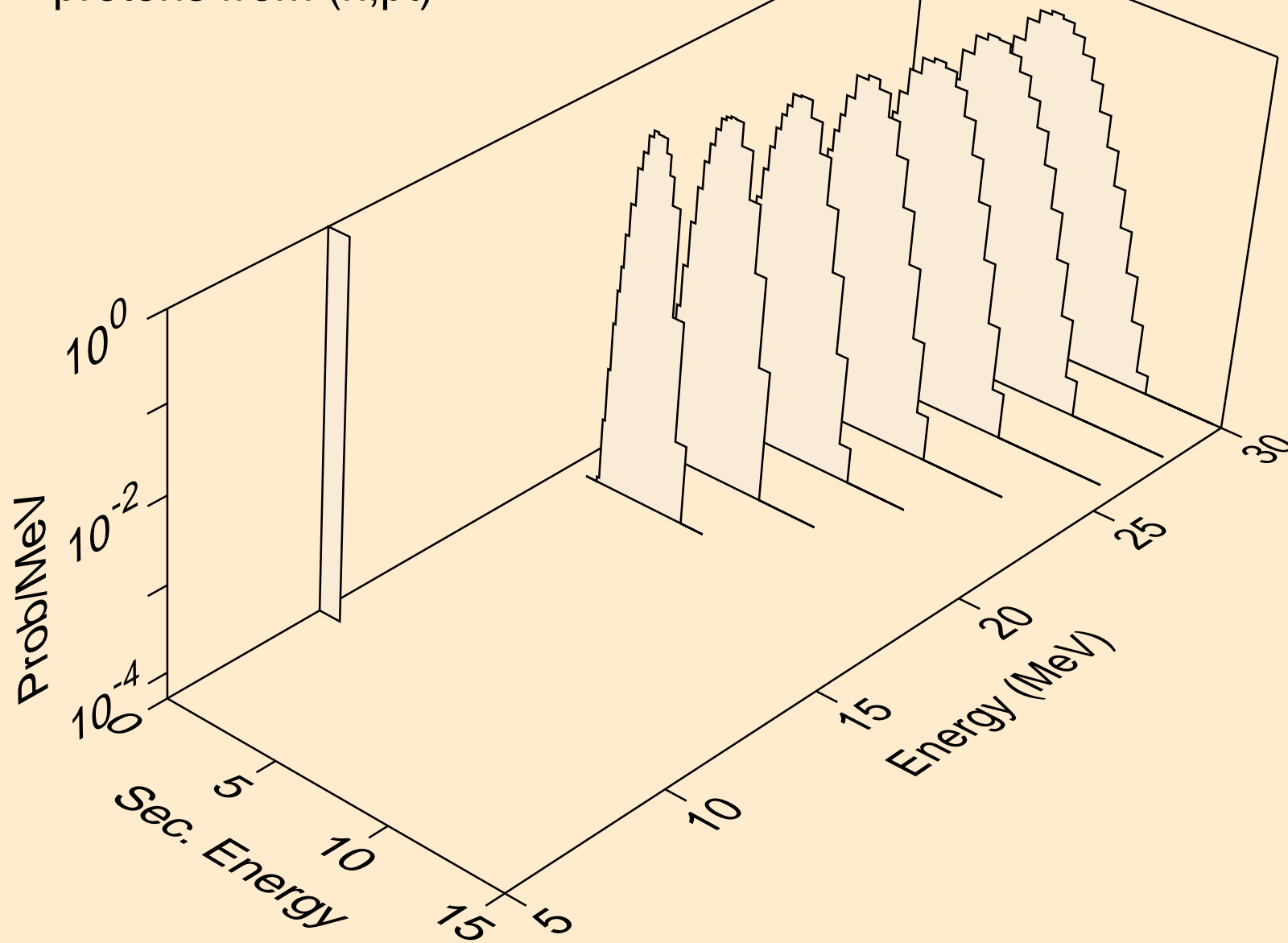

AU194 NEUTRON ACER TENDL-2023 LIBRARY; T=0.K  
deuterons from (n,x)

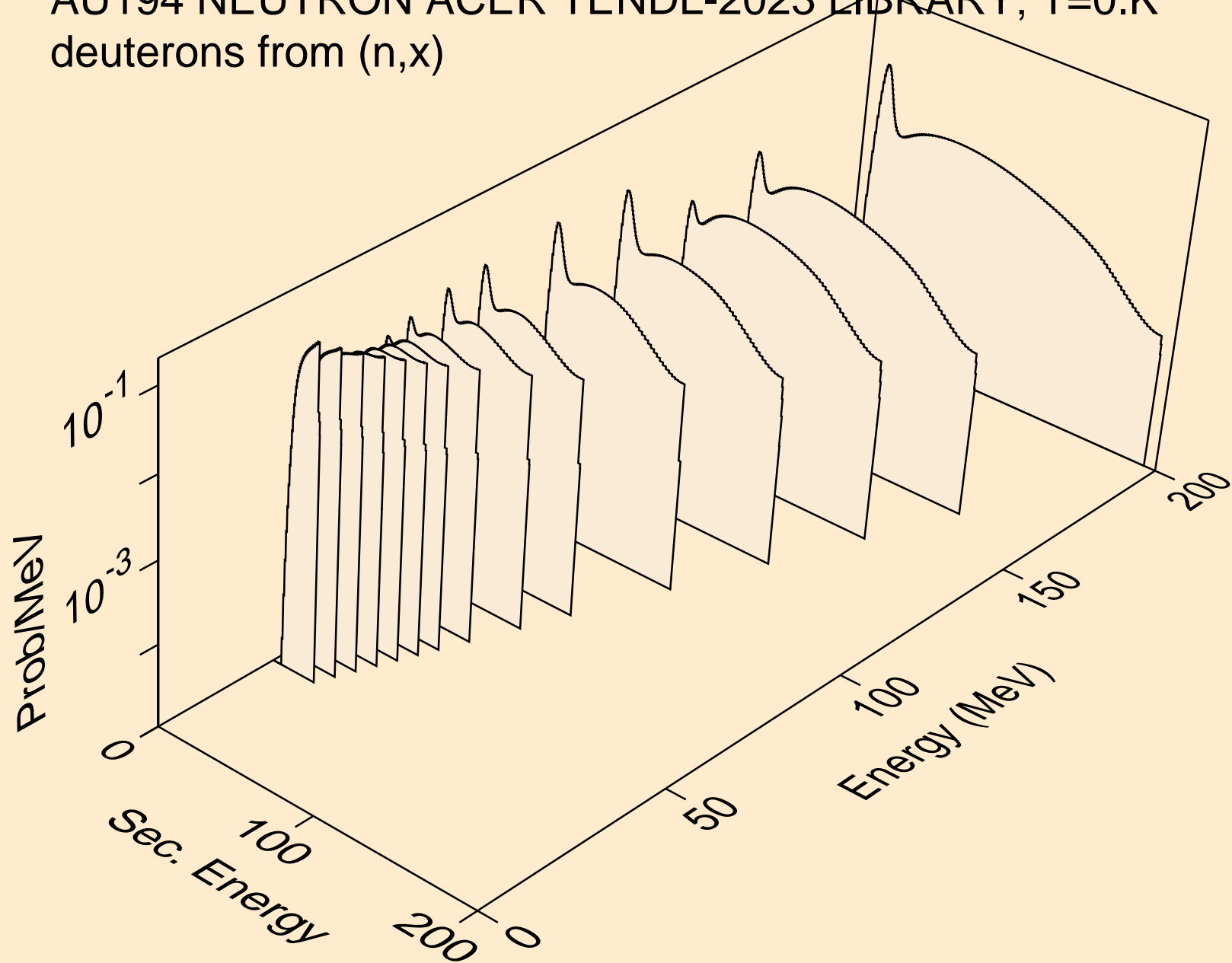

AU194 NEUTRON ACER TENDL-2023 LIBRARY; T=0.K  
deuterons from (n,2nd)

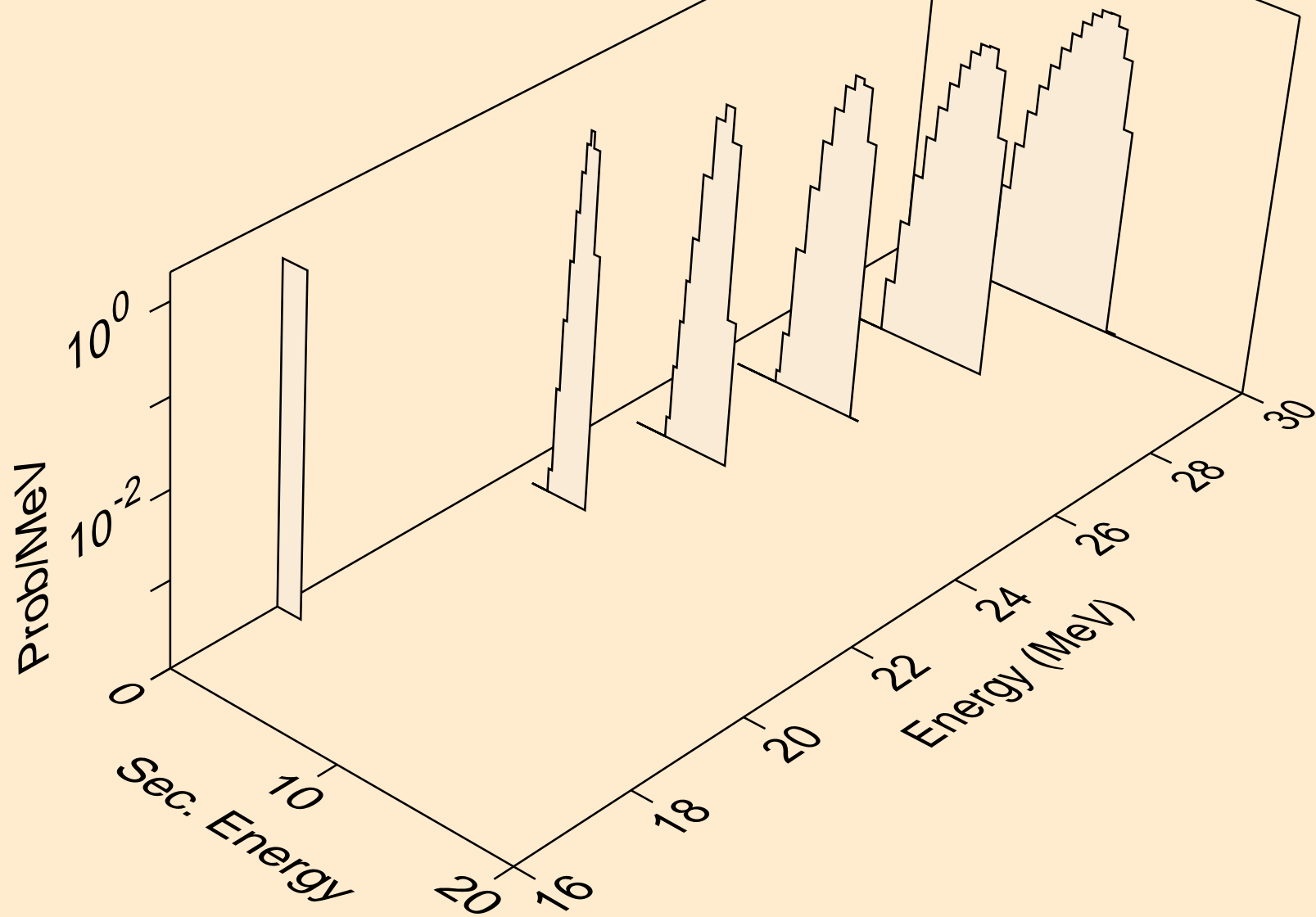



AU194 NEUTRON ACER TENDL-2023 LIBRARY; T=0.K  
deuterons from (n,n\*)d

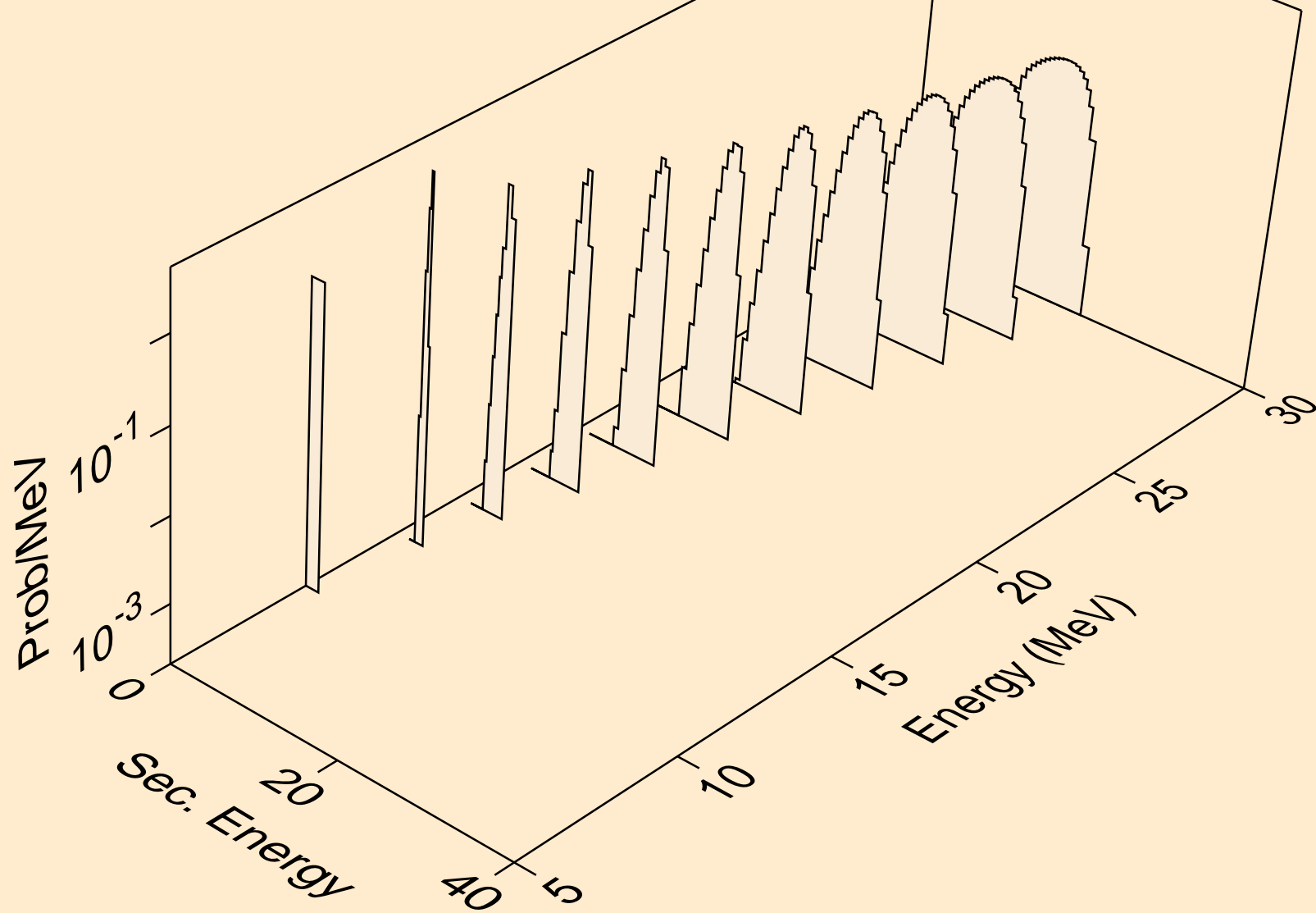

AU194 NEUTRON ACER TENDL-2023 LIBRARY; T=0.K  
deuterons from (n,d)

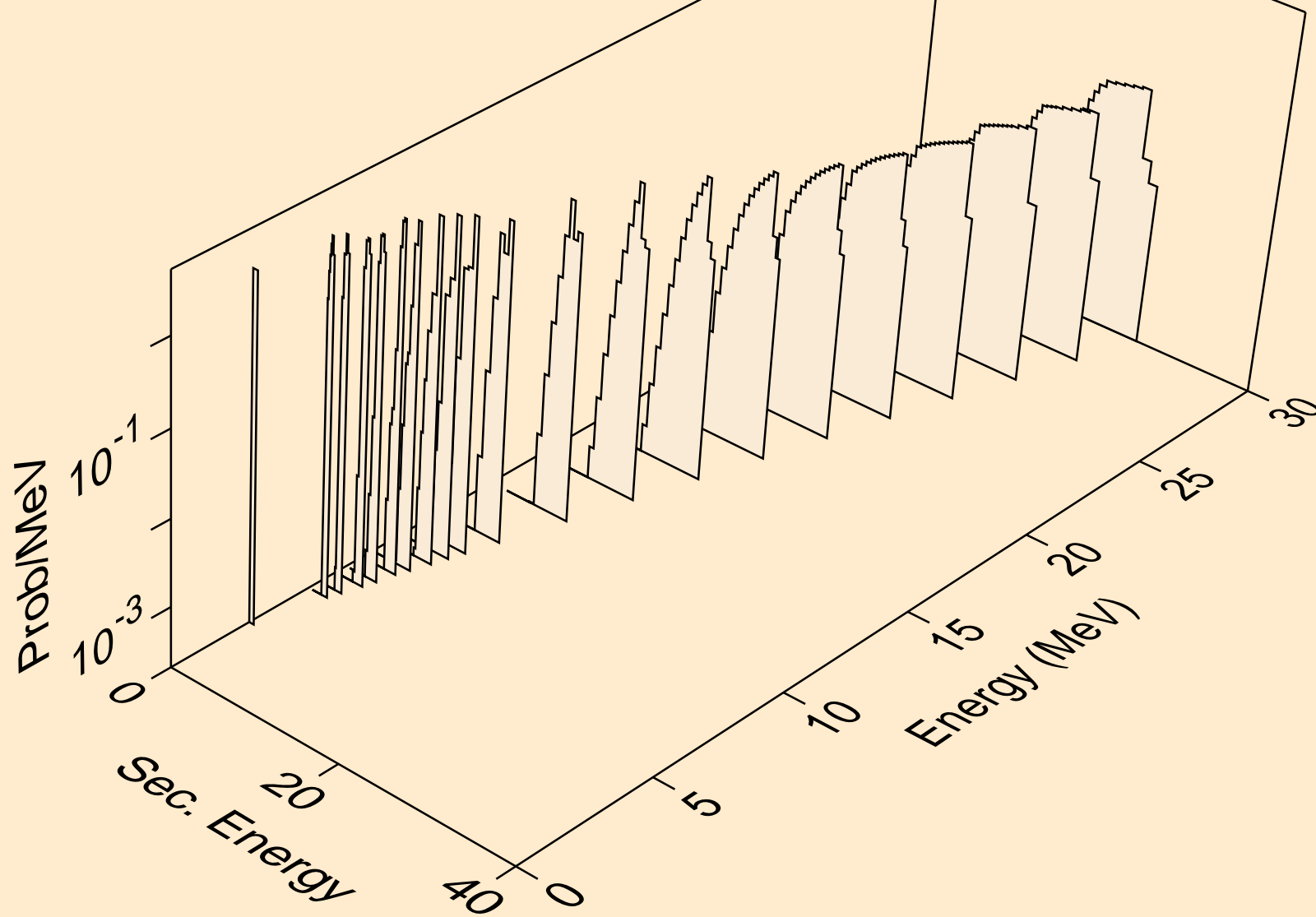

AU194 NEUTRON ACER TENDL-2023 LIBRARY; T=0.K  
deuterons from (n,pd)

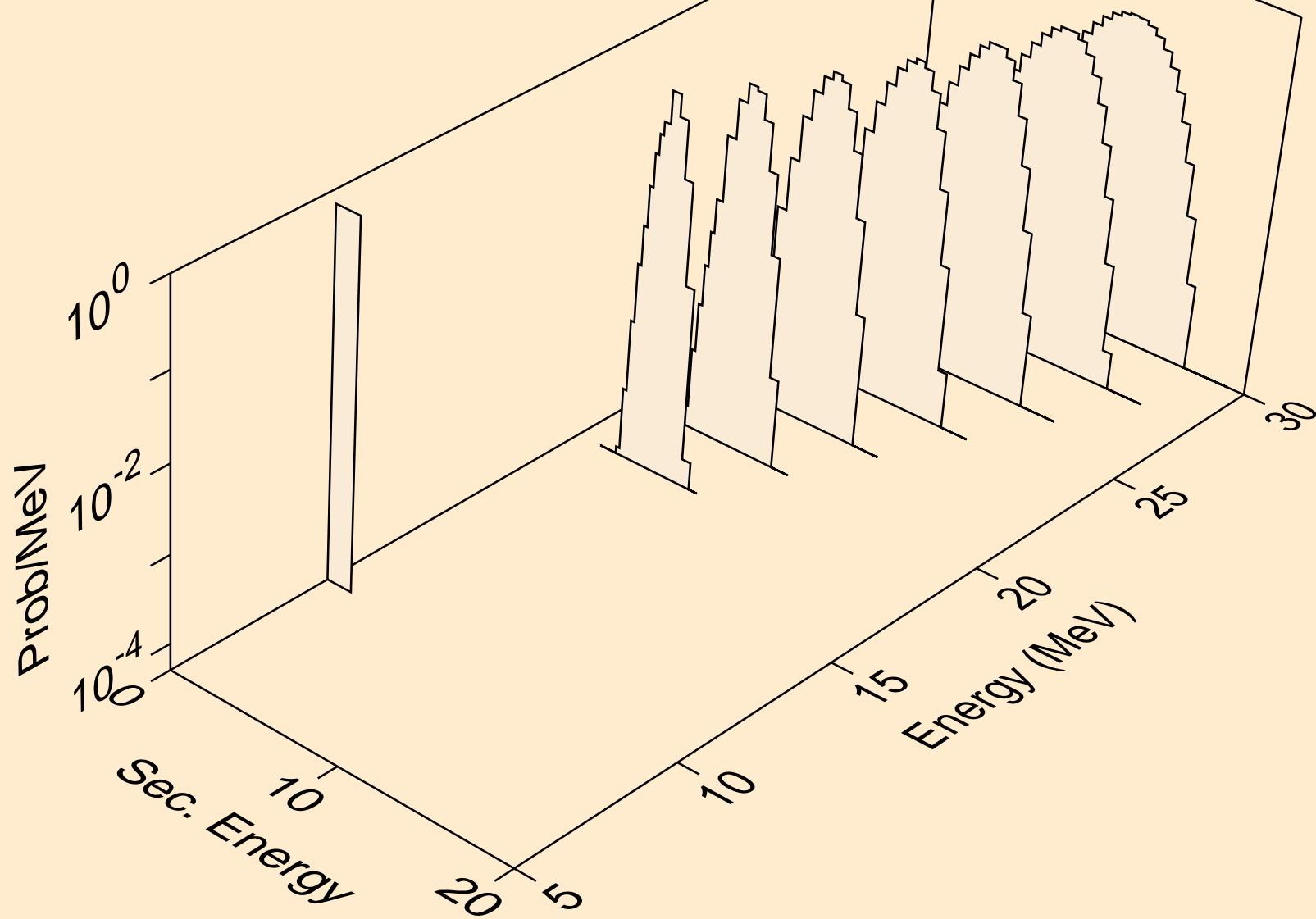

AU194 NEUTRON ACER TENDL-2023 LIBRARY; T=0.K  
deuterons from (n,da)

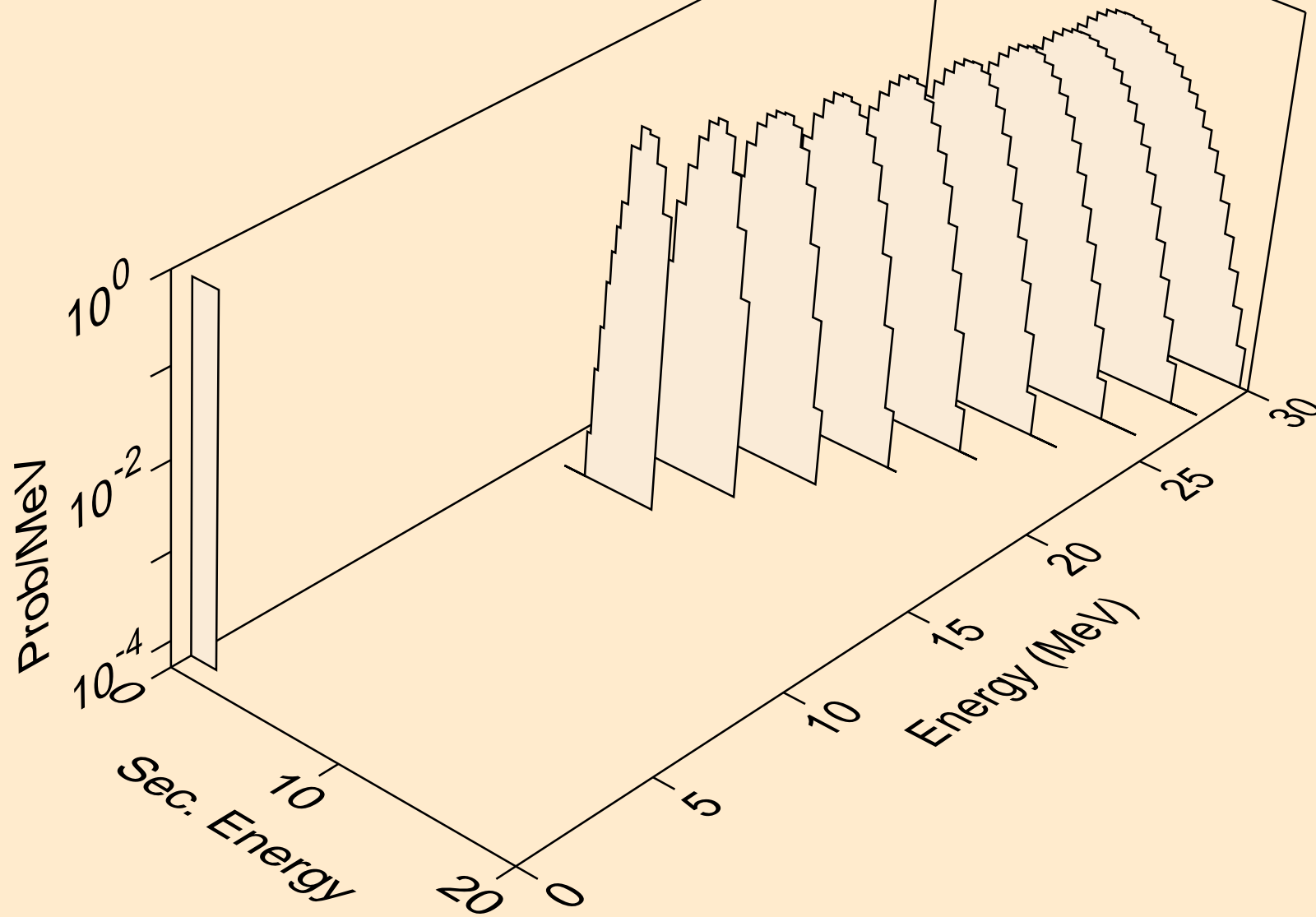

AU194 NEUTRON ACER TENDL-2023 LIBRARY; T=0.K  
tritons from (n,x)

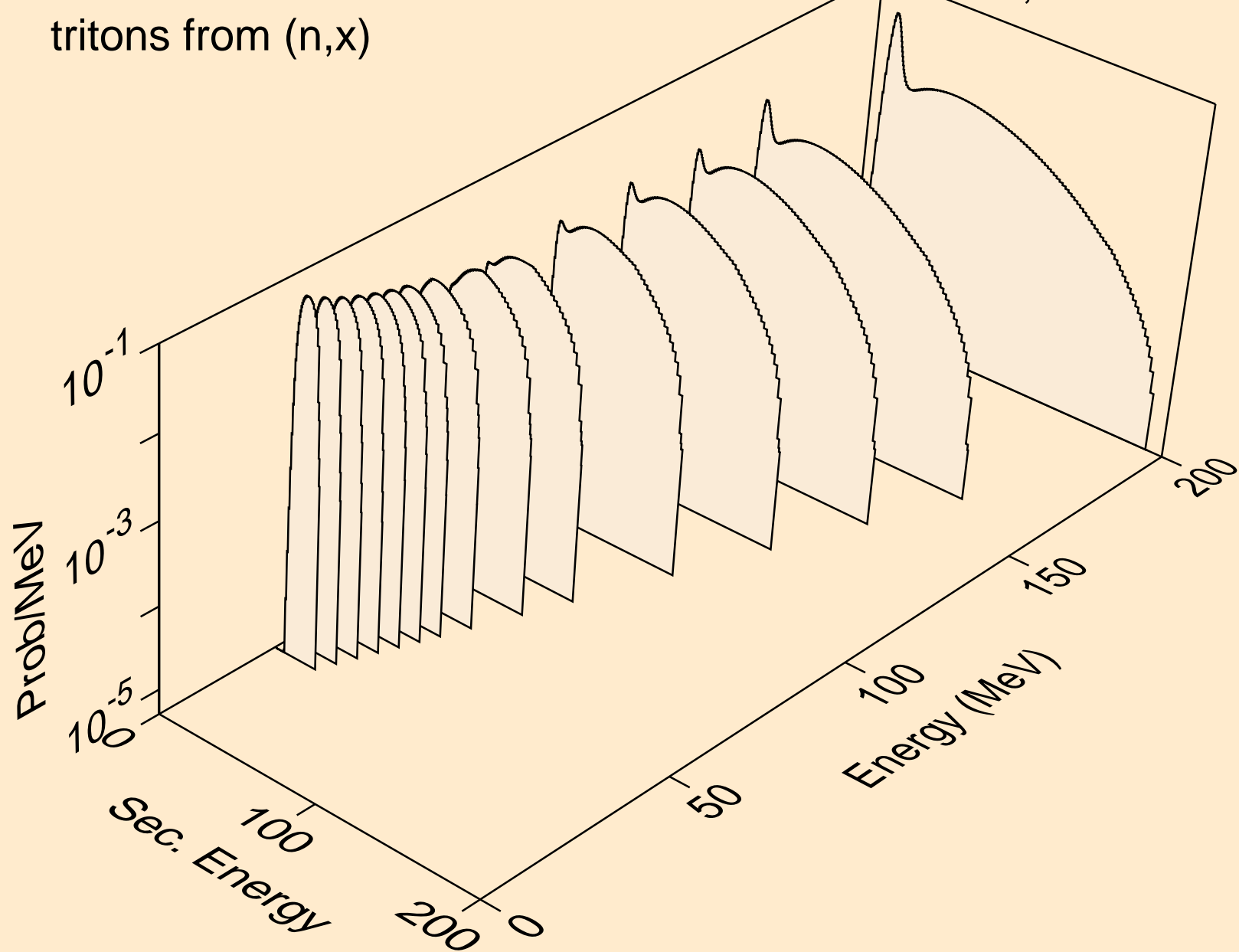

AU194 NEUTRON ACER TENDL-2023 LIBRARY; T=0.K  
tritons from (n,n\*)t

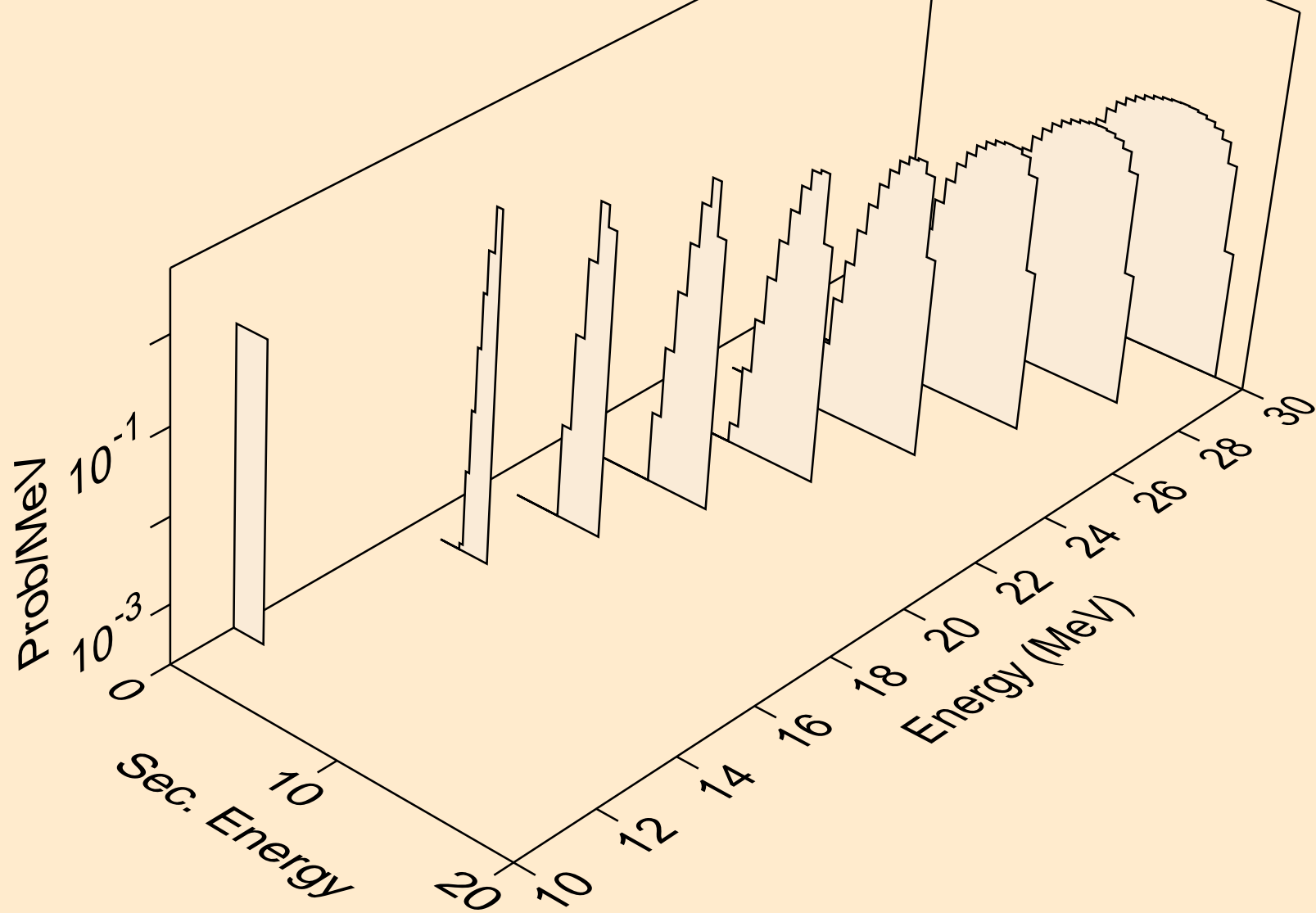

AU194 NEUTRON ACER TENDL-2023 LIBRARY; T=0.K  
tritons from (n,t)

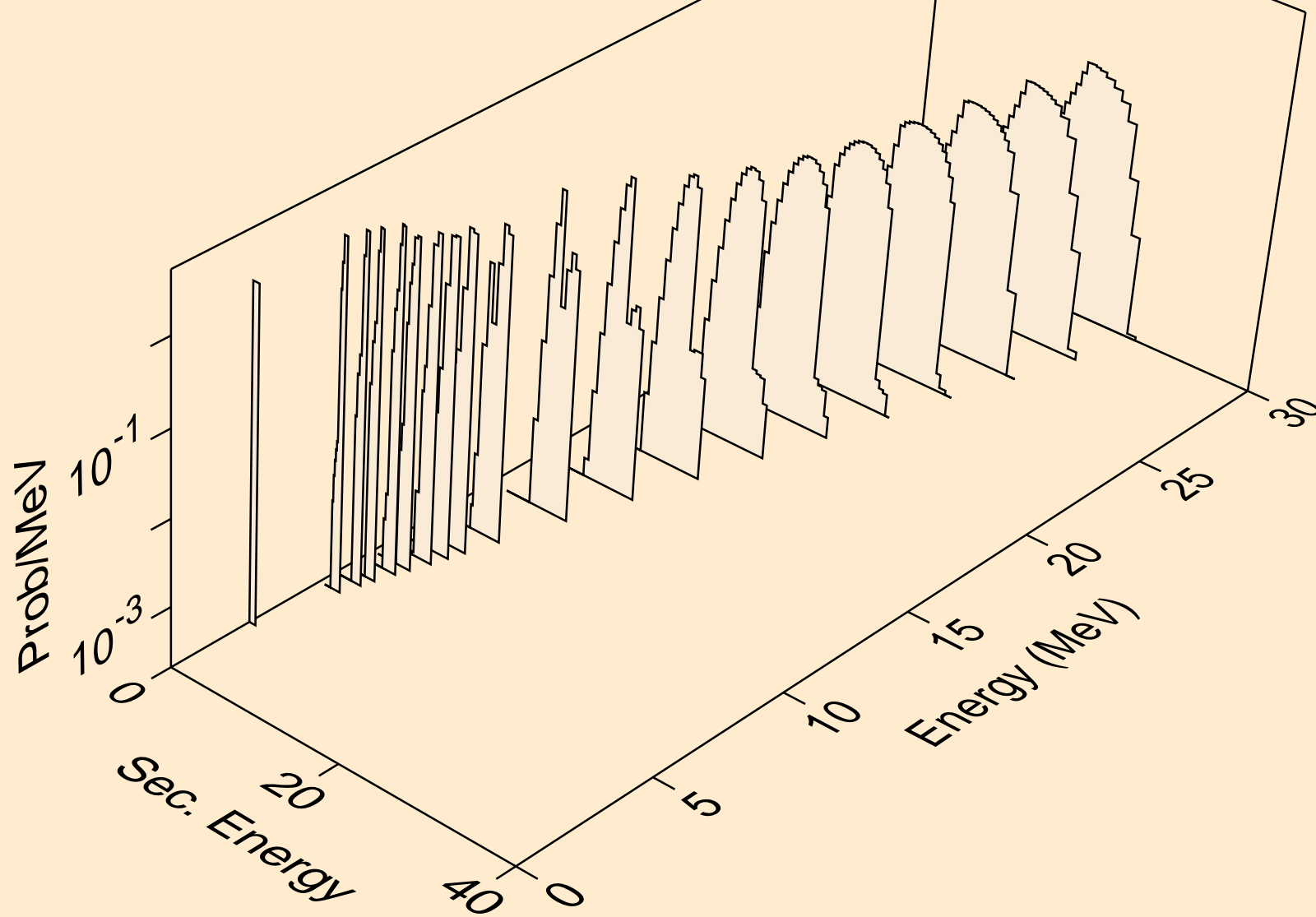

AU194 NEUTRON ACER TENDL-2023 LIBRARY; T=0.K  
tritons from (n,pt)

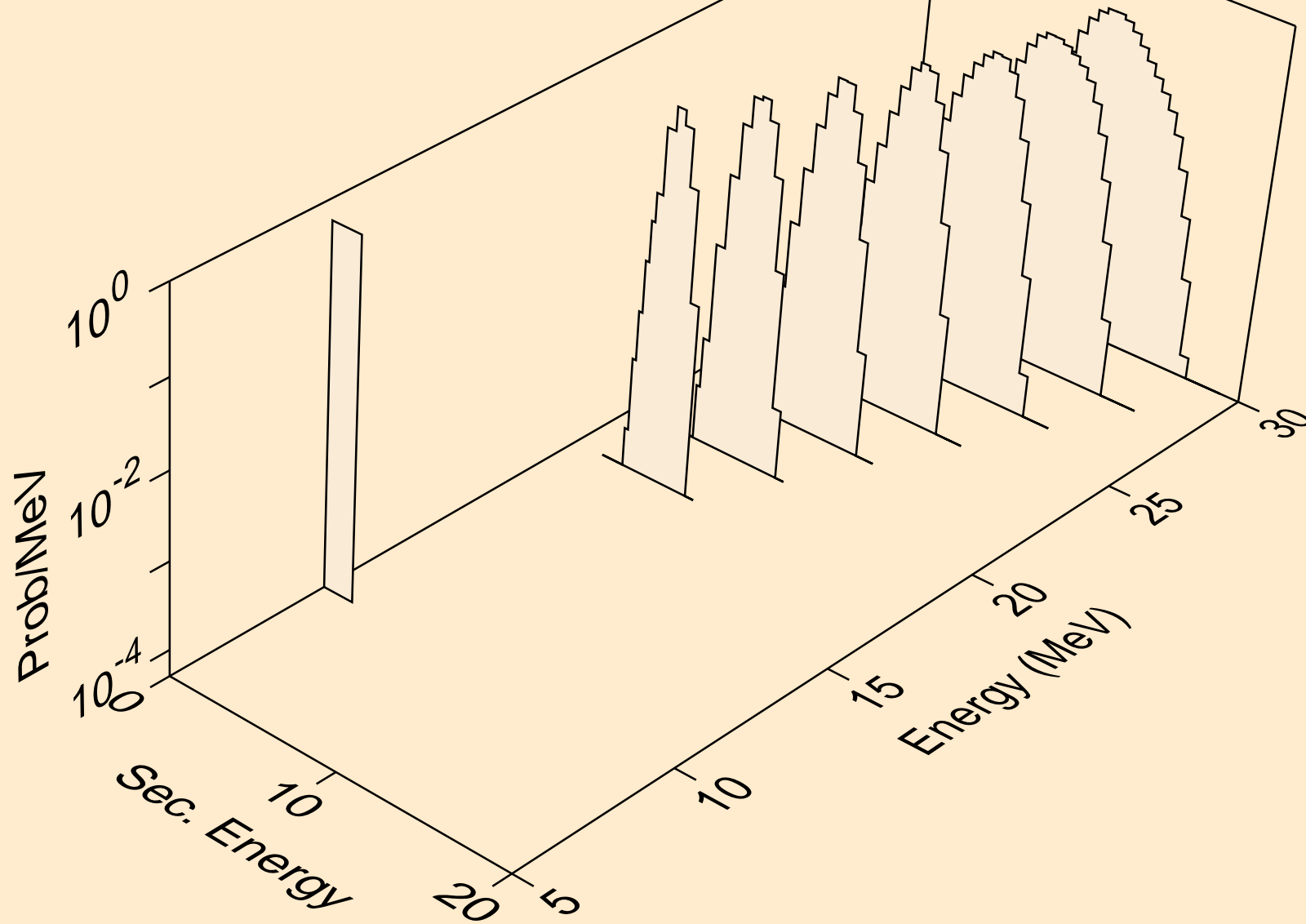



AU194 NEUTRON ACER TENDL-2023 LIBRARY; T=0.K  
he3s from (n,x)

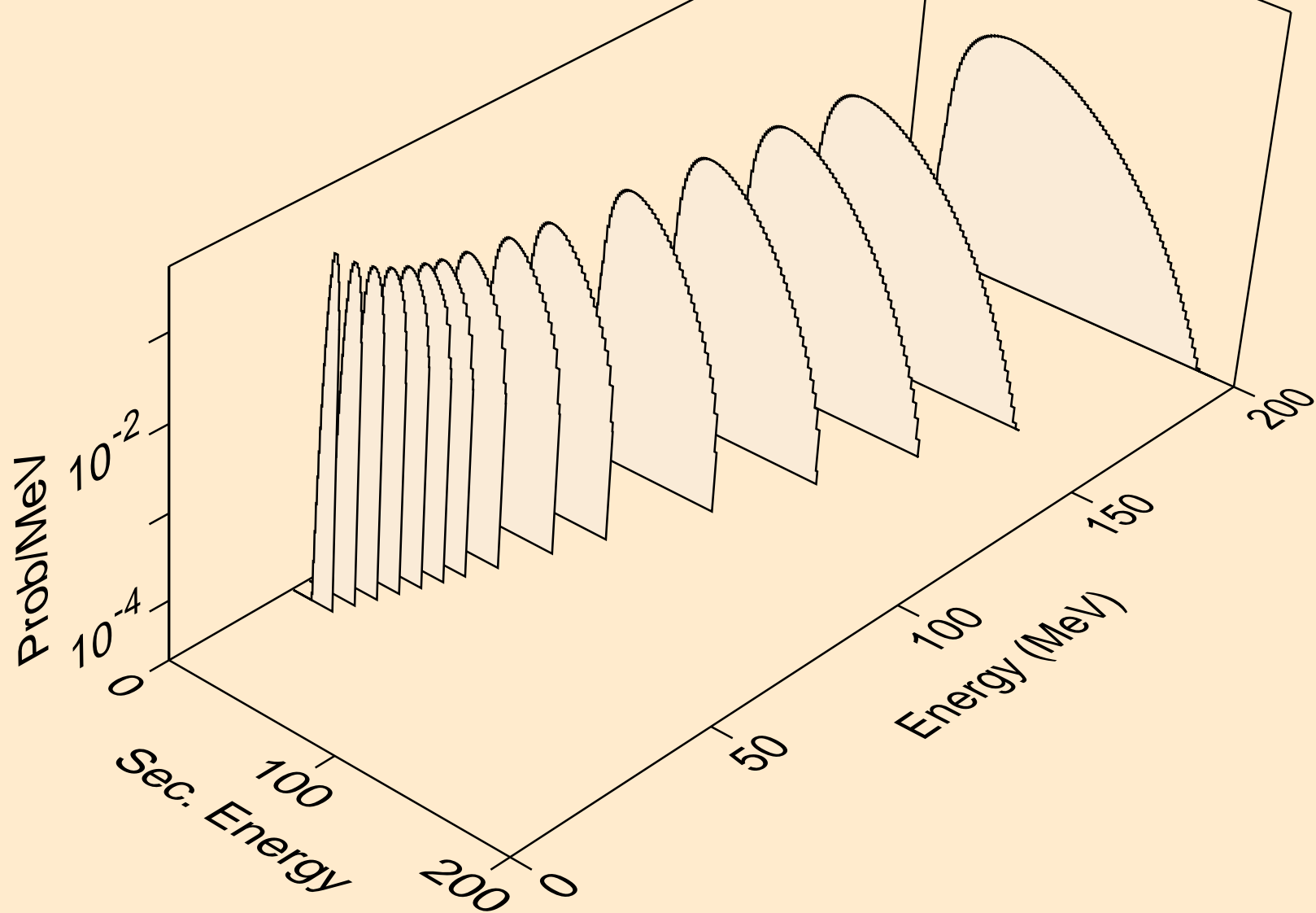

AU194 NEUTRON ACER TENDL-2023 LIBRARY; T=0.K  
he3s from (n,n\*)he3

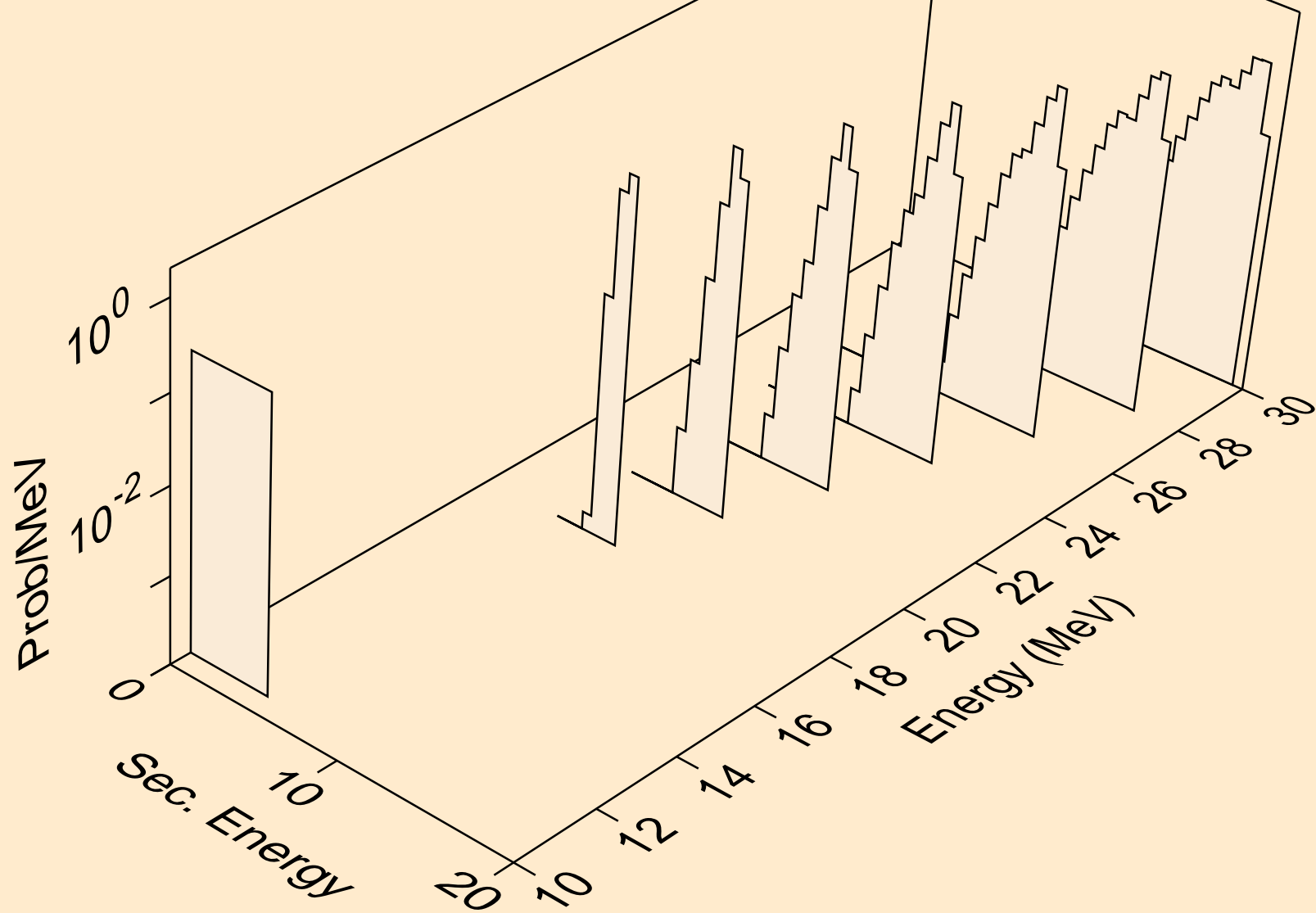

AU194 NEUTRON ACER TENDL-2023 LIBRARY; T=0.K  
he3s from (n,he3)

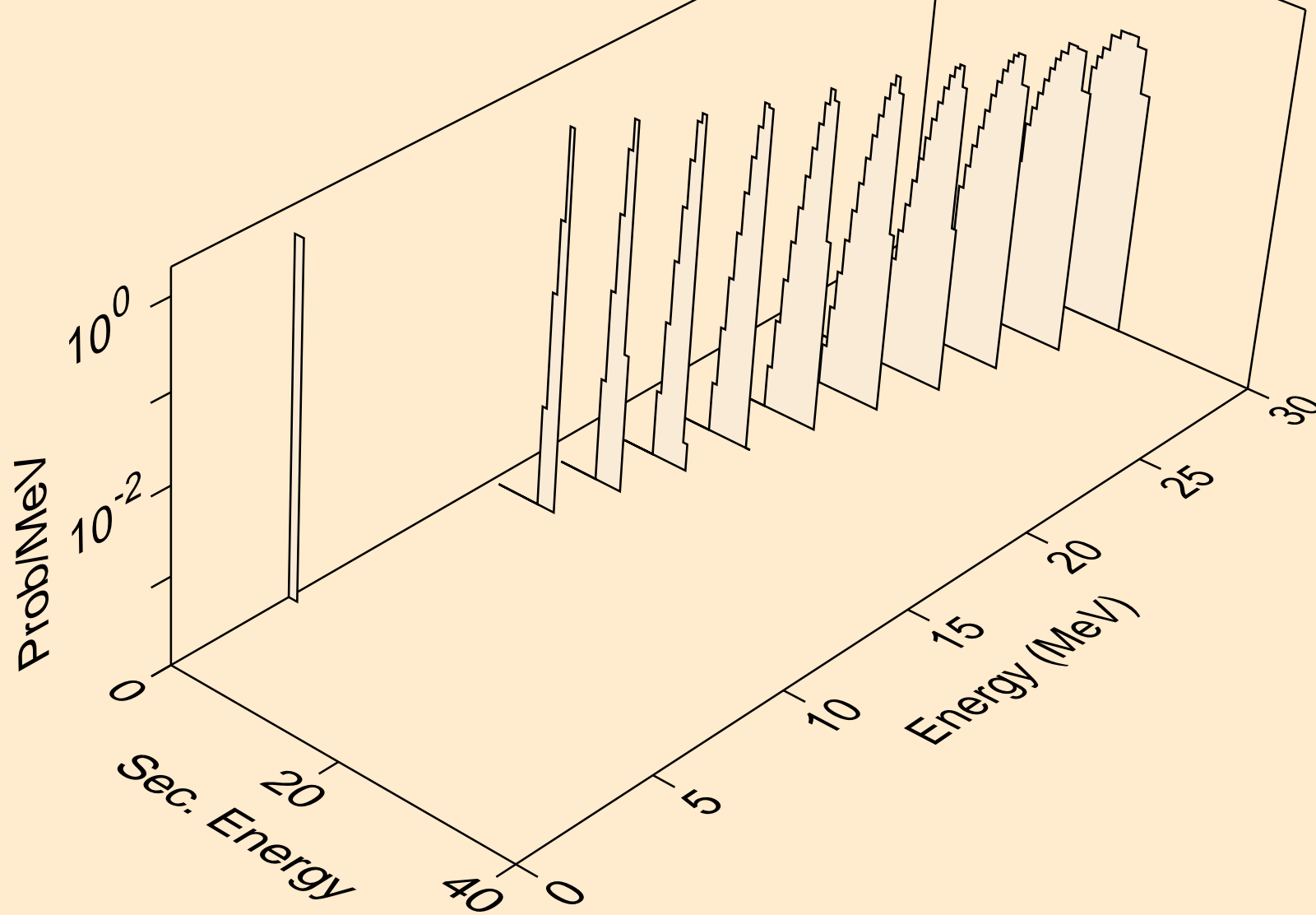

AU194 NEUTRON ACER TENDL-2023 LIBRARY; T=0.K  
alphas from (n,x)

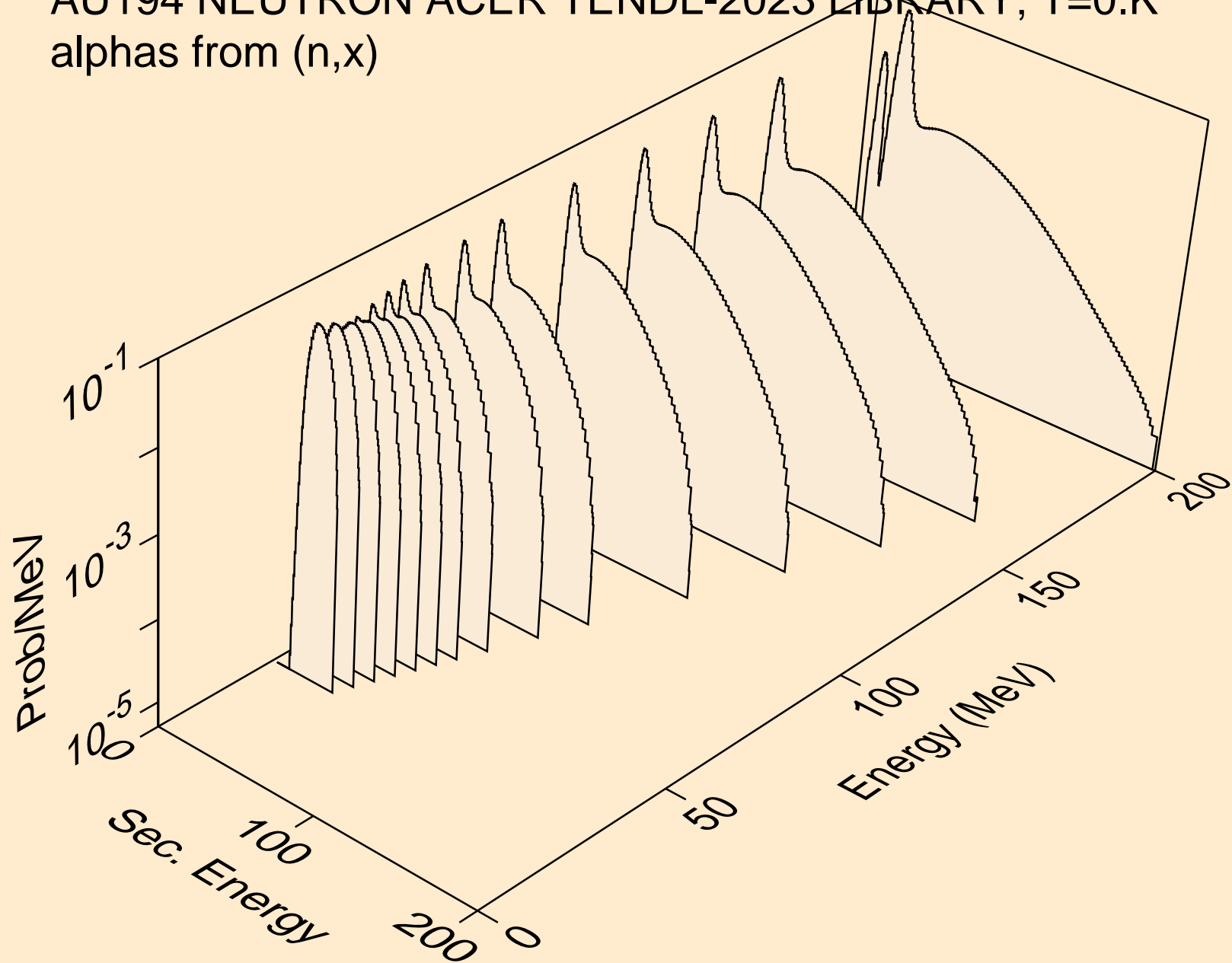

AU194 NEUTRON ACER TENDL-2023 LIBRARY; T=0.K  
alphas from (n,n\*)a

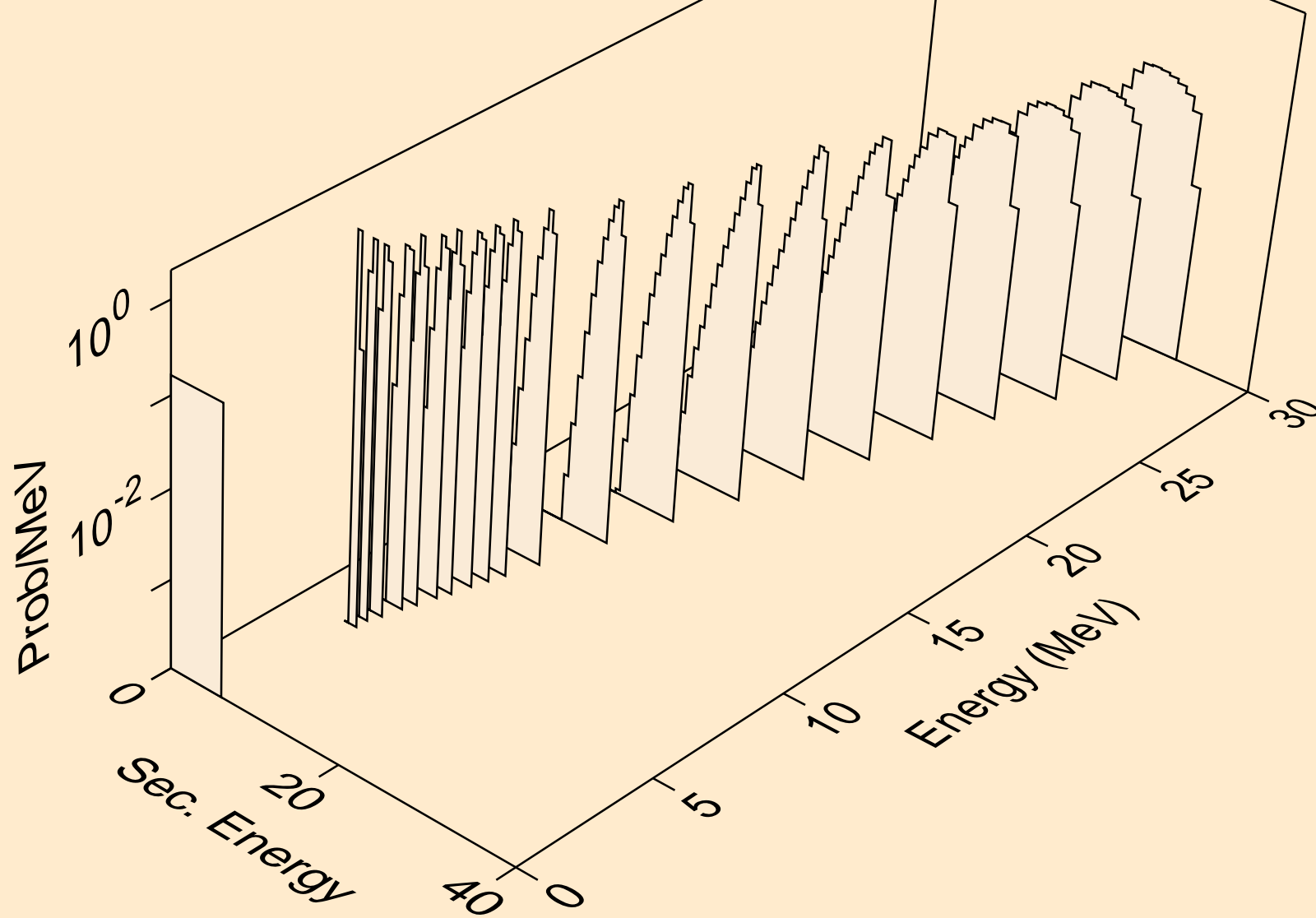

AU194 NEUTRON ACER TENDL-2023 LIBRARY; T=0.K  
alphas from (n,2n)a

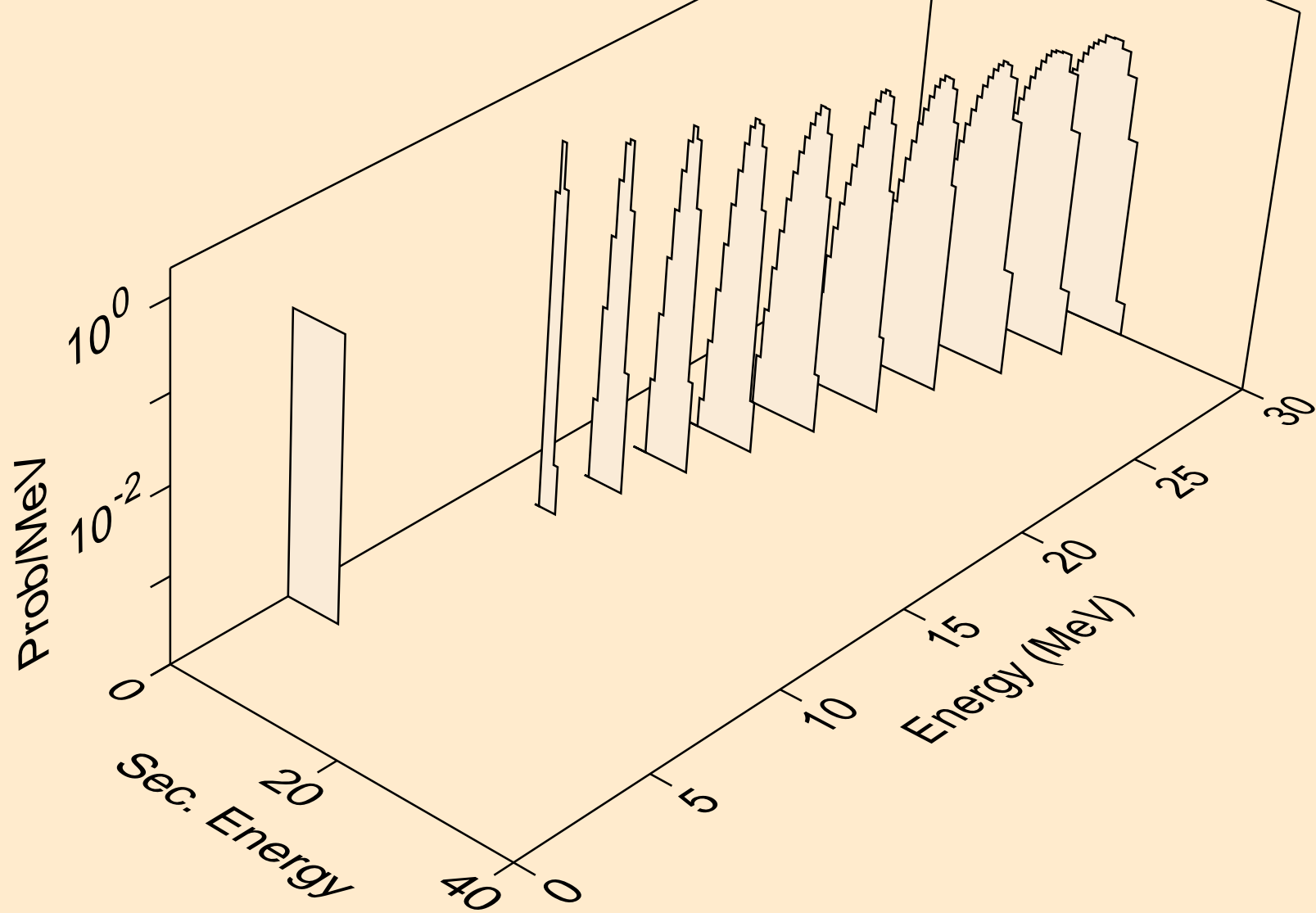

AU194 NEUTRON ACER TENDL-2023 LIBRARY; T=0.K  
alphas from (n,3n)a

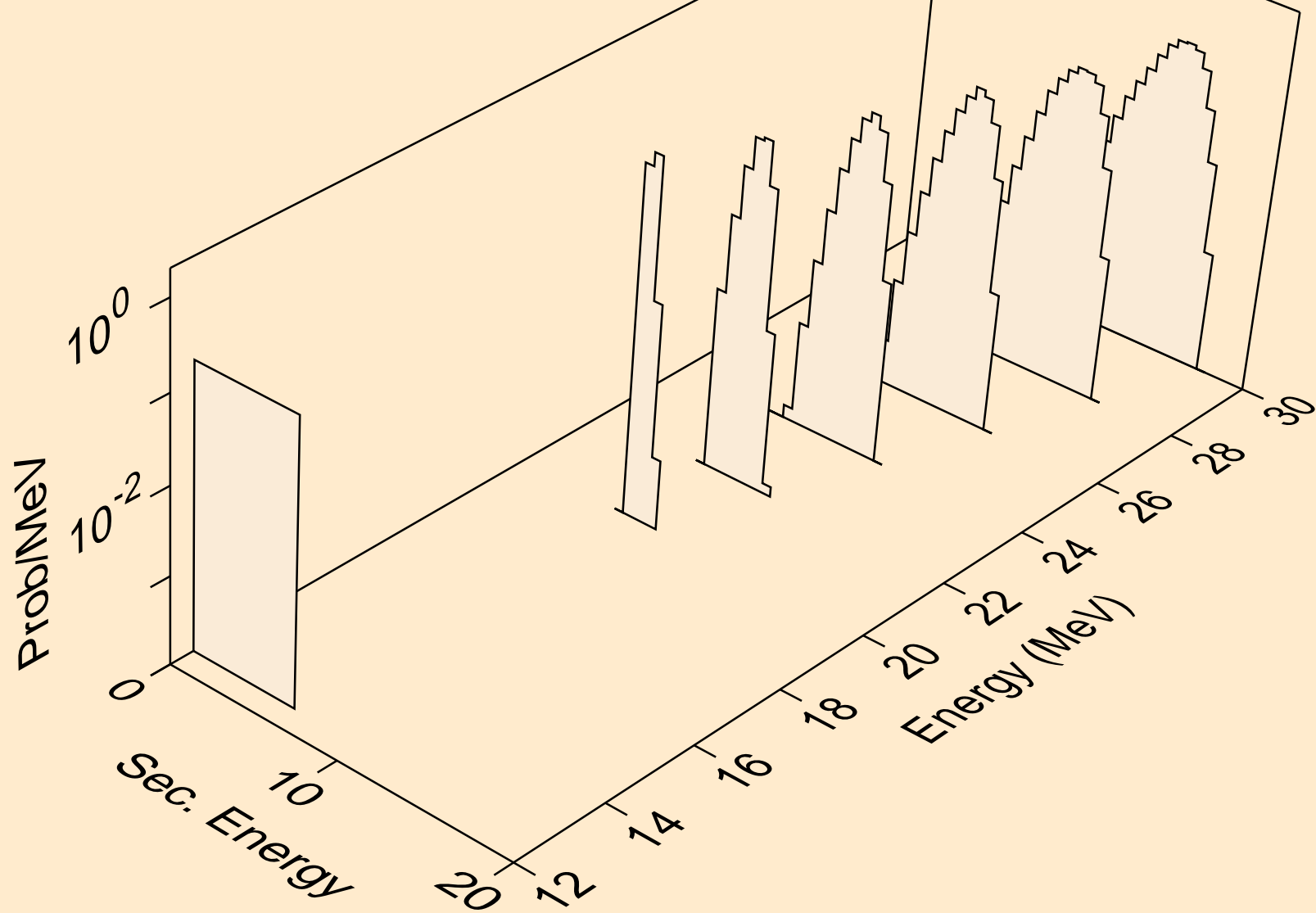

AU194 NEUTRON ACER TENDL-2023 LIBRARY; T=0.K  
alphas from (n,n\*)2a

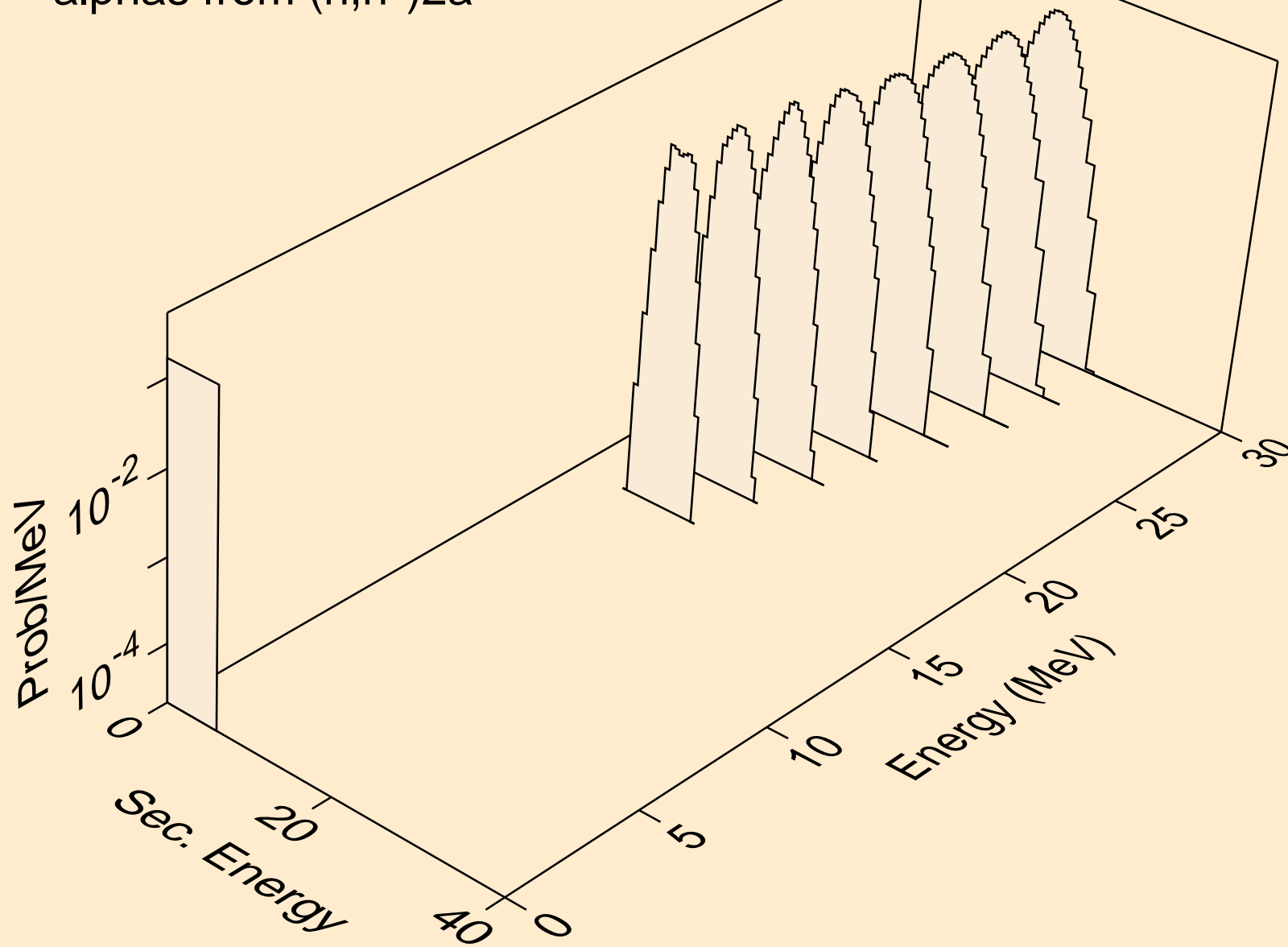



AU194 NEUTRON ACER TENDL-2023 LIBRARY; T=0.K  
alphas from (n,npa)

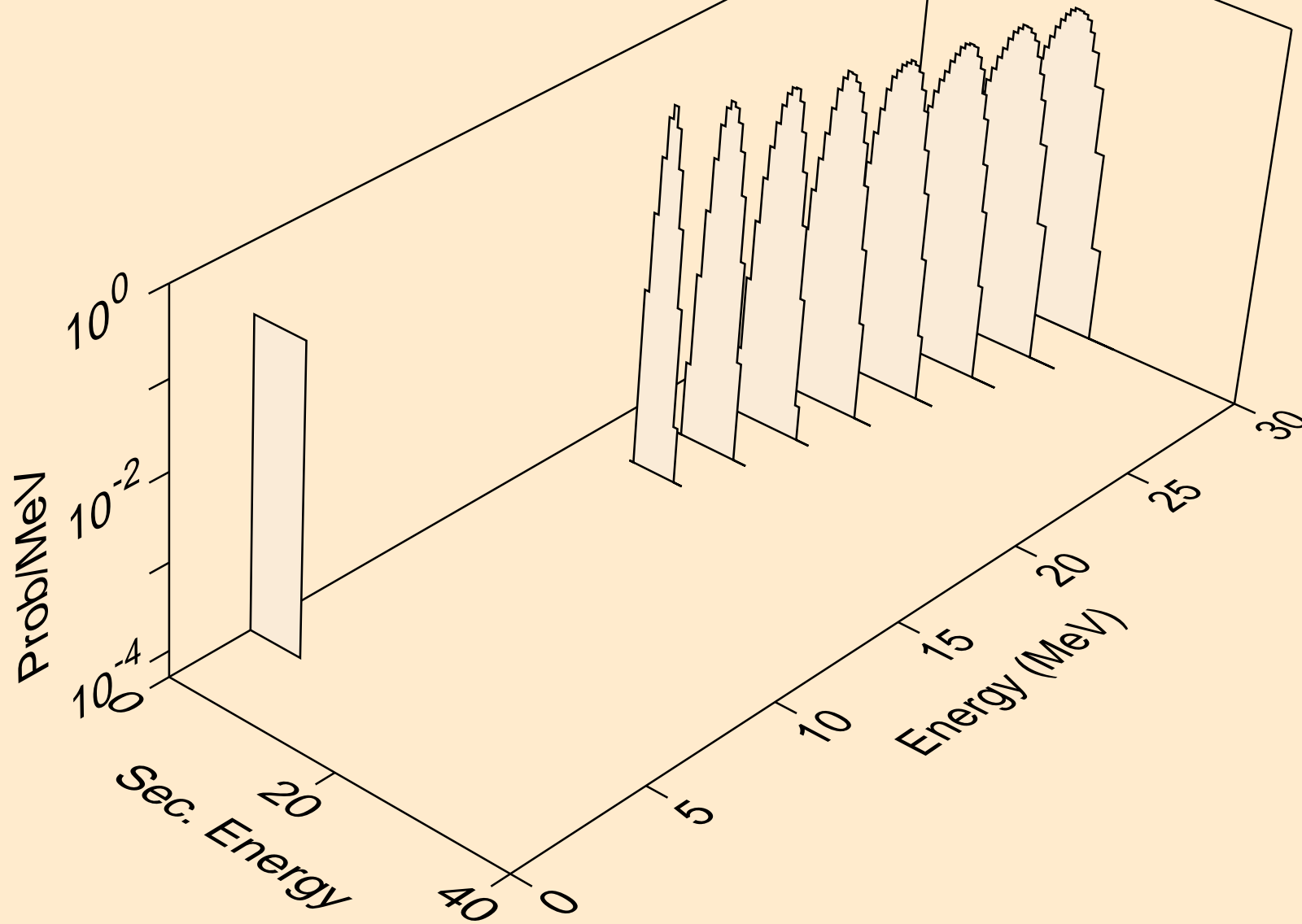

AU194 NEUTRON ACER TENDL-2023 LIBRARY; T=0.K  
alphas from (n,a)

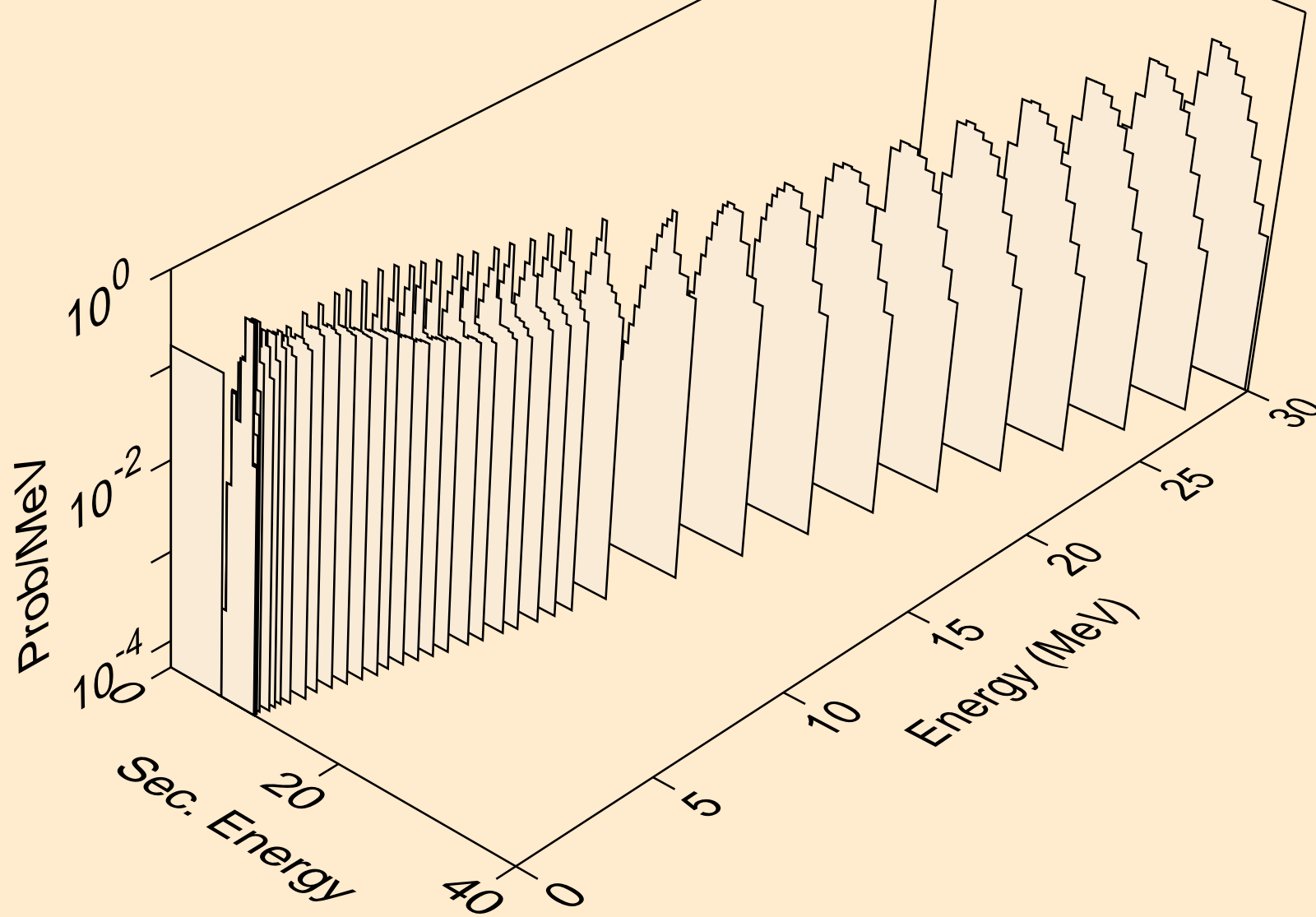

AU194 NEUTRON ACER TENDL-2023 LIBRARY; T=0.K  
alphas from (n,2a)

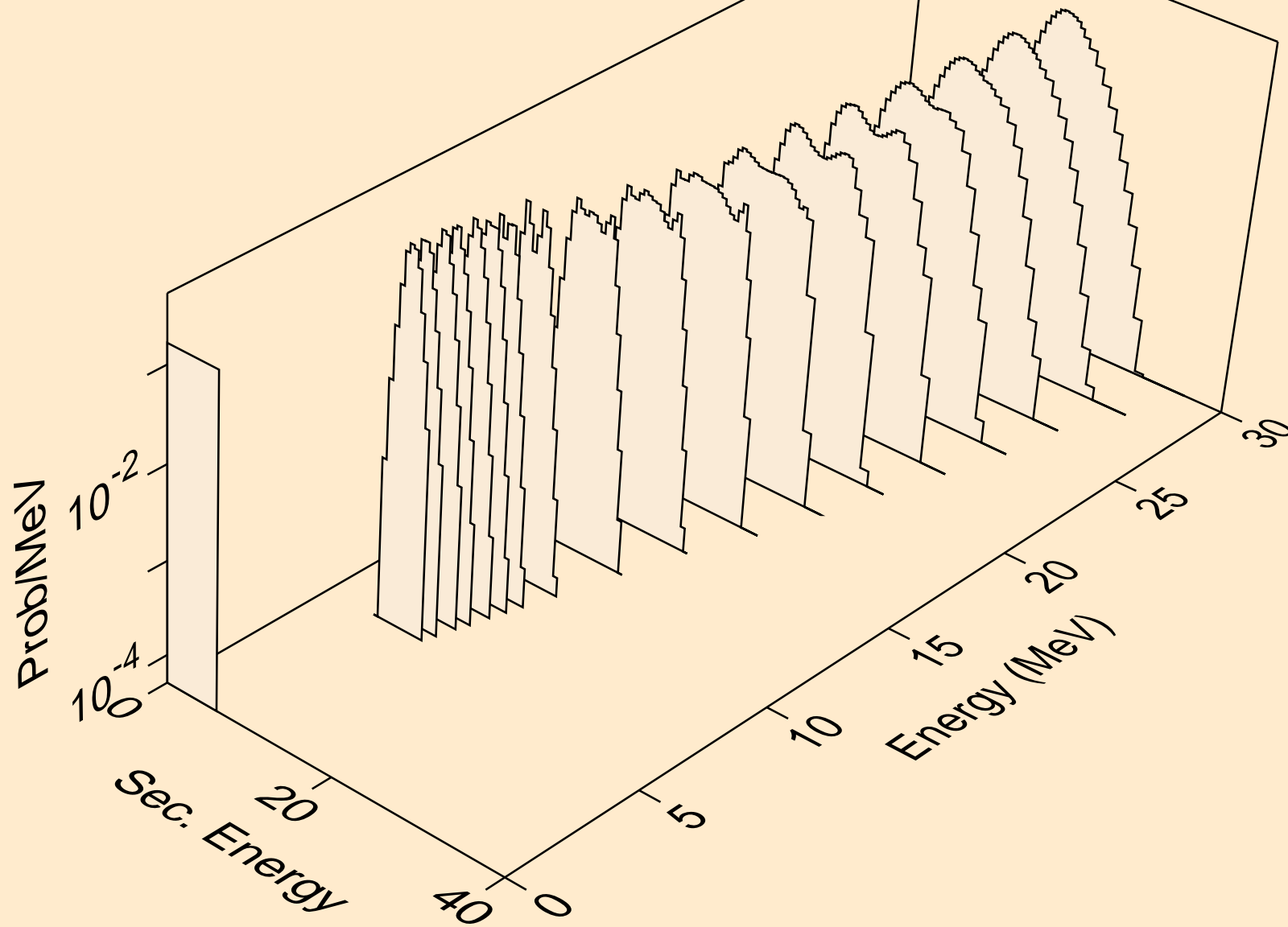

AU194 NEUTRON ACER TENDL-2023 LIBRARY; T=0.K  
alphas from (n,pa)

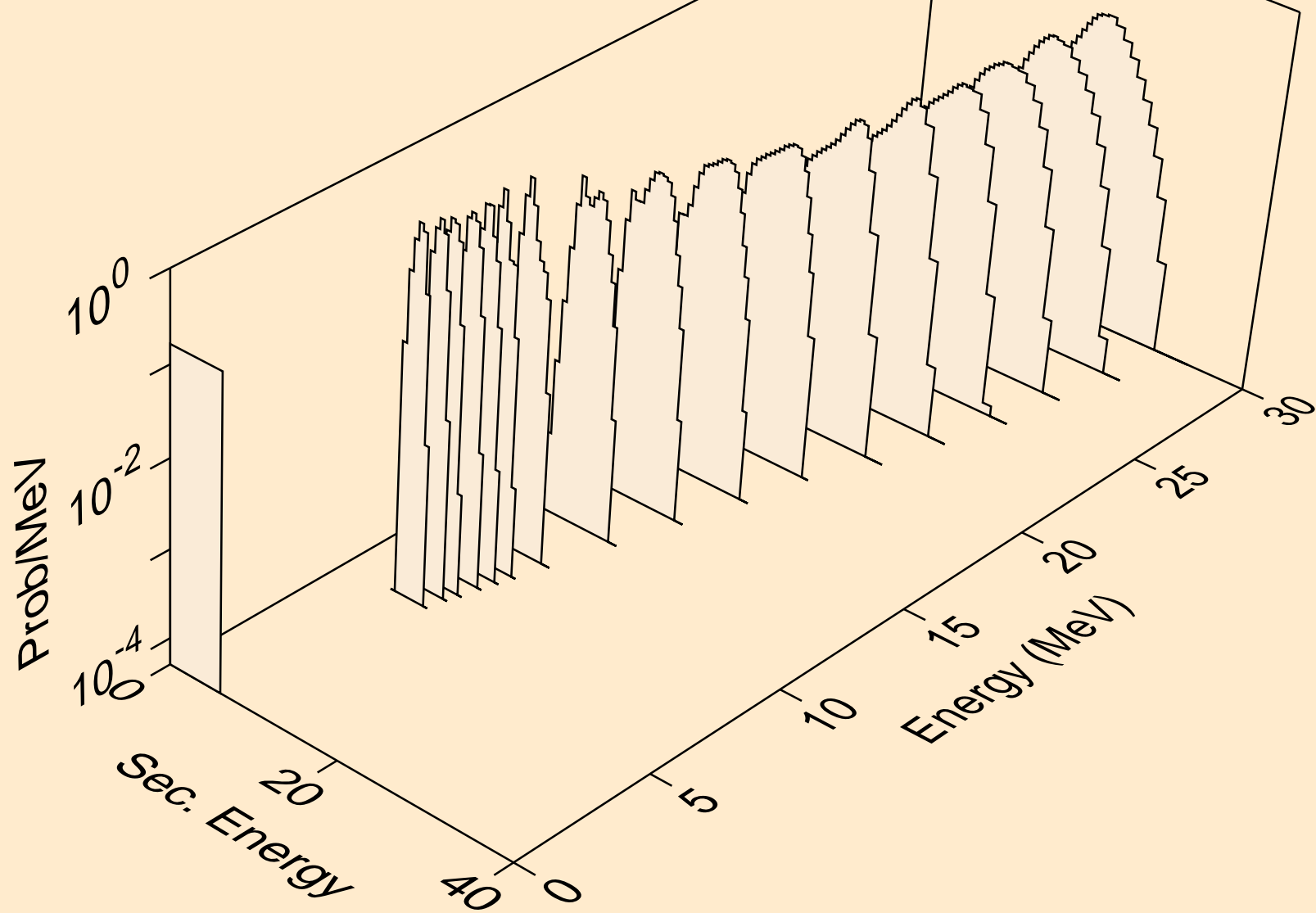

AU194 NEUTRON ACER TENDL-2023 LIBRARY; T=0.K  
alphas from (n,da)

