

AU197M NEUTRON ACER TENDL-2023 LIBRARY; T=0.K

Principal cross sections

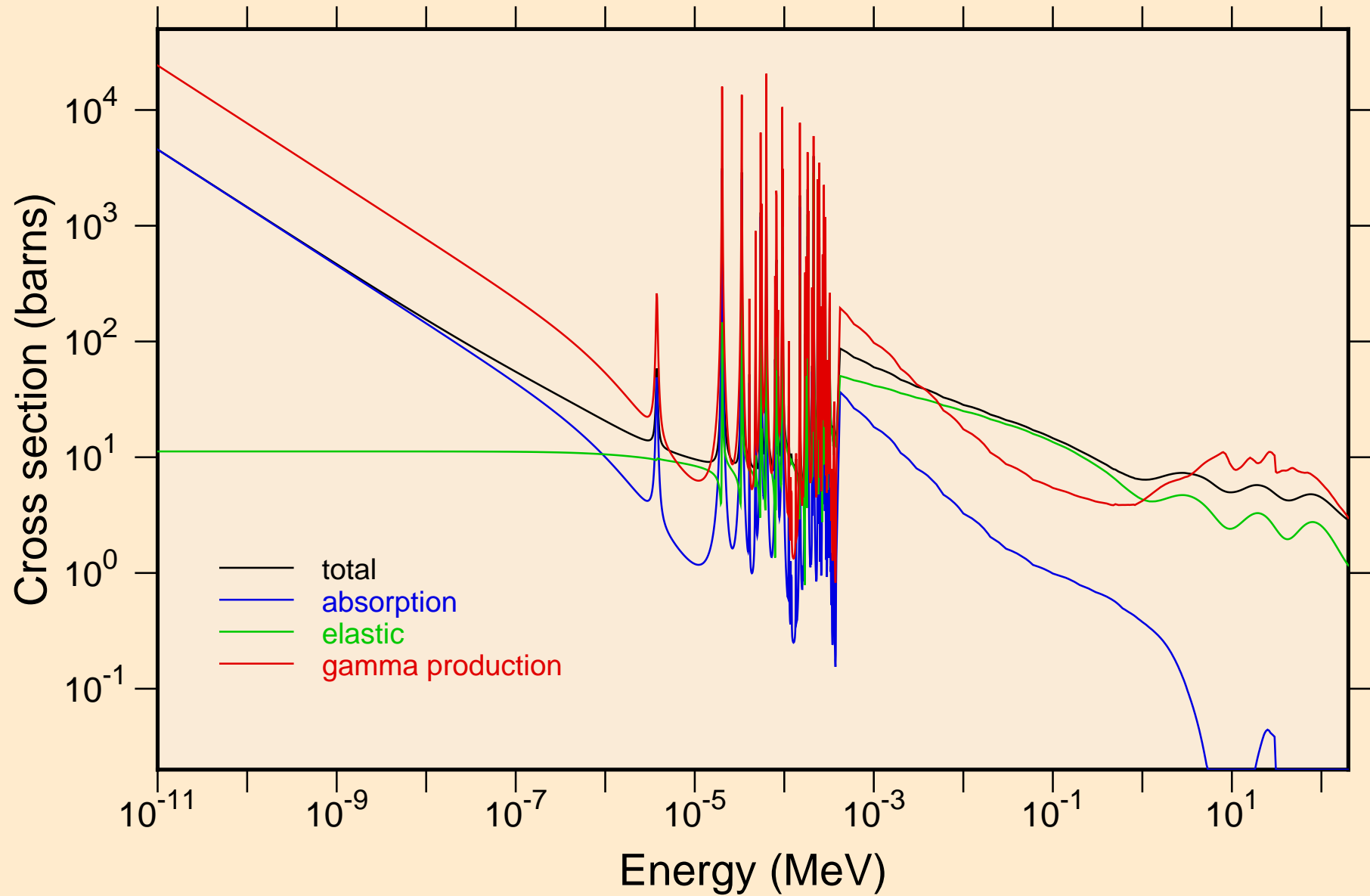

AU197M NEUTRON ACER TENDL-2023 LIBRARY; T=0.K
resonance total cross section

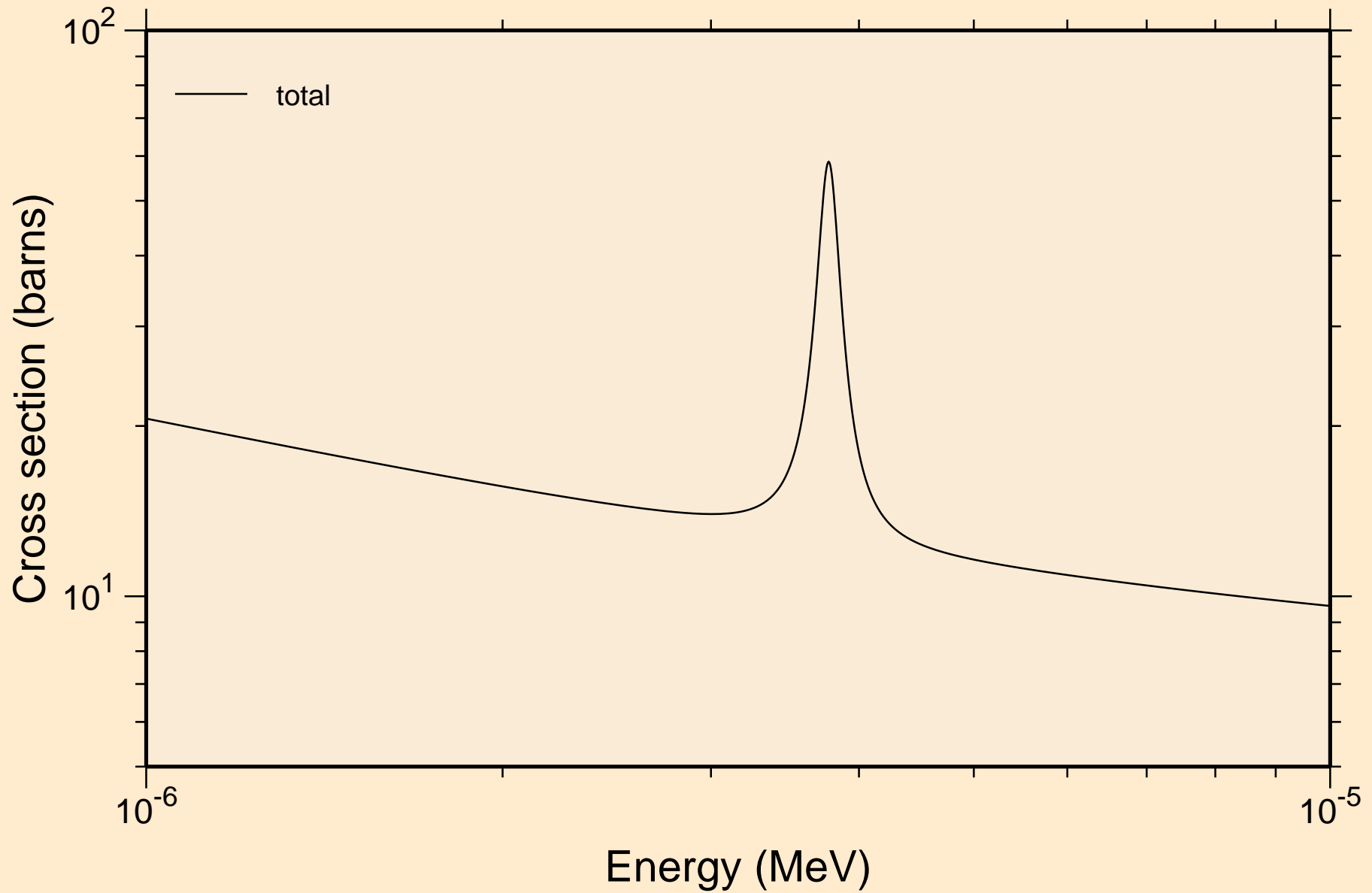

AU197M NEUTRON ACER TENDL-2023 LIBRARY; T=0.K
resonance total cross section

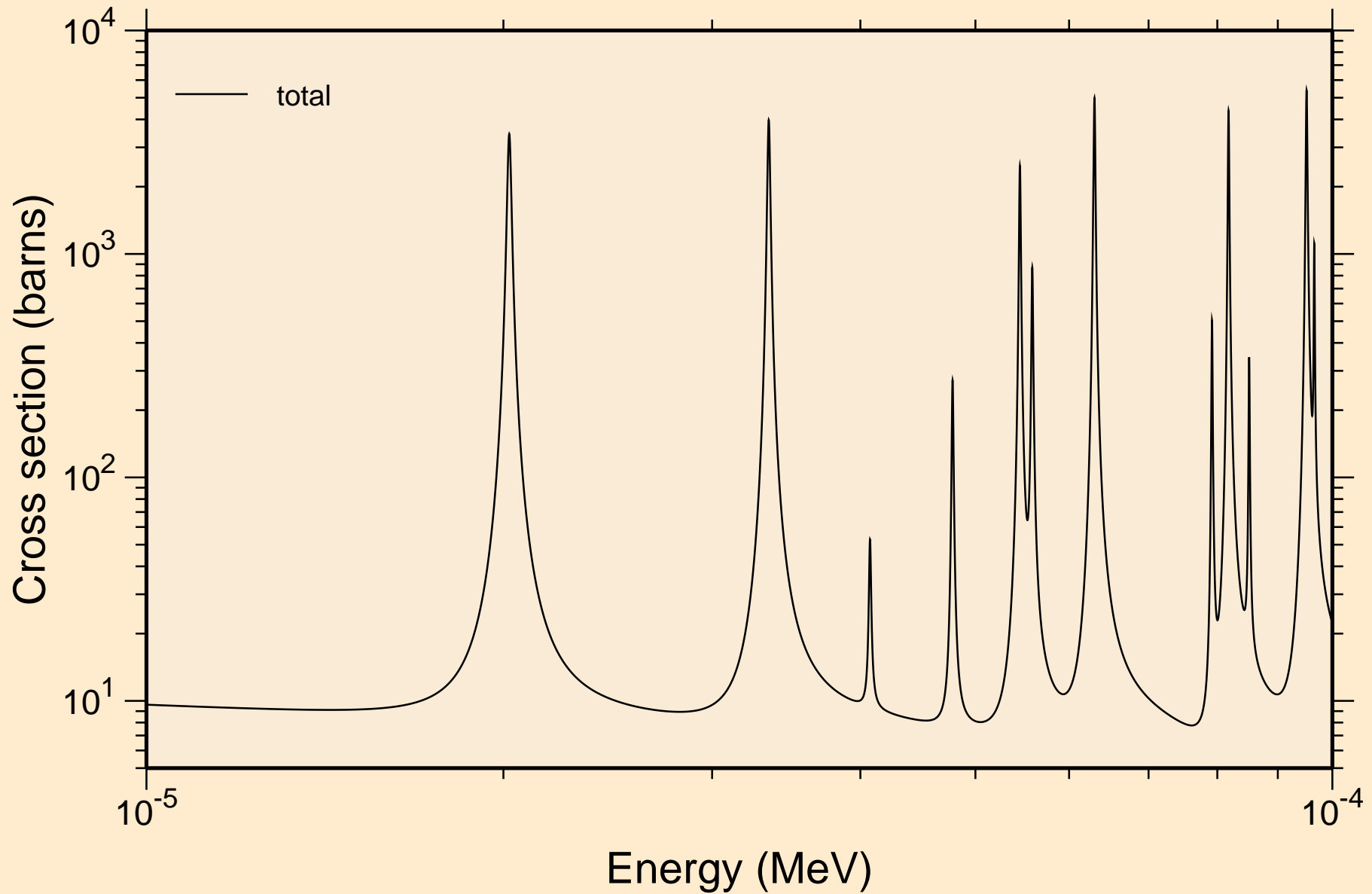

AU197M NEUTRON ACER TENDL-2023 LIBRARY; T=0.K
resonance total cross section

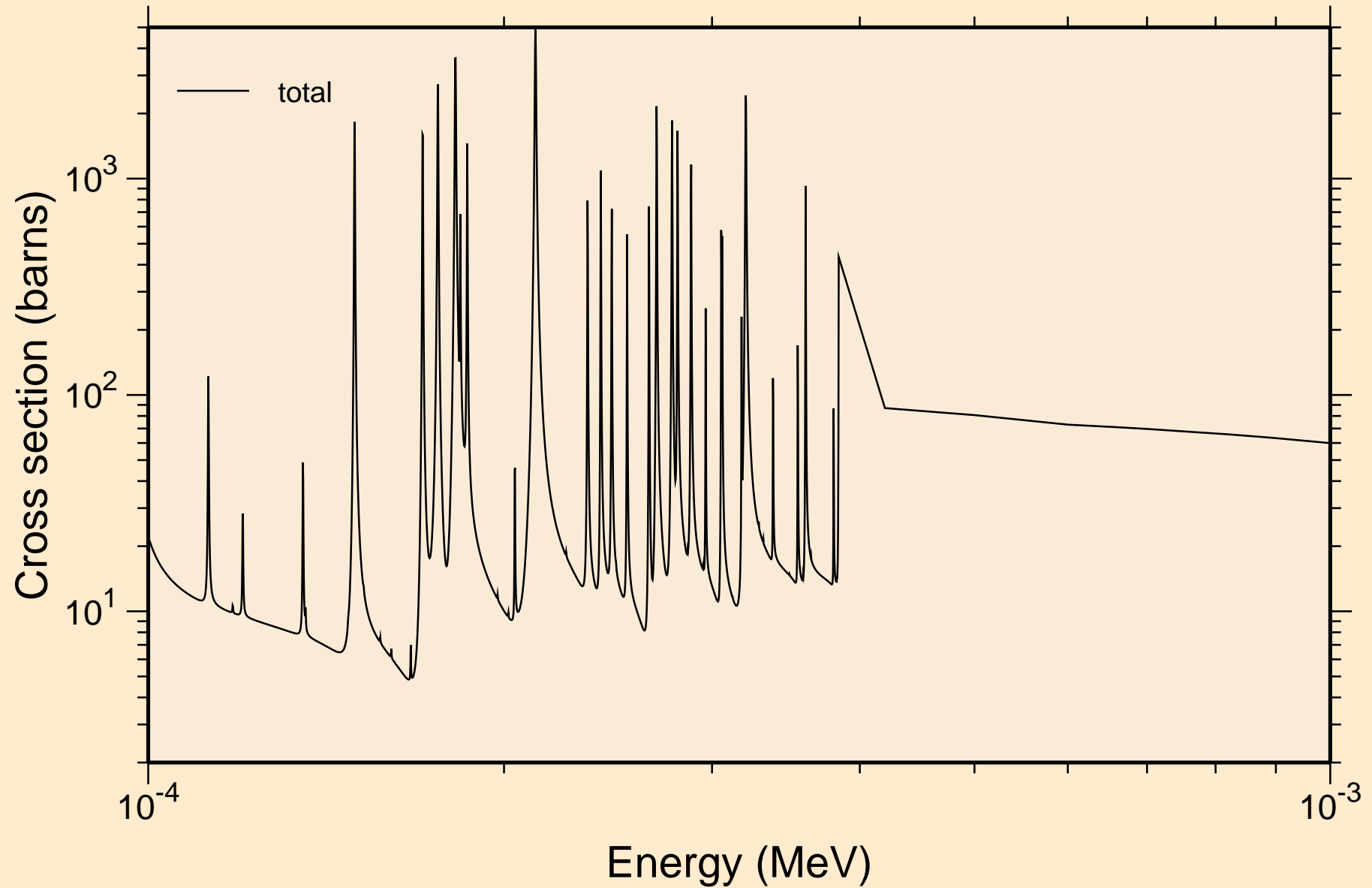

AU197M NEUTRON ACER TENDL-2023 LIBRARY; T=0.K
resonance total cross section

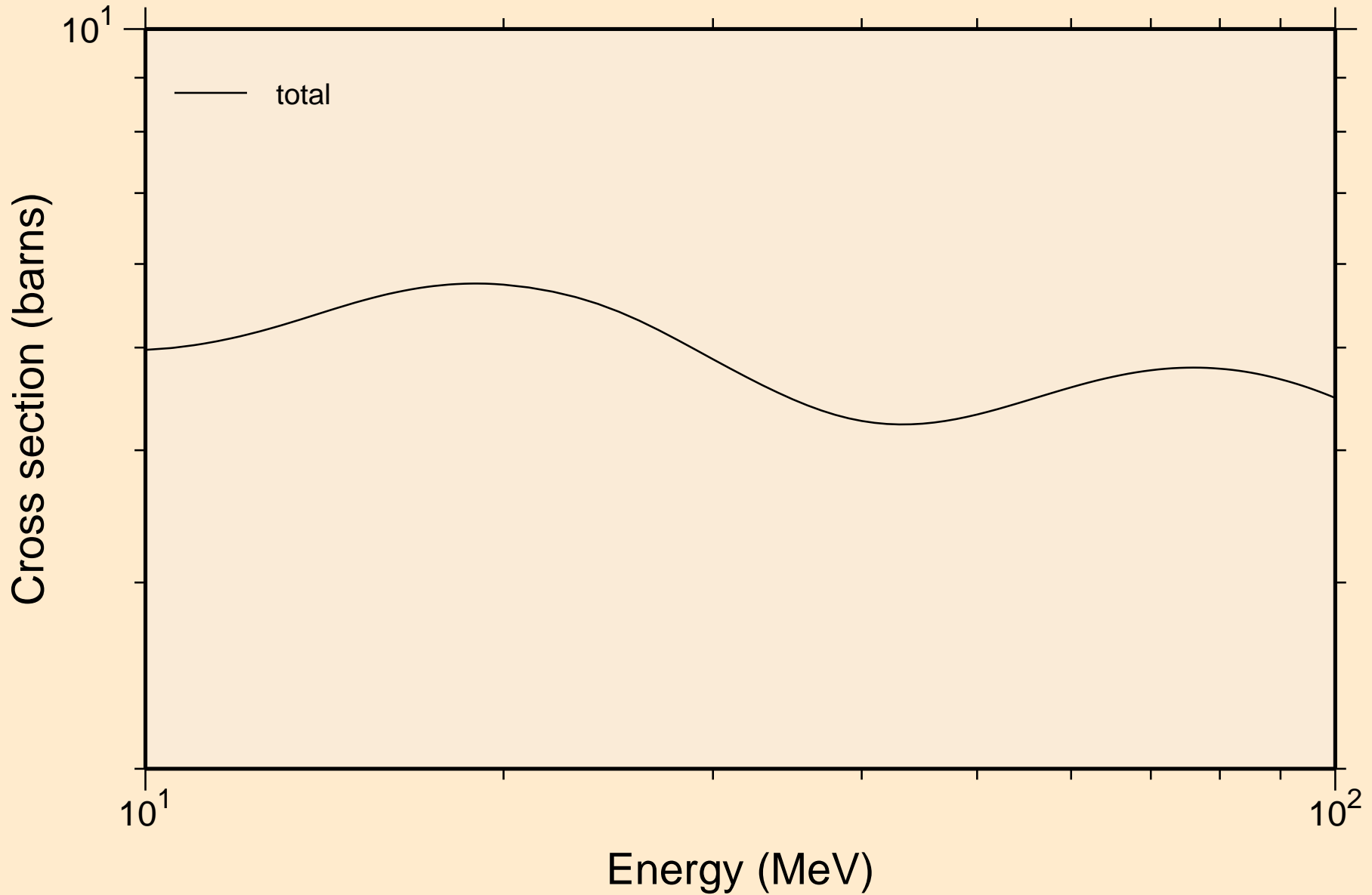

AU197M NEUTRON ACER TENDL-2023 LIBRARY; T=0.K
resonance absorption cross sections

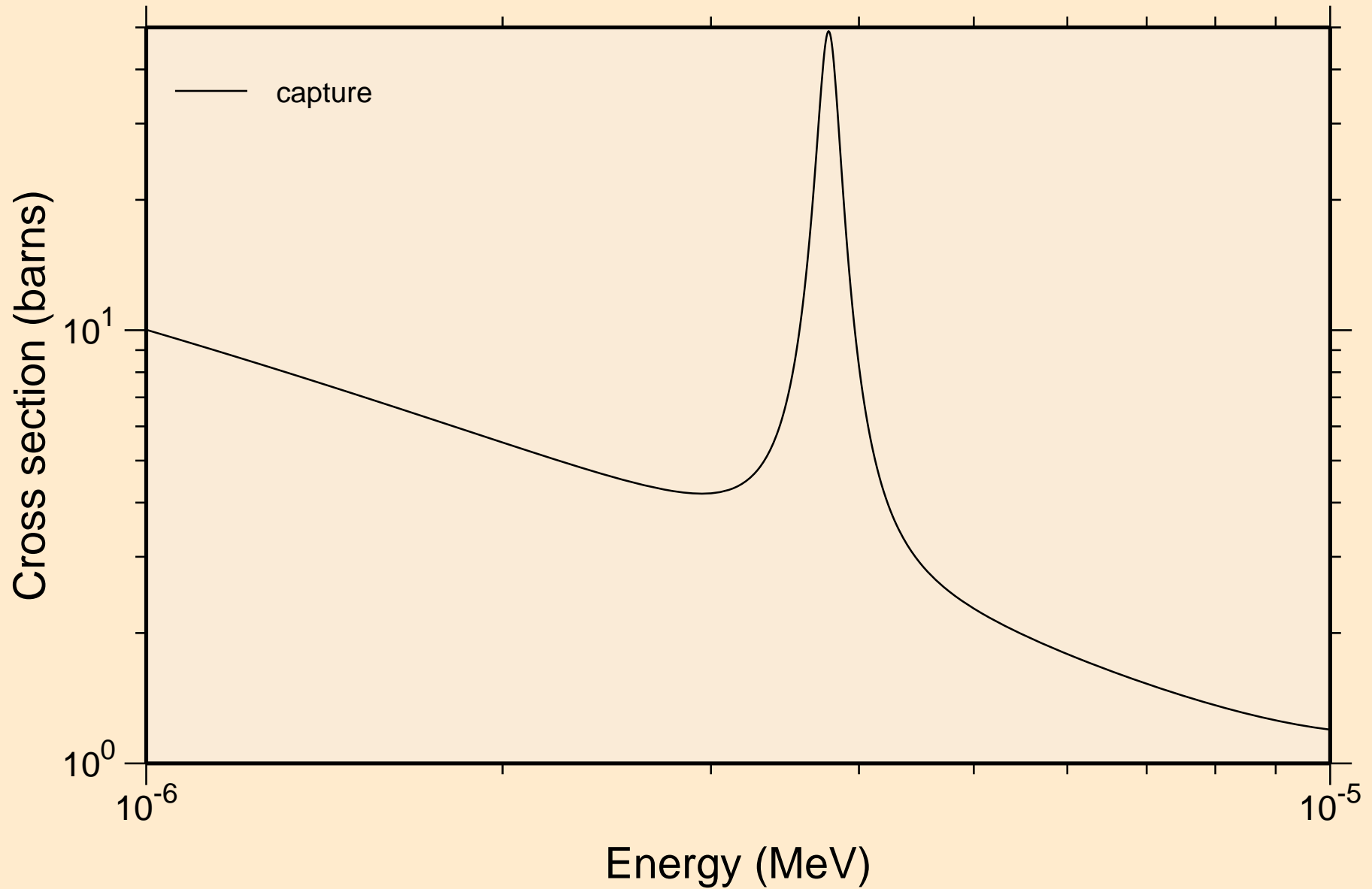

AU197M NEUTRON ACER TENDL-2023 LIBRARY; T=0.K
resonance absorption cross sections

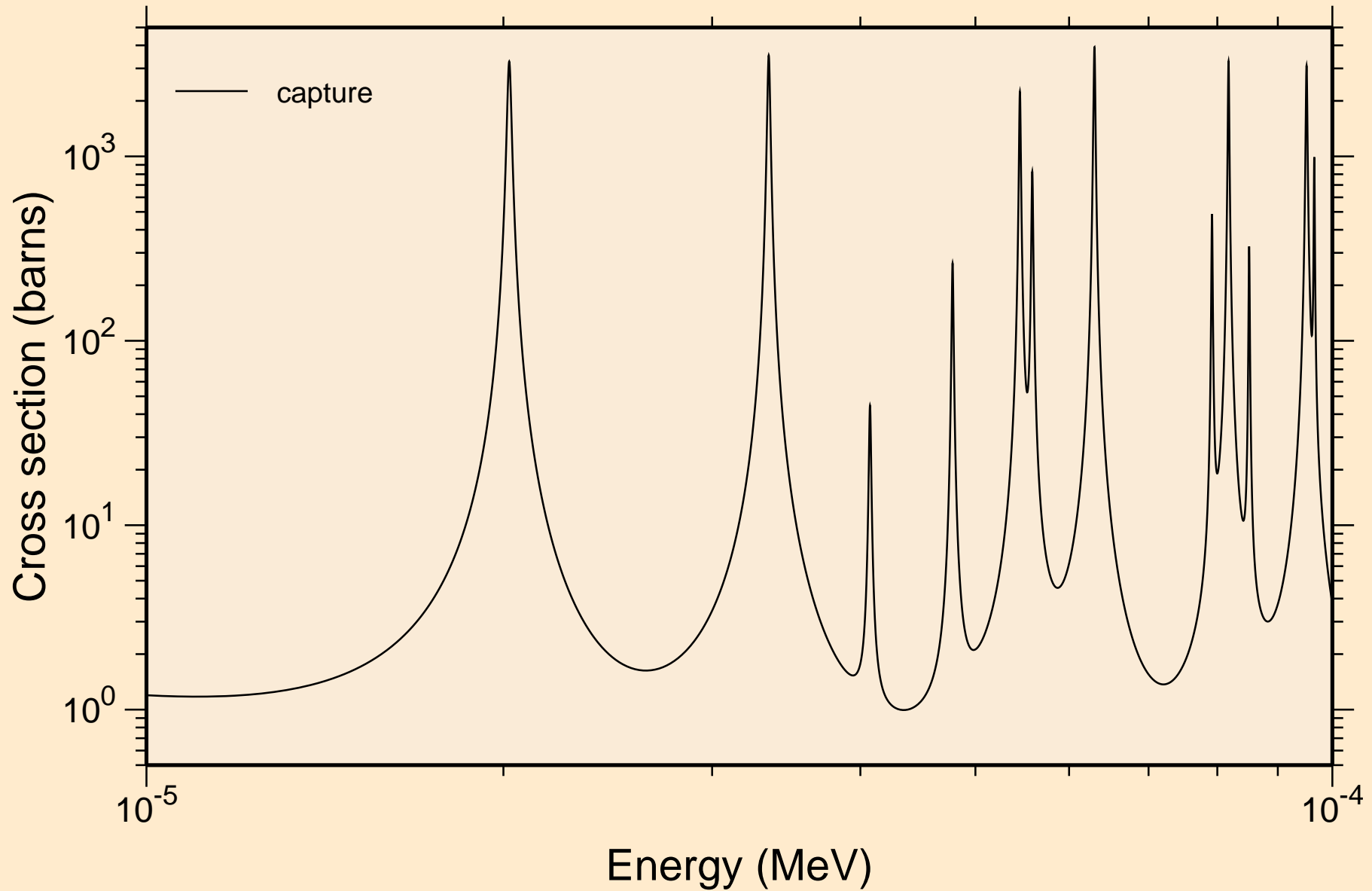

AU197M NEUTRON ACER TENDL-2023 LIBRARY; T=0.K
resonance absorption cross sections

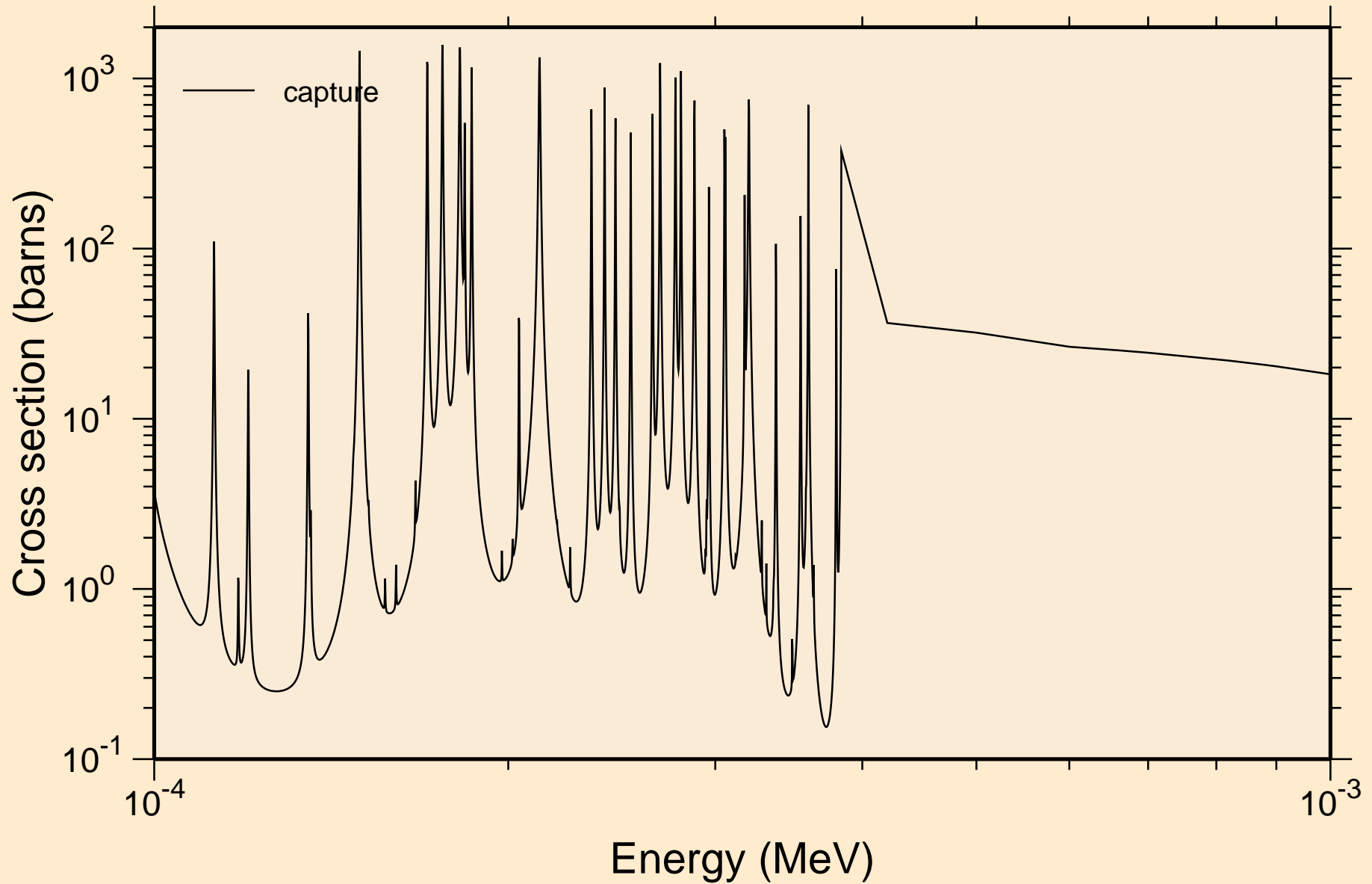

AU197M NEUTRON ACER TENDL-2023 LIBRARY; T=0.K
resonance absorption cross sections

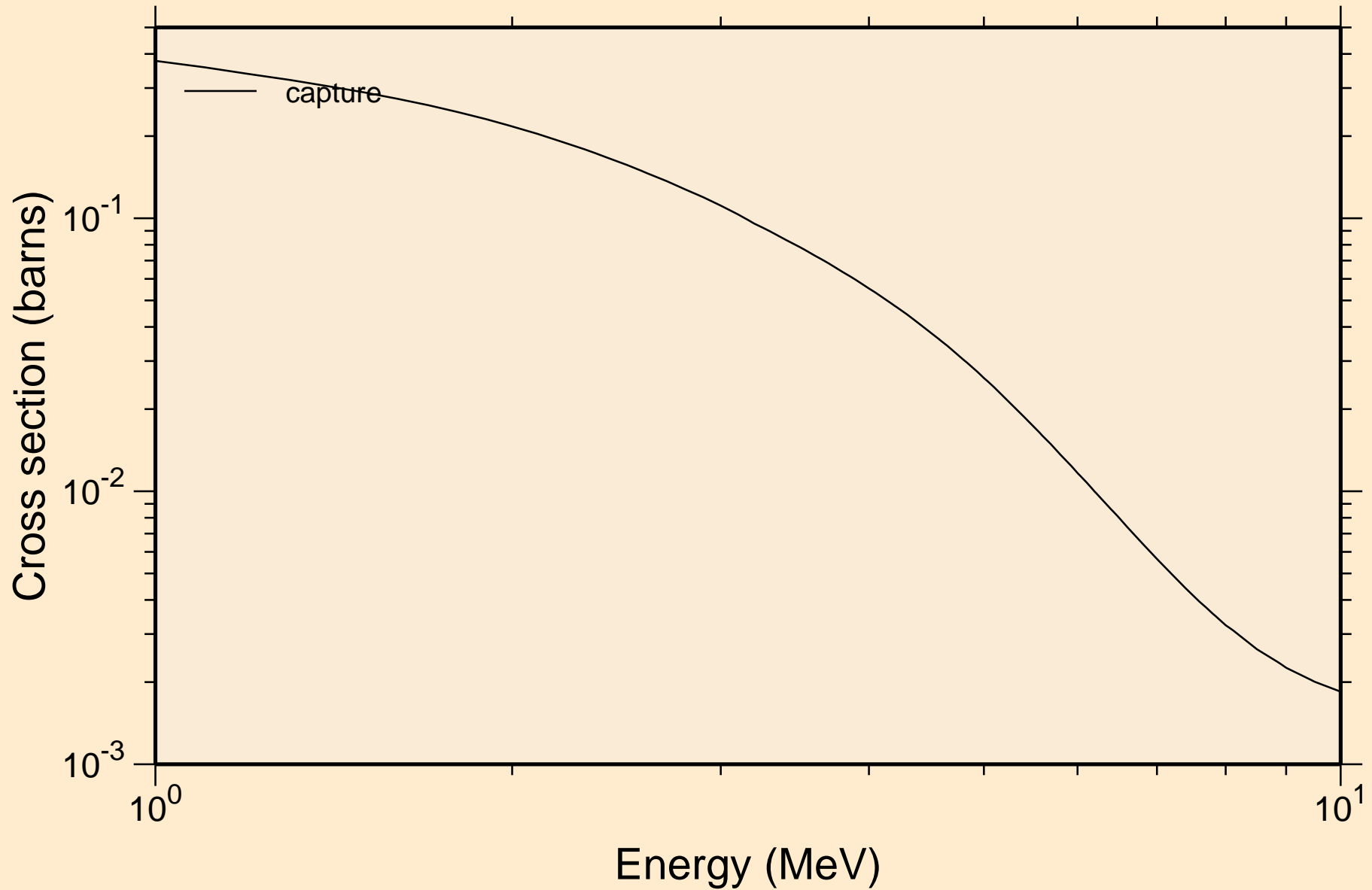

AU197M NEUTRON ACER TENDL-2023 LIBRARY; T=0.K
Heating

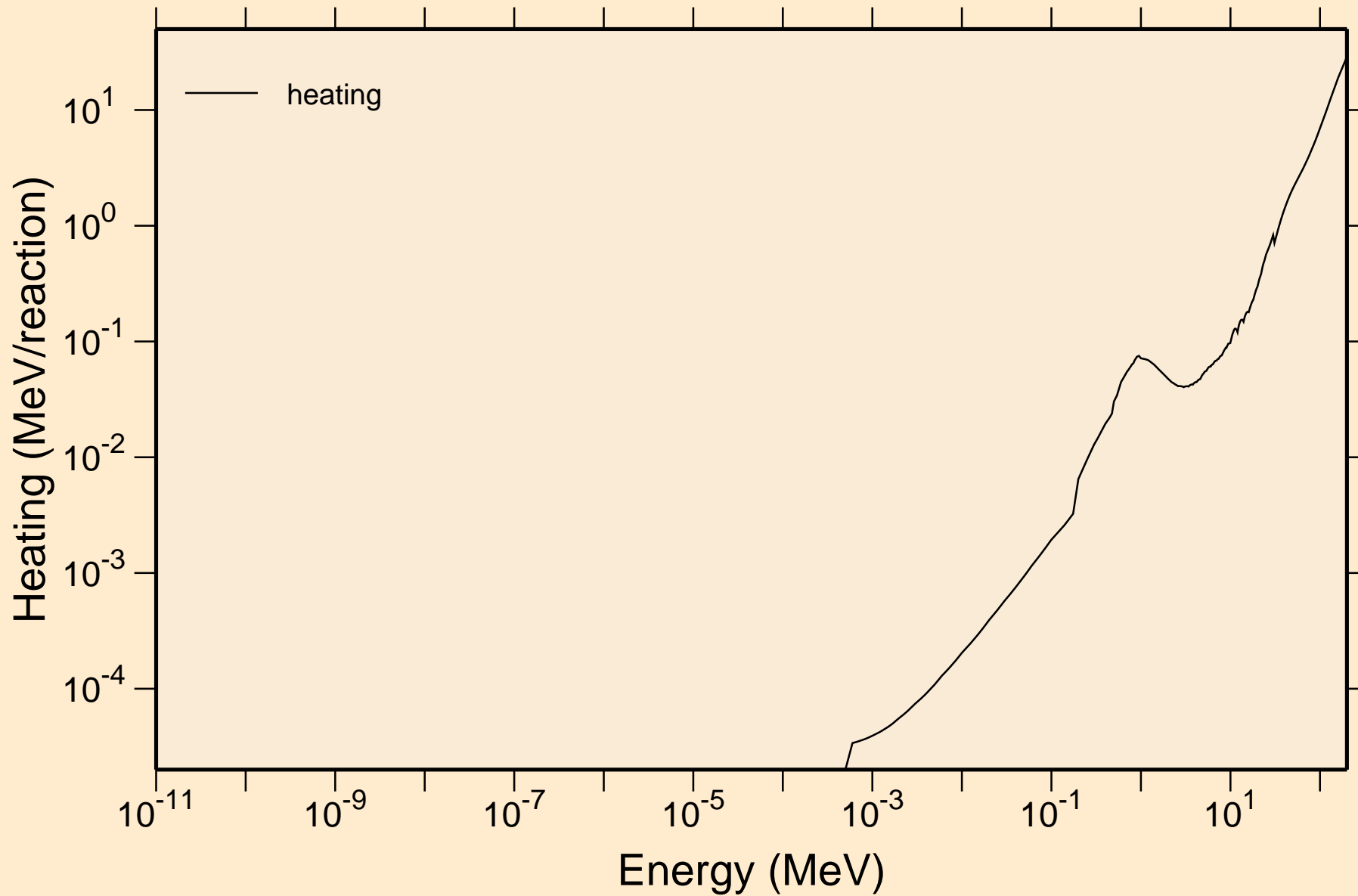

AU197M NEUTRON ACER TENDL-2023 LIBRARY; T=0.K
Damage

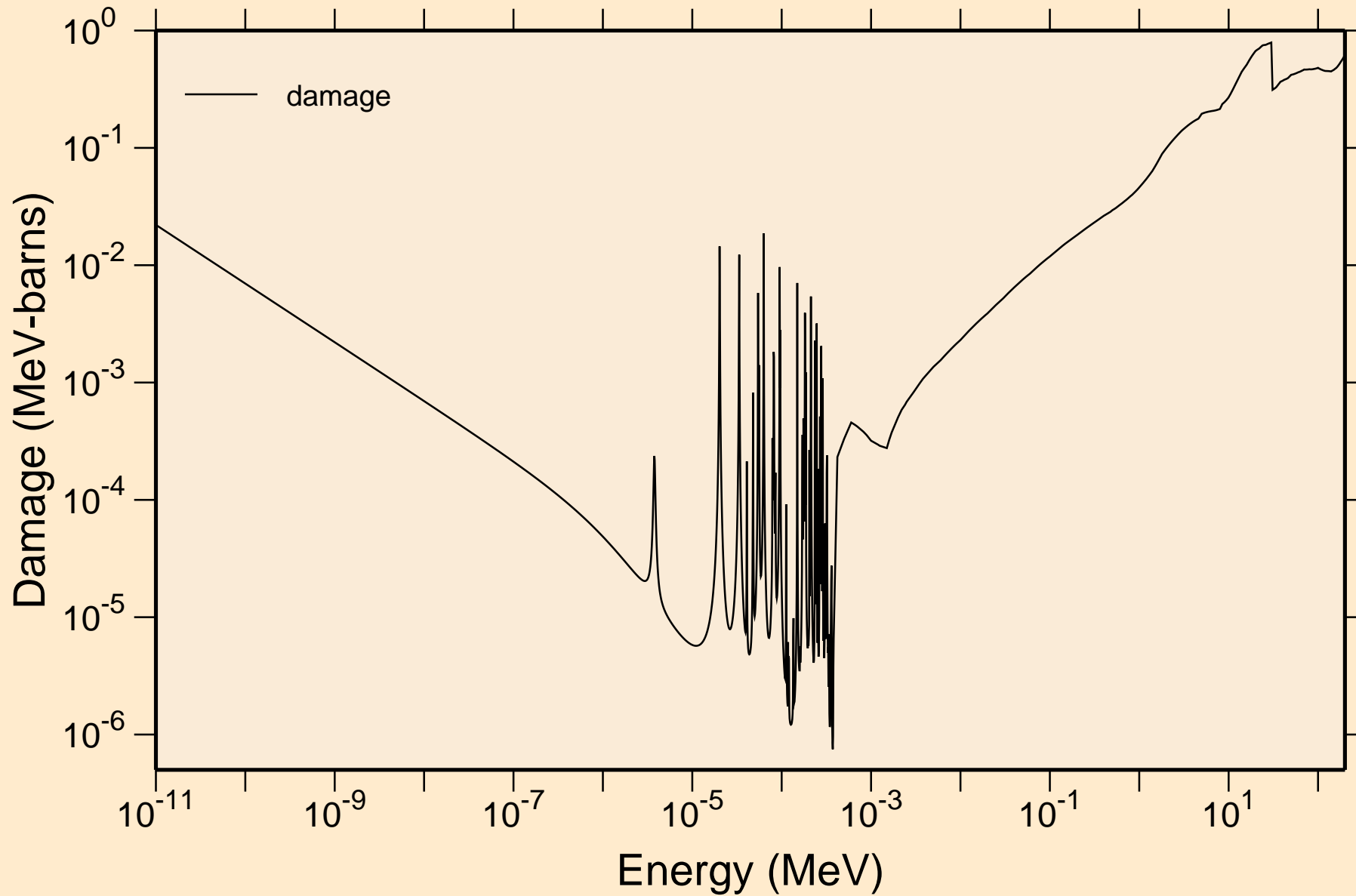

AU197M NEUTRON ACER TENDL-2023 LIBRARY; T=0.K

Non-threshold reactions

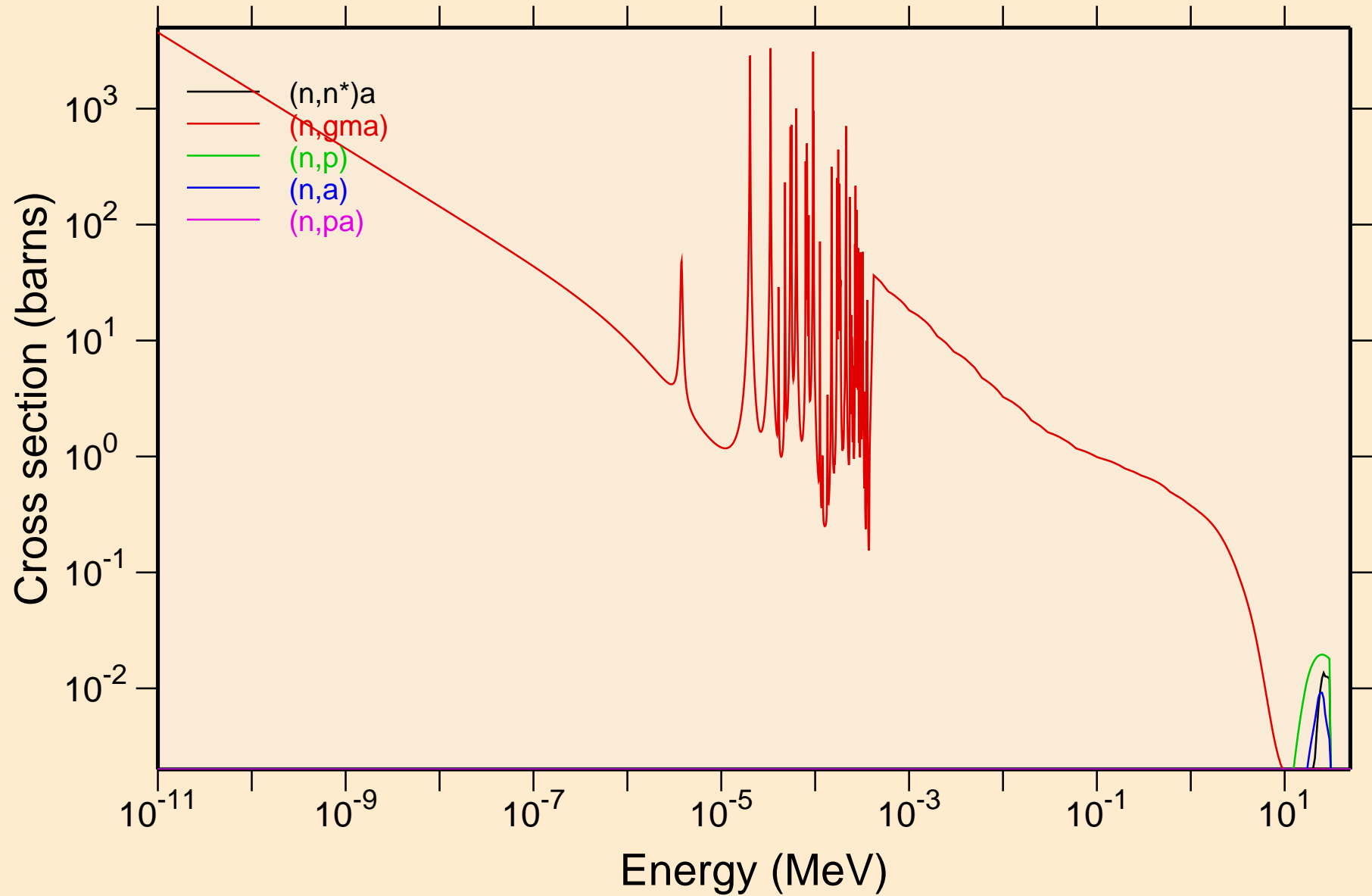

AU197M NEUTRON ACER TENDL-2023 LIBRARY; T=0.K
Non-threshold reactions

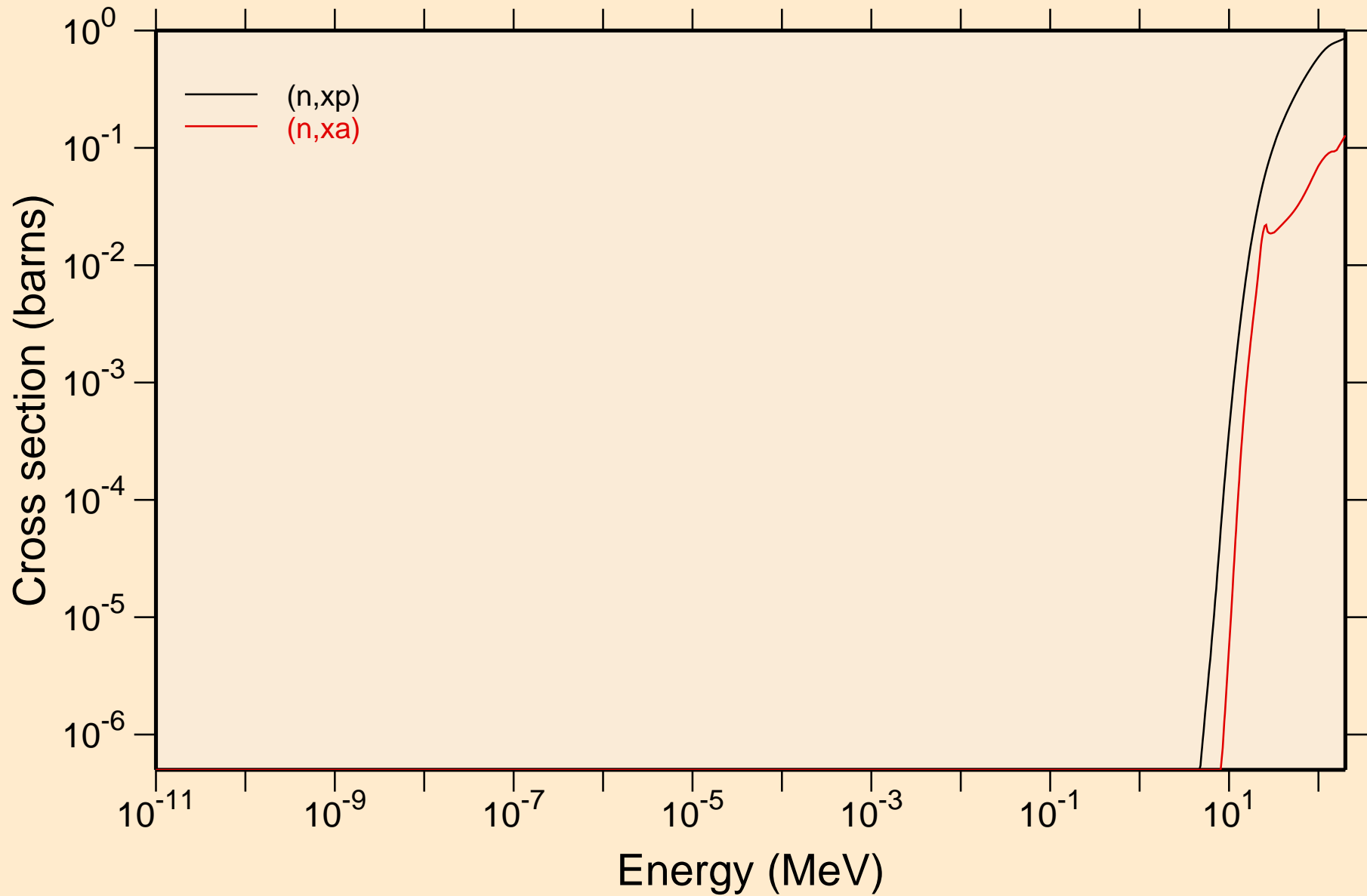

AU197M NEUTRON ACER TENDL-2023 LIBRARY; T=0.K
Principal cross sections

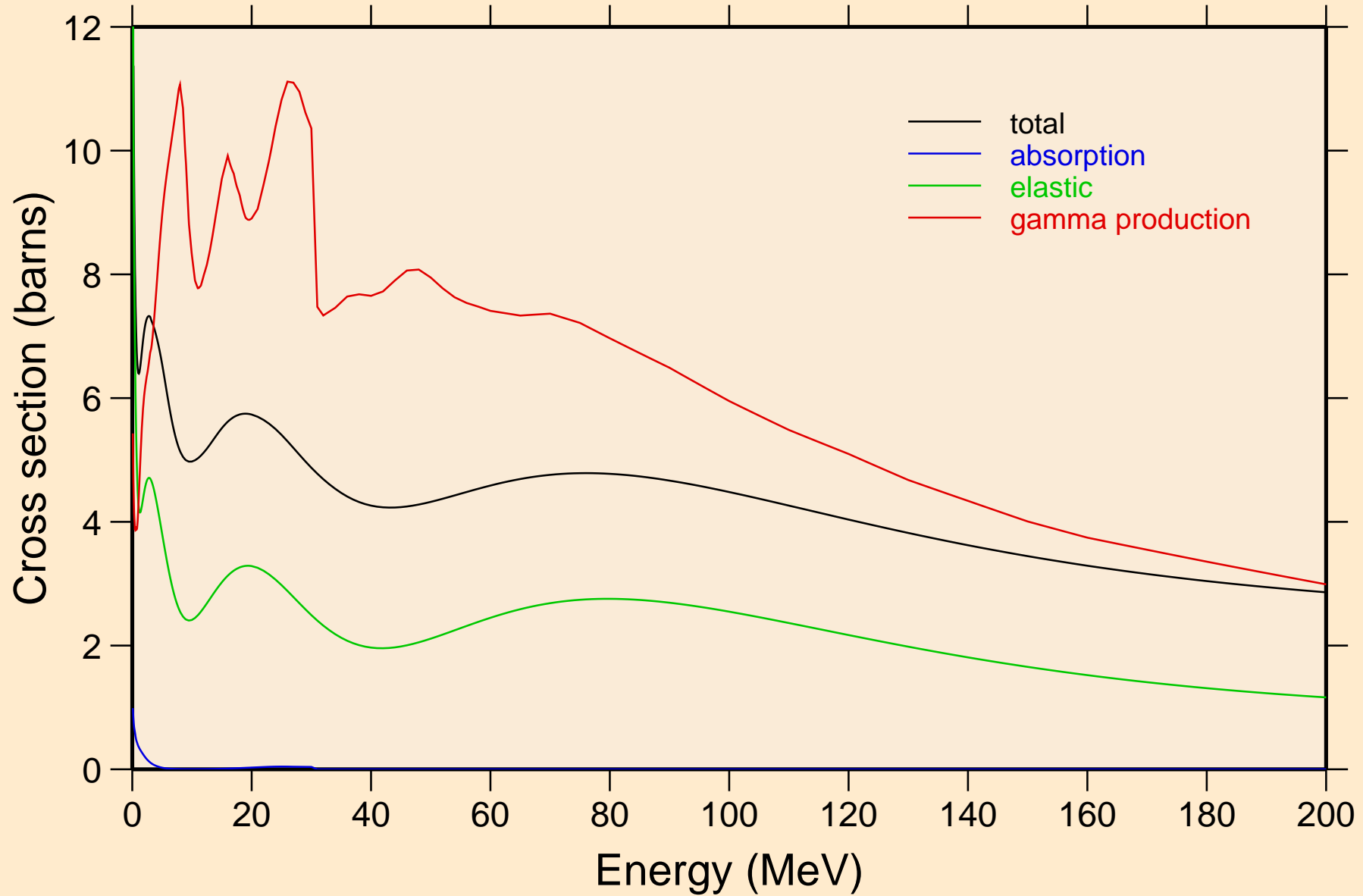

AU197M NEUTRON ACER TENDL-2023 LIBRARY; T=0.K

Heating

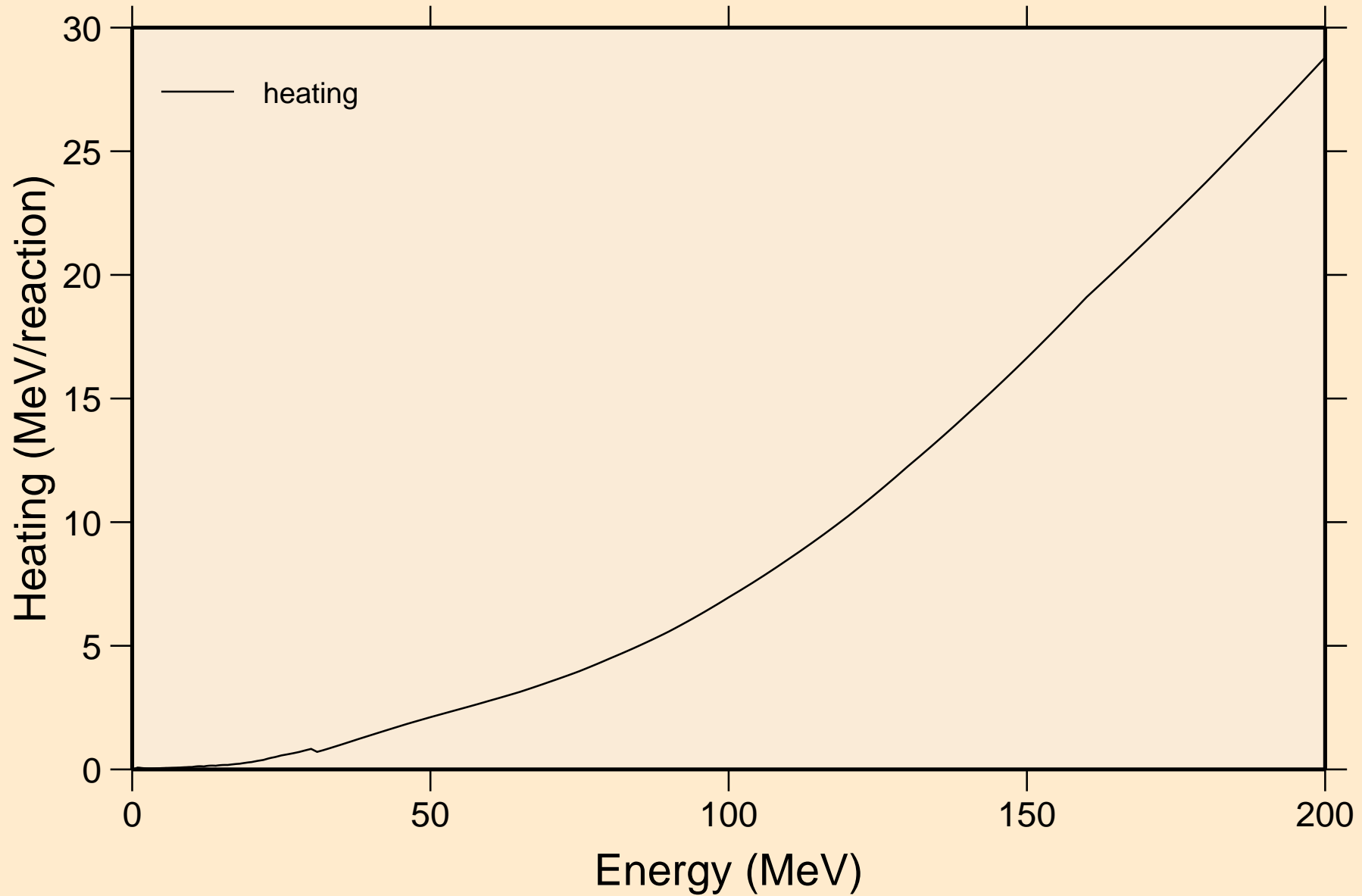

AU197M NEUTRON ACER TENDL-2023 LIBRARY; T=0.K
Damage

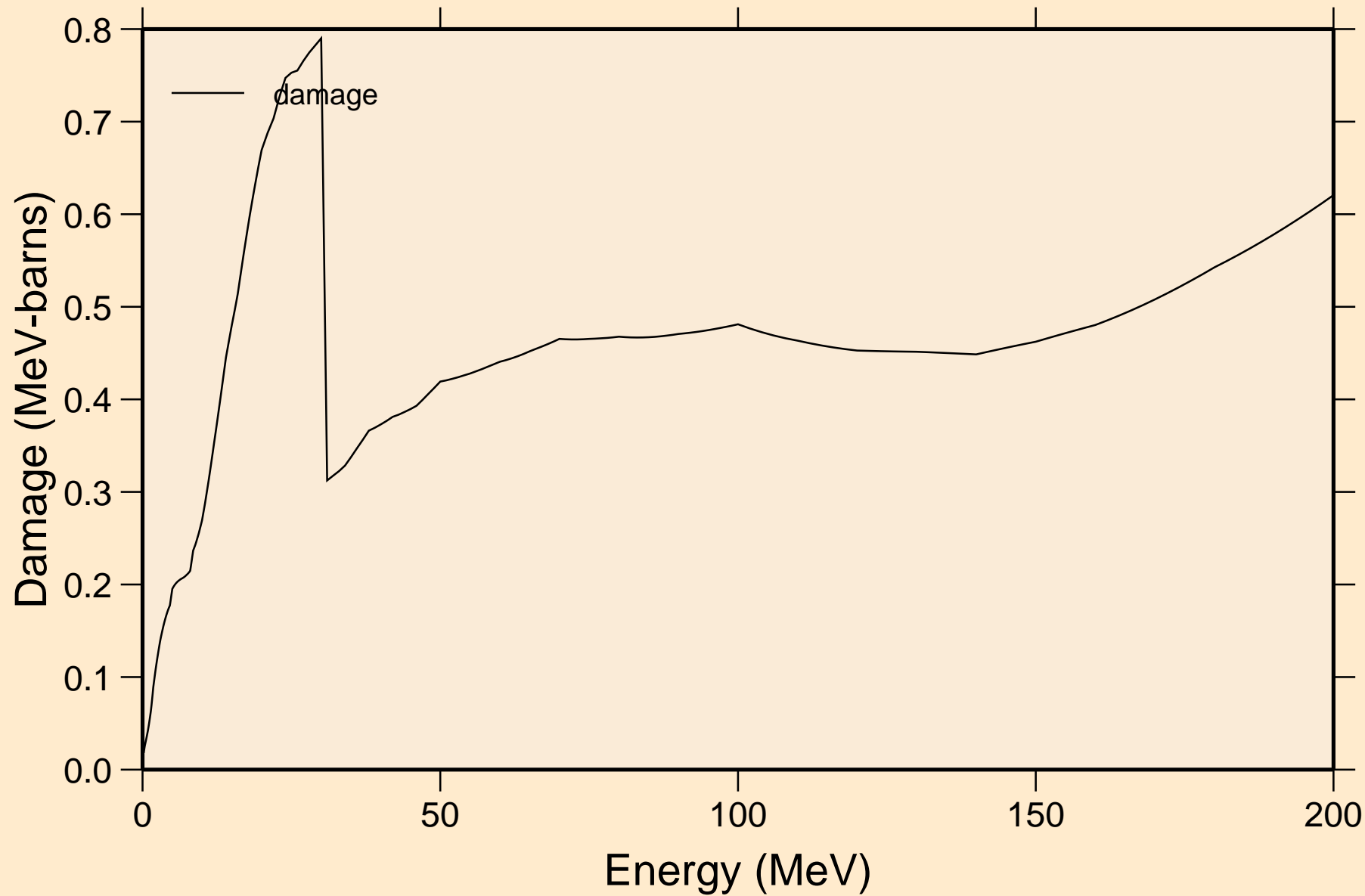

AU197M NEUTRON ACER TENDL-2023 LIBRARY; T=0.K
Non-threshold reactions

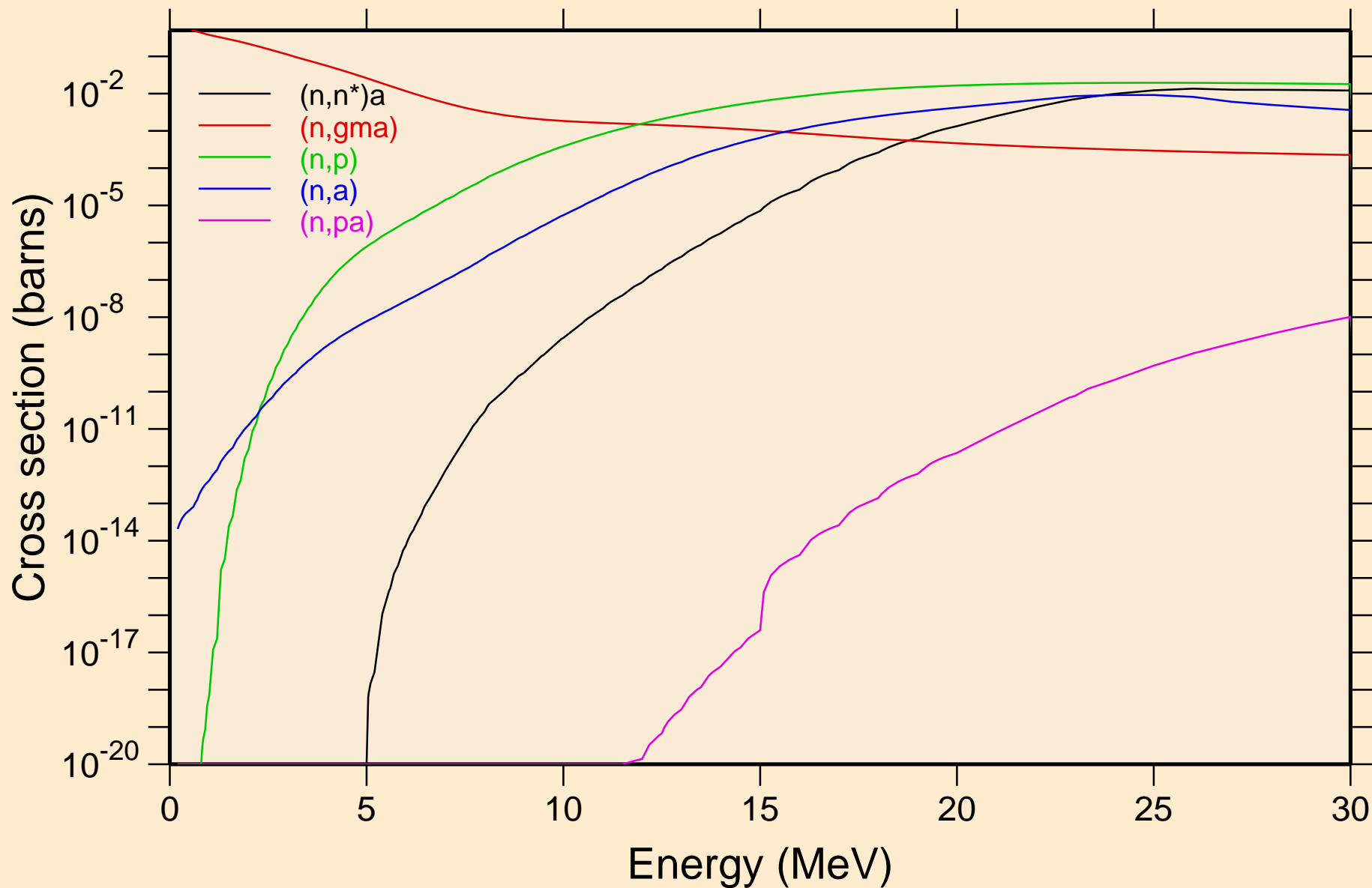

AU197M NEUTRON ACER TENDL-2023 LIBRARY; T=0.K
Non-threshold reactions

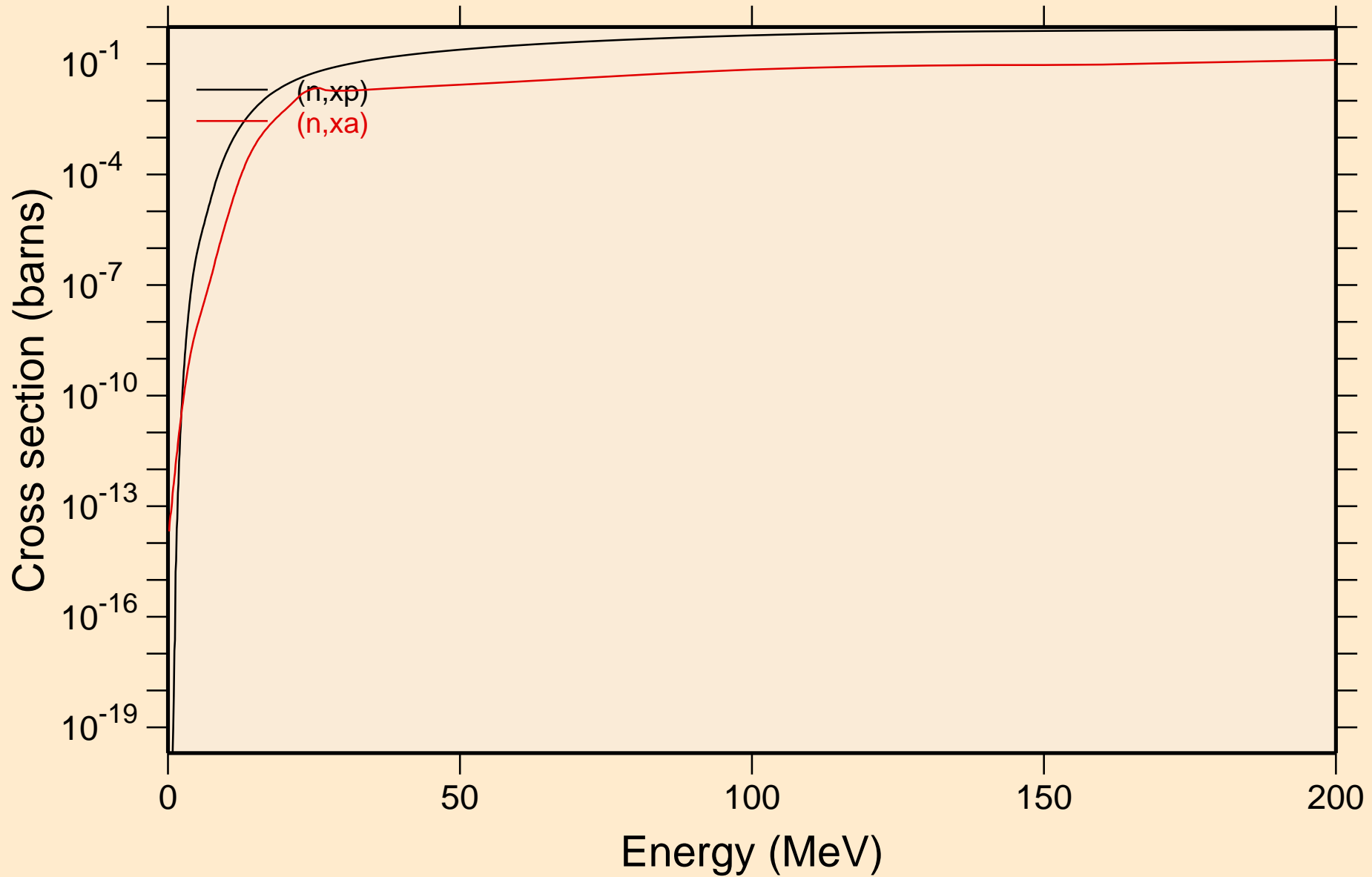

AU197M NEUTRON ACER TENDL-2023 LIBRARY; T=0.K
Inelastic levels

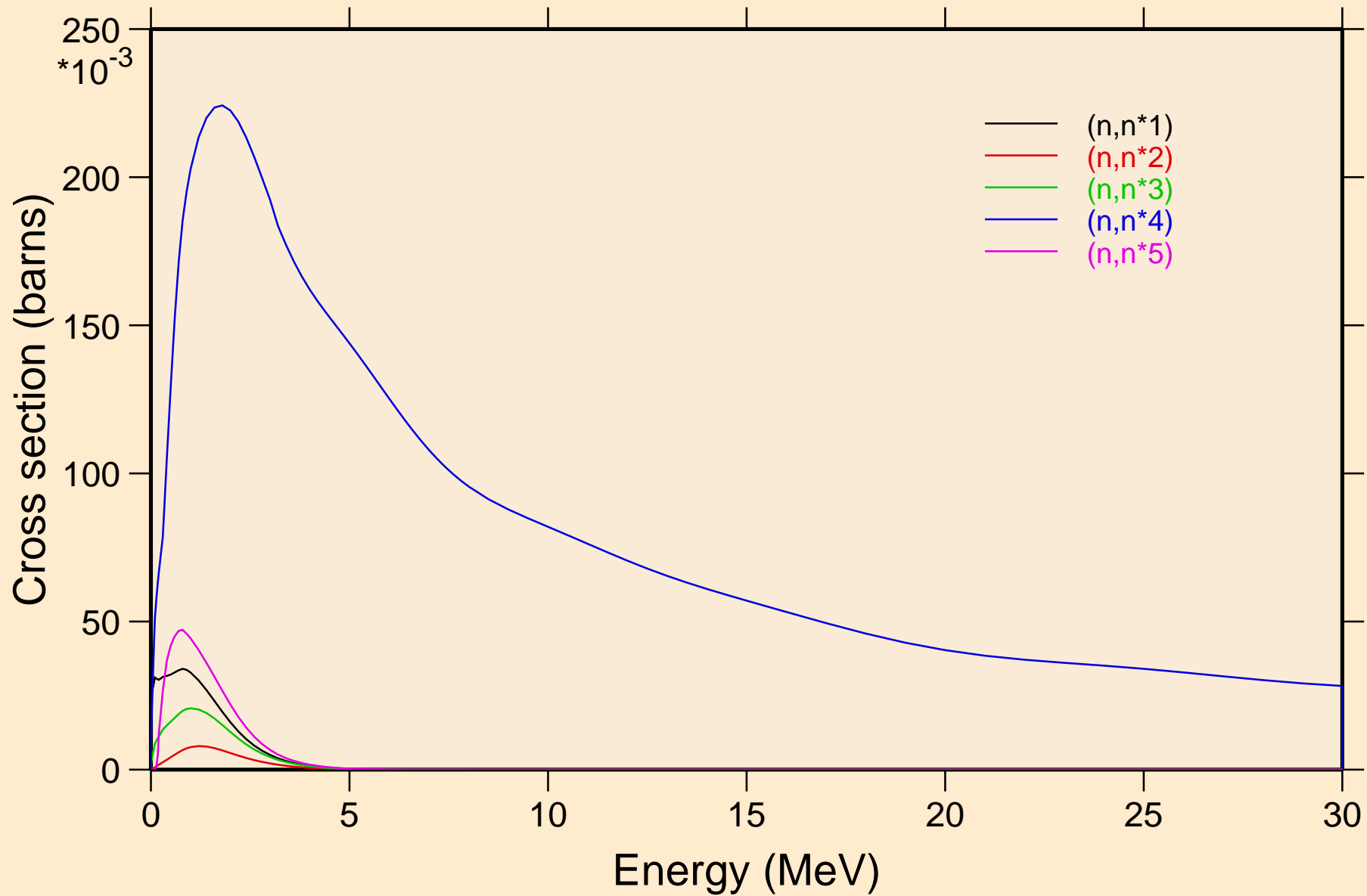

AU197M NEUTRON ACER TENDL-2023 LIBRARY; T=0.K

Inelastic levels

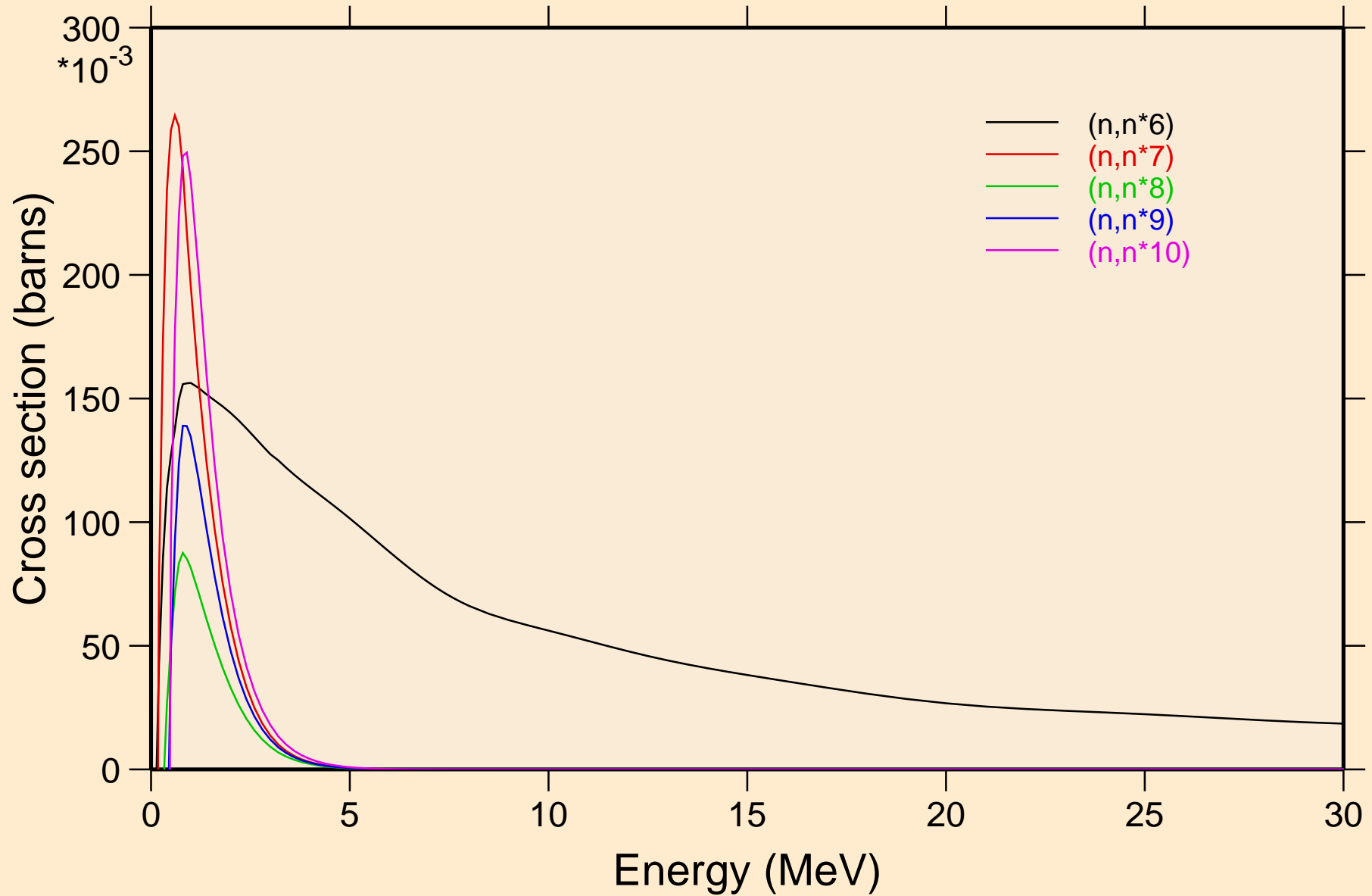

AU197M NEUTRON ACER TENDL-2023 LIBRARY; T=0.K
Inelastic levels

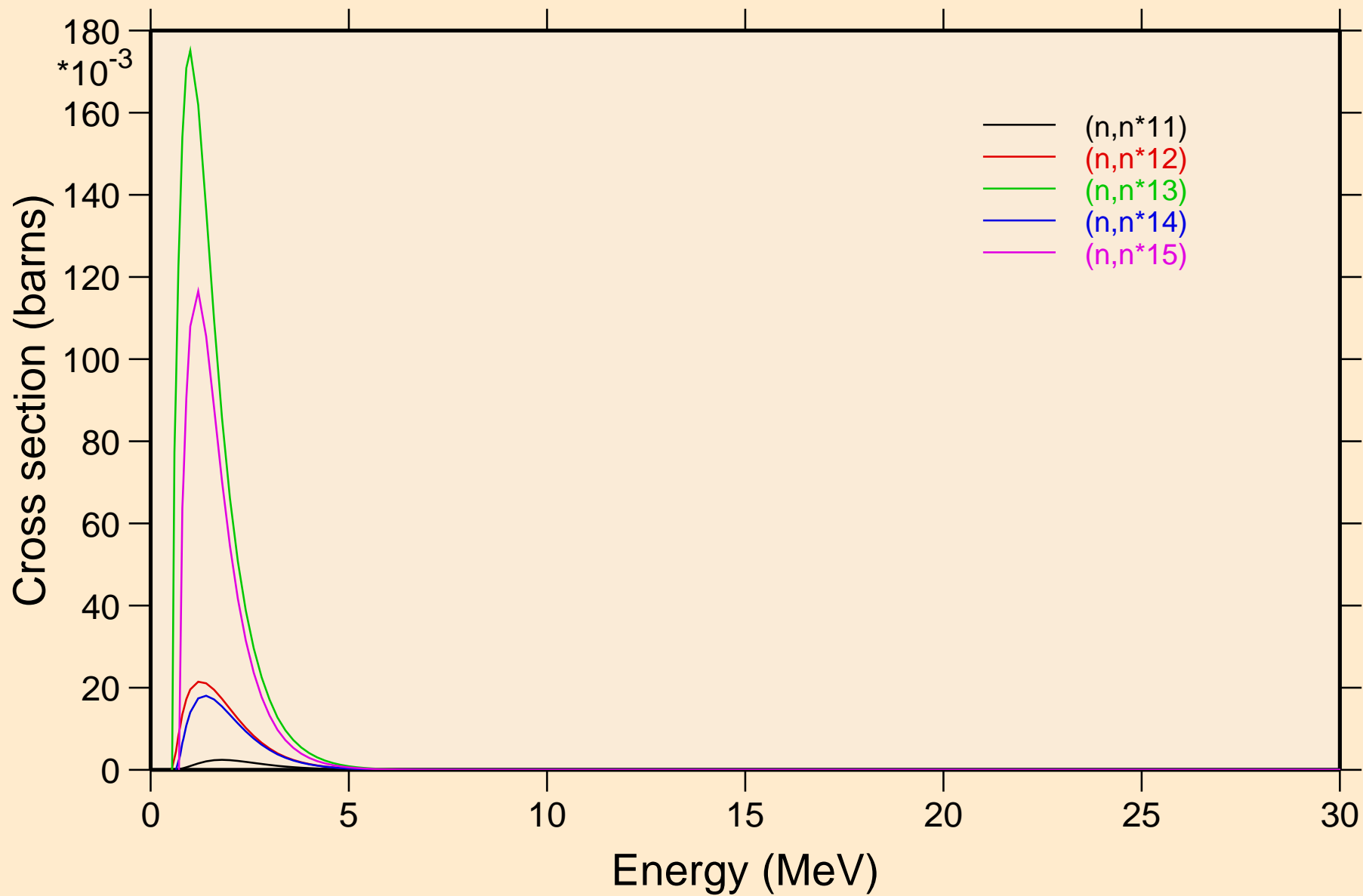

AU197M NEUTRON ACER TENDL-2023 LIBRARY; T=0.K
Inelastic levels

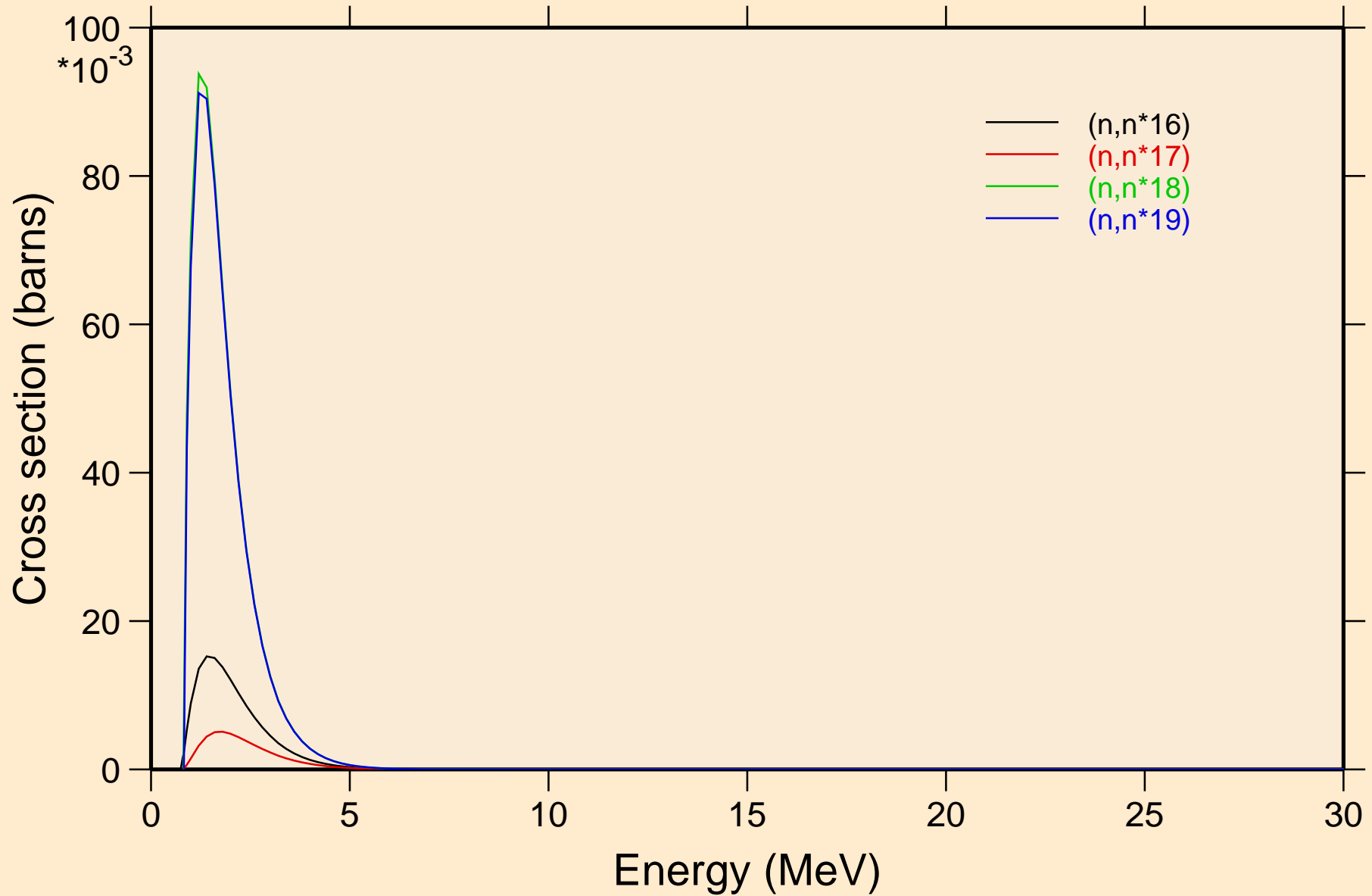

AU197M NEUTRON ACER TENDL-2023 LIBRARY; T=0.K
Threshold reactions

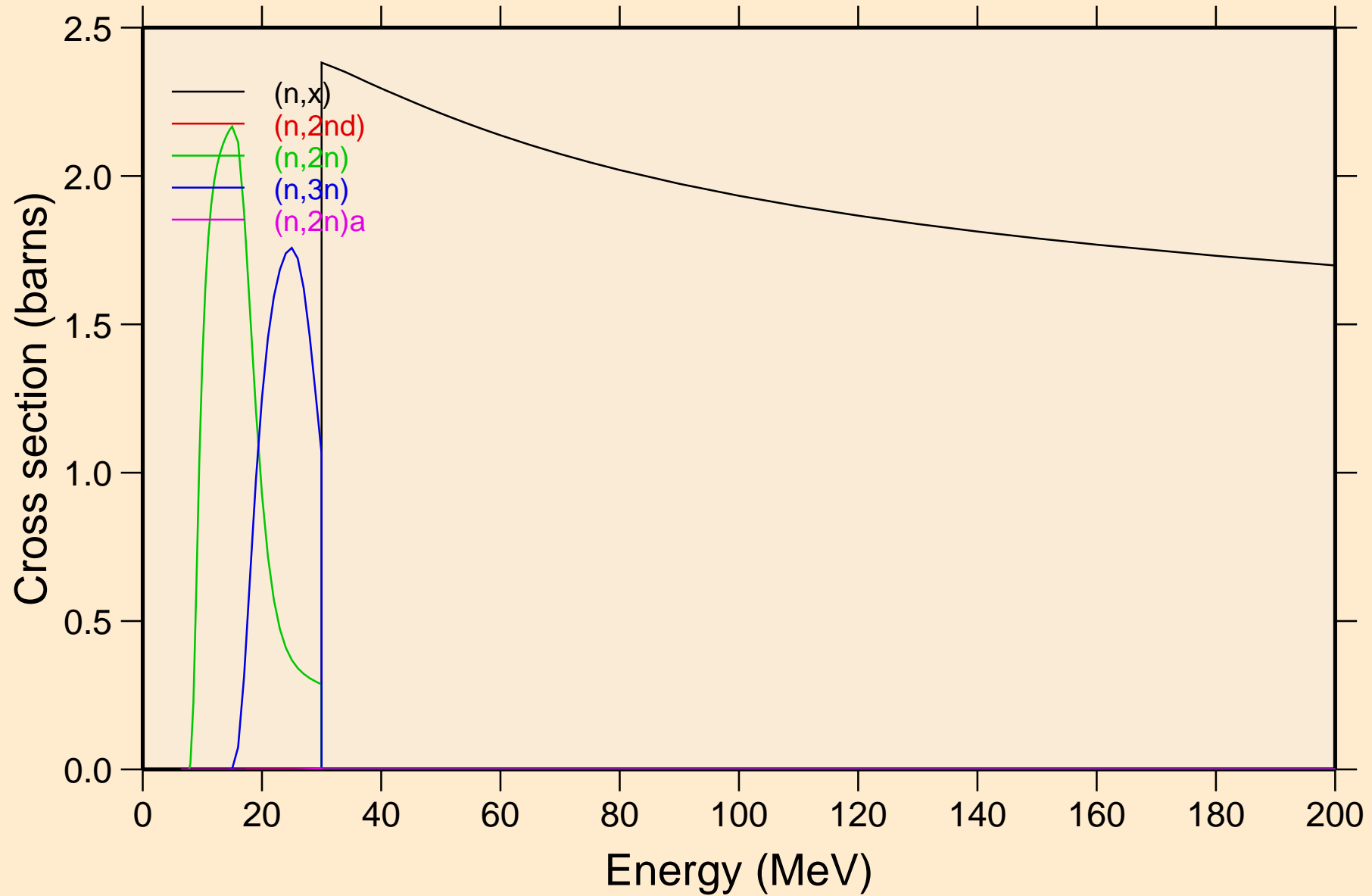

AU197M NEUTRON ACER TENDL-2023 LIBRARY; T=0.K

Threshold reactions

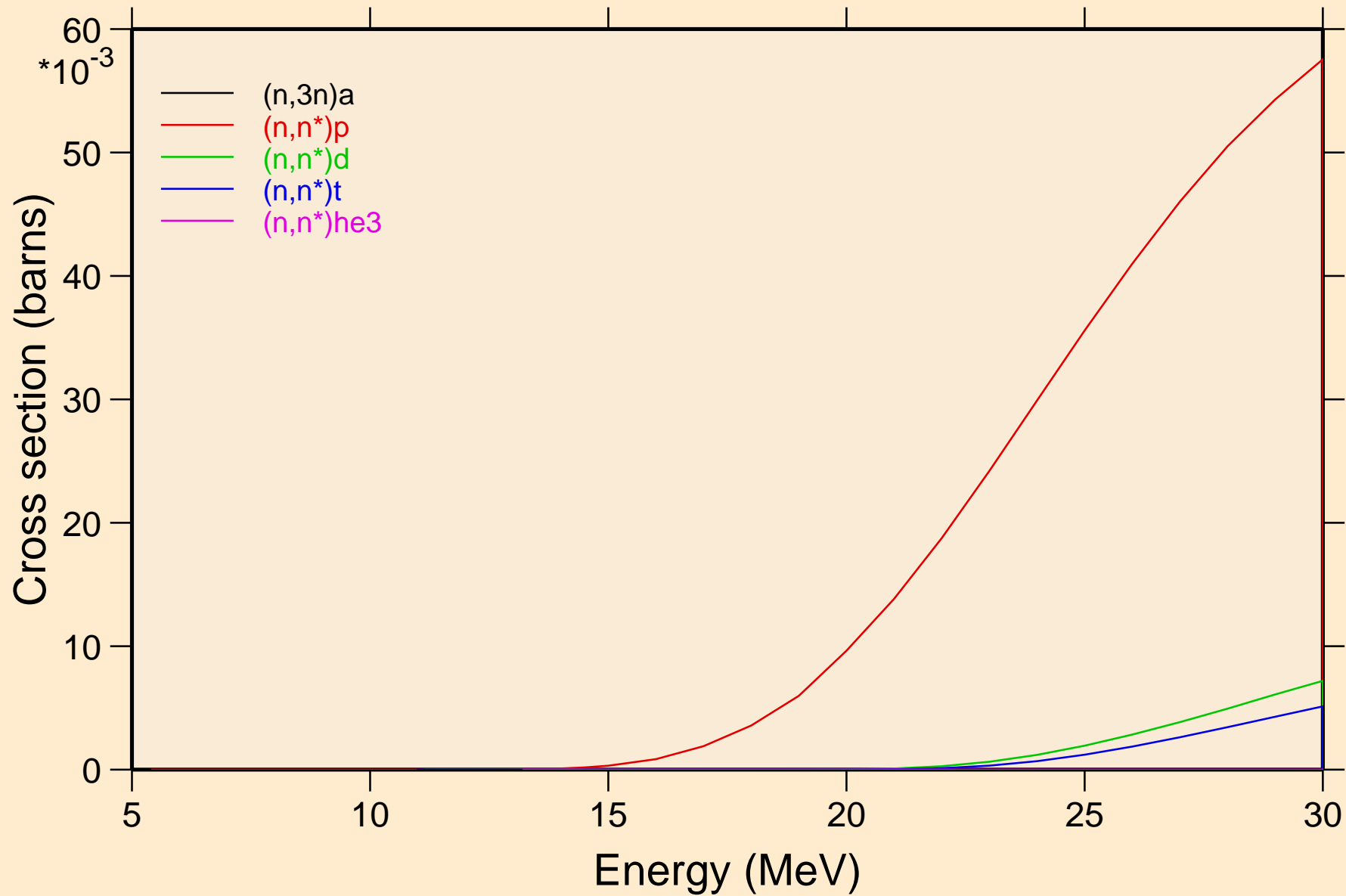

AU197M NEUTRON ACER TENDL-2023 LIBRARY; T=0.K
Threshold reactions

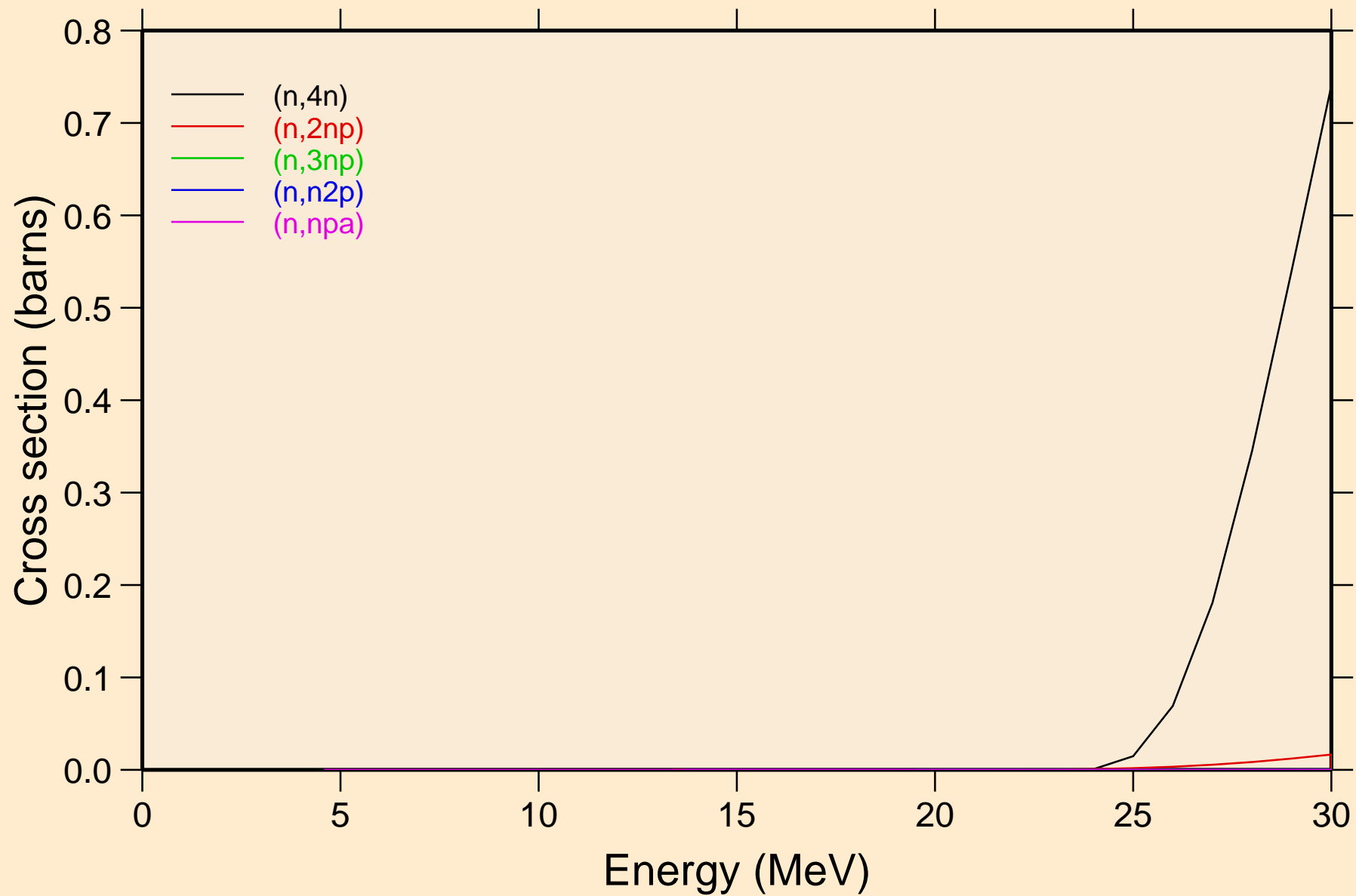

AU197M NEUTRON ACER TENDL-2023 LIBRARY; T=0.K
Threshold reactions

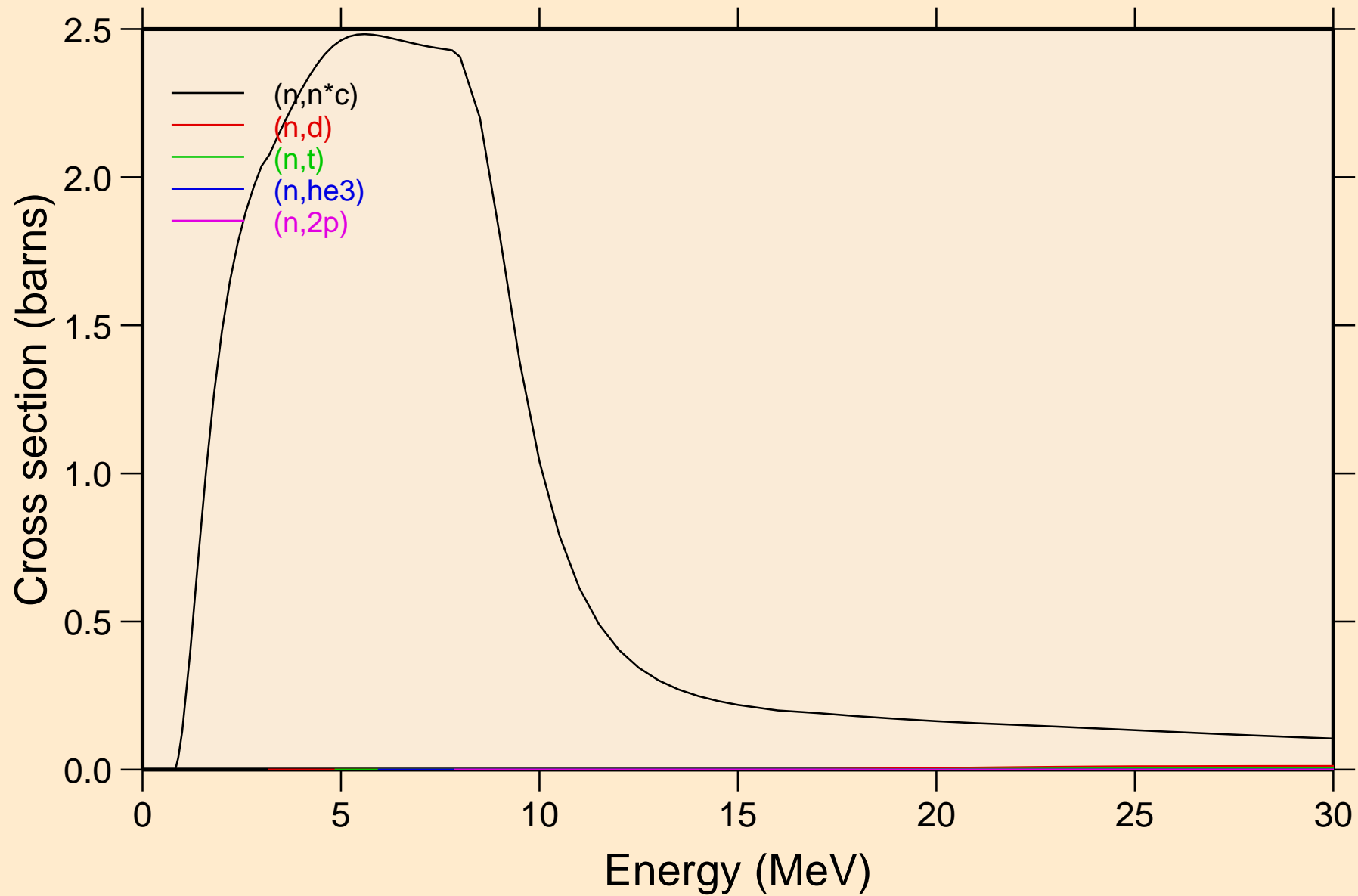

AU197M NEUTRON ACER TENDL-2023 LIBRARY; T=0.K

Threshold reactions

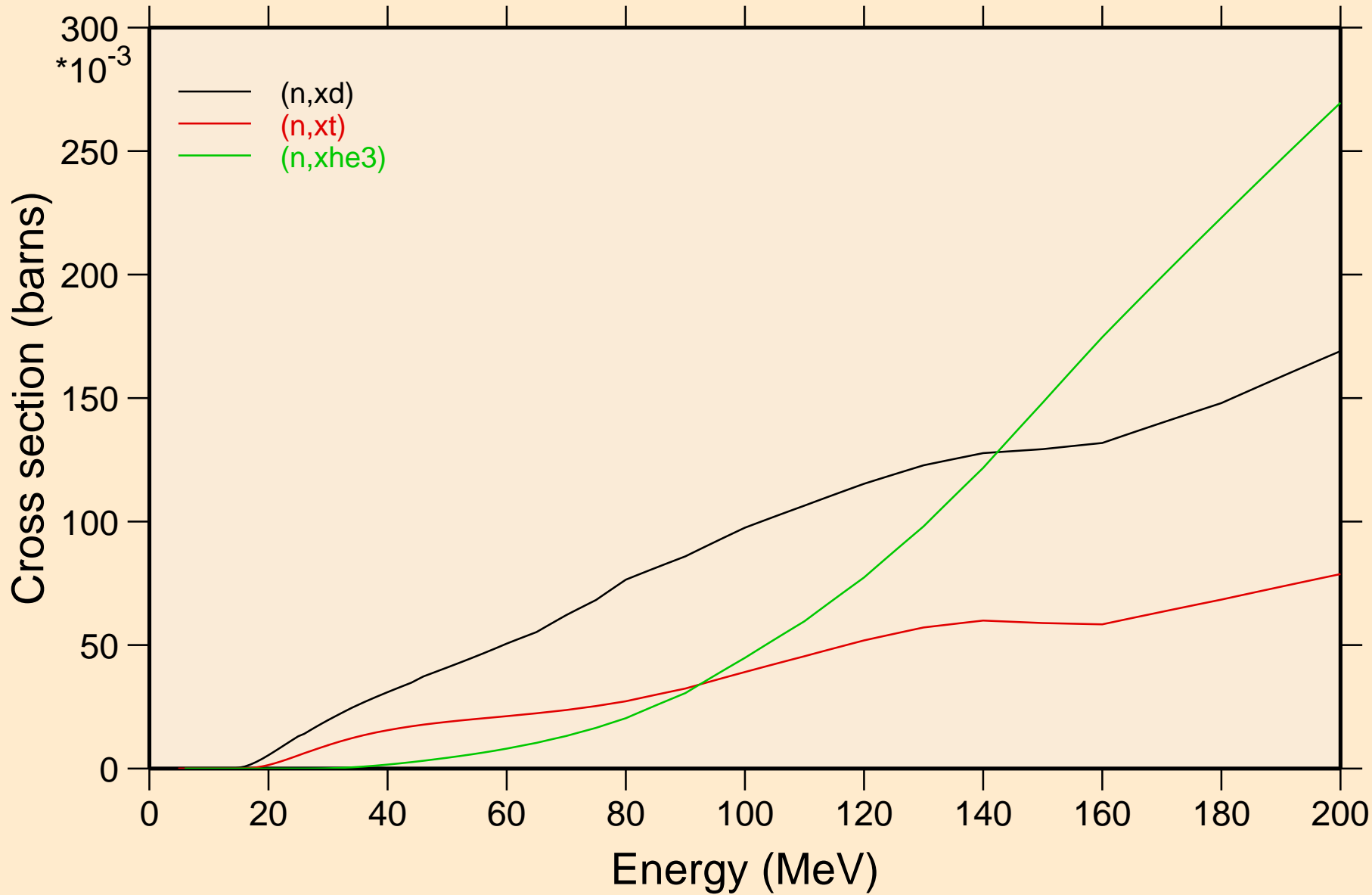

AU197M NEUTRON ACER TENDL-2023 LIBRARY; T=0.K
angular distribution for elastic

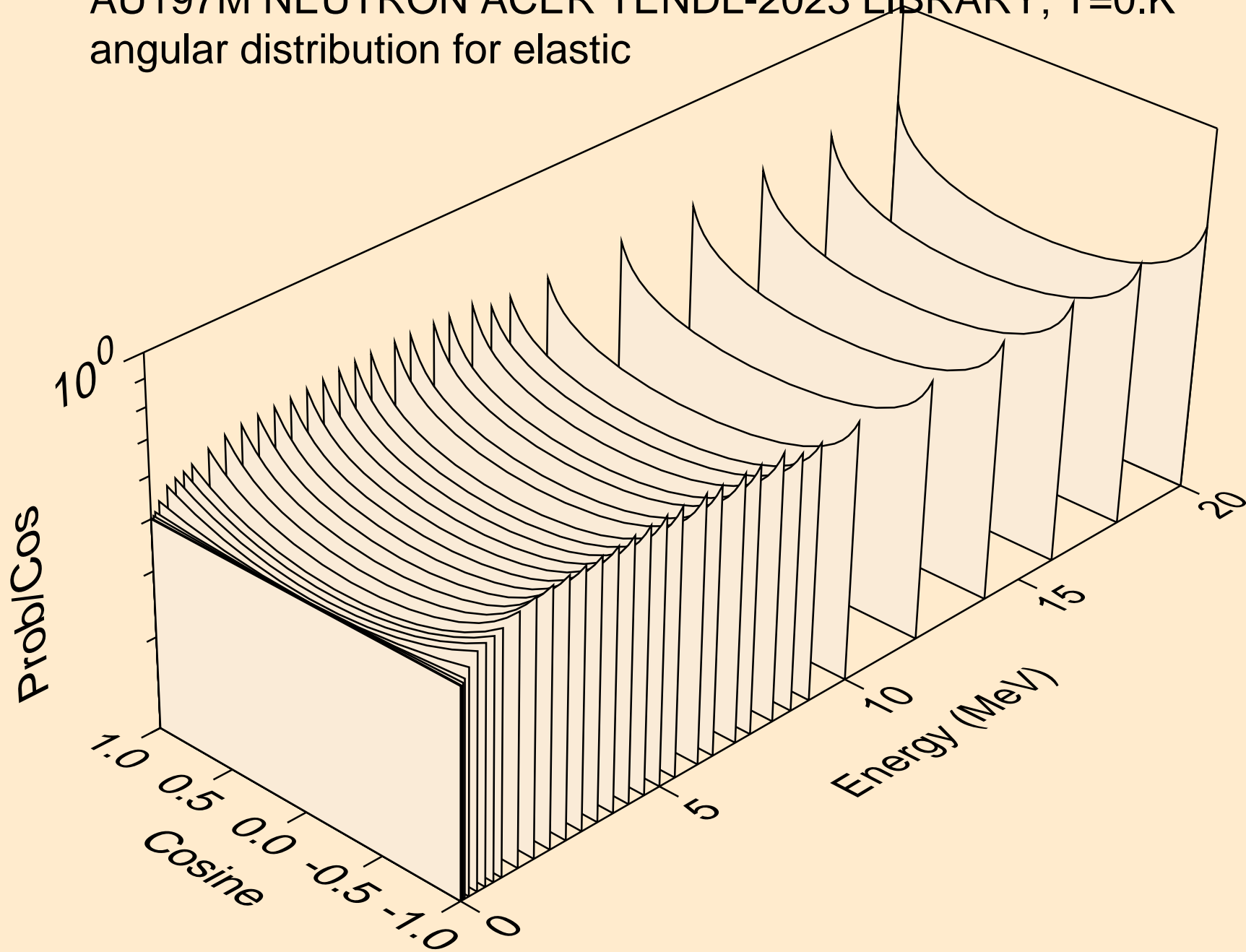

AU197M NEUTRON ACER TENDL-2023 LIBRARY; T=0.K
angular distribution for elastic

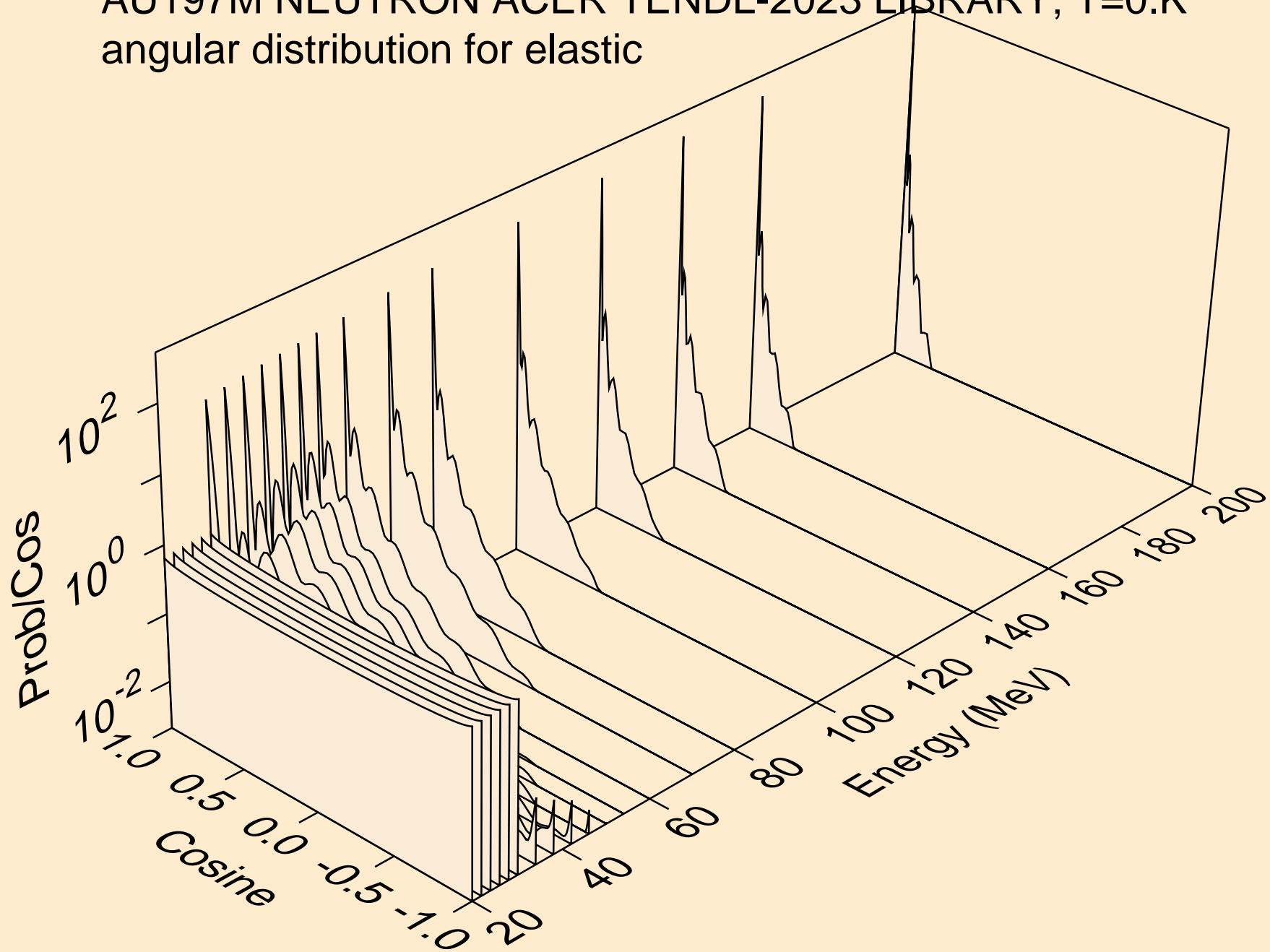

AU197M NEUTRON ACER TENDL-2023 LIBRARY; T=0.K
angular distribution for (n,n*1)

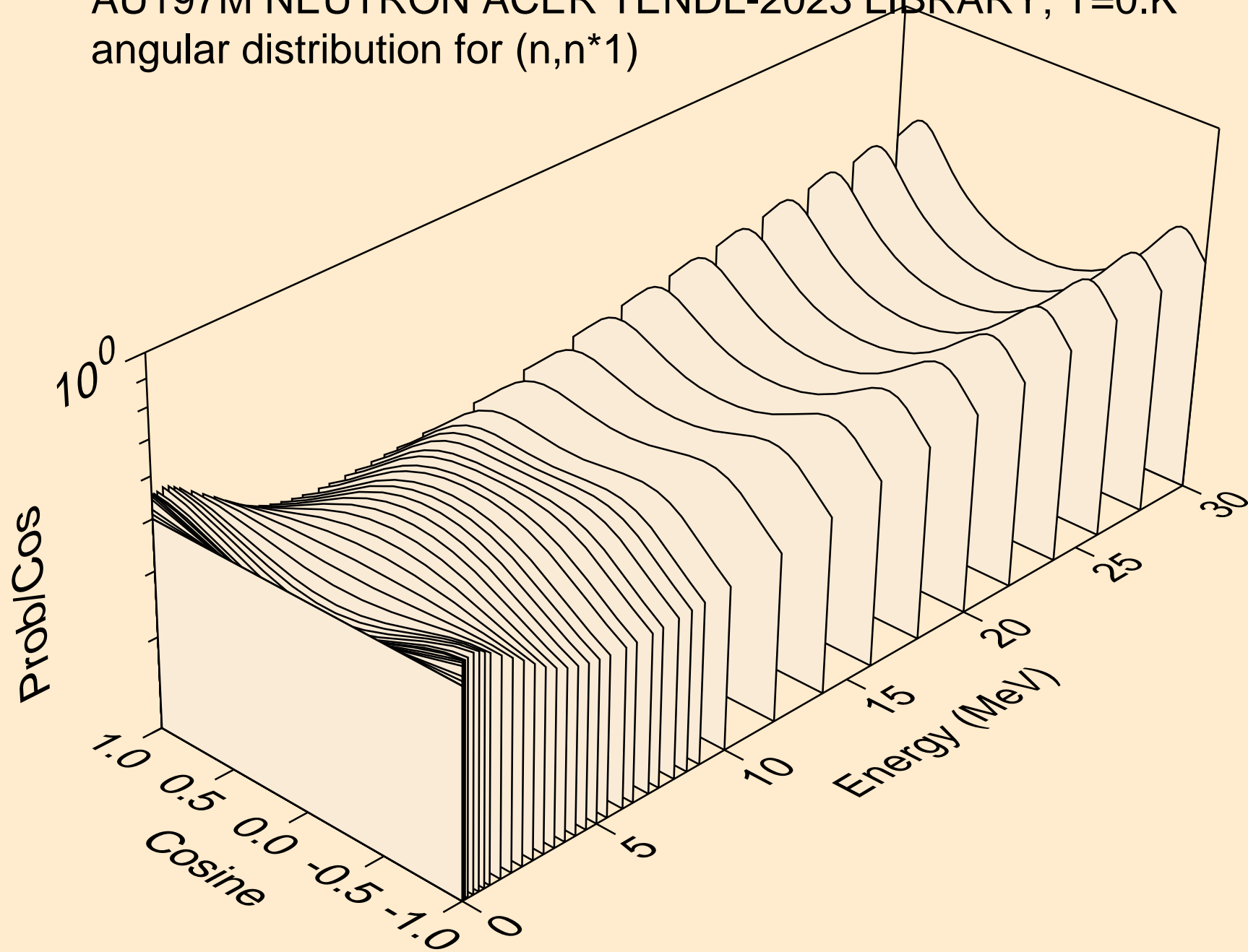

AU197M NEUTRON ACER TENDL-2023 LIBRARY; T=0.K
angular distribution for (n,n*2)

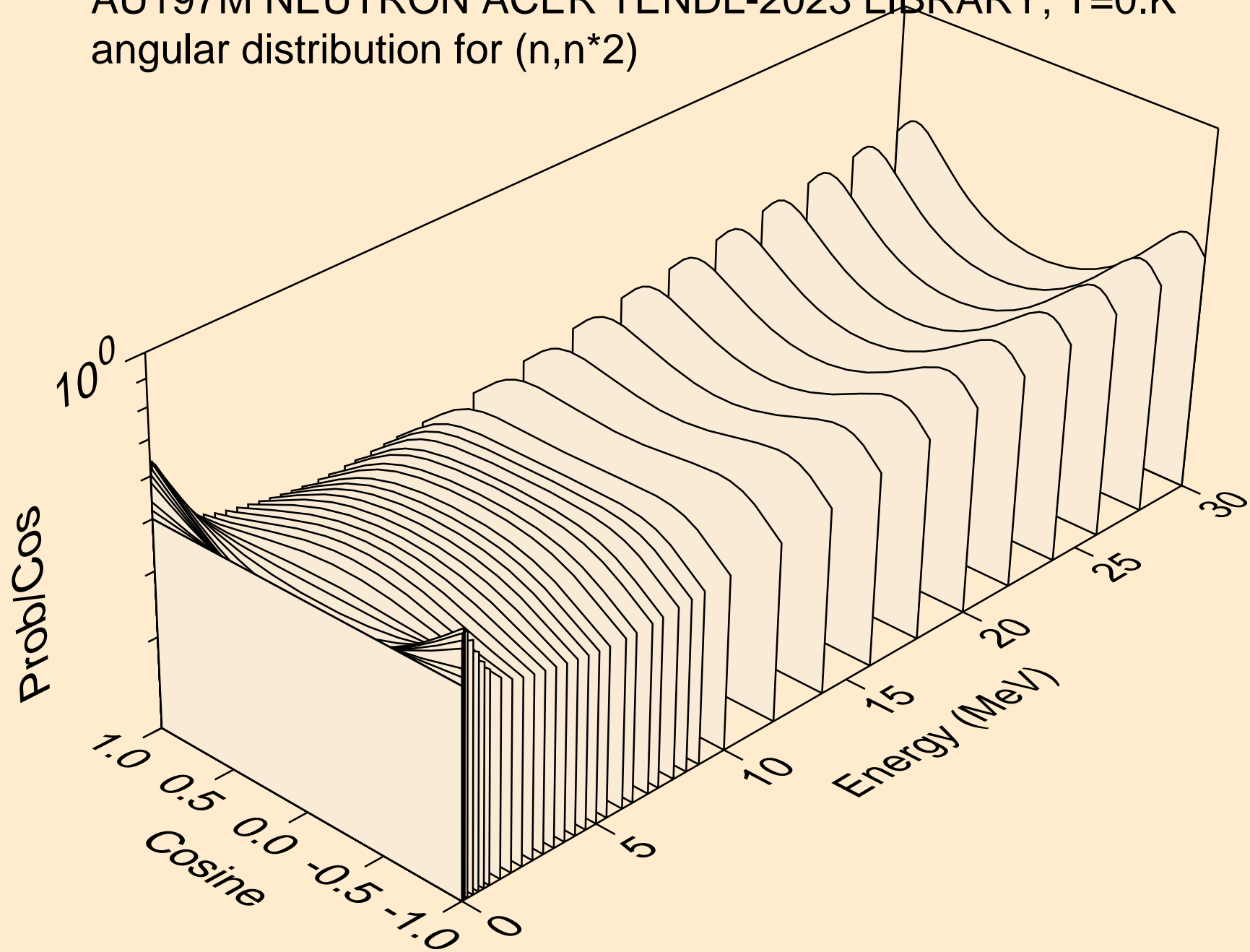

AU197M NEUTRON ACER TENDL-2023 LIBRARY; T=0.K
angular distribution for (n,n*3)

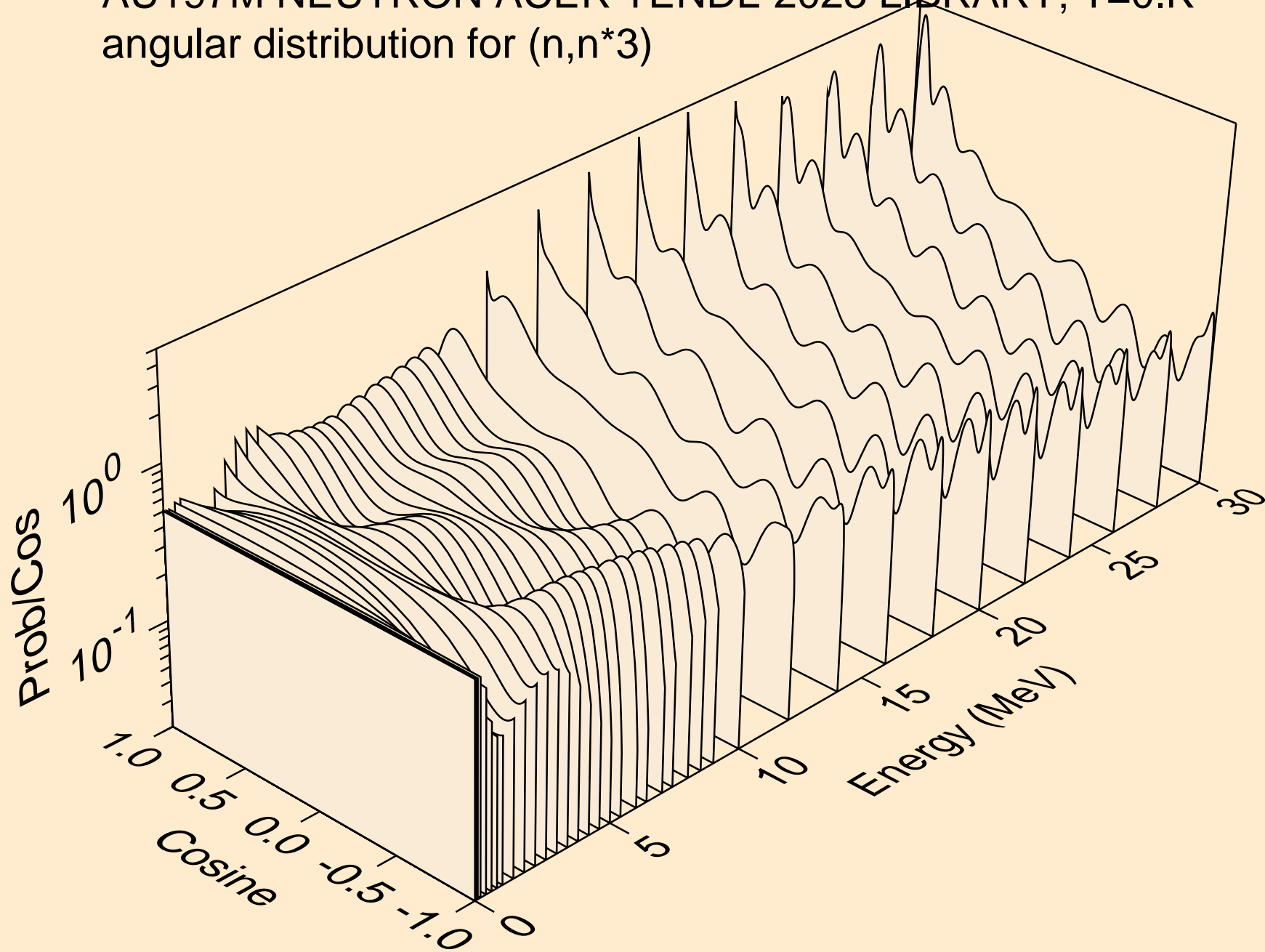

AU197M NEUTRON ACER TENDL-2023 LIBRARY; T=0.K
angular distribution for (n,n*4)

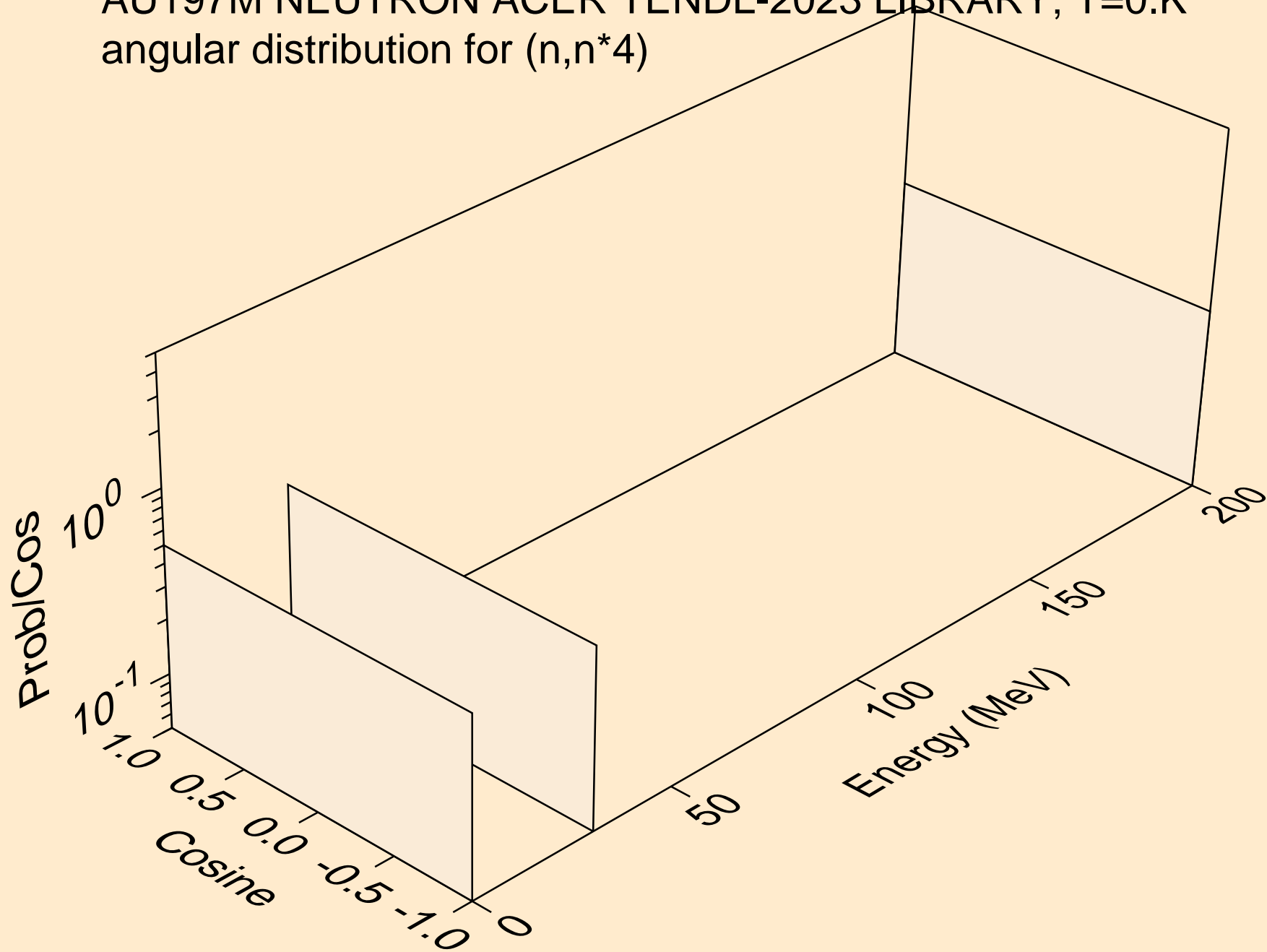

AU197M NEUTRON ACER TENDL-2023 LIBRARY; T=0.K
angular distribution for (n,n*5)

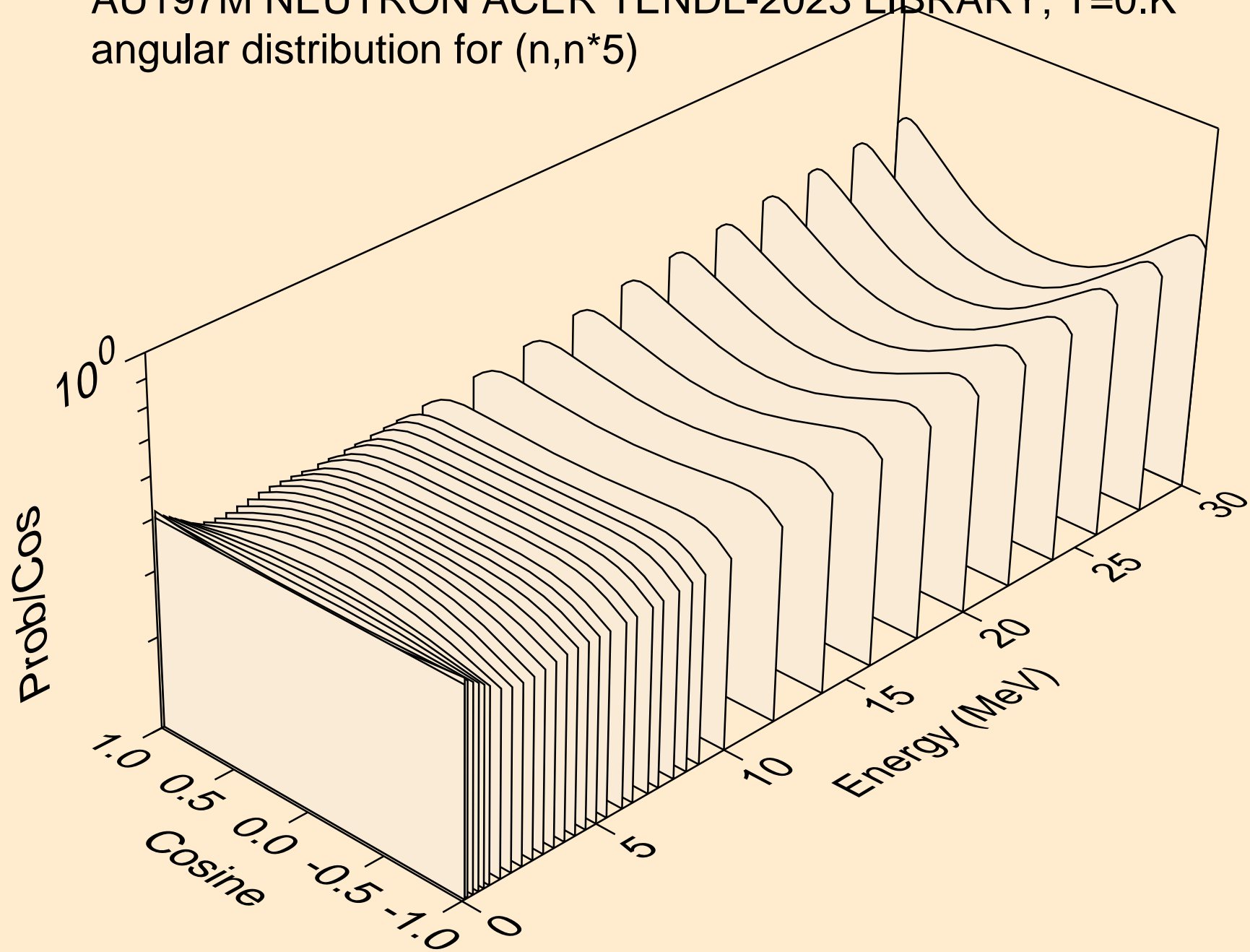

AU197M NEUTRON ACER TENDL-2023 LIBRARY; T=0.K
angular distribution for (n,n*6)

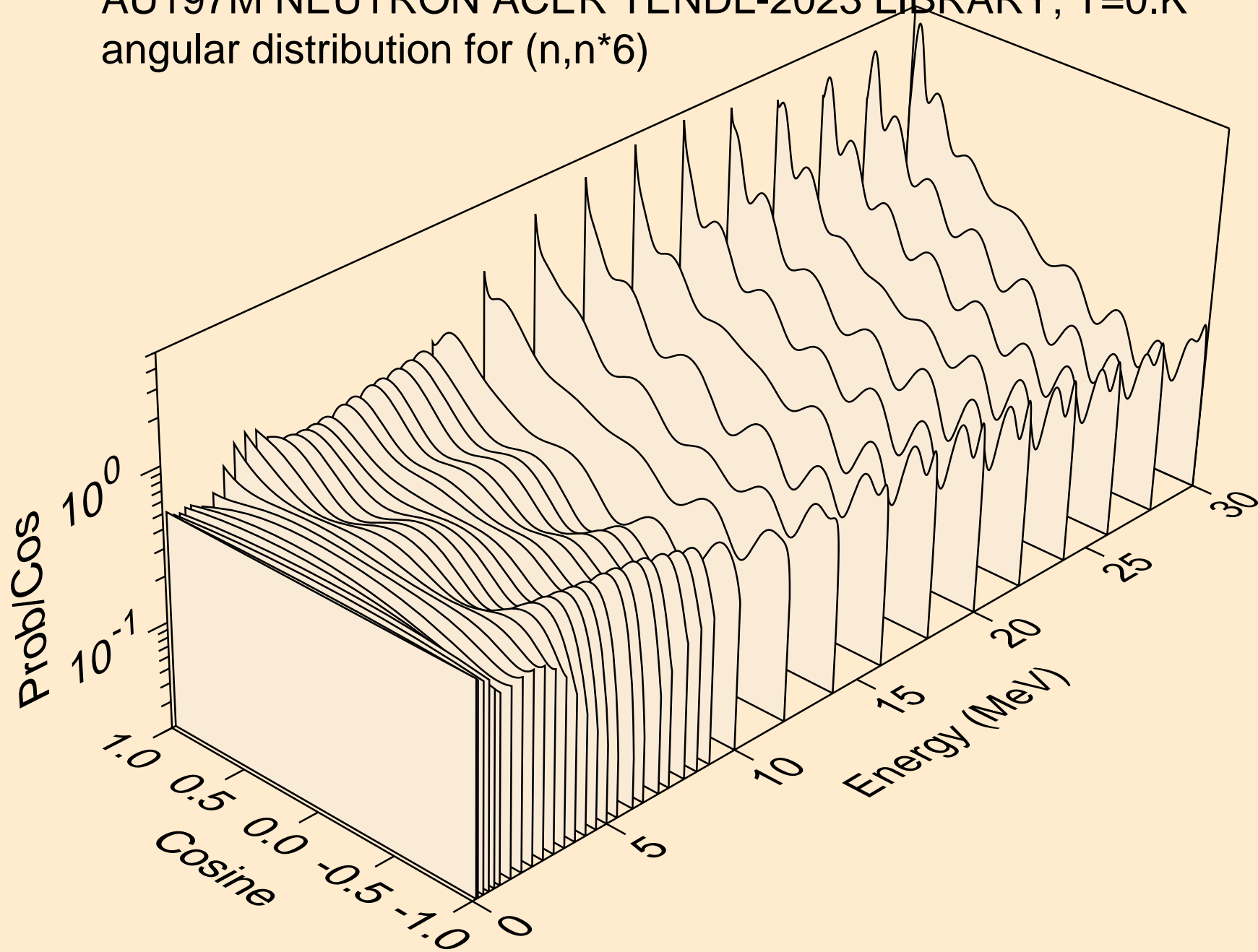

AU197M NEUTRON ACER TENDL-2023 LIBRARY; T=0.K
angular distribution for (n,n*7)

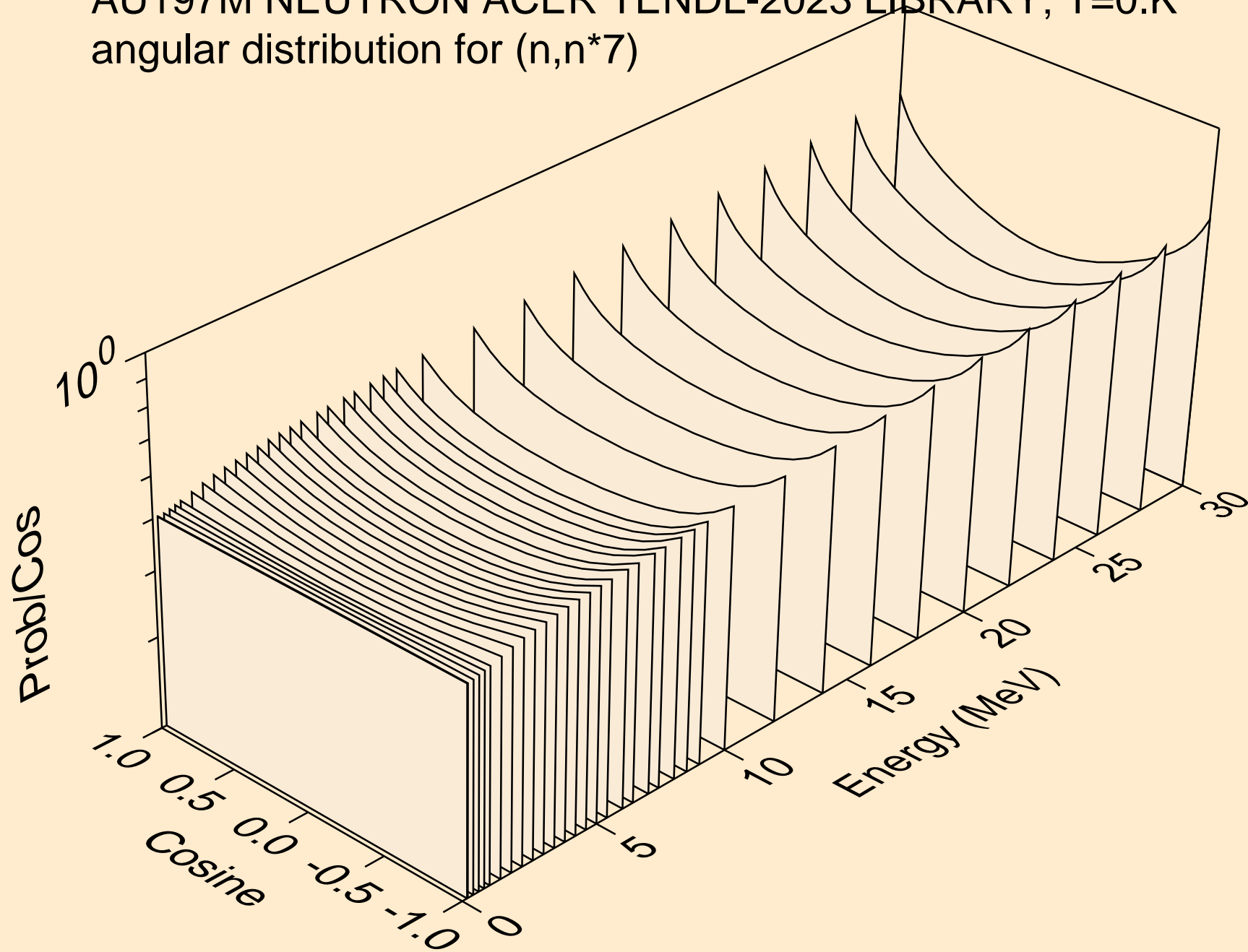

AU197M NEUTRON ACER TENDL-2023 LIBRARY; T=0.K
angular distribution for (n,n*8)

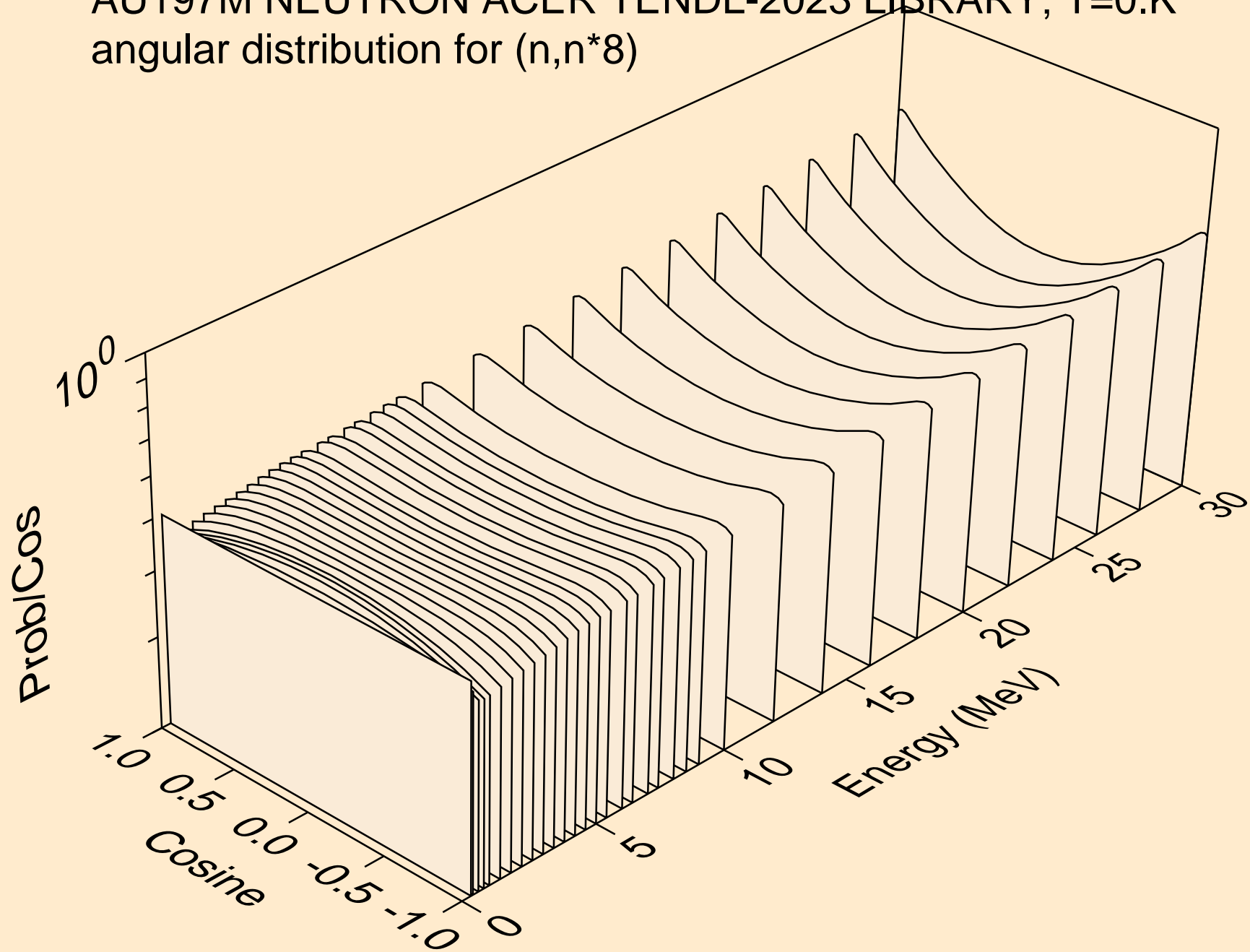

AU197M NEUTRON ACER TENDL-2023 LIBRARY; T=0.K
angular distribution for (n,n*9)

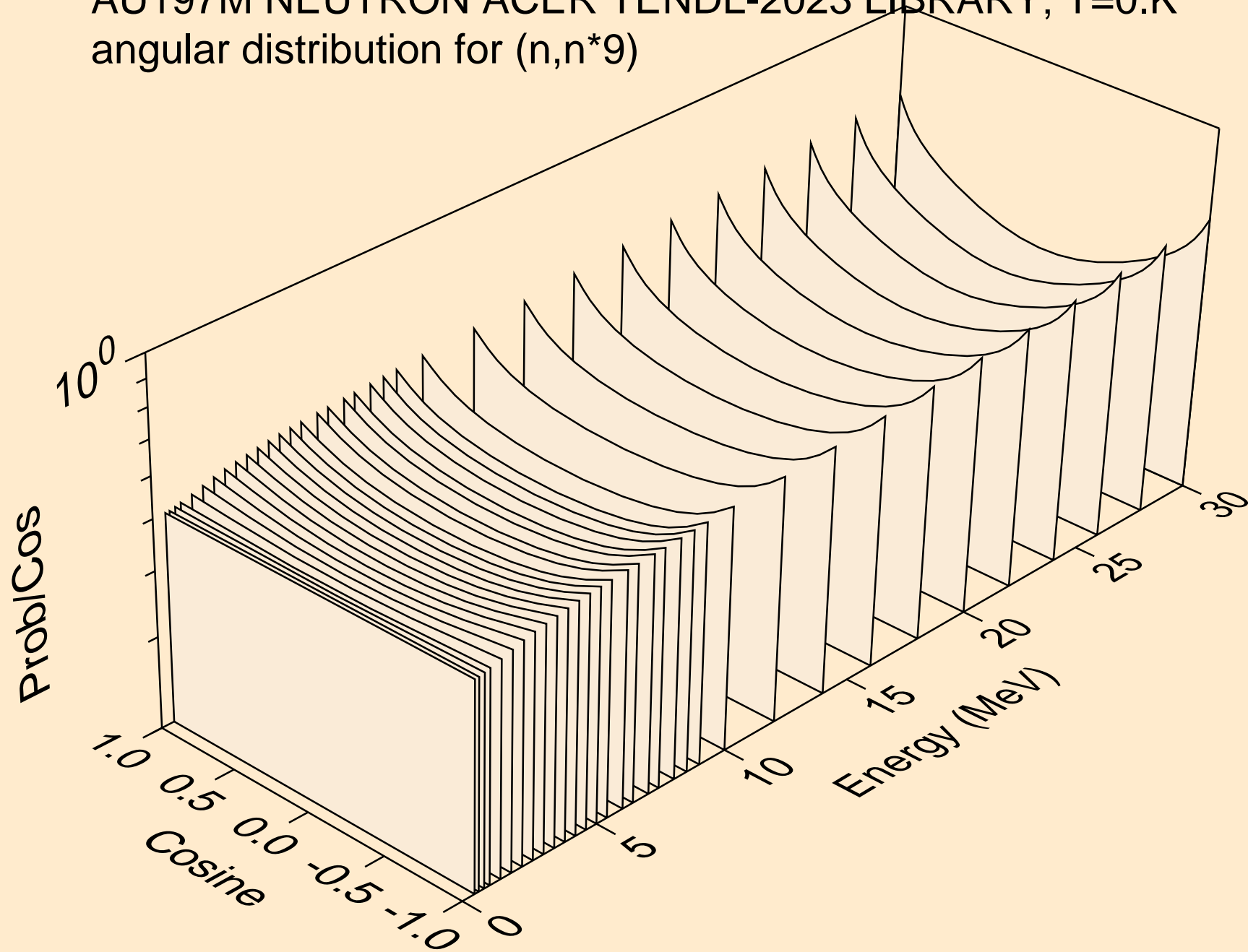

AU197M NEUTRON ACER TENDL-2023 LIBRARY; T=0.K
angular distribution for (n,n*10)

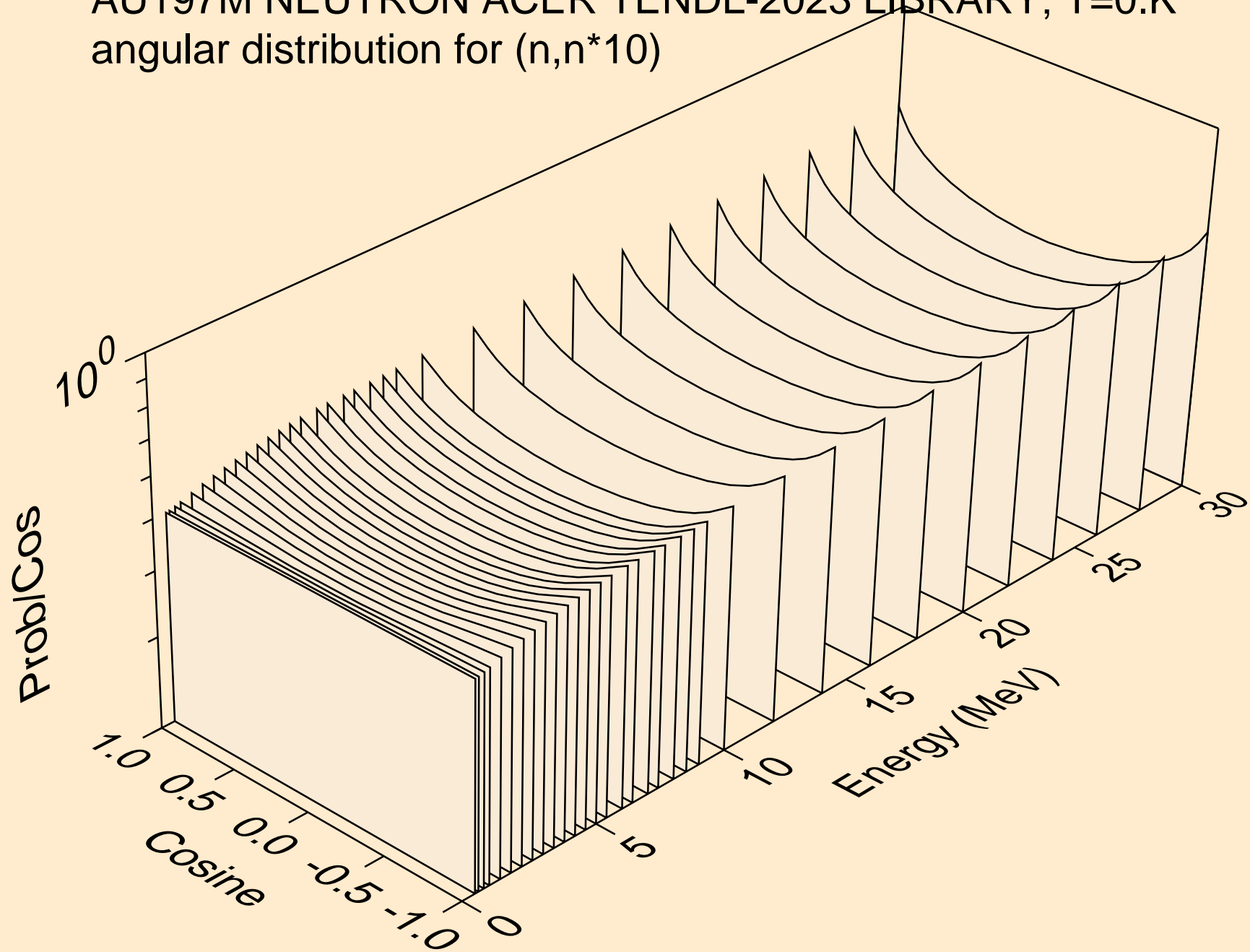

AU197M NEUTRON ACER TENDL-2023 LIBRARY; T=0.K
angular distribution for (n,n*11)

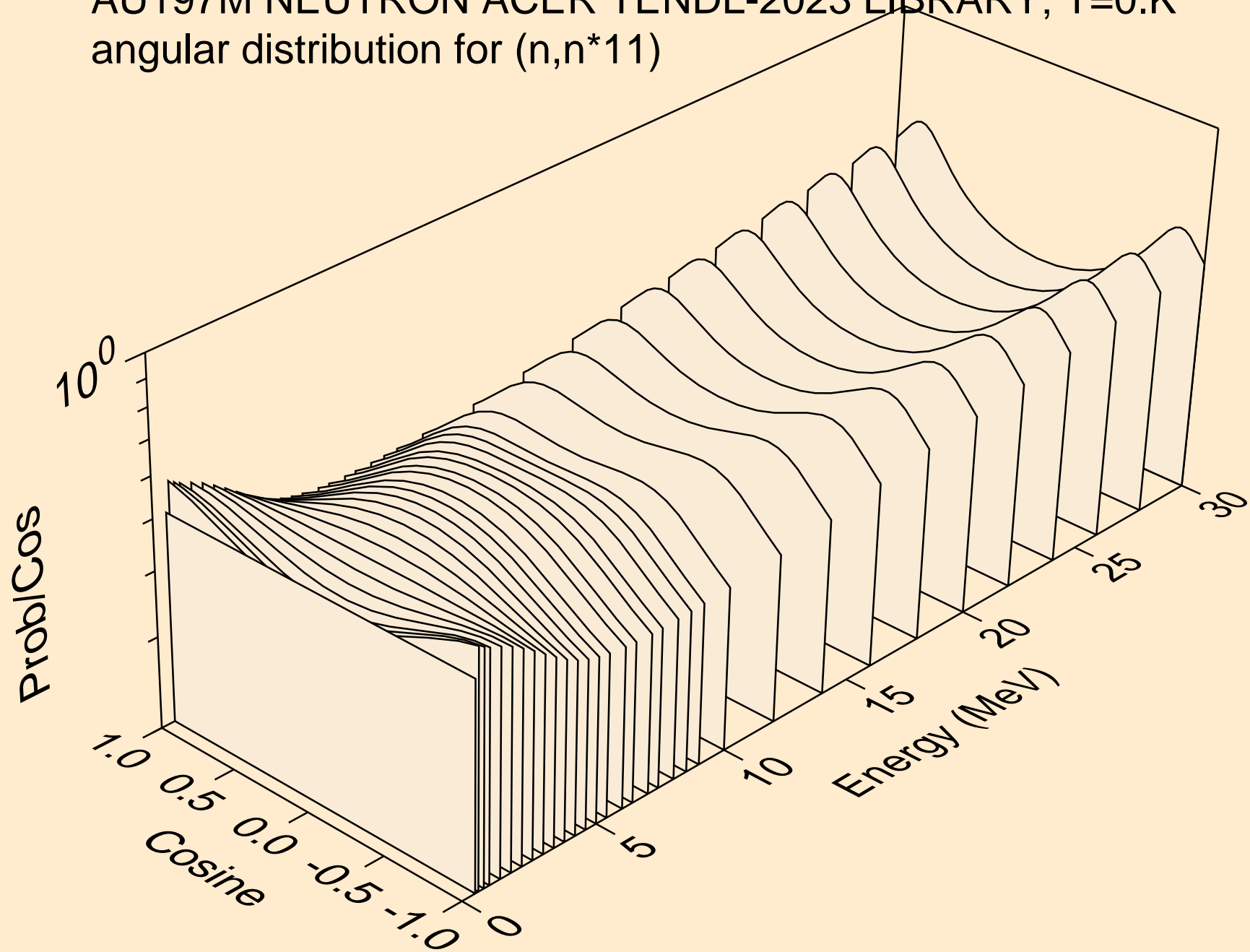

AU197M NEUTRON ACER TENDL-2023 LIBRARY; T=0.K
angular distribution for (n,n*12)

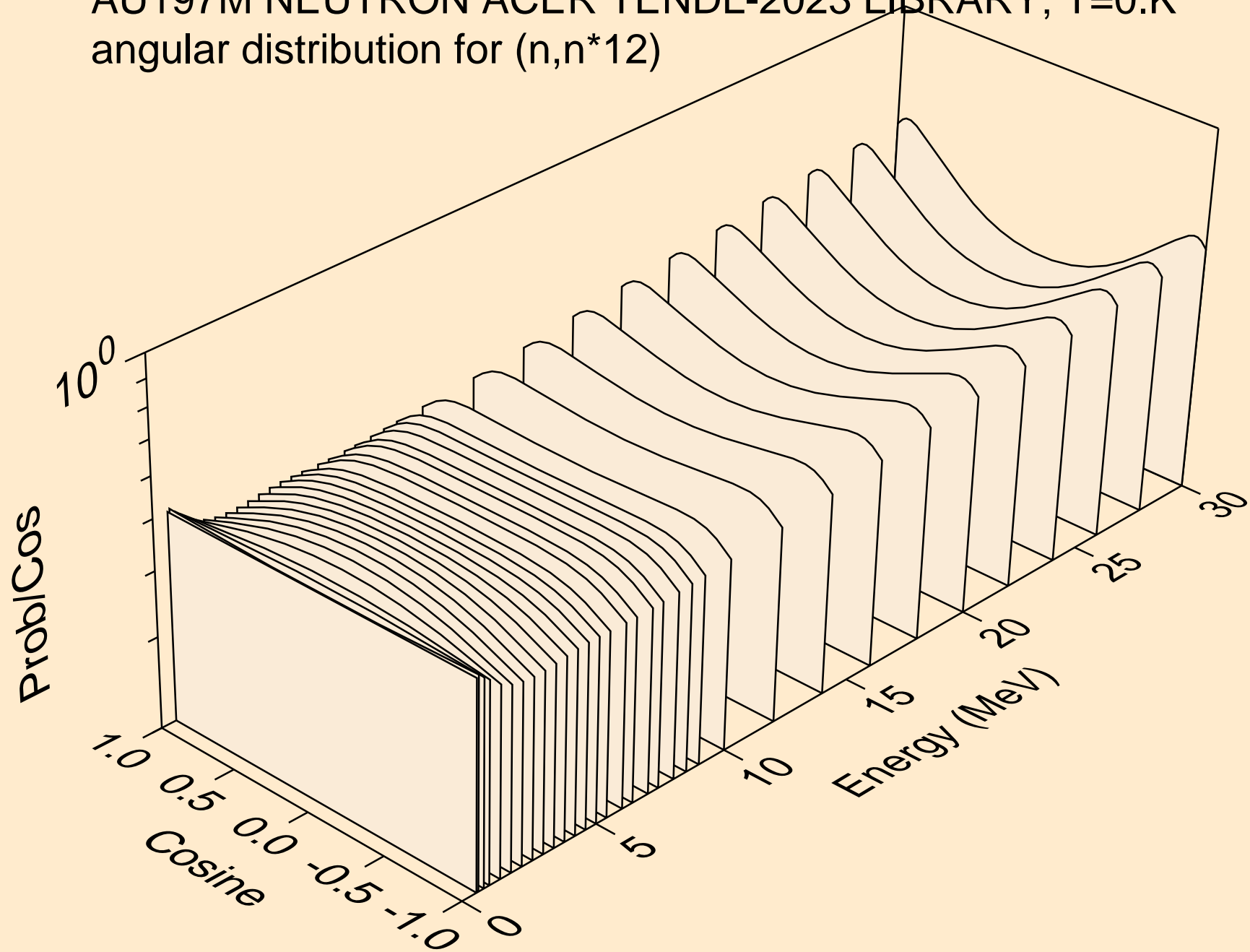

AU197M NEUTRON ACER TENDL-2023 LIBRARY; T=0.K
angular distribution for (n,n*13)

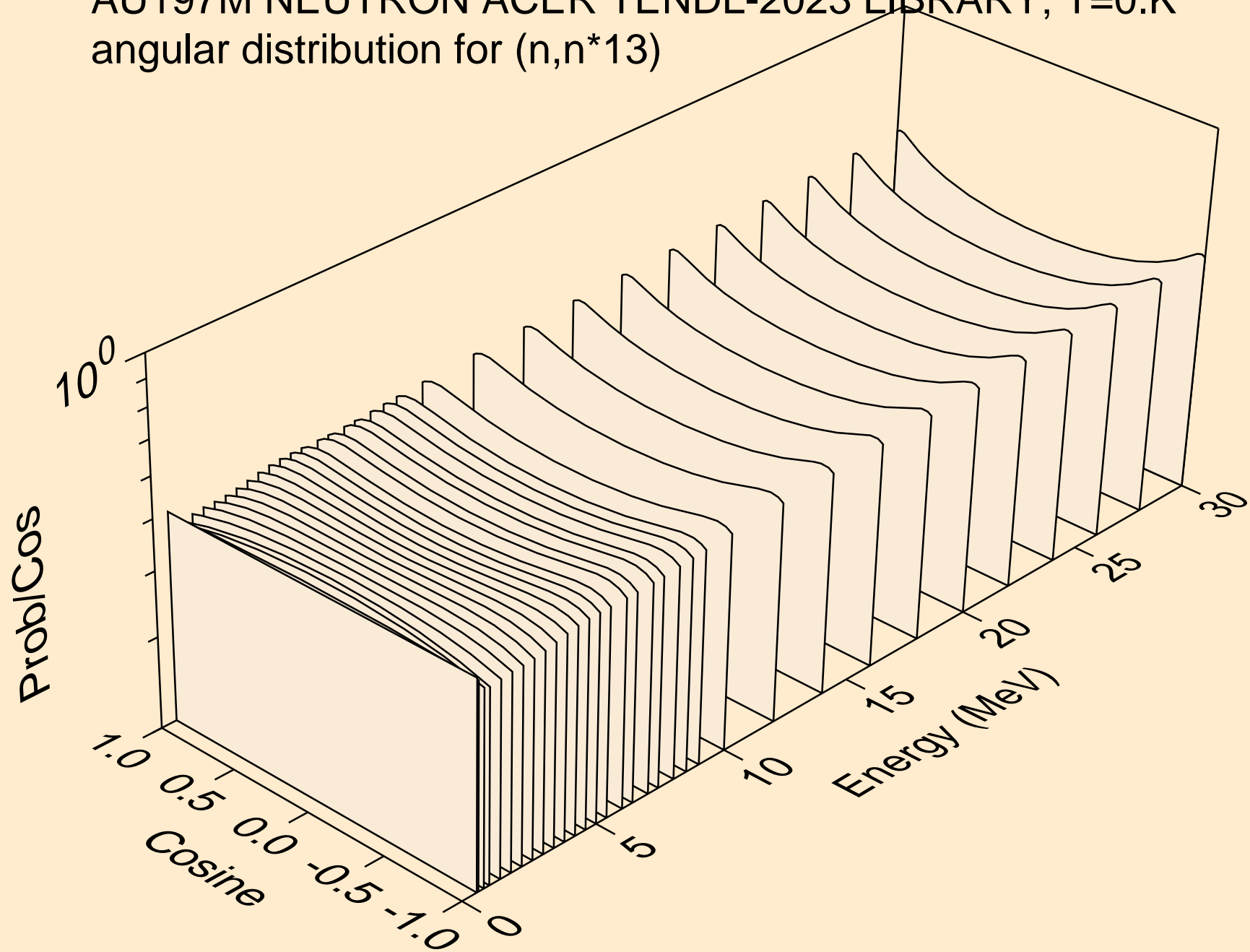

AU197M NEUTRON ACER TENDL-2023 LIBRARY; T=0.K
angular distribution for (n,n*14)

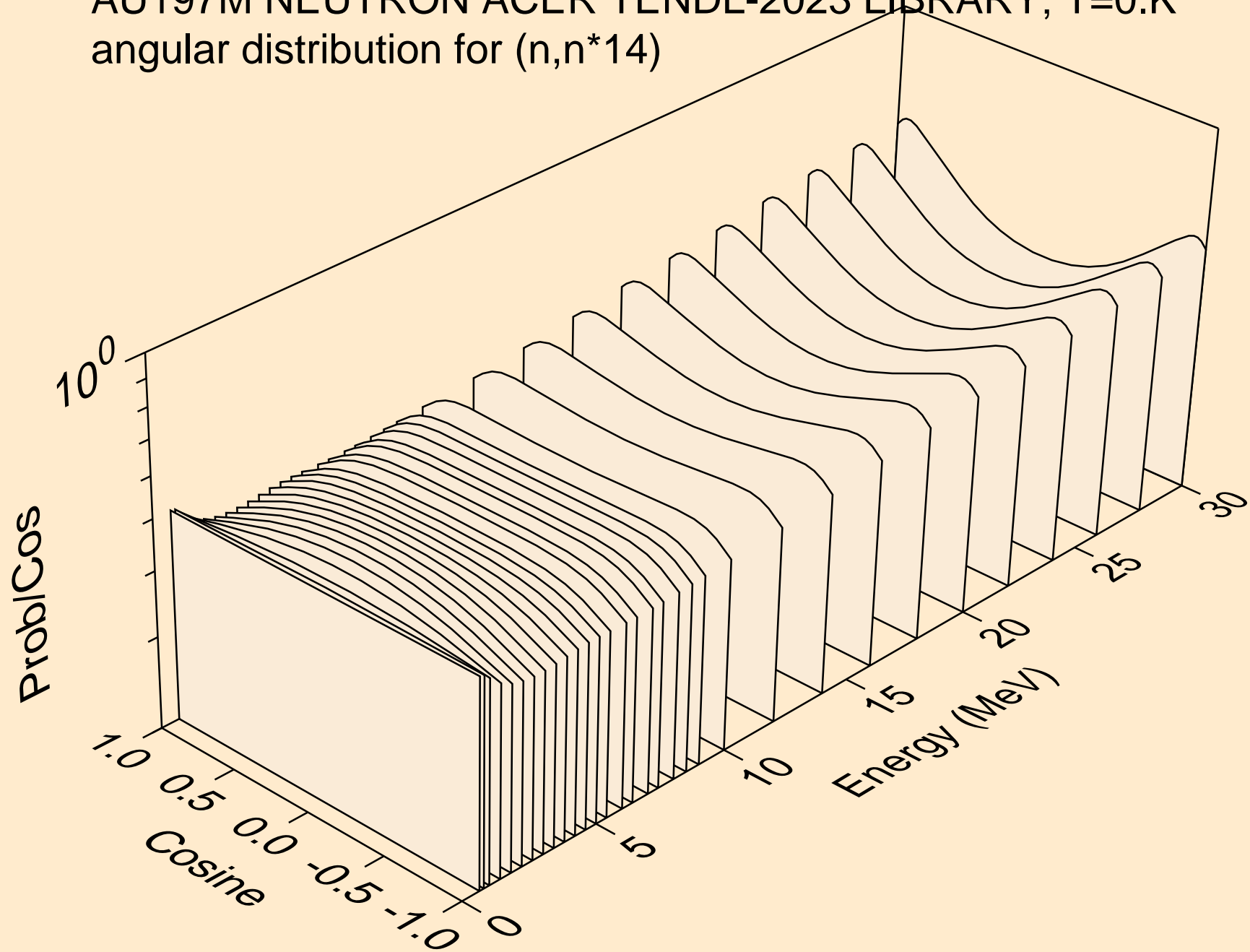

AU197M NEUTRON ACER TENDL-2023 LIBRARY; T=0.K
angular distribution for (n,n*15)

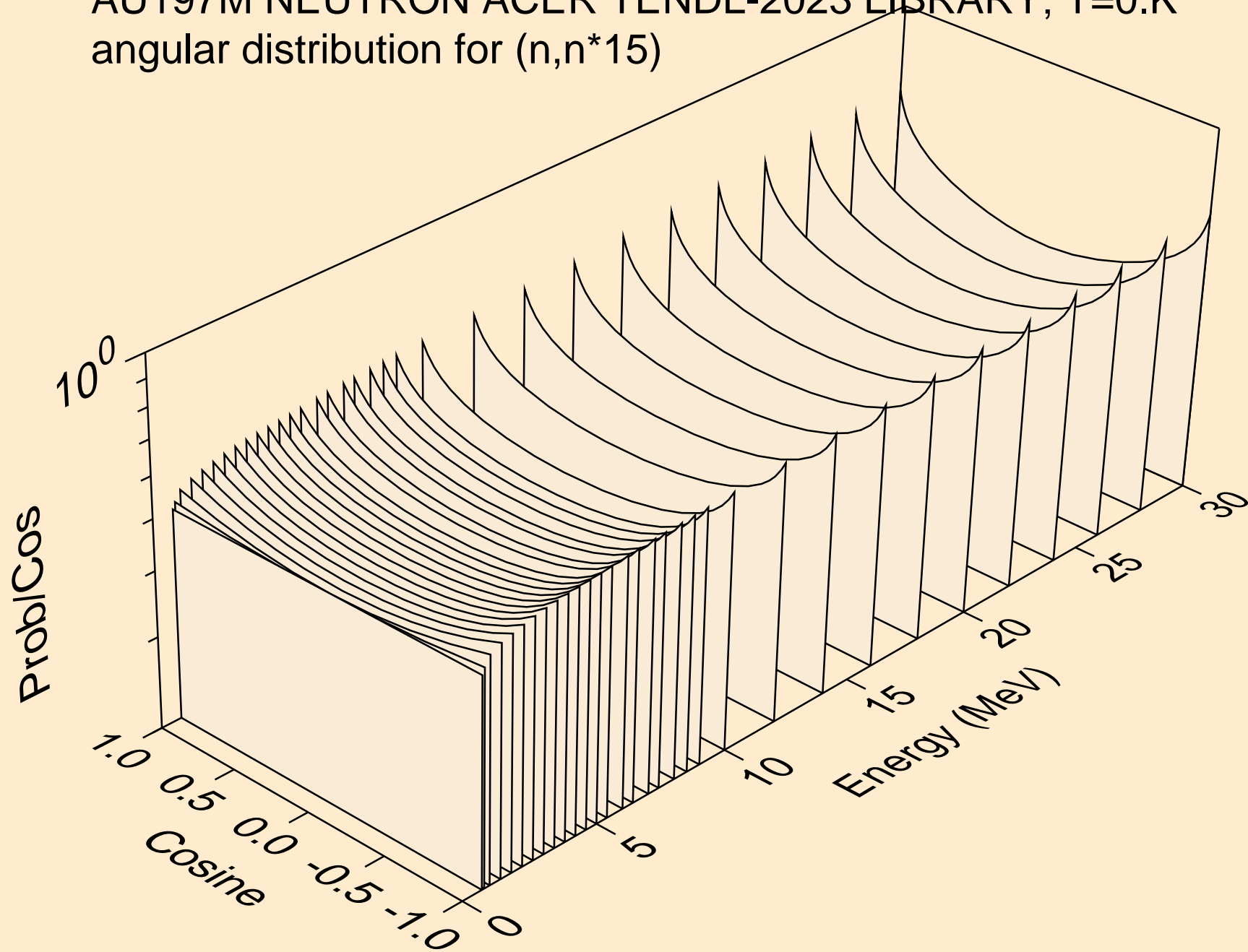

AU197M NEUTRON ACER TENDL-2023 LIBRARY; T=0.K
angular distribution for (n,n*16)

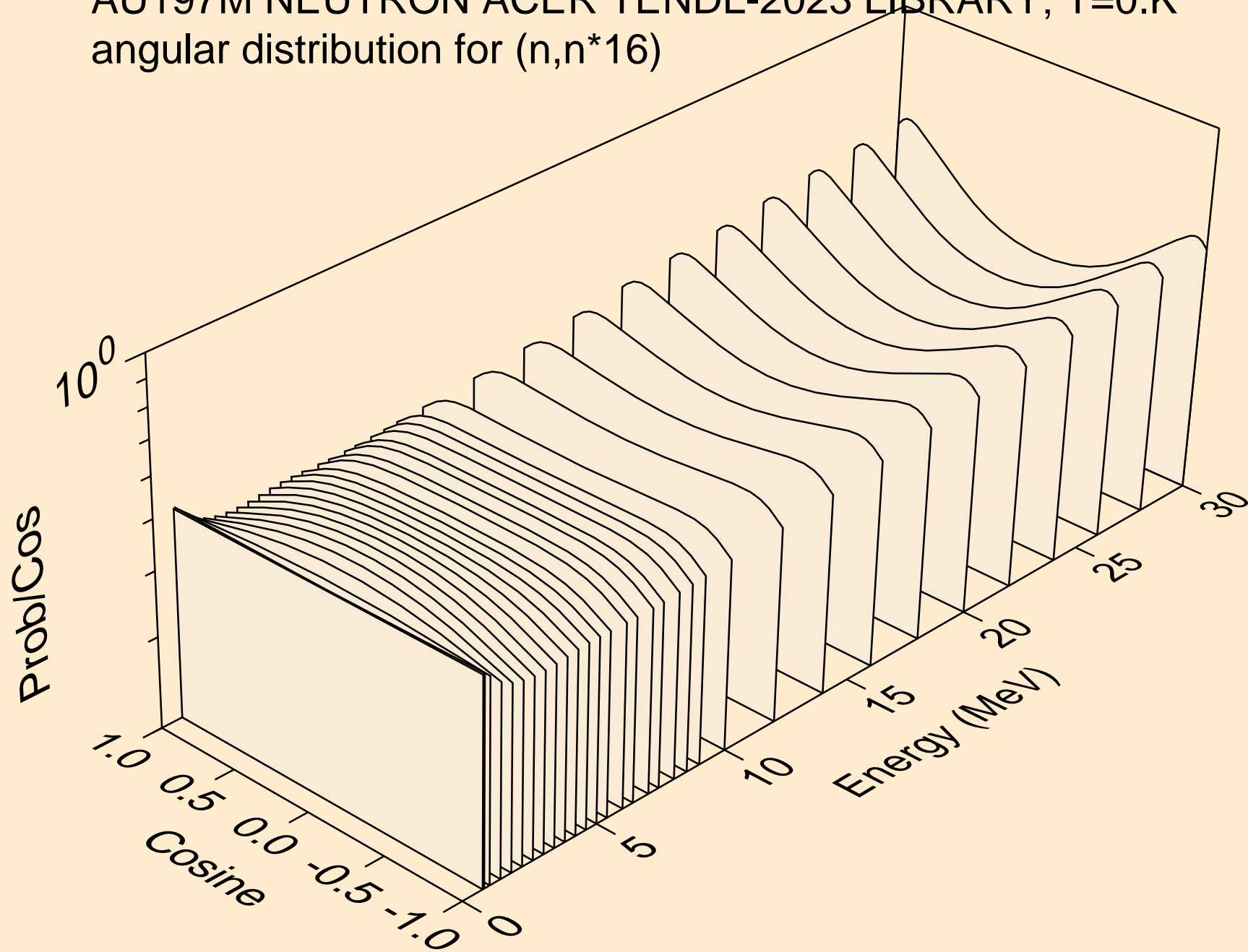

AU197M NEUTRON ACER TENDL-2023 LIBRARY; T=0.K
angular distribution for (n,n*17)

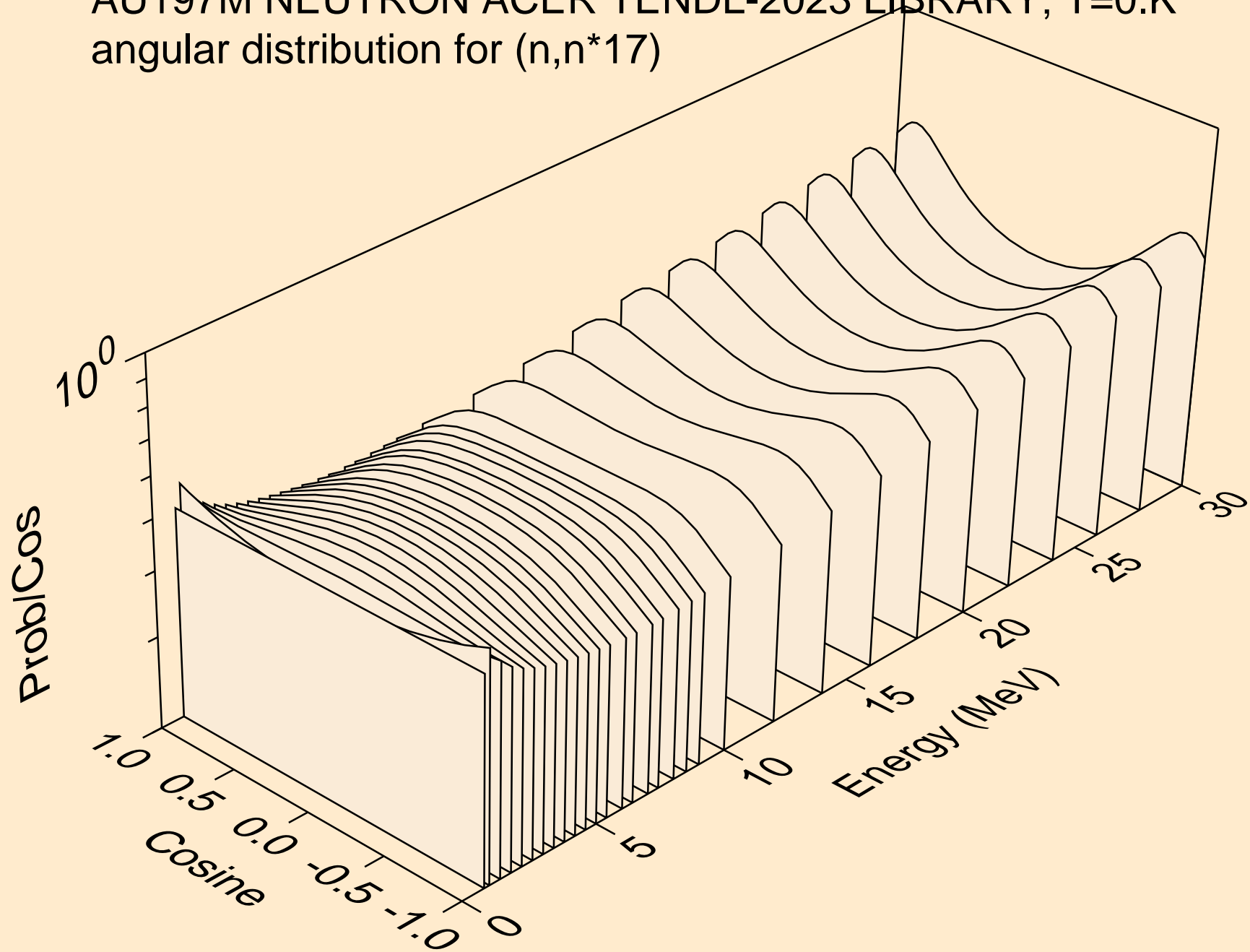

AU197M NEUTRON ACER TENDL-2023 LIBRARY; T=0.K
angular distribution for (n,n*18)

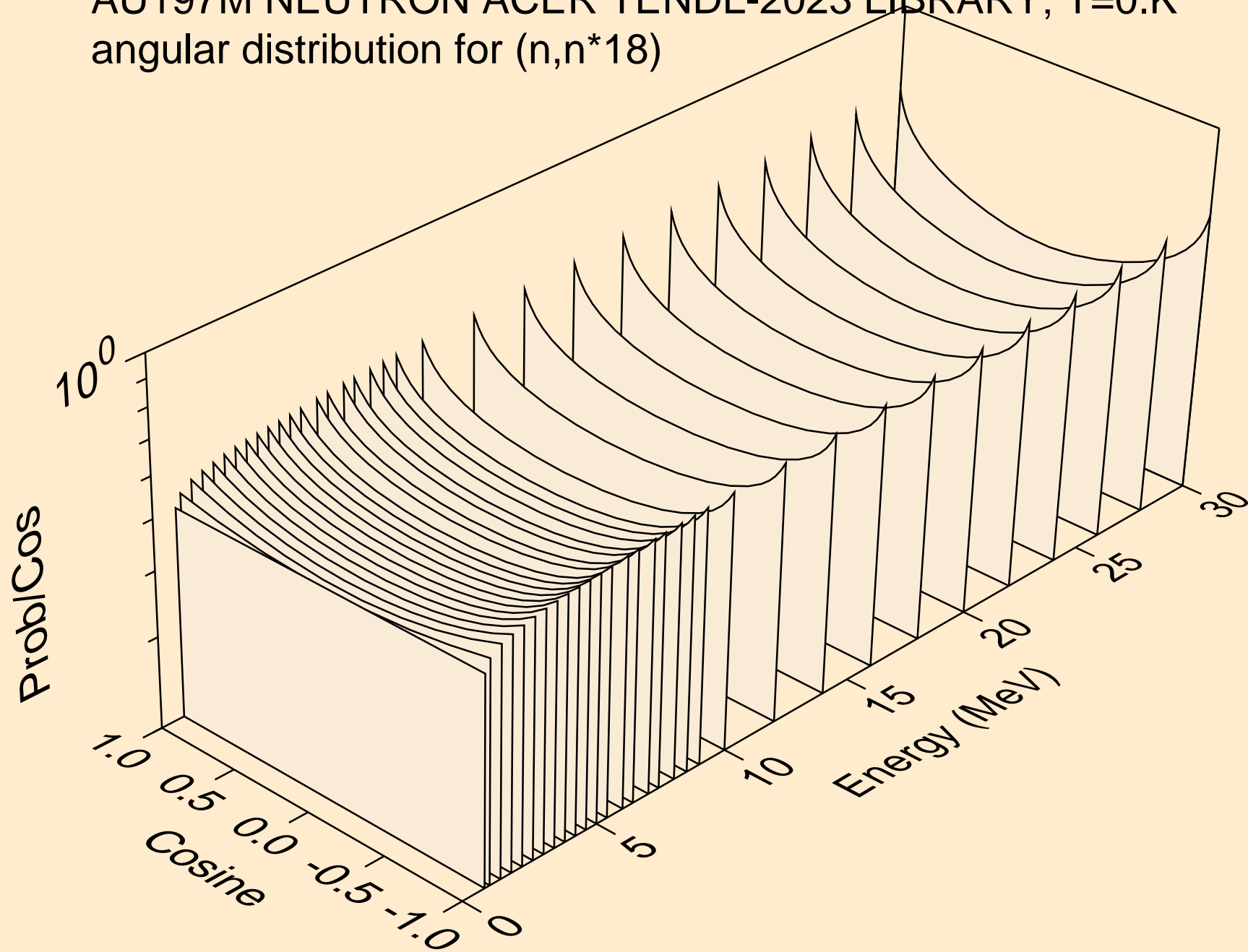

AU197M NEUTRON ACER TENDL-2023 LIBRARY; T=0.K
angular distribution for (n,n*19)

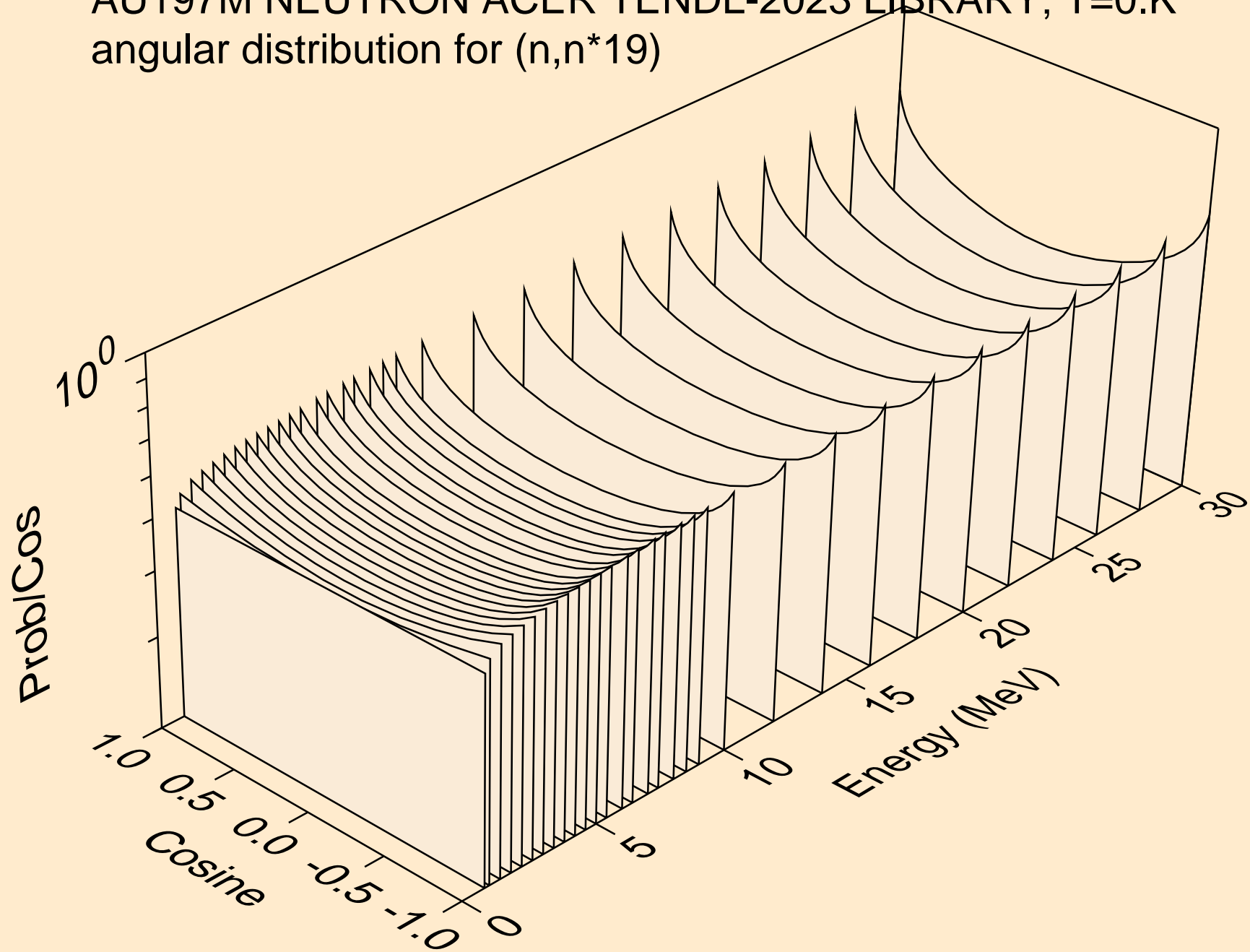

AU197M NEUTRON ACER TENDL-2023 LIBRARY; T=0.K
Neutron emission for (n,x)

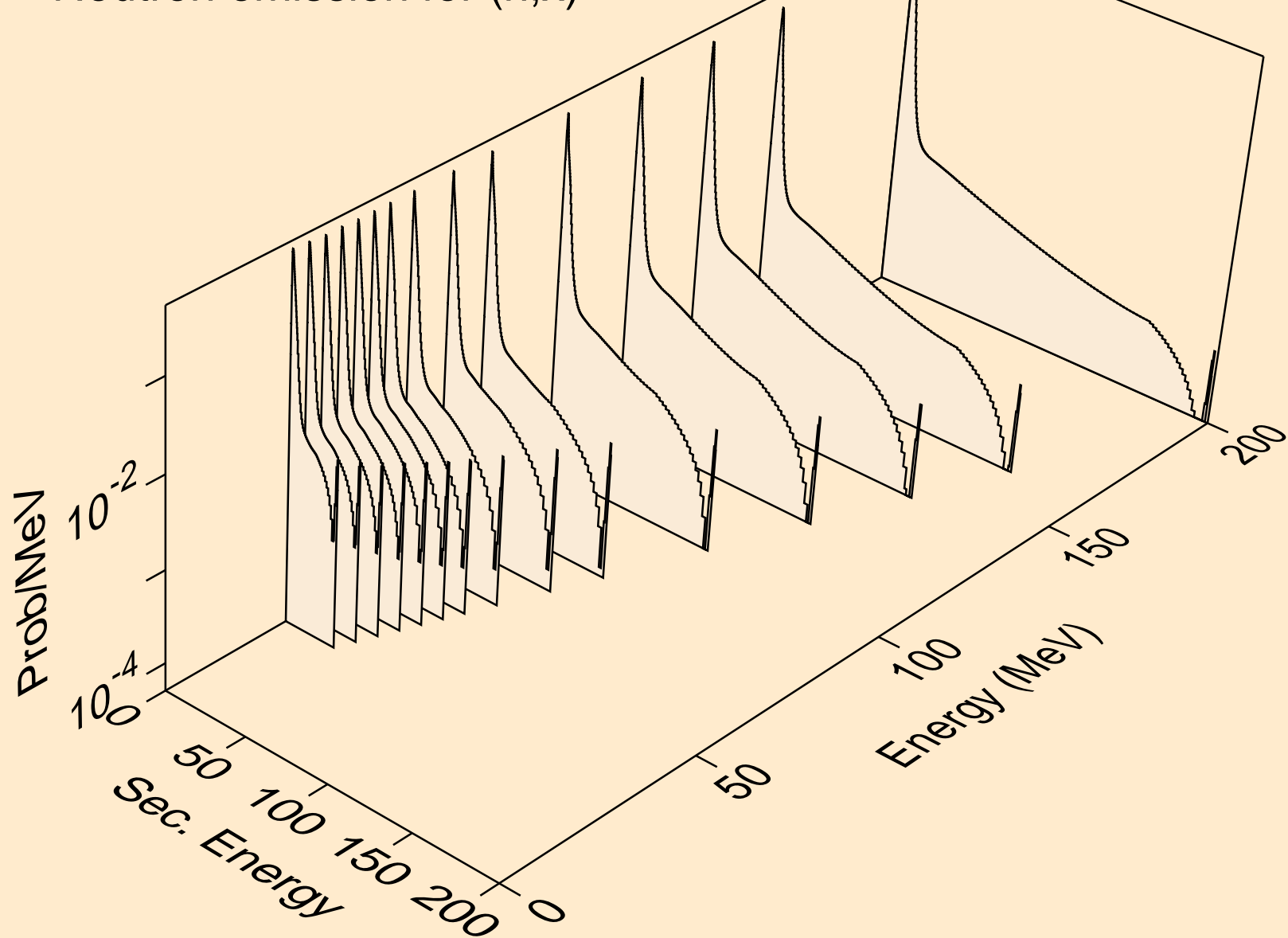

AU197M NEUTRON ACER TENDL-2023 LIBRARY; T=0.K
Neutron emission for (n,2nd)

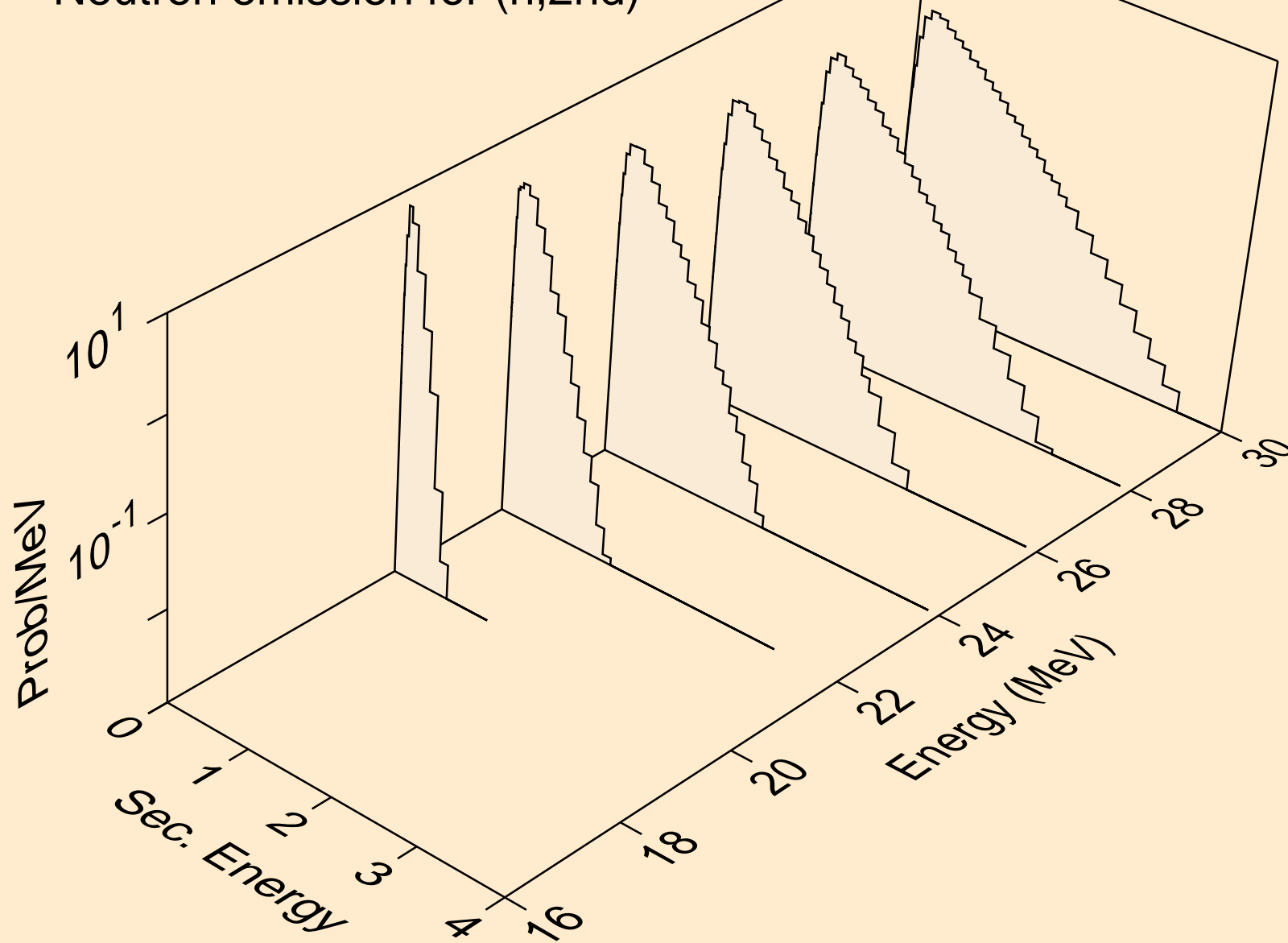

AU197M NEUTRON ACER TENDL-2023 LIBRARY; T=0.K
Neutron emission for (n,2n)

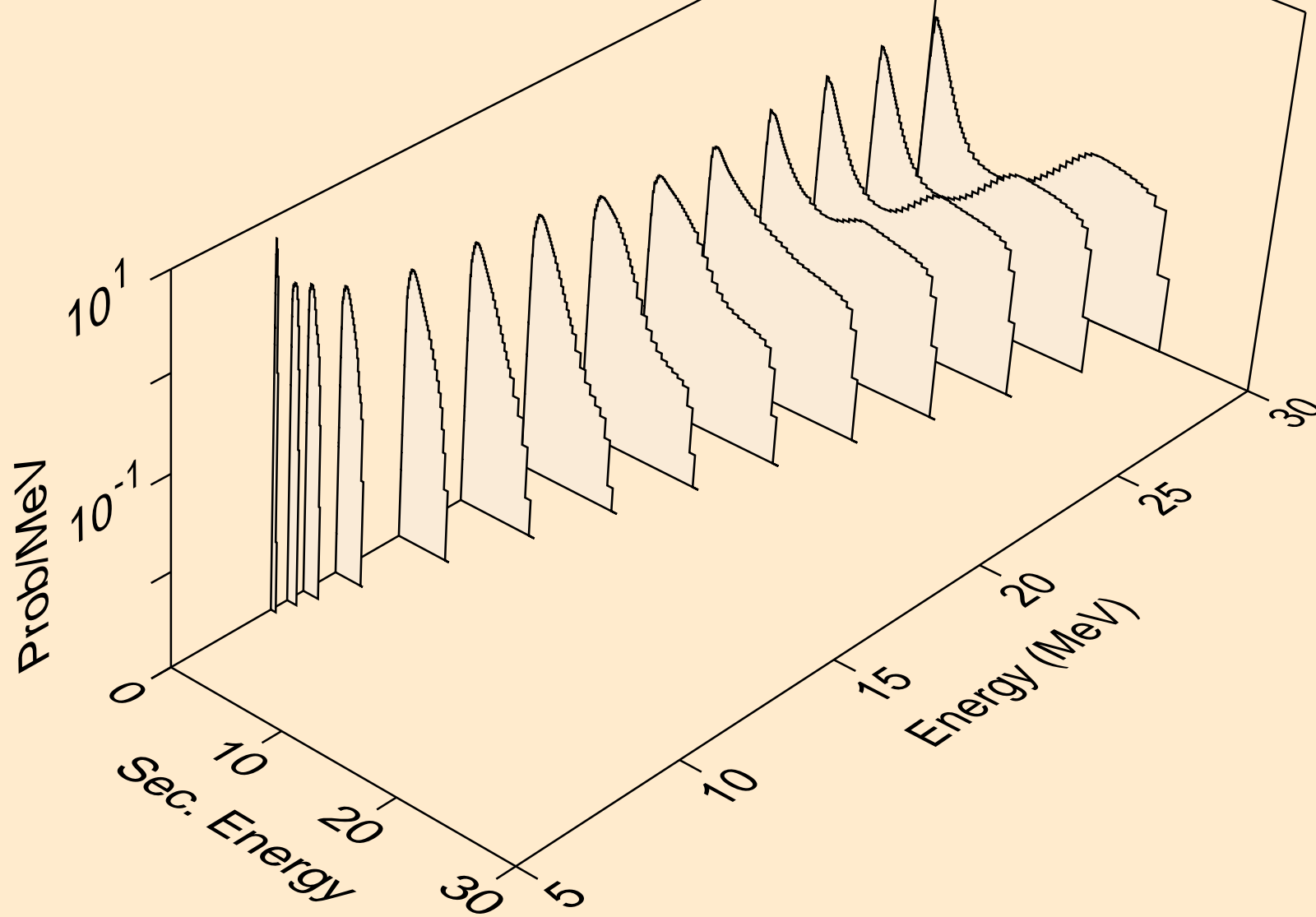

AU197M NEUTRON ACER TENDL-2023 LIBRARY; T=0.K
Neutron emission for (n,3n)

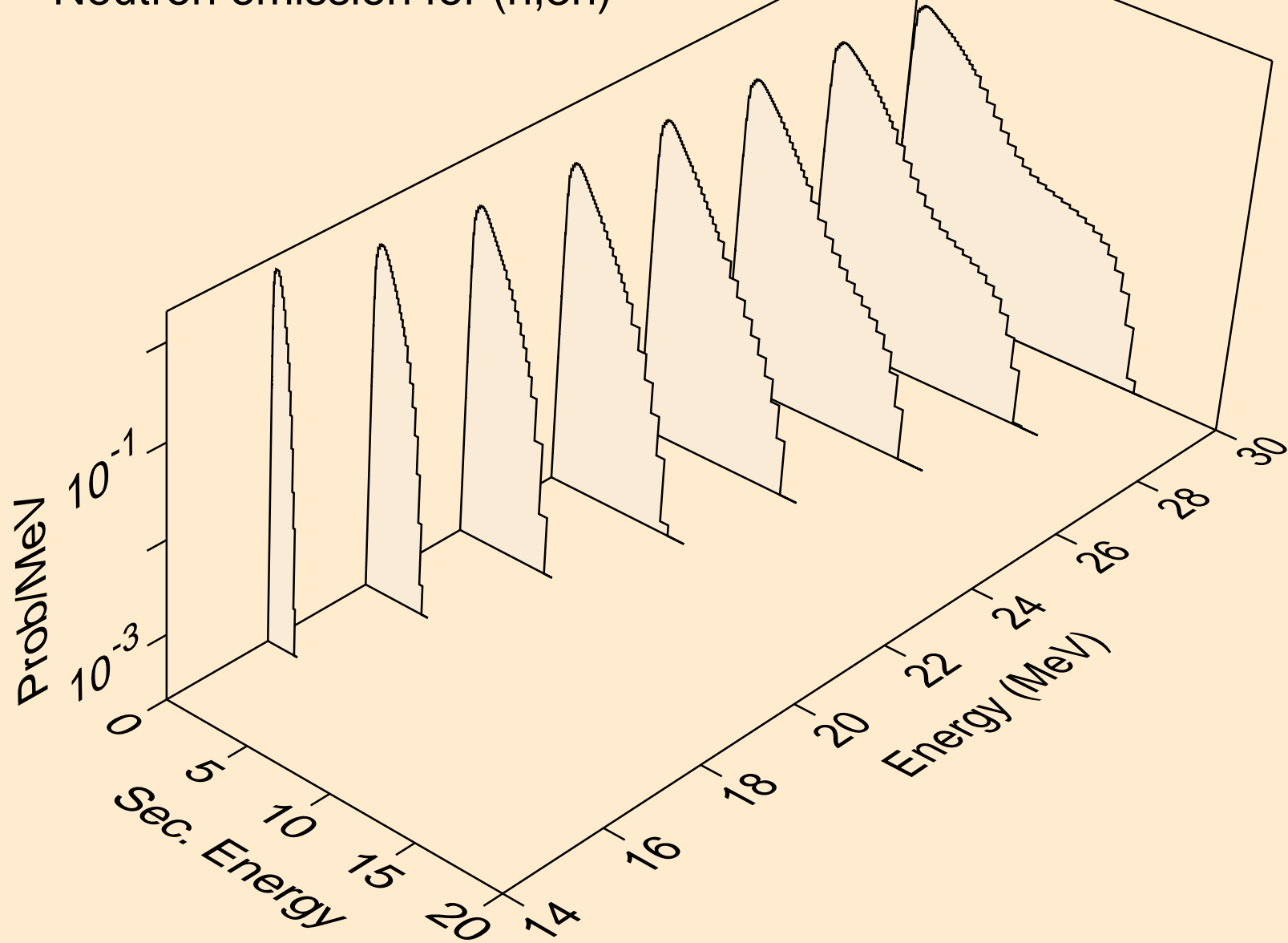

AU197M NEUTRON ACER TENDL-2023 LIBRARY; T=0.K
Neutron emission for (n,n*)a

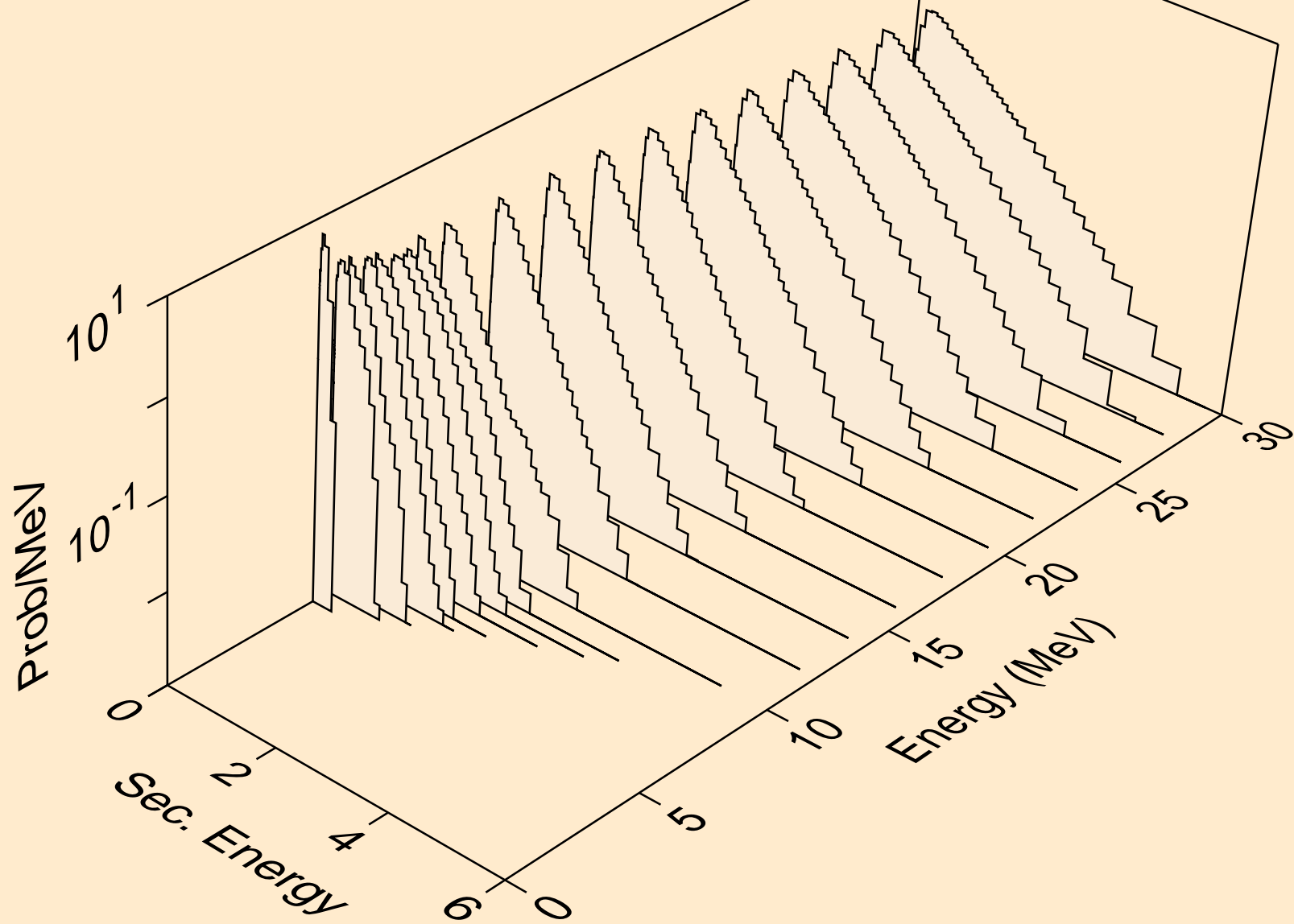

AU197M NEUTRON ACER TENDL-2023 LIBRARY; T=0.K
Neutron emission for (n,2n)a

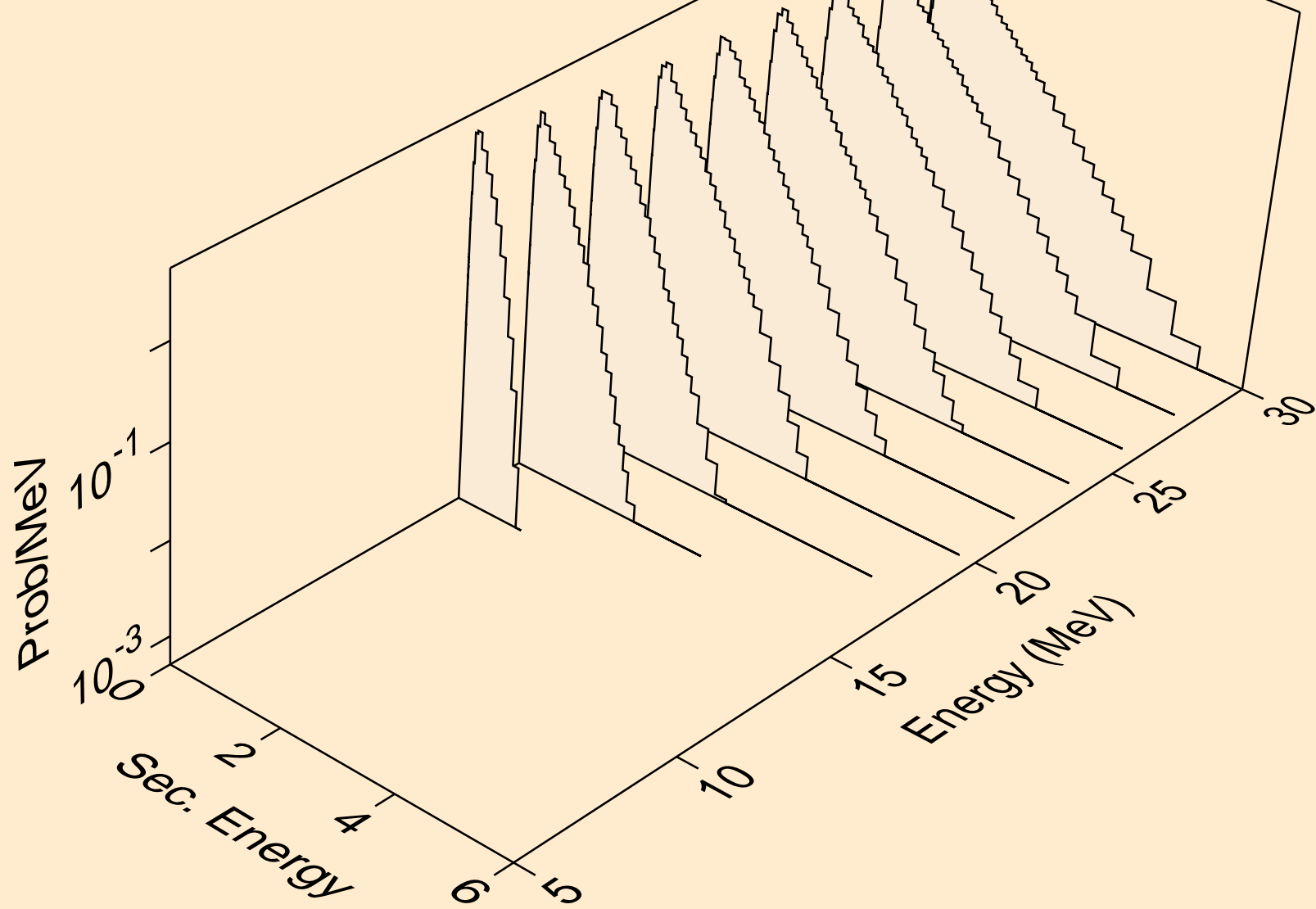

AU197M NEUTRON ACER TENDL-2023 LIBRARY; T=0.K
Neutron emission for (n,3n)a

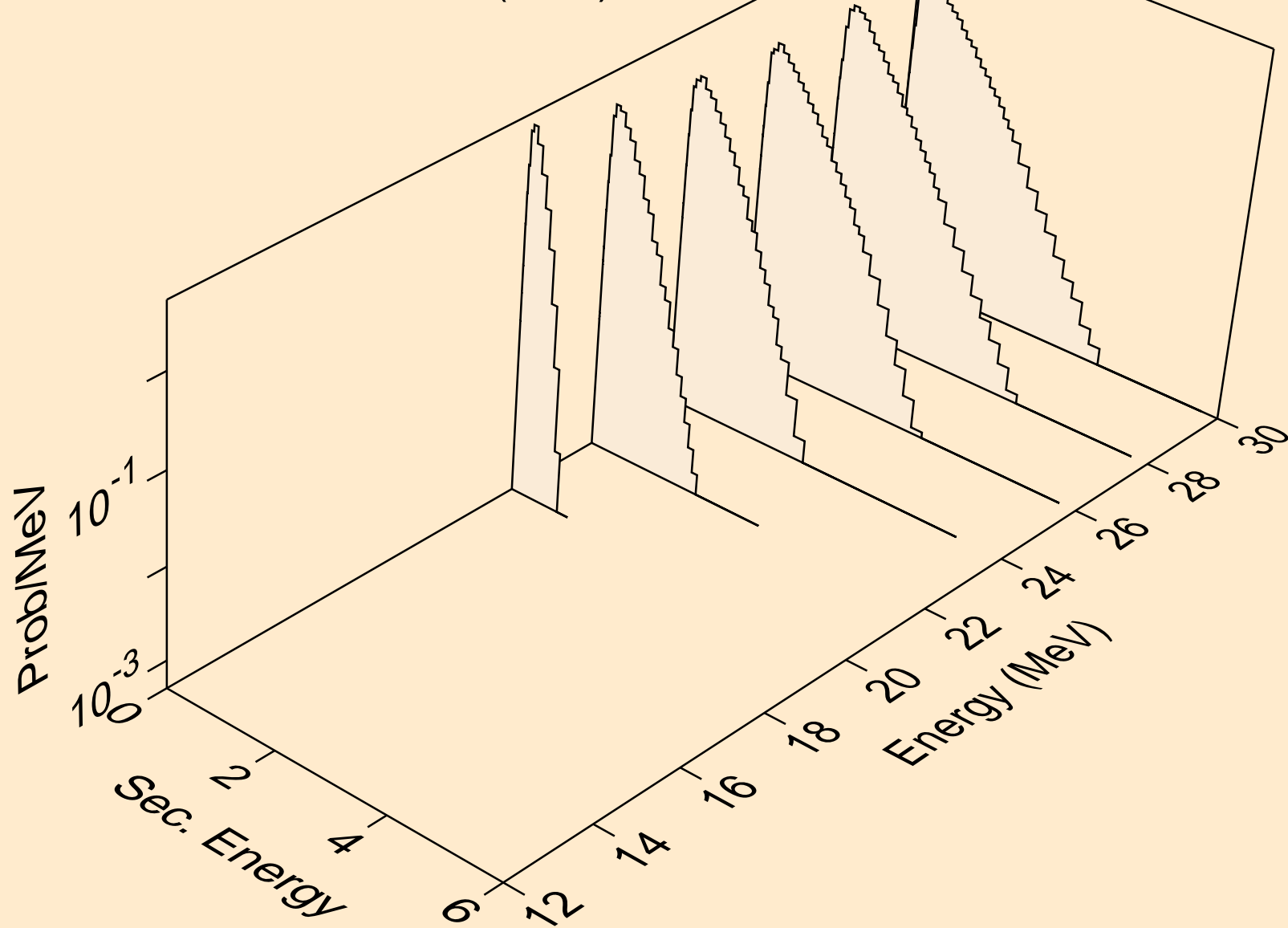

AU197M NEUTRON ACER TENDL-2023 LIBRARY; T=0.K
Neutron emission for (n,n*)p

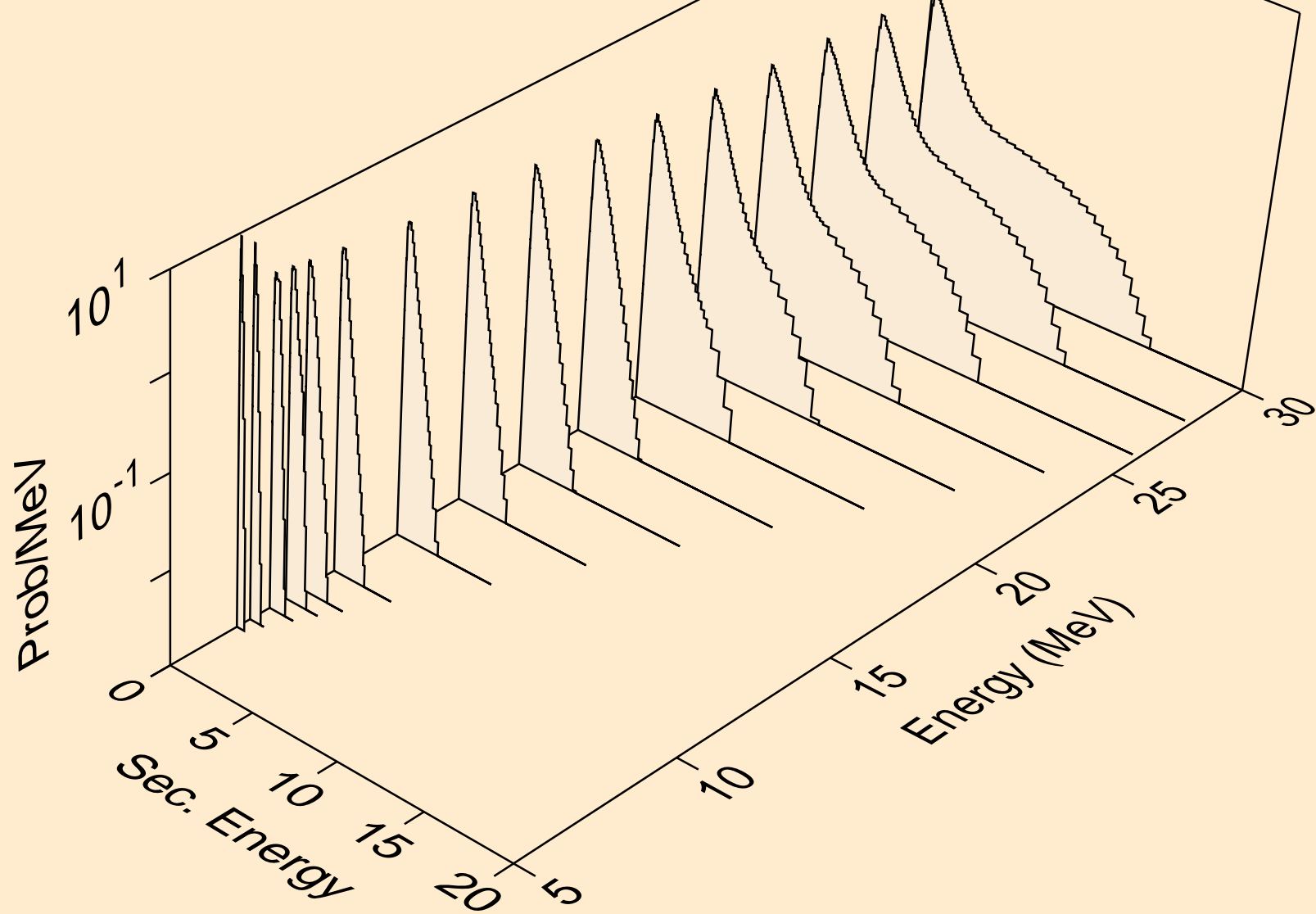

AU197M NEUTRON ACER TENDL-2023 LIBRARY; T=0.K
Neutron emission for (n,n*)d

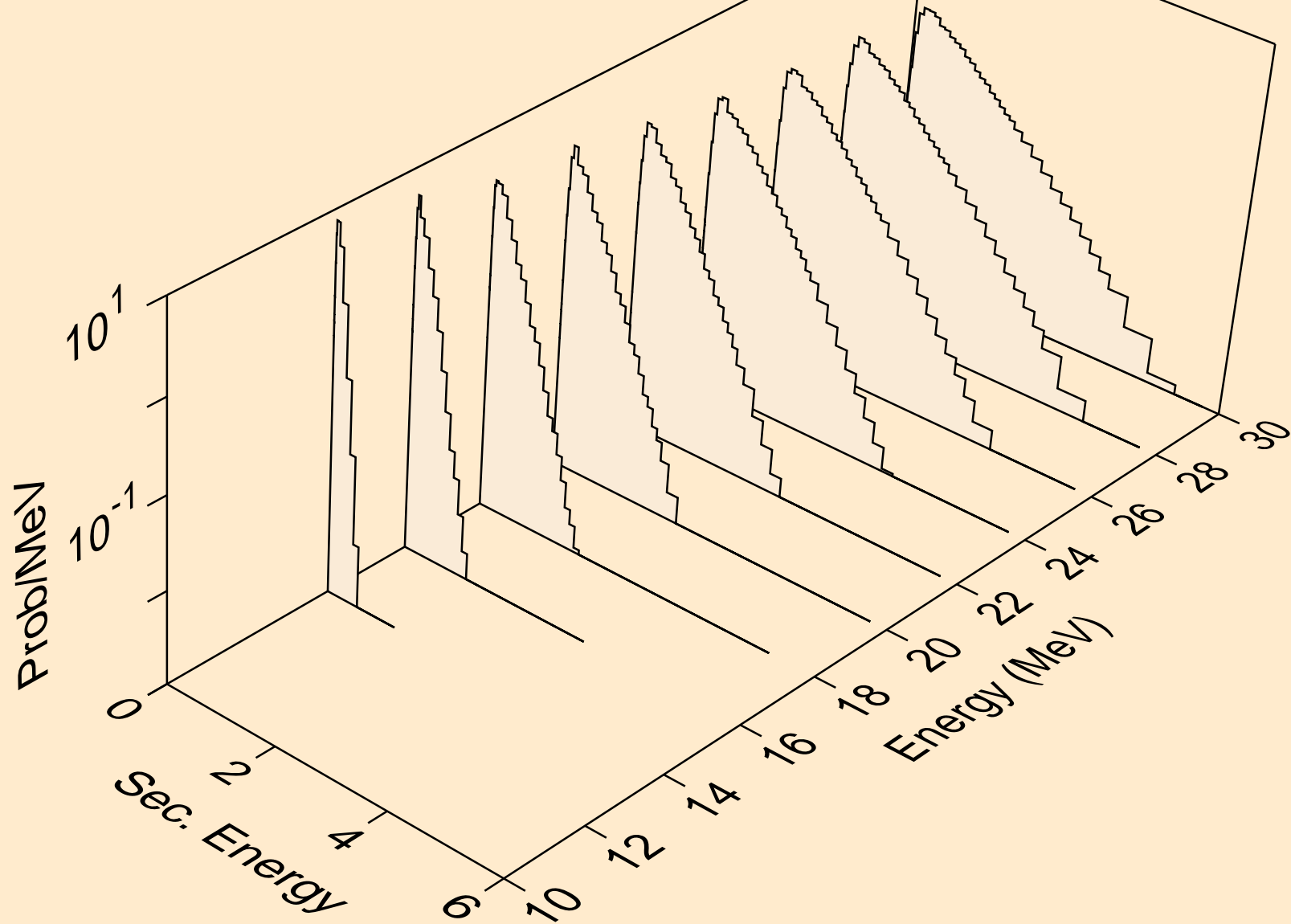

AU197M NEUTRON ACER TENDL-2023 LIBRARY; T=0.K
Neutron emission for (n,n*)t

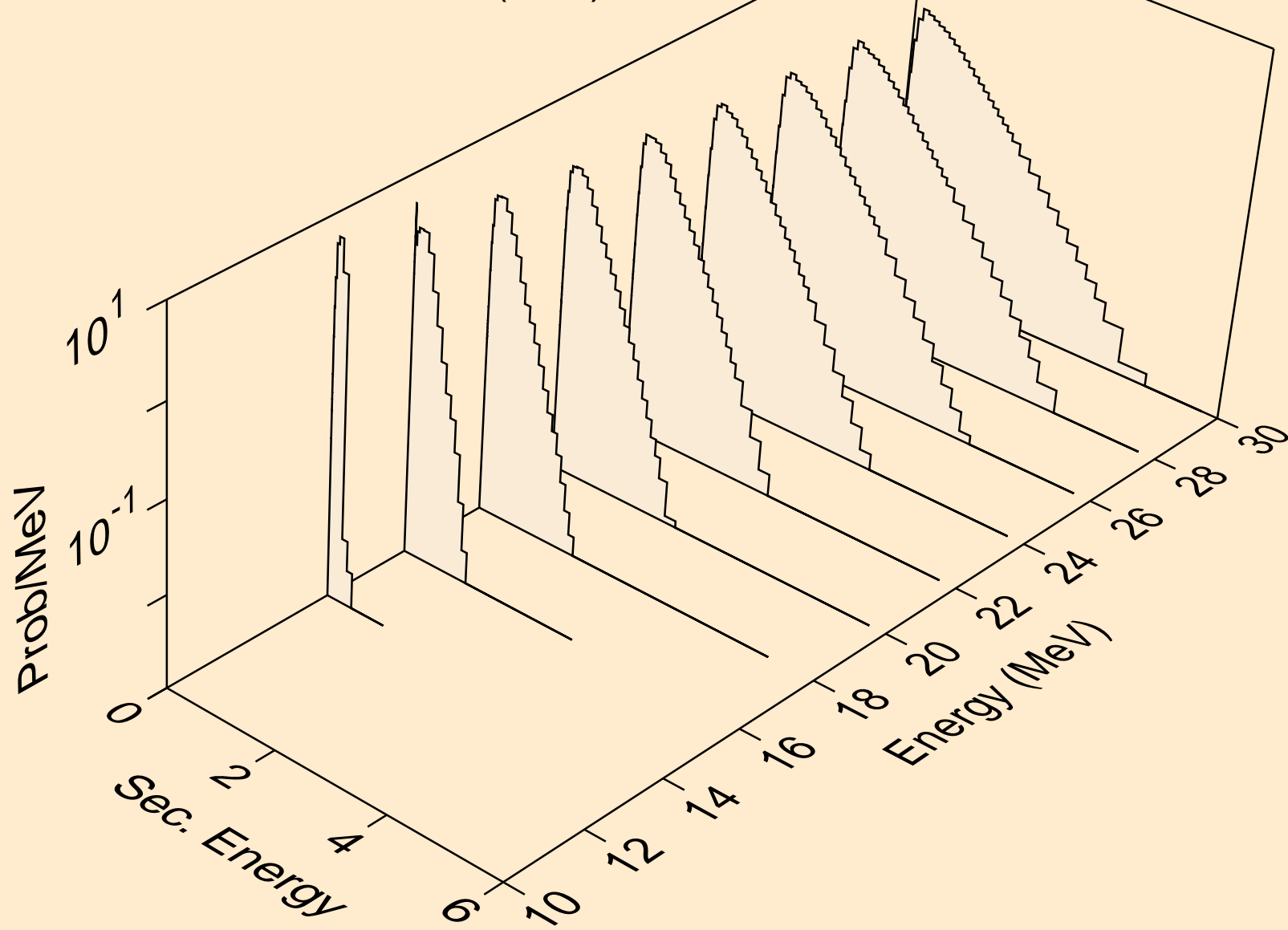

AU197M NEUTRON ACER TENDL-2023 LIBRARY; T=0.K
Neutron emission for (n,n*)he3

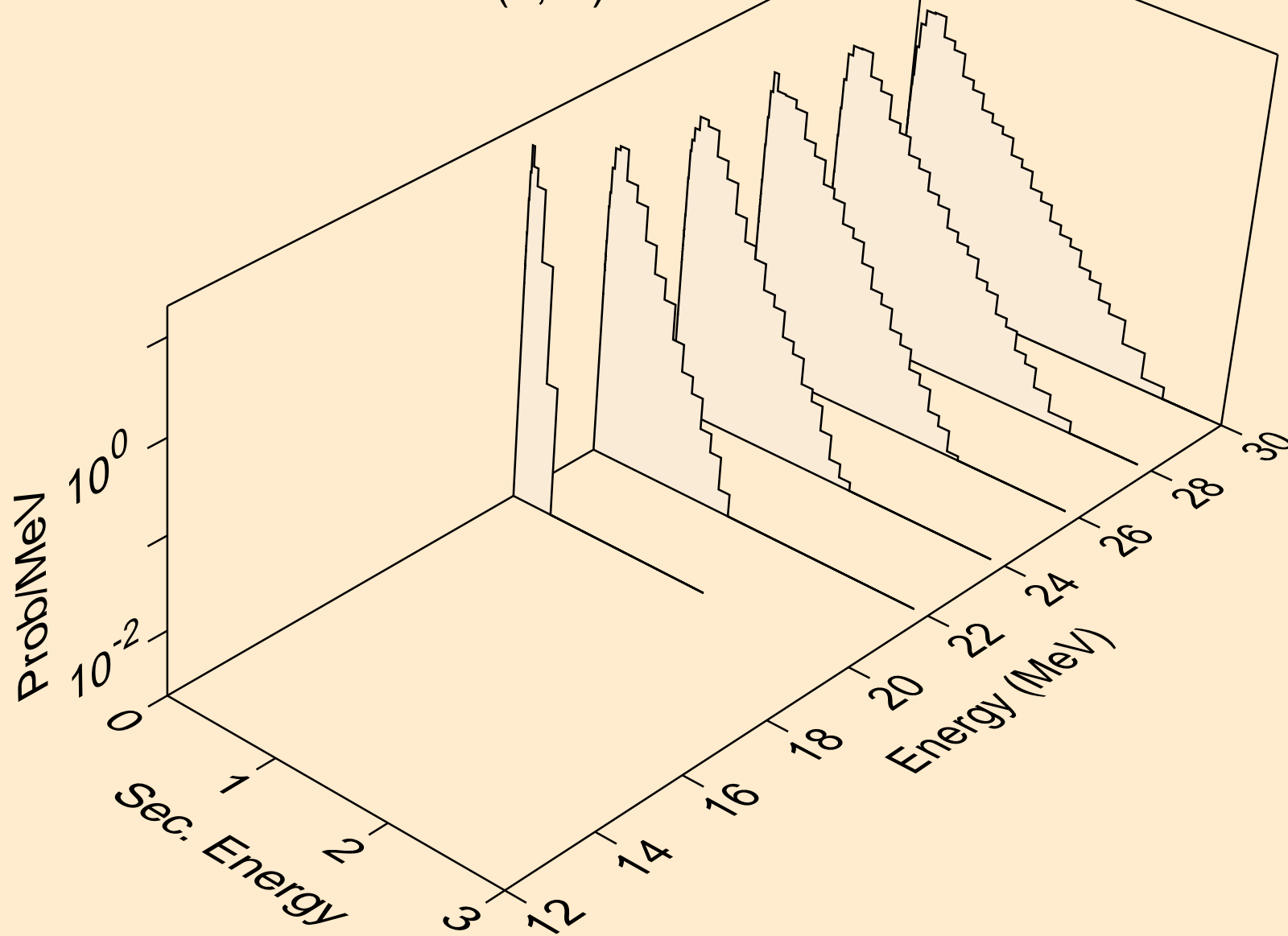

AU197M NEUTRON ACER TENDL-2023 LIBRARY; T=0.K
Neutron emission for (n,4n)

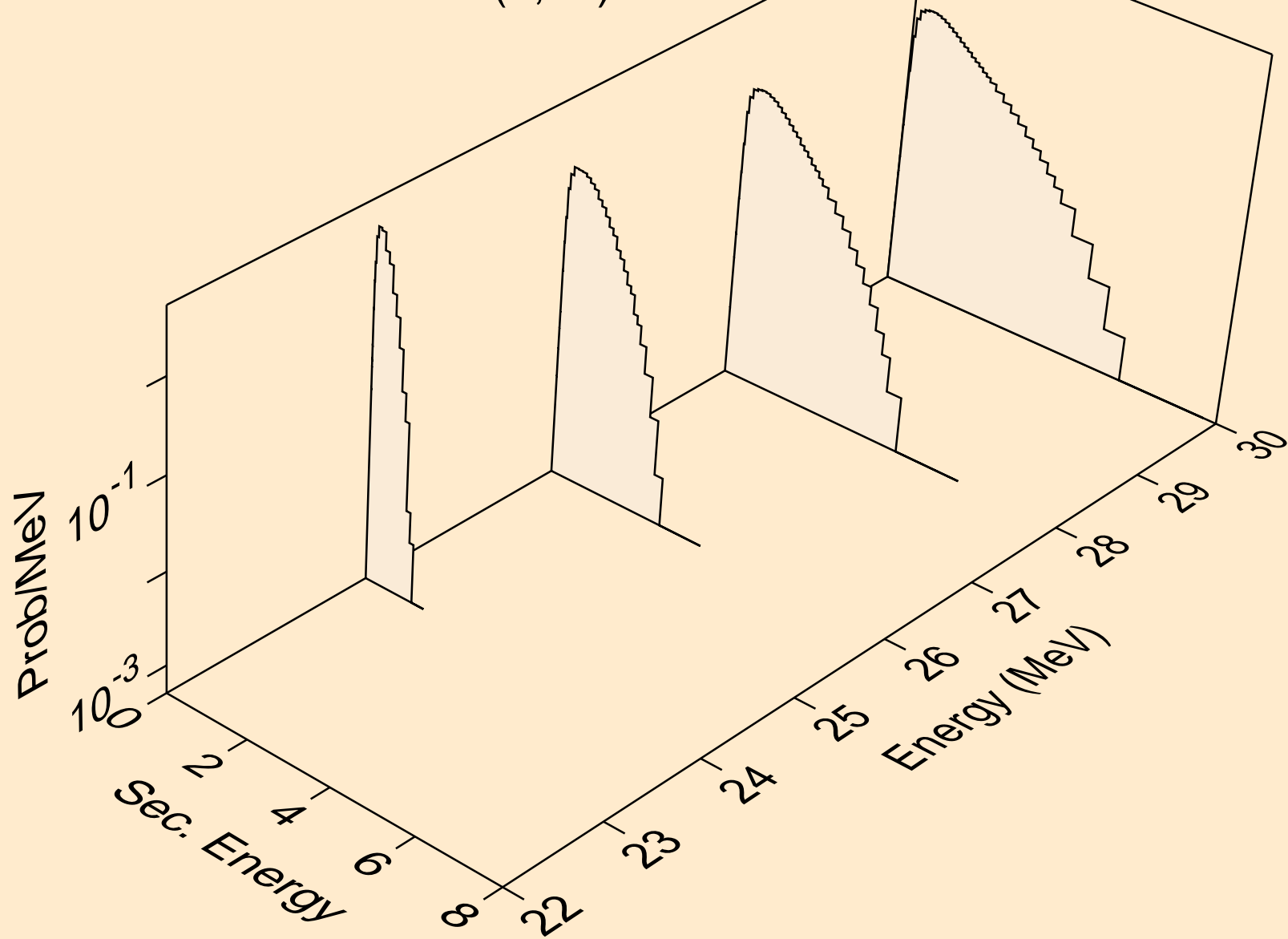

AU197M NEUTRON ACER TENDL-2023 LIBRARY; T=0.K
Neutron emission for (n,2np)

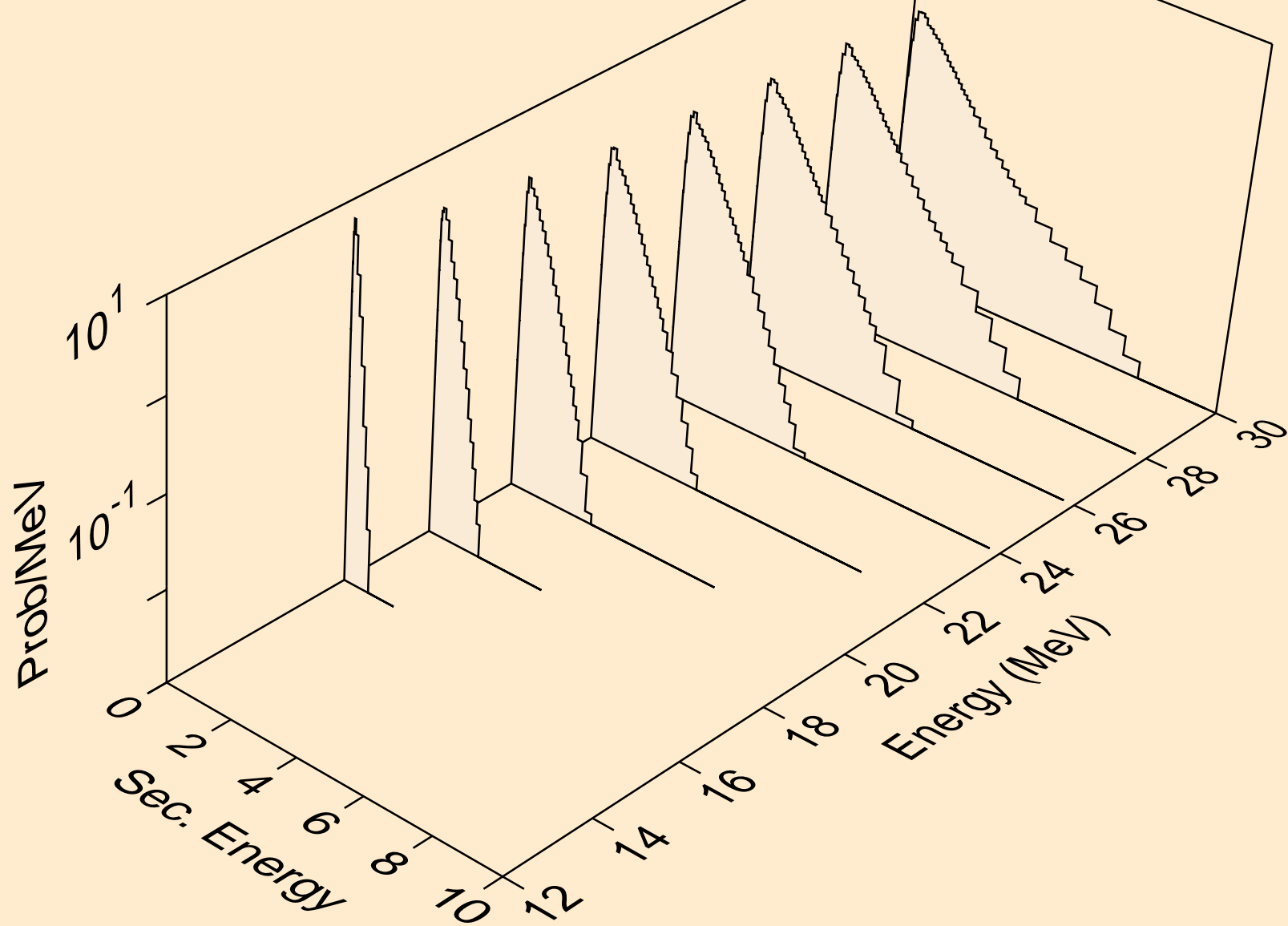

AU197M NEUTRON ACER TENDL-2023 LIBRARY; T=0.K
Neutron emission for (n,3np)

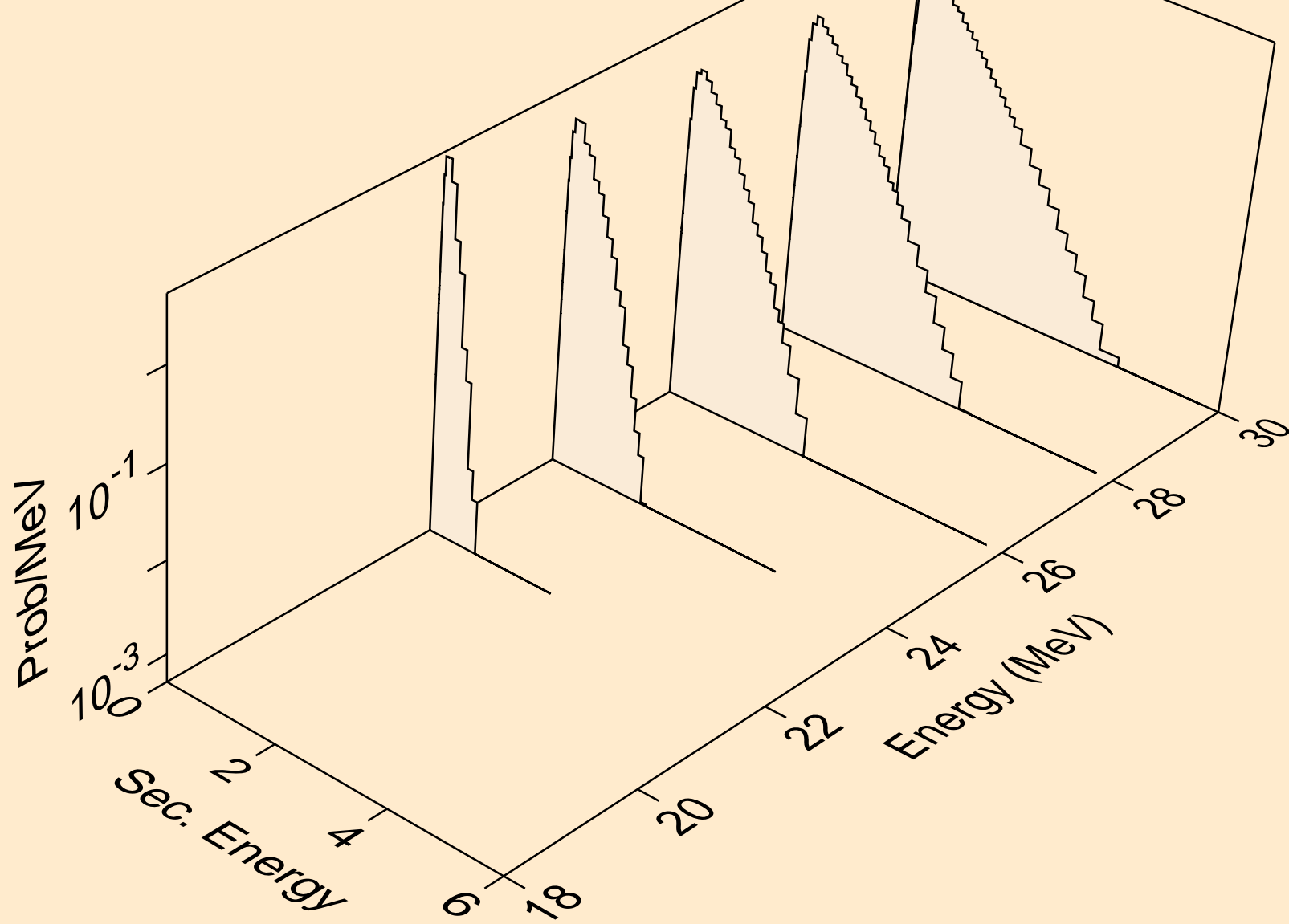

AU197M NEUTRON ACER TENDL-2023 LIBRARY; T=0.K
Neutron emission for (n,n2p)

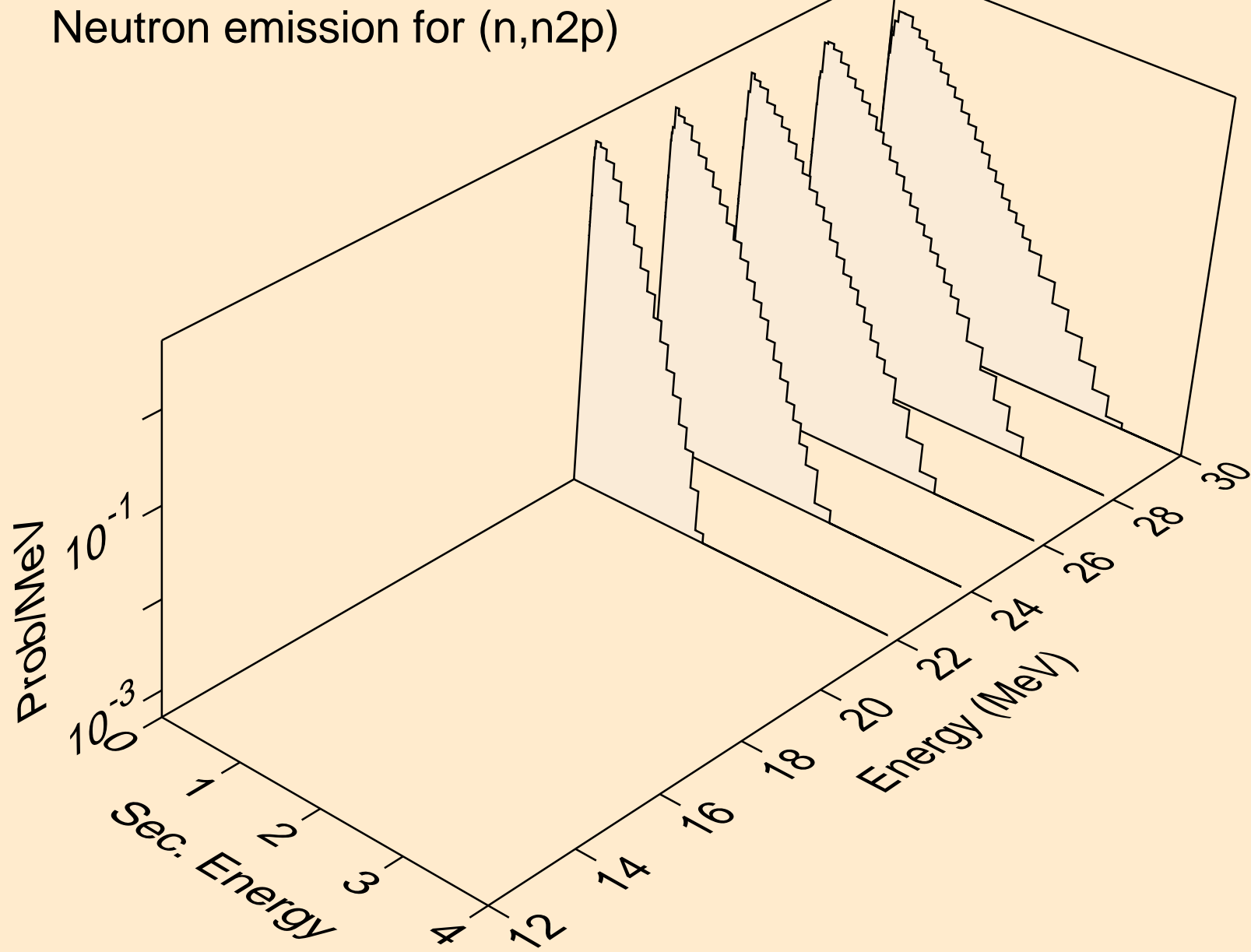

AU197M NEUTRON ACER TENDL-2023 LIBRARY; T=0.K
Neutron emission for (n,npa)

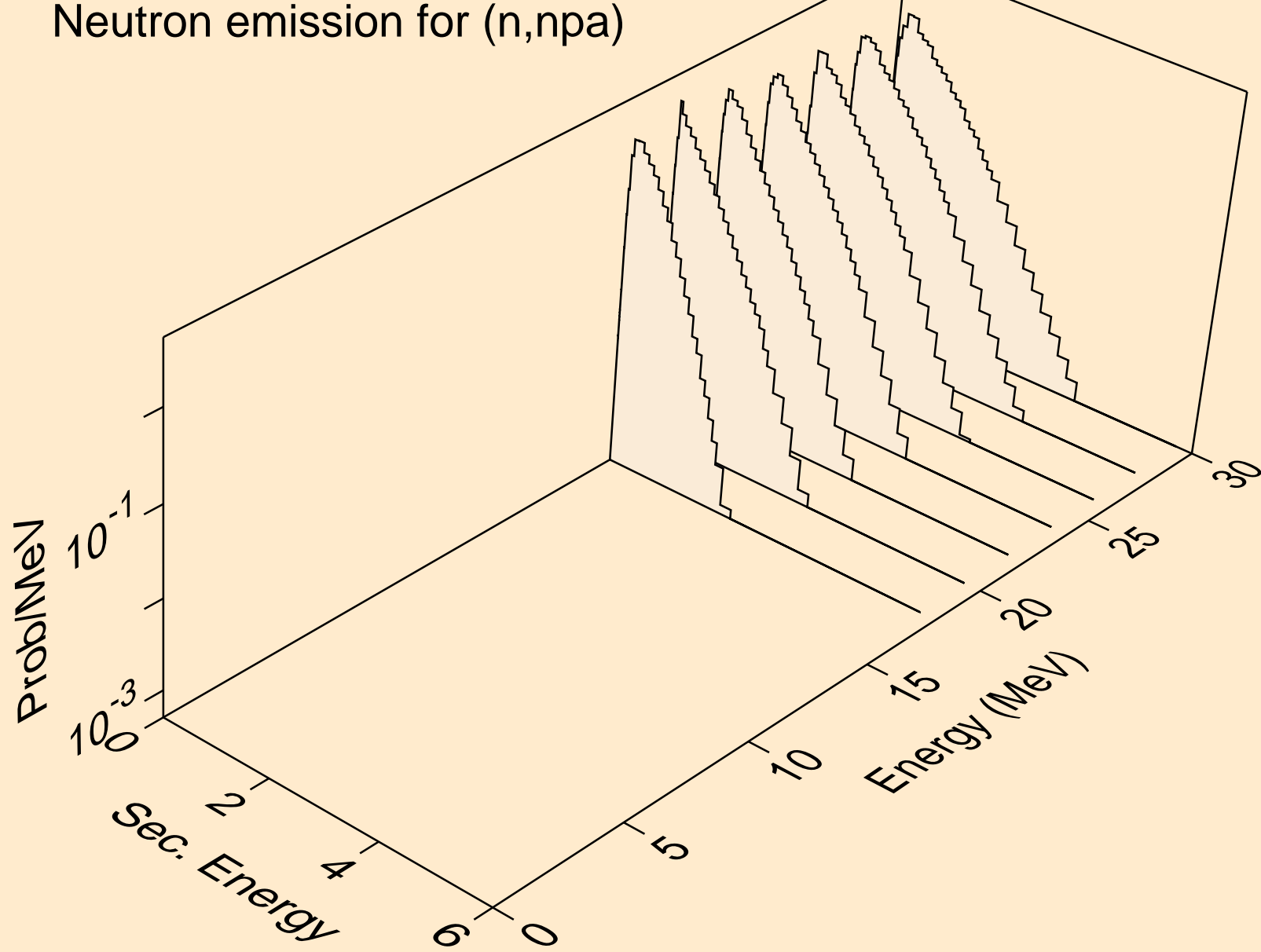

AU197M NEUTRON ACER TENDL-2023 LIBRARY; T=0.K
Neutron emission for (n,n*c)

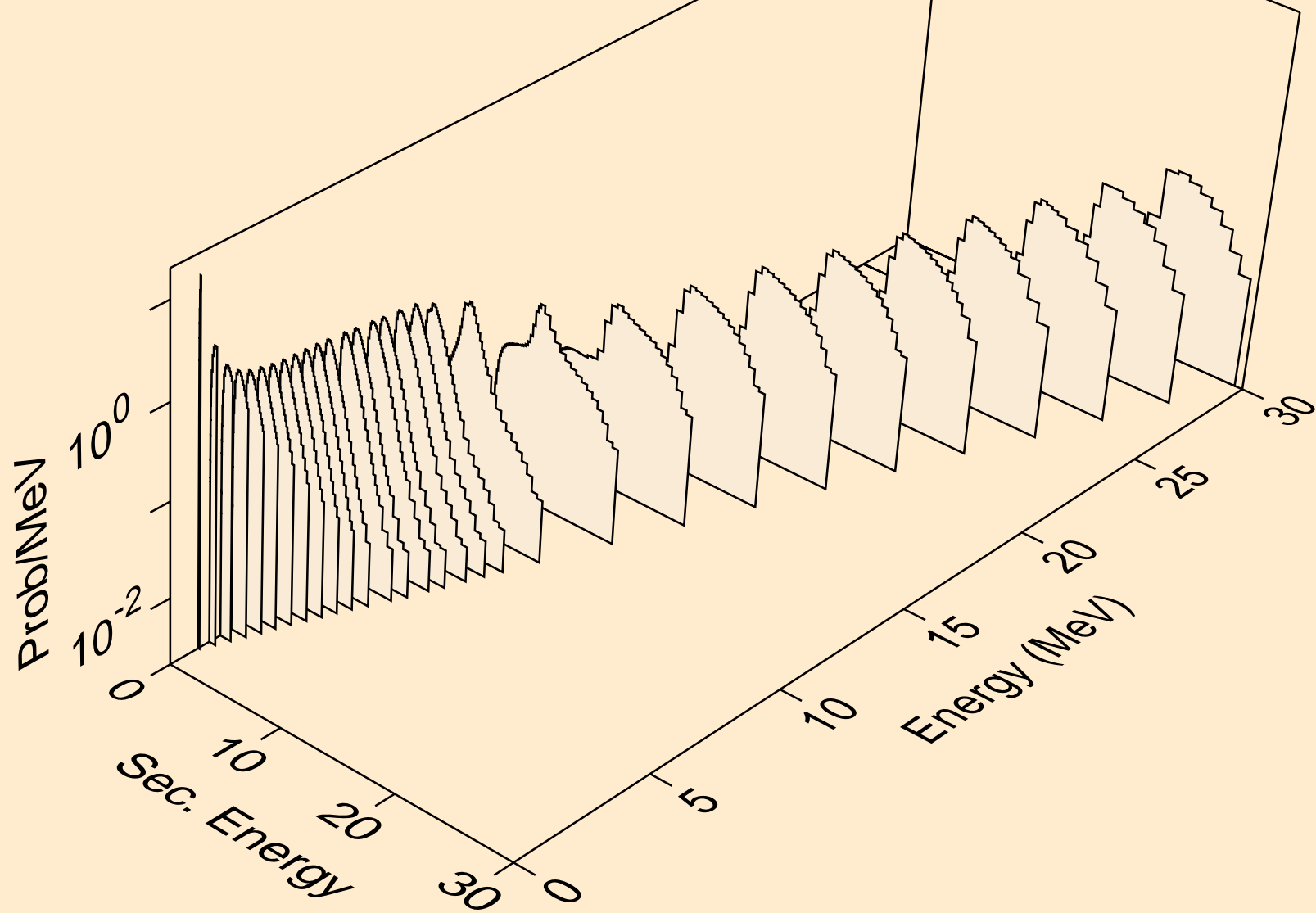

AU197M NEUTRON ACER TENDL-2023 LIBRARY; T=0.K
Photon emission for (n,x)

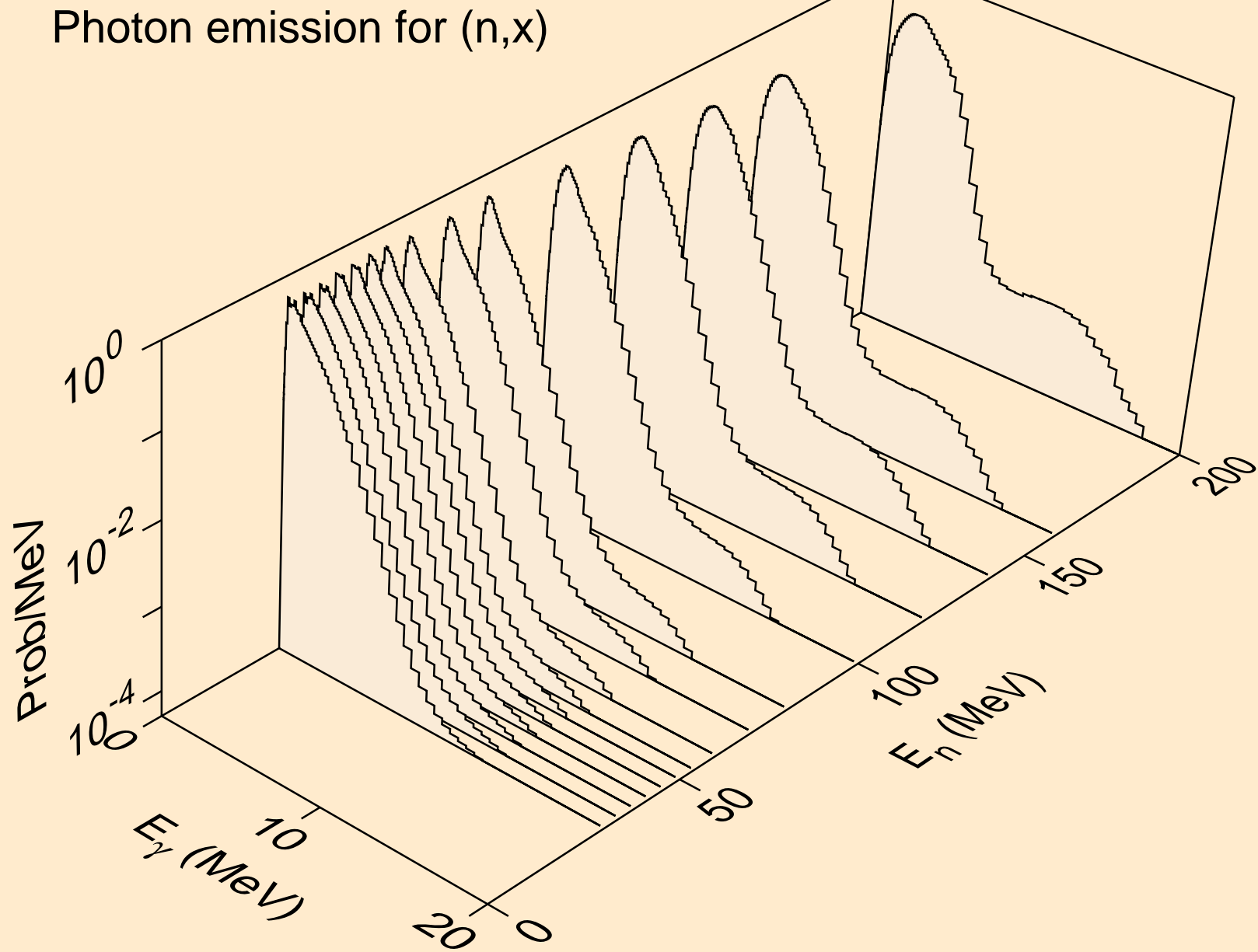

AU197M NEUTRON ACER TENDL-2023 LIBRARY; T=0.K
Photon emission for (n,2nd)

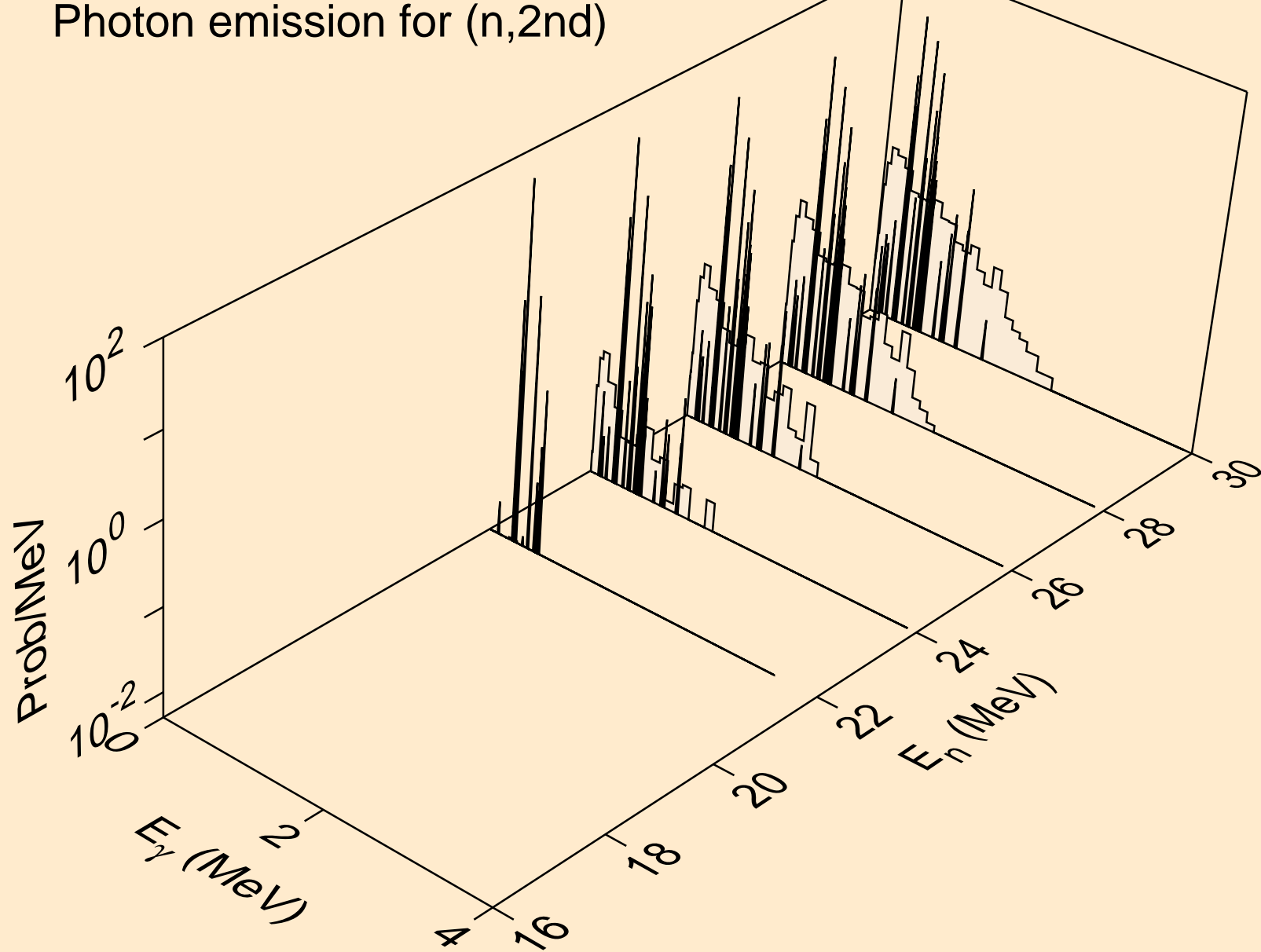

AU197M NEUTRON ACER TENDL-2023 LIBRARY; T=0.K
Photon emission for (n,2n)

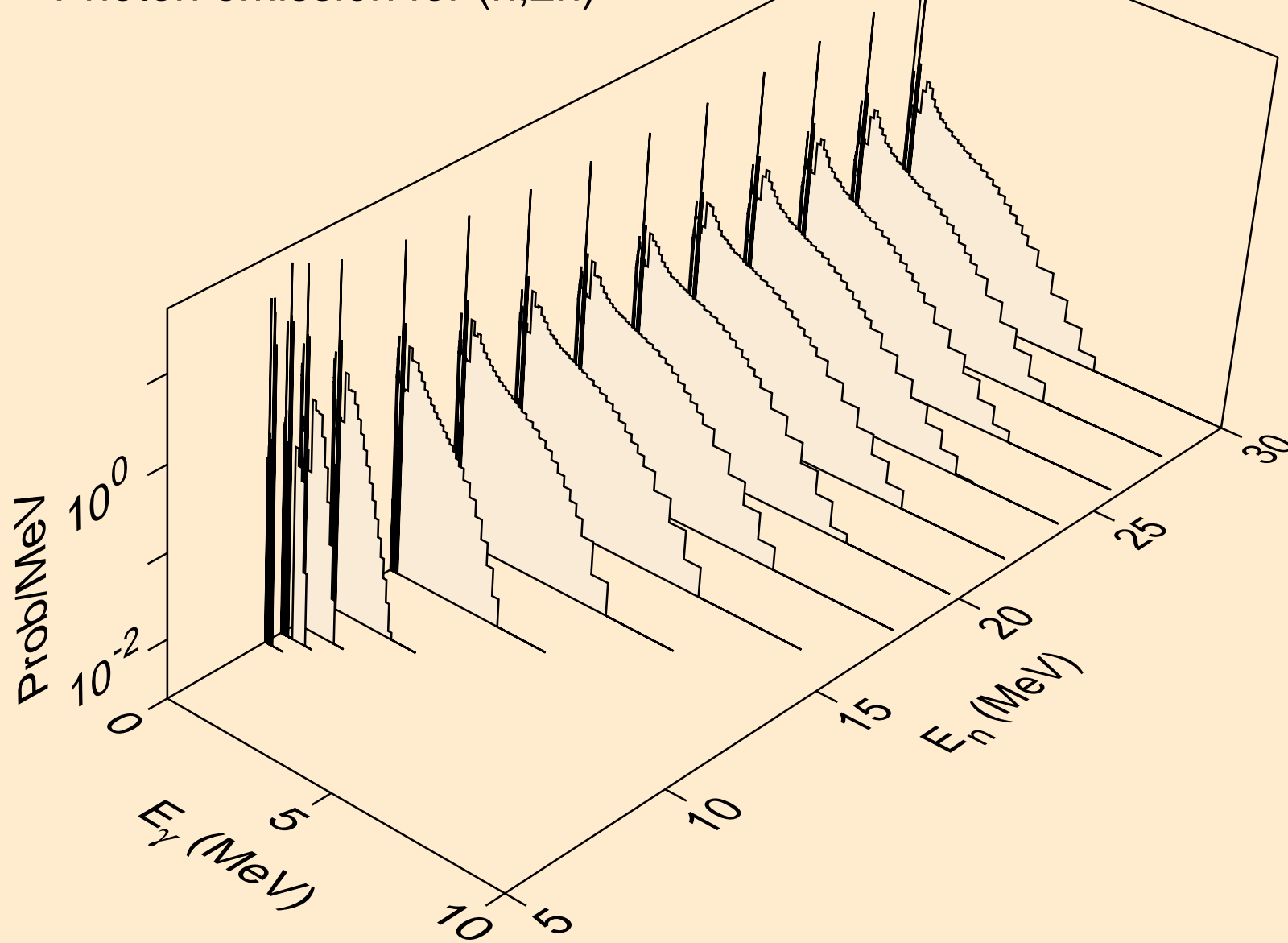

AU197M NEUTRON ACER TENDL-2023 LIBRARY; T=0.K
Photon emission for (n,3n)

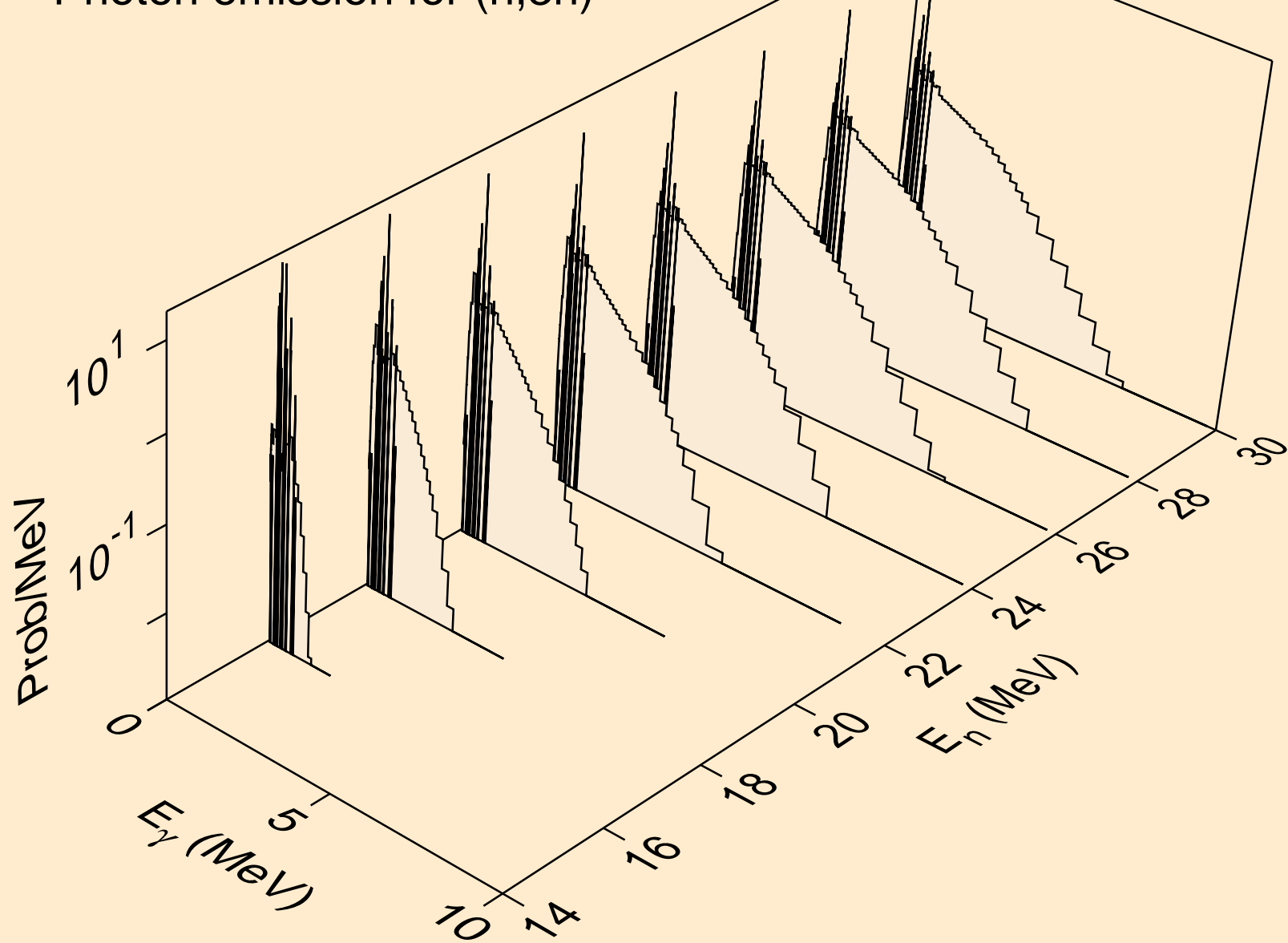

AU197M NEUTRON ACER TENDL-2023 LIBRARY; T=0.K
Photon emission for (n,n*)a

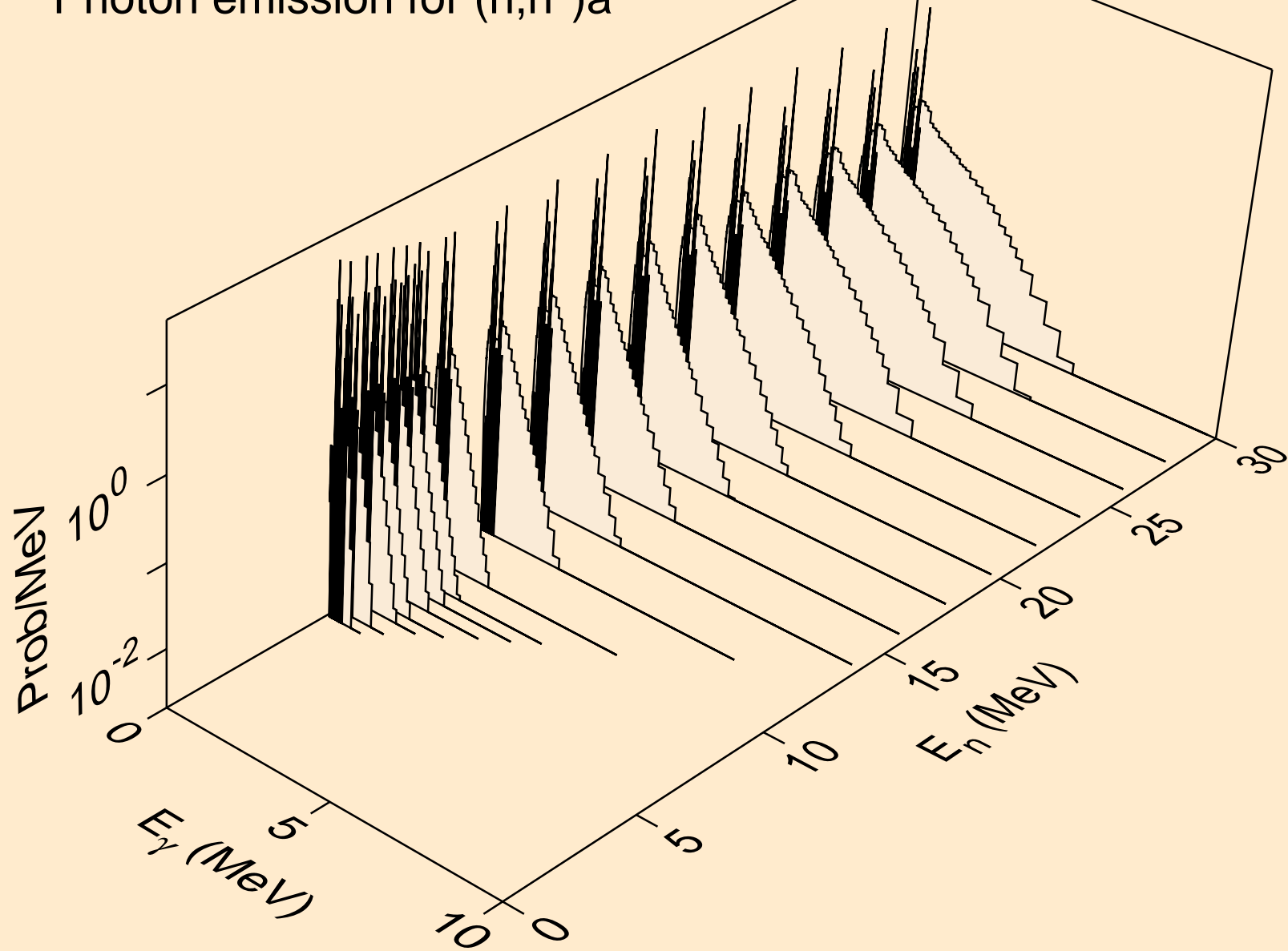

AU197M NEUTRON ACER TENDL-2023 LIBRARY; T=0.K
Photon emission for (n,2n)a

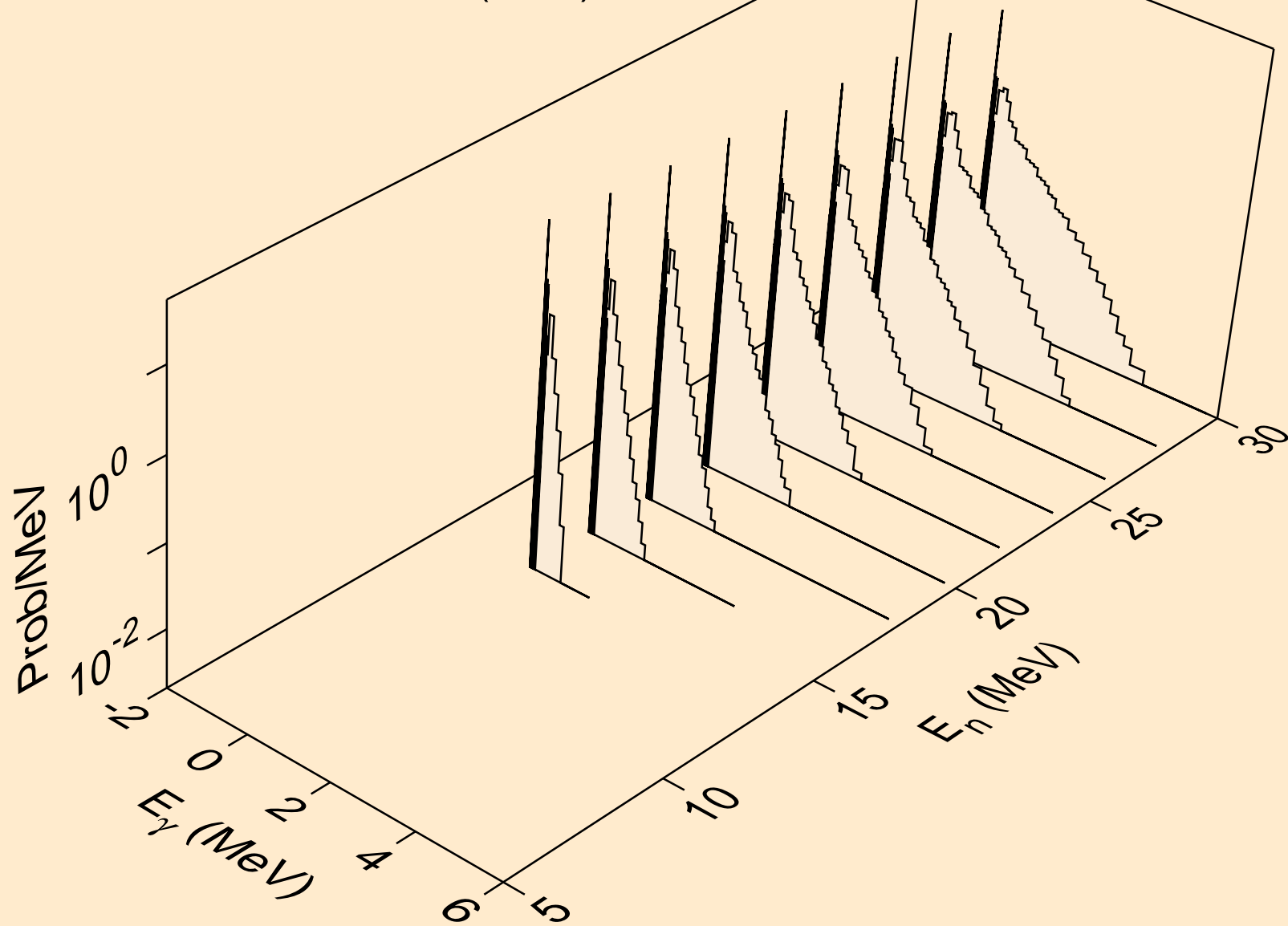

AU197M NEUTRON ACER TENDL-2023 LIBRARY; T=0.K
Photon emission for (n,3n)a

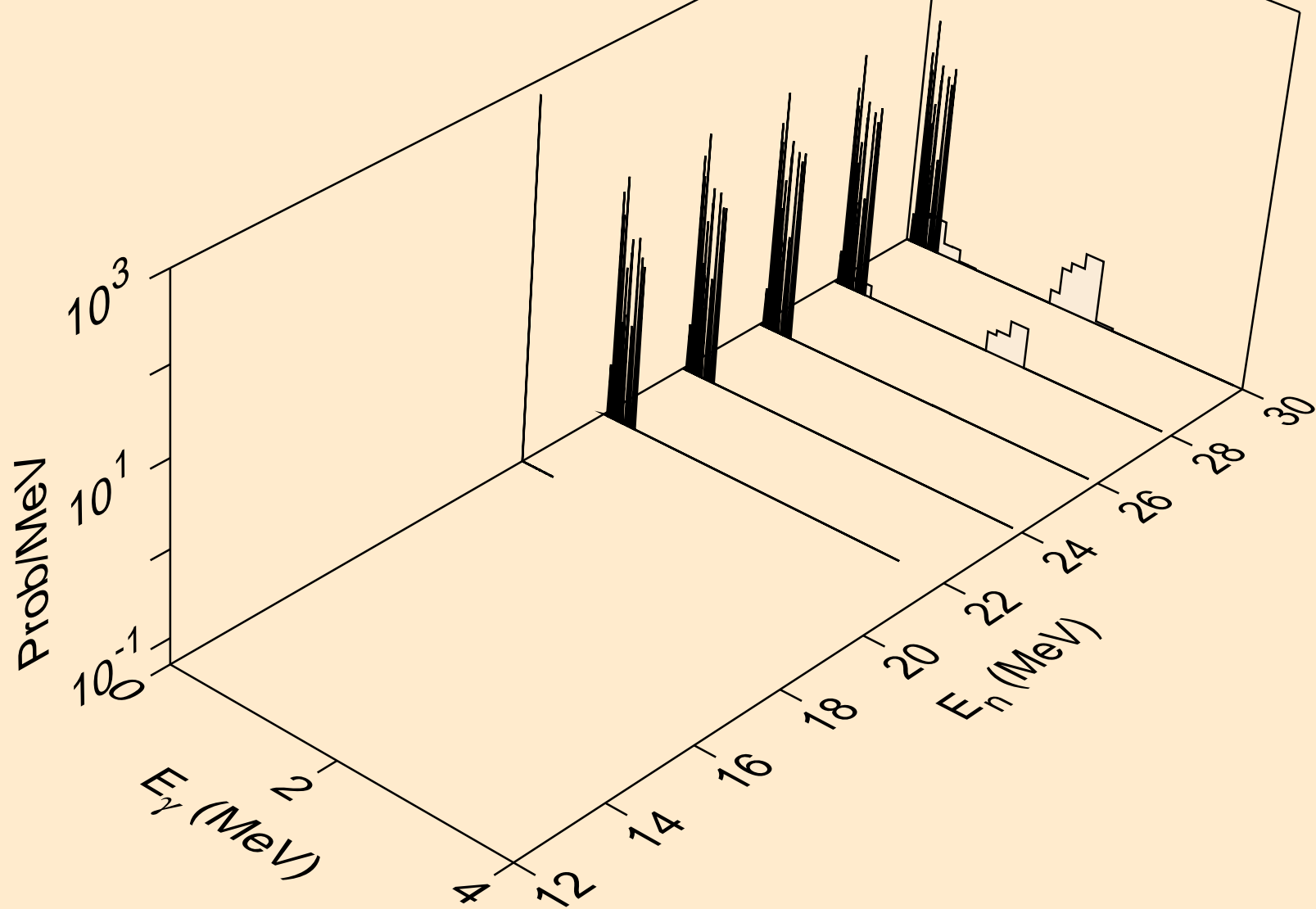

AU197M NEUTRON ACER TENDL-2023 LIBRARY; T=0.K
Photon emission for (n,n*)p

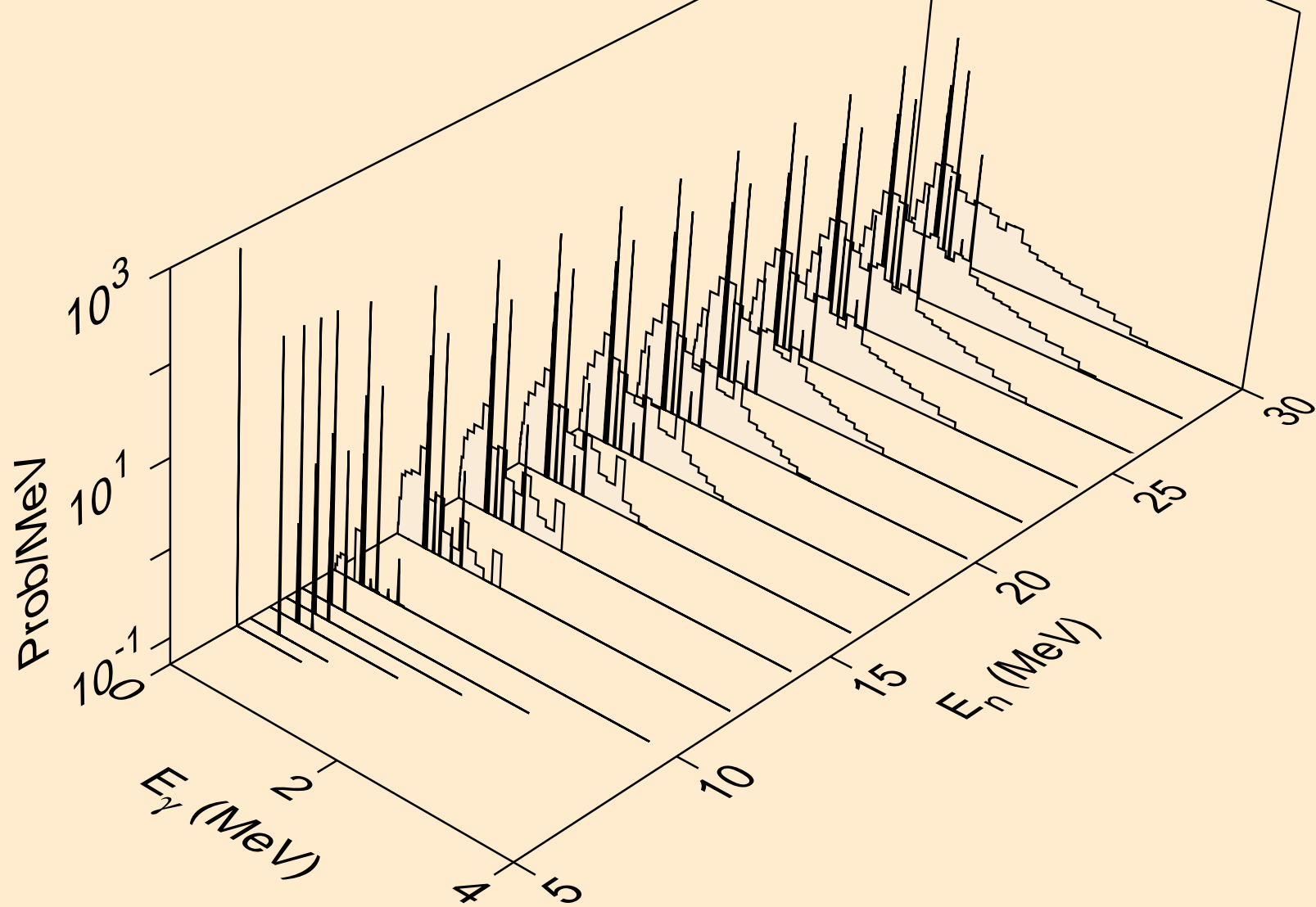

AU197M NEUTRON ACER TENDL-2023 LIBRARY; T=0.K
Photon emission for (n,n*)d

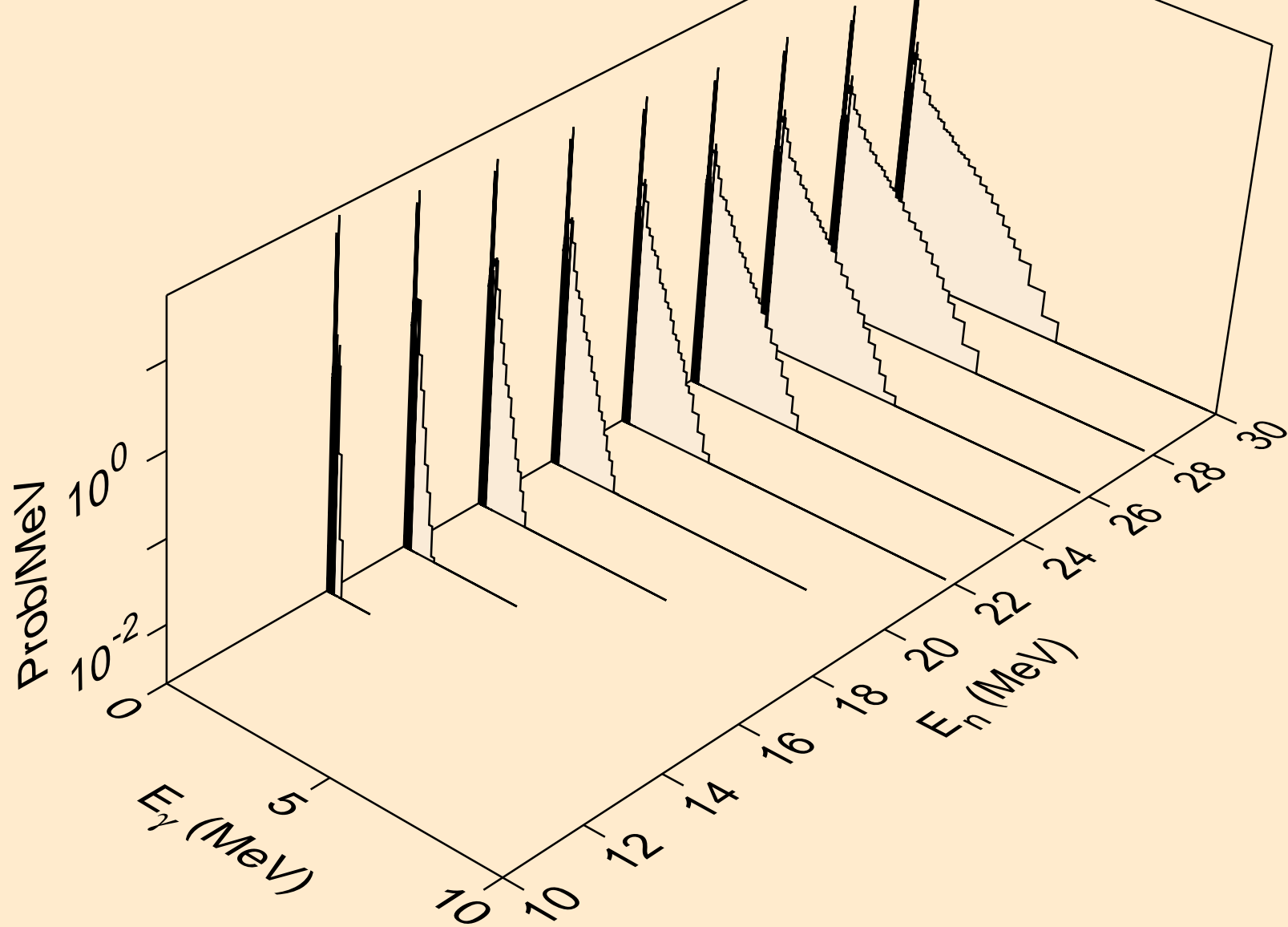

AU197M NEUTRON ACER TENDL-2023 LIBRARY; T=0.K
Photon emission for (n,n*)t

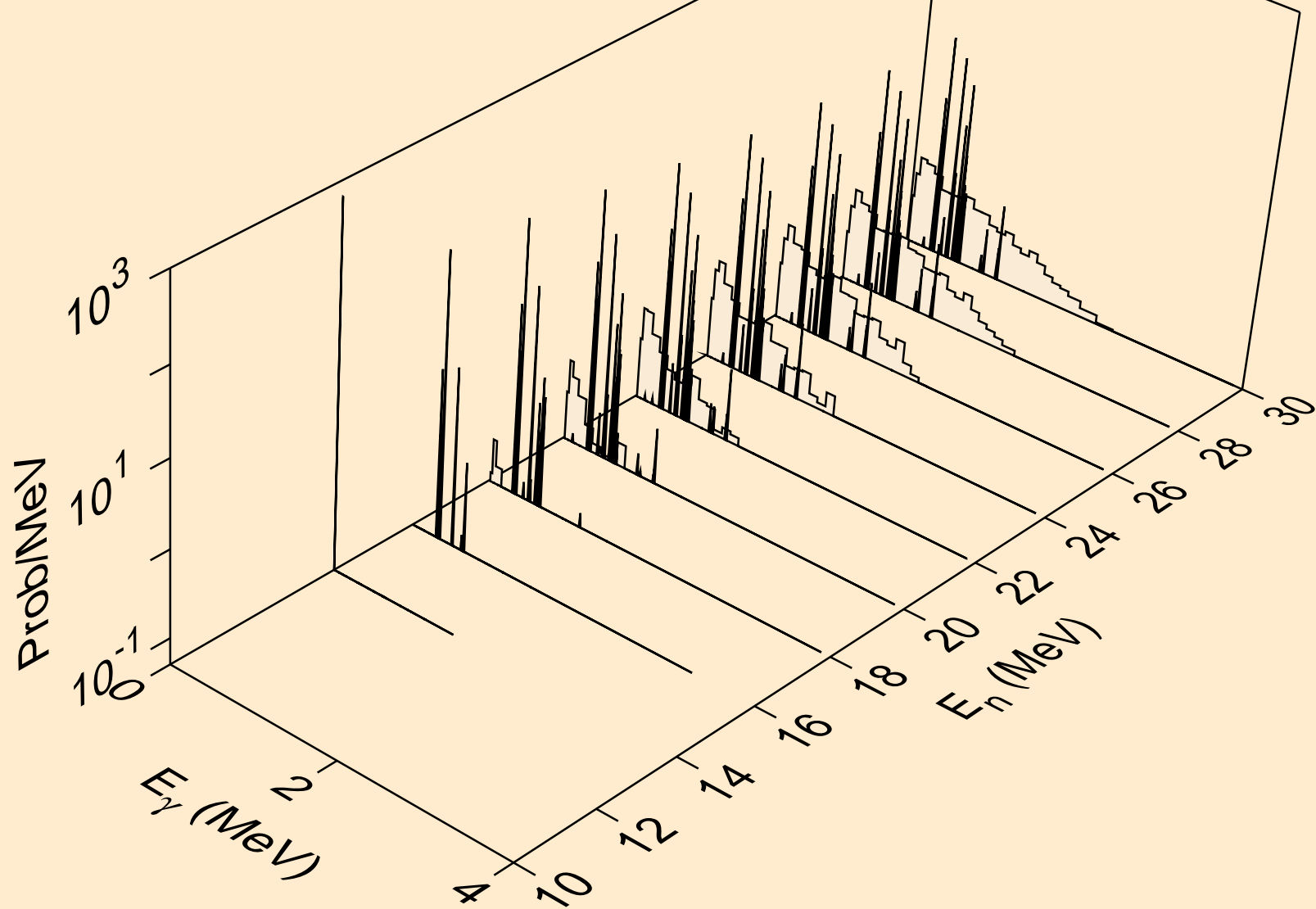

AU197M NEUTRON ACER TENDL-2023 LIBRARY; T=0.K
Photon emission for (n,n*)he3

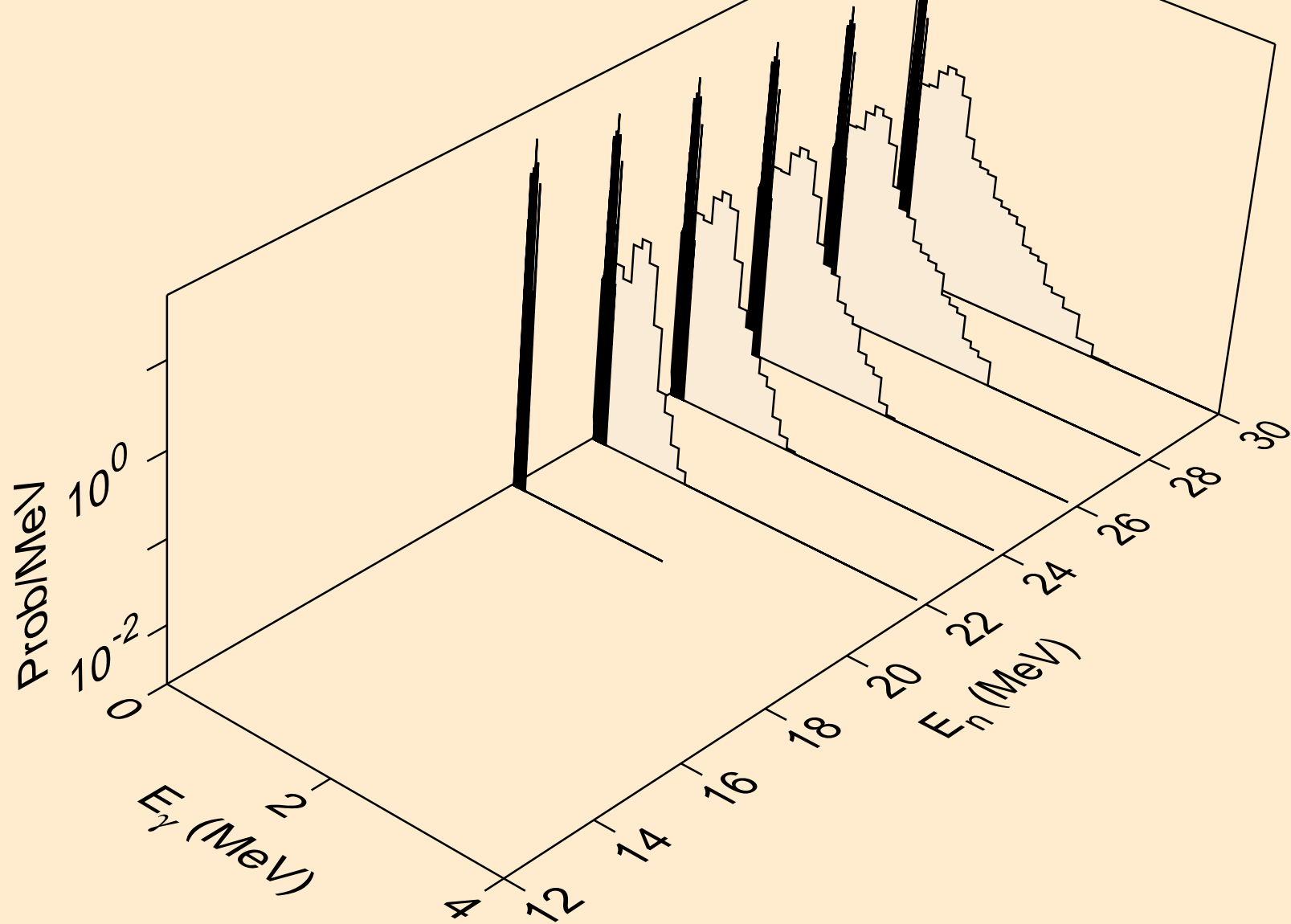

AU197M NEUTRON ACER TENDL-2023 LIBRARY; T=0.K
Photon emission for (n,4n)

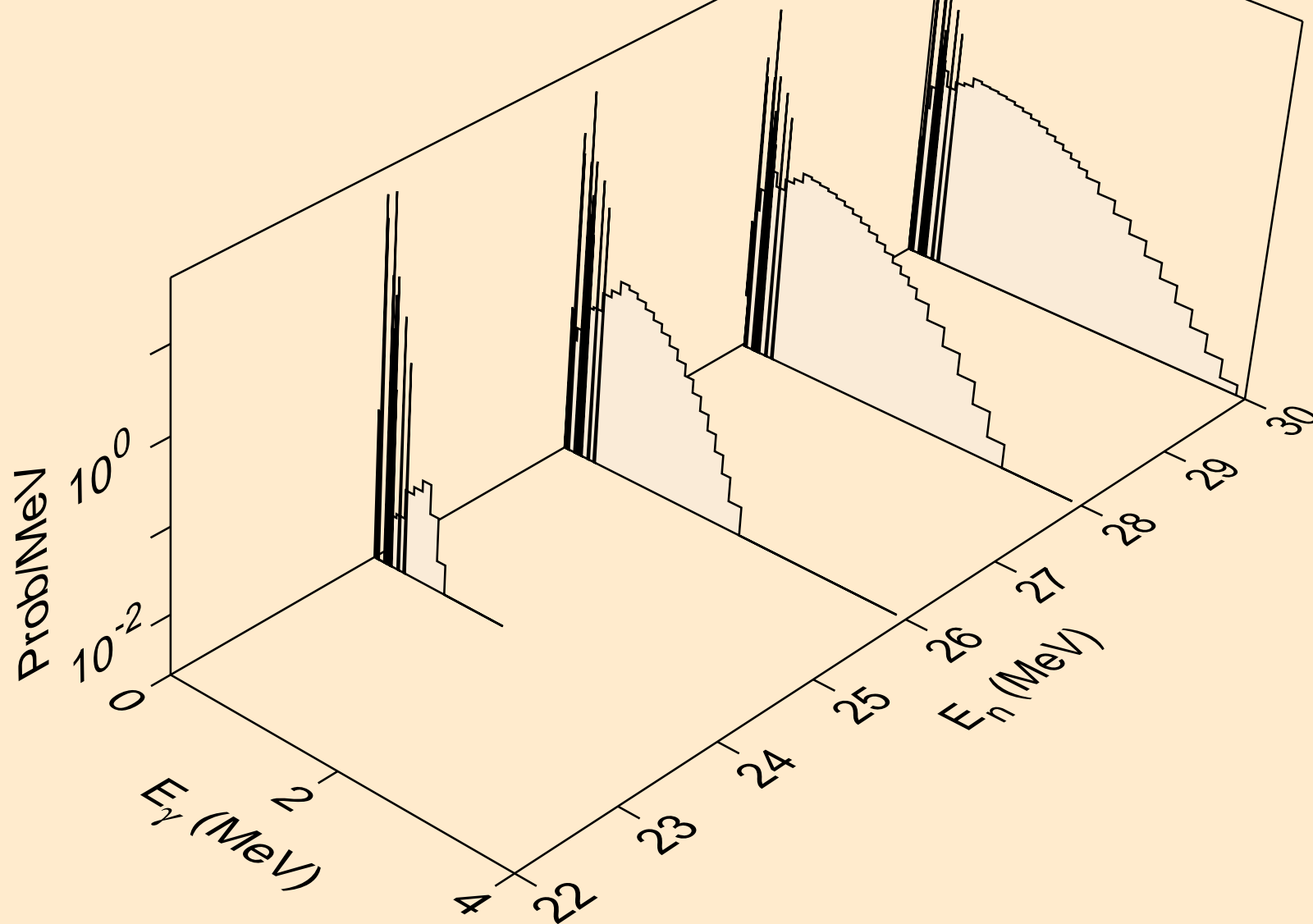

AU197M NEUTRON ACER TENDL-2023 LIBRARY; T=0.K
Photon emission for (n,2np)

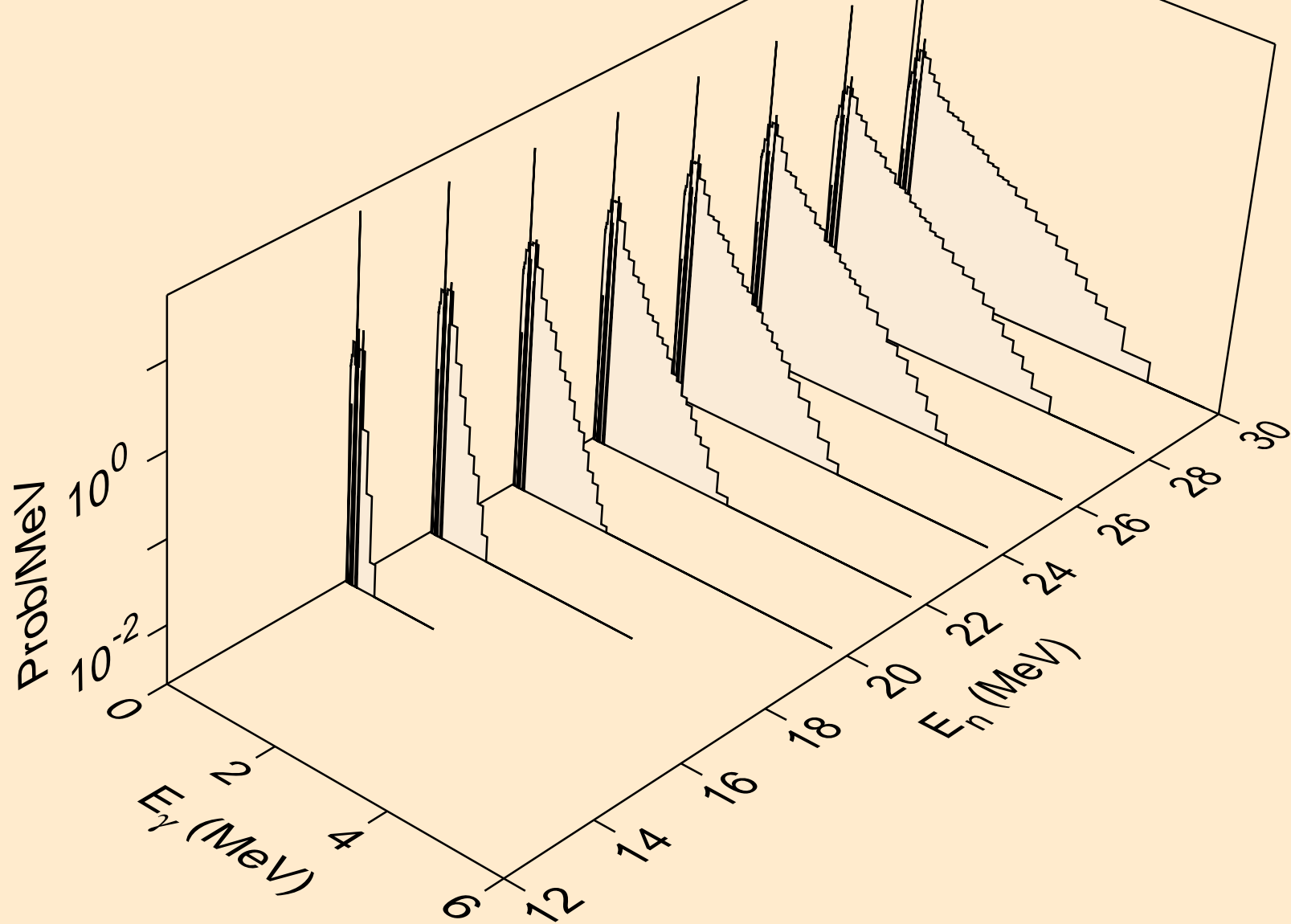

AU197M NEUTRON ACER TENDL-2023 LIBRARY; T=0.K
Photon emission for (n,3np)

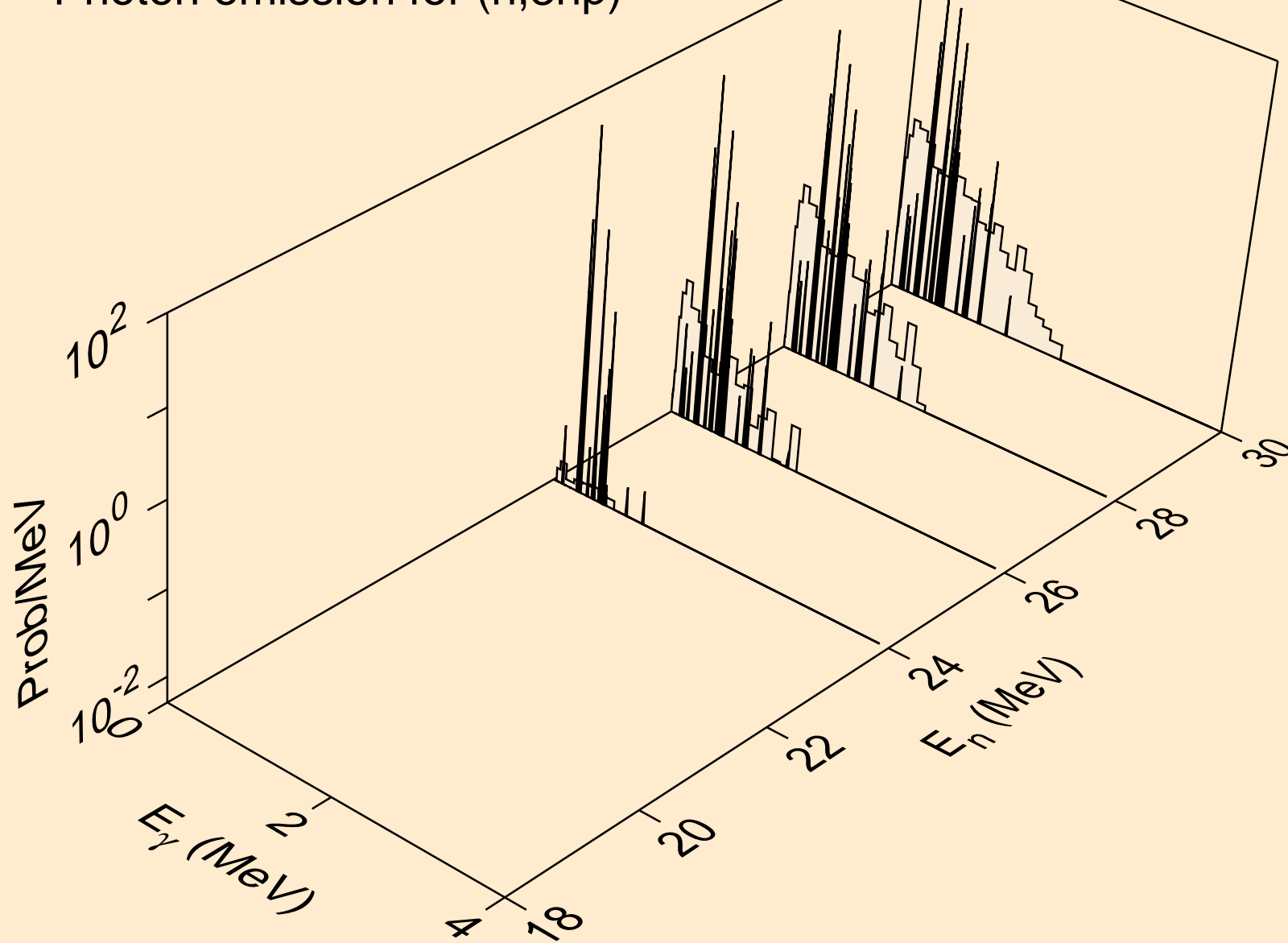

AU197M NEUTRON ACER TENDL-2023 LIBRARY; T=0.K
Photon emission for (n,n2p)

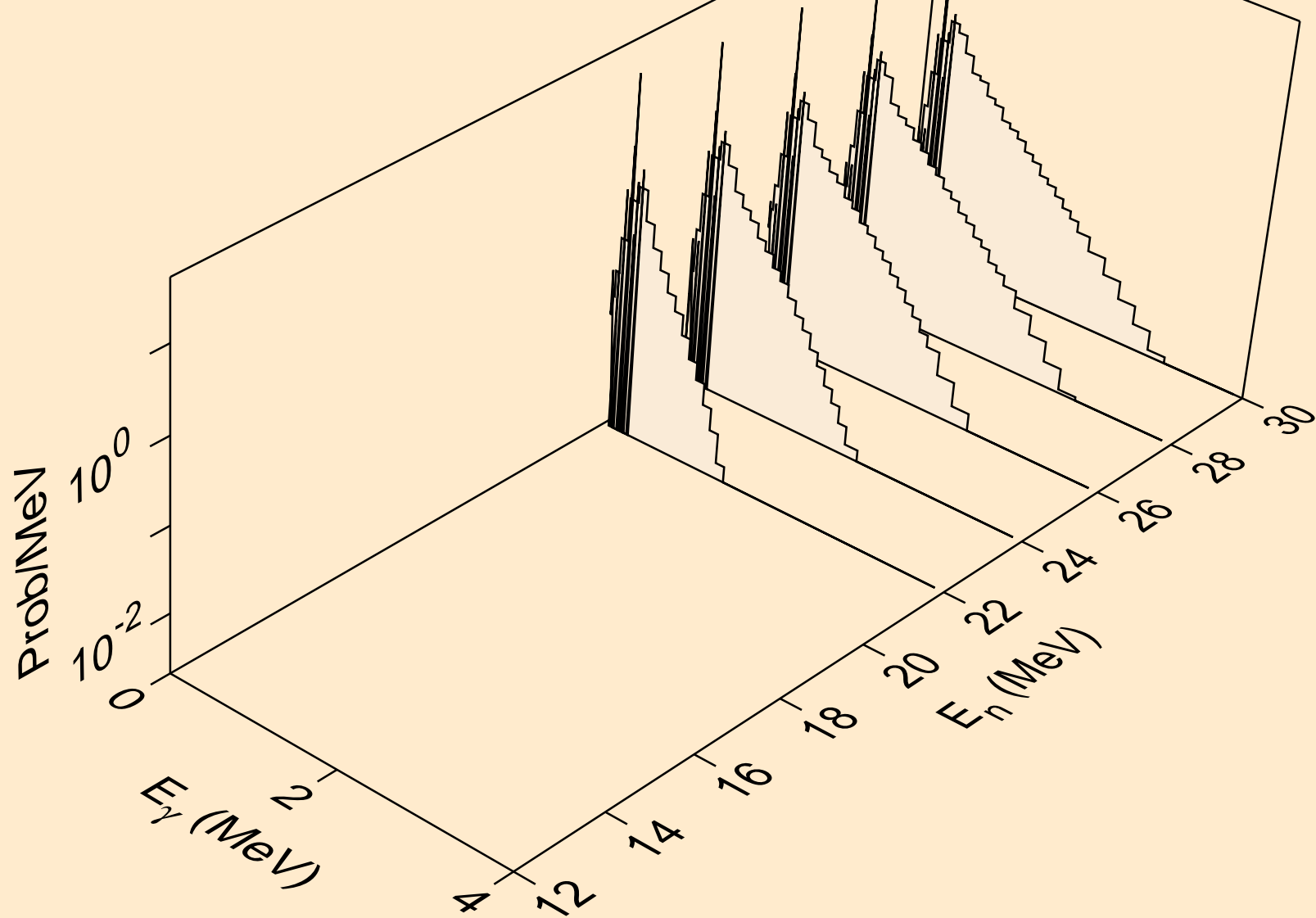

AU197M NEUTRON ACER TENDL-2023 LIBRARY; T=0.K
Photon emission for (n,npa)

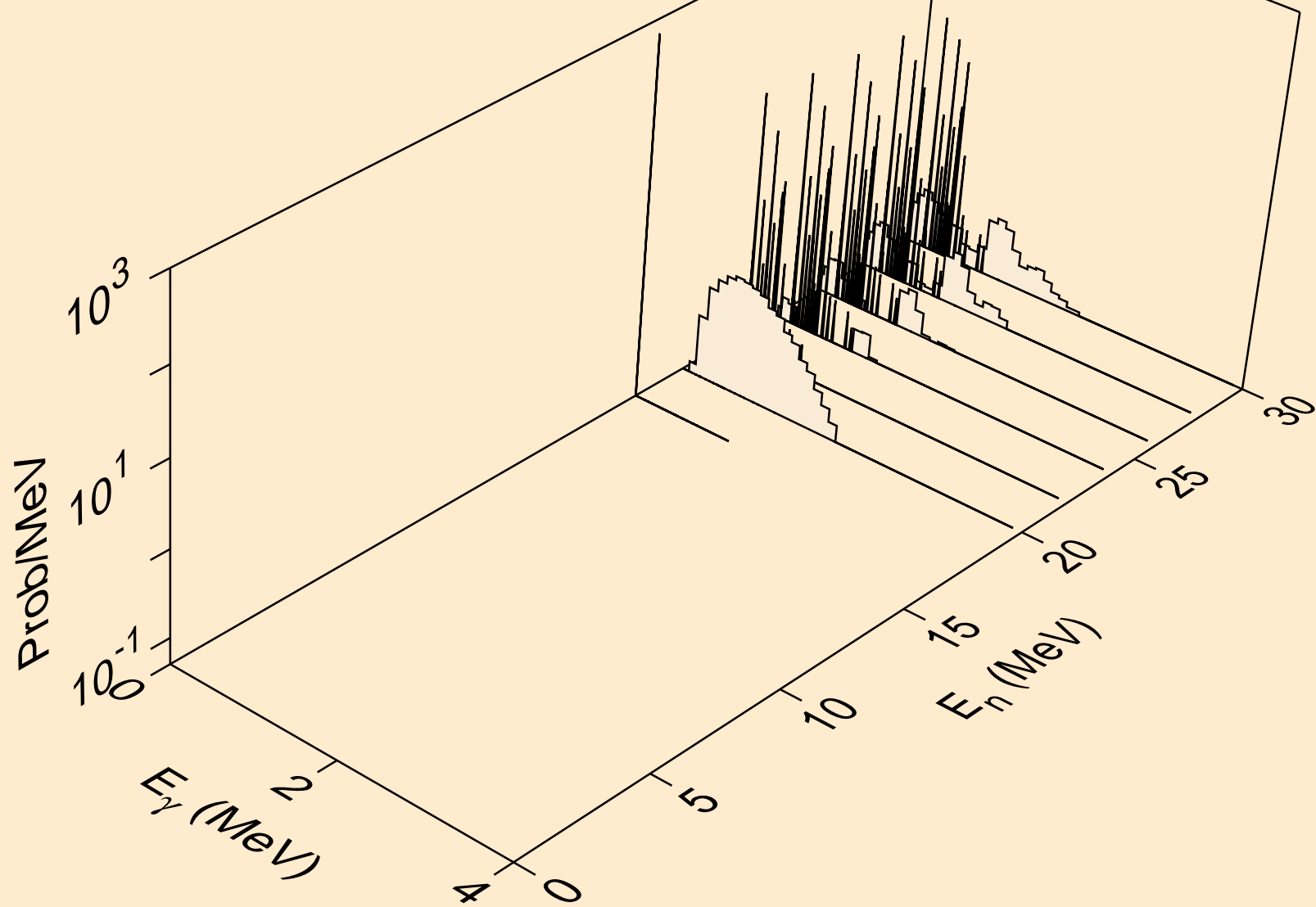

AU197M NEUTRON ACER TENDL-2023 LIBRARY; T=0.K
Photon emission for (n,n*1)

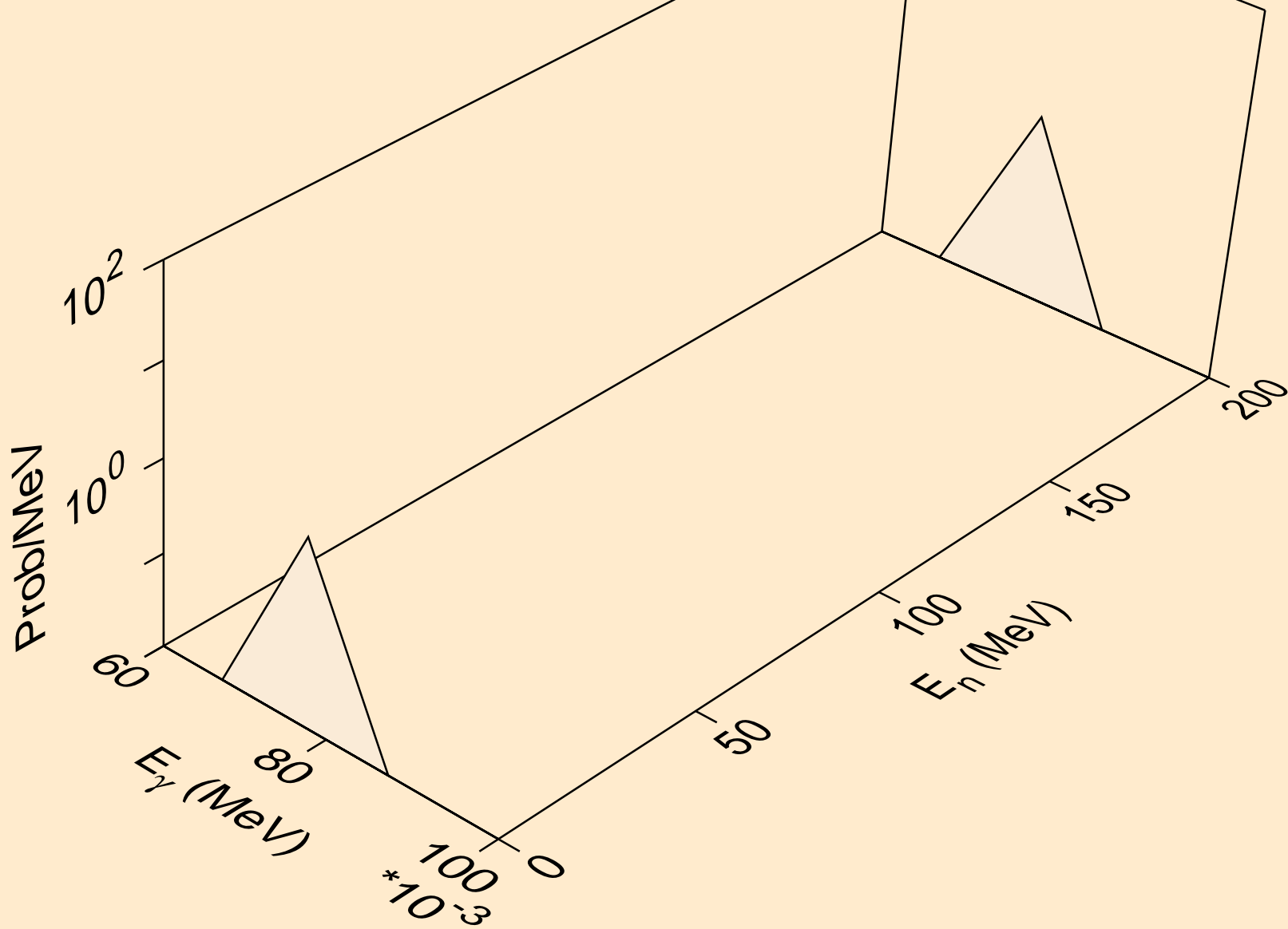

AU197M NEUTRON ACER TENDL-2023 LIBRARY; T=0.K
Photon emission for (n,n*2)

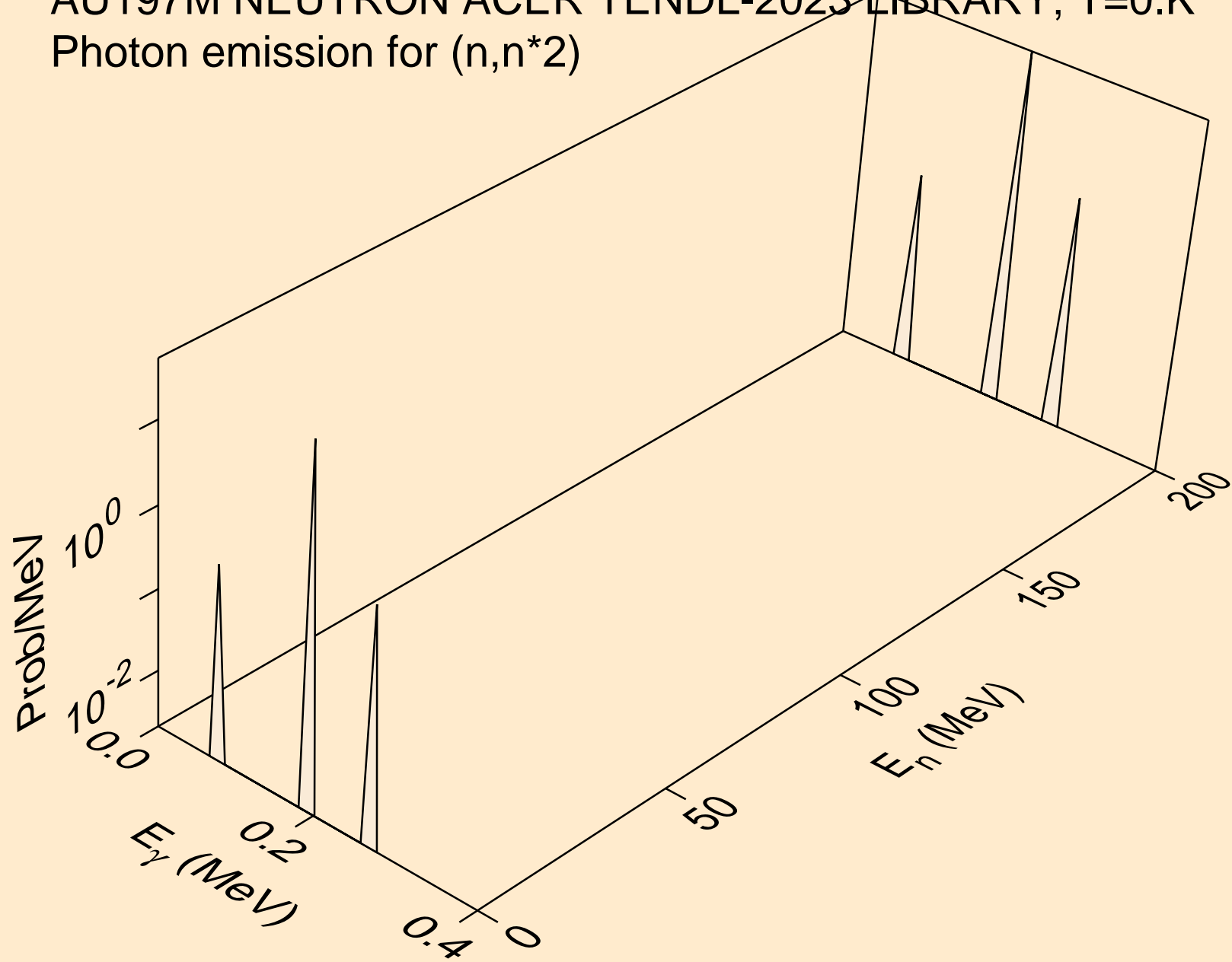

AU197M NEUTRON ACER TENDL-2023 LIBRARY; T=0.K
Photon emission for (n,n*3)

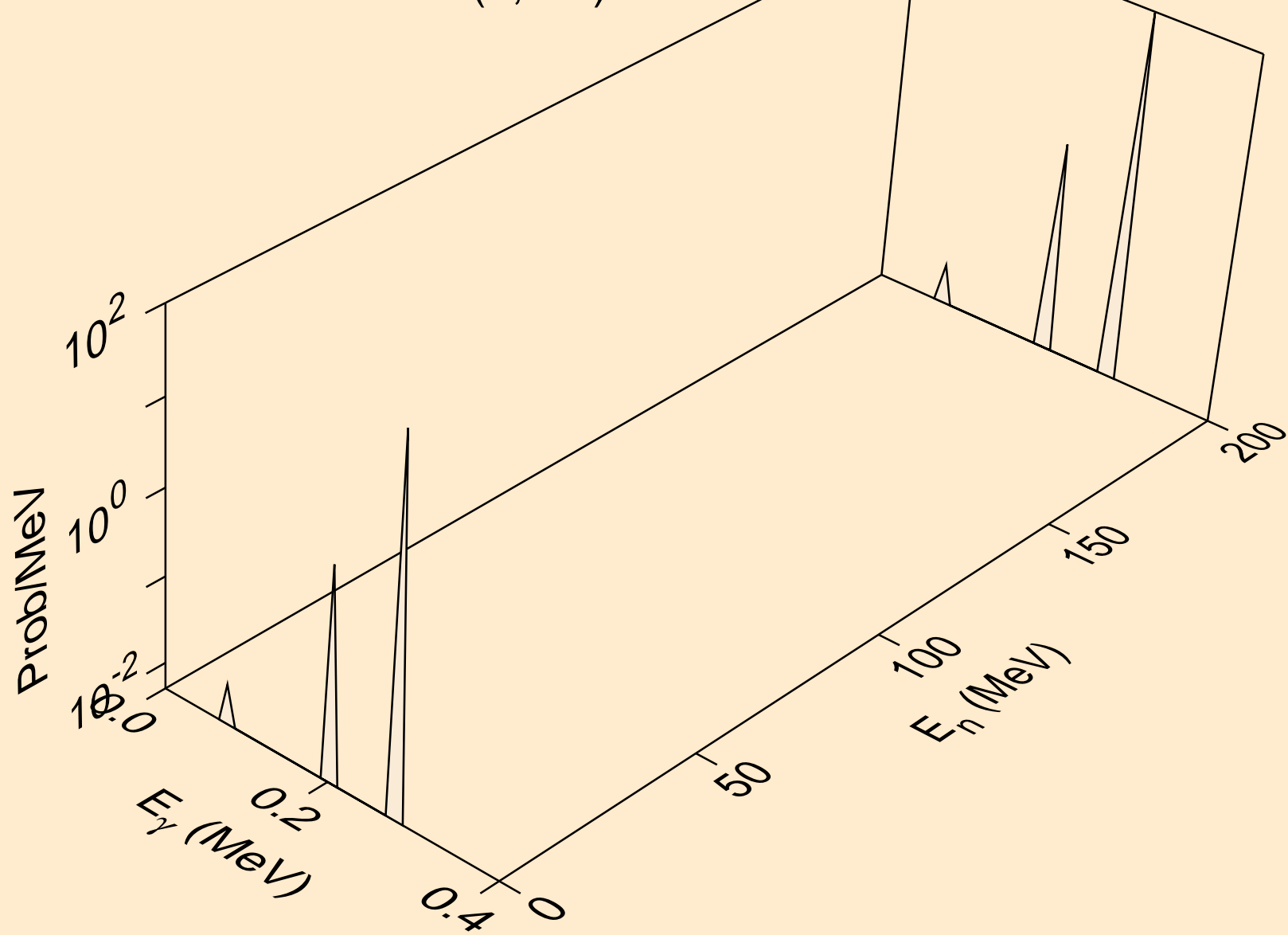

AU197M NEUTRON ACER TENDL-2023 LIBRARY; T=0.K
Photon emission for (n,n*5)

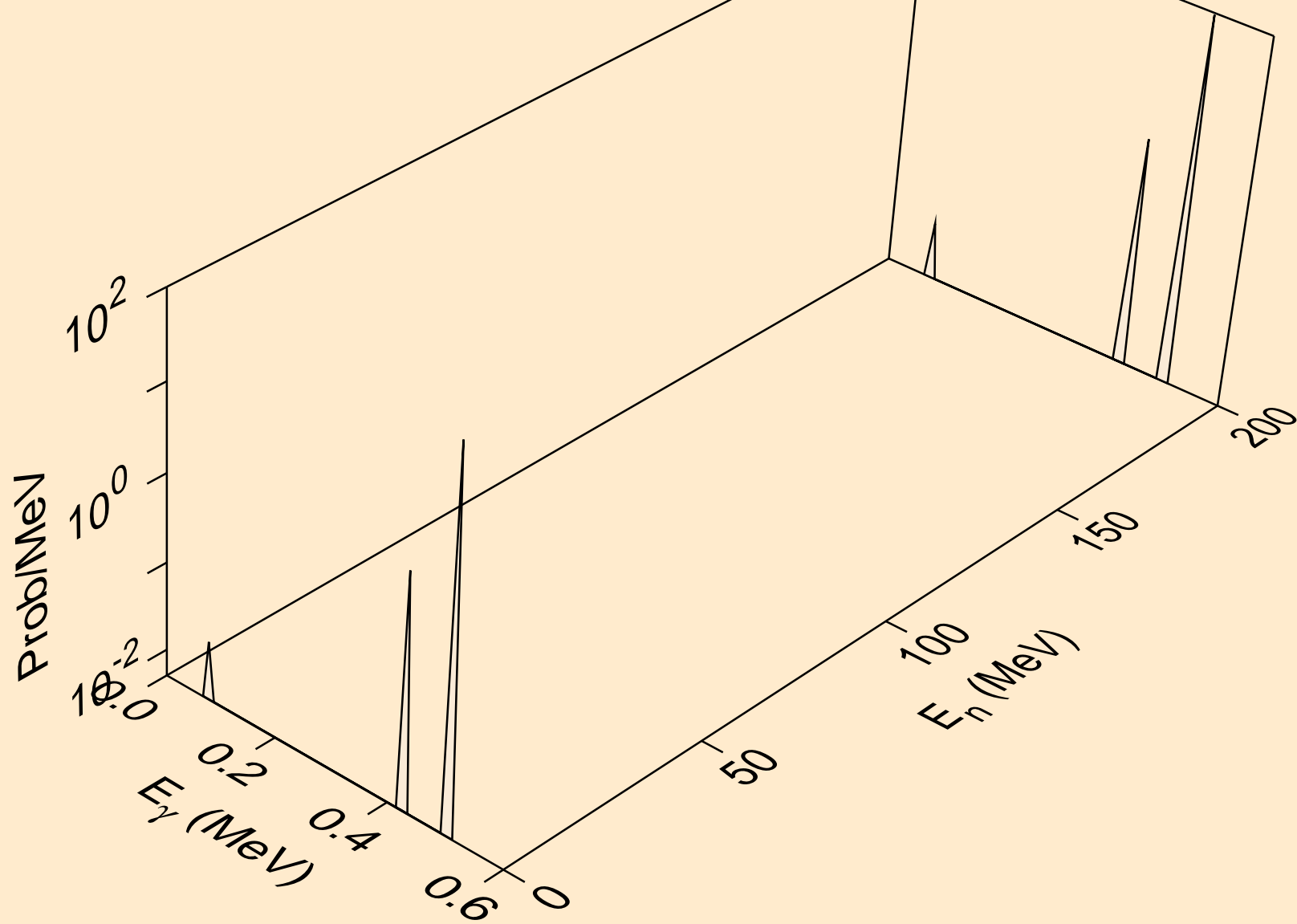

AU197M NEUTRON ACER TENDL-2023 LIBRARY; T=0.K
Photon emission for (n,n*6)

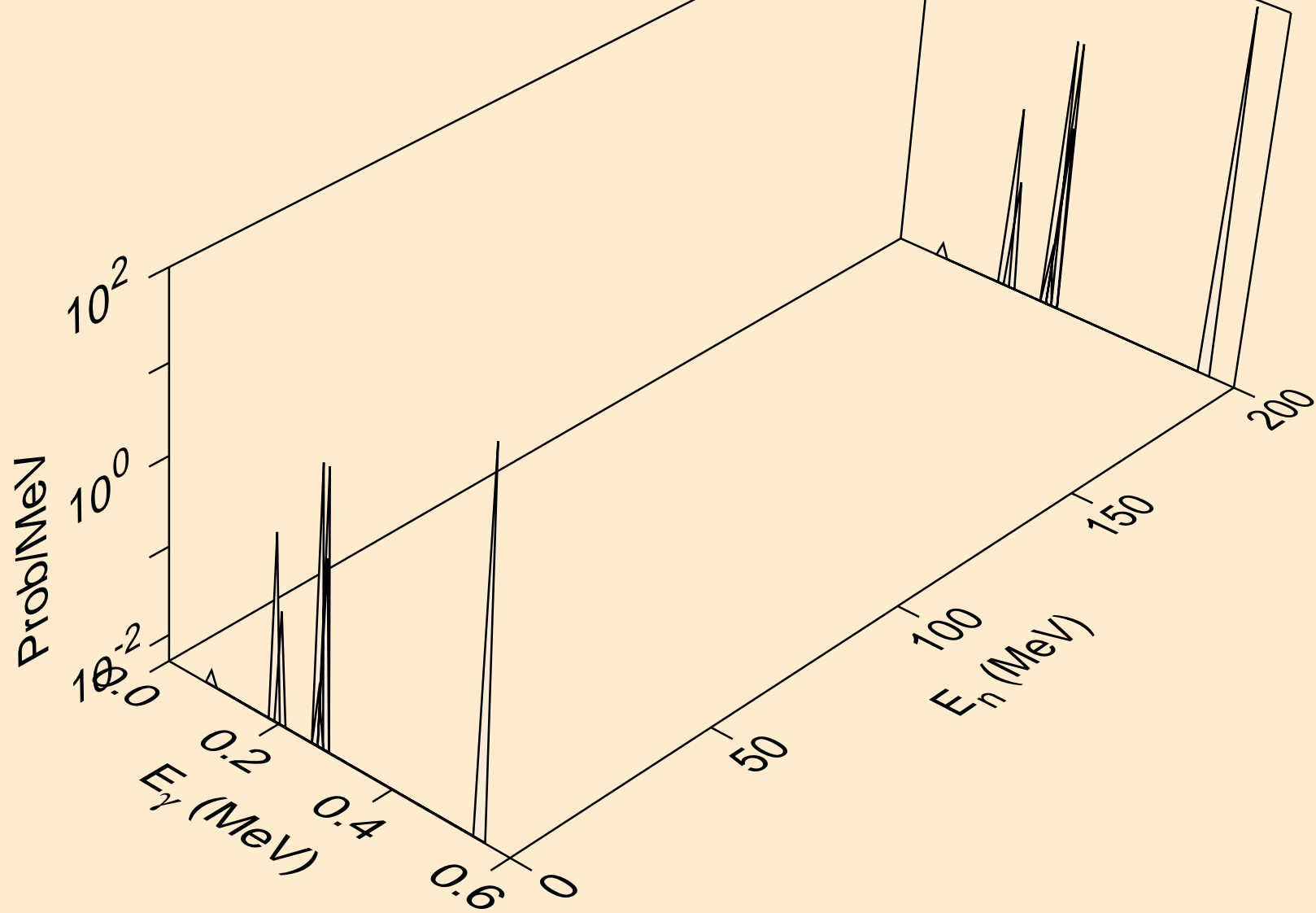

AU197M NEUTRON ACER TENDL-2023 LIBRARY; T=0.K
Photon emission for (n,n*7)

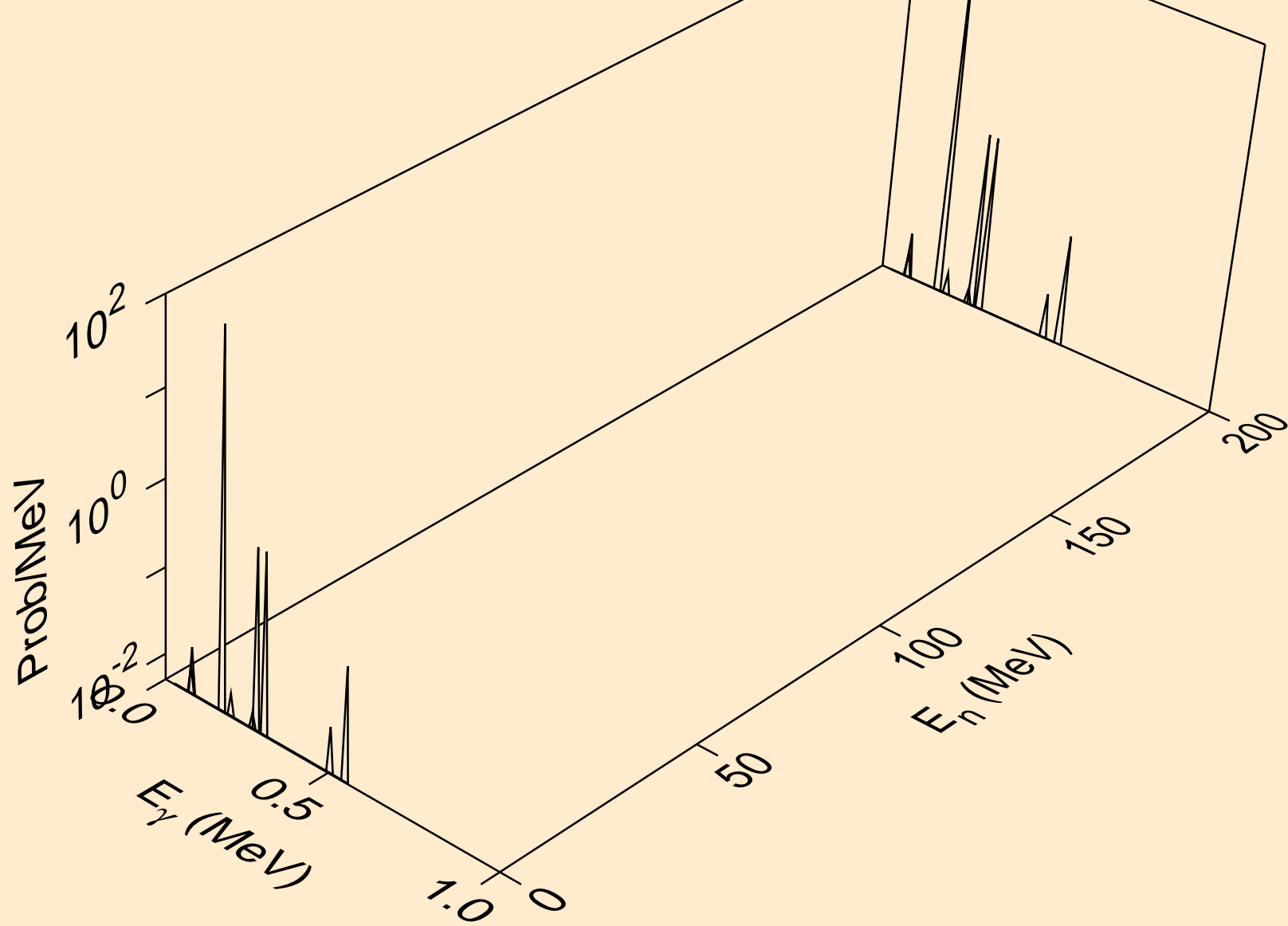

AU197M NEUTRON ACER TENDL-2023 LIBRARY; T=0.K
Photon emission for (n,n*8)

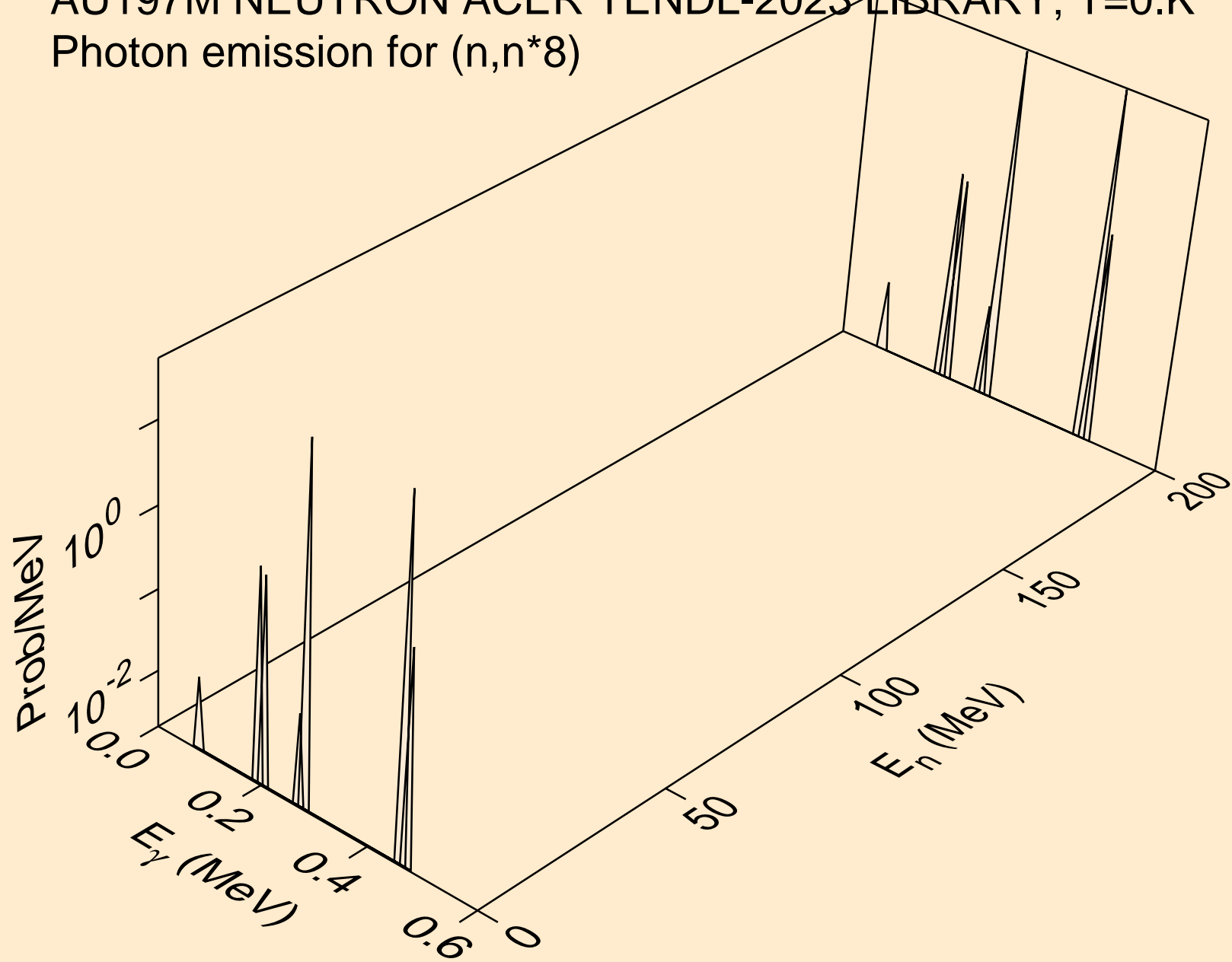

AU197M NEUTRON ACER TENDL-2023 LIBRARY; T=0.K
Photon emission for (n,n*9)

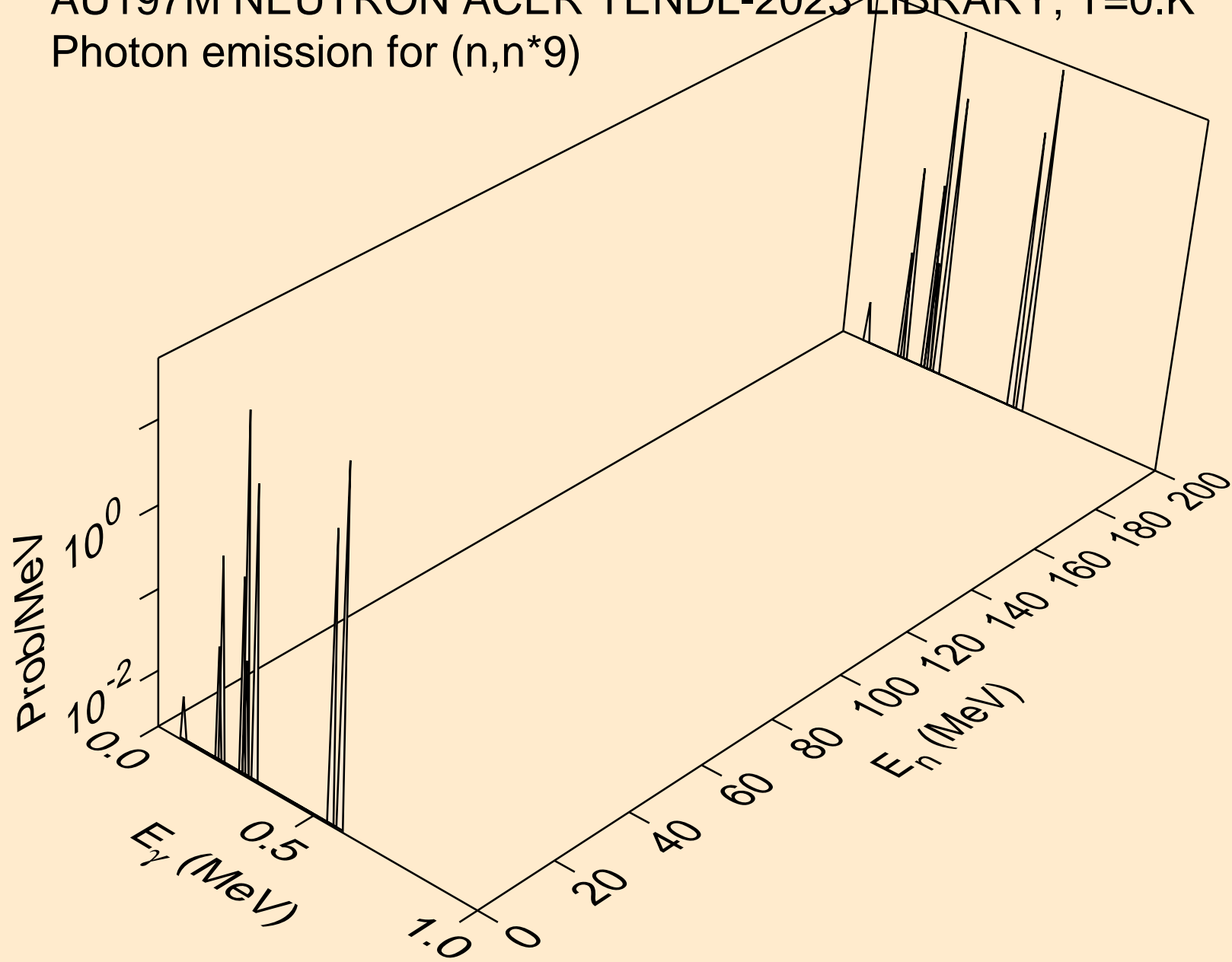

AU197M NEUTRON ACER TENDL-2023 LIBRARY; T=0.K
Photon emission for (n,n*10)

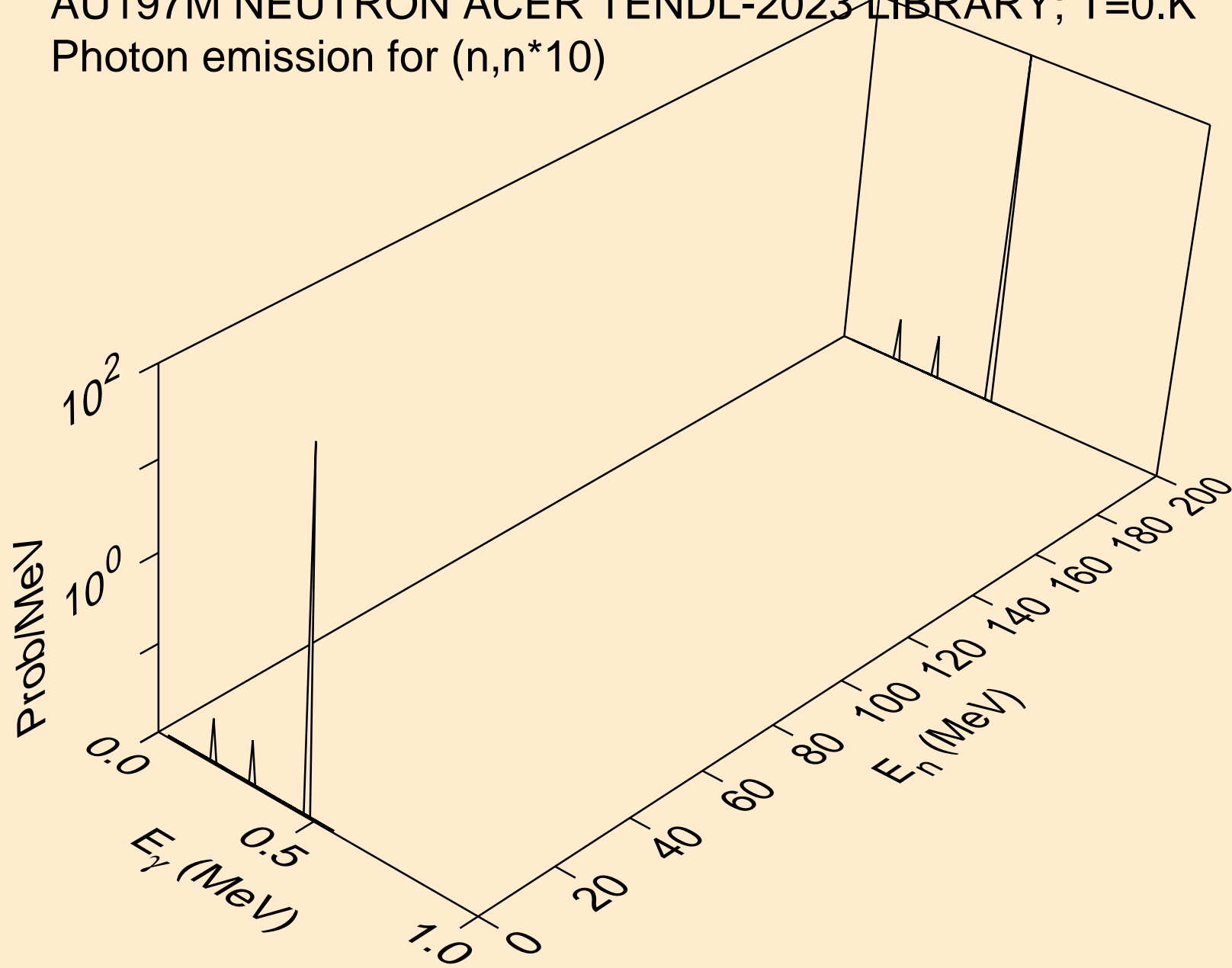

AU197M NEUTRON ACER TENDL-2023 LIBRARY; T=0.K
Photon emission for (n,n*11)

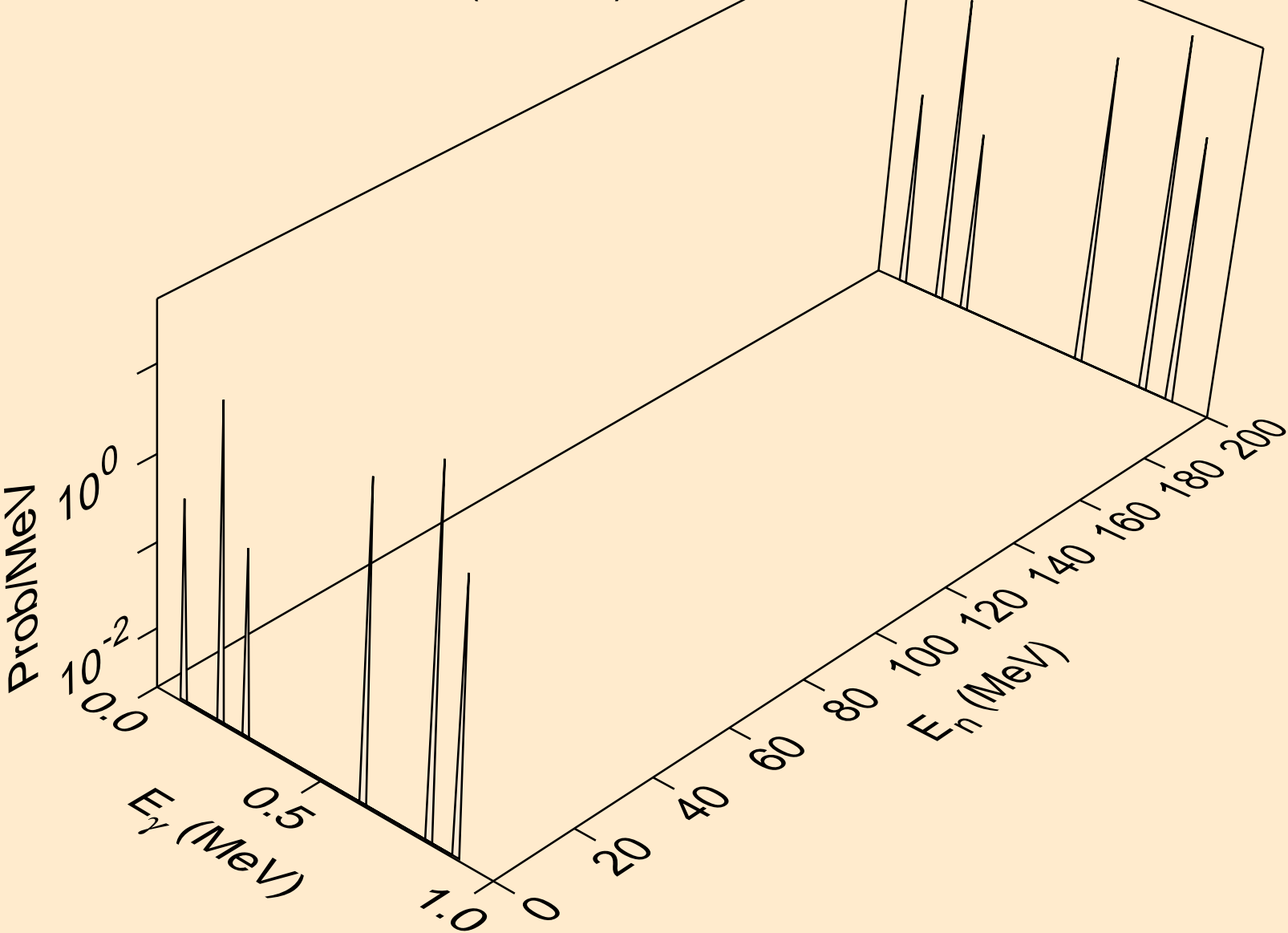

AU197M NEUTRON ACER TENDL-2023 LIBRARY; T=0.K
Photon emission for (n,n*12)

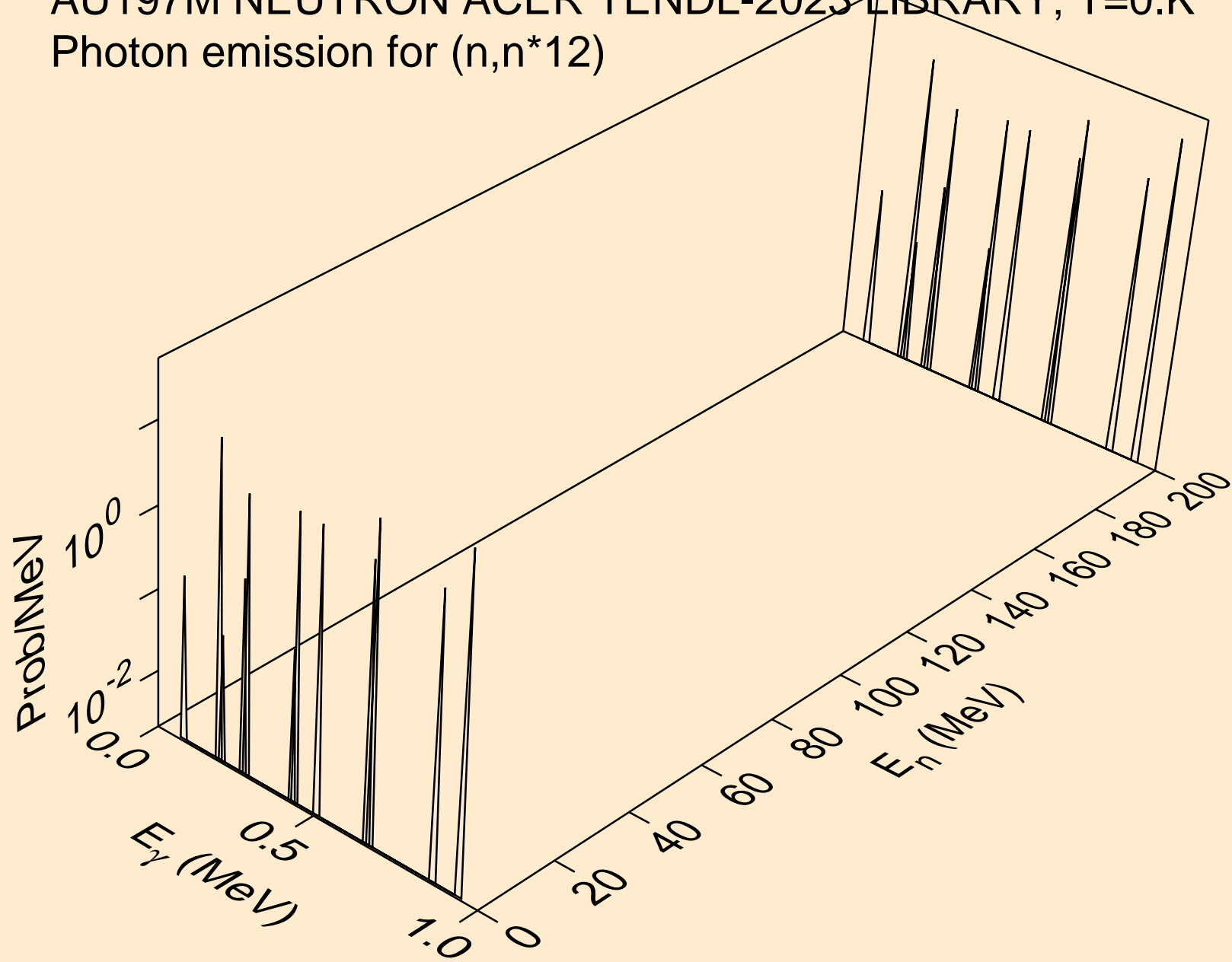

AU197M NEUTRON ACER TENDL-2023 LIBRARY; T=0.K
Photon emission for (n,n*13)

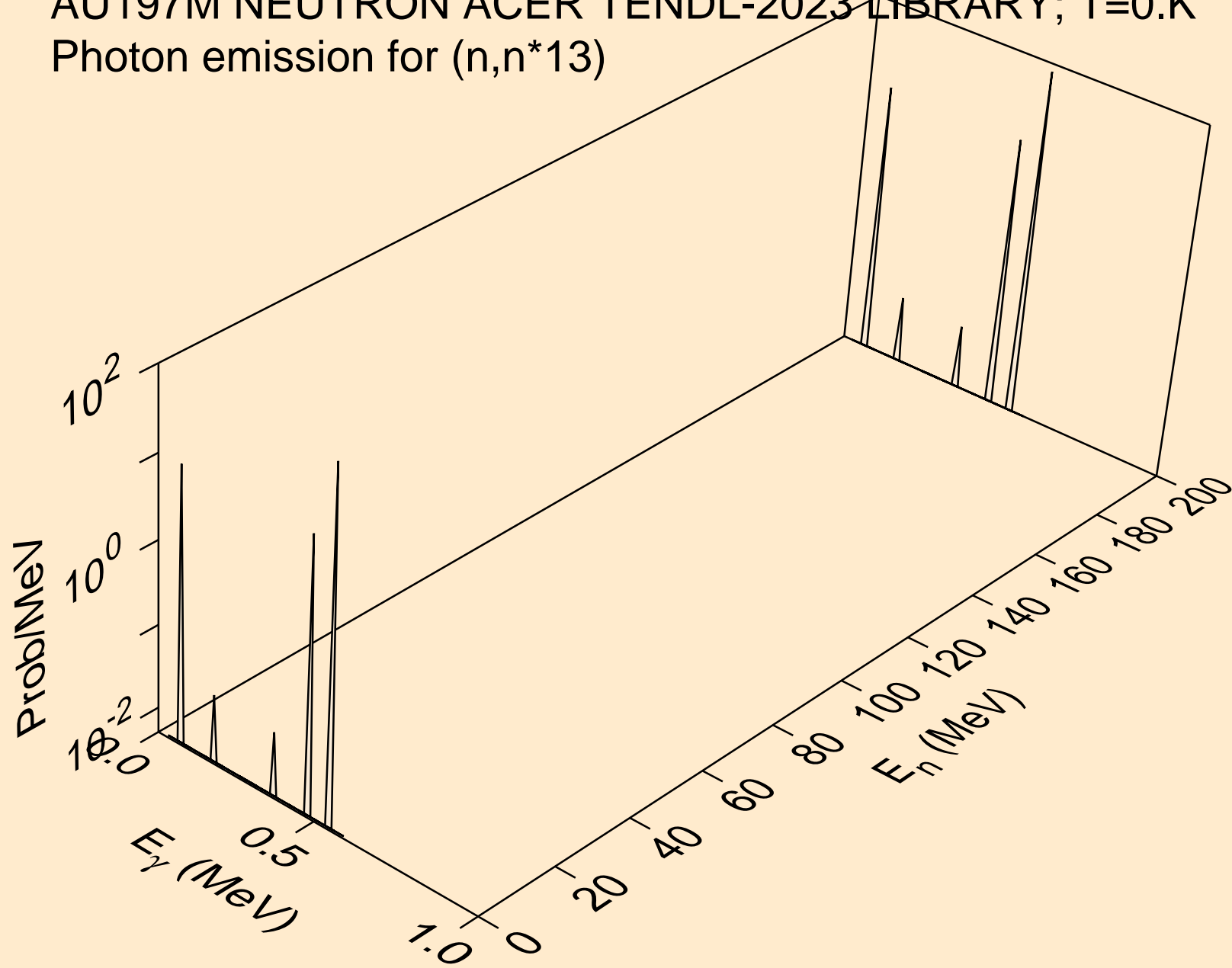

AU197M NEUTRON ACER TENDL-2023 LIBRARY; T=0.K
Photon emission for (n,n*14)

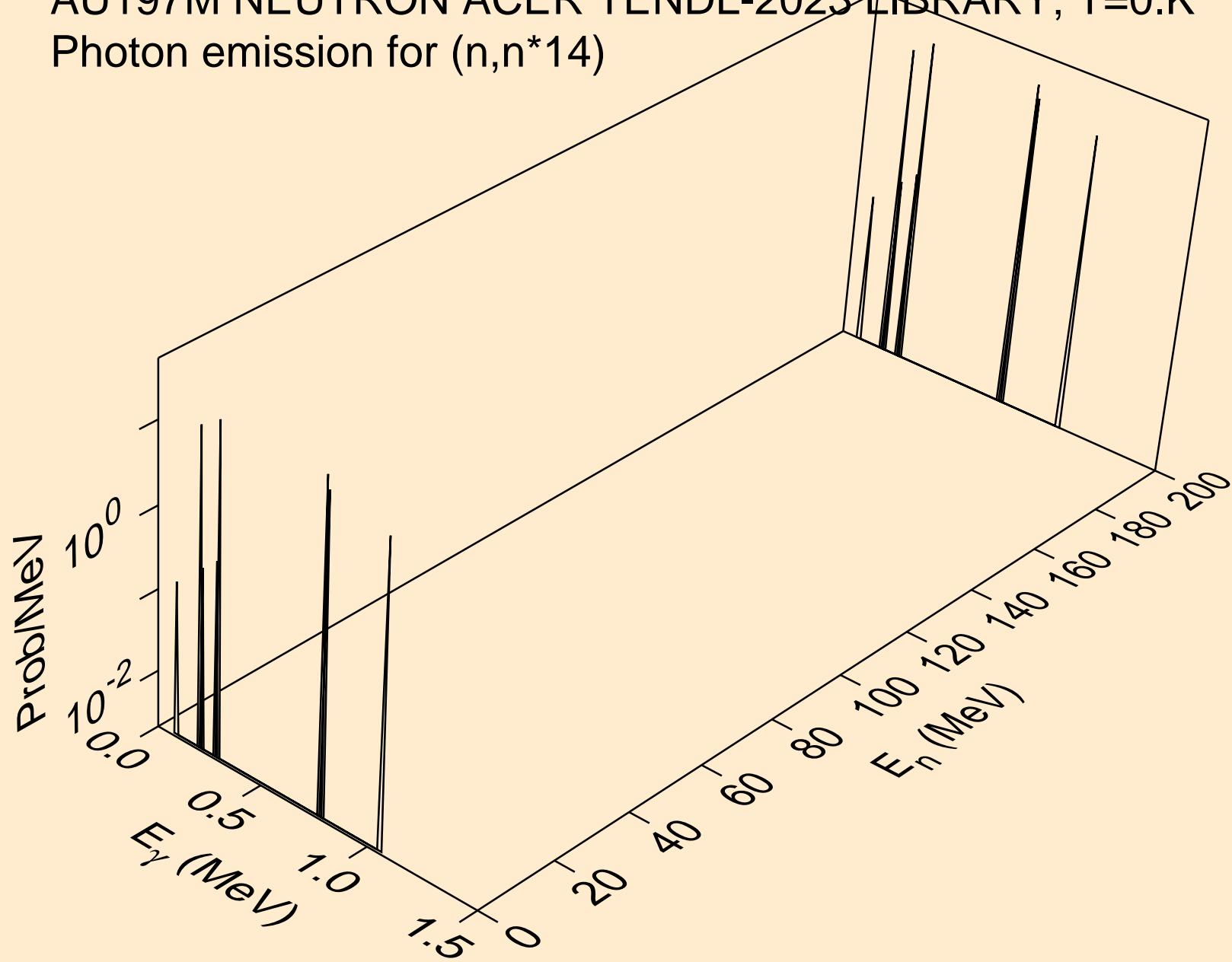

AU197M NEUTRON ACER TENDL-2023 LIBRARY; T=0.K
Photon emission for (n,n*15)

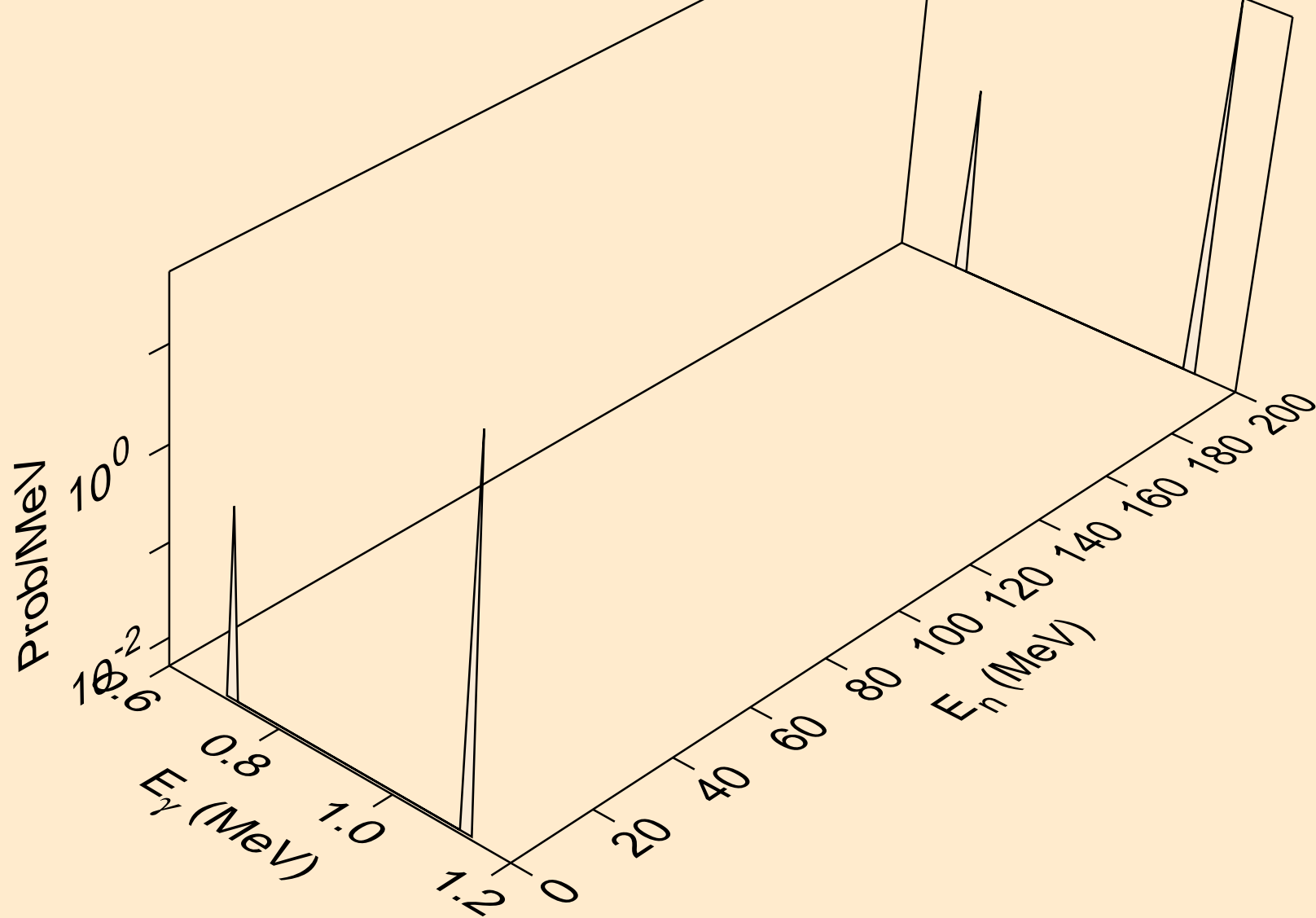

AU197M NEUTRON ACER TENDL-2023 LIBRARY; T=0.K
Photon emission for (n,n*16)

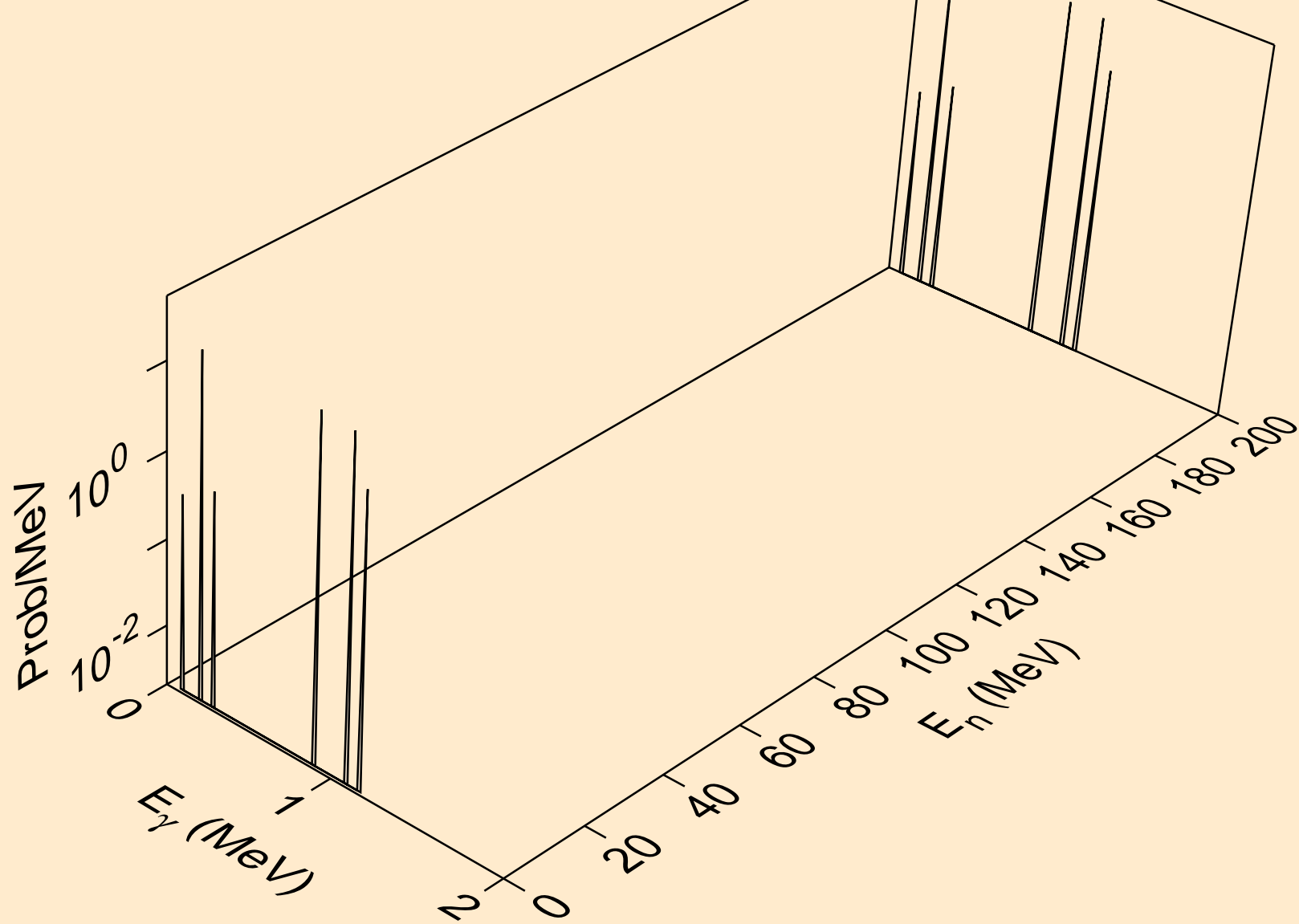

AU197M NEUTRON ACER TENDL-2023 LIBRARY; T=0.K
Photon emission for (n,n*17)

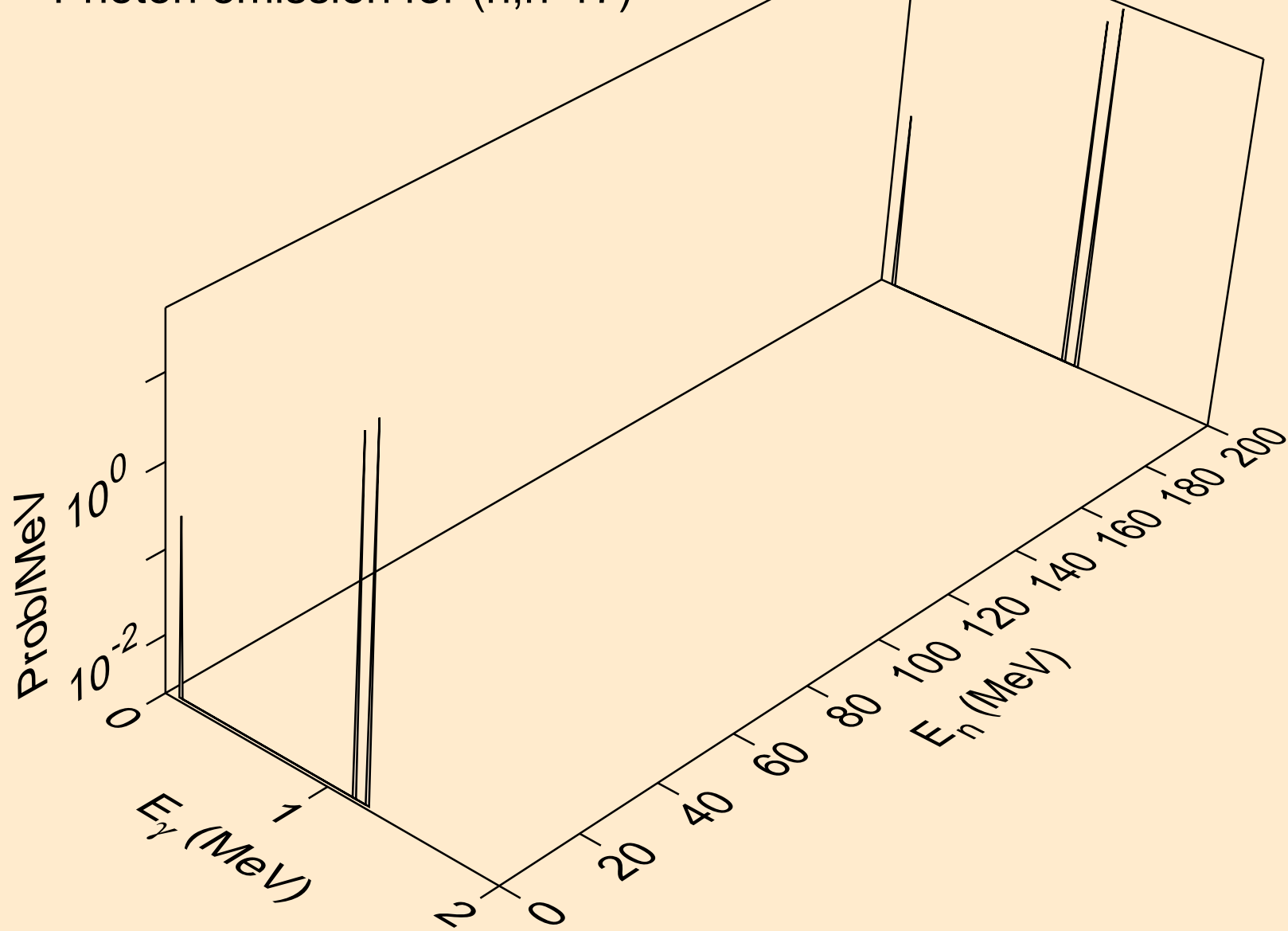

AU197M NEUTRON ACER TENDL-2023 LIBRARY; T=0.K
Photon emission for (n,n*18)

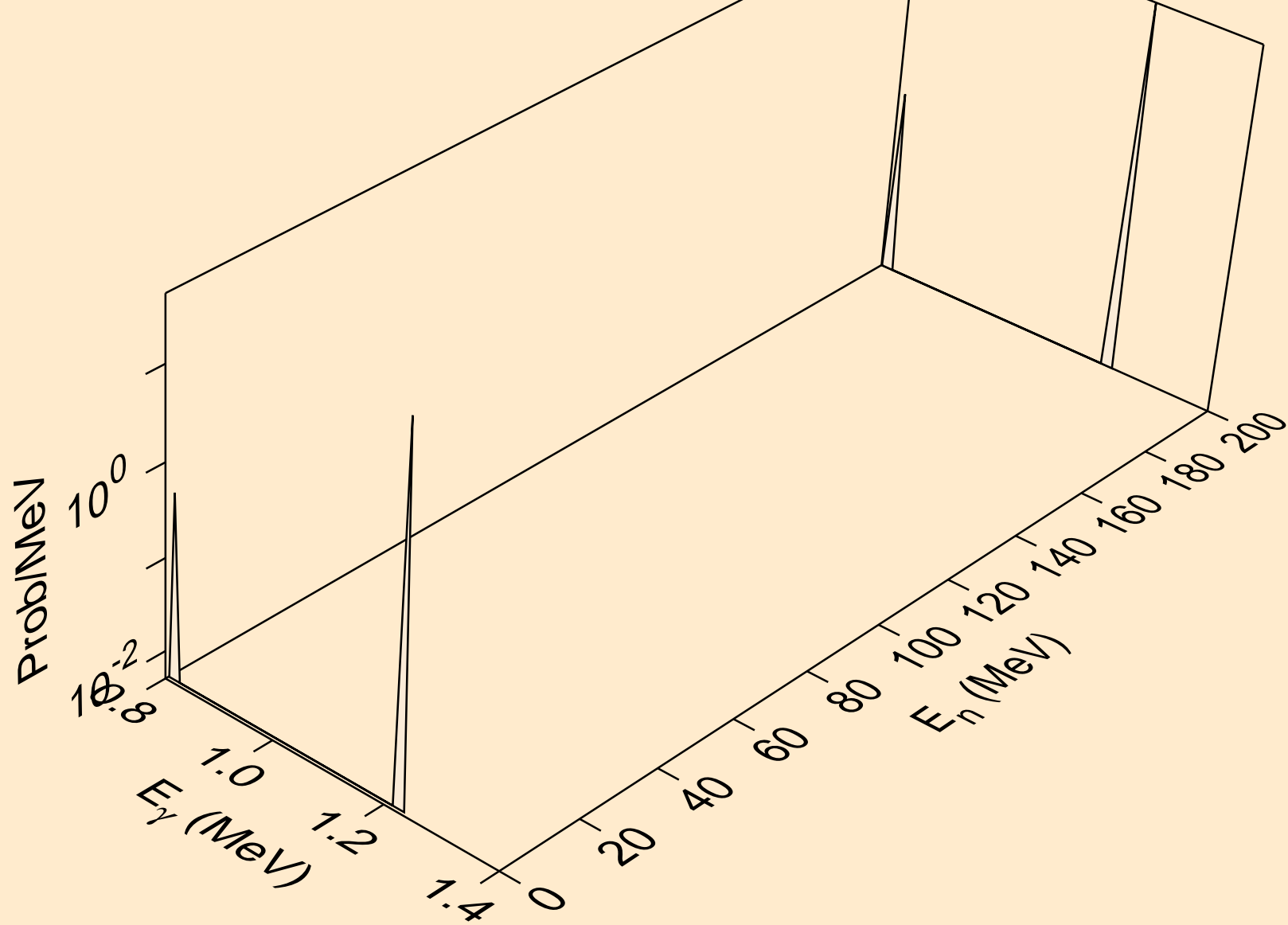

AU197M NEUTRON ACER TENDL-2023 LIBRARY; T=0.K
Photon emission for (n,n*19)

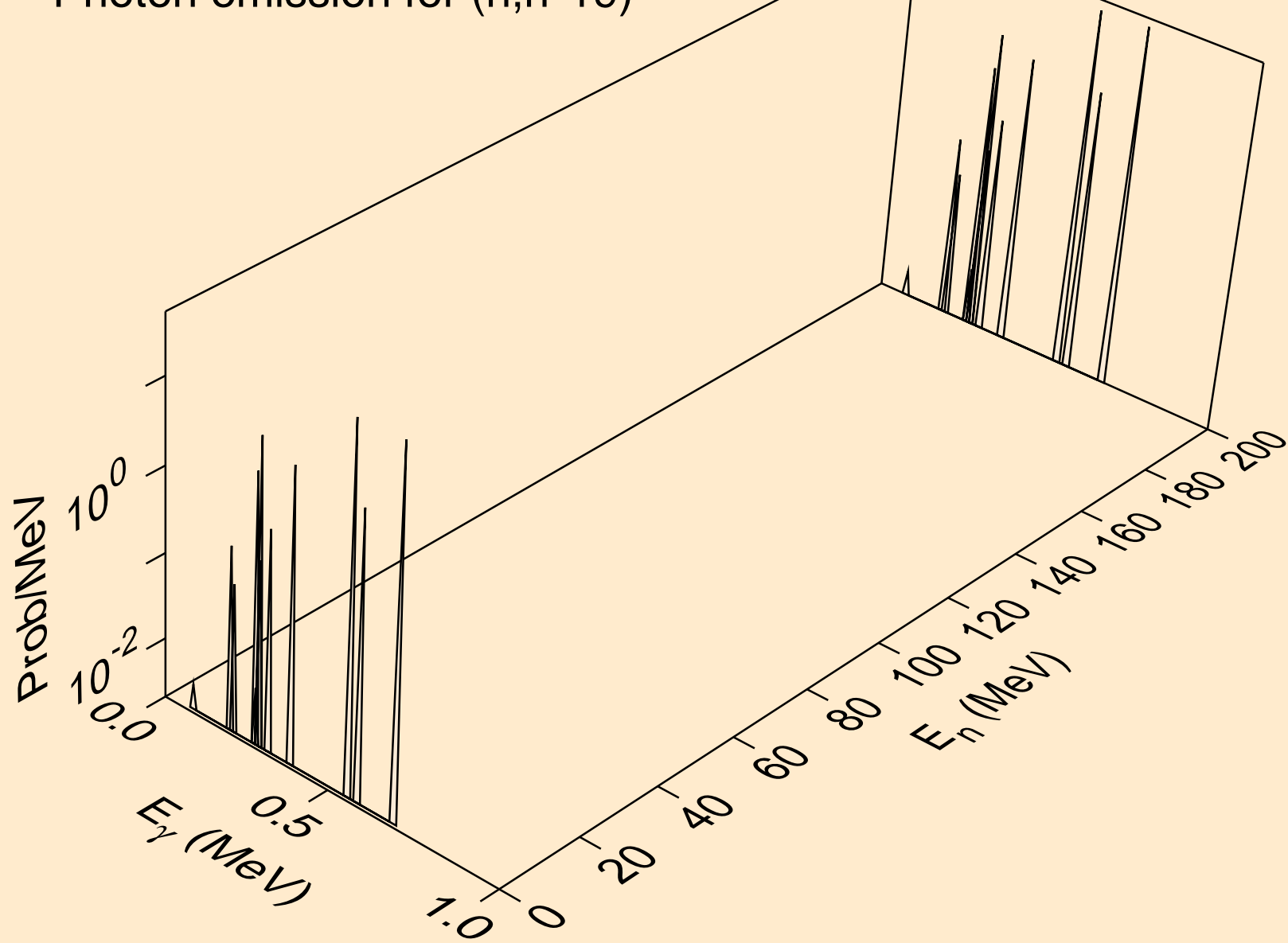

AU197M NEUTRON ACER TENDL-2023 LIBRARY; T=0.K
Photon emission for (n,n*c)

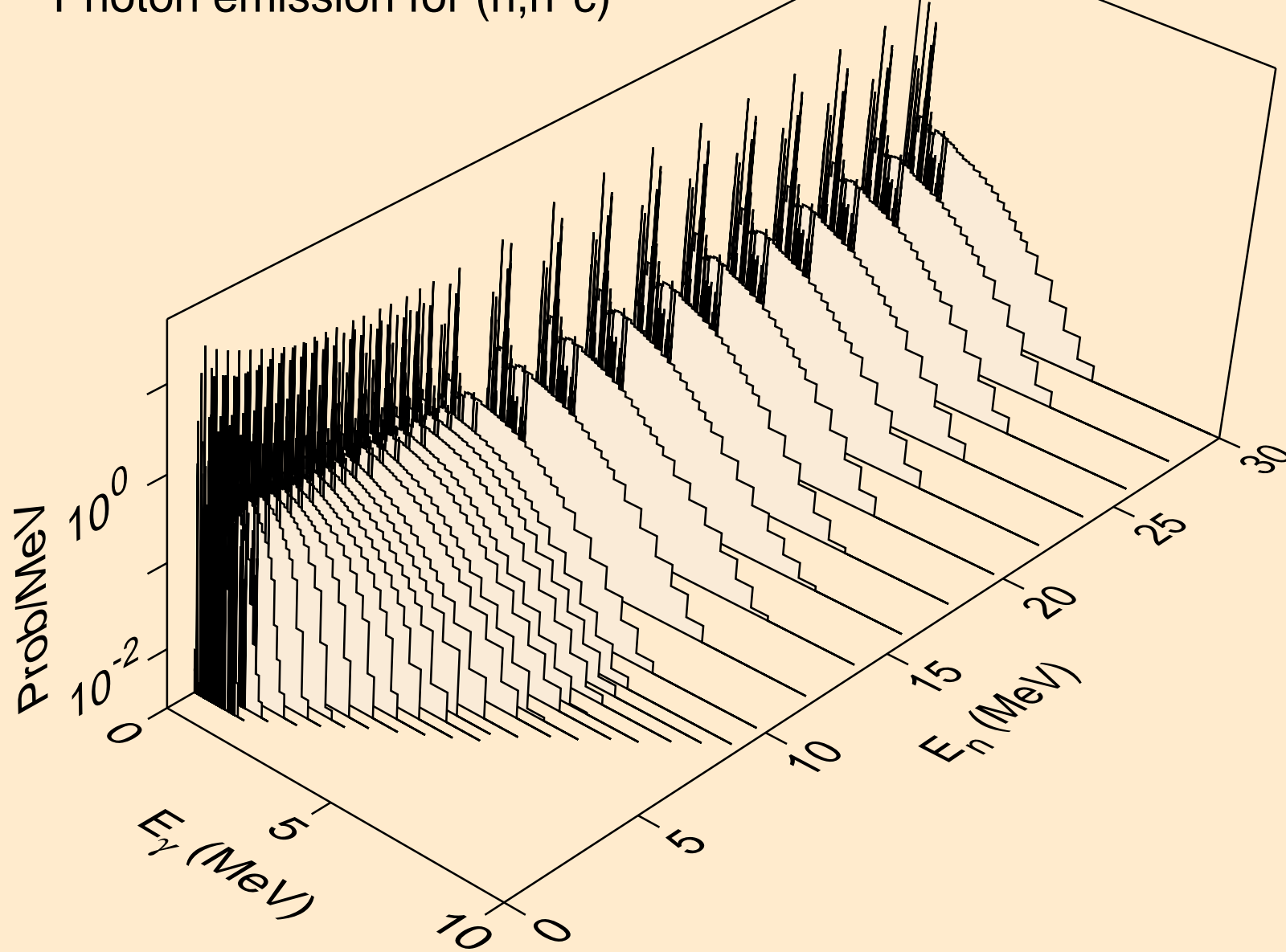

AU197M NEUTRON ACER TENDL-2023 LIBRARY; T=0.K
Photon emission for (n,gma)

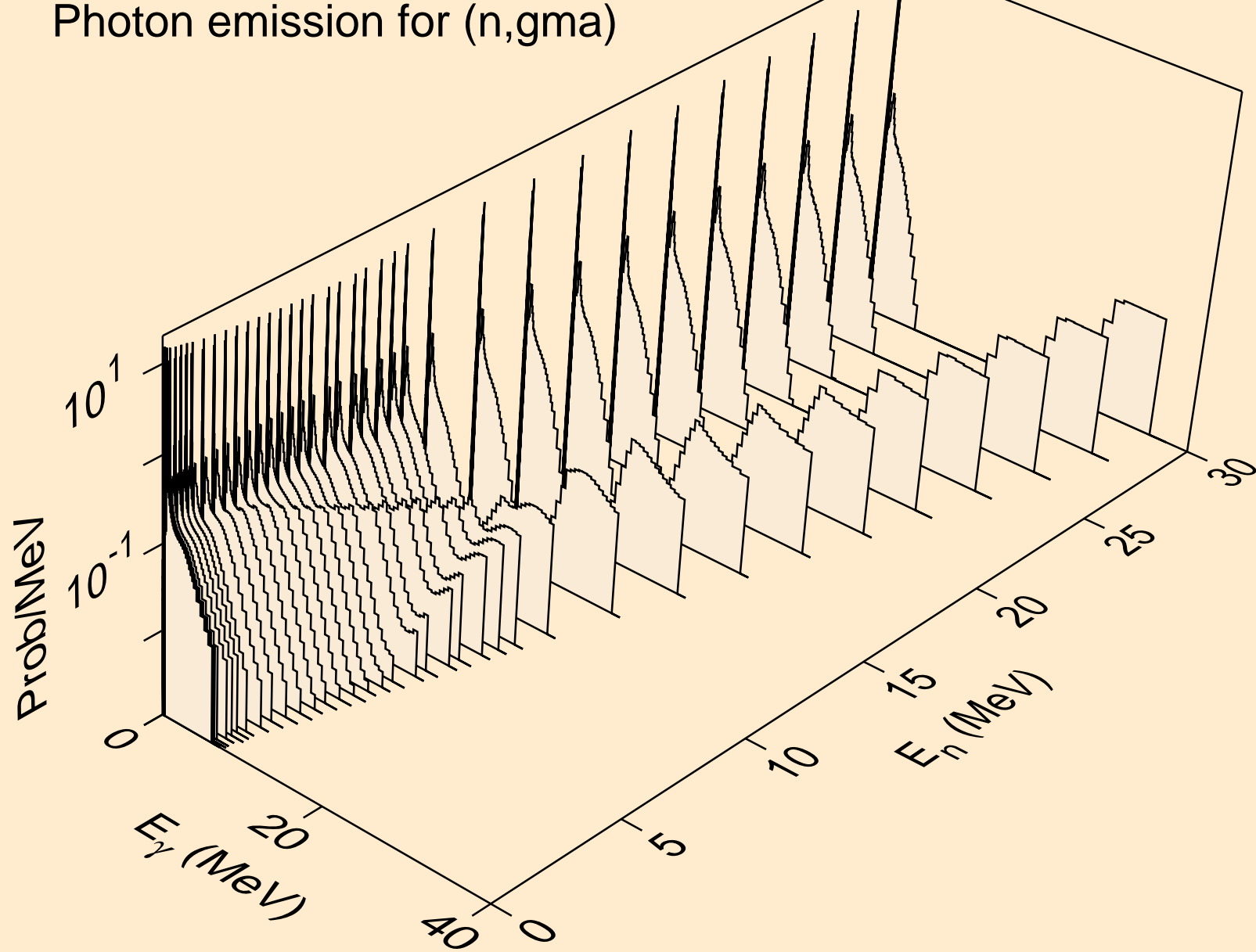

AU197M NEUTRON ACER TENDL-2023 LIBRARY; T=0.K
Photon emission for (n,p)

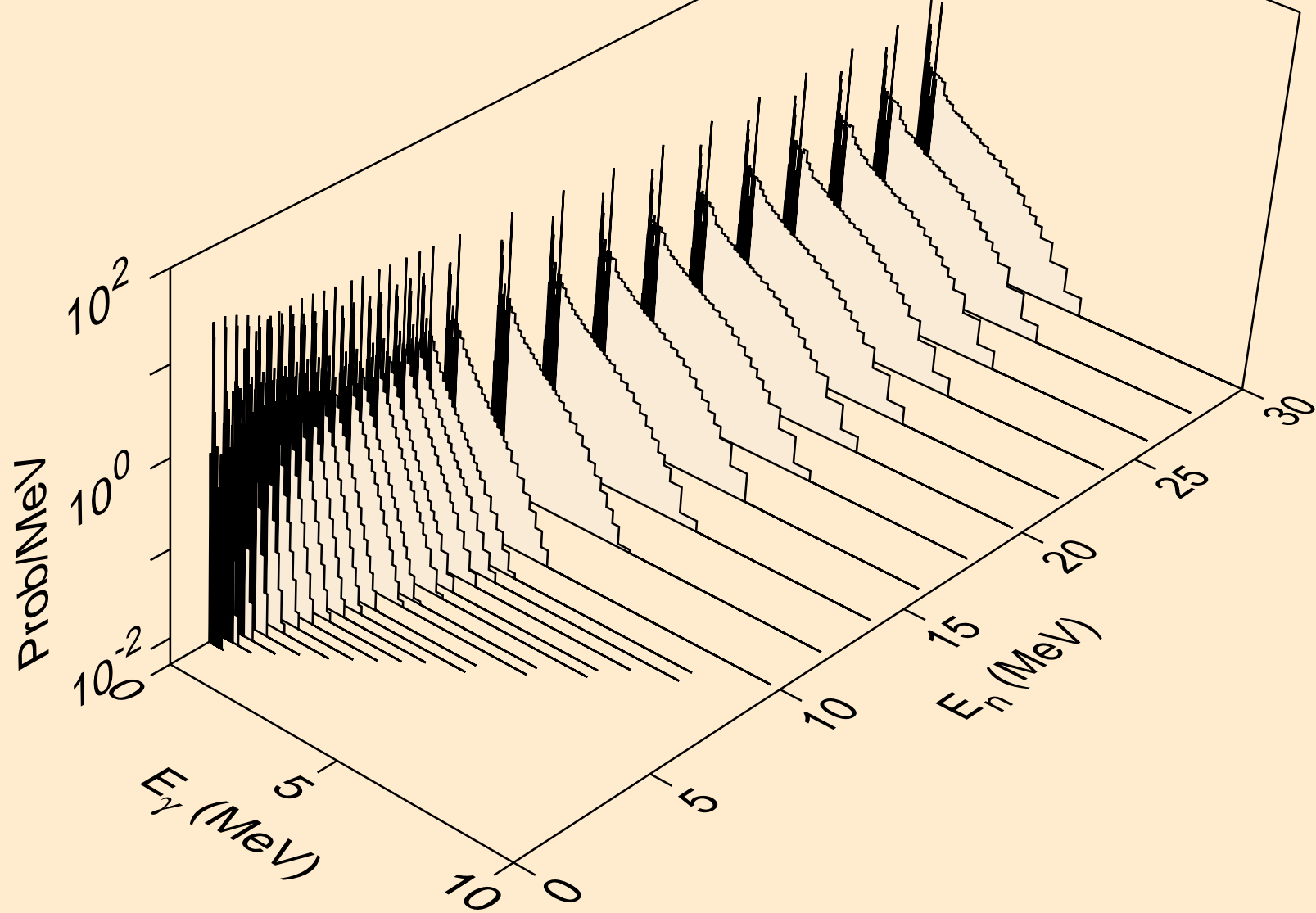

AU197M NEUTRON ACER TENDL-2023 LIBRARY; T=0.K
Photon emission for (n,d)

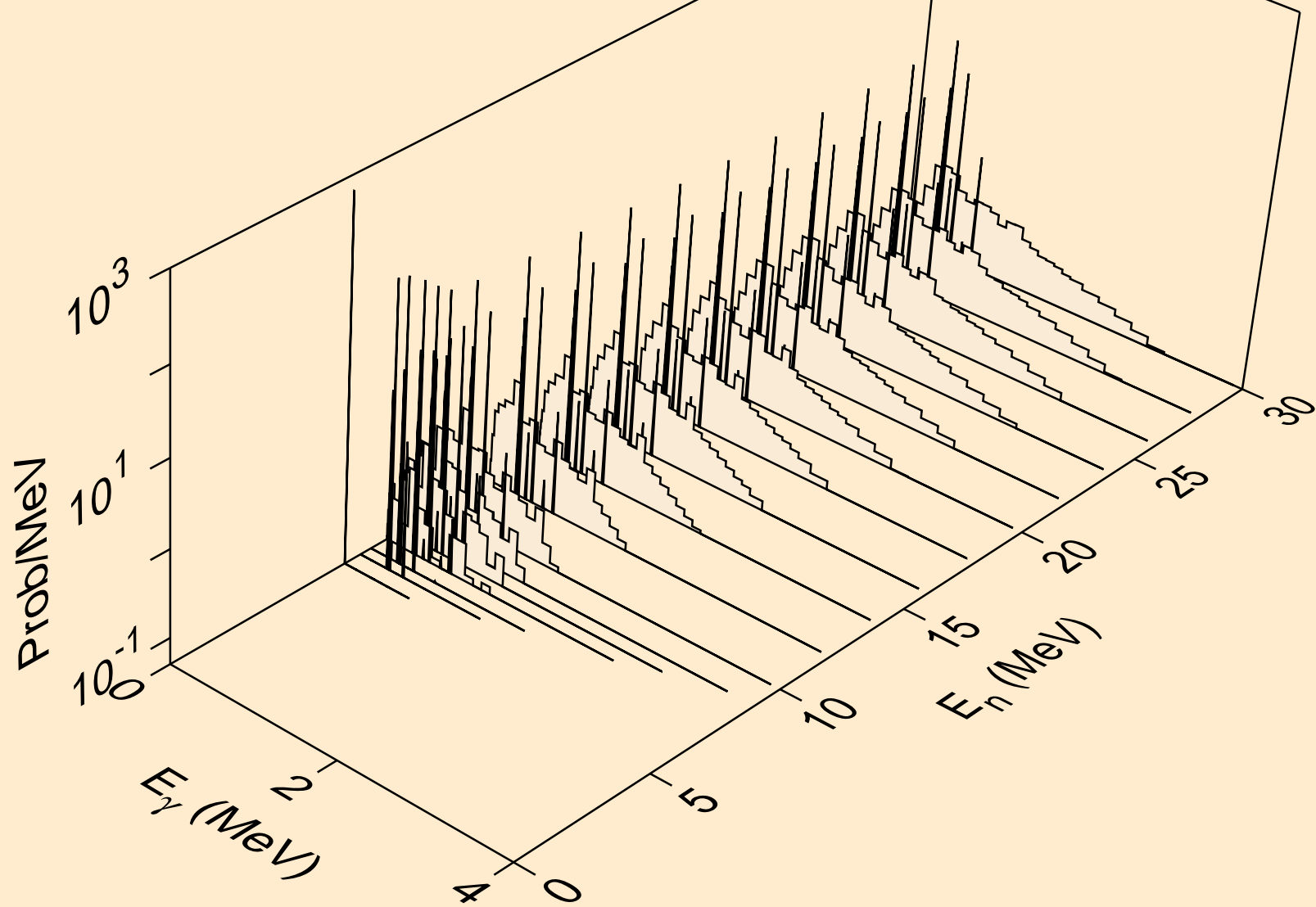

AU197M NEUTRON ACER TENDL-2023 LIBRARY; T=0.K
Photon emission for (n,t)

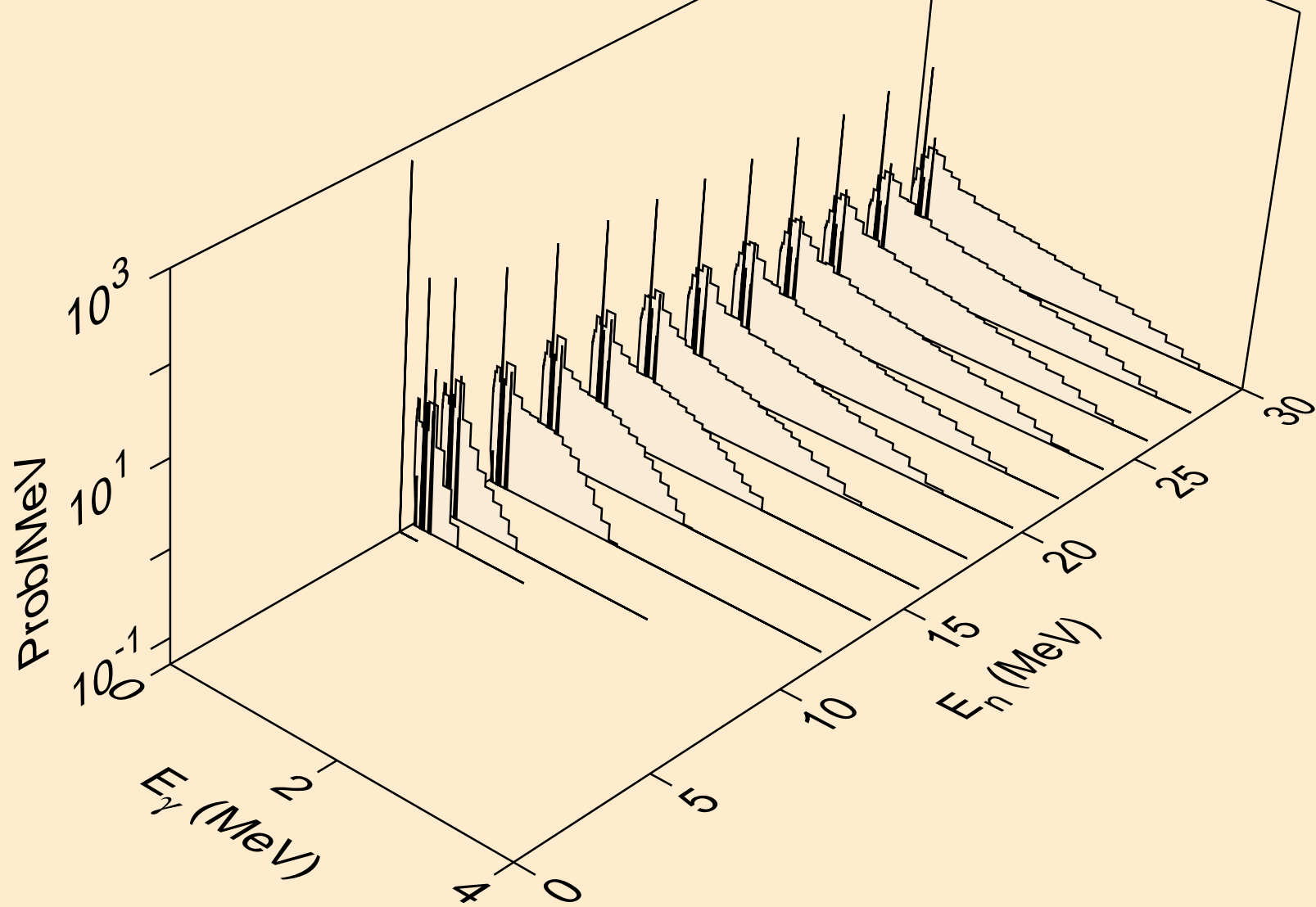

AU197M NEUTRON ACER TENDL-2023 LIBRARY; T=0.K
Photon emission for (n,he3)

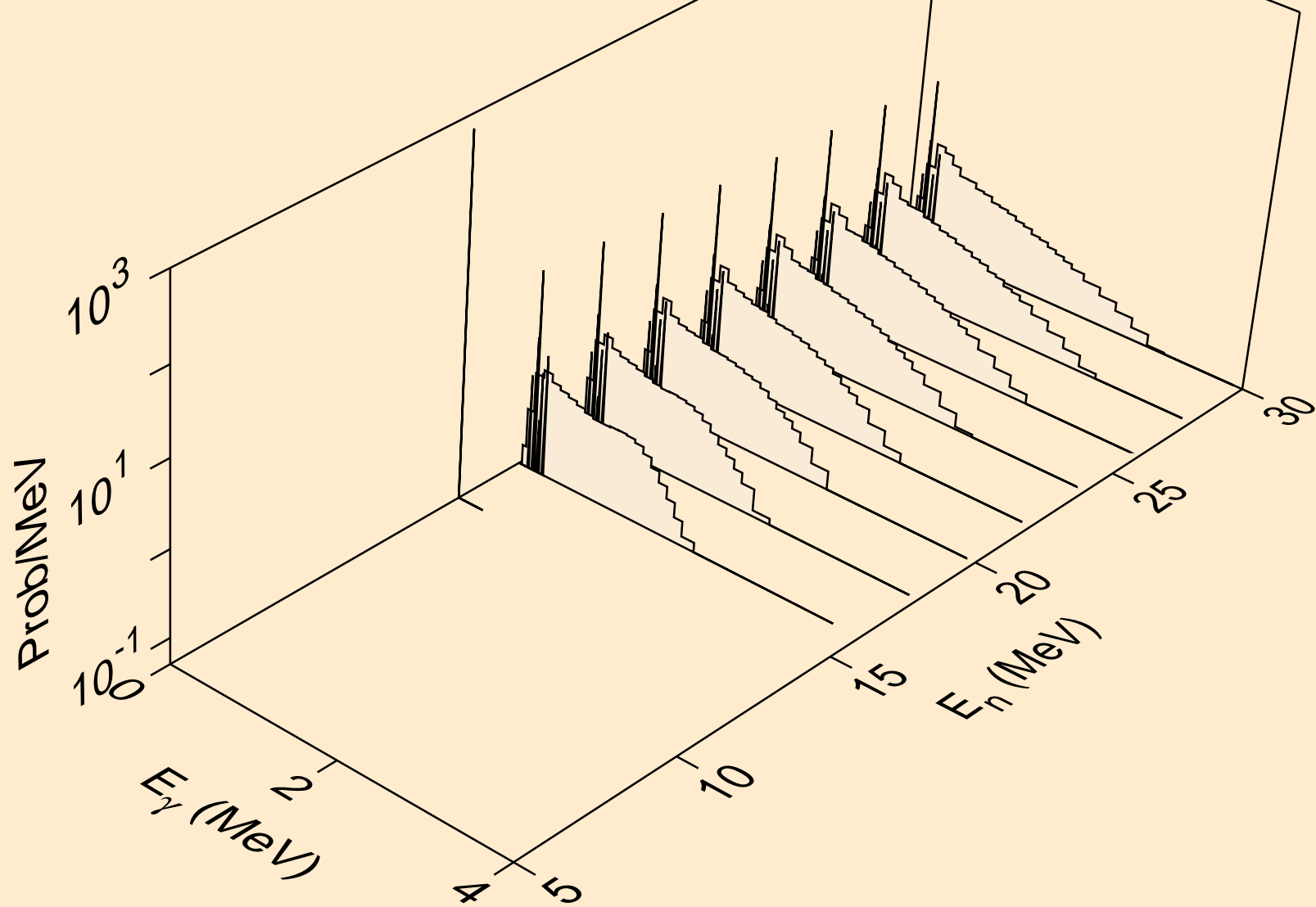

AU197M NEUTRON ACER TENDL-2023 LIBRARY; T=0.K
Photon emission for (n,a)

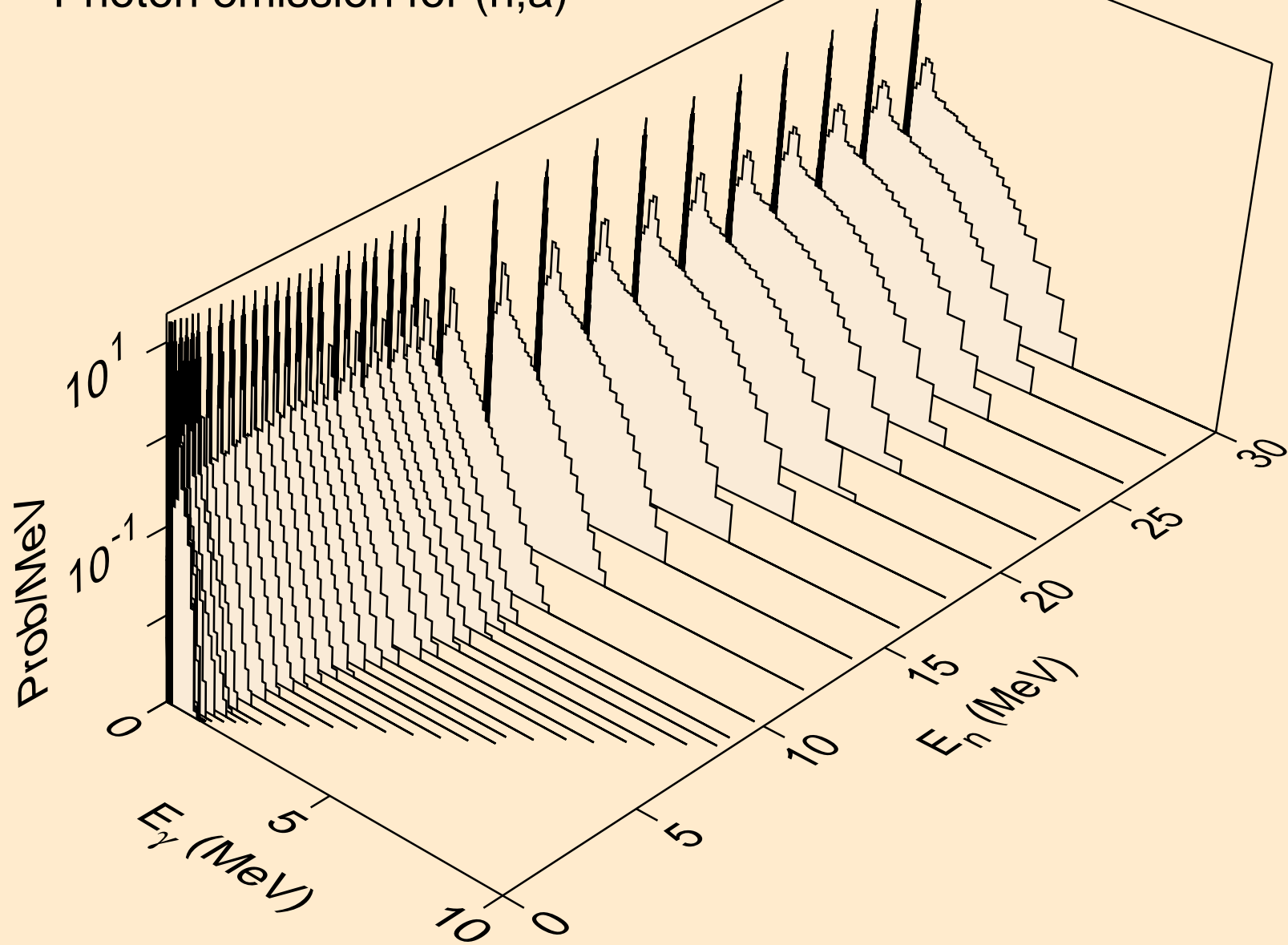

AU197M NEUTRON ACER TENDL-2023 LIBRARY; T=0.K
Photon emission for (n,2p)

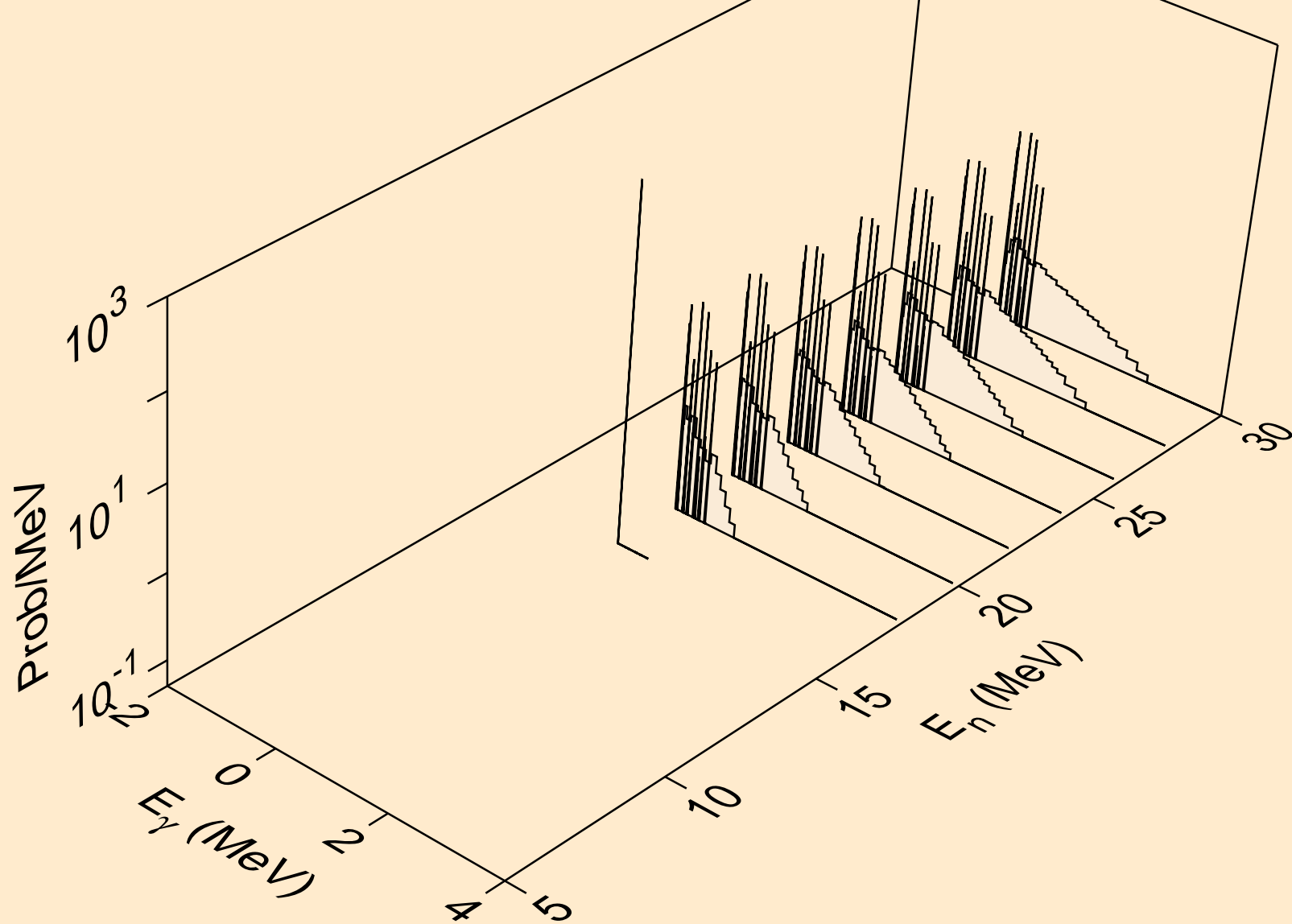

AU197M NEUTRON ACER TENDL-2023 LIBRARY; T=0.K
Photon emission for (n,pa)

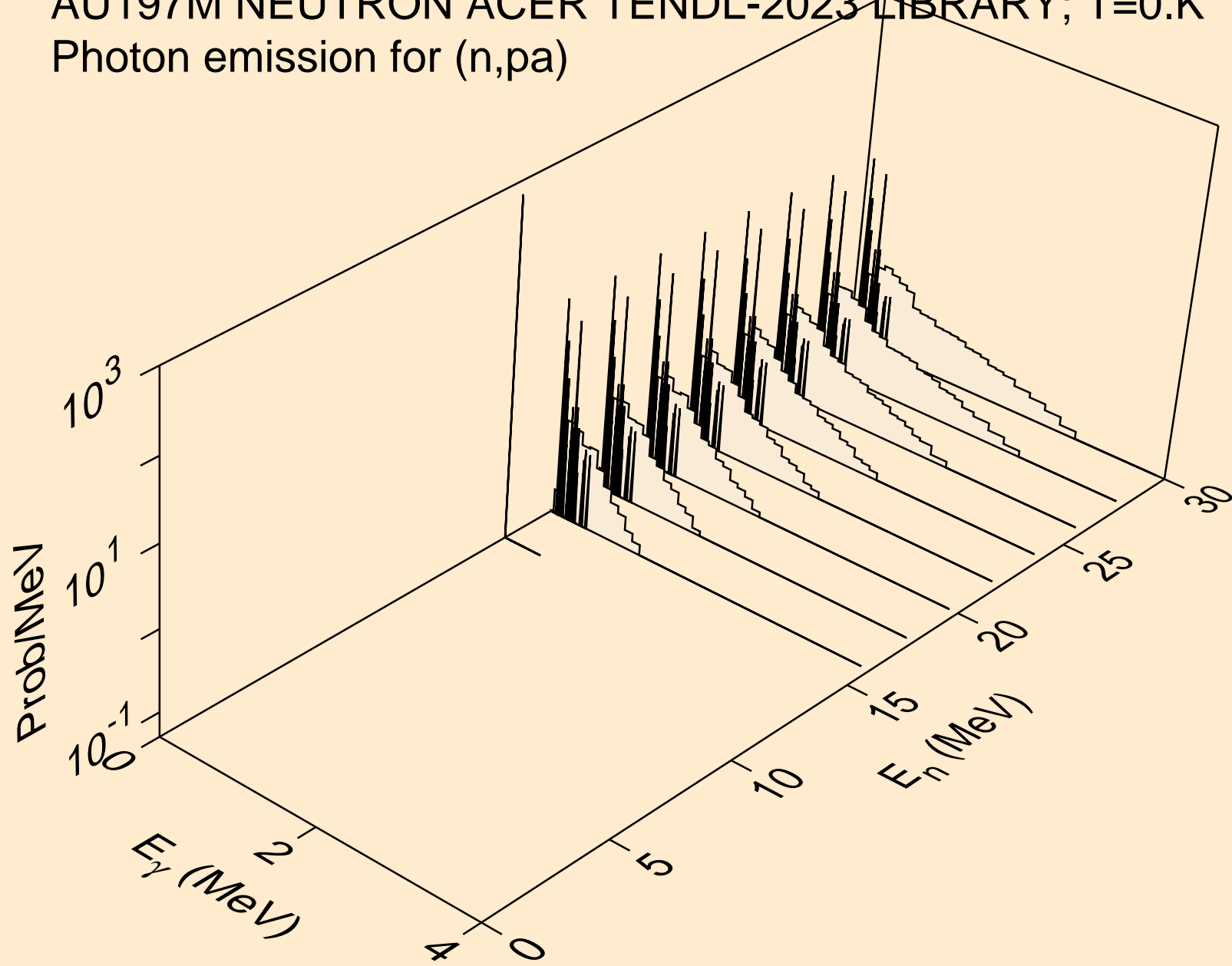

AU197M NEUTRON ACER TENDL-2023 LIBRARY; T=0.K
thermal capture photon spectrum

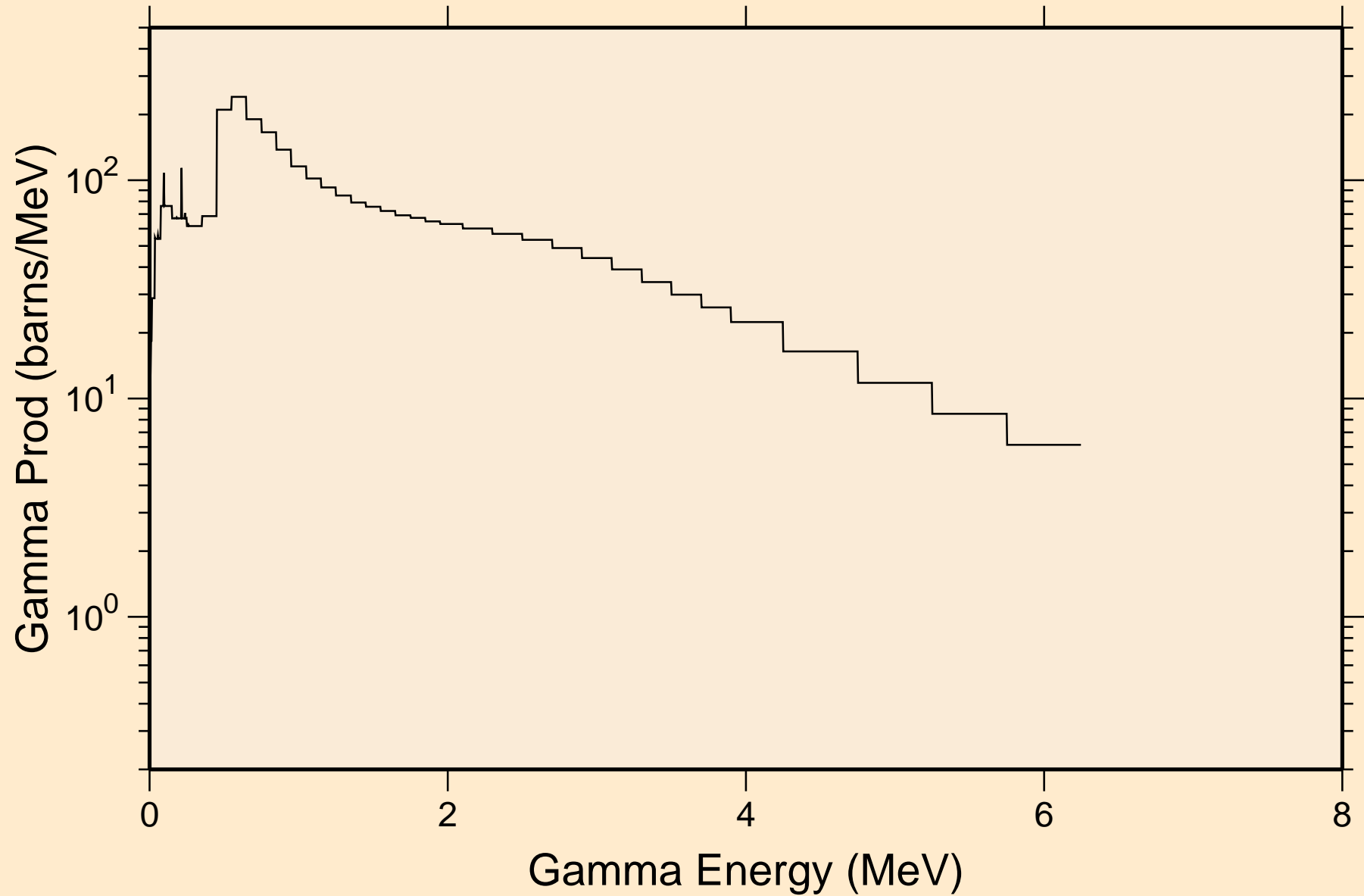

AU197M NEUTRON ACER TENDL-2023 LIBRARY; T=0.K
14 MeV photon spectrum

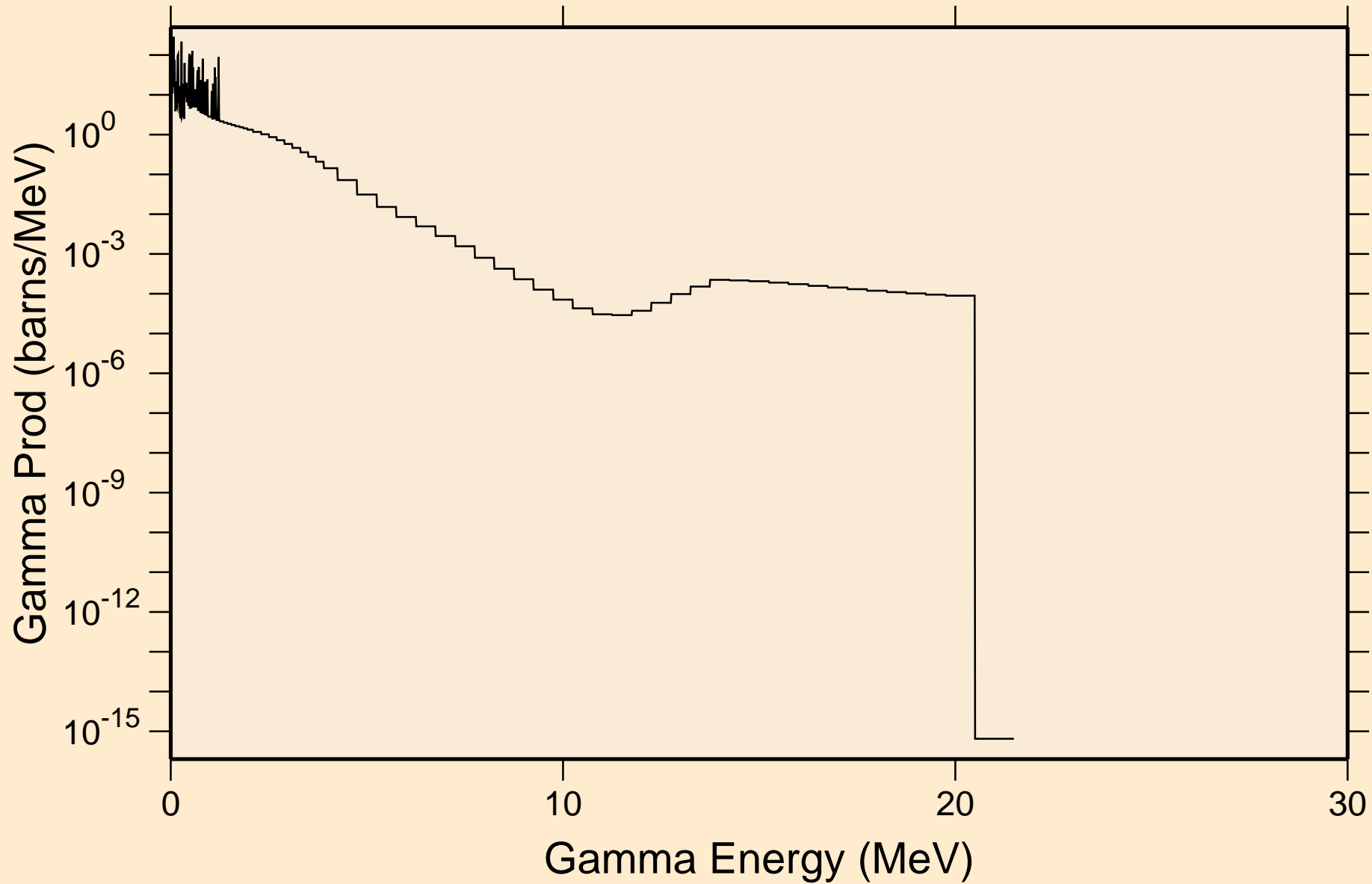

AU197M NEUTRON ACER TENDL-2023 LIBRARY; T=0.K

Particle heating contributions

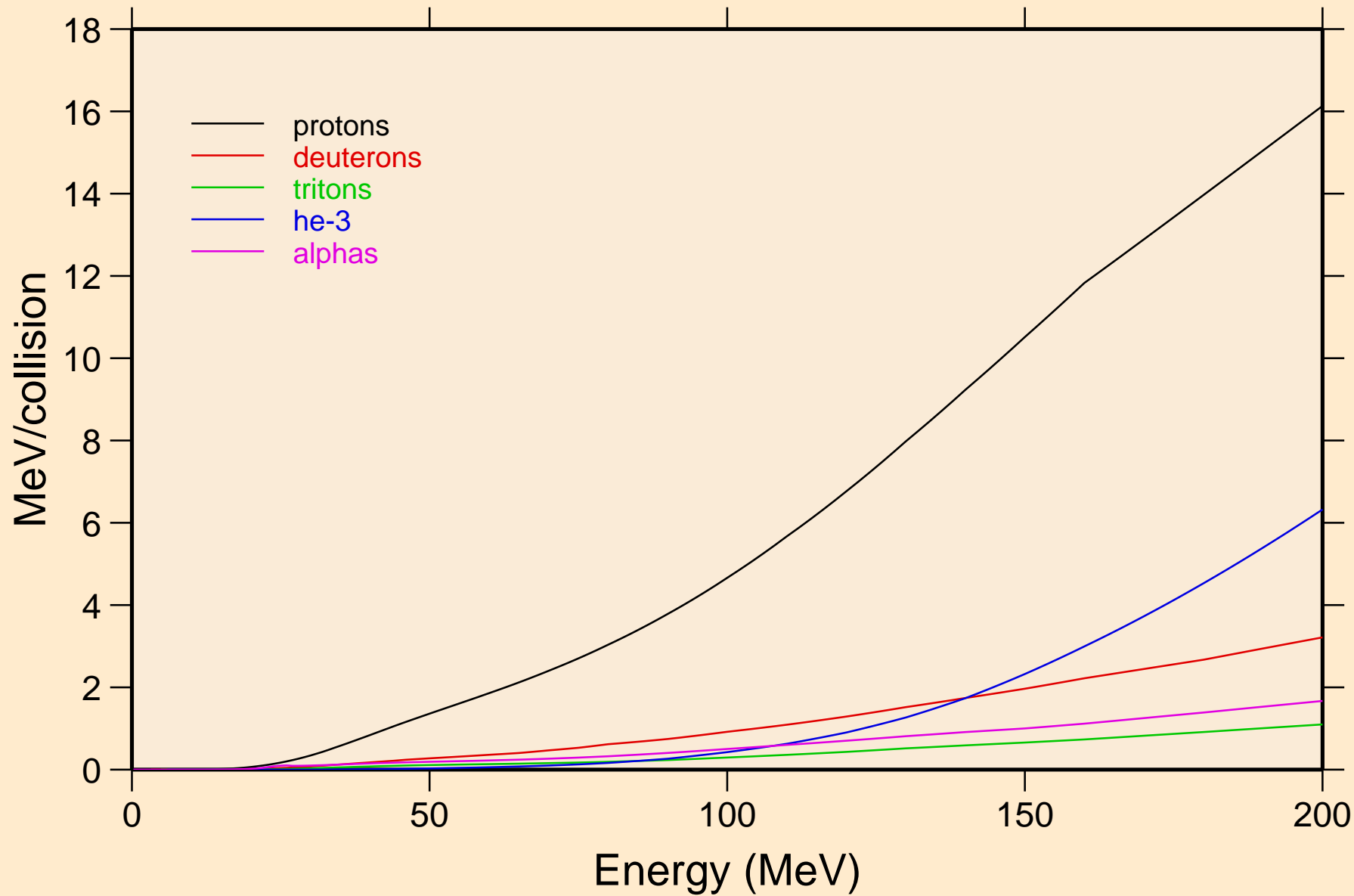

AU197M NEUTRON ACER TENDL-2023 LIBRARY; T=0.K
Recoil Heating

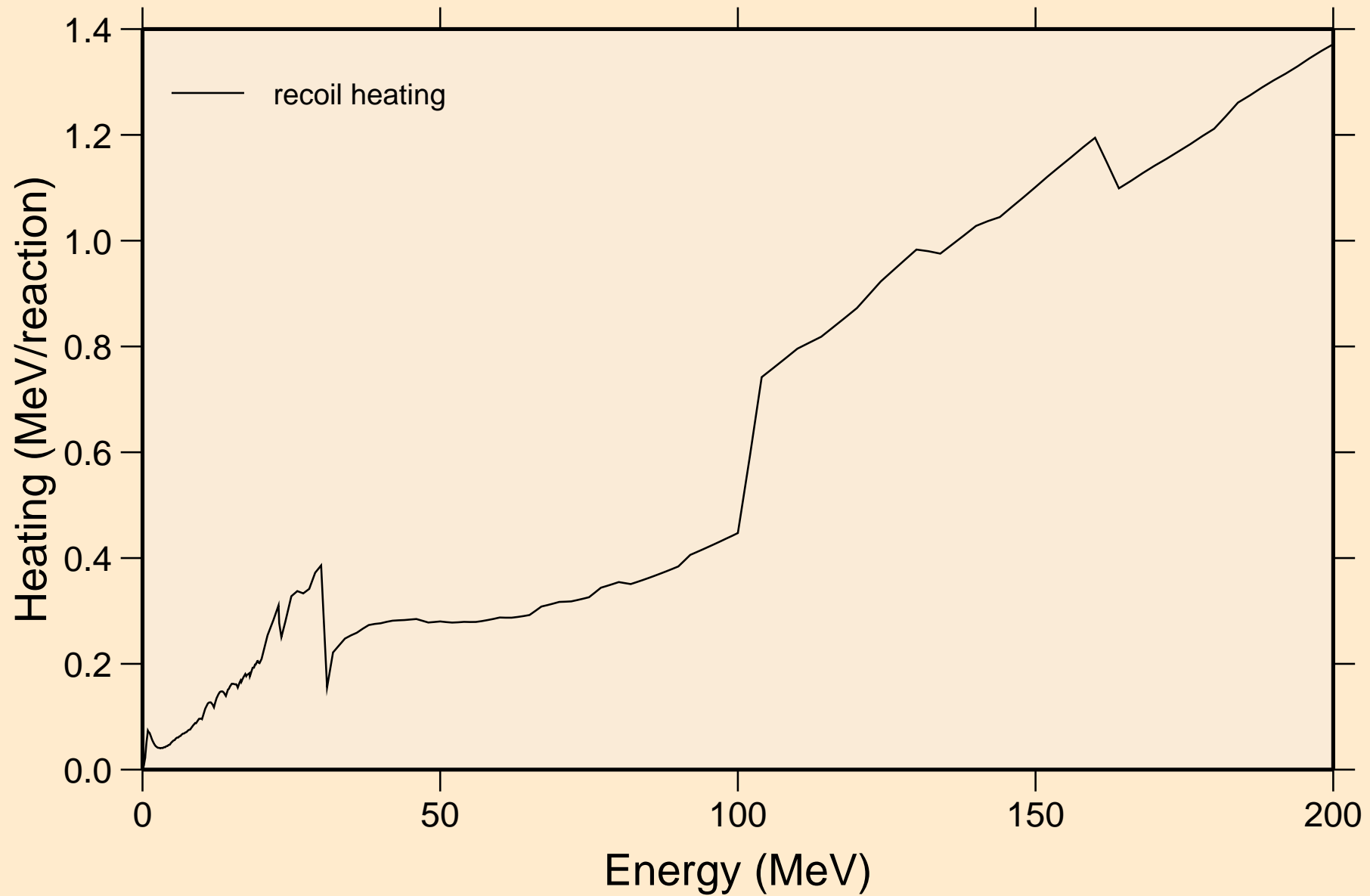

AU197M NEUTRON ACER TENDL-2023 LIBRARY; T=0.K
Particle production cross sections

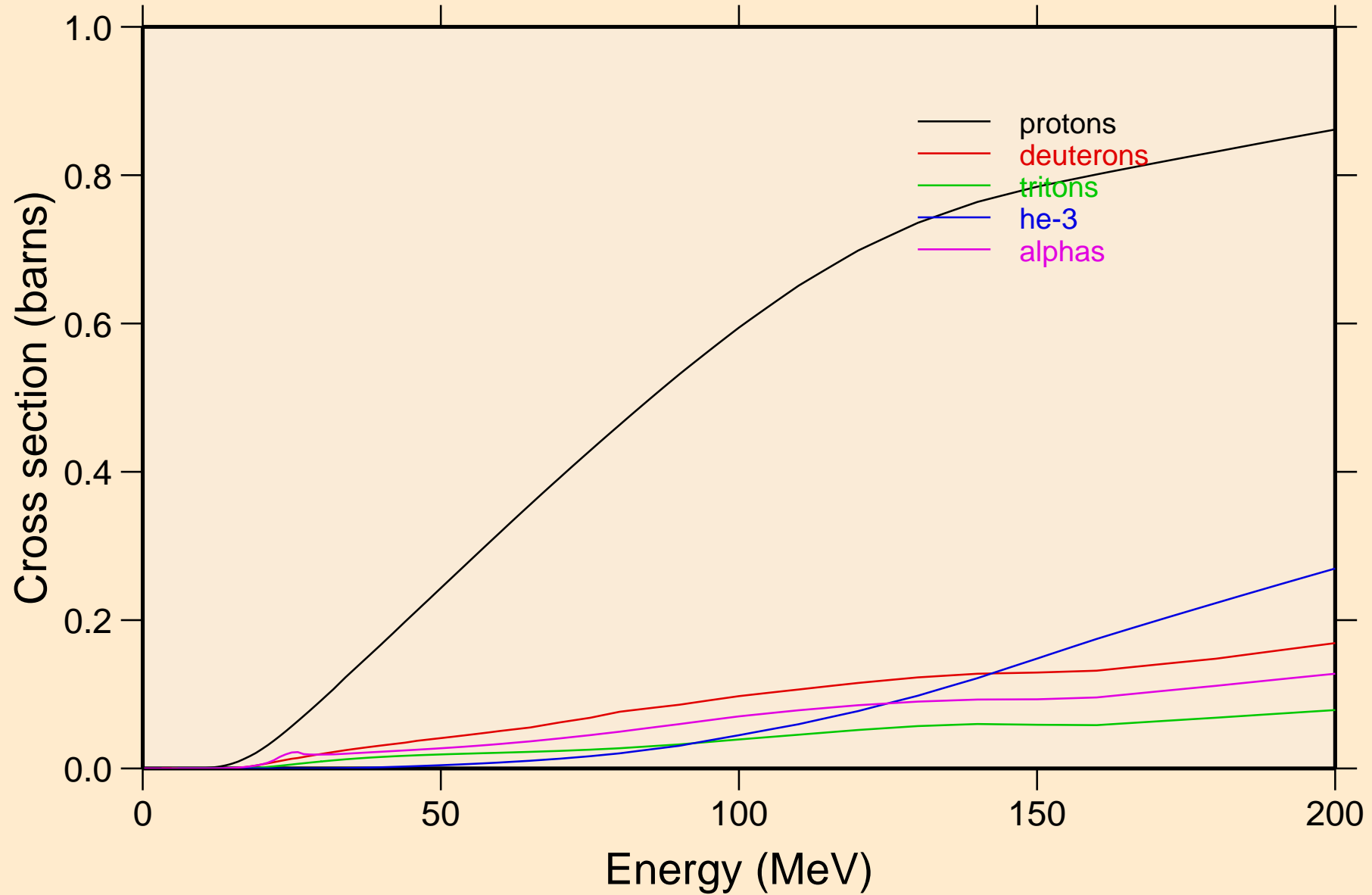

AU197M NEUTRON ACER TENDL-2023 LIBRARY; T=0.K
protons from (n,x)

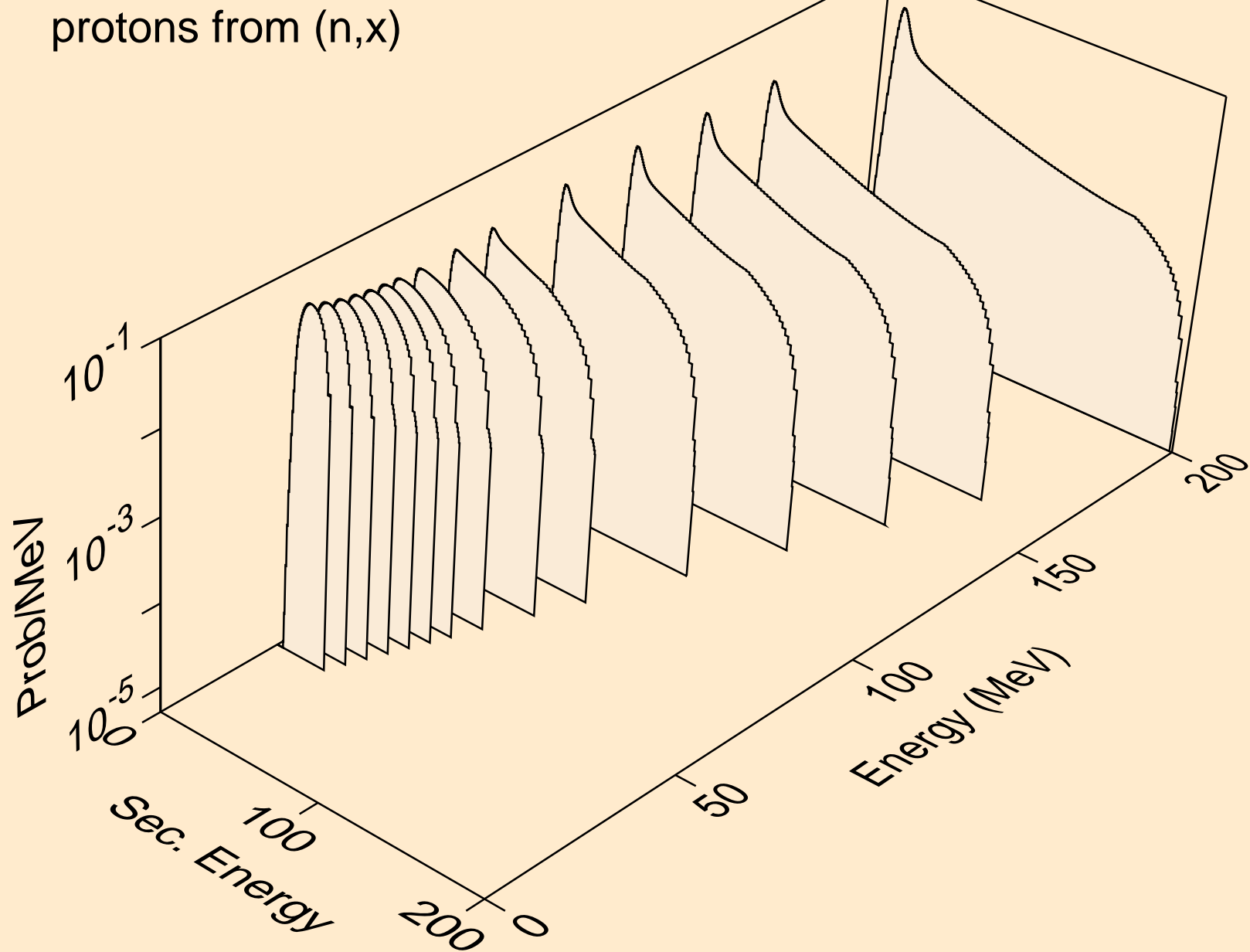

AU197M NEUTRON ACER TENDL-2023 LIBRARY; T=0.K
protons from (n,n*)p

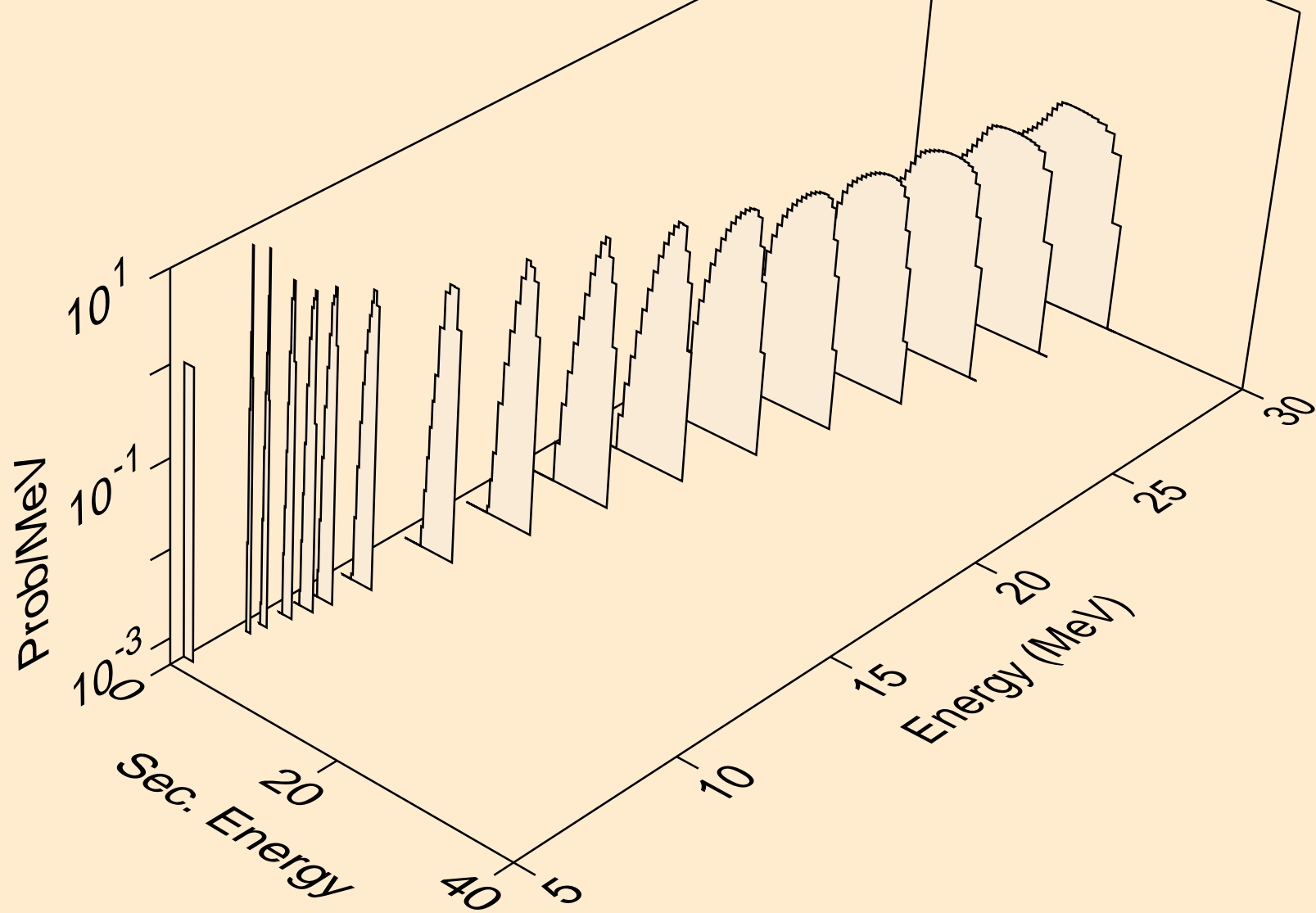

AU197M NEUTRON ACER TENDL-2023 LIBRARY; T=0.K
protons from (n,2np)

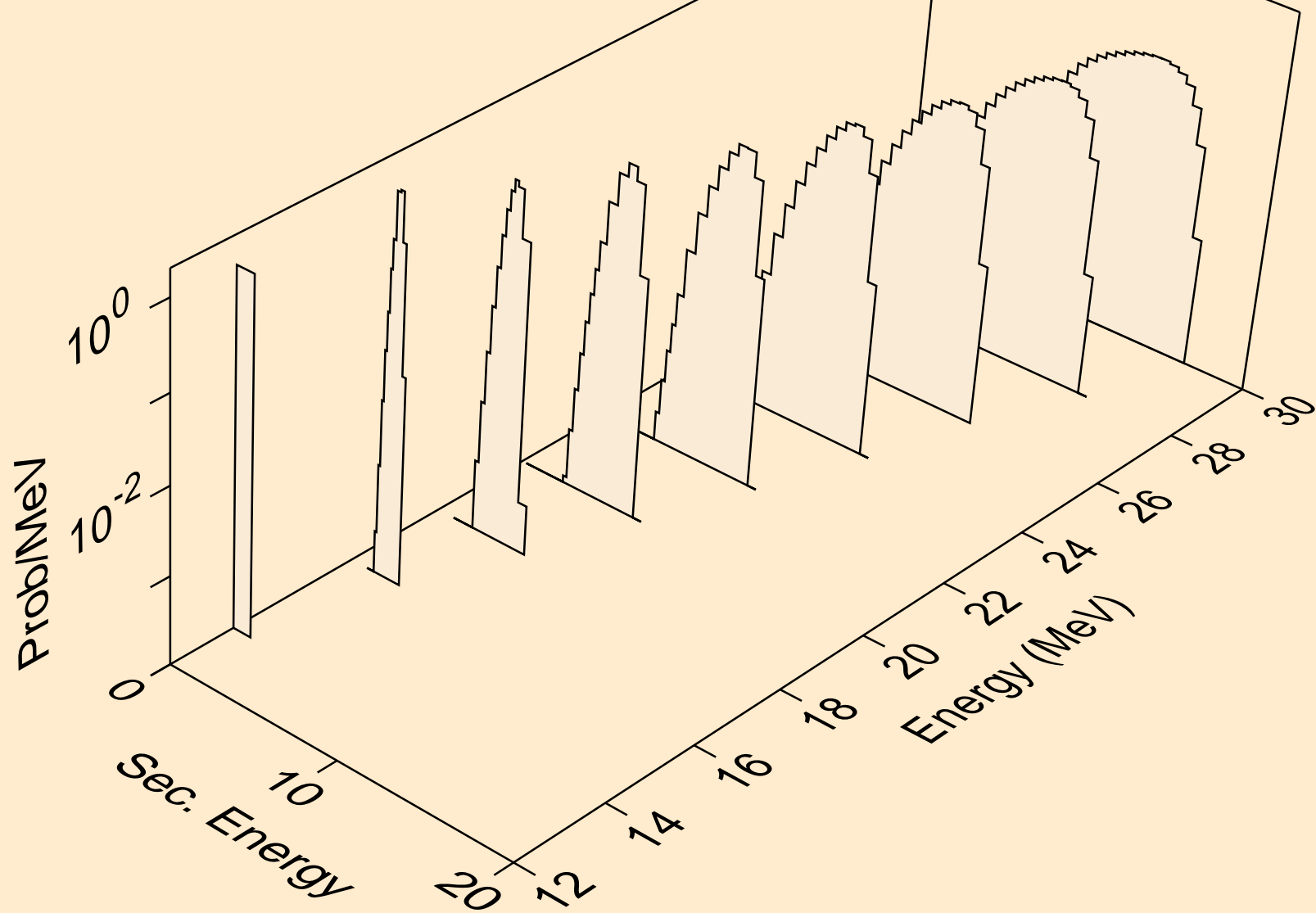

AU197M NEUTRON ACER TENDL-2023 LIBRARY; T=0.K
protons from (n,3np)

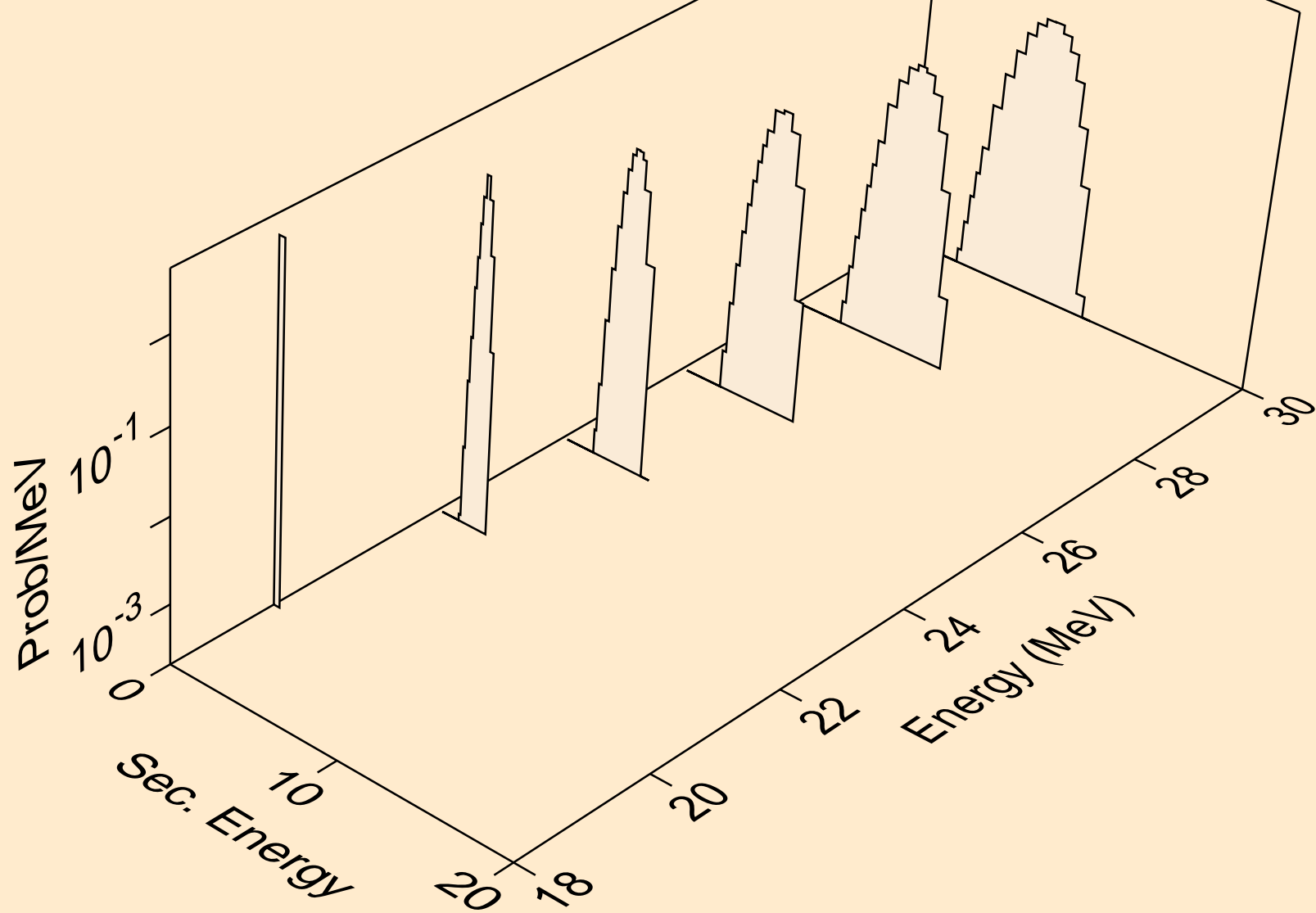

AU197M NEUTRON ACER TENDL-2023 LIBRARY; T=0.K
protons from (n,n2p)

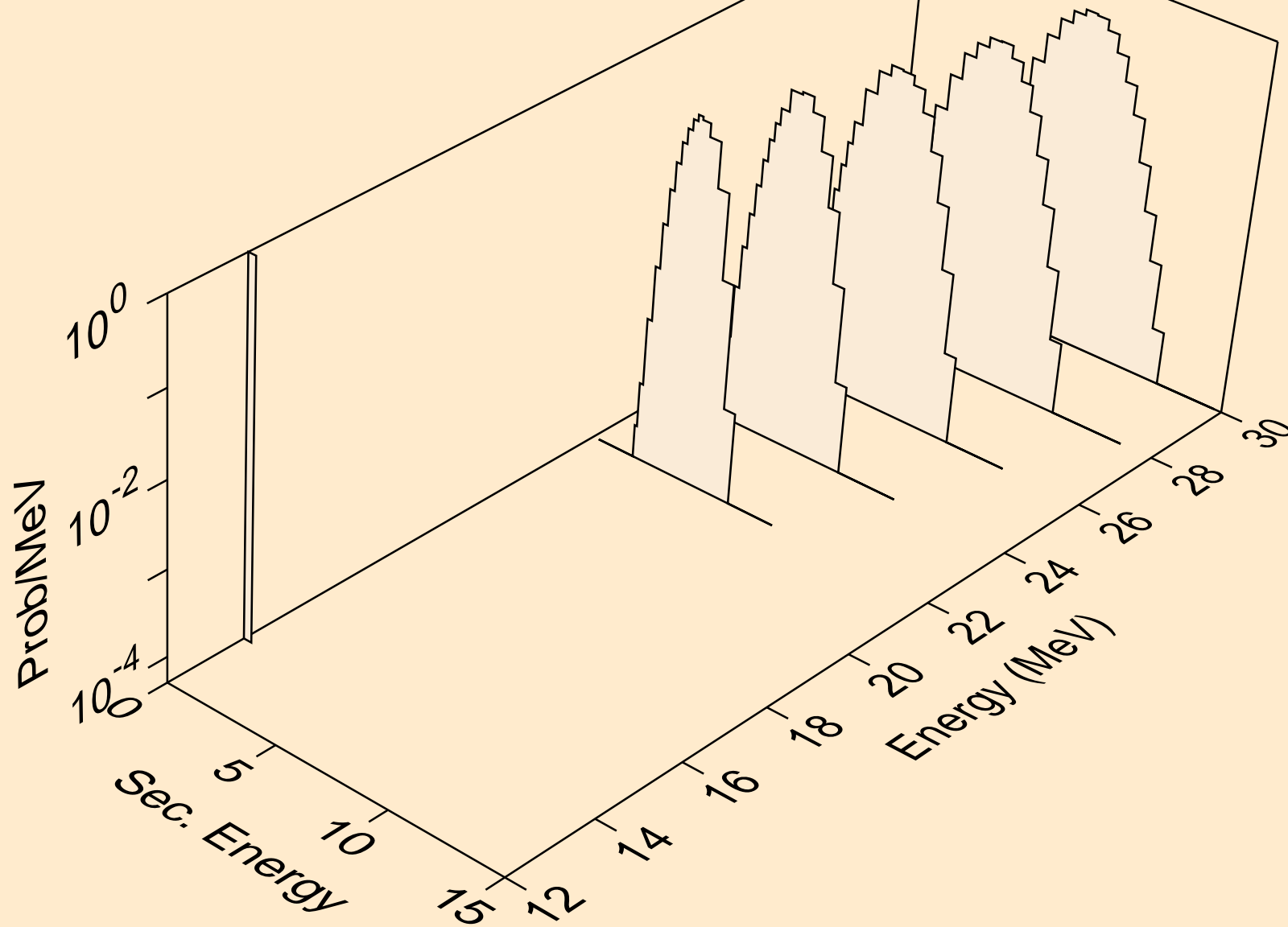

AU197M NEUTRON ACER TENDL-2023 LIBRARY; T=0.K
protons from (n,npa)

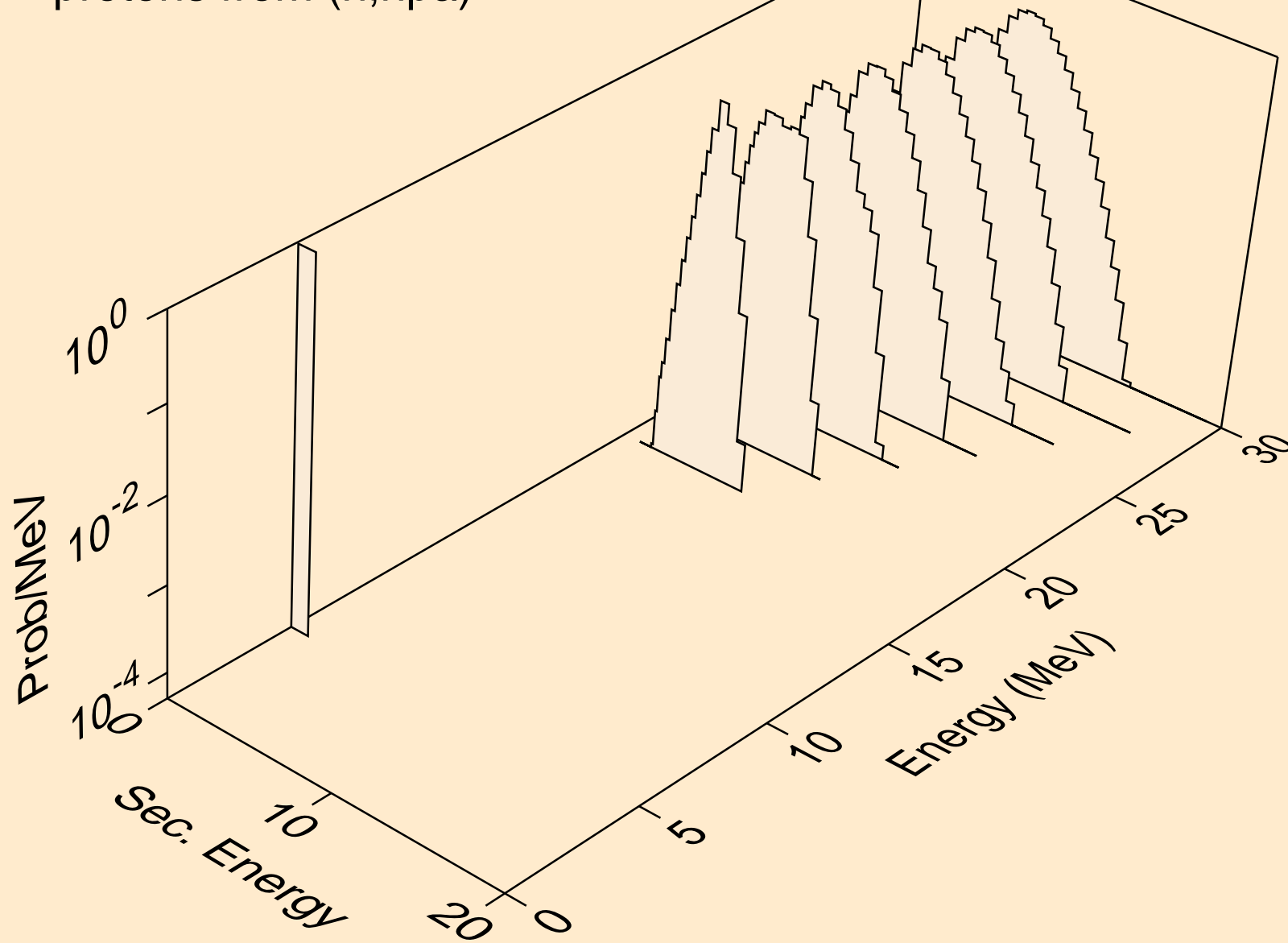

AU197M NEUTRON ACER TENDL-2023 LIBRARY; T=0.K
protons from (n,p)

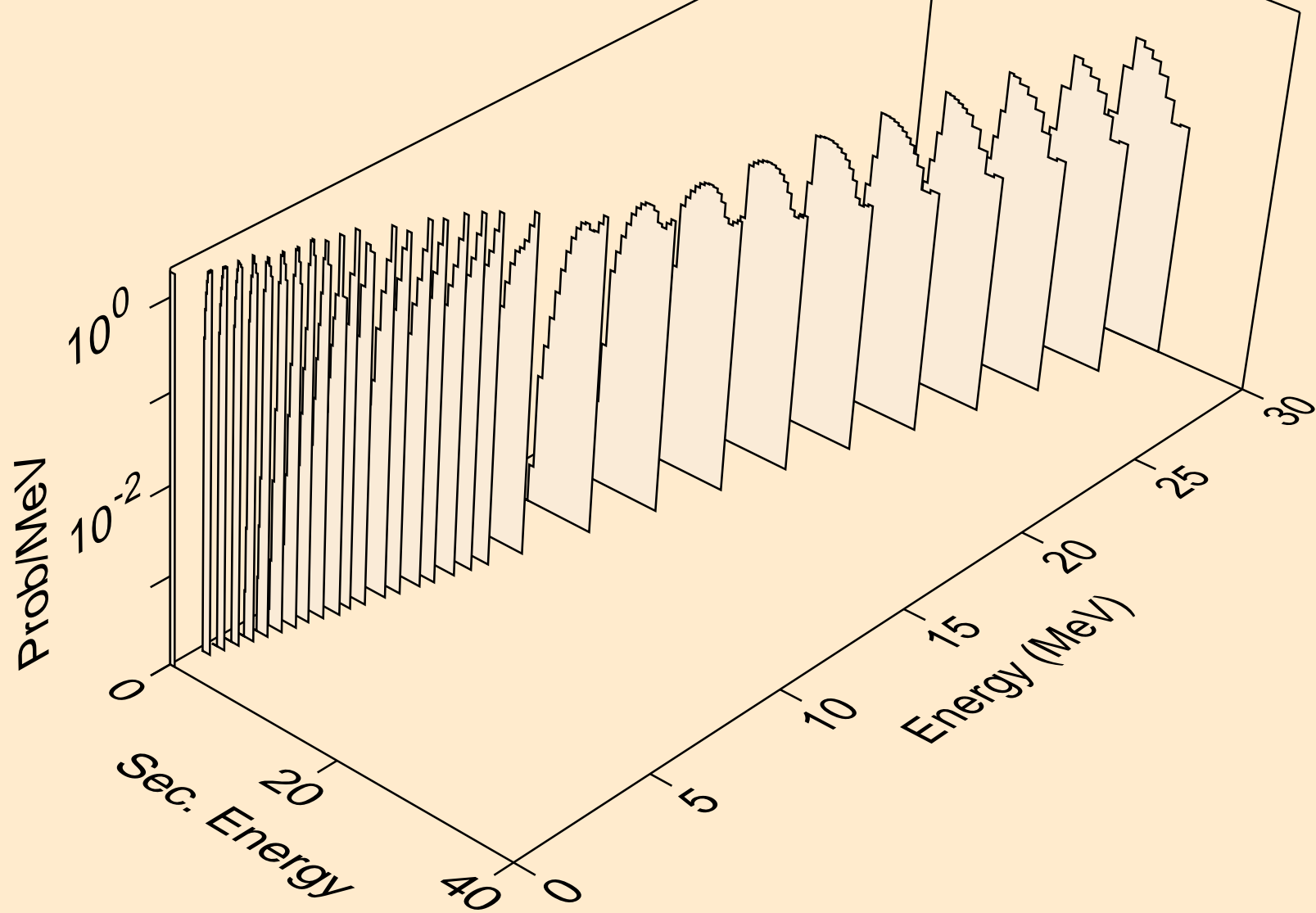

AU197M NEUTRON ACER TENDL-2023 LIBRARY; T=0.K
protons from (n,2p)

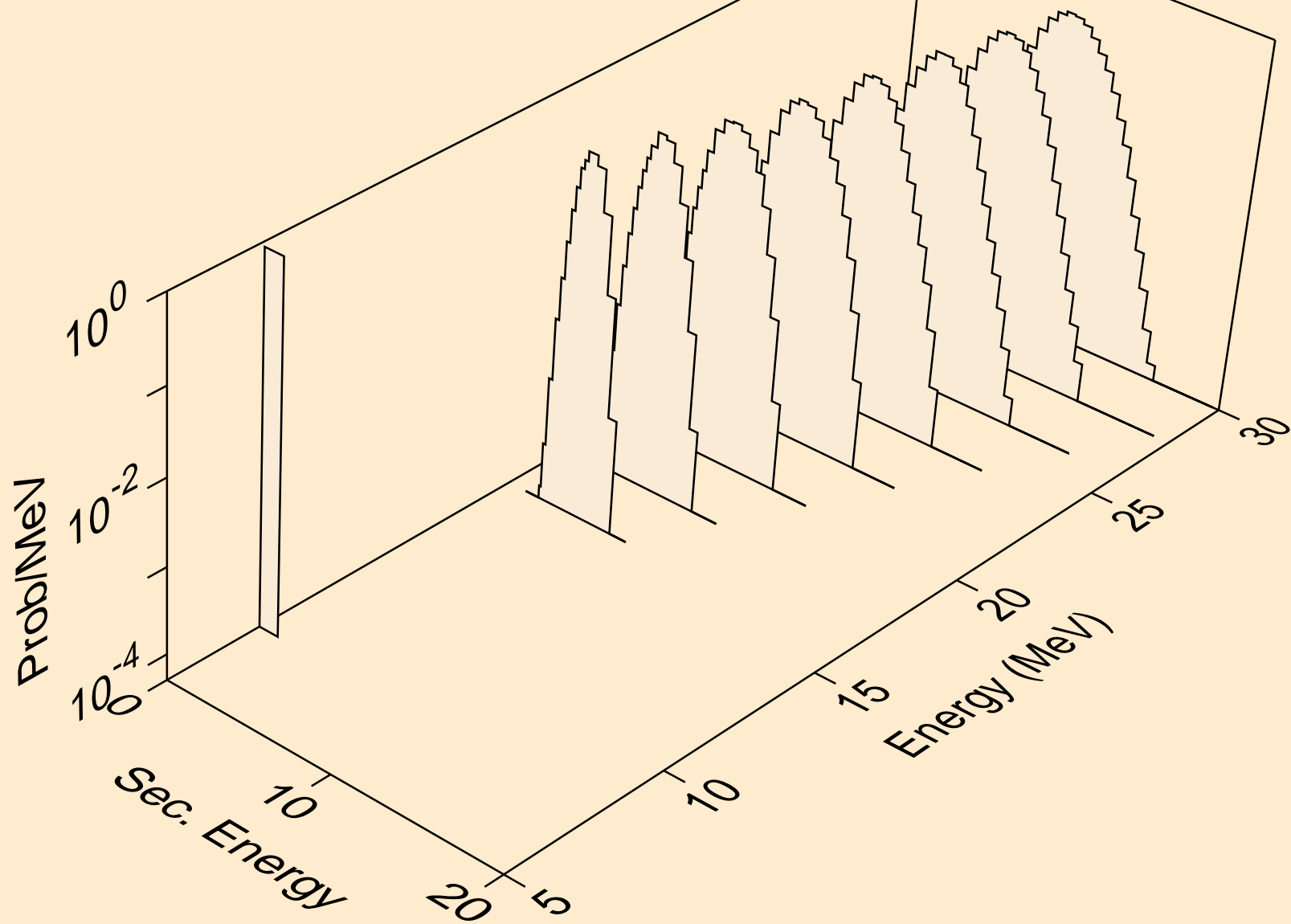

AU197M NEUTRON ACER TENDL-2023 LIBRARY; T=0.K
protons from (n,p)

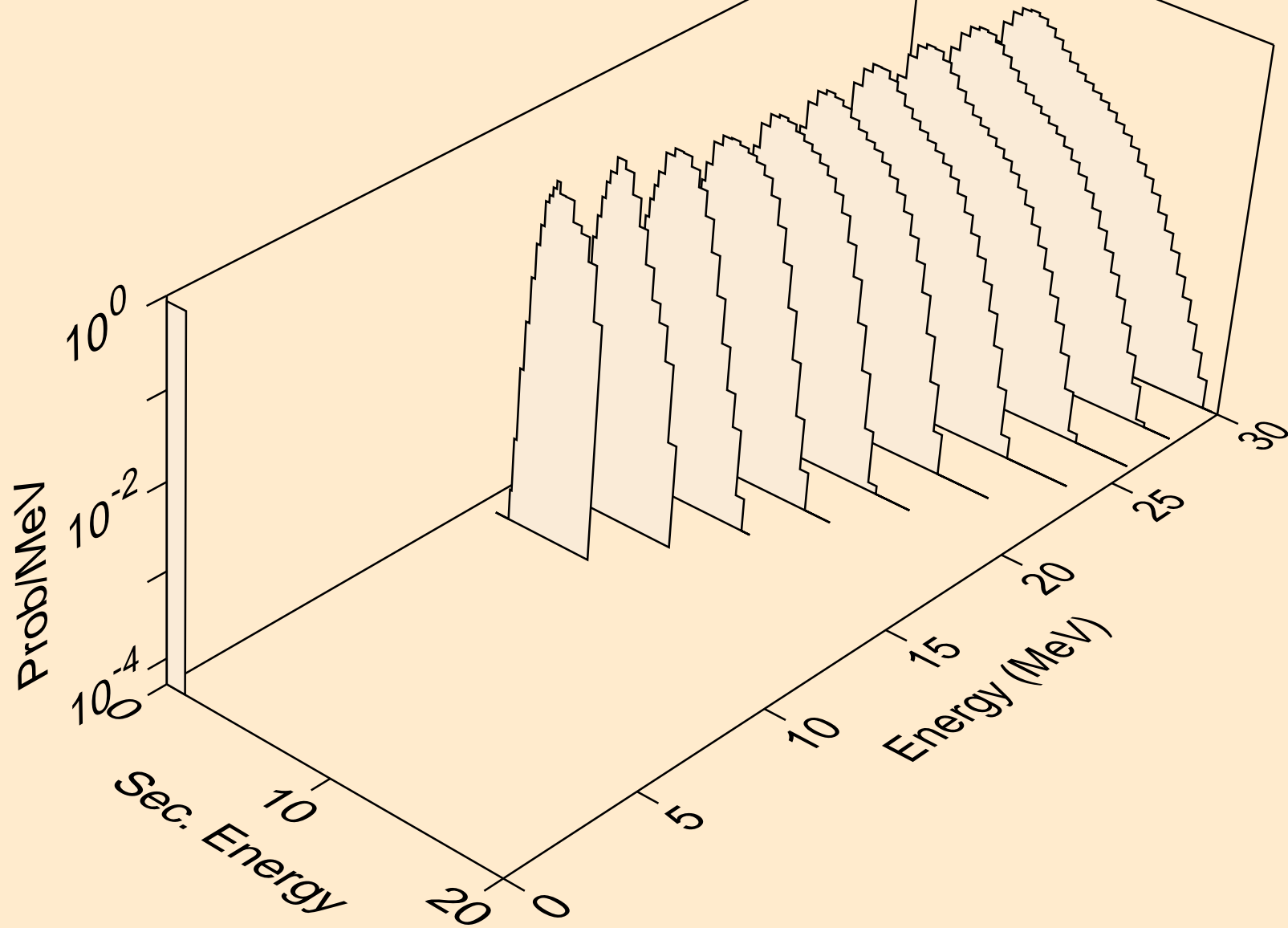

AU197M NEUTRON ACER TENDL-2023 LIBRARY; T=0.K
deuterons from (n,x)

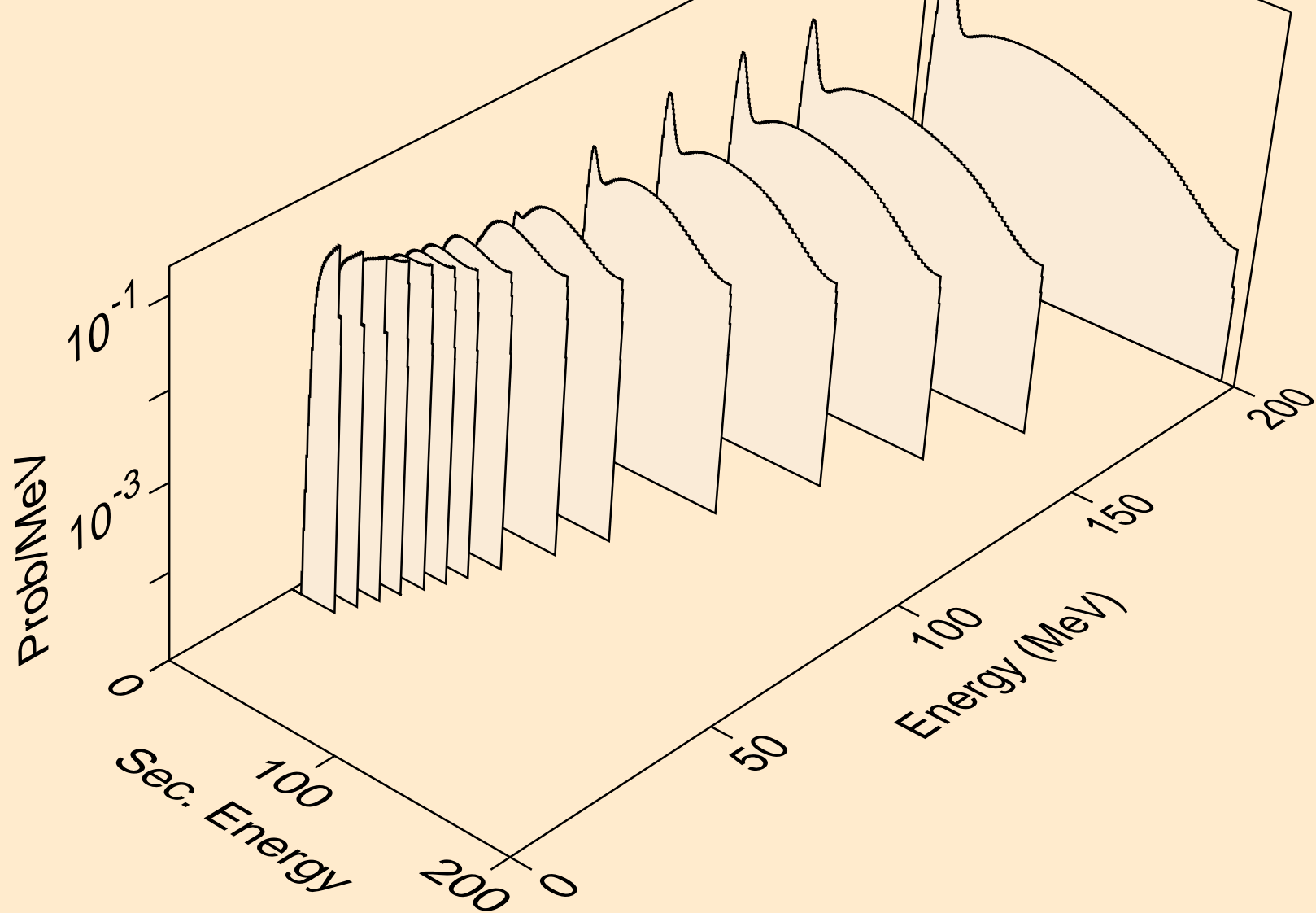

AU197M NEUTRON ACER TENDL-2023 LIBRARY; T=0.K
deuterons from (n,2nd)

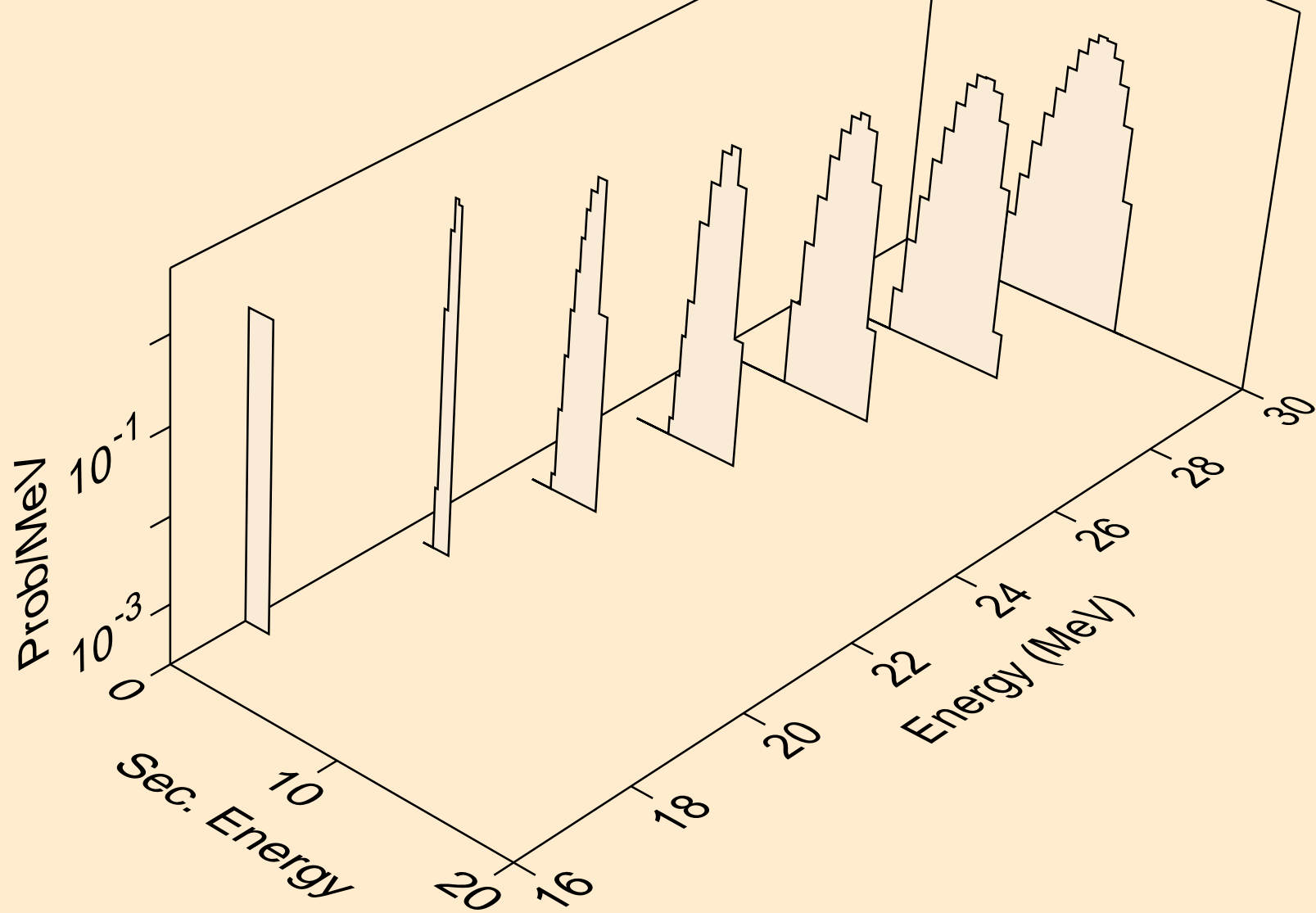

AU197M NEUTRON ACER TENDL-2023 LIBRARY; T=0.K
deuterons from (n,n*)d

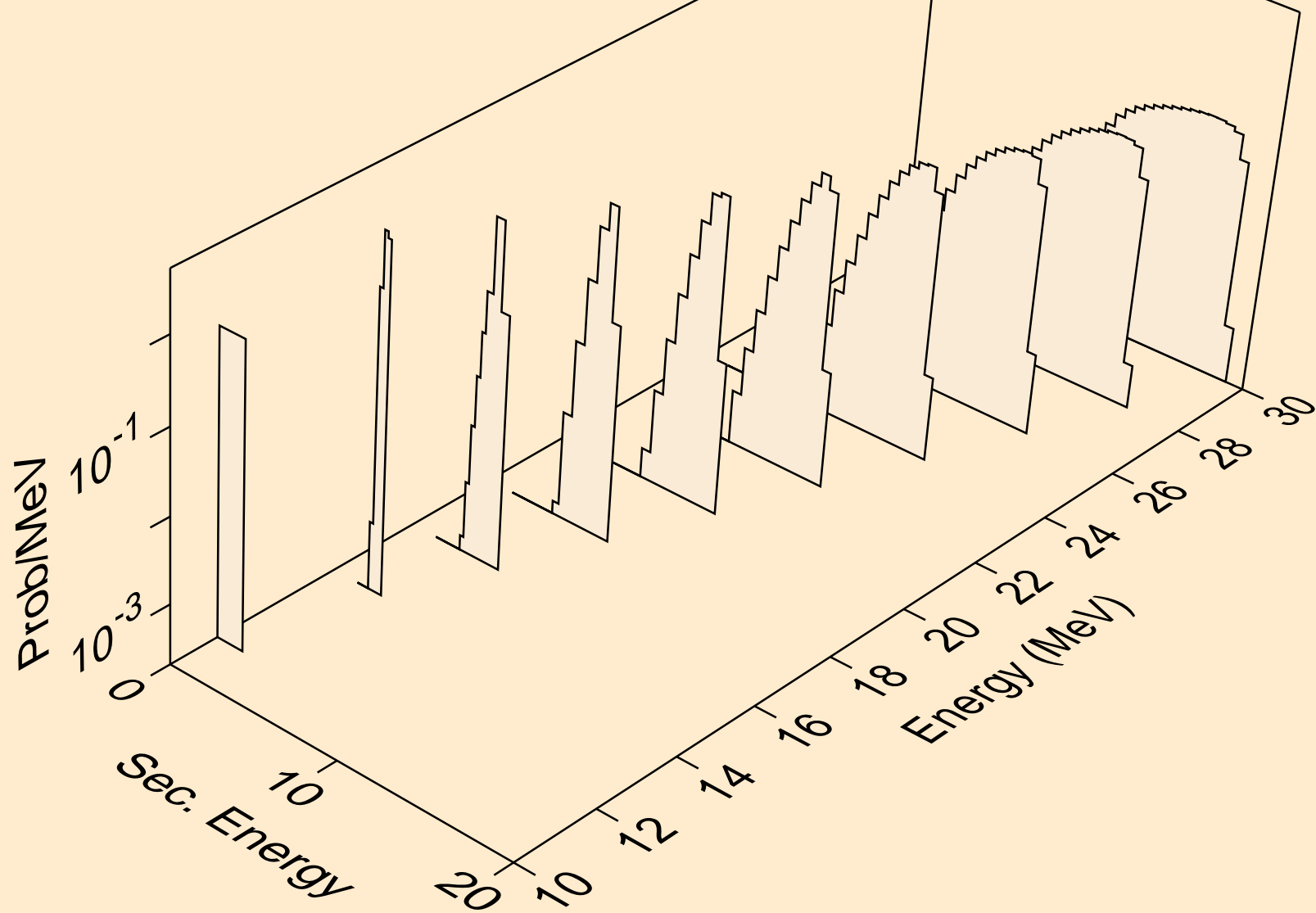

AU197M NEUTRON ACER TENDL-2023 LIBRARY; T=0.K
deuterons from (n,d)

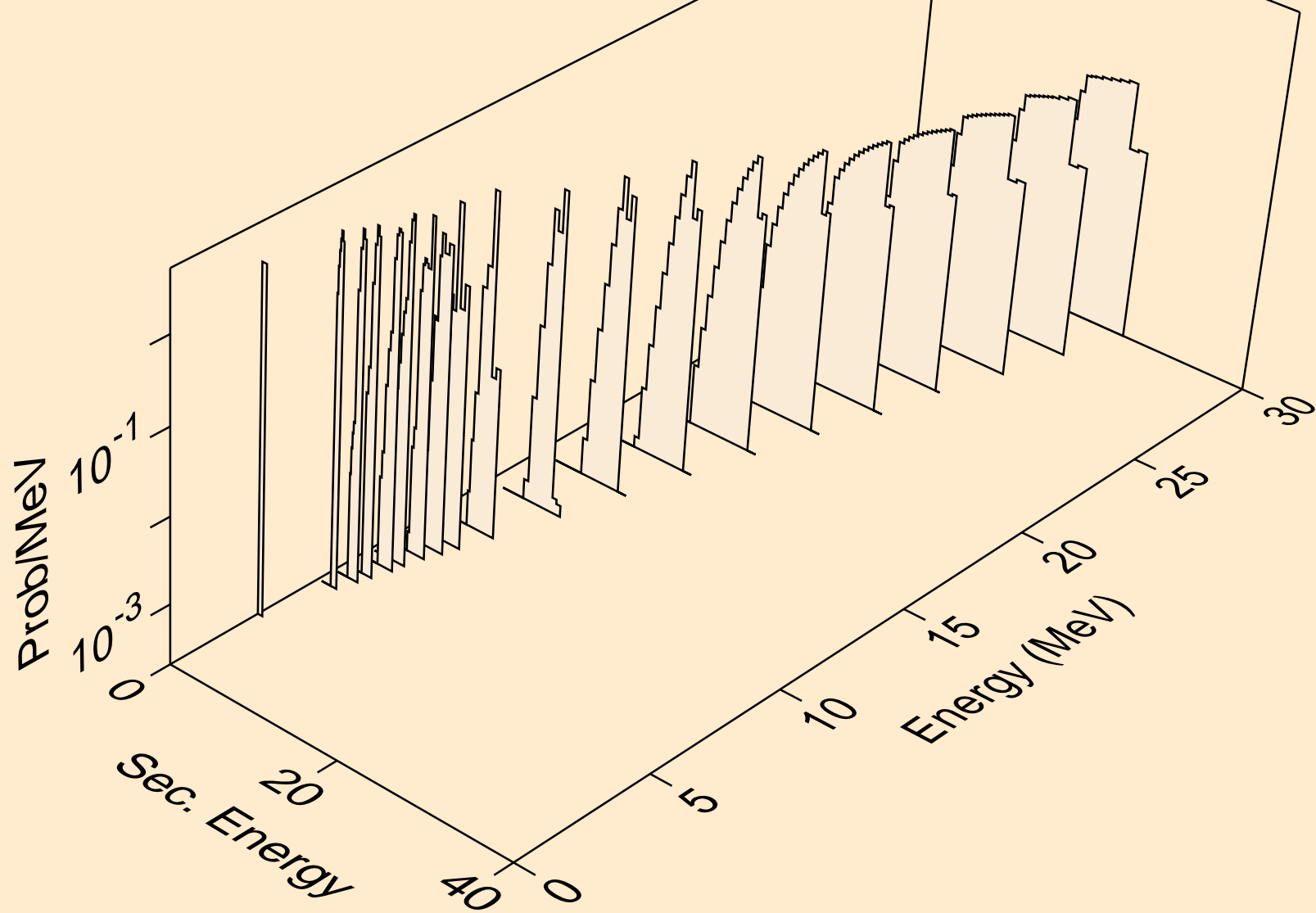

AU197M NEUTRON ACER TENDL-2023 LIBRARY; T=0.K
tritons from (n,x)

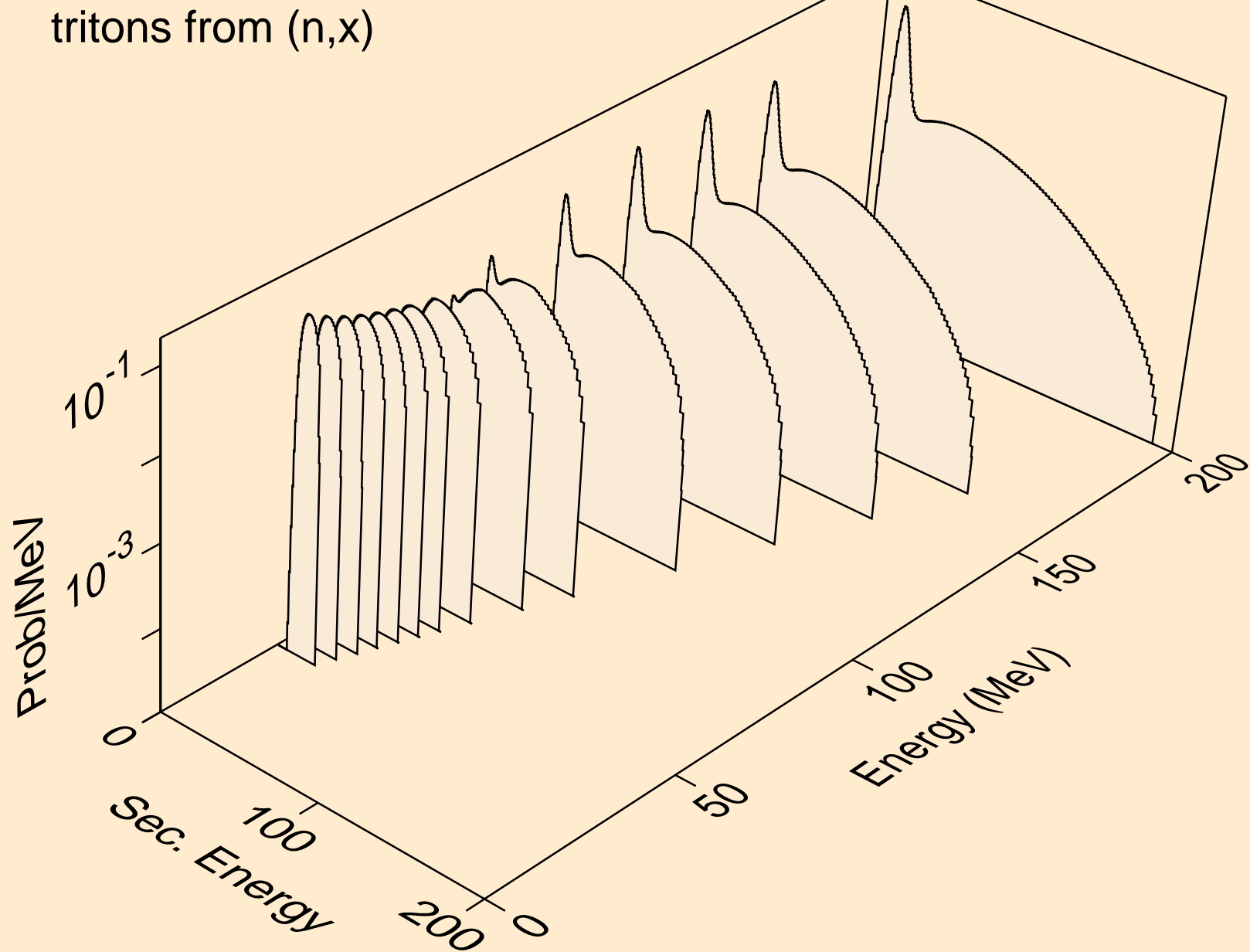

AU197M NEUTRON ACER TENDL-2023 LIBRARY; T=0.K
tritons from (n,n*)t

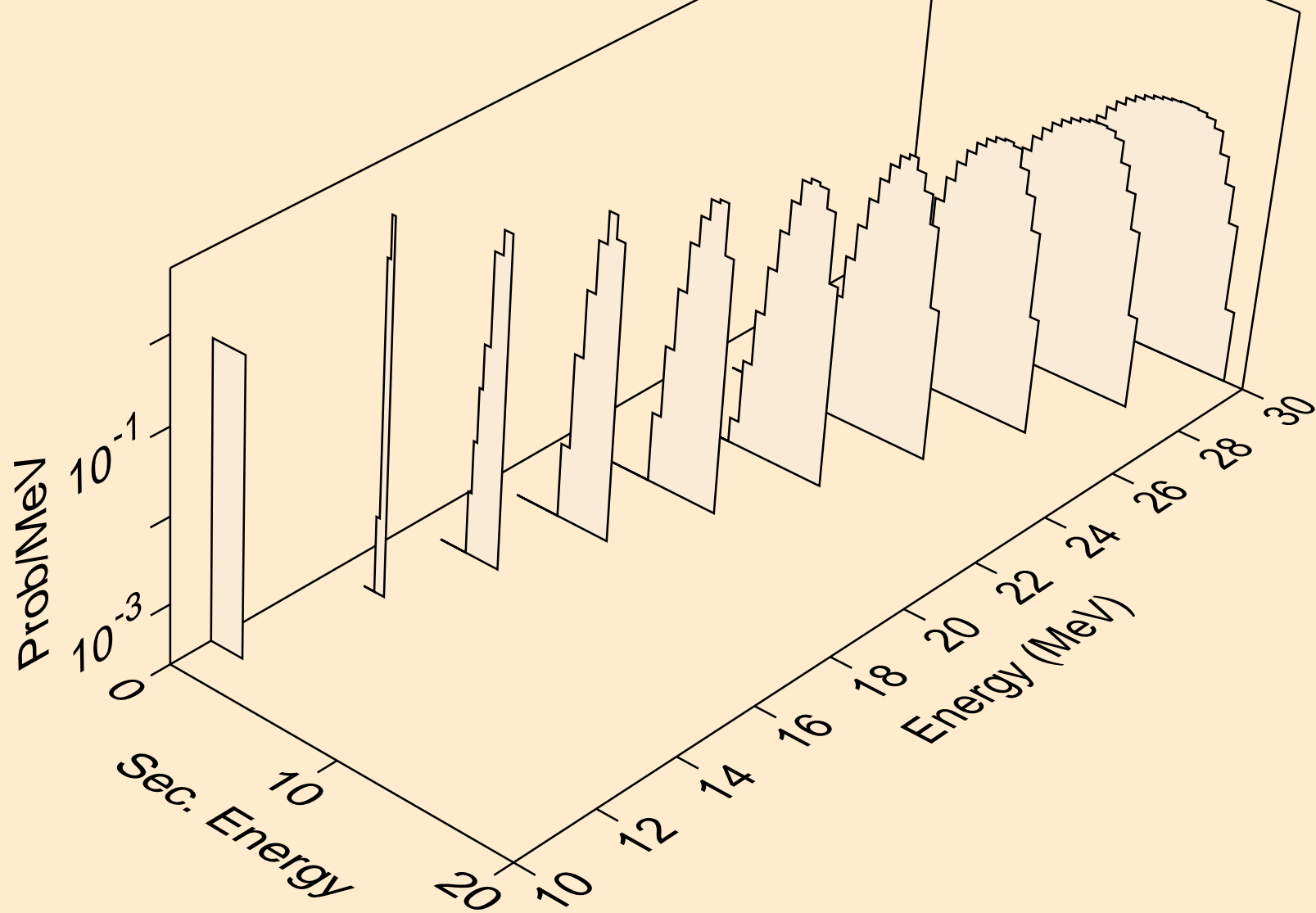

AU197M NEUTRON ACER TENDL-2023 LIBRARY; T=0.K
tritons from (n,t)

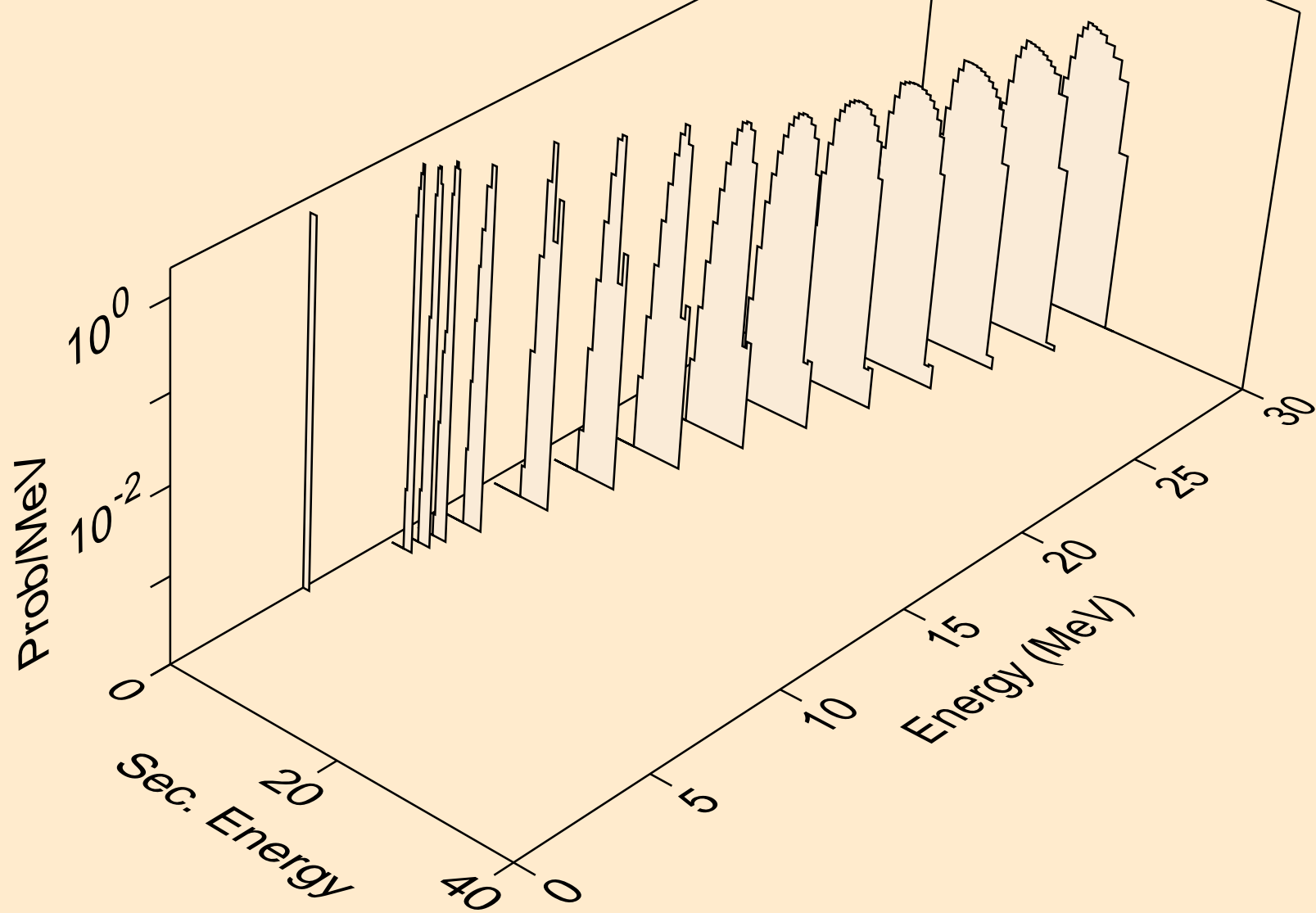

AU197M NEUTRON ACER TENDL-2023 LIBRARY; T=0.K
he3s from (n,x)

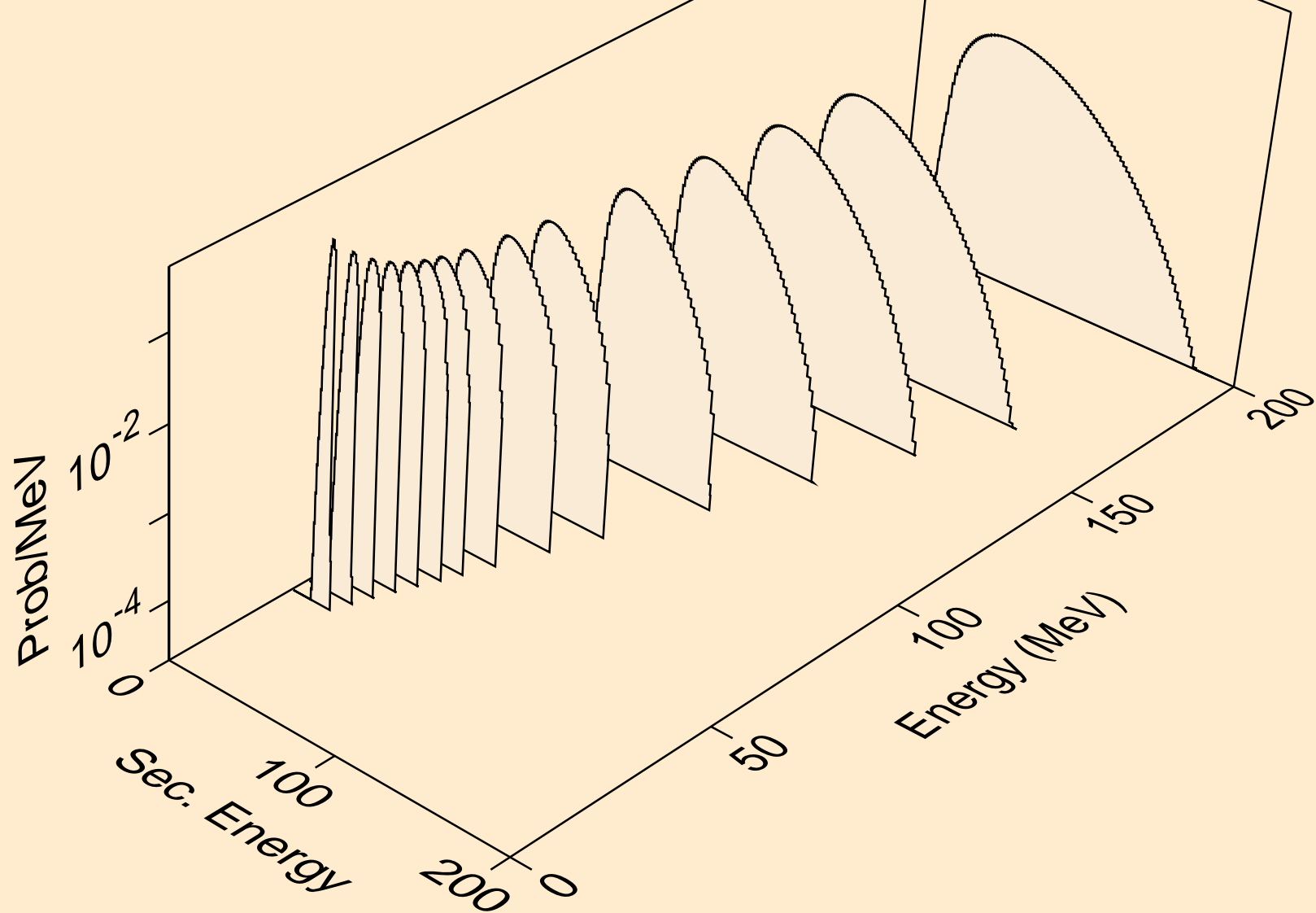

AU197M NEUTRON ACER TENDL-2023 LIBRARY; T=0.K
he3s from (n,n*)he3

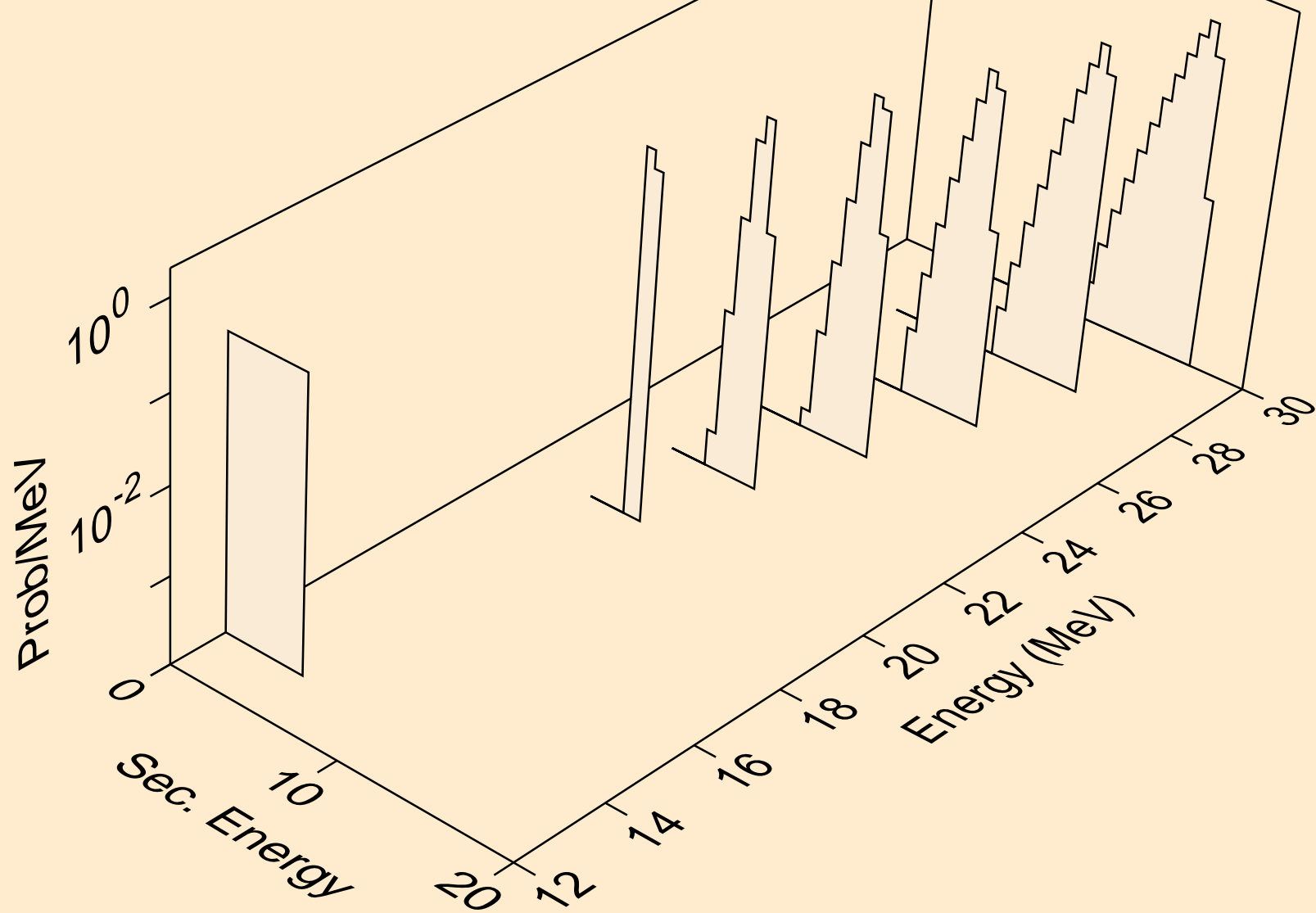

AU197M NEUTRON ACER TENDL-2023 LIBRARY; T=0.K
he3s from (n,he3)

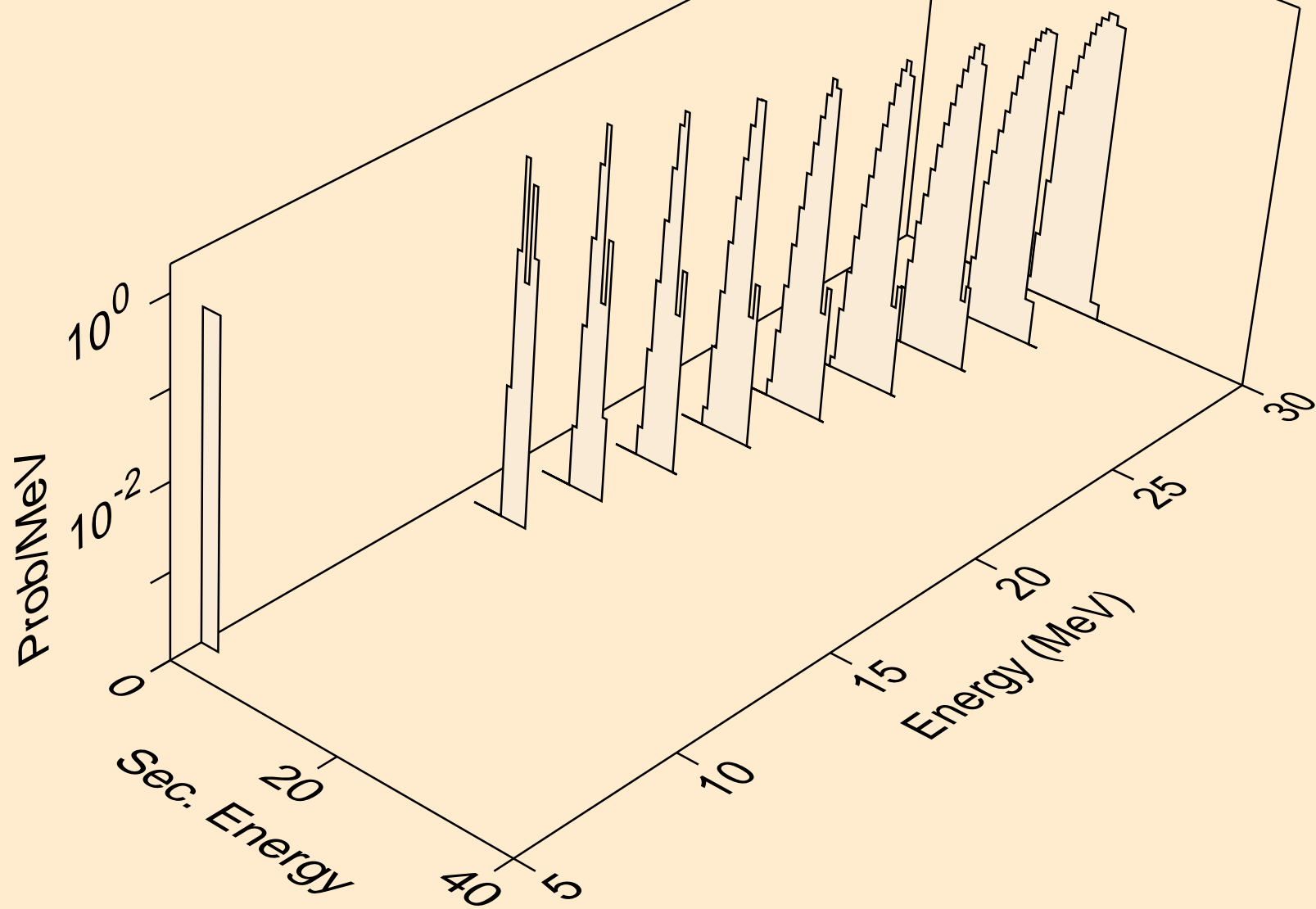

AU197M NEUTRON ACER TENDL-2023 LIBRARY; T=0.K
alphas from (n,x)

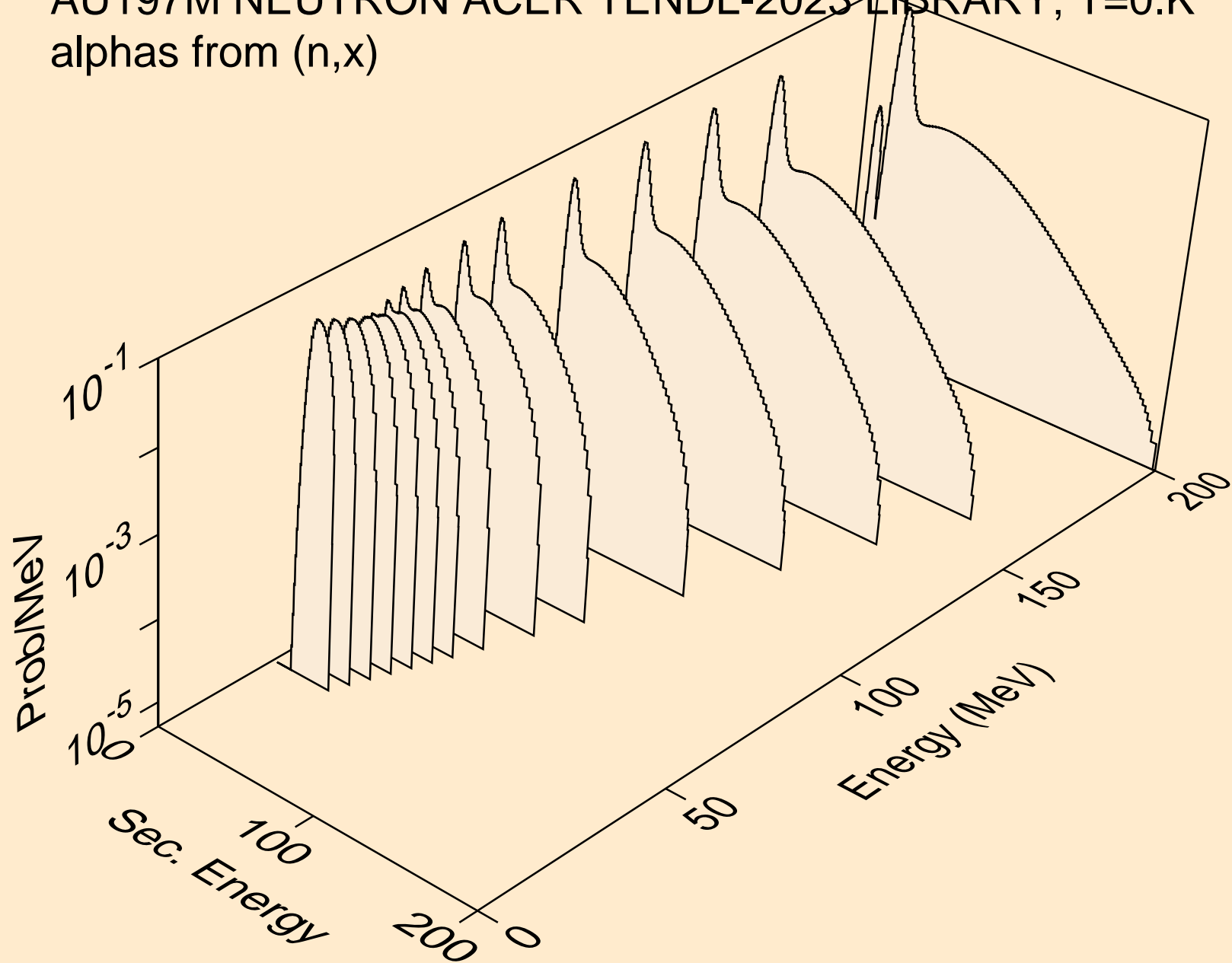

AU197M NEUTRON ACER TENDL-2023 LIBRARY; T=0.K
alphas from (n,n*)a

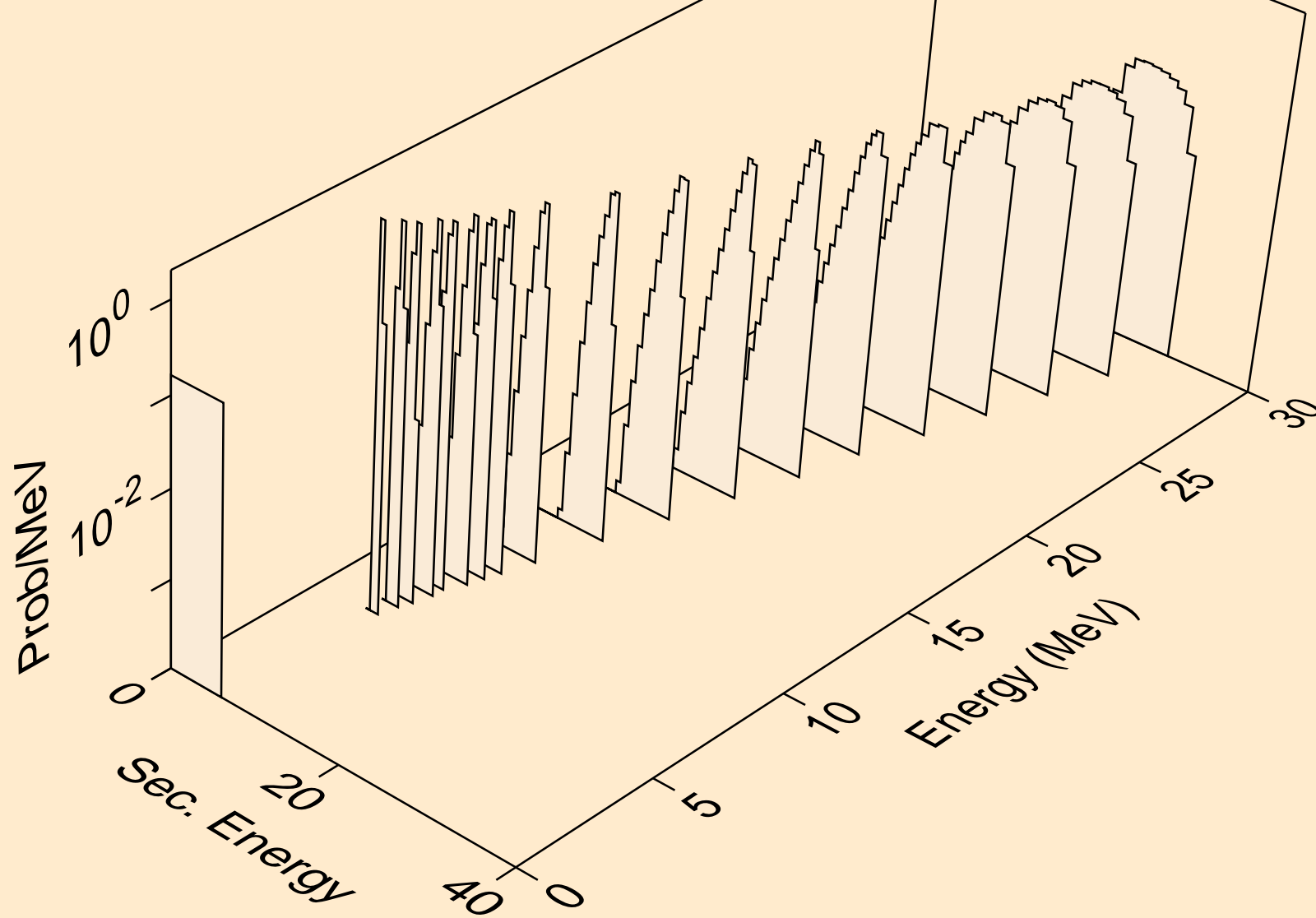

AU197M NEUTRON ACER TENDL-2023 LIBRARY; T=0.K
alphas from (n,2n)a

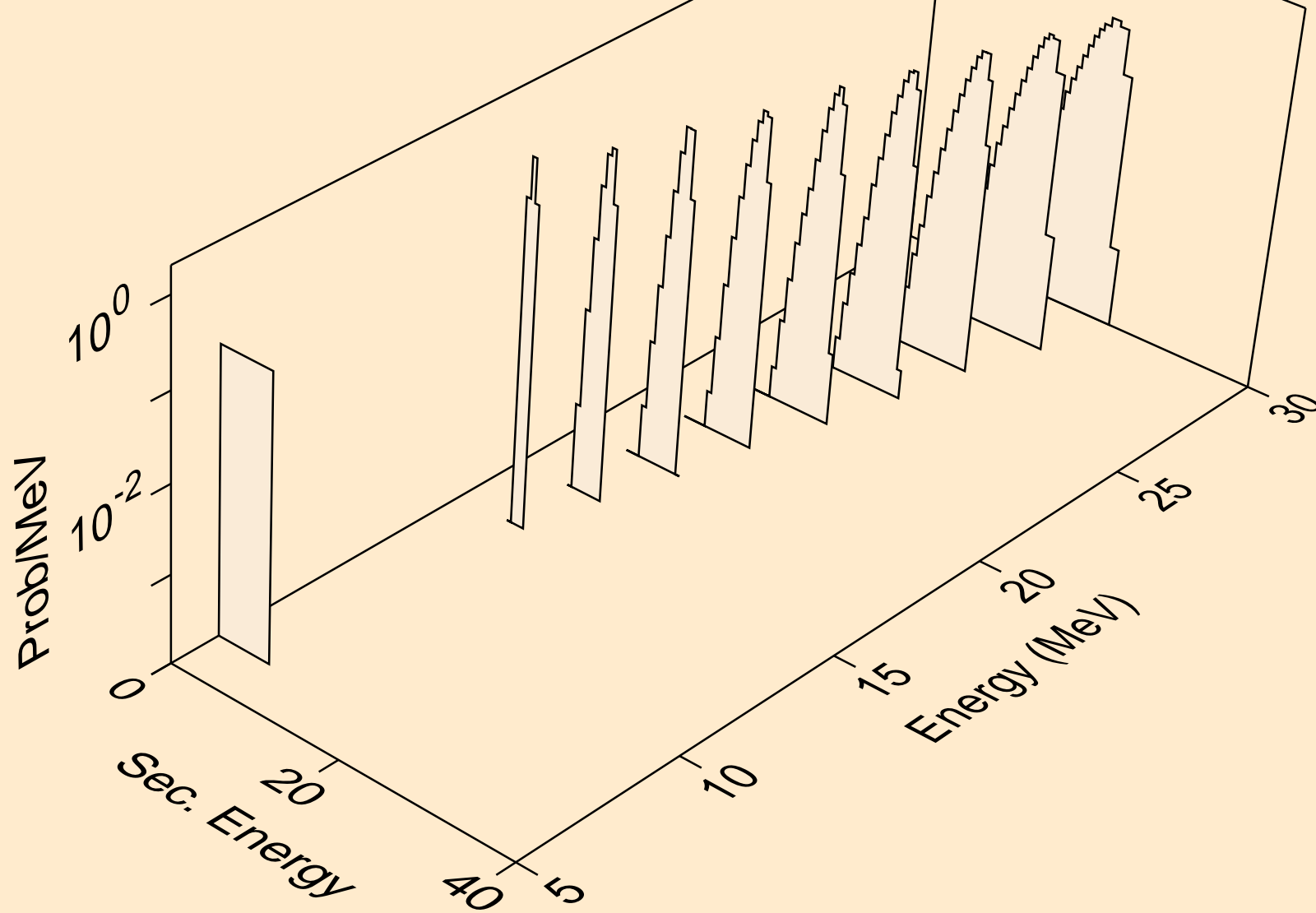

AU197M NEUTRON ACER TENDL-2023 LIBRARY; T=0.K
alphas from (n,3n)a

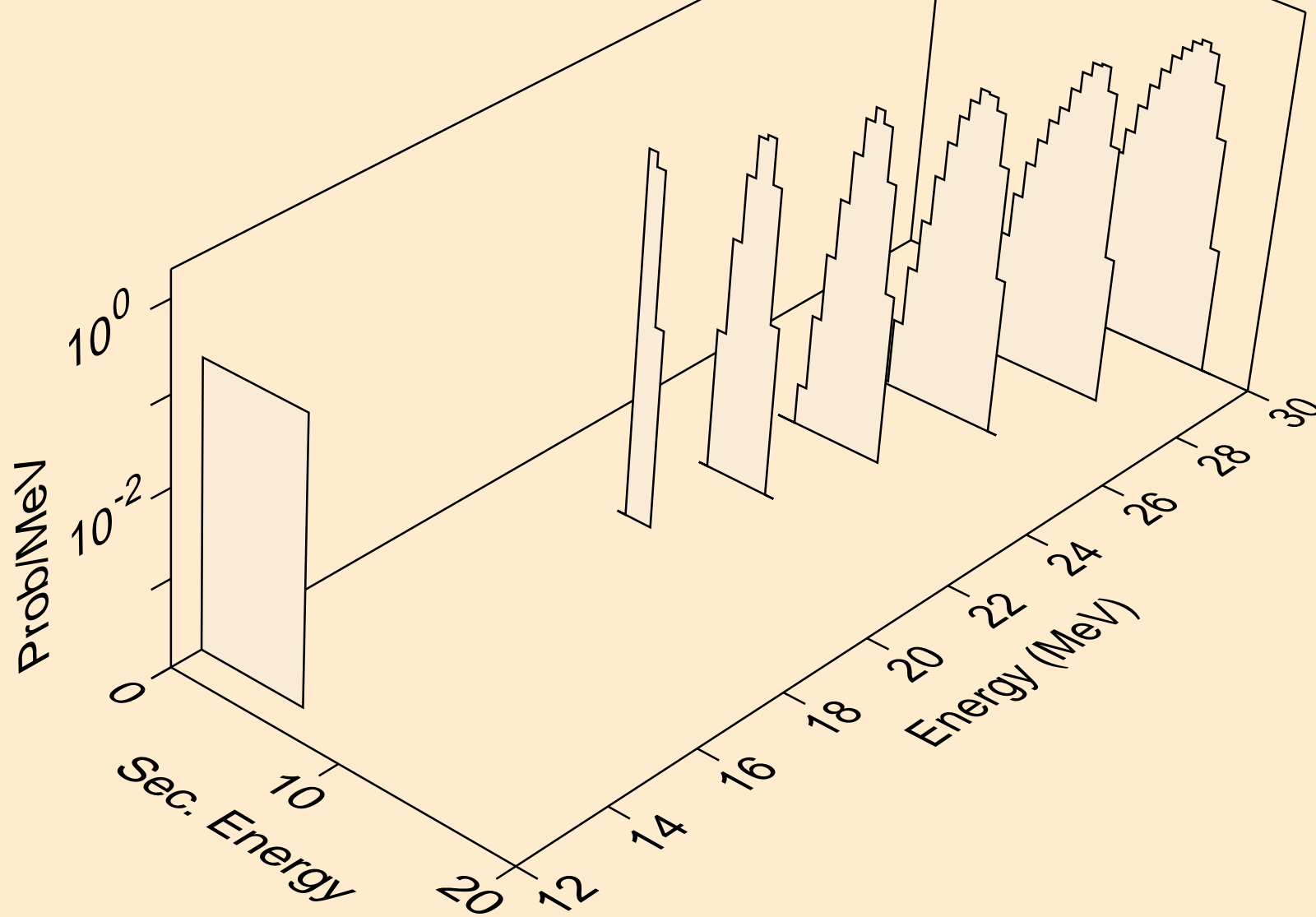

AU197M NEUTRON ACER TENDL-2023 LIBRARY; T=0.K
alphas from (n,npa)

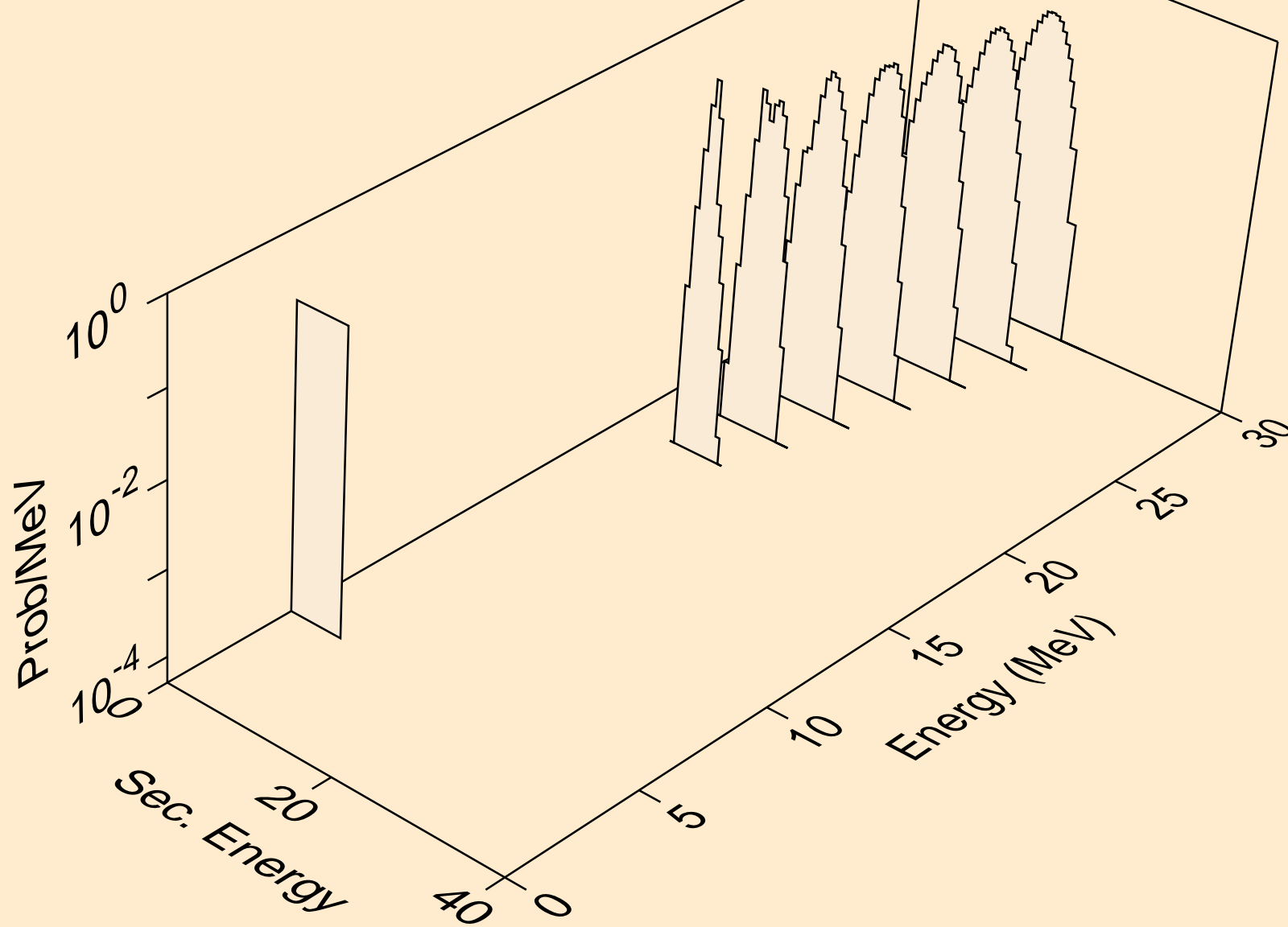

AU197M NEUTRON ACER TENDL-2023 LIBRARY; T=0.K
alphas from (n,a)

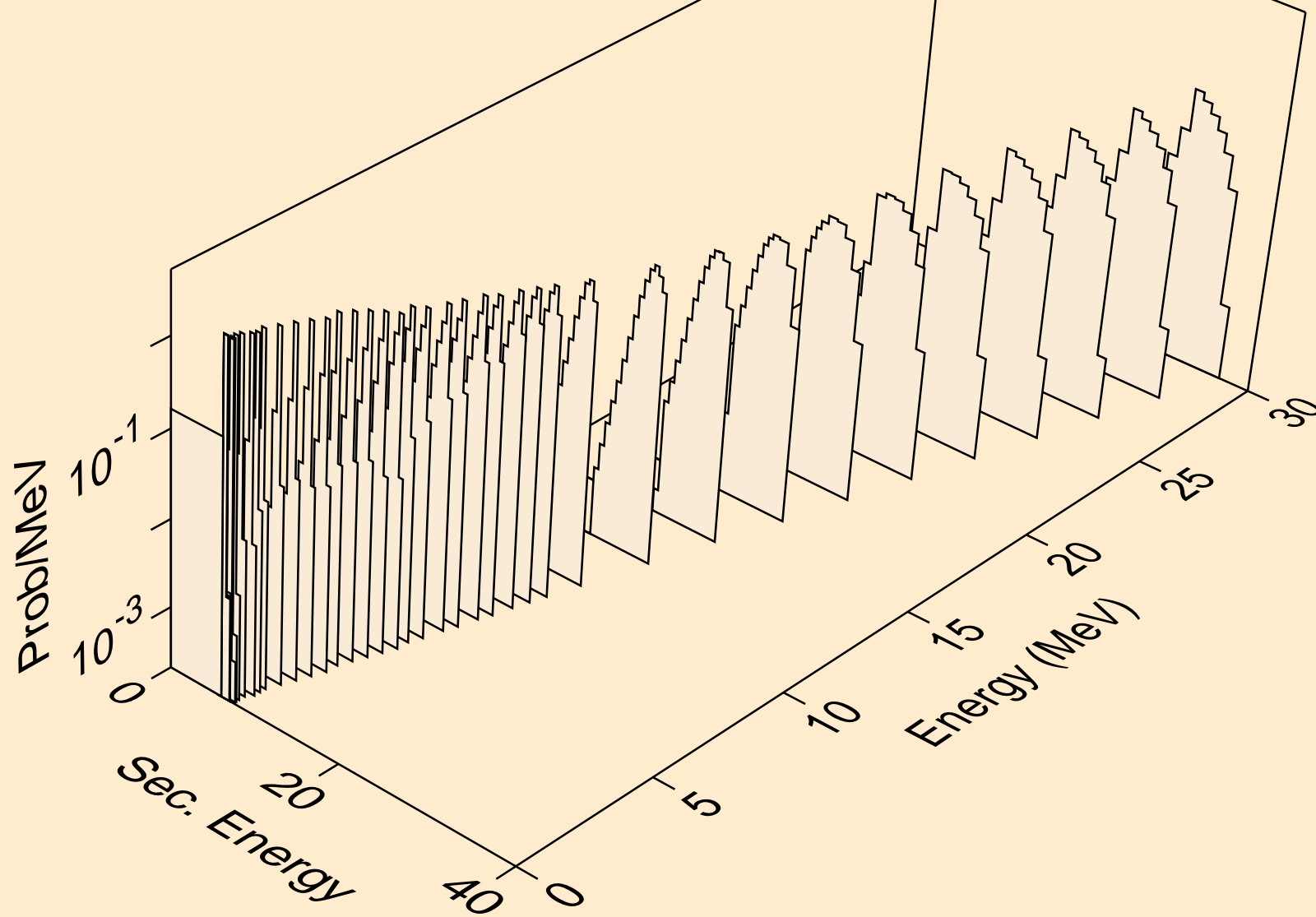

AU197M NEUTRON ACER TENDL-2023 LIBRARY; T=0.K
alphas from (n,pa)

