

# BA118 NEUTRON ACER TENDL-2023 LIBRARY; T=0.K

## Principal cross sections

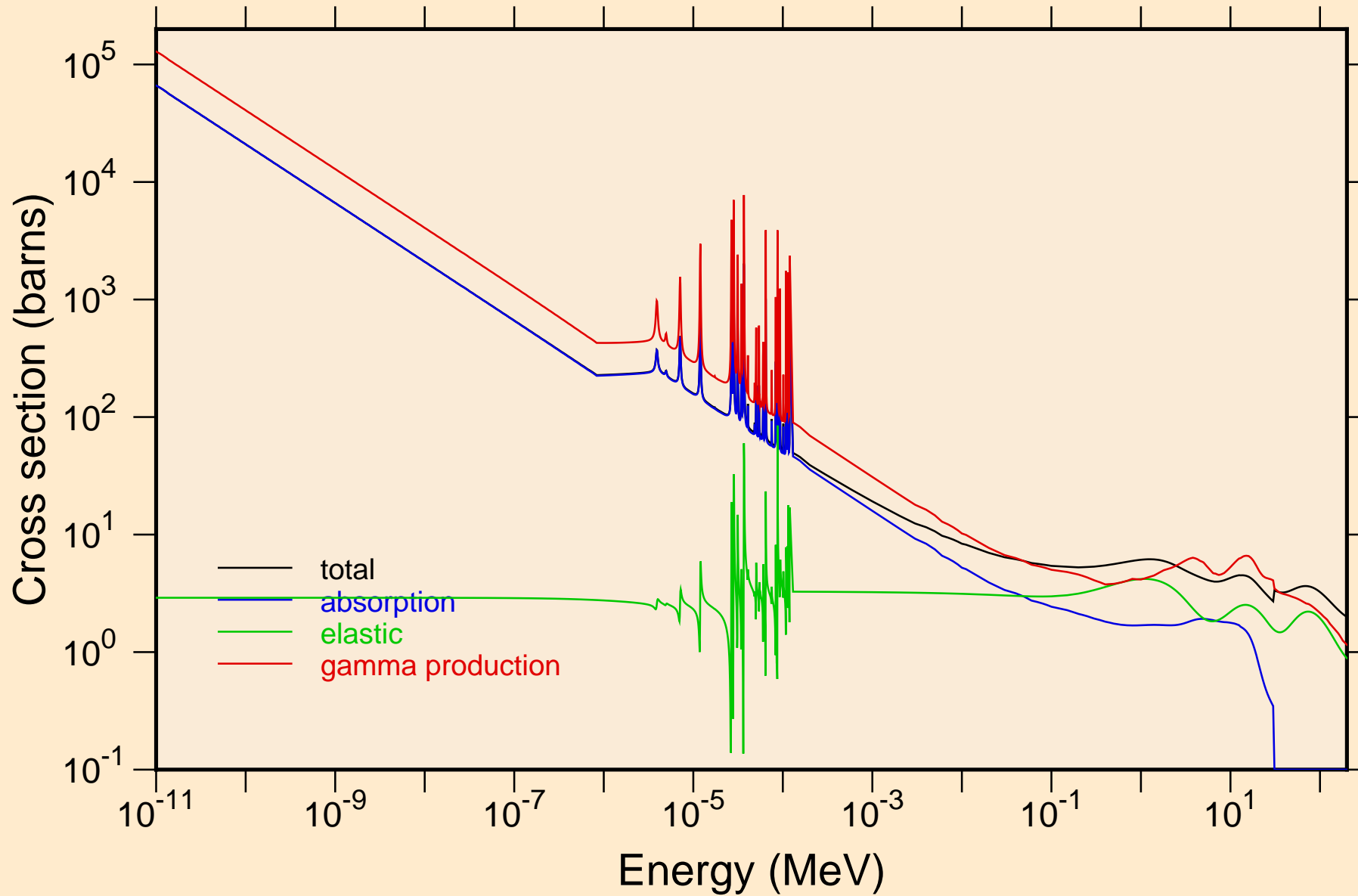

BA118 NEUTRON ACER TENDL-2023 LIBRARY; T=0.K  
resonance total cross section

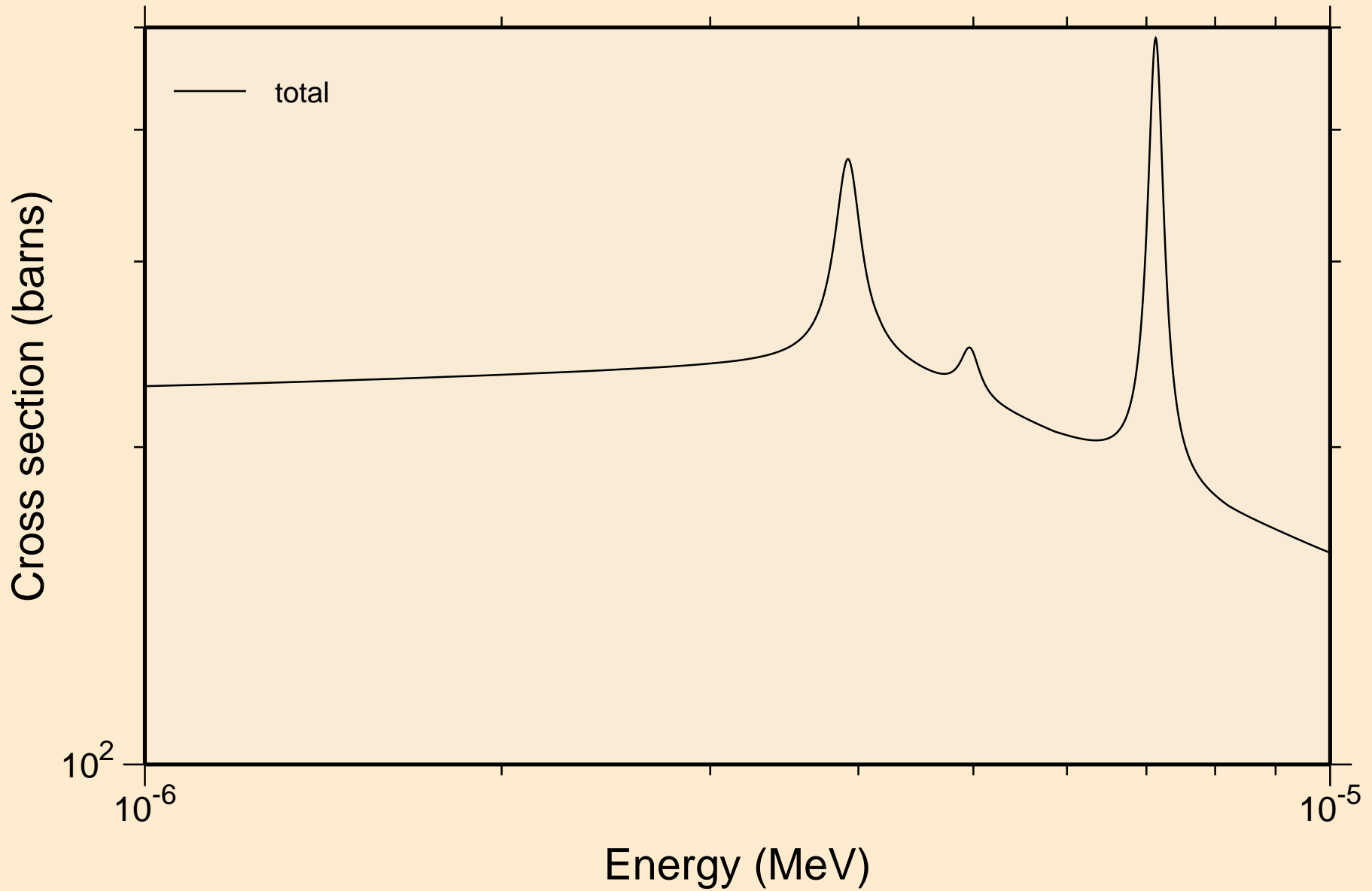

BA118 NEUTRON ACER TENDL-2023 LIBRARY; T=0.K  
resonance total cross section

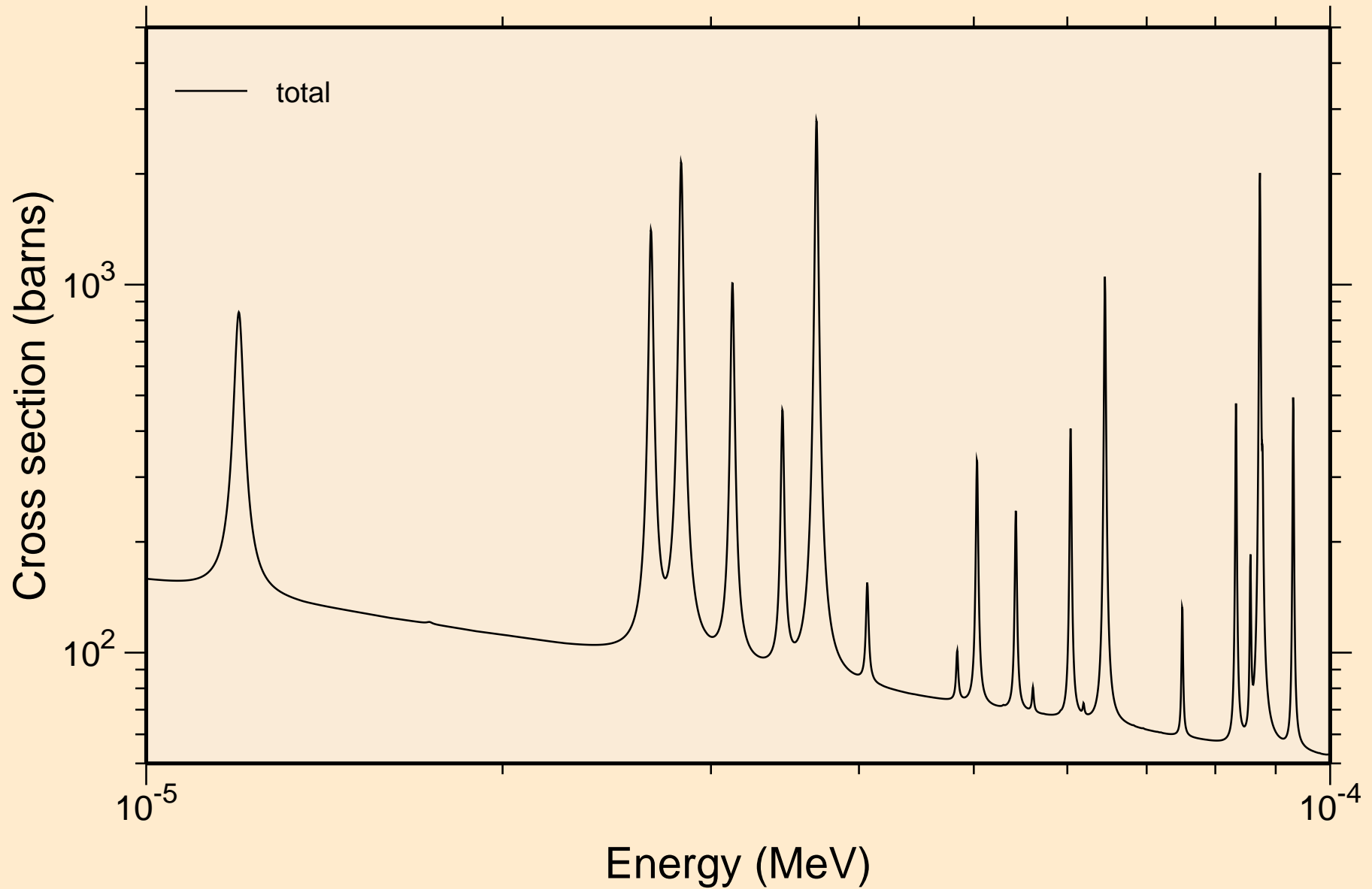

BA118 NEUTRON ACER TENDL-2023 LIBRARY; T=0.K  
resonance total cross section

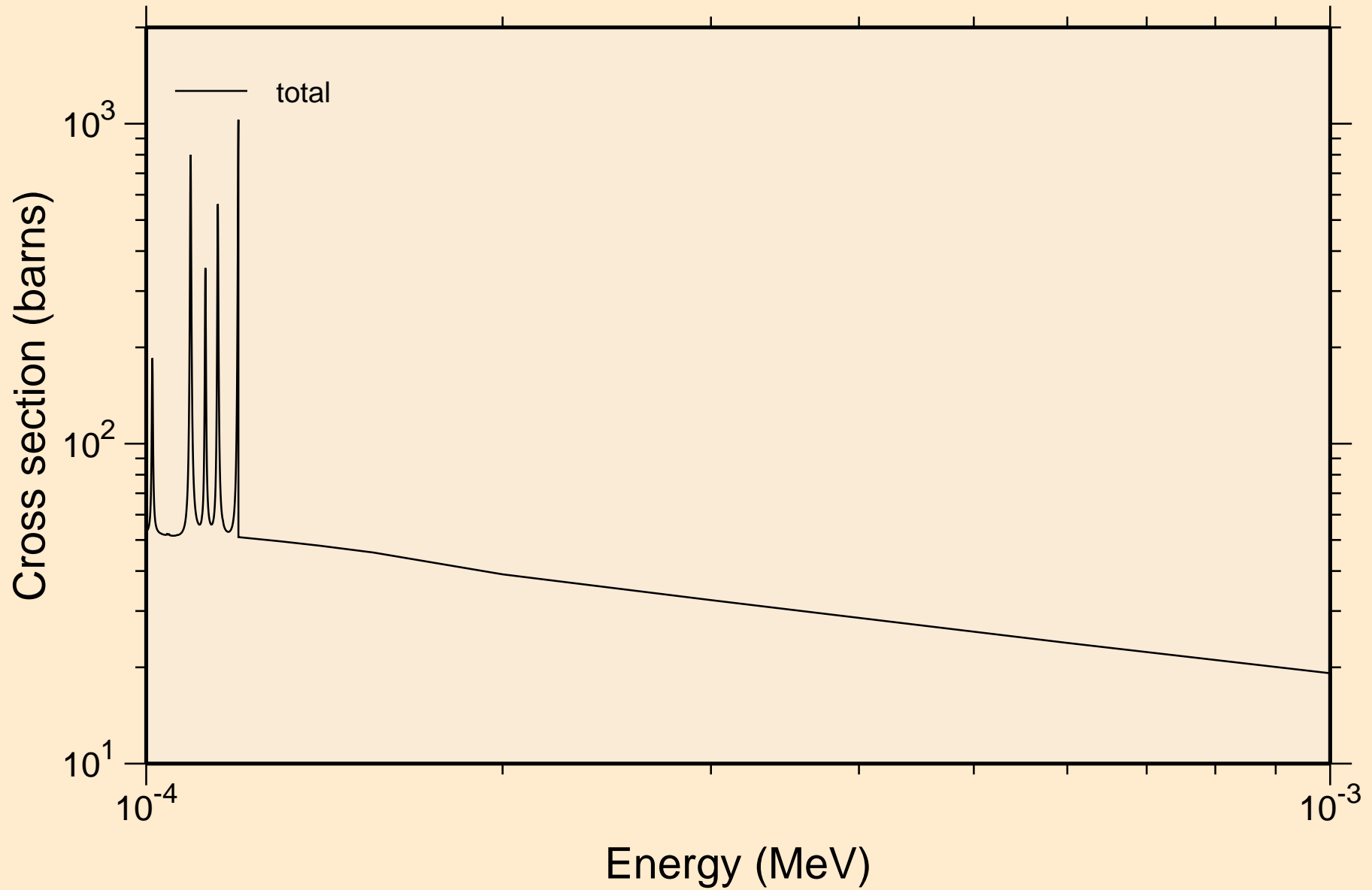

BA118 NEUTRON ACER TENDL-2023 LIBRARY; T=0.K  
resonance total cross section

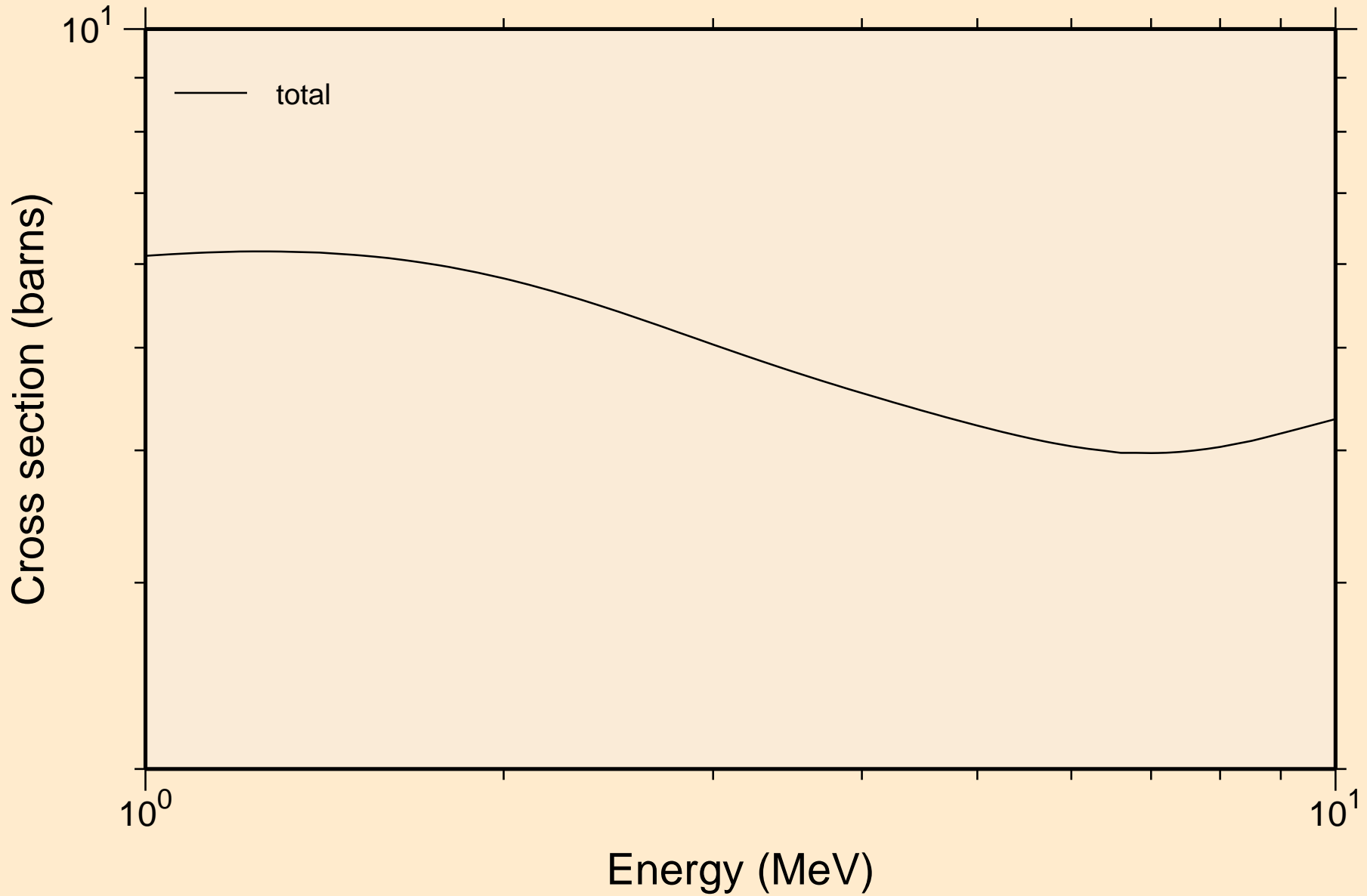

BA118 NEUTRON ACER TENDL-2023 LIBRARY; T=0.K  
resonance absorption cross sections

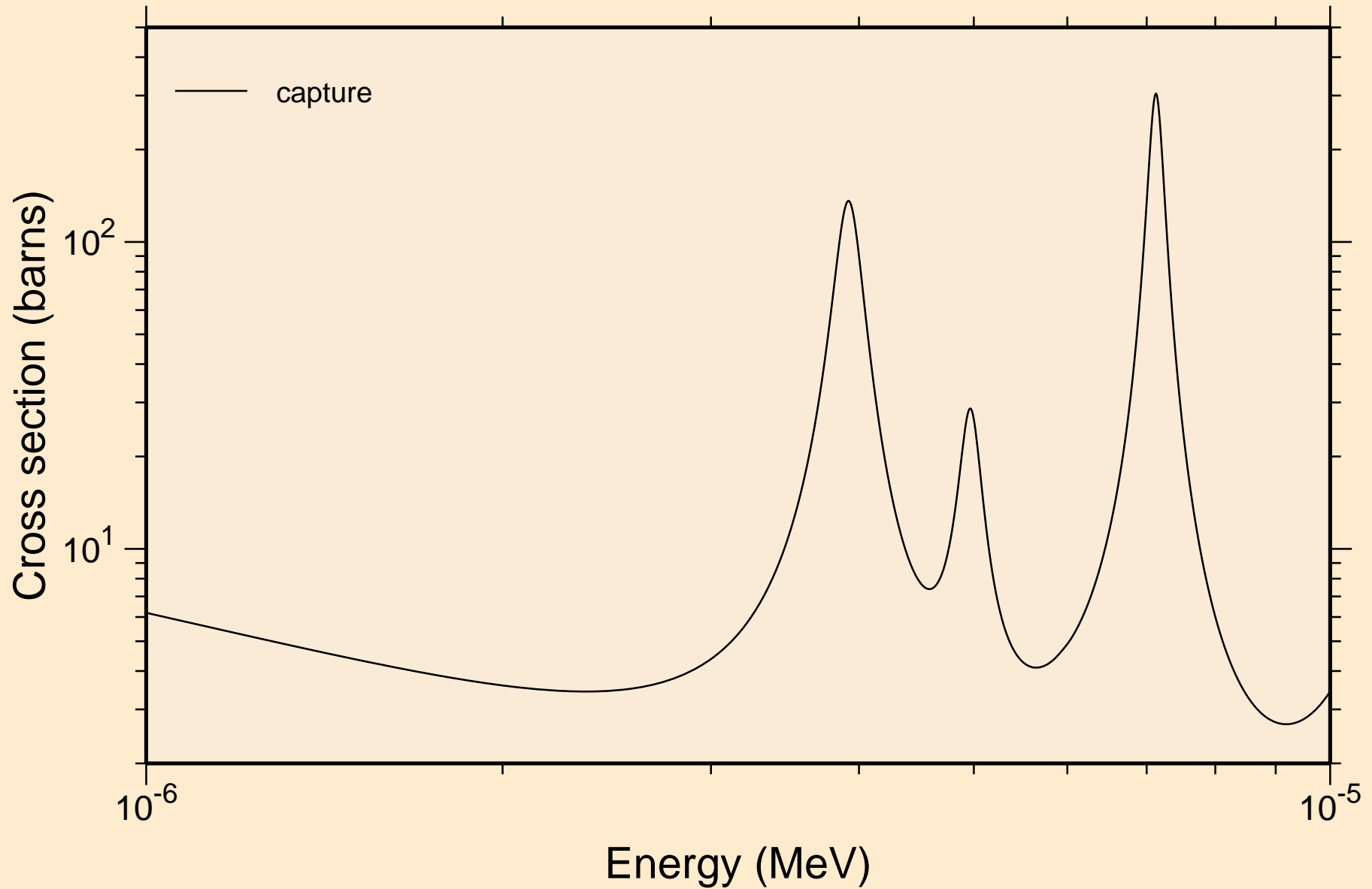

BA118 NEUTRON ACER TENDL-2023 LIBRARY; T=0.K  
resonance absorption cross sections

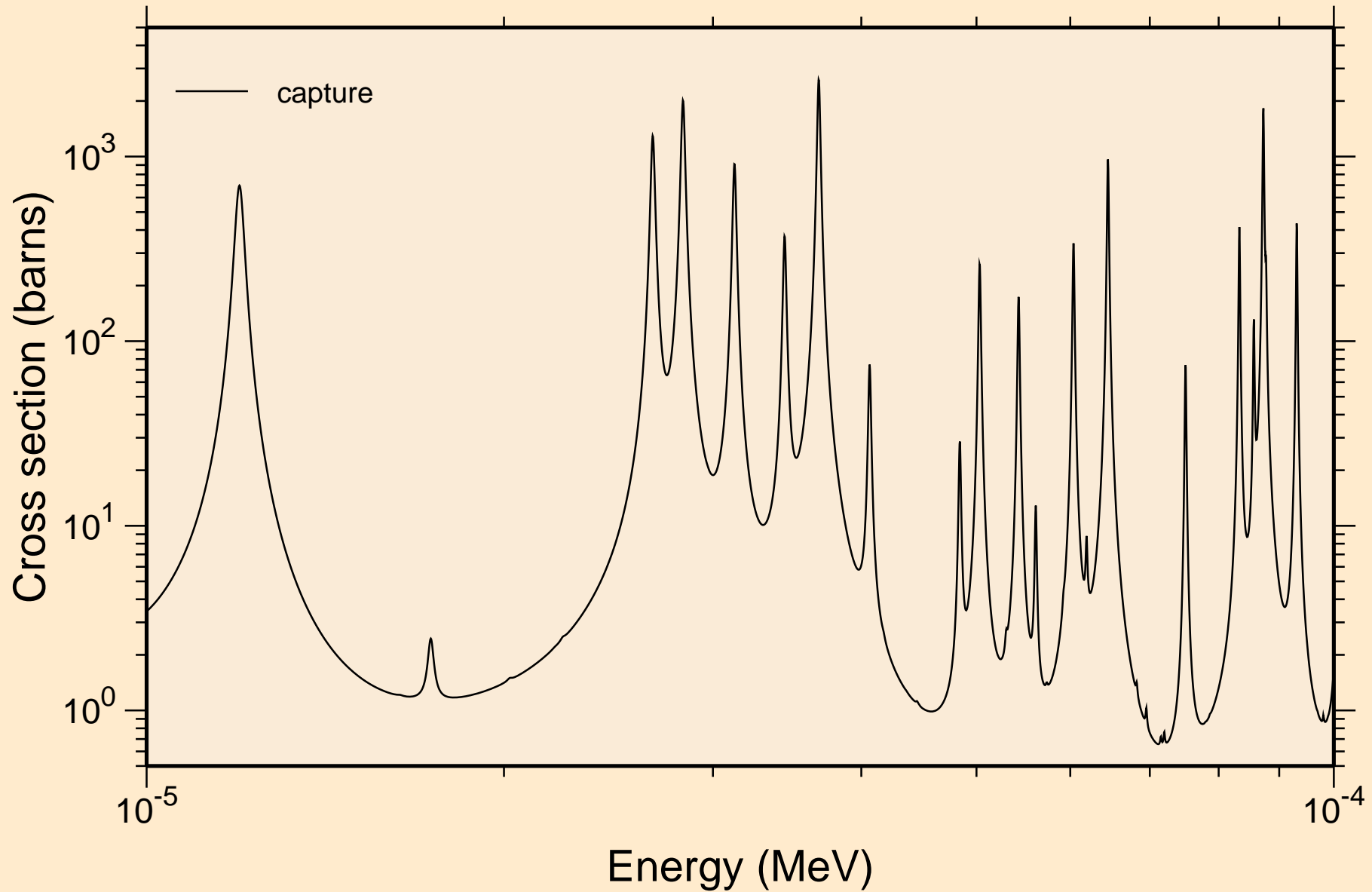

BA118 NEUTRON ACER TENDL-2023 LIBRARY; T=0.K  
resonance absorption cross sections

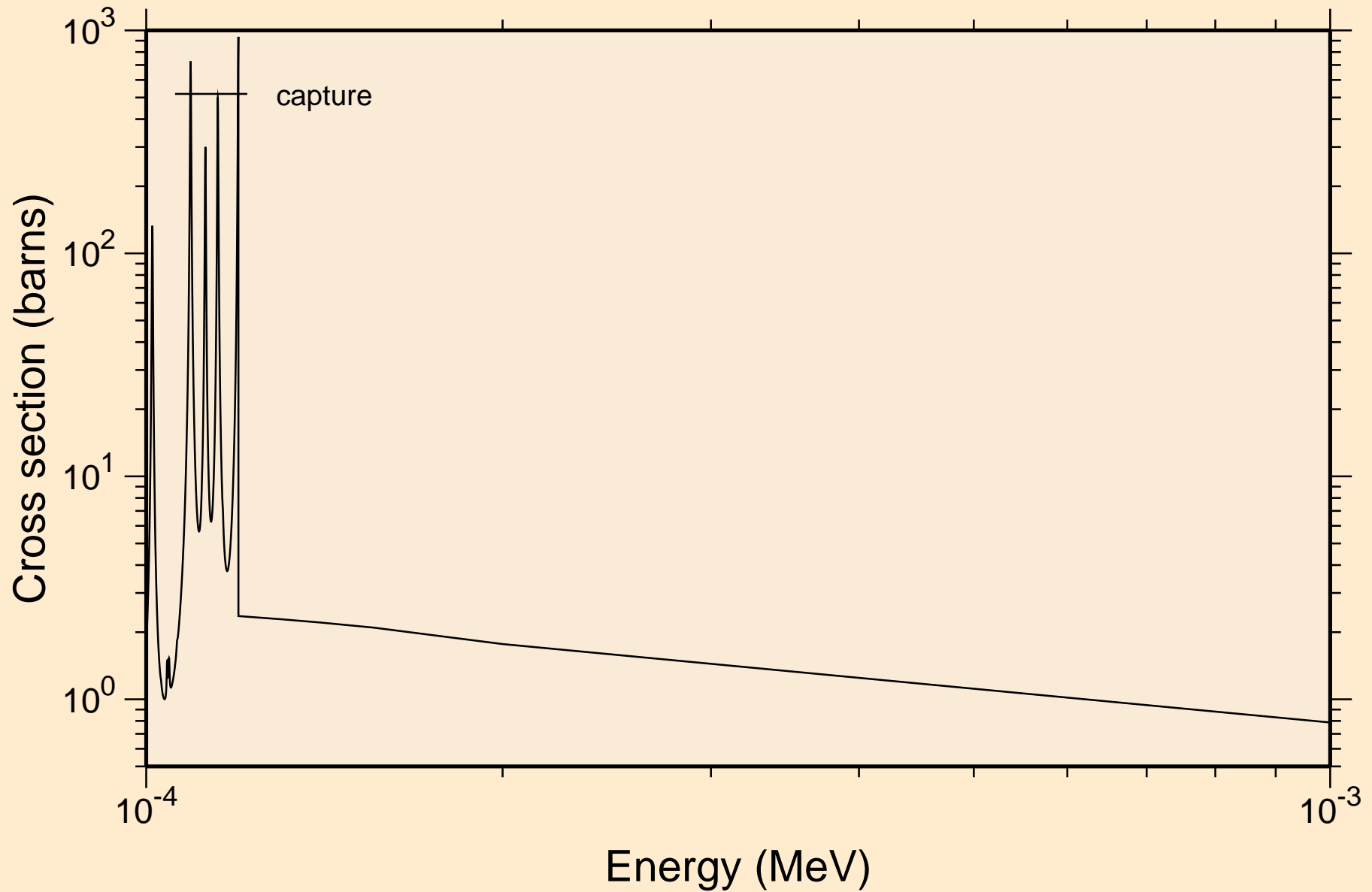



BA118 NEUTRON ACER TENDL-2023 LIBRARY; T=0.K  
resonance absorption cross sections

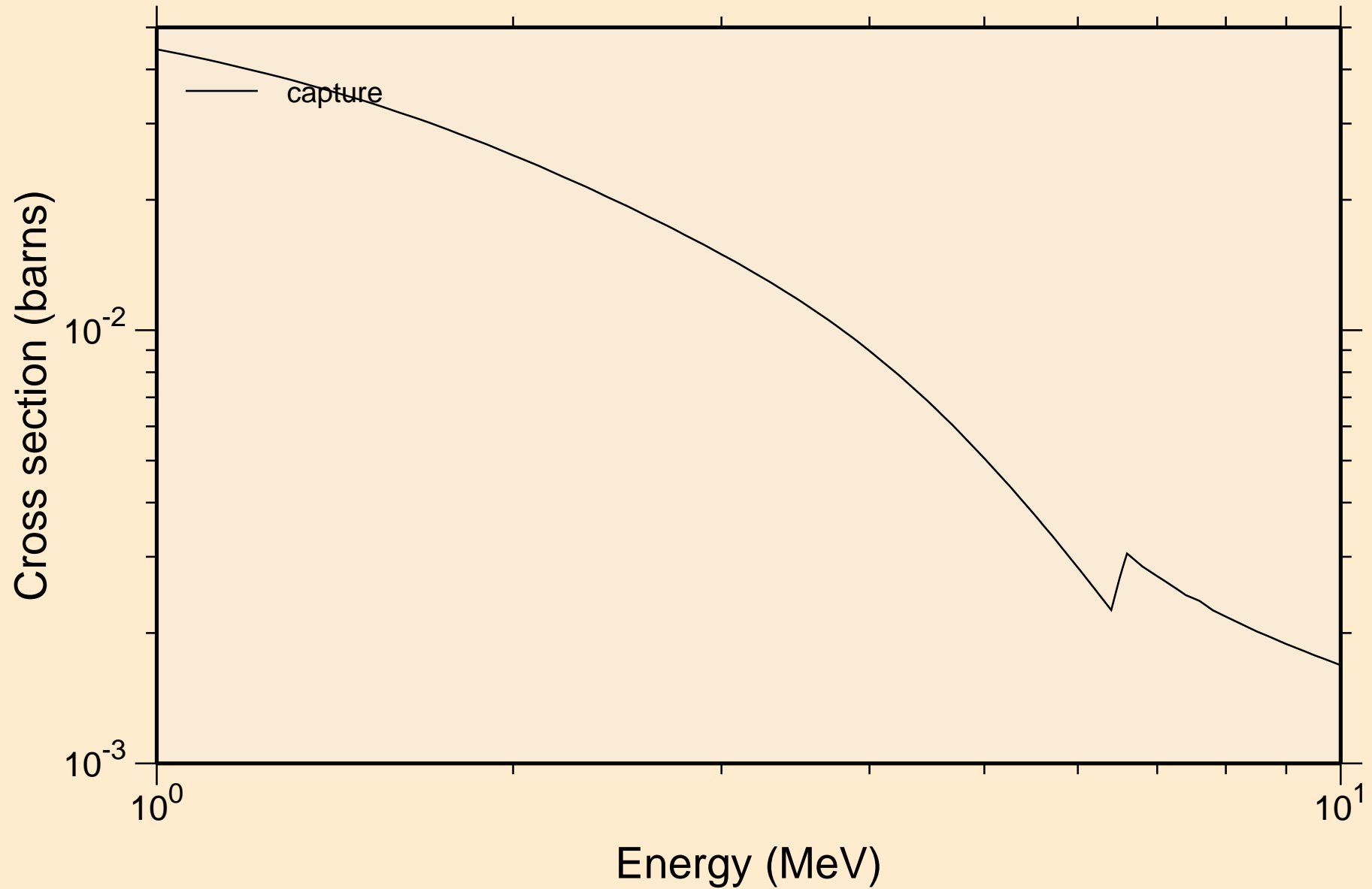

# BA118 NEUTRON ACER TENDL-2023 LIBRARY; T=0.K

## Heating

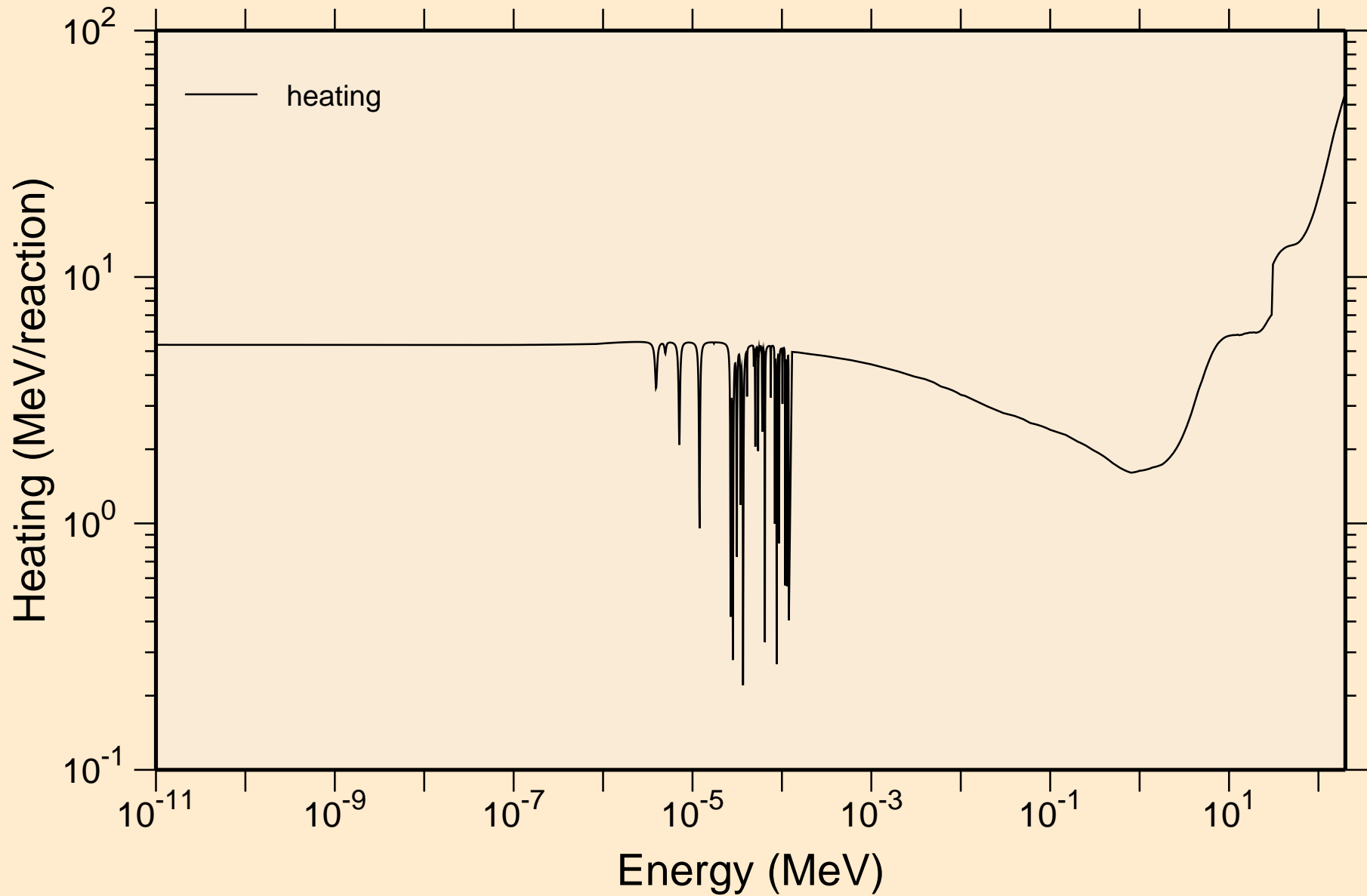

BA118 NEUTRON ACER TENDL-2023 LIBRARY; T=0.K  
Damage

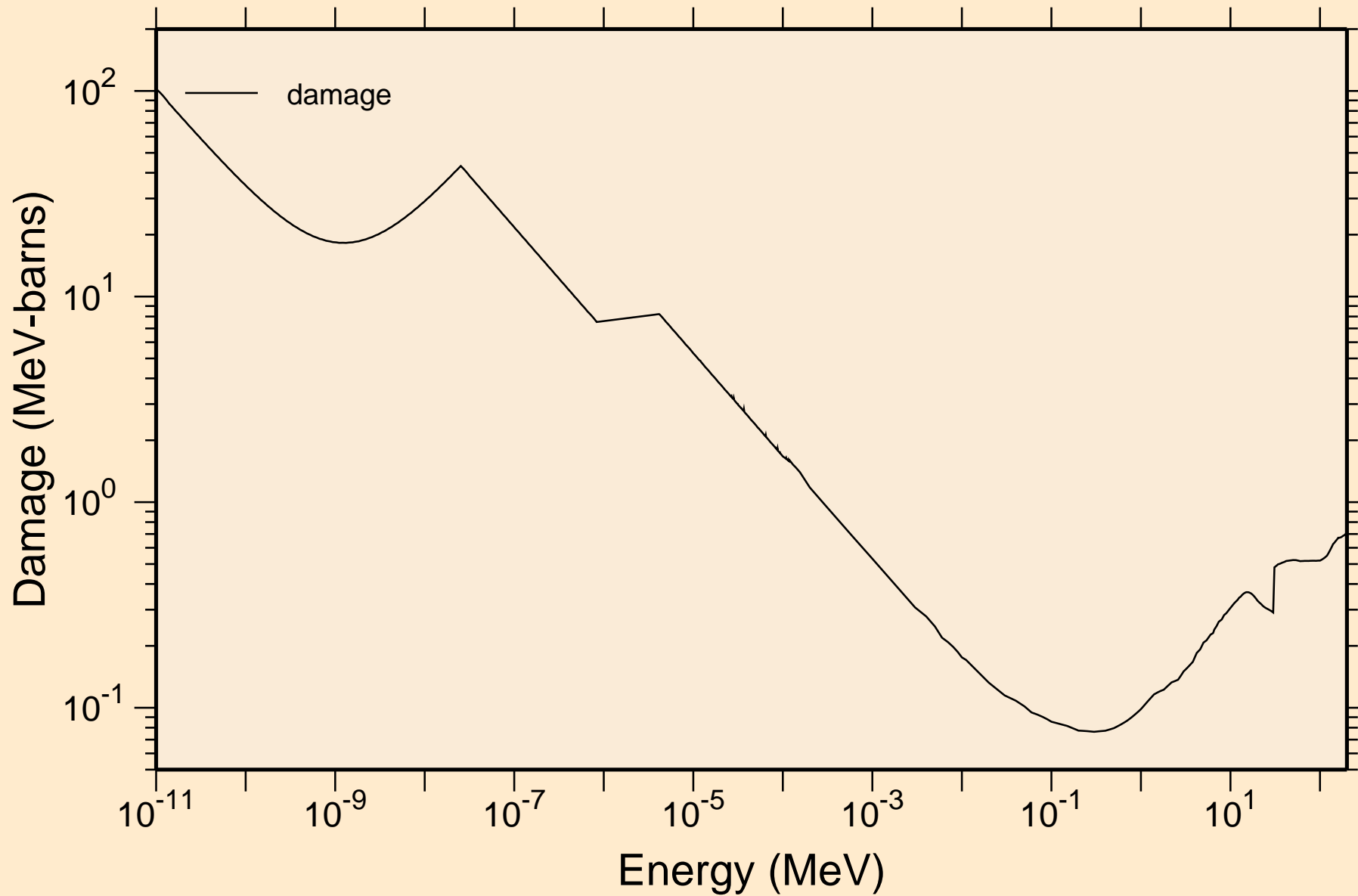

BA118 NEUTRON ACER TENDL-2023 LIBRARY; T=0.K  
Non-threshold reactions

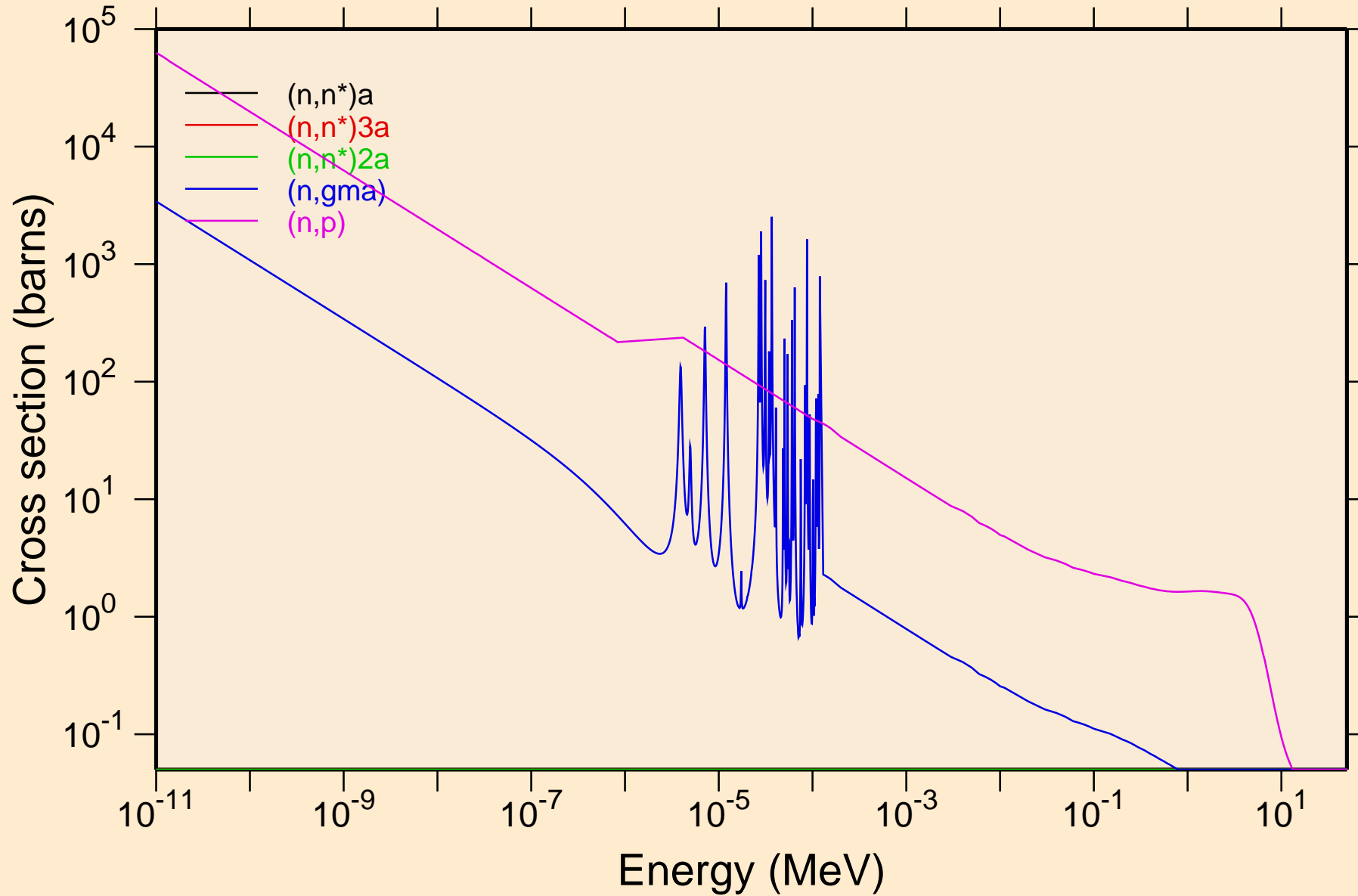

BA118 NEUTRON ACER TENDL-2023 LIBRARY; T=0.K  
Non-threshold reactions

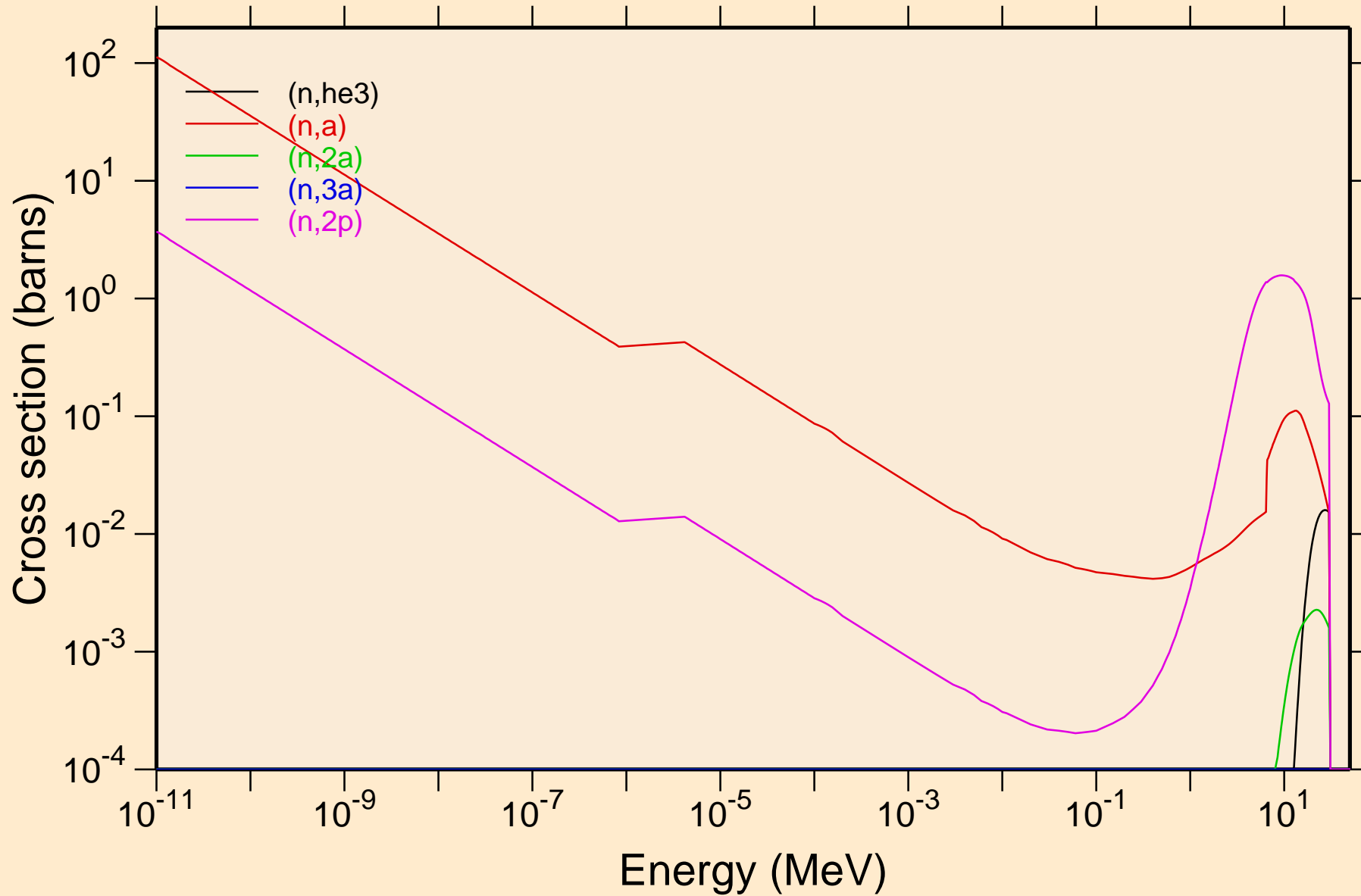

BA118 NEUTRON ACER TENDL-2023 LIBRARY; T=0.K  
Non-threshold reactions

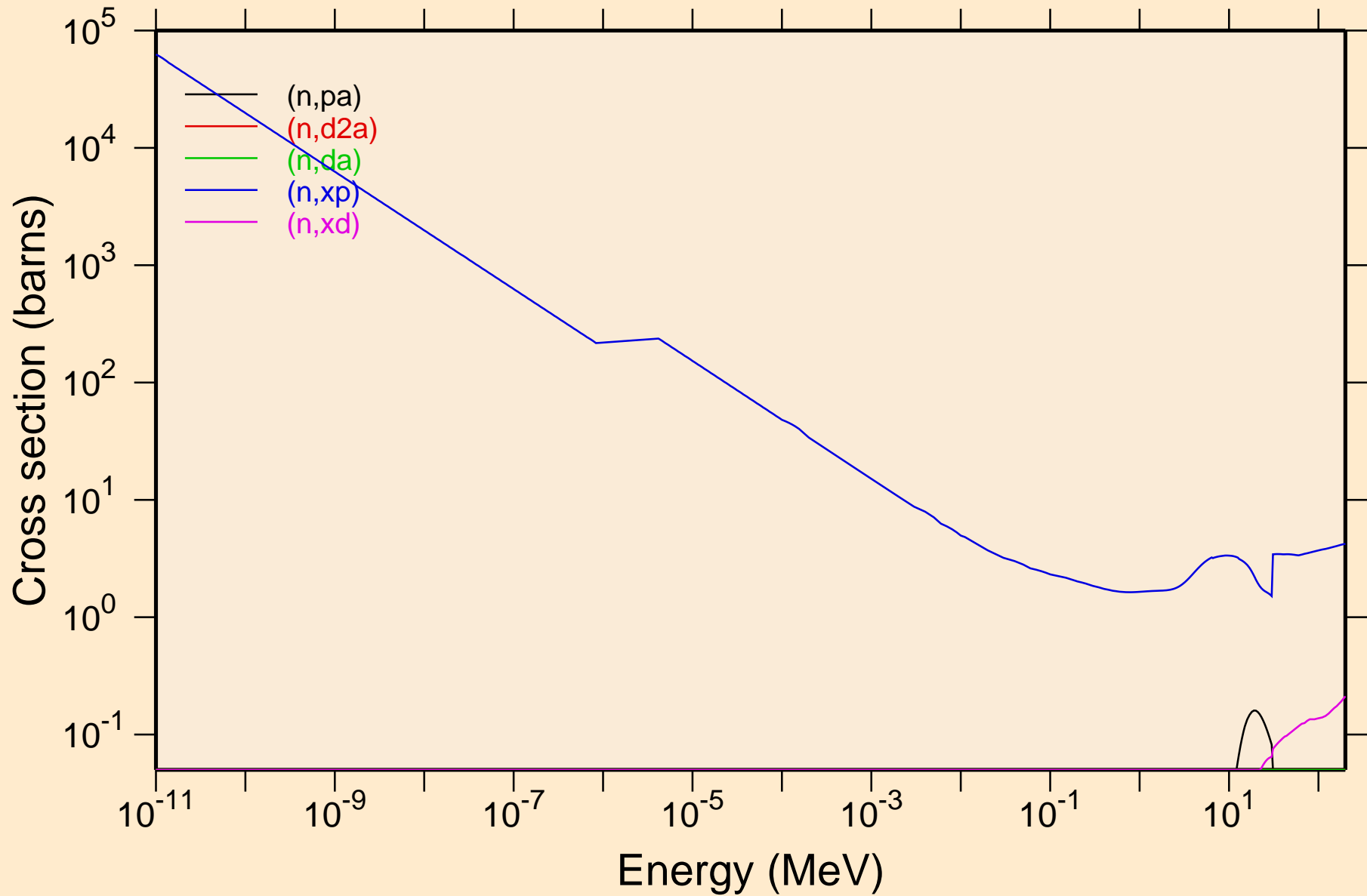

BA118 NEUTRON ACER TENDL-2023 LIBRARY; T=0.K  
Non-threshold reactions

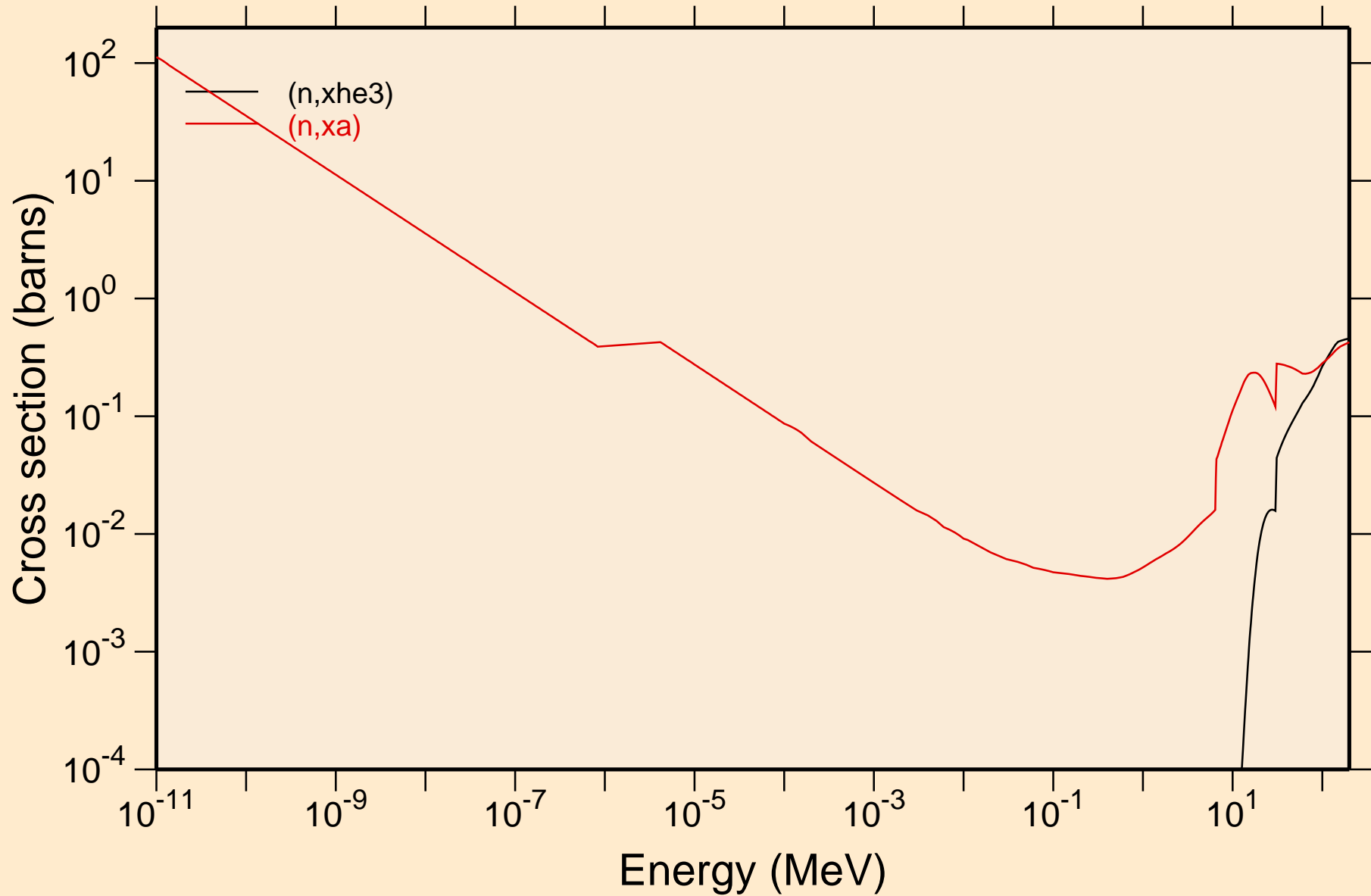

# BA118 NEUTRON ACER TENDL-2023 LIBRARY; T=0.K

## Principal cross sections

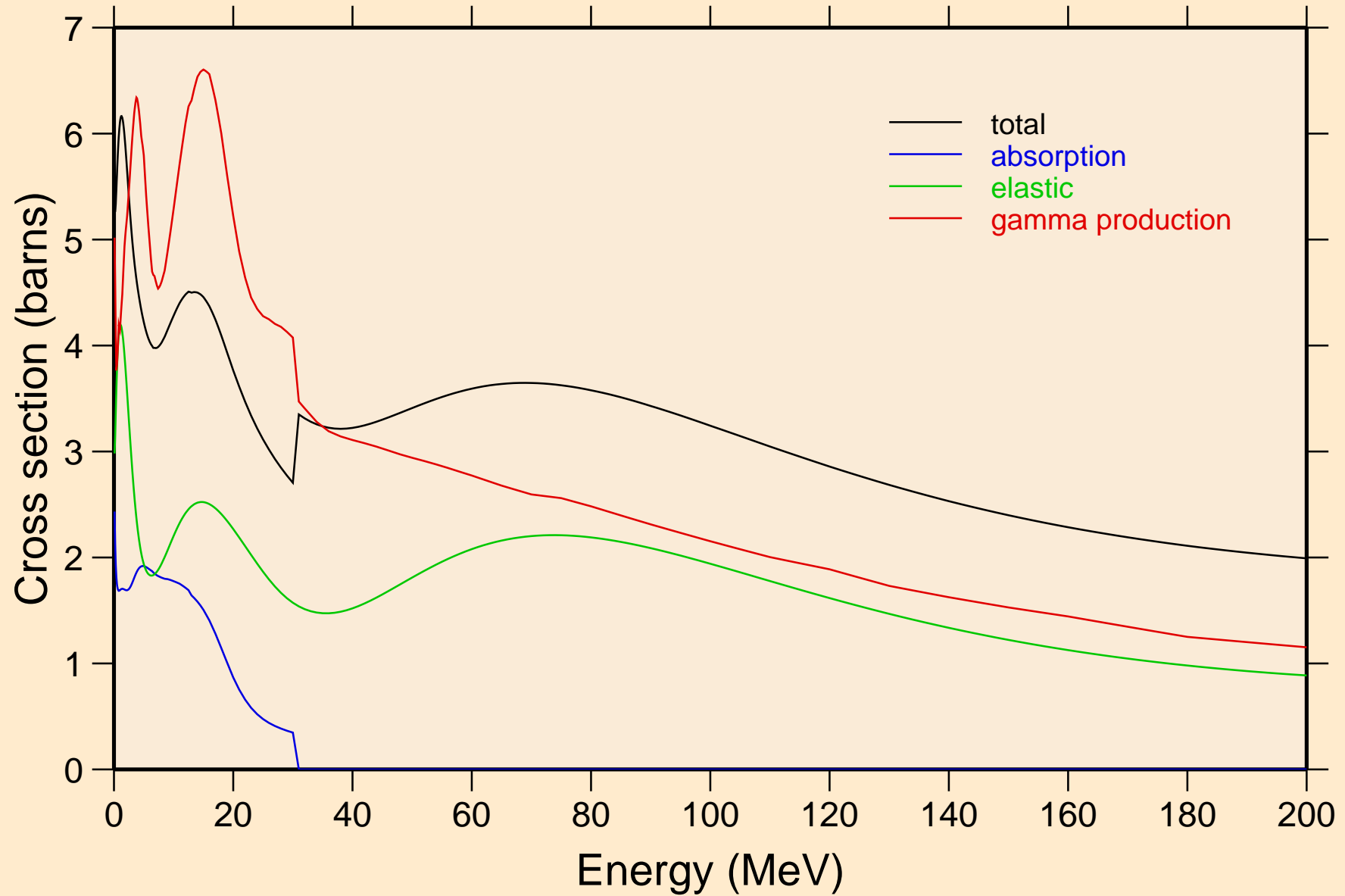



# BA118 NEUTRON ACER TENDL-2023 LIBRARY; T=0.K

## Heating

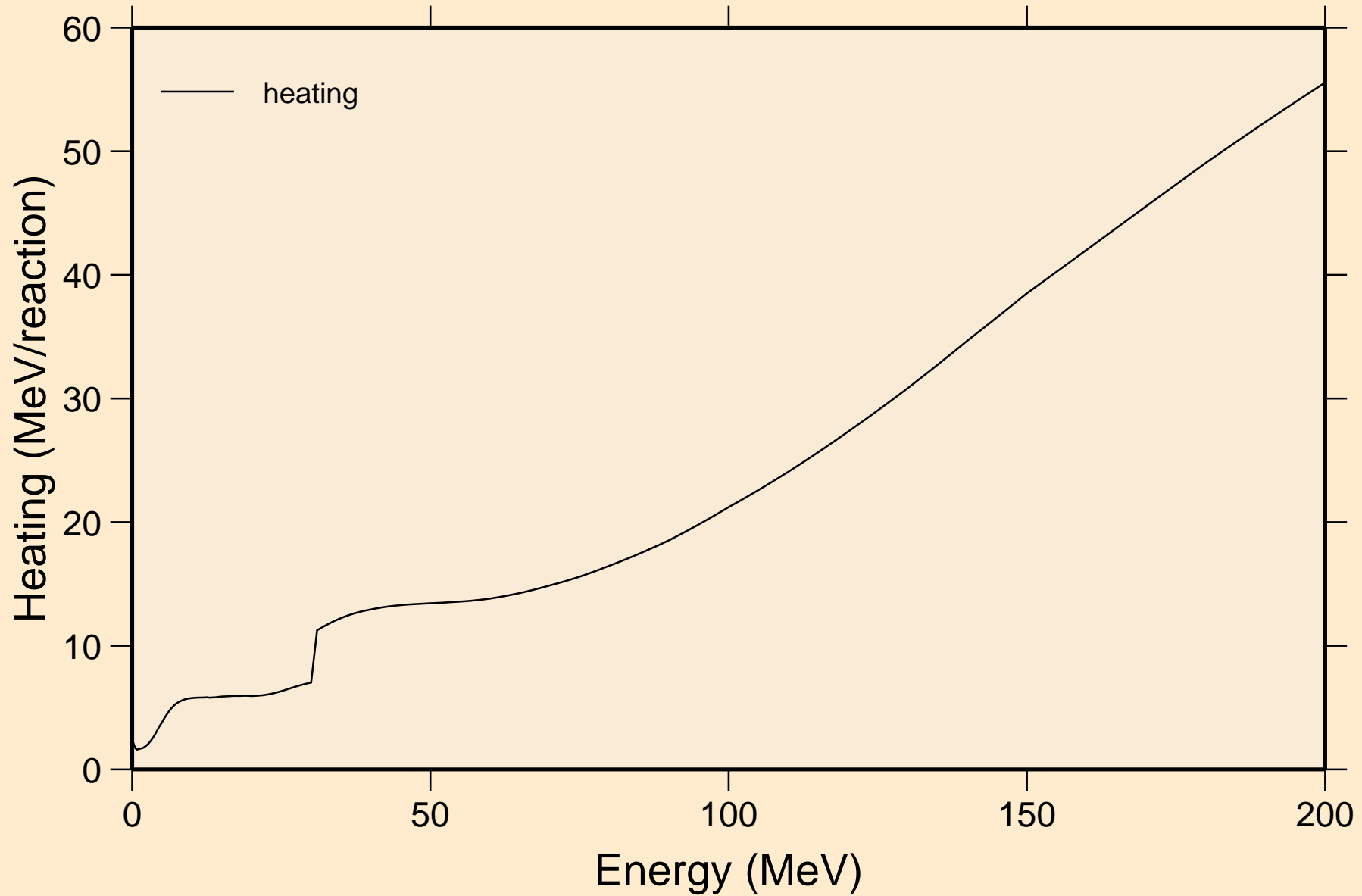

# BA118 NEUTRON ACER TENDL-2023 LIBRARY; T=0.K

## Damage

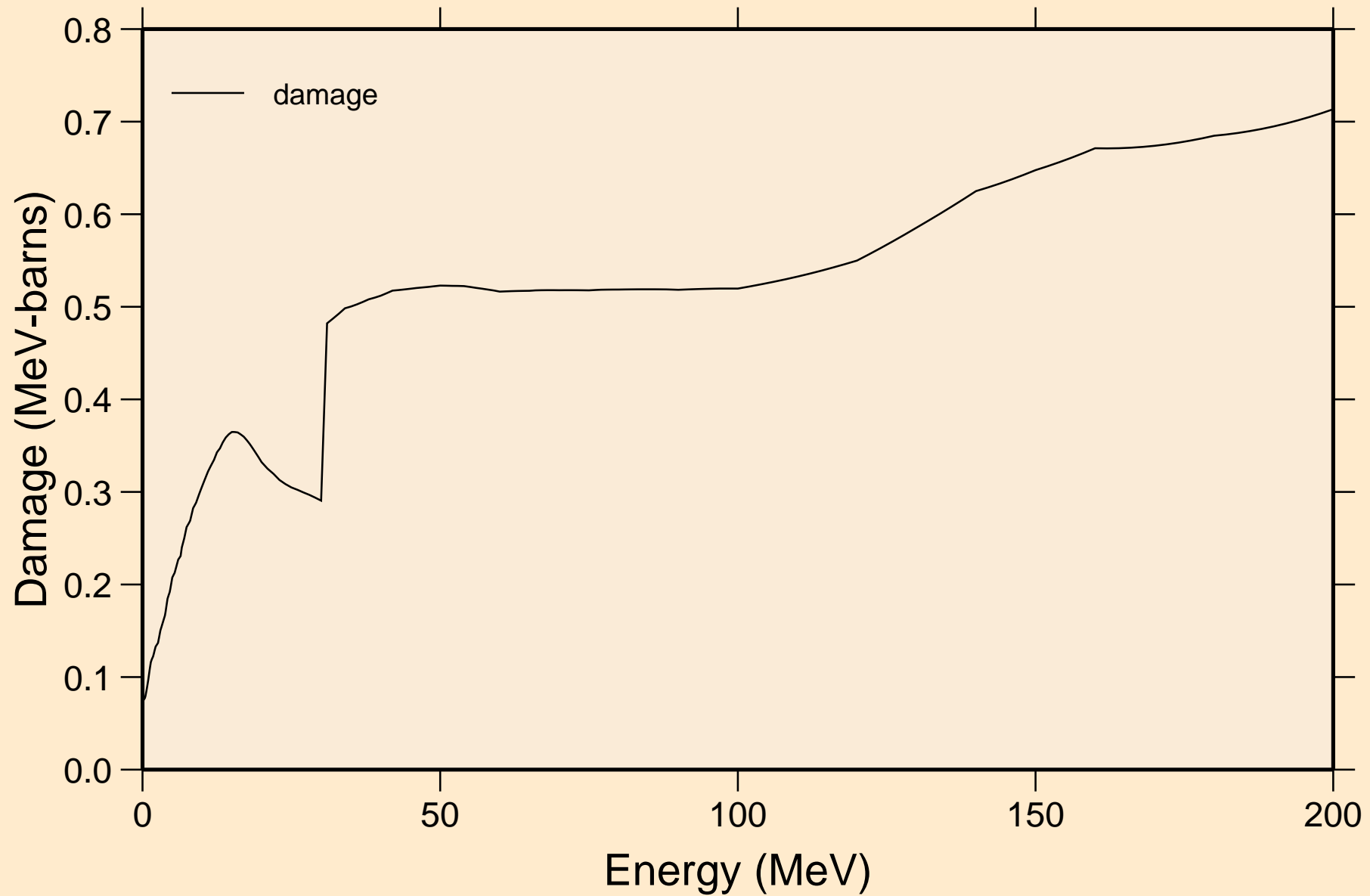

BA118 NEUTRON ACER TENDL-2023 LIBRARY; T=0.K  
Non-threshold reactions

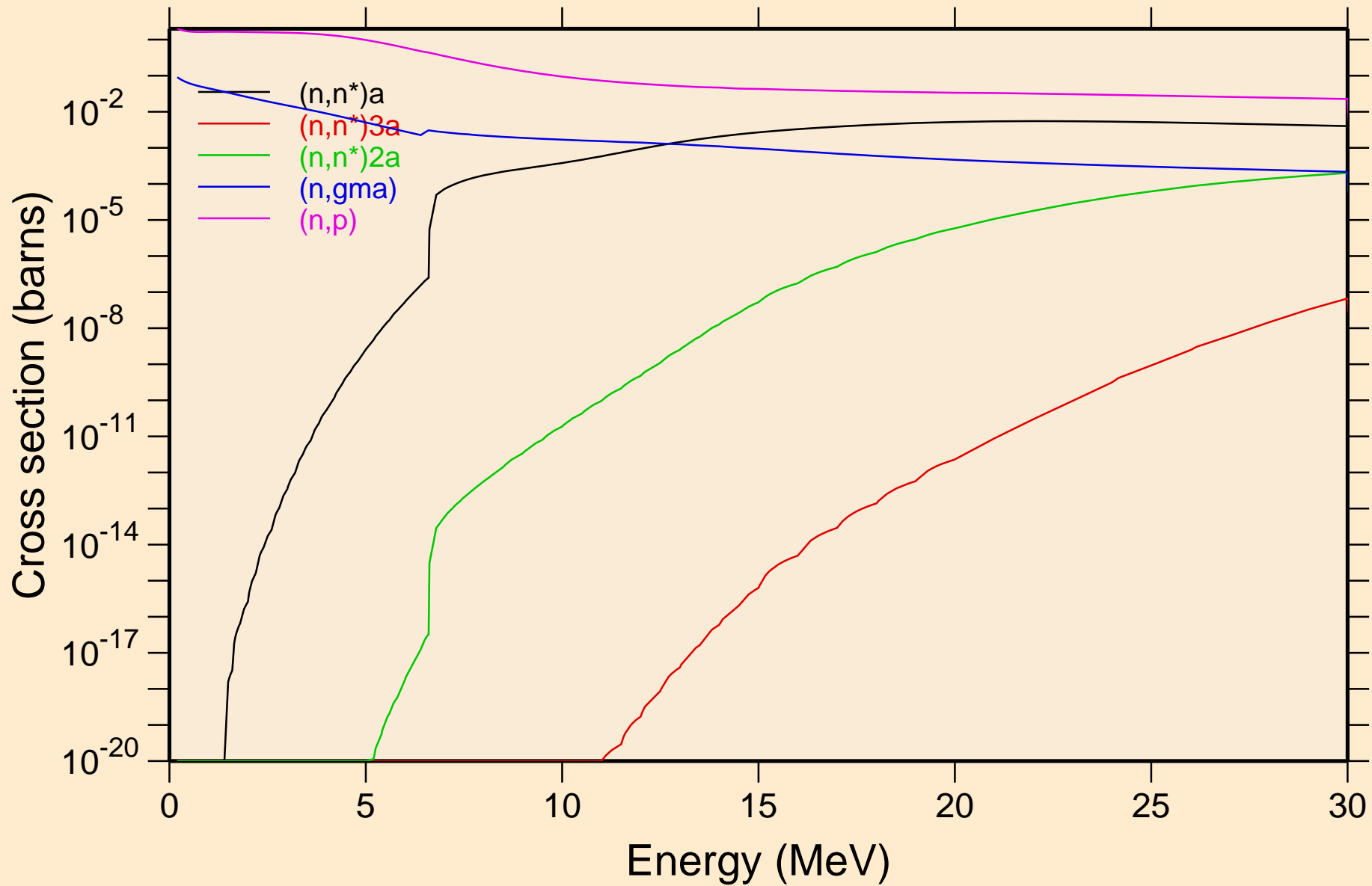

BA118 NEUTRON ACER TENDL-2023 LIBRARY; T=0.K  
Non-threshold reactions

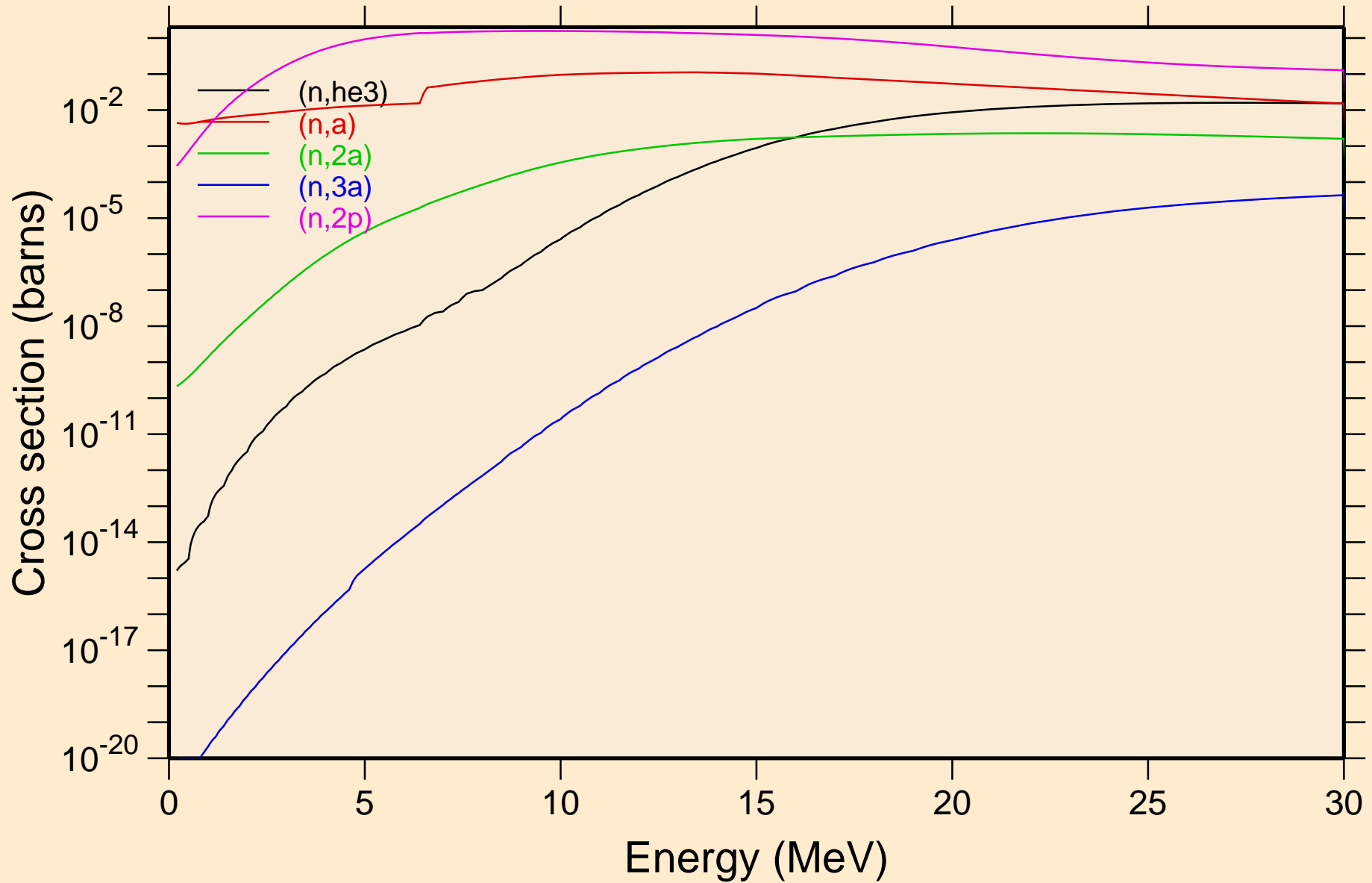

# BA118 NEUTRON ACER TENDL-2023 LIBRARY; T=0.K

## Non-threshold reactions

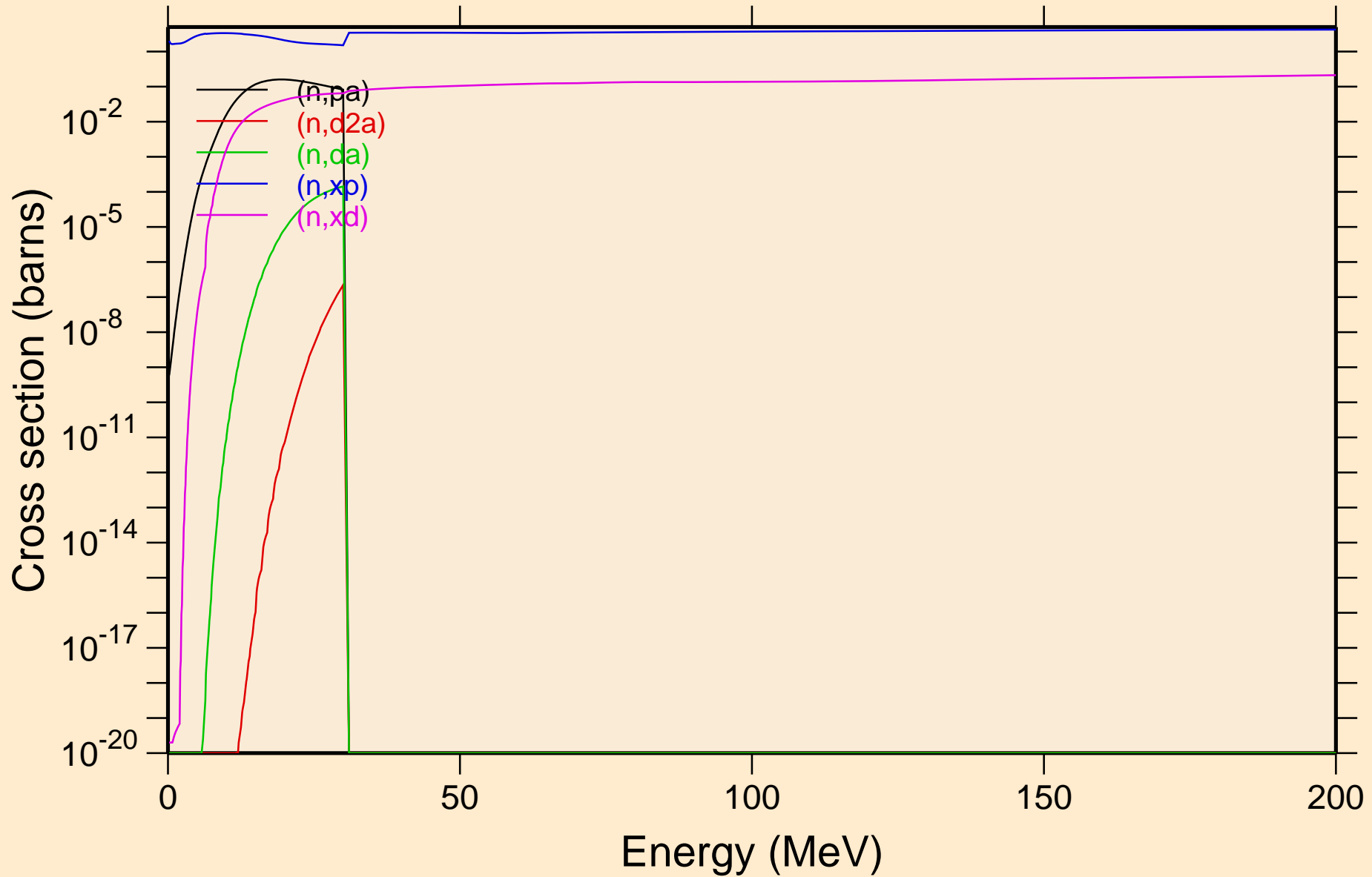

BA118 NEUTRON ACER TENDL-2023 LIBRARY; T=0.K  
Non-threshold reactions

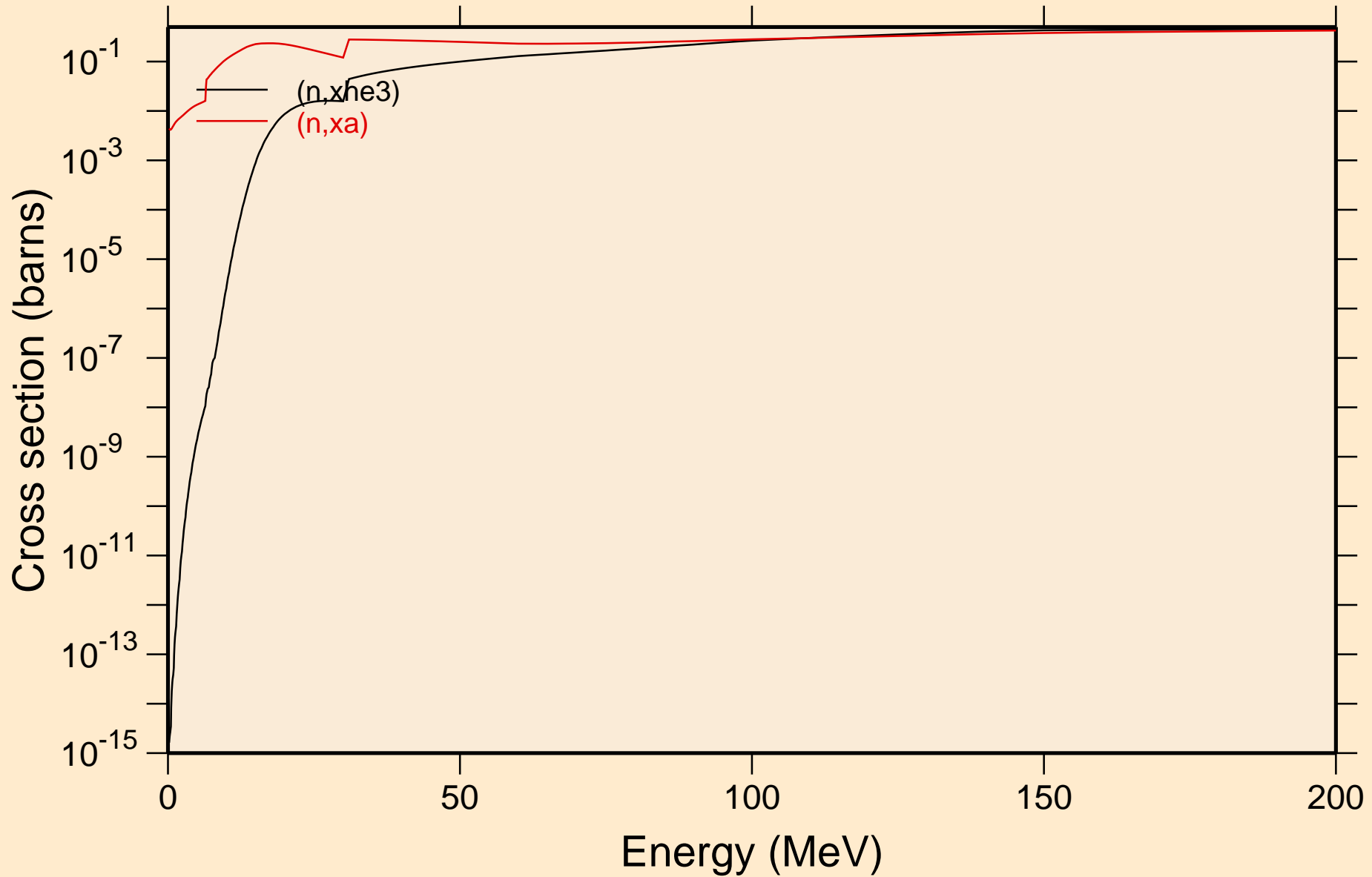

BA118 NEUTRON ACER TENDL-2023 LIBRARY; T=0.K  
Inelastic levels

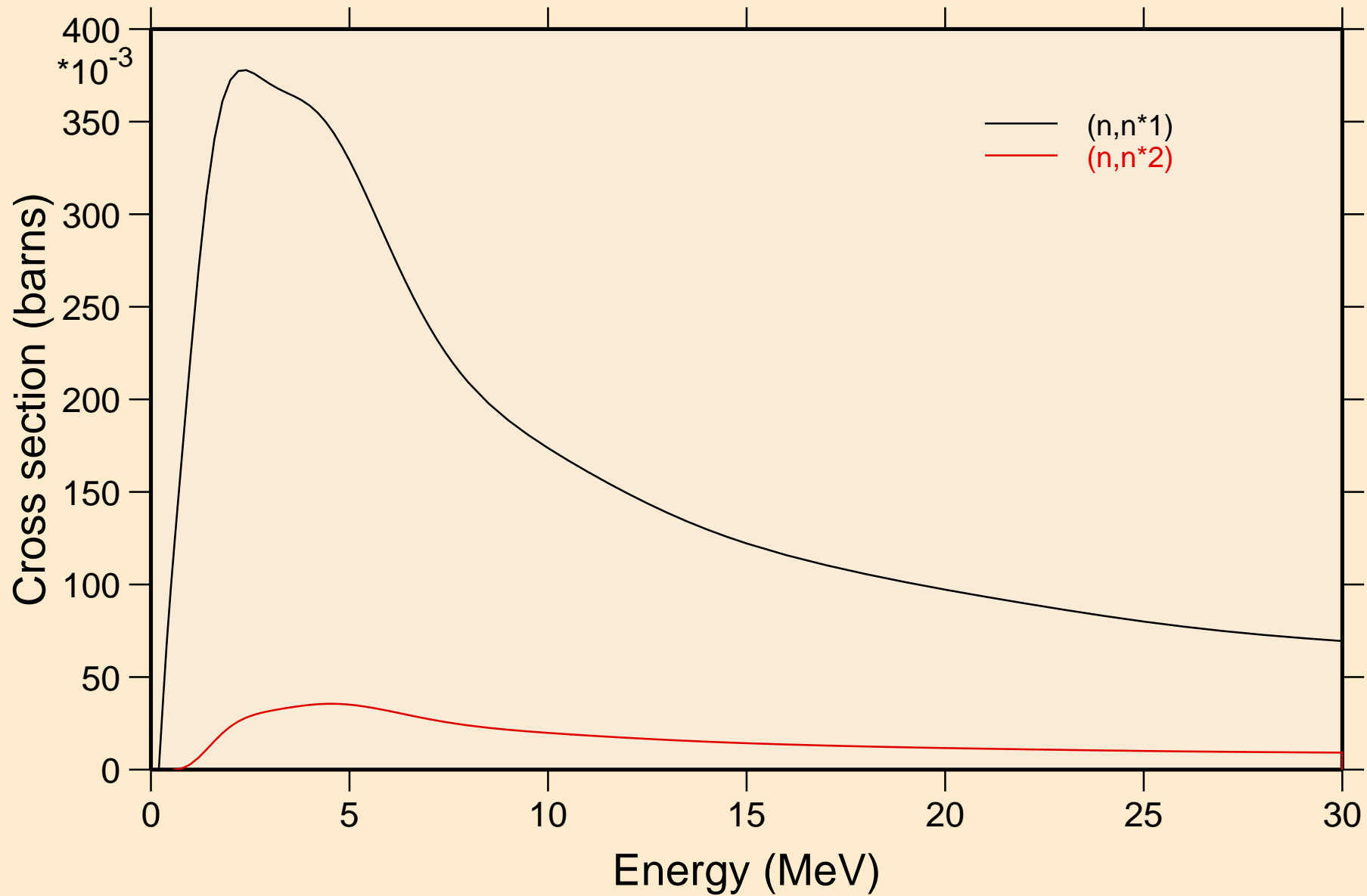

# BA118 NEUTRON ACER TENDL-2023 LIBRARY; T=0.K

## Threshold reactions

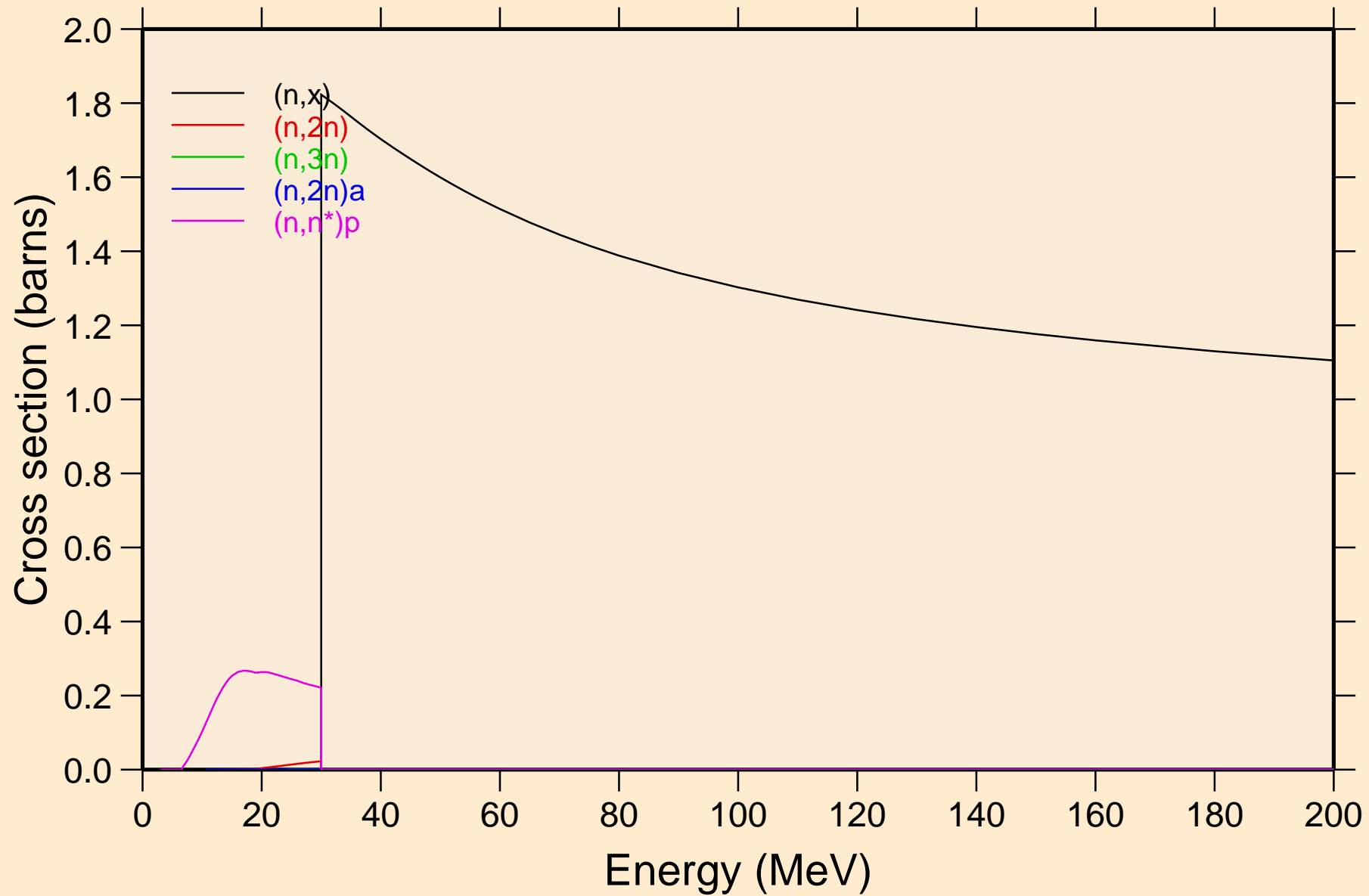



BA118 NEUTRON ACER TENDL-2023 LIBRARY; T=0.K  
Threshold reactions

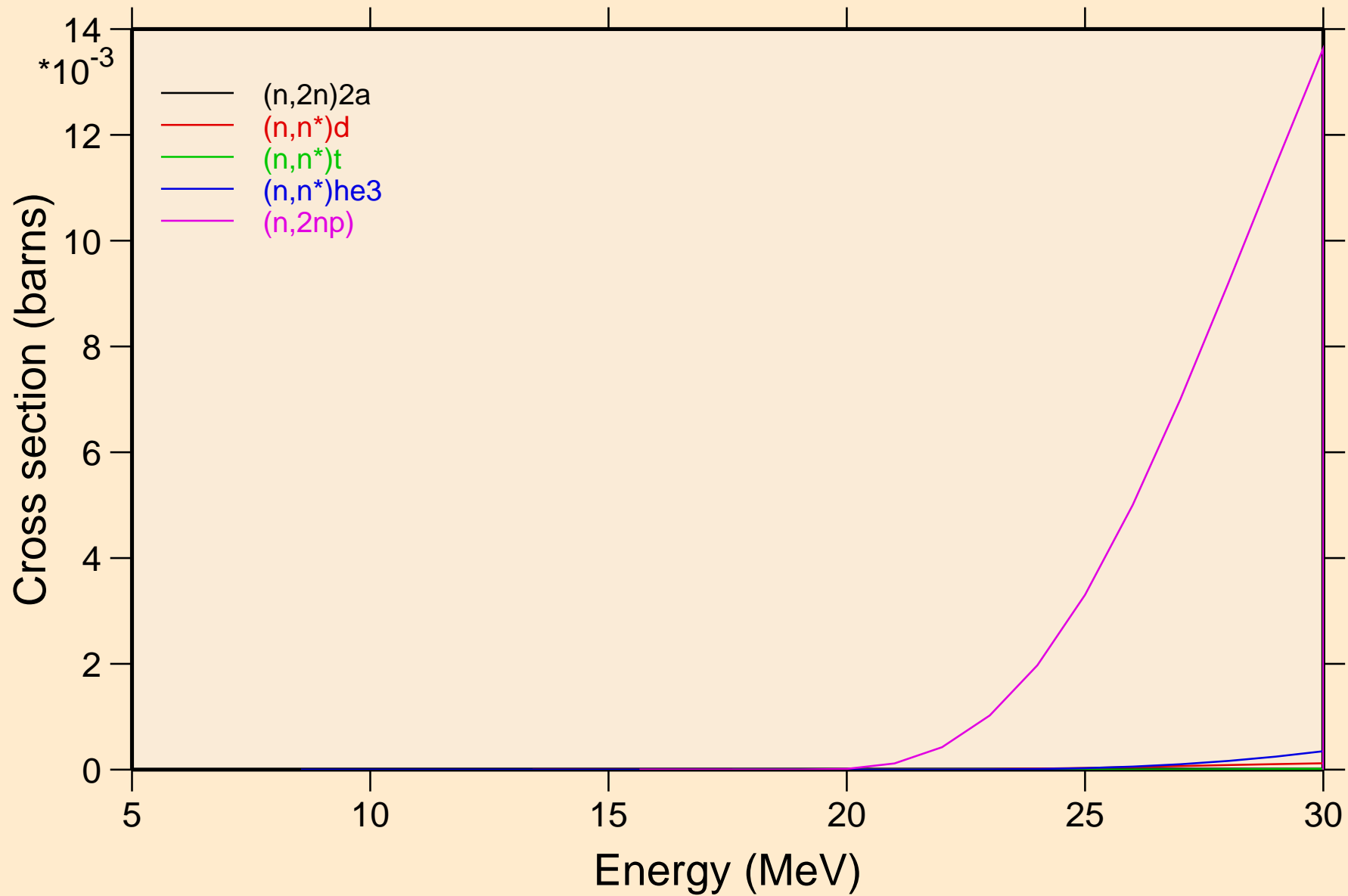

BA118 NEUTRON ACER TENDL-2023 LIBRARY; T=0.K  
Threshold reactions

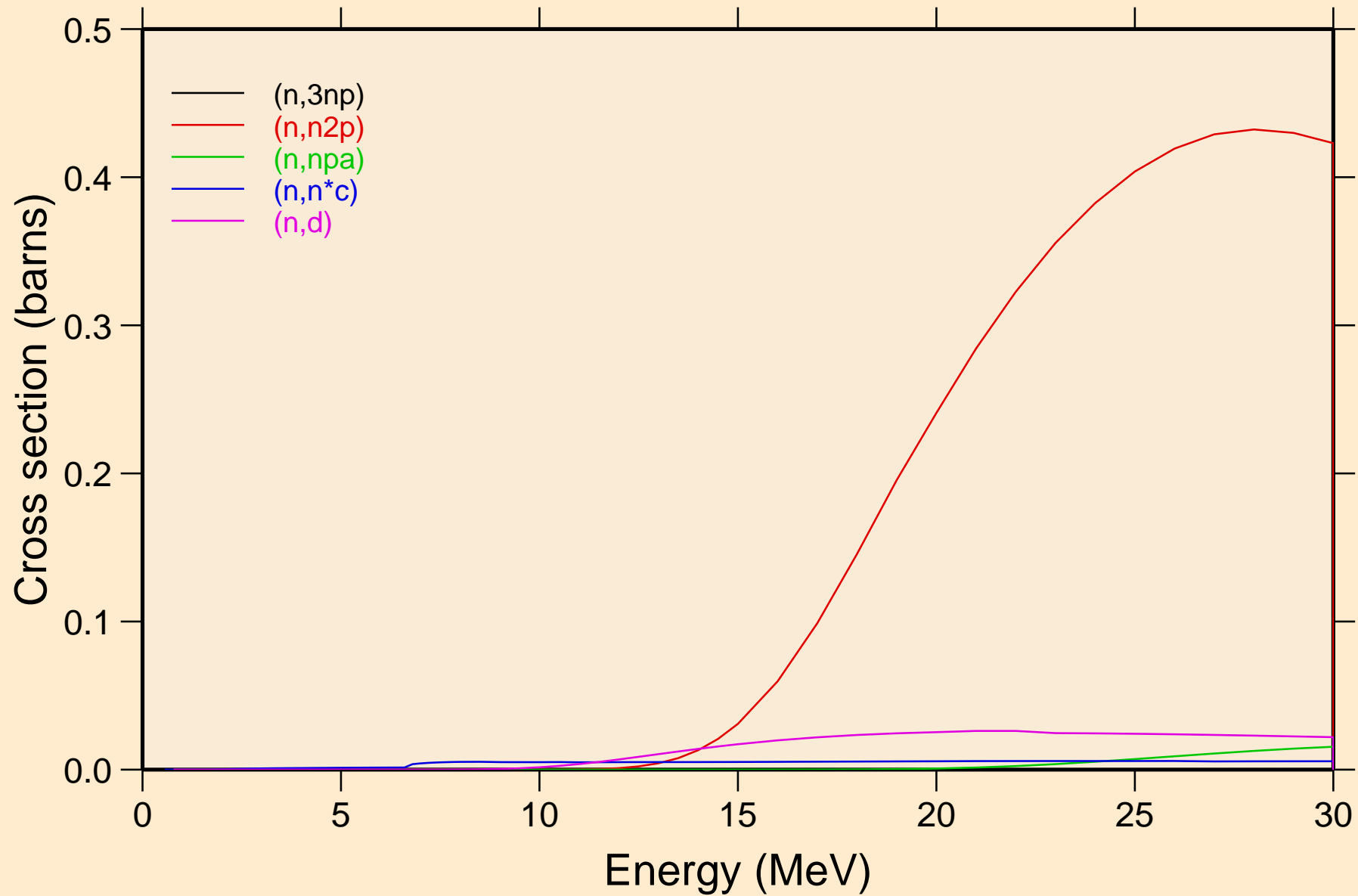

BA118 NEUTRON ACER TENDL-2023 LIBRARY; T=0.K  
Threshold reactions

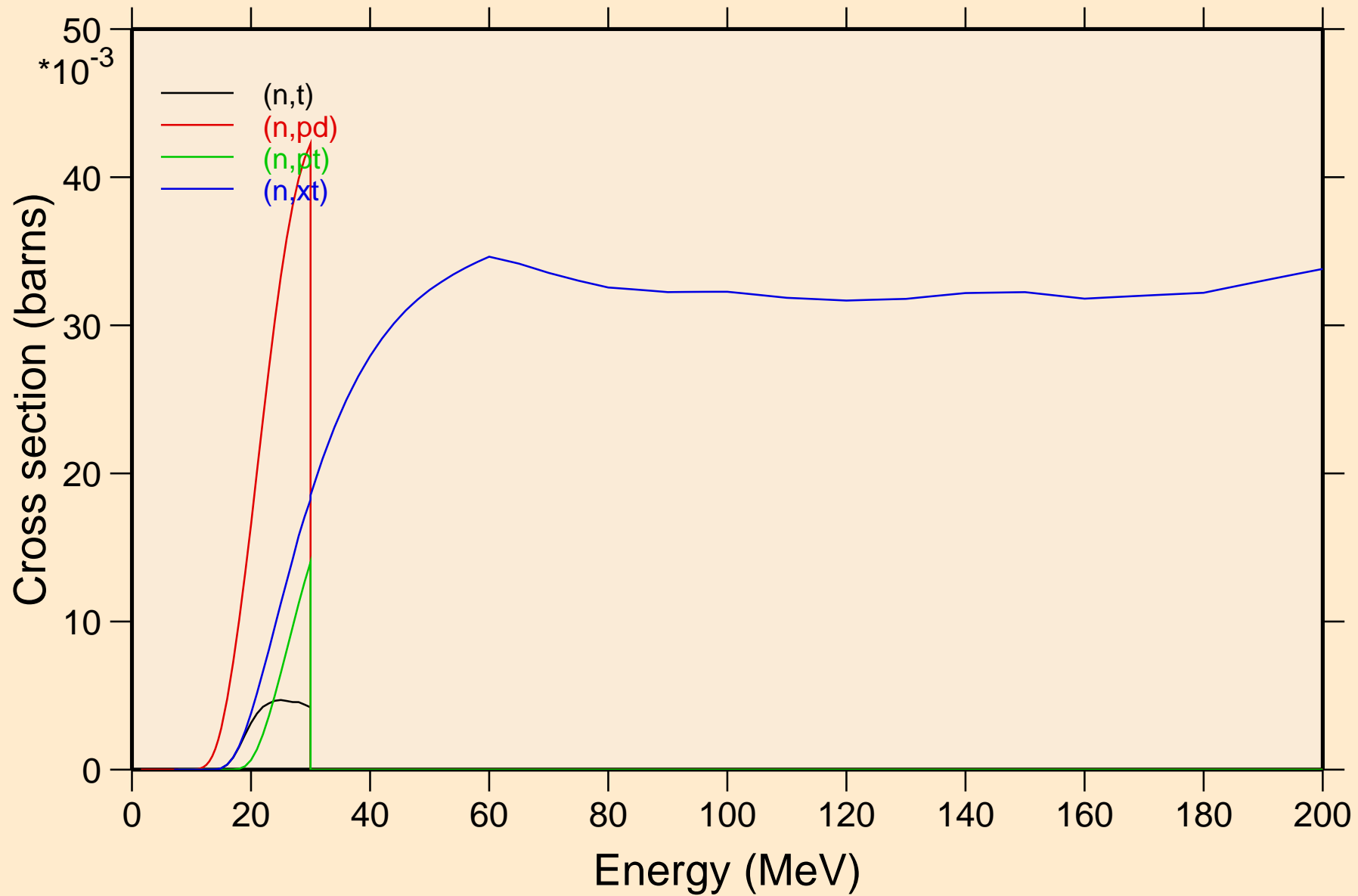

BA118 NEUTRON ACER TENDL-2023 LIBRARY; T=0.K  
angular distribution for elastic

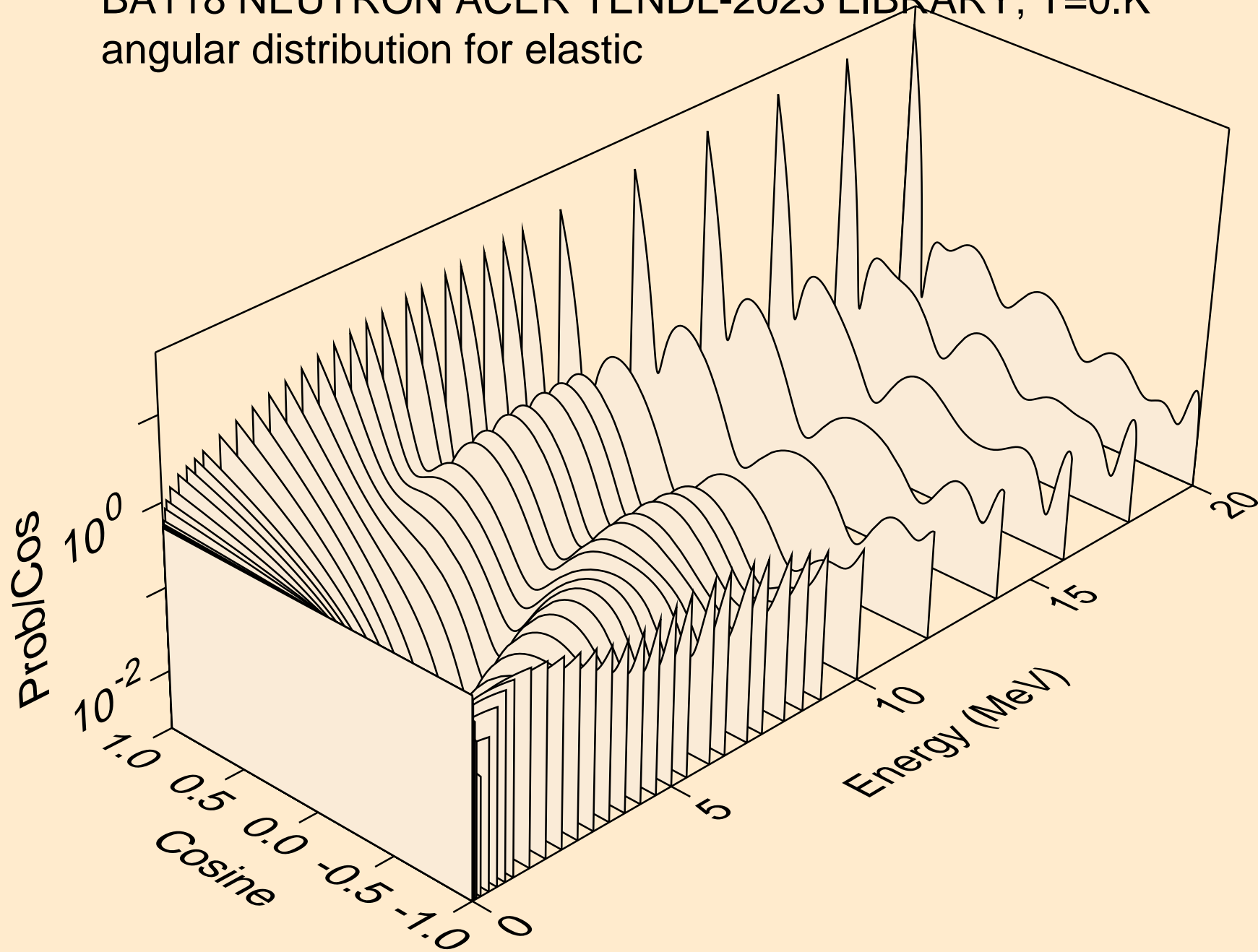

BA118 NEUTRON ACER TENDL-2023 LIBRARY; T=0.K  
angular distribution for elastic

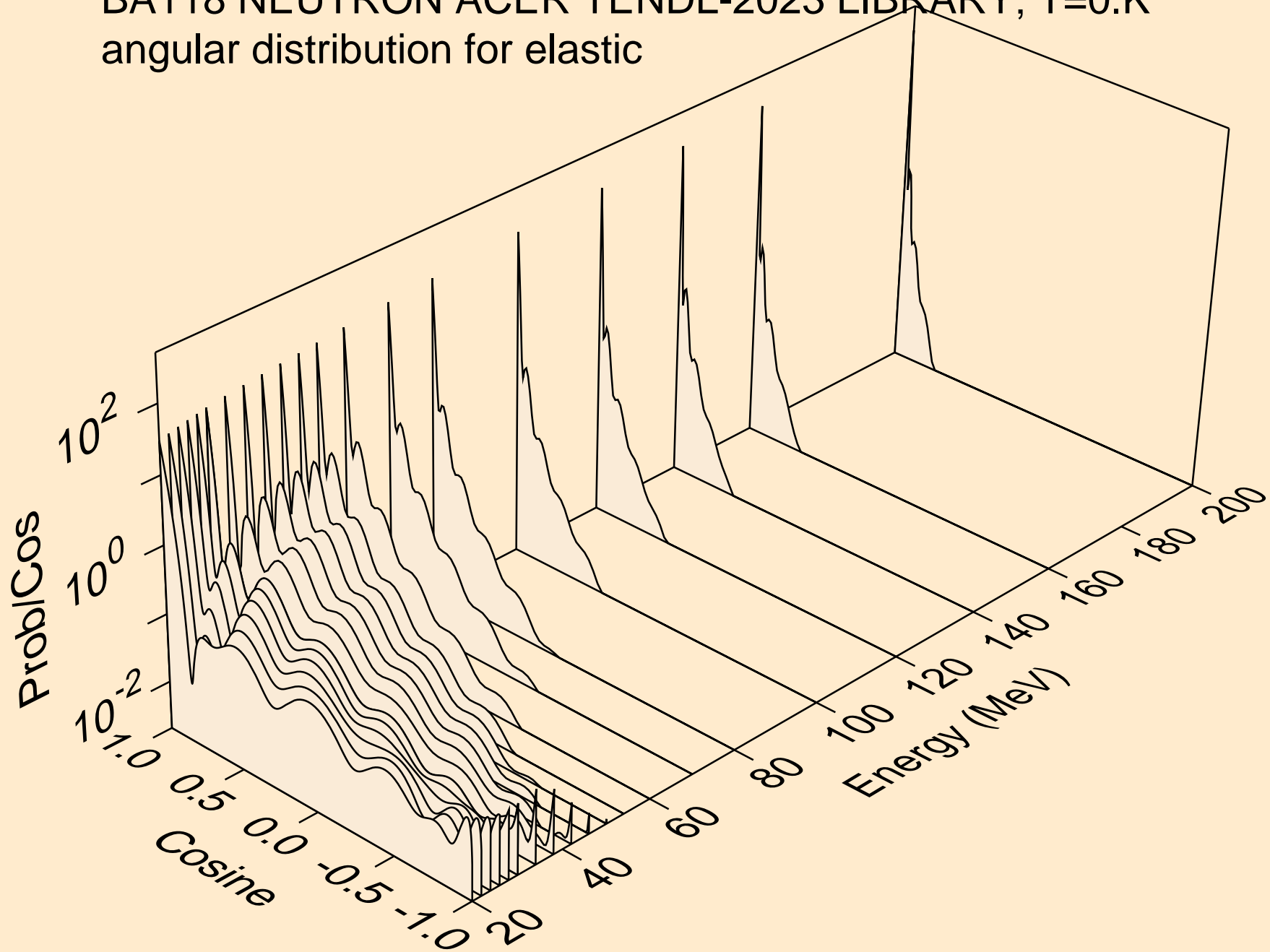

BA118 NEUTRON ACER TENDL-2023 LIBRARY; T=0.K  
angular distribution for (n,n\*1)

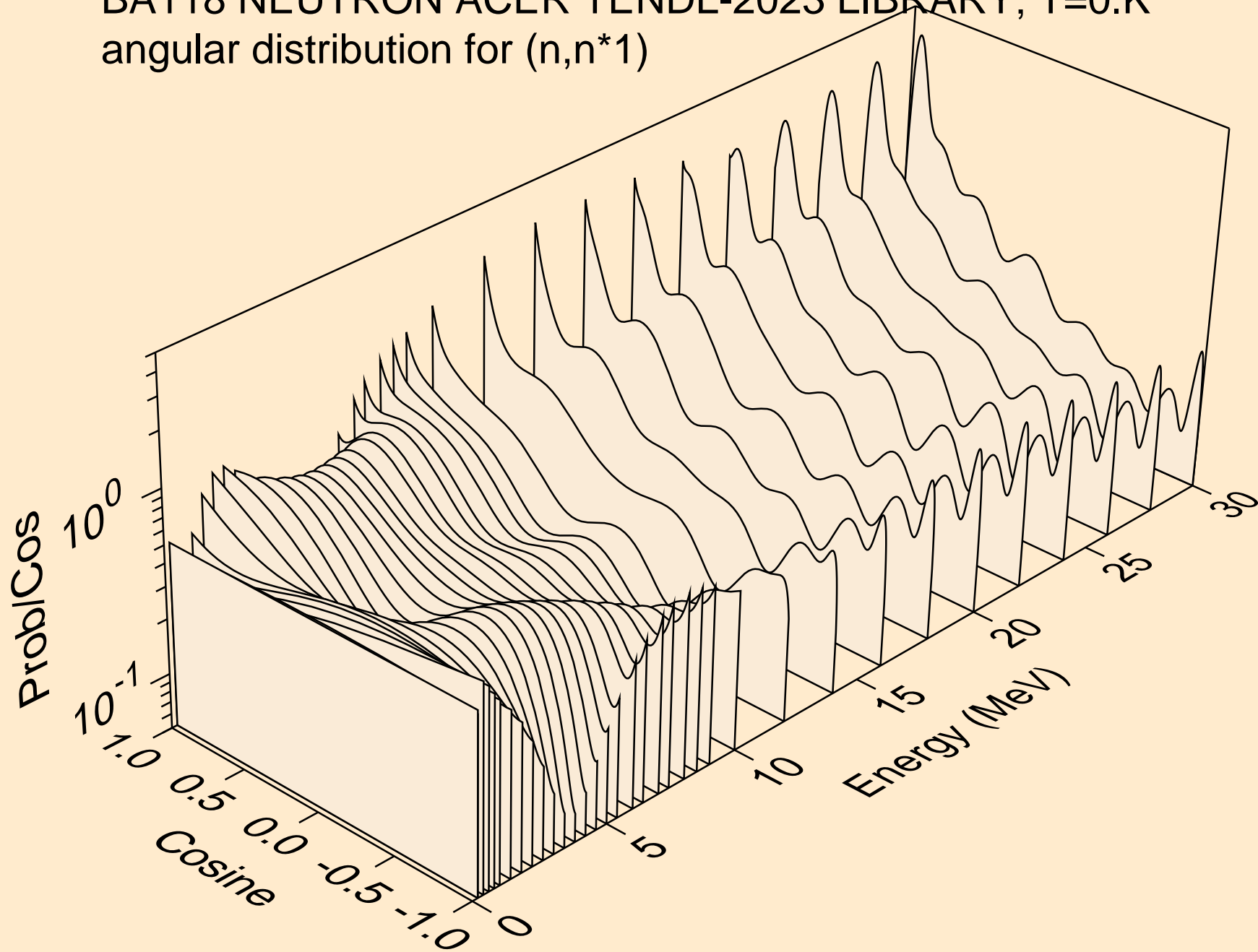

BA118 NEUTRON ACER TENDL-2023 LIBRARY; T=0.K  
angular distribution for (n,n\*2)

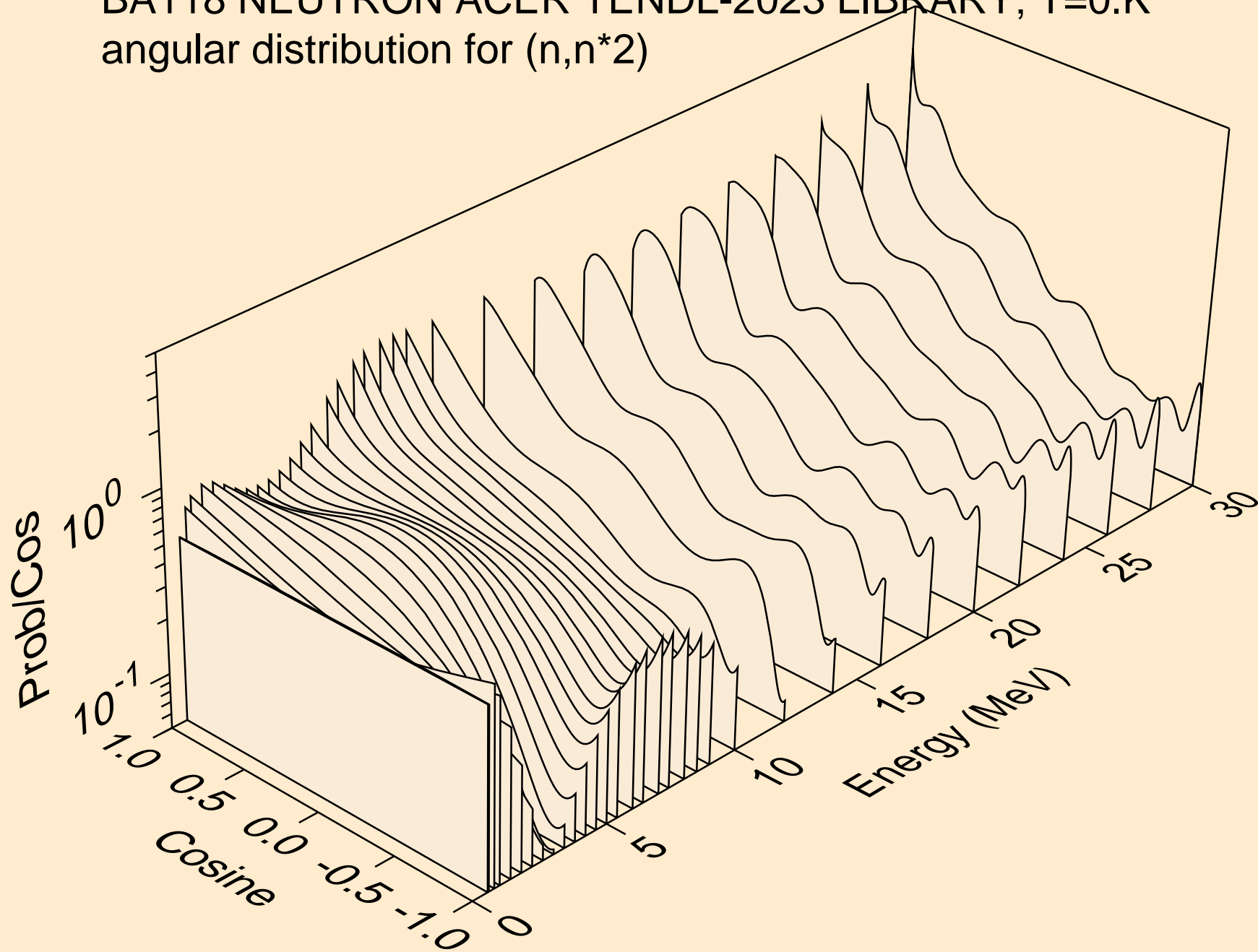

BA118 NEUTRON ACER TENDL-2023 LIBRARY; T=0.K  
Neutron emission for (n,x)

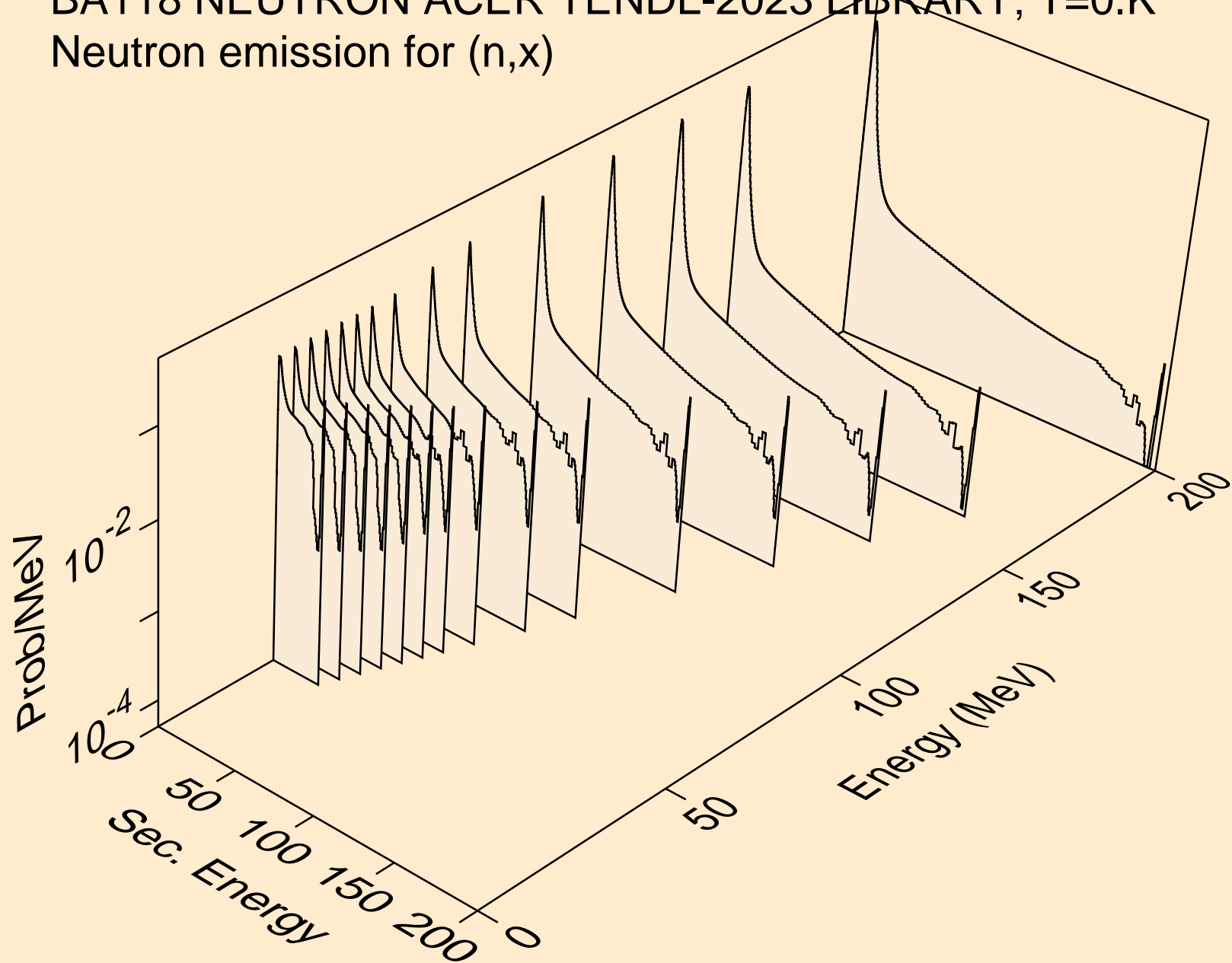



BA118 NEUTRON ACER TENDL-2023 LIBRARY; T=0.K  
Neutron emission for (n,2n)

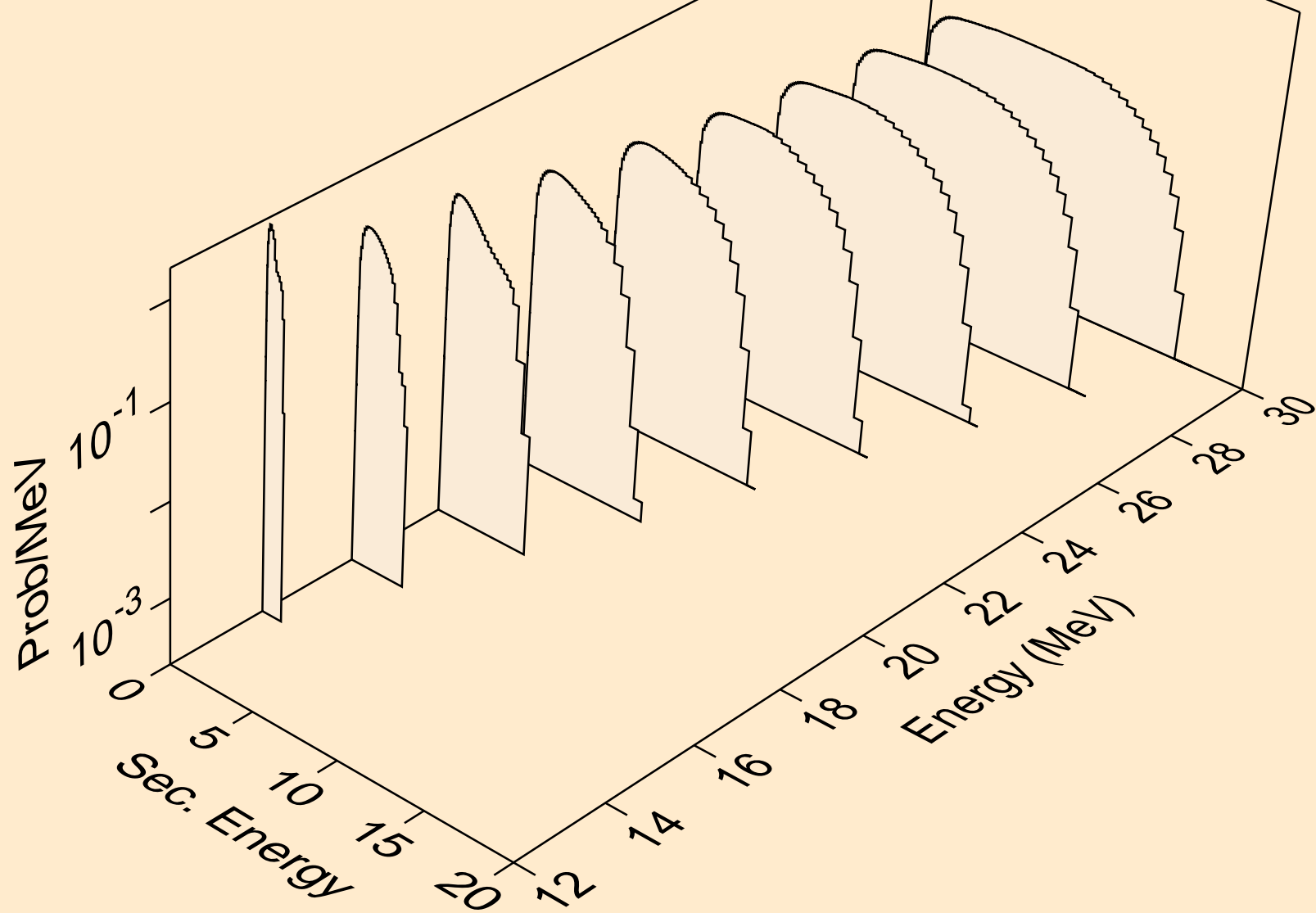

BA118 NEUTRON ACER TENDL-2023 LIBRARY; T=0.K  
Neutron emission for (n,3n)

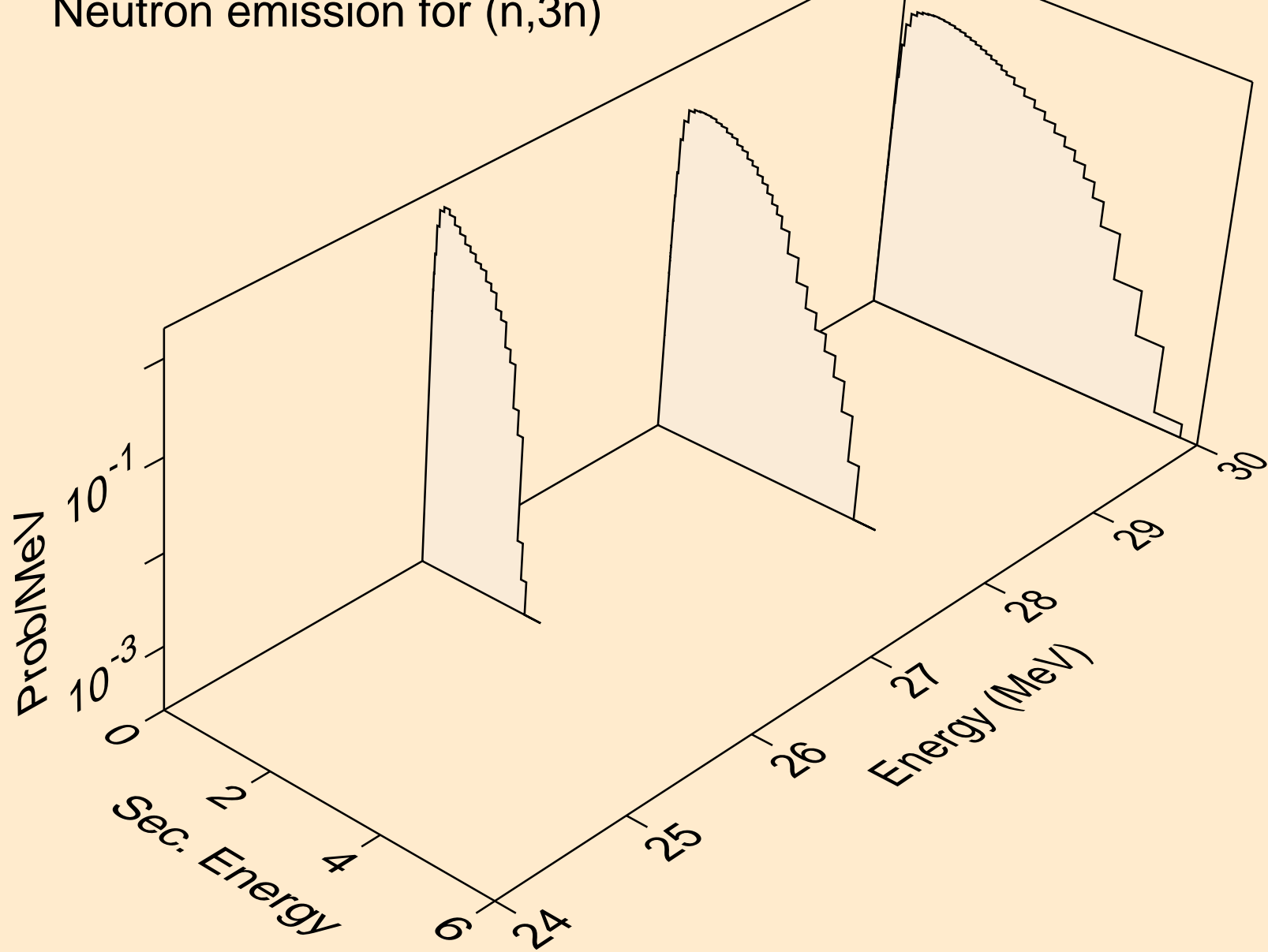

BA118 NEUTRON ACER TENDL-2023 LIBRARY; T=0.K  
Neutron emission for (n,n\*)a

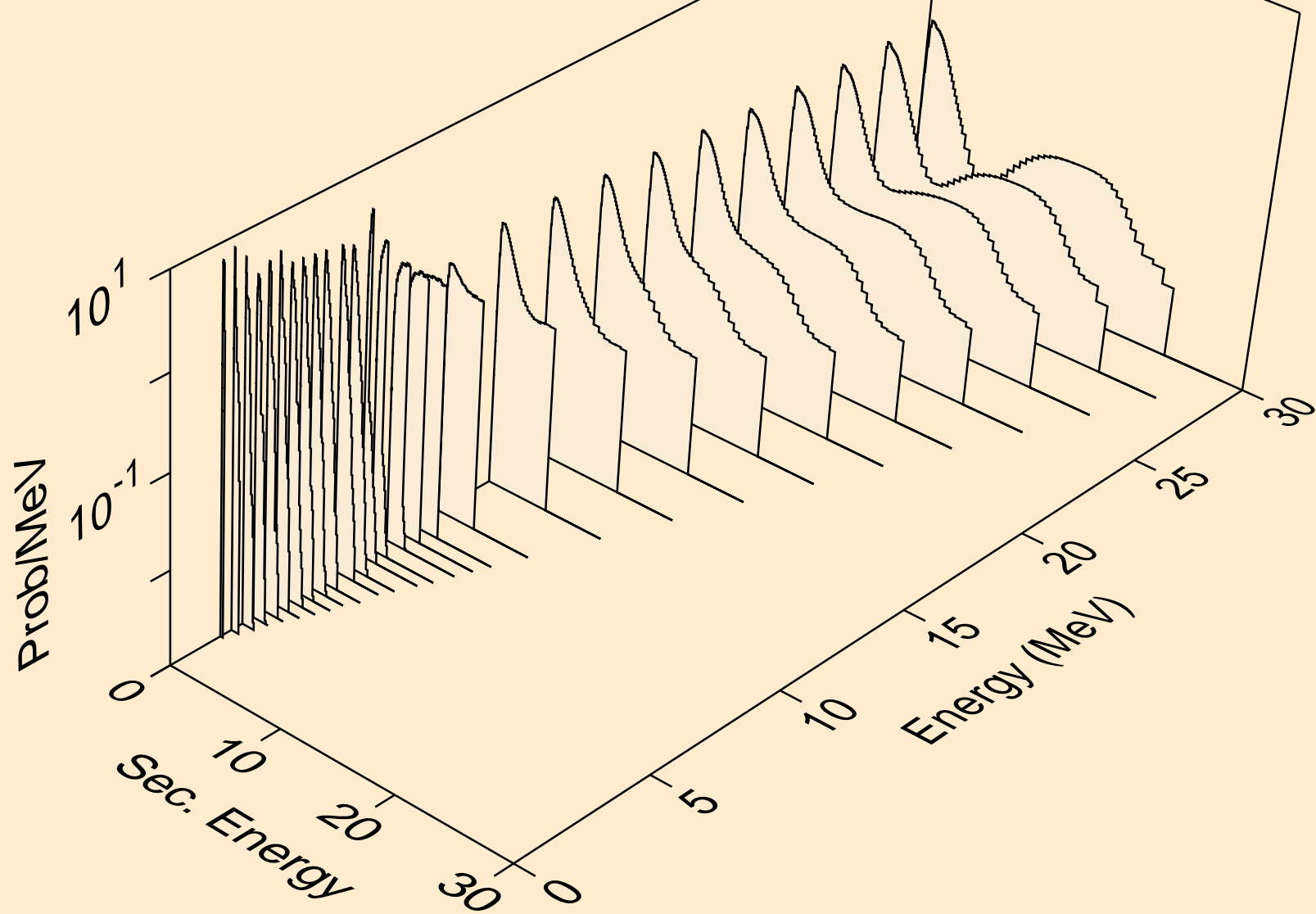

BA118 NEUTRON ACER TENDL-2023 LIBRARY; T=0.K  
Neutron emission for (n,n\*)3a

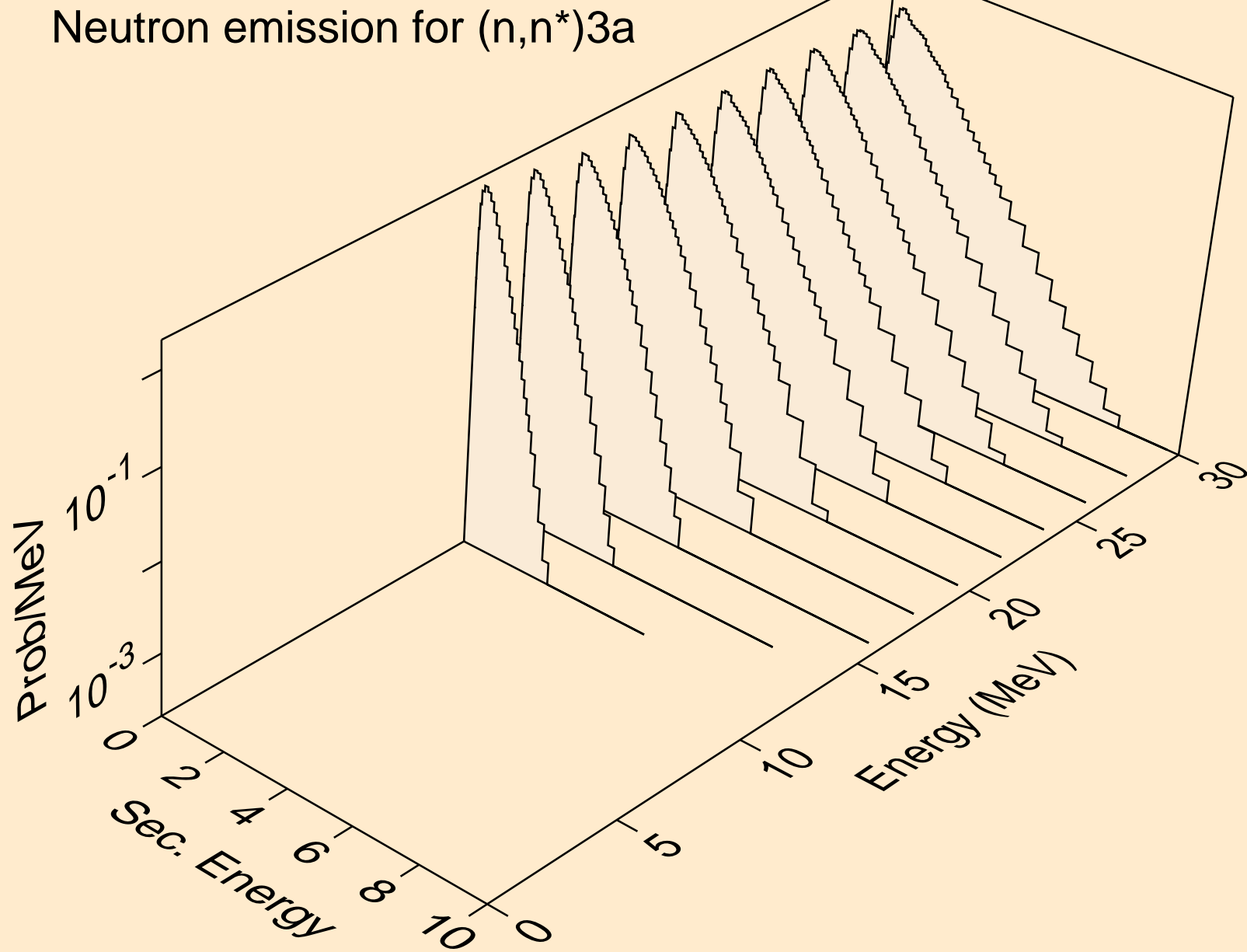

BA118 NEUTRON ACER TENDL-2023 LIBRARY; T=0.K  
Neutron emission for (n,2n)<sub>a</sub>

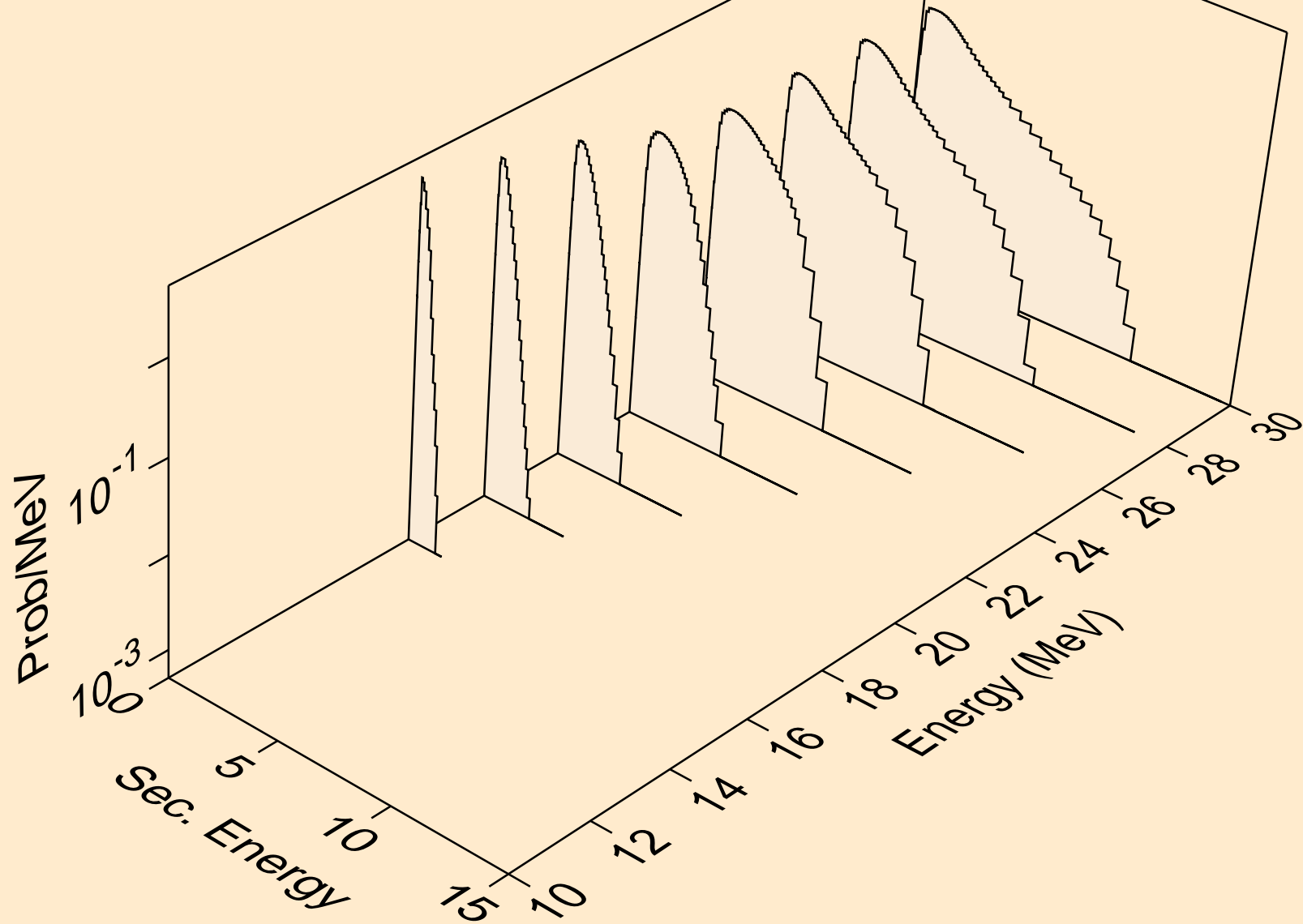

BA118 NEUTRON ACER TENDL-2023 LIBRARY; T=0.K  
Neutron emission for (n,n\*)p

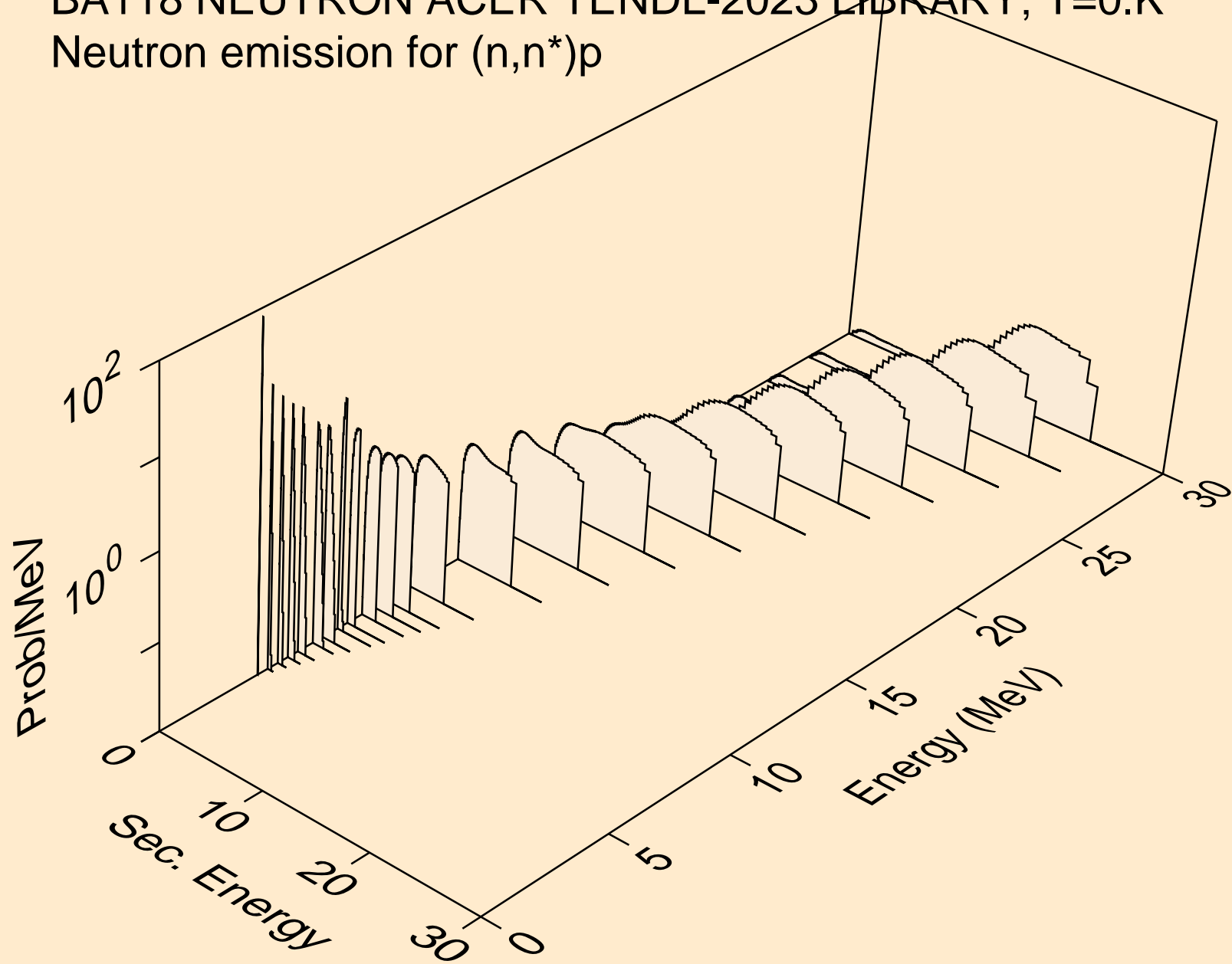

BA118 NEUTRON ACER TENDL-2023 LIBRARY; T=0.K  
Neutron emission for (n,n\*)2a

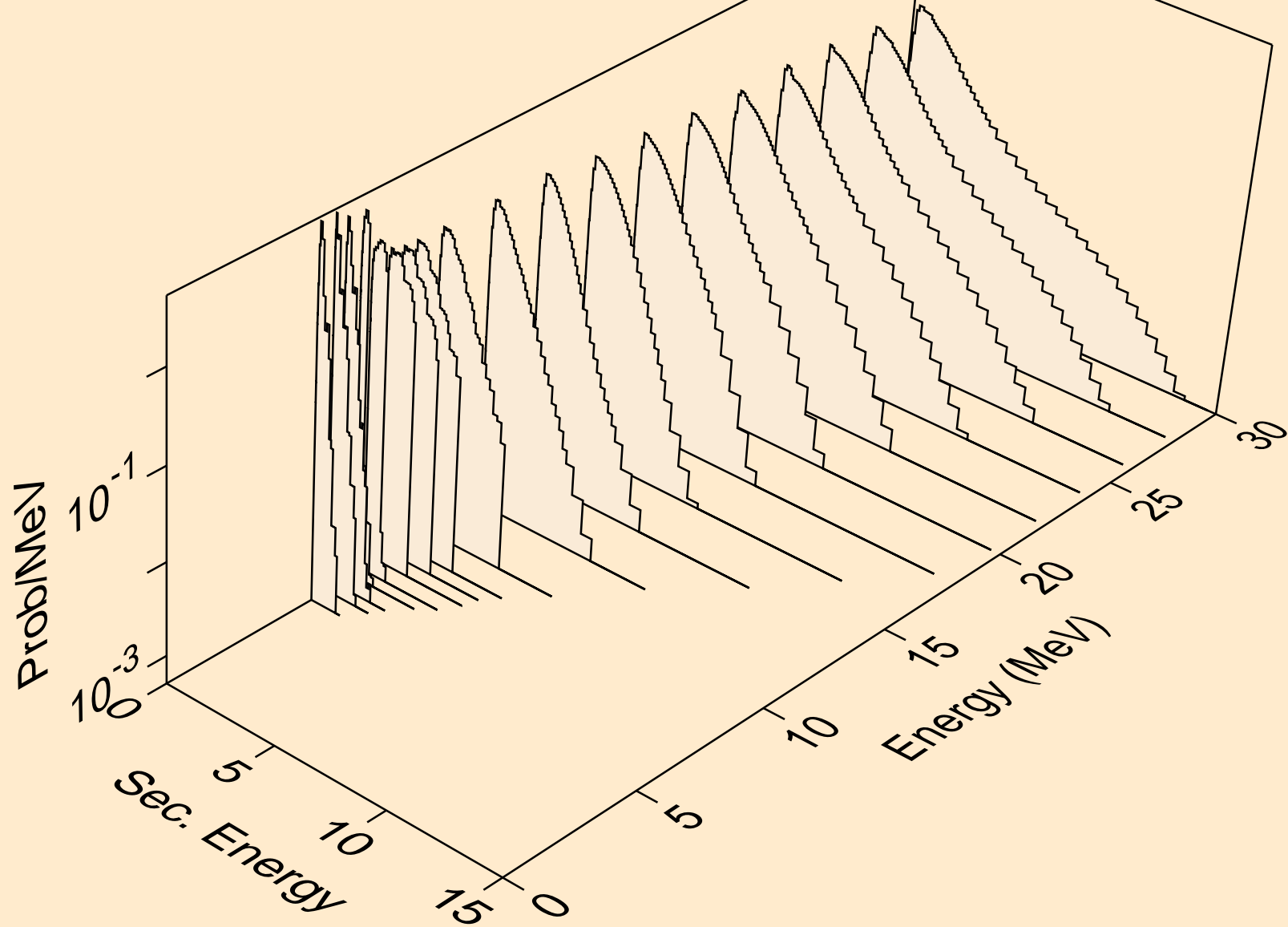

BA118 NEUTRON ACER TENDL-2023 LIBRARY; T=0.K  
Neutron emission for (n,2n)2a

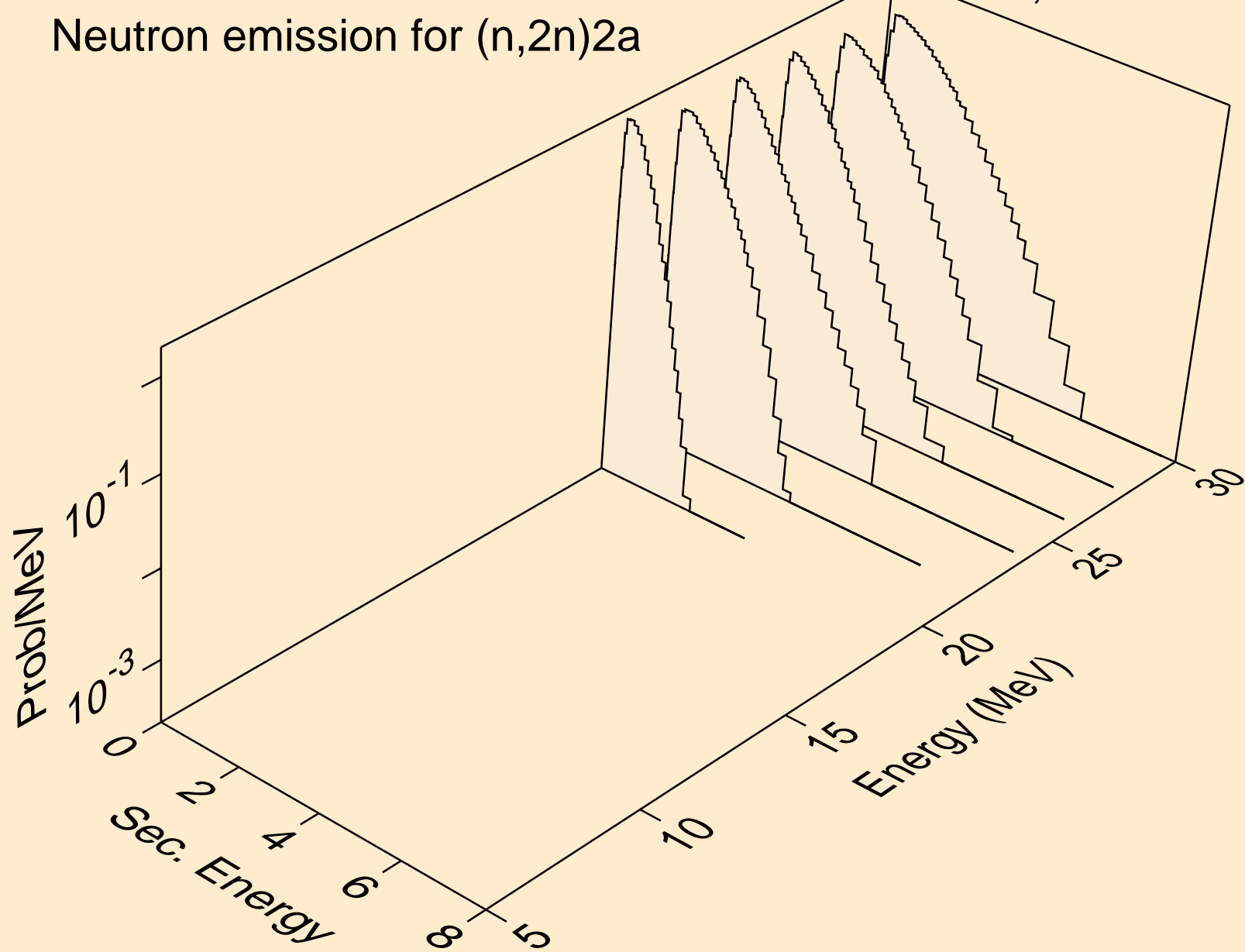



BA118 NEUTRON ACER TENDL-2023 LIBRARY; T=0.K  
Neutron emission for (n,n\*)d

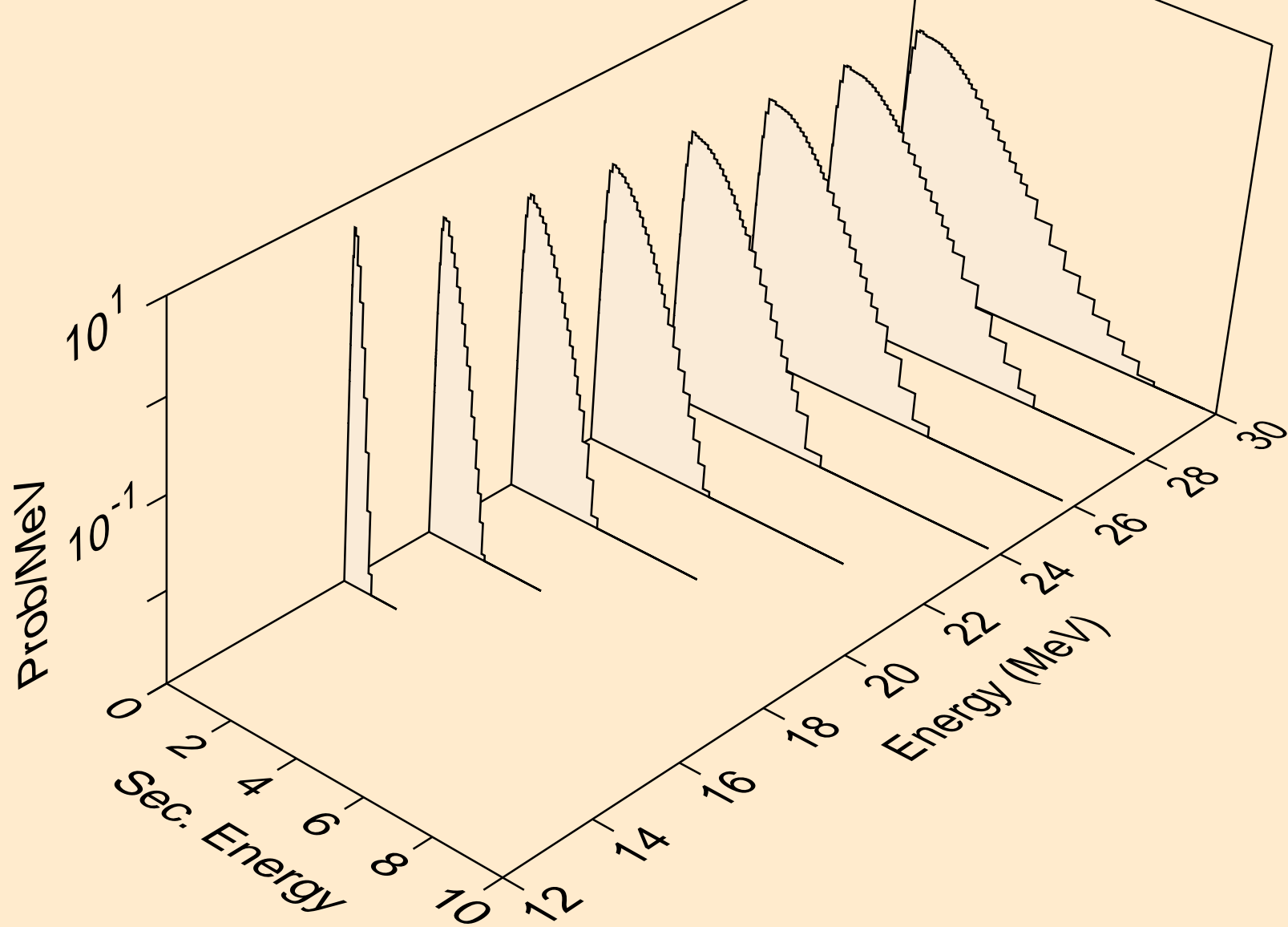

BA118 NEUTRON ACER TENDL-2023 LIBRARY; T=0.K  
Neutron emission for (n,n\*)t

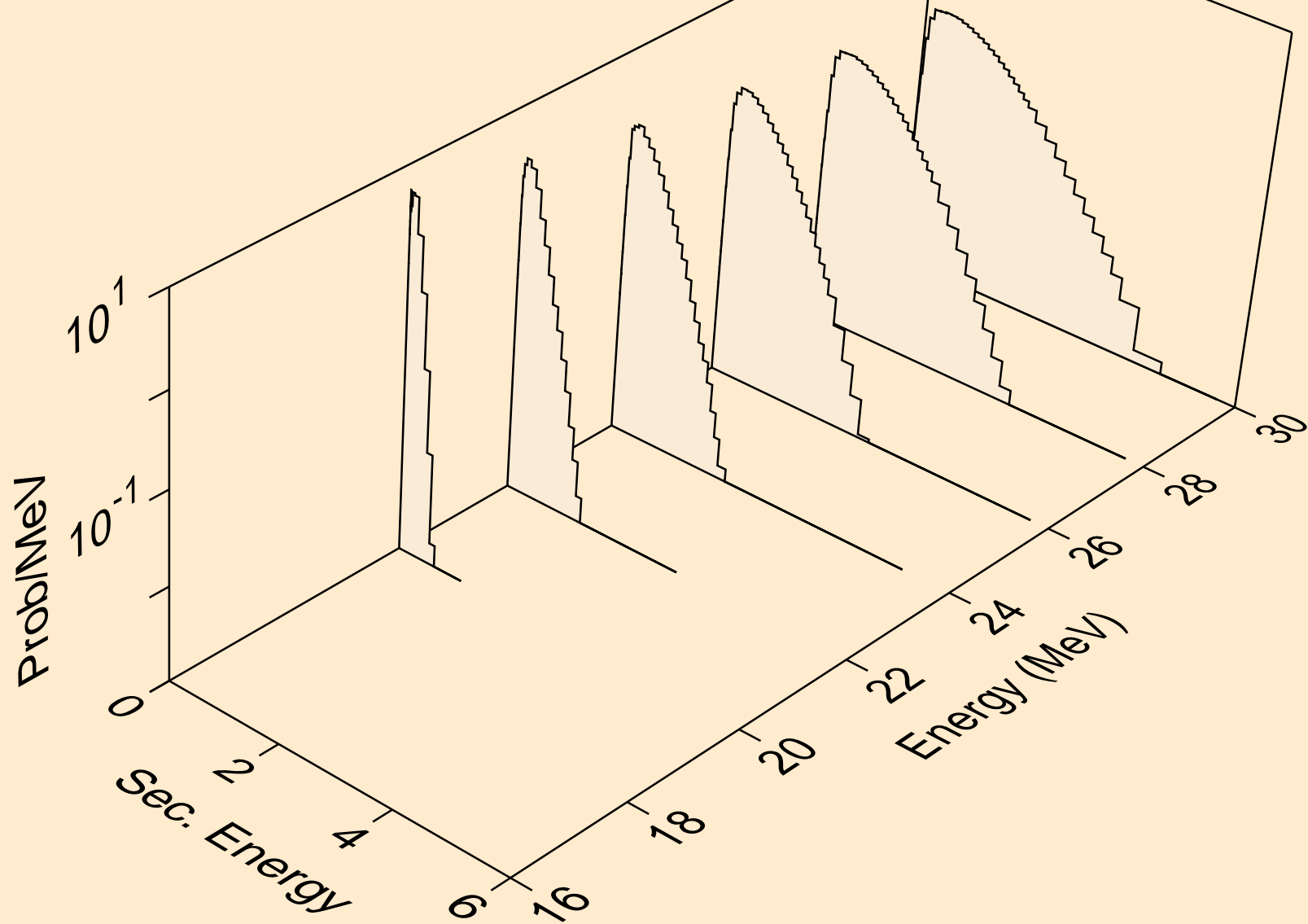

BA118 NEUTRON ACER TENDL-2023 LIBRARY; T=0.K  
Neutron emission for (n,n\*)he3

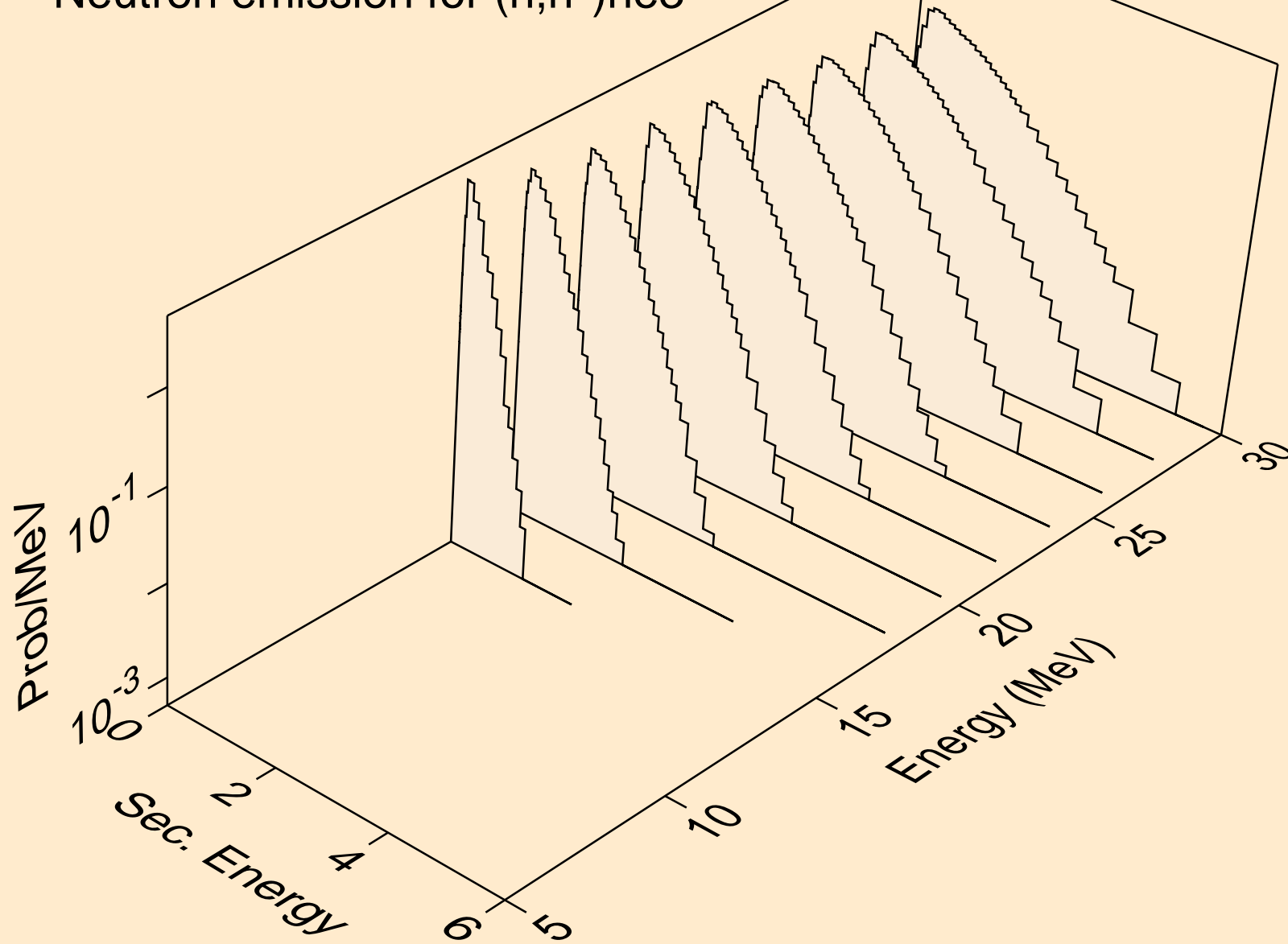

BA118 NEUTRON ACER TENDL-2023 LIBRARY; T=0.K  
Neutron emission for (n,2np)

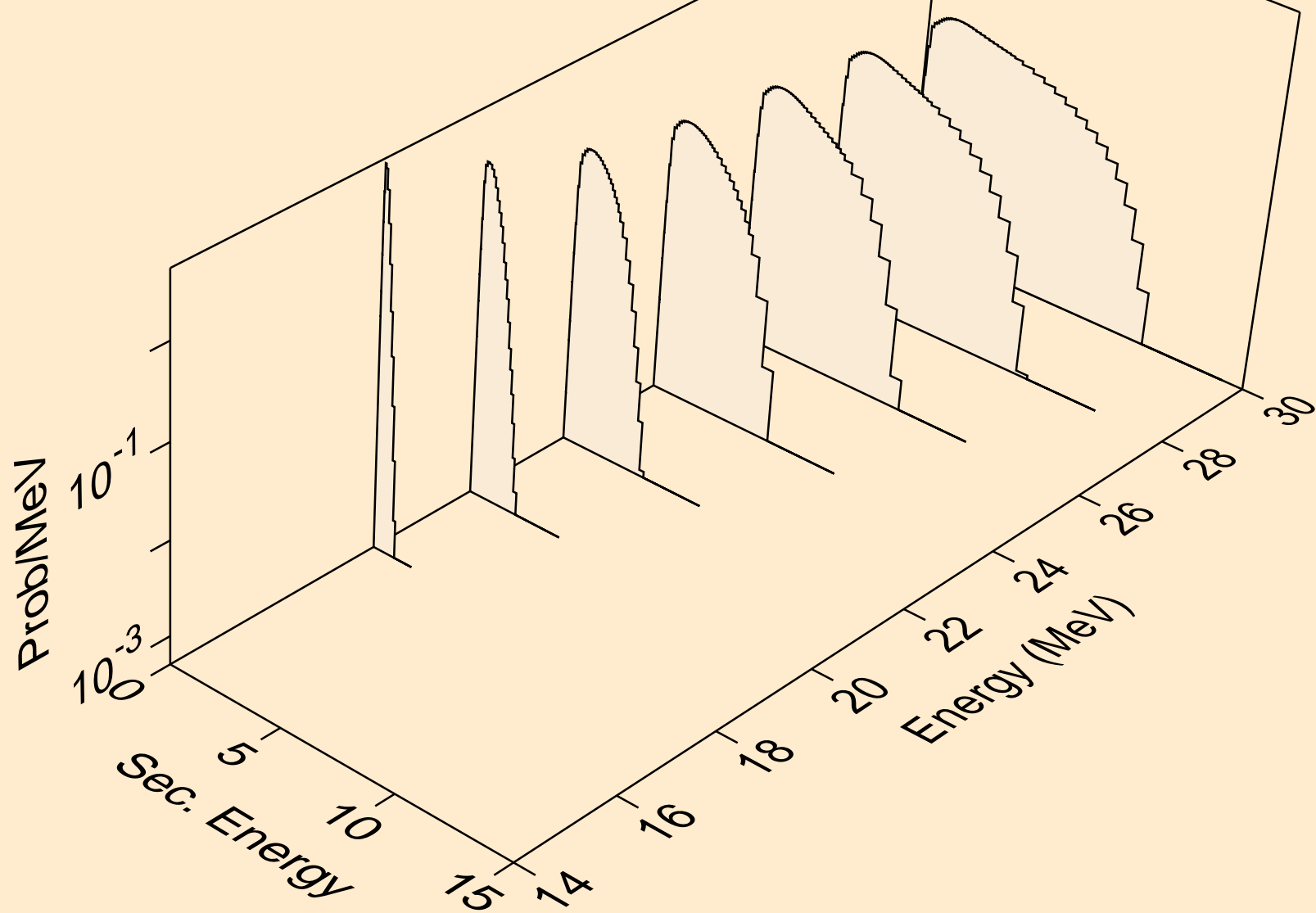

BA118 NEUTRON ACER TENDL-2023 LIBRARY; T=0.K  
Neutron emission for (n,3np)

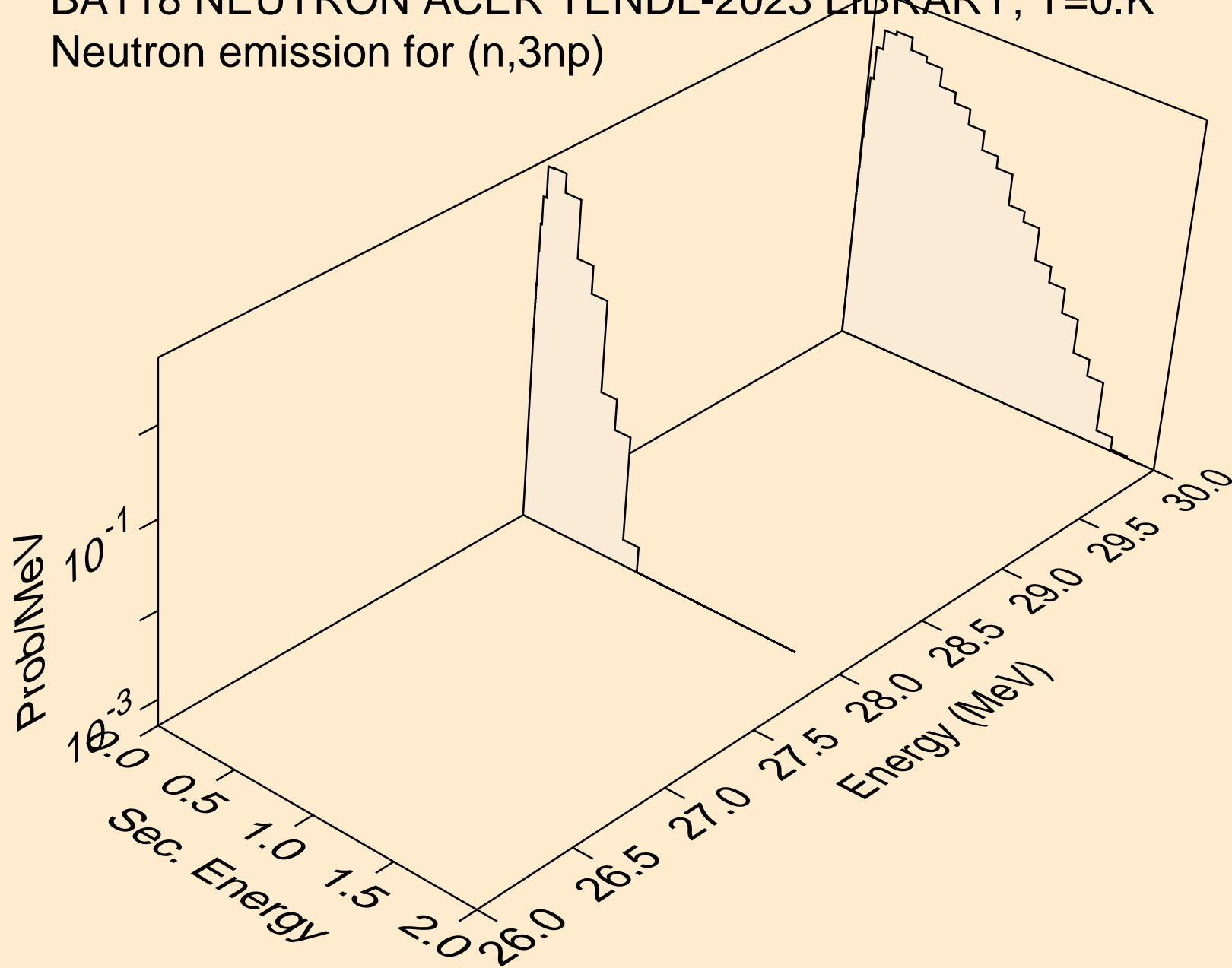

BA118 NEUTRON ACER TENDL-2023 LIBRARY; T=0.K  
Neutron emission for (n,n2p)

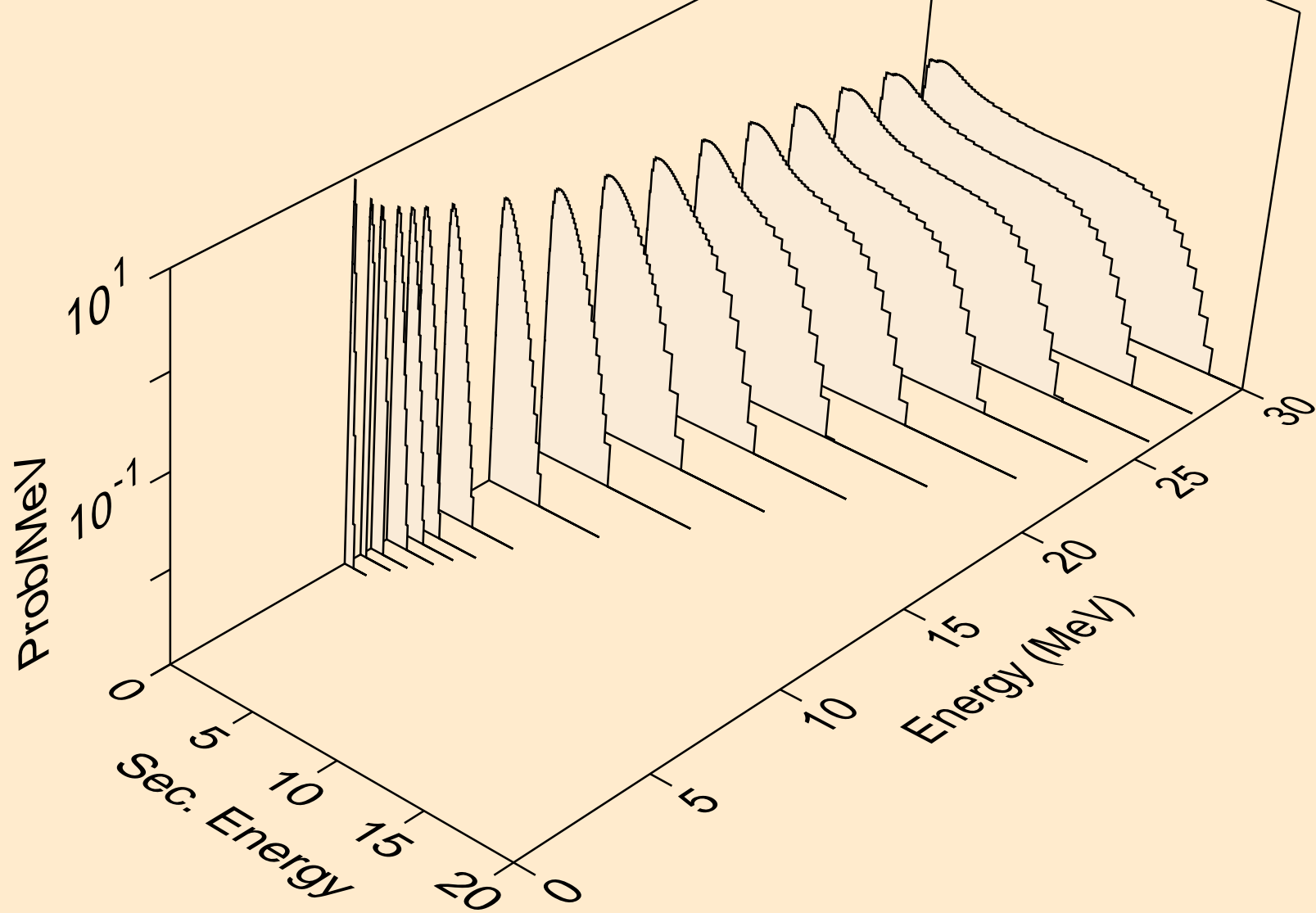

BA118 NEUTRON ACER TENDL-2023 LIBRARY; T=0.K  
Neutron emission for (n,npa)

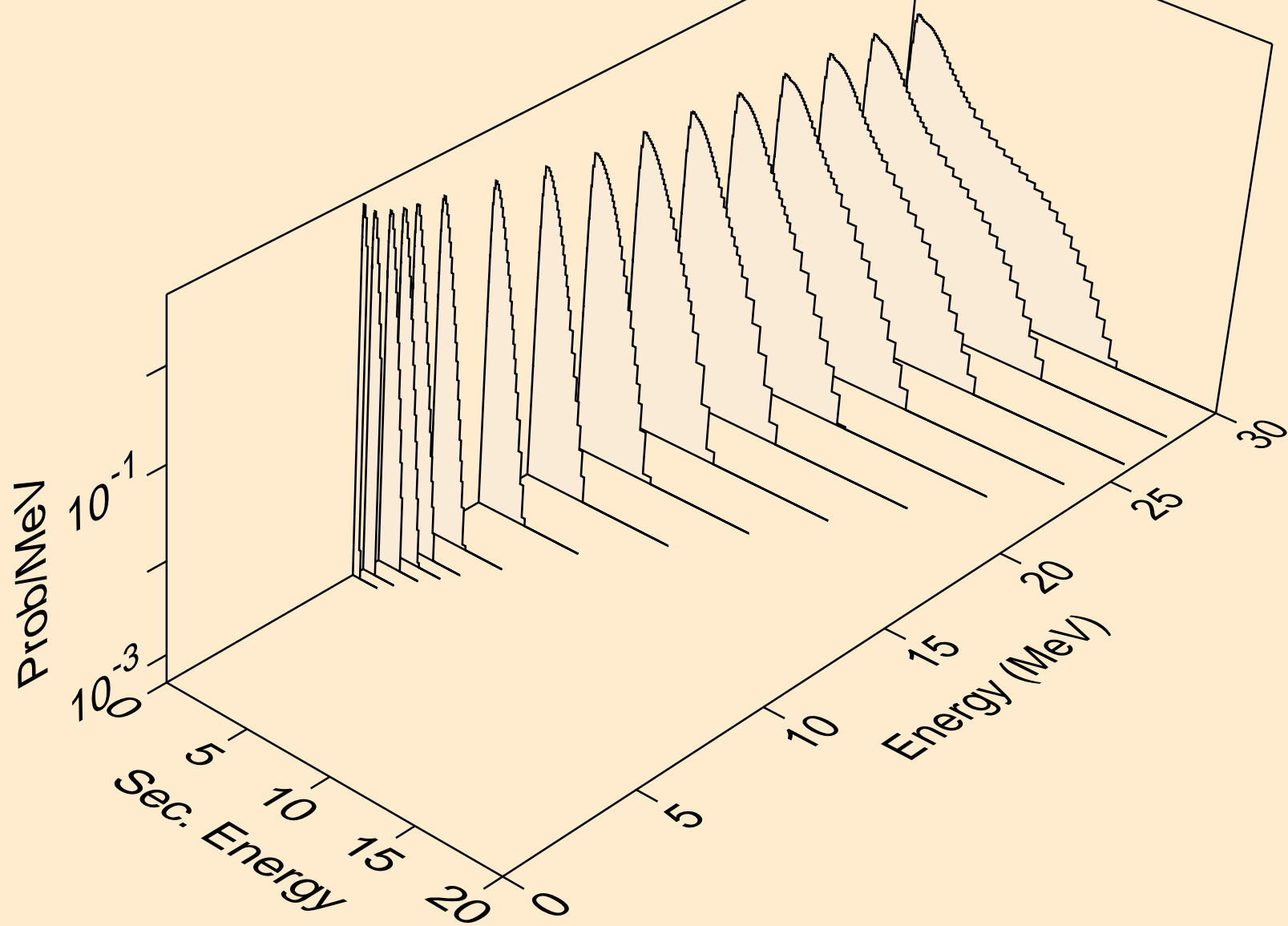

BA118 NEUTRON ACER TENDL-2023 LIBRARY; T=0.K  
Neutron emission for (n,n\*c)

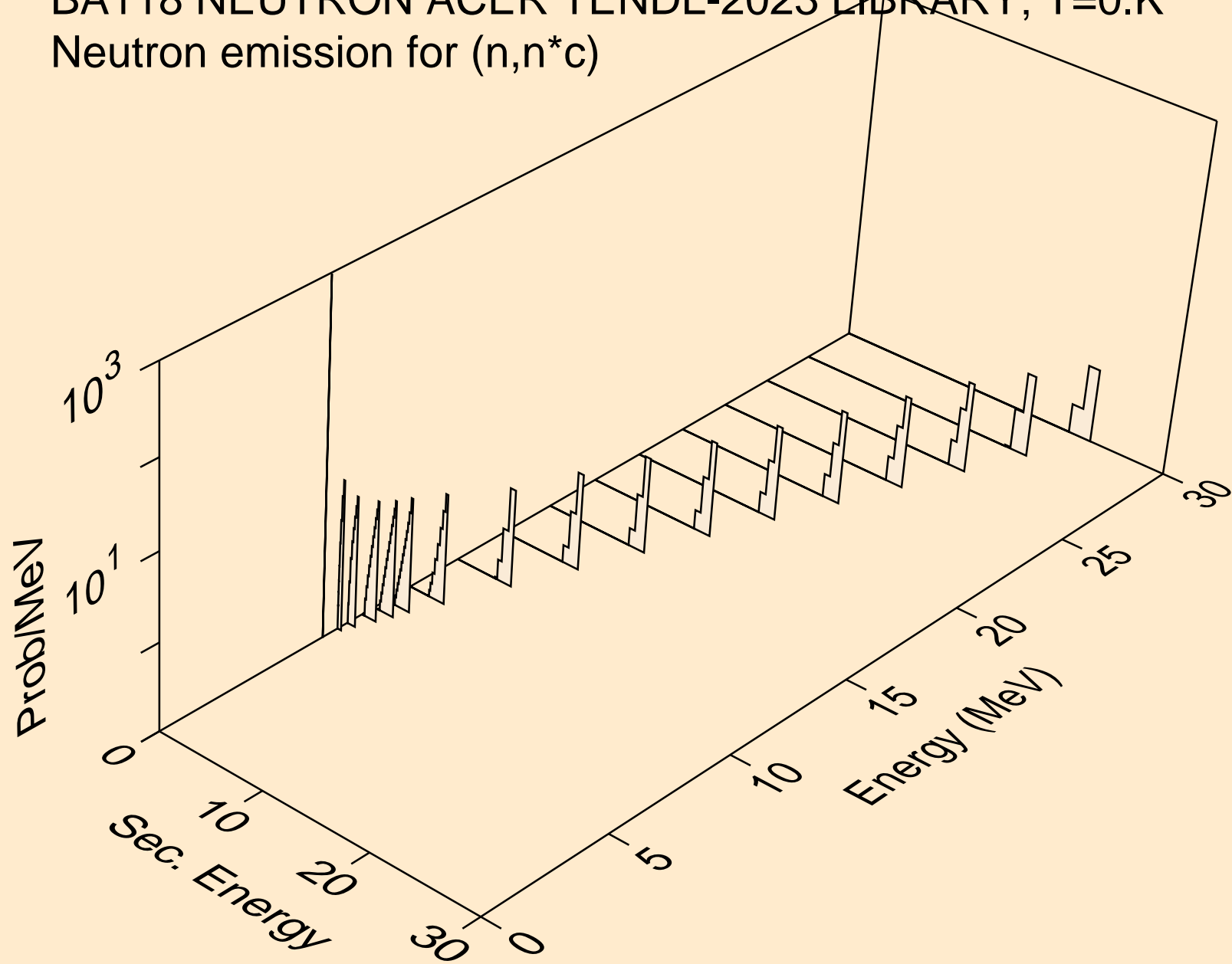



BA118 NEUTRON ACER TENDL-2023 LIBRARY; T=0.K  
Photon emission for (n,x)

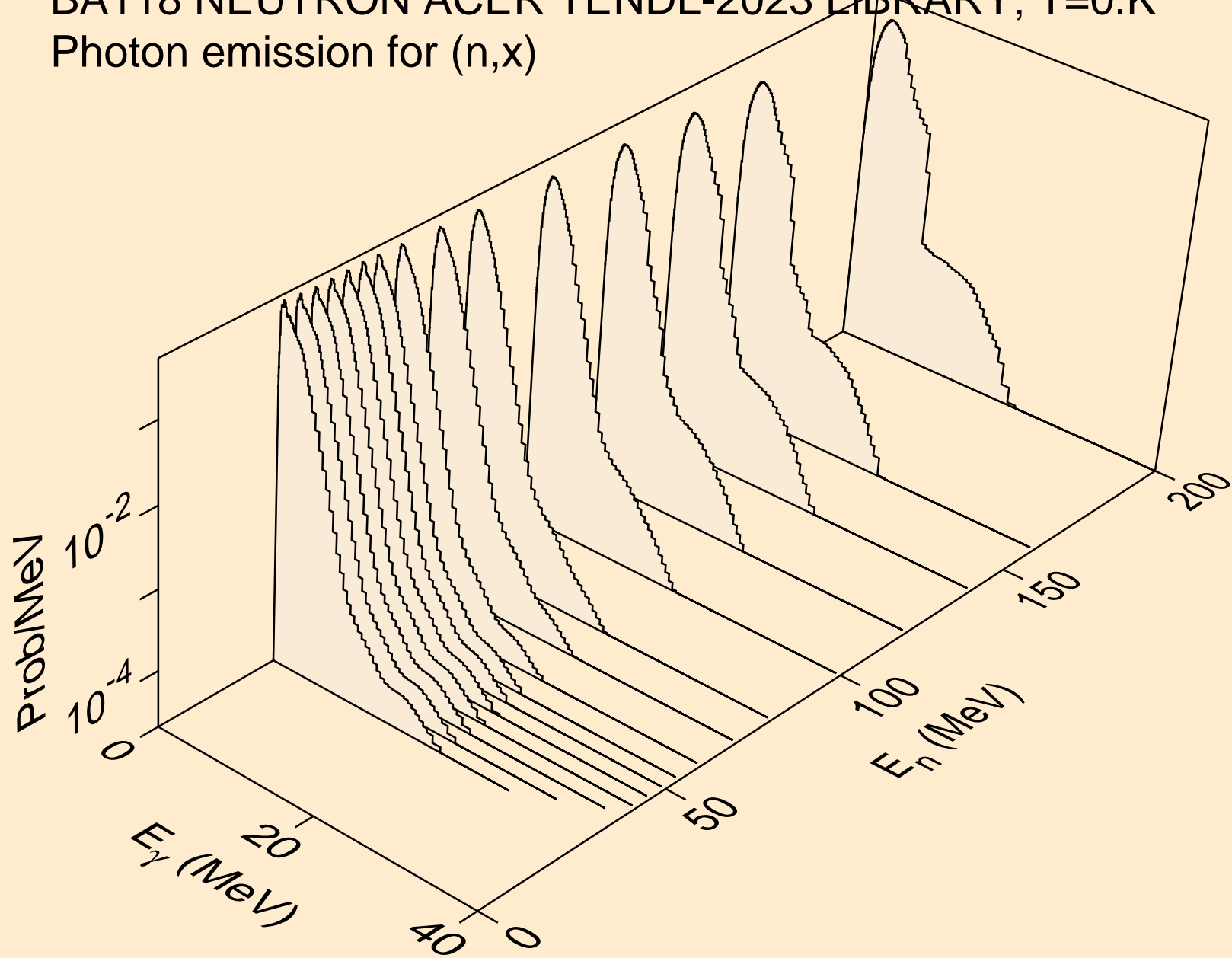

BA118 NEUTRON ACER TENDL-2023 LIBRARY; T=0.K  
Photon emission for (n,2n)

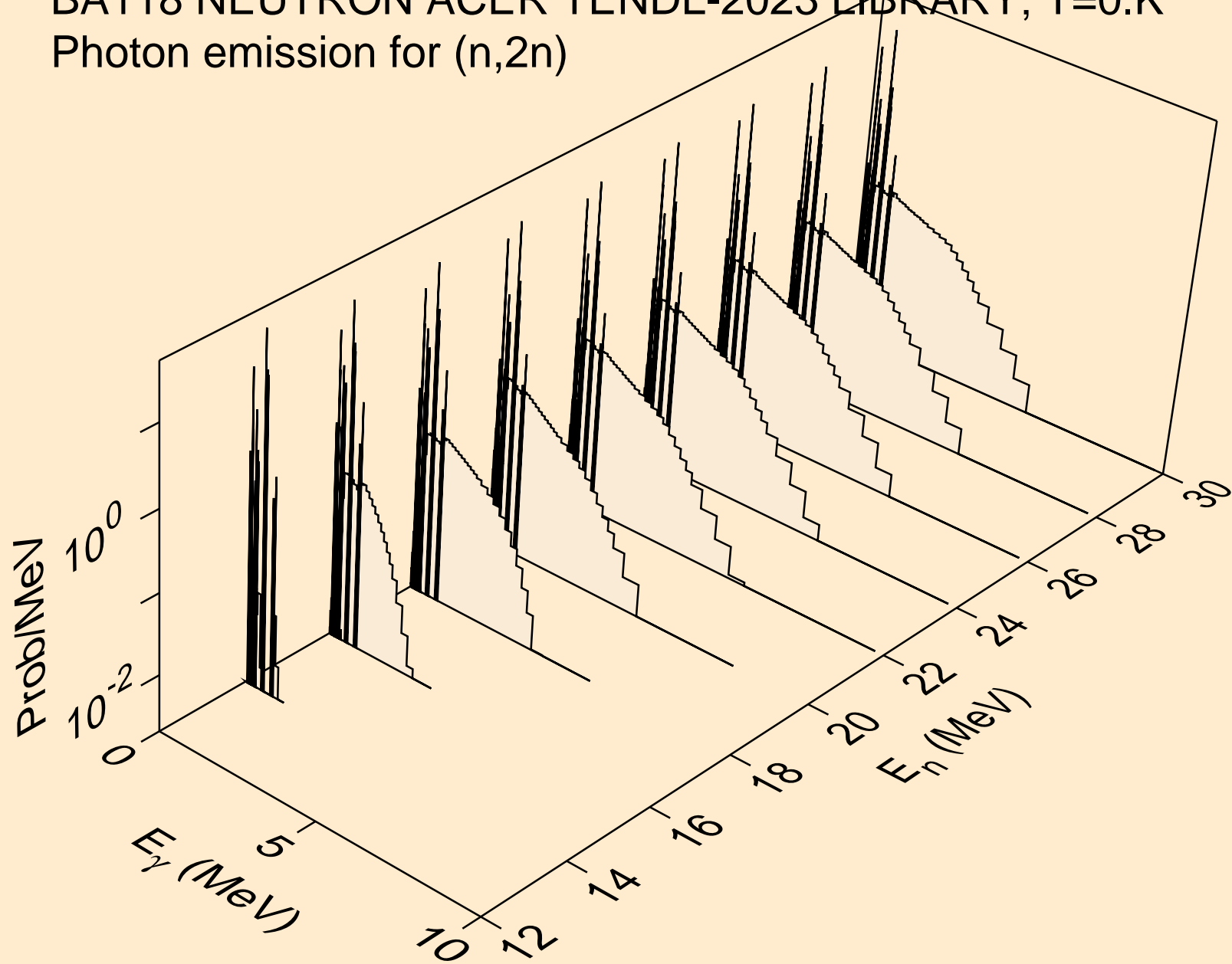

BA118 NEUTRON ACER TENDL-2023 LIBRARY; T=0.K  
Photon emission for (n,3n)

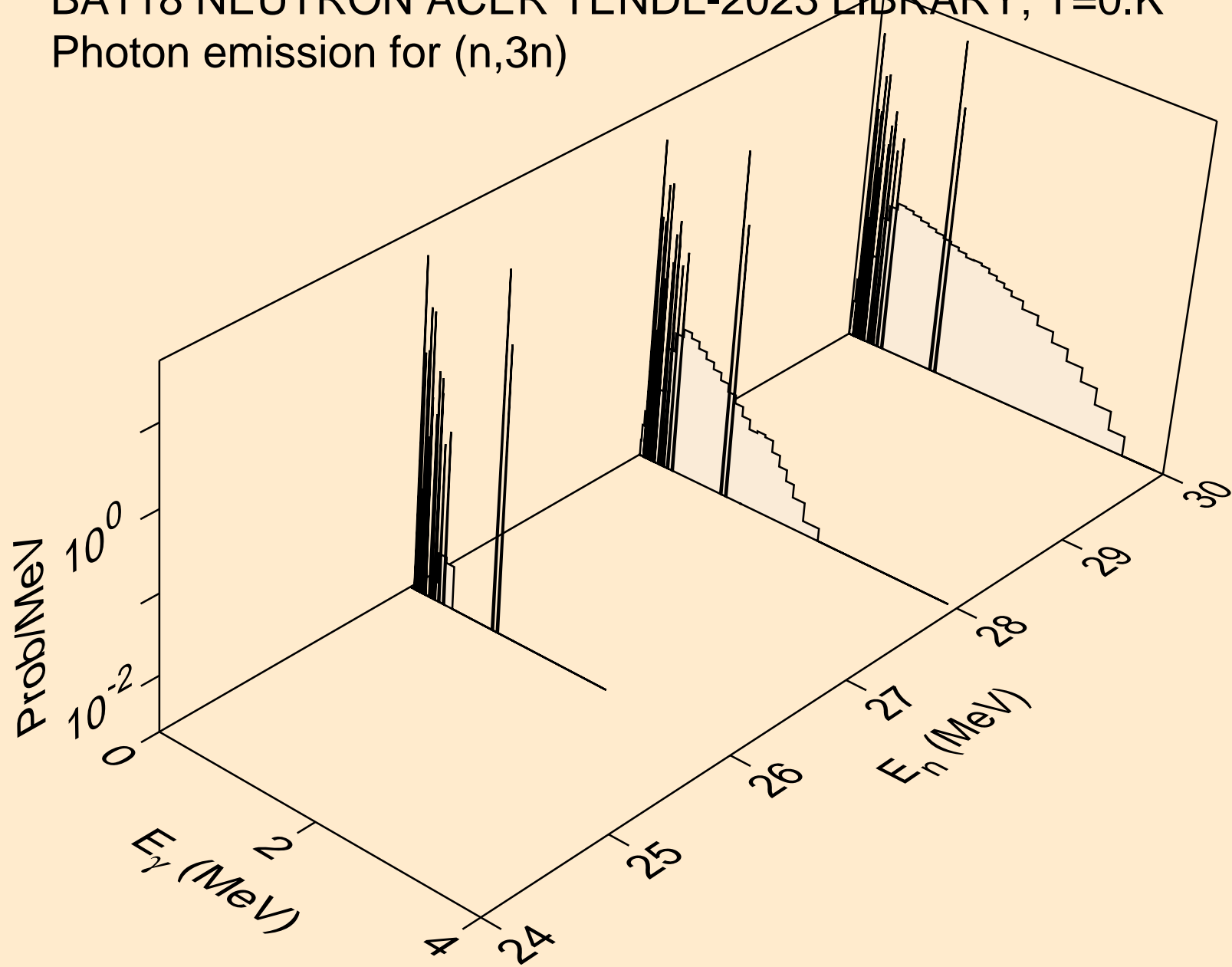

BA118 NEUTRON ACER TENDL-2023 LIBRARY; T=0.K  
Photon emission for (n,n\*)a

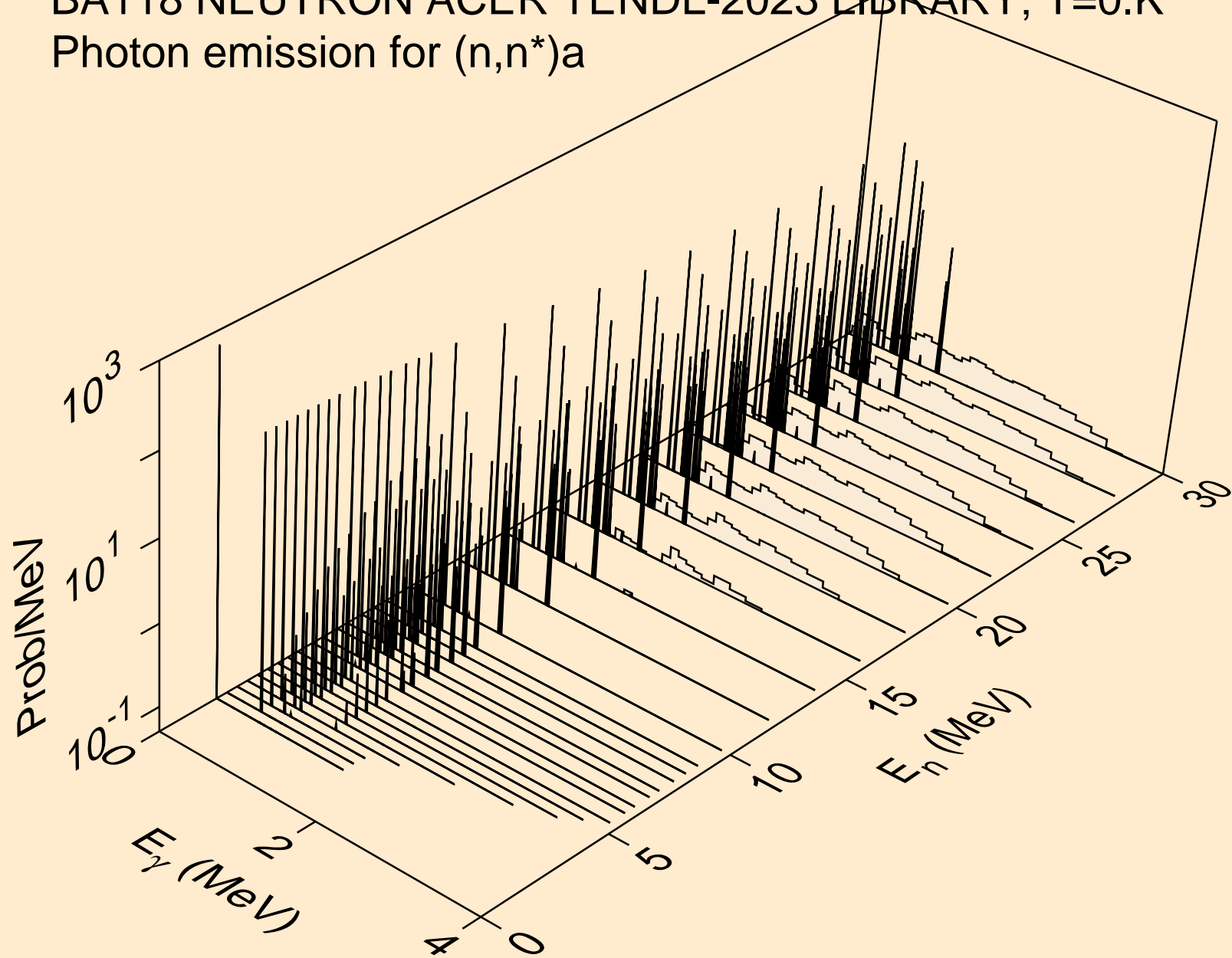

BA118 NEUTRON ACER TENDL-2023 LIBRARY; T=0.K  
Photon emission for (n,n\*)3a

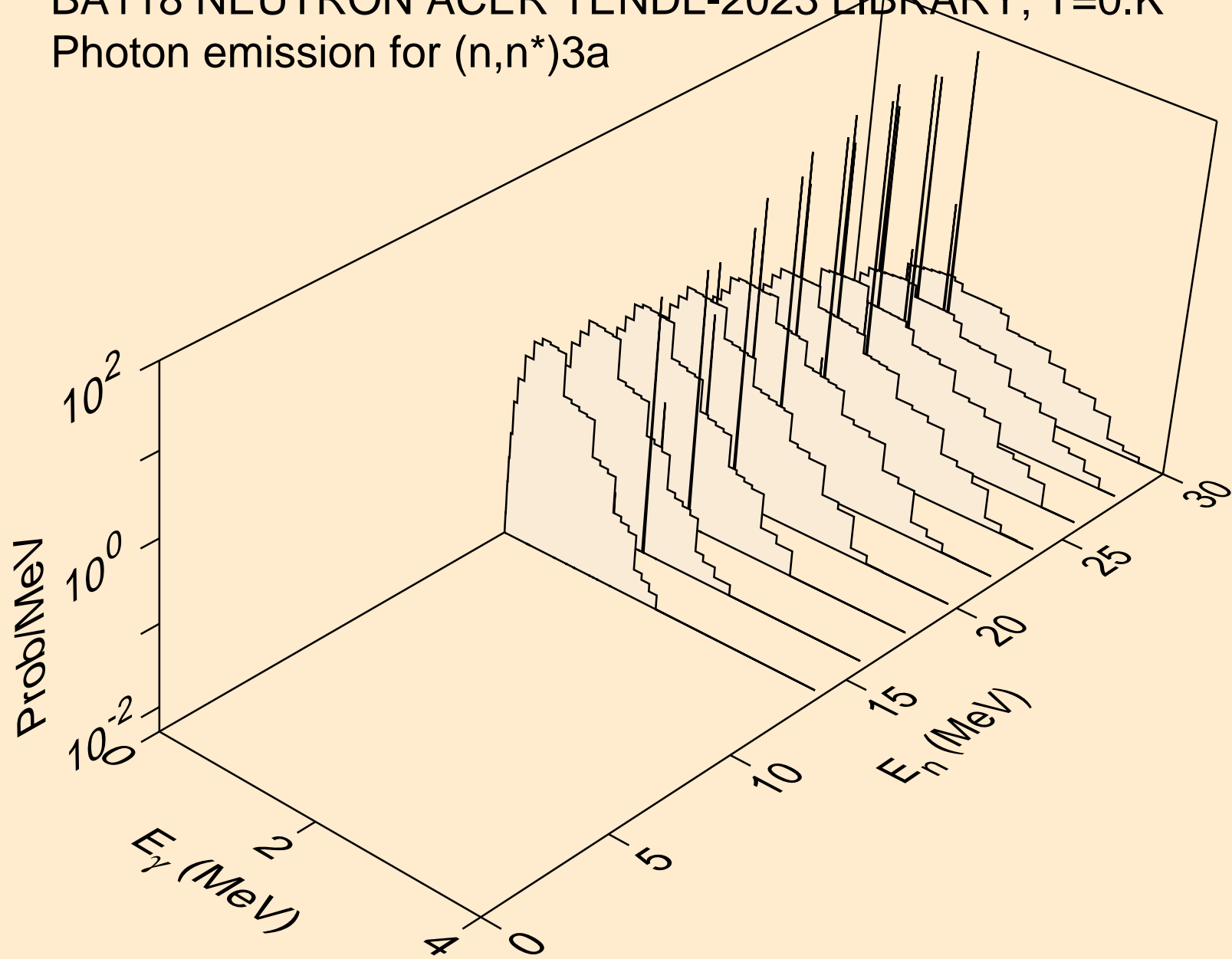

BA118 NEUTRON ACER TENDL-2023 LIBRARY; T=0.K  
Photon emission for (n,2n)a

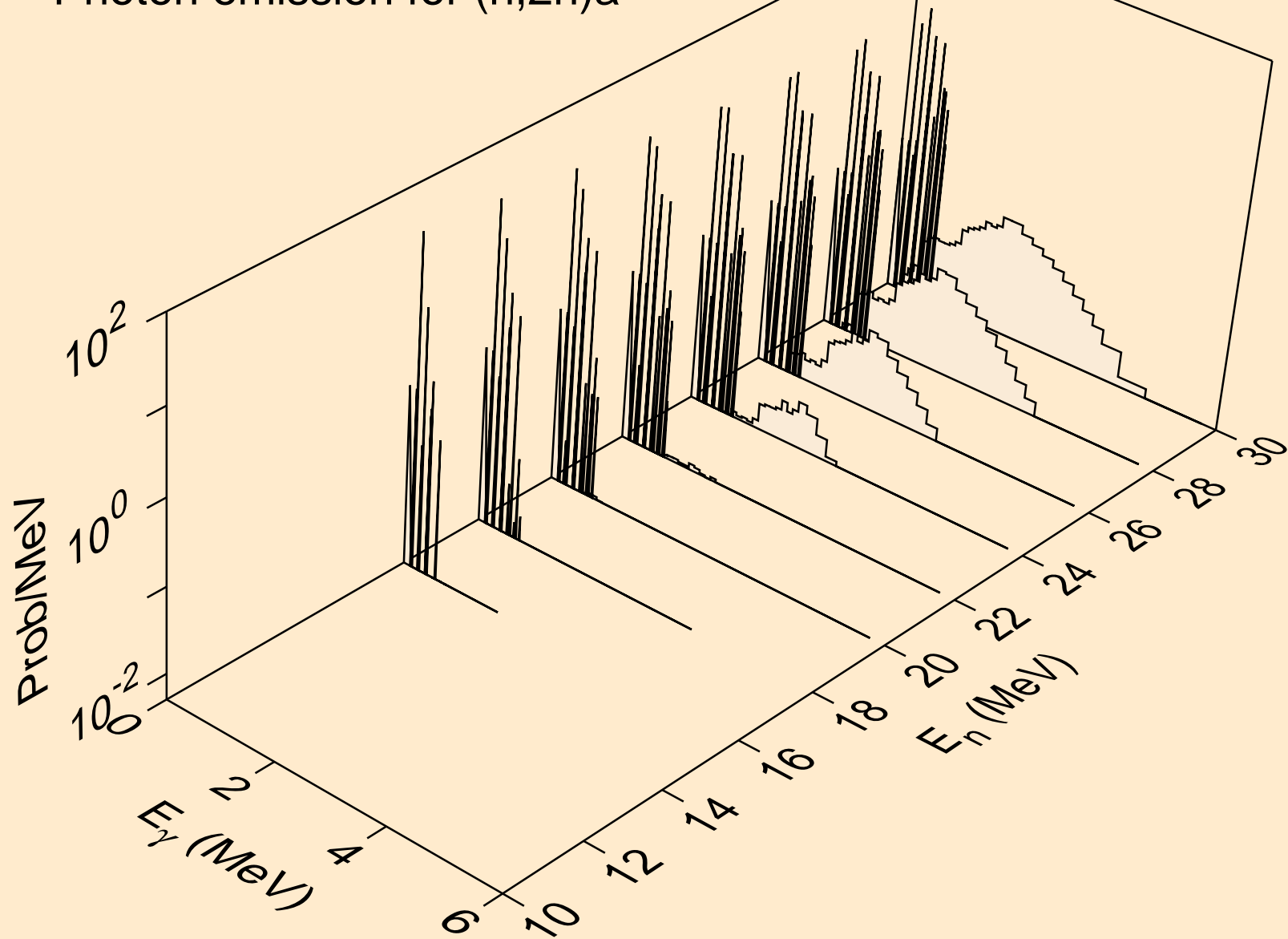

BA118 NEUTRON ACER TENDL-2023 LIBRARY; T=0.K  
Photon emission for (n,n\*)p

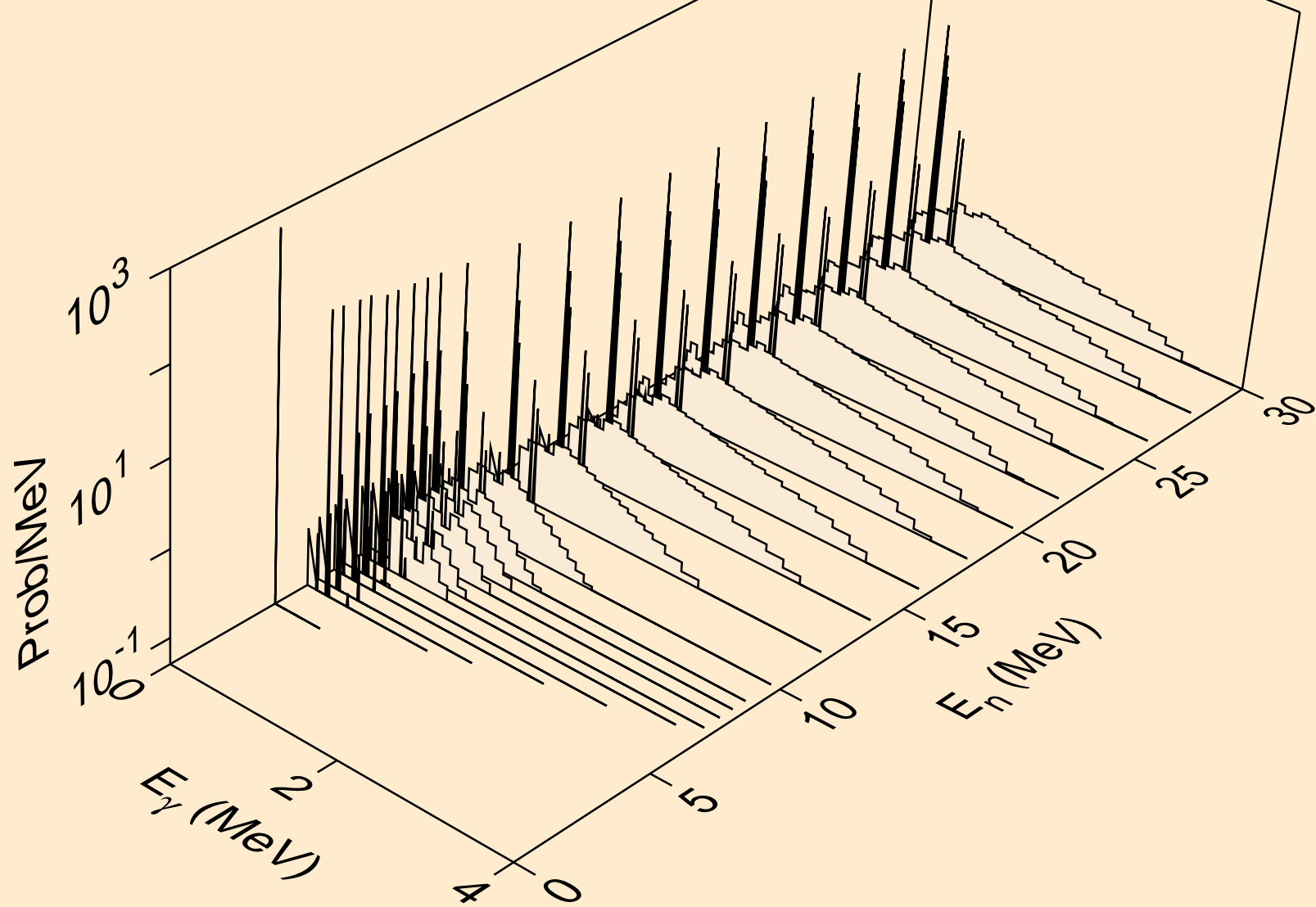

BA118 NEUTRON ACER TENDL-2023 LIBRARY; T=0.K  
Photon emission for (n,n\*)2a

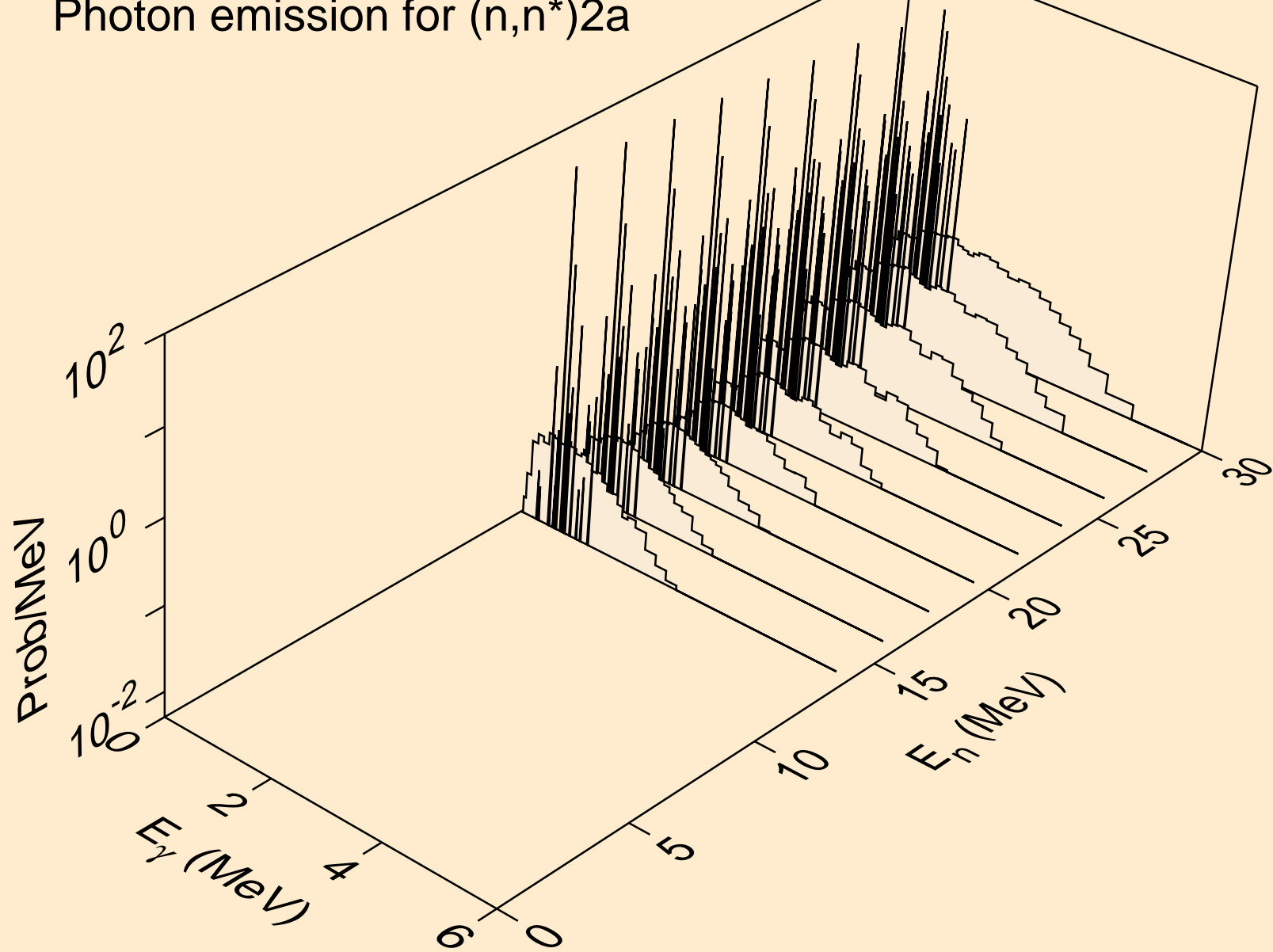



BA118 NEUTRON ACER TENDL-2023 LIBRARY; T=0.K  
Photon emission for (n,2n)2a

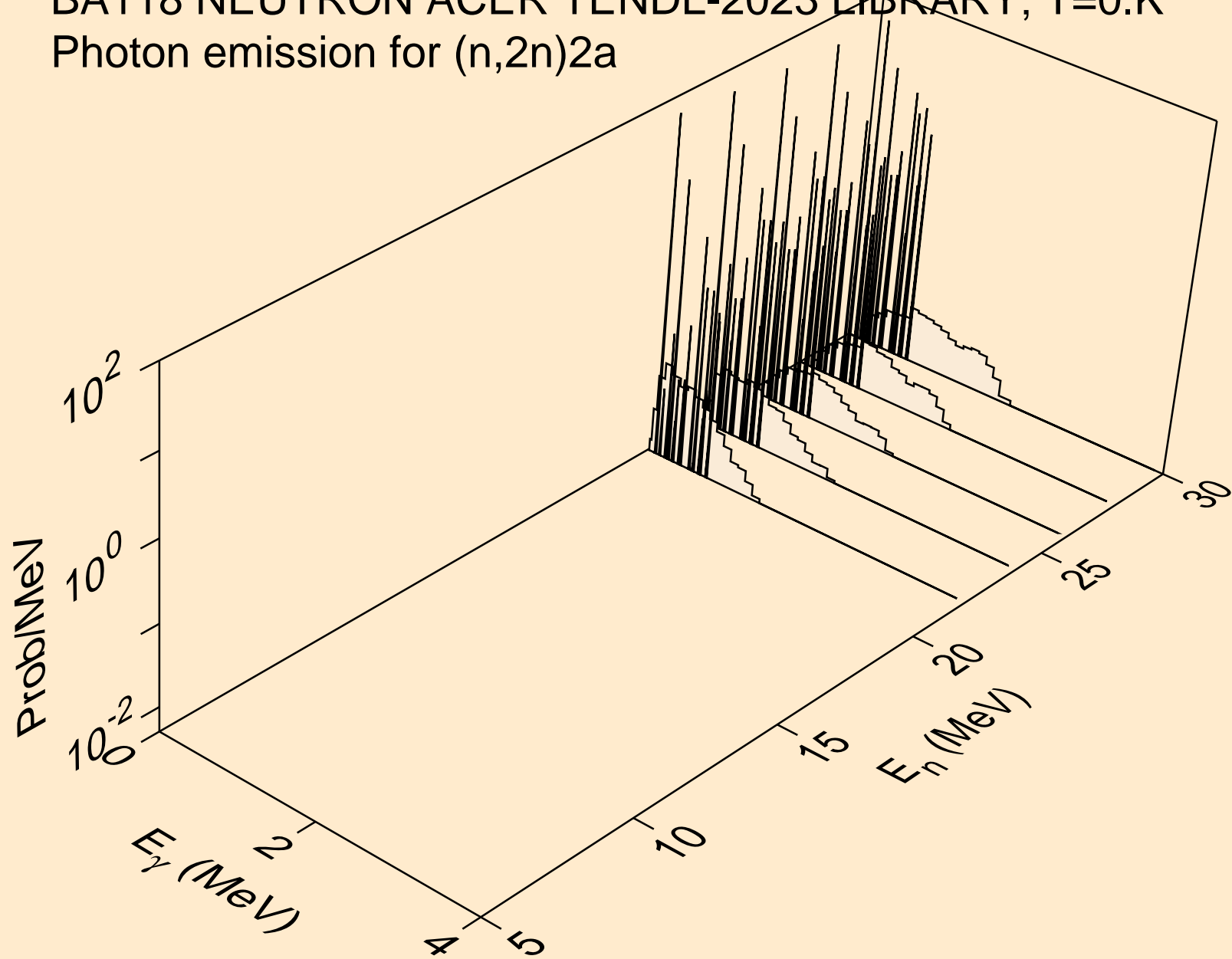

BA118 NEUTRON ACER TENDL-2023 LIBRARY; T=0.K  
Photon emission for (n,n\*)d

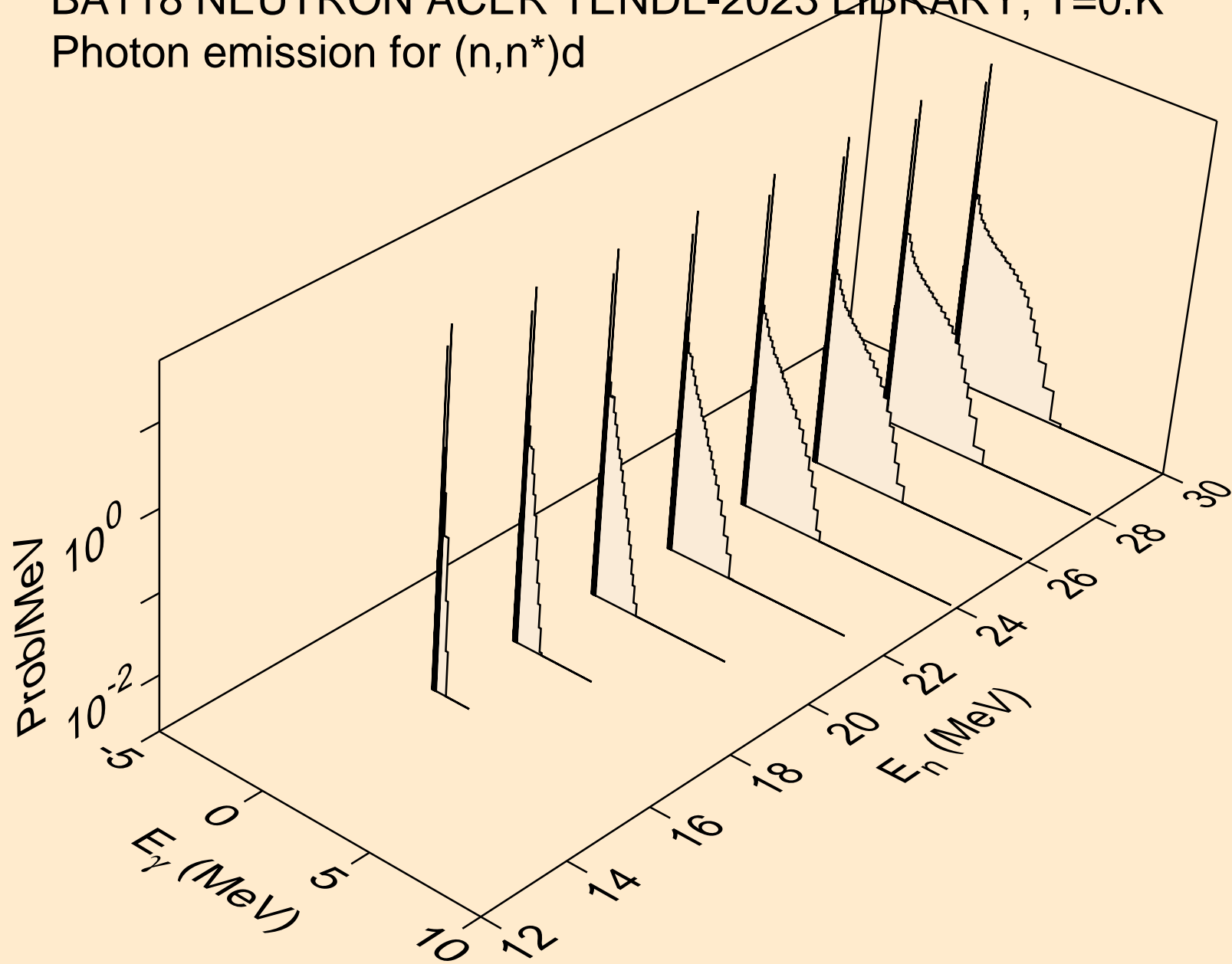

BA118 NEUTRON ACER TENDL-2023 LIBRARY; T=0.K  
Photon emission for (n,n\*)t

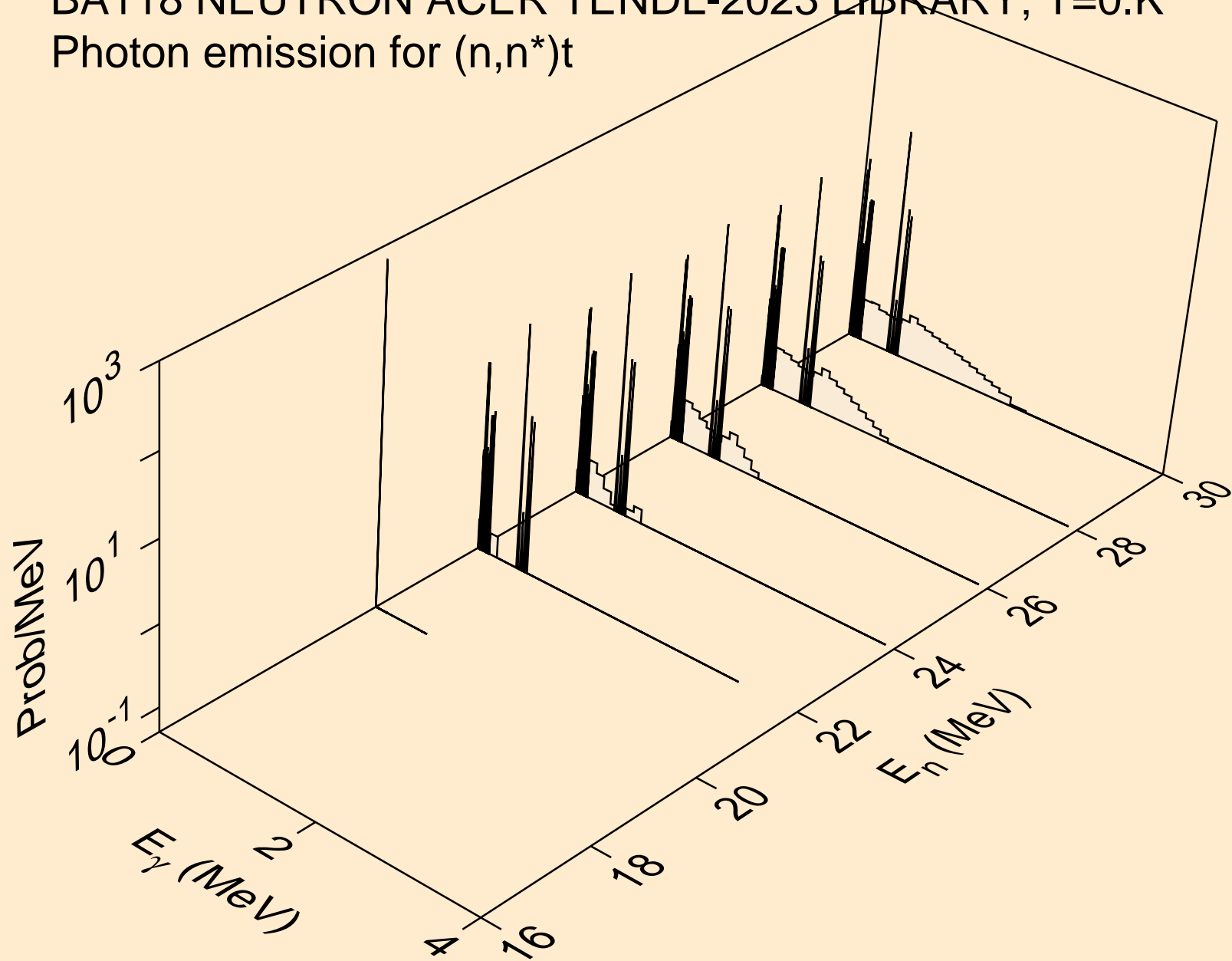

BA118 NEUTRON ACER TENDL-2023 LIBRARY; T=0.K  
Photon emission for (n,n\*)he3

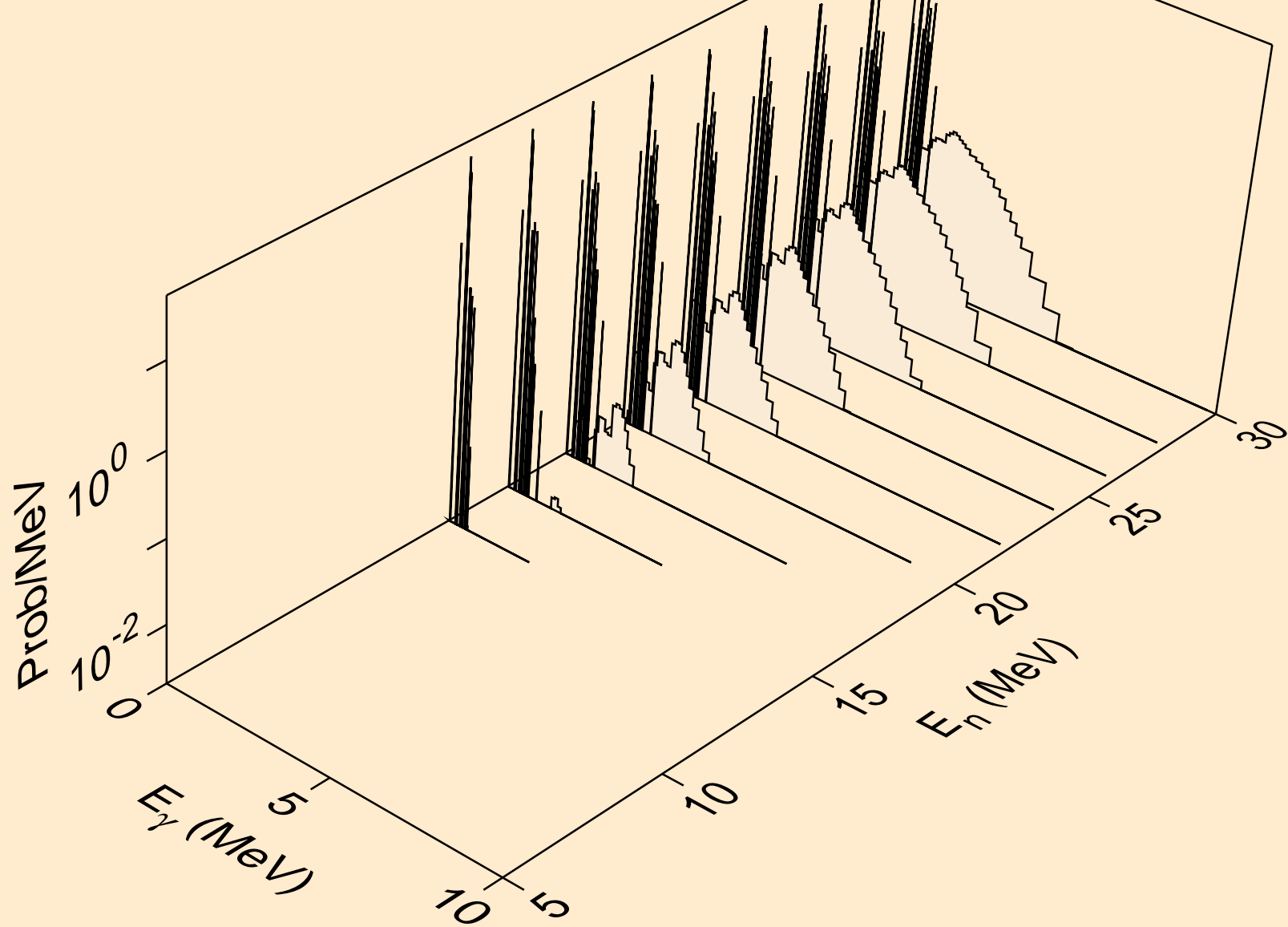

BA118 NEUTRON ACER TENDL-2023 LIBRARY; T=0.K  
Photon emission for (n,2np)

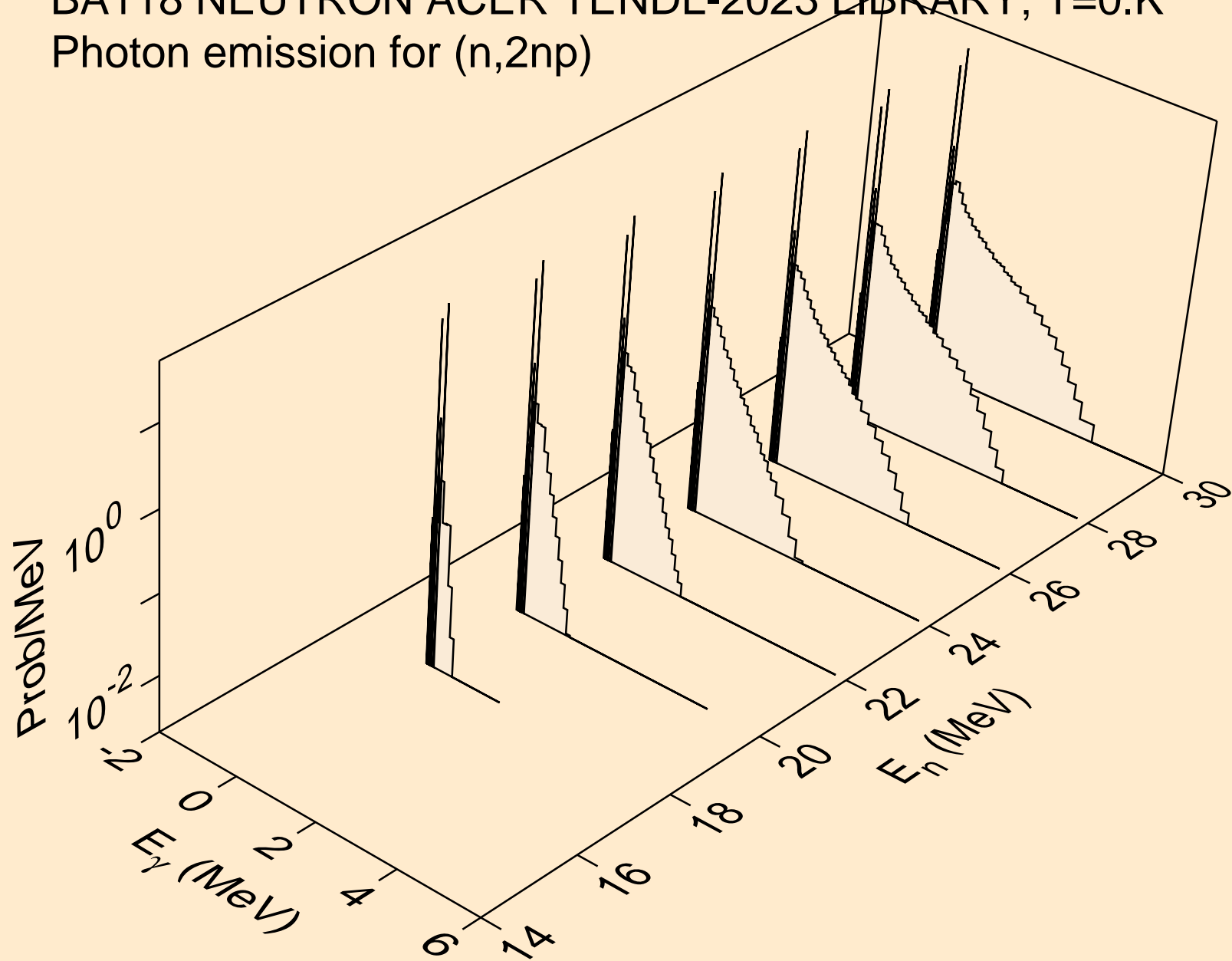

BA118 NEUTRON ACER TENDL-2023 LIBRARY; T=0.K  
Photon emission for (n,3np)

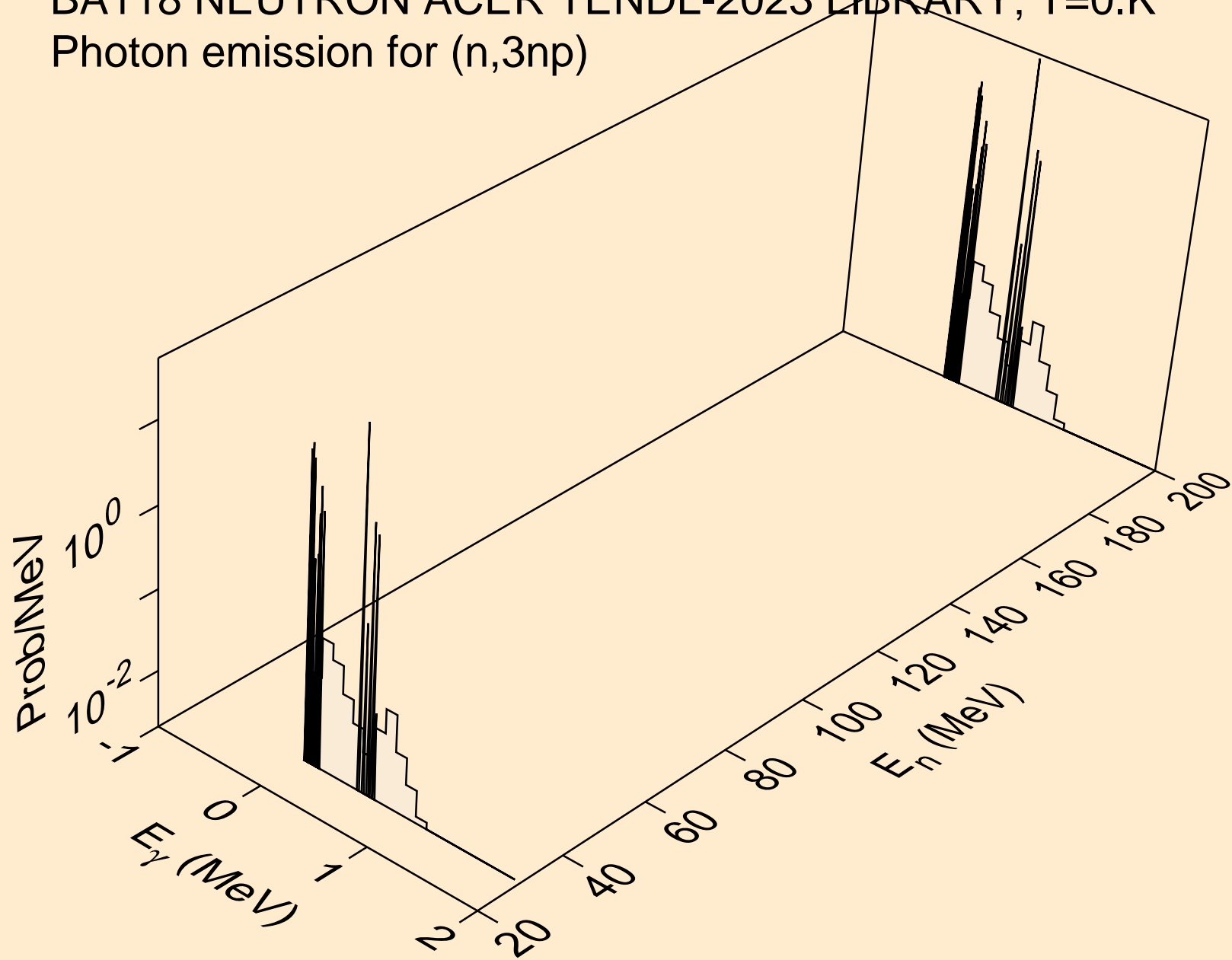

BA118 NEUTRON ACER TENDL-2023 LIBRARY; T=0.K  
Photon emission for (n,n2p)

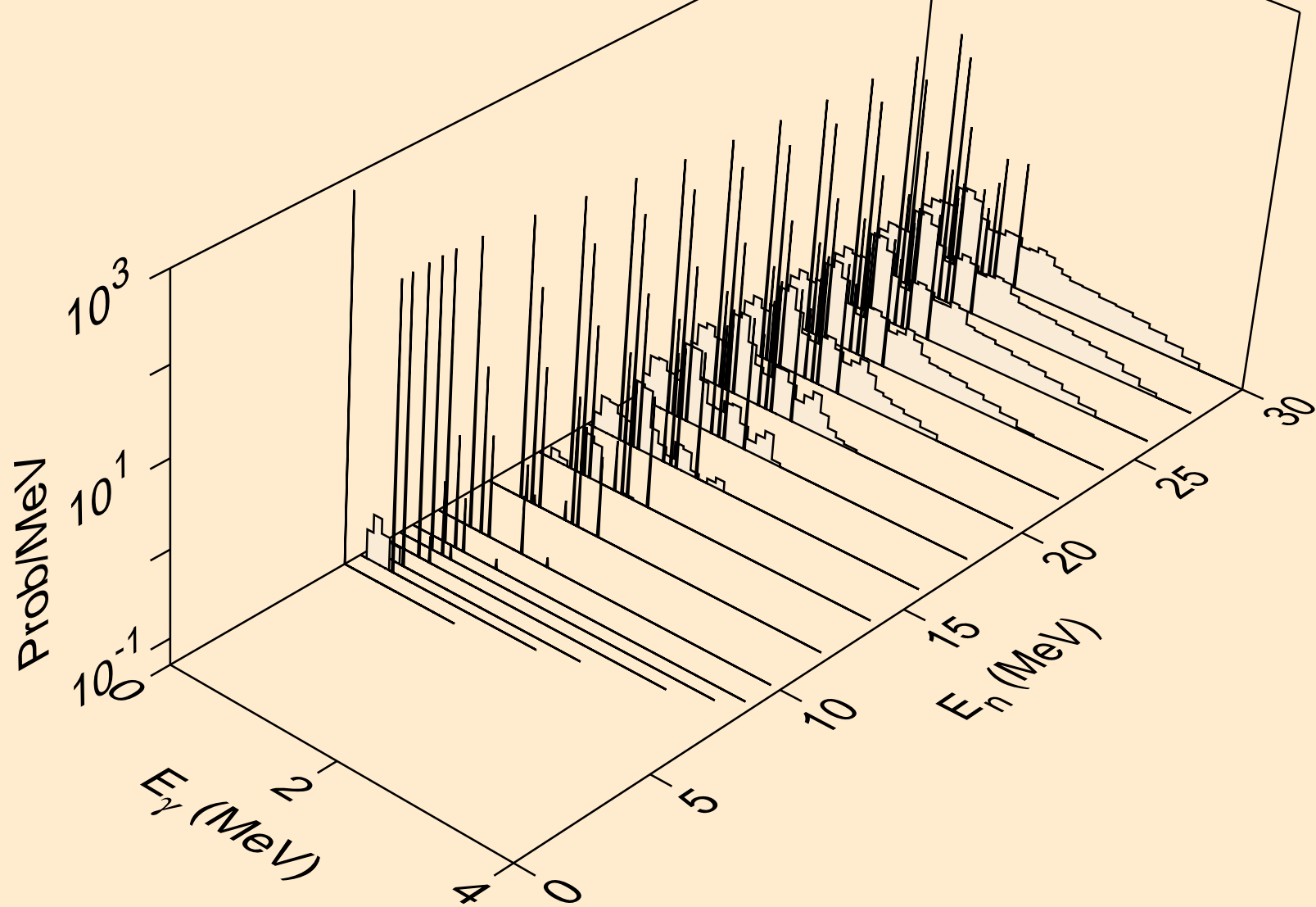

BA118 NEUTRON ACER TENDL-2023 LIBRARY; T=0.K  
Photon emission for (n,npa)

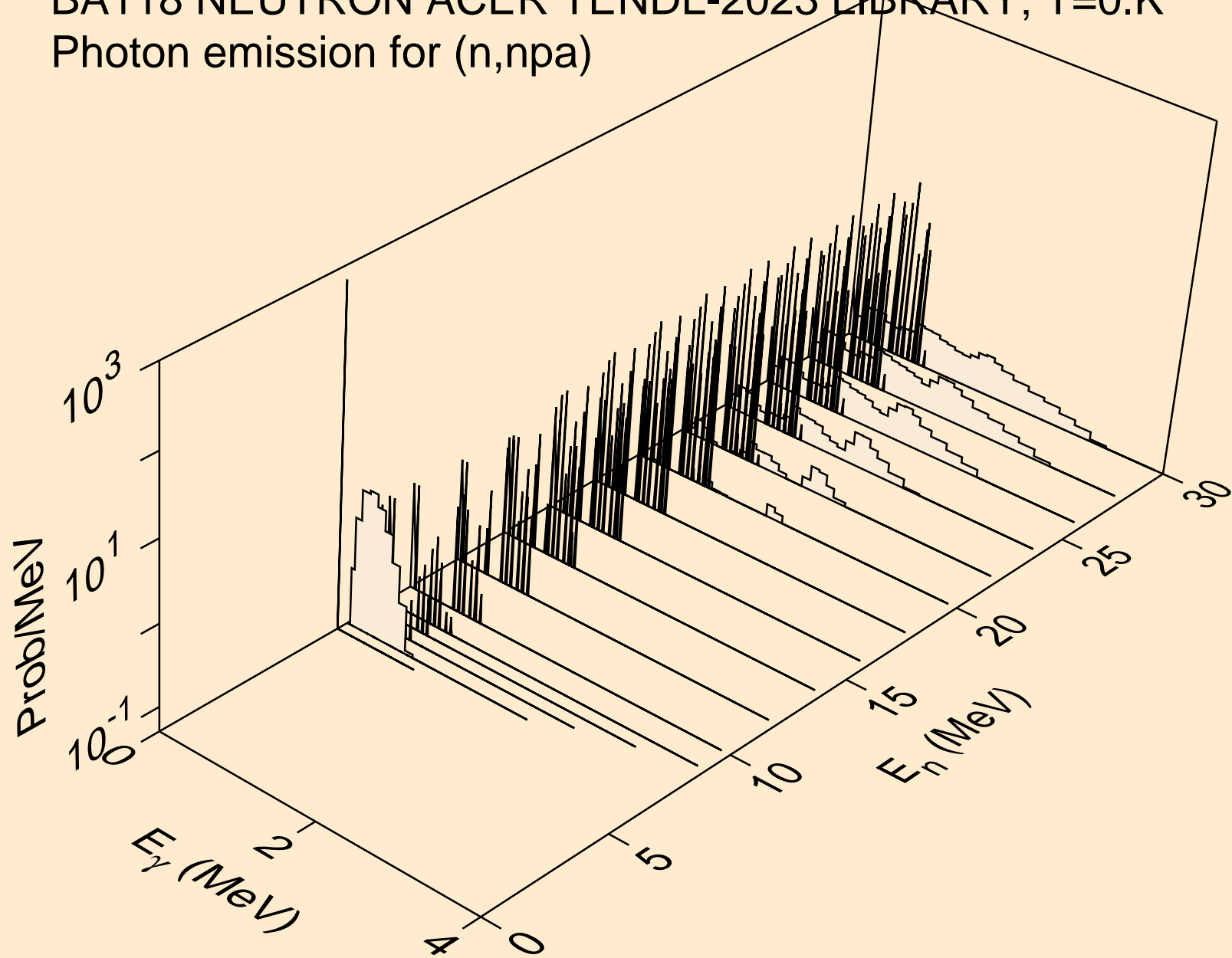



BA118 NEUTRON ACER TENDL-2023 LIBRARY; T=0.K  
Photon emission for (n,n\*c)

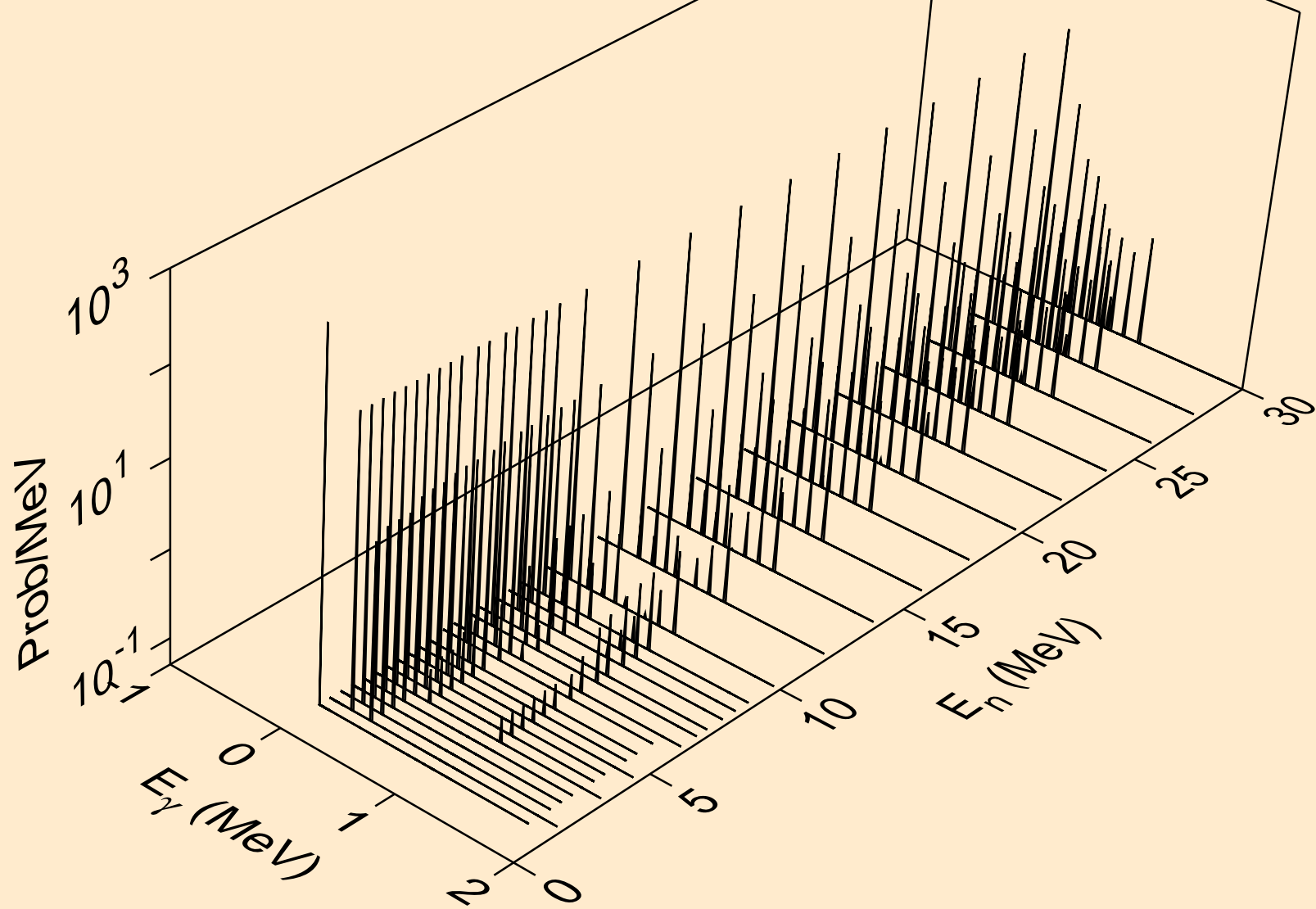

BA118 NEUTRON ACER TENDL-2023 LIBRARY; T=0.K  
Photon emission for (n,gma)

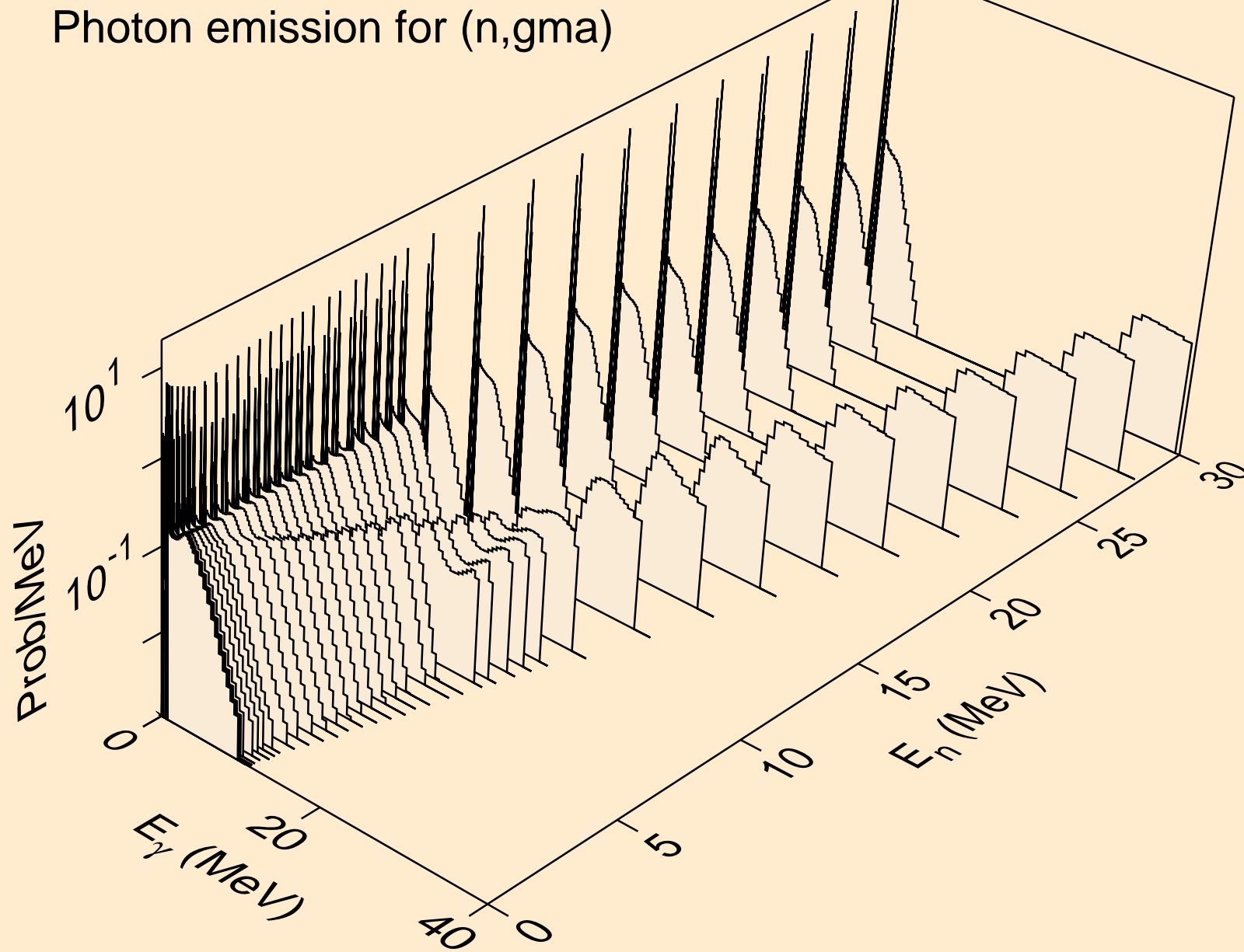

BA118 NEUTRON ACER TENDL-2023 LIBRARY; T=0.K  
Photon emission for (n,p)

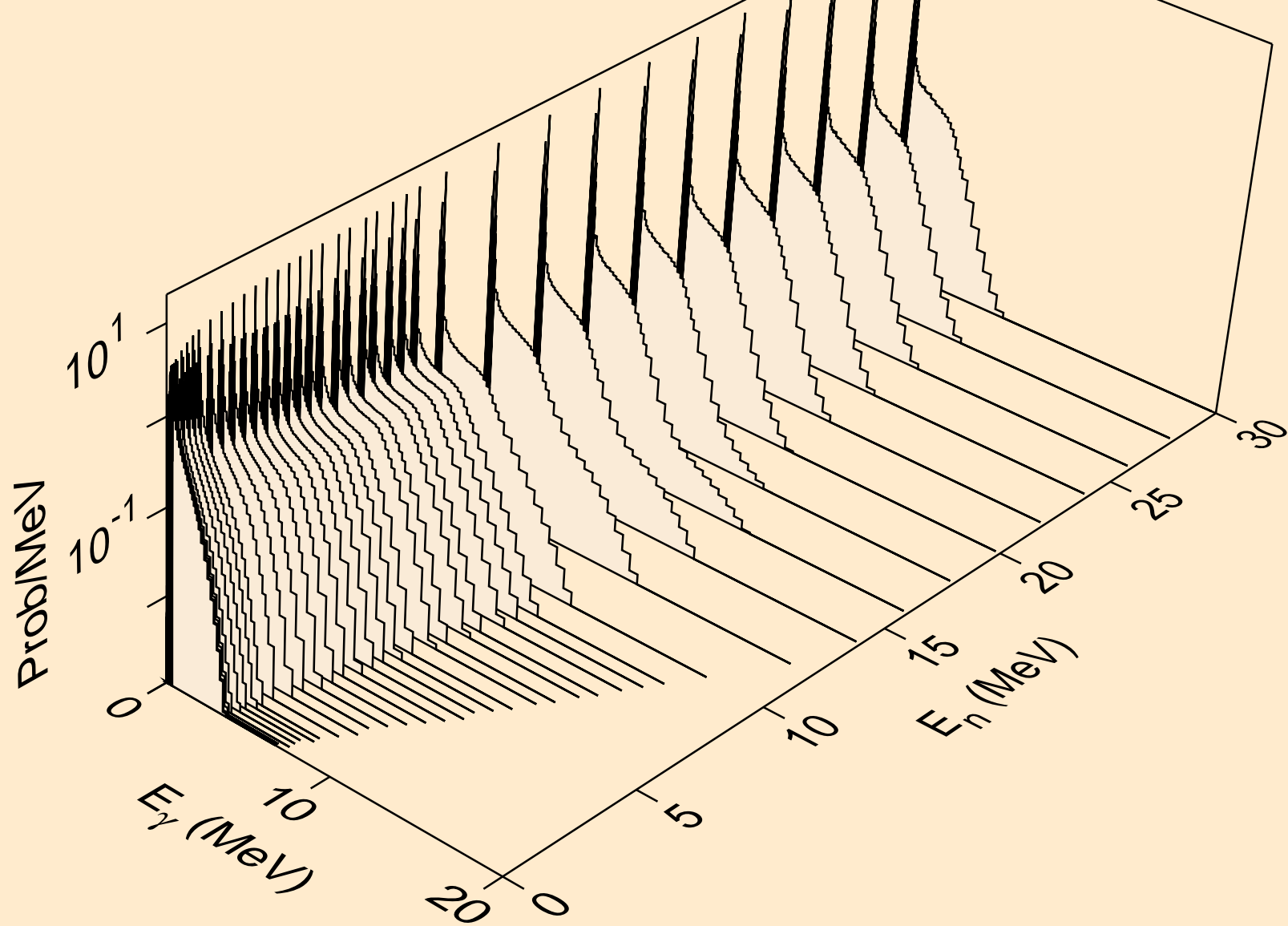

BA118 NEUTRON ACER TENDL-2023 LIBRARY; T=0.K  
Photon emission for (n,d)

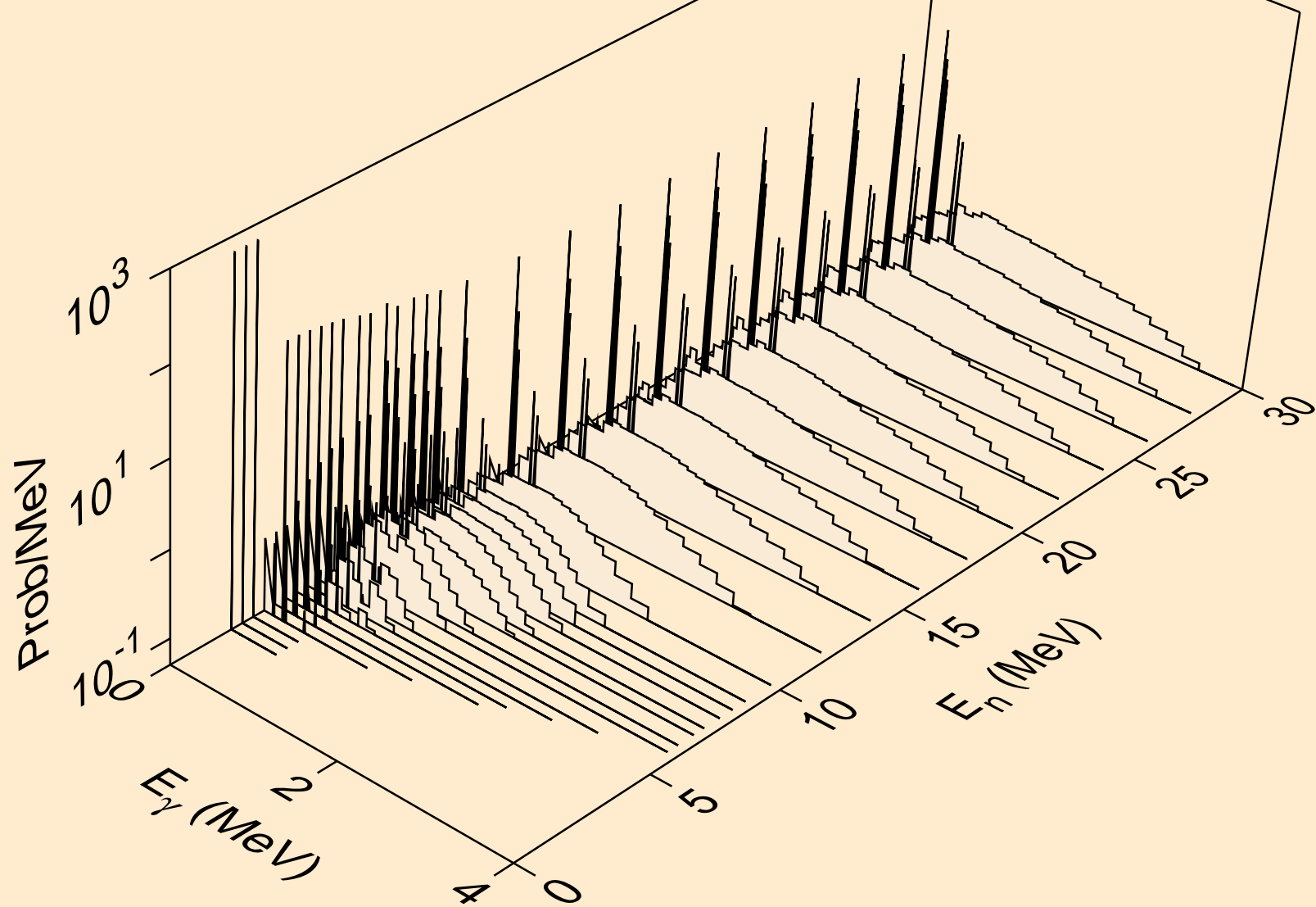

BA118 NEUTRON ACER TENDL-2023 LIBRARY; T=0.K  
Photon emission for (n,t)

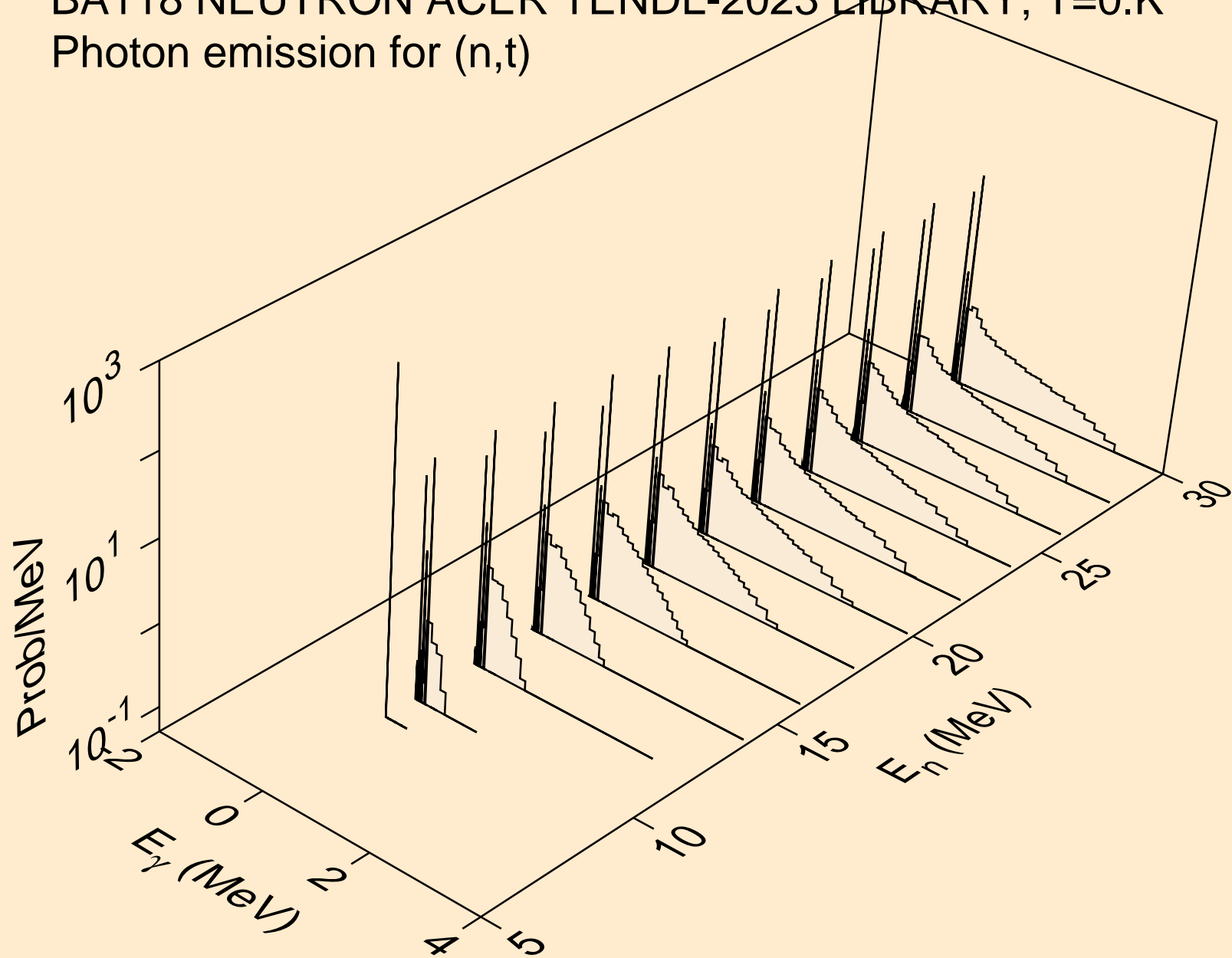

BA118 NEUTRON ACER TENDL-2023 LIBRARY; T=0.K  
Photon emission for (n,he3)

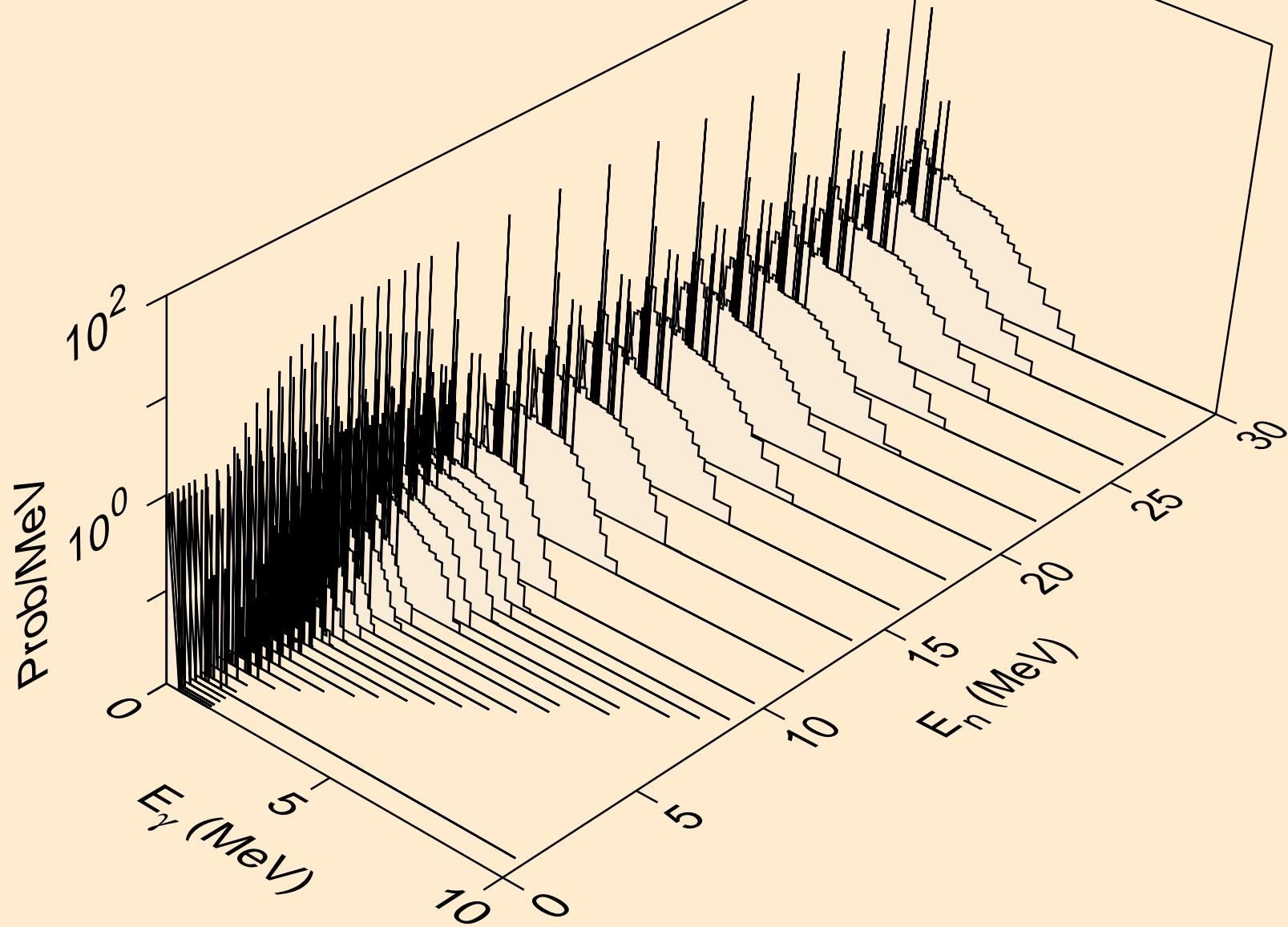

BA118 NEUTRON ACER TENDL-2023 LIBRARY; T=0.K  
Photon emission for (n,a)

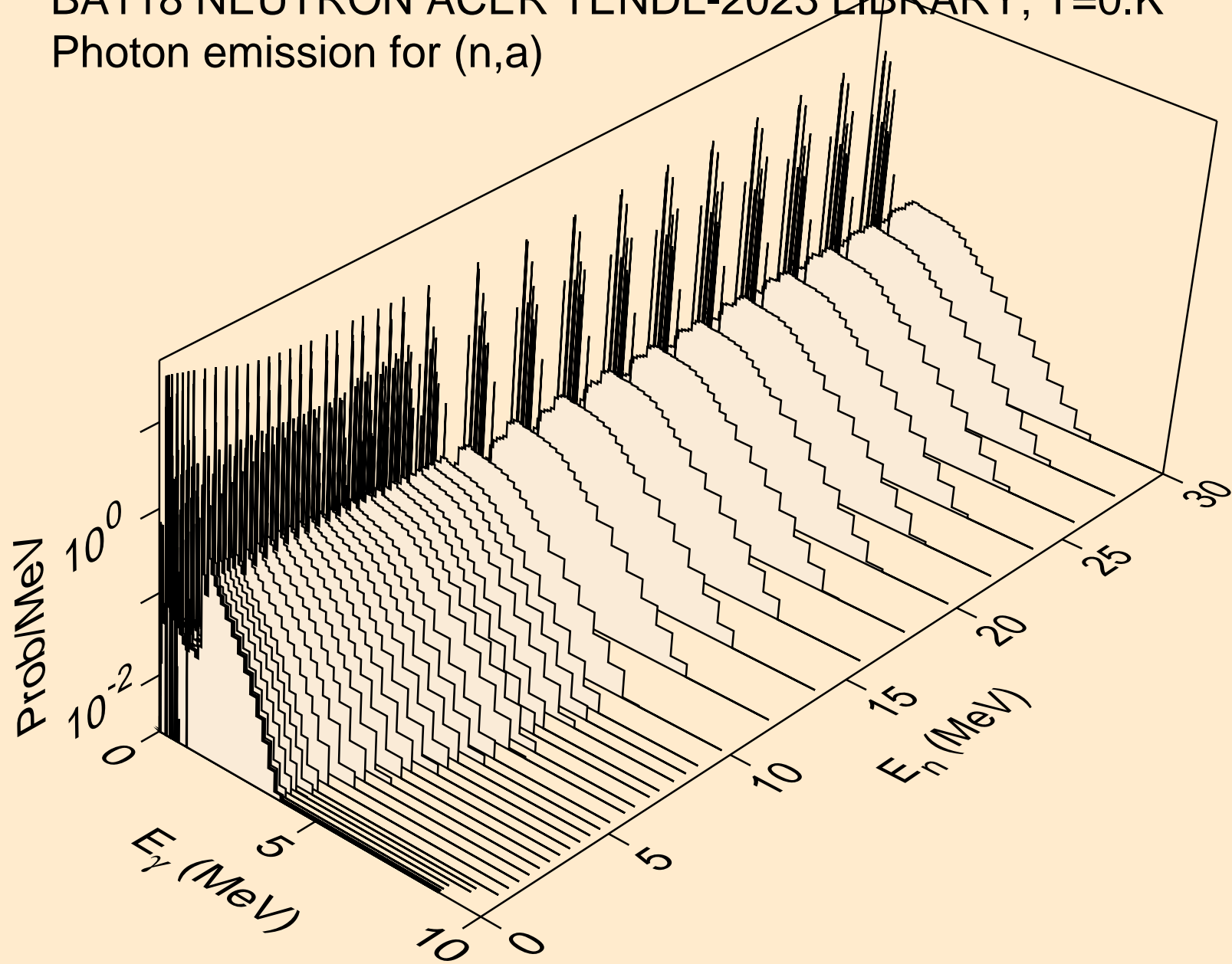

BA118 NEUTRON ACER TENDL-2023 LIBRARY; T=0.K  
Photon emission for (n,2a)

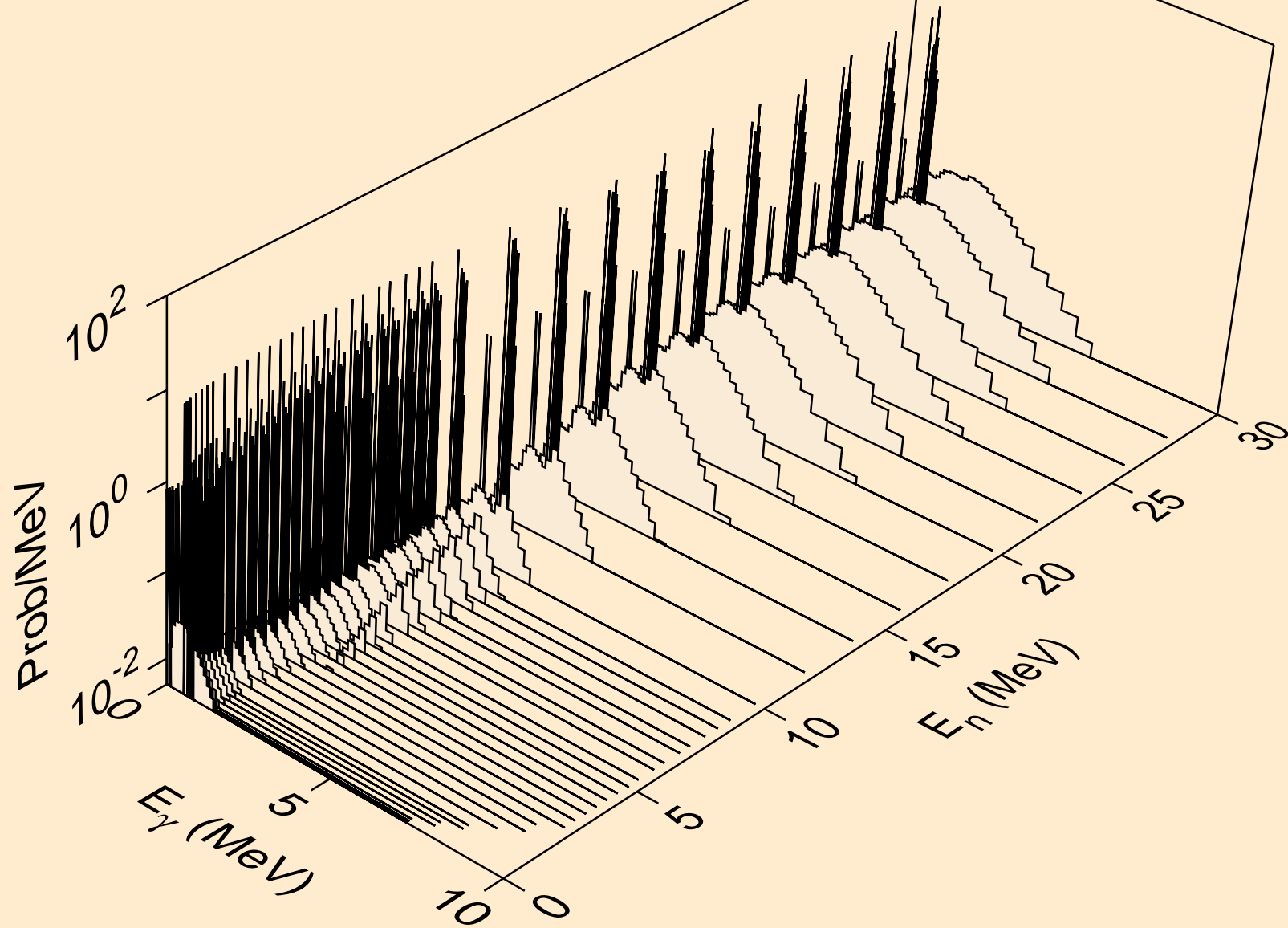



BA118 NEUTRON ACER TENDL-2023 LIBRARY; T=0.K  
Photon emission for (n,3a)

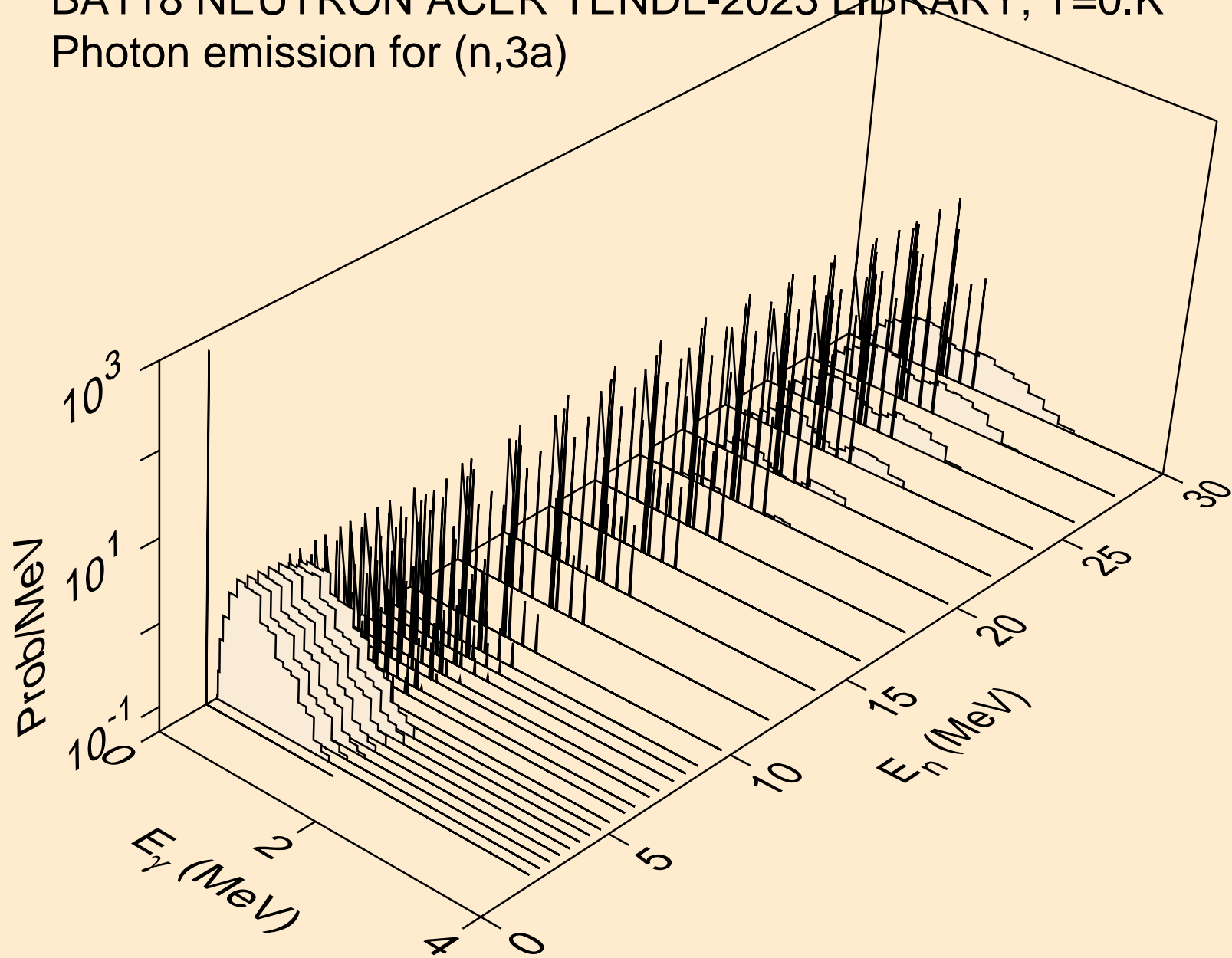

BA118 NEUTRON ACER TENDL-2023 LIBRARY; T=0.K  
Photon emission for (n,2p)

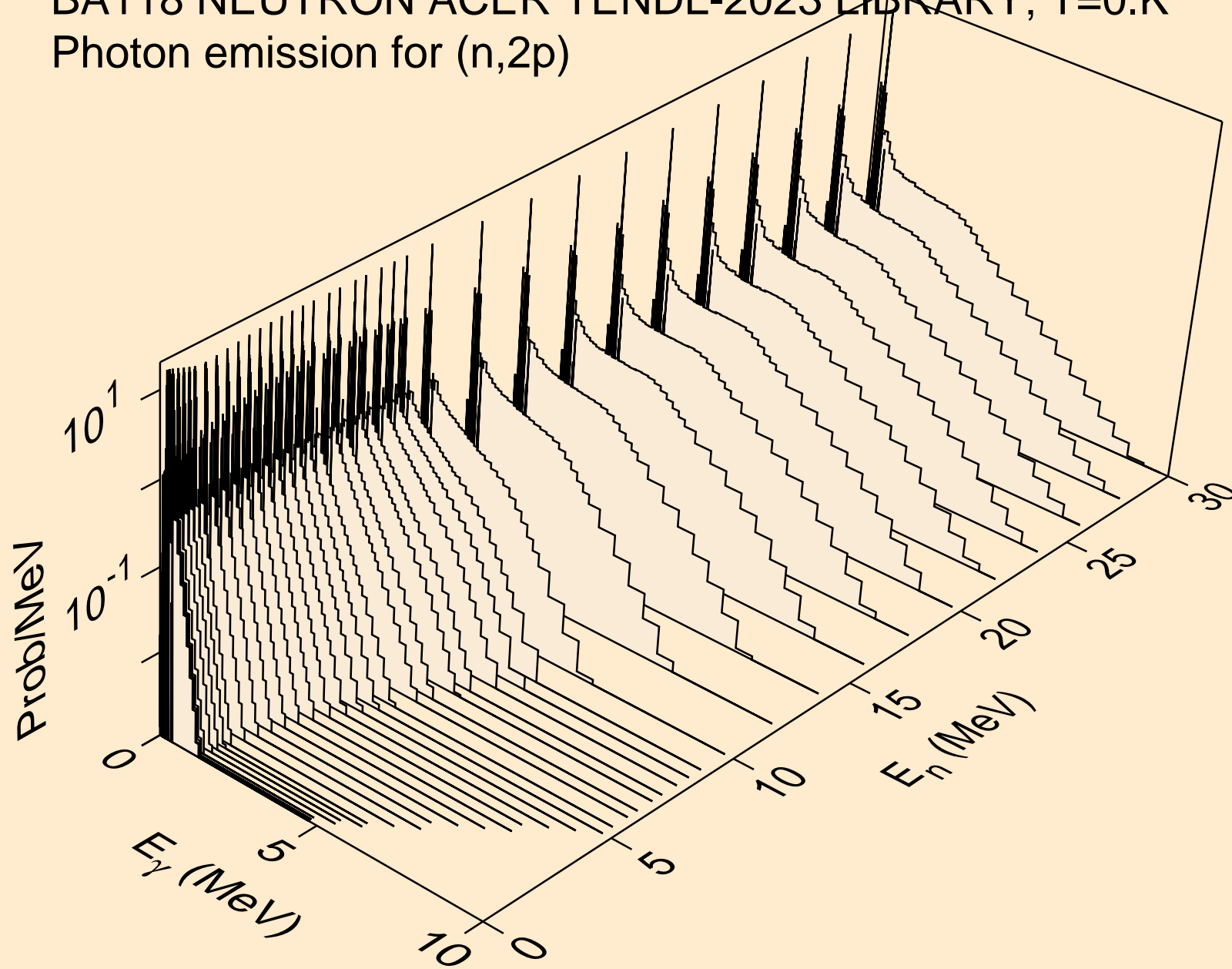

BA118 NEUTRON ACER TENDL-2023 LIBRARY; T=0.K  
Photon emission for (n,p)

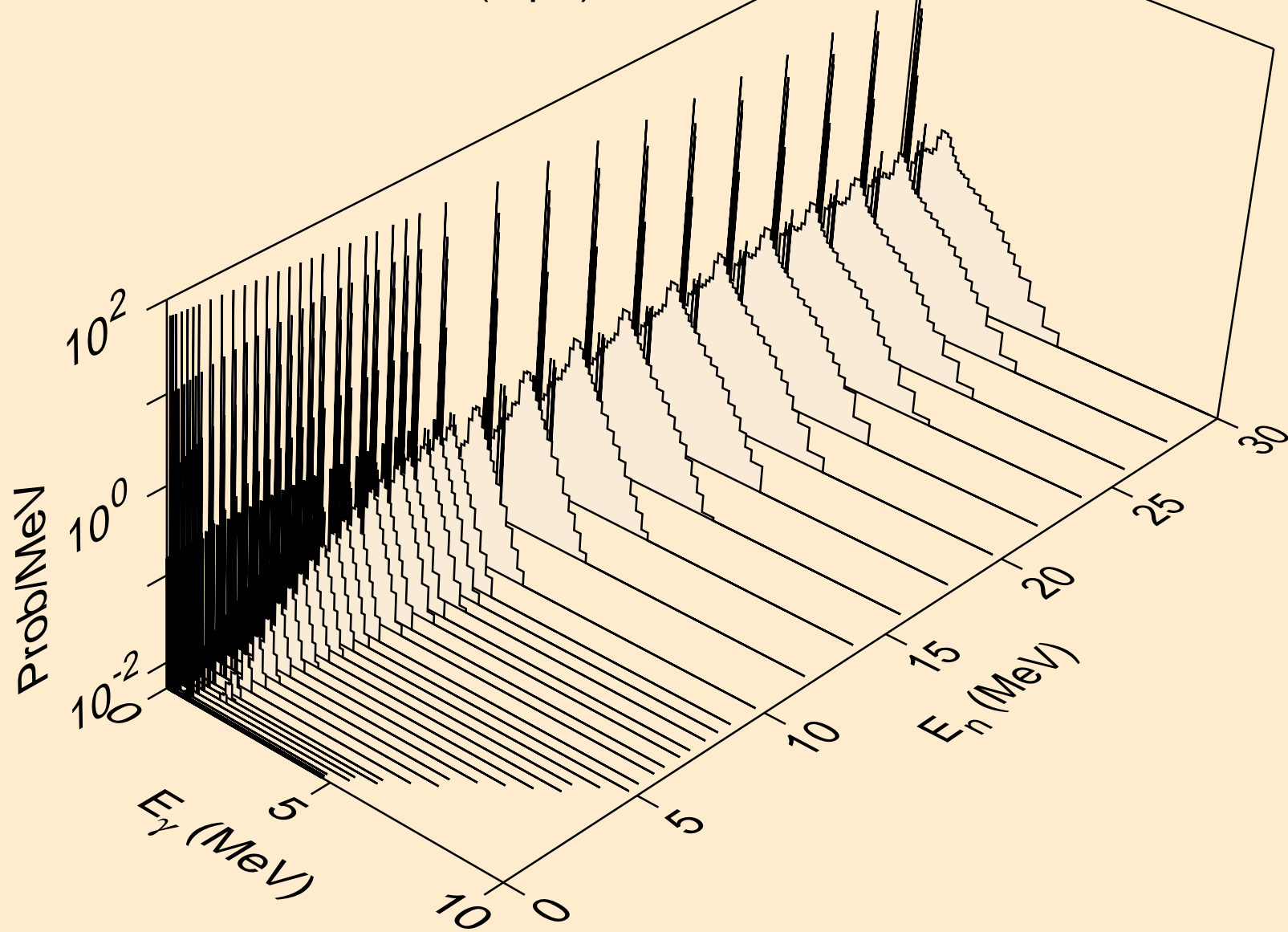

BA118 NEUTRON ACER TENDL-2023 LIBRARY; T=0.K  
Photon emission for (n,d2a)

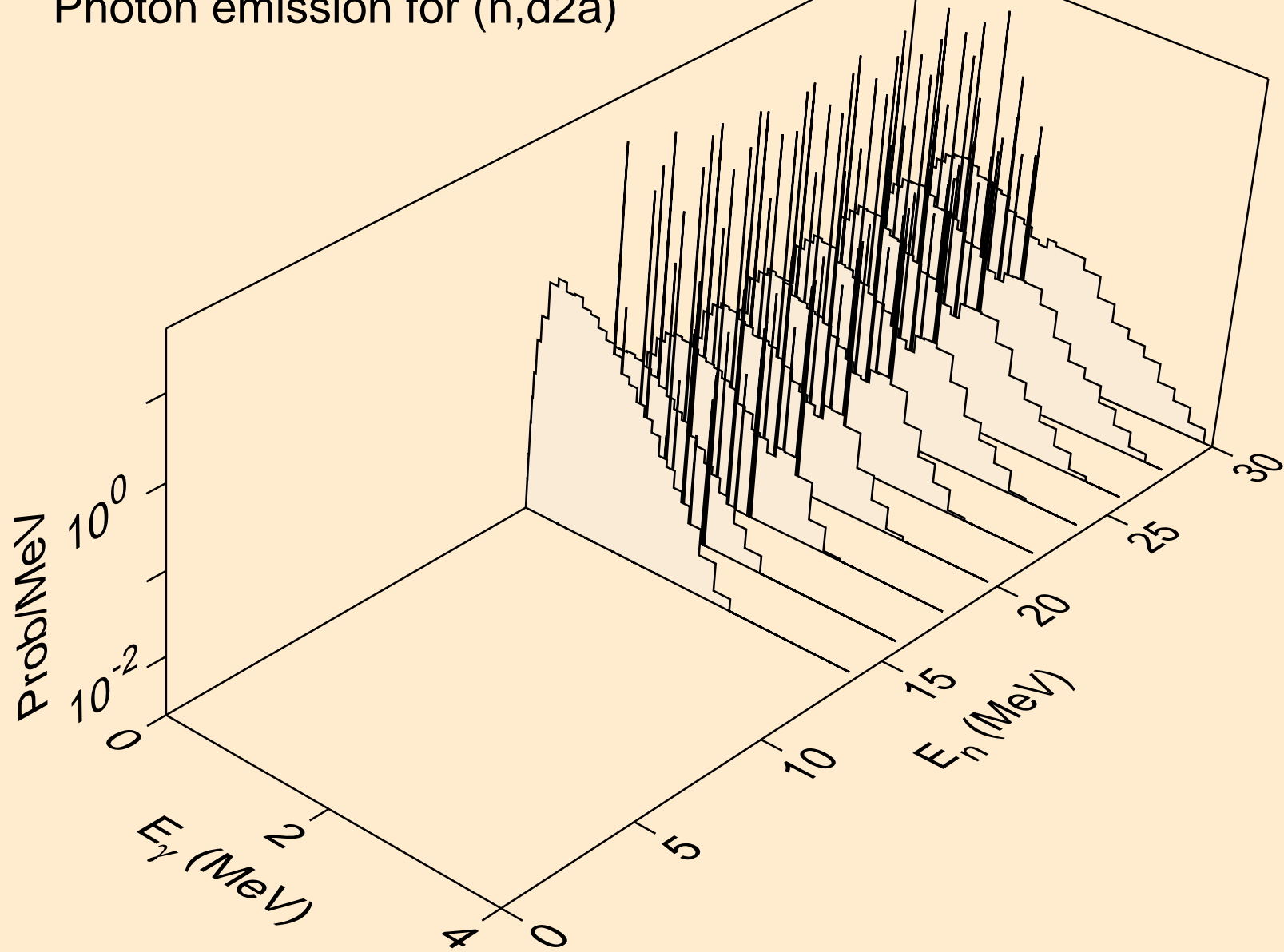

BA118 NEUTRON ACER TENDL-2023 LIBRARY; T=0.K  
Photon emission for (n,pd)

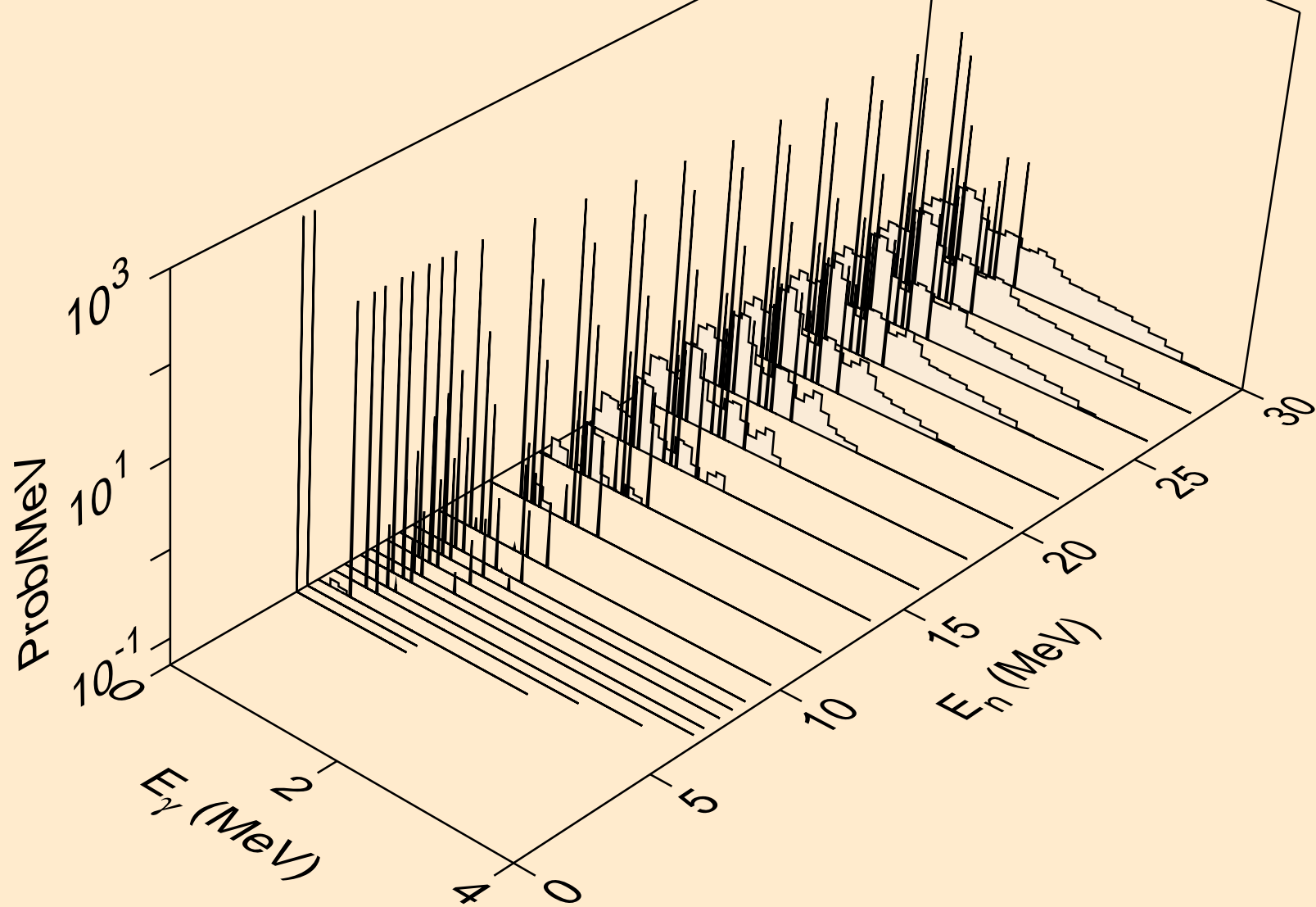

BA118 NEUTRON ACER TENDL-2023 LIBRARY; T=0.K  
Photon emission for (n,pt)

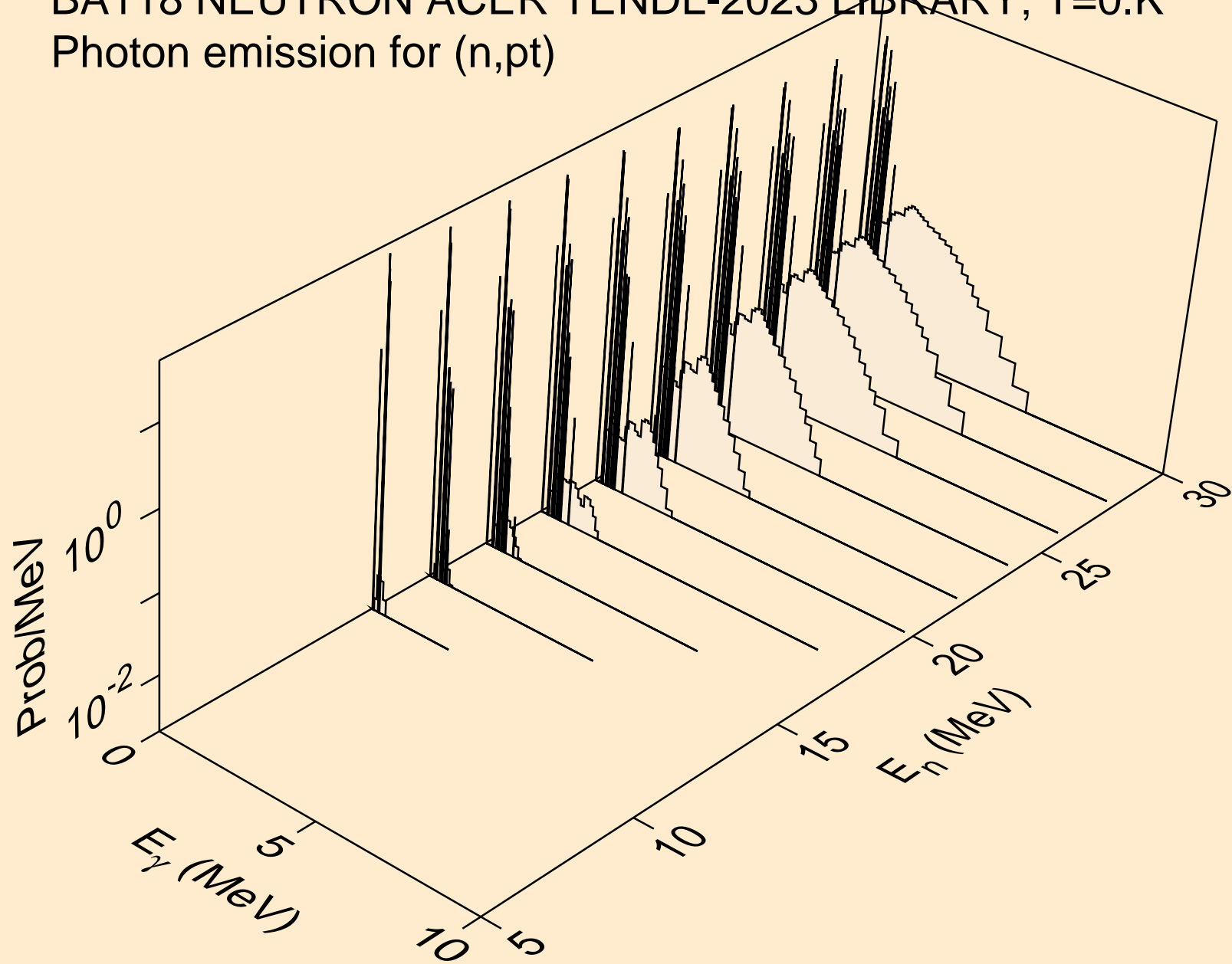

BA118 NEUTRON ACER TENDL-2023 LIBRARY; T=0.K  
Photon emission for (n,da)

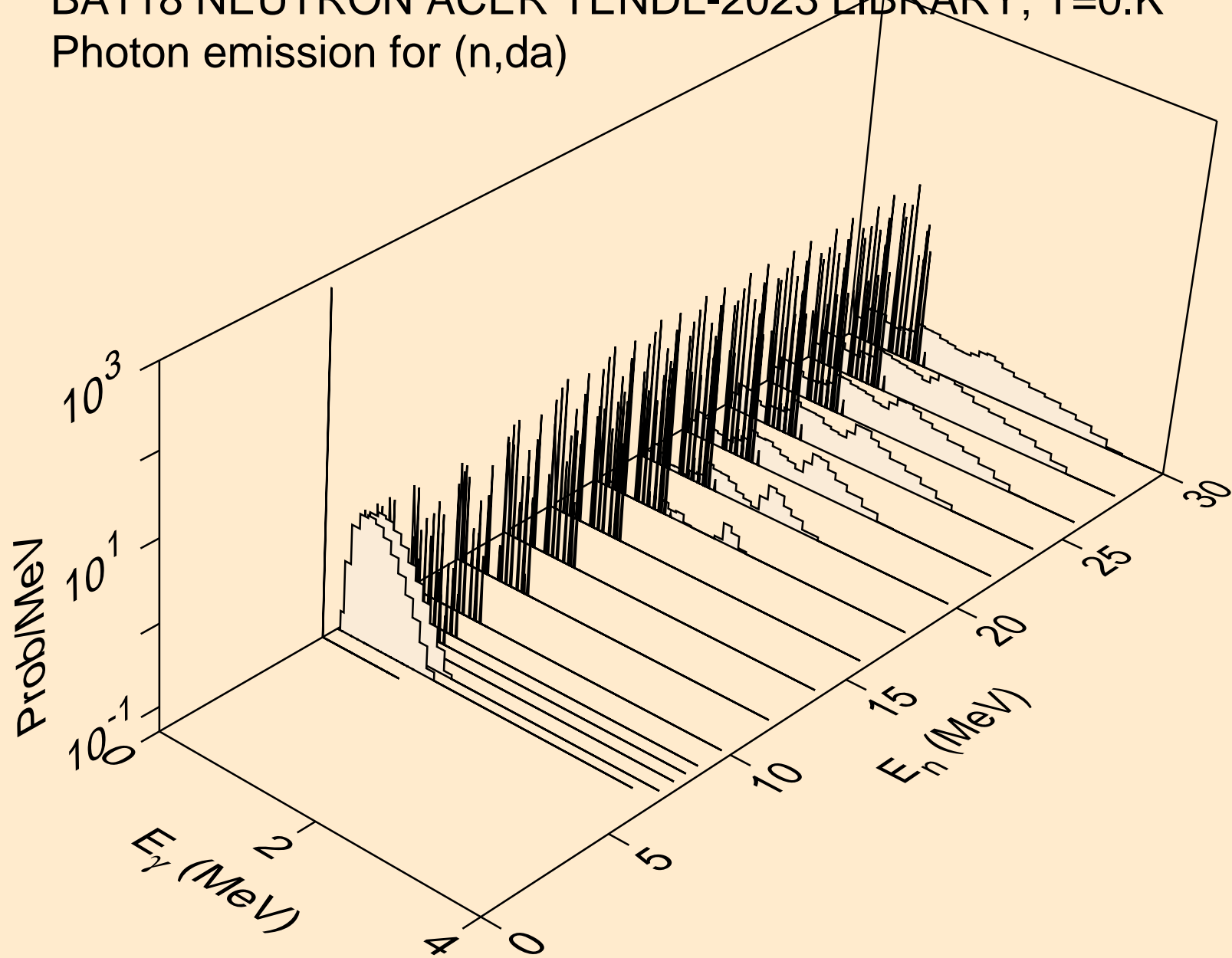

BA118 NEUTRON ACER TENDL-2023 LIBRARY; T=0.K  
thermal capture photon spectrum

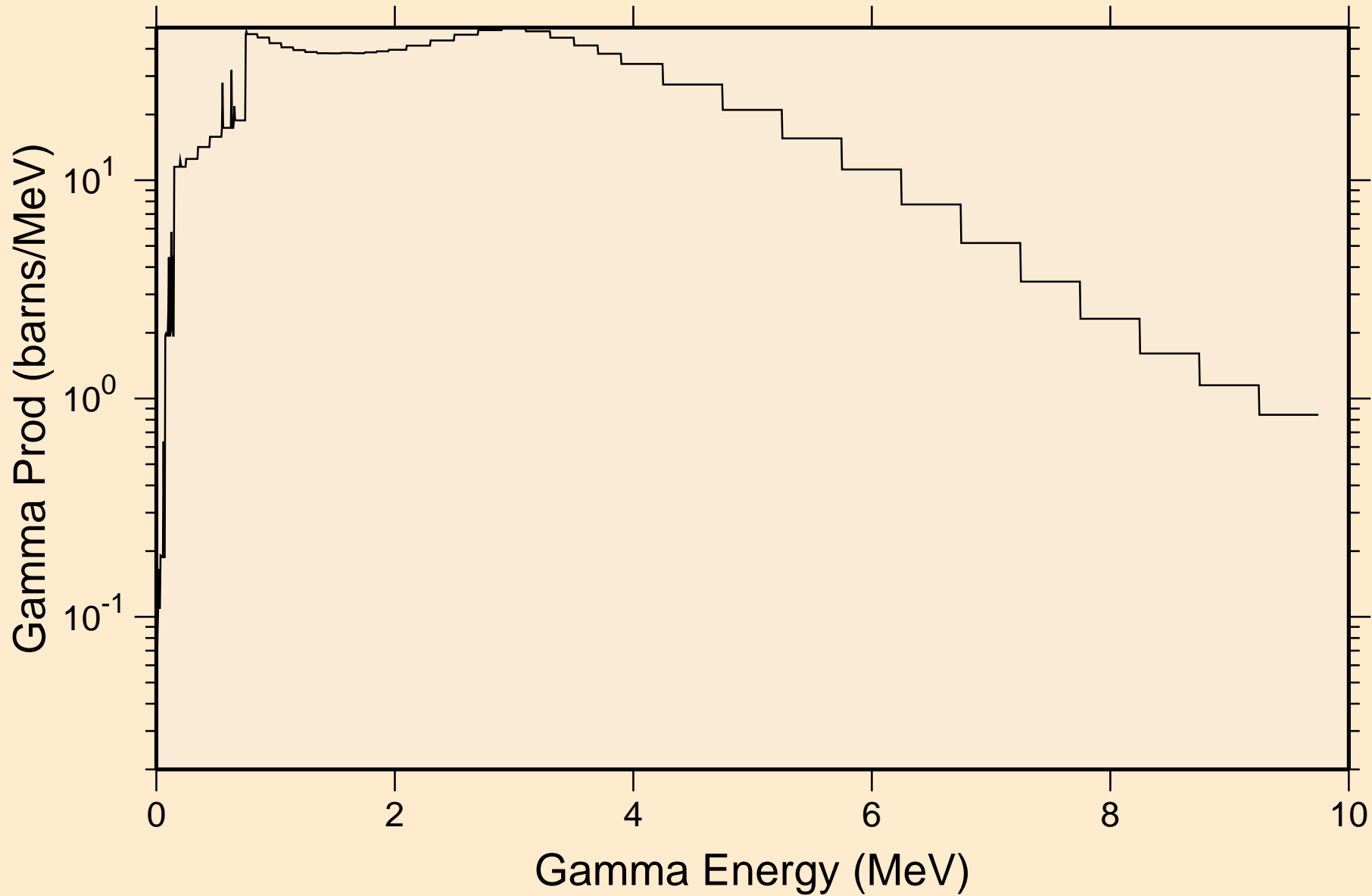



BA118 NEUTRON ACER TENDL-2023 LIBRARY; T=0.K  
14 MeV photon spectrum

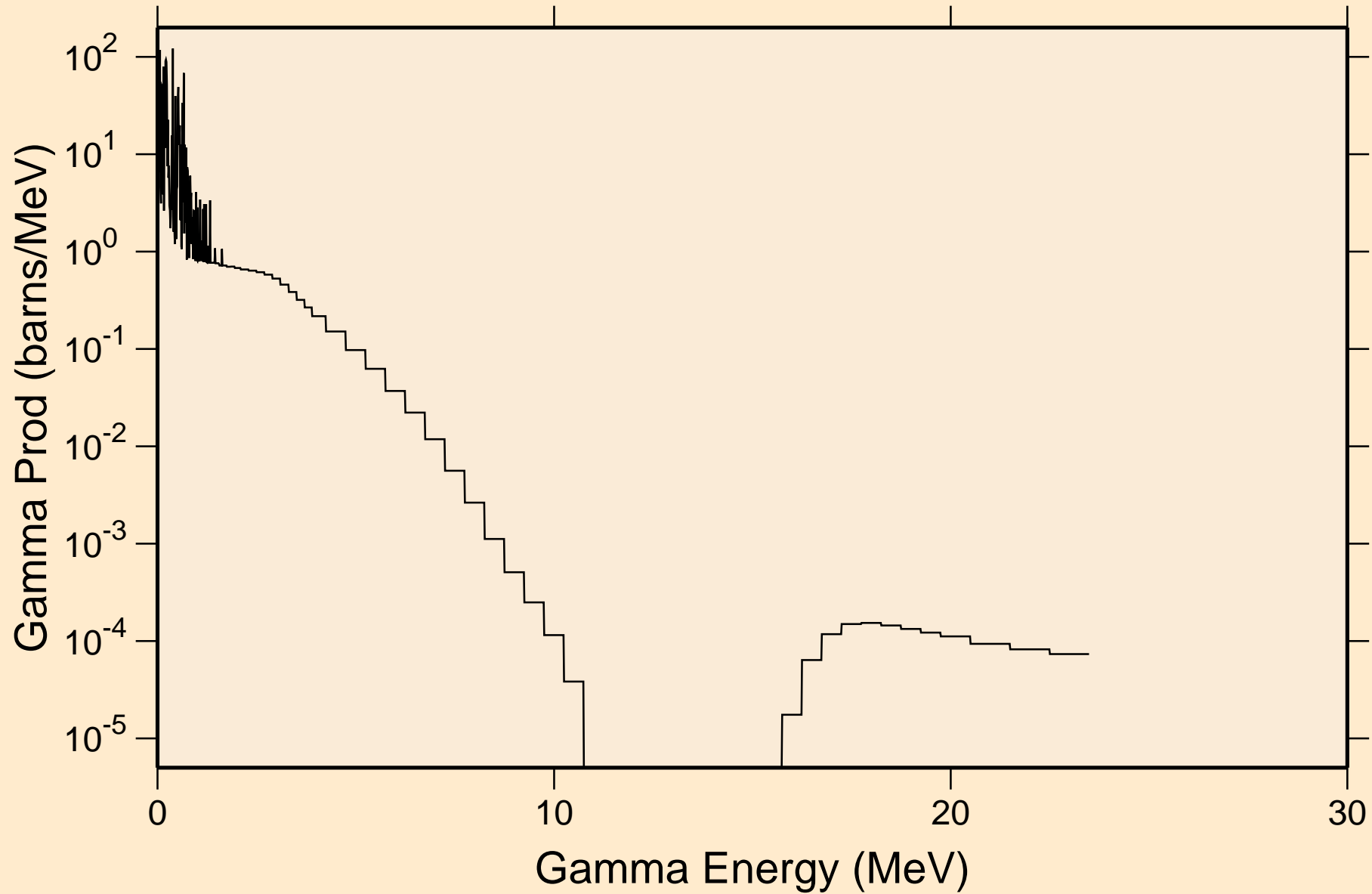

# BA118 NEUTRON ACER TENDL-2023 LIBRARY; T=0.K

## Particle heating contributions

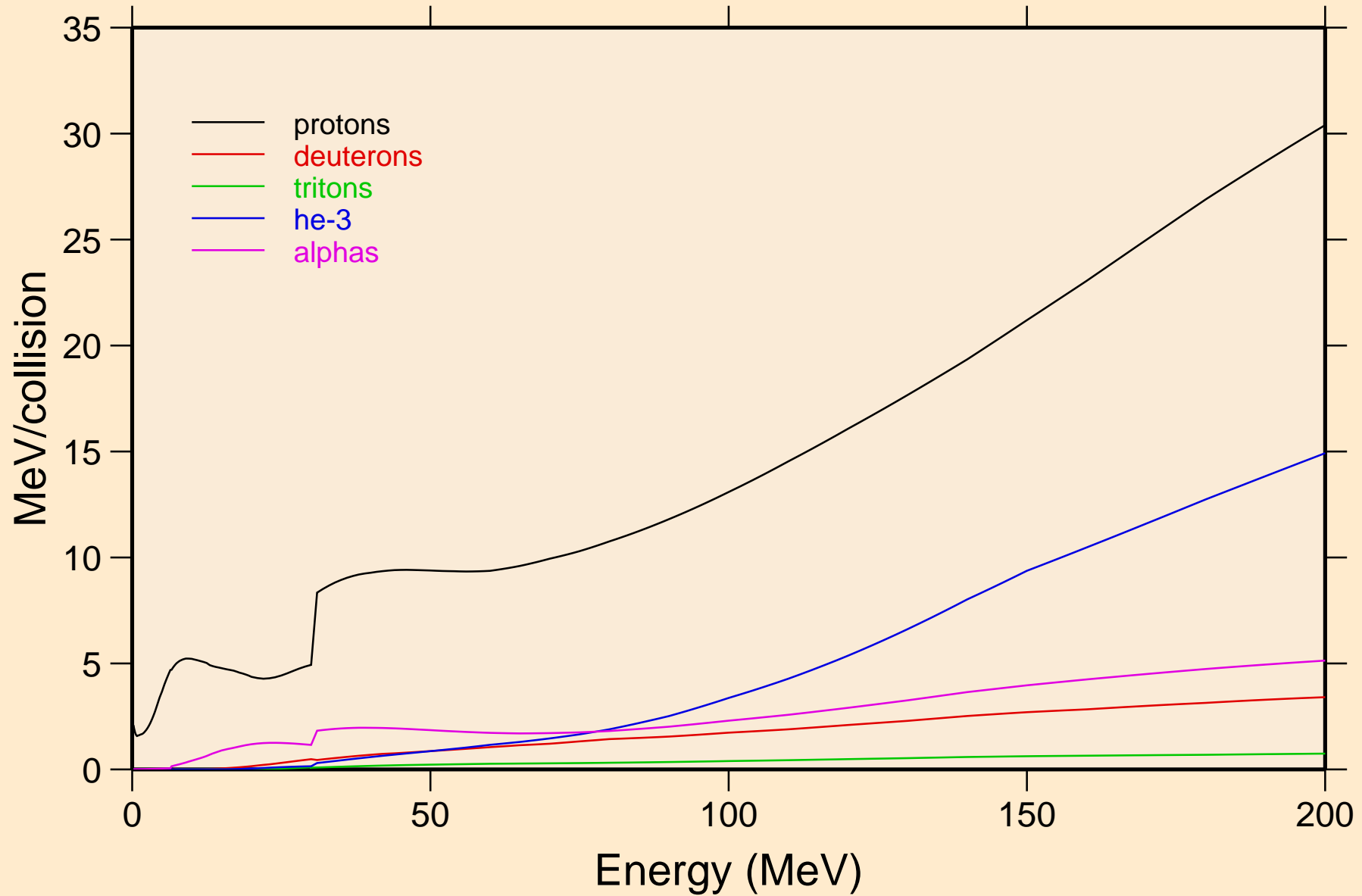

BA118 NEUTRON ACER TENDL-2023 LIBRARY; T=0.K  
Recoil Heating

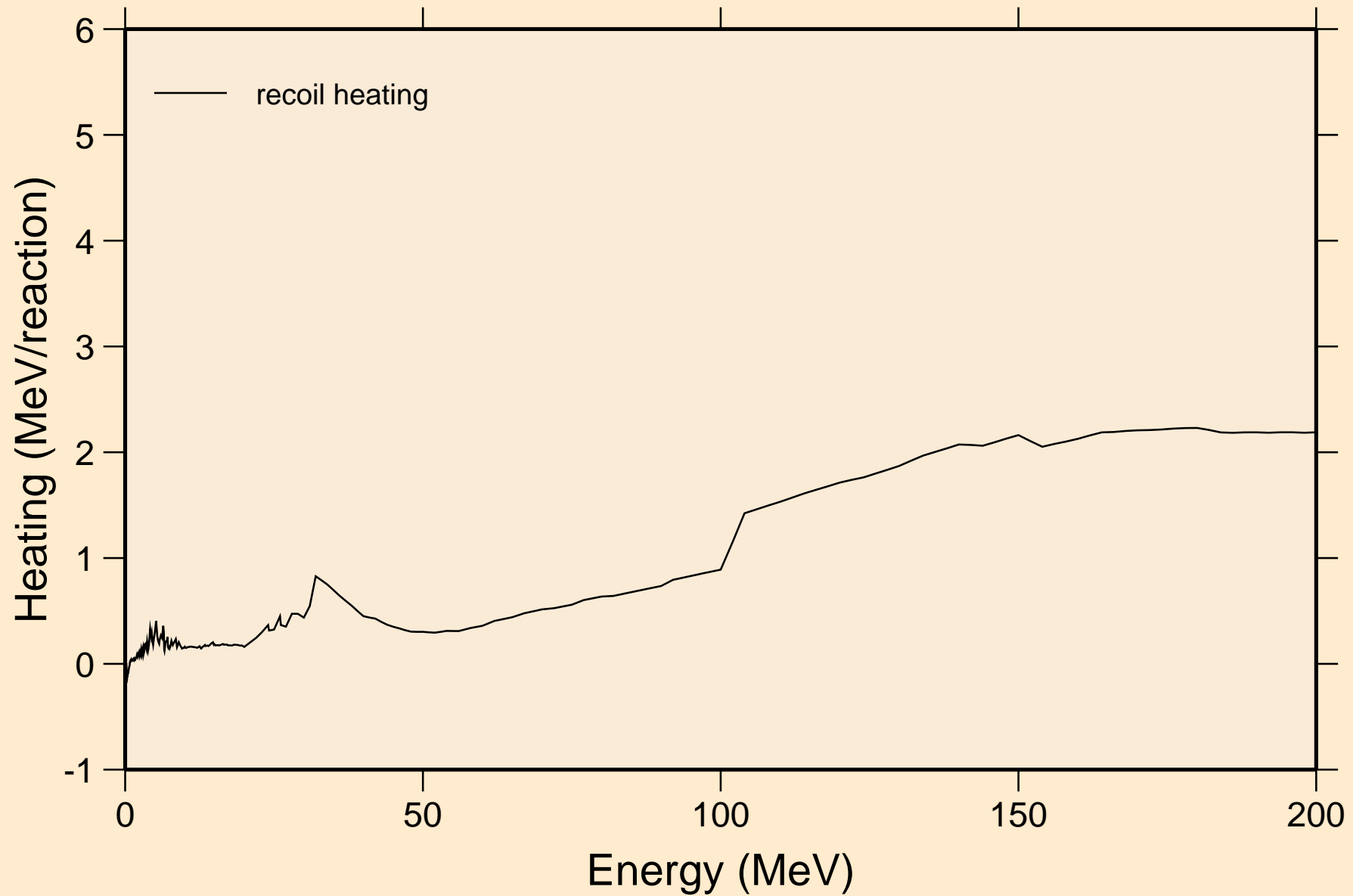

# BA118 NEUTRON ACER TENDL-2023 LIBRARY; T=0.K

## Particle production cross sections

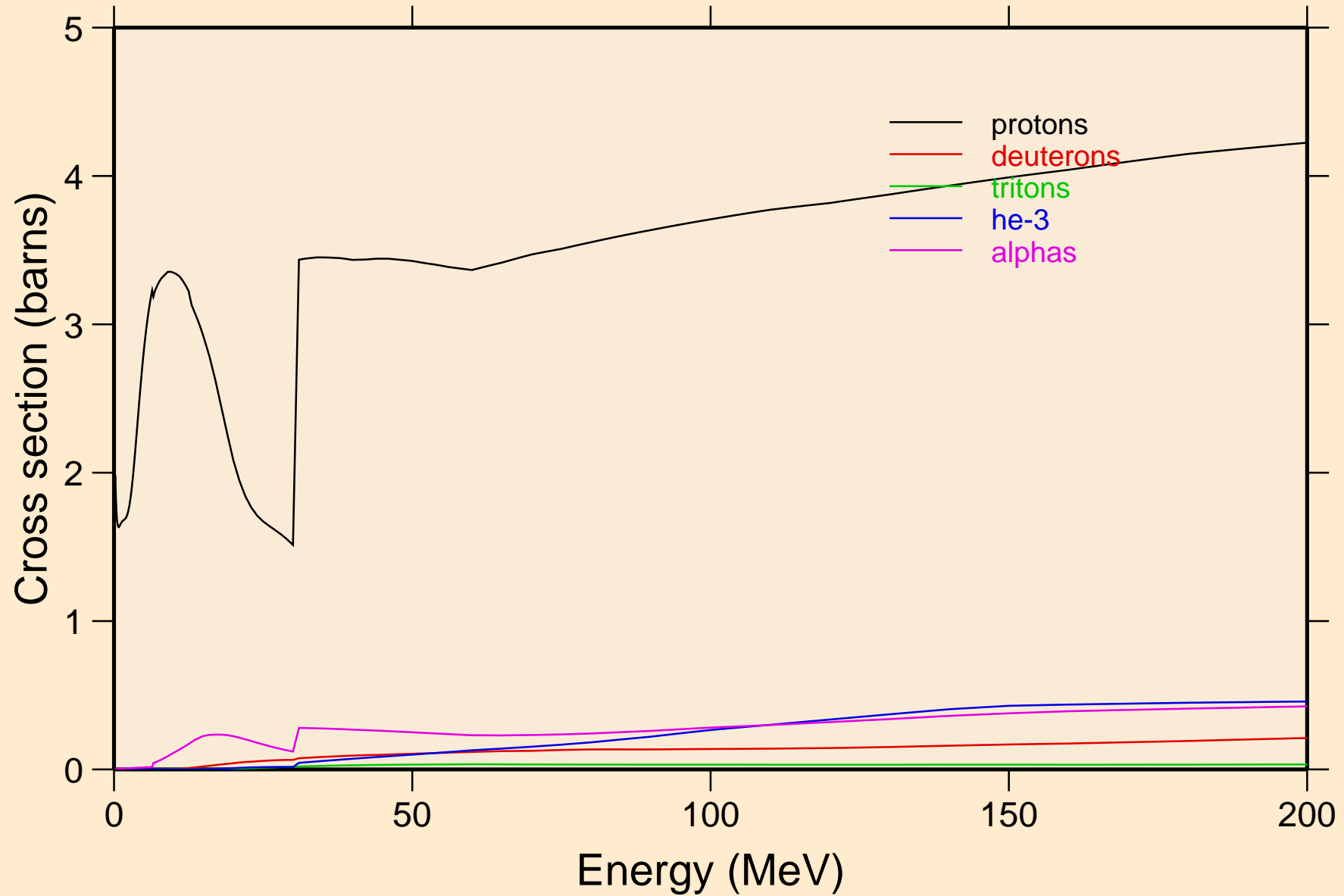

BA118 NEUTRON ACER TENDL-2023 LIBRARY; T=0.K  
protons from (n,x)

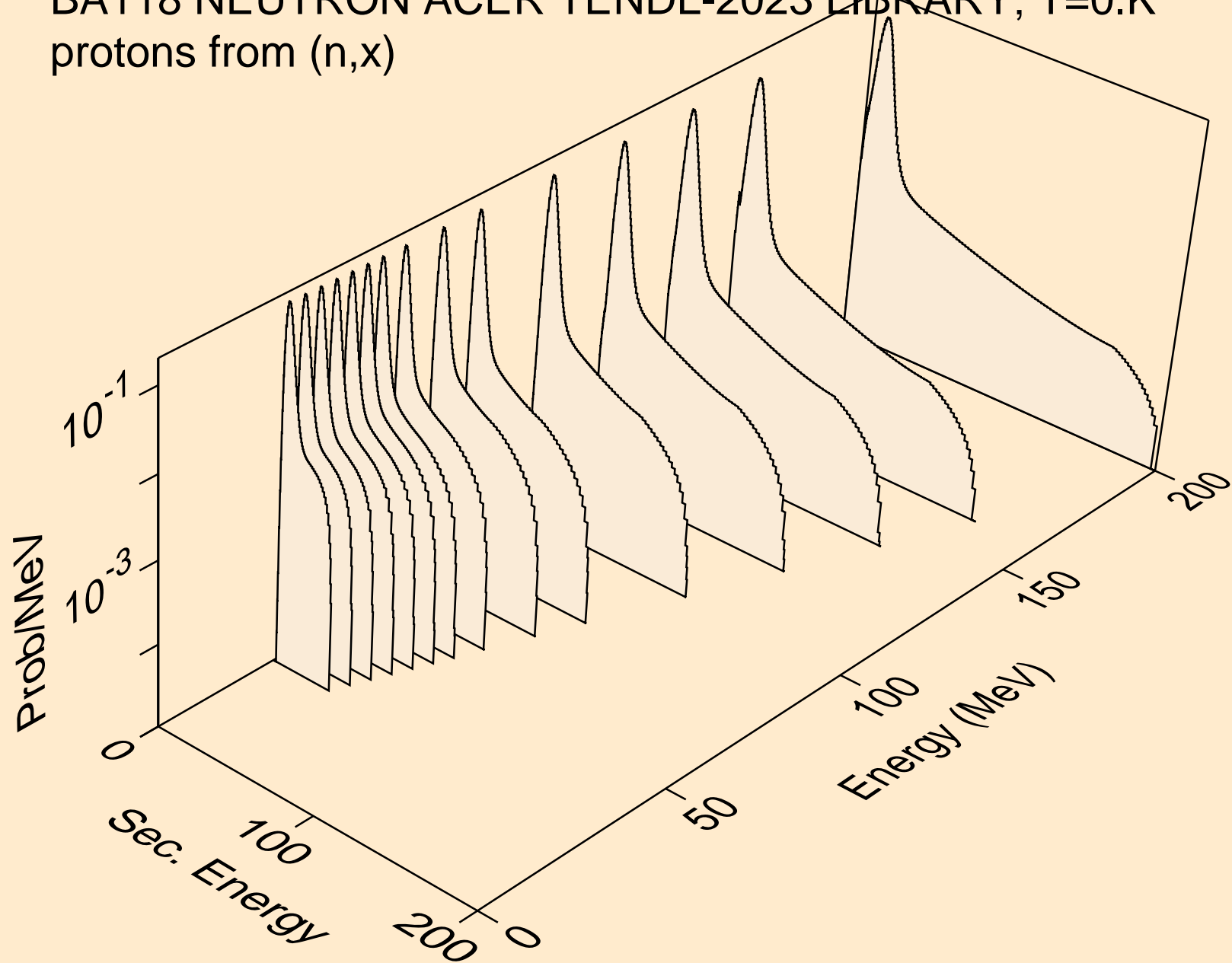

BA118 NEUTRON ACER TENDL-2023 LIBRARY; T=0.K  
protons from (n,n\*)p

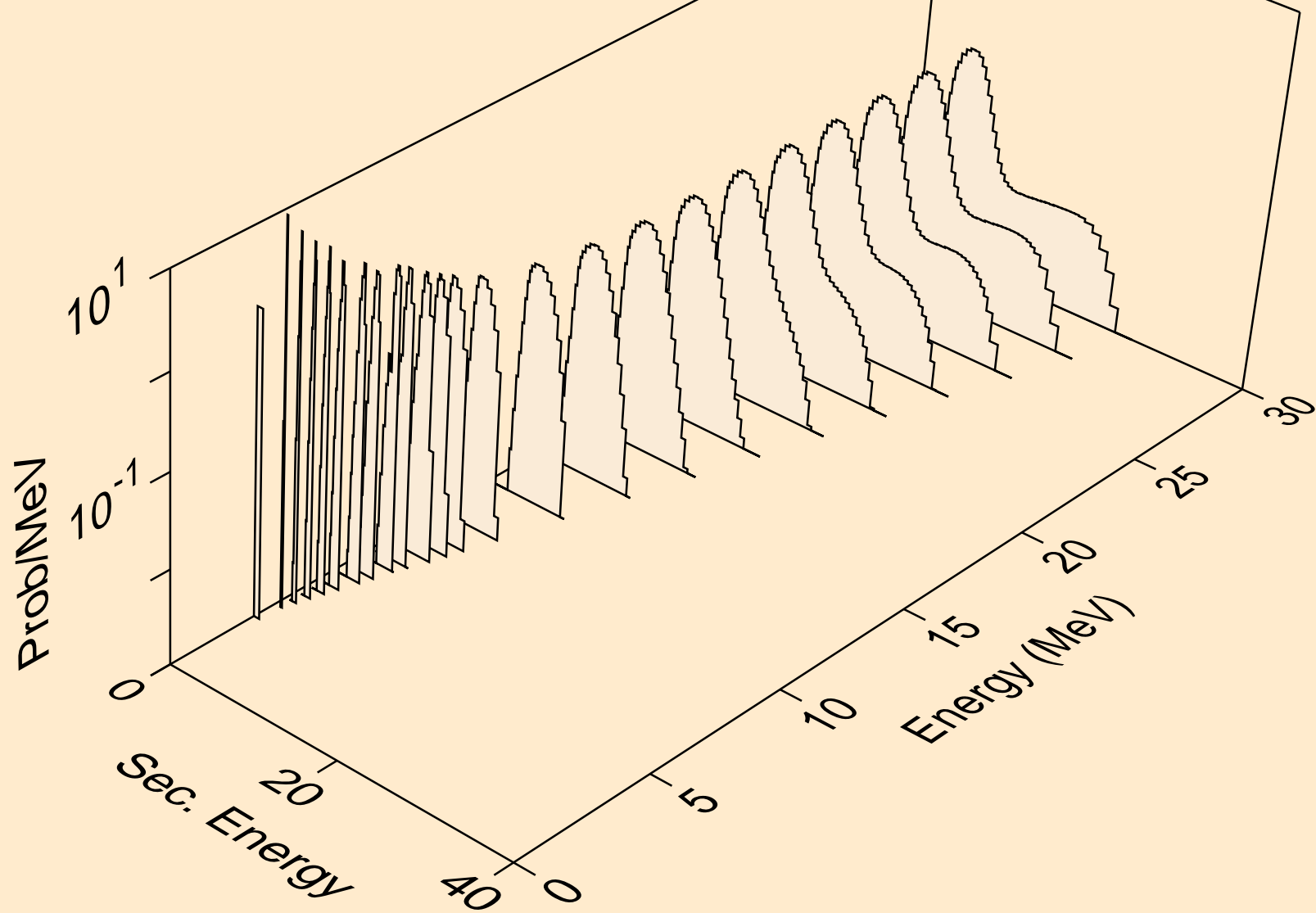

BA118 NEUTRON ACER TENDL-2023 LIBRARY; T=0.K  
protons from (n,2np)

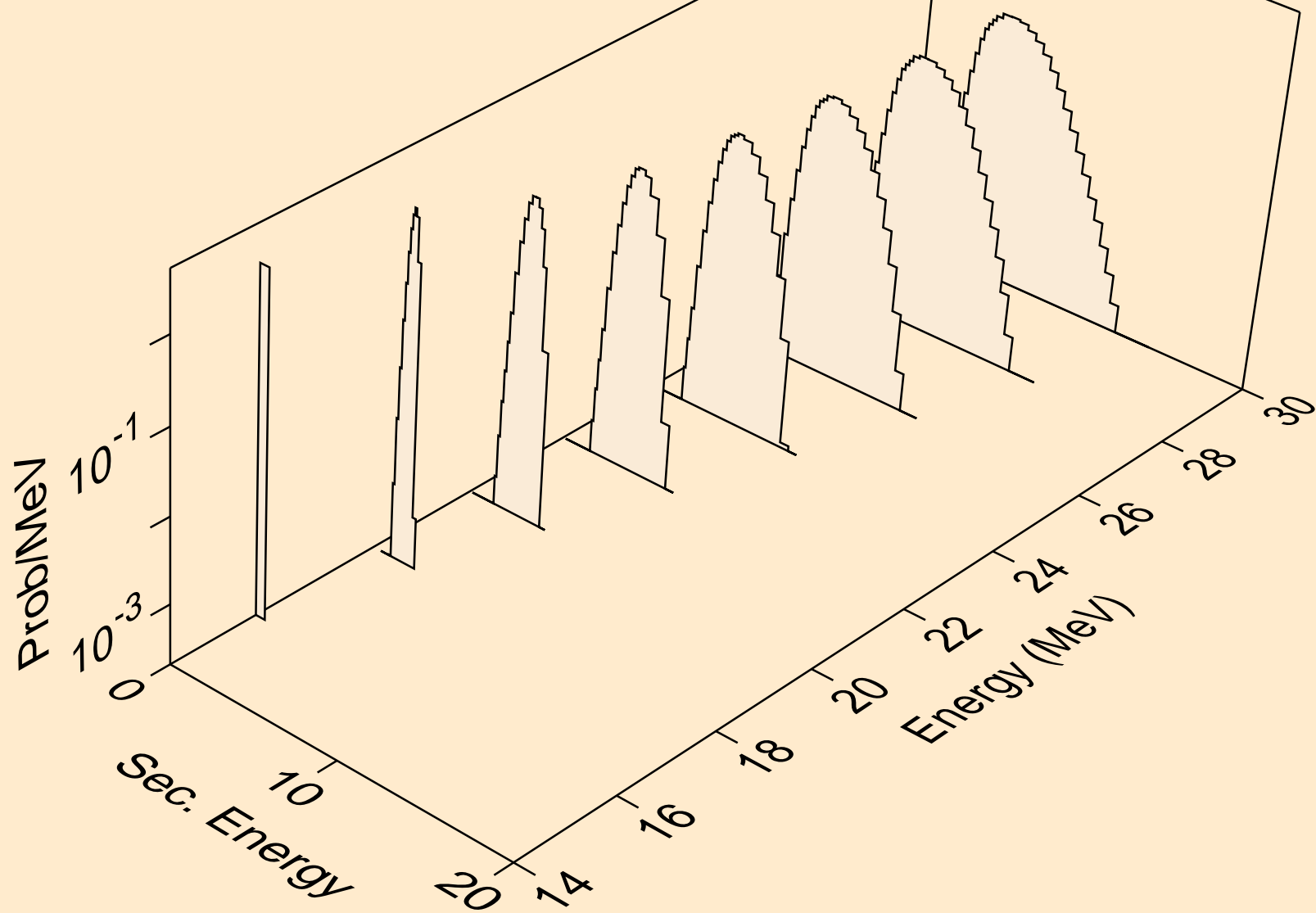

BA118 NEUTRON ACER TENDL-2023 LIBRARY; T=0.K  
protons from (n,3np)

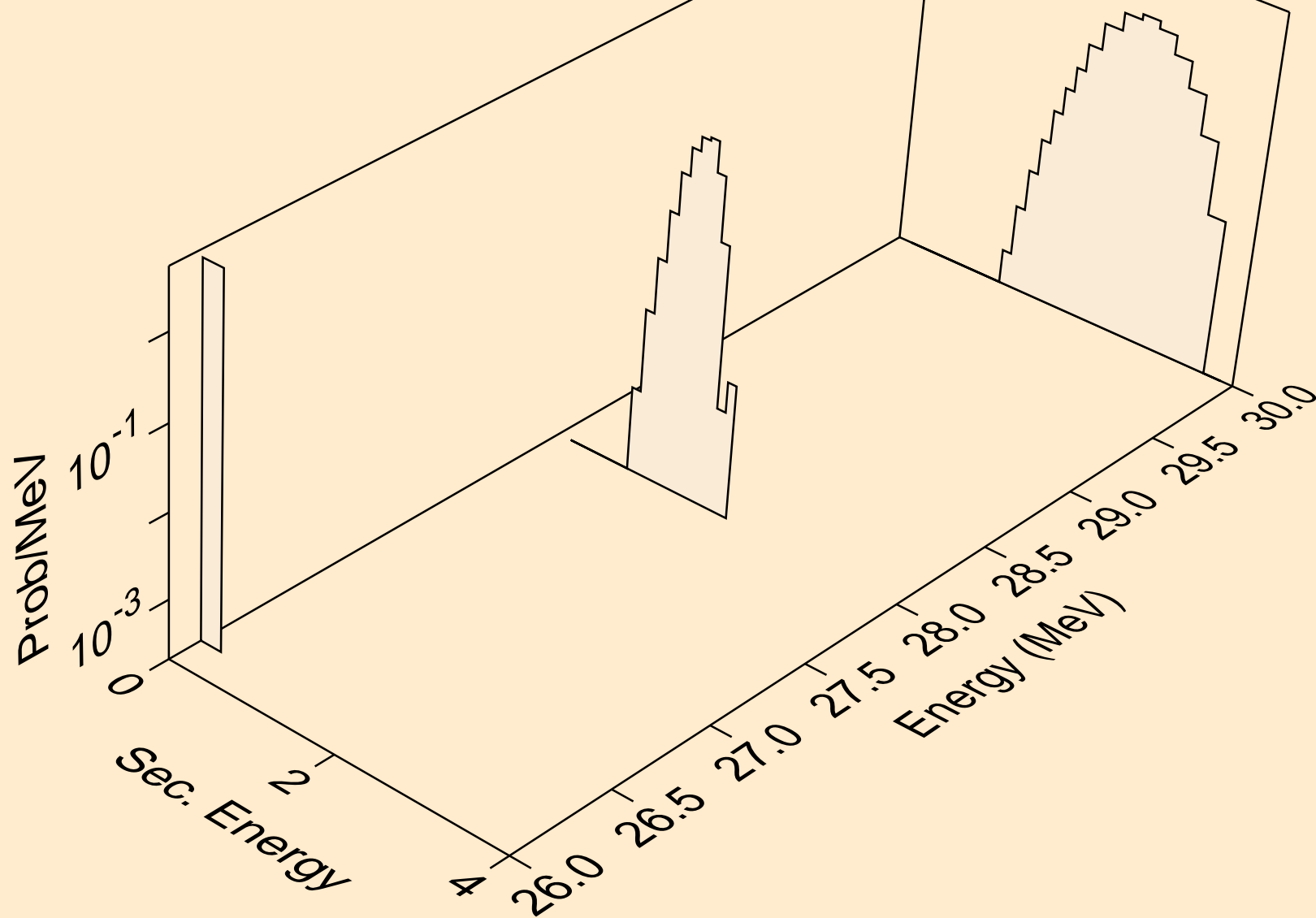



BA118 NEUTRON ACER TENDL-2023 LIBRARY; T=0.K  
protons from (n,n2p)

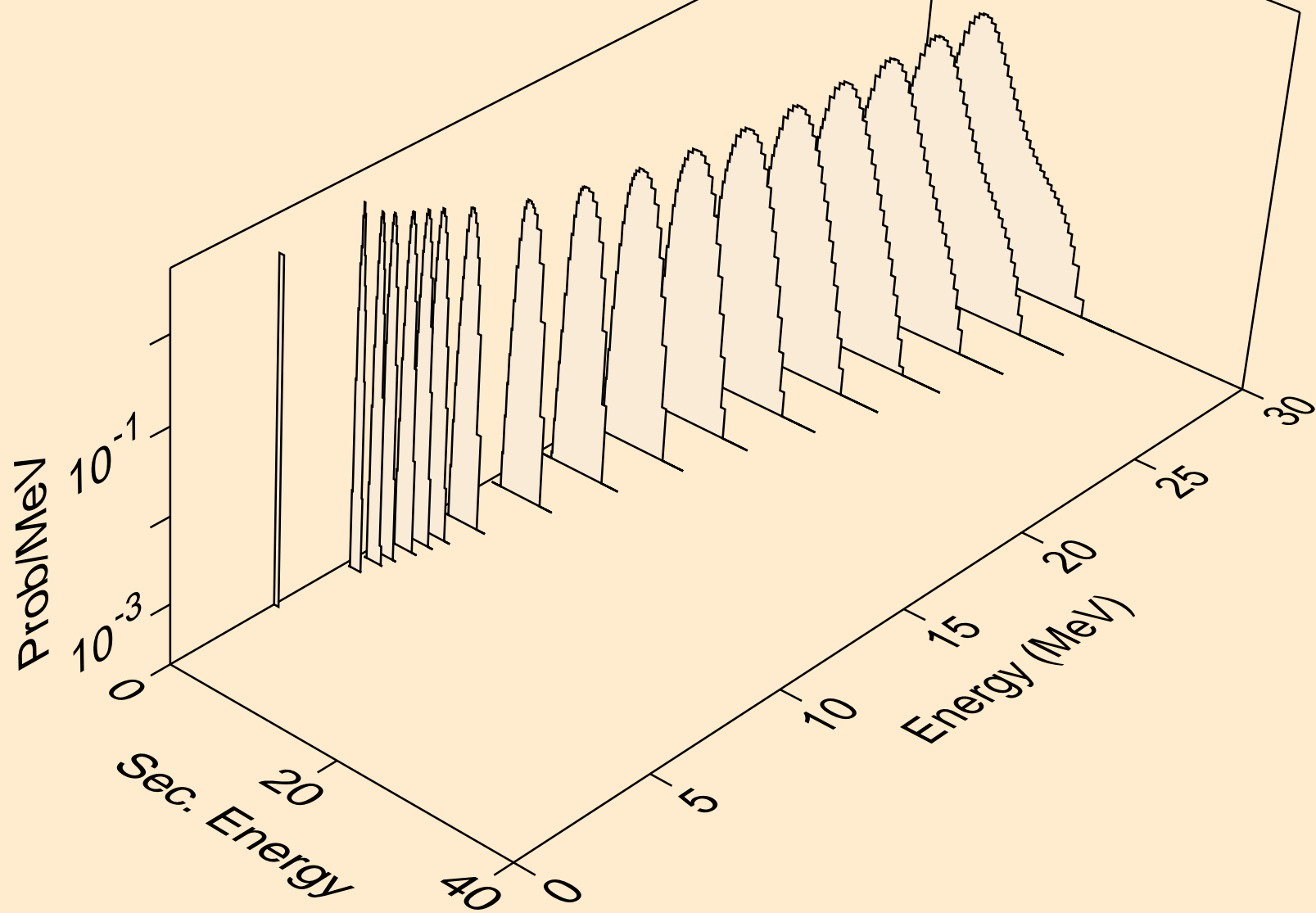

BA118 NEUTRON ACER TENDL-2023 LIBRARY; T=0.K  
protons from (n,npa)

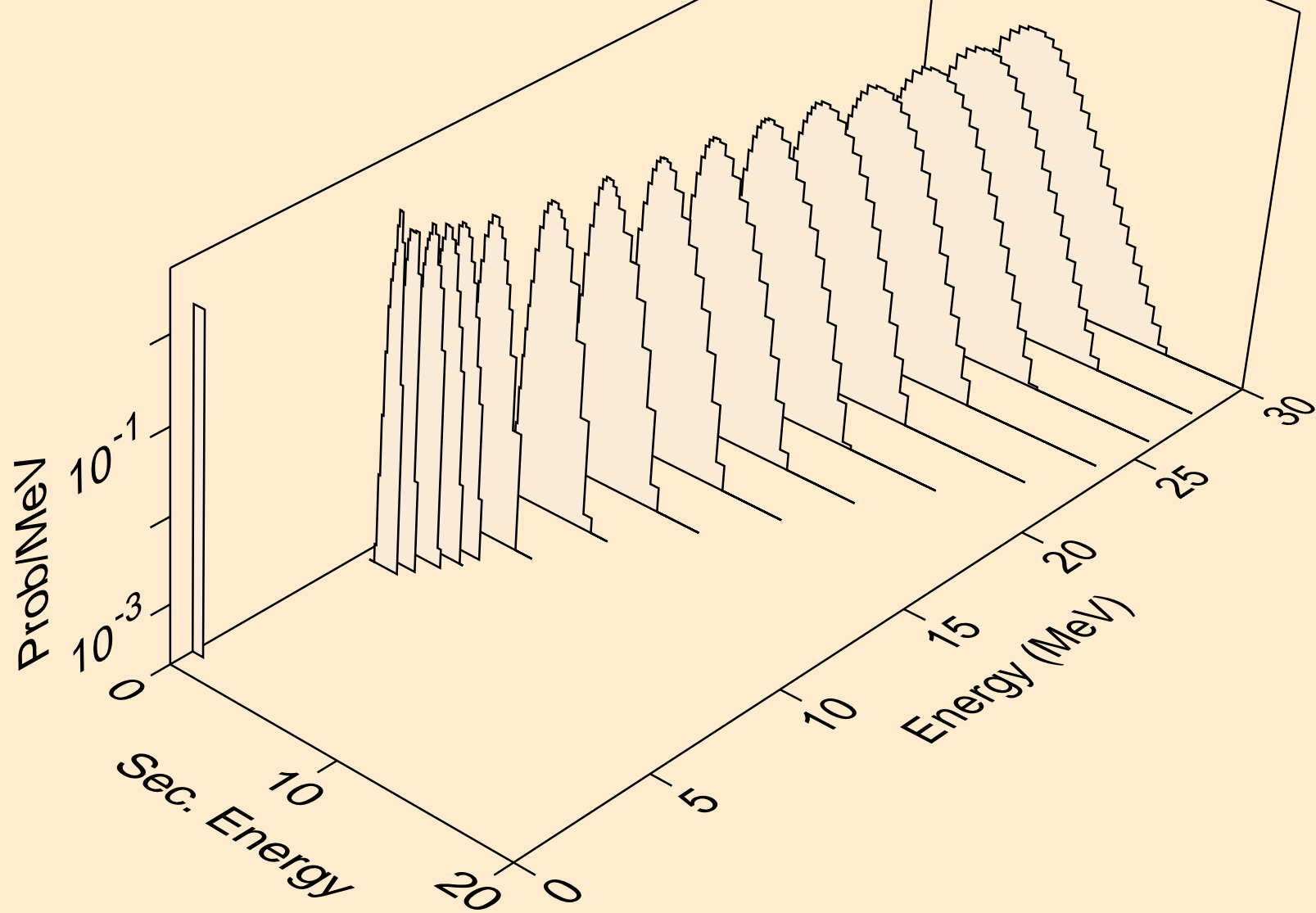

BA118 NEUTRON ACER TENDL-2023 LIBRARY; T=0.K  
protons from (n,p)

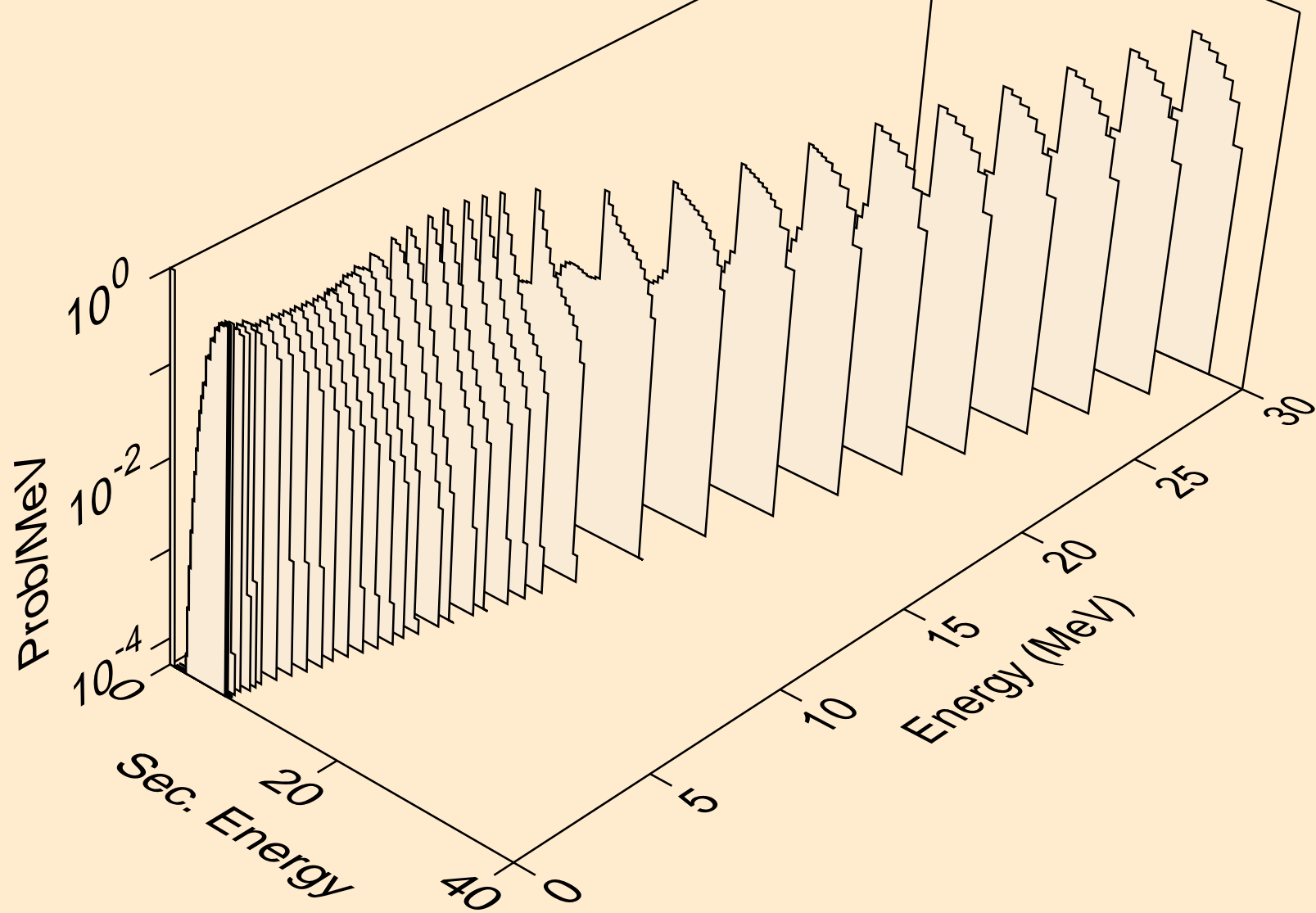

BA118 NEUTRON ACER TENDL-2023 LIBRARY; T=0.K  
protons from (n,2p)

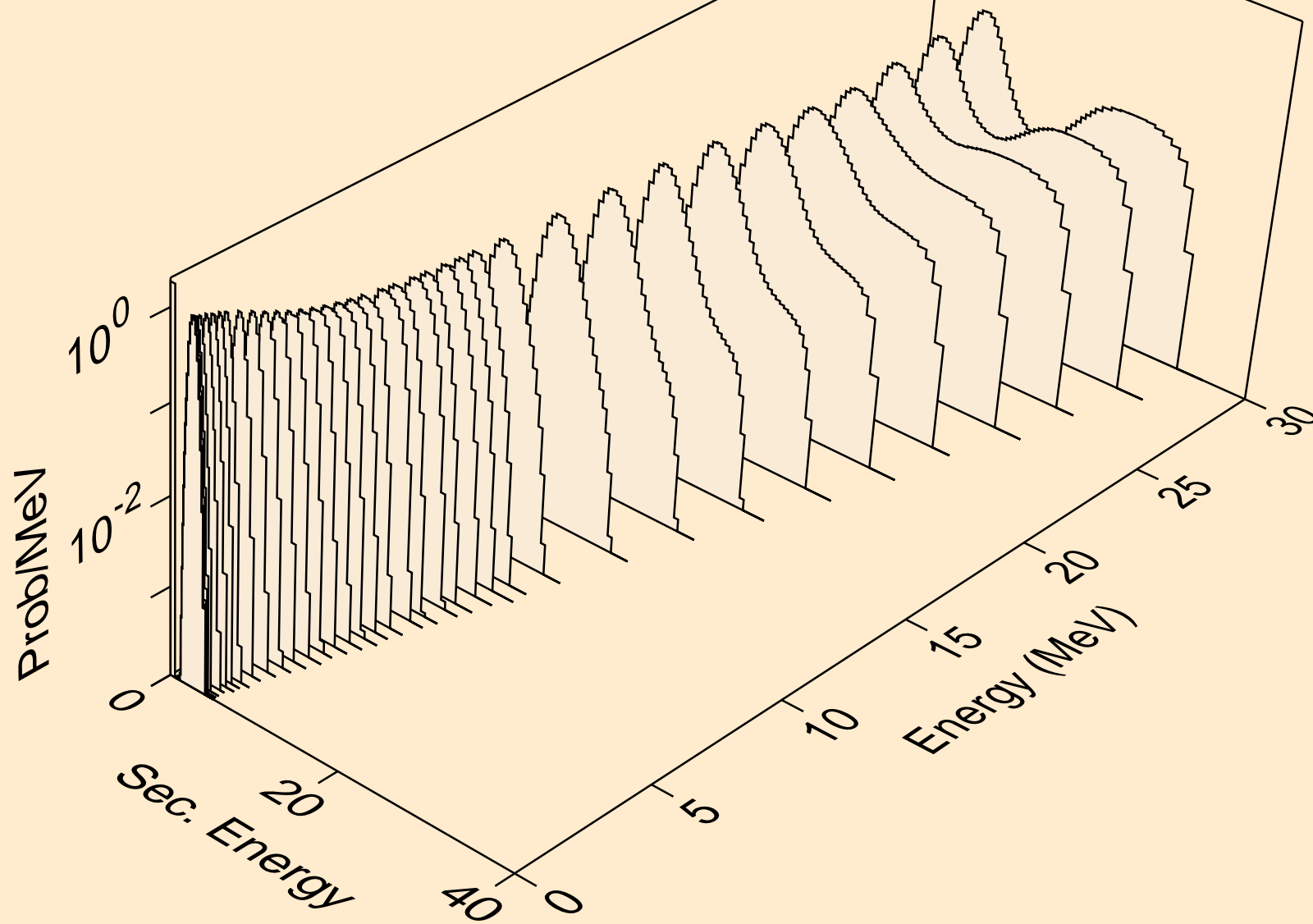

BA118 NEUTRON ACER TENDL-2023 LIBRARY; T=0.K  
protons from (n,p)

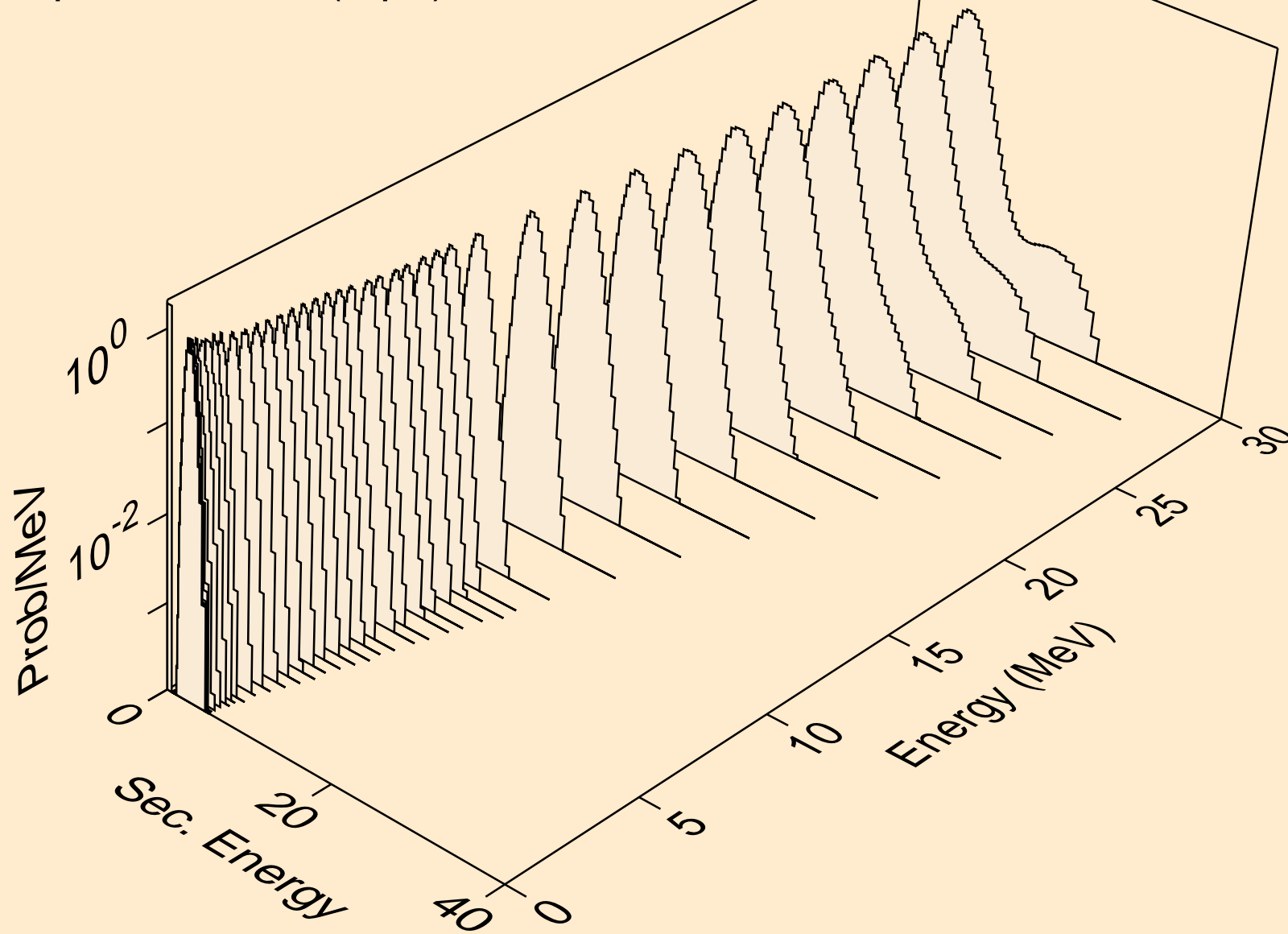

BA118 NEUTRON ACER TENDL-2023 LIBRARY; T=0.K  
protons from (n,pd)

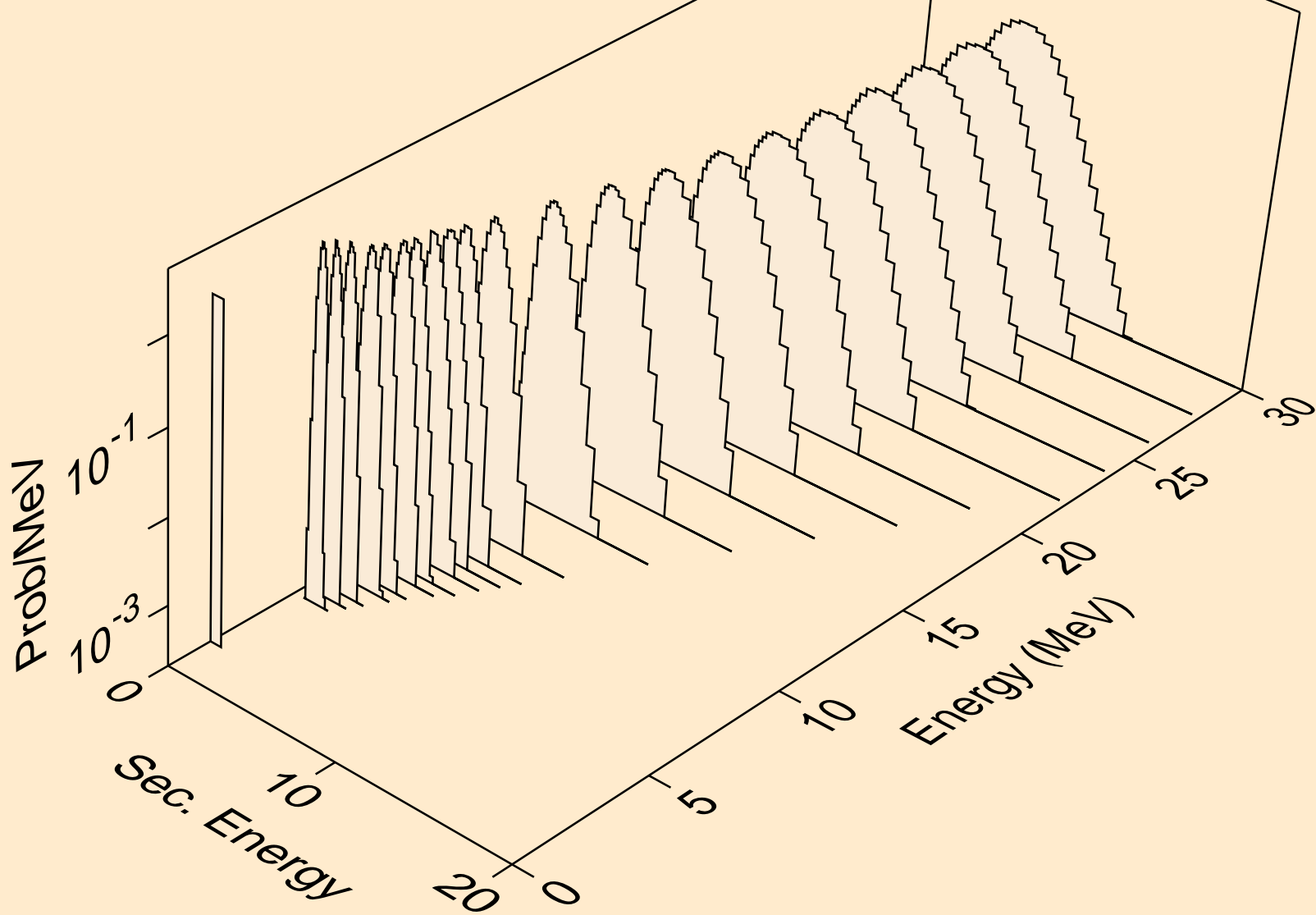

BA118 NEUTRON ACER TENDL-2023 LIBRARY; T=0.K  
protons from (n,pt)

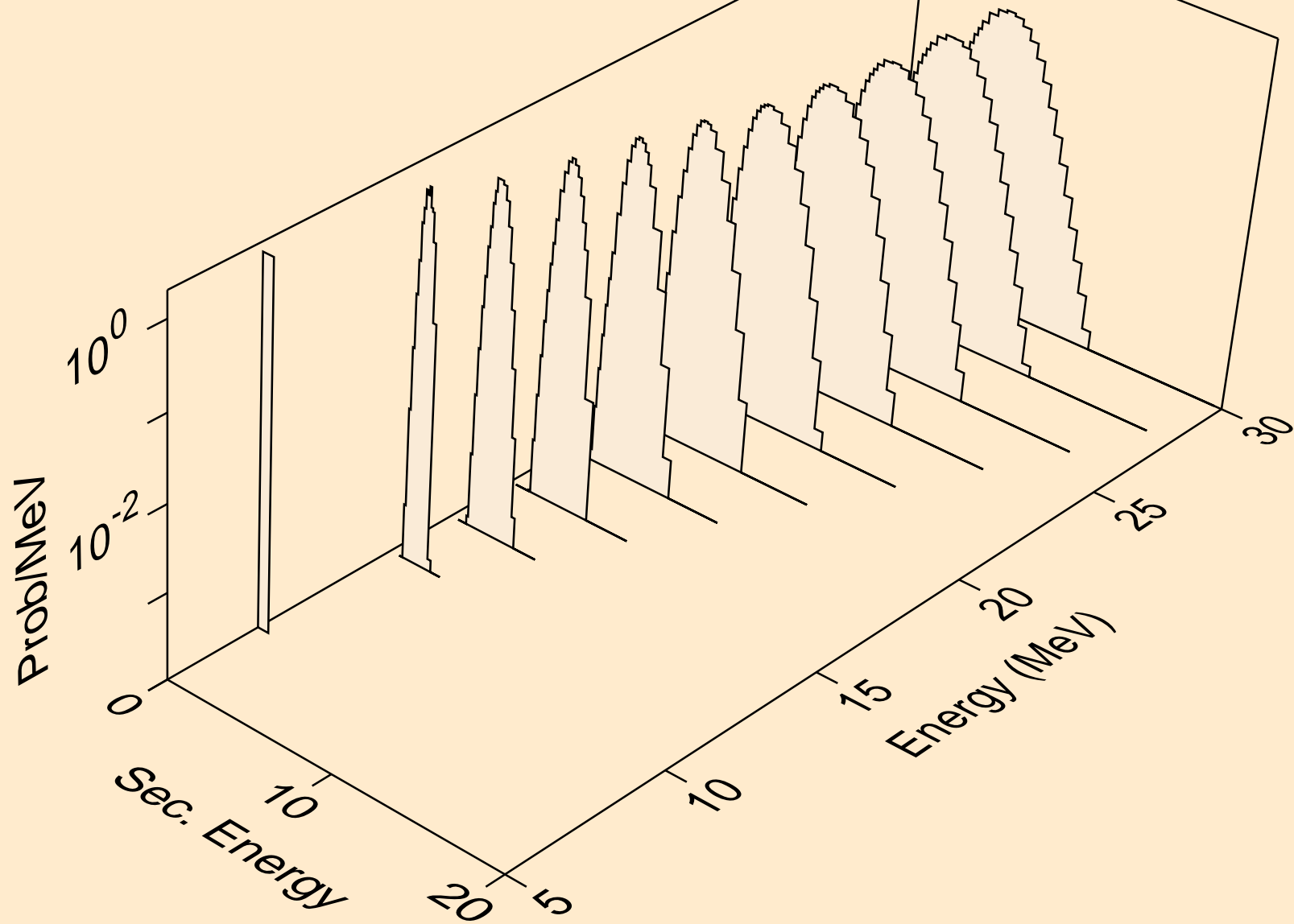

BA118 NEUTRON ACER TENDL-2023 LIBRARY; T=0.K  
deuterons from (n,x)

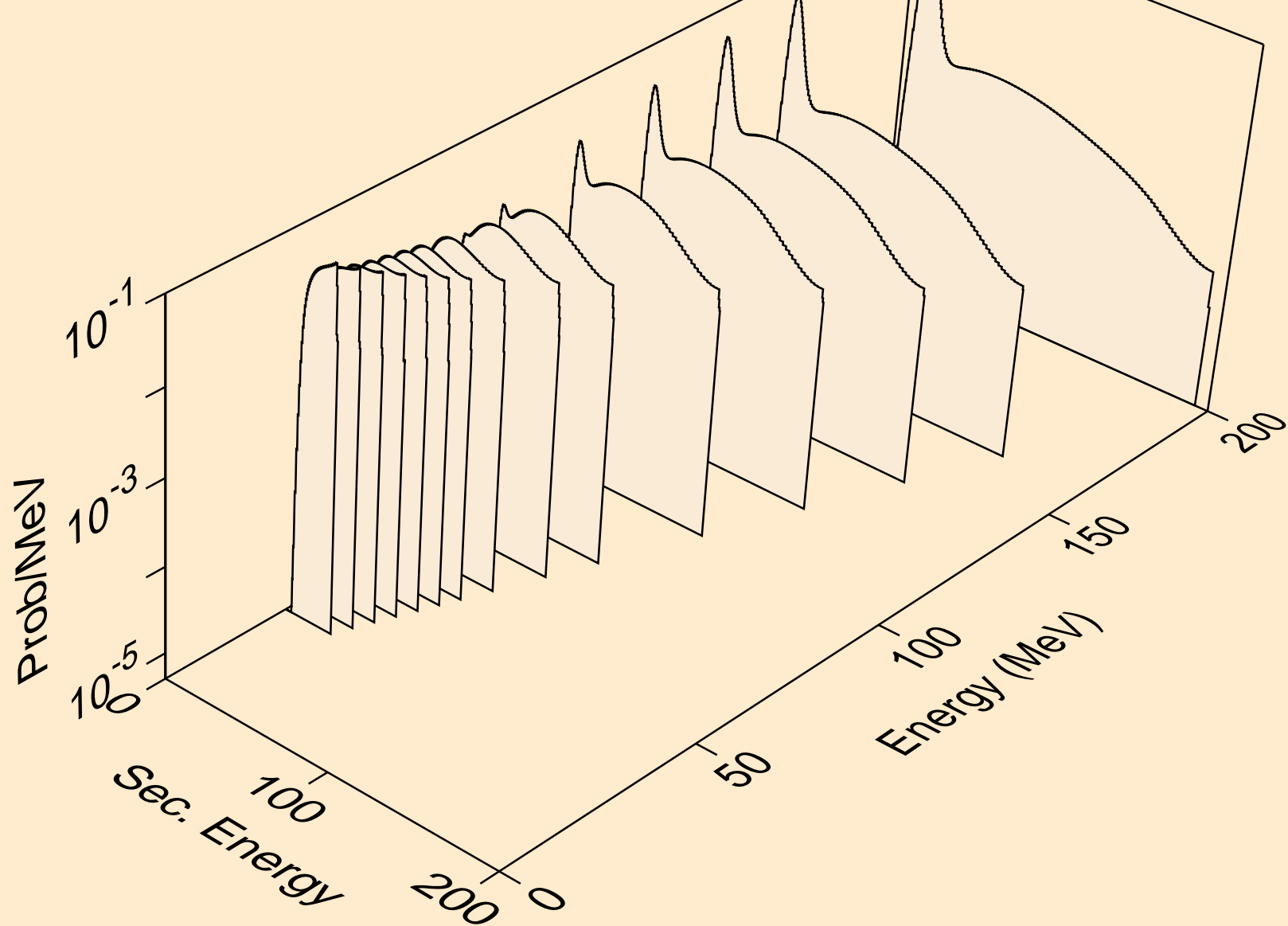



BA118 NEUTRON ACER TENDL-2023 LIBRARY; T=0.K  
deuterons from (n,n\*)d

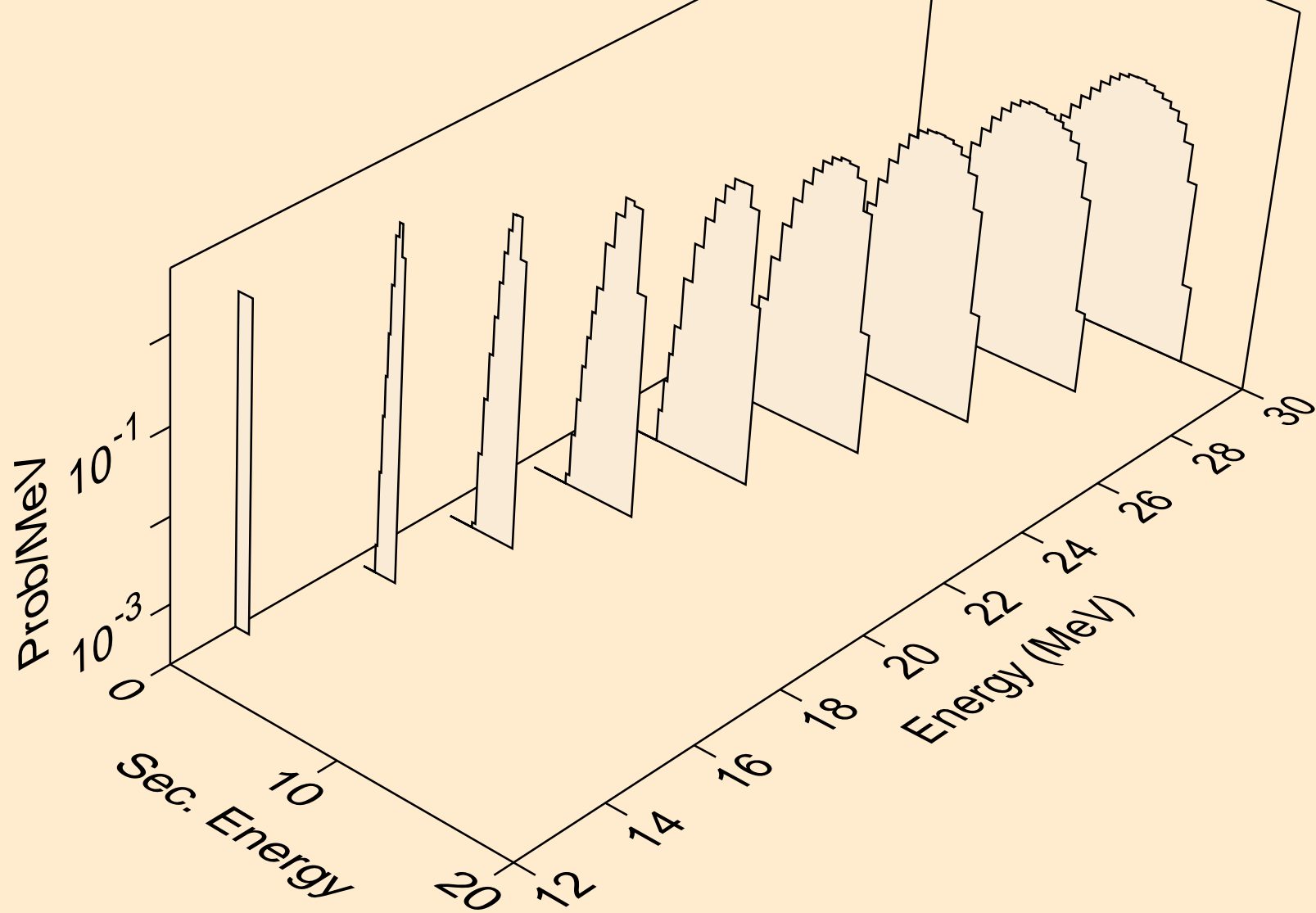

BA118 NEUTRON ACER TENDL-2023 LIBRARY; T=0.K  
deuterons from (n,d)

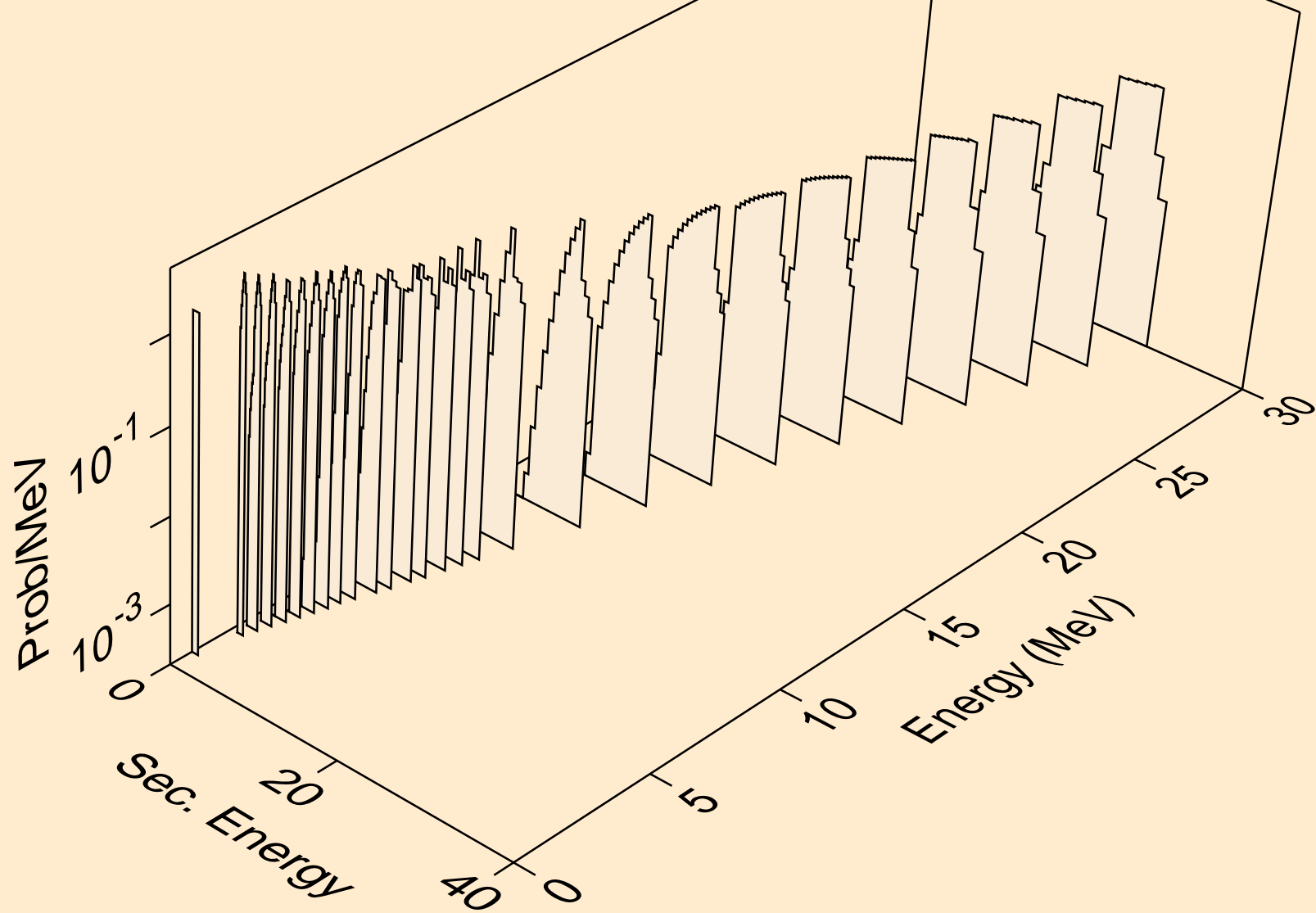

BA118 NEUTRON ACER TENDL-2023 LIBRARY; T=0.K  
deuterons from (n,d2a)

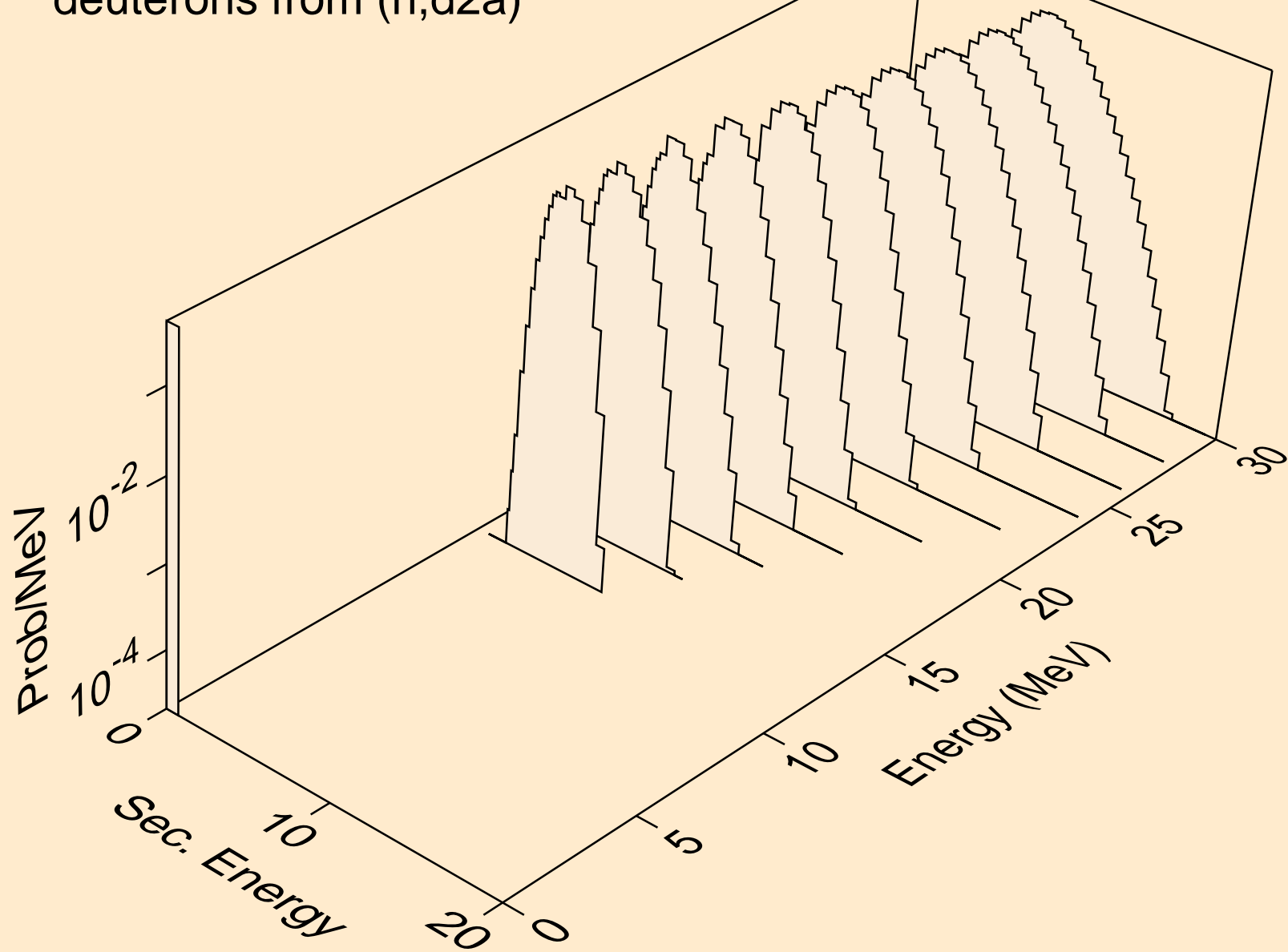

BA118 NEUTRON ACER TENDL-2023 LIBRARY; T=0.K  
deuterons from (n,pd)

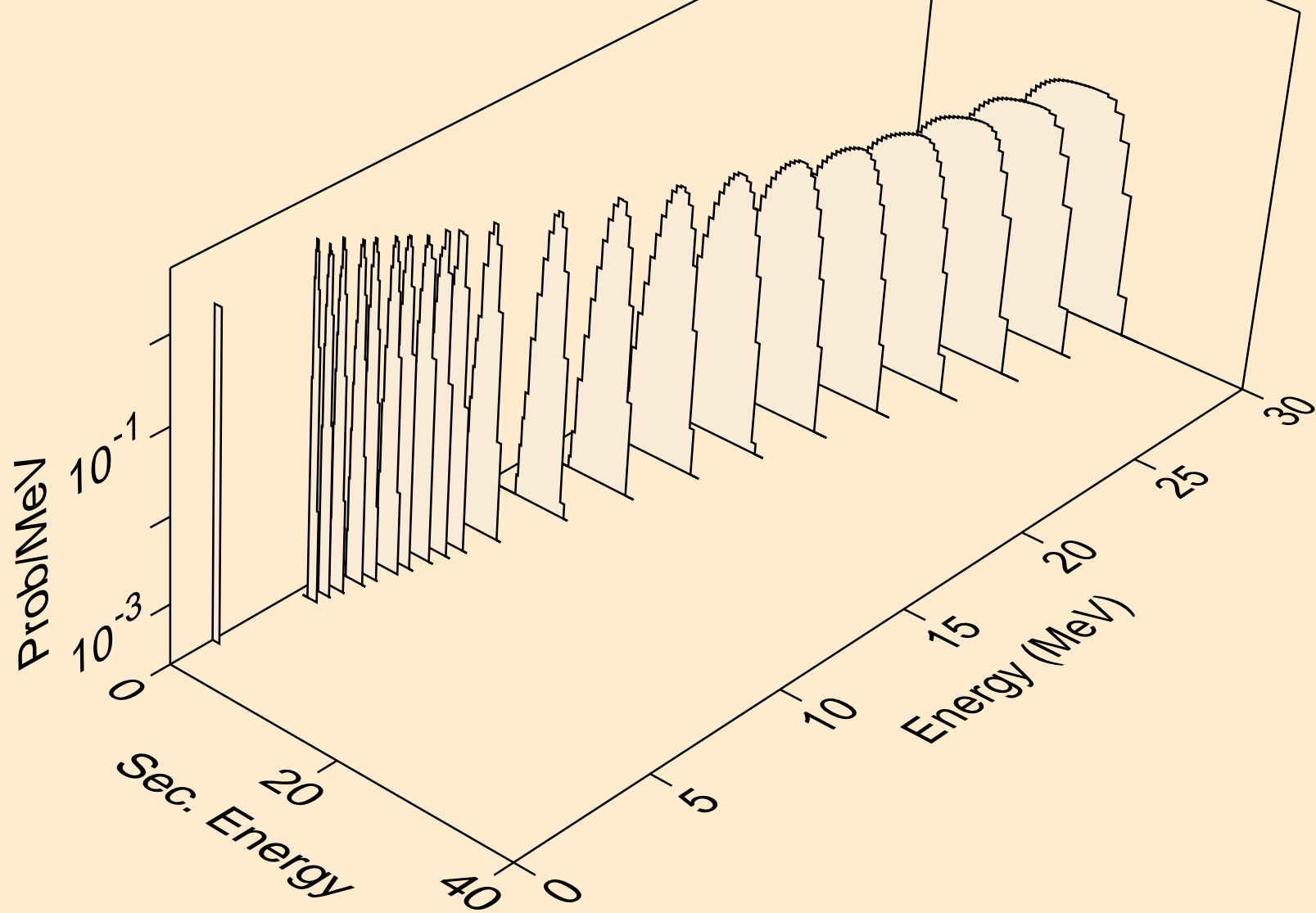

BA118 NEUTRON ACER TENDL-2023 LIBRARY; T=0.K  
deuterons from (n,da)

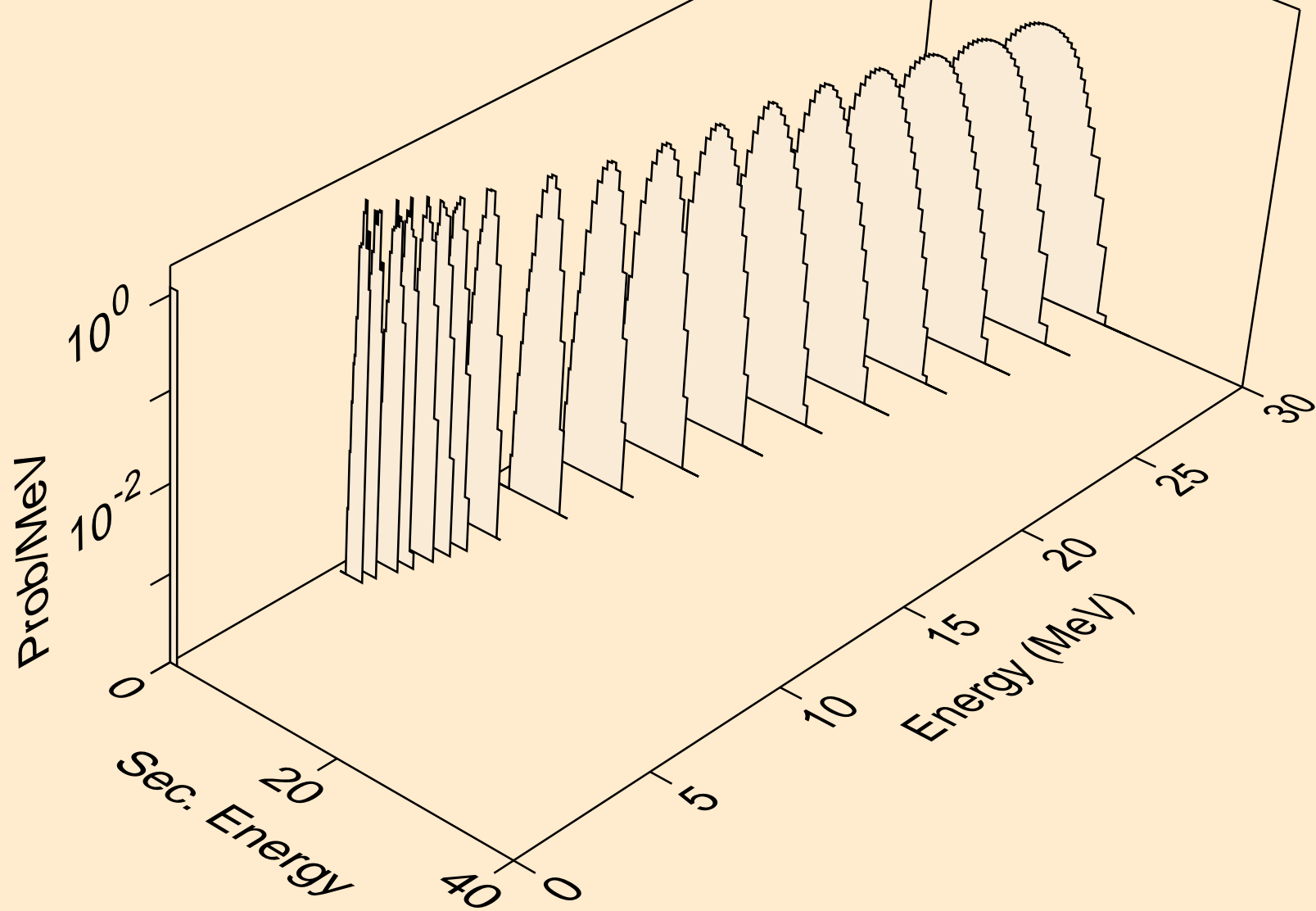

BA118 NEUTRON ACER TENDL-2023 LIBRARY; T=0.K  
tritons from (n,x)

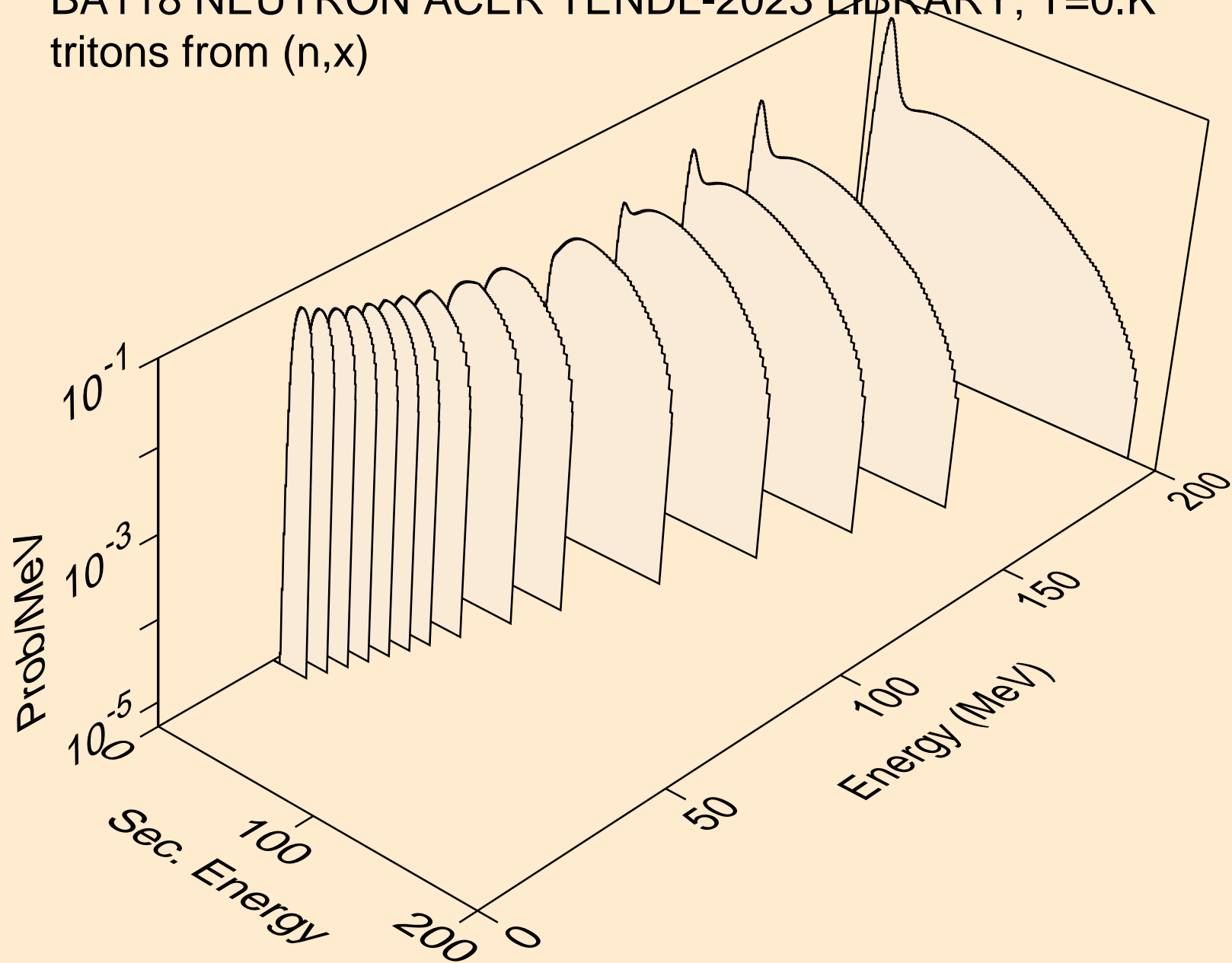

BA118 NEUTRON ACER TENDL-2023 LIBRARY; T=0.K  
tritons from (n,n\*)t

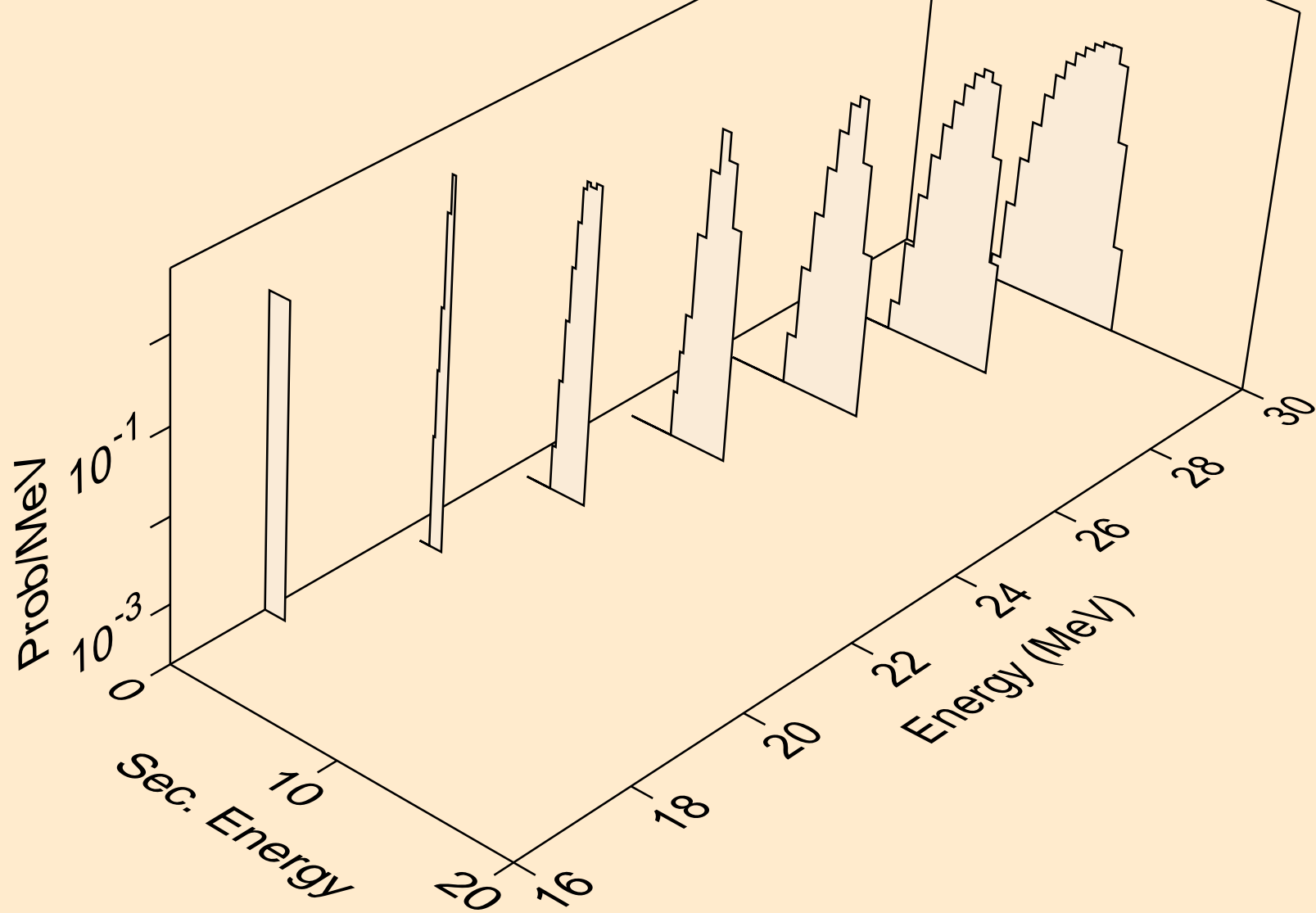

BA118 NEUTRON ACER TENDL-2023 LIBRARY; T=0.K  
tritons from (n,t)

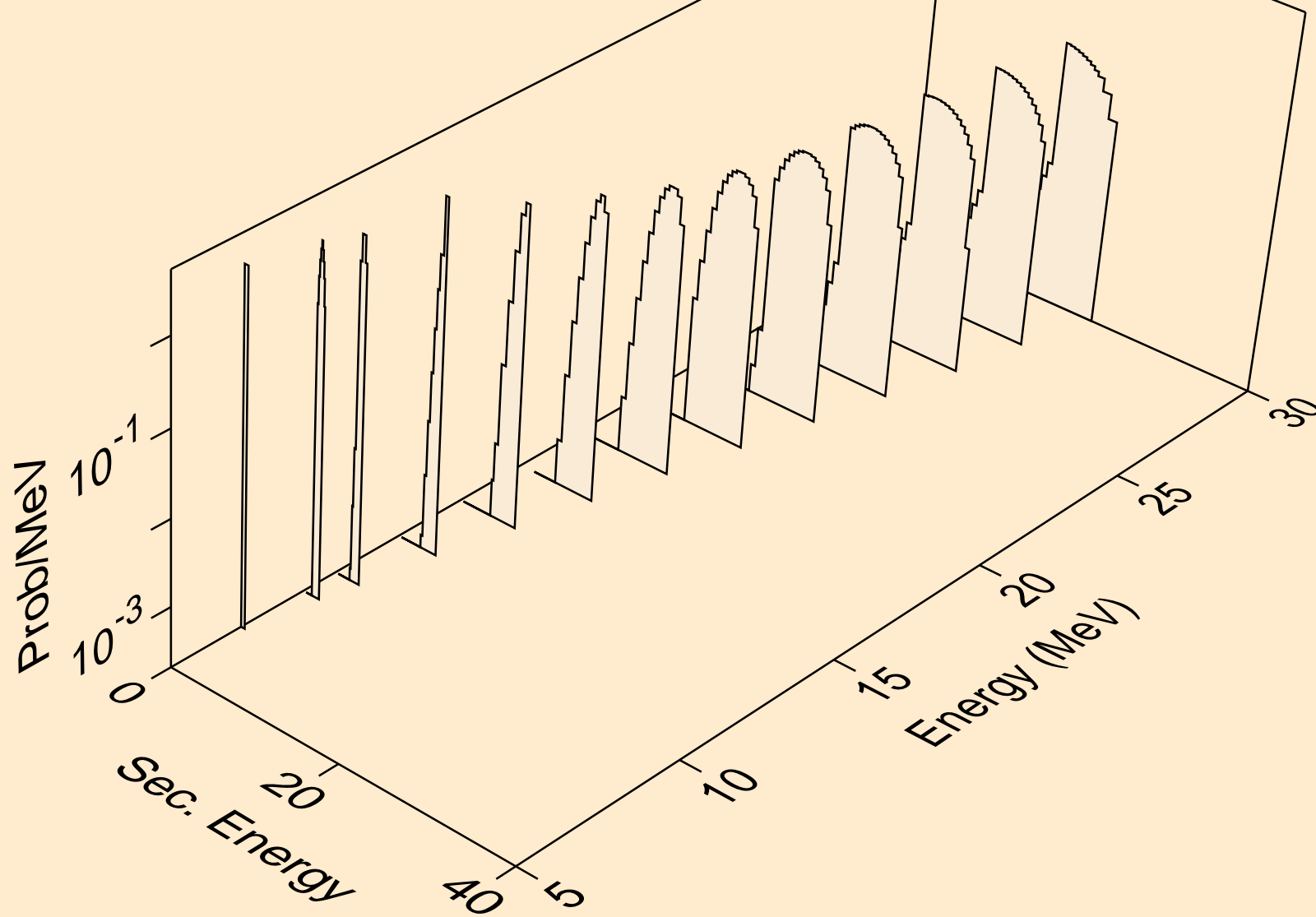



BA118 NEUTRON ACER TENDL-2023 LIBRARY; T=0.K  
tritons from (n,pt)

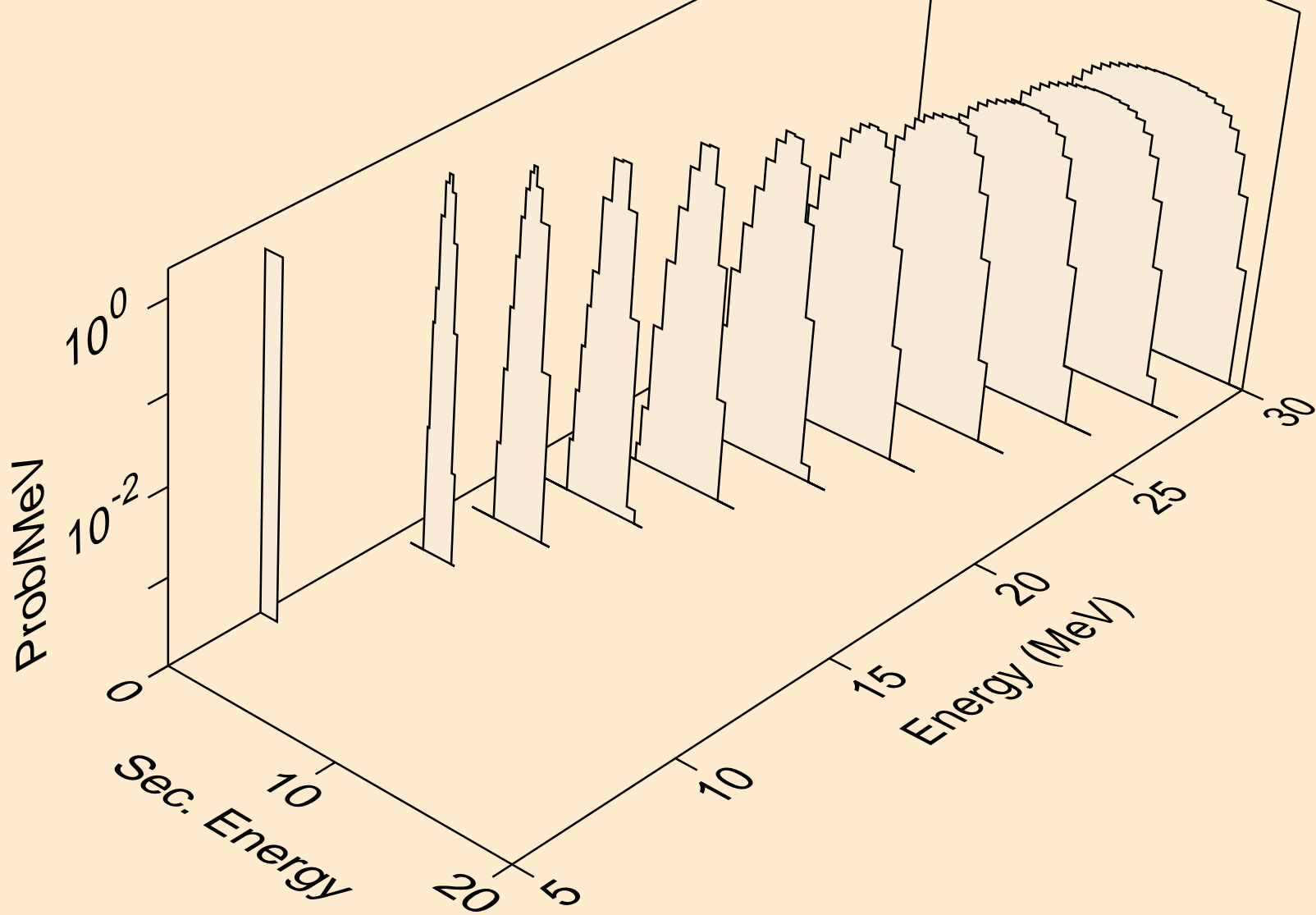

BA118 NEUTRON ACER TENDL-2023 LIBRARY; T=0.K  
he3s from (n,x)

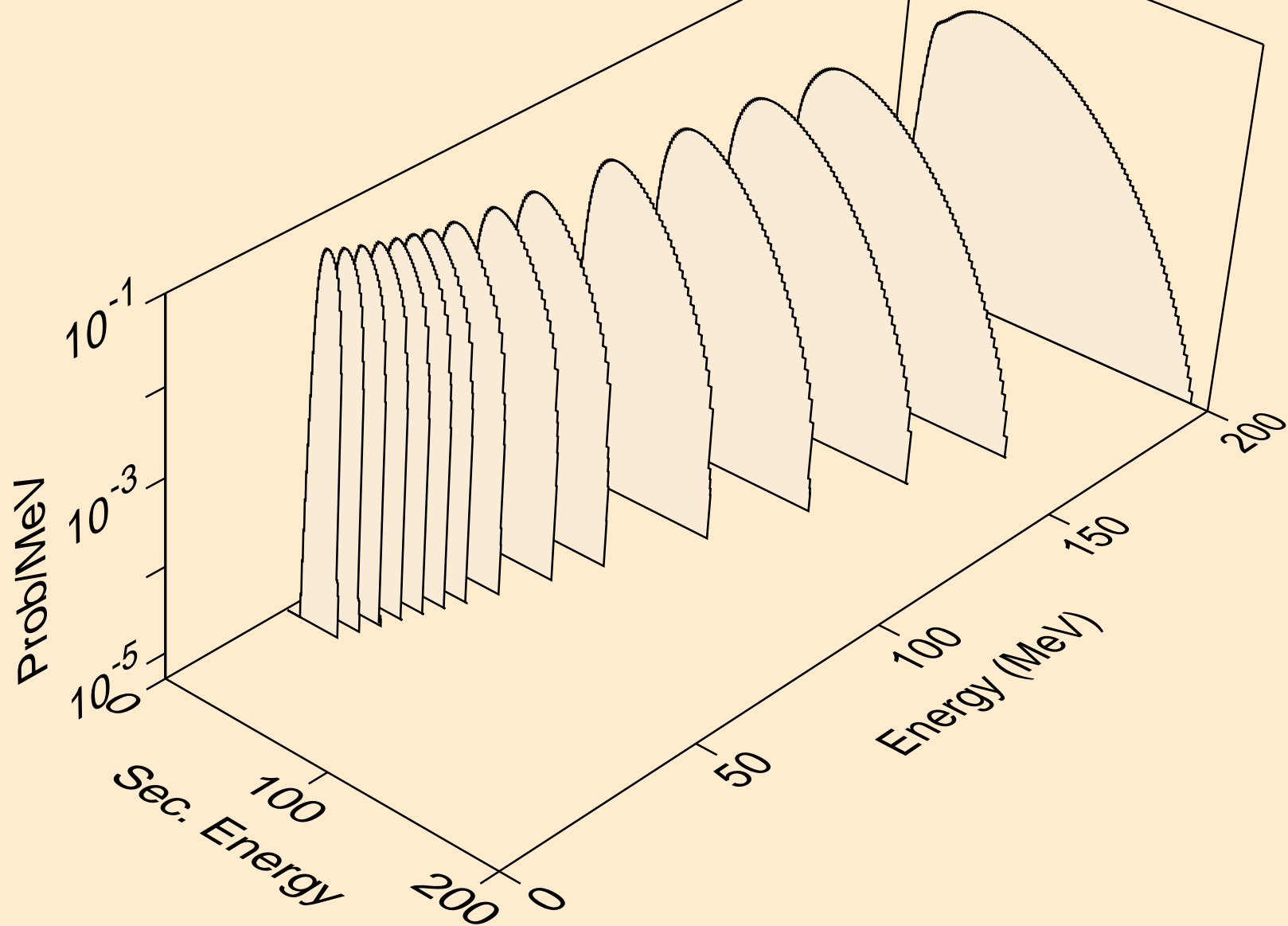

BA118 NEUTRON ACER TENDL-2023 LIBRARY; T=0.K  
he3s from (n,n\*)he3

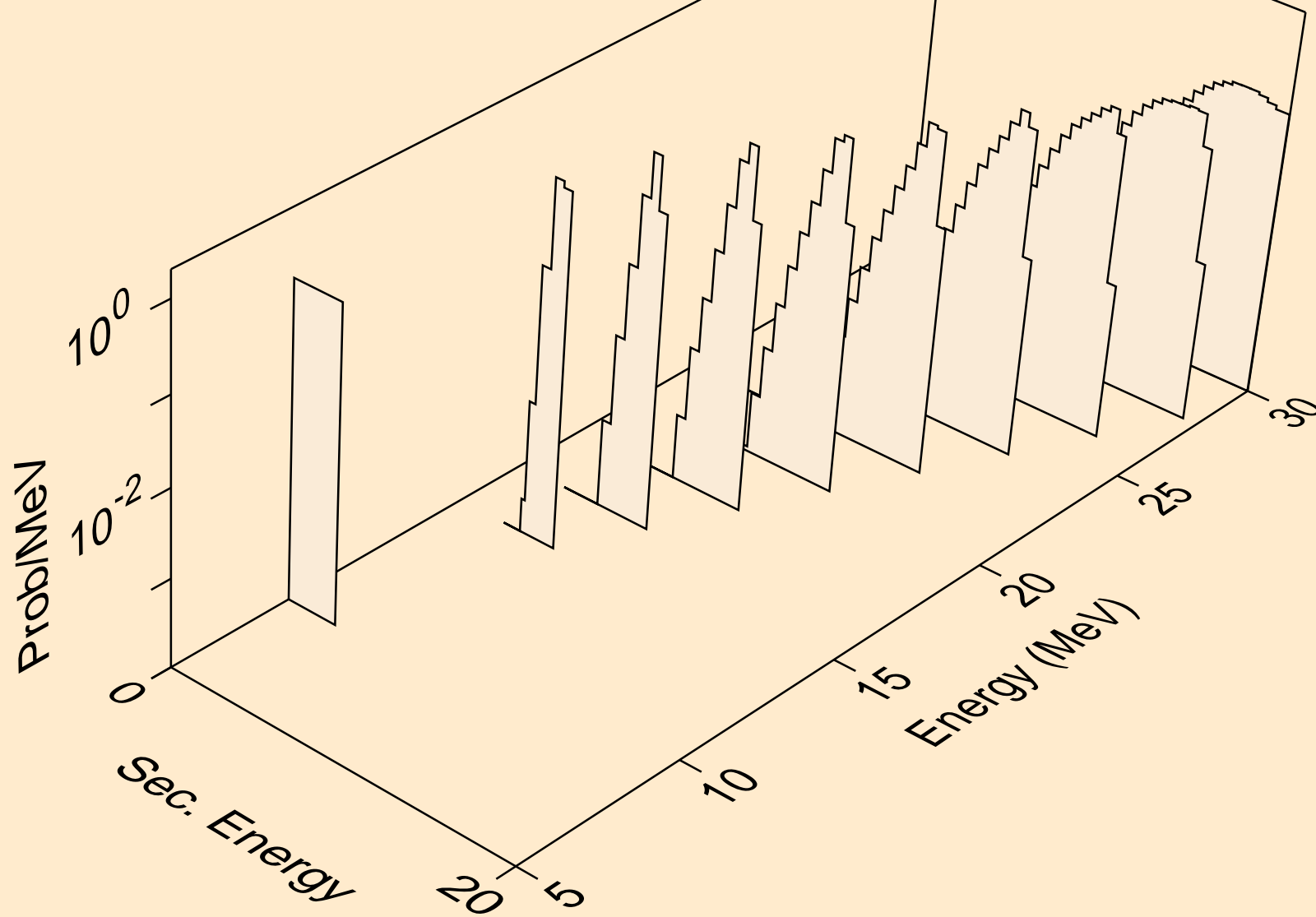

BA118 NEUTRON ACER TENDL-2023 LIBRARY; T=0.K  
he3s from (n,he3)

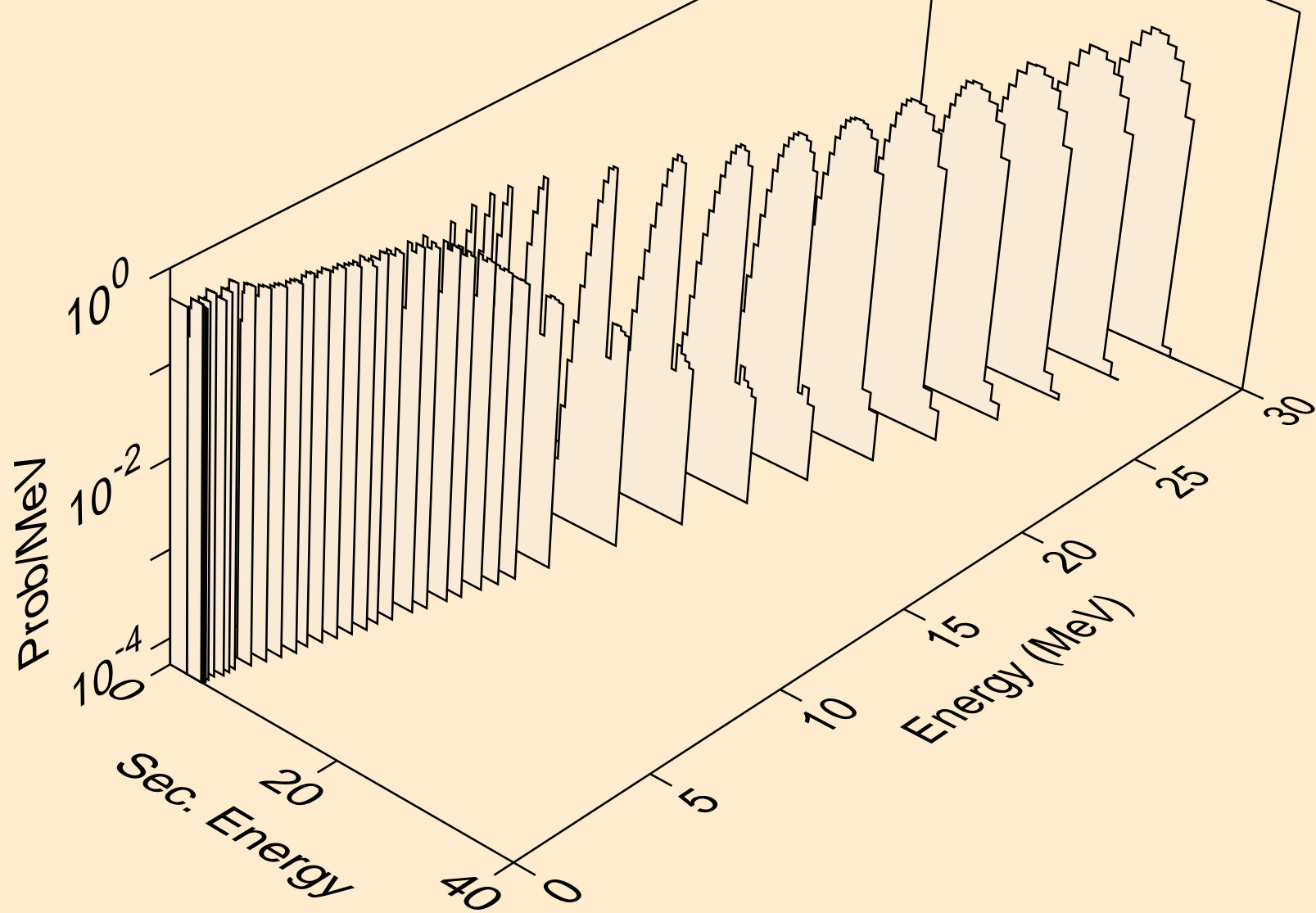

BA118 NEUTRON ACER TENDL-2023 LIBRARY; T=0.K  
alphas from (n,x)

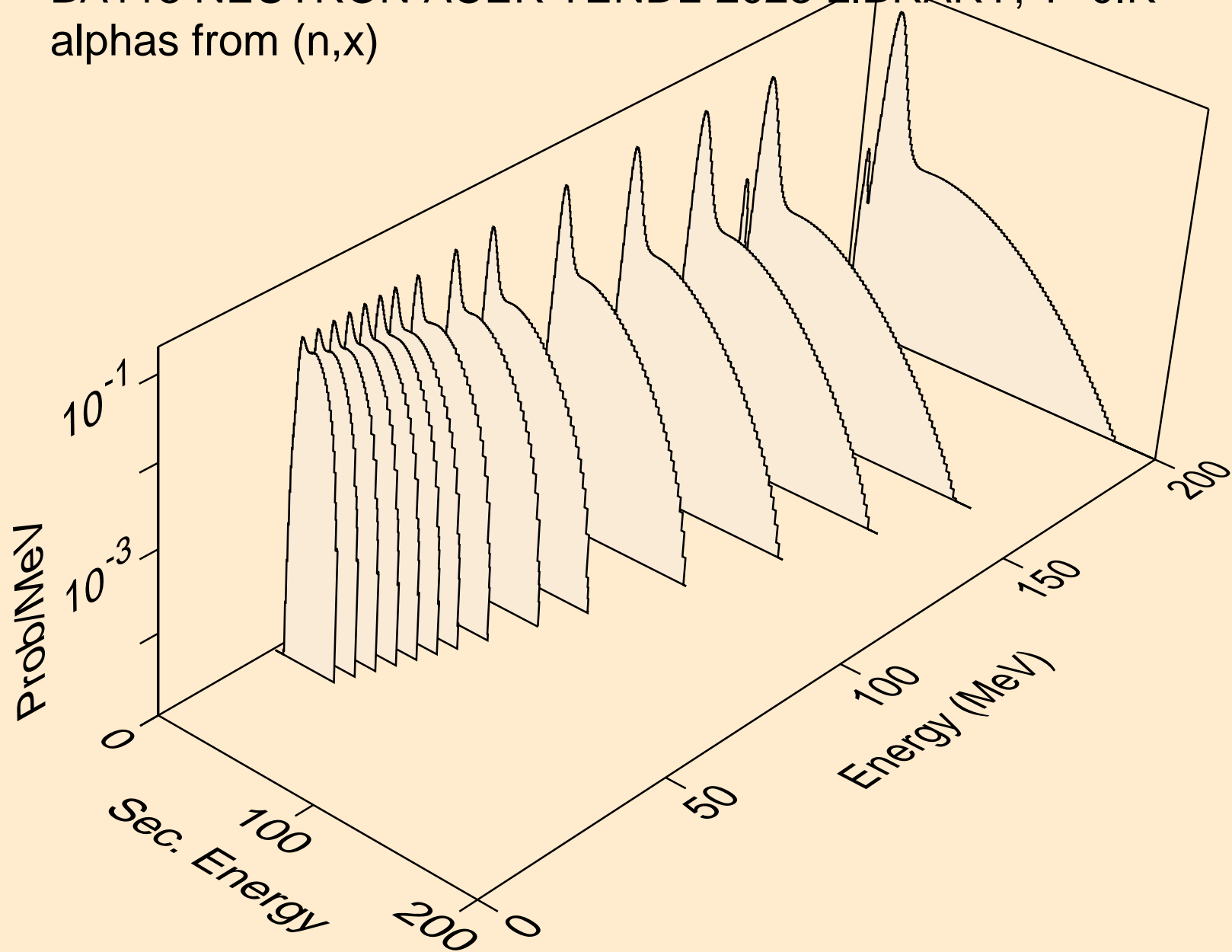

BA118 NEUTRON ACER TENDL-2023 LIBRARY; T=0.K  
alphas from (n,n\*)a

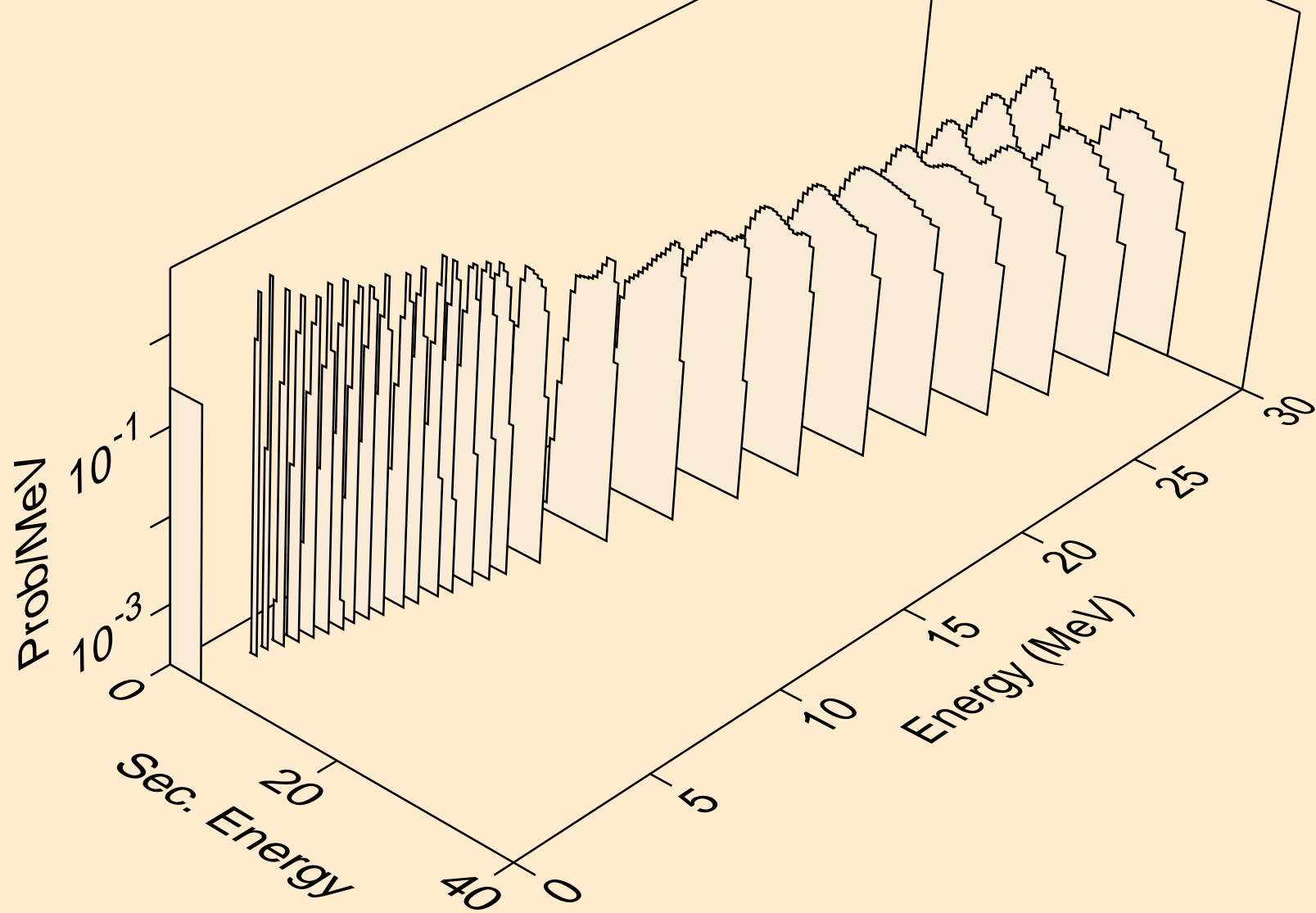

BA118 NEUTRON ACER TENDL-2023 LIBRARY; T=0.K  
alphas from (n,n\*)3a

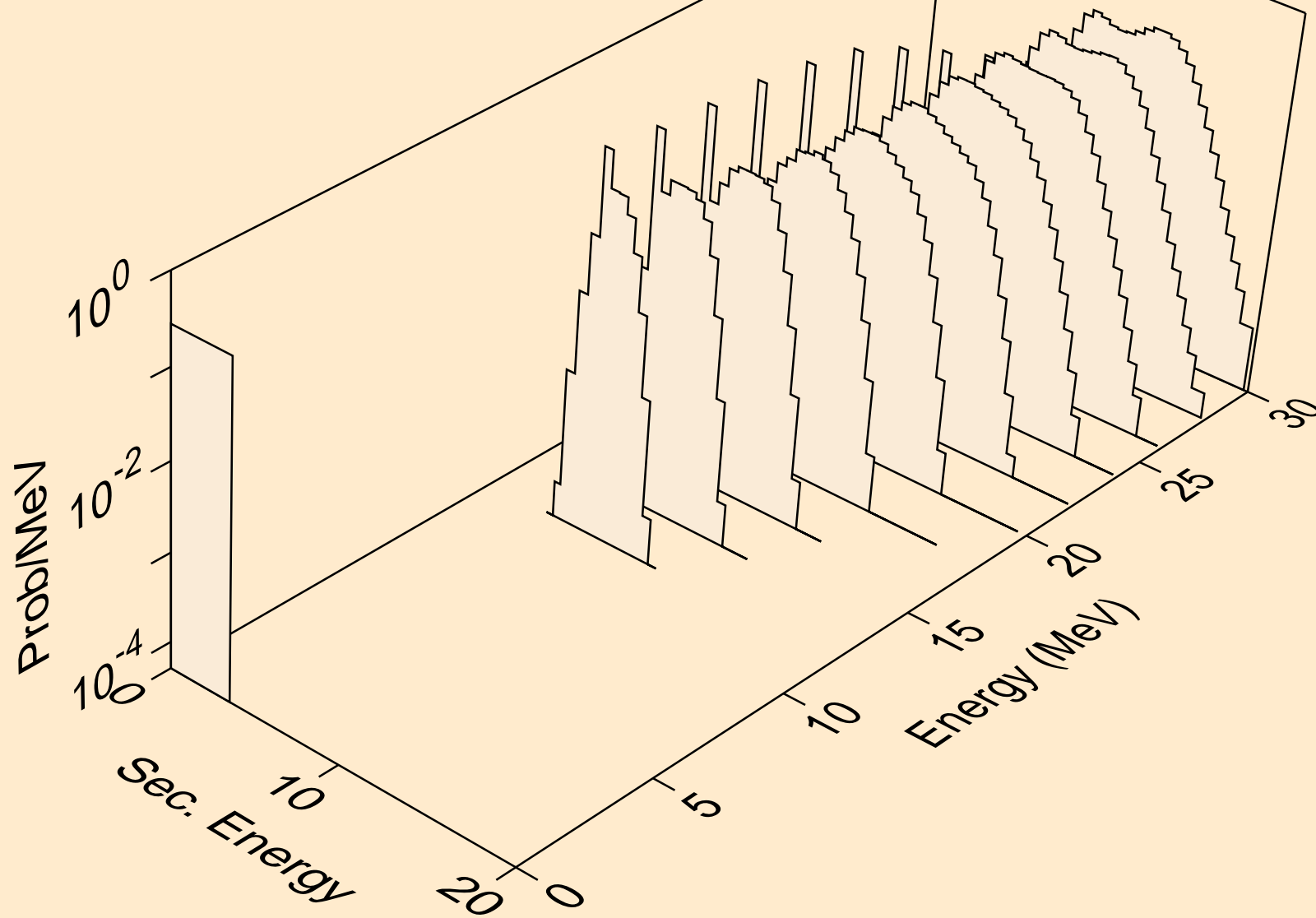

BA118 NEUTRON ACER TENDL-2023 LIBRARY; T=0.K  
alphas from (n,2n)a

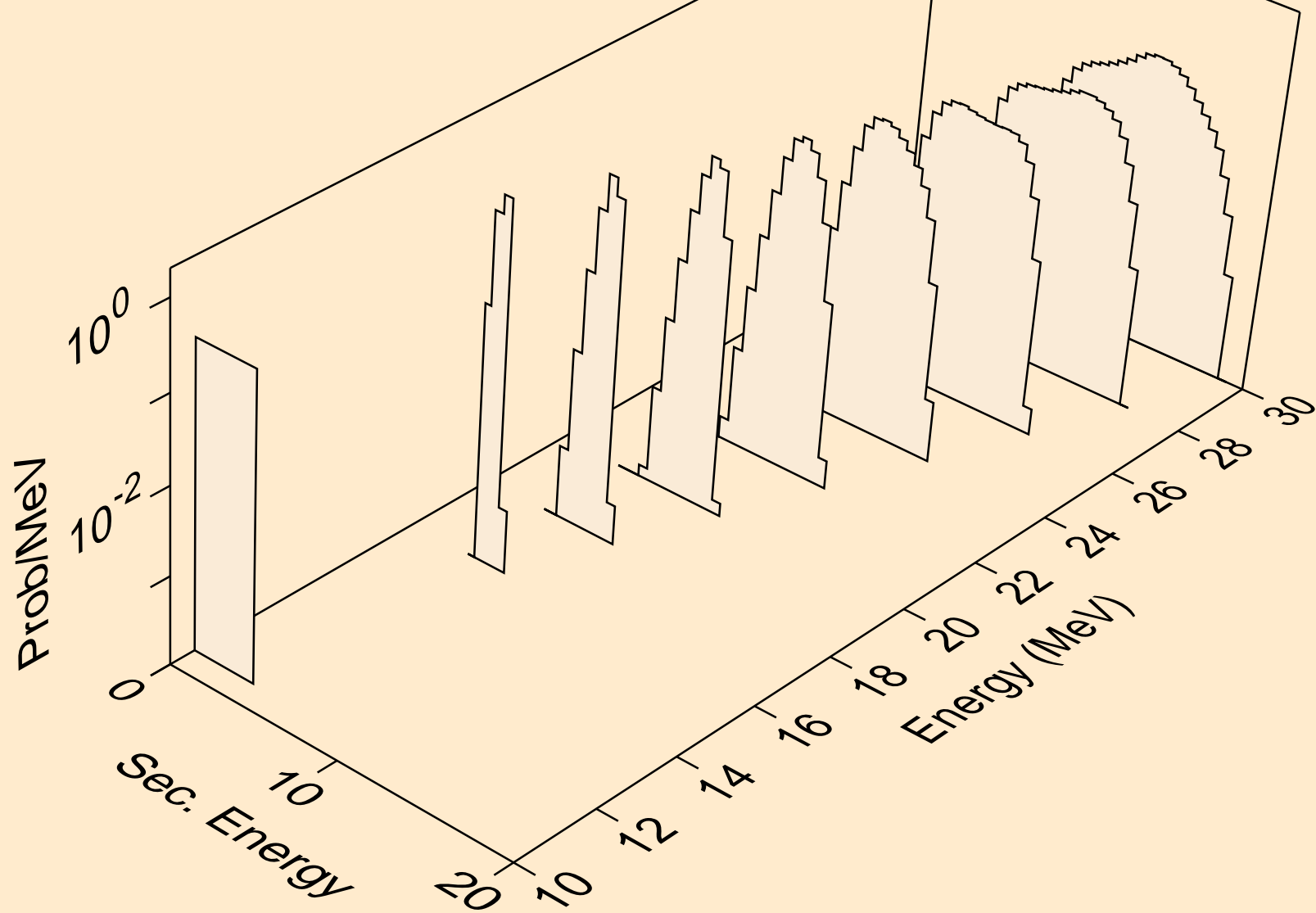



BA118 NEUTRON ACER TENDL-2023 LIBRARY; T=0.K  
alphas from (n,n\*)2a

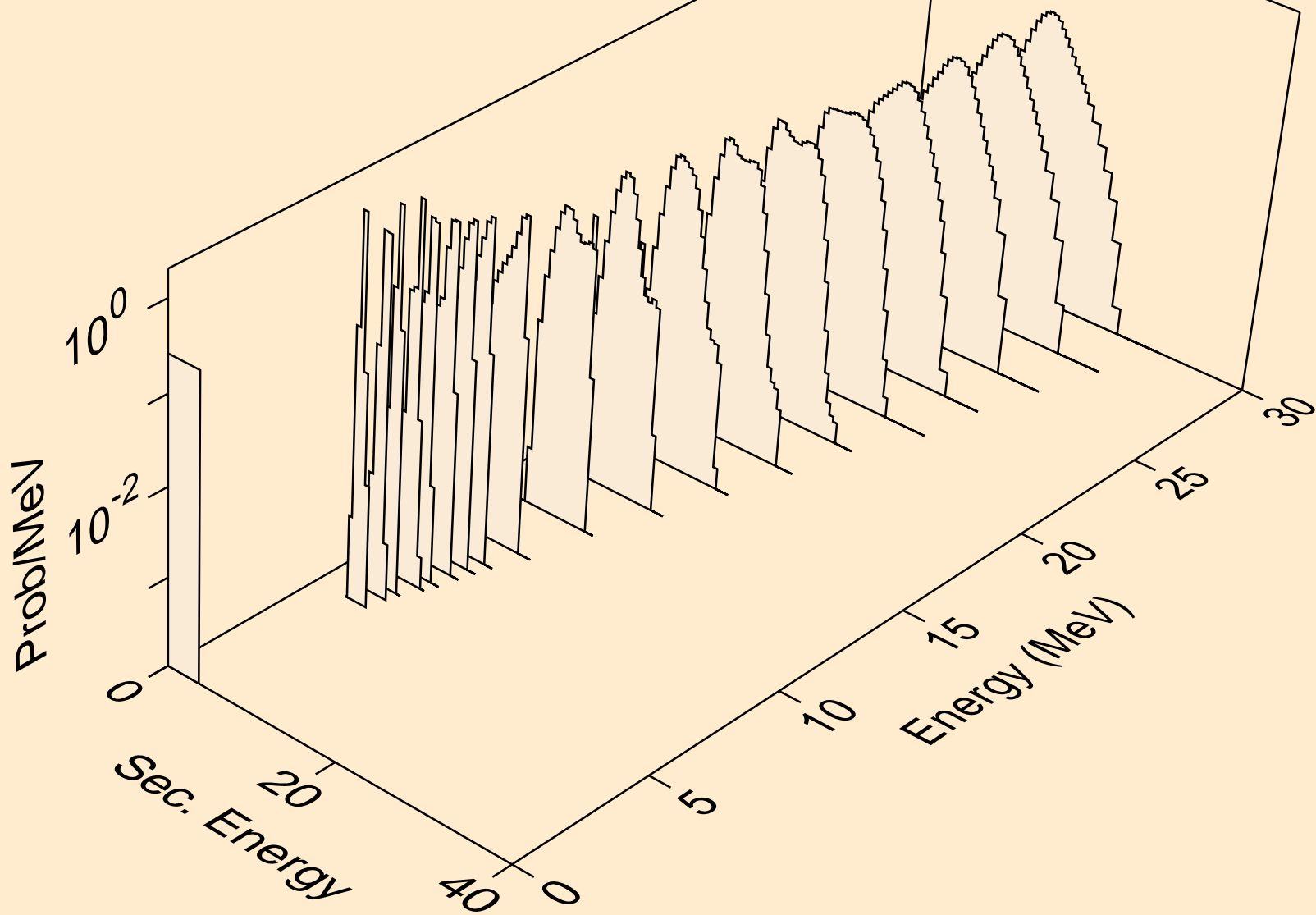

BA118 NEUTRON ACER TENDL-2023 LIBRARY; T=0.K  
alphas from (n,2n)2a

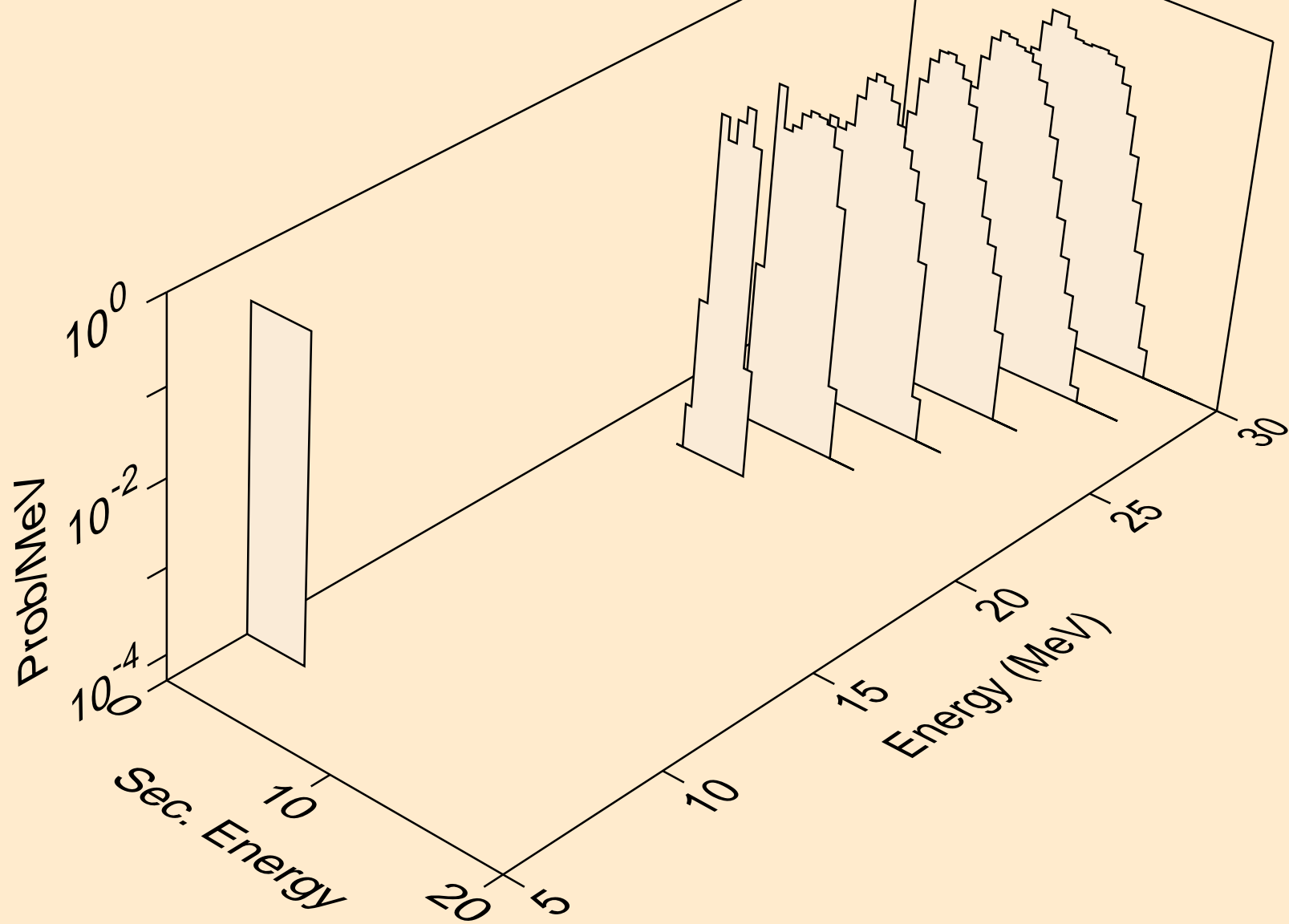

BA118 NEUTRON ACER TENDL-2023 LIBRARY; T=0.K  
alphas from (n,npa)

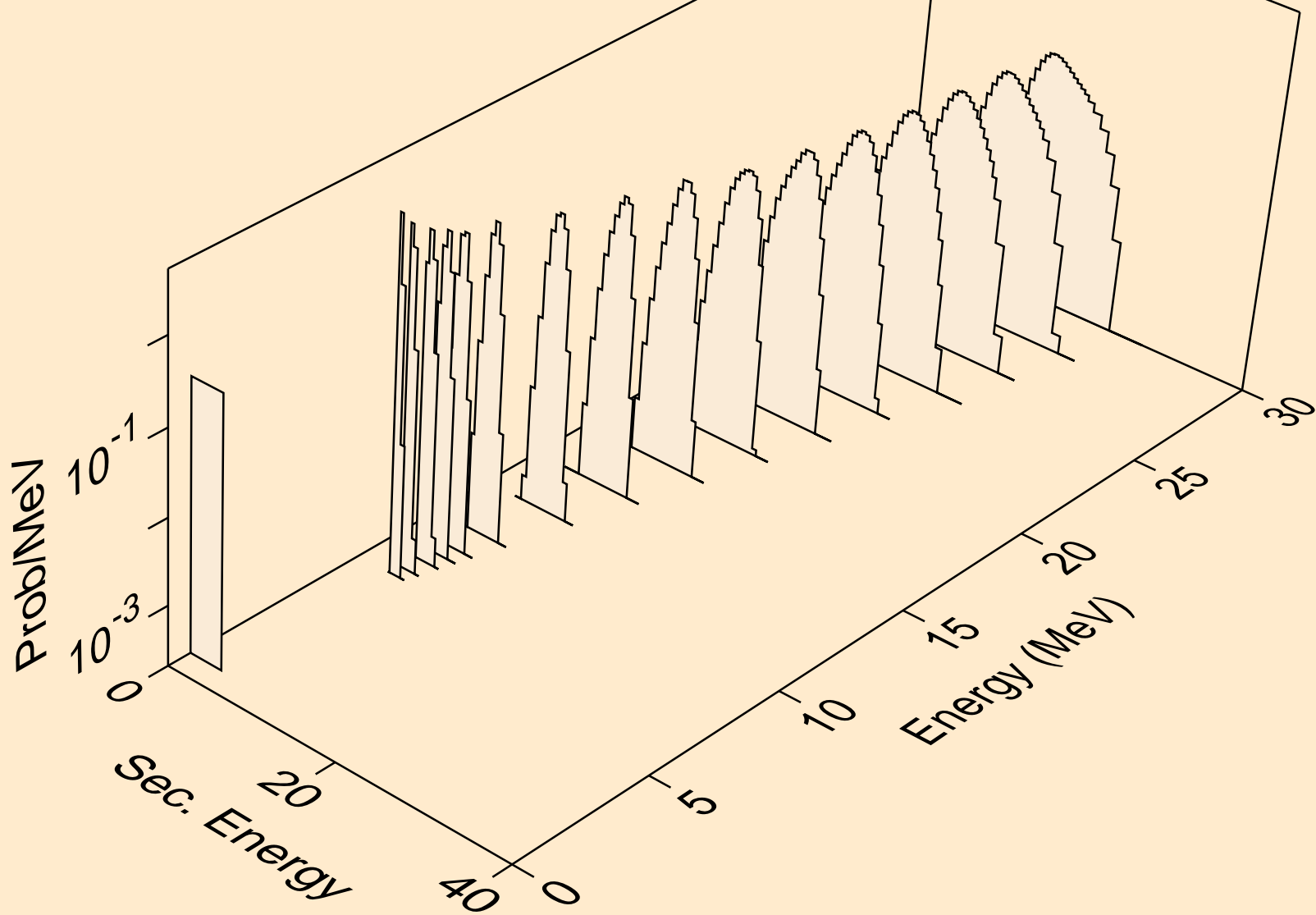

BA118 NEUTRON ACER TENDL-2023 LIBRARY; T=0.K  
alphas from (n,a)

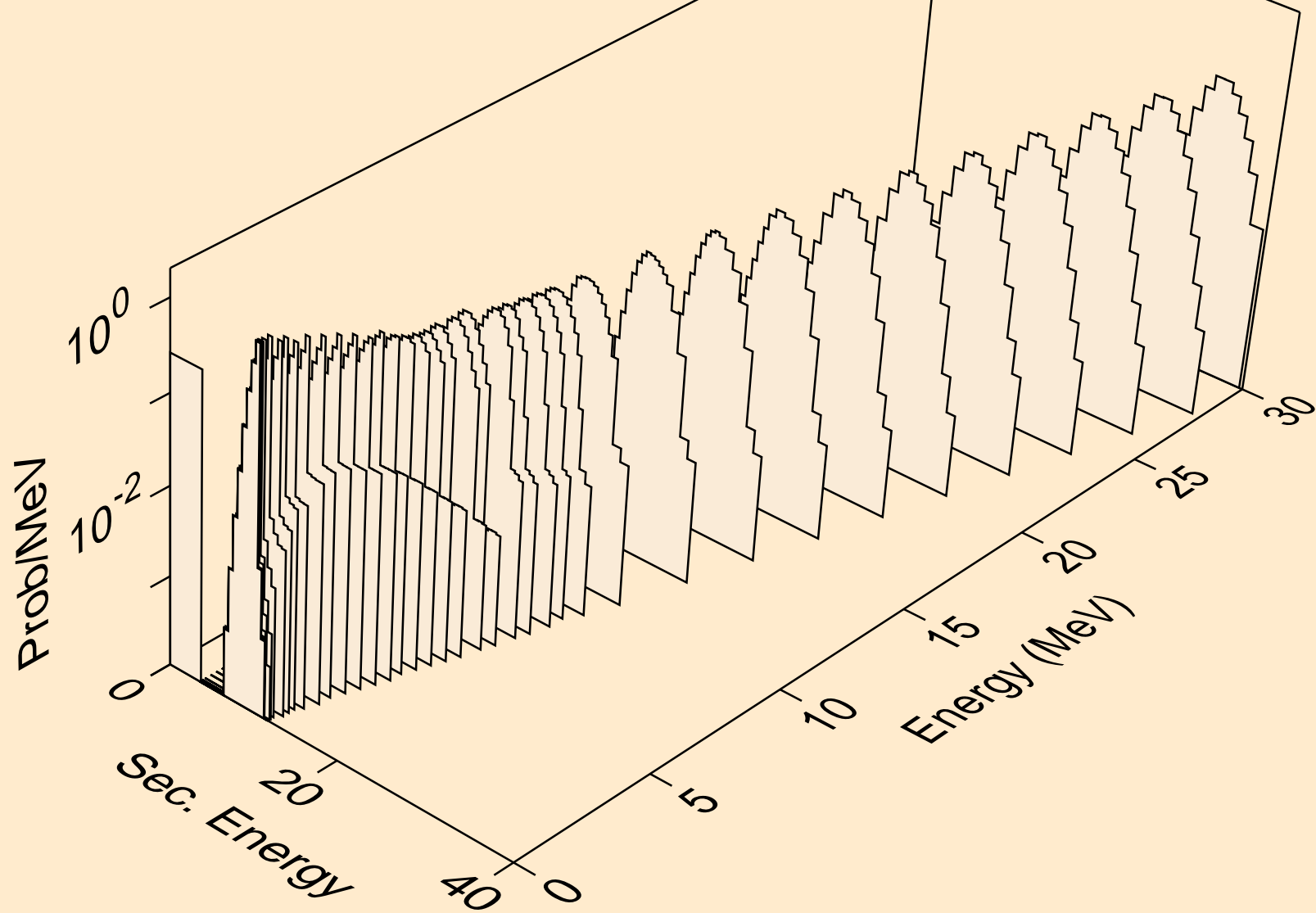

BA118 NEUTRON ACER TENDL-2023 LIBRARY; T=0.K  
alphas from (n,2a)

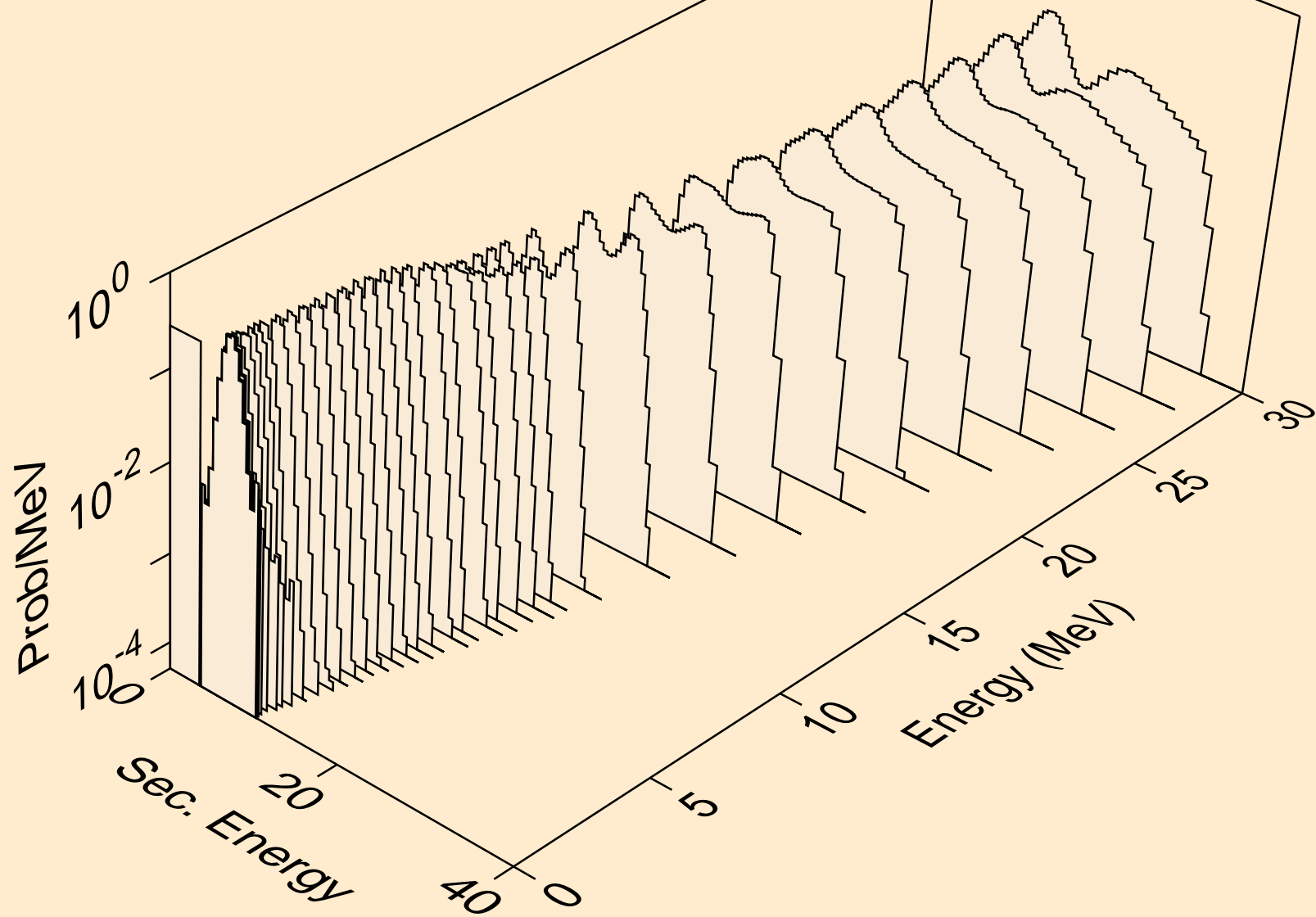

BA118 NEUTRON ACER TENDL-2023 LIBRARY; T=0.K  
alphas from (n,3a)

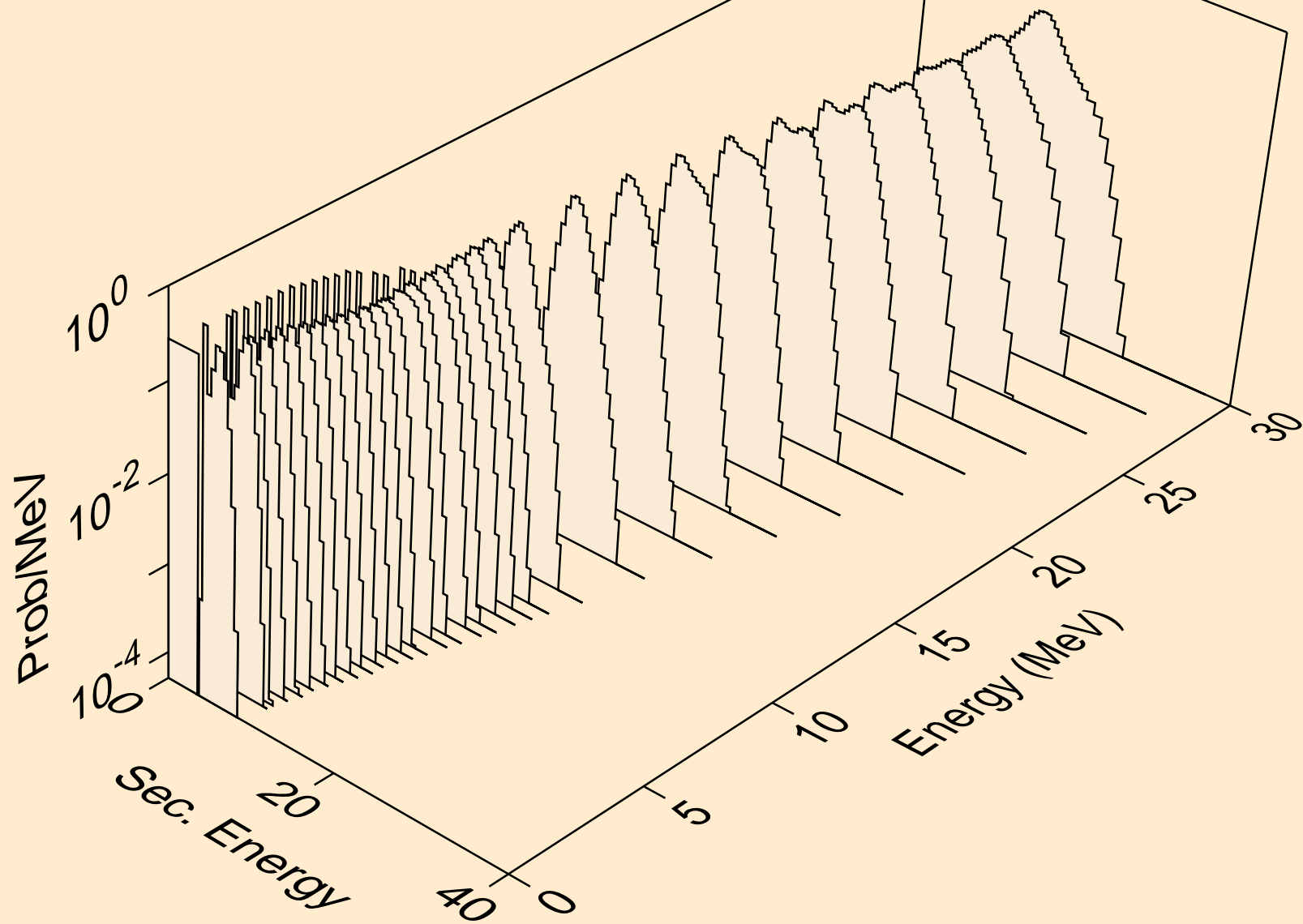

BA118 NEUTRON ACER TENDL-2023 LIBRARY; T=0.K  
alphas from (n,pa)

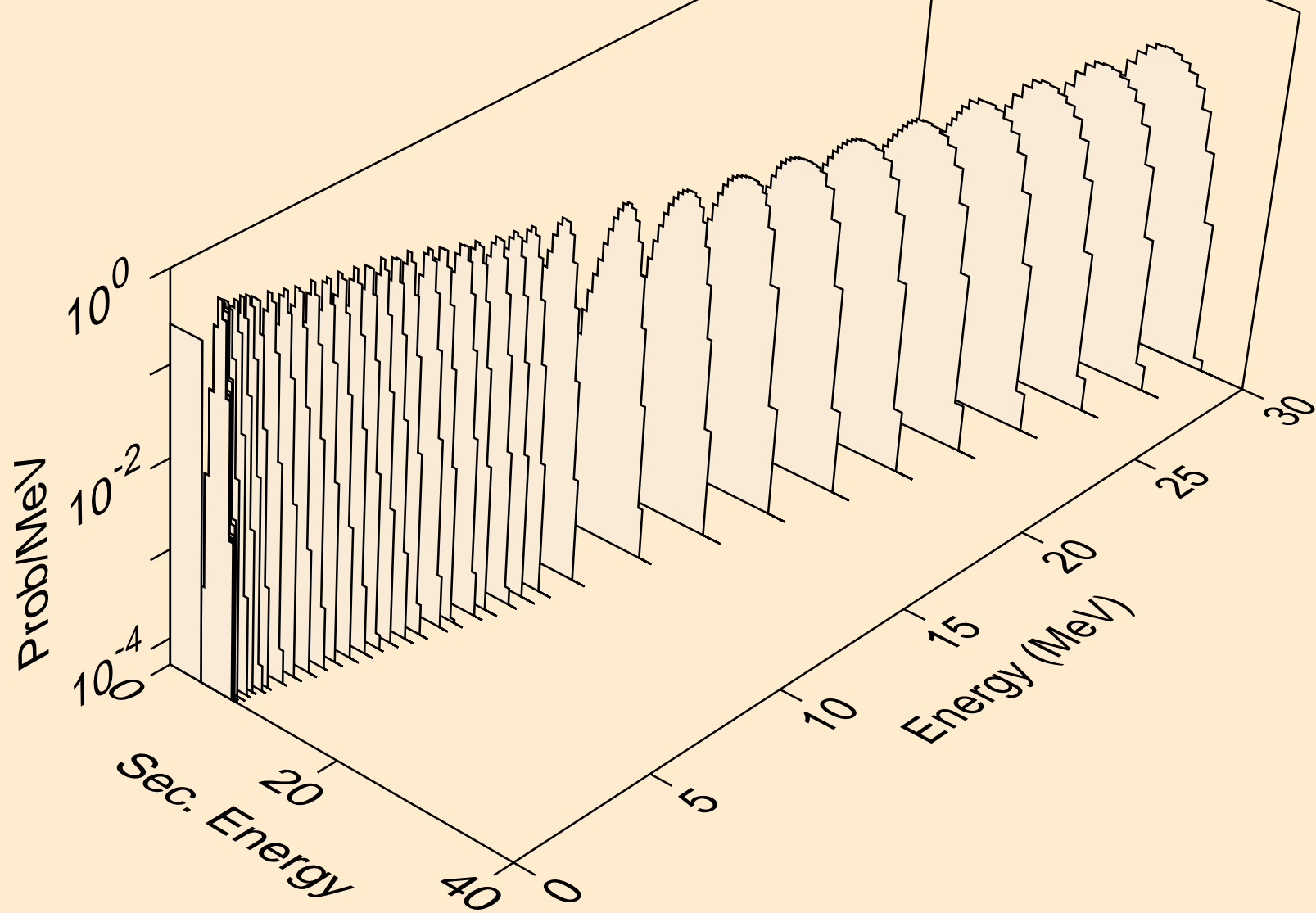

BA118 NEUTRON ACER TENDL-2023 LIBRARY; T=0.K  
alphas from (n,d2a)

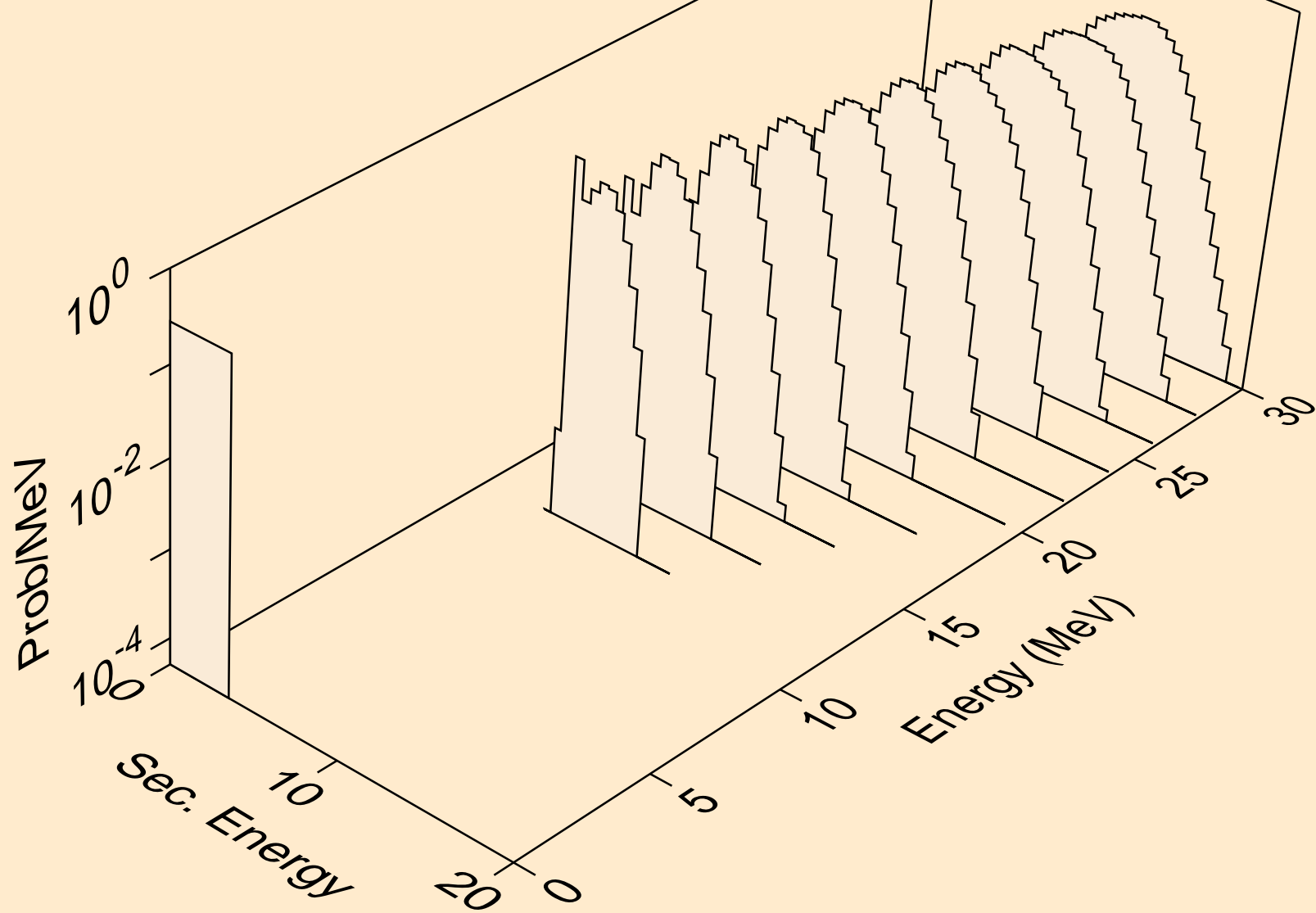



BA118 NEUTRON ACER TENDL-2023 LIBRARY; T=0.K  
alphas from (n,da)

