

BK254 NEUTRON ACER TENDL-2023 LIBRARY; T=0.K
Principal cross sections

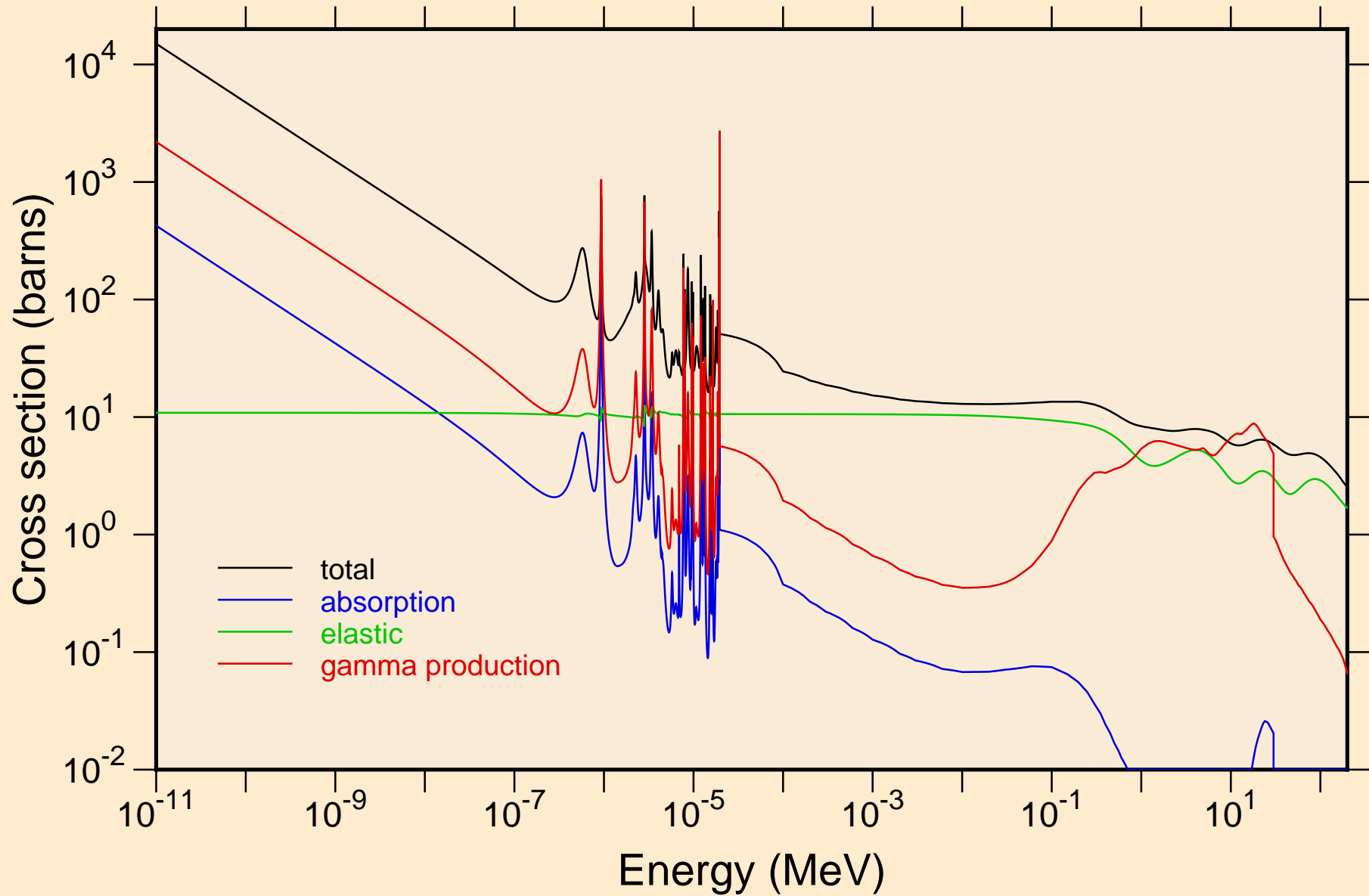

BK254 NEUTRON ACER TENDL-2023 LIBRARY; T=0.K
resonance total cross section

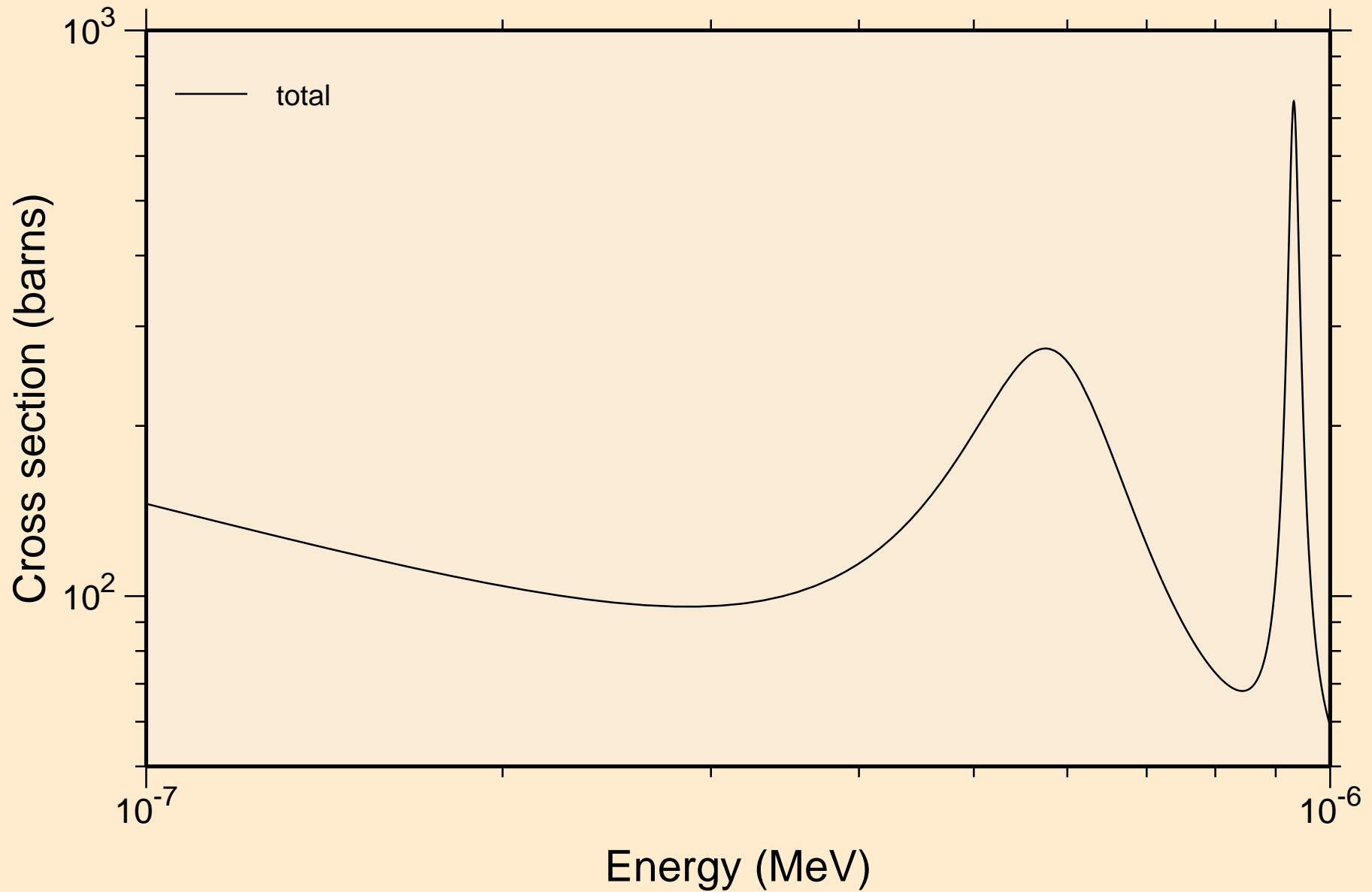

BK254 NEUTRON ACER TENDL-2023 LIBRARY; T=0.K
resonance total cross section

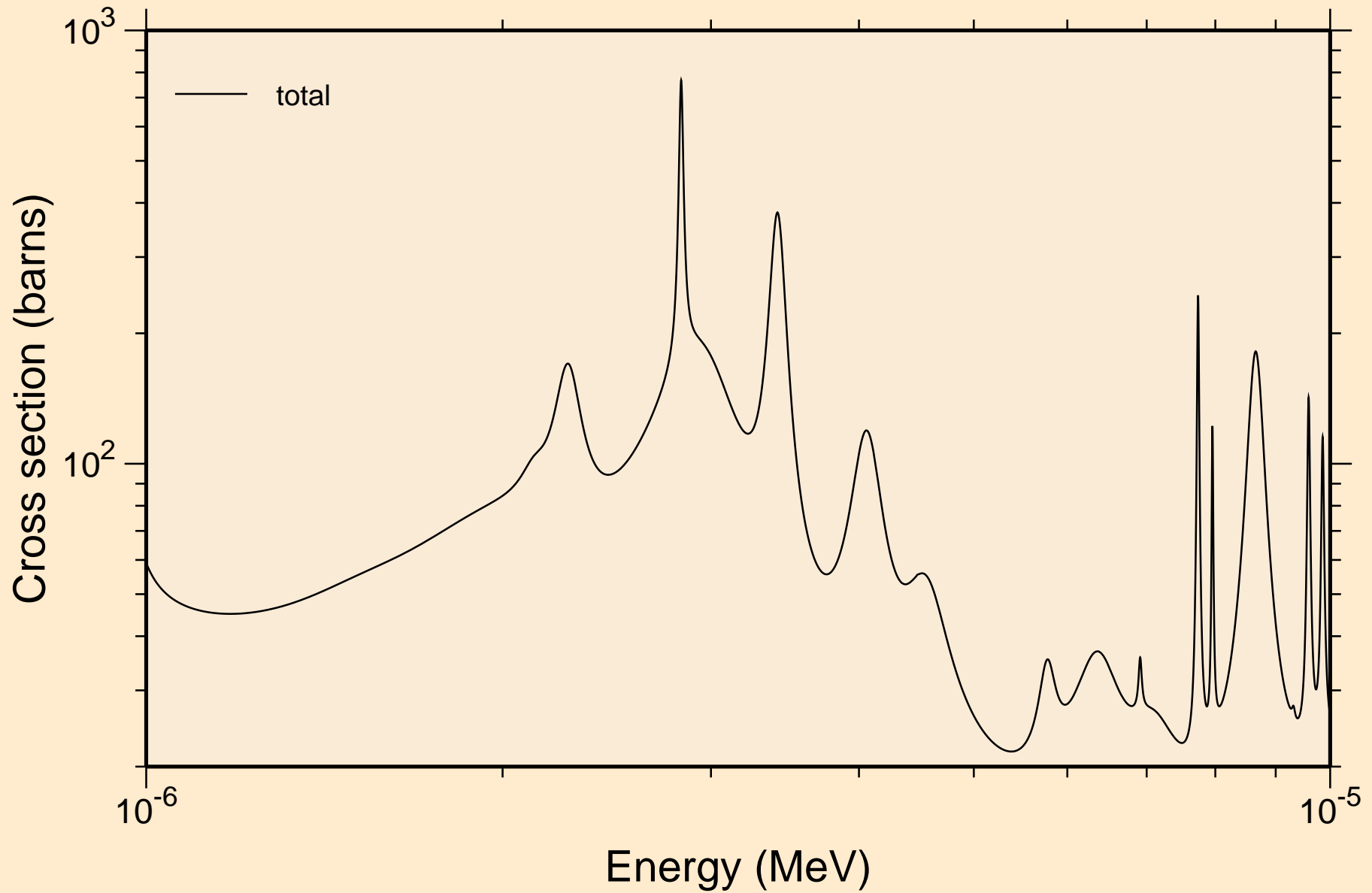

BK254 NEUTRON ACER TENDL-2023 LIBRARY; T=0.K
resonance total cross section

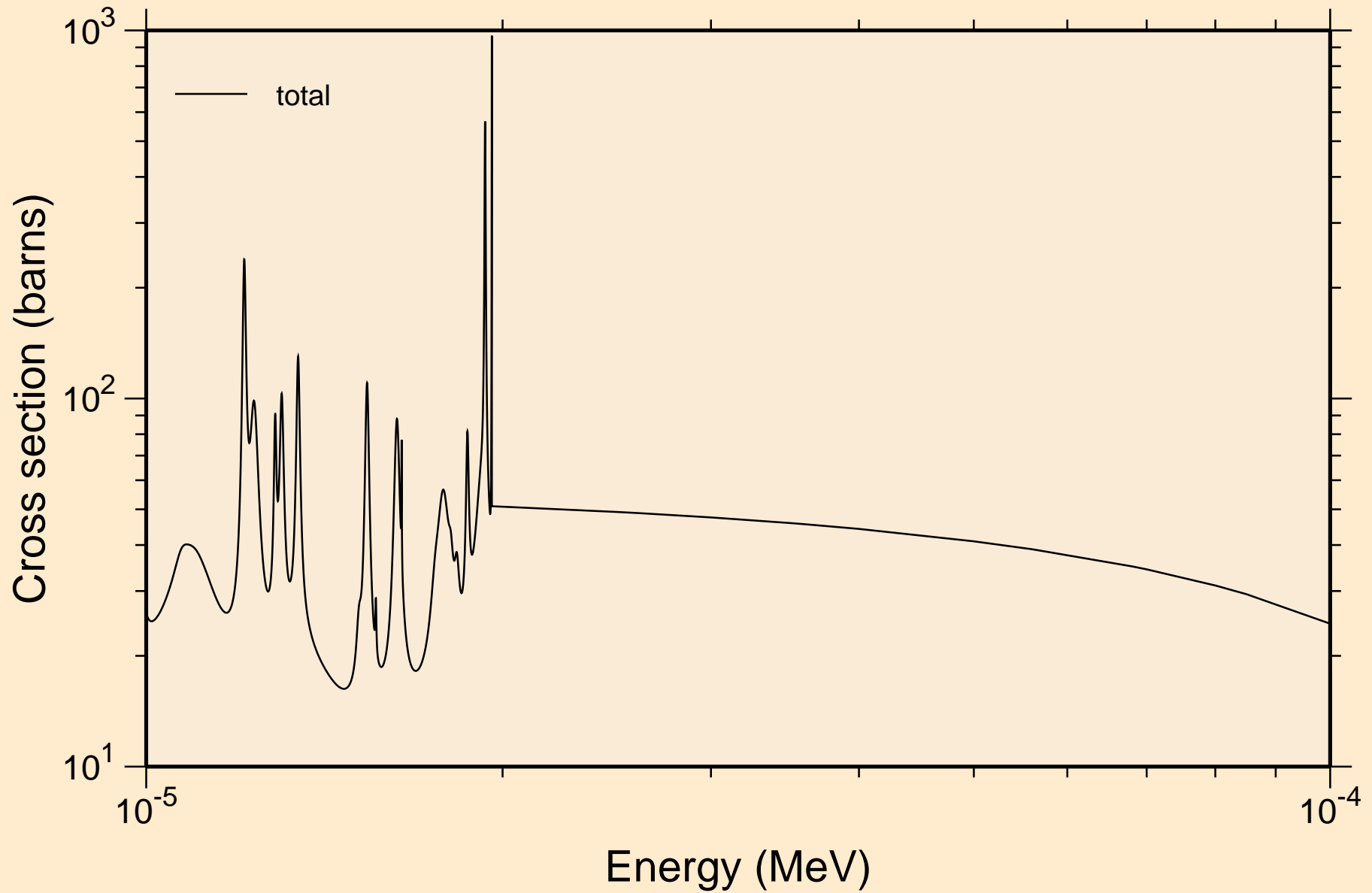

BK254 NEUTRON ACER TENDL-2023 LIBRARY; T=0.K
resonance total cross section

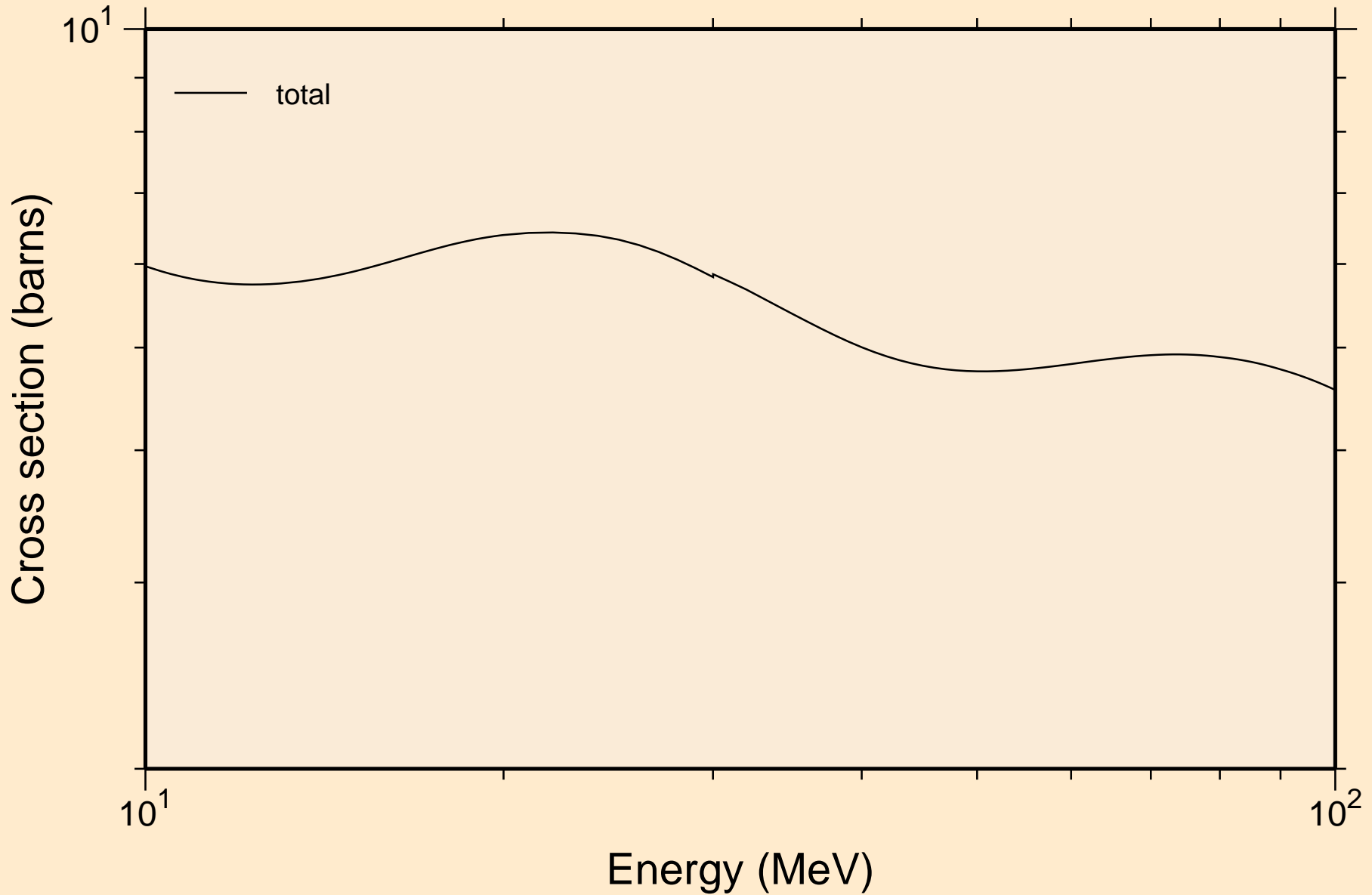

BK254 NEUTRON ACER TENDL-2023 LIBRARY; T=0.K
resonance absorption cross sections

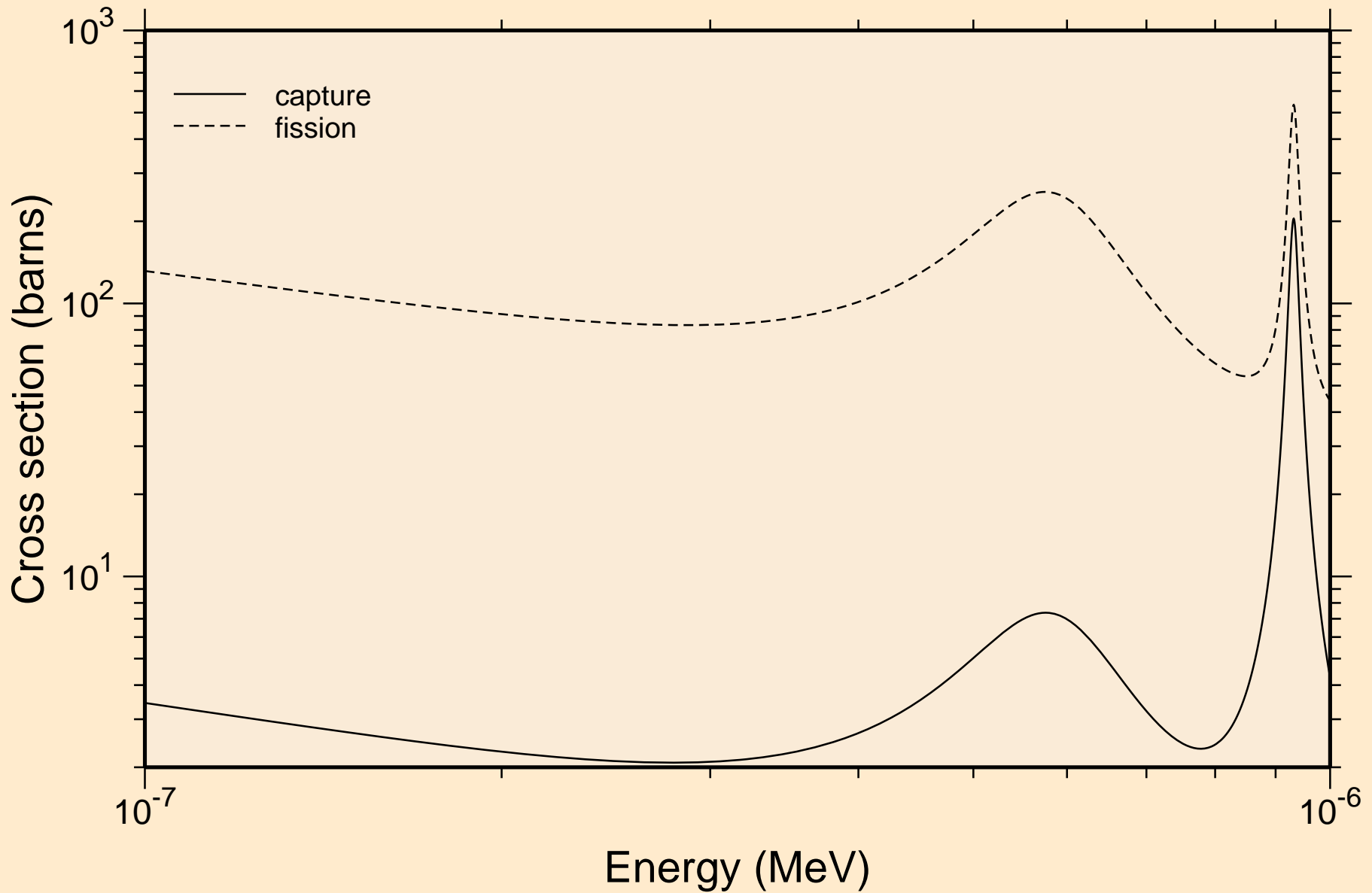

BK254 NEUTRON ACER TENDL-2023 LIBRARY; T=0.K
resonance absorption cross sections

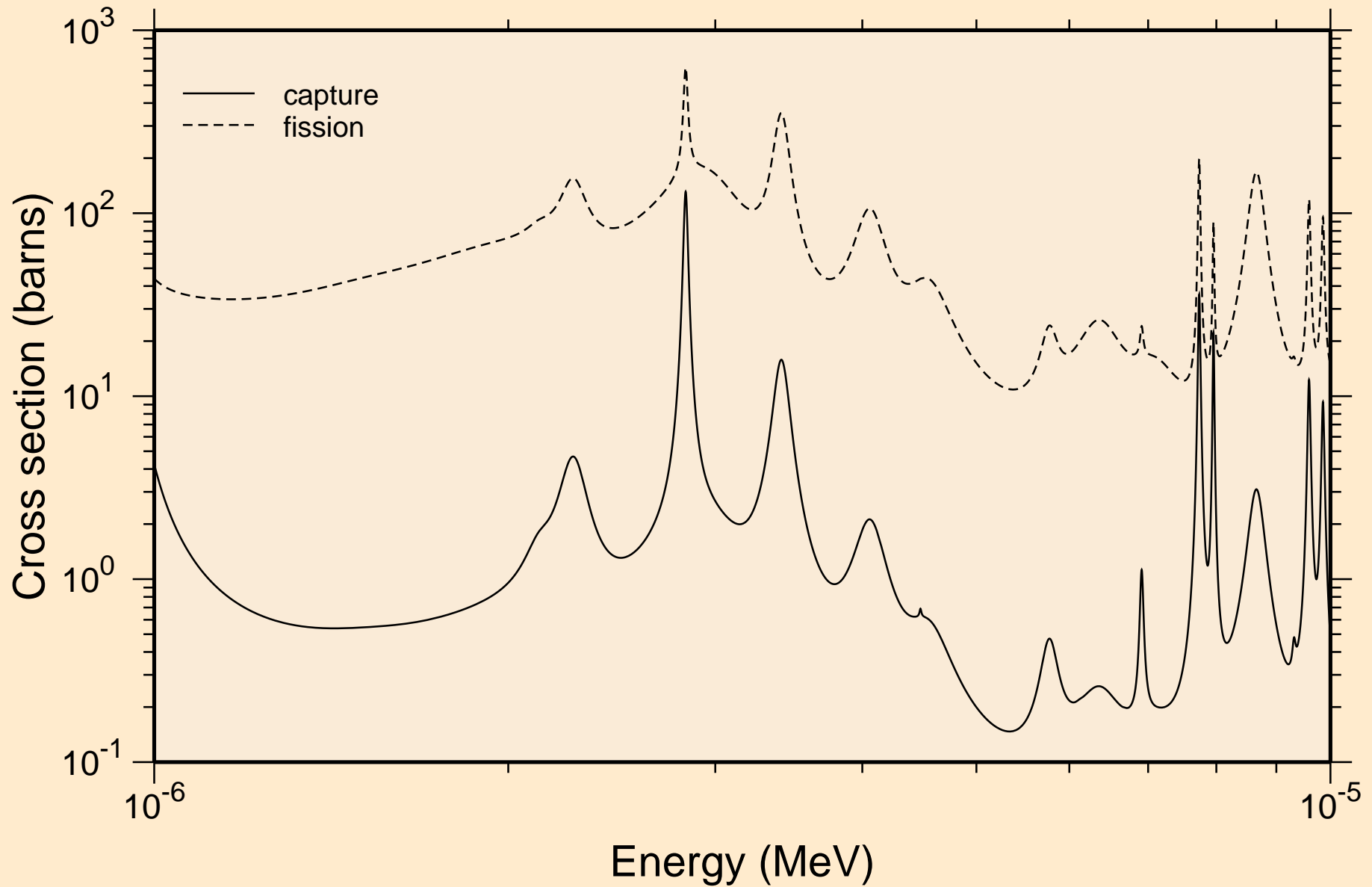

BK254 NEUTRON ACER TENDL-2023 LIBRARY; T=0.K
resonance absorption cross sections

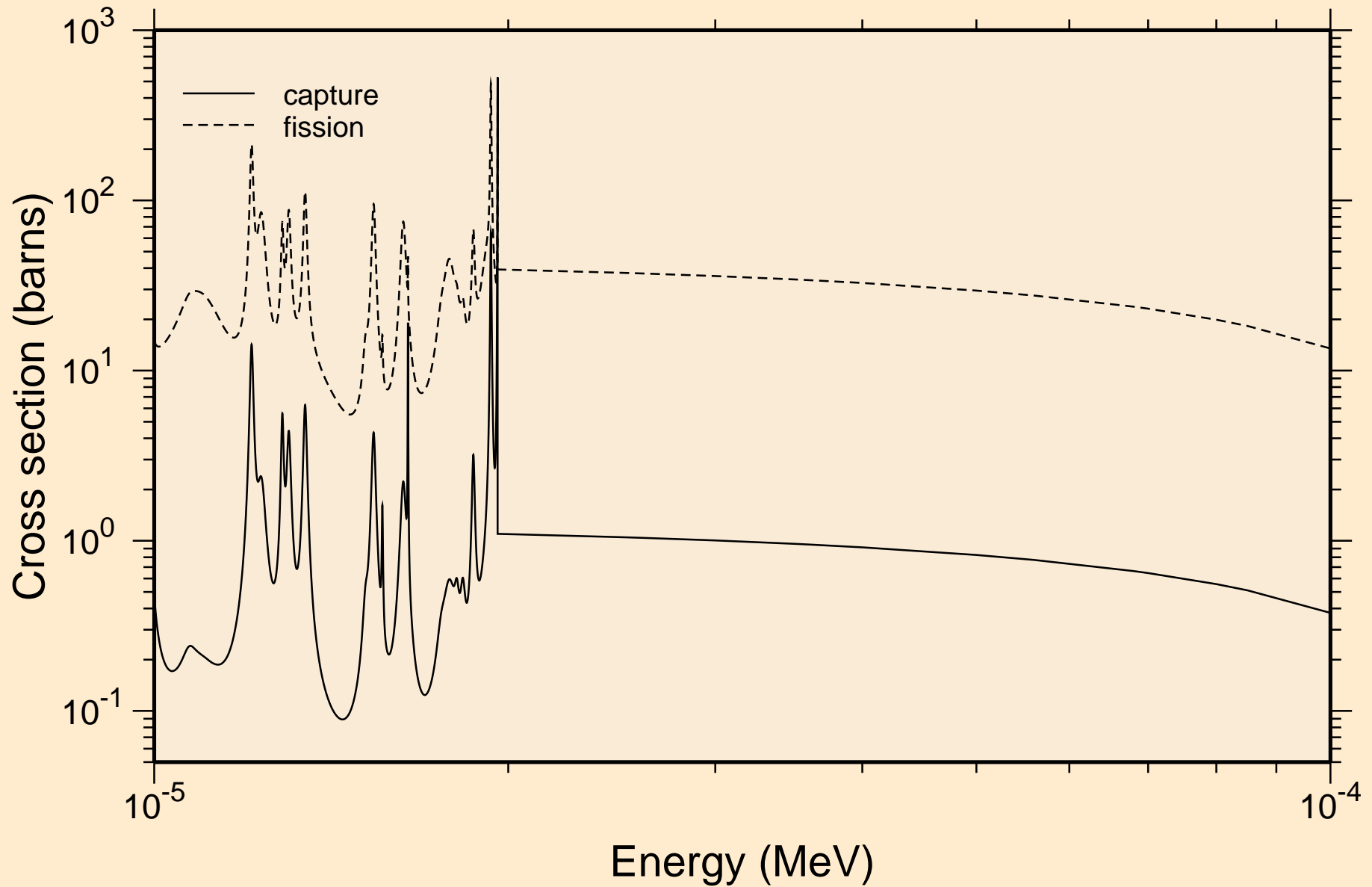

BK254 NEUTRON ACER TENDL-2023 LIBRARY; T=0.K
resonance absorption cross sections

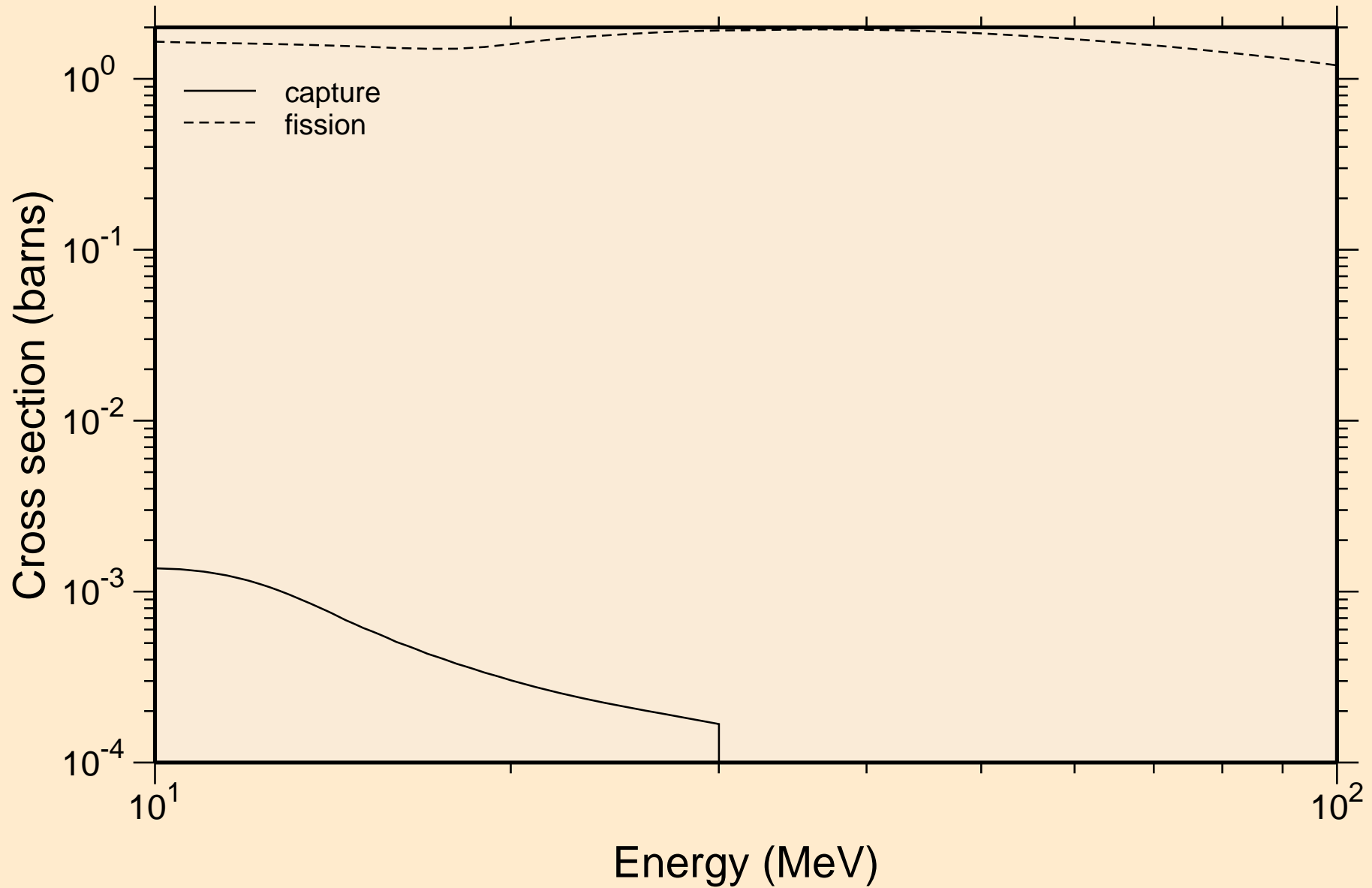

BK254 NEUTRON ACER TENDL-2023 LIBRARY; T=0.K

Heating

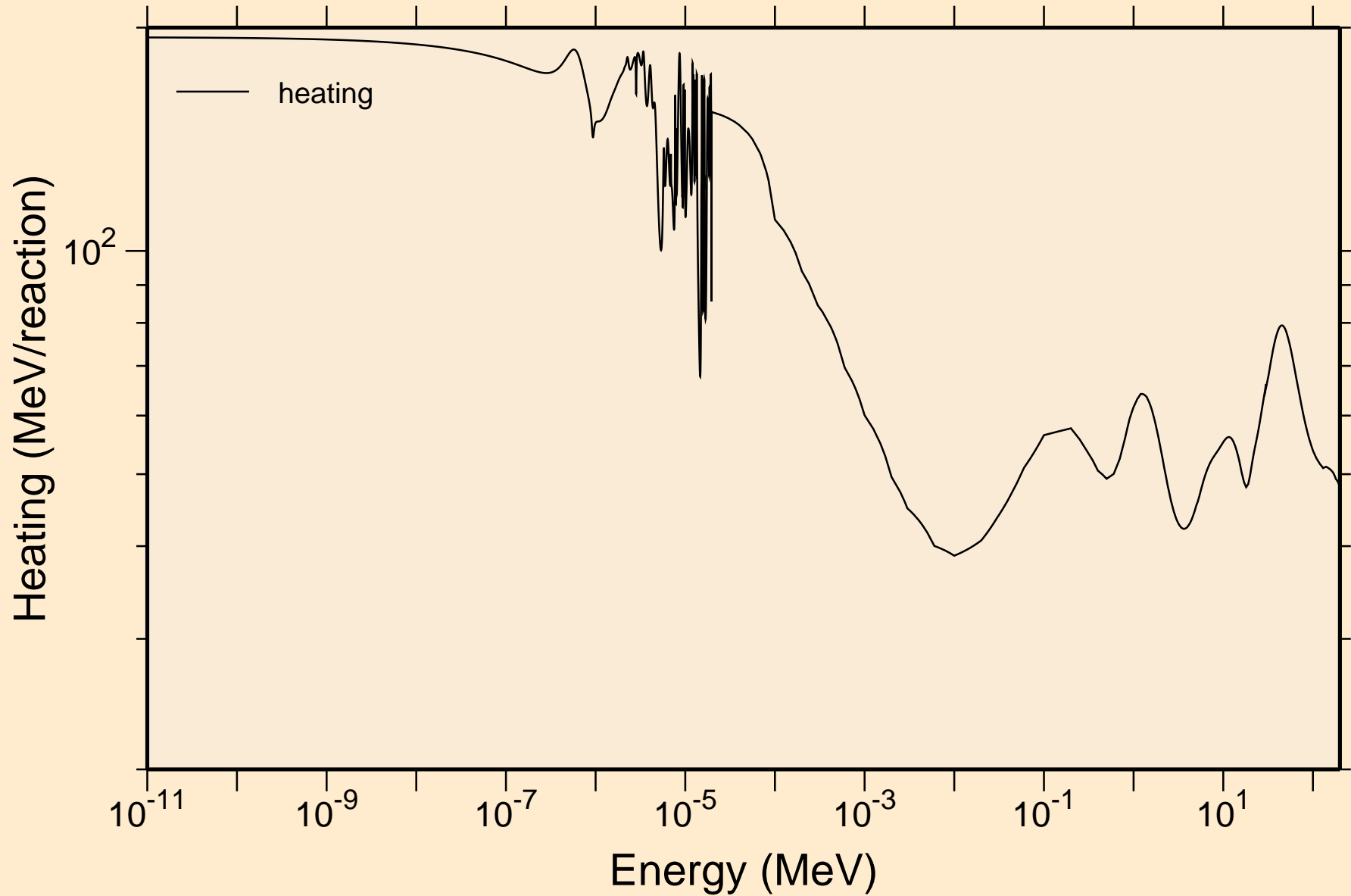

BK254 NEUTRON ACER TENDL-2023 LIBRARY; T=0.K
Damage

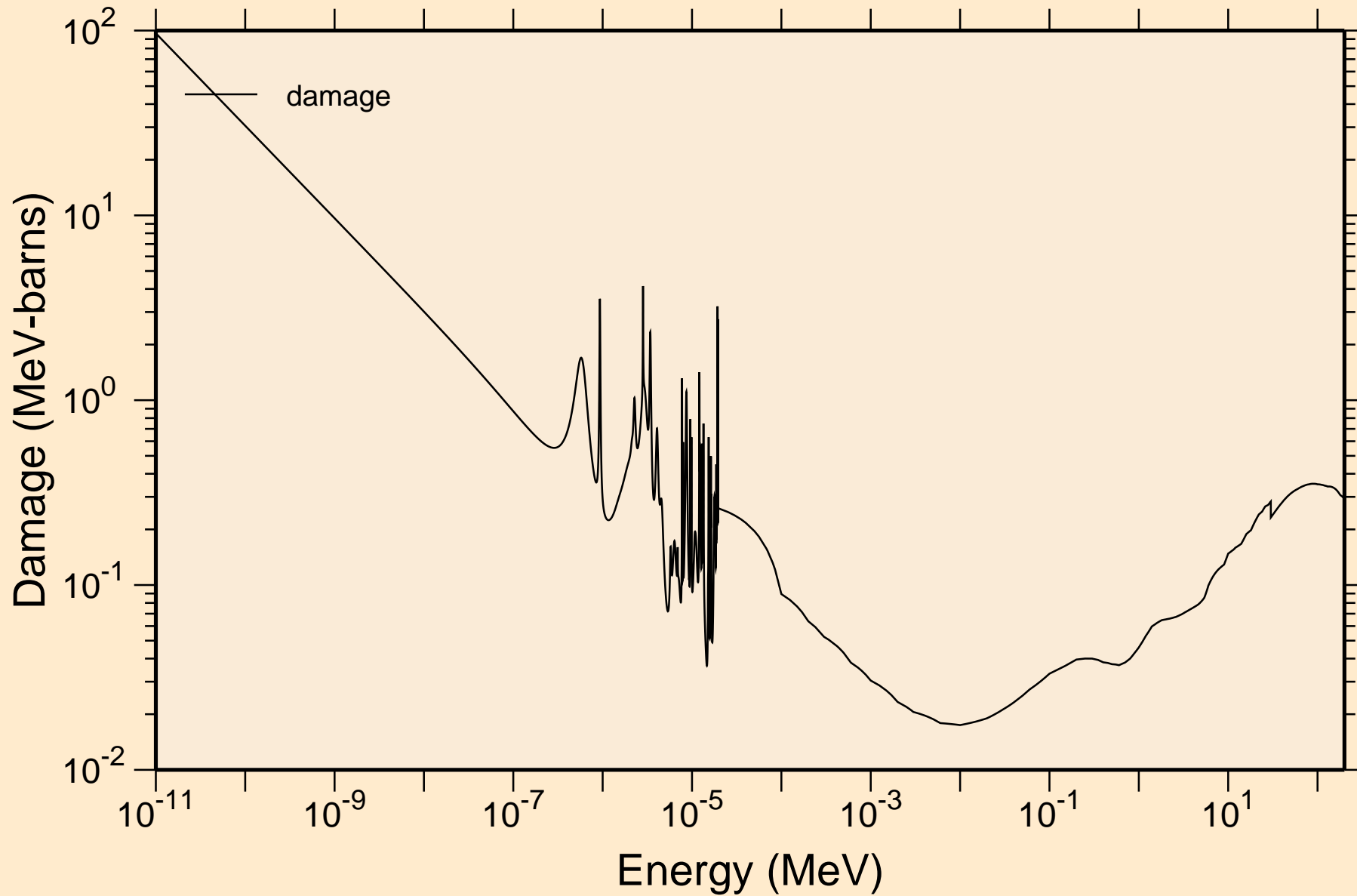

BK254 NEUTRON ACER TENDL-2023 LIBRARY; T=0.K
Non-threshold reactions

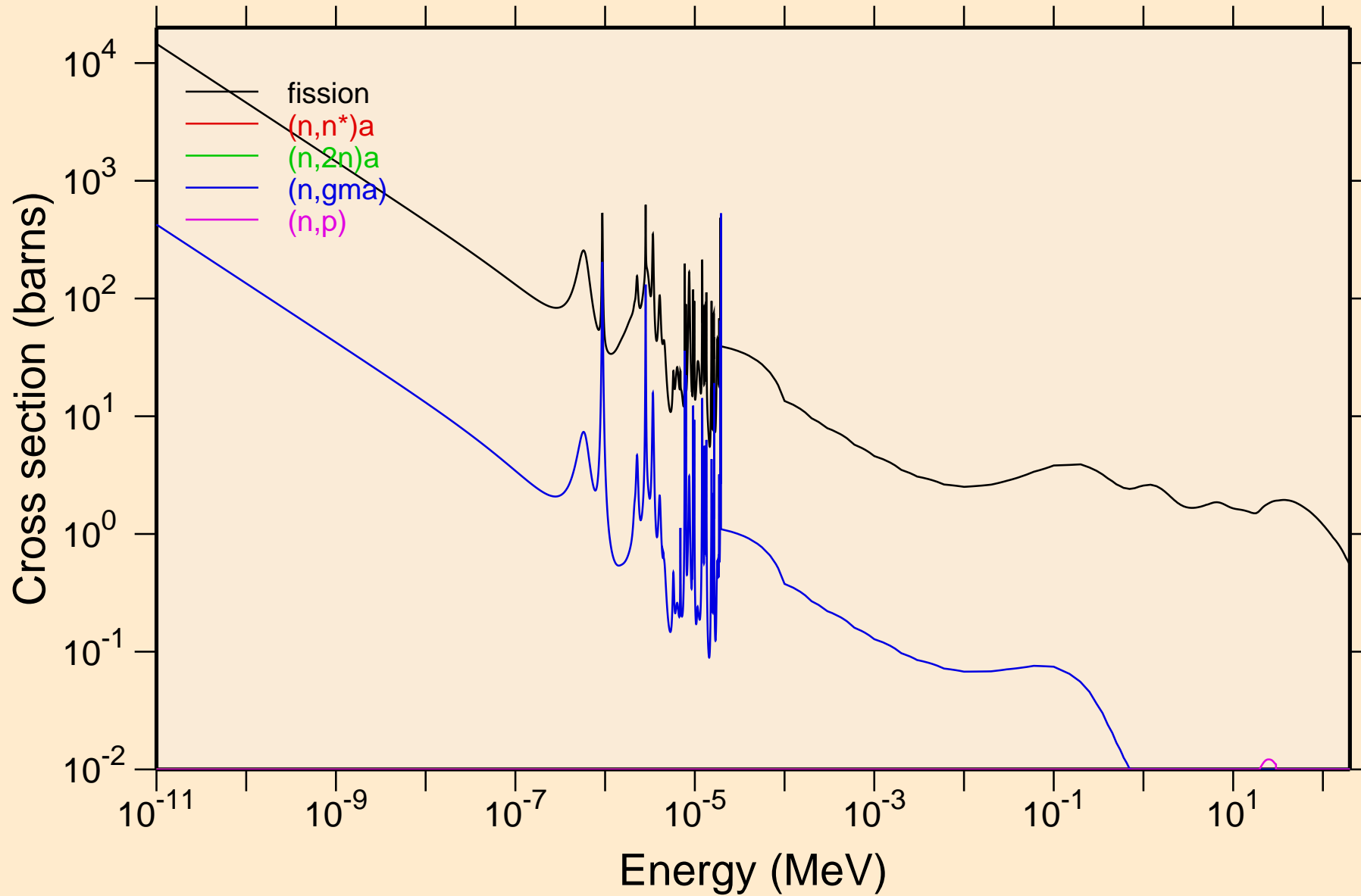

BK254 NEUTRON ACER TENDL-2023 LIBRARY; T=0.K
Non-threshold reactions

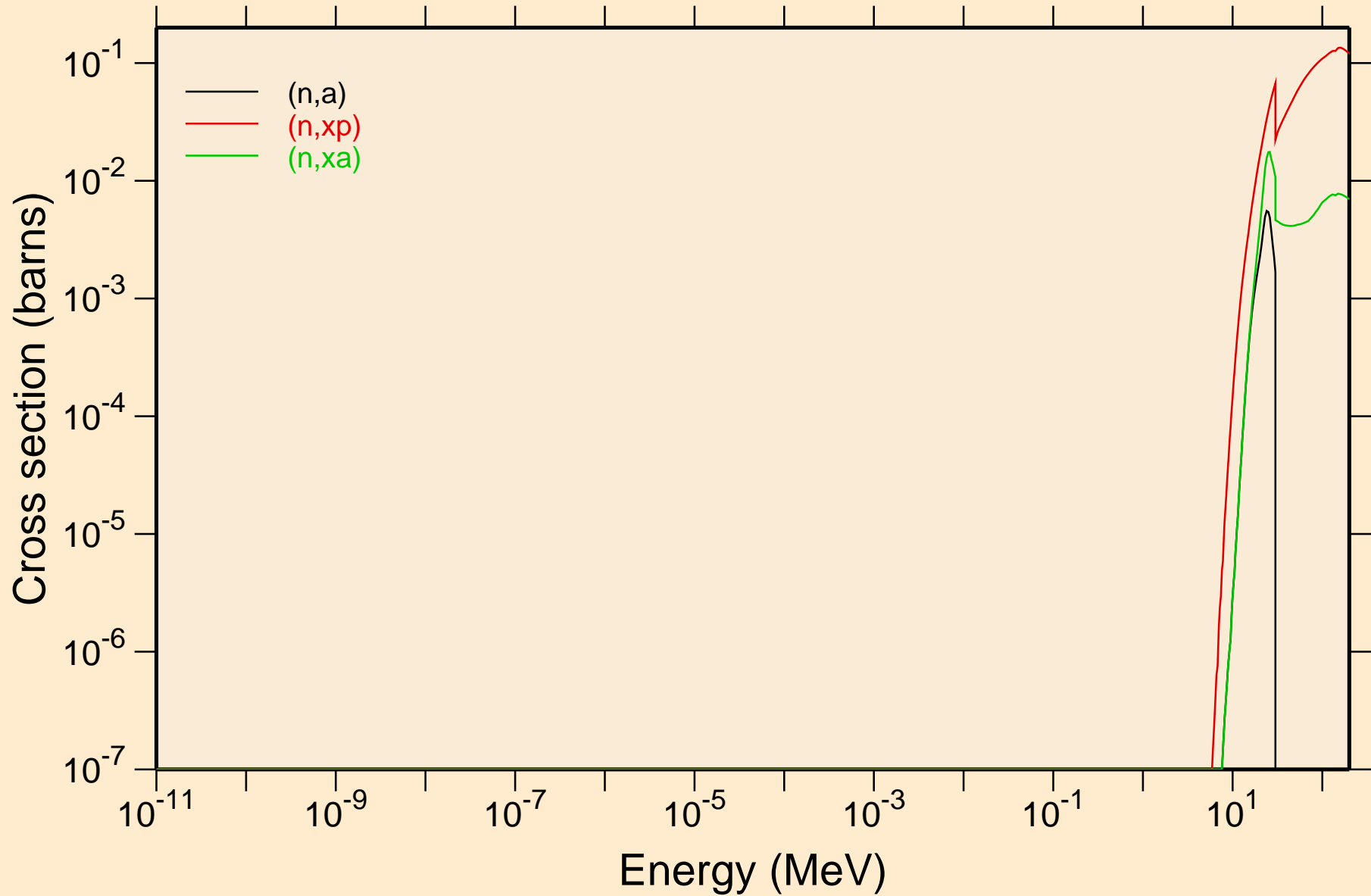

BK254 NEUTRON ACER TENDL-2023 LIBRARY; T=0.K
Principal cross sections

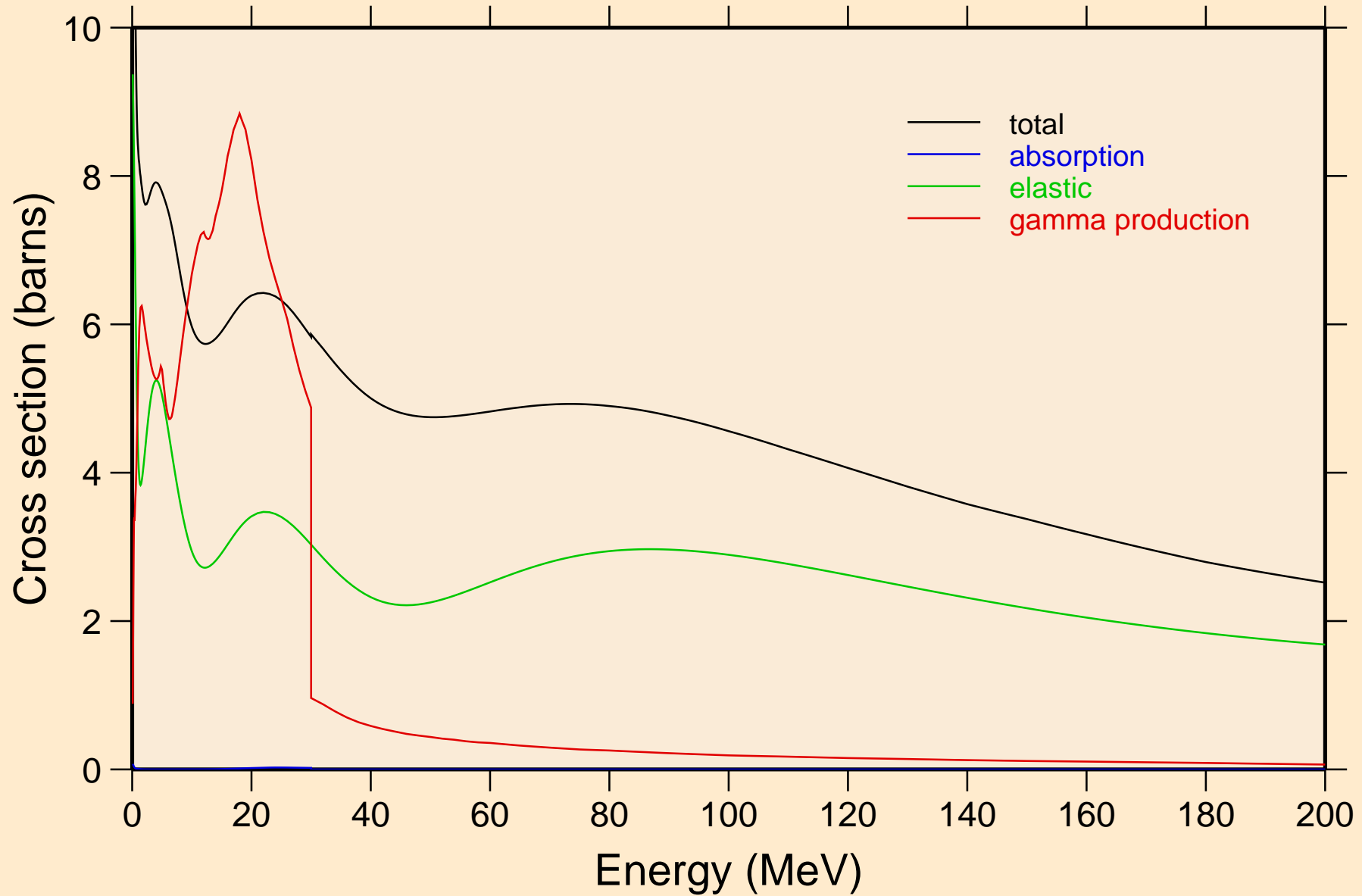

BK254 NEUTRON ACER TENDL-2023 LIBRARY; T=0.K

Heating

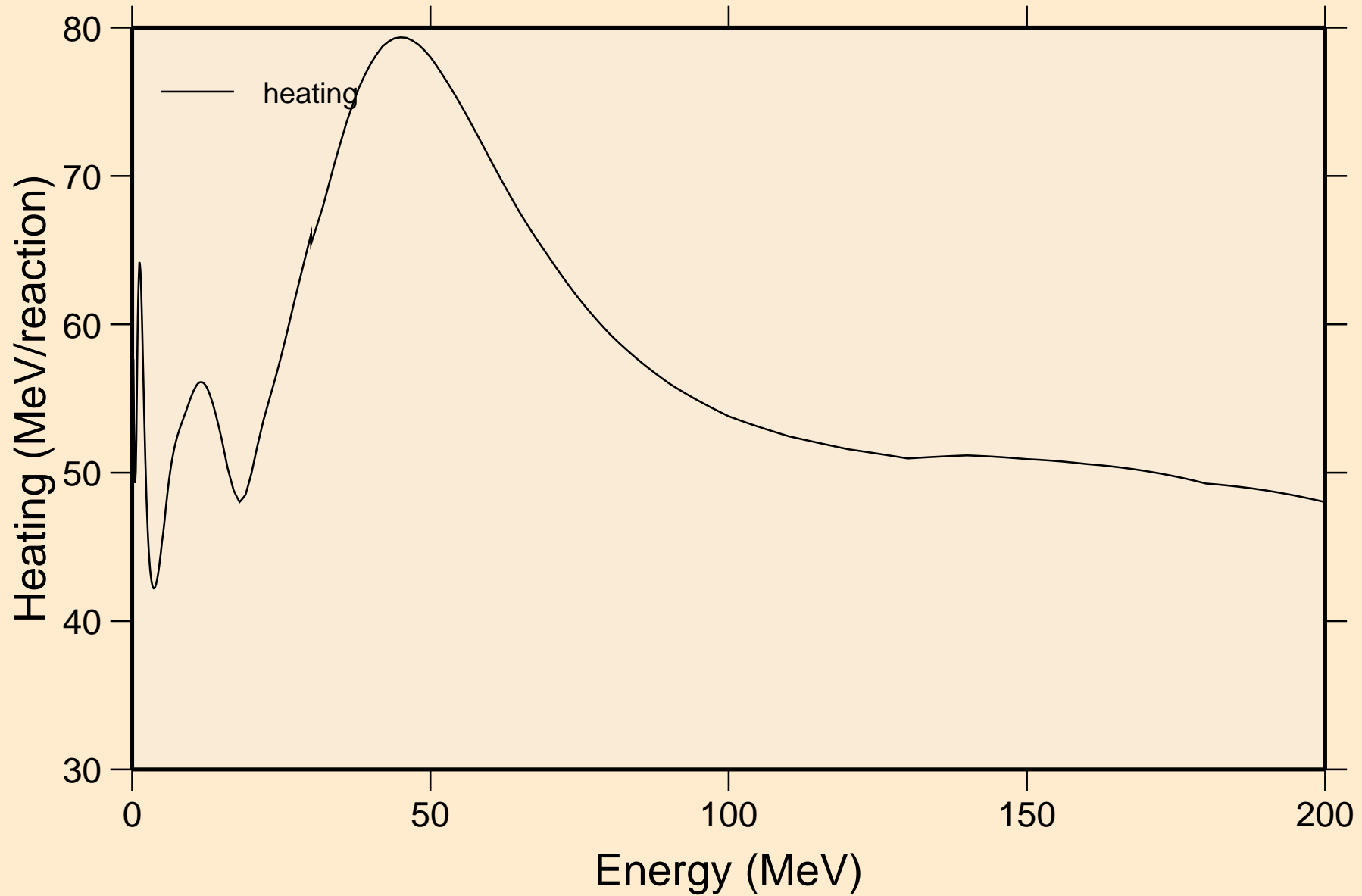

BK254 NEUTRON ACER TENDL-2023 LIBRARY; T=0.K

Damage

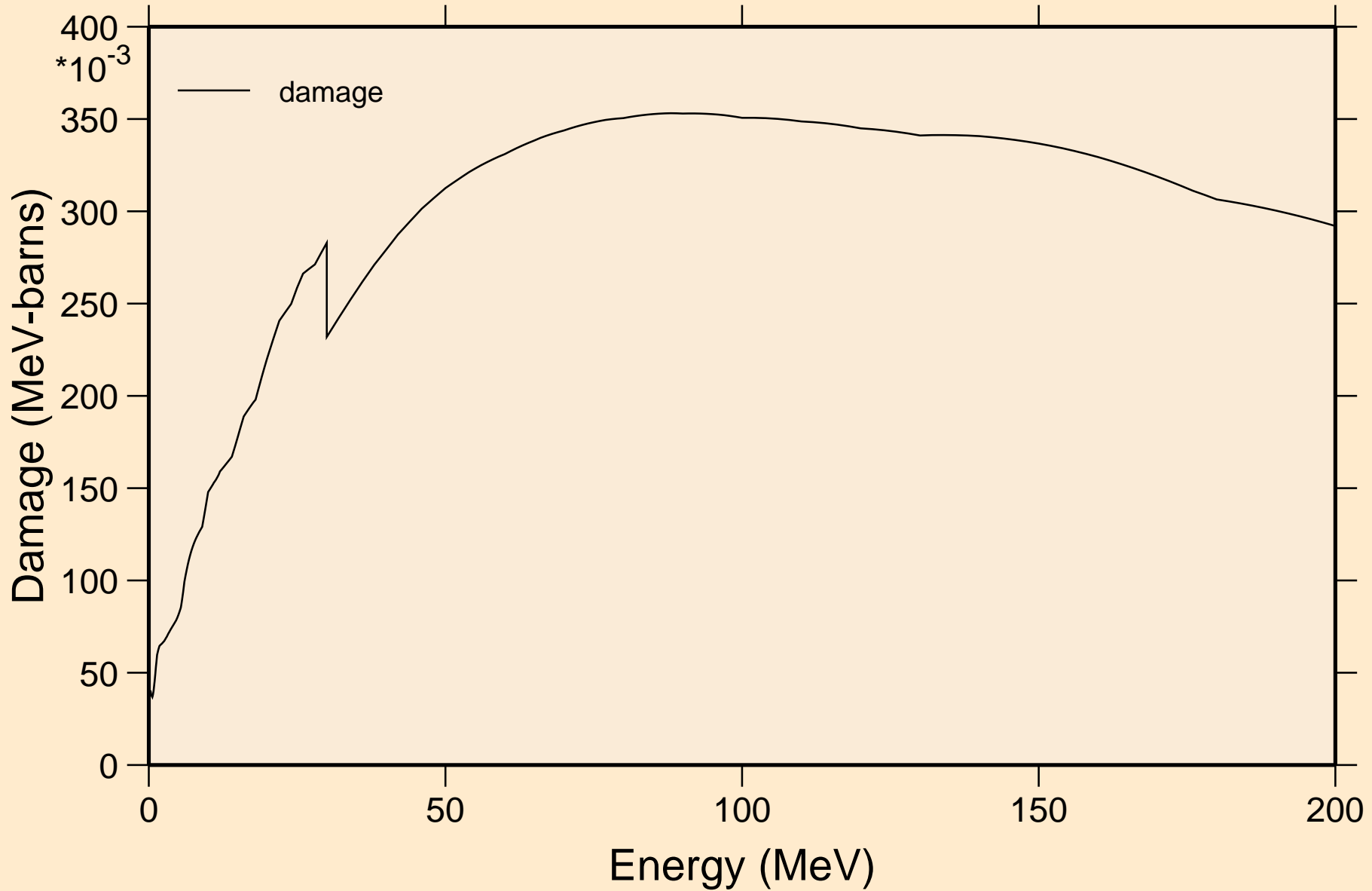

BK254 NEUTRON ACER TENDL-2023 LIBRARY; T=0.K

Non-threshold reactions

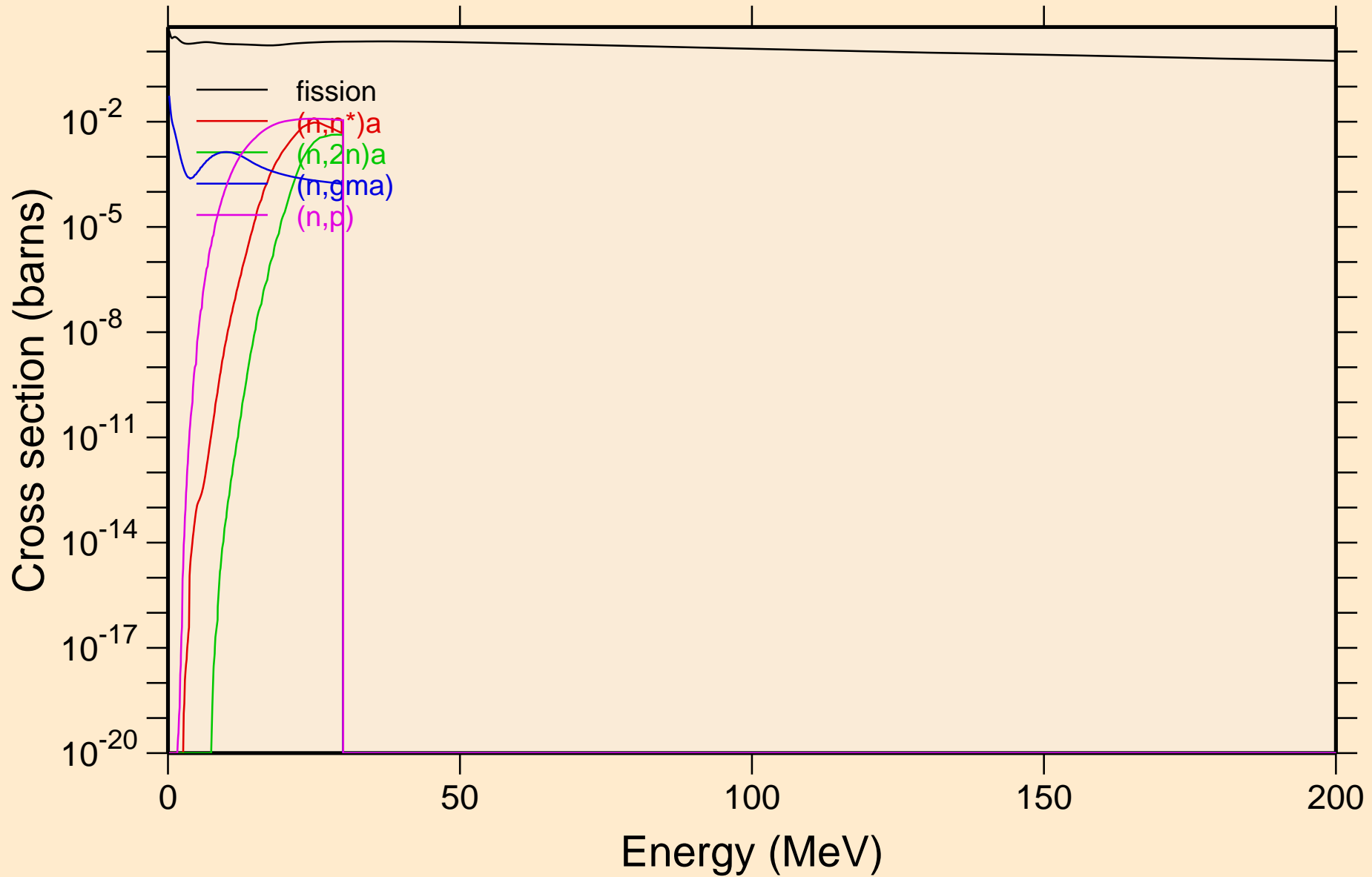

BK254 NEUTRON ACER TENDL-2023 LIBRARY; T=0.K
Non-threshold reactions

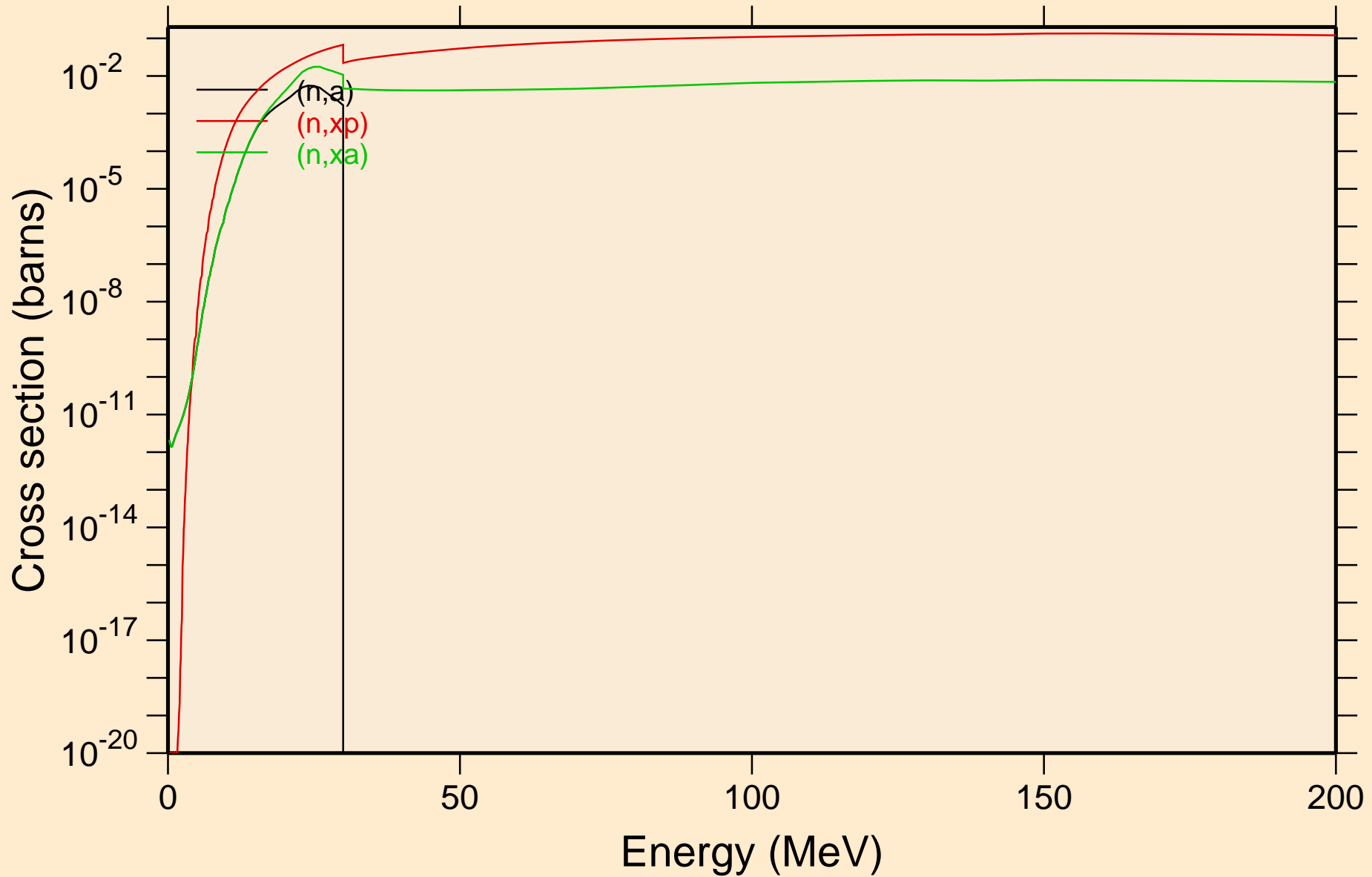

BK254 NEUTRON ACER TENDL-2023 LIBRARY; T=0.K
Inelastic levels

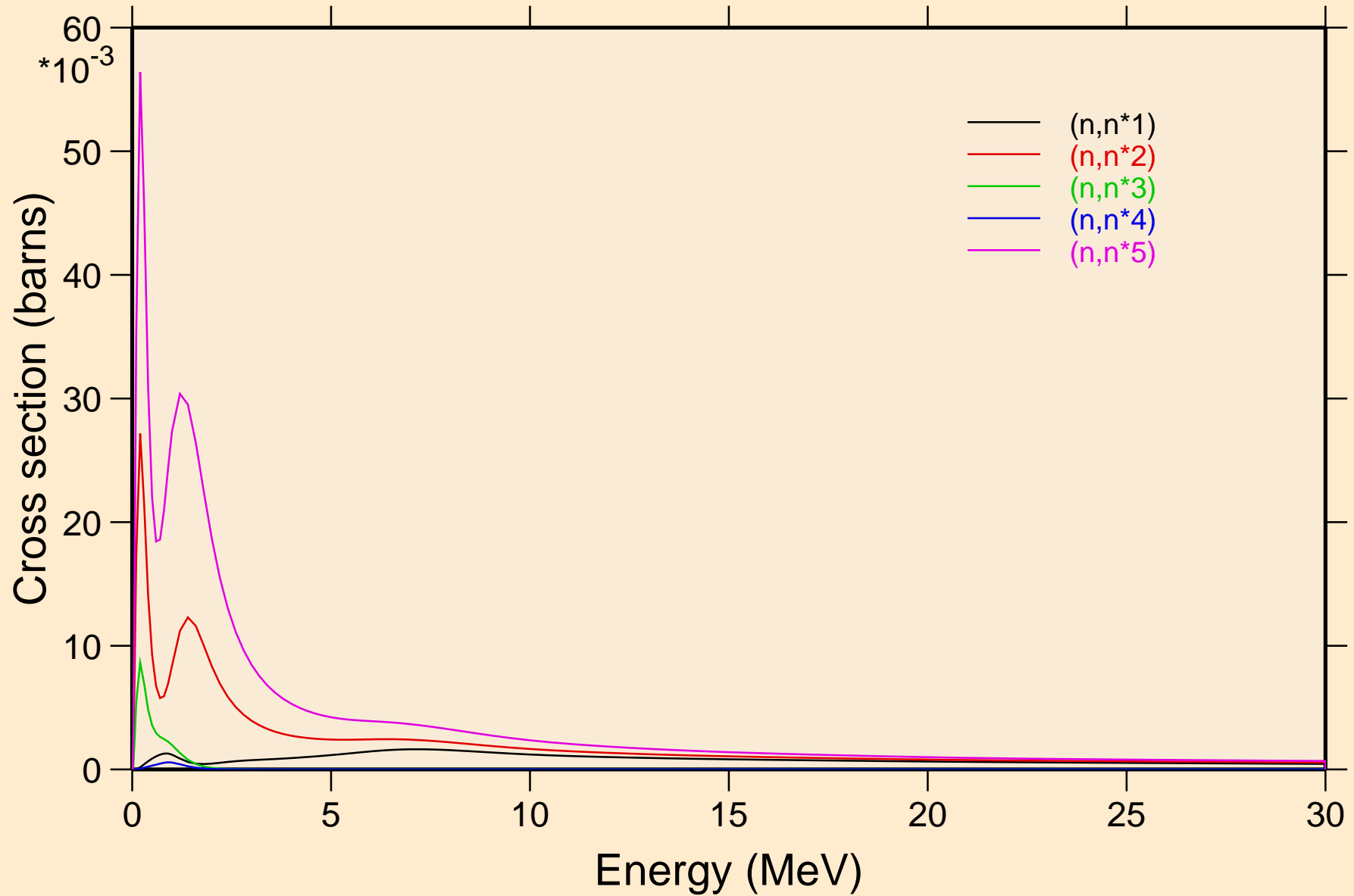

BK254 NEUTRON ACER TENDL-2023 LIBRARY; T=0.K
Inelastic levels

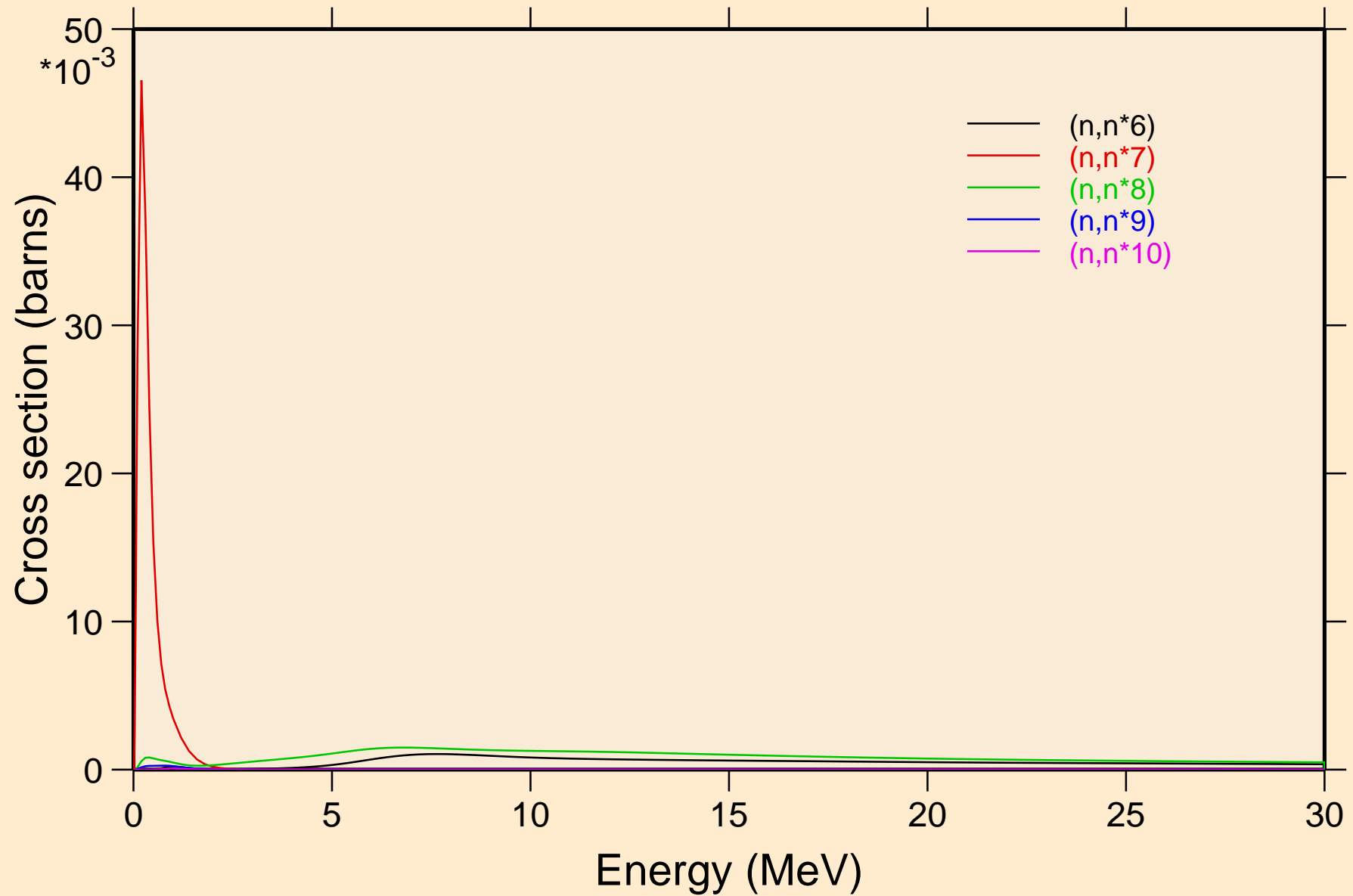

BK254 NEUTRON ACER TENDL-2023 LIBRARY; T=0.K

Inelastic levels

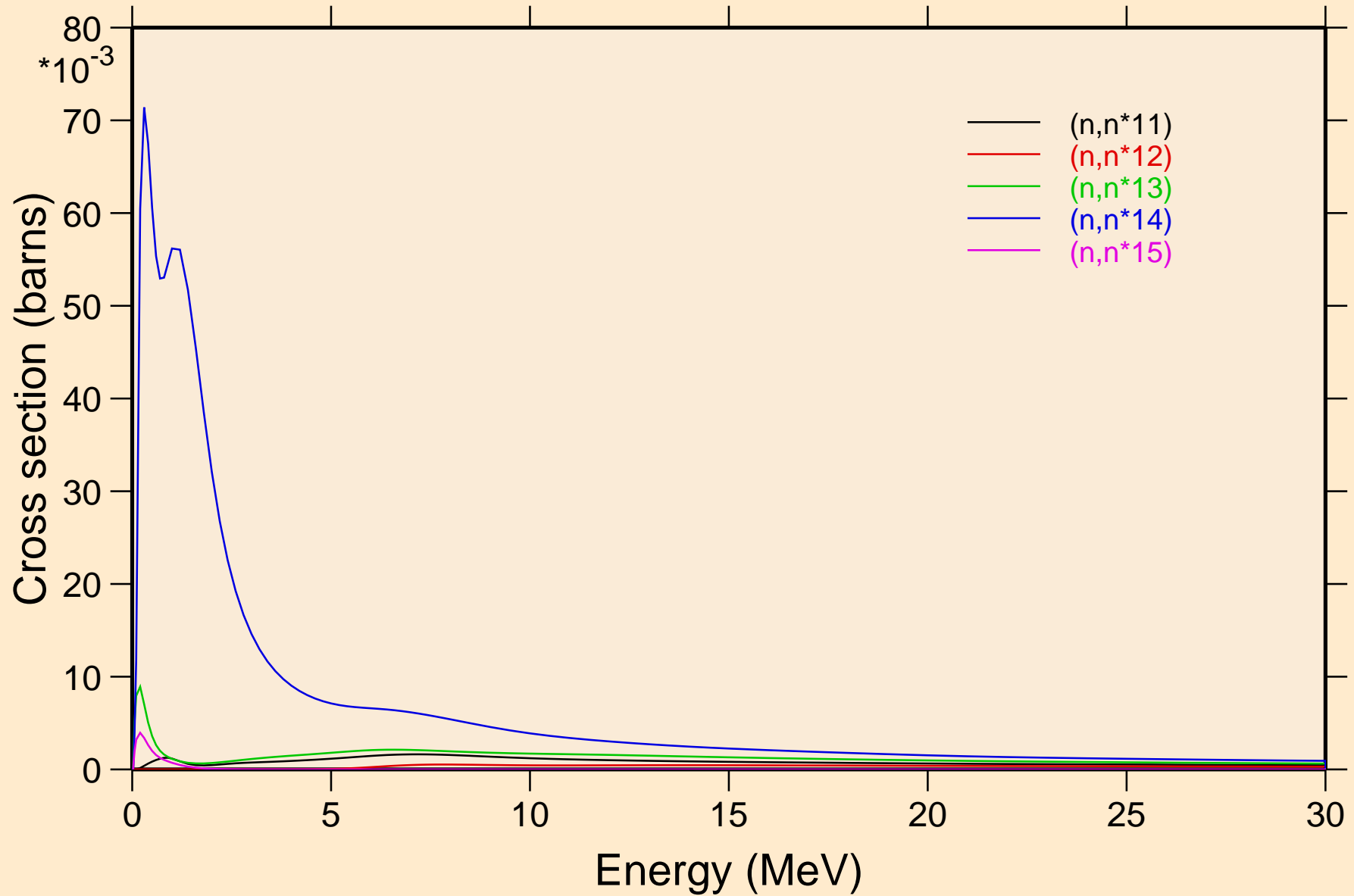

BK254 NEUTRON ACER TENDL-2023 LIBRARY; T=0.K
Inelastic levels

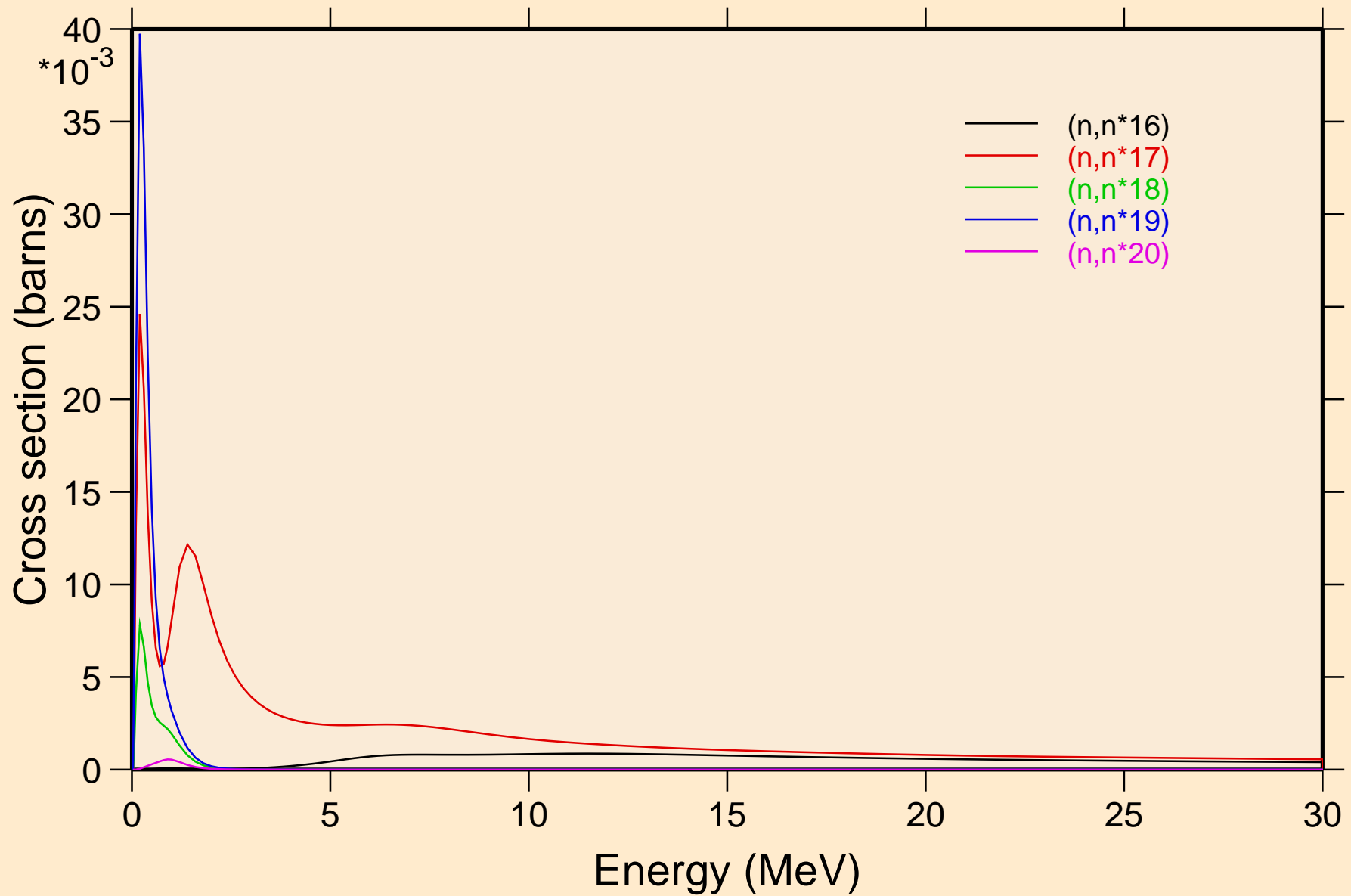

BK254 NEUTRON ACER TENDL-2023 LIBRARY; T=0.K
Inelastic levels

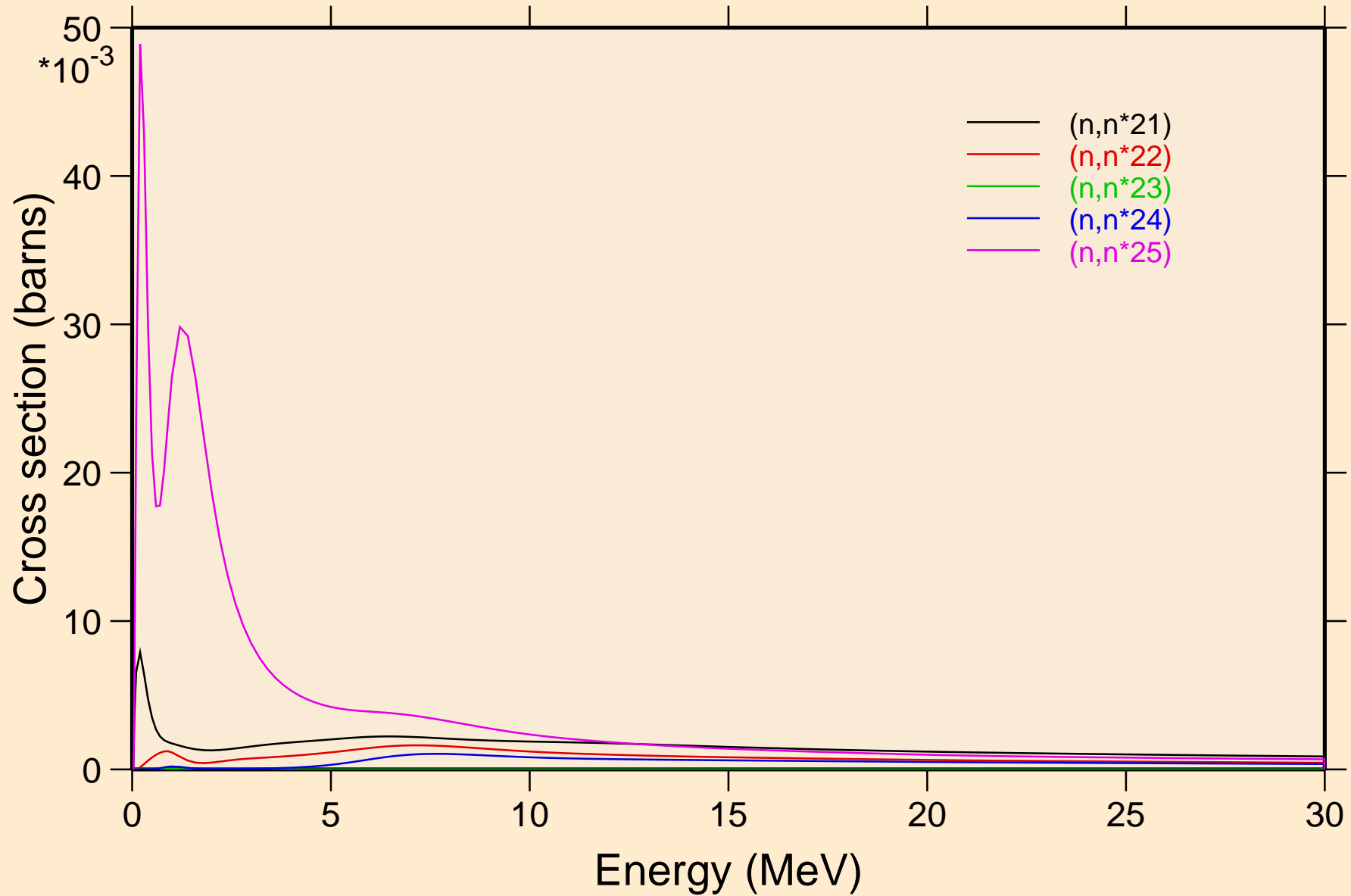

BK254 NEUTRON ACER TENDL-2023 LIBRARY; T=0.K
Inelastic levels

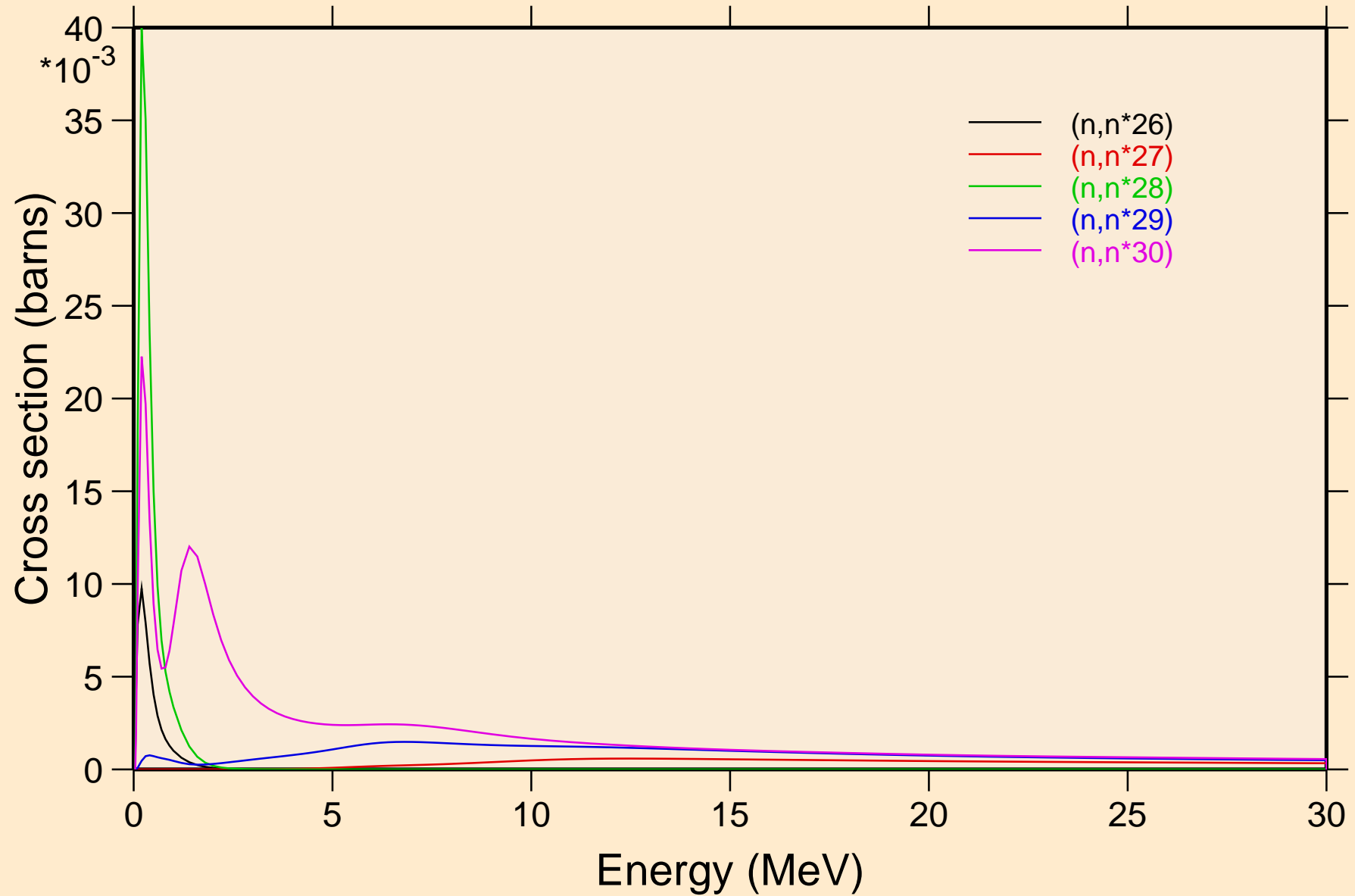

BK254 NEUTRON ACER TENDL-2023 LIBRARY; T=0.K
Threshold reactions

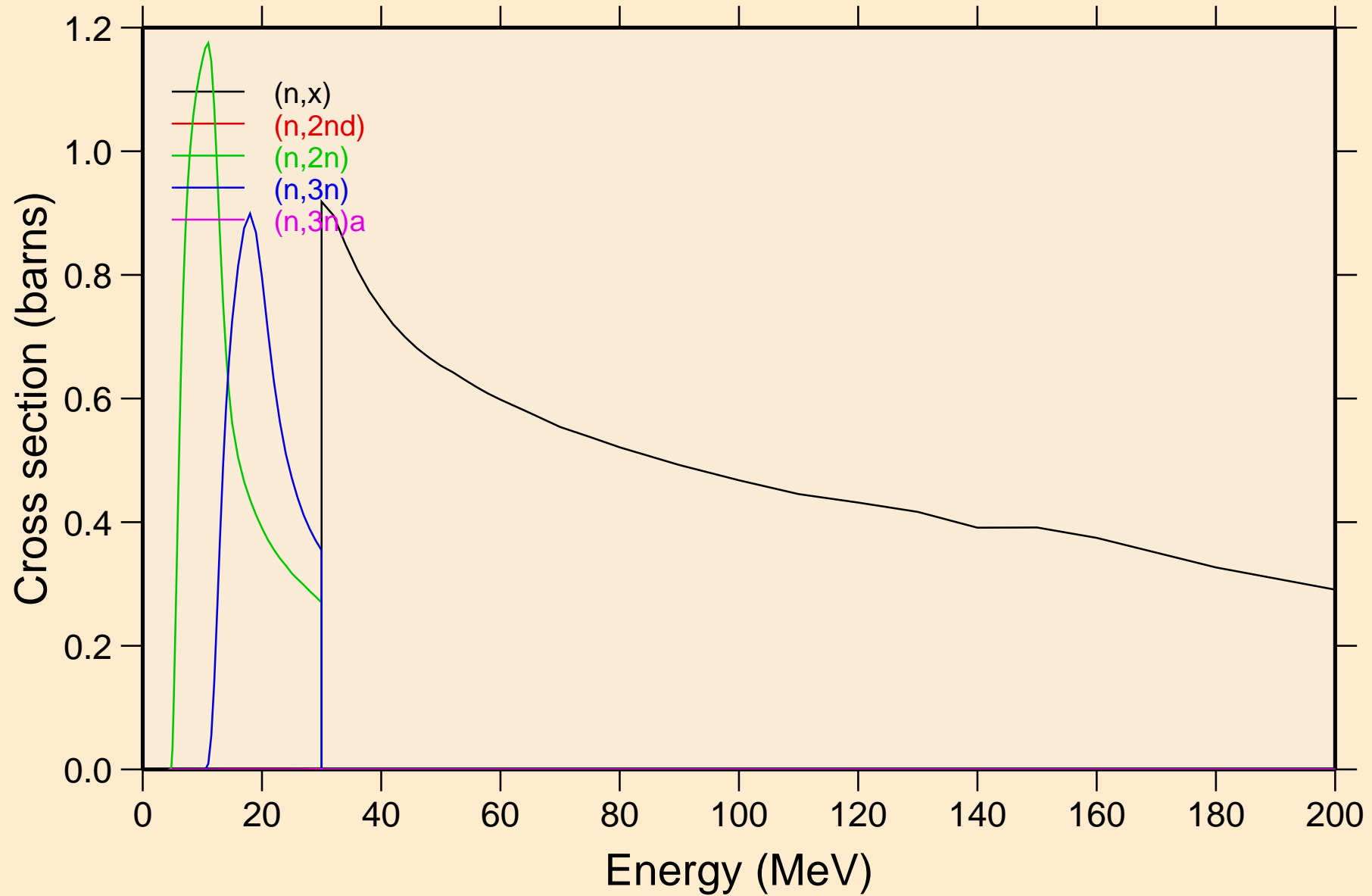

BK254 NEUTRON ACER TENDL-2023 LIBRARY; T=0.K
Threshold reactions

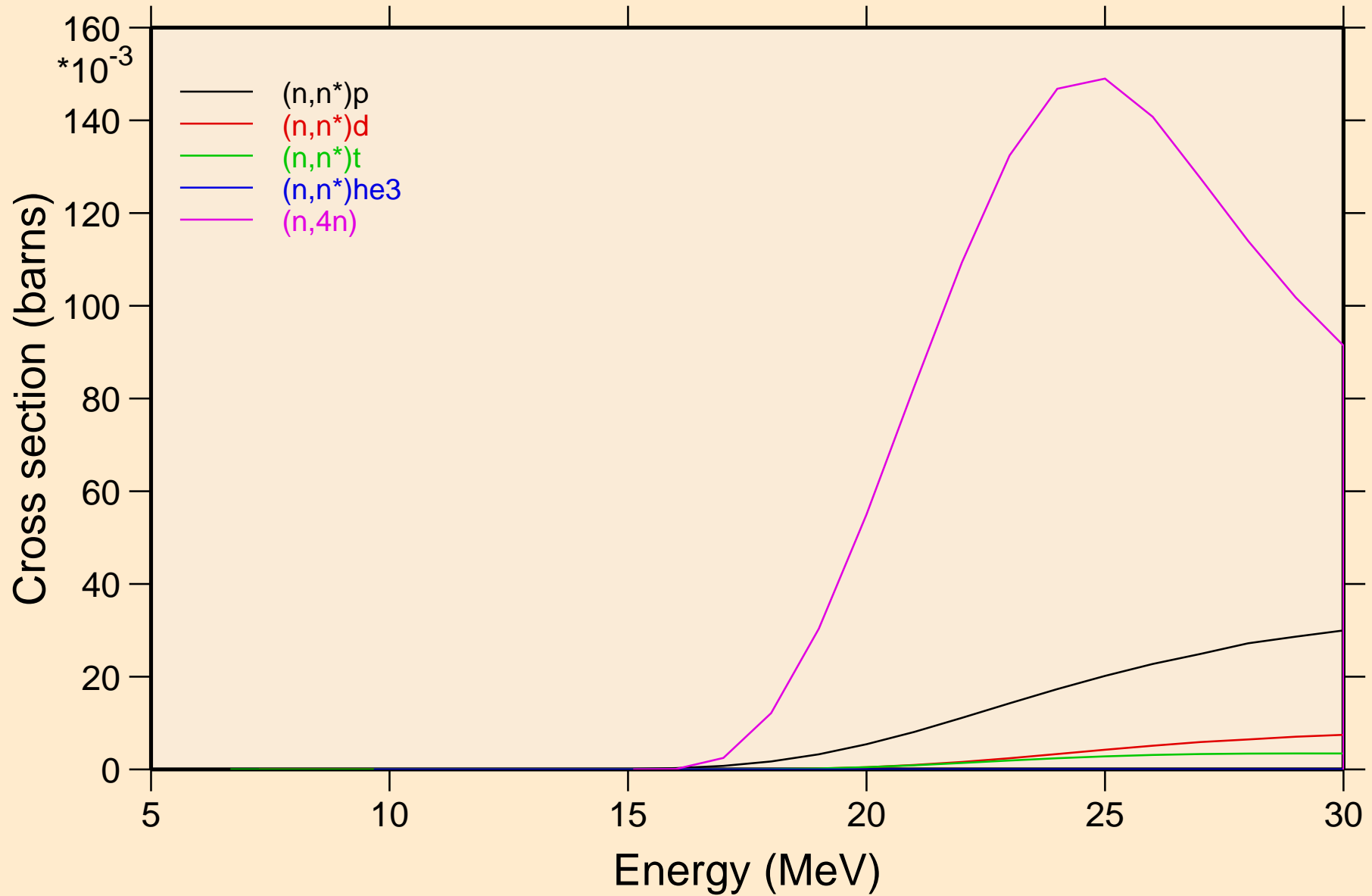

BK254 NEUTRON ACER TENDL-2023 LIBRARY; T=0.K
Threshold reactions

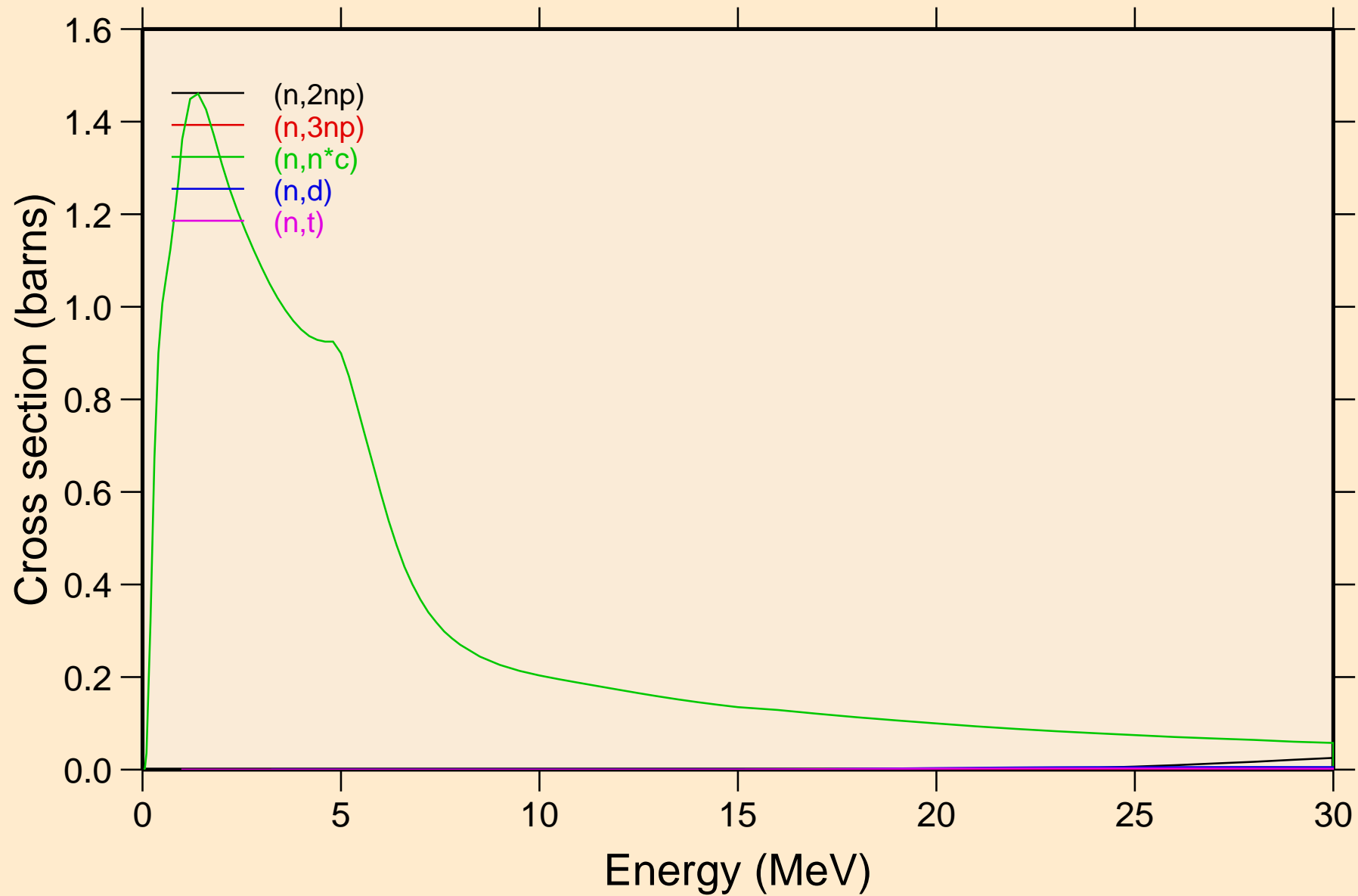

BK254 NEUTRON ACER TENDL-2023 LIBRARY; T=0.K
Threshold reactions

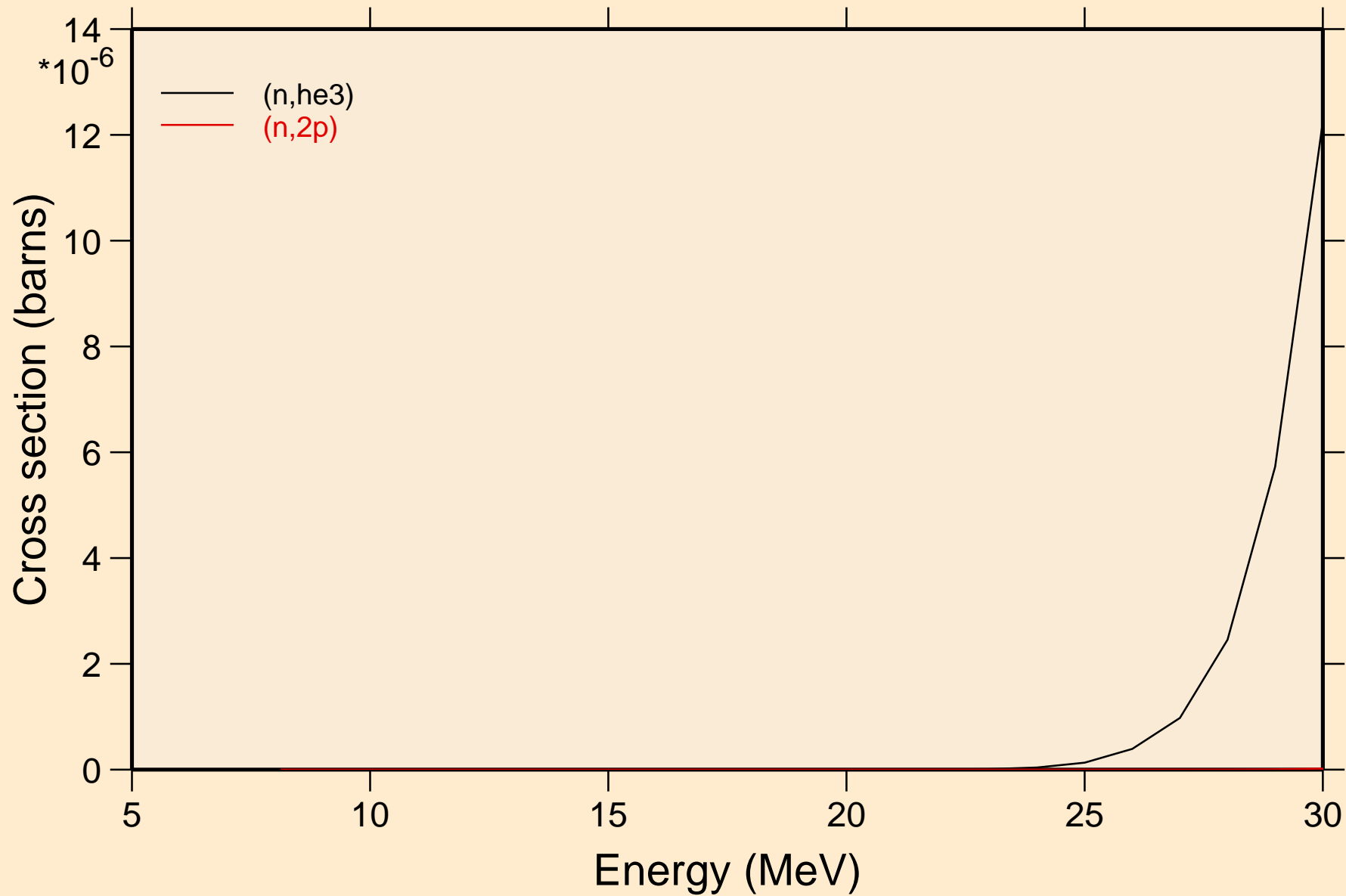

BK254 NEUTRON ACER TENDL-2023 LIBRARY; T=0.K
Threshold reactions

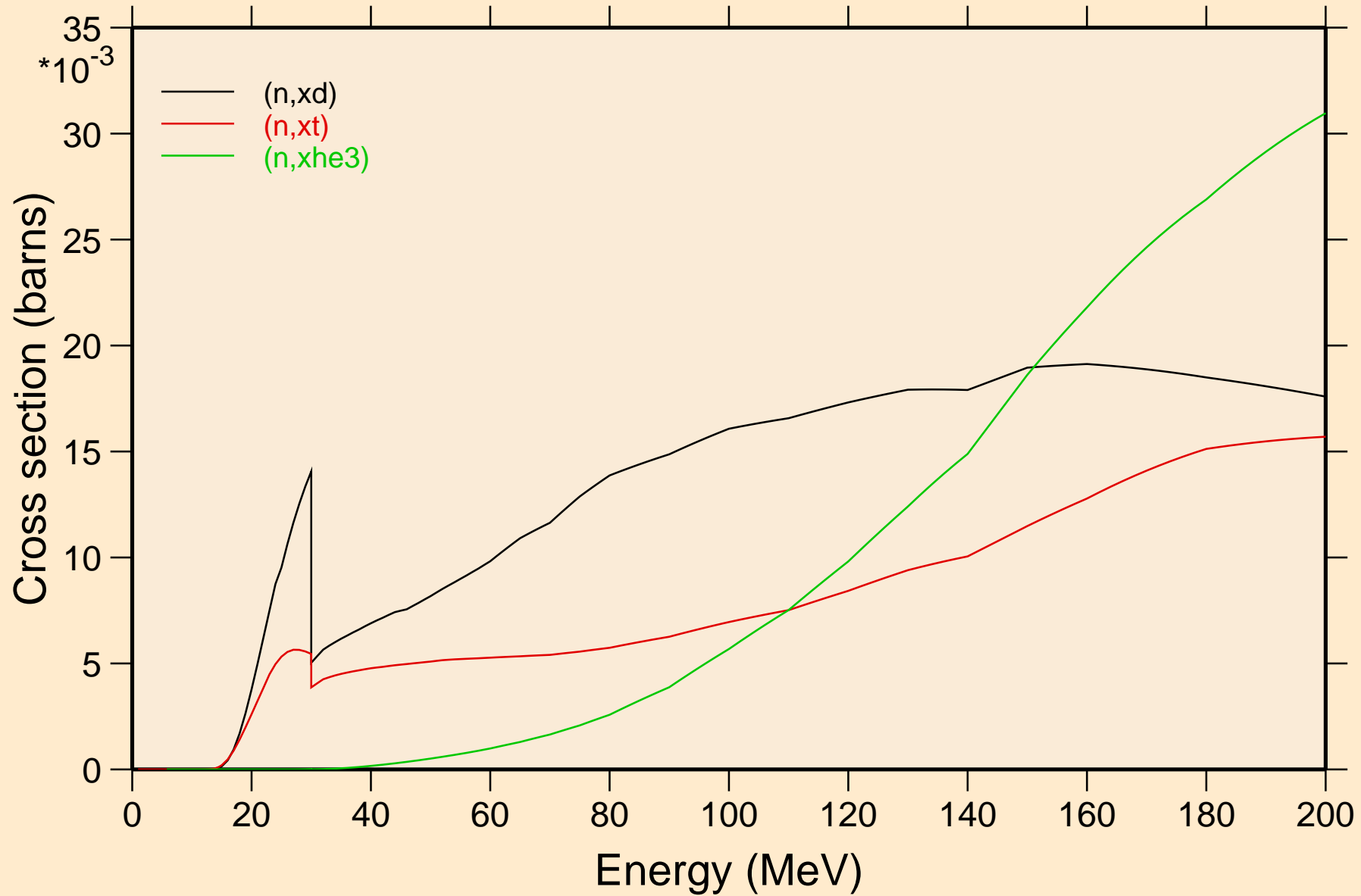

BK254 NEUTRON ACER TENDL-2023 LIBRARY; T=0.K
angular distribution for elastic

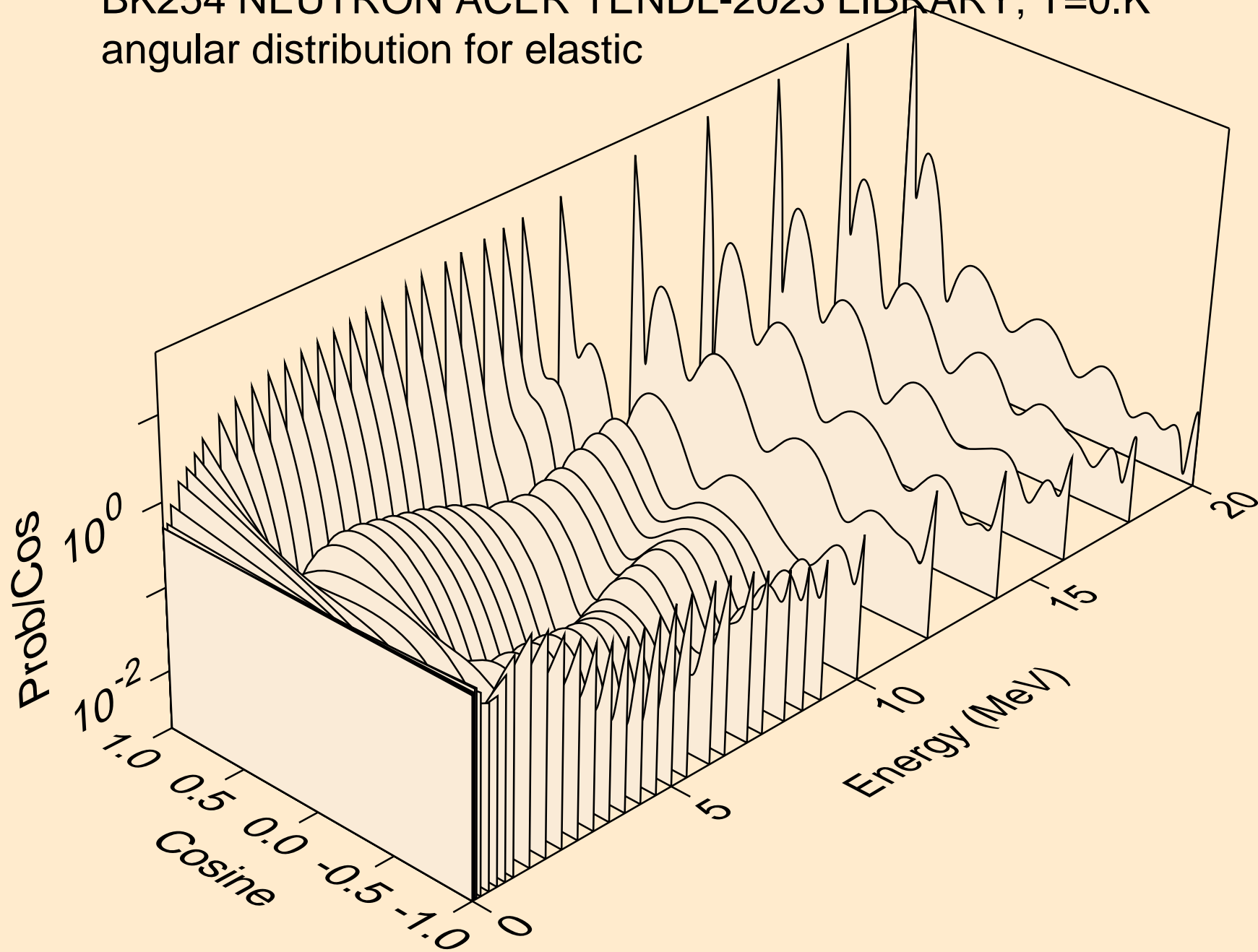

BK254 NEUTRON ACER TENDL-2023 LIBRARY; T=0.K
angular distribution for elastic

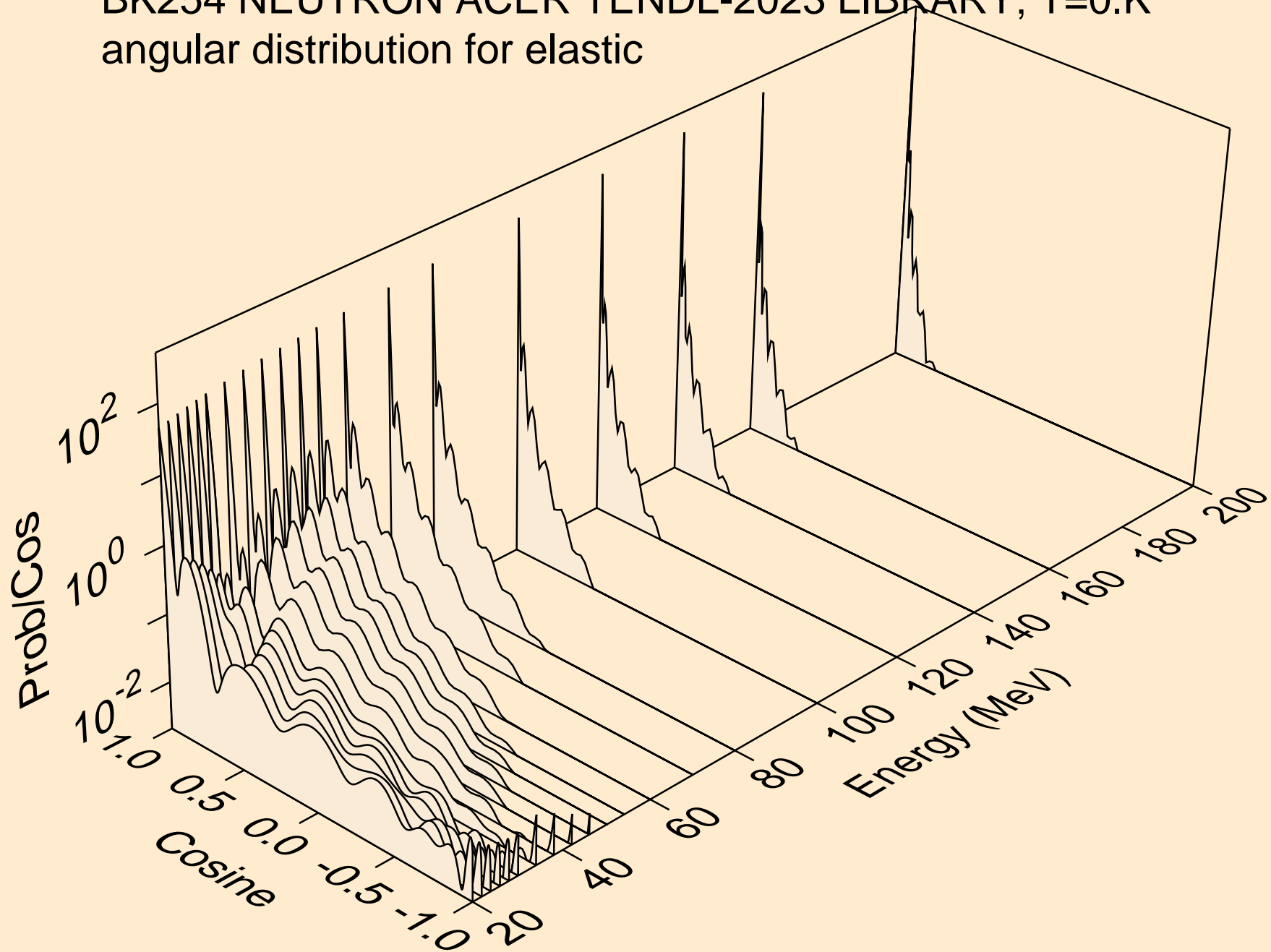

BK254 NEUTRON ACER TENDL-2023 LIBRARY; T=0.K
angular distribution for (n,n*1)

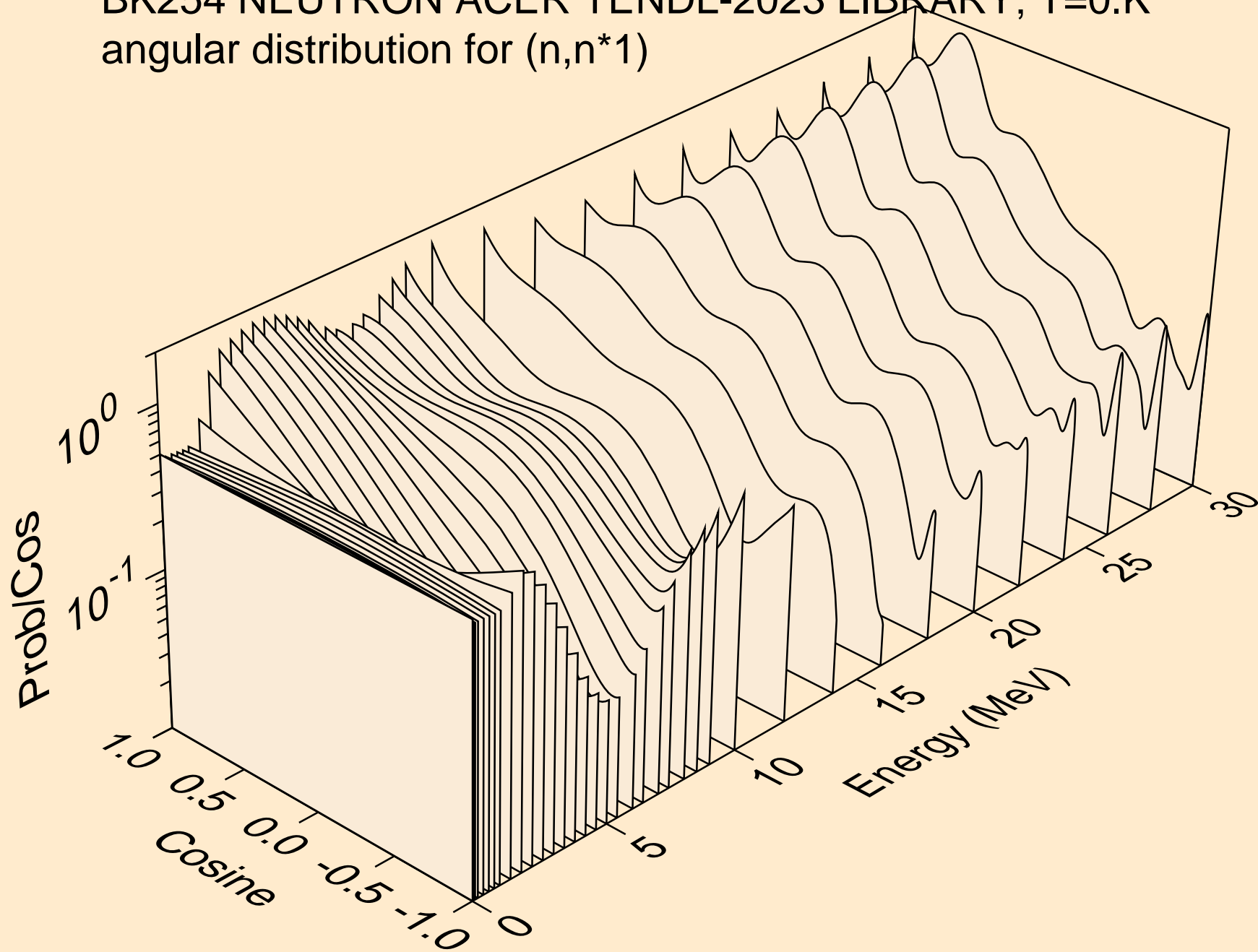

BK254 NEUTRON ACER TENDL-2023 LIBRARY; T=0.K
angular distribution for (n,n*2)

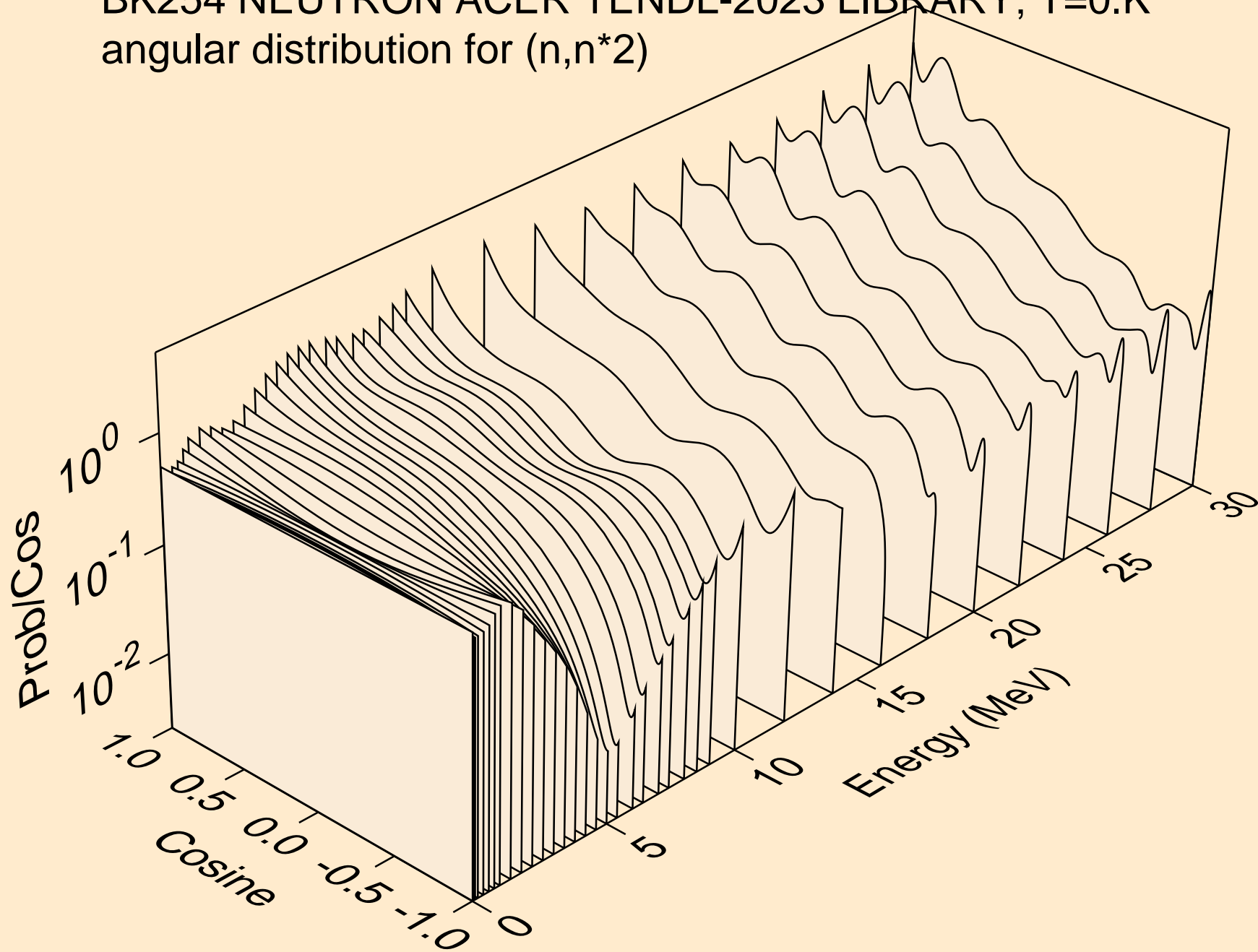

BK254 NEUTRON ACER TENDL-2023 LIBRARY; T=0.K
angular distribution for (n,n*3)

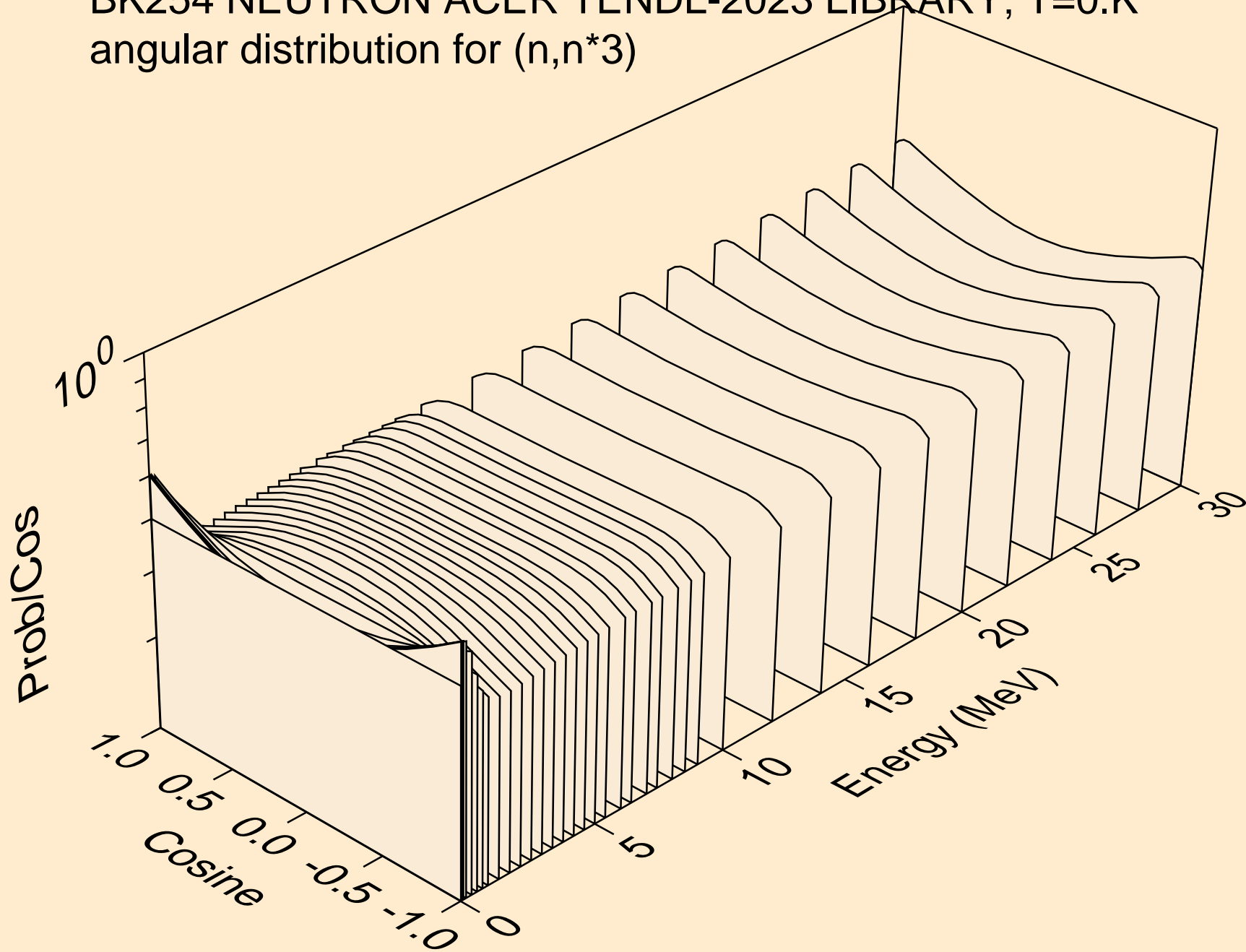

BK254 NEUTRON ACER TENDL-2023 LIBRARY; T=0.K
angular distribution for (n,n*4)

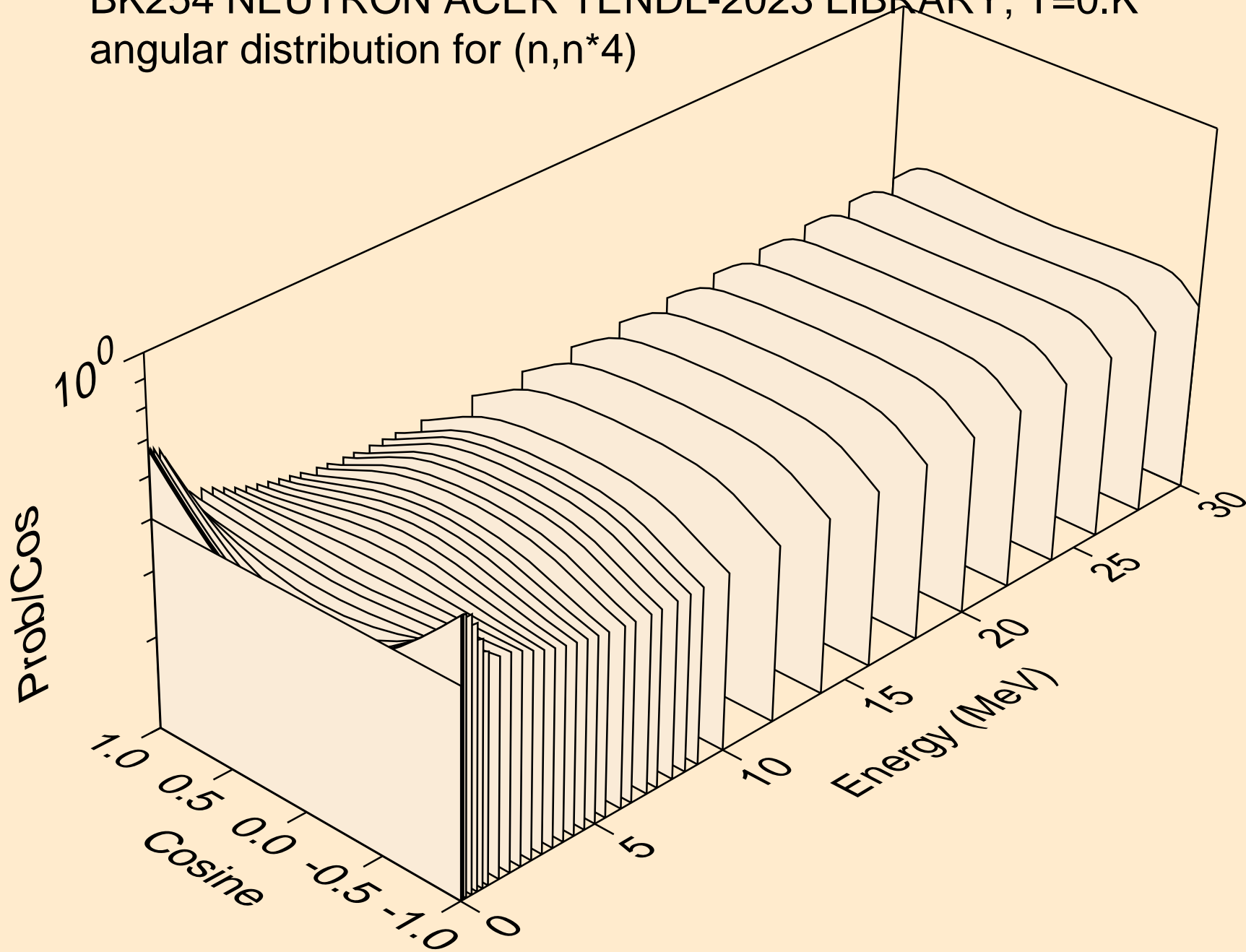

BK254 NEUTRON ACER TENDL-2023 LIBRARY; T=0.K
angular distribution for (n,n*5)

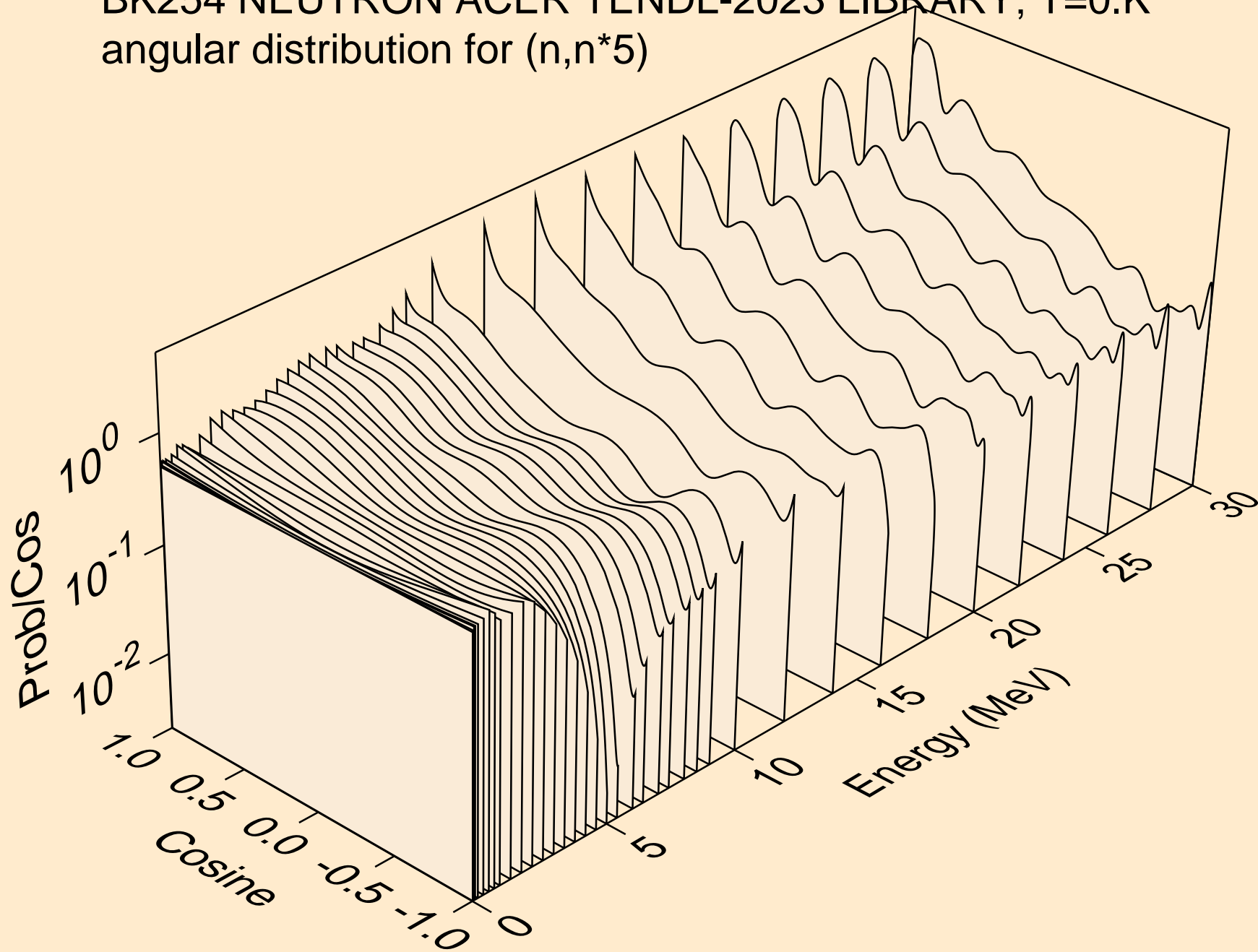

BK254 NEUTRON ACER TENDL-2023 LIBRARY; T=0.K
angular distribution for (n,n*6)

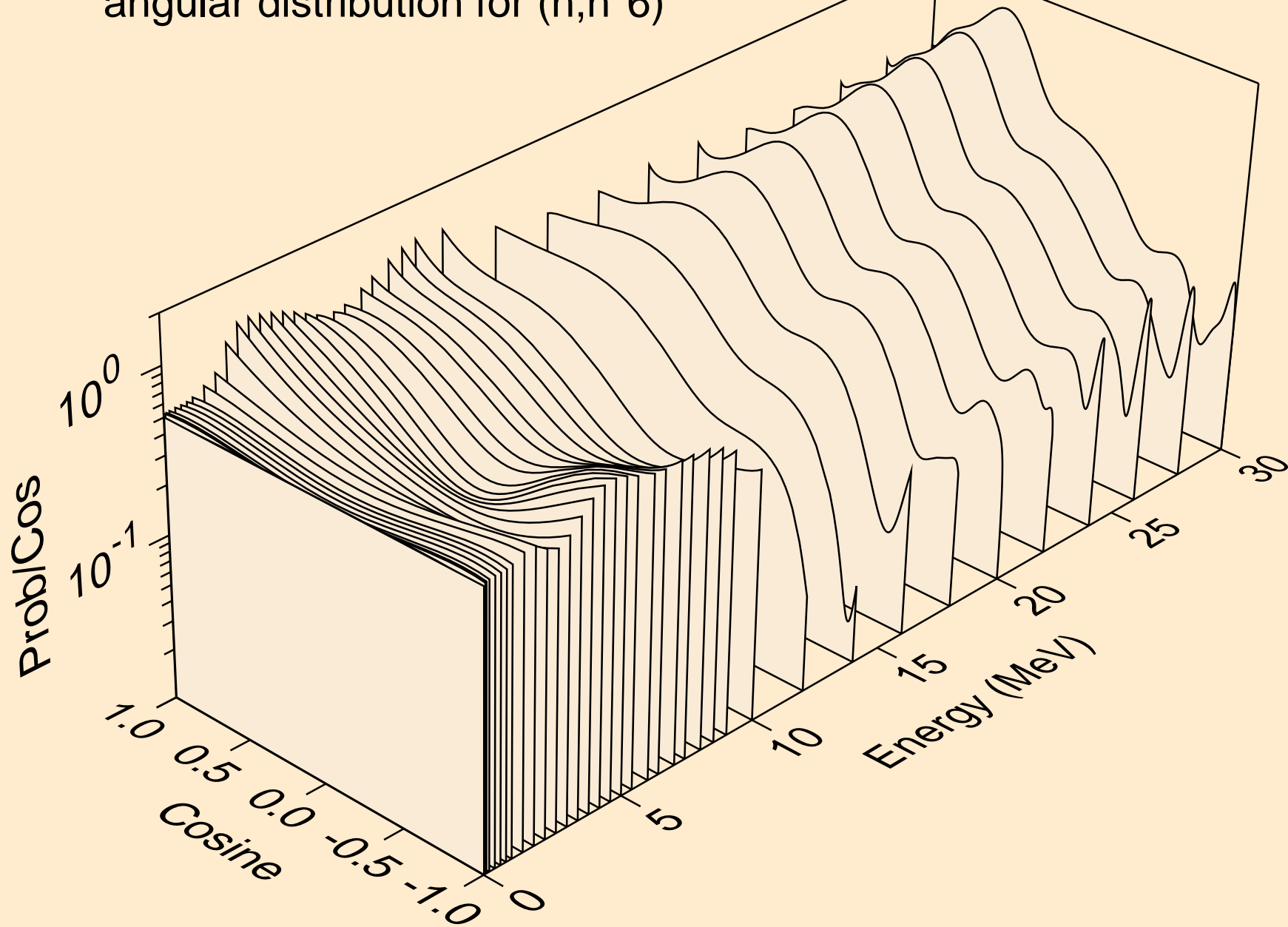

BK254 NEUTRON ACER TENDL-2023 LIBRARY; T=0.K
angular distribution for (n,n*7)

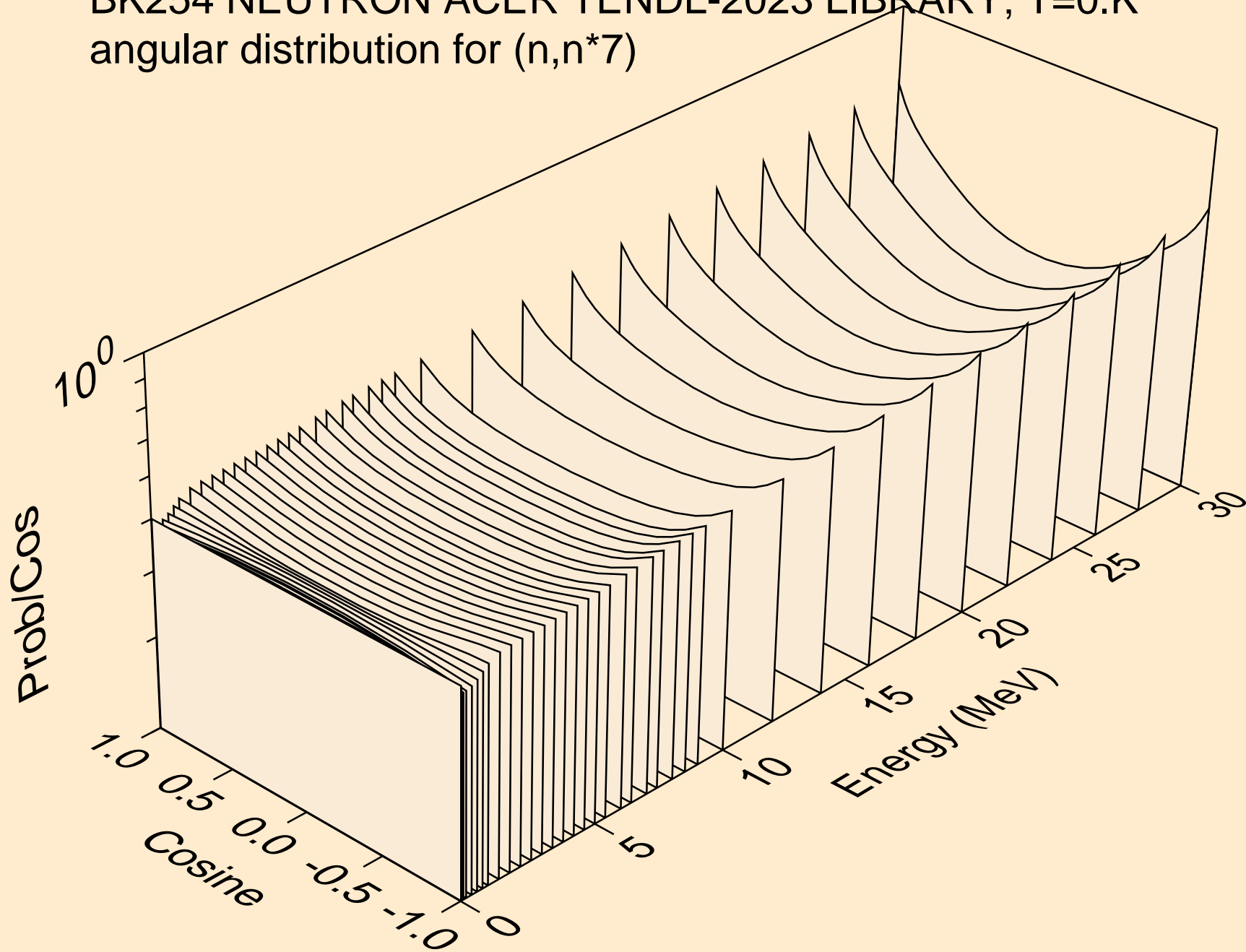

BK254 NEUTRON ACER TENDL-2023 LIBRARY; T=0.K
angular distribution for (n,n*8)

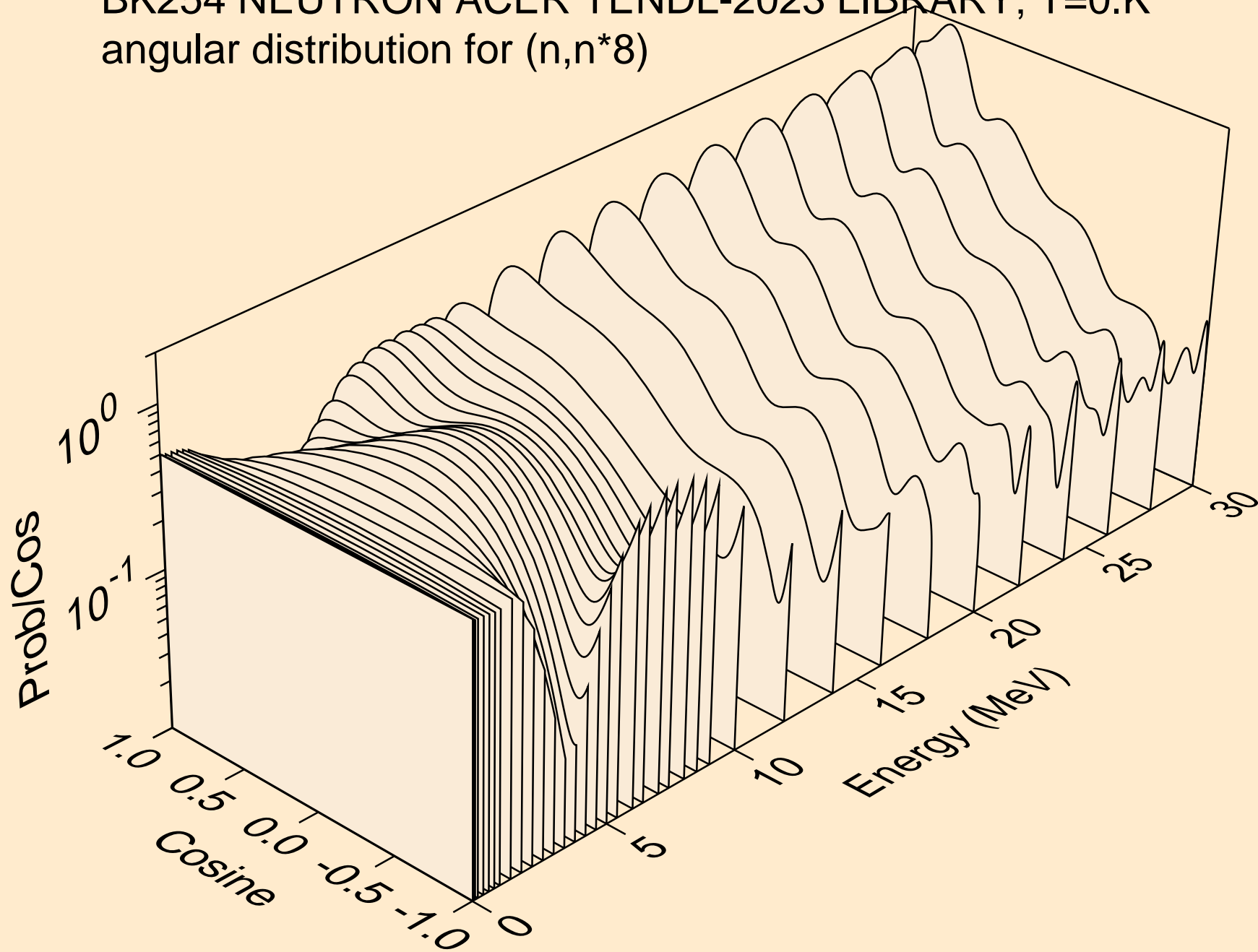

BK254 NEUTRON ACER TENDL-2023 LIBRARY; T=0.K
angular distribution for (n,n*9)

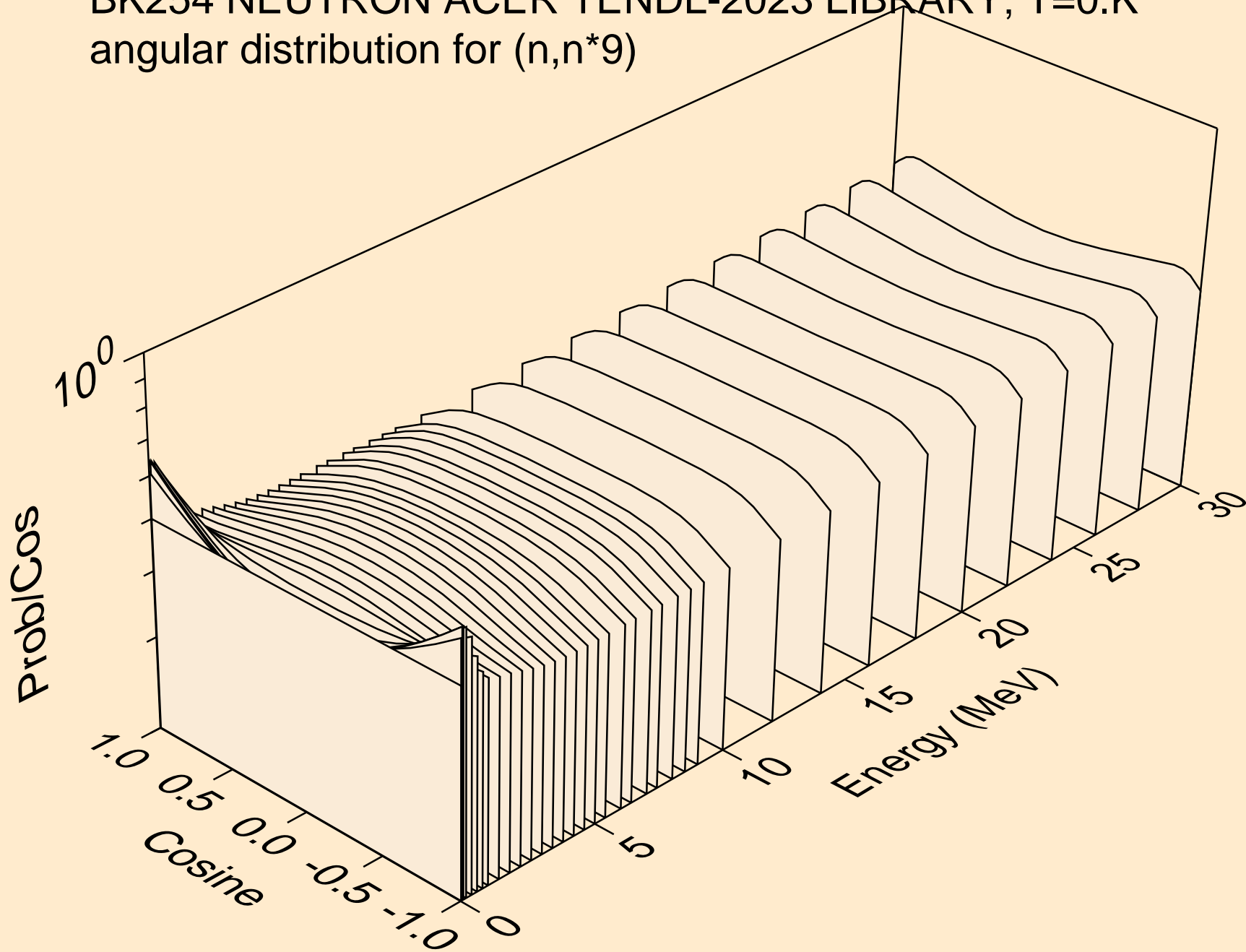

BK254 NEUTRON ACER TENDL-2023 LIBRARY; T=0.K
angular distribution for (n,n*10)

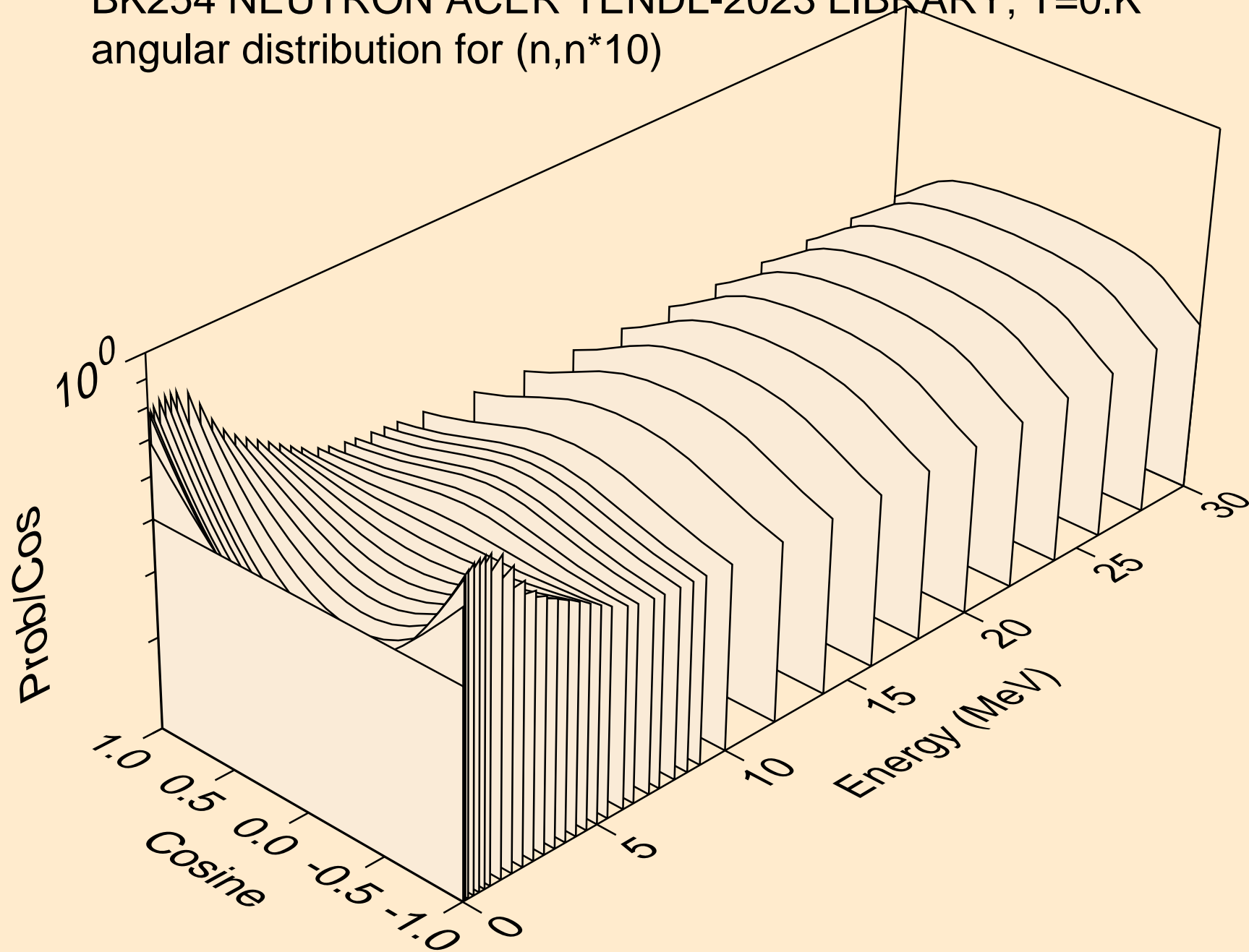

BK254 NEUTRON ACER TENDL-2023 LIBRARY; T=0.K
angular distribution for (n,n*11)

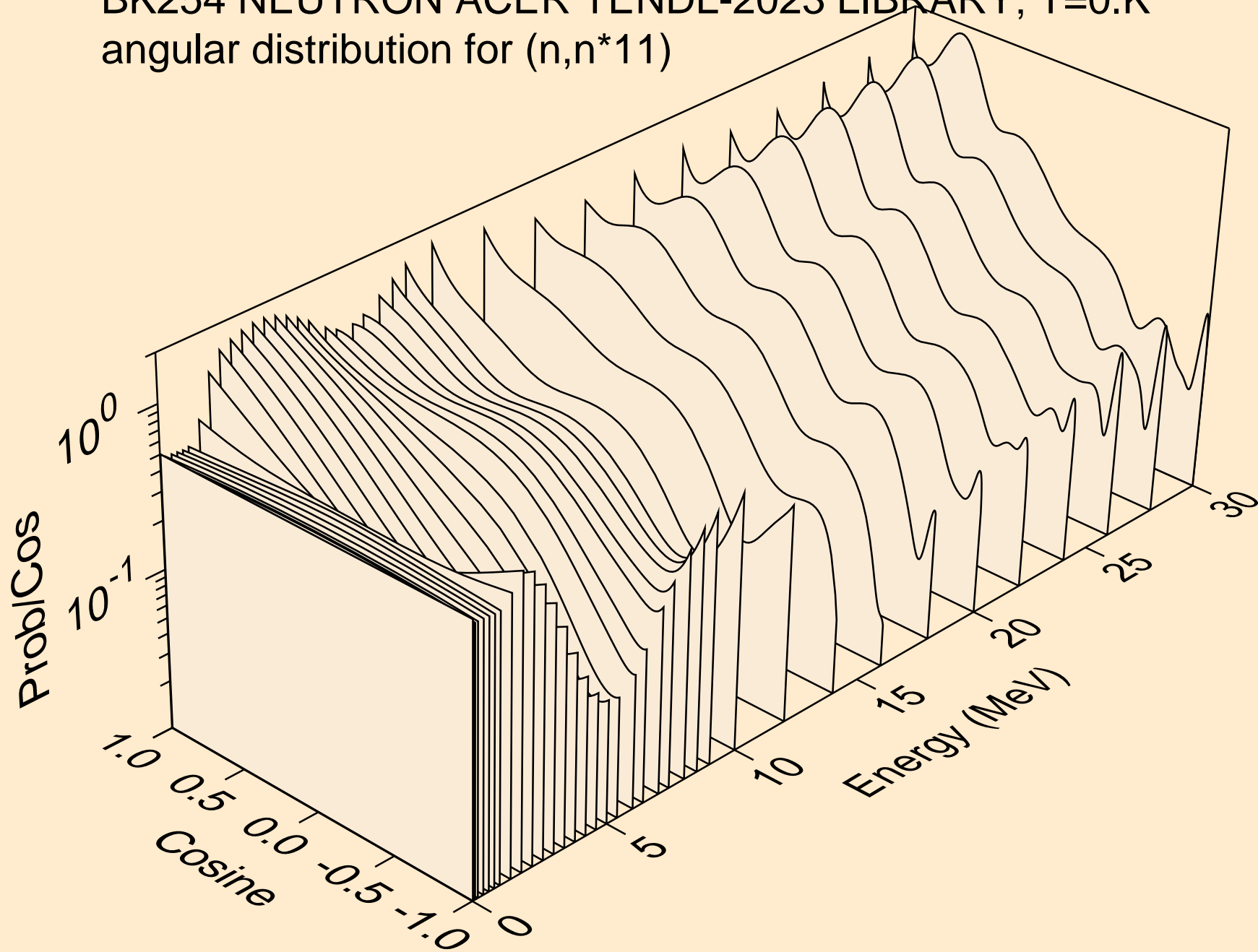

BK254 NEUTRON ACER TENDL-2023 LIBRARY; T=0.K
angular distribution for (n,n*12)

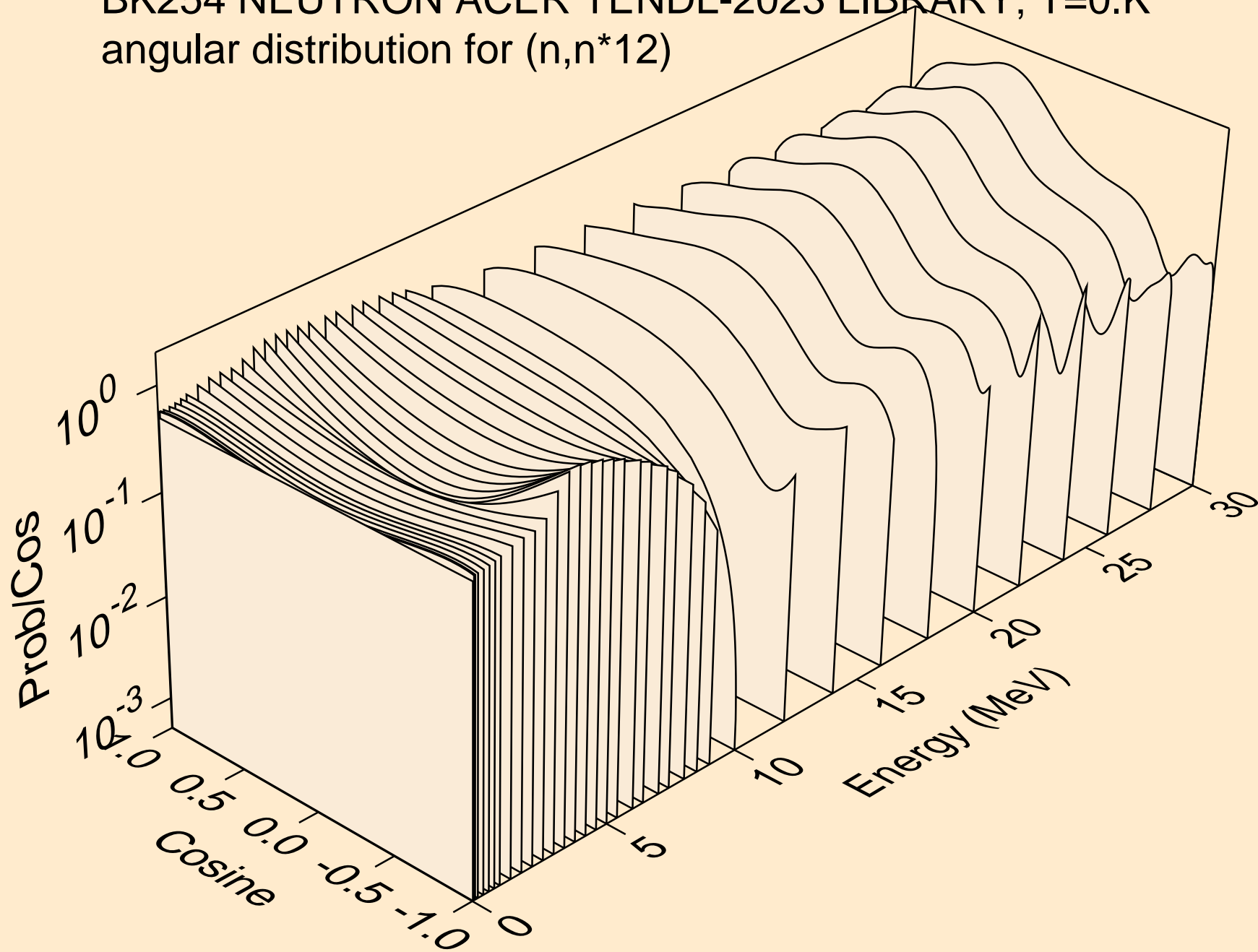

BK254 NEUTRON ACER TENDL-2023 LIBRARY; T=0.K
angular distribution for (n,n*13)

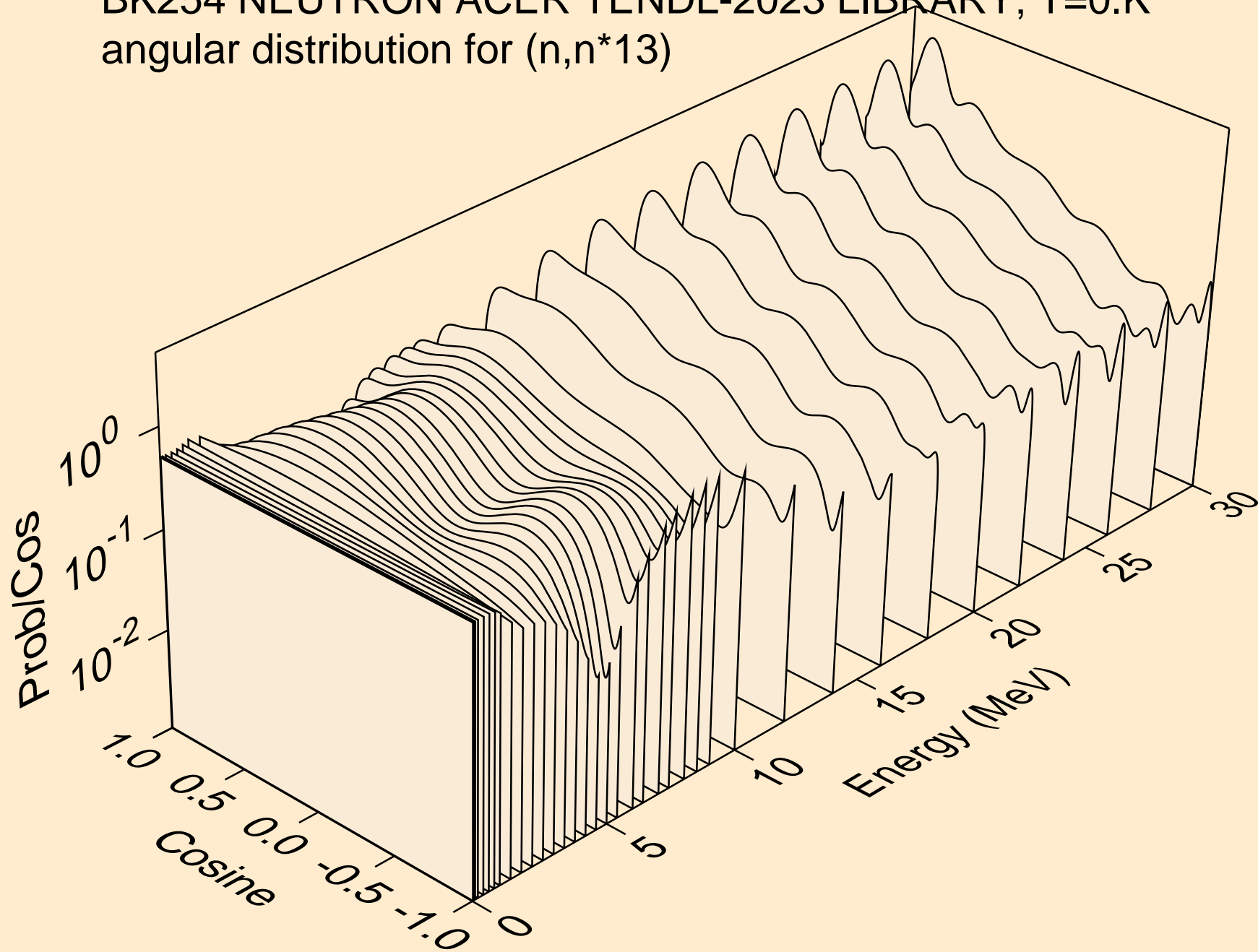

BK254 NEUTRON ACER TENDL-2023 LIBRARY; T=0.K
angular distribution for (n,n*14)

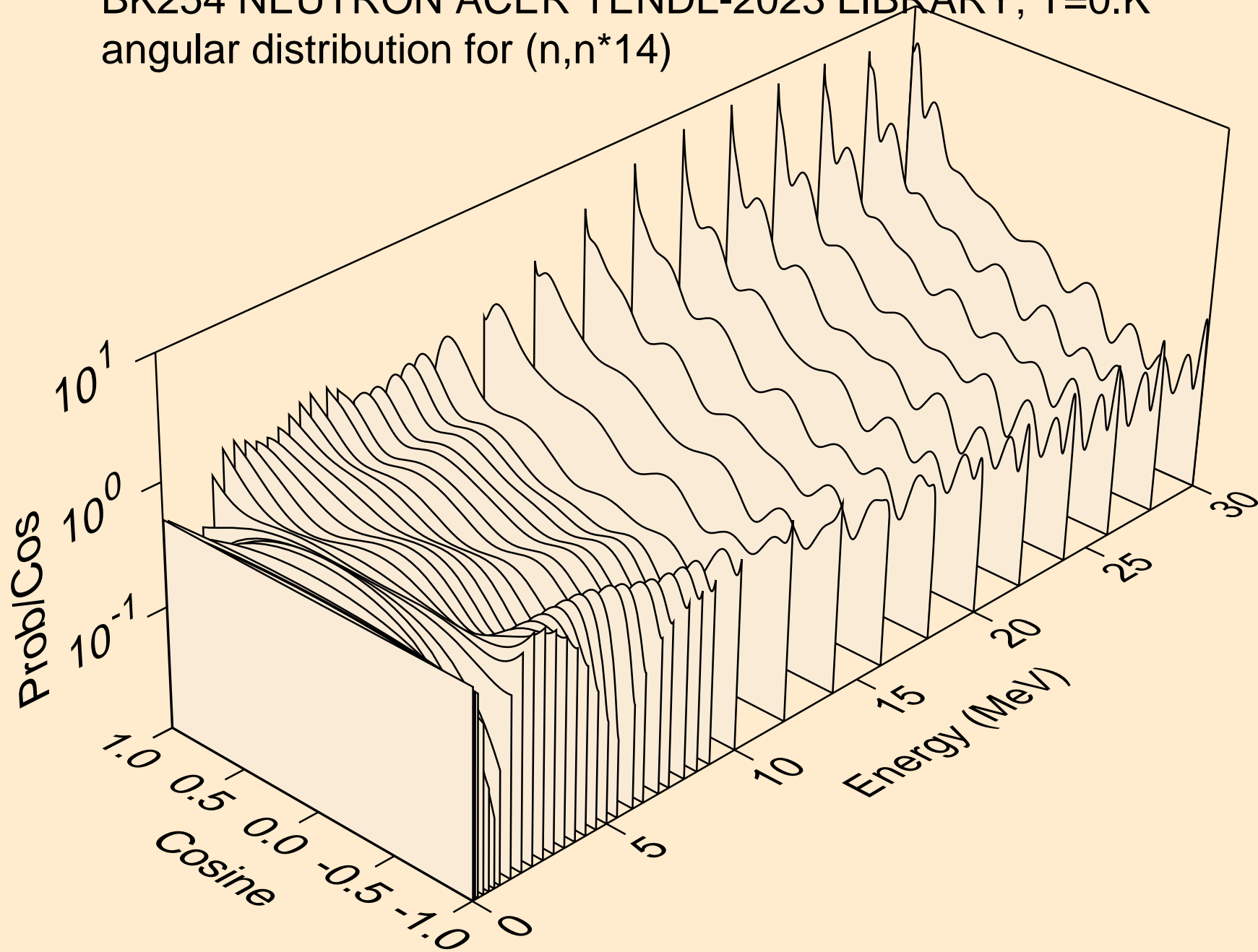

BK254 NEUTRON ACER TENDL-2023 LIBRARY; T=0.K
angular distribution for (n,n*15)

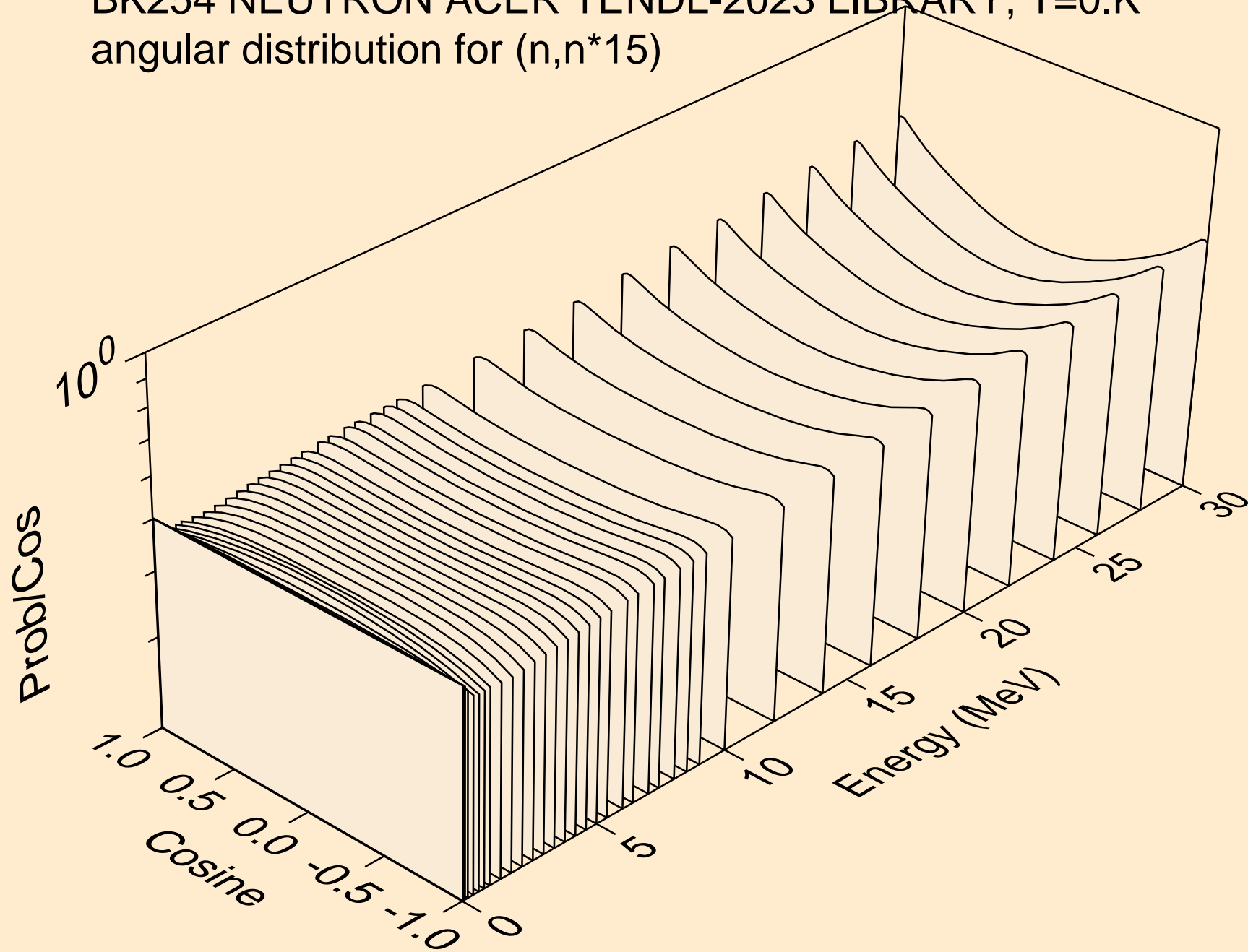

BK254 NEUTRON ACER TENDL-2023 LIBRARY; T=0.K
angular distribution for (n,n*16)

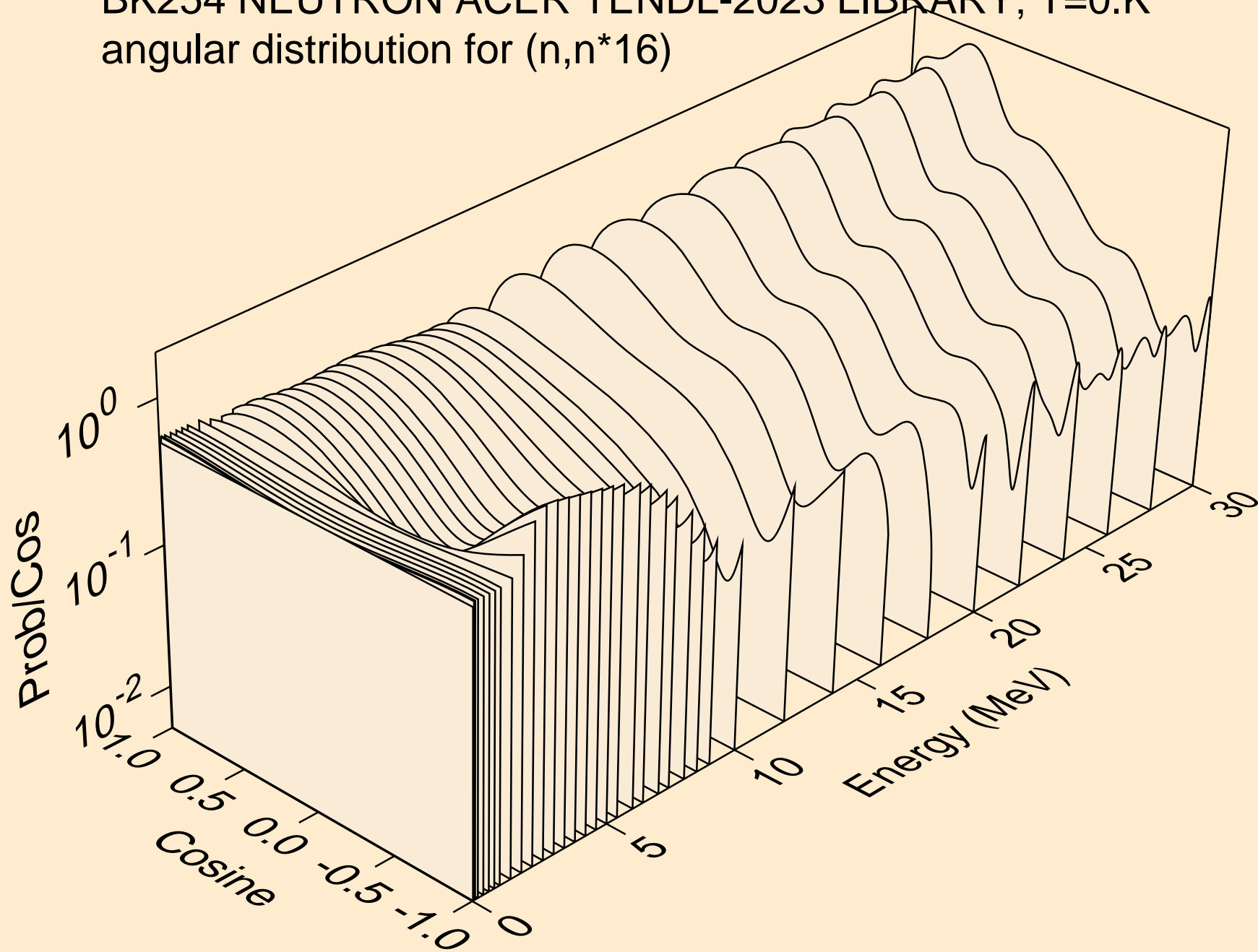

BK254 NEUTRON ACER TENDL-2023 LIBRARY; T=0.K
angular distribution for (n,n*17)

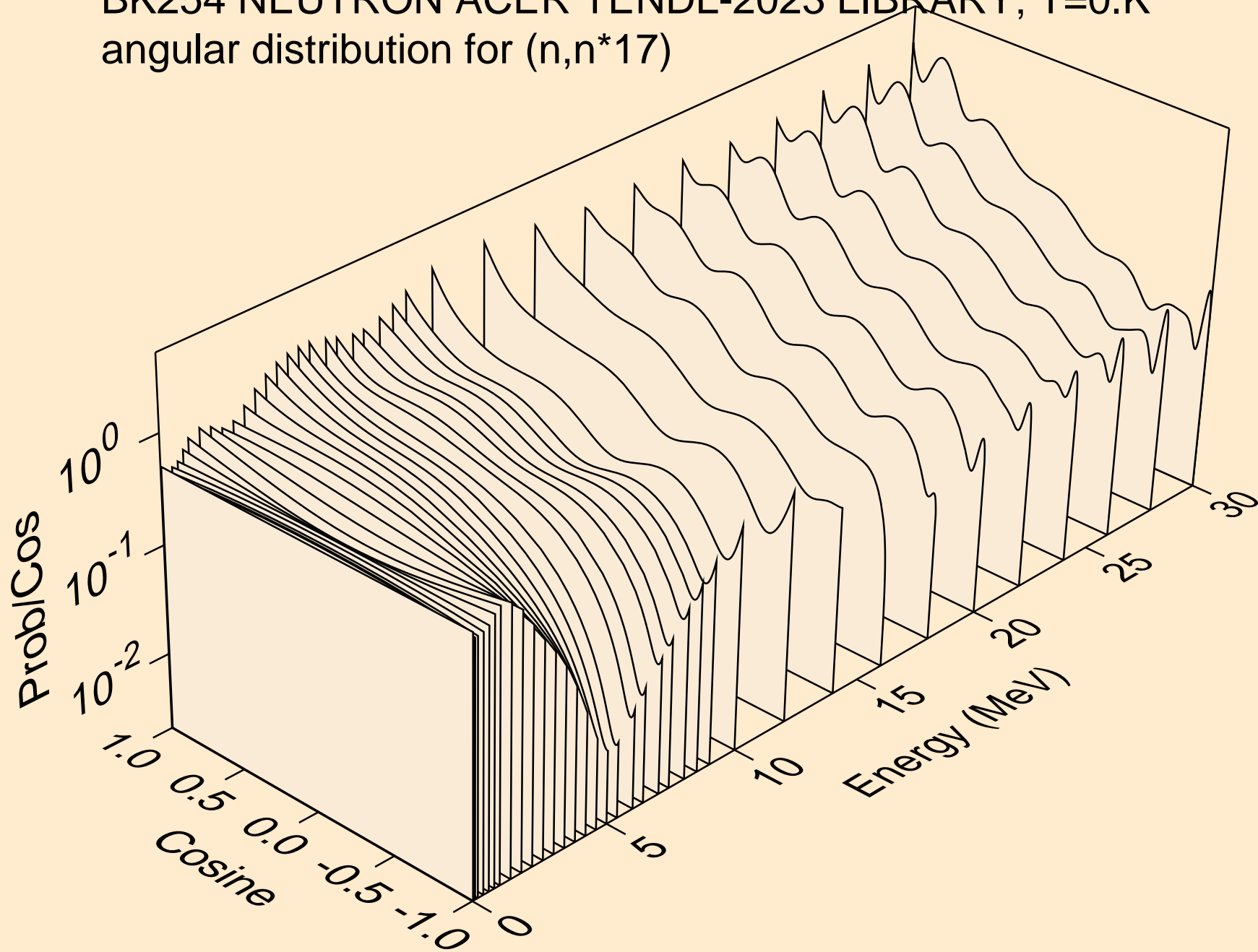

BK254 NEUTRON ACER TENDL-2023 LIBRARY; T=0.K
angular distribution for (n,n*18)

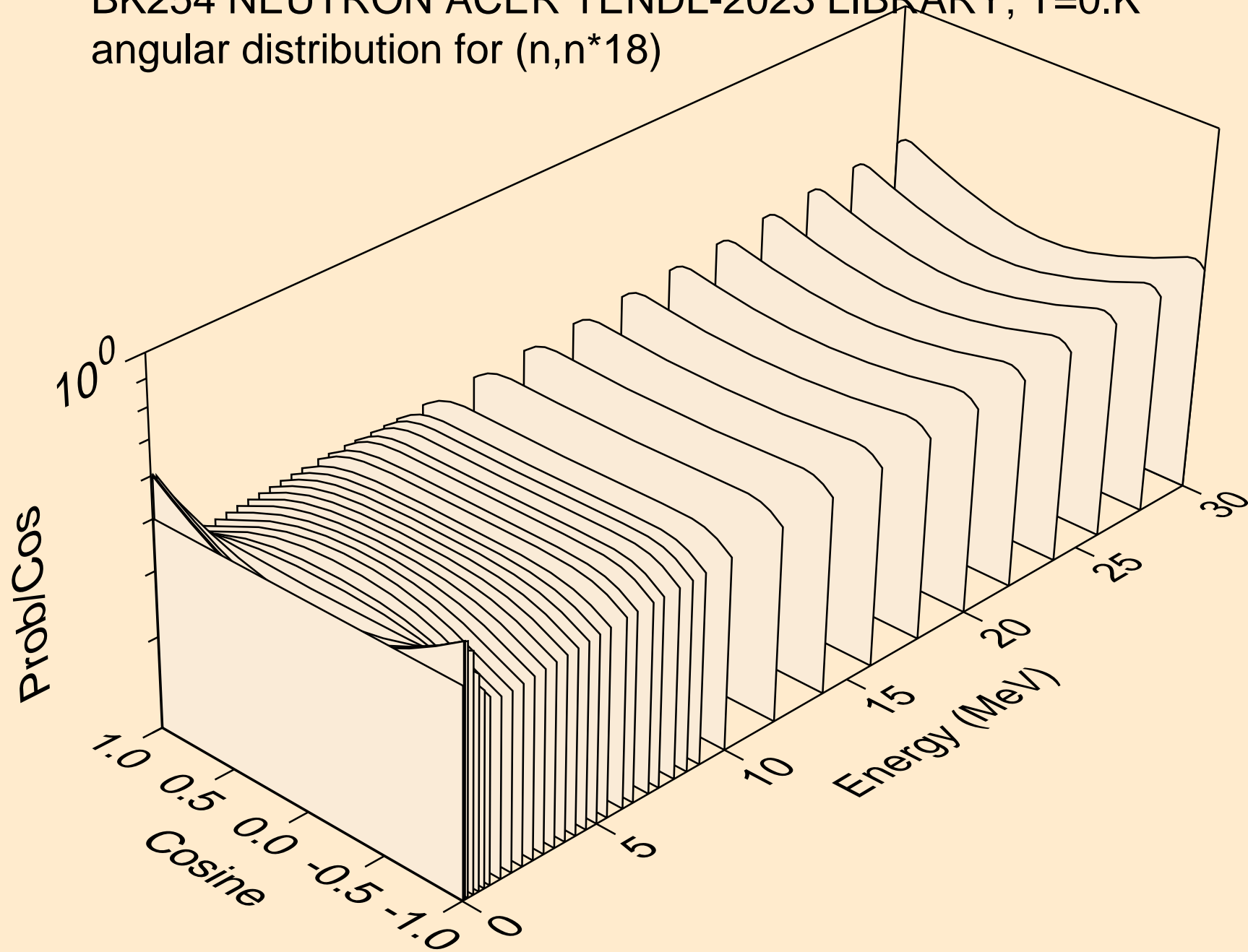

BK254 NEUTRON ACER TENDL-2023 LIBRARY; T=0.K
angular distribution for (n,n*19)

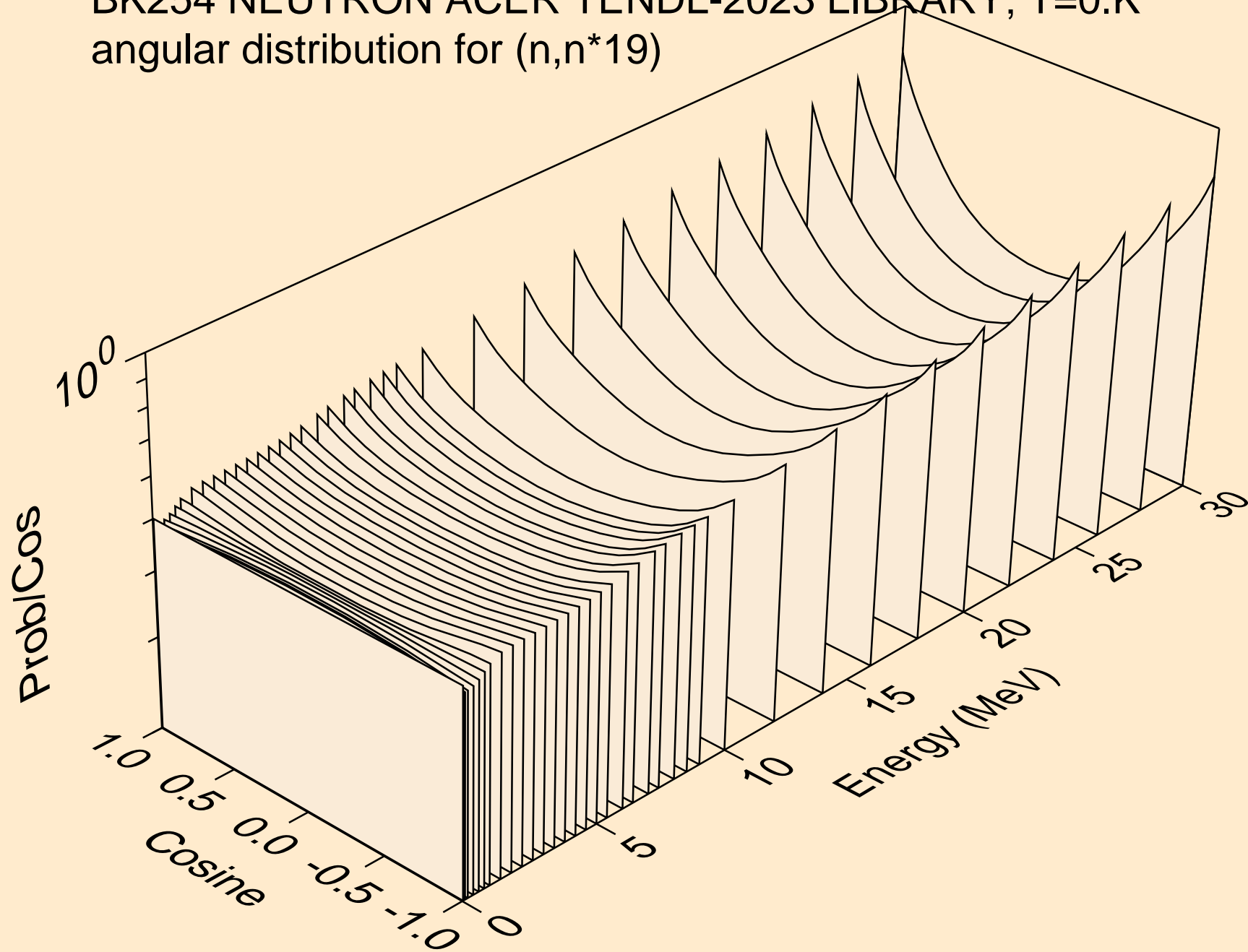

BK254 NEUTRON ACER TENDL-2023 LIBRARY; T=0.K
angular distribution for (n,n*20)

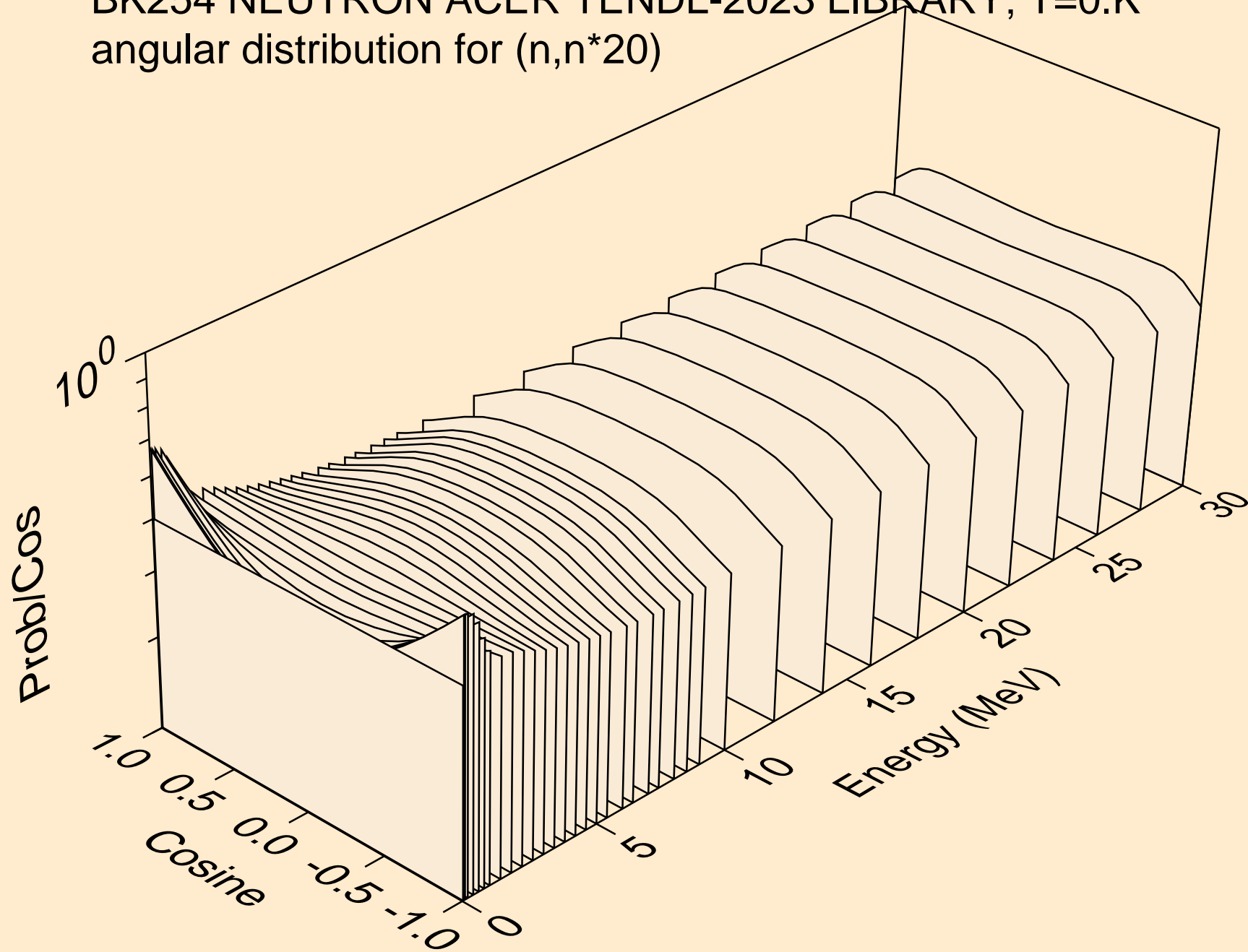

BK254 NEUTRON ACER TENDL-2023 LIBRARY; T=0.K
angular distribution for (n,n*21)

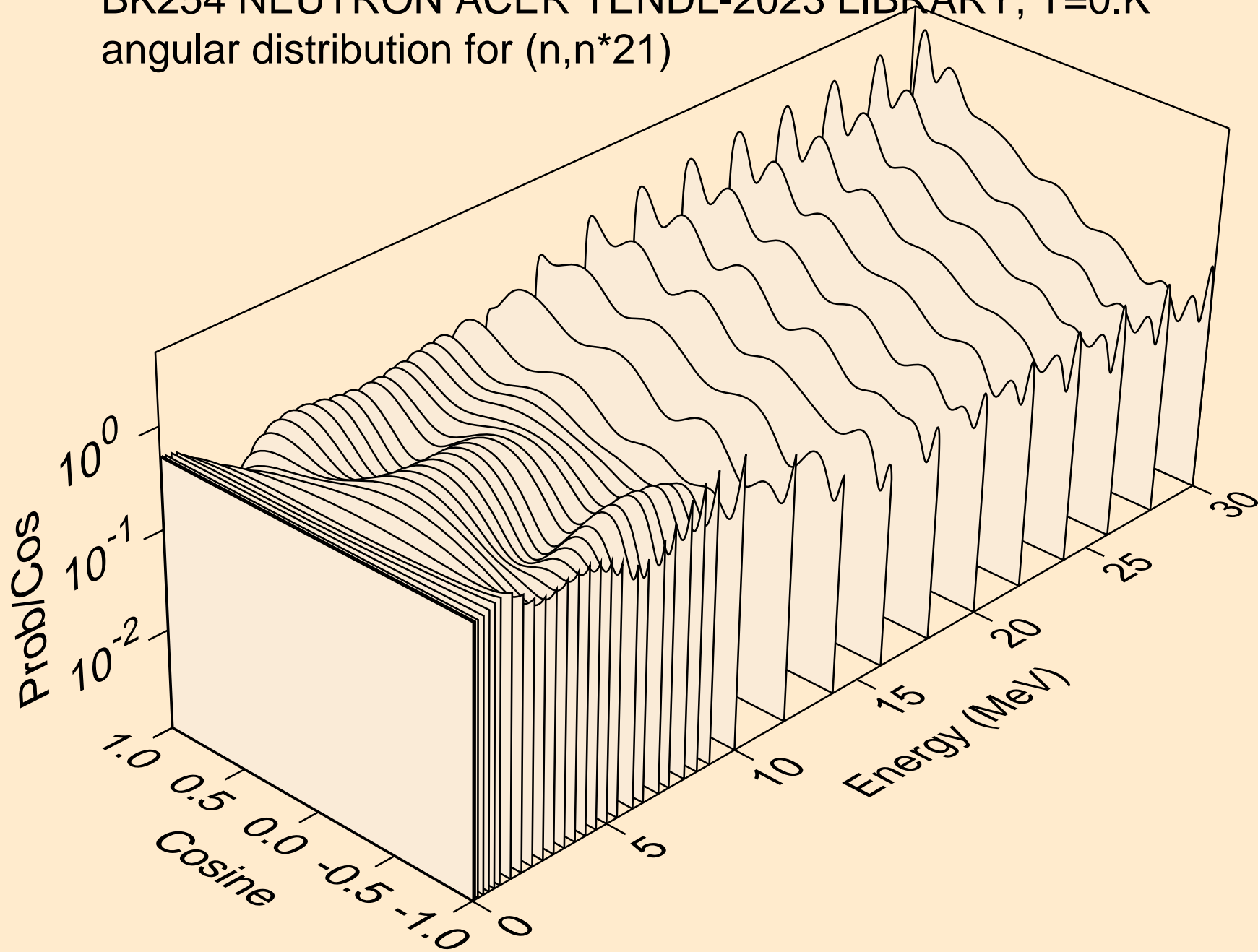

BK254 NEUTRON ACER TENDL-2023 LIBRARY; T=0.K
angular distribution for (n,n*22)

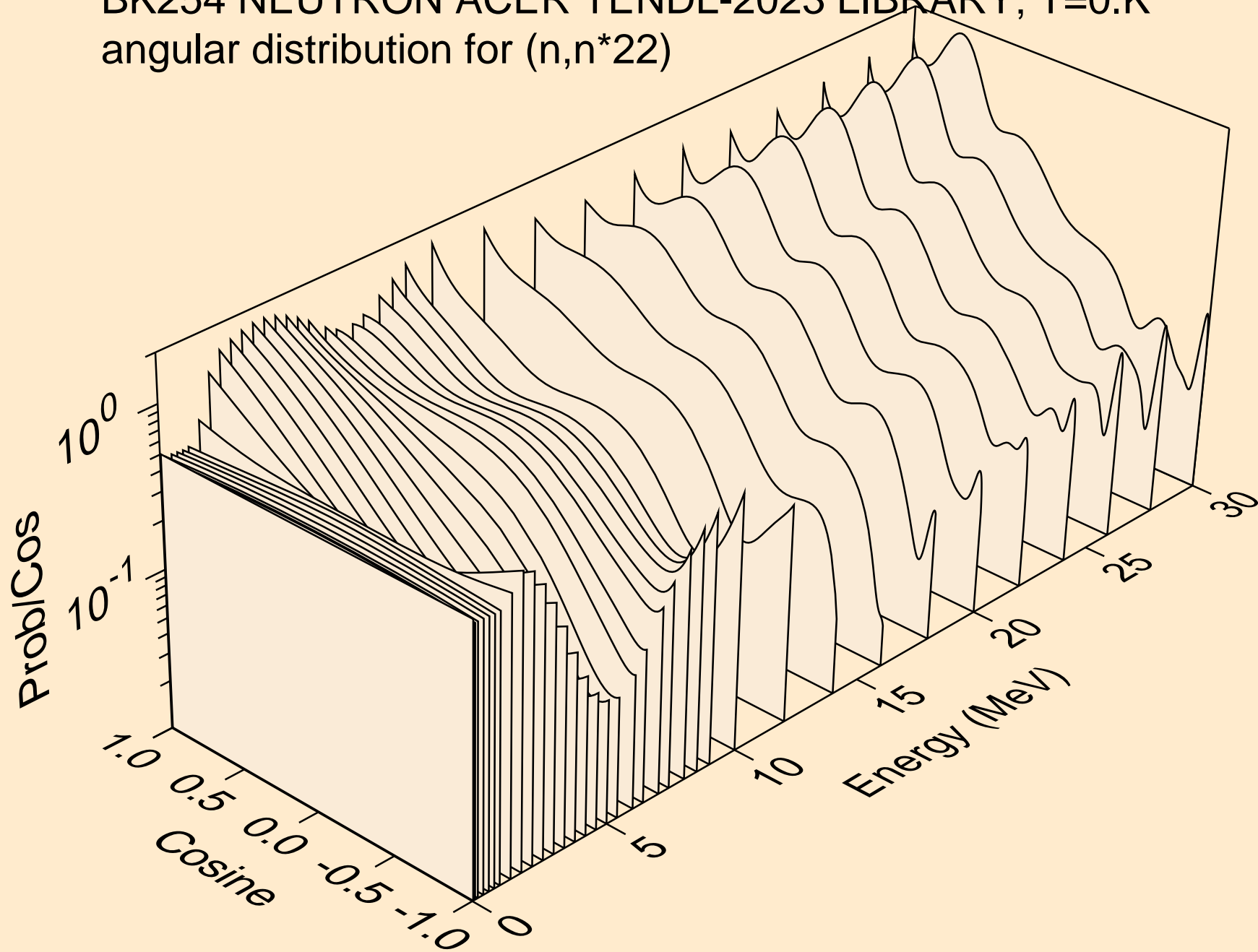

BK254 NEUTRON ACER TENDL-2023 LIBRARY; T=0.K
angular distribution for (n,n*23)

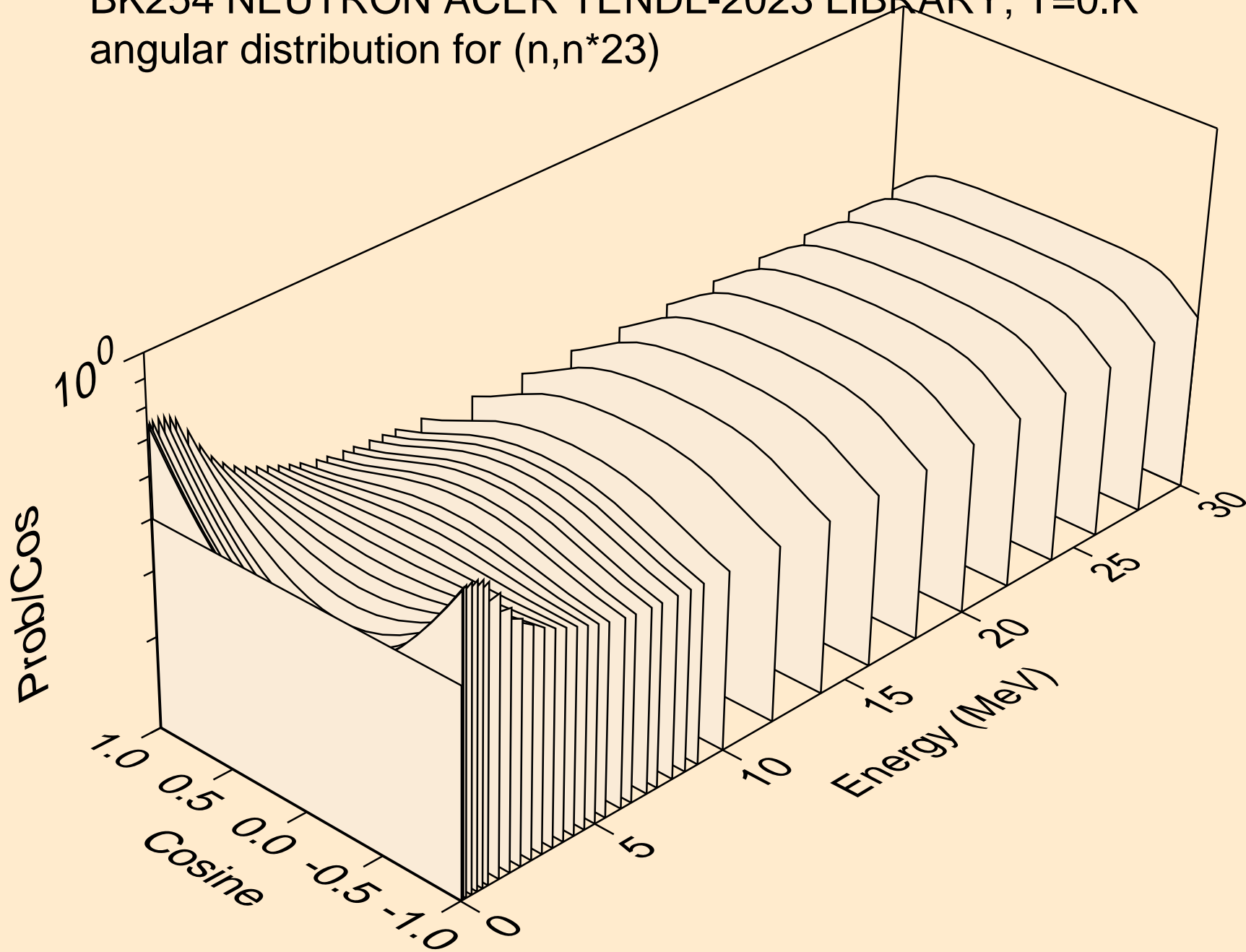

BK254 NEUTRON ACER TENDL-2023 LIBRARY; T=0.K
angular distribution for (n,n*24)

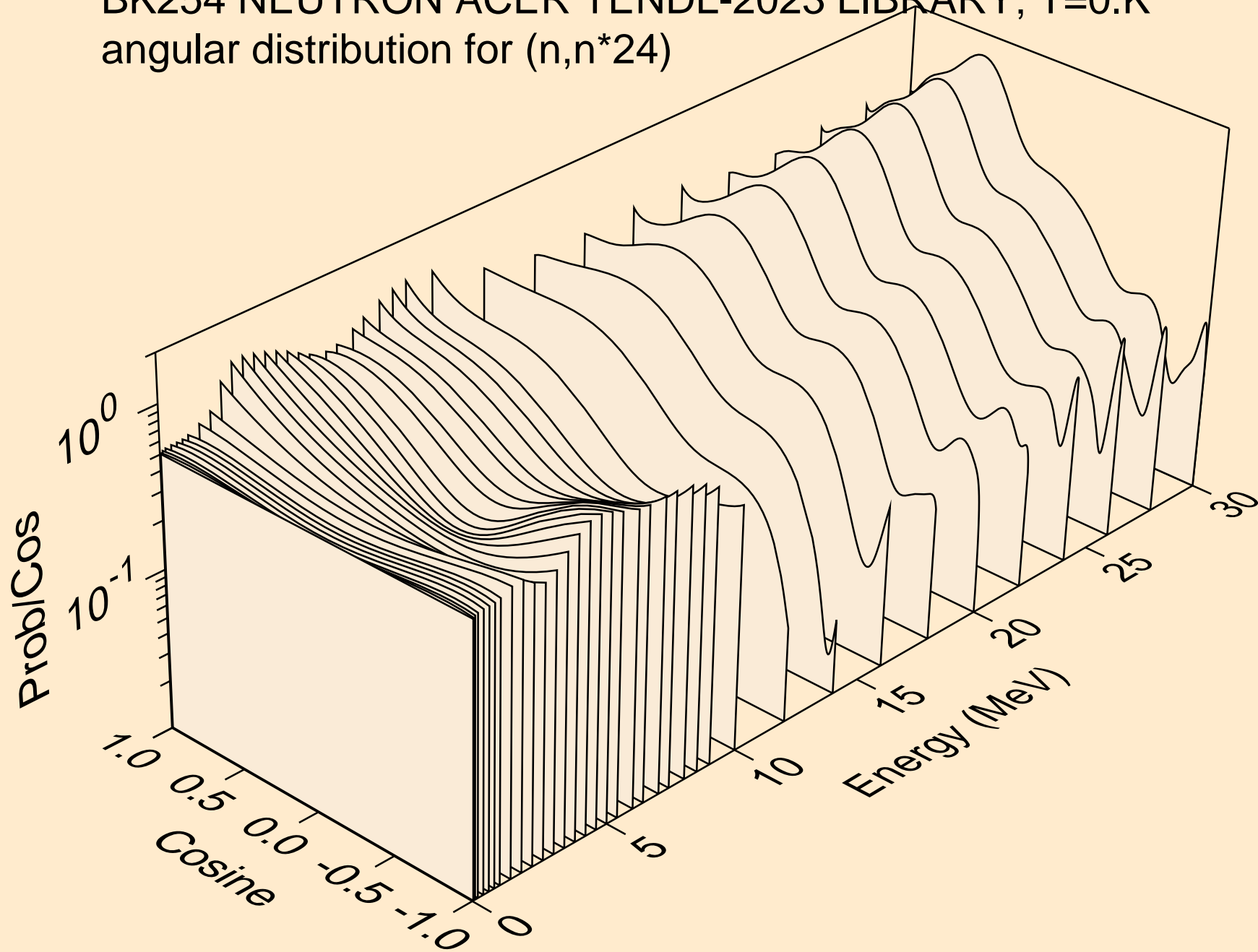

BK254 NEUTRON ACER TENDL-2023 LIBRARY; T=0.K
angular distribution for (n,n*25)

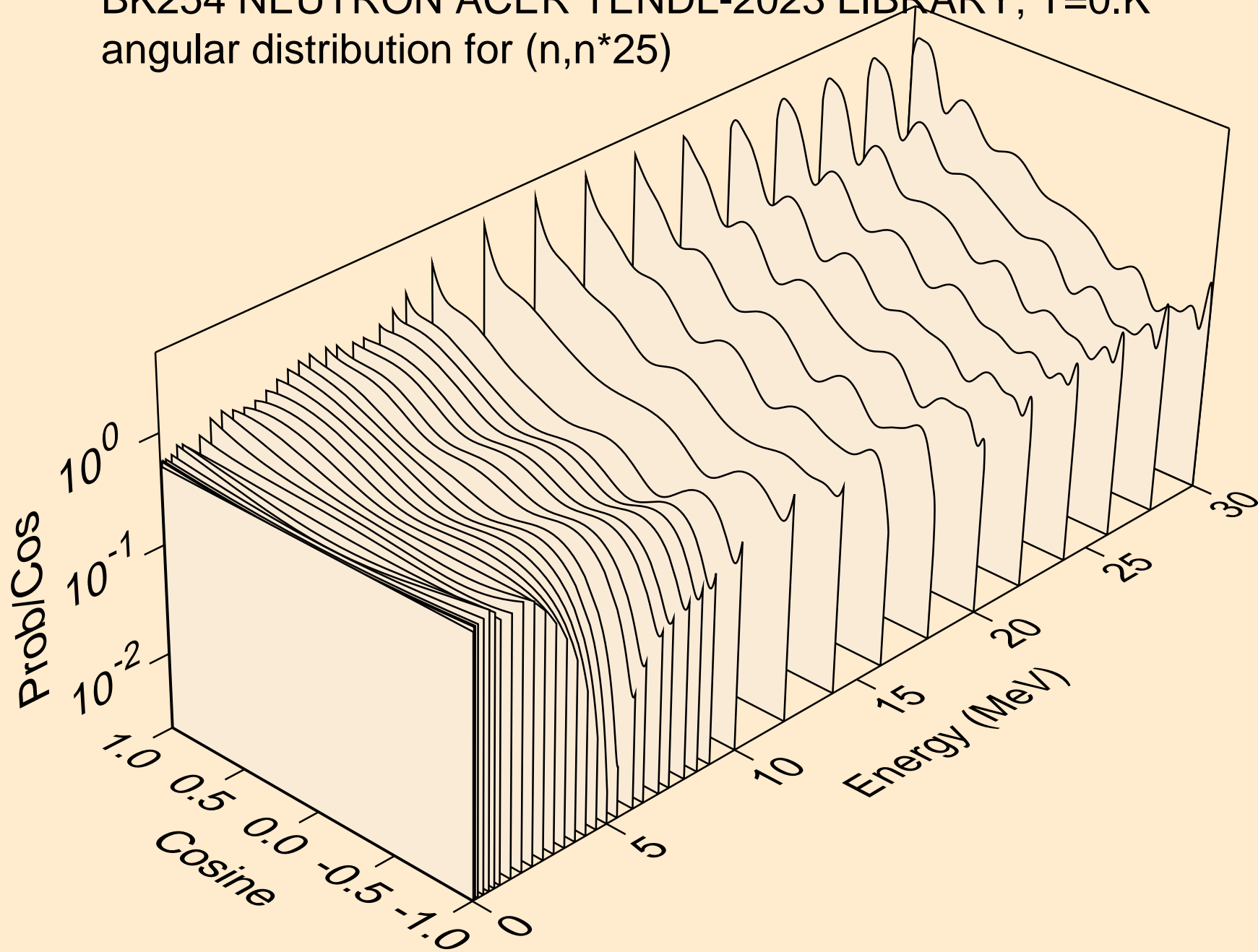

BK254 NEUTRON ACER TENDL-2023 LIBRARY; T=0.K
angular distribution for (n,n*26)

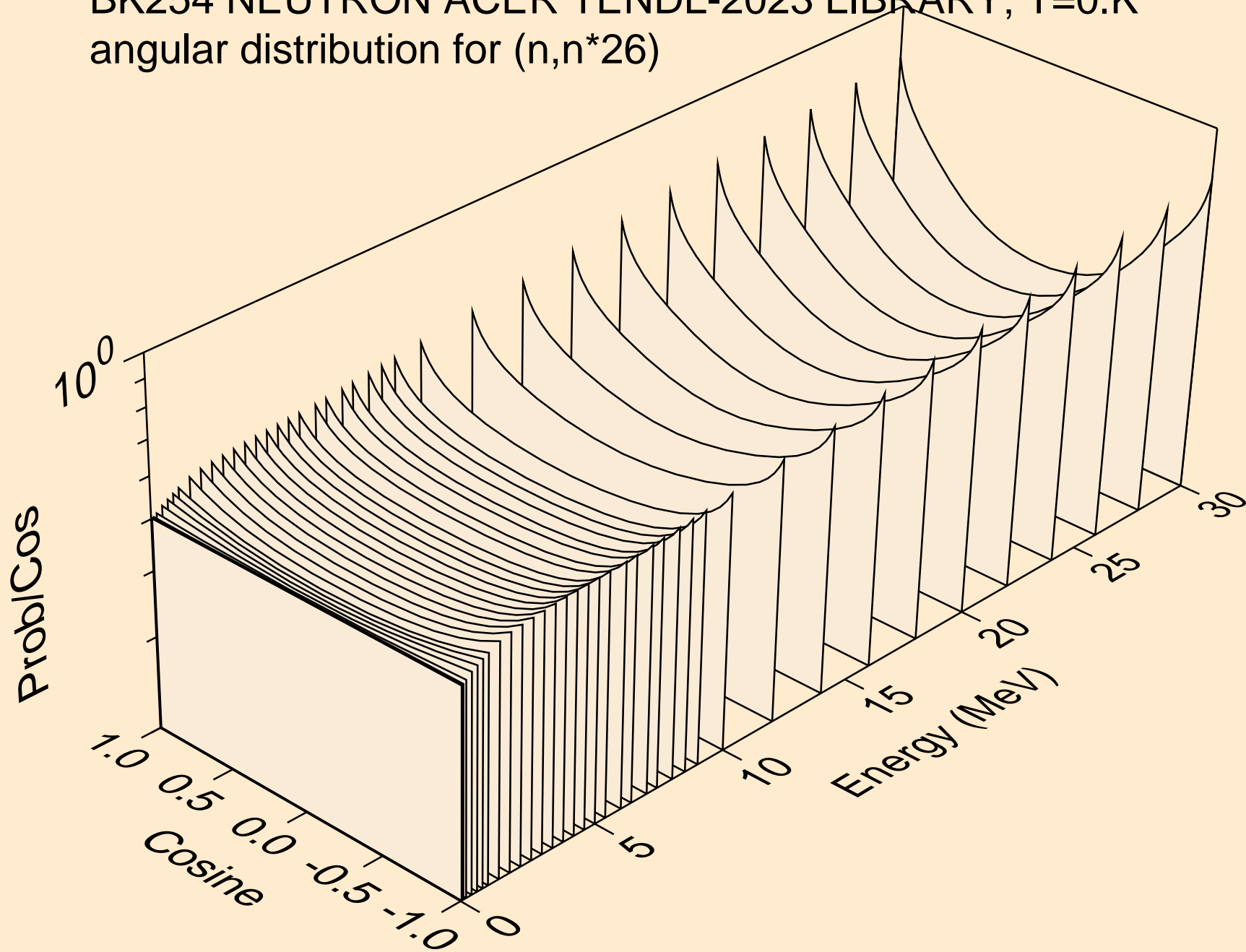

BK254 NEUTRON ACER TENDL-2023 LIBRARY; T=0.K
angular distribution for (n,n*27)

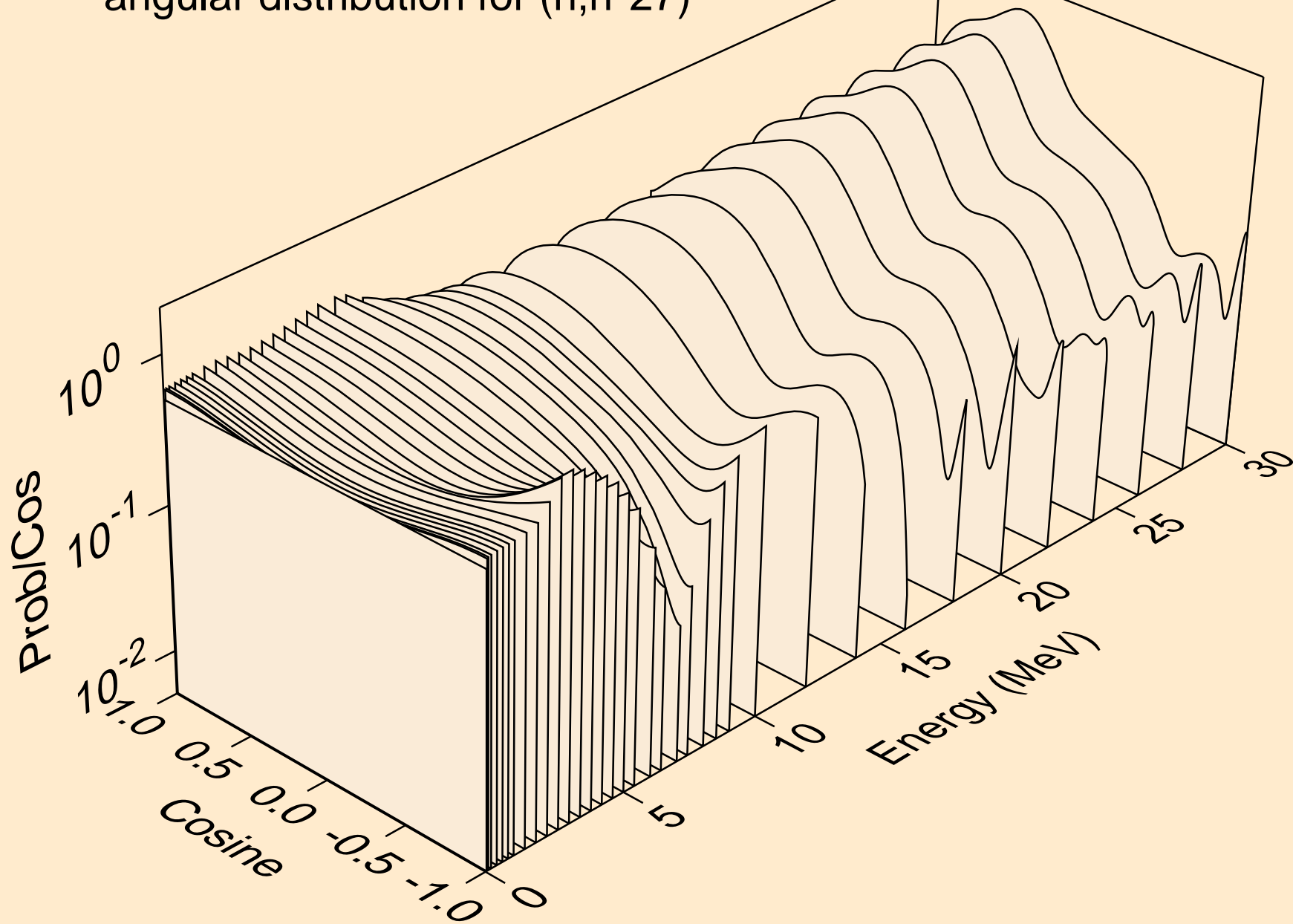

BK254 NEUTRON ACER TENDL-2023 LIBRARY; T=0.K
angular distribution for (n,n*28)

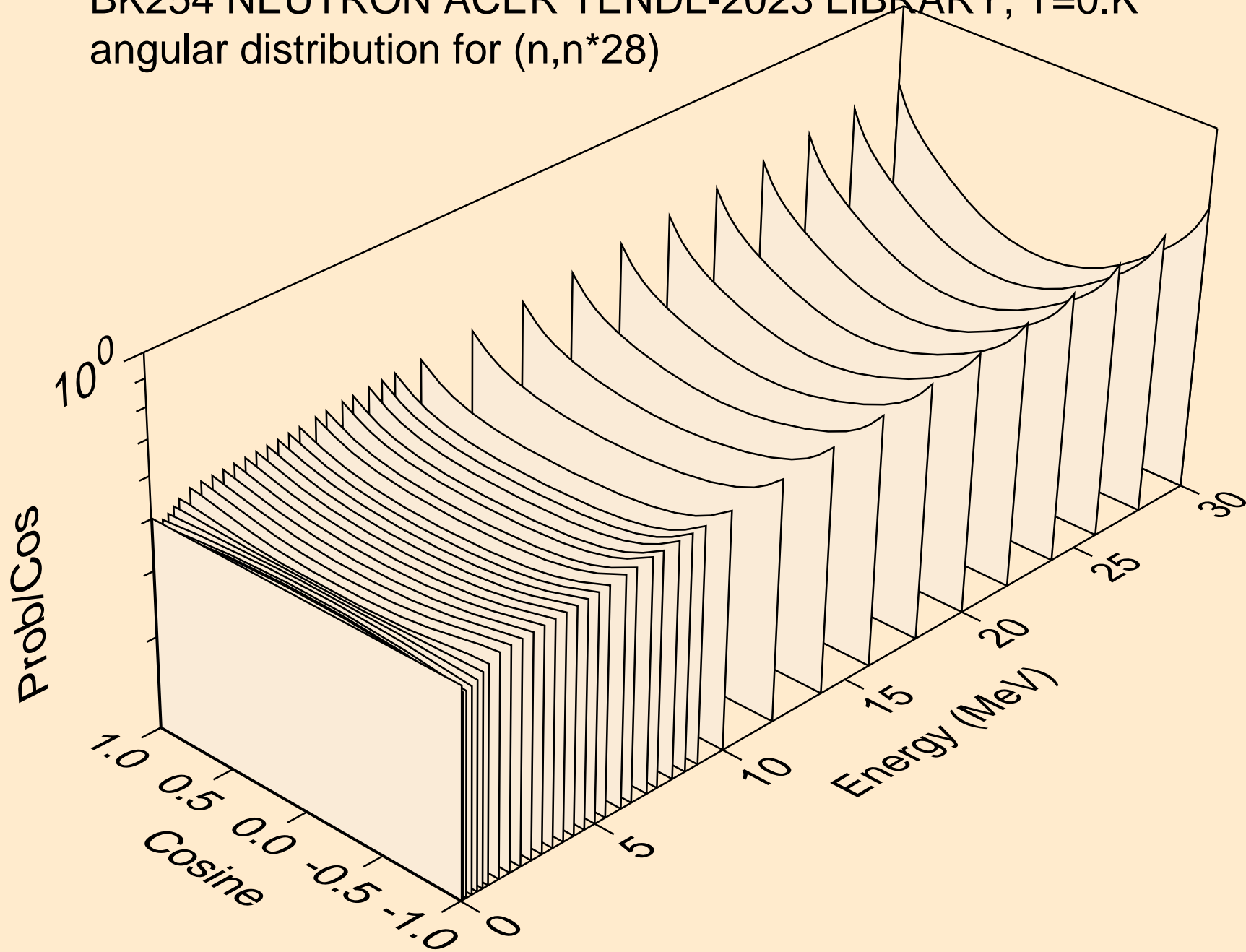

BK254 NEUTRON ACER TENDL-2023 LIBRARY; T=0.K
angular distribution for (n,n*29)

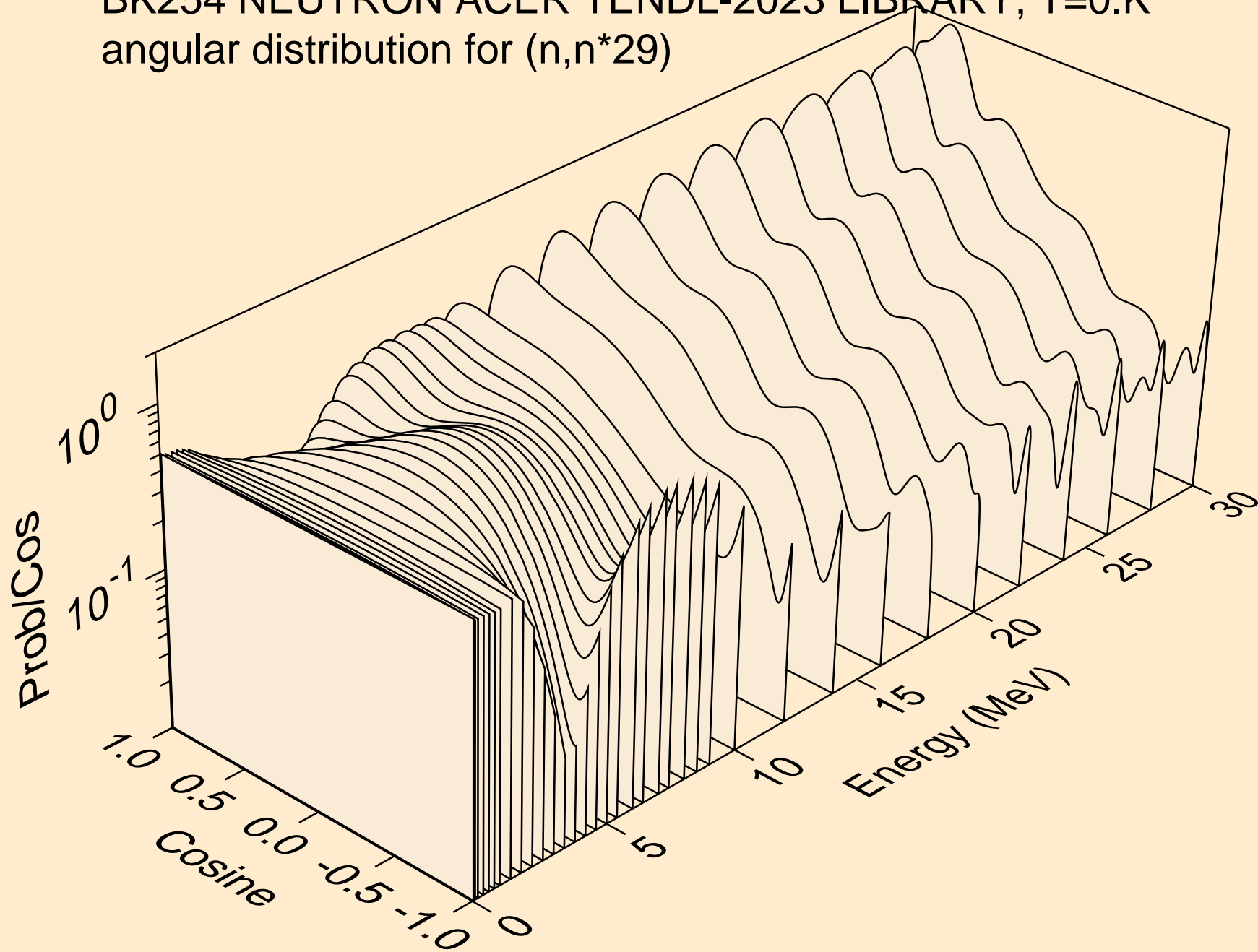

BK254 NEUTRON ACER TENDL-2023 LIBRARY; T=0.K
angular distribution for (n,n*30)

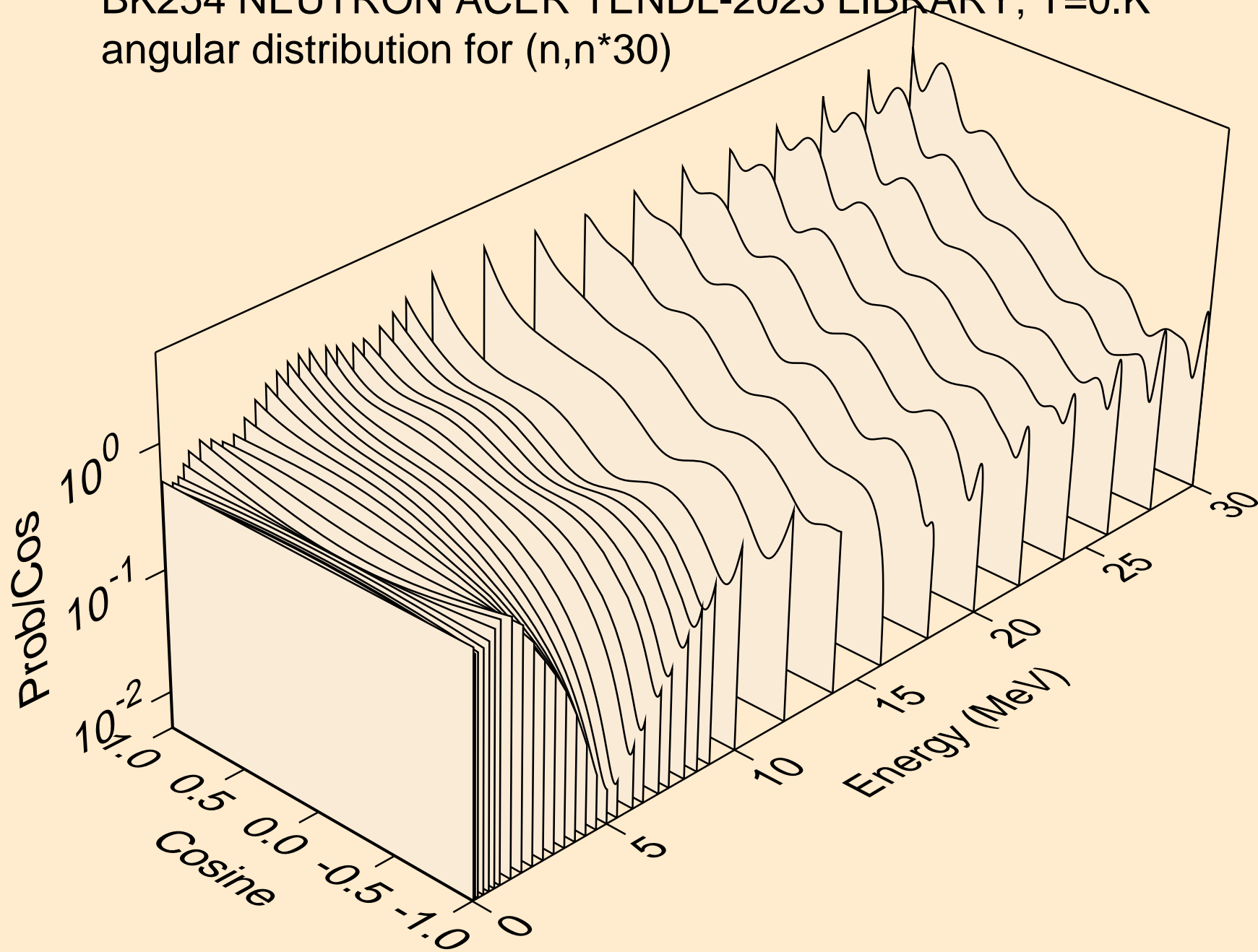

BK254 NEUTRON ACER TENDL-2023 LIBRARY; T=0.K

Total fission nubar

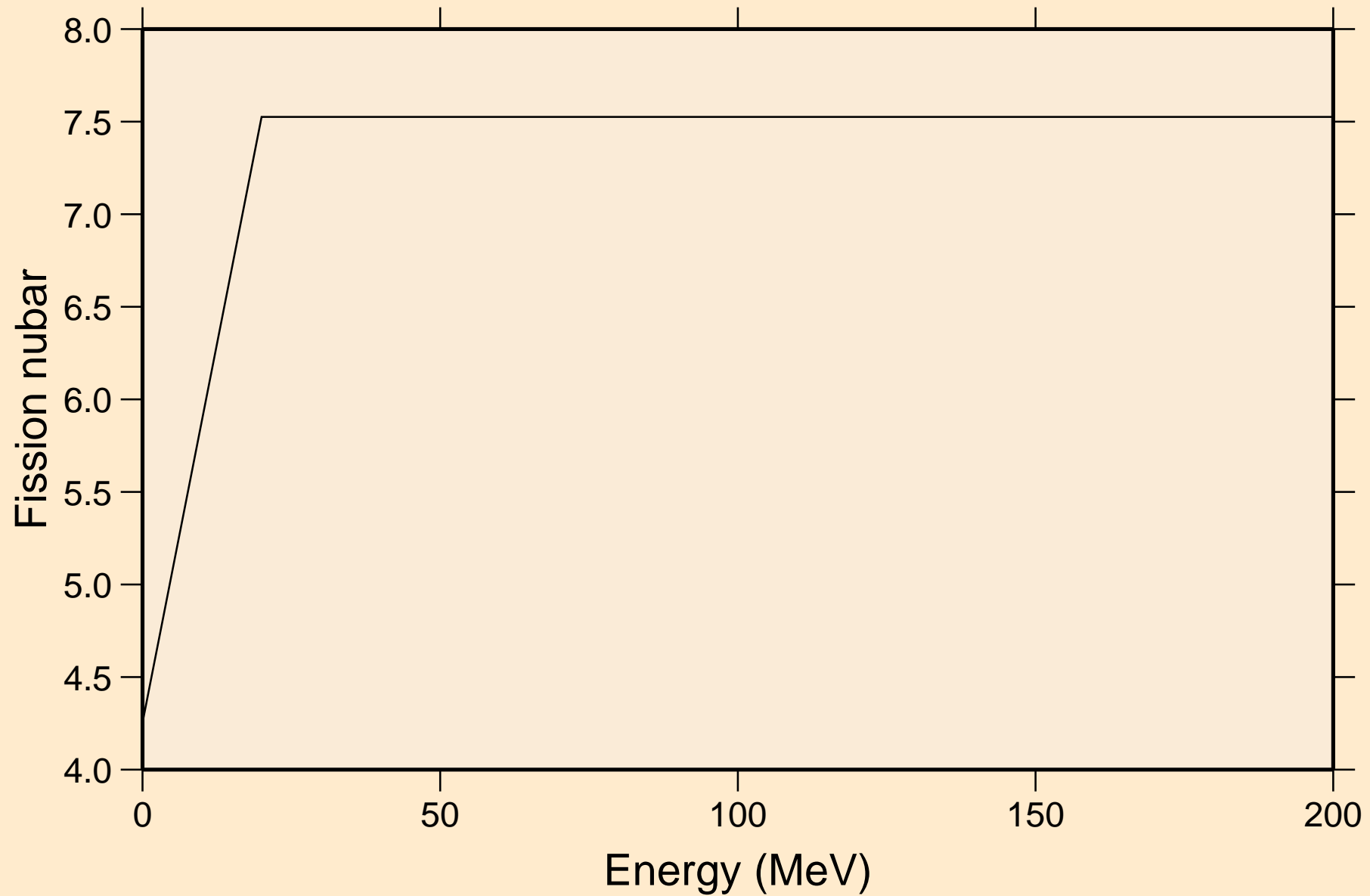

BK254 NEUTRON ACER TENDL-2023 LIBRARY; T=0.K
Neutron emission for (n,x)

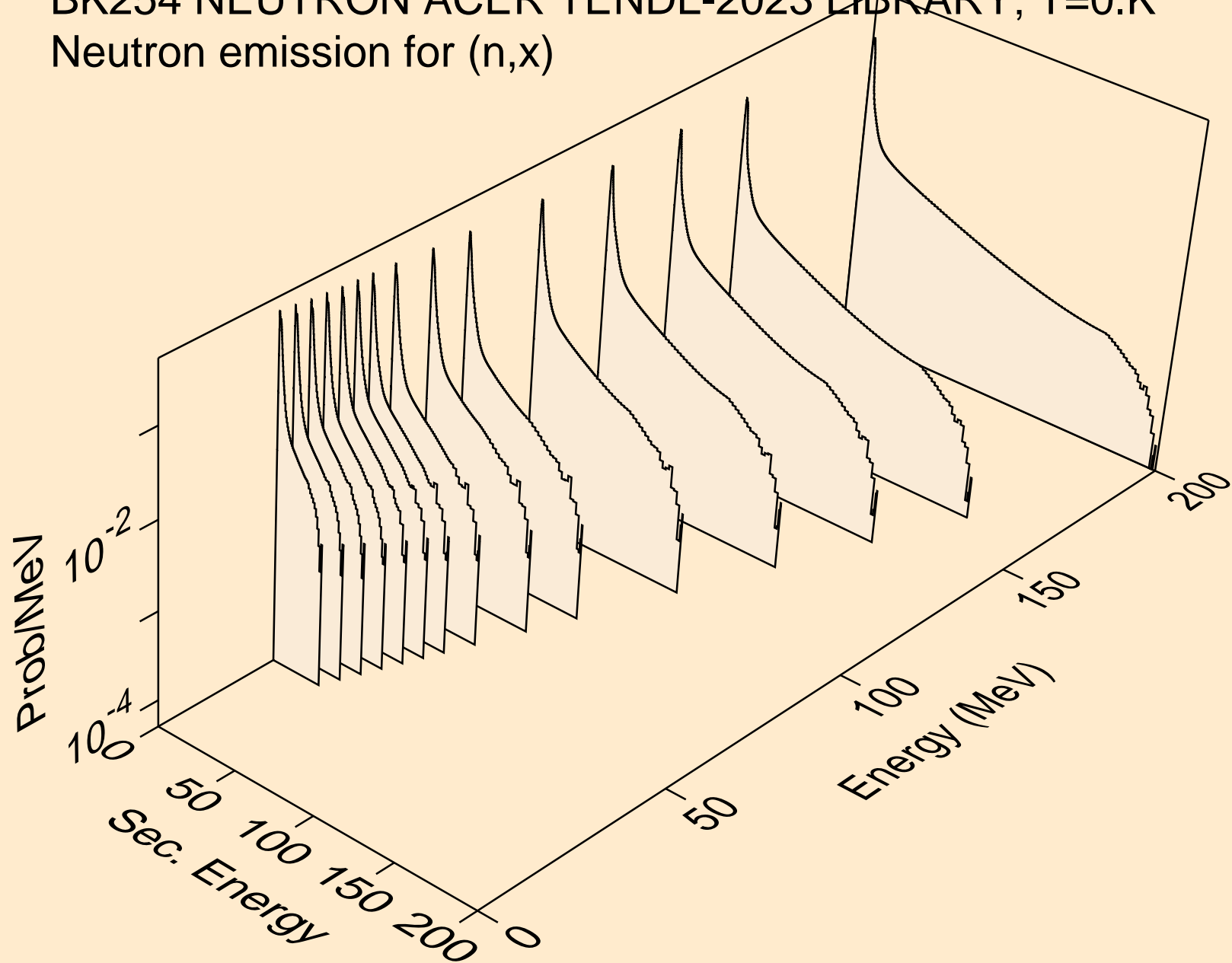

BK254 NEUTRON ACER TENDL-2023 LIBRARY; T=0.K
Neutron emission for (n,2nd)

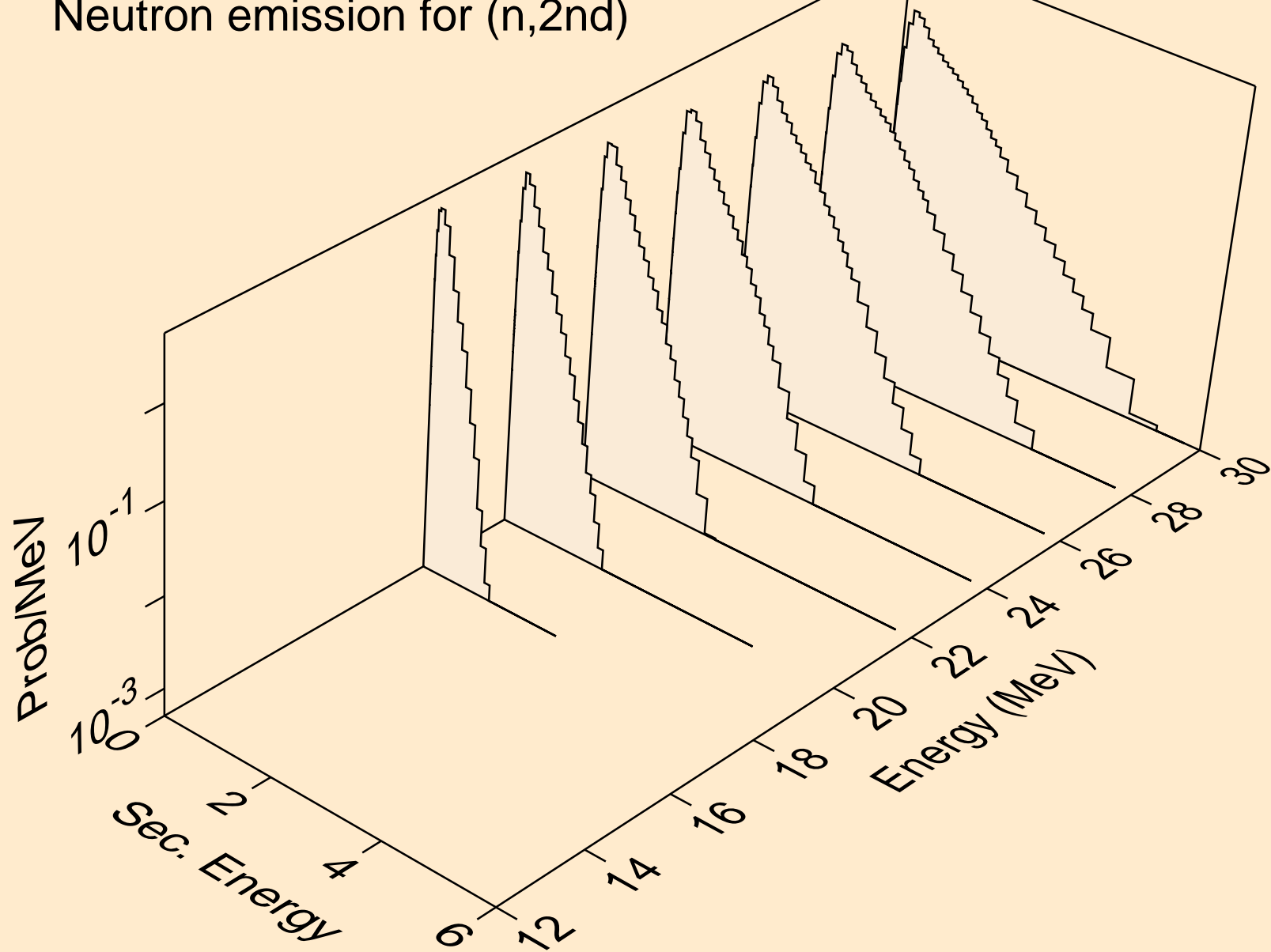

BK254 NEUTRON ACER TENDL-2023 LIBRARY; T=0.K
Neutron emission for (n,2n)

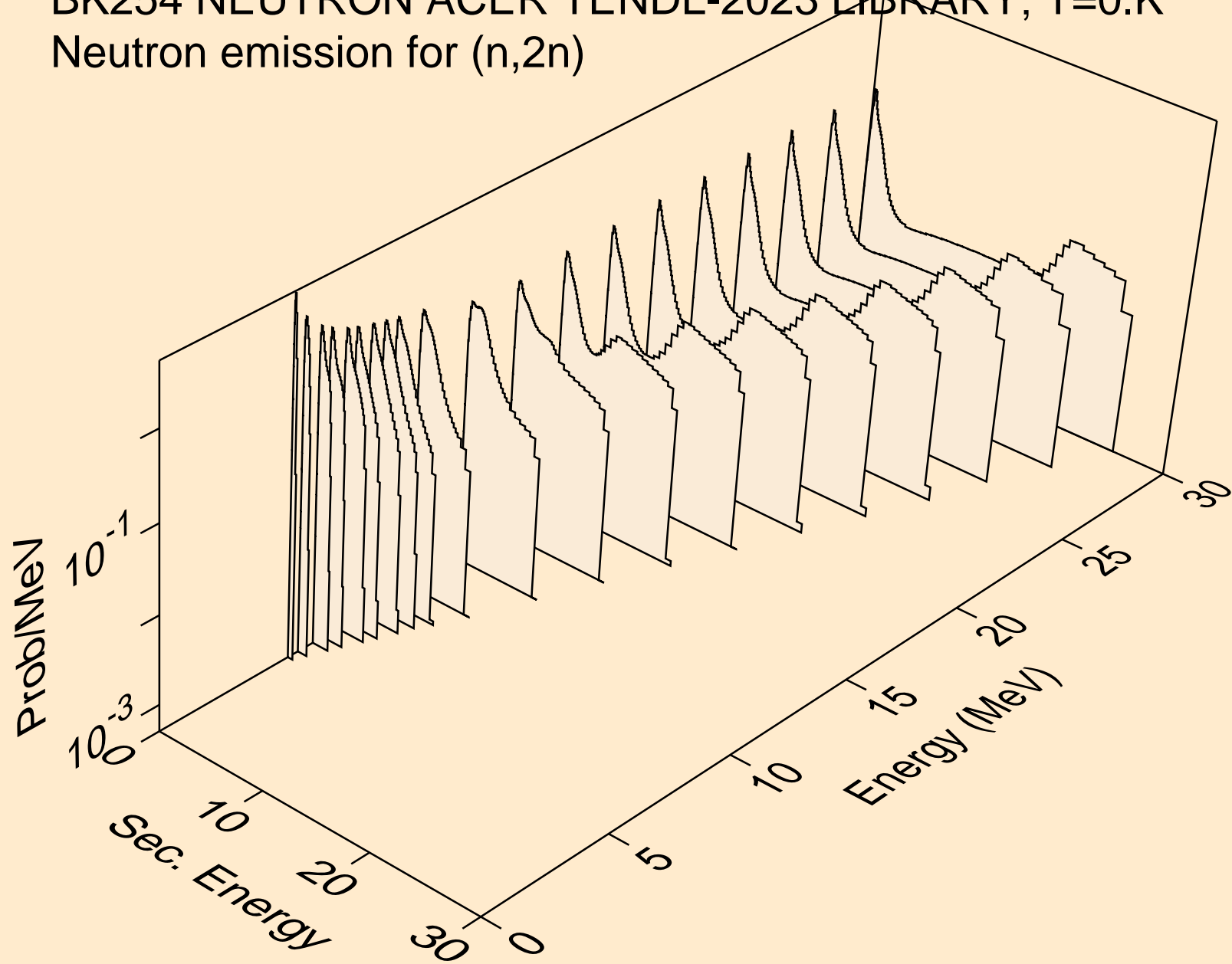

BK254 NEUTRON ACER TENDL-2023 LIBRARY; T=0.K
Neutron emission for (n,3n)

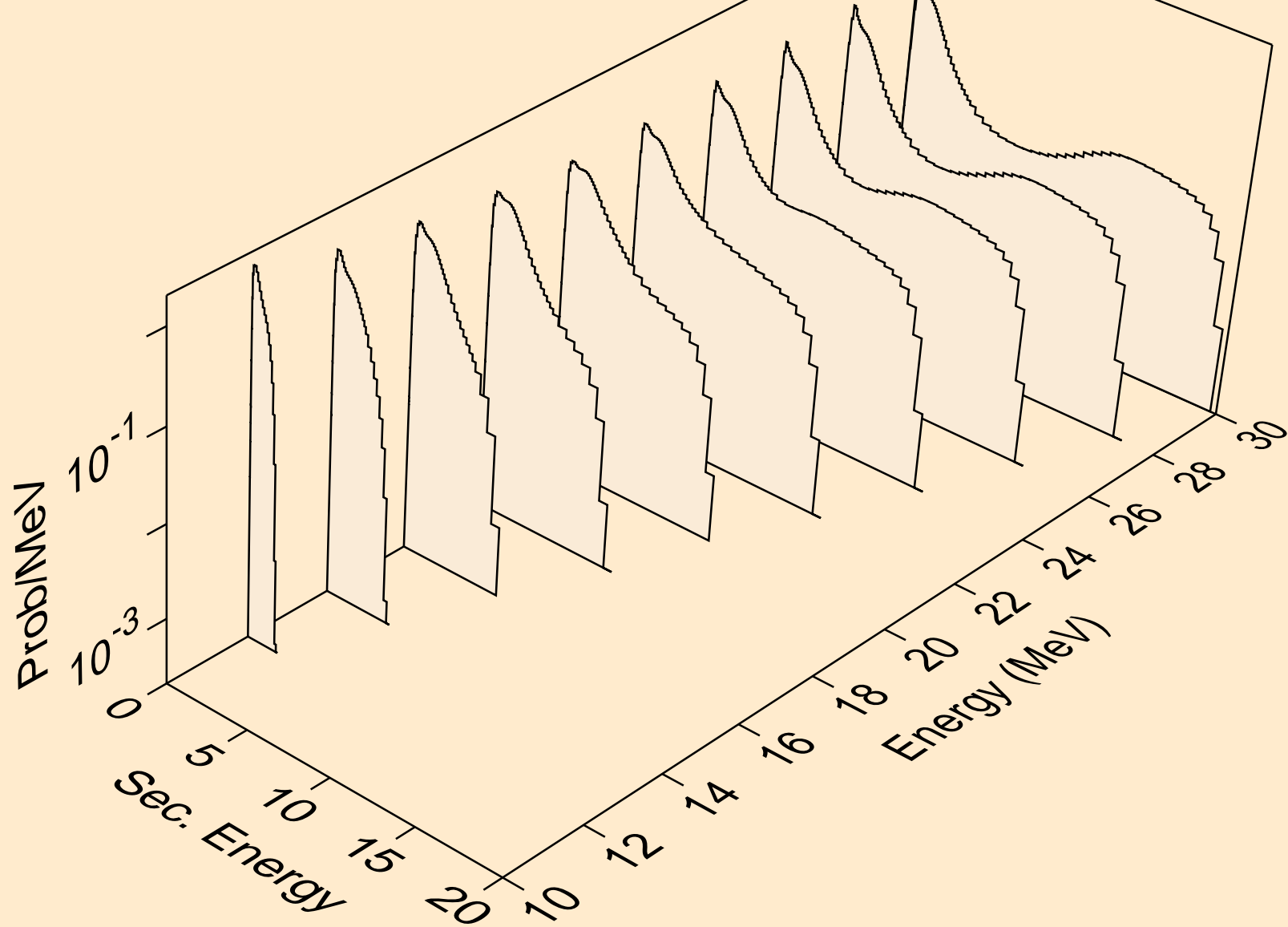

BK254 NEUTRON ACER TENDL-2023 LIBRARY; T=0.K
Neutron emission for fission

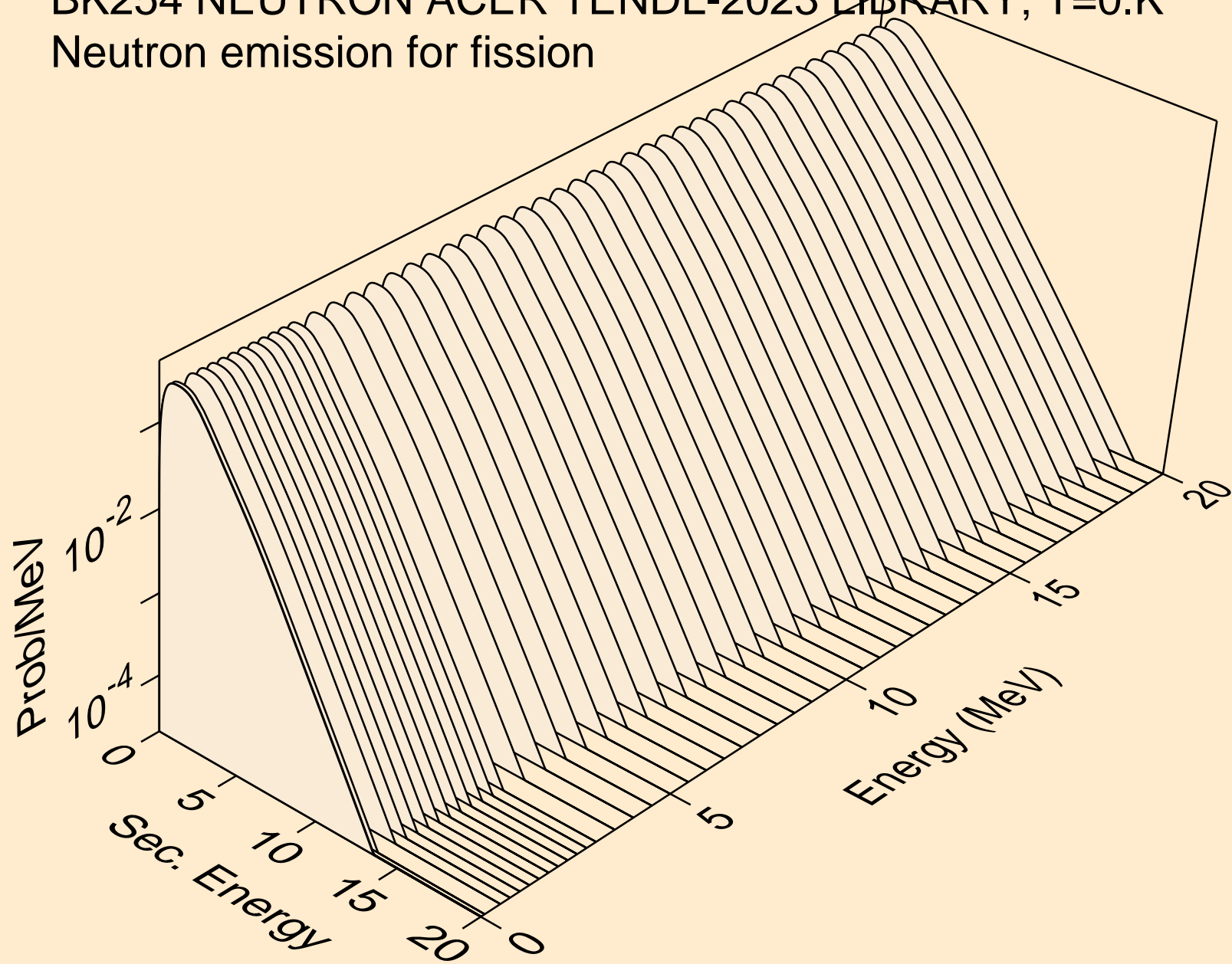

BK254 NEUTRON ACER TENDL-2023 LIBRARY; T=0.K
Neutron emission for (n,n*)a

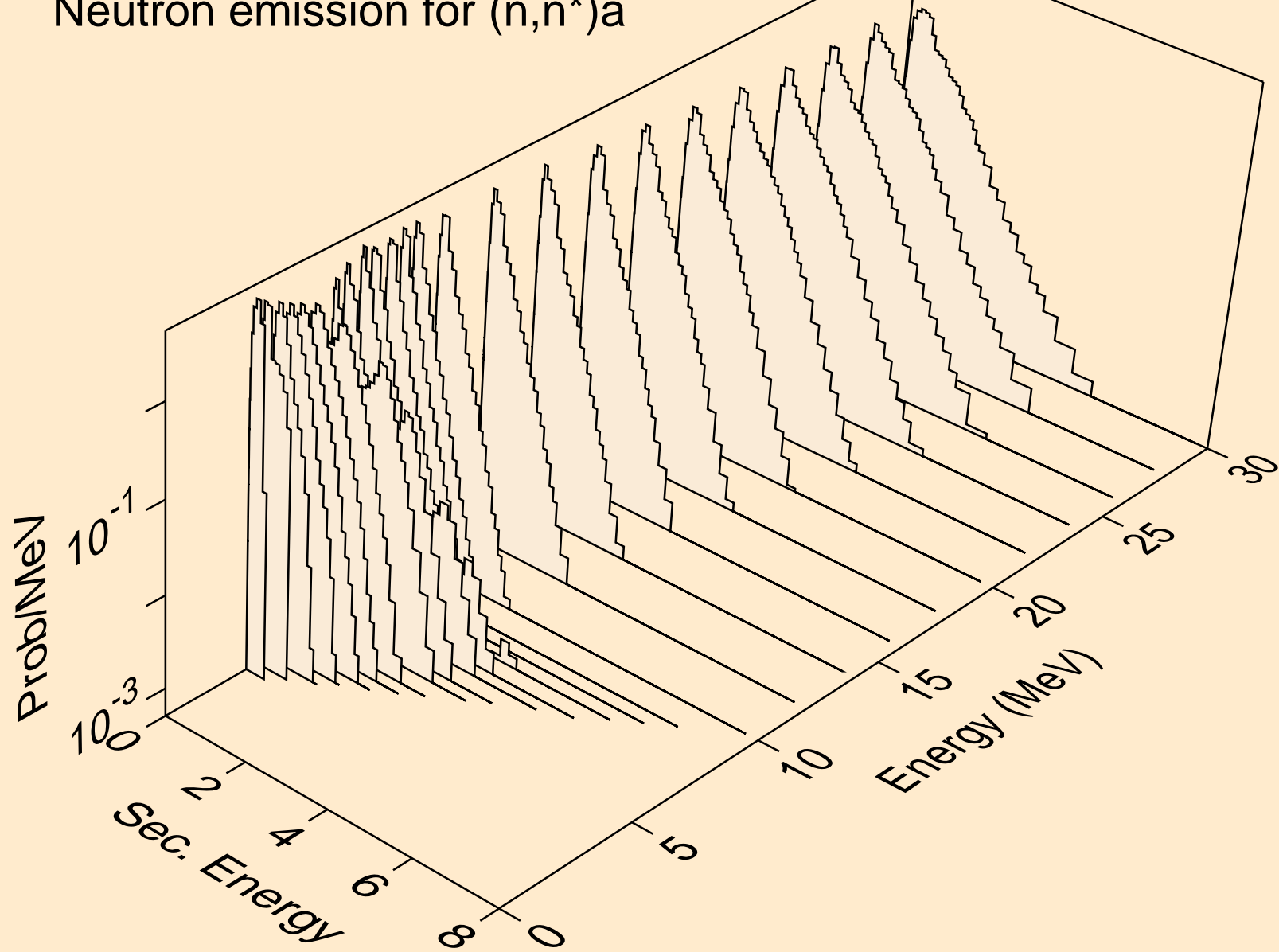

BK254 NEUTRON ACER TENDL-2023 LIBRARY; T=0.K
Neutron emission for (n,2n)a

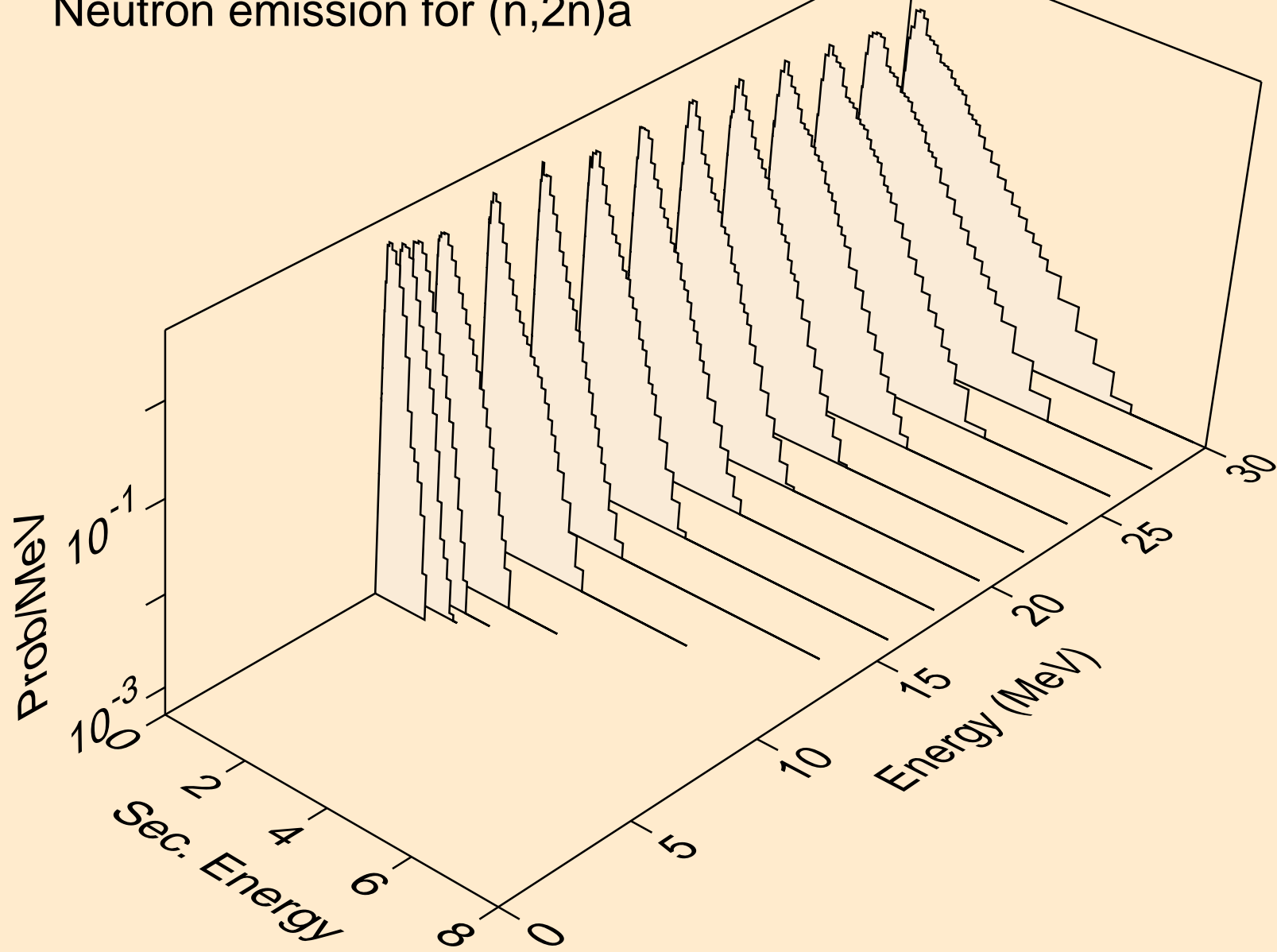

BK254 NEUTRON ACER TENDL-2023 LIBRARY; T=0.K
Neutron emission for (n,3n)a

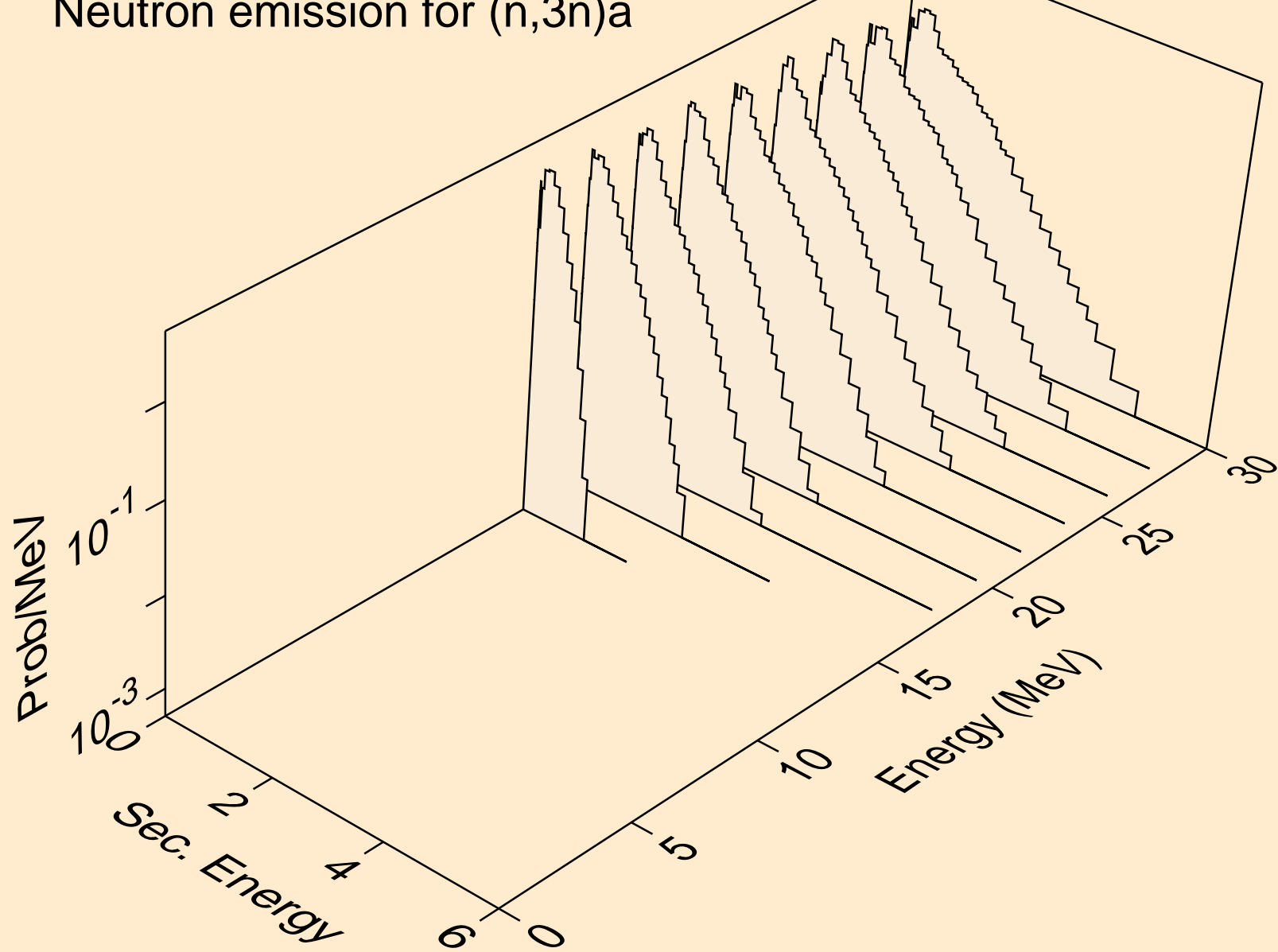

BK254 NEUTRON ACER TENDL-2023 LIBRARY; T=0.K
Neutron emission for (n,n*)p

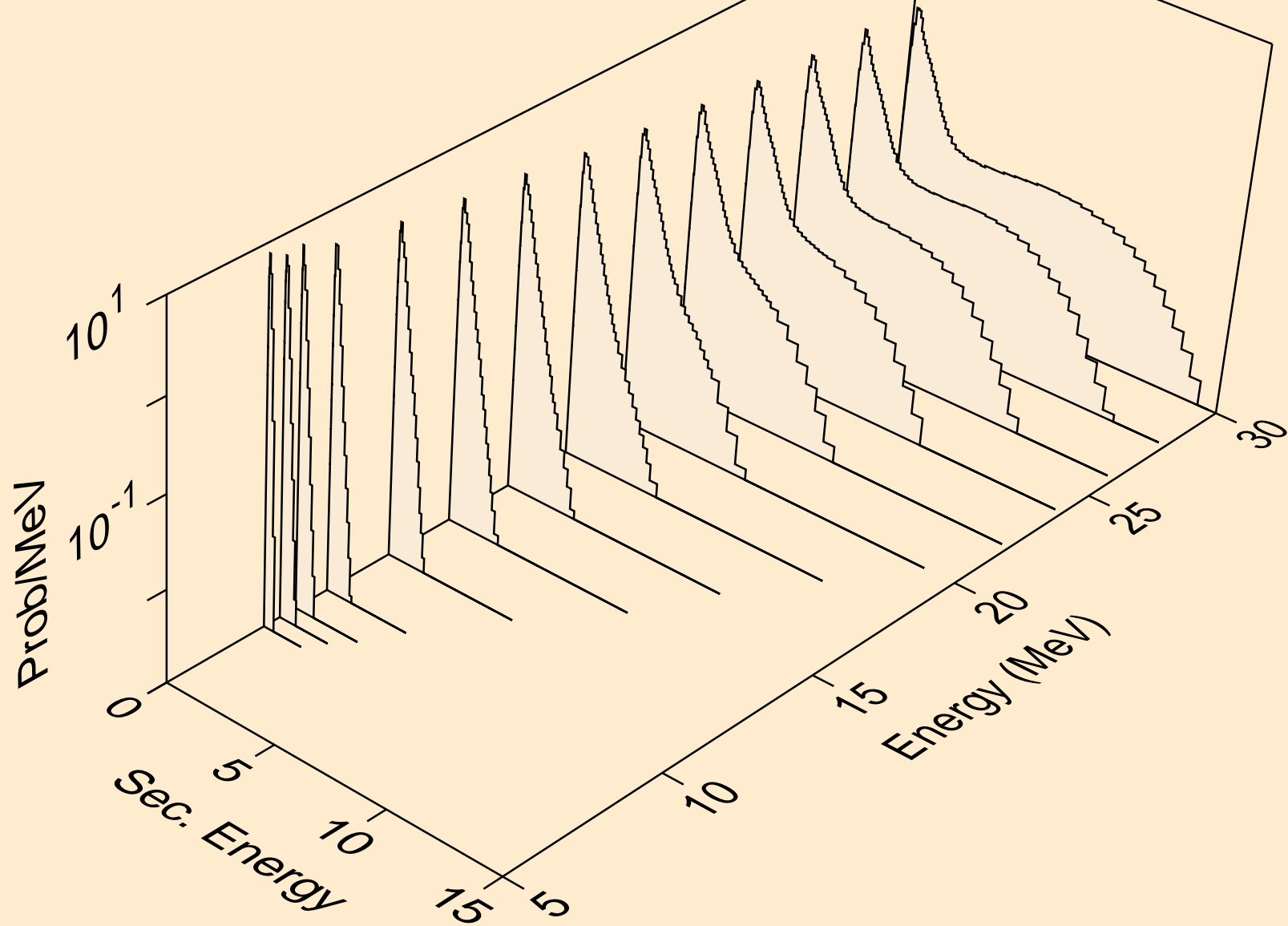

BK254 NEUTRON ACER TENDL-2023 LIBRARY; T=0.K
Neutron emission for (n,n*)d

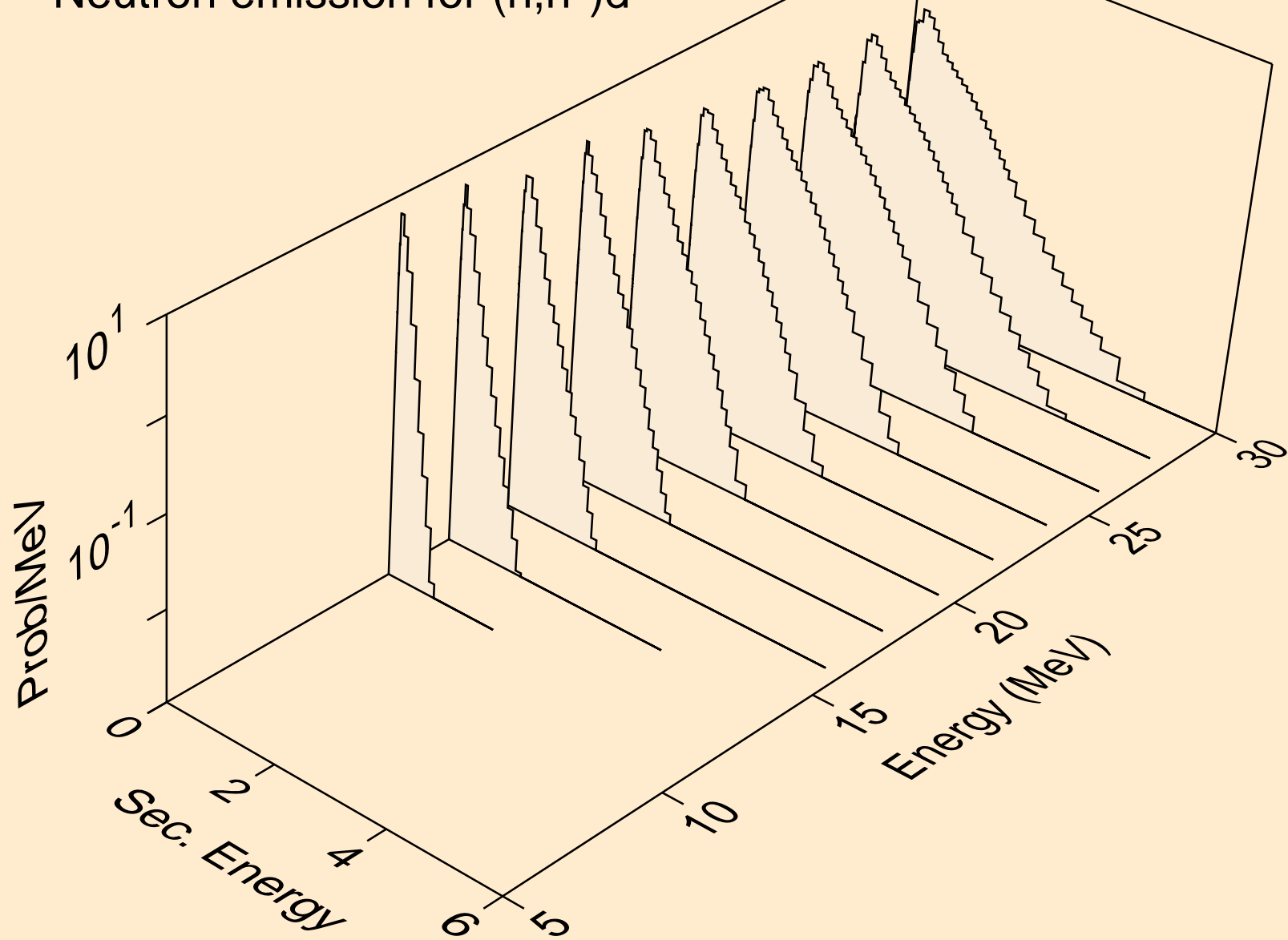

BK254 NEUTRON ACER TENDL-2023 LIBRARY; T=0.K
Neutron emission for (n,n*)t

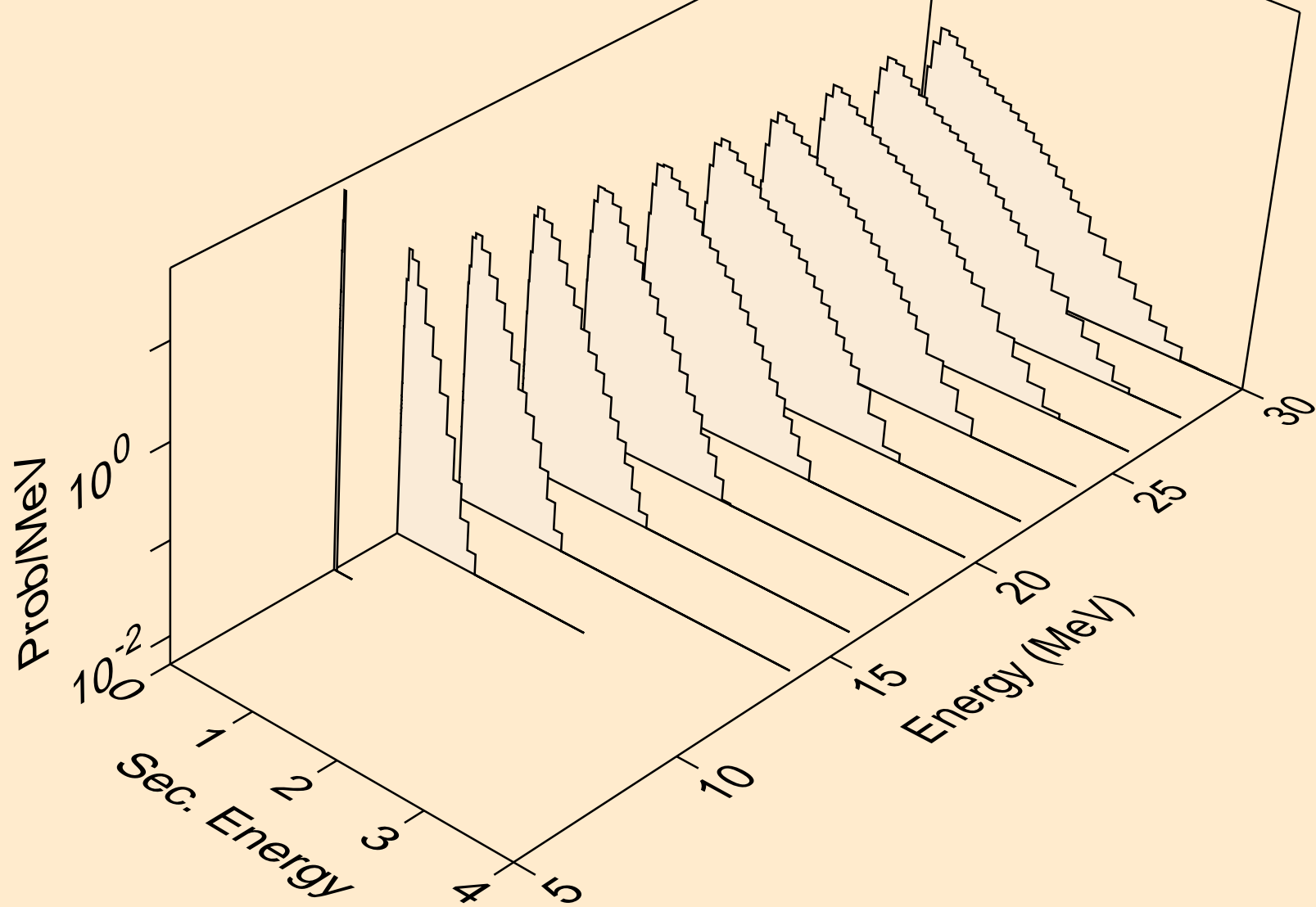

BK254 NEUTRON ACER TENDL-2023 LIBRARY; T=0.K
Neutron emission for (n,n*)he3

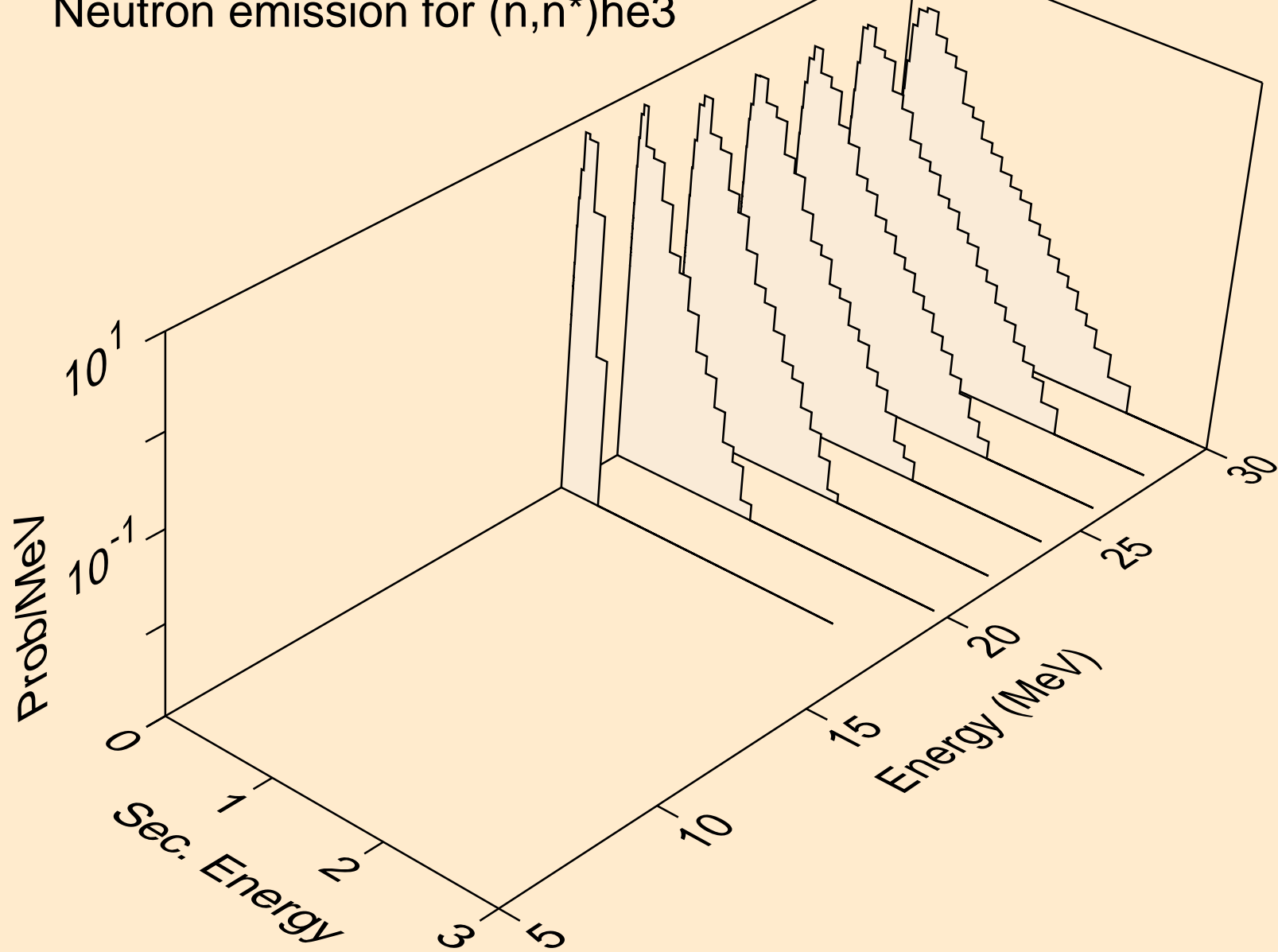

BK254 NEUTRON ACER TENDL-2023 LIBRARY; T=0.K
Neutron emission for (n,4n)

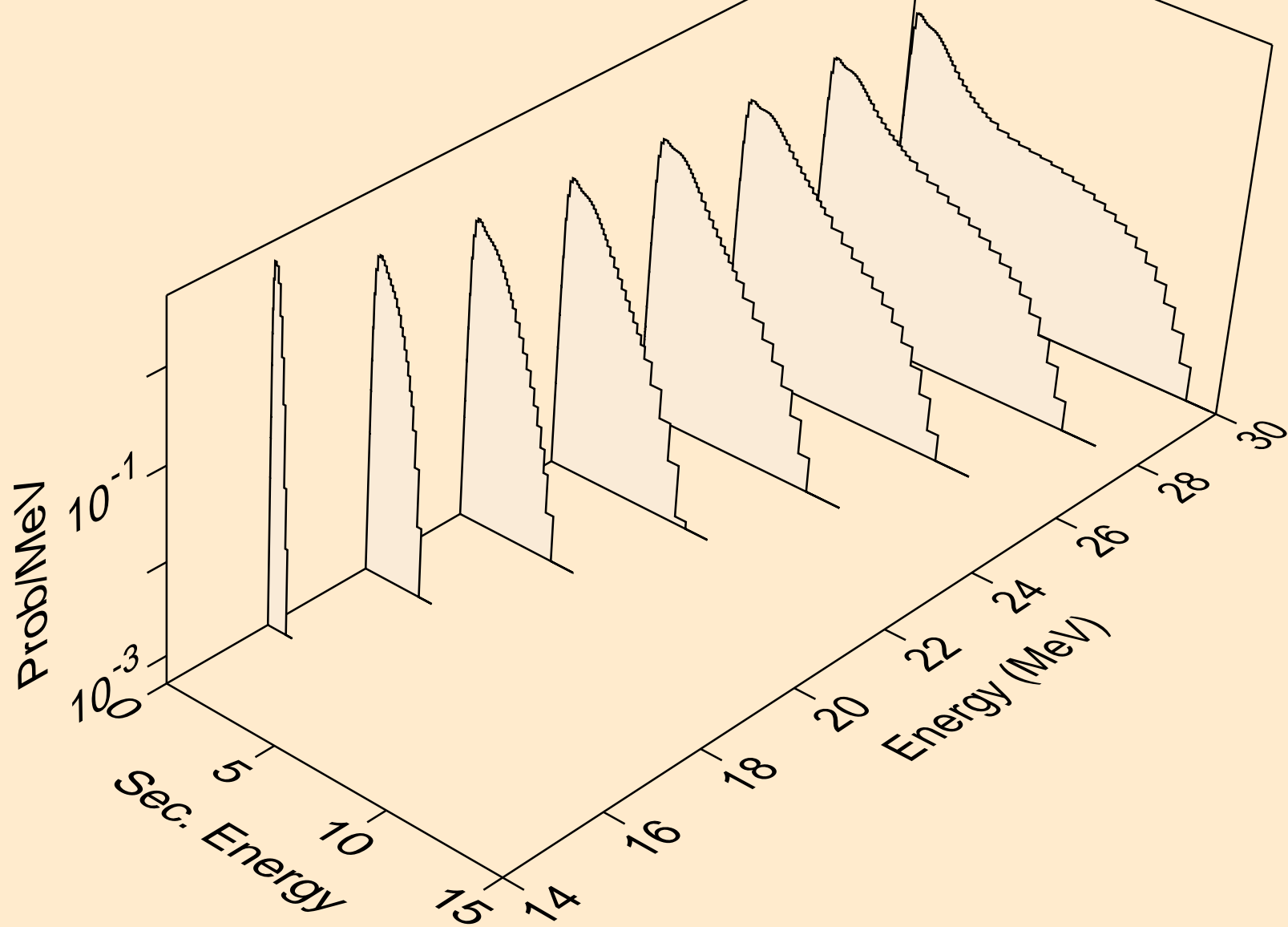

BK254 NEUTRON ACER TENDL-2023 LIBRARY; T=0.K
Neutron emission for (n,2np)

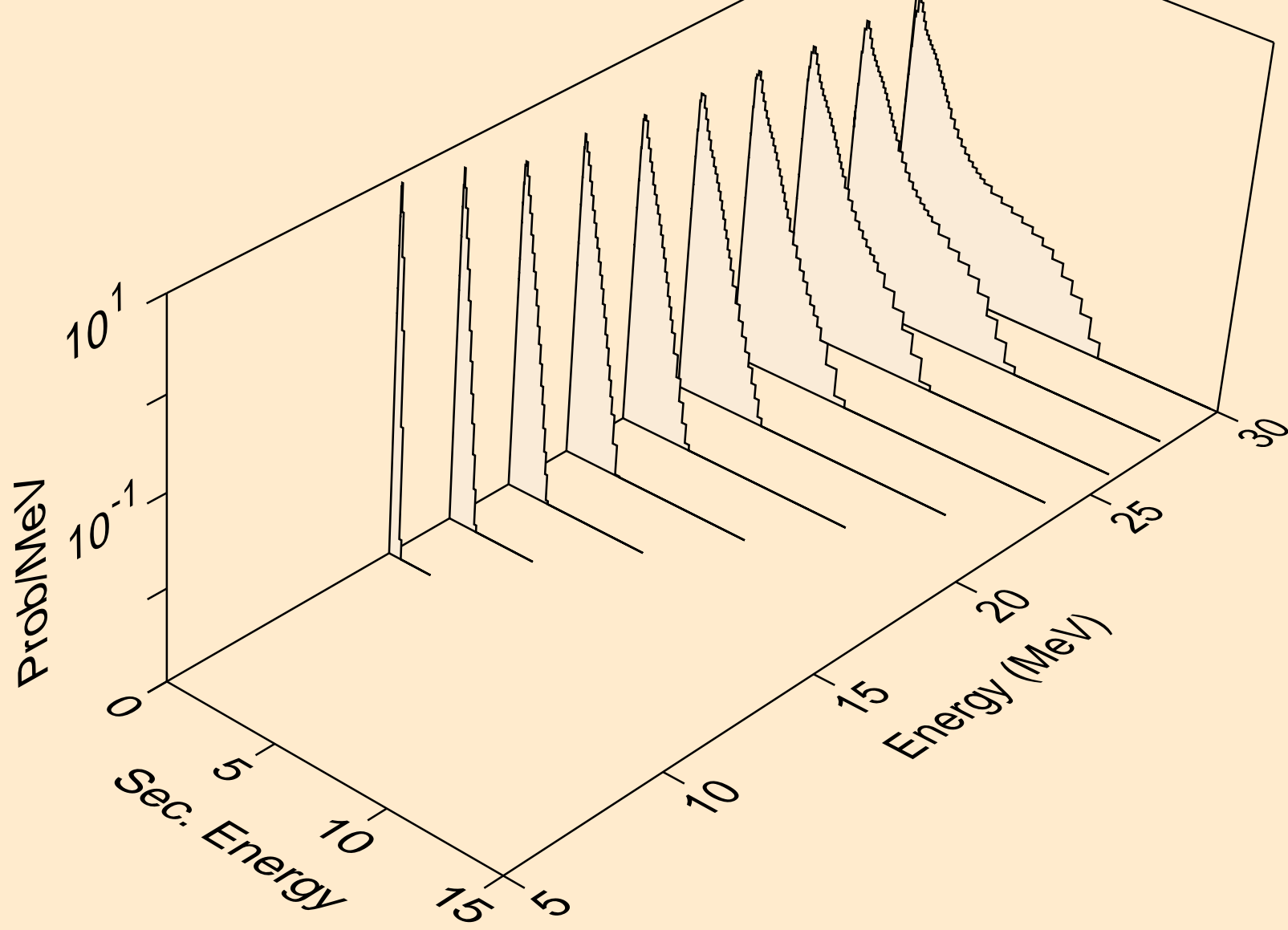

BK254 NEUTRON ACER TENDL-2023 LIBRARY; T=0.K
Neutron emission for (n,3np)

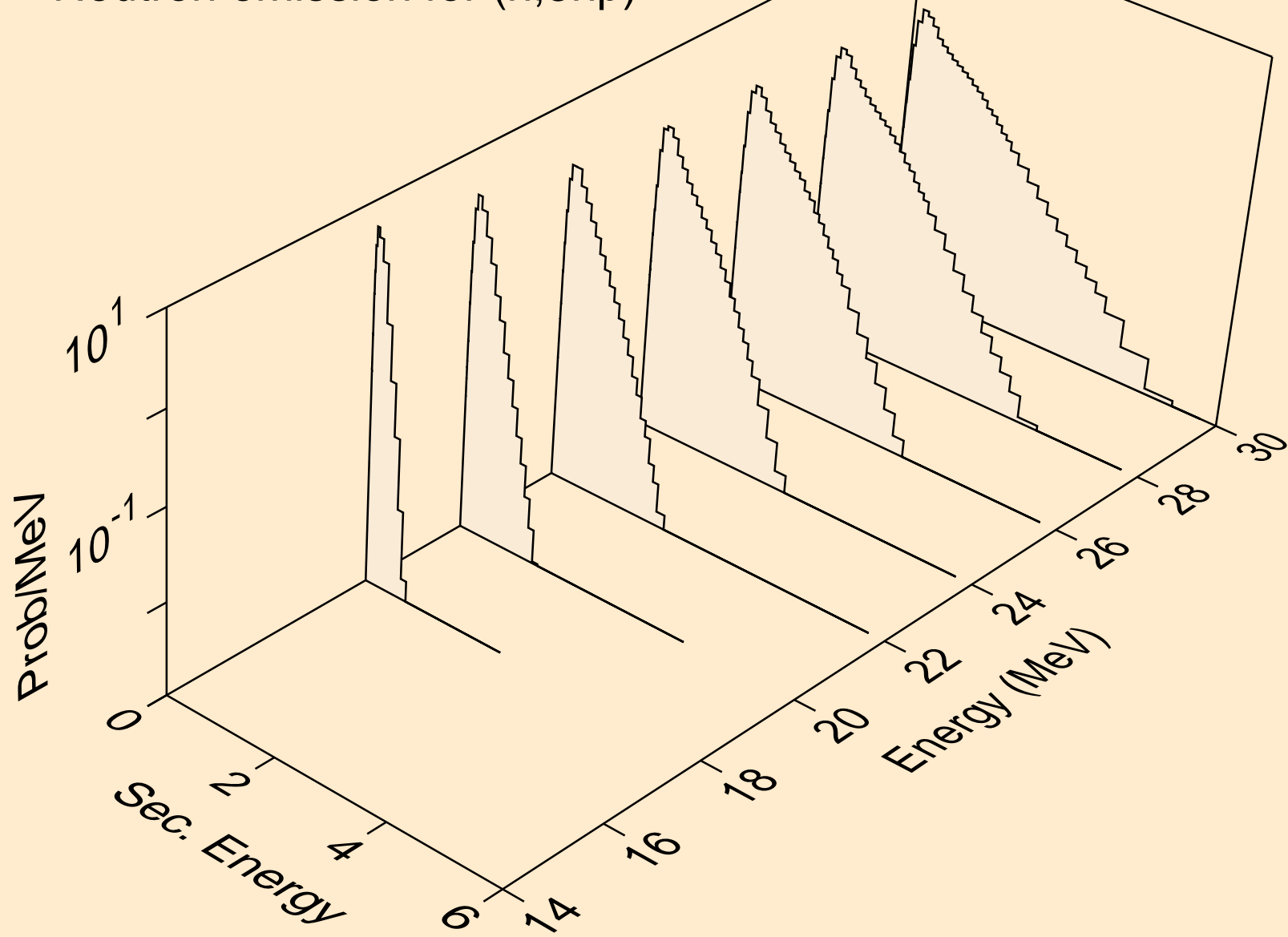

BK254 NEUTRON ACER TENDL-2023 LIBRARY; T=0.K
Neutron emission for (n,n*c)

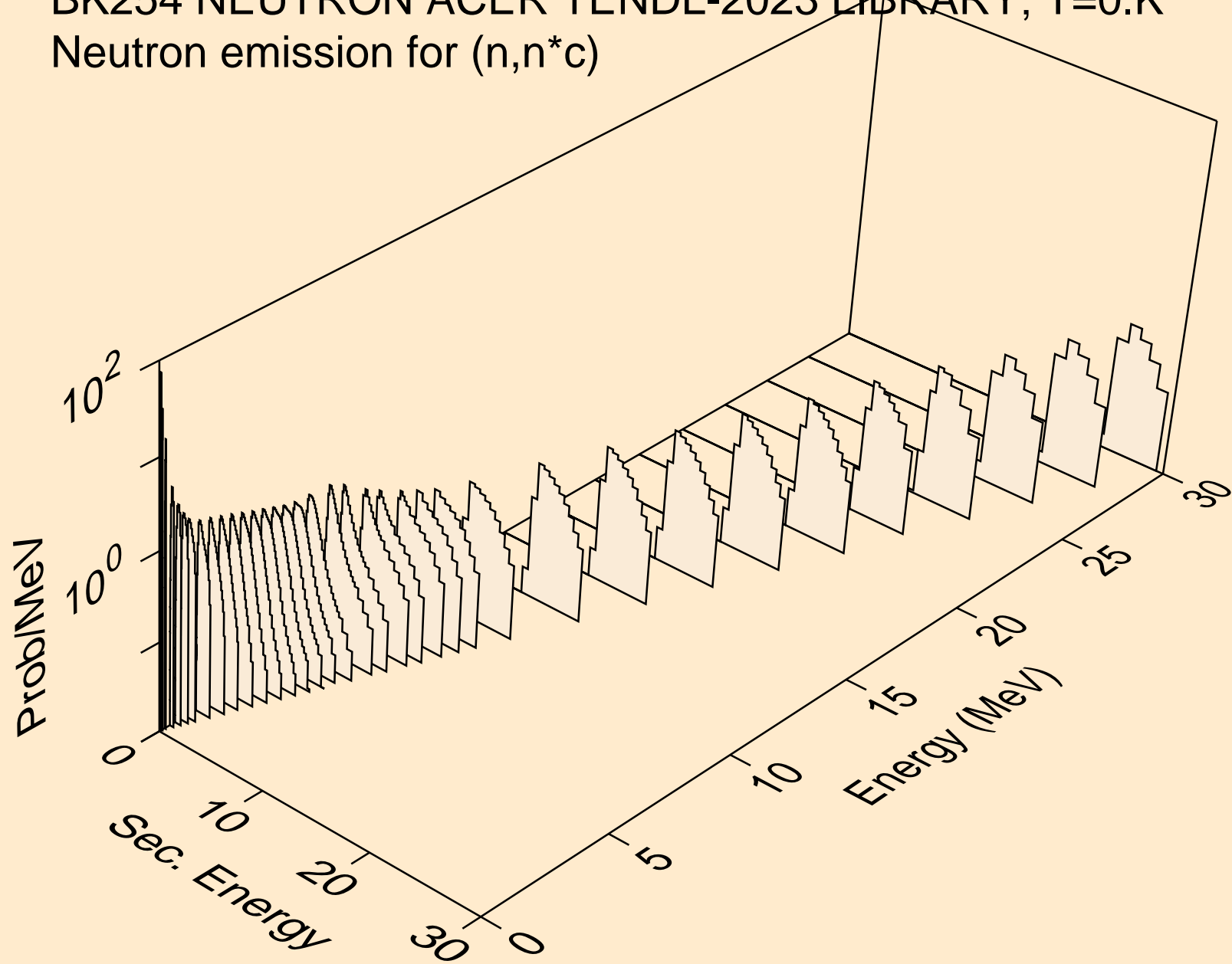

BK254 NEUTRON ACER TENDL-2023 LIBRARY; T=0.K

Delayed nubar

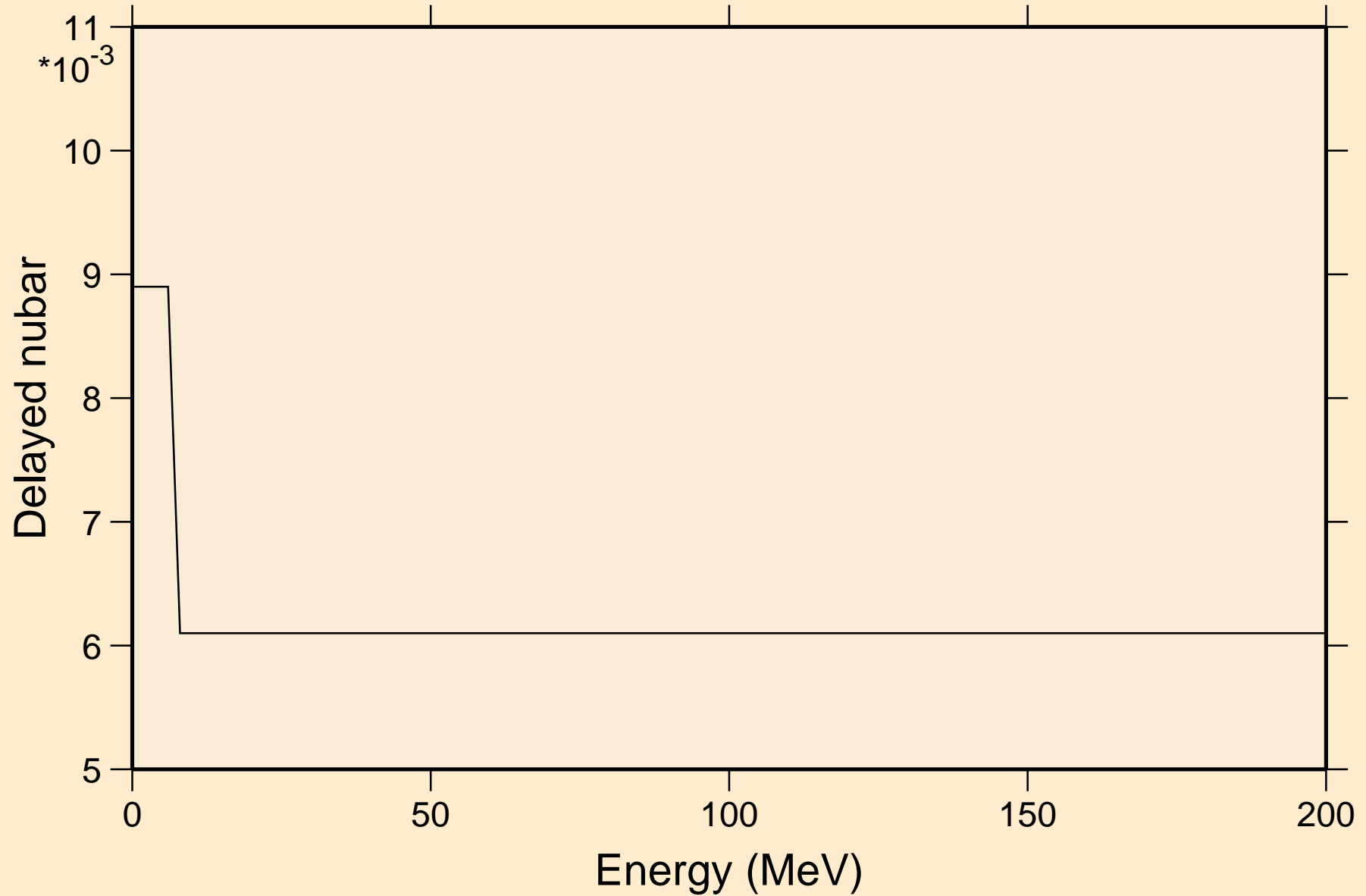

BK254 NEUTRON ACER TENDL-2023 LIBRARY; T=0.K

Delayed neutron spectra

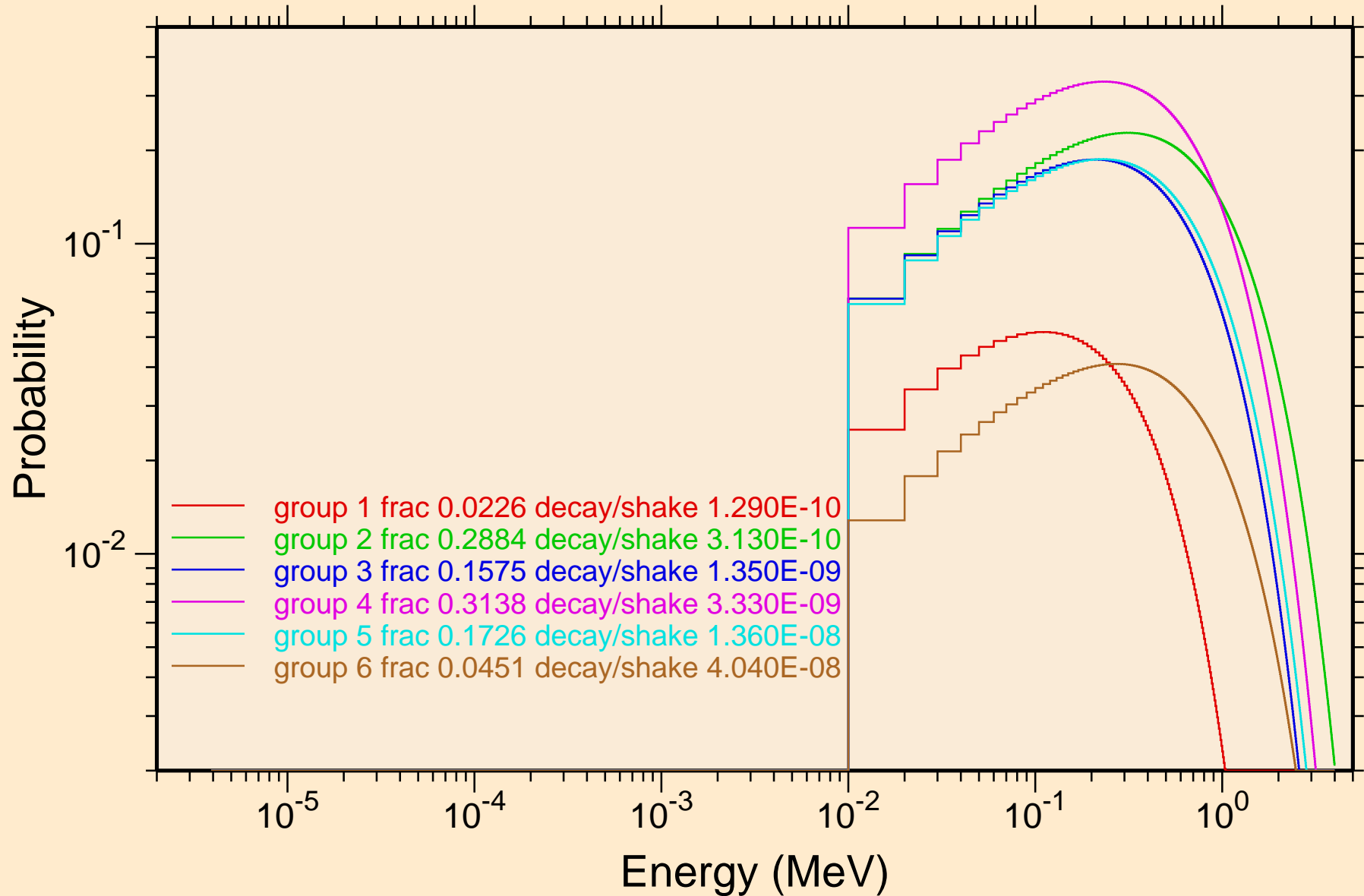

BK254 NEUTRON ACER TENDL-2023 LIBRARY; T=0.K
Photon emission for (n,x)

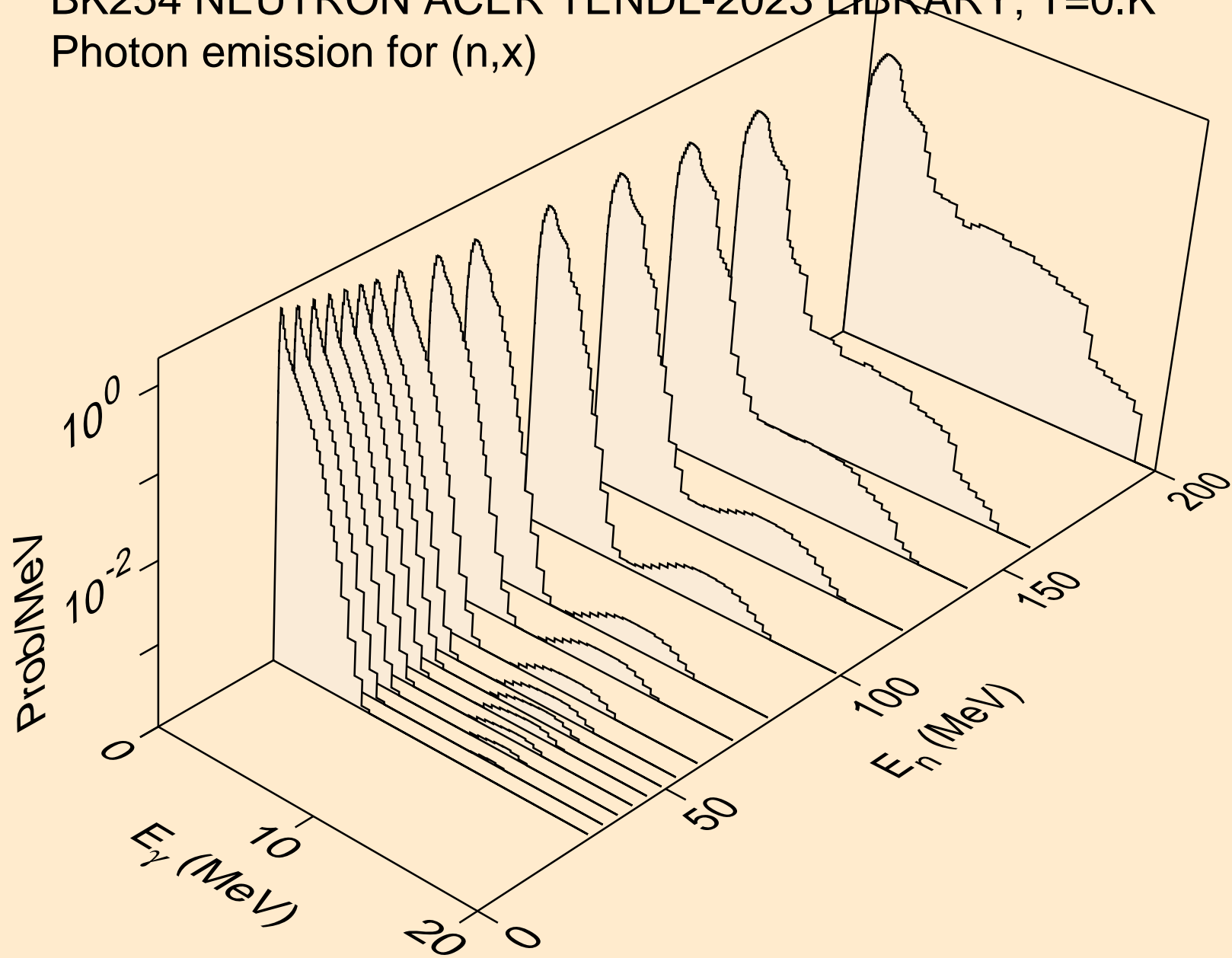

BK254 NEUTRON ACER TENDL-2023 LIBRARY; T=0.K
Photon emission for (n,2nd)

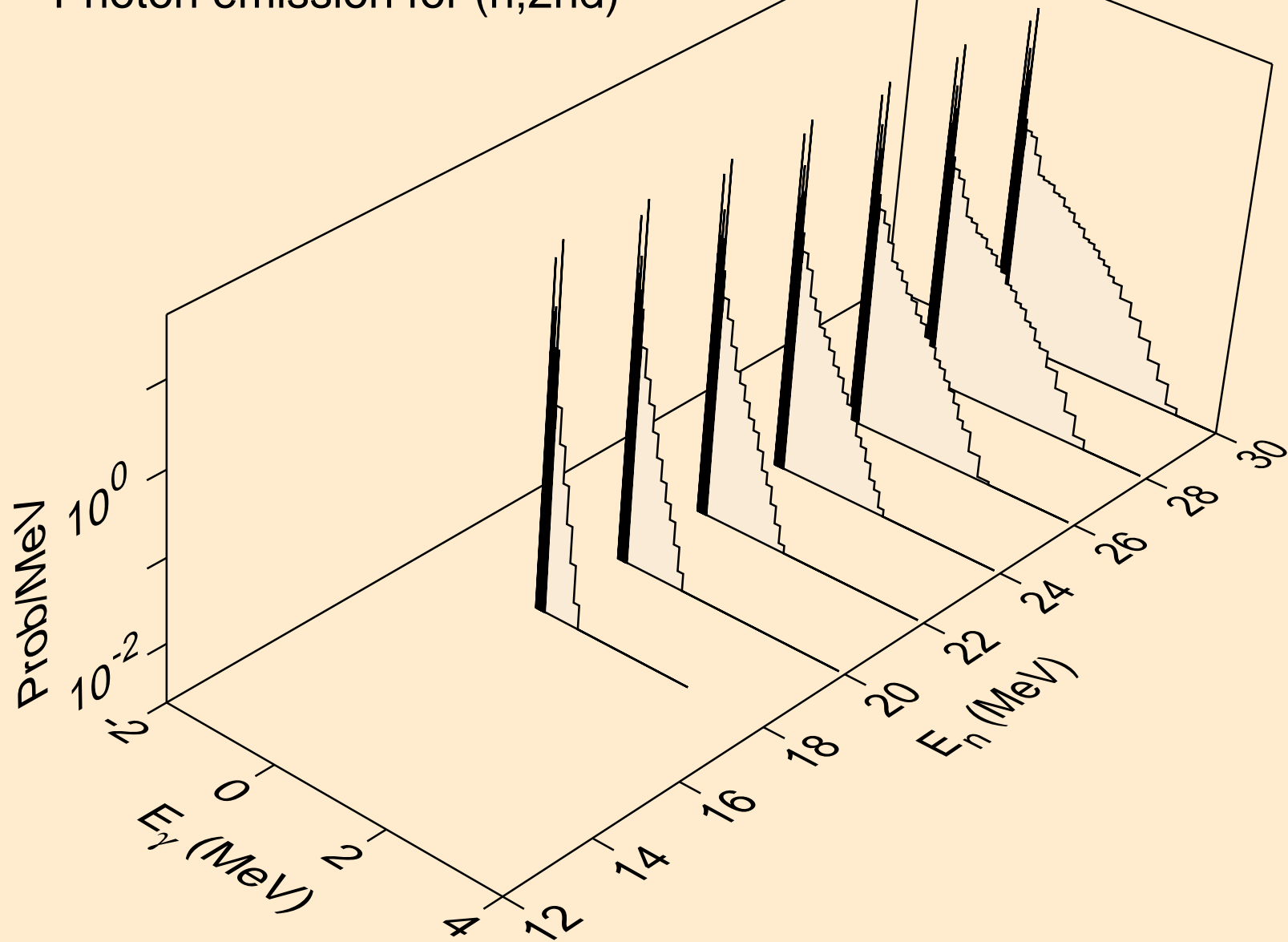

BK254 NEUTRON ACER TENDL-2023 LIBRARY; T=0.K
Photon emission for (n,2n)

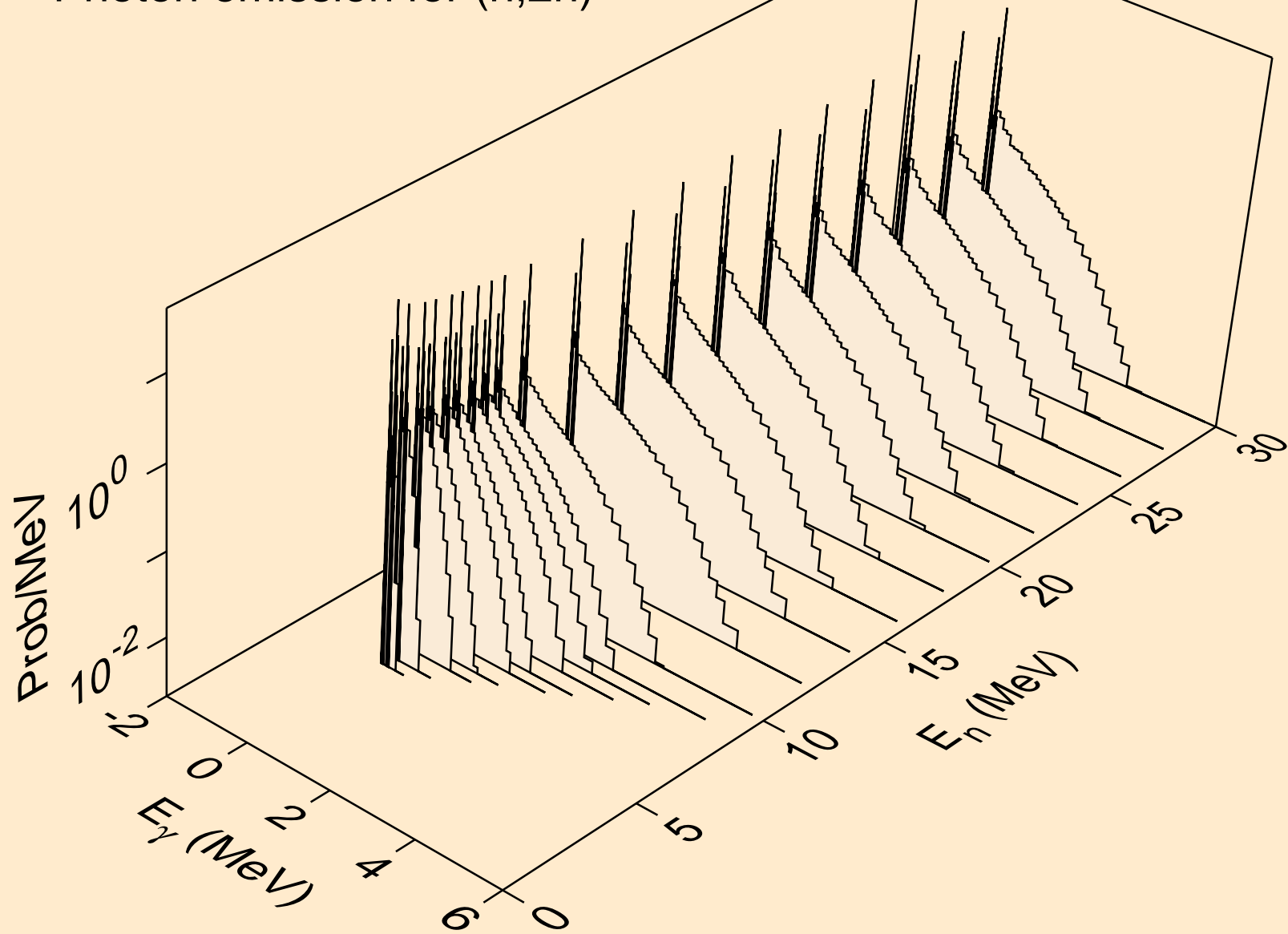

BK254 NEUTRON ACER TENDL-2023 LIBRARY; T=0.K
Photon emission for (n,3n)

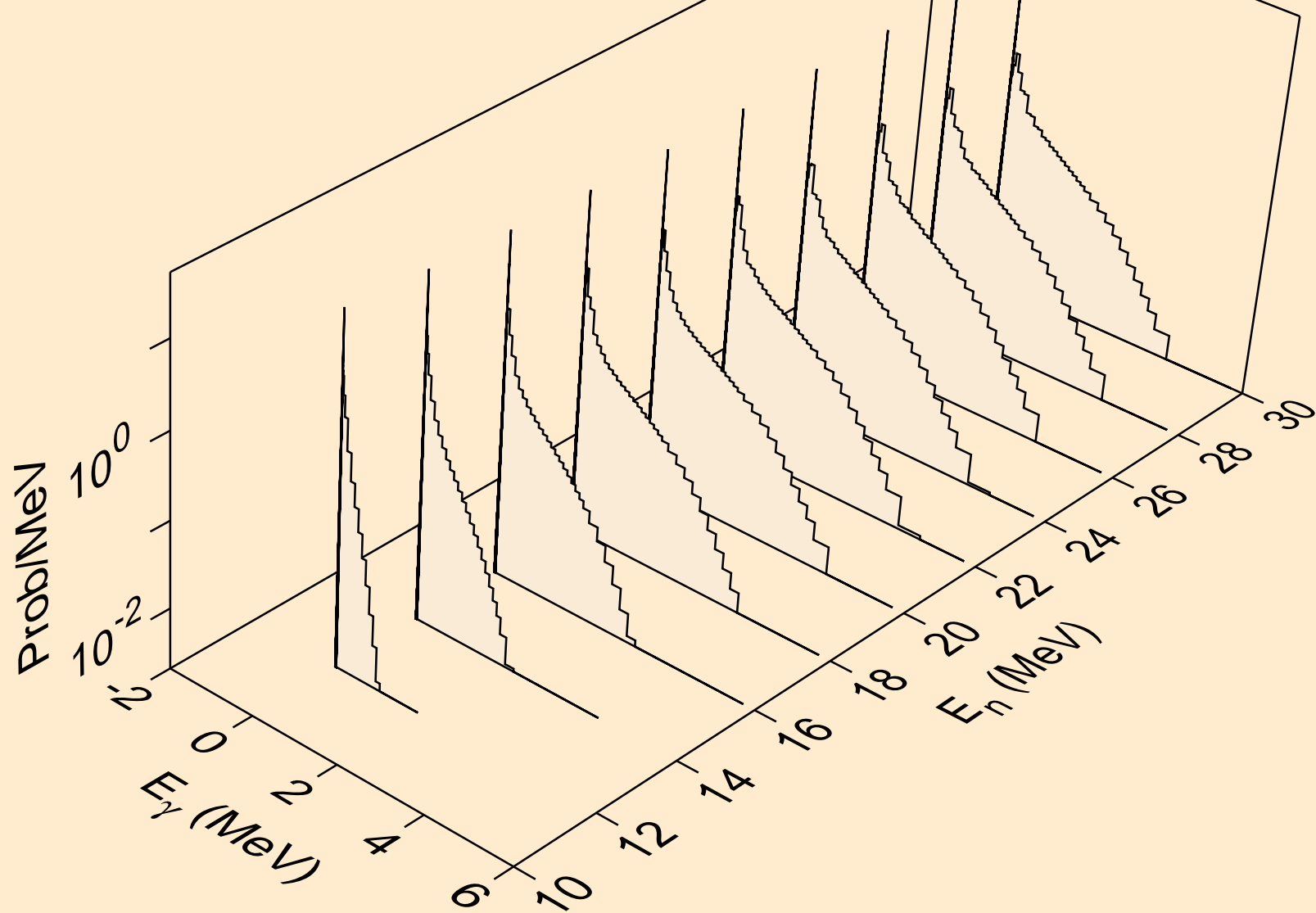

BK254 NEUTRON ACER TENDL-2023 LIBRARY; T=0.K
Photon emission for (n,n*)a

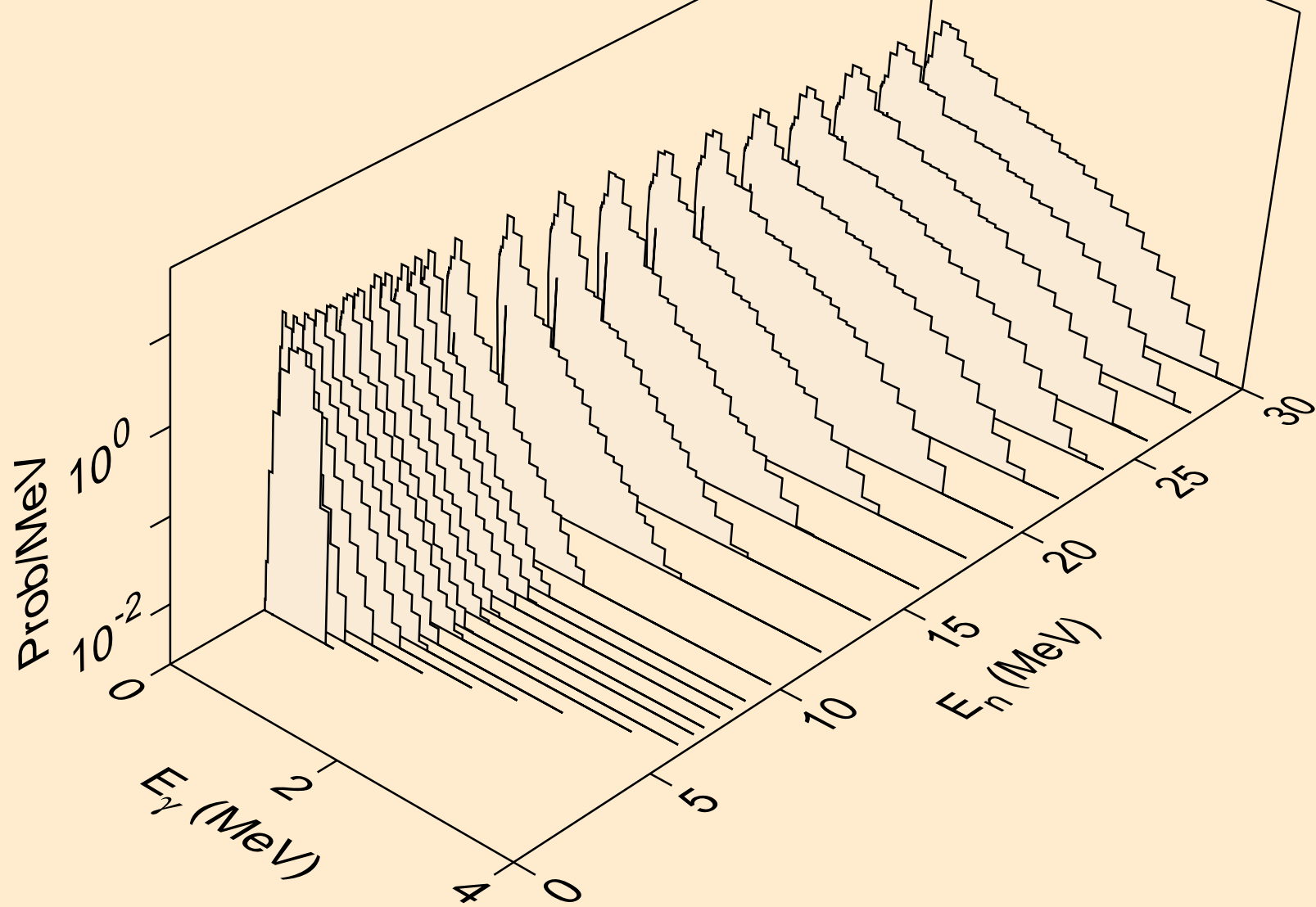

BK254 NEUTRON ACER TENDL-2023 LIBRARY; T=0.K
Photon emission for (n,2n)a

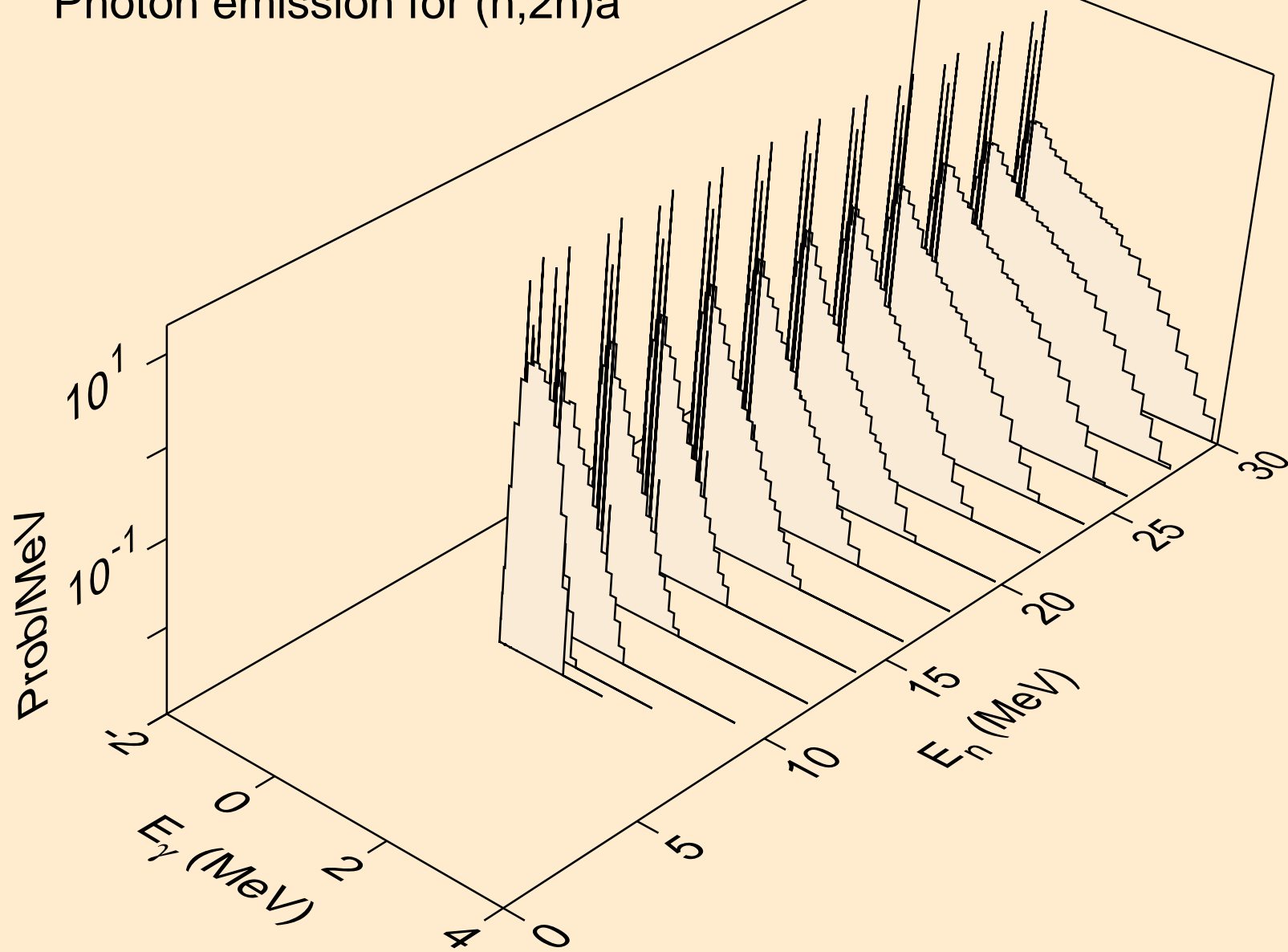

BK254 NEUTRON ACER TENDL-2023 LIBRARY; T=0.K
Photon emission for (n,3n)a

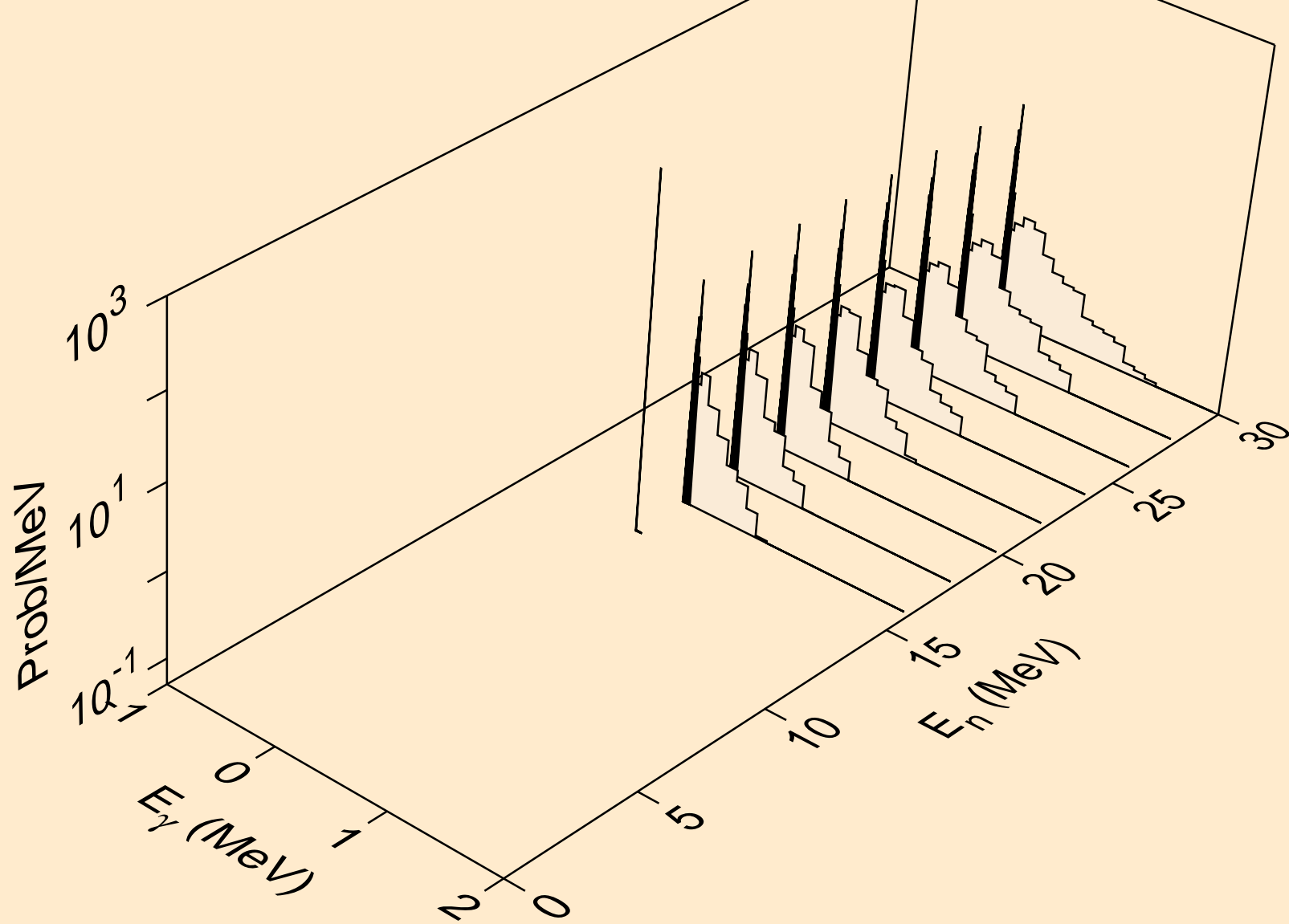

BK254 NEUTRON ACER TENDL-2023 LIBRARY; T=0.K
Photon emission for (n,n*)p

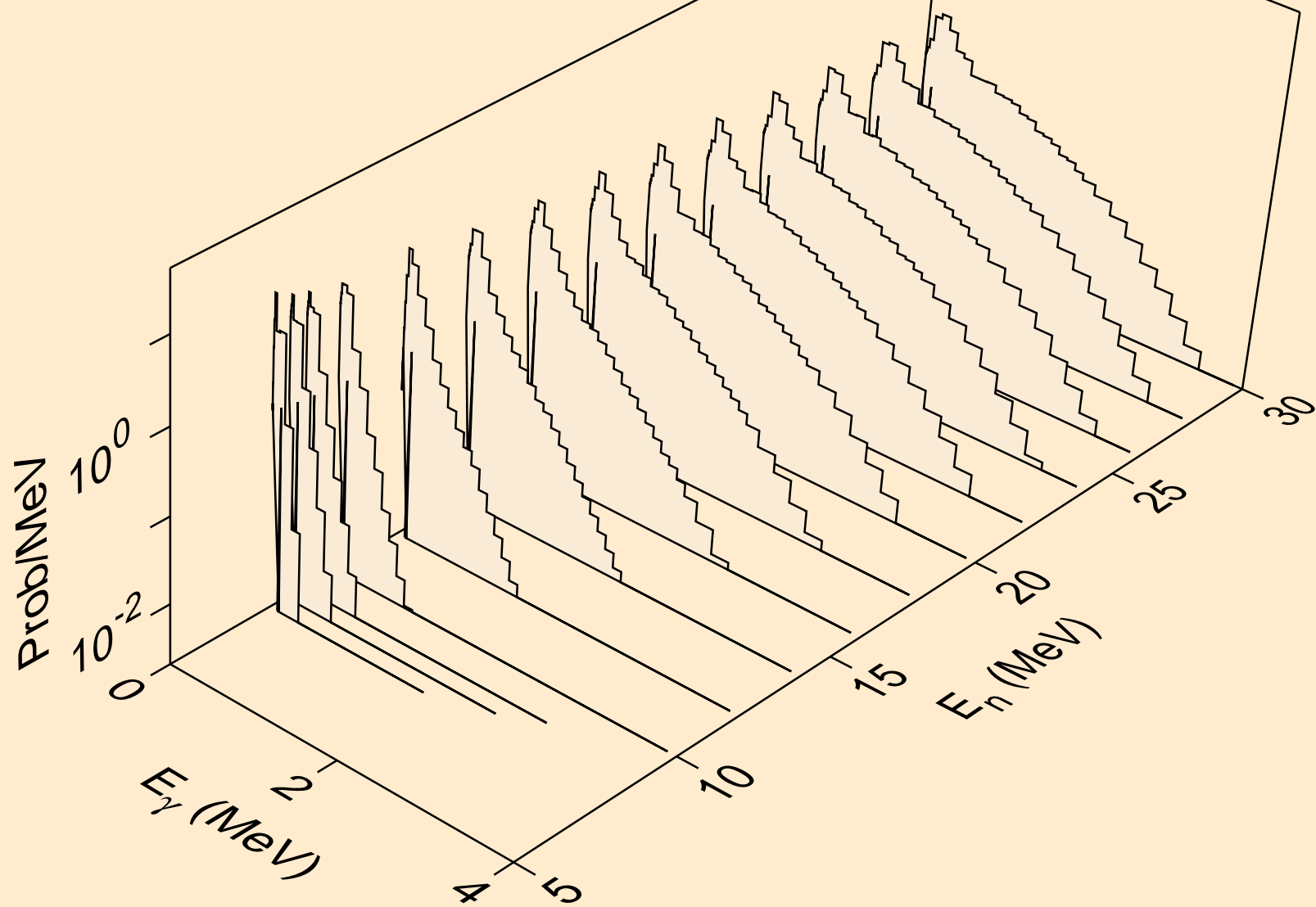

BK254 NEUTRON ACER TENDL-2023 LIBRARY; T=0.K
Photon emission for (n,n*)d

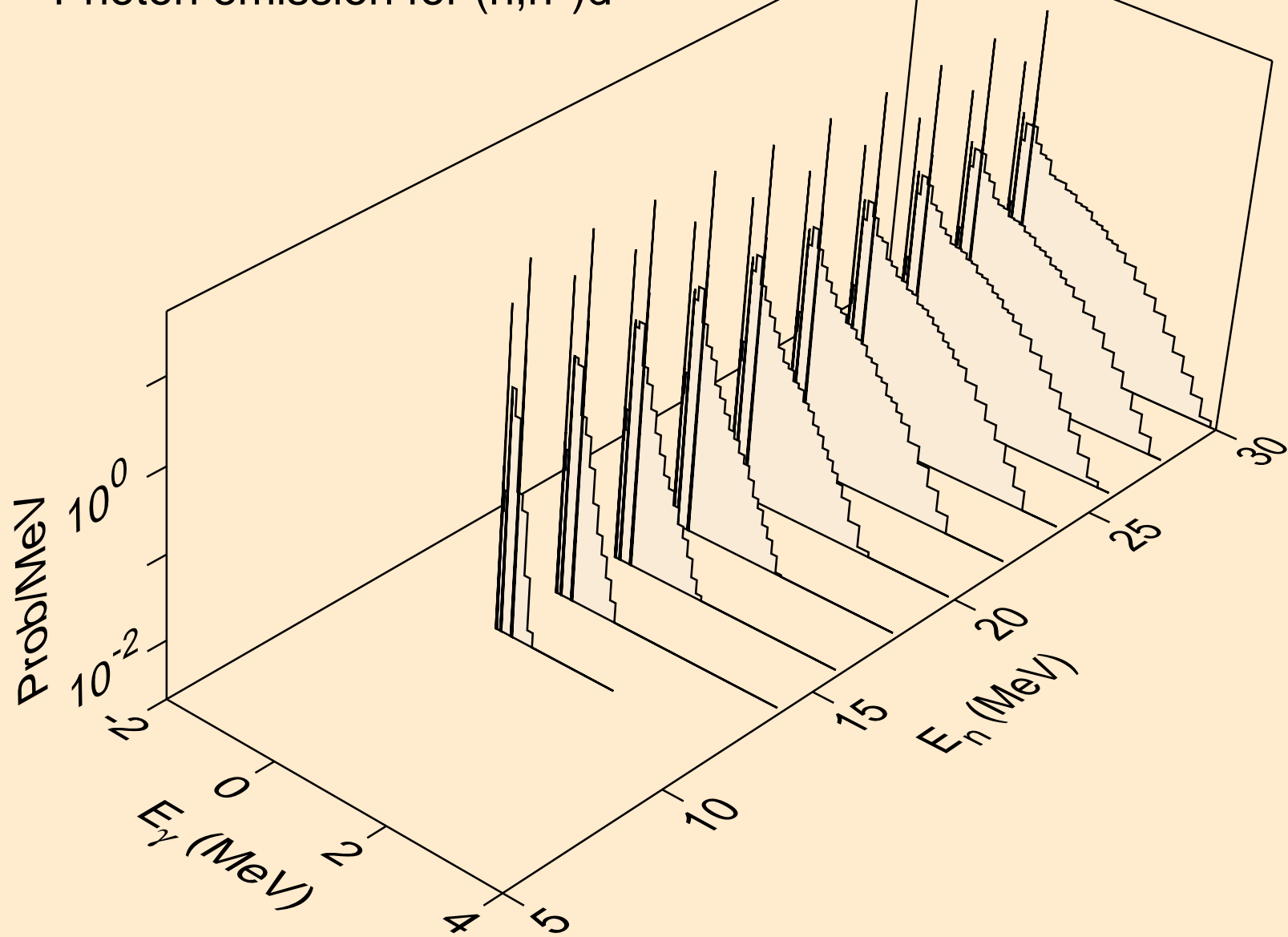

BK254 NEUTRON ACER TENDL-2023 LIBRARY; T=0.K
Photon emission for (n,n*)t

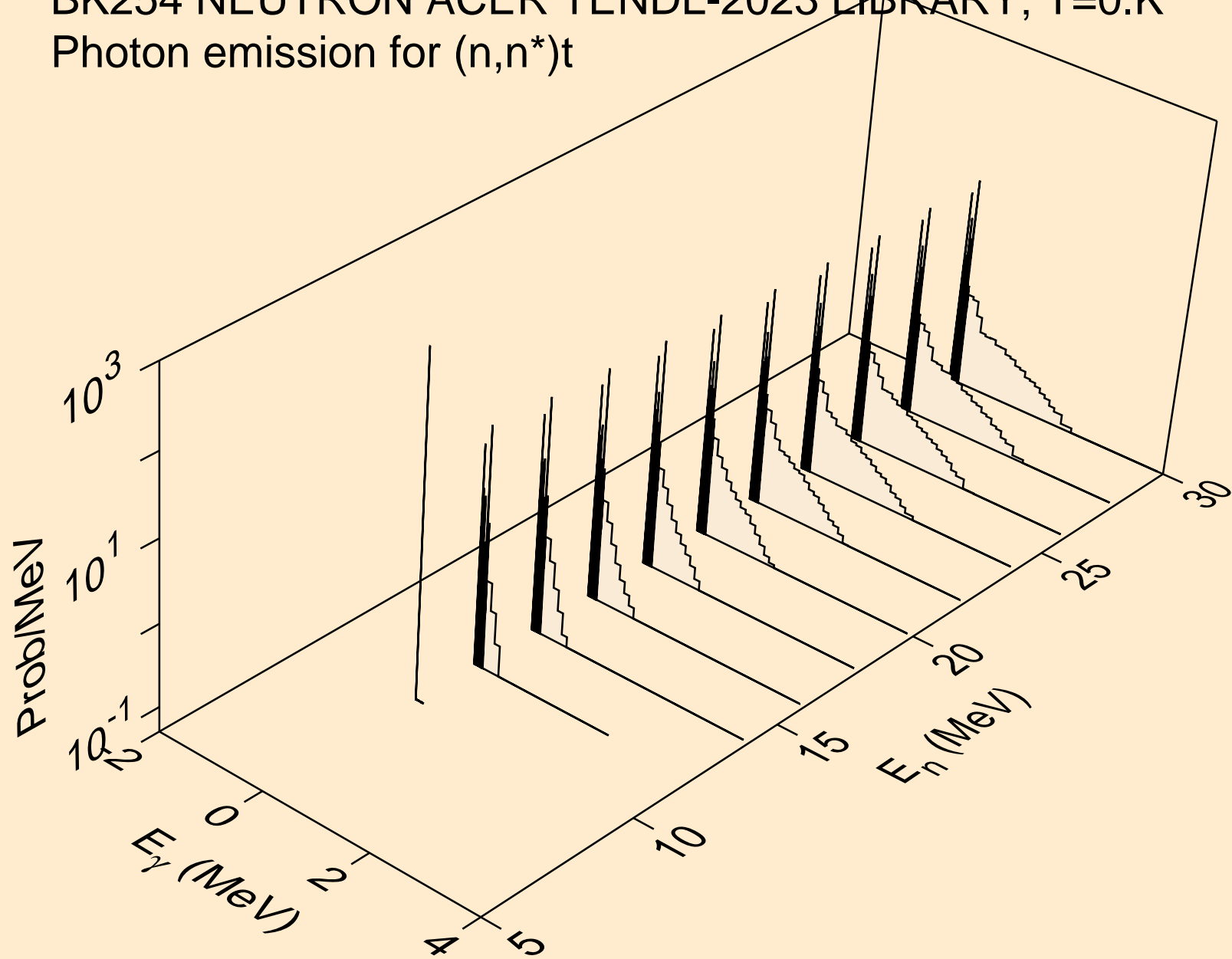

BK254 NEUTRON ACER TENDL-2023 LIBRARY; T=0.K
Photon emission for (n,n*)he3

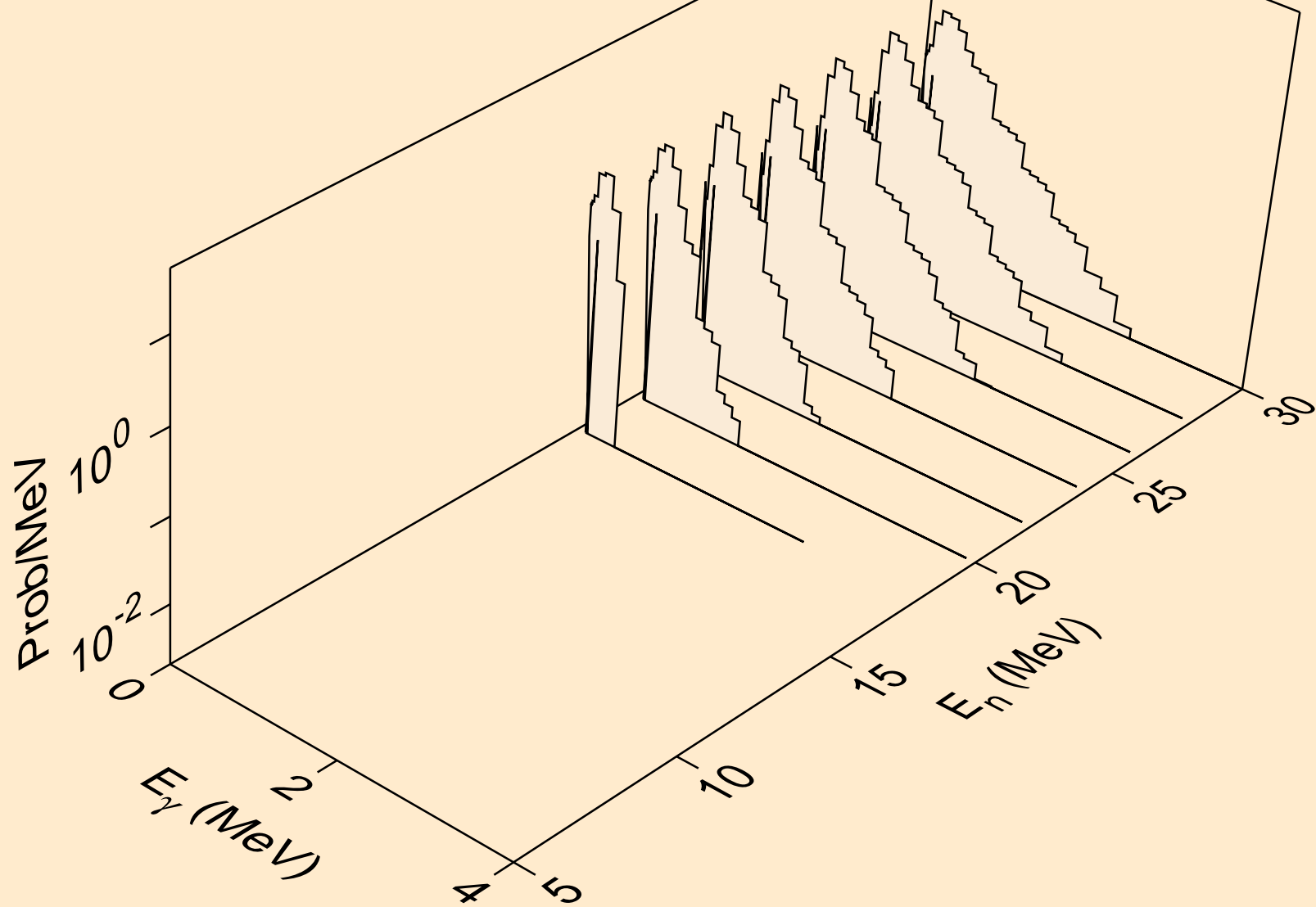

BK254 NEUTRON ACER TENDL-2023 LIBRARY; T=0.K
Photon emission for (n,4n)

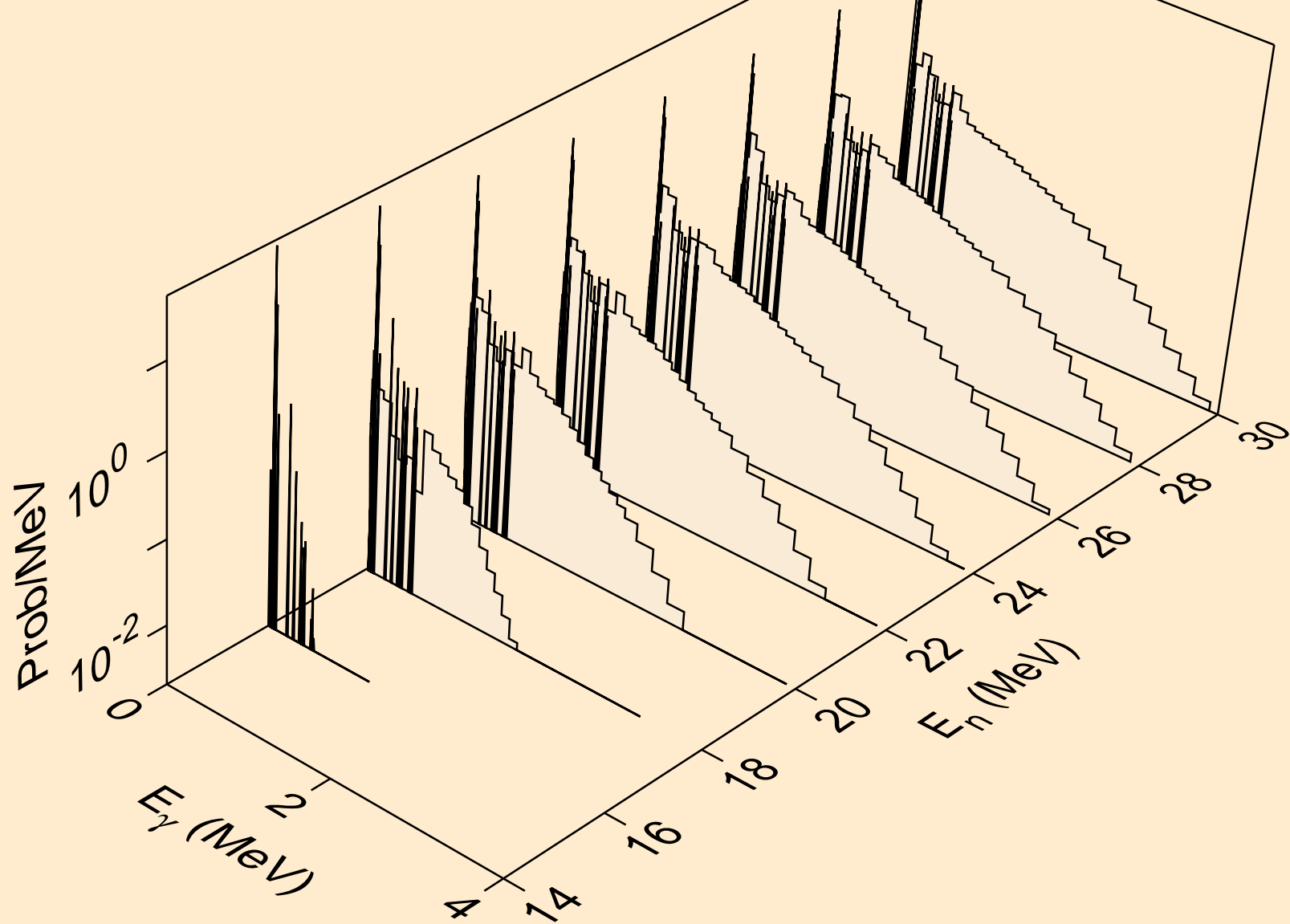

BK254 NEUTRON ACER TENDL-2023 LIBRARY; T=0.K
Photon emission for (n,2np)

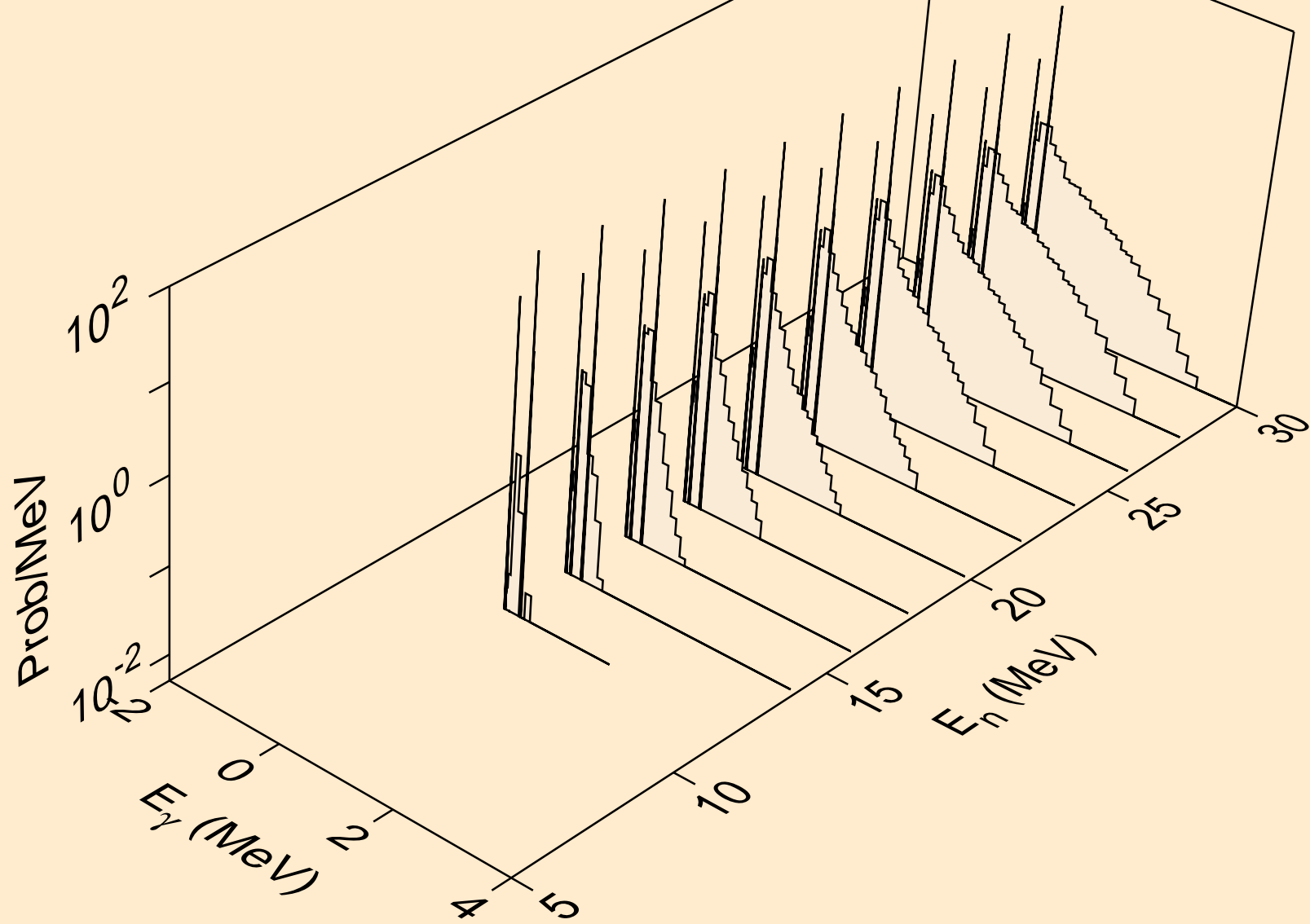

BK254 NEUTRON ACER TENDL-2023 LIBRARY; T=0.K
Photon emission for (n,3np)

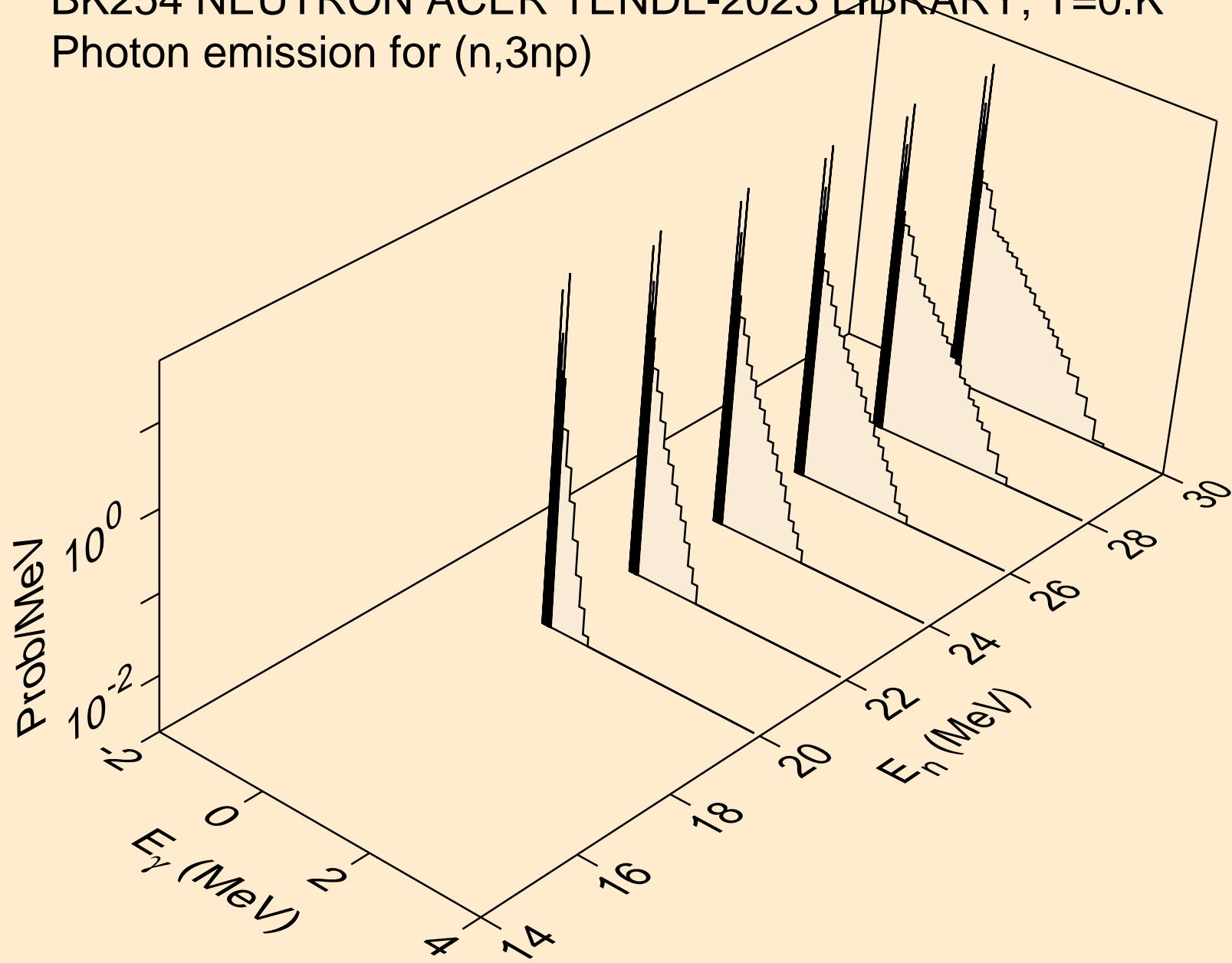

BK254 NEUTRON ACER TENDL-2023 LIBRARY; T=0.K
Photon emission for (n,n*c)

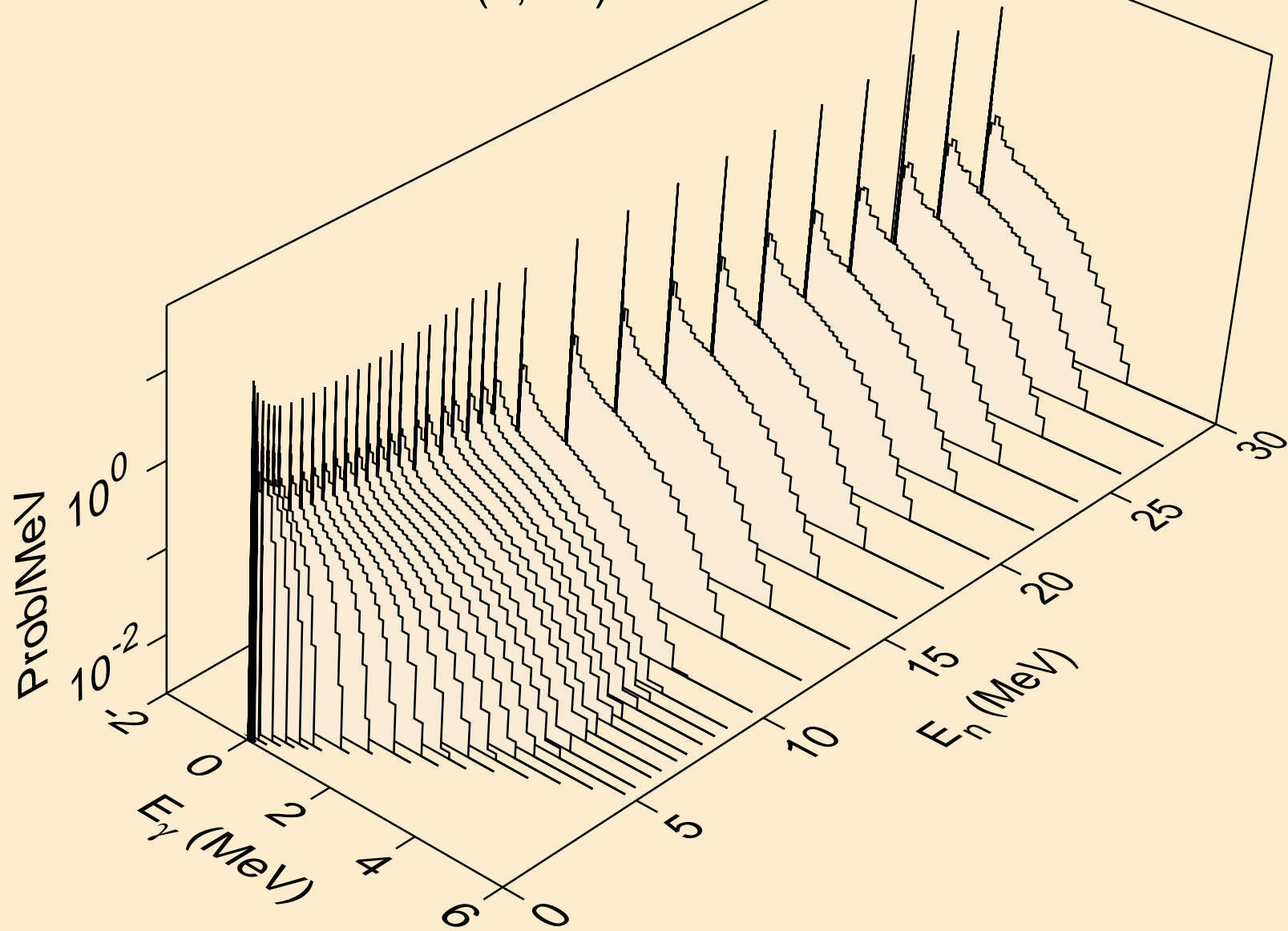

BK254 NEUTRON ACER TENDL-2023 LIBRARY; T=0.K
Photon emission for (n,gma)

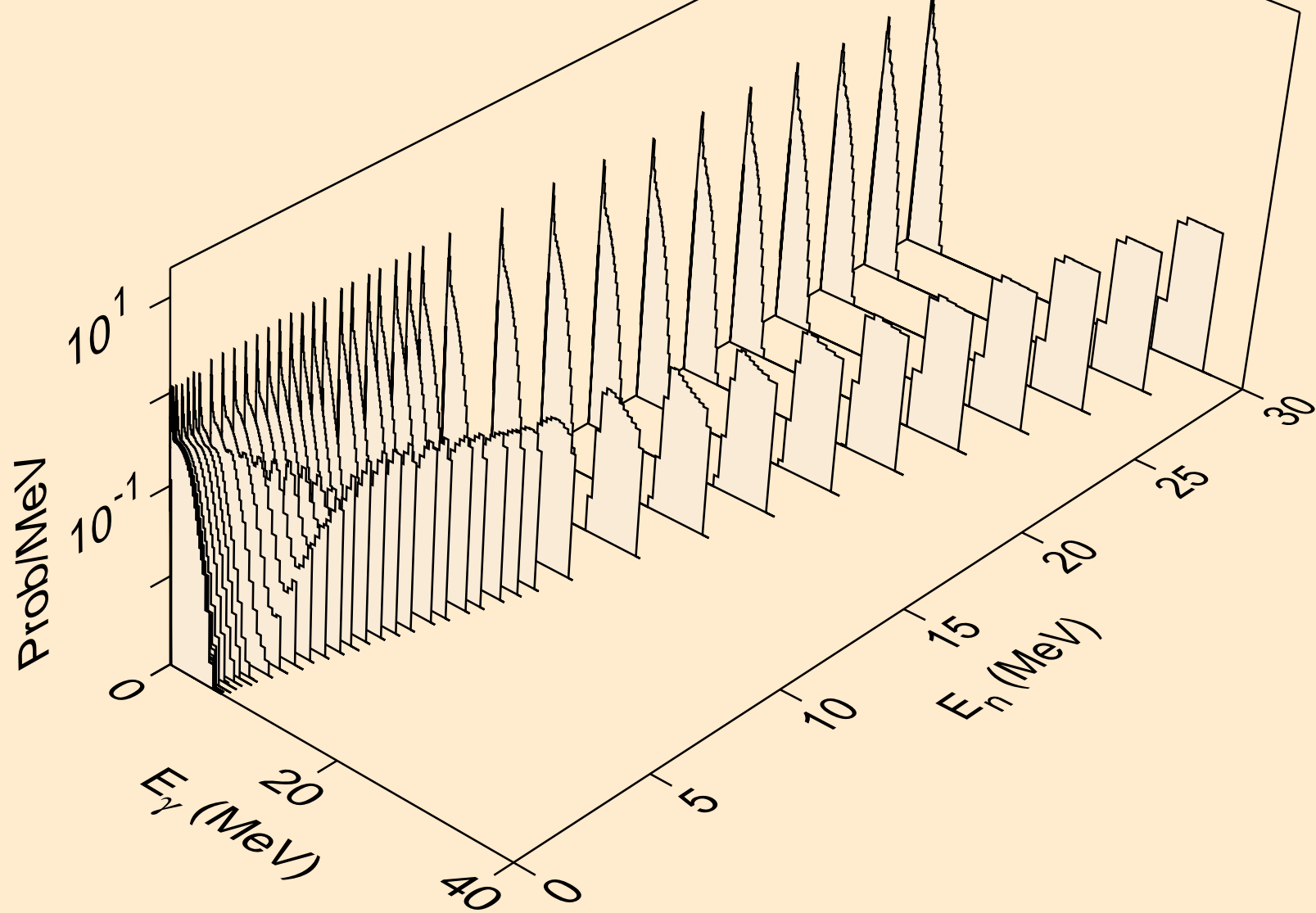

BK254 NEUTRON ACER TENDL-2023 LIBRARY; T=0.K
Photon emission for (n,p)

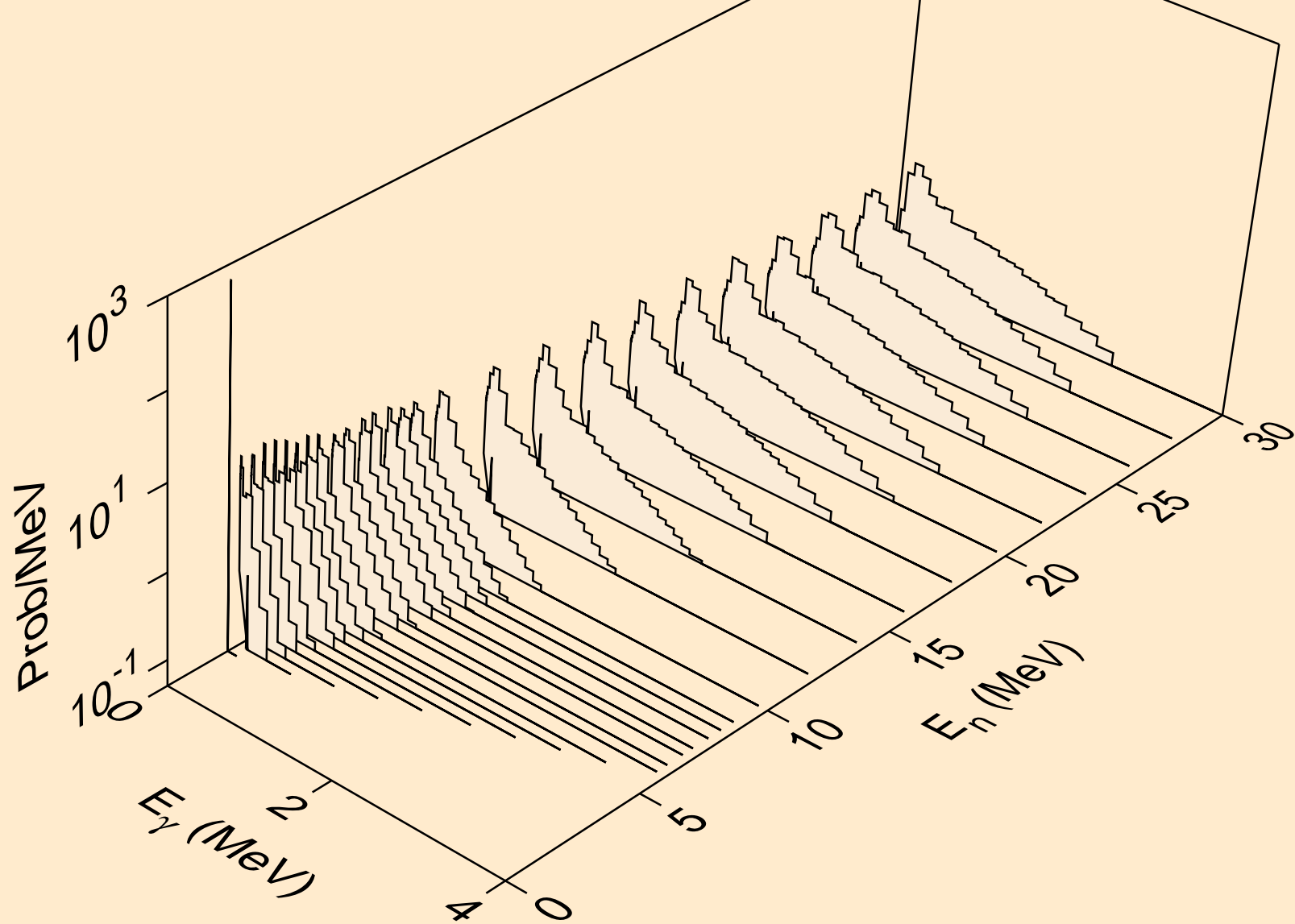

BK254 NEUTRON ACER TENDL-2023 LIBRARY; T=0.K
Photon emission for (n,d)

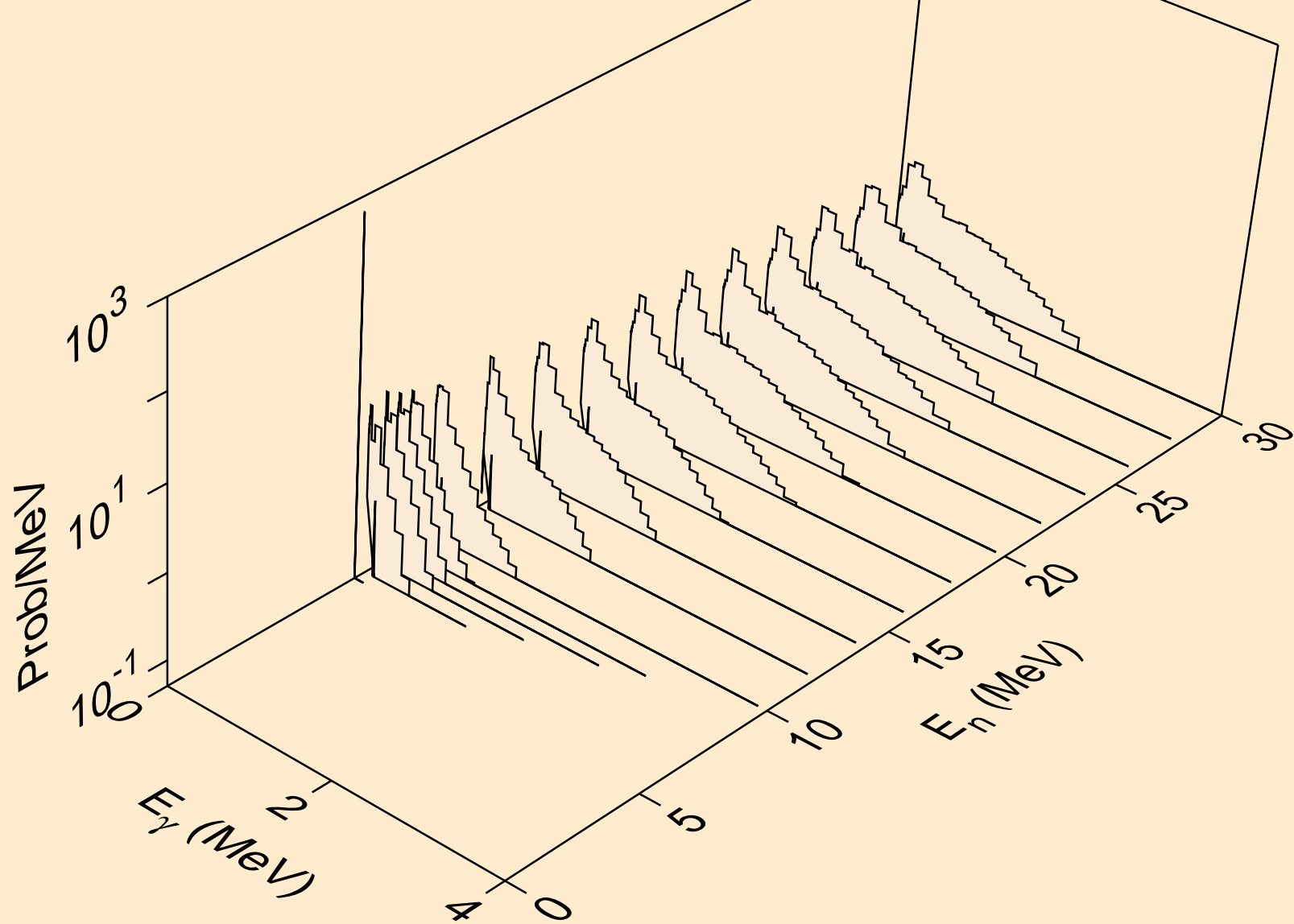

BK254 NEUTRON ACER TENDL-2023 LIBRARY; T=0.K
Photon emission for (n,t)

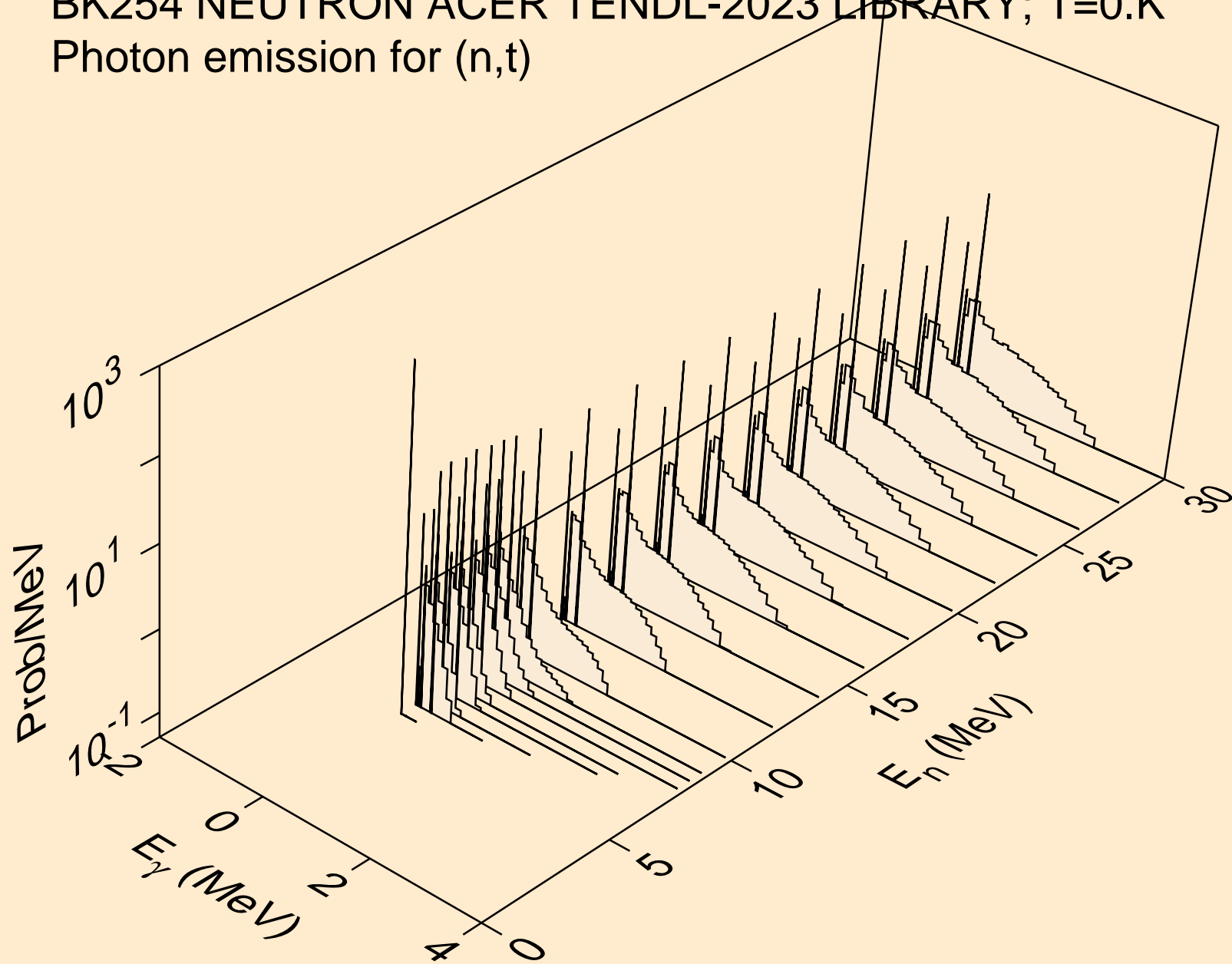

BK254 NEUTRON ACER TENDL-2023 LIBRARY; T=0.K
Photon emission for (n,he3)

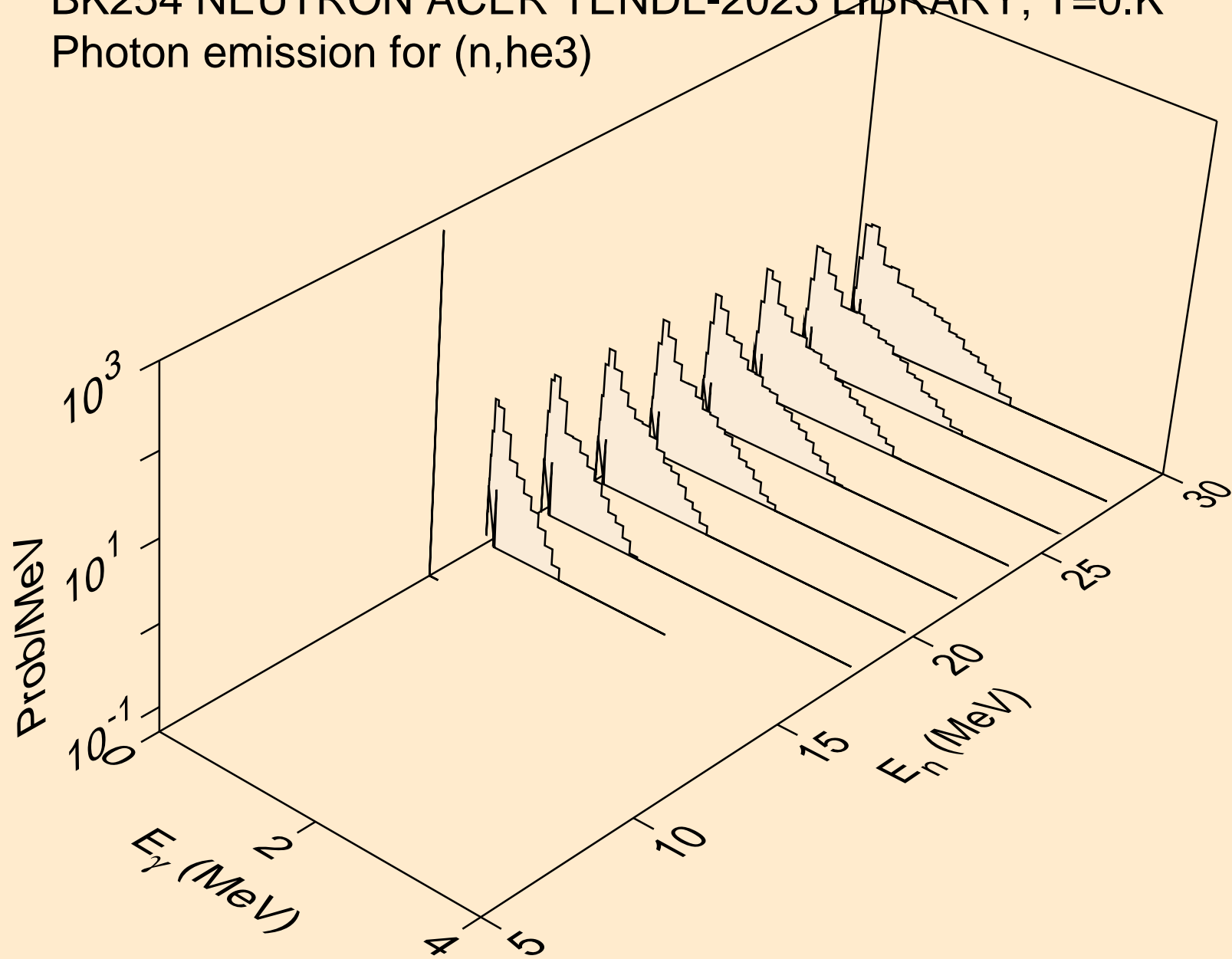

BK254 NEUTRON ACER TENDL-2023 LIBRARY; T=0.K
Photon emission for (n,a)

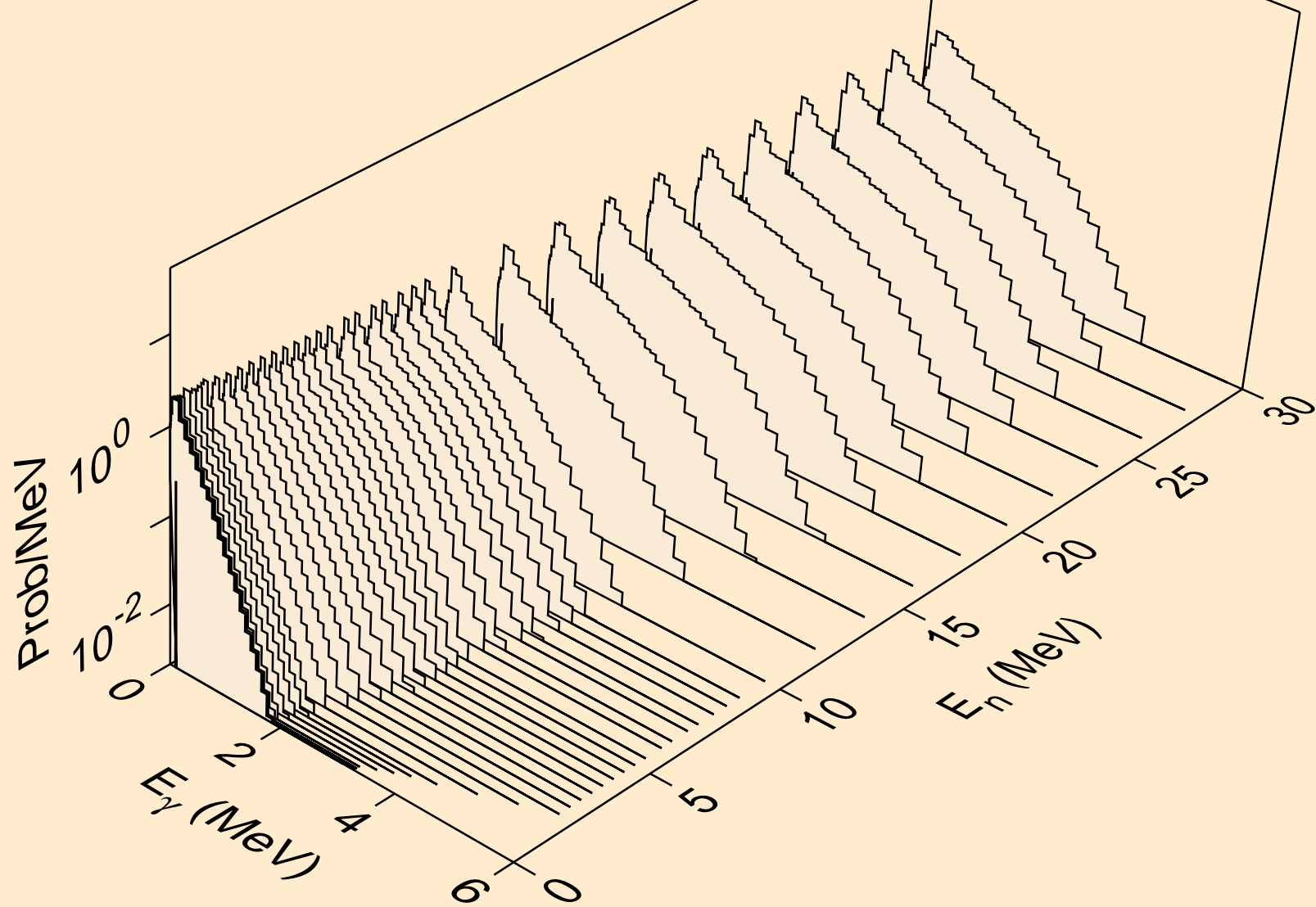

BK254 NEUTRON ACER TENDL-2023 LIBRARY; T=0.K
Photon emission for (n,2p)

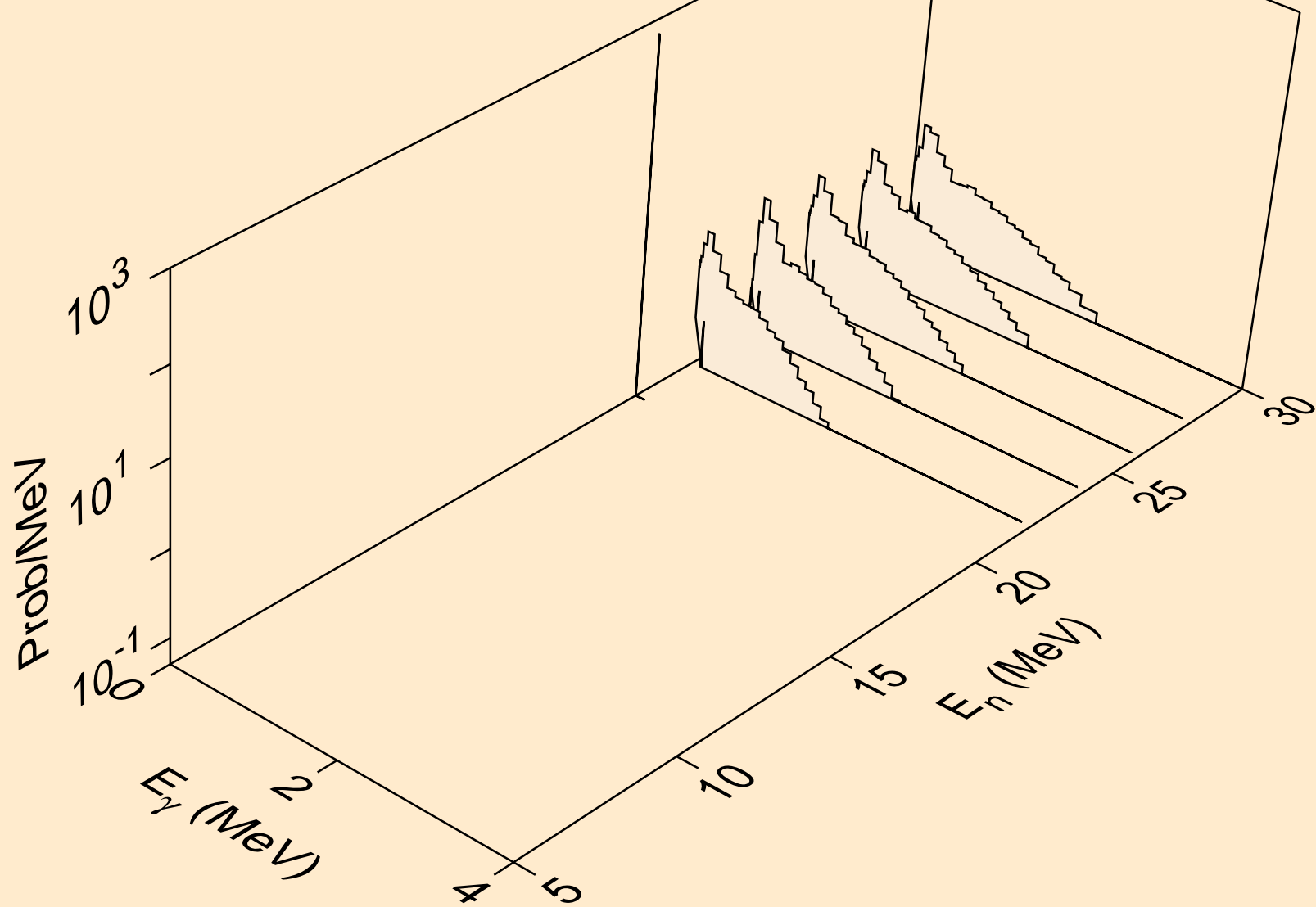

BK254 NEUTRON ACER TENDL-2023 LIBRARY; T=0.K
thermal capture photon spectrum

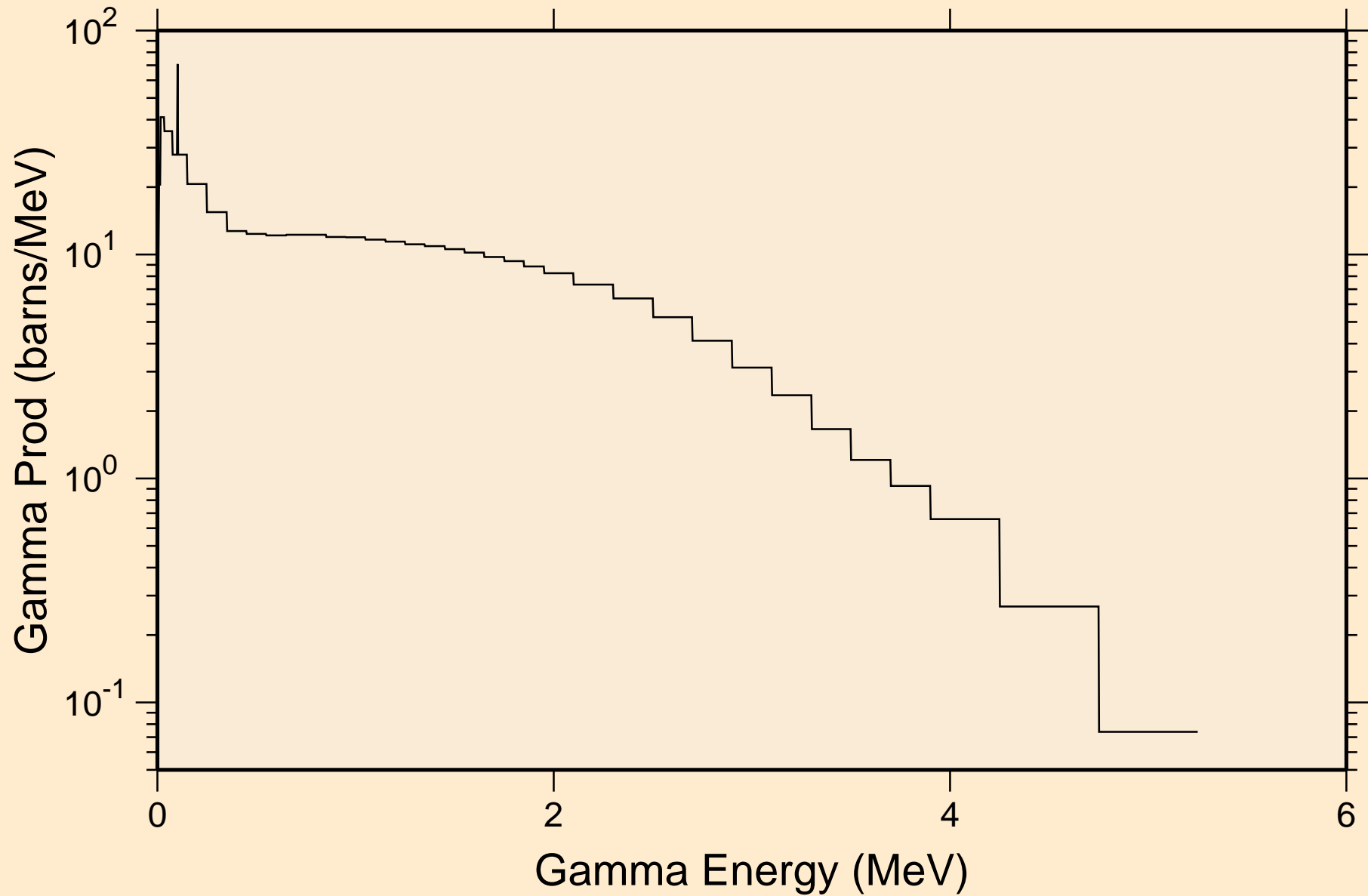

BK254 NEUTRON ACER TENDL-2023 LIBRARY; T=0.K
14 MeV photon spectrum

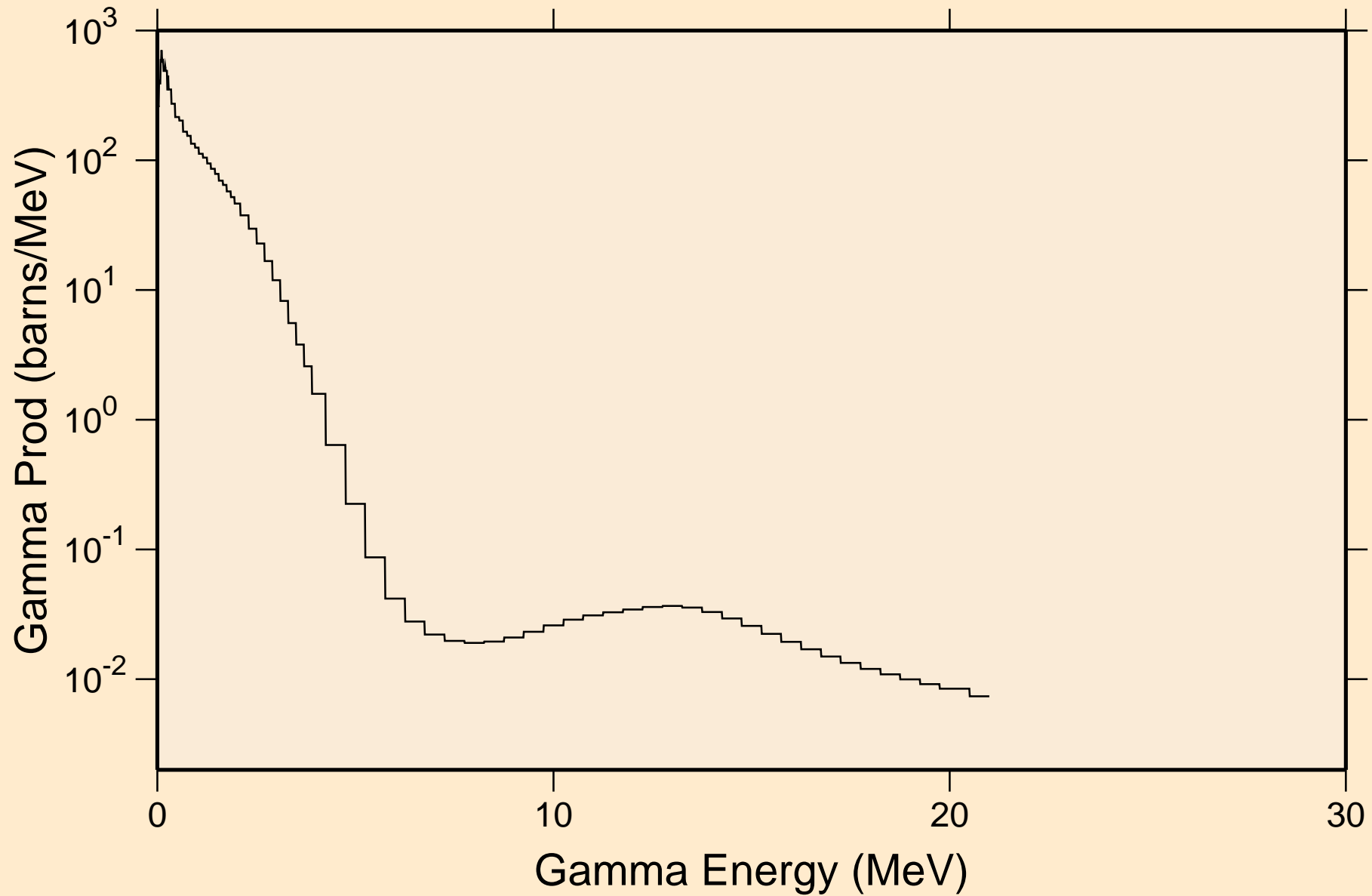

BK254 NEUTRON ACER TENDL-2023 LIBRARY; T=0.K

Particle heating contributions

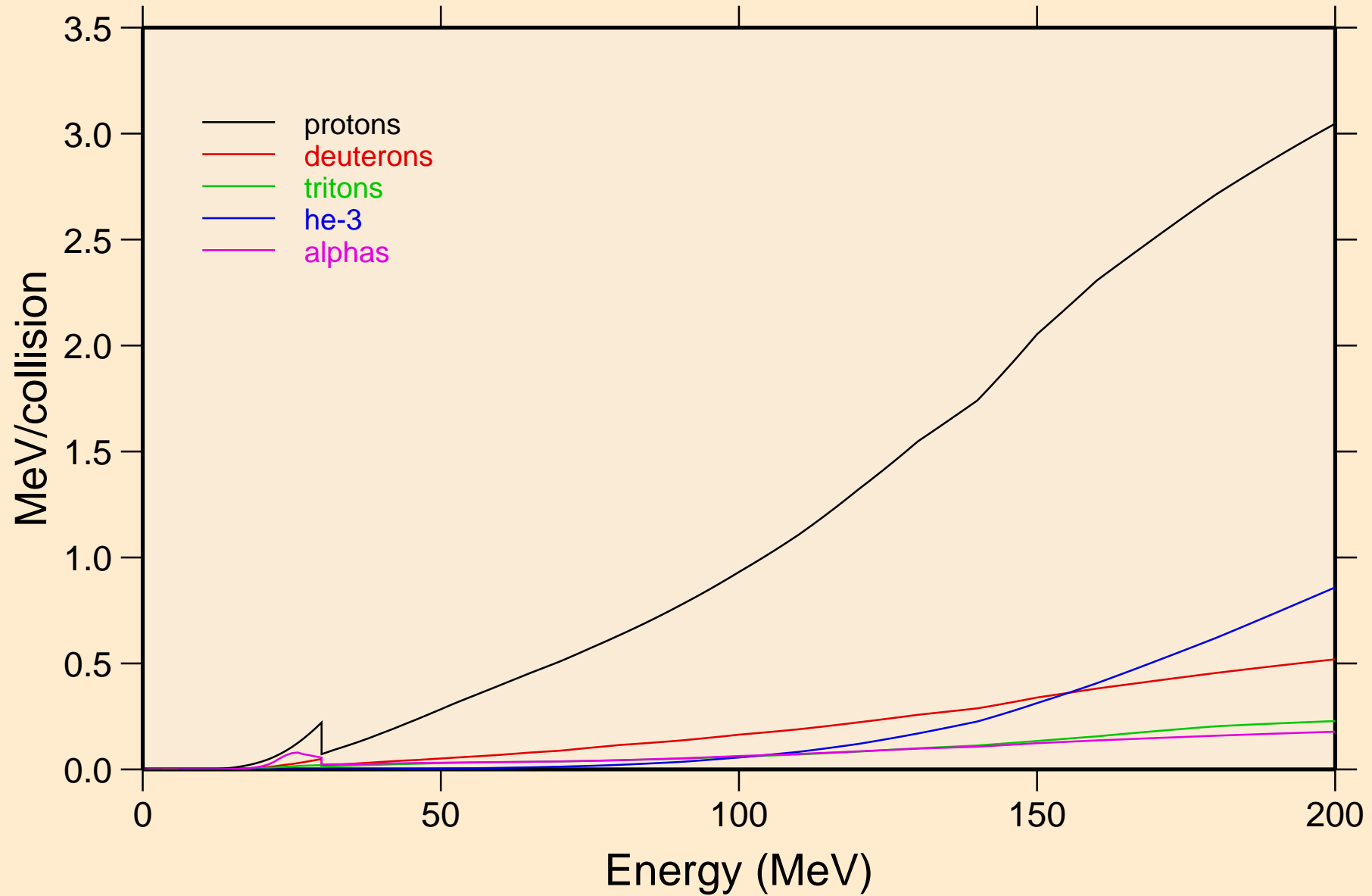

BK254 NEUTRON ACER TENDL-2023 LIBRARY; T=0.K
Recoil Heating

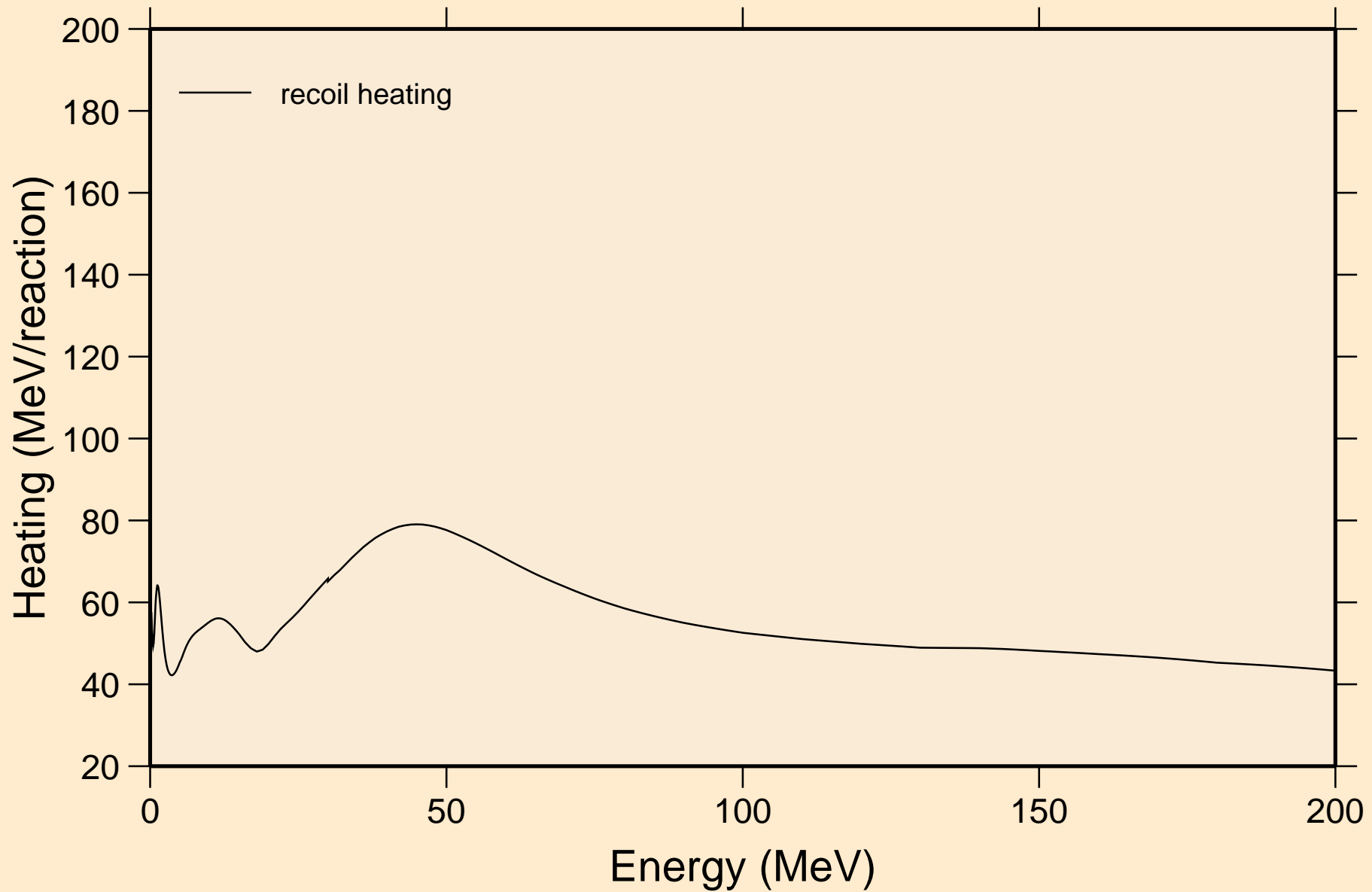

BK254 NEUTRON ACER TENDL-2023 LIBRARY; T=0.K
Particle production cross sections

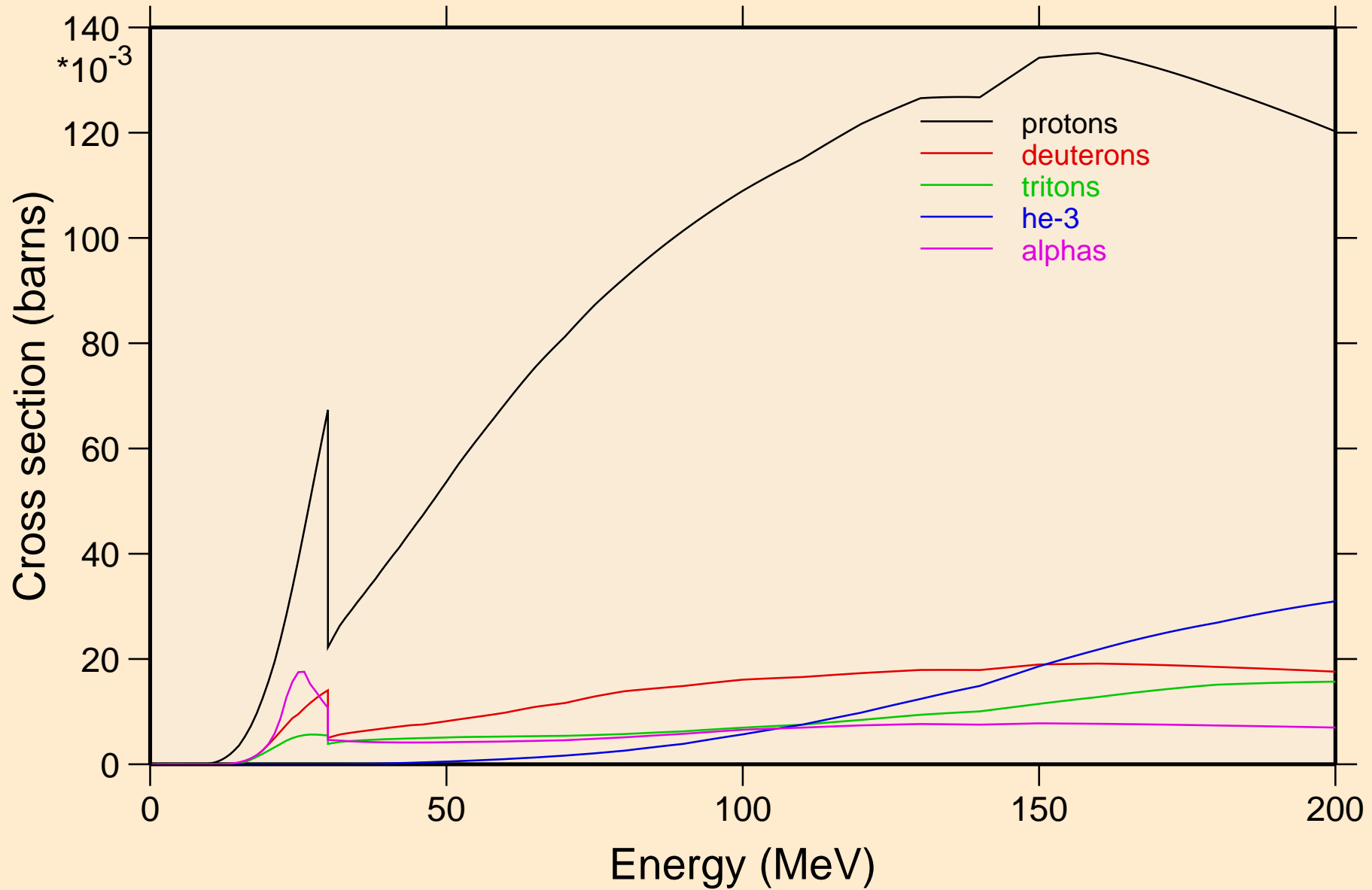

BK254 NEUTRON ACER TENDL-2023 LIBRARY; T=0.K
protons from (n,x)

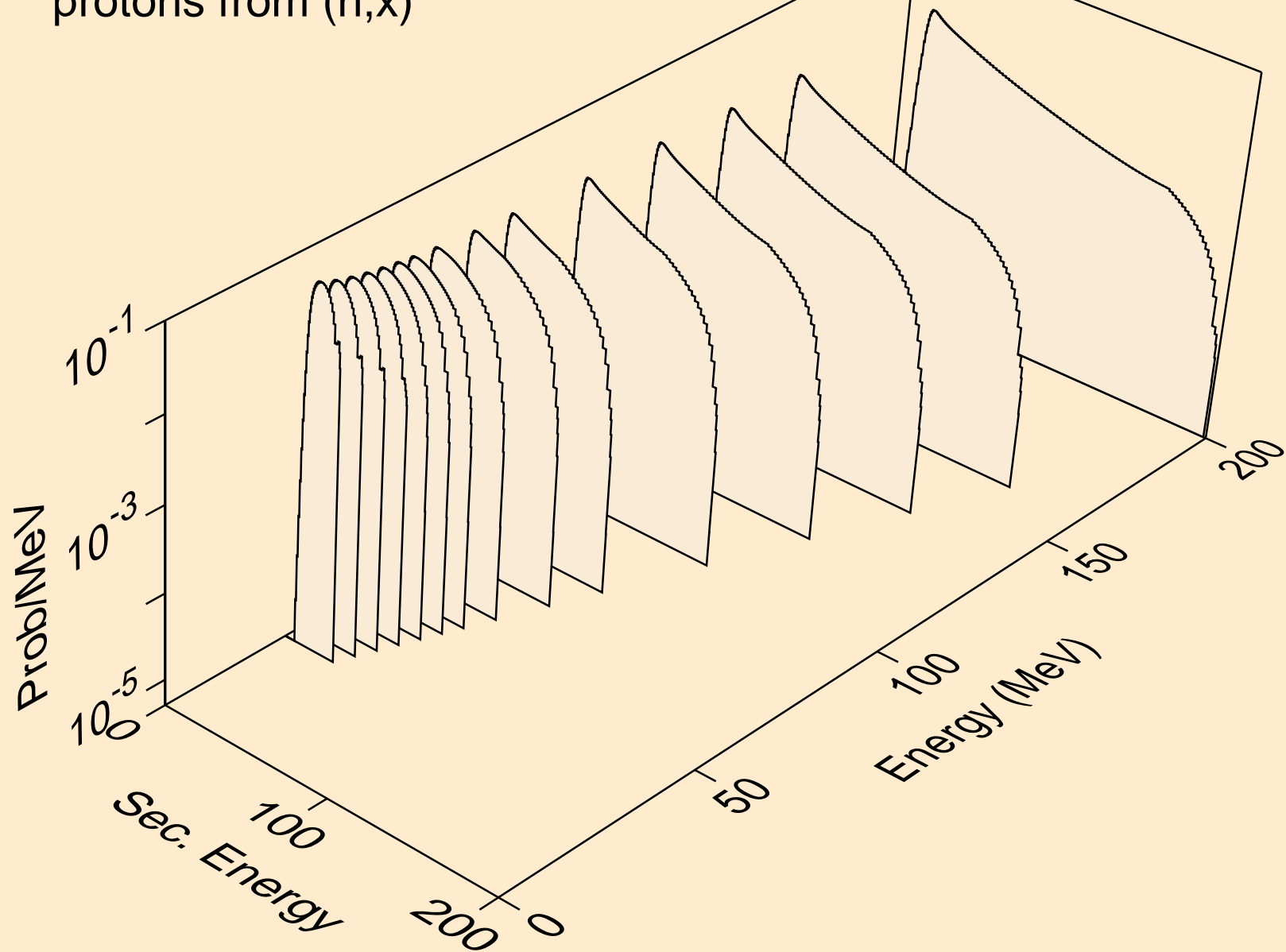

BK254 NEUTRON ACER TENDL-2023 LIBRARY; T=0.K
protons from (n,n*)p

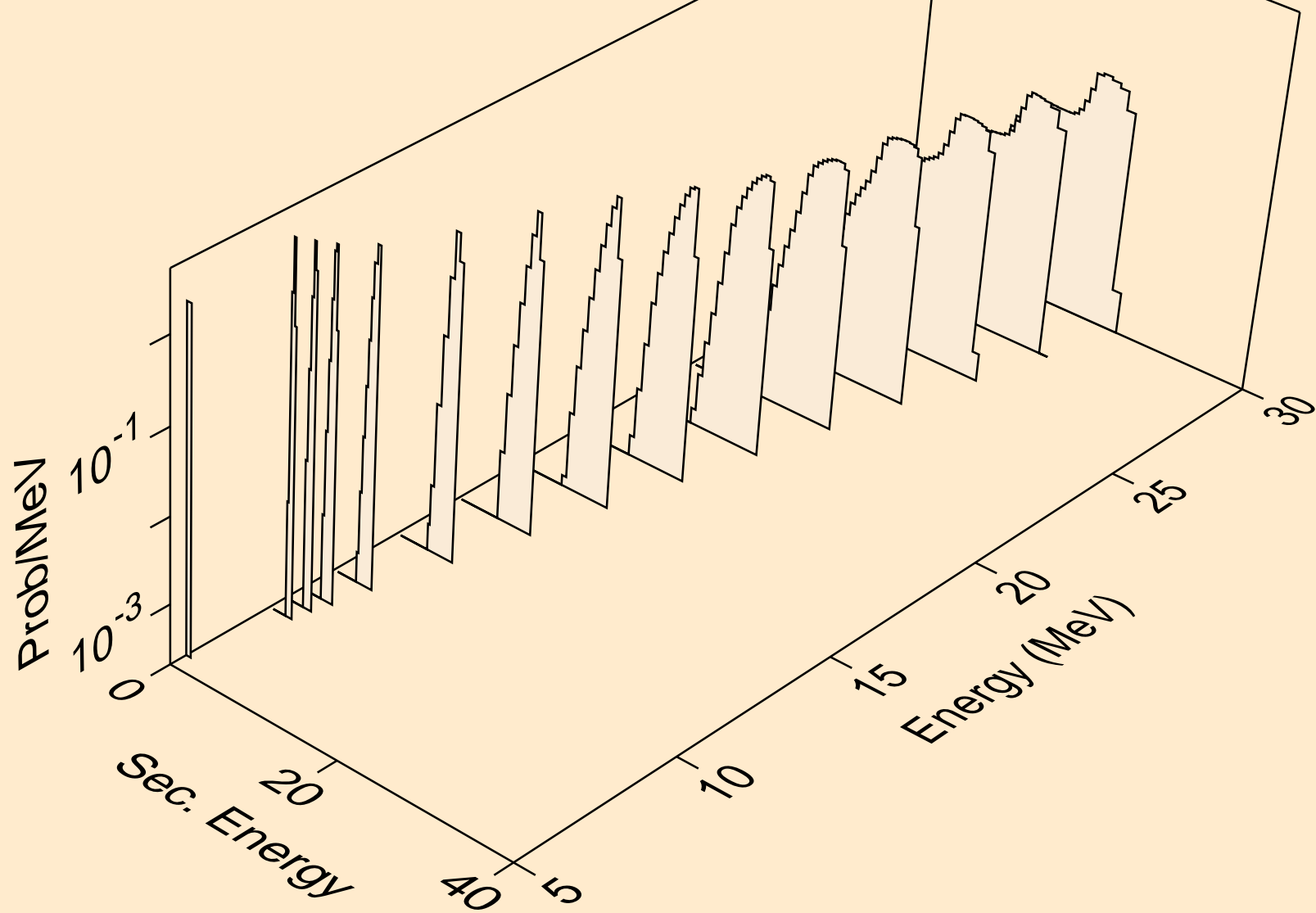

BK254 NEUTRON ACER TENDL-2023 LIBRARY; T=0.K
protons from (n,2np)

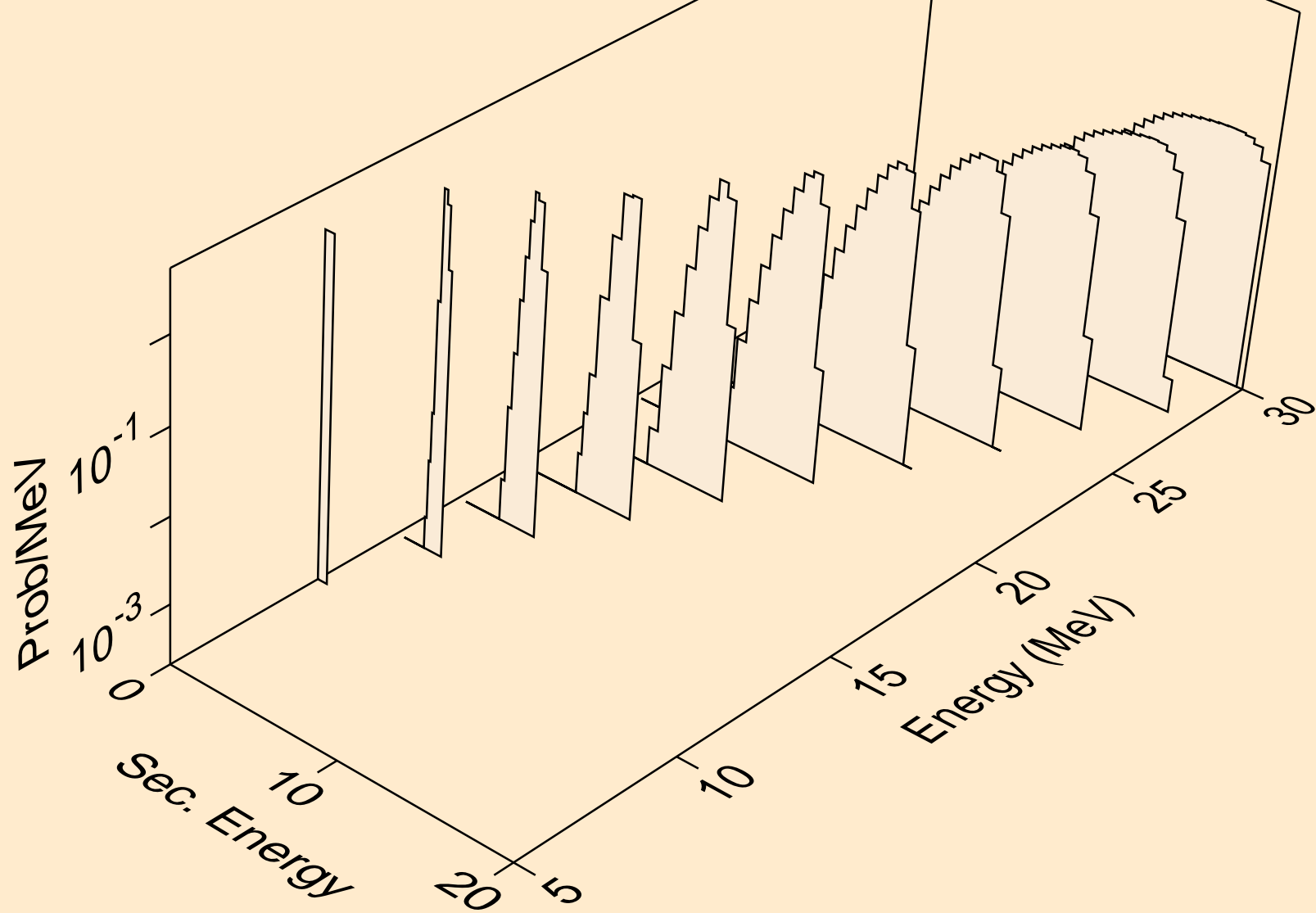

BK254 NEUTRON ACER TENDL-2023 LIBRARY; T=0.K
protons from (n,3np)

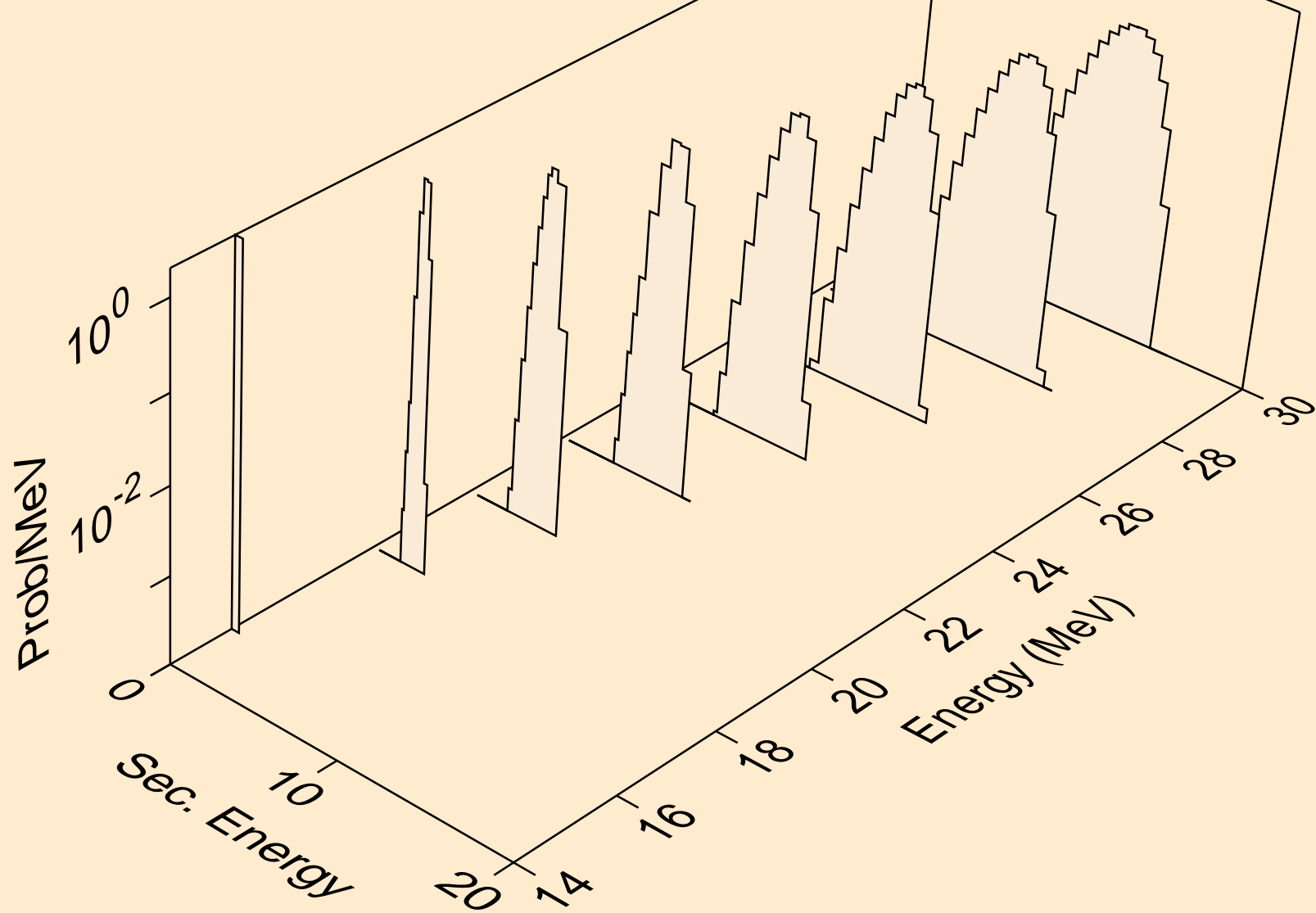

BK254 NEUTRON ACER TENDL-2023 LIBRARY; T=0.K
protons from (n,p)

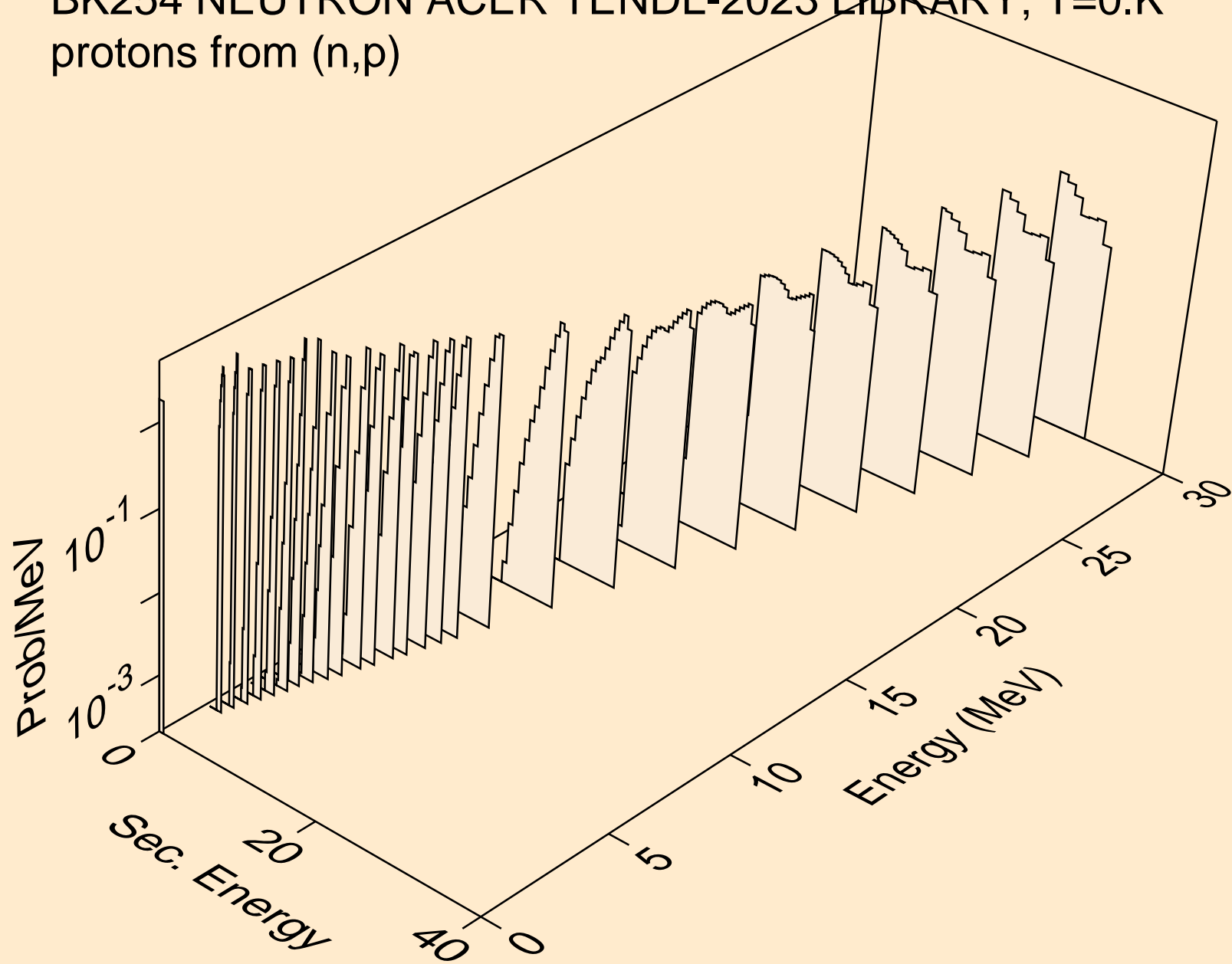

BK254 NEUTRON ACER TENDL-2023 LIBRARY; T=0.K
protons from (n,2p)

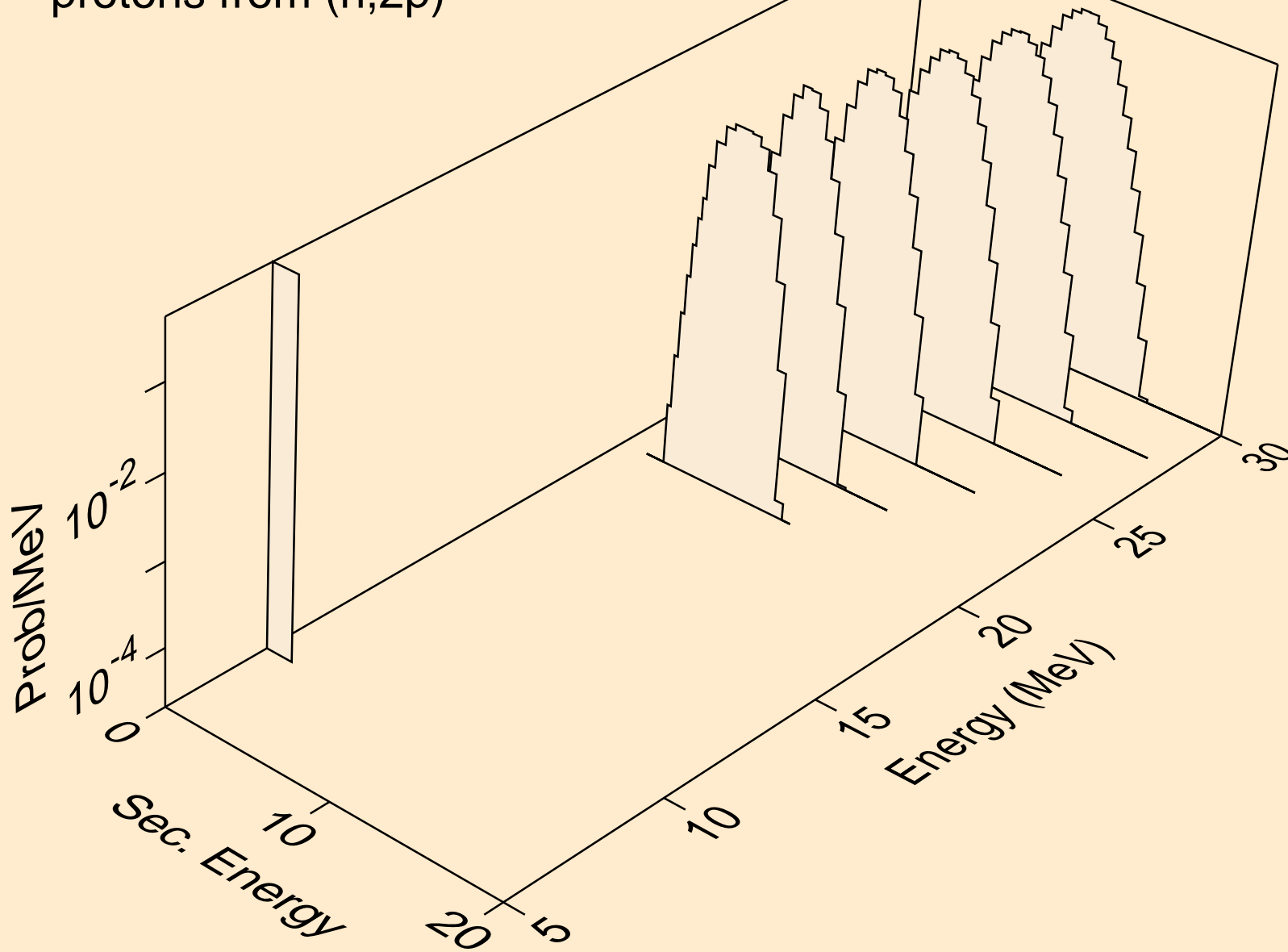

BK254 NEUTRON ACER TENDL-2023 LIBRARY; T=0.K
deuterons from (n,x)

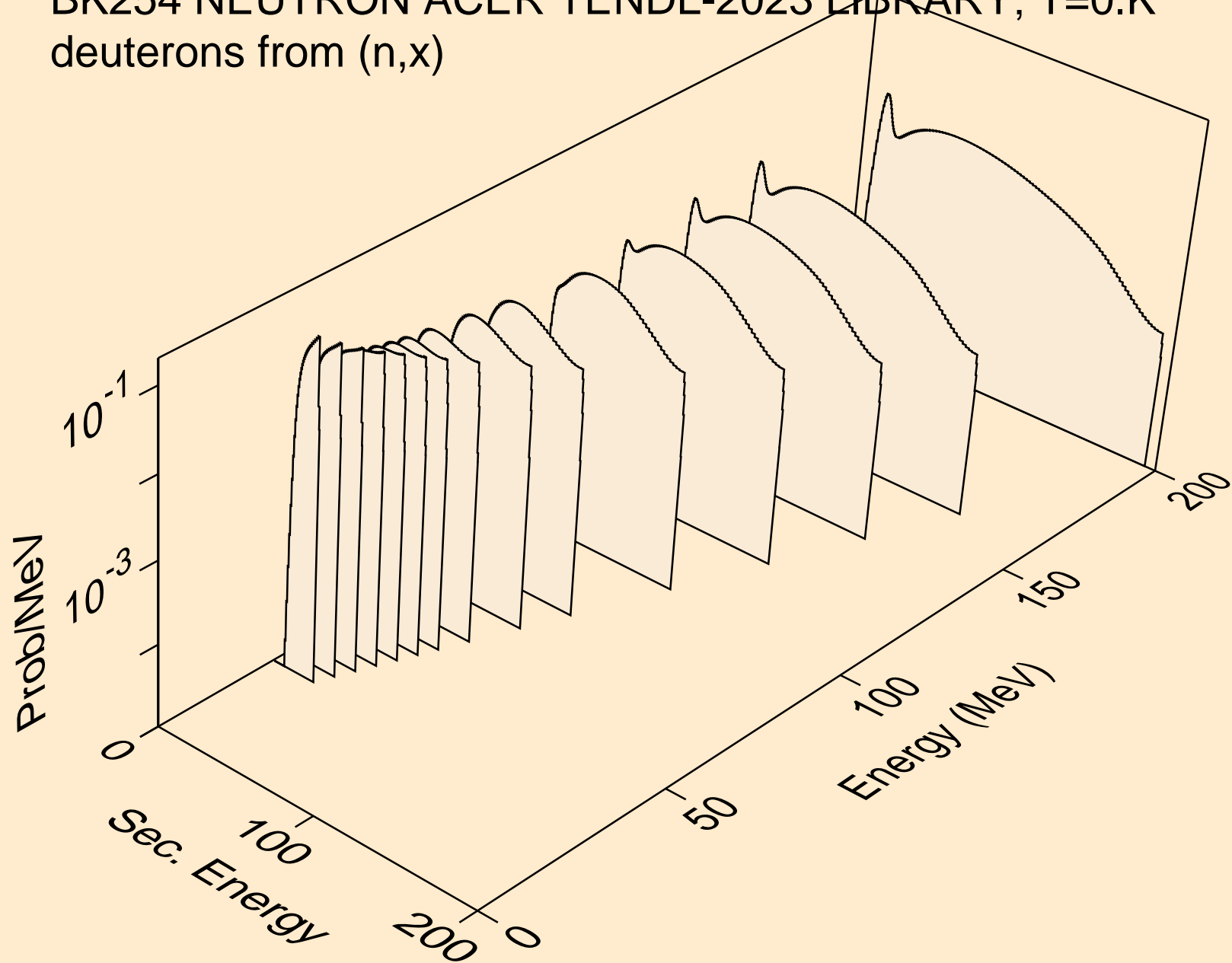

BK254 NEUTRON ACER TENDL-2023 LIBRARY; T=0.K
deuterons from (n,2nd)

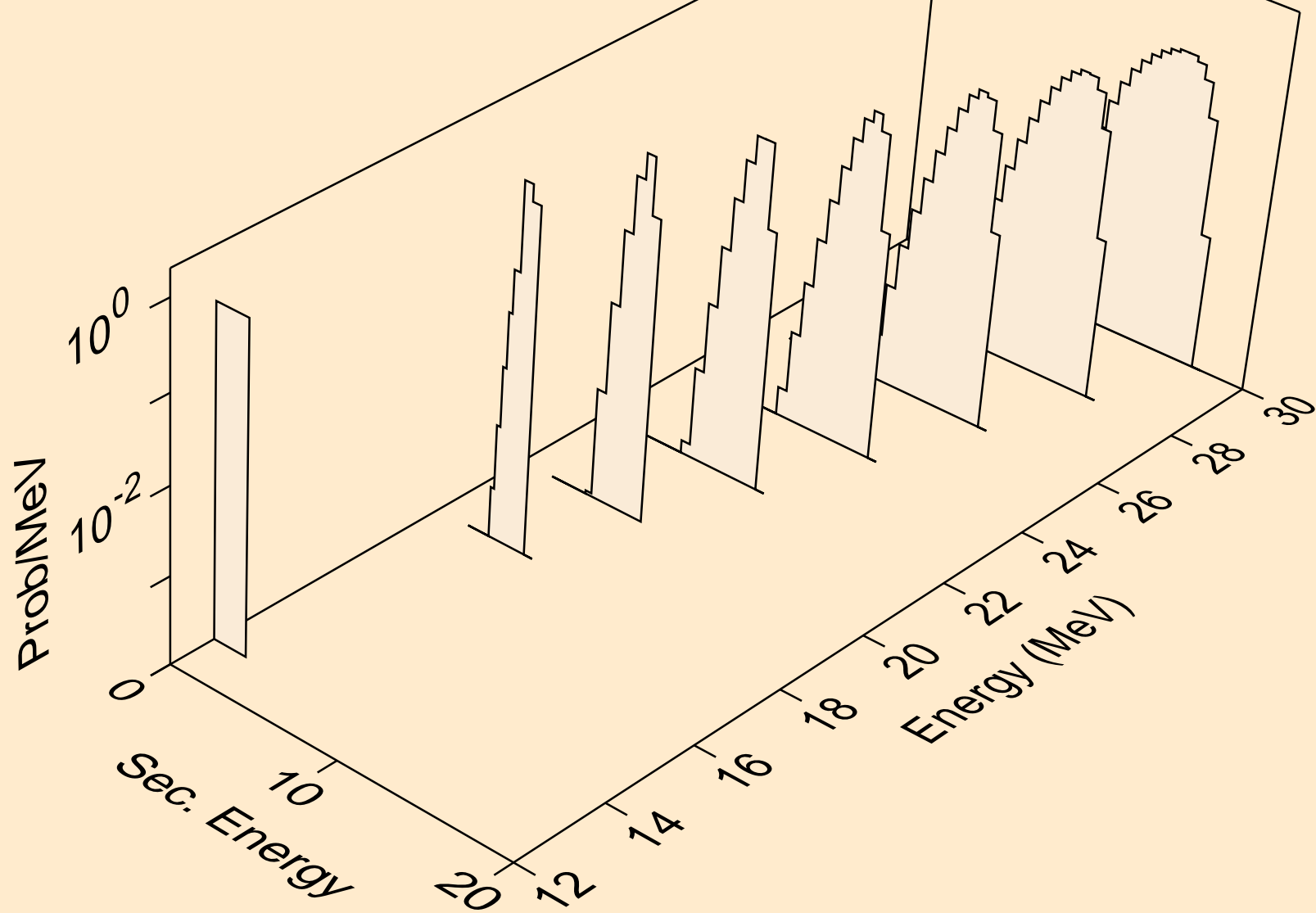

BK254 NEUTRON ACER TENDL-2023 LIBRARY; T=0.K
deuterons from (n,n*)d

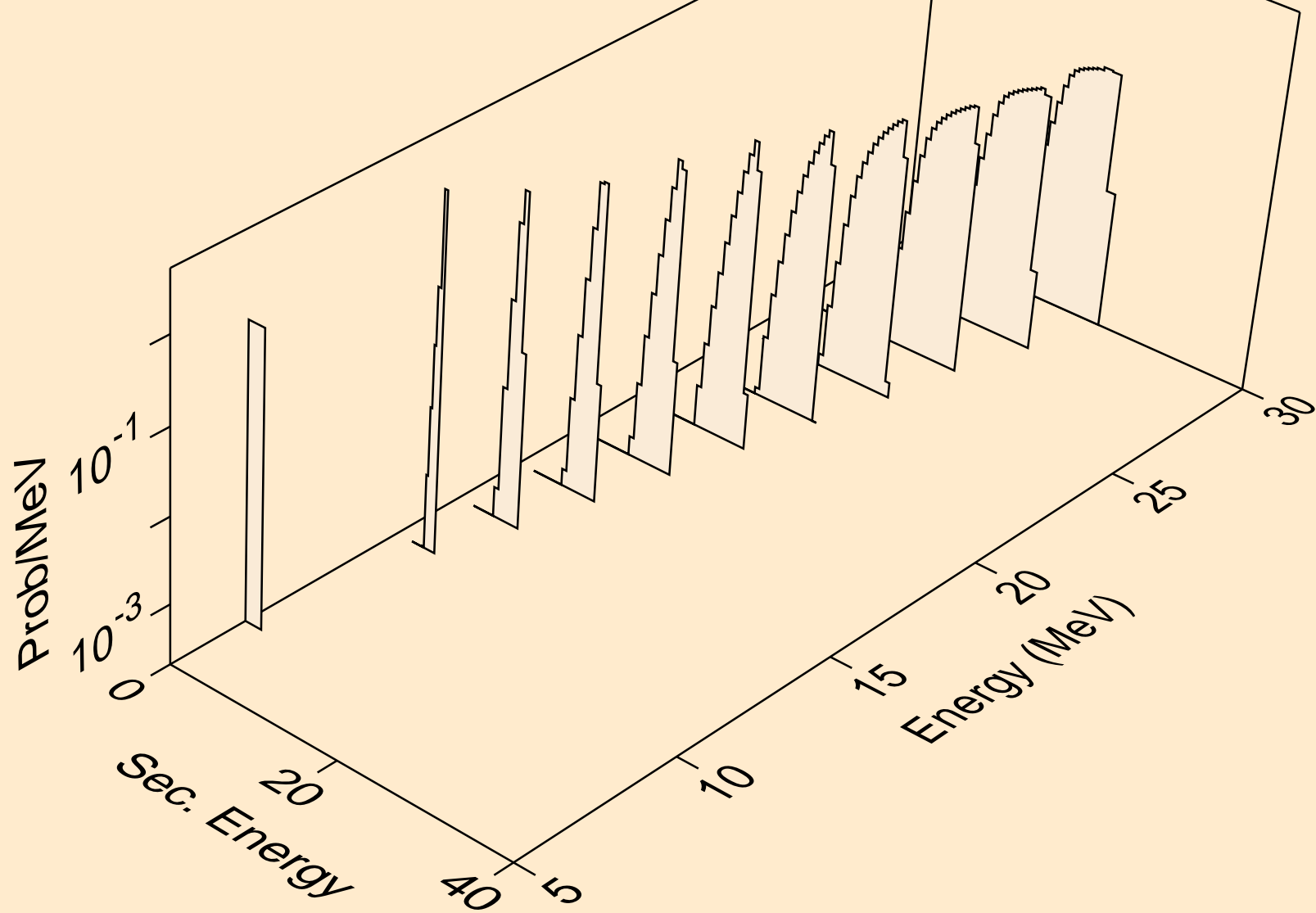

BK254 NEUTRON ACER TENDL-2023 LIBRARY; T=0.K
deuterons from (n,d)

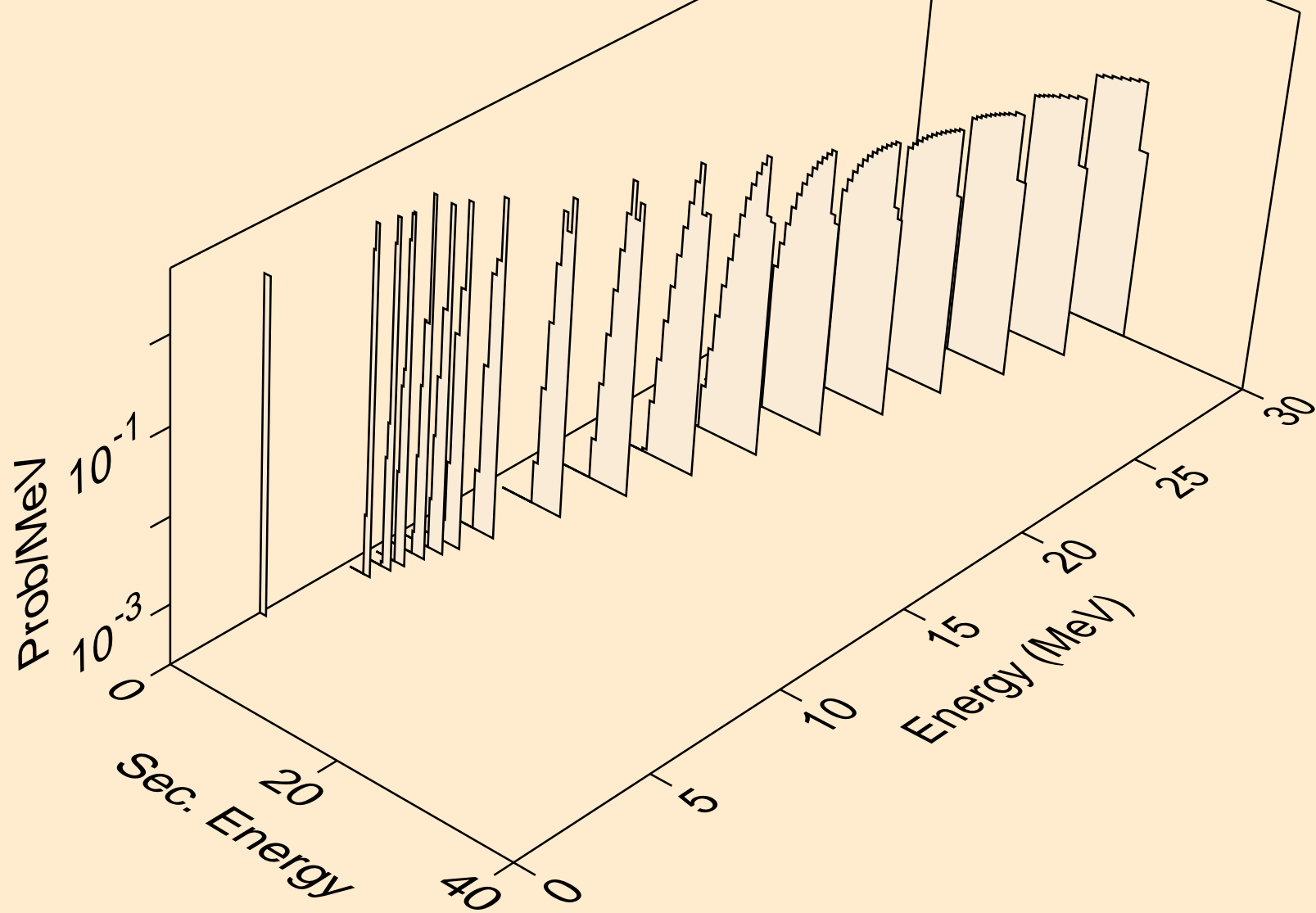

BK254 NEUTRON ACER TENDL-2023 LIBRARY; T=0.K
tritons from (n,x)

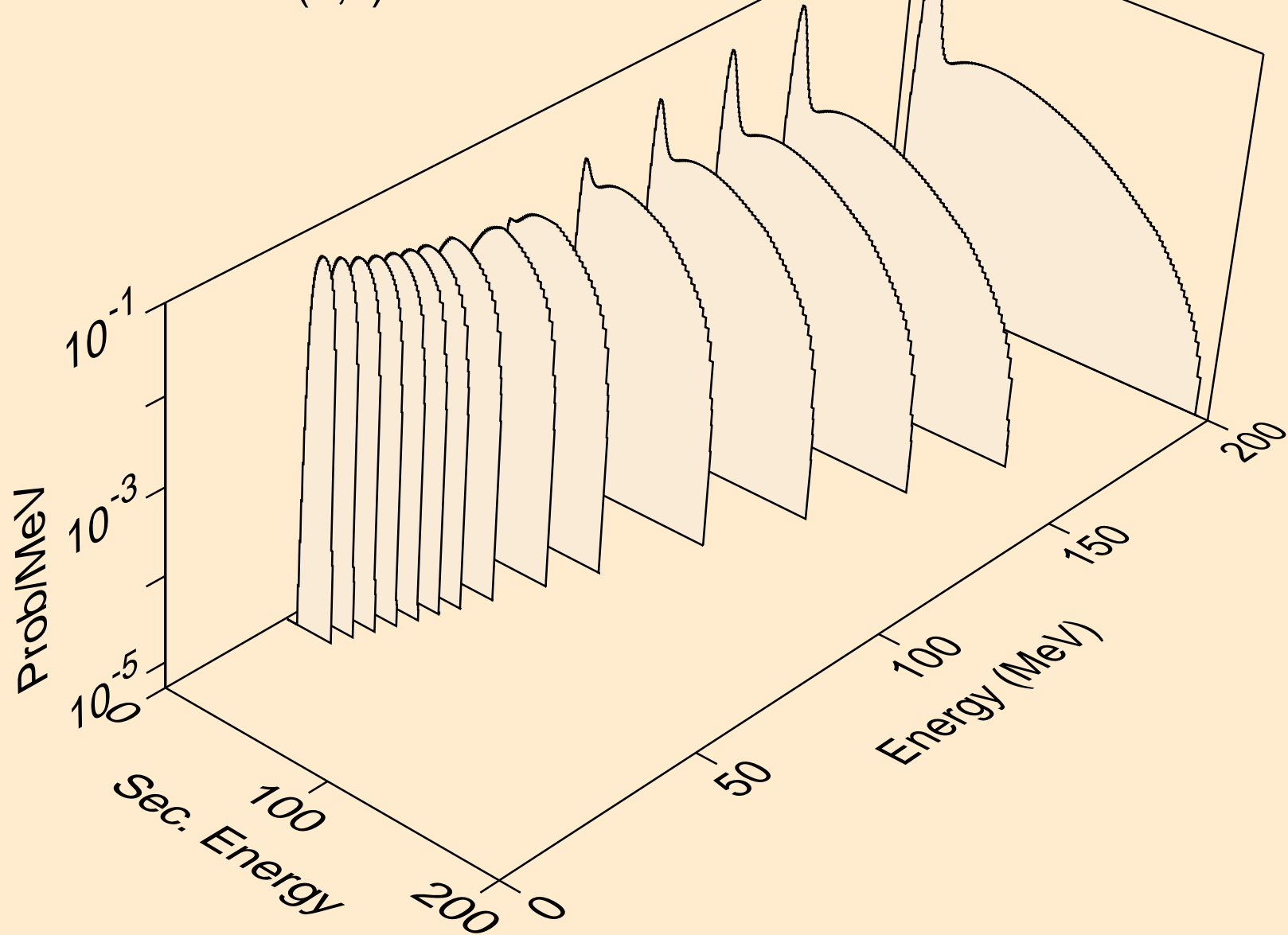

BK254 NEUTRON ACER TENDL-2023 LIBRARY; T=0.K
tritons from (n,n*)t

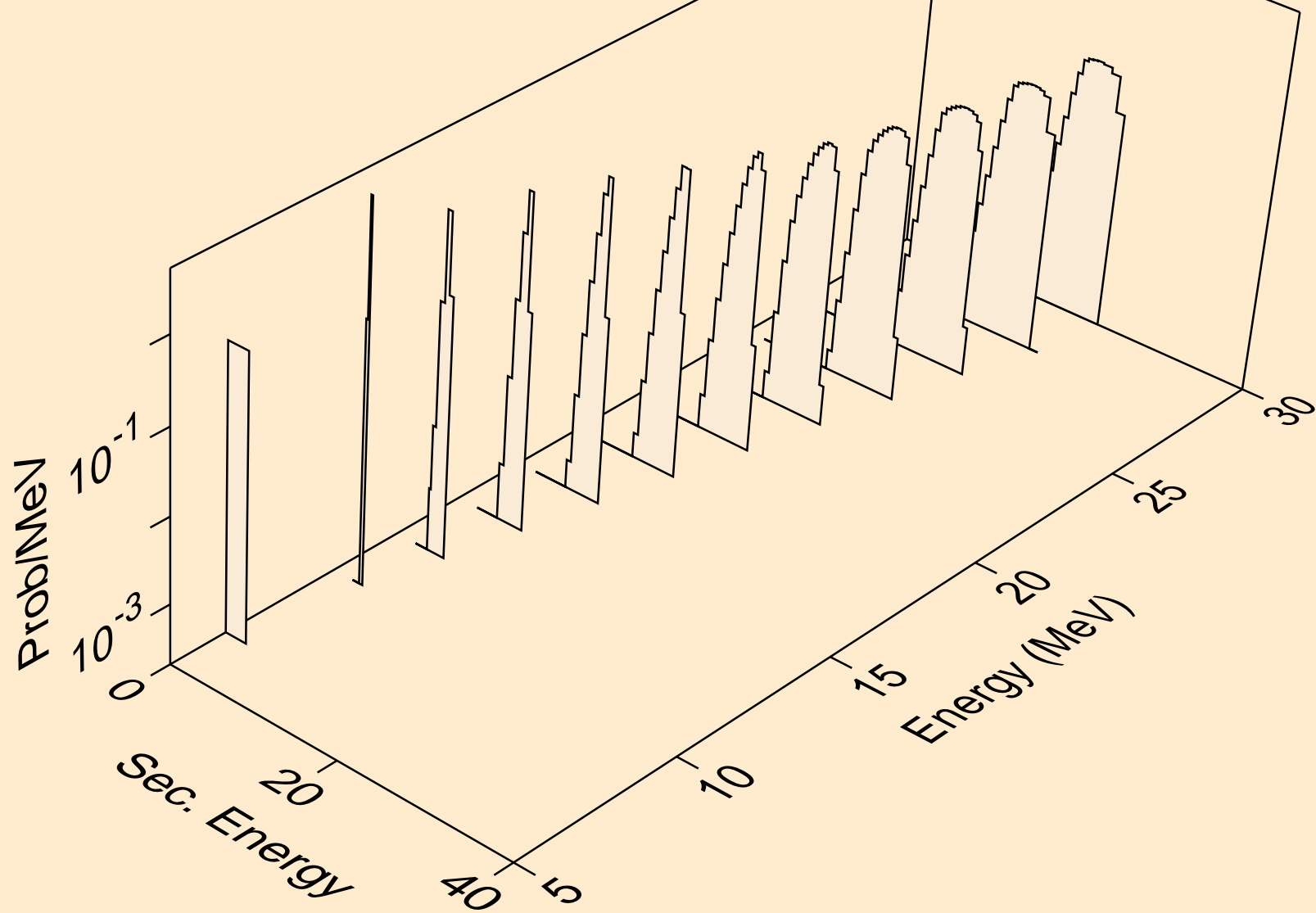

BK254 NEUTRON ACER TENDL-2023 LIBRARY; T=0.K
tritons from (n,t)

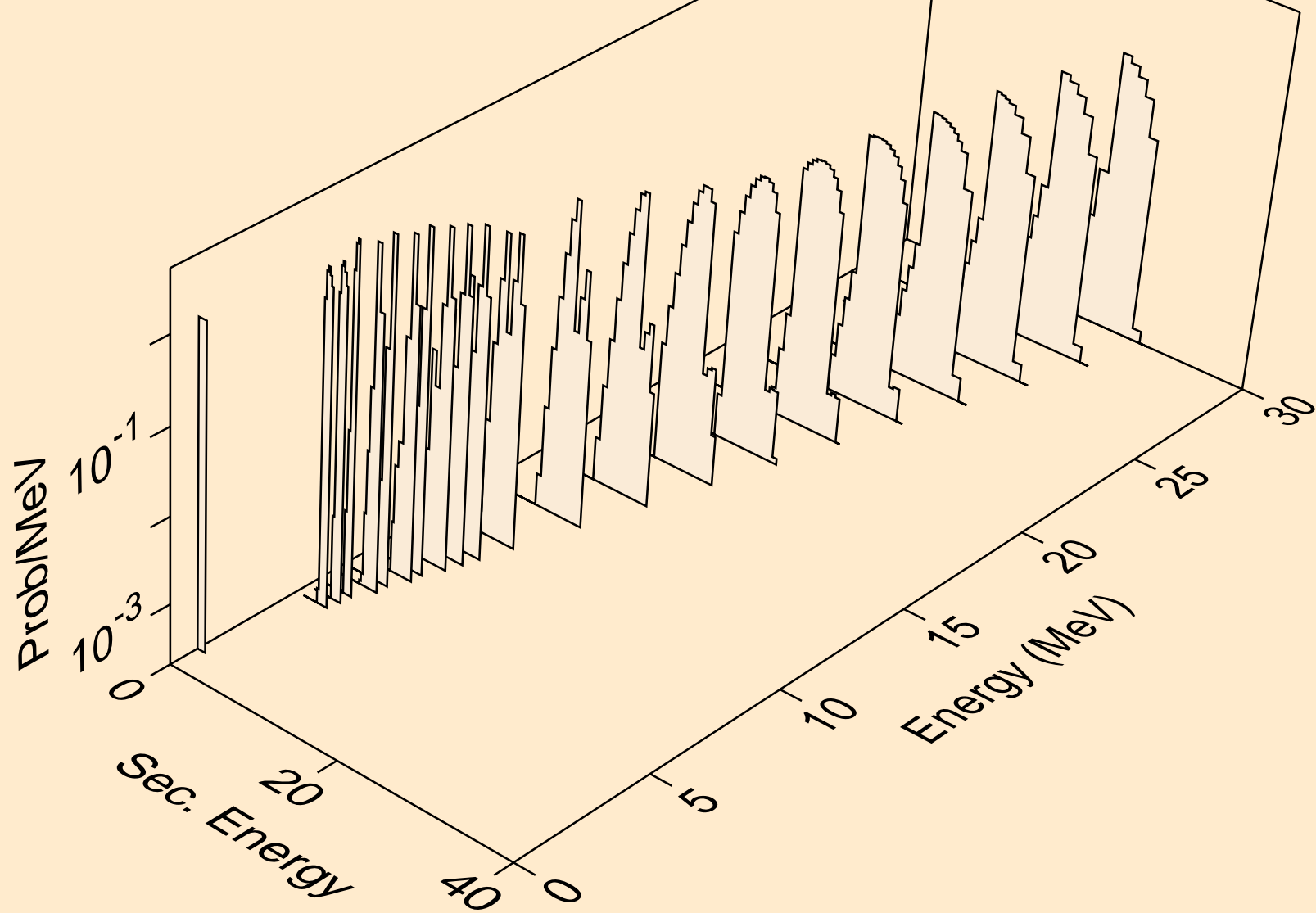

BK254 NEUTRON ACER TENDL-2023 LIBRARY; T=0.K
he3s from (n,x)

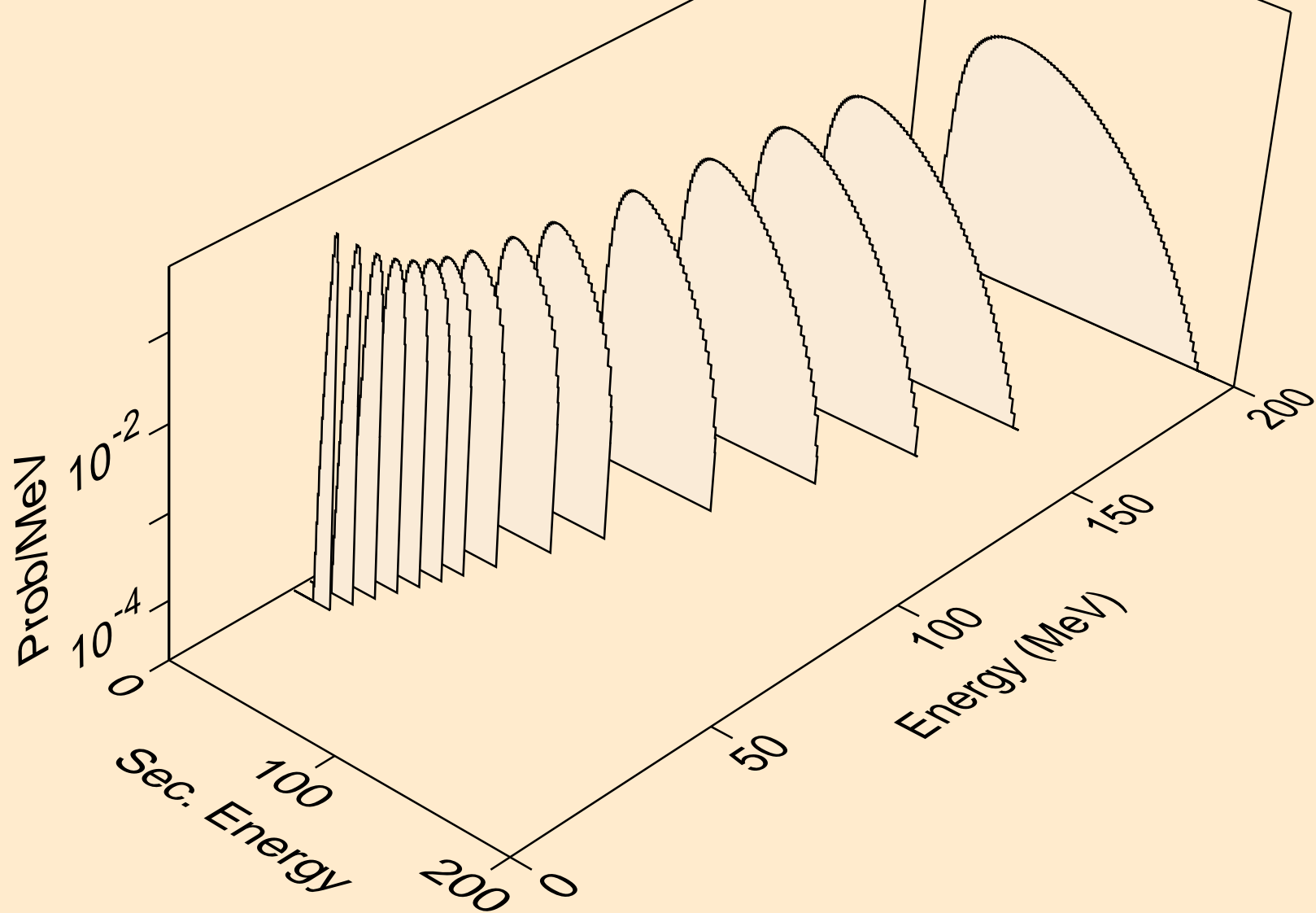

BK254 NEUTRON ACER TENDL-2023 LIBRARY; T=0.K
he3s from (n,n*)he3

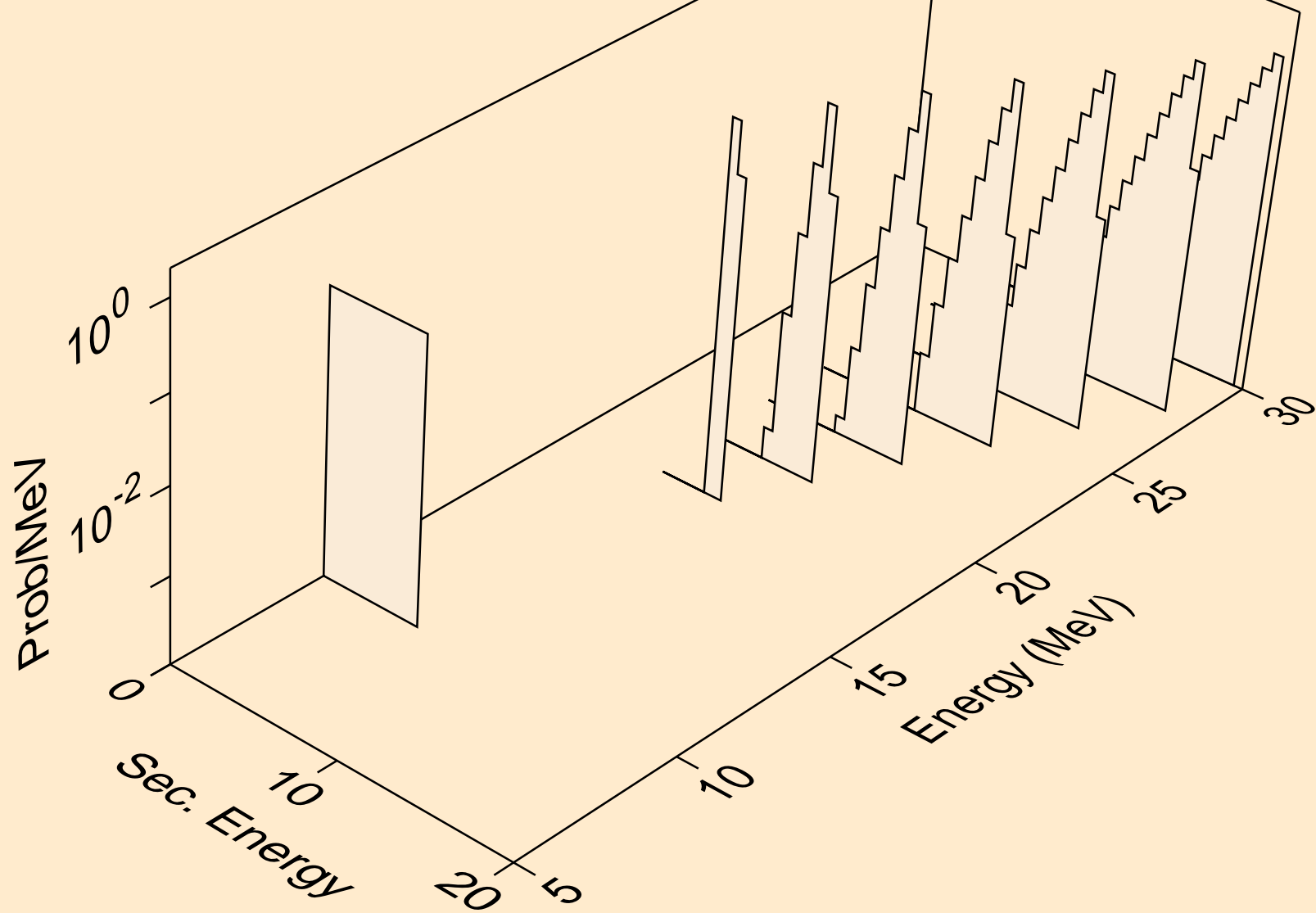

BK254 NEUTRON ACER TENDL-2023 LIBRARY; T=0.K
he3s from (n,he3)

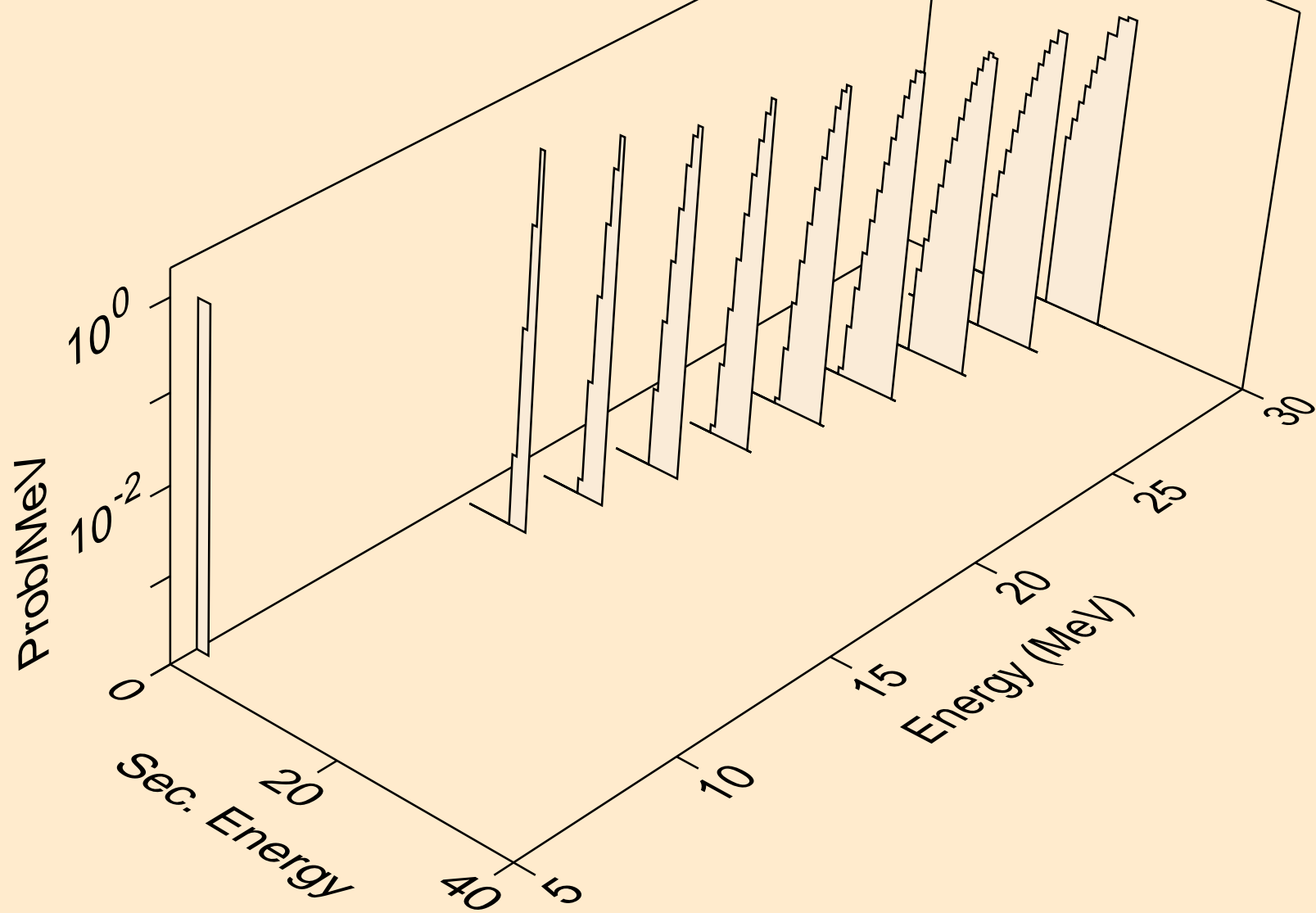

BK254 NEUTRON ACER TENDL-2023 LIBRARY; T=0.K
alphas from (n,x)

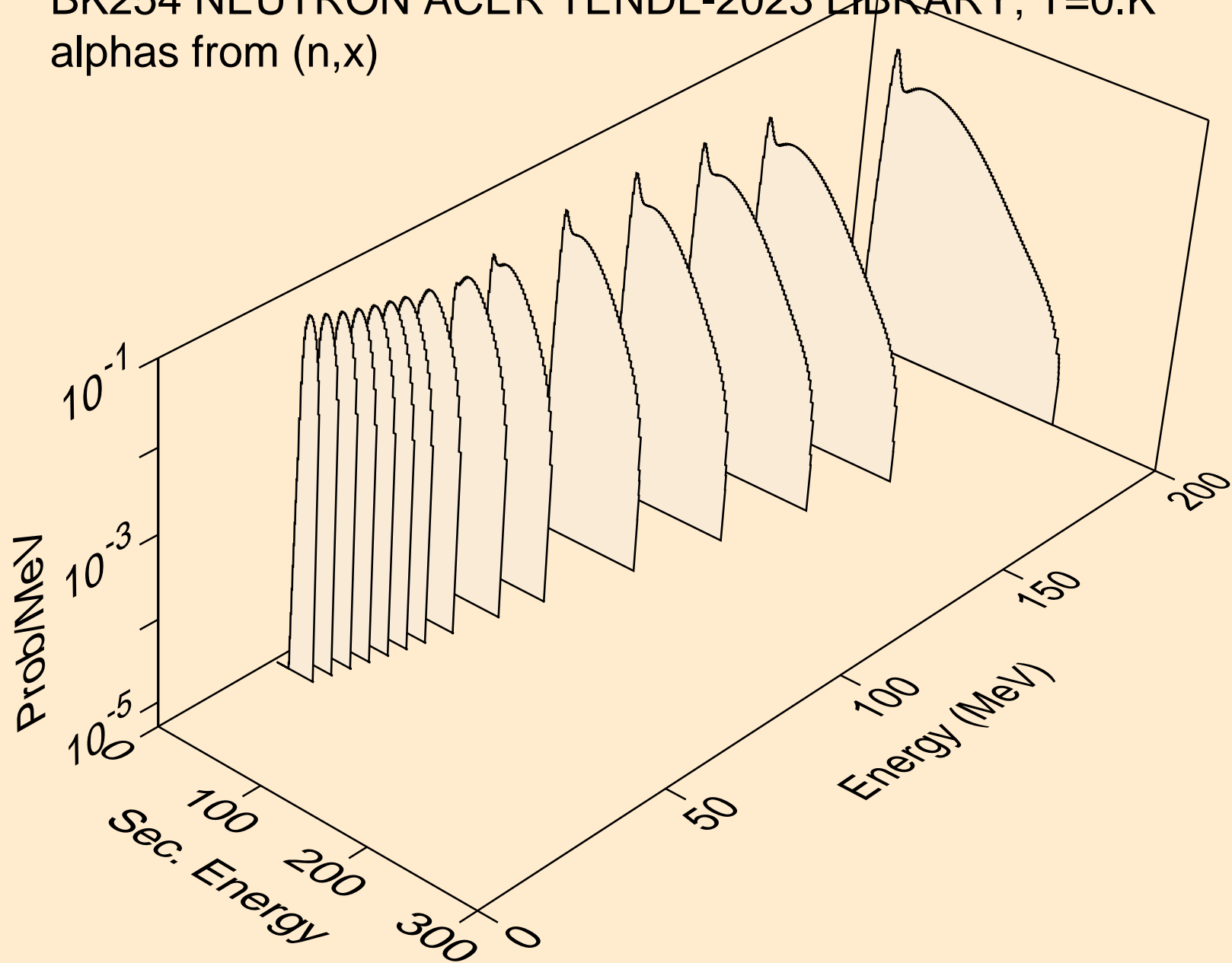

BK254 NEUTRON ACER TENDL-2023 LIBRARY; T=0.K
alphas from (n,n*)a

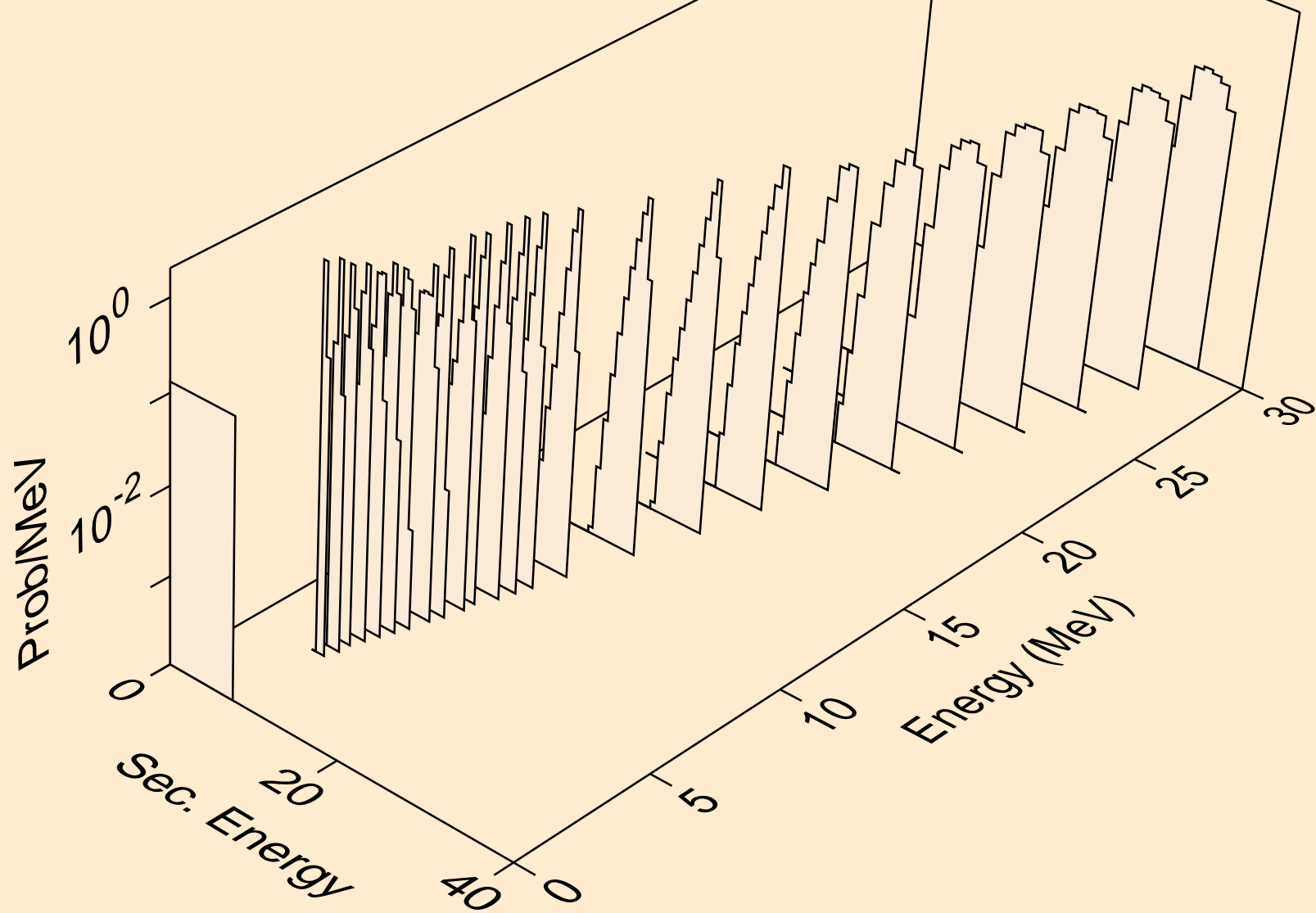

BK254 NEUTRON ACER TENDL-2023 LIBRARY; T=0.K
alphas from (n,2n)a

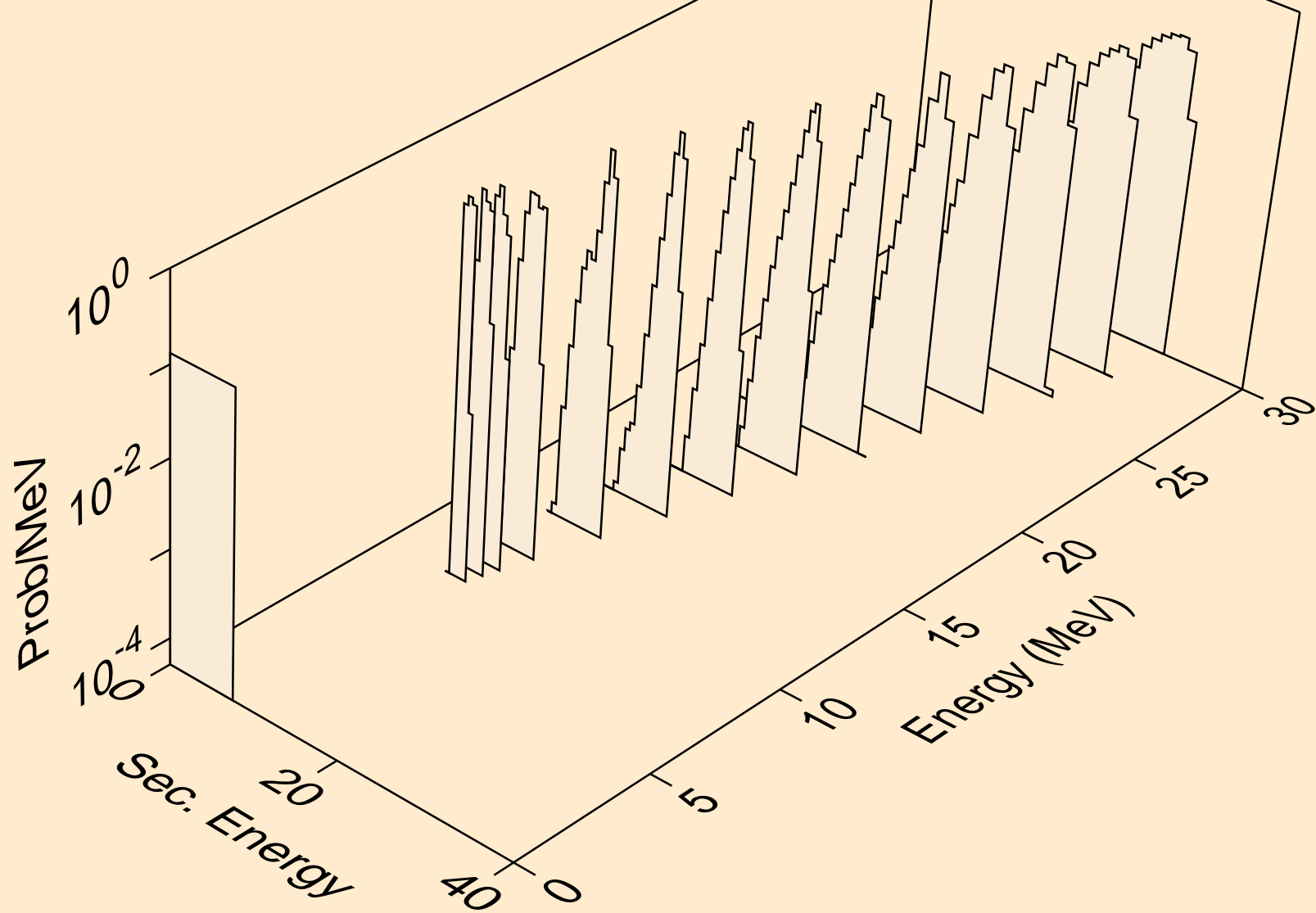

BK254 NEUTRON ACER TENDL-2023 LIBRARY; T=0.K
alphas from (n,3n)a

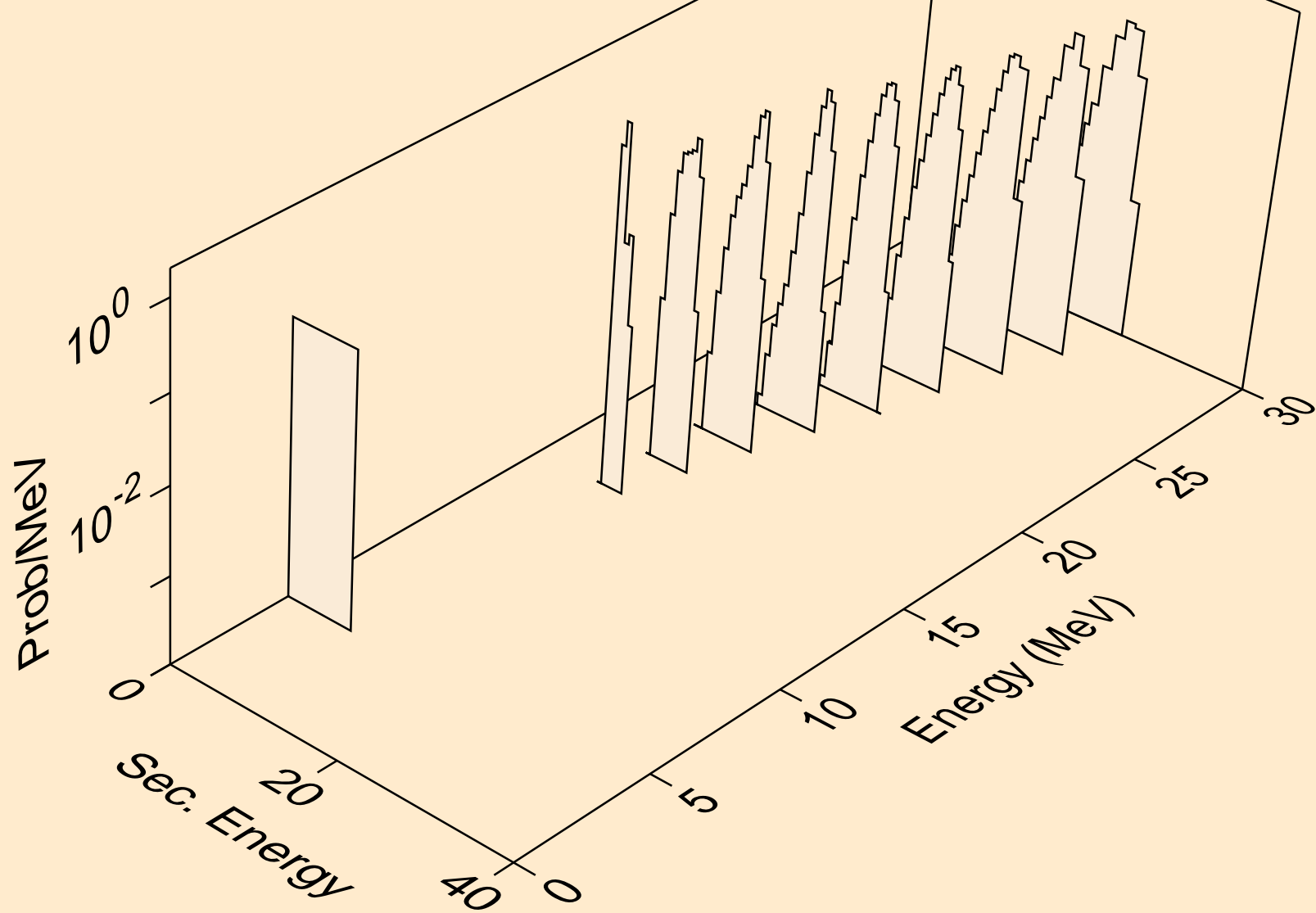

BK254 NEUTRON ACER TENDL-2023 LIBRARY; T=0.K
alphas from (n,a)

