

CE131M NEUTRON ACER TENDL-2023 LIBRARY; T=0.K

Principal cross sections

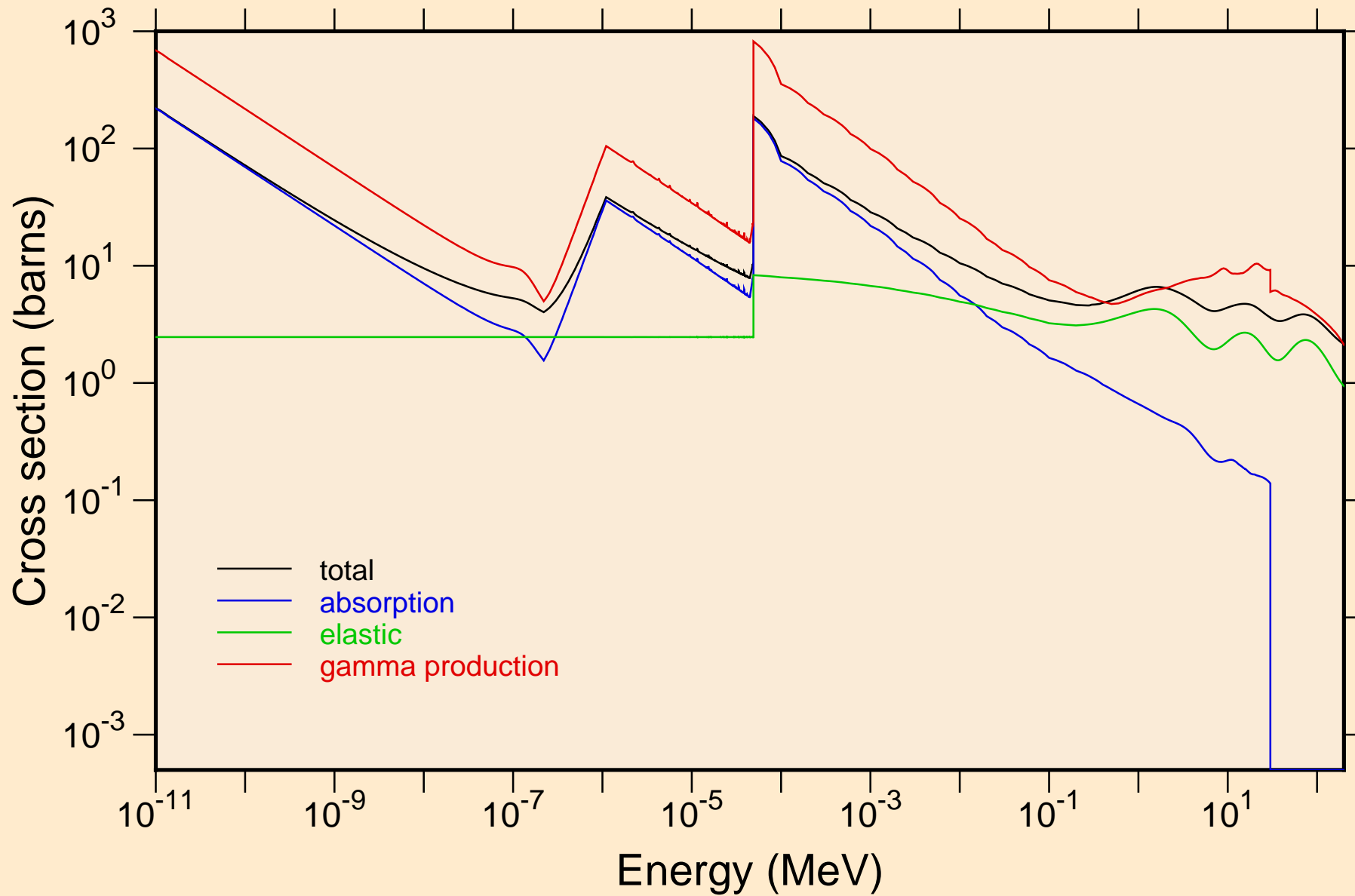

CE131M NEUTRON ACER TENDL-2023 LIBRARY; T=0.K
resonance total cross section

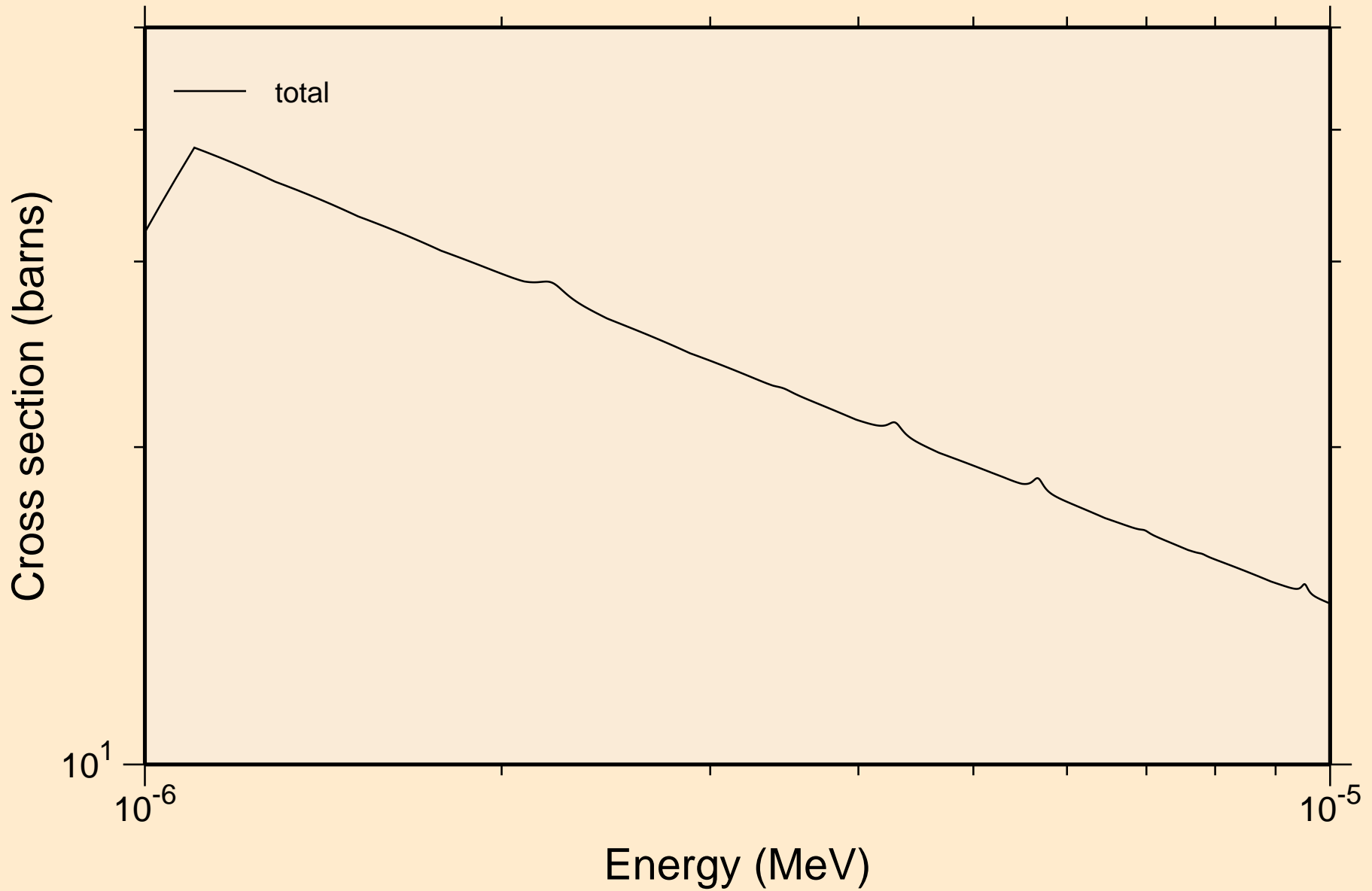

CE131M NEUTRON ACER TENDL-2023 LIBRARY; T=0.K
resonance total cross section

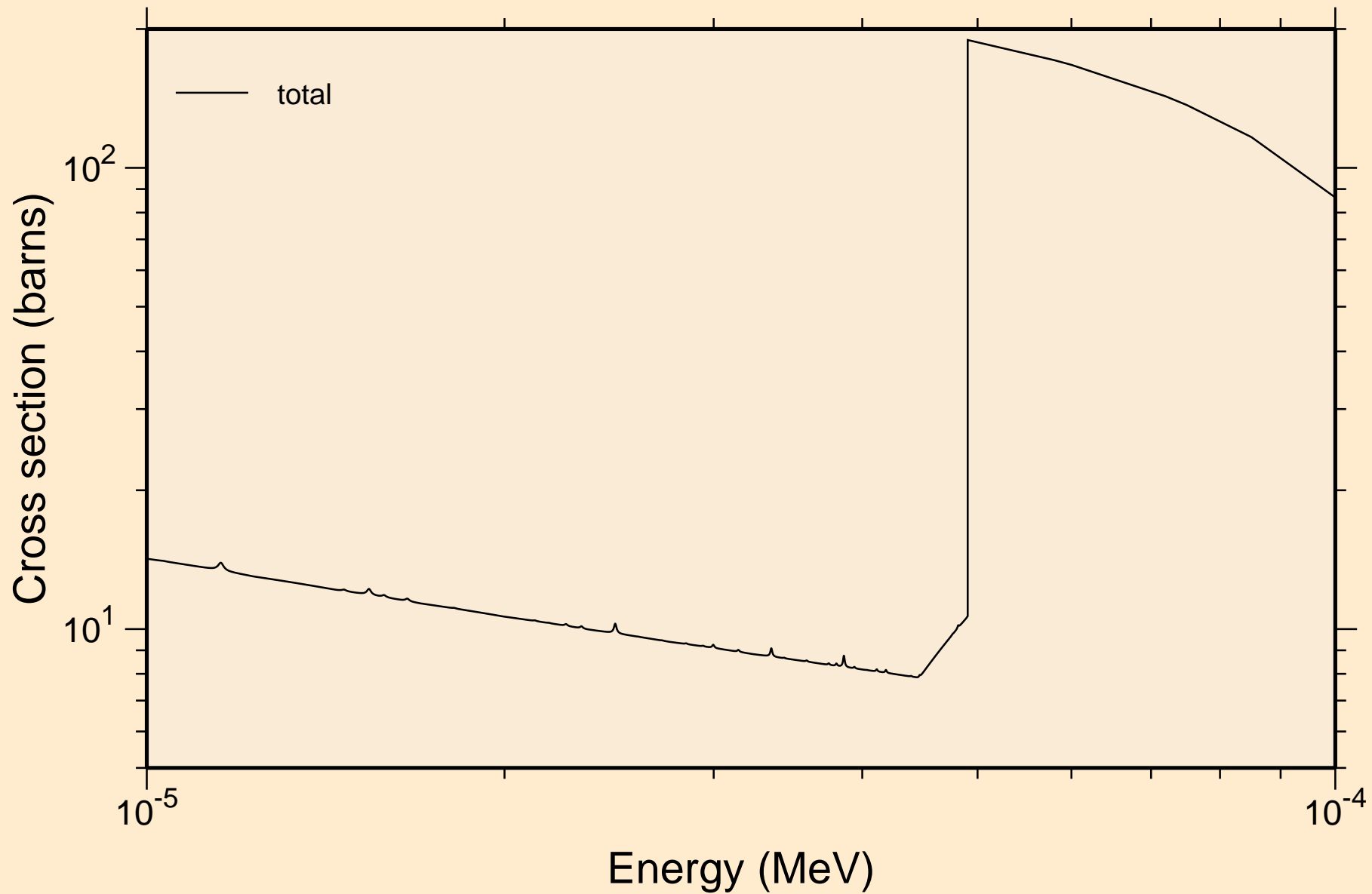

C¹³¹M NEUTRON ACER TENDL-2023 LIBRARY; T=0.K
resonance total cross section

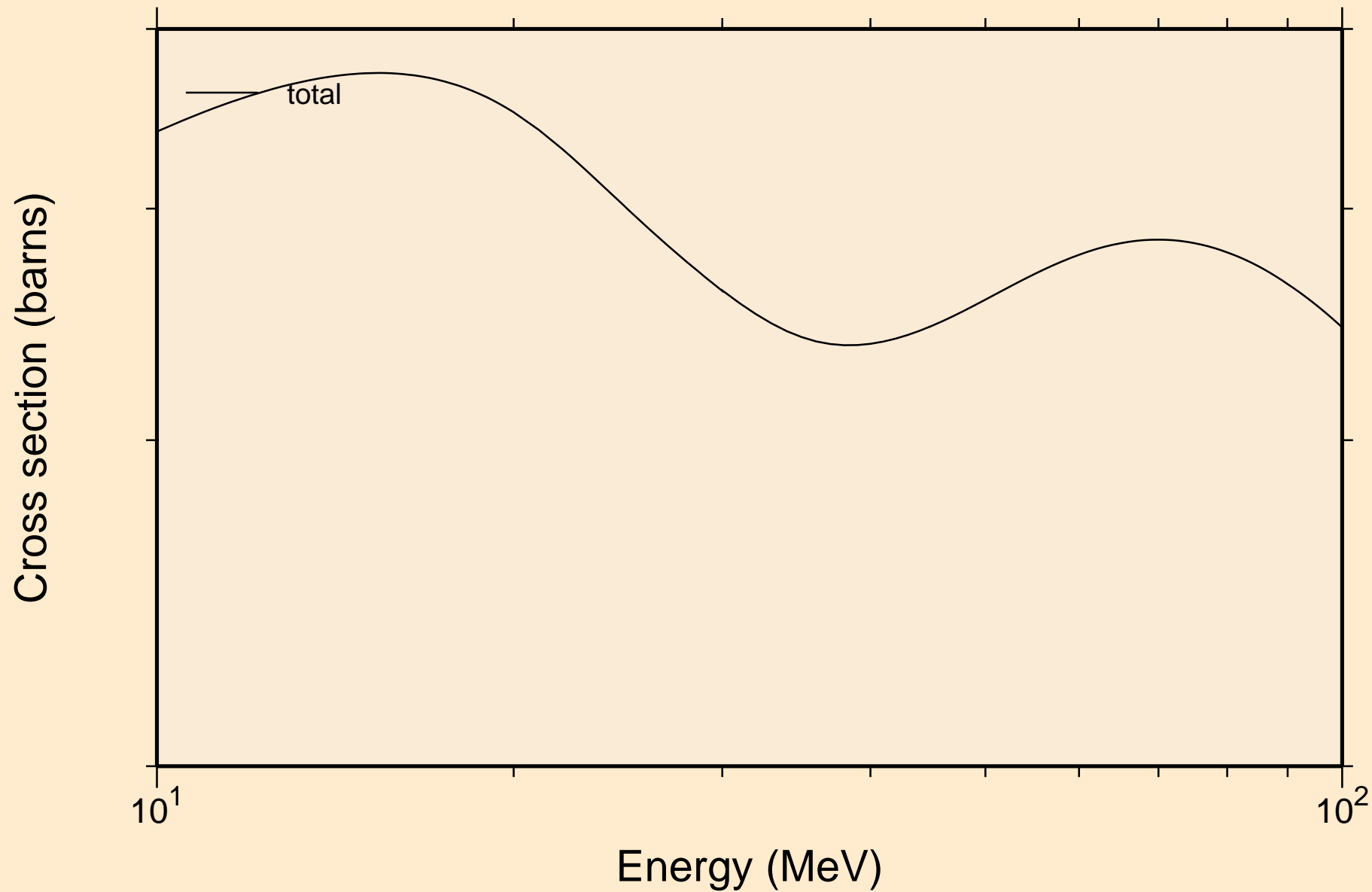

CE131M NEUTRON ACER TENDL-2023 LIBRARY; T=0.K
resonance absorption cross sections

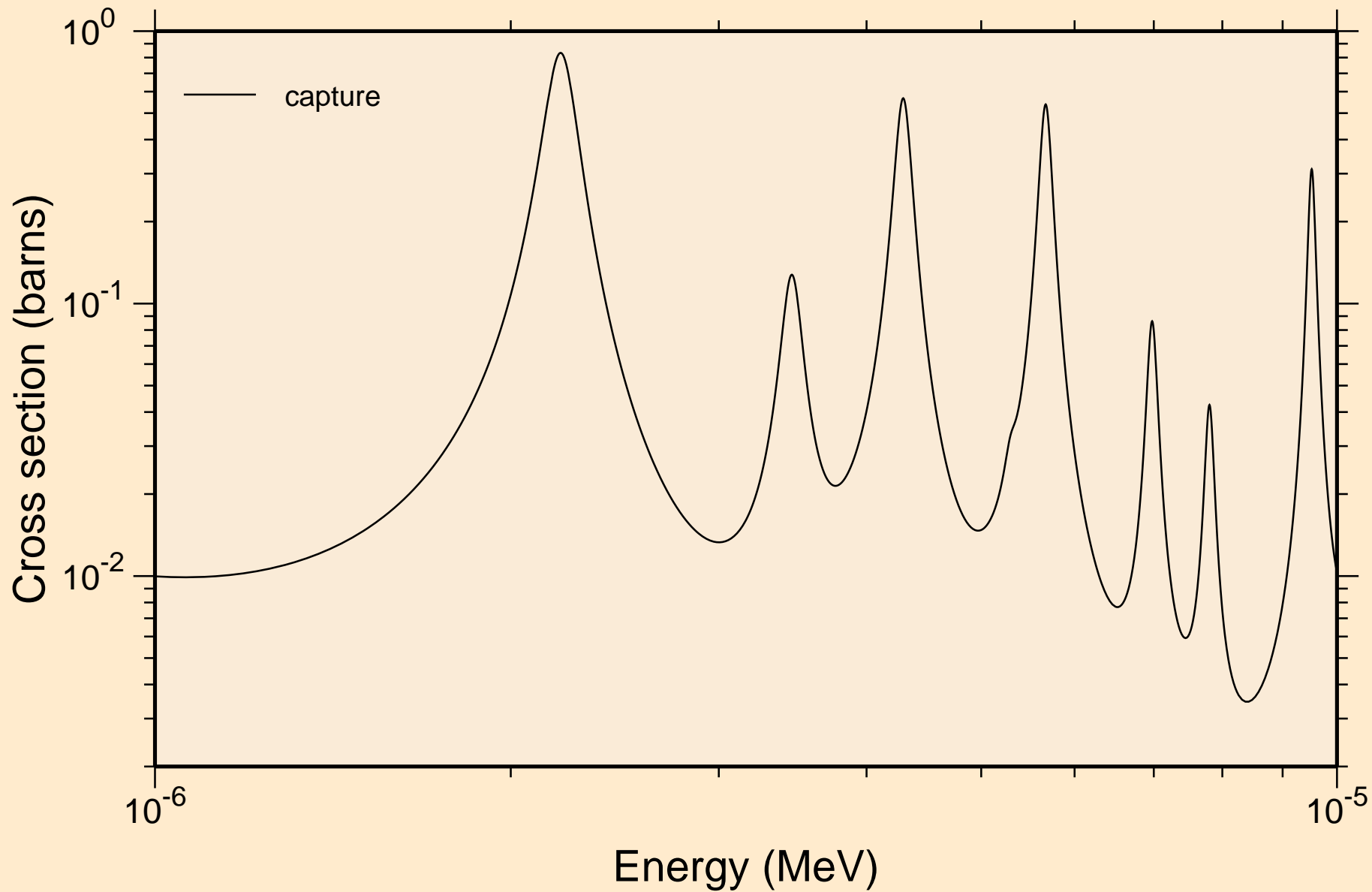

CE131M NEUTRON ACER TENDL-2023 LIBRARY; T=0.K
resonance absorption cross sections

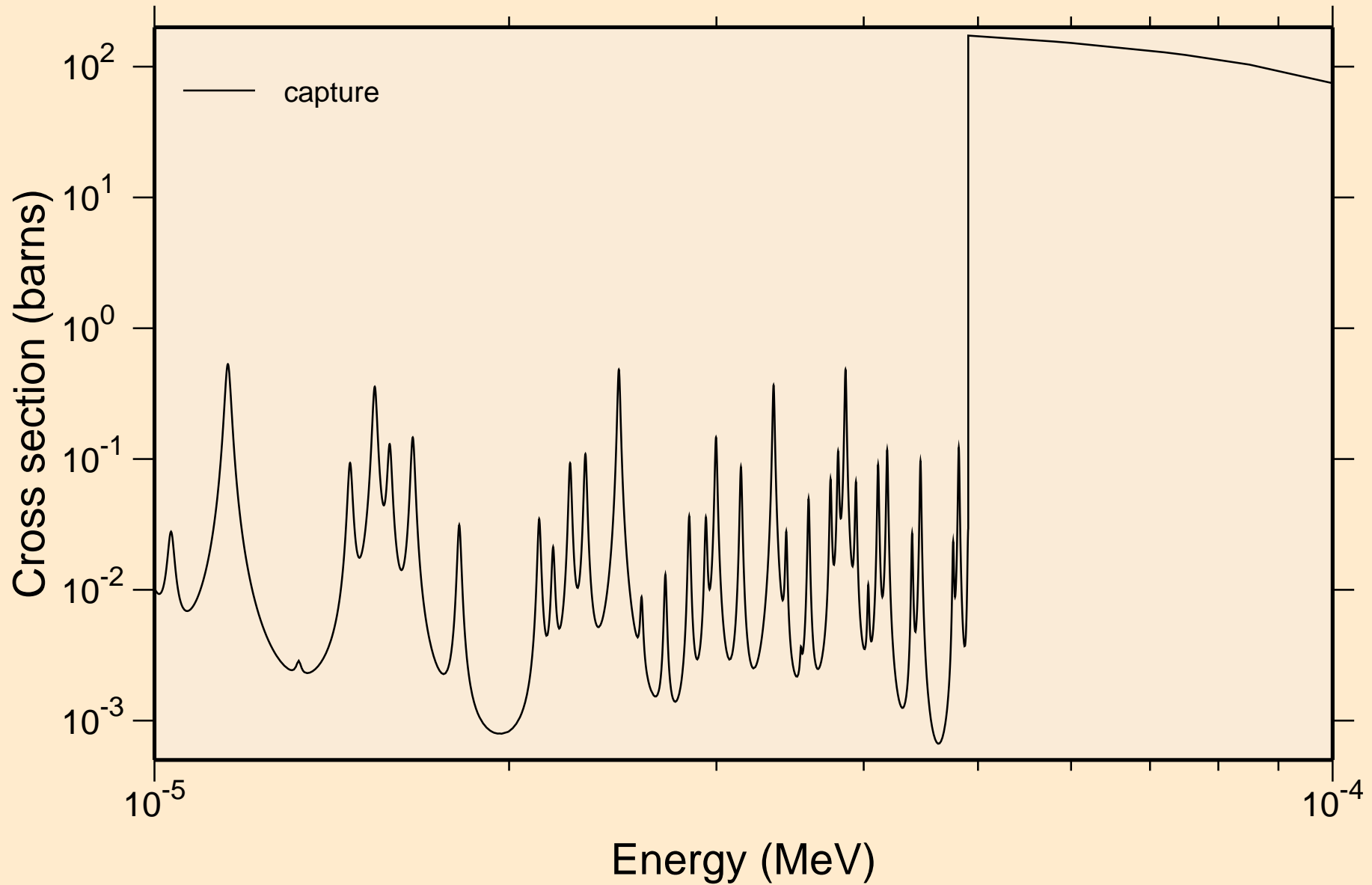

CE131M NEUTRON ACER TENDL-2023 LIBRARY; T=0.K
resonance absorption cross sections

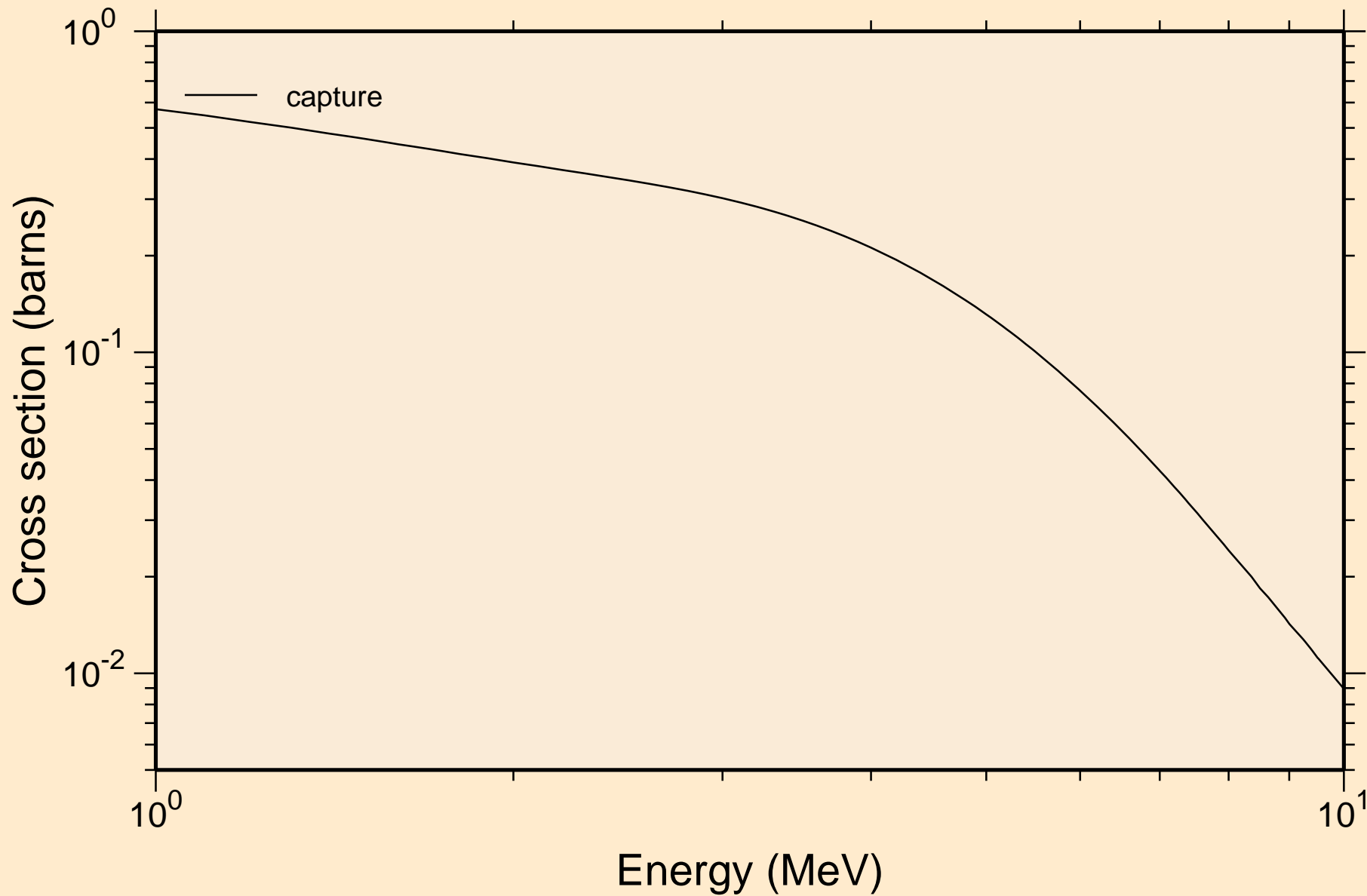

CE131M NEUTRON ACER TENDL-2023 LIBRARY; T=0.K

Heating

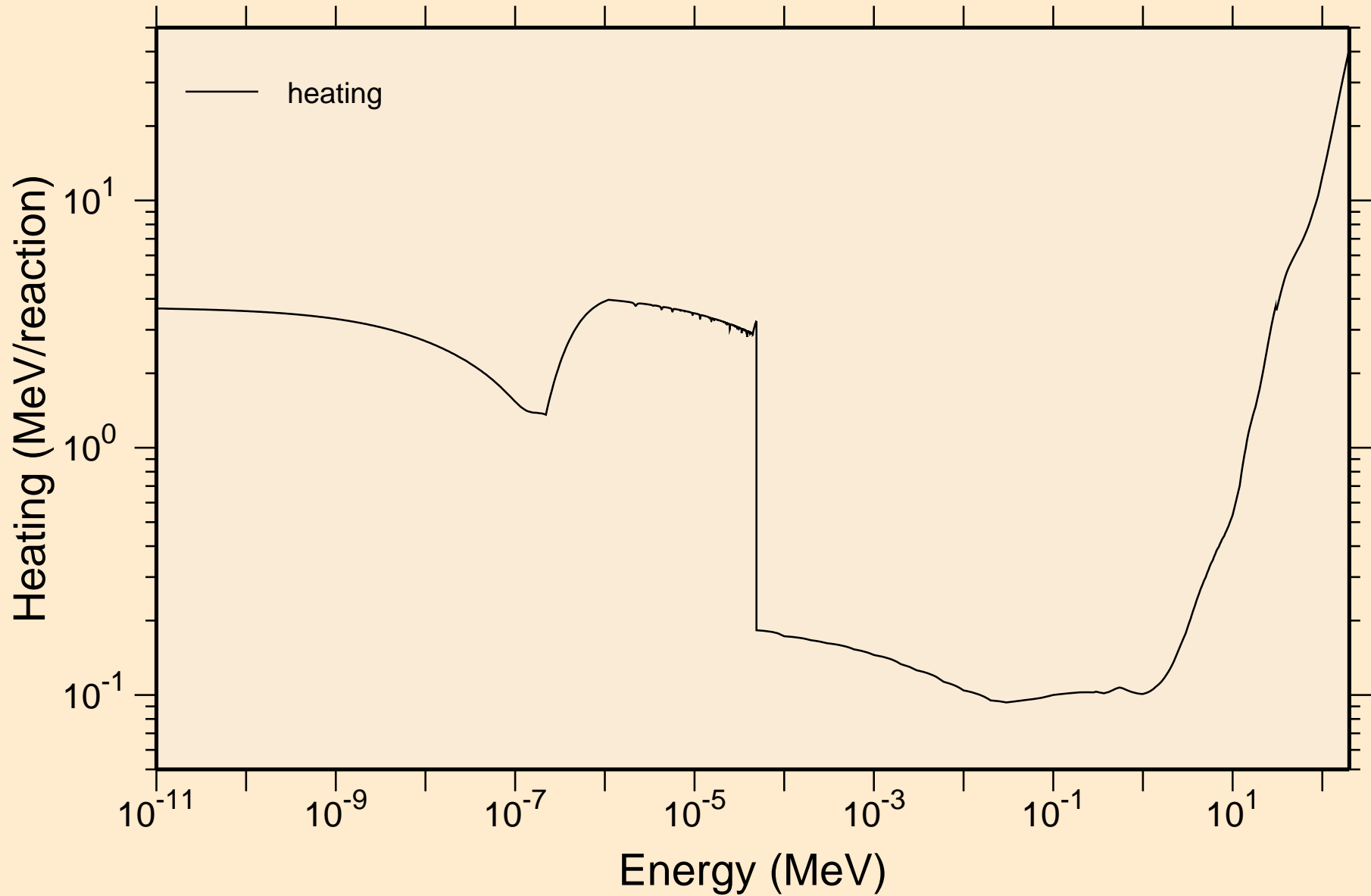

CE131M NEUTRON ACER TENDL-2023 LIBRARY; T=0.K
Damage

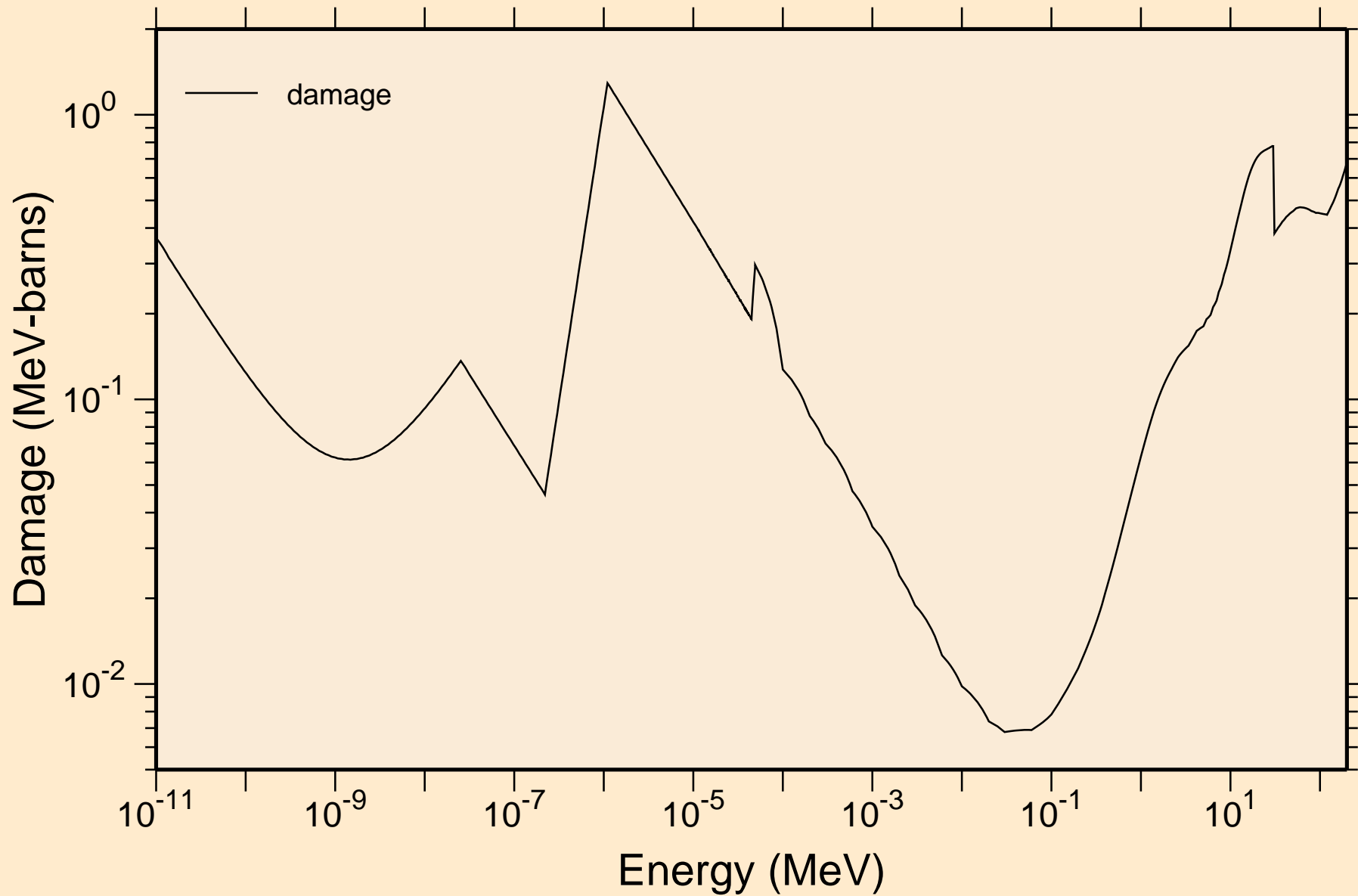

CE131M NEUTRON ACER TENDL-2023 LIBRARY; T=0.K

Non-threshold reactions

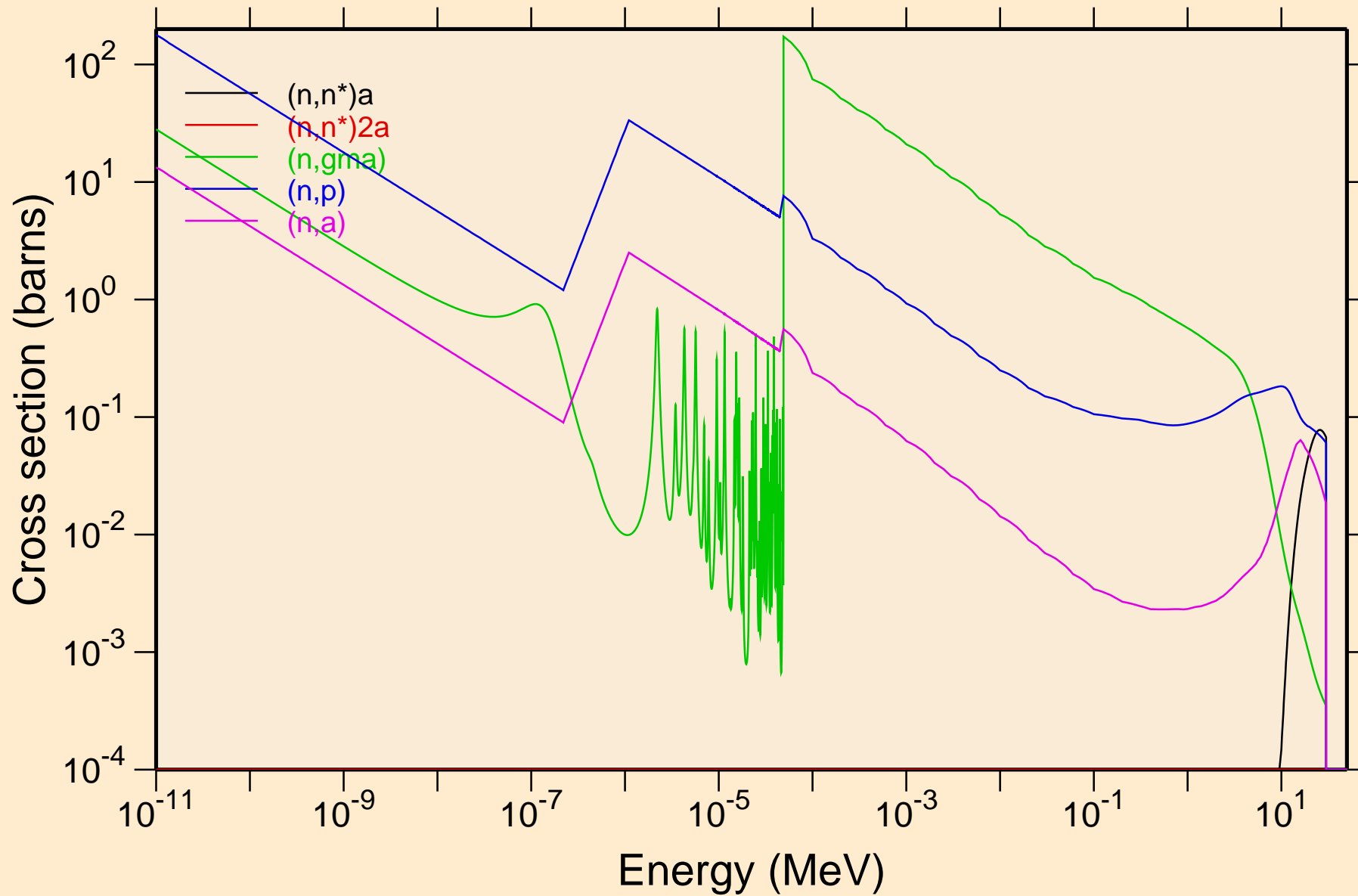

CE131M NEUTRON ACER TENDL-2023 LIBRARY; T=0.K
Non-threshold reactions

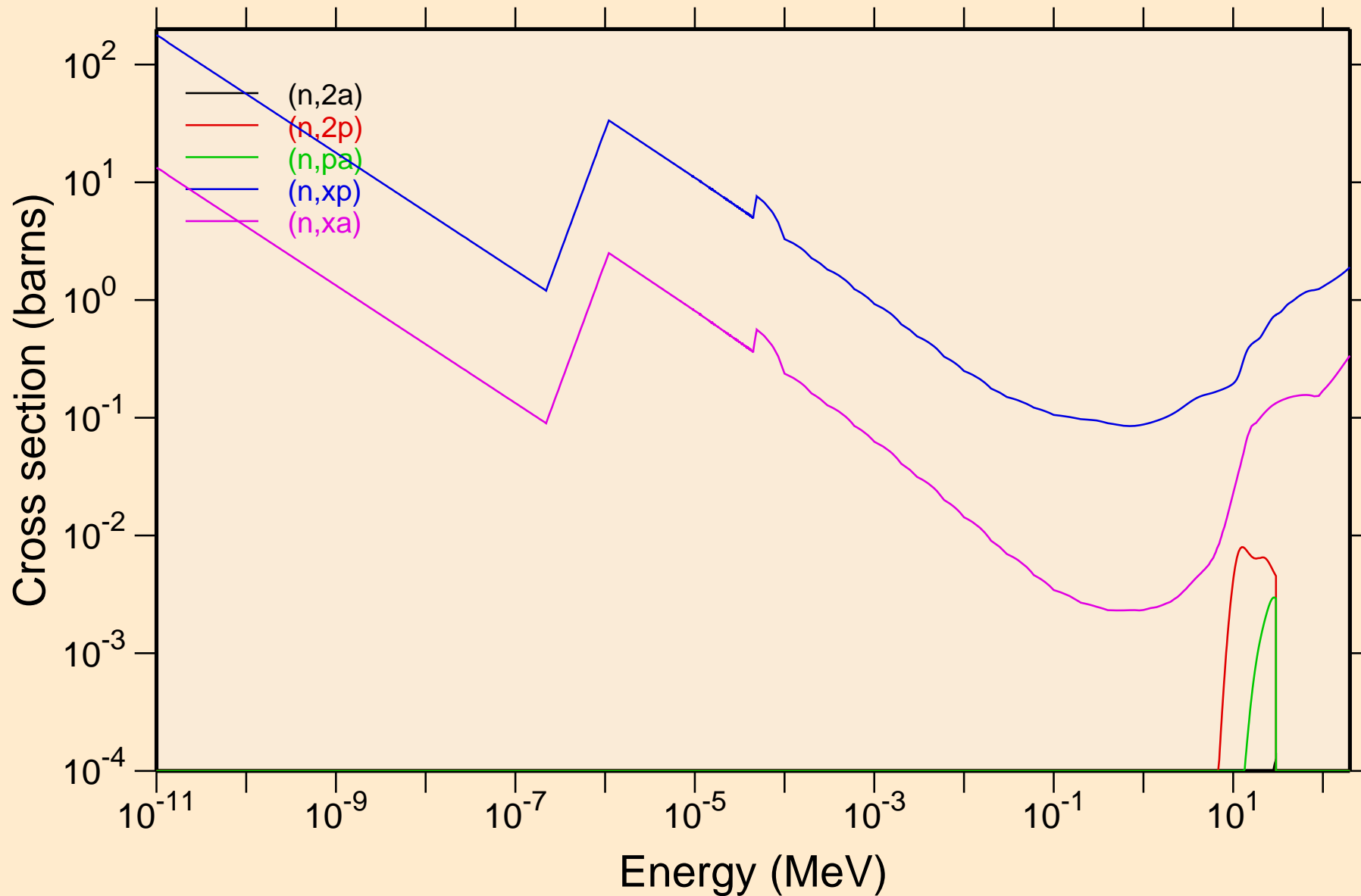

CE131M NEUTRON ACER TENDL-2023 LIBRARY; T=0.K

Principal cross sections

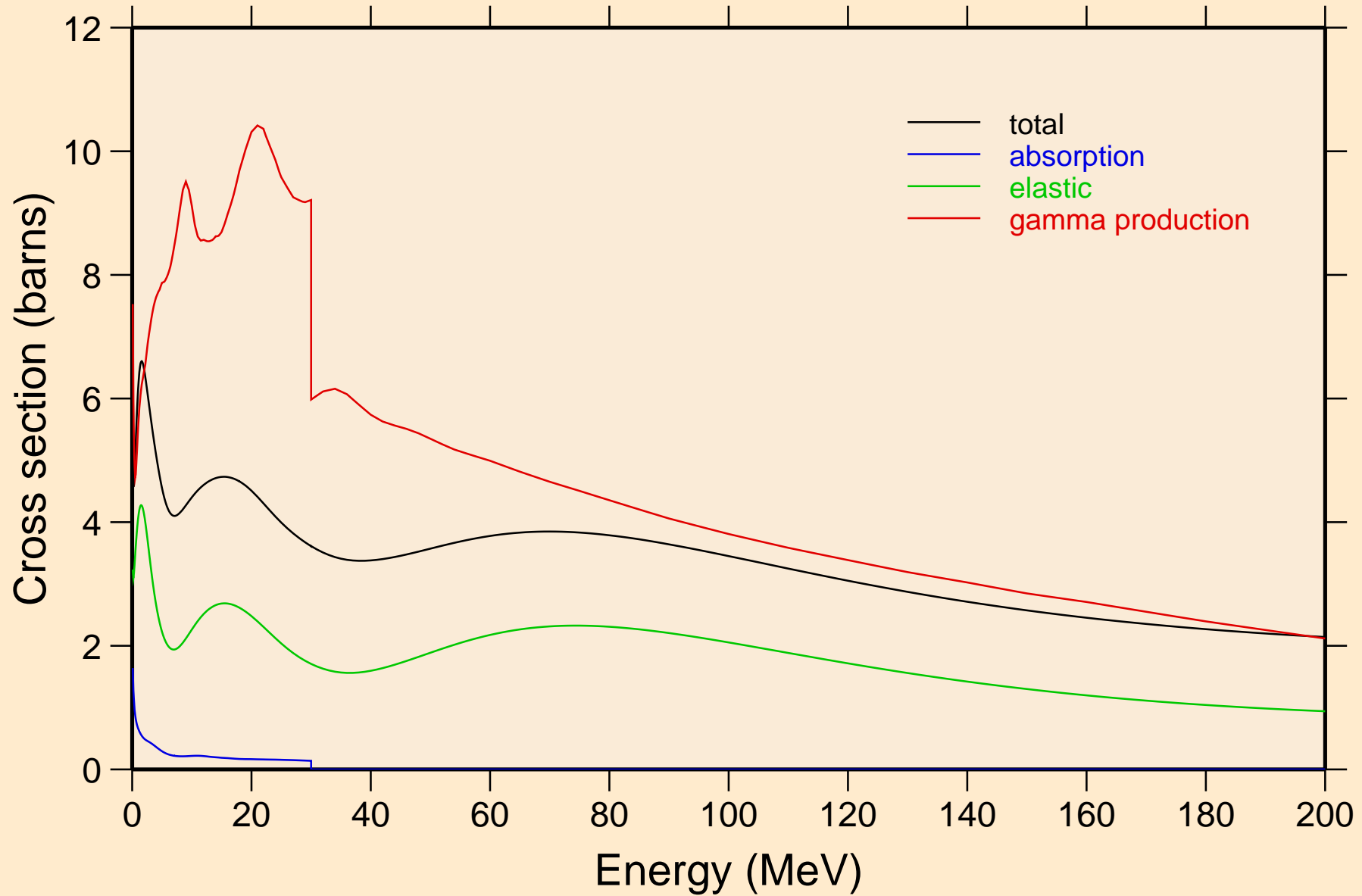

CE131M NEUTRON ACER TENDL-2023 LIBRARY; T=0.K

Heating

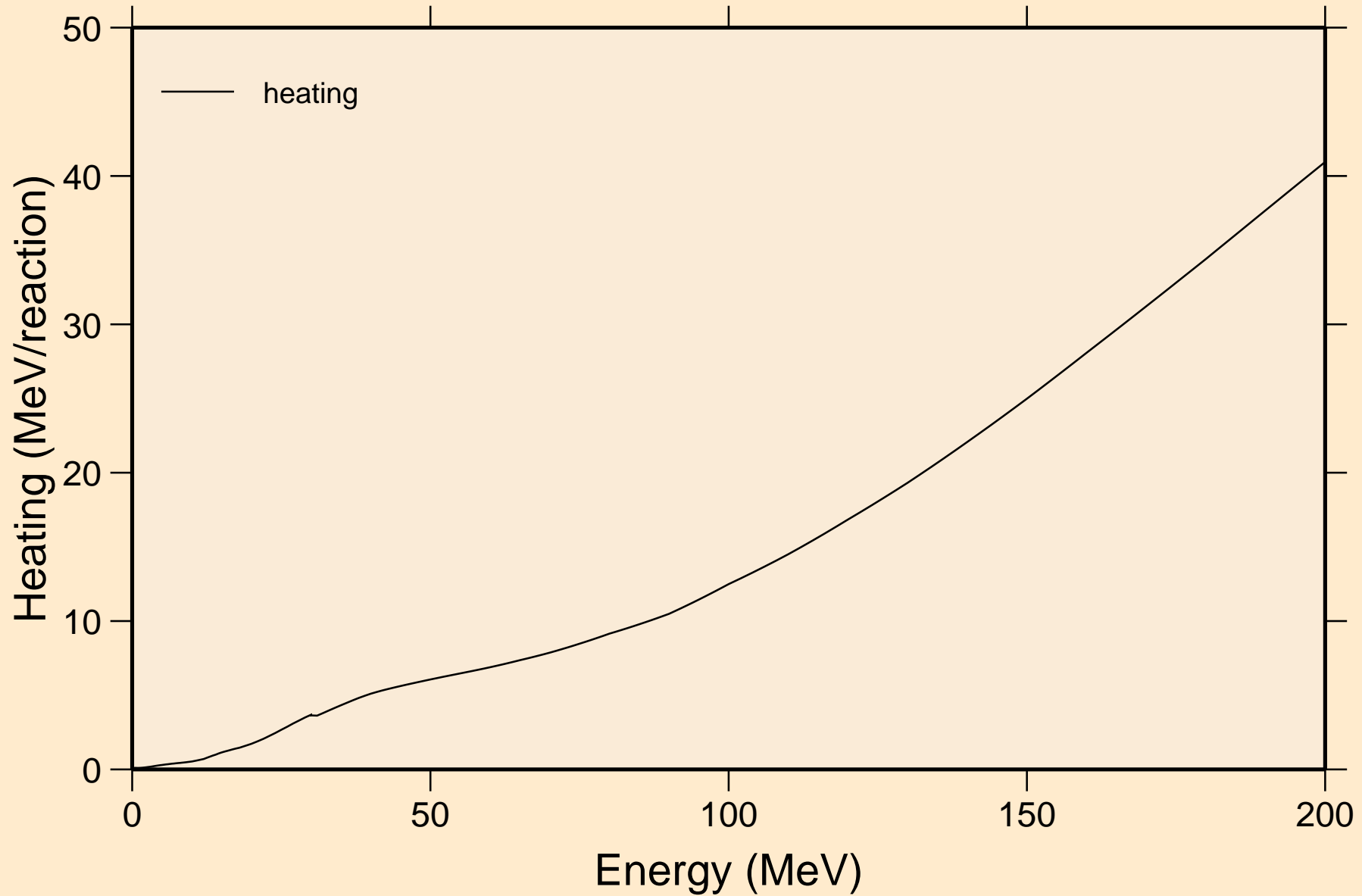

CE131M NEUTRON ACER TENDL-2023 LIBRARY; T=0.K

Damage

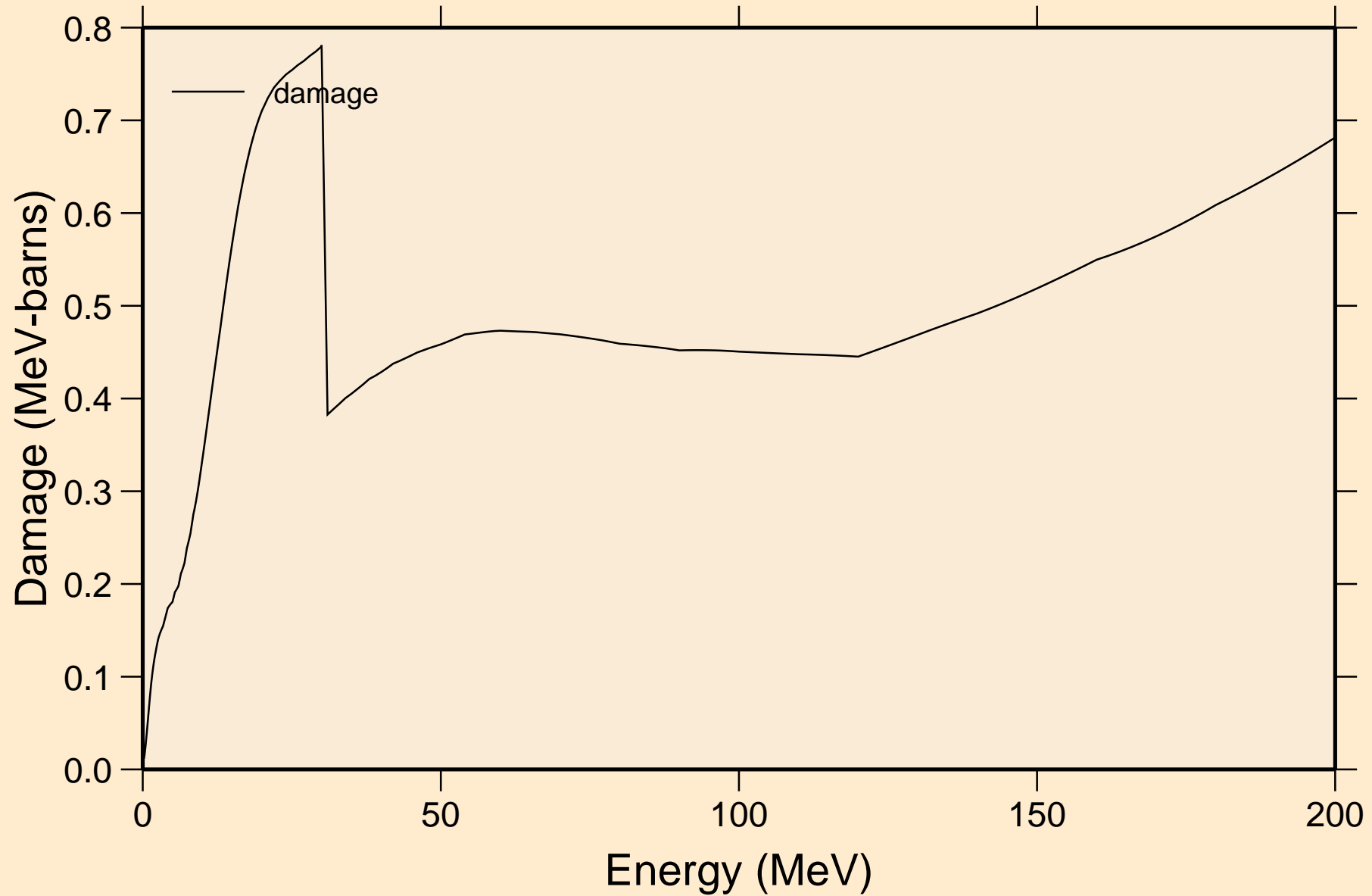

CE131M NEUTRON ACER TENDL-2023 LIBRARY; T=0.K

Non-threshold reactions

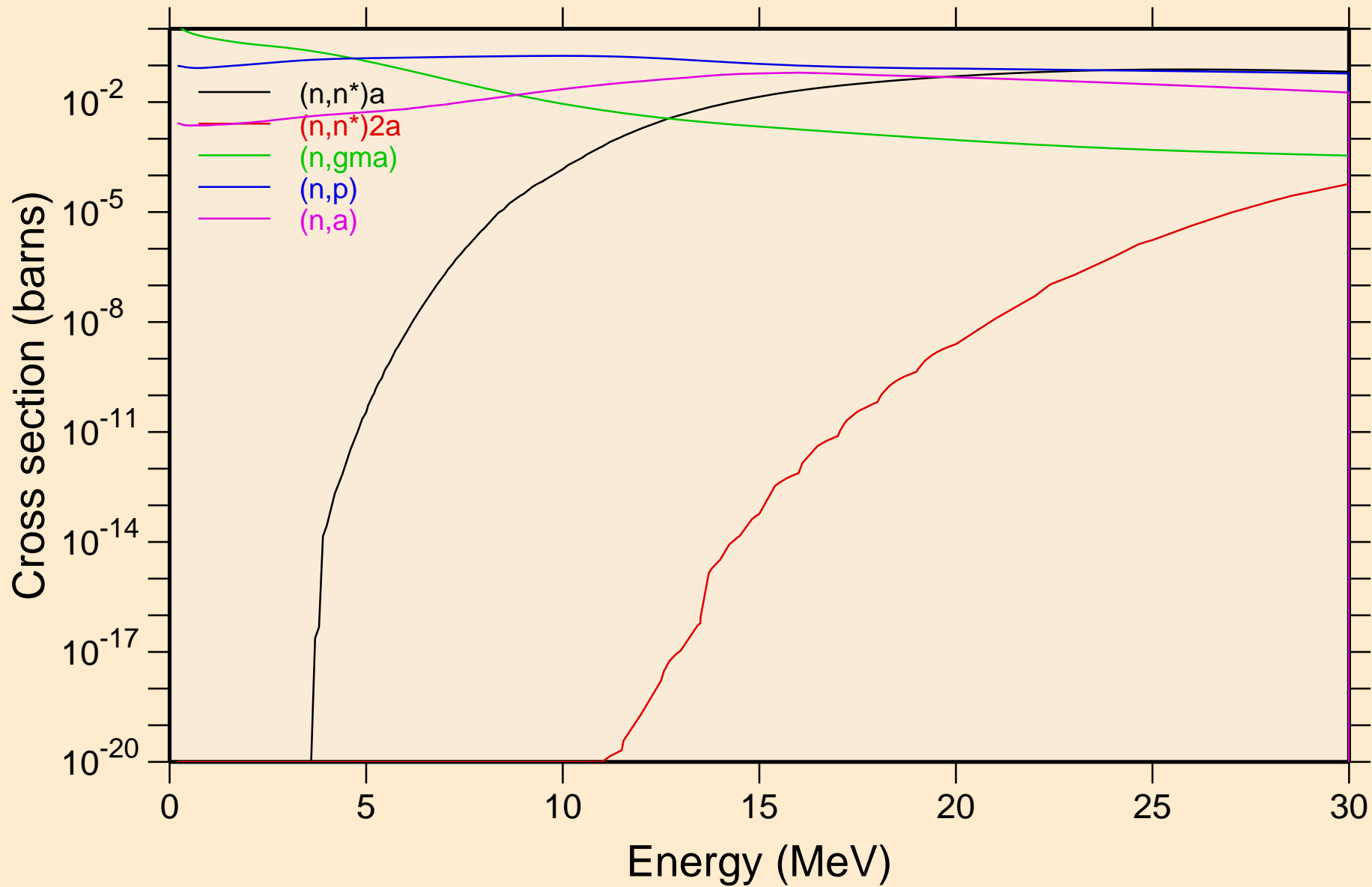

CE131M NEUTRON ACER TENDL-2023 LIBRARY; T=0.K

Non-threshold reactions

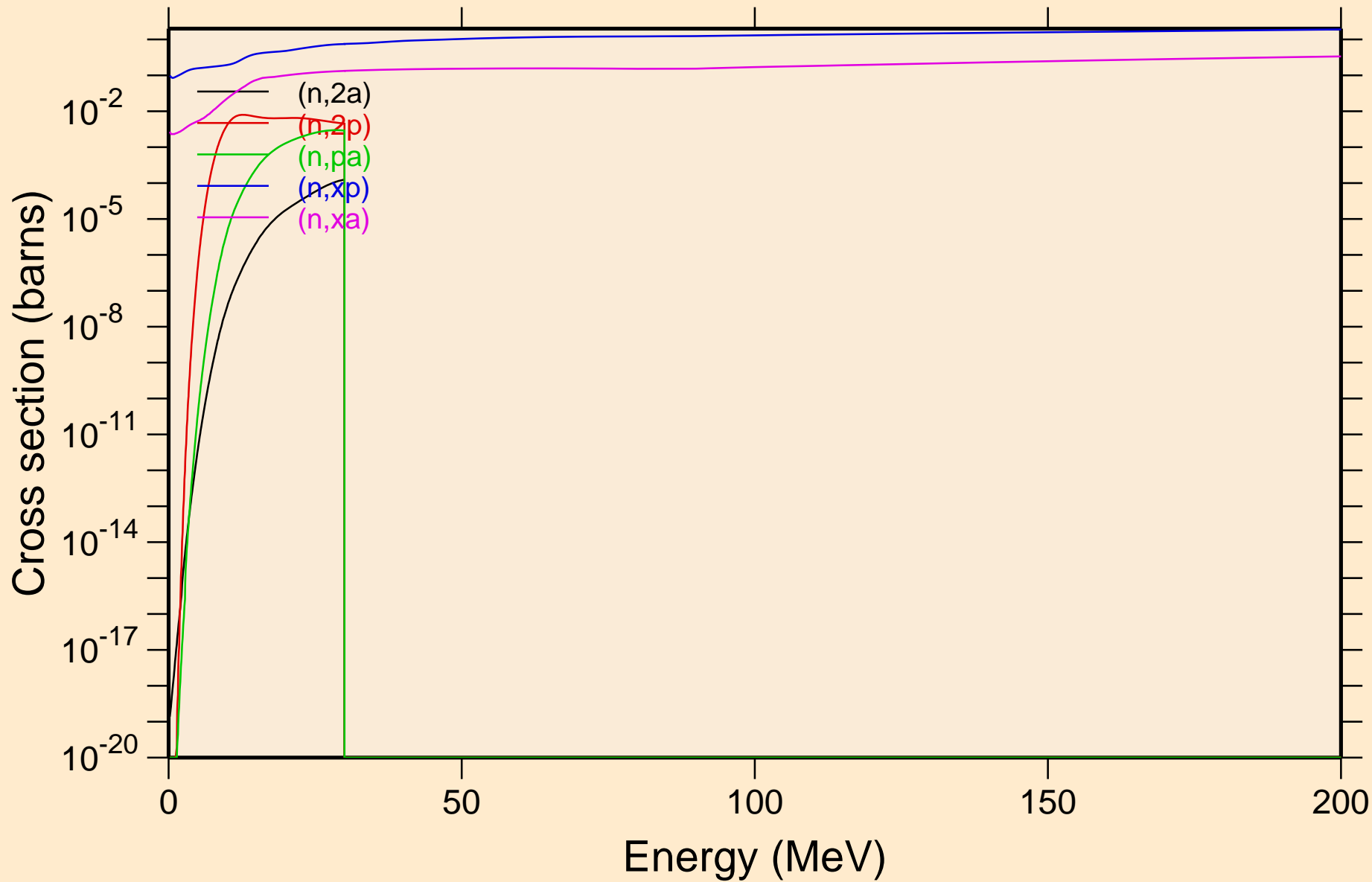

CE131M NEUTRON ACER TENDL-2023 LIBRARY; T=0.K
Inelastic levels

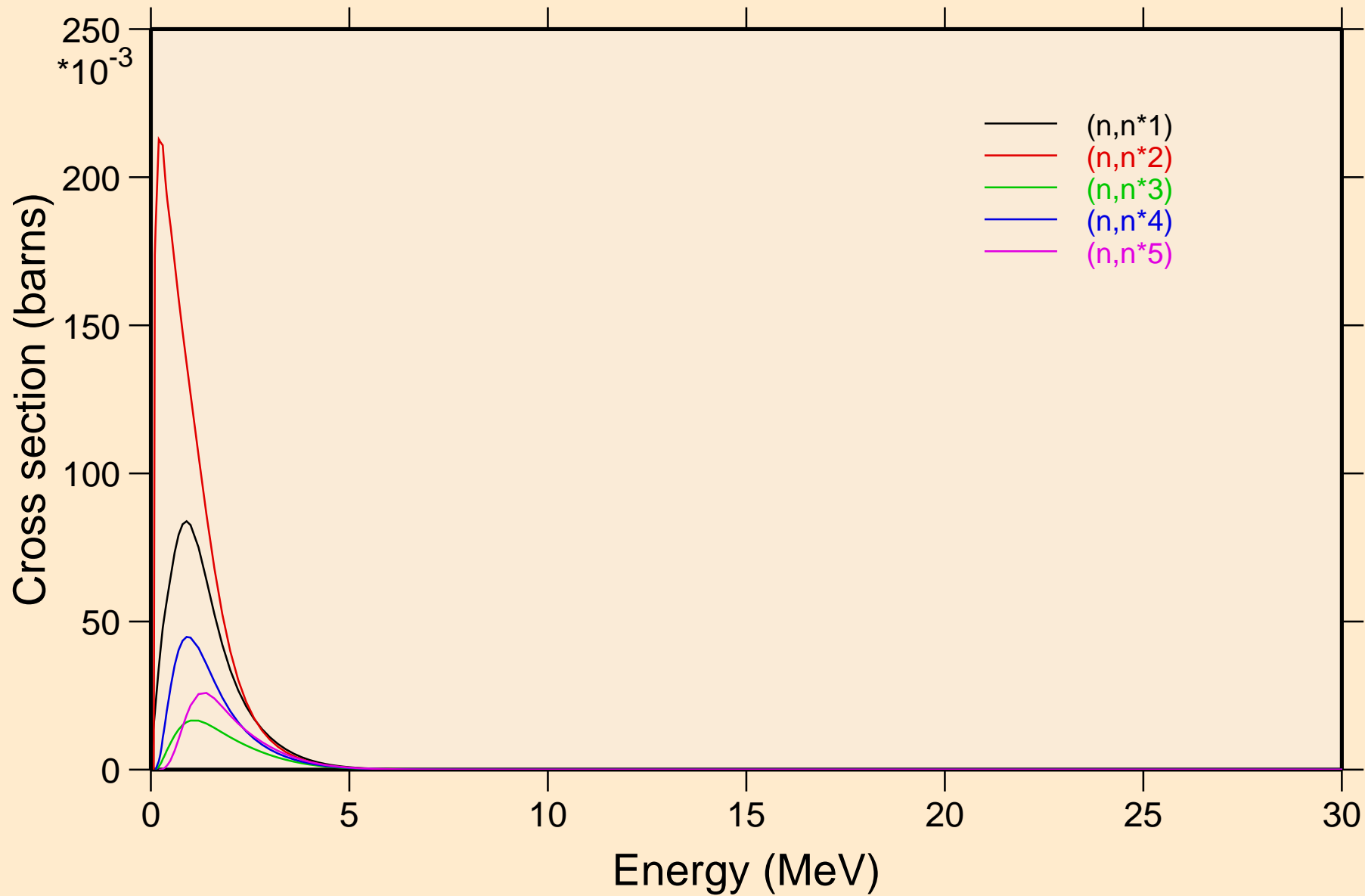

CE131M NEUTRON ACER TENDL-2023 LIBRARY; T=0.K
Inelastic levels

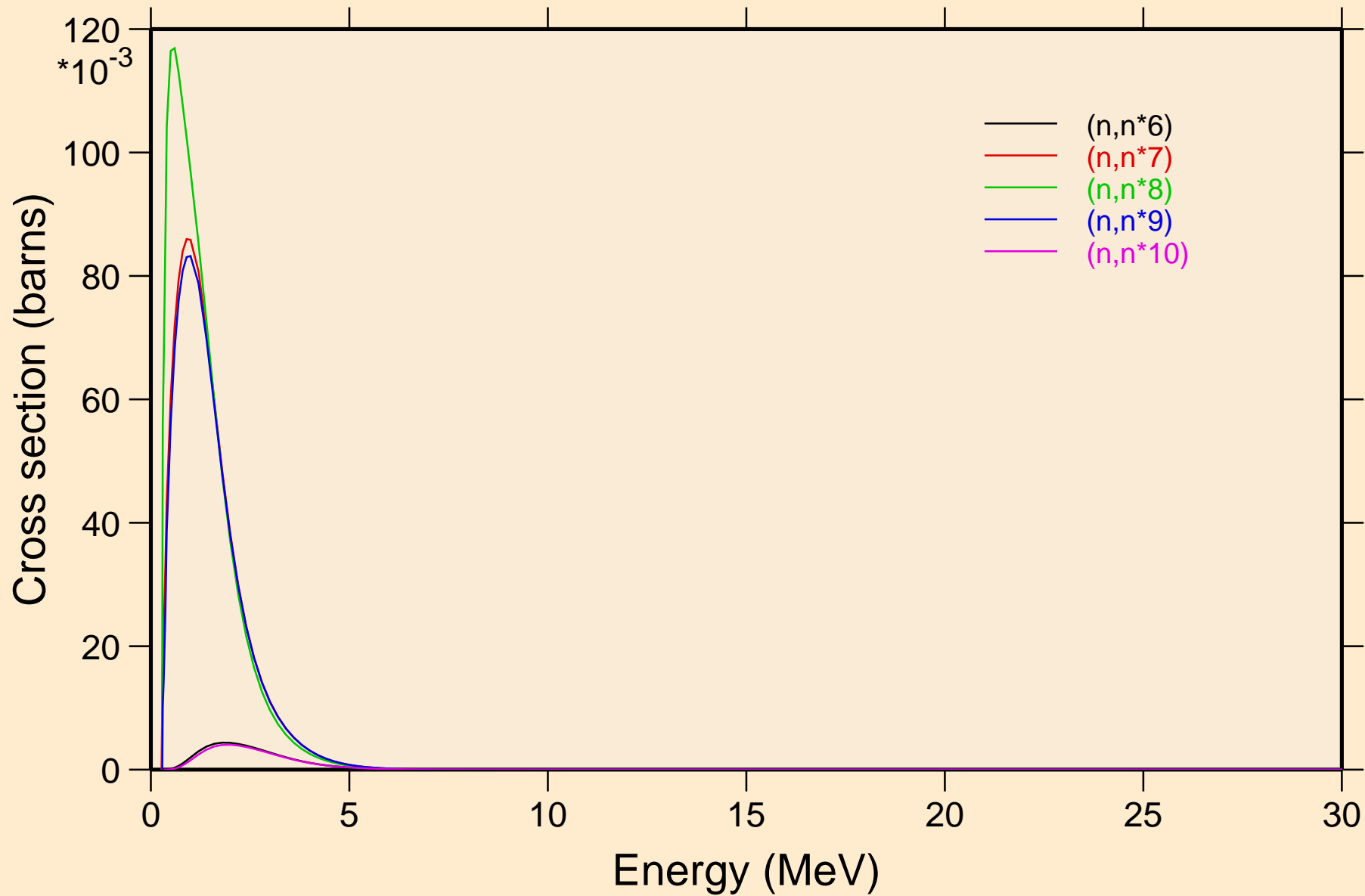

CE131M NEUTRON ACER TENDL-2023 LIBRARY; T=0.K
Inelastic levels

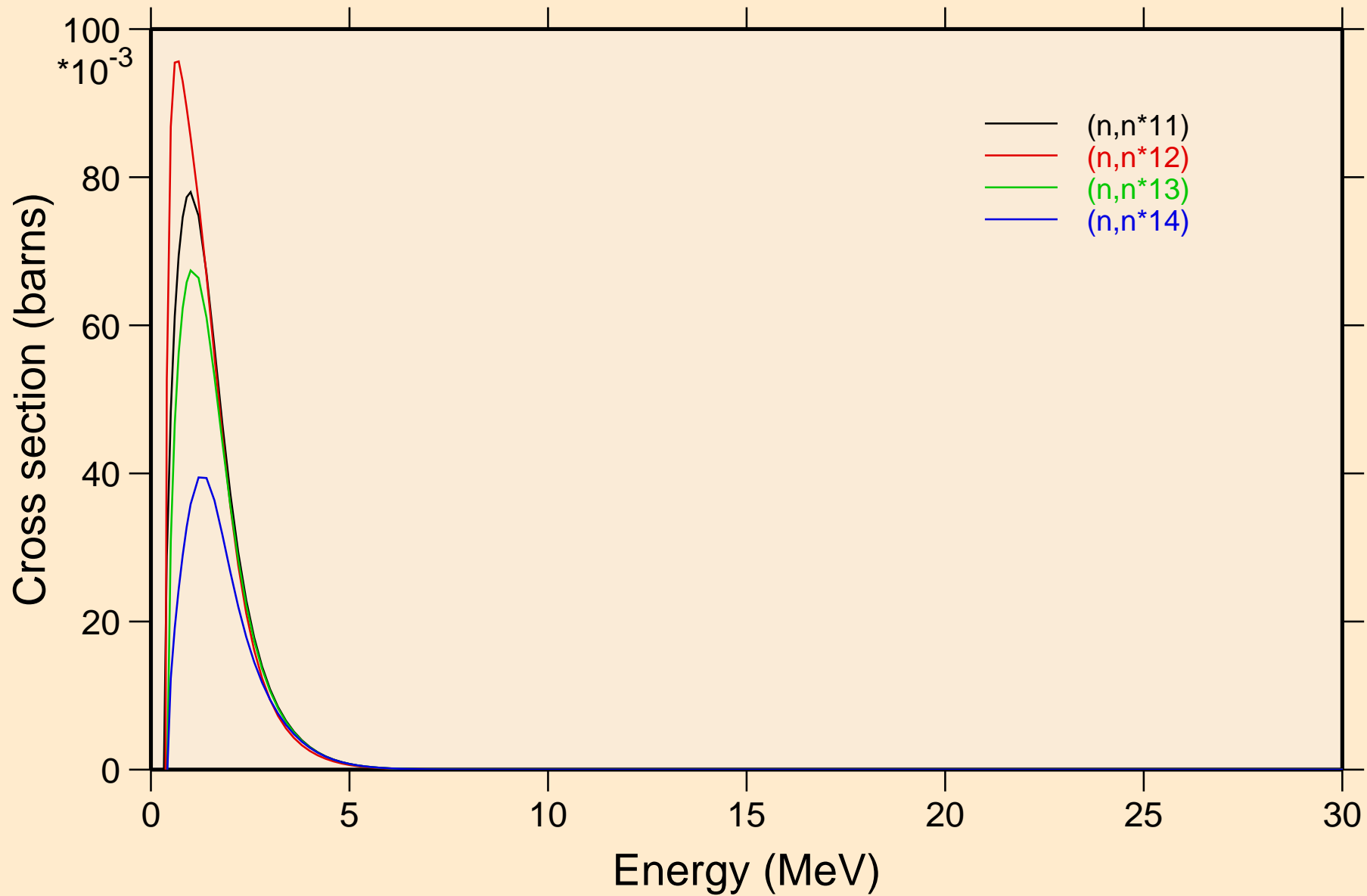

CE131M NEUTRON ACER TENDL-2023 LIBRARY; T=0.K

Threshold reactions

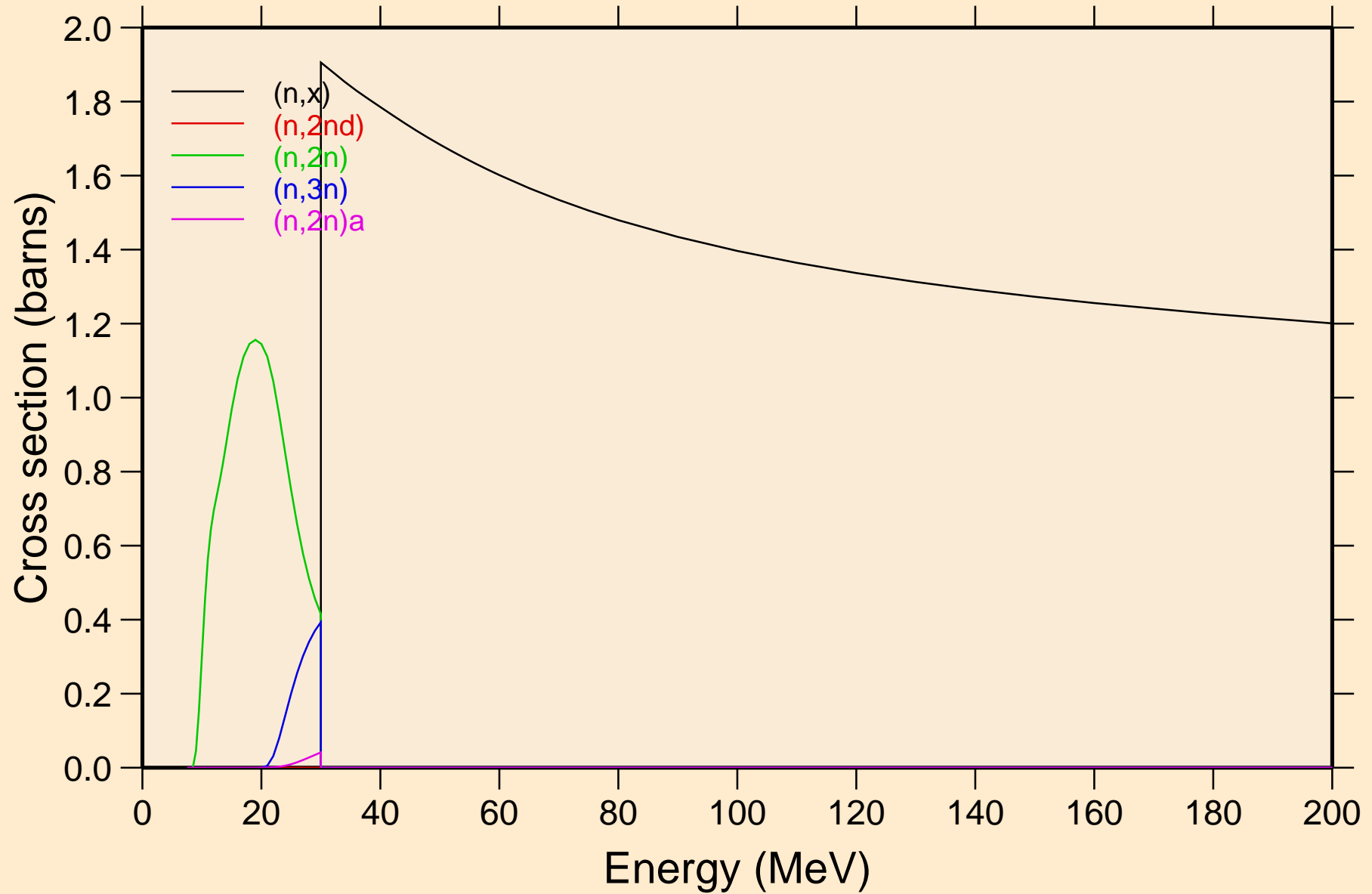

CE131M NEUTRON ACER TENDL-2023 LIBRARY; T=0.K

Threshold reactions

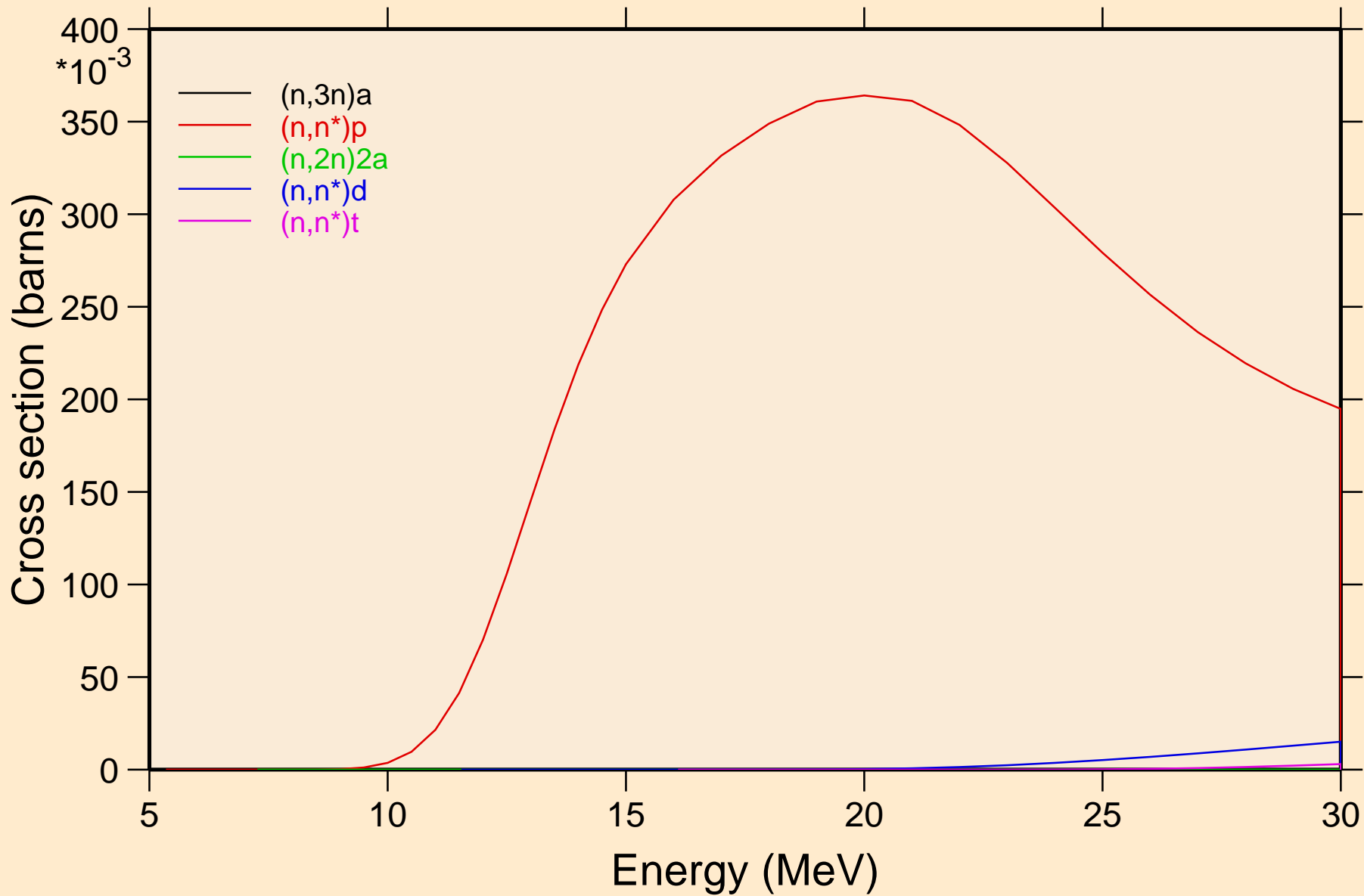

CE131M NEUTRON ACER TENDL-2023 LIBRARY; T=0.K
Threshold reactions

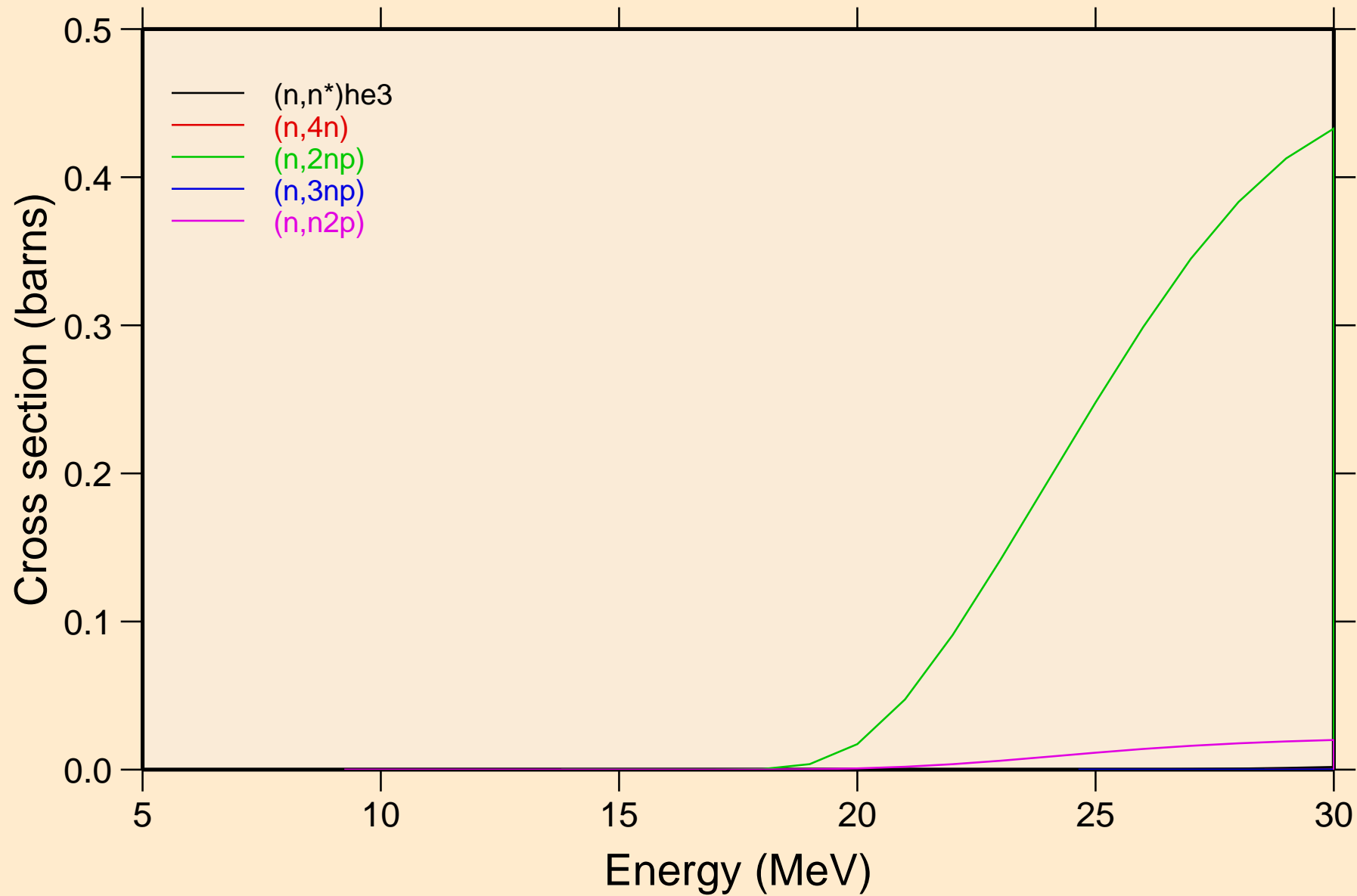

CE131M NEUTRON ACER TENDL-2023 LIBRARY; T=0.K

Threshold reactions

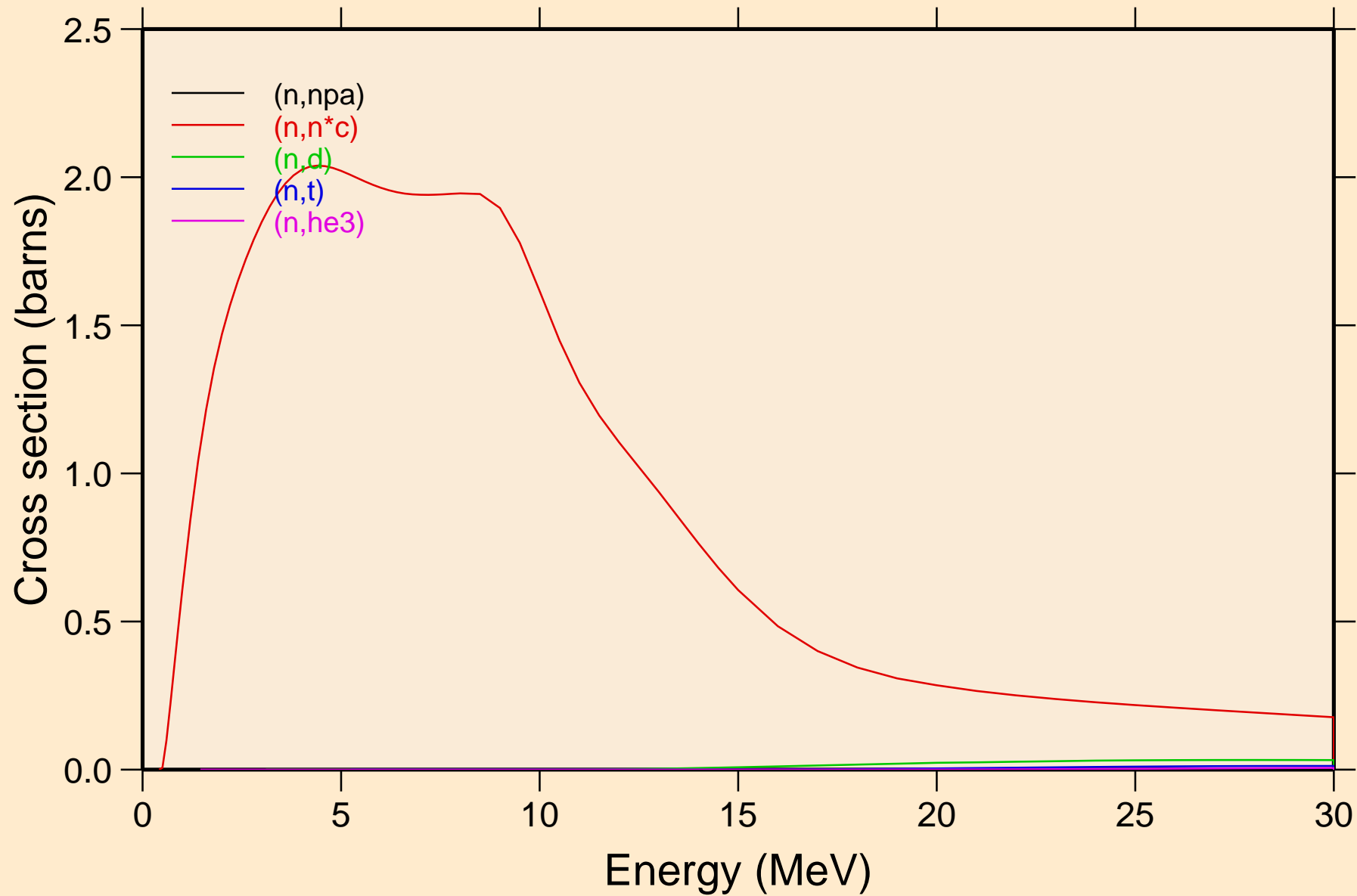

CE131M NEUTRON ACER TENDL-2023 LIBRARY; T=0.K

Threshold reactions

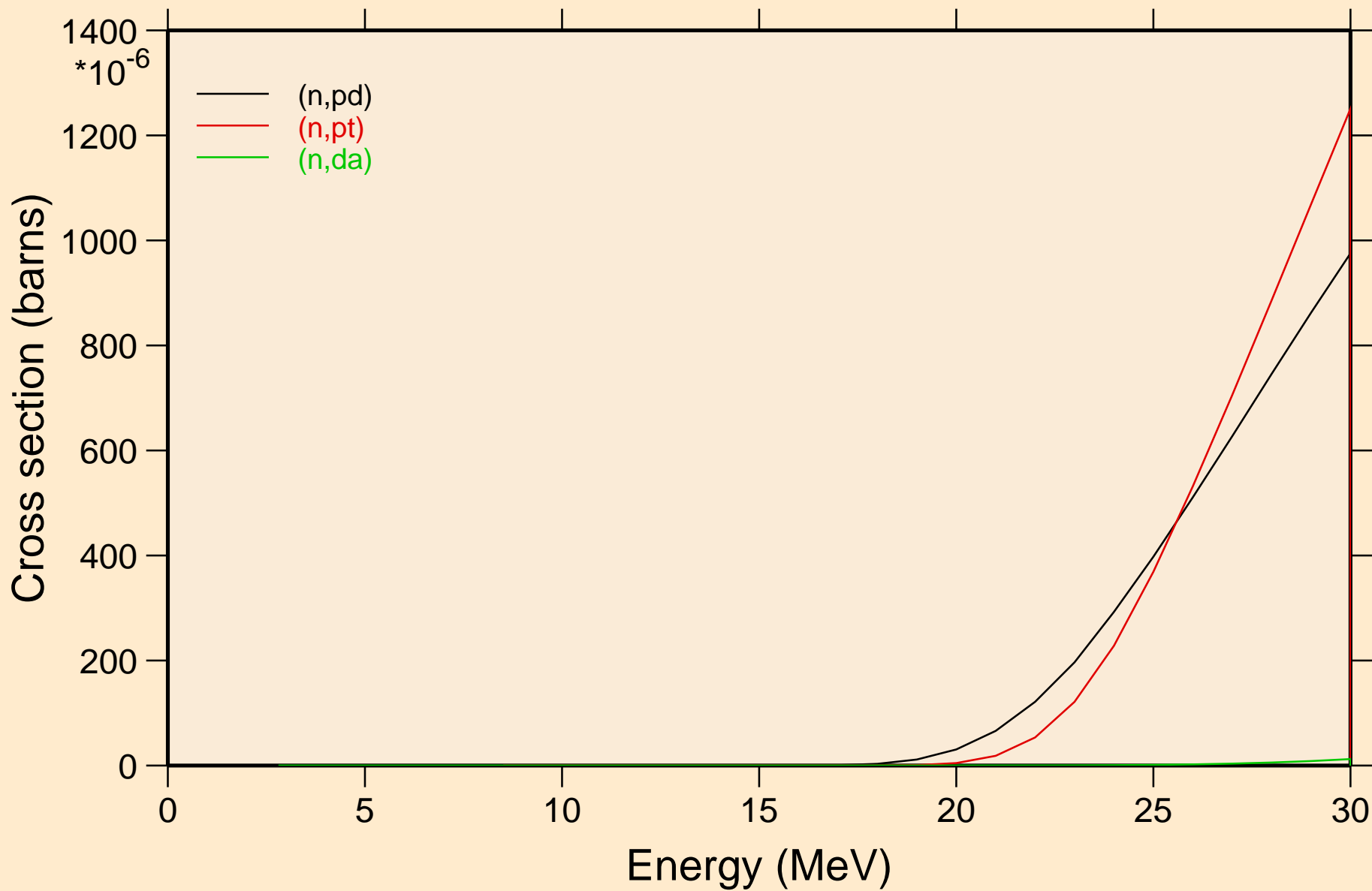

CE131M NEUTRON ACER TENDL-2023 LIBRARY; T=0.K
Threshold reactions

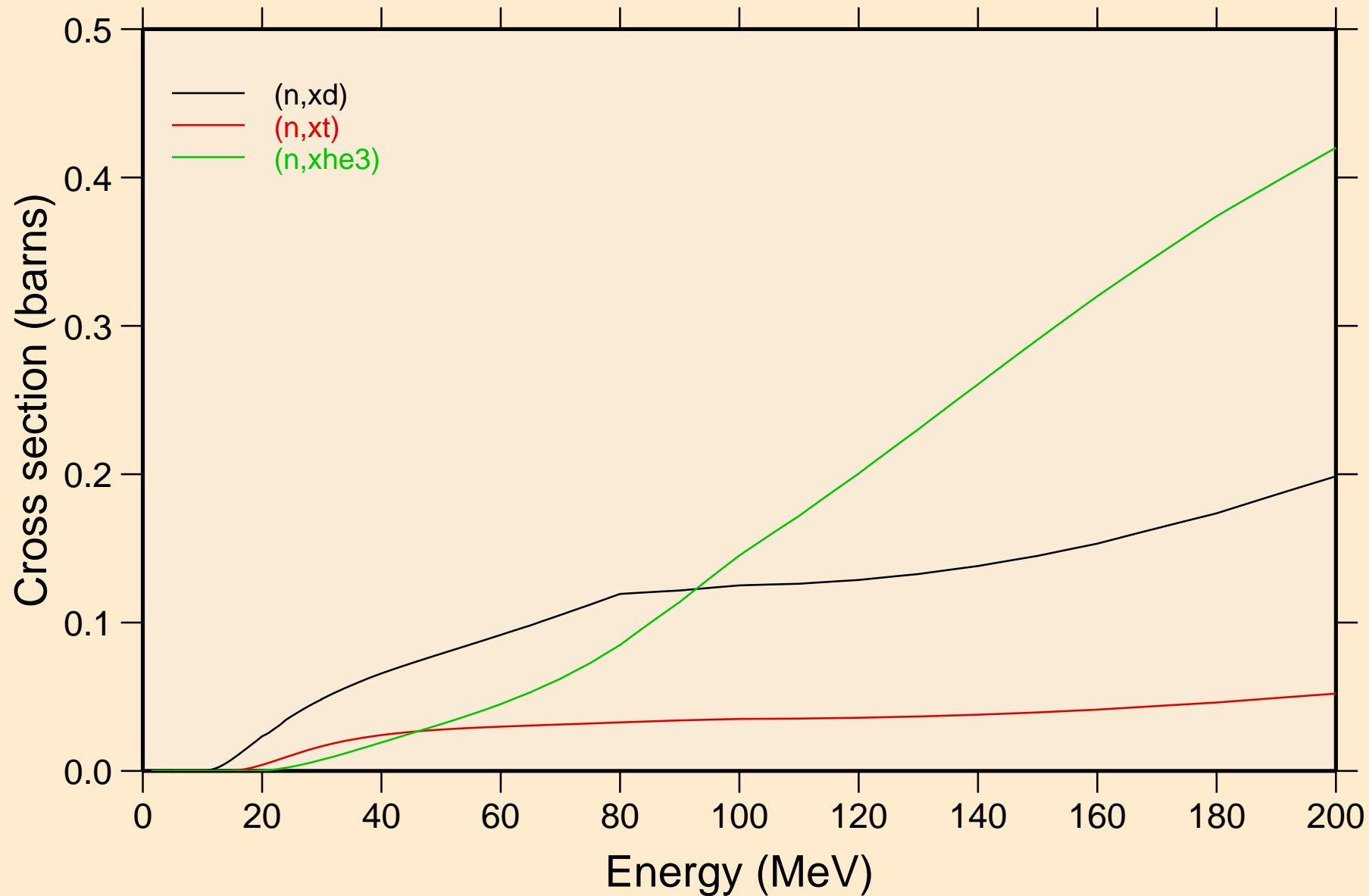

CE131M NEUTRON ACER TENDL-2023 LIBRARY; T=0.K
angular distribution for elastic

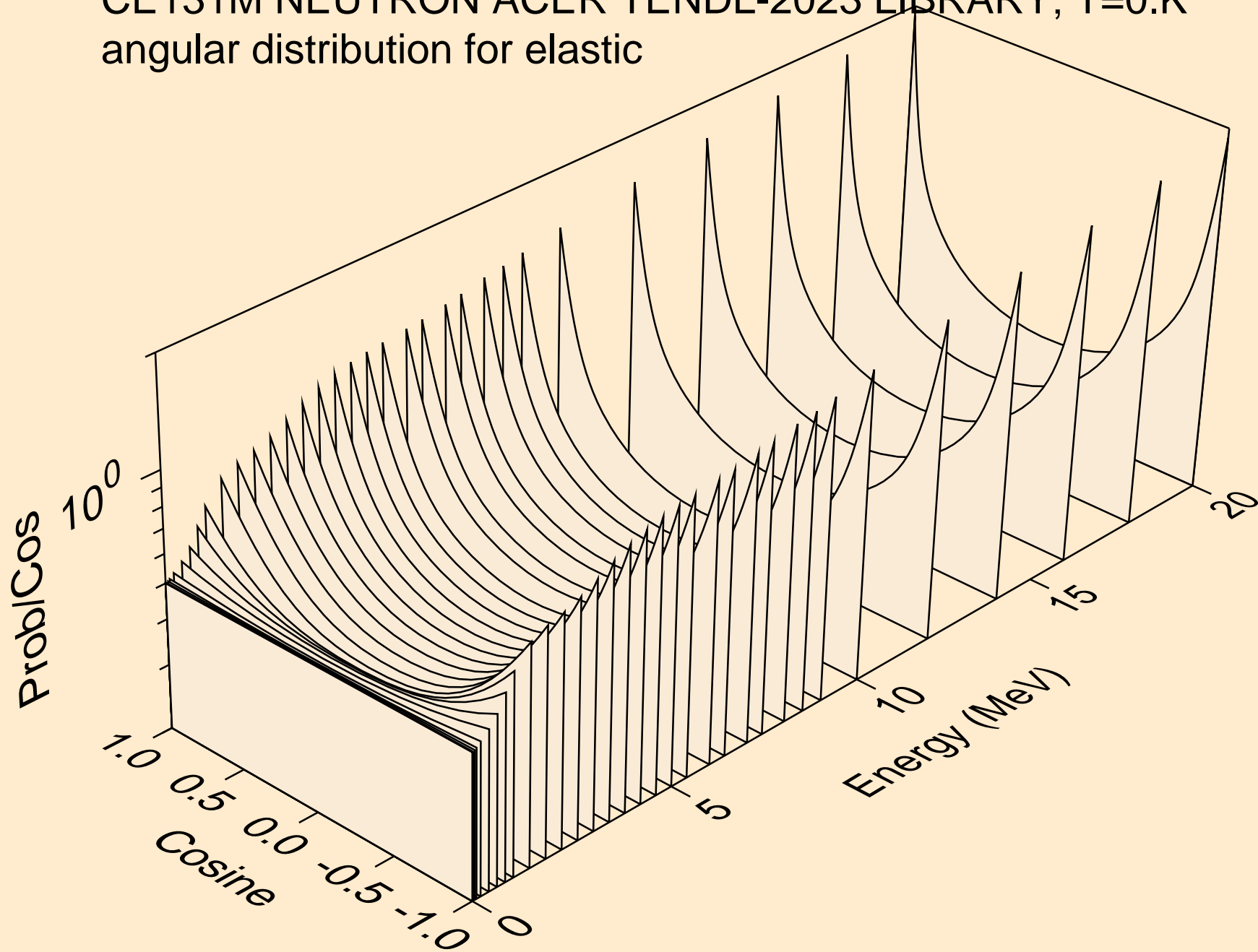

CE131M NEUTRON ACER TENDL-2023 LIBRARY; T=0.K
angular distribution for elastic

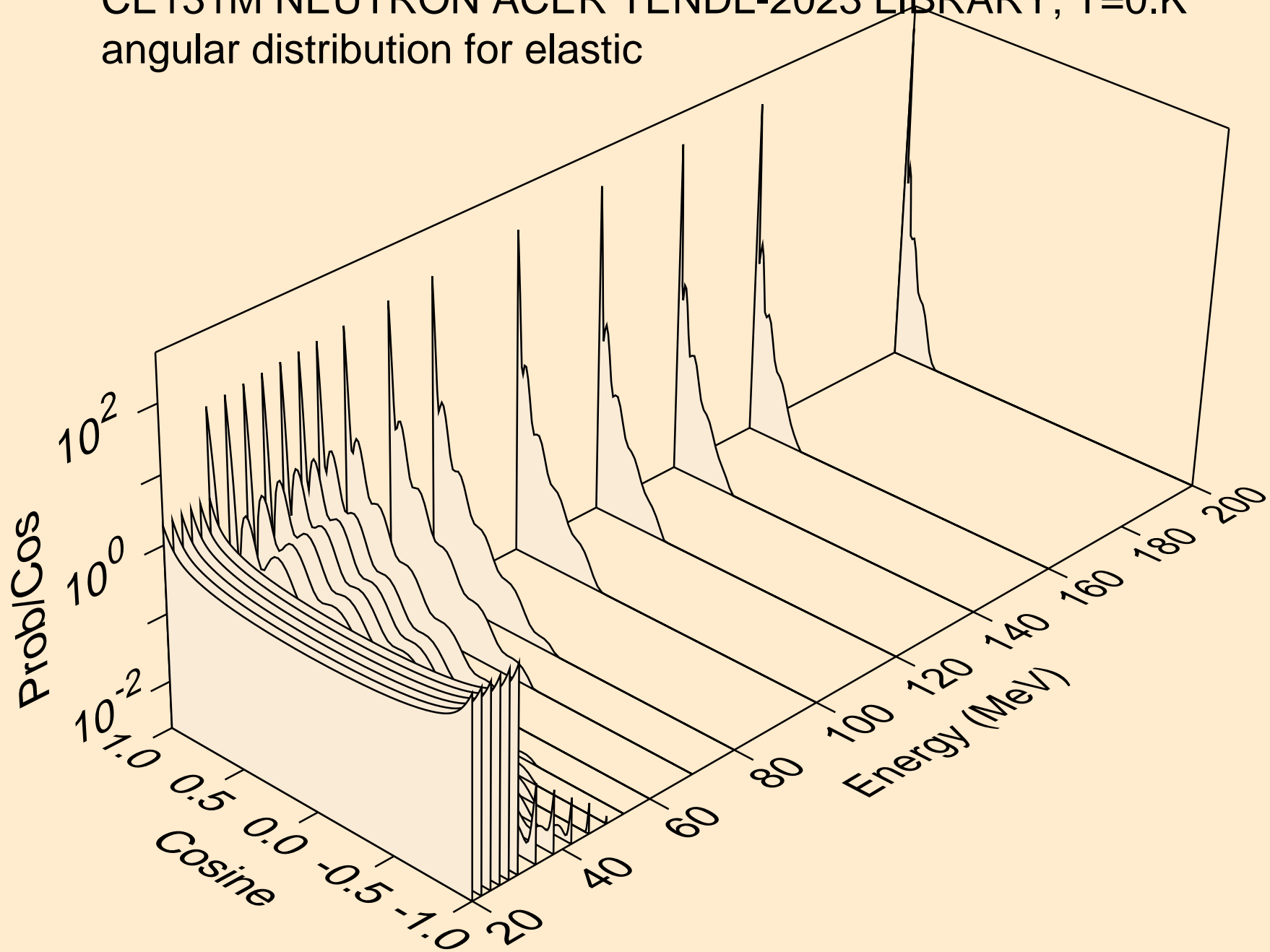

CE131M NEUTRON ACER TENDL-2023 LIBRARY; T=0.K
angular distribution for (n,n*1)

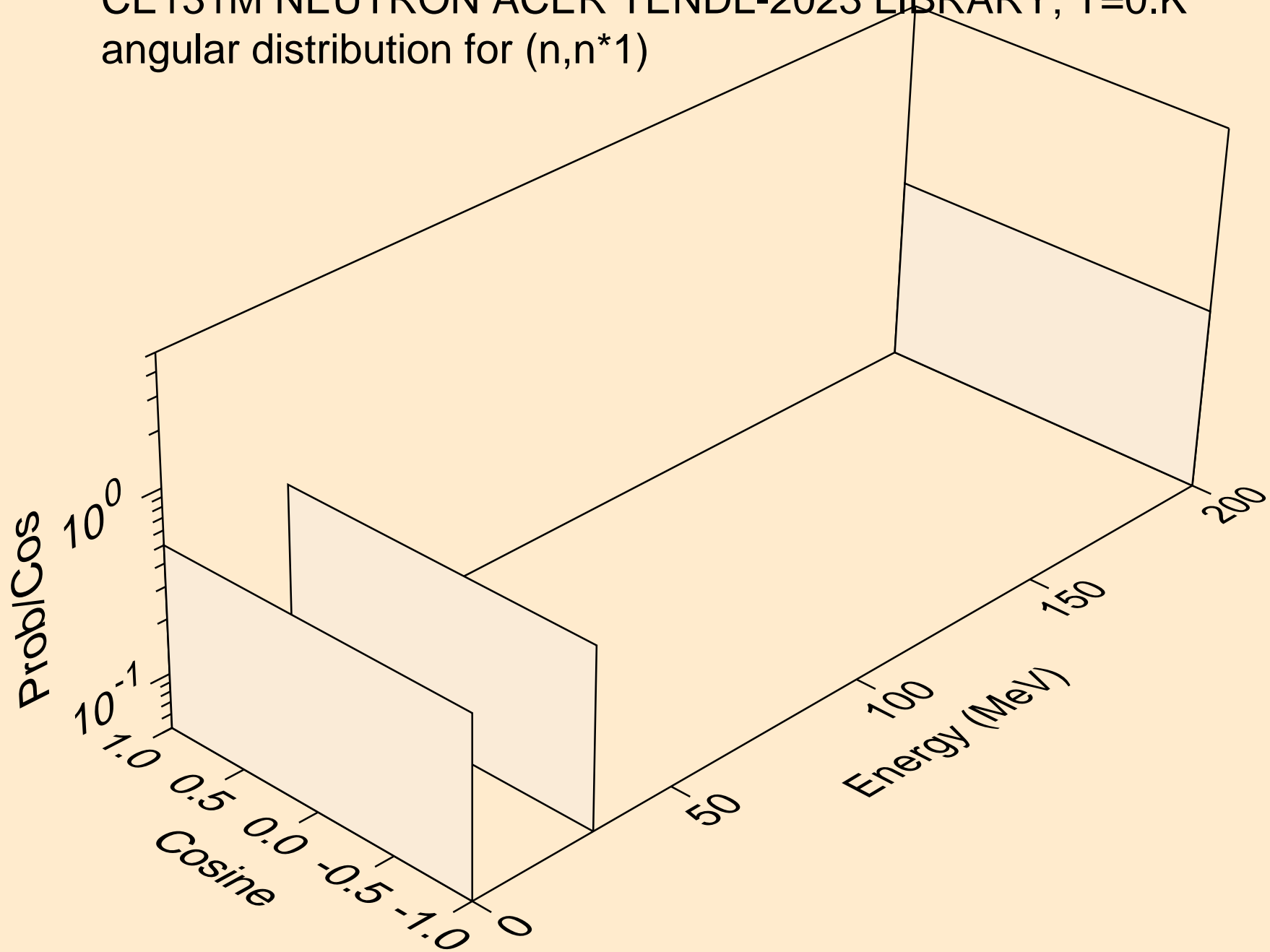

CE131M NEUTRON ACER TENDL-2023 LIBRARY; T=0.K
angular distribution for (n,n*2)

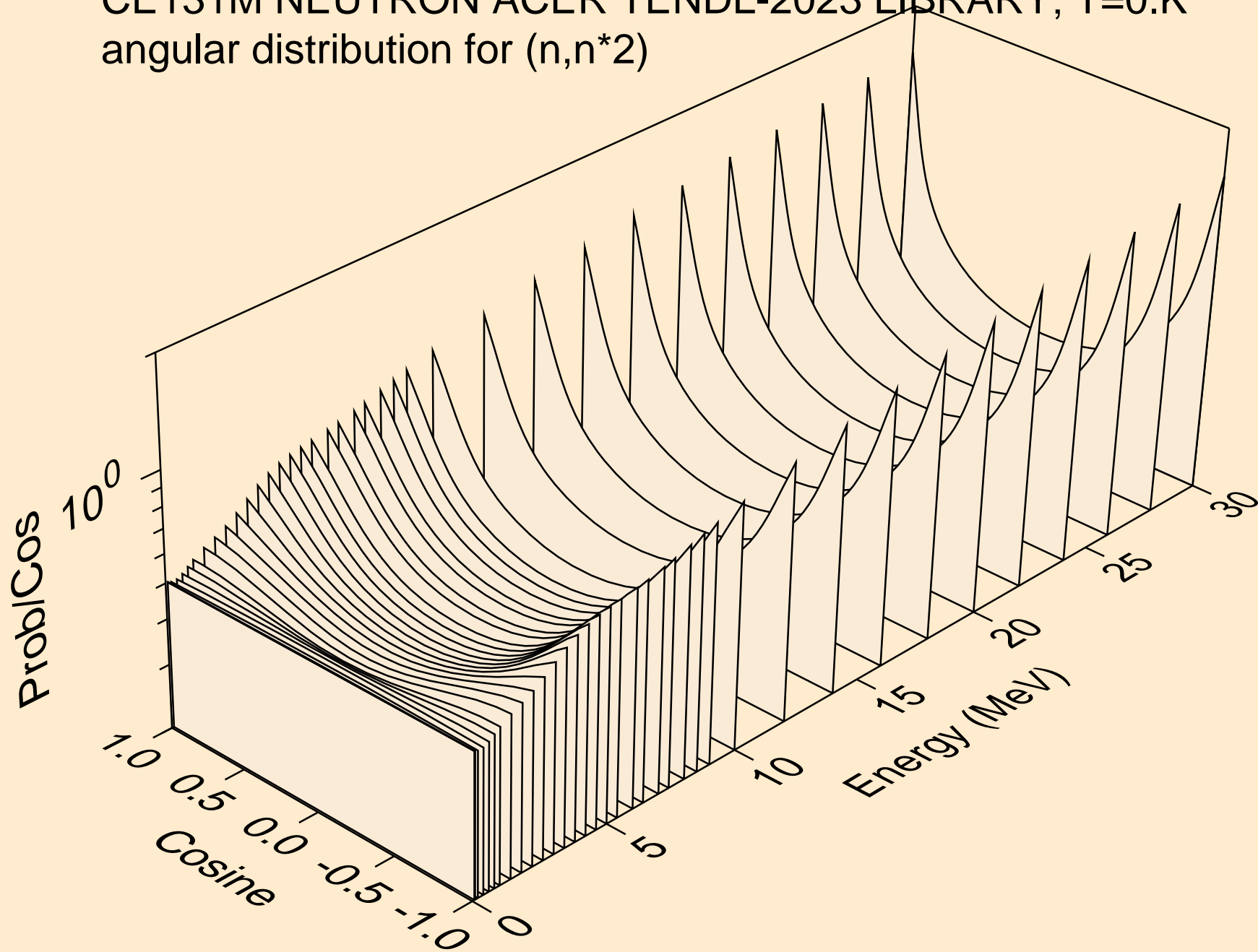

CE131M NEUTRON ACER TENDL-2023 LIBRARY; T=0.K
angular distribution for (n,n*3)

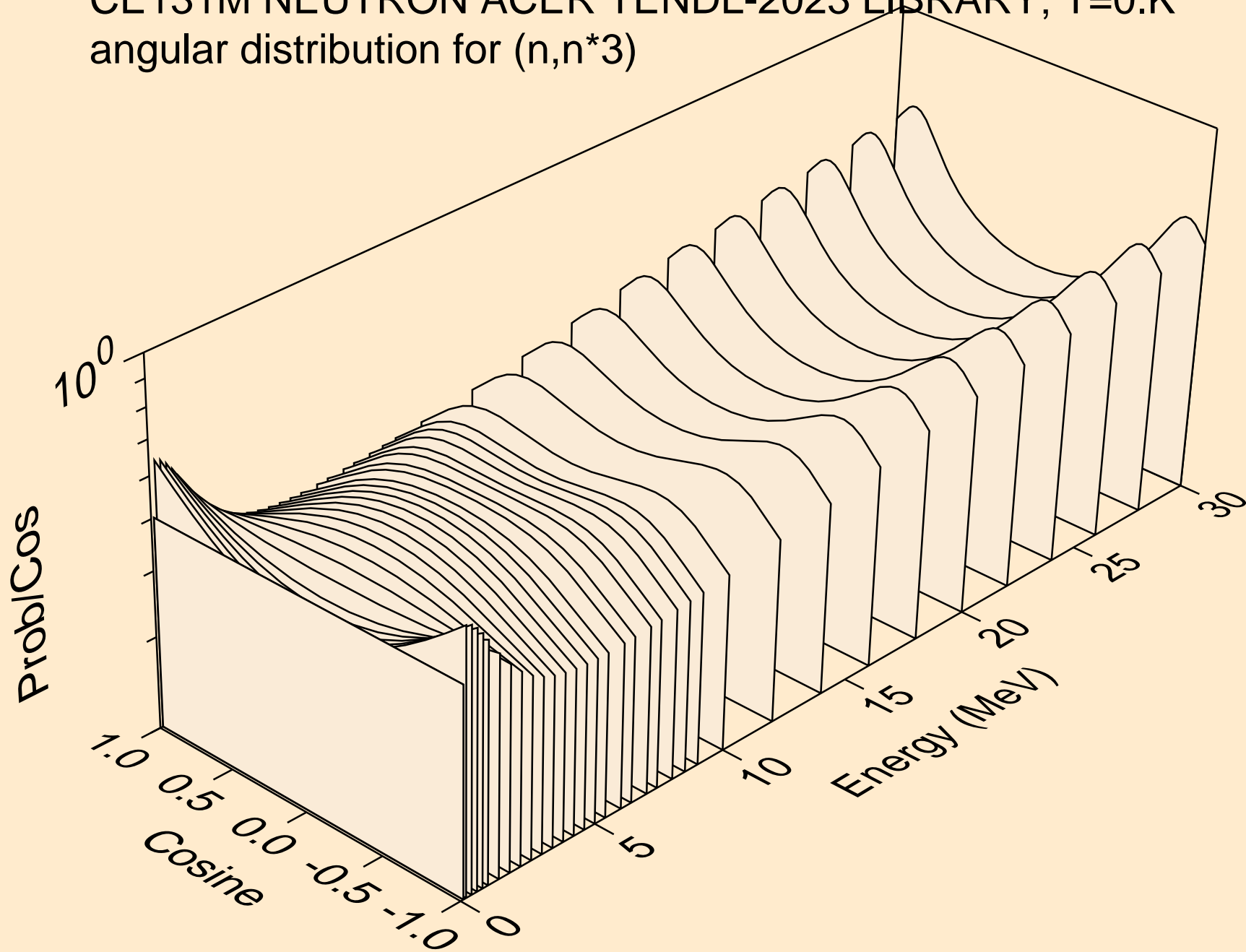

CE131M NEUTRON ACER TENDL-2023 LIBRARY; T=0.K
angular distribution for (n,n*4)

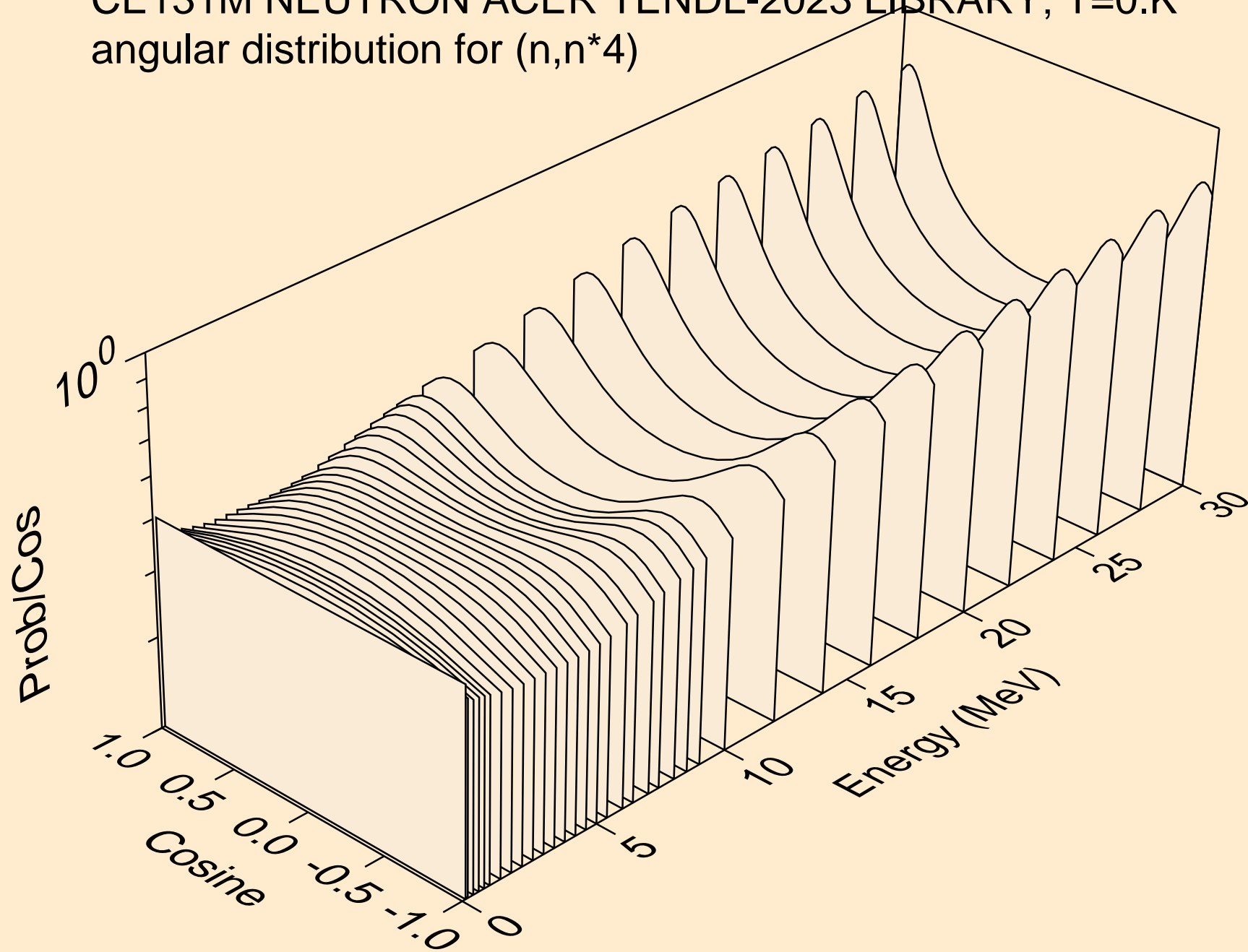

CE131M NEUTRON ACER TENDL-2023 LIBRARY; T=0.K
angular distribution for (n,n*5)

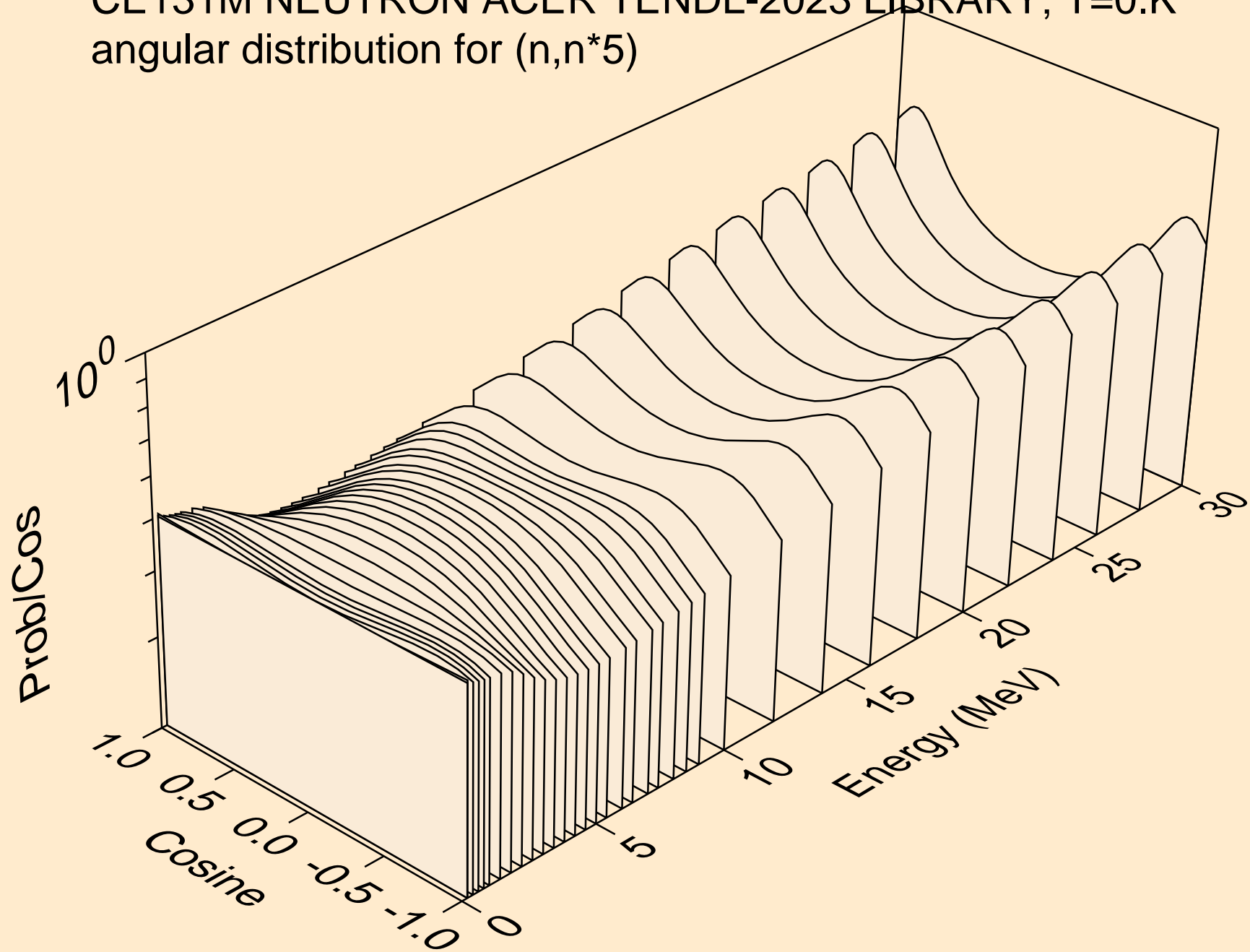

CE131M NEUTRON ACER TENDL-2023 LIBRARY; T=0.K
angular distribution for (n,n*6)

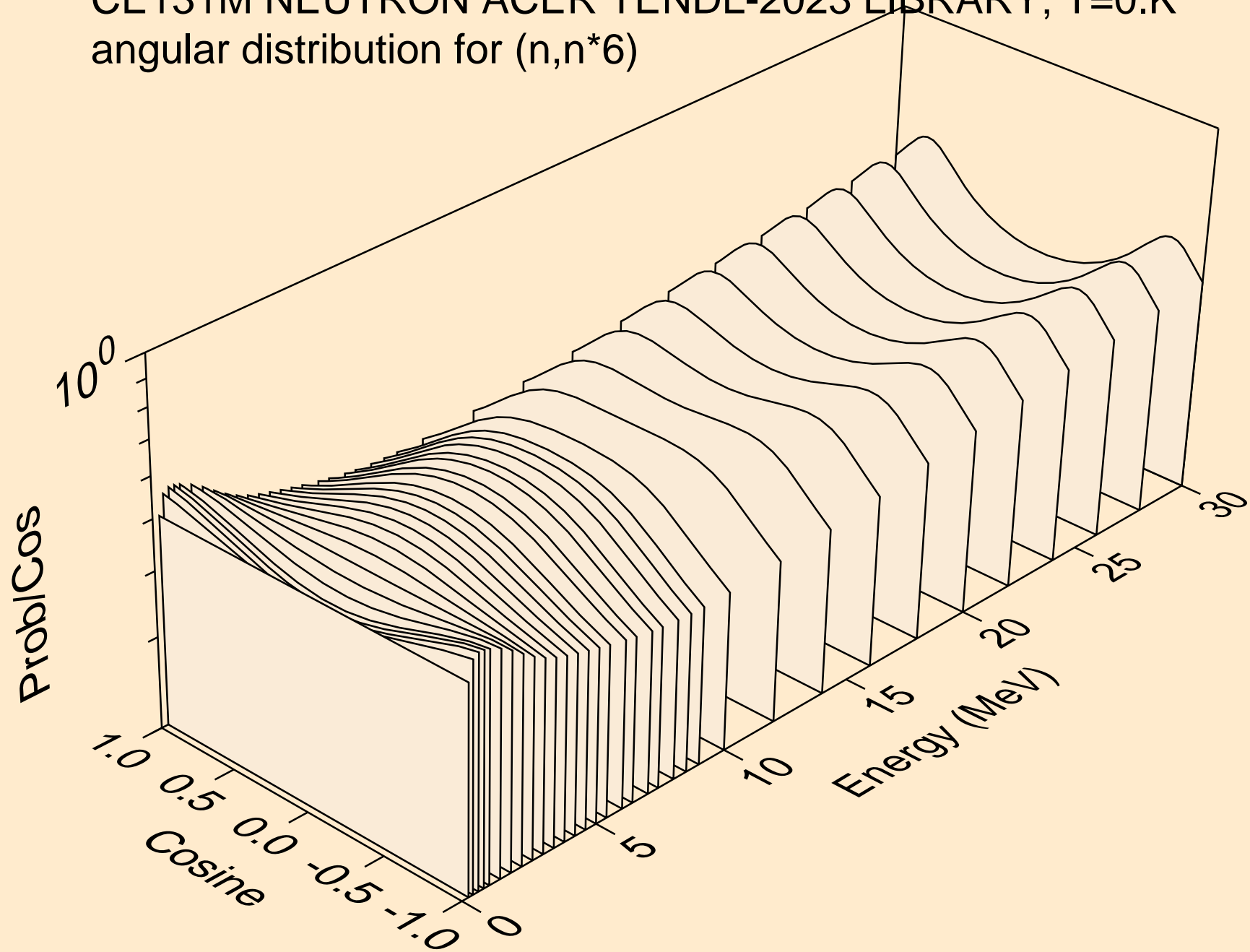

CE131M NEUTRON ACER TENDL-2023 LIBRARY; T=0.K
angular distribution for (n,n*7)

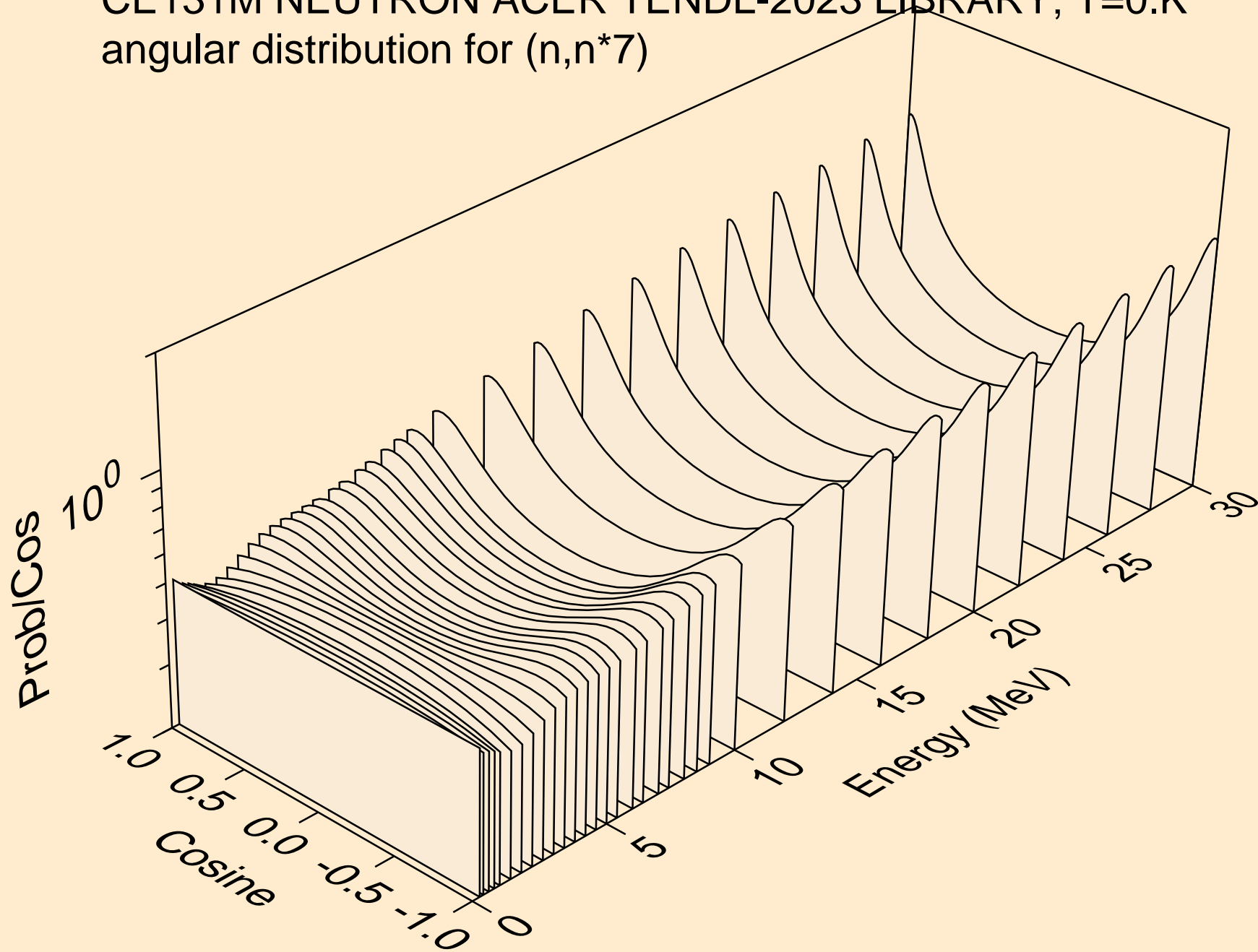

CE131M NEUTRON ACER TENDL-2023 LIBRARY; T=0.K
angular distribution for (n,n*8)

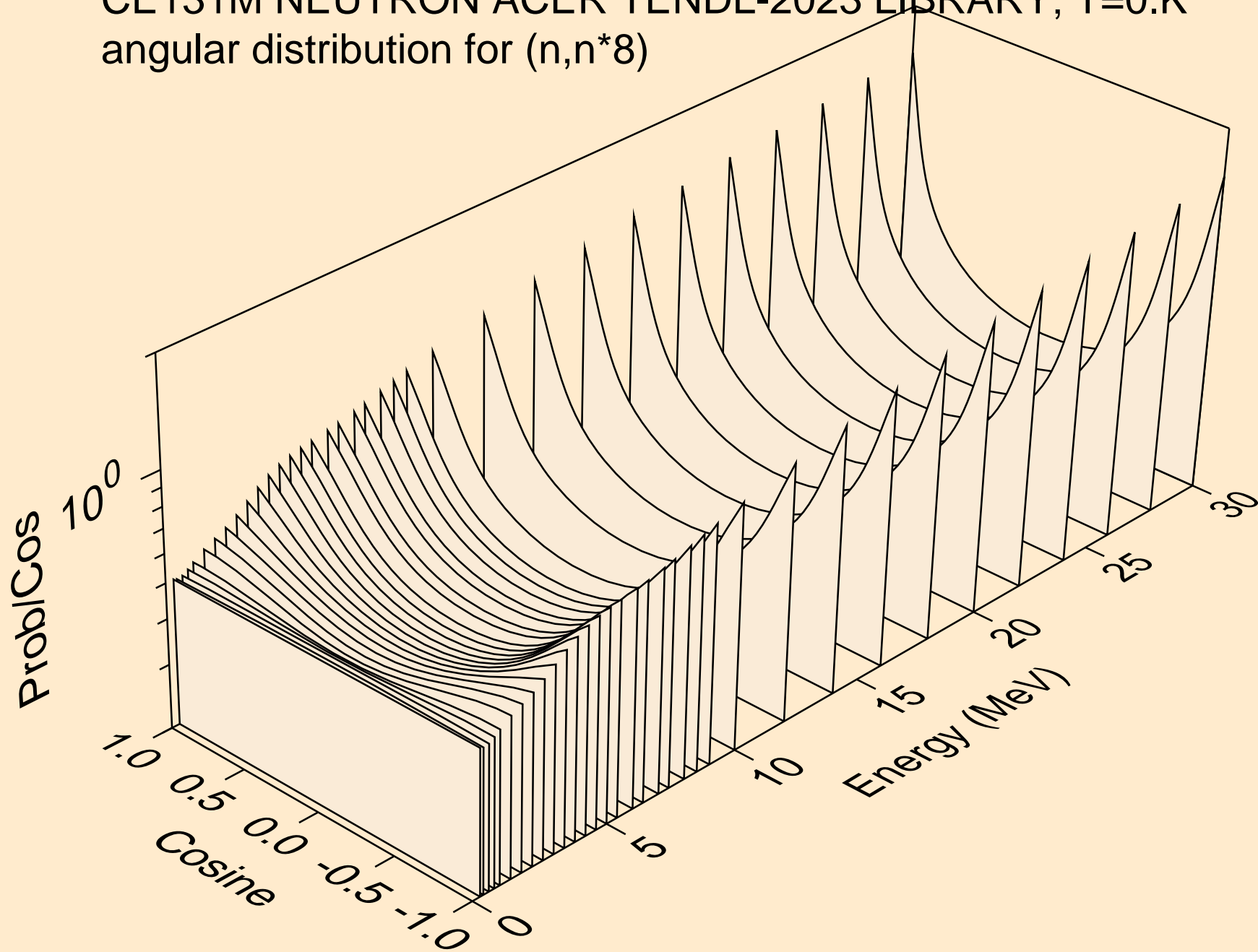

CE131M NEUTRON ACER TENDL-2023 LIBRARY; T=0.K
angular distribution for (n,n*9)

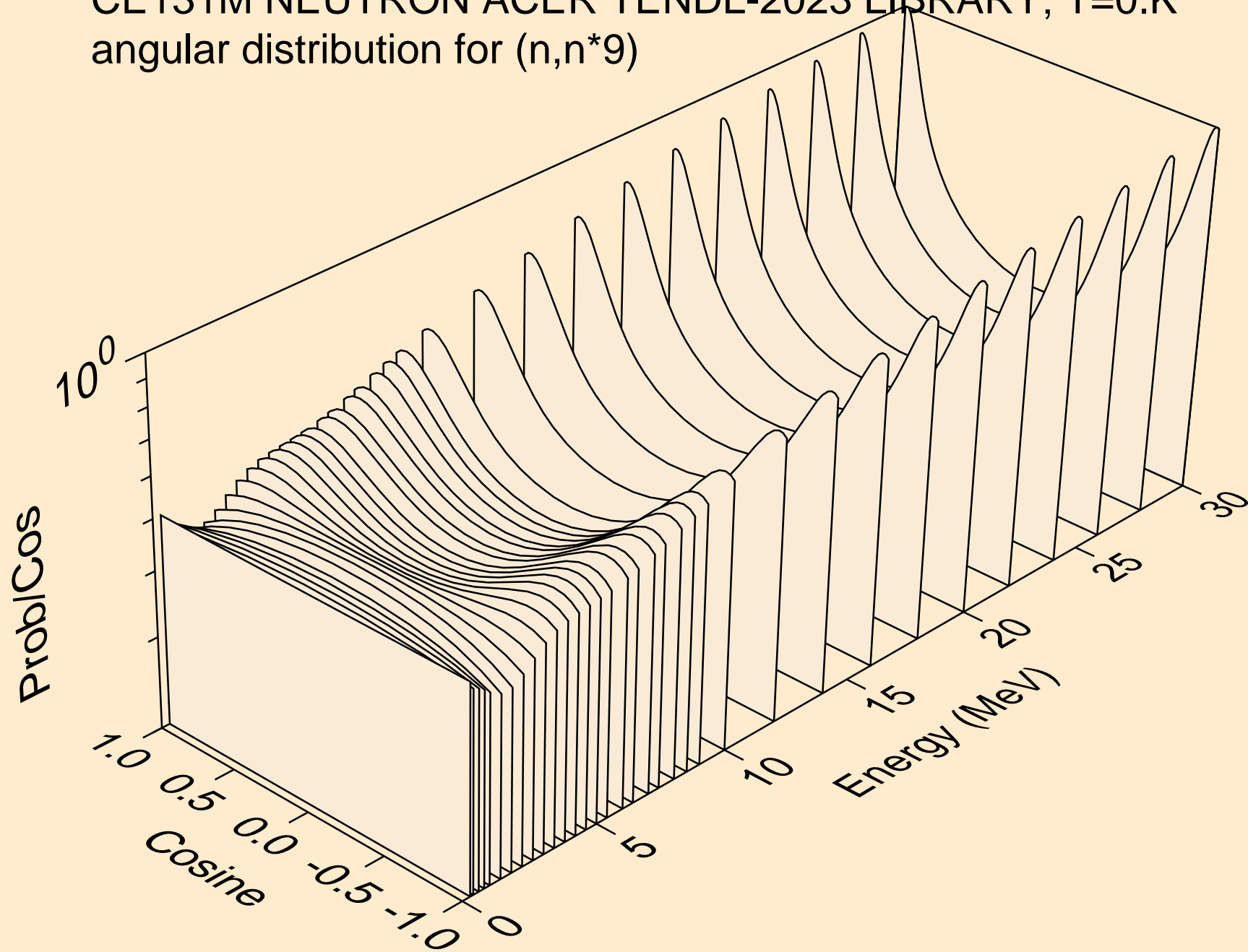

CE131M NEUTRON ACER TENDL-2023 LIBRARY; T=0.K
angular distribution for (n,n*10)

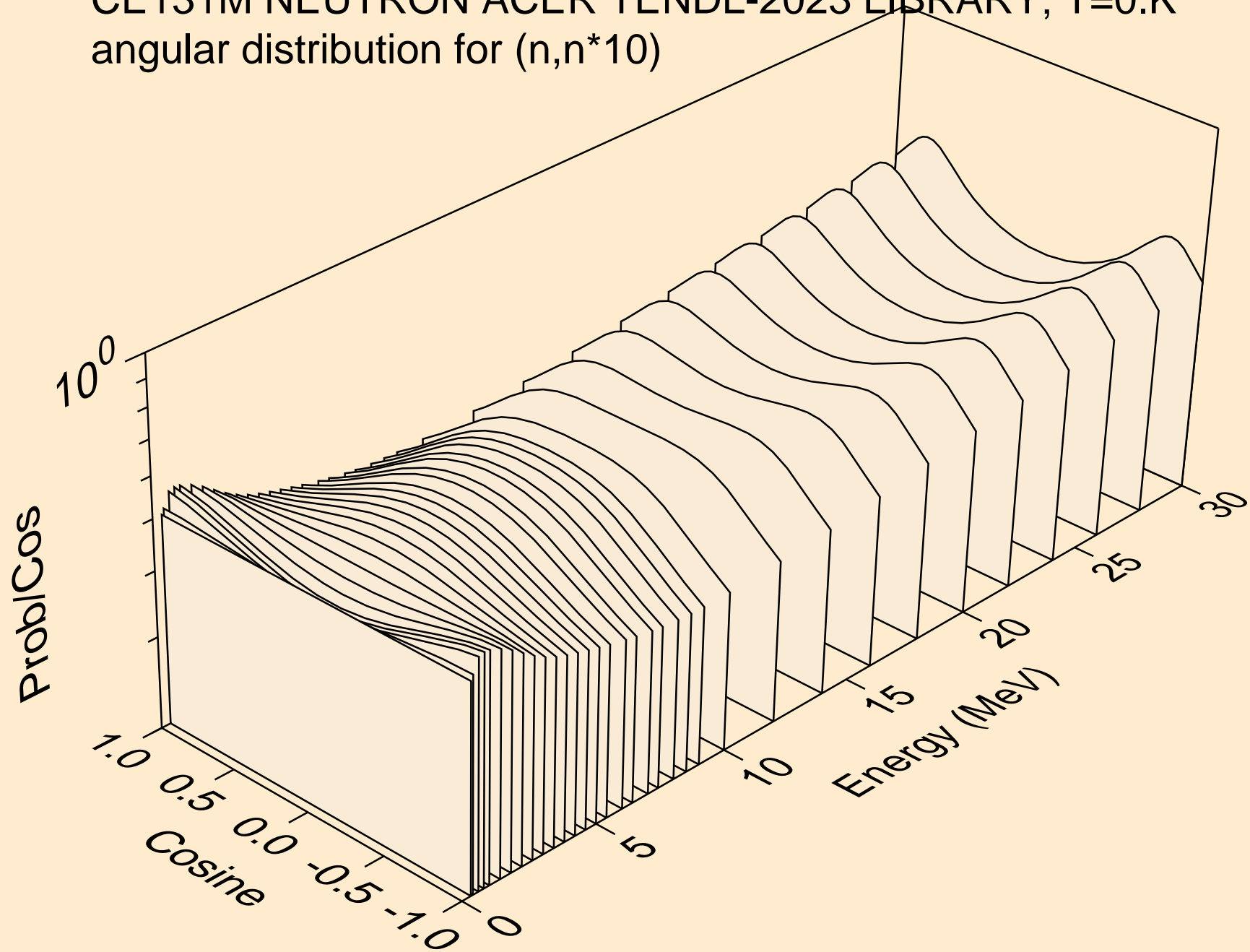

CE131M NEUTRON ACER TENDL-2023 LIBRARY; T=0.K
angular distribution for (n,n*11)

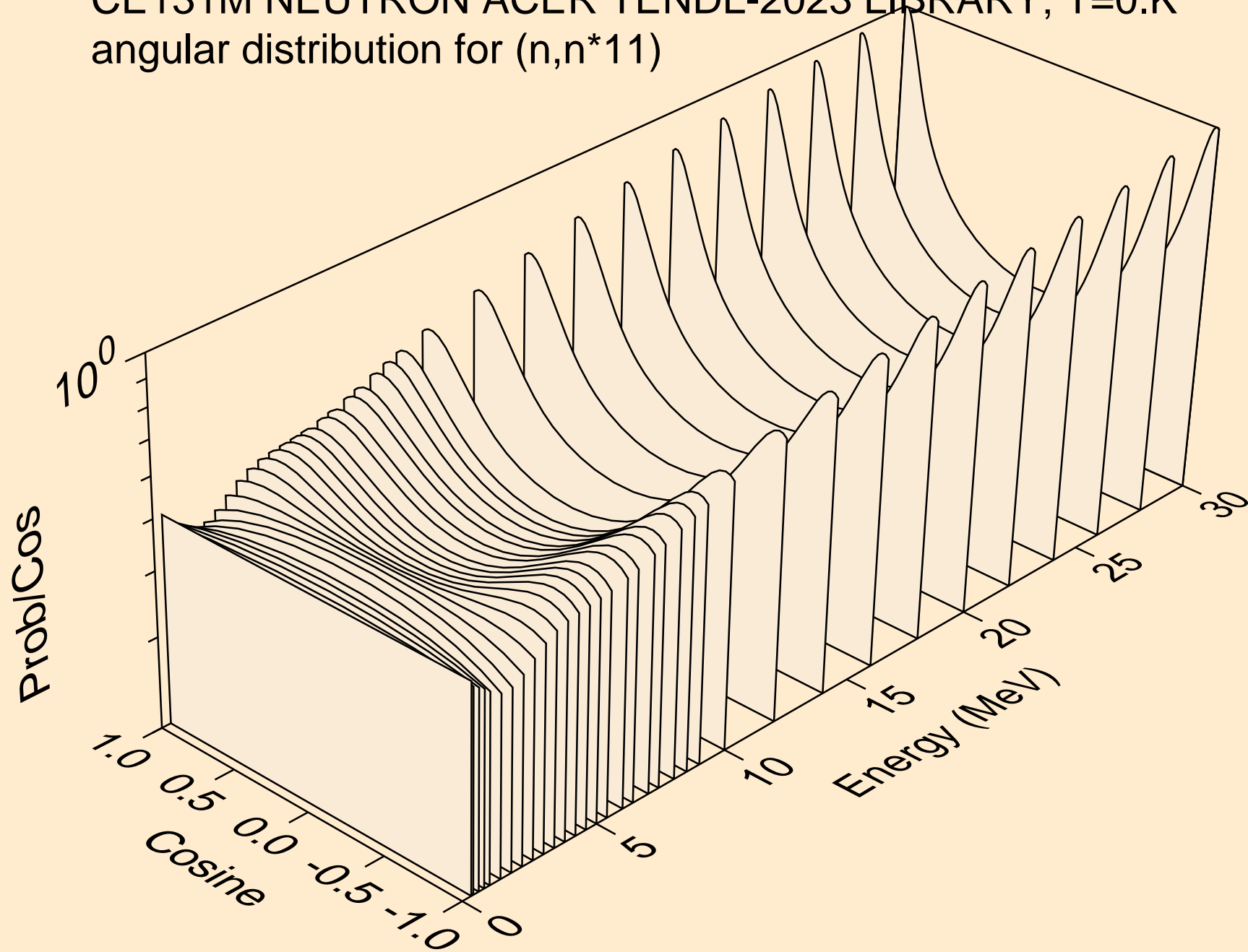

CE131M NEUTRON ACER TENDL-2023 LIBRARY; T=0.K
angular distribution for (n,n*12)

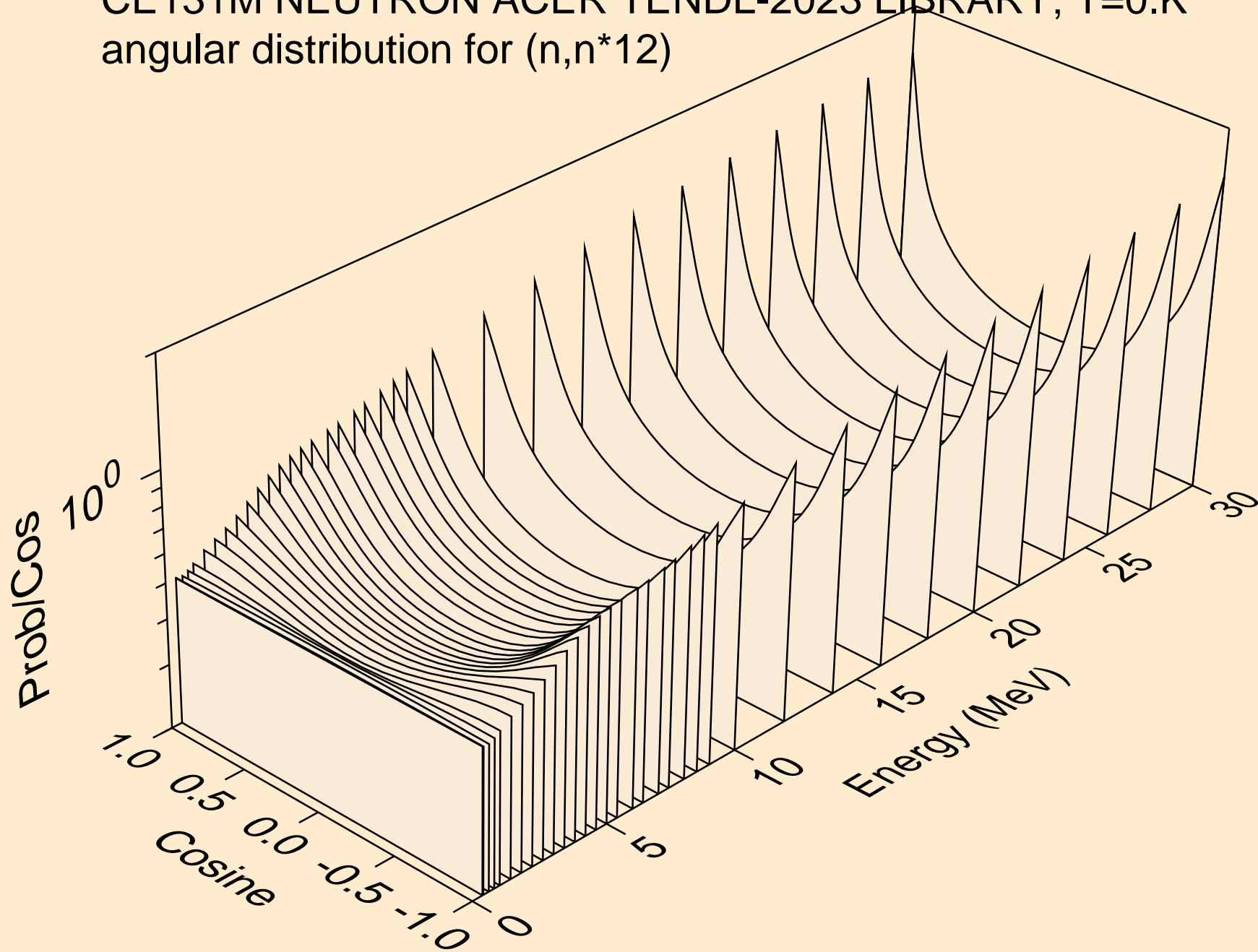

CE131M NEUTRON ACER TENDL-2023 LIBRARY; T=0.K
angular distribution for (n,n*13)

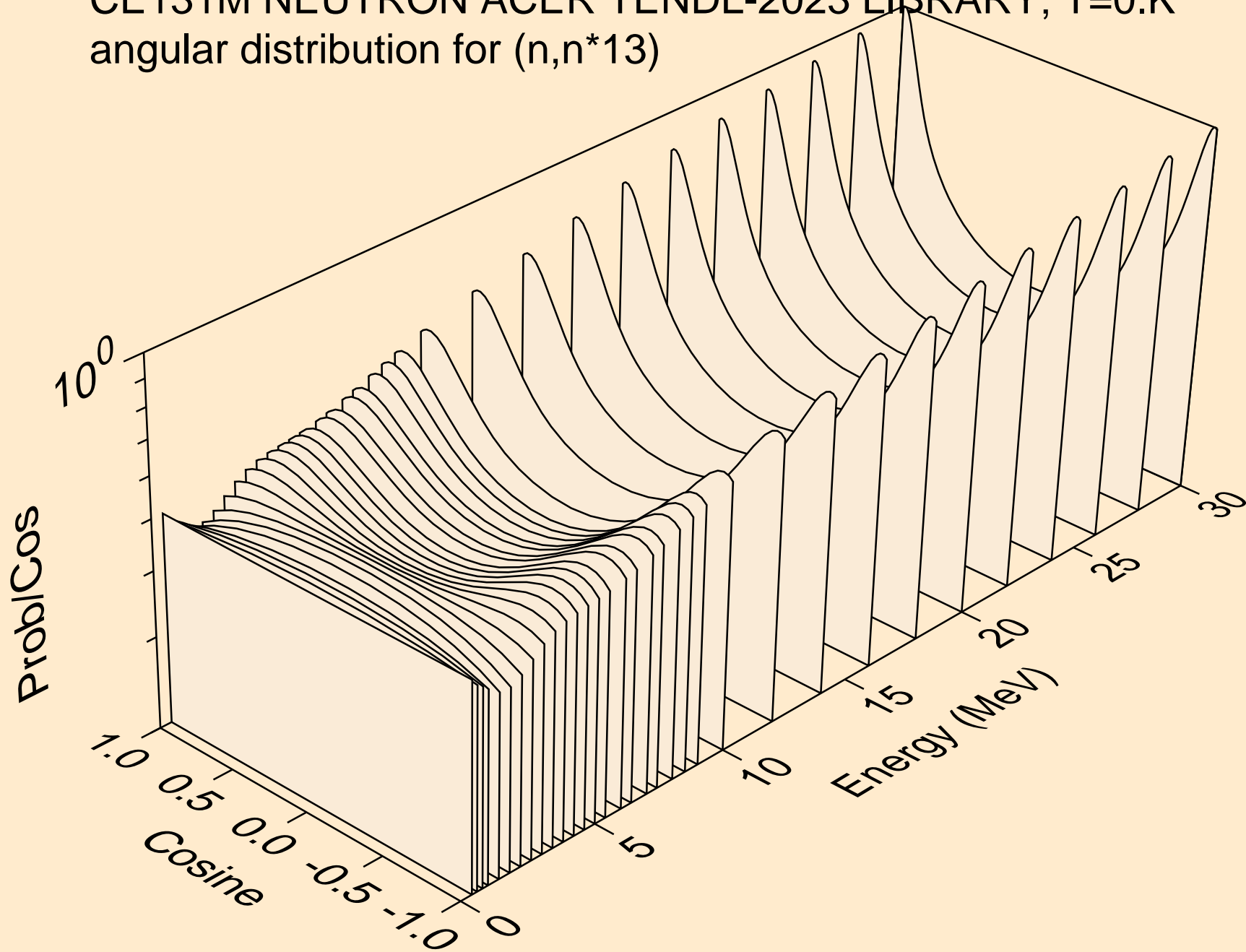

CE131M NEUTRON ACER TENDL-2023 LIBRARY; T=0.K
angular distribution for (n,n*14)

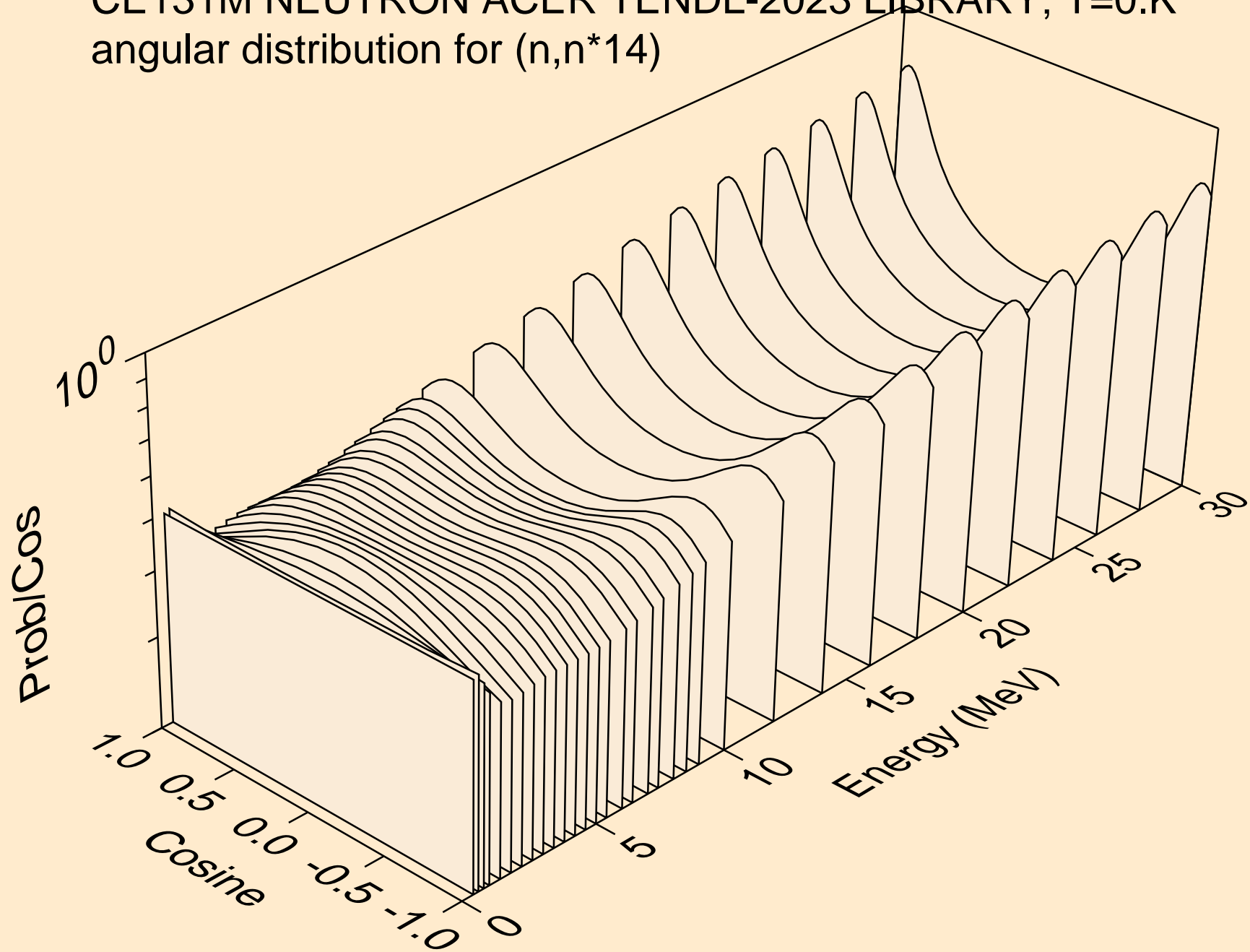

CE131M NEUTRON ACER TENDL-2023 LIBRARY; T=0.K
Neutron emission for (n,x)

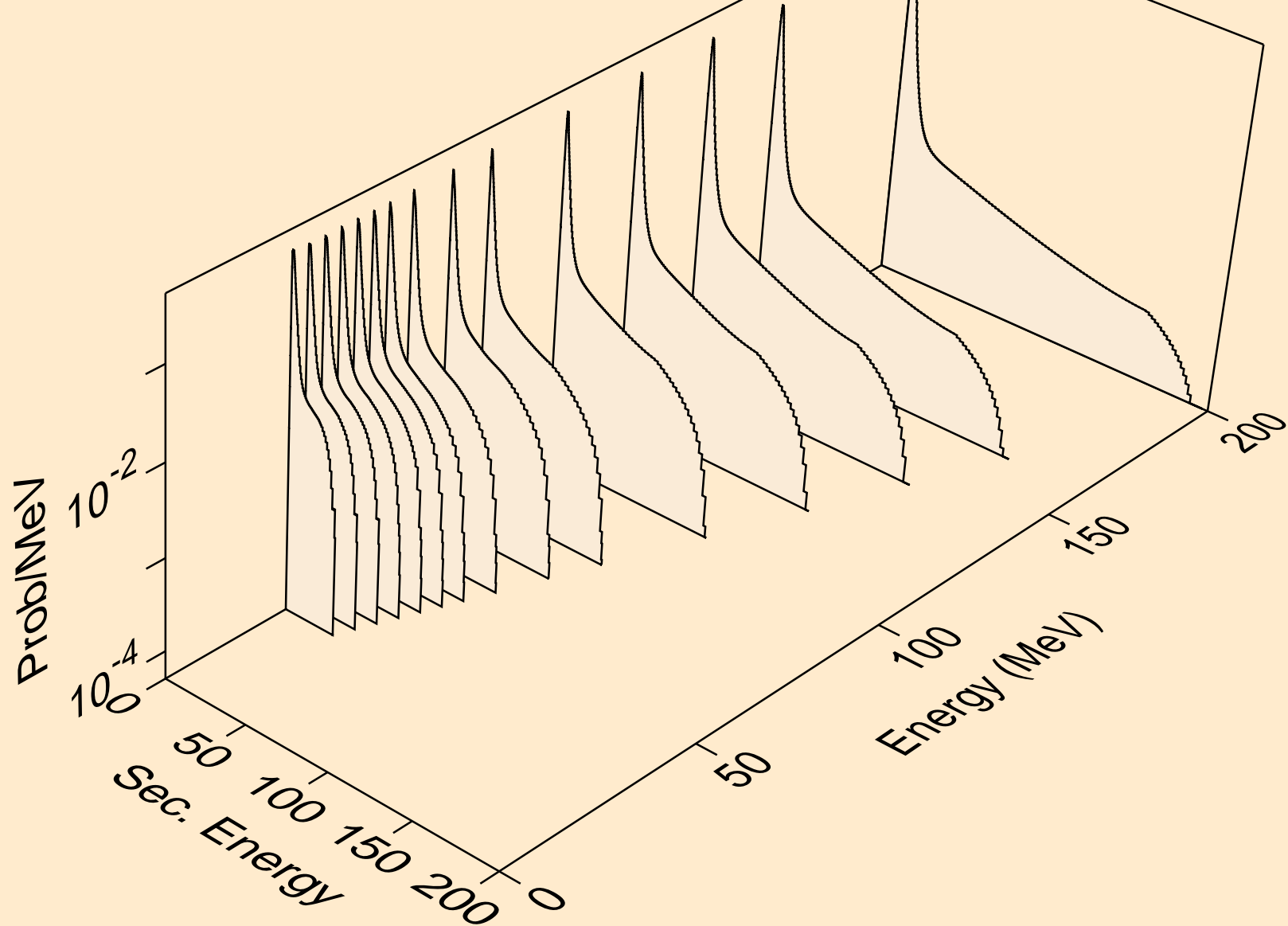

CE131M NEUTRON ACER TENDL-2023 LIBRARY; T=0.K
Neutron emission for (n,2nd)

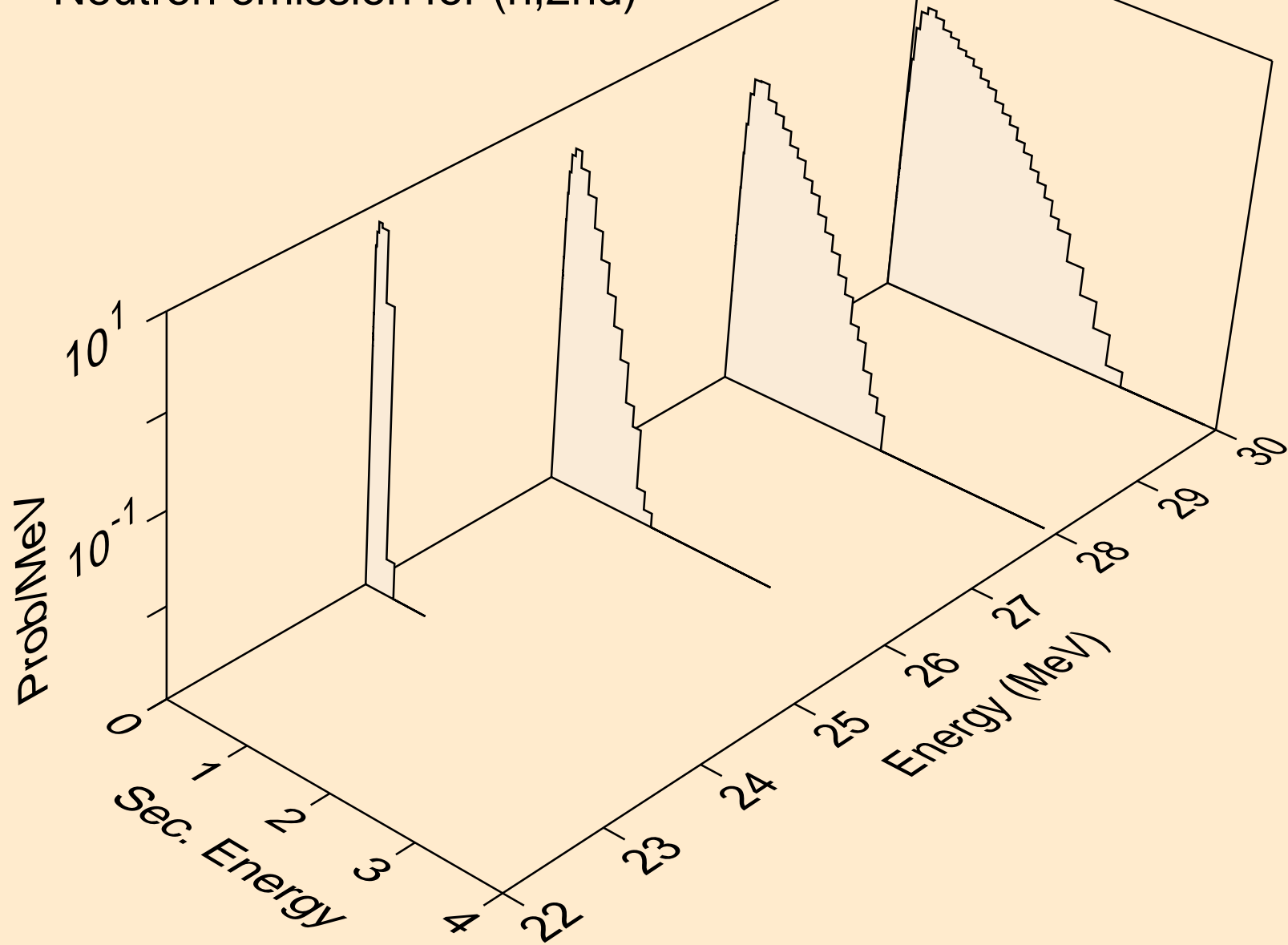

CE131M NEUTRON ACER TENDL-2023 LIBRARY; T=0.K
Neutron emission for (n,2n)

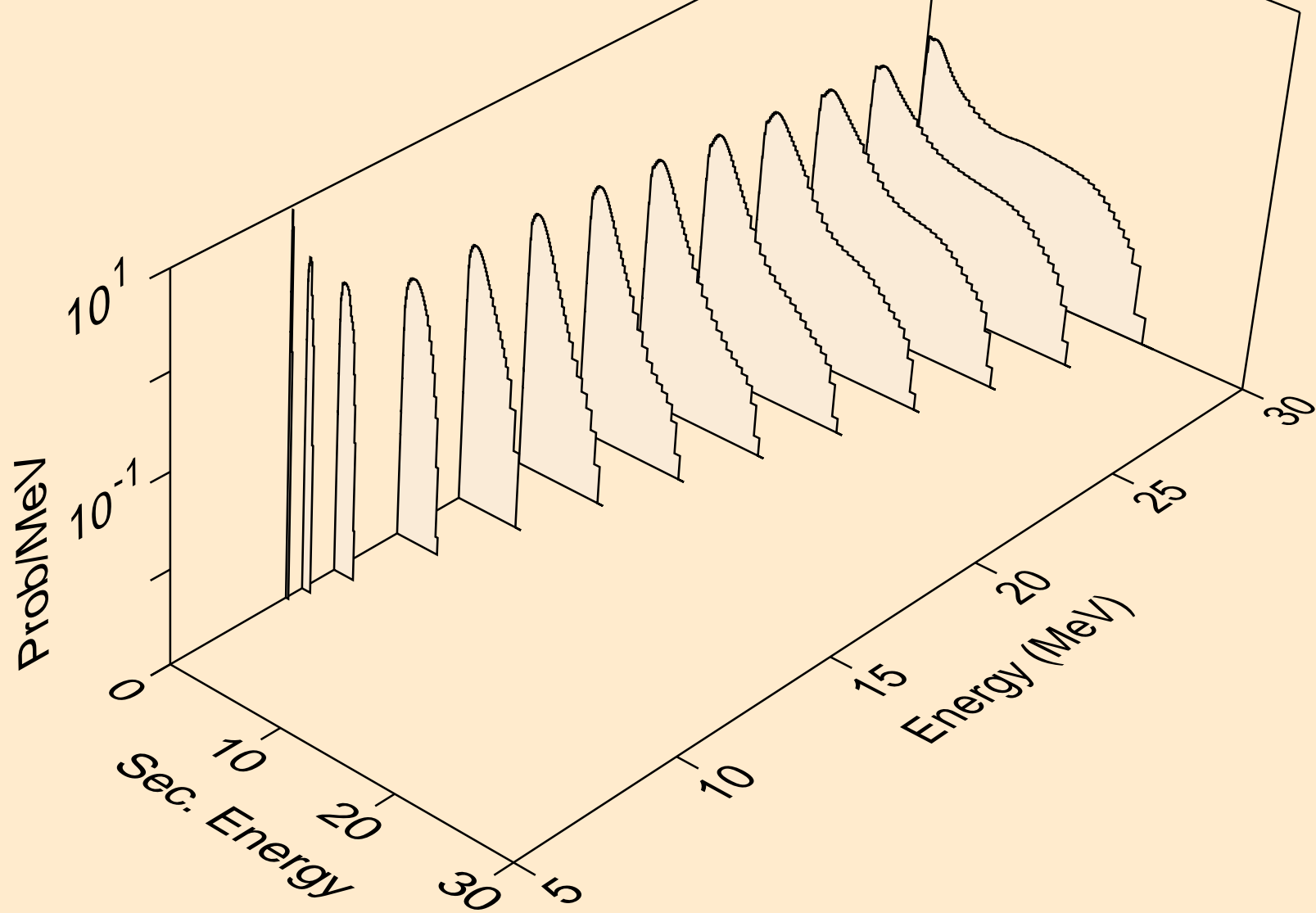

CE131M NEUTRON ACER TENDL-2023 LIBRARY; T=0.K
Neutron emission for (n,3n)

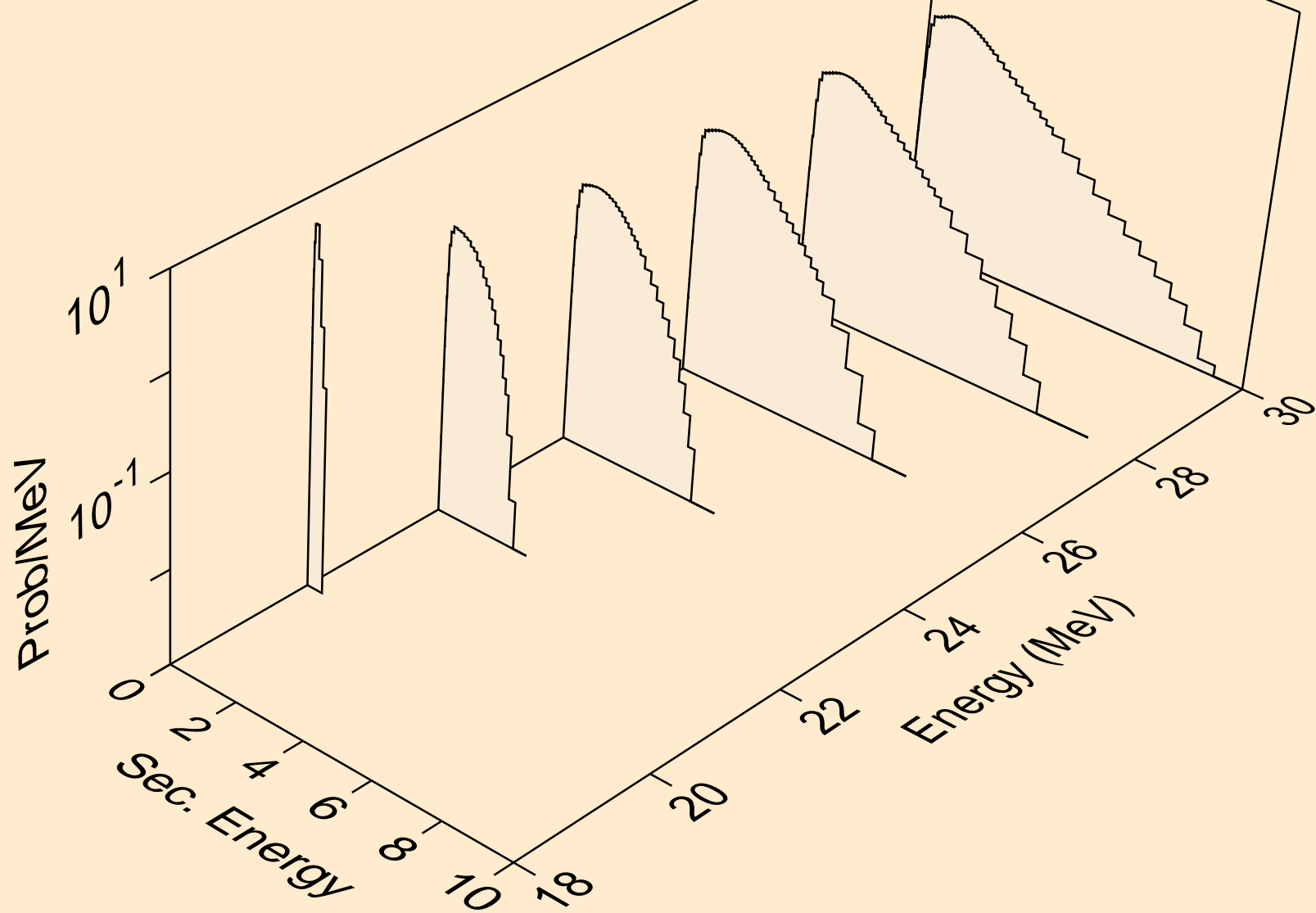

CE131M NEUTRON ACER TENDL-2023 LIBRARY; T=0.K
Neutron emission for (n,n*)a

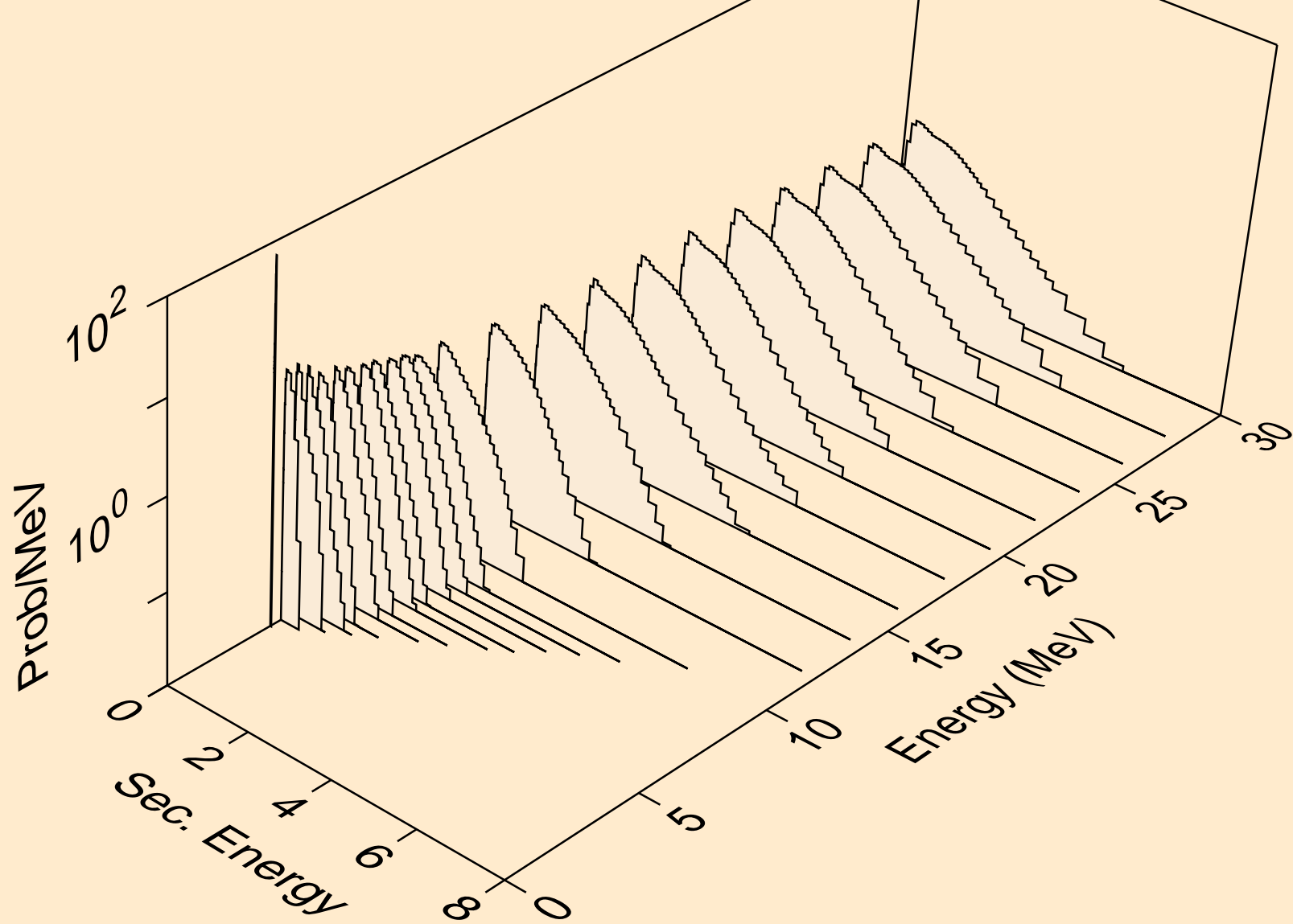

CE131M NEUTRON ACER TENDL-2023 LIBRARY; T=0.K
Neutron emission for (n,2n)a

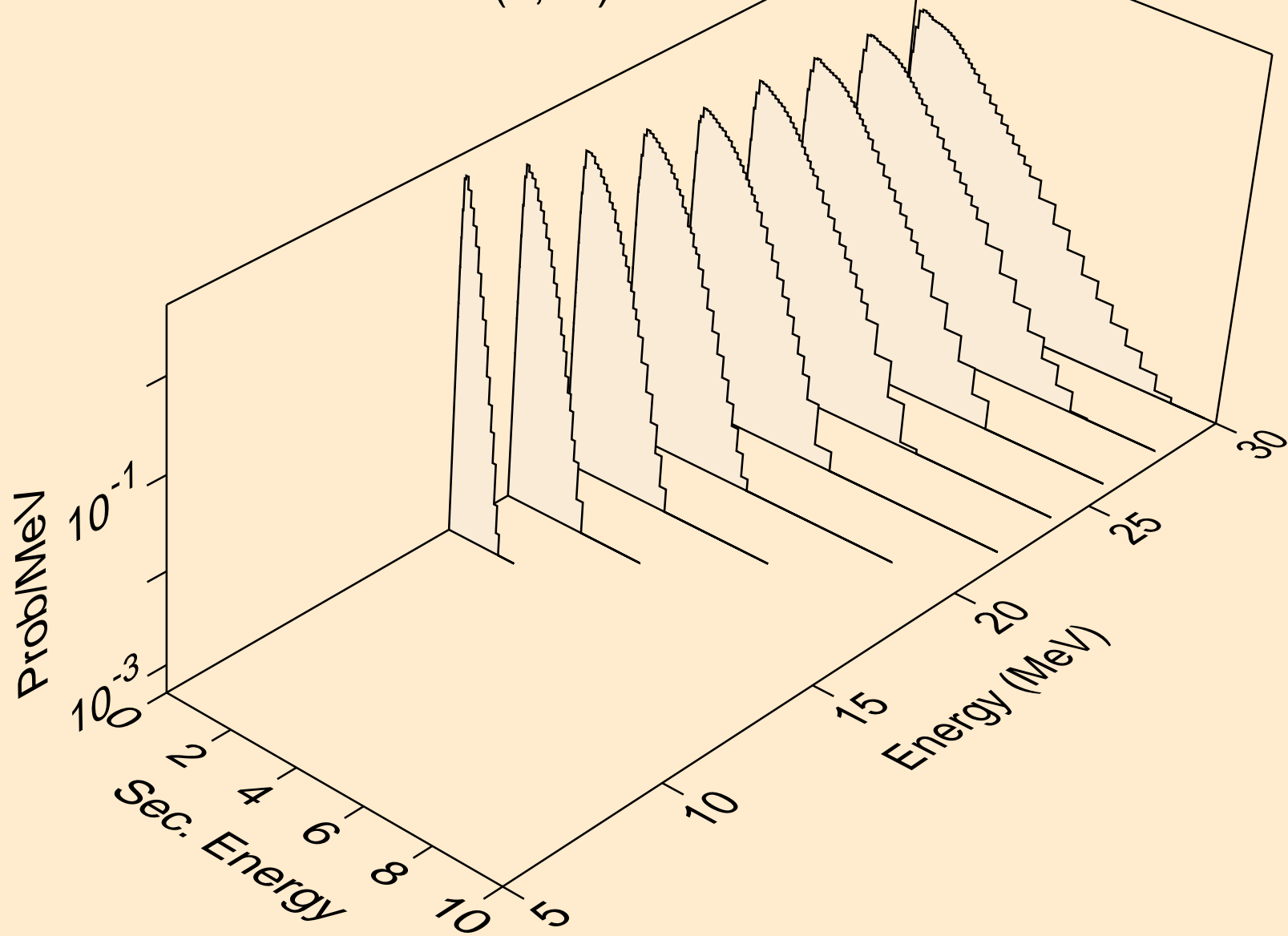

CE131M NEUTRON ACER TENDL-2023 LIBRARY; T=0.K
Neutron emission for (n,3n)a

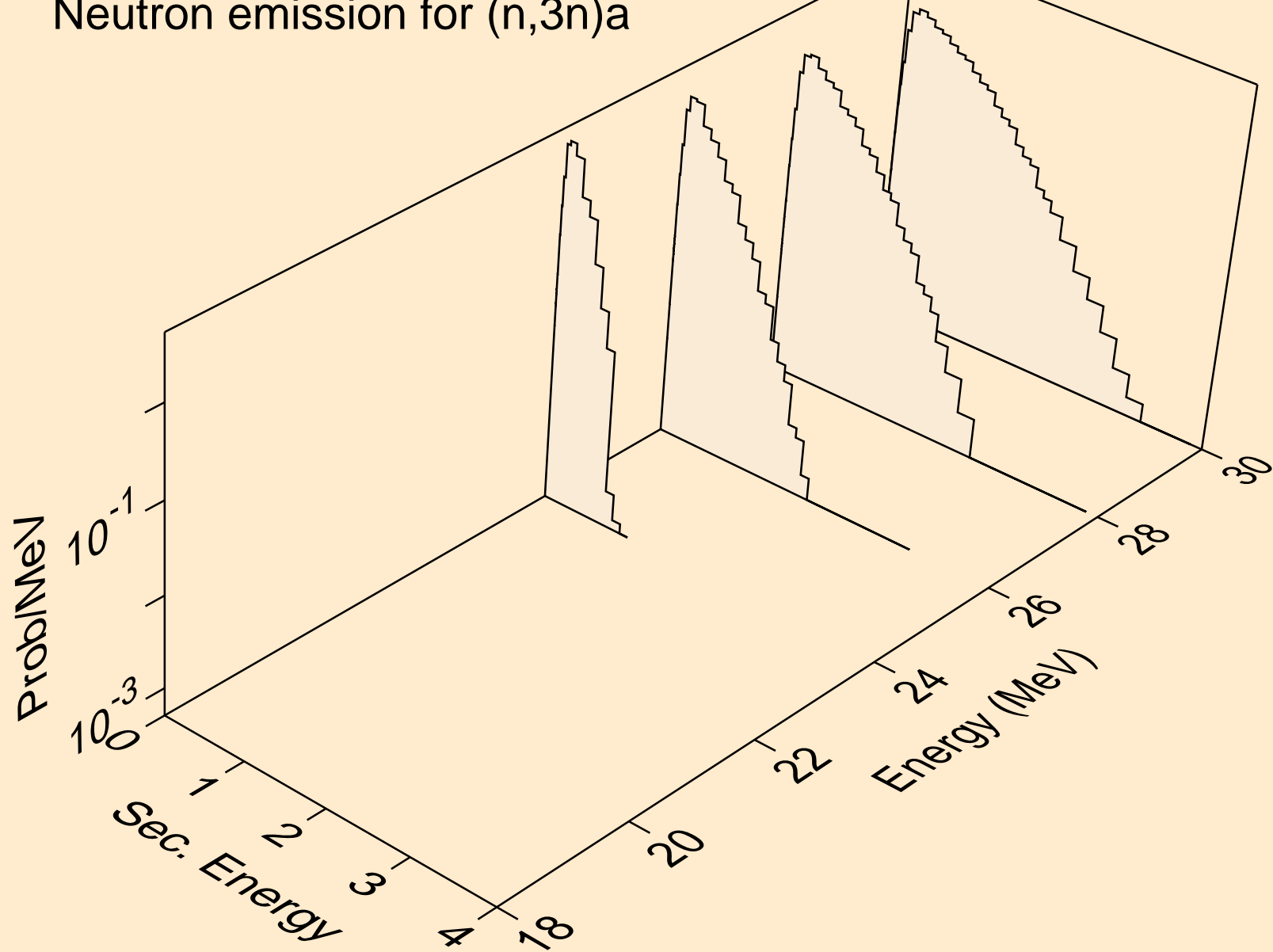

CE131M NEUTRON ACER TENDL-2023 LIBRARY; T=0.K
Neutron emission for (n,n*)p

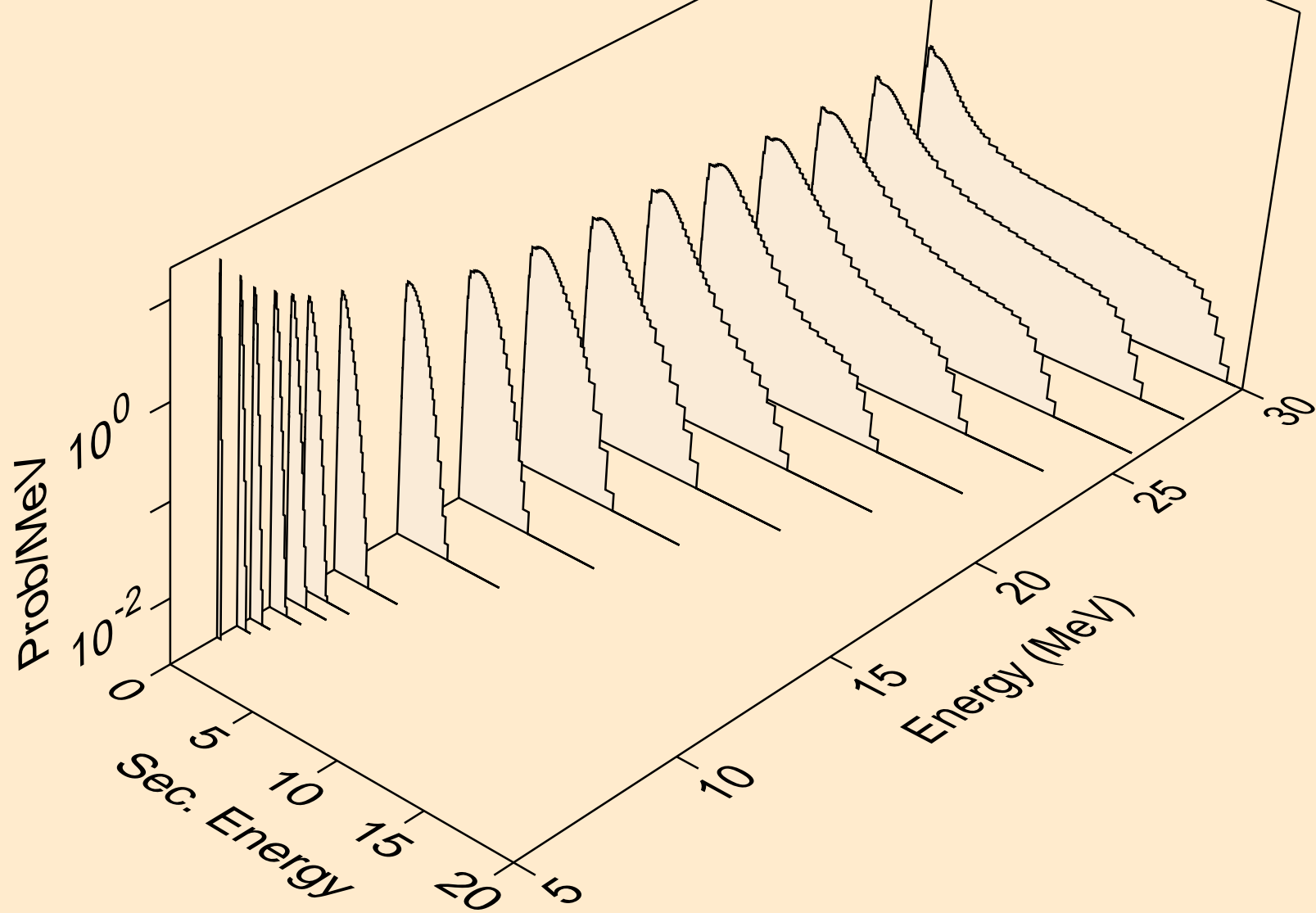

CE131M NEUTRON ACER TENDL-2023 LIBRARY; T=0.K
Neutron emission for (n,n*)2a

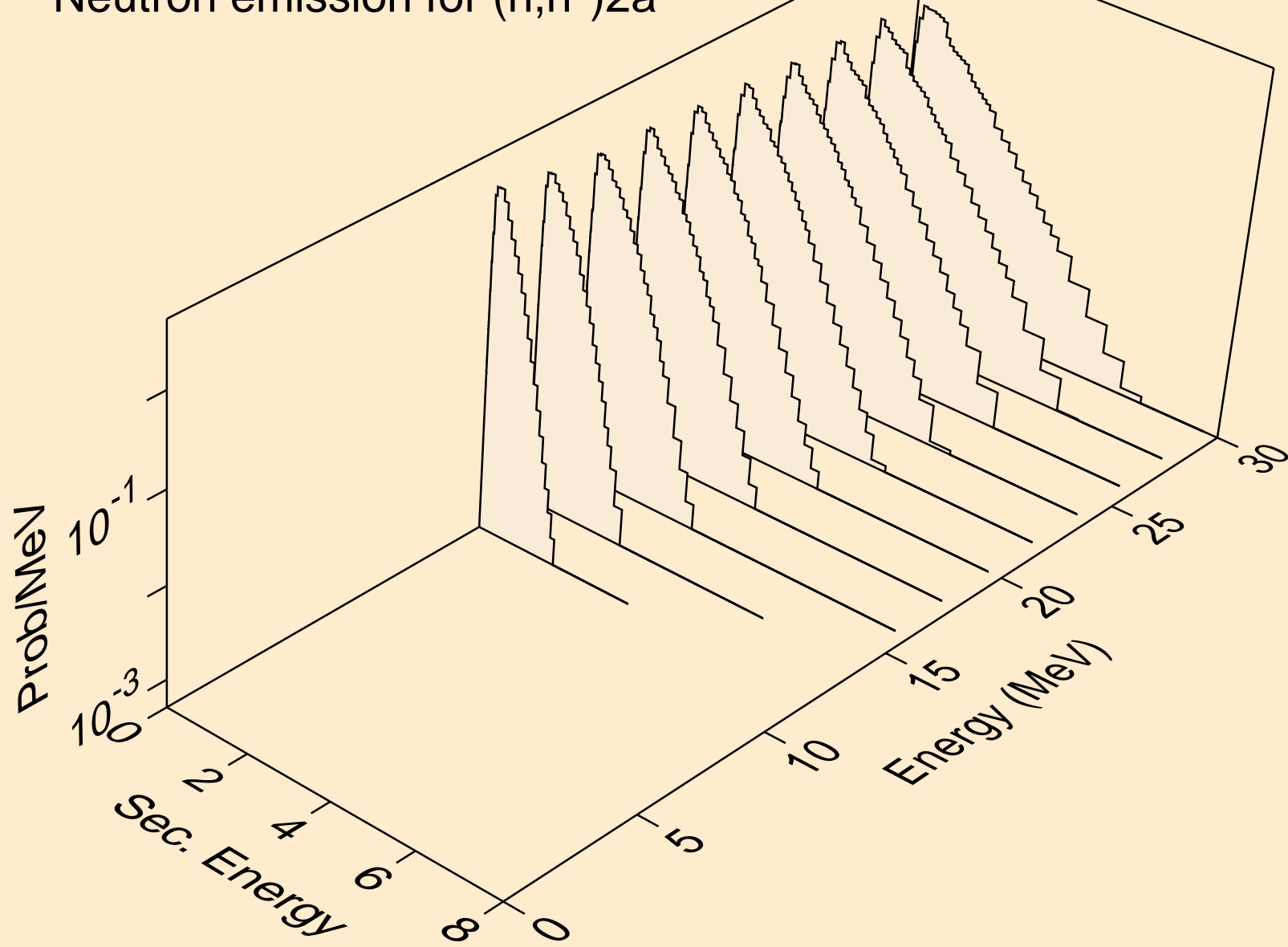

CE131M NEUTRON ACER TENDL-2023 LIBRARY; T=0.K
Neutron emission for (n,2n)2a

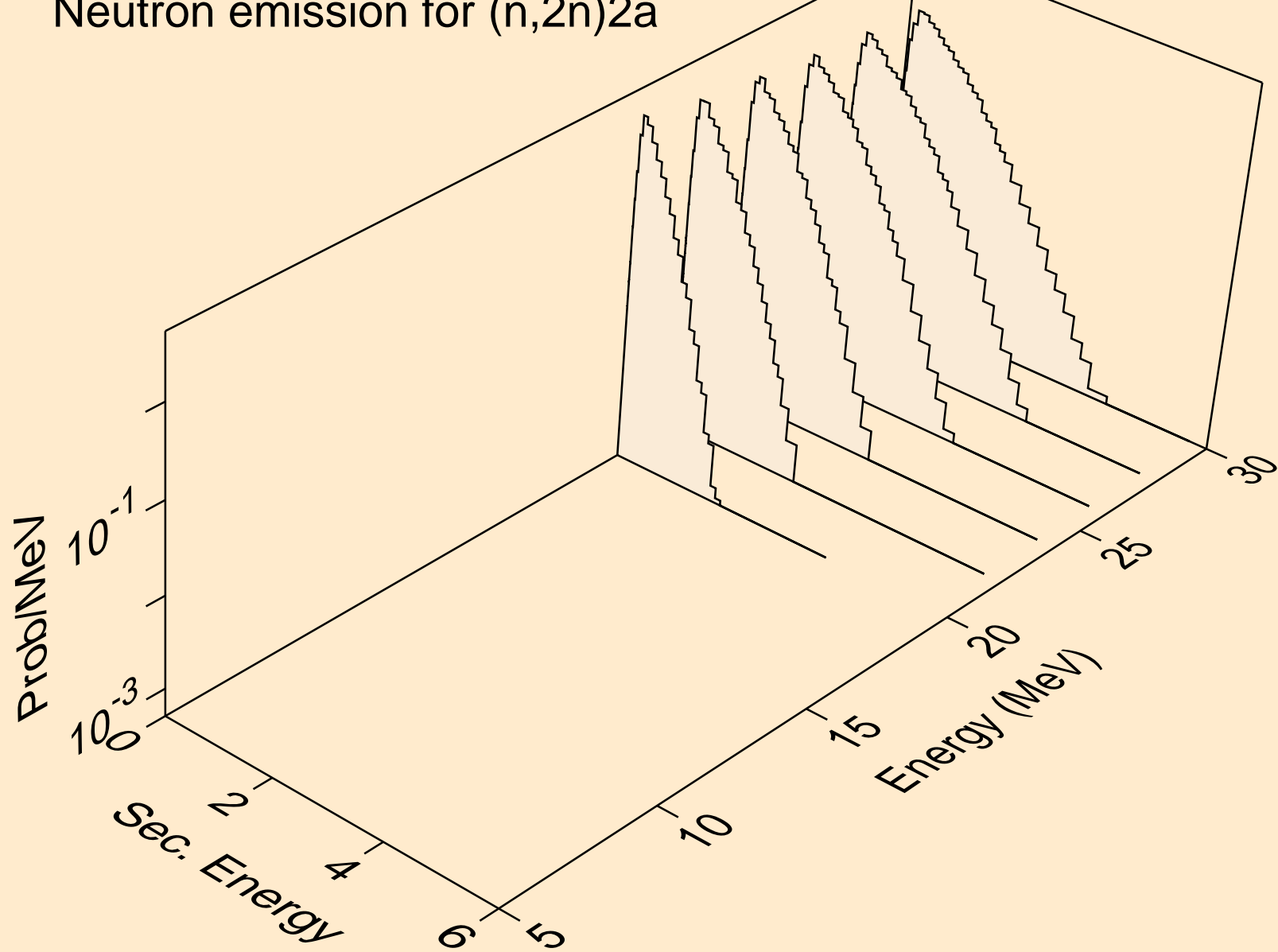

CE131M NEUTRON ACER TENDL-2023 LIBRARY; T=0.K
Neutron emission for (n,n*)d

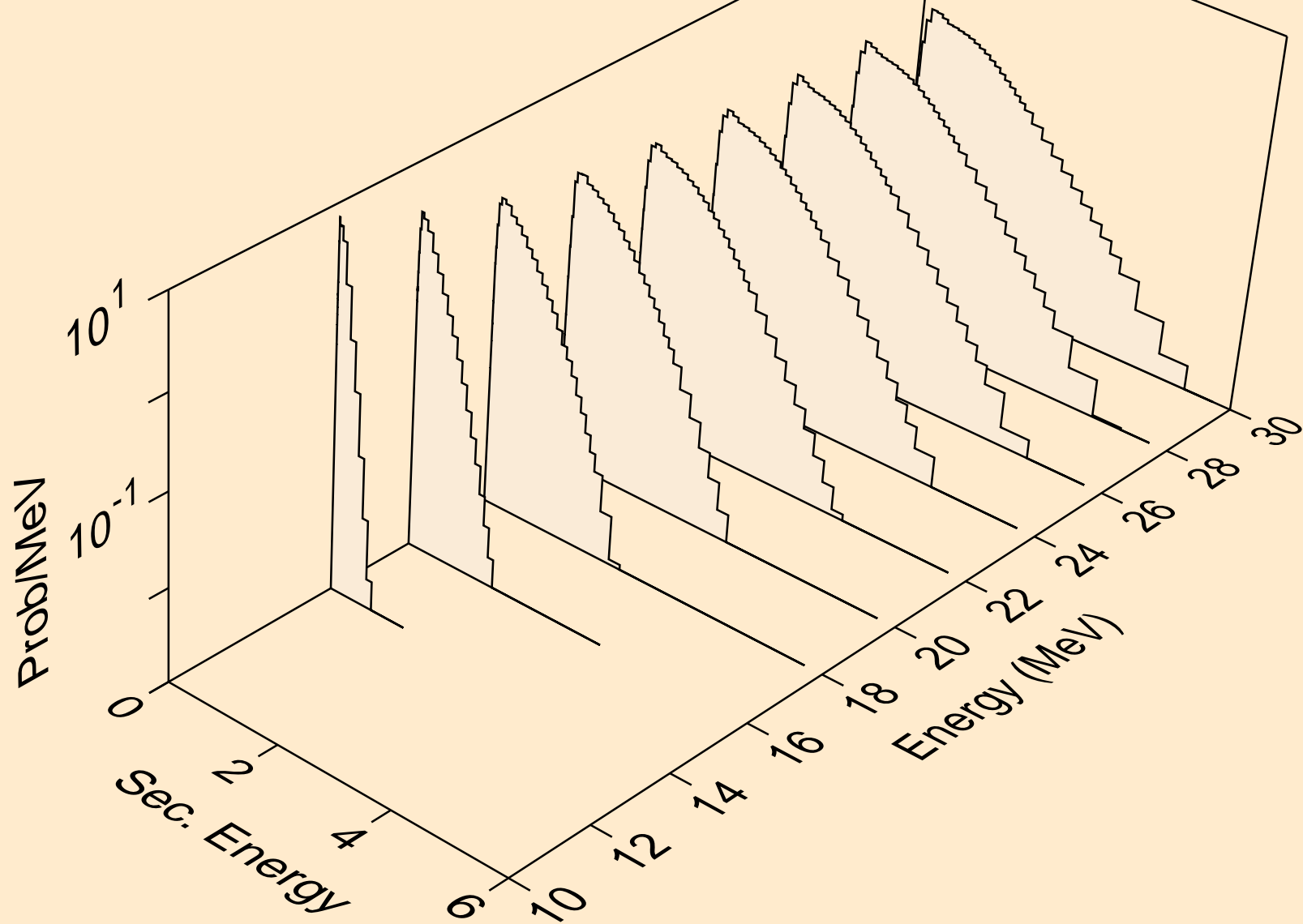

CE131M NEUTRON ACER TENDL-2023 LIBRARY; T=0.K
Neutron emission for (n,n*)t

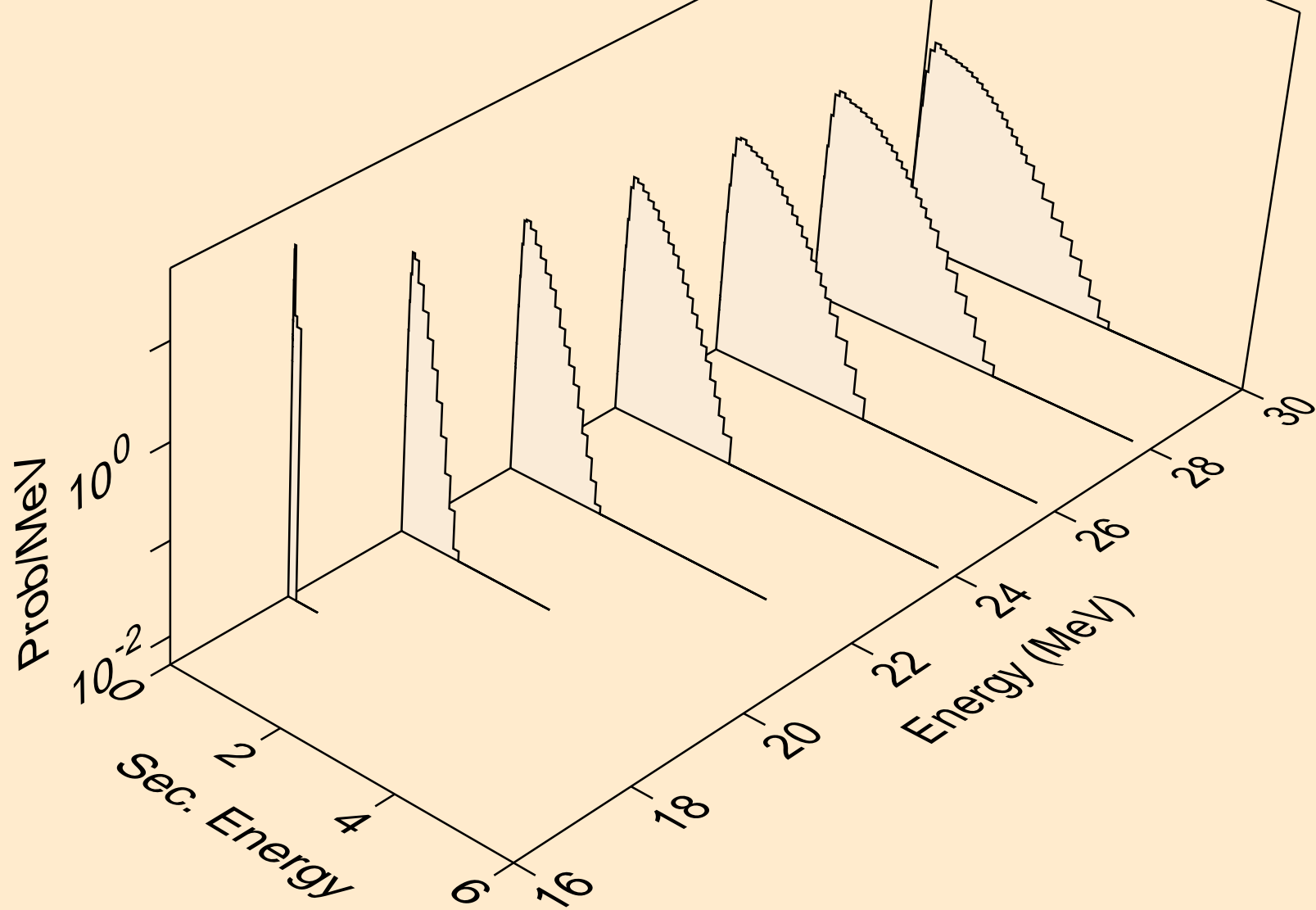

CE131M NEUTRON ACER TENDL-2023 LIBRARY; T=0.K
Neutron emission for (n,n*)he3

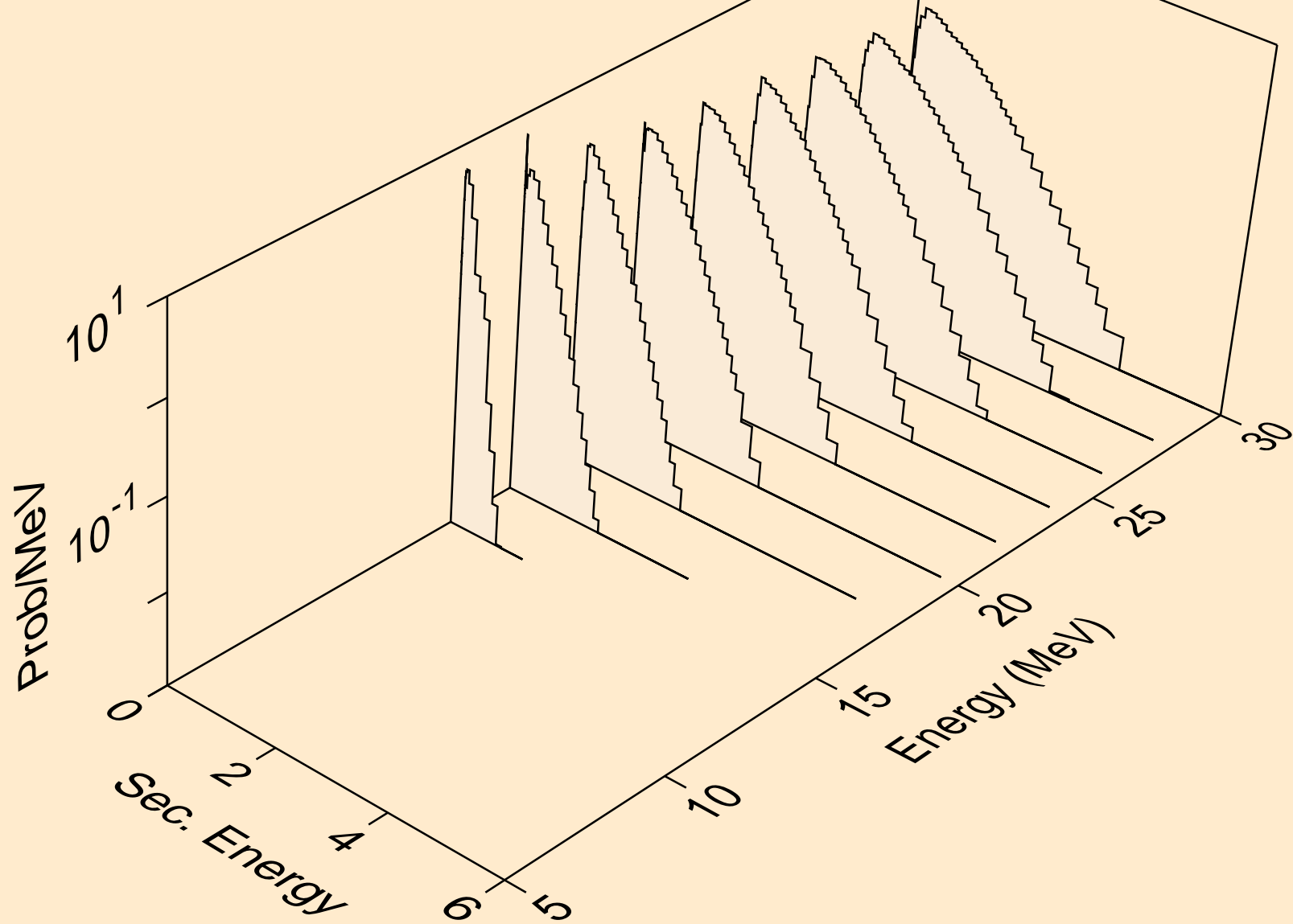

CE131M NEUTRON ACER TENDL-2023 LIBRARY; T=0.K
Neutron emission for (n,4n)

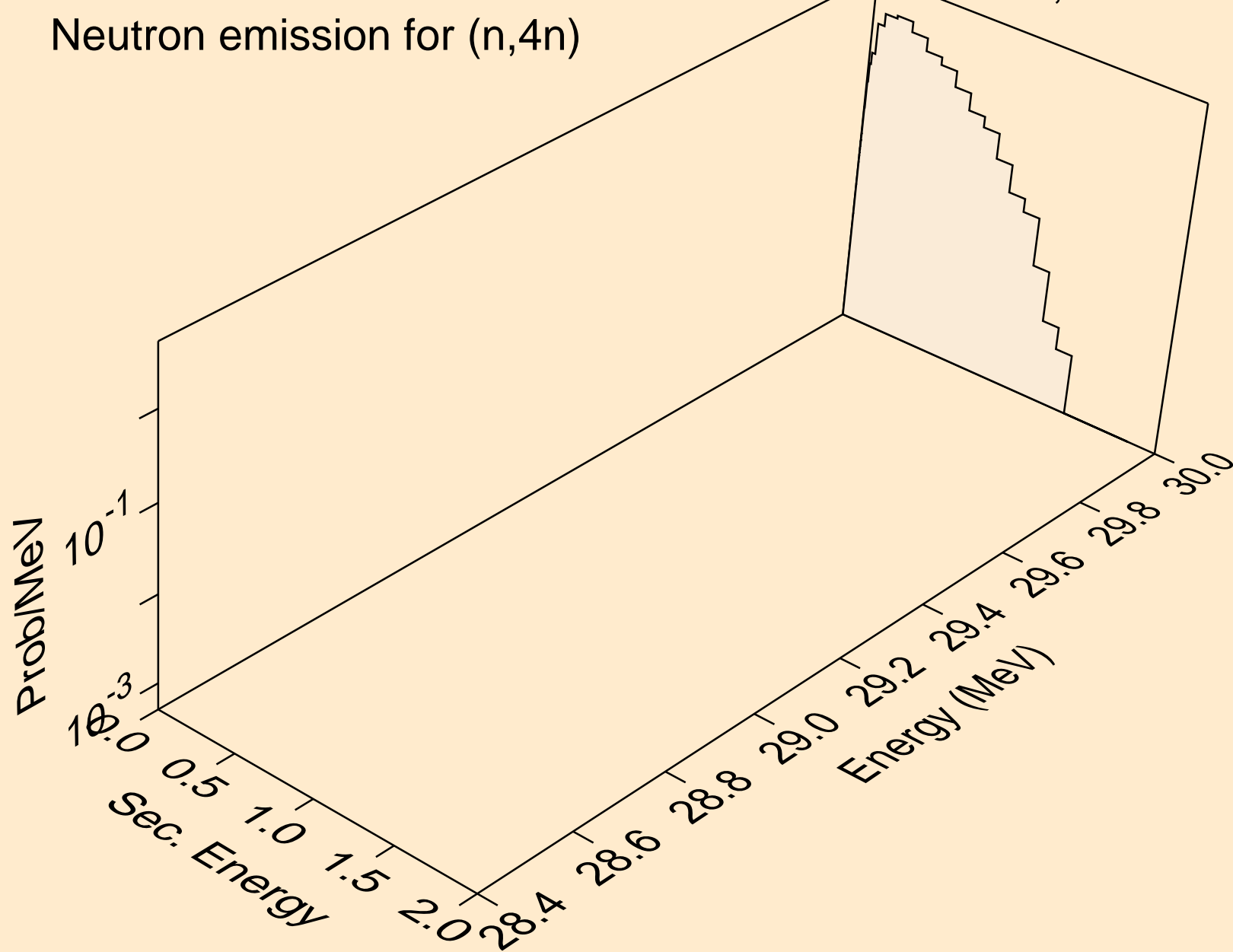

CE131M NEUTRON ACER TENDL-2023 LIBRARY; T=0.K
Neutron emission for (n,2np)

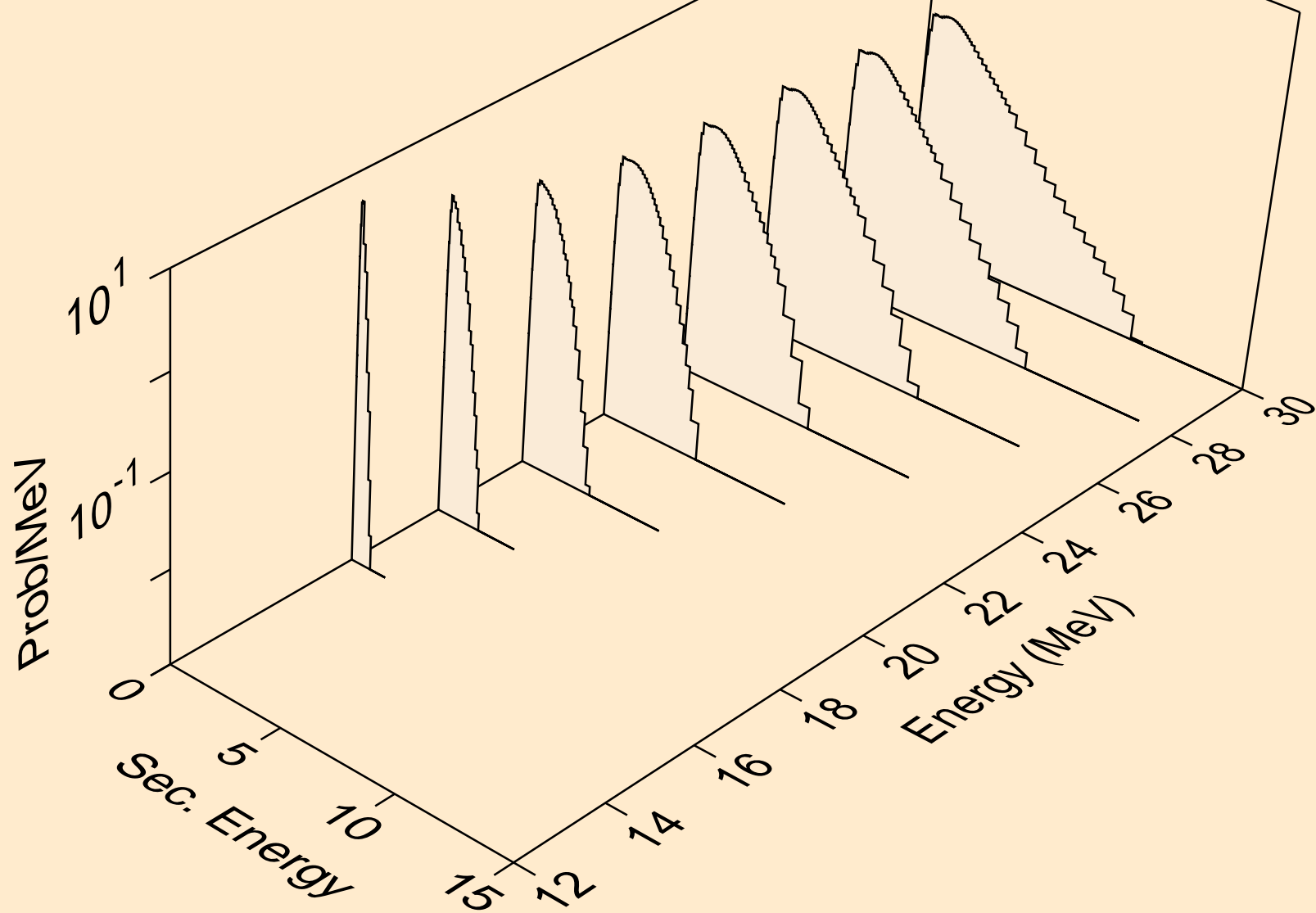

CE131M NEUTRON ACER TENDL-2023 LIBRARY; T=0.K
Neutron emission for (n,3np)

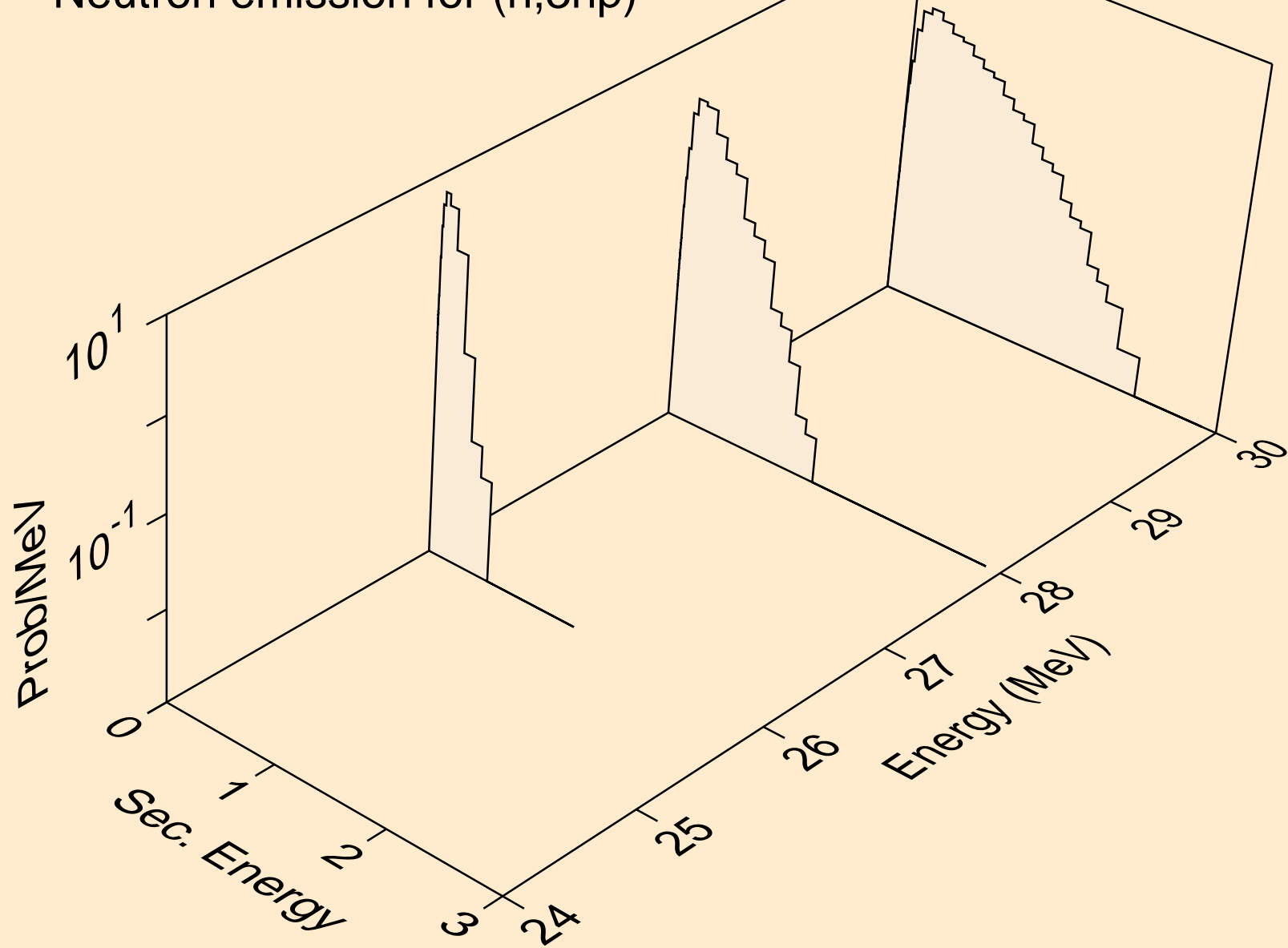

CE131M NEUTRON ACER TENDL-2023 LIBRARY; T=0.K
Neutron emission for (n,n2p)

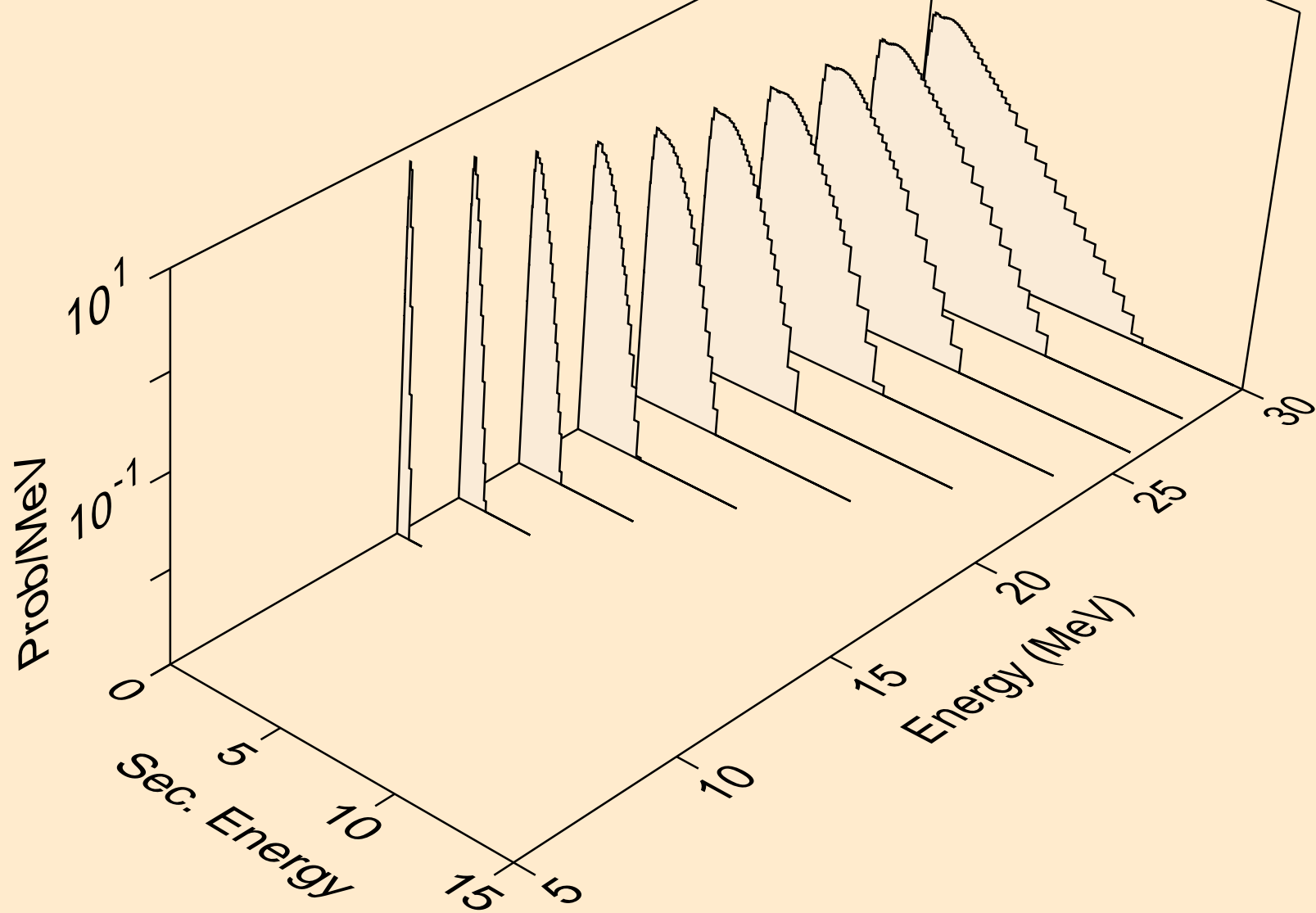

CE131M NEUTRON ACER TENDL-2023 LIBRARY; T=0.K
Neutron emission for (n,npa)

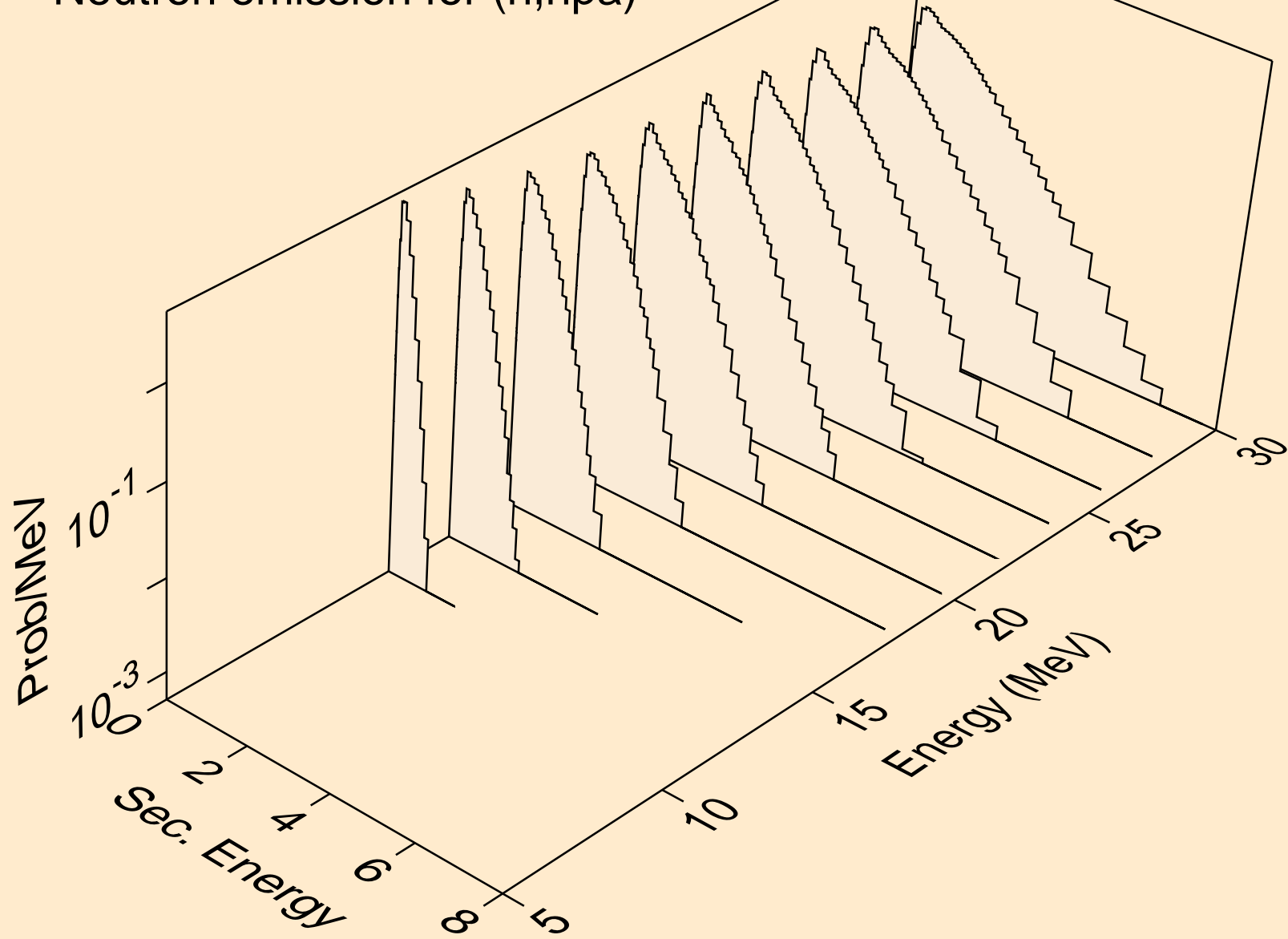

CE131M NEUTRON ACER TENDL-2023 LIBRARY; T=0.K
Neutron emission for (n,n*c)

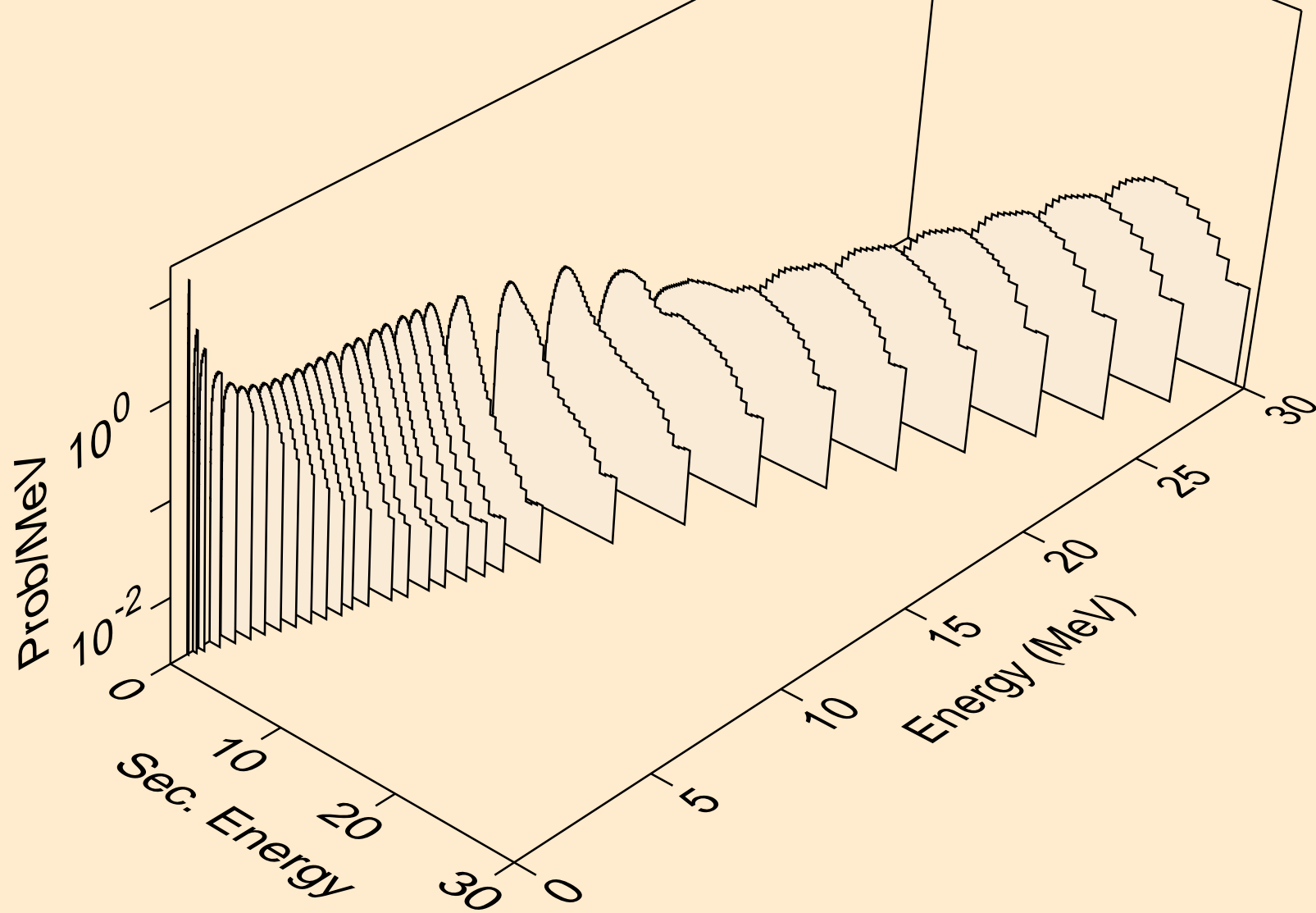

CE131M NEUTRON ACER TENDL-2023 LIBRARY; T=0.K
Photon emission for (n,x)

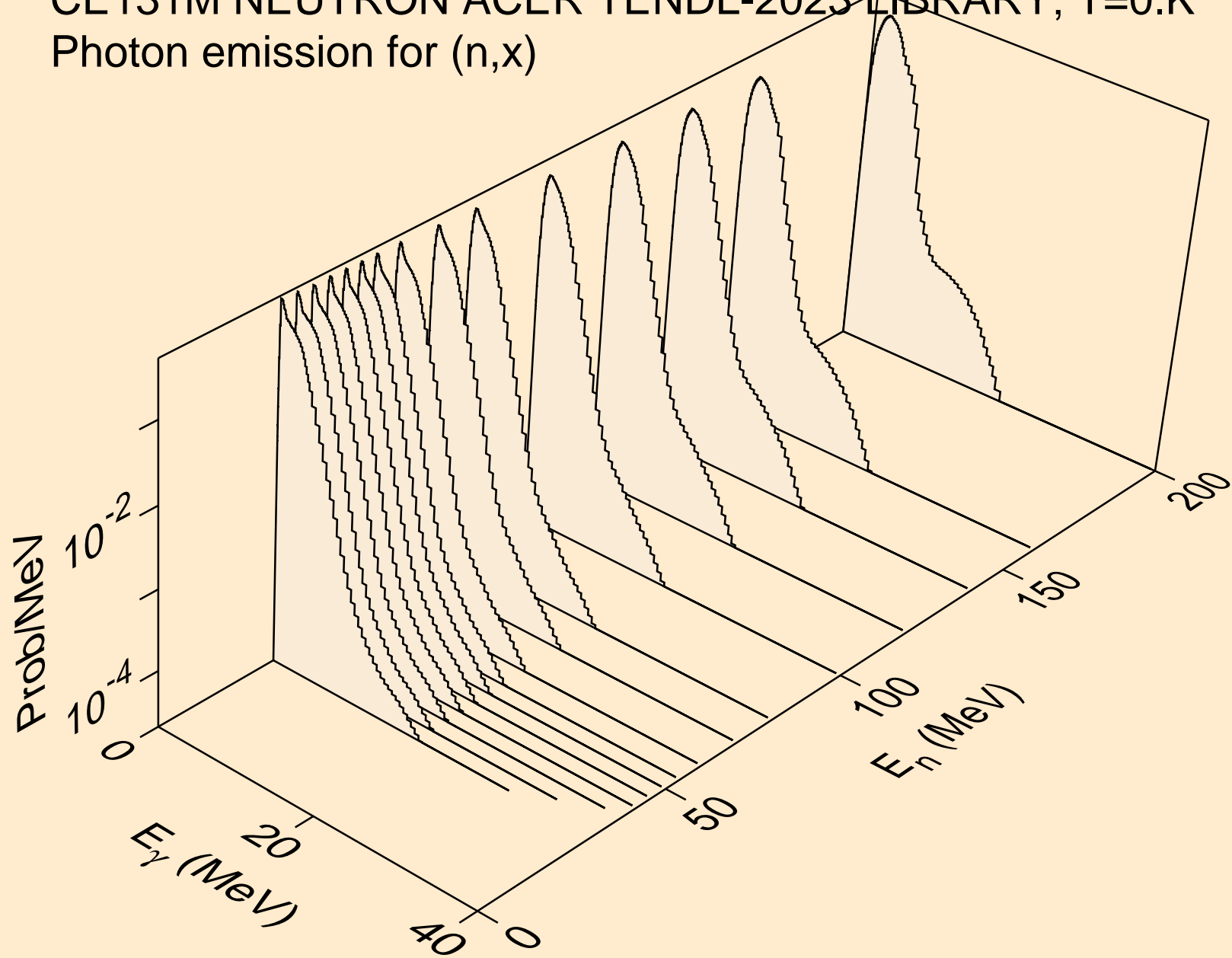

CE131M NEUTRON ACER TENDL-2023 LIBRARY; T=0.K
Photon emission for (n,2nd)

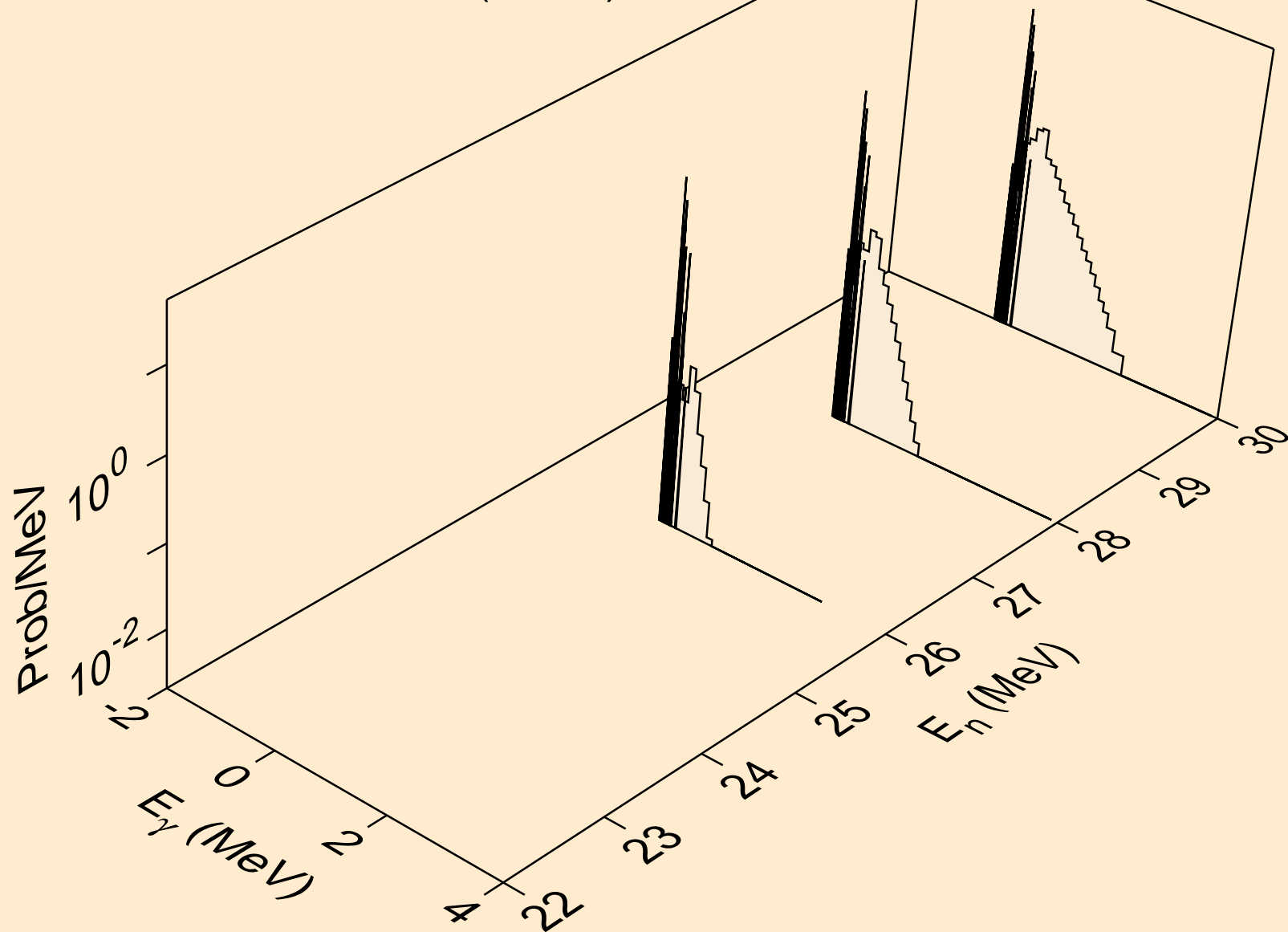

CE131M NEUTRON ACER TENDL-2023 LIBRARY; T=0.K
Photon emission for (n,2n)

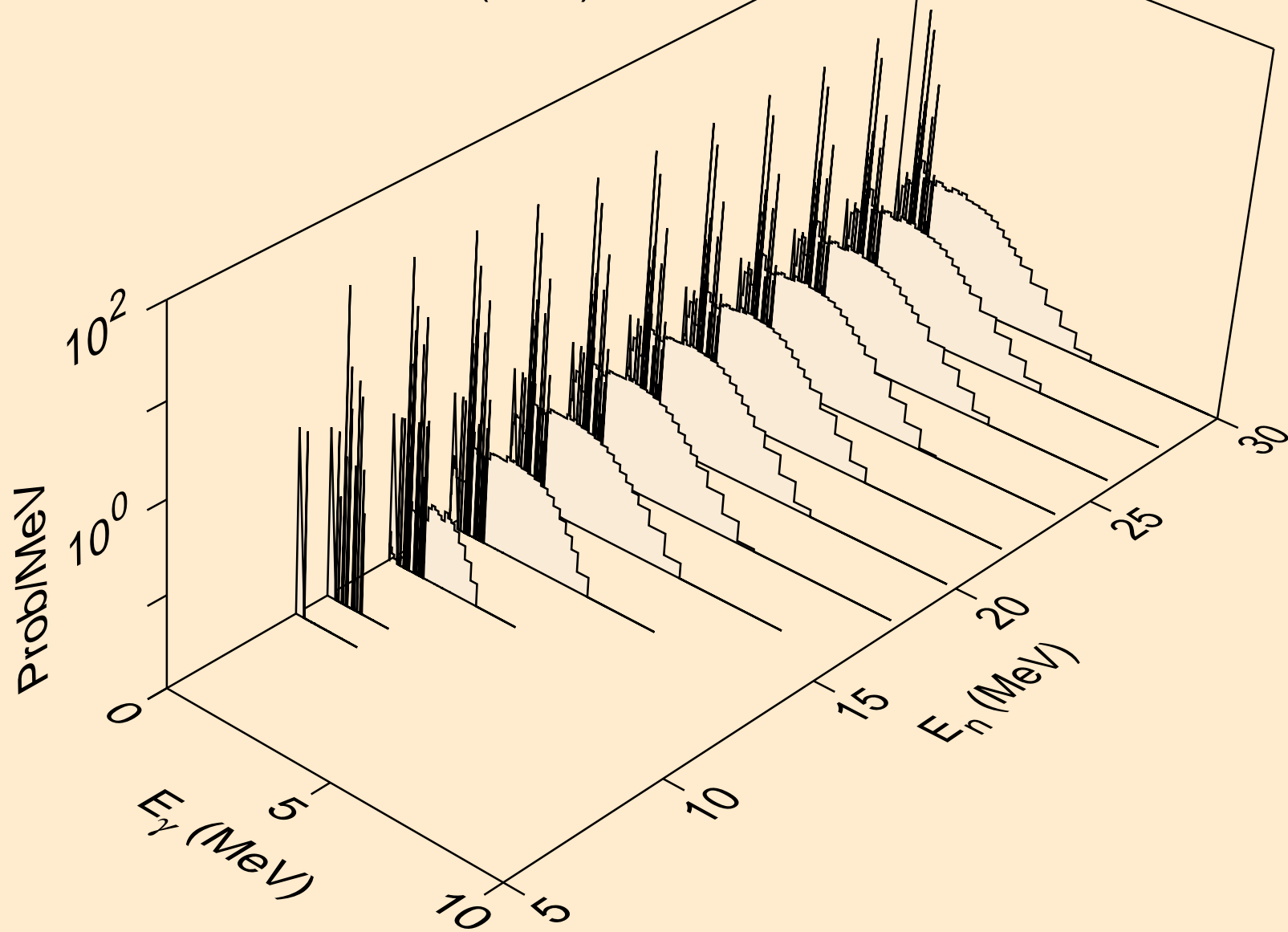

CE131M NEUTRON ACER TENDL-2023 LIBRARY; T=0.K
Photon emission for (n,3n)

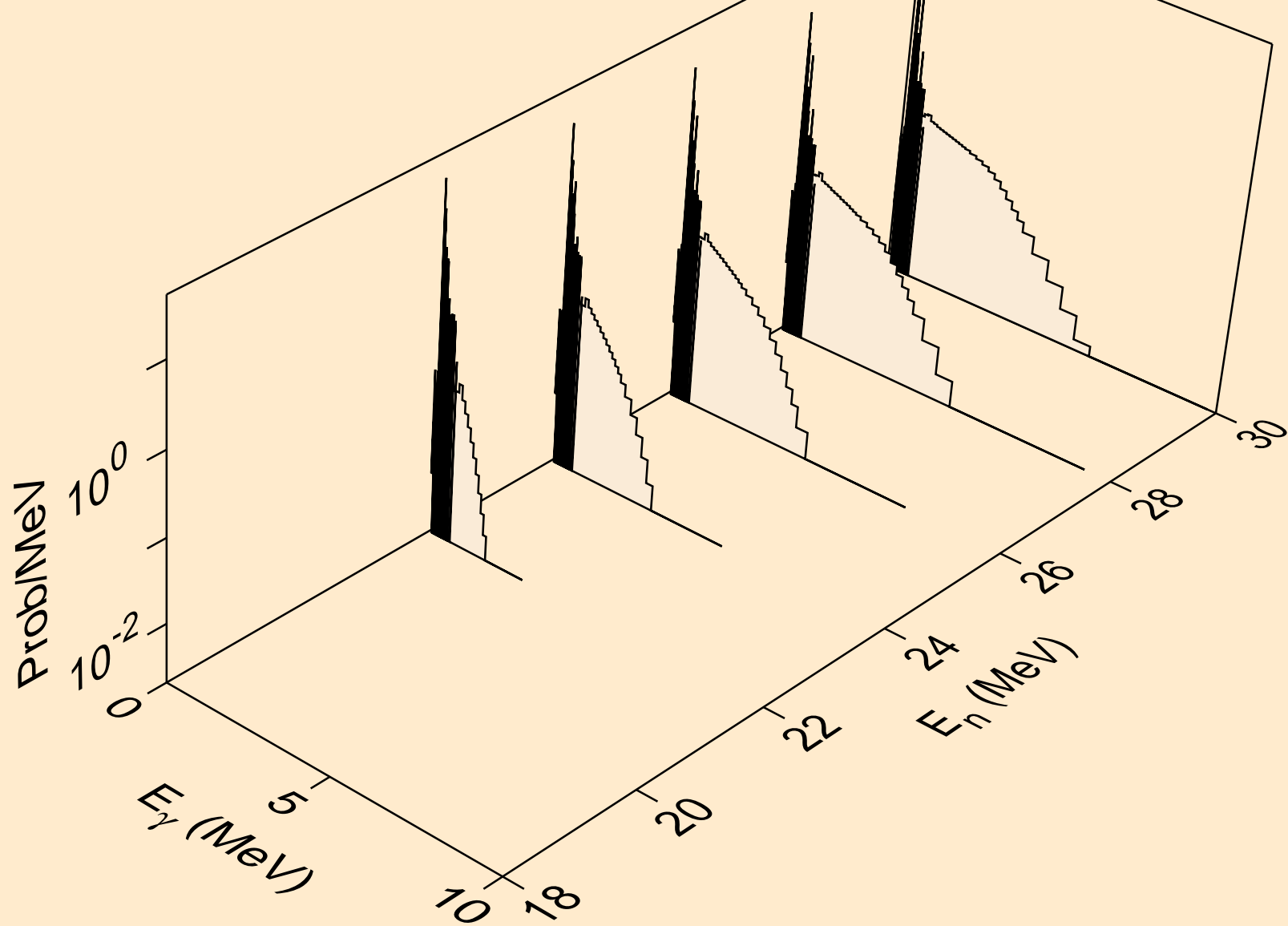

CE131M NEUTRON ACER TENDL-2023 LIBRARY; T=0.K
Photon emission for (n,n*)a

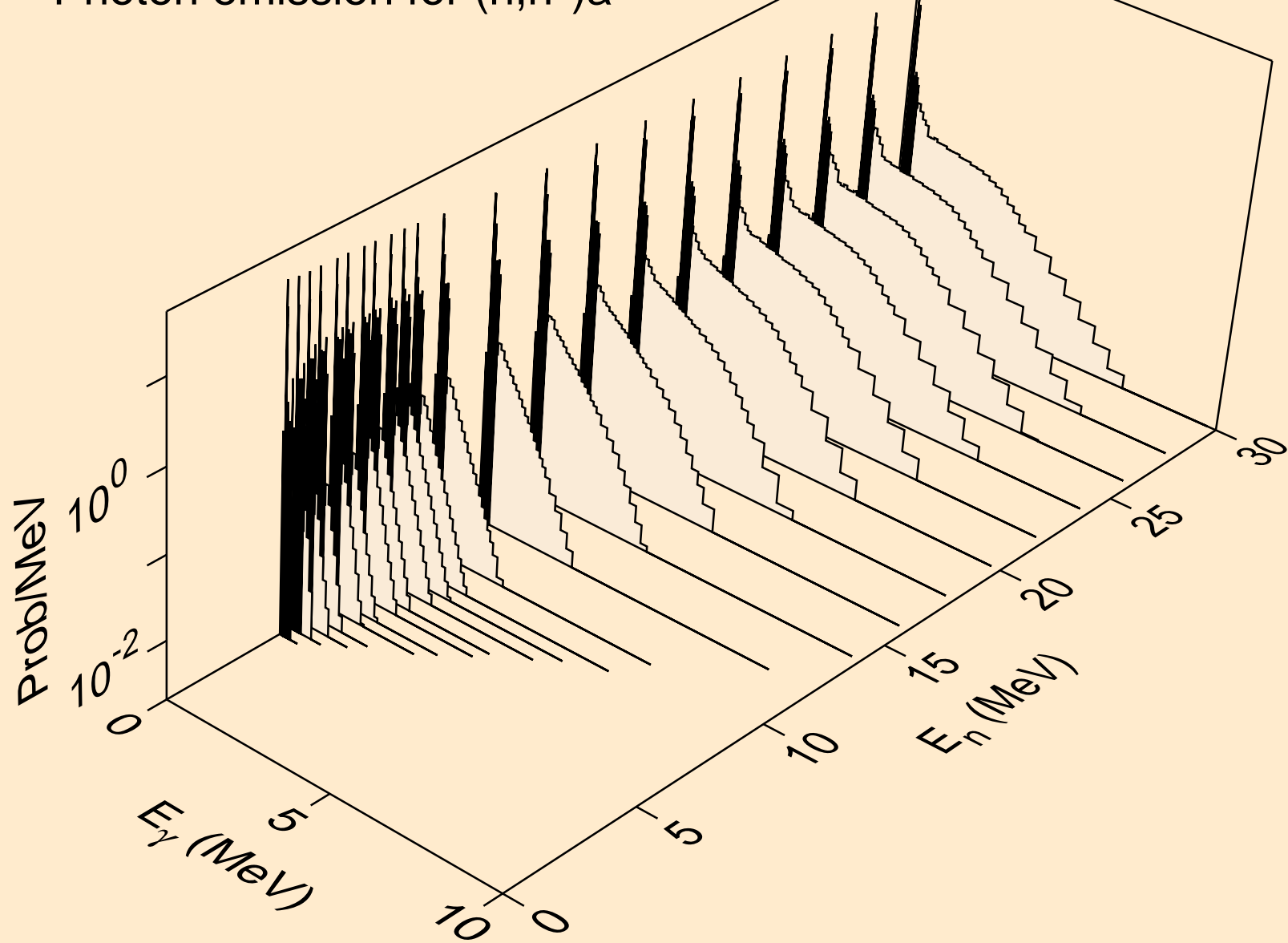

CE131M NEUTRON ACER TENDL-2023 LIBRARY; T=0.K
Photon emission for (n,2n)a

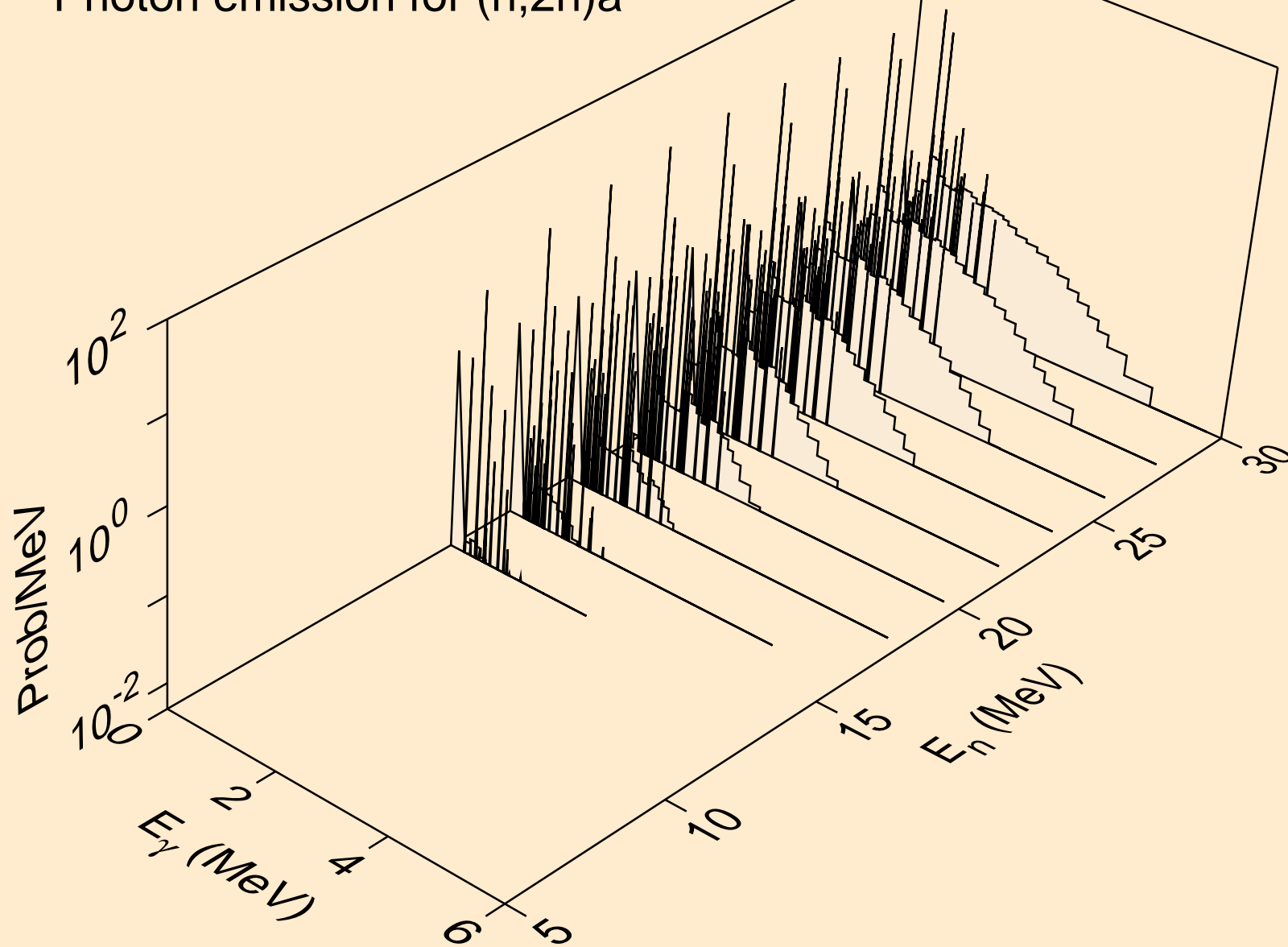

CE131M NEUTRON ACER TENDL-2023 LIBRARY; T=0.K
Photon emission for (n,3n)a

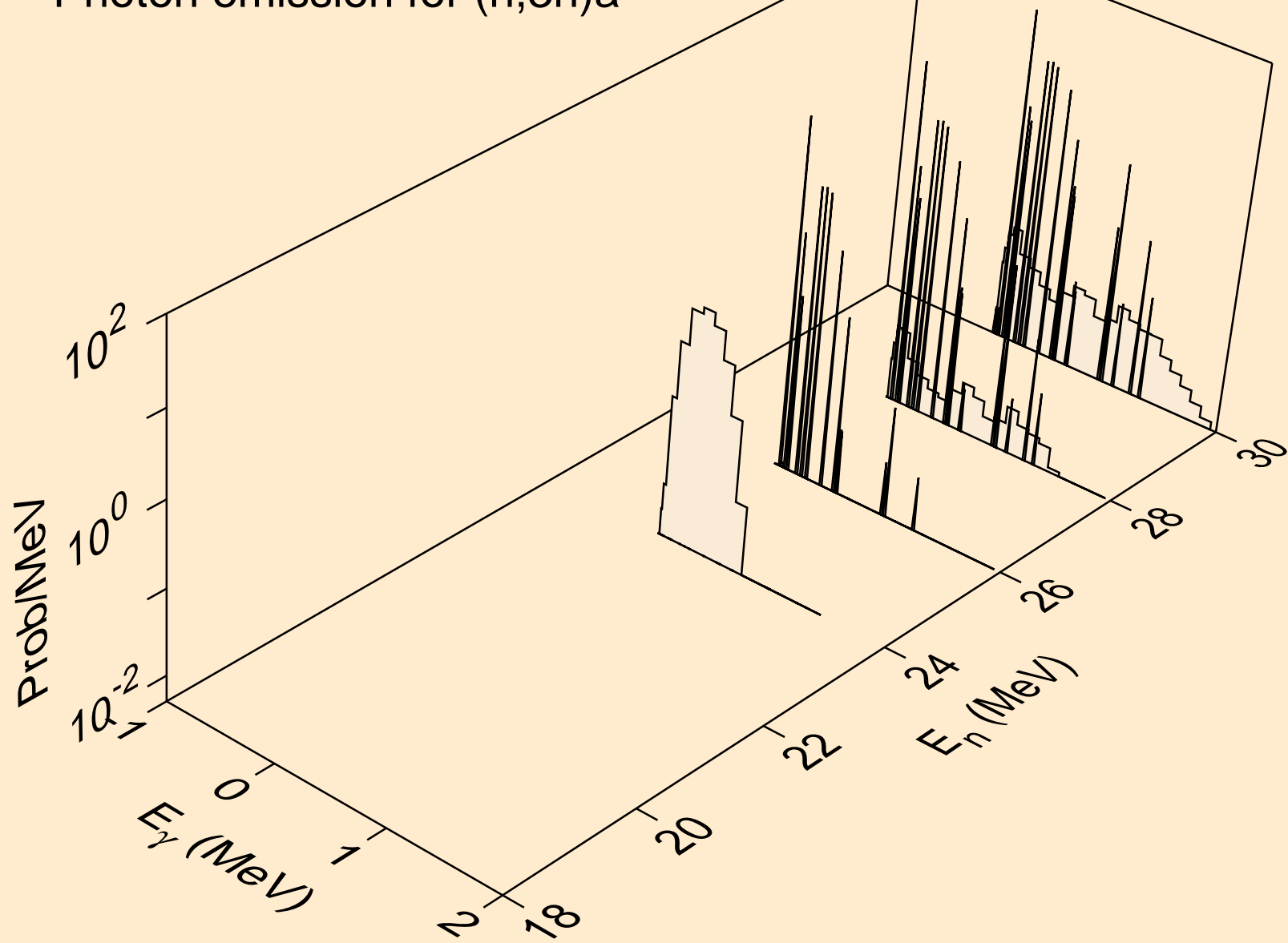

CE131M NEUTRON ACER TENDL-2023 LIBRARY; T=0.K
Photon emission for (n,n*)p

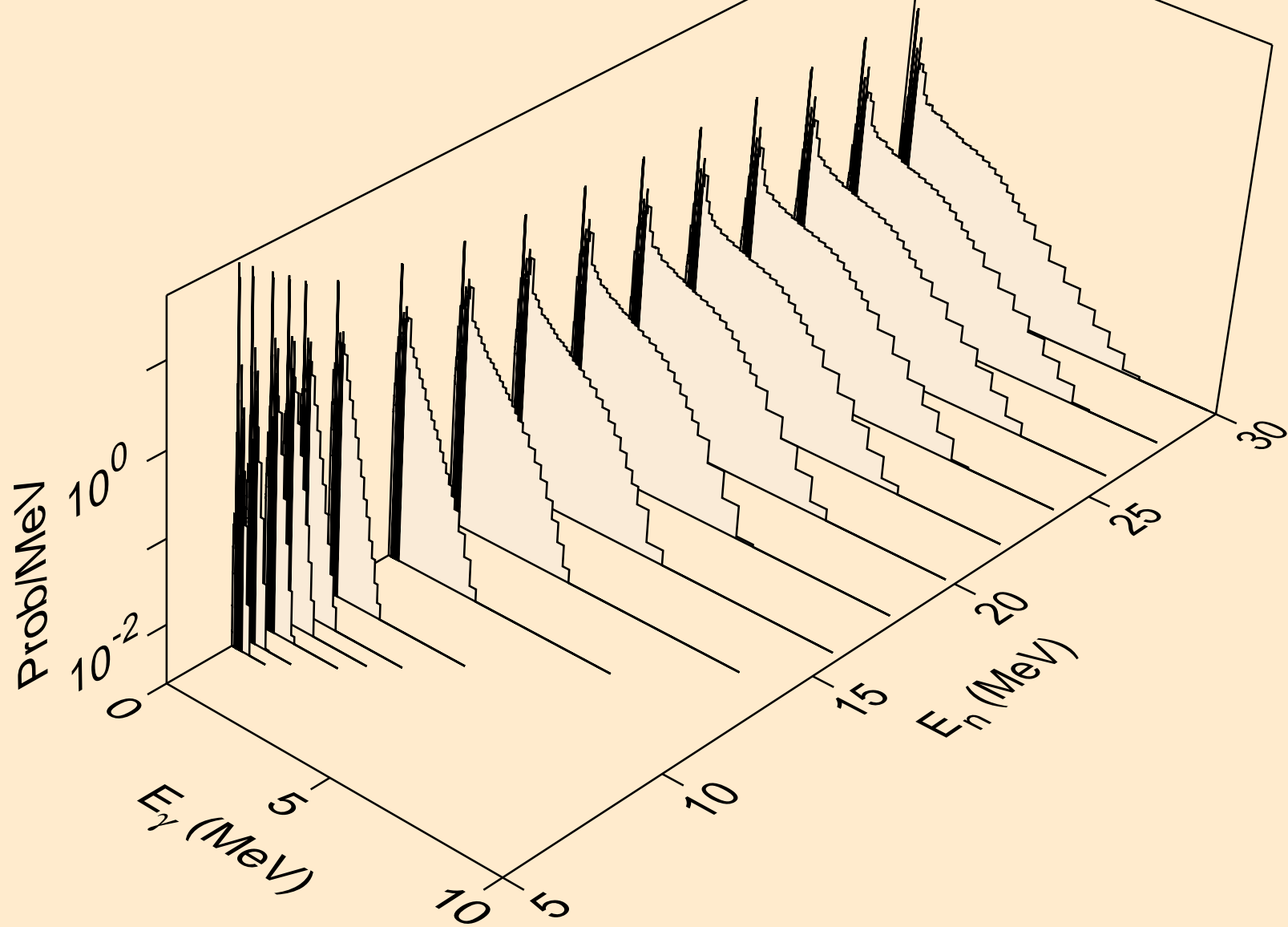

CE131M NEUTRON ACER TENDL-2023 LIBRARY; T=0.K
Photon emission for (n,n*)2a

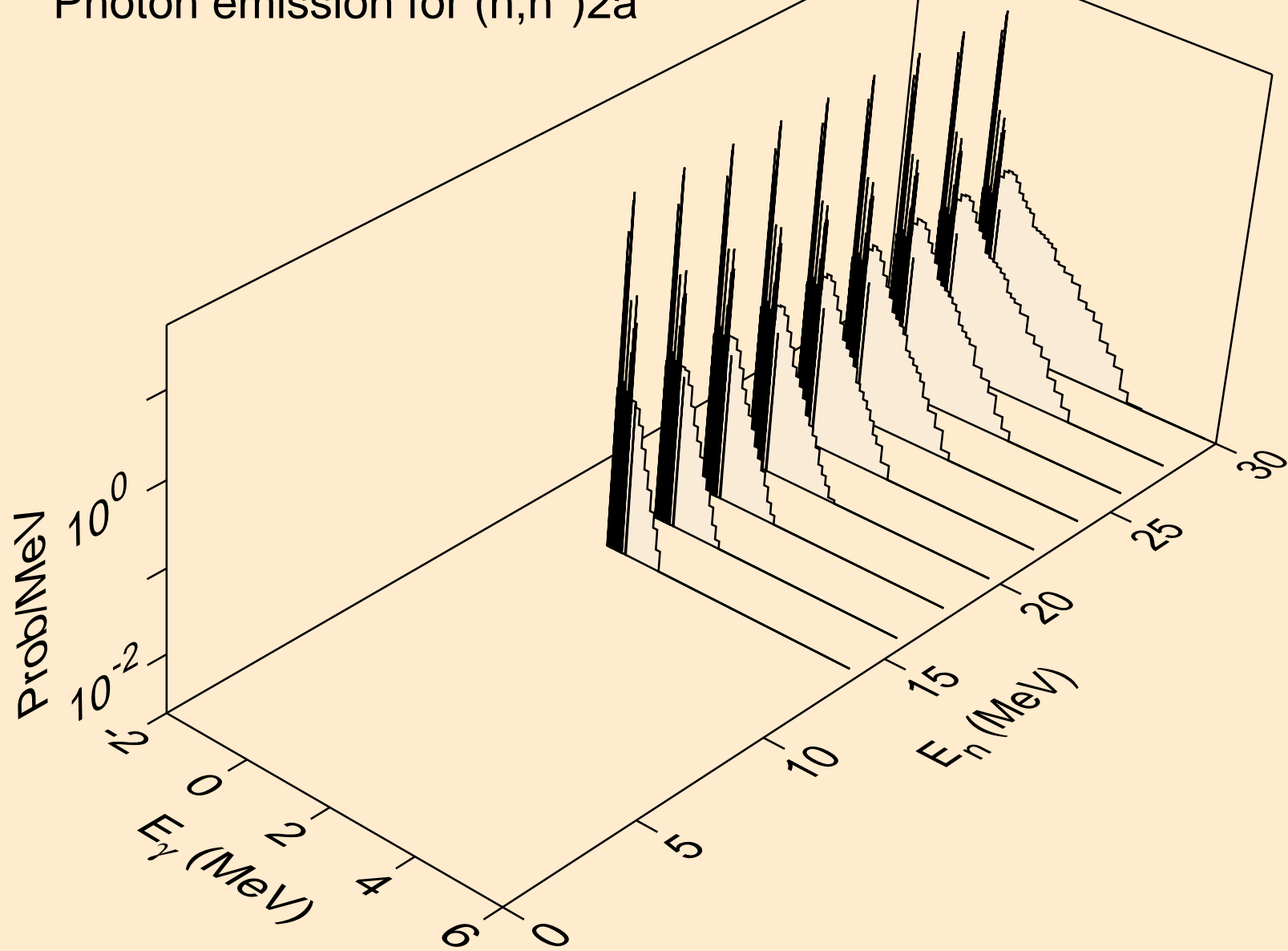

CE131M NEUTRON ACER TENDL-2023 LIBRARY; T=0.K
Photon emission for (n,2n)2a

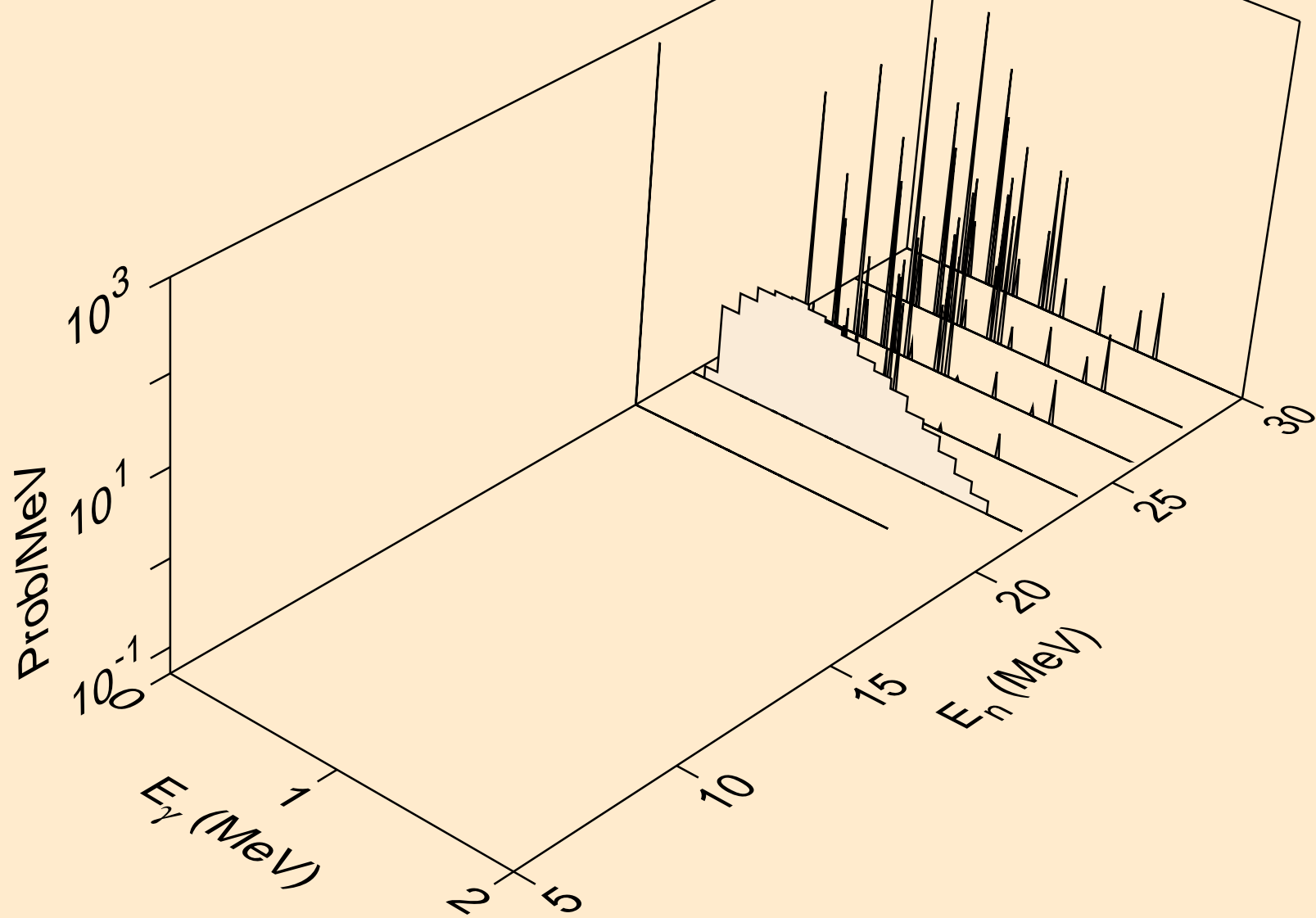

CE131M NEUTRON ACER TENDL-2023 LIBRARY; T=0.K
Photon emission for (n,n*)d

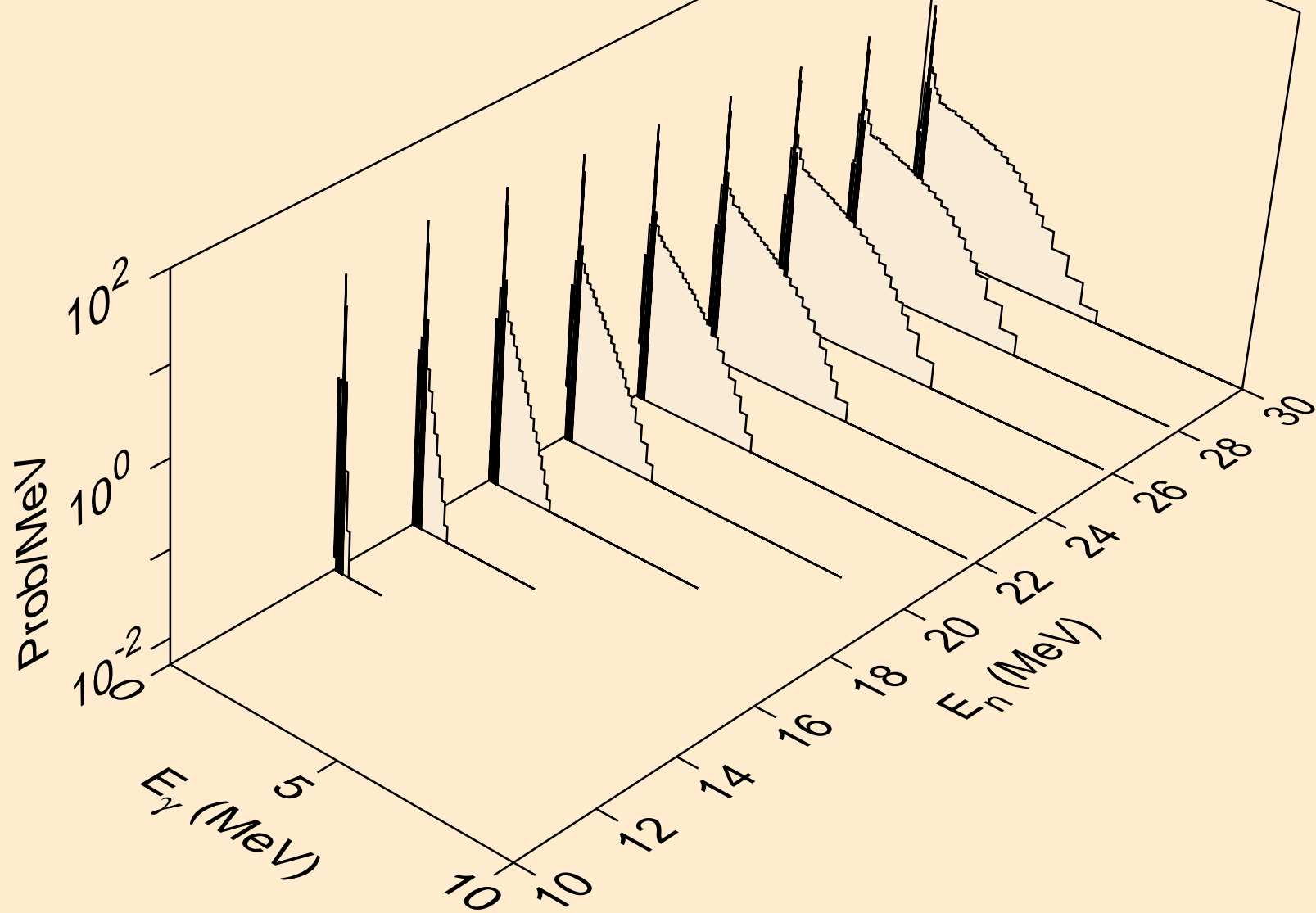

CE131M NEUTRON ACER TENDL-2023 LIBRARY; T=0.K
Photon emission for (n,n*)t

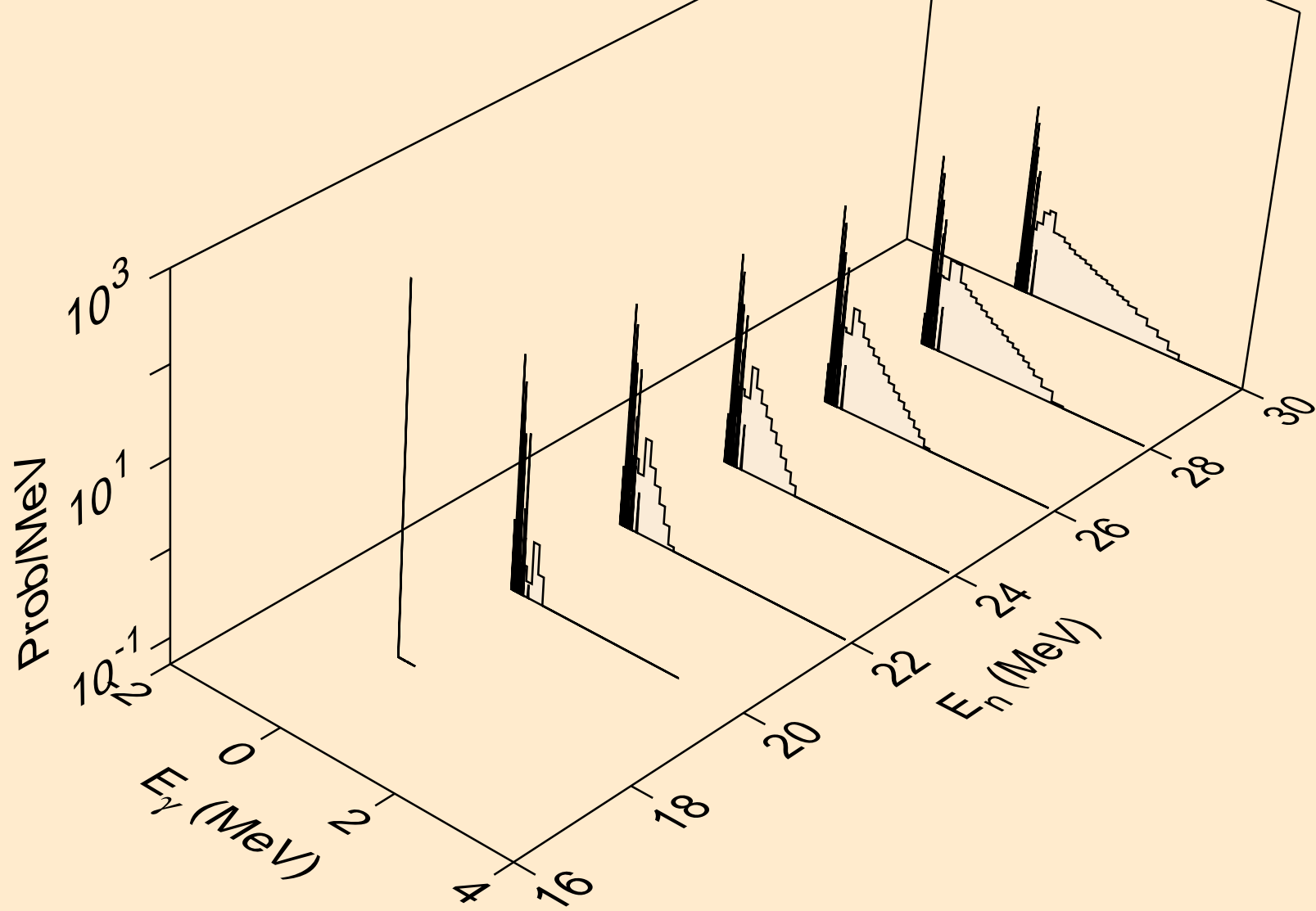

CE131M NEUTRON ACER TENDL-2023 LIBRARY; T=0.K
Photon emission for (n,n*)he3

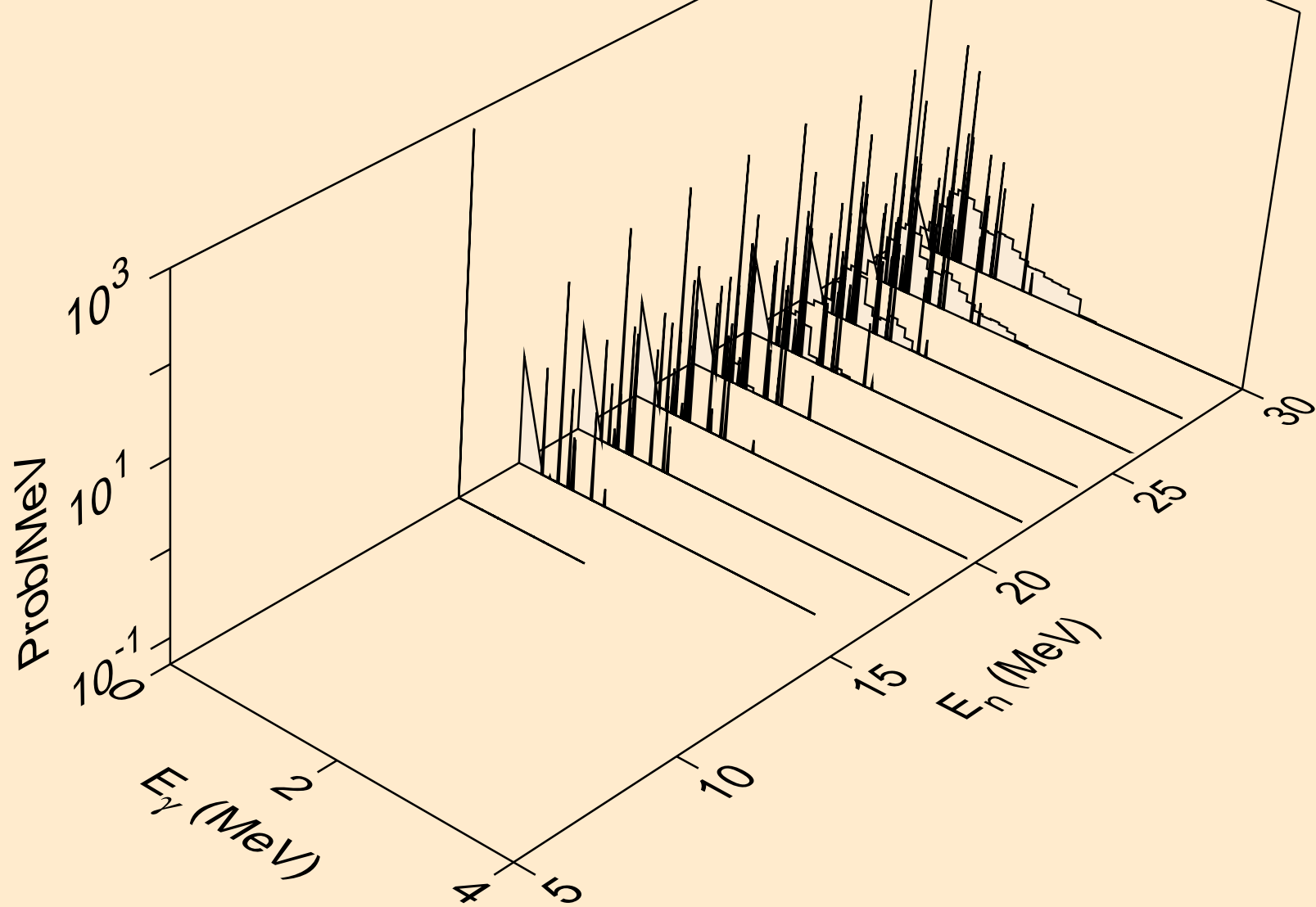

CE131M NEUTRON ACER TENDL-2023 LIBRARY; T=0.K
Photon emission for (n,4n)

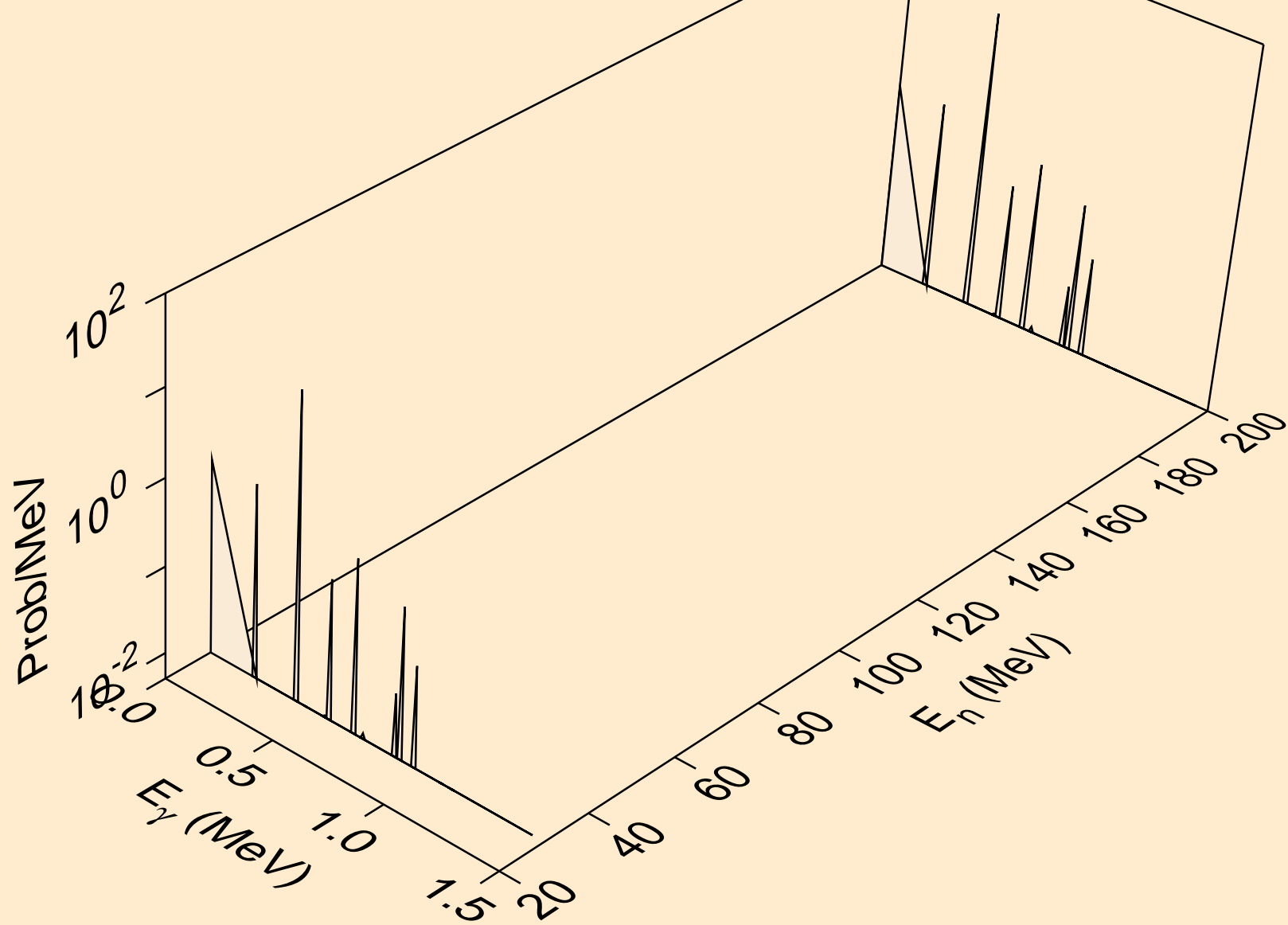

CE131M NEUTRON ACER TENDL-2023 LIBRARY; T=0.K
Photon emission for (n,2np)

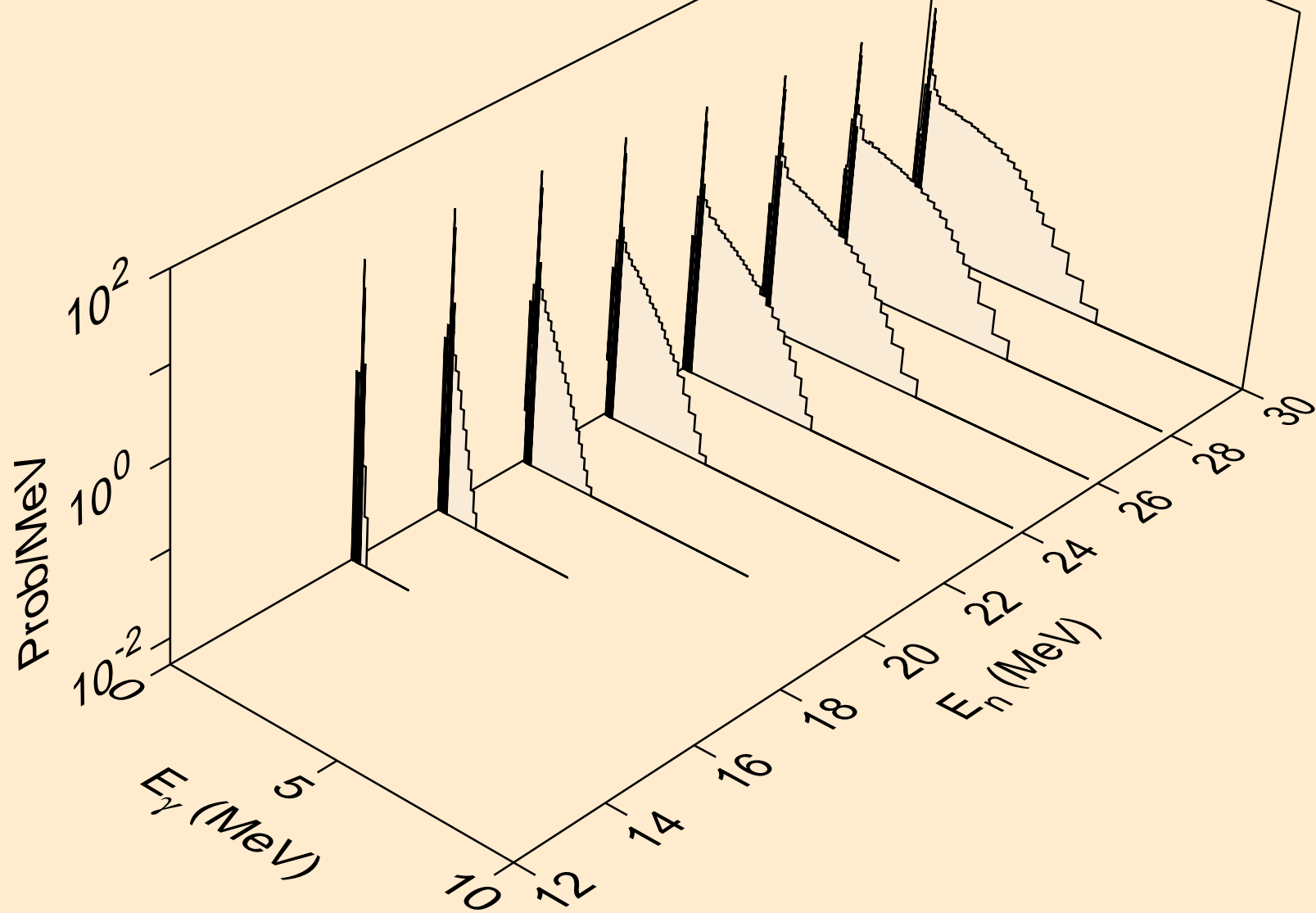

CE131M NEUTRON ACER TENDL-2023 LIBRARY; T=0.K
Photon emission for (n,3np)

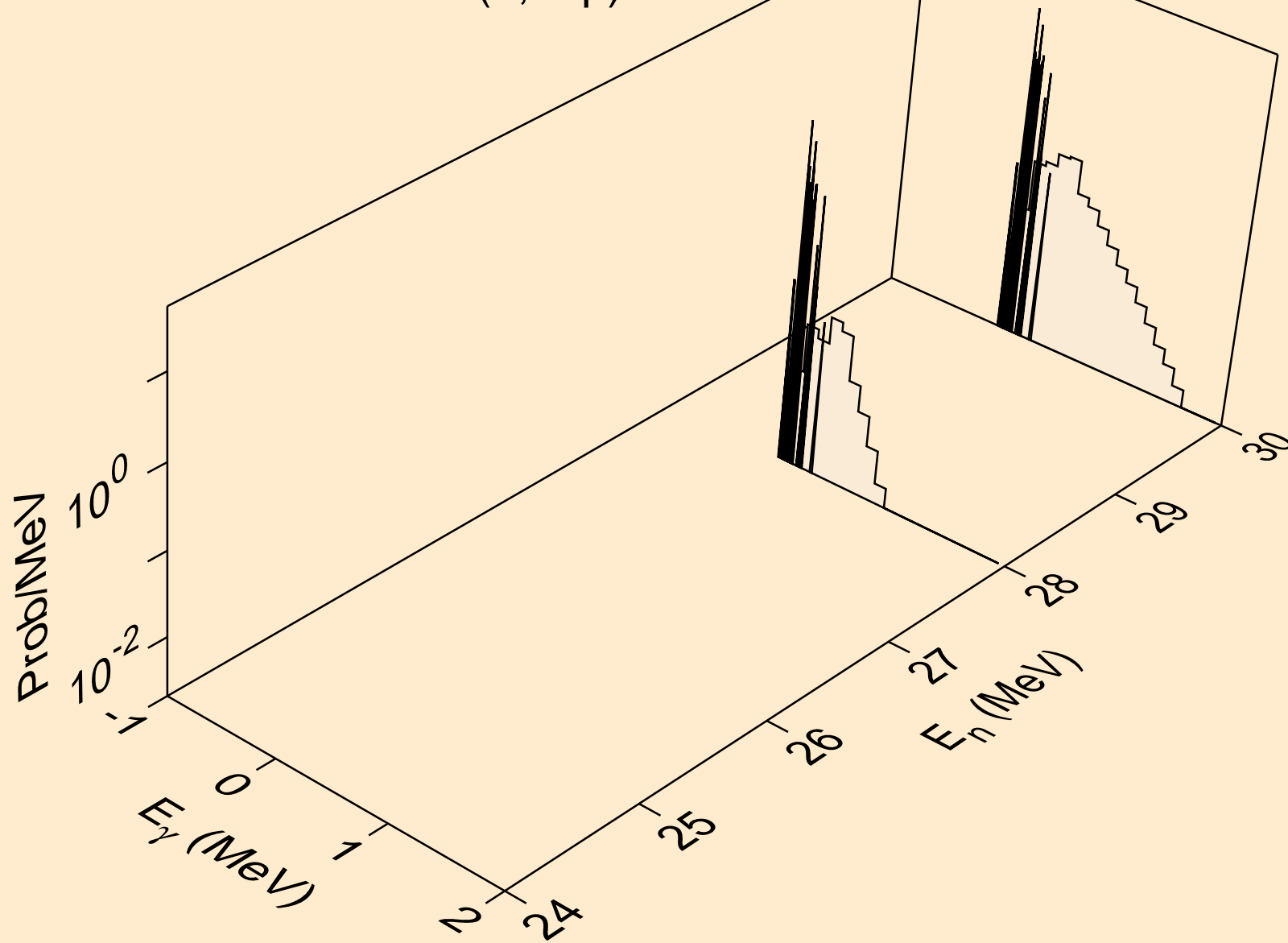

CE131M NEUTRON ACER TENDL-2023 LIBRARY; T=0.K
Photon emission for (n,n2p)

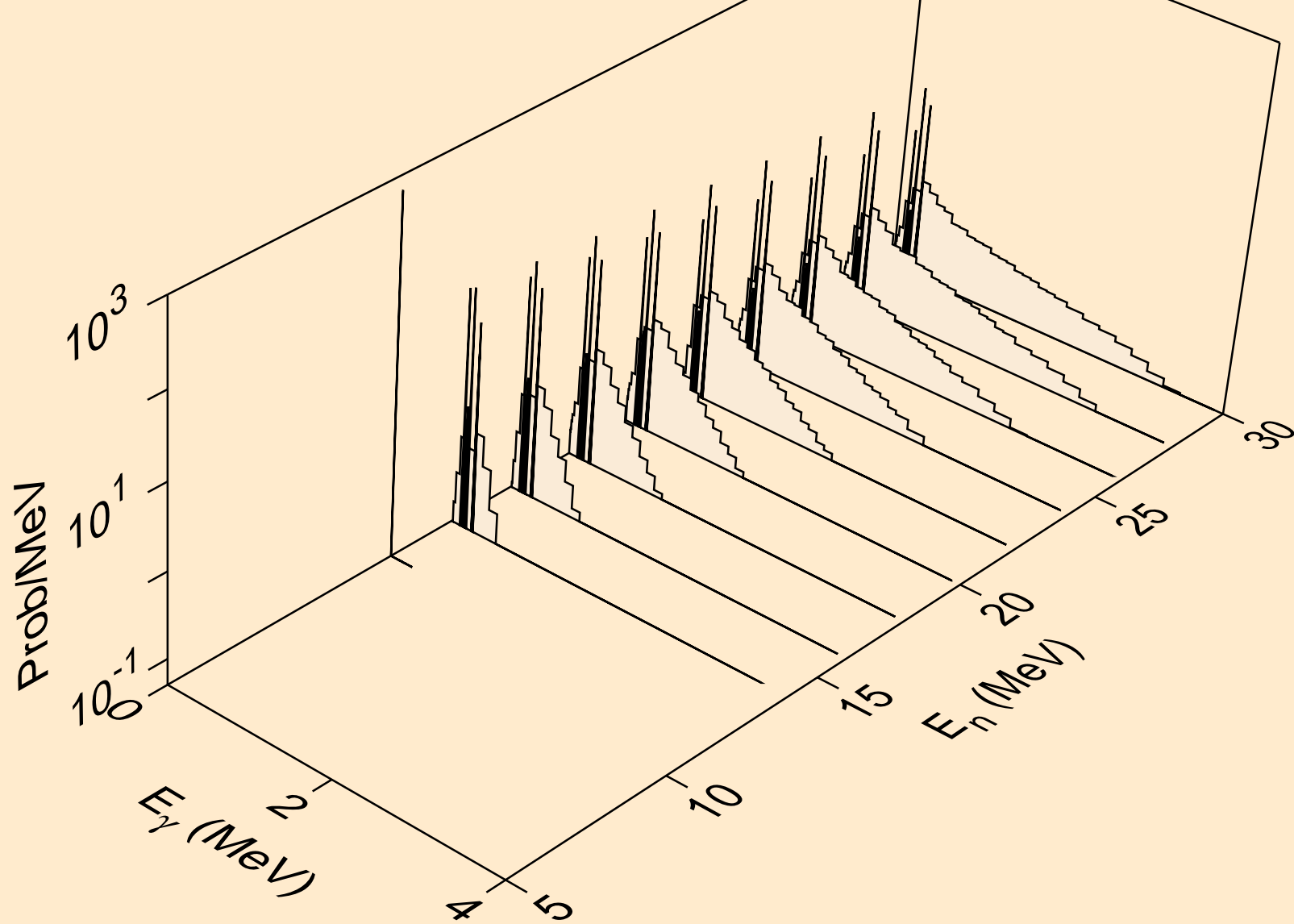

CE131M NEUTRON ACER TENDL-2023 LIBRARY; T=0.K
Photon emission for (n,npa)

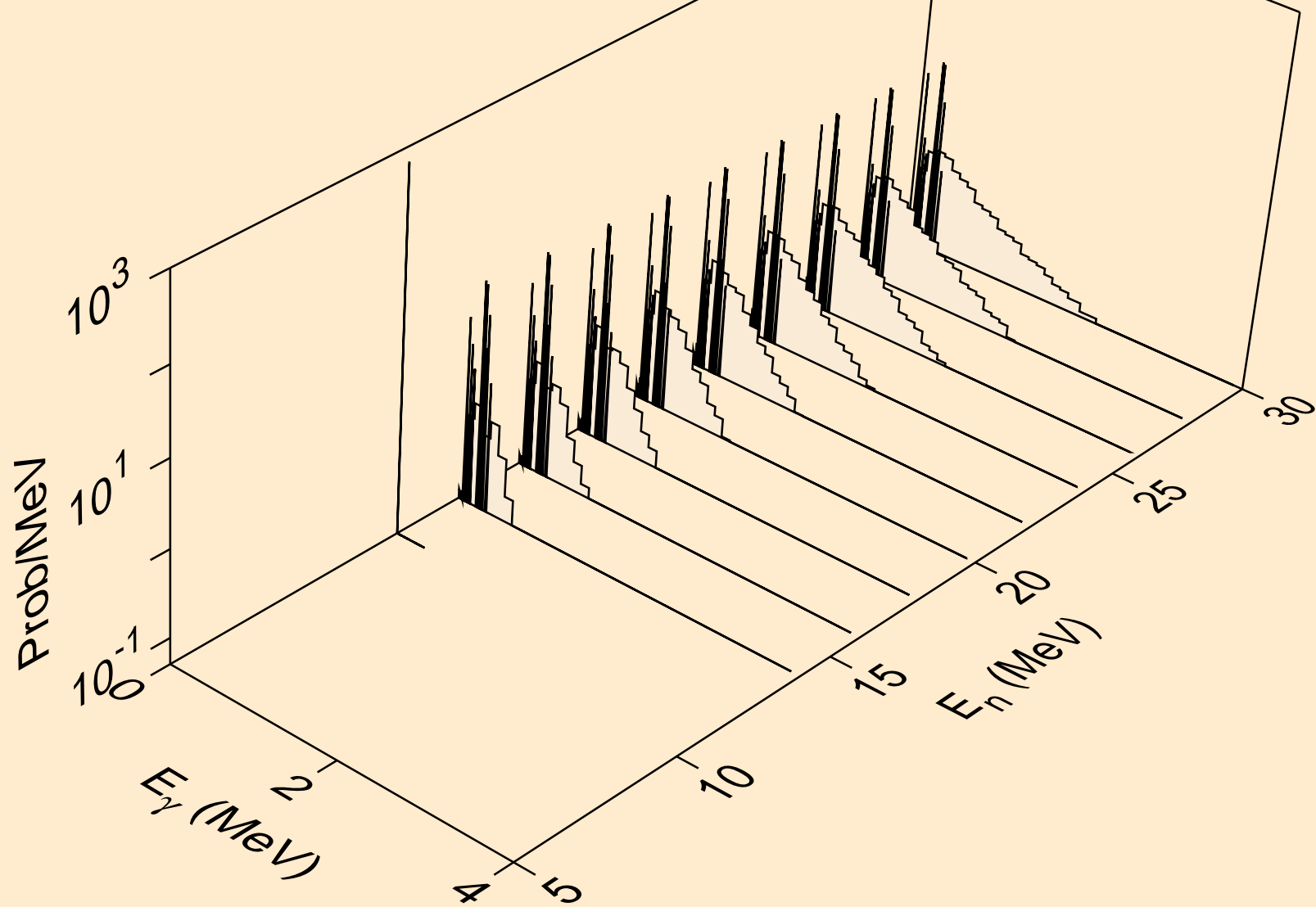

CE131M NEUTRON ACER TENDL-2023 LIBRARY; T=0.K
Photon emission for (n,n*2)

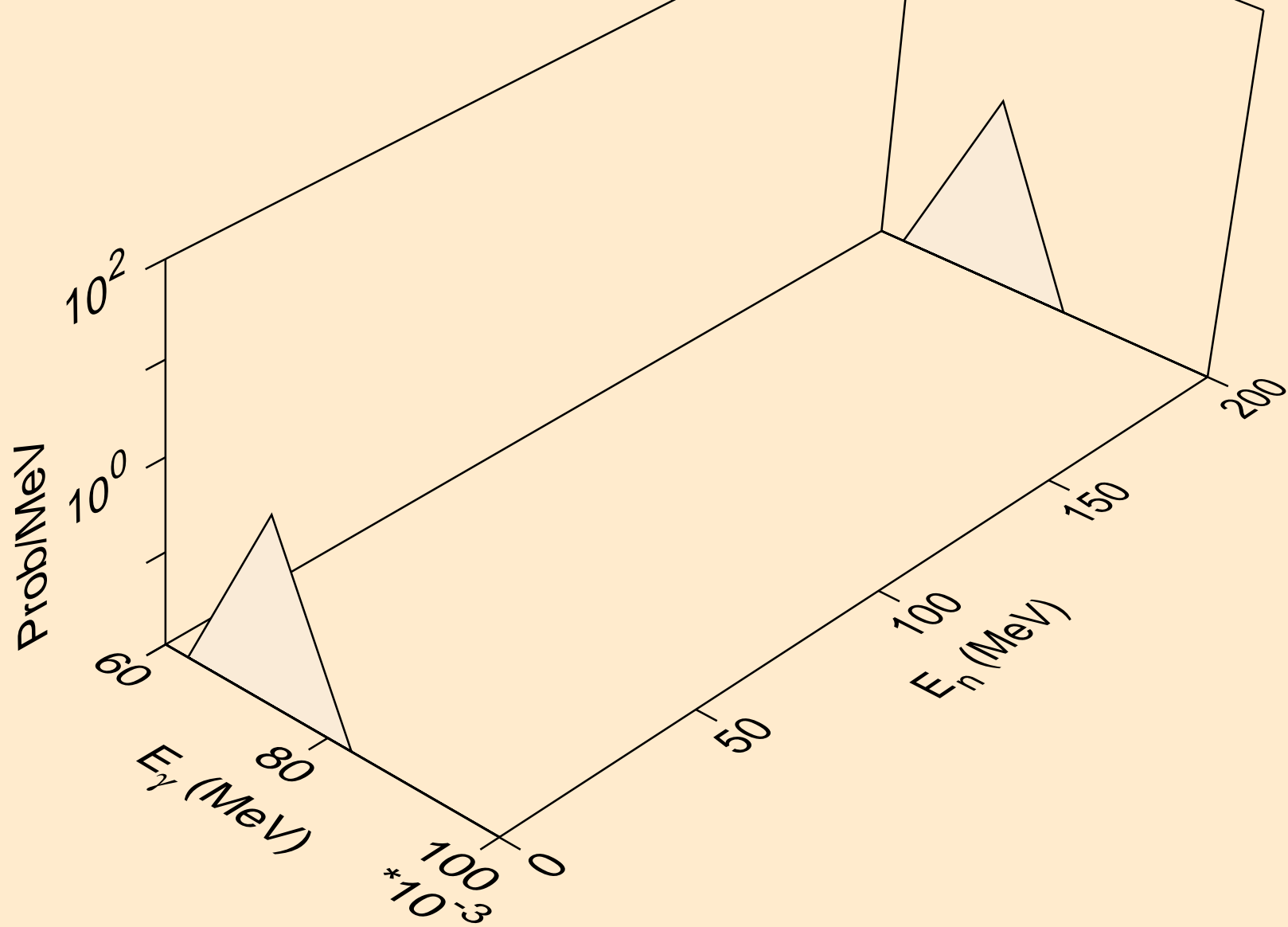

CE131M NEUTRON ACER TENDL-2023 LIBRARY; T=0.K
Photon emission for (n,n*3)

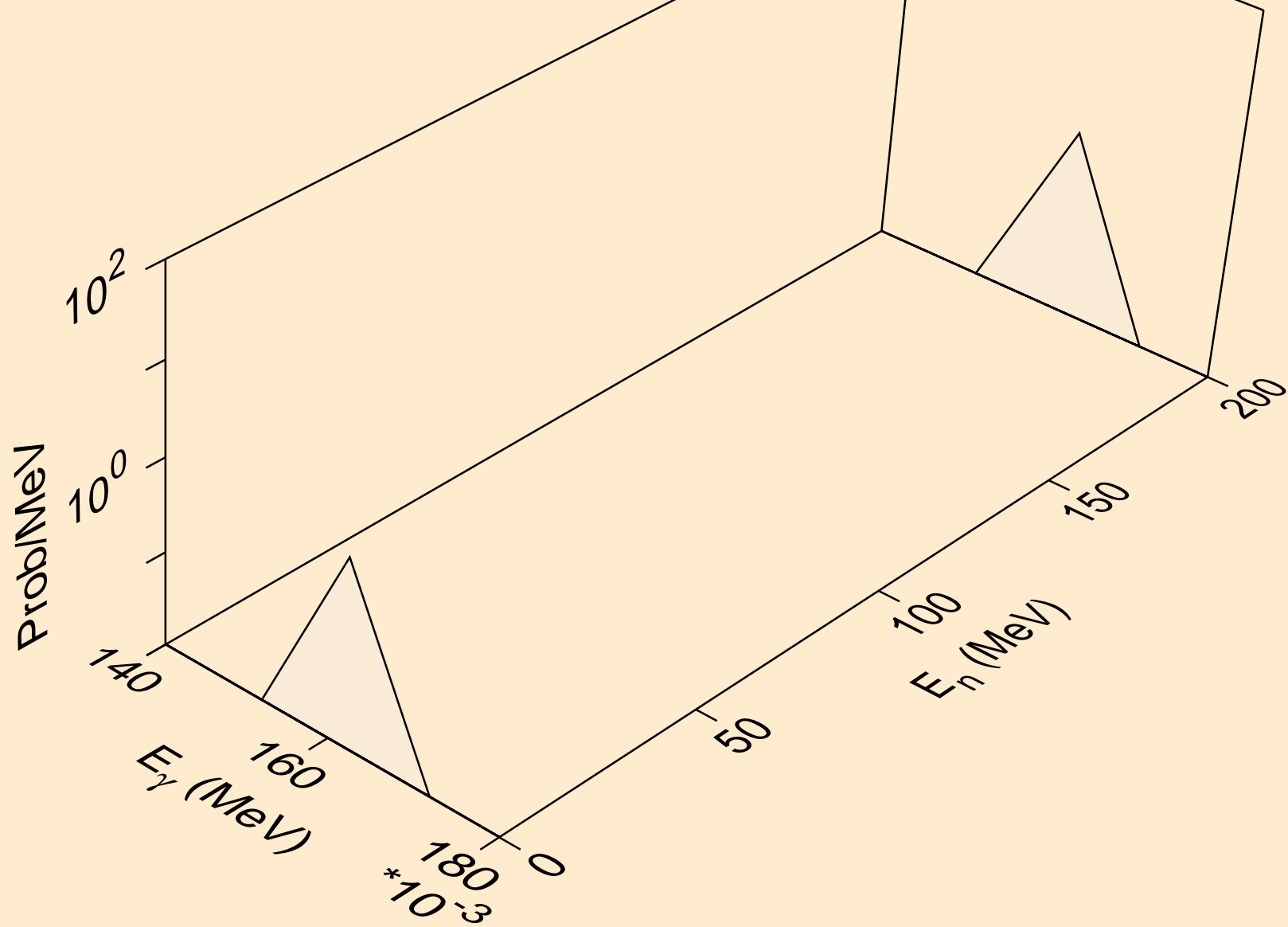

CE131M NEUTRON ACER TENDL-2023 LIBRARY; T=0.K
Photon emission for (n,n*4)

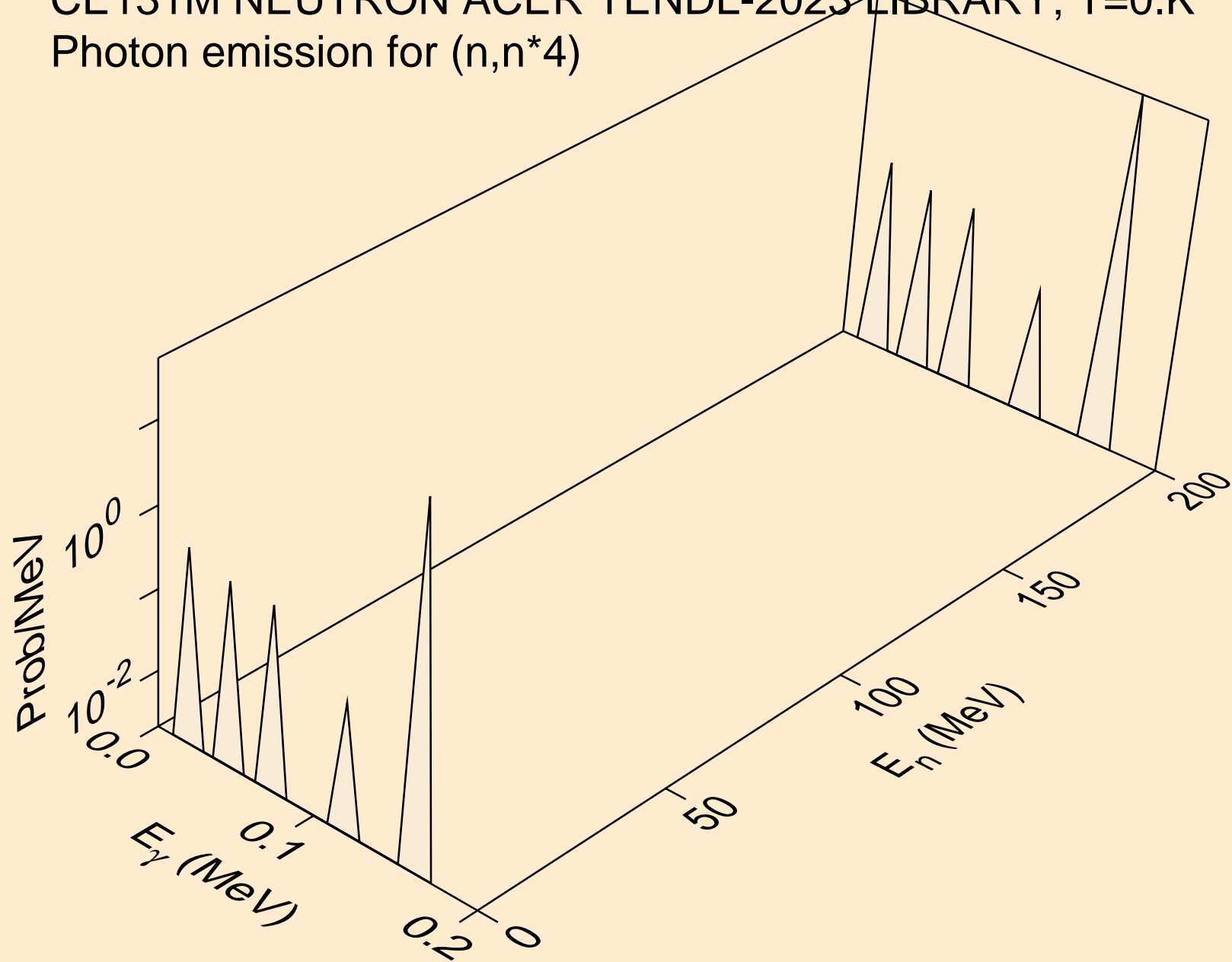

CE131M NEUTRON ACER TENDL-2023 LIBRARY; T=0.K
Photon emission for (n,n*5)

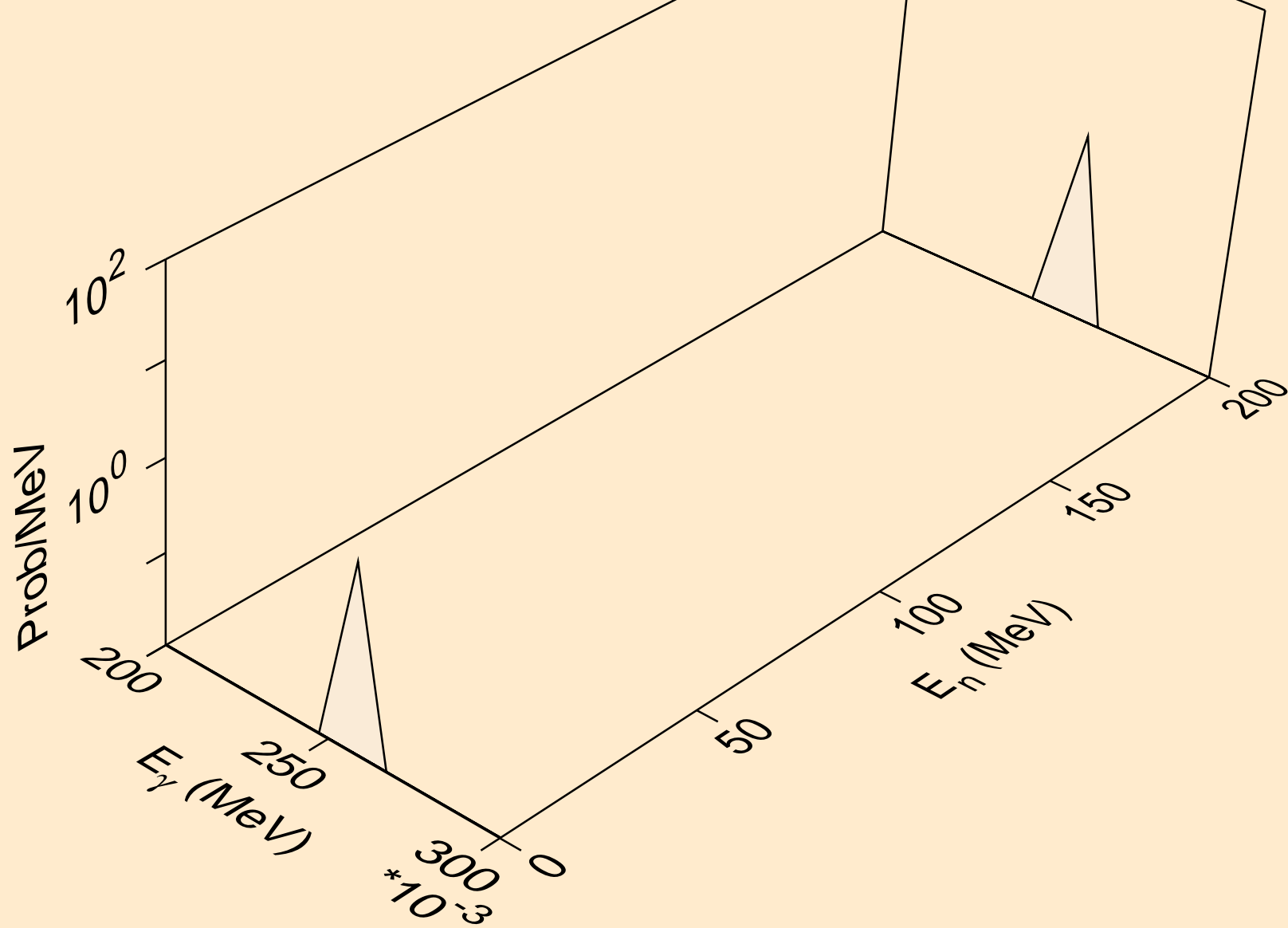

CE131M NEUTRON ACER TENDL-2023 LIBRARY; T=0.K
Photon emission for (n,n*6)

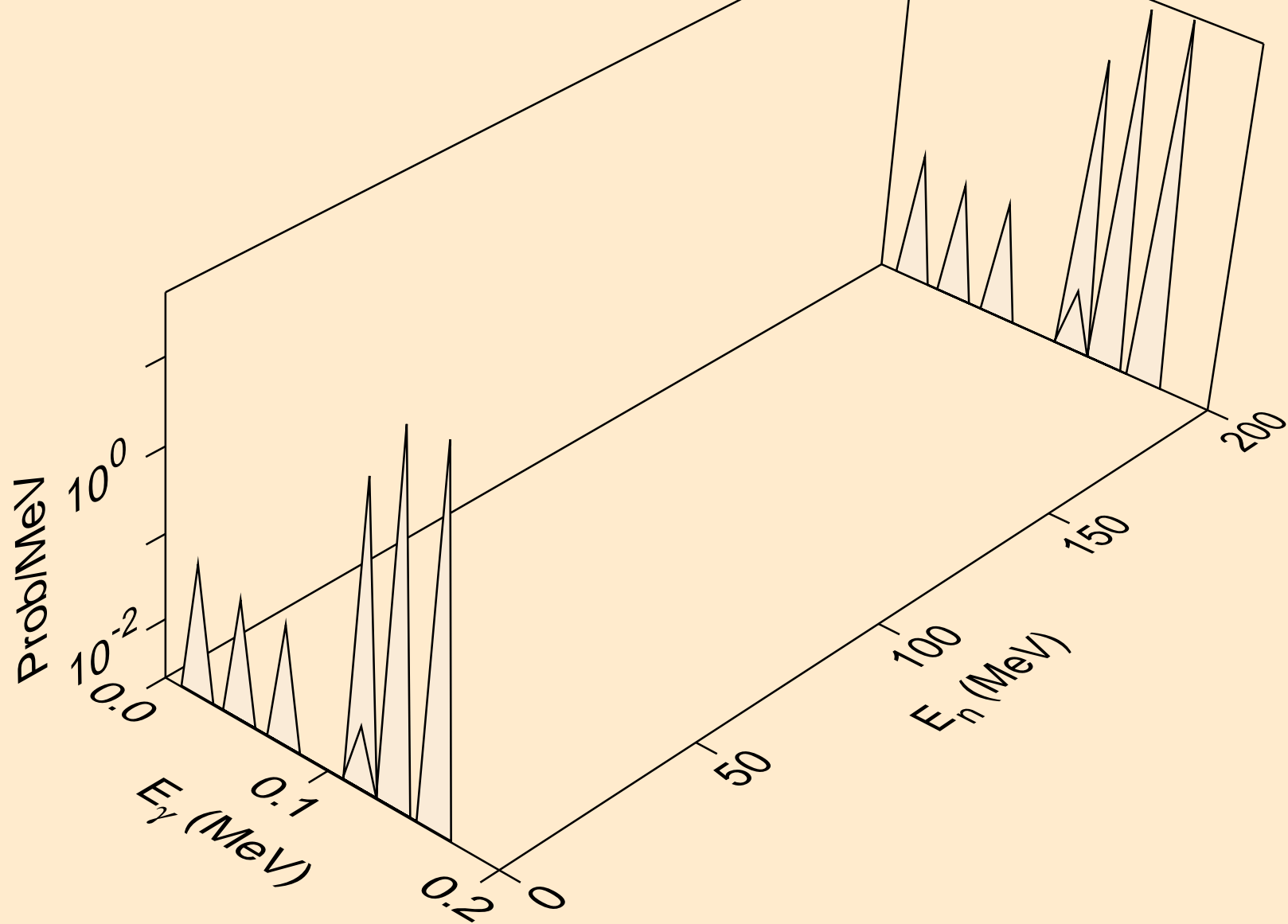

CE131M NEUTRON ACER TENDL-2023 LIBRARY; T=0.K
Photon emission for (n,n*7)

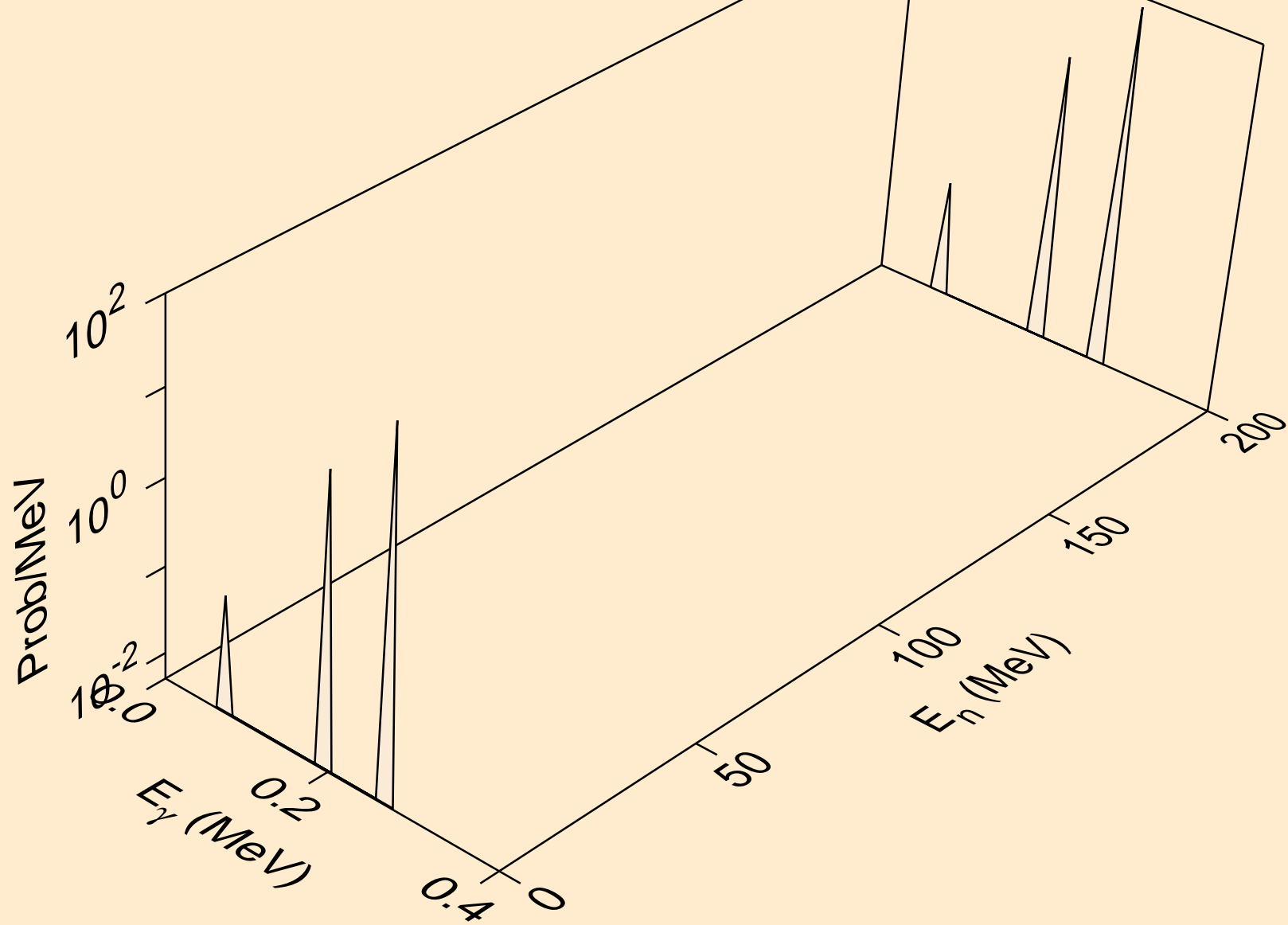

CE131M NEUTRON ACER TENDL-2023 LIBRARY; T=0.K
Photon emission for (n,n*8)

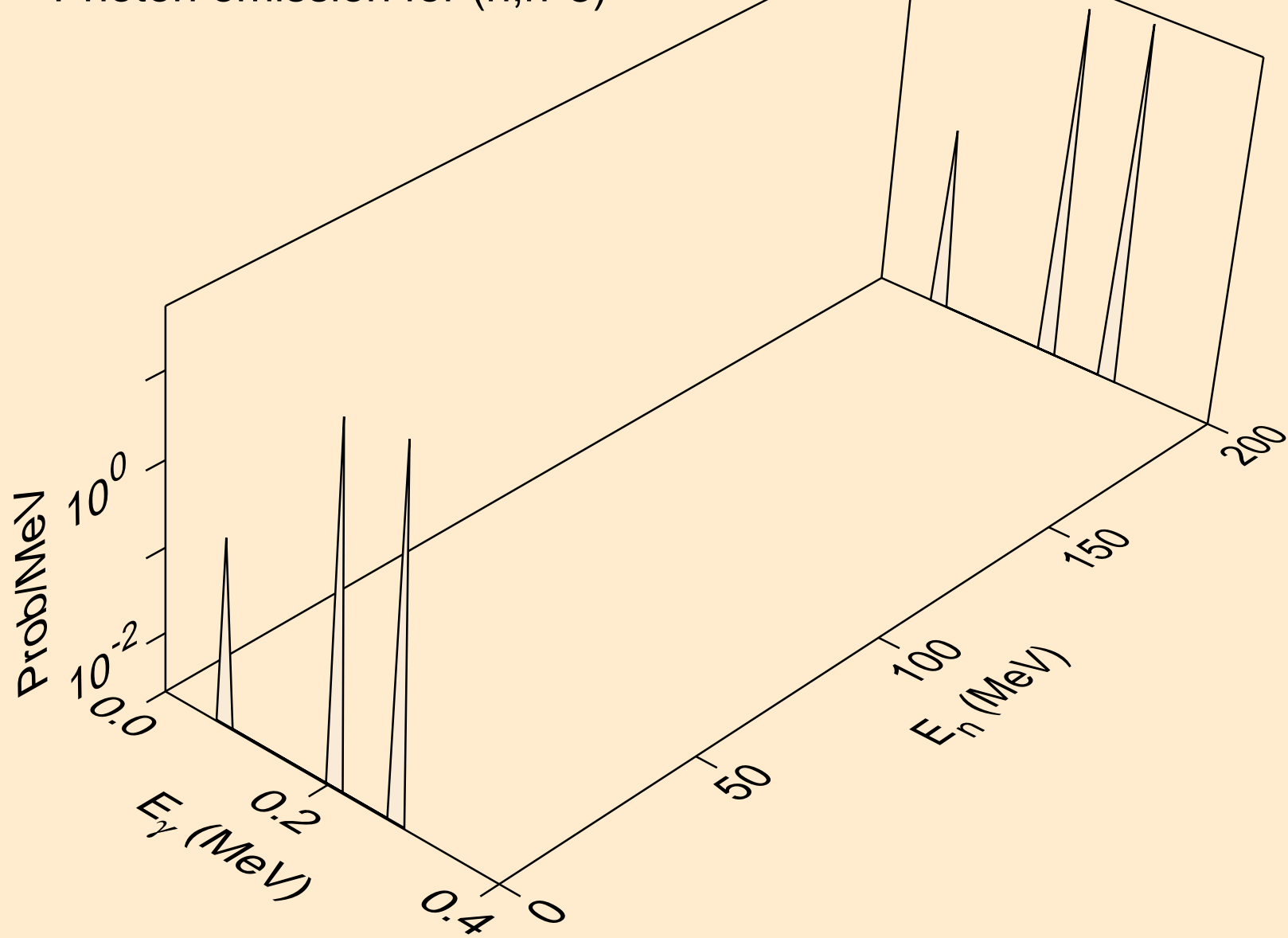

CE131M NEUTRON ACER TENDL-2023 LIBRARY; T=0.K
Photon emission for (n,n*9)

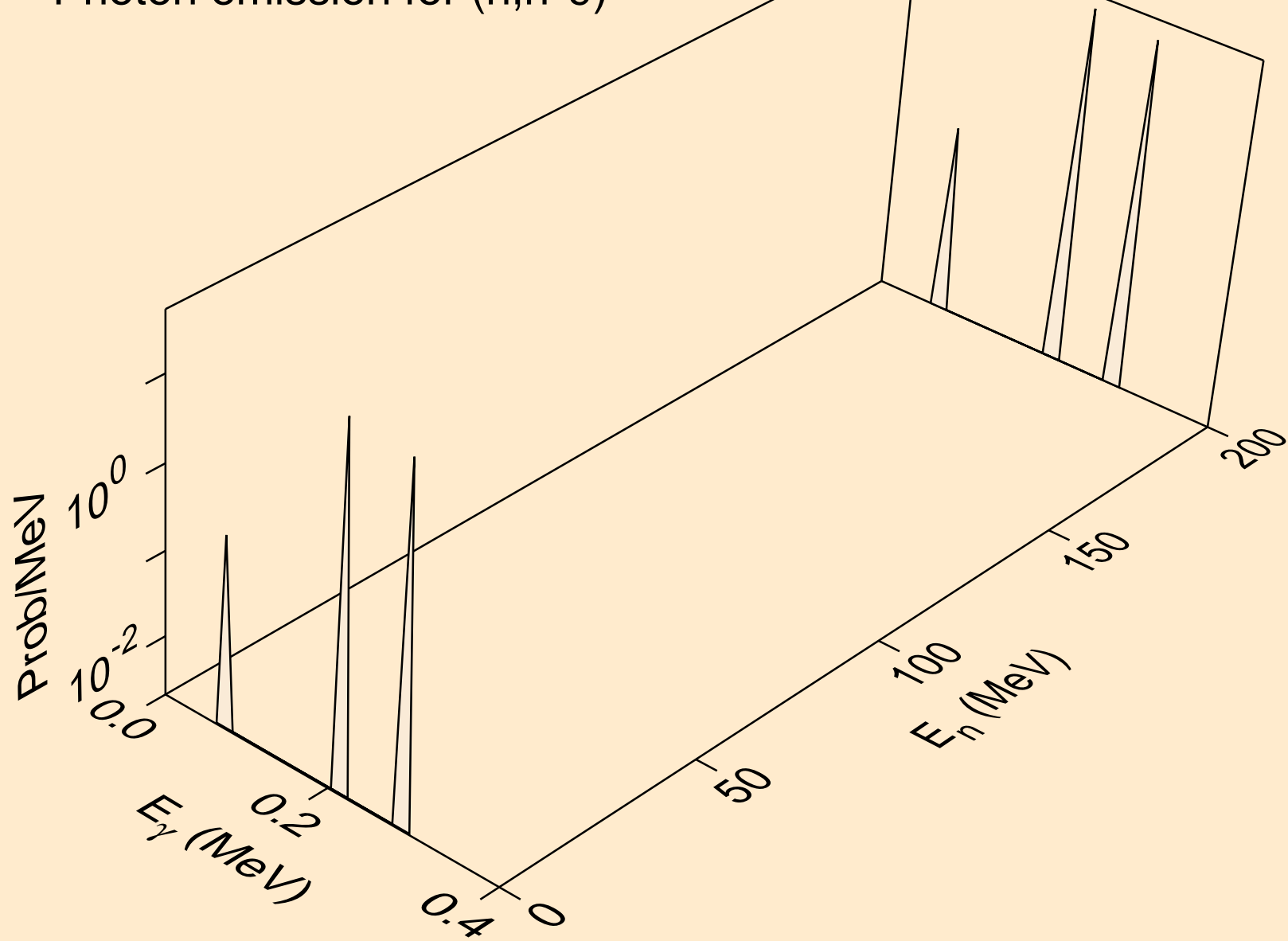

CE131M NEUTRON ACER TENDL-2023 LIBRARY; T=0.K
Photon emission for (n,n*10)

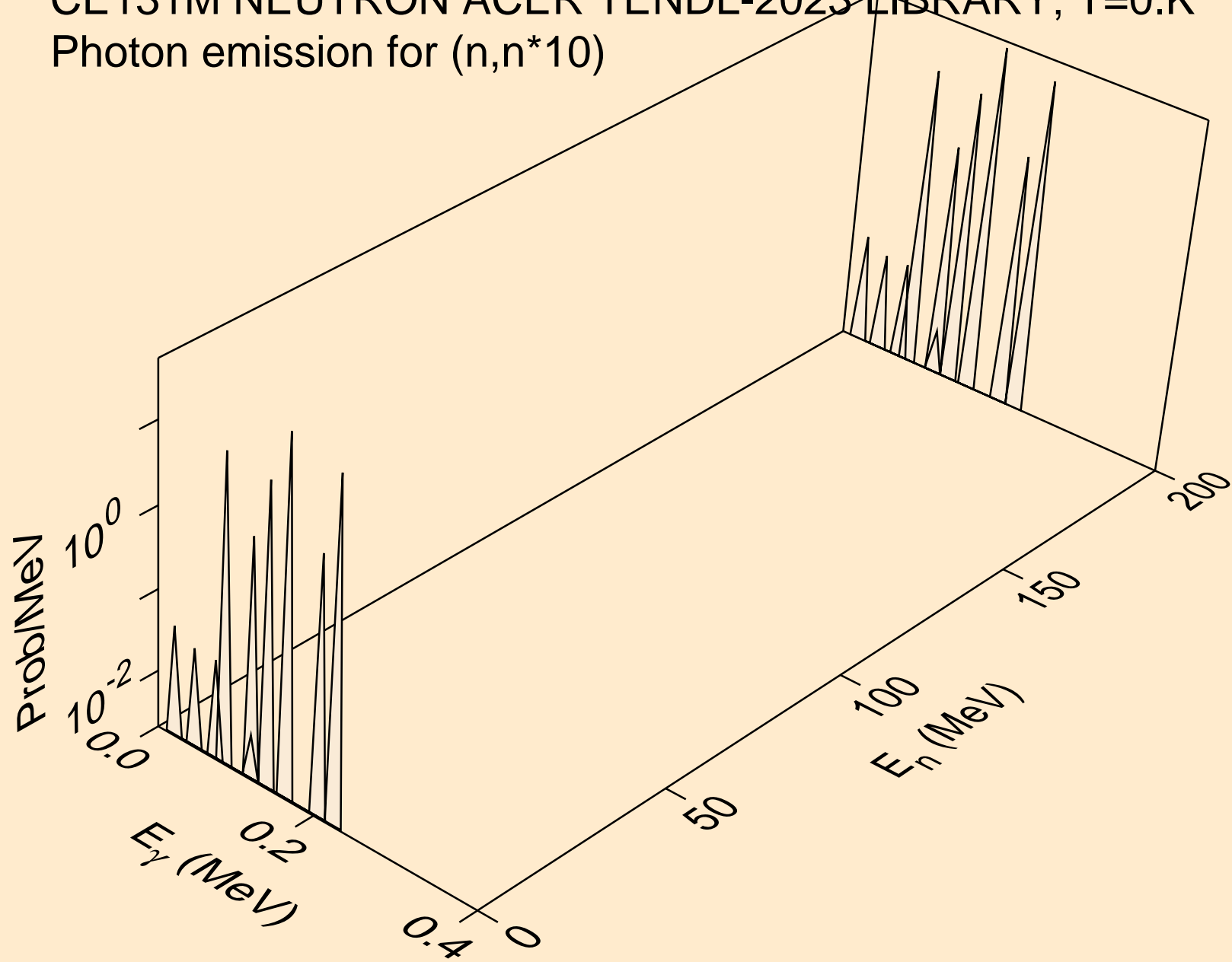

CE131M NEUTRON ACER TENDL-2023 LIBRARY; T=0.K
Photon emission for (n,n*11)

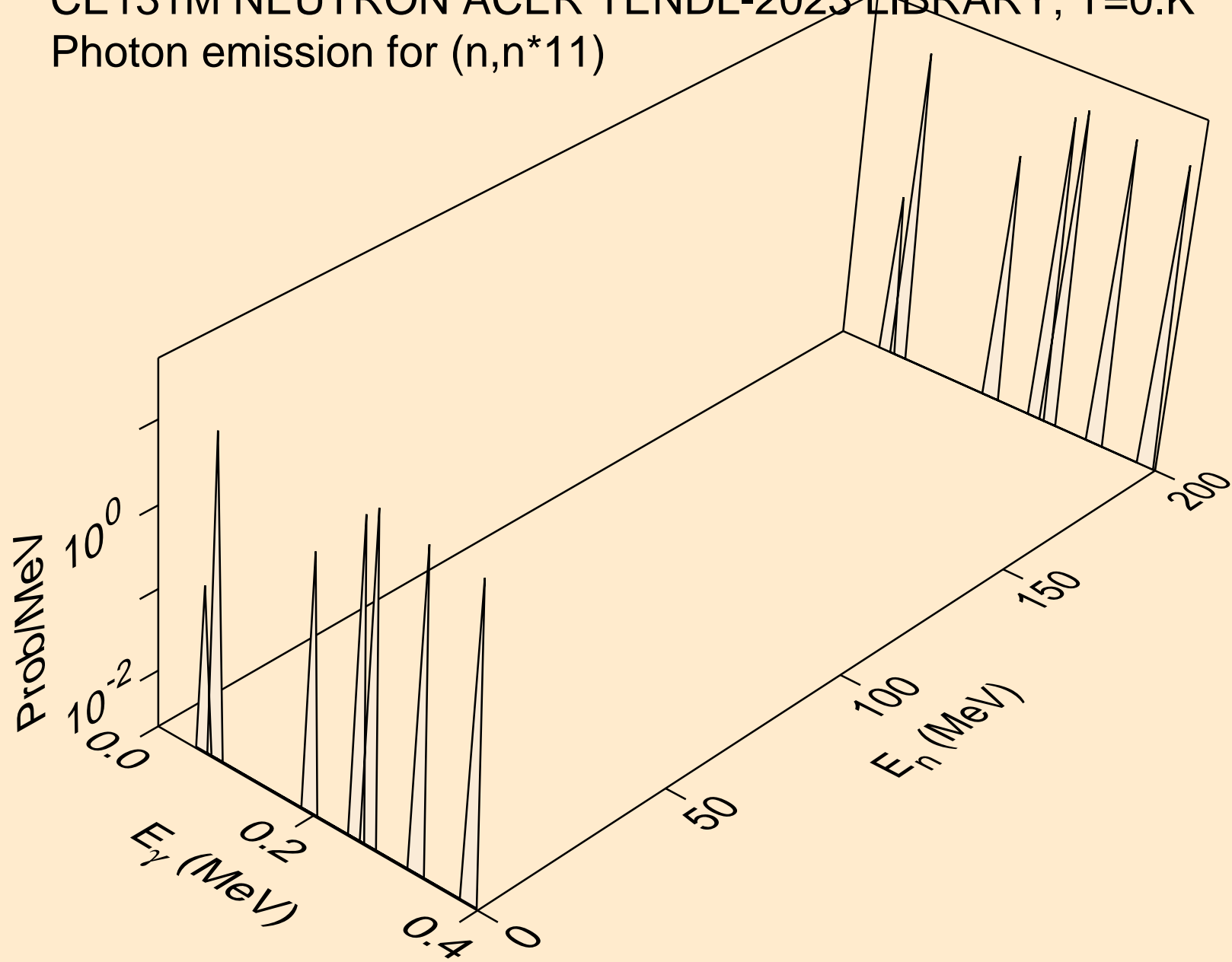

CE131M NEUTRON ACER TENDL-2023 LIBRARY; T=0.K
Photon emission for (n,n*12)

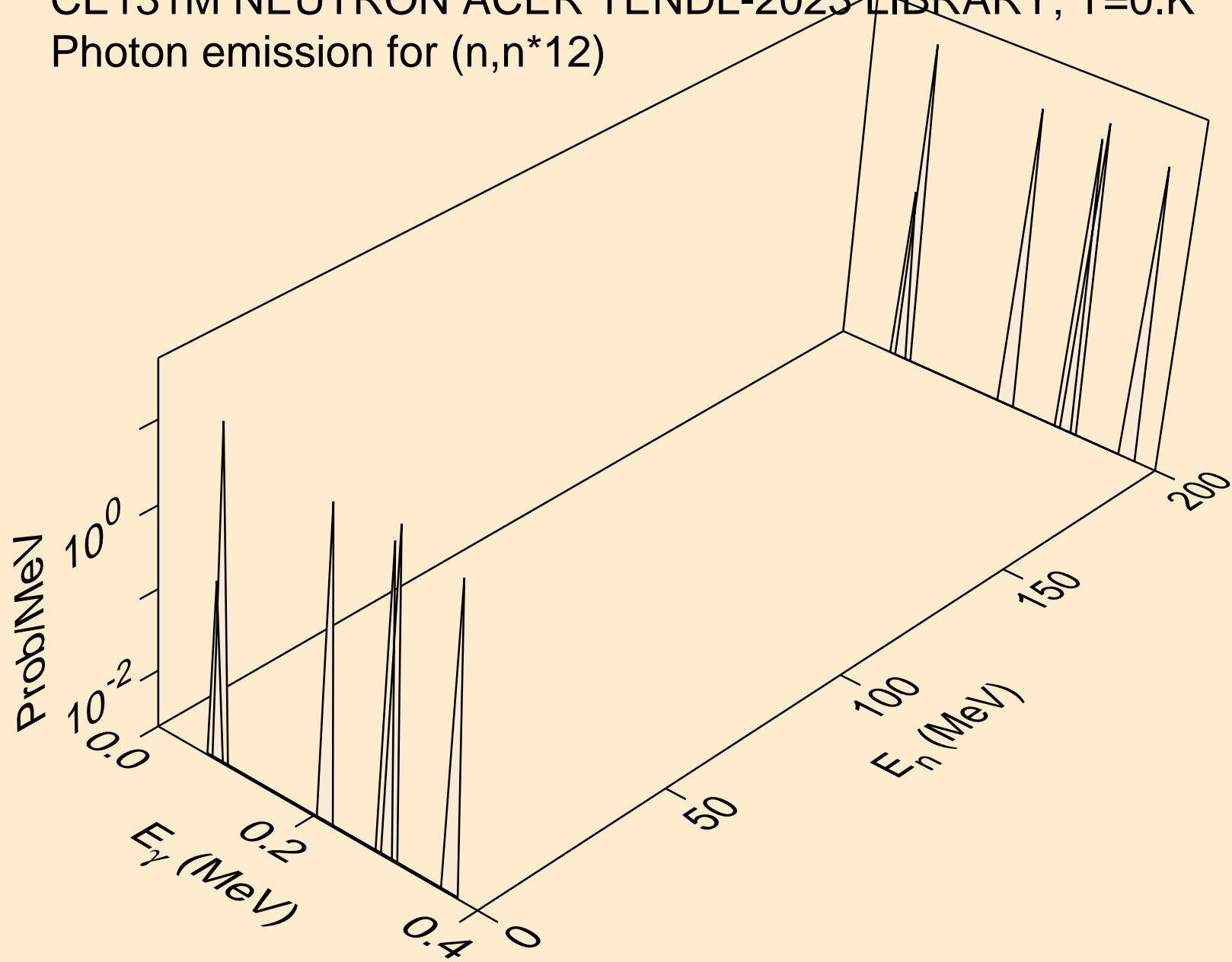

CE131M NEUTRON ACER TENDL-2023 LIBRARY; T=0.K
Photon emission for (n,n*13)

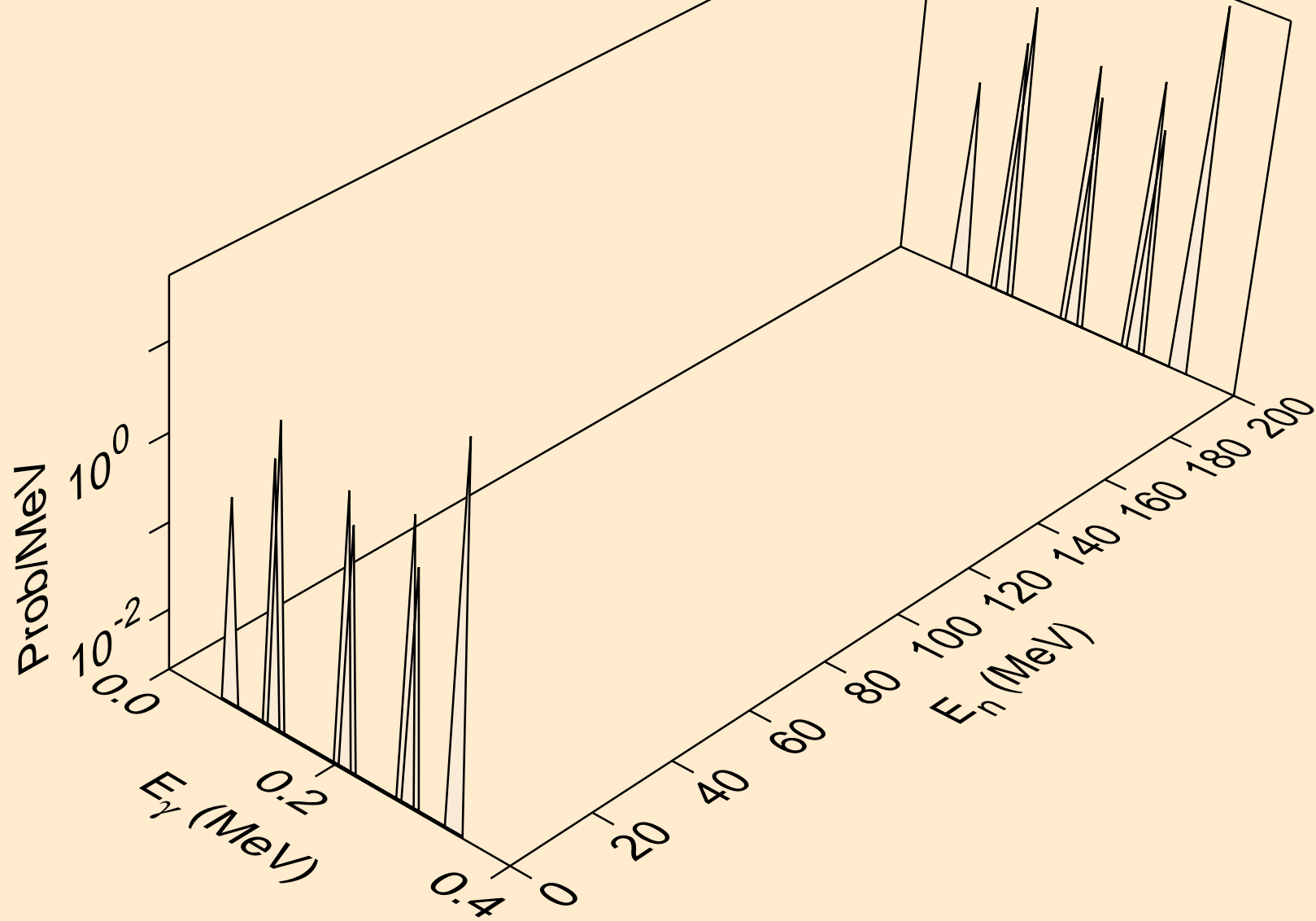

CE131M NEUTRON ACER TENDL-2023 LIBRARY; T=0.K
Photon emission for (n,n*14)

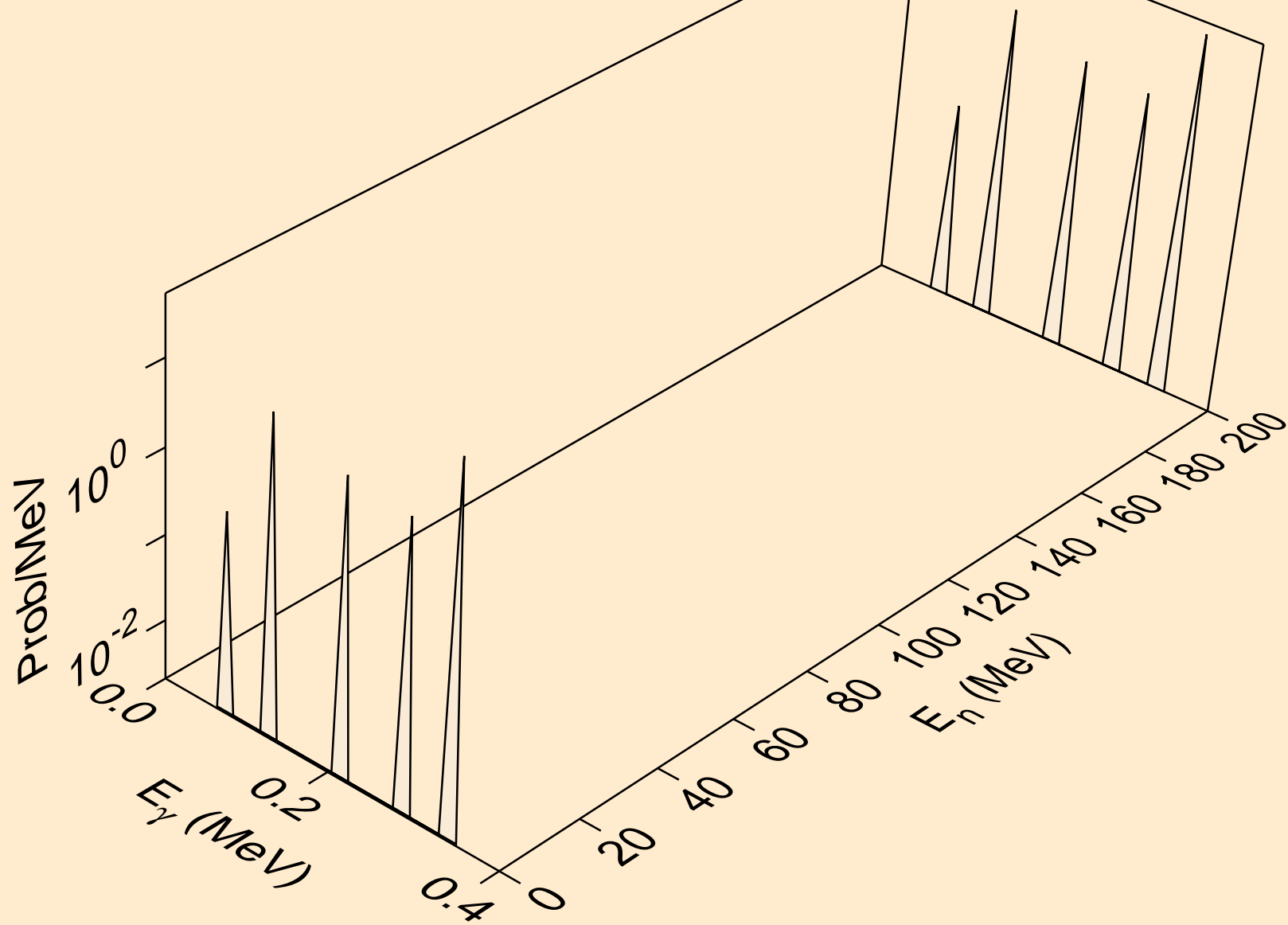

CE131M NEUTRON ACER TENDL-2023 LIBRARY; T=0.K
Photon emission for (n,n*c)

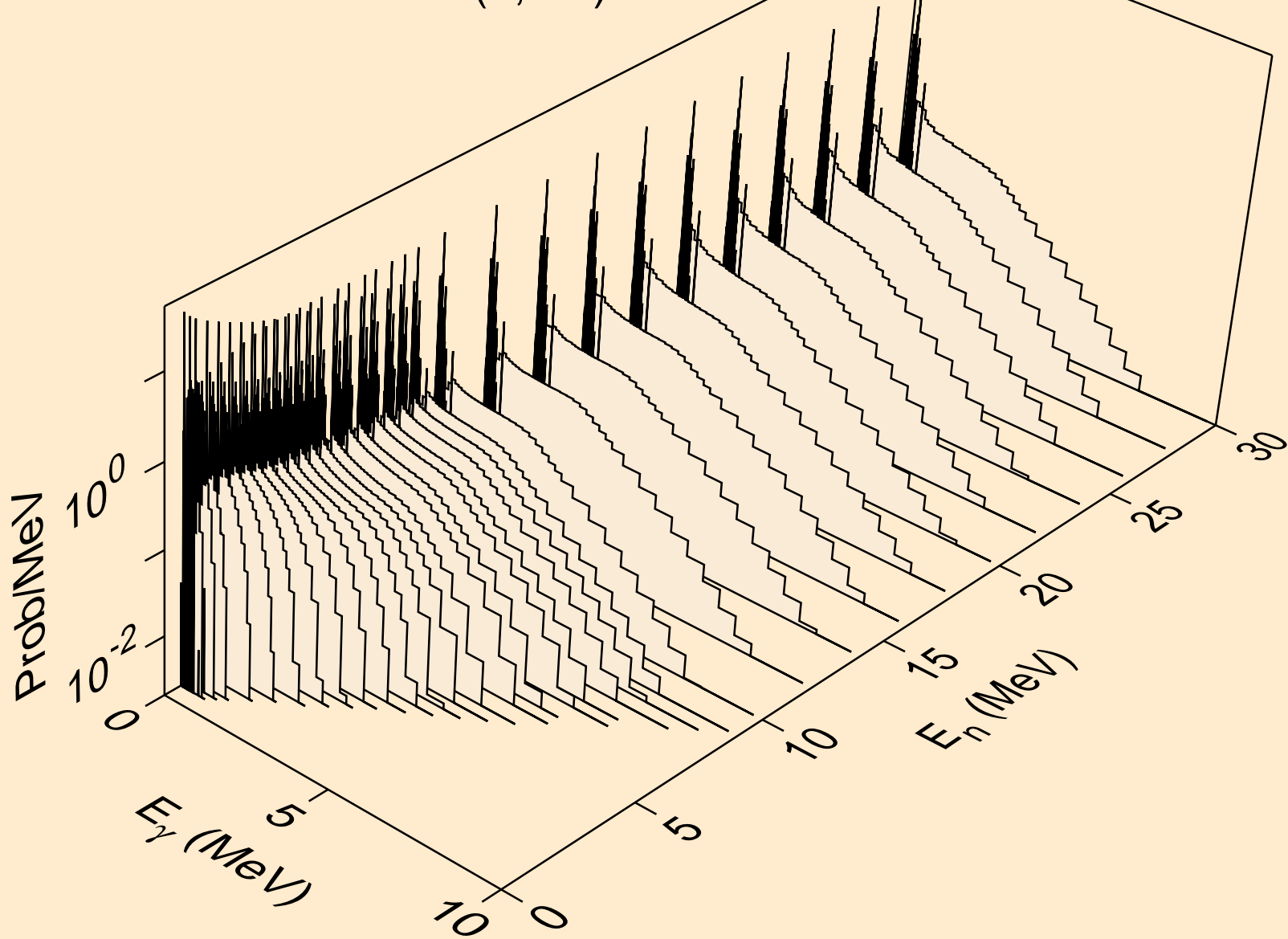

CE131M NEUTRON ACER TENDL-2023 LIBRARY; T=0.K
Photon emission for (n,gma)

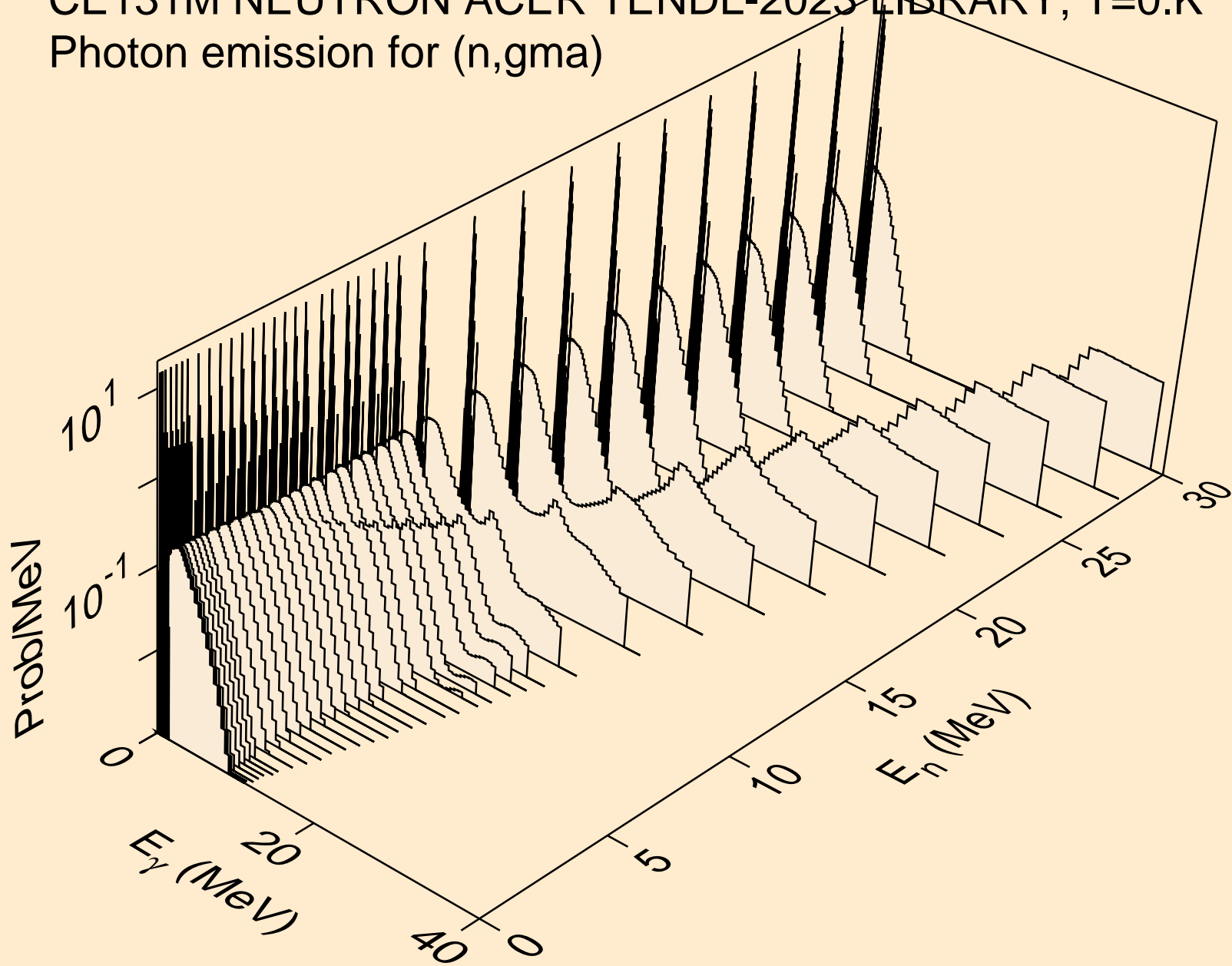

CE131M NEUTRON ACER TENDL-2023 LIBRARY; T=0.K
Photon emission for (n,p)

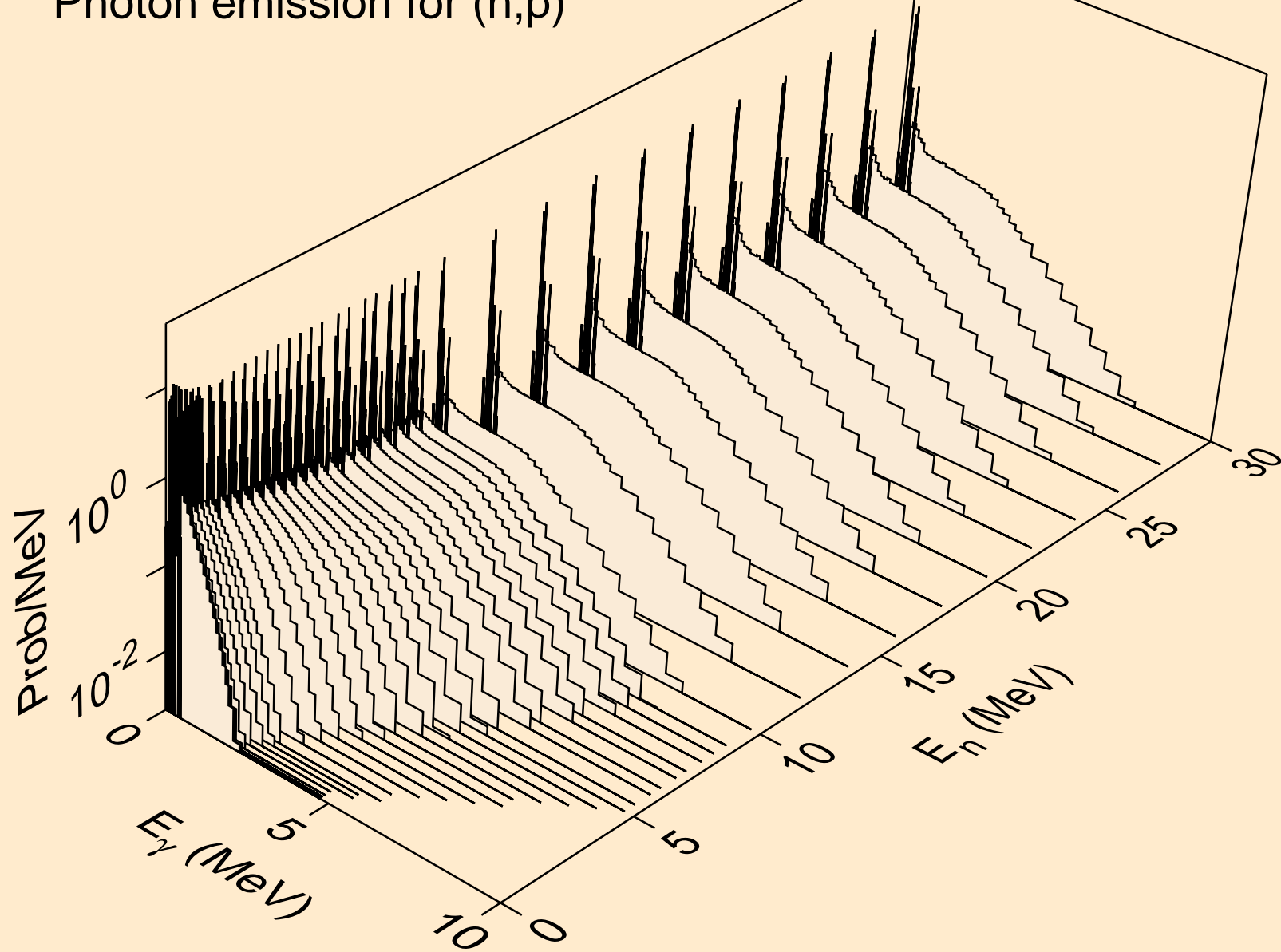

CE131M NEUTRON ACER TENDL-2023 LIBRARY; T=0.K
Photon emission for (n,d)

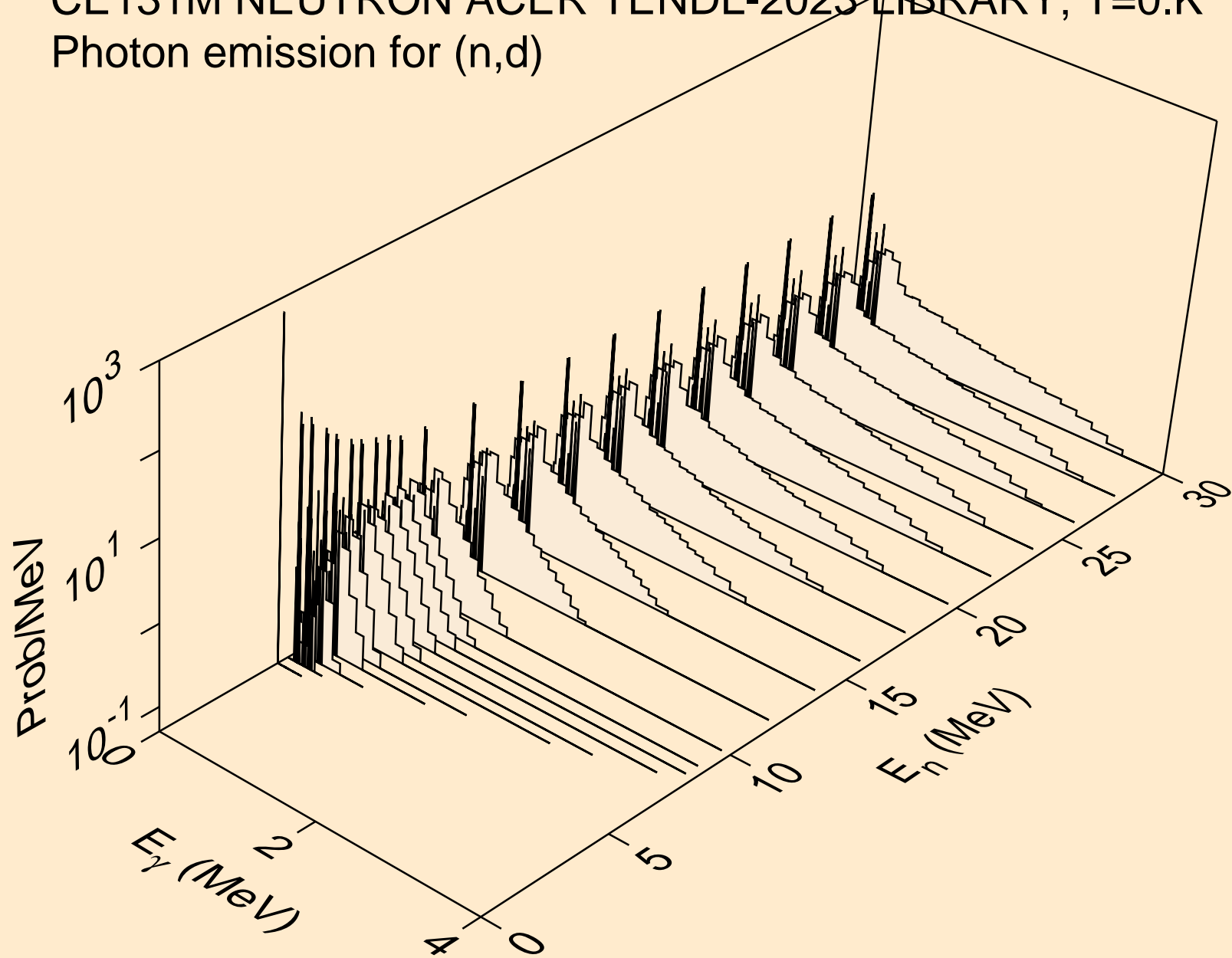

CE131M NEUTRON ACER TENDL-2023 LIBRARY; T=0.K
Photon emission for (n,t)

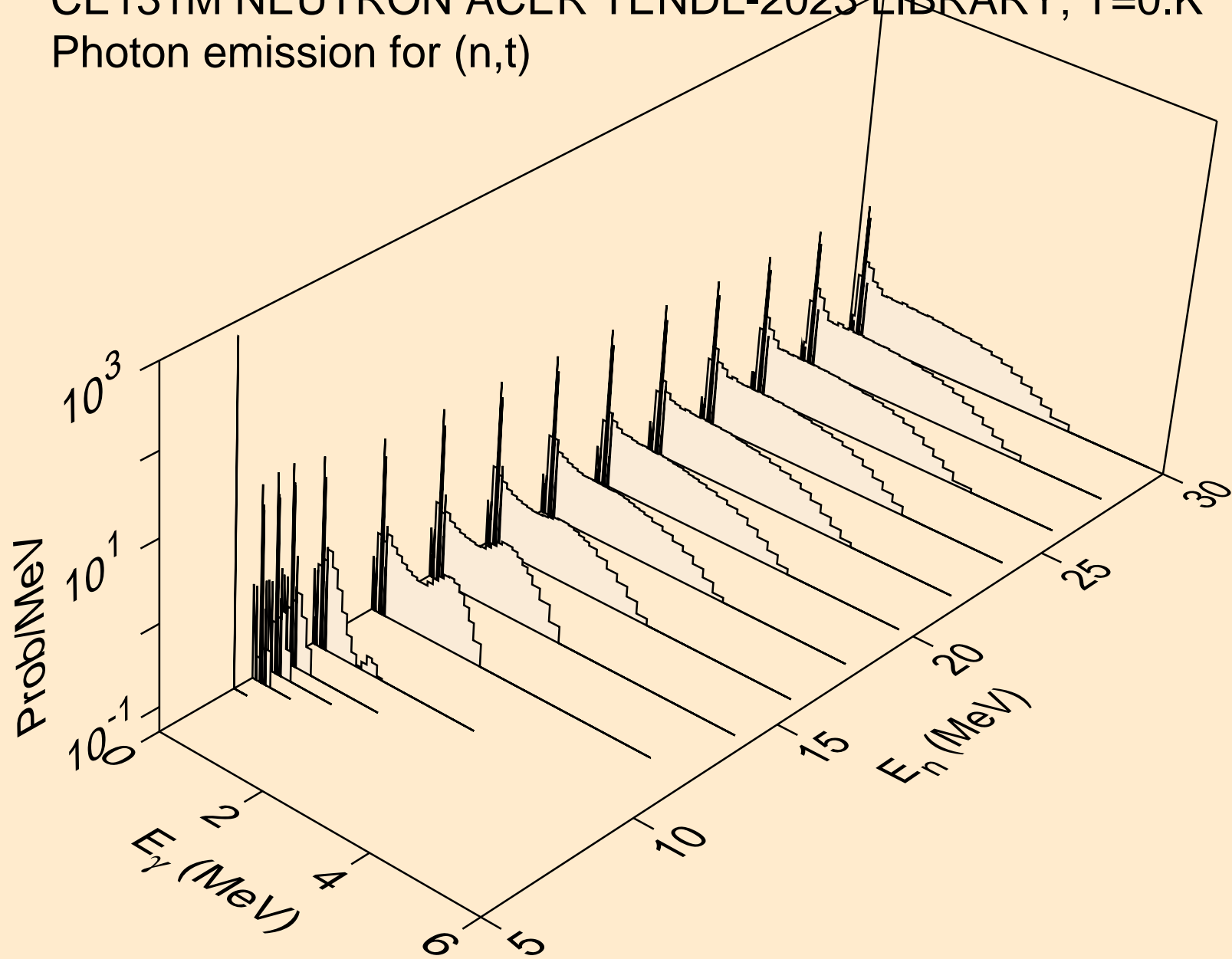

CE131M NEUTRON ACER TENDL-2023 LIBRARY; T=0.K
Photon emission for (n,he3)

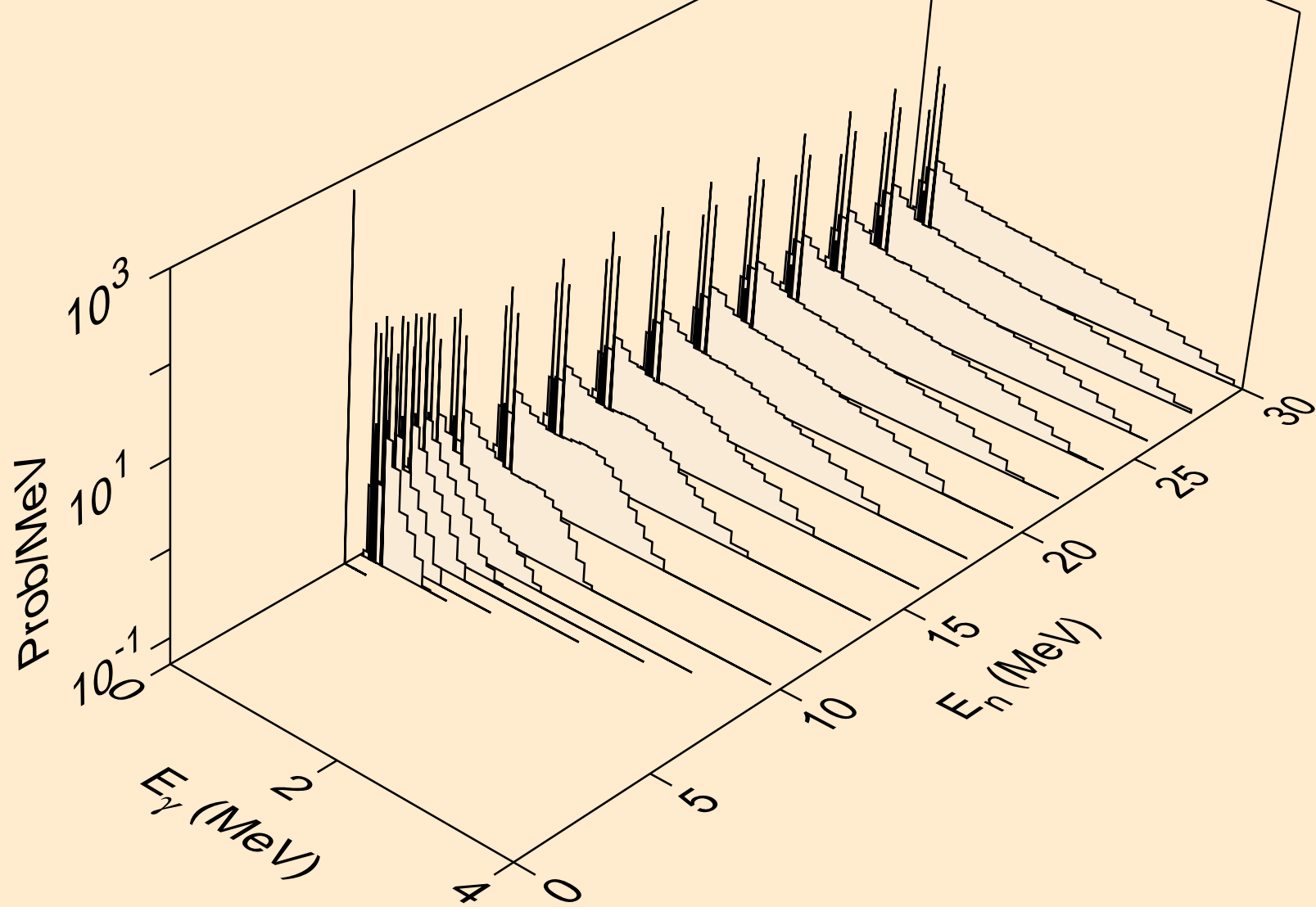

CE131M NEUTRON ACER TENDL-2023 LIBRARY; T=0.K
Photon emission for (n,a)

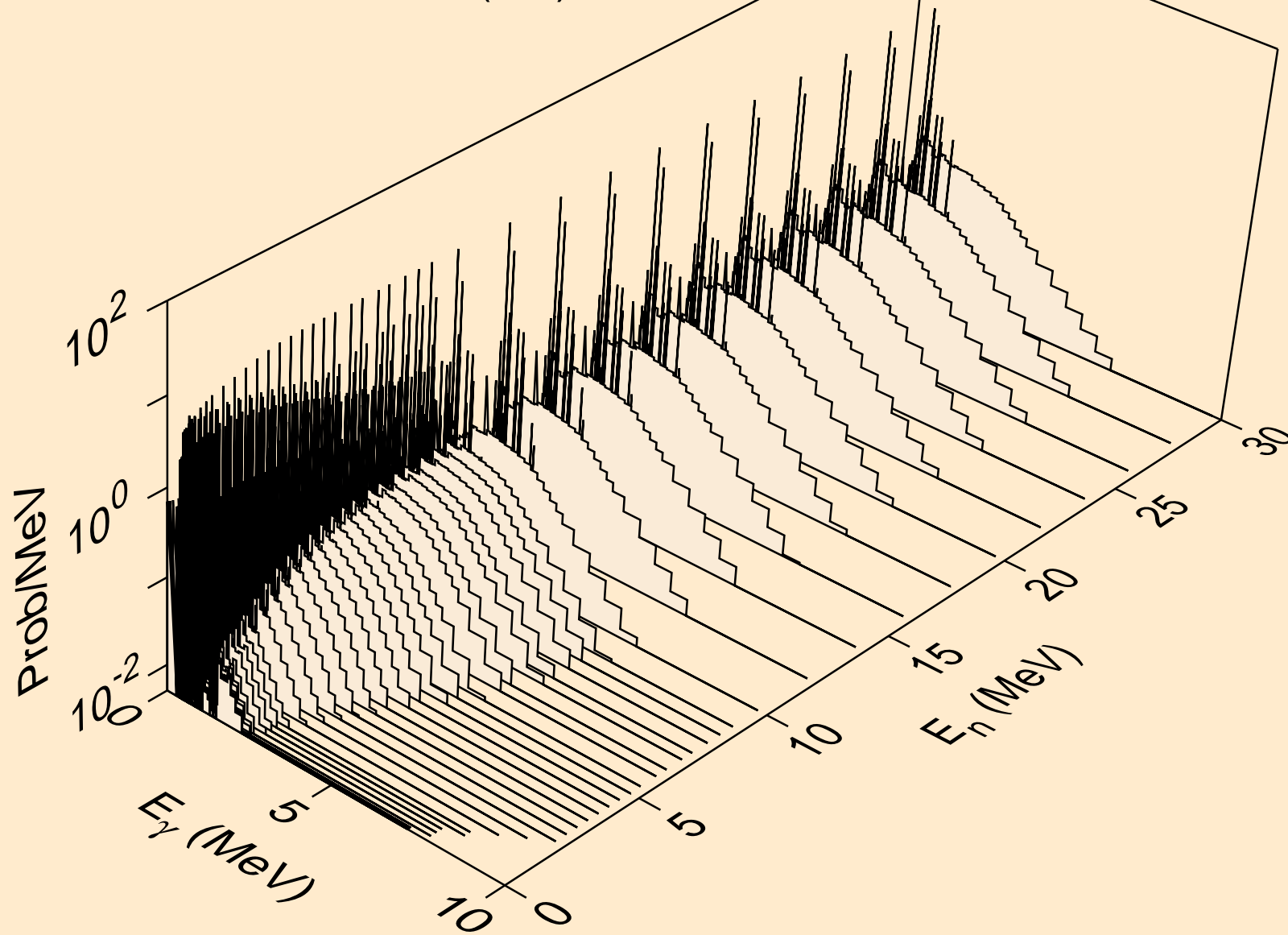

CE131M NEUTRON ACER TENDL-2023 LIBRARY; T=0.K
Photon emission for (n,2a)

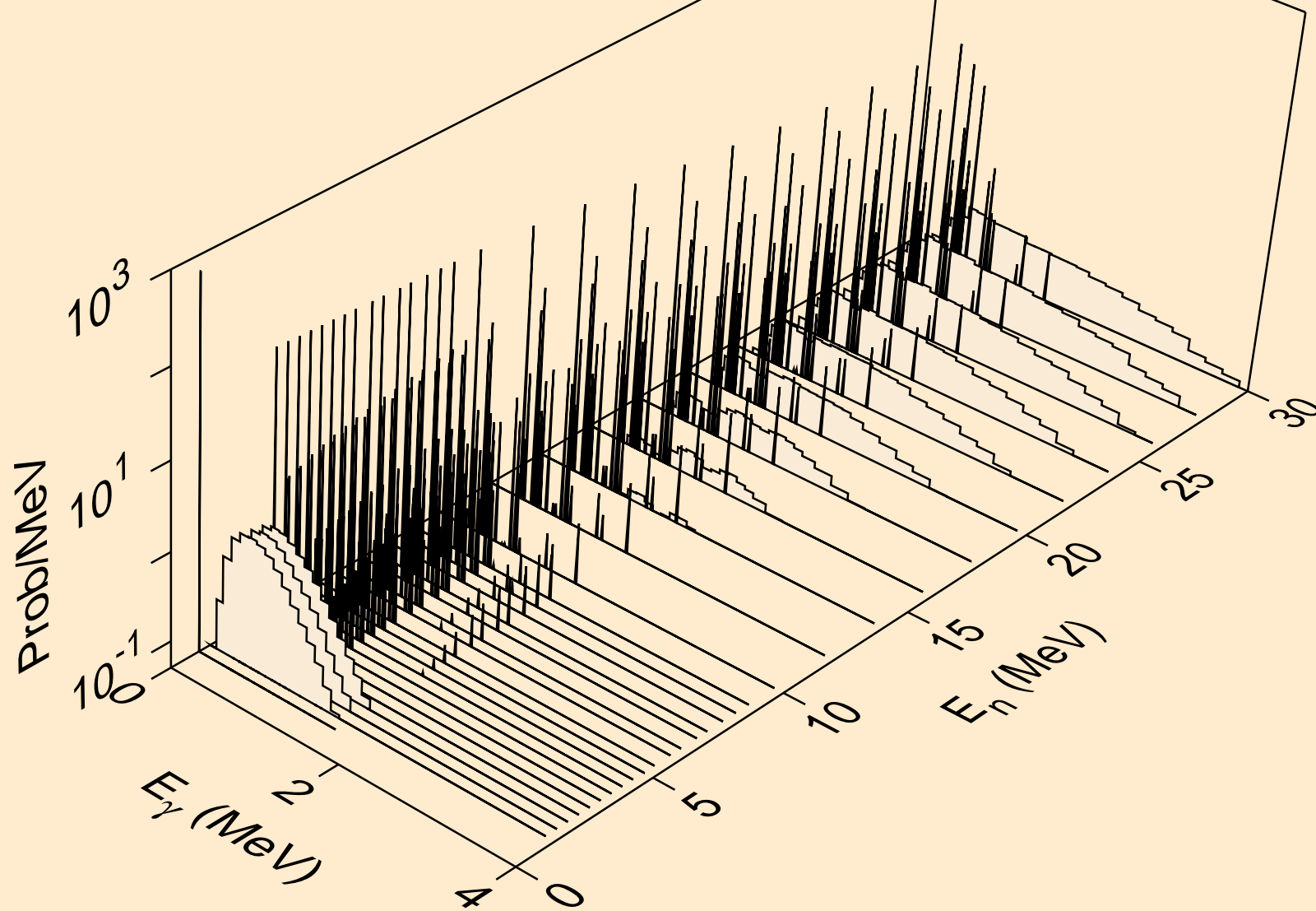

CE131M NEUTRON ACER TENDL-2023 LIBRARY; T=0.K
Photon emission for (n,2p)

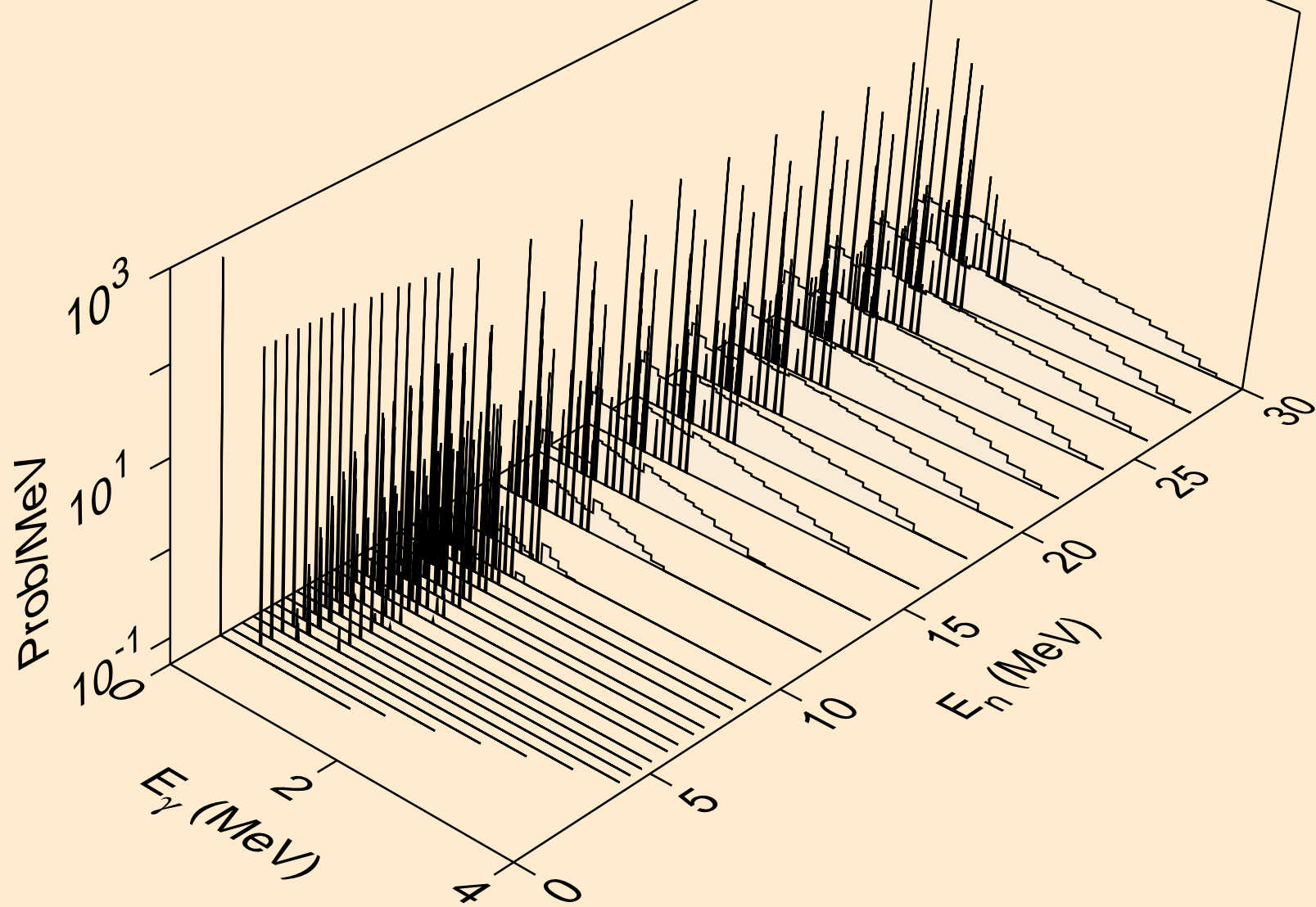

CE131M NEUTRON ACER TENDL-2023 LIBRARY; T=0.K
Photon emission for (n,p)

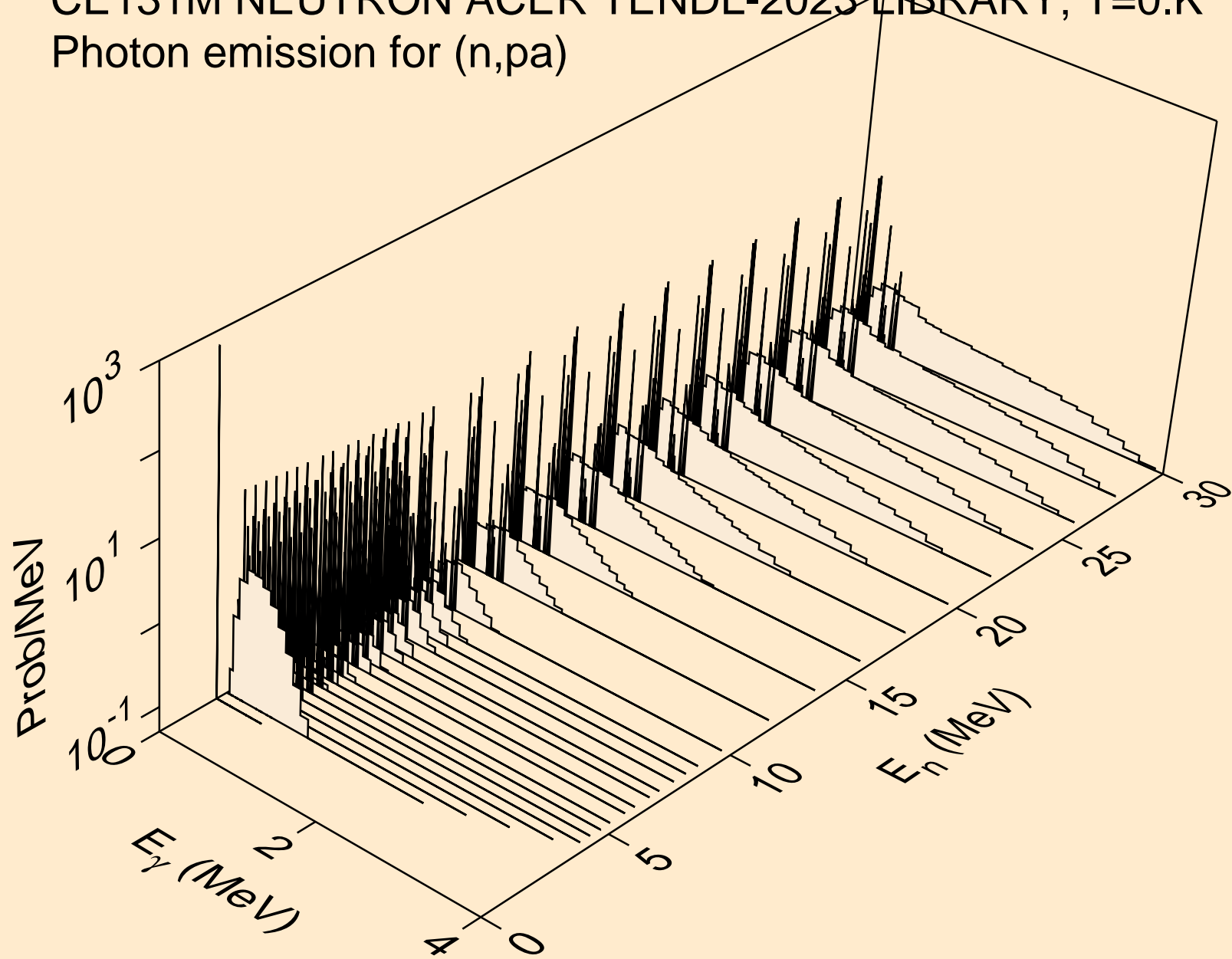

CE131M NEUTRON ACER TENDL-2023 LIBRARY; T=0.K
Photon emission for (n,pd)

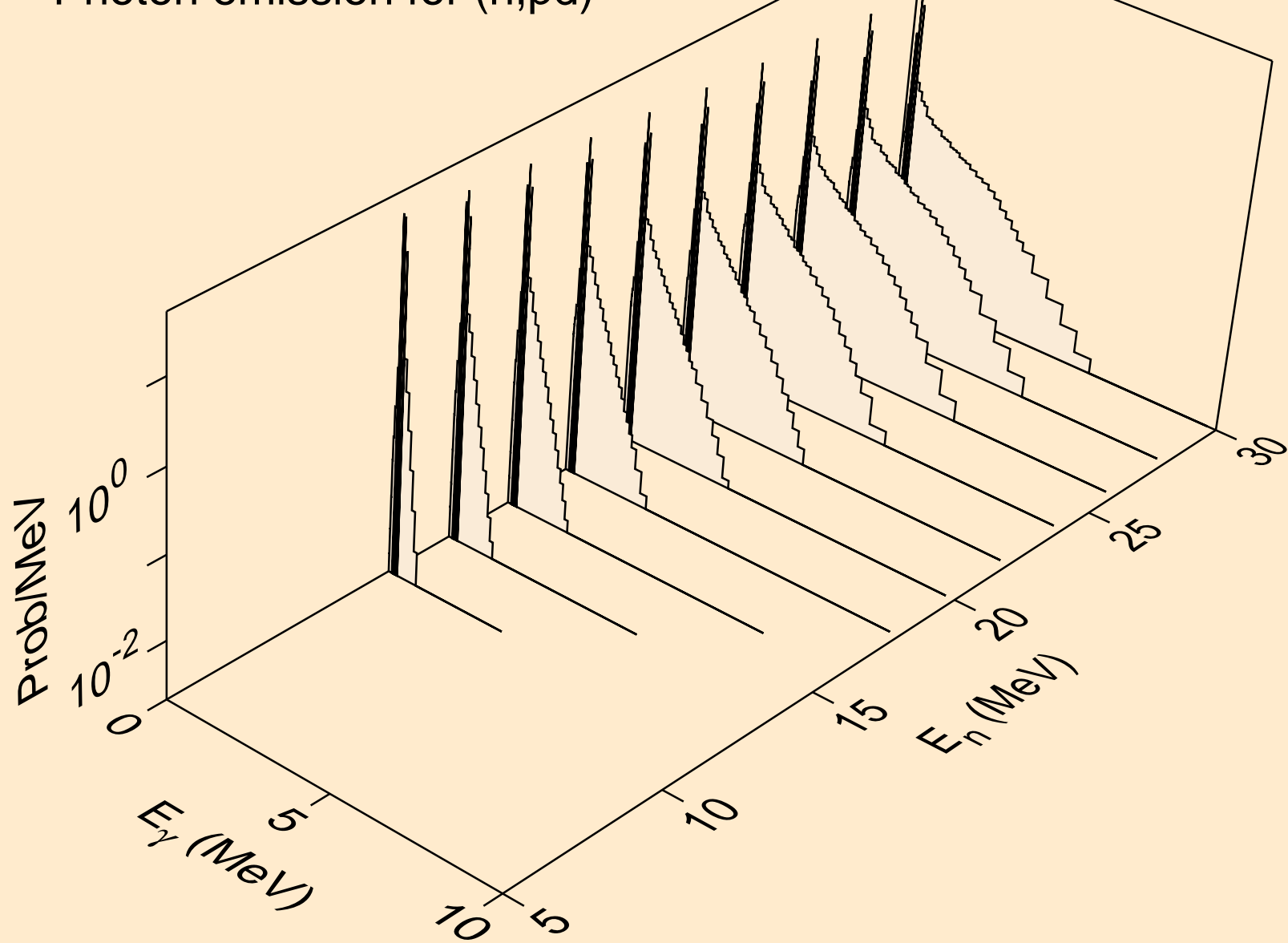

CE131M NEUTRON ACER TENDL-2023 LIBRARY; T=0.K
Photon emission for (n,pt)

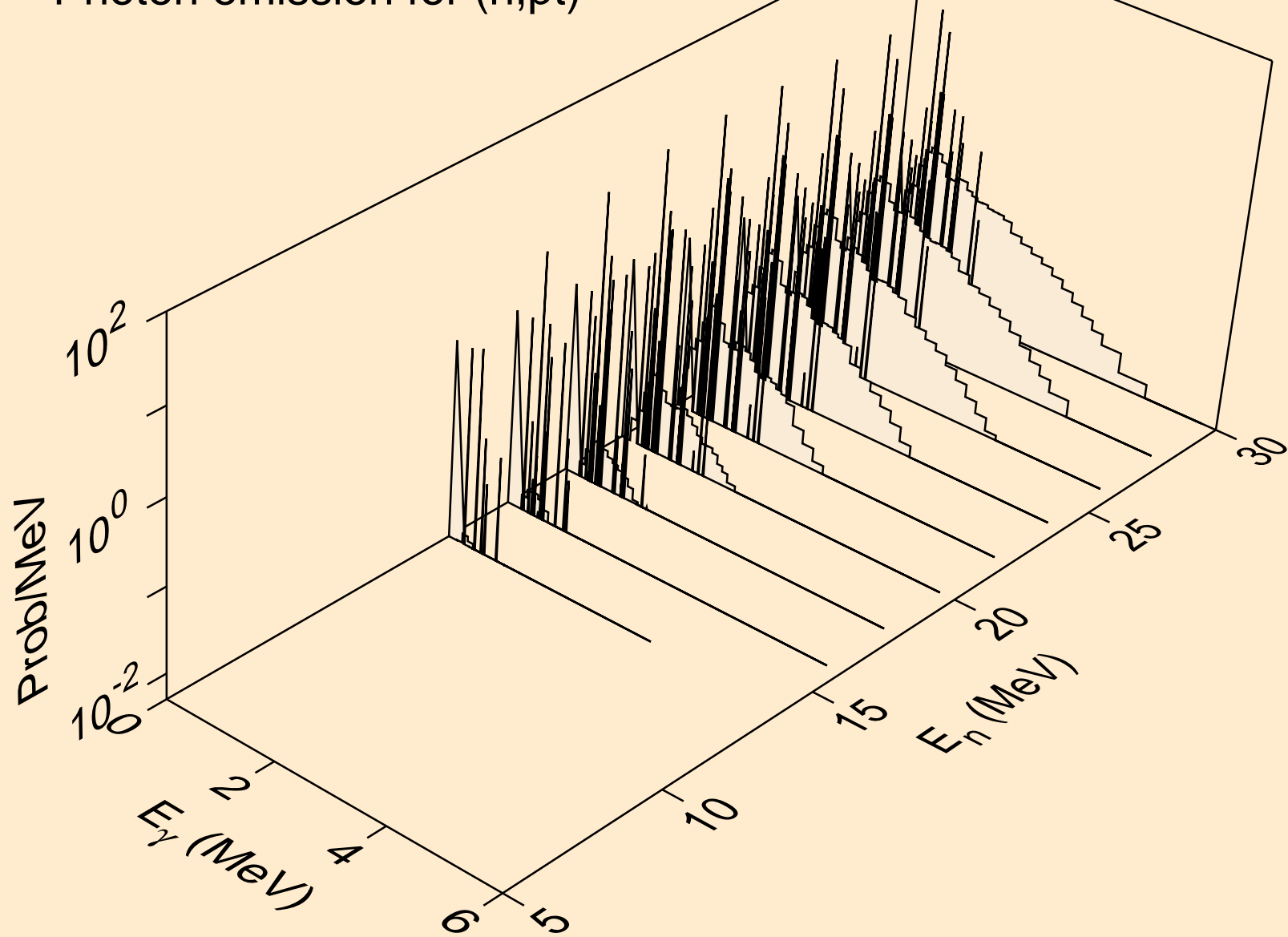

CE131M NEUTRON ACER TENDL-2023 LIBRARY; T=0.K
Photon emission for (n,da)

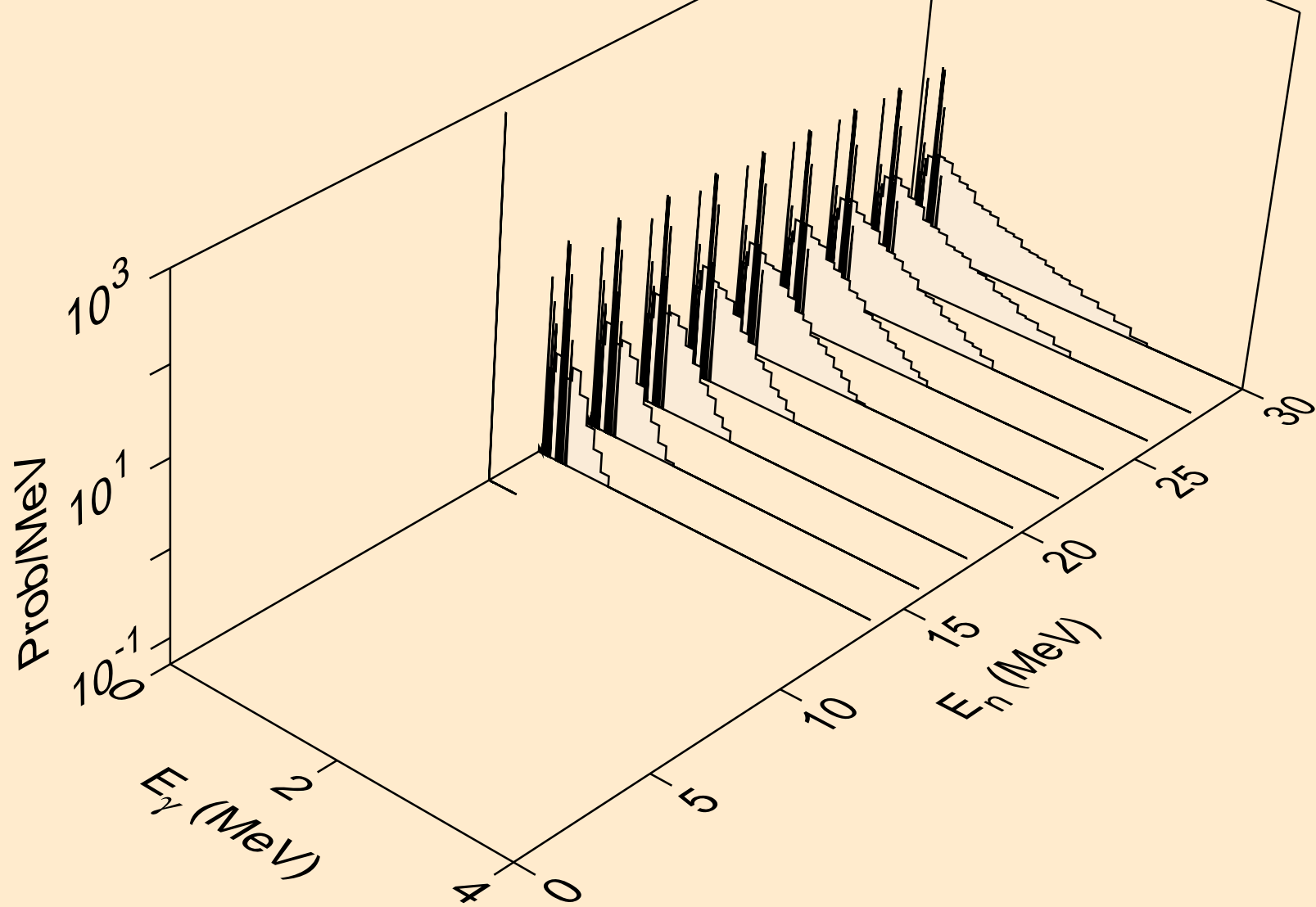

CE131M NEUTRON ACER TENDL-2023 LIBRARY; T=0.K
thermal capture photon spectrum

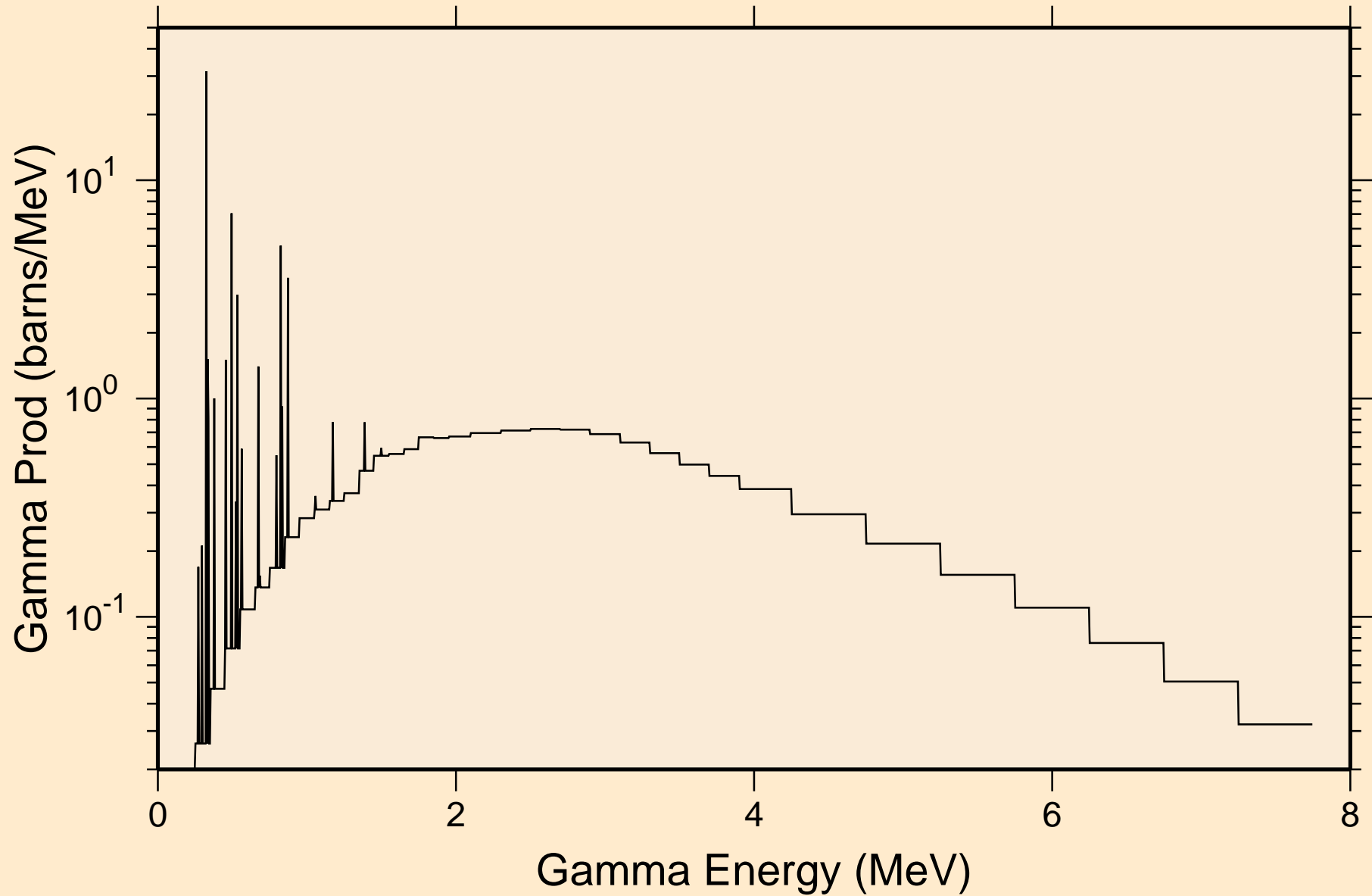

CE131M NEUTRON ACER TENDL-2023 LIBRARY; T=0.K
14 MeV photon spectrum

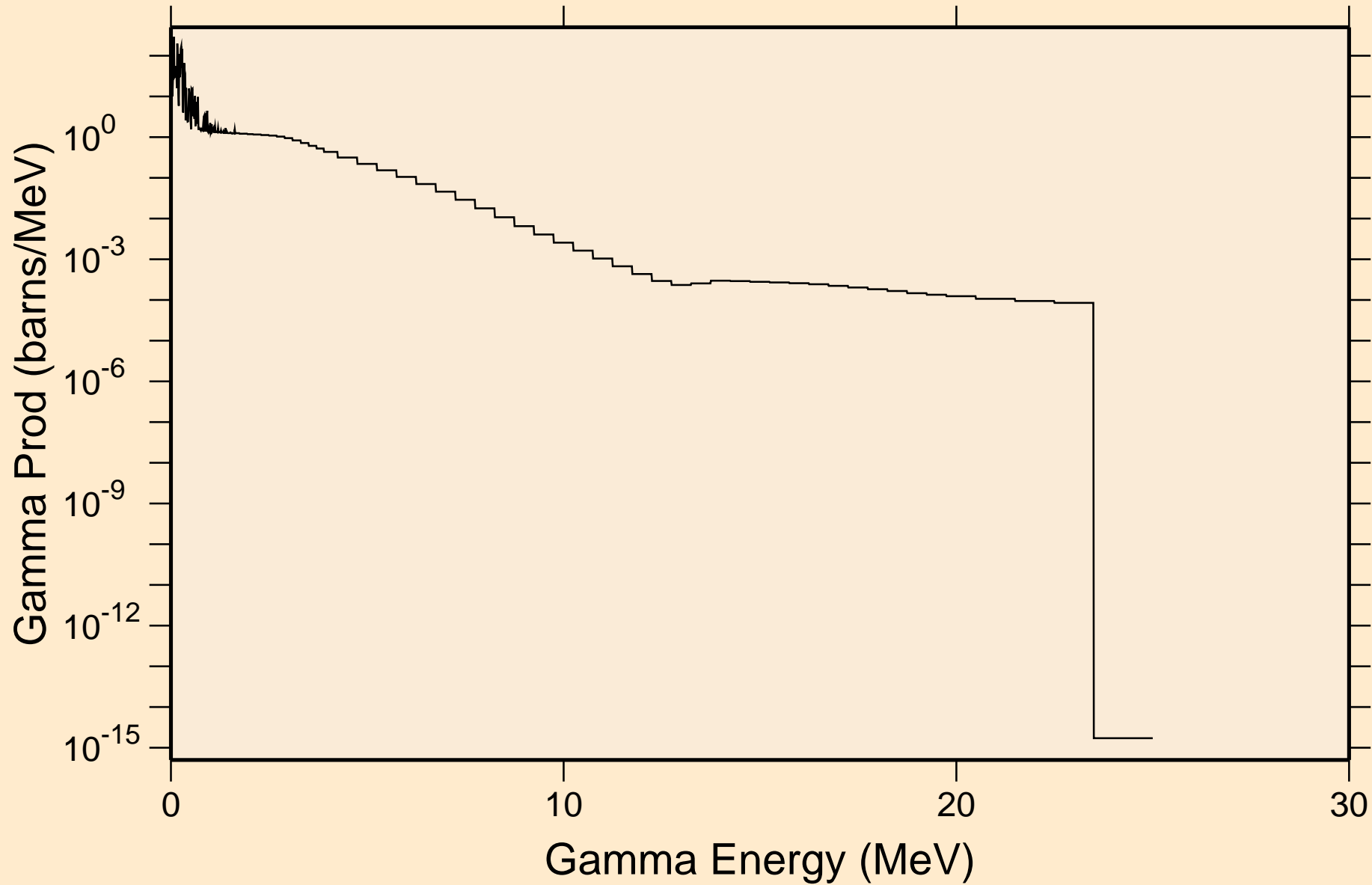

CE131M NEUTRON ACER TENDL-2023 LIBRARY; T=0.K

Particle heating contributions

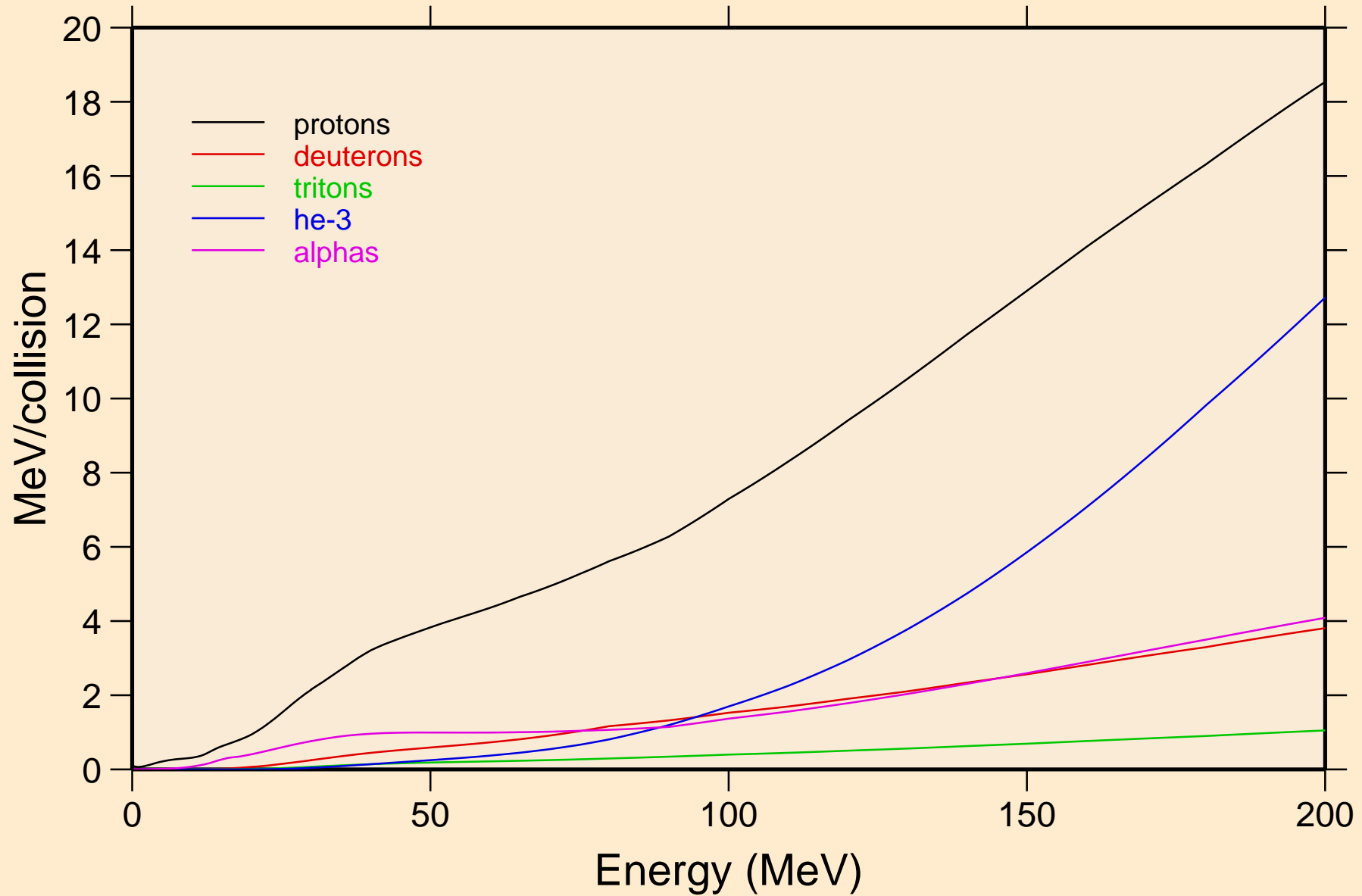

CE131M NEUTRON ACER TENDL-2023 LIBRARY; T=0.K
Recoil Heating

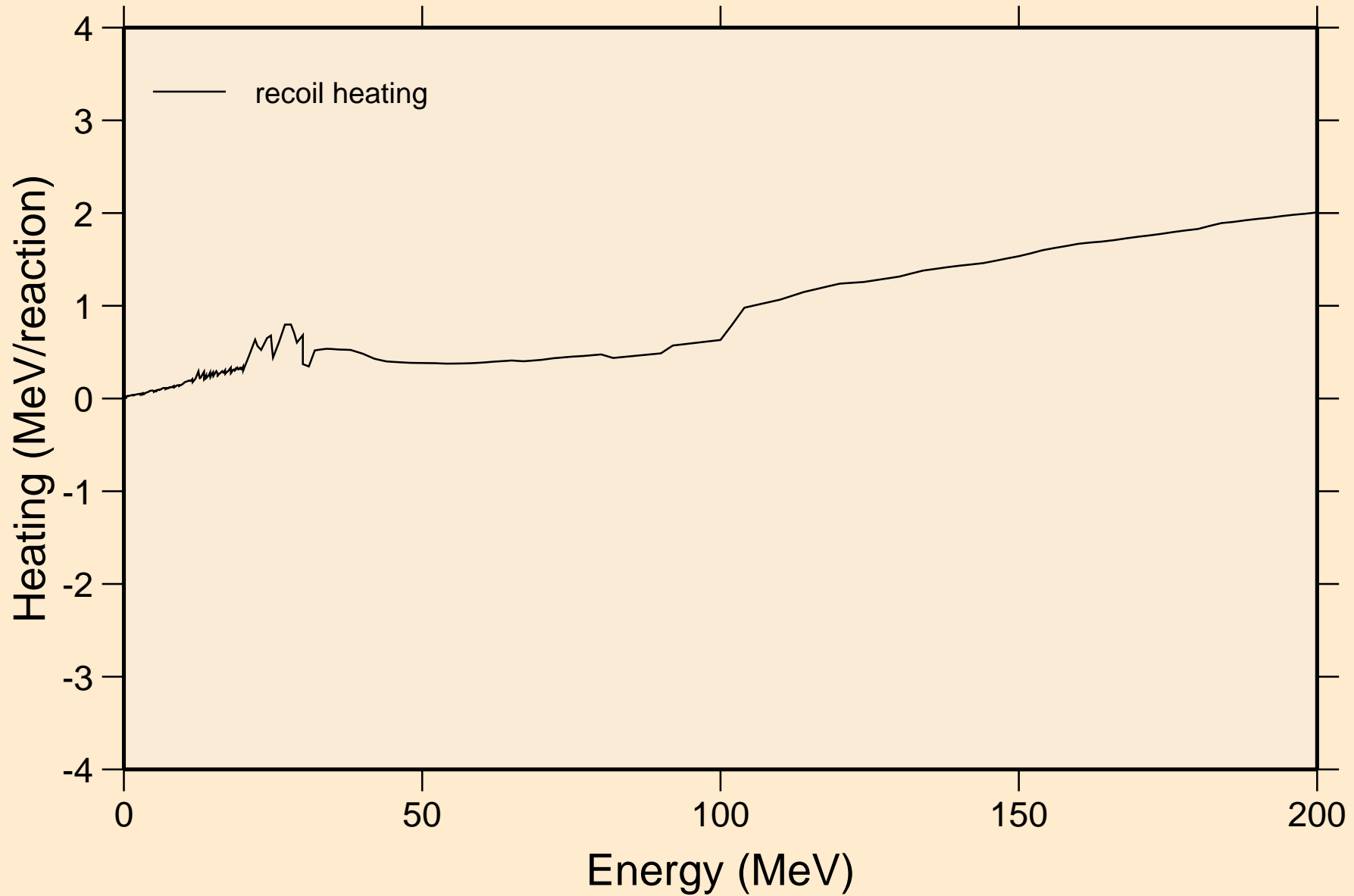

CE131M NEUTRON ACER TENDL-2023 LIBRARY; T=0.K

Particle production cross sections

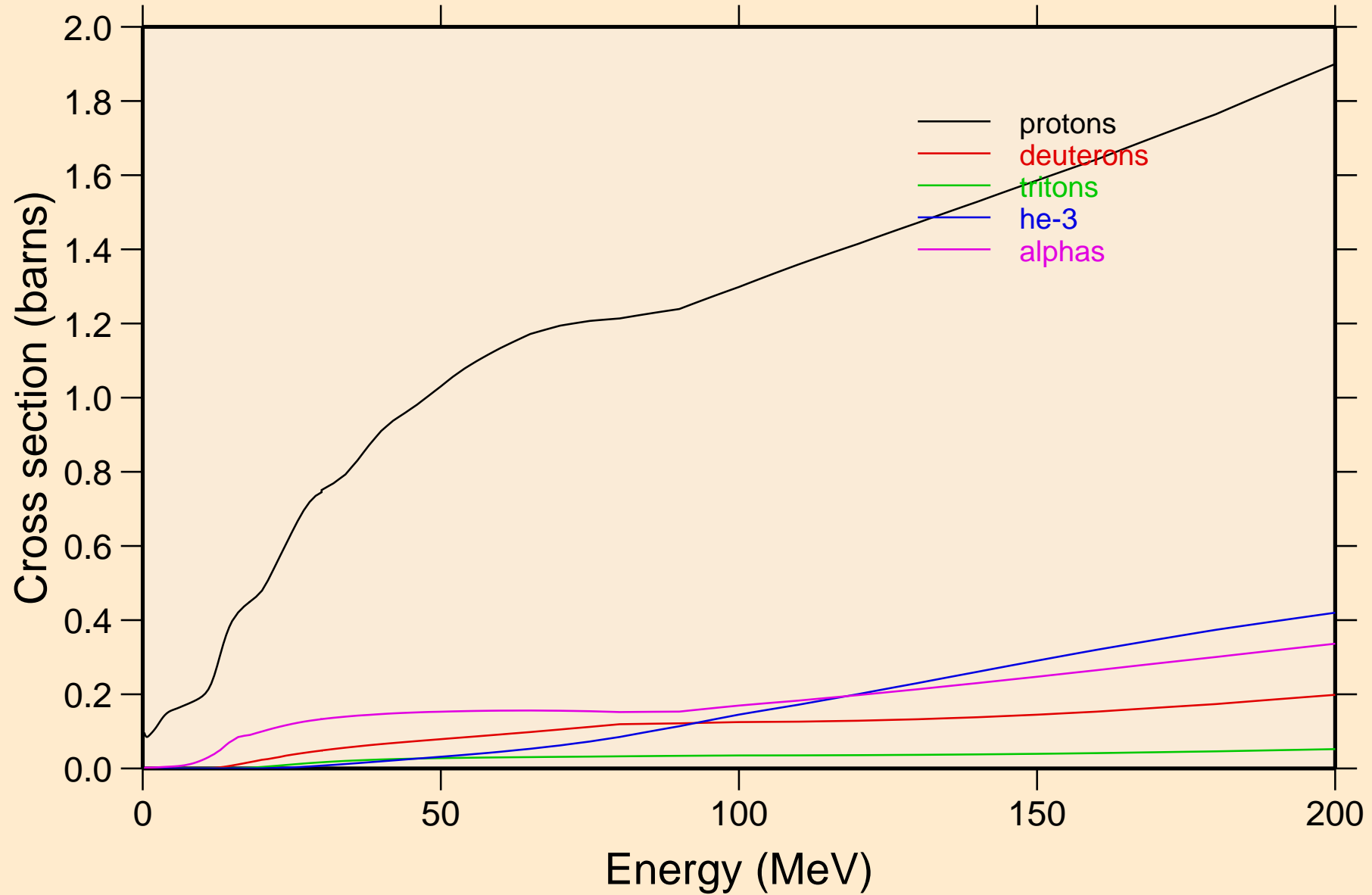

CE131M NEUTRON ACER TENDL-2023 LIBRARY; T=0.K
protons from (n,x)

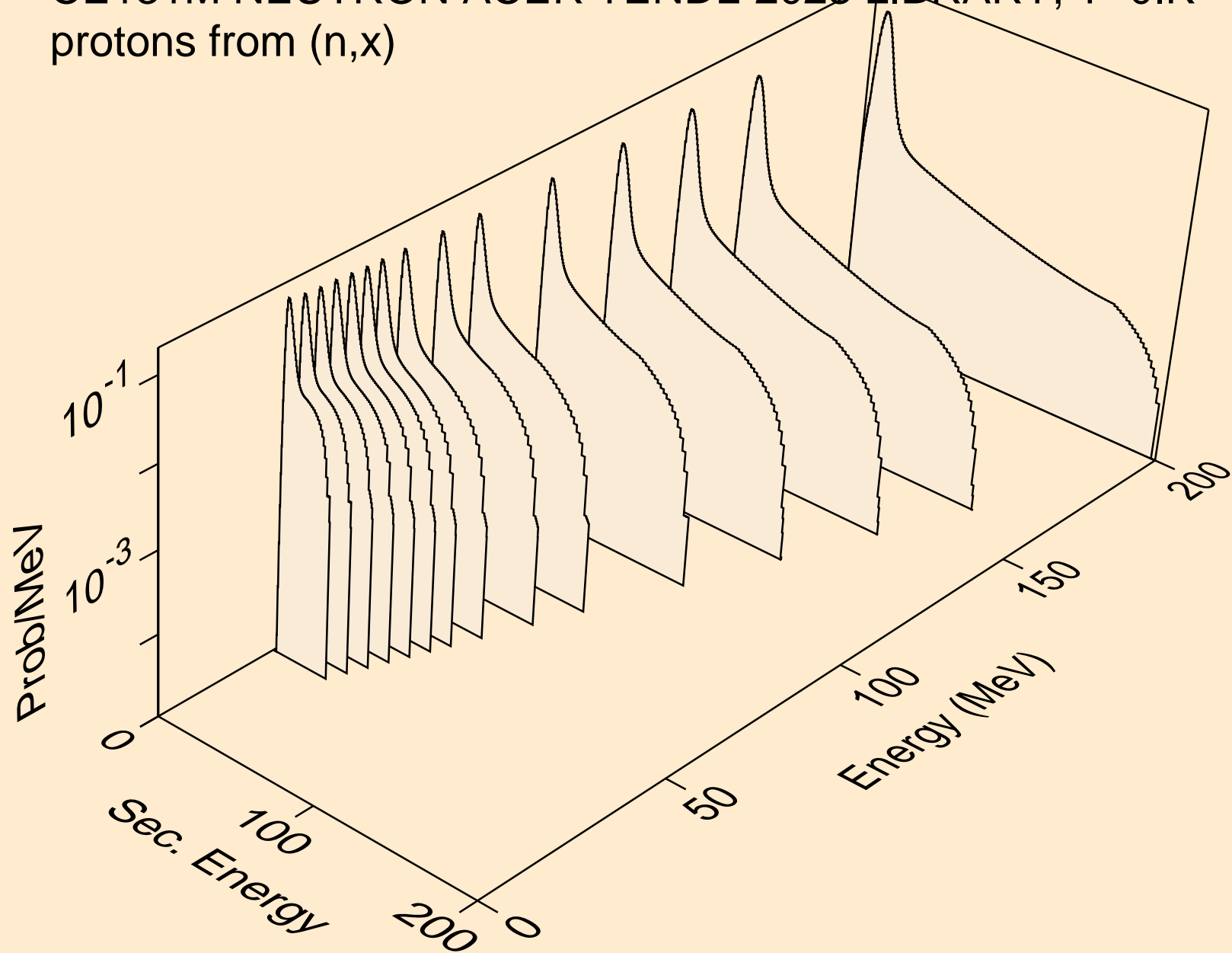

CE131M NEUTRON ACER TENDL-2023 LIBRARY; T=0.K
protons from (n,n*)p

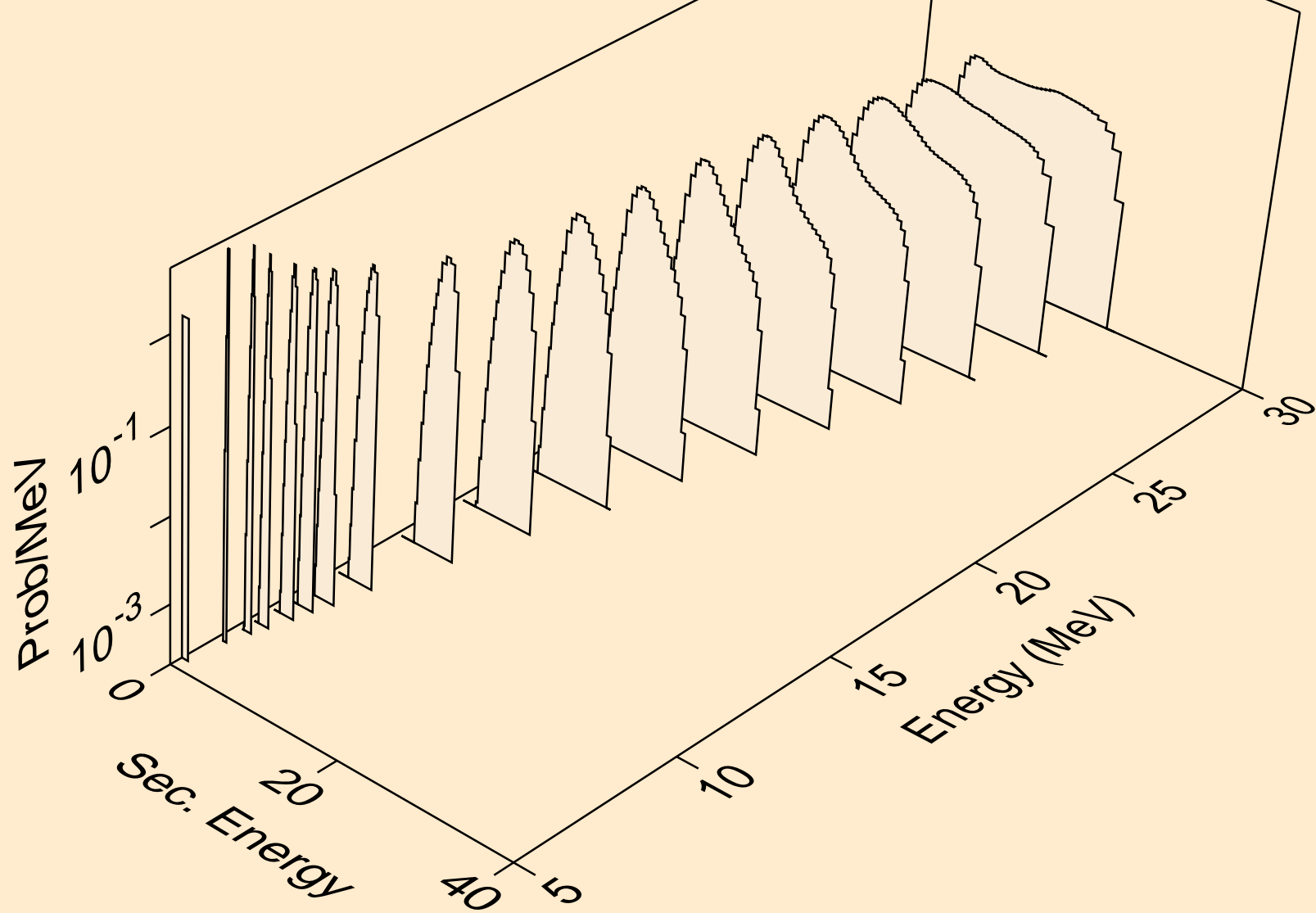

CE131M NEUTRON ACER TENDL-2023 LIBRARY; T=0.K
protons from (n,2np)

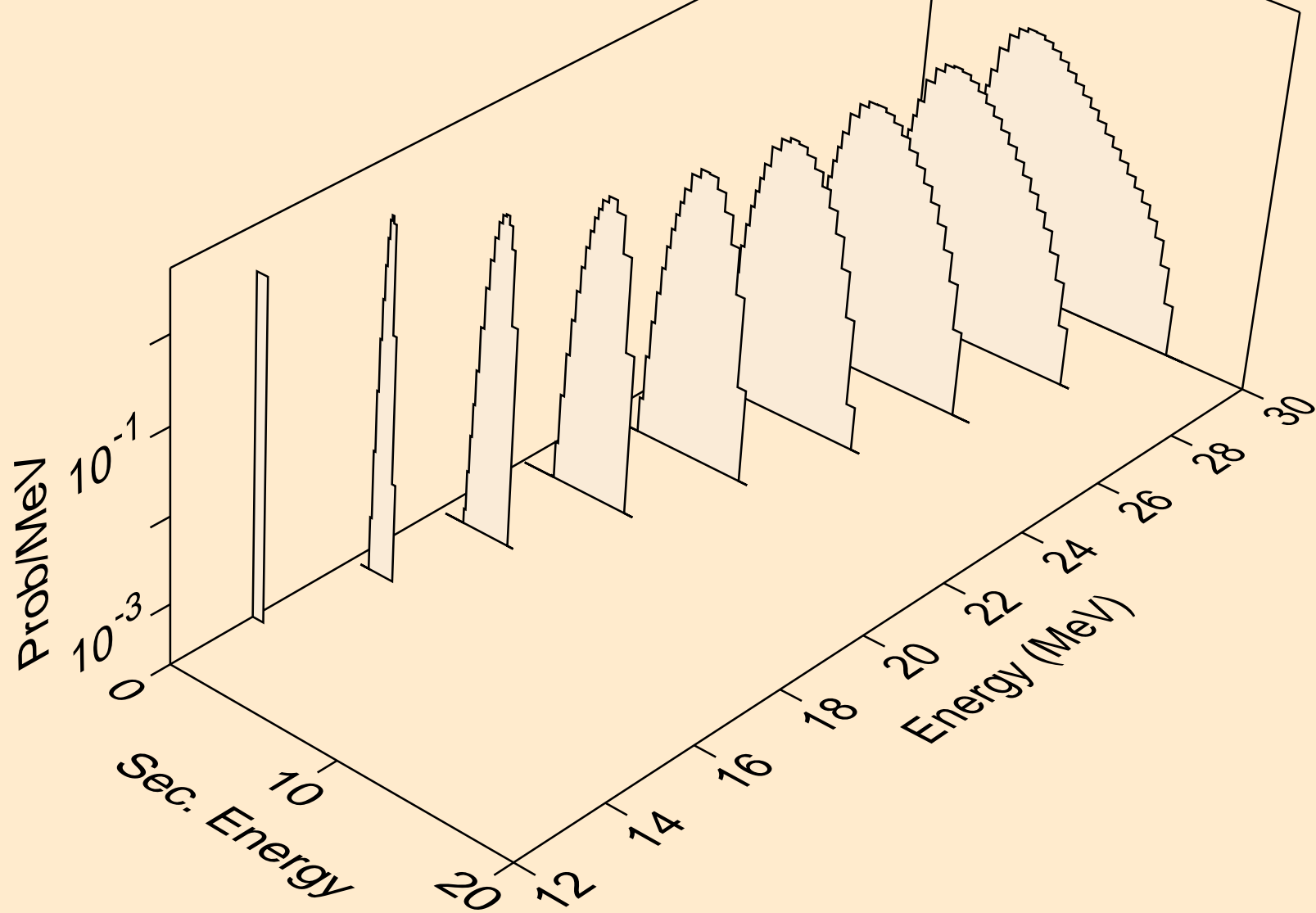

CE131M NEUTRON ACER TENDL-2023 LIBRARY; T=0.K
protons from (n,3np)

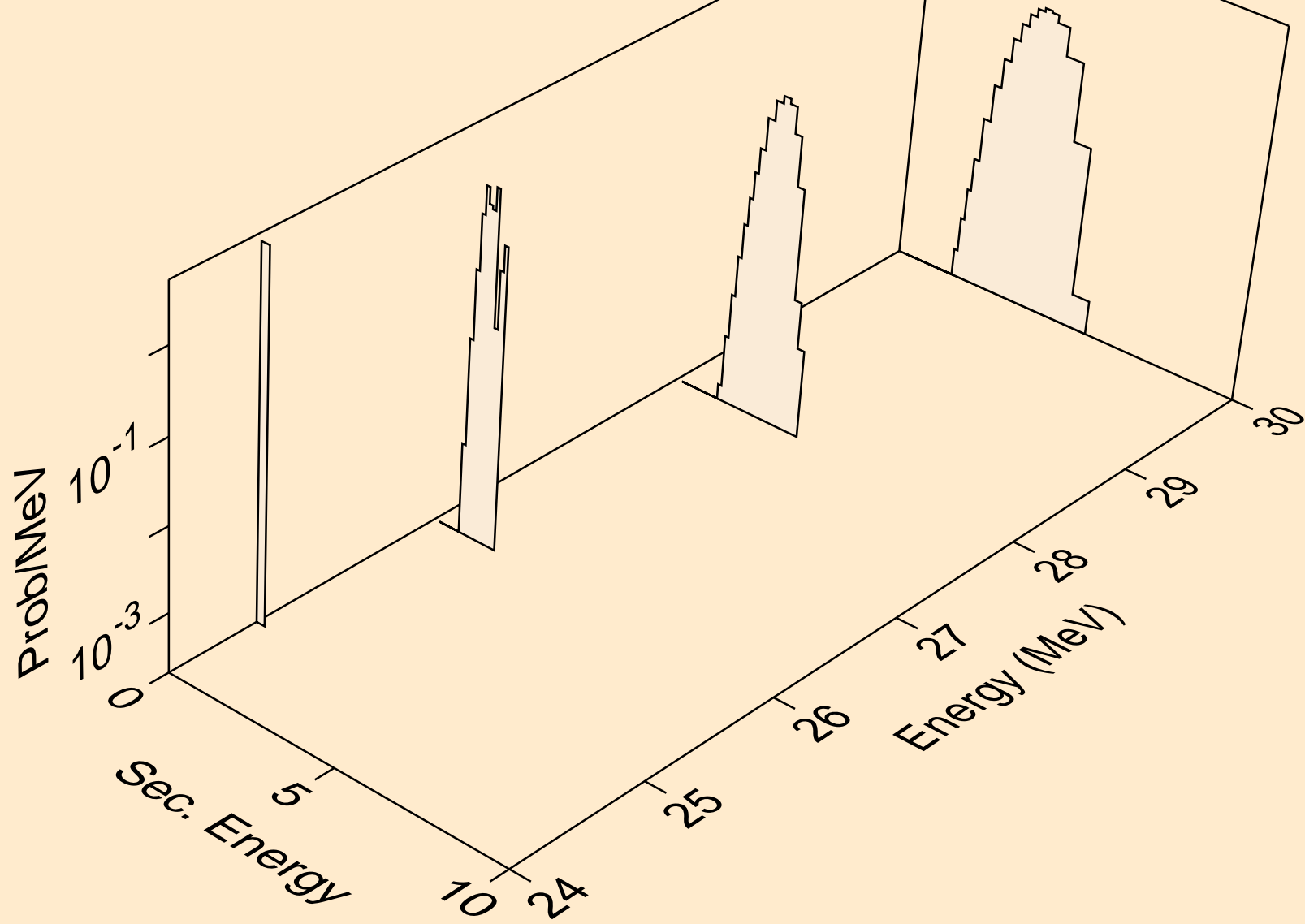

CE131M NEUTRON ACER TENDL-2023 LIBRARY; T=0.K
protons from (n,n2p)

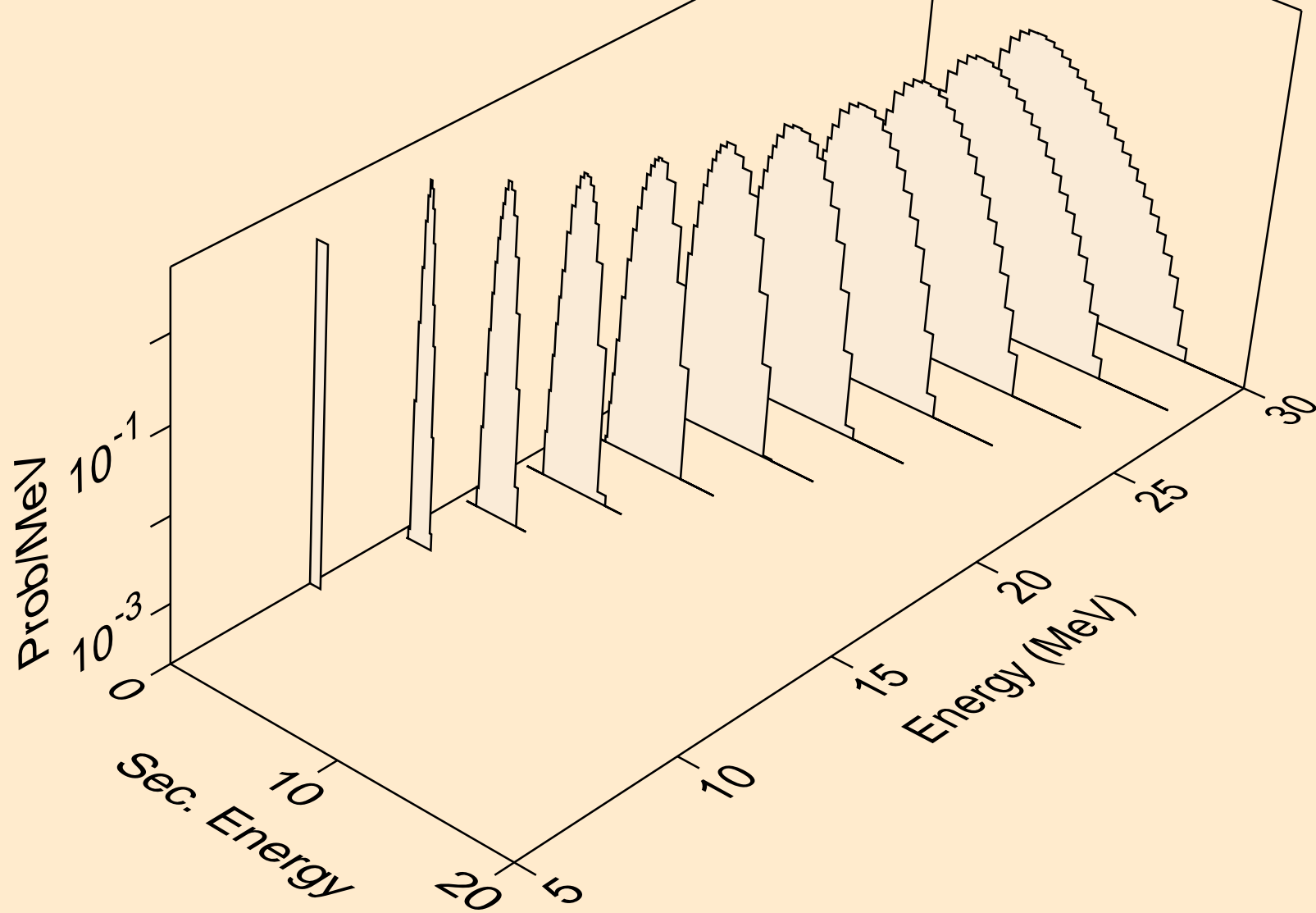

CE131M NEUTRON ACER TENDL-2023 LIBRARY; T=0.K
protons from (n,npa)

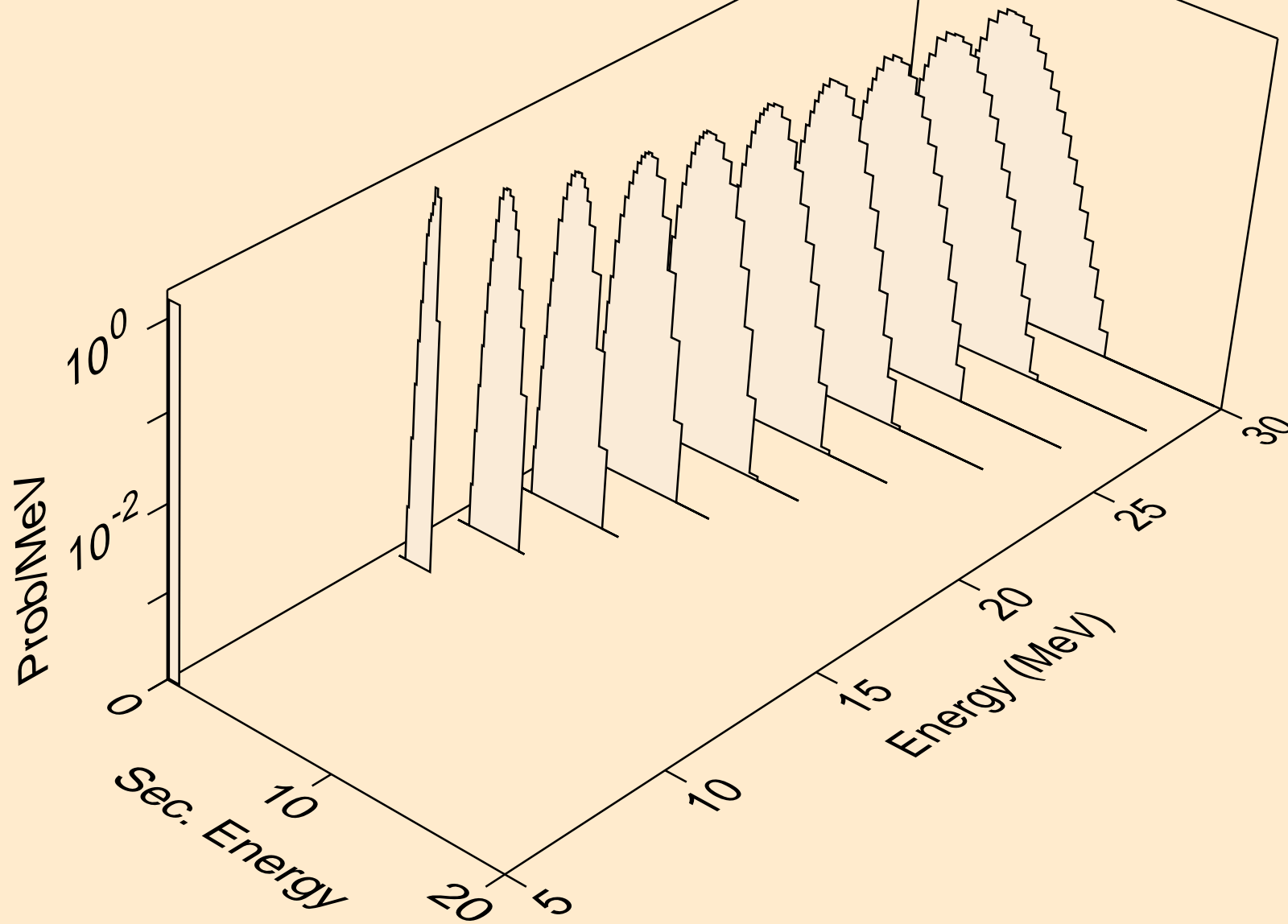

CE131M NEUTRON ACER TENDL-2023 LIBRARY; T=0.K
protons from (n,p)

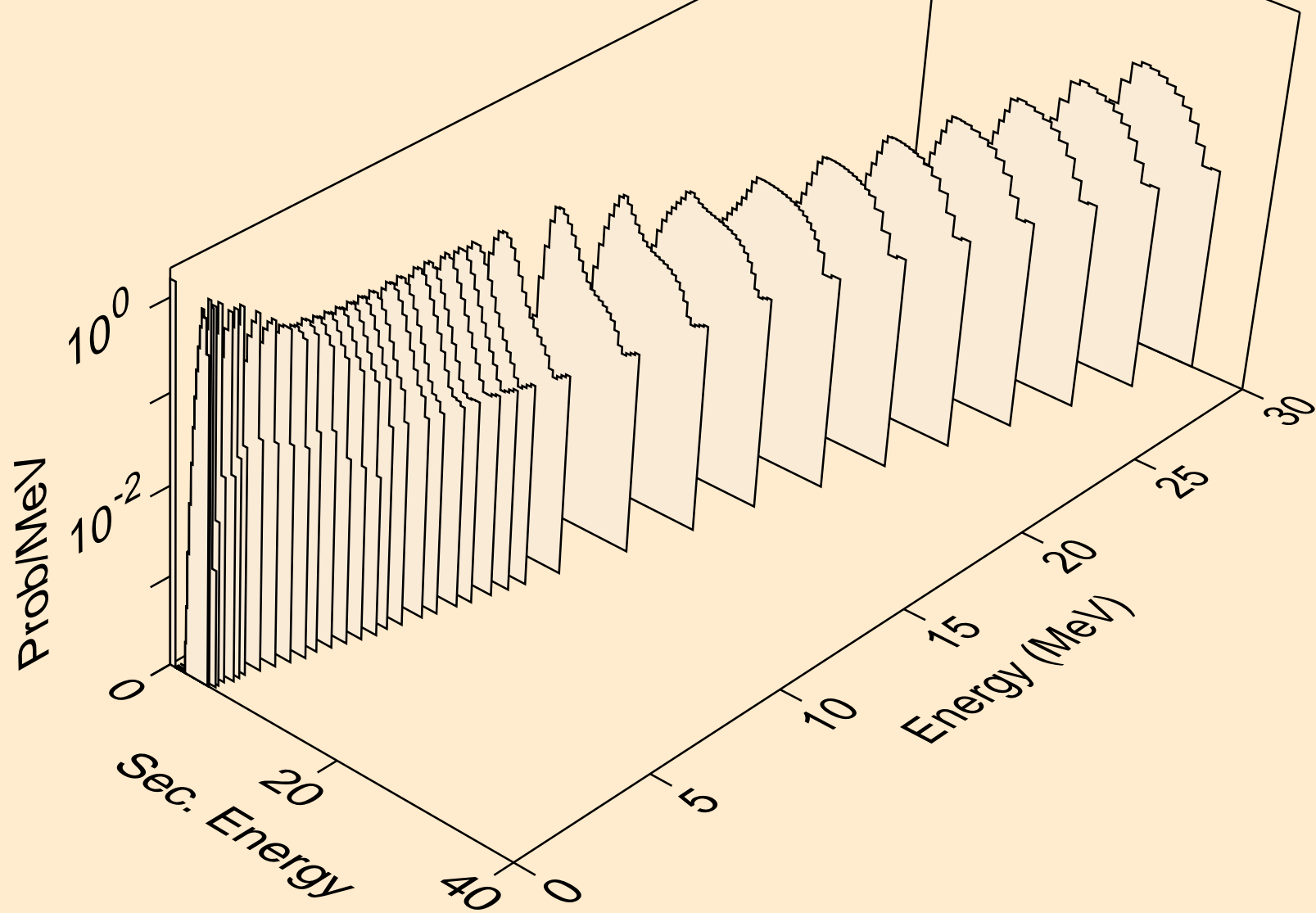

CE131M NEUTRON ACER TENDL-2023 LIBRARY; T=0.K
protons from (n,2p)

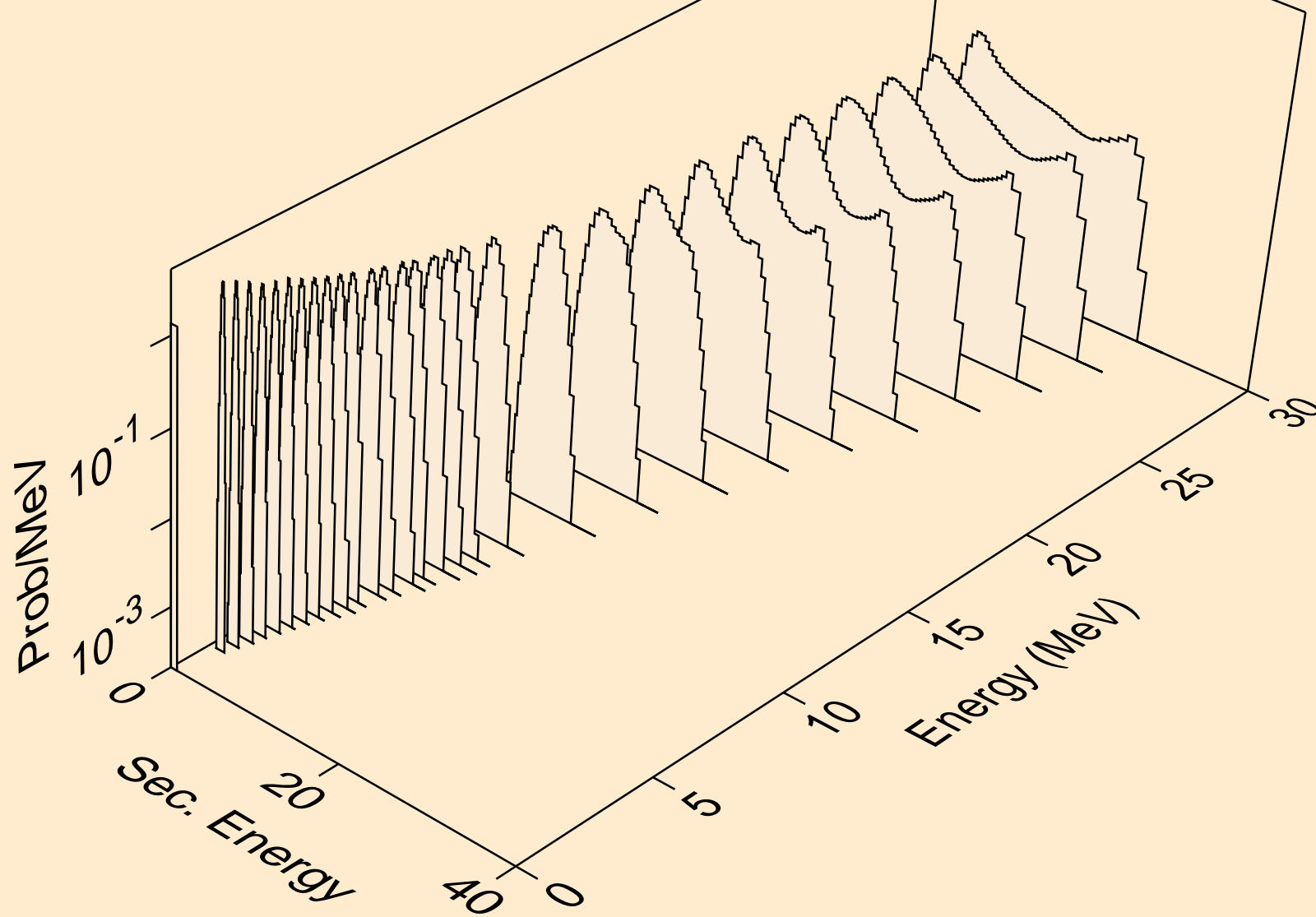

CE131M NEUTRON ACER TENDL-2023 LIBRARY; T=0.K
protons from (n,p)

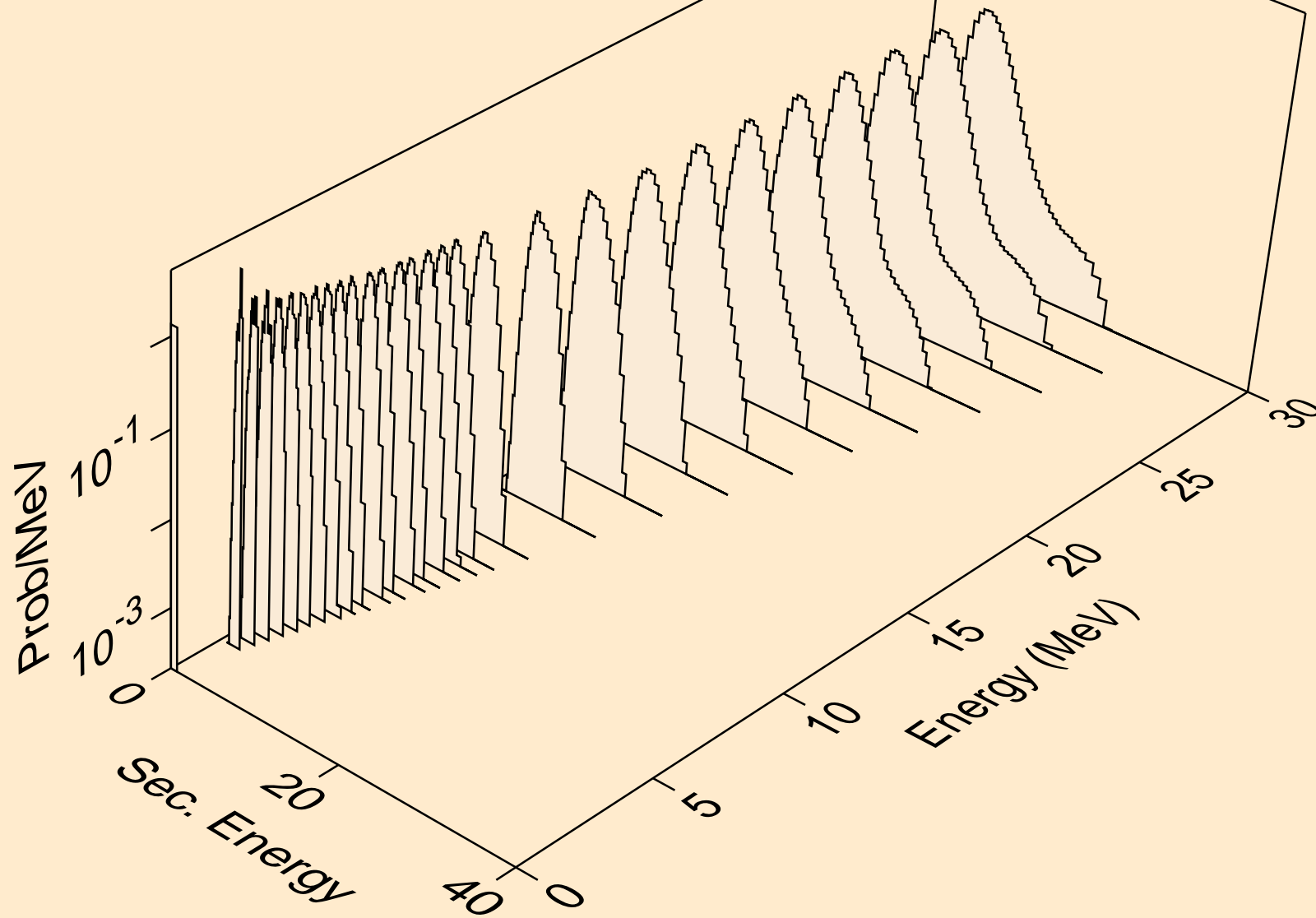

CE131M NEUTRON ACER TENDL-2023 LIBRARY; T=0.K
protons from (n,pd)

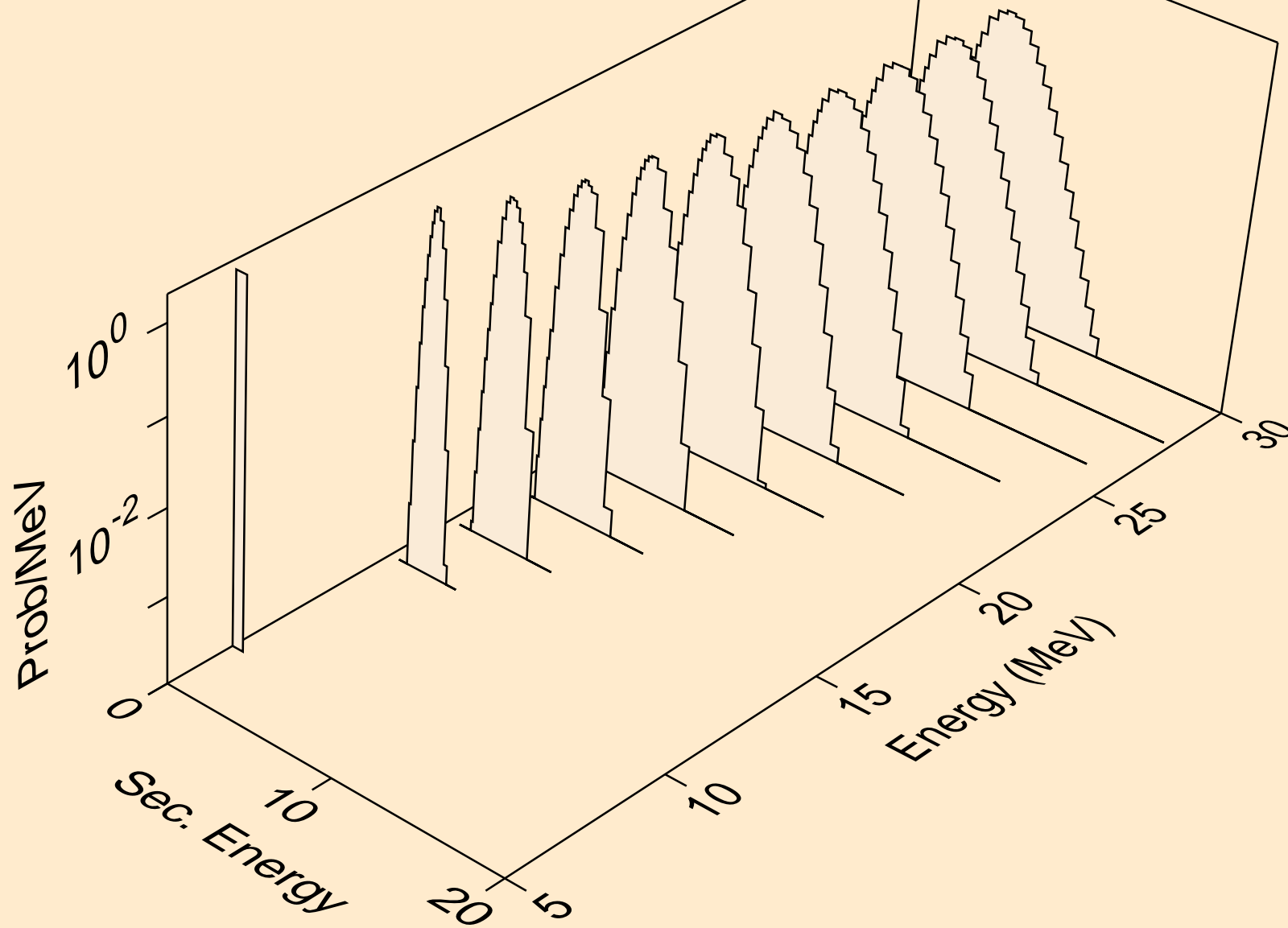

CE131M NEUTRON ACER TENDL-2023 LIBRARY; T=0.K
protons from (n,pt)

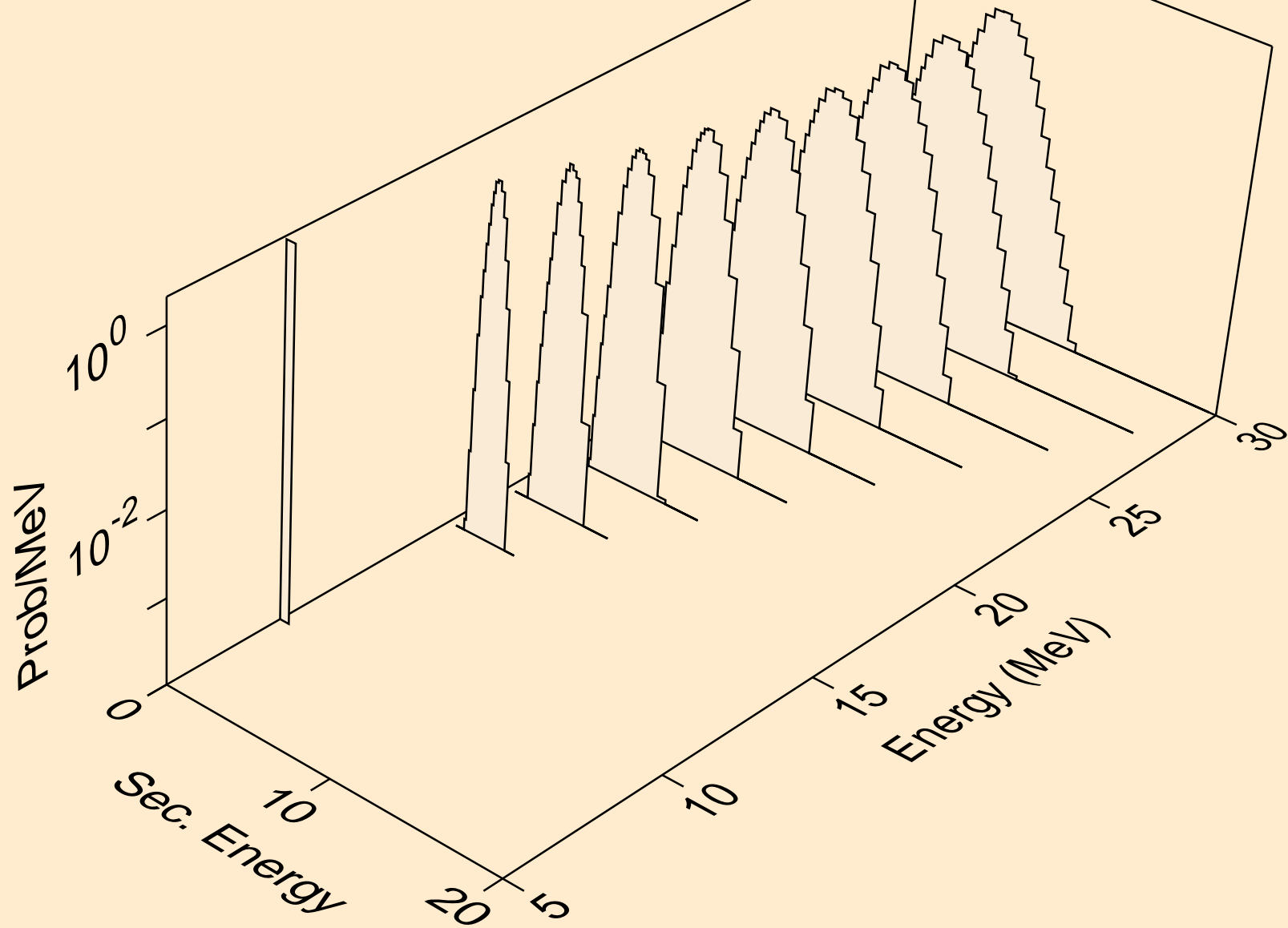

CE131M NEUTRON ACER TENDL-2023 LIBRARY; T=0.K
deuterons from (n,x)

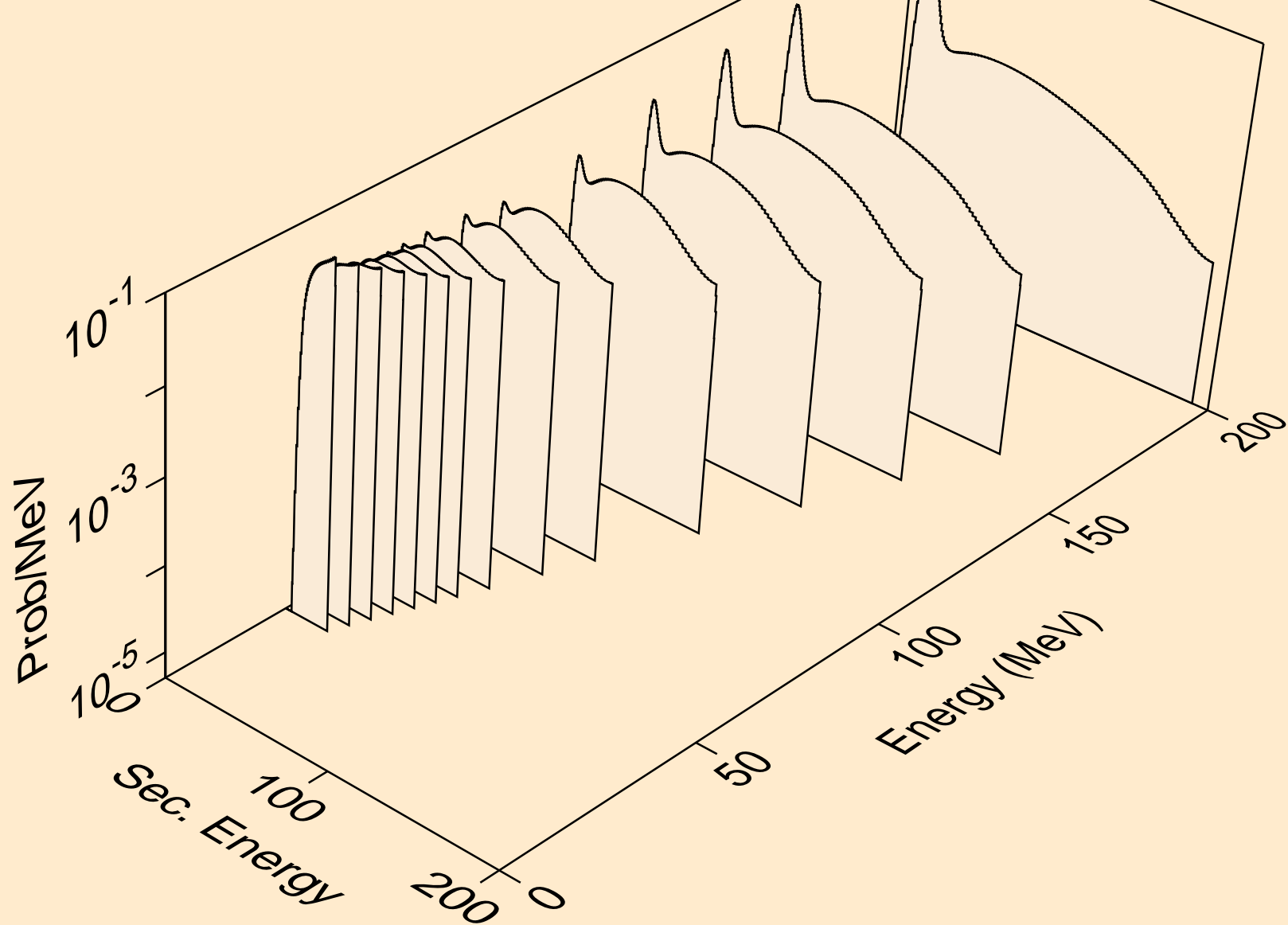

CE131M NEUTRON ACER TENDL-2023 LIBRARY; T=0.K
deuterons from (n,2nd)

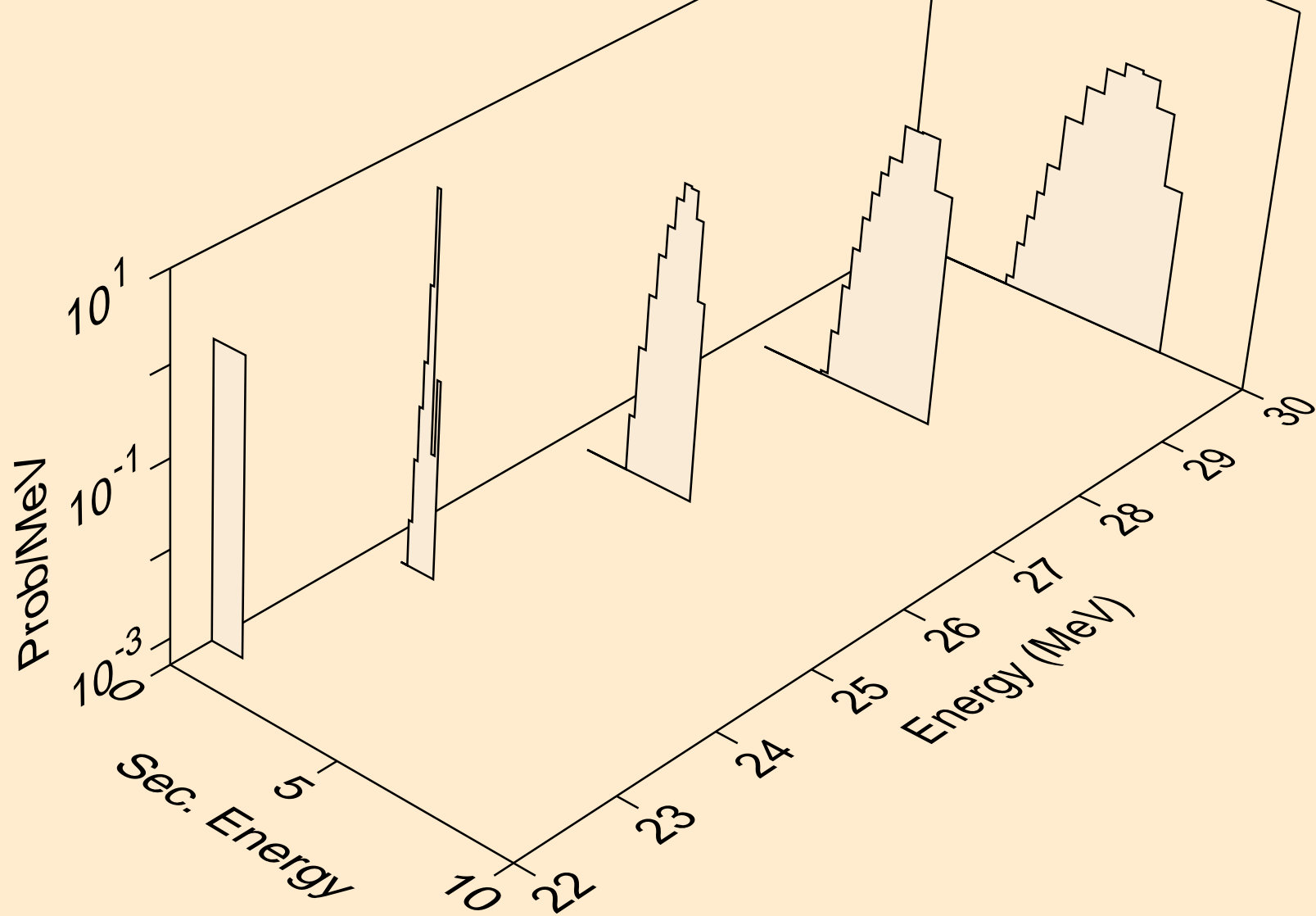

CE131M NEUTRON ACER TENDL-2023 LIBRARY; T=0.K
deuterons from (n,n*)d

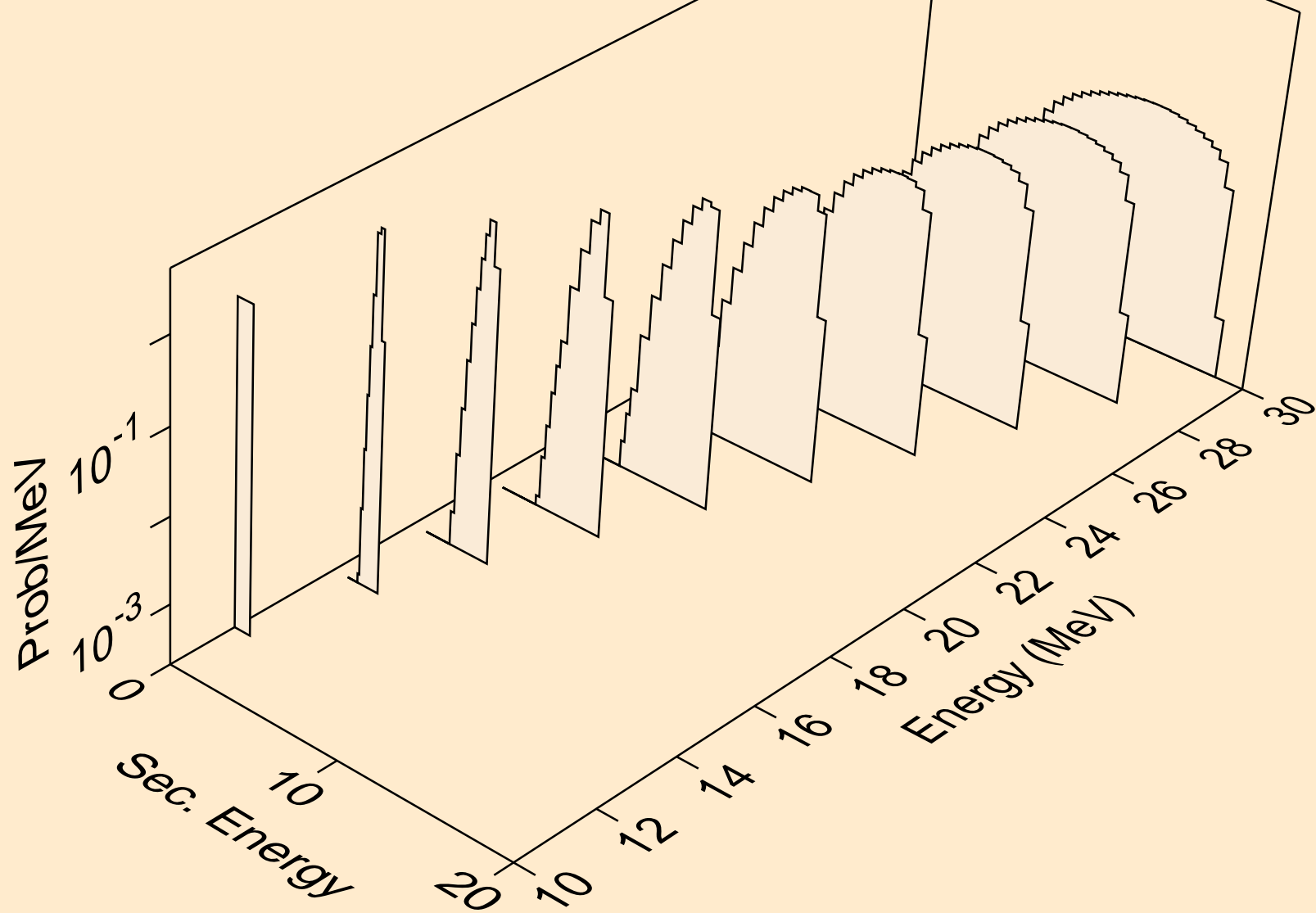

CE131M NEUTRON ACER TENDL-2023 LIBRARY; T=0.K
deuterons from (n,d)

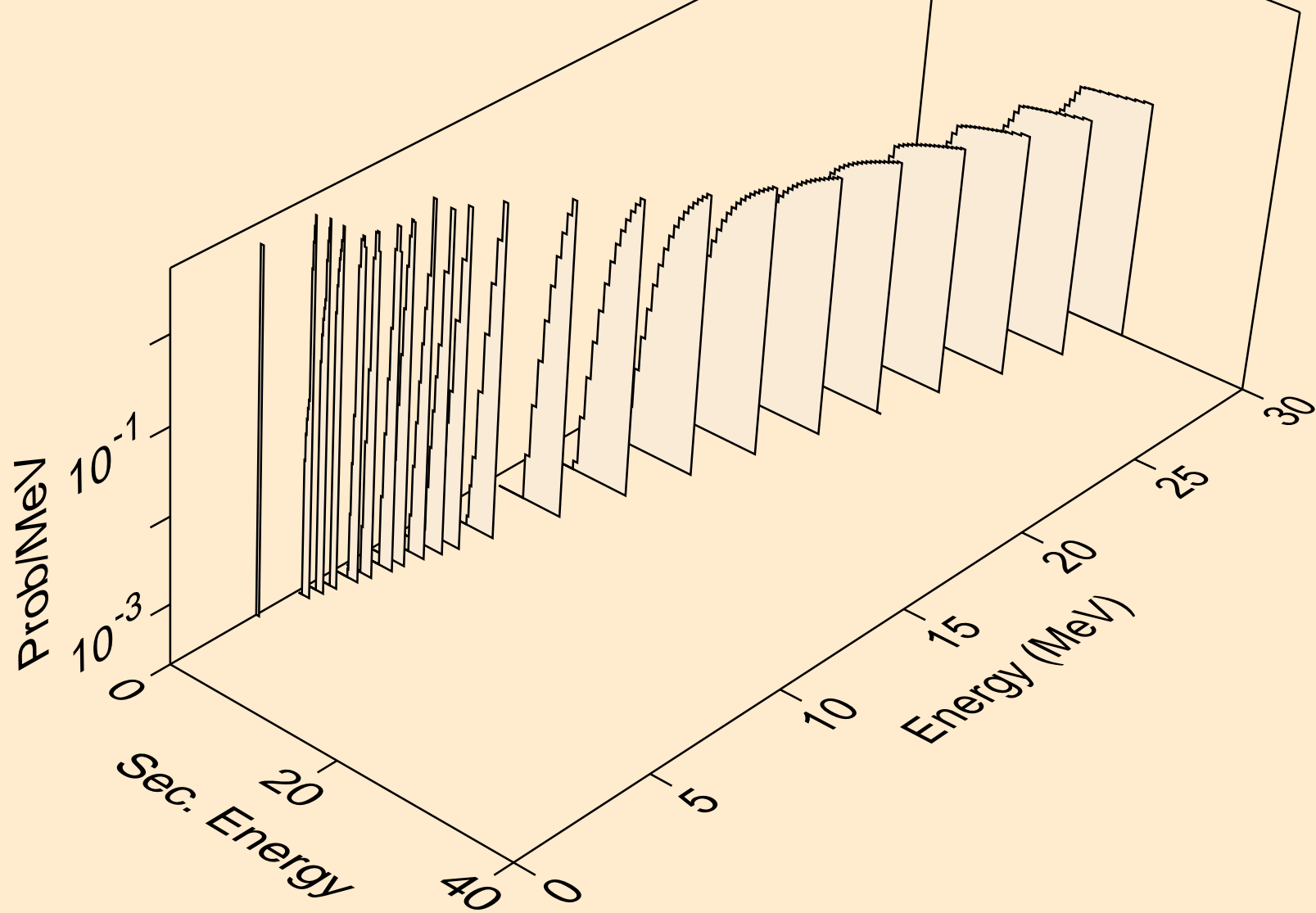

CE131M NEUTRON ACER TENDL-2023 LIBRARY; T=0.K
deuterons from (n,pd)

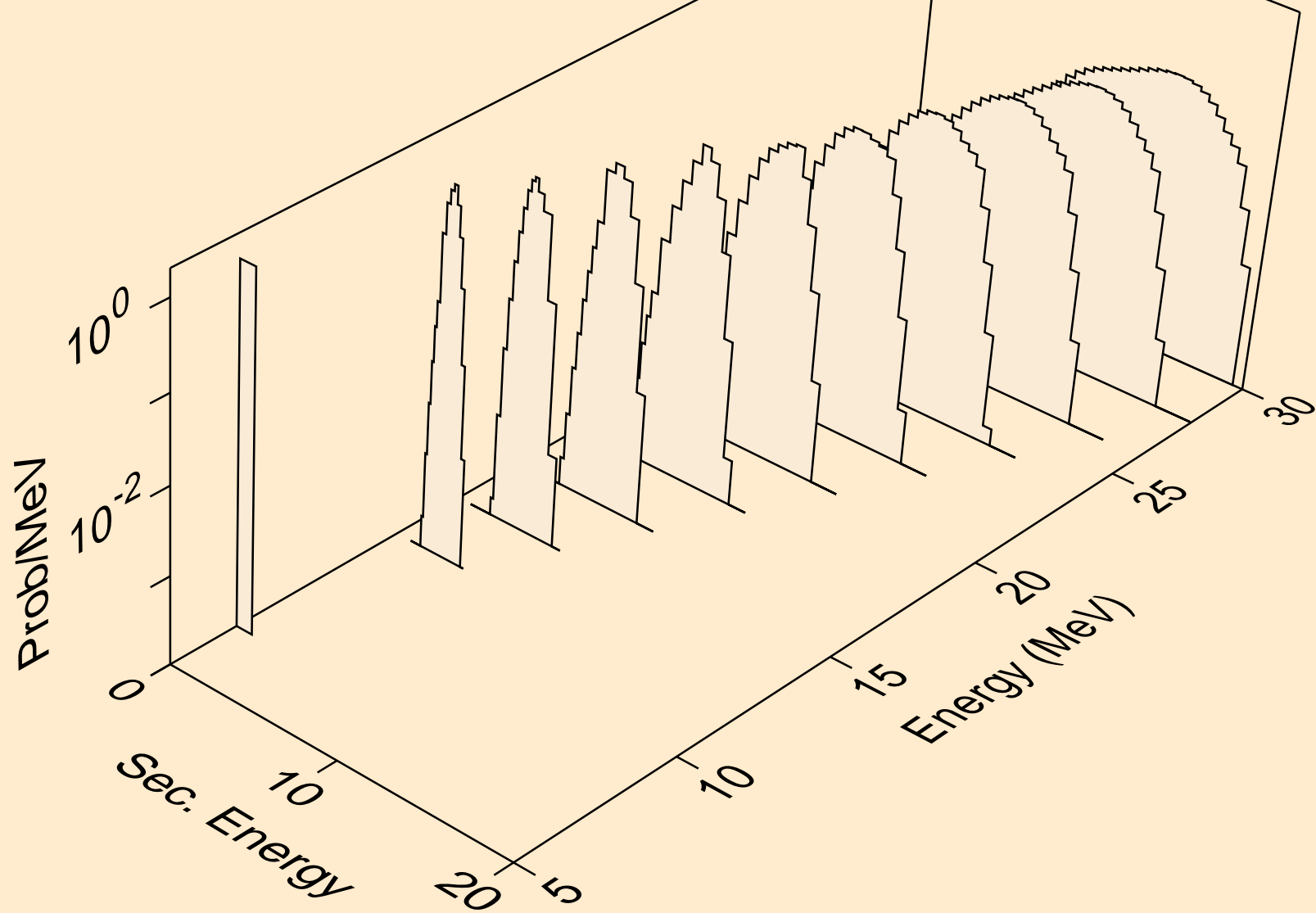

CE131M NEUTRON ACER TENDL-2023 LIBRARY; T=0.K
deuterons from (n,da)

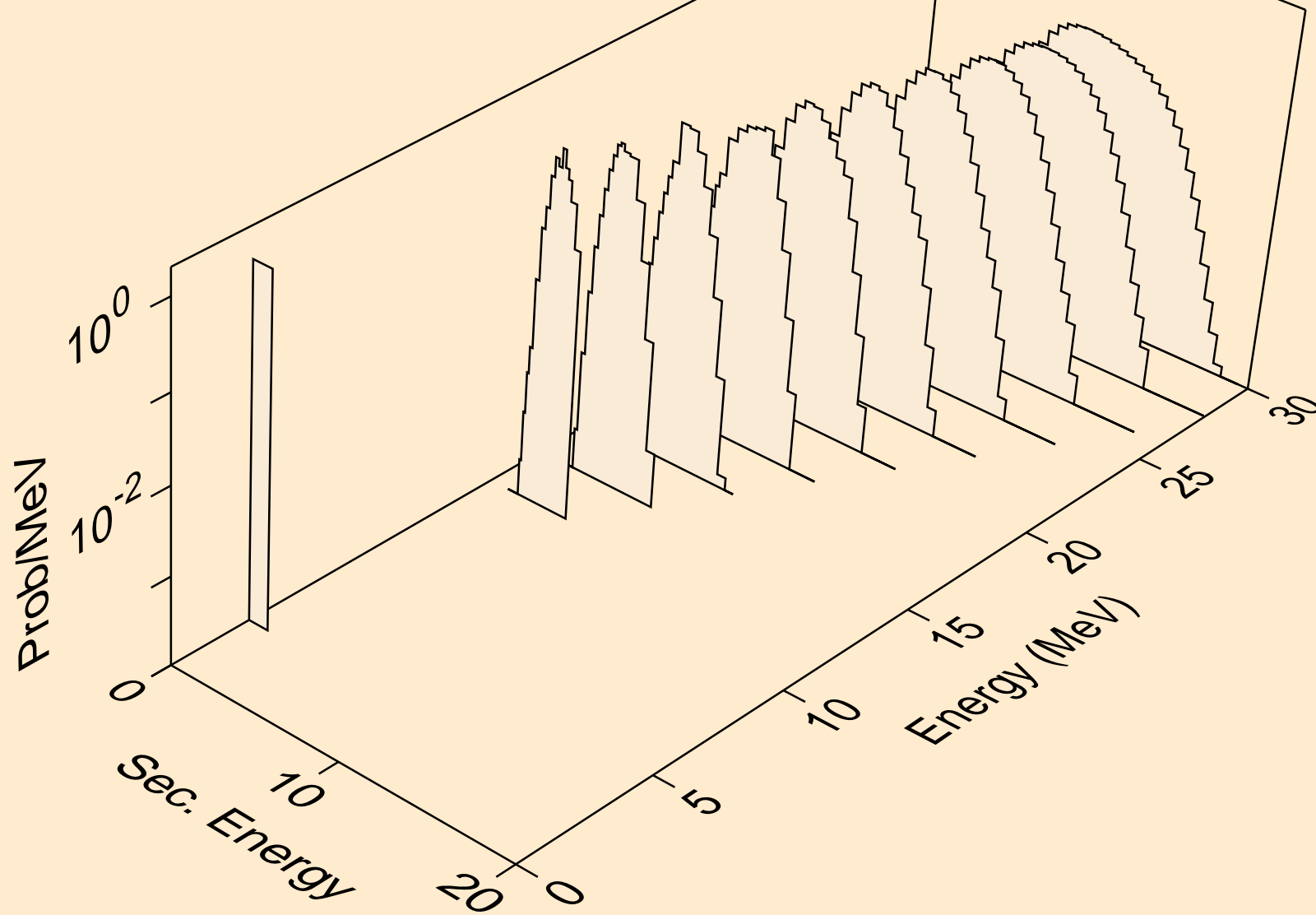

CE131M NEUTRON ACER TENDL-2023 LIBRARY; T=0.K
tritons from (n,x)

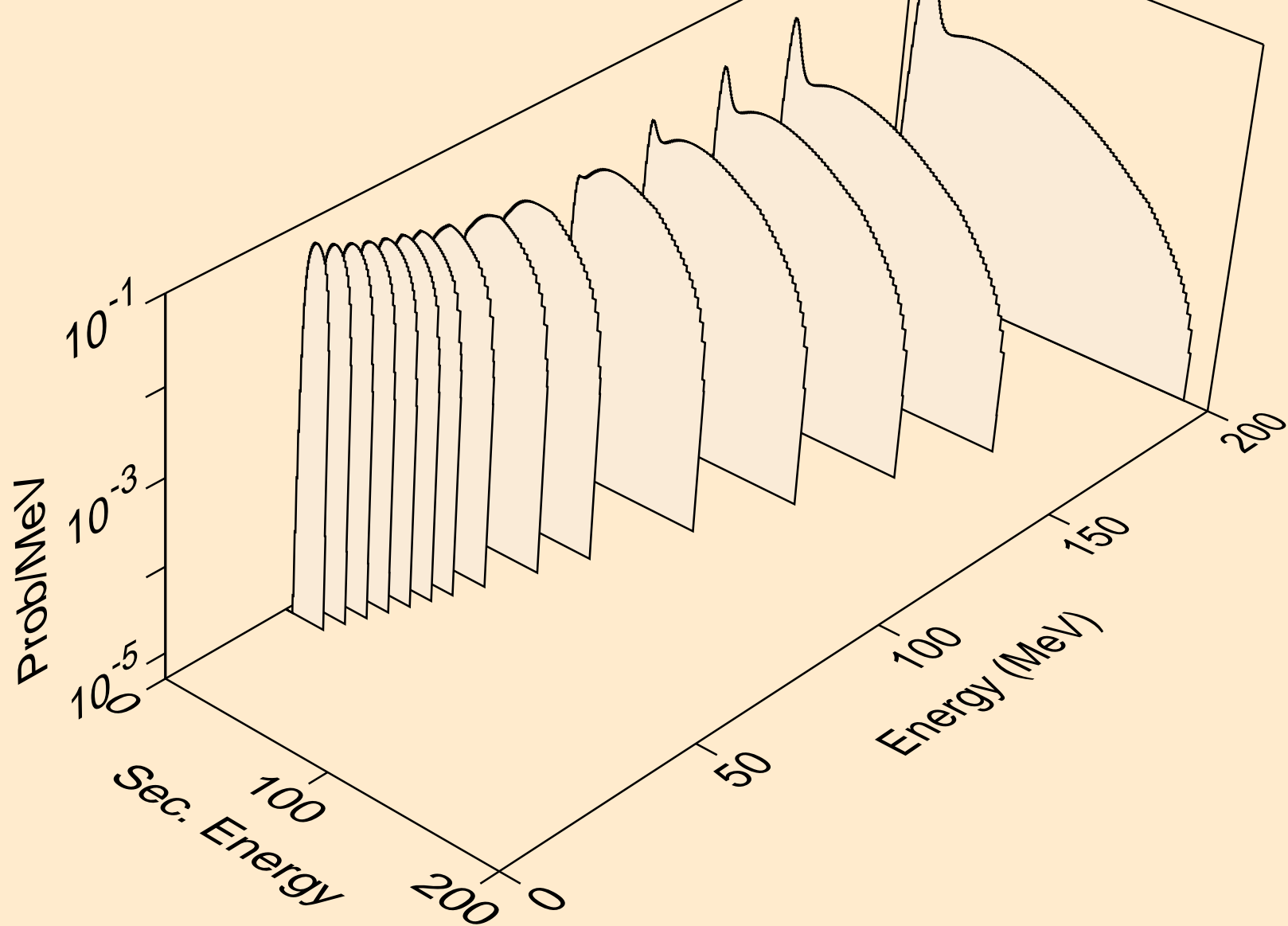

CE131M NEUTRON ACER TENDL-2023 LIBRARY; T=0.K
tritons from (n,n*)t

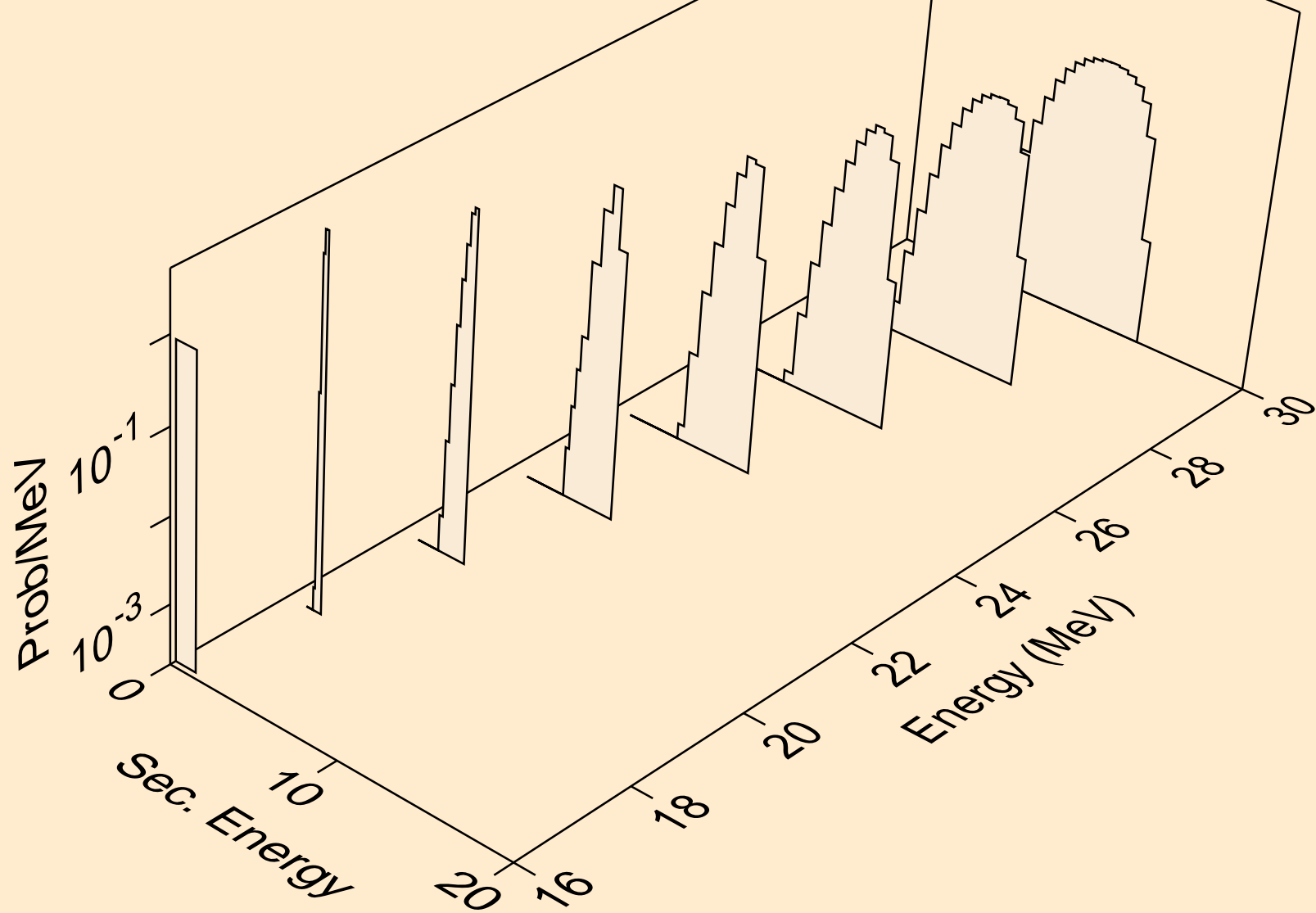

CE131M NEUTRON ACER TENDL-2023 LIBRARY; T=0.K
tritons from (n,t)

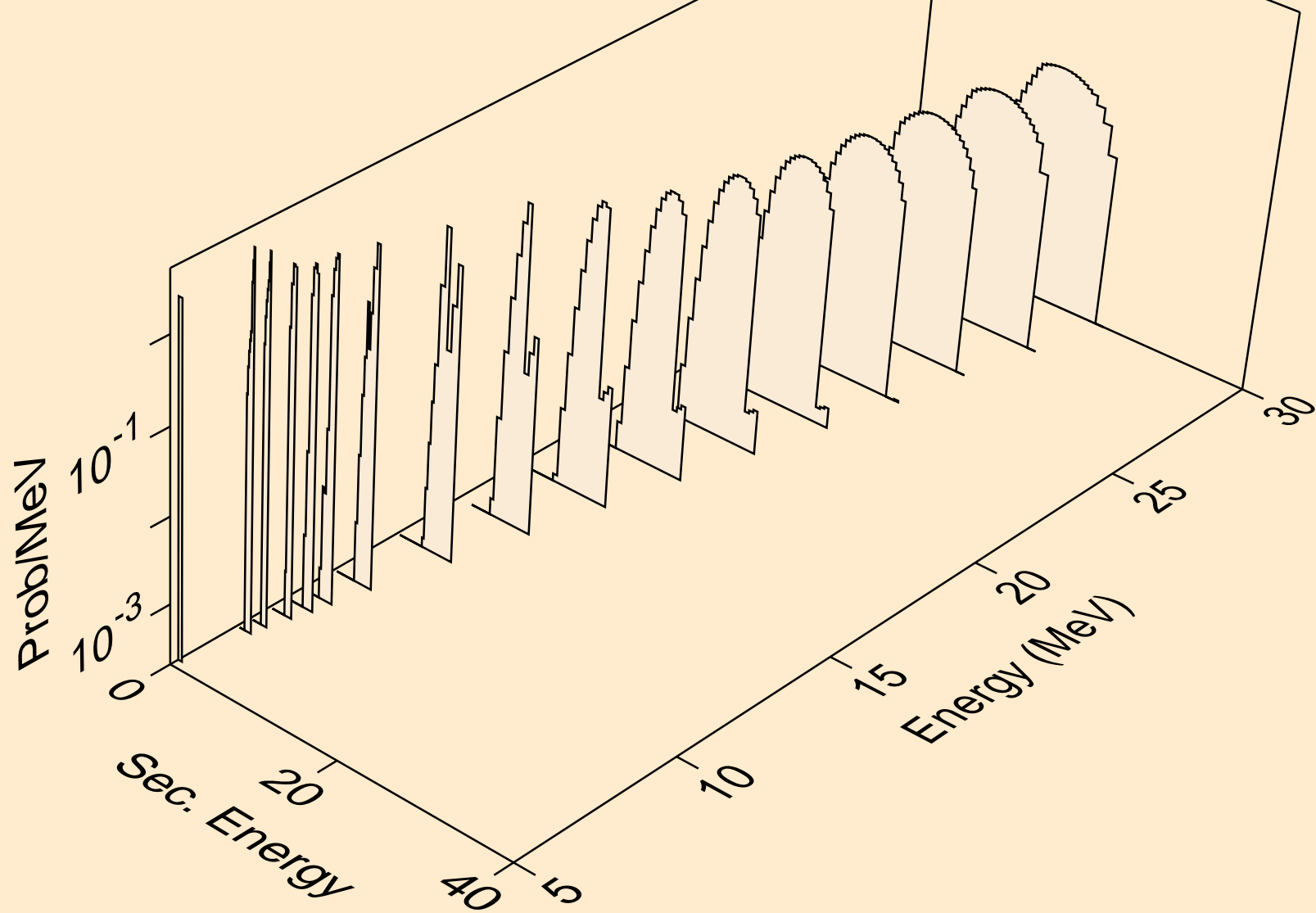

CE131M NEUTRON ACER TENDL-2023 LIBRARY; T=0.K
tritons from (n,pt)

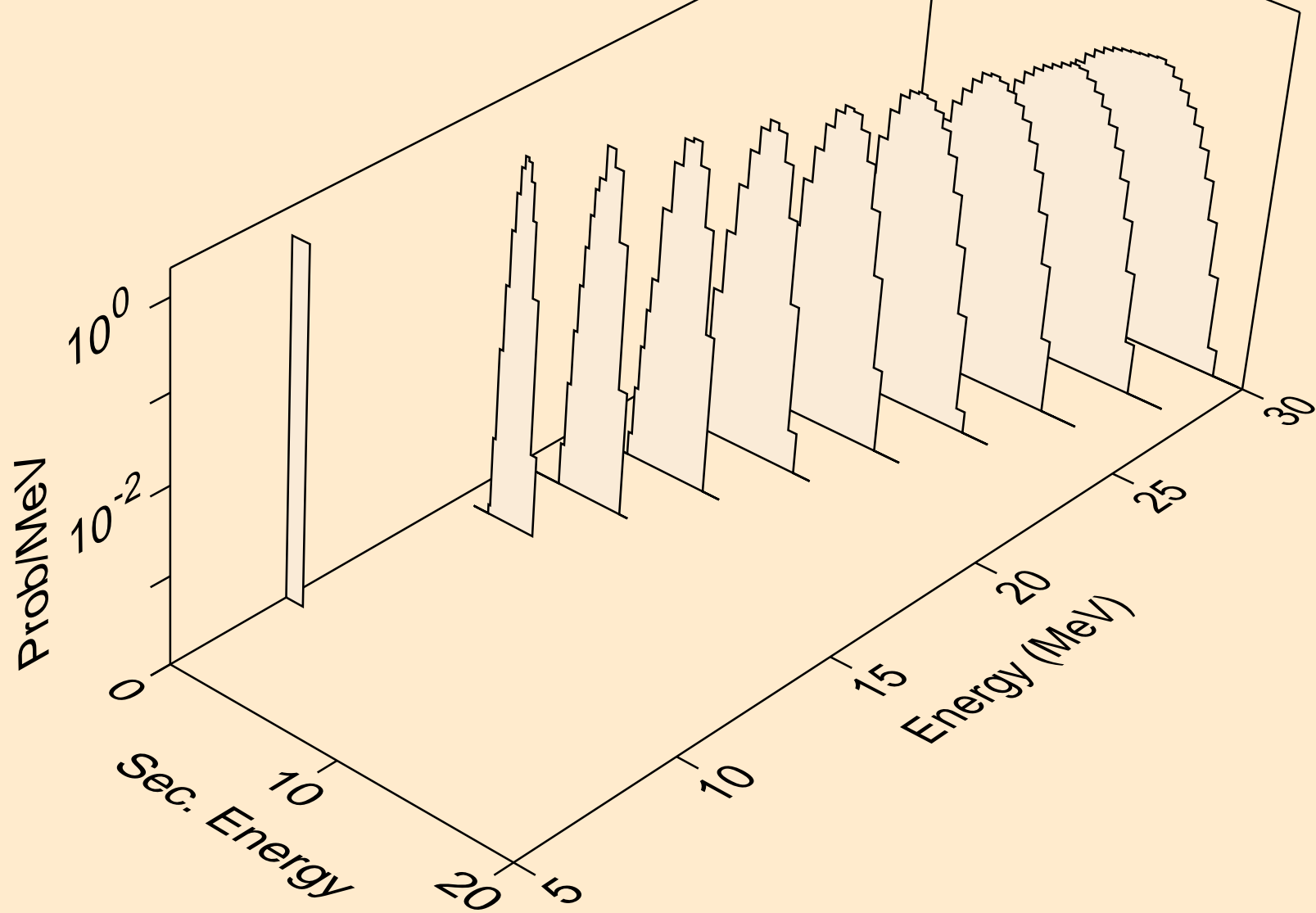

CE131M NEUTRON ACER TENDL-2023 LIBRARY; T=0.K
he3s from (n,x)

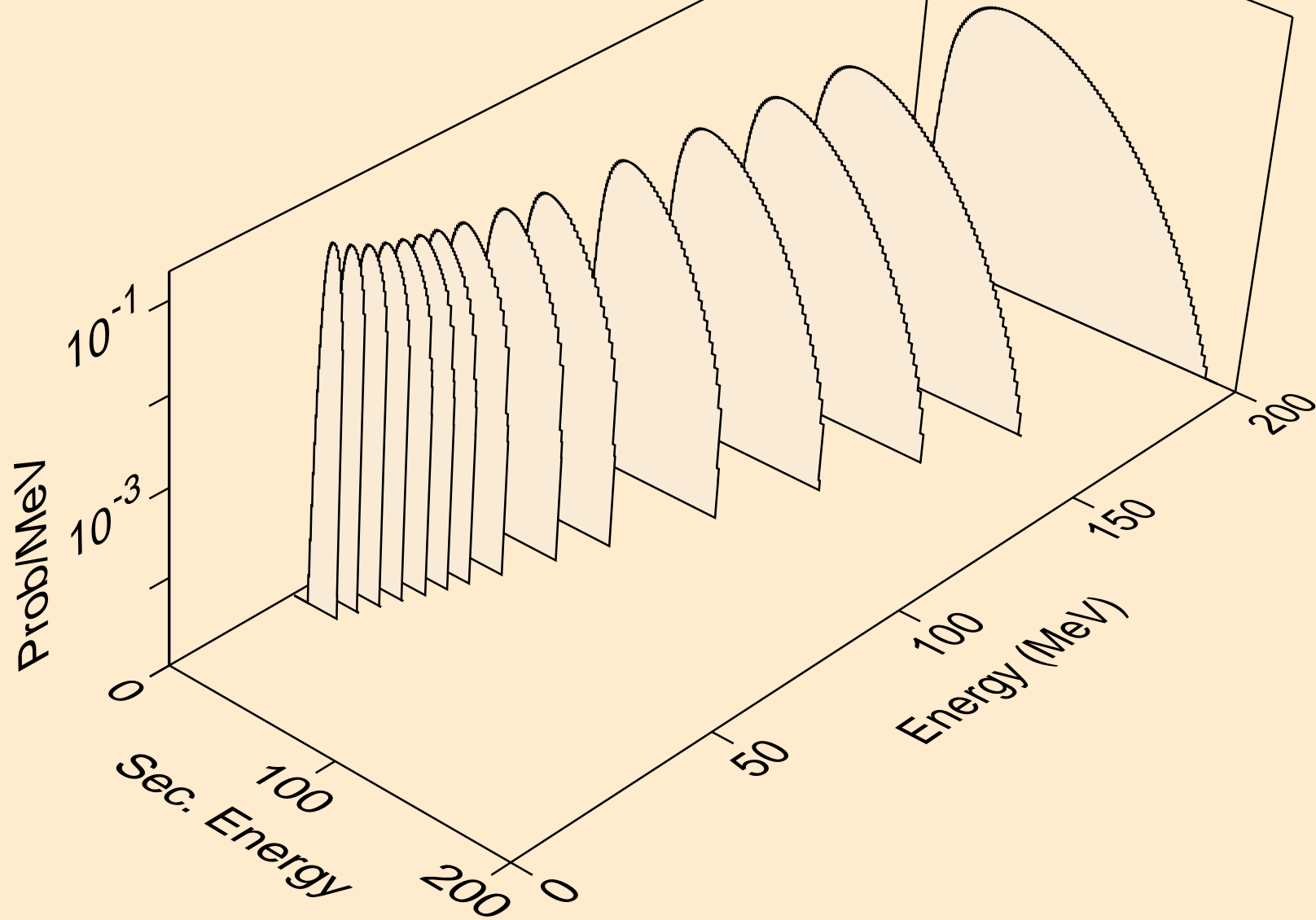

CE131M NEUTRON ACER TENDL-2023 LIBRARY; T=0.K
he3s from (n,n*)he3

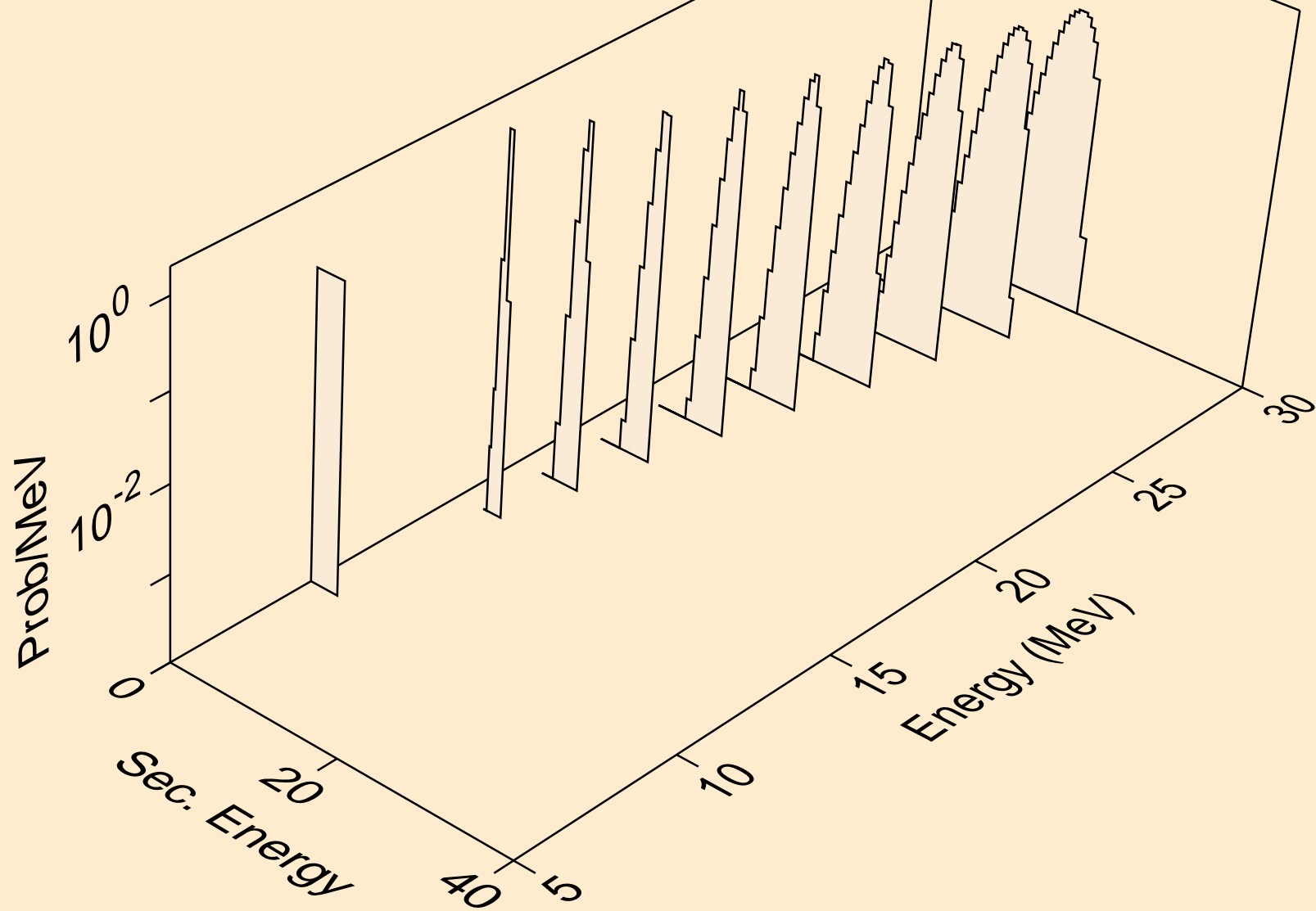

CE131M NEUTRON ACER TENDL-2023 LIBRARY; T=0.K
he3s from (n,he3)

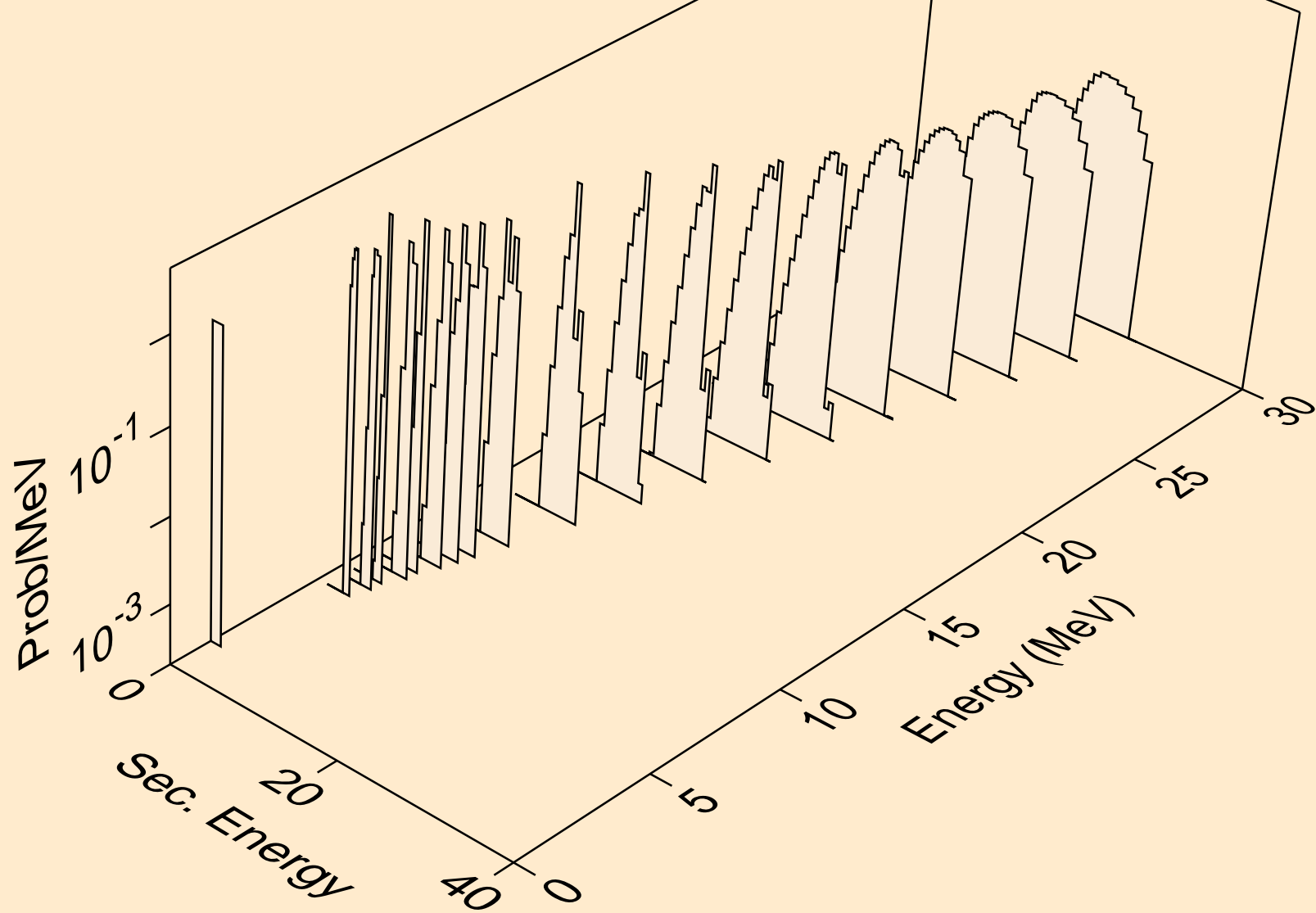

CE131M NEUTRON ACER TENDL-2023 LIBRARY; T=0.K
alphas from (n,x)

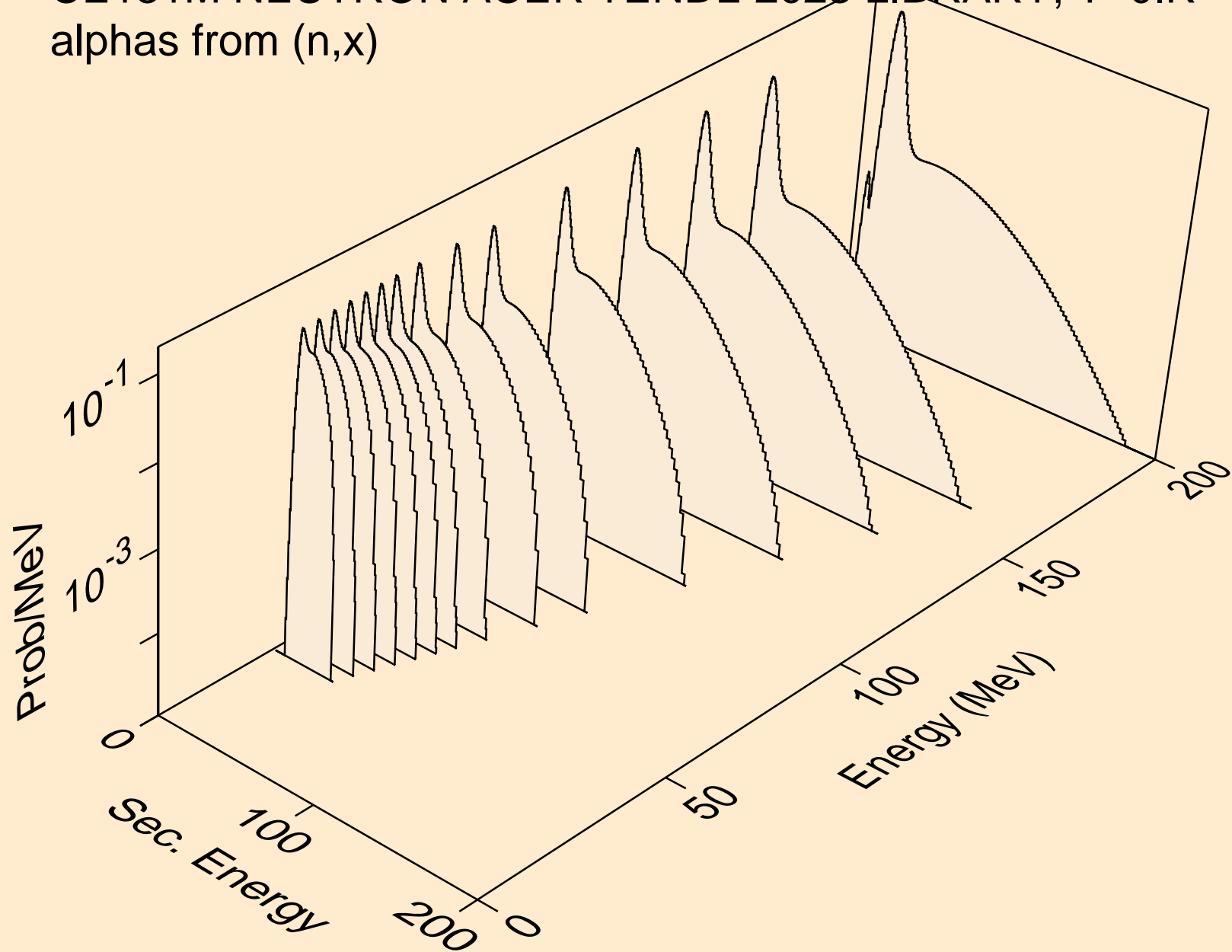

CE131M NEUTRON ACER TENDL-2023 LIBRARY; T=0.K
alphas from (n,n*)a

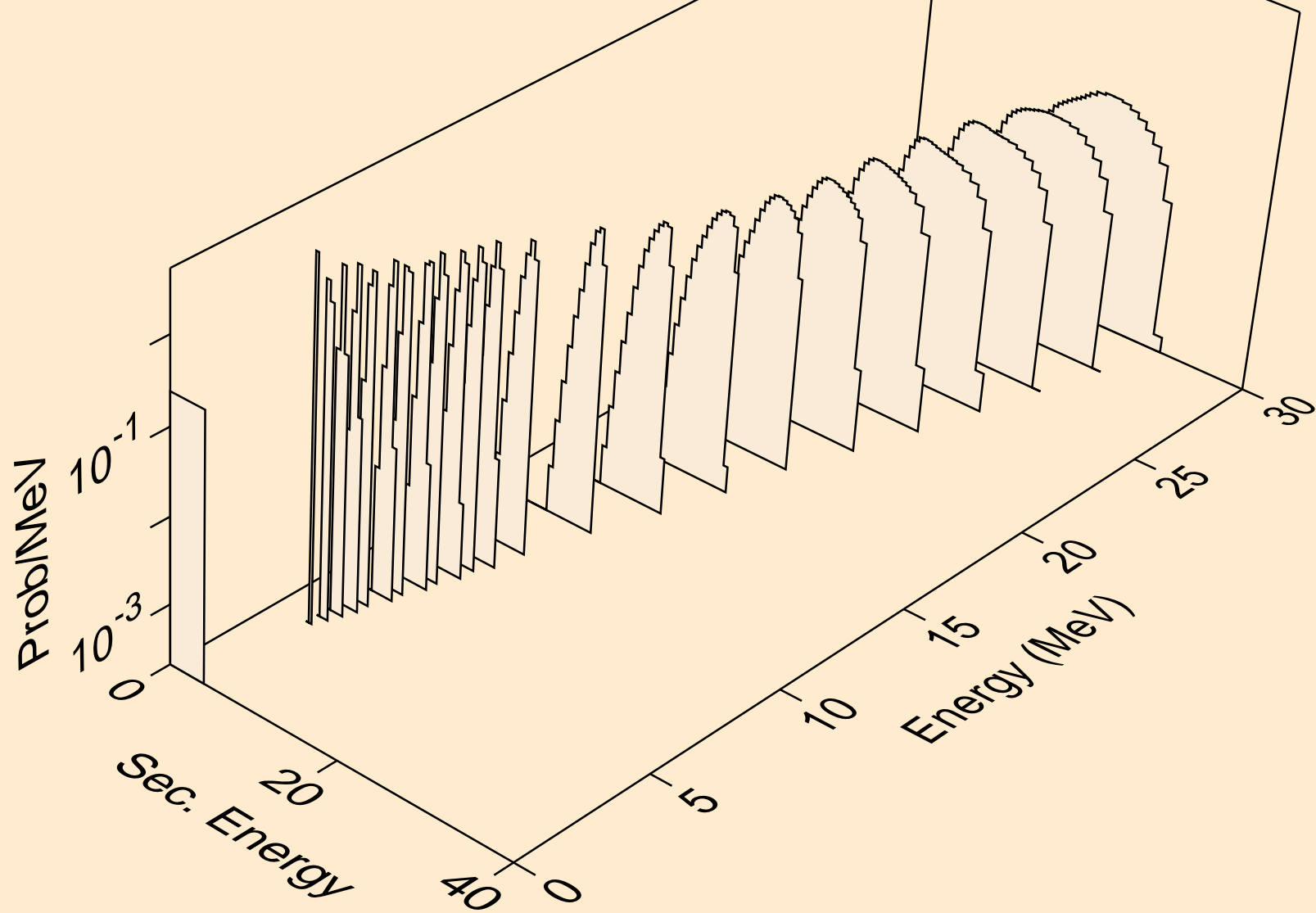

CE131M NEUTRON ACER TENDL-2023 LIBRARY; T=0.K
alphas from (n,2n)a

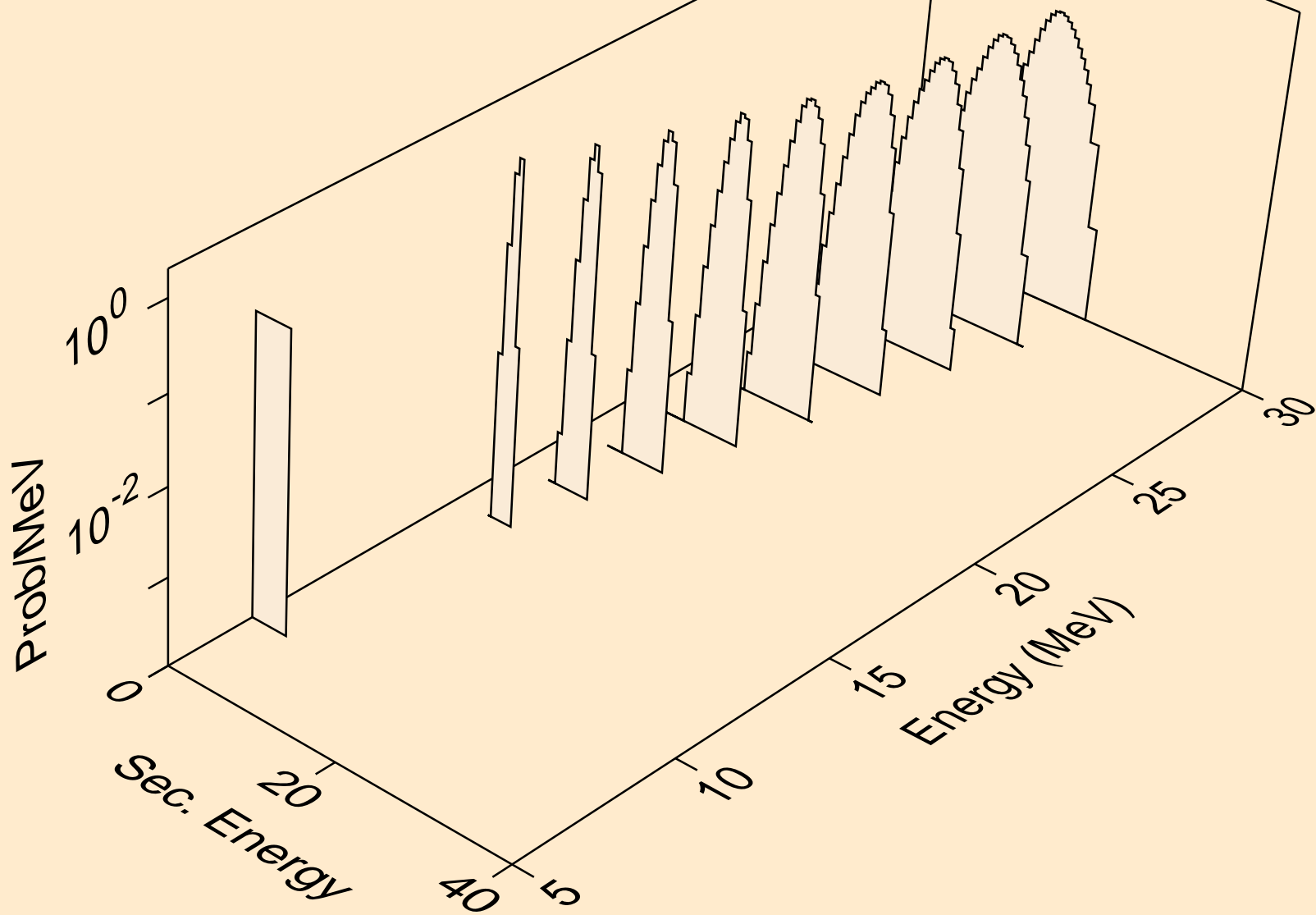

CE131M NEUTRON ACER TENDL-2023 LIBRARY; T=0.K
alphas from (n,3n)a

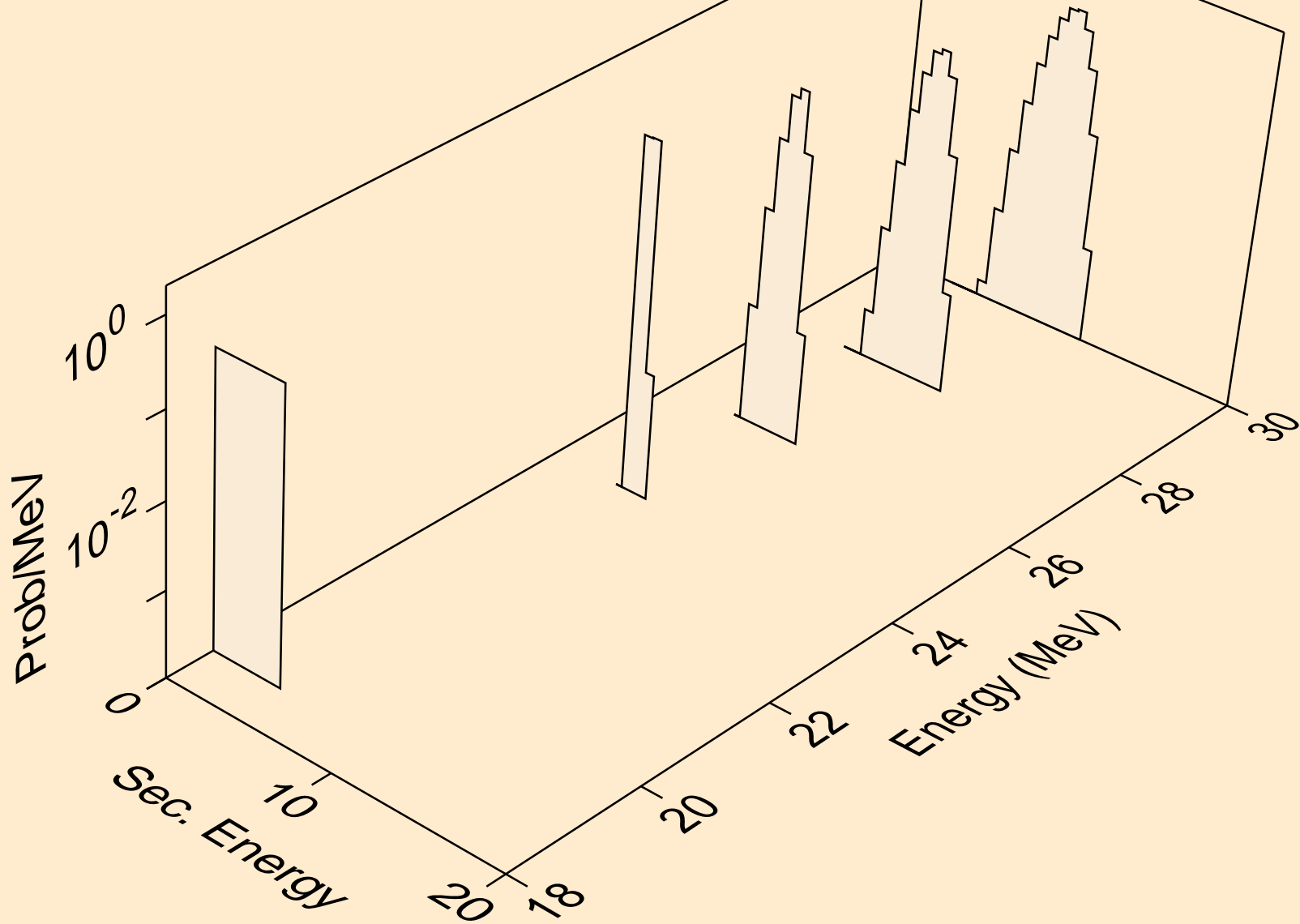

CE131M NEUTRON ACER TENDL-2023 LIBRARY; T=0.K
alphas from (n,n*)2a

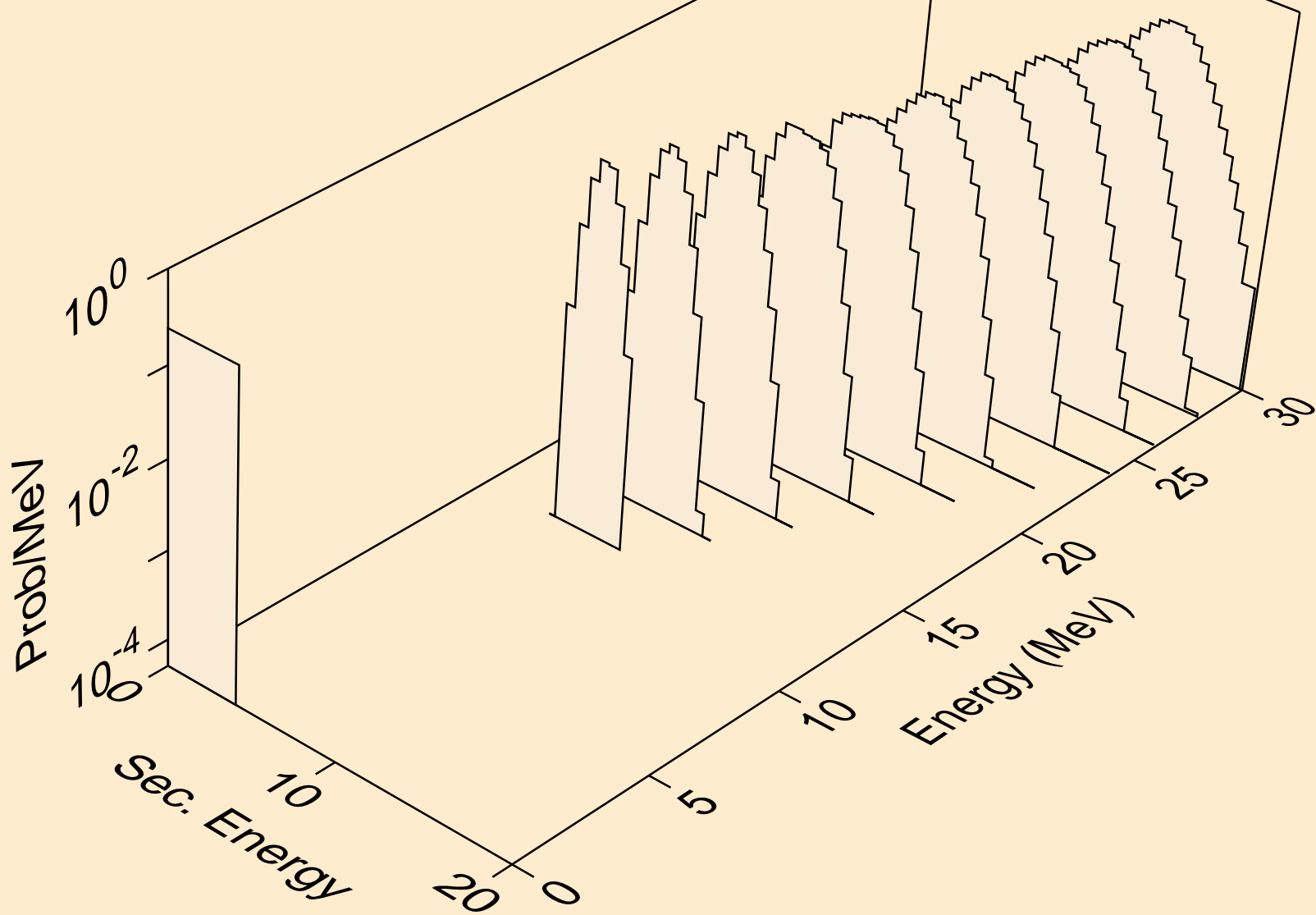

CE131M NEUTRON ACER TENDL-2023 LIBRARY; T=0.K
alphas from (n,2n)2a

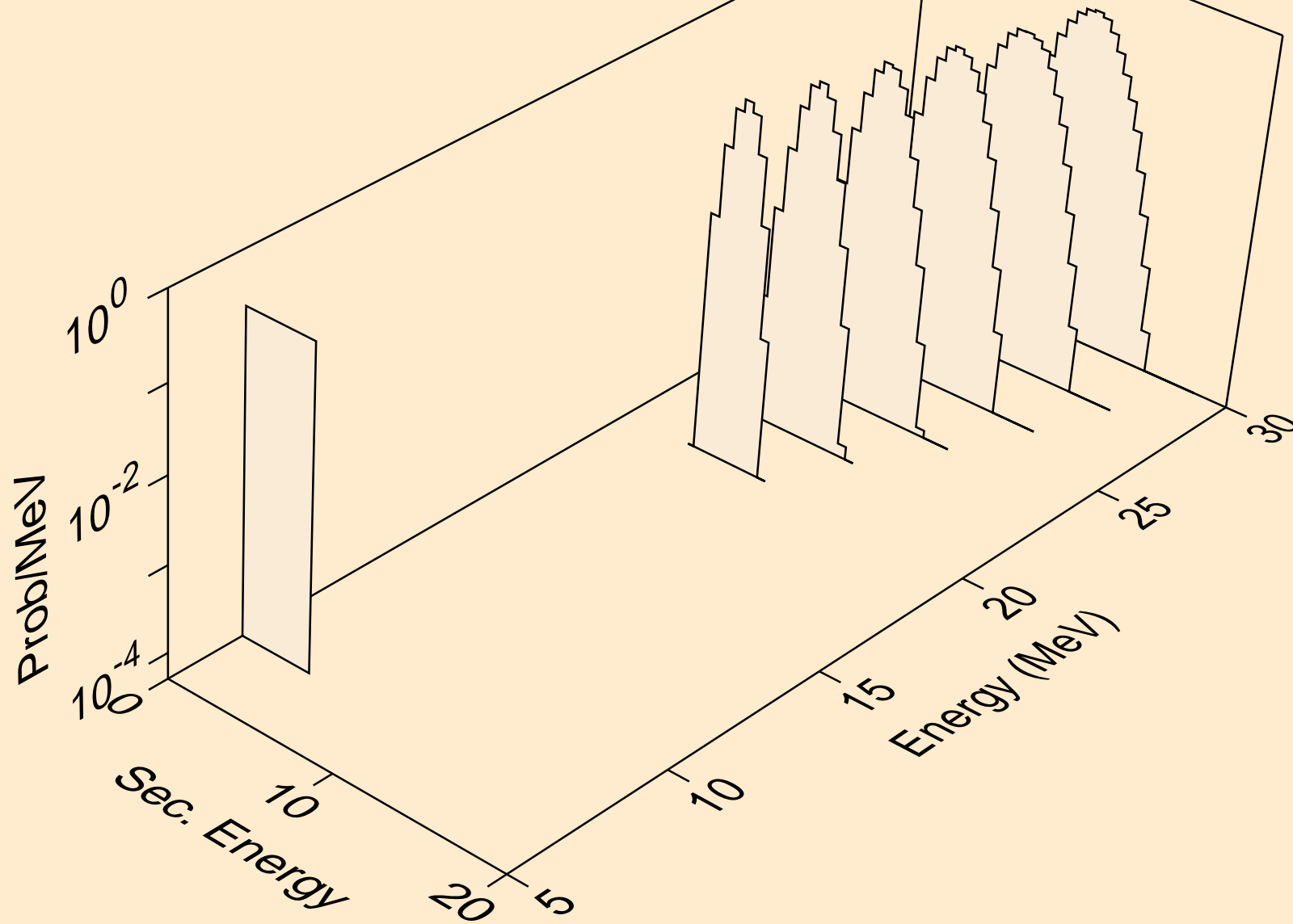

CE131M NEUTRON ACER TENDL-2023 LIBRARY; T=0.K
alphas from (n,npa)

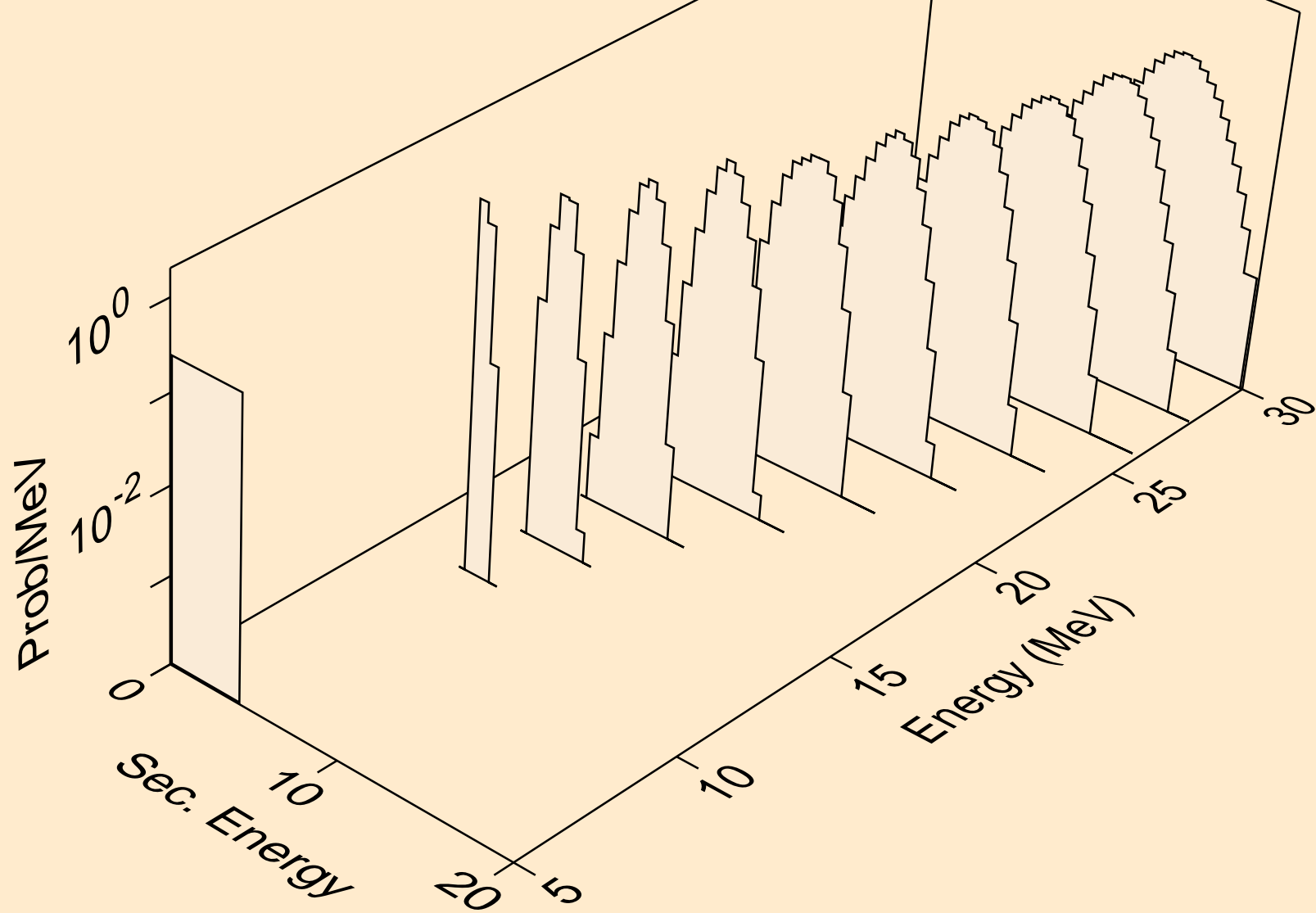

CE131M NEUTRON ACER TENDL-2023 LIBRARY; T=0.K
alphas from (n,a)

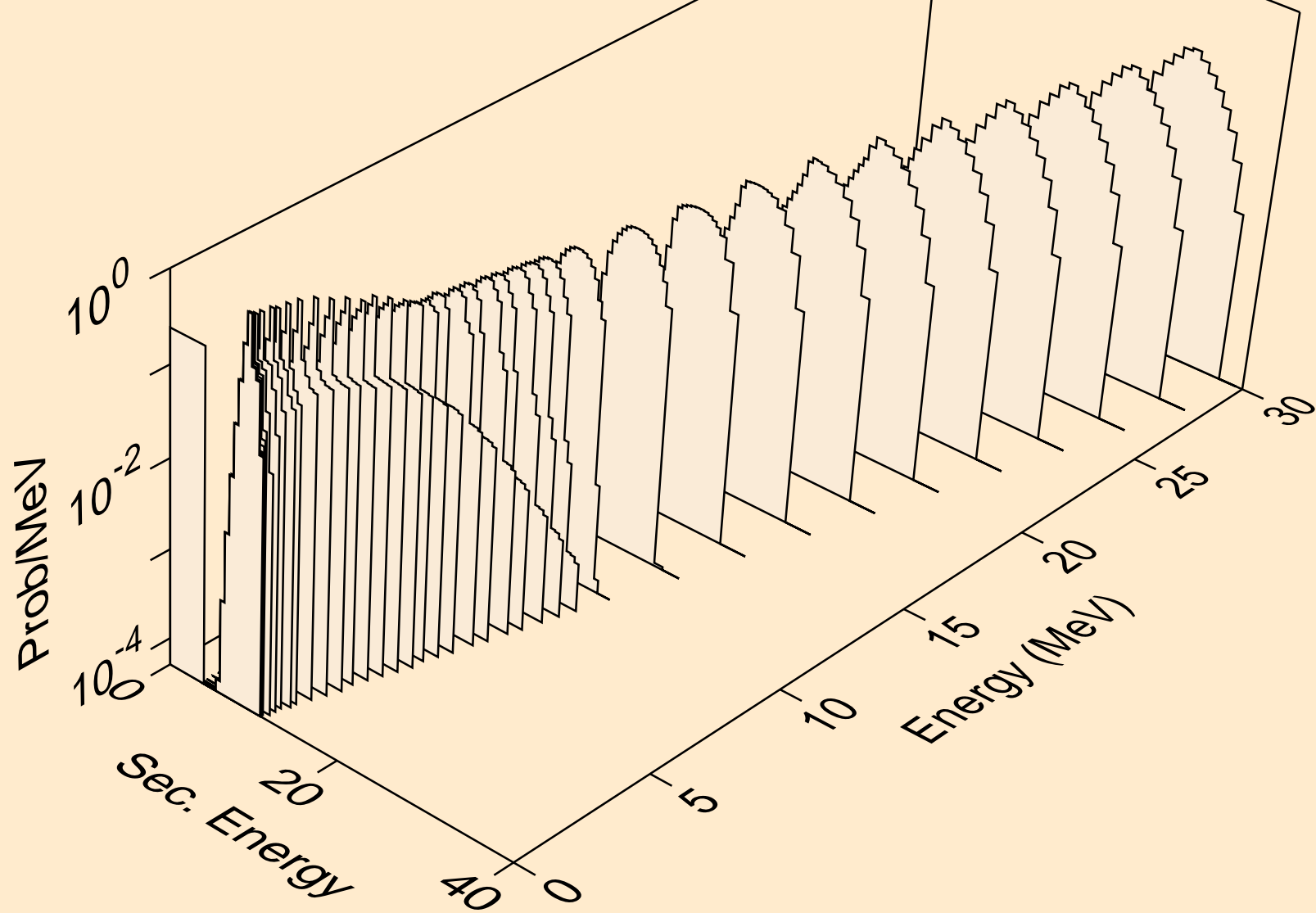

CE131M NEUTRON ACER TENDL-2023 LIBRARY; T=0.K
alphas from (n,2a)

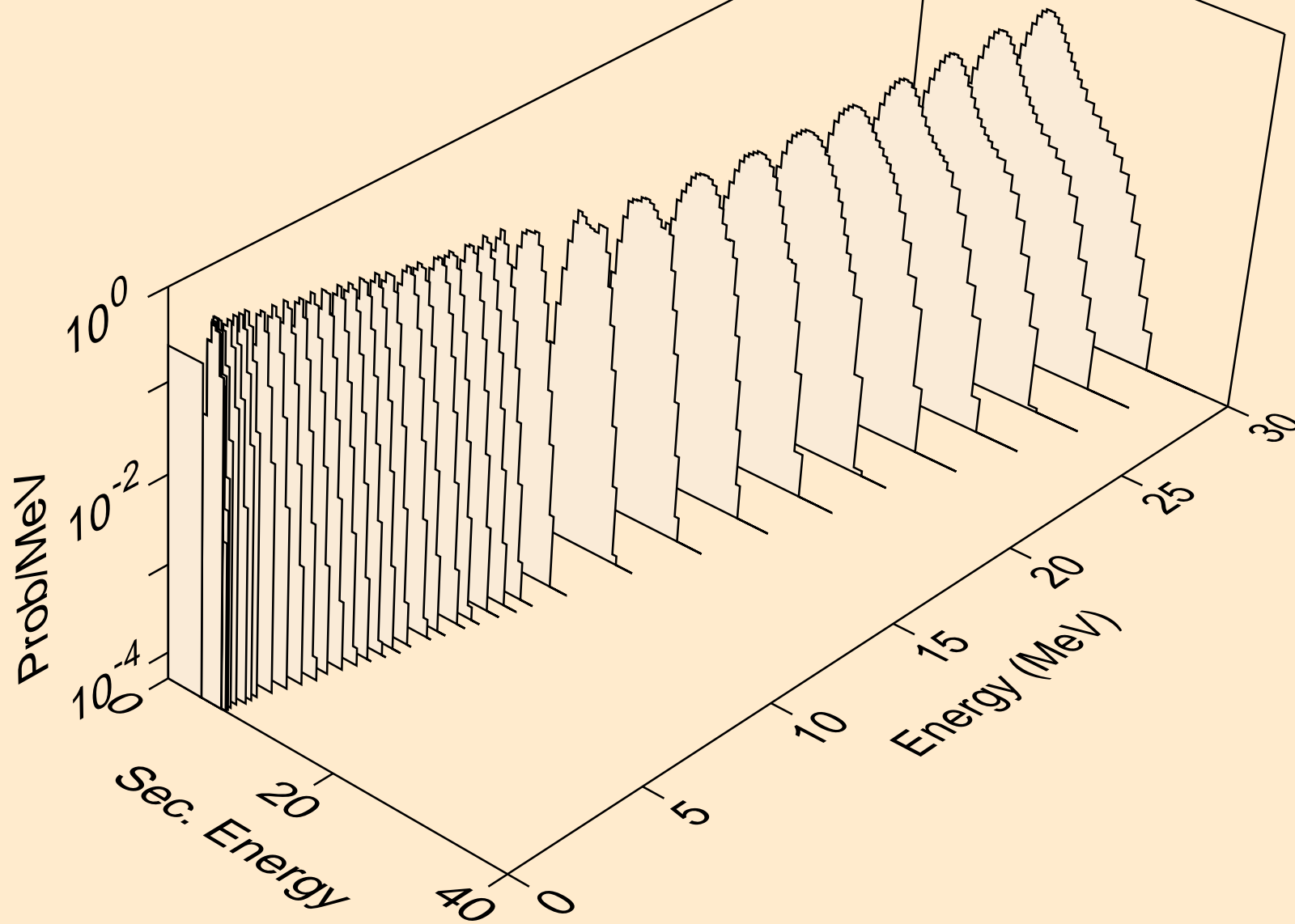

CE131M NEUTRON ACER TENDL-2023 LIBRARY; T=0.K
alphas from (n,pa)

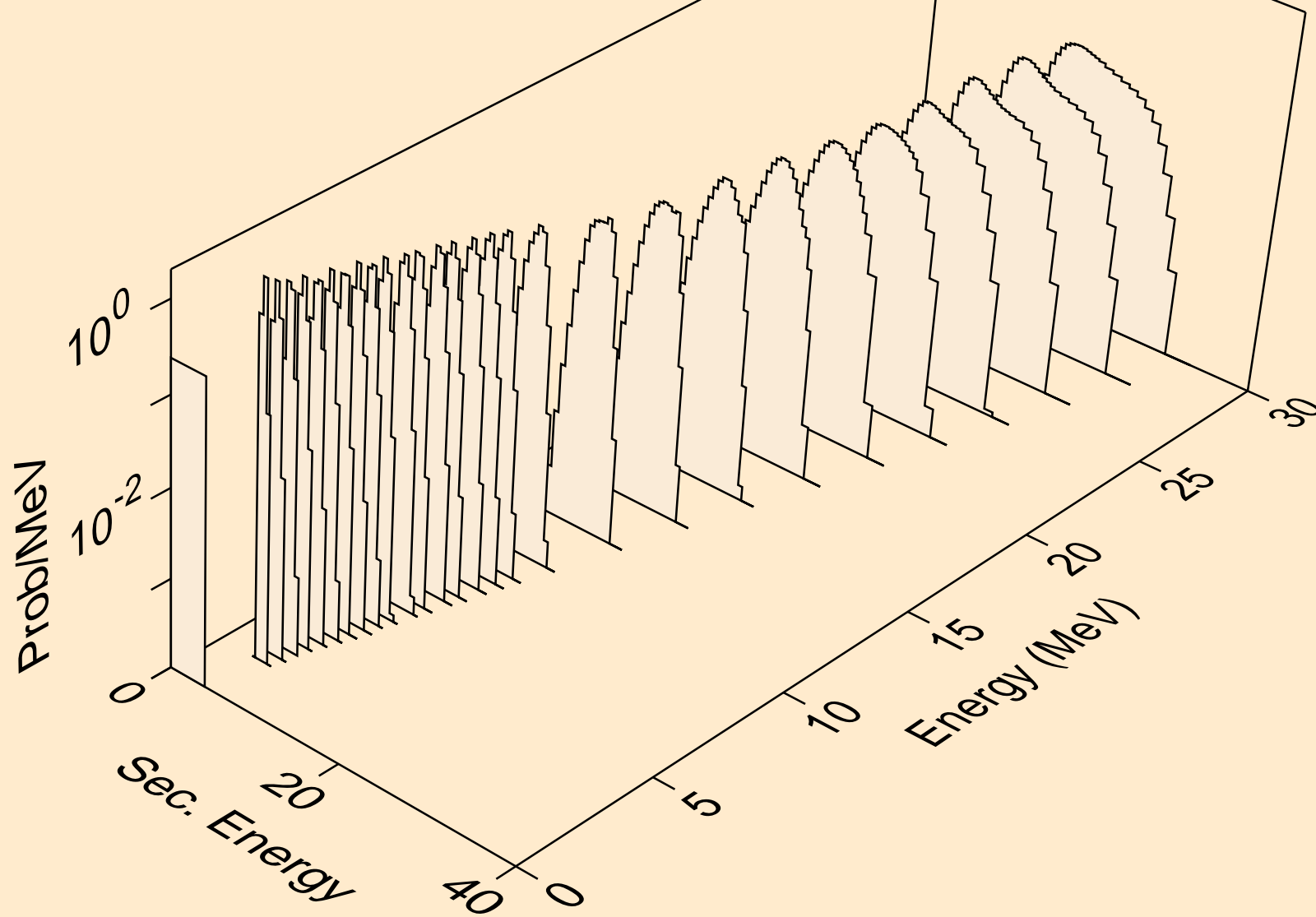

CE131M NEUTRON ACER TENDL-2023 LIBRARY; T=0.K
alphas from (n,da)

