

# CM235 NEUTRON ACER TENDL-2023 LIBRARY; T=0.K

## Principal cross sections

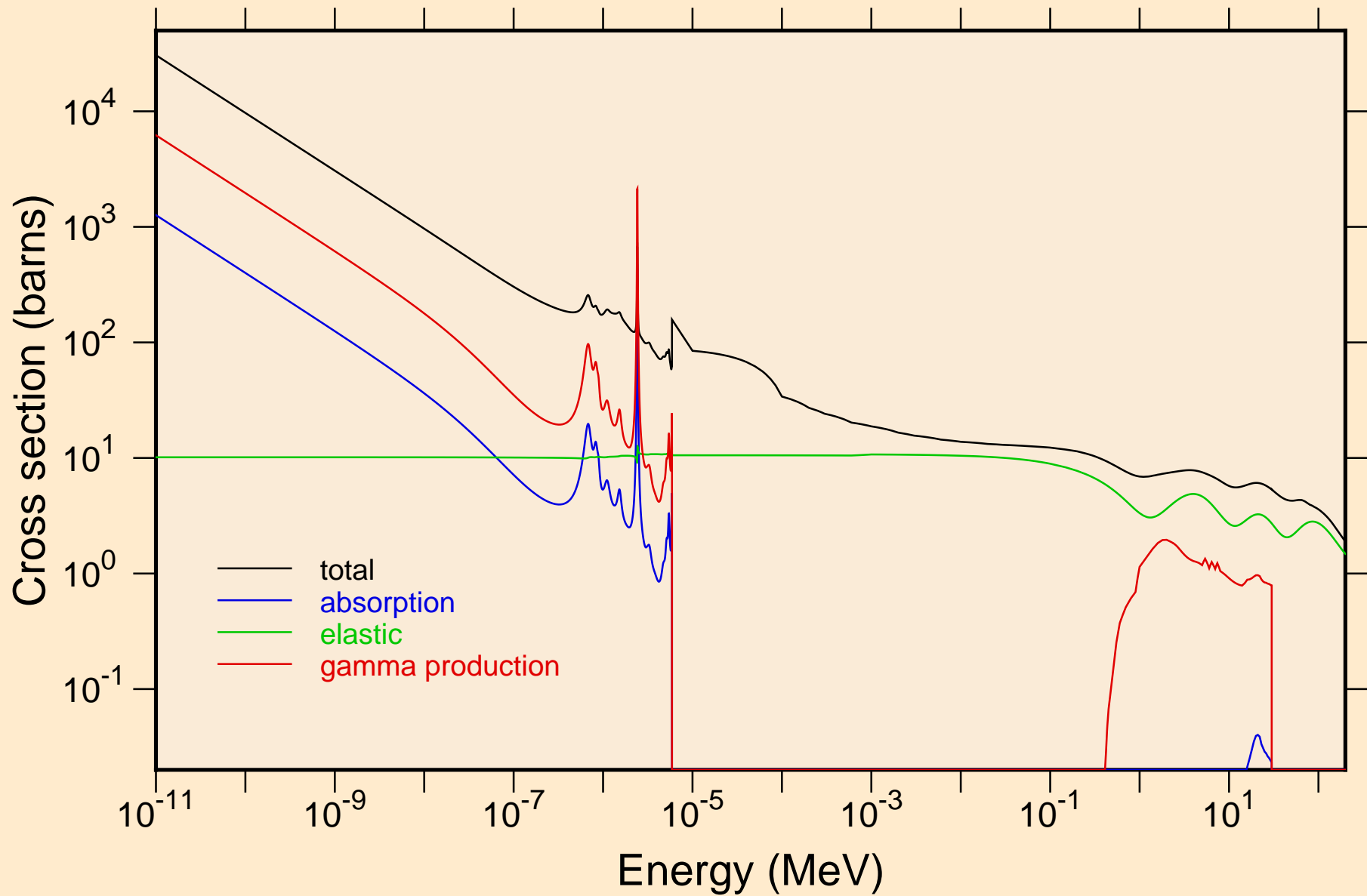

# CM235 NEUTRON ACER TENDL-2023 LIBRARY; T=0.K

## Heating

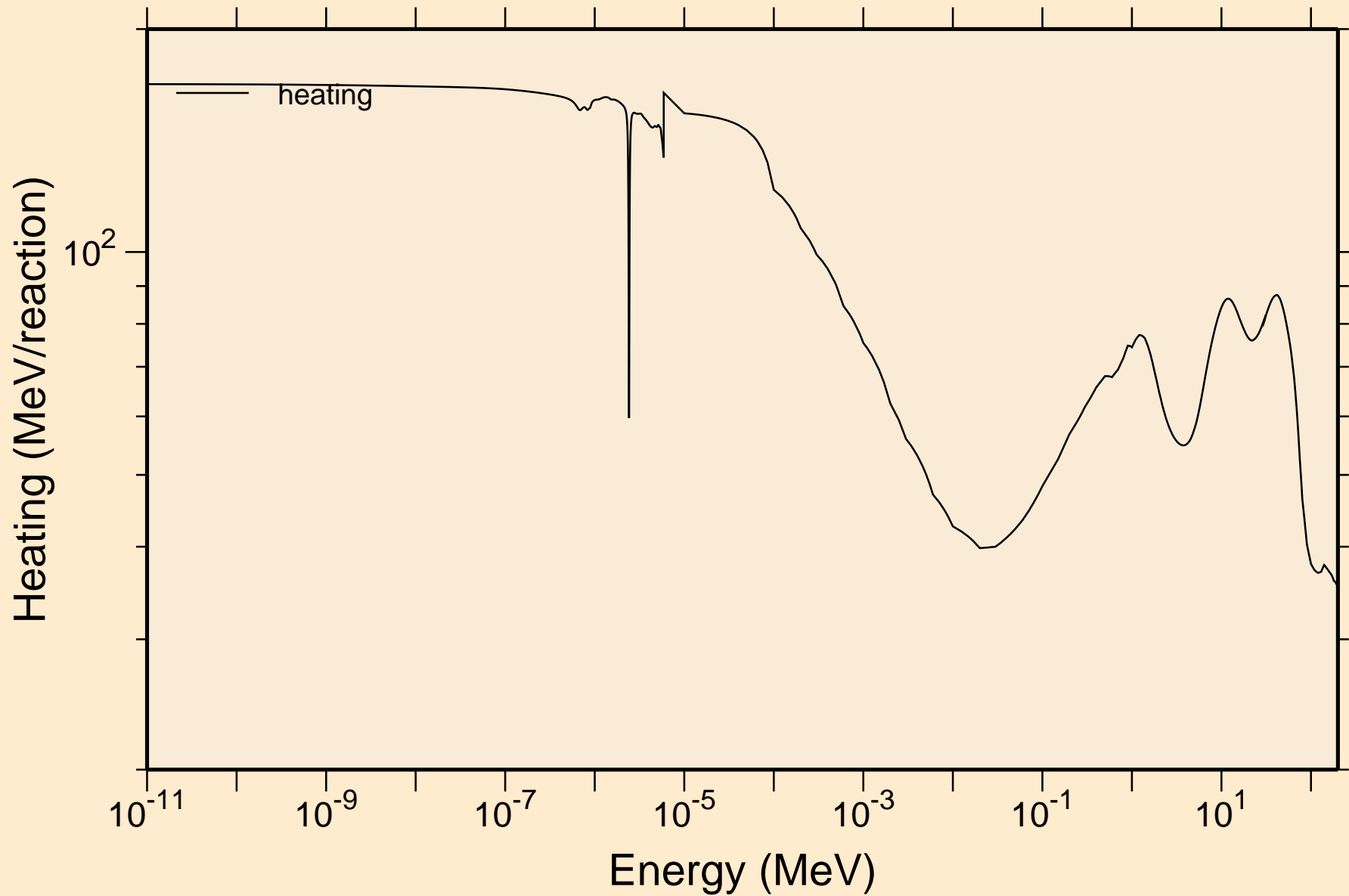

CM235 NEUTRON ACER TENDL-2023 LIBRARY; T=0.K  
Damage

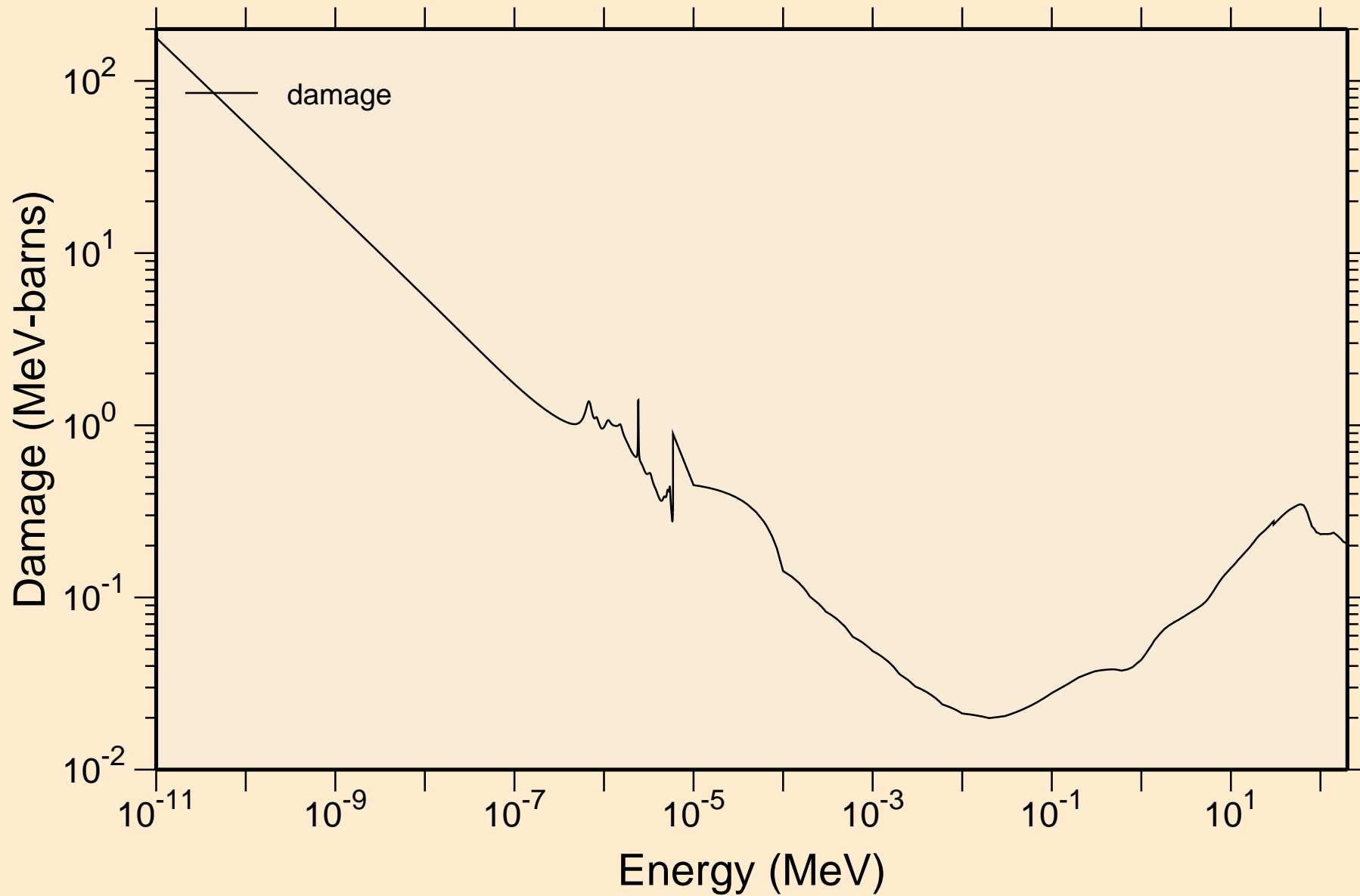

# CM235 NEUTRON ACER TENDL-2023 LIBRARY; T=0.K

## Non-threshold reactions

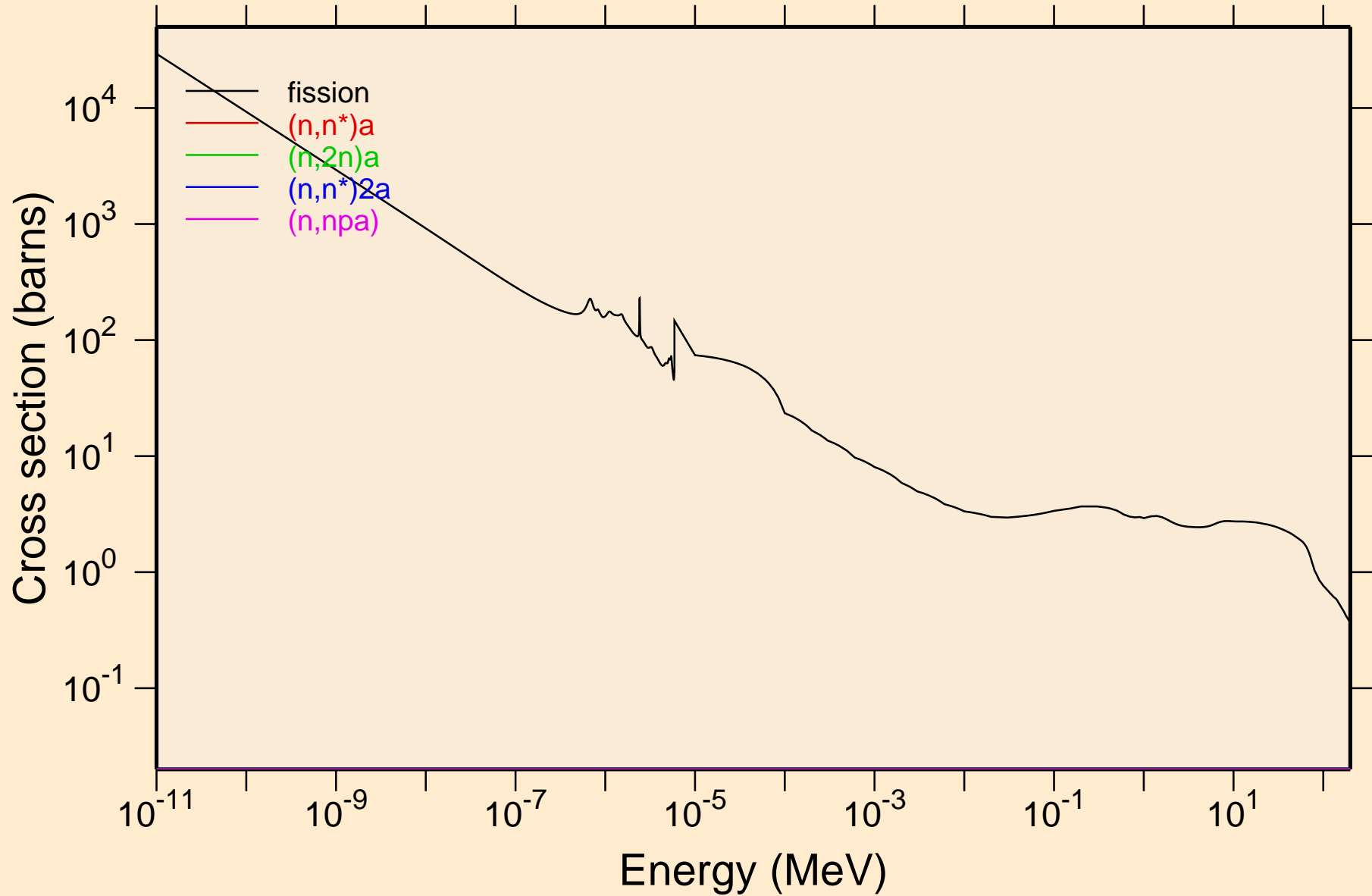

# CM235 NEUTRON ACER TENDL-2023 LIBRARY; T=0.K

## Non-threshold reactions

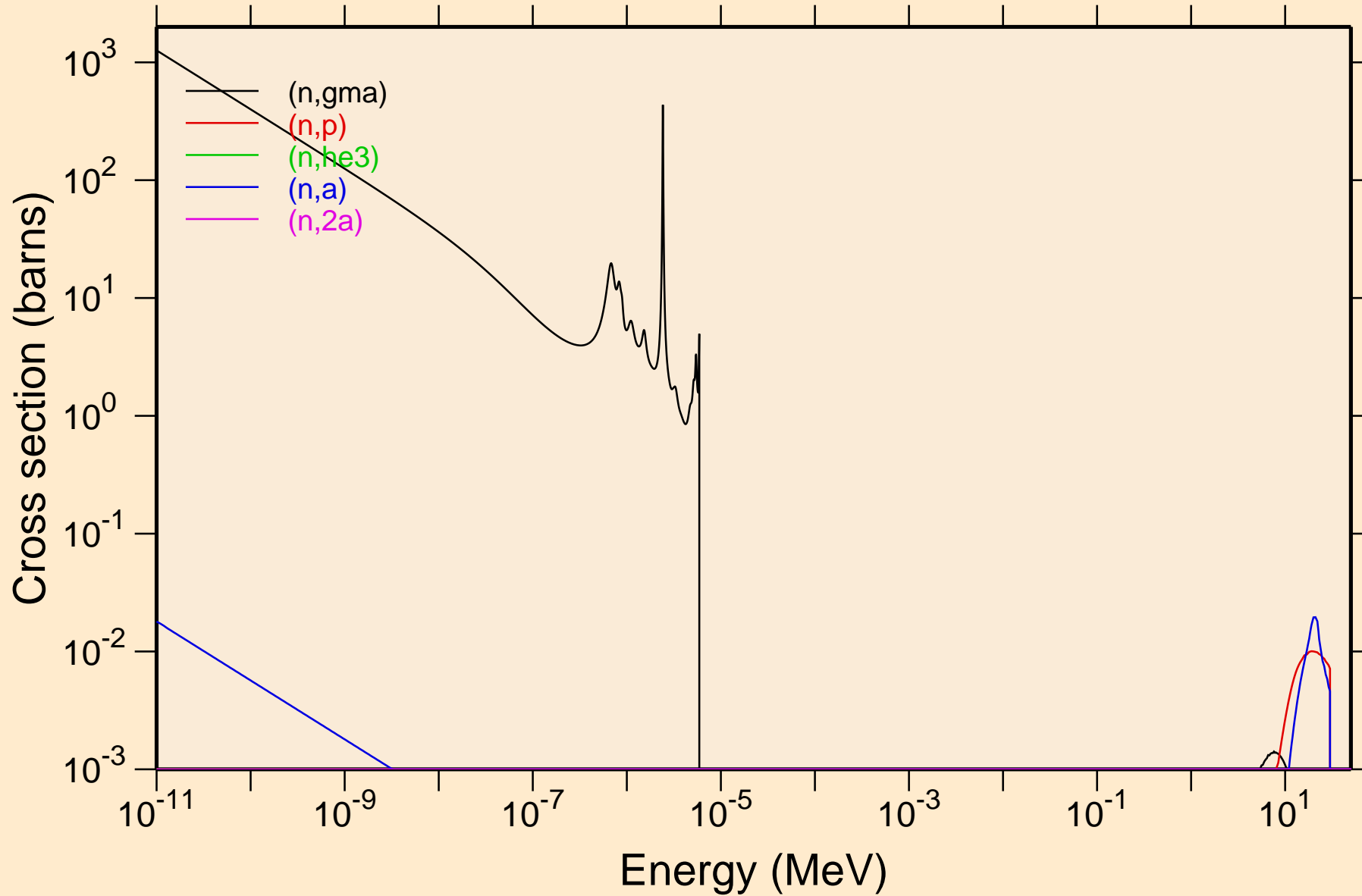

CM235 NEUTRON ACER TENDL-2023 LIBRARY; T=0.K  
Non-threshold reactions

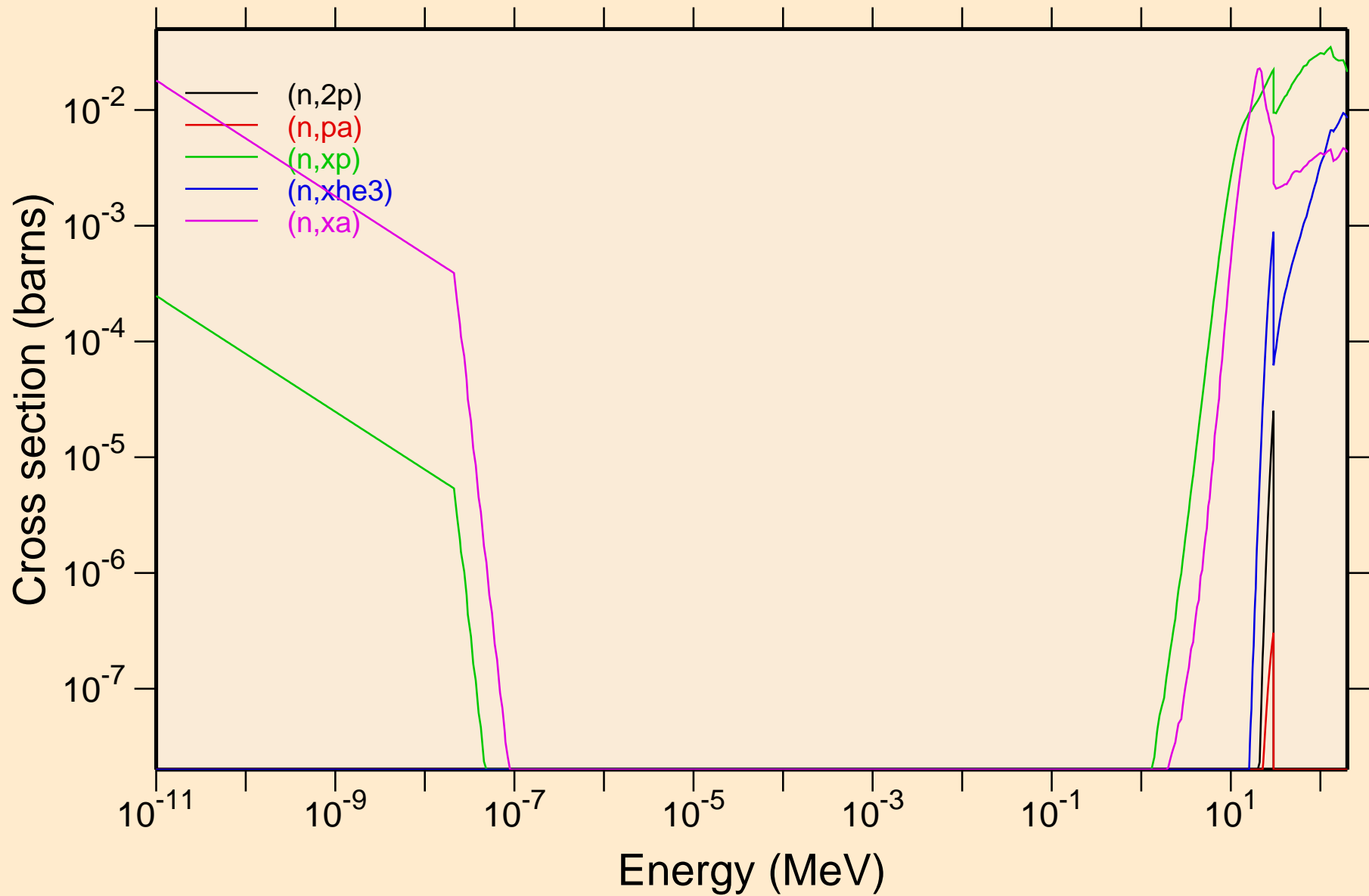

# CM235 NEUTRON ACER TENDL-2023 LIBRARY; T=0.K

## Principal cross sections

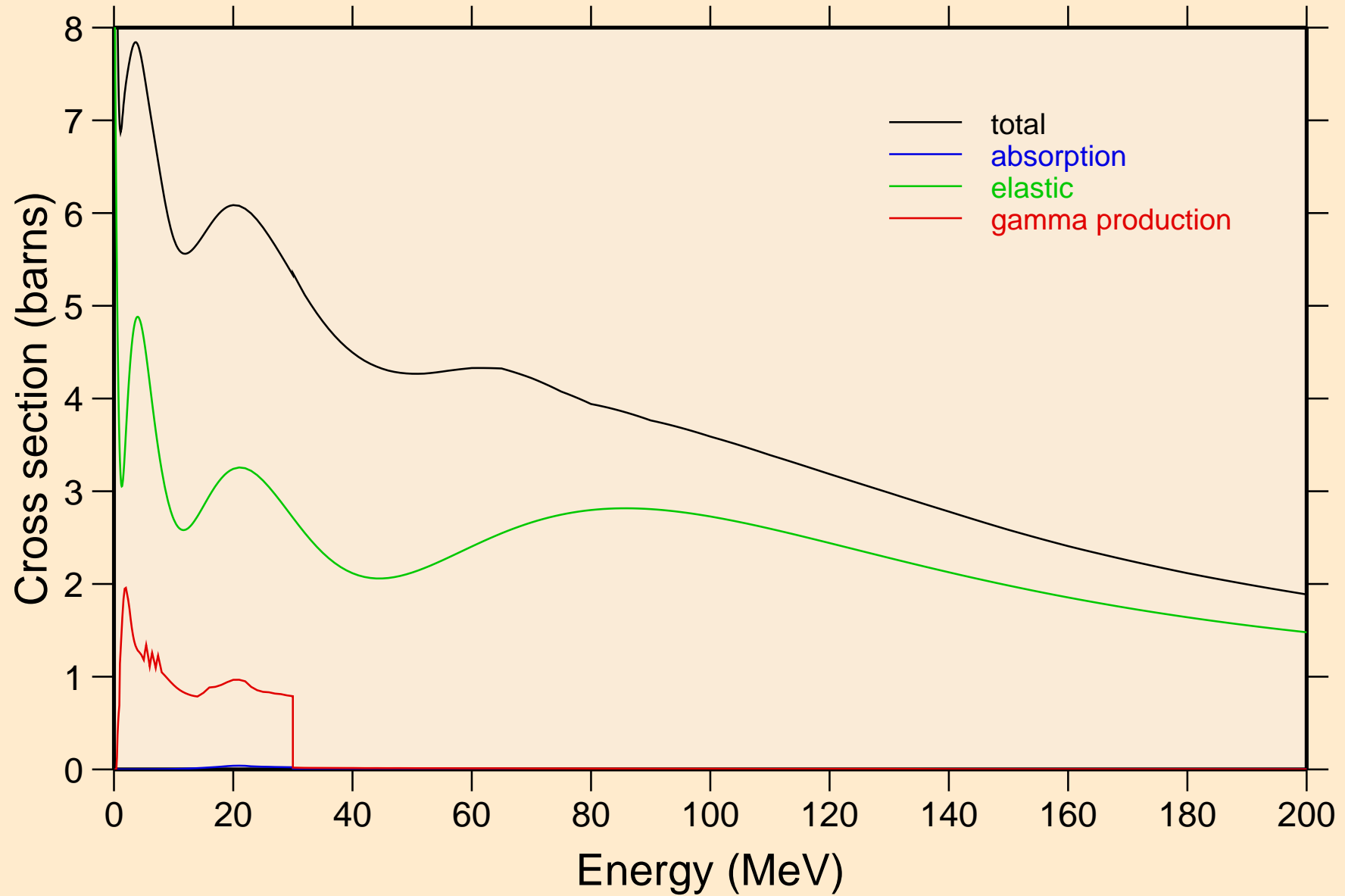

# CM235 NEUTRON ACER TENDL-2023 LIBRARY; T=0.K

## Heating

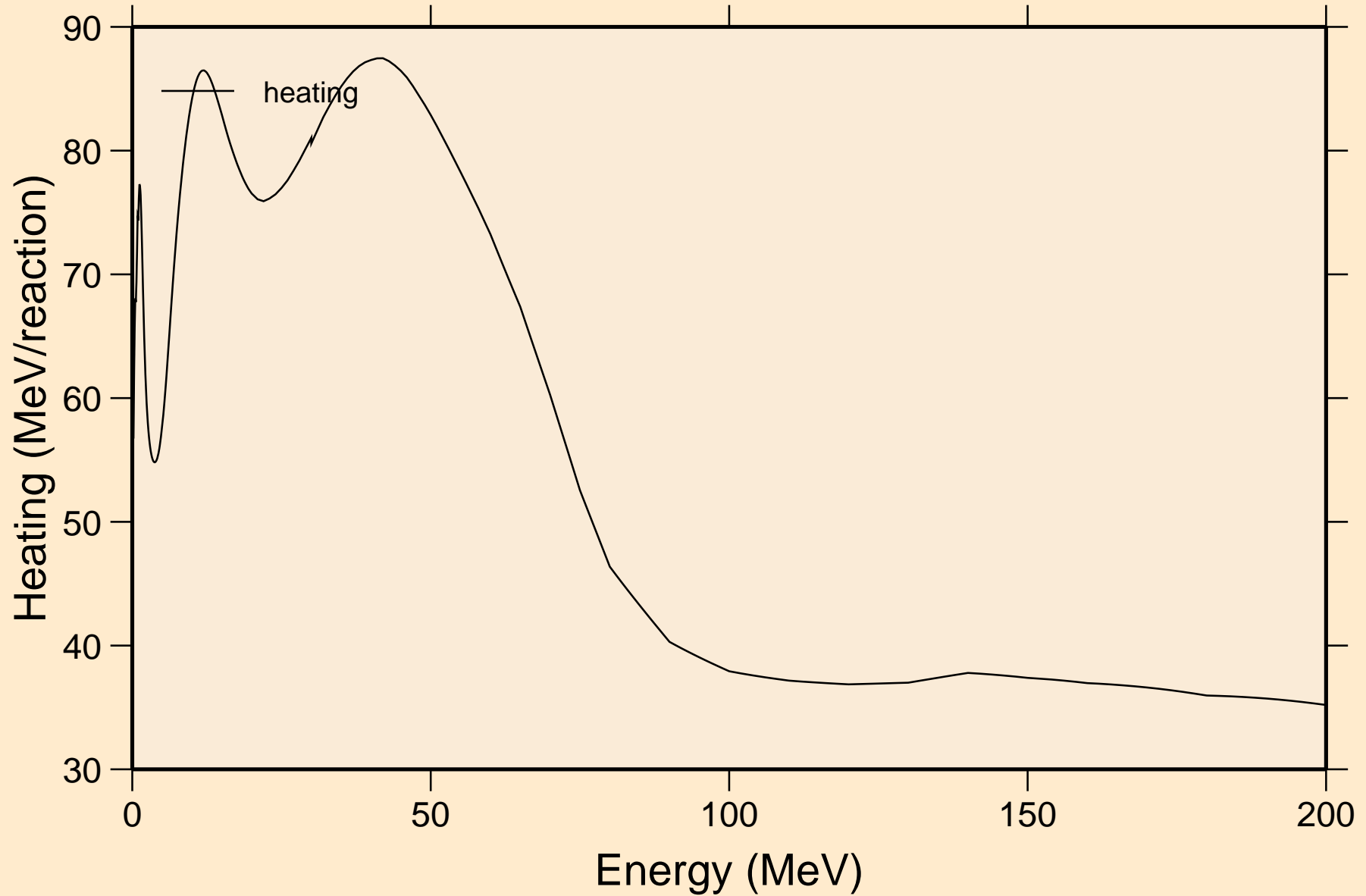



CM235 NEUTRON ACER TENDL-2023 LIBRARY; T=0.K  
Damage

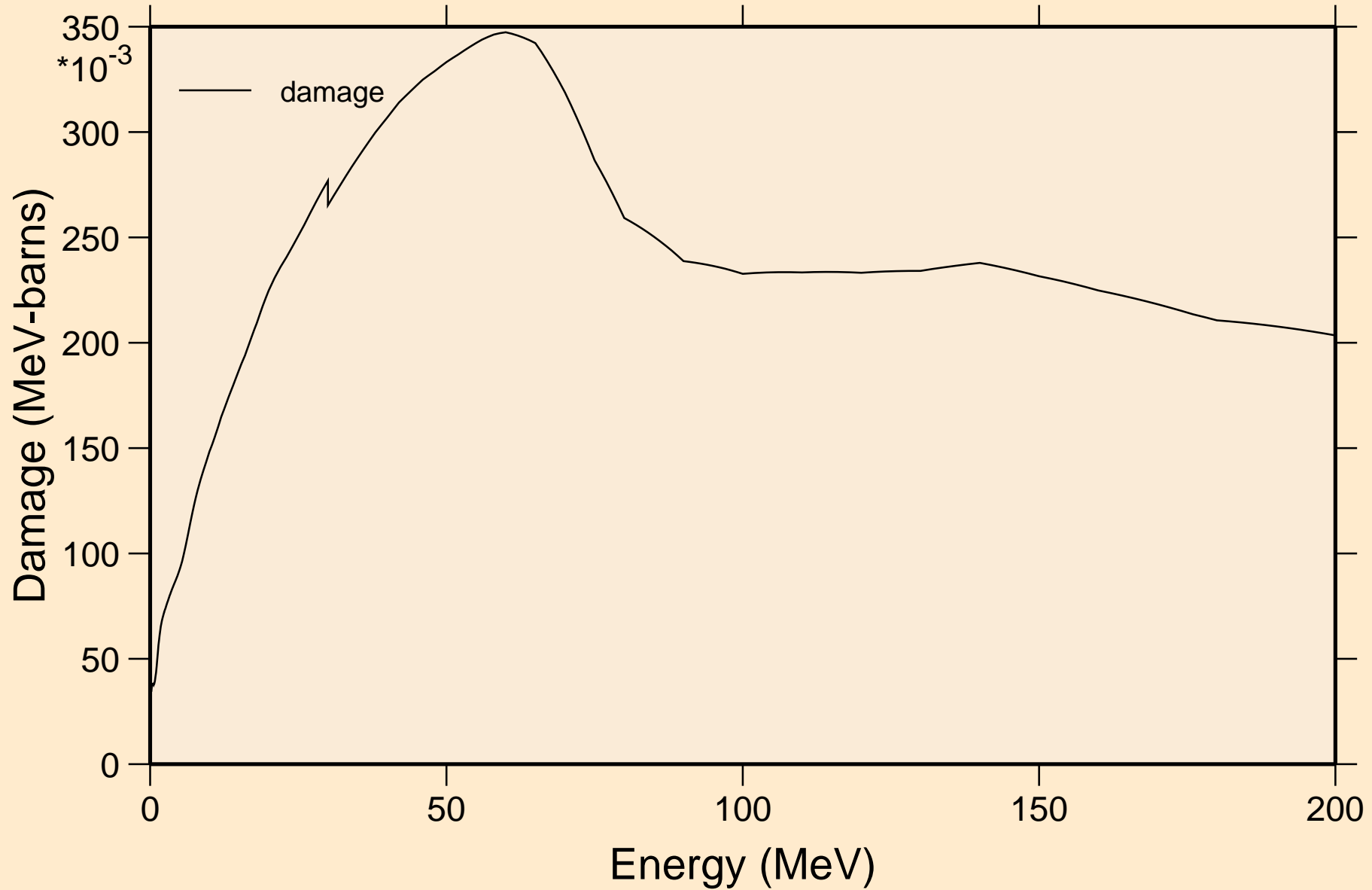

CM235 NEUTRON ACER TENDL-2023 LIBRARY; T=0.K  
Non-threshold reactions

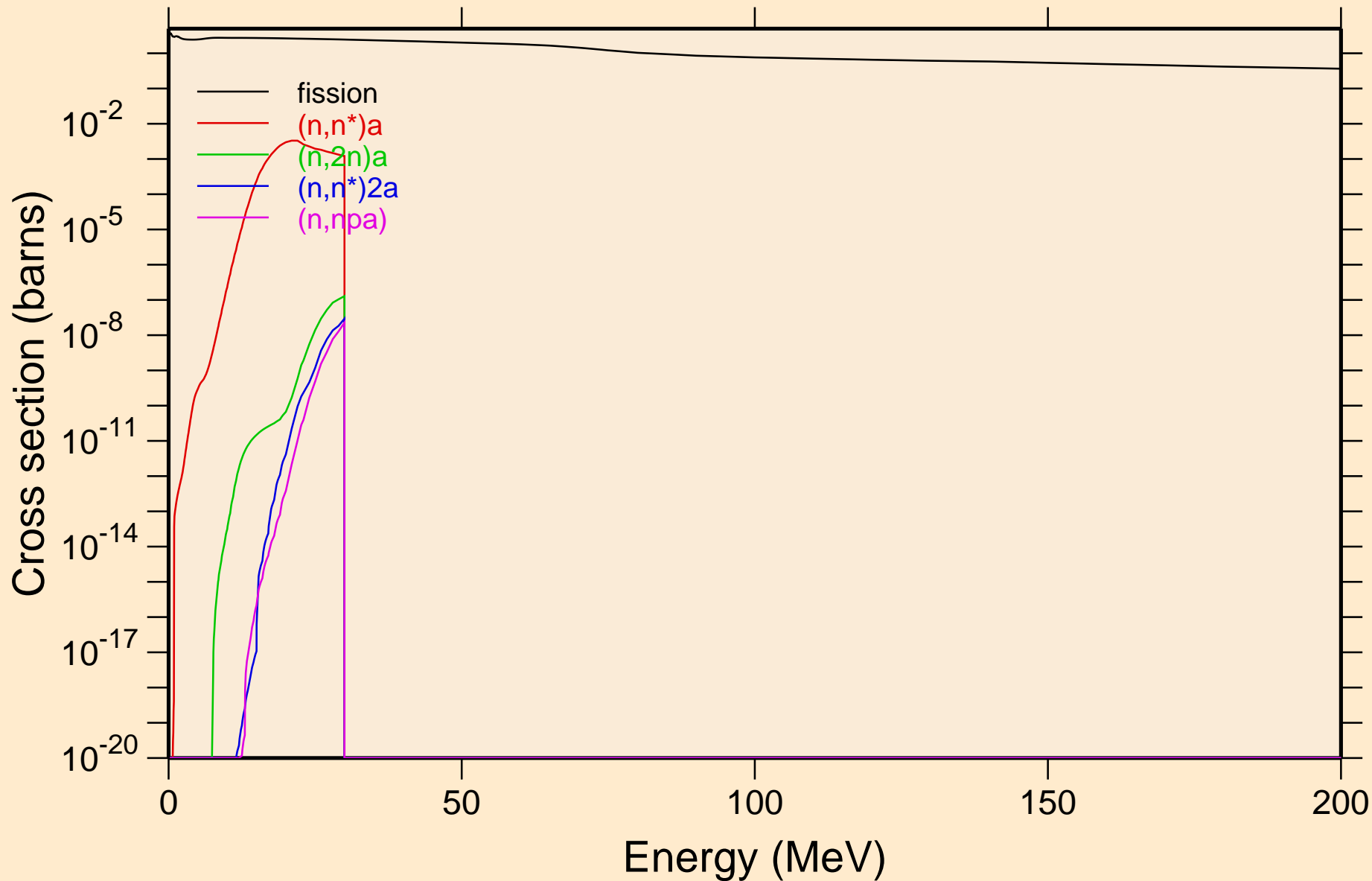

# CM235 NEUTRON ACER TENDL-2023 LIBRARY; T=0.K

## Non-threshold reactions

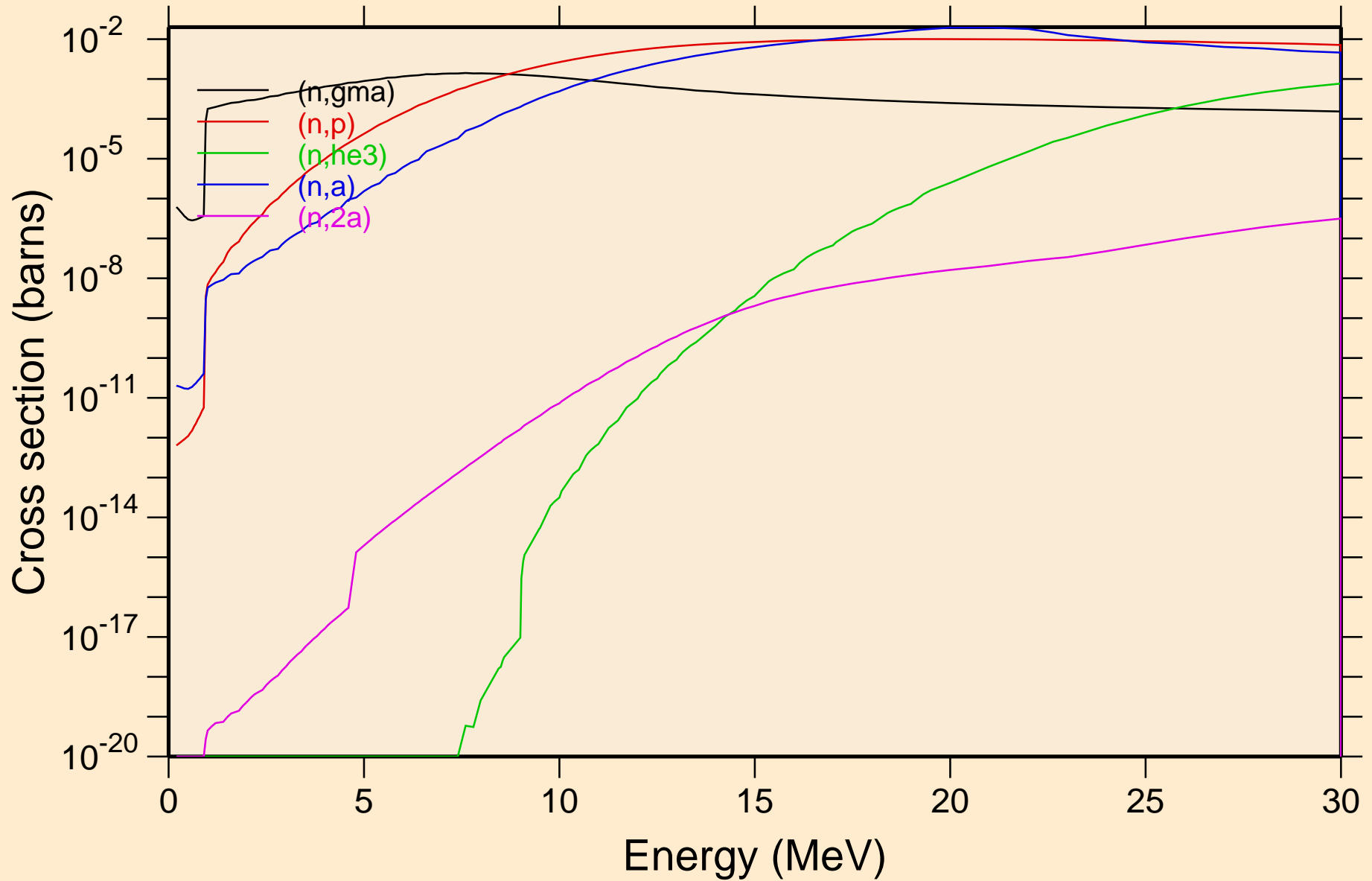

# CM235 NEUTRON ACER TENDL-2023 LIBRARY; T=0.K

## Non-threshold reactions

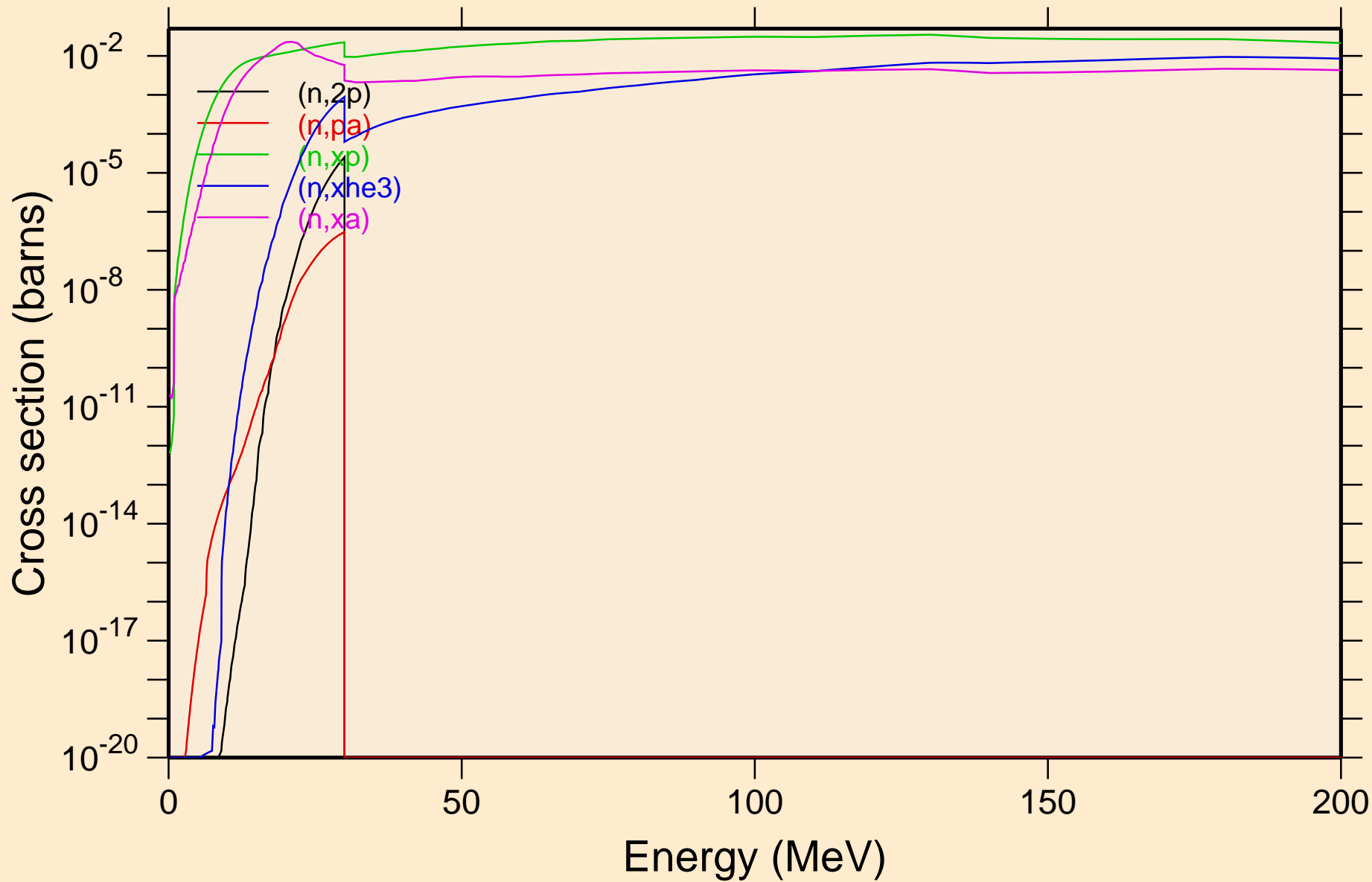

CM235 NEUTRON ACER TENDL-2023 LIBRARY; T=0.K  
Inelastic levels

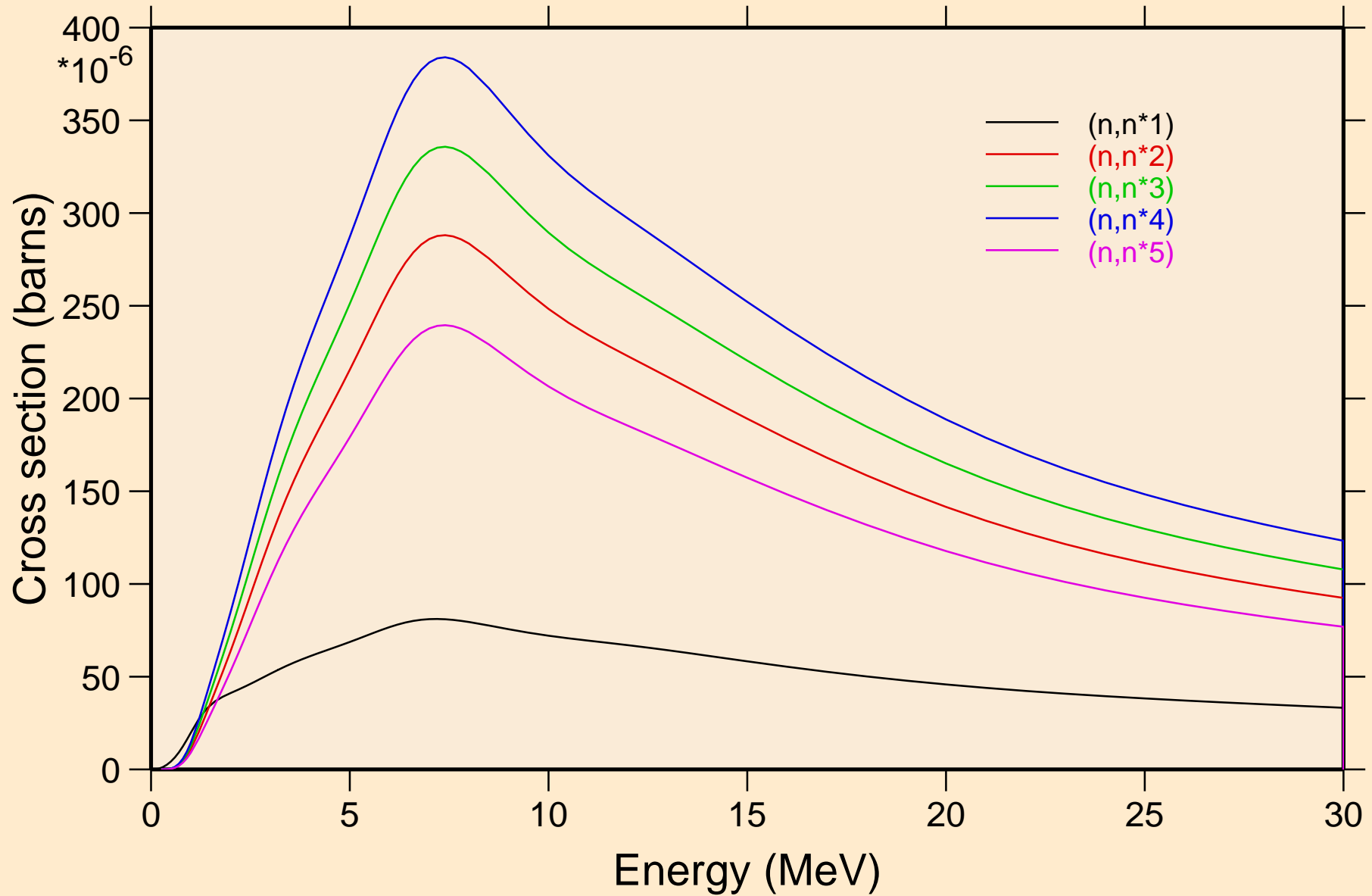

CM235 NEUTRON ACER TENDL-2023 LIBRARY; T=0.K  
Inelastic levels

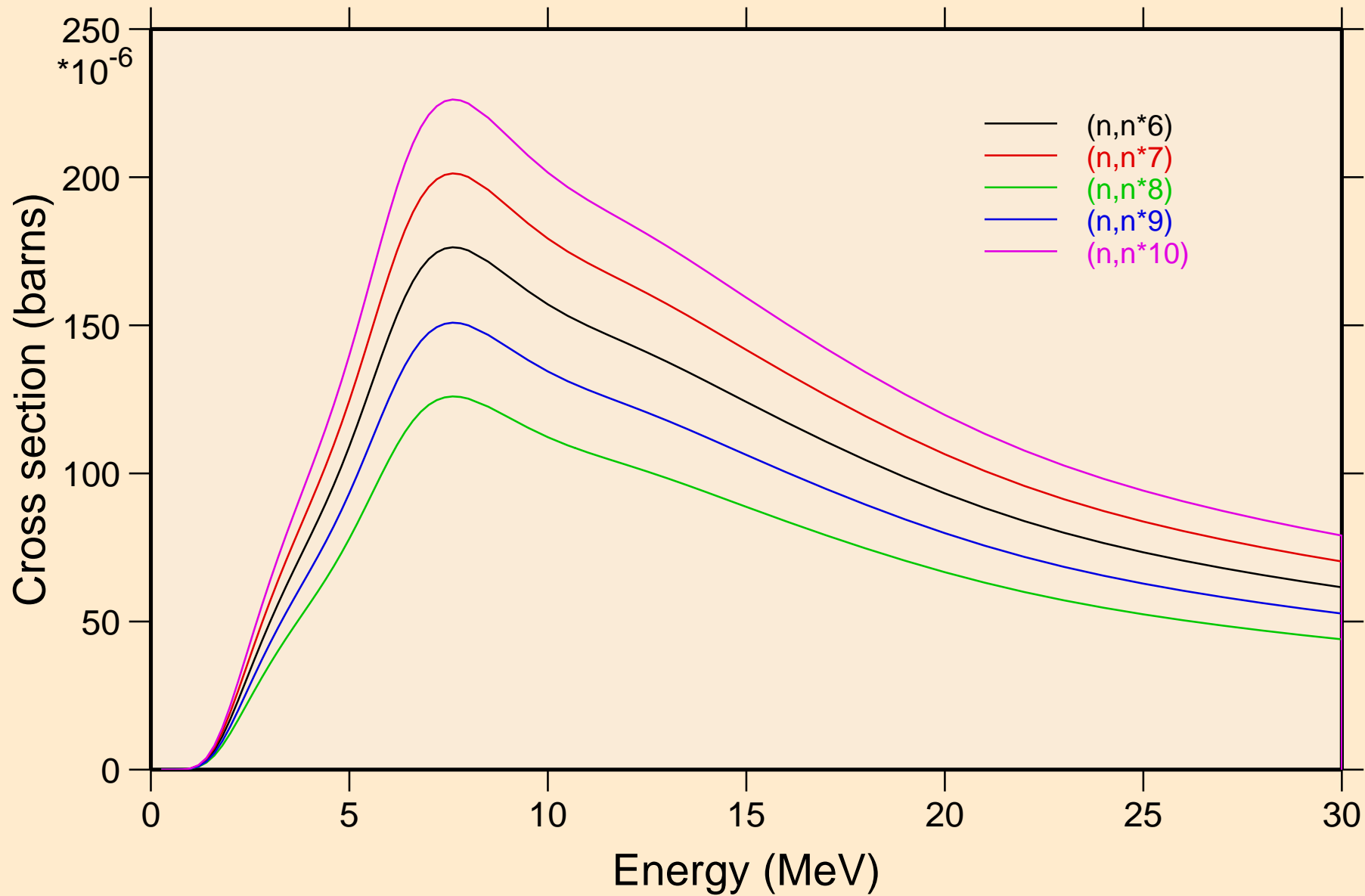

CM235 NEUTRON ACER TENDL-2023 LIBRARY; T=0.K  
Inelastic levels

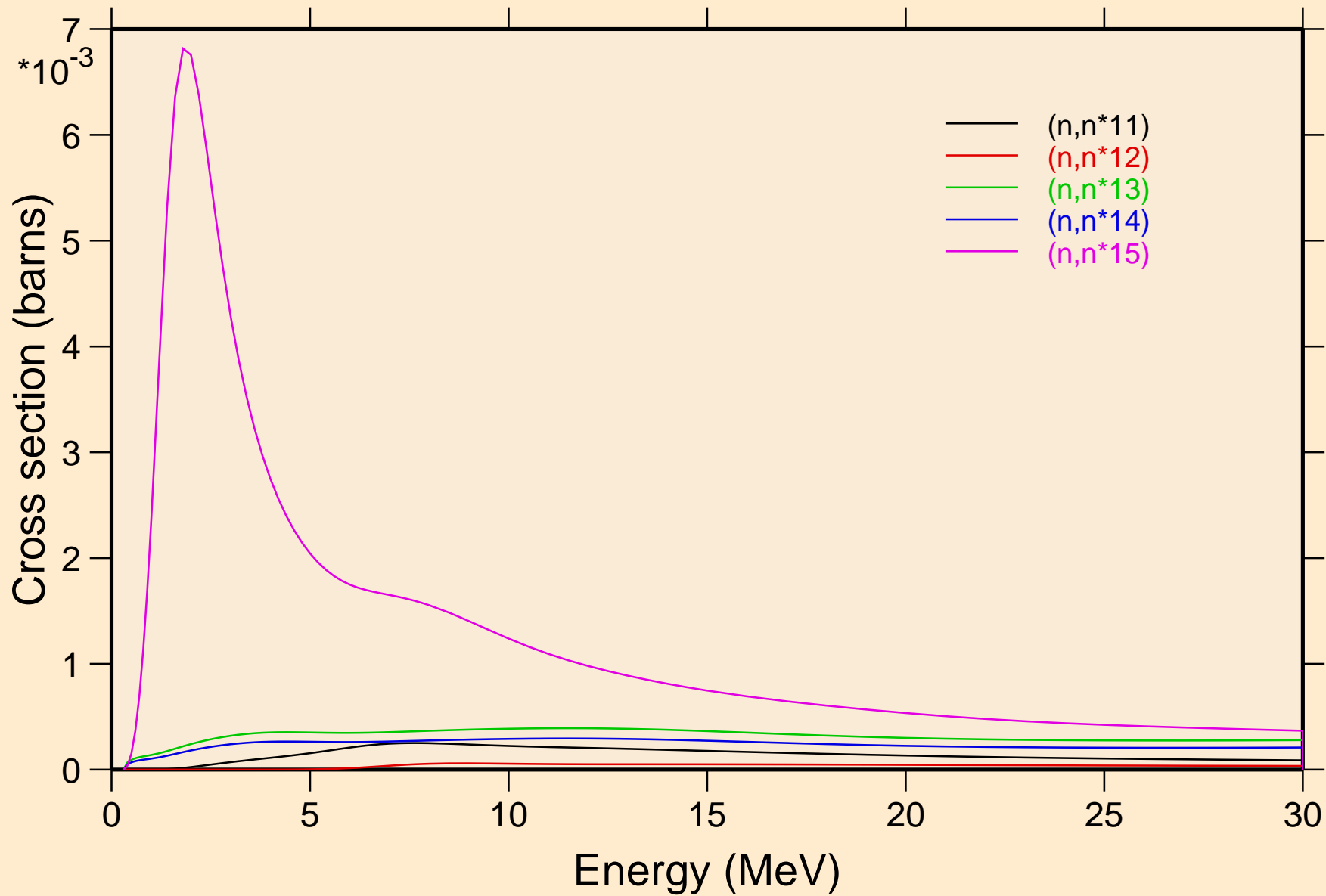

CM235 NEUTRON ACER TENDL-2023 LIBRARY; T=0.K  
Inelastic levels

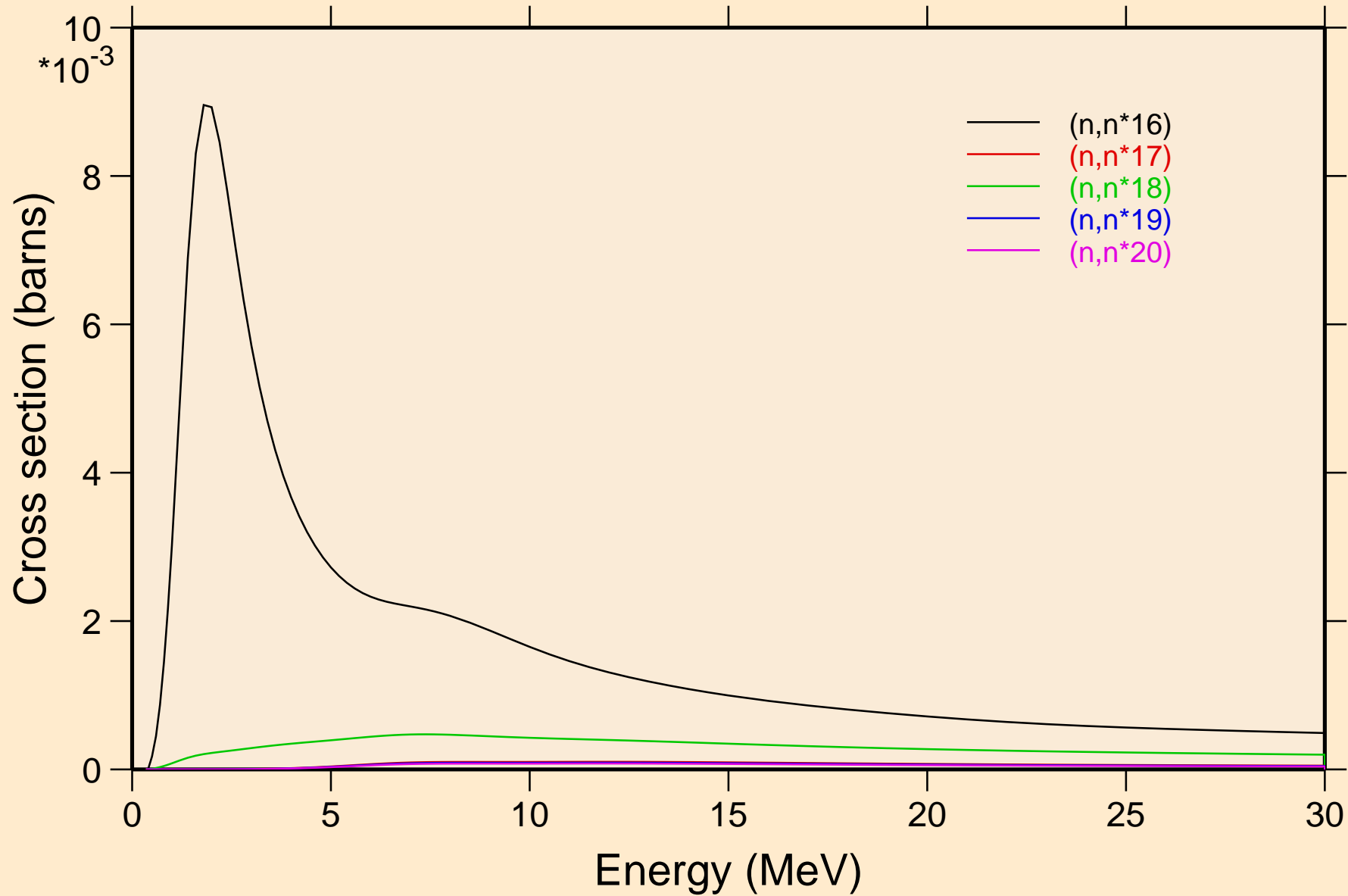



# CM235 NEUTRON ACER TENDL-2023 LIBRARY; T=0.K

## Inelastic levels

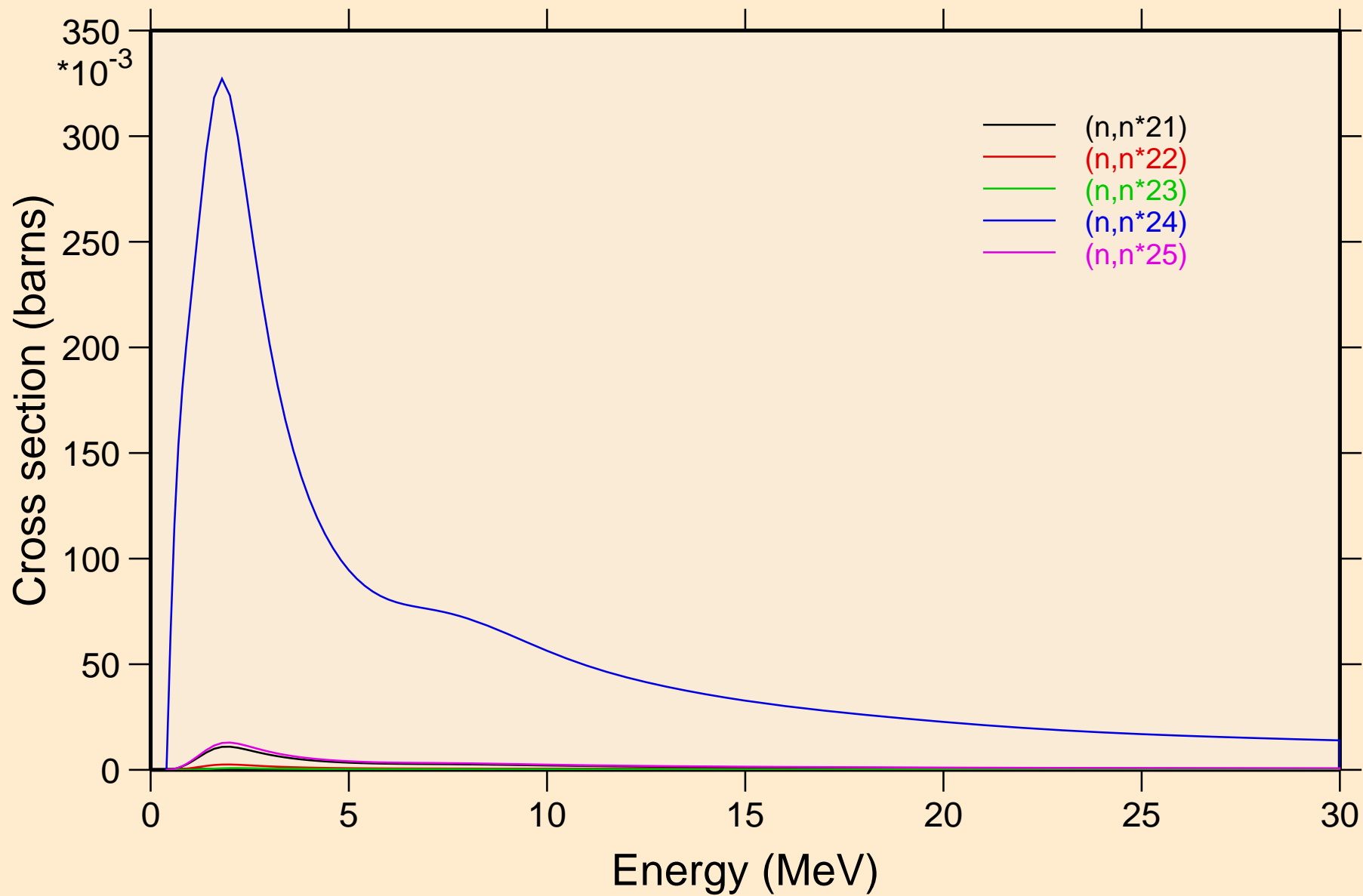

# CM235 NEUTRON ACER TENDL-2023 LIBRARY; T=0.K

## Inelastic levels

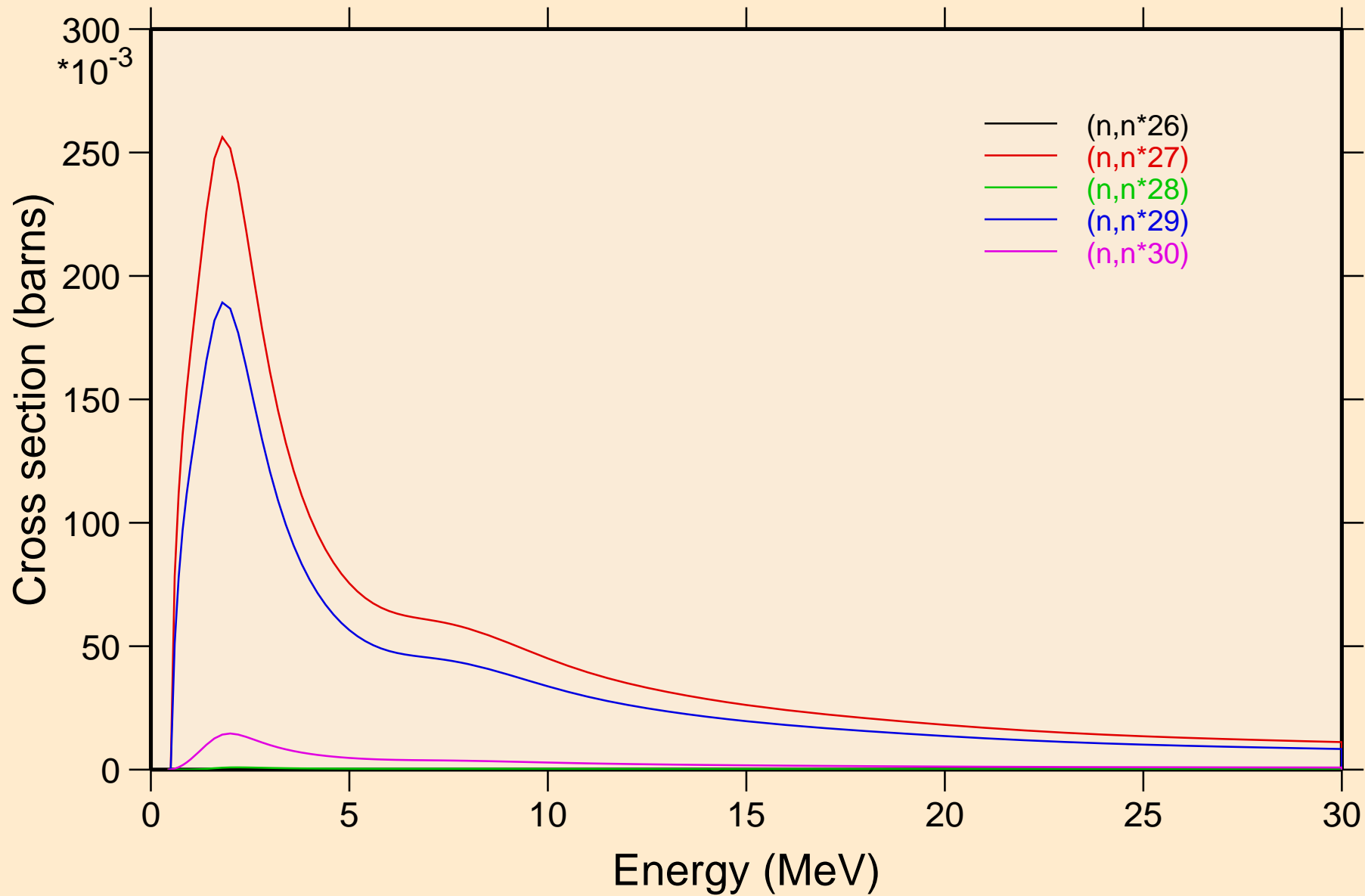

# CM235 NEUTRON ACER TENDL-2023 LIBRARY; T=0.K

## Threshold reactions

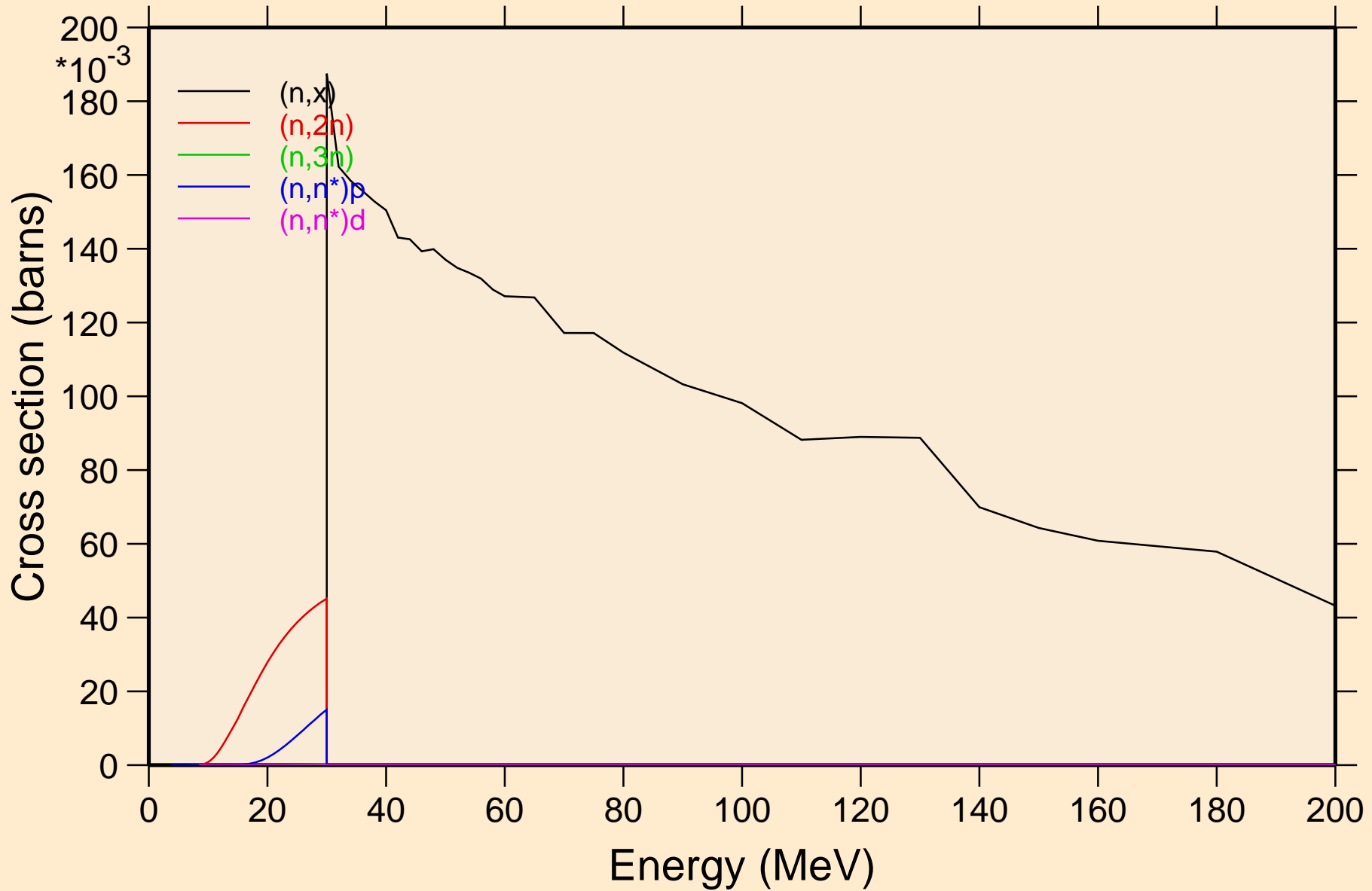

# CM235 NEUTRON ACER TENDL-2023 LIBRARY; T=0.K

## Threshold reactions

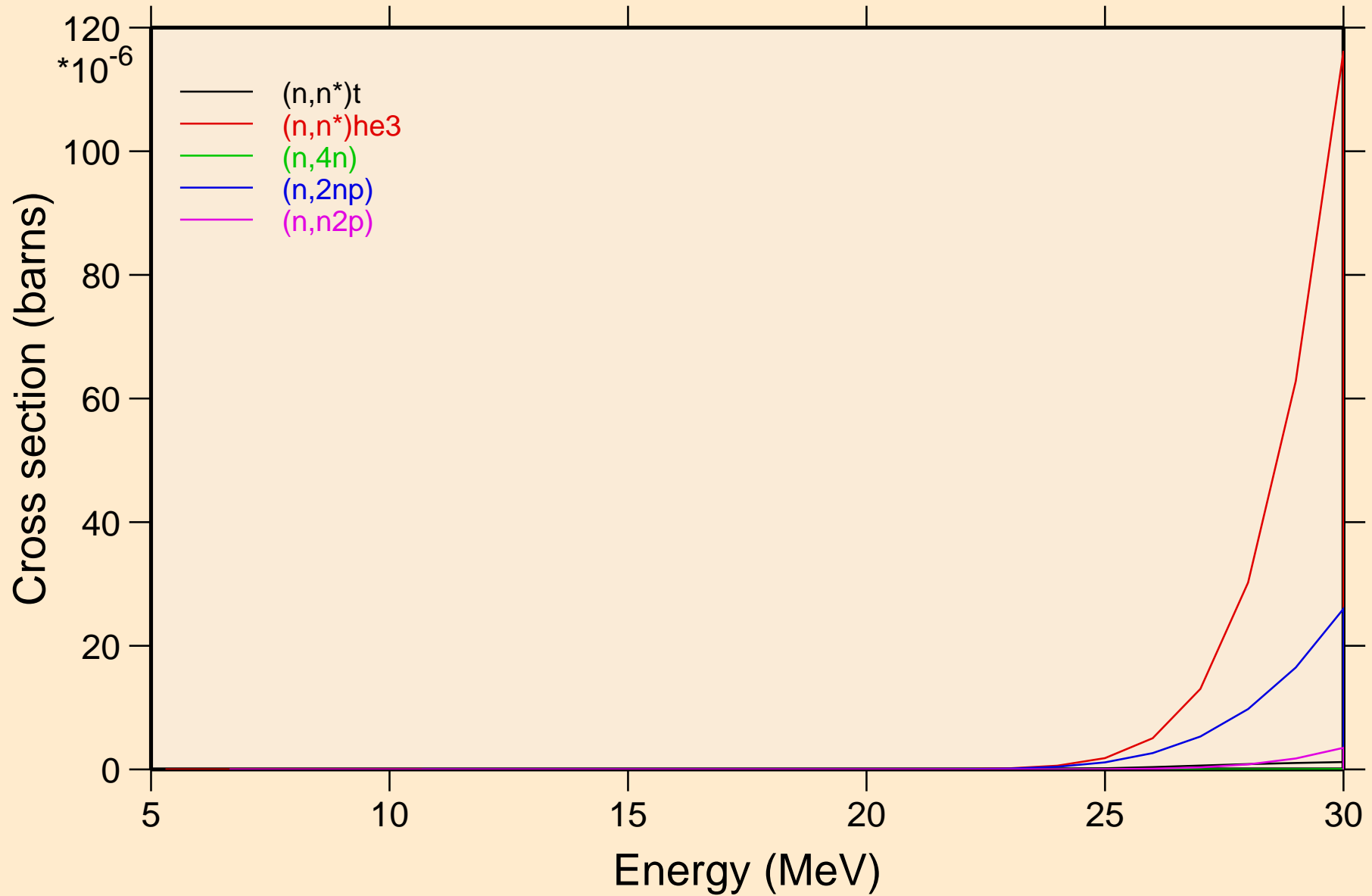

# CM235 NEUTRON ACER TENDL-2023 LIBRARY; T=0.K

## Threshold reactions

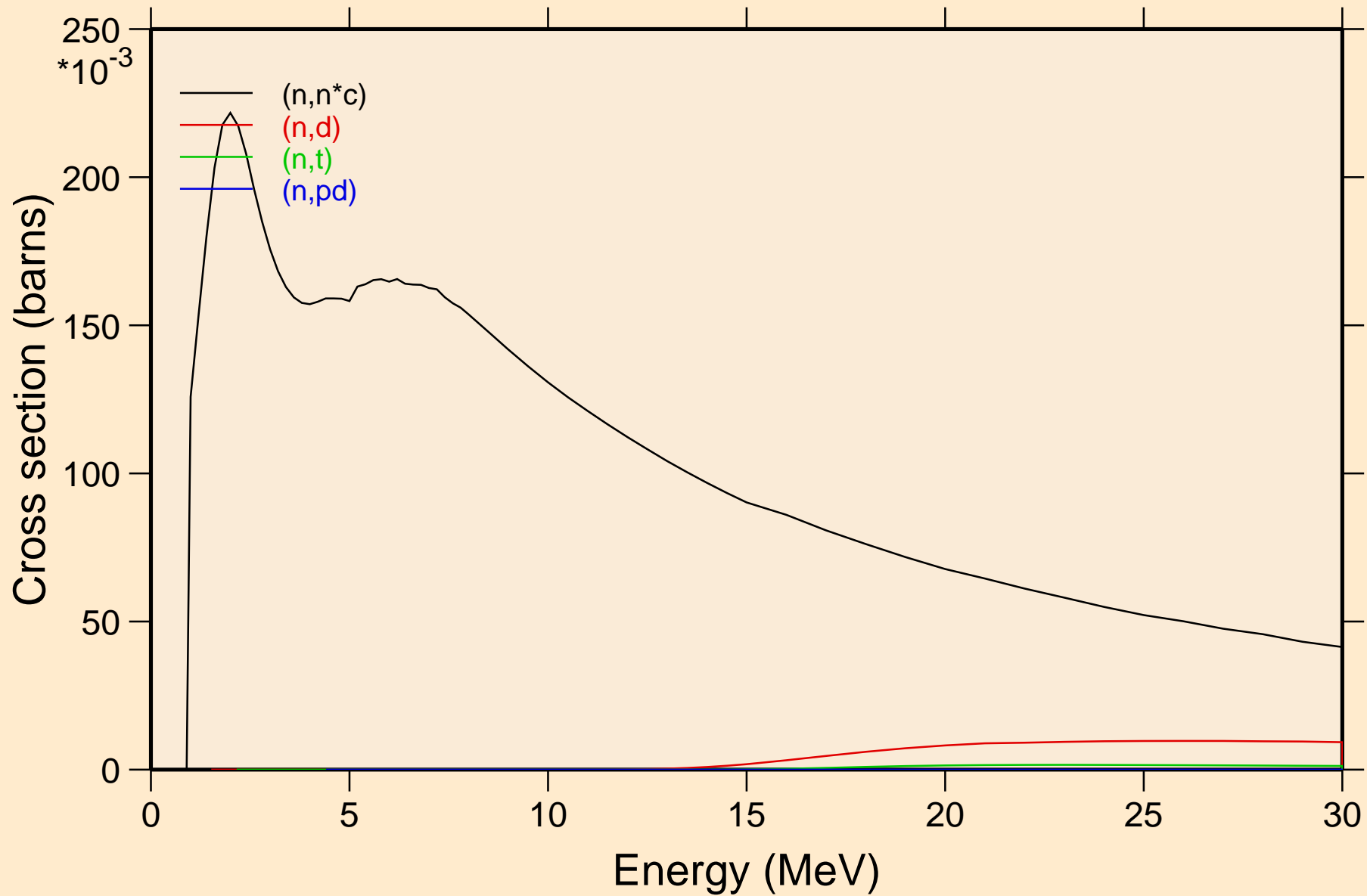

CM235 NEUTRON ACER TENDL-2023 LIBRARY; T=0.K  
Threshold reactions

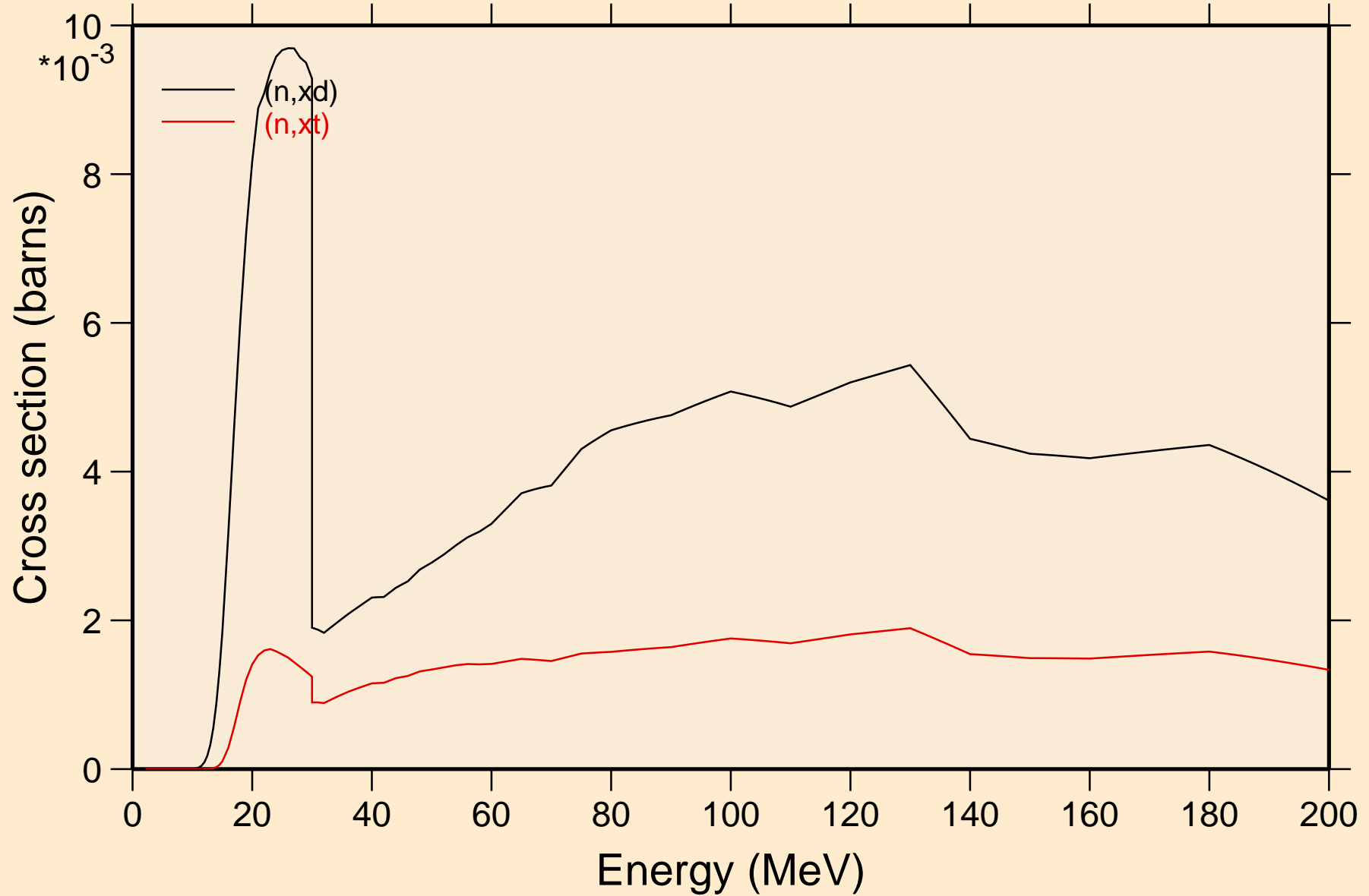

CM235 NEUTRON ACER TENDL-2023 LIBRARY; T=0.K  
angular distribution for elastic

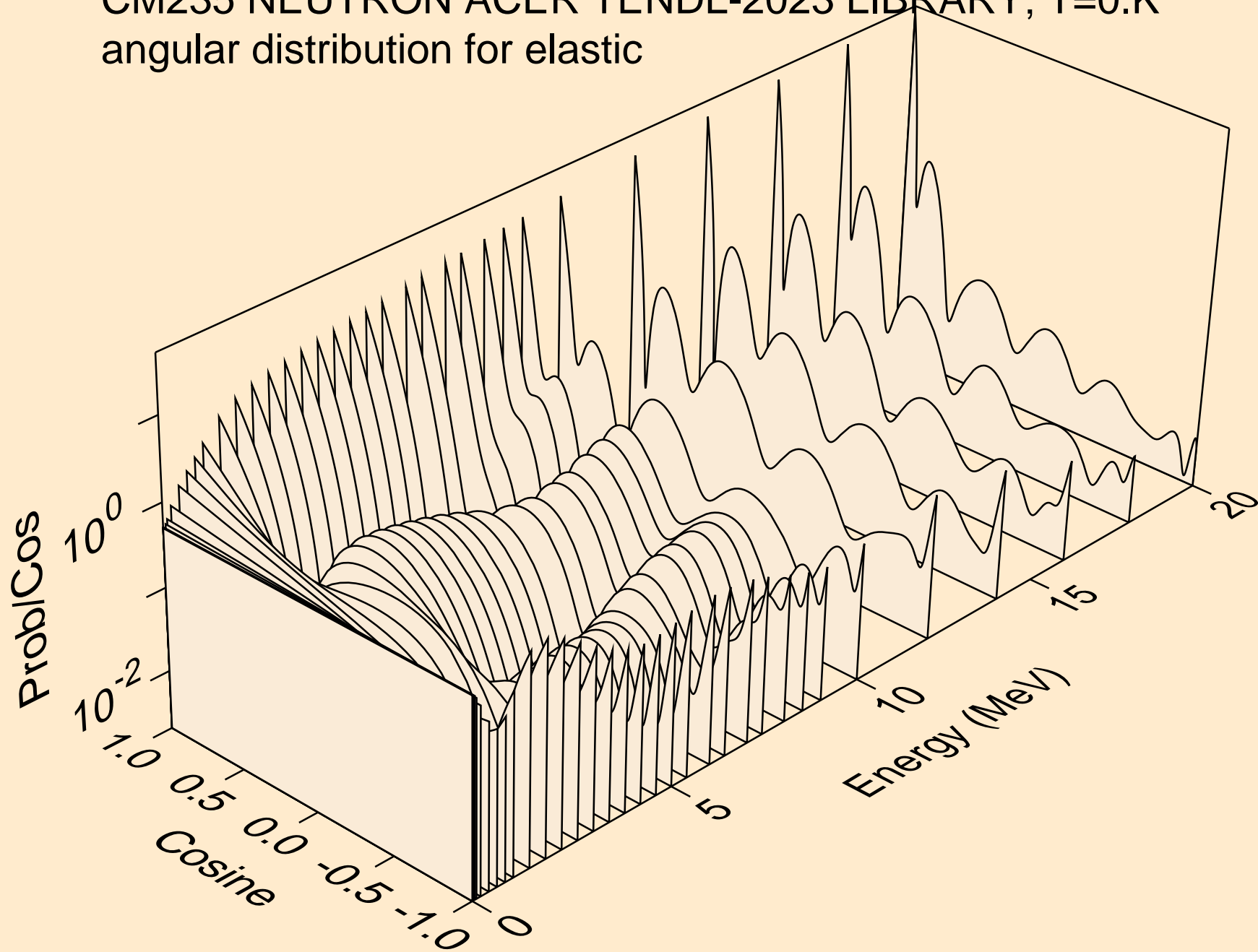

CM235 NEUTRON ACER TENDL-2023 LIBRARY; T=0.K  
angular distribution for elastic

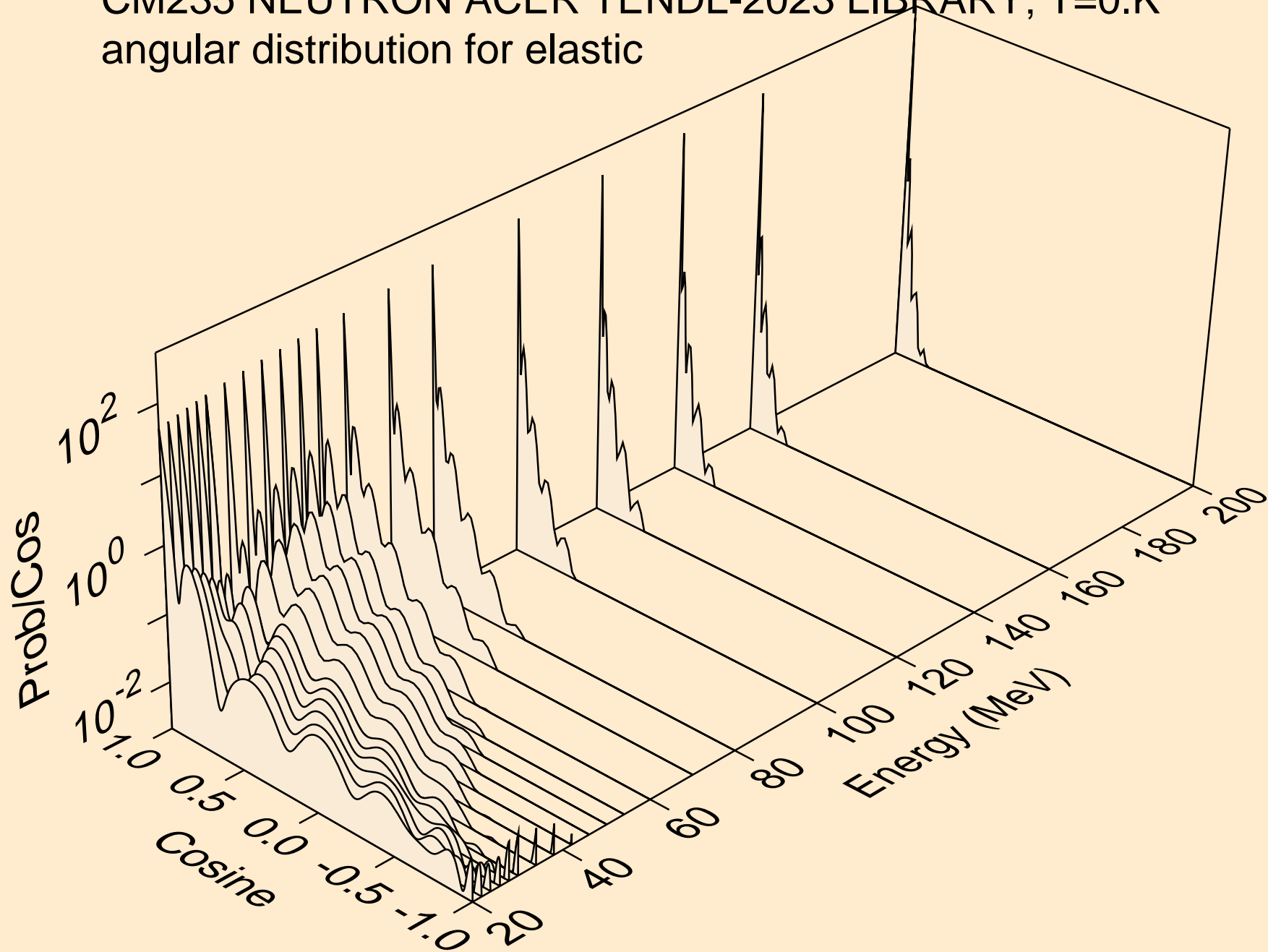



CM235 NEUTRON ACER TENDL-2023 LIBRARY; T=0.K  
angular distribution for (n,n\*1)

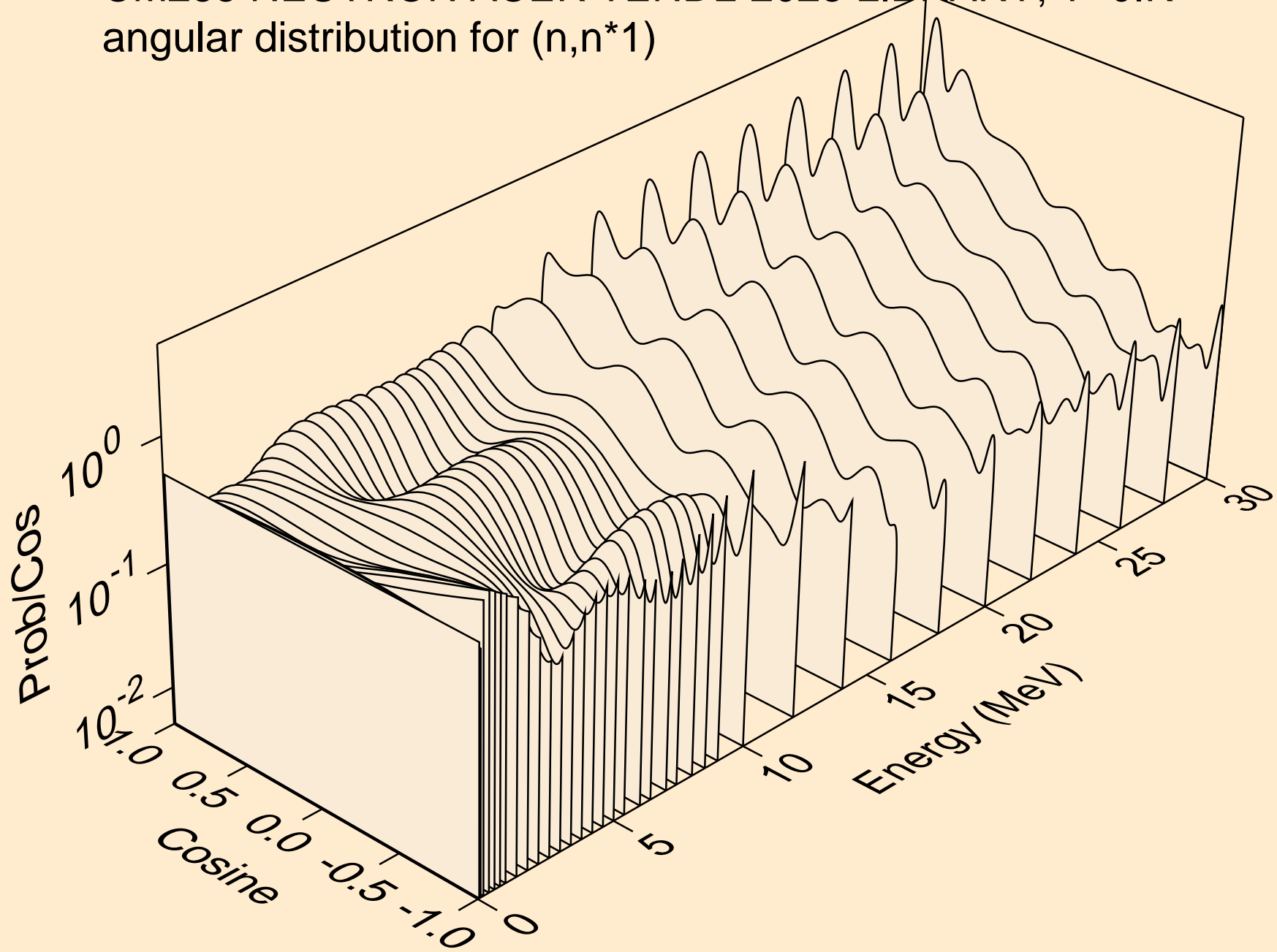

CM235 NEUTRON ACER TENDL-2023 LIBRARY; T=0.K  
angular distribution for (n,n\*2)

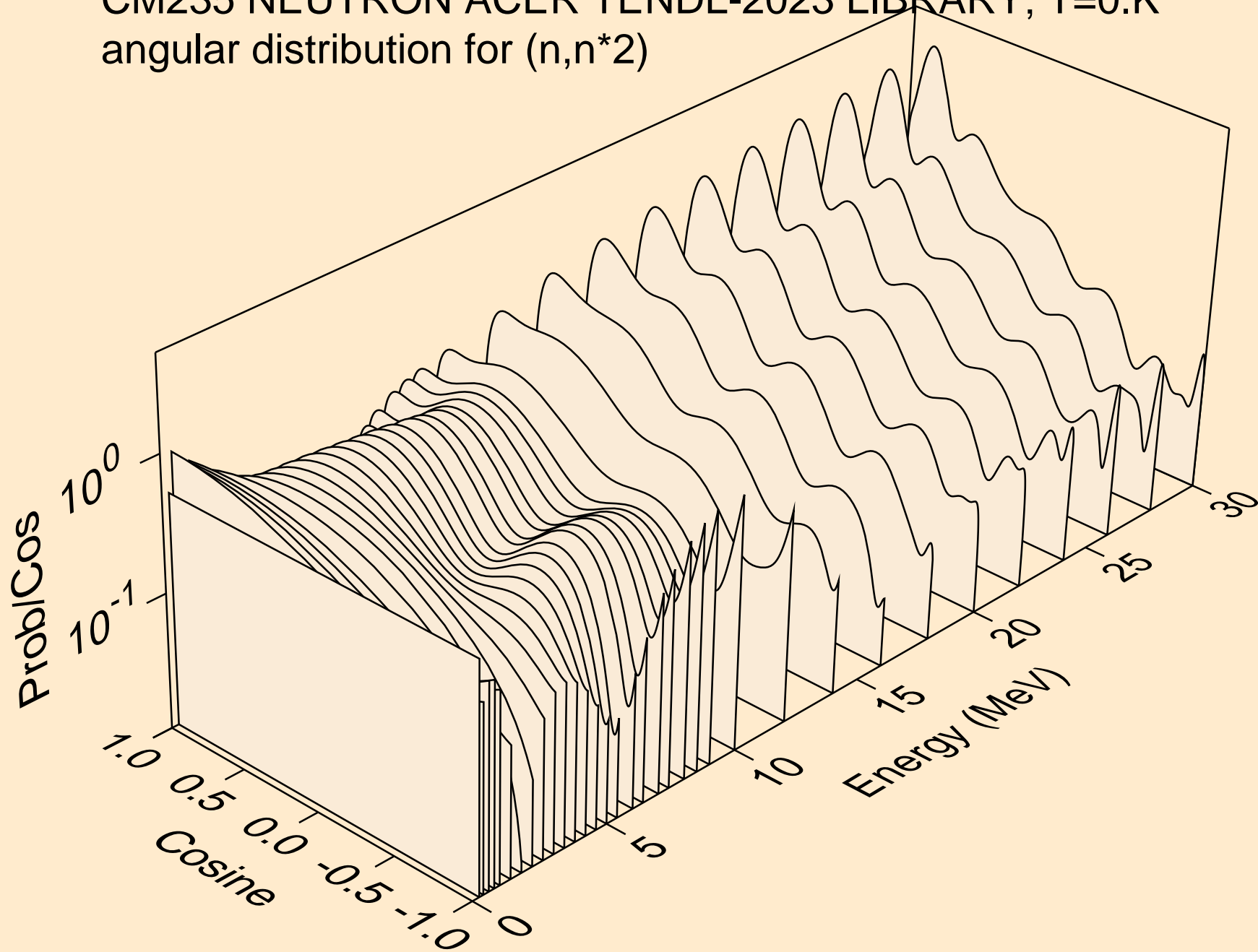

CM235 NEUTRON ACER TENDL-2023 LIBRARY; T=0.K  
angular distribution for (n,n\*3)

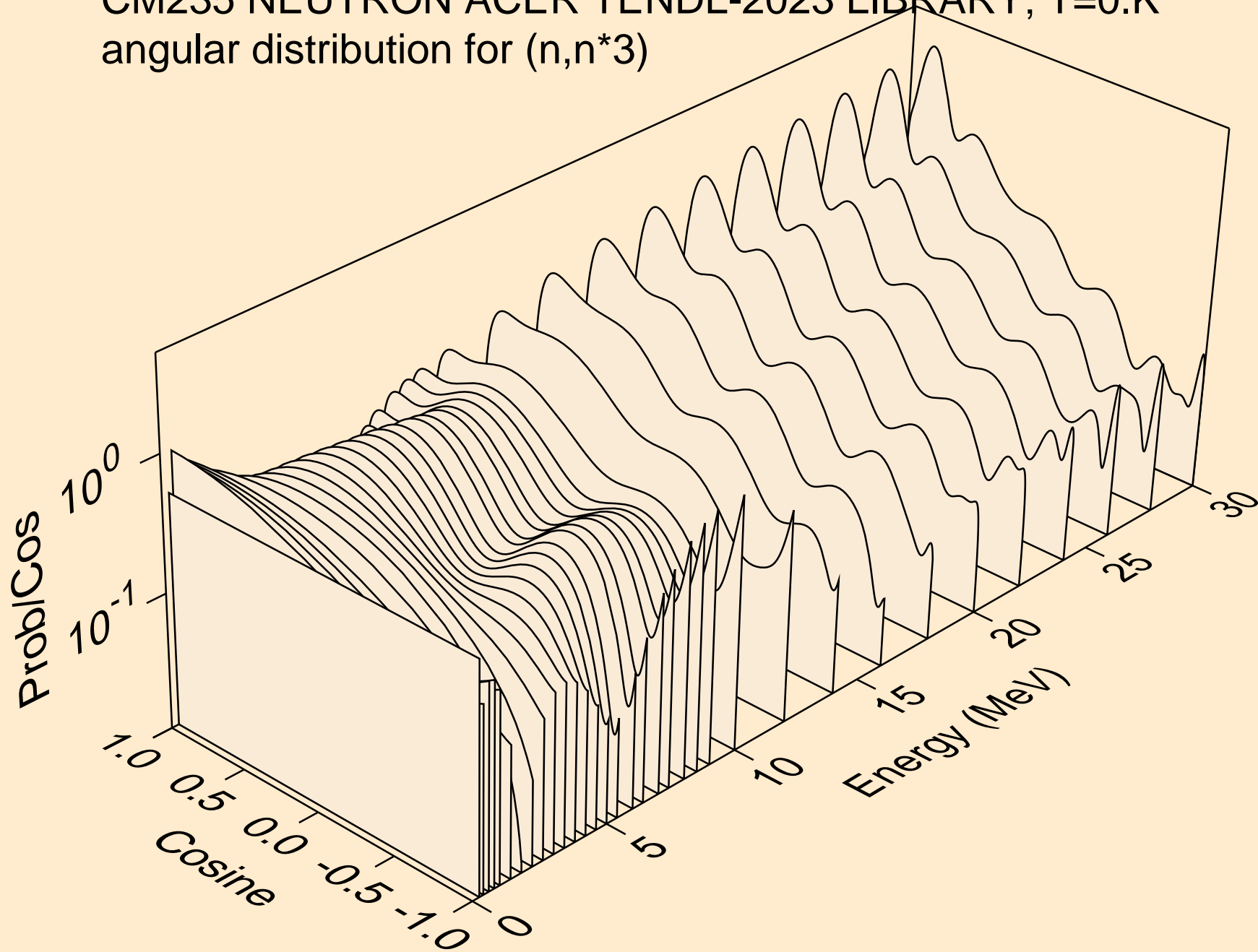

CM235 NEUTRON ACER TENDL-2023 LIBRARY; T=0.K  
angular distribution for (n,n\*4)

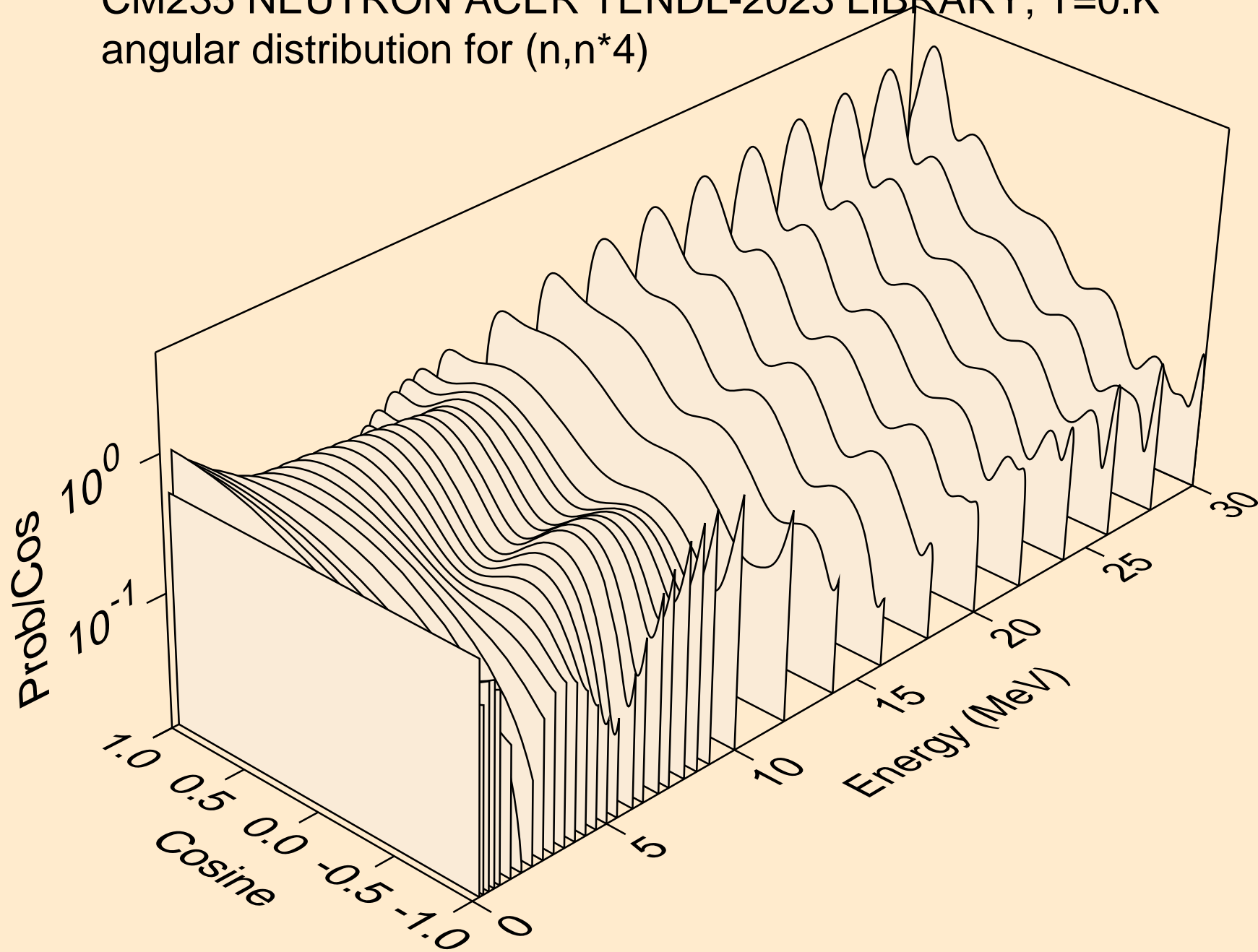

CM235 NEUTRON ACER TENDL-2023 LIBRARY; T=0.K  
angular distribution for (n,n\*5)

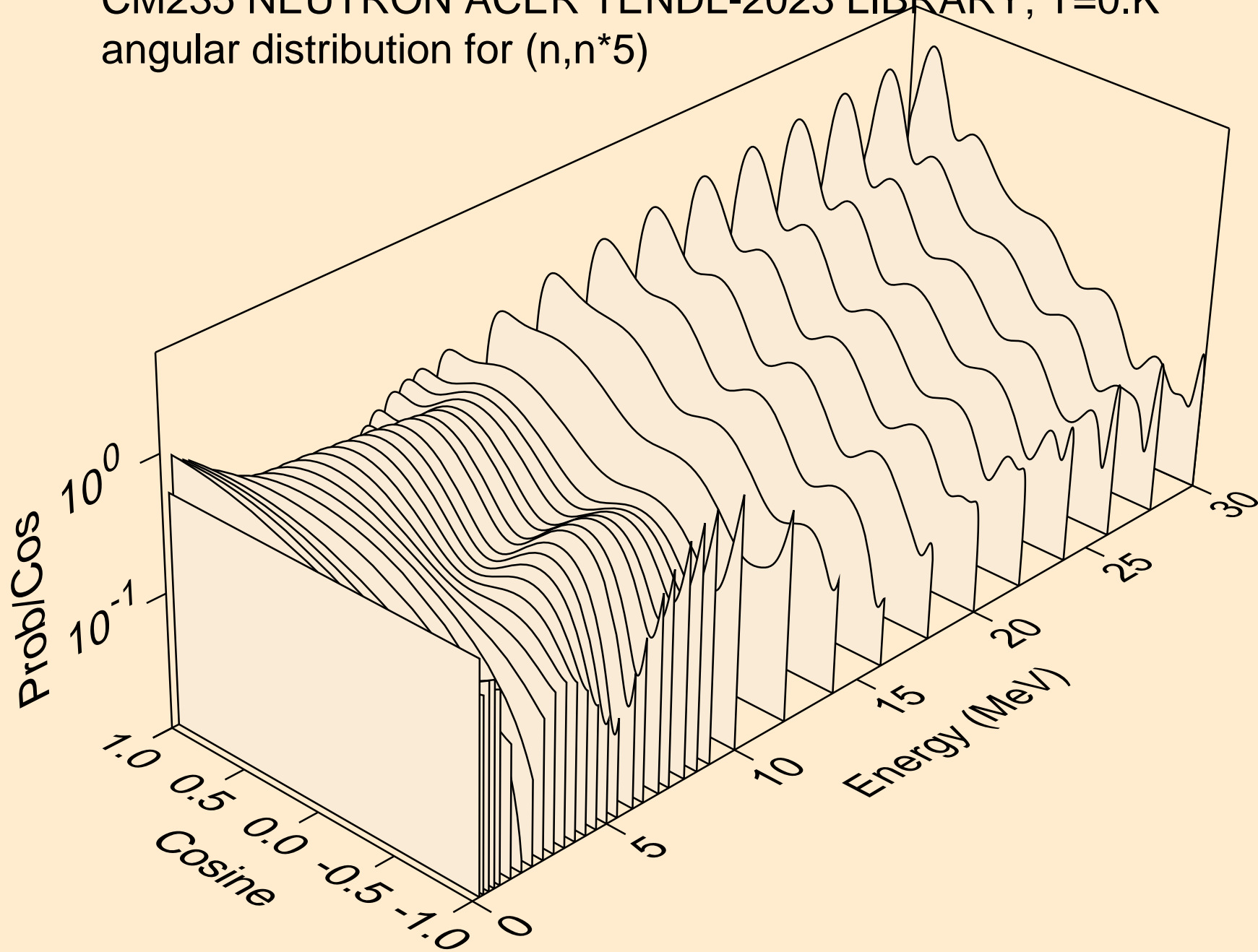

CM235 NEUTRON ACER TENDL-2023 LIBRARY; T=0.K  
angular distribution for (n,n\*6)

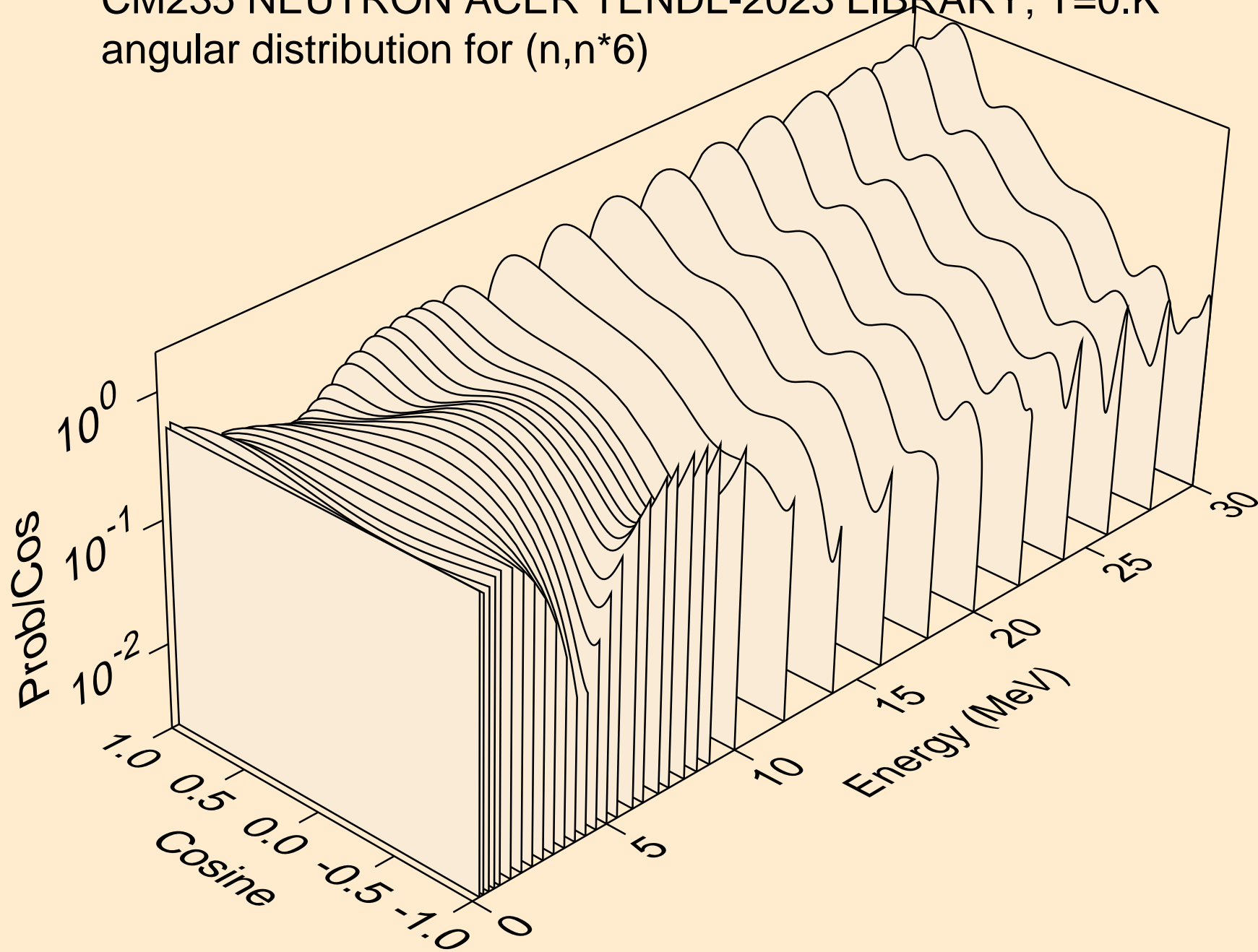

CM235 NEUTRON ACER TENDL-2023 LIBRARY; T=0.K  
angular distribution for (n,n\*7)

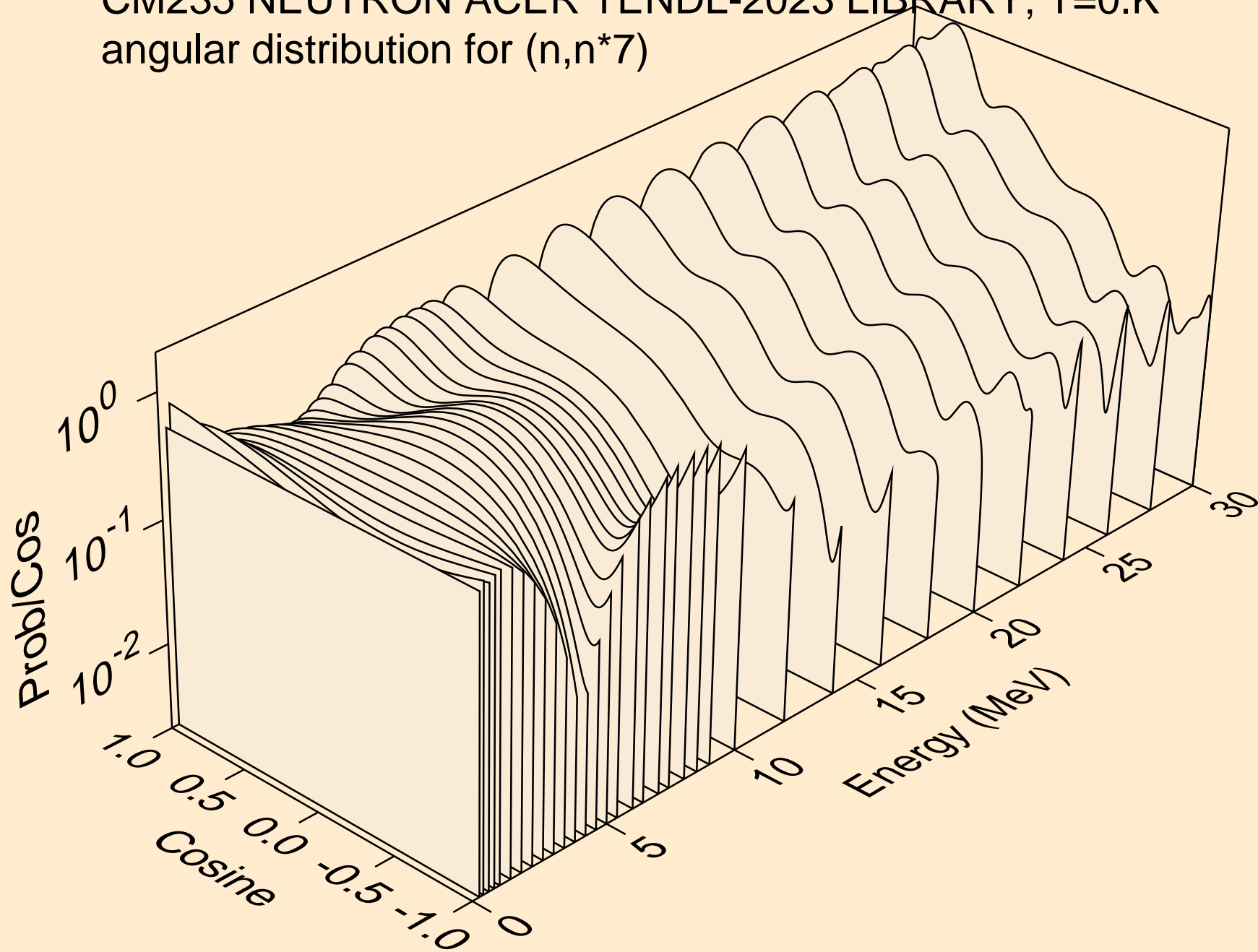

CM235 NEUTRON ACER TENDL-2023 LIBRARY; T=0.K  
angular distribution for (n,n\*8)

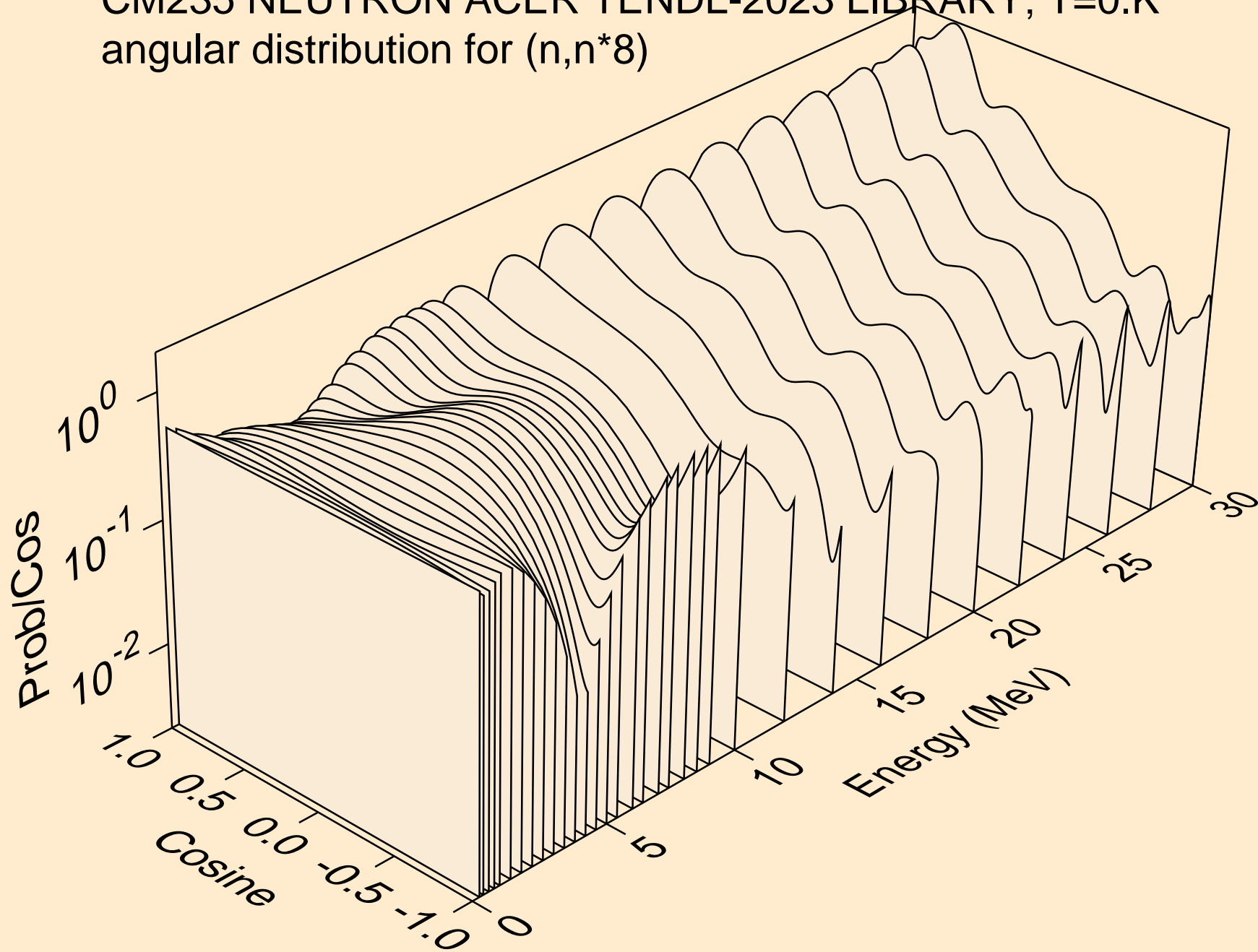



CM235 NEUTRON ACER TENDL-2023 LIBRARY; T=0.K  
angular distribution for (n,n\*9)

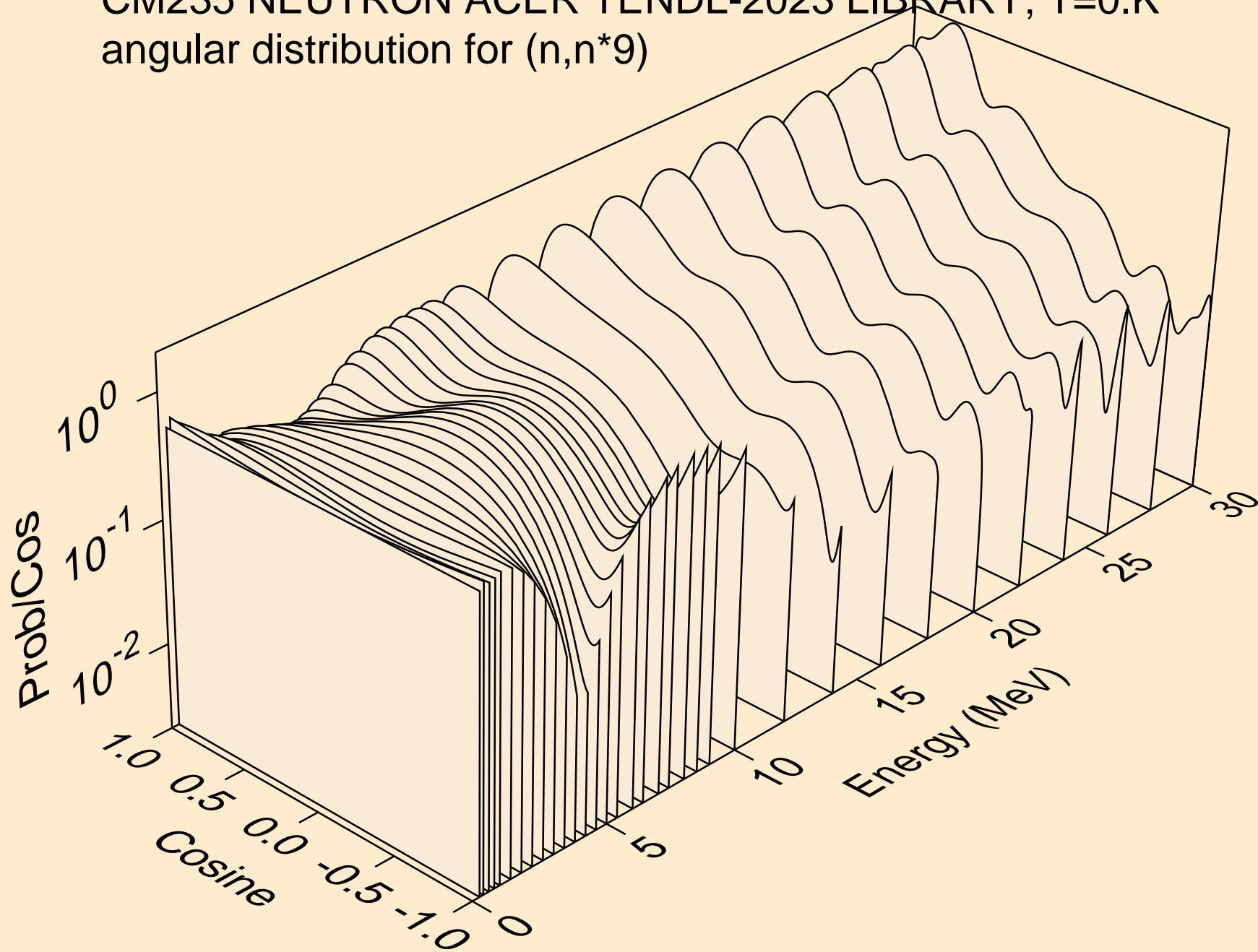

CM235 NEUTRON ACER TENDL-2023 LIBRARY; T=0.K  
angular distribution for (n,n\*10)

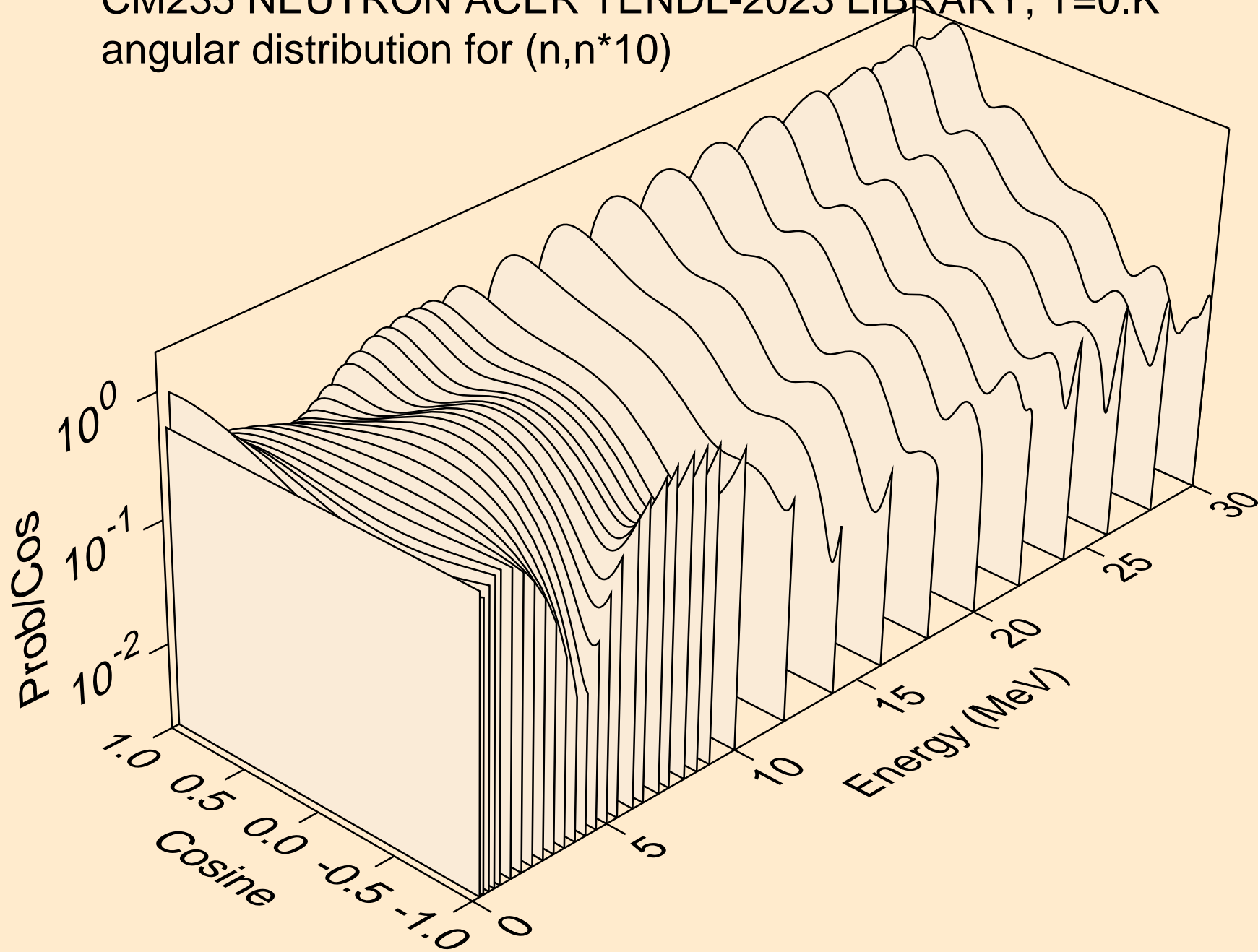

CM235 NEUTRON ACER TENDL-2023 LIBRARY; T=0.K  
angular distribution for (n,n\*11)

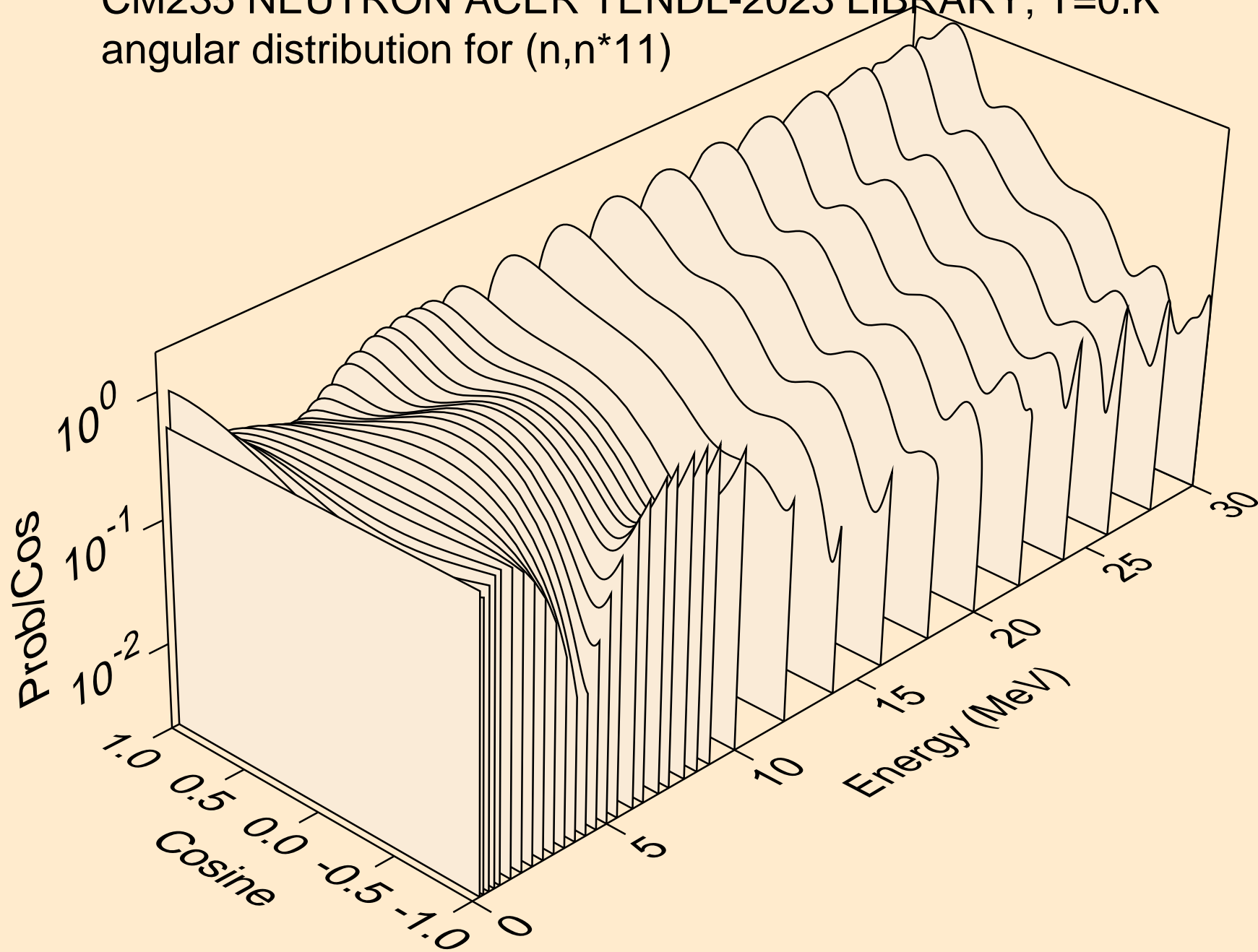

CM235 NEUTRON ACER TENDL-2023 LIBRARY; T=0.K  
angular distribution for (n,n\*12)

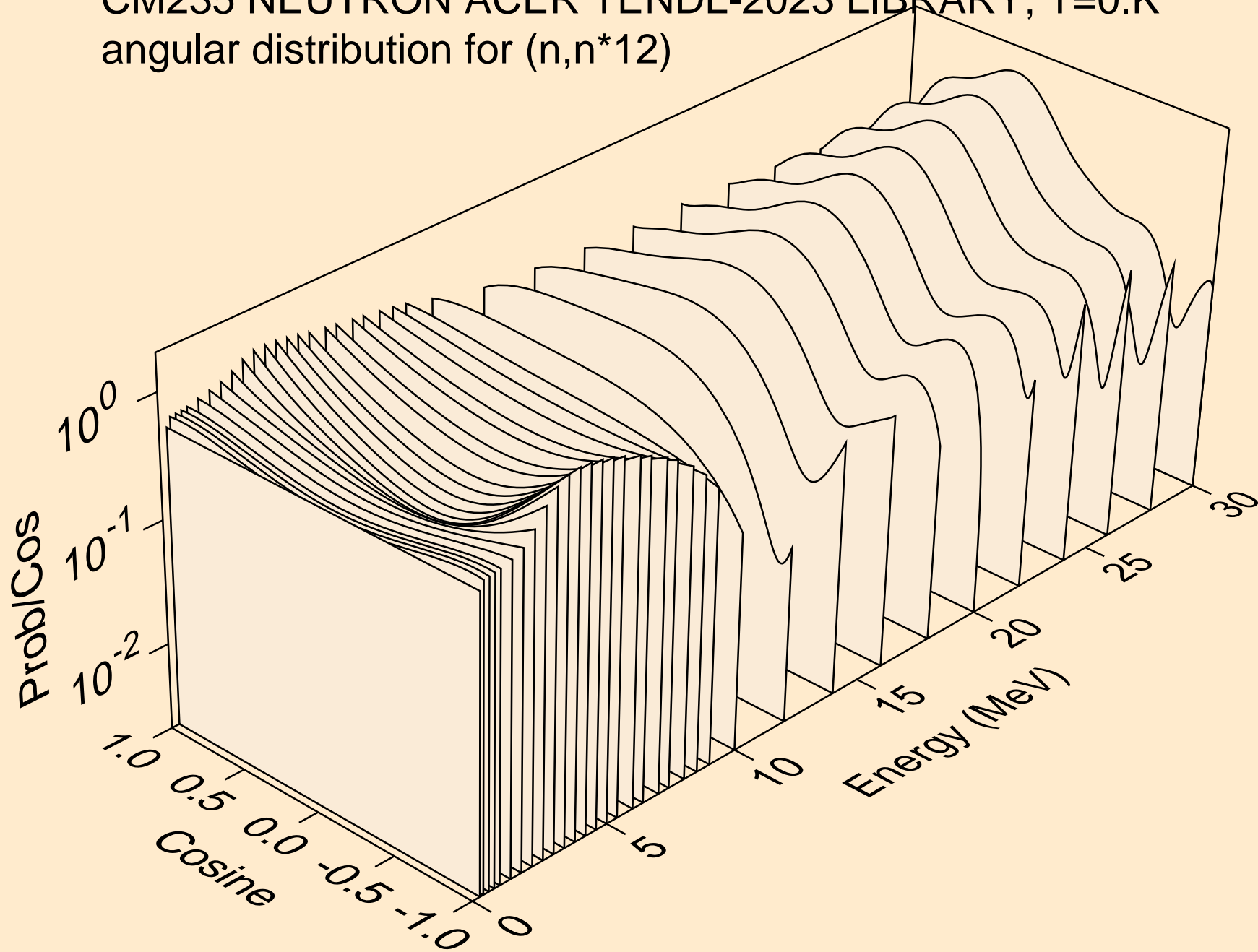

CM235 NEUTRON ACER TENDL-2023 LIBRARY; T=0.K  
angular distribution for (n,n\*13)

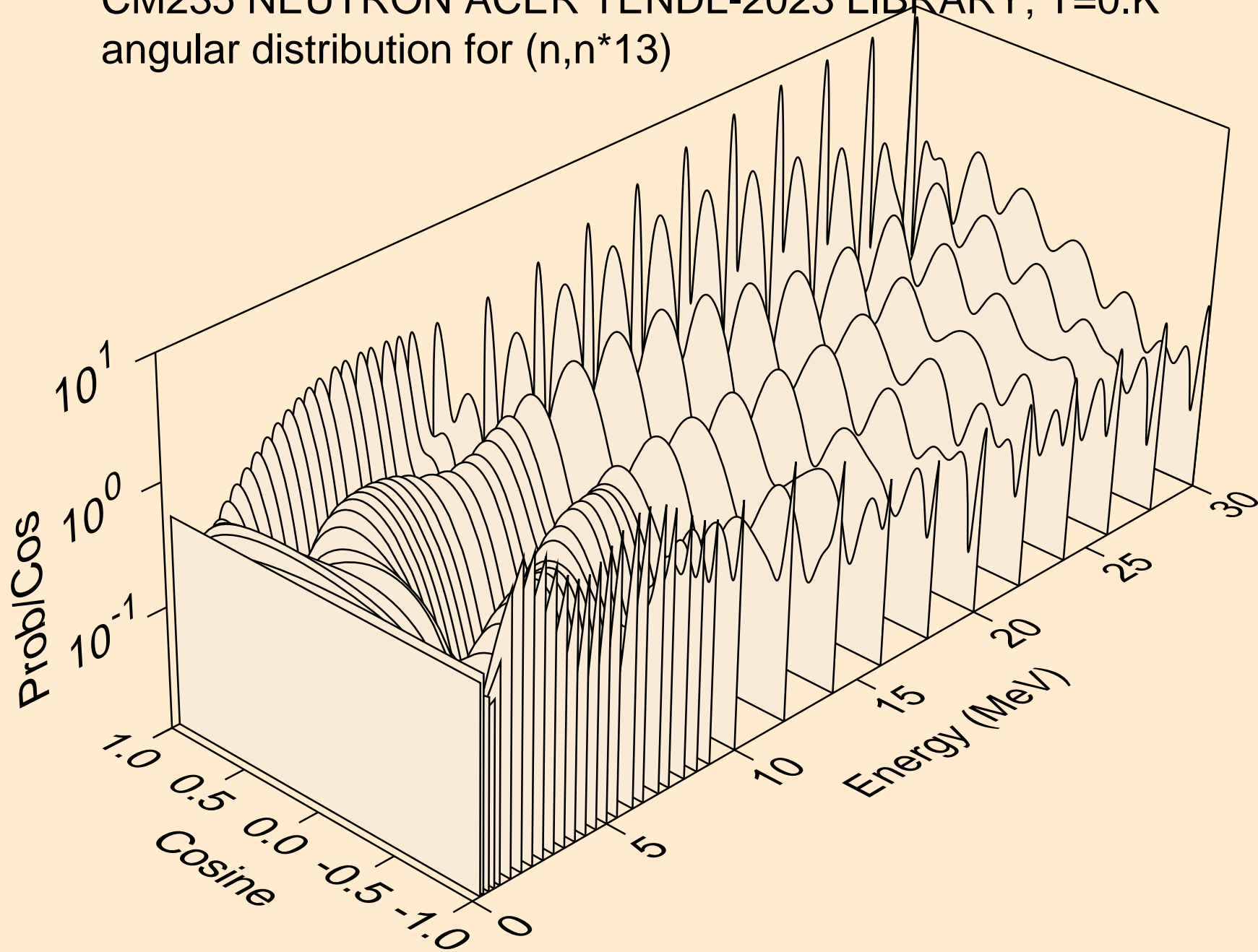

CM235 NEUTRON ACER TENDL-2023 LIBRARY; T=0.K  
angular distribution for (n,n\*14)

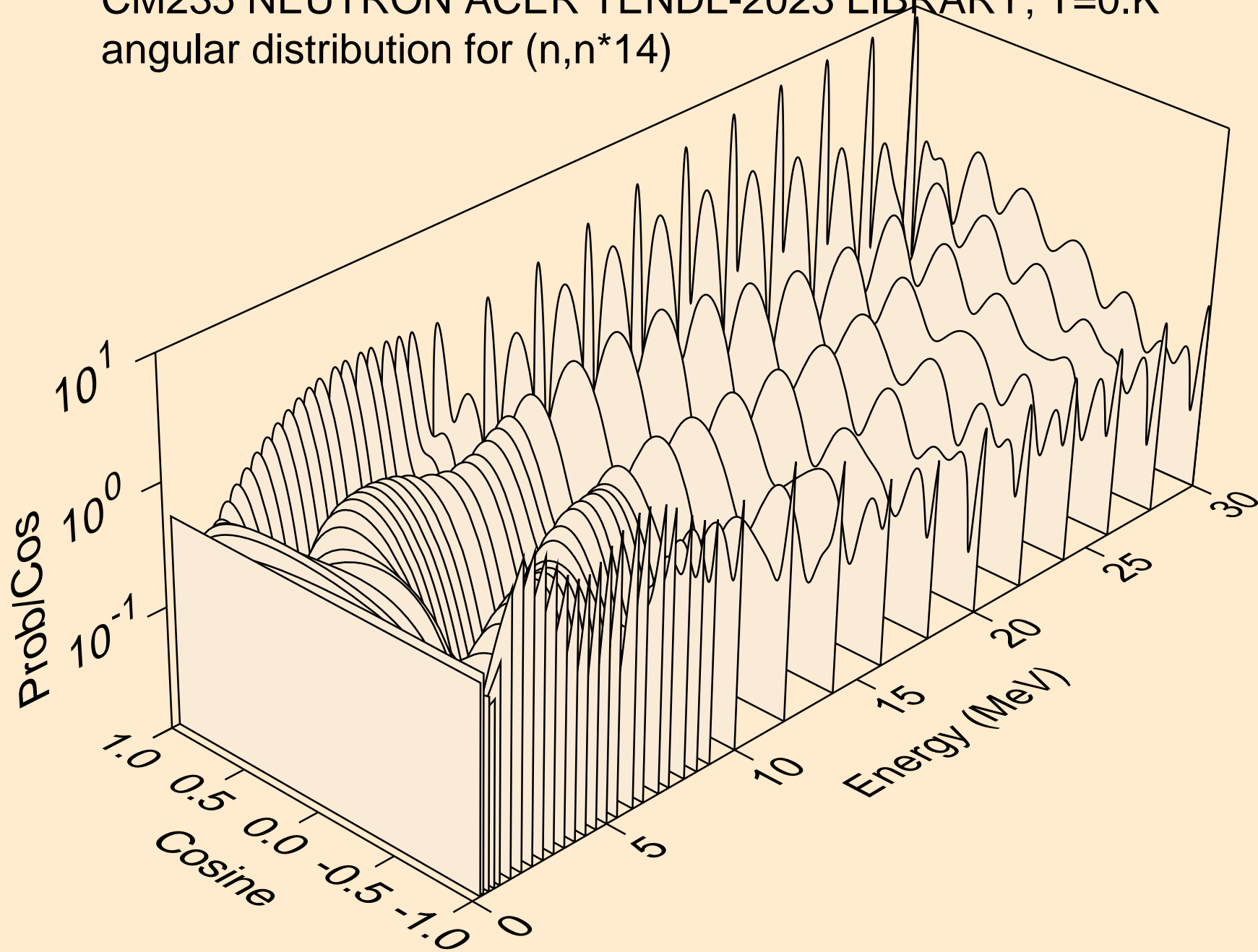

CM235 NEUTRON ACER TENDL-2023 LIBRARY; T=0.K  
angular distribution for (n,n\*15)

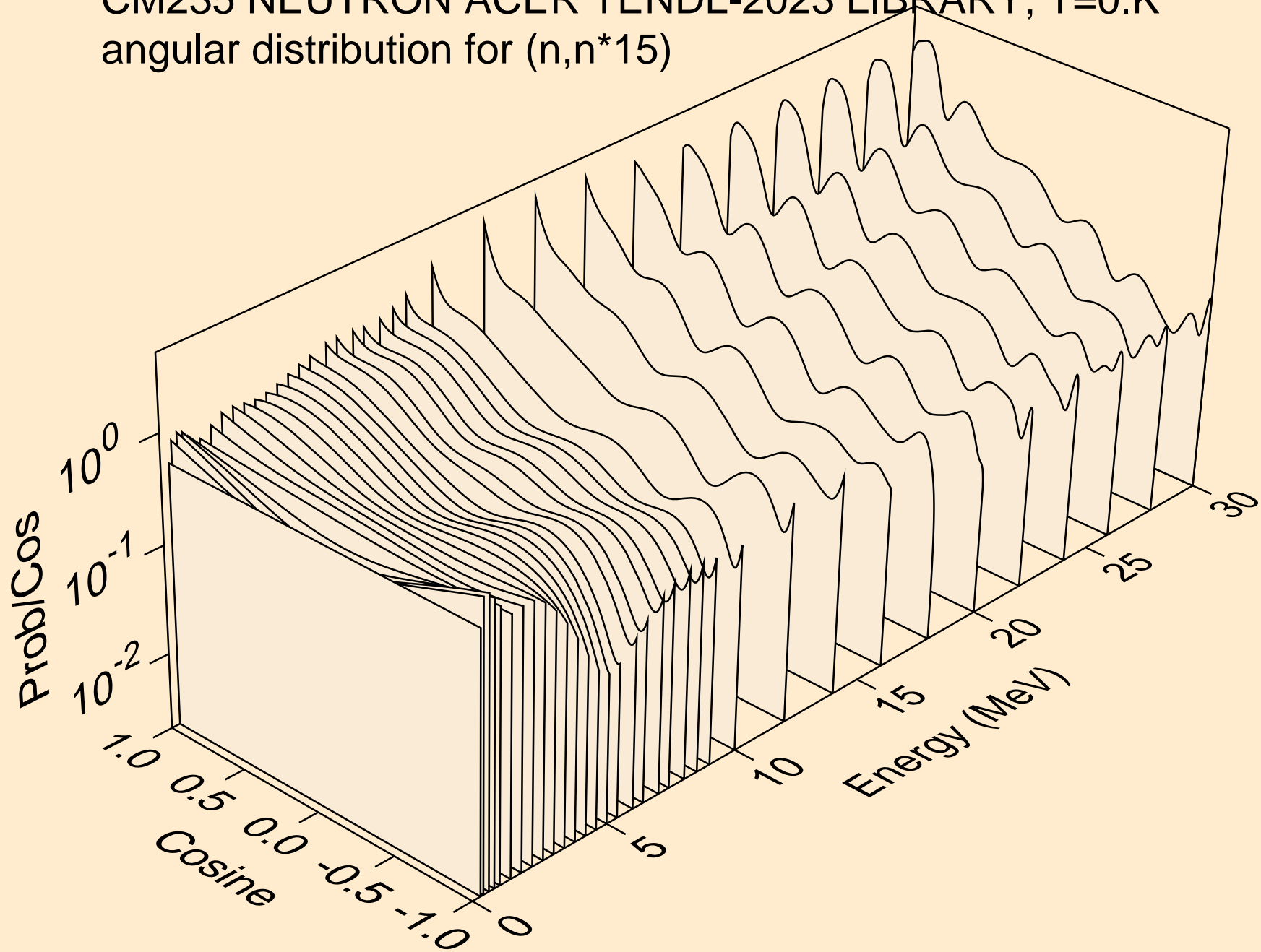



CM235 NEUTRON ACER TENDL-2023 LIBRARY; T=0.K  
angular distribution for (n,n\*16)

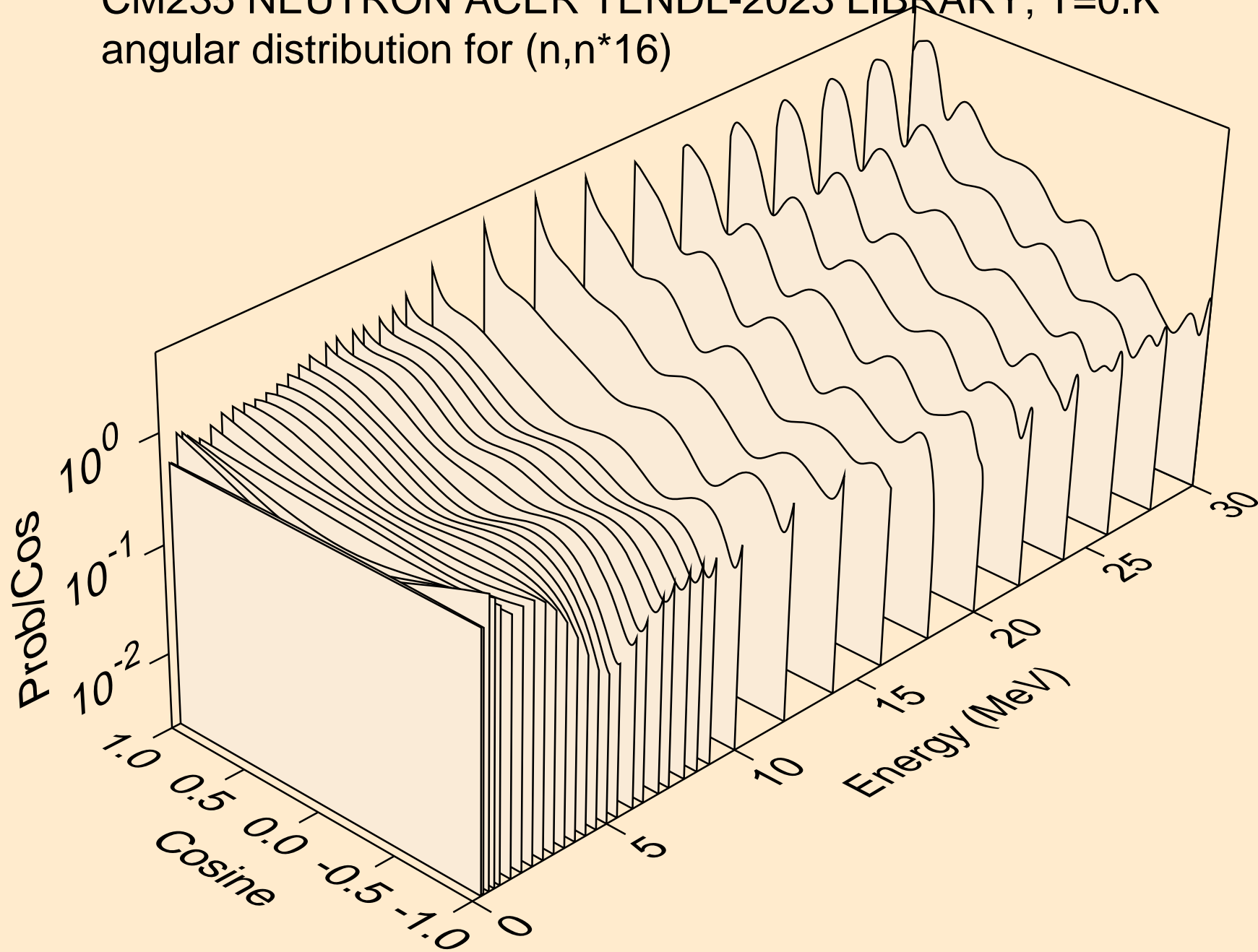



CM235 NEUTRON ACER TENDL-2023 LIBRARY; T=0.K  
angular distribution for (n,n\*17)

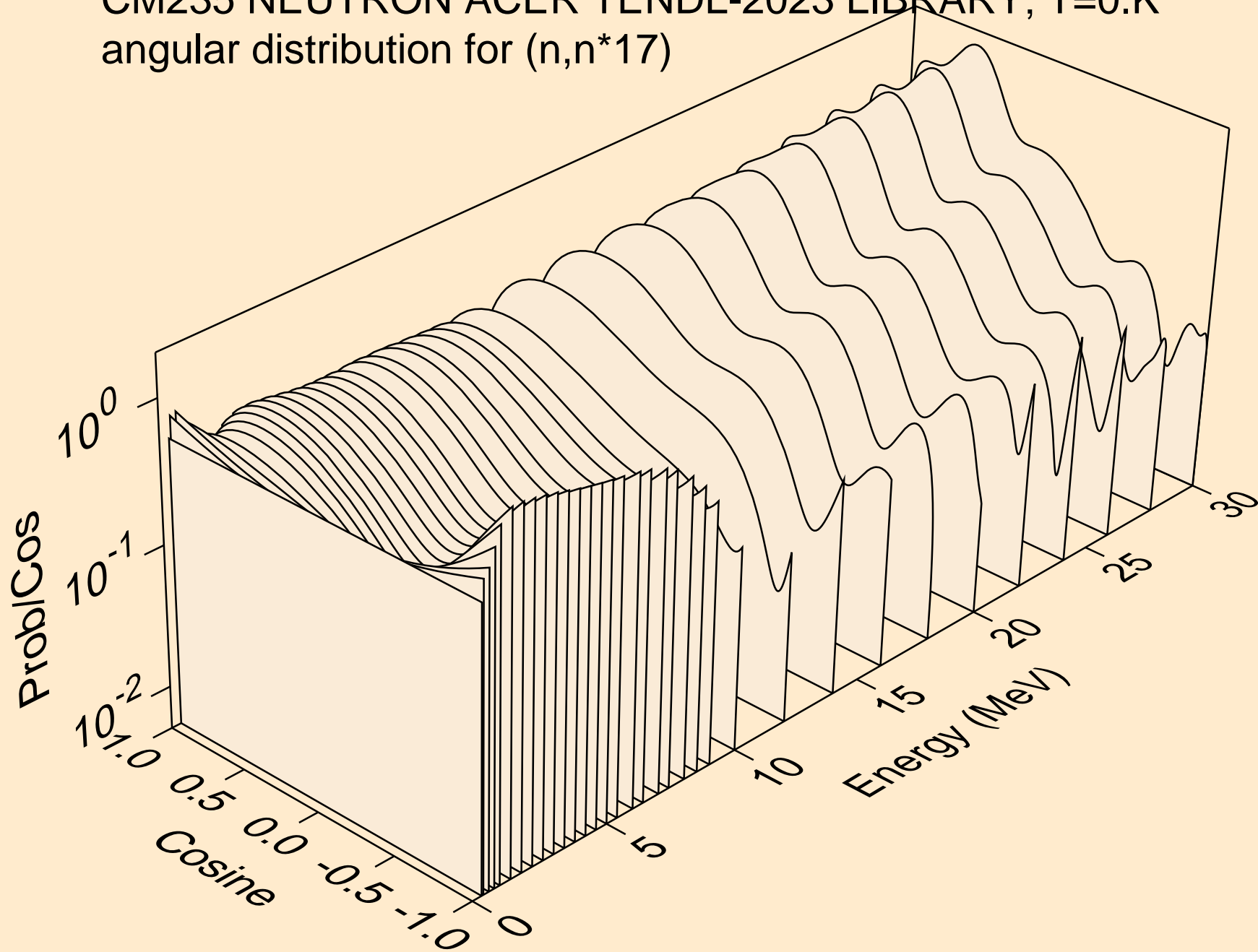

CM235 NEUTRON ACER TENDL-2023 LIBRARY; T=0.K  
angular distribution for (n,n\*18)

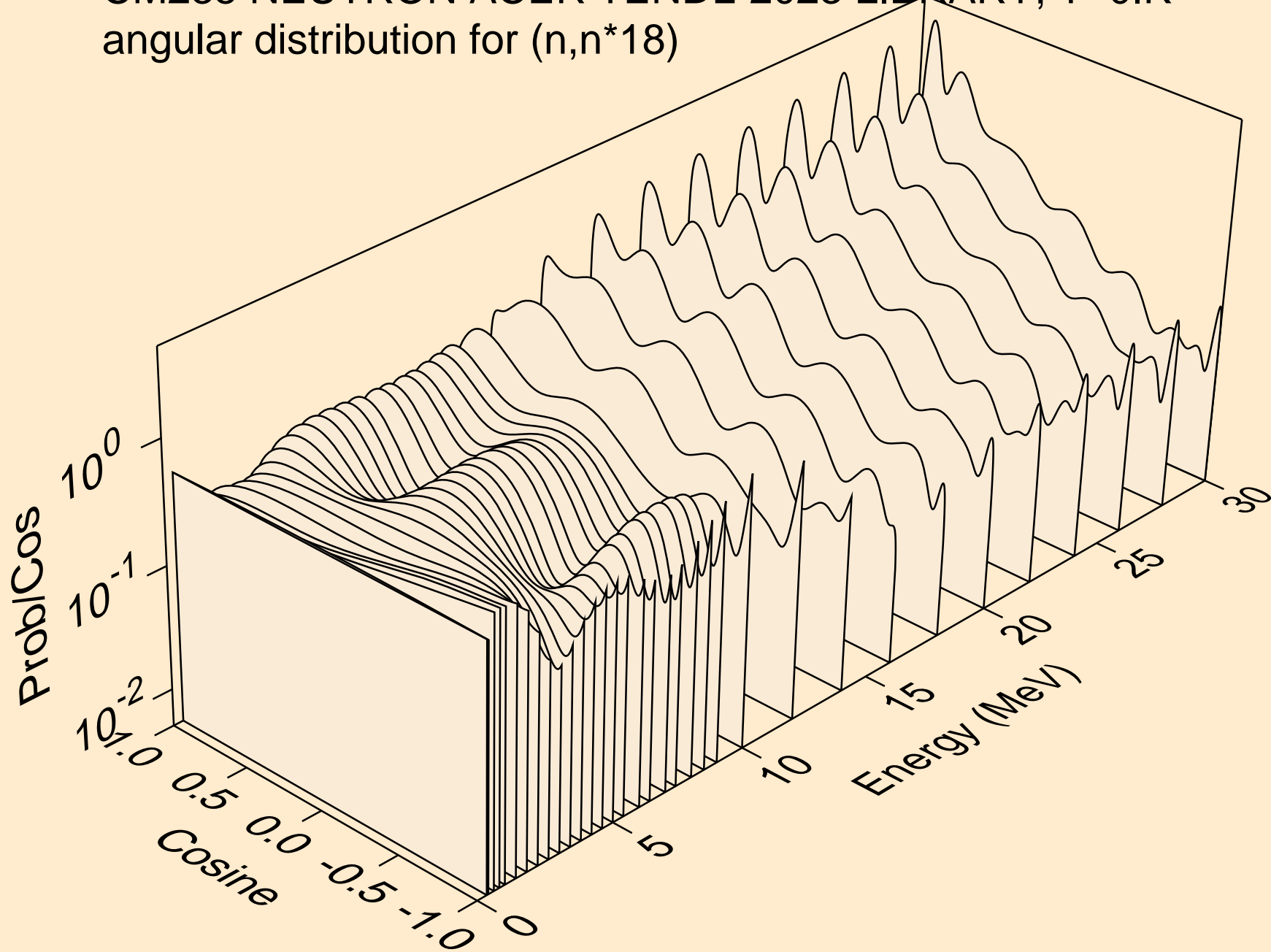

CM235 NEUTRON ACER TENDL-2023 LIBRARY; T=0.K  
angular distribution for (n,n\*19)

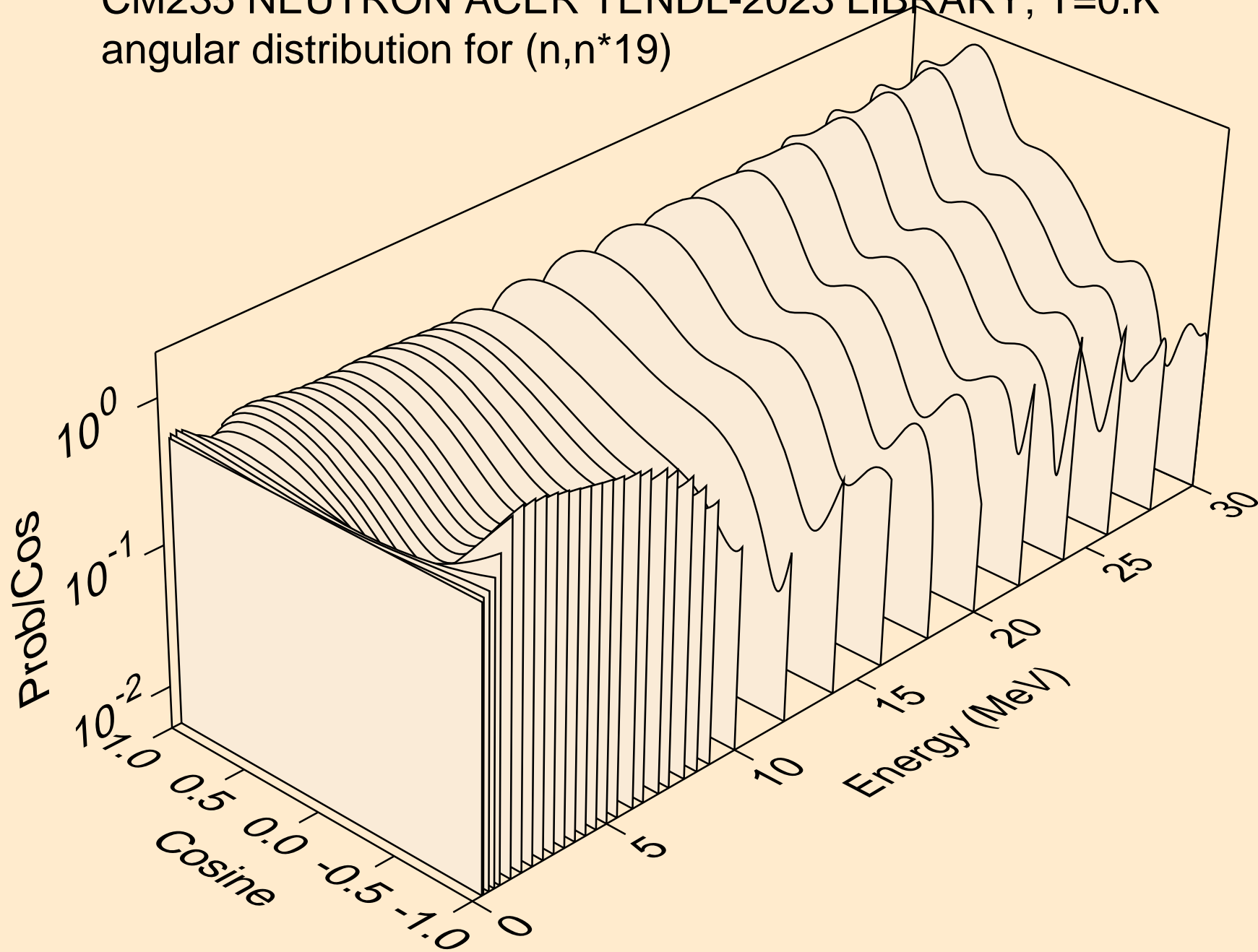

CM235 NEUTRON ACER TENDL-2023 LIBRARY; T=0.K  
angular distribution for (n,n\*20)

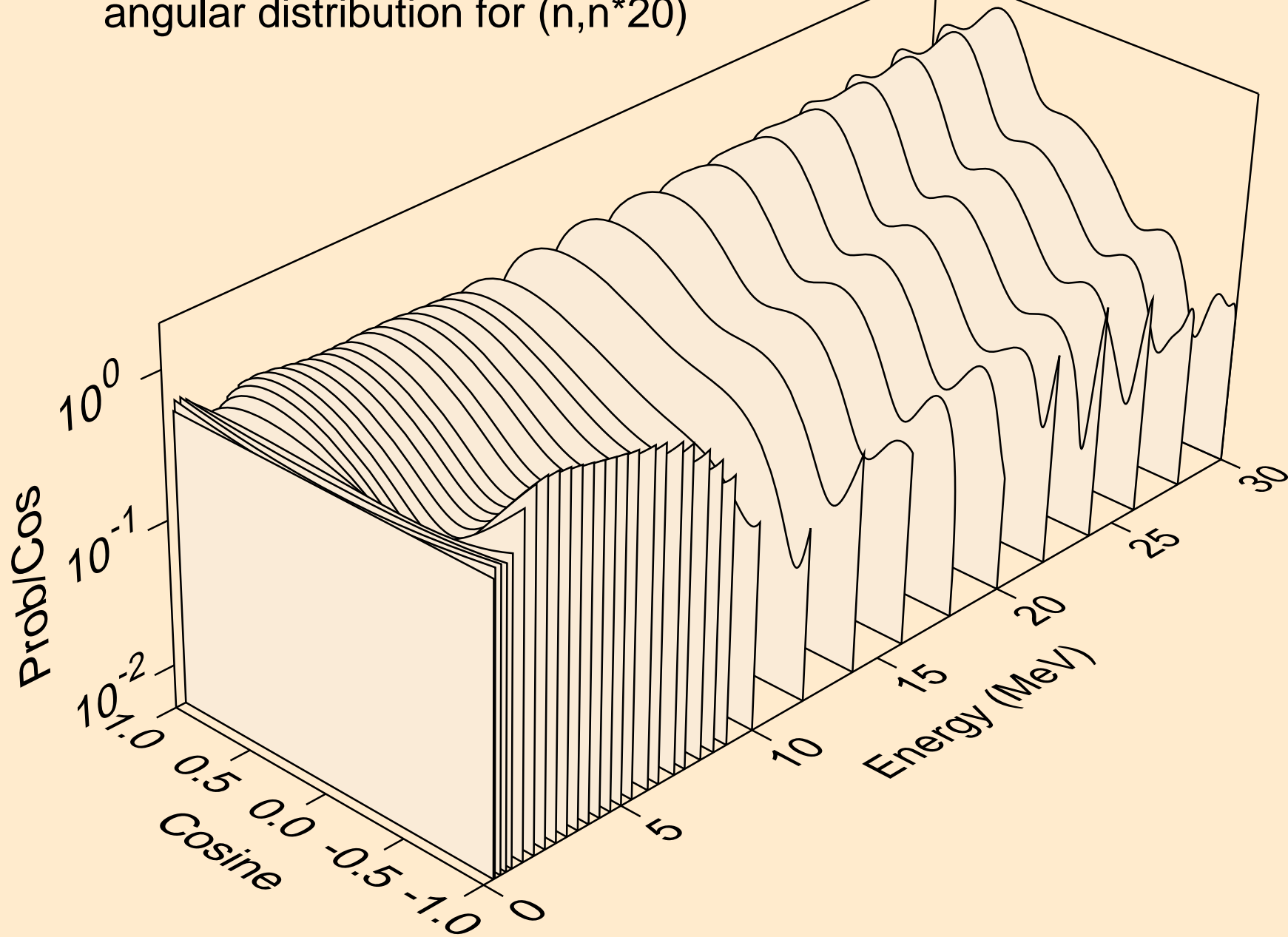

CM235 NEUTRON ACER TENDL-2023 LIBRARY; T=0.K  
angular distribution for (n,n\*21)

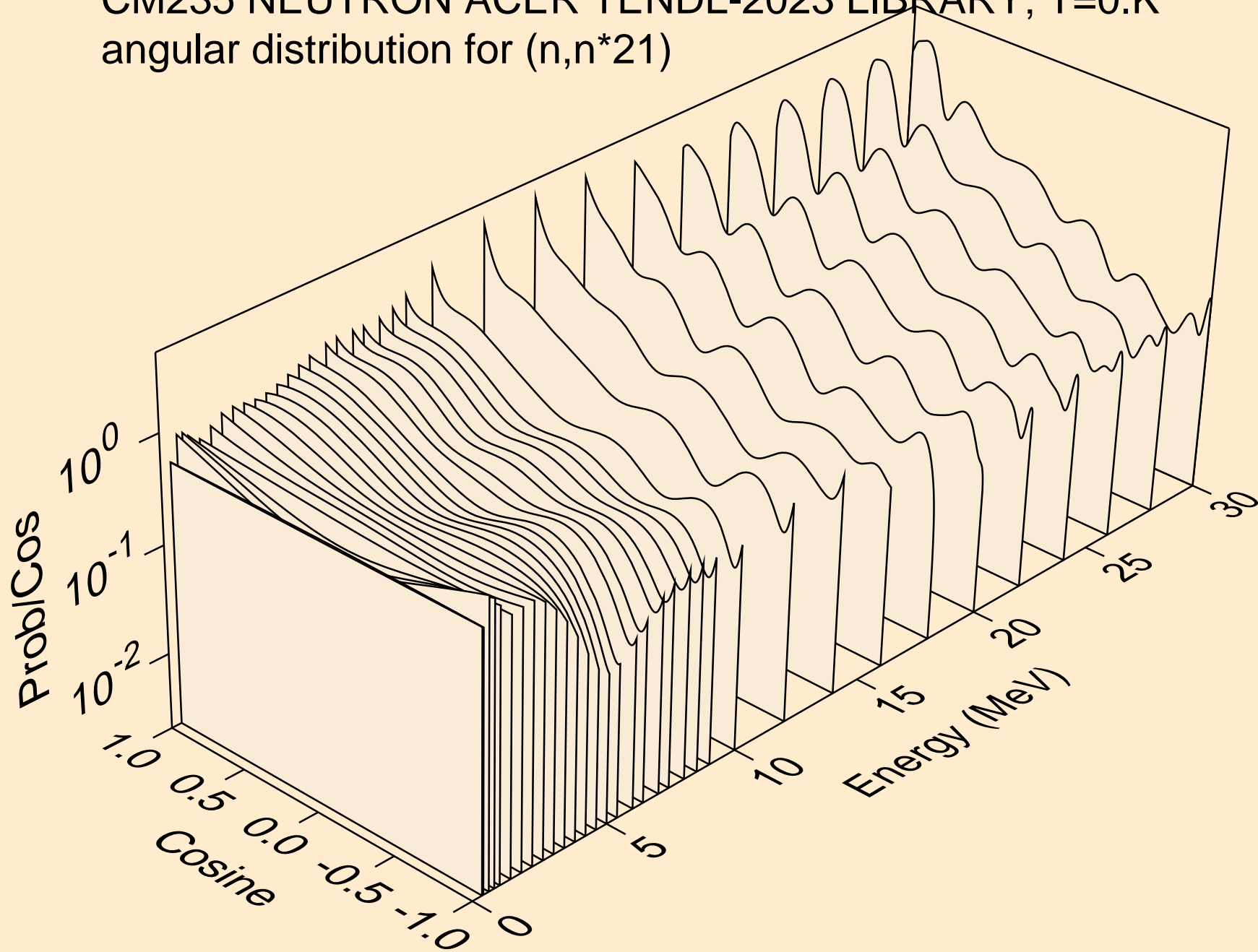

CM235 NEUTRON ACER TENDL-2023 LIBRARY; T=0.K  
angular distribution for (n,n\*22)

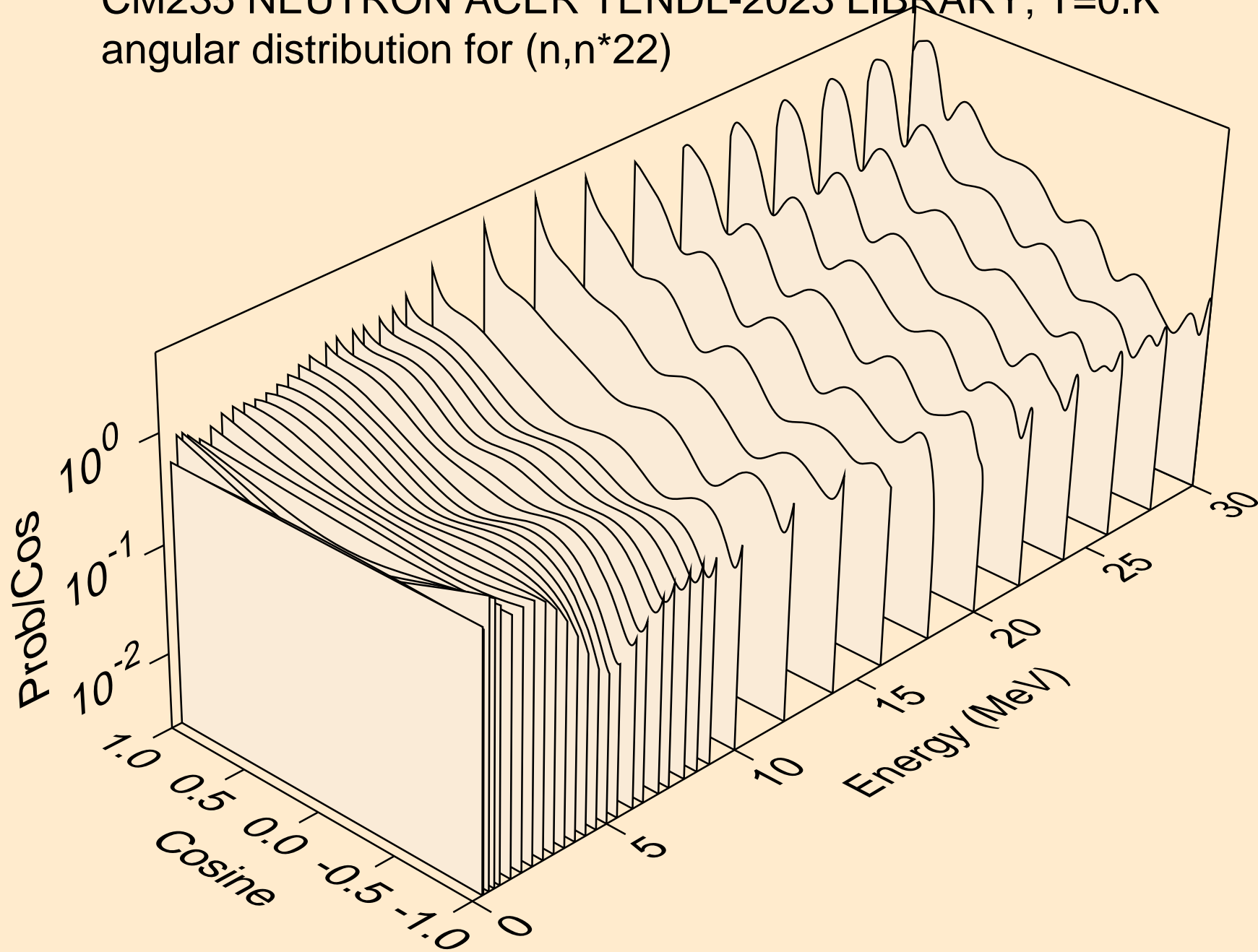

CM235 NEUTRON ACER TENDL-2023 LIBRARY; T=0.K  
angular distribution for (n,n\*23)

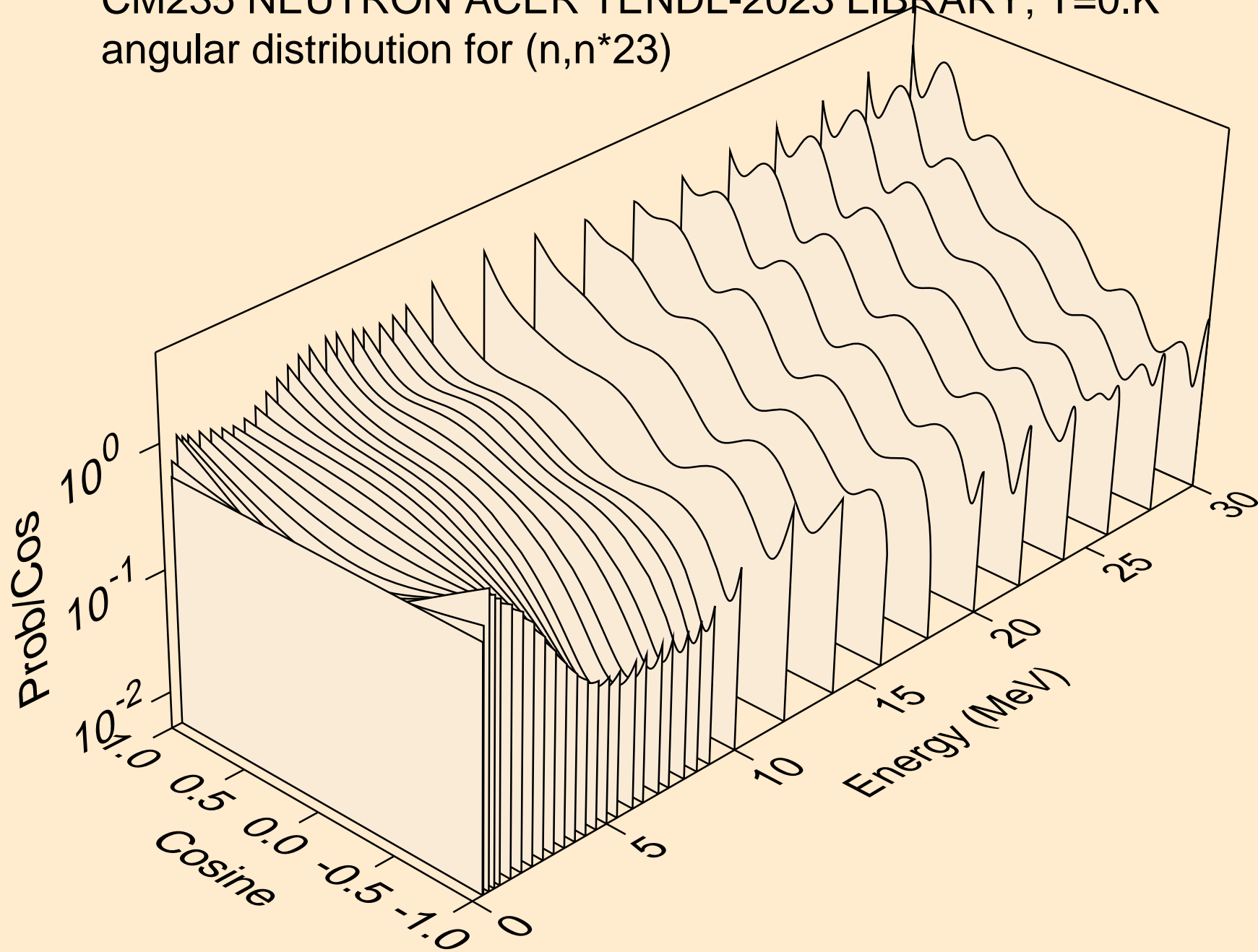

CM235 NEUTRON ACER TENDL-2023 LIBRARY; T=0.K  
angular distribution for (n,n\*24)

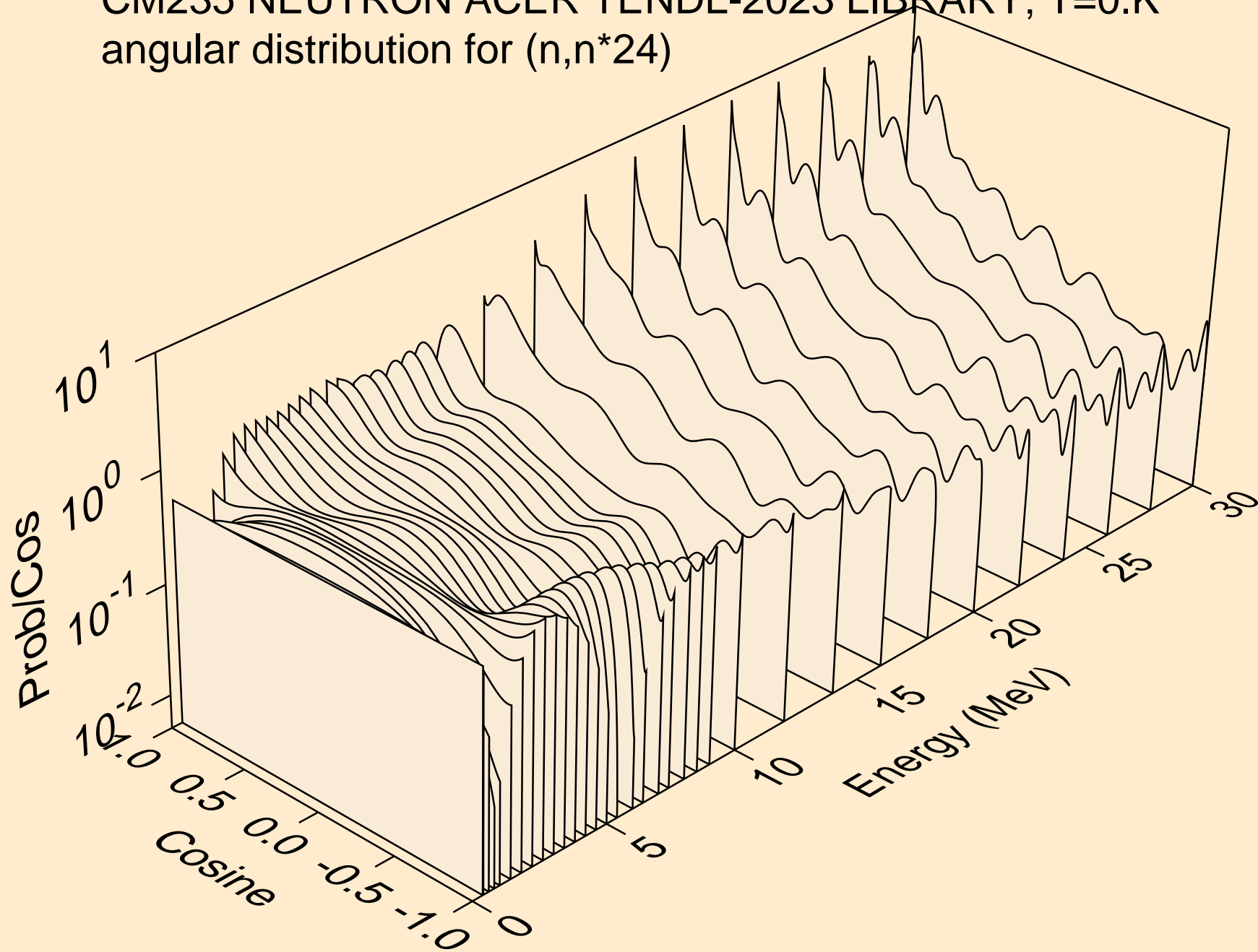



CM235 NEUTRON ACER TENDL-2023 LIBRARY; T=0.K  
angular distribution for (n,n\*25)

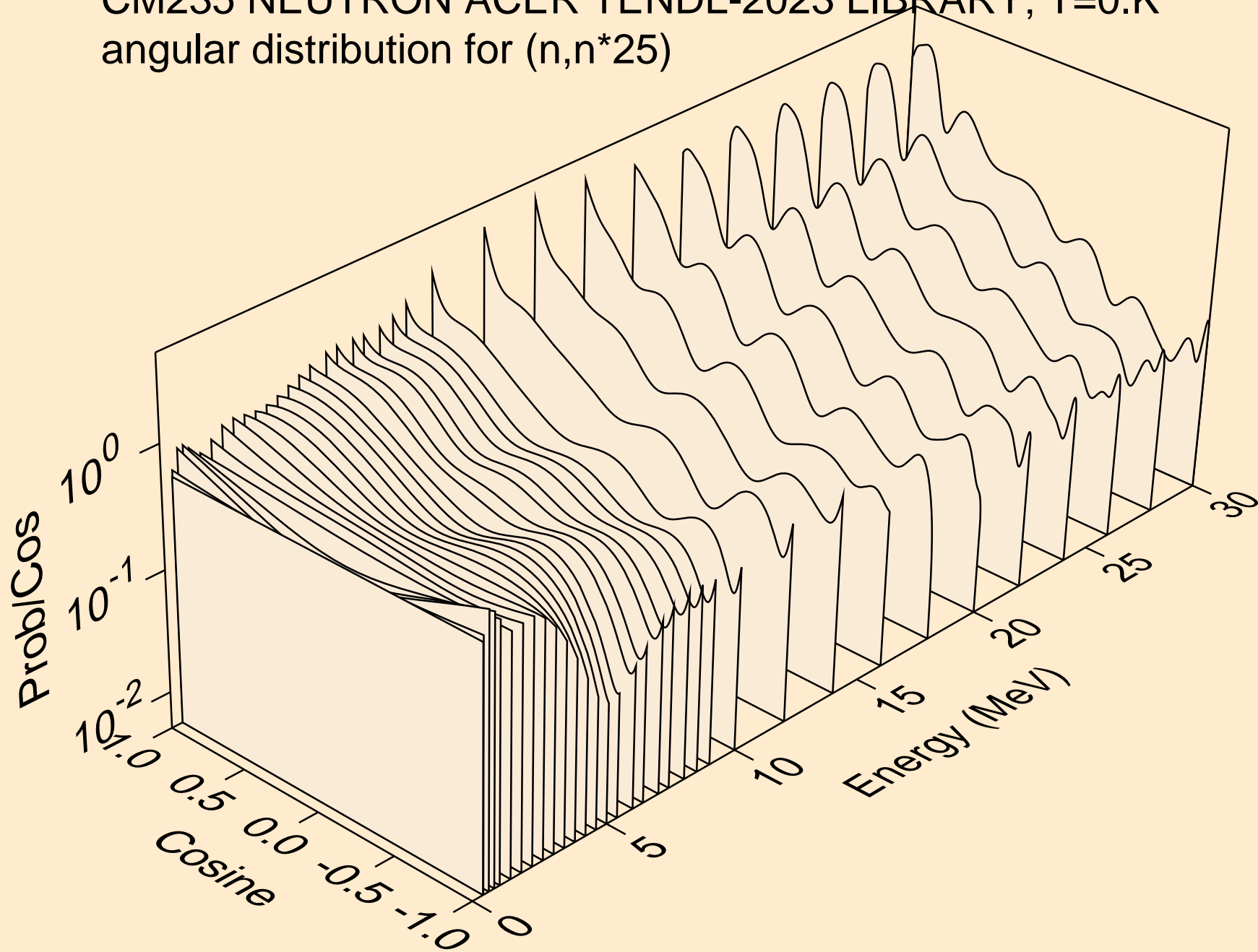

CM235 NEUTRON ACER TENDL-2023 LIBRARY; T=0.K  
angular distribution for (n,n\*26)

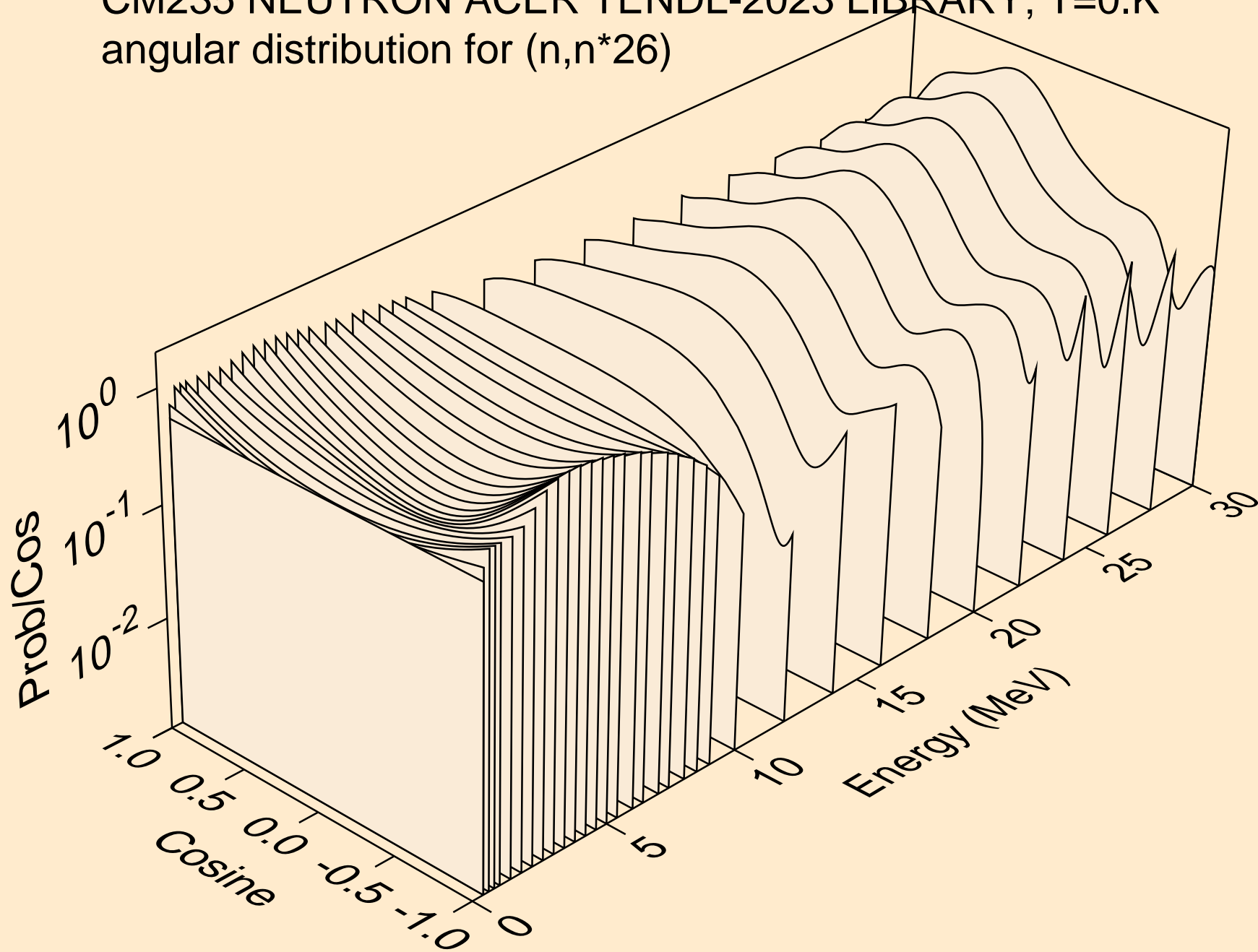

CM235 NEUTRON ACER TENDL-2023 LIBRARY; T=0.K  
angular distribution for (n,n\*27)

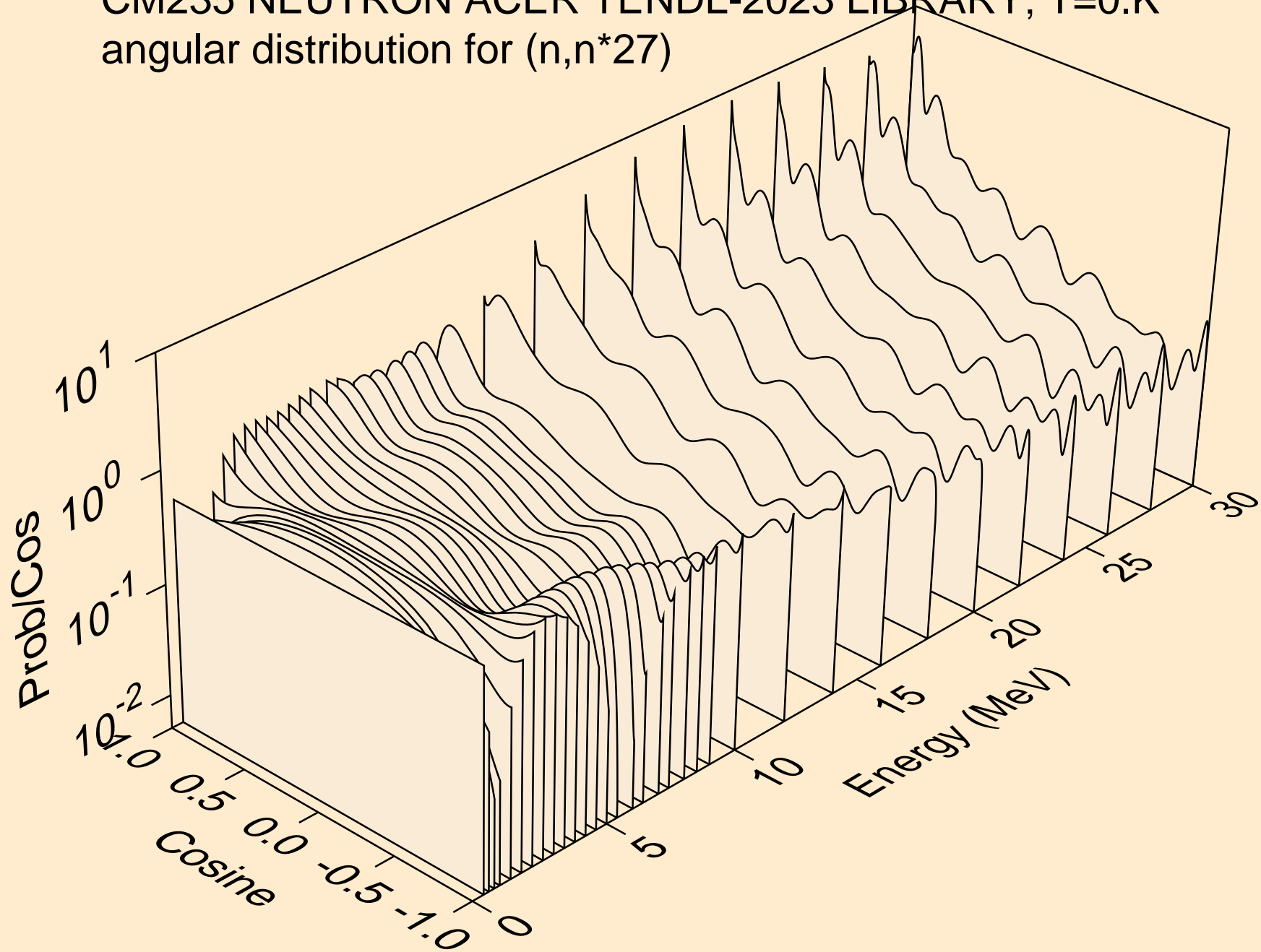

CM235 NEUTRON ACER TENDL-2023 LIBRARY; T=0.K  
angular distribution for (n,n\*28)

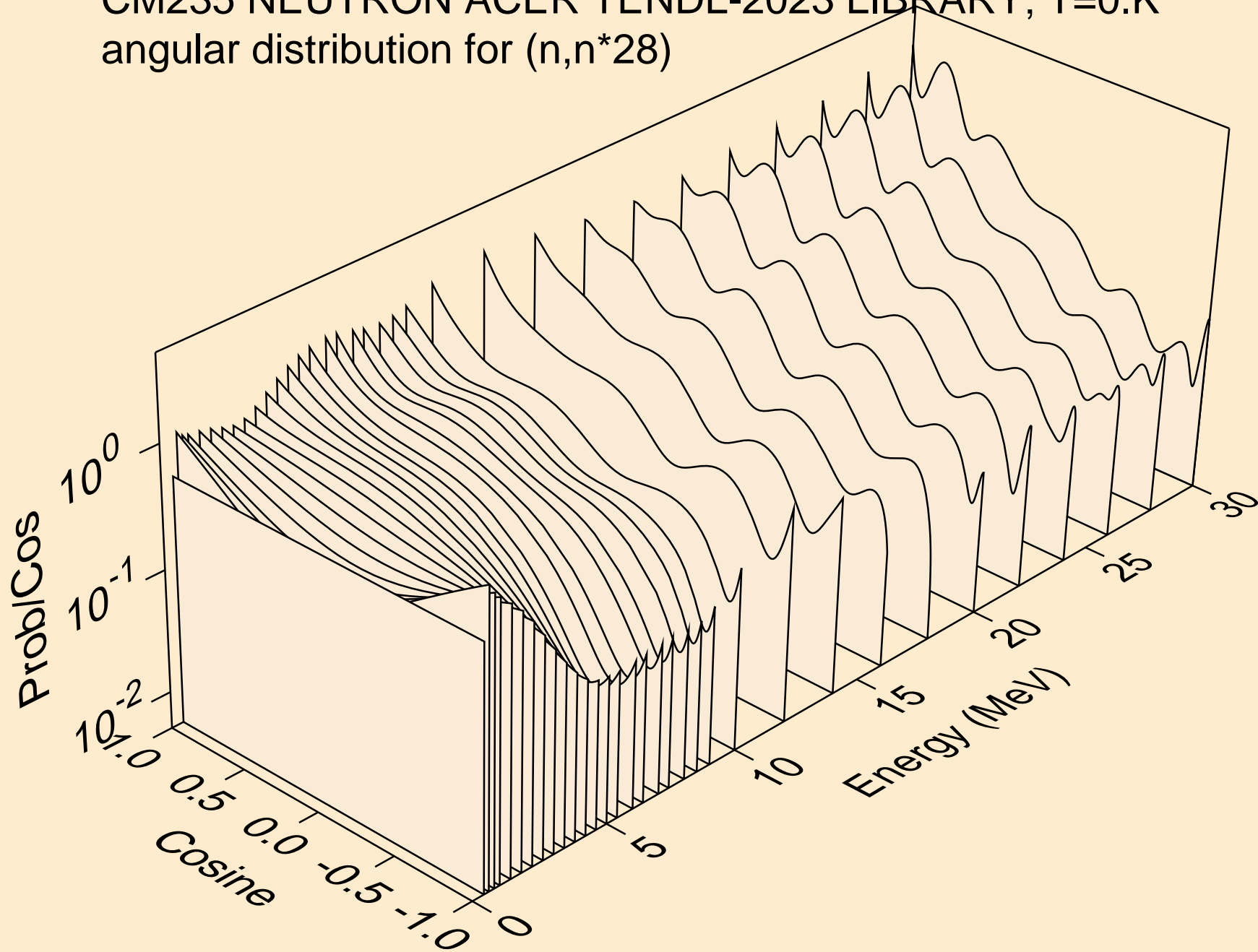

CM235 NEUTRON ACER TENDL-2023 LIBRARY; T=0.K  
angular distribution for (n,n\*29)

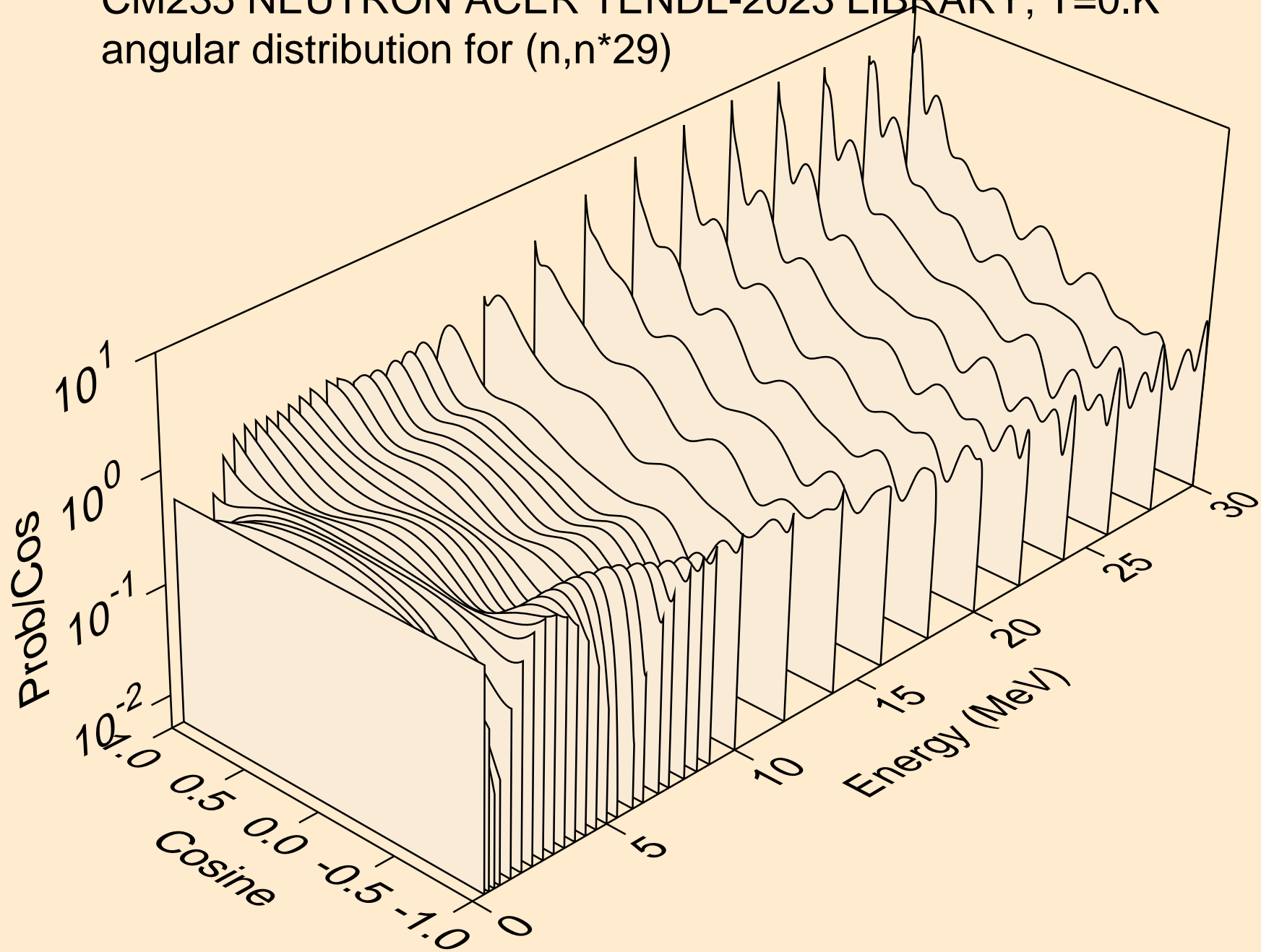

CM235 NEUTRON ACER TENDL-2023 LIBRARY; T=0.K  
angular distribution for (n,n\*30)

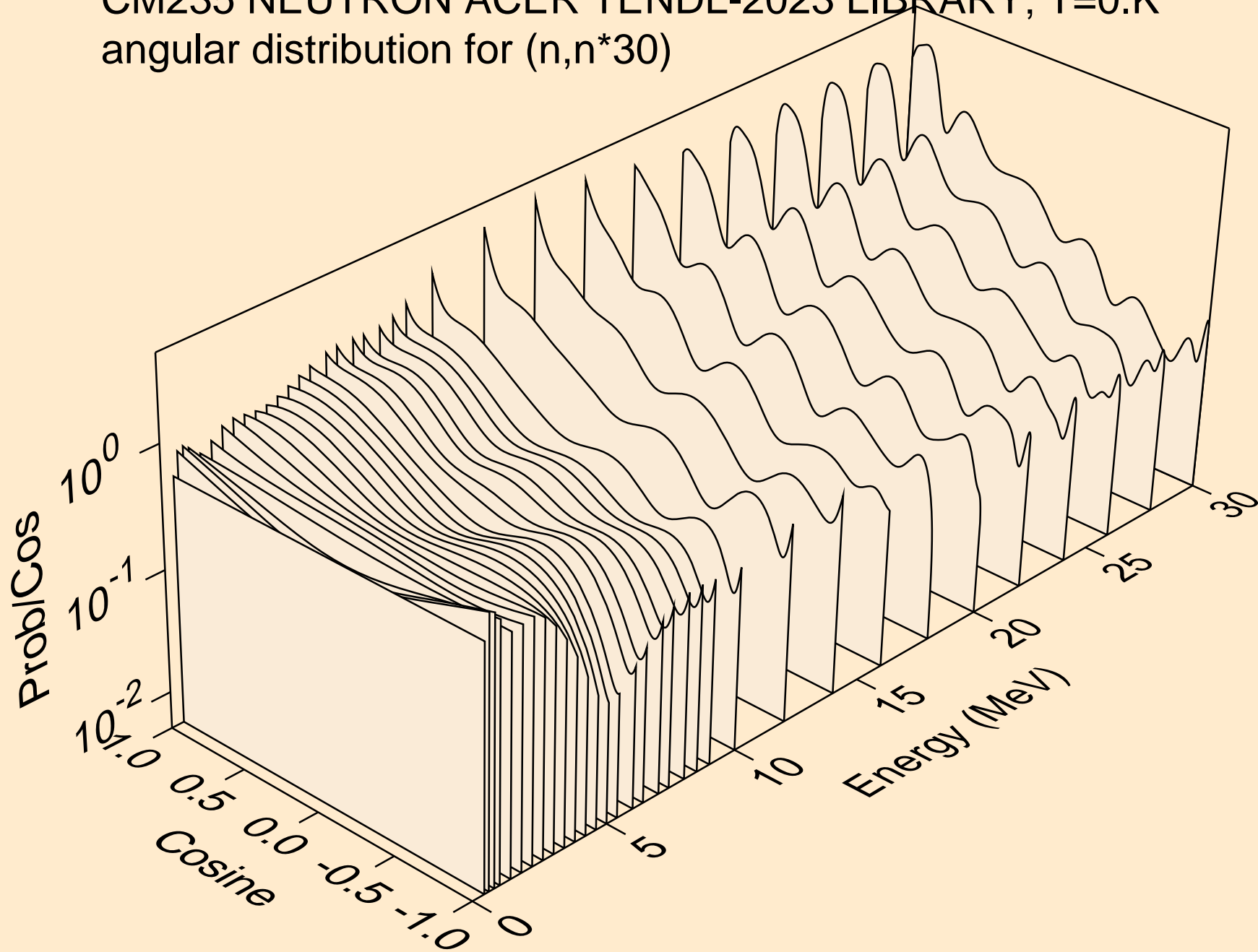

# CM235 NEUTRON ACER TENDL-2023 LIBRARY; T=0.K

## Total fission nubar

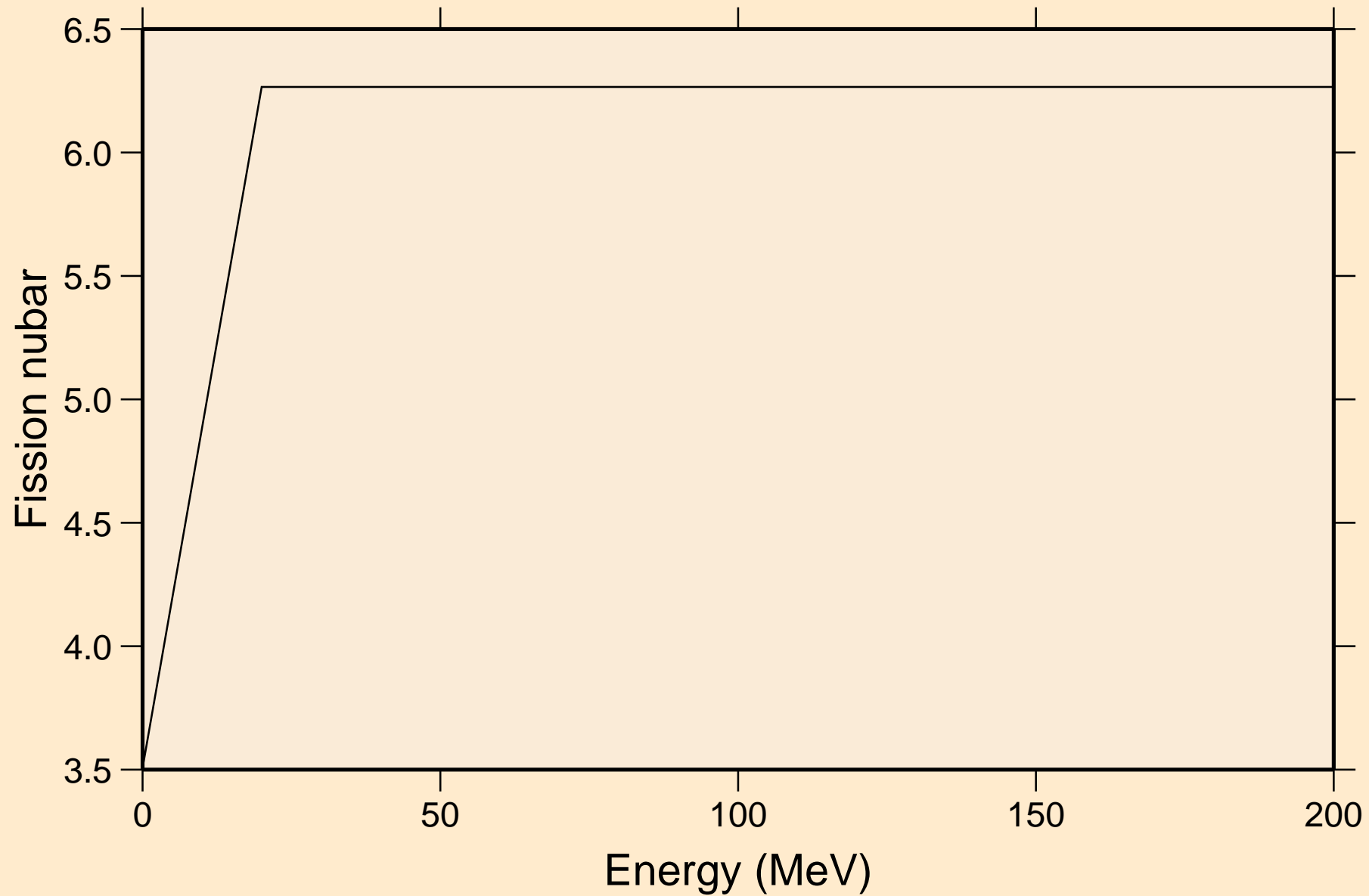

CM235 NEUTRON ACER TENDL-2023 LIBRARY; T=0.K  
Neutron emission for (n,x)

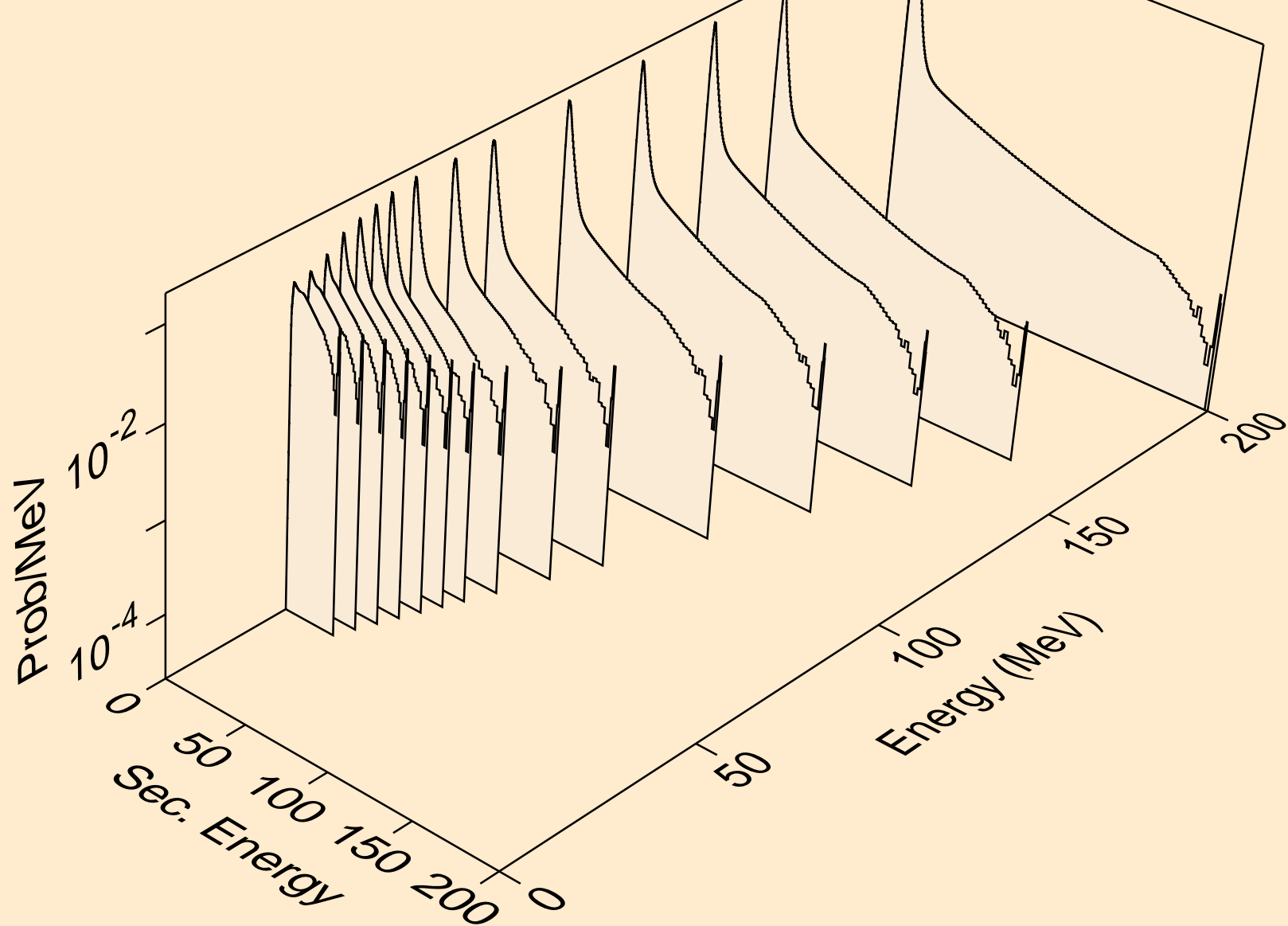



CM235 NEUTRON ACER TENDL-2023 LIBRARY; T=0.K  
Neutron emission for (n,2n)

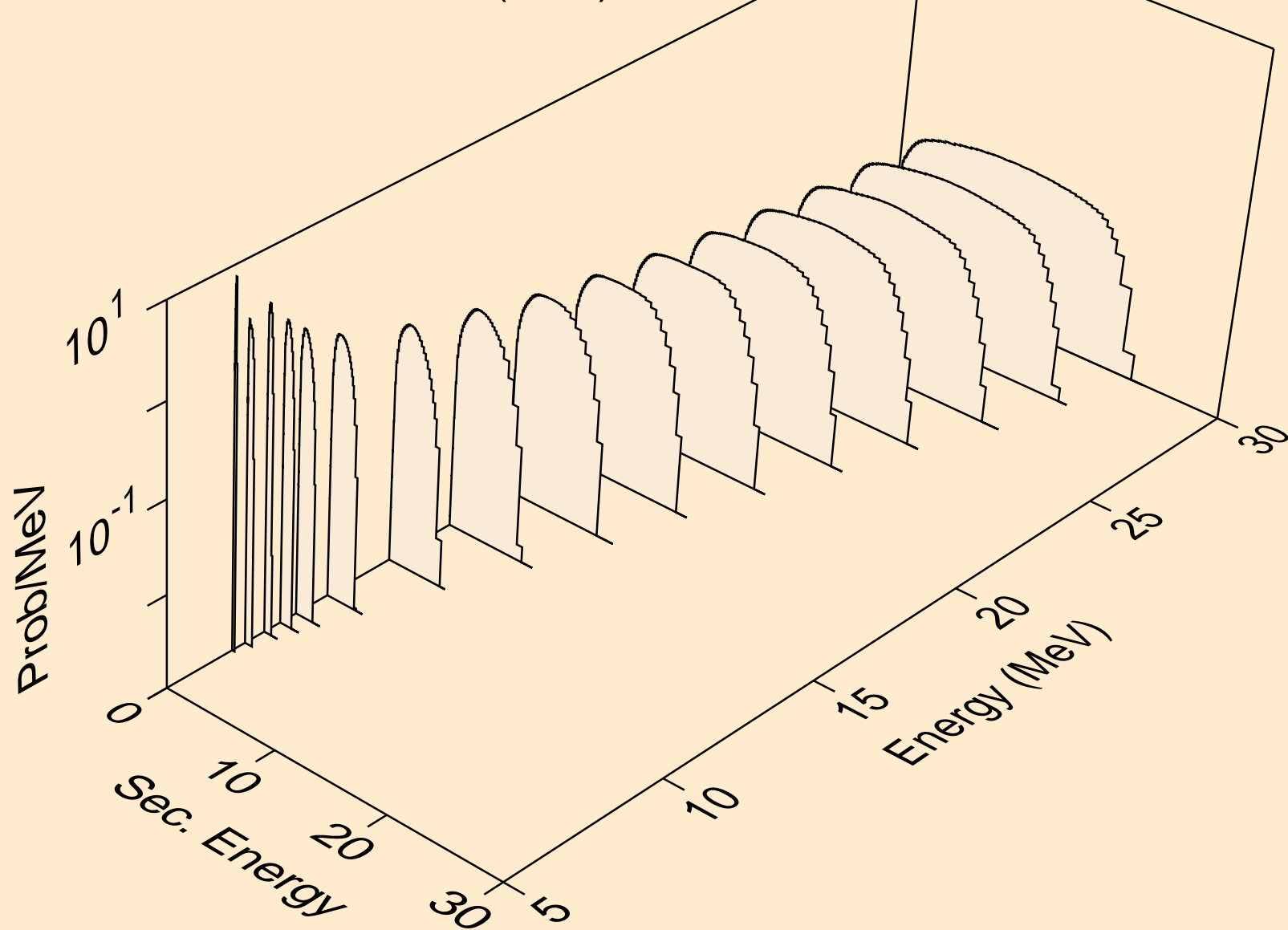

CM235 NEUTRON ACER TENDL-2023 LIBRARY; T=0.K  
Neutron emission for (n,3n)

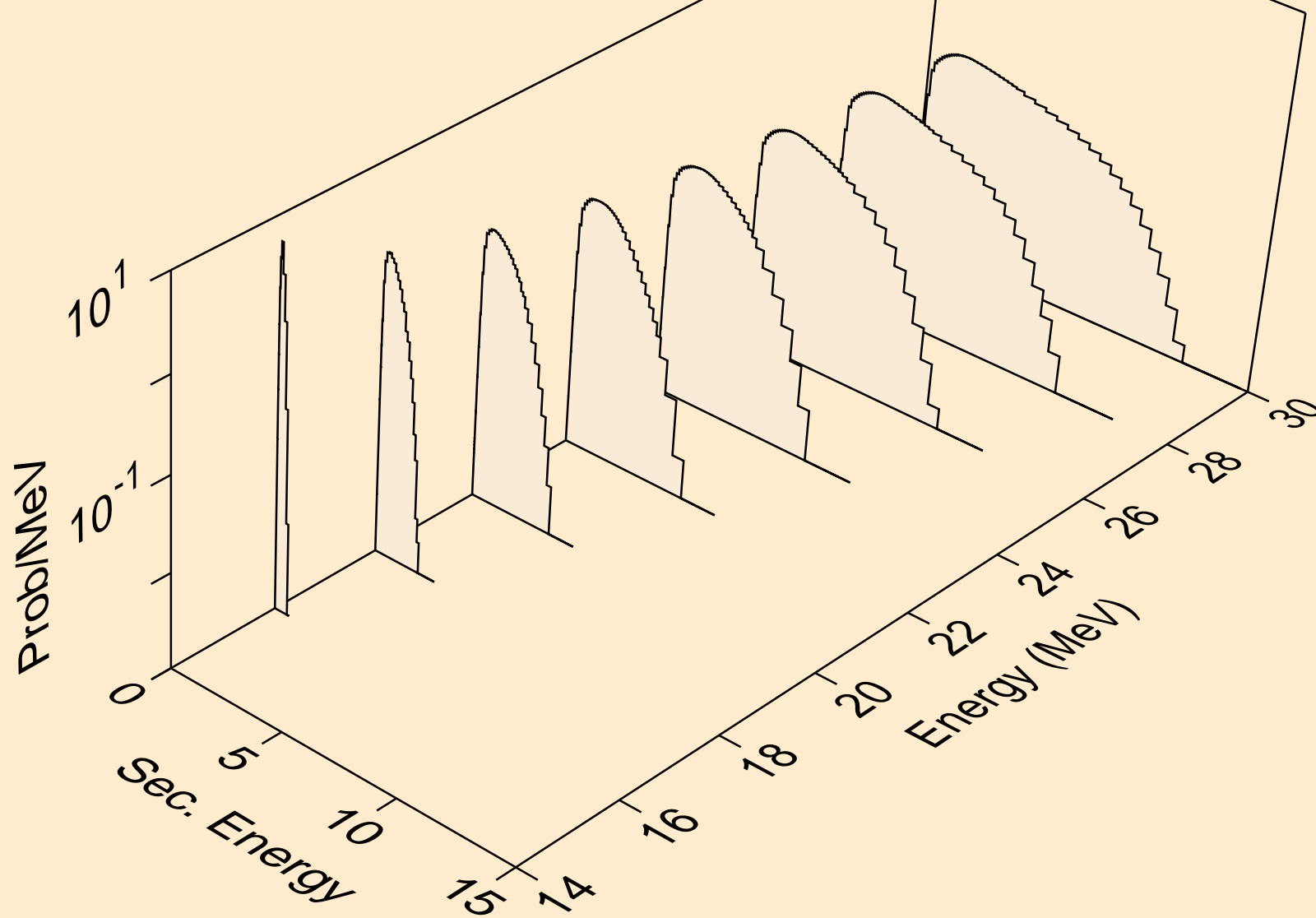

CM235 NEUTRON ACER TENDL-2023 LIBRARY; T=0.K  
Neutron emission for fission

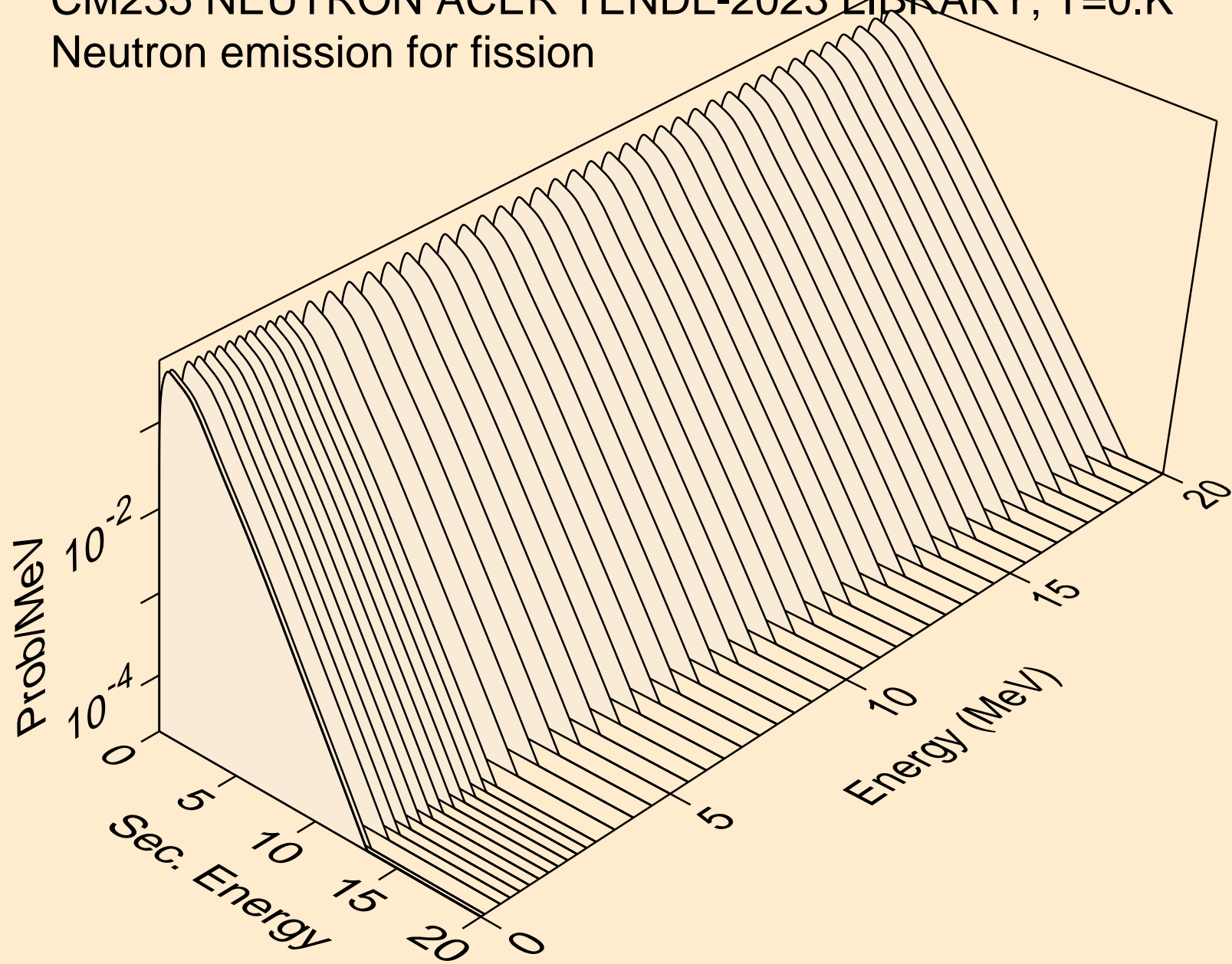

CM235 NEUTRON ACER TENDL-2023 LIBRARY; T=0.K  
Neutron emission for (n,n\*)a

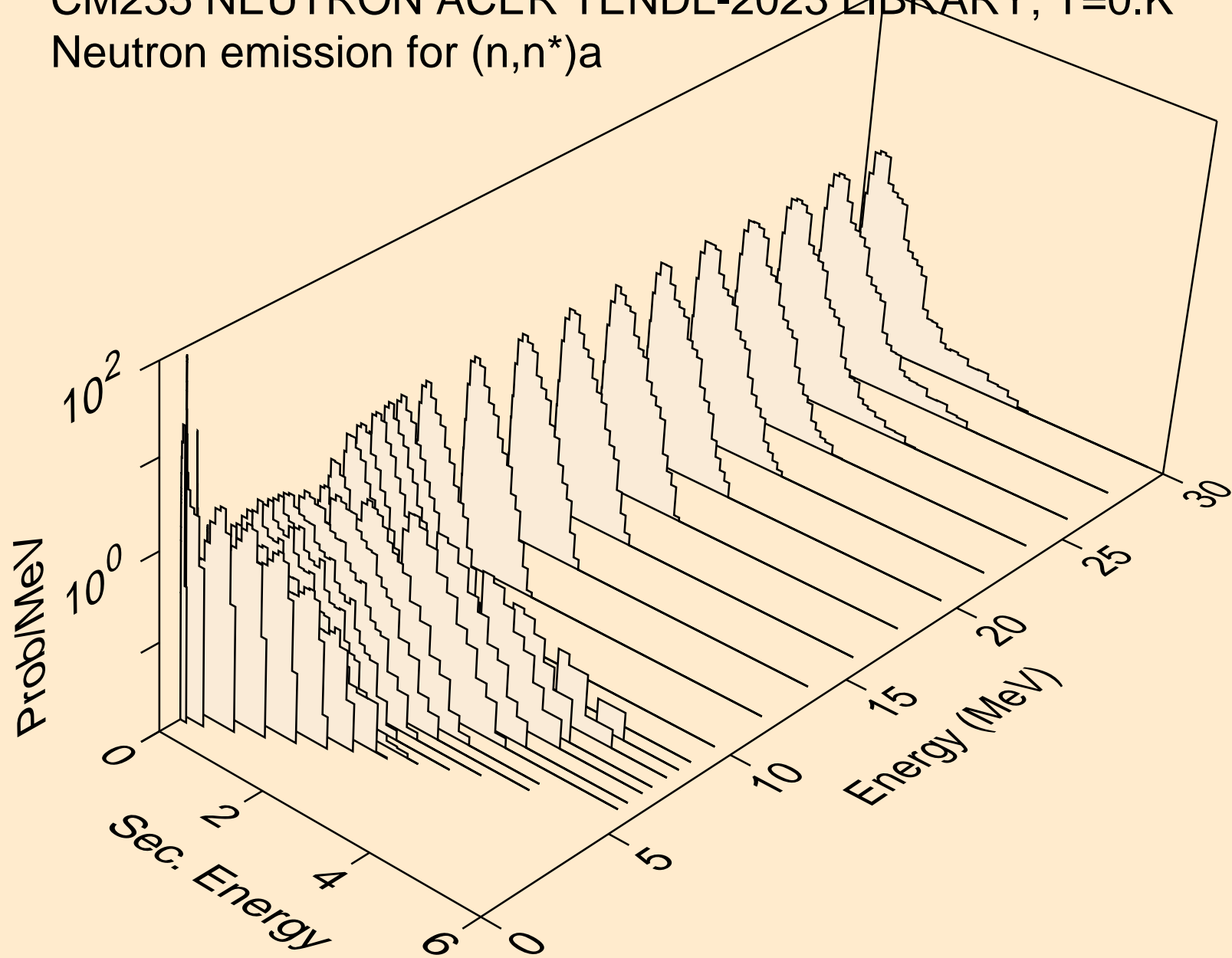

CM235 NEUTRON ACER TENDL-2023 LIBRARY; T=0.K  
Neutron emission for (n,2n)a

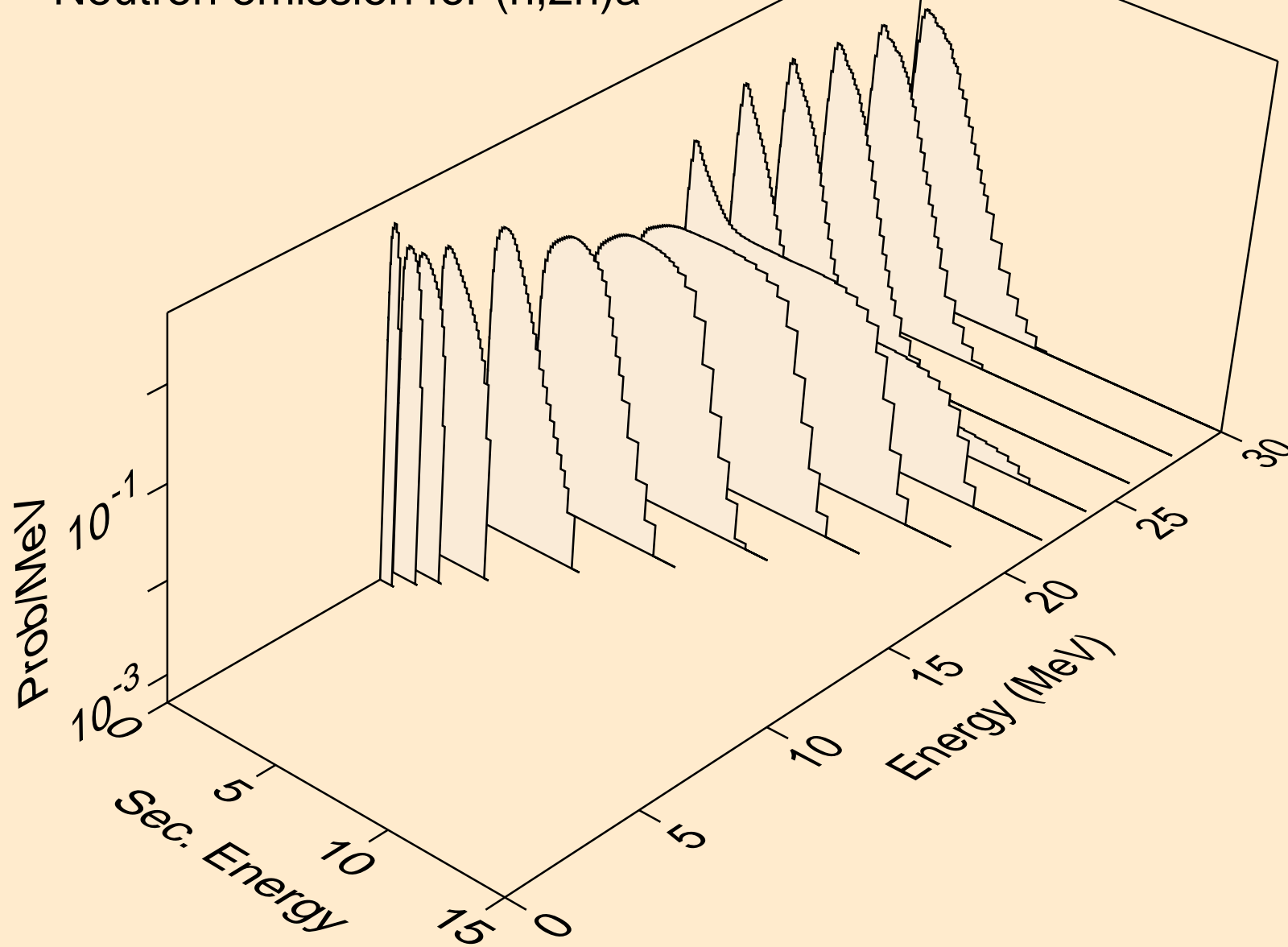

CM235 NEUTRON ACER TENDL-2023 LIBRARY; T=0.K  
Neutron emission for (n,n\*)p

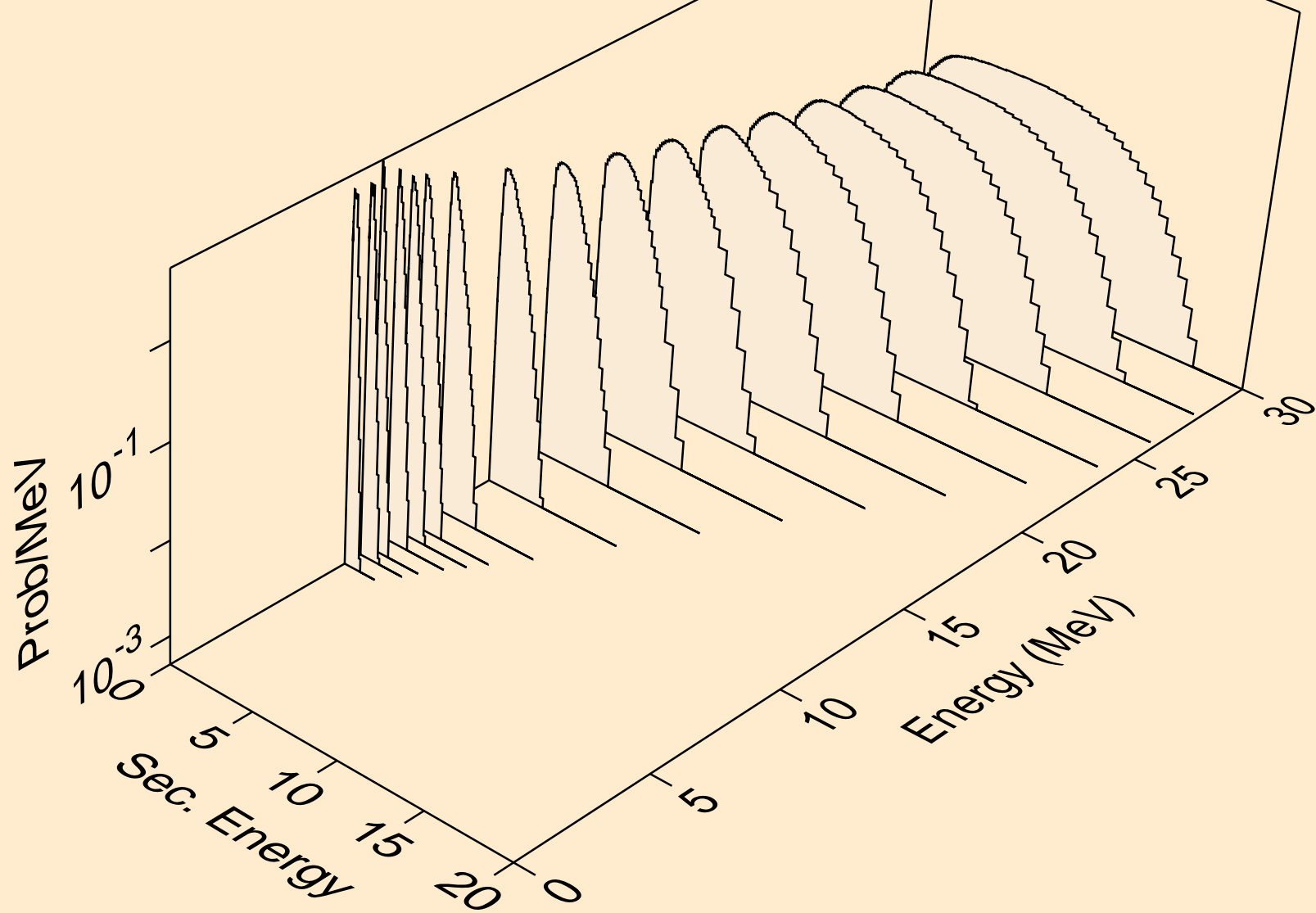

CM235 NEUTRON ACER TENDL-2023 LIBRARY; T=0.K  
Neutron emission for (n,n\*)2a

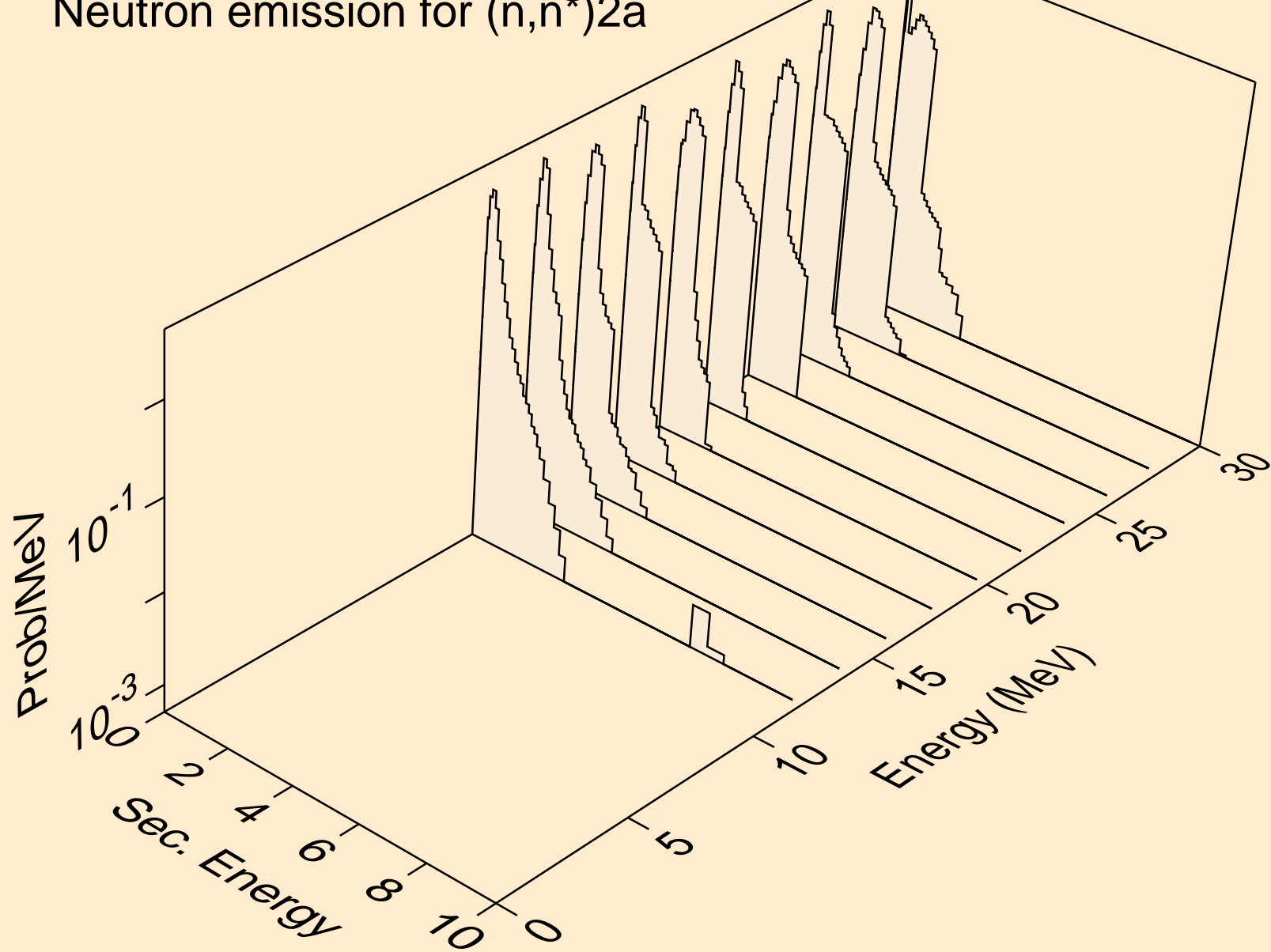

CM235 NEUTRON ACER TENDL-2023 LIBRARY; T=0.K  
Neutron emission for (n,n\*)d

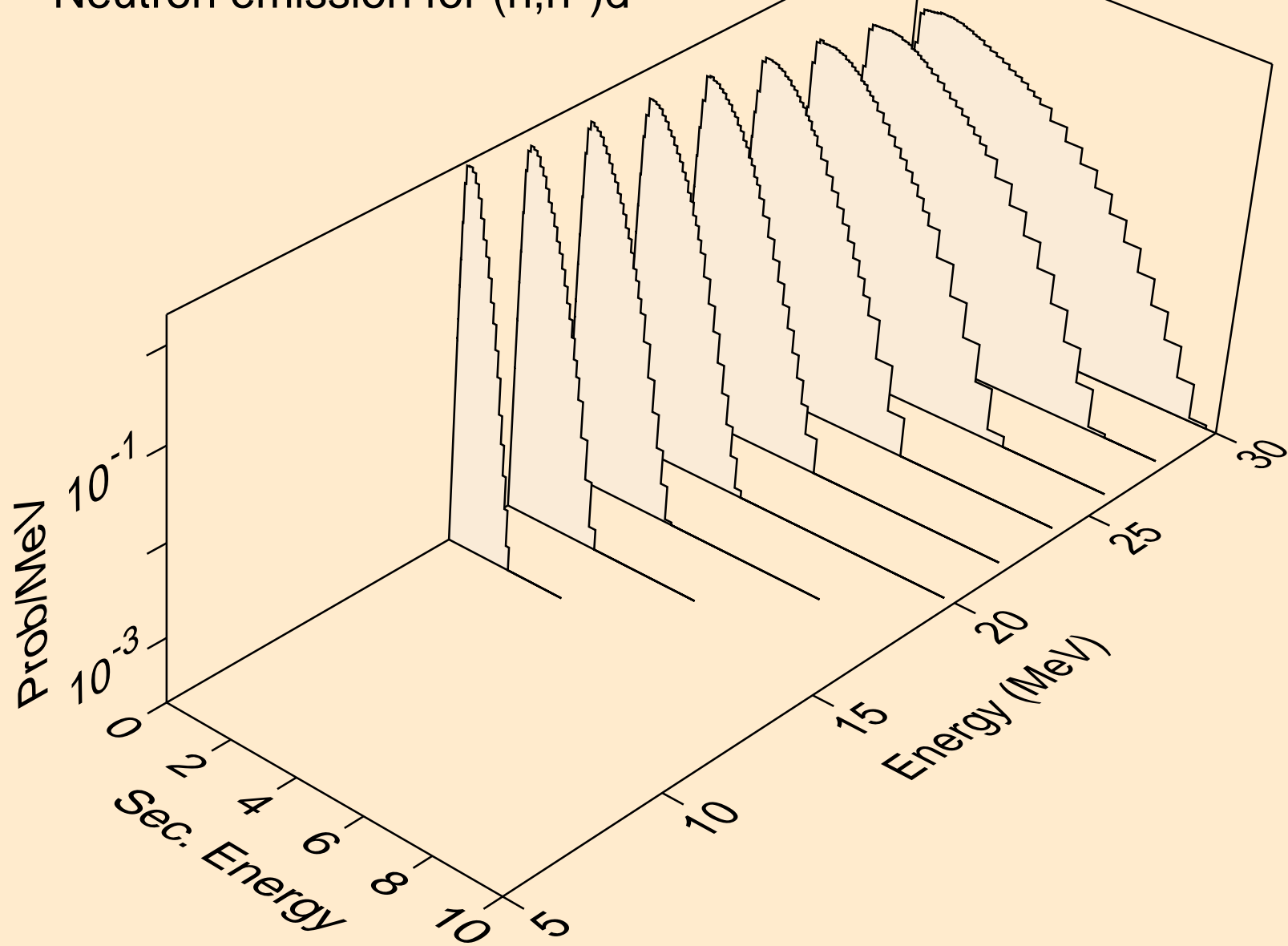



CM235 NEUTRON ACER TENDL-2023 LIBRARY; T=0.K  
Neutron emission for (n,n\*)t

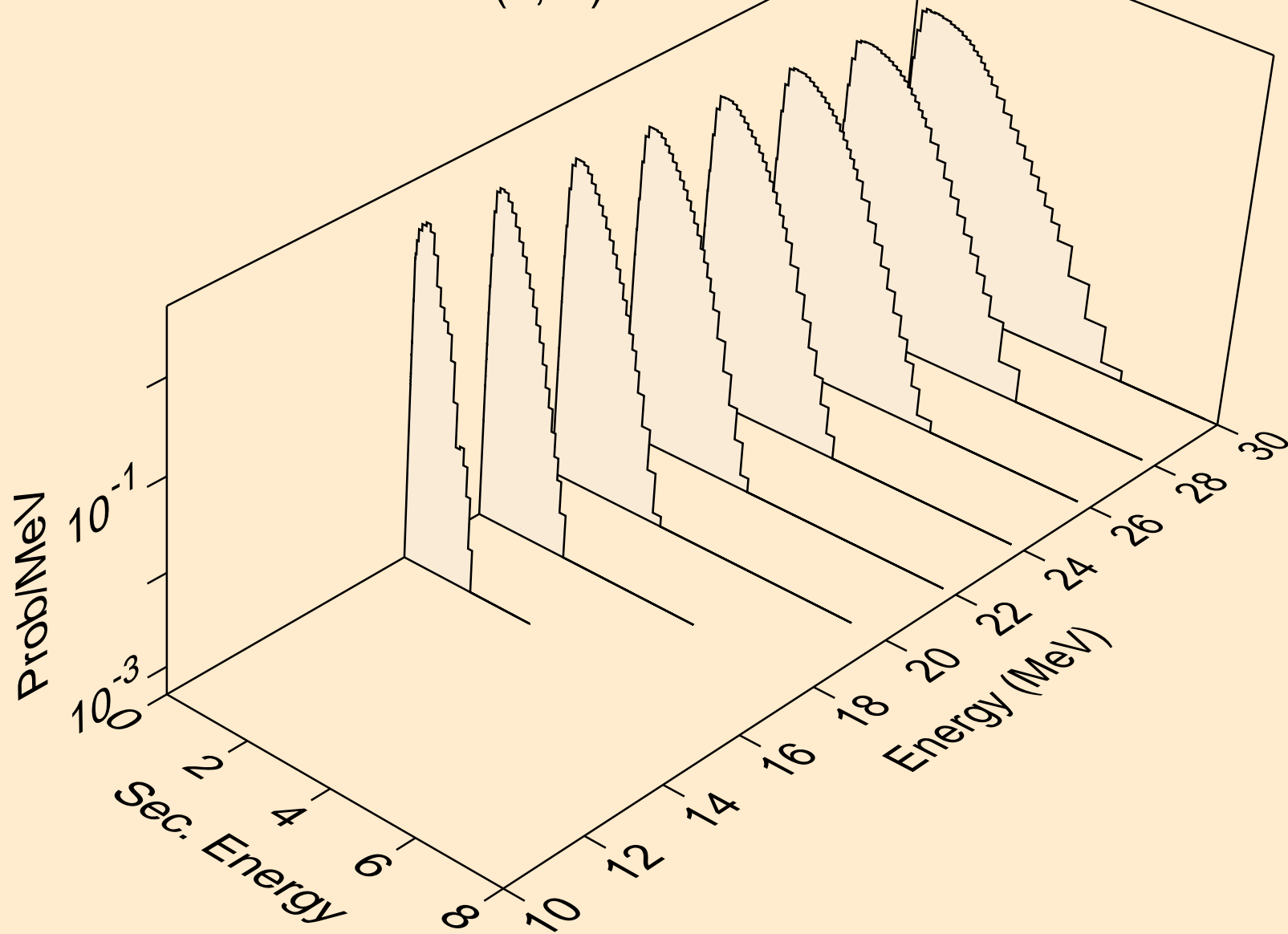

CM235 NEUTRON ACER TENDL-2023 LIBRARY; T=0.K  
Neutron emission for (n,n\*)he3

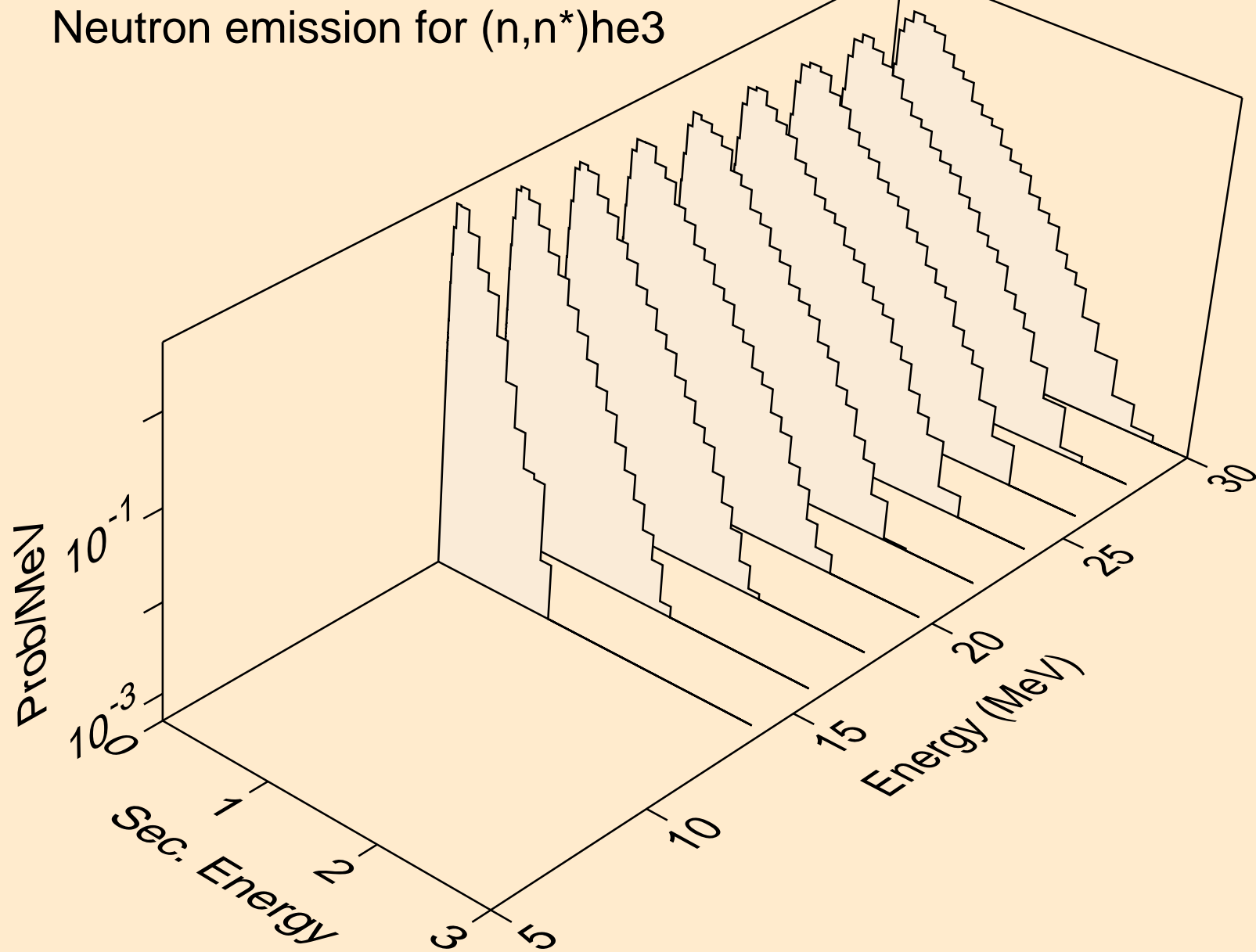

CM235 NEUTRON ACER TENDL-2023 LIBRARY; T=0.K  
Neutron emission for (n,4n)

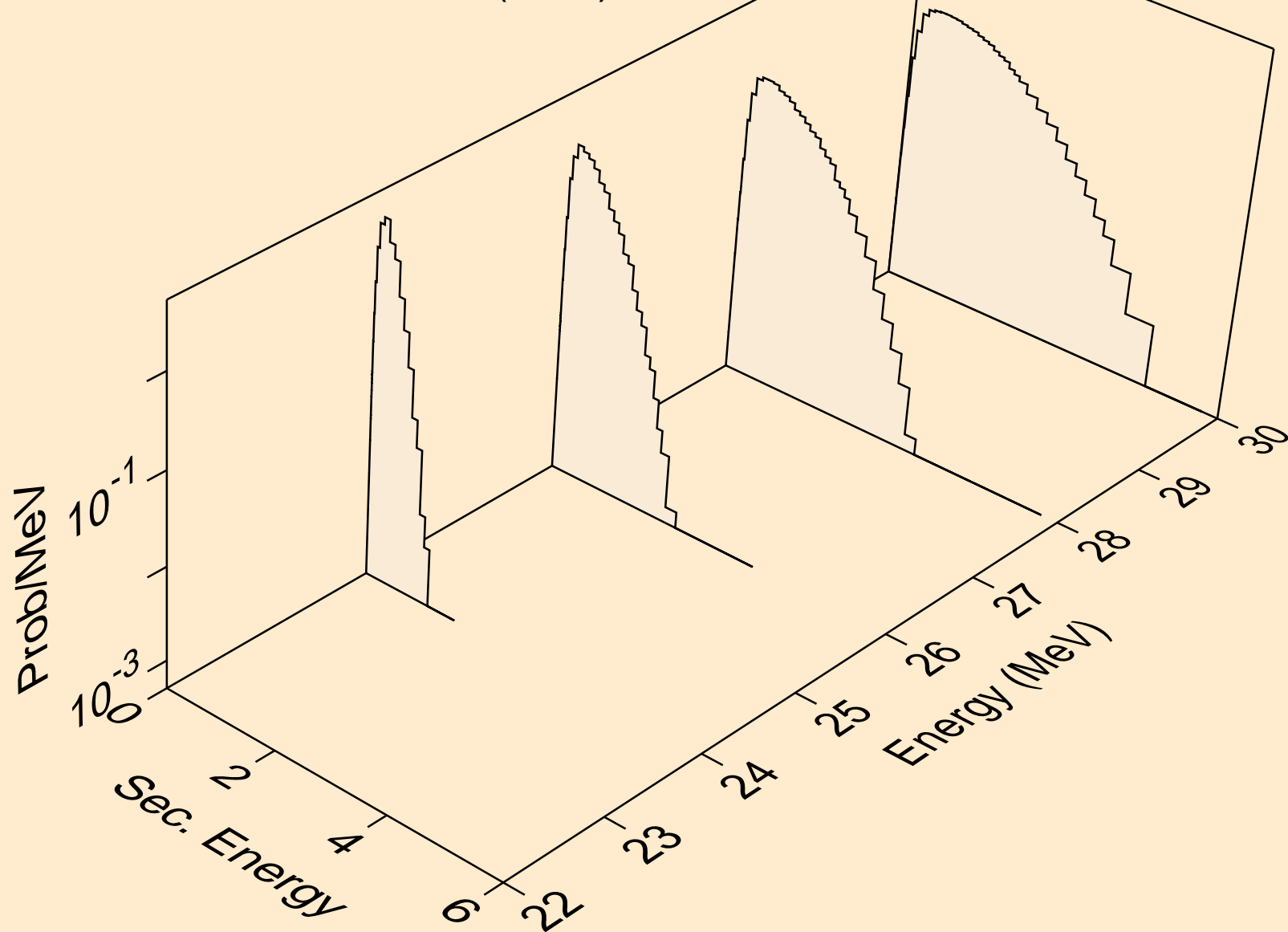

CM235 NEUTRON ACER TENDL-2023 LIBRARY; T=0.K  
Neutron emission for (n,2np)

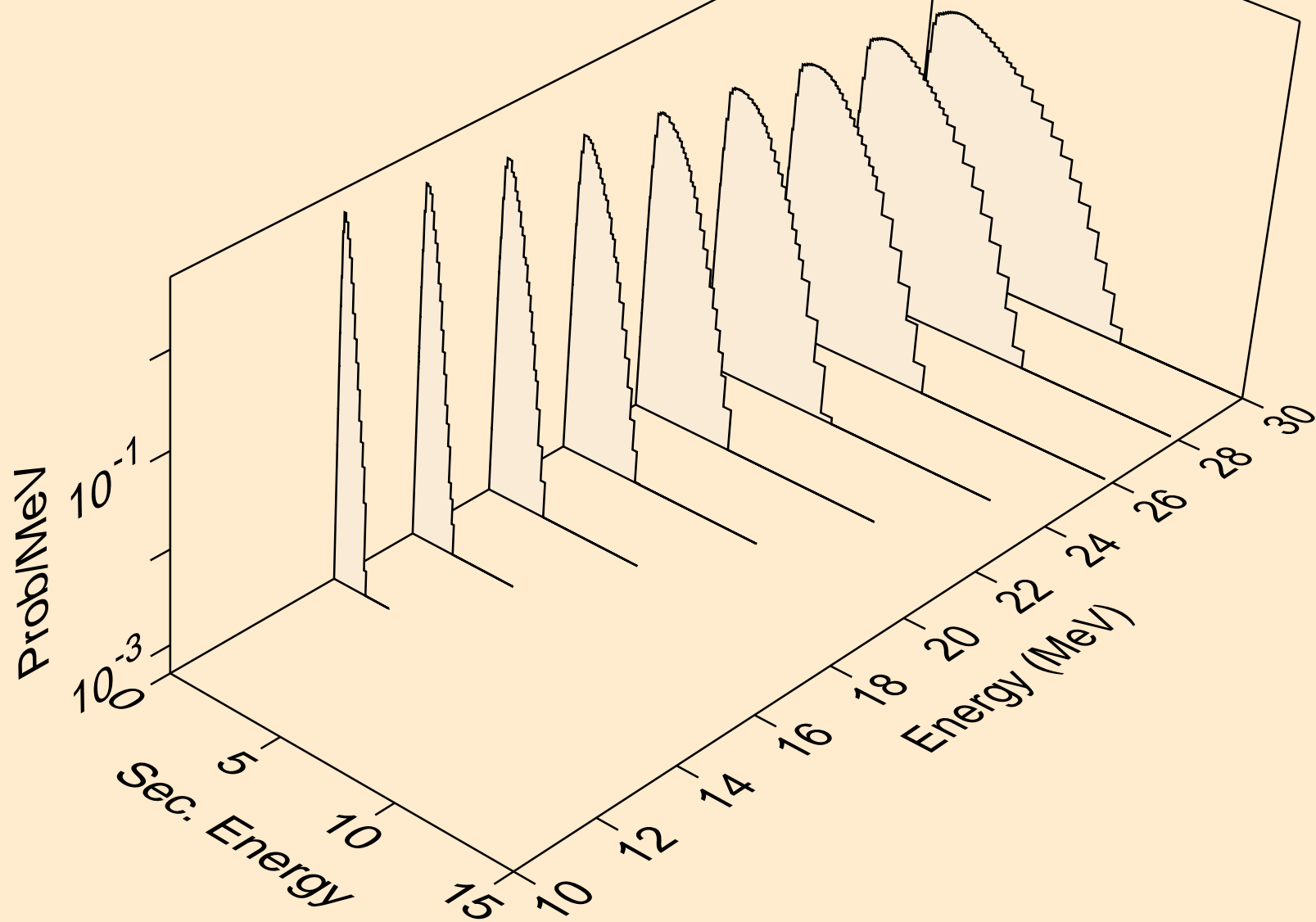

CM235 NEUTRON ACER TENDL-2023 LIBRARY; T=0.K  
Neutron emission for (n,n2p)

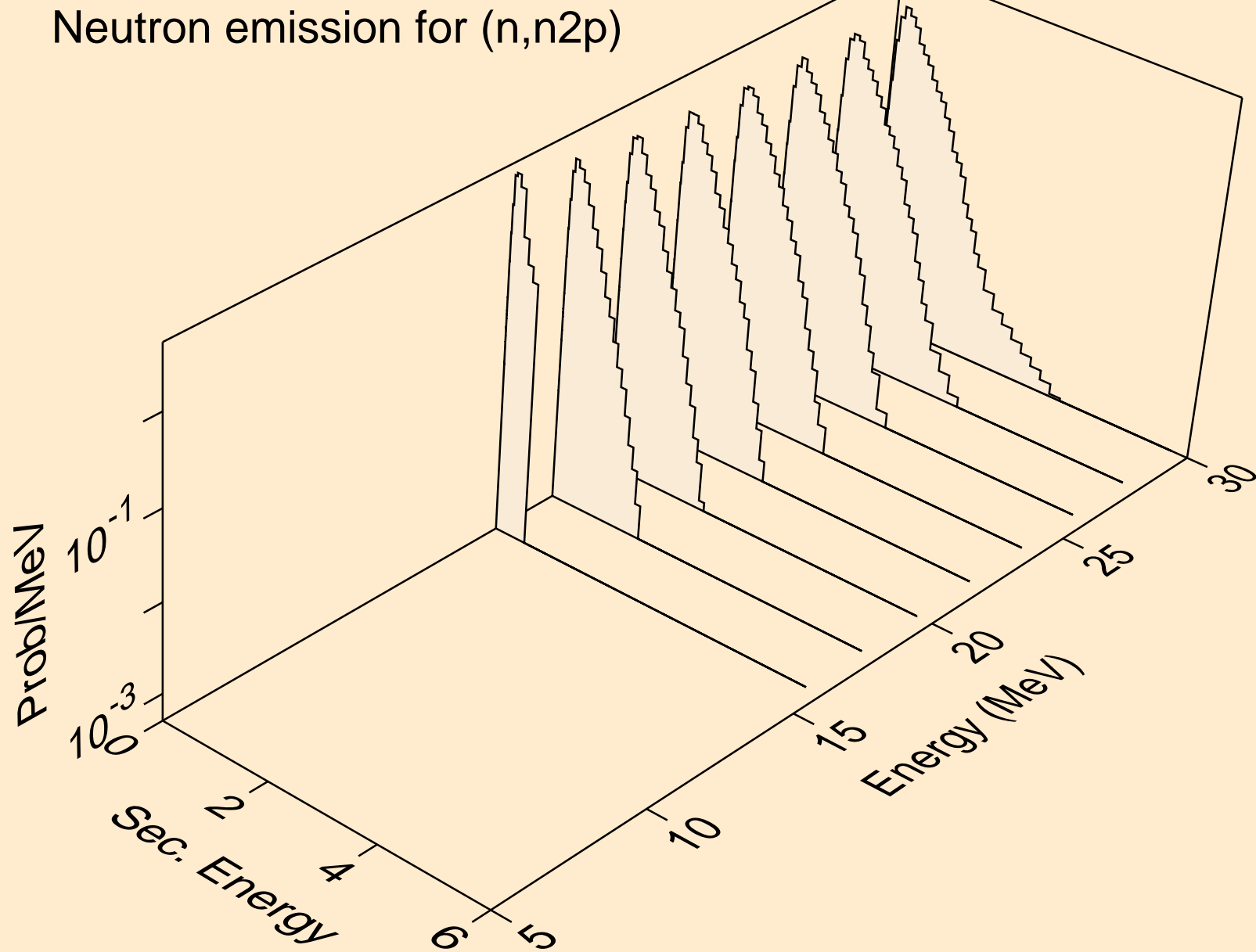

CM235 NEUTRON ACER TENDL-2023 LIBRARY; T=0.K  
Neutron emission for (n,npa)

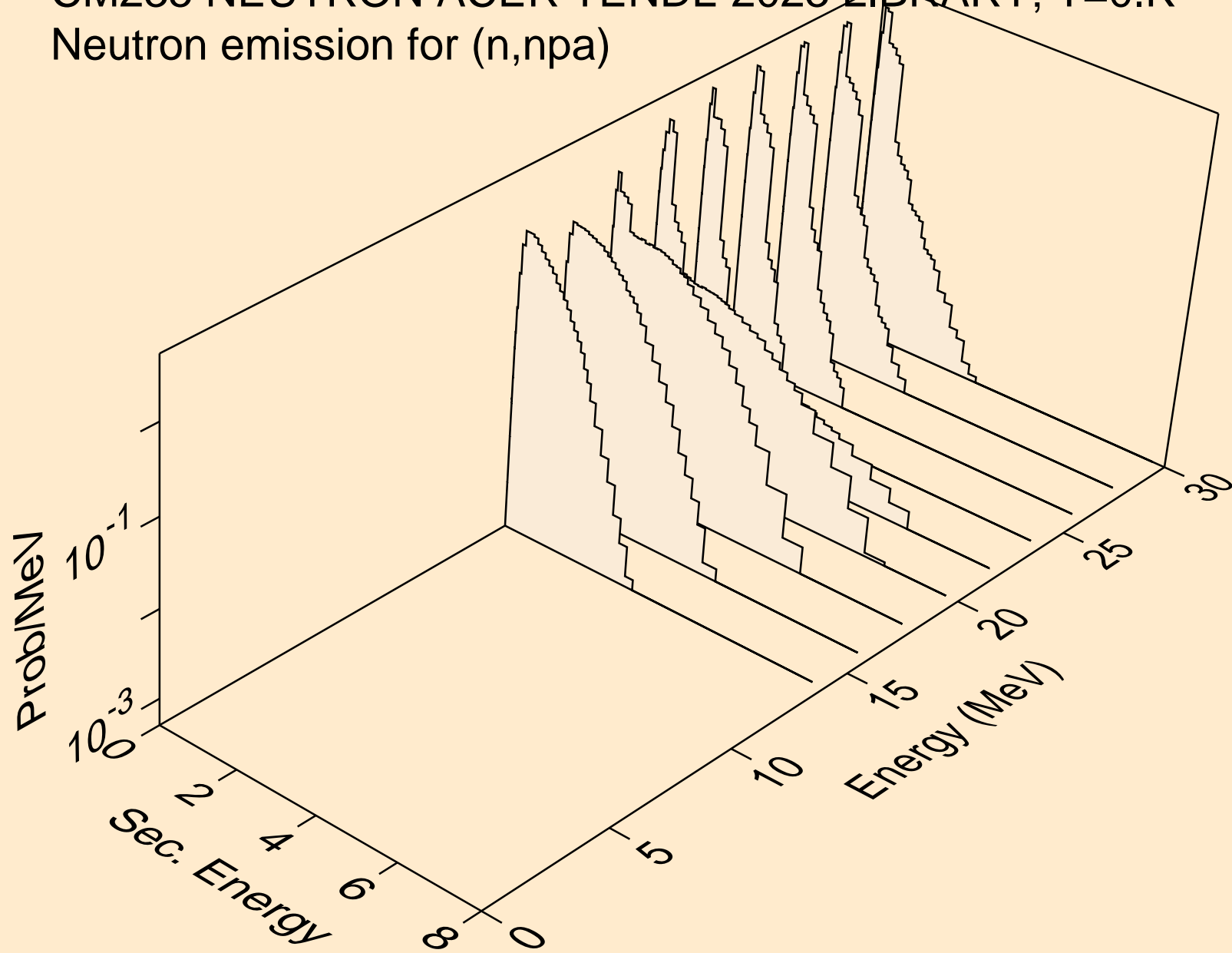

CM235 NEUTRON ACER TENDL-2023 LIBRARY; T=0.K  
Neutron emission for (n,n\*c)

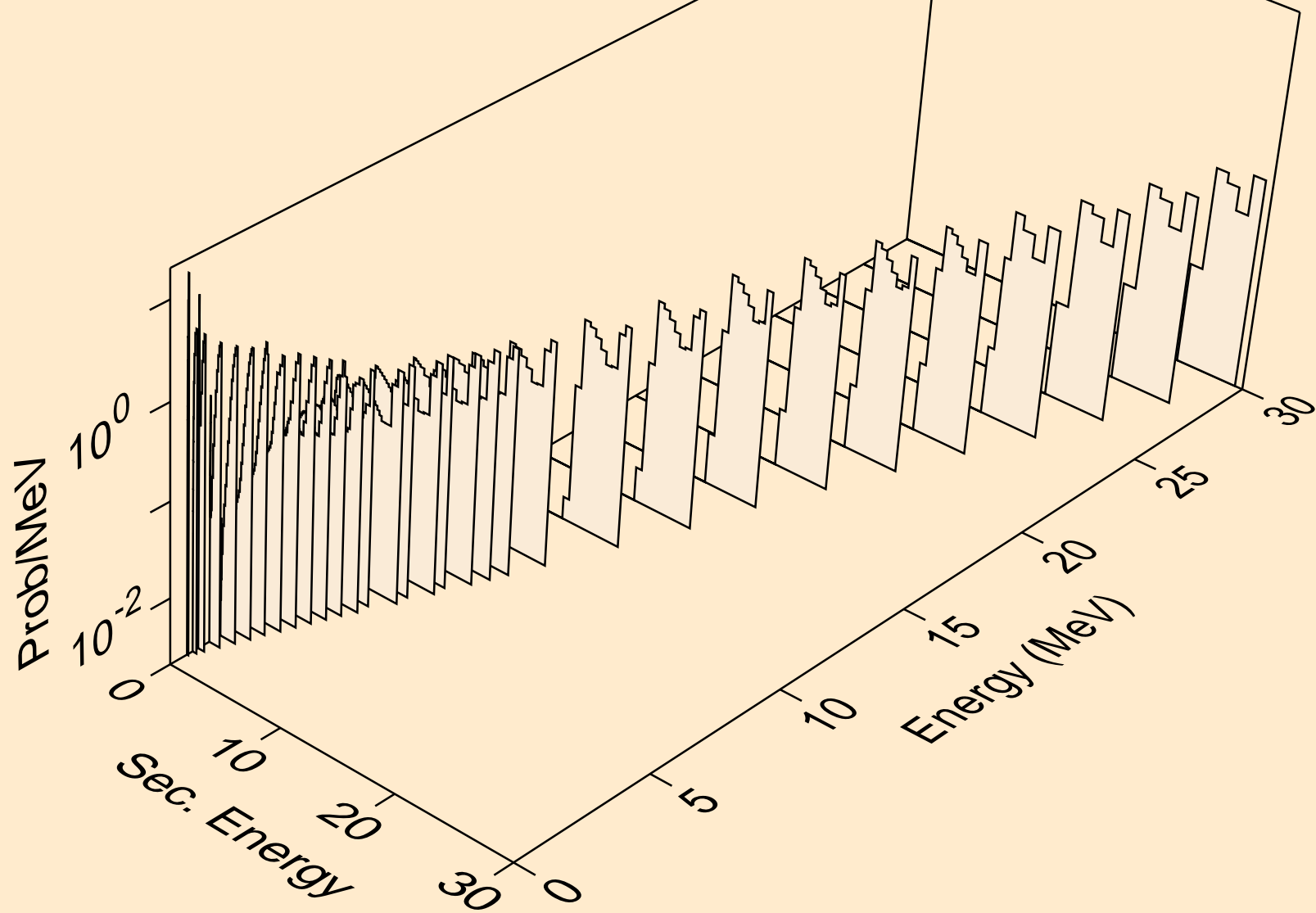

# CM235 NEUTRON ACER TENDL-2023 LIBRARY; T=0.K

Delayed nubar

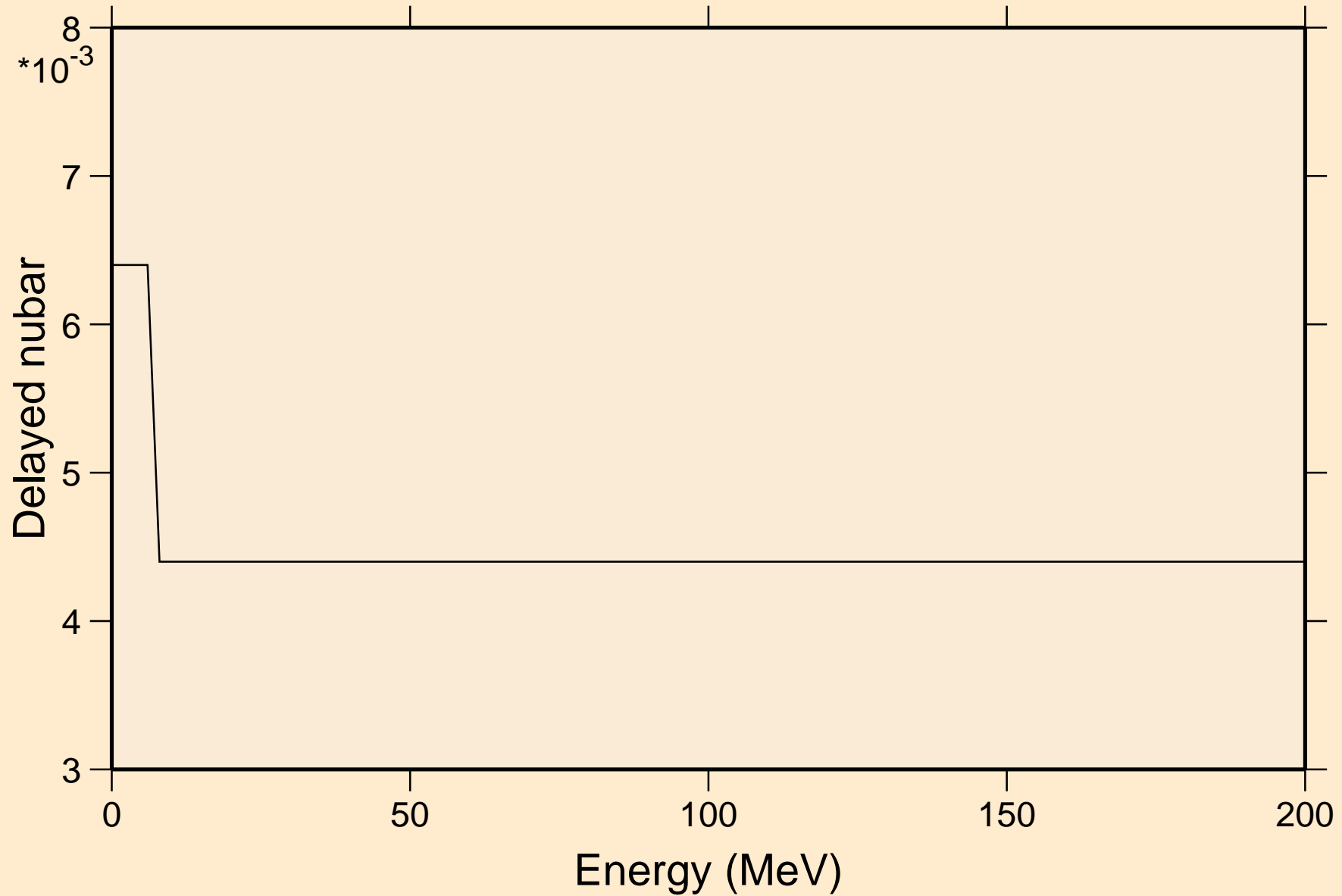



# CM235 NEUTRON ACER TENDL-2023 LIBRARY; T=0.K

## Delayed neutron spectra

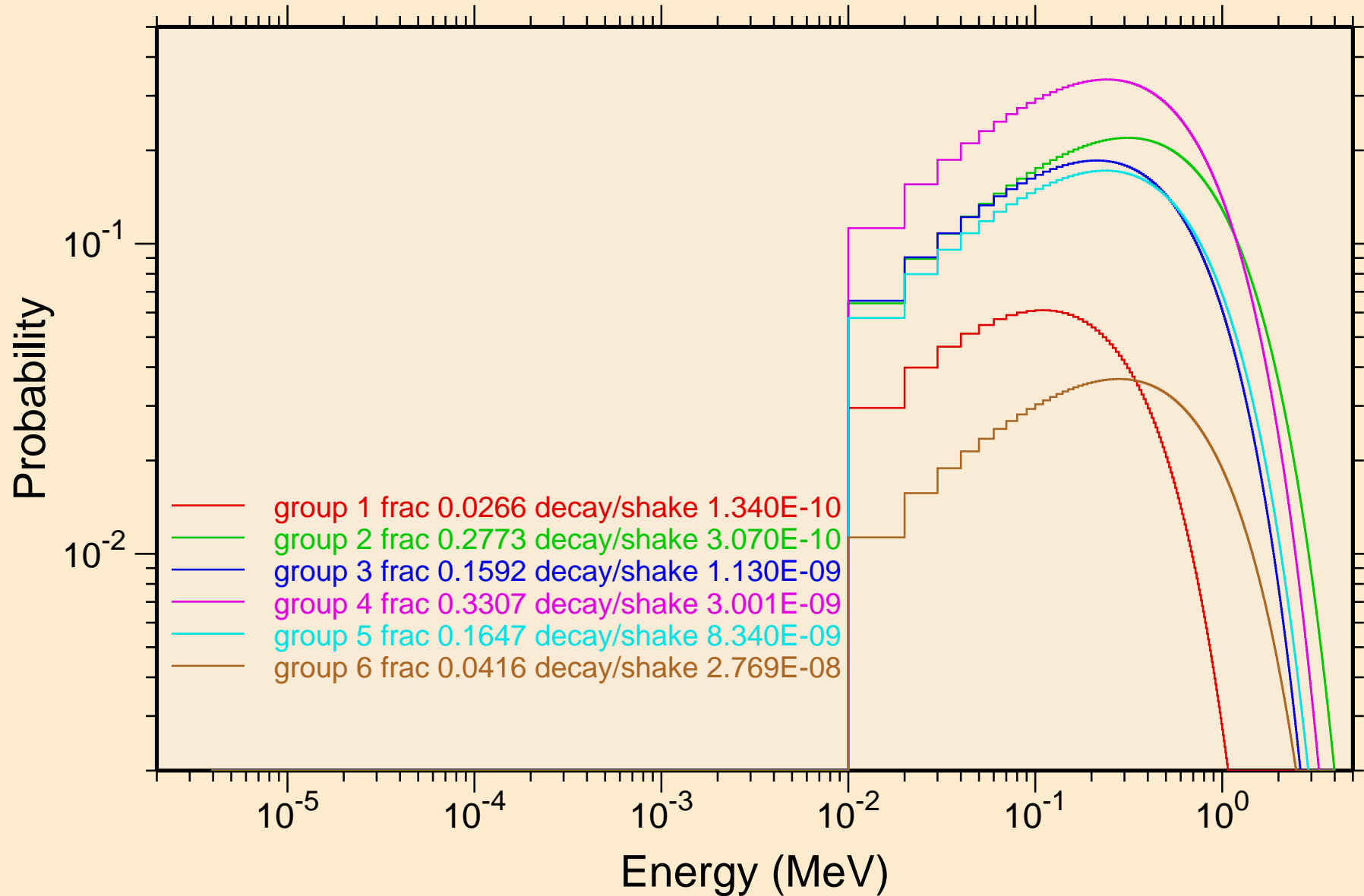

CM235 NEUTRON ACER TENDL-2023 LIBRARY; T=0.K  
Photon emission for (n,x)

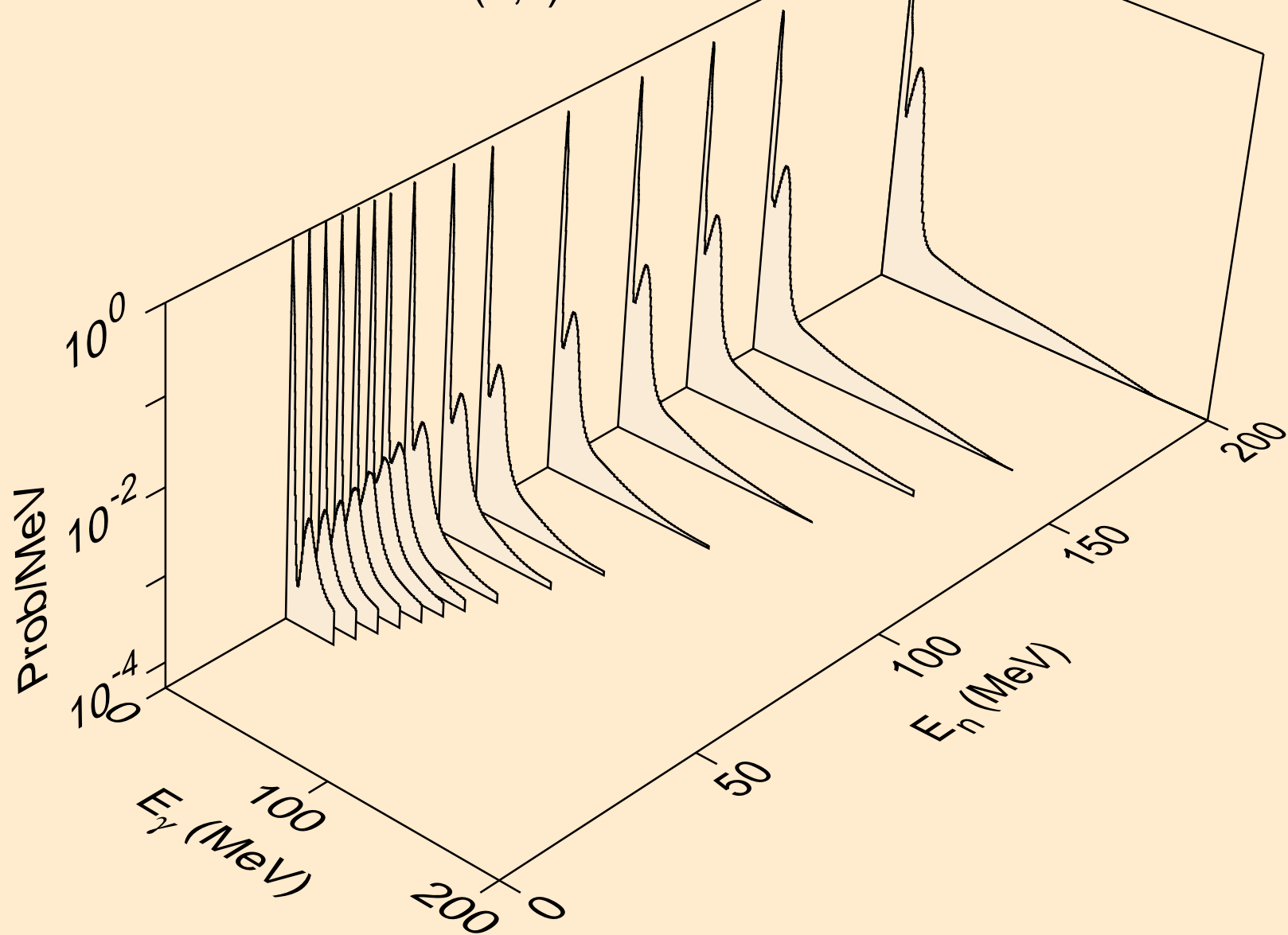

CM235 NEUTRON ACER TENDL-2023 LIBRARY; T=0.K  
Photon emission for (n,2n)

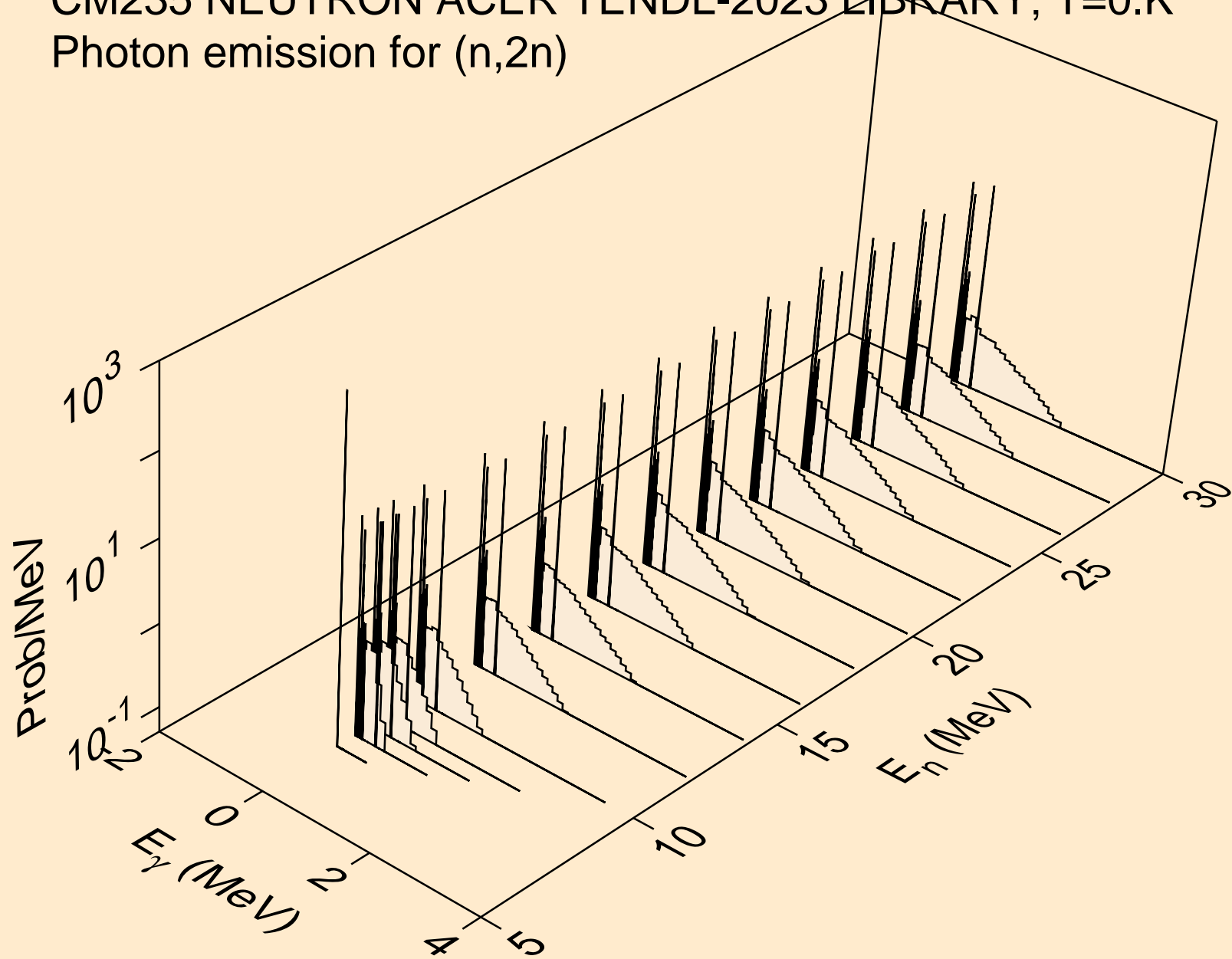

CM235 NEUTRON ACER TENDL-2023 LIBRARY; T=0.K  
Photon emission for (n,3n)

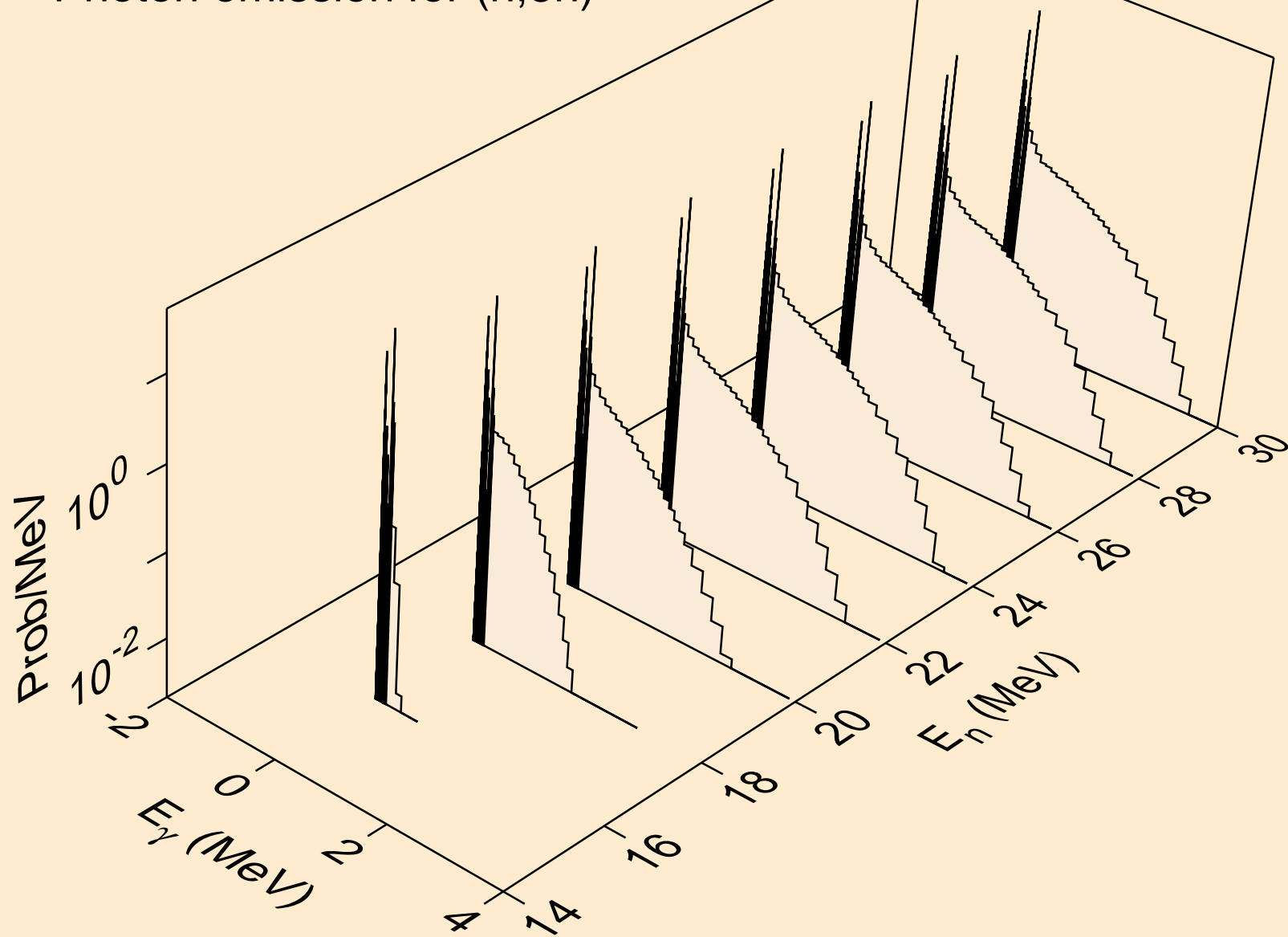

CM235 NEUTRON ACER TENDL-2023 LIBRARY; T=0.K  
Photon emission for (n,n\*)a

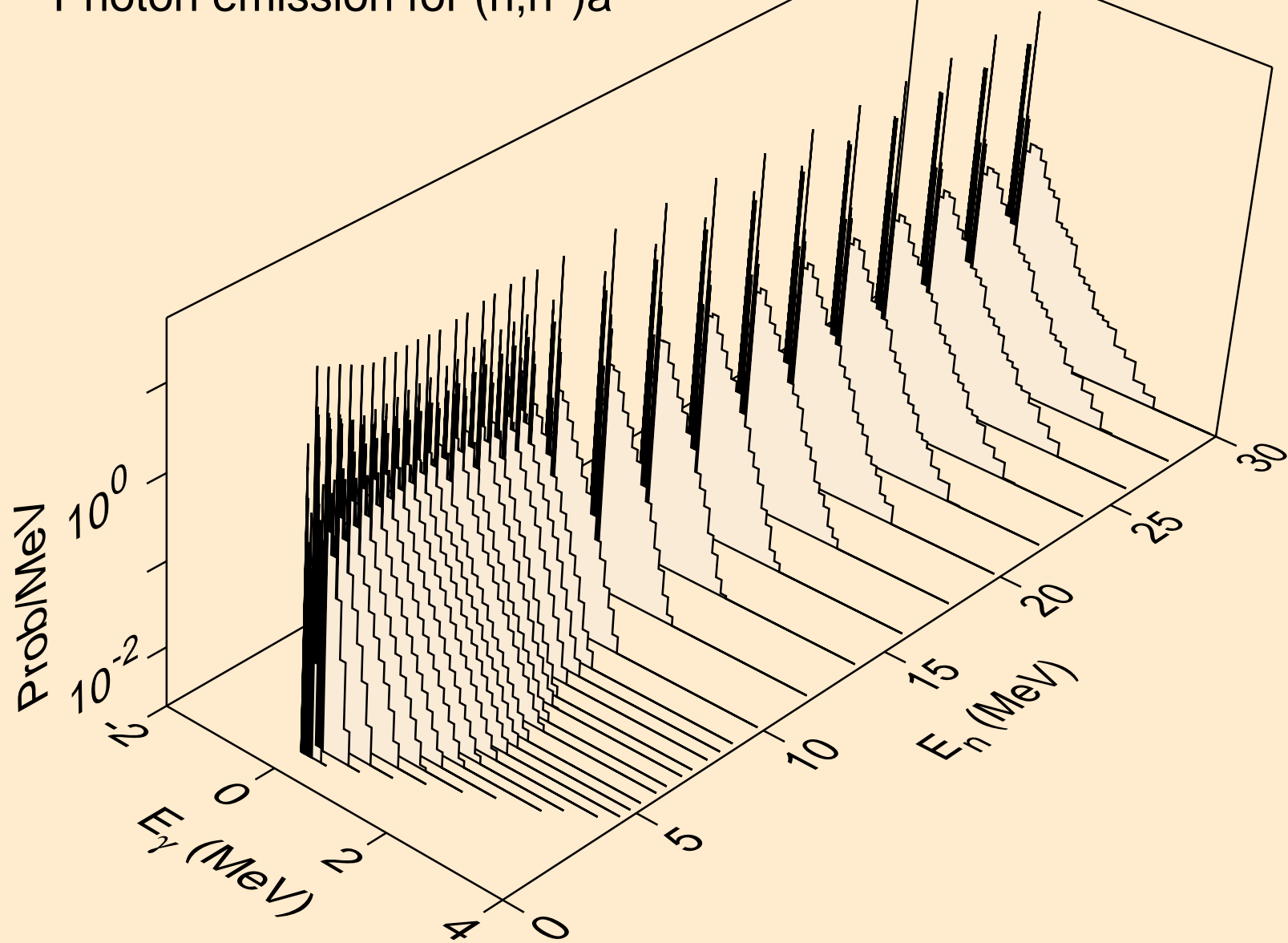

CM235 NEUTRON ACER TENDL-2023 LIBRARY; T=0.K  
Photon emission for (n,2n)a

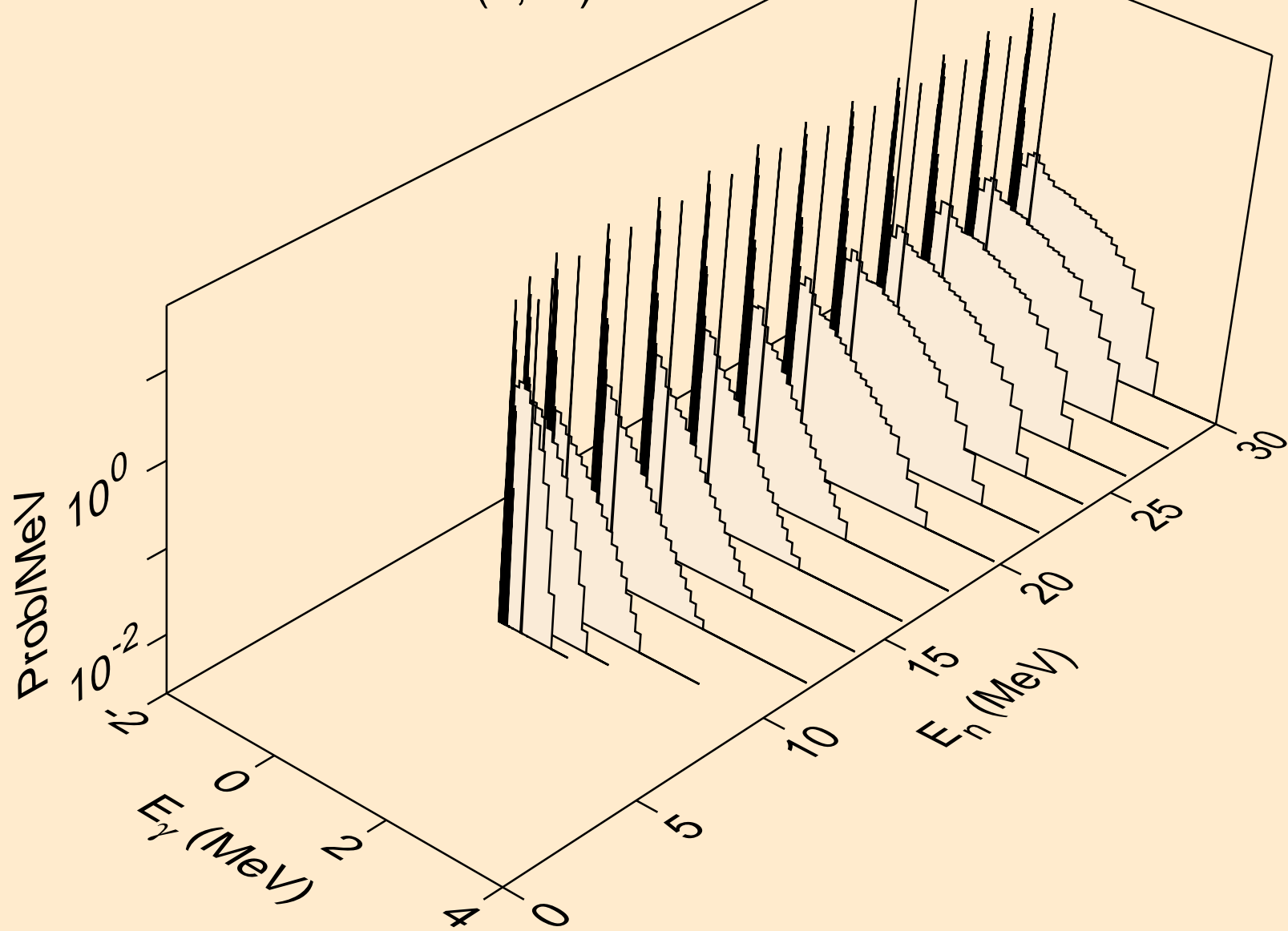

CM235 NEUTRON ACER TENDL-2023 LIBRARY; T=0.K  
Photon emission for (n,n\*)p

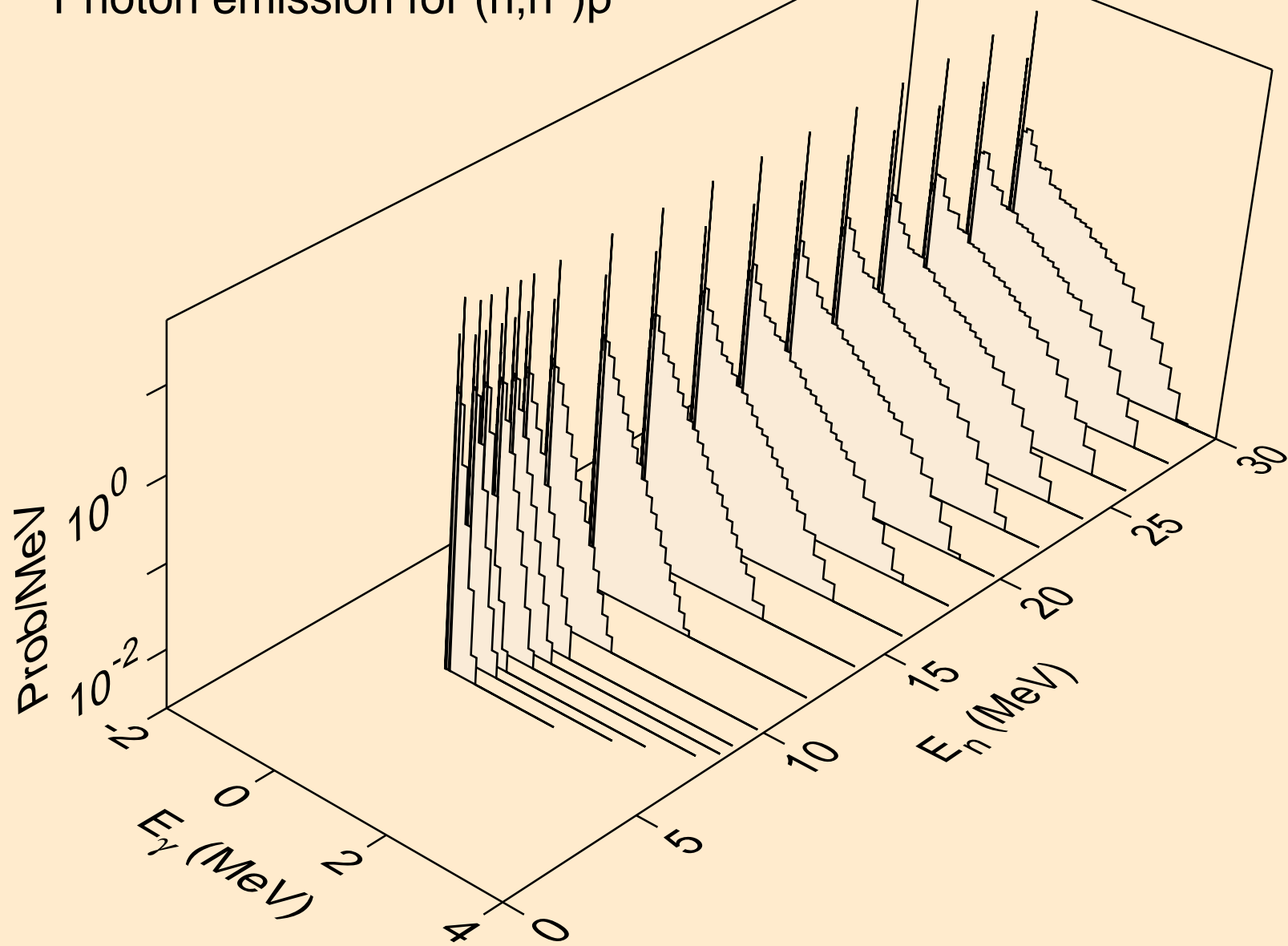

CM235 NEUTRON ACER TENDL-2023 LIBRARY; T=0.K  
Photon emission for (n,n\*)2a

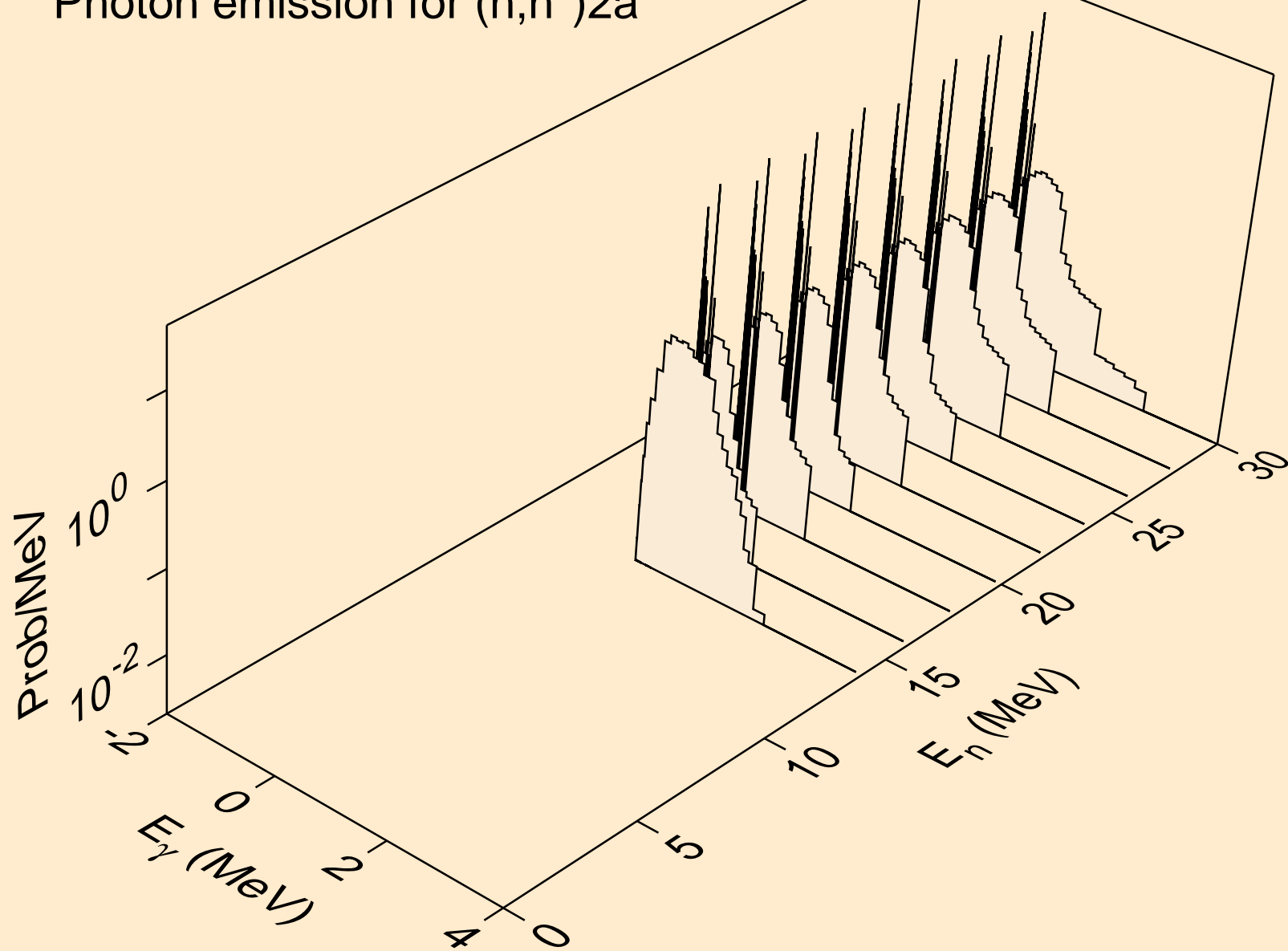



CM235 NEUTRON ACER TENDL-2023 LIBRARY; T=0.K  
Photon emission for (n,n\*)d

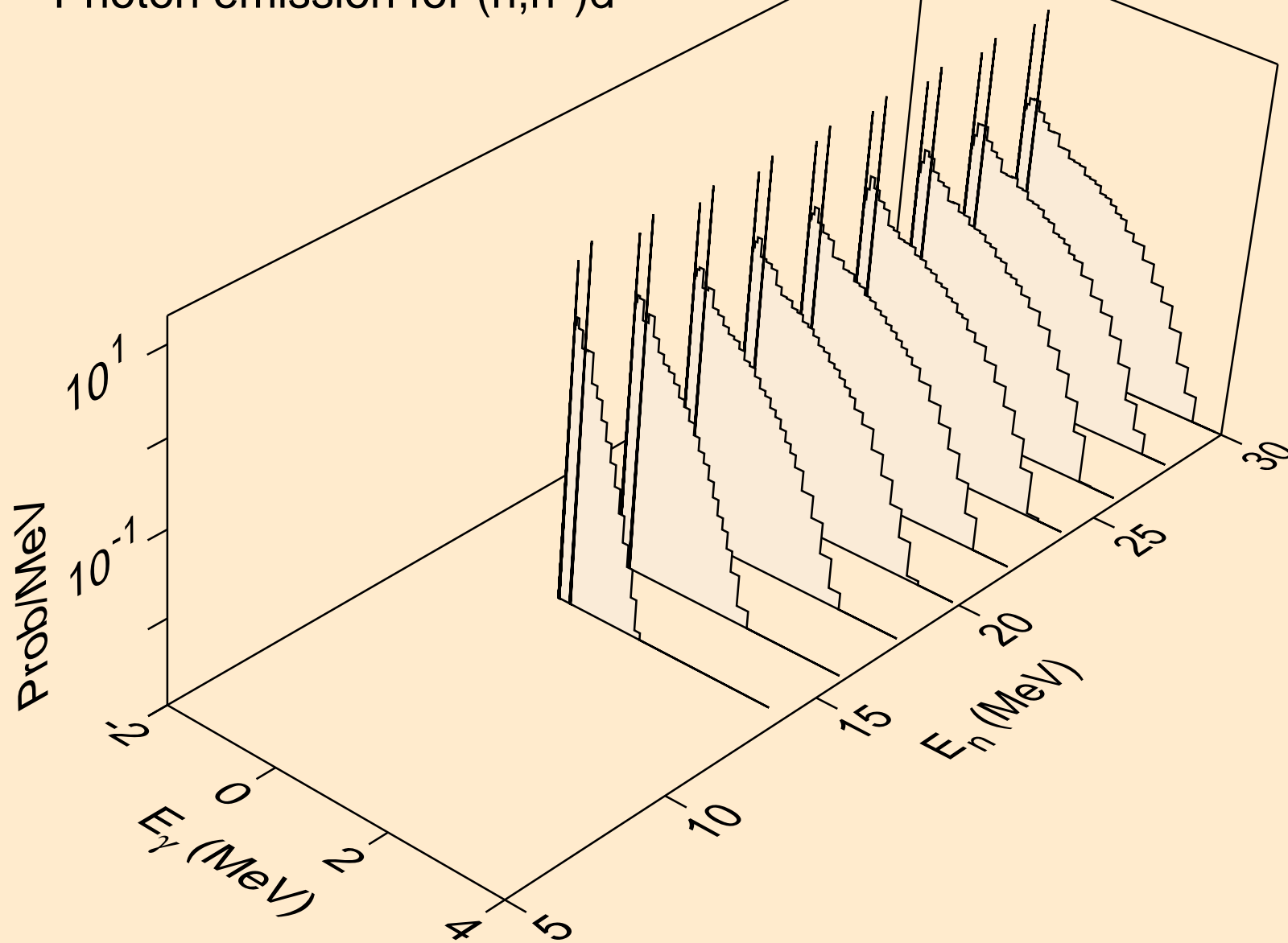

CM235 NEUTRON ACER TENDL-2023 LIBRARY; T=0.K  
Photon emission for (n,n\*)t

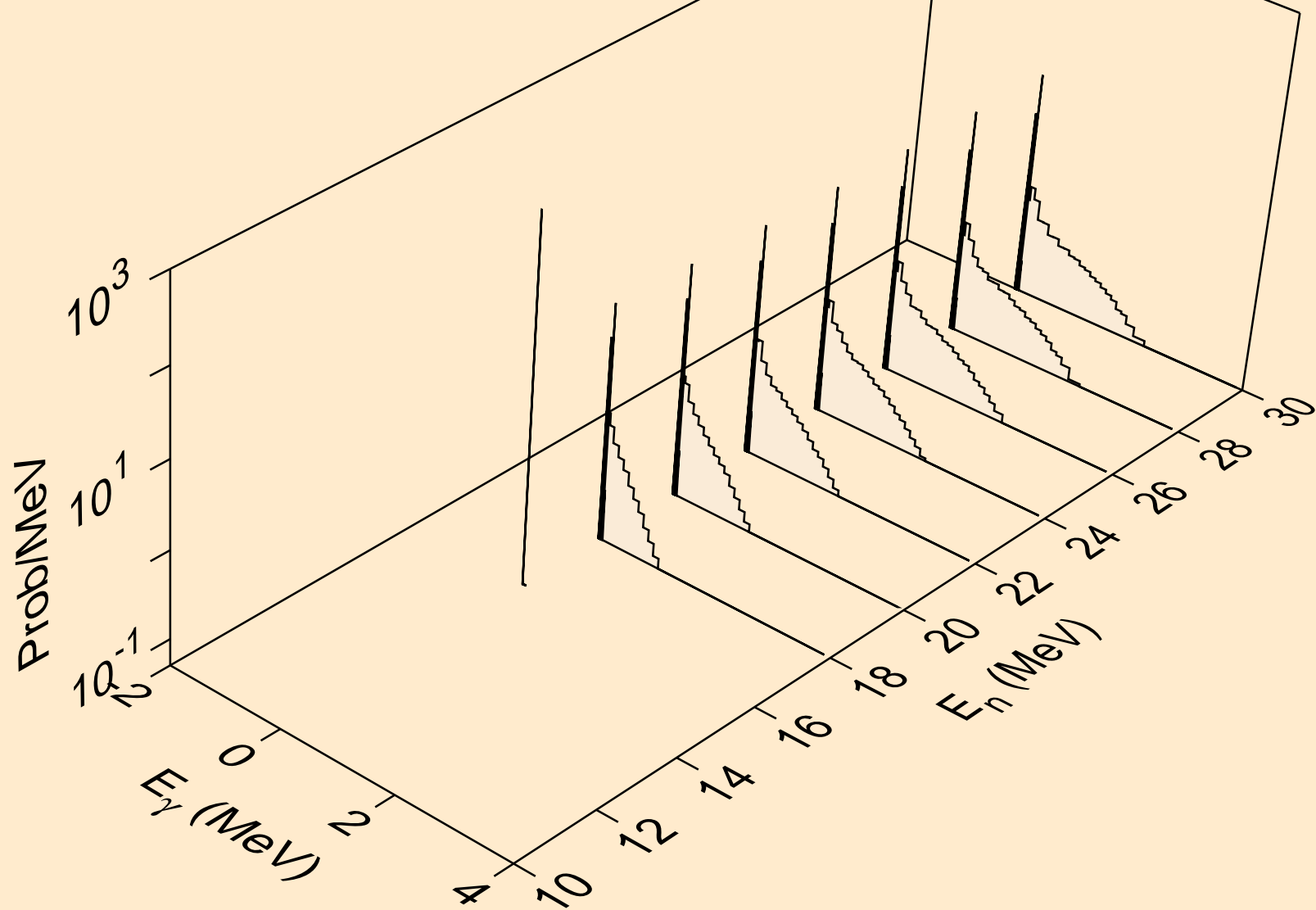

CM235 NEUTRON ACER TENDL-2023 LIBRARY; T=0.K  
Photon emission for (n,n\*)he3

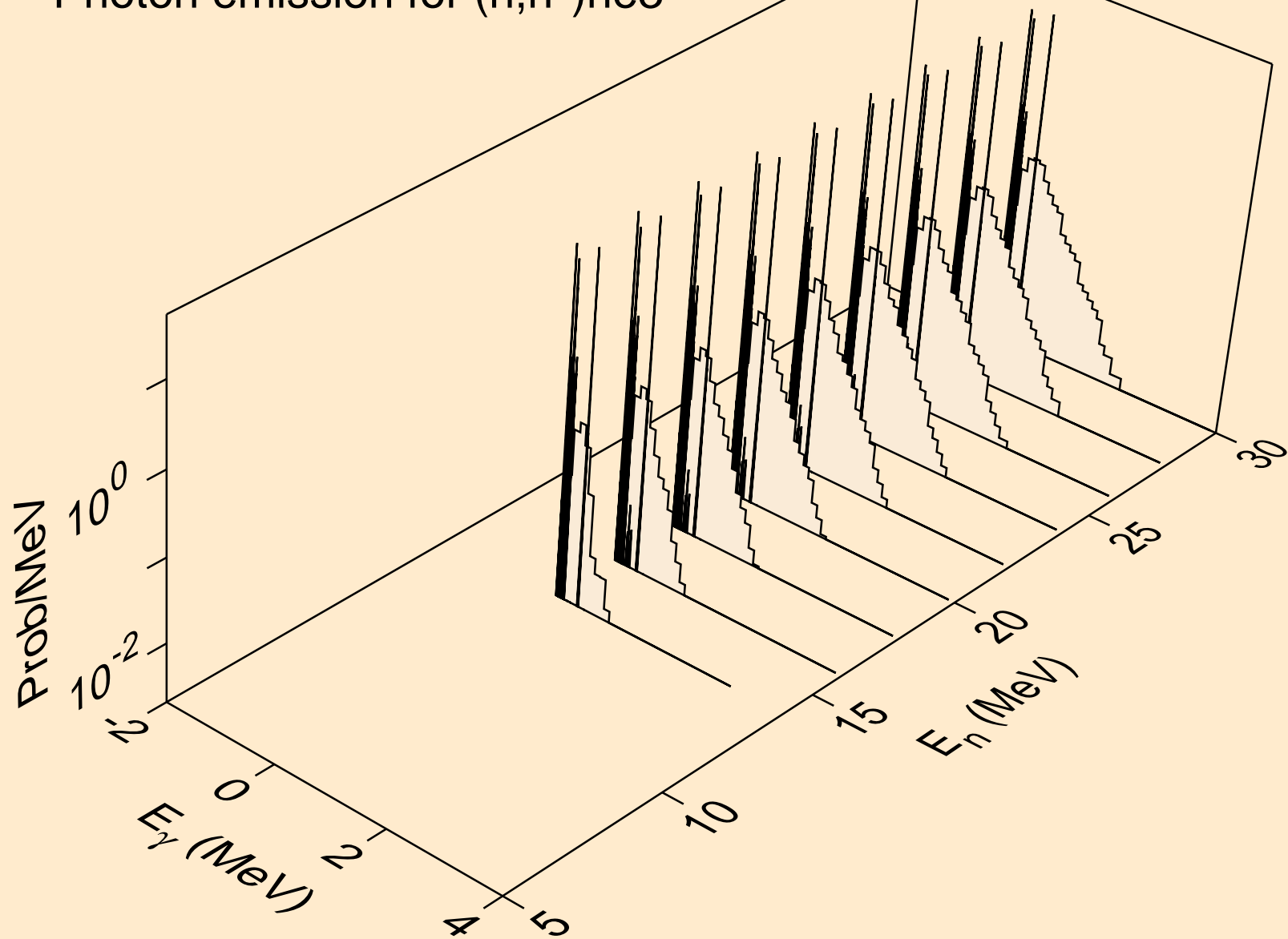

CM235 NEUTRON ACER TENDL-2023 LIBRARY; T=0.K  
Photon emission for (n,4n)

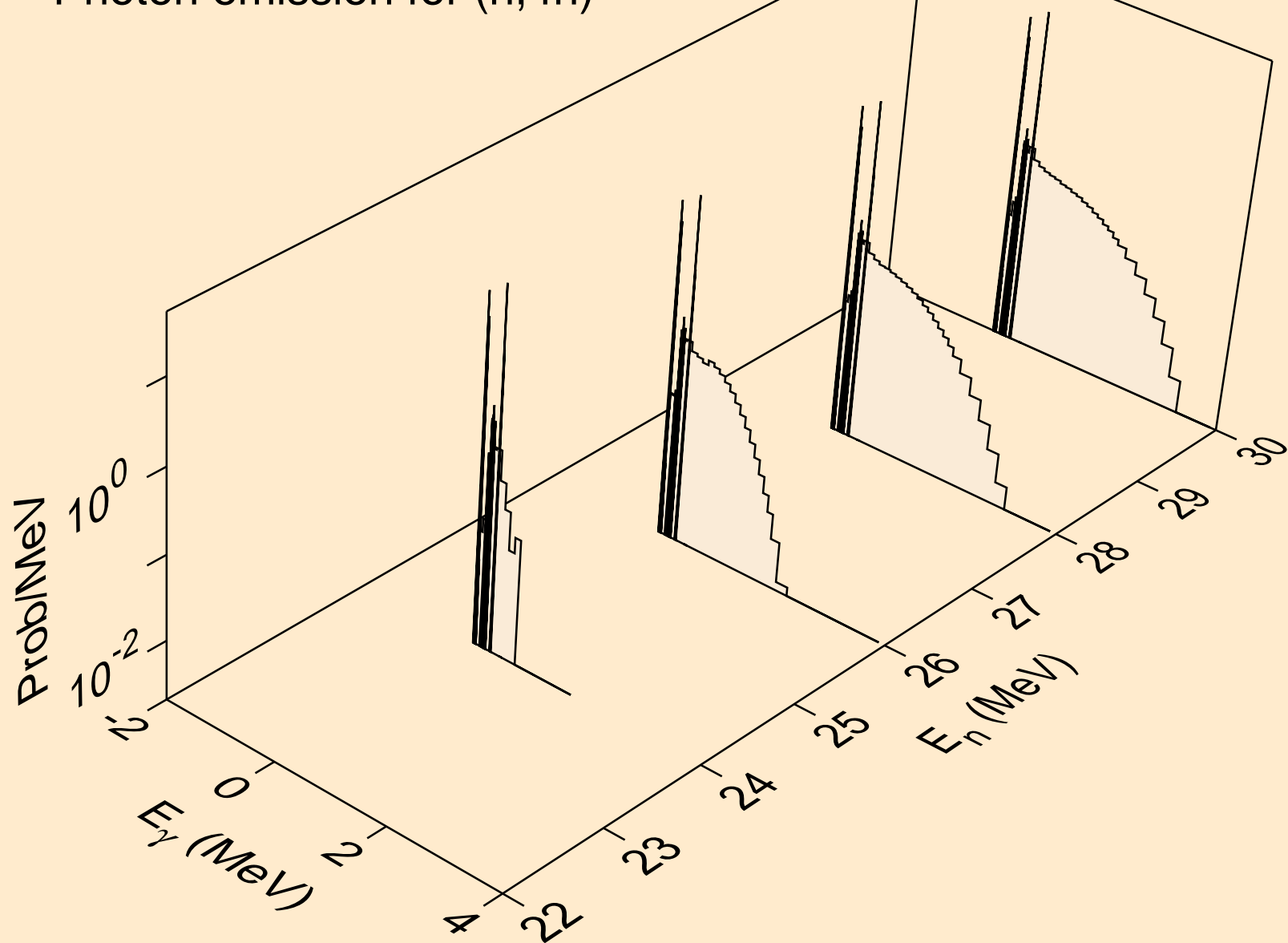

CM235 NEUTRON ACER TENDL-2023 LIBRARY; T=0.K  
Photon emission for (n,2np)

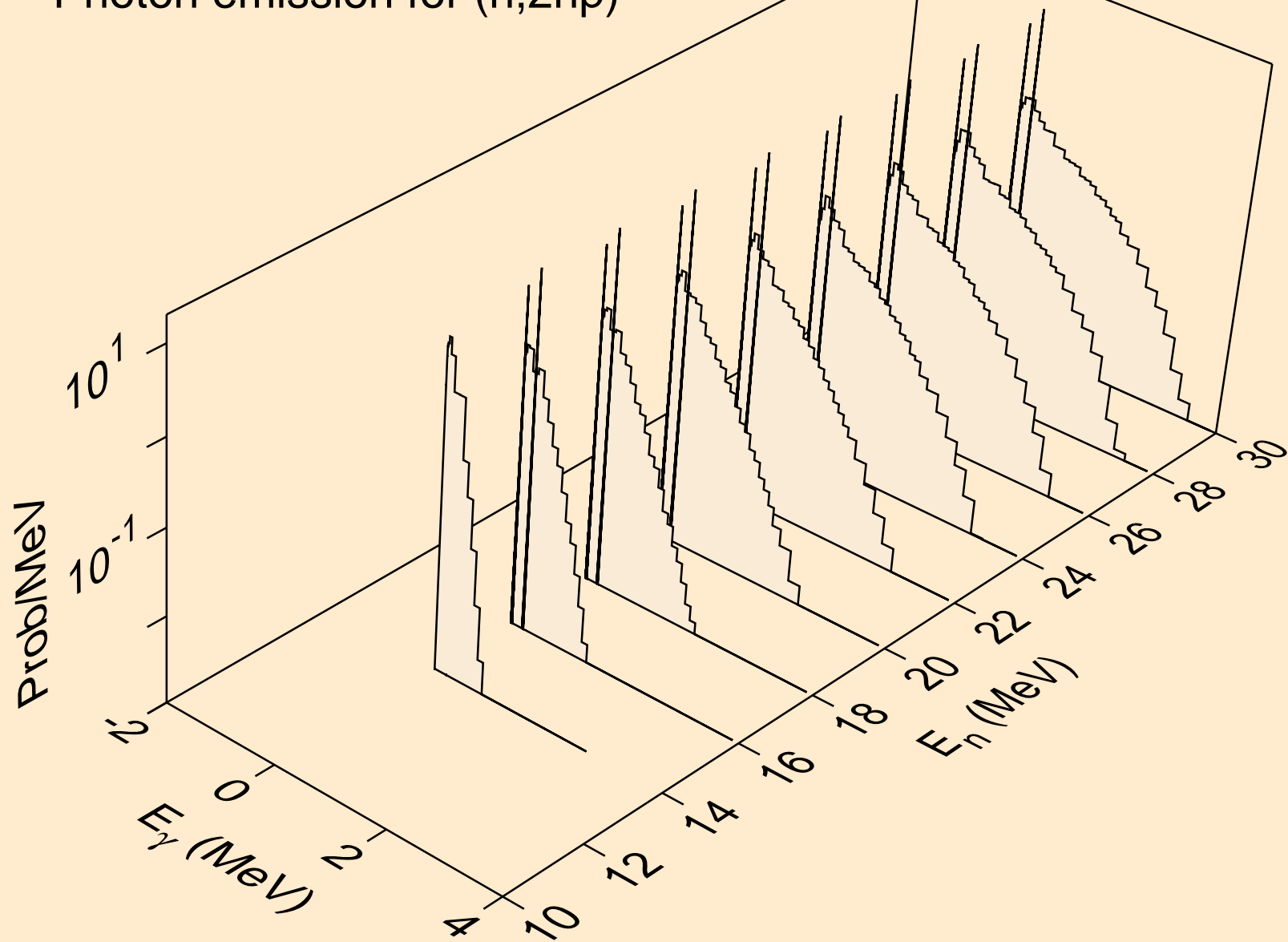

CM235 NEUTRON ACER TENDL-2023 LIBRARY; T=0.K  
Photon emission for (n,n2p)

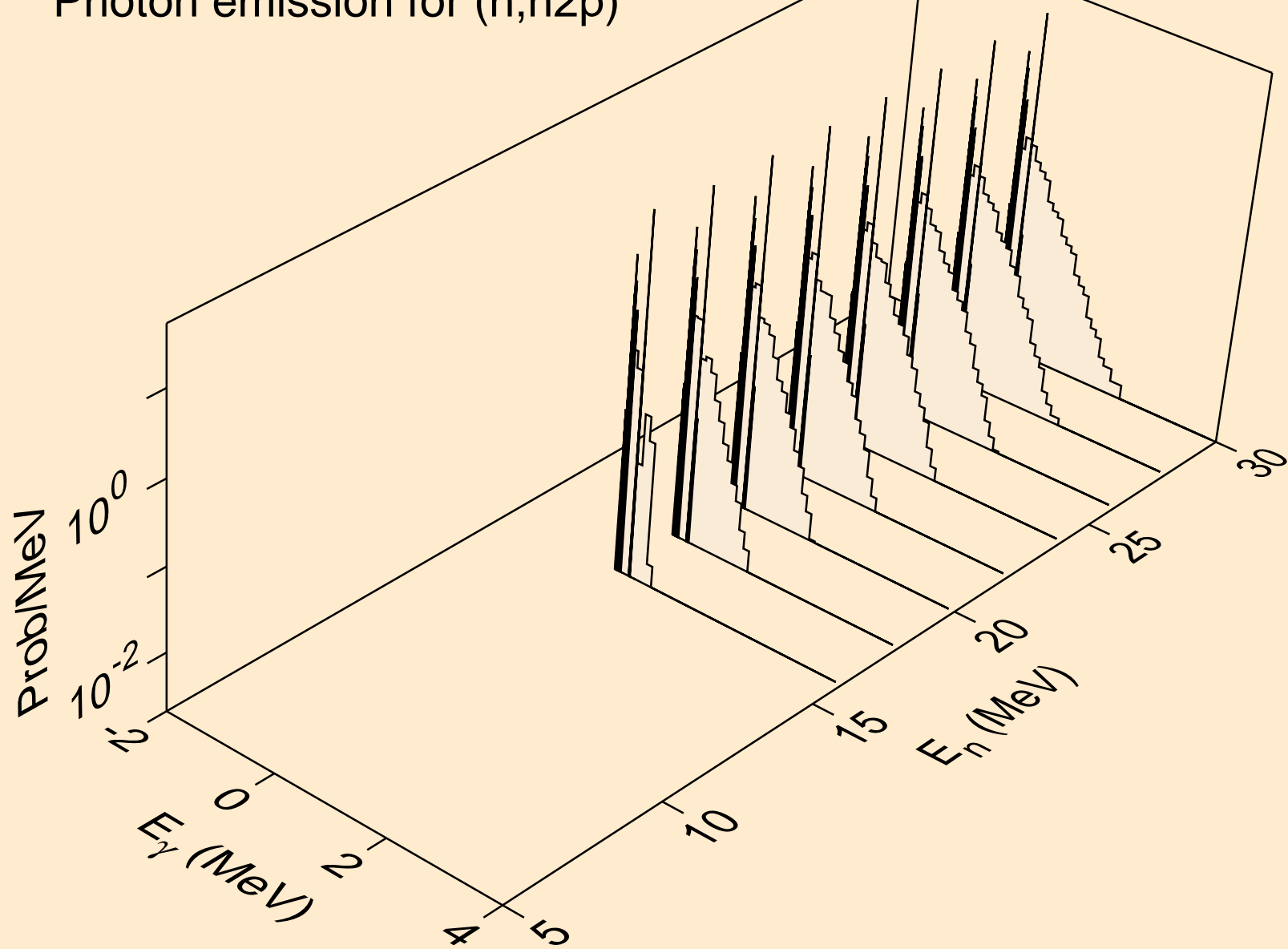

CM235 NEUTRON ACER TENDL-2023 LIBRARY; T=0.K  
Photon emission for (n,npa)

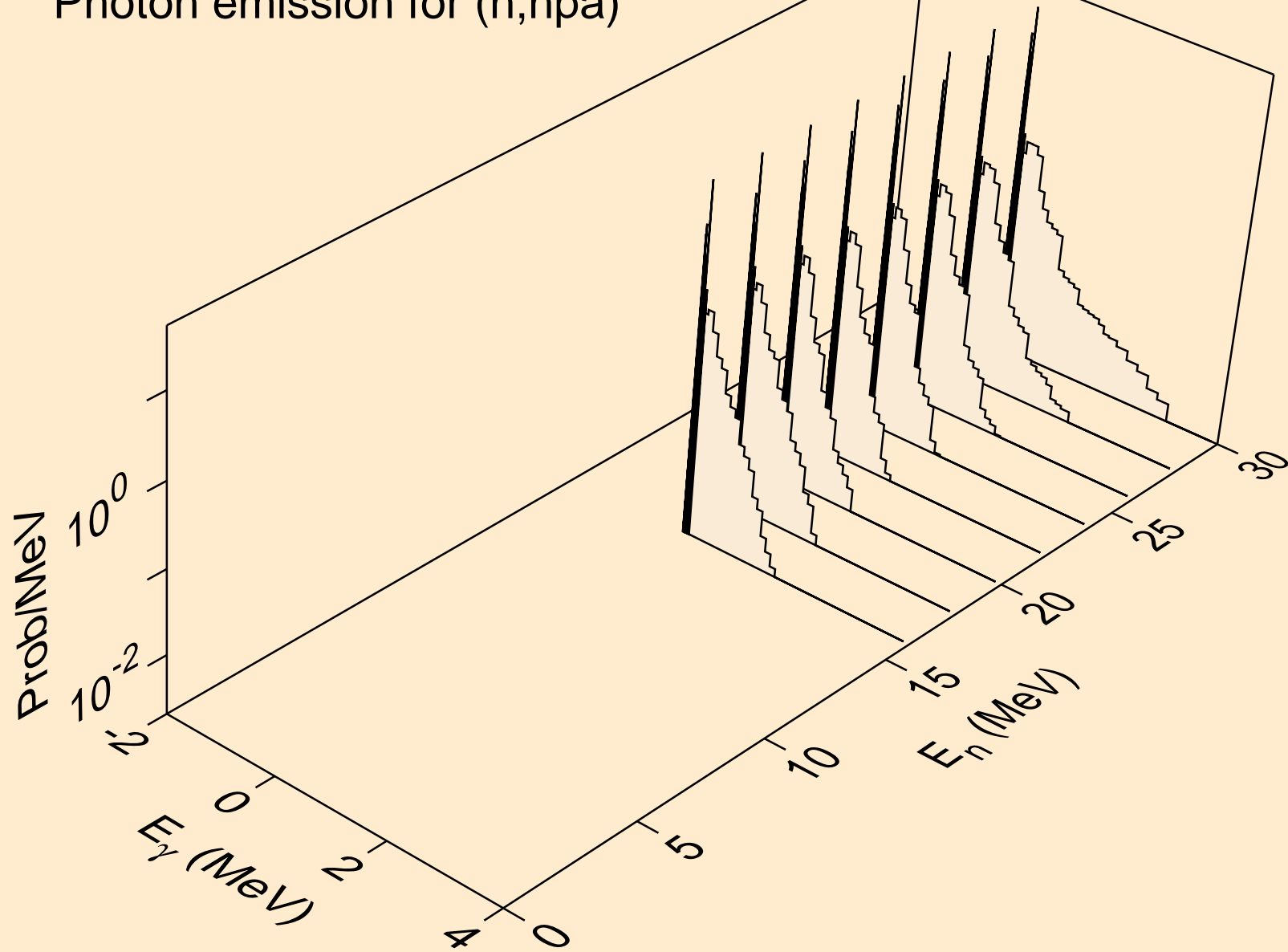

CM235 NEUTRON ACER TENDL-2023 LIBRARY; T=0.K  
Photon emission for (n,n\*c)

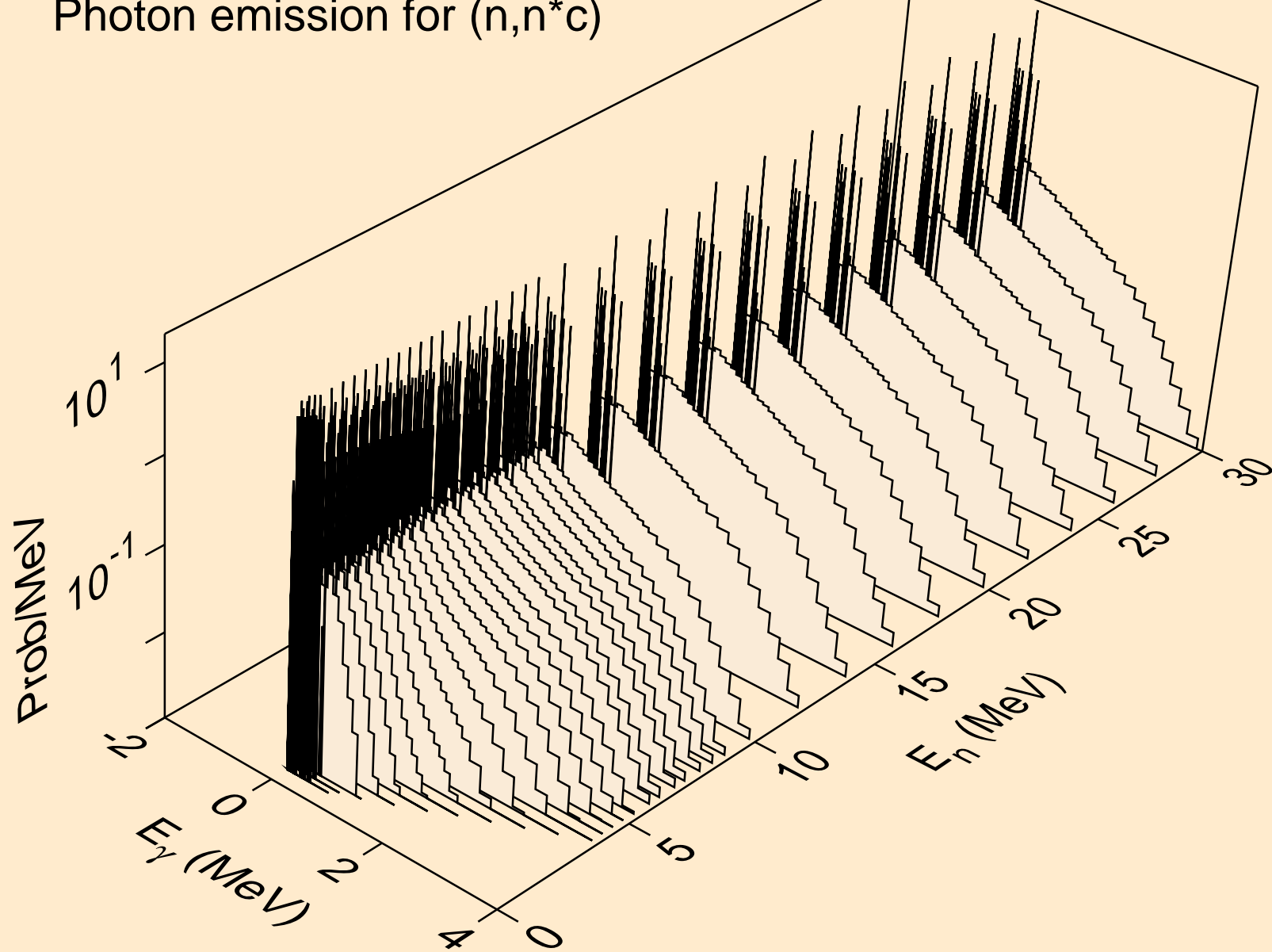



CM235 NEUTRON ACER TENDL-2023 LIBRARY; T=0.K  
Photon emission for (n,gma)

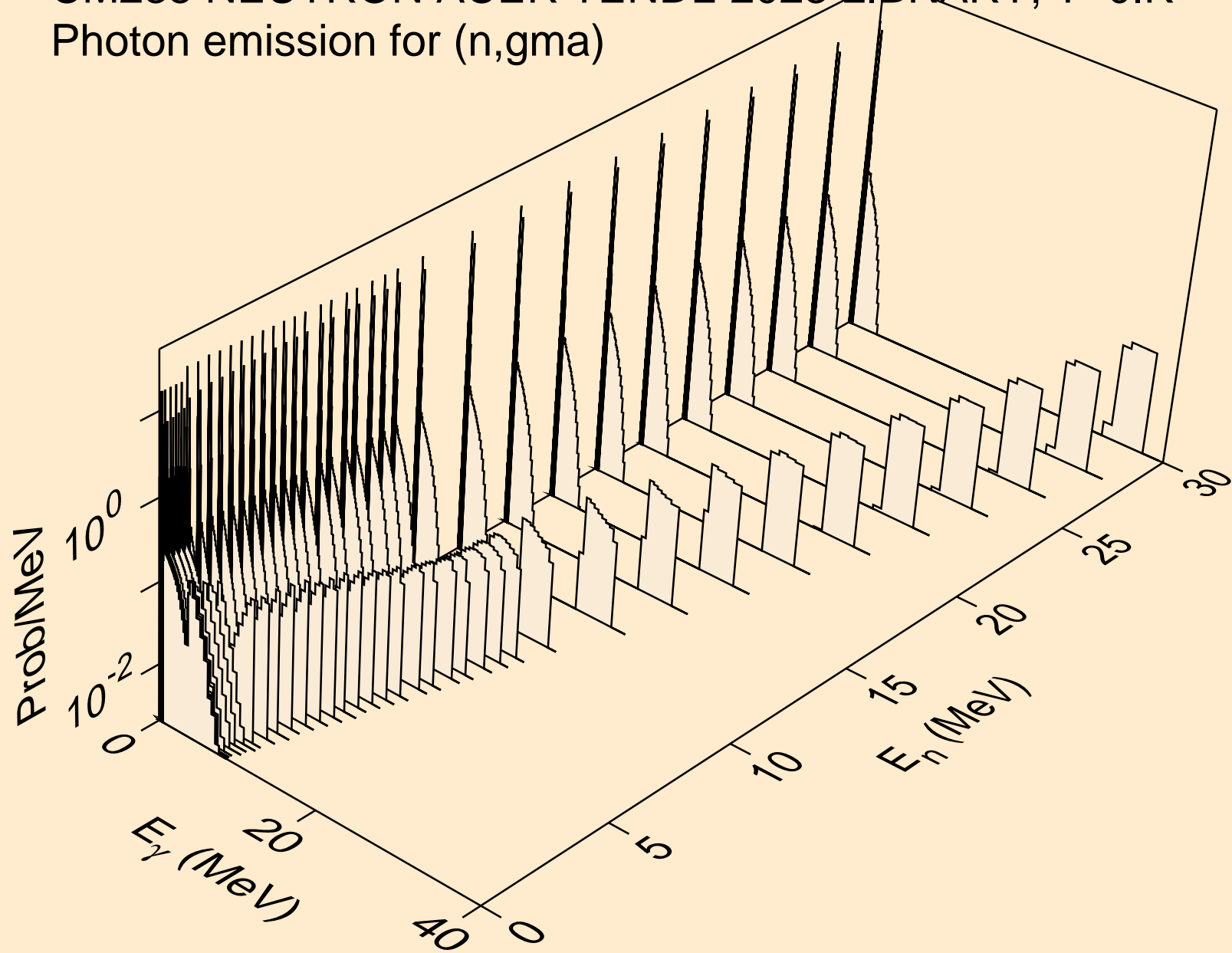

CM235 NEUTRON ACER TENDL-2023 LIBRARY; T=0.K  
Photon emission for (n,p)

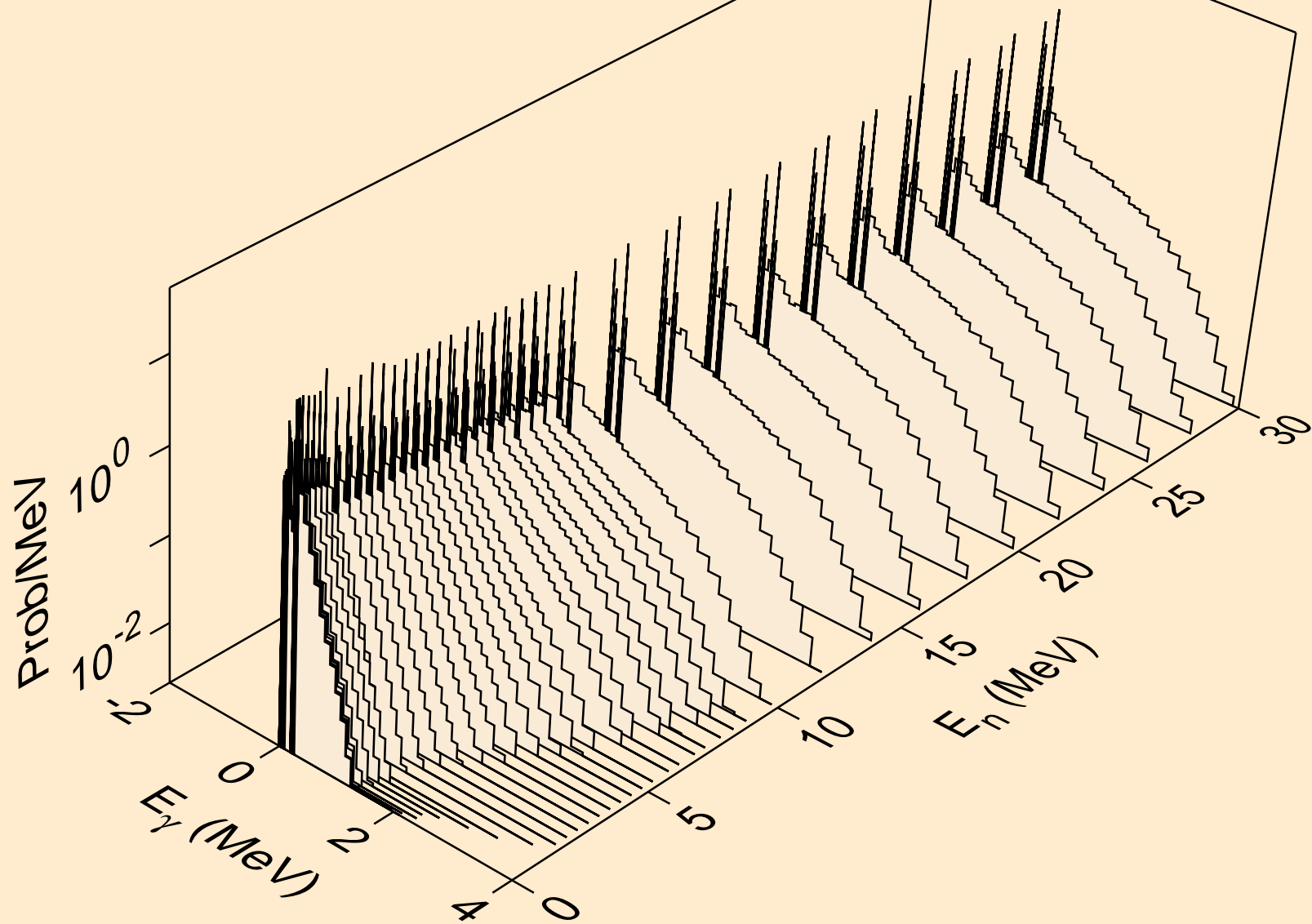

CM235 NEUTRON ACER TENDL-2023 LIBRARY; T=0.K  
Photon emission for (n,d)

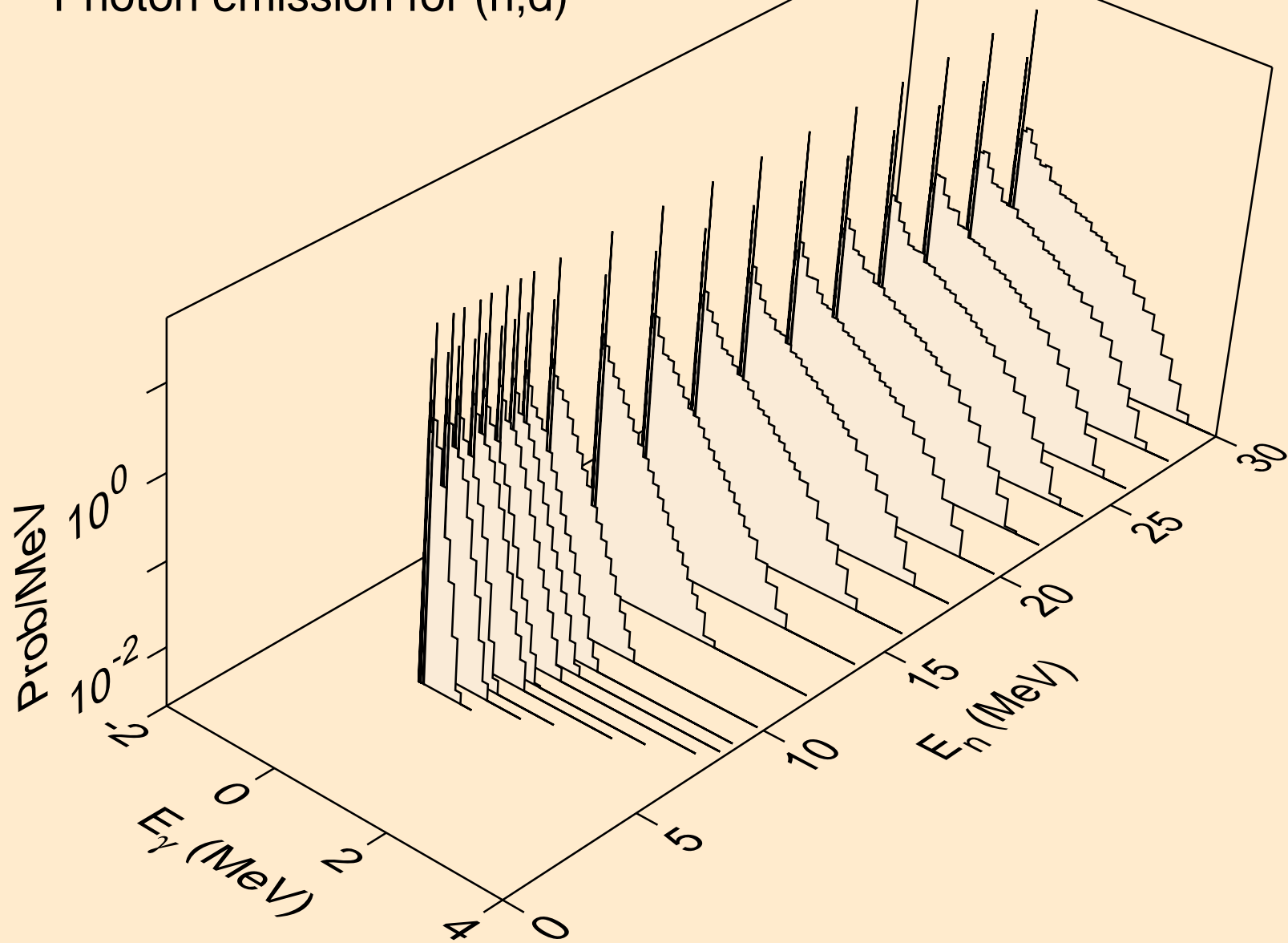

CM235 NEUTRON ACER TENDL-2023 LIBRARY; T=0.K  
Photon emission for (n,t)

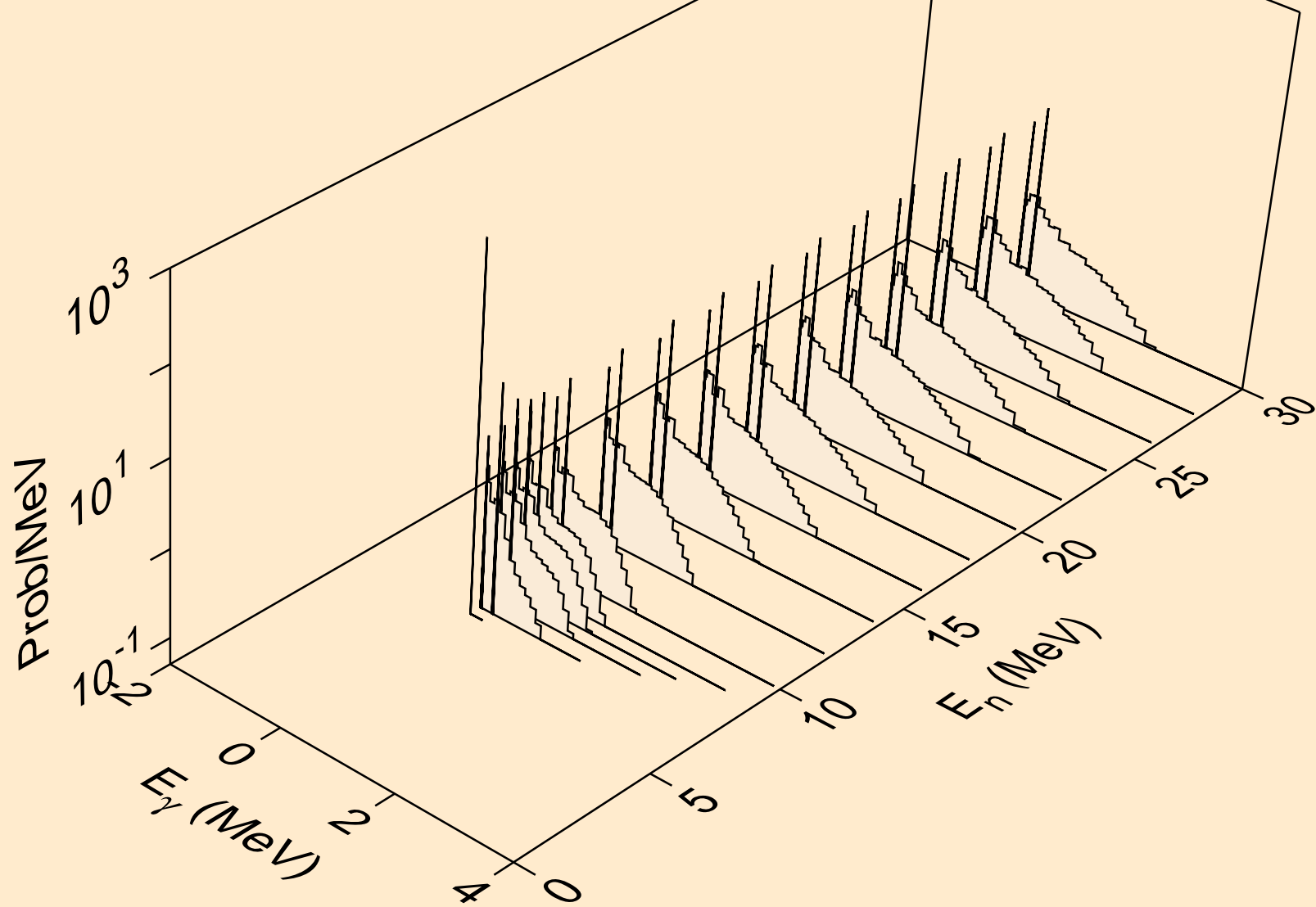

CM235 NEUTRON ACER TENDL-2023 LIBRARY; T=0.K  
Photon emission for (n,he3)

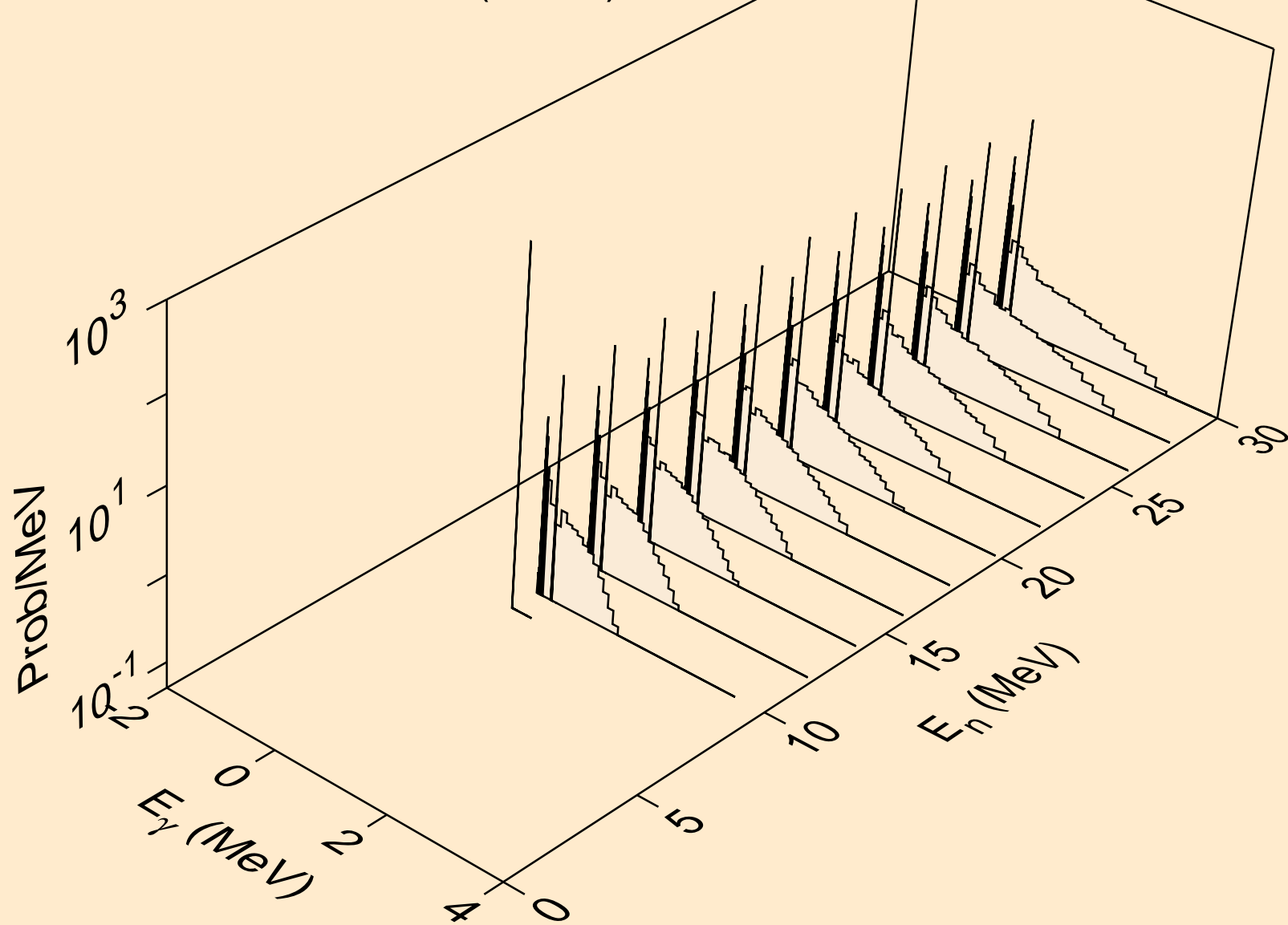

CM235 NEUTRON ACER TENDL-2023 LIBRARY; T=0.K  
Photon emission for (n,a)

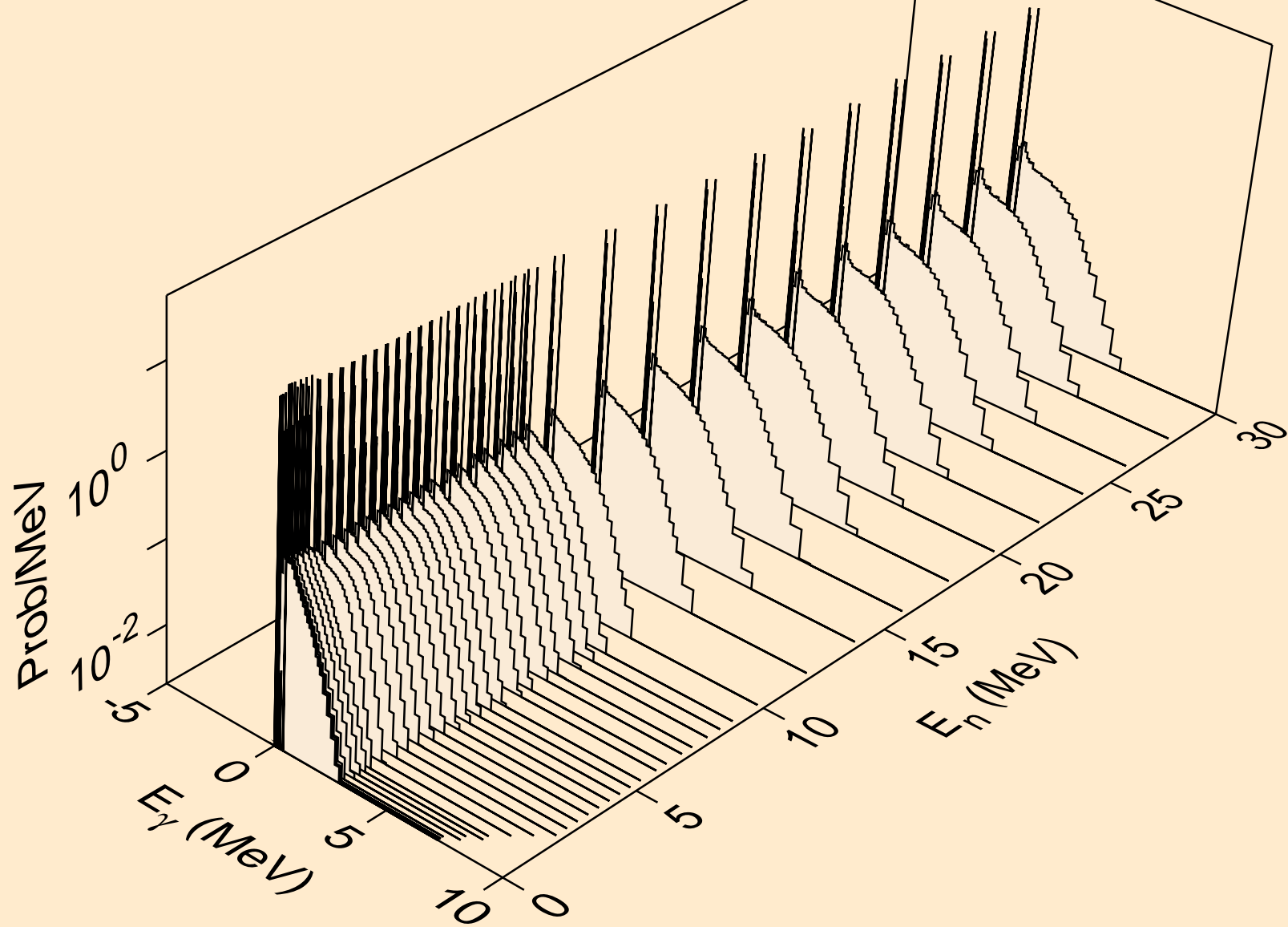

CM235 NEUTRON ACER TENDL-2023 LIBRARY; T=0.K  
Photon emission for (n,2a)

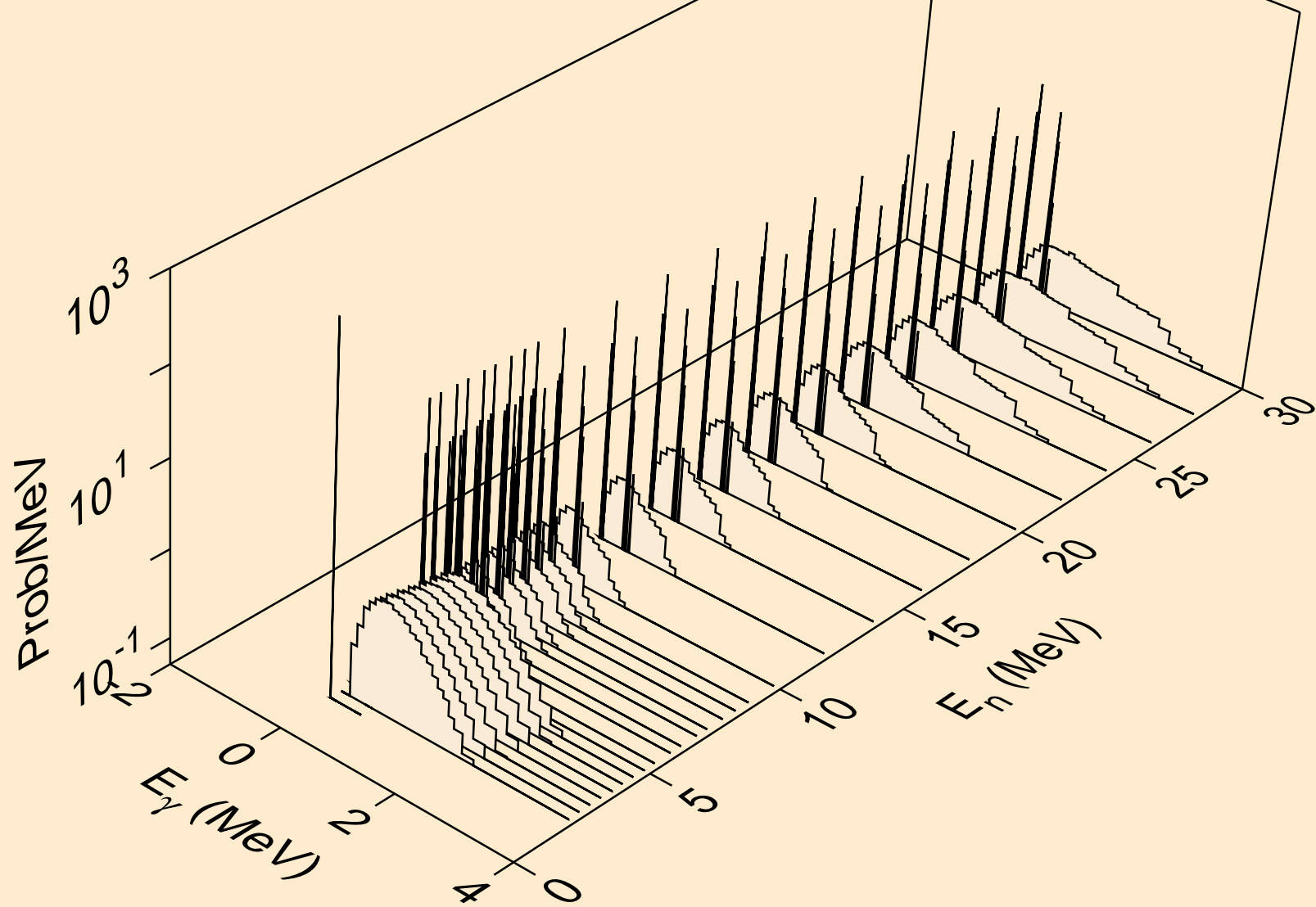

CM235 NEUTRON ACER TENDL-2023 LIBRARY; T=0.K  
Photon emission for (n,2p)

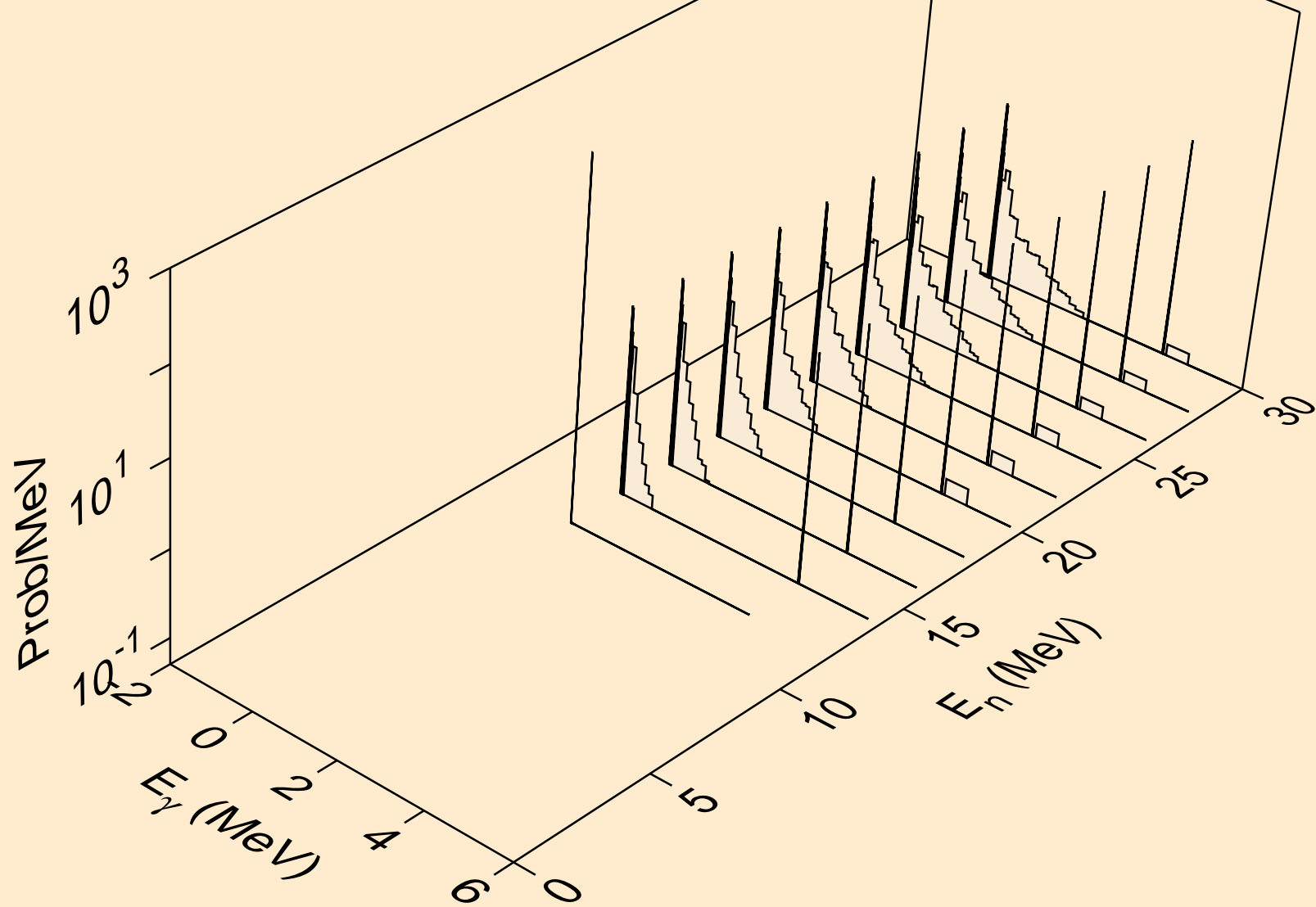



CM235 NEUTRON ACER TENDL-2023 LIBRARY; T=0.K  
Photon emission for (n,p $\alpha$ )

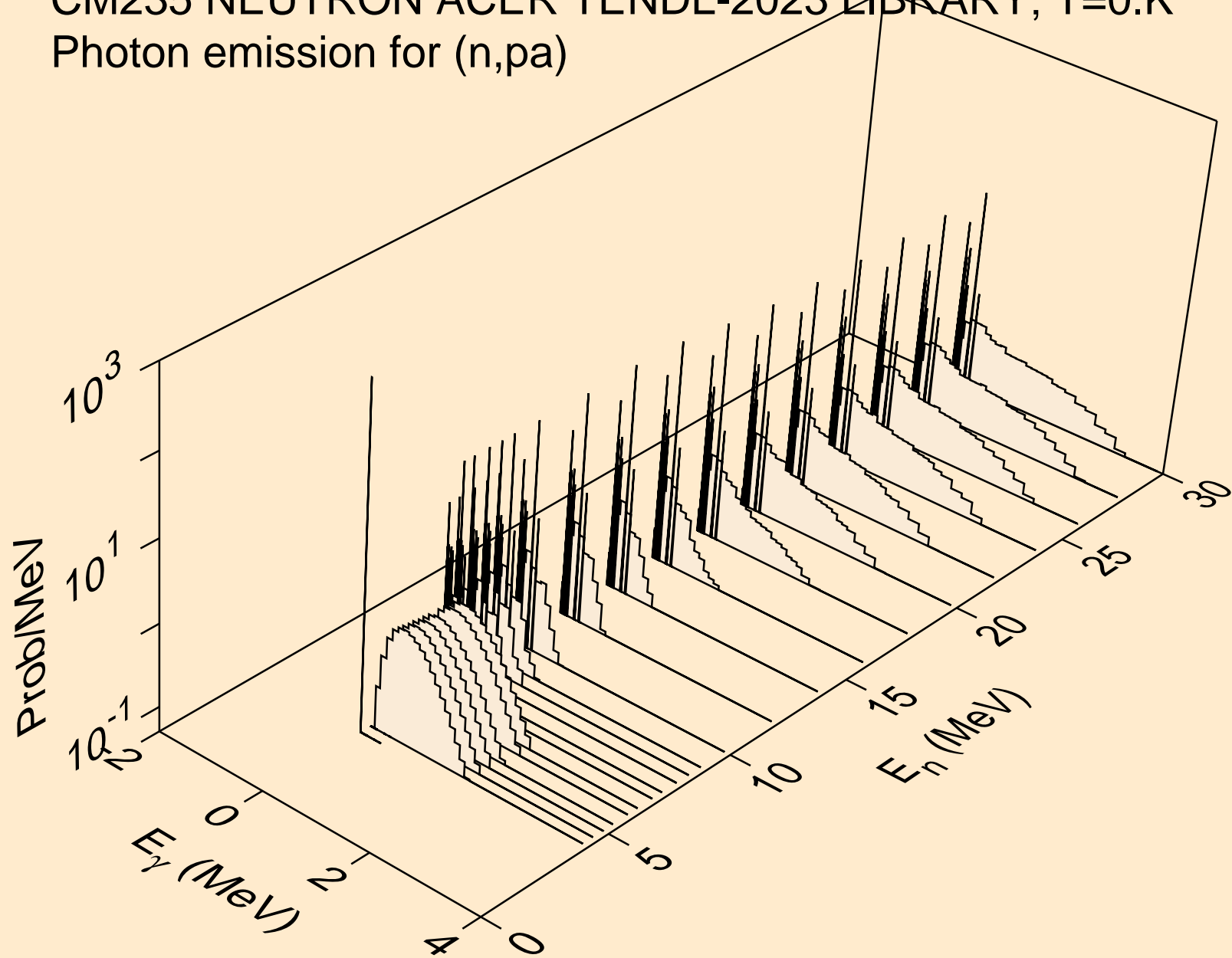

CM235 NEUTRON ACER TENDL-2023 LIBRARY; T=0.K  
Photon emission for (n,pd)

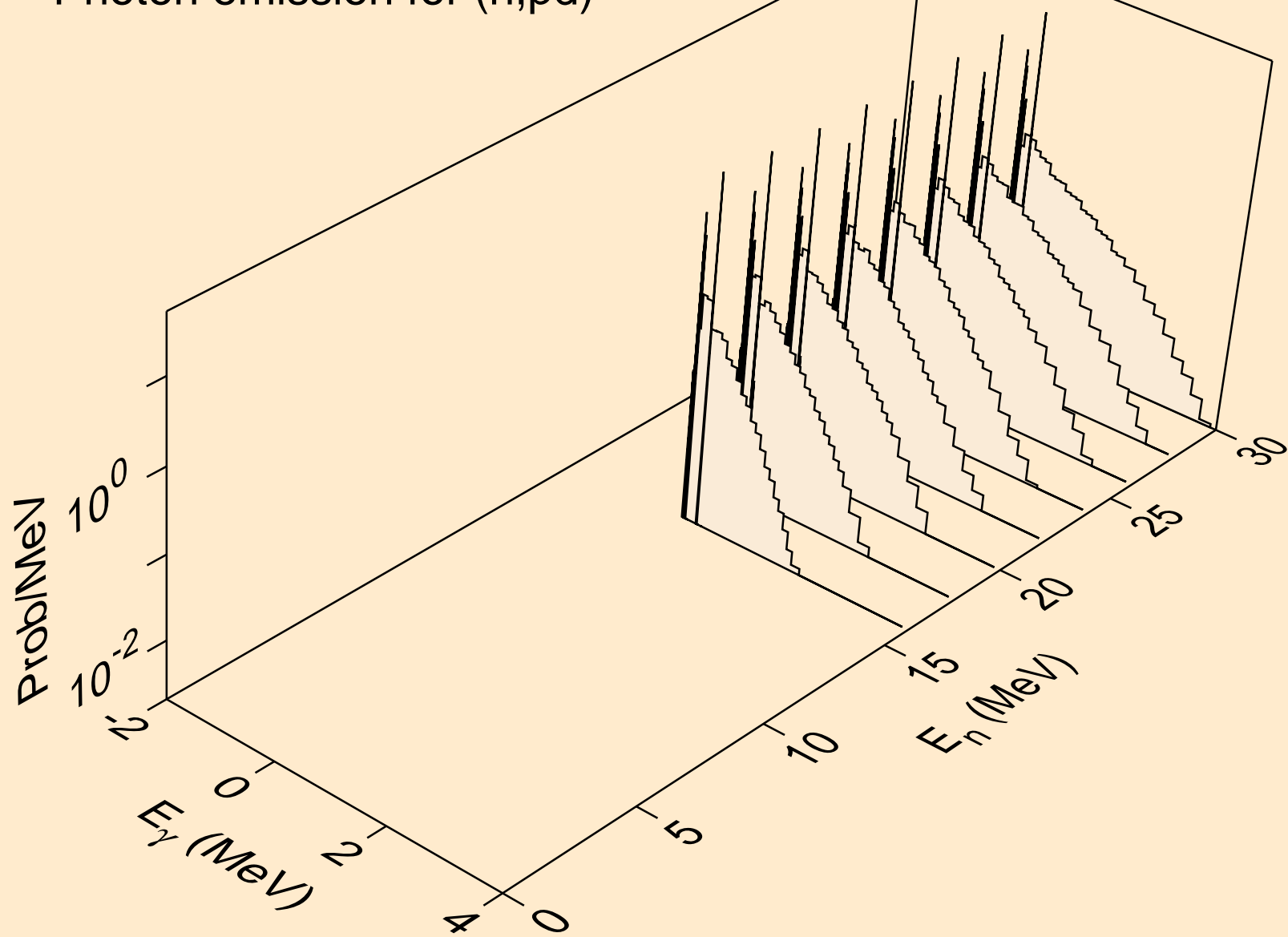

CM235 NEUTRON ACER TENDL-2023 LIBRARY; T=0.K  
thermal capture photon spectrum

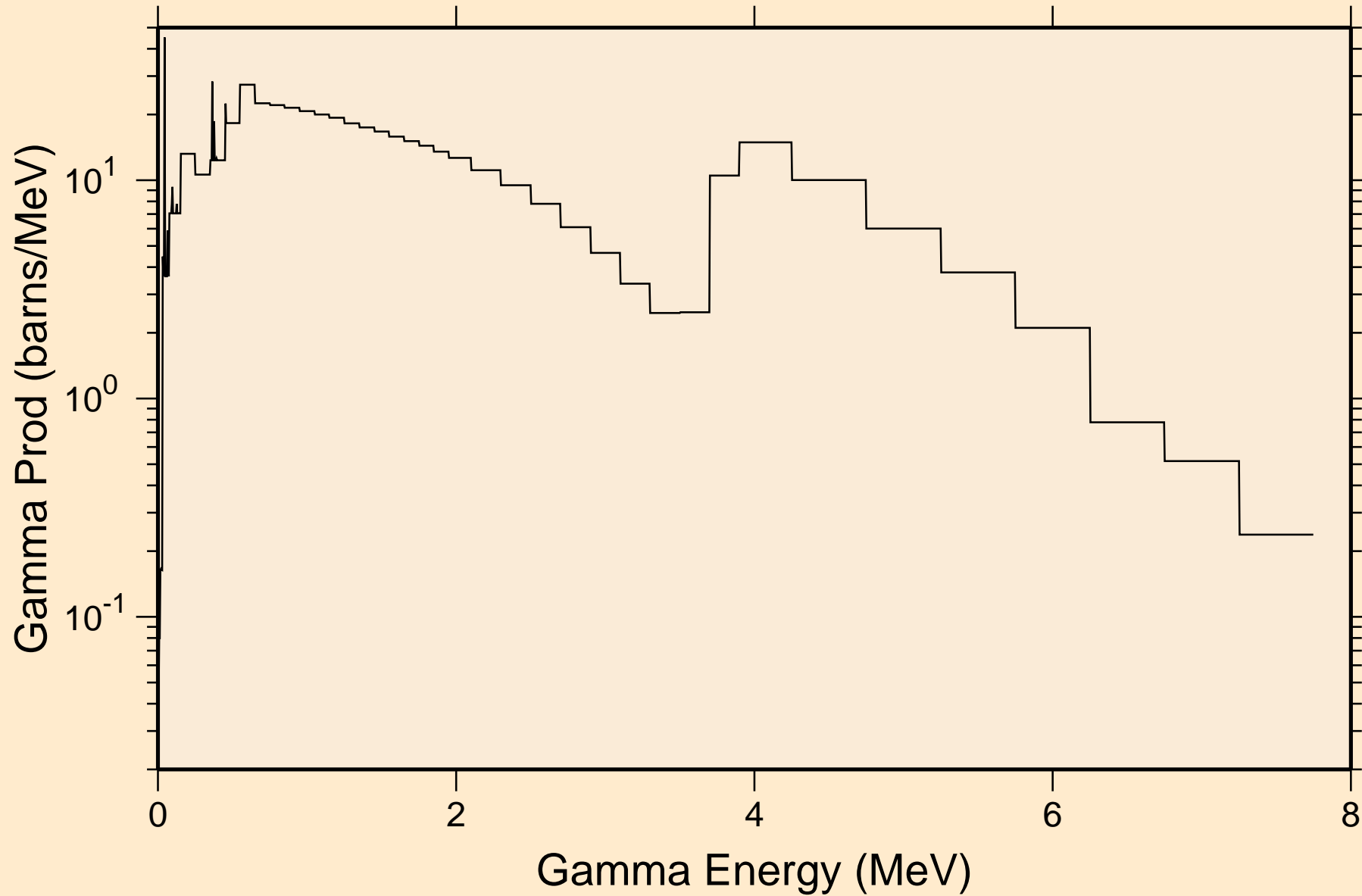

CM235 NEUTRON ACER TENDL-2023 LIBRARY; T=0.K  
14 MeV photon spectrum

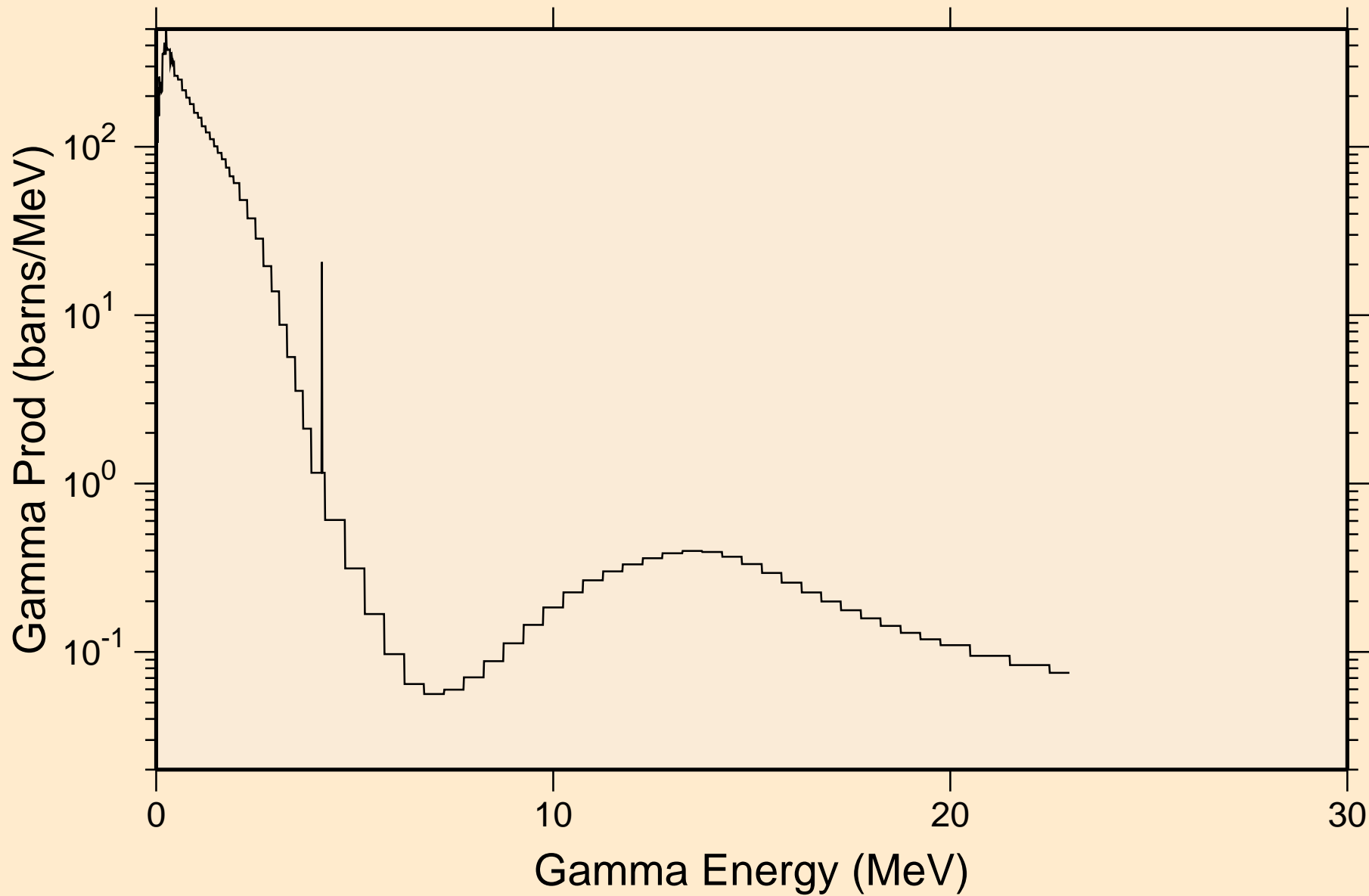

# CM235 NEUTRON ACER TENDL-2023 LIBRARY; T=0.K

## Particle heating contributions

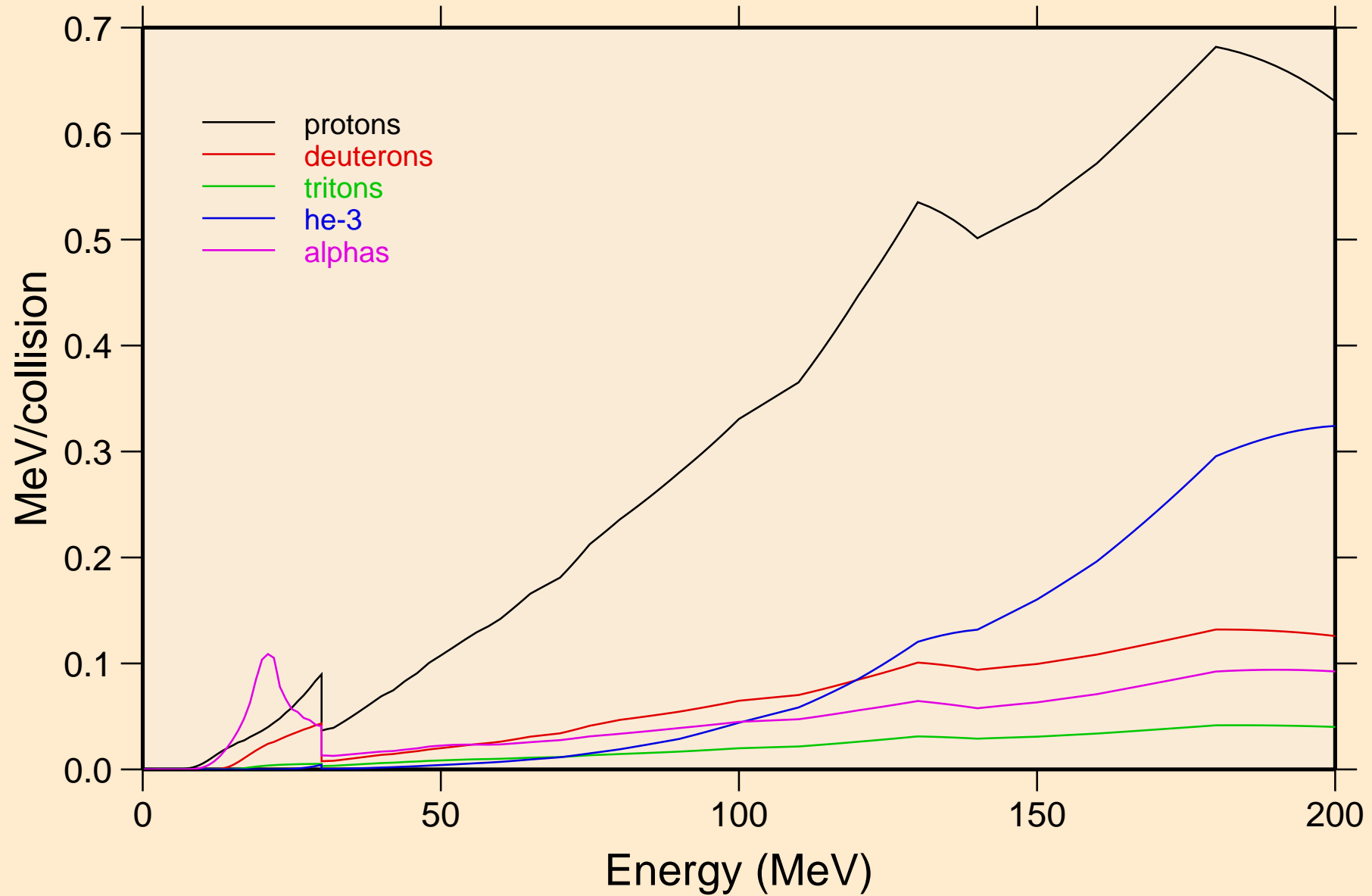

CM235 NEUTRON ACER TENDL-2023 LIBRARY; T=0.K  
Recoil Heating

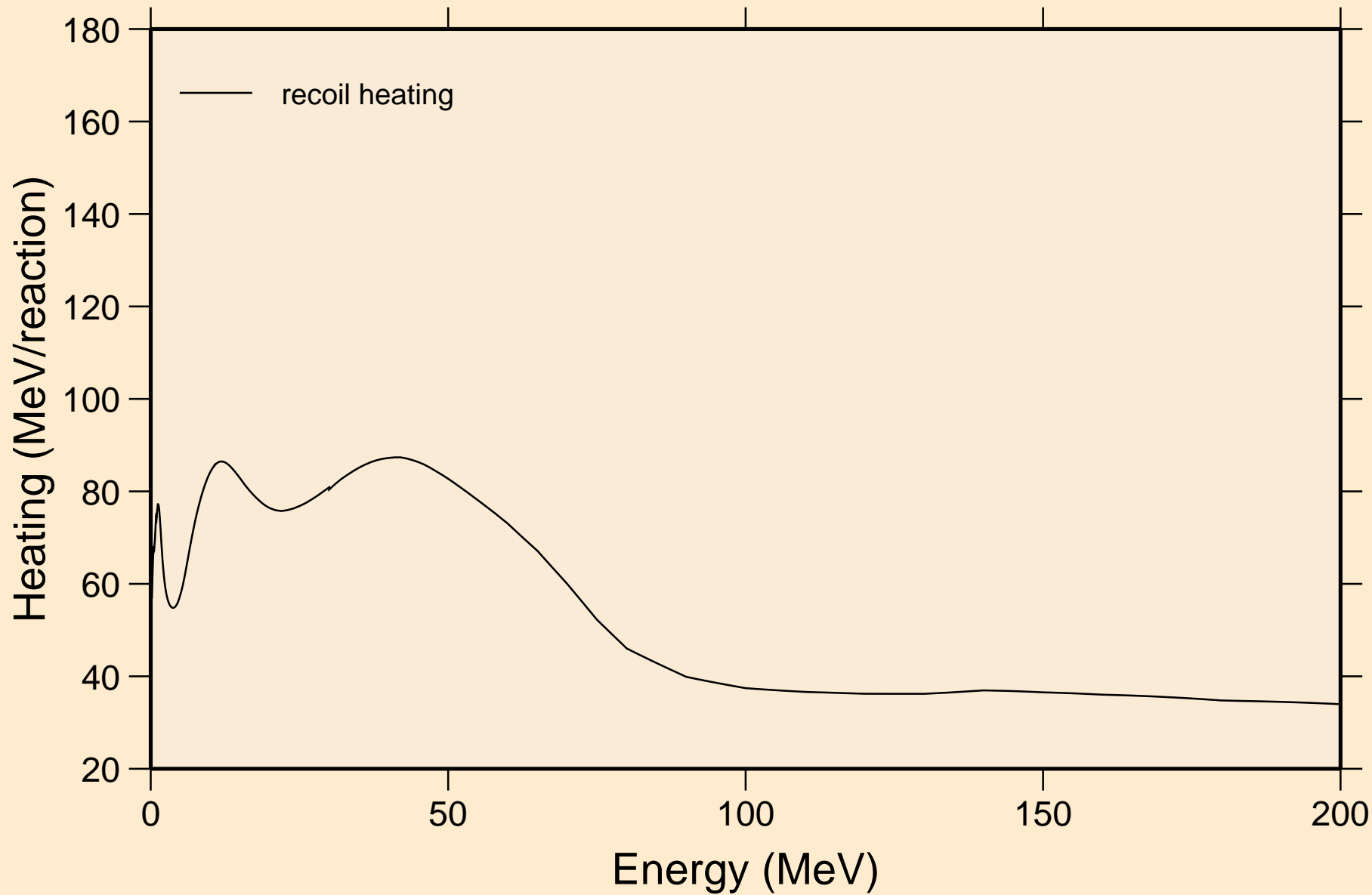

# CM235 NEUTRON ACER TENDL-2023 LIBRARY; T=0.K

## Particle production cross sections

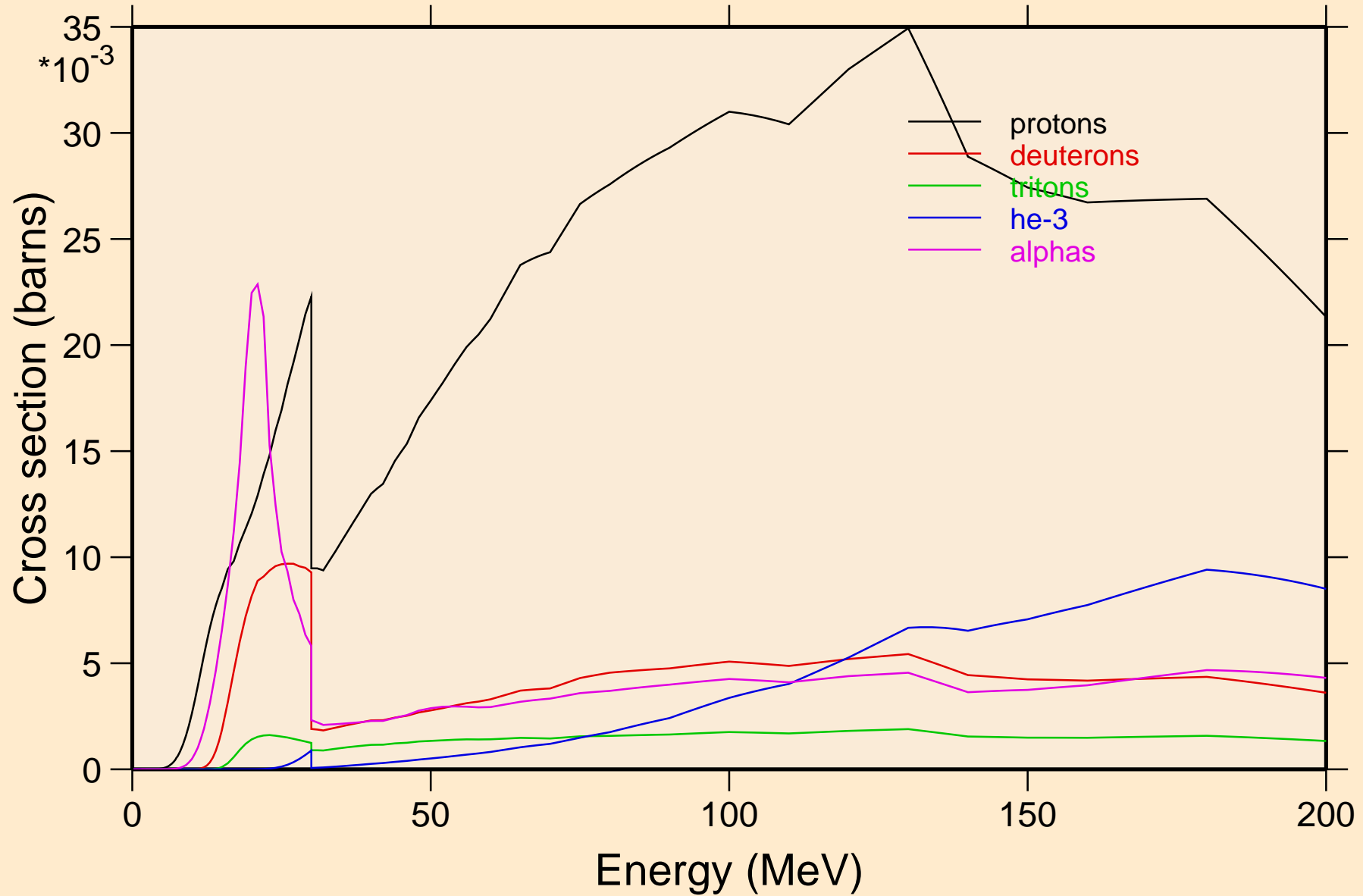

CM235 NEUTRON ACER TENDL-2023 LIBRARY; T=0.K  
protons from (n,x)

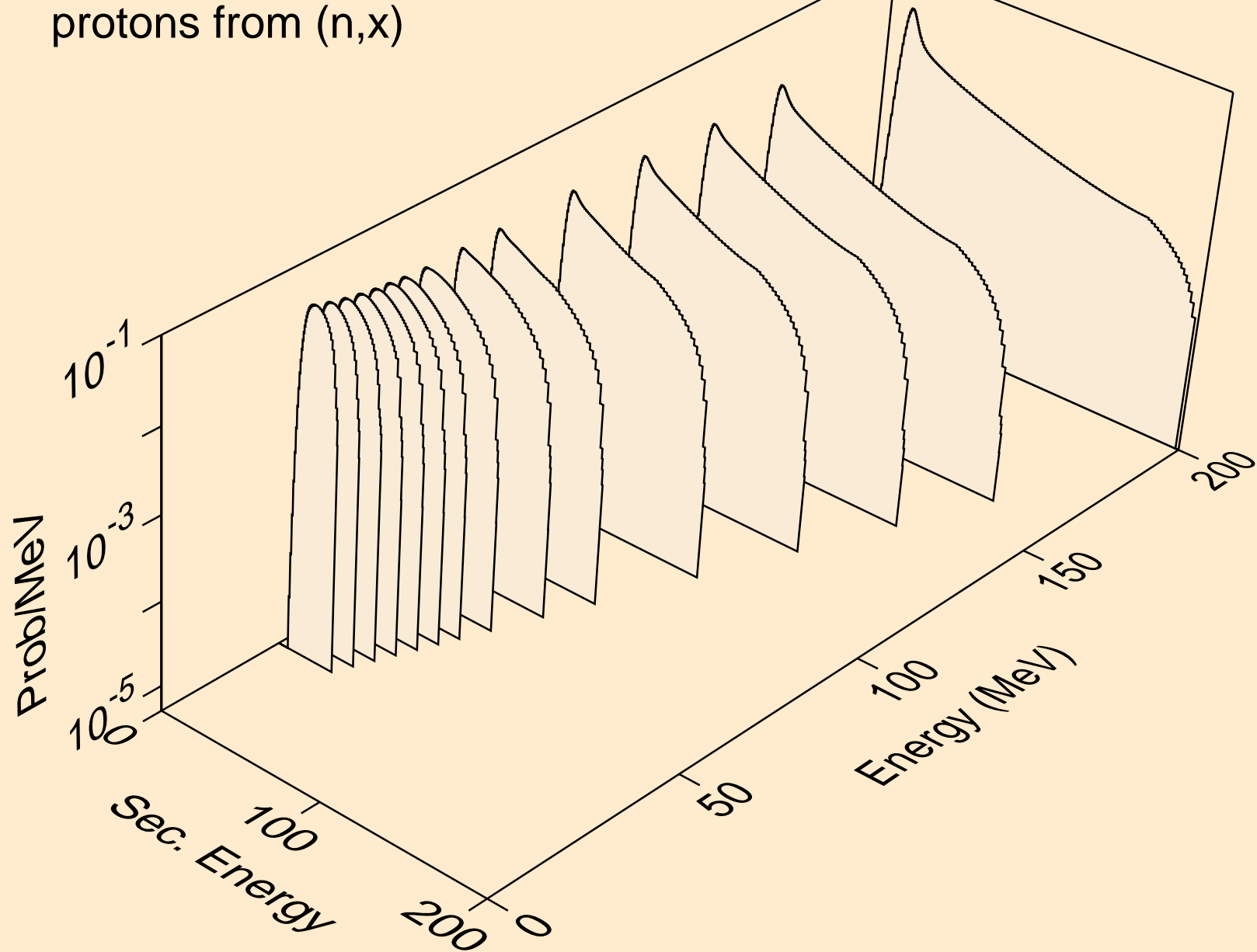



CM235 NEUTRON ACER TENDL-2023 LIBRARY; T=0.K  
protons from (n,n\*)p

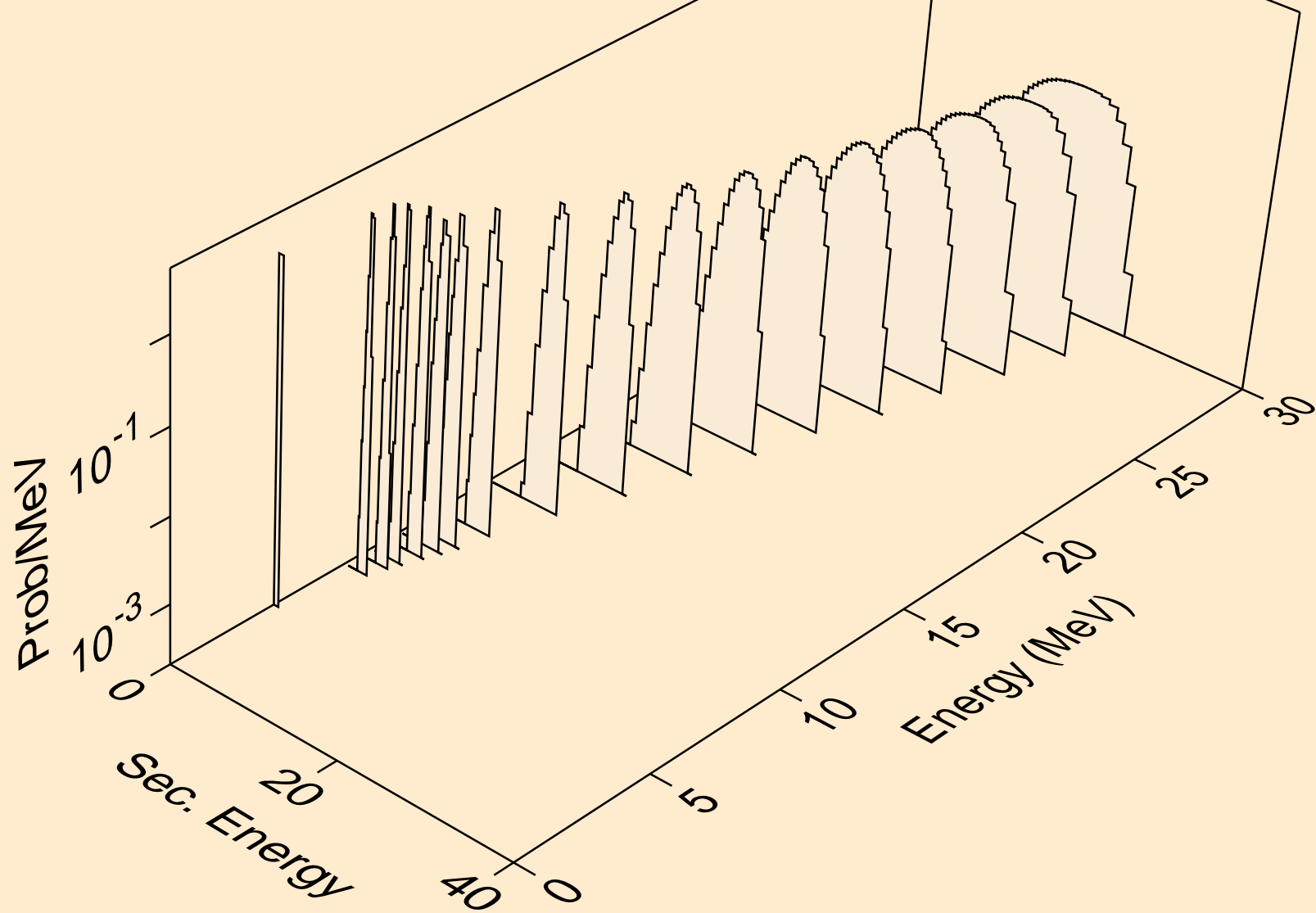

CM235 NEUTRON ACER TENDL-2023 LIBRARY; T=0.K  
protons from (n,2np)

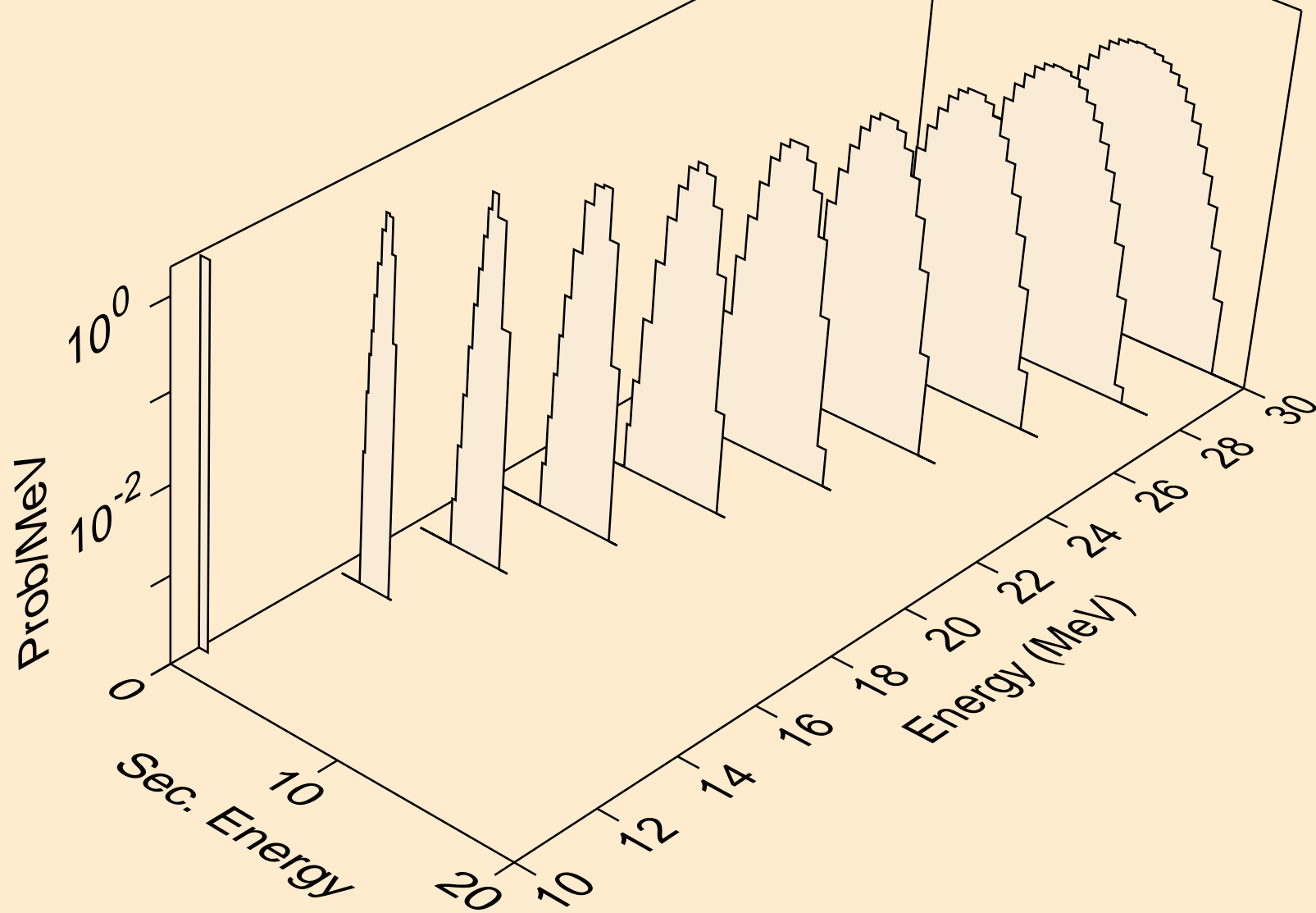

CM235 NEUTRON ACER TENDL-2023 LIBRARY; T=0.K  
protons from (n,n2p)

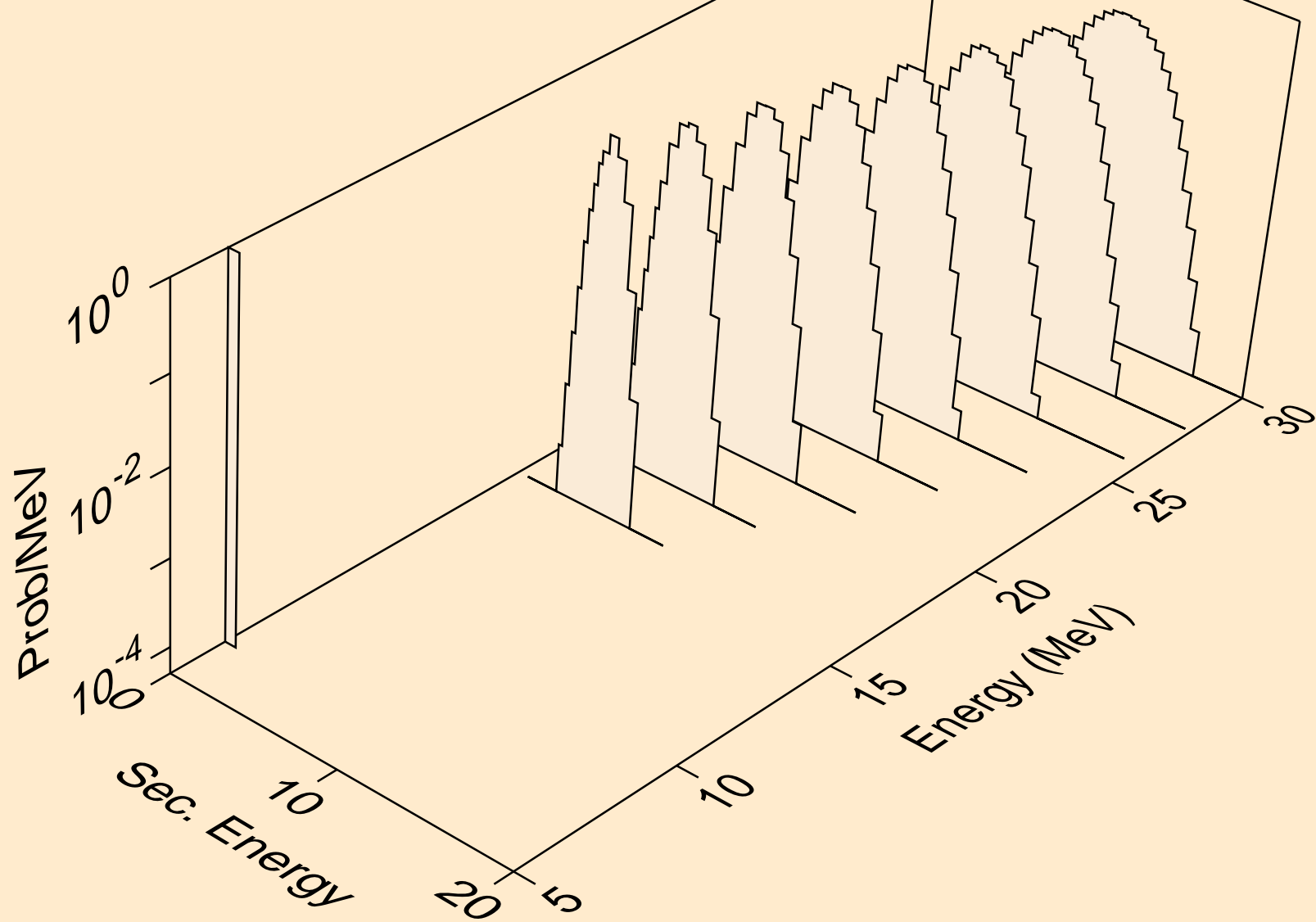

CM235 NEUTRON ACER TENDL-2023 LIBRARY; T=0.K  
protons from (n,npa)

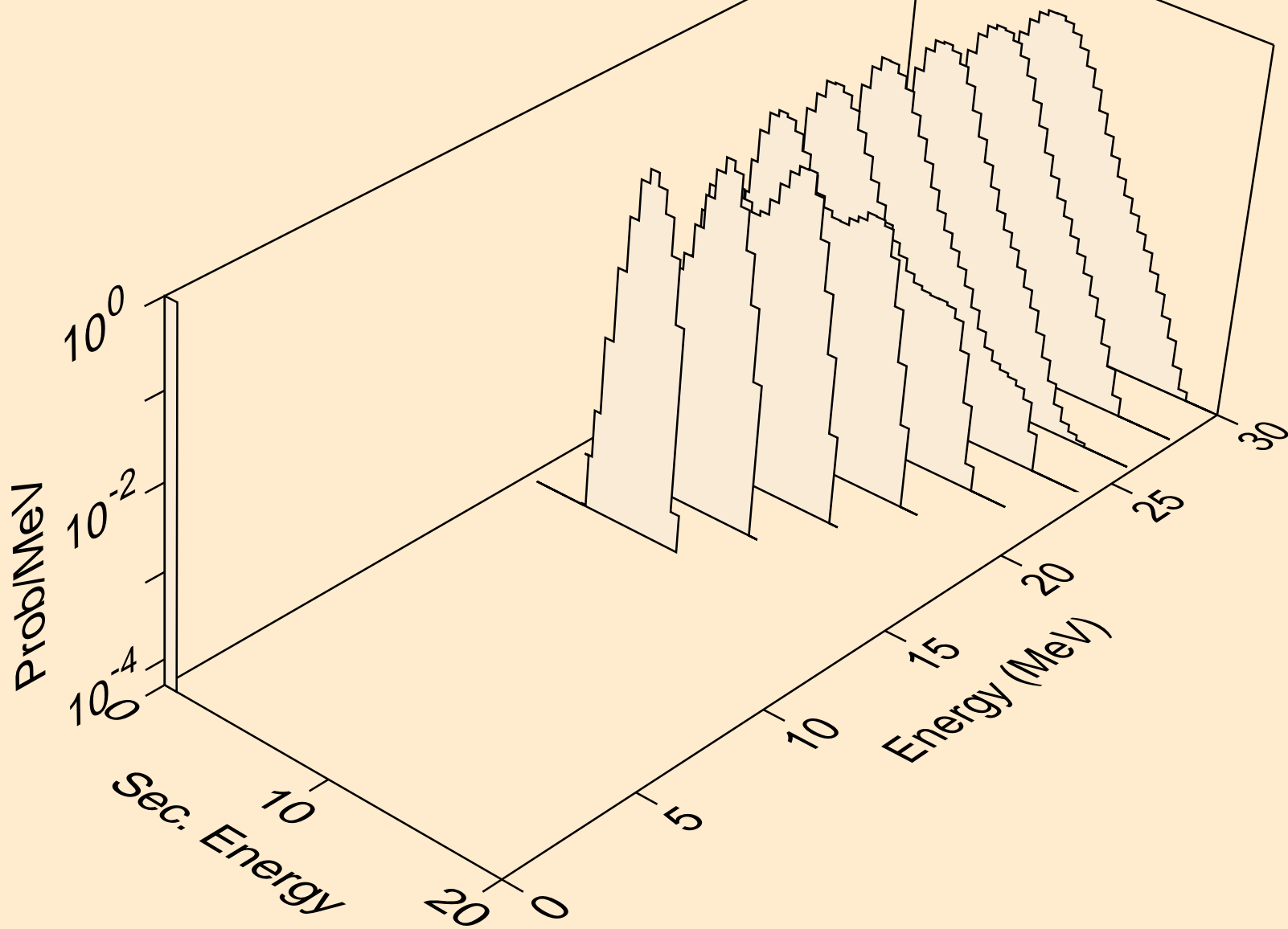

CM235 NEUTRON ACER TENDL-2023 LIBRARY; T=0.K  
protons from (n,p)

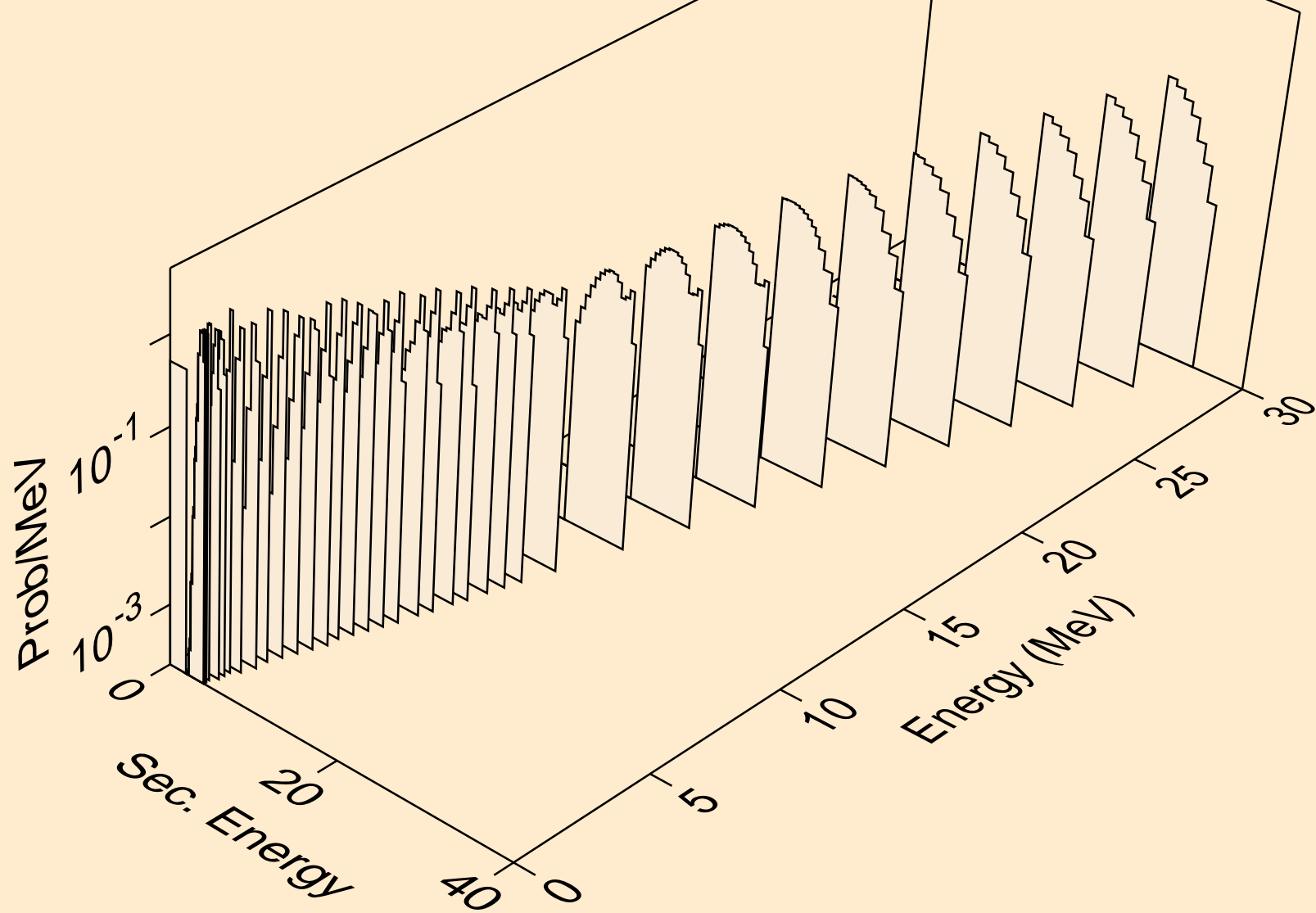

CM235 NEUTRON ACER TENDL-2023 LIBRARY; T=0.K  
protons from (n,2p)

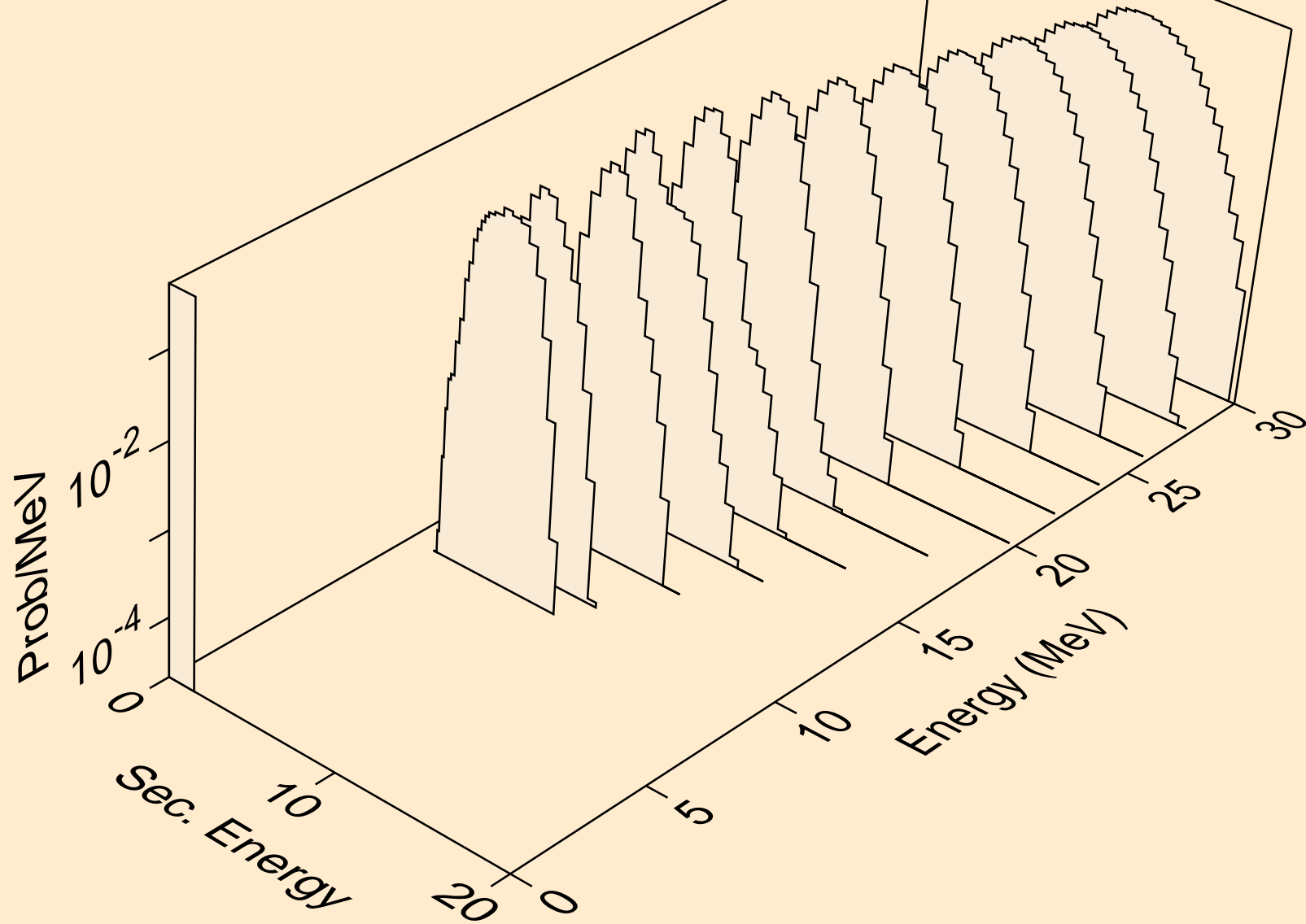

CM235 NEUTRON ACER TENDL-2023 LIBRARY; T=0.K  
protons from (n,p)

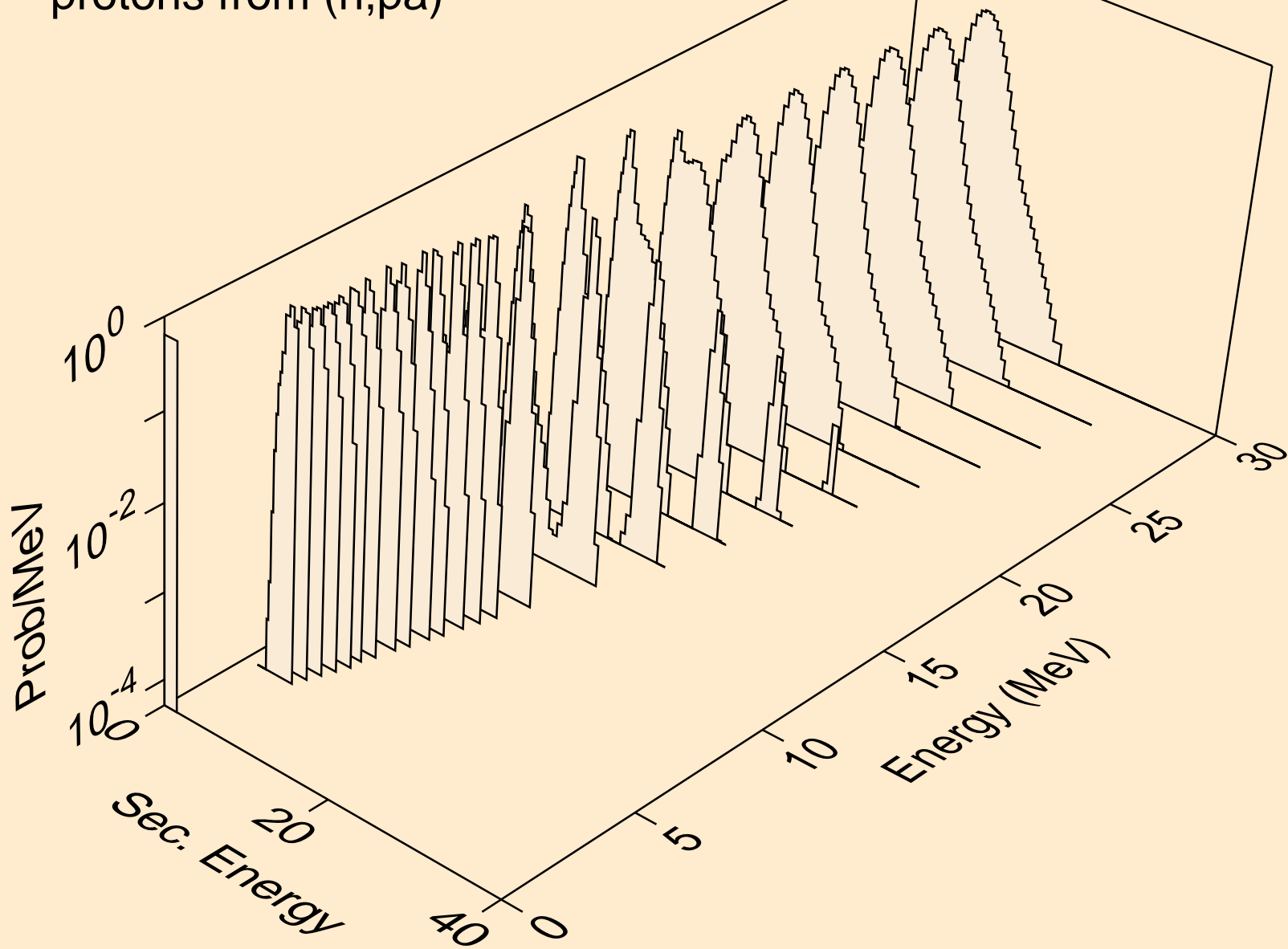

CM235 NEUTRON ACER TENDL-2023 LIBRARY; T=0.K  
protons from (n,pd)

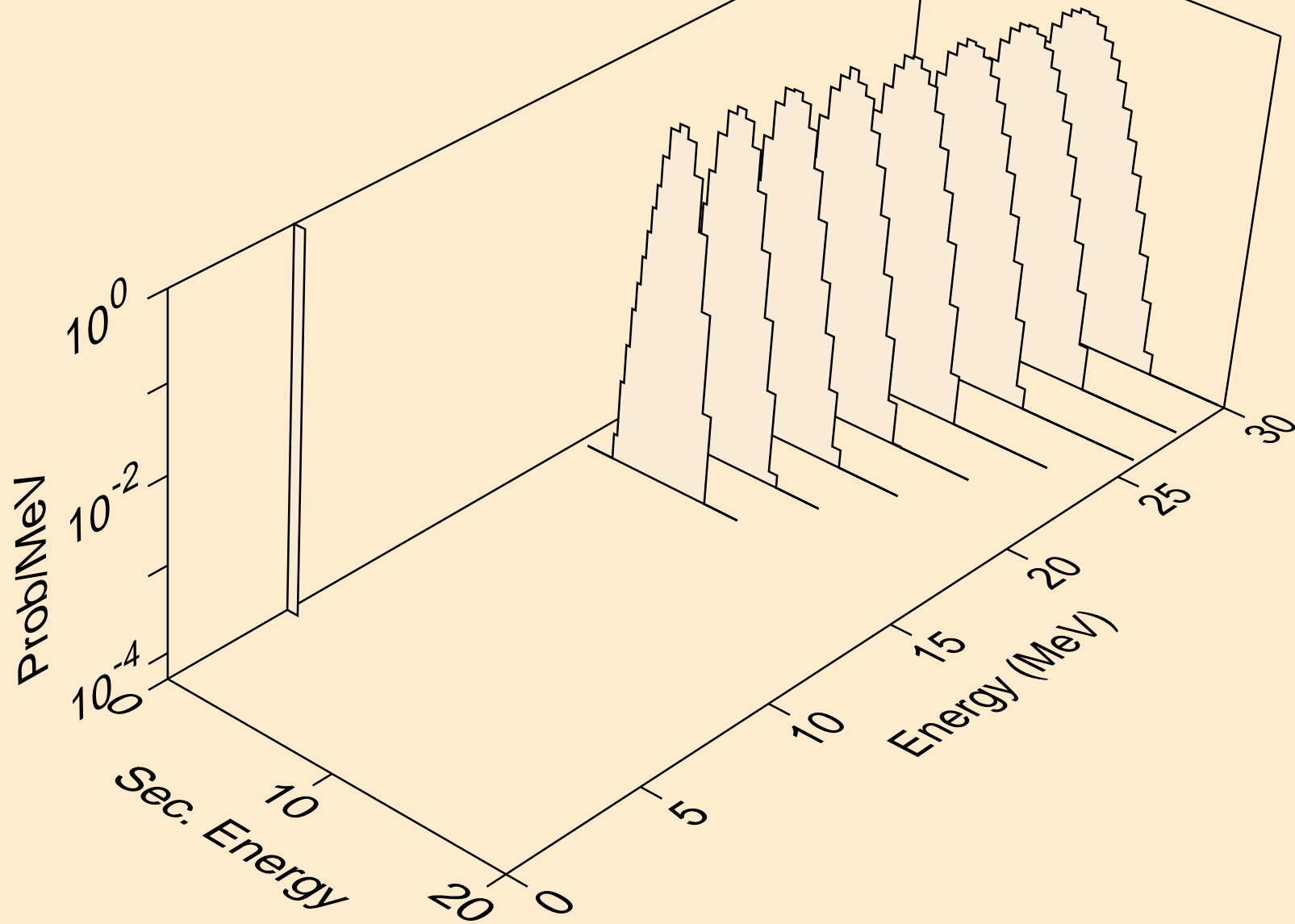



CM235 NEUTRON ACER TENDL-2023 LIBRARY; T=0.K  
deuterons from (n,x)

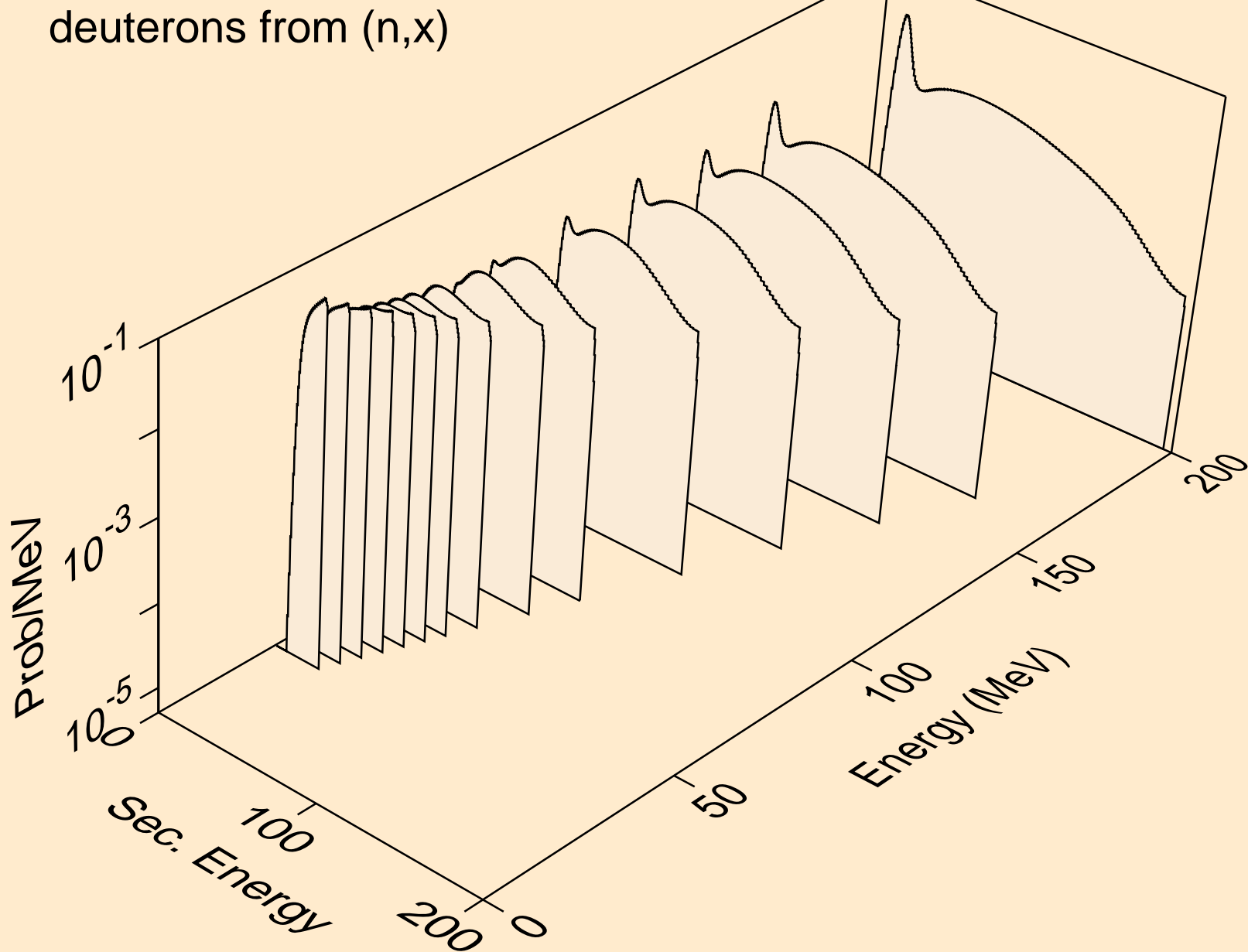

CM235 NEUTRON ACER TENDL-2023 LIBRARY; T=0.K  
deuterons from (n,n\*)d

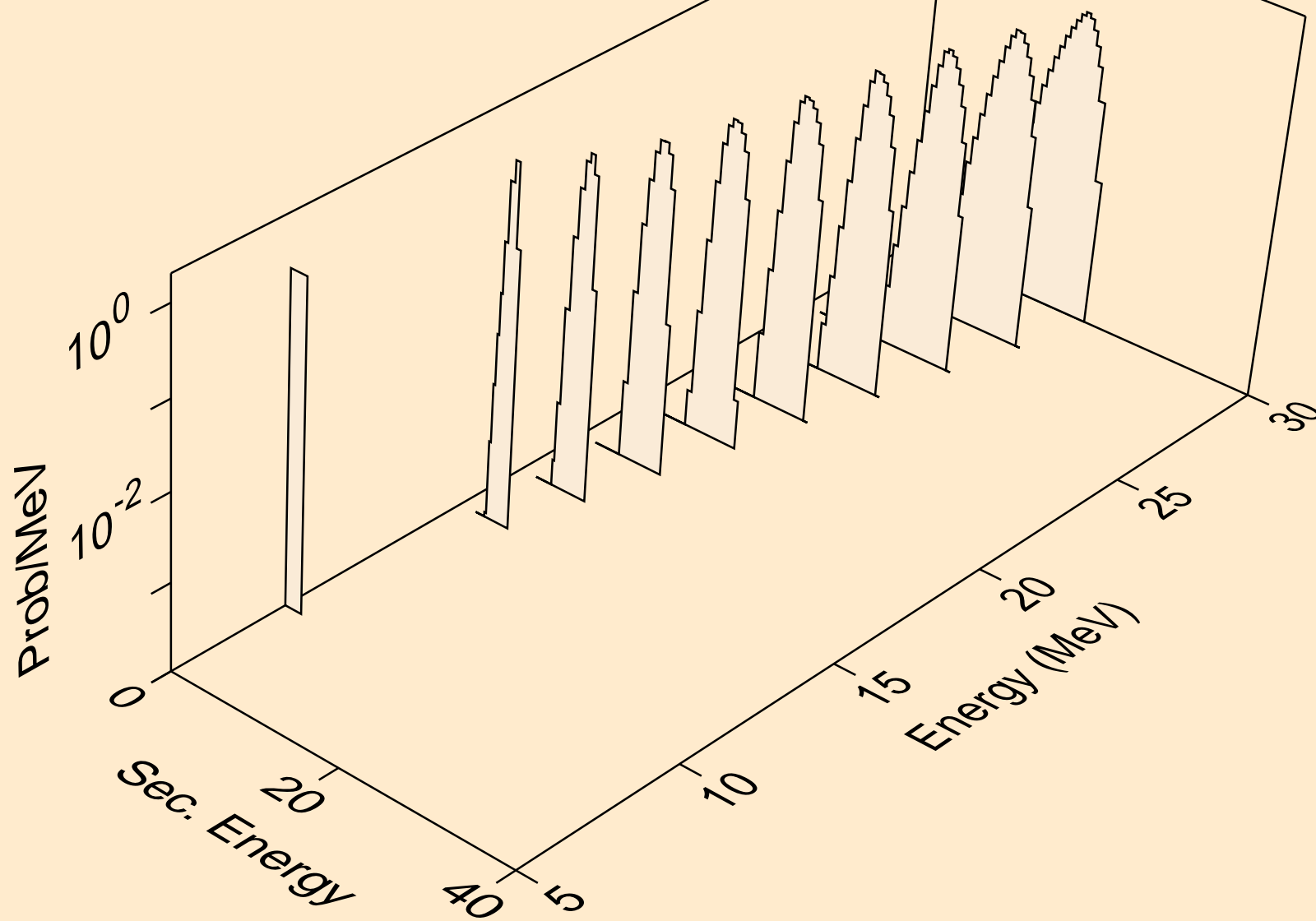

CM235 NEUTRON ACER TENDL-2023 LIBRARY; T=0.K  
deuterons from (n,d)

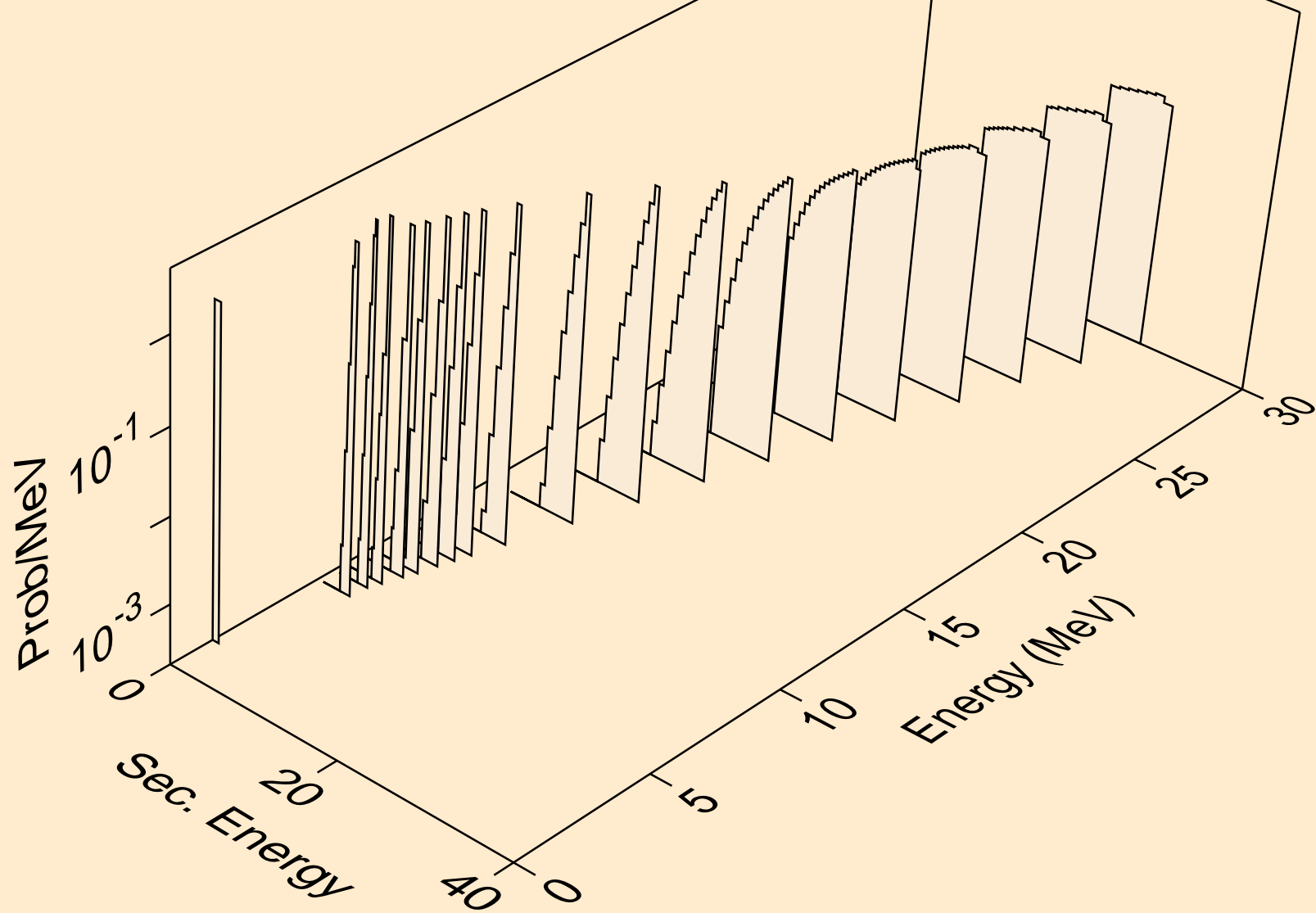

CM235 NEUTRON ACER TENDL-2023 LIBRARY; T=0.K  
deuterons from (n,pd)

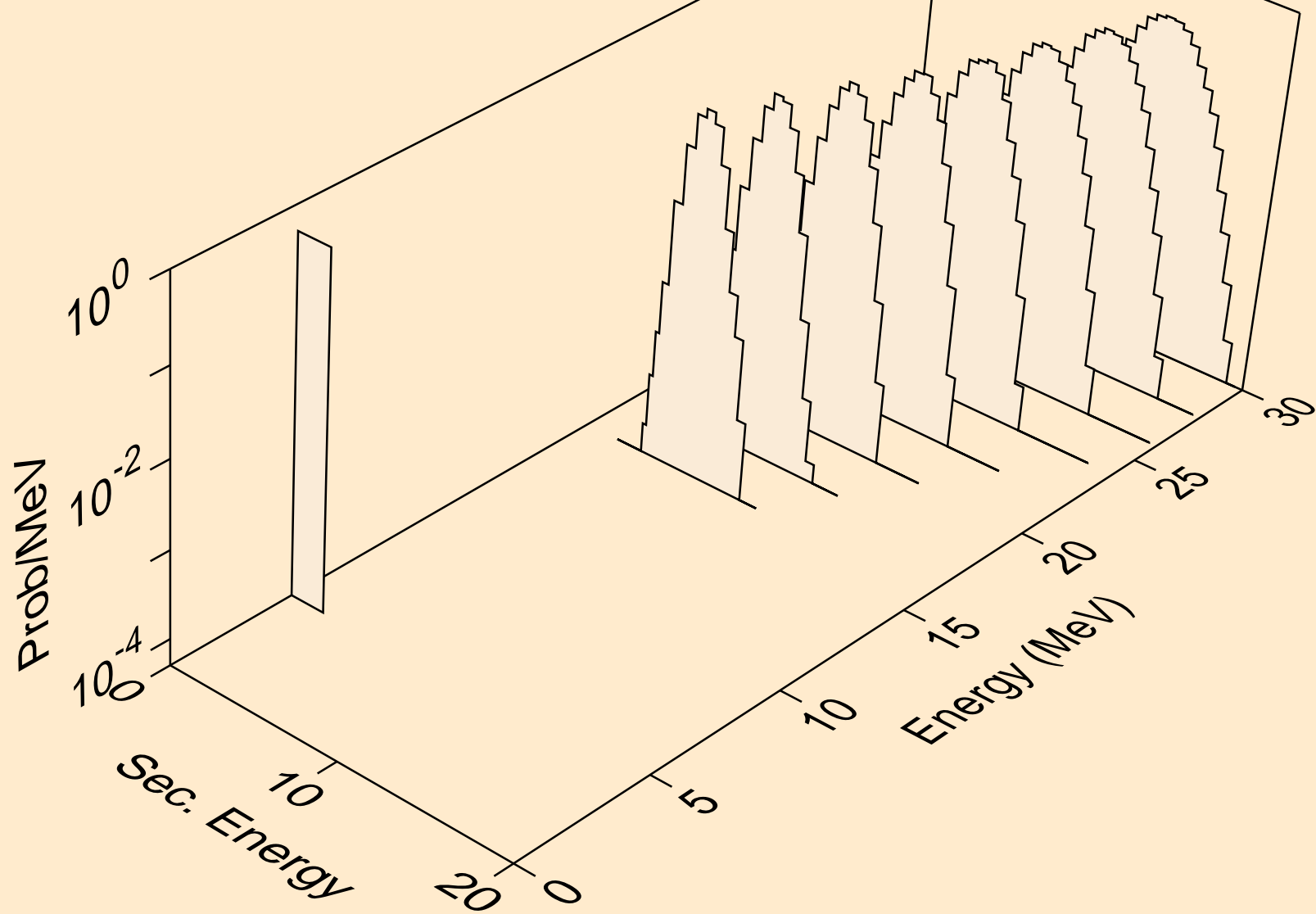

CM235 NEUTRON ACER TENDL-2023 LIBRARY; T=0.K  
tritons from (n,x)

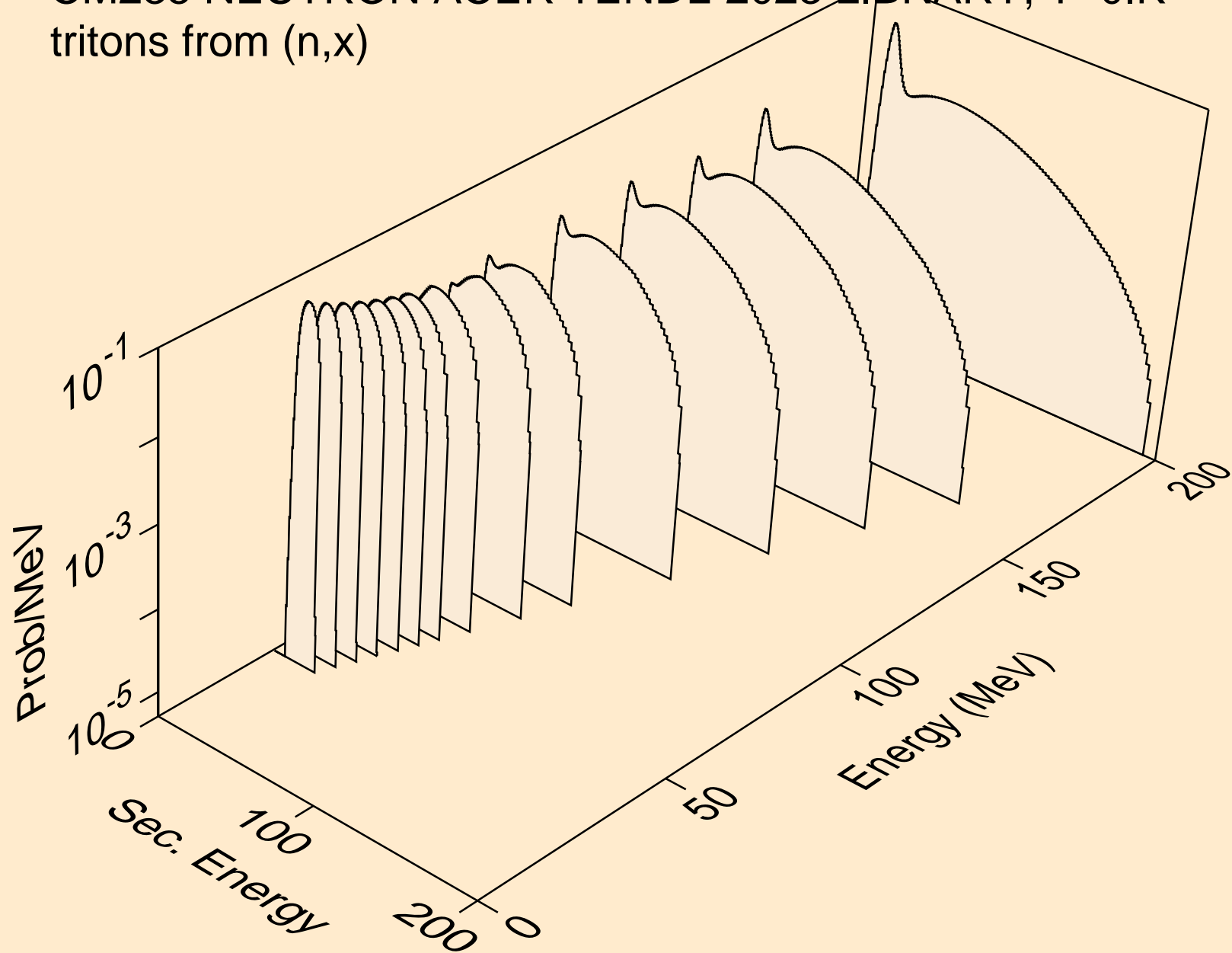

CM235 NEUTRON ACER TENDL-2023 LIBRARY; T=0.K  
tritons from (n,n\*)t

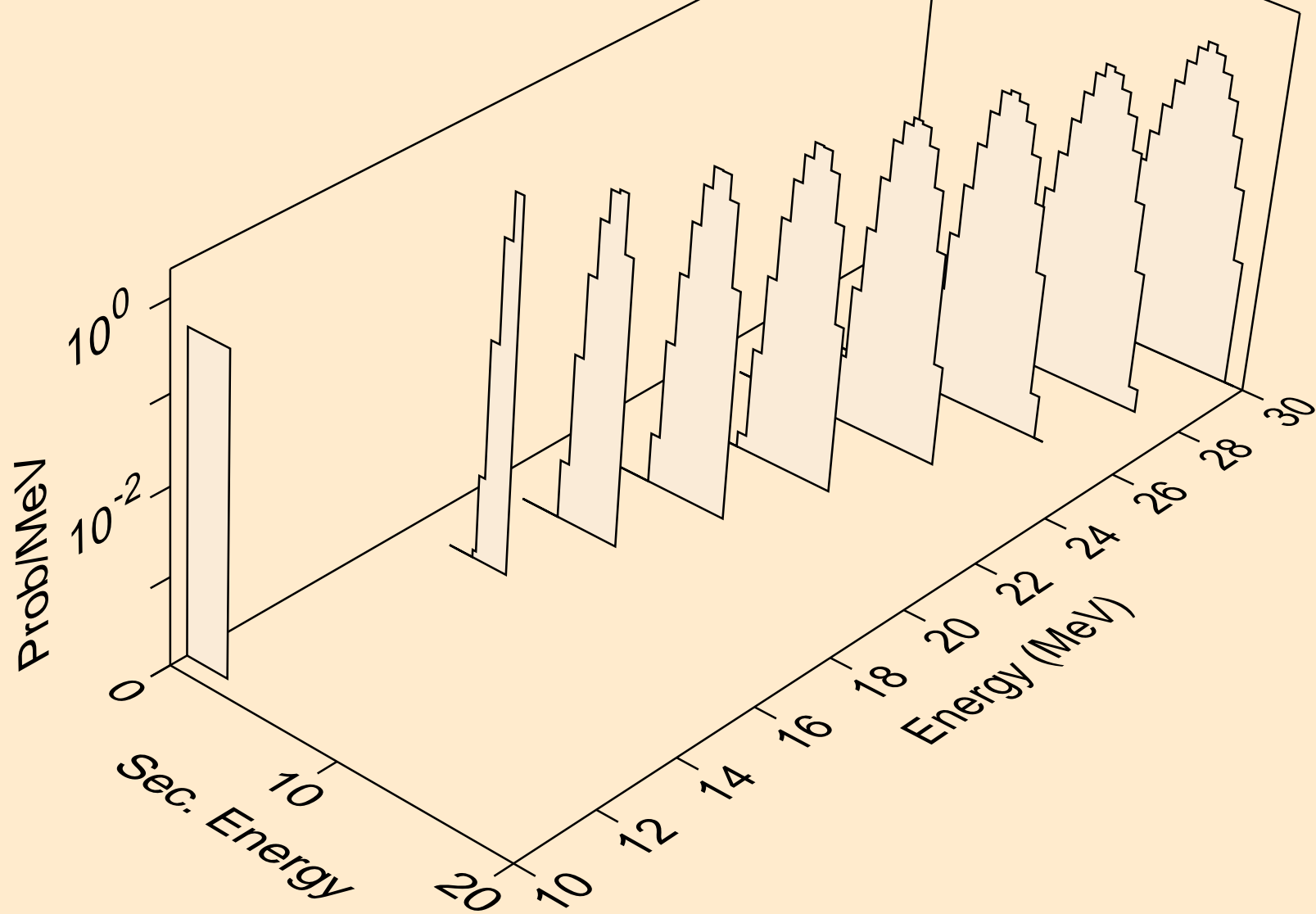

CM235 NEUTRON ACER TENDL-2023 LIBRARY; T=0.K  
tritons from (n,t)

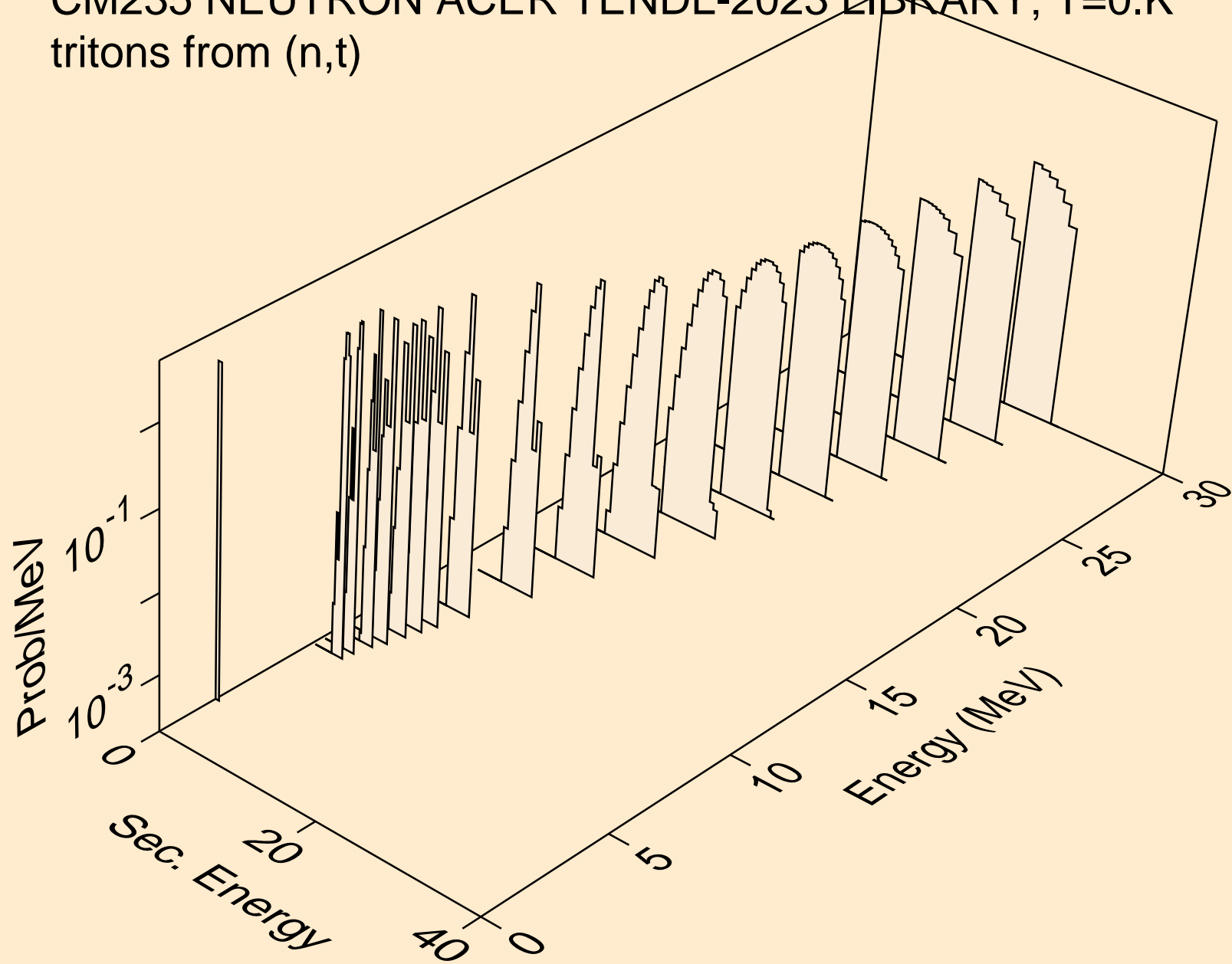

CM235 NEUTRON ACER TENDL-2023 LIBRARY; T=0.K  
he3s from (n,x)

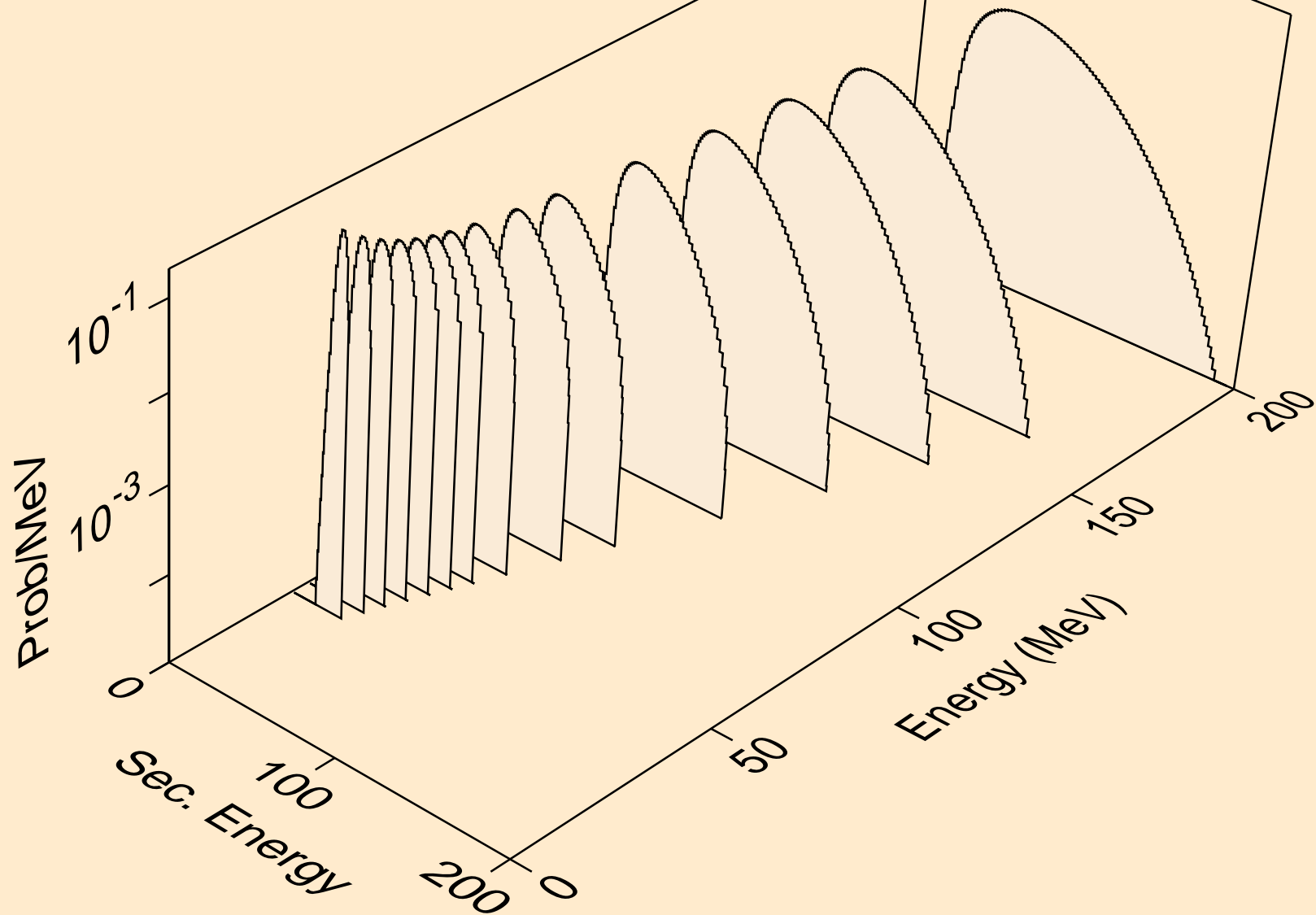



CM235 NEUTRON ACER TENDL-2023 LIBRARY; T=0.K  
he3s from (n,n\*)he3

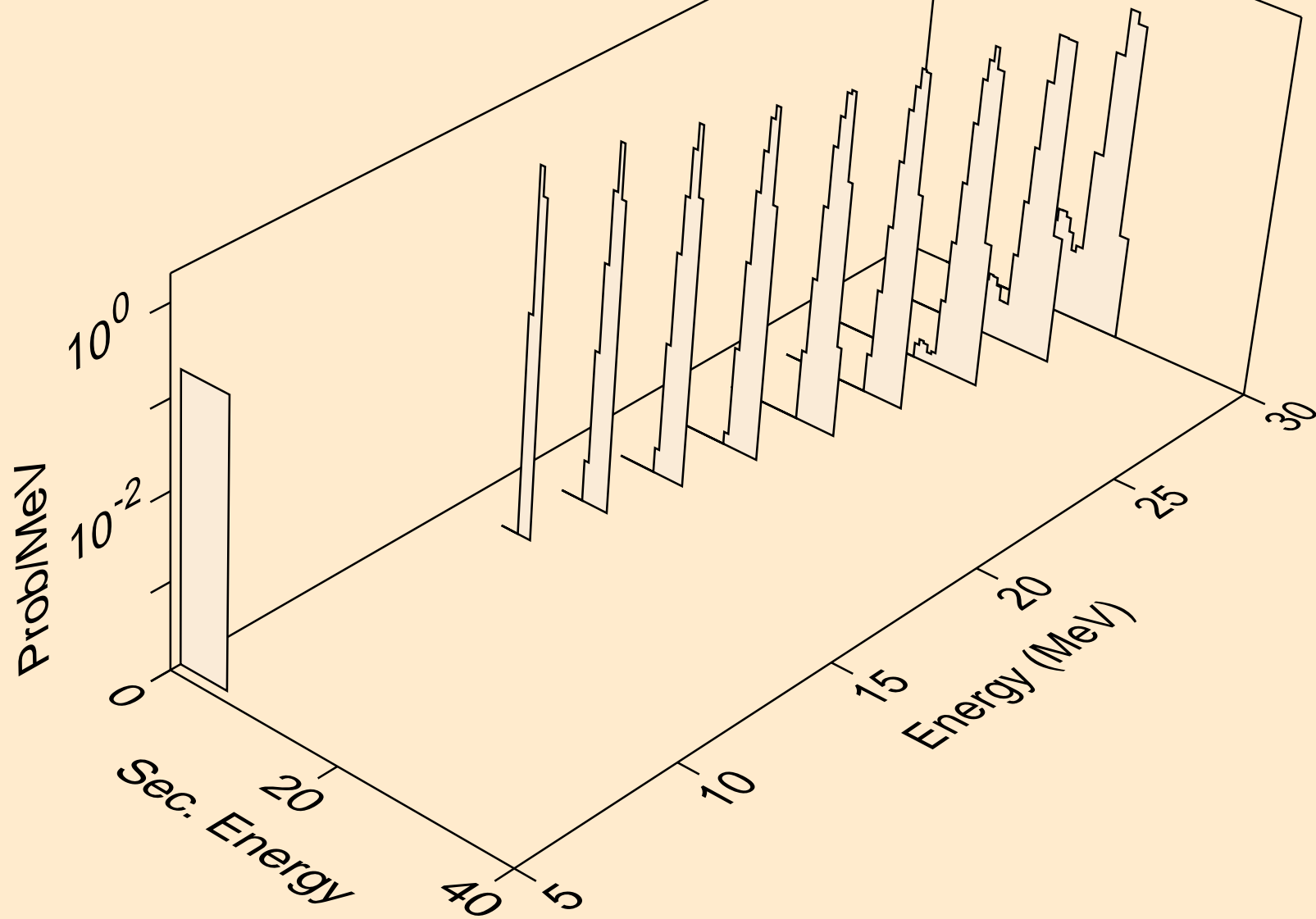

CM235 NEUTRON ACER TENDL-2023 LIBRARY; T=0.K  
he3s from (n,he3)

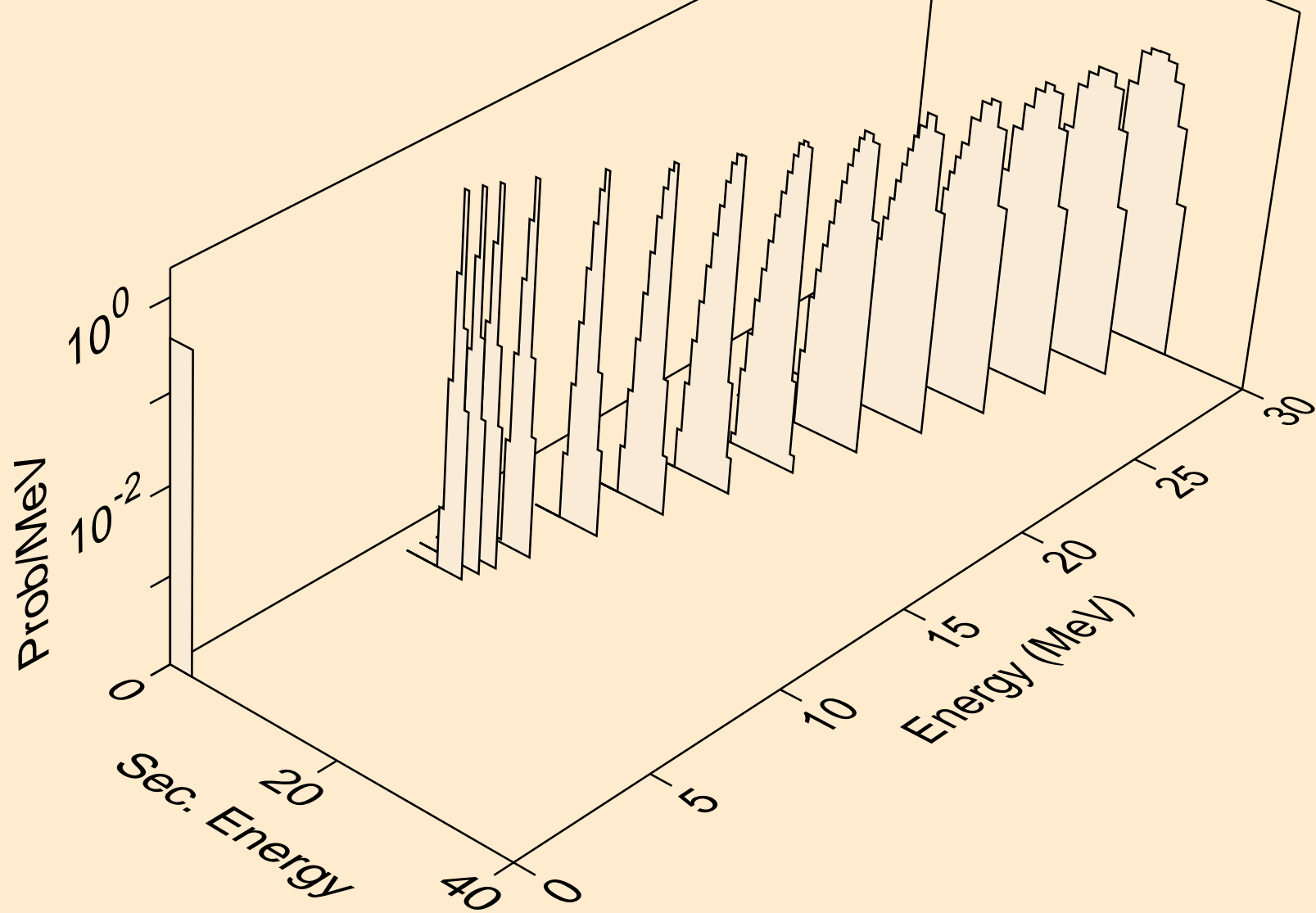

CM235 NEUTRON ACER TENDL-2023 LIBRARY; T=0.K  
alphas from (n,x)

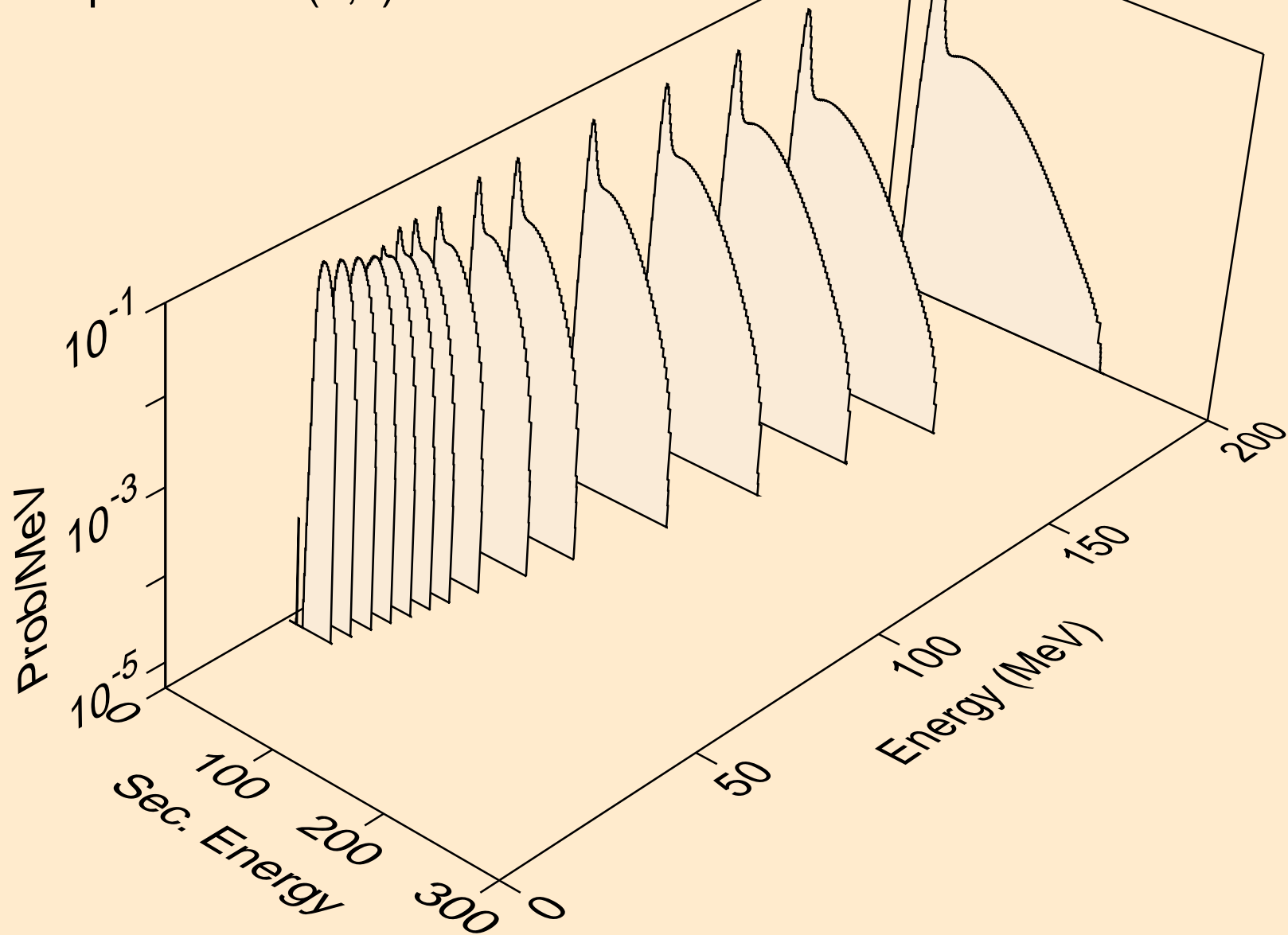

CM235 NEUTRON ACER TENDL-2023 LIBRARY; T=0.K  
alphas from (n,n\*)a

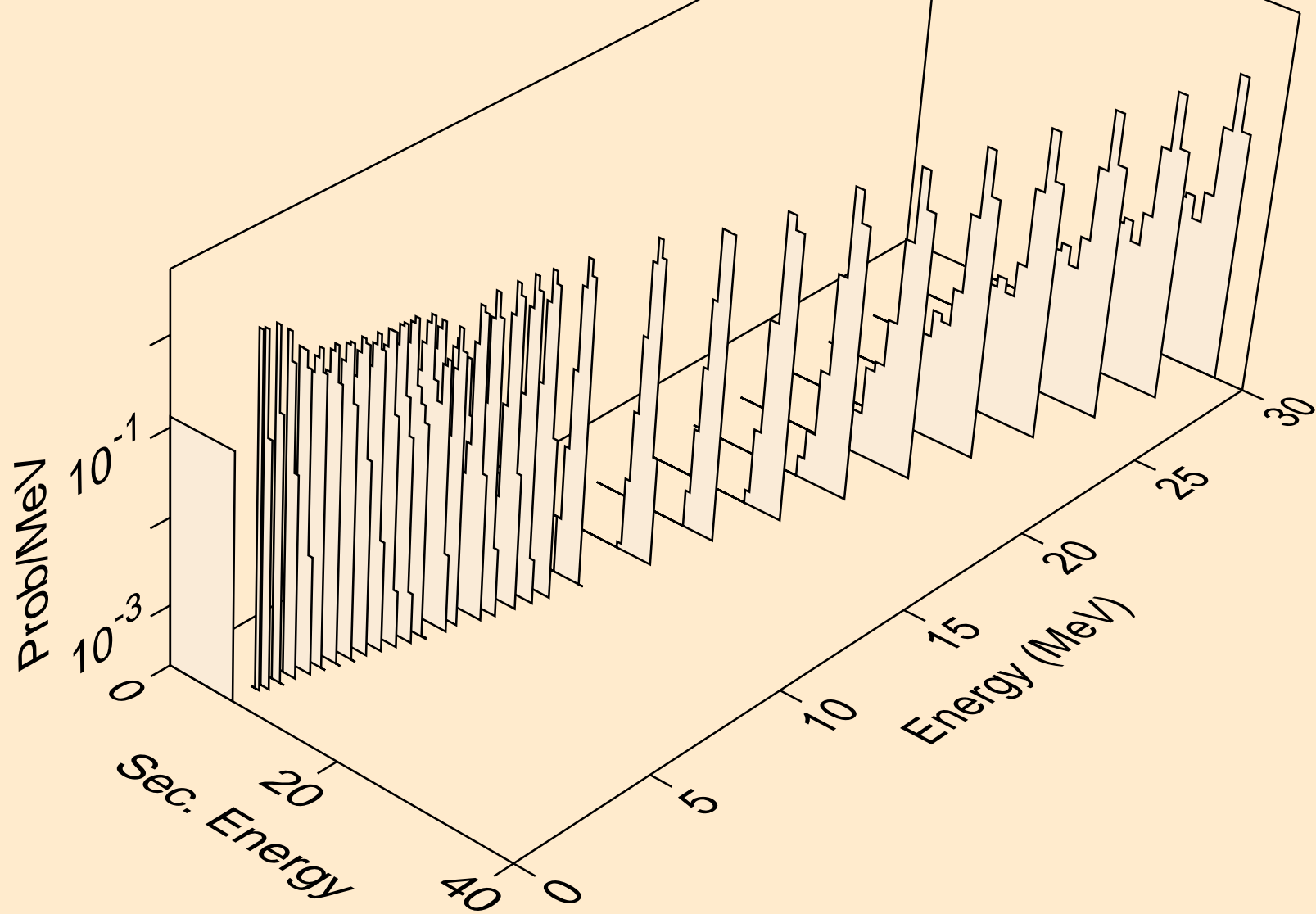

CM235 NEUTRON ACER TENDL-2023 LIBRARY; T=0.K  
alphas from (n,2n)a

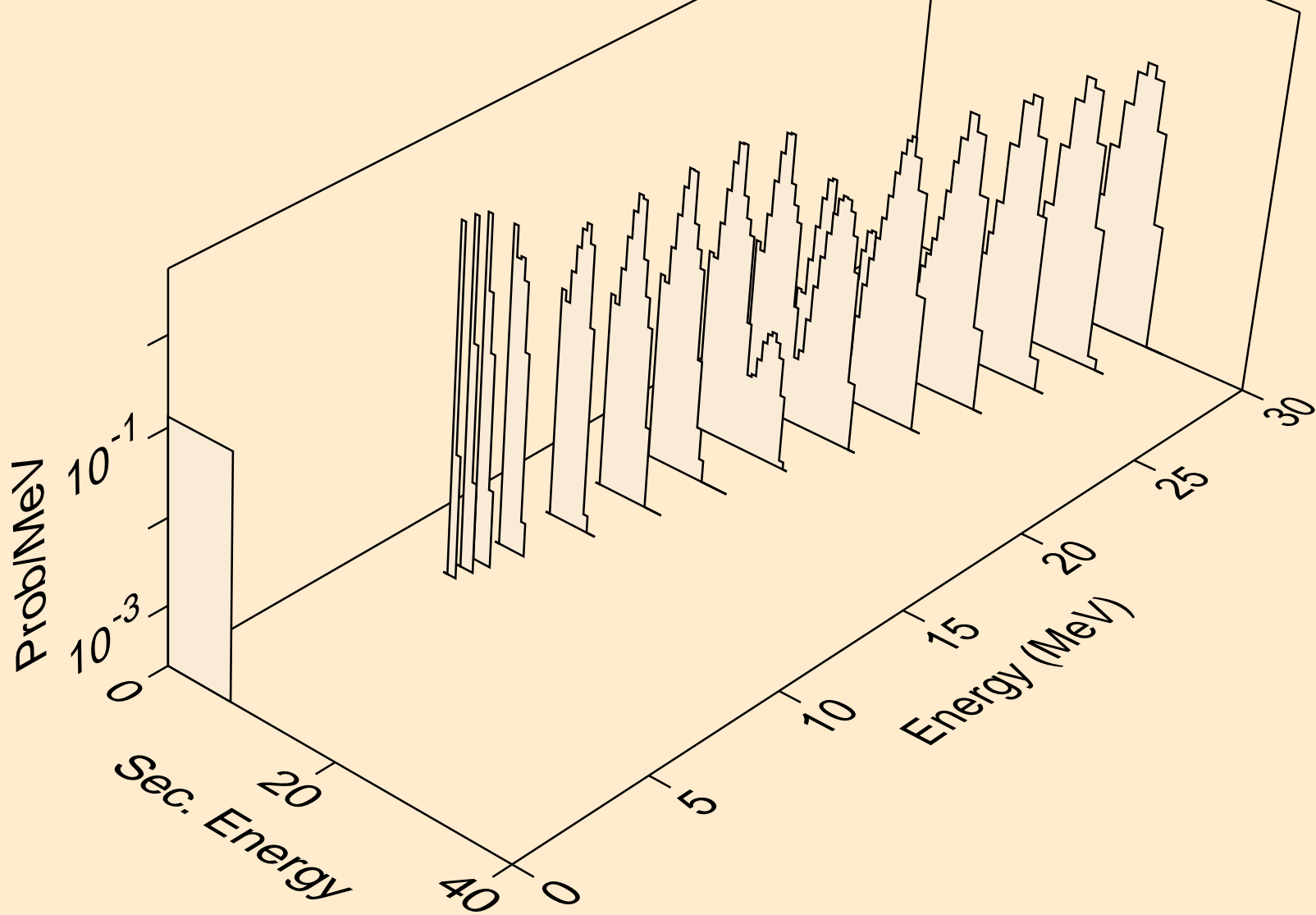

CM235 NEUTRON ACER TENDL-2023 LIBRARY; T=0.K  
alphas from (n,n\*)2a

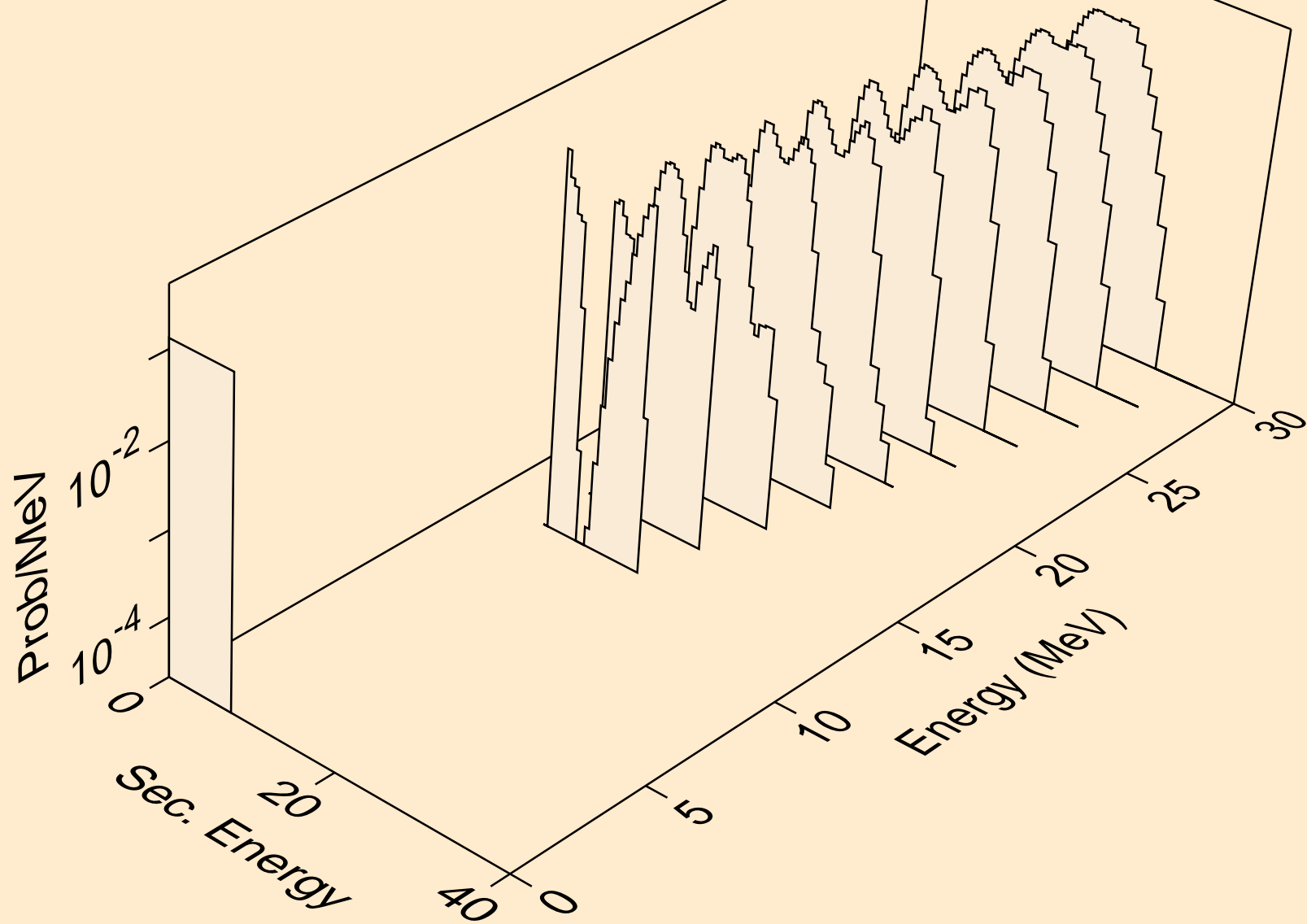

CM235 NEUTRON ACER TENDL-2023 LIBRARY; T=0.K  
alphas from (n,npa)

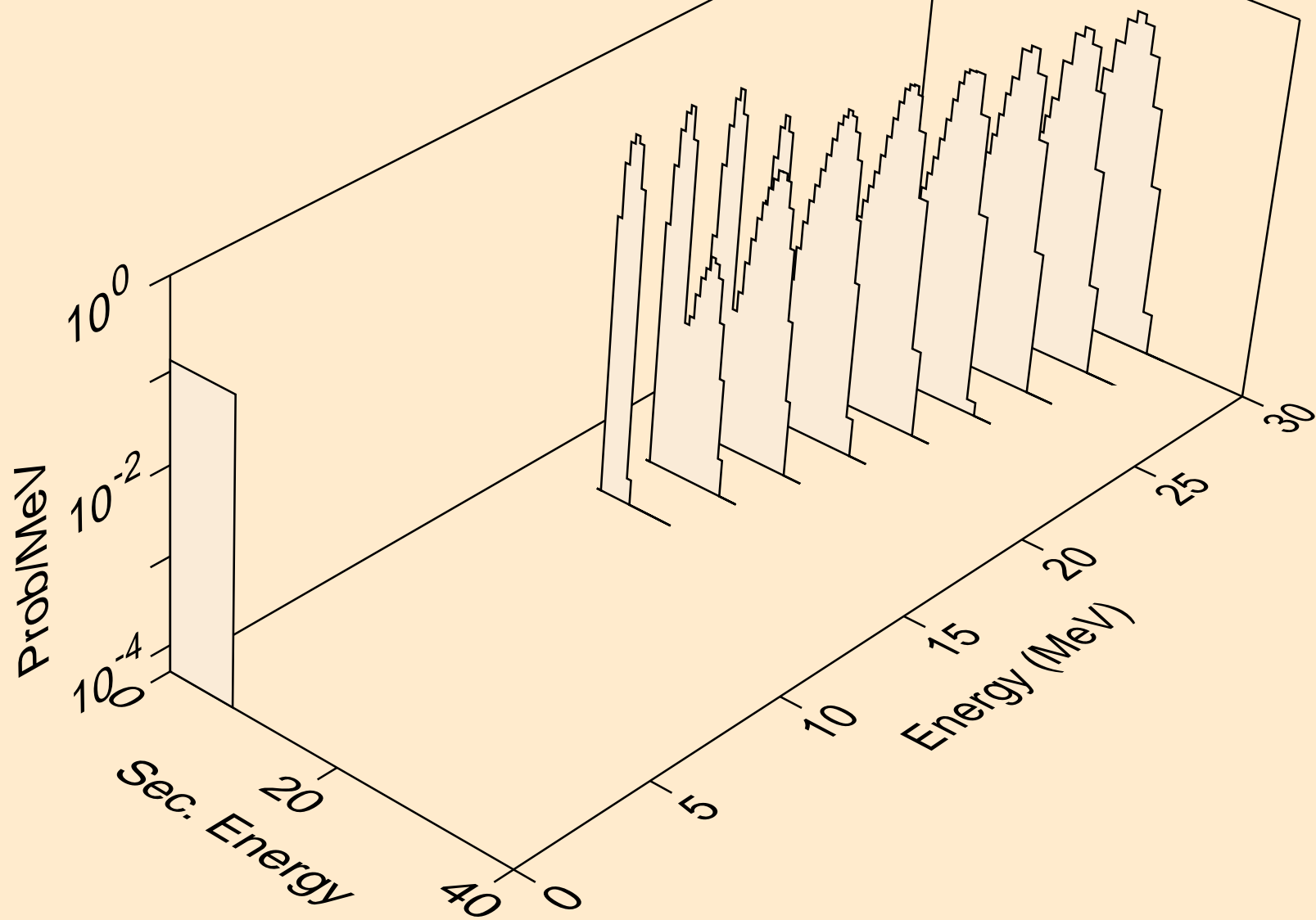

CM235 NEUTRON ACER TENDL-2023 LIBRARY; T=0.K  
alphas from (n,a)

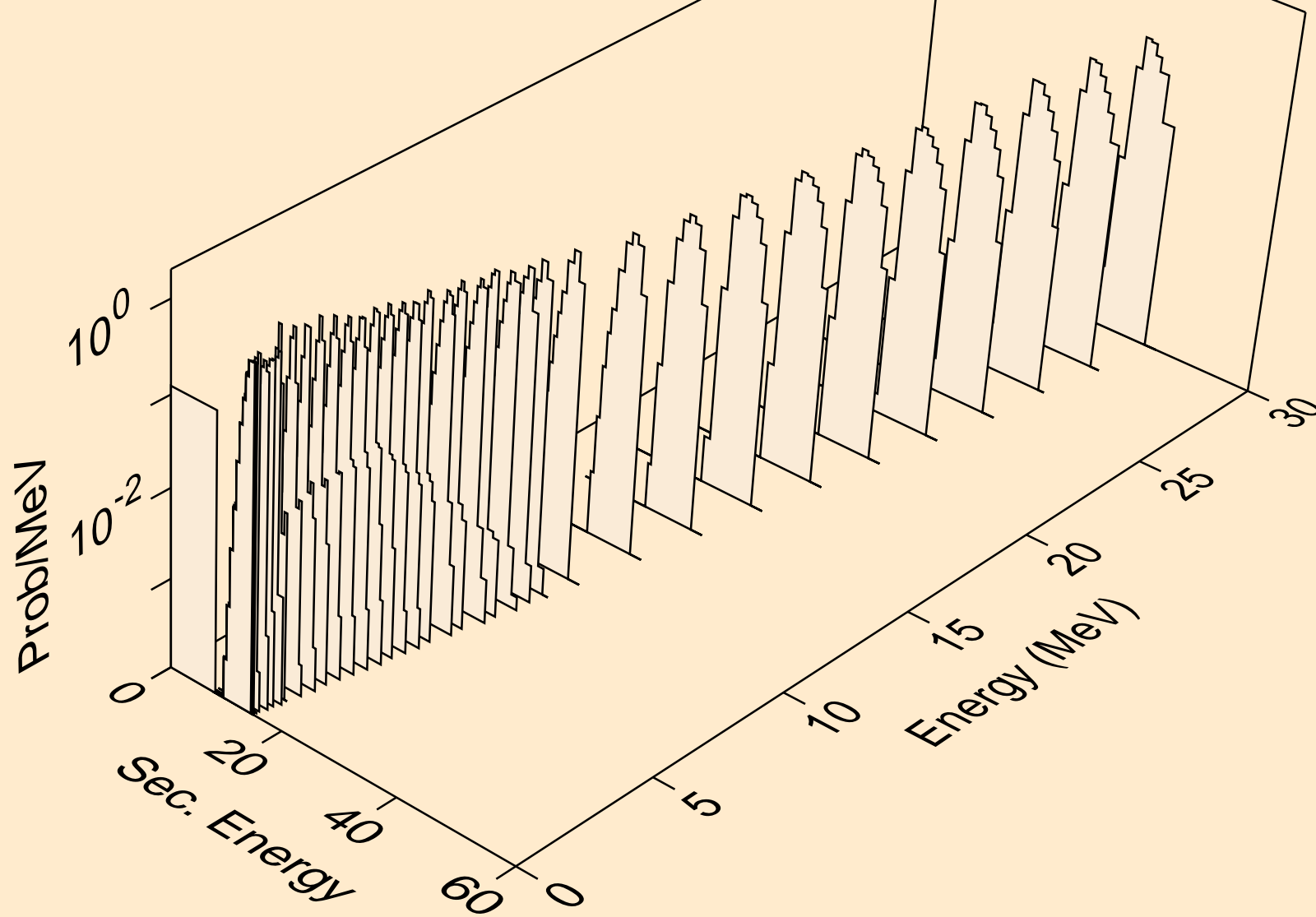



CM235 NEUTRON ACER TENDL-2023 LIBRARY; T=0.K  
alphas from (n,2a)

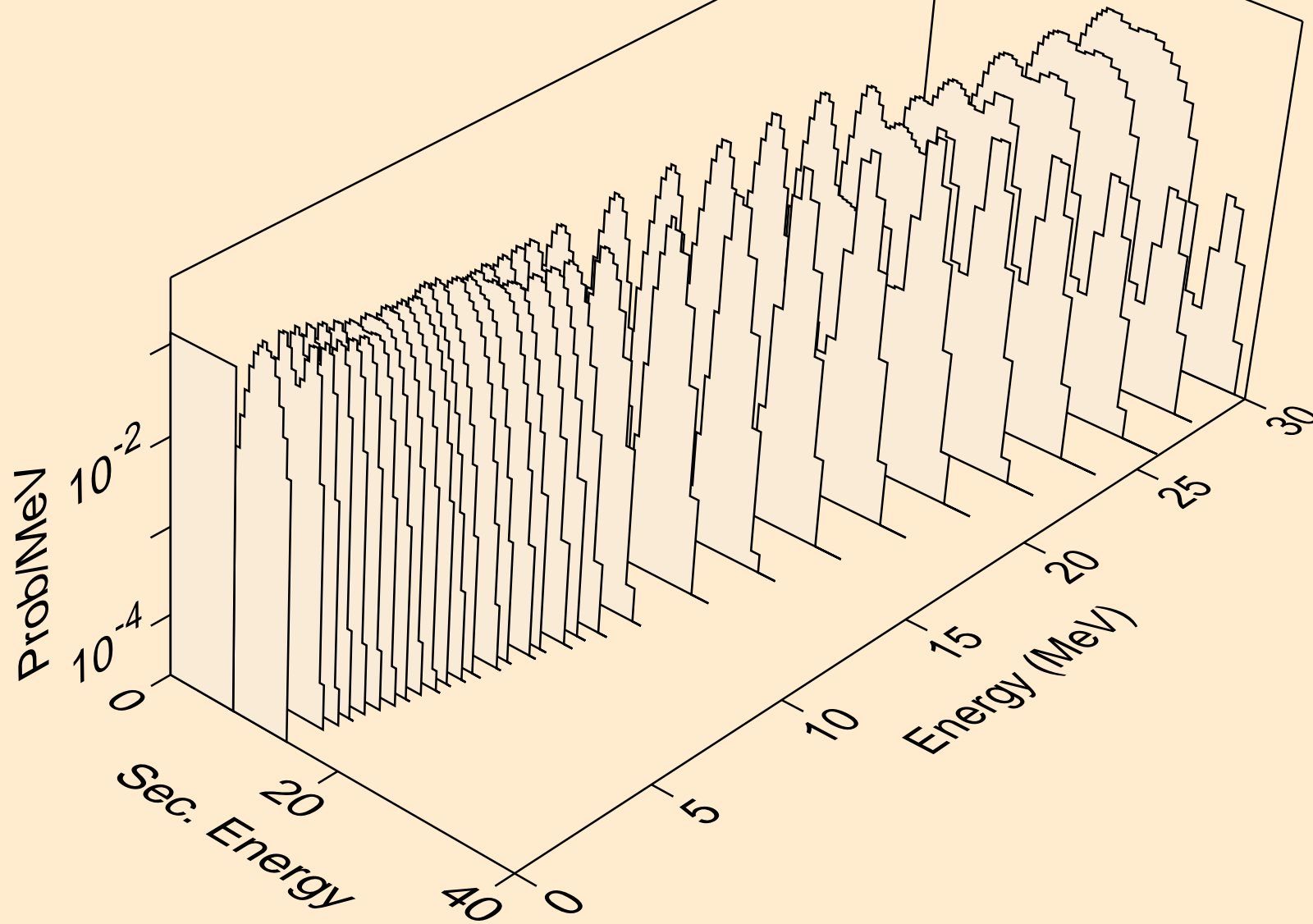

CM235 NEUTRON ACER TENDL-2023 LIBRARY; T=0.K  
alphas from (n,p)

