

# CM250 NEUTRON ACER TENDL-2023 LIBRARY; T=0.K

## Principal cross sections

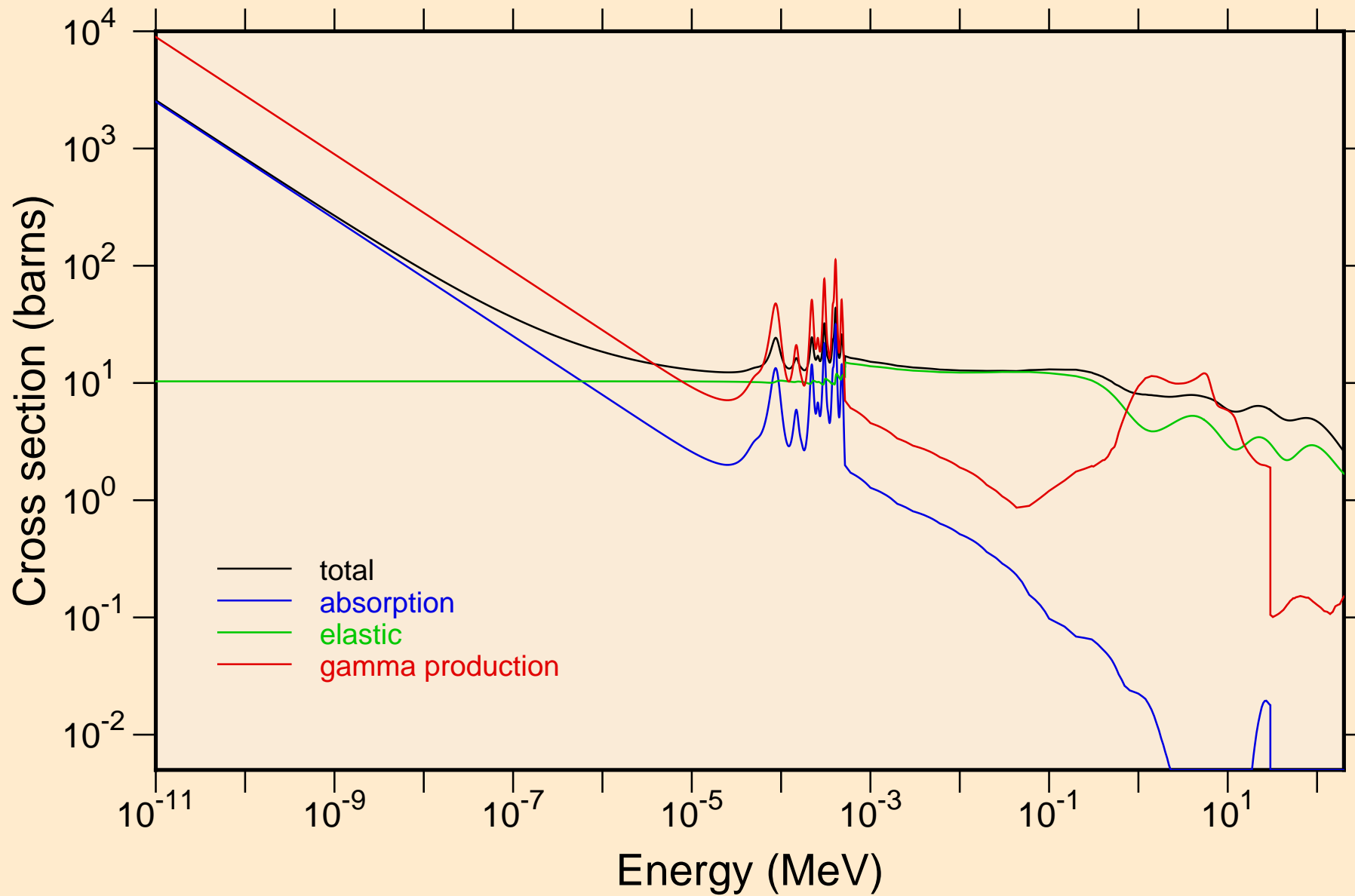

# CM250 NEUTRON ACER TENDL-2023 LIBRARY; T=0.K

## Heating

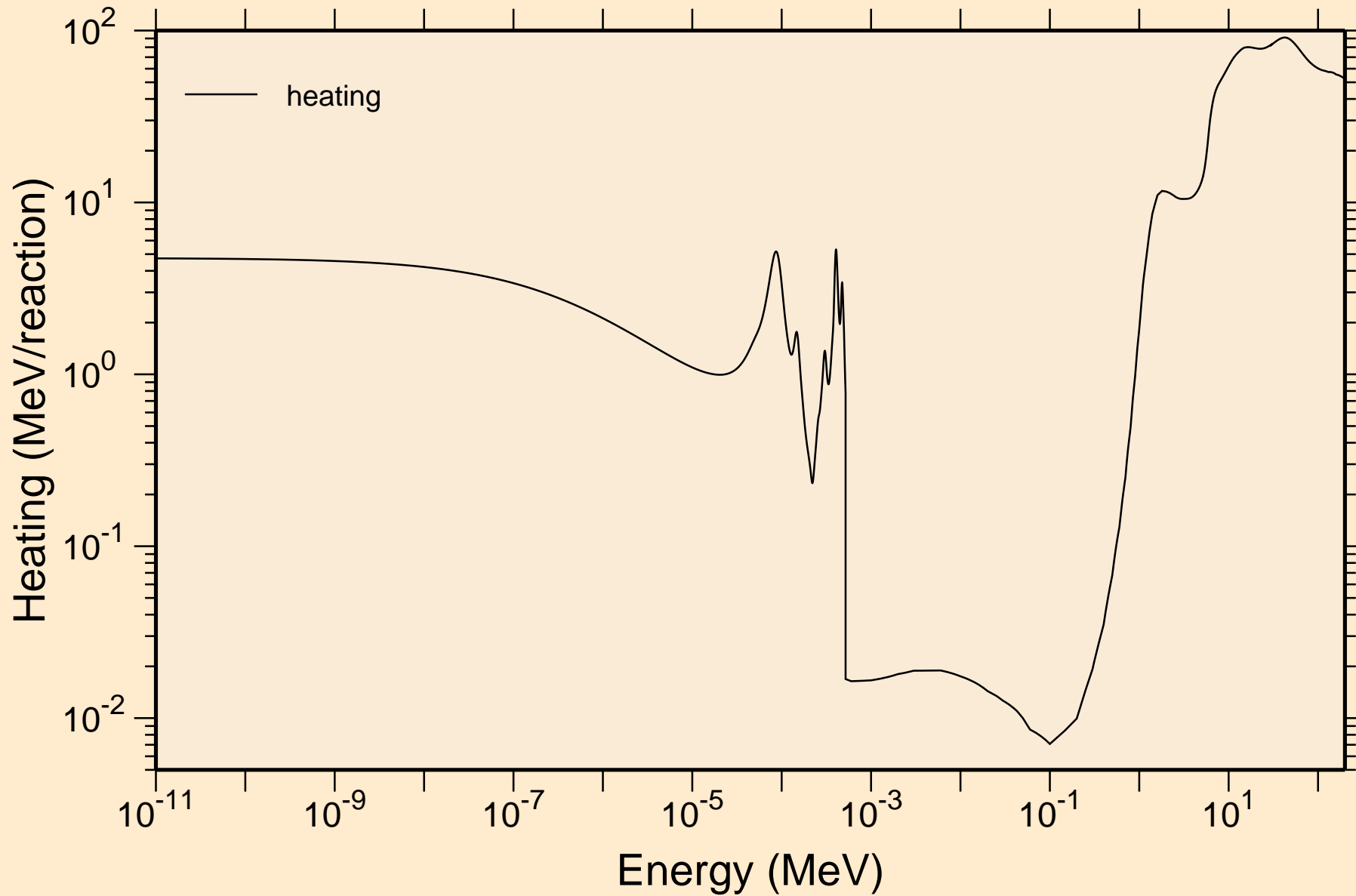

CM250 NEUTRON ACER TENDL-2023 LIBRARY; T=0.K  
Damage

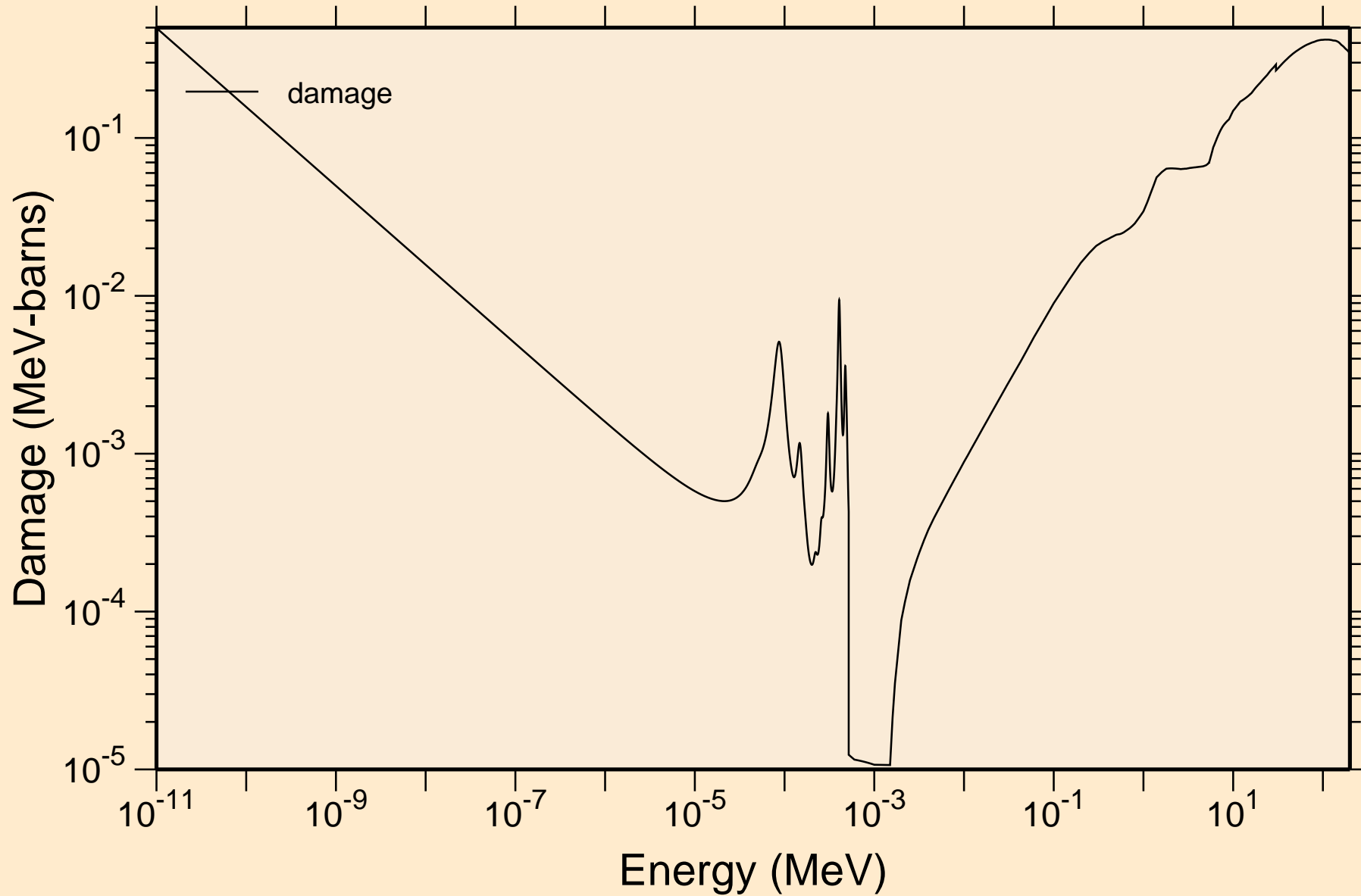

# CM250 NEUTRON ACER TENDL-2023 LIBRARY; T=0.K

## Non-threshold reactions

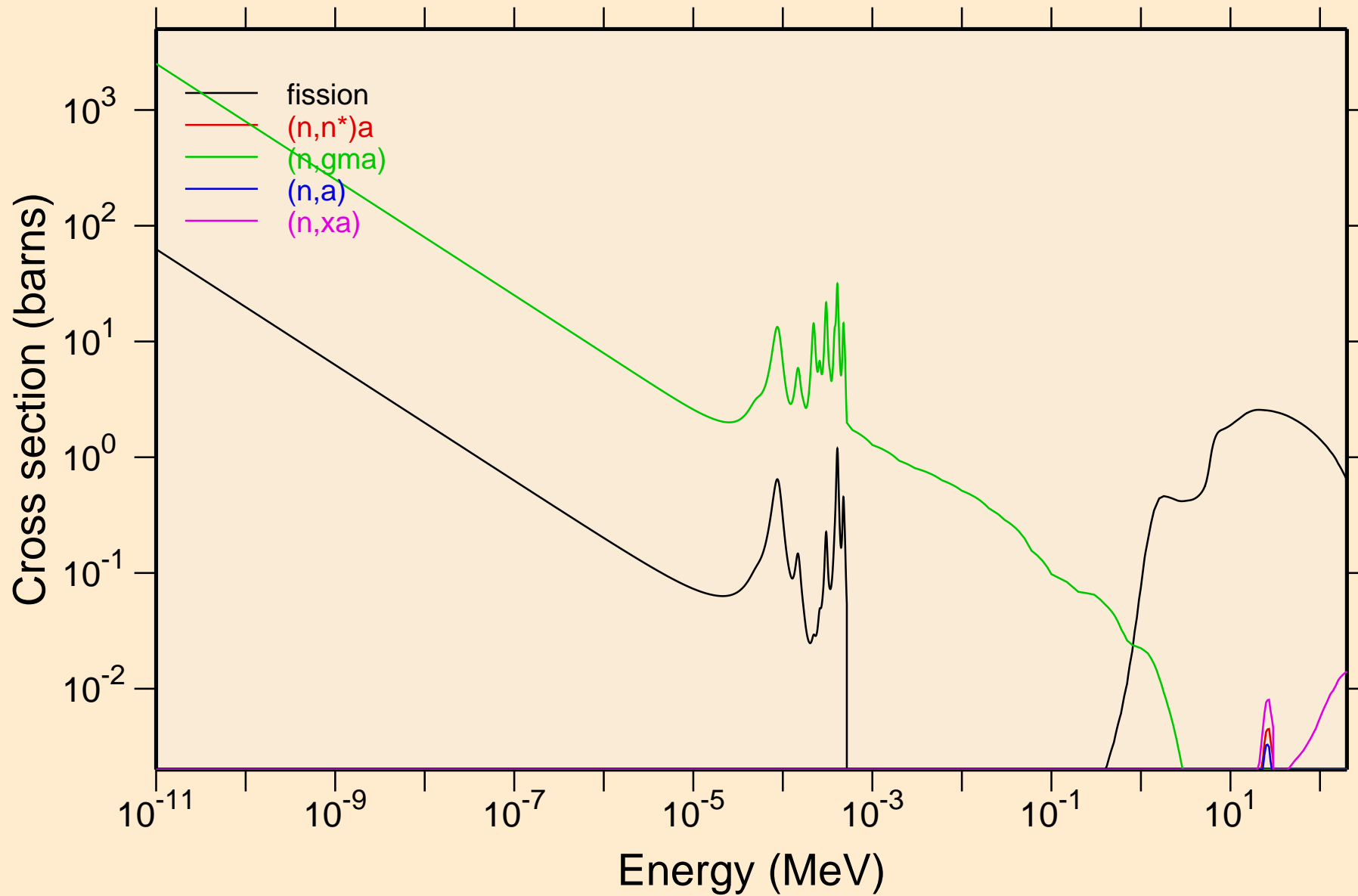

# CM250 NEUTRON ACER TENDL-2023 LIBRARY; T=0.K

## Principal cross sections

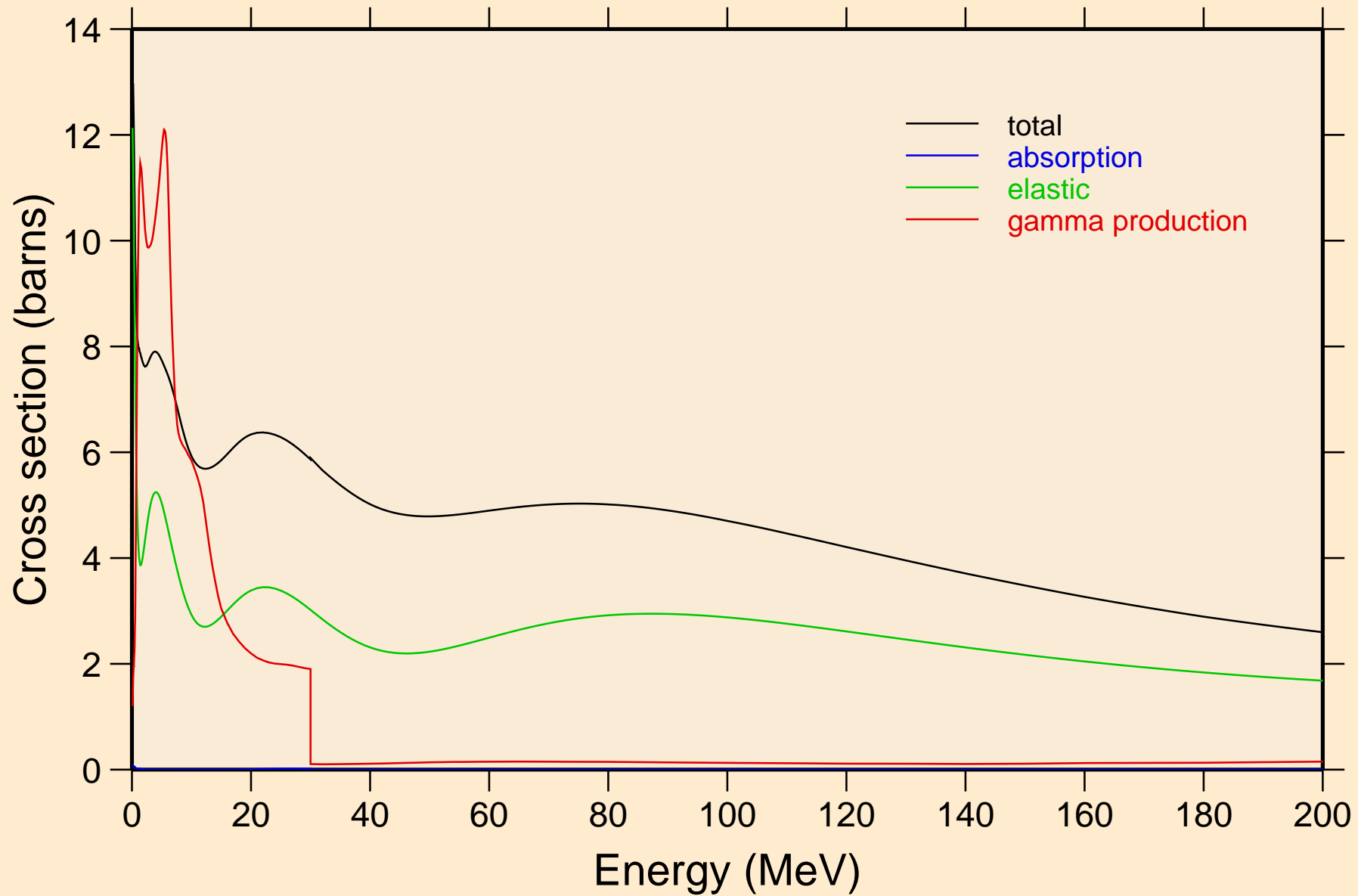

# CM250 NEUTRON ACER TENDL-2023 LIBRARY; T=0.K

## Heating

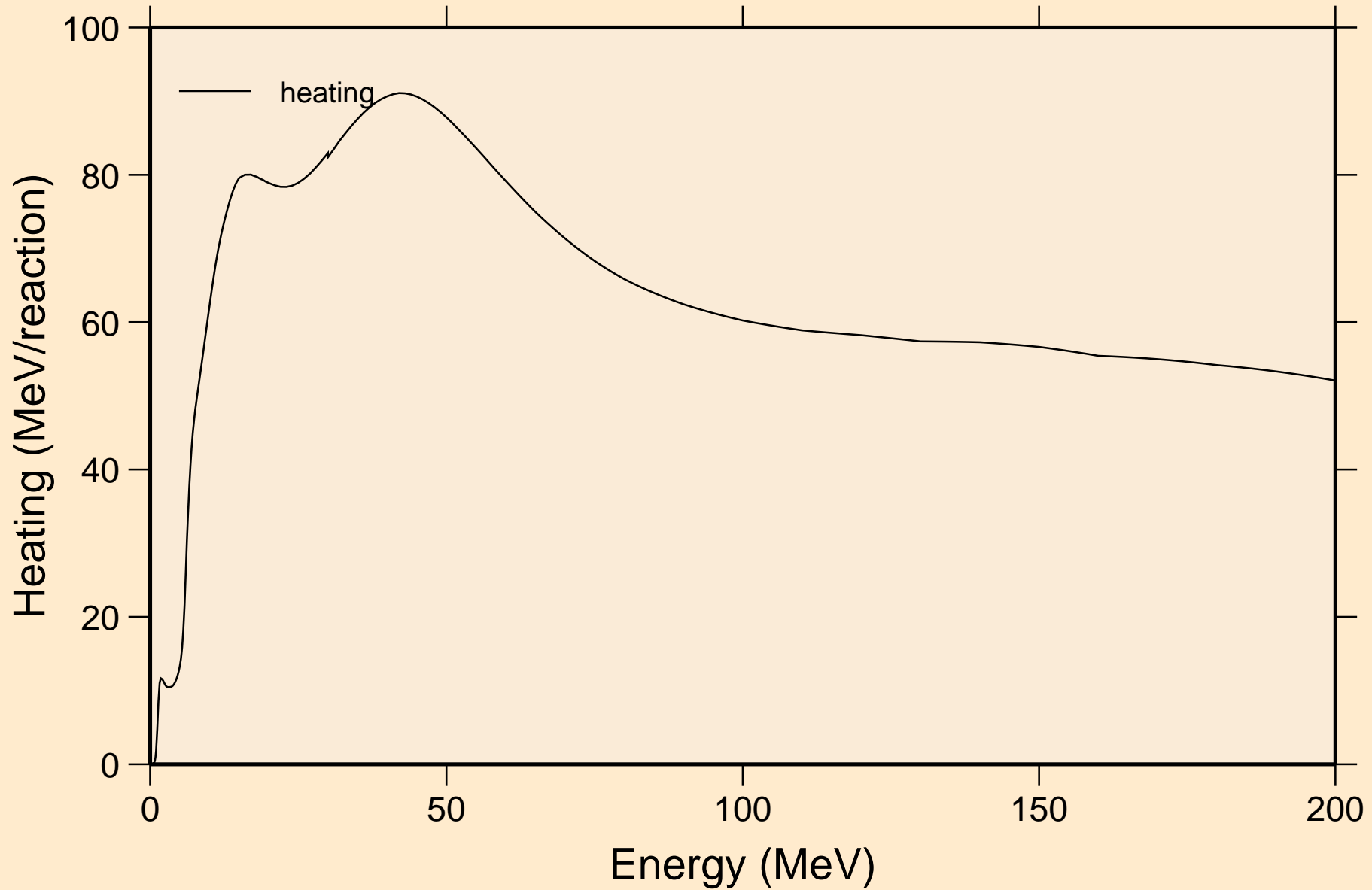

# CM250 NEUTRON ACER TENDL-2023 LIBRARY; T=0.K

## Damage

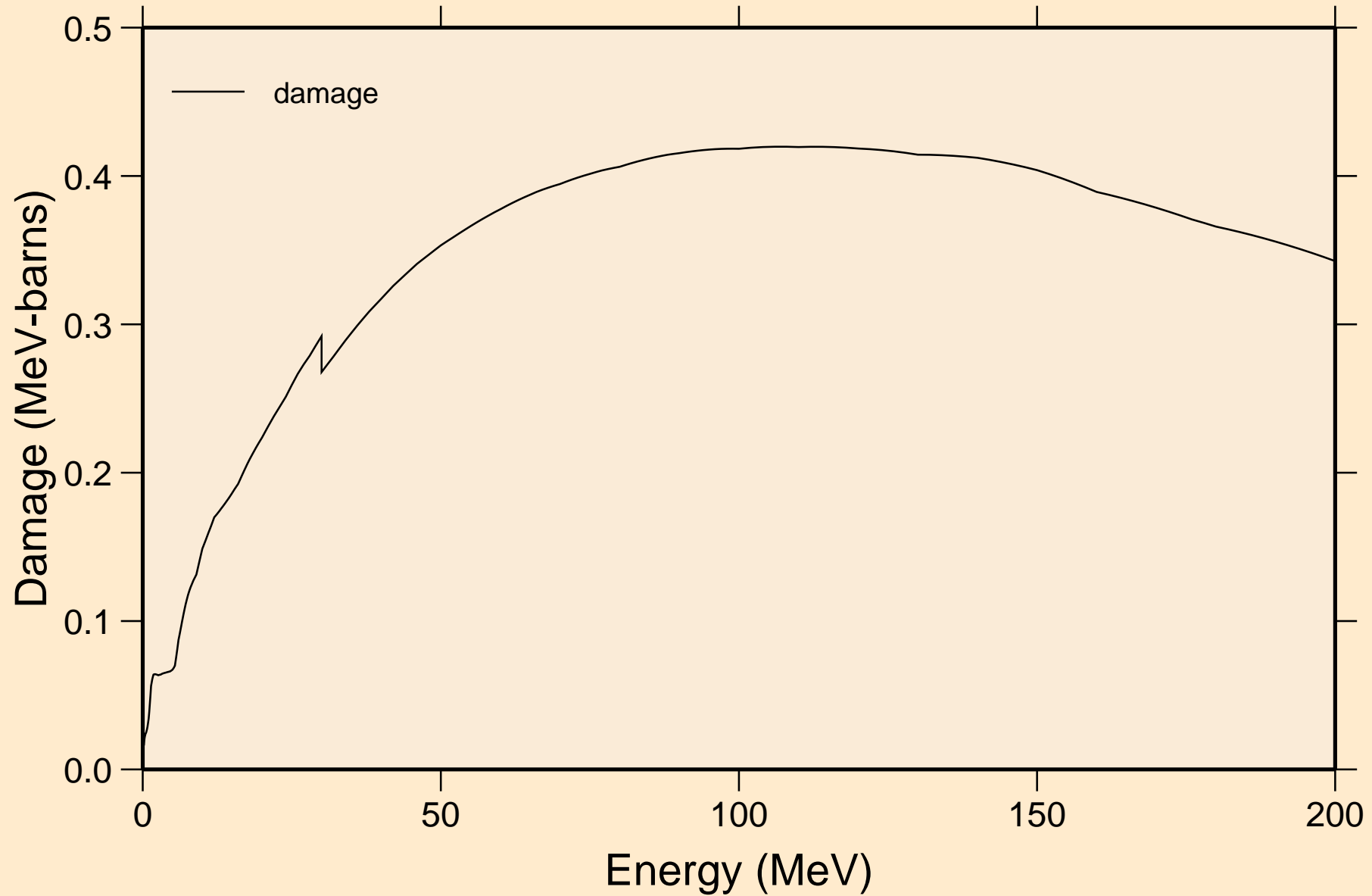

# CM250 NEUTRON ACER TENDL-2023 LIBRARY; T=0.K

## Non-threshold reactions

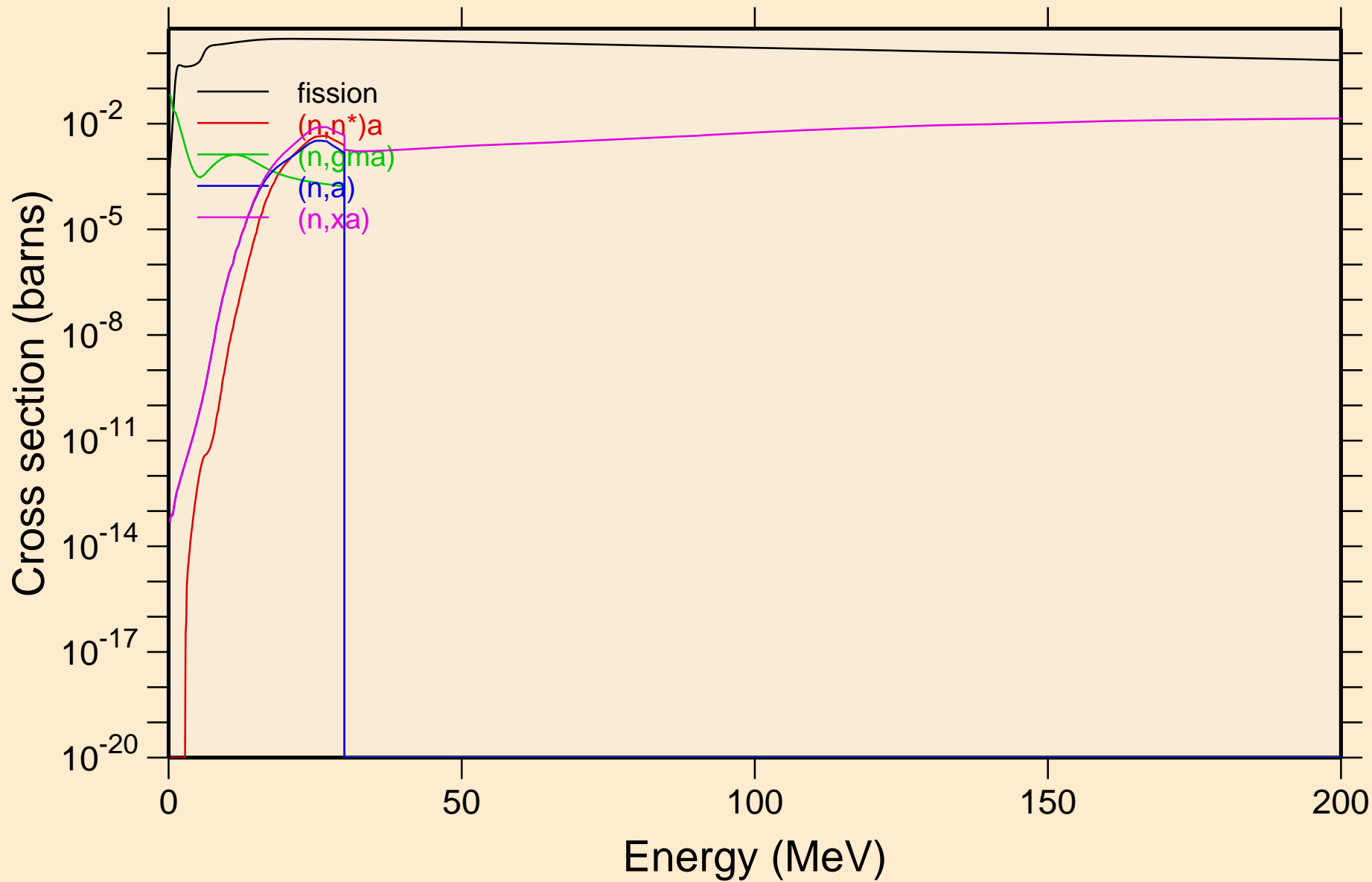



CM250 NEUTRON ACER TENDL-2023 LIBRARY; T=0.K  
Inelastic levels

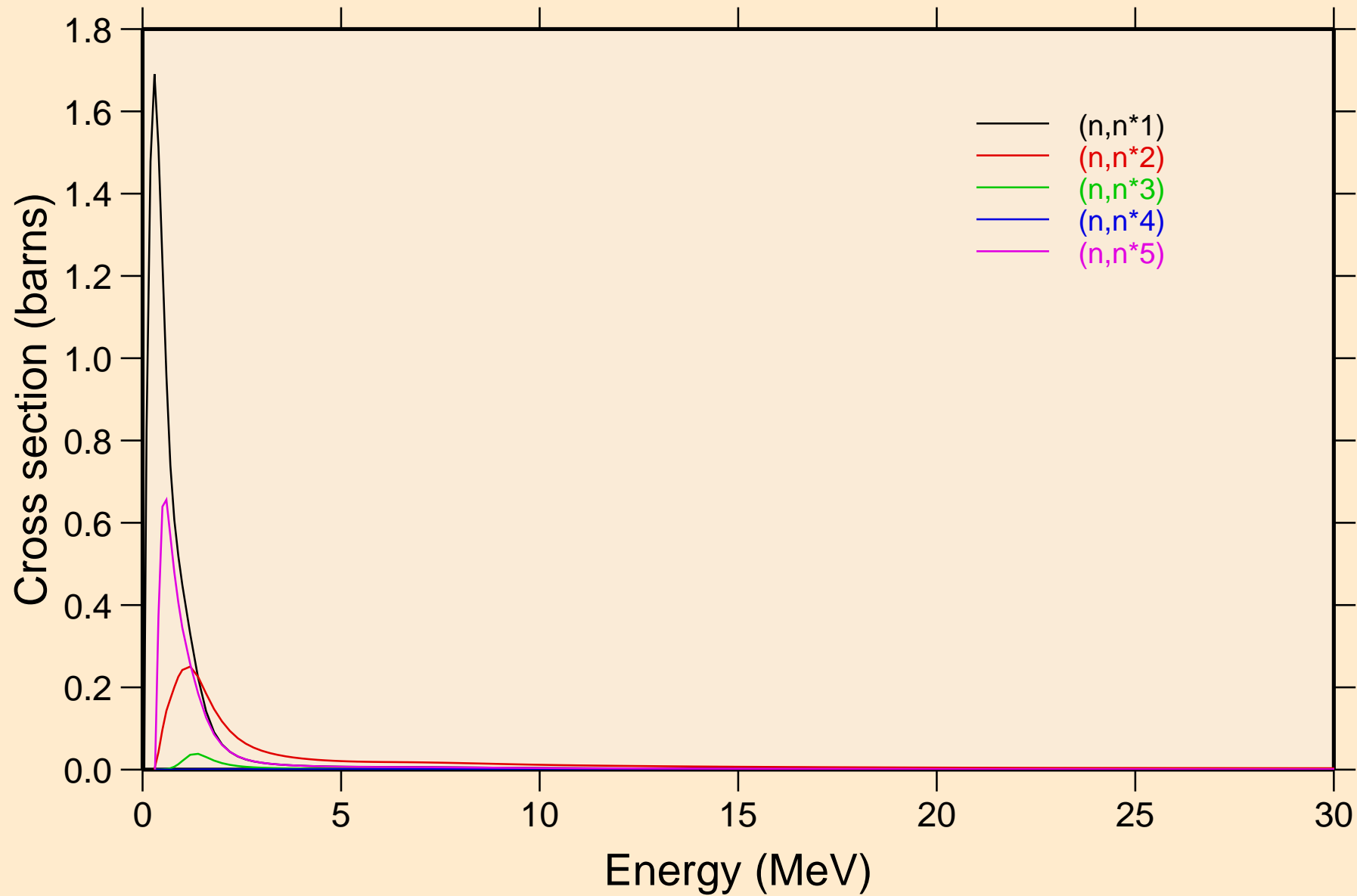

CM250 NEUTRON ACER TENDL-2023 LIBRARY; T=0.K  
Inelastic levels

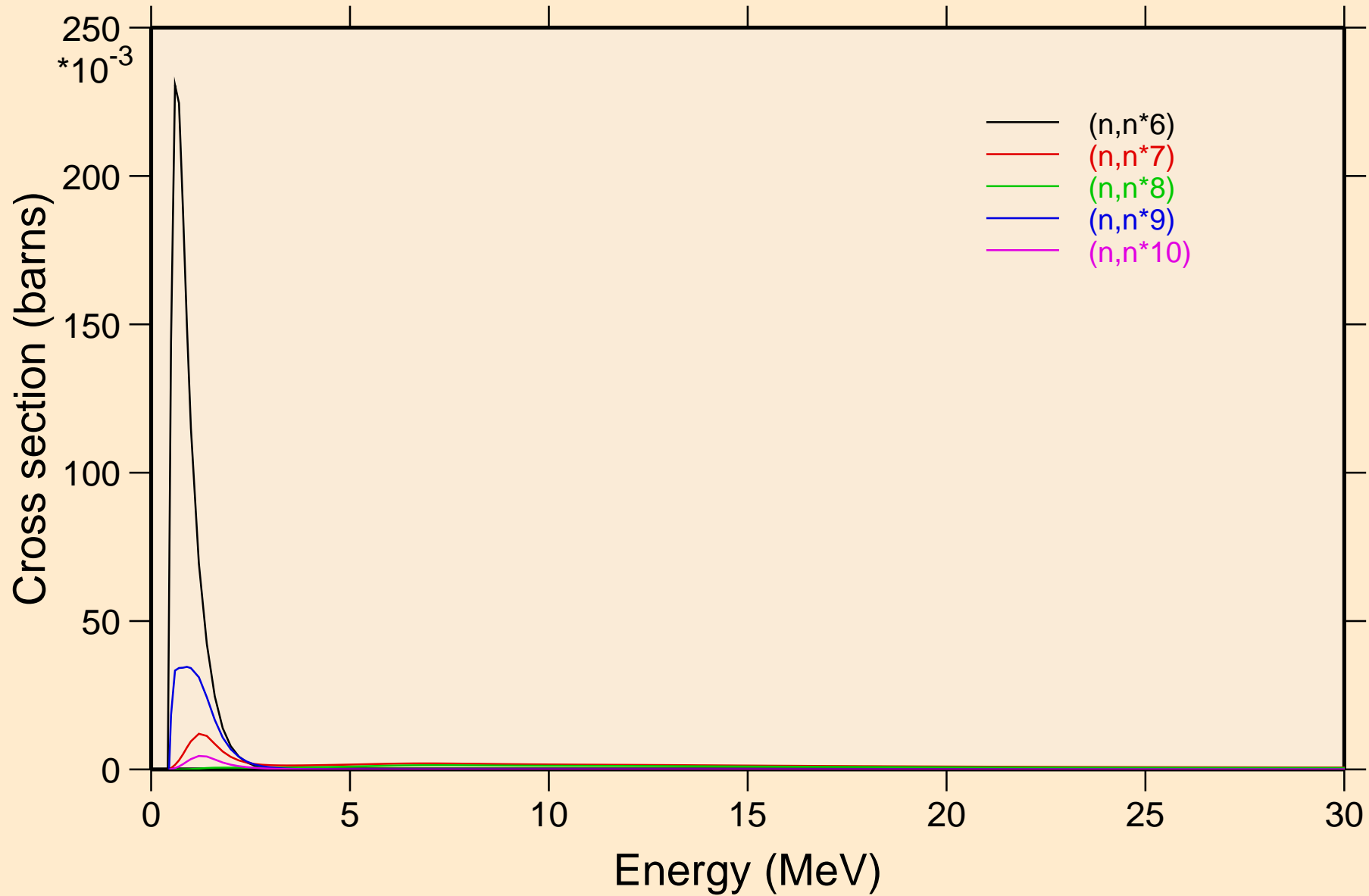

CM250 NEUTRON ACER TENDL-2023 LIBRARY; T=0.K  
Inelastic levels

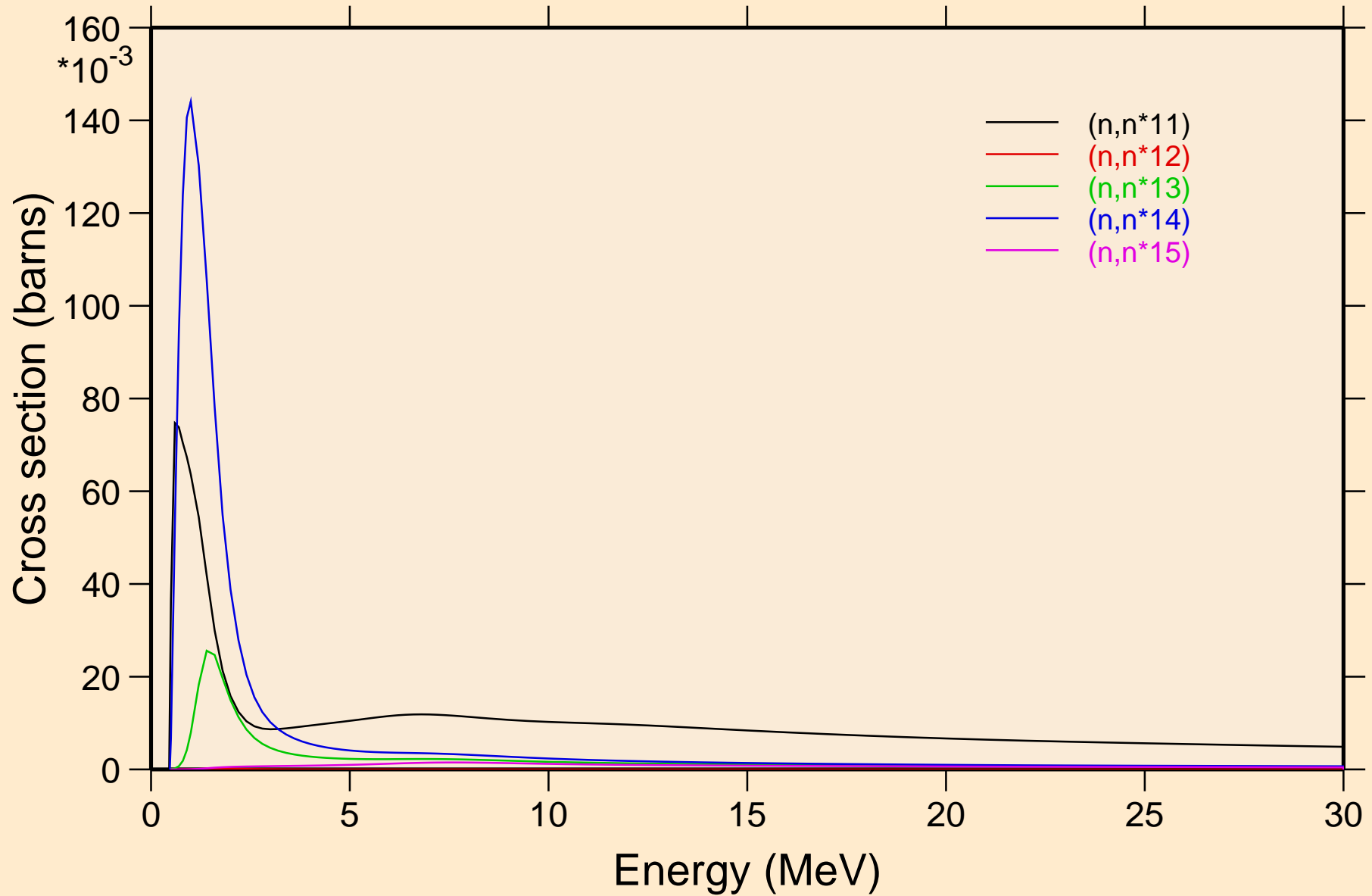

CM250 NEUTRON ACER TENDL-2023 LIBRARY; T=0.K  
Inelastic levels

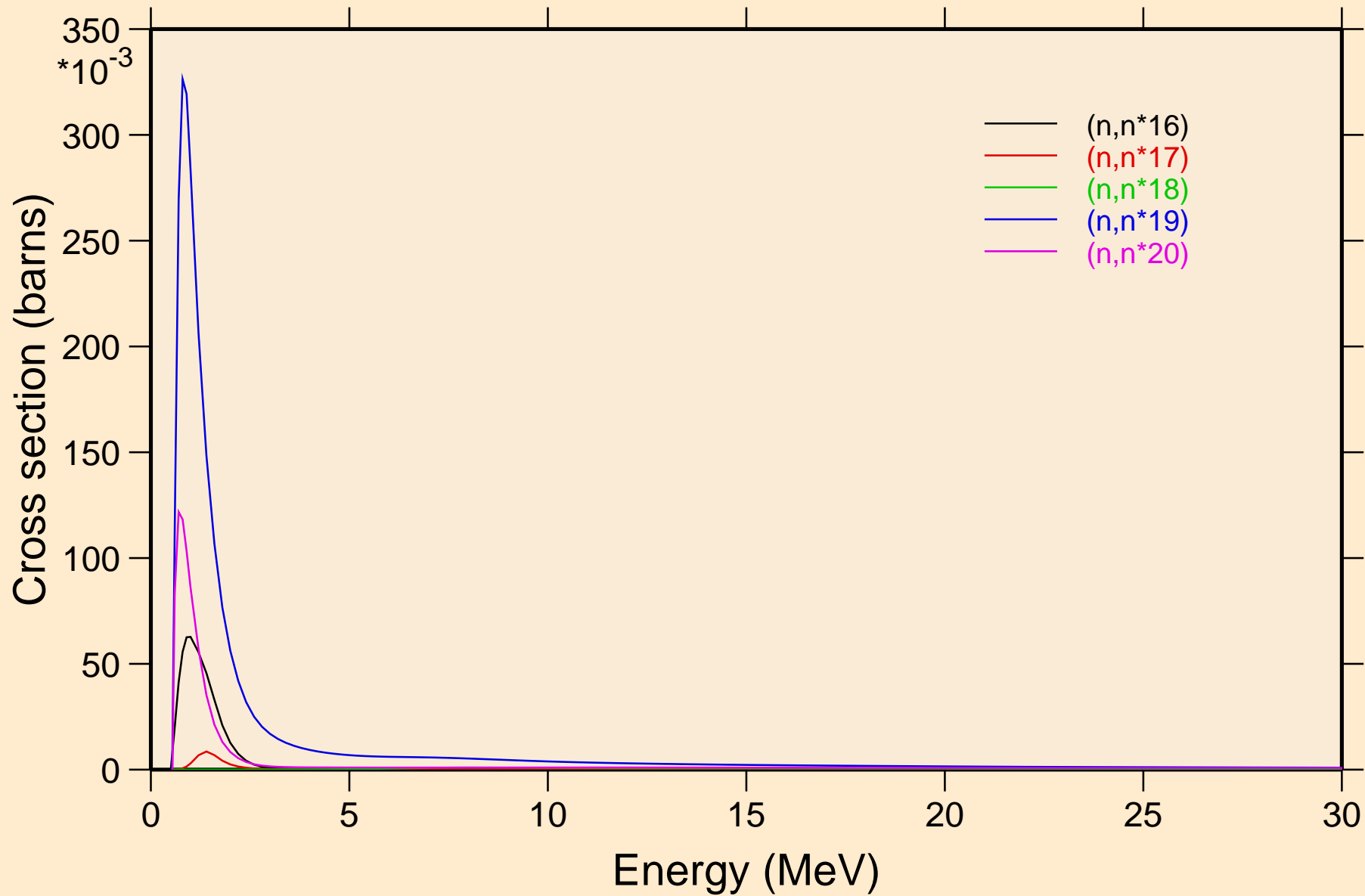

# CM250 NEUTRON ACER TENDL-2023 LIBRARY; T=0.K

## Inelastic levels

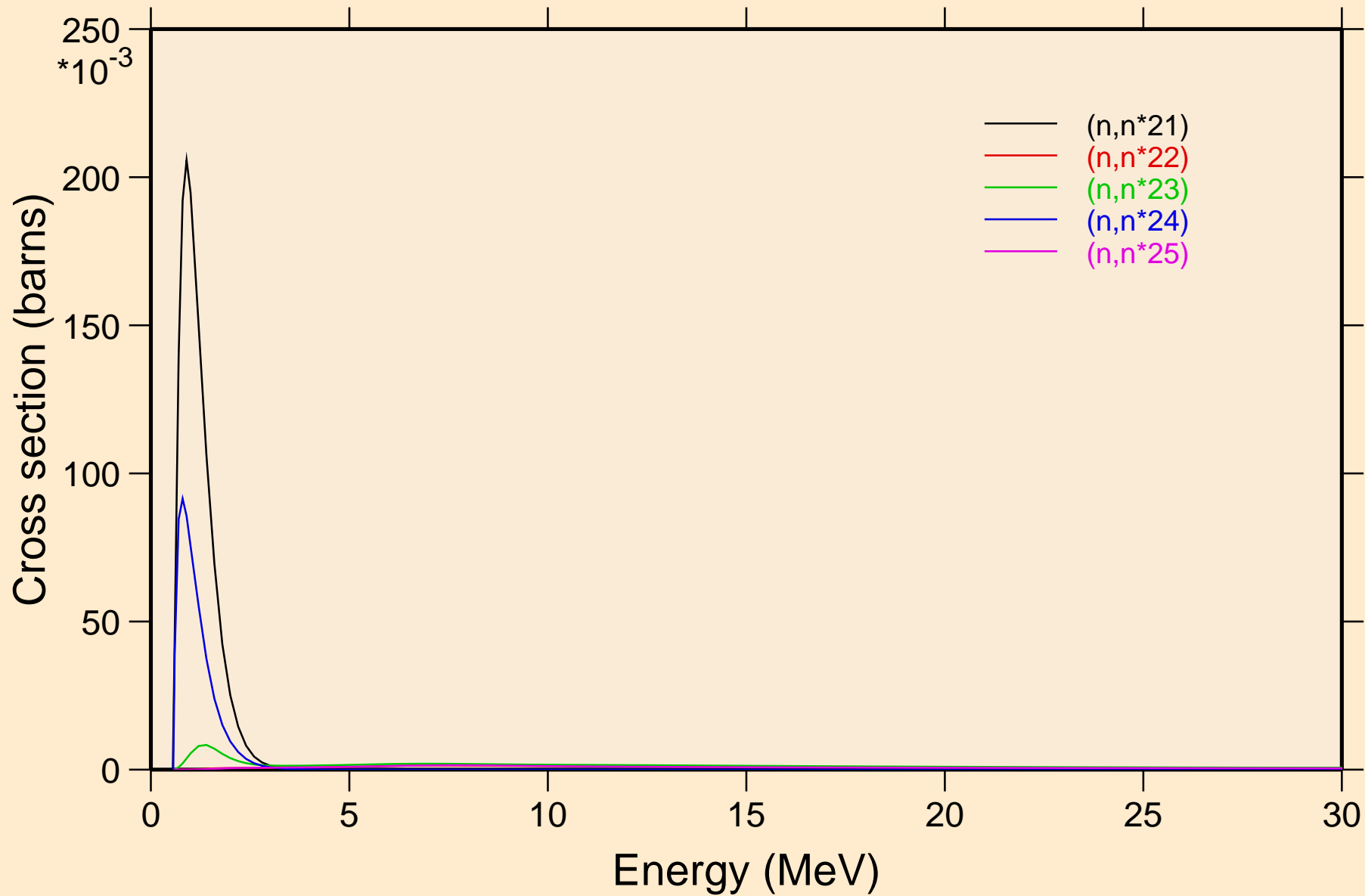

CM250 NEUTRON ACER TENDL-2023 LIBRARY; T=0.K  
Inelastic levels

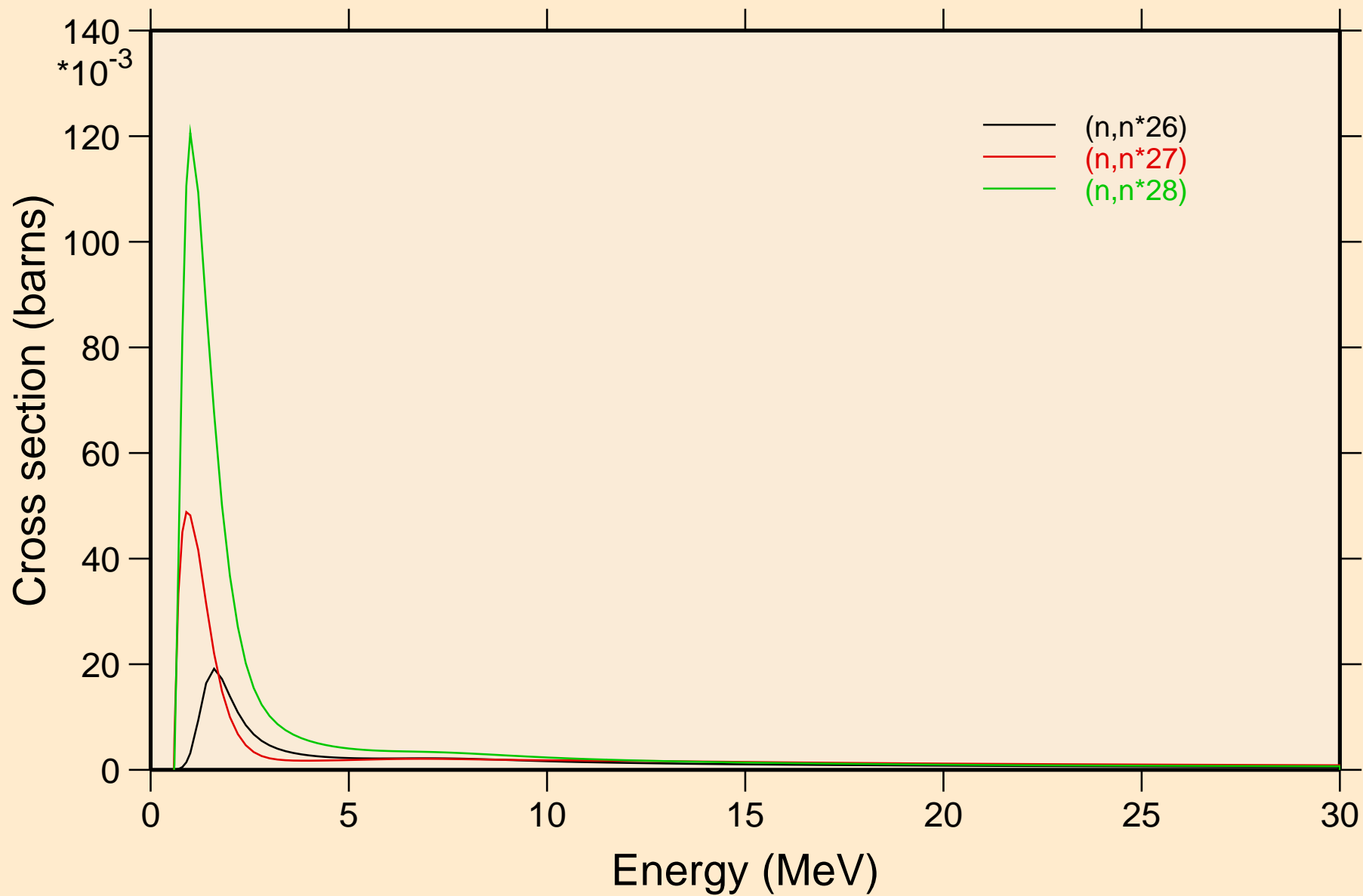

# CM250 NEUTRON ACER TENDL-2023 LIBRARY; T=0.K

## Threshold reactions

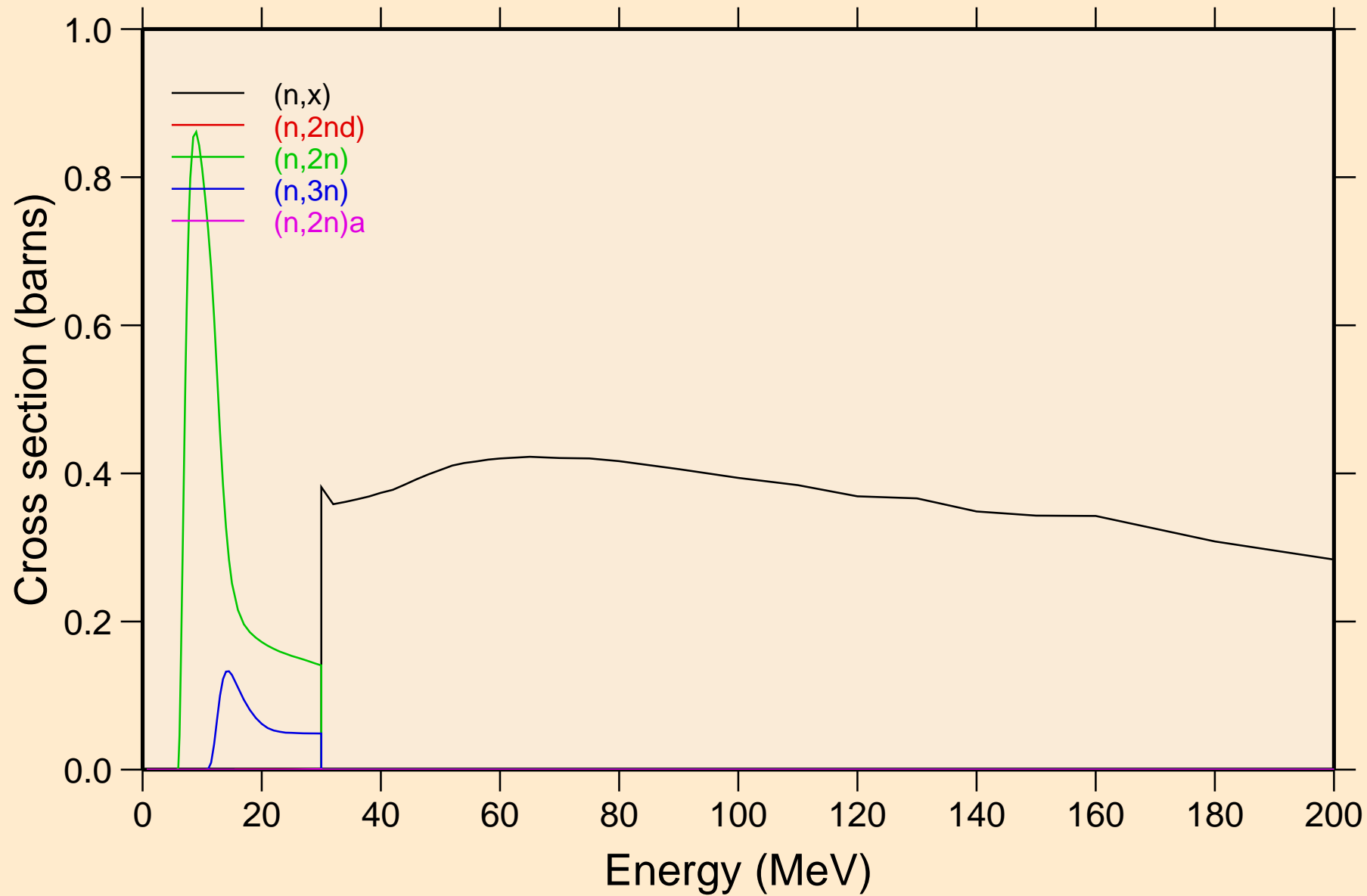

CM250 NEUTRON ACER TENDL-2023 LIBRARY; T=0.K  
Threshold reactions

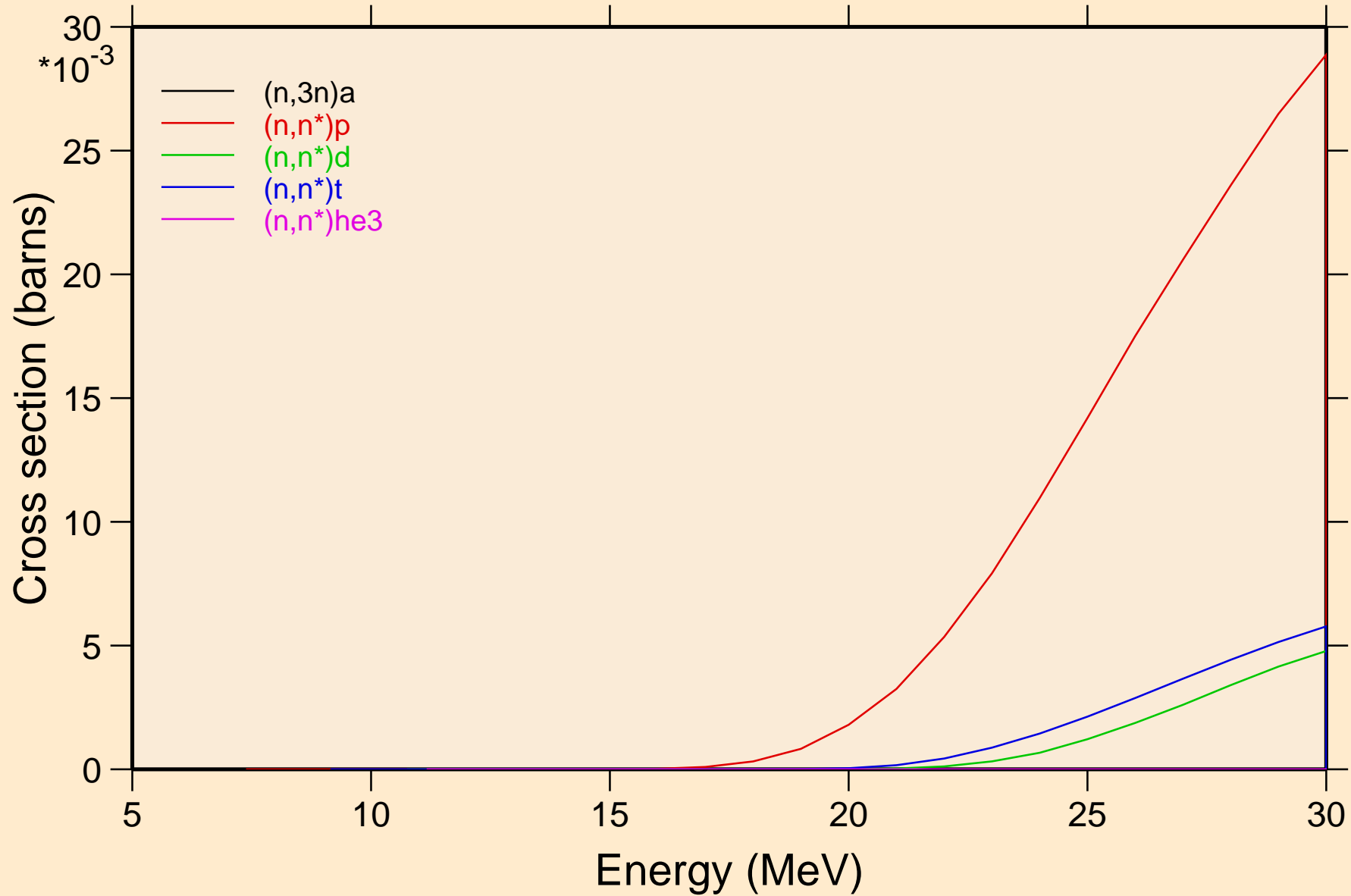



# CM250 NEUTRON ACER TENDL-2023 LIBRARY; T=0.K

## Threshold reactions

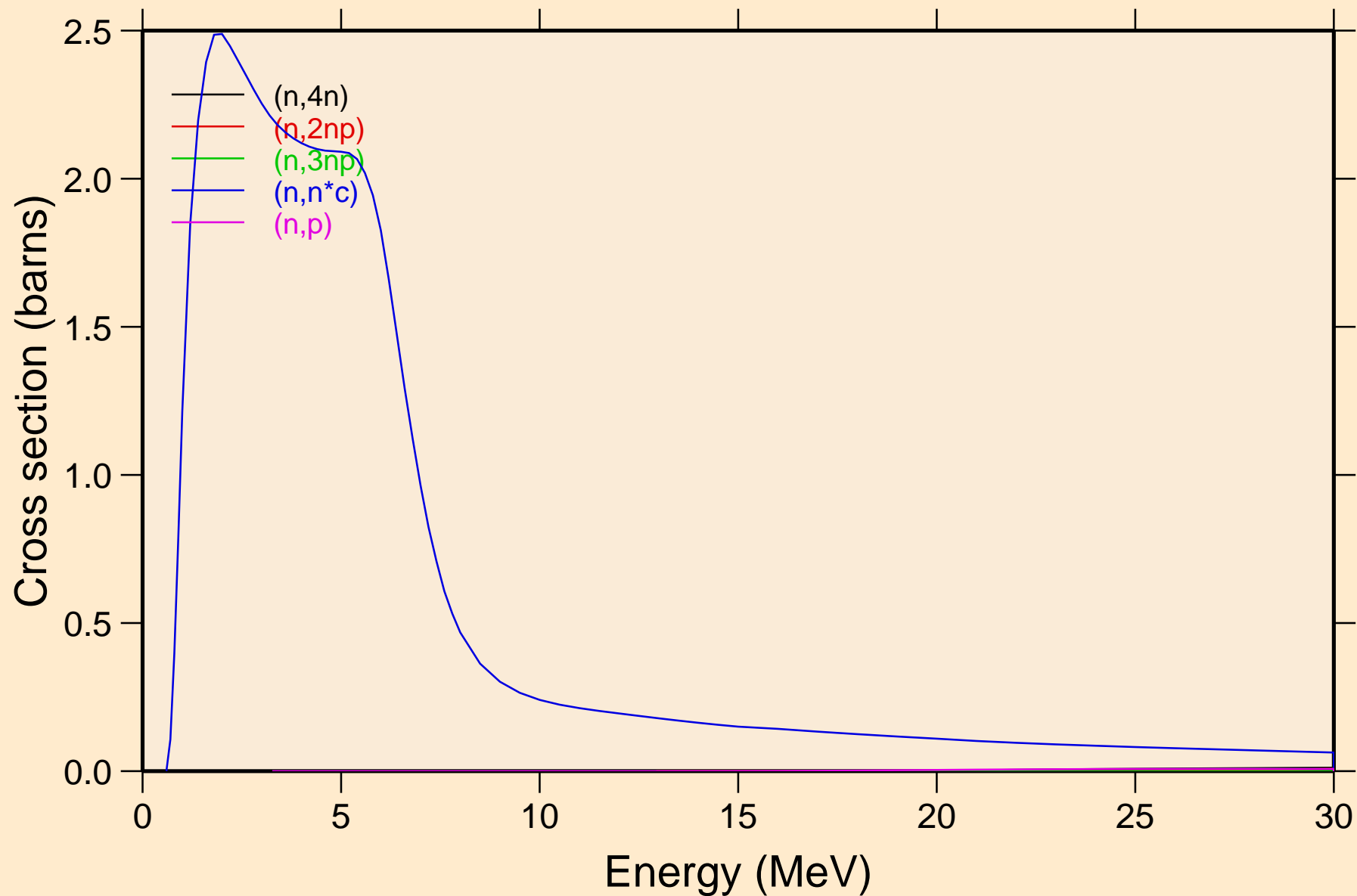

CM250 NEUTRON ACER TENDL-2023 LIBRARY; T=0.K  
Threshold reactions

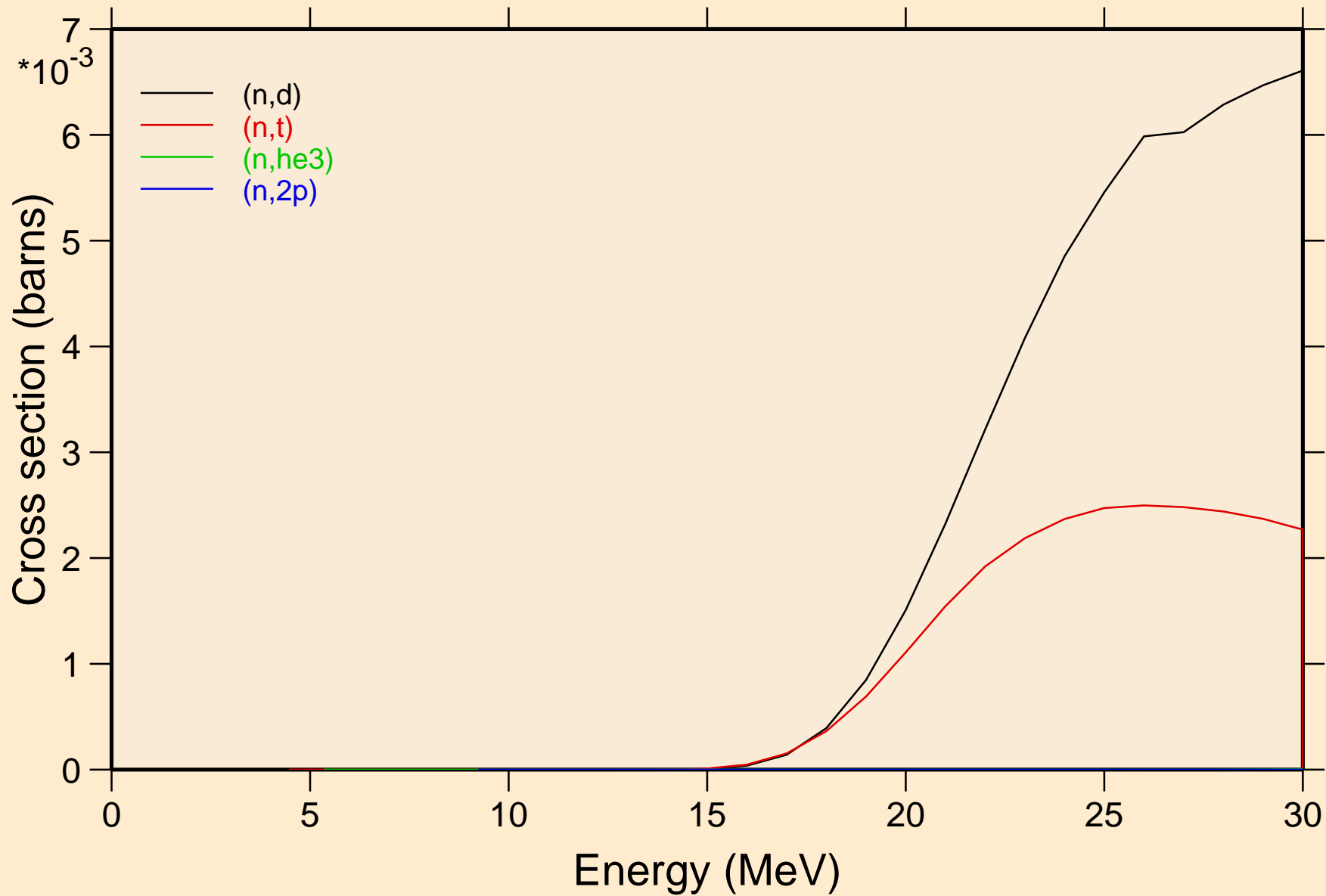

# CM250 NEUTRON ACER TENDL-2023 LIBRARY; T=0.K

## Threshold reactions

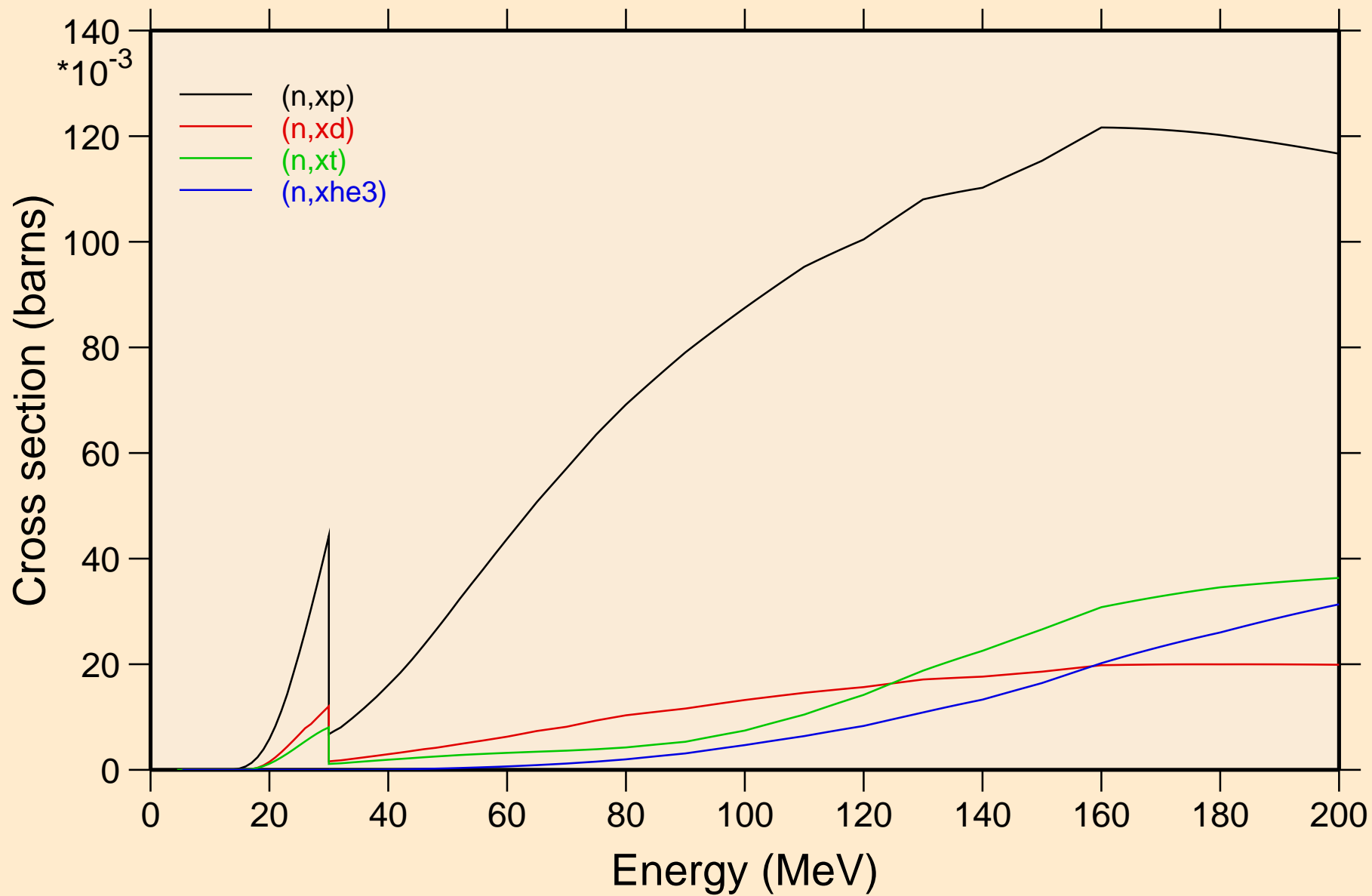

CM250 NEUTRON ACER TENDL-2023 LIBRARY; T=0.K  
angular distribution for elastic

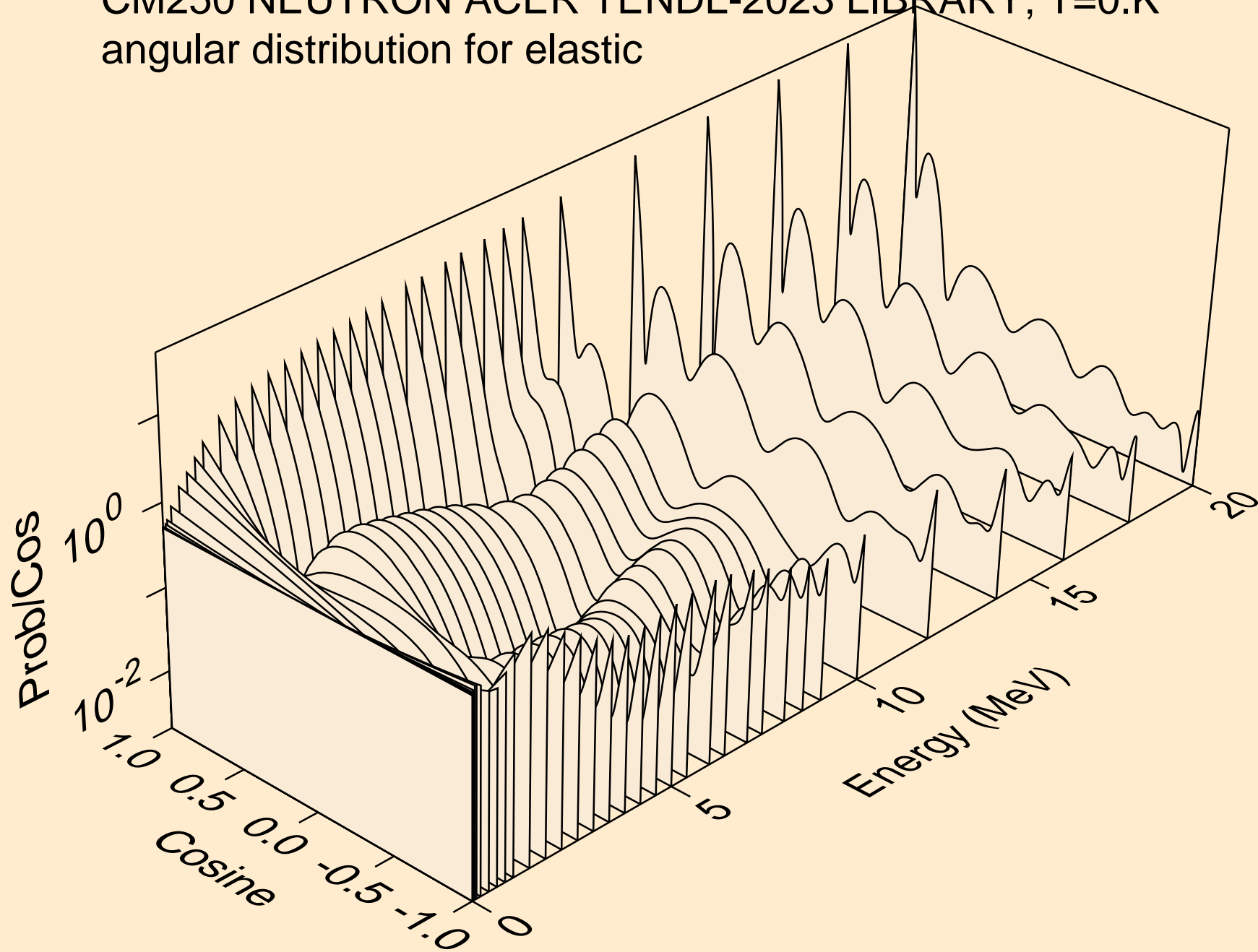

CM250 NEUTRON ACER TENDL-2023 LIBRARY; T=0.K  
angular distribution for elastic

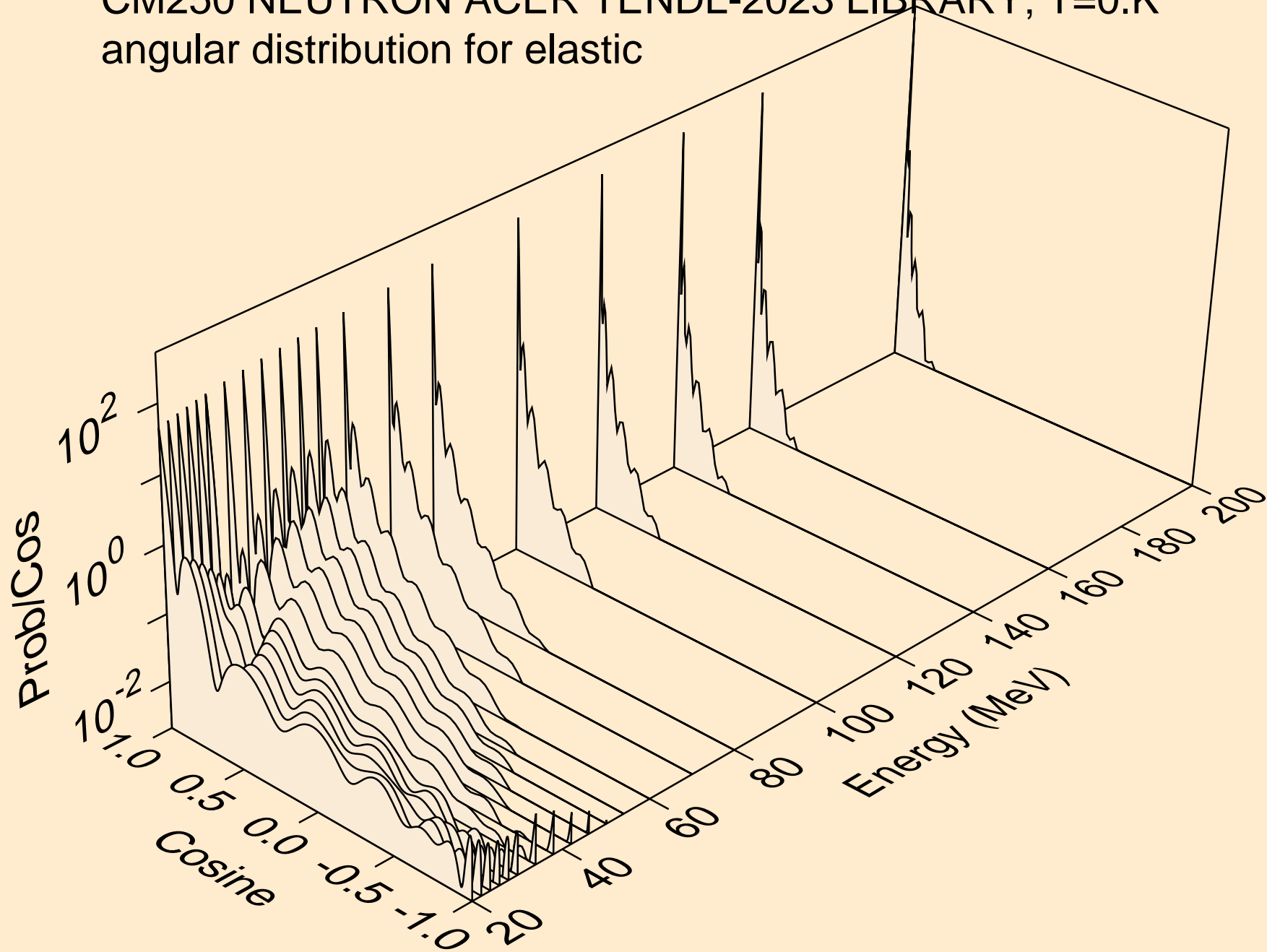

CM250 NEUTRON ACER TENDL-2023 LIBRARY; T=0.K  
angular distribution for (n,n\*1)

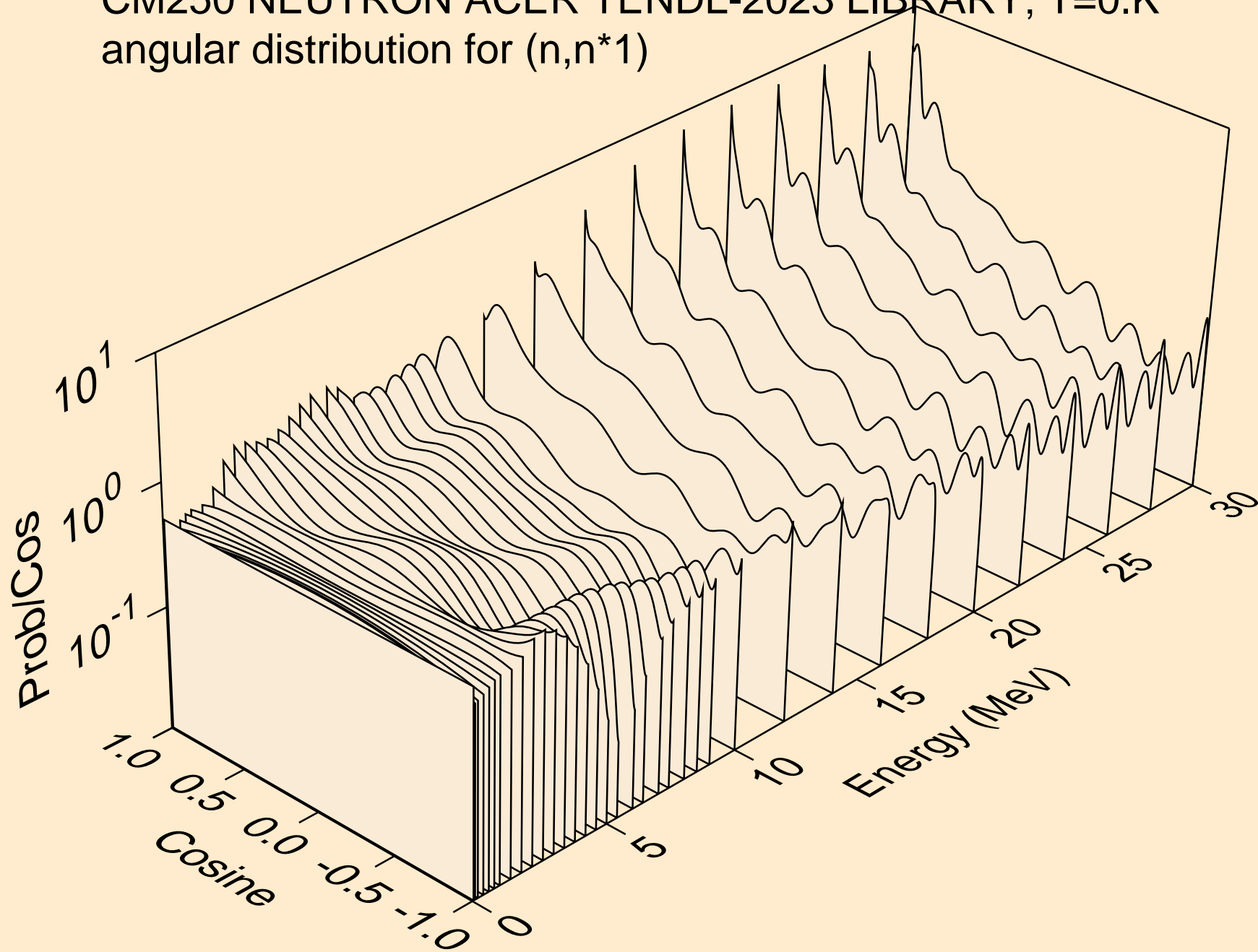

CM250 NEUTRON ACER TENDL-2023 LIBRARY; T=0.K  
angular distribution for (n,n\*2)

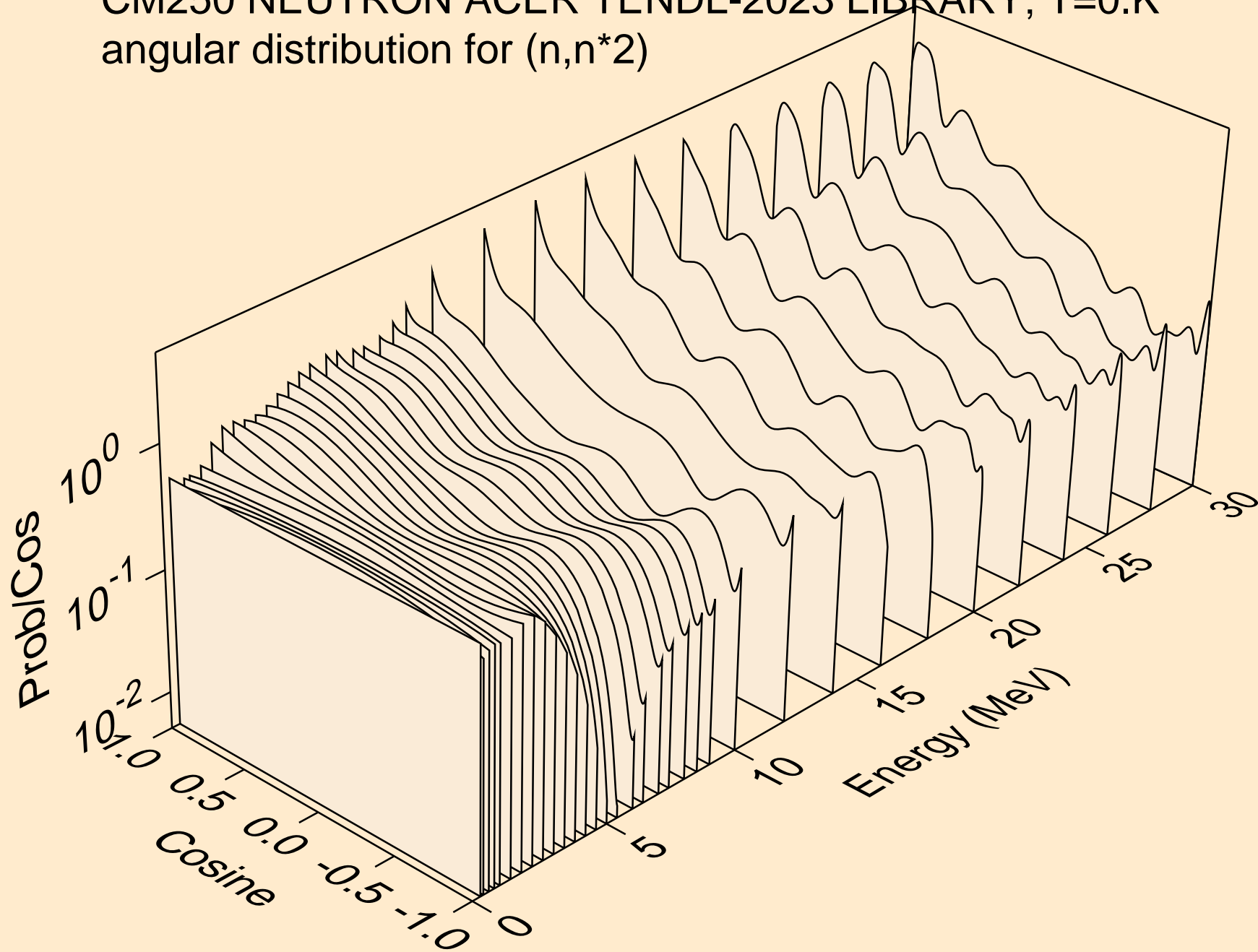

CM250 NEUTRON ACER TENDL-2023 LIBRARY; T=0.K  
angular distribution for (n,n\*3)

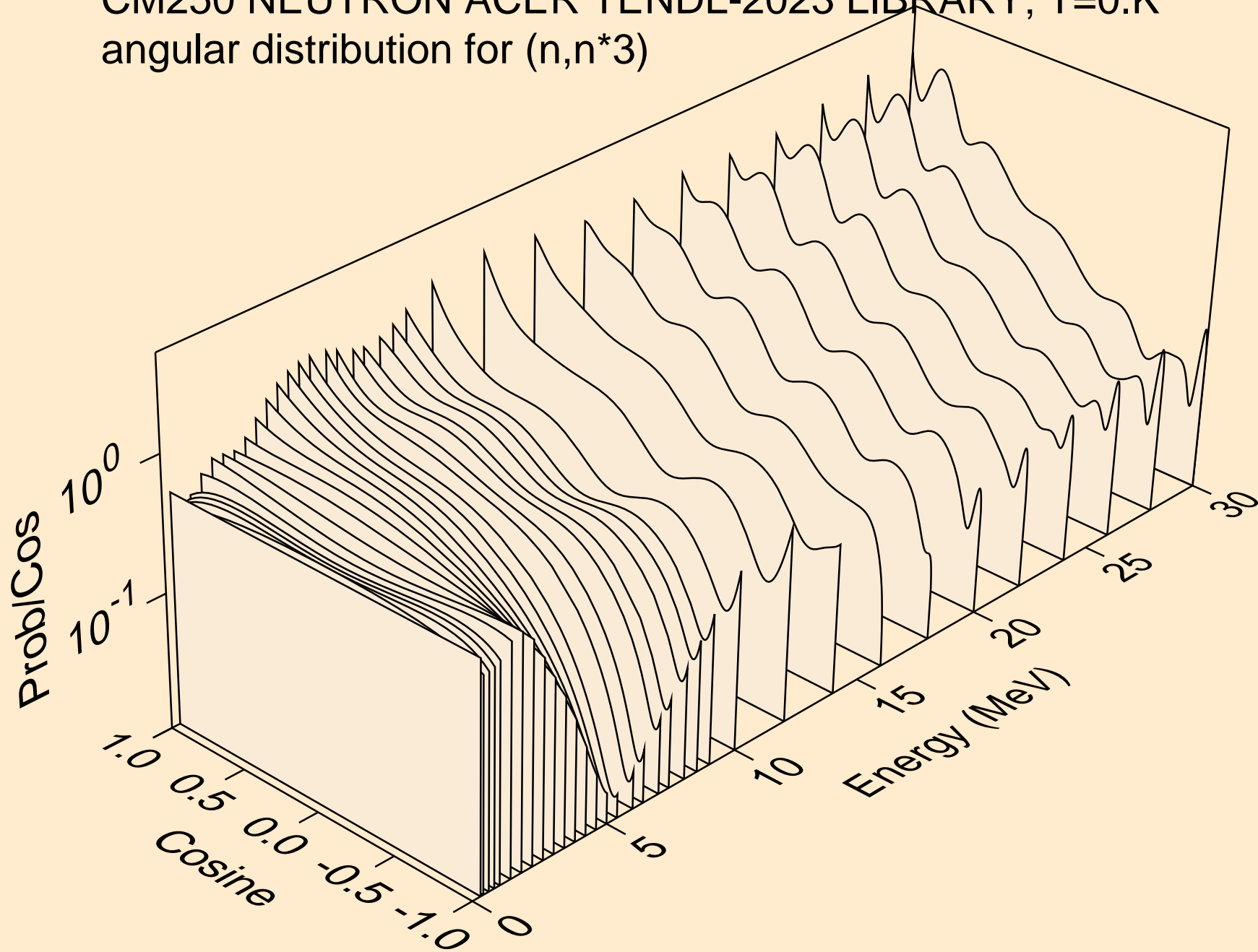



CM250 NEUTRON ACER TENDL-2023 LIBRARY; T=0.K  
angular distribution for (n,n\*4)

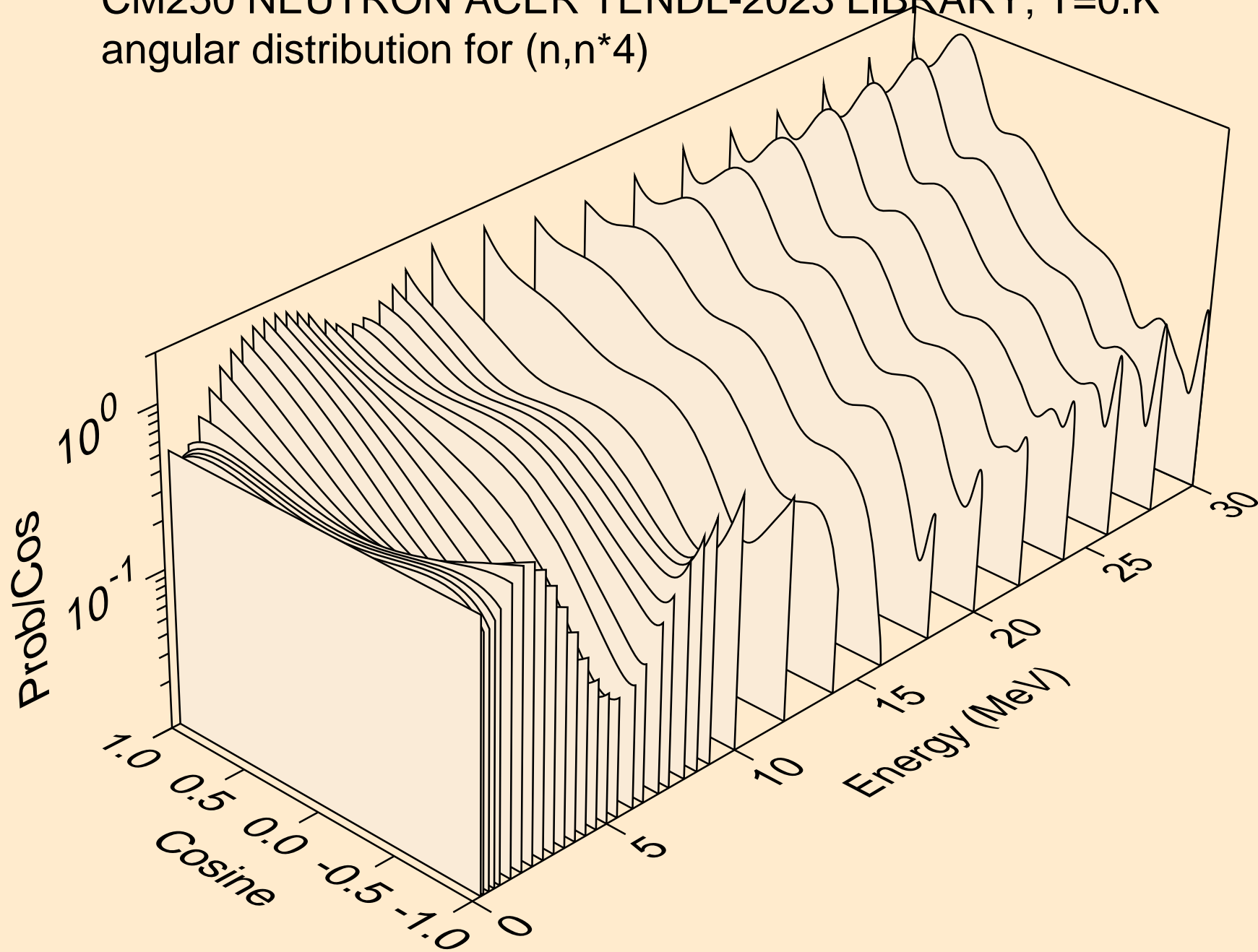

CM250 NEUTRON ACER TENDL-2023 LIBRARY; T=0.K  
angular distribution for (n,n\*5)

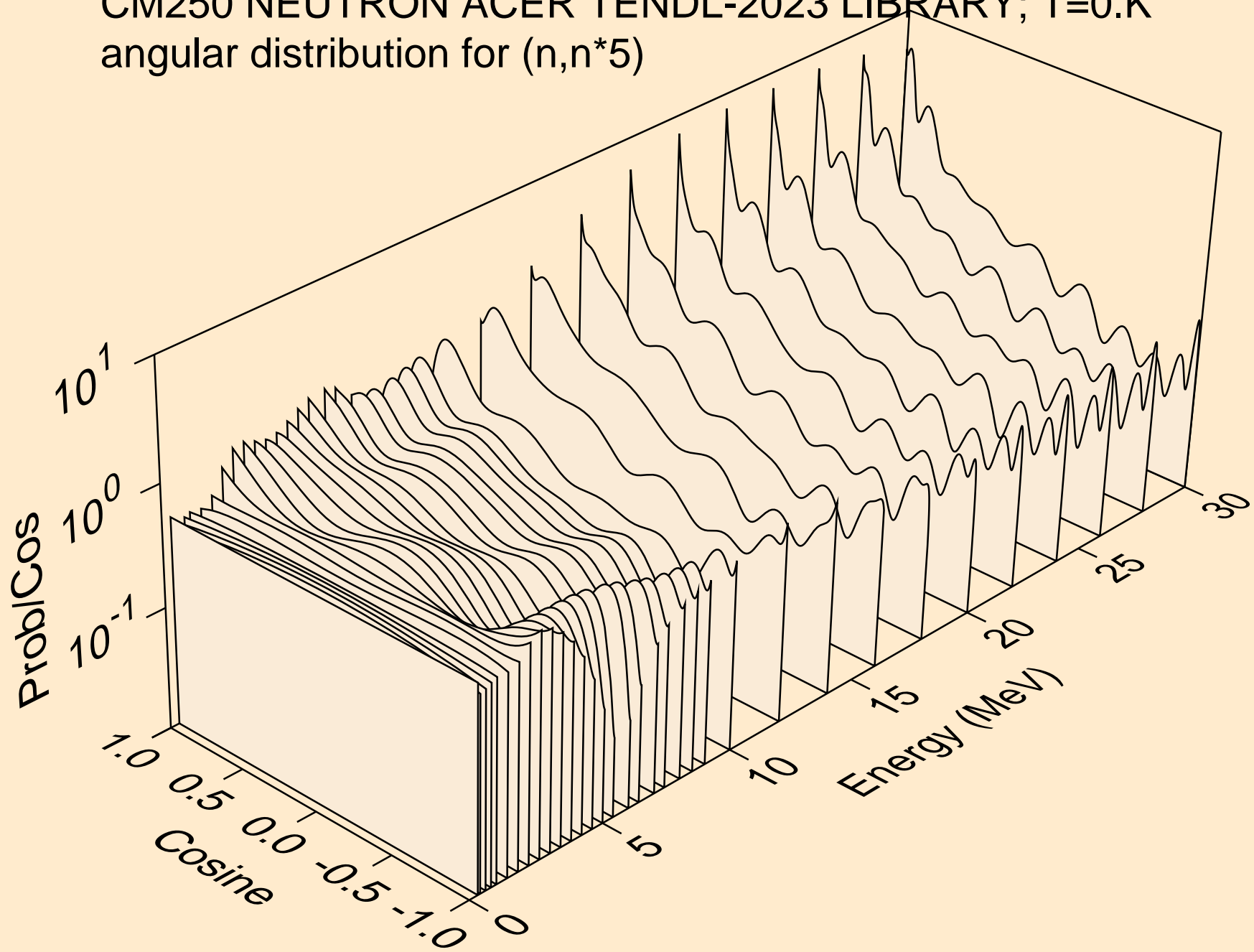

CM250 NEUTRON ACER TENDL-2023 LIBRARY; T=0.K  
angular distribution for (n,n\*6)

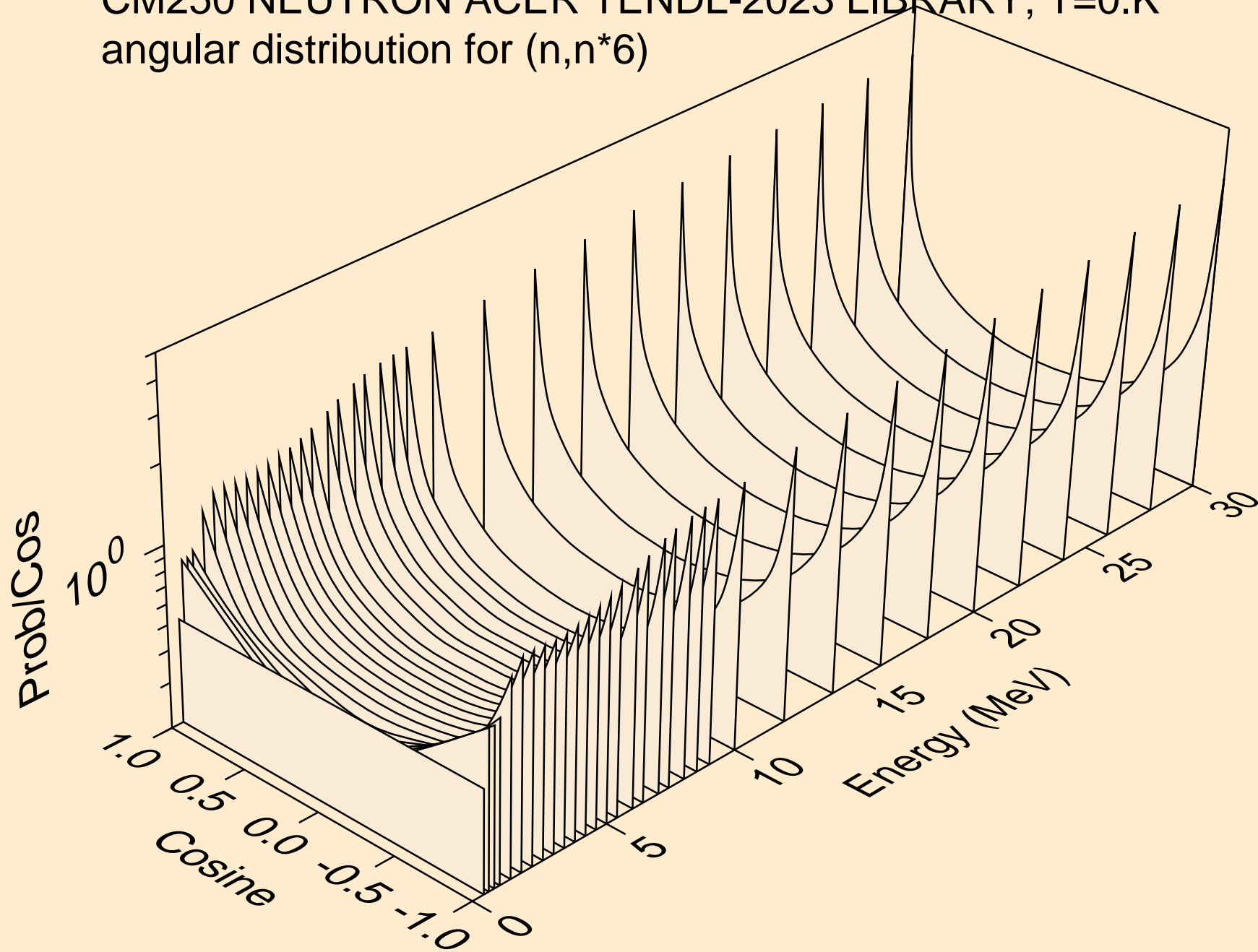

CM250 NEUTRON ACER TENDL-2023 LIBRARY; T=0.K  
angular distribution for (n,n\*7)

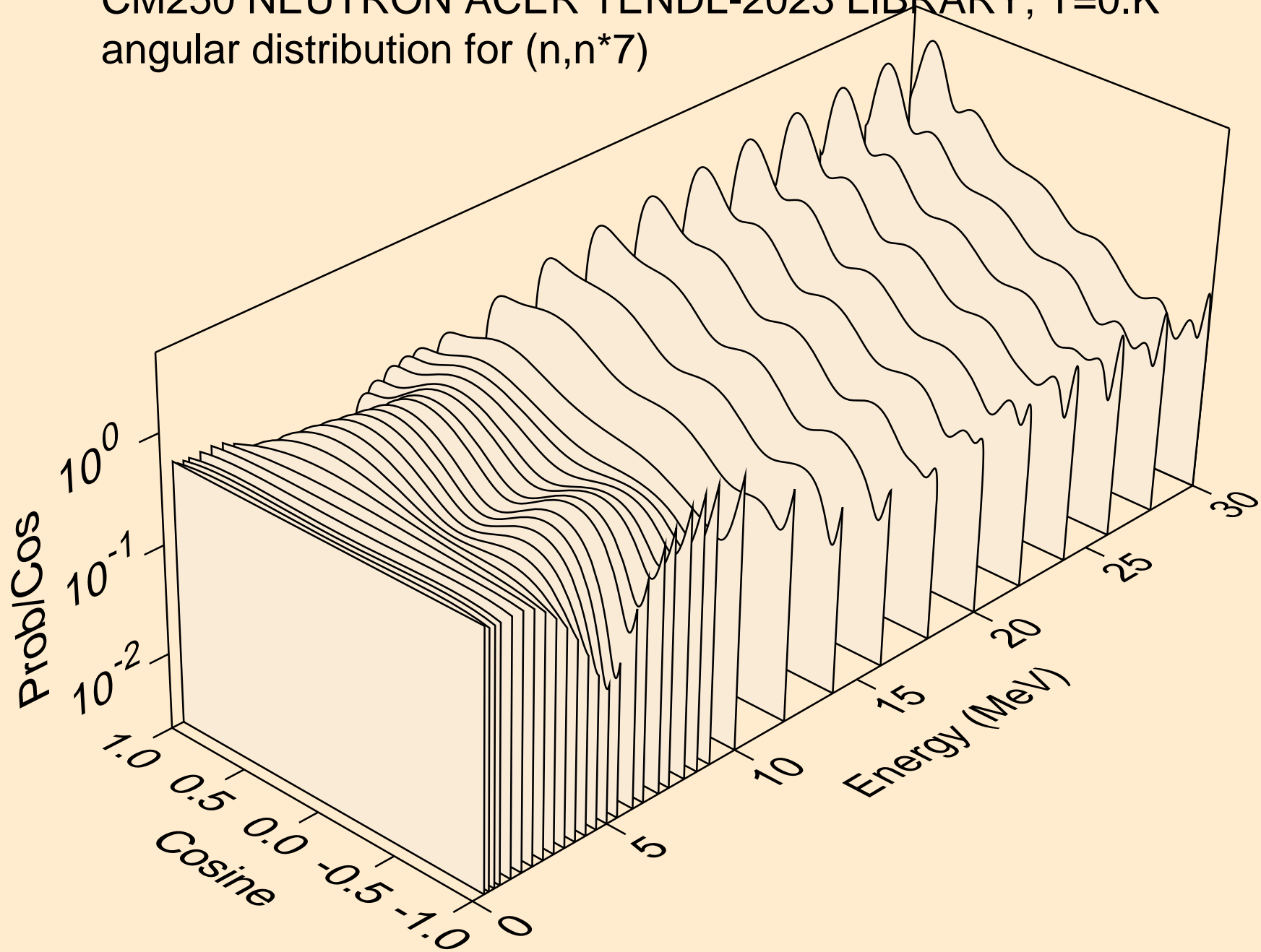

CM250 NEUTRON ACER TENDL-2023 LIBRARY; T=0.K  
angular distribution for (n,n\*8)

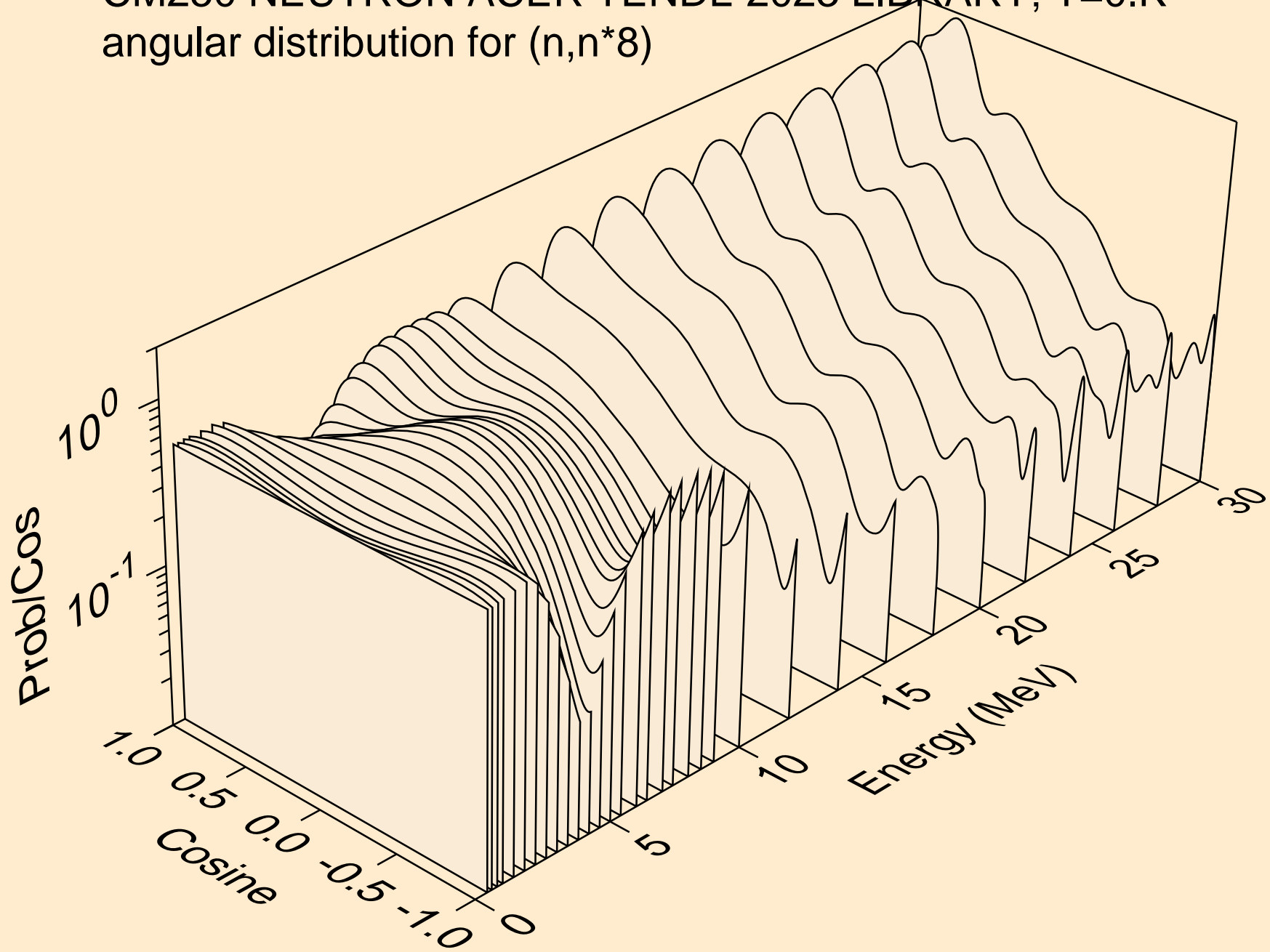

CM250 NEUTRON ACER TENDL-2023 LIBRARY; T=0.K  
angular distribution for (n,n\*9)

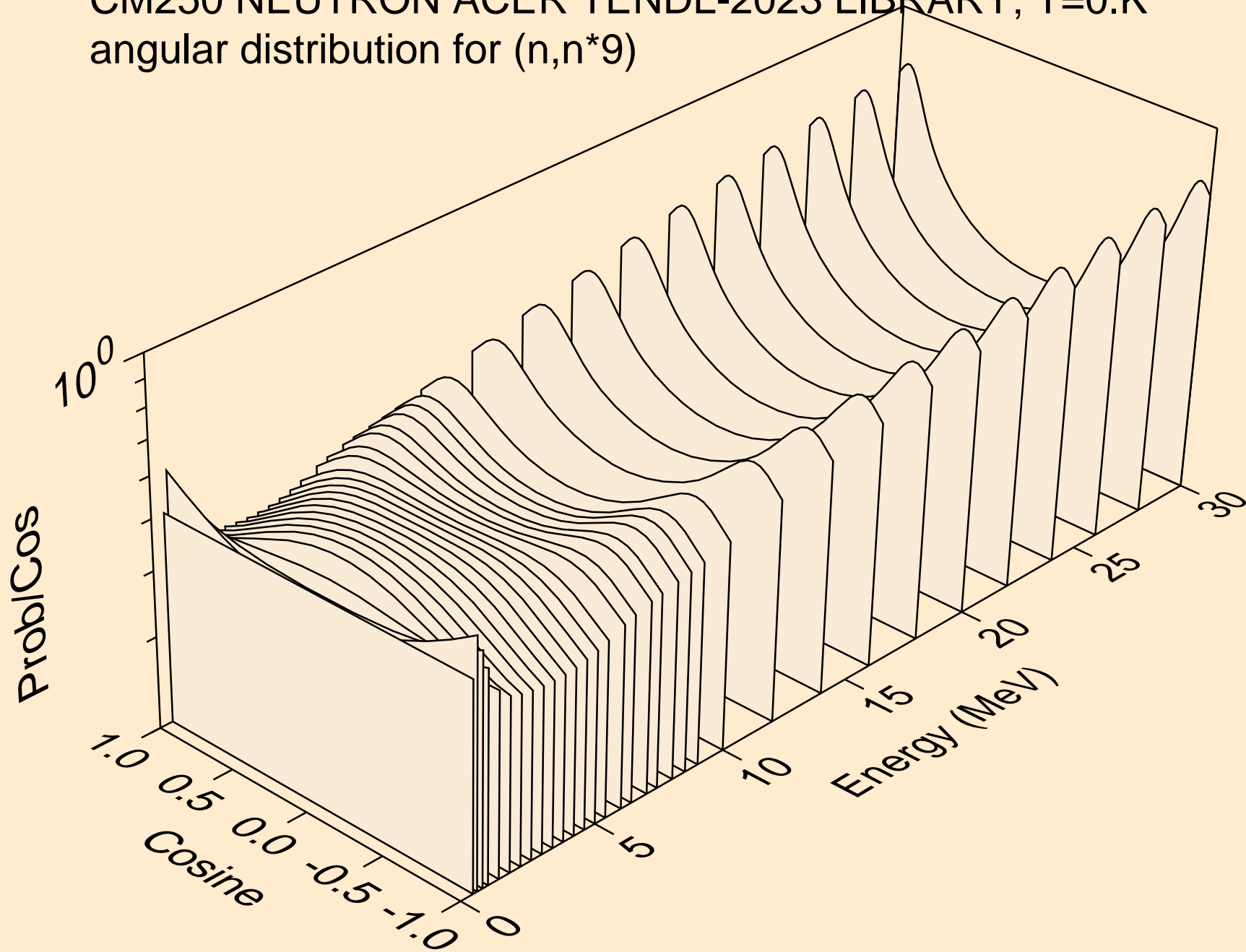

CM250 NEUTRON ACER TENDL-2023 LIBRARY; T=0.K  
angular distribution for (n,n\*10)

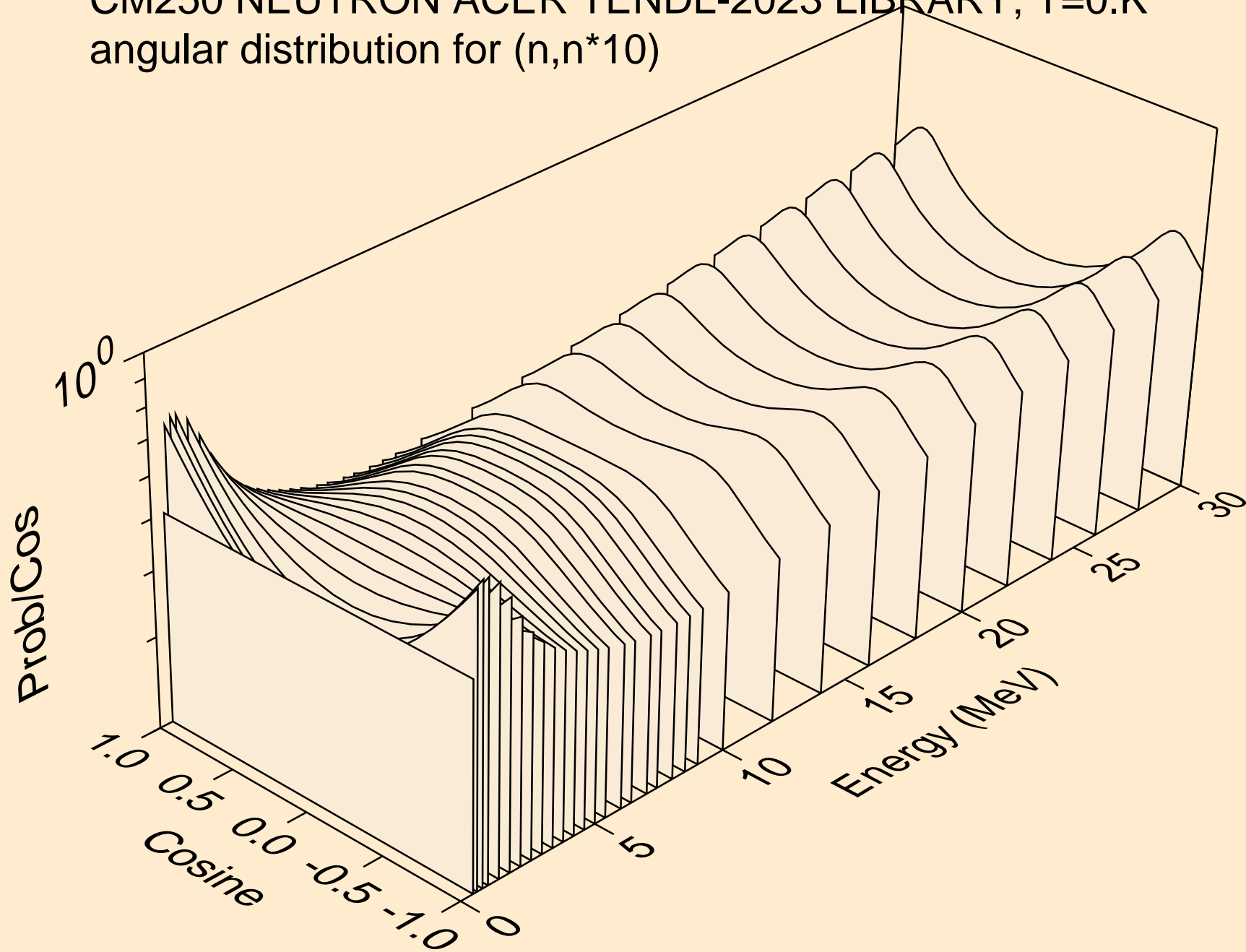

CM250 NEUTRON ACER TENDL-2023 LIBRARY; T=0.K  
angular distribution for (n,n\*11)

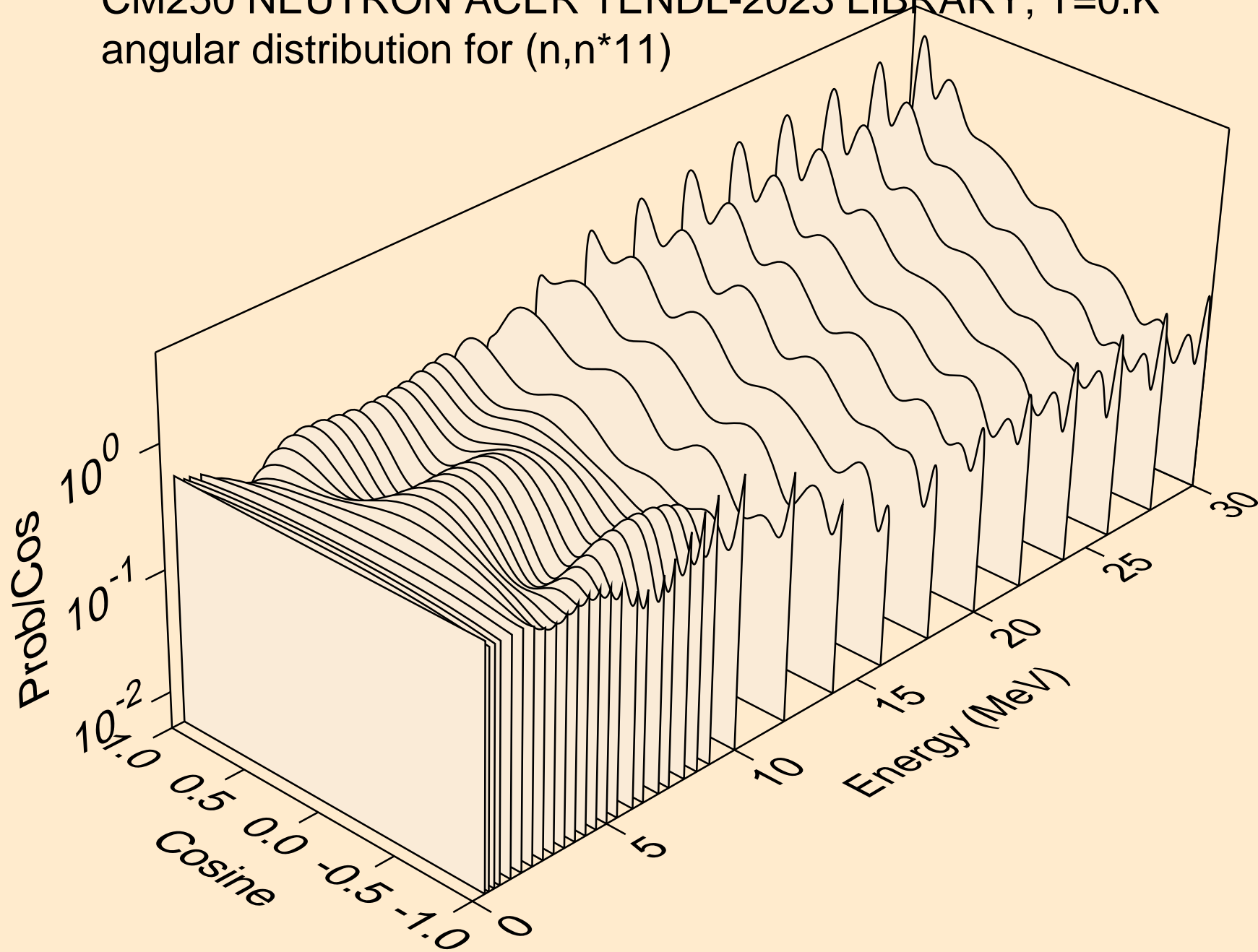



CM250 NEUTRON ACER TENDL-2023 LIBRARY; T=0.K  
angular distribution for (n,n\*12)

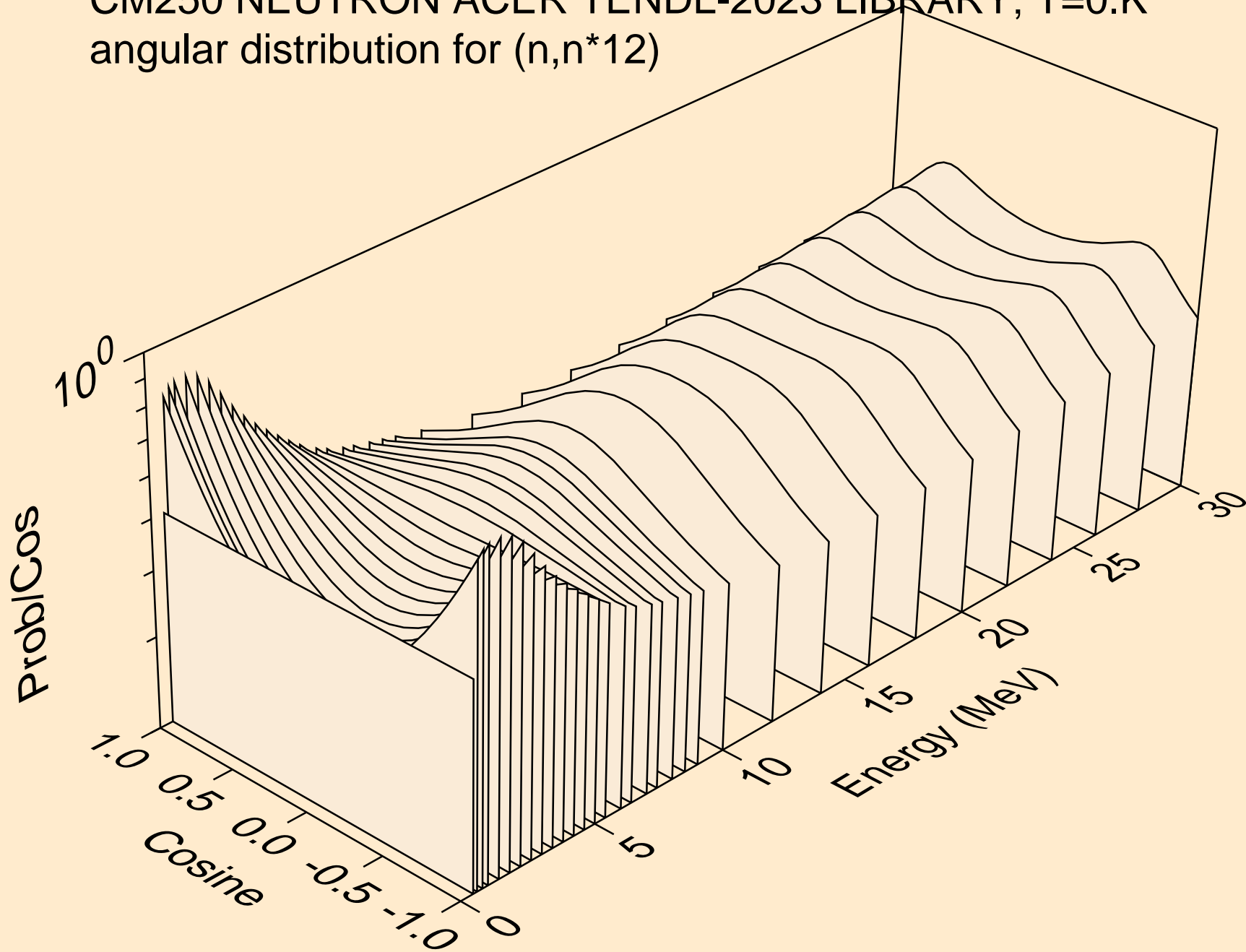

CM250 NEUTRON ACER TENDL-2023 LIBRARY; T=0.K  
angular distribution for (n,n\*13)

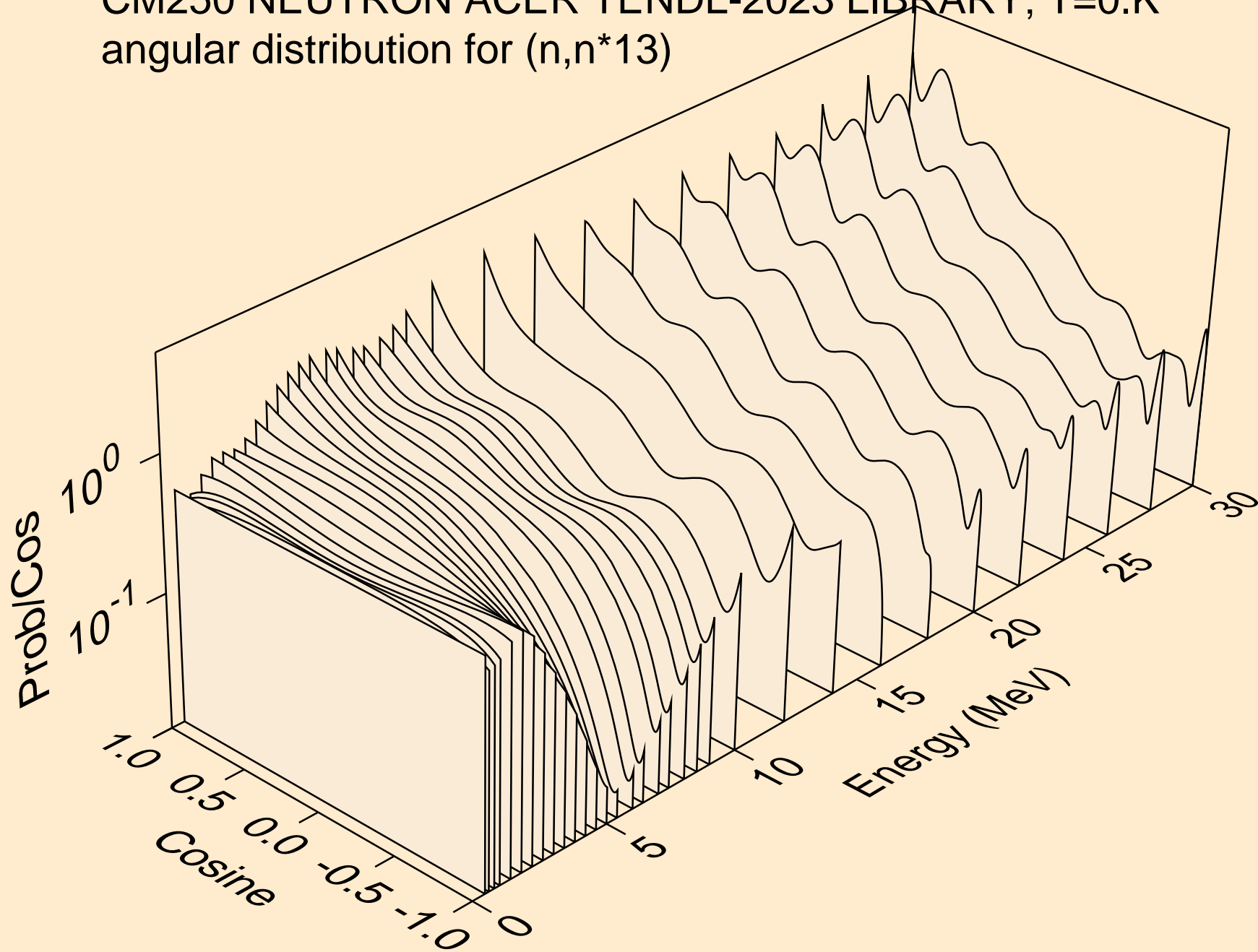

CM250 NEUTRON ACER TENDL-2023 LIBRARY; T=0.K  
angular distribution for (n,n\*14)

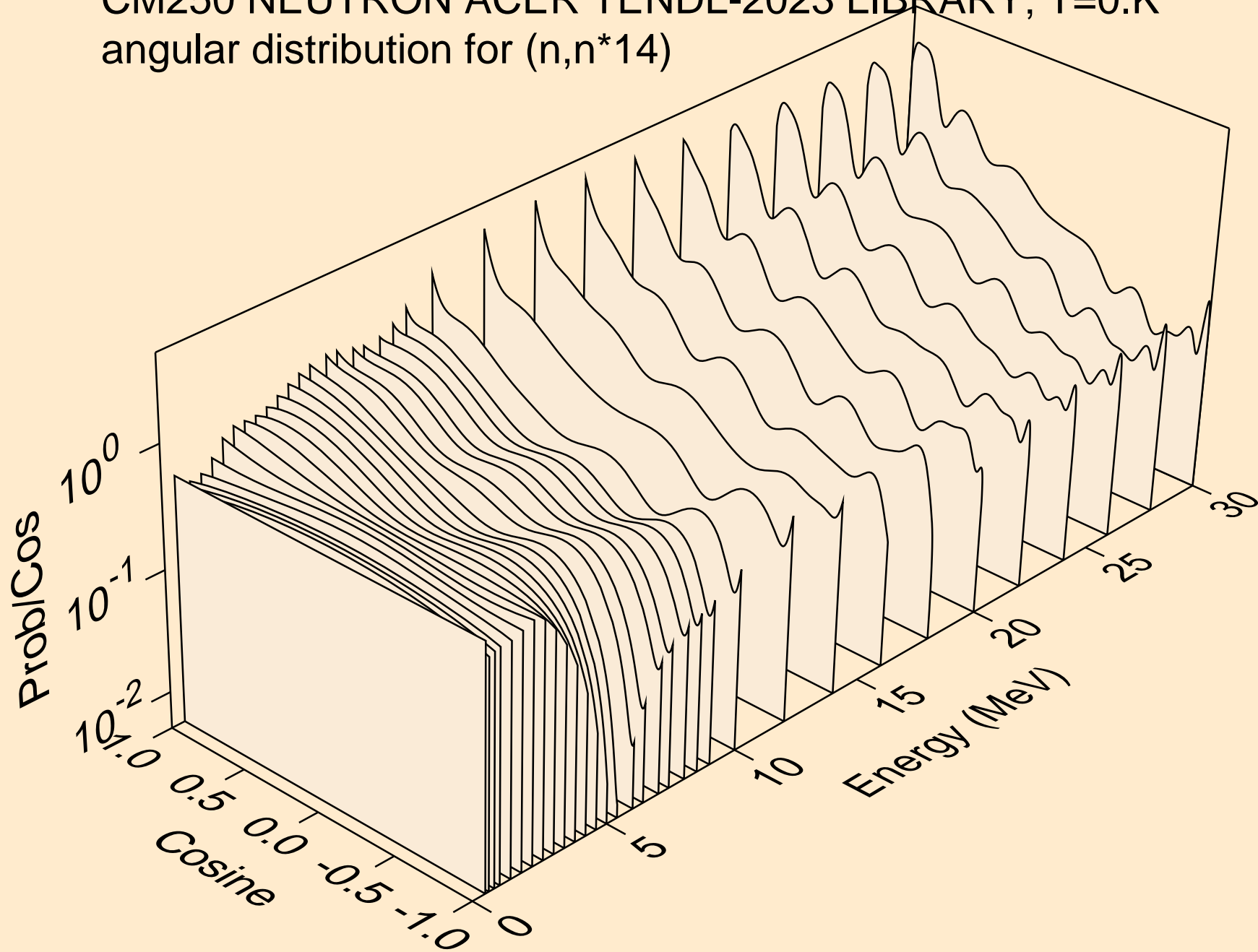

CM250 NEUTRON ACER TENDL-2023 LIBRARY; T=0.K  
angular distribution for (n,n\*15)

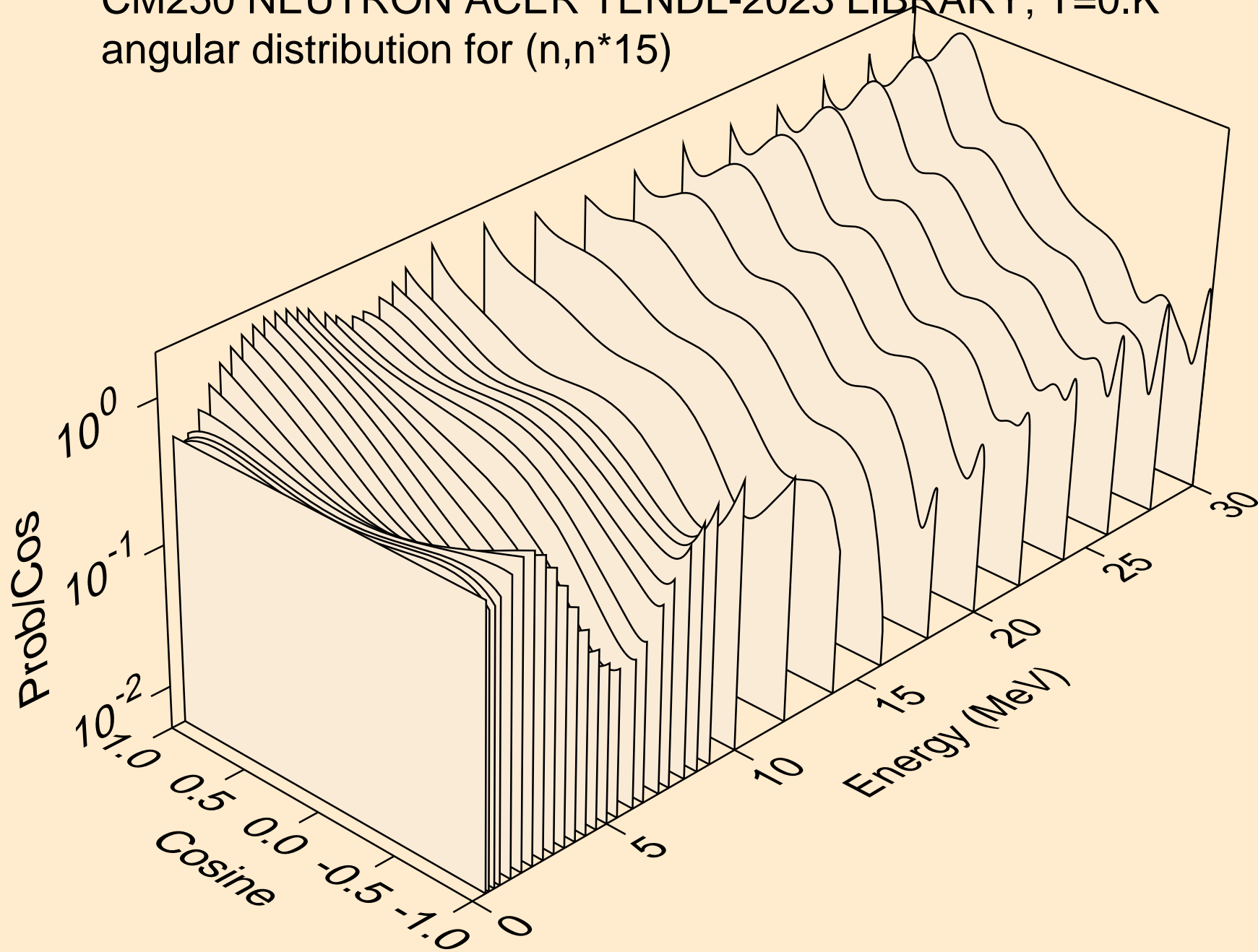

CM250 NEUTRON ACER TENDL-2023 LIBRARY; T=0.K  
angular distribution for (n,n\*16)

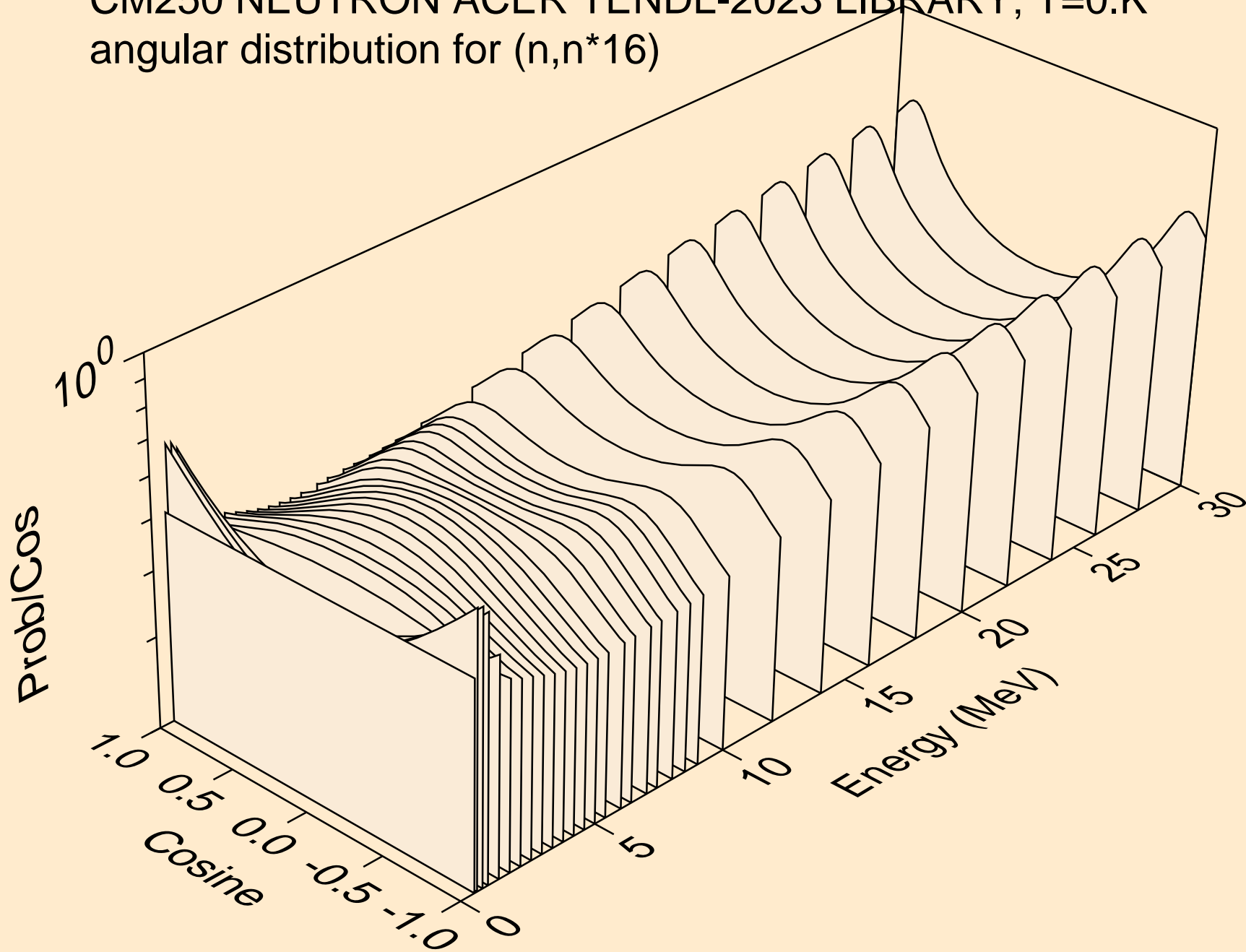

CM250 NEUTRON ACER TENDL-2023 LIBRARY; T=0.K  
angular distribution for (n,n\*17)

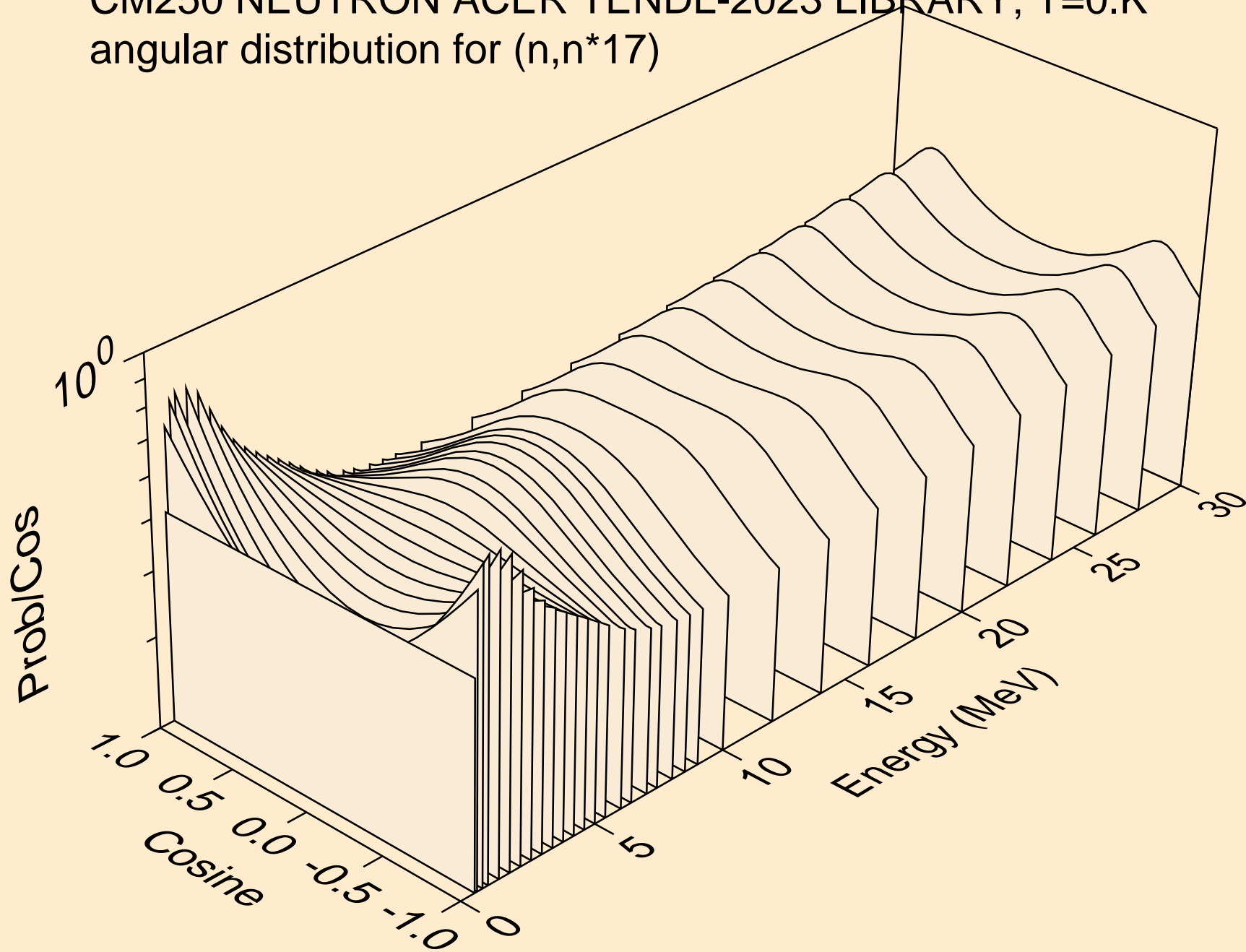

CM250 NEUTRON ACER TENDL-2023 LIBRARY; T=0.K  
angular distribution for (n,n\*18)

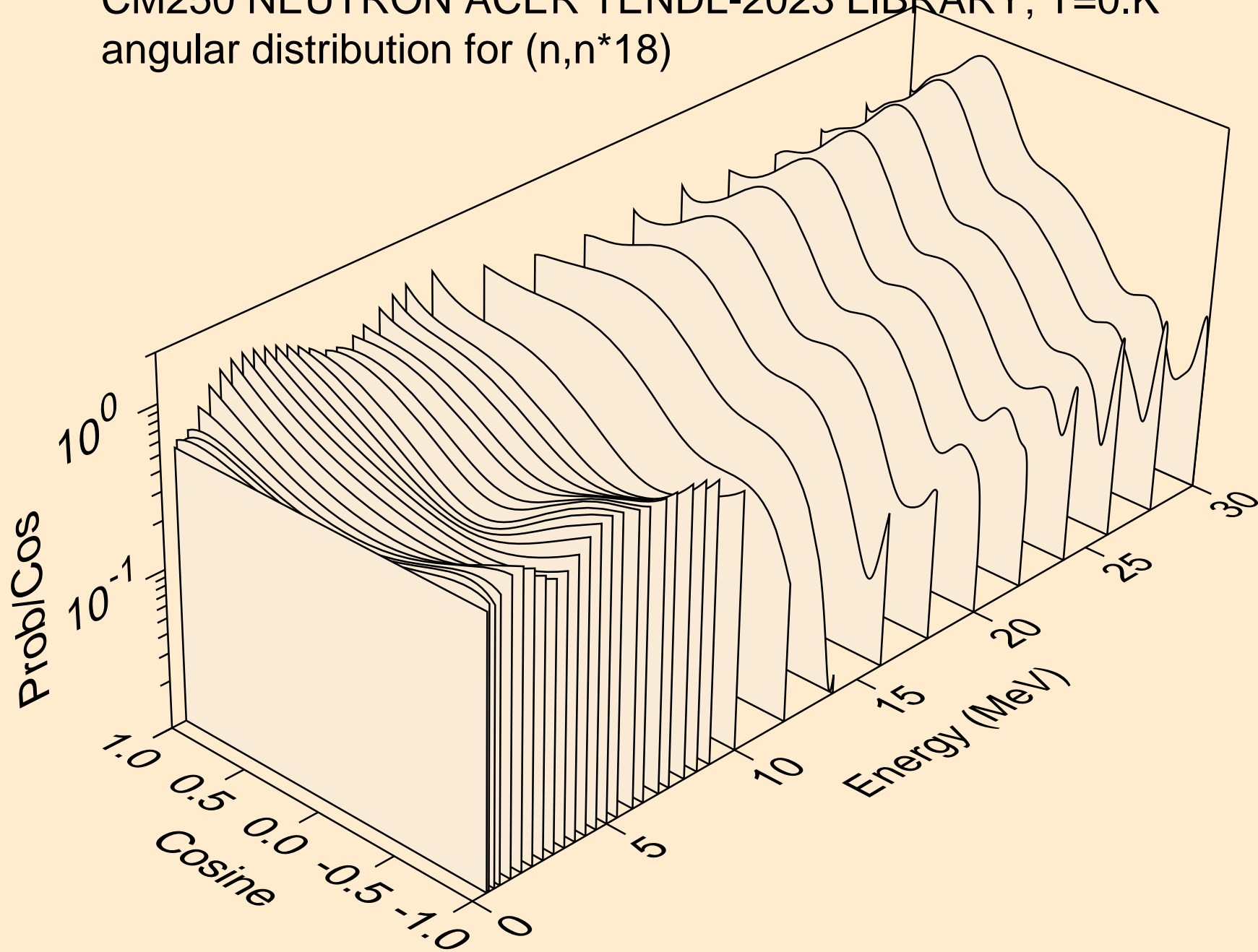

CM250 NEUTRON ACER TENDL-2023 LIBRARY; T=0.K  
angular distribution for (n,n\*19)

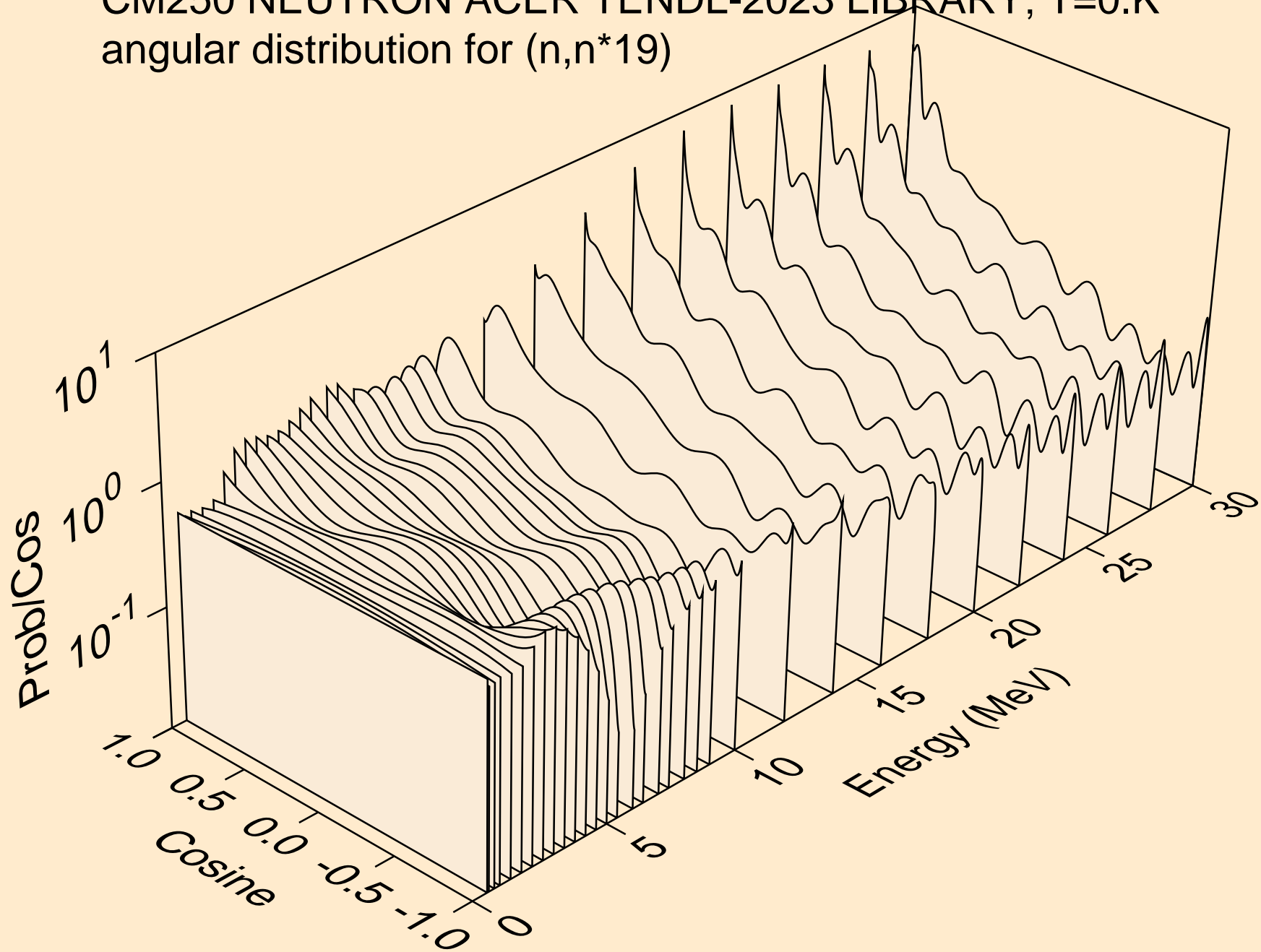



CM250 NEUTRON ACER TENDL-2023 LIBRARY; T=0.K  
angular distribution for (n,n\*20)

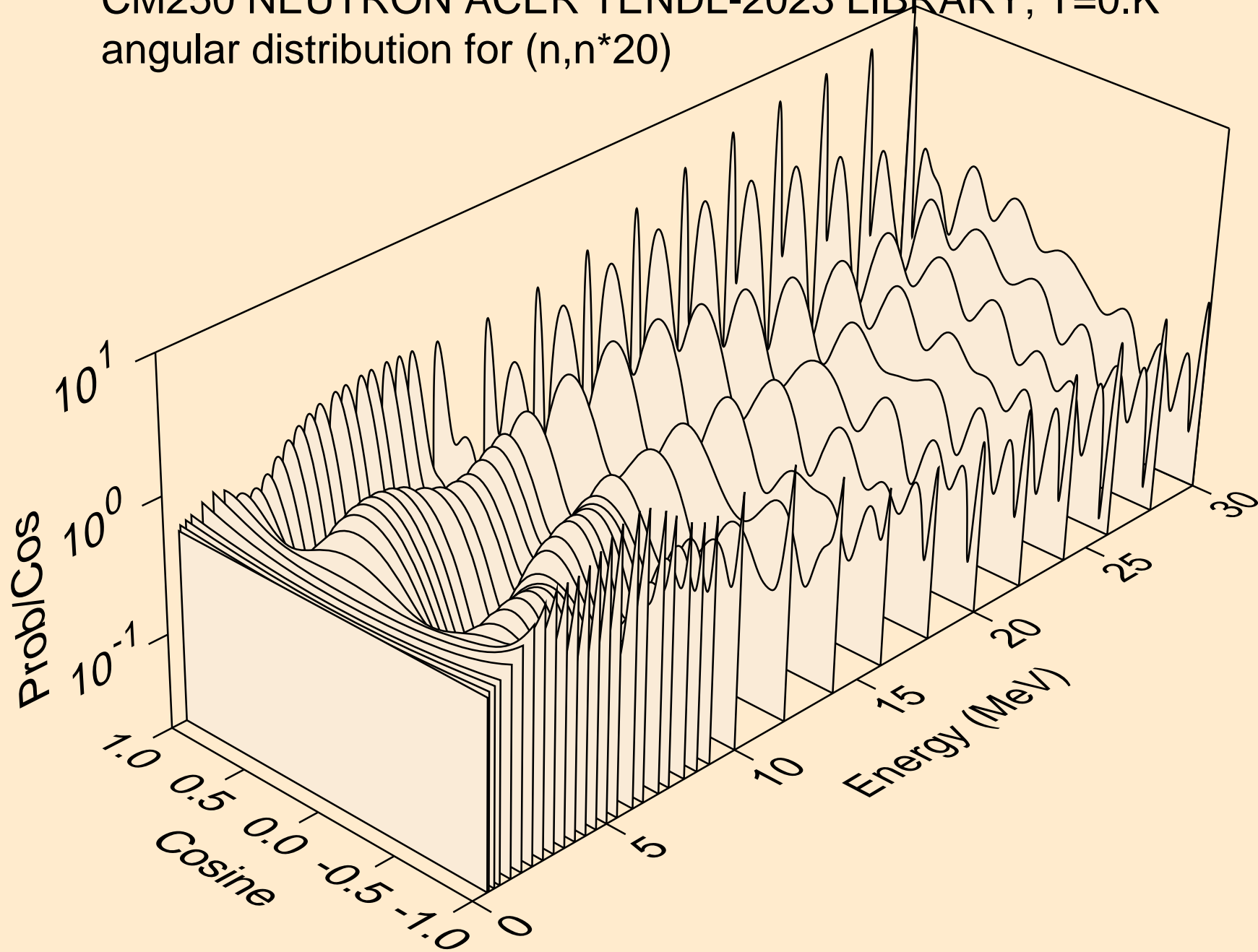

CM250 NEUTRON ACER TENDL-2023 LIBRARY; T=0.K  
angular distribution for (n,n\*21)

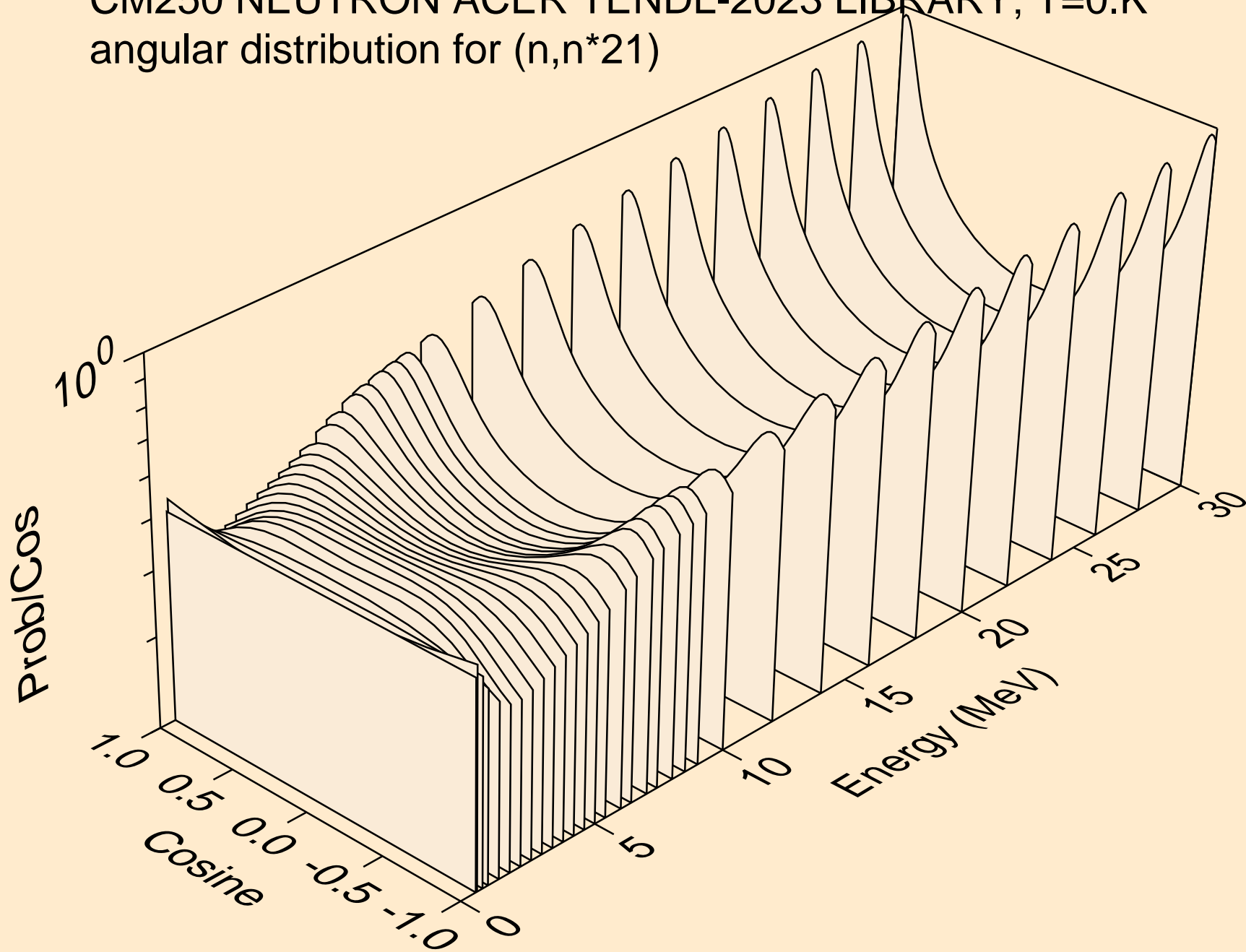

CM250 NEUTRON ACER TENDL-2023 LIBRARY; T=0.K  
angular distribution for (n,n\*22)

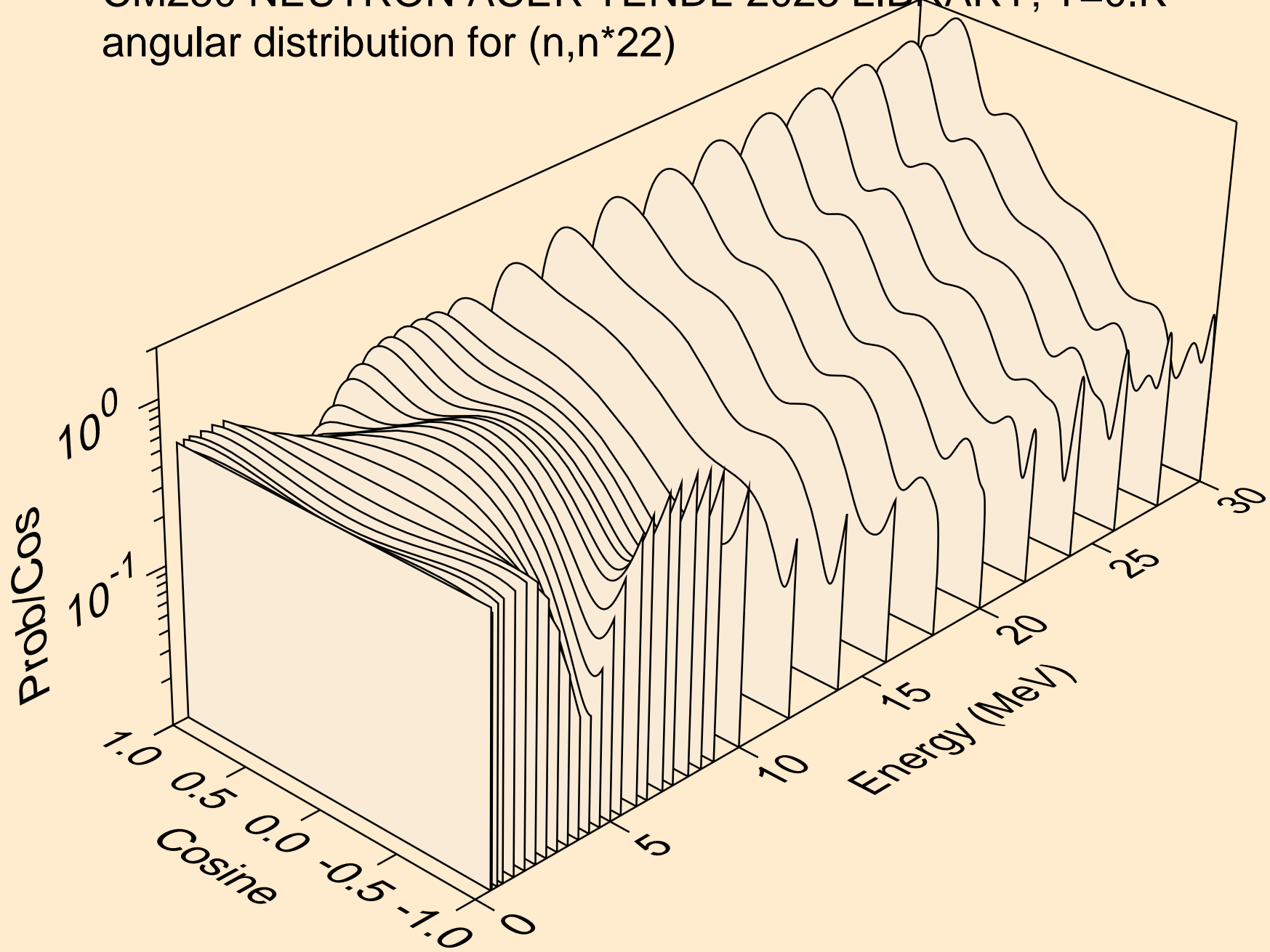

CM250 NEUTRON ACER TENDL-2023 LIBRARY; T=0.K  
angular distribution for (n,n\*23)

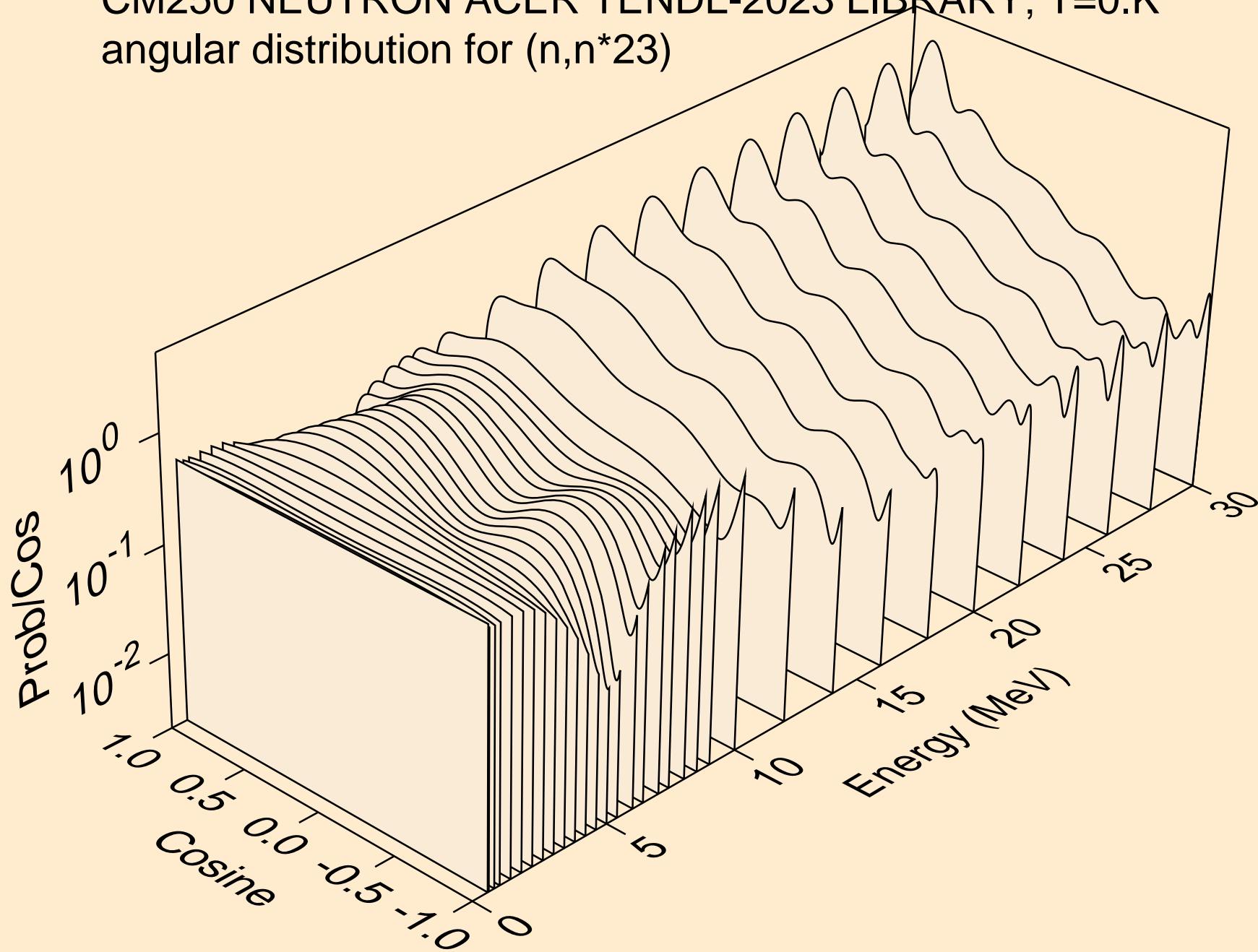

CM250 NEUTRON ACER TENDL-2023 LIBRARY; T=0.K  
angular distribution for (n,n\*24)

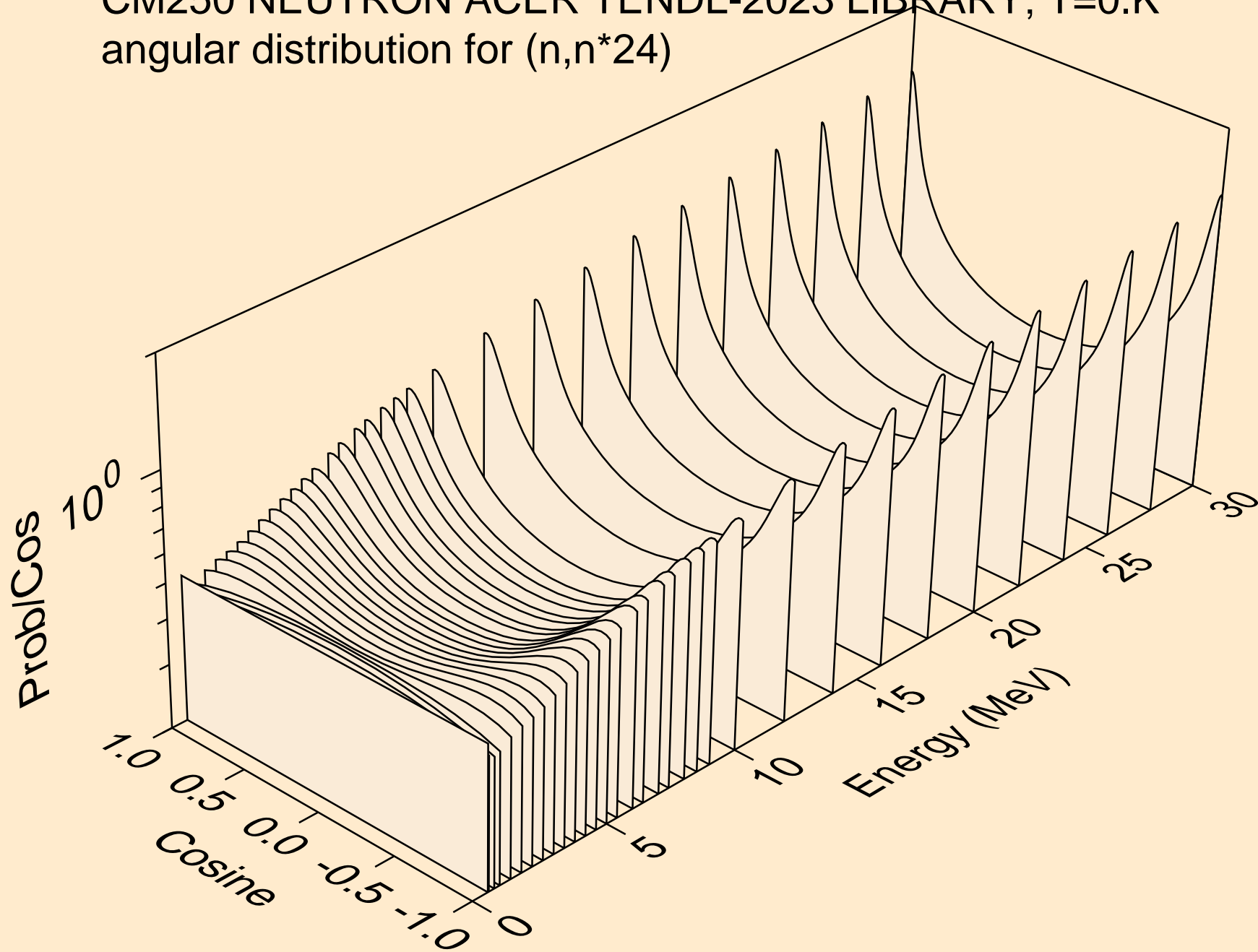

CM250 NEUTRON ACER TENDL-2023 LIBRARY; T=0.K  
angular distribution for (n,n\*25)

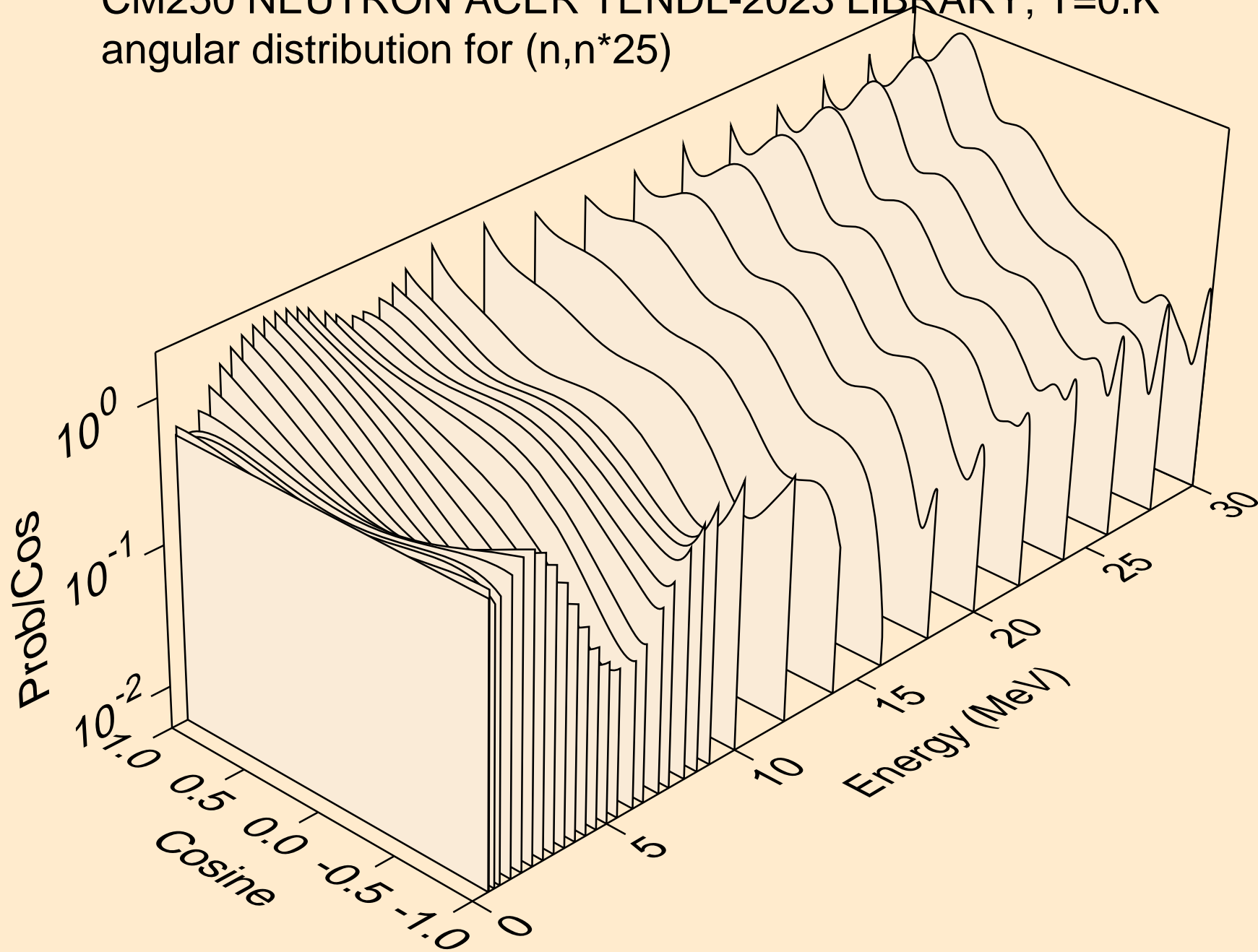

CM250 NEUTRON ACER TENDL-2023 LIBRARY; T=0.K  
angular distribution for (n,n\*26)

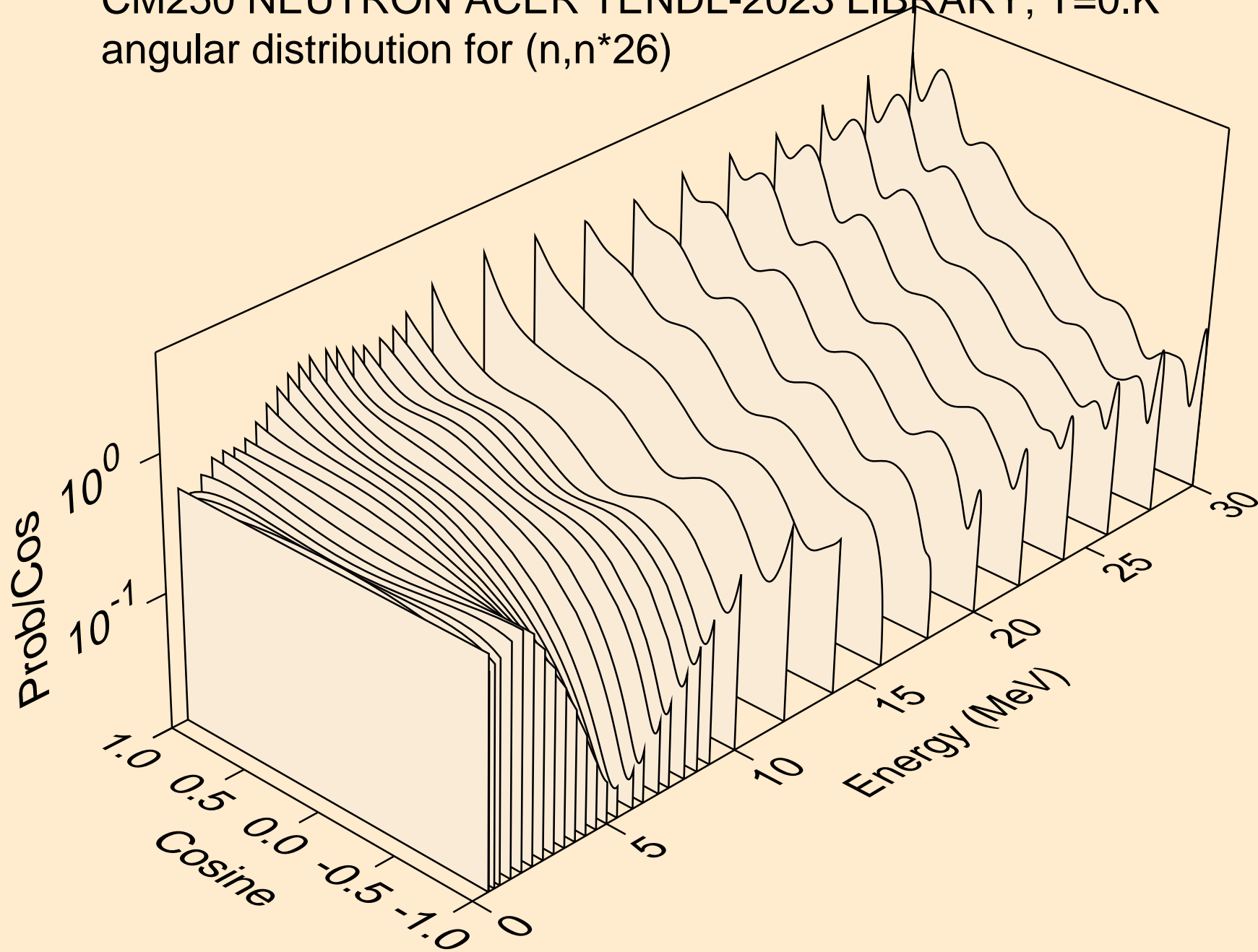



CM250 NEUTRON ACER TENDL-2023 LIBRARY; T=0.K  
angular distribution for (n,n\*27)

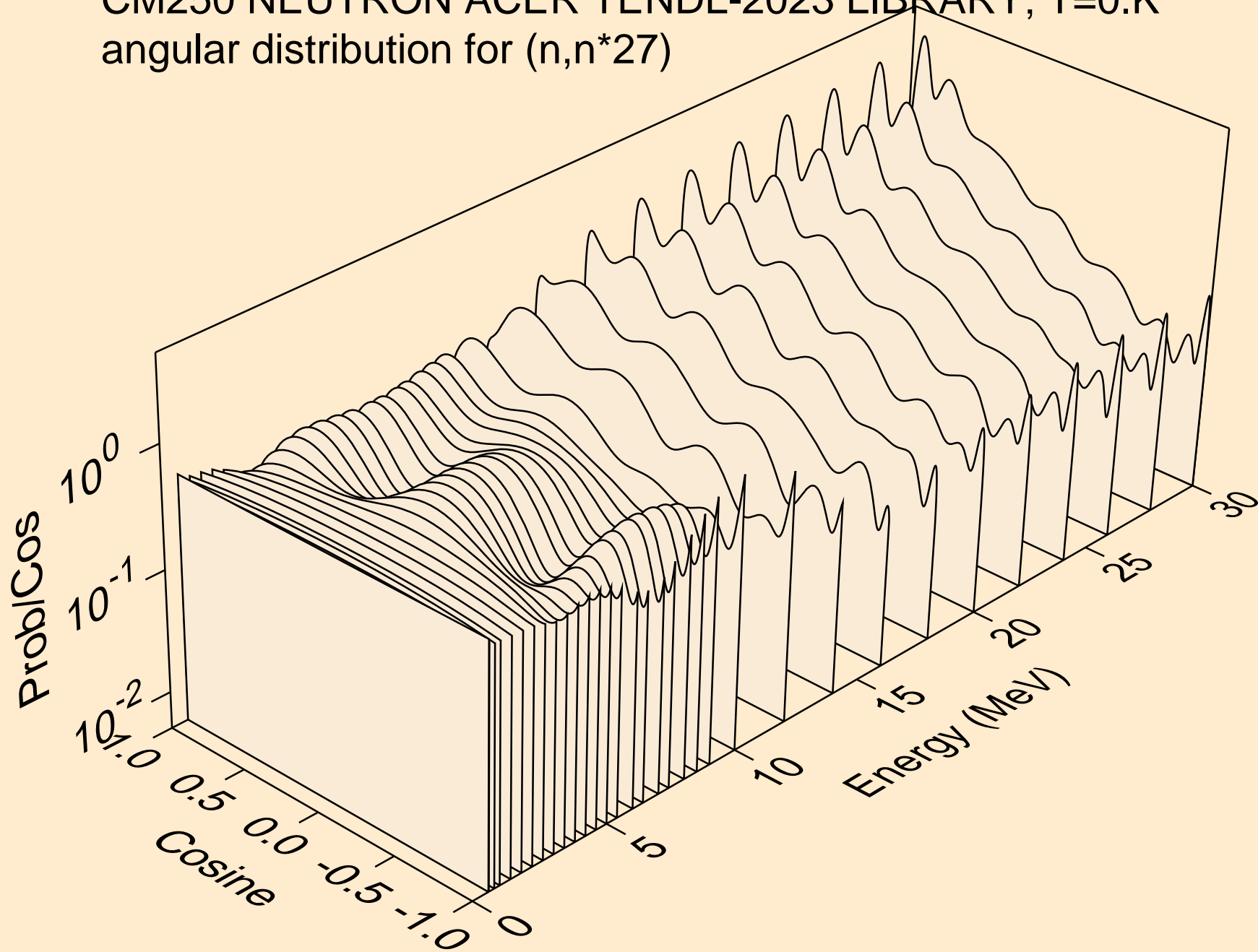



CM250 NEUTRON ACER TENDL-2023 LIBRARY; T=0.K  
angular distribution for (n,n\*28)

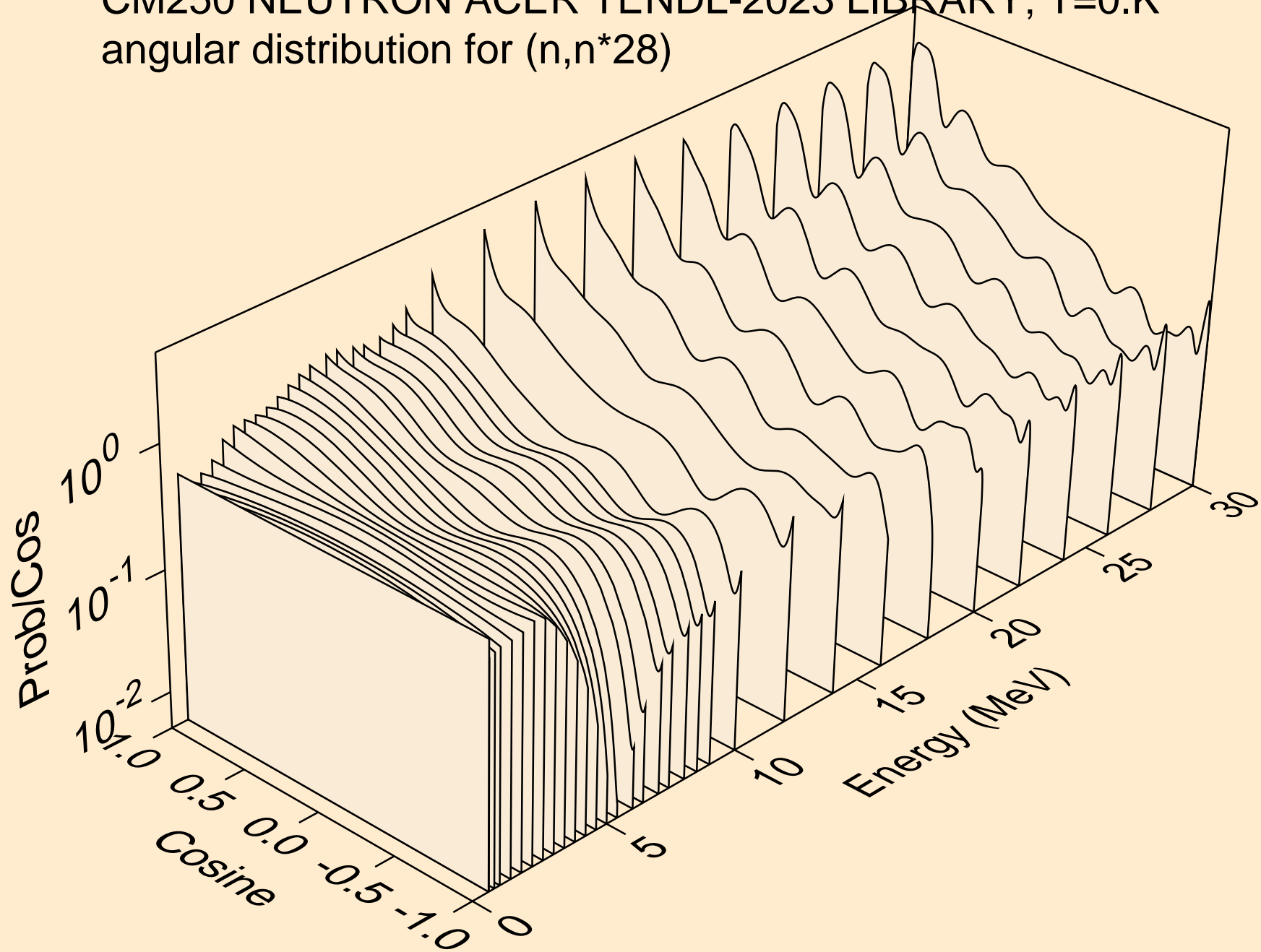

CM250 NEUTRON ACER TENDL-2023 LIBRARY; T=0.K

Total fission nubar

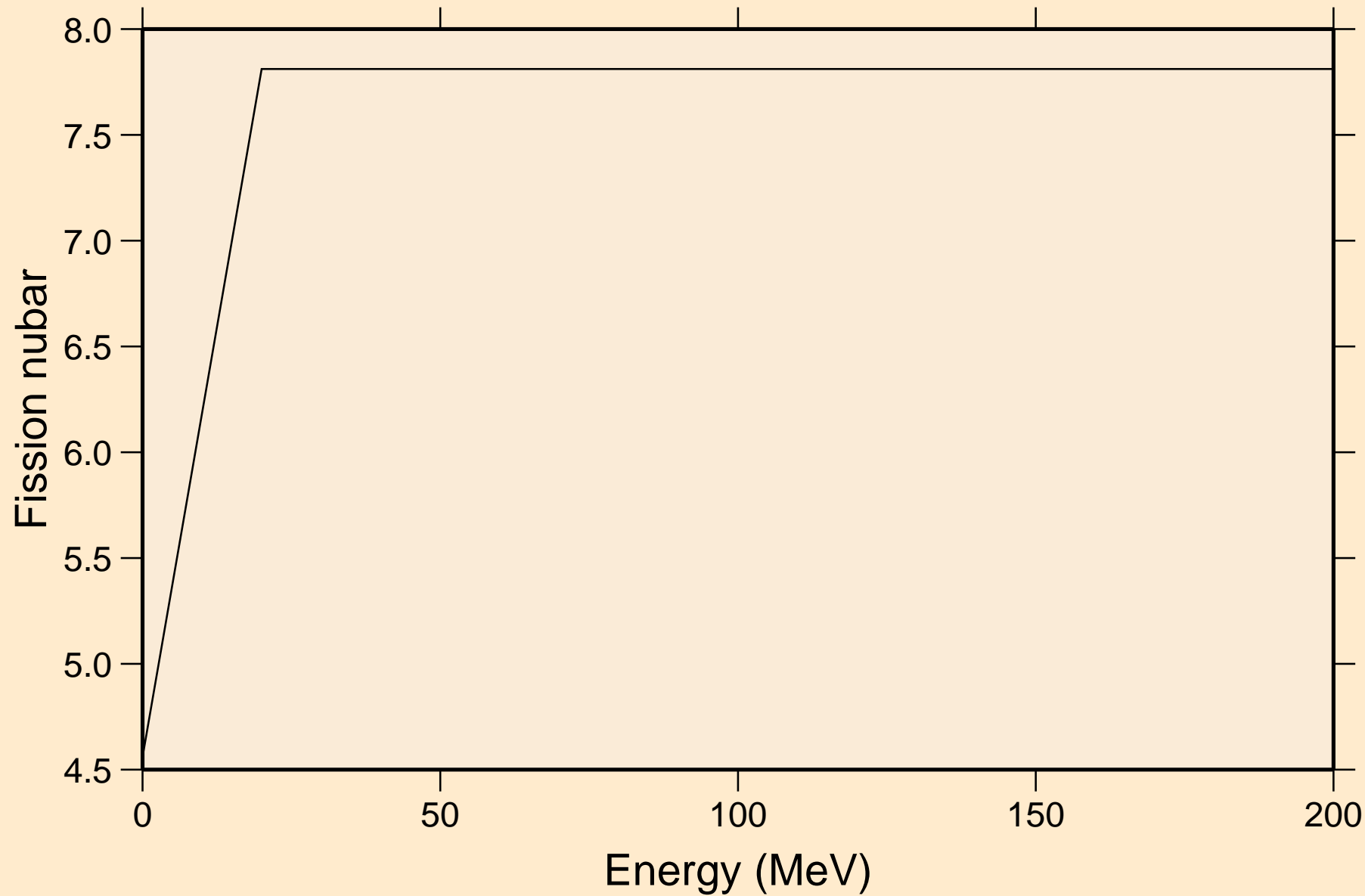

CM250 NEUTRON ACER TENDL-2023 LIBRARY; T=0.K  
Neutron emission for (n,x)

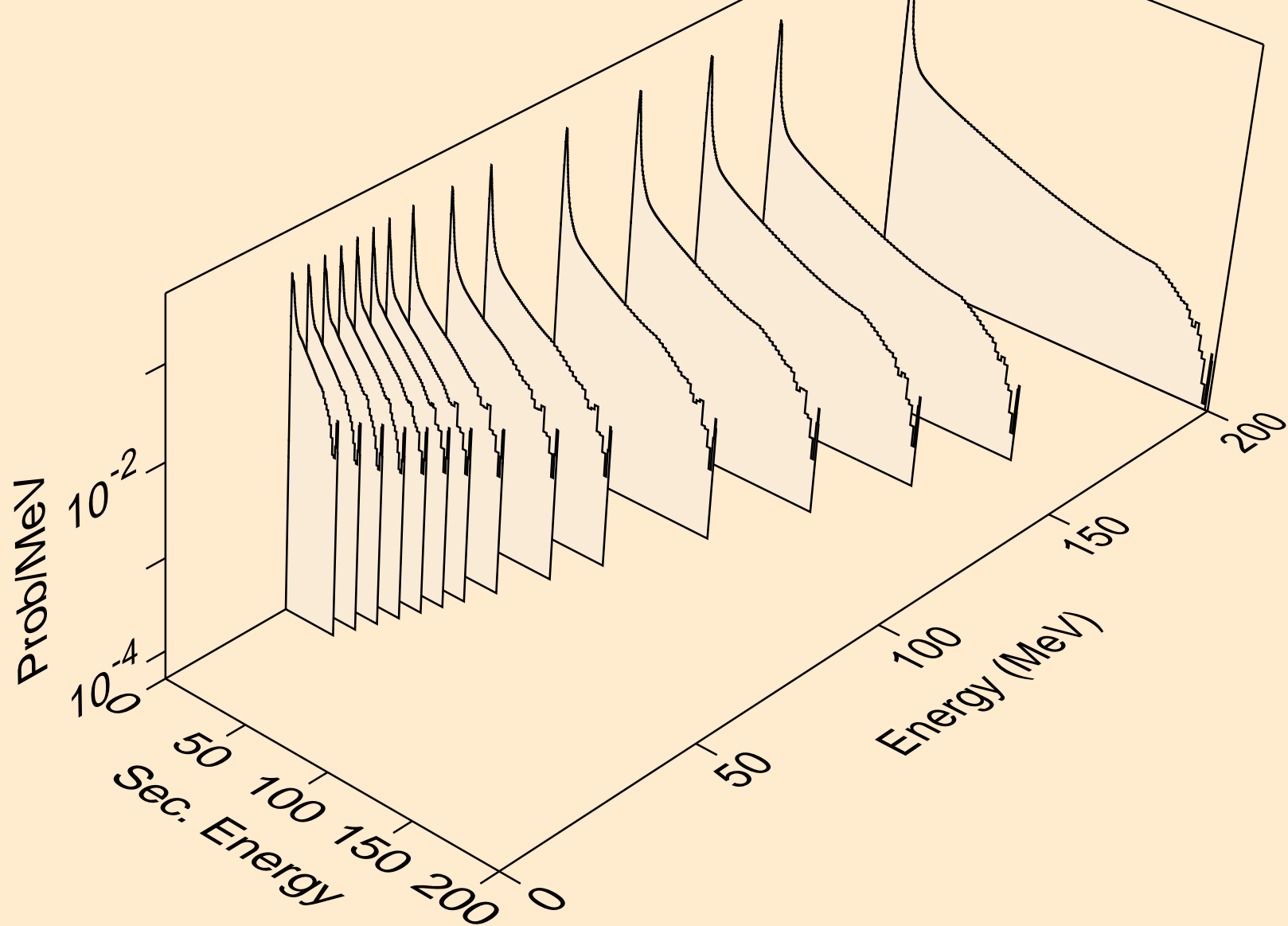

CM250 NEUTRON ACER TENDL-2023 LIBRARY; T=0.K  
Neutron emission for (n,2nd)

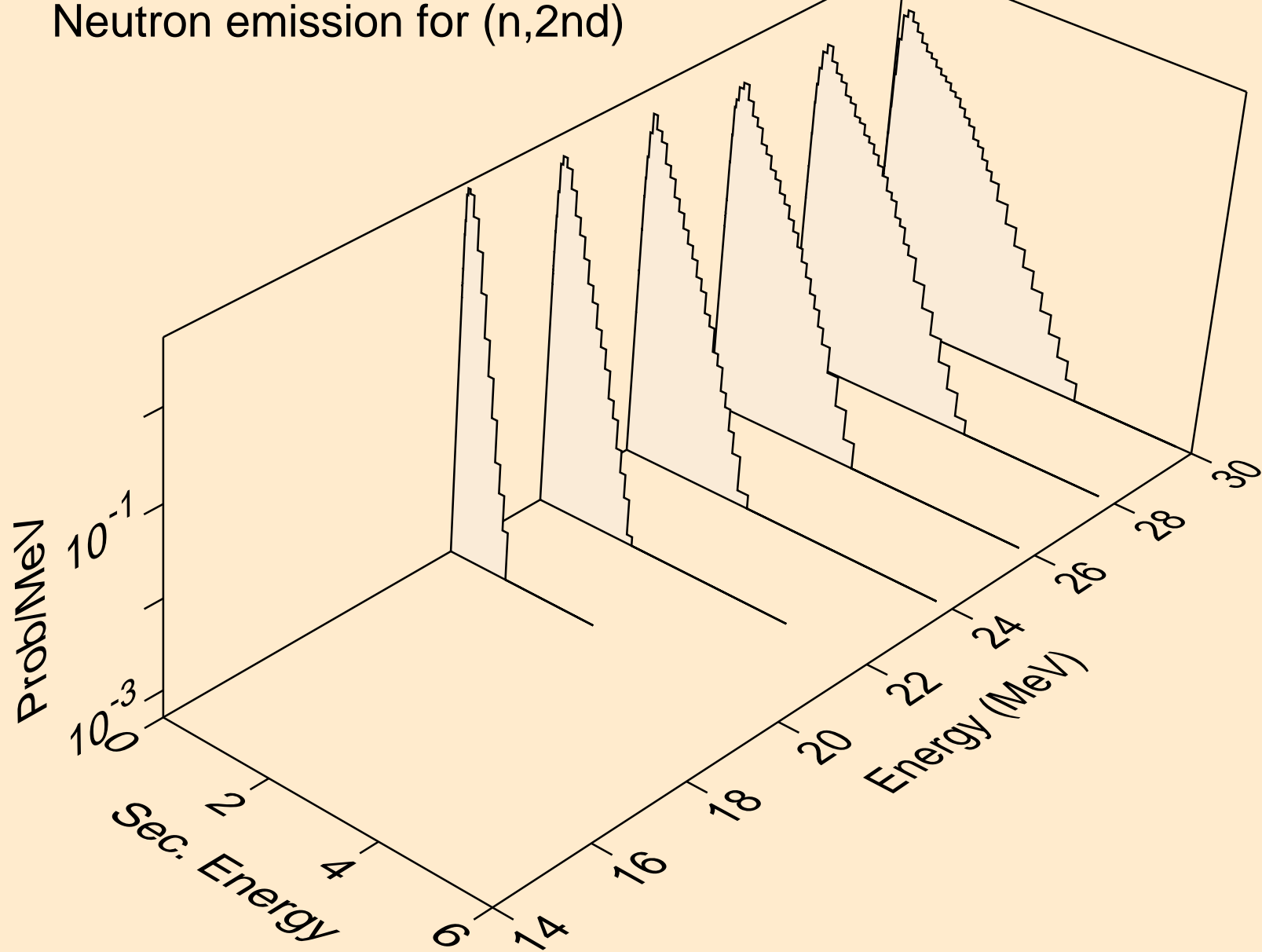

CM250 NEUTRON ACER TENDL-2023 LIBRARY; T=0.K  
Neutron emission for (n,2n)

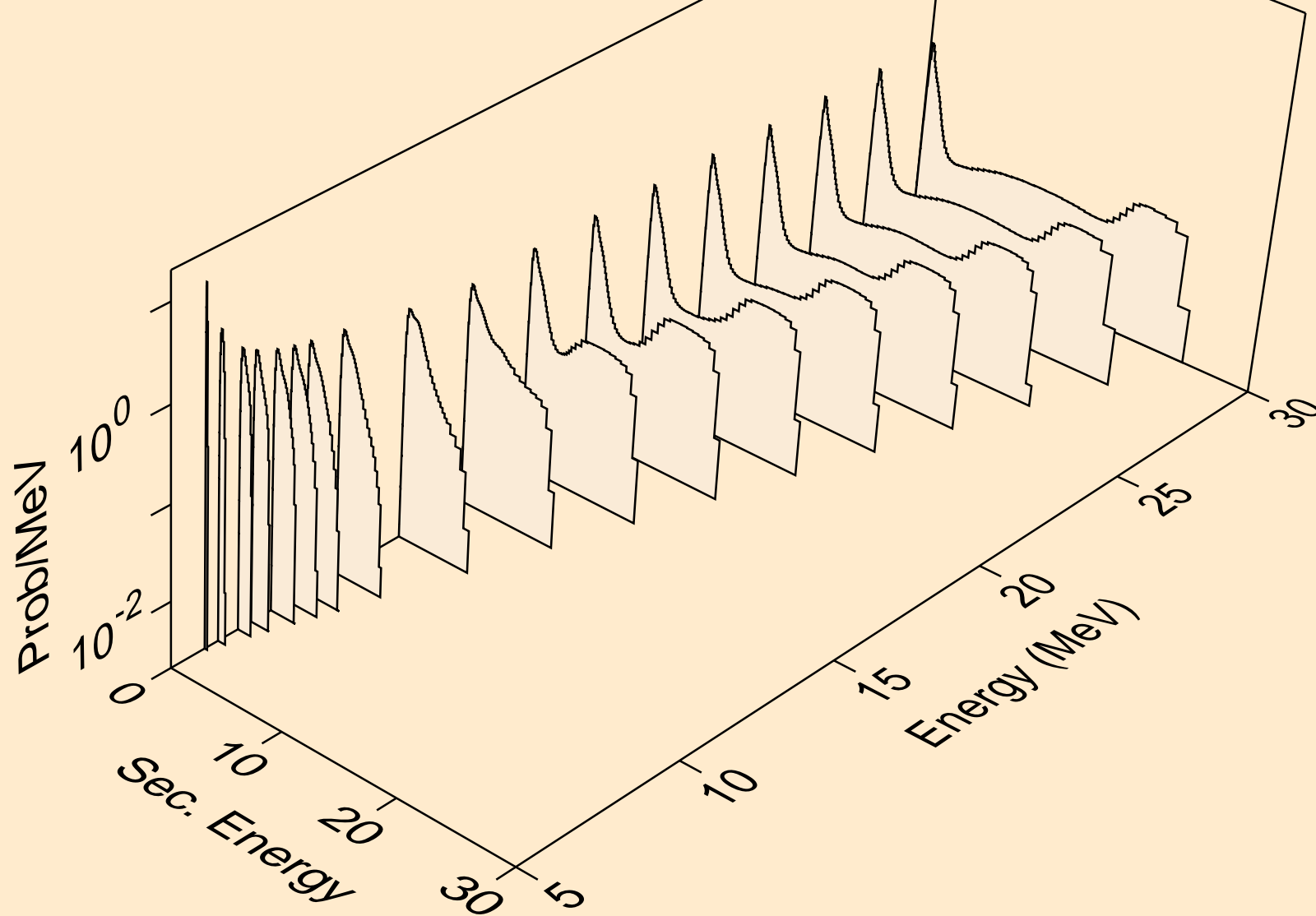

CM250 NEUTRON ACER TENDL-2023 LIBRARY; T=0.K  
Neutron emission for (n,3n)

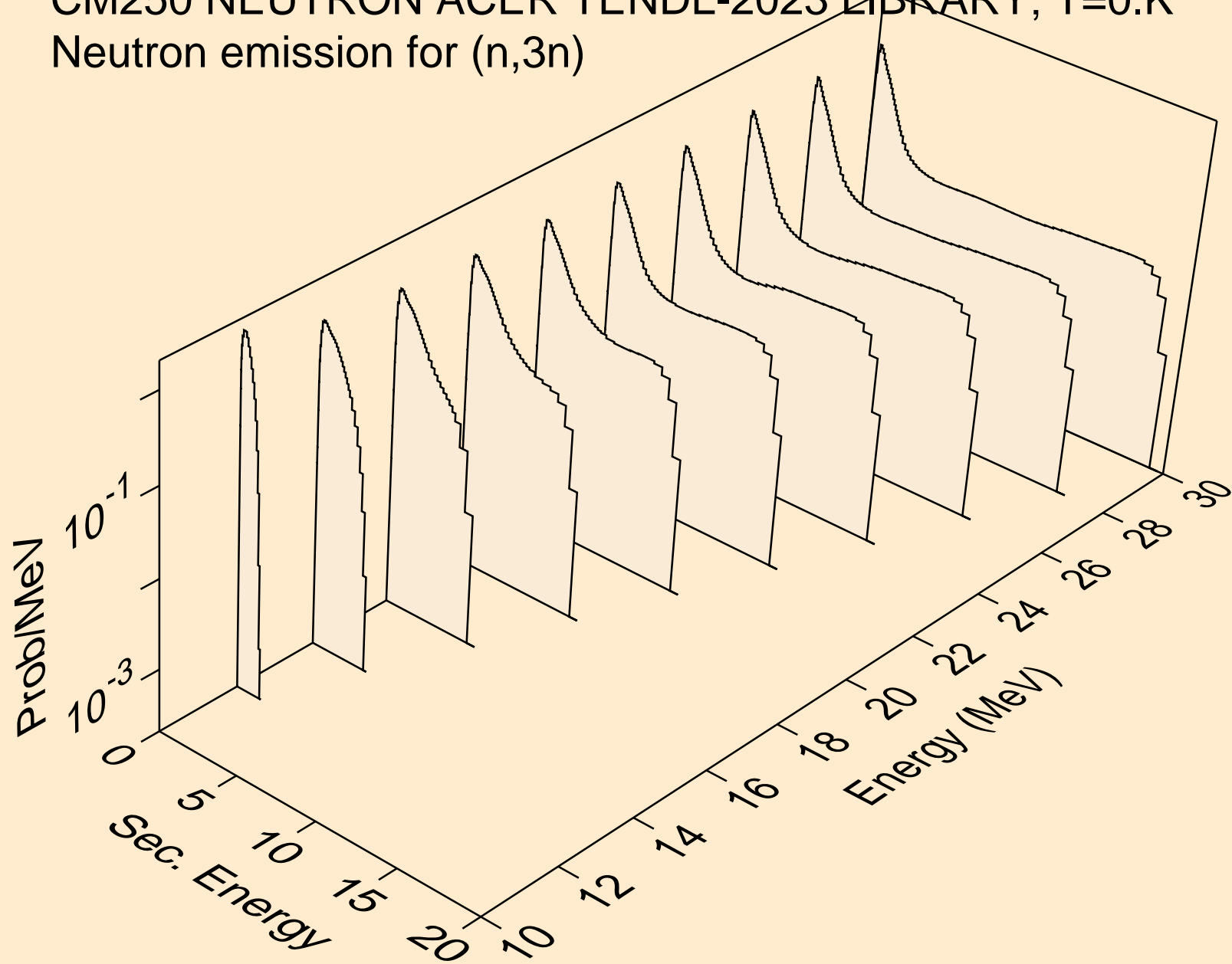

CM250 NEUTRON ACER TENDL-2023 LIBRARY; T=0.K  
Neutron emission for fission

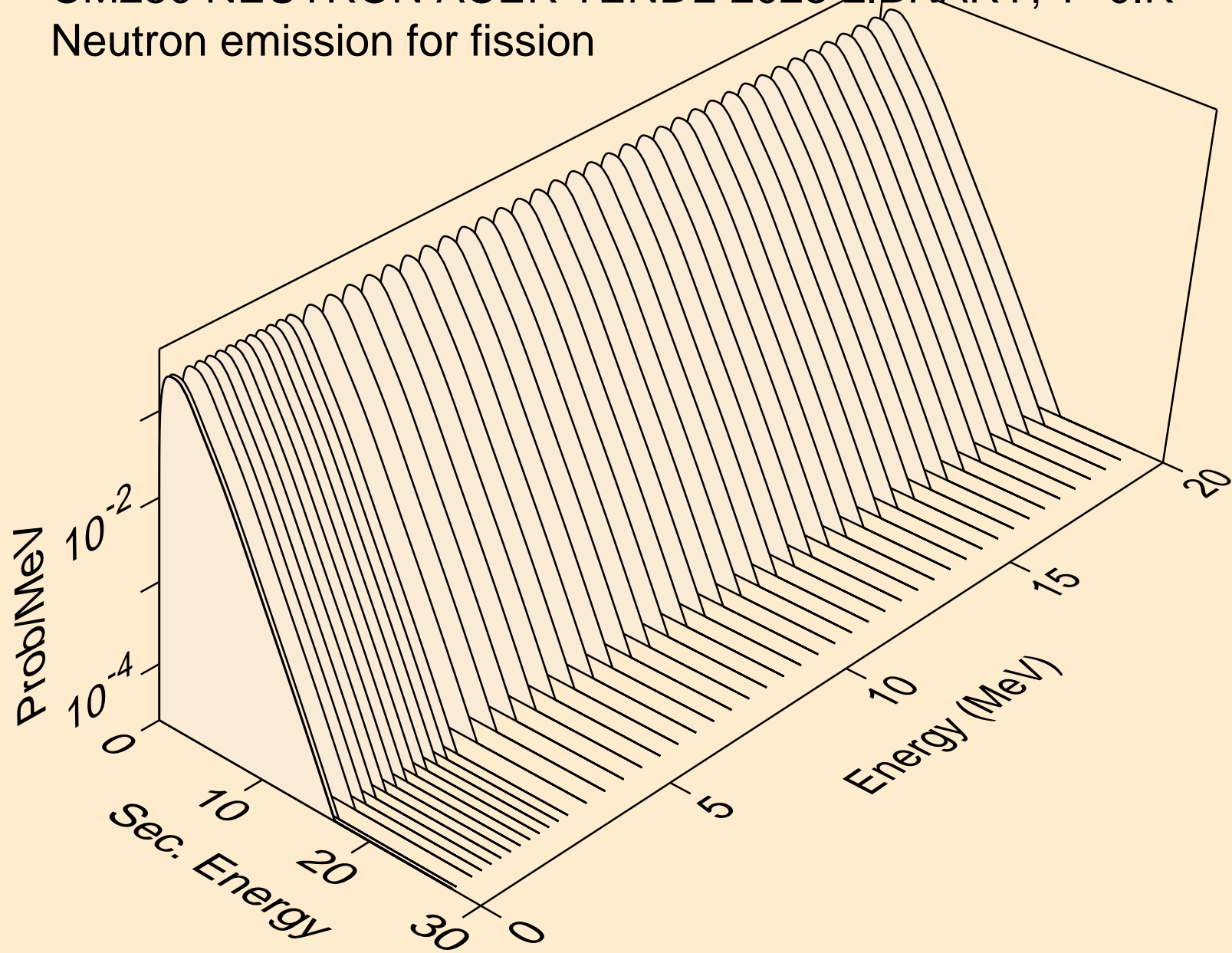

CM250 NEUTRON ACER TENDL-2023 LIBRARY; T=0.K  
Neutron emission for (n,n\*)a

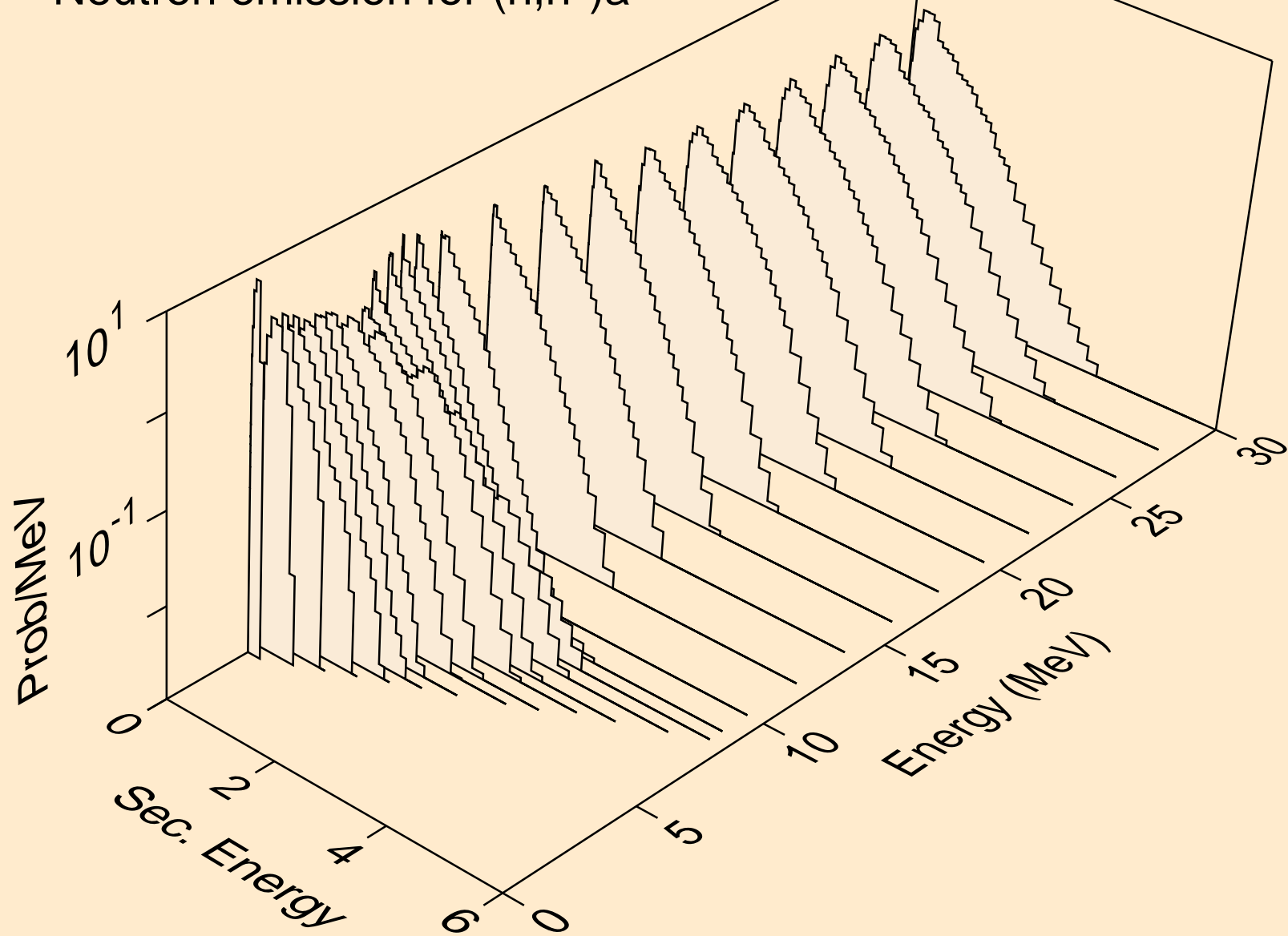



CM250 NEUTRON ACER TENDL-2023 LIBRARY; T=0.K  
Neutron emission for (n,2n)a

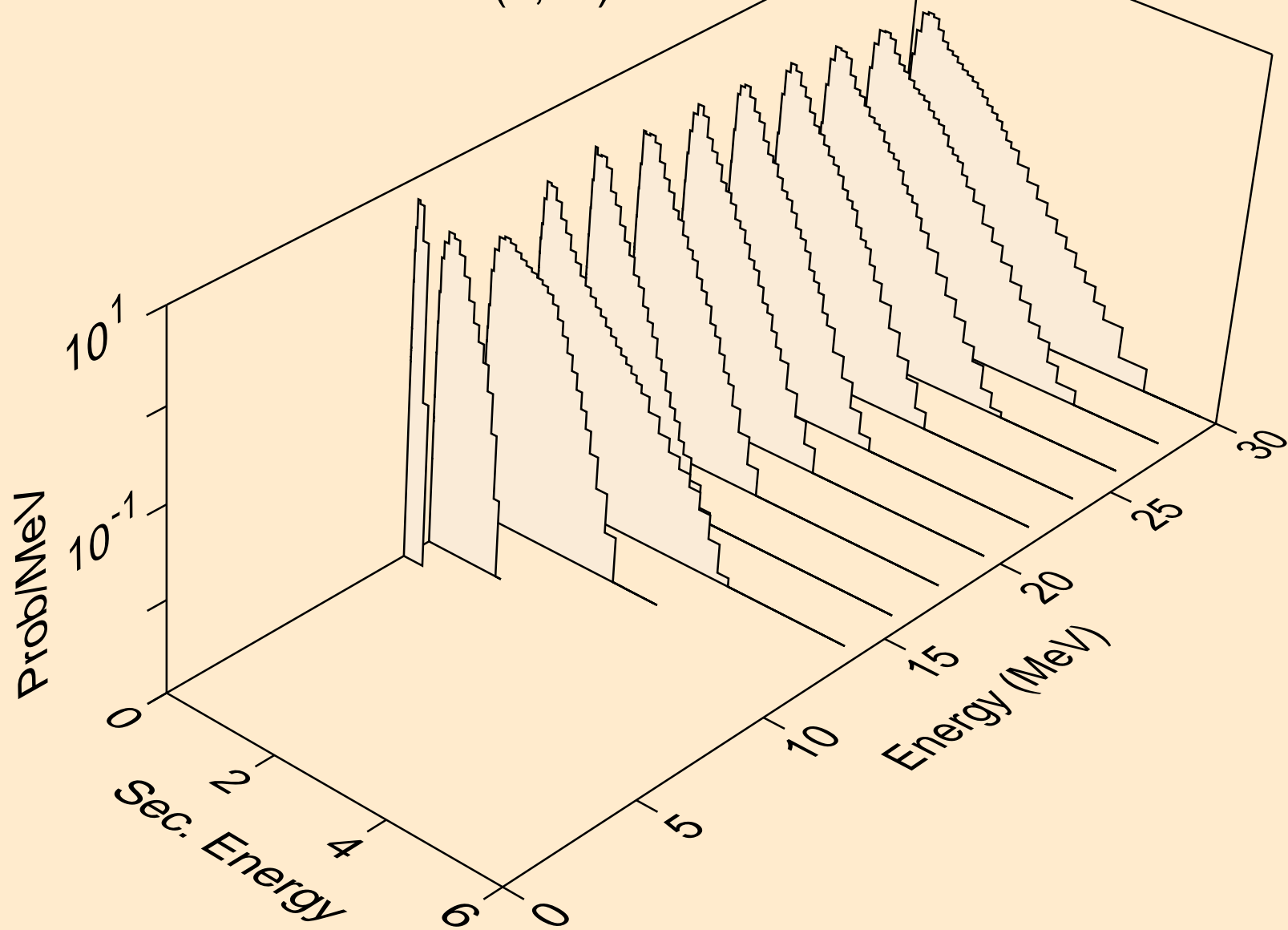

CM250 NEUTRON ACER TENDL-2023 LIBRARY; T=0.K  
Neutron emission for (n,3n)a

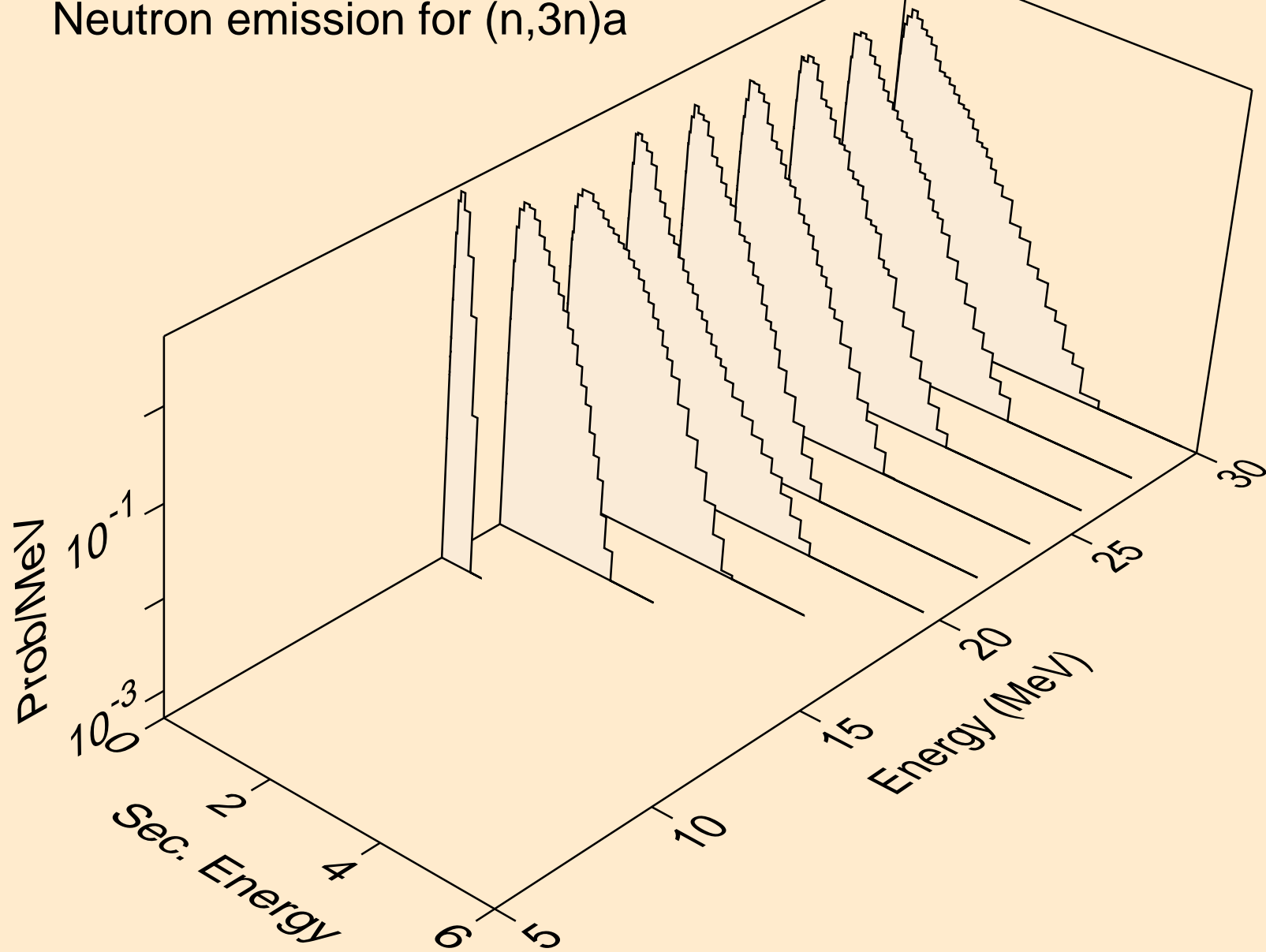

CM250 NEUTRON ACER TENDL-2023 LIBRARY; T=0.K  
Neutron emission for (n,n\*)p

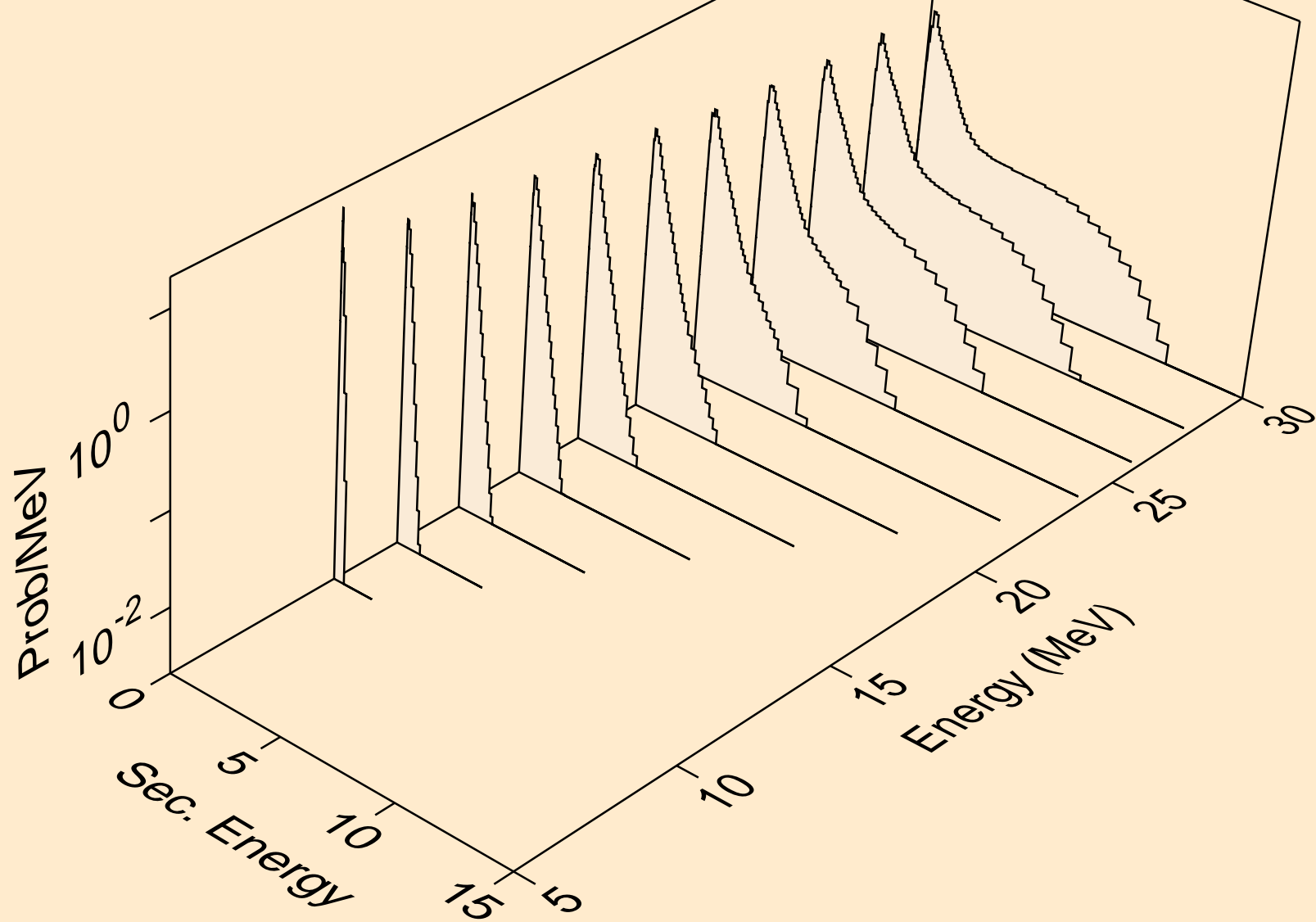

CM250 NEUTRON ACER TENDL-2023 LIBRARY; T=0.K  
Neutron emission for (n,n\*)d

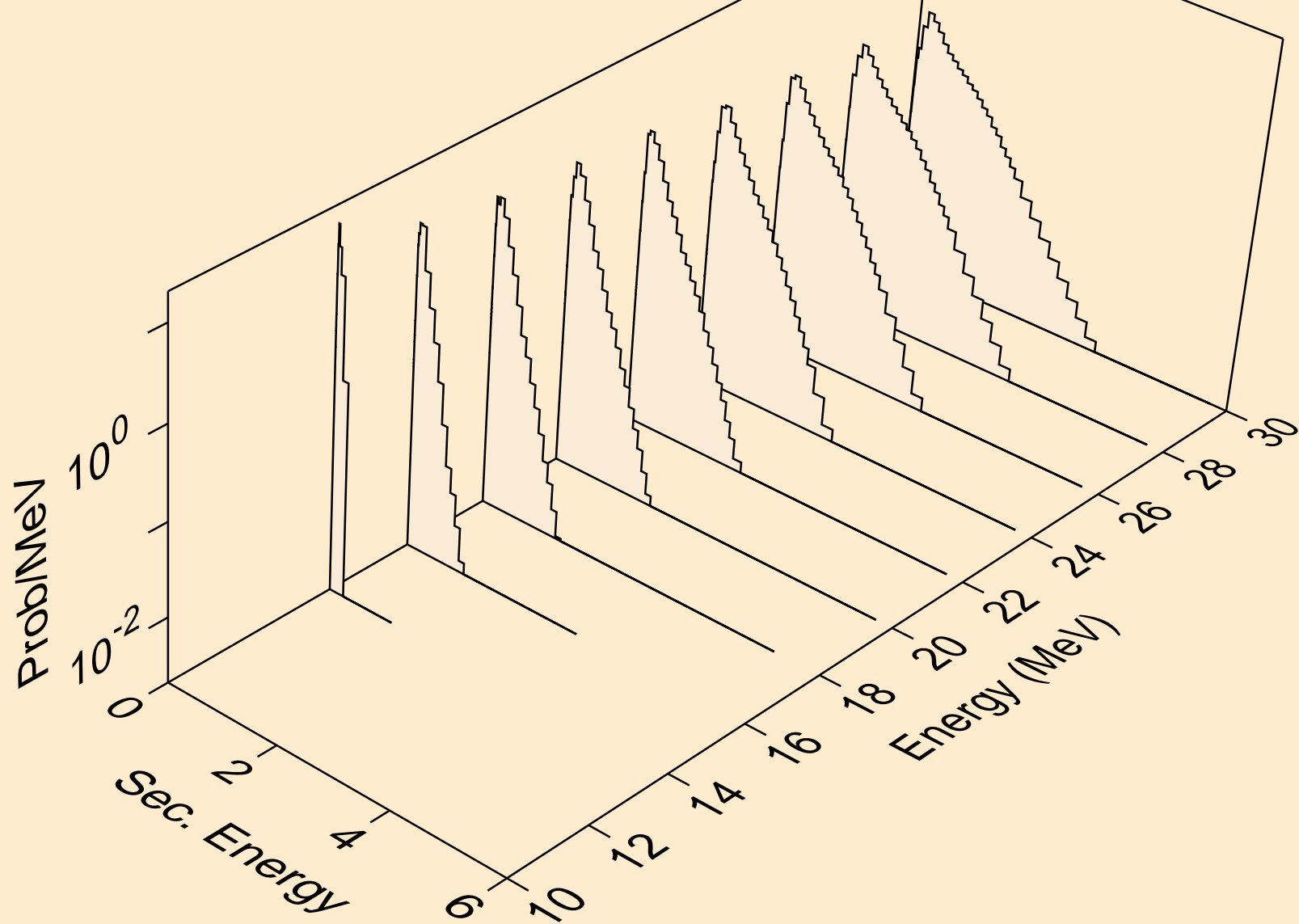

CM250 NEUTRON ACER TENDL-2023 LIBRARY; T=0.K  
Neutron emission for (n,n\*)t

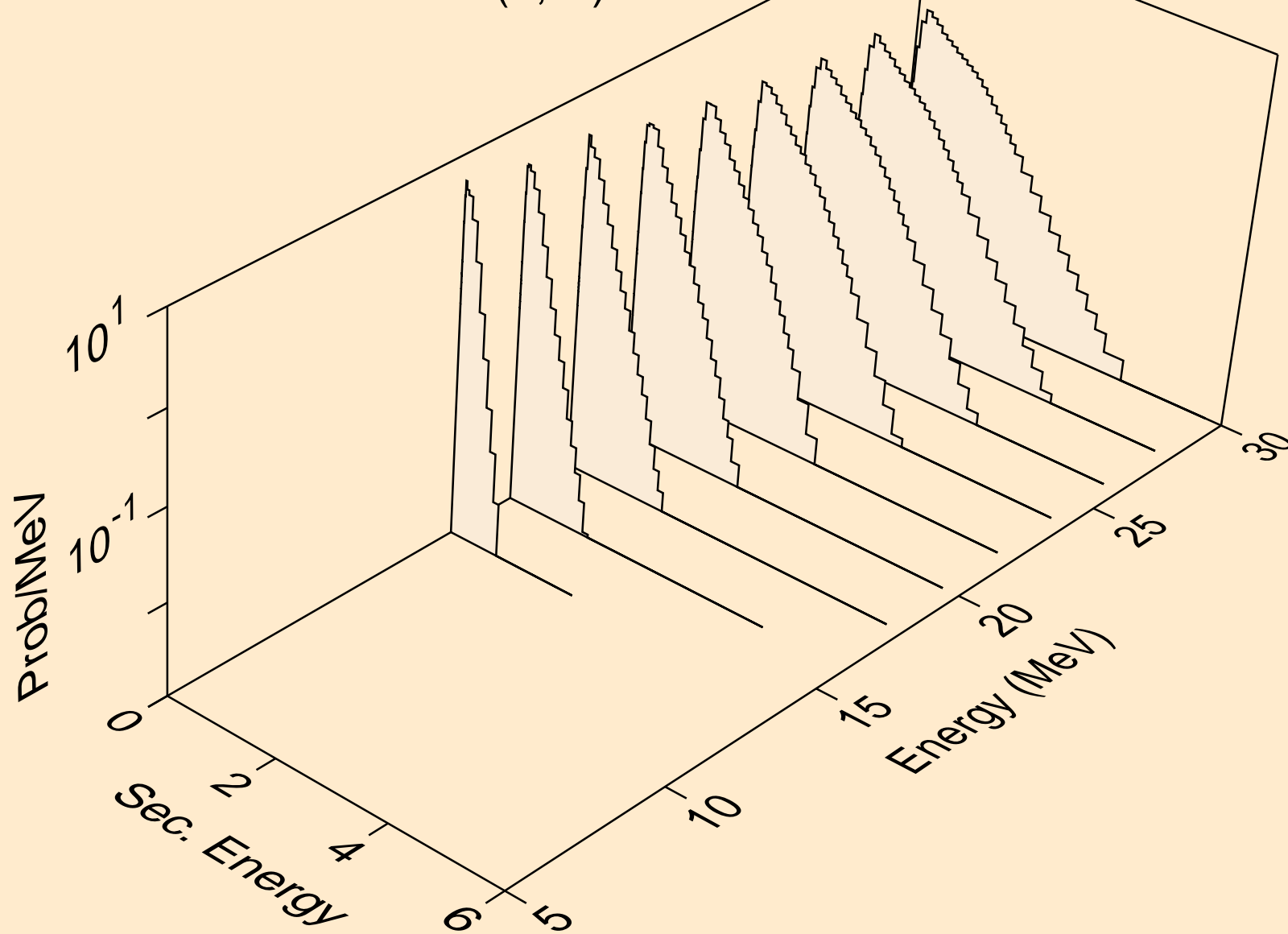

CM250 NEUTRON ACER TENDL-2023 LIBRARY; T=0.K  
Neutron emission for (n,n\*)he3

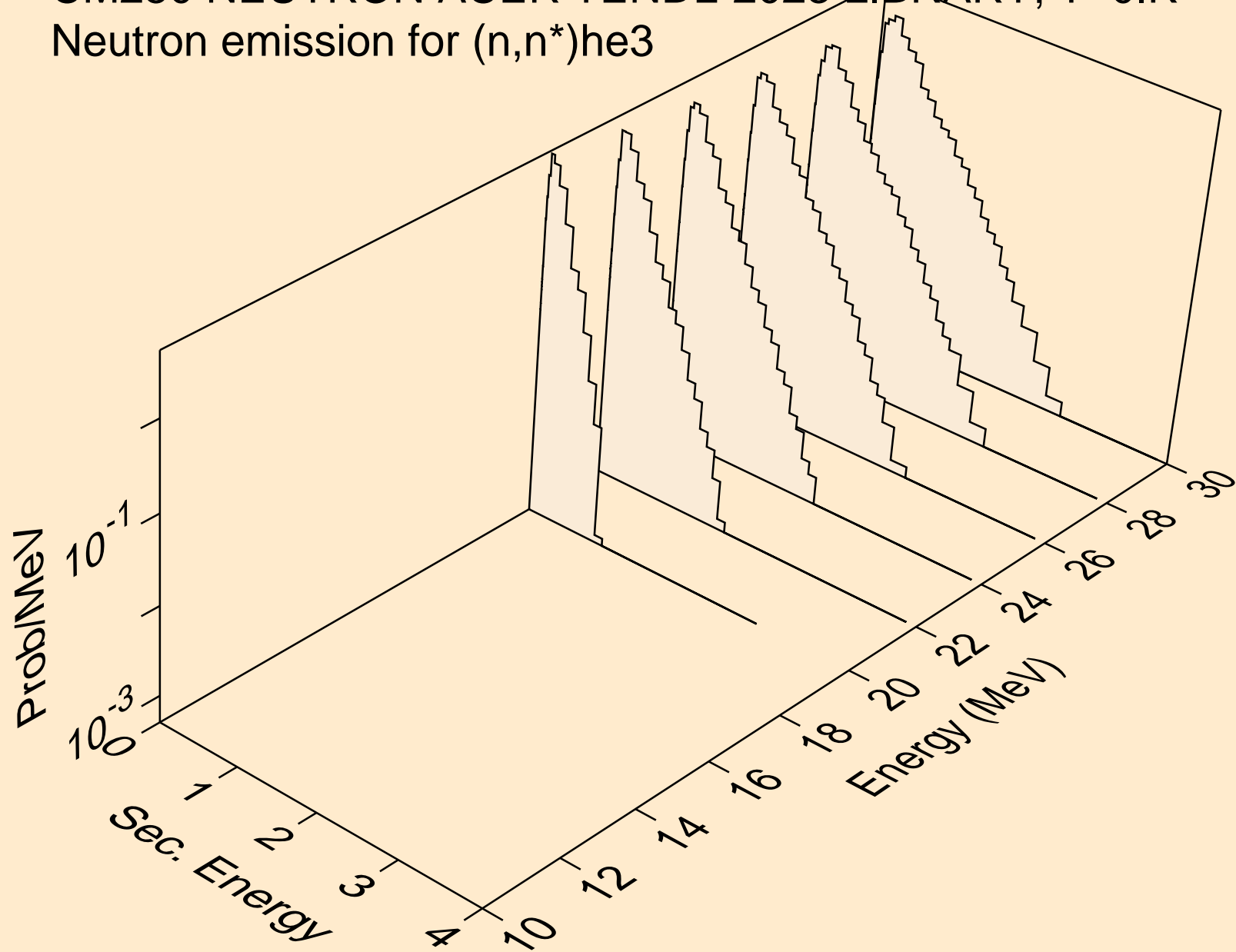

CM250 NEUTRON ACER TENDL-2023 LIBRARY; T=0.K  
Neutron emission for (n,4n)

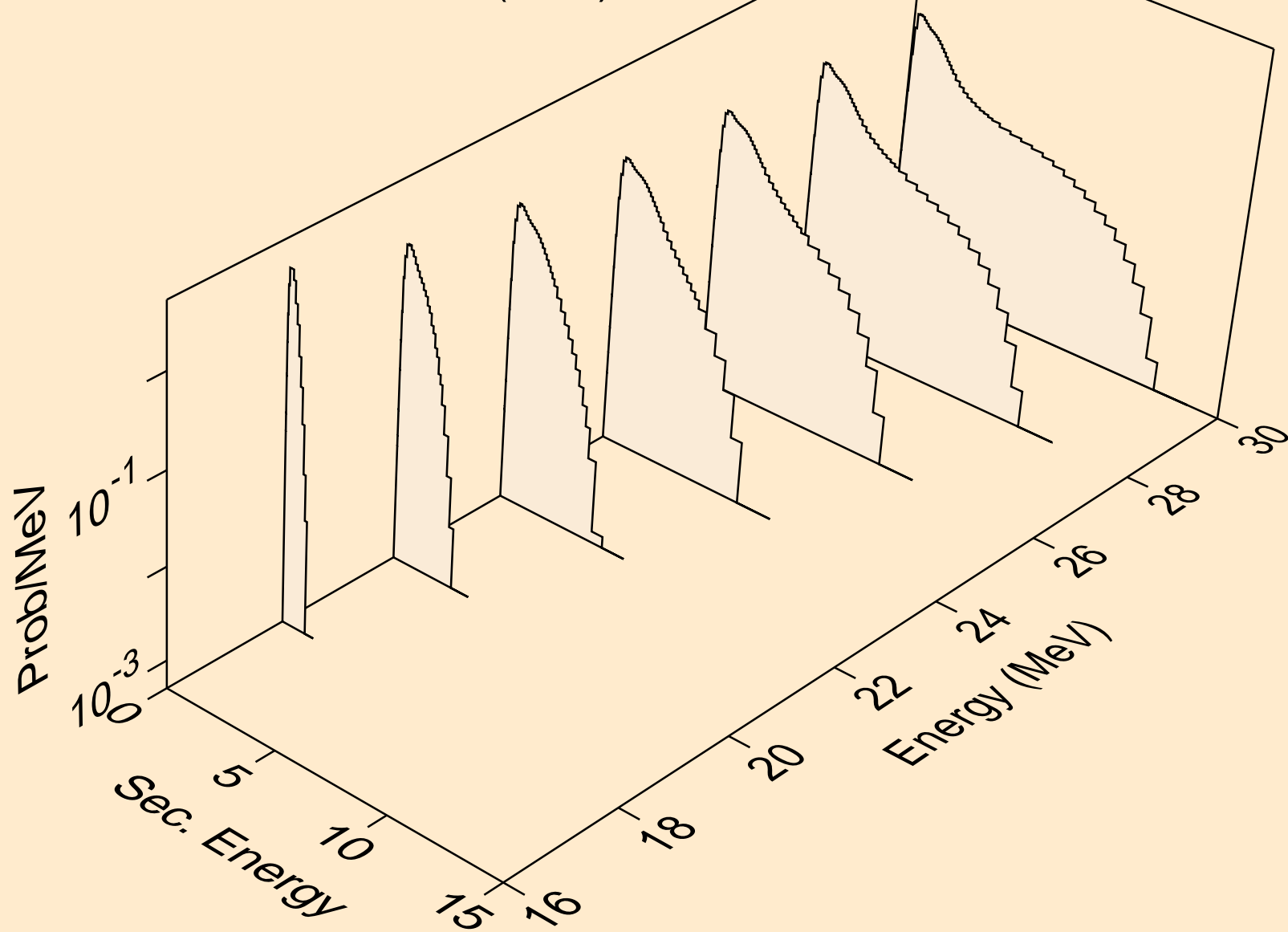

CM250 NEUTRON ACER TENDL-2023 LIBRARY; T=0.K  
Neutron emission for (n,2np)

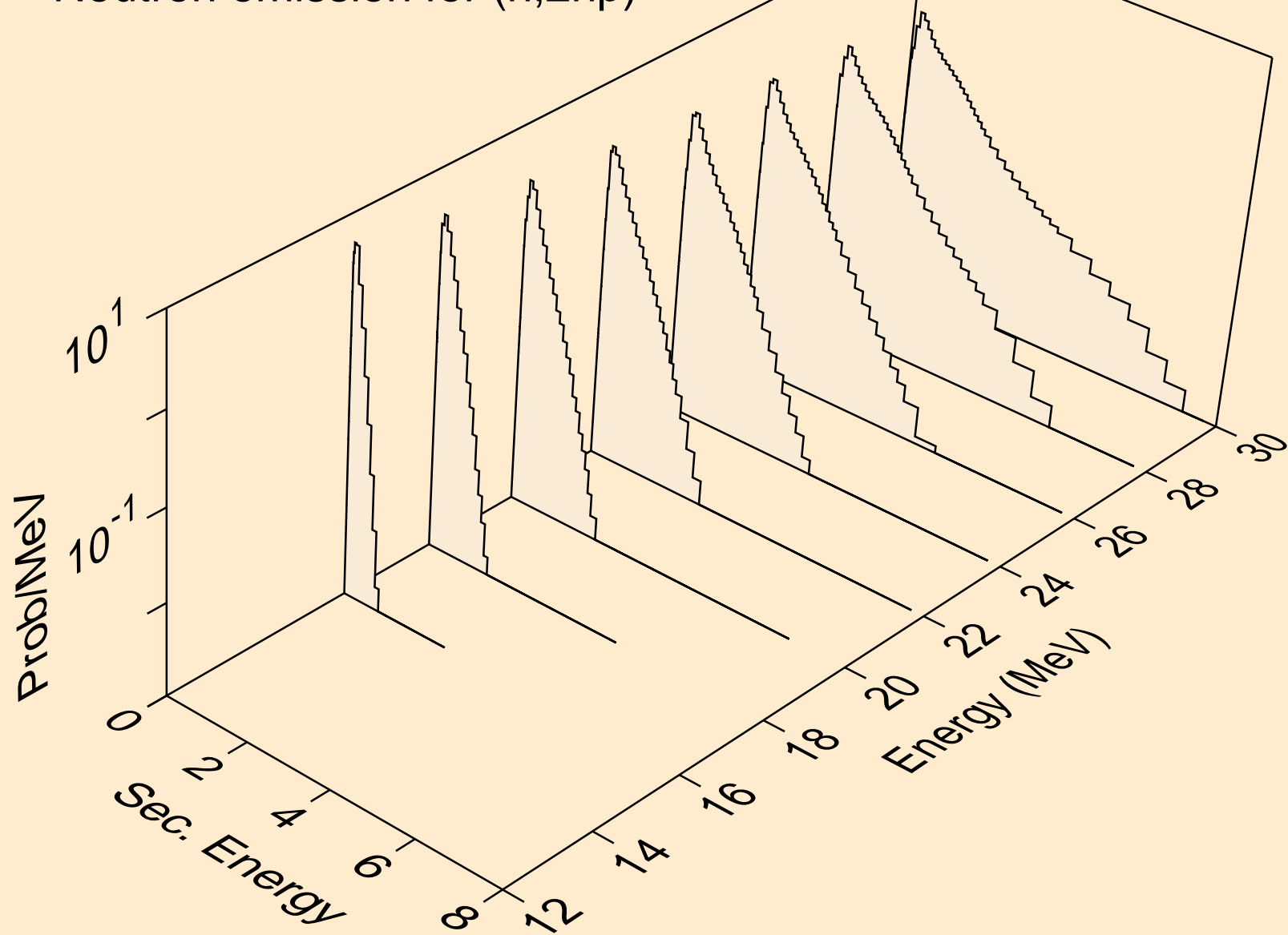



CM250 NEUTRON ACER TENDL-2023 LIBRARY; T=0.K  
Neutron emission for (n,3np)

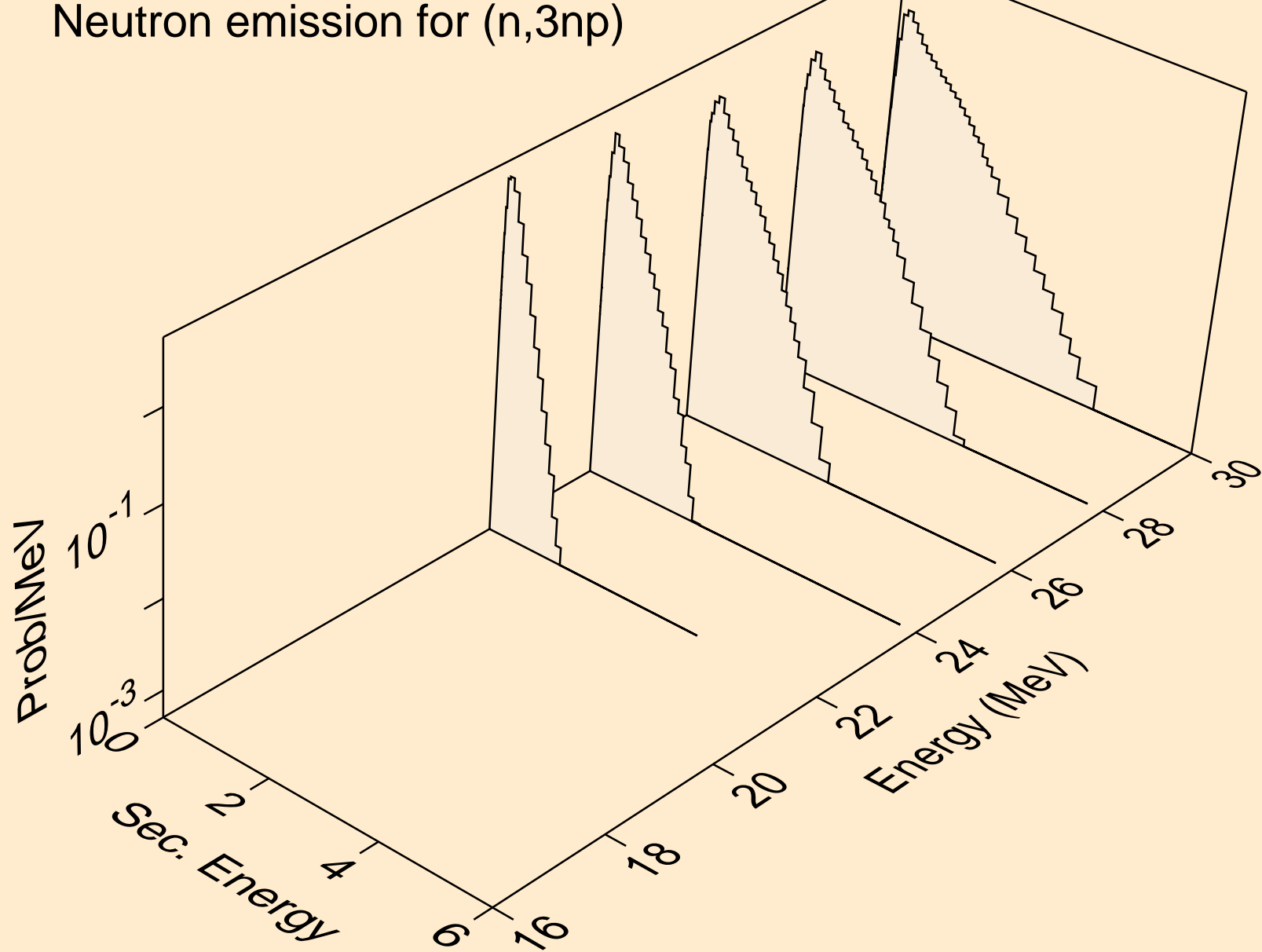

CM250 NEUTRON ACER TENDL-2023 LIBRARY; T=0.K  
Neutron emission for (n,n\*c)

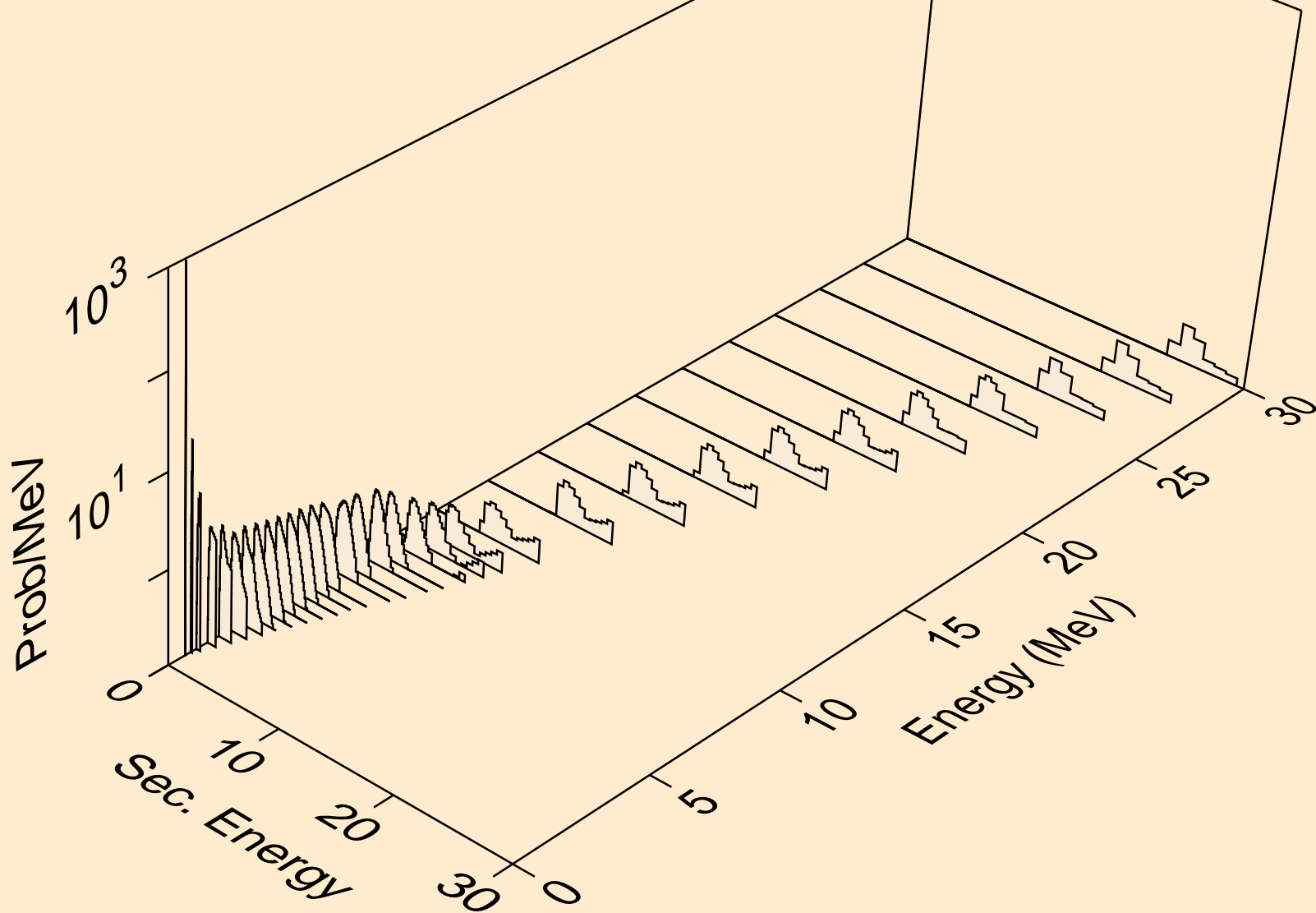

# CM250 NEUTRON ACER TENDL-2023 LIBRARY; T=0.K

Delayed nubar

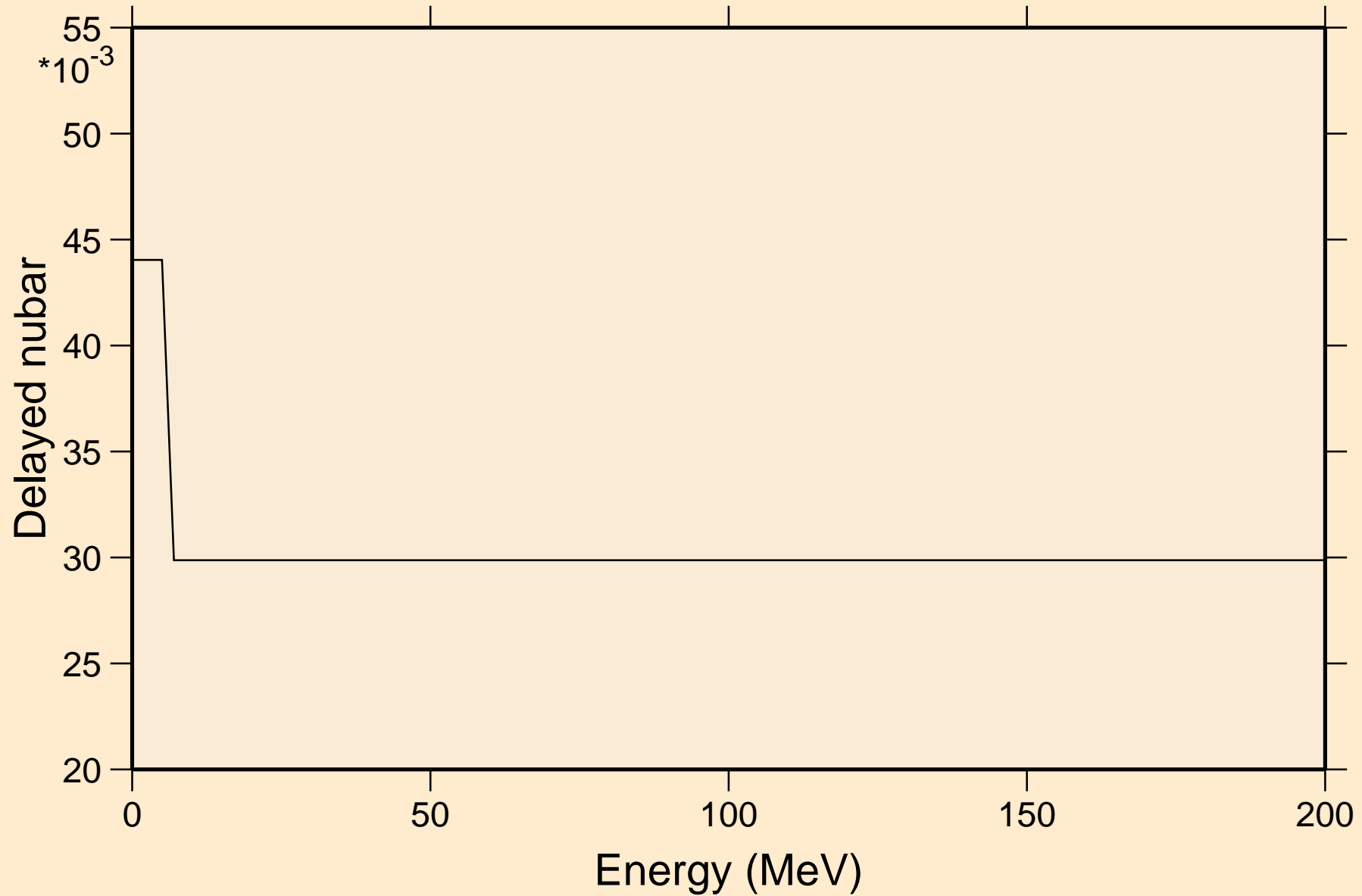

# CM250 NEUTRON ACER TENDL-2023 LIBRARY; T=0.K

## Delayed neutron spectra

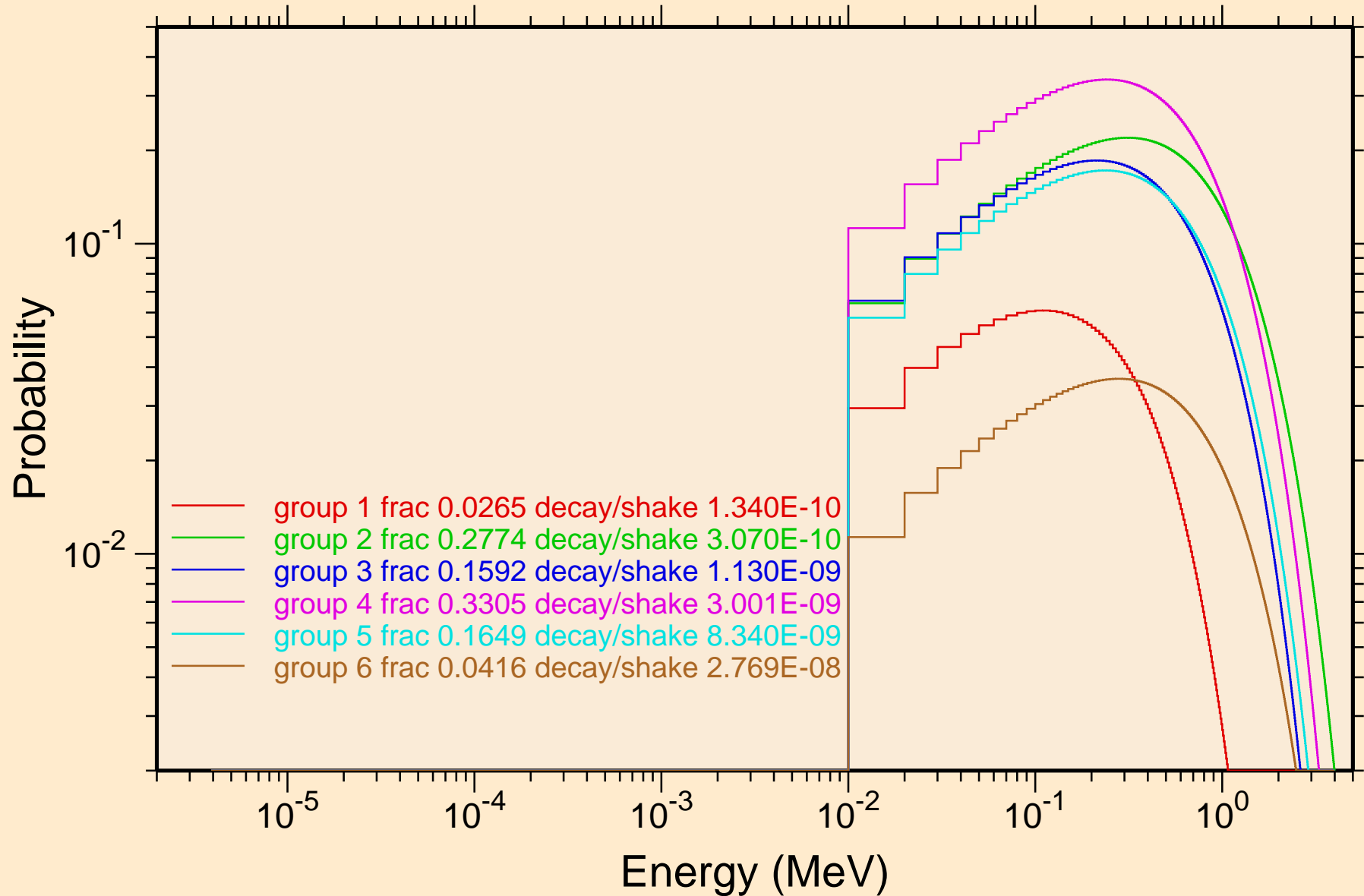

CM250 NEUTRON ACER TENDL-2023 LIBRARY; T=0.K  
Photon emission for (n,x)

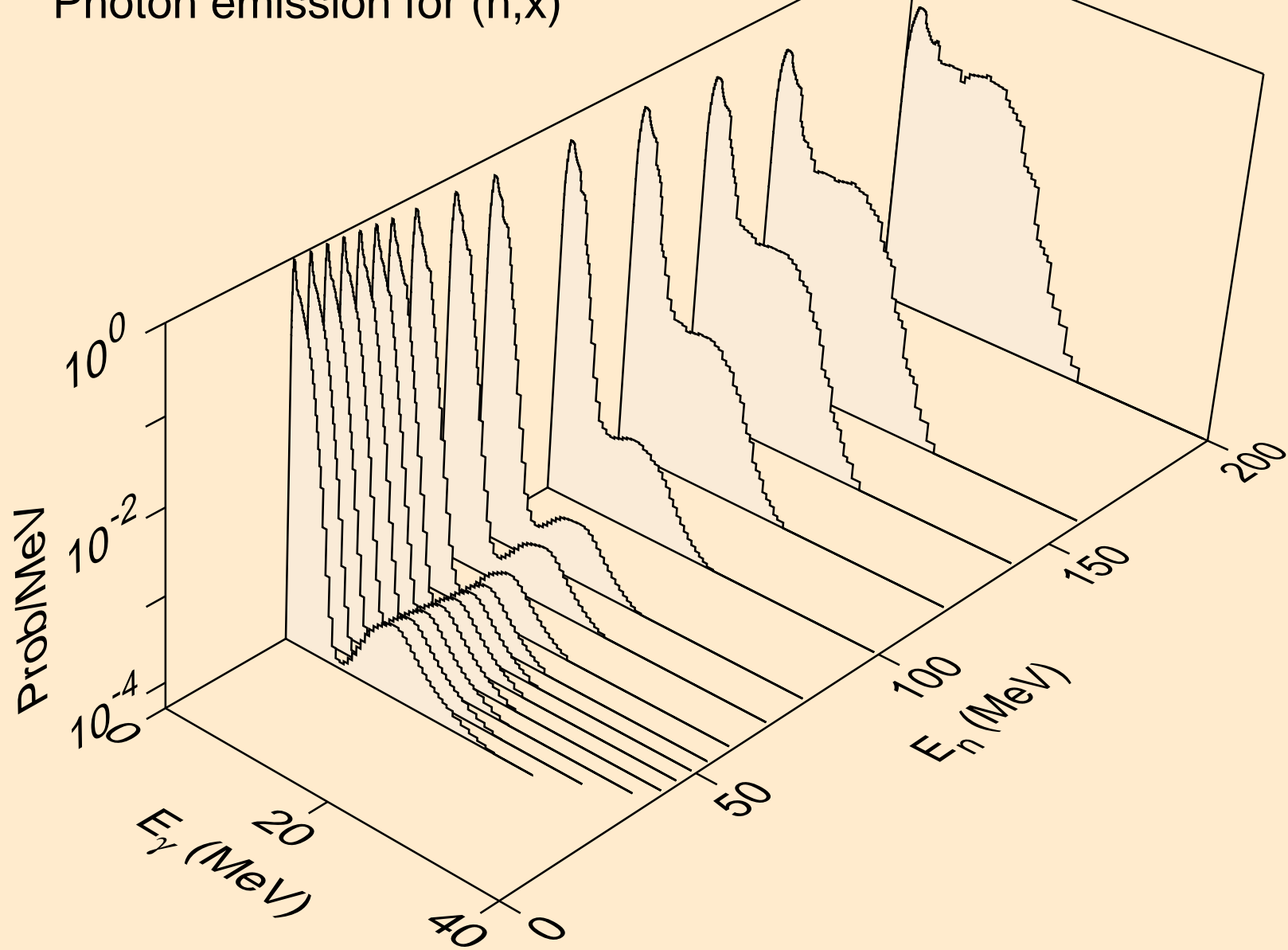

CM250 NEUTRON ACER TENDL-2023 LIBRARY; T=0.K  
Photon emission for (n,2nd)

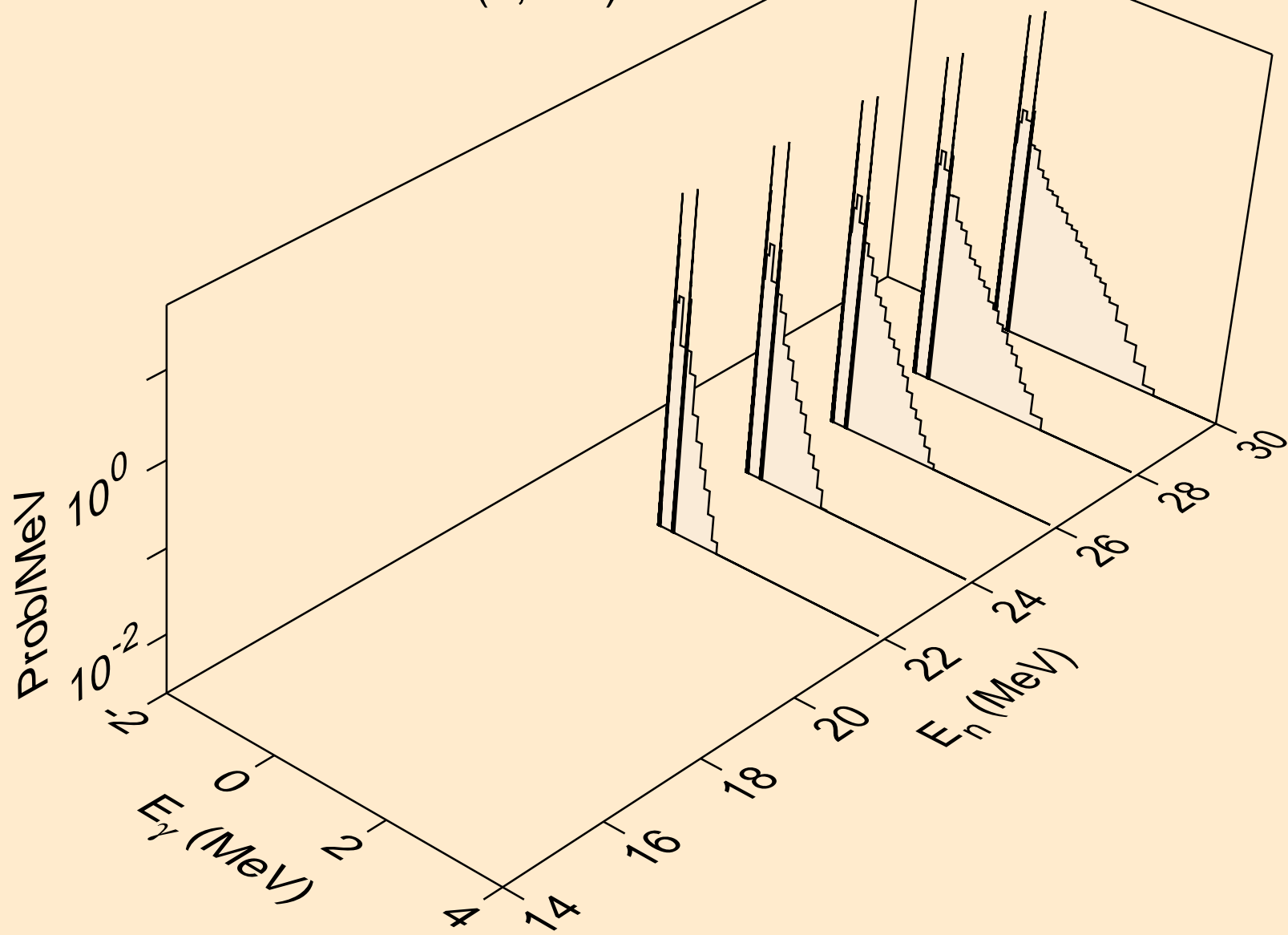

CM250 NEUTRON ACER TENDL-2023 LIBRARY; T=0.K  
Photon emission for (n,2n)

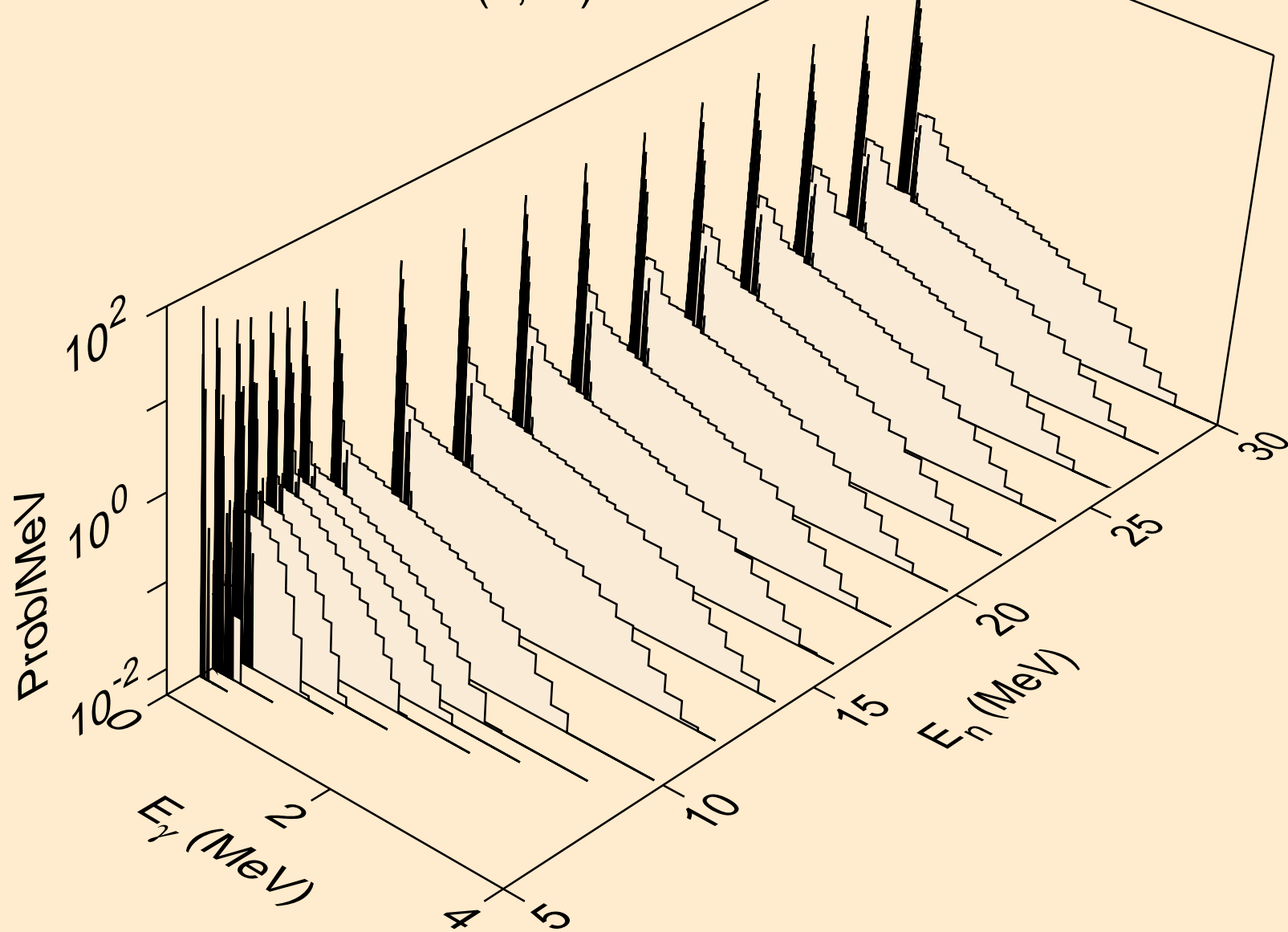

CM250 NEUTRON ACER TENDL-2023 LIBRARY; T=0.K  
Photon emission for (n,3n)

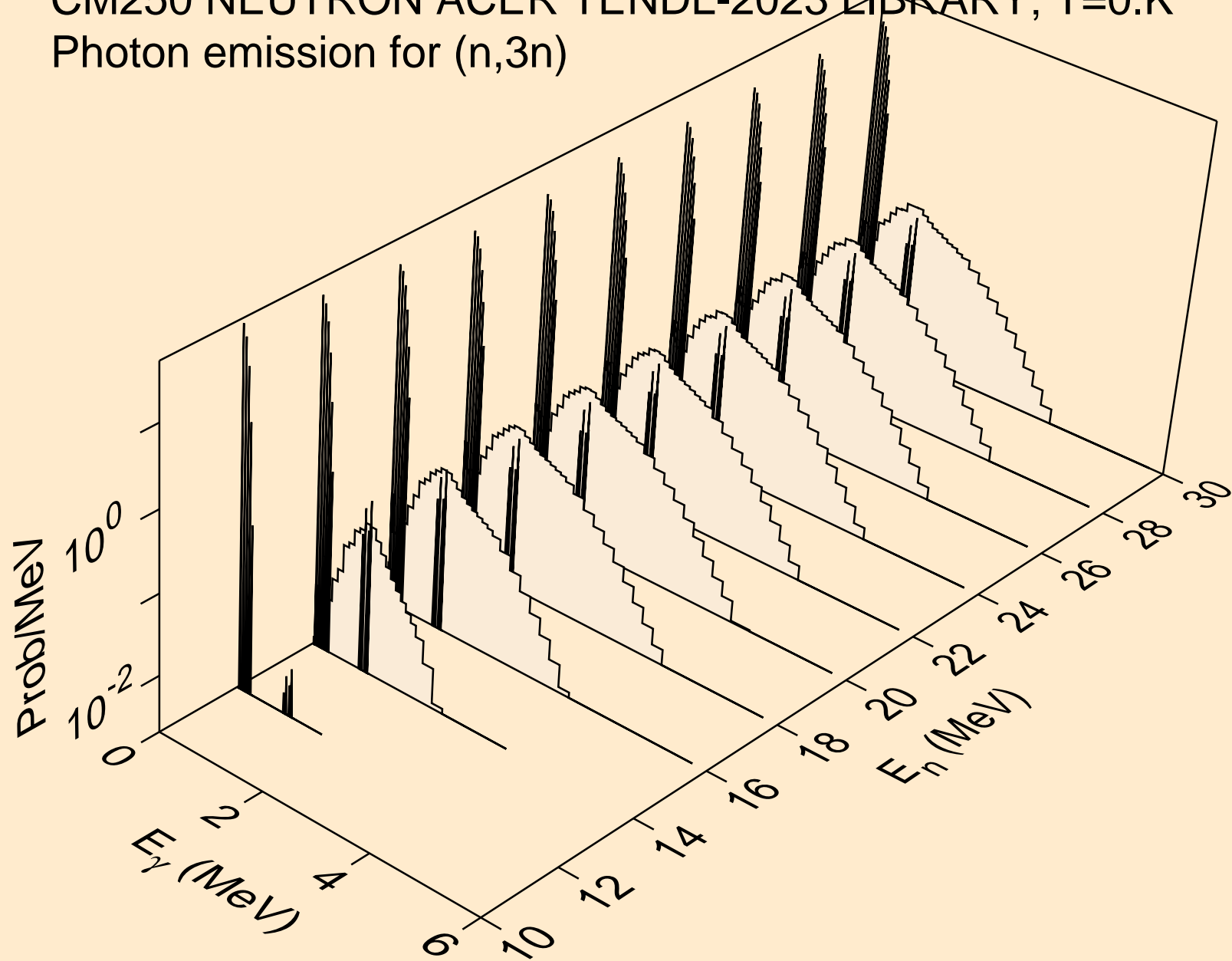



CM250 NEUTRON ACER TENDL-2023 LIBRARY; T=0.K  
Photon emission for (n,n\*)a

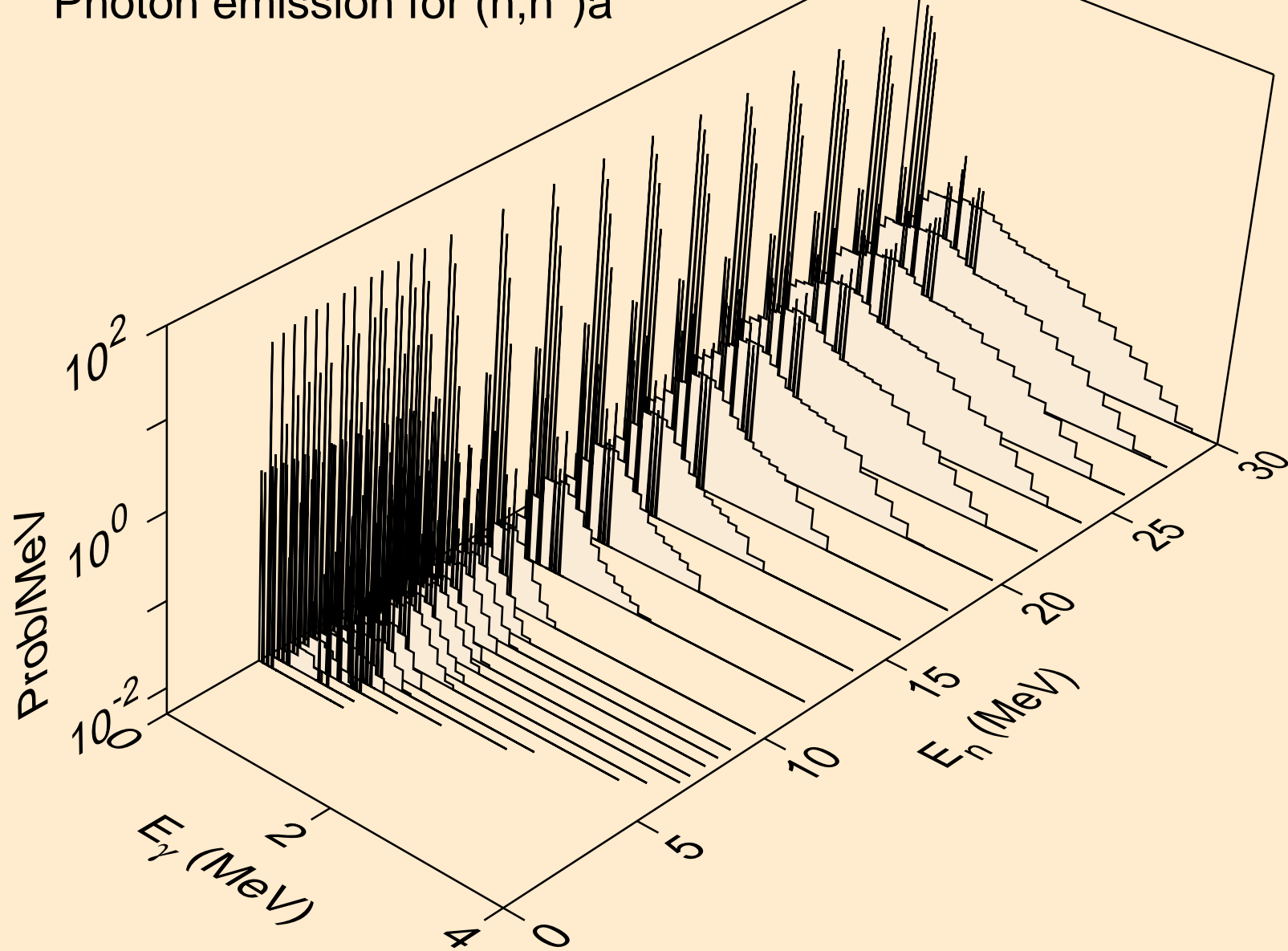

CM250 NEUTRON ACER TENDL-2023 LIBRARY; T=0.K  
Photon emission for (n,2n)a

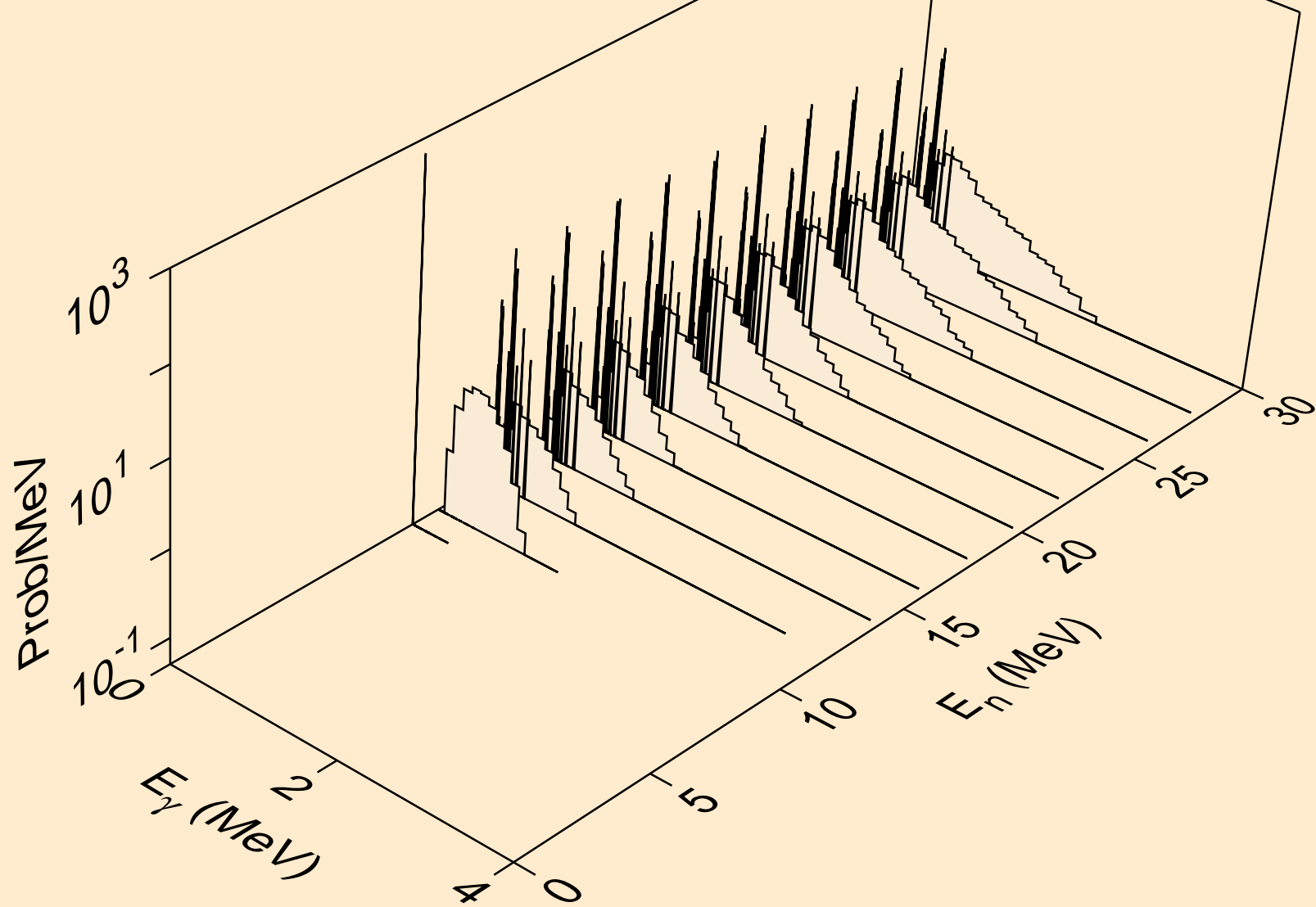

CM250 NEUTRON ACER TENDL-2023 LIBRARY; T=0.K  
Photon emission for (n,3n)a

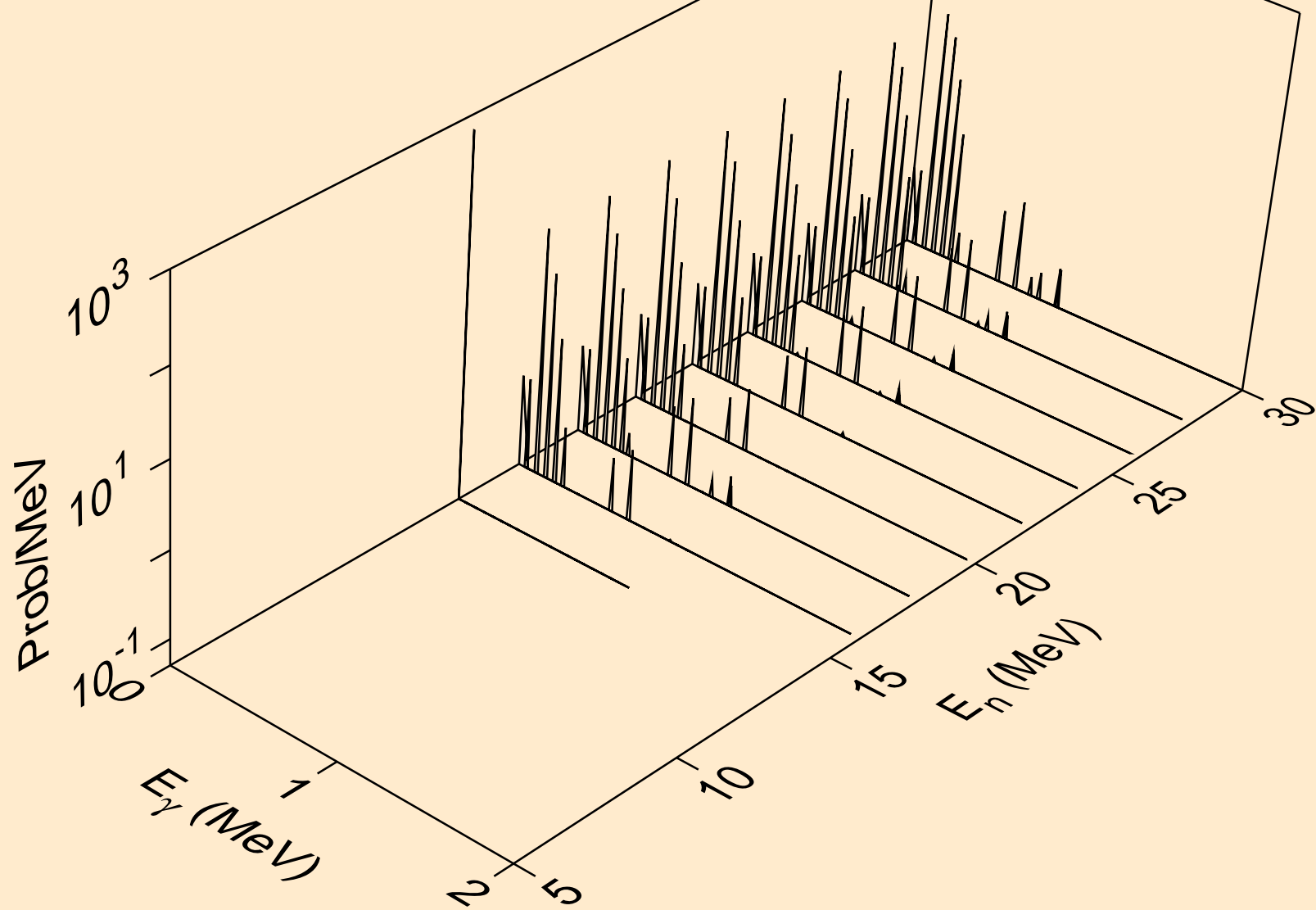

CM250 NEUTRON ACER TENDL-2023 LIBRARY; T=0.K  
Photon emission for (n,n\*)p

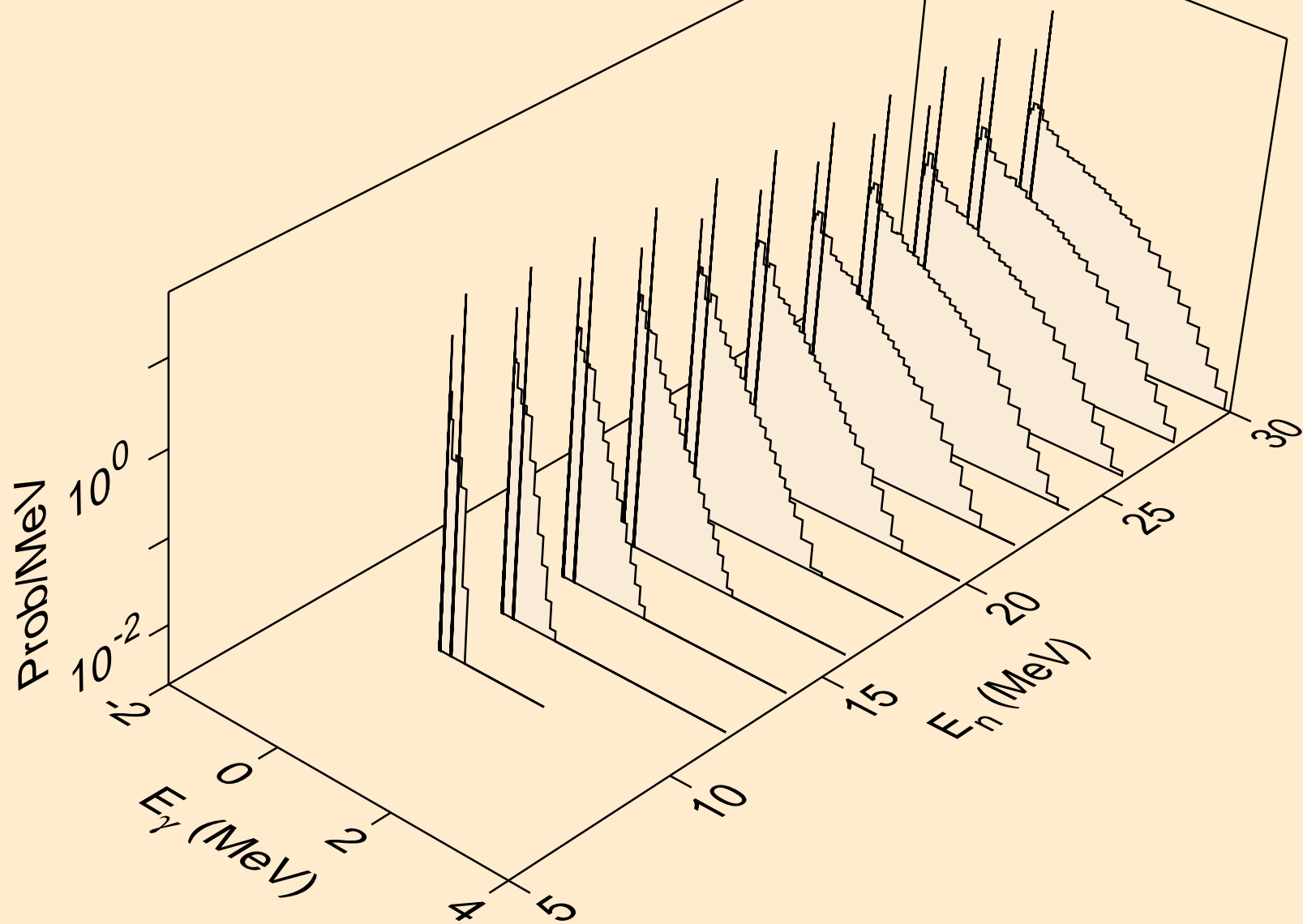

CM250 NEUTRON ACER TENDL-2023 LIBRARY; T=0.K  
Photon emission for (n,n\*)d

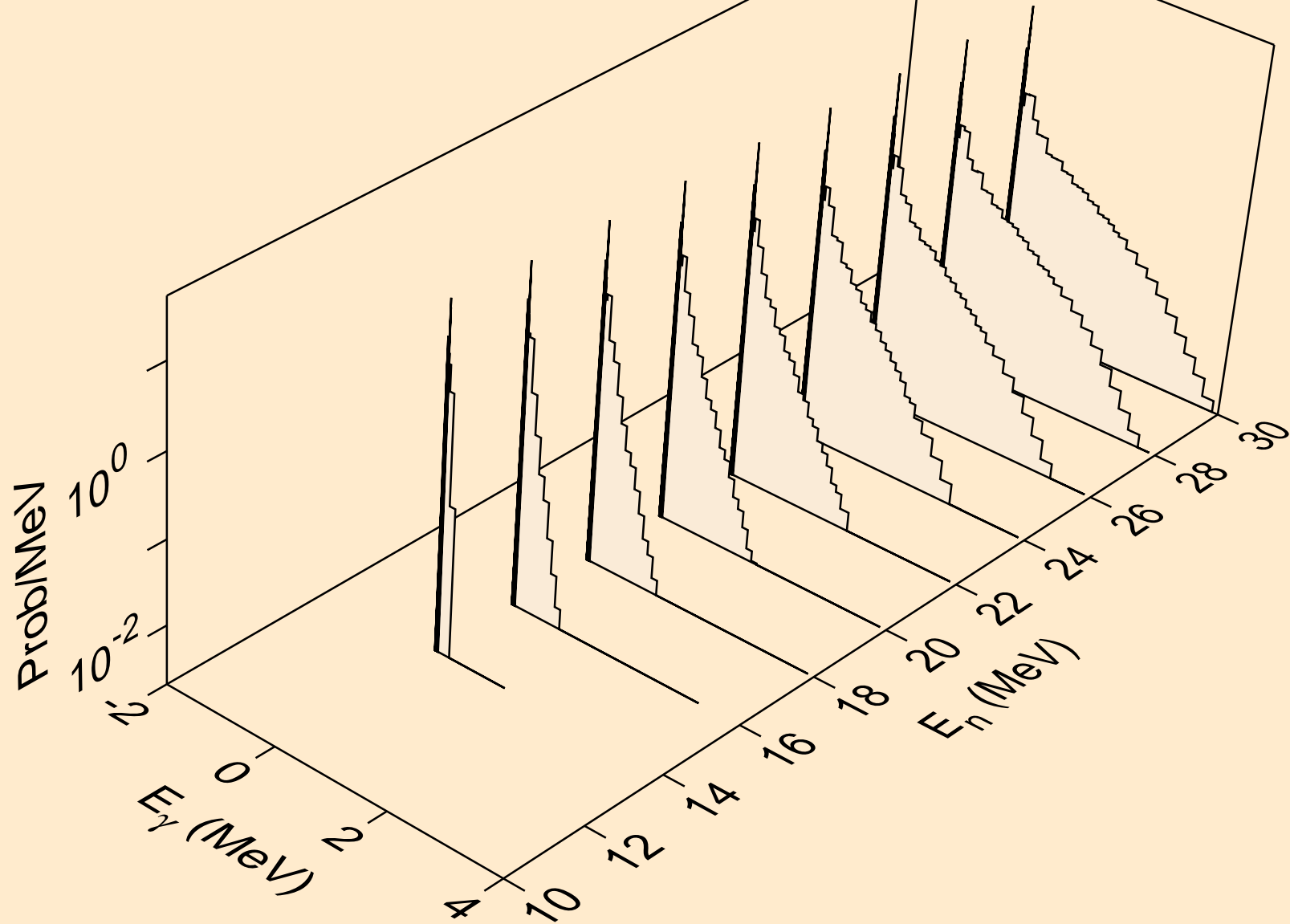

CM250 NEUTRON ACER TENDL-2023 LIBRARY; T=0.K  
Photon emission for (n,n\*)t

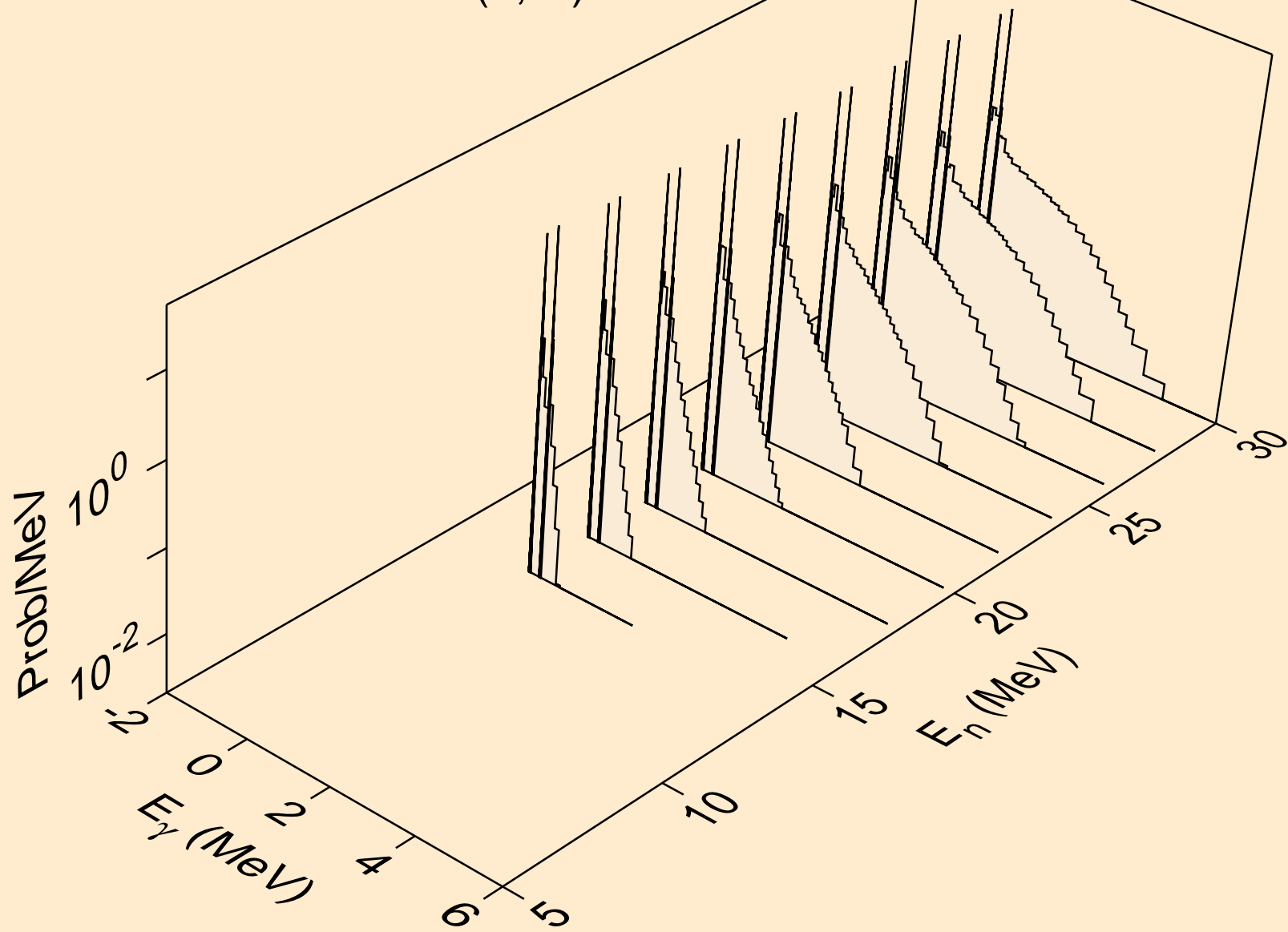

CM250 NEUTRON ACER TENDL-2023 LIBRARY; T=0.K  
Photon emission for (n,n\*)he3

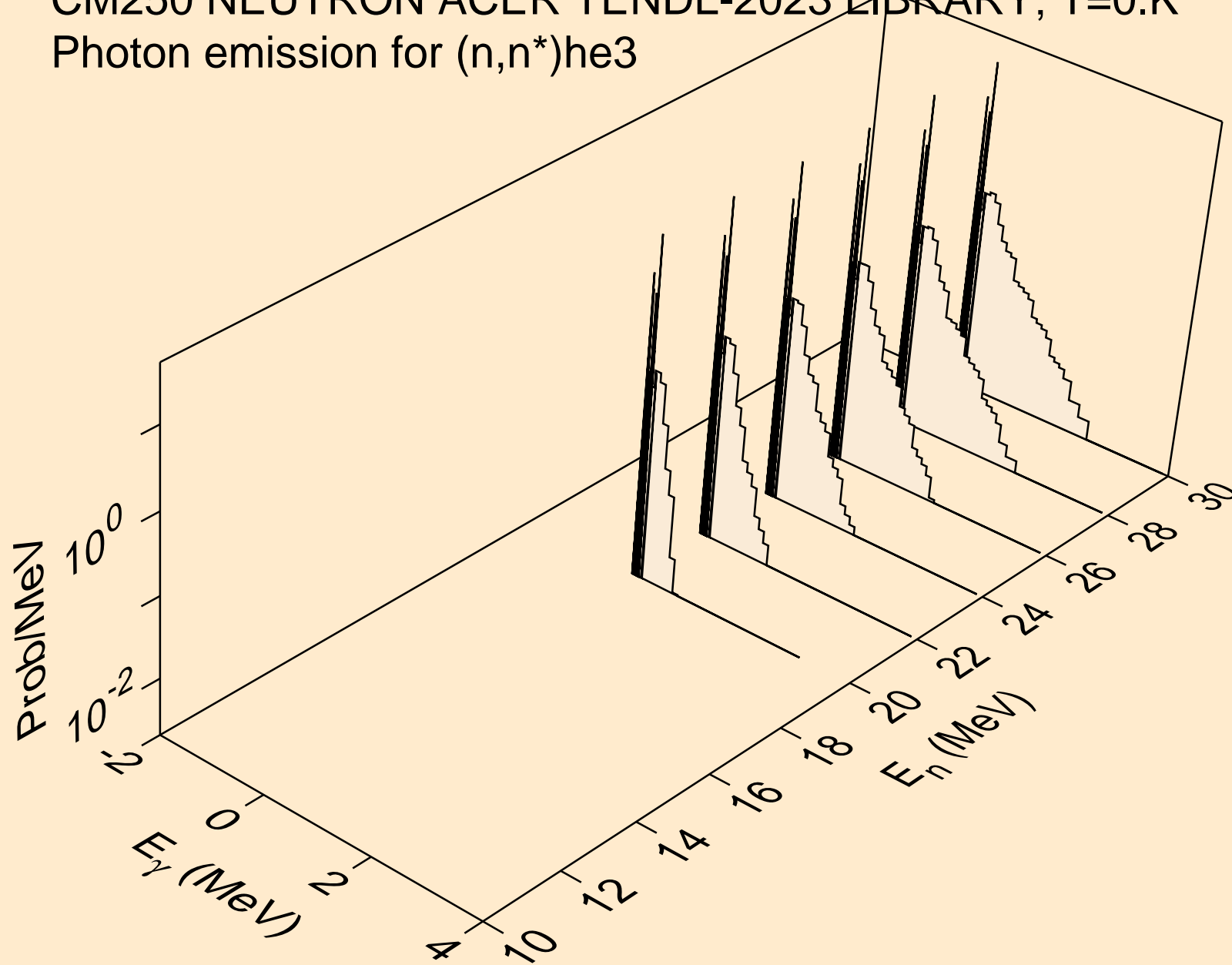

CM250 NEUTRON ACER TENDL-2023 LIBRARY; T=0.K  
Photon emission for (n,4n)

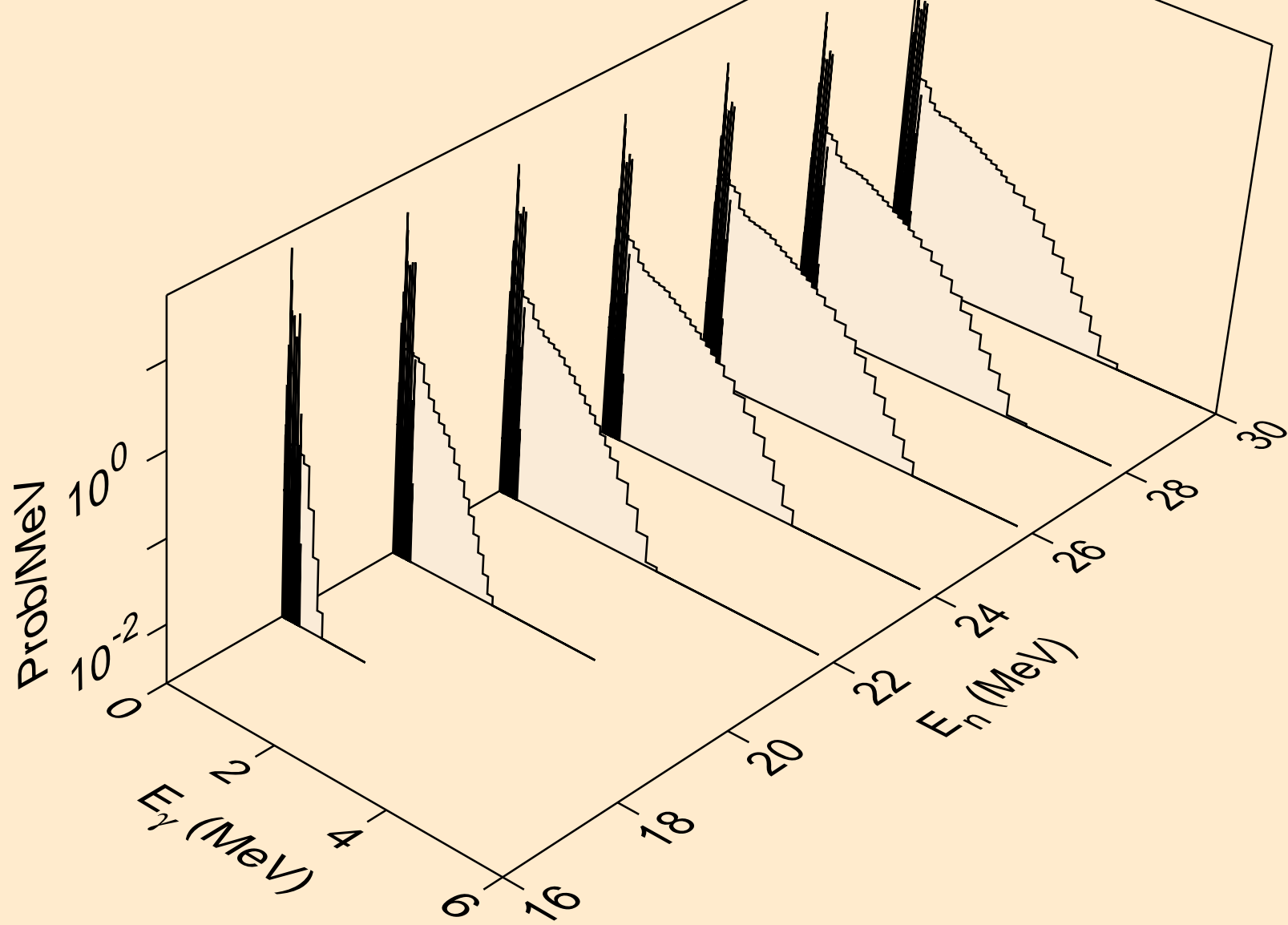



CM250 NEUTRON ACER TENDL-2023 LIBRARY; T=0.K  
Photon emission for (n,2np)

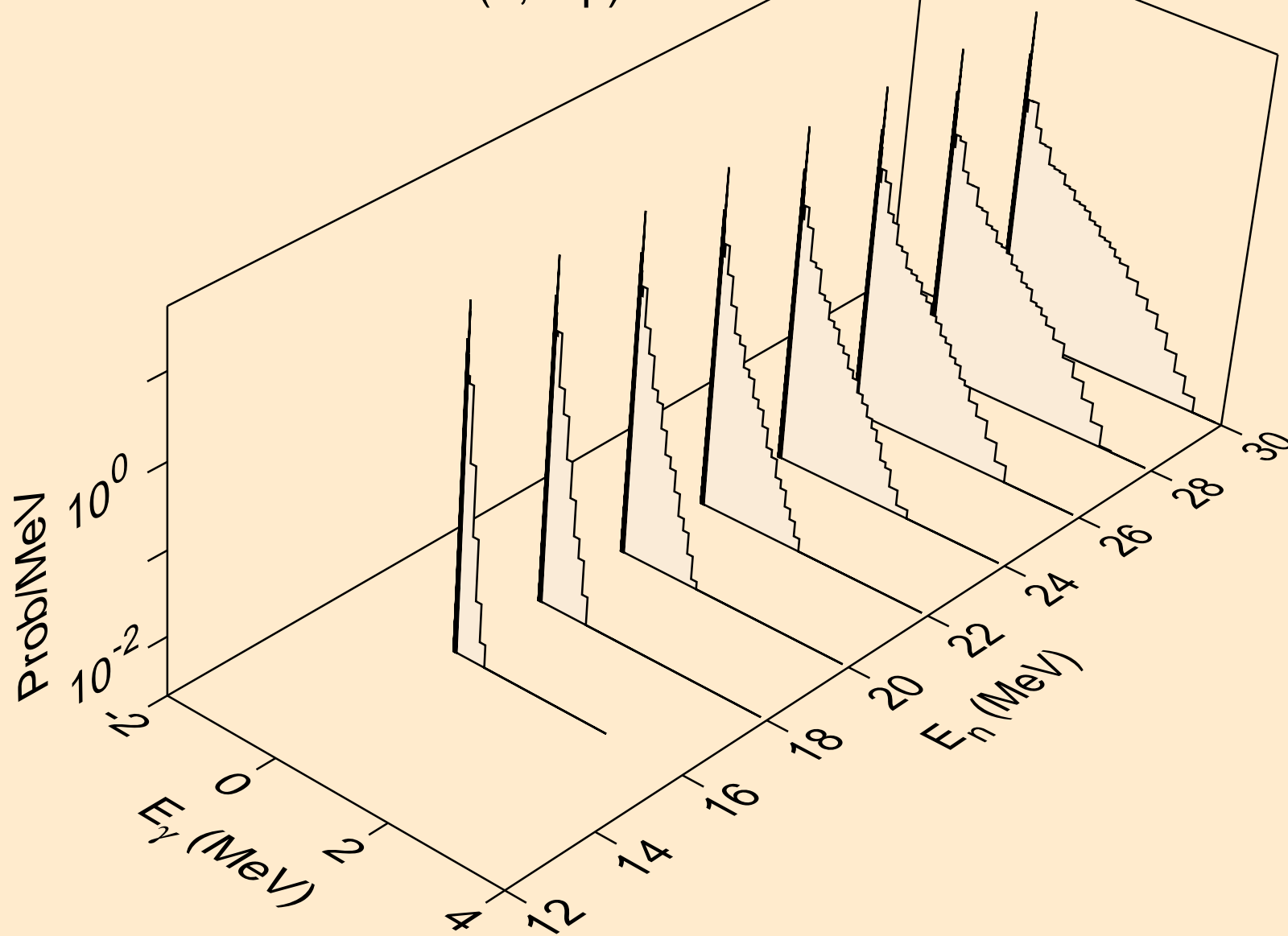

CM250 NEUTRON ACER TENDL-2023 LIBRARY; T=0.K  
Photon emission for (n,3np)

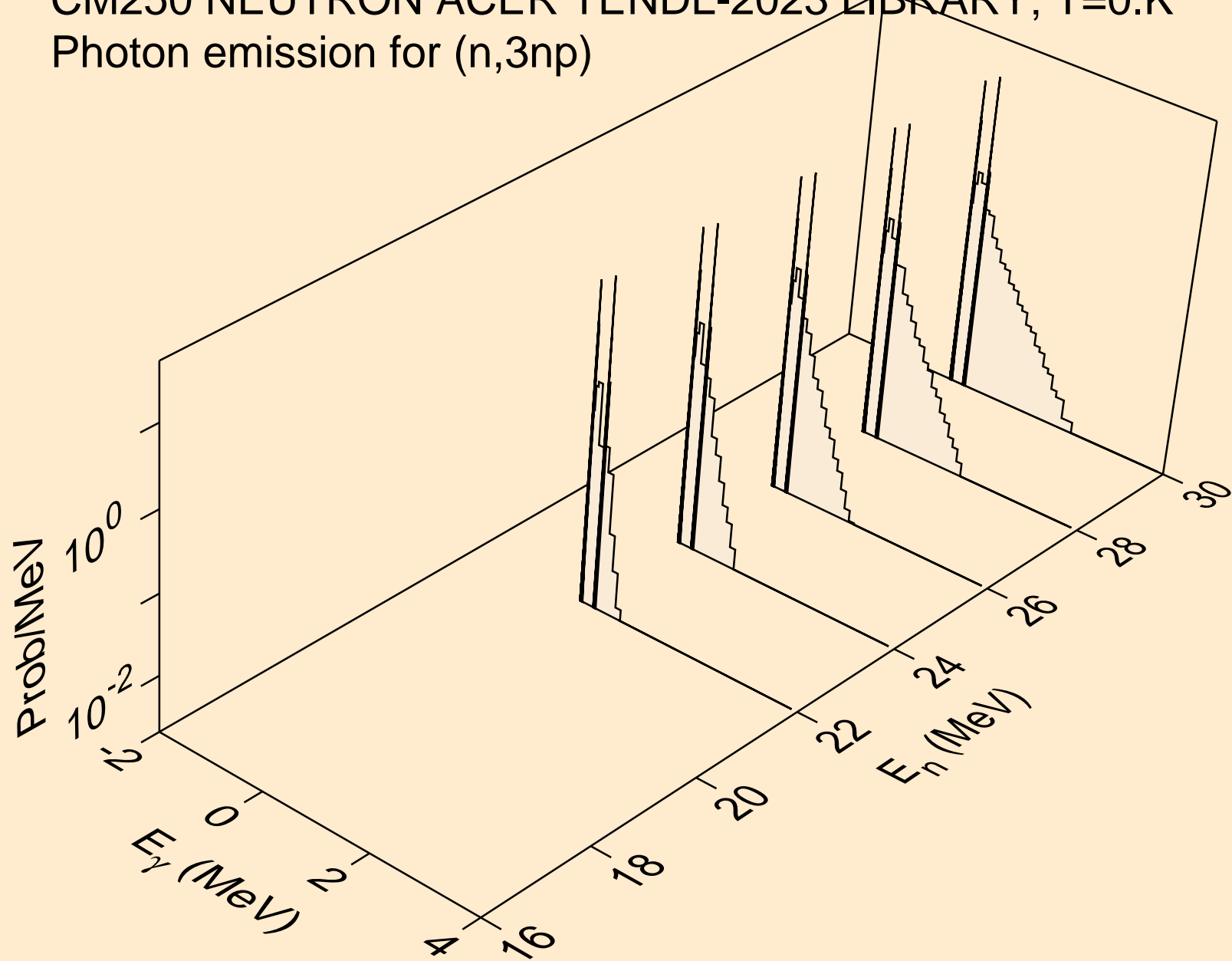

CM250 NEUTRON ACER TENDL-2023 LIBRARY; T=0.K  
Photon emission for (n,n\*c)

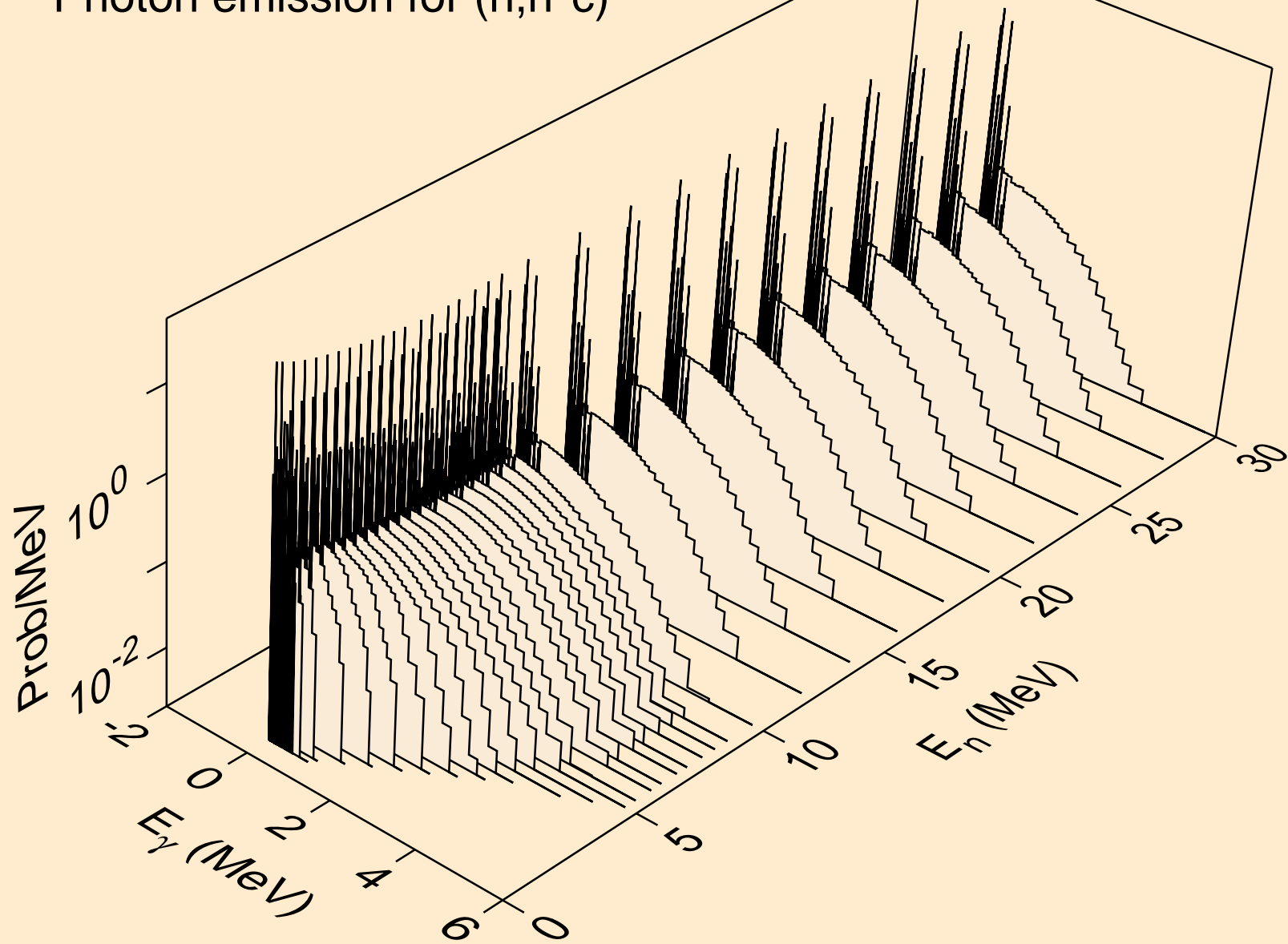

CM250 NEUTRON ACER TENDL-2023 LIBRARY; T=0.K  
Photon emission for (n,gma)

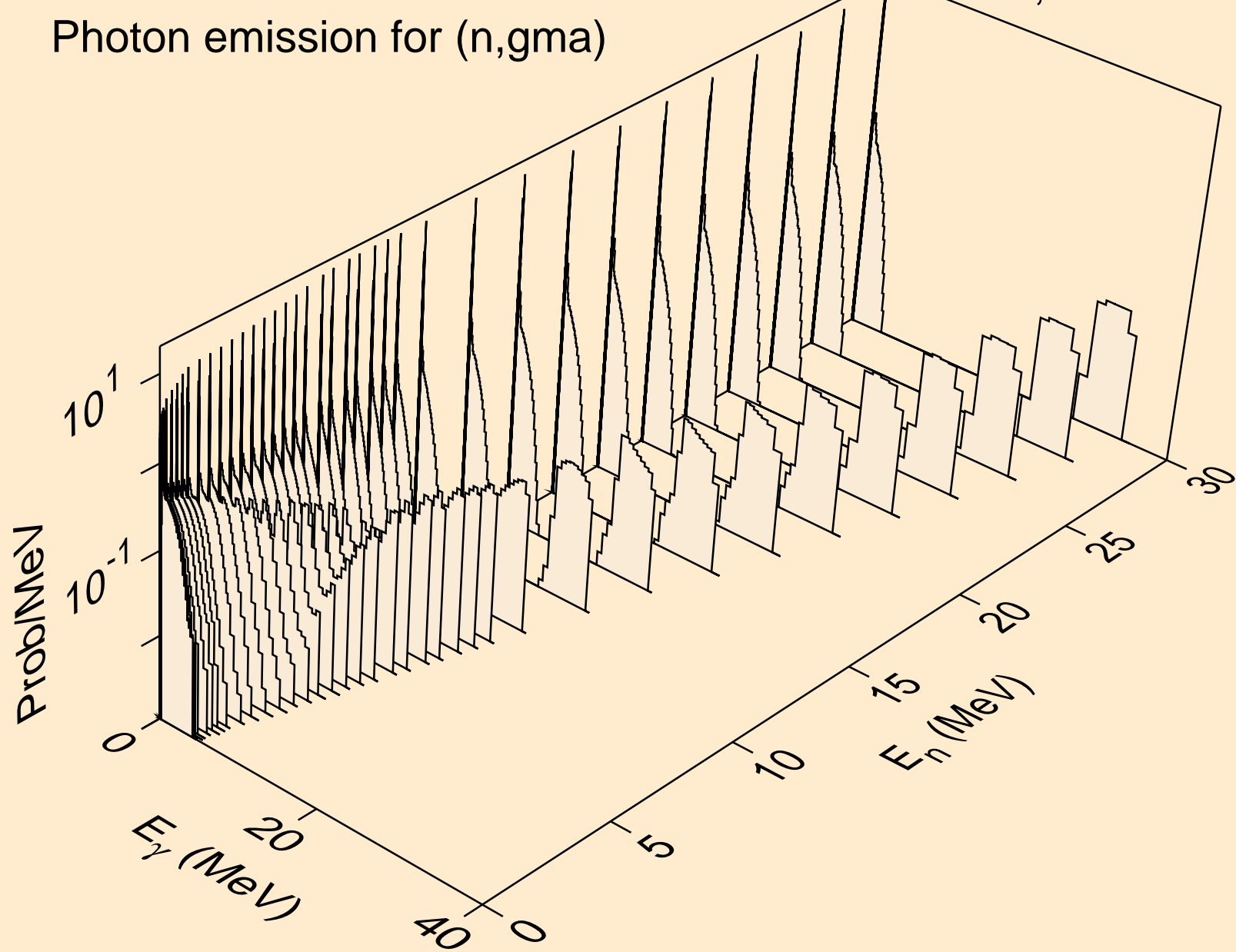

CM250 NEUTRON ACER TENDL-2023 LIBRARY; T=0.K  
Photon emission for (n,p)

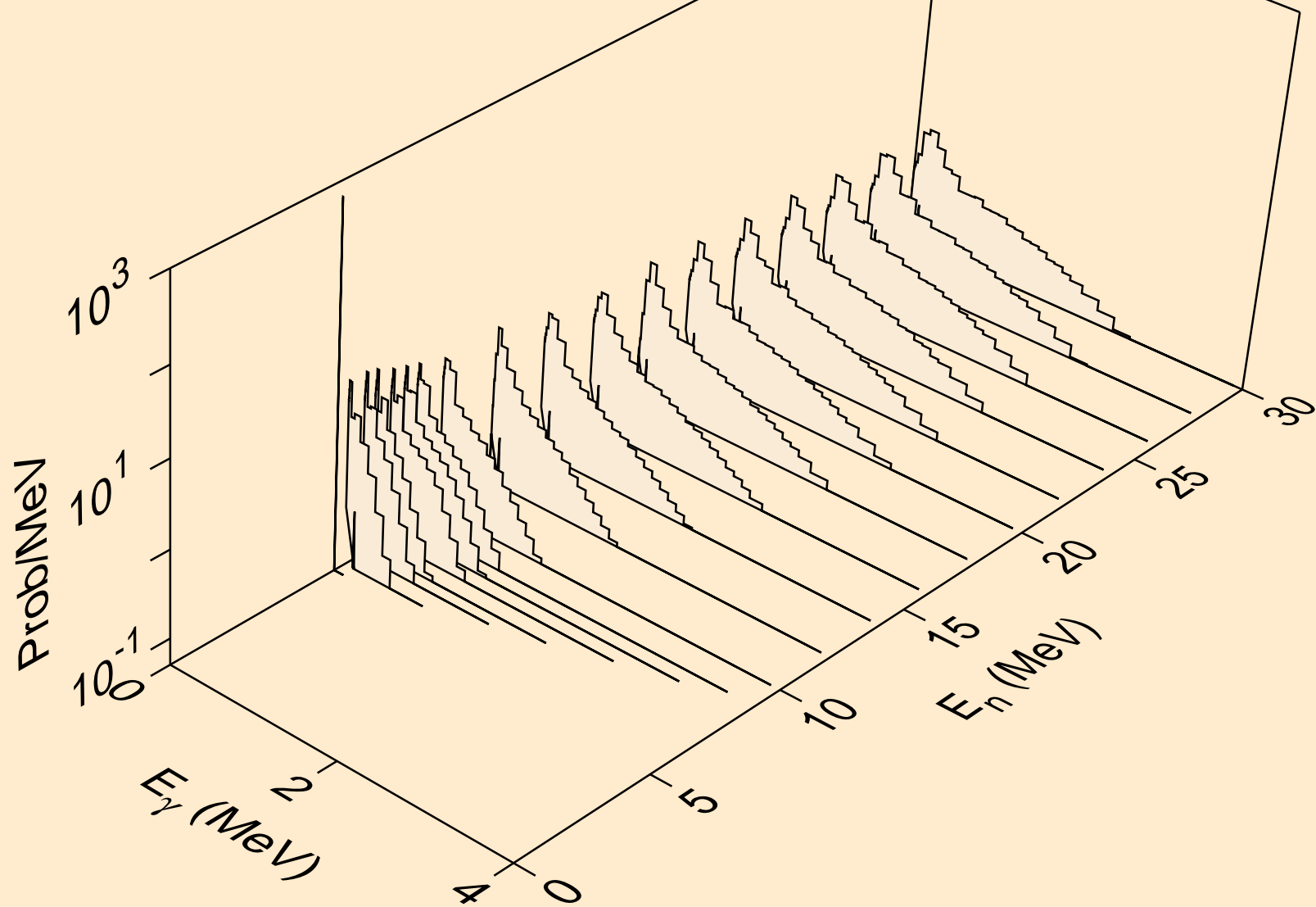

CM250 NEUTRON ACER TENDL-2023 LIBRARY; T=0.K  
Photon emission for (n,d)

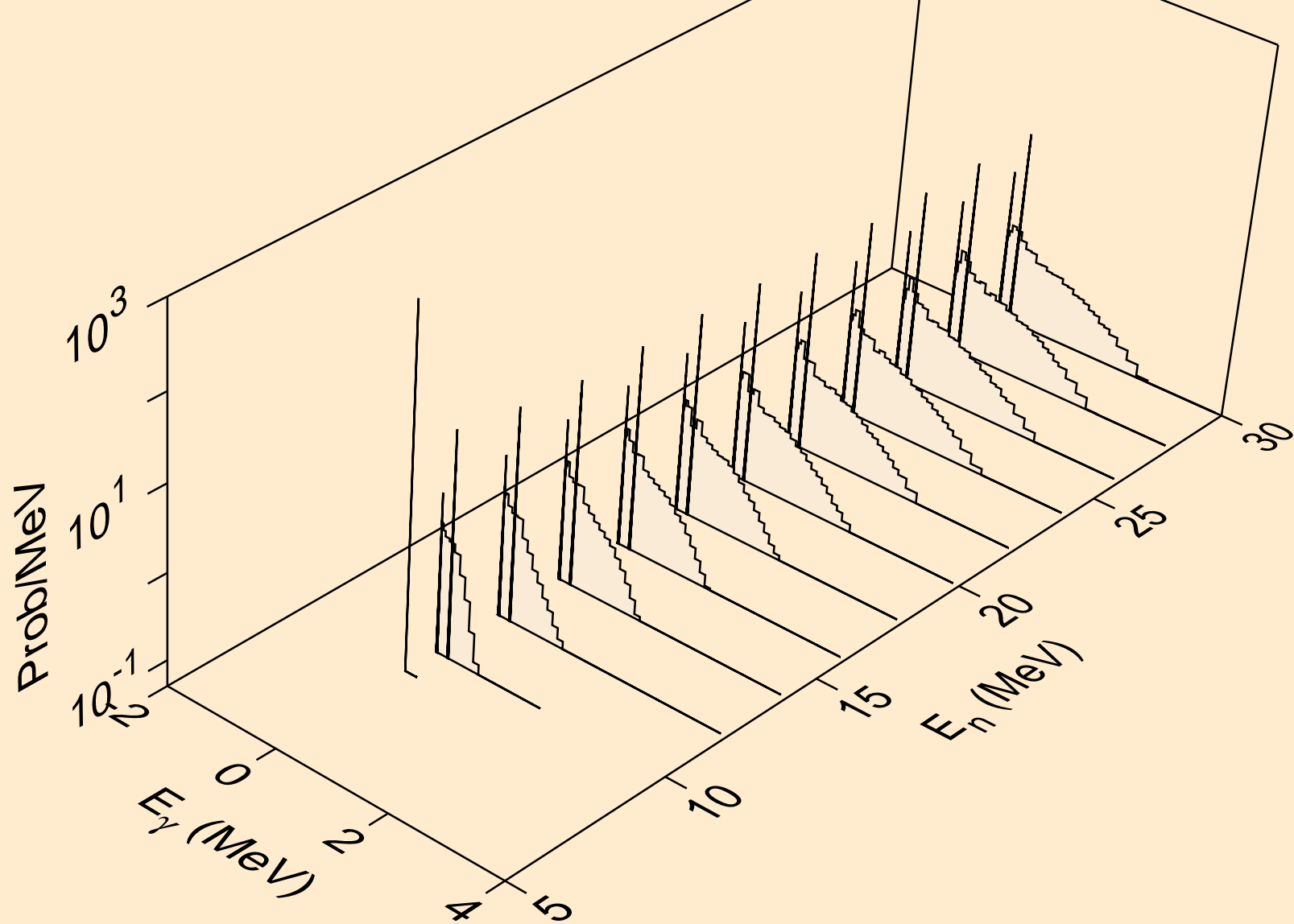

CM250 NEUTRON ACER TENDL-2023 LIBRARY; T=0.K  
Photon emission for (n,t)

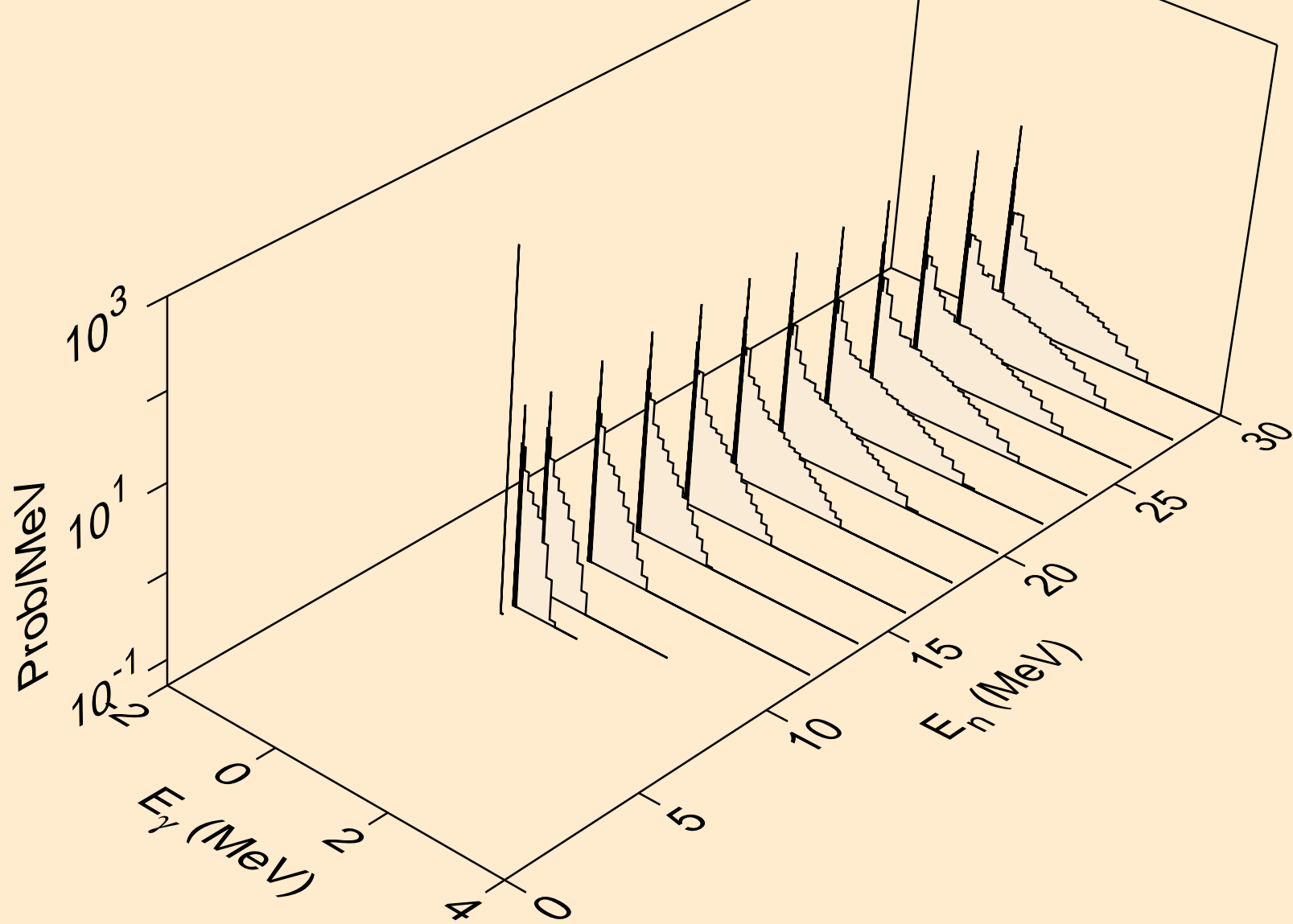

CM250 NEUTRON ACER TENDL-2023 LIBRARY; T=0.K  
Photon emission for (n,he3)

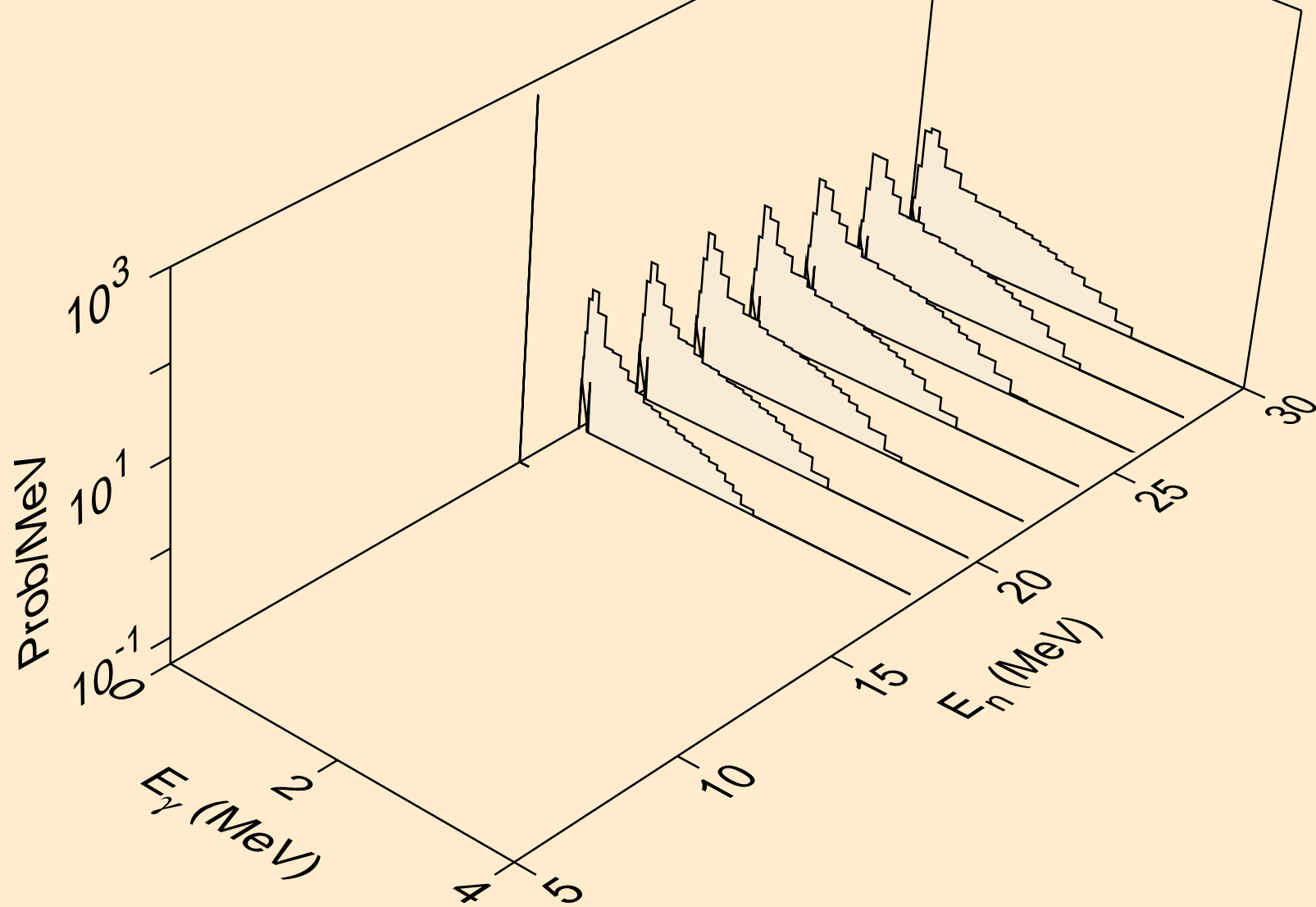



CM250 NEUTRON ACER TENDL-2023 LIBRARY; T=0.K  
Photon emission for (n,a)

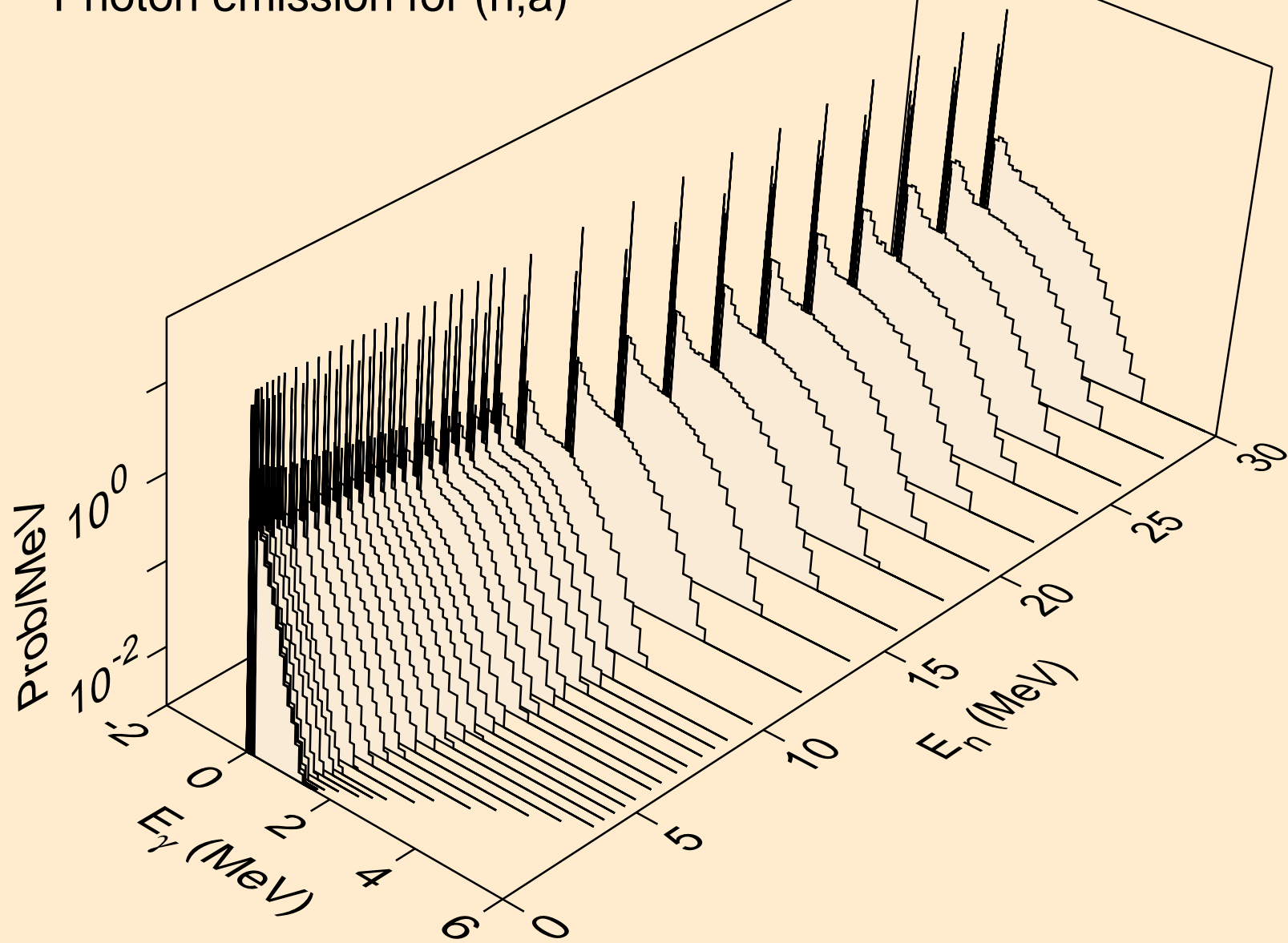

CM250 NEUTRON ACER TENDL-2023 LIBRARY; T=0.K  
Photon emission for (n,2p)

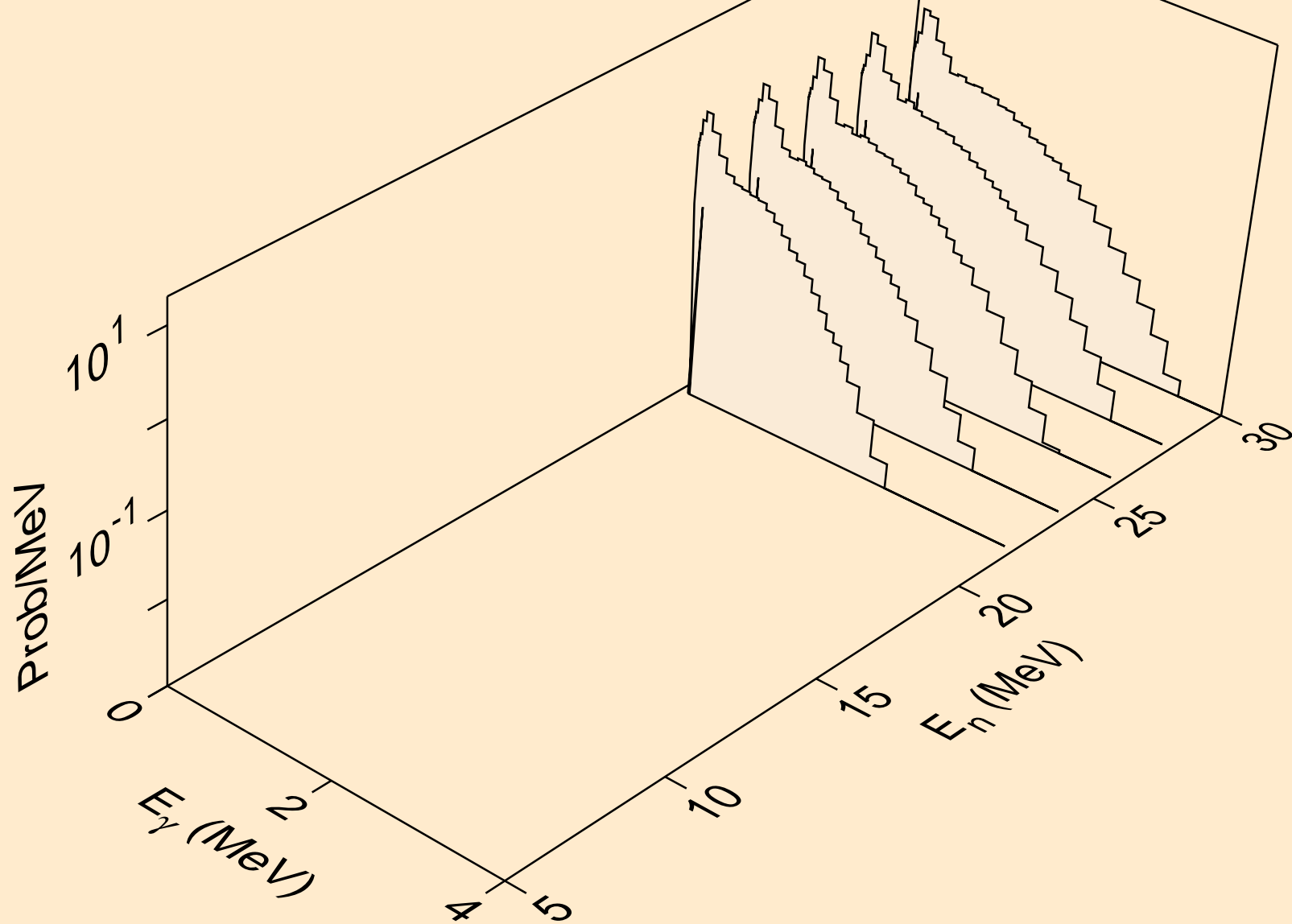

CM250 NEUTRON ACER TENDL-2023 LIBRARY; T=0.K  
thermal capture photon spectrum

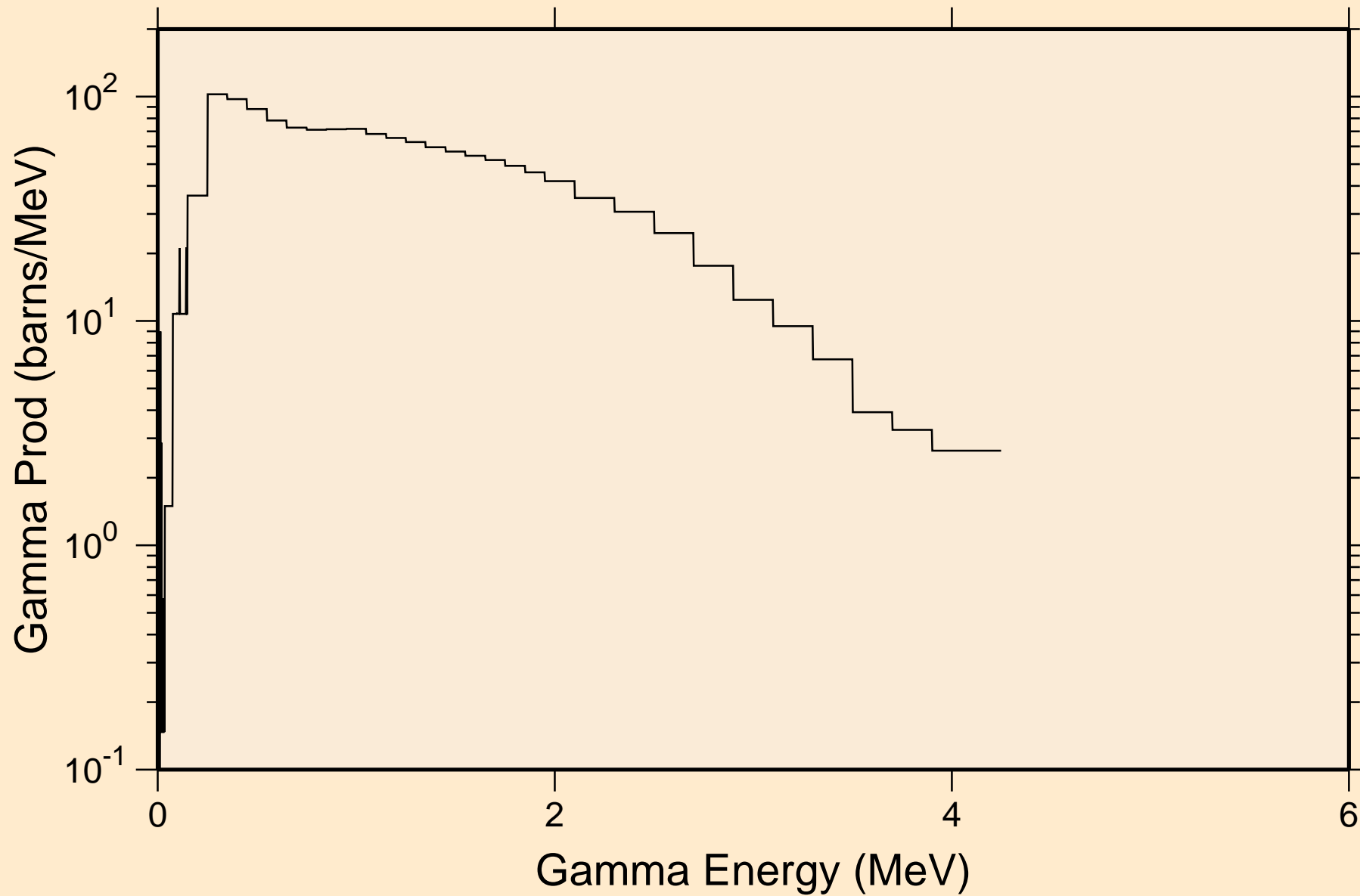

CM250 NEUTRON ACER TENDL-2023 LIBRARY; T=0.K  
14 MeV photon spectrum

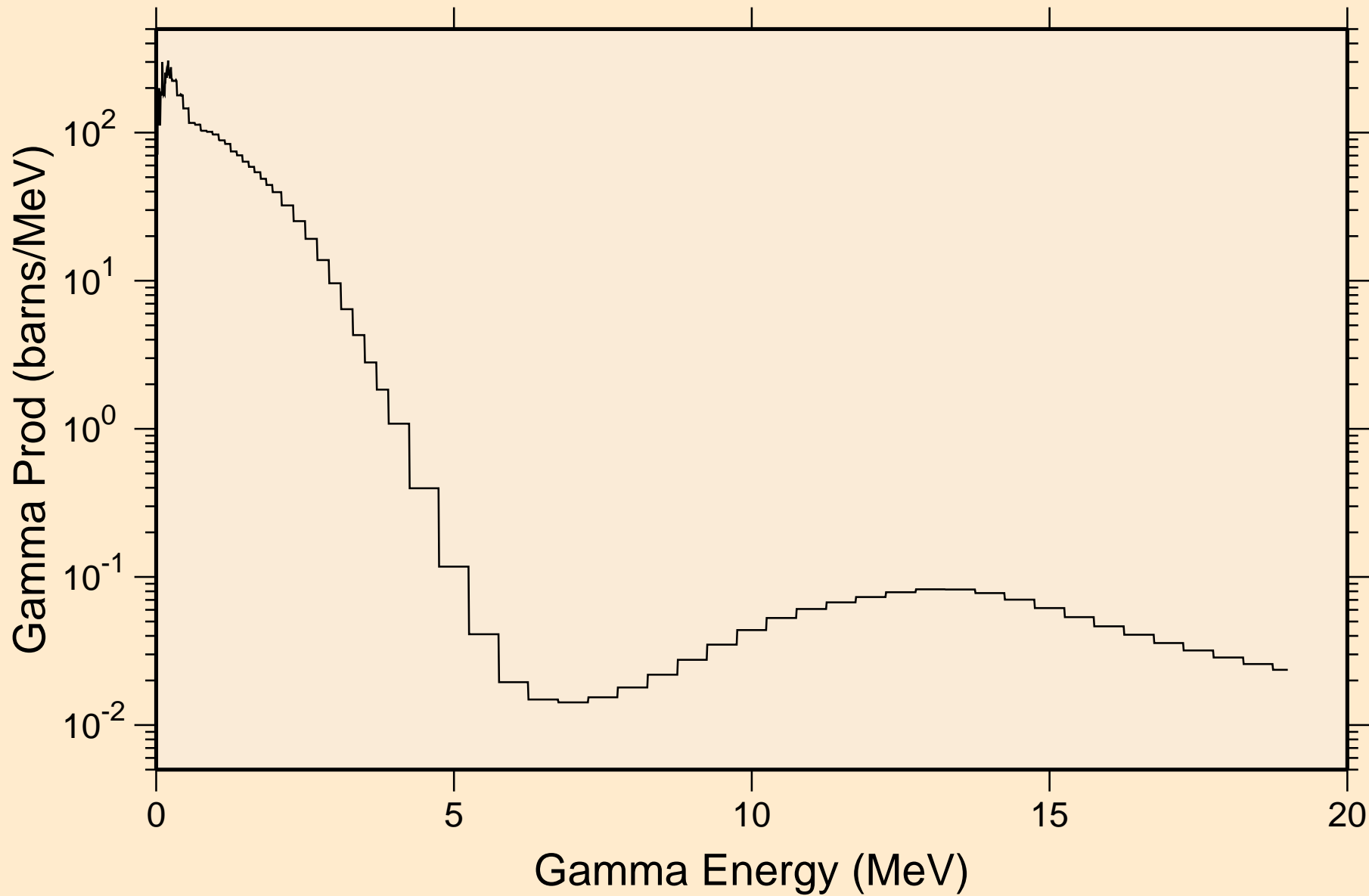

# CM250 NEUTRON ACER TENDL-2023 LIBRARY; T=0.K

## Particle heating contributions

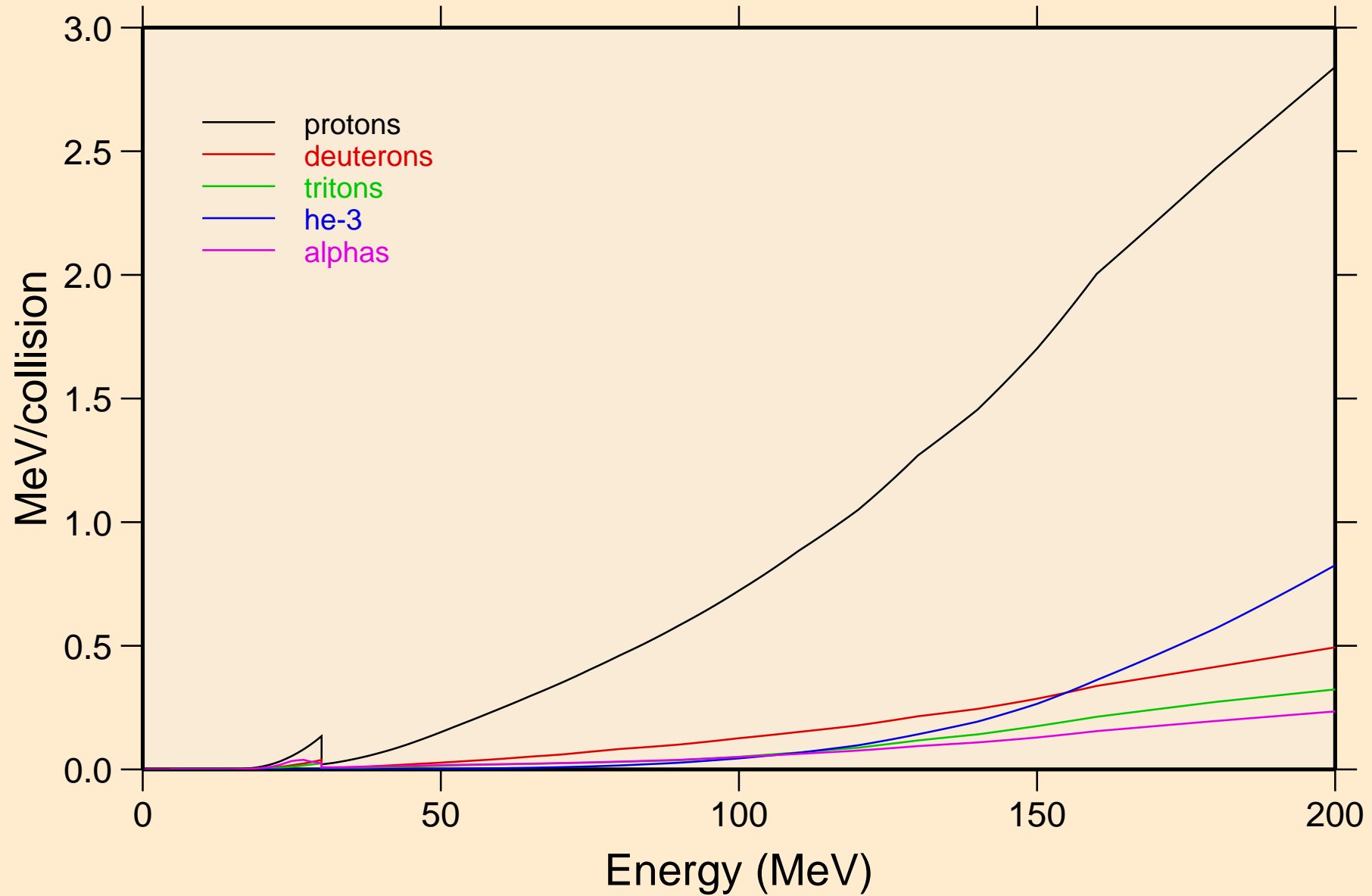

CM250 NEUTRON ACER TENDL-2023 LIBRARY; T=0.K  
Recoil Heating

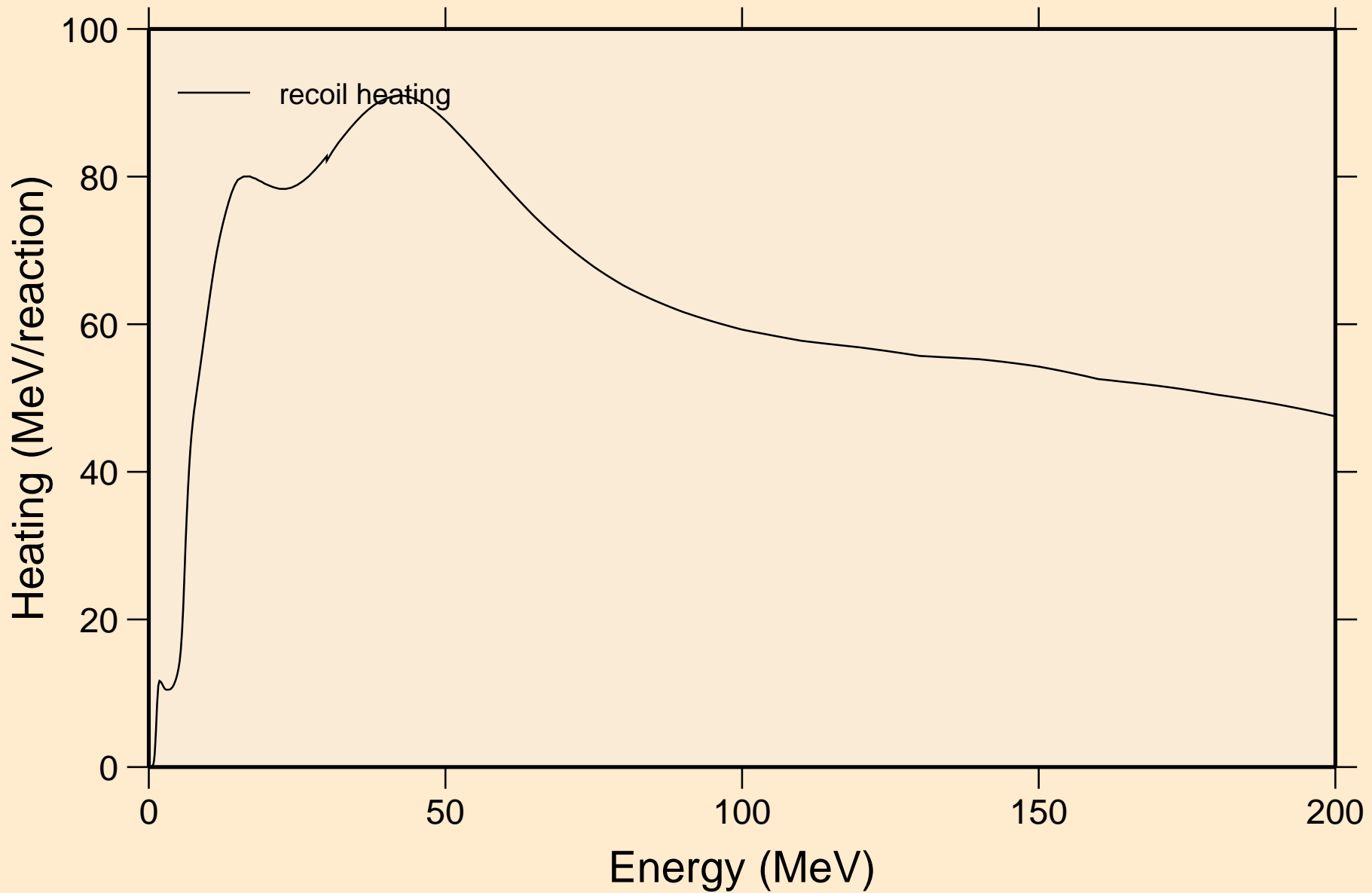

# CM250 NEUTRON ACER TENDL-2023 LIBRARY; T=0.K

## Particle production cross sections

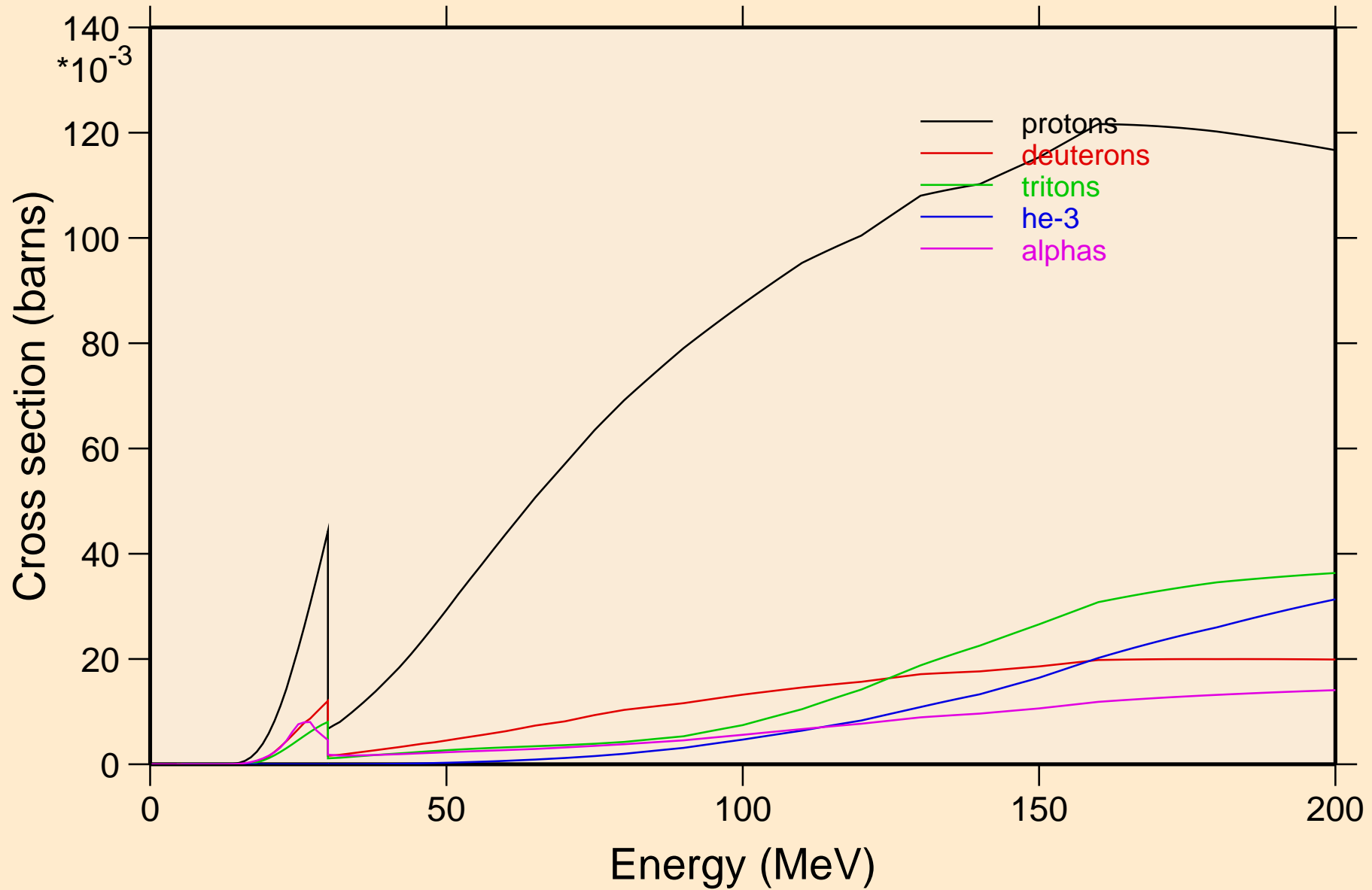

CM250 NEUTRON ACER TENDL-2023 LIBRARY; T=0.K  
protons from (n,x)

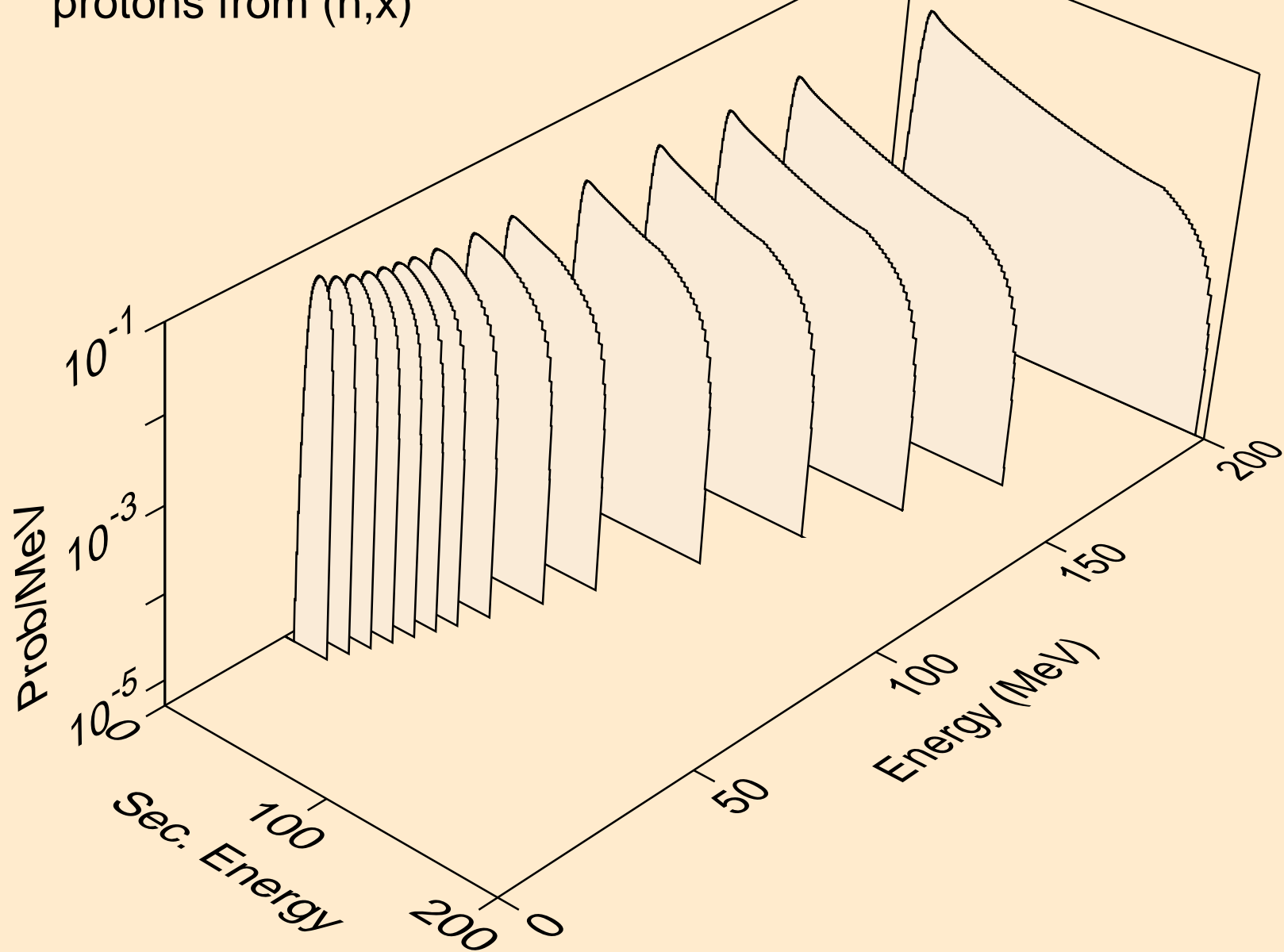



CM250 NEUTRON ACER TENDL-2023 LIBRARY; T=0.K  
protons from (n,n\*)p

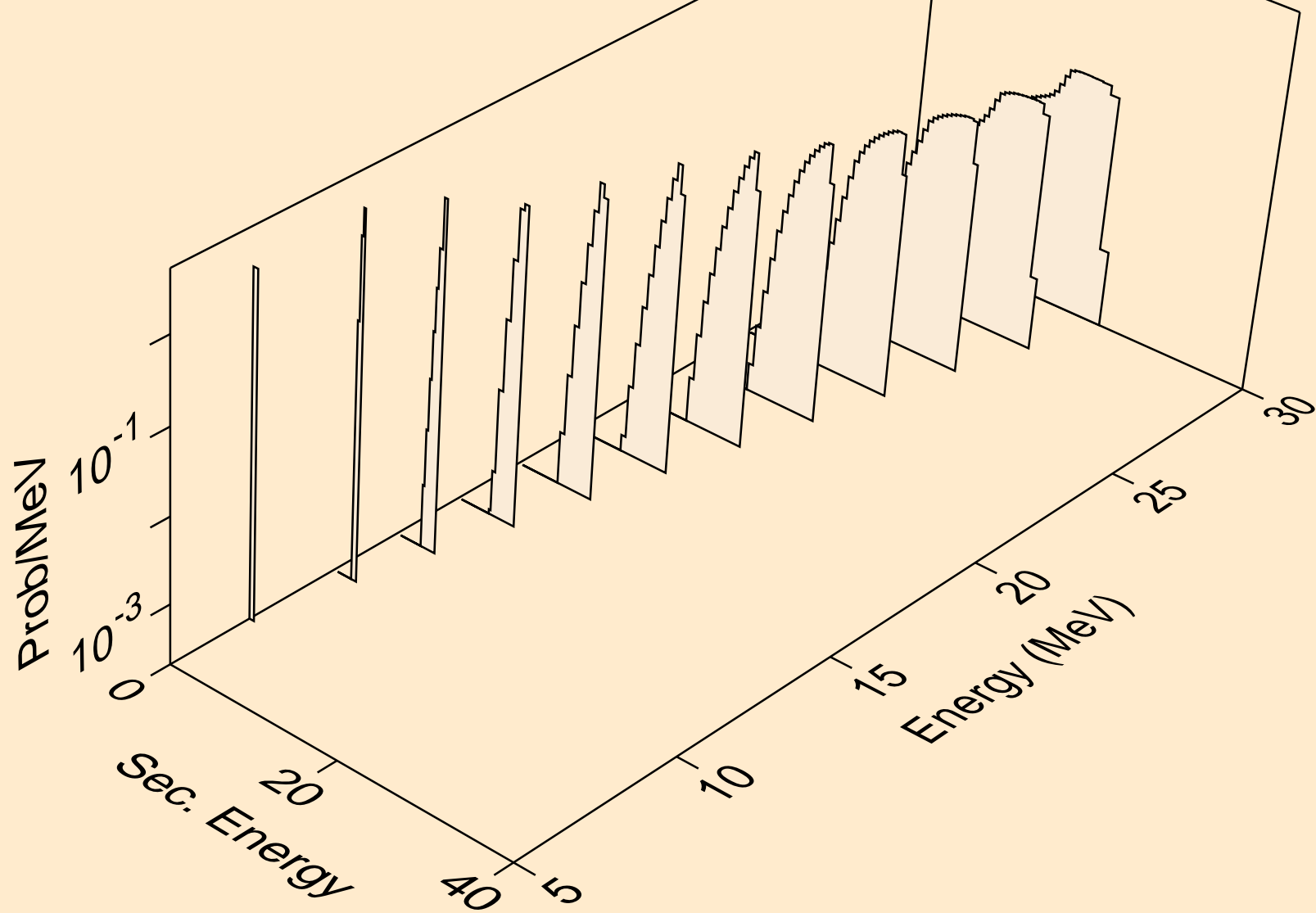

CM250 NEUTRON ACER TENDL-2023 LIBRARY; T=0.K  
protons from (n,2np)

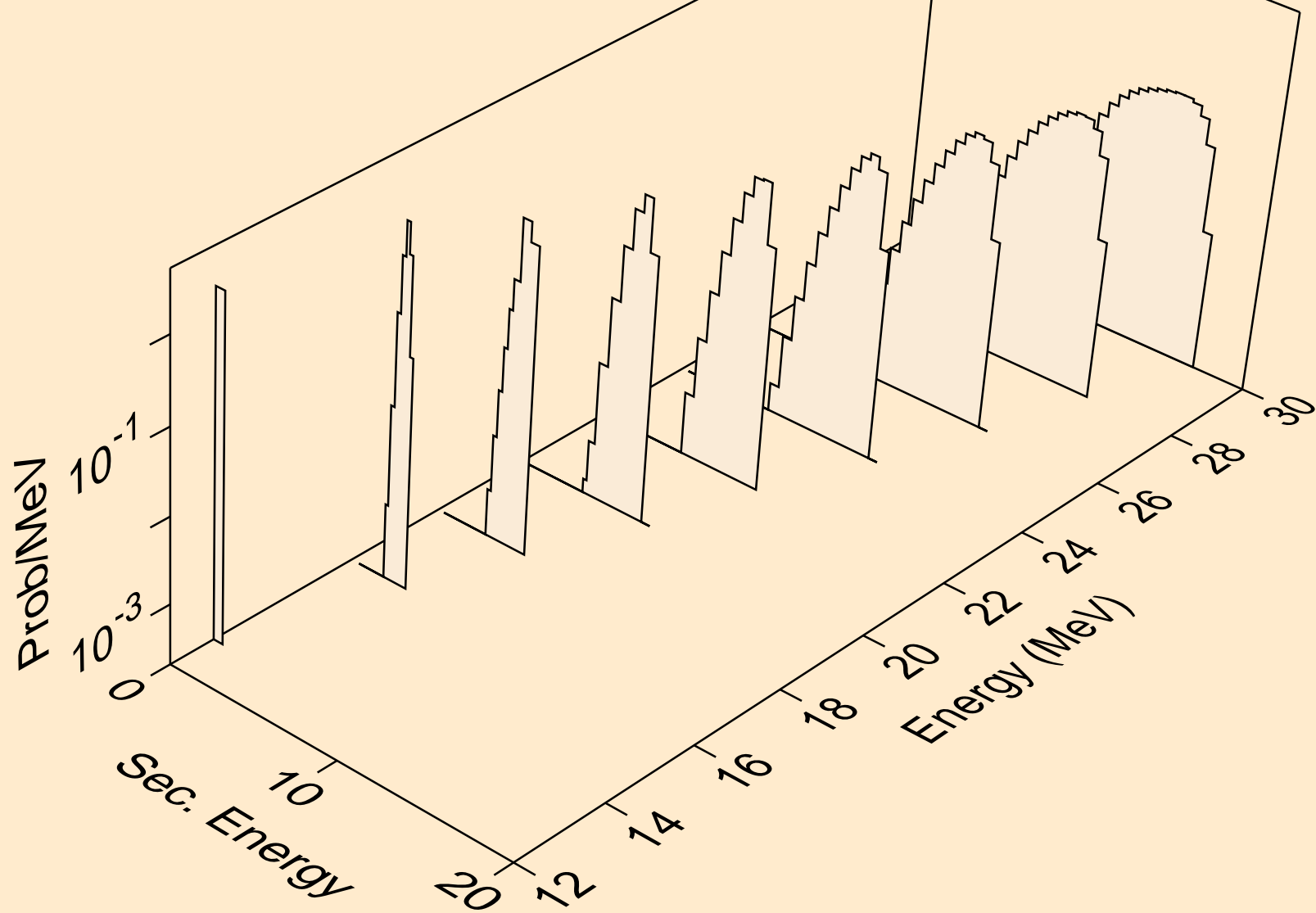

CM250 NEUTRON ACER TENDL-2023 LIBRARY; T=0.K  
protons from (n,3np)

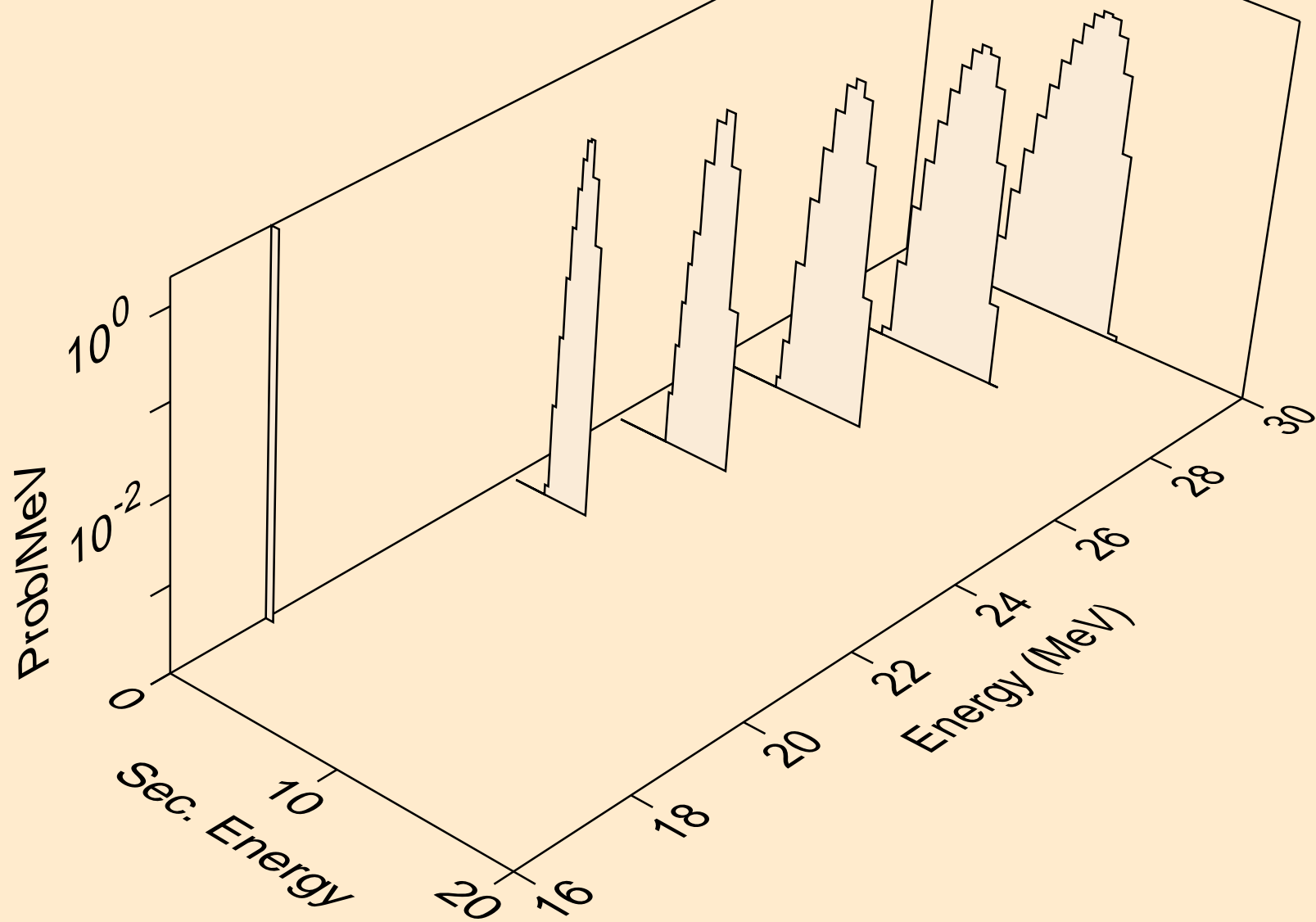

CM250 NEUTRON ACER TENDL-2023 LIBRARY; T=0.K  
protons from (n,p)

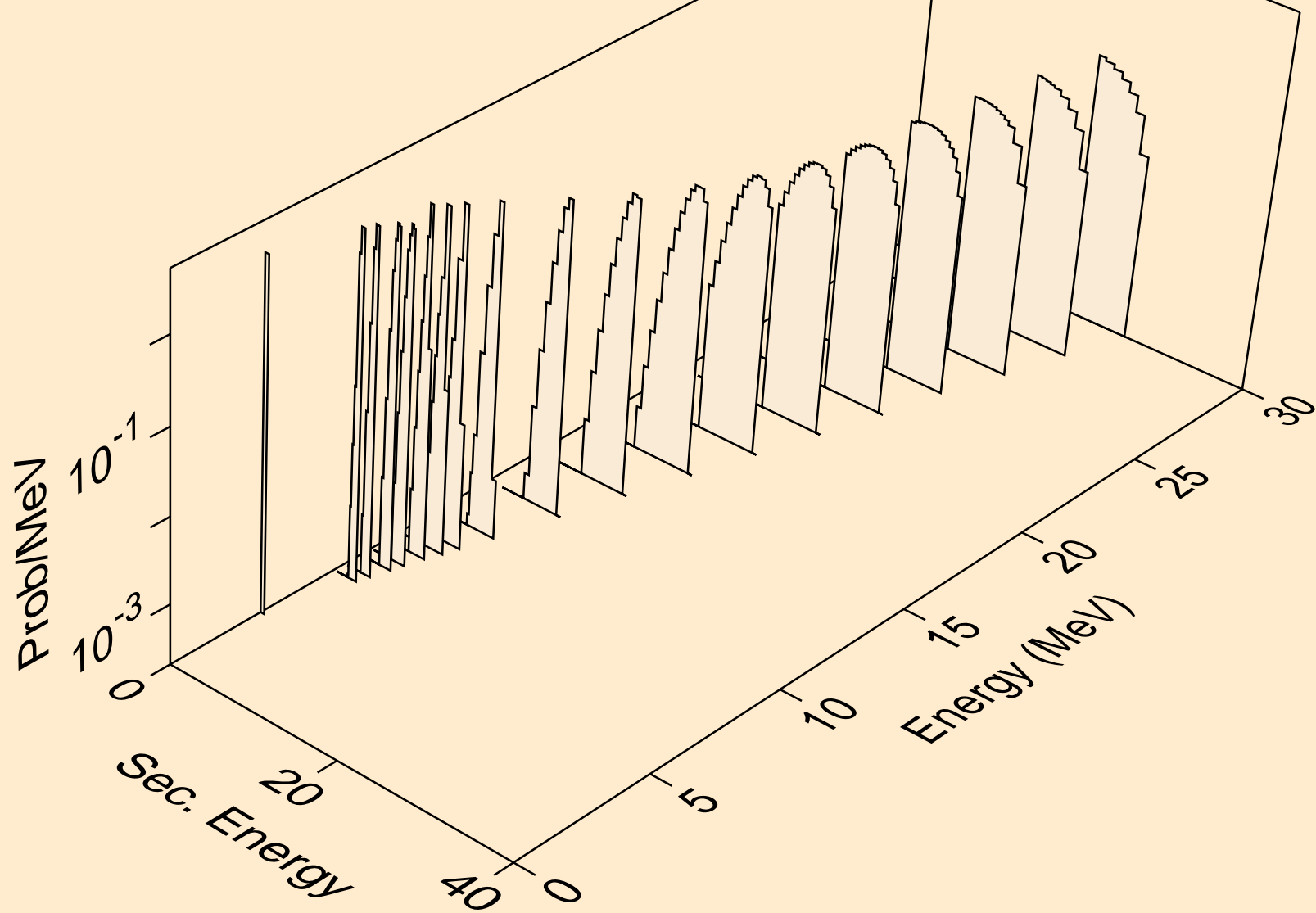

CM250 NEUTRON ACER TENDL-2023 LIBRARY; T=0.K  
protons from (n,2p)

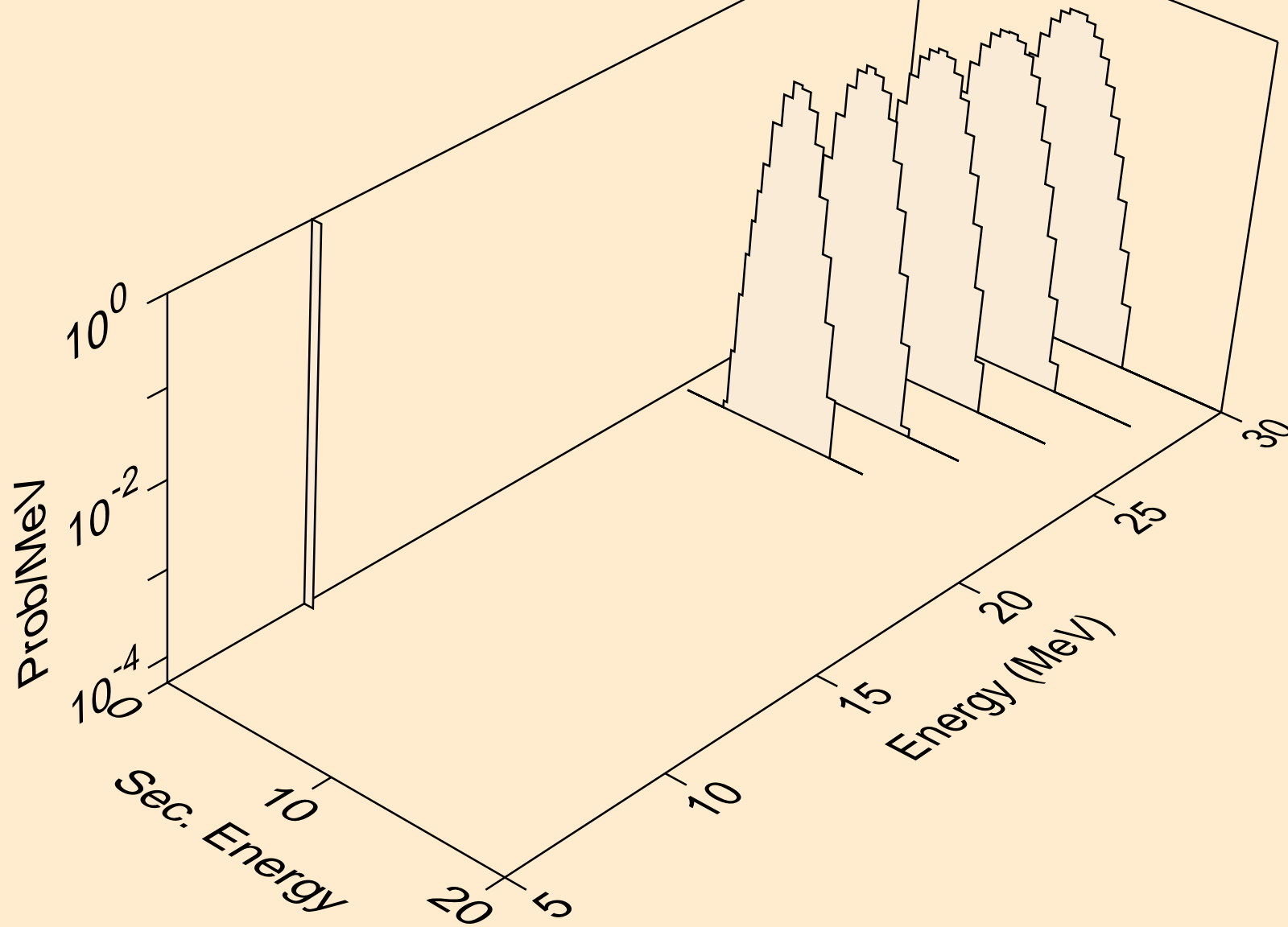

CM250 NEUTRON ACER TENDL-2023 LIBRARY; T=0.K  
deuterons from (n,x)

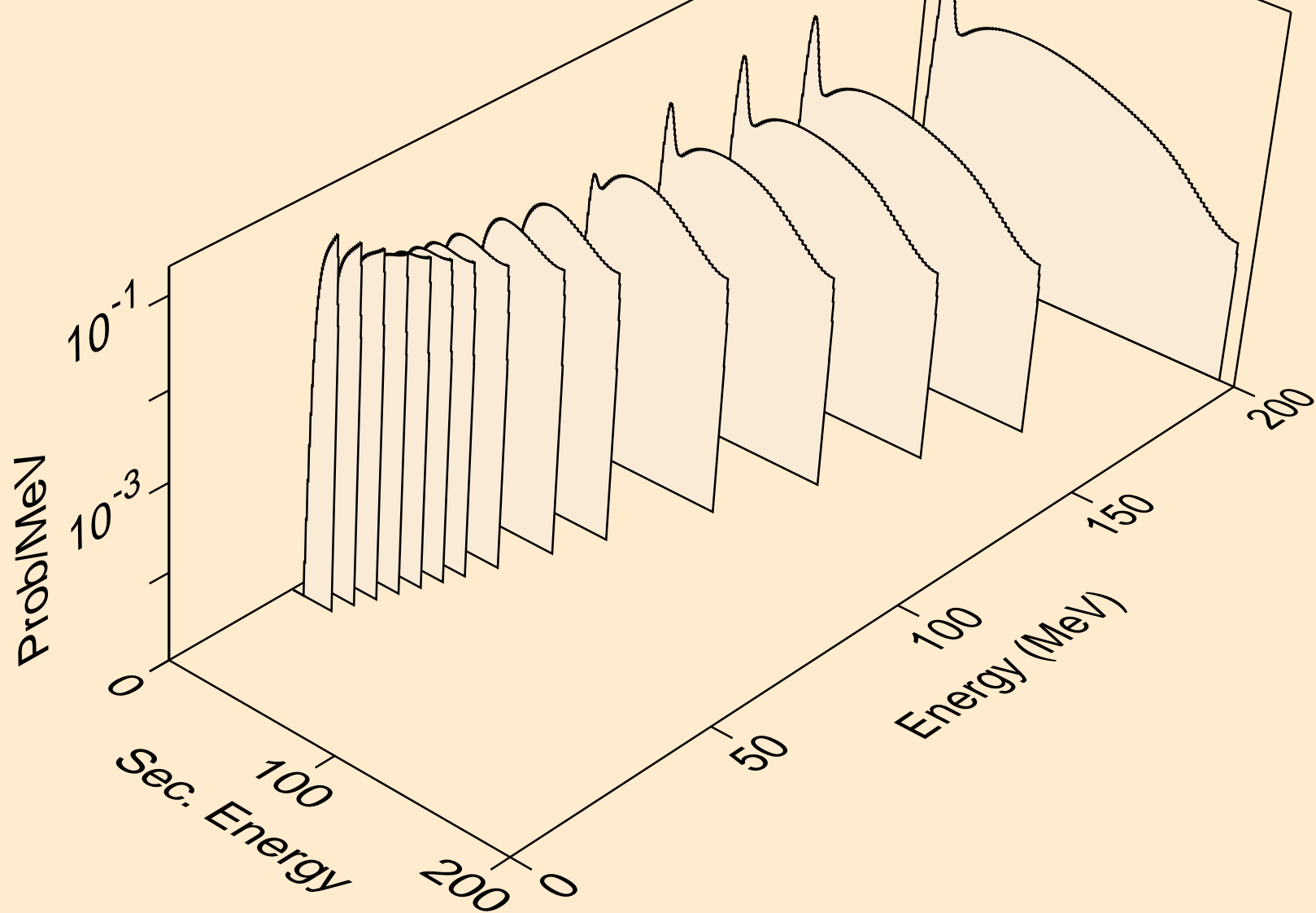

CM250 NEUTRON ACER TENDL-2023 LIBRARY; T=0.K  
deuterons from (n,2nd)

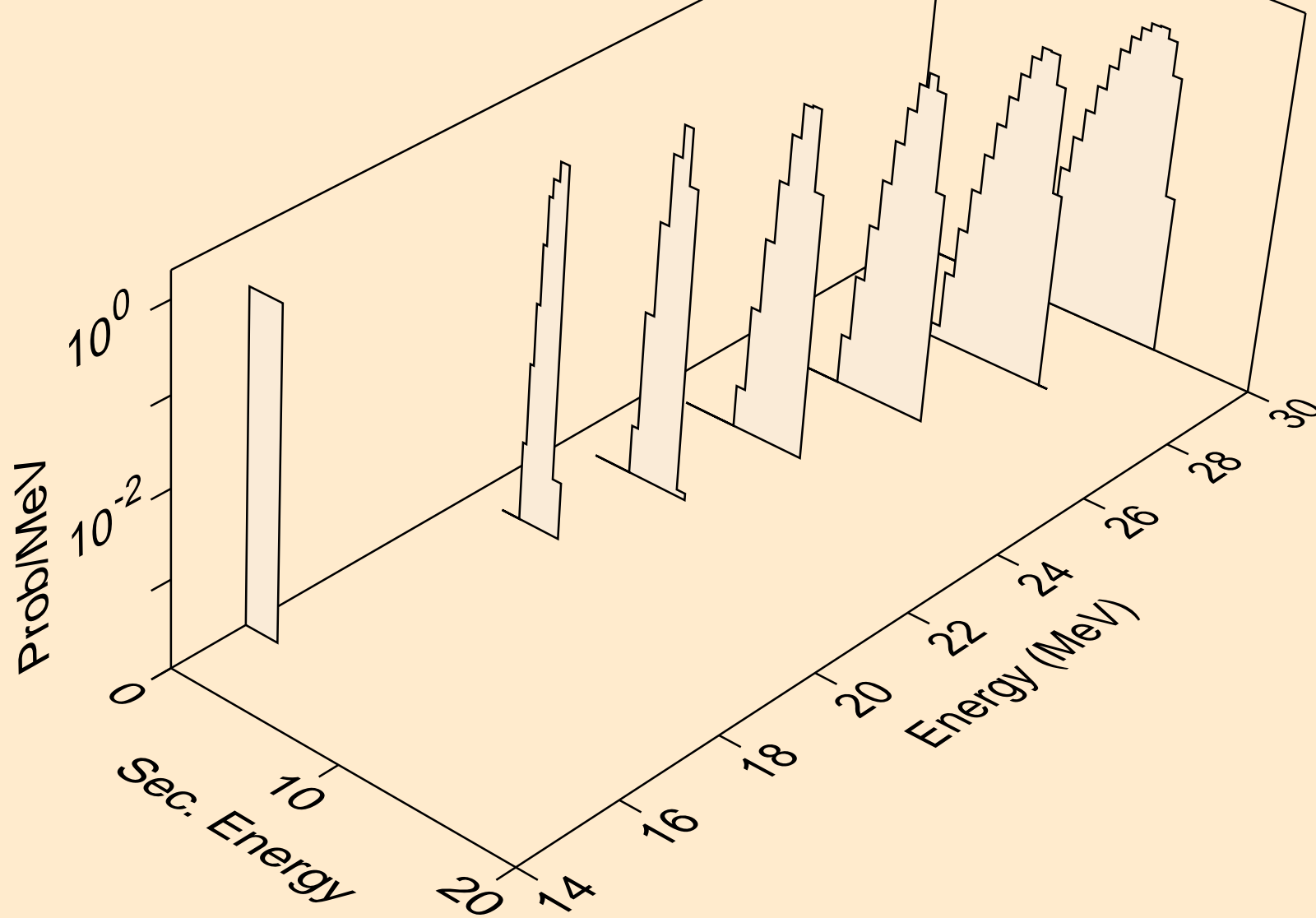

CM250 NEUTRON ACER TENDL-2023 LIBRARY; T=0.K  
deuterons from (n,n\*)d

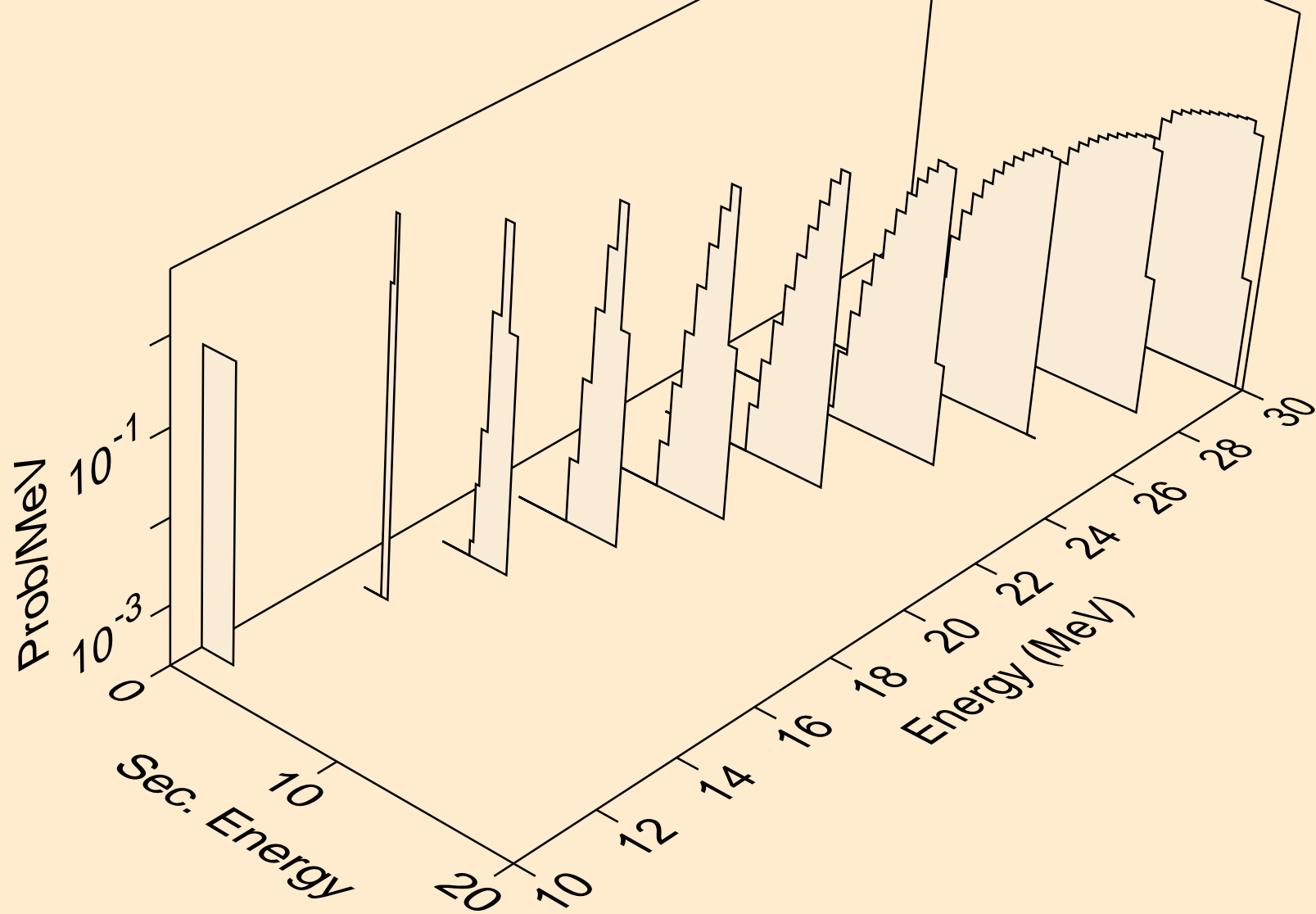



CM250 NEUTRON ACER TENDL-2023 LIBRARY; T=0.K  
deuterons from (n,d)

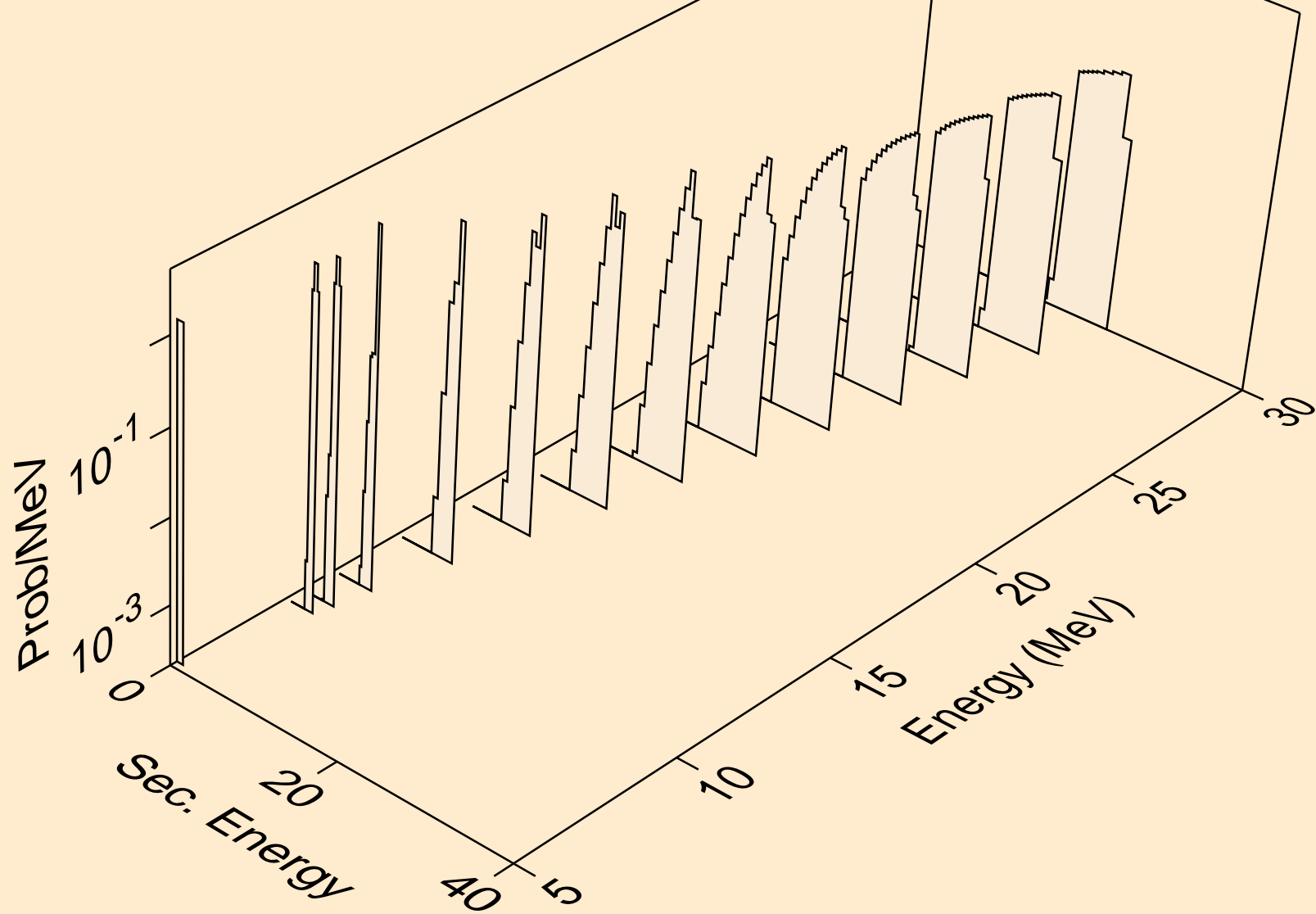

CM250 NEUTRON ACER TENDL-2023 LIBRARY; T=0.K  
tritons from (n,x)

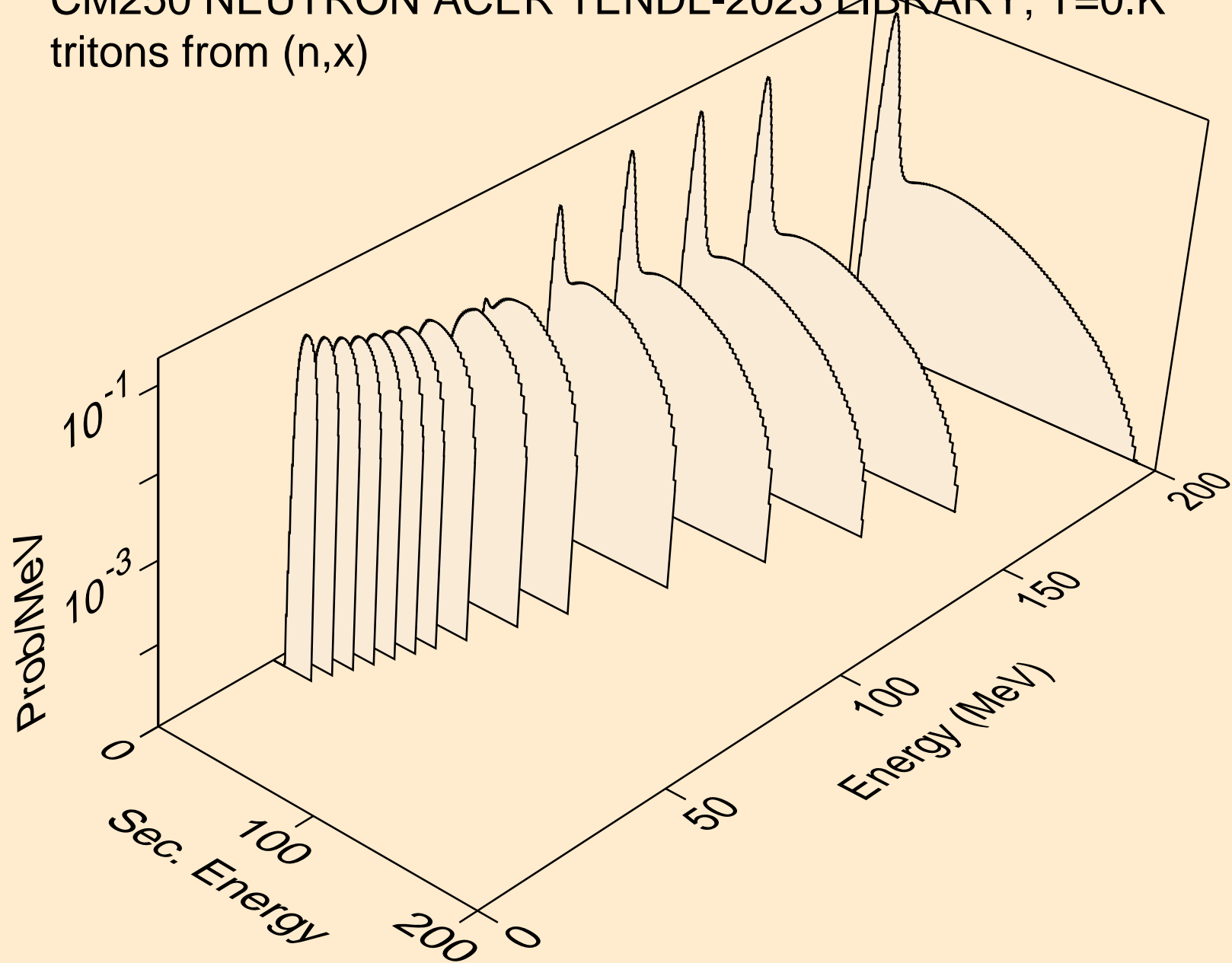

CM250 NEUTRON ACER TENDL-2023 LIBRARY; T=0.K  
tritons from (n,n\*)t

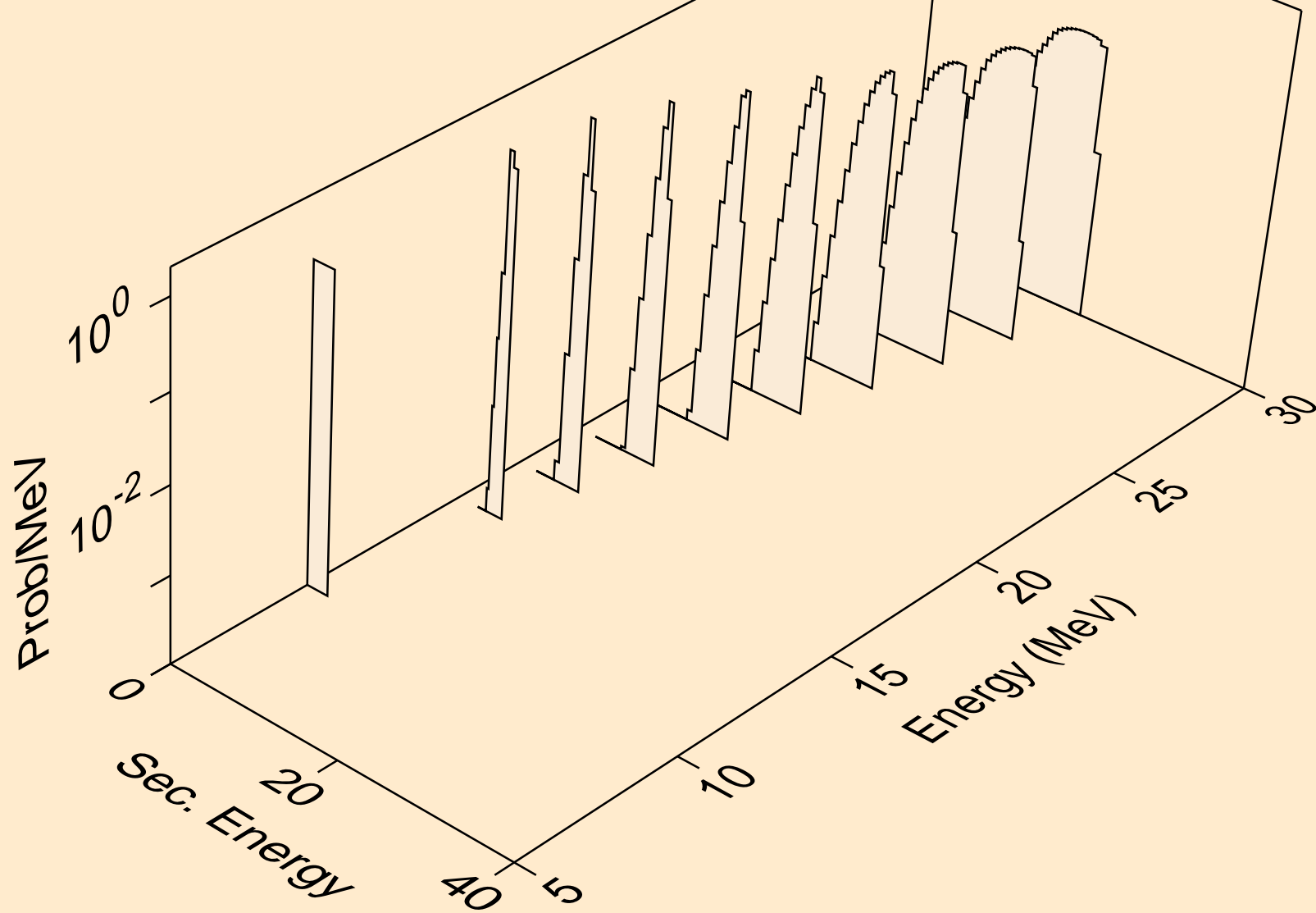

CM250 NEUTRON ACER TENDL-2023 LIBRARY; T=0.K  
tritons from (n,t)

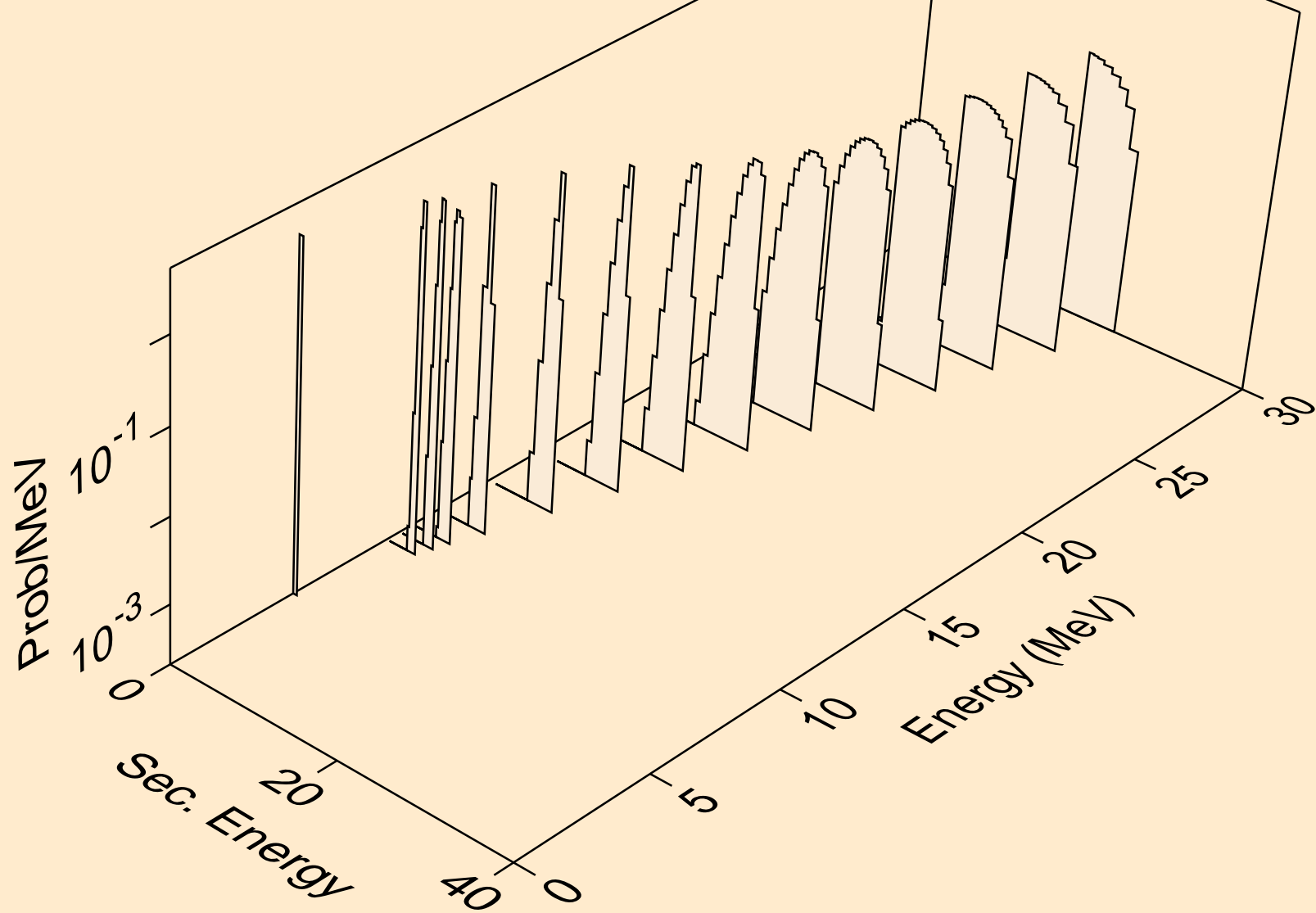

CM250 NEUTRON ACER TENDL-2023 LIBRARY; T=0.K  
he3s from (n,x)

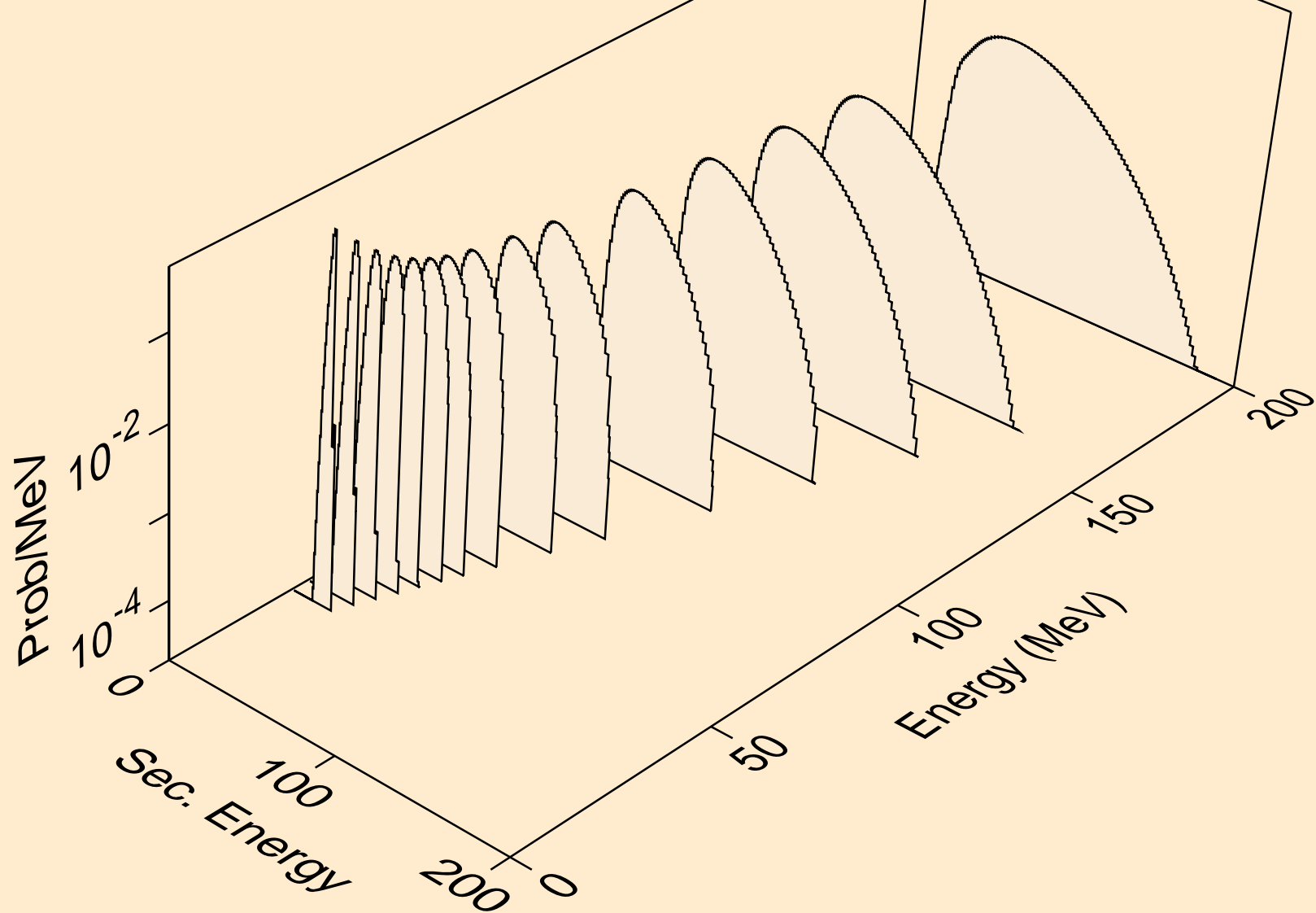

CM250 NEUTRON ACER TENDL-2023 LIBRARY; T=0.K  
he3s from (n,n\*)he3

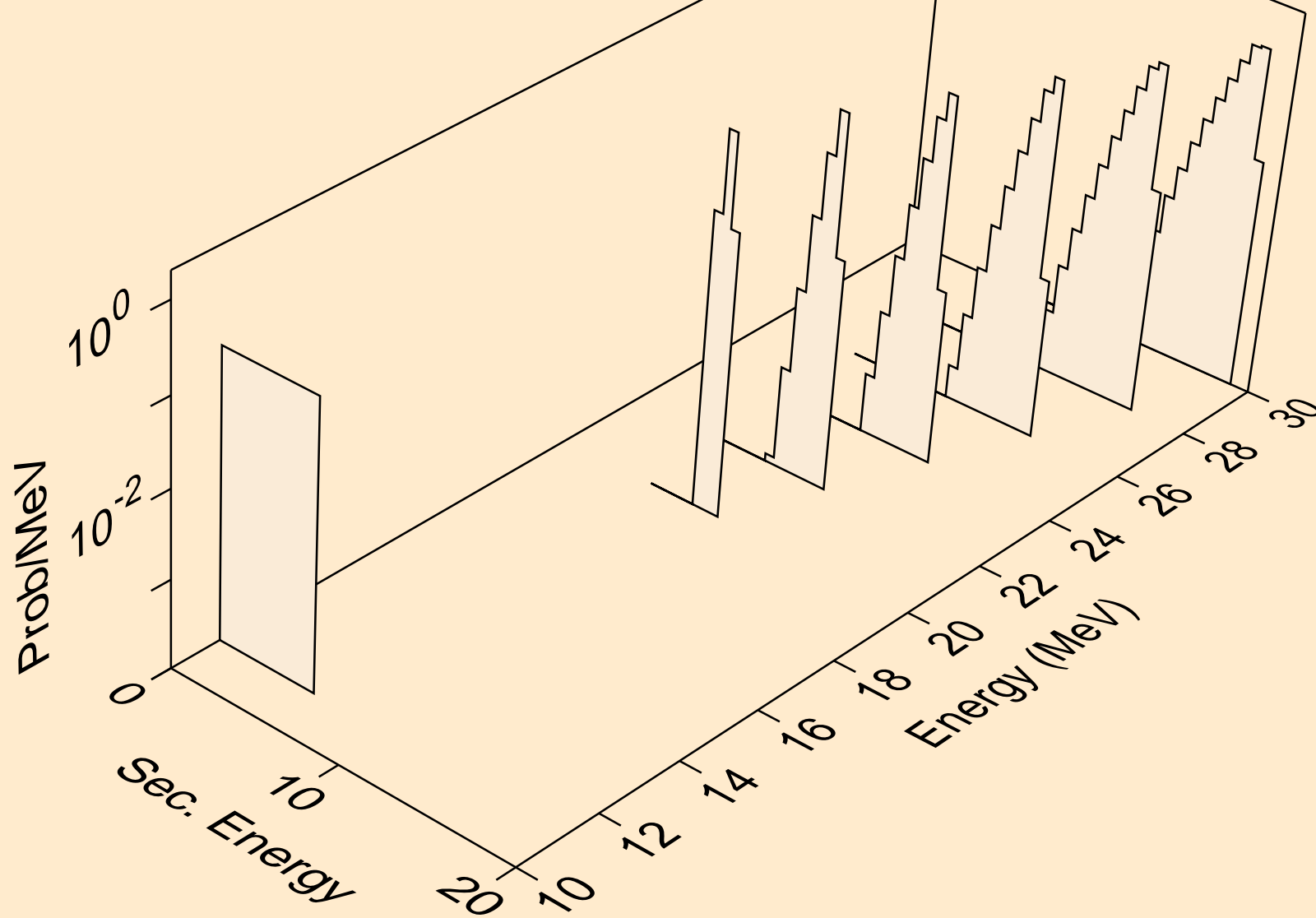

CM250 NEUTRON ACER TENDL-2023 LIBRARY; T=0.K  
he3s from (n,he3)

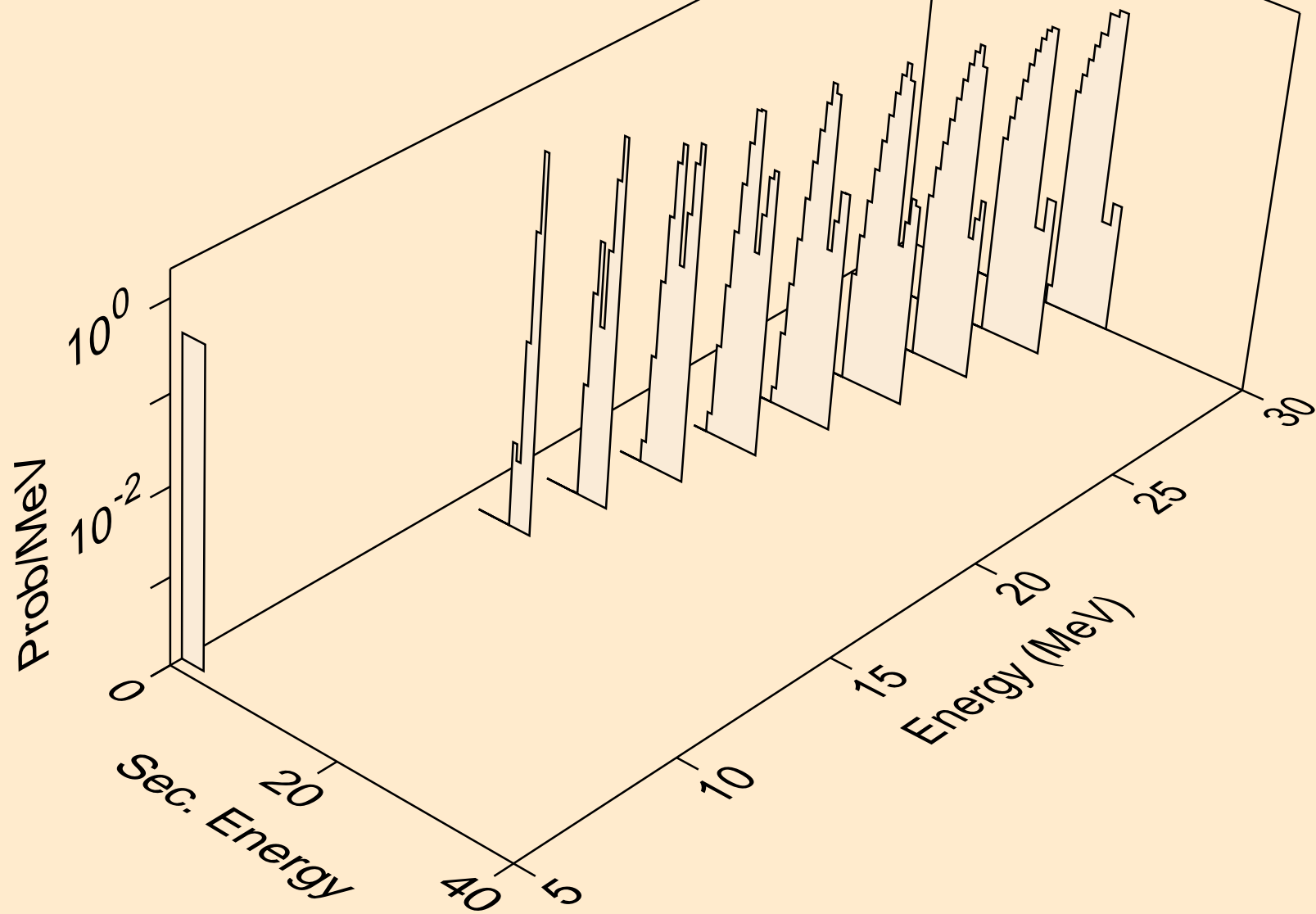

CM250 NEUTRON ACER TENDL-2023 LIBRARY; T=0.K  
alphas from (n,x)

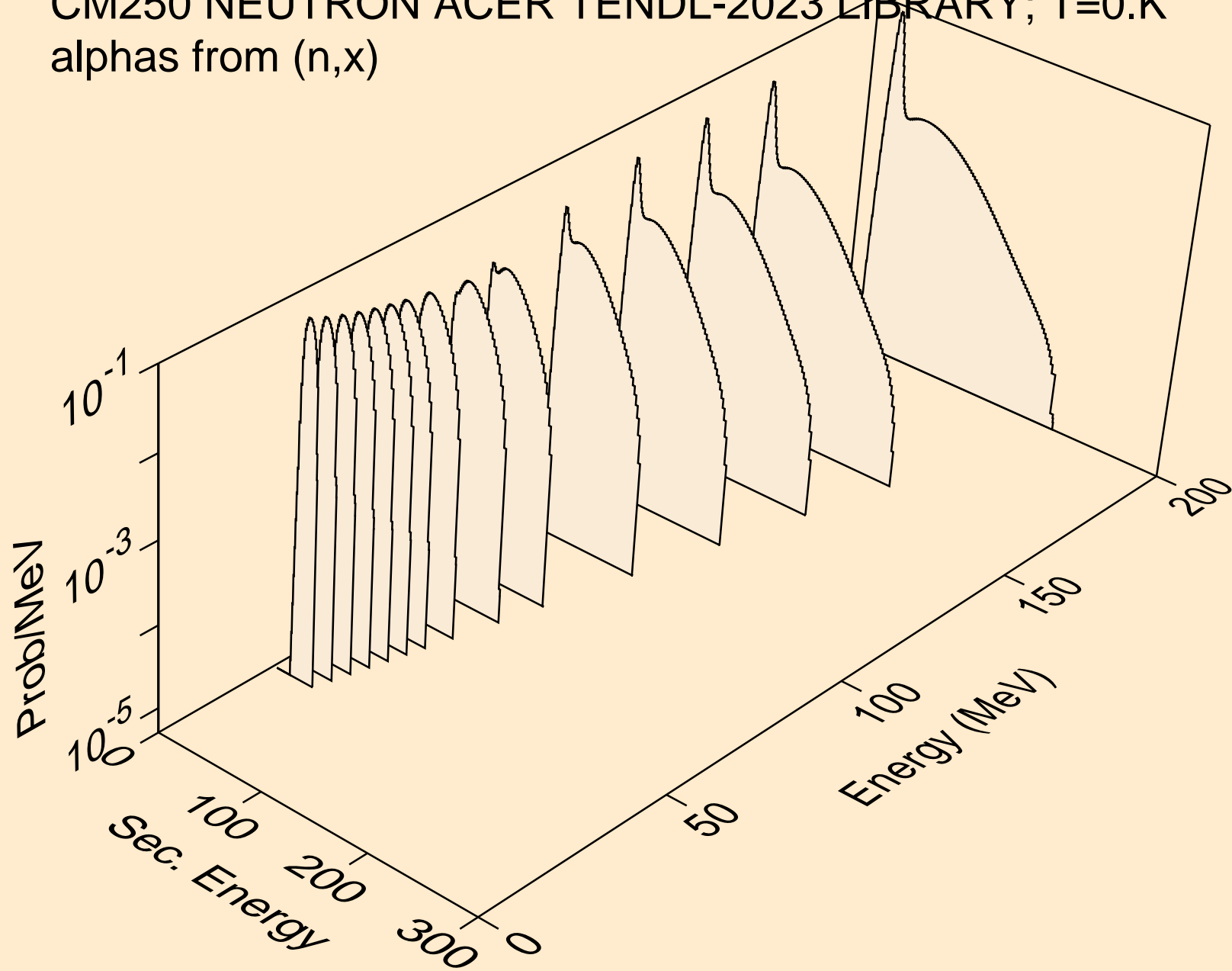



CM250 NEUTRON ACER TENDL-2023 LIBRARY; T=0.K  
alphas from (n,n\*)a

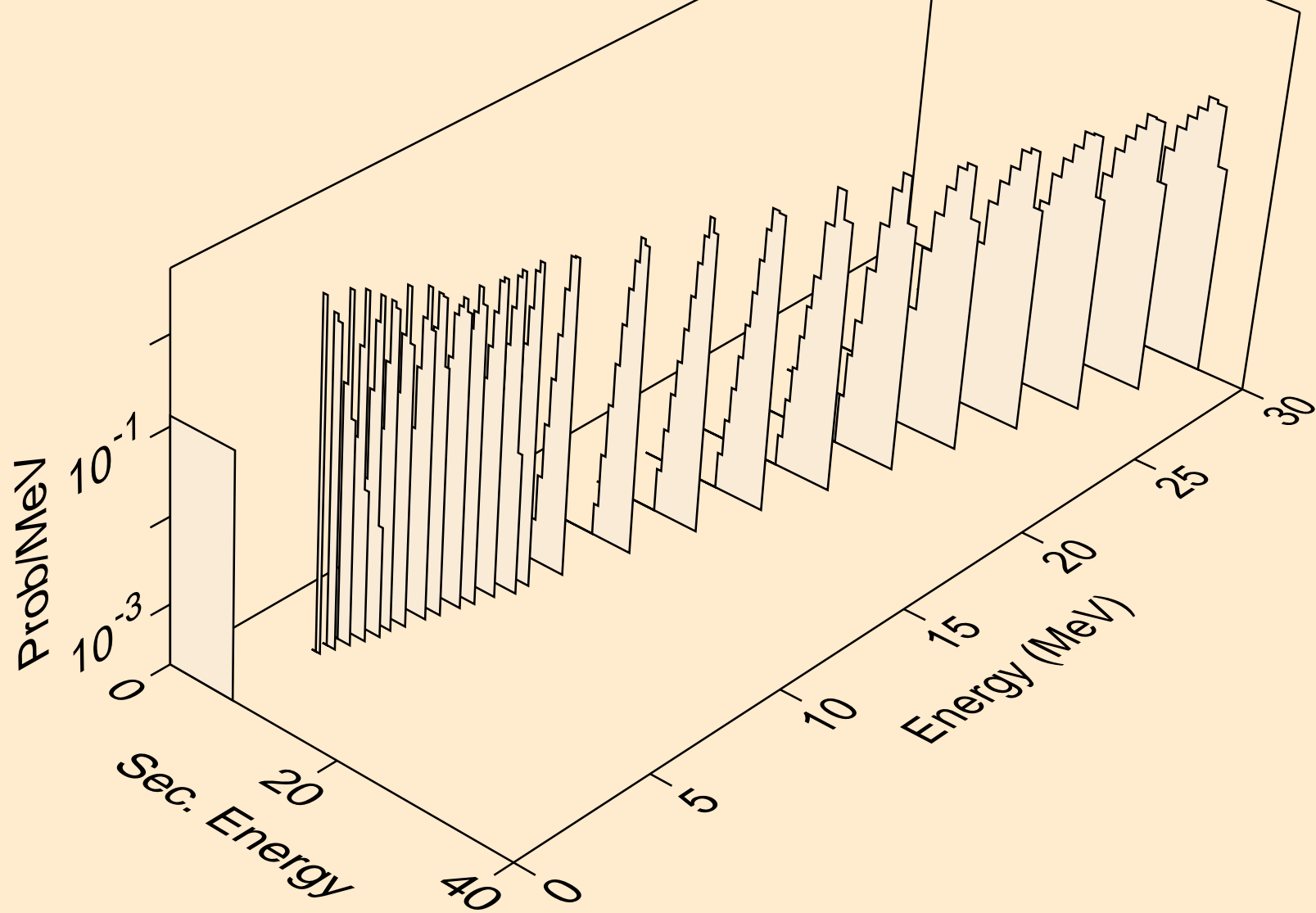

CM250 NEUTRON ACER TENDL-2023 LIBRARY; T=0.K  
alphas from (n,2n)a

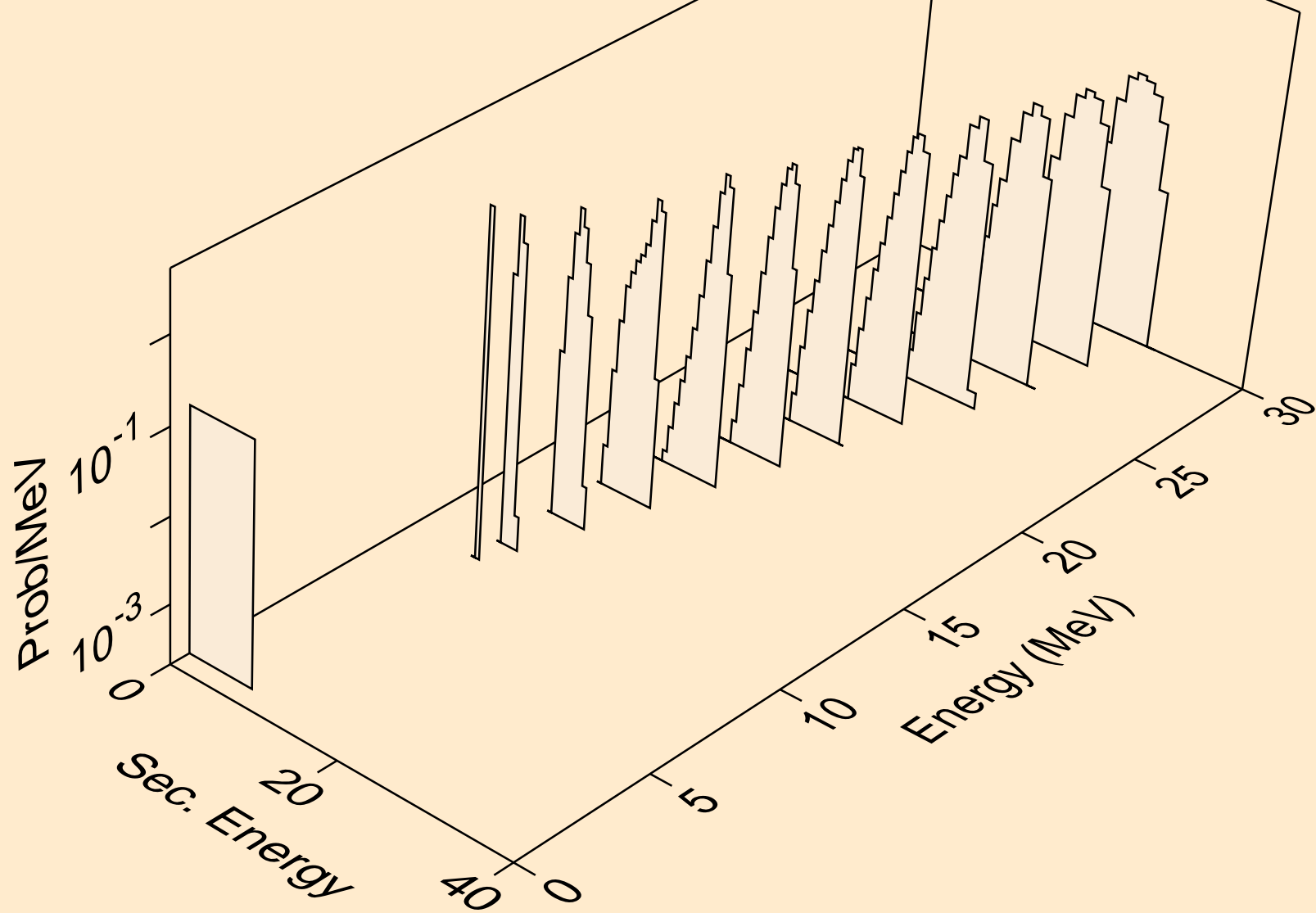

CM250 NEUTRON ACER TENDL-2023 LIBRARY; T=0.K  
alphas from (n,3n)a

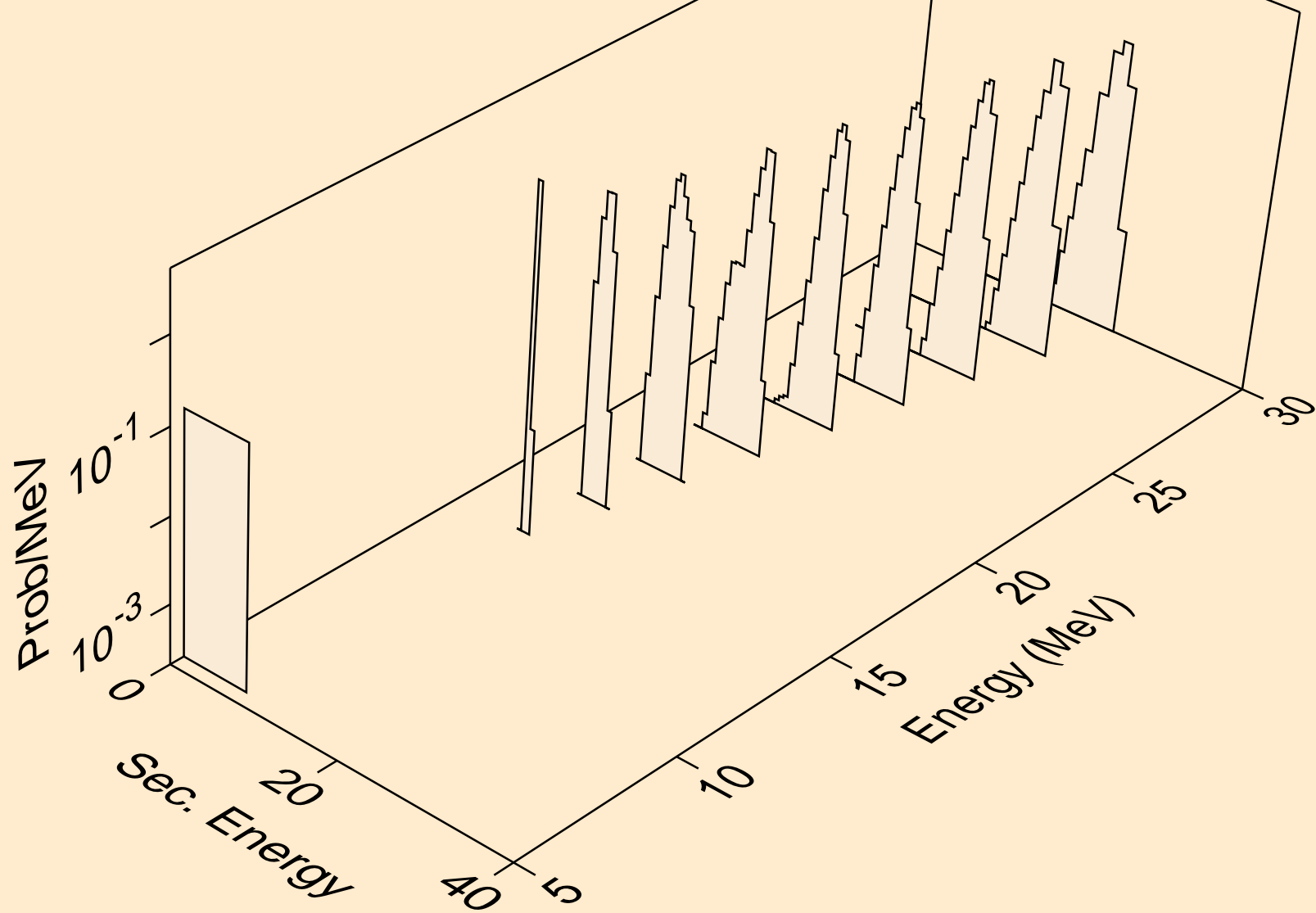

CM250 NEUTRON ACER TENDL-2023 LIBRARY; T=0.K  
alphas from (n,a)

