

# CR049 NEUTRON ACER TENDL-2023 LIBRARY; T=0.K

## Principal cross sections

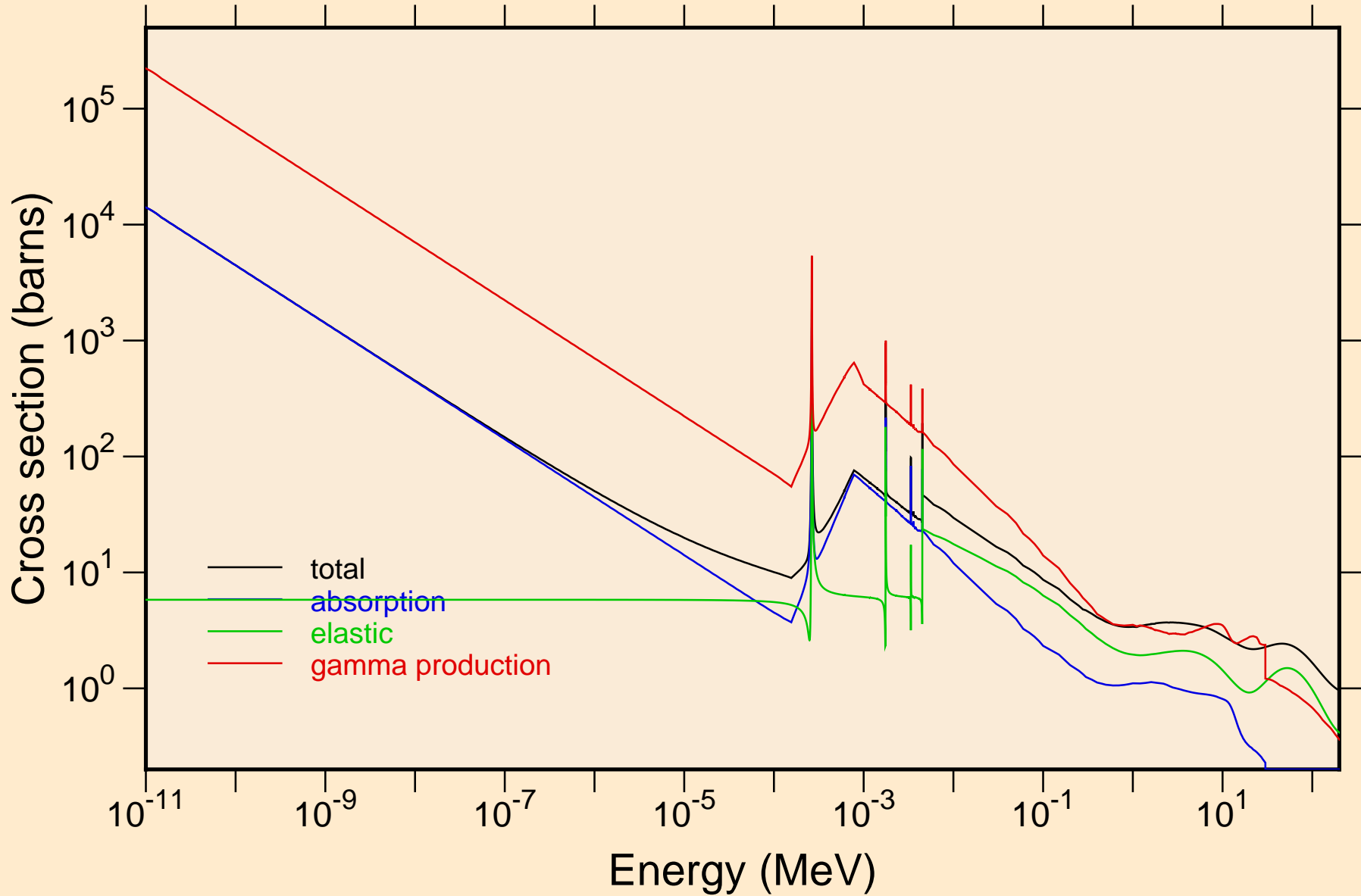

CR049 NEUTRON ACER TENDL-2023 LIBRARY; T=0.K  
resonance total cross section

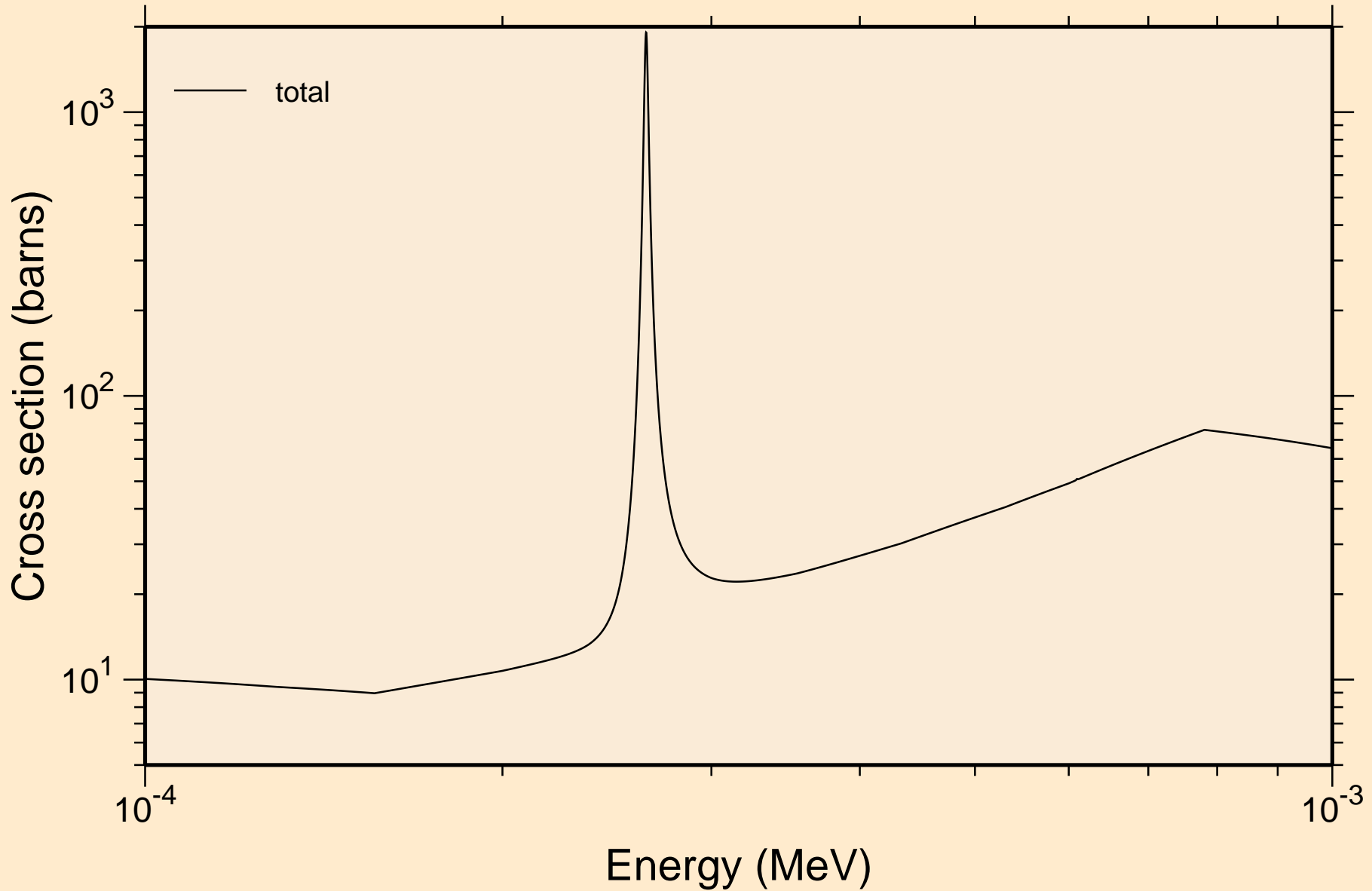

CR049 NEUTRON ACER TENDL-2023 LIBRARY; T=0.K  
resonance total cross section

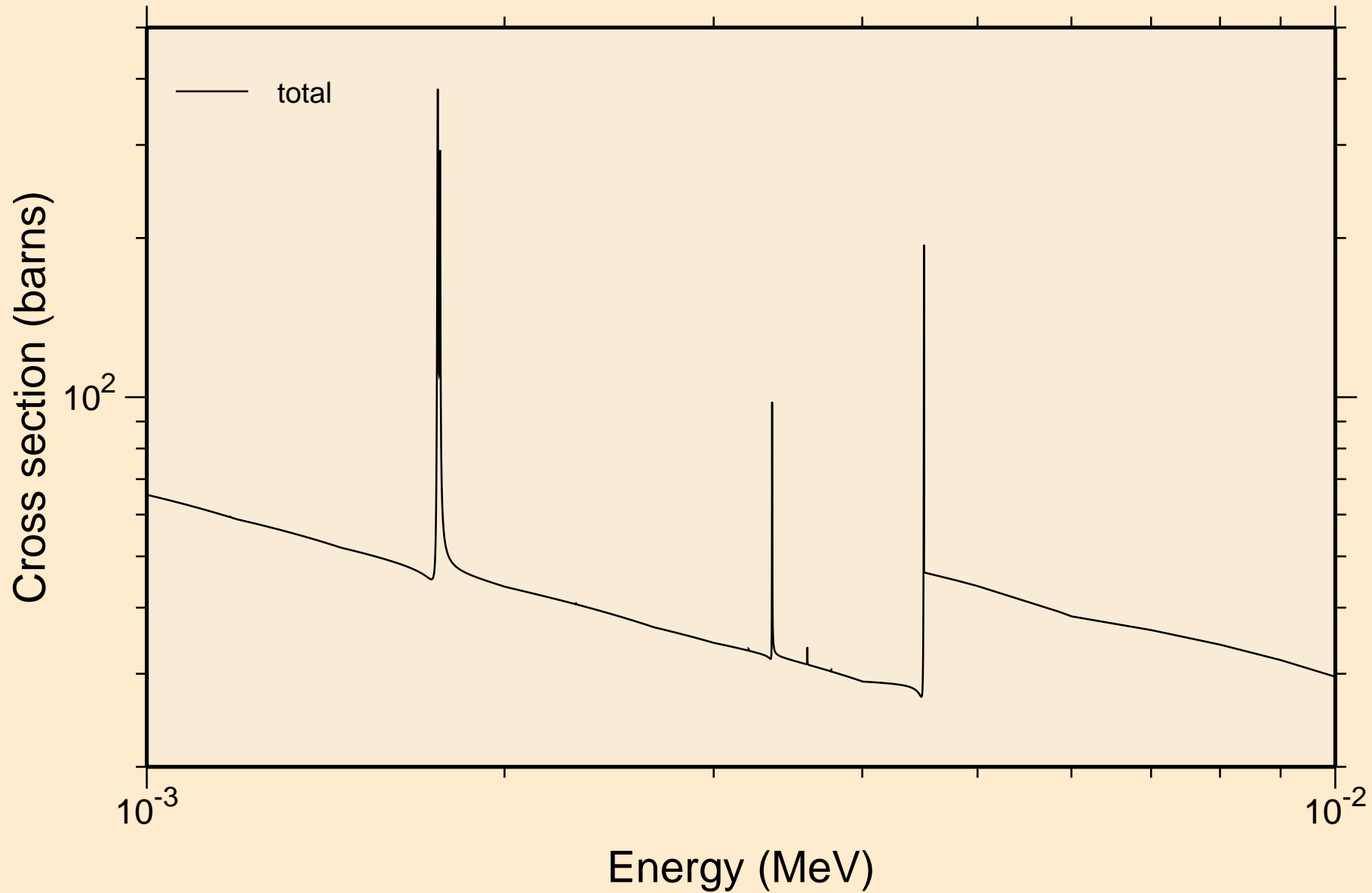

CR049 NEUTRON ACER TENDL-2023 LIBRARY; T=0.K  
resonance total cross section

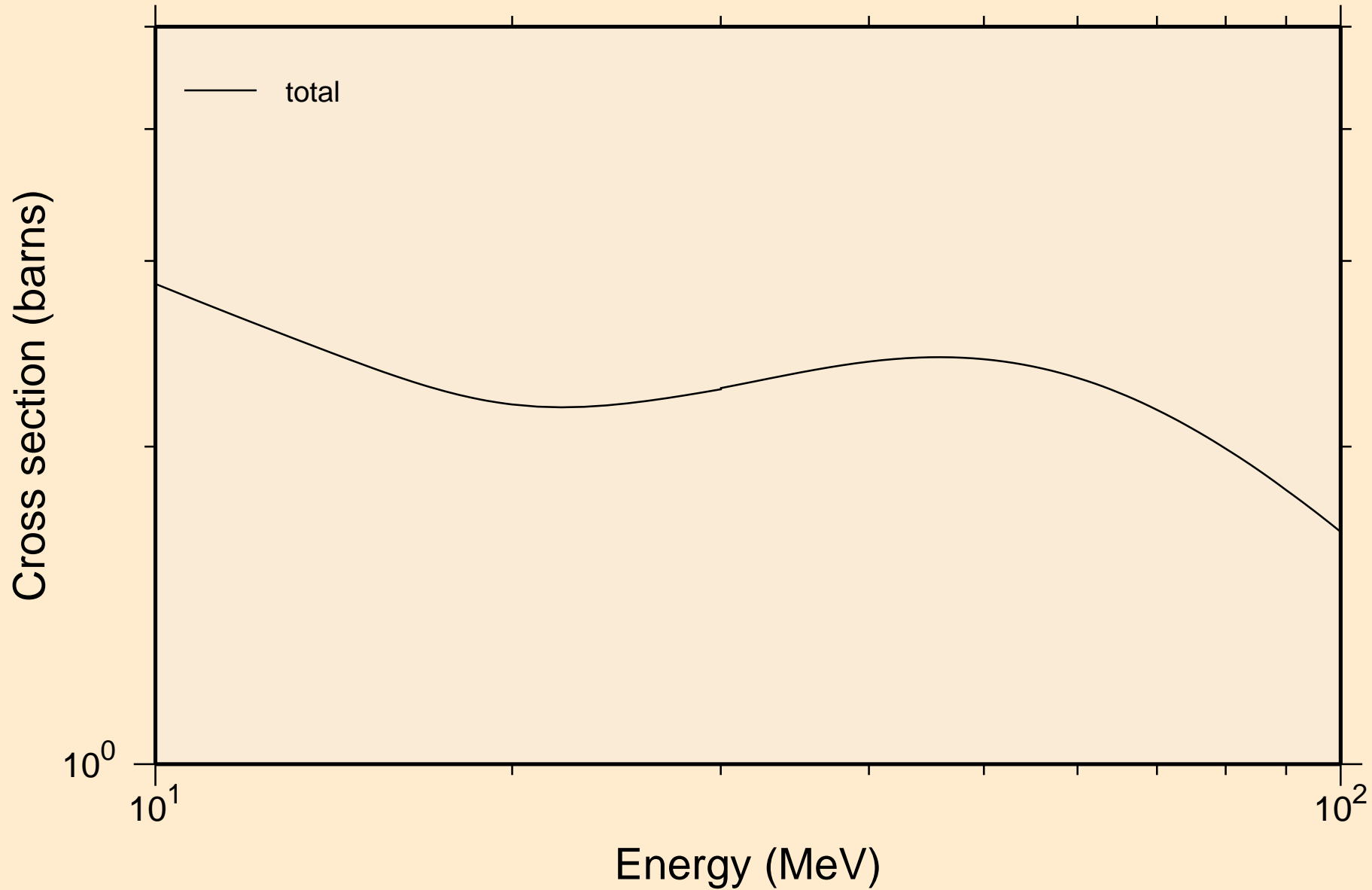

CR049 NEUTRON ACER TENDL-2023 LIBRARY; T=0.K  
resonance absorption cross sections

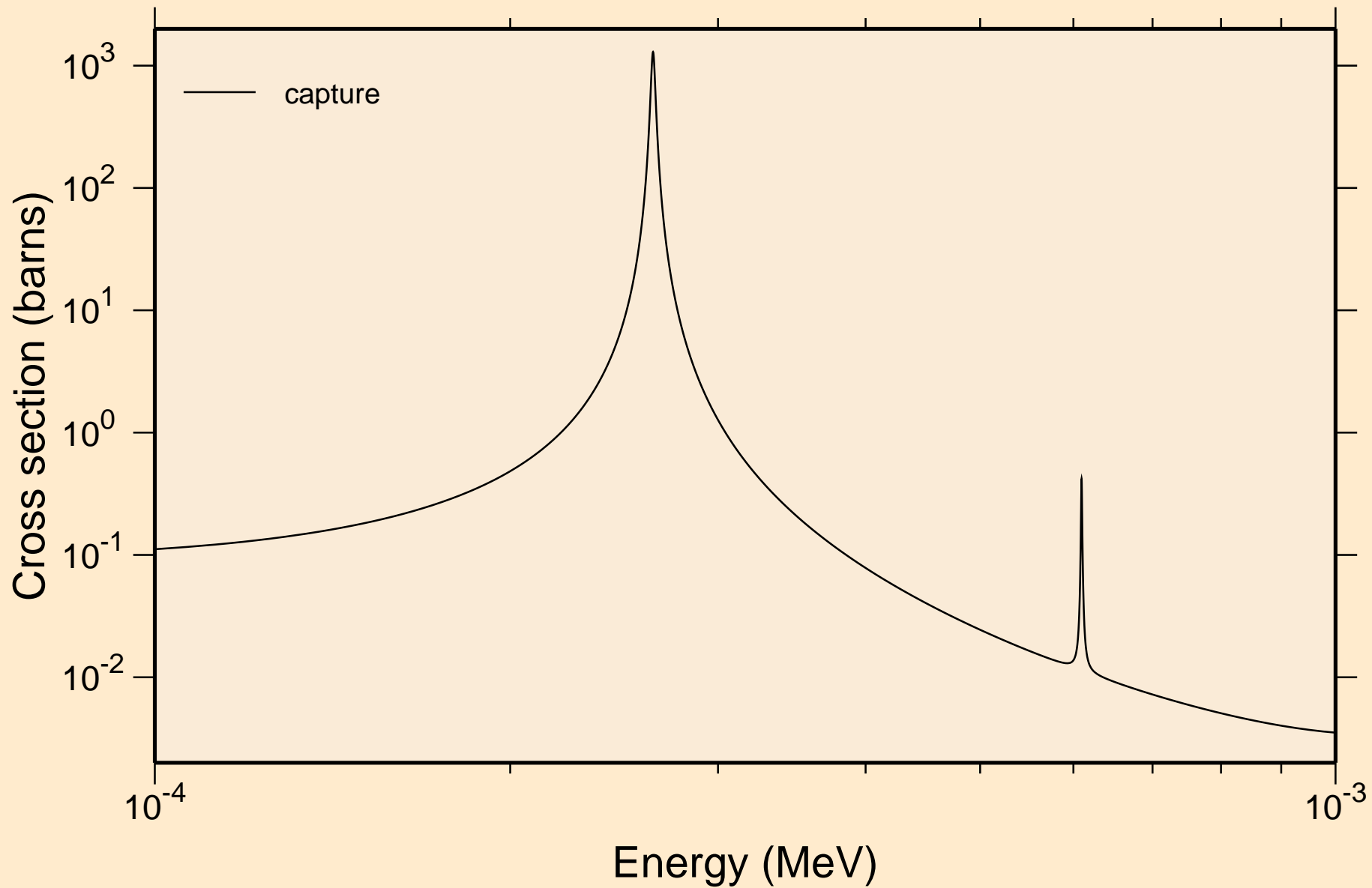

CR049 NEUTRON ACER TENDL-2023 LIBRARY; T=0.K  
resonance absorption cross sections

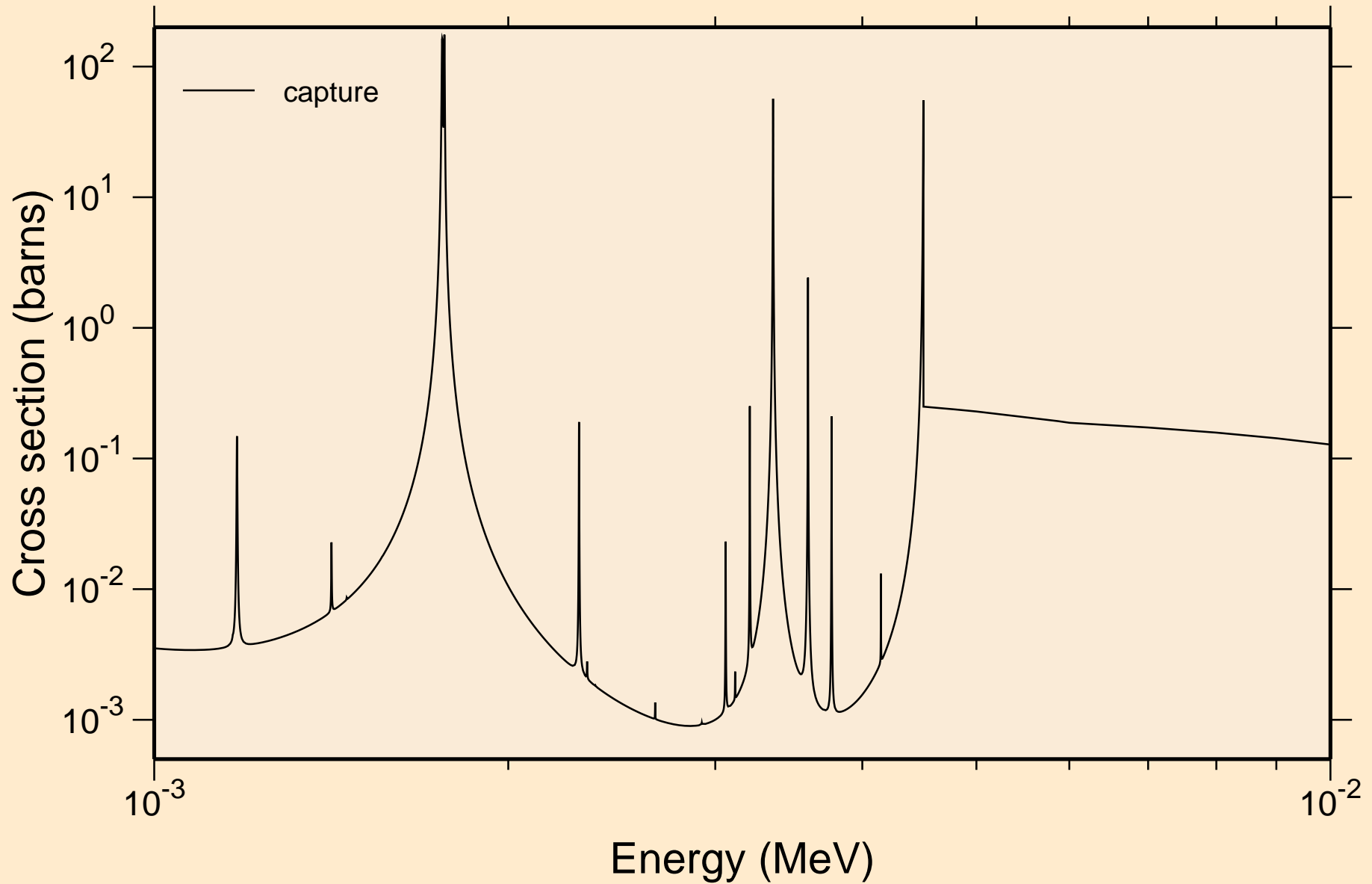

CR049 NEUTRON ACER TENDL-2023 LIBRARY; T=0.K  
resonance absorption cross sections

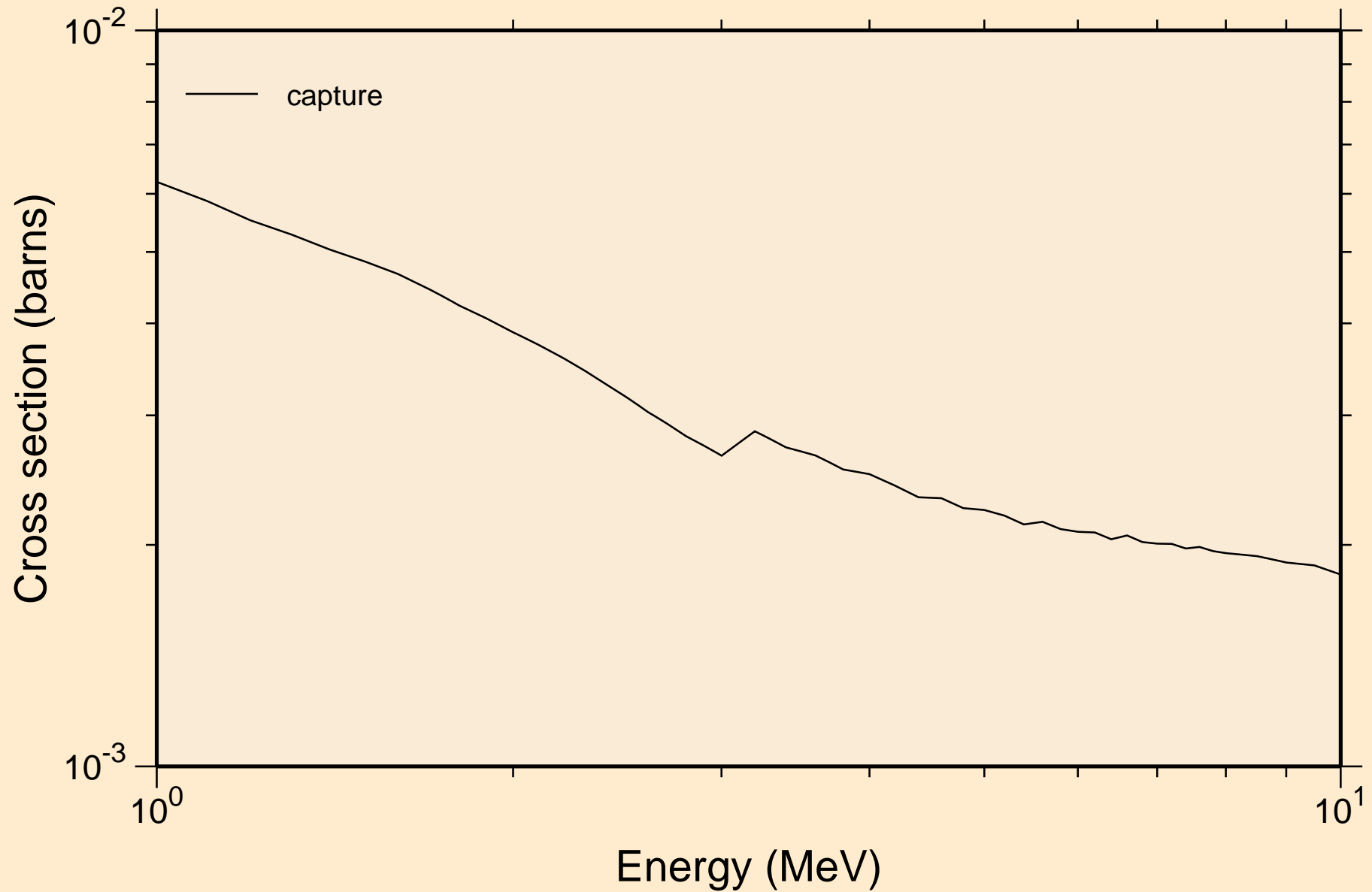

CR049 NEUTRON ACER TENDL-2023 LIBRARY; T=0.K  
Heating

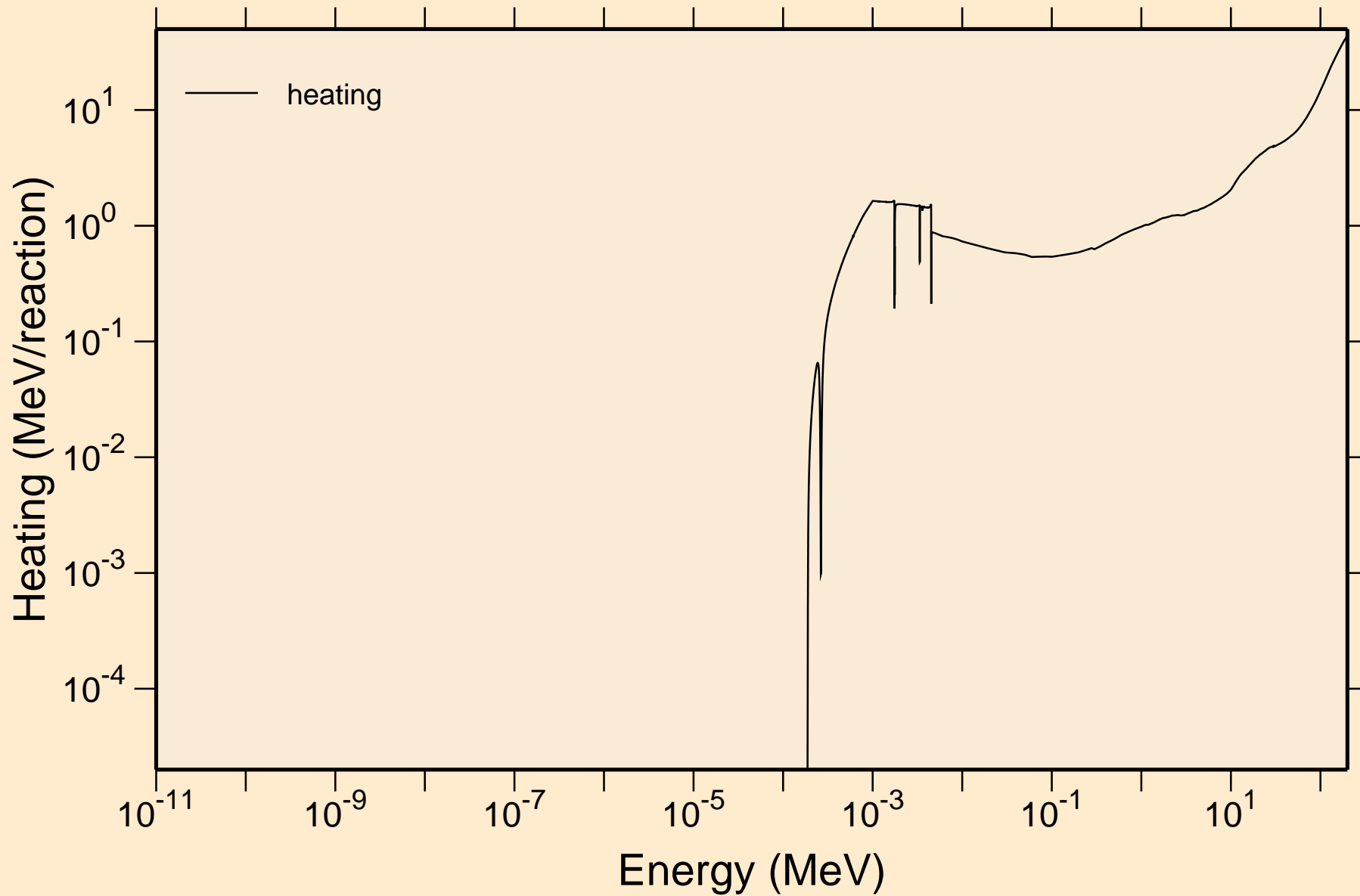



CR049 NEUTRON ACER TENDL-2023 LIBRARY; T=0.K  
Damage

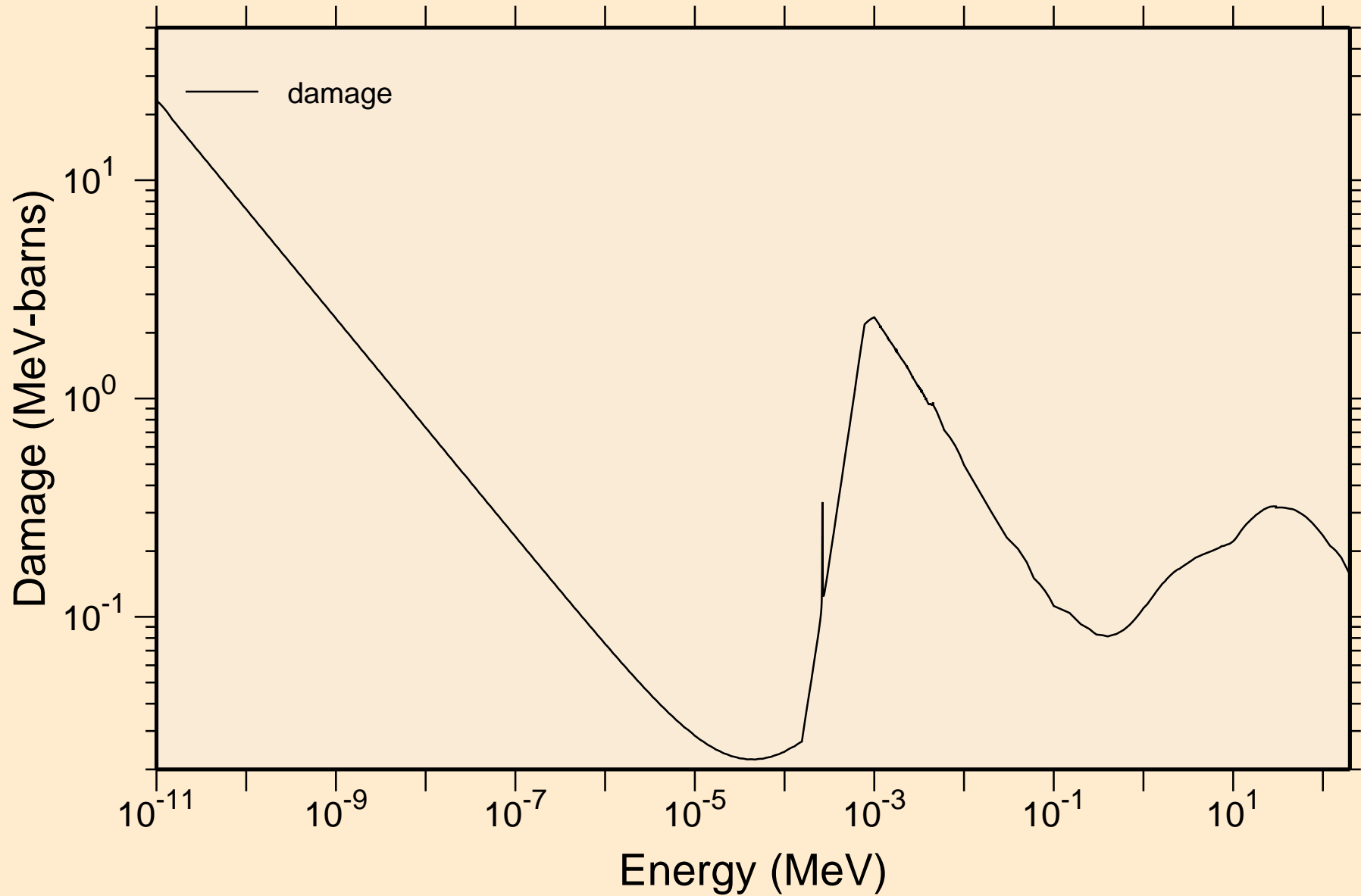

# CR049 NEUTRON ACER TENDL-2023 LIBRARY; T=0.K

## Non-threshold reactions

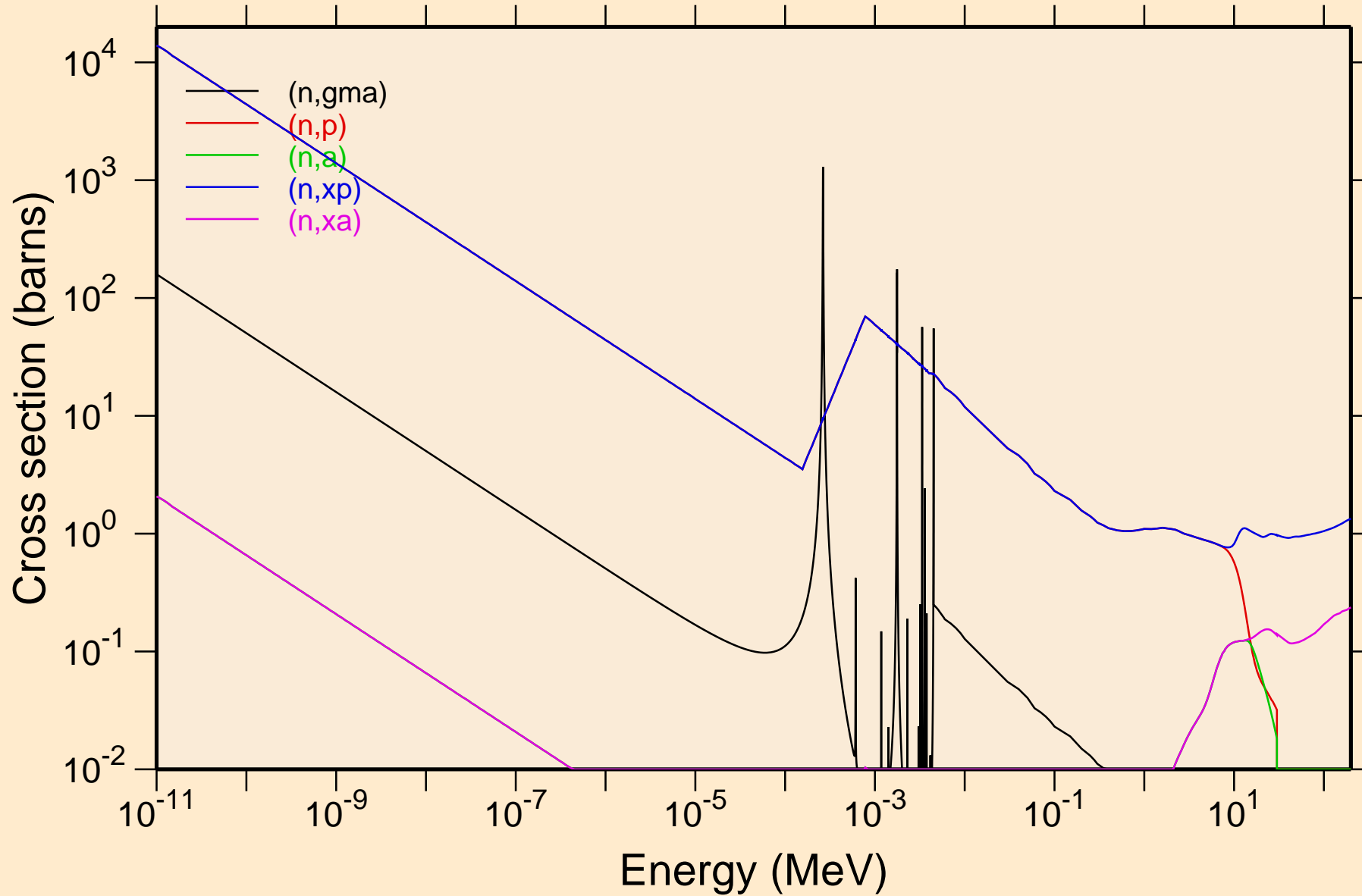

# CR049 NEUTRON ACER TENDL-2023 LIBRARY; T=0.K

## Principal cross sections

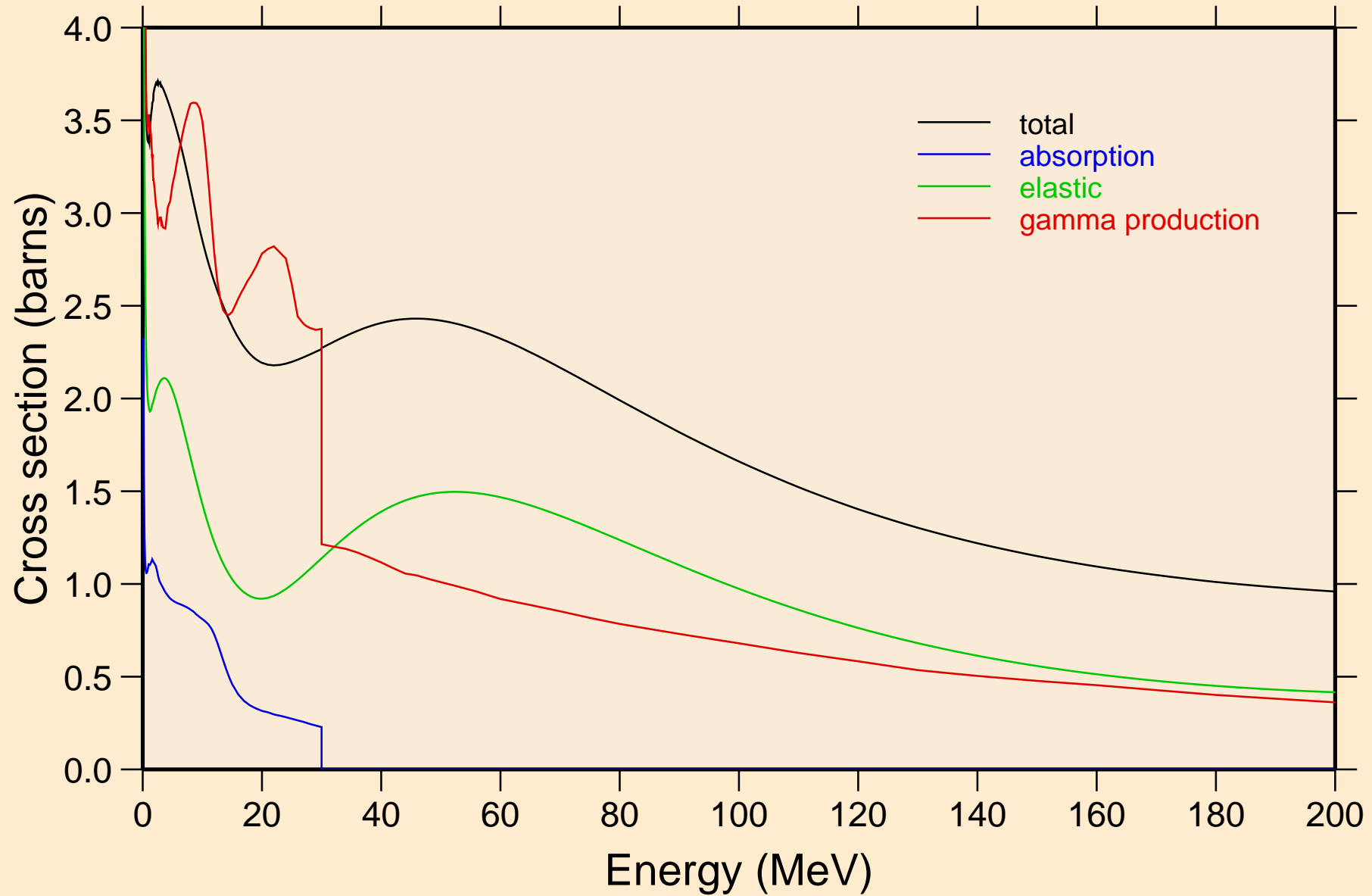

# CR049 NEUTRON ACER TENDL-2023 LIBRARY; T=0.K

## Heating

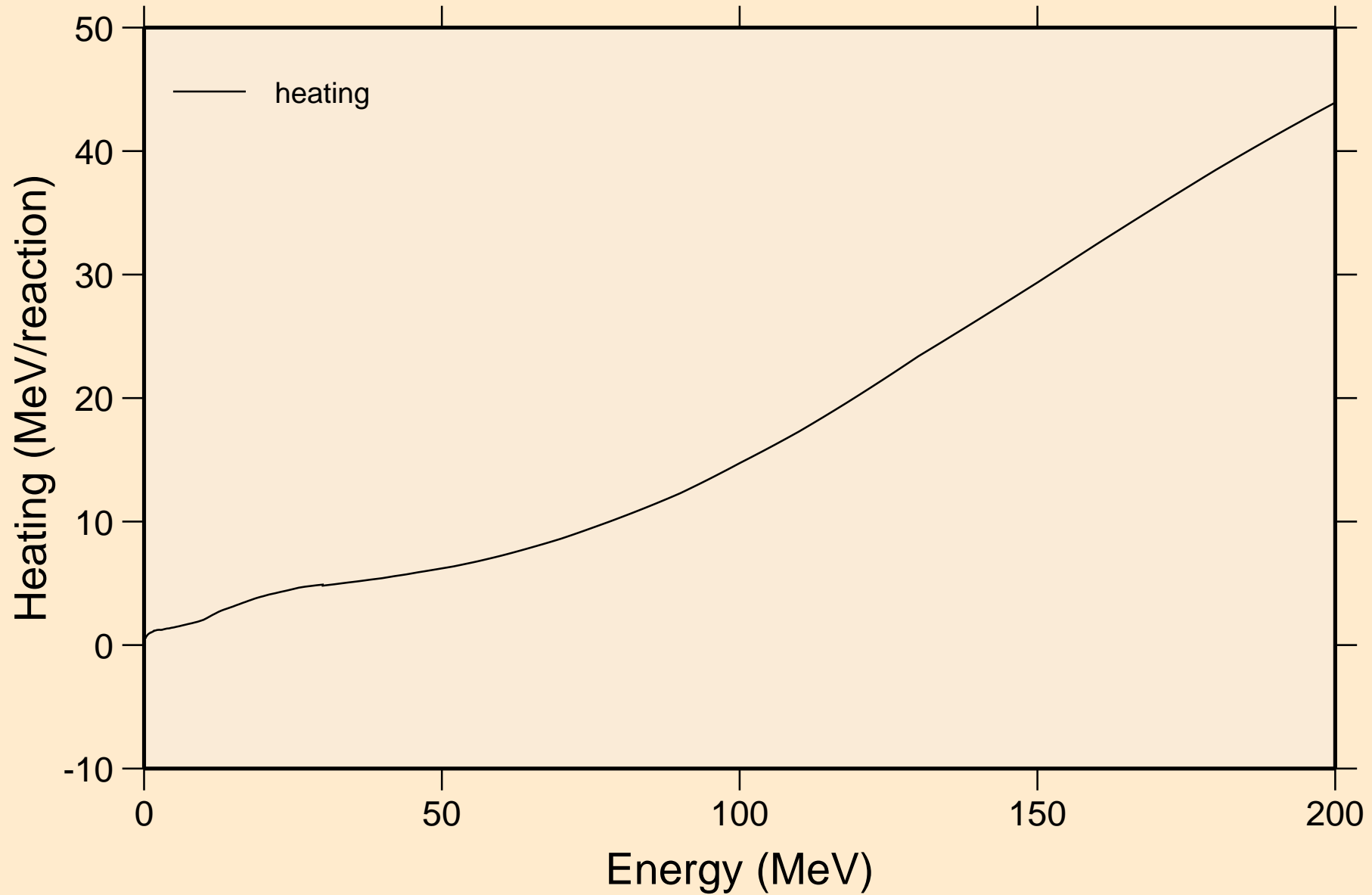

CR049 NEUTRON ACER TENDL-2023 LIBRARY; T=0.K  
Damage

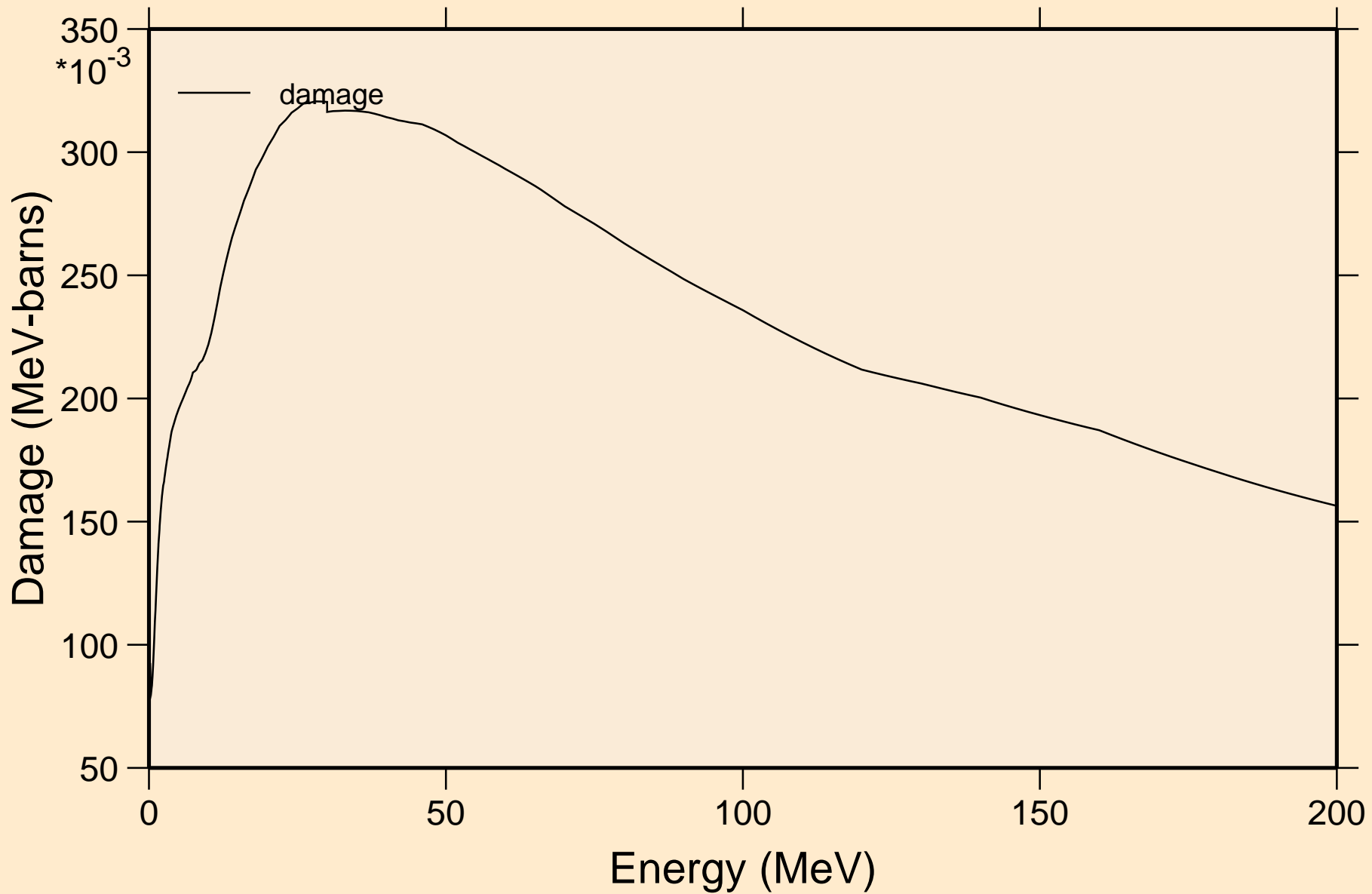

# CR049 NEUTRON ACER TENDL-2023 LIBRARY; T=0.K

## Non-threshold reactions

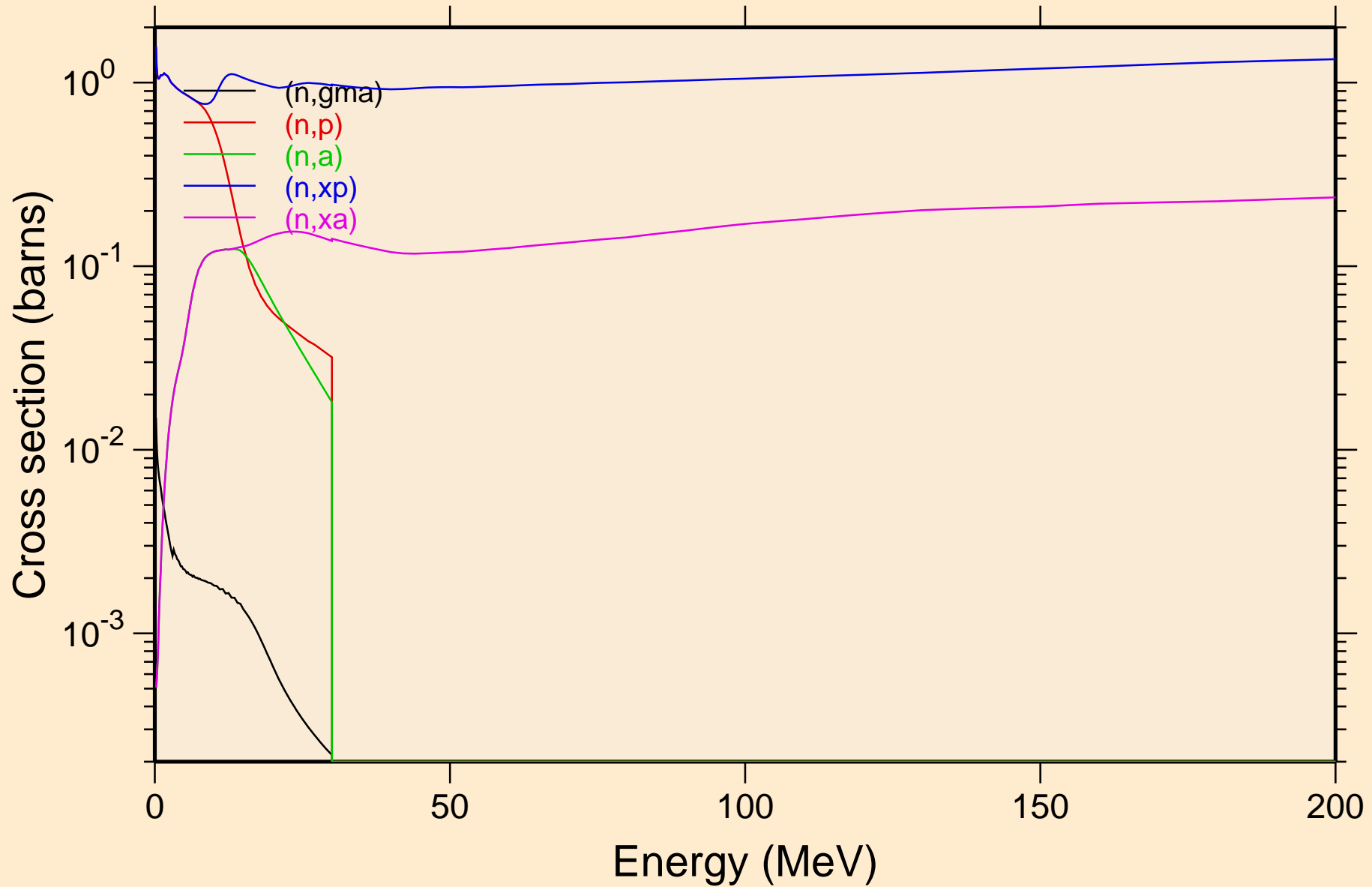

CR049 NEUTRON ACER TENDL-2023 LIBRARY; T=0.K  
Inelastic levels

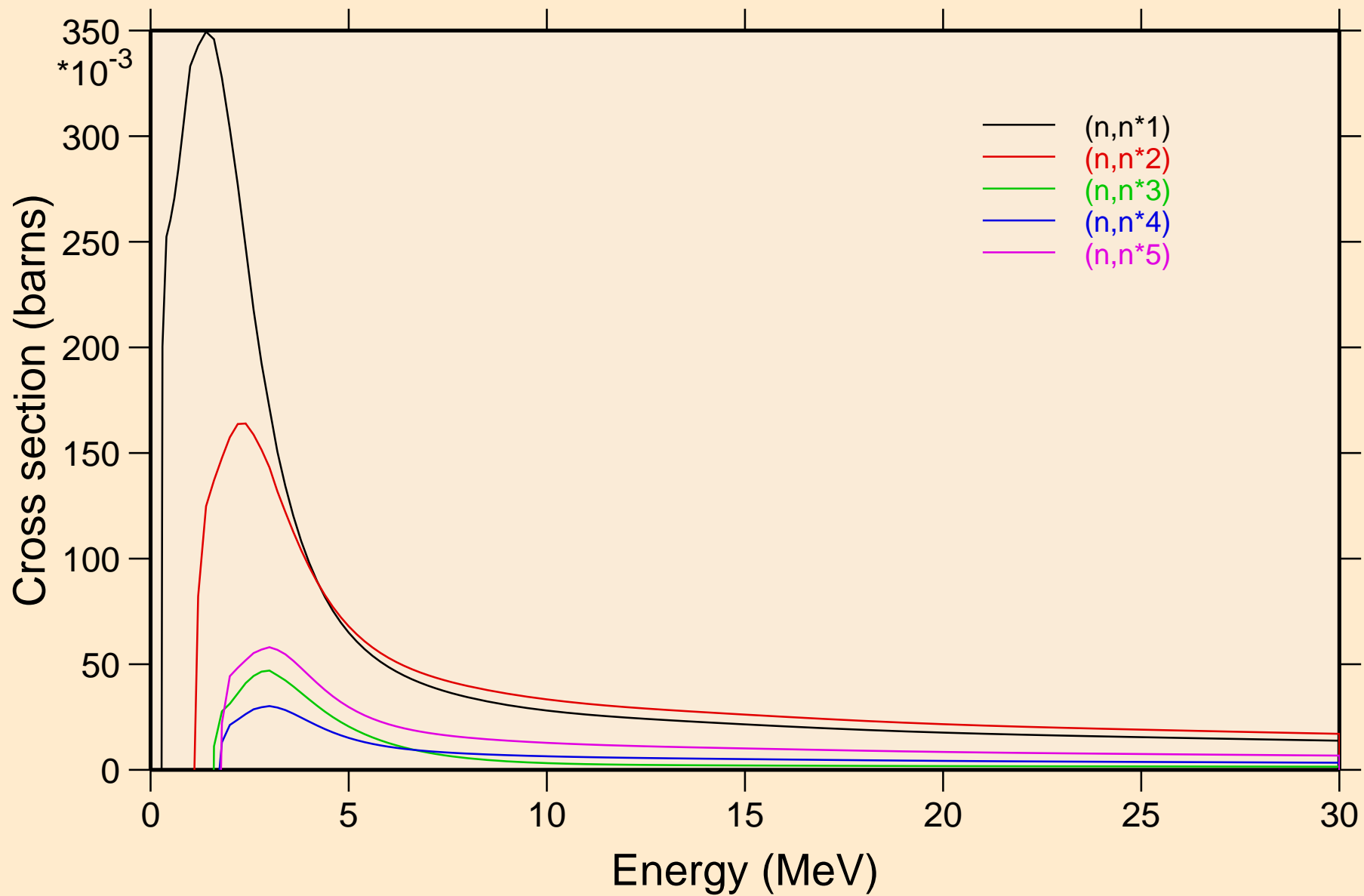

CR049 NEUTRON ACER TENDL-2023 LIBRARY; T=0.K  
Inelastic levels

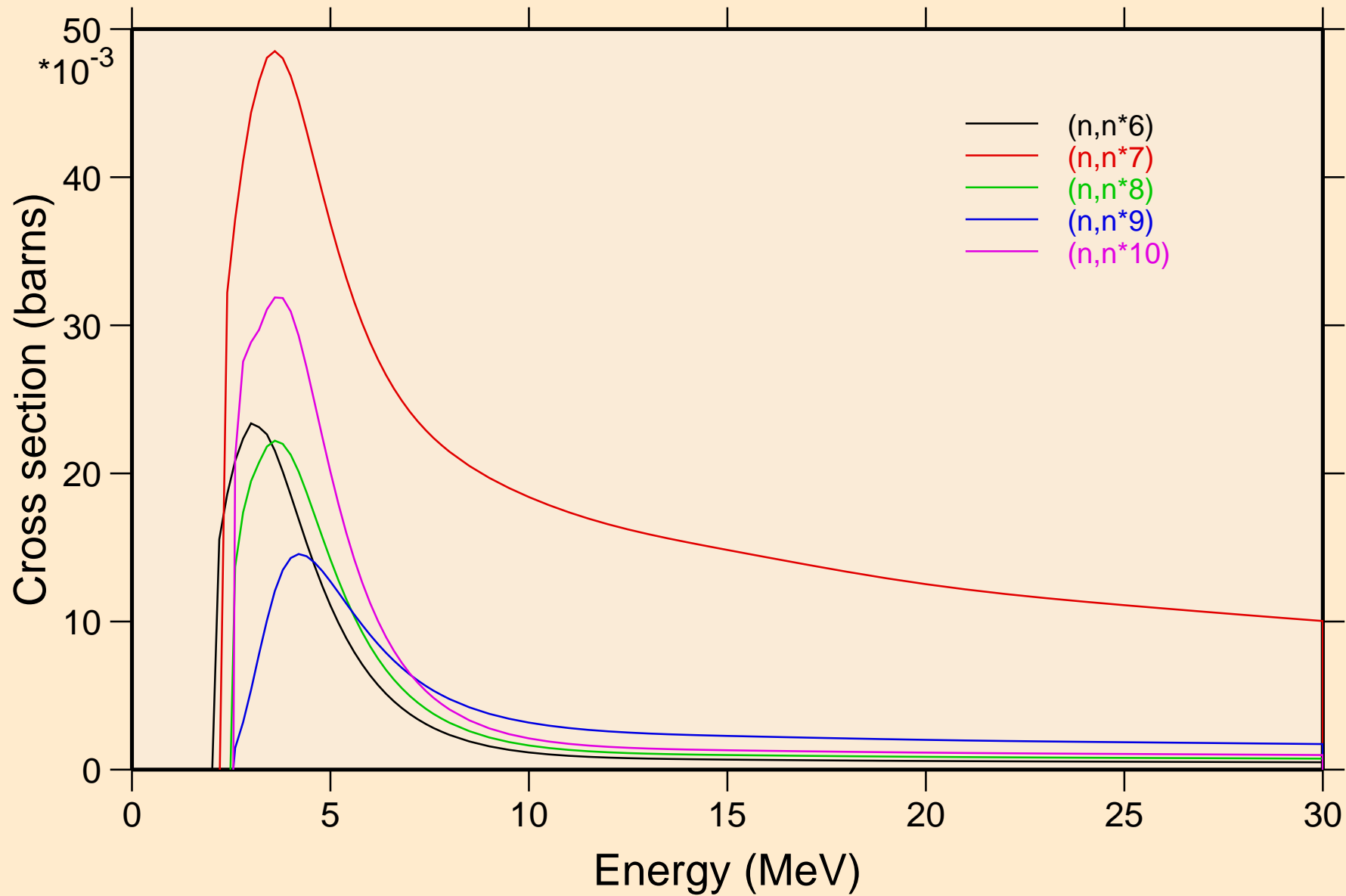



CR049 NEUTRON ACER TENDL-2023 LIBRARY; T=0.K  
Inelastic levels

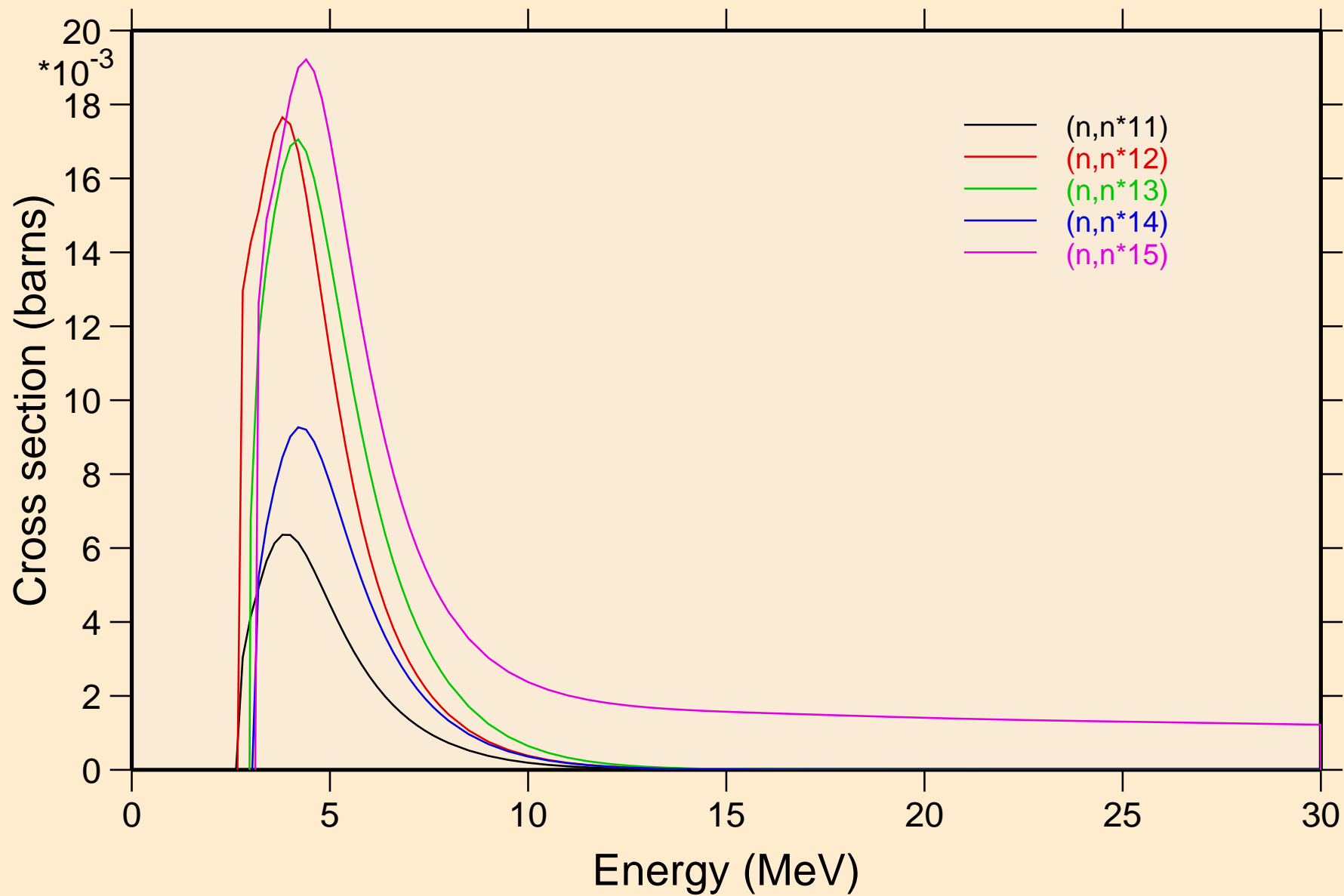

CR049 NEUTRON ACER TENDL-2023 LIBRARY; T=0.K  
Threshold reactions

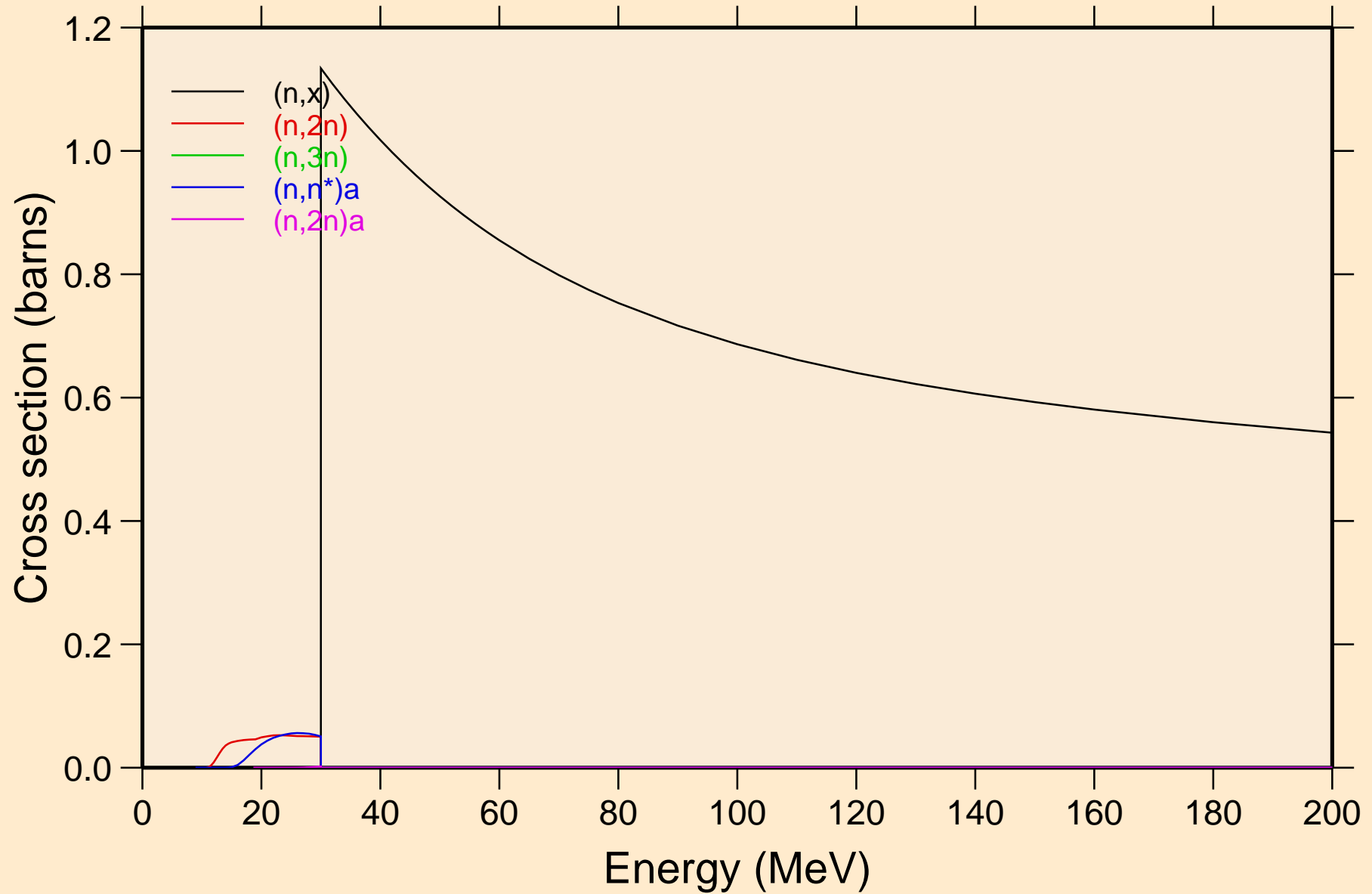

CR049 NEUTRON ACER TENDL-2023 LIBRARY; T=0.K  
Threshold reactions

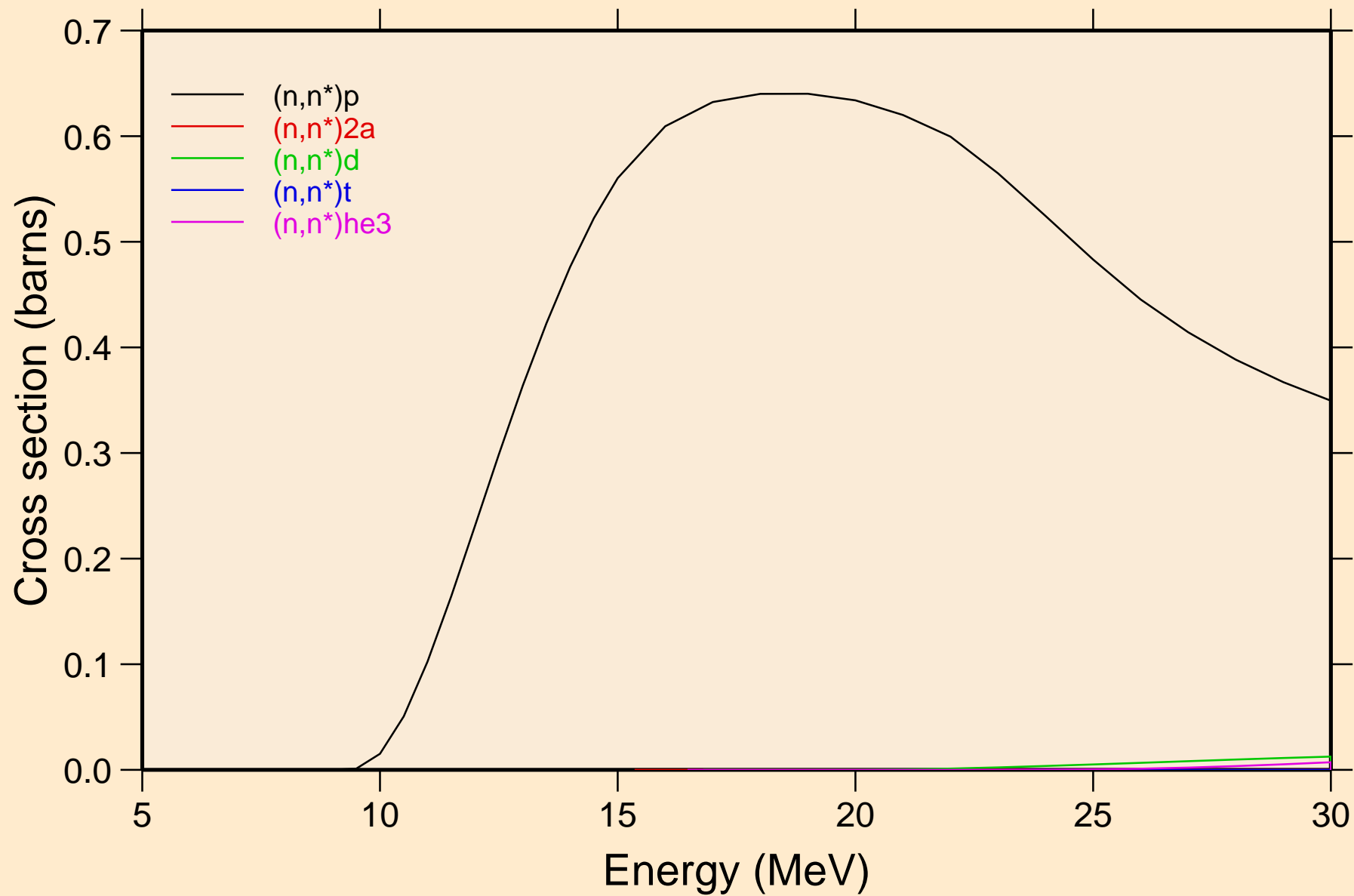

# CR049 NEUTRON ACER TENDL-2023 LIBRARY; T=0.K

## Threshold reactions

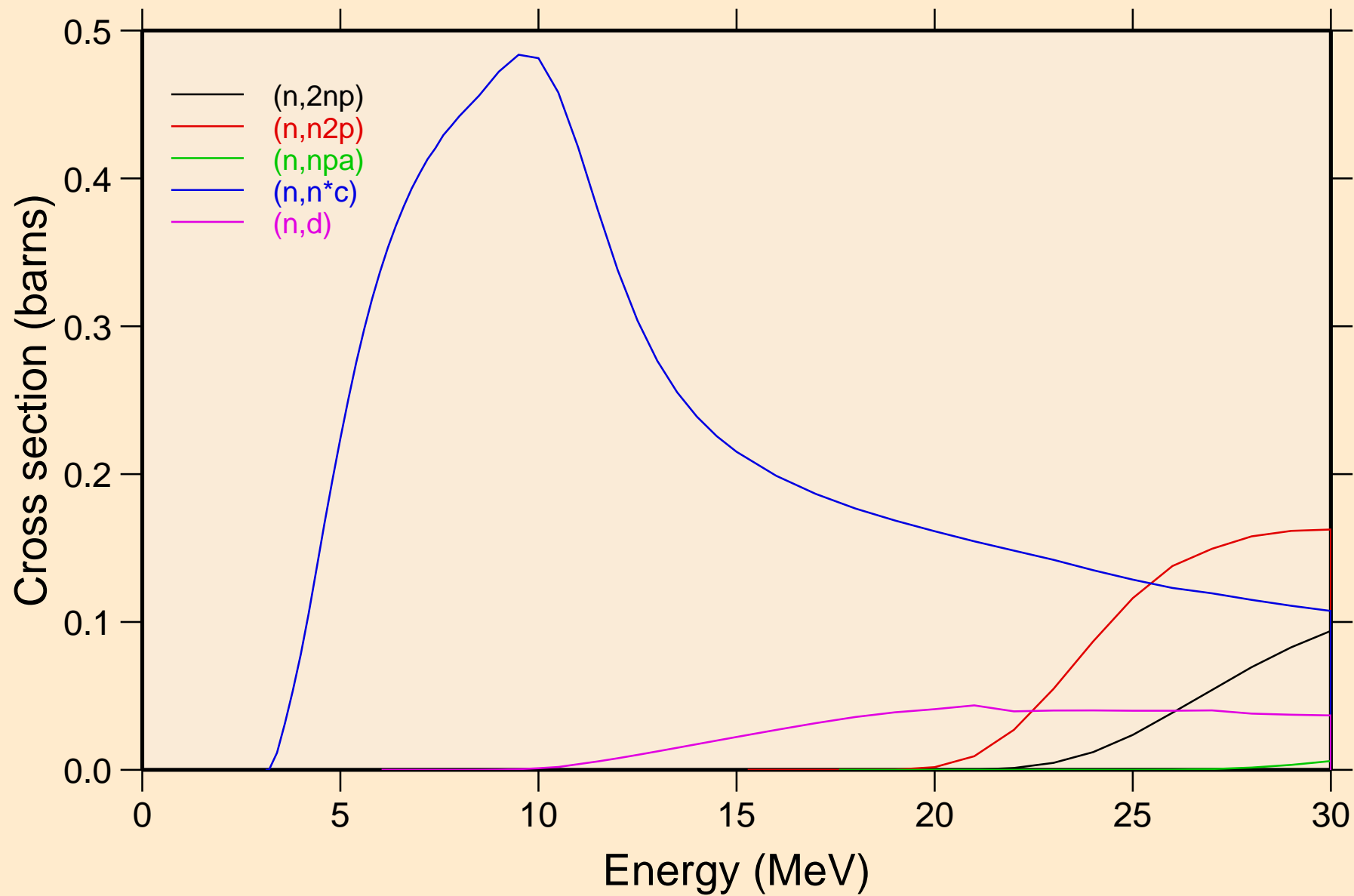

# CR049 NEUTRON ACER TENDL-2023 LIBRARY; T=0.K

## Threshold reactions

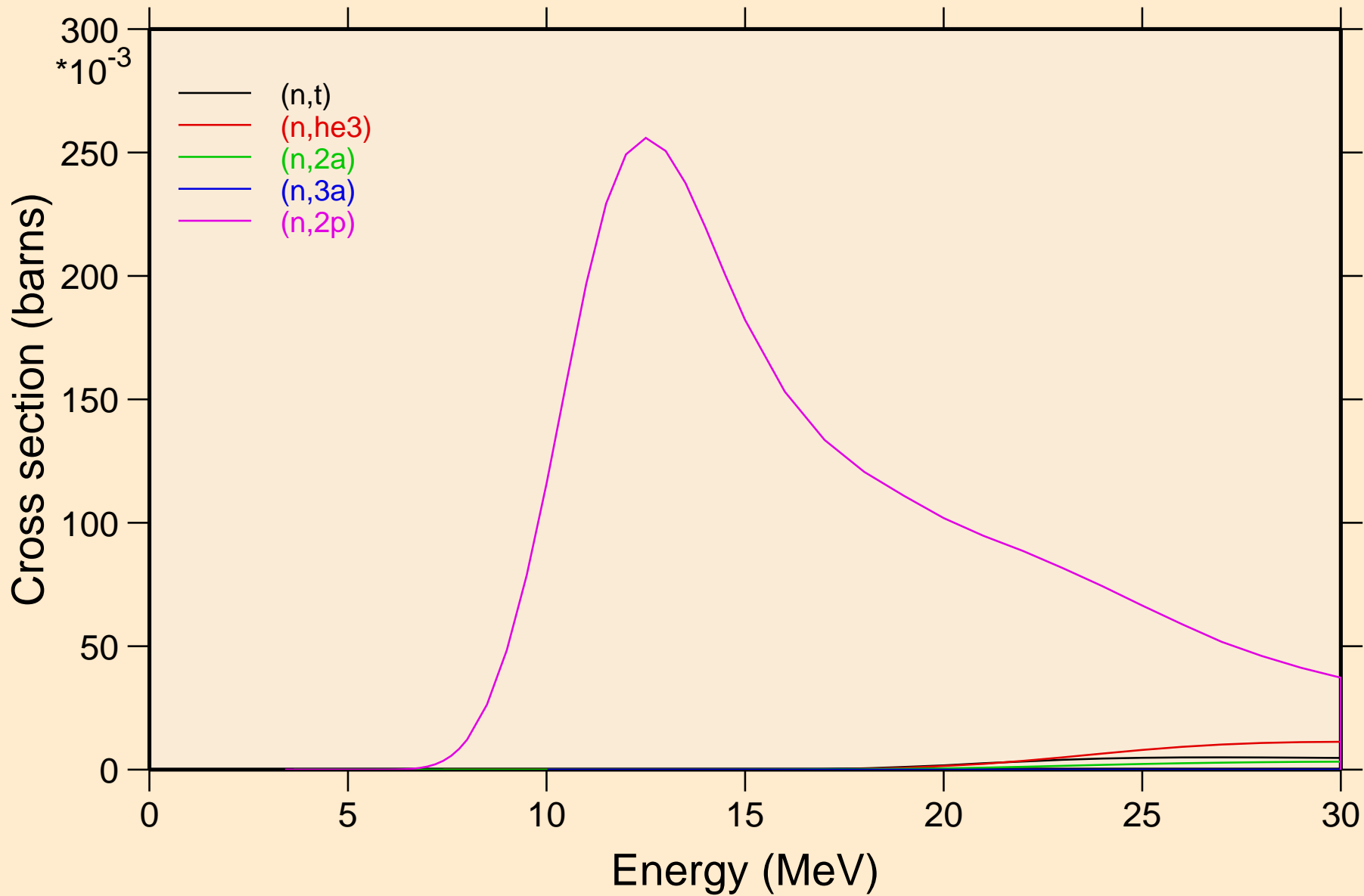

# CR049 NEUTRON ACER TENDL-2023 LIBRARY; T=0.K

## Threshold reactions

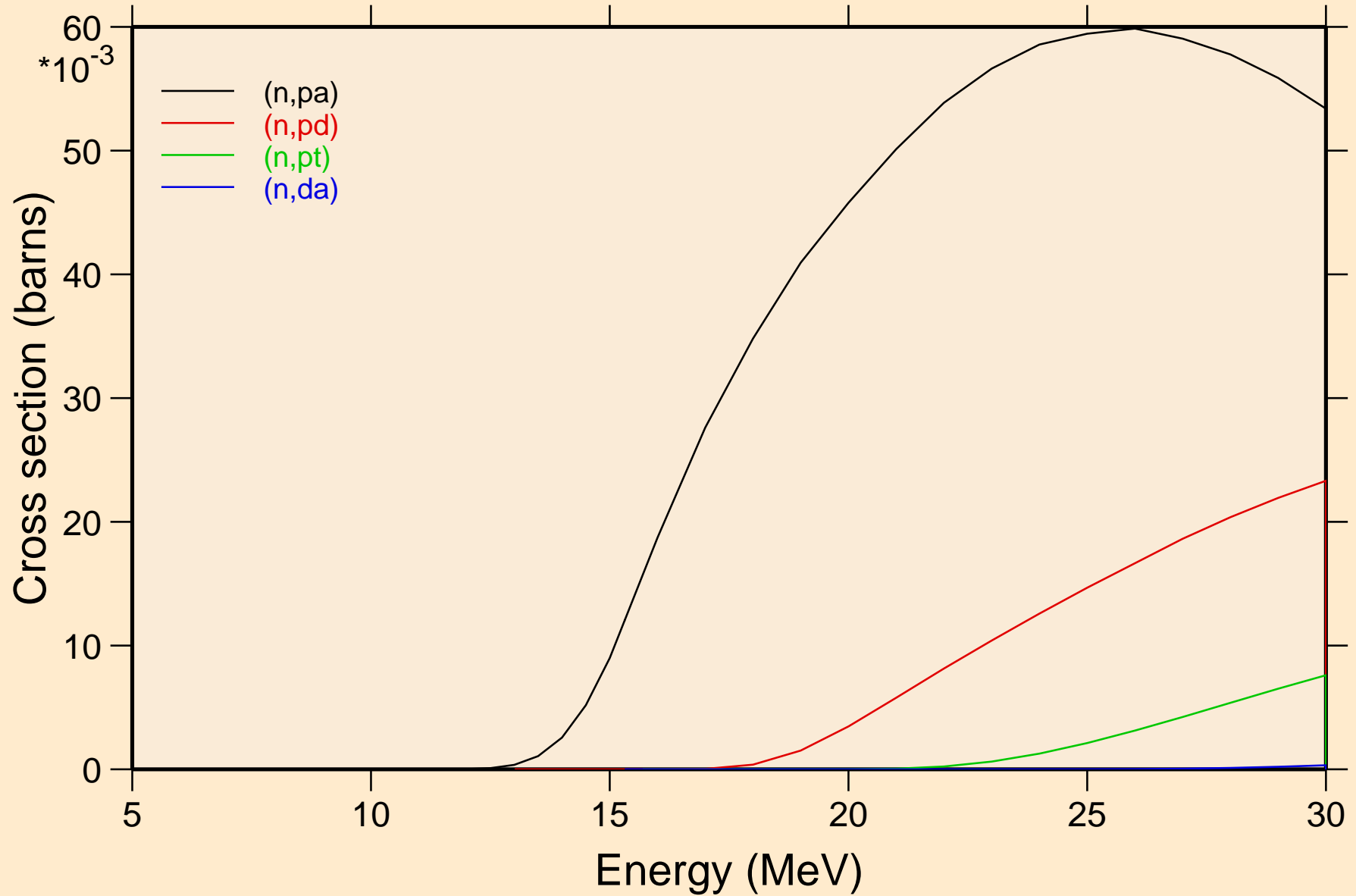

# CR049 NEUTRON ACER TENDL-2023 LIBRARY; T=0.K

## Threshold reactions

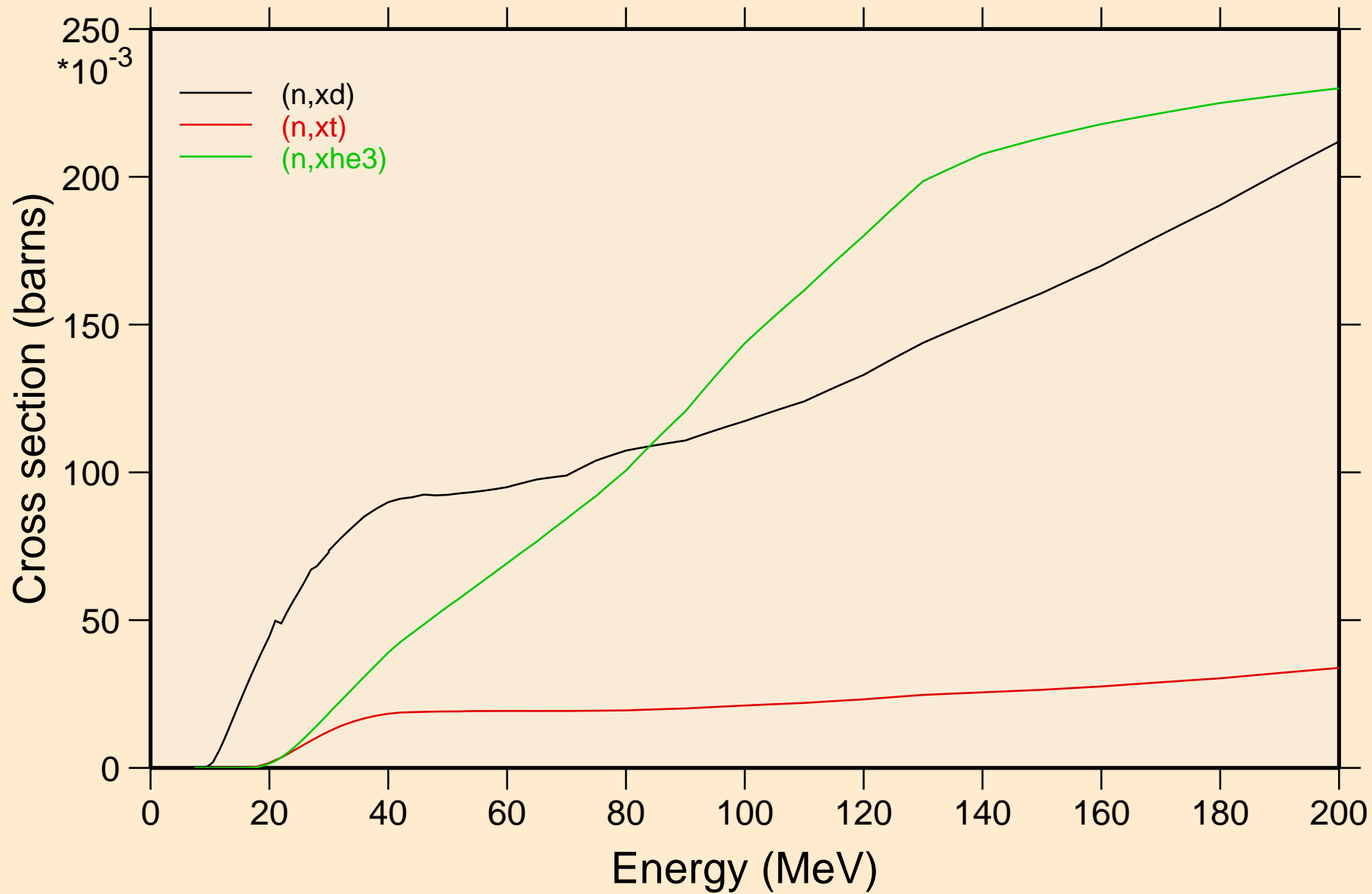

CR049 NEUTRON ACER TENDL-2023 LIBRARY; T=0.K  
angular distribution for elastic

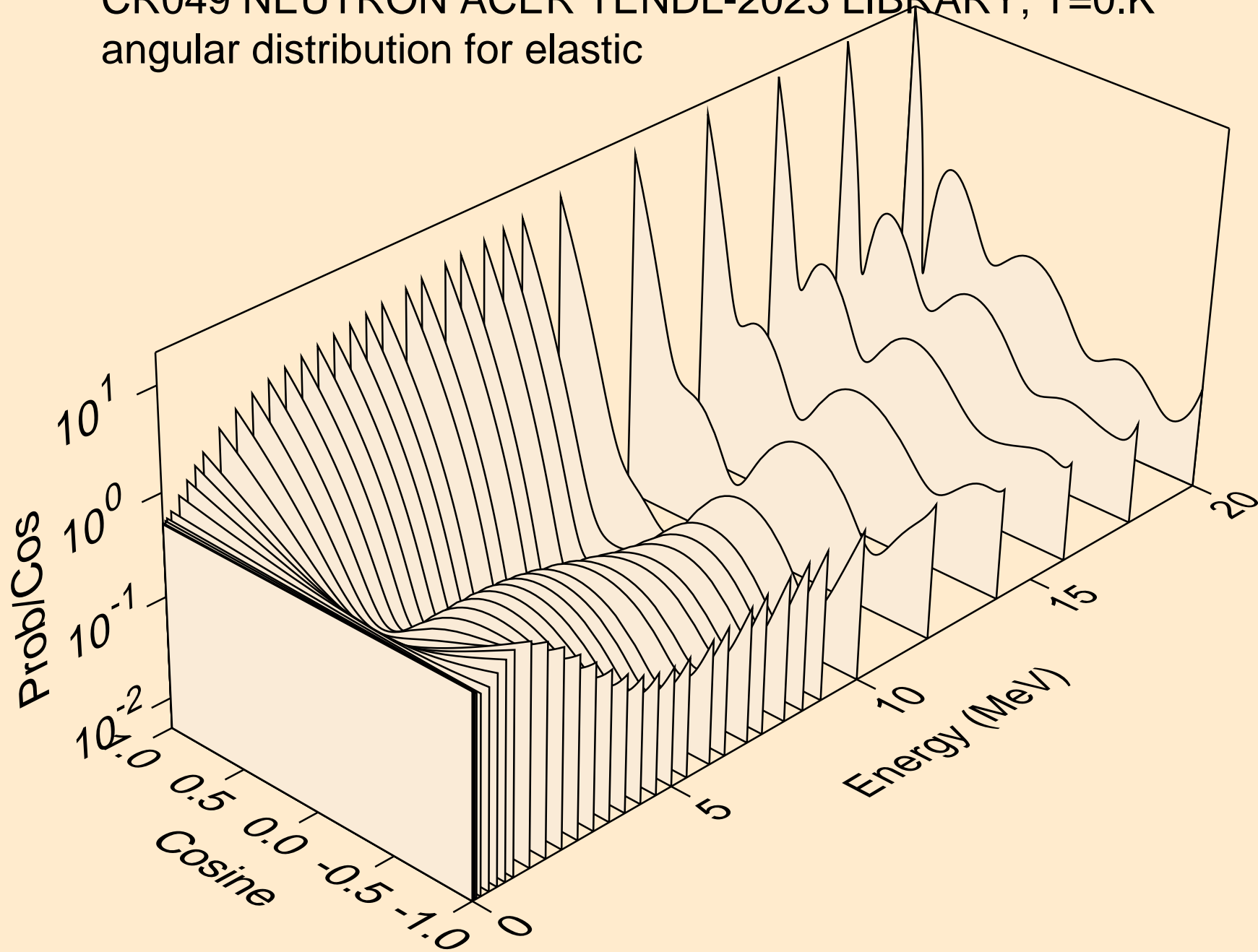



CR049 NEUTRON ACER TENDL-2023 LIBRARY; T=0.K  
angular distribution for elastic

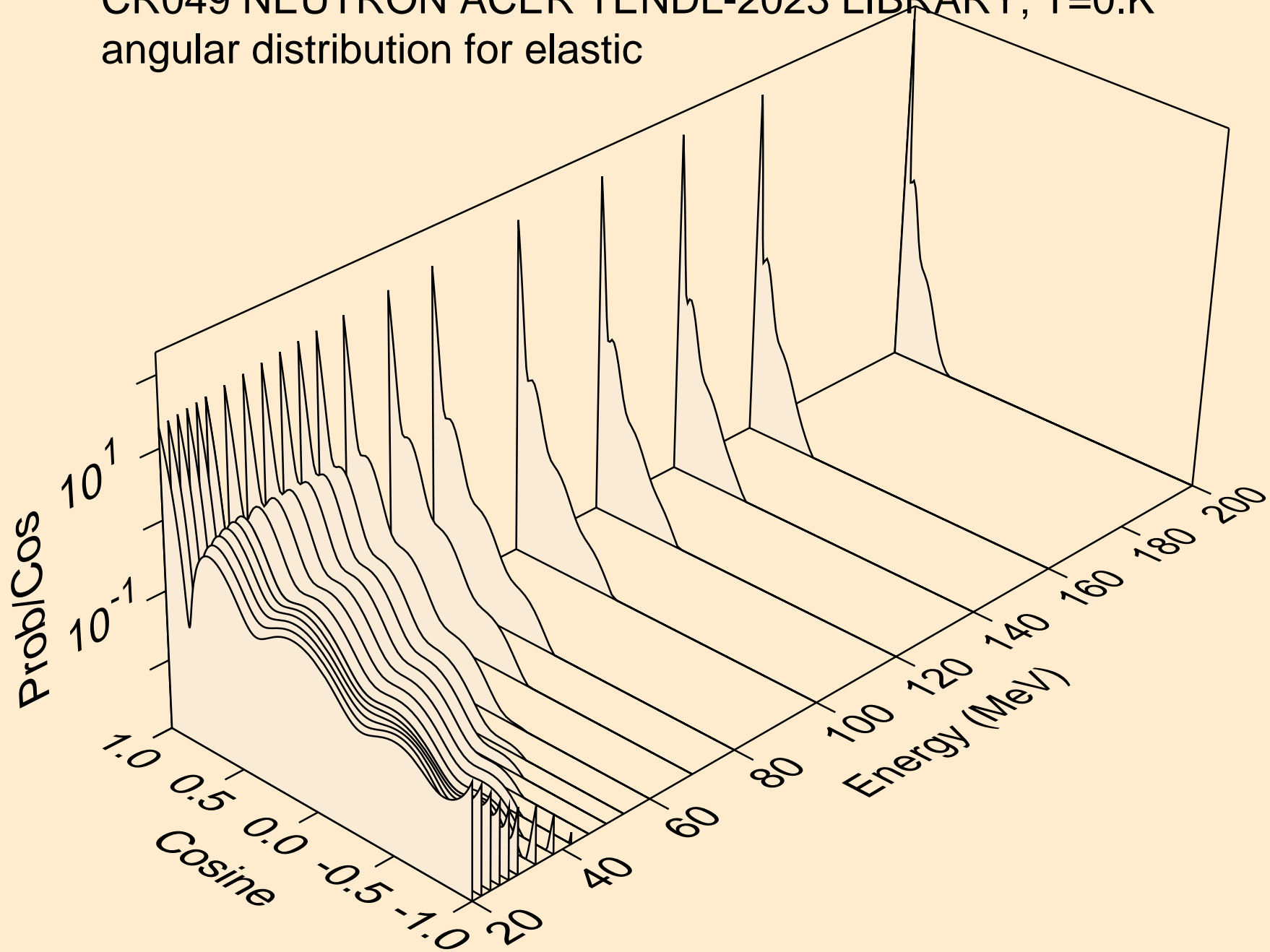

CR049 NEUTRON ACER TENDL-2023 LIBRARY; T=0.K  
angular distribution for (n,n\*1)

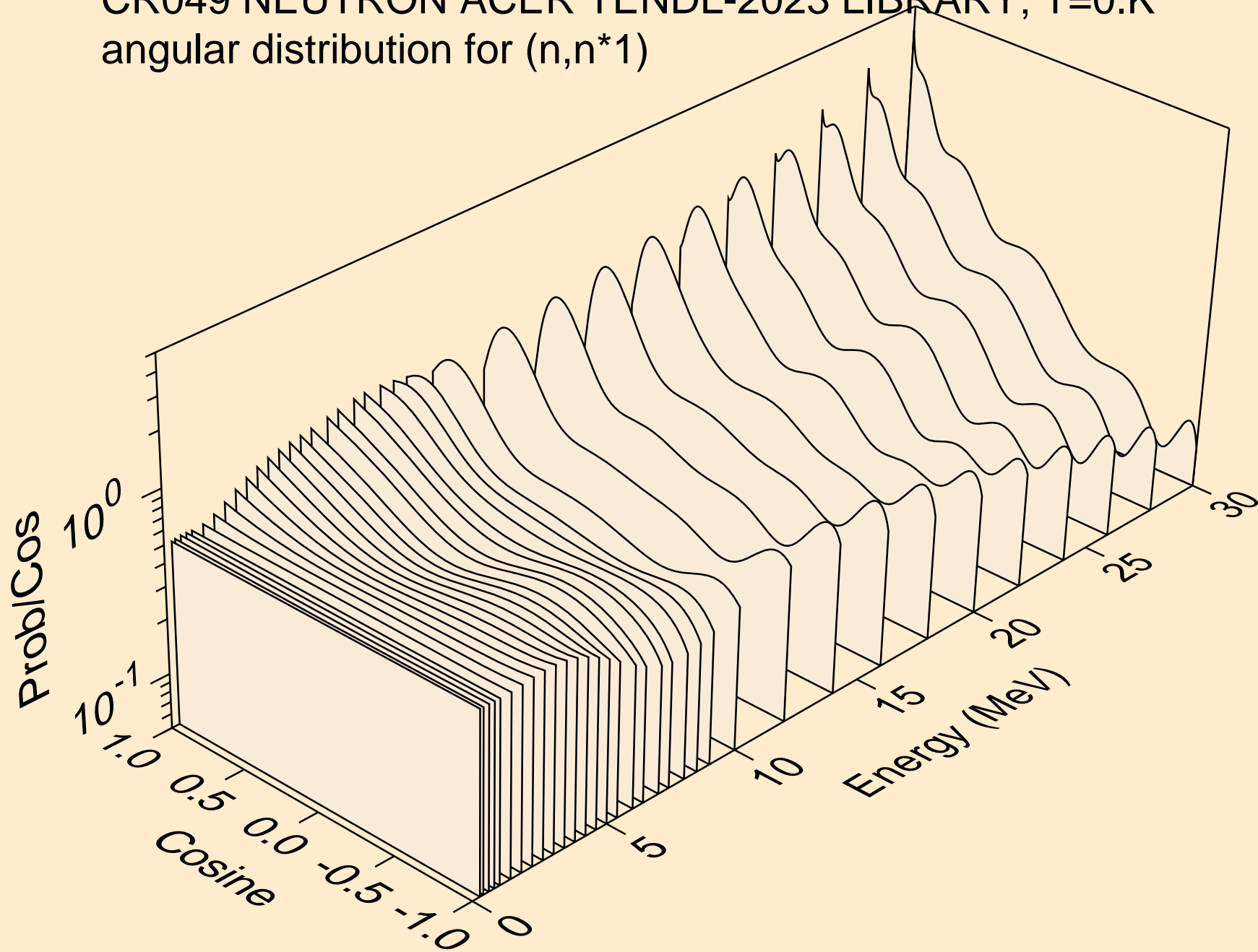

CR049 NEUTRON ACER TENDL-2023 LIBRARY; T=0.K  
angular distribution for (n,n\*2)

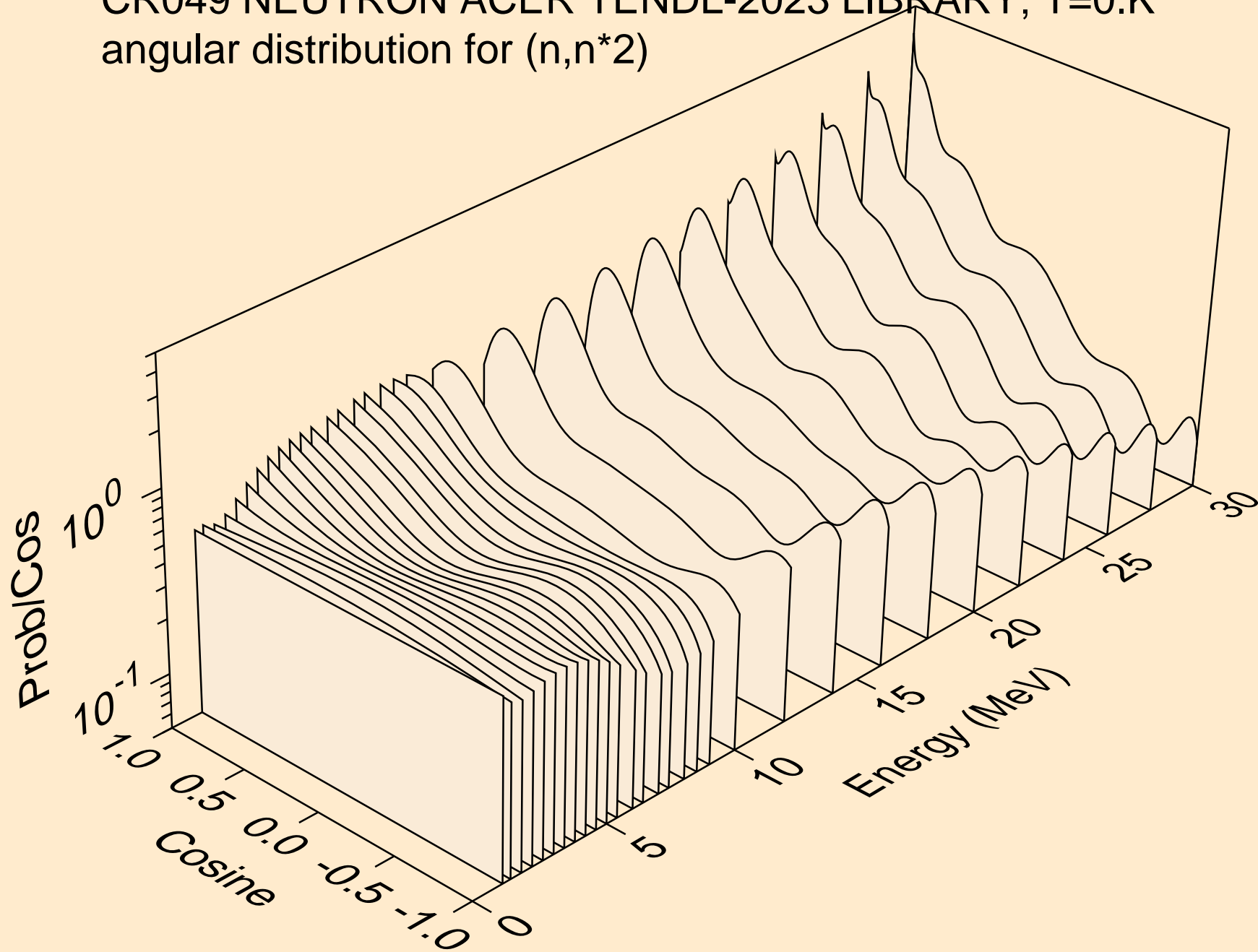

CR049 NEUTRON ACER TENDL-2023 LIBRARY; T=0.K  
angular distribution for (n,n\*3)

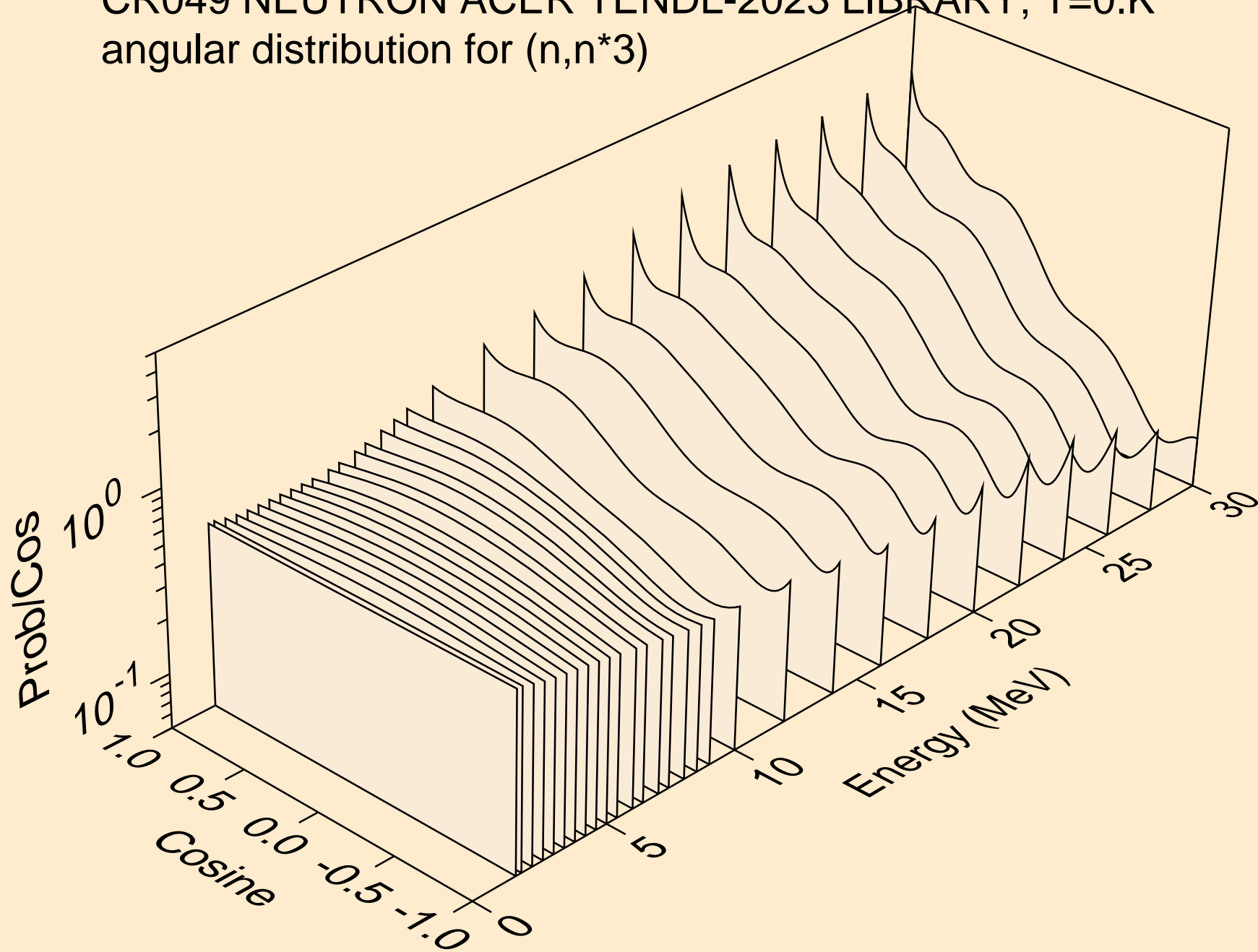

CR049 NEUTRON ACER TENDL-2023 LIBRARY; T=0.K  
angular distribution for (n,n\*4)

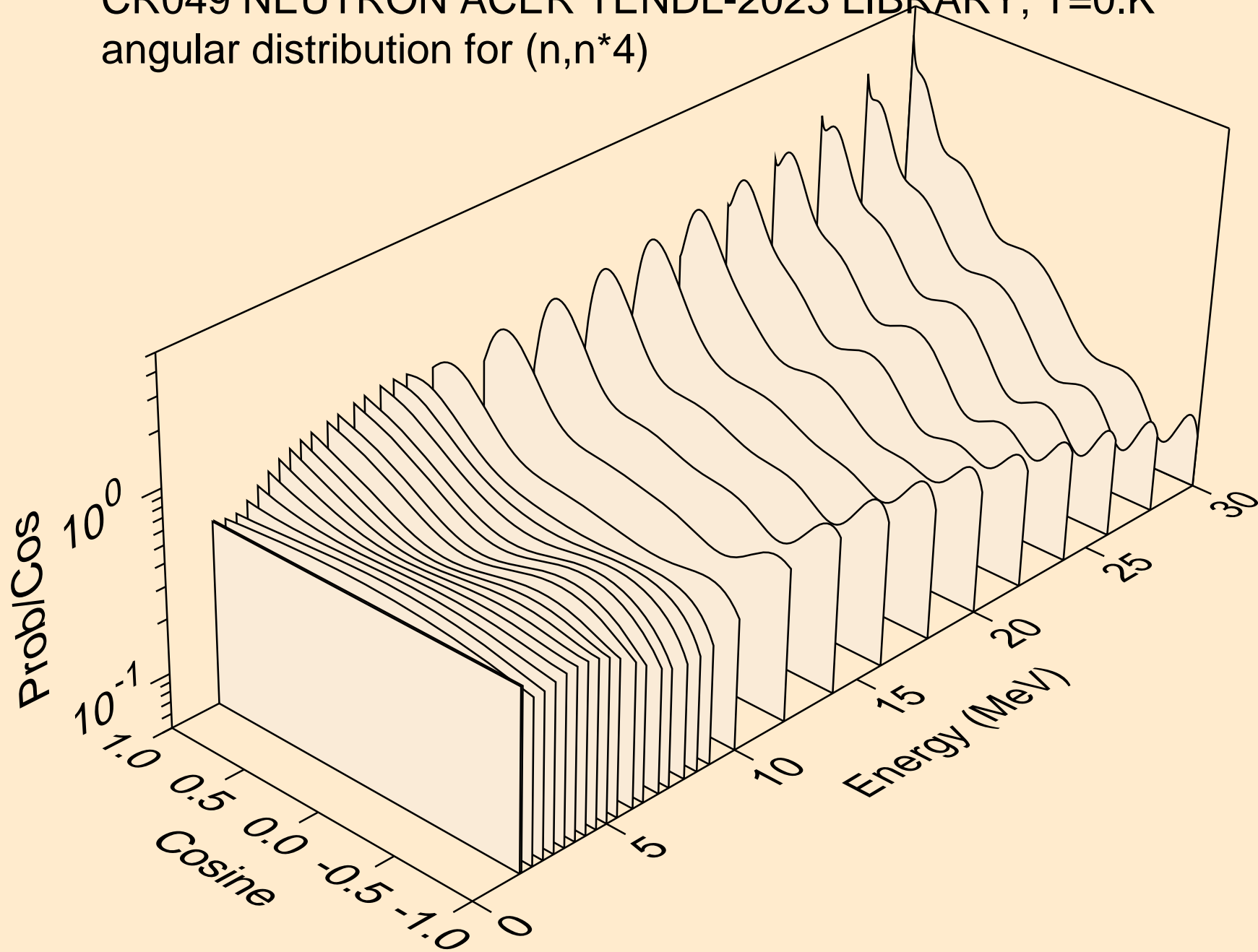

CR049 NEUTRON ACER TENDL-2023 LIBRARY; T=0.K  
angular distribution for (n,n\*5)

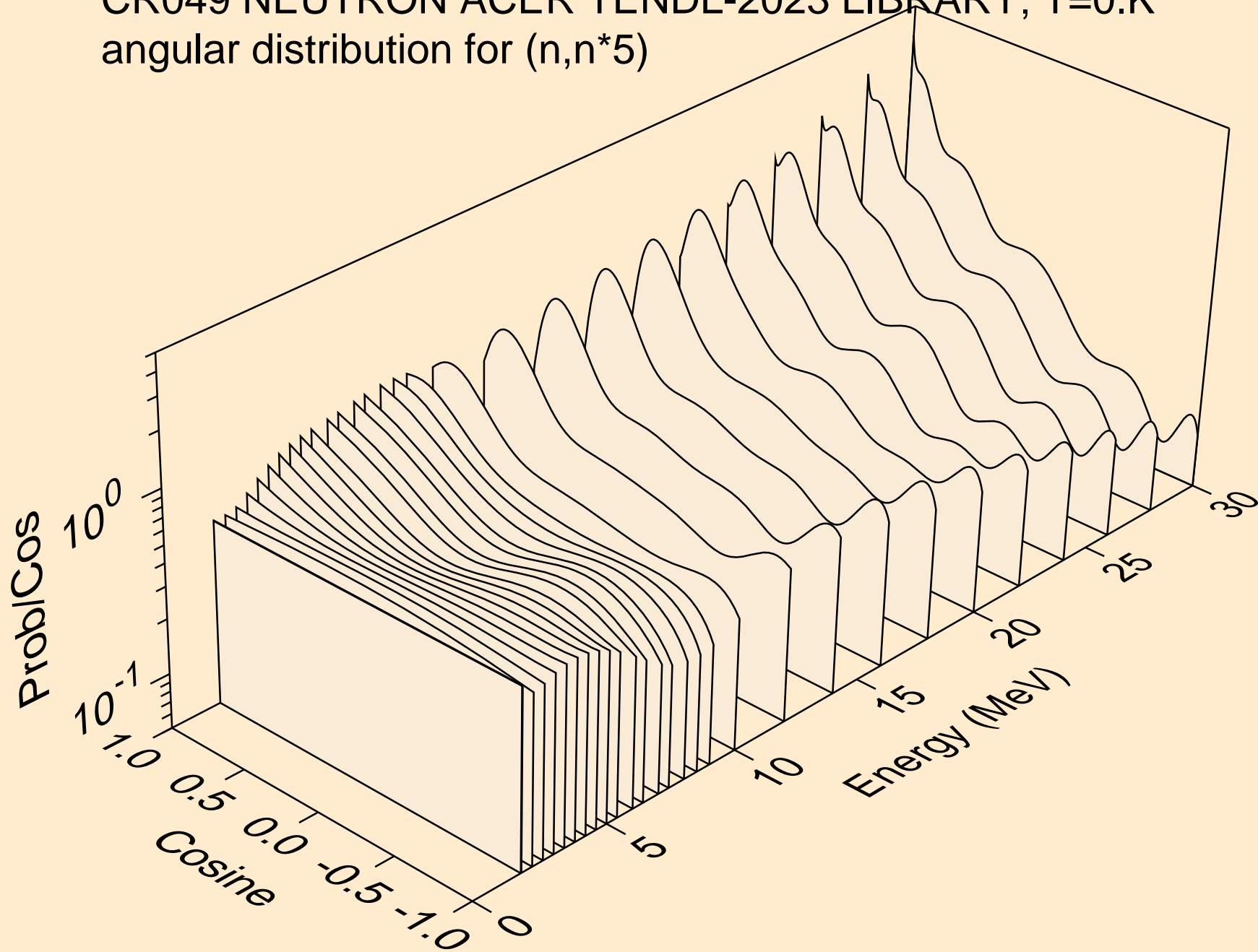

CR049 NEUTRON ACER TENDL-2023 LIBRARY; T=0.K  
angular distribution for (n,n\*6)

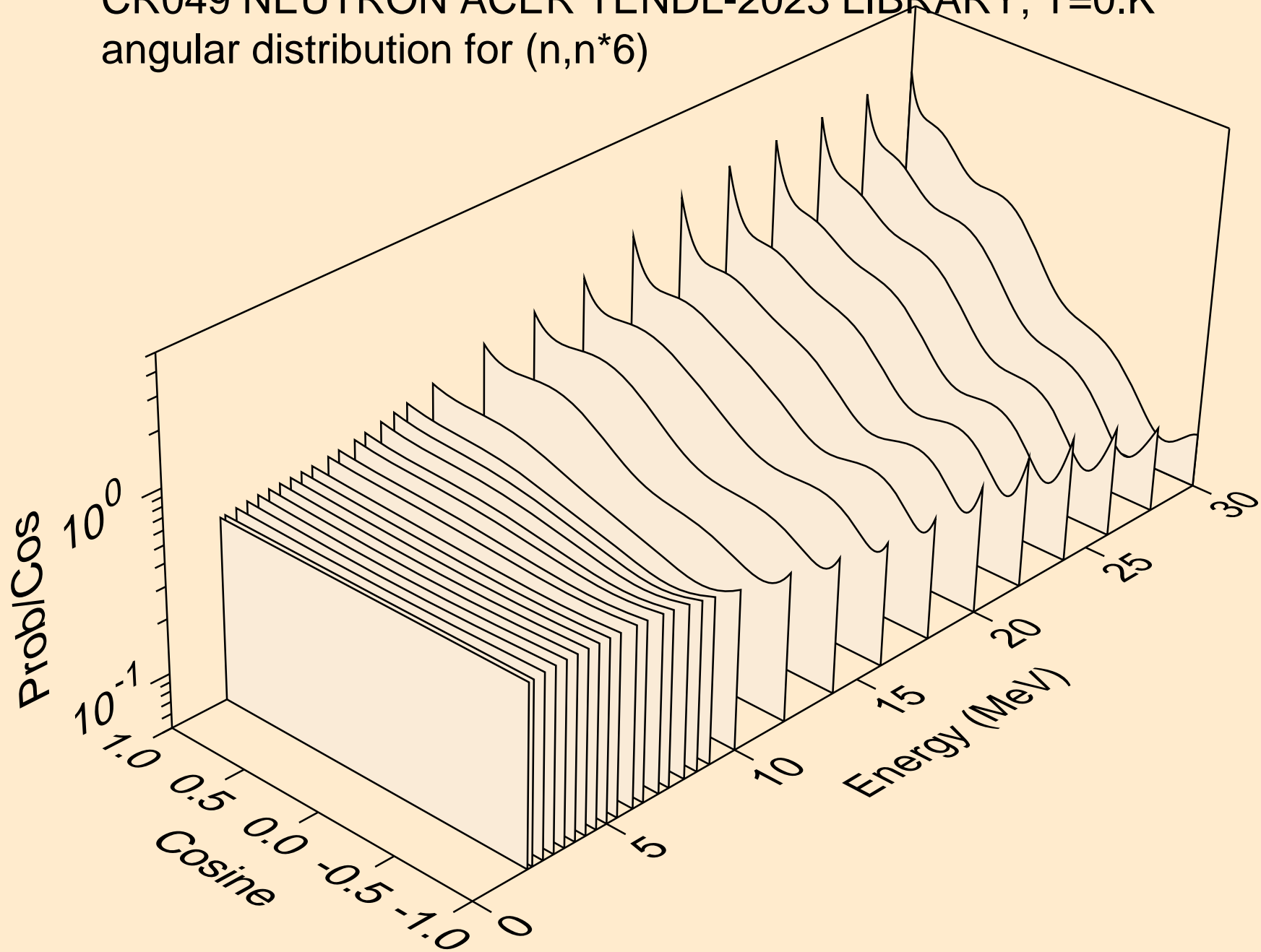

CR049 NEUTRON ACER TENDL-2023 LIBRARY; T=0.K  
angular distribution for (n,n\*7)

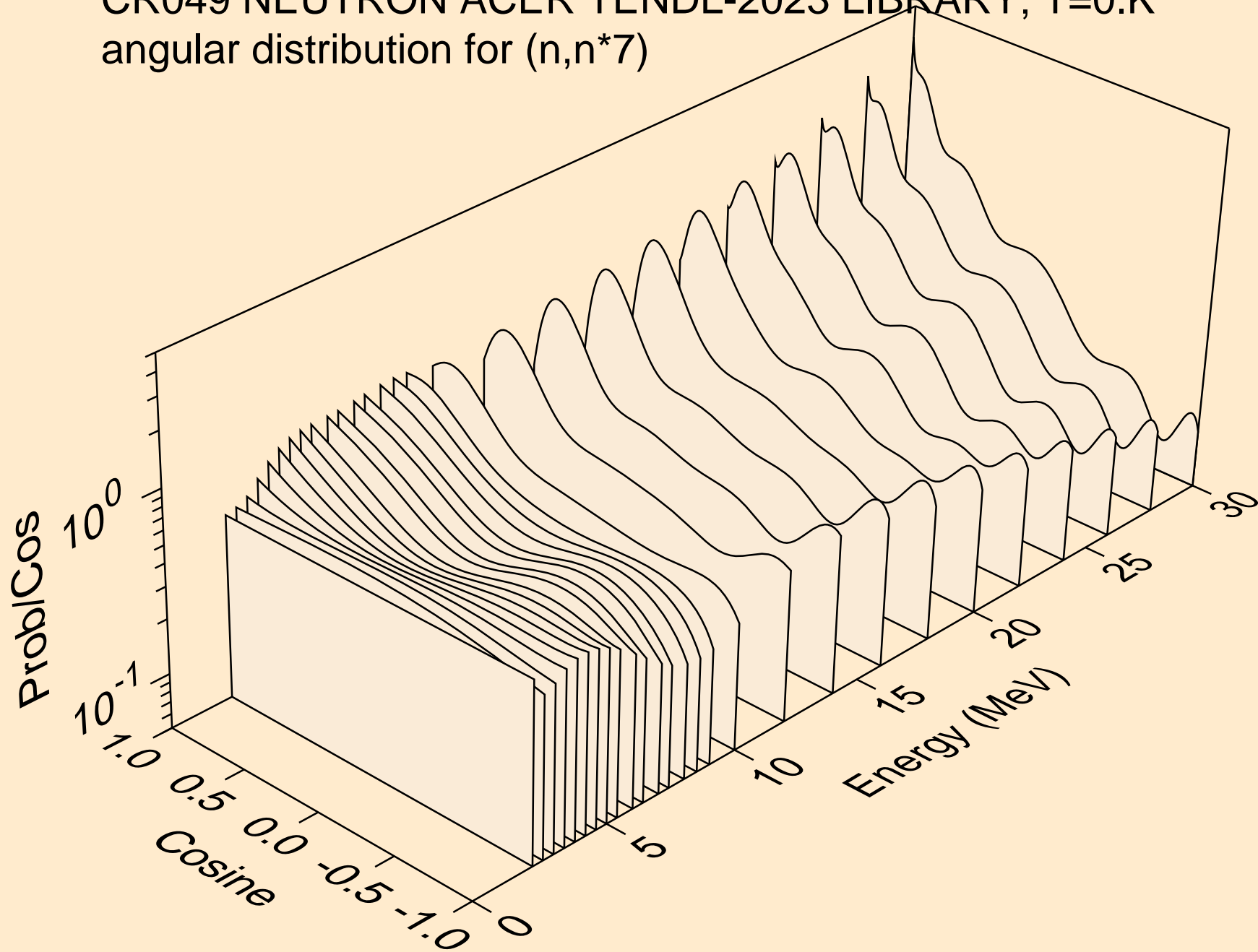



CR049 NEUTRON ACER TENDL-2023 LIBRARY; T=0.K  
angular distribution for (n,n\*8)

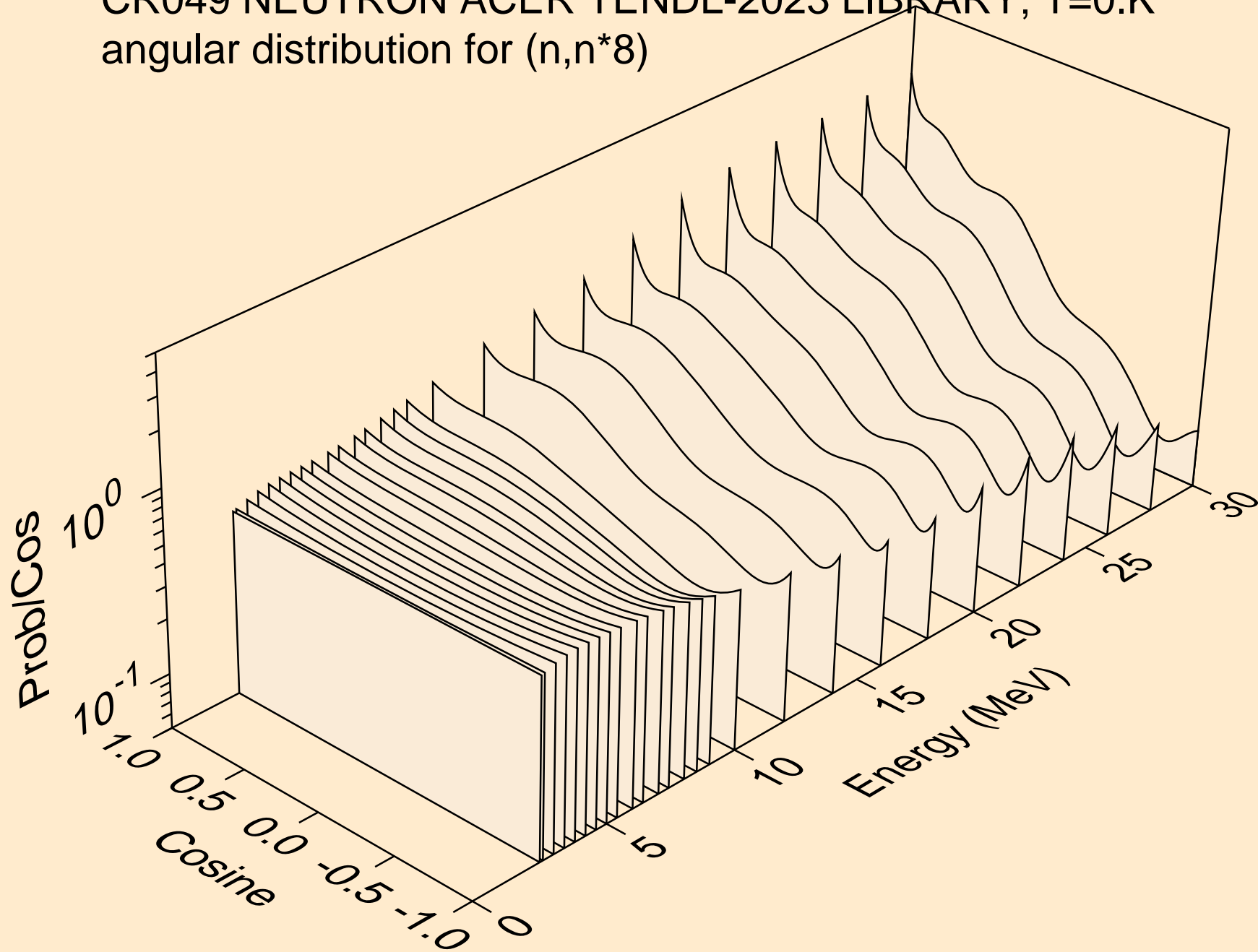

CR049 NEUTRON ACER TENDL-2023 LIBRARY; T=0.K  
angular distribution for (n,n\*9)

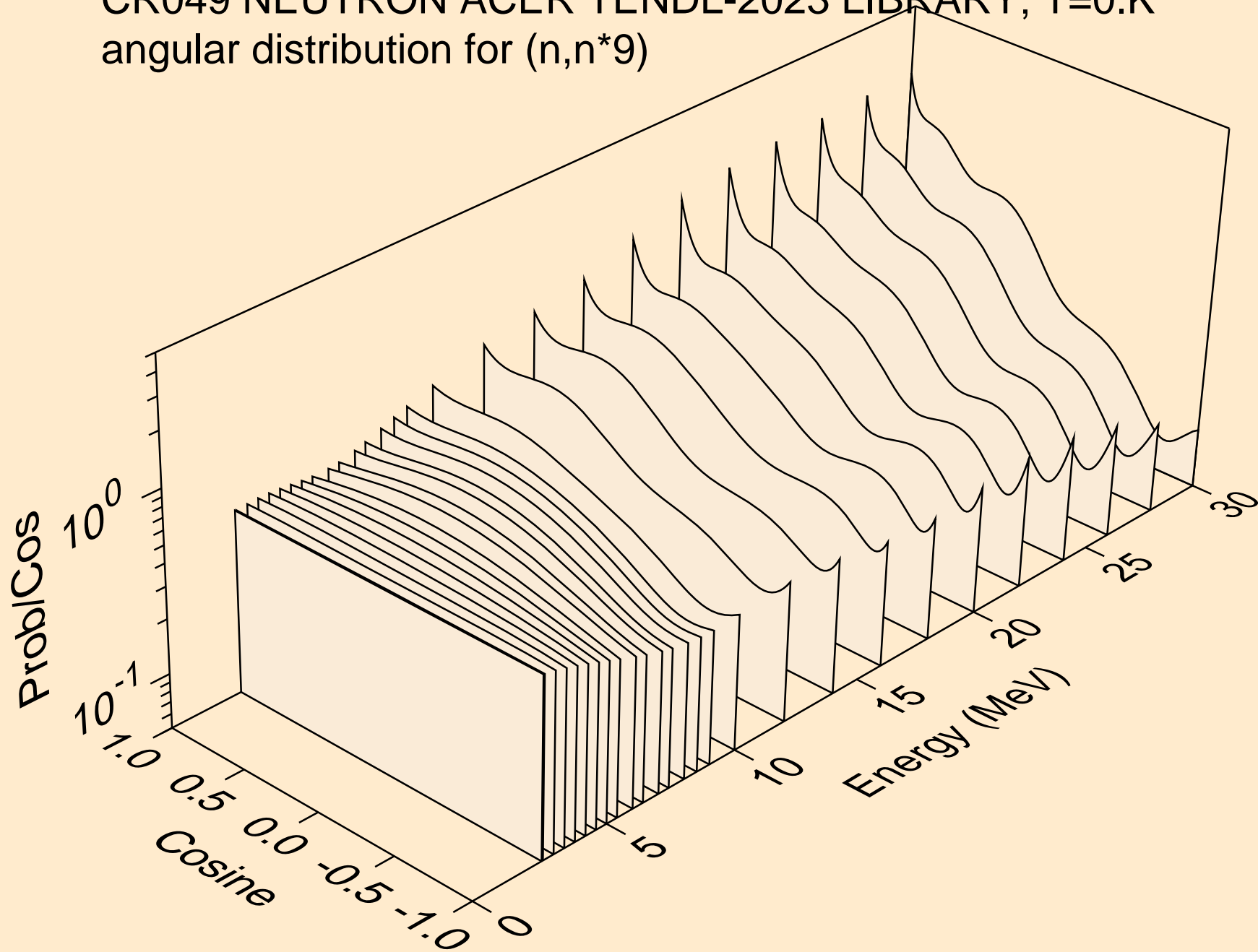

CR049 NEUTRON ACER TENDL-2023 LIBRARY; T=0.K  
angular distribution for (n,n\*10)

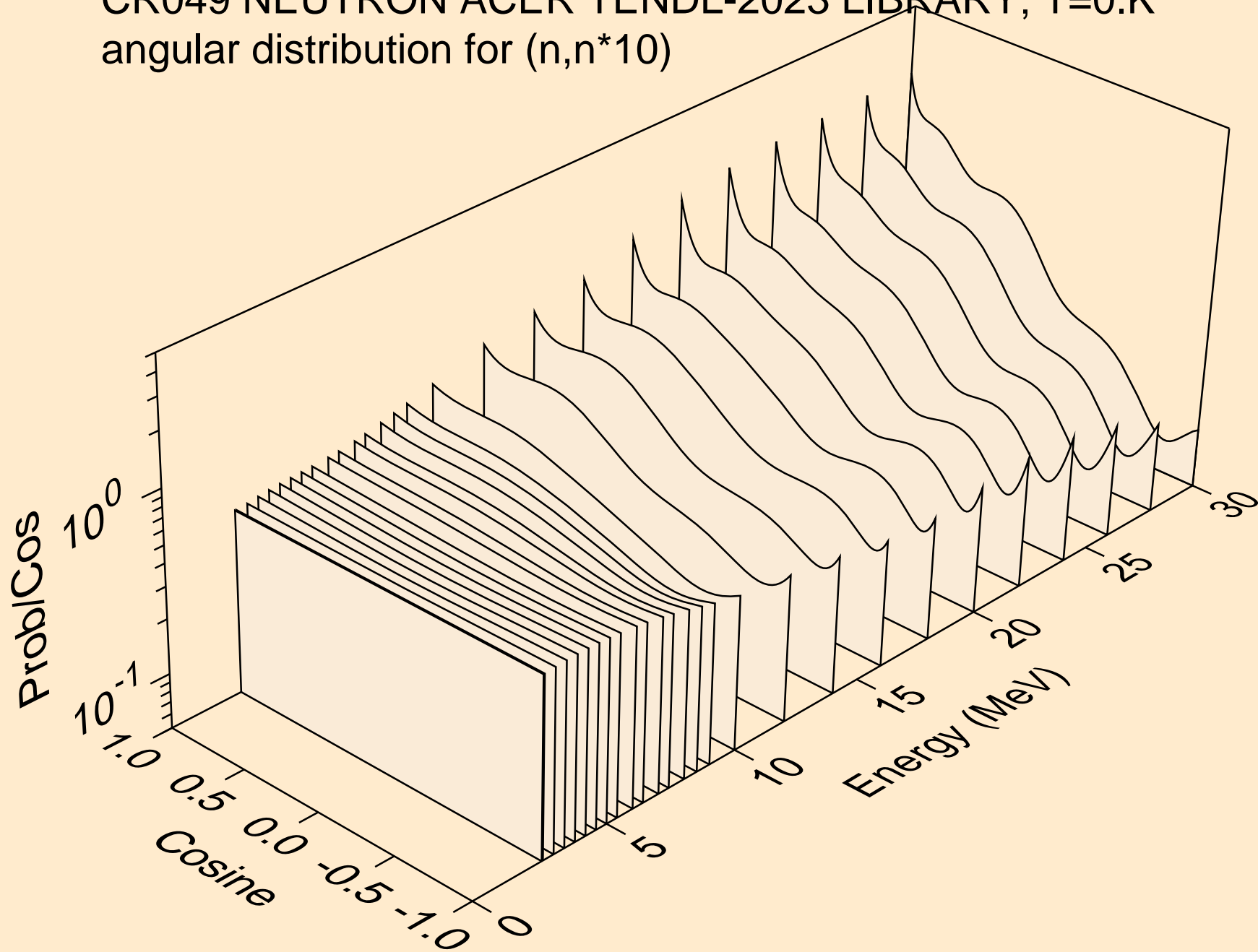

CR049 NEUTRON ACER TENDL-2023 LIBRARY; T=0.K  
angular distribution for (n,n\*11)

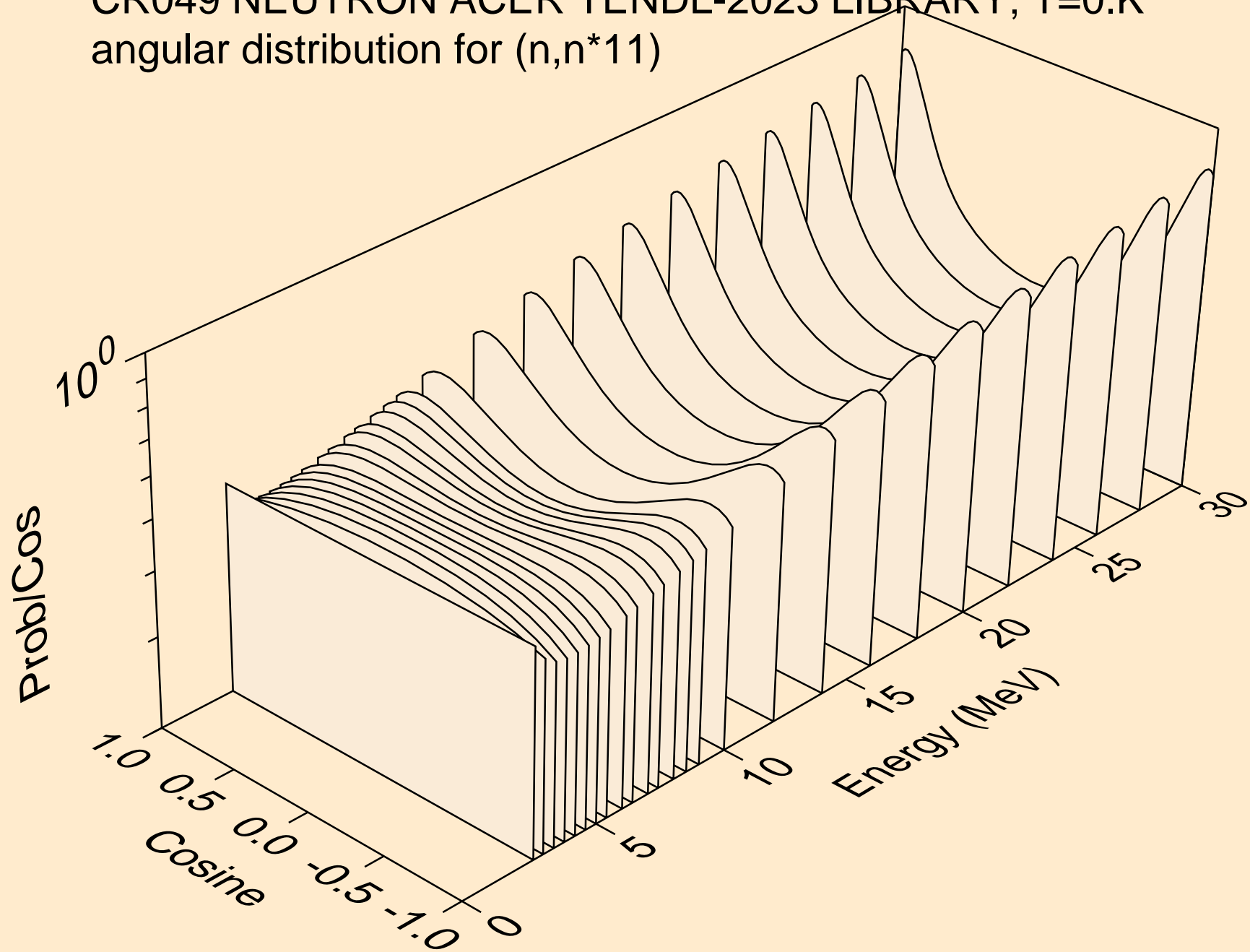

CR049 NEUTRON ACER TENDL-2023 LIBRARY; T=0.K  
angular distribution for (n,n\*12)

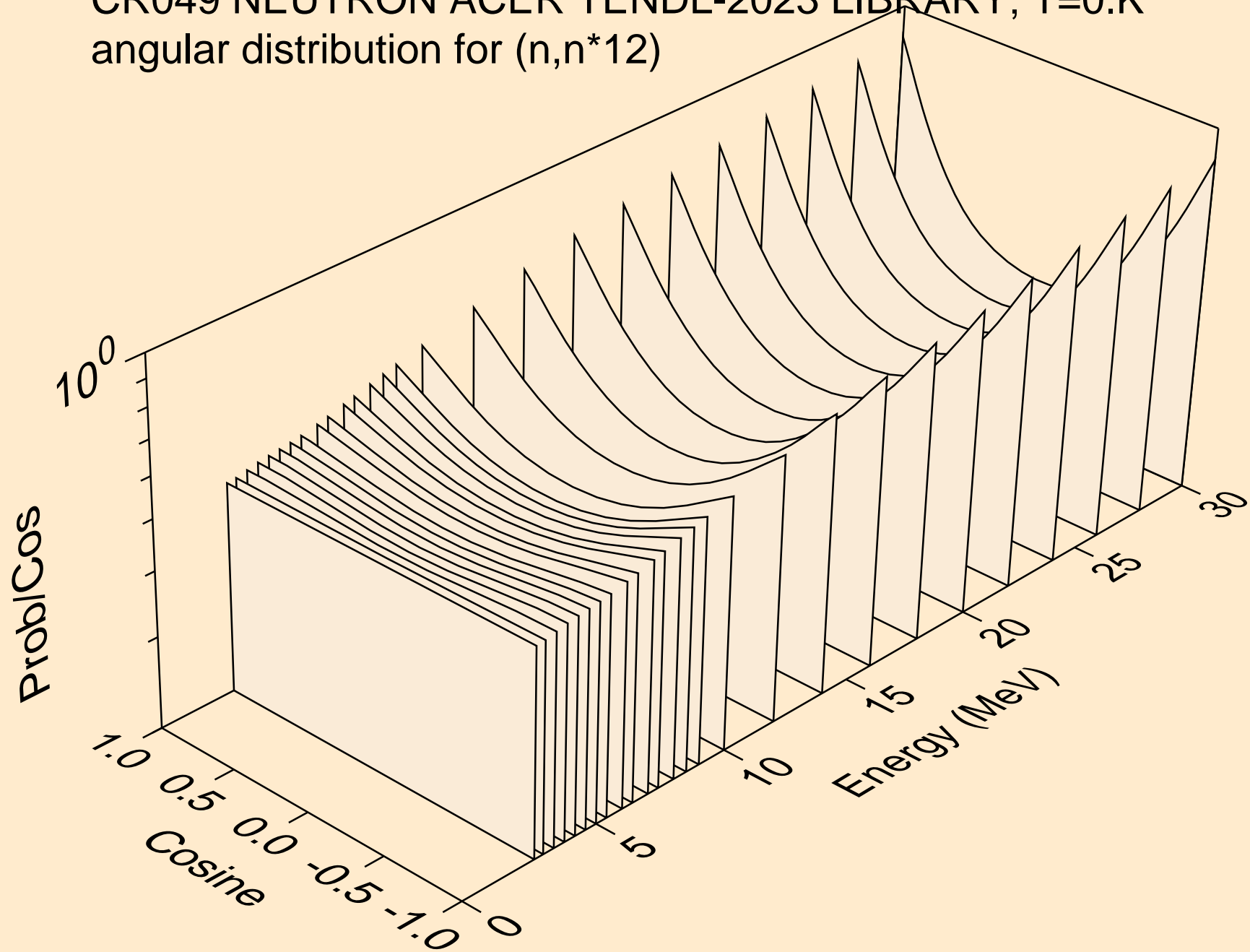

CR049 NEUTRON ACER TENDL-2023 LIBRARY; T=0.K  
angular distribution for (n,n\*13)

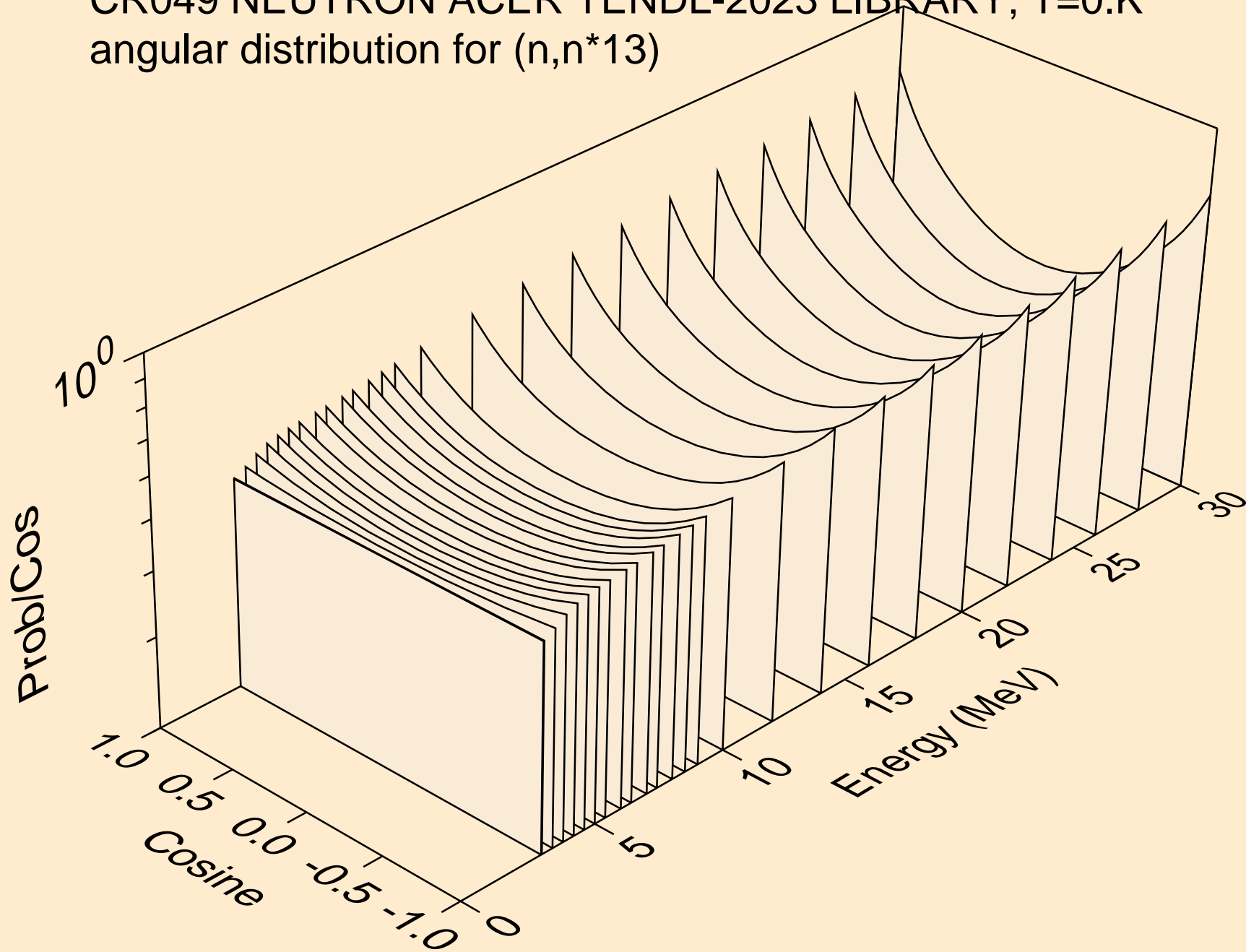

CR049 NEUTRON ACER TENDL-2023 LIBRARY; T=0.K  
angular distribution for (n,n\*14)

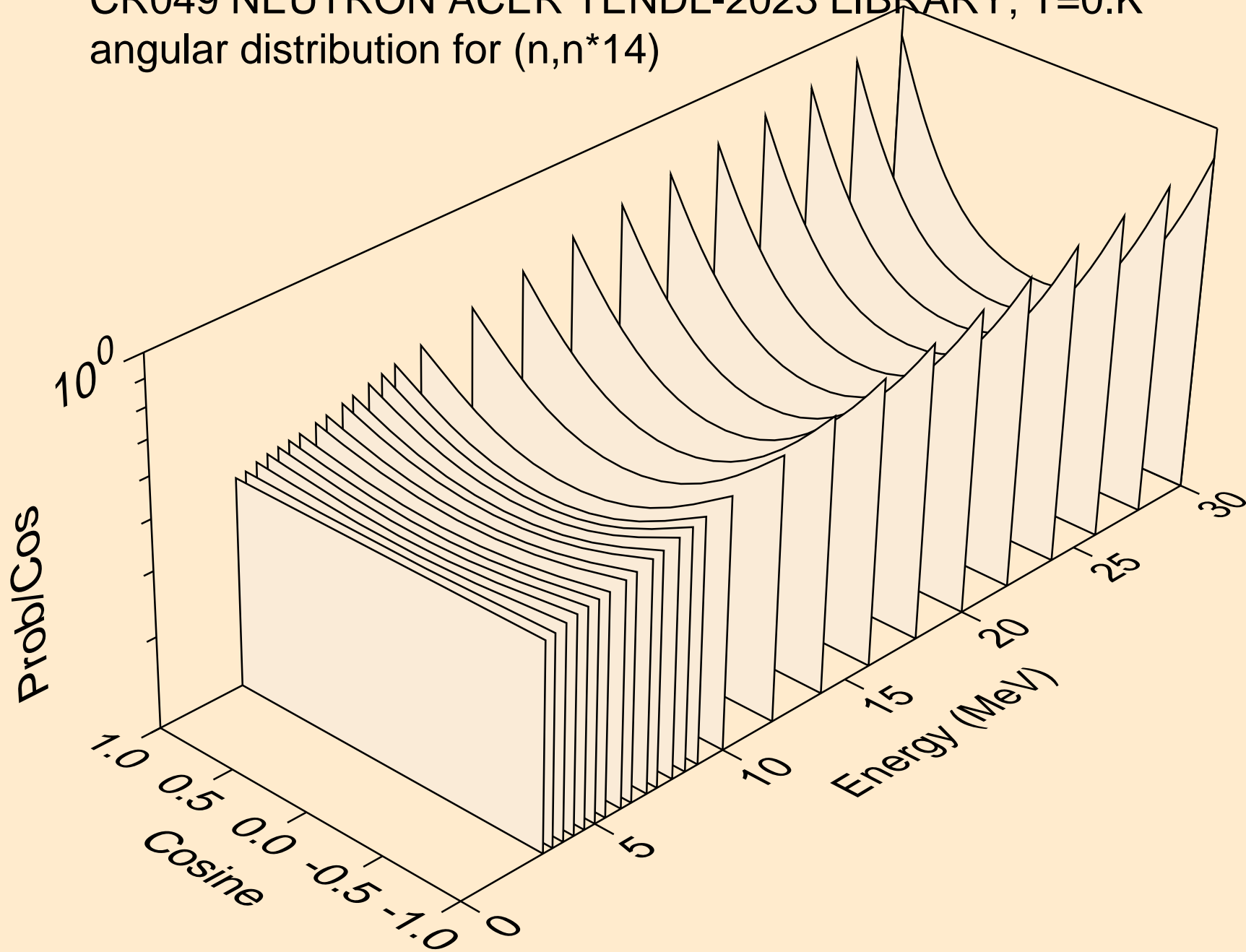

CR049 NEUTRON ACER TENDL-2023 LIBRARY; T=0.K  
angular distribution for (n,n\*15)

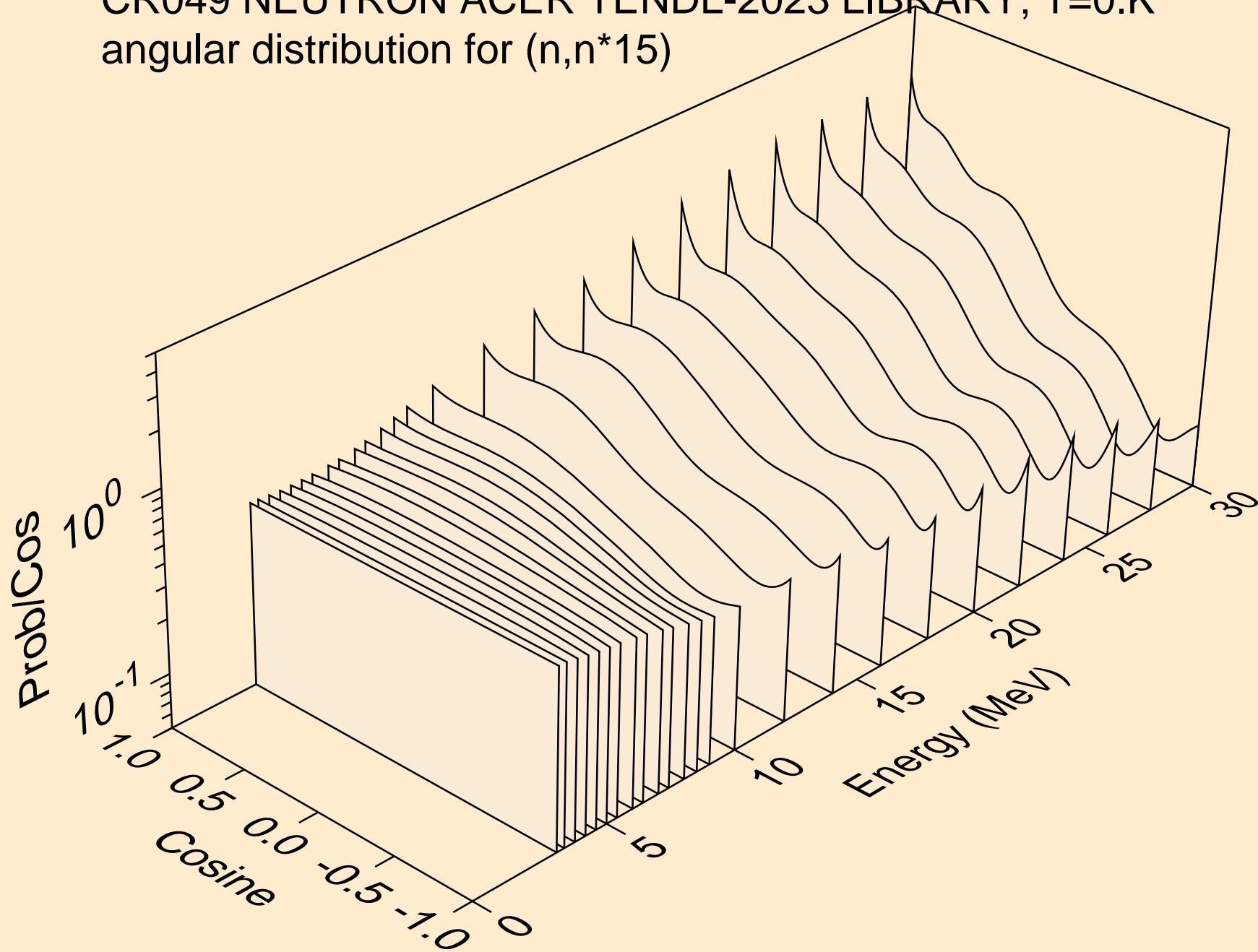



CR049 NEUTRON ACER TENDL-2023 LIBRARY; T=0.K  
Neutron emission for (n,x)

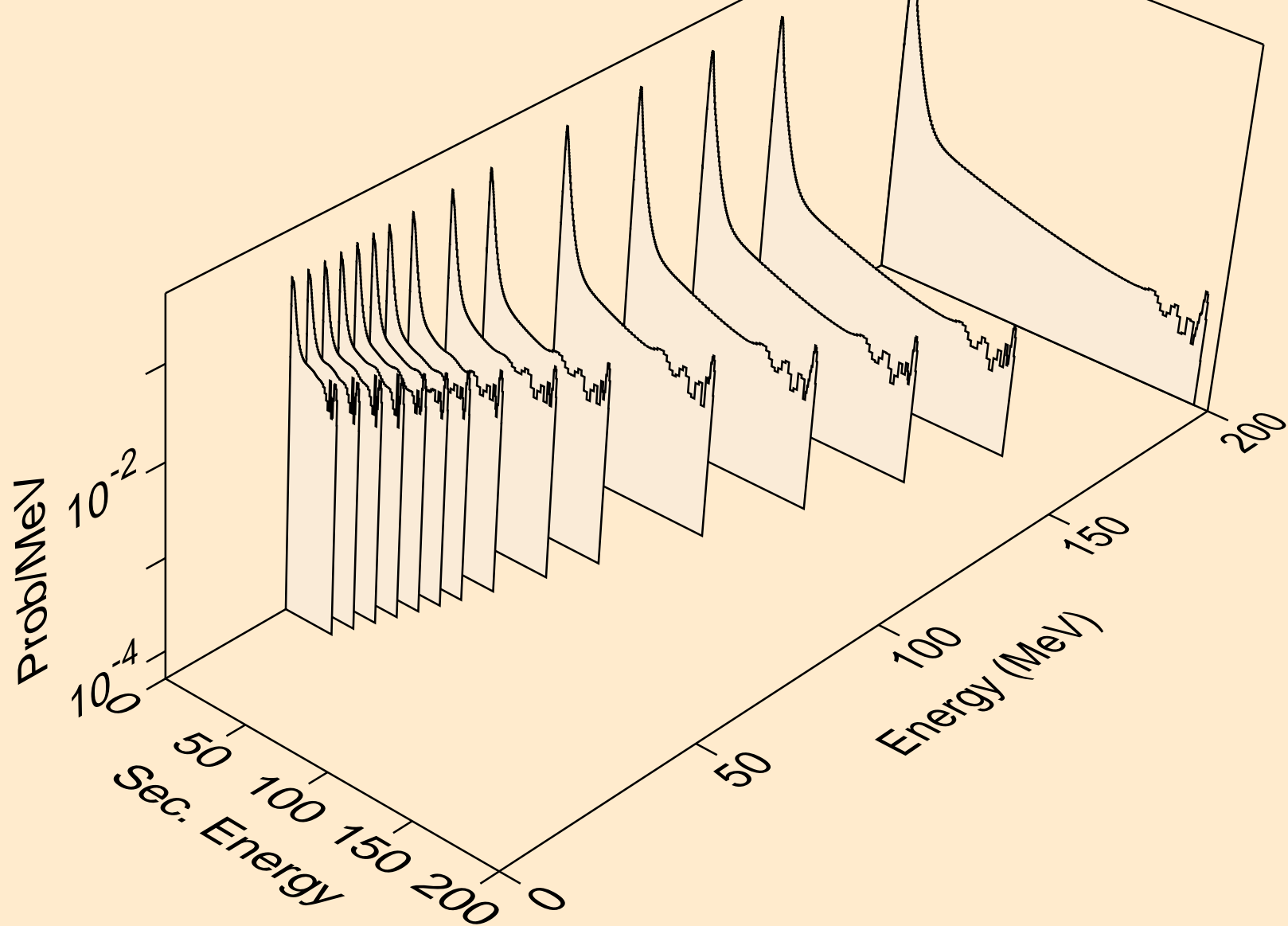

CR049 NEUTRON ACER TENDL-2023 LIBRARY; T=0.K  
Neutron emission for (n,2n)

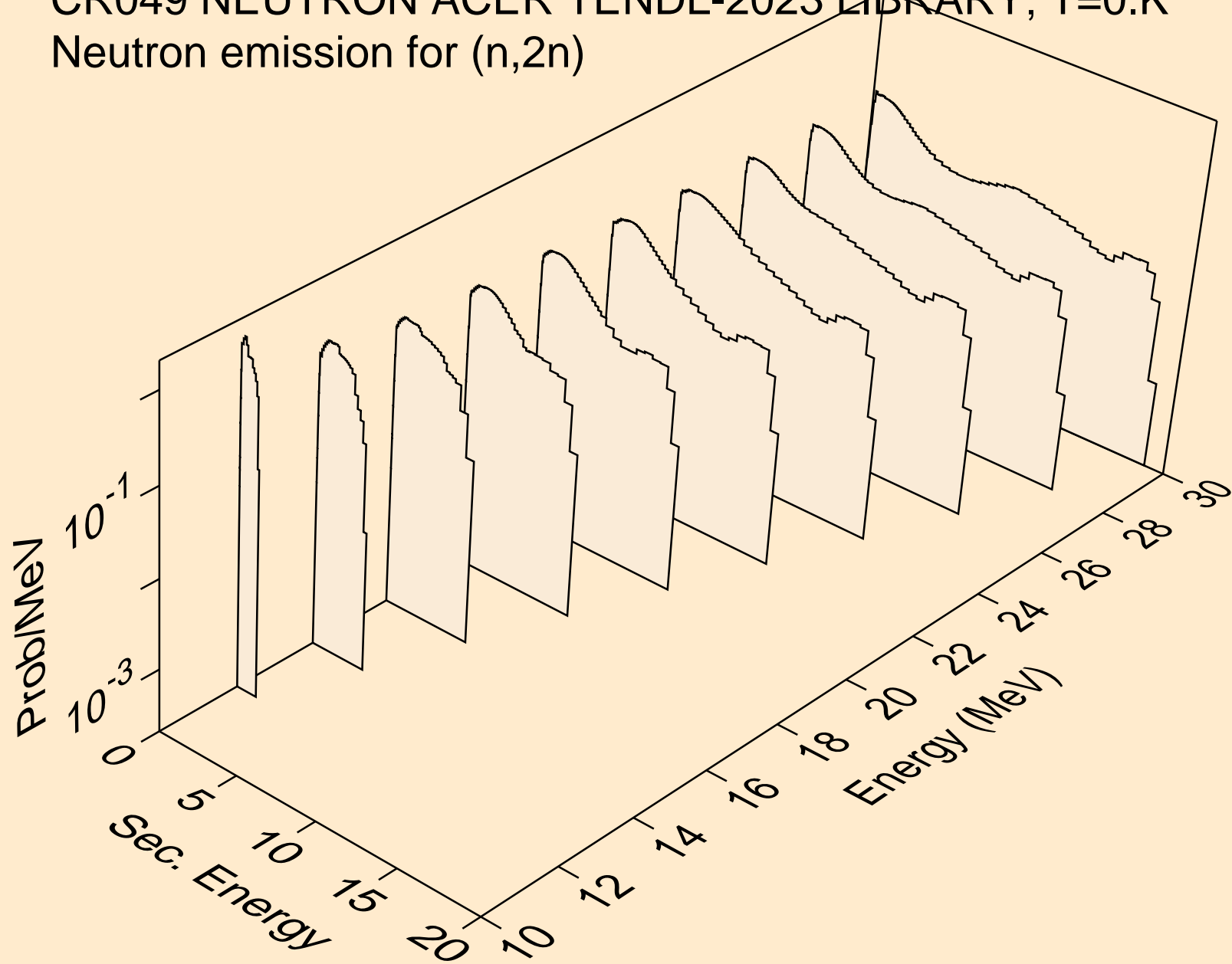

CR049 NEUTRON ACER TENDL-2023 LIBRARY; T=0.K  
Neutron emission for (n,3n)

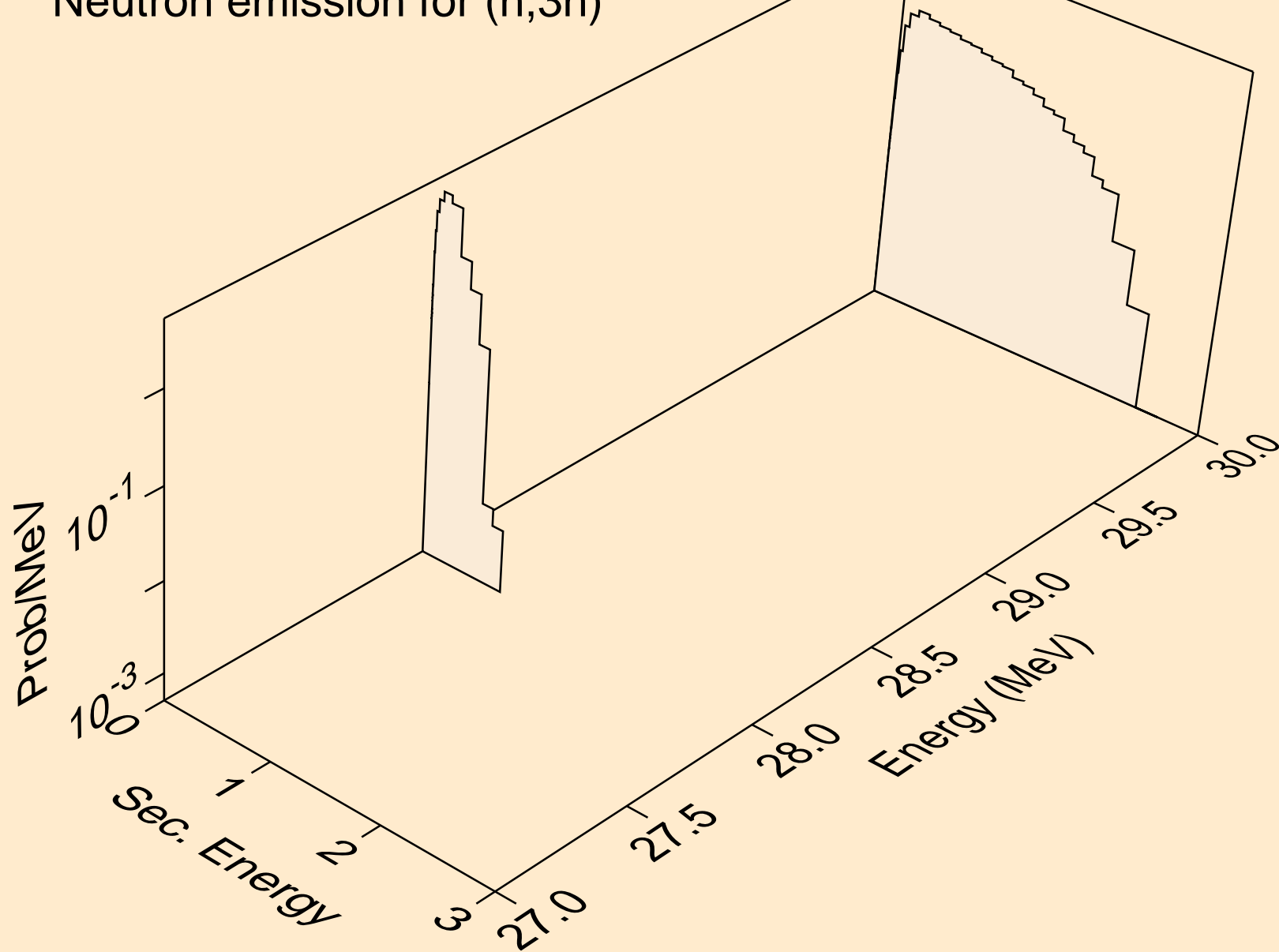

CR049 NEUTRON ACER TENDL-2023 LIBRARY; T=0.K  
Neutron emission for (n,n\*)a

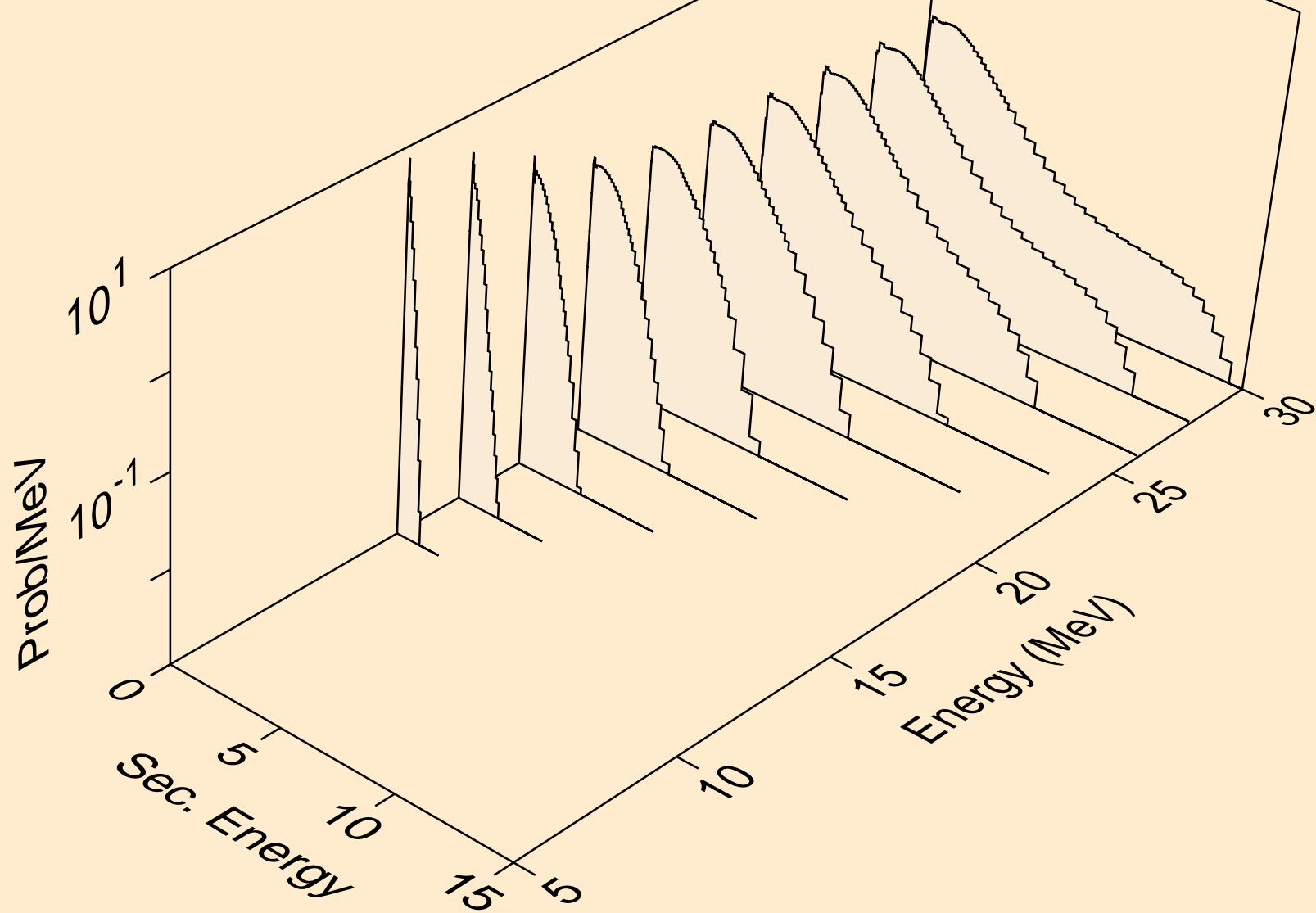

CR049 NEUTRON ACER TENDL-2023 LIBRARY; T=0.K  
Neutron emission for (n,2n)a

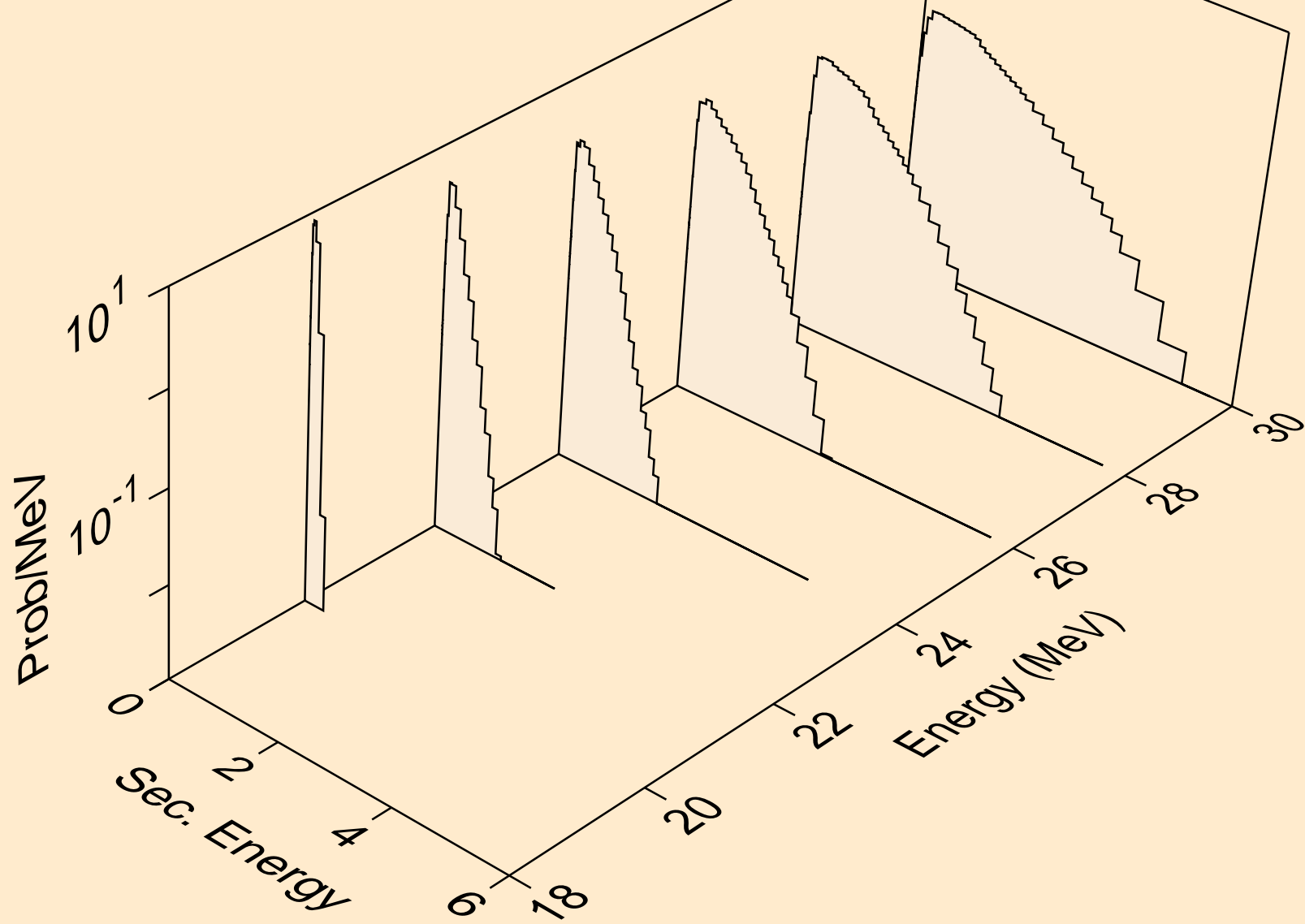

CR049 NEUTRON ACER TENDL-2023 LIBRARY; T=0.K  
Neutron emission for (n,n\*)p

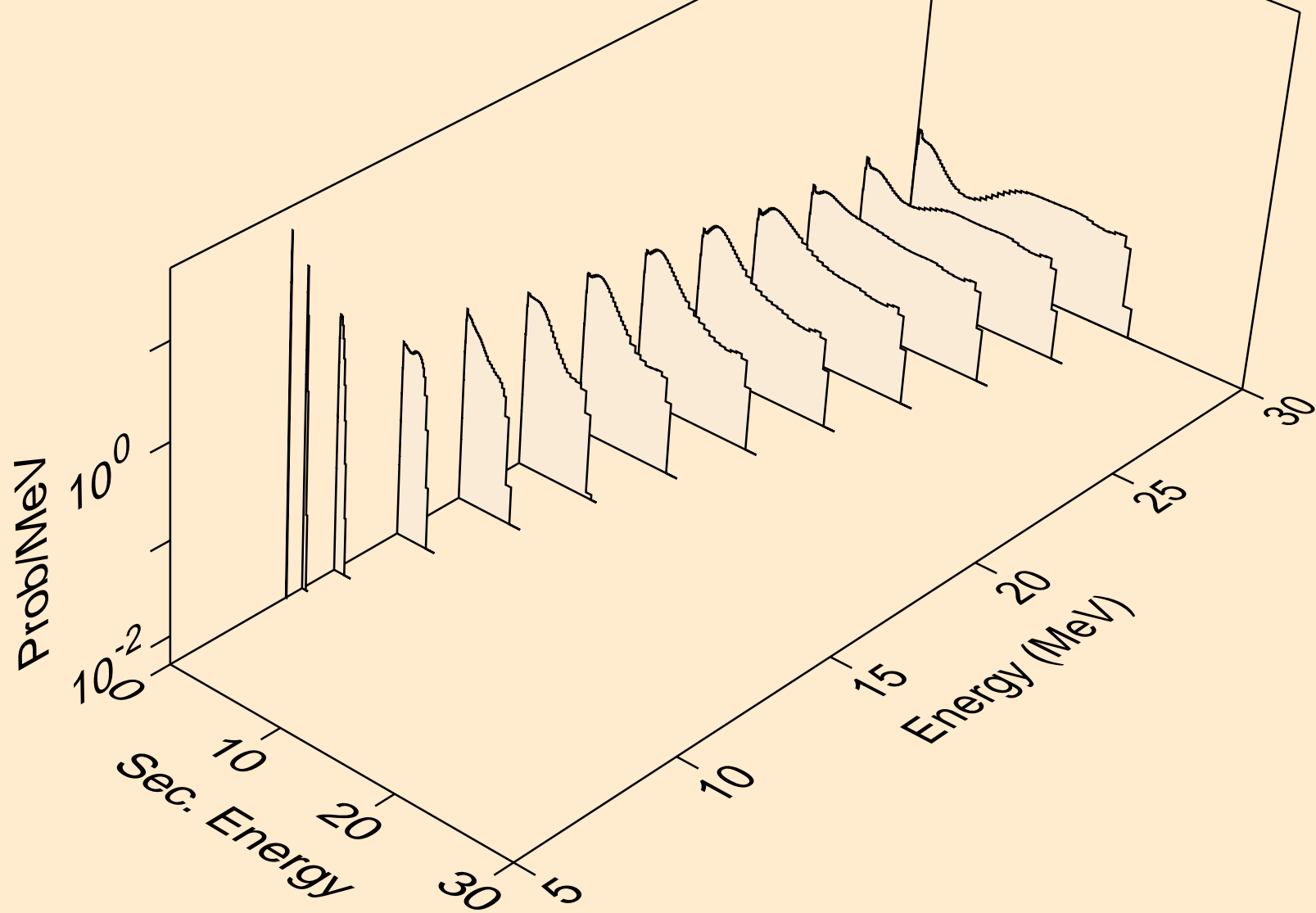

CR049 NEUTRON ACER TENDL-2023 LIBRARY; T=0.K  
Neutron emission for (n,n\*)2a

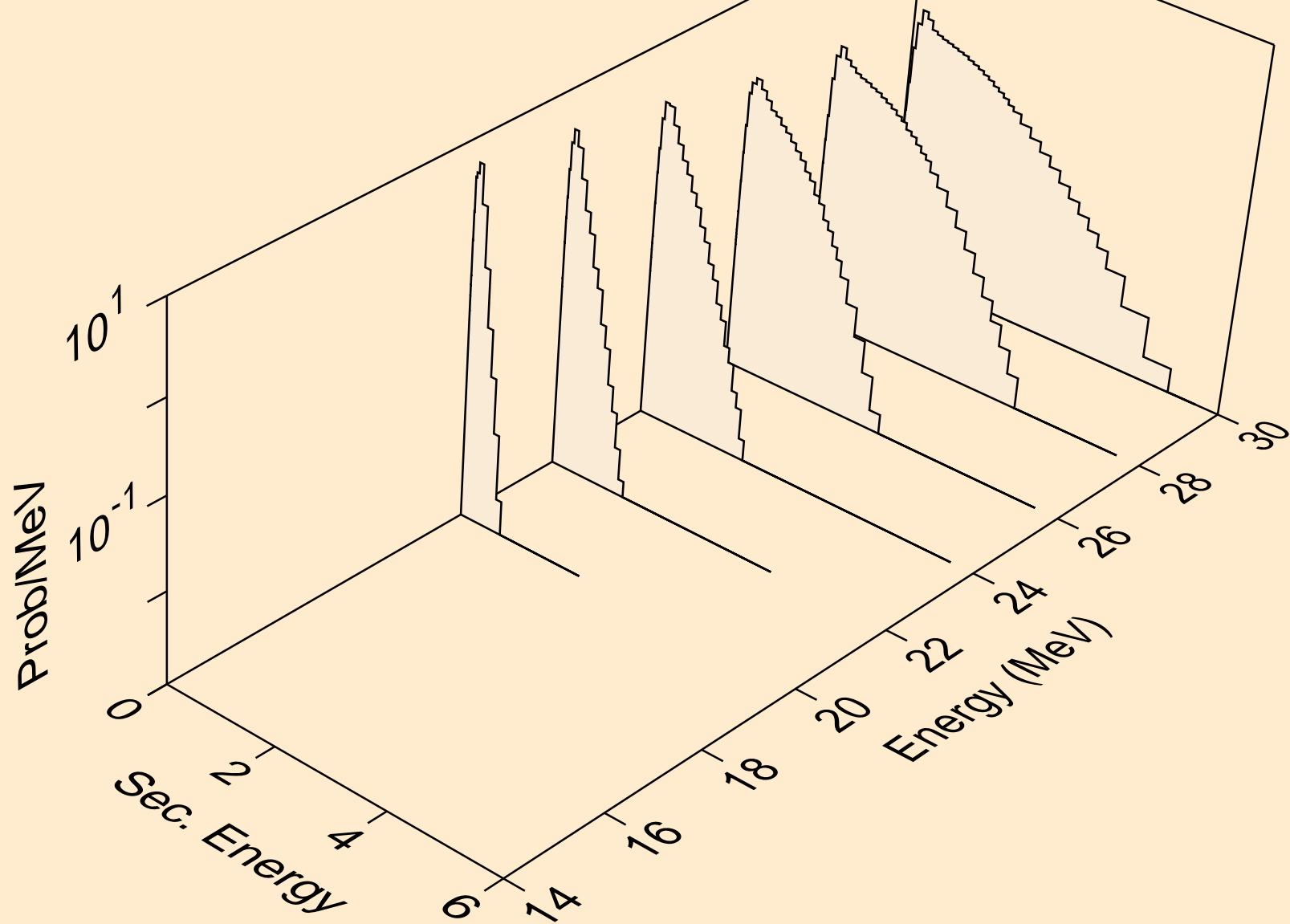

CR049 NEUTRON ACER TENDL-2023 LIBRARY; T=0.K  
Neutron emission for (n,n\*)d

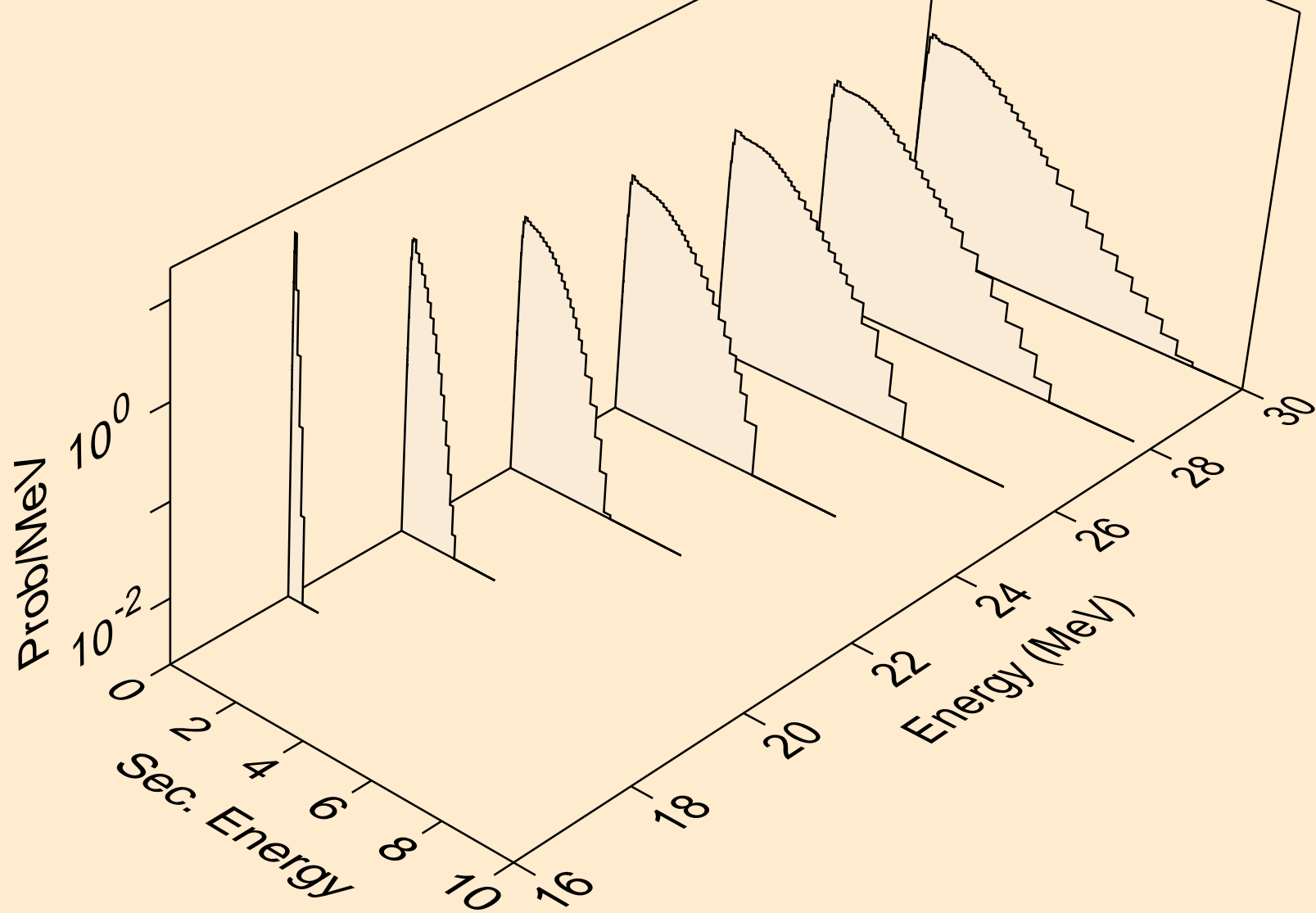



CR049 NEUTRON ACER TENDL-2023 LIBRARY; T=0.K  
Neutron emission for (n,n\*)t

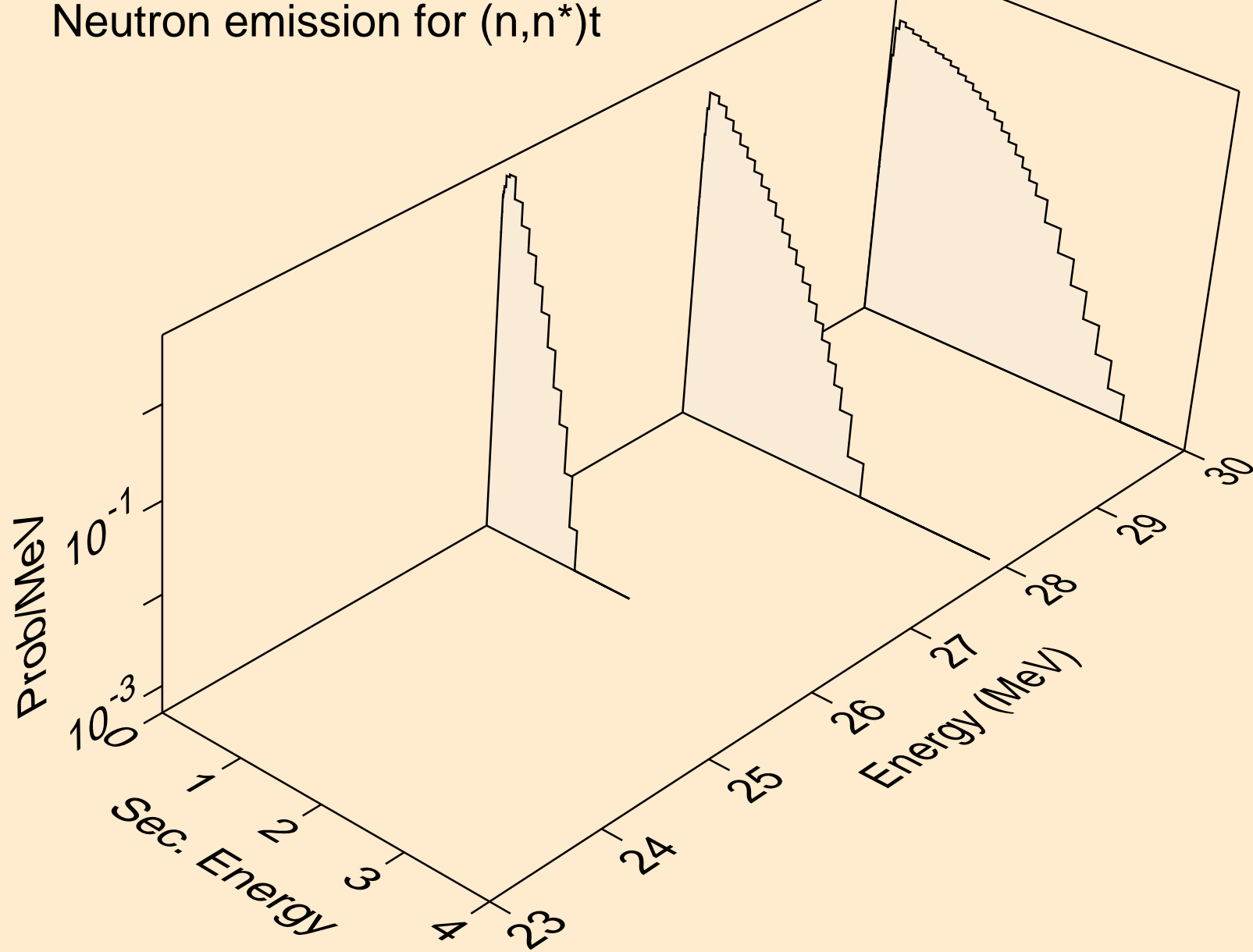

CR049 NEUTRON ACER TENDL-2023 LIBRARY; T=0.K  
Neutron emission for (n,n\*)he3

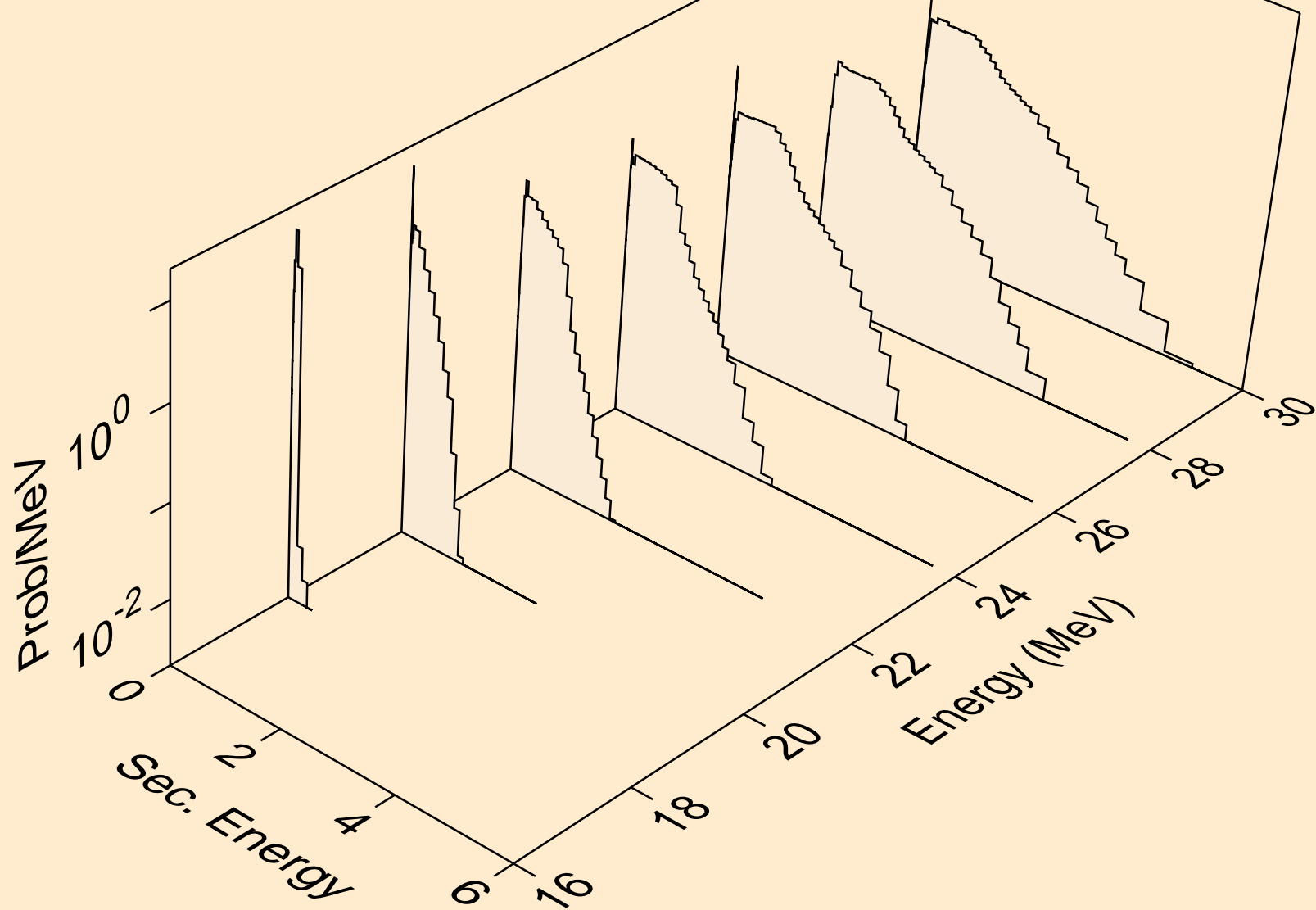

CR049 NEUTRON ACER TENDL-2023 LIBRARY; T=0.K  
Neutron emission for (n,2np)

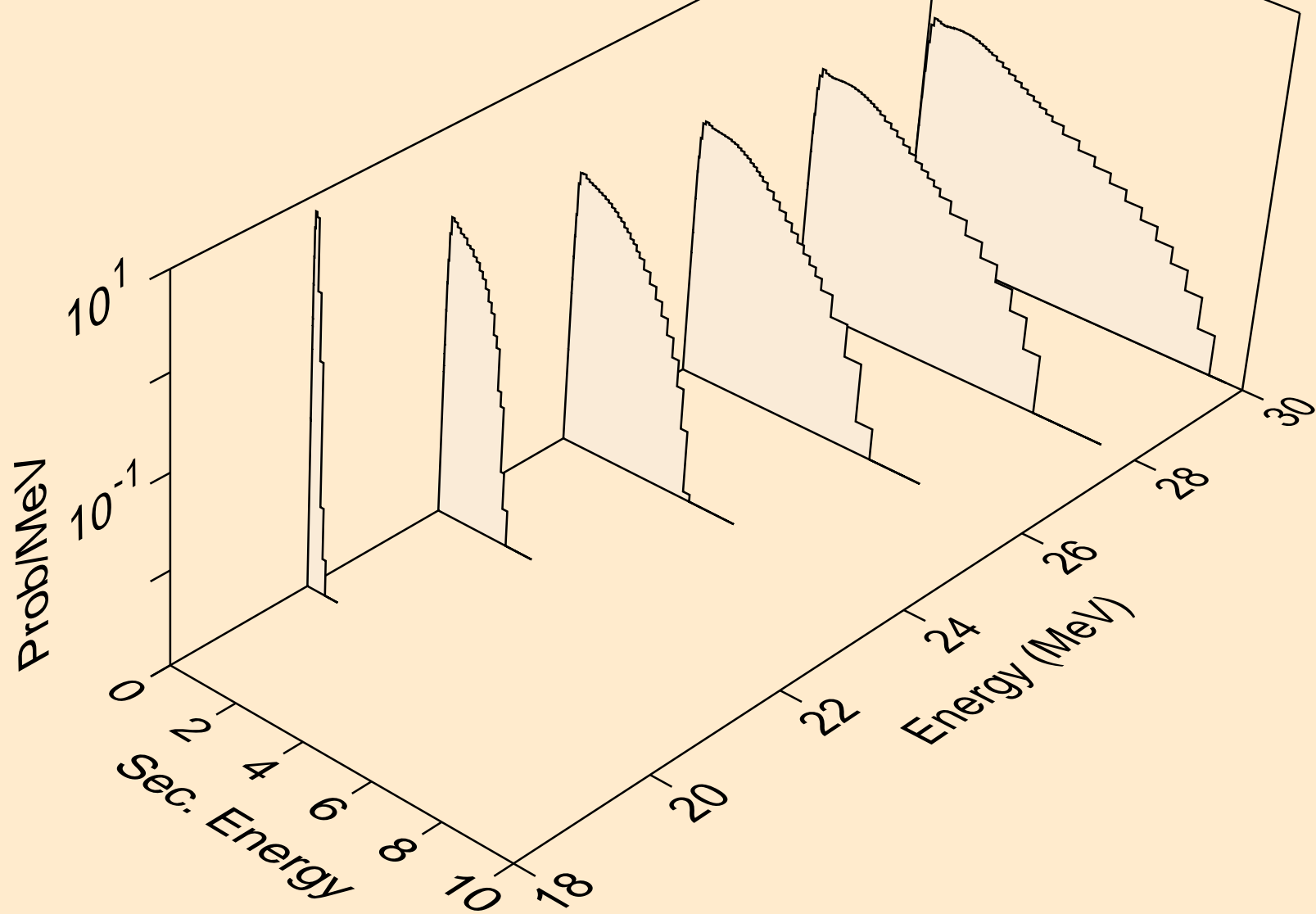

CR049 NEUTRON ACER TENDL-2023 LIBRARY; T=0.K  
Neutron emission for (n,n2p)

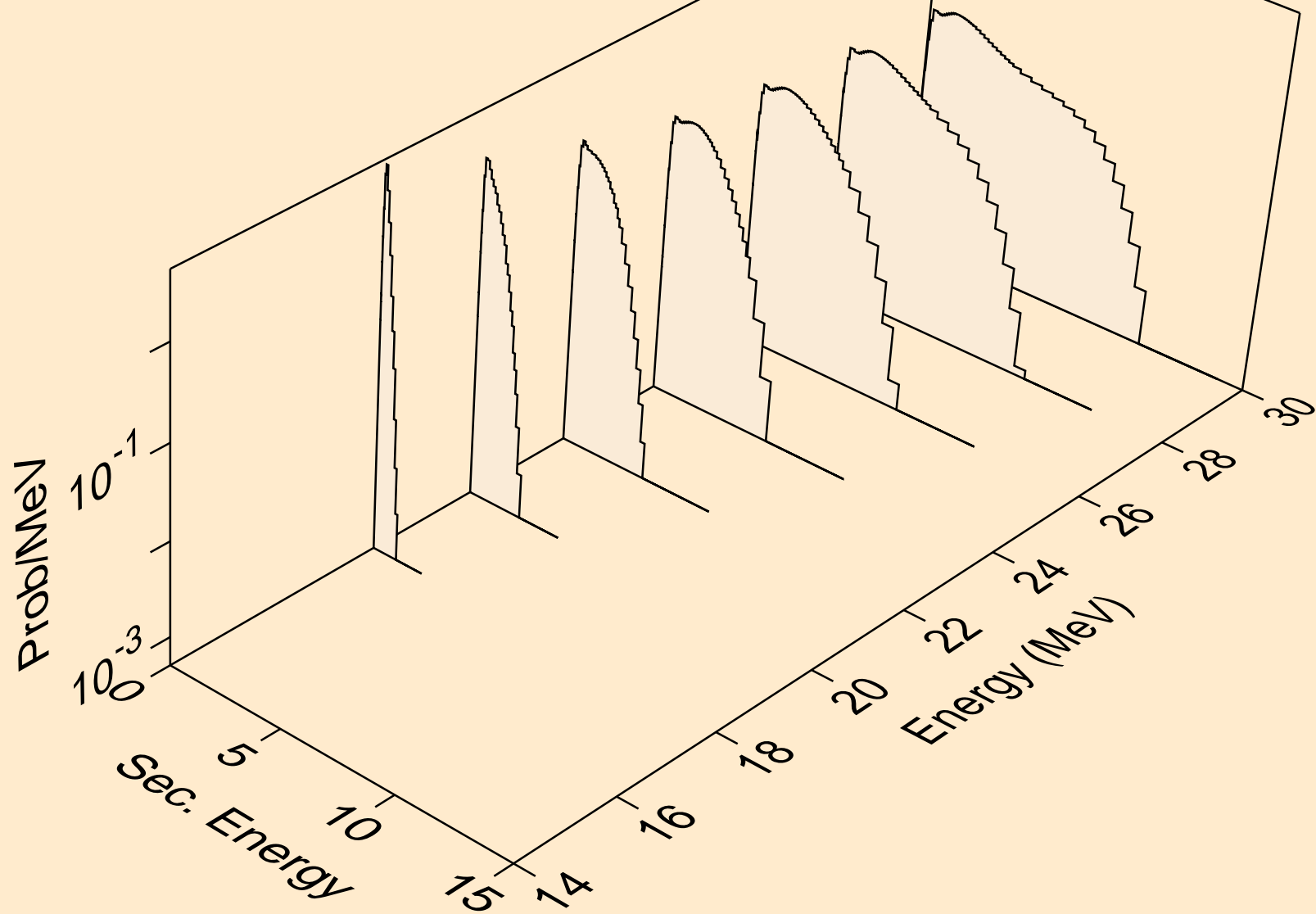

CR049 NEUTRON ACER TENDL-2023 LIBRARY; T=0.K  
Neutron emission for (n,npa)

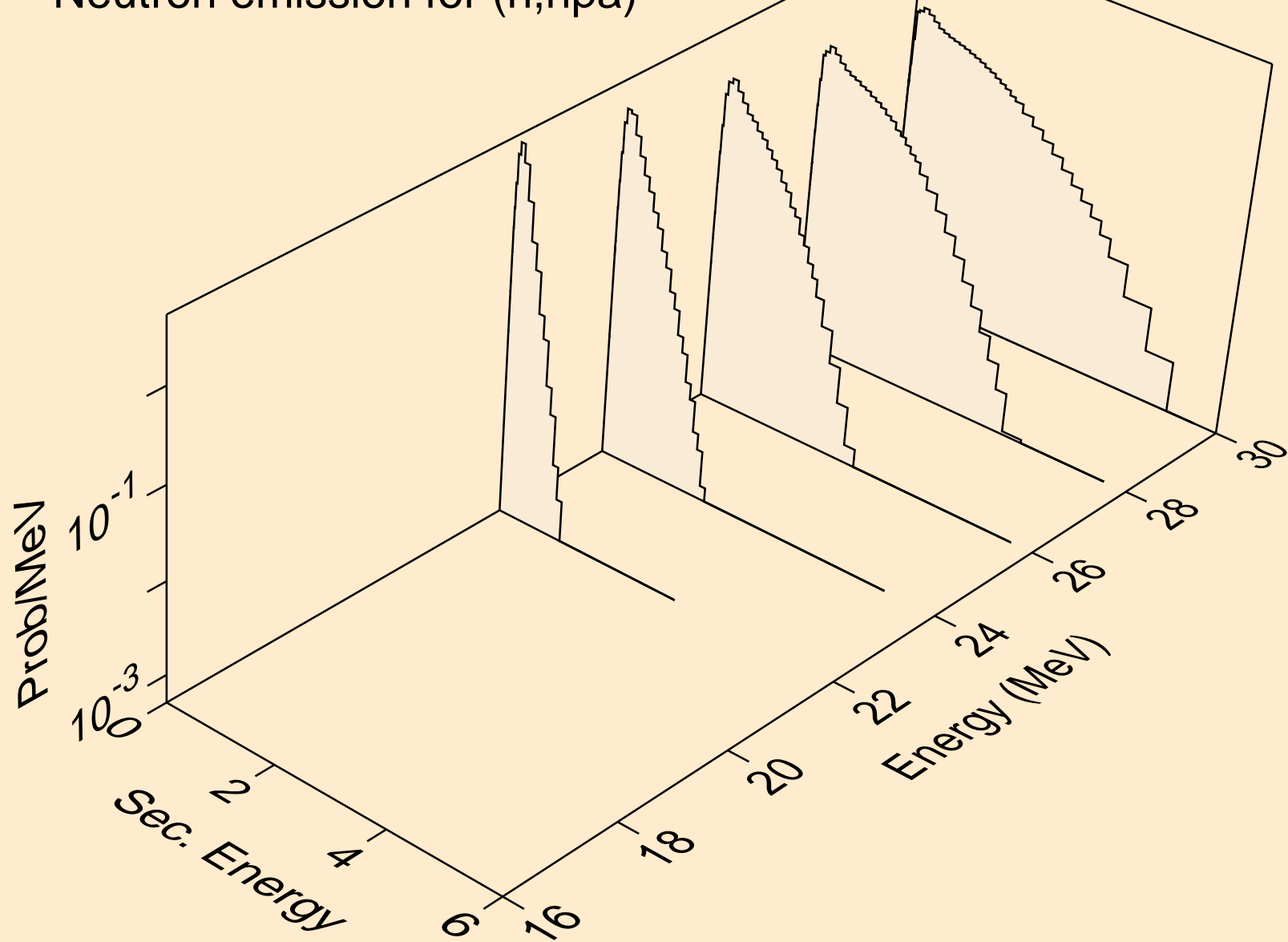

CR049 NEUTRON ACER TENDL-2023 LIBRARY; T=0.K  
Neutron emission for (n,n\*c)

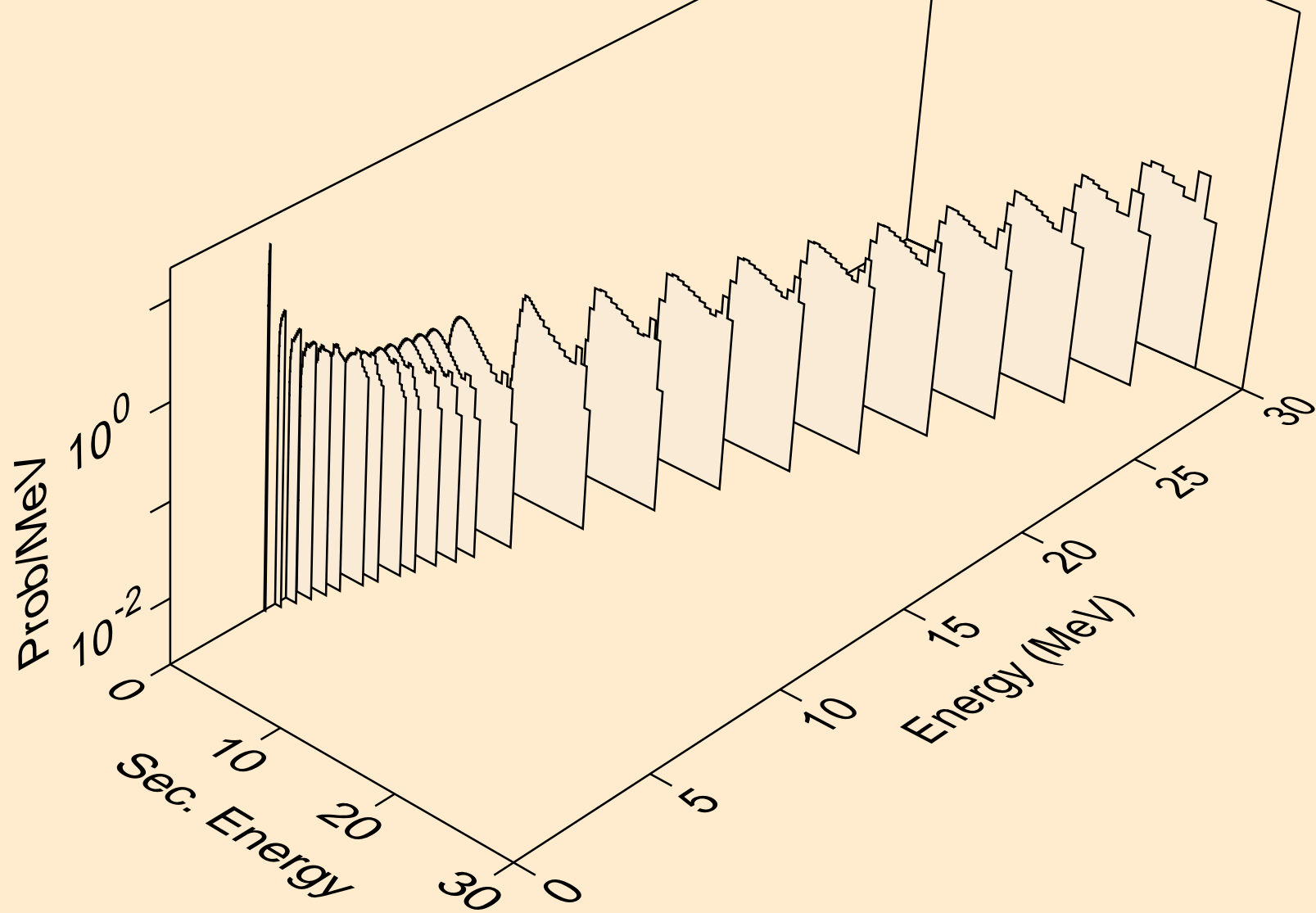

CR049 NEUTRON ACER TENDL-2023 LIBRARY; T=0.K  
Photon emission for (n,x)

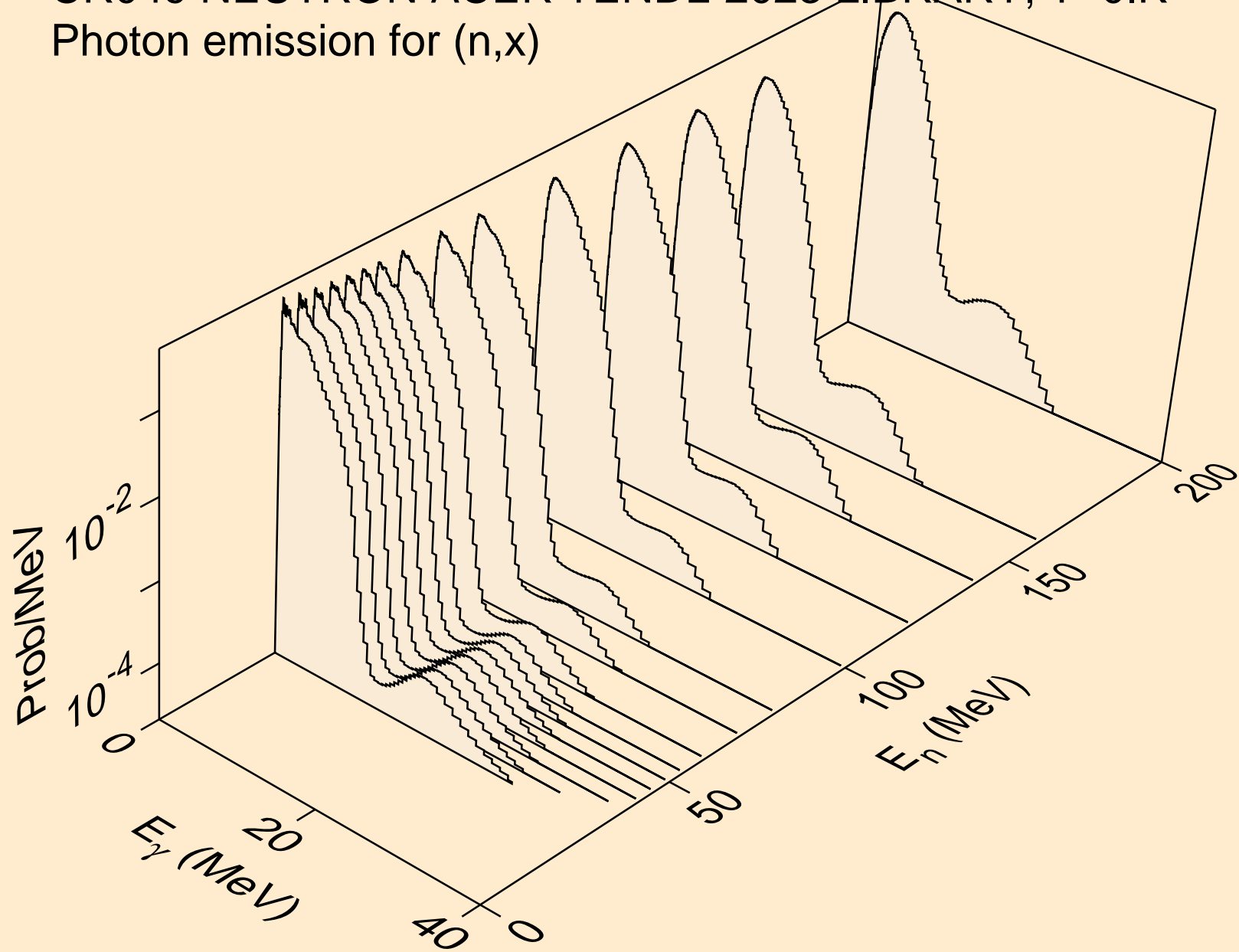

CR049 NEUTRON ACER TENDL-2023 LIBRARY; T=0.K  
Photon emission for (n,2n)

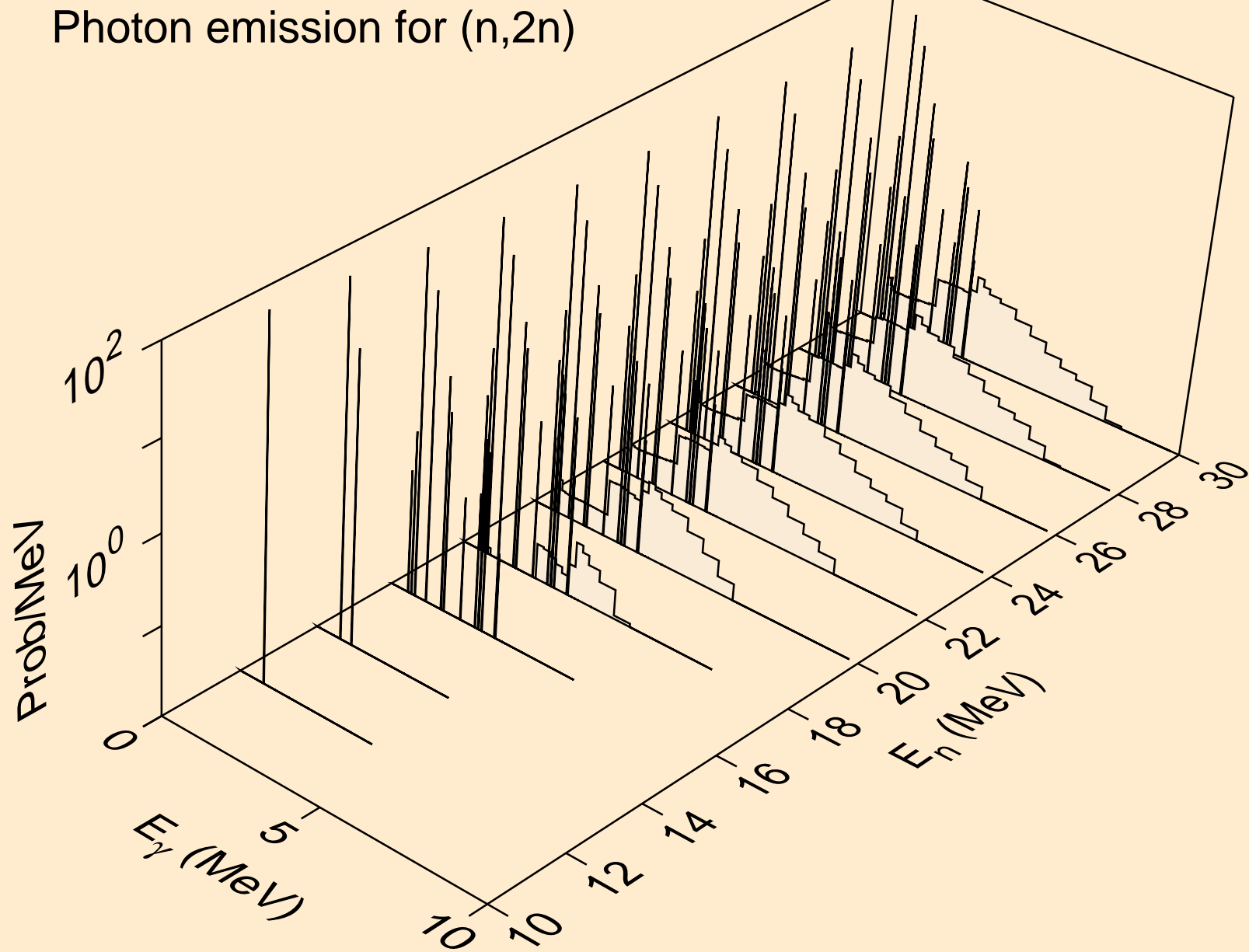



CR049 NEUTRON ACER TENDL-2023 LIBRARY; T=0.K  
Photon emission for (n,3n)

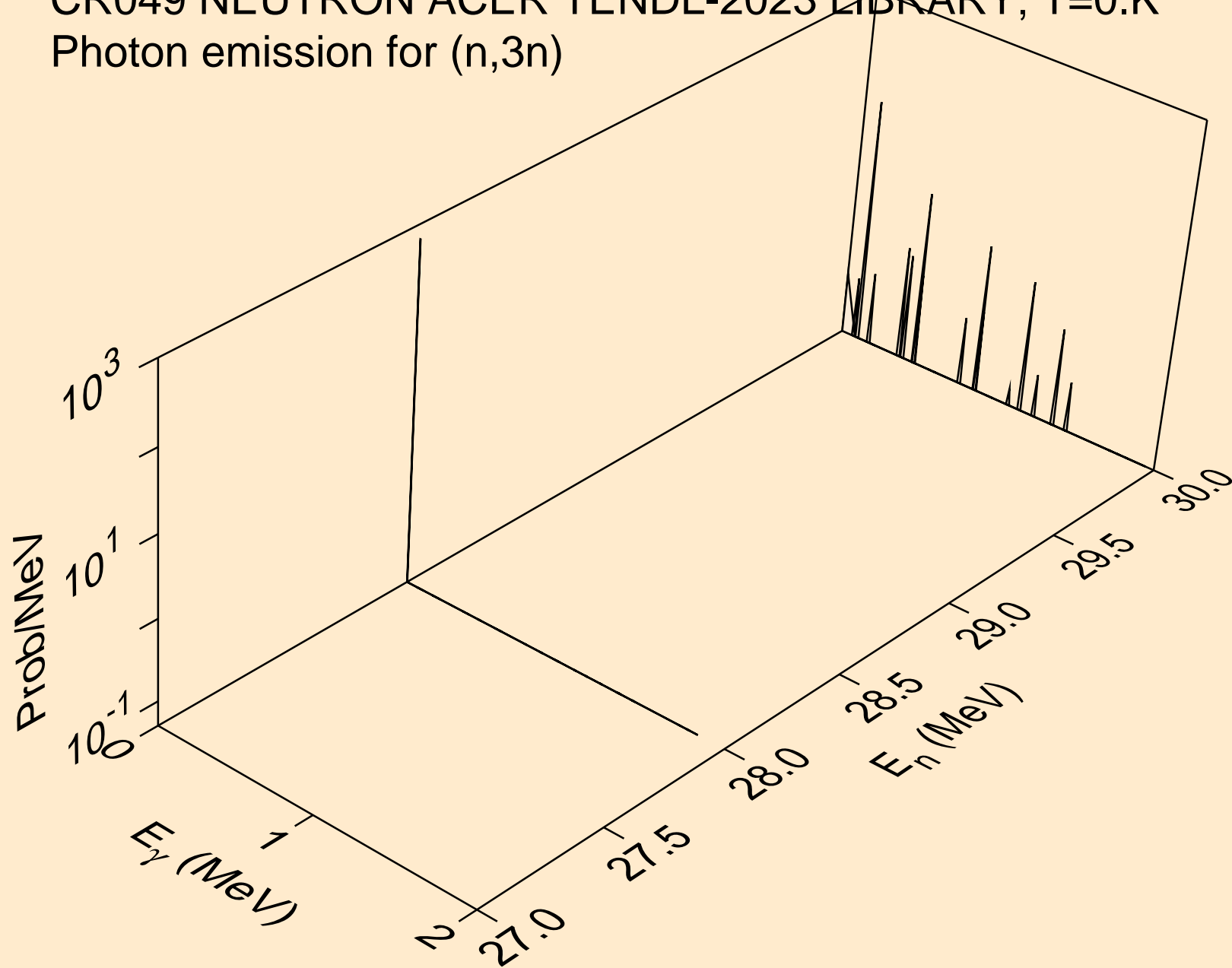

CR049 NEUTRON ACER TENDL-2023 LIBRARY; T=0.K  
Photon emission for (n,n\*)a

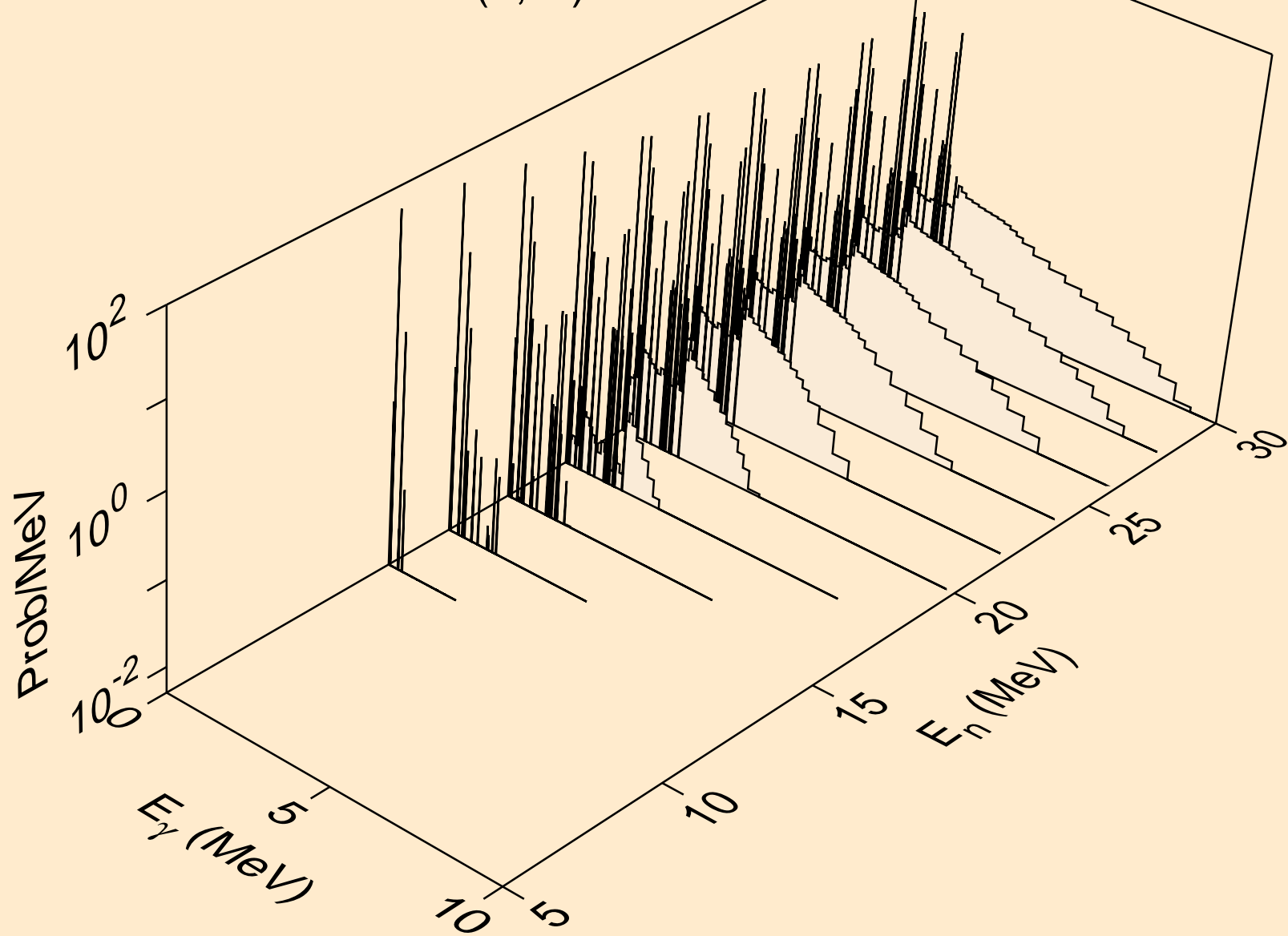

CR049 NEUTRON ACER TENDL-2023 LIBRARY; T=0.K  
Photon emission for (n,2n)a

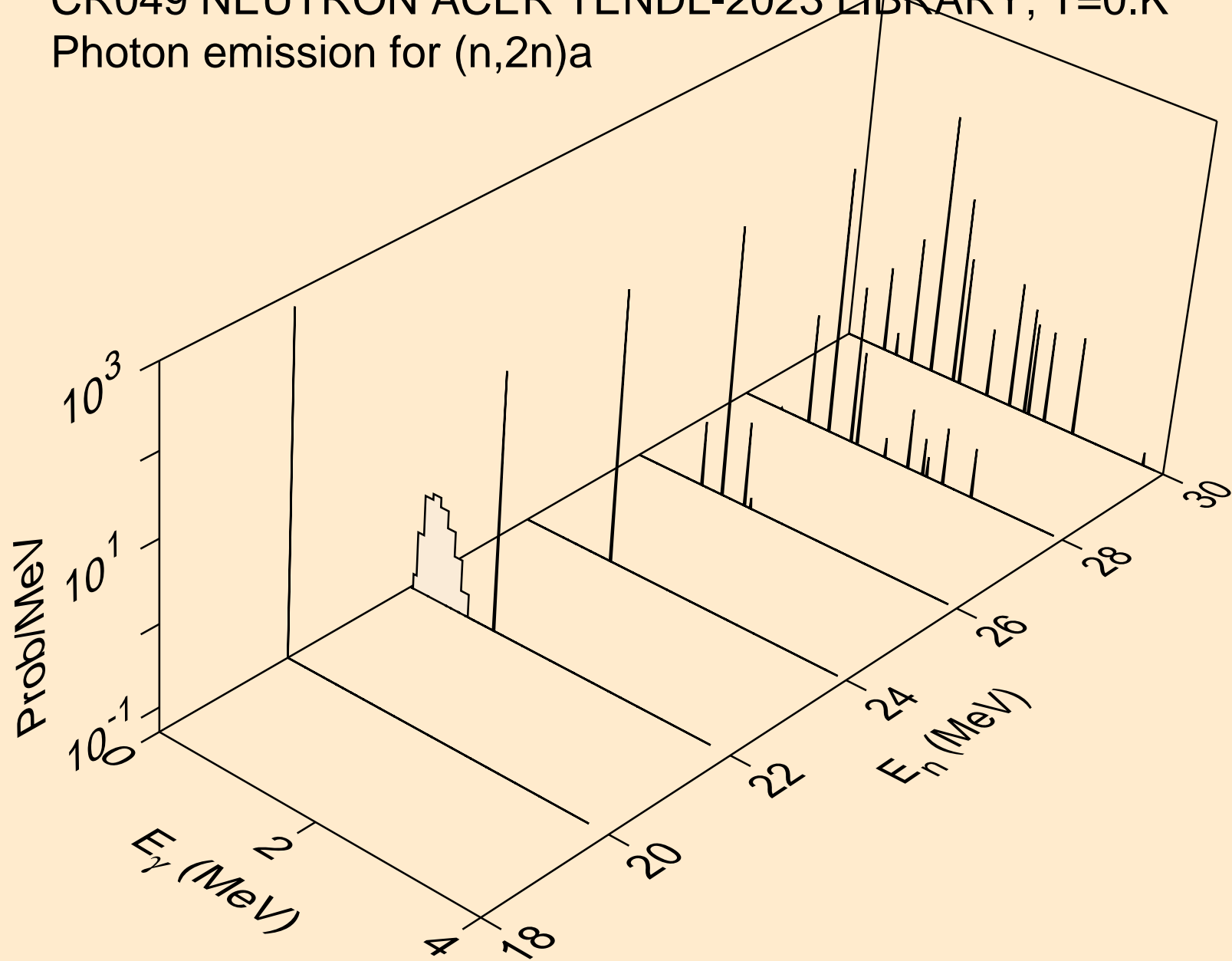

CR049 NEUTRON ACER TENDL-2023 LIBRARY; T=0.K  
Photon emission for (n,n\*)p

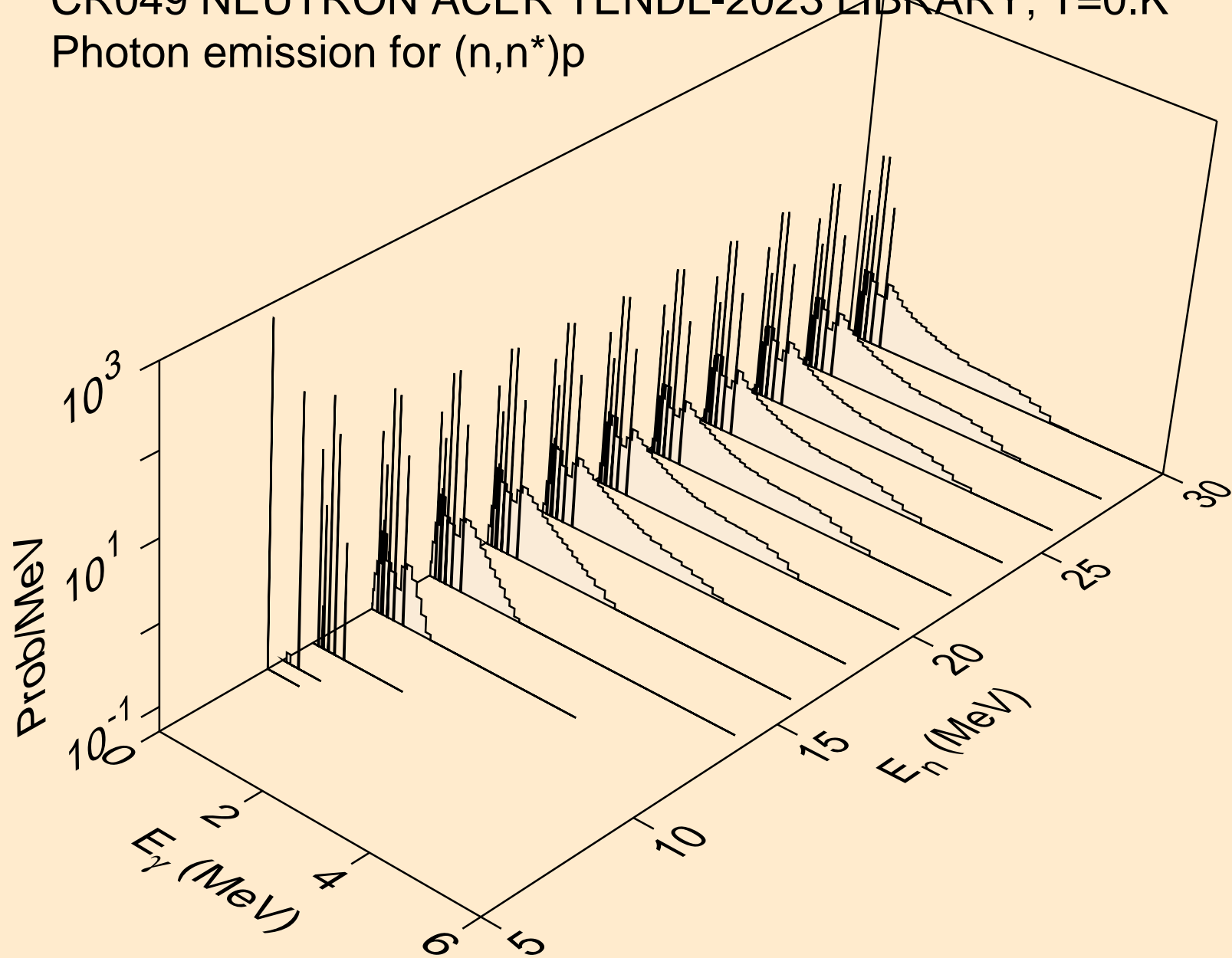

CR049 NEUTRON ACER TENDL-2023 LIBRARY; T=0.K  
Photon emission for (n,n\*)2a

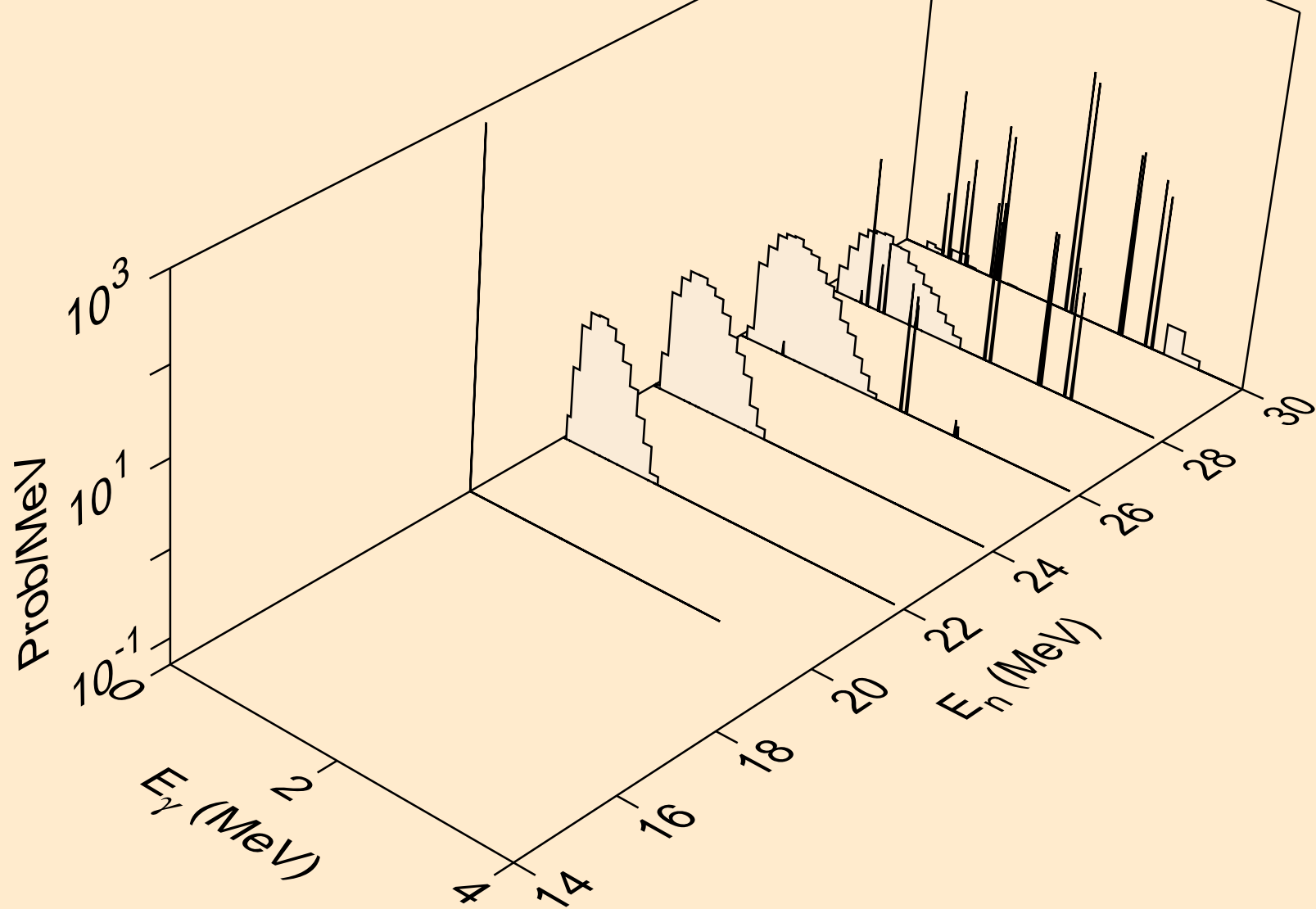

CR049 NEUTRON ACER TENDL-2023 LIBRARY; T=0.K  
Photon emission for (n,n\*)d

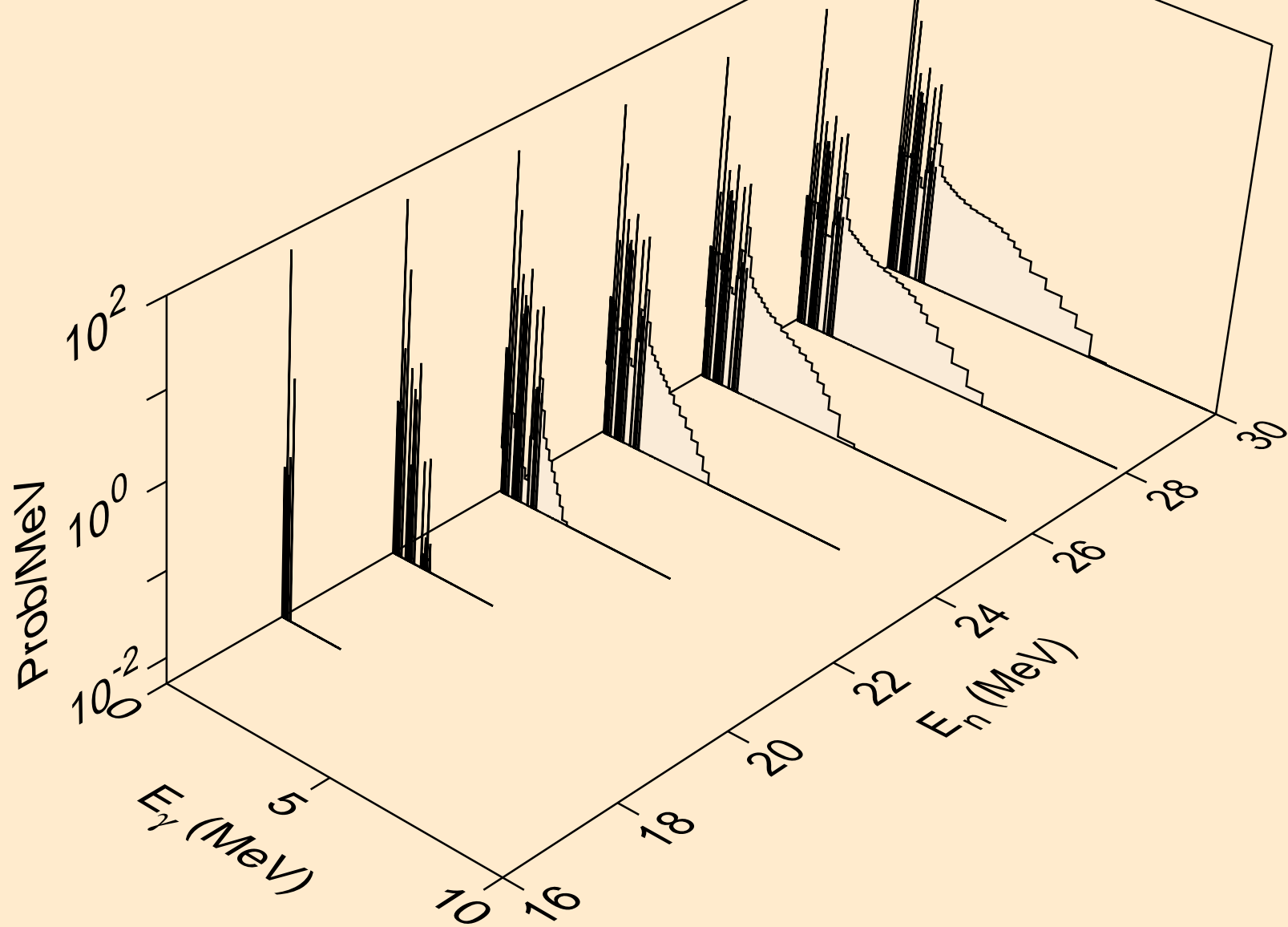

CR049 NEUTRON ACER TENDL-2023 LIBRARY; T=0.K  
Photon emission for (n,n\*)t

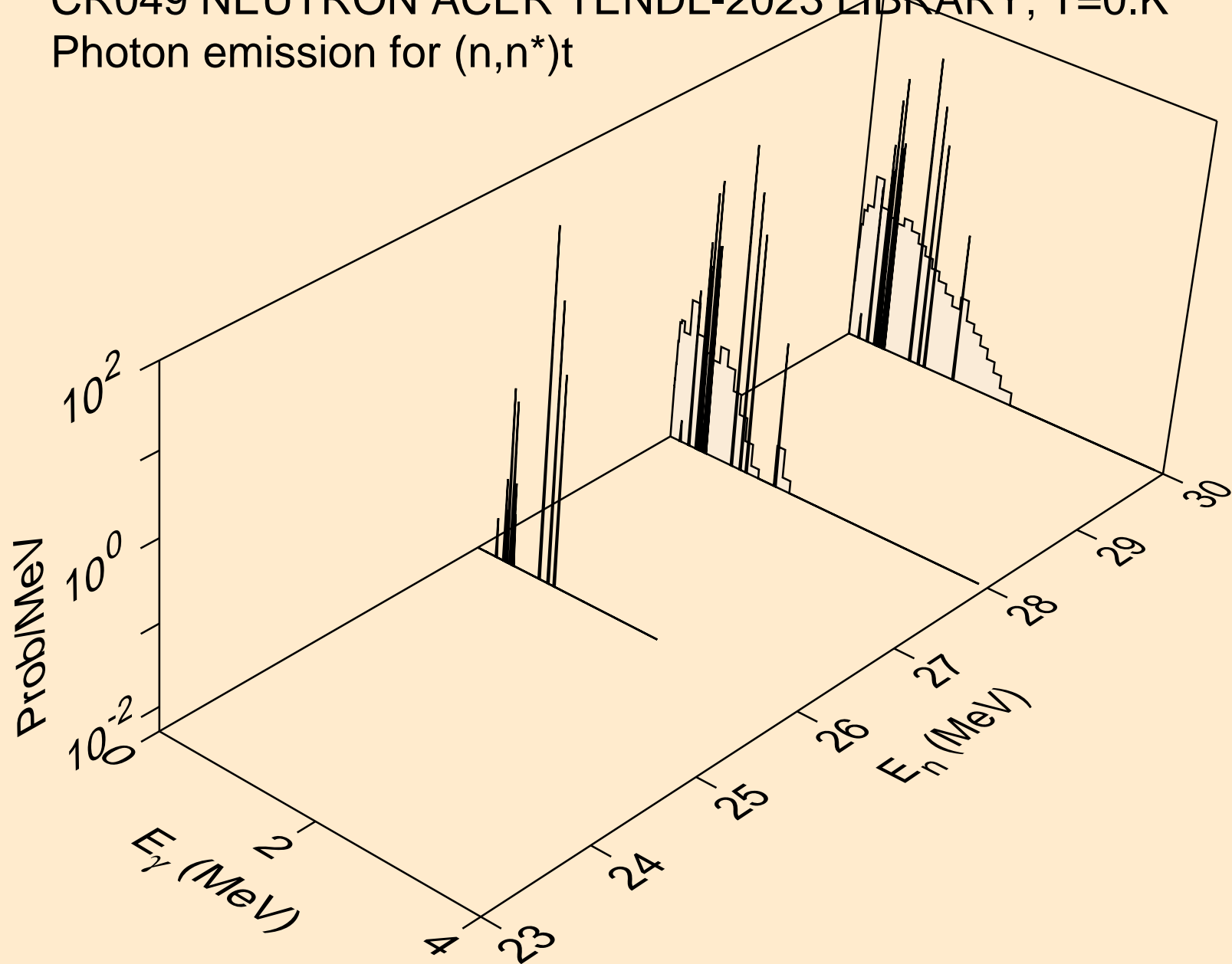

CR049 NEUTRON ACER TENDL-2023 LIBRARY; T=0.K  
Photon emission for (n,n\*)he3

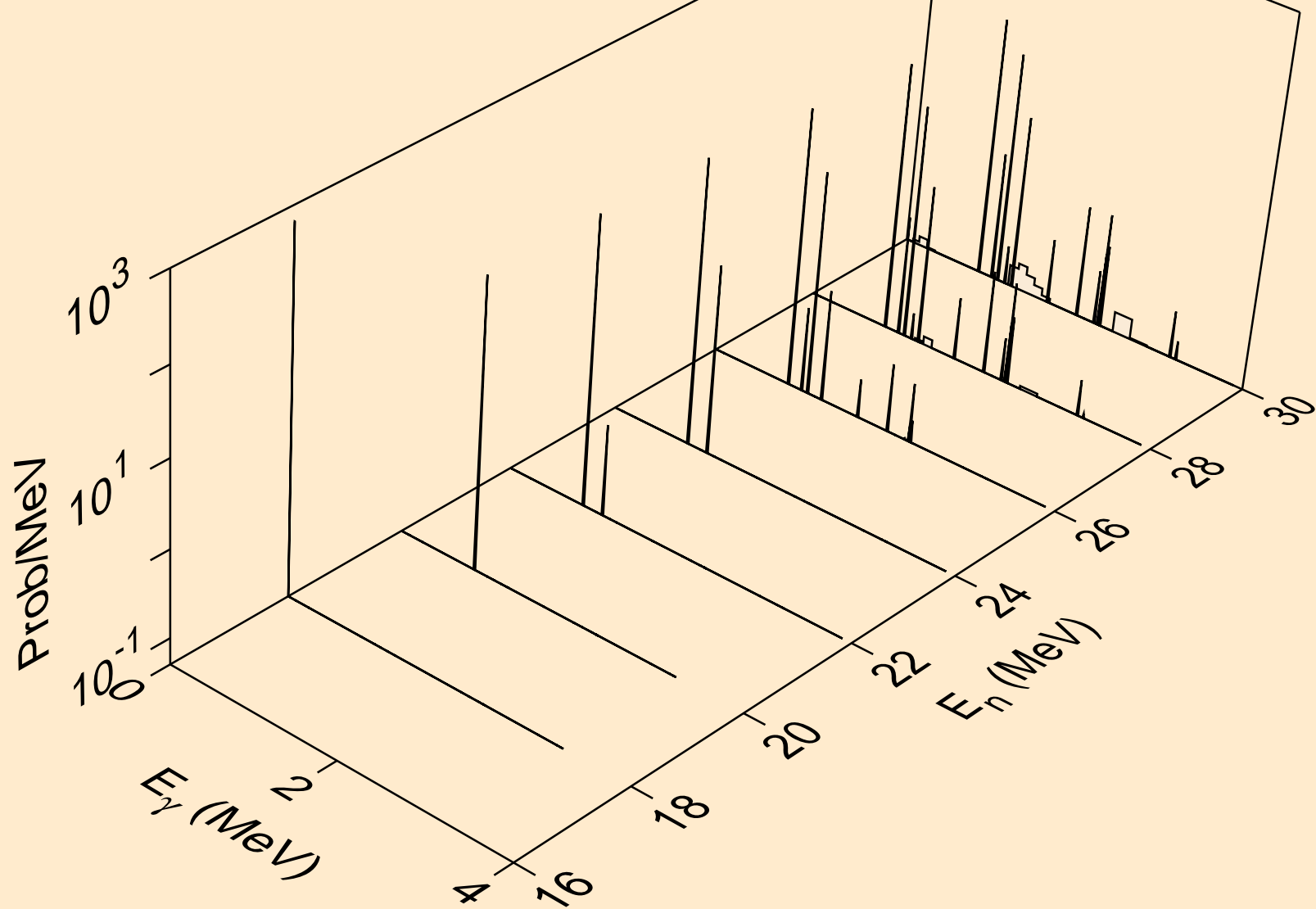



CR049 NEUTRON ACER TENDL-2023 LIBRARY; T=0.K  
Photon emission for (n,2np)

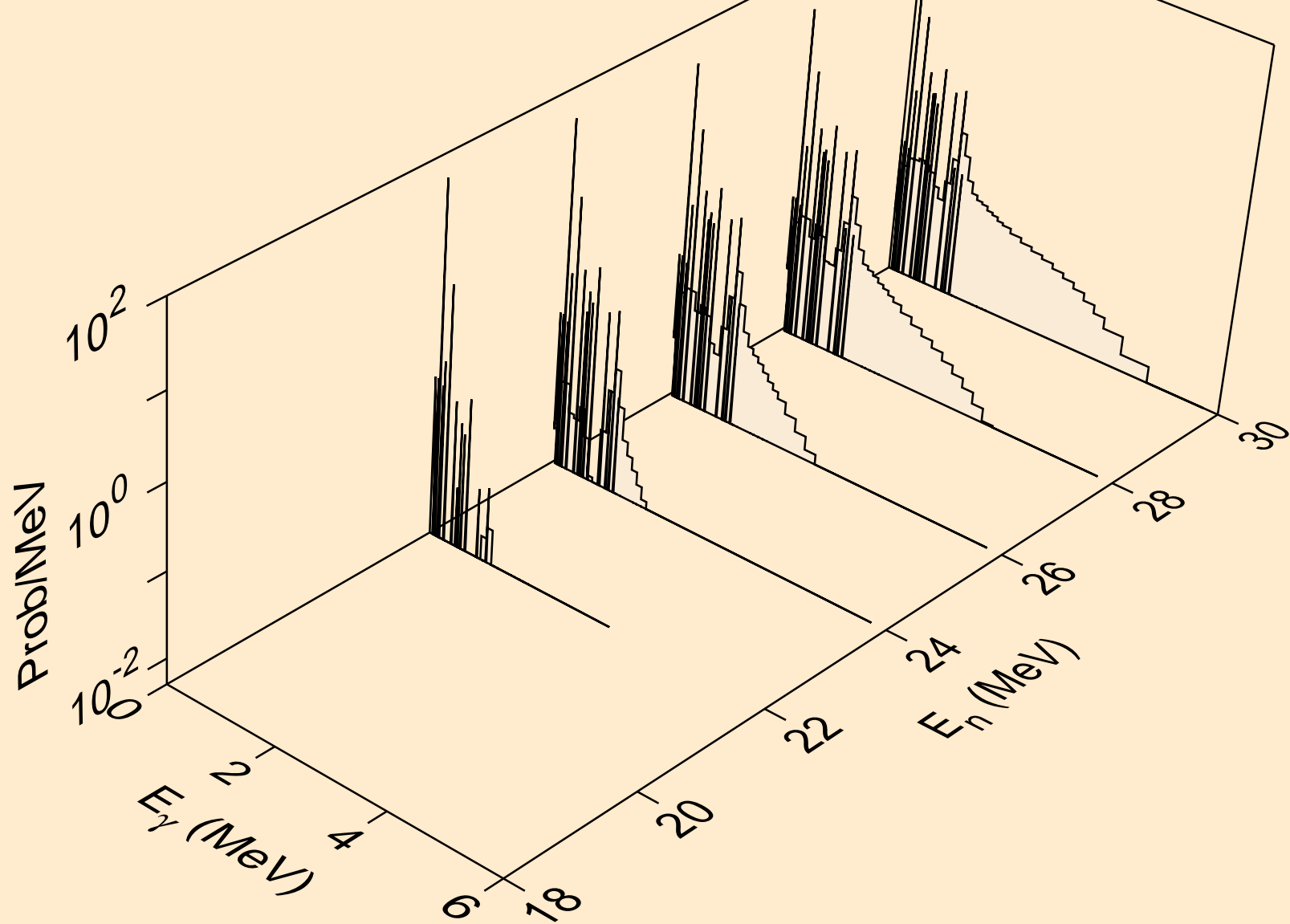

CR049 NEUTRON ACER TENDL-2023 LIBRARY; T=0.K  
Photon emission for (n,n2p)

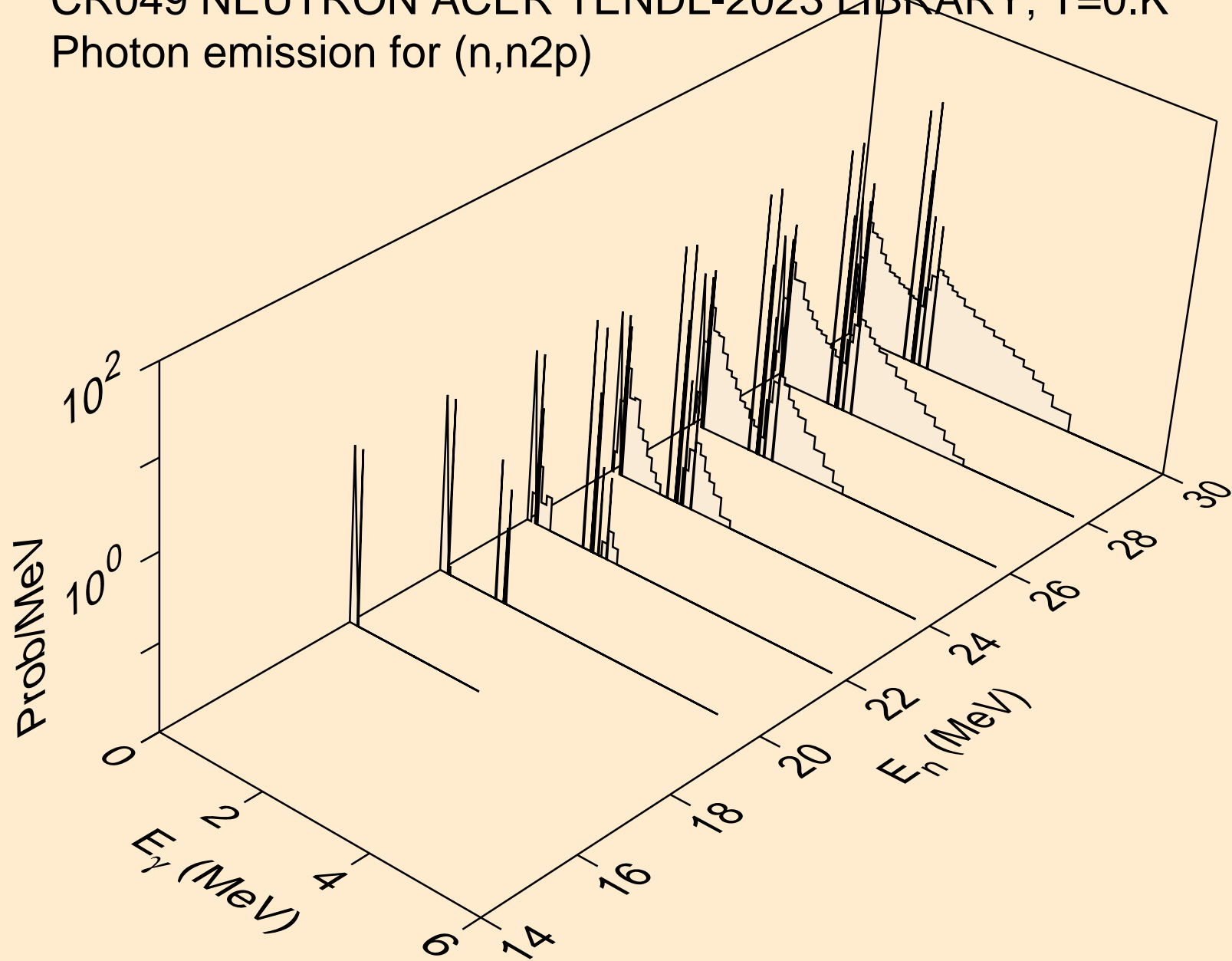

CR049 NEUTRON ACER TENDL-2023 LIBRARY; T=0.K  
Photon emission for (n,npa)

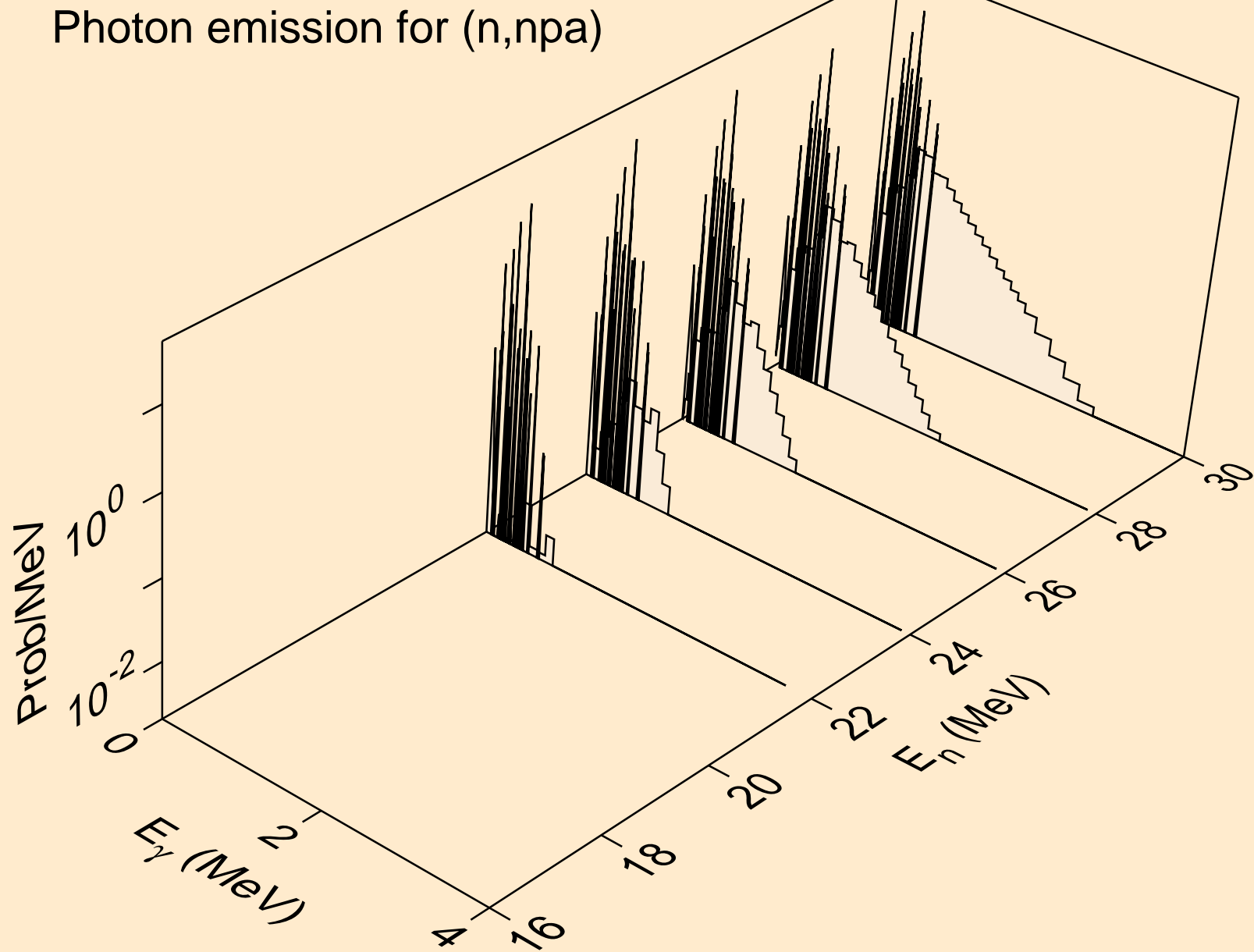

CR049 NEUTRON ACER TENDL-2023 LIBRARY; T=0.K  
Photon emission for (n,n\*c)

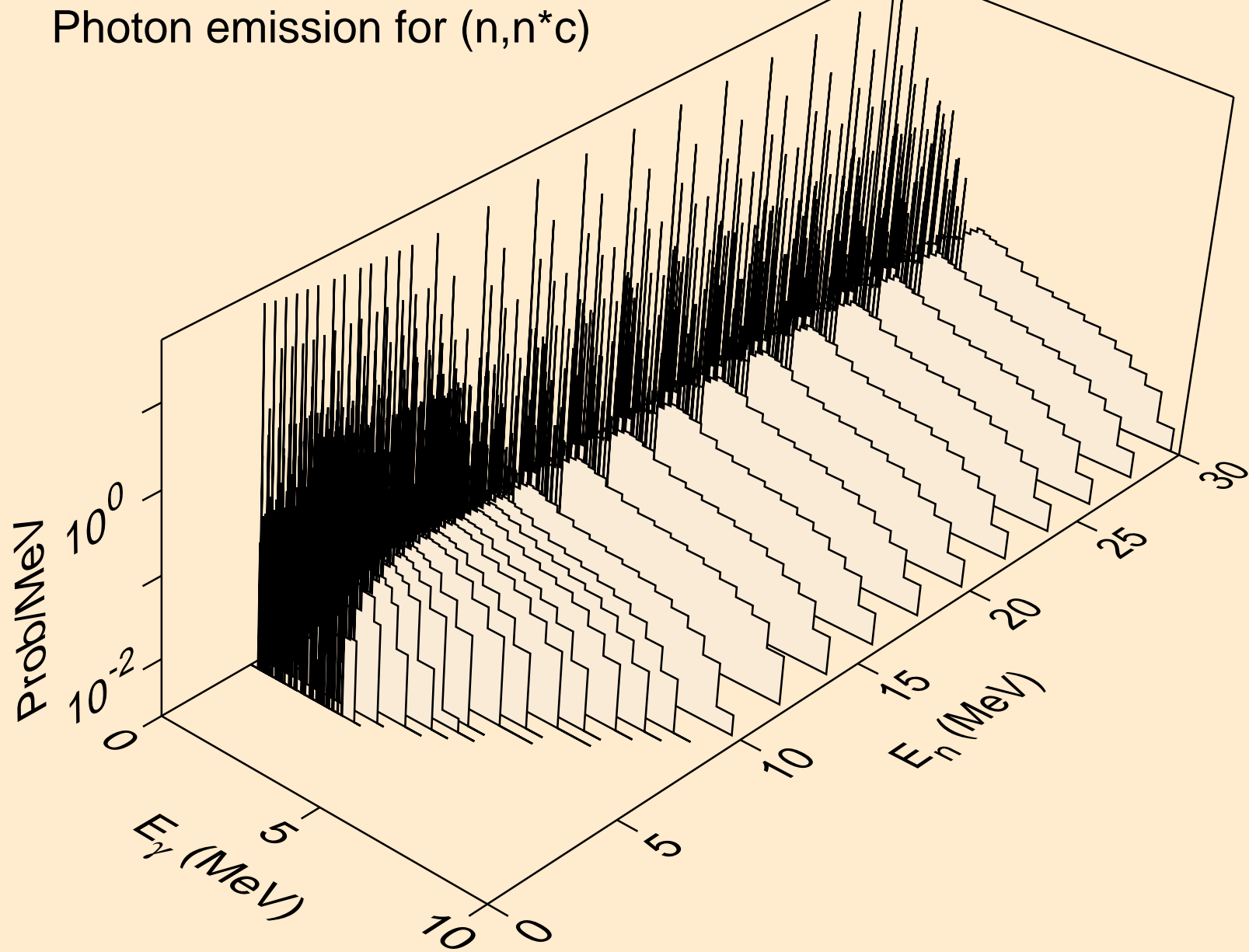

CR049 NEUTRON ACER TENDL-2023 LIBRARY; T=0.K  
Photon emission for (n,gma)

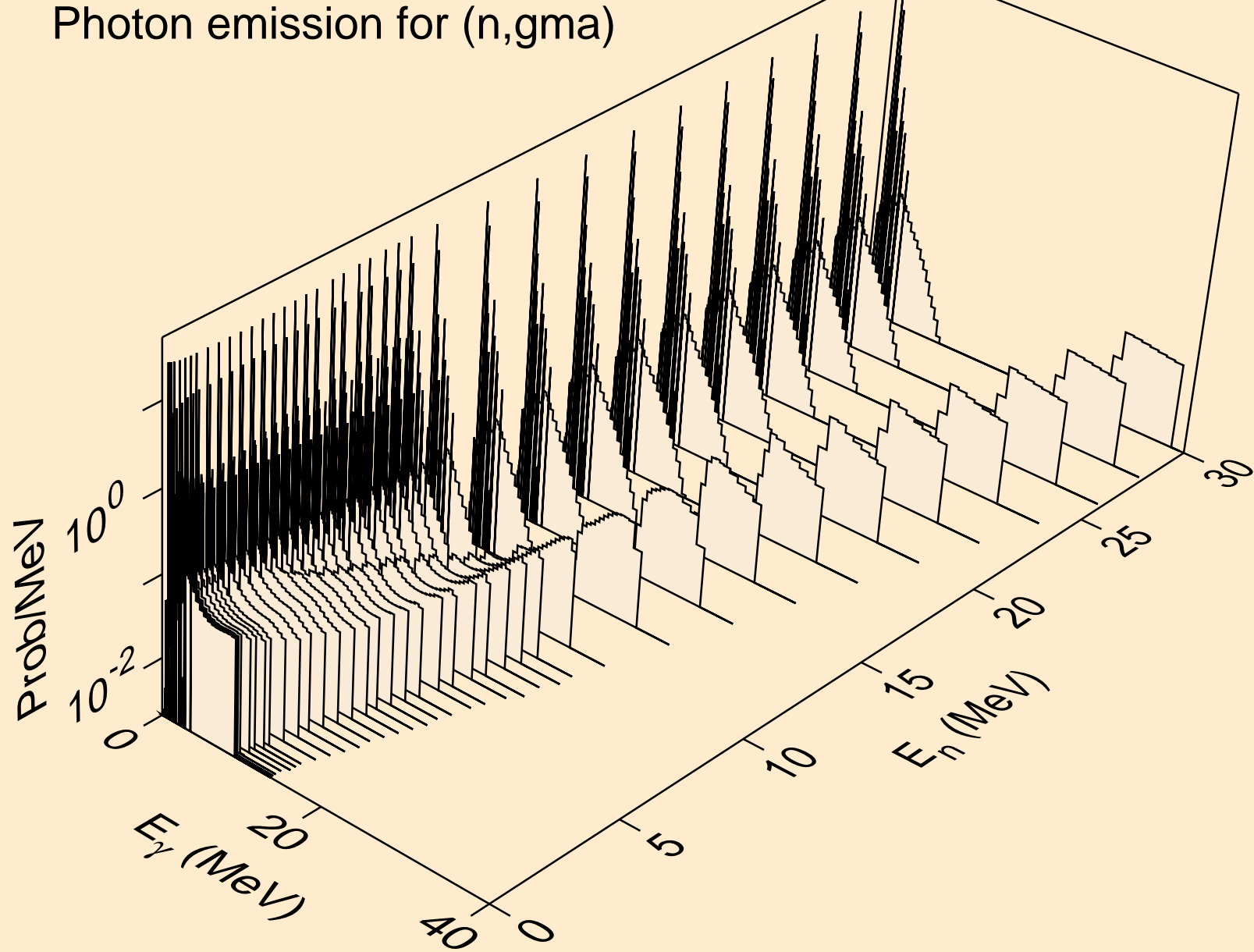

CR049 NEUTRON ACER TENDL-2023 LIBRARY; T=0.K  
Photon emission for (n,p)

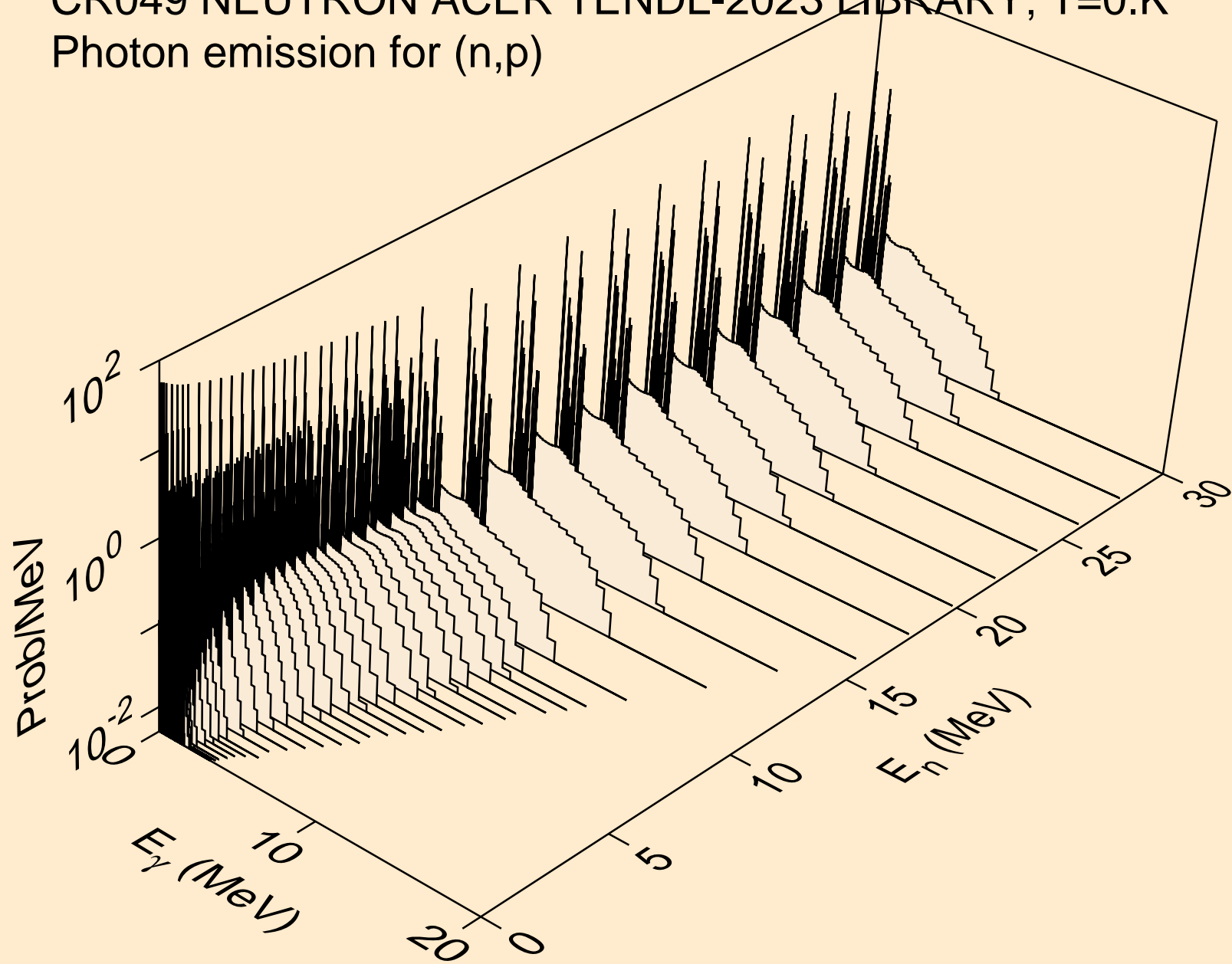

CR049 NEUTRON ACER TENDL-2023 LIBRARY; T=0.K  
Photon emission for (n,d)

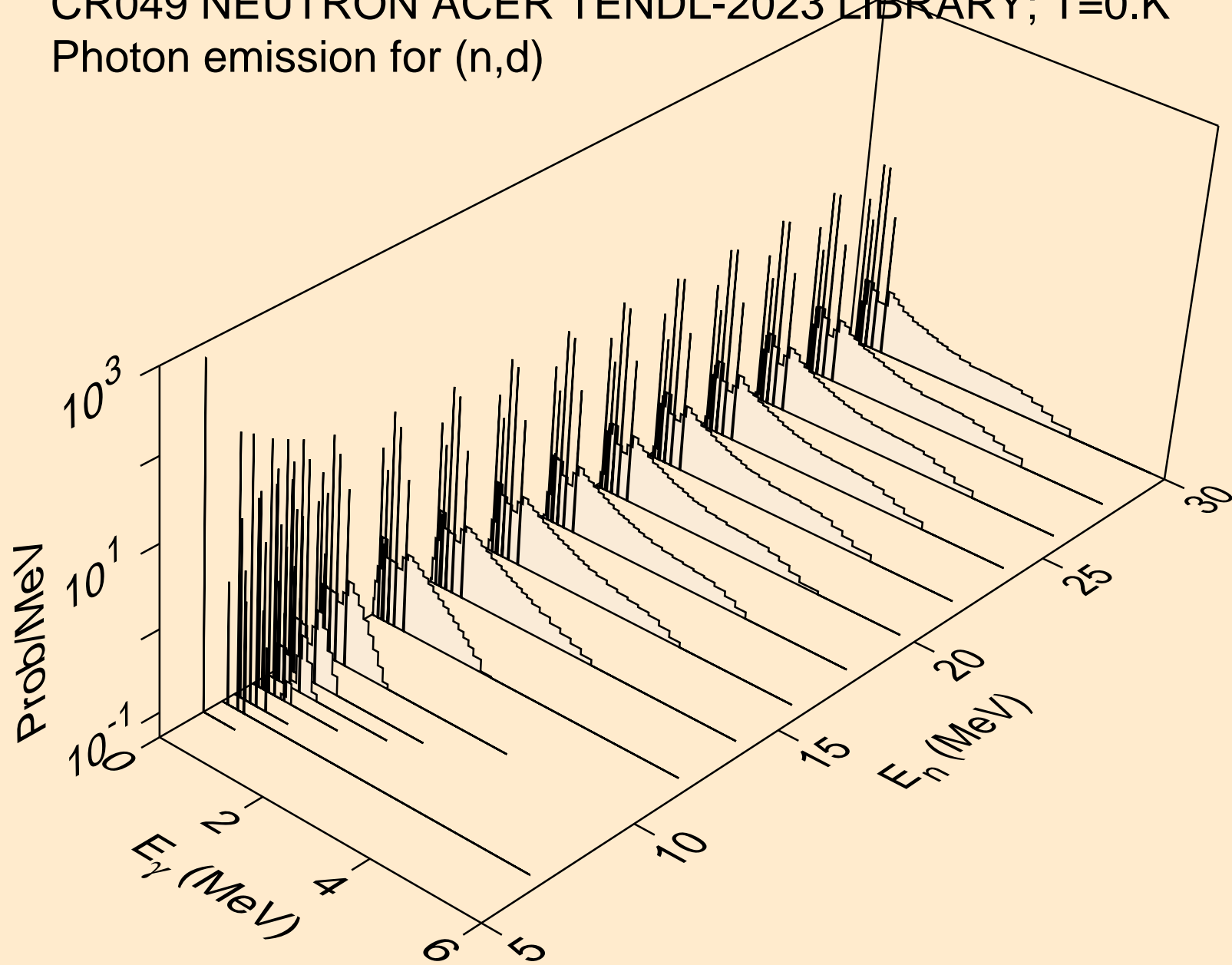

CR049 NEUTRON ACER TENDL-2023 LIBRARY; T=0.K  
Photon emission for (n,t)

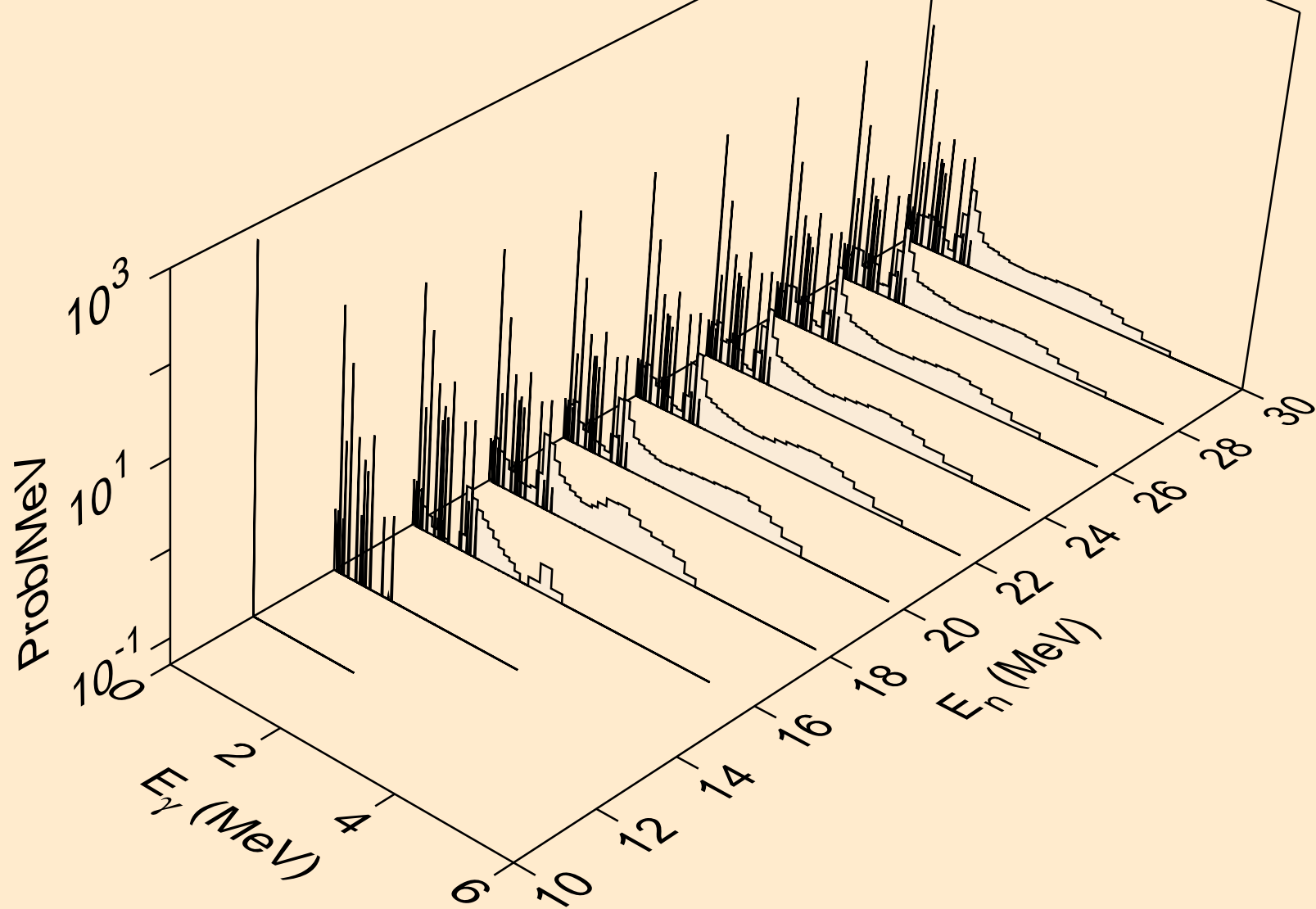



CR049 NEUTRON ACER TENDL-2023 LIBRARY; T=0.K  
Photon emission for (n,he3)

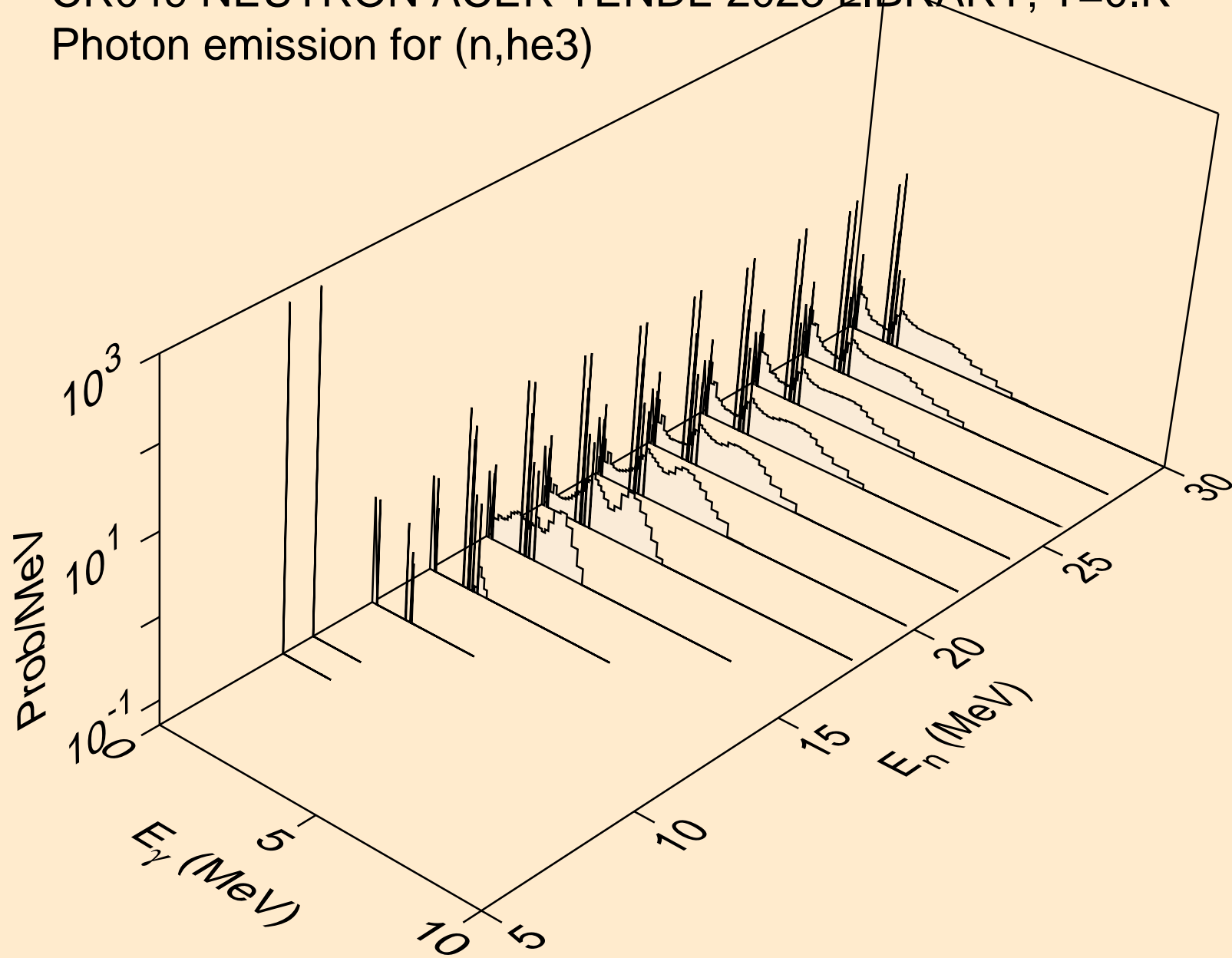

CR049 NEUTRON ACER TENDL-2023 LIBRARY; T=0.K  
Photon emission for (n,a)

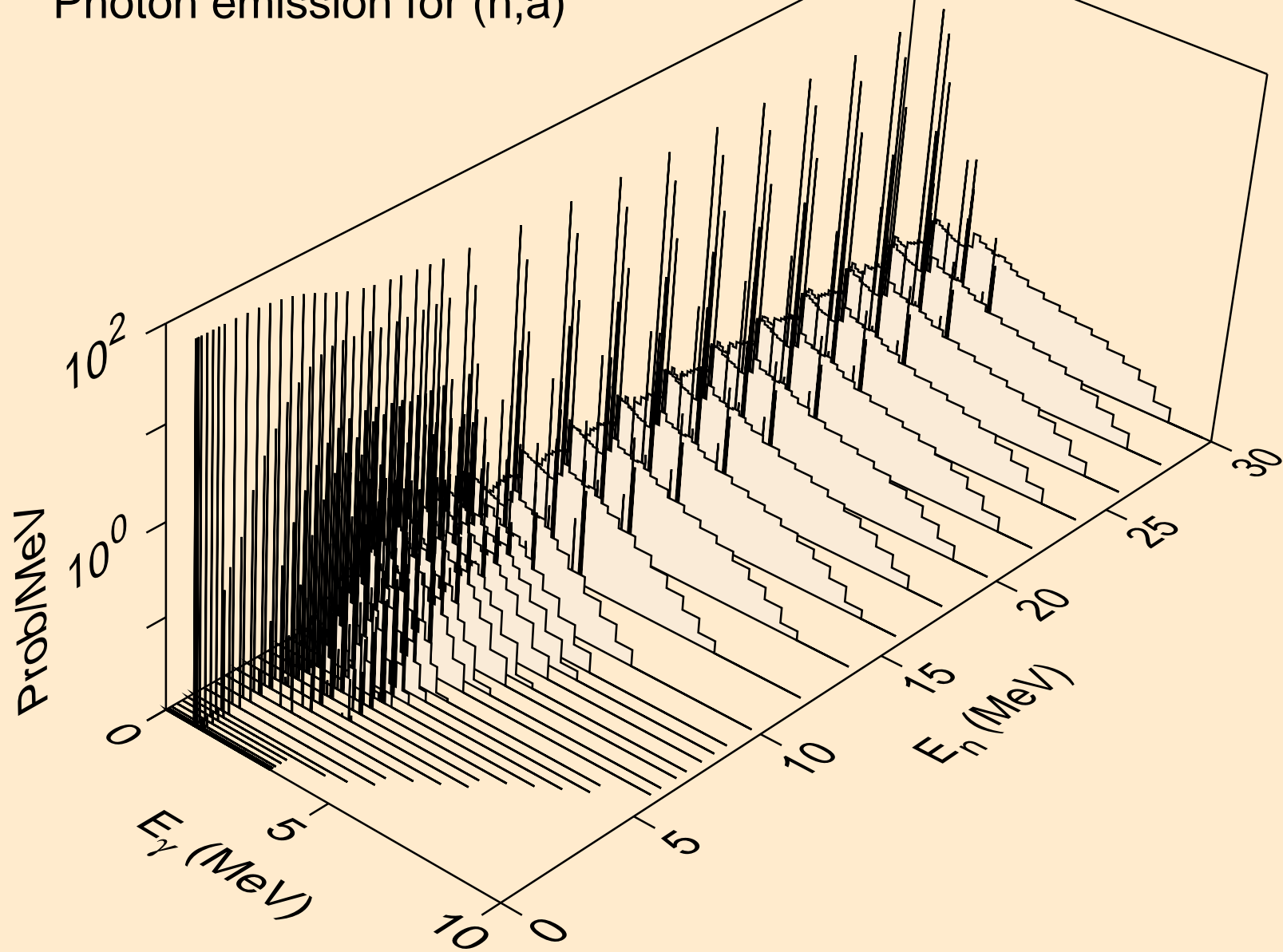

CR049 NEUTRON ACER TENDL-2023 LIBRARY; T=0.K  
Photon emission for (n,2a)

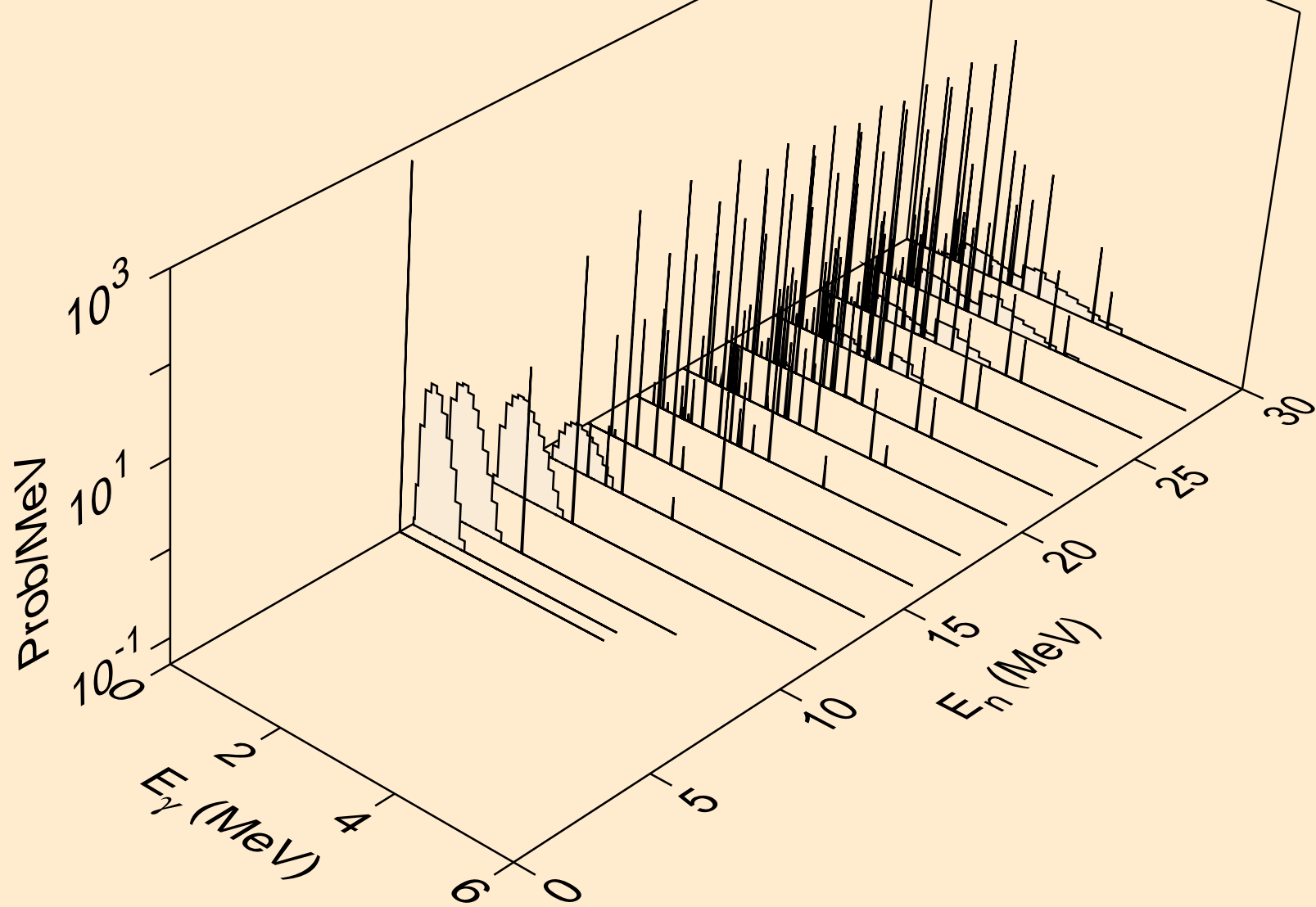

CR049 NEUTRON ACER TENDL-2023 LIBRARY; T=0.K  
Photon emission for (n,3a)

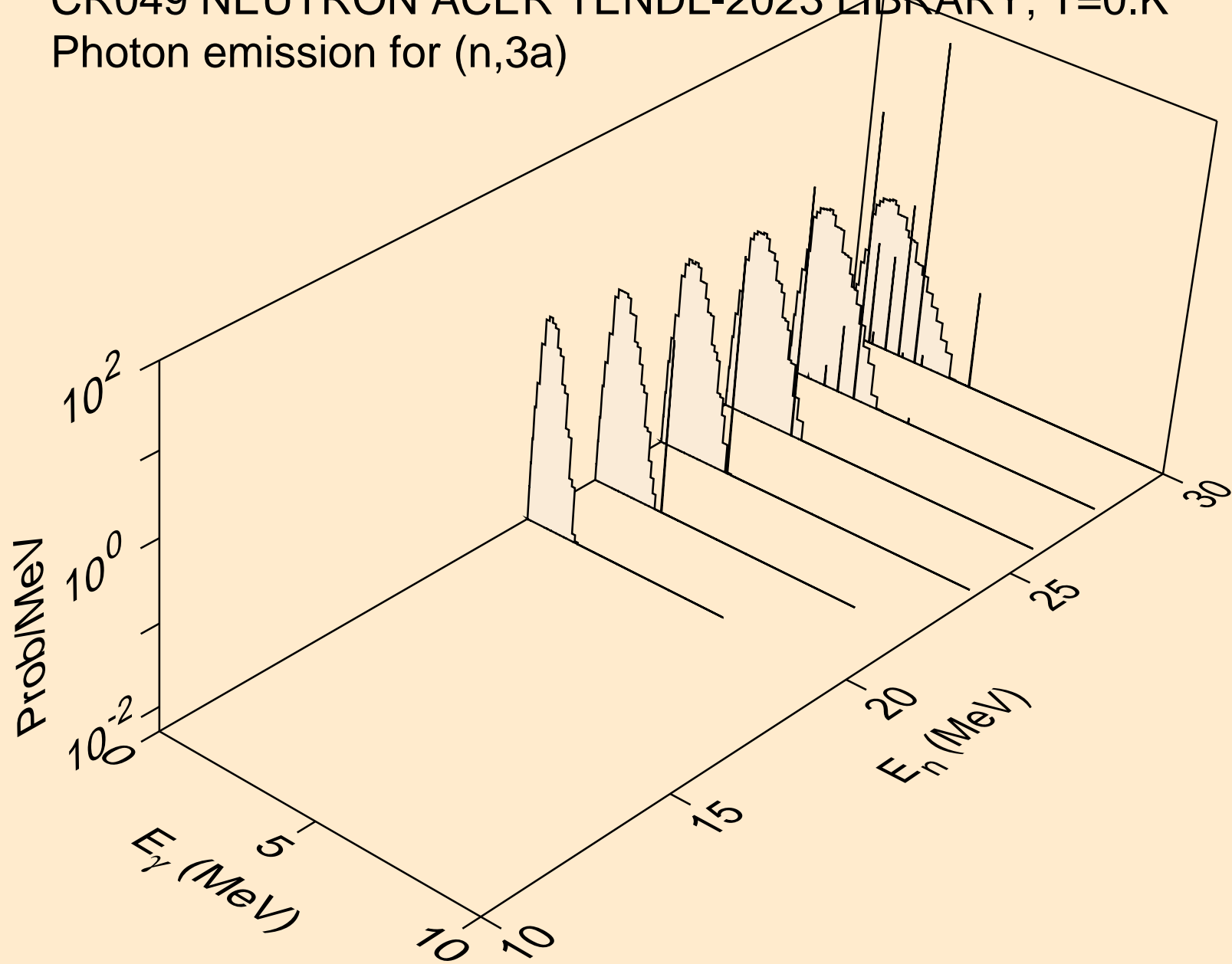

CR049 NEUTRON ACER TENDL-2023 LIBRARY; T=0.K  
Photon emission for (n,2p)

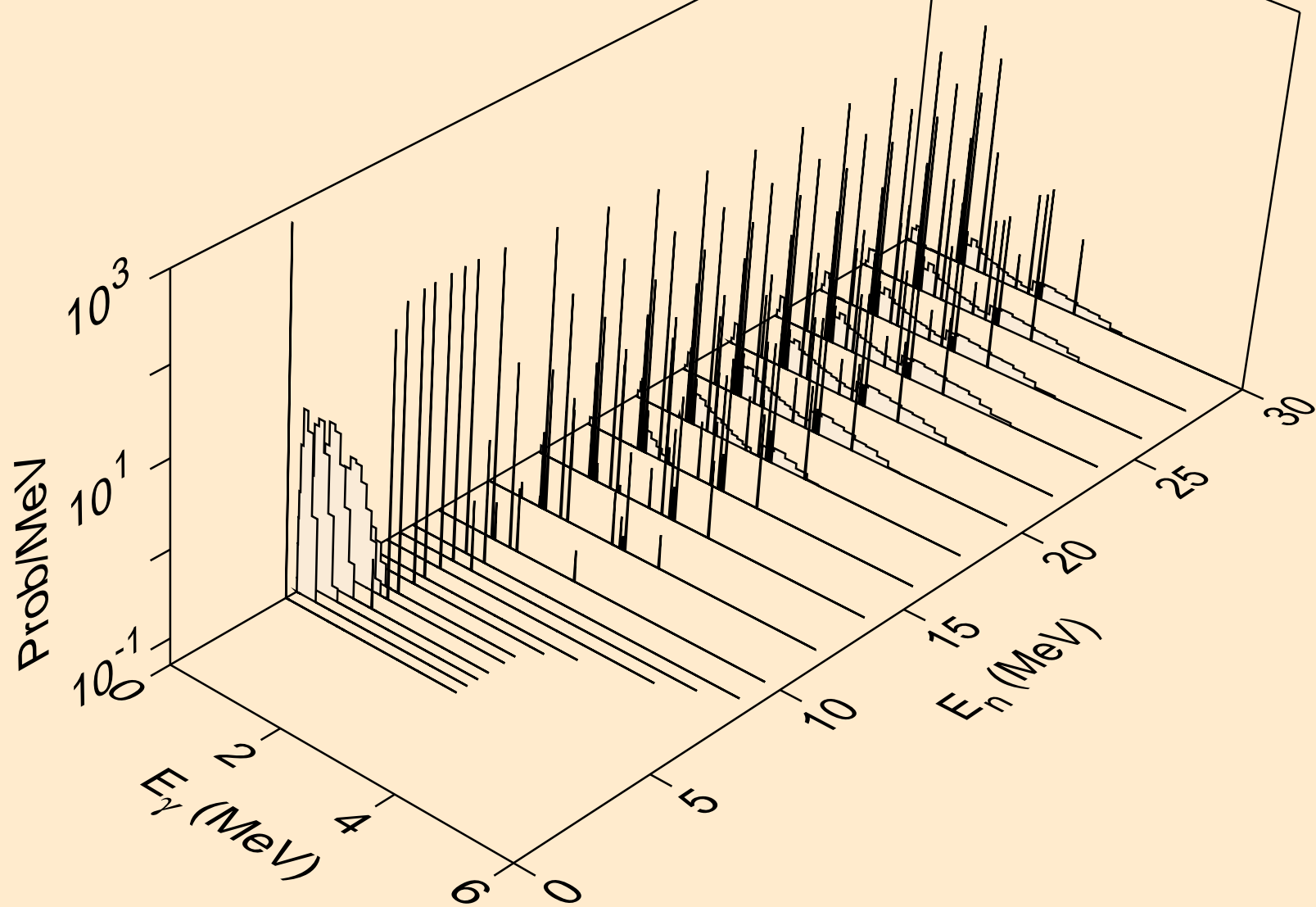

CR049 NEUTRON ACER TENDL-2023 LIBRARY; T=0.K  
Photon emission for (n,p $\alpha$ )

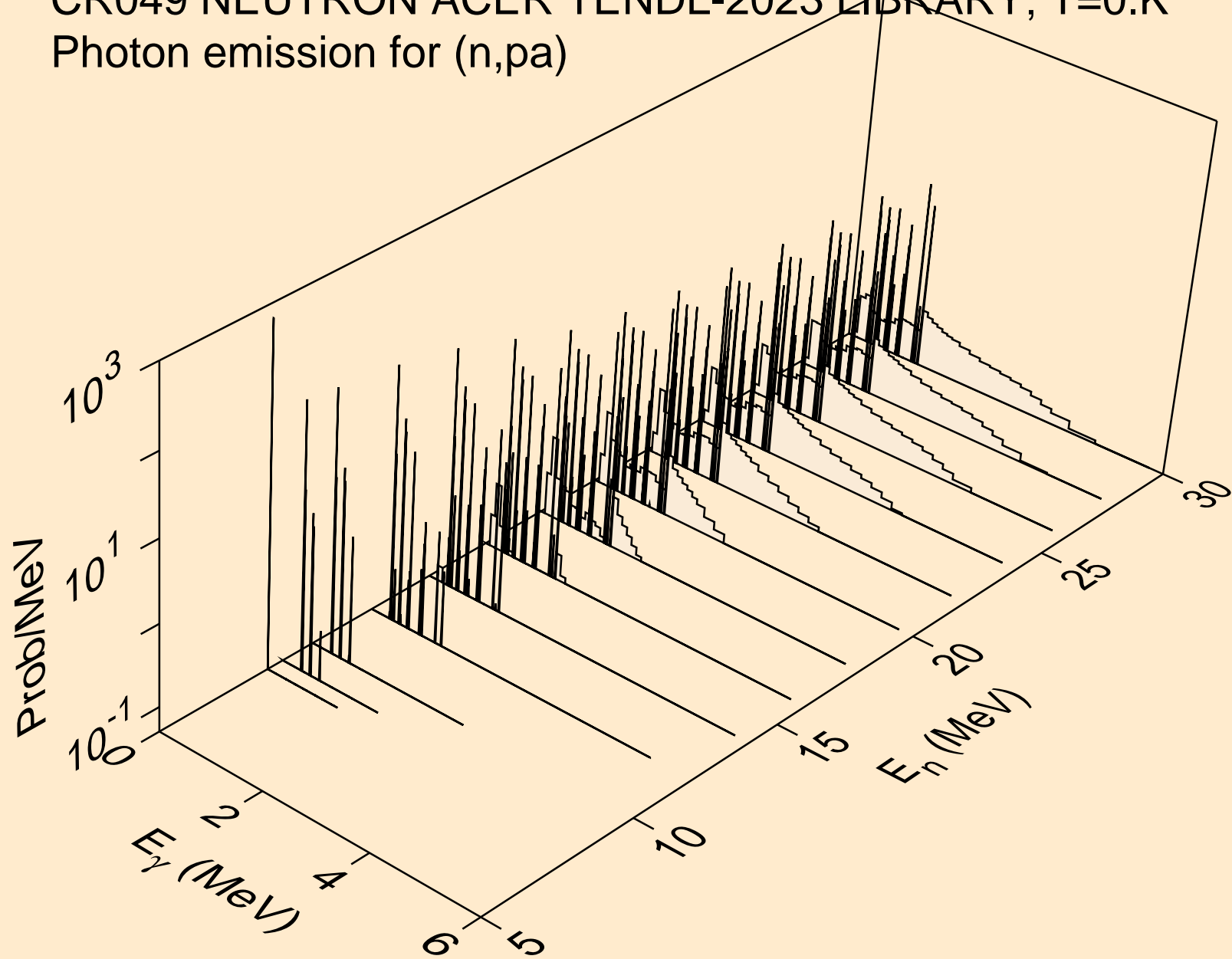

CR049 NEUTRON ACER TENDL-2023 LIBRARY; T=0.K  
Photon emission for (n,pd)

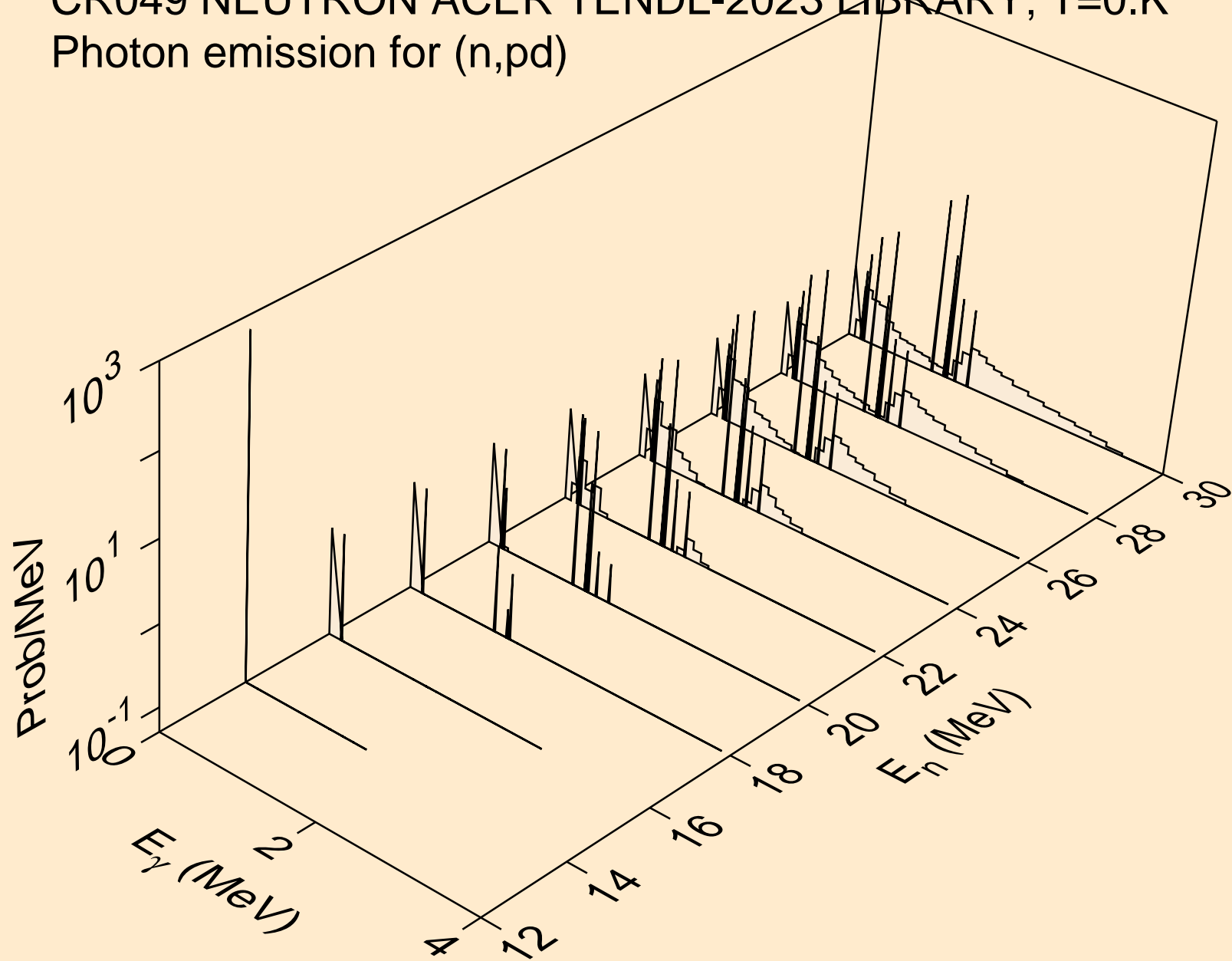

CR049 NEUTRON ACER TENDL-2023 LIBRARY; T=0.K  
Photon emission for (n,pt)

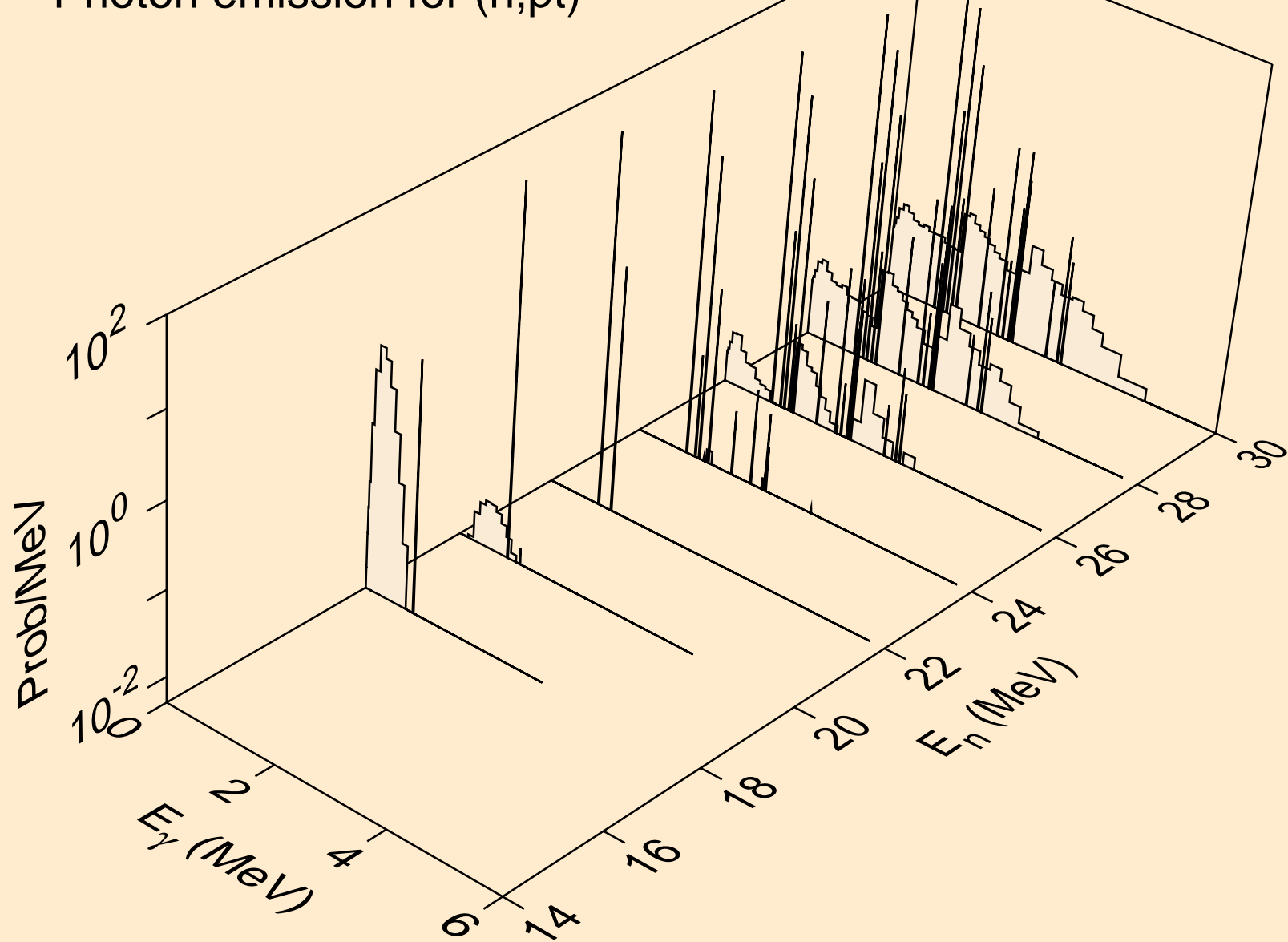



CR049 NEUTRON ACER TENDL-2023 LIBRARY; T=0.K  
Photon emission for (n,da)

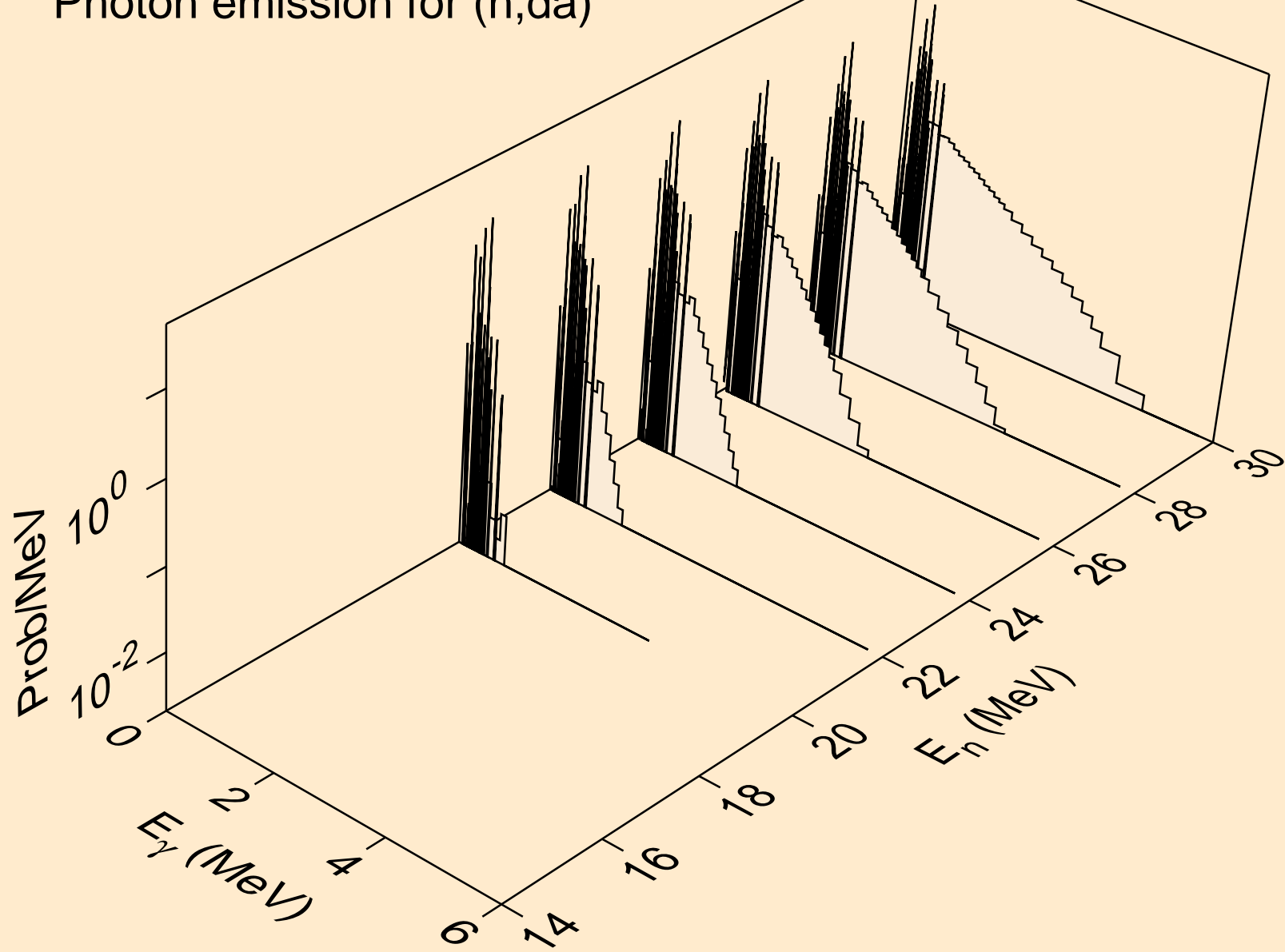

CR049 NEUTRON ACER TENDL-2023 LIBRARY; T=0.K  
thermal capture photon spectrum

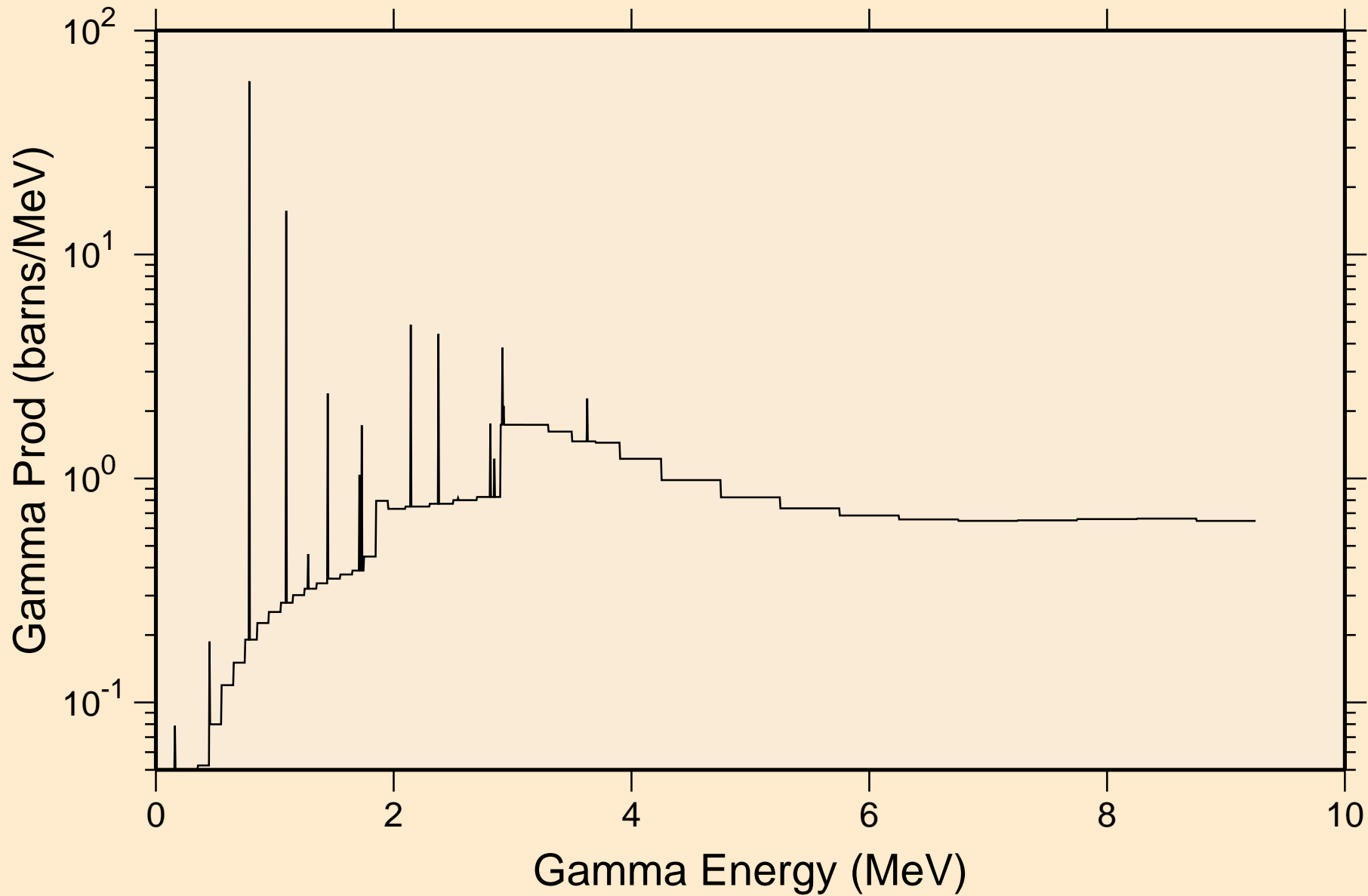

CR049 NEUTRON ACER TENDL-2023 LIBRARY; T=0.K  
14 MeV photon spectrum

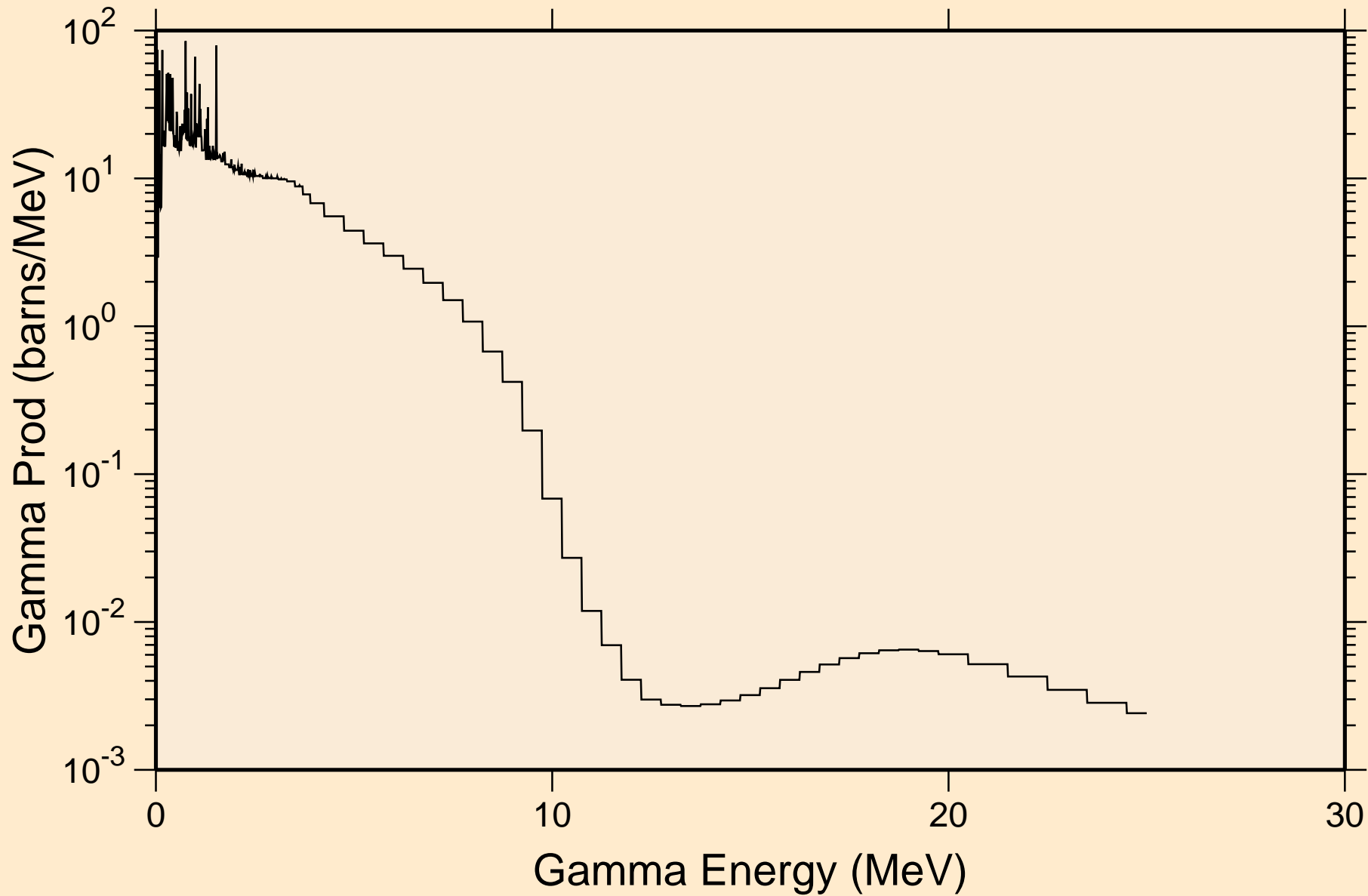

# CR049 NEUTRON ACER TENDL-2023 LIBRARY; T=0.K

## Particle heating contributions

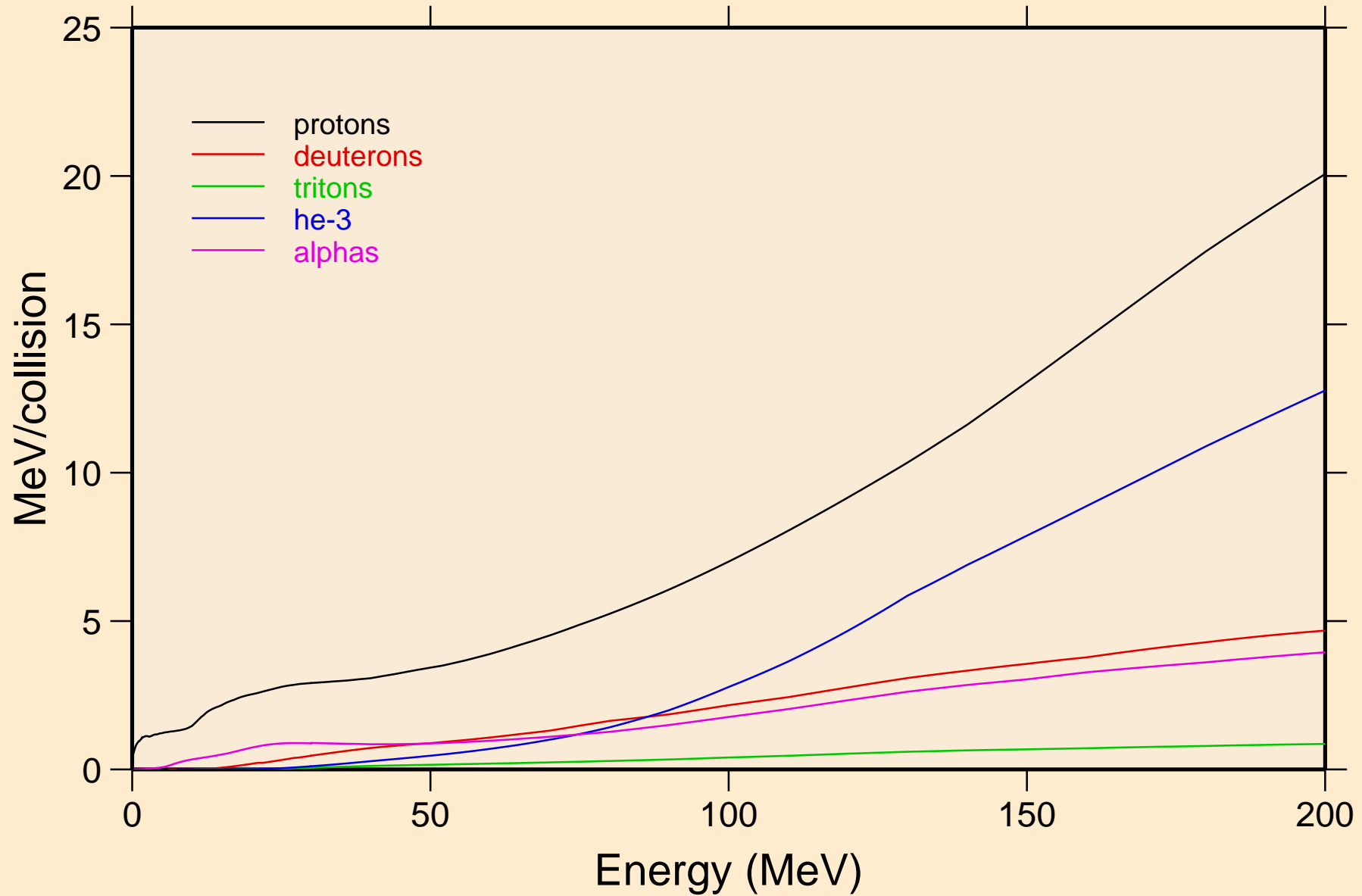

# CR049 NEUTRON ACER TENDL-2023 LIBRARY; T=0.K

## Recoil Heating

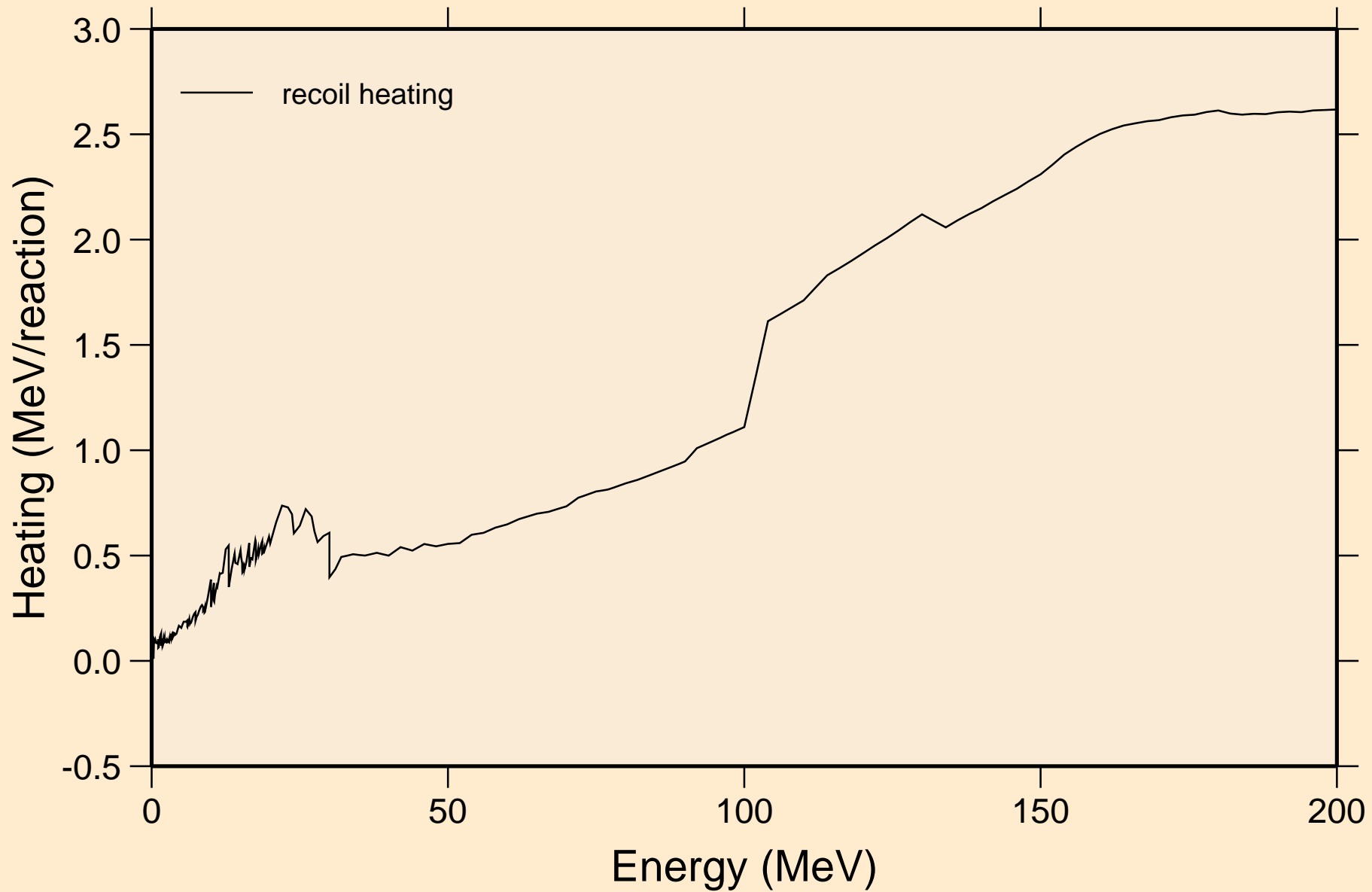

# CR049 NEUTRON ACER TENDL-2023 LIBRARY; T=0.K

## Particle production cross sections

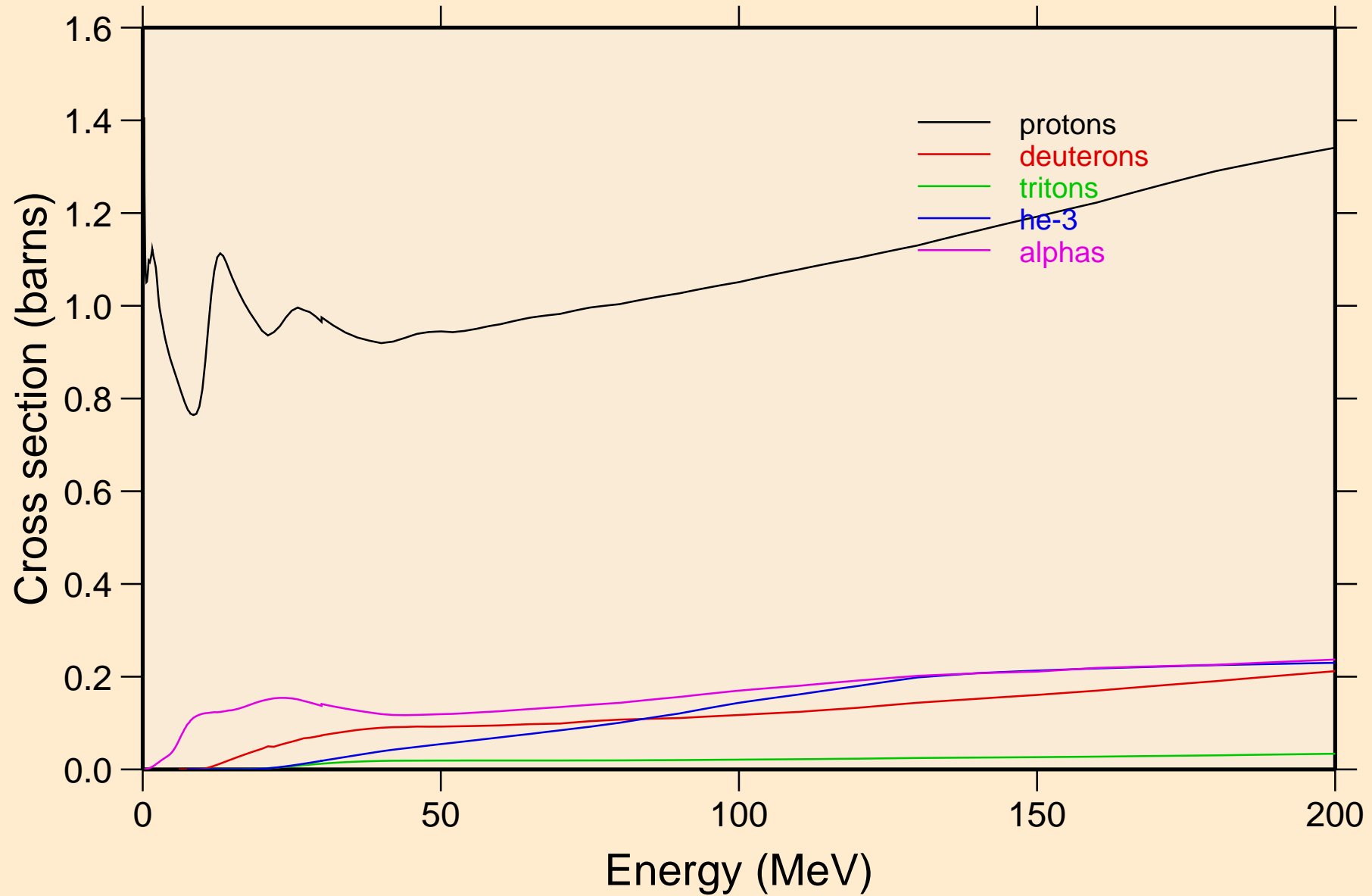

CR049 NEUTRON ACER TENDL-2023 LIBRARY; T=0.K  
protons from (n,x)

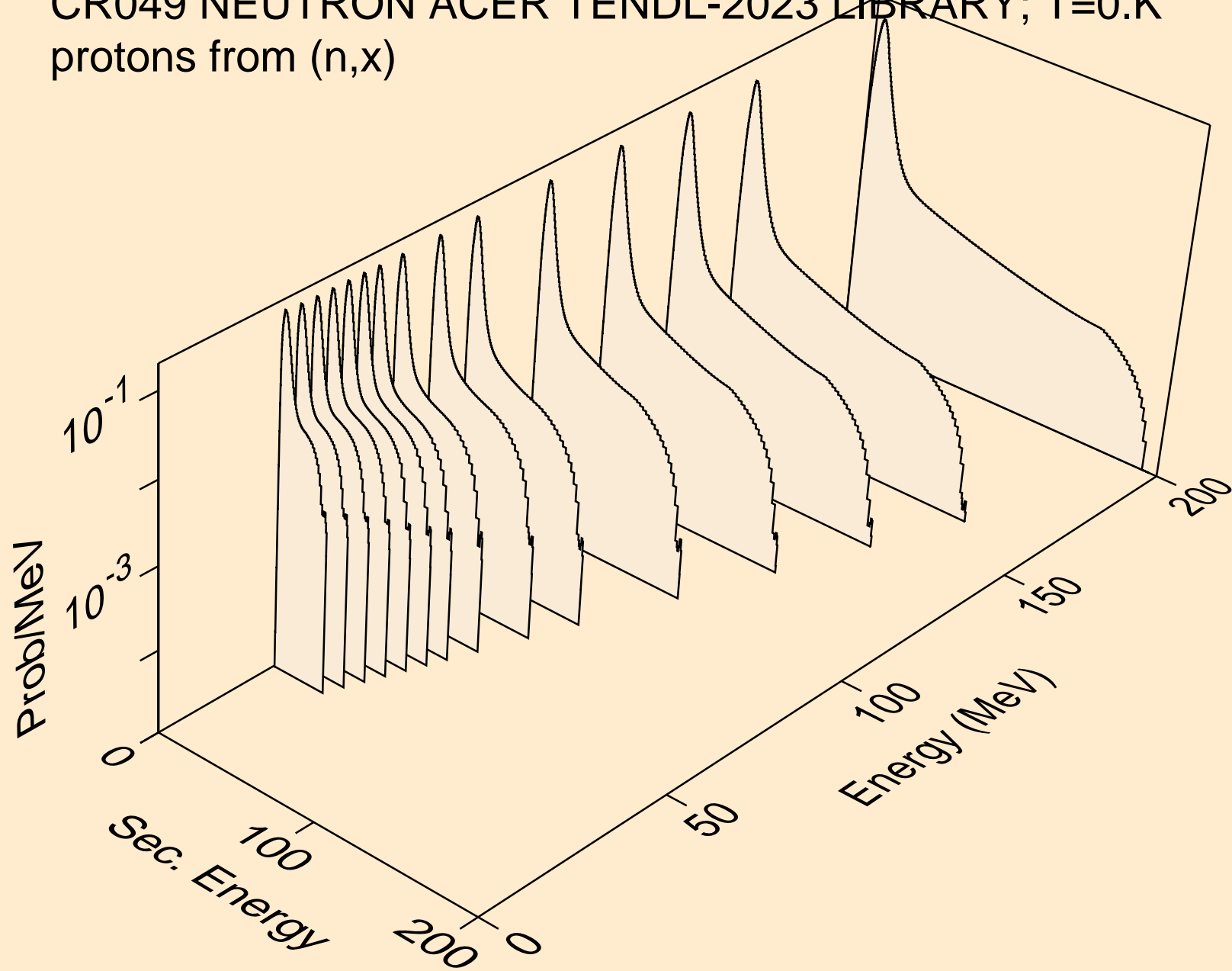

CR049 NEUTRON ACER TENDL-2023 LIBRARY; T=0.K  
protons from (n,n\*)p

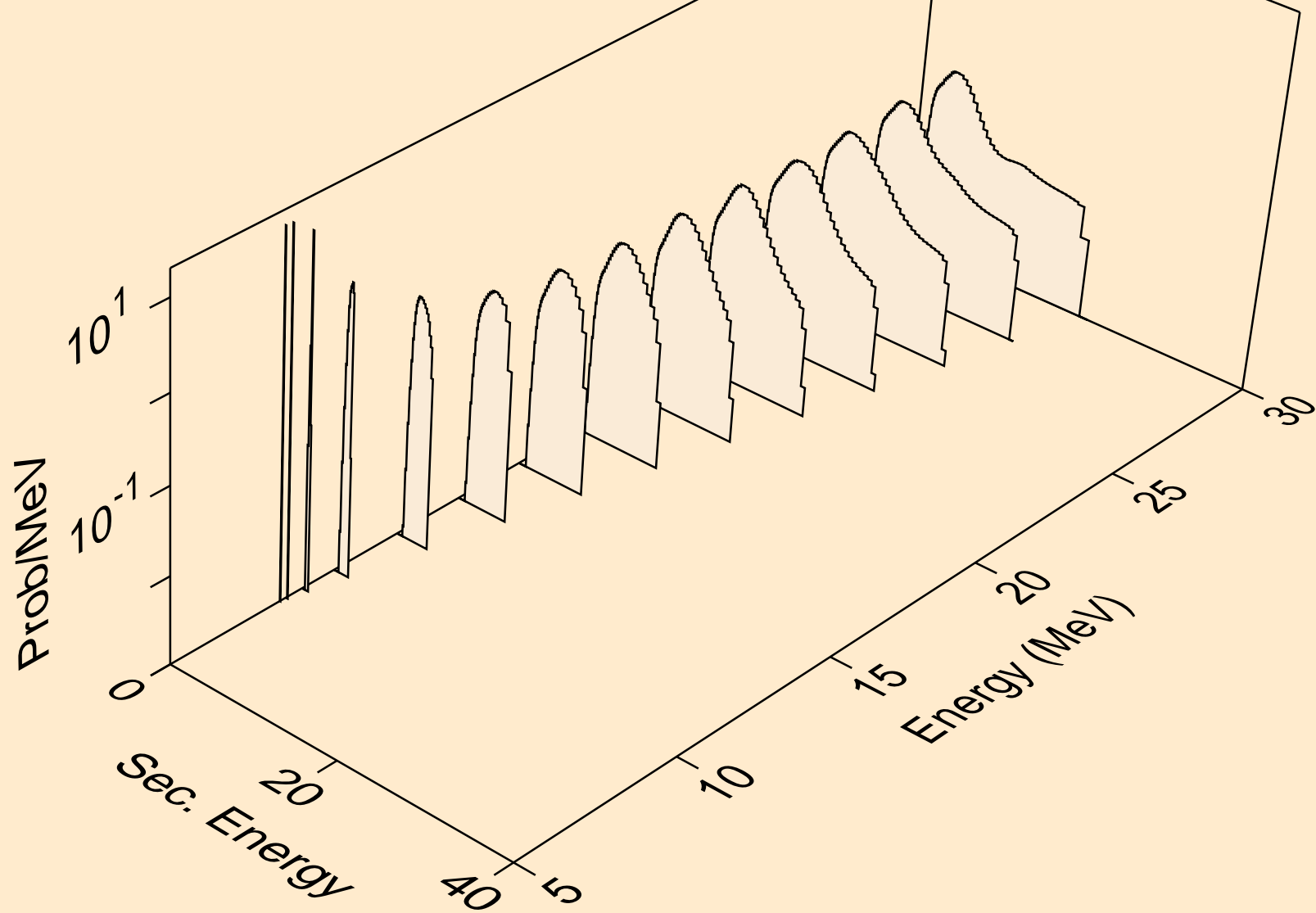



CR049 NEUTRON ACER TENDL-2023 LIBRARY; T=0.K  
protons from (n,2np)

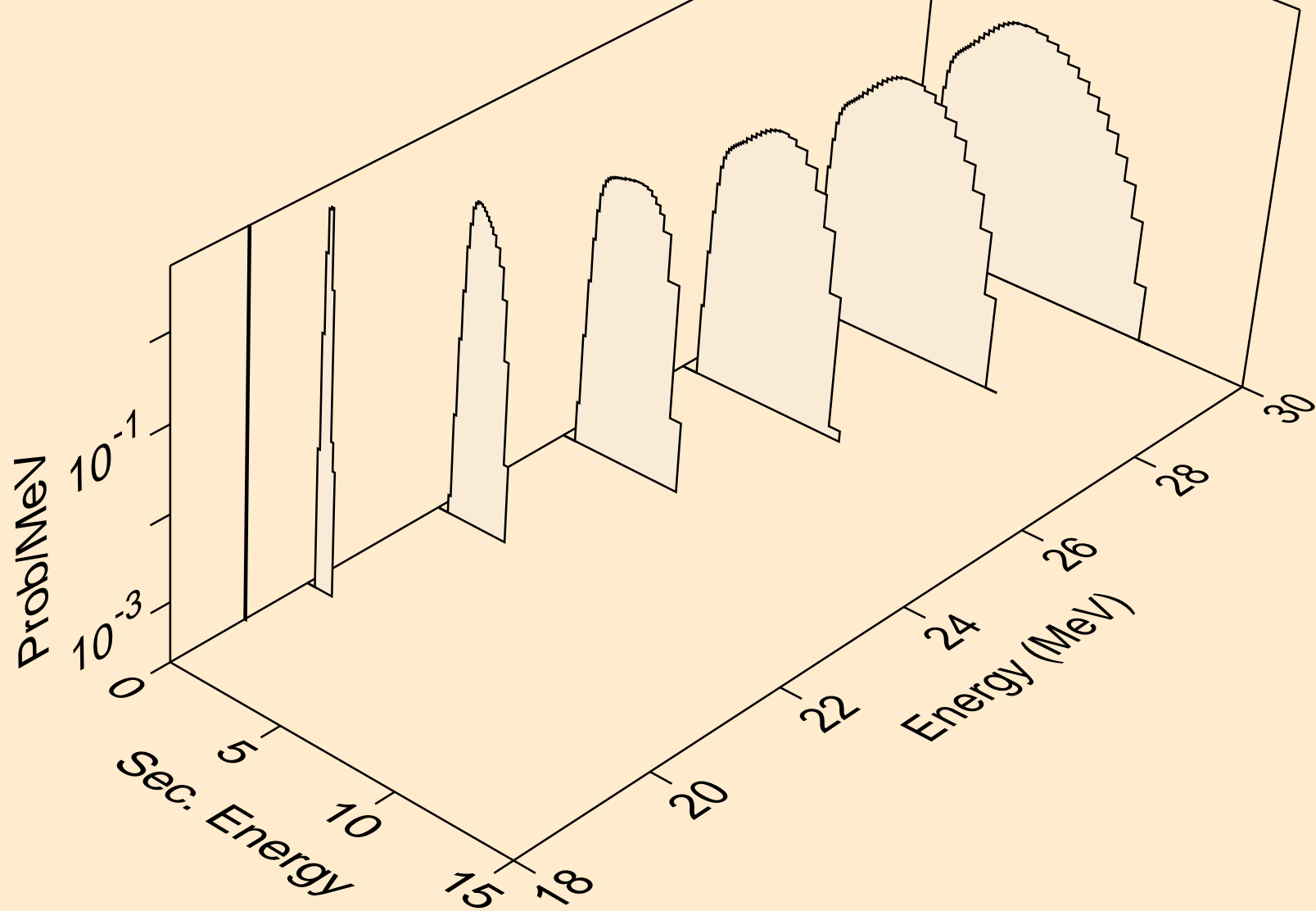

CR049 NEUTRON ACER TENDL-2023 LIBRARY; T=0.K  
protons from (n,n2p)

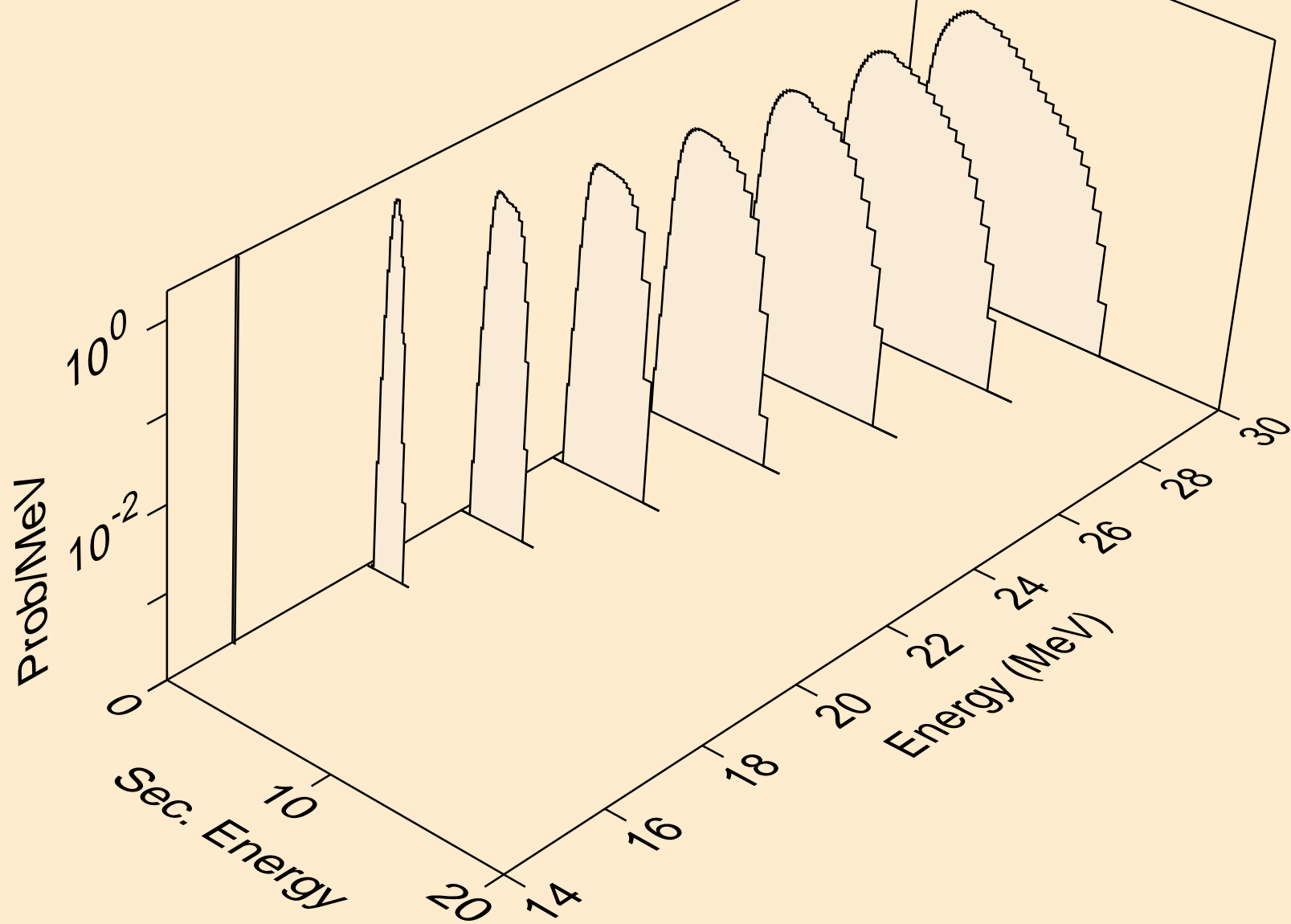

CR049 NEUTRON ACER TENDL-2023 LIBRARY; T=0.K  
protons from (n,npa)

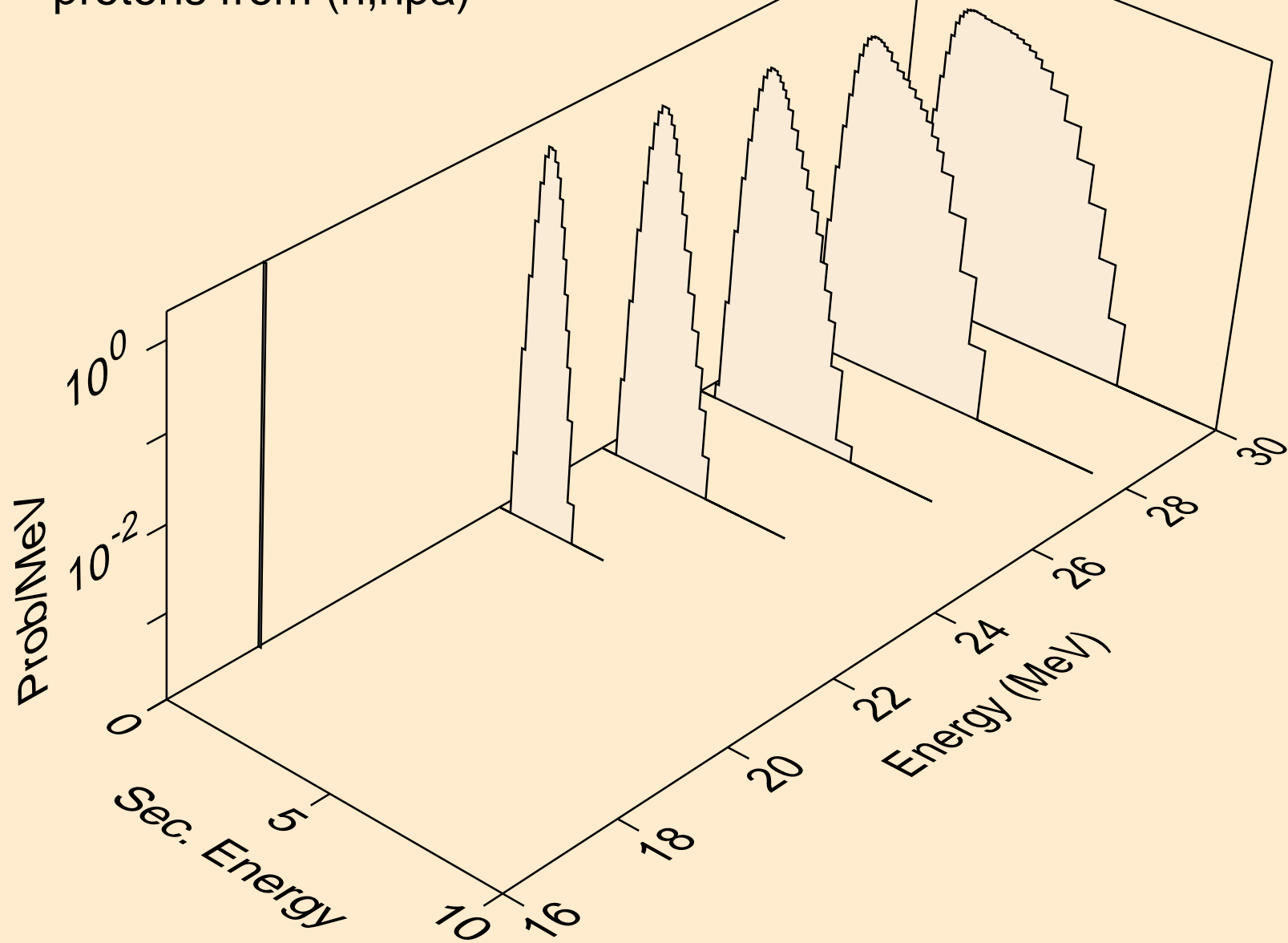

CR049 NEUTRON ACER TENDL-2023 LIBRARY; T=0.K  
protons from (n,p)

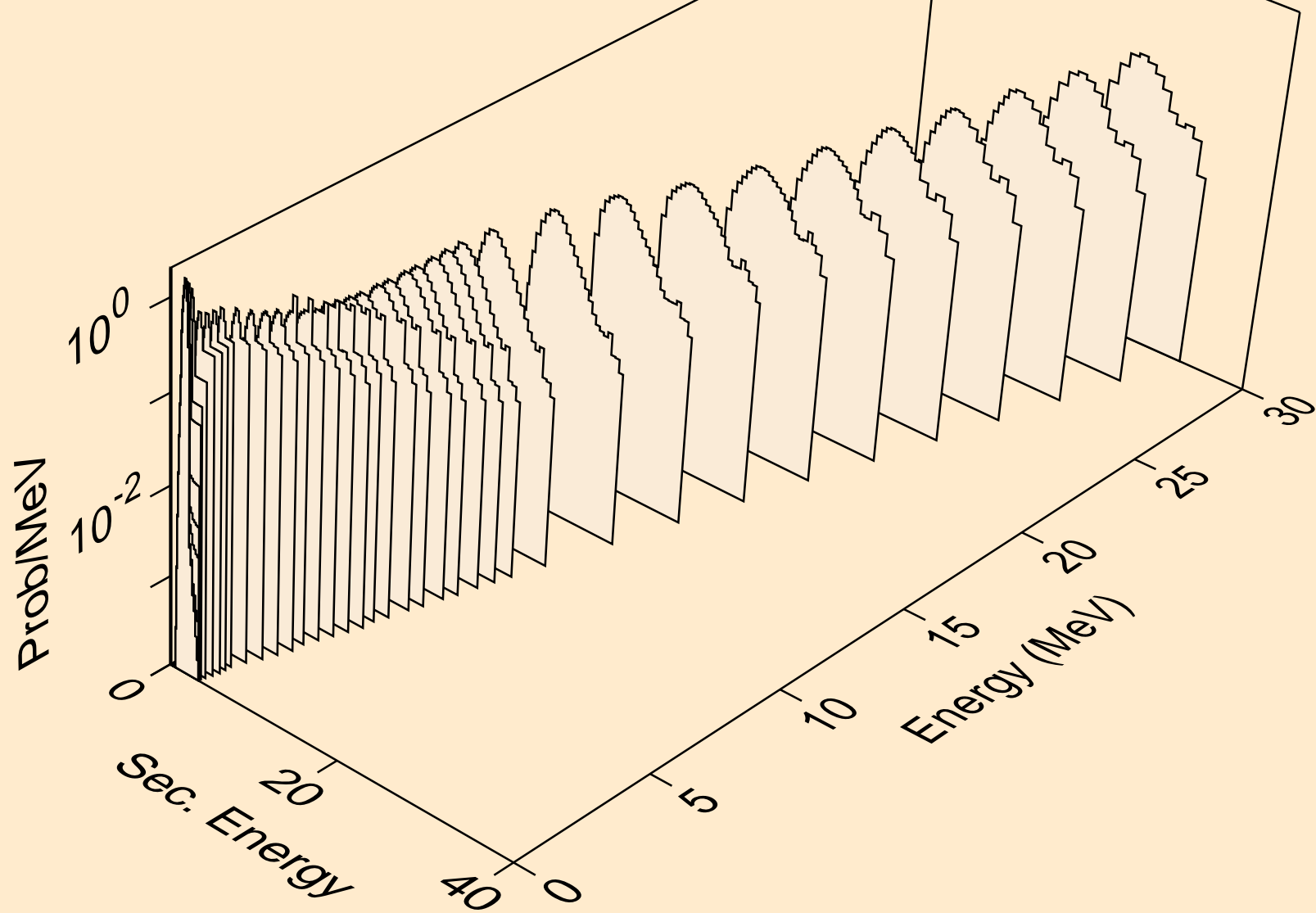

CR049 NEUTRON ACER TENDL-2023 LIBRARY; T=0.K  
protons from (n,2p)

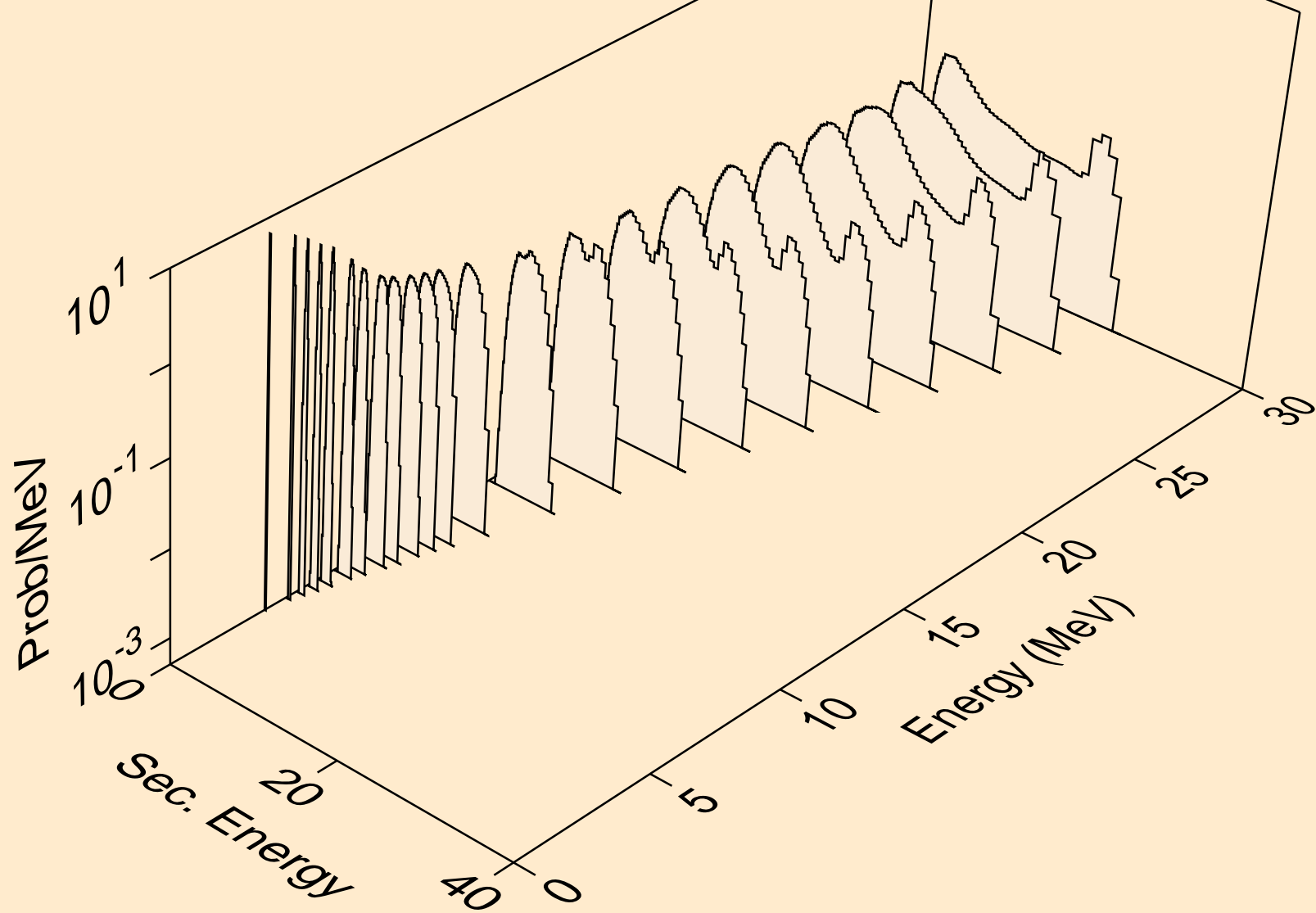

CR049 NEUTRON ACER TENDL-2023 LIBRARY; T=0.K  
protons from (n,p)

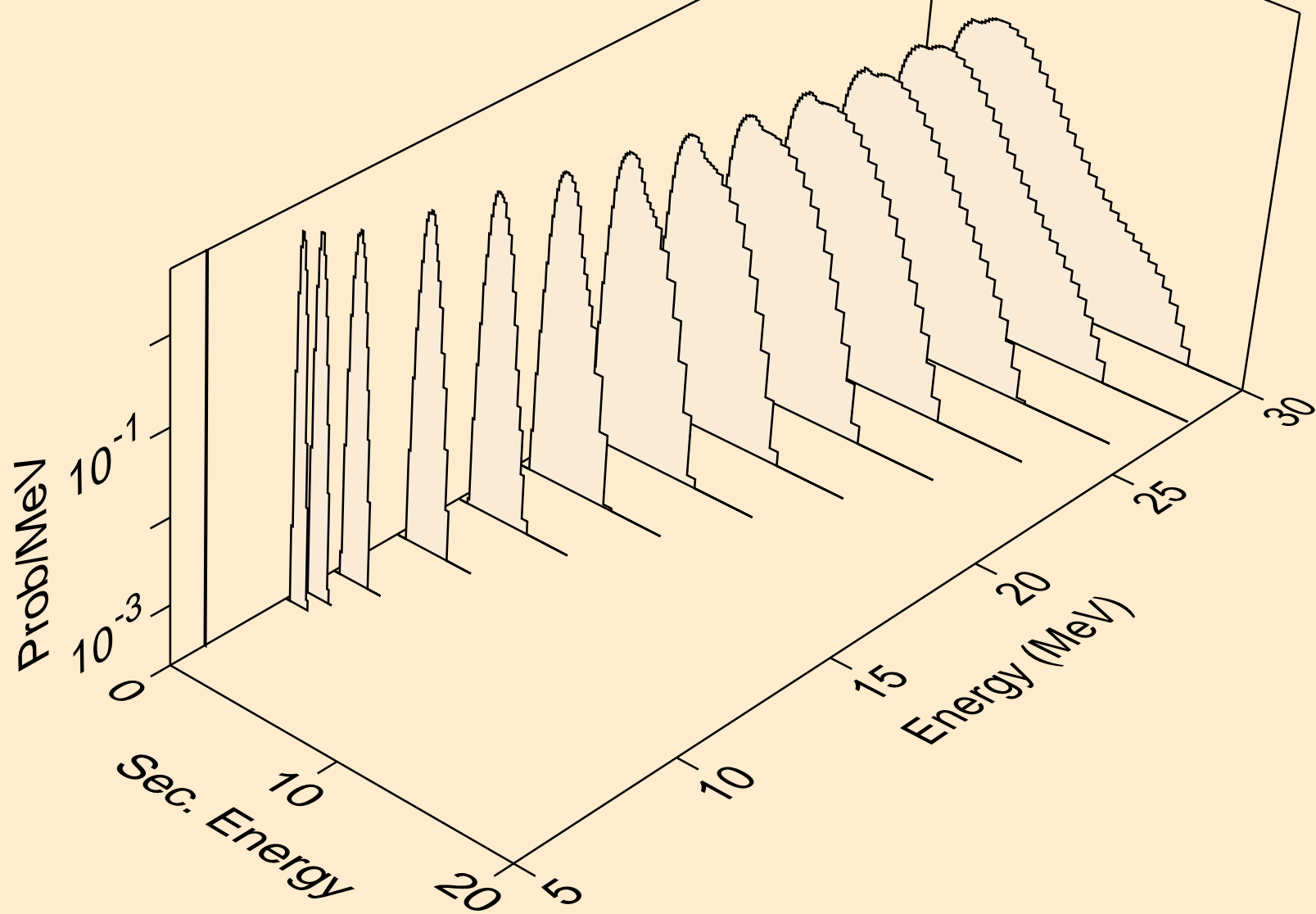

CR049 NEUTRON ACER TENDL-2023 LIBRARY; T=0.K  
protons from (n,pd)

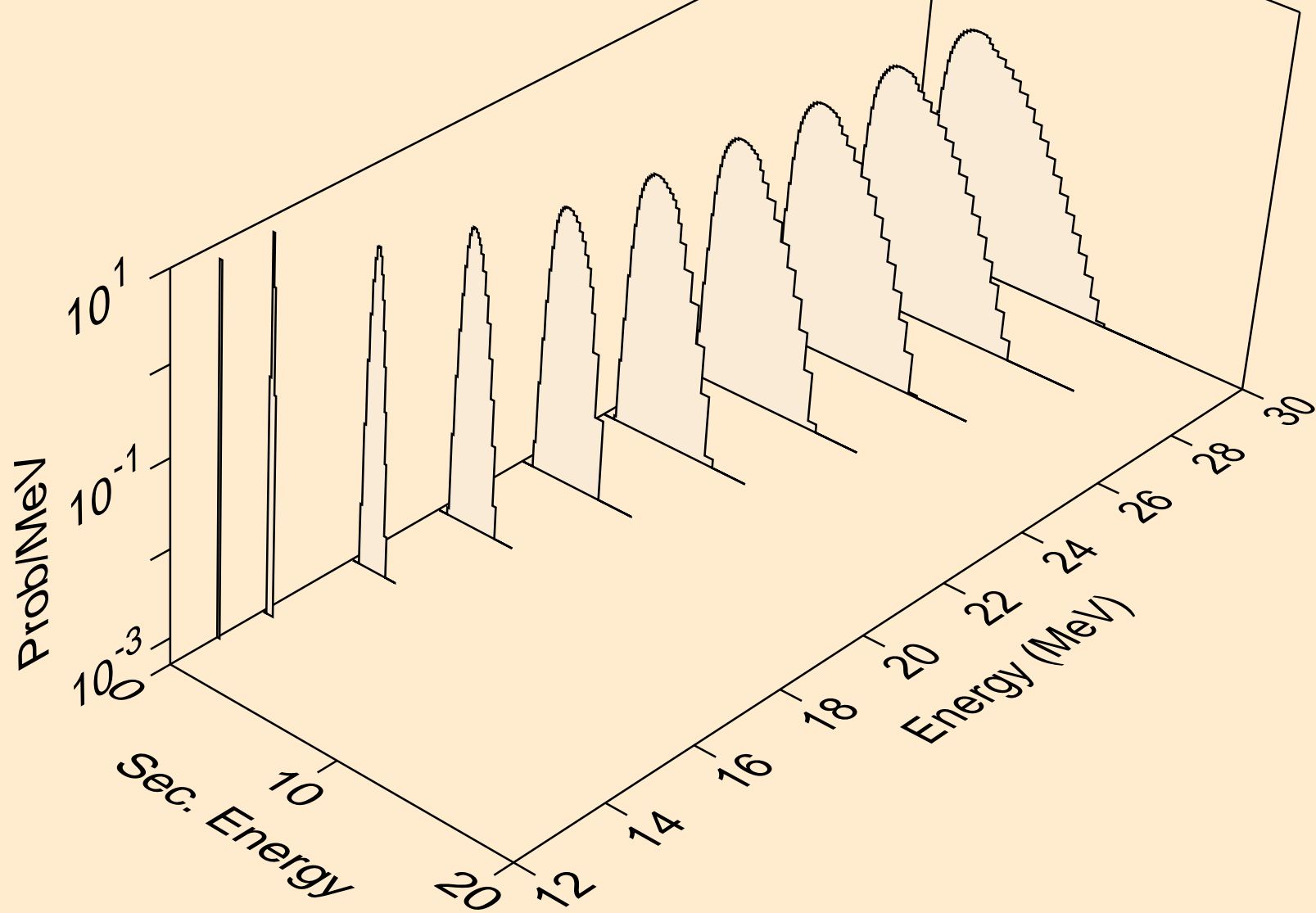

CR049 NEUTRON ACER TENDL-2023 LIBRARY; T=0.K  
protons from (n,pt)

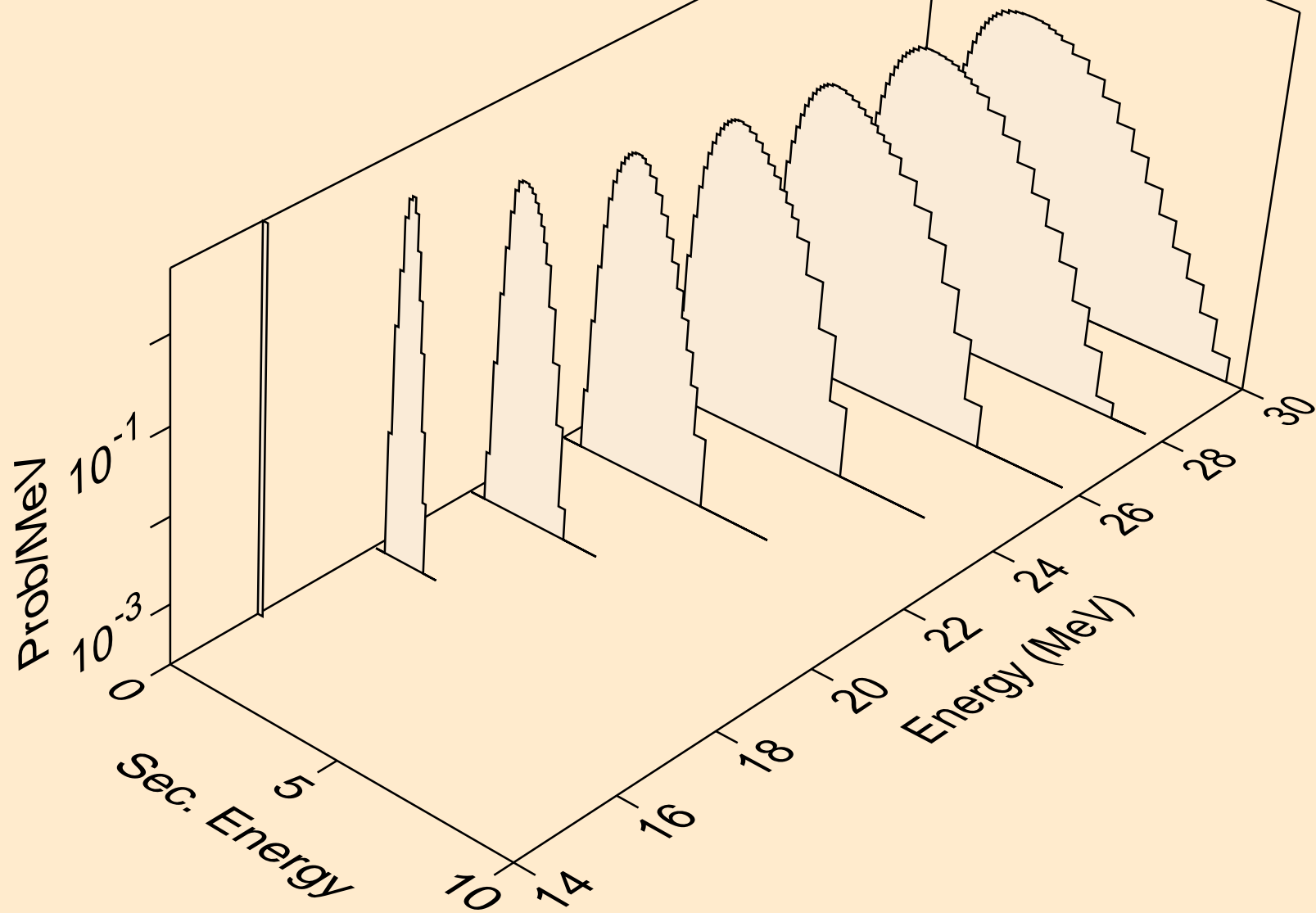



CR049 NEUTRON ACER TENDL-2023 LIBRARY; T=0.K  
deuterons from (n,x)

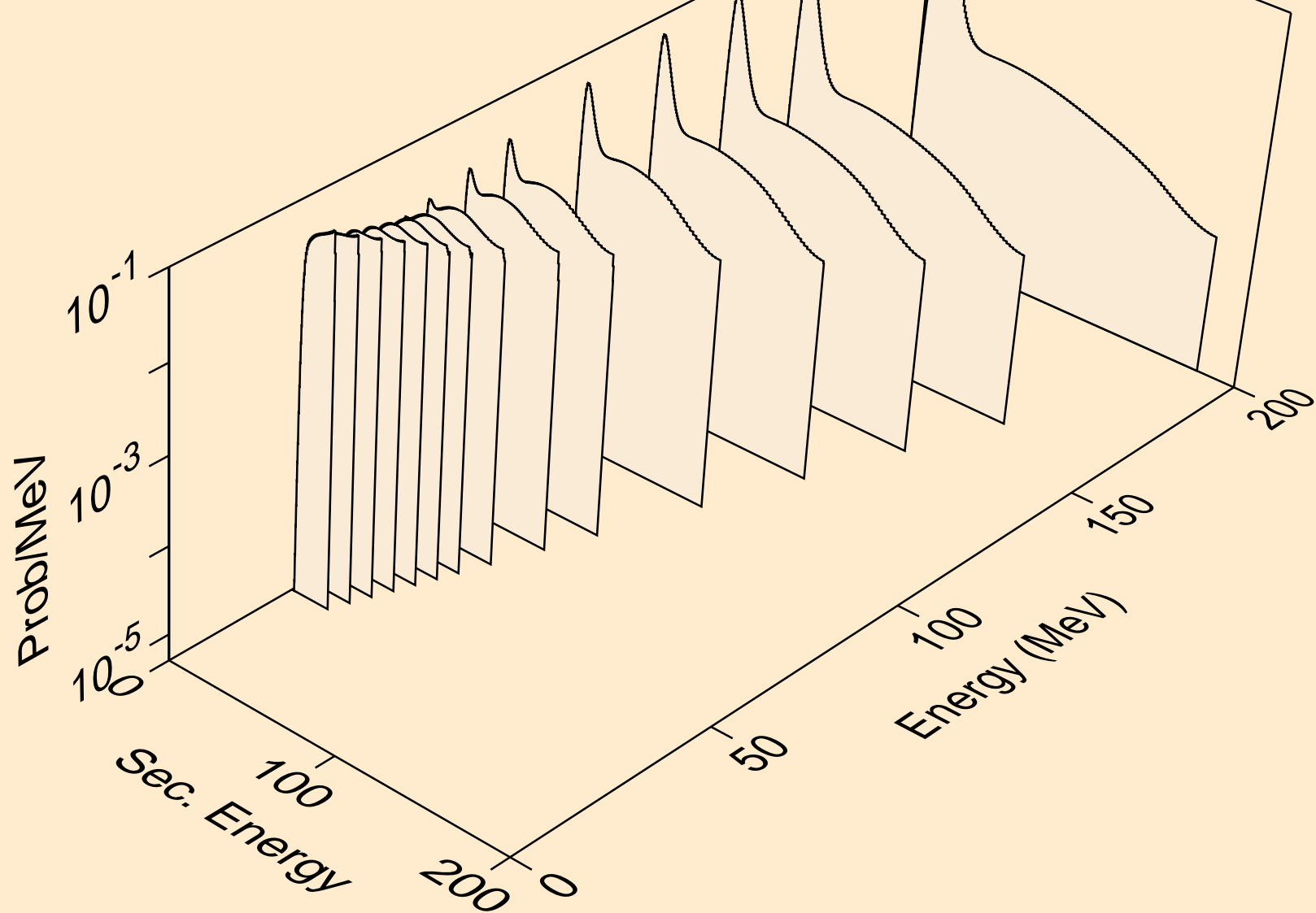

CR049 NEUTRON ACER TENDL-2023 LIBRARY; T=0.K  
deuterons from (n,n\*)d

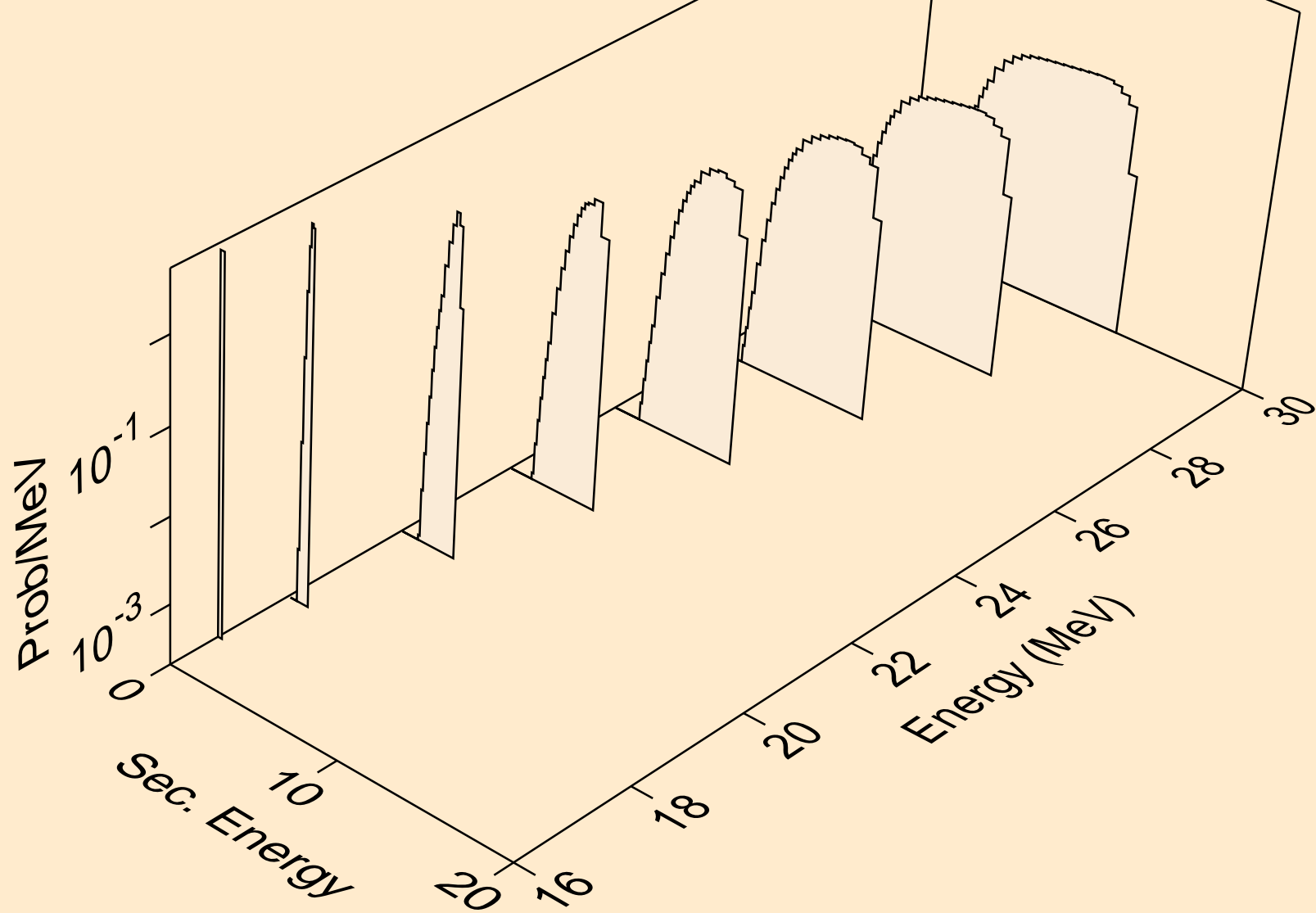

CR049 NEUTRON ACER TENDL-2023 LIBRARY; T=0.K  
deuterons from (n,d)

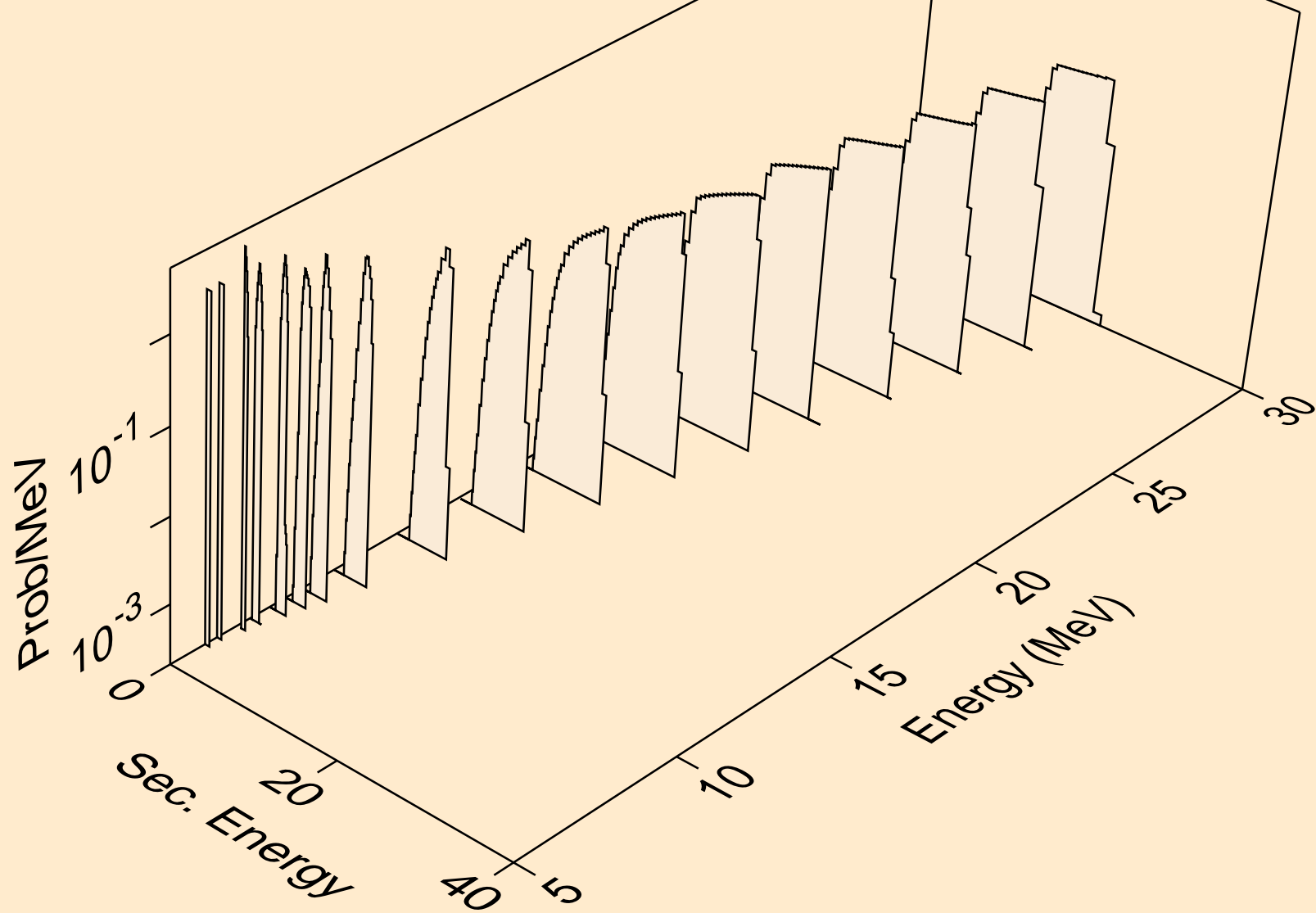

CR049 NEUTRON ACER TENDL-2023 LIBRARY; T=0.K  
deuterons from (n,pd)

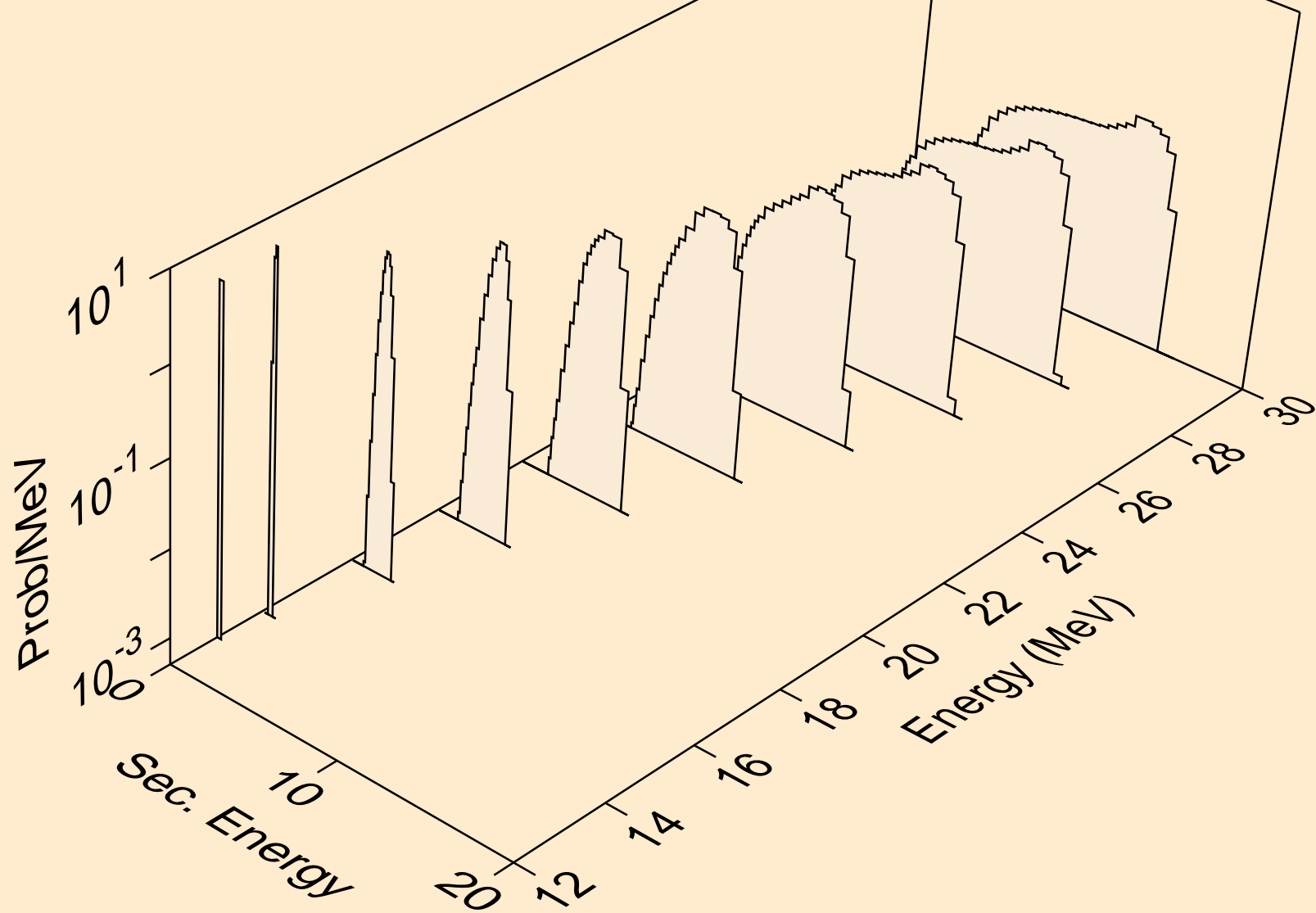

CR049 NEUTRON ACER TENDL-2023 LIBRARY; T=0.K  
deuterons from (n,da)

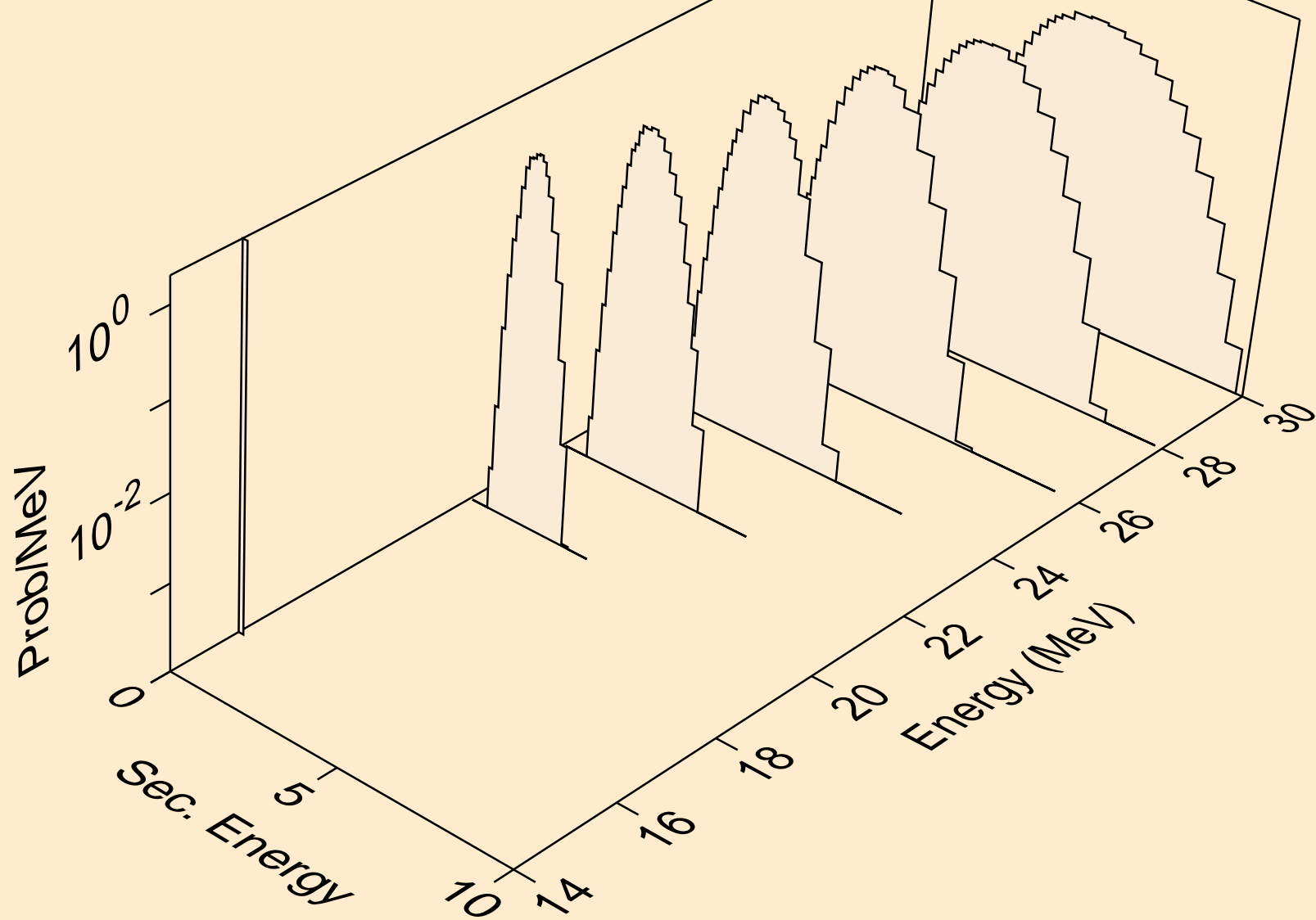

CR049 NEUTRON ACER TENDL-2023 LIBRARY; T=0.K  
tritons from (n,x)

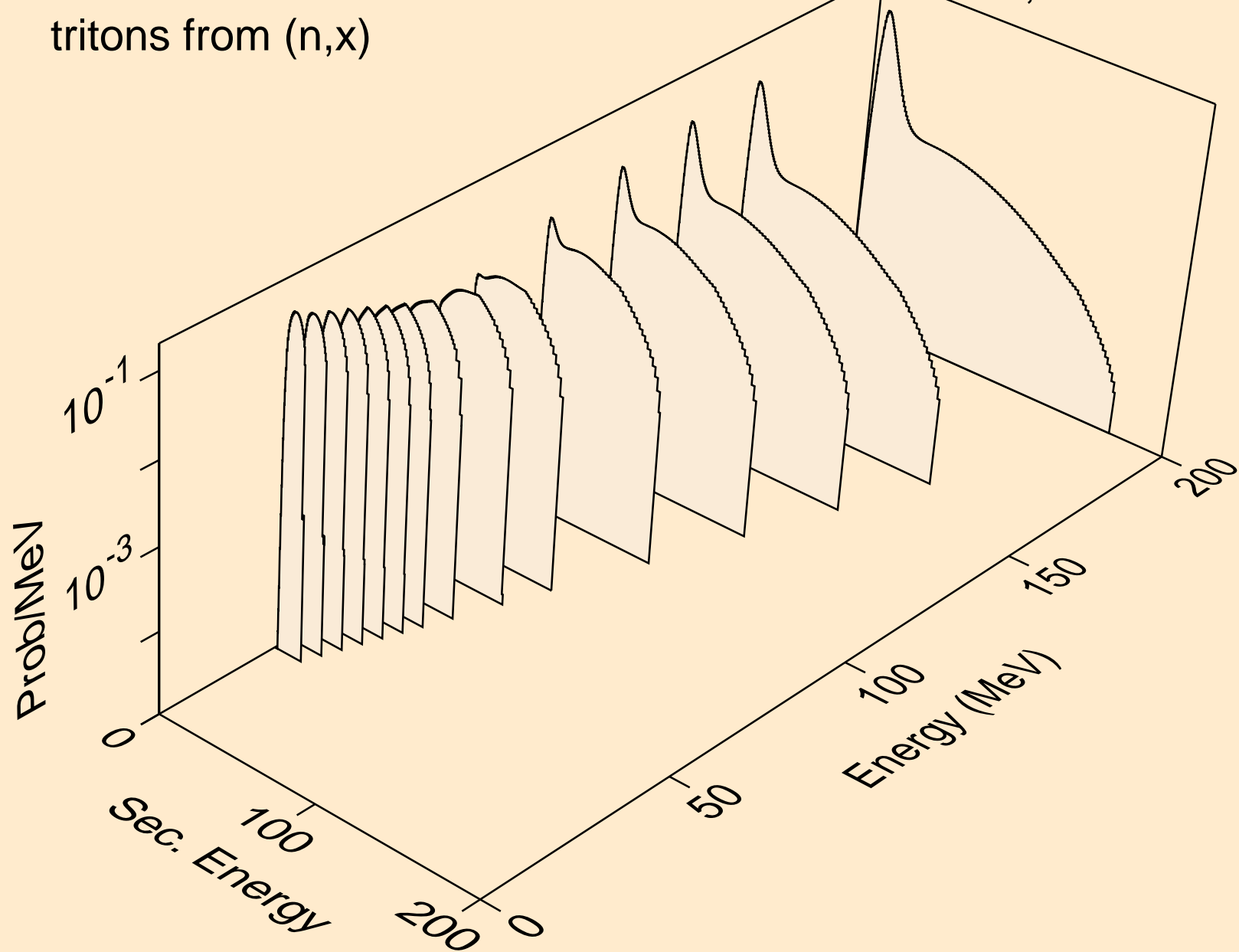

CR049 NEUTRON ACER TENDL-2023 LIBRARY; T=0.K  
tritons from (n,n\*)t

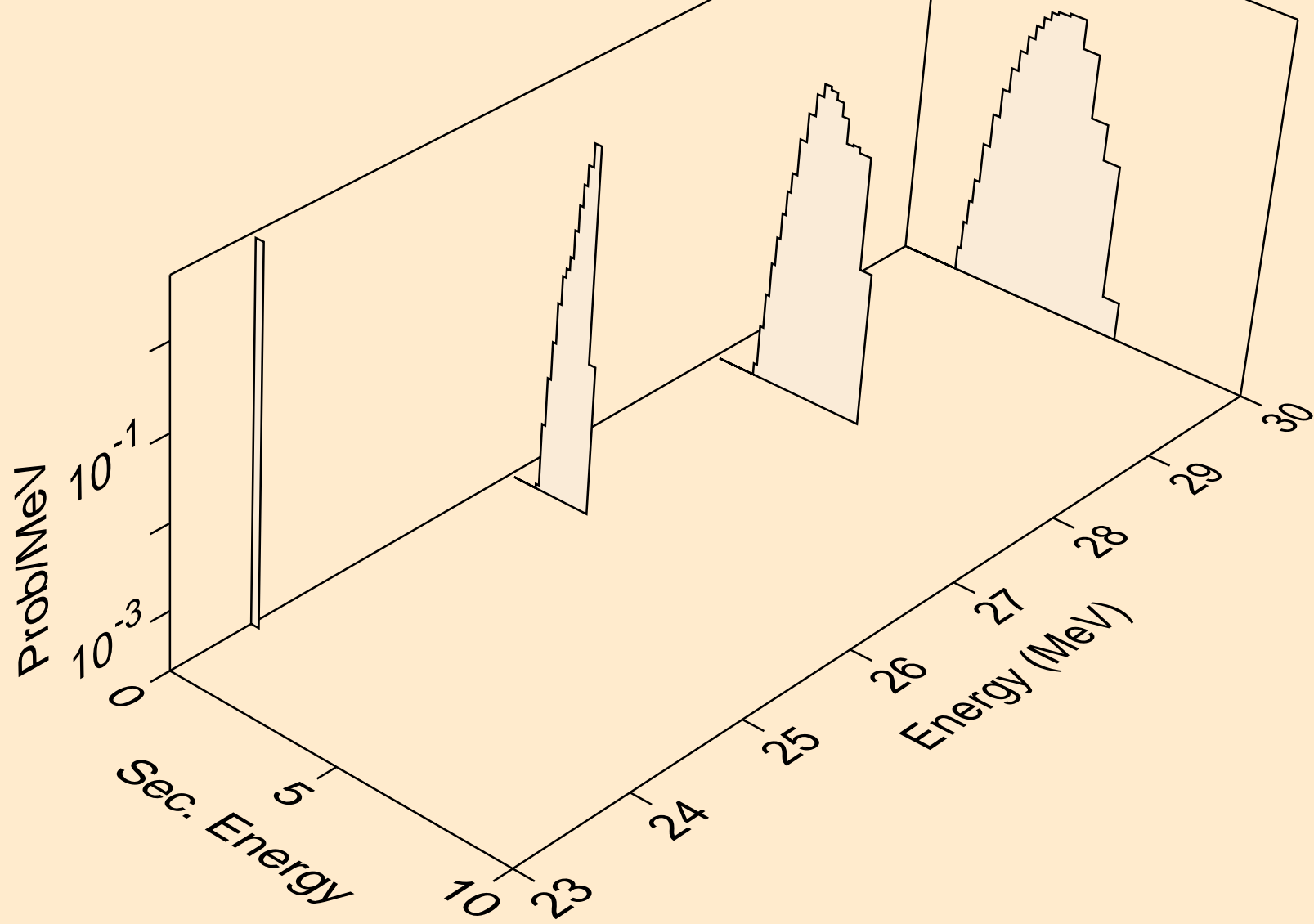

CR049 NEUTRON ACER TENDL-2023 LIBRARY; T=0.K  
tritons from (n,t)

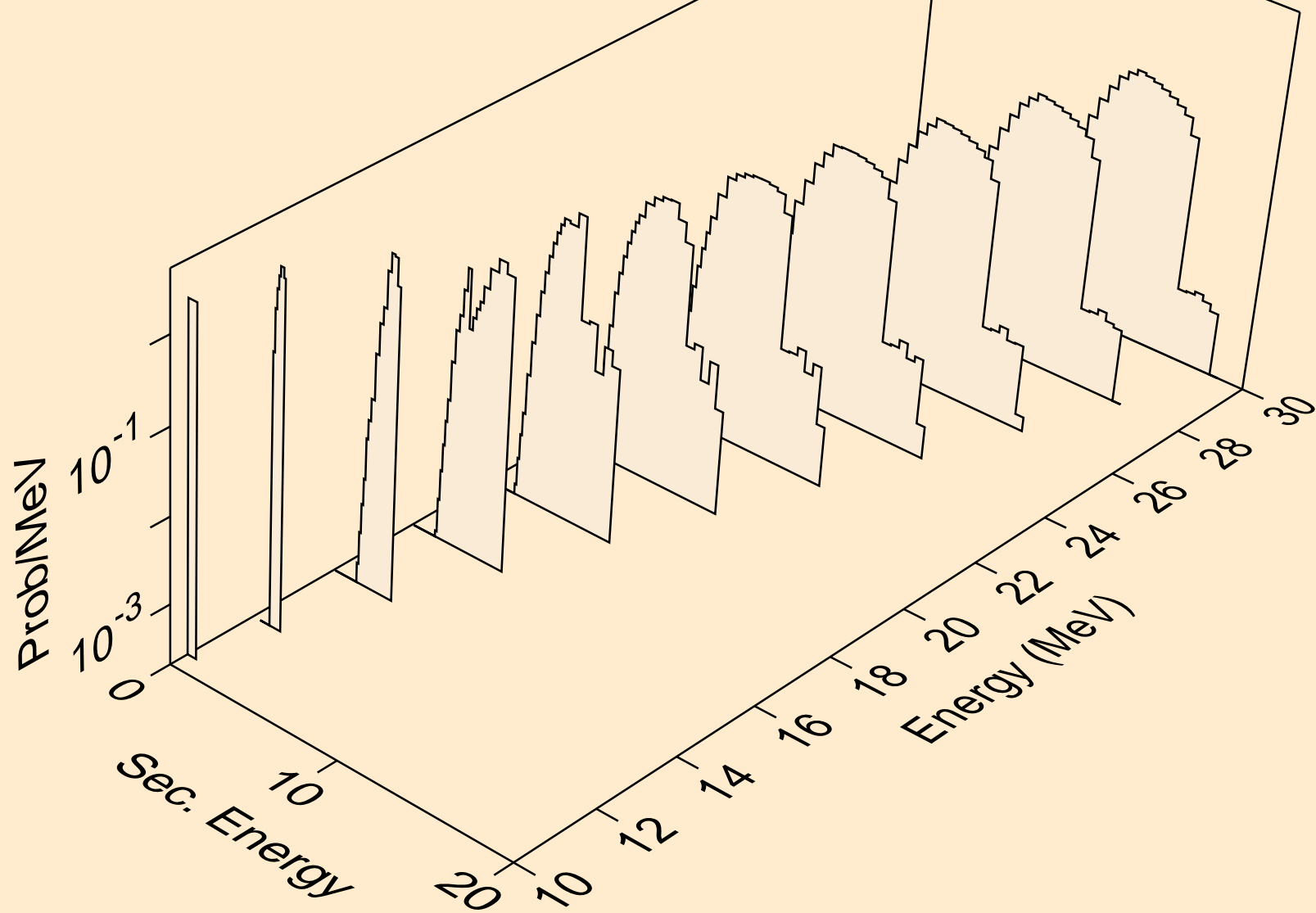



CR049 NEUTRON ACER TENDL-2023 LIBRARY; T=0.K  
tritons from (n,pt)

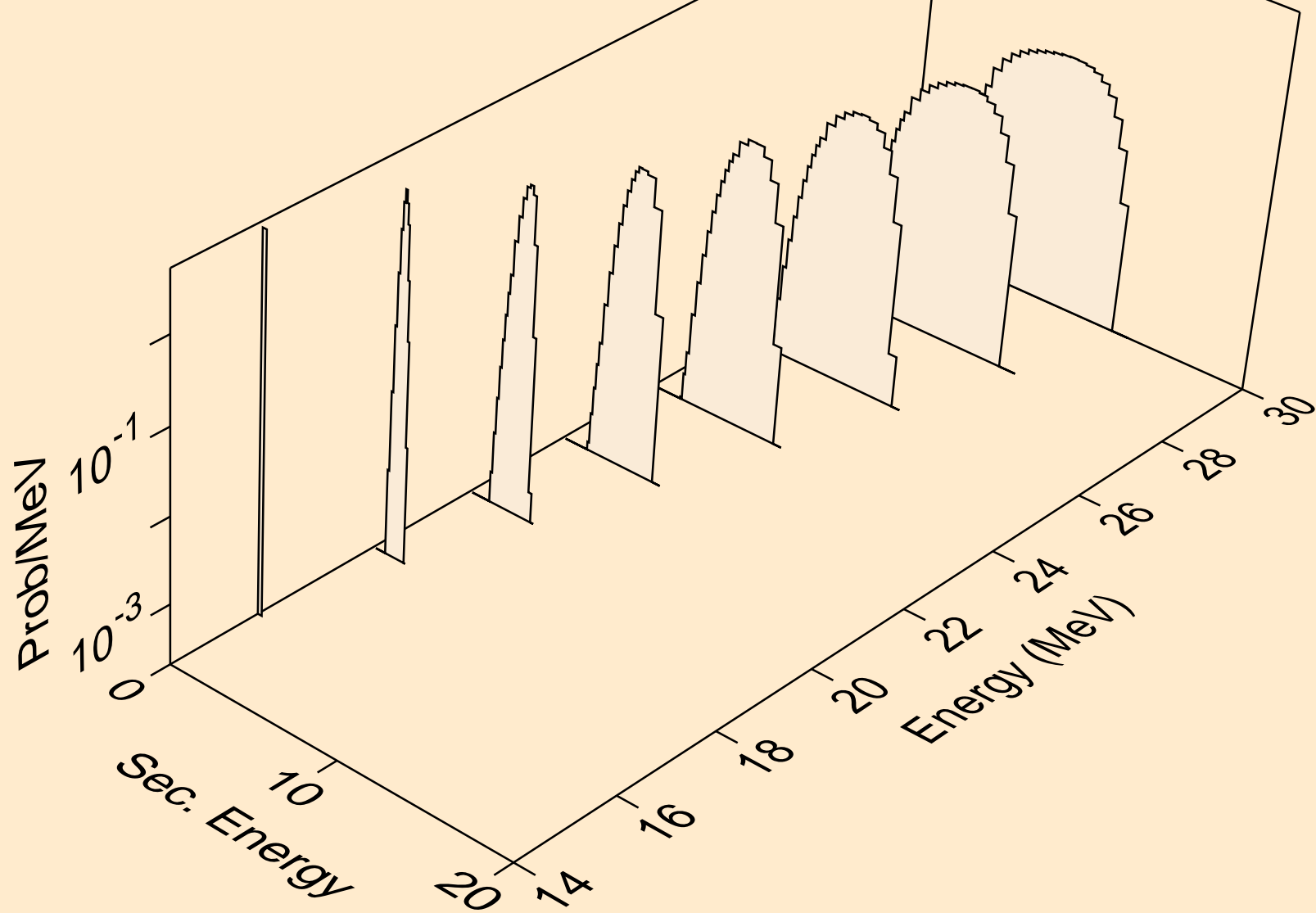

CR049 NEUTRON ACER TENDL-2023 LIBRARY; T=0.K  
he3s from (n,x)

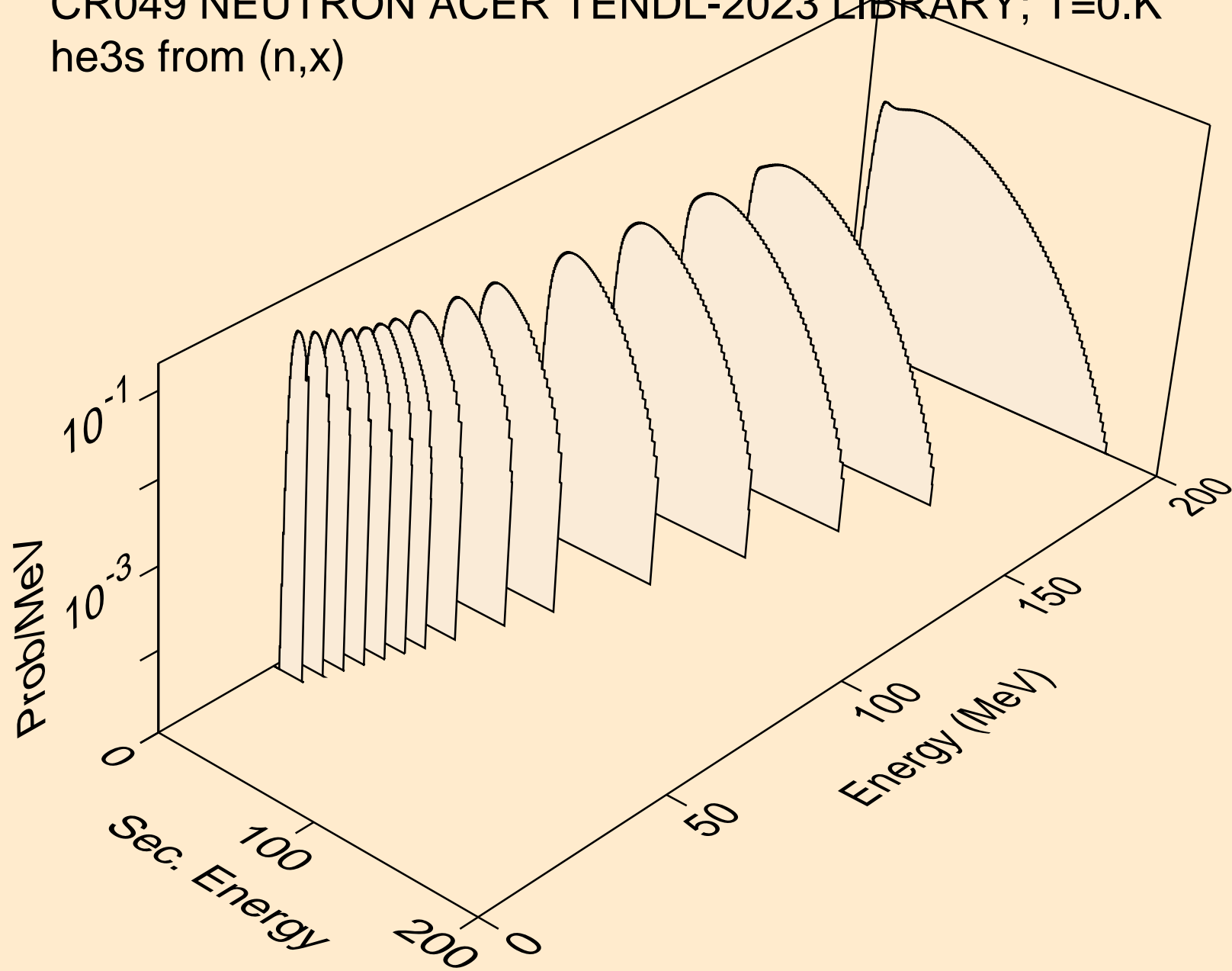

CR049 NEUTRON ACER TENDL-2023 LIBRARY; T=0.K  
he3s from (n,n\*)he3

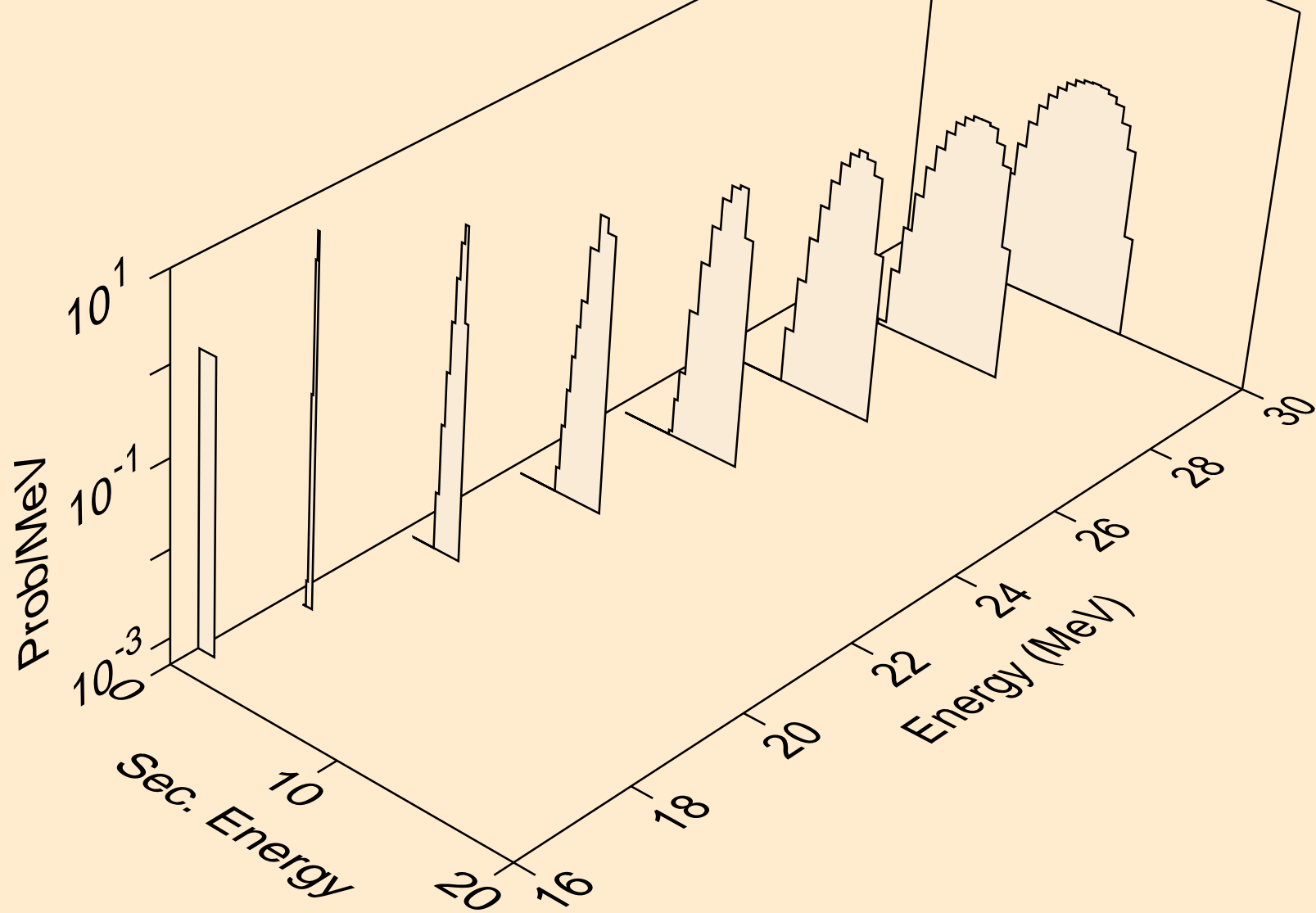

CR049 NEUTRON ACER TENDL-2023 LIBRARY; T=0.K  
he3s from (n,he3)

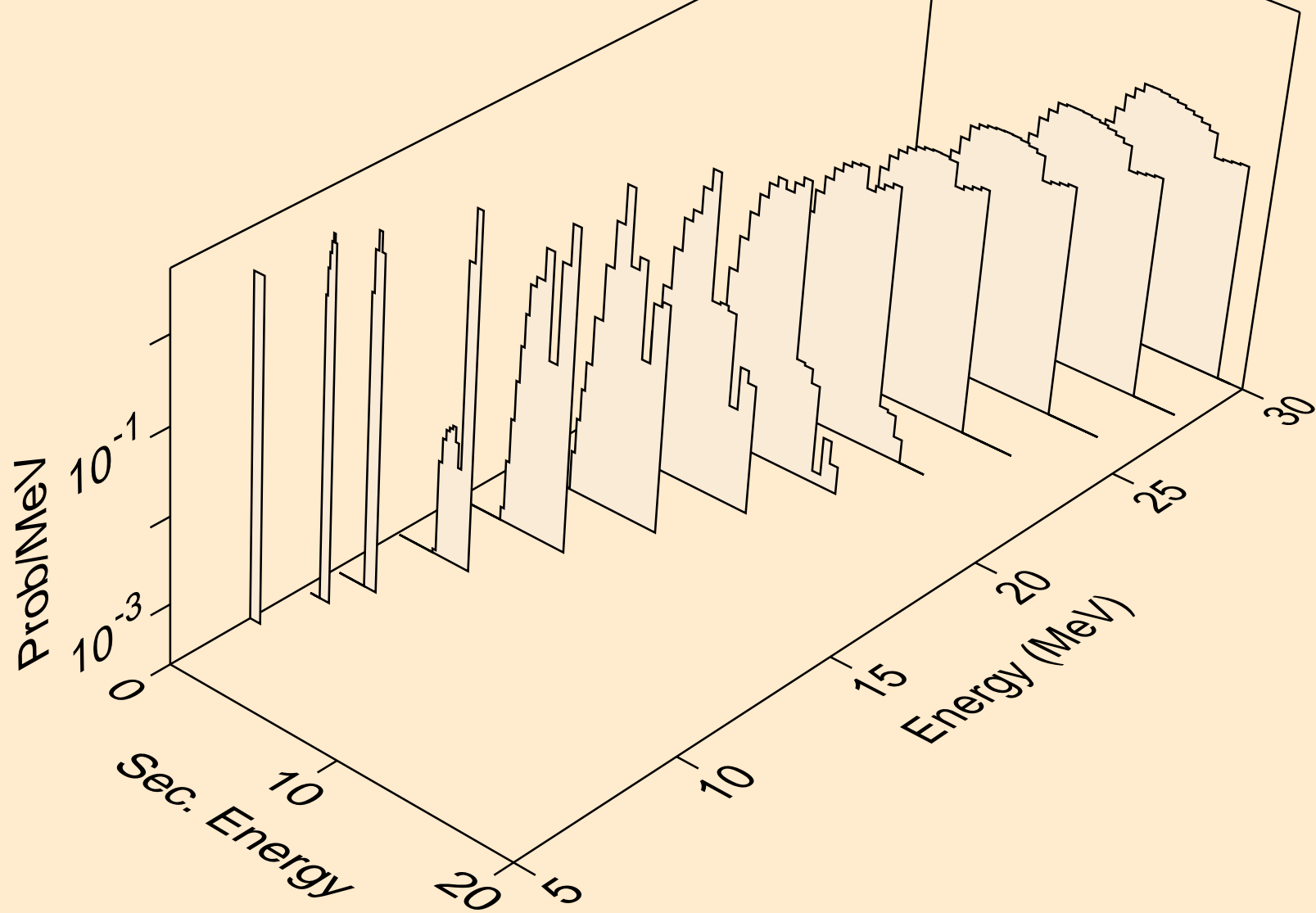

CR049 NEUTRON ACER TENDL-2023 LIBRARY; T=0.K  
alphas from (n,x)

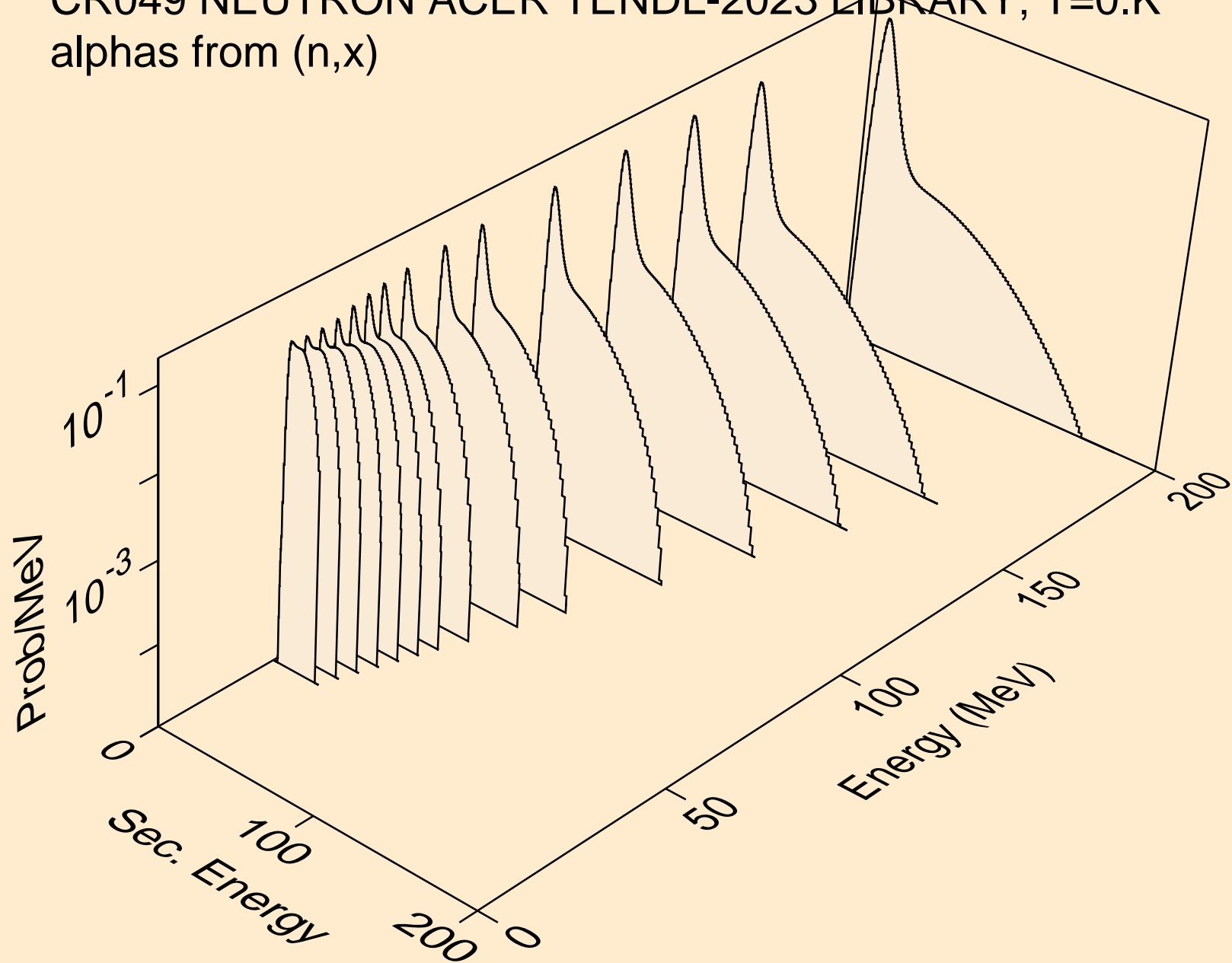

CR049 NEUTRON ACER TENDL-2023 LIBRARY; T=0.K  
alphas from (n,n\*)a

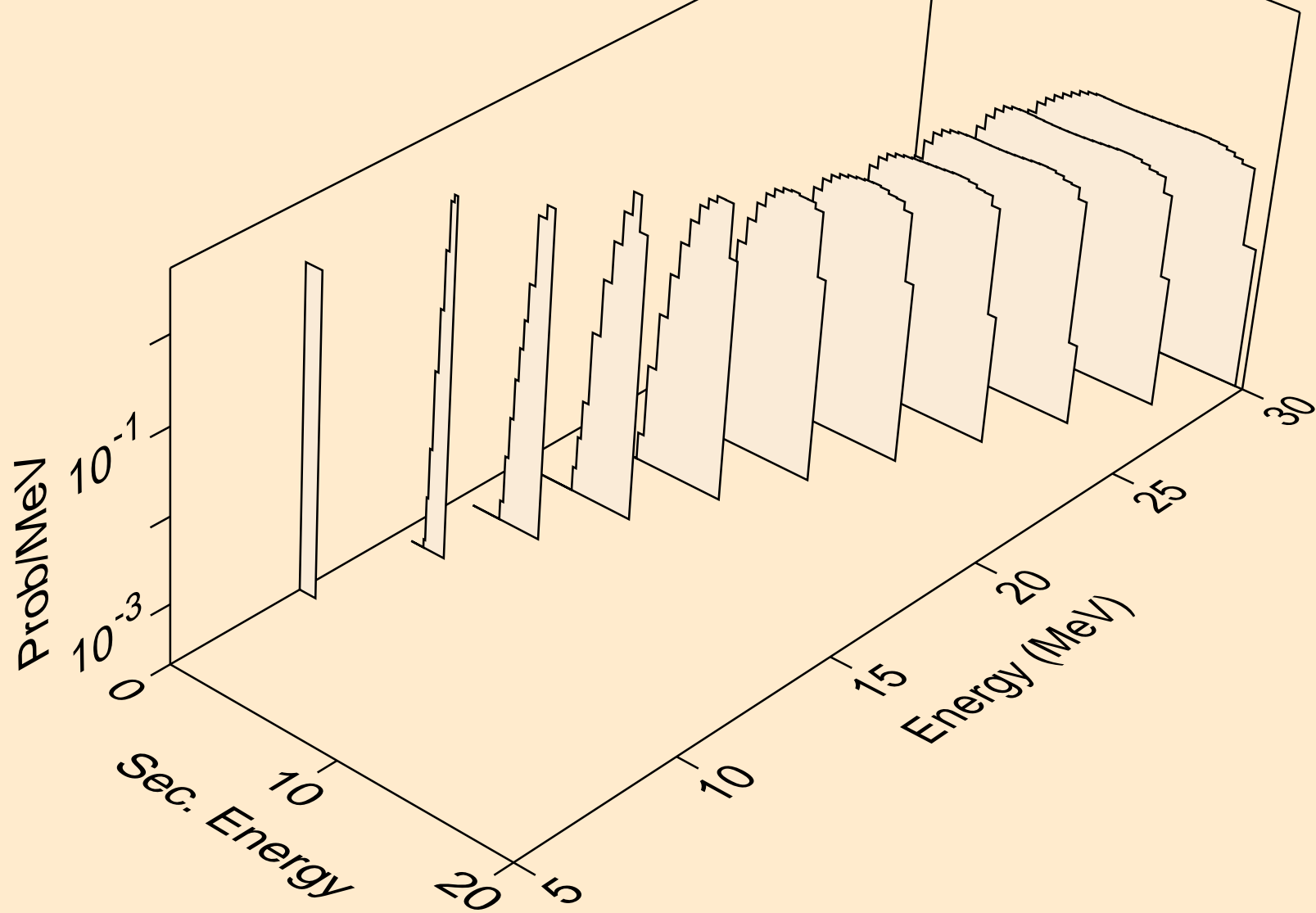

CR049 NEUTRON ACER TENDL-2023 LIBRARY; T=0.K  
alphas from (n,2n)a

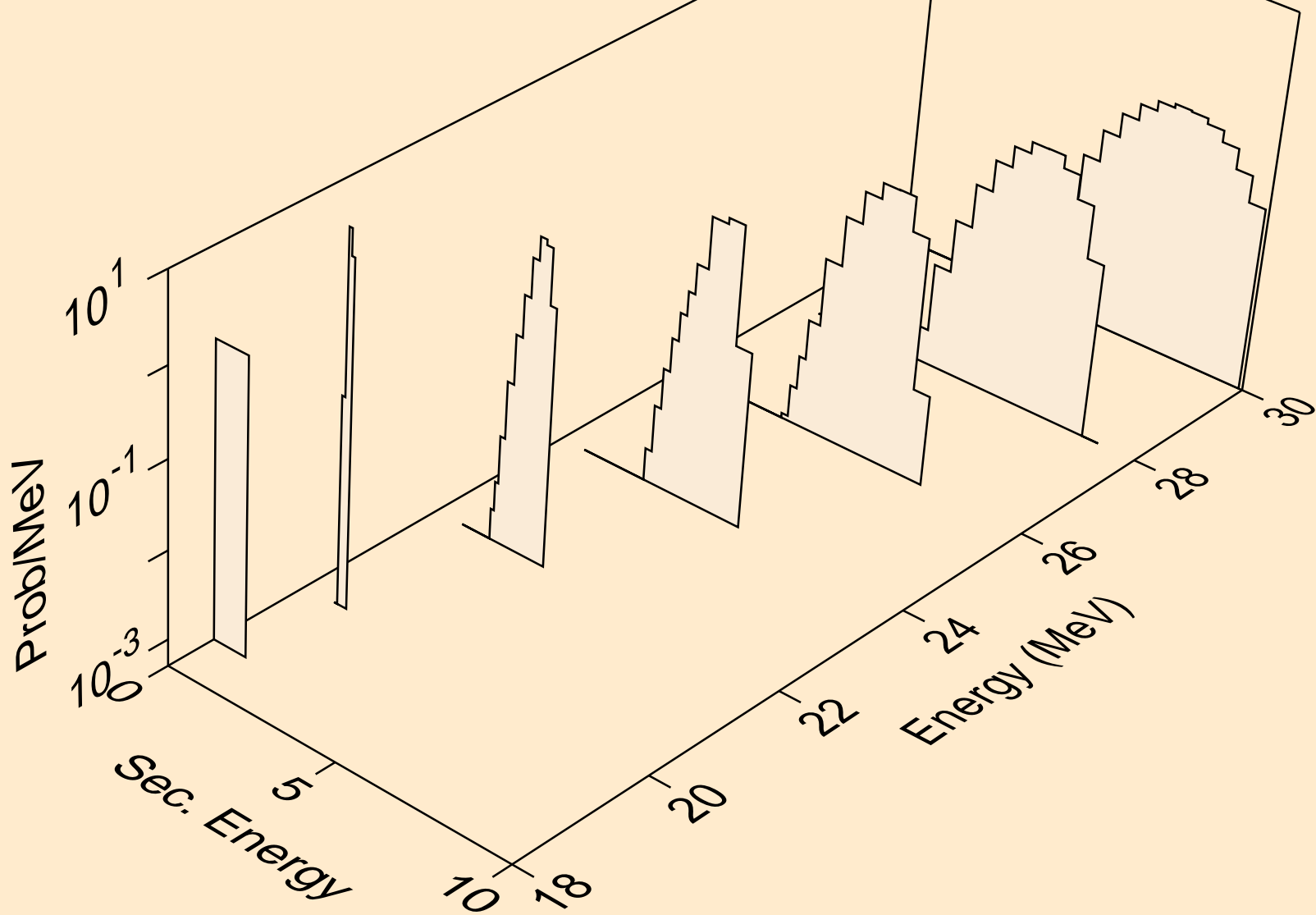

CR049 NEUTRON ACER TENDL-2023 LIBRARY; T=0.K  
alphas from (n,n\*)2a

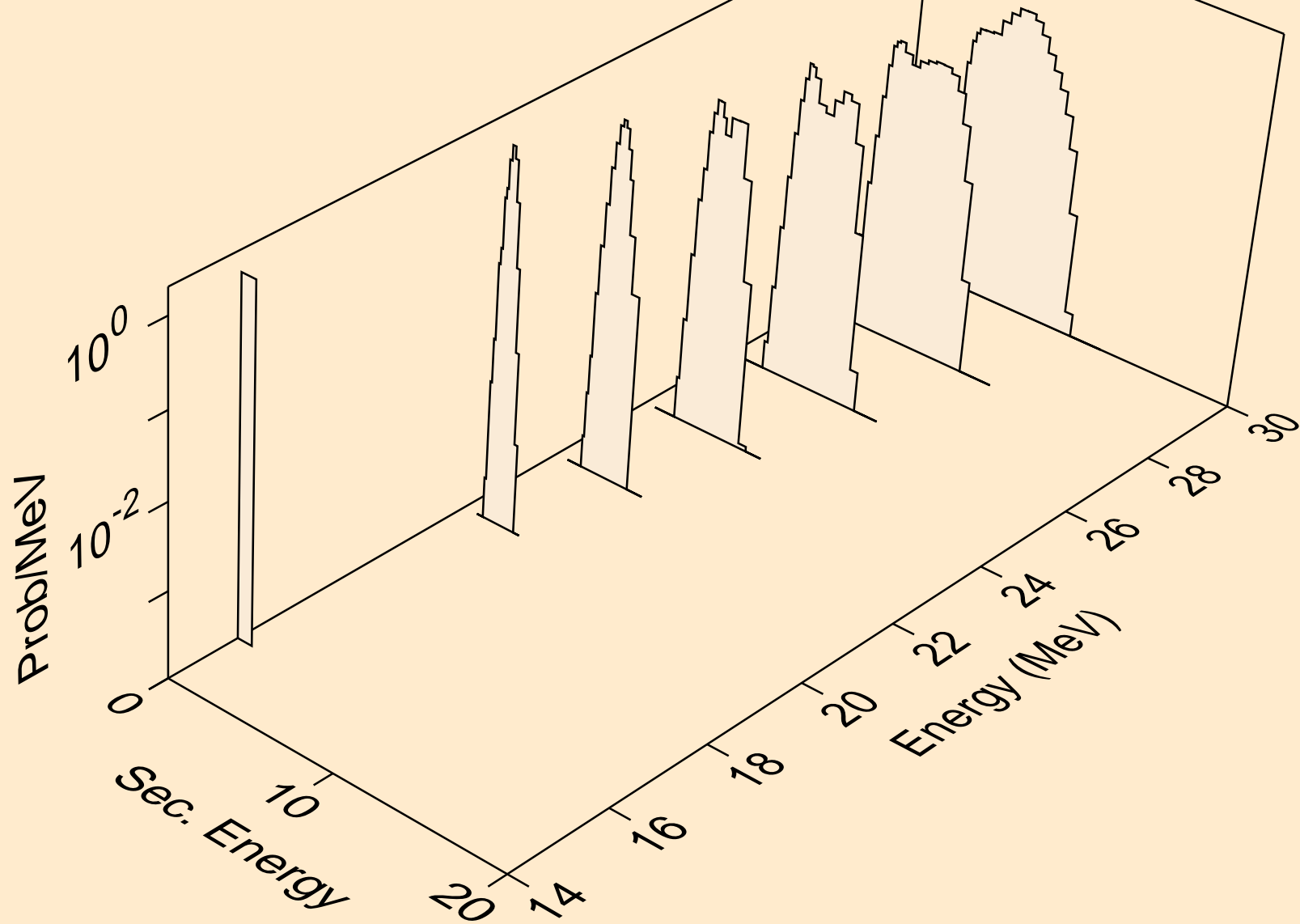



CR049 NEUTRON ACER TENDL-2023 LIBRARY; T=0.K  
alphas from (n,npa)

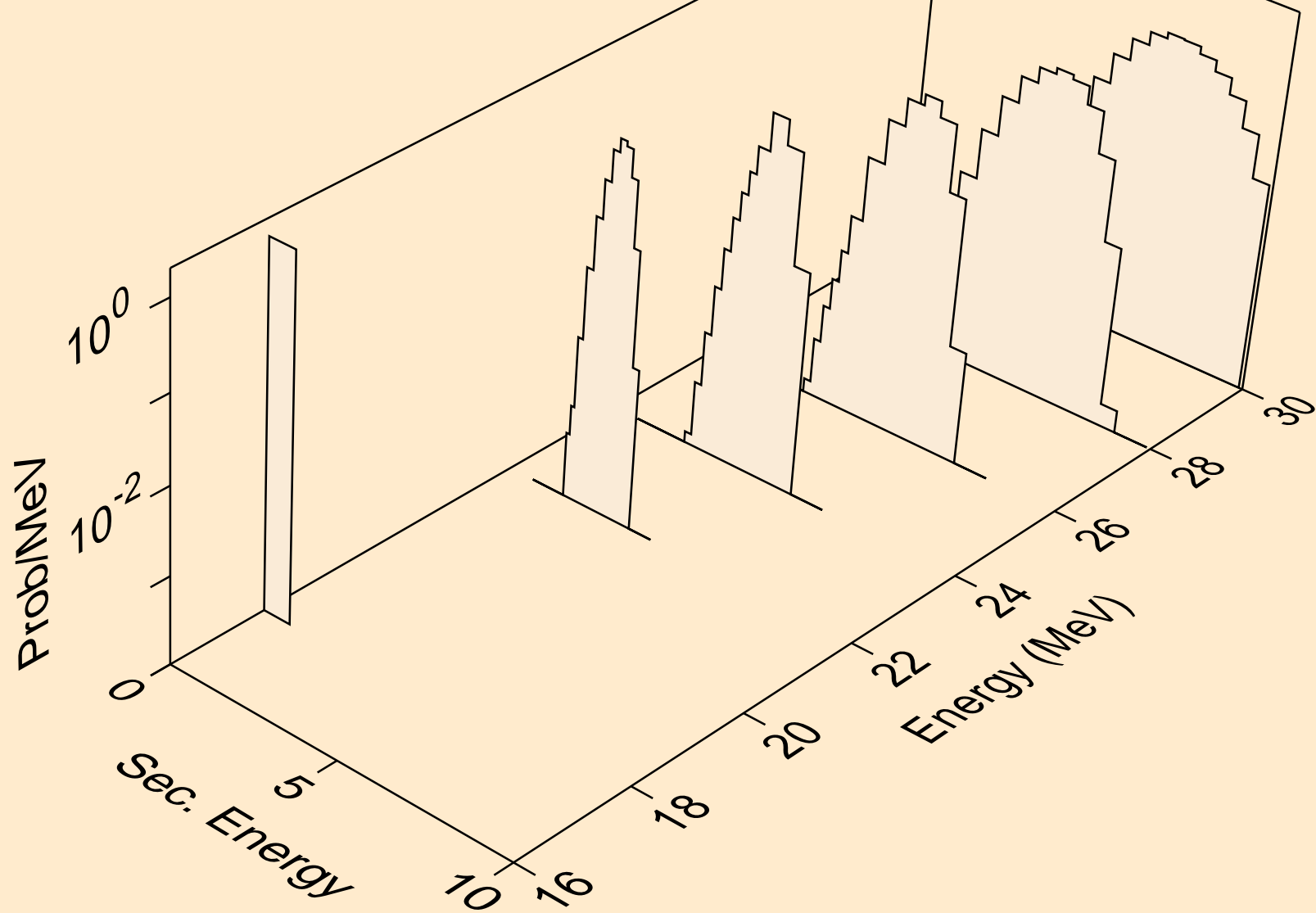

CR049 NEUTRON ACER TENDL-2023 LIBRARY; T=0.K  
alphas from (n,a)

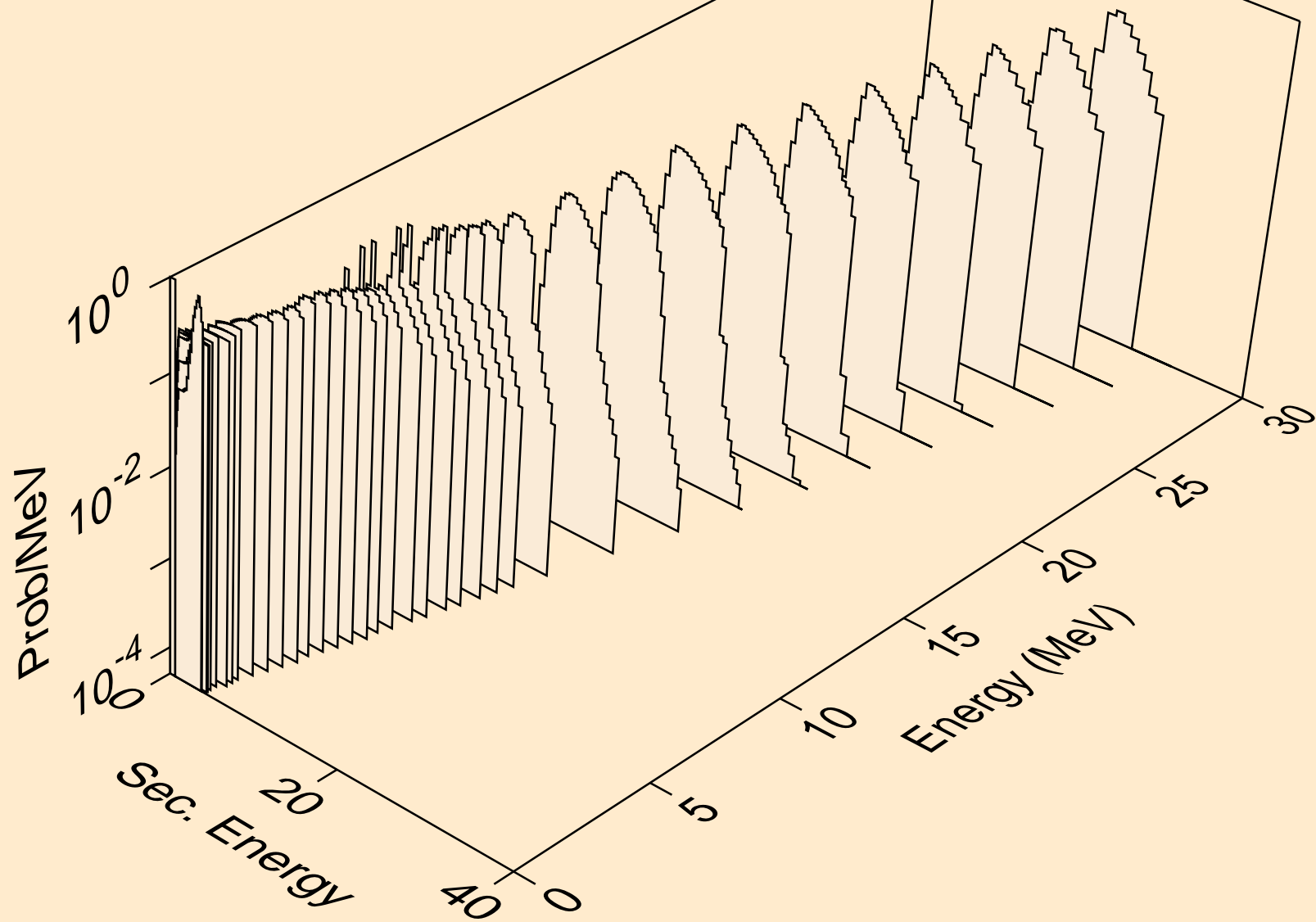

CR049 NEUTRON ACER TENDL-2023 LIBRARY; T=0.K  
alphas from (n,2a)

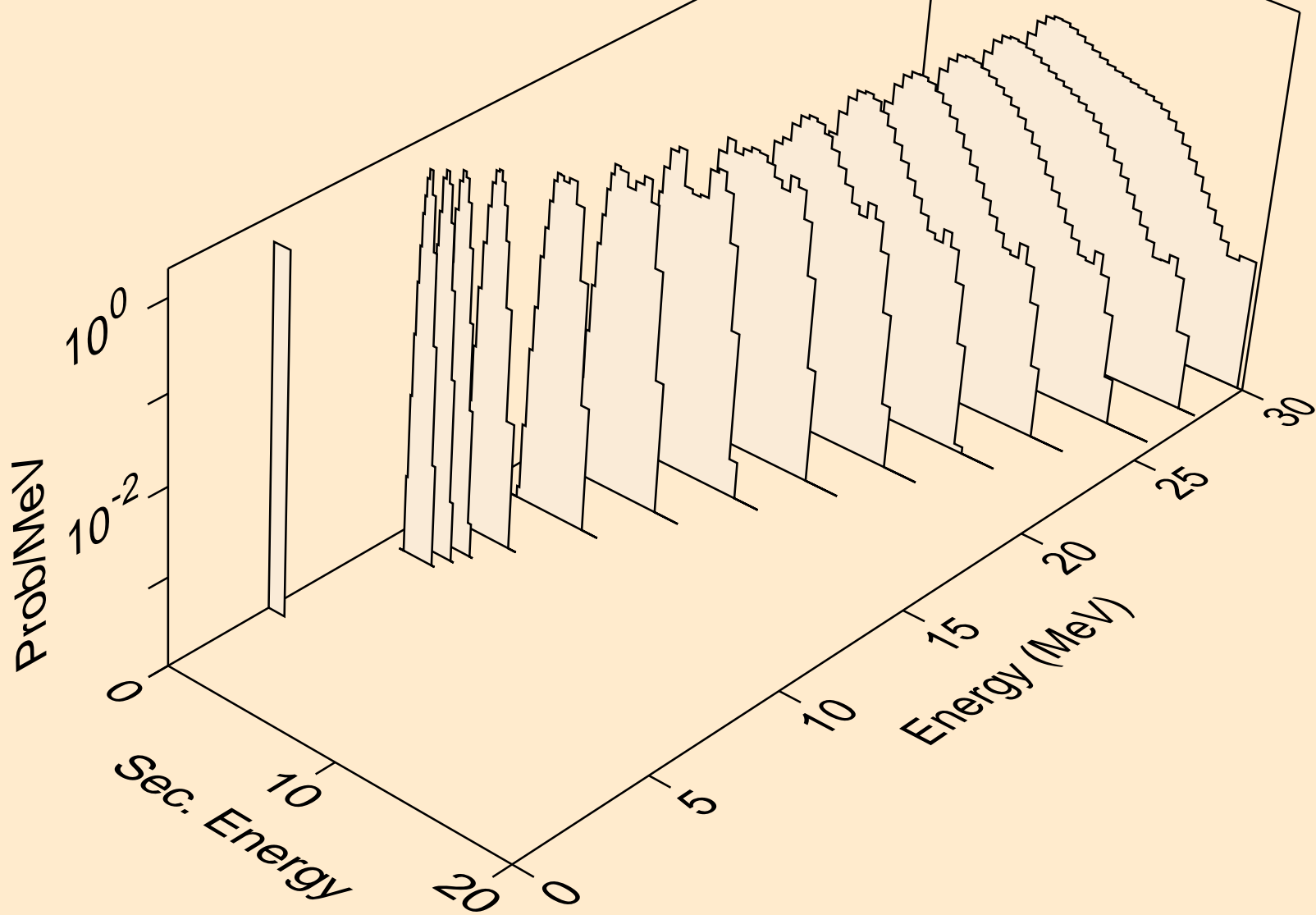

CR049 NEUTRON ACER TENDL-2023 LIBRARY; T=0.K  
alphas from (n,3a)

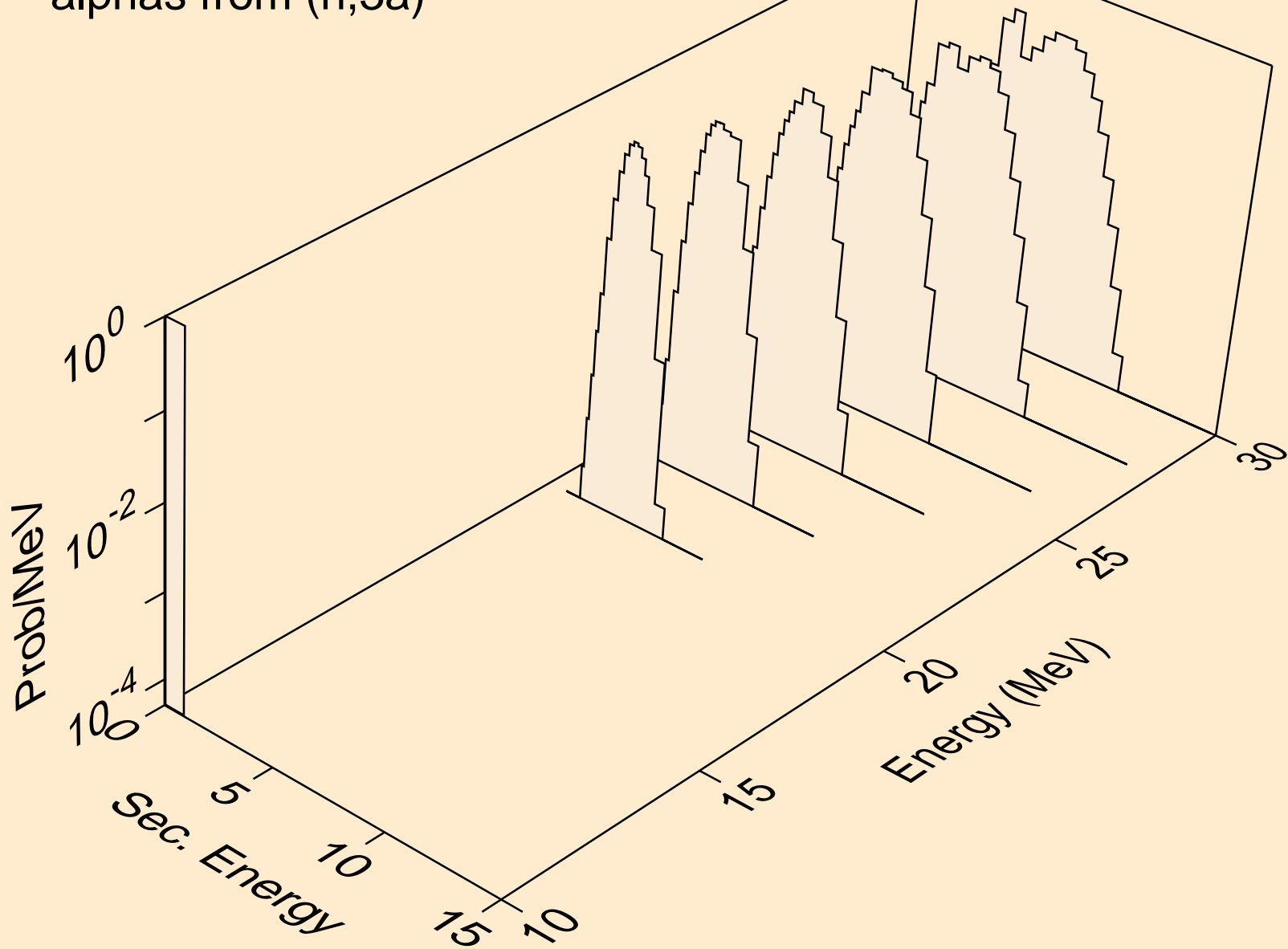

CR049 NEUTRON ACER TENDL-2023 LIBRARY; T=0.K  
alphas from (n,pa)

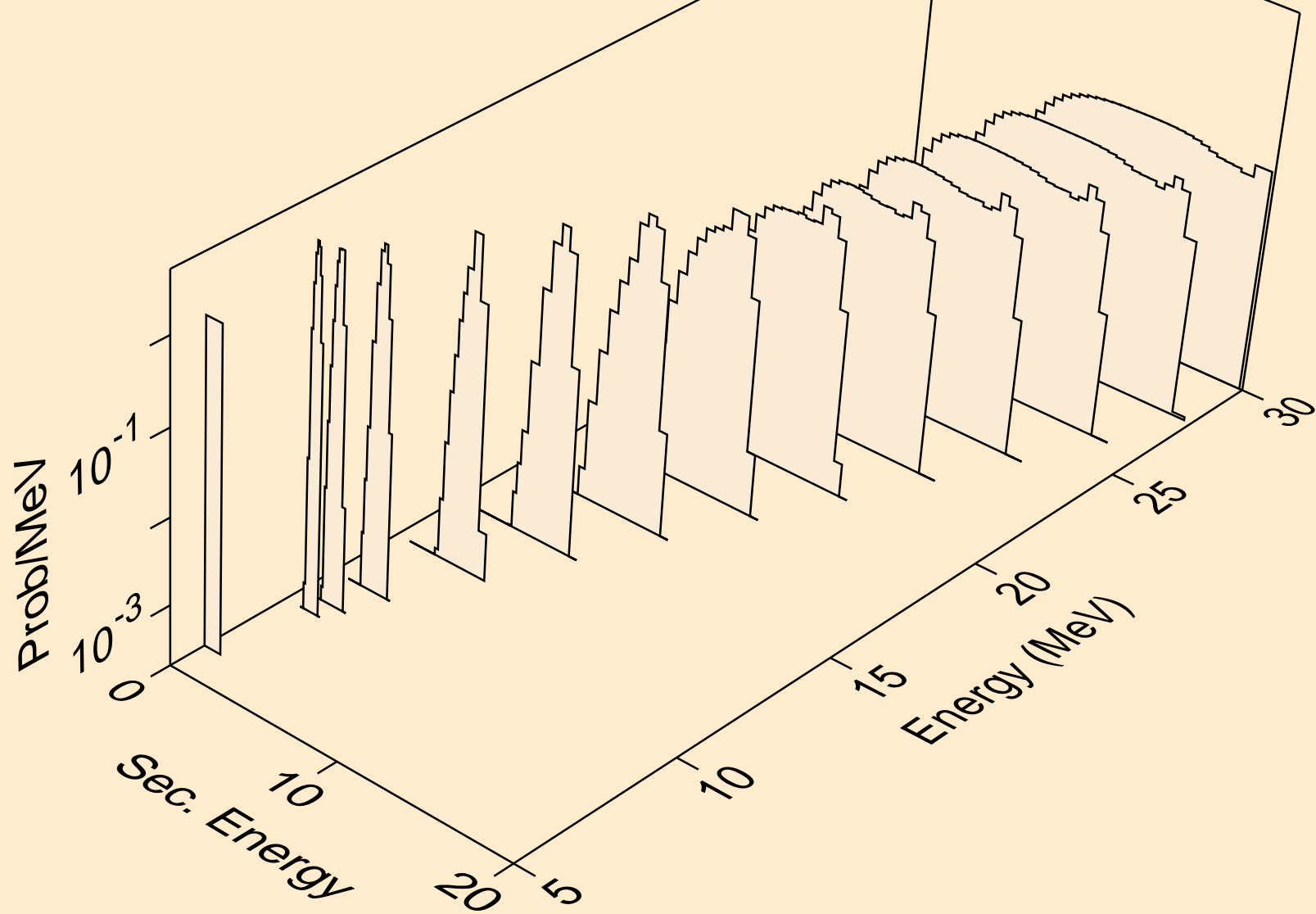

CR049 NEUTRON ACER TENDL-2023 LIBRARY; T=0.K  
alphas from (n,da)

