

# CR052 NEUTRON ACER TENDL-2023 LIBRARY; T=0.K

## Principal cross sections

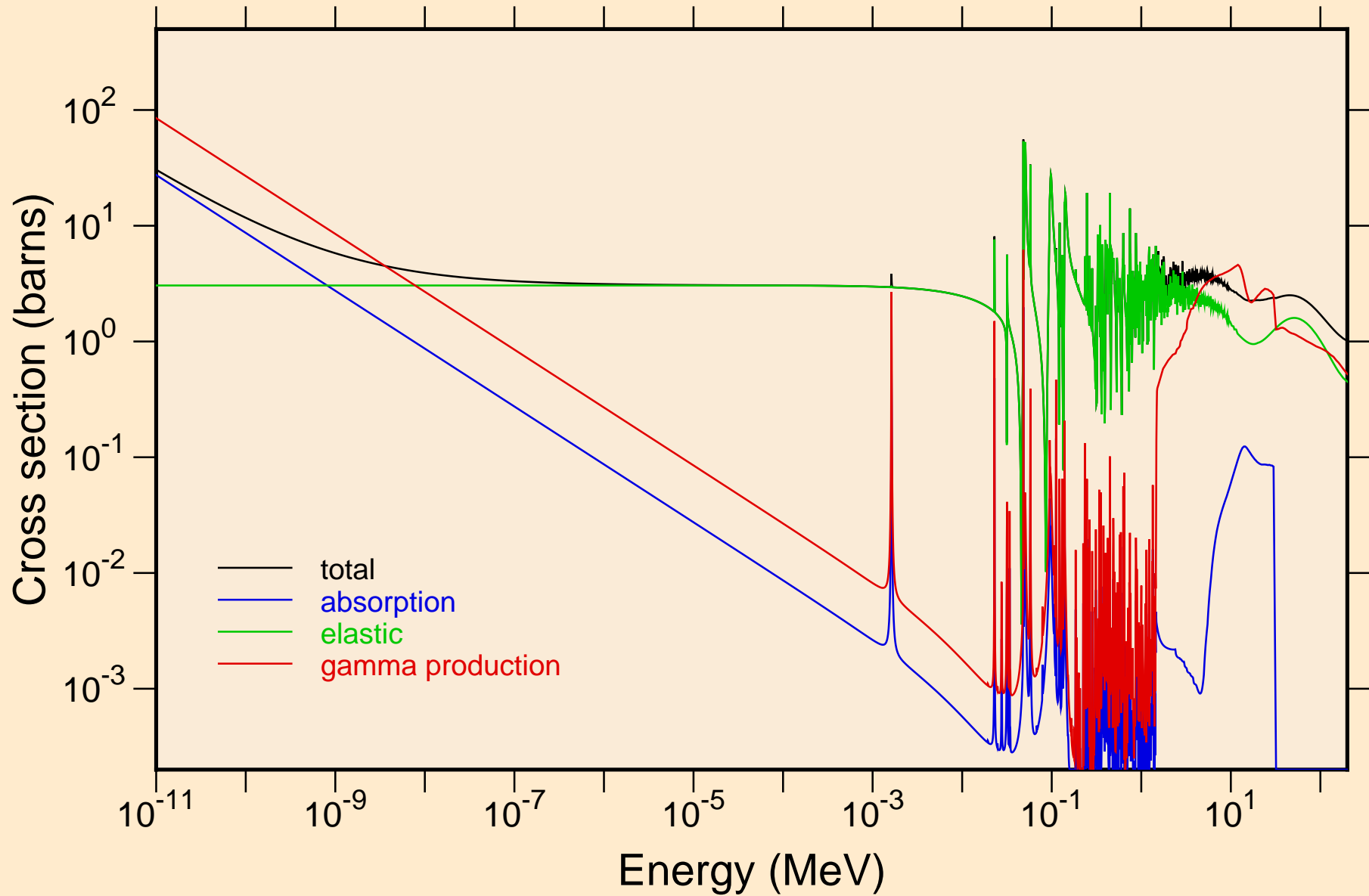

CR052 NEUTRON ACER TENDL-2023 LIBRARY; T=0.K  
resonance total cross section

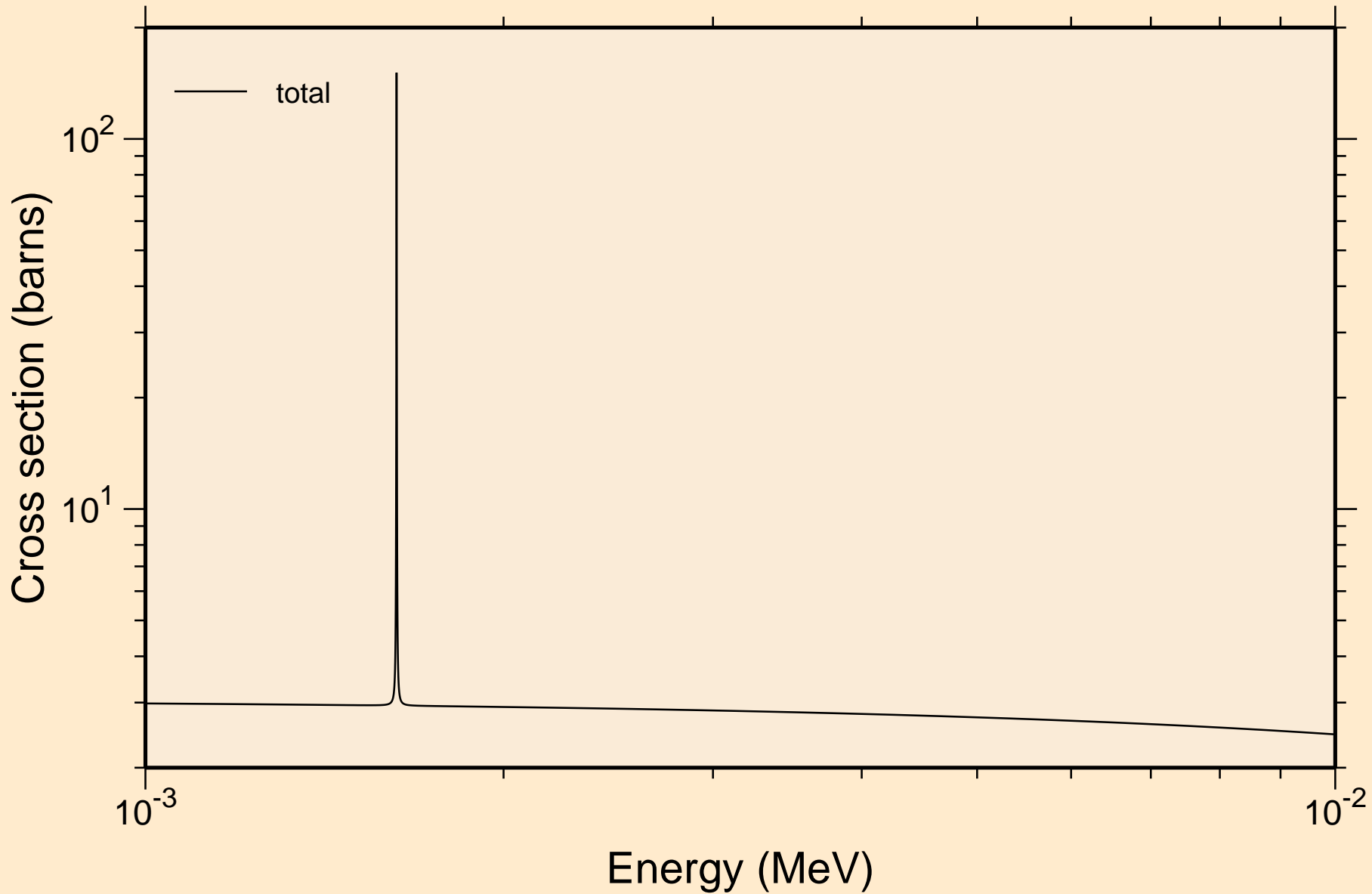

CR052 NEUTRON ACER TENDL-2023 LIBRARY; T=0.K  
resonance total cross section

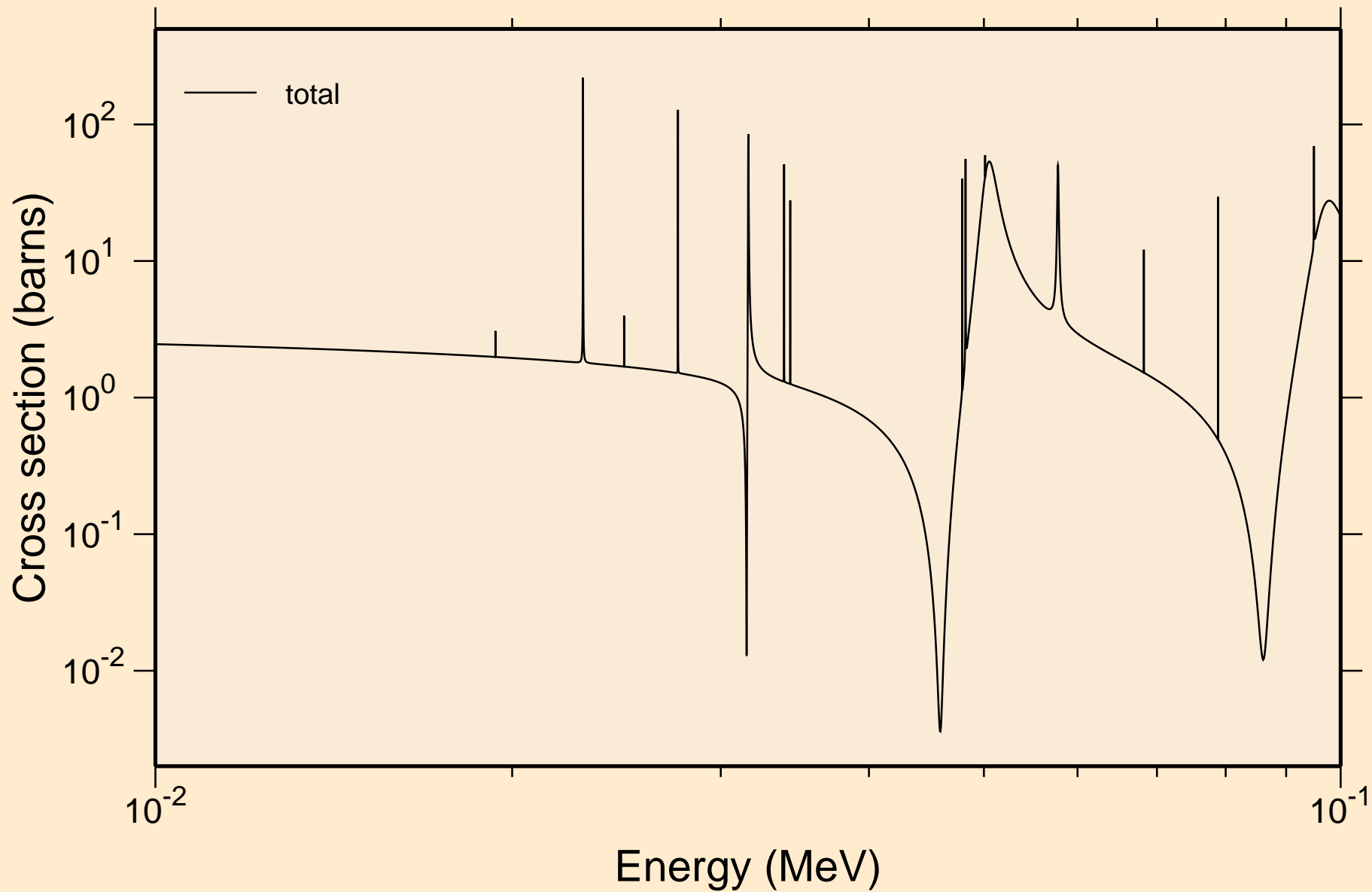

CR052 NEUTRON ACER TENDL-2023 LIBRARY; T=0.K  
resonance total cross section

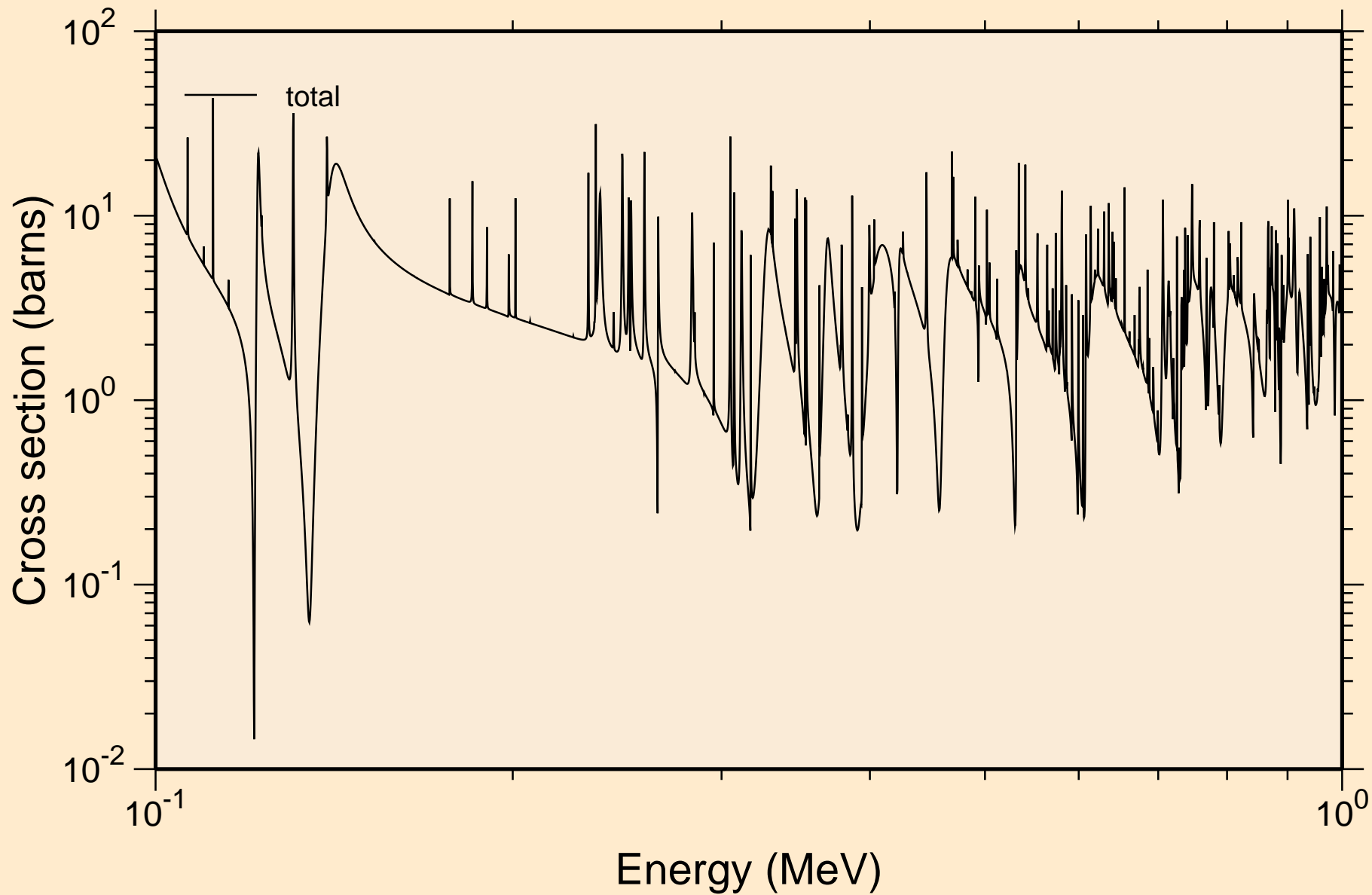

CR052 NEUTRON ACER TENDL-2023 LIBRARY; T=0.K  
resonance total cross section

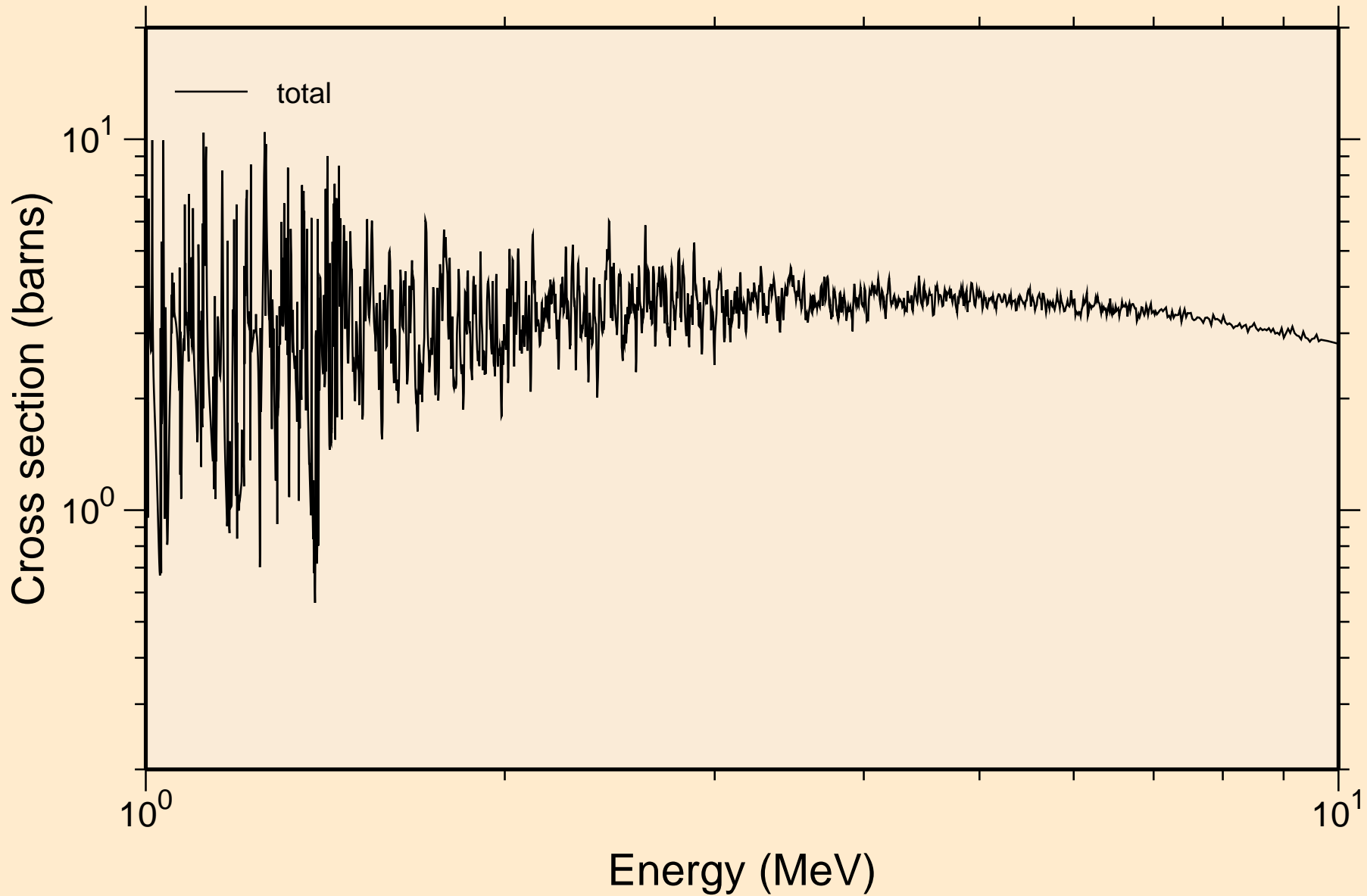

CR052 NEUTRON ACER TENDL-2023 LIBRARY; T=0.K  
resonance absorption cross sections

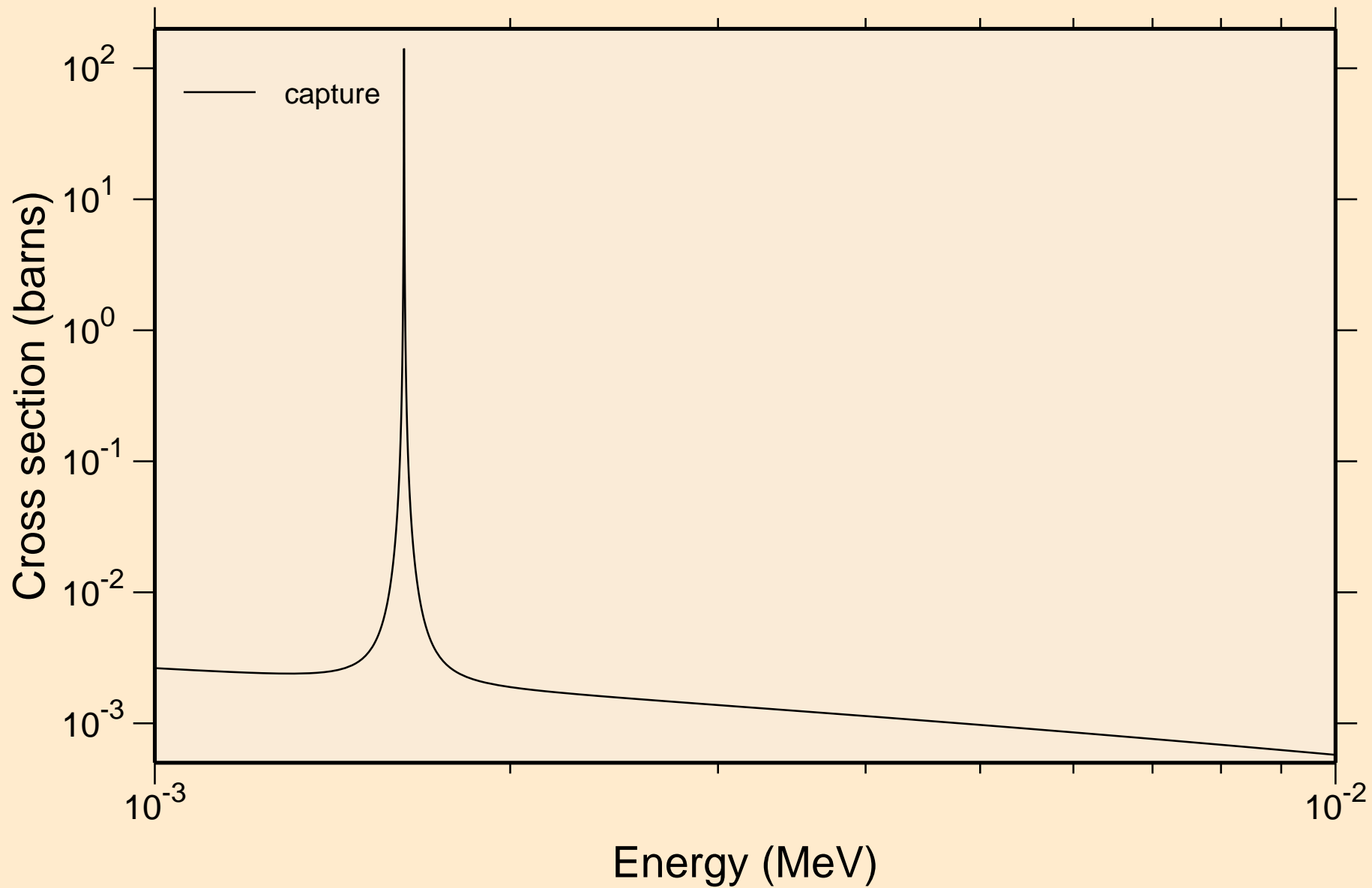

CR052 NEUTRON ACER TENDL-2023 LIBRARY; T=0.K  
resonance absorption cross sections

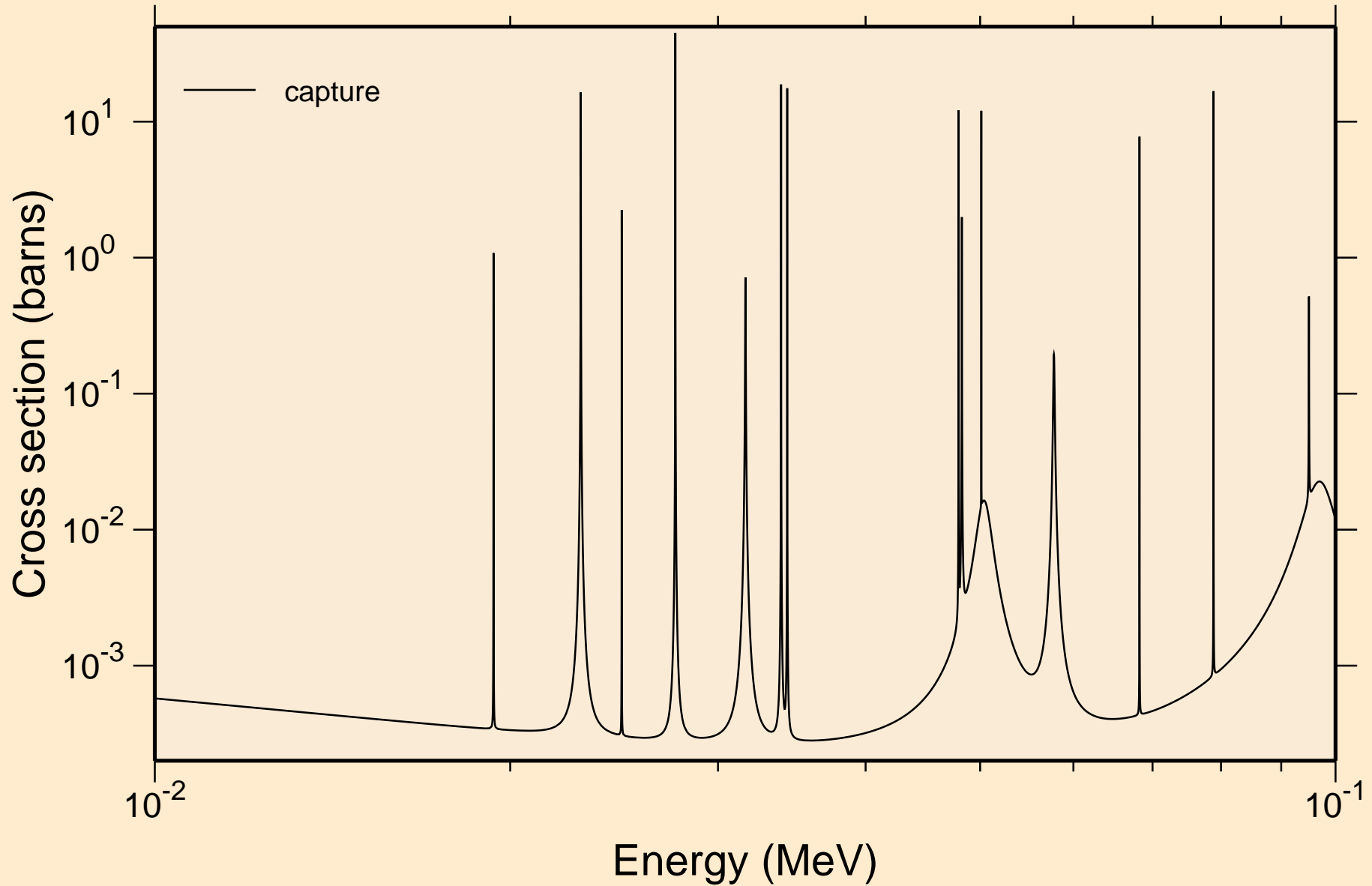

CR052 NEUTRON ACER TENDL-2023 LIBRARY; T=0.K  
resonance absorption cross sections

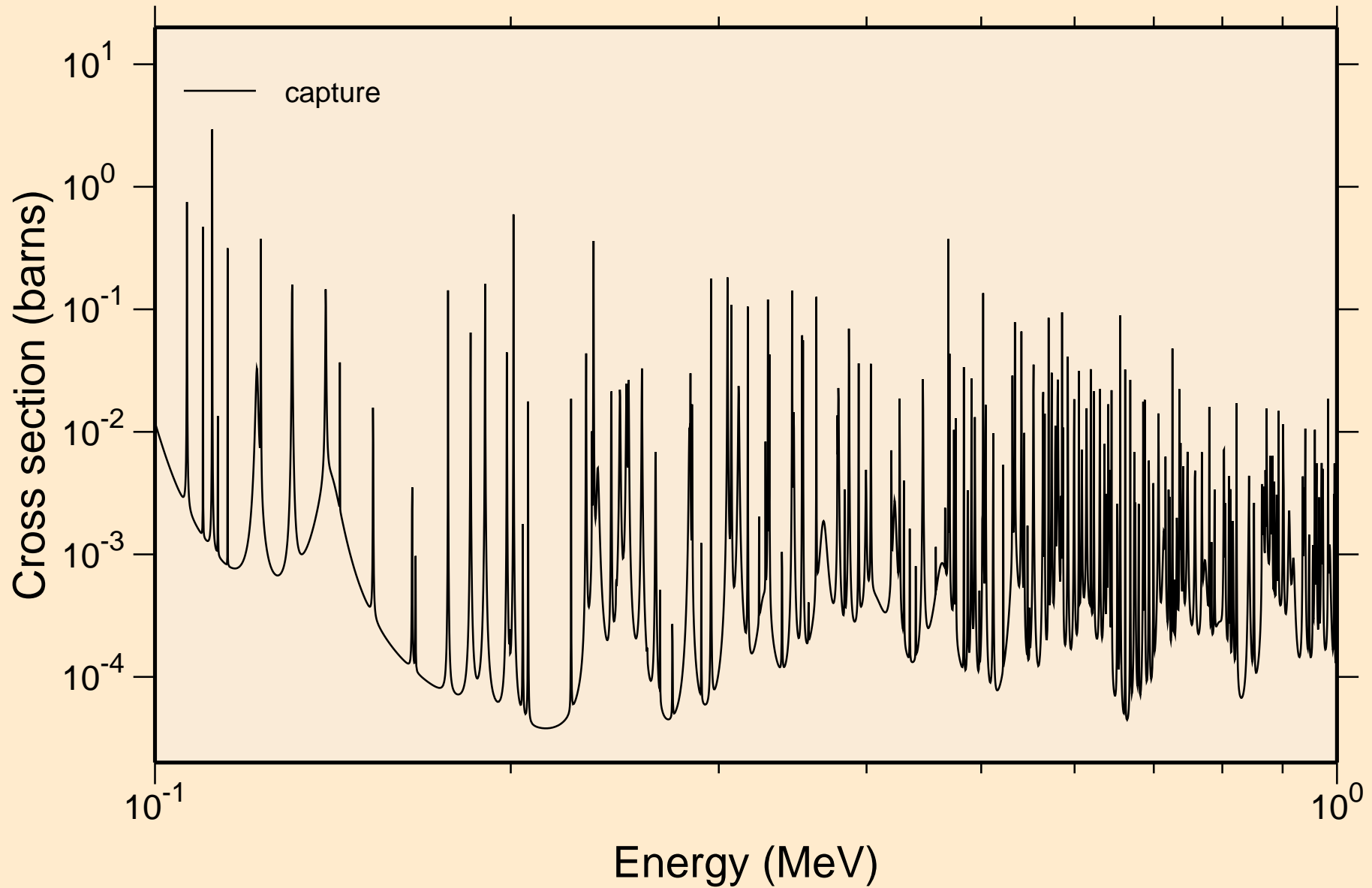



CR052 NEUTRON ACER TENDL-2023 LIBRARY; T=0.K  
resonance absorption cross sections

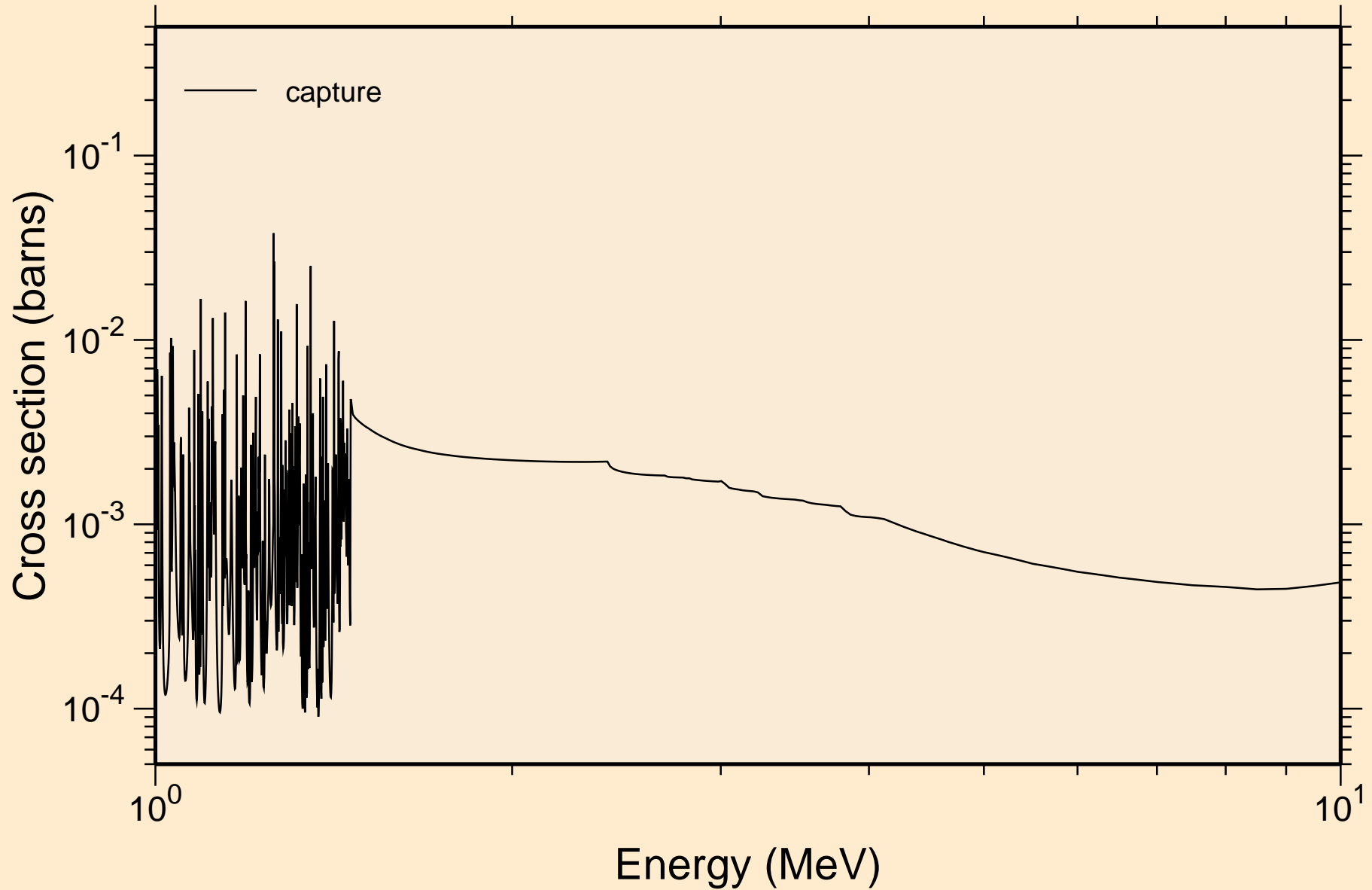

CR052 NEUTRON ACER TENDL-2023 LIBRARY; T=0.K  
Heating

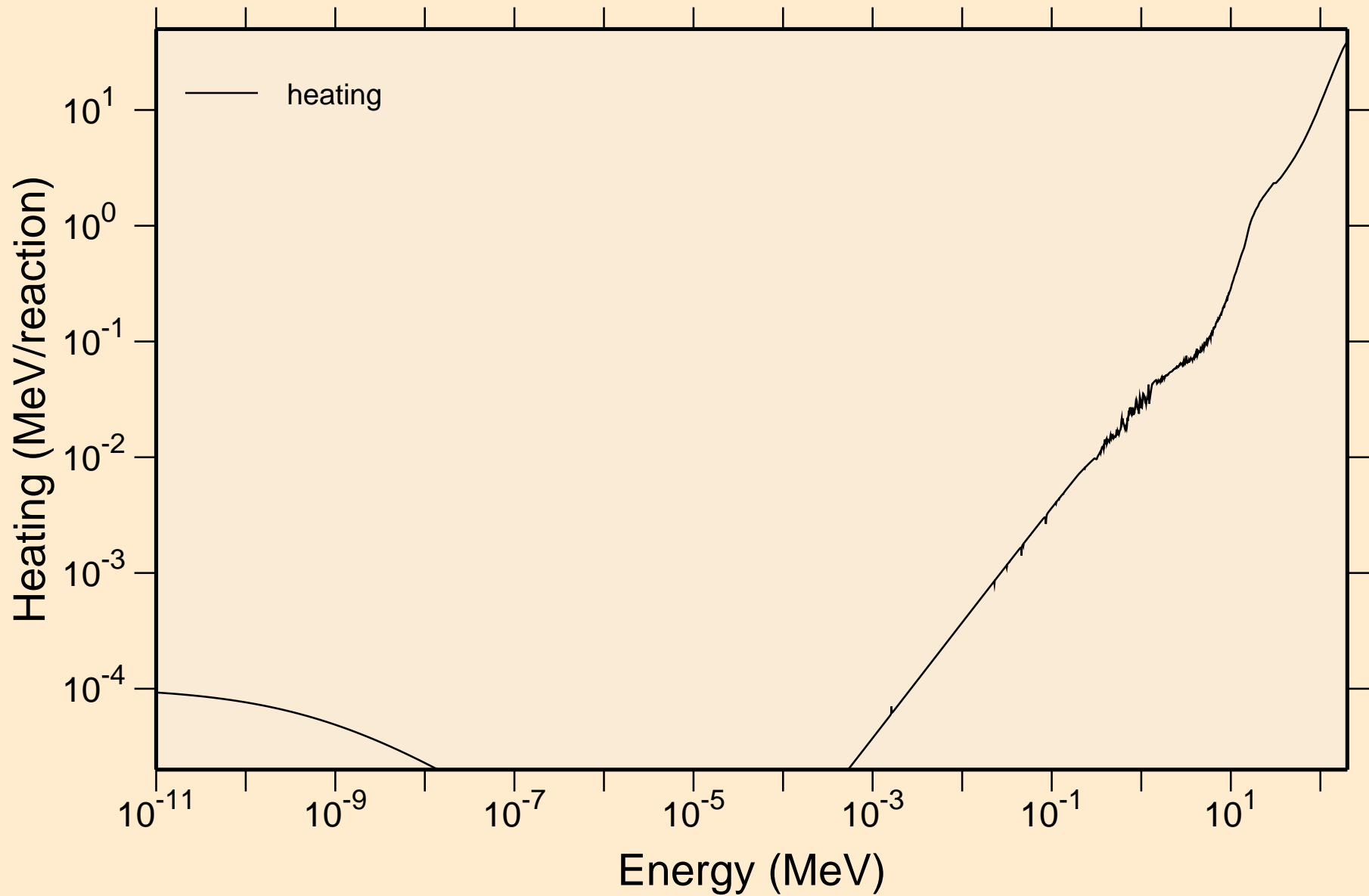

CR052 NEUTRON ACER TENDL-2023 LIBRARY; T=0.K  
Damage

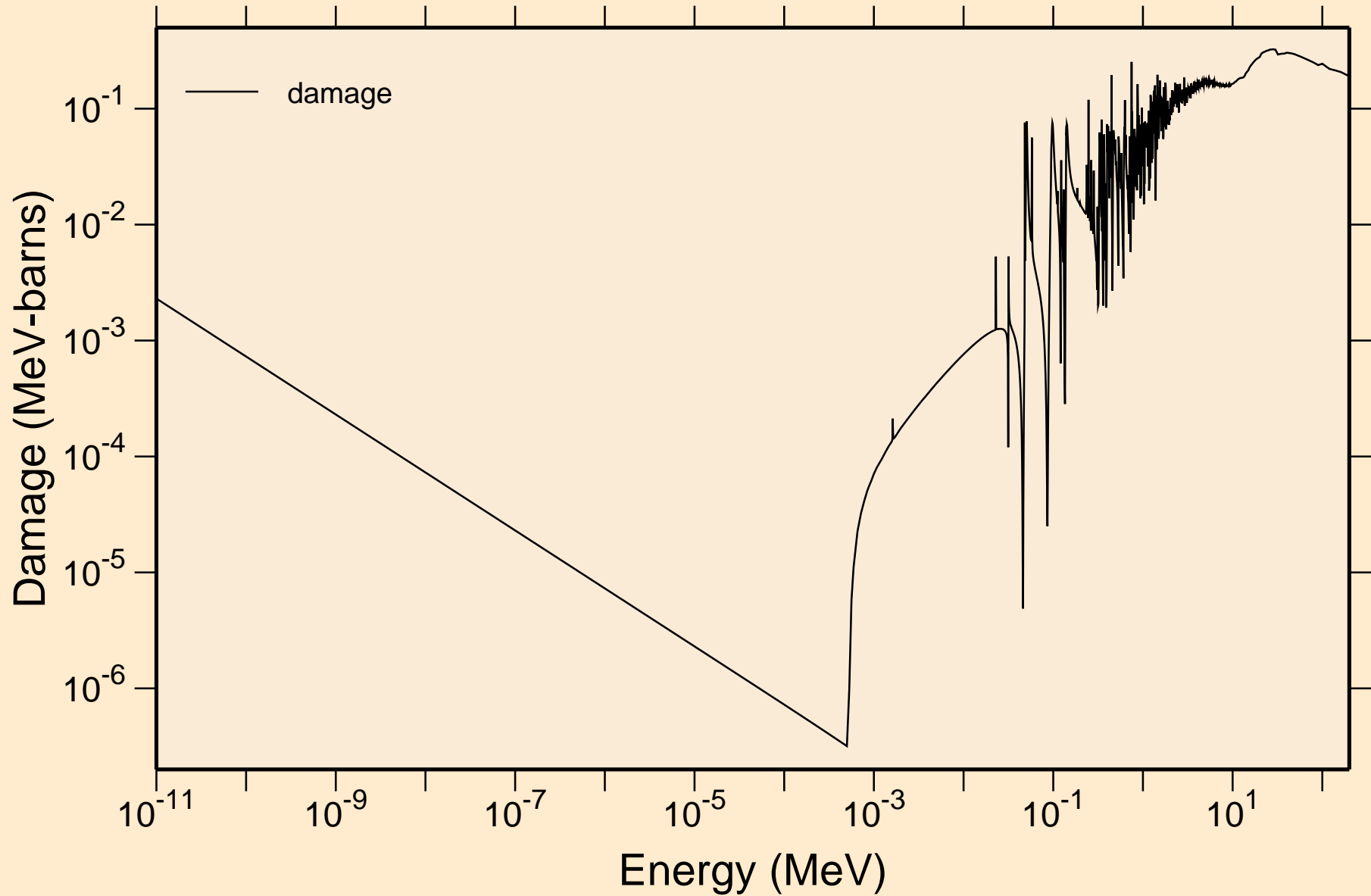

CR052 NEUTRON ACER TENDL-2023 LIBRARY; T=0.K  
Non-threshold reactions

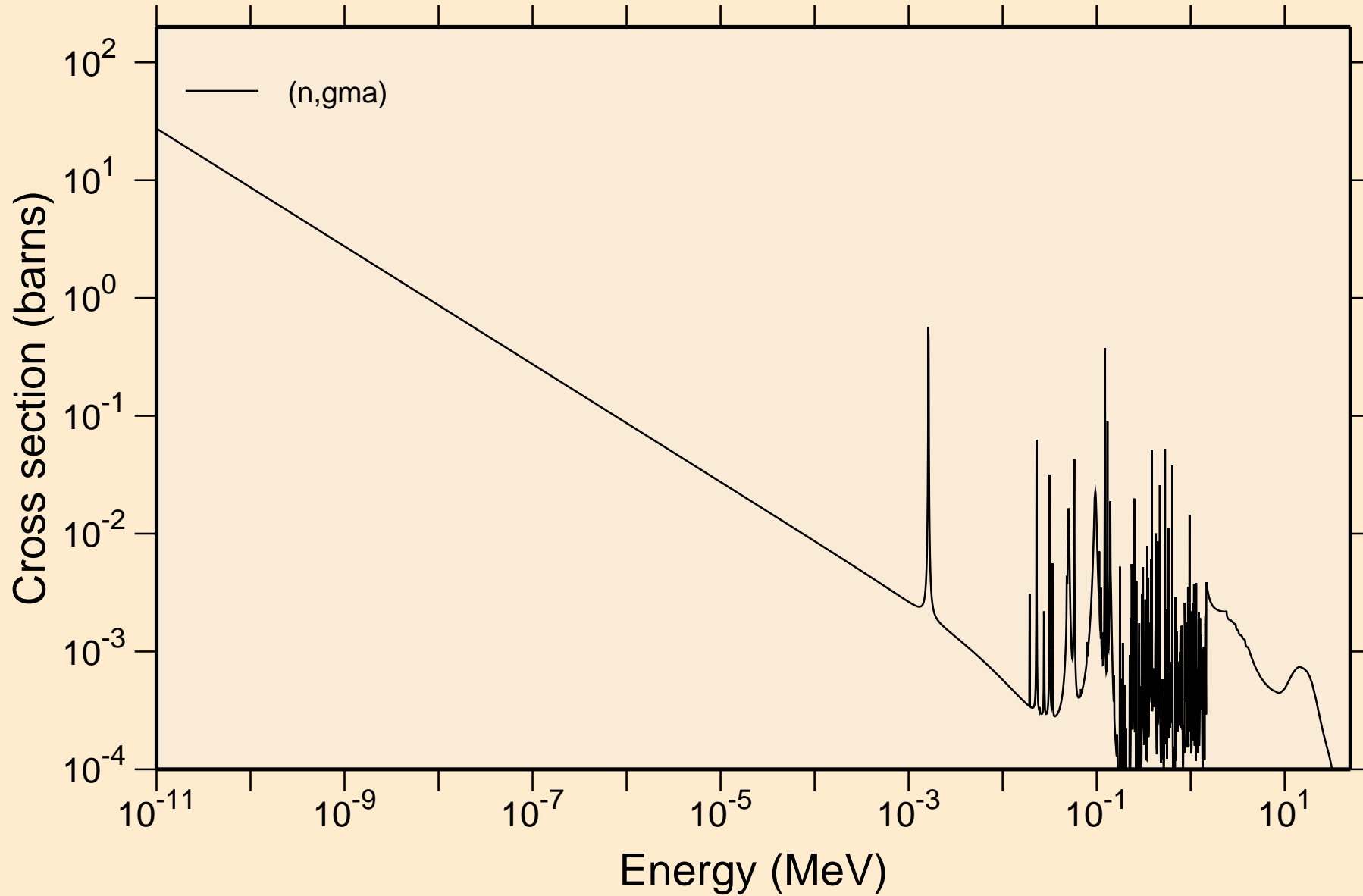

# CR052 NEUTRON ACER TENDL-2023 LIBRARY; T=0.K

## Principal cross sections

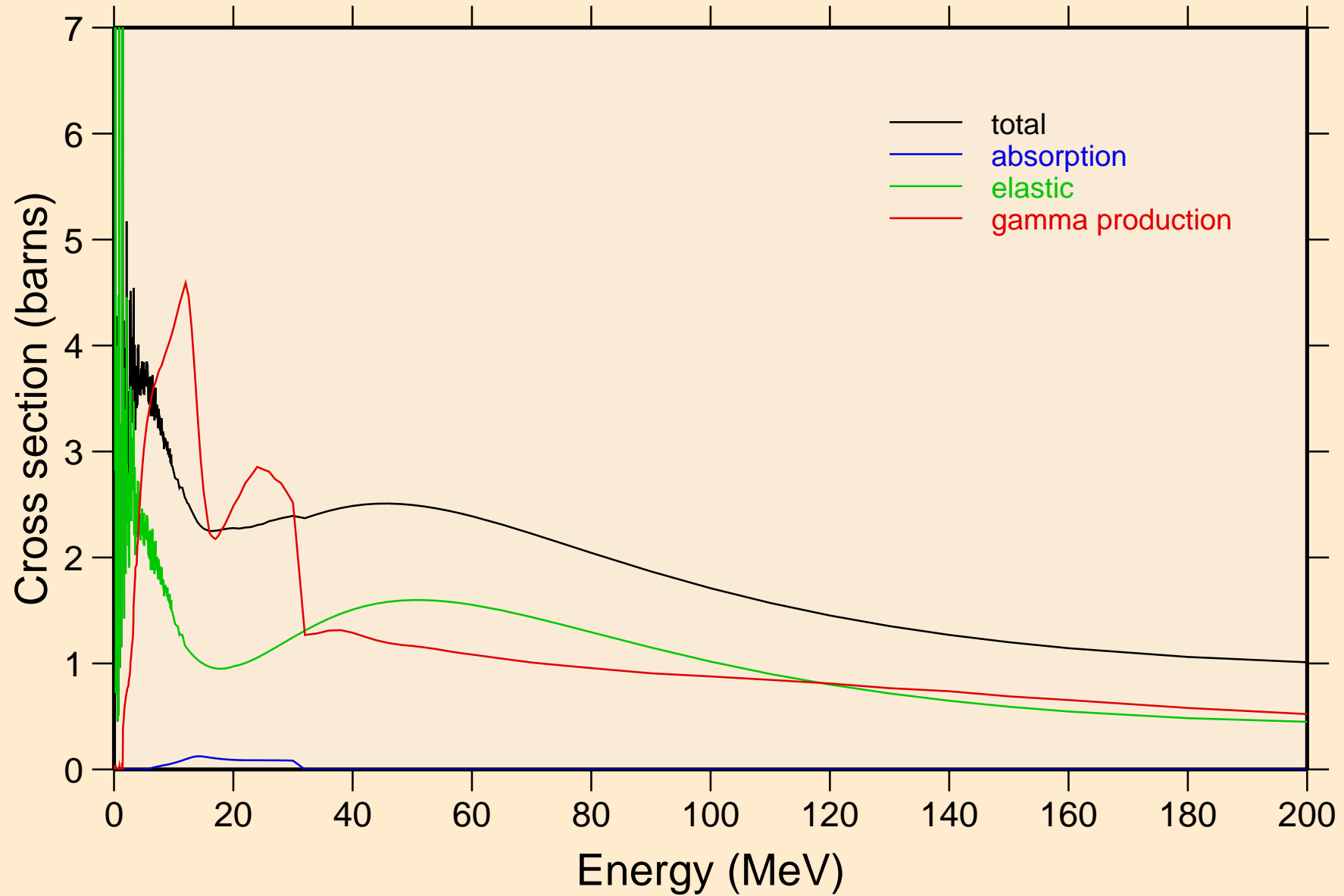

# CR052 NEUTRON ACER TENDL-2023 LIBRARY; T=0.K

## Heating

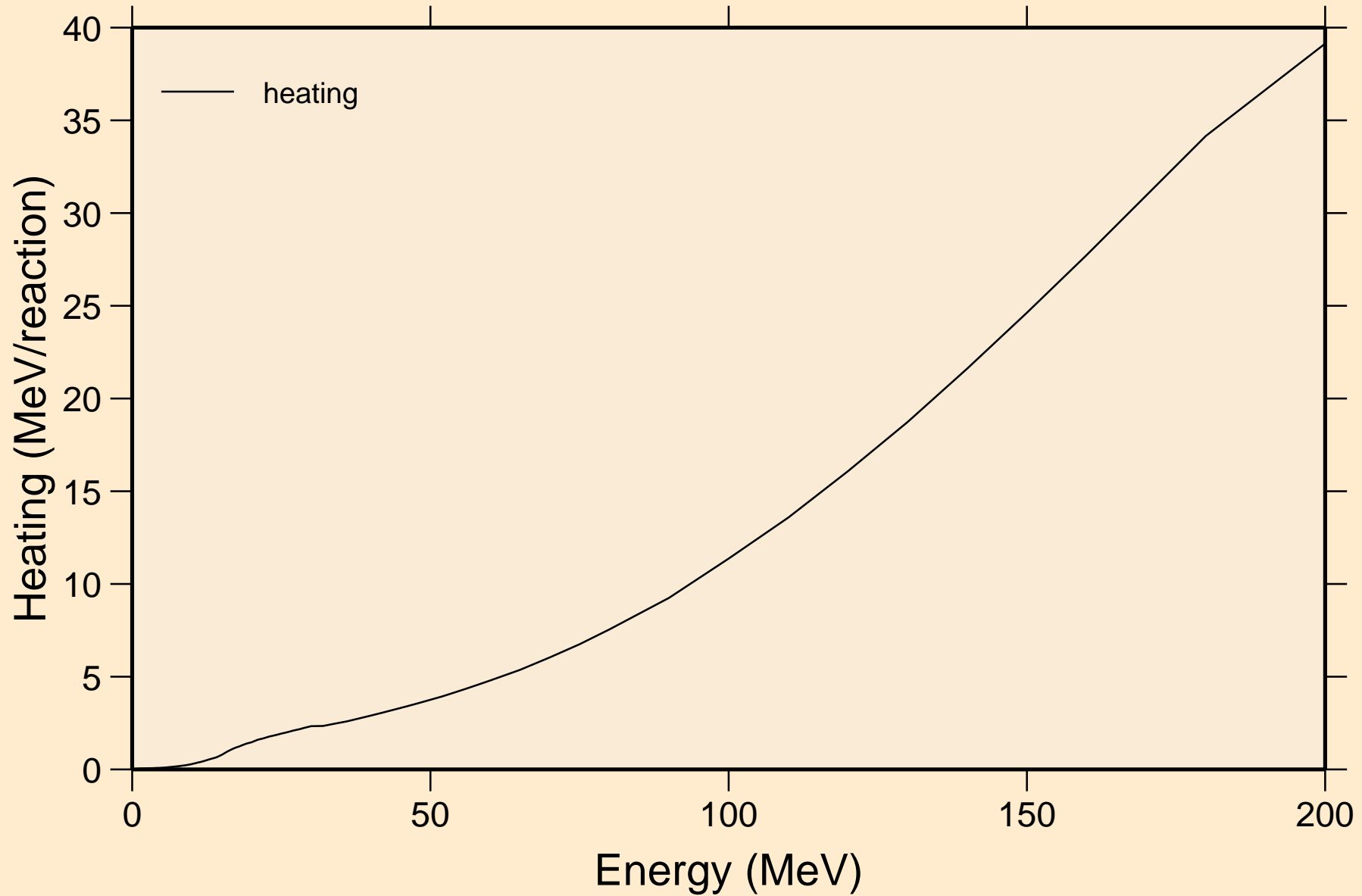

# CR052 NEUTRON ACER TENDL-2023 LIBRARY; T=0.K

## Damage

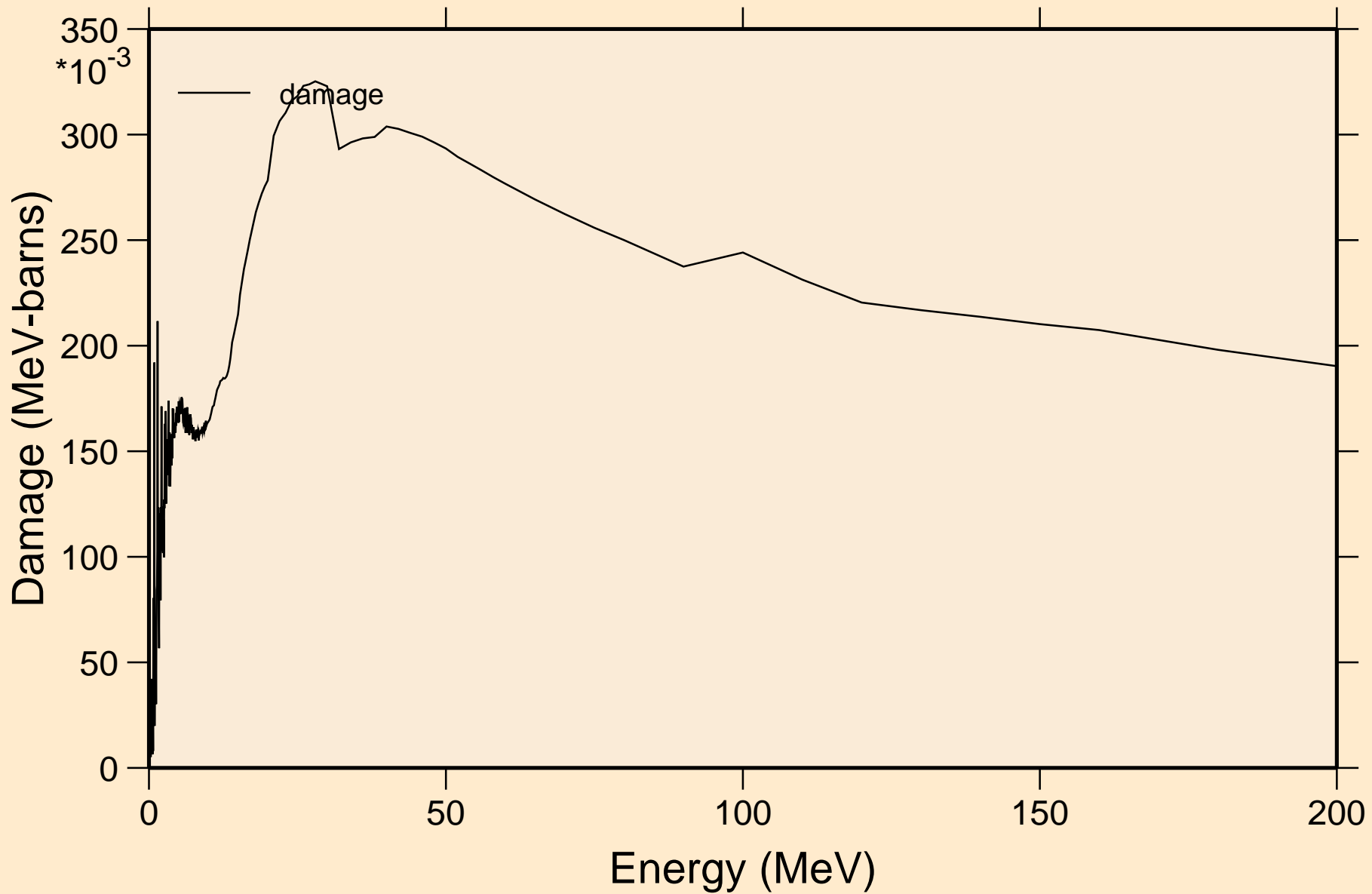

CR052 NEUTRON ACER TENDL-2023 LIBRARY; T=0.K  
Non-threshold reactions

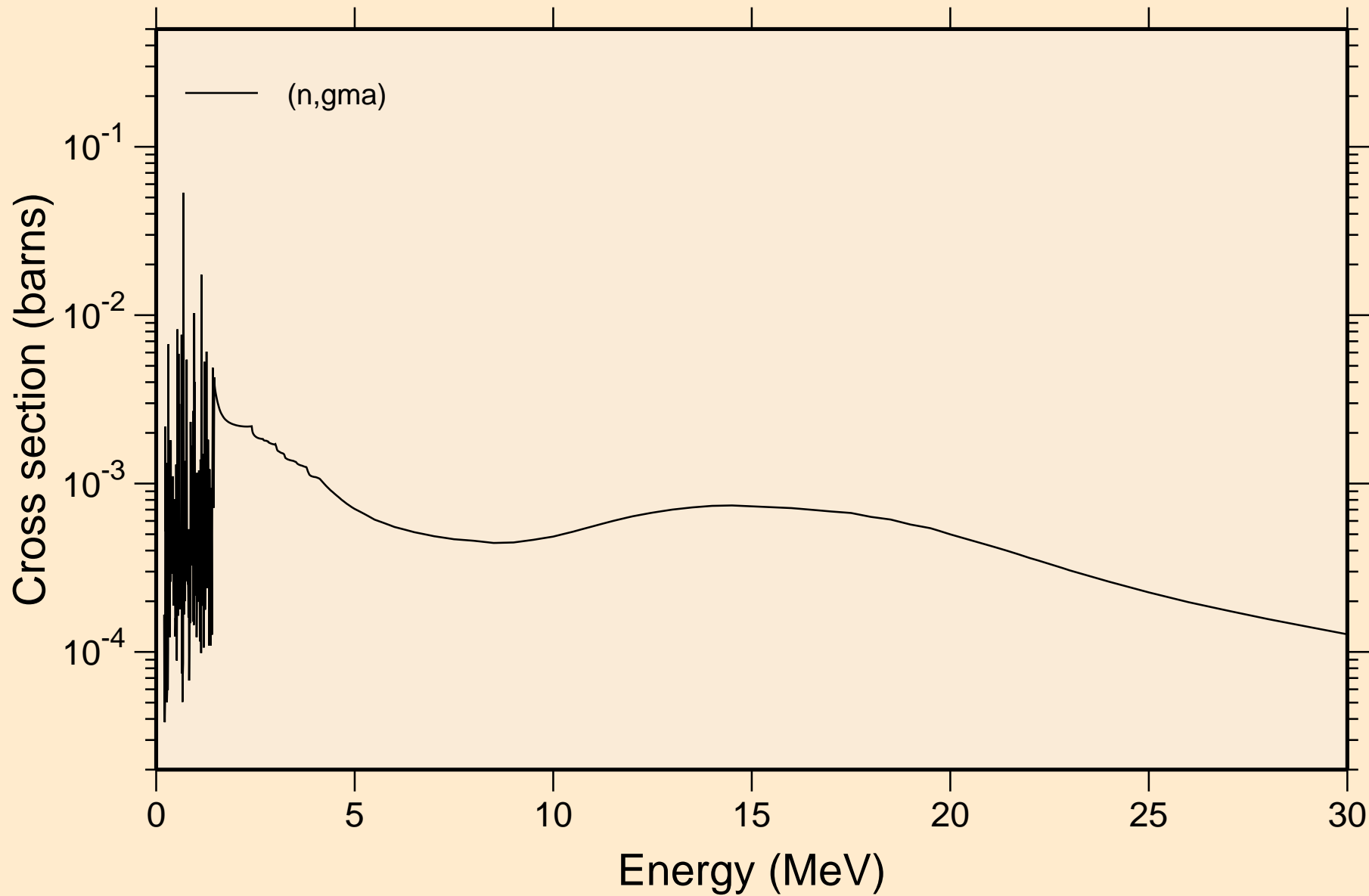



CR052 NEUTRON ACER TENDL-2023 LIBRARY; T=0.K  
Inelastic levels

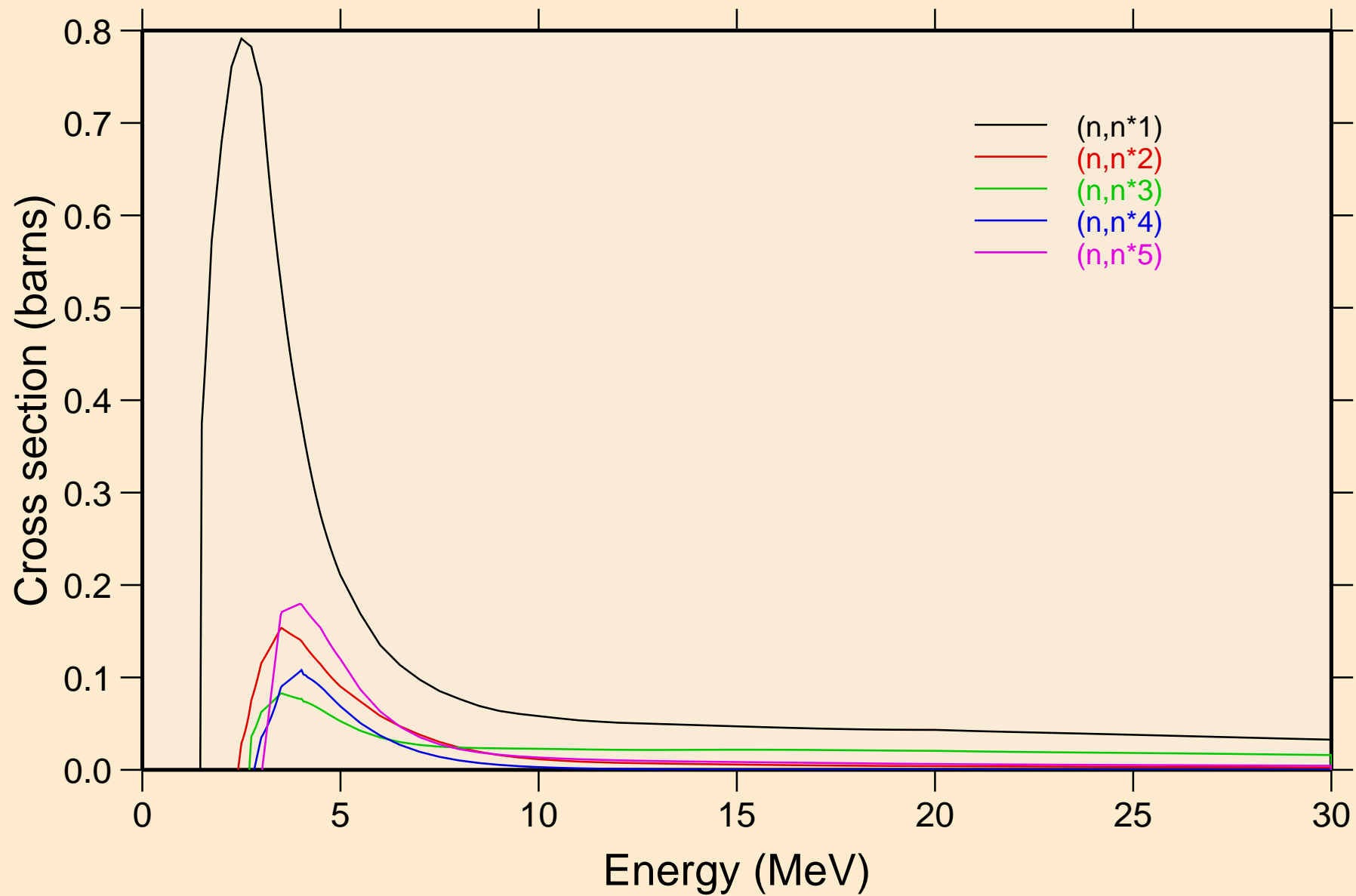

CR052 NEUTRON ACER TENDL-2023 LIBRARY; T=0.K  
Inelastic levels

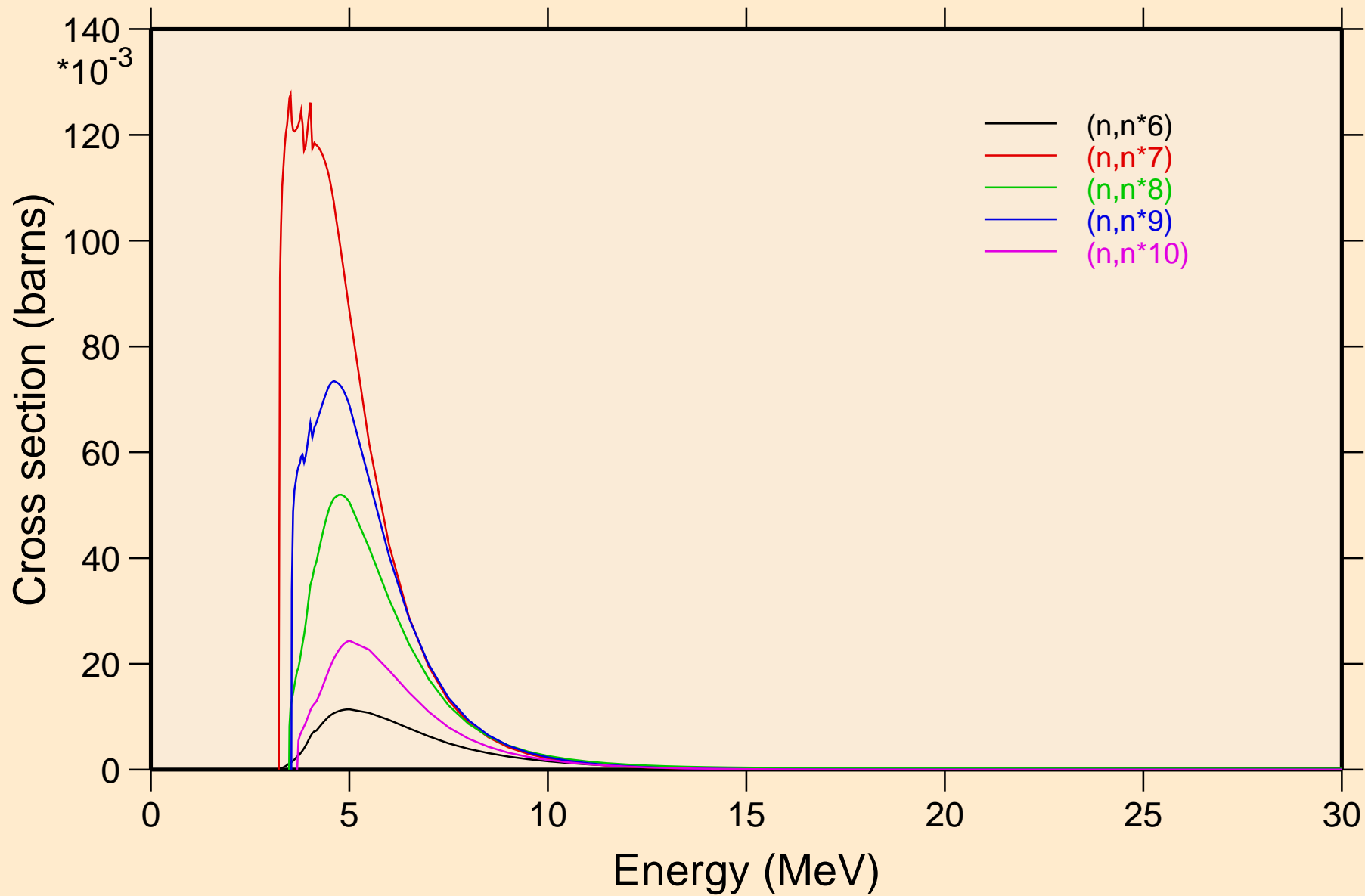

CR052 NEUTRON ACER TENDL-2023 LIBRARY; T=0.K  
Inelastic levels

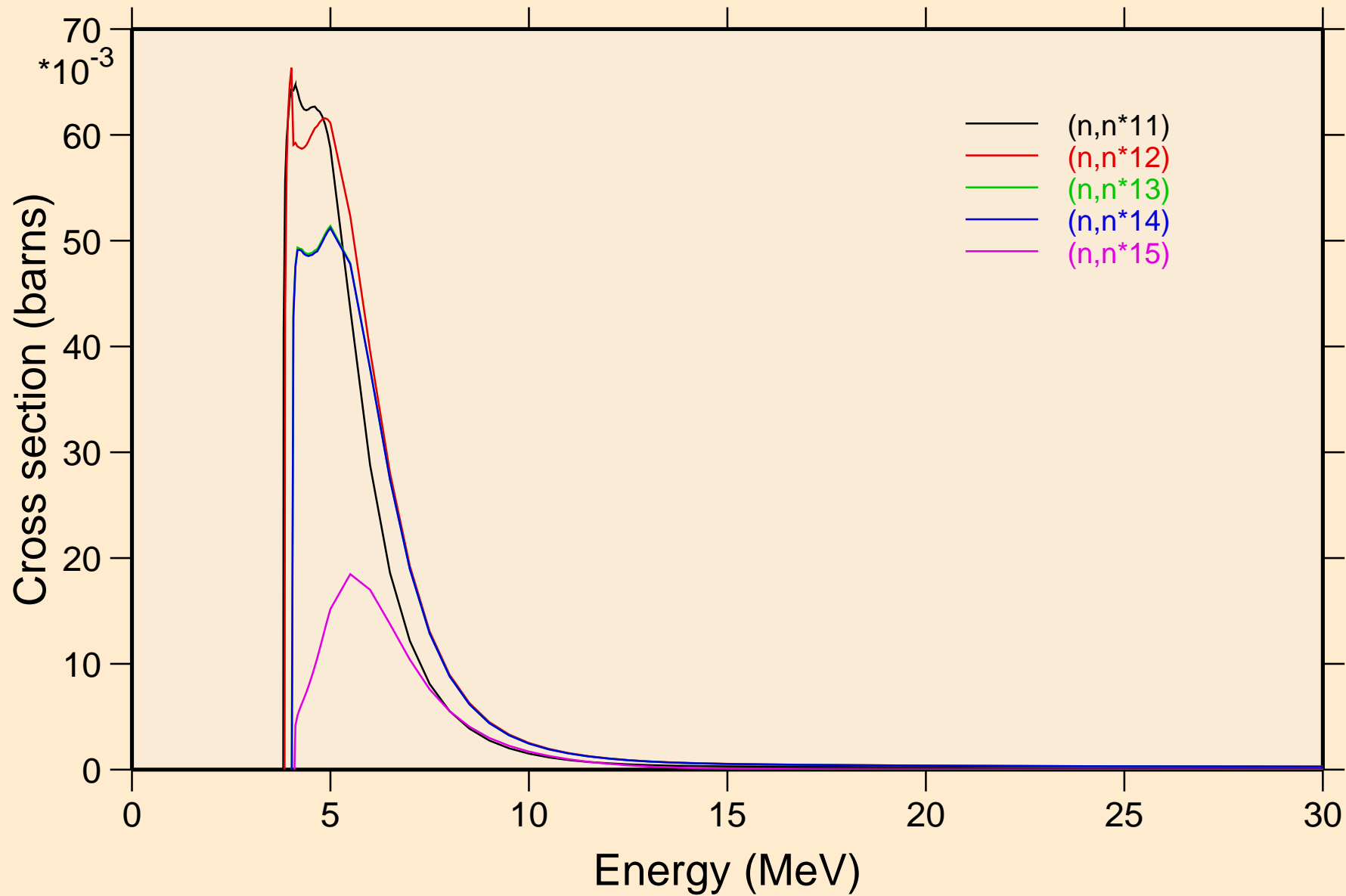

CR052 NEUTRON ACER TENDL-2023 LIBRARY; T=0.K  
Inelastic levels

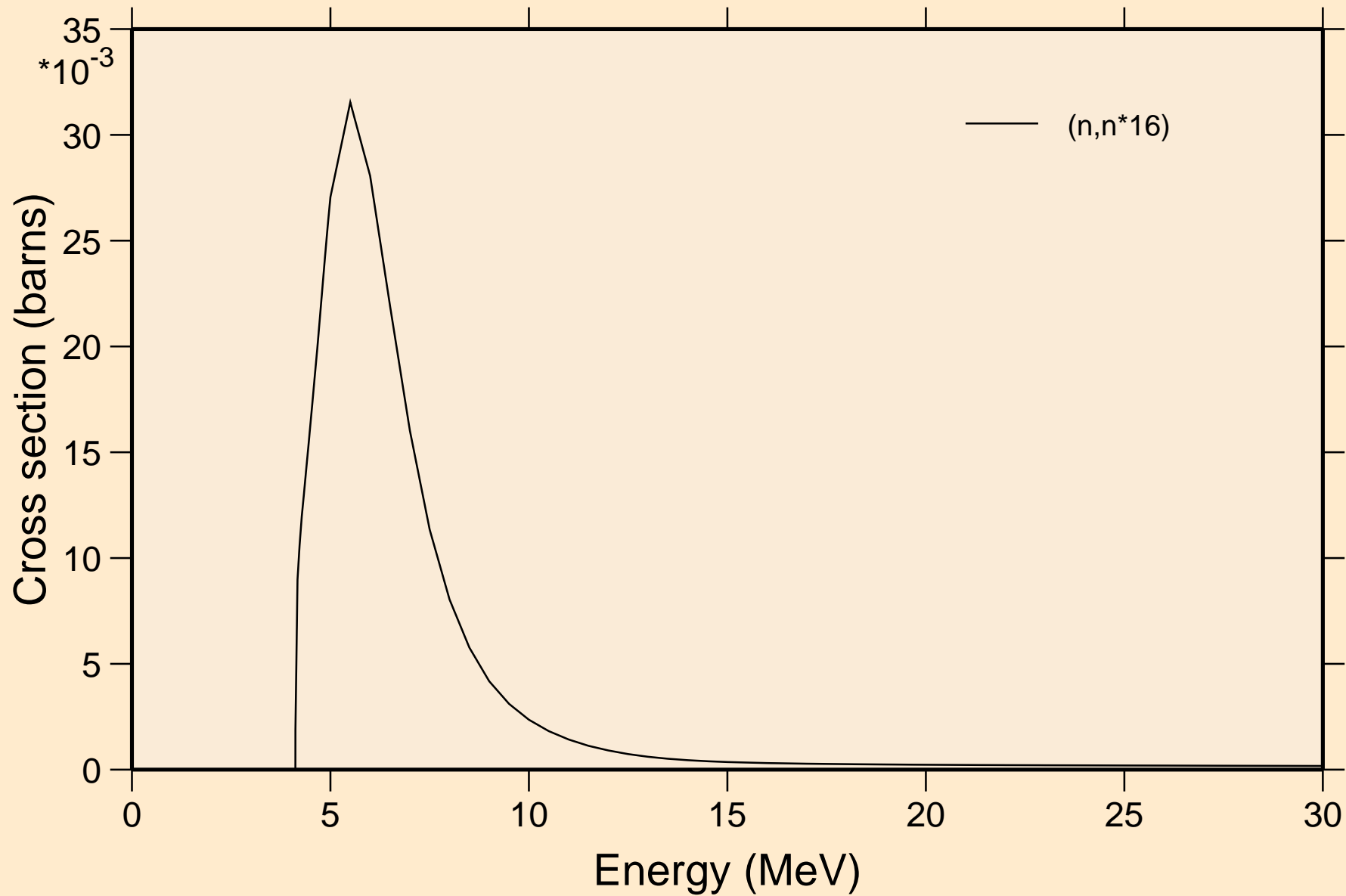

# CR052 NEUTRON ACER TENDL-2023 LIBRARY; T=0.K

## Threshold reactions

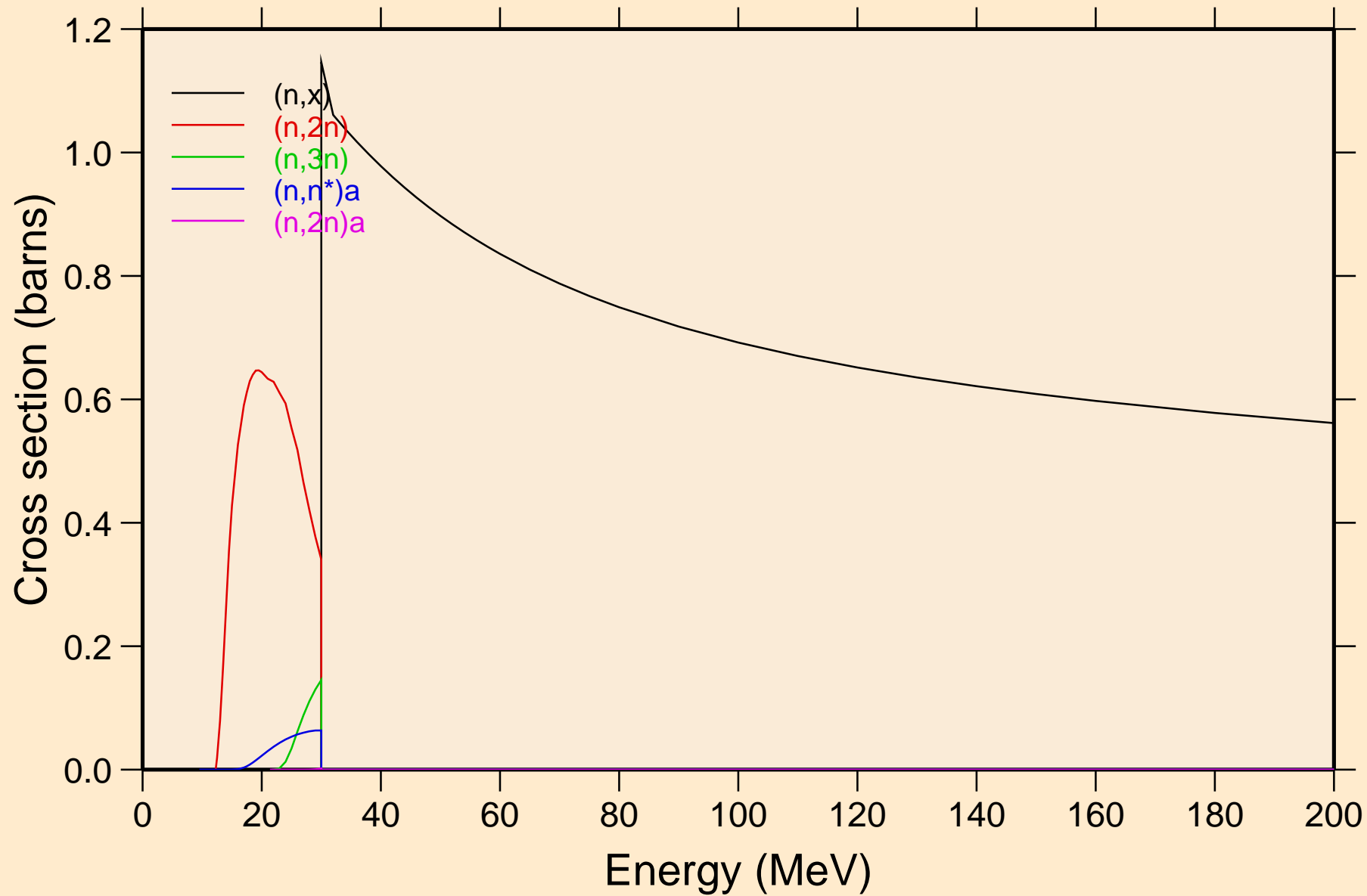

# CR052 NEUTRON ACER TENDL-2023 LIBRARY; T=0.K

## Threshold reactions

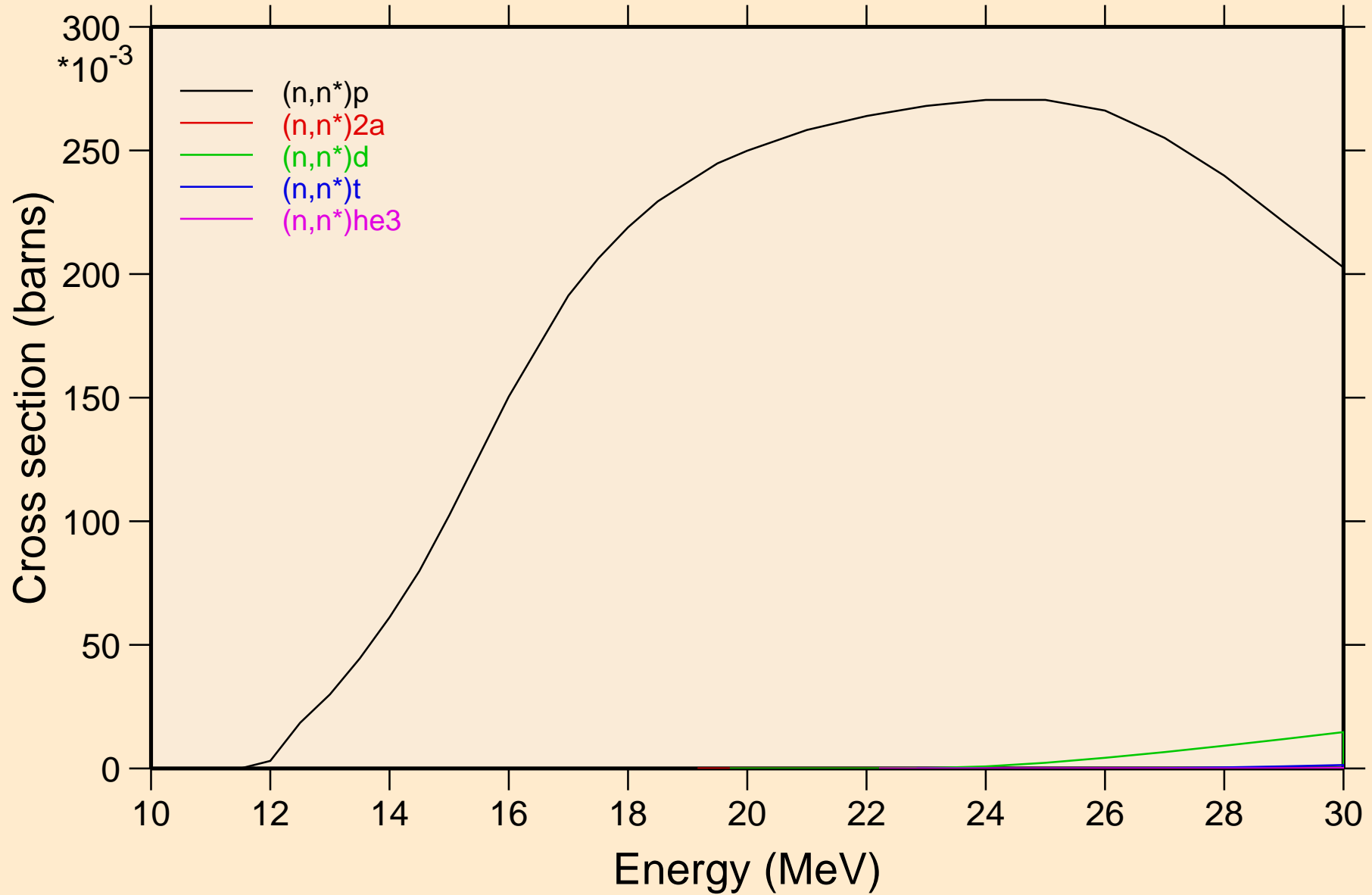

# CR052 NEUTRON ACER TENDL-2023 LIBRARY; T=0.K

## Threshold reactions

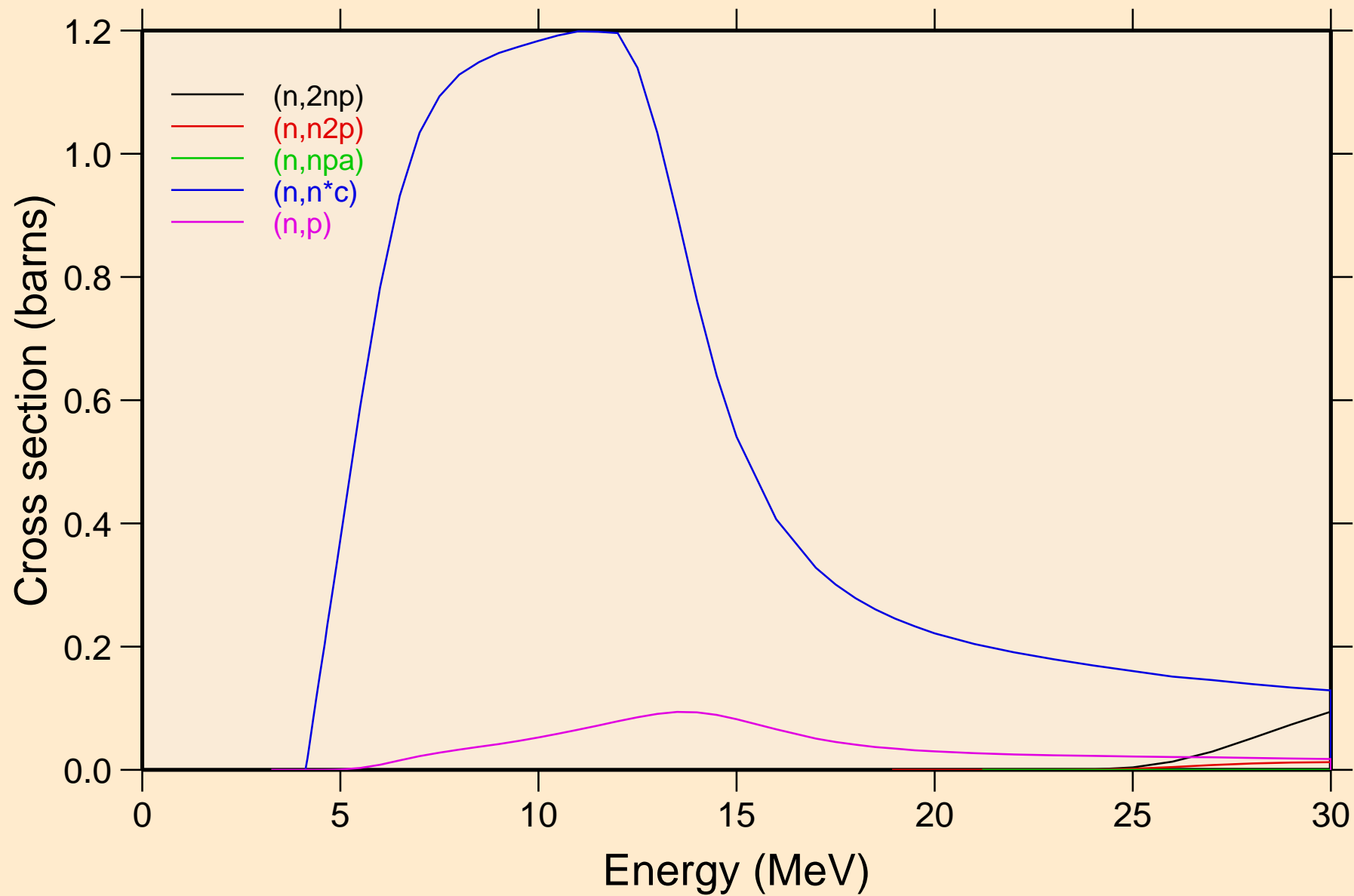

# CR052 NEUTRON ACER TENDL-2023 LIBRARY; T=0.K

## Threshold reactions

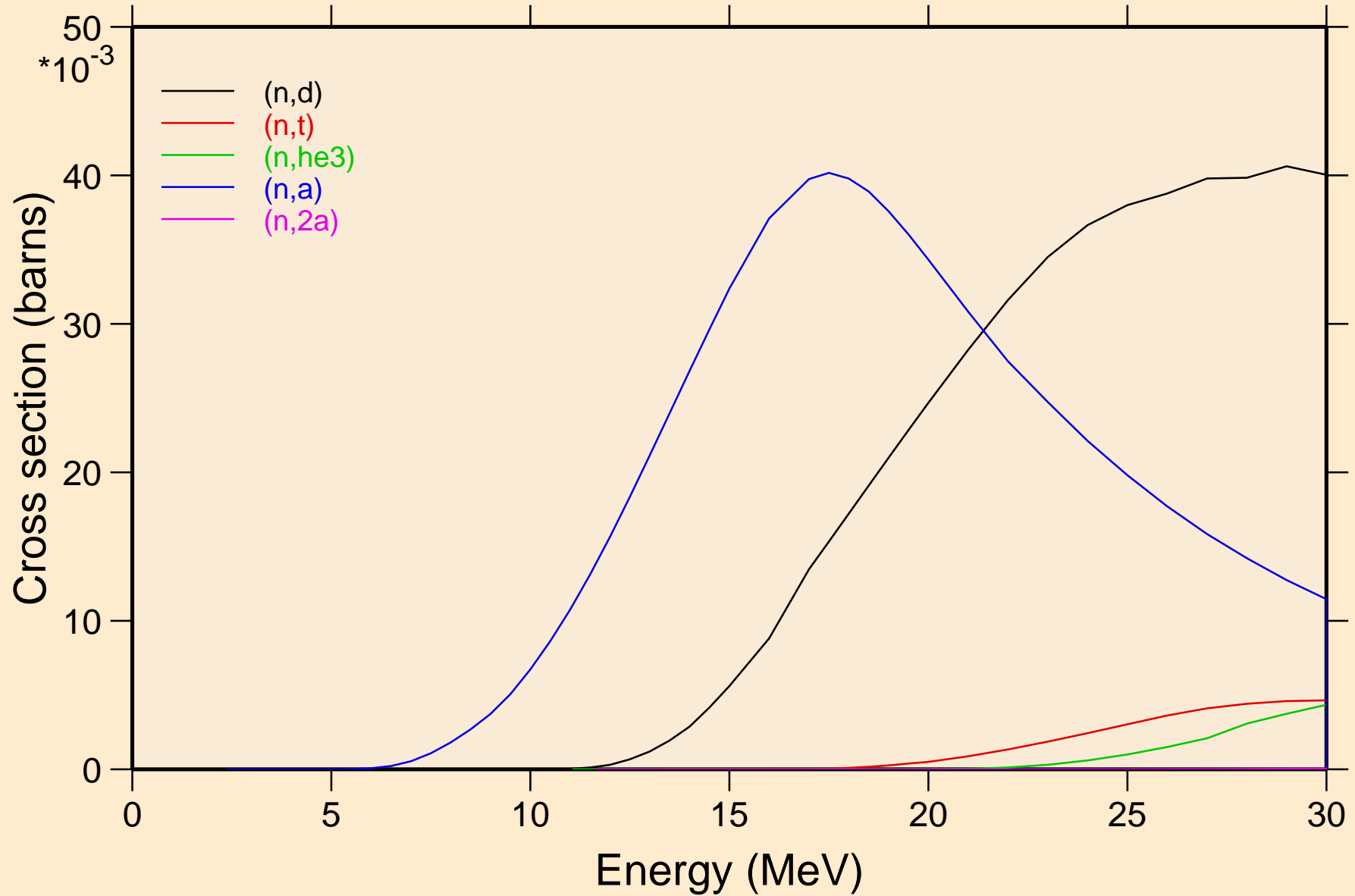



# CR052 NEUTRON ACER TENDL-2023 LIBRARY; T=0.K

## Threshold reactions

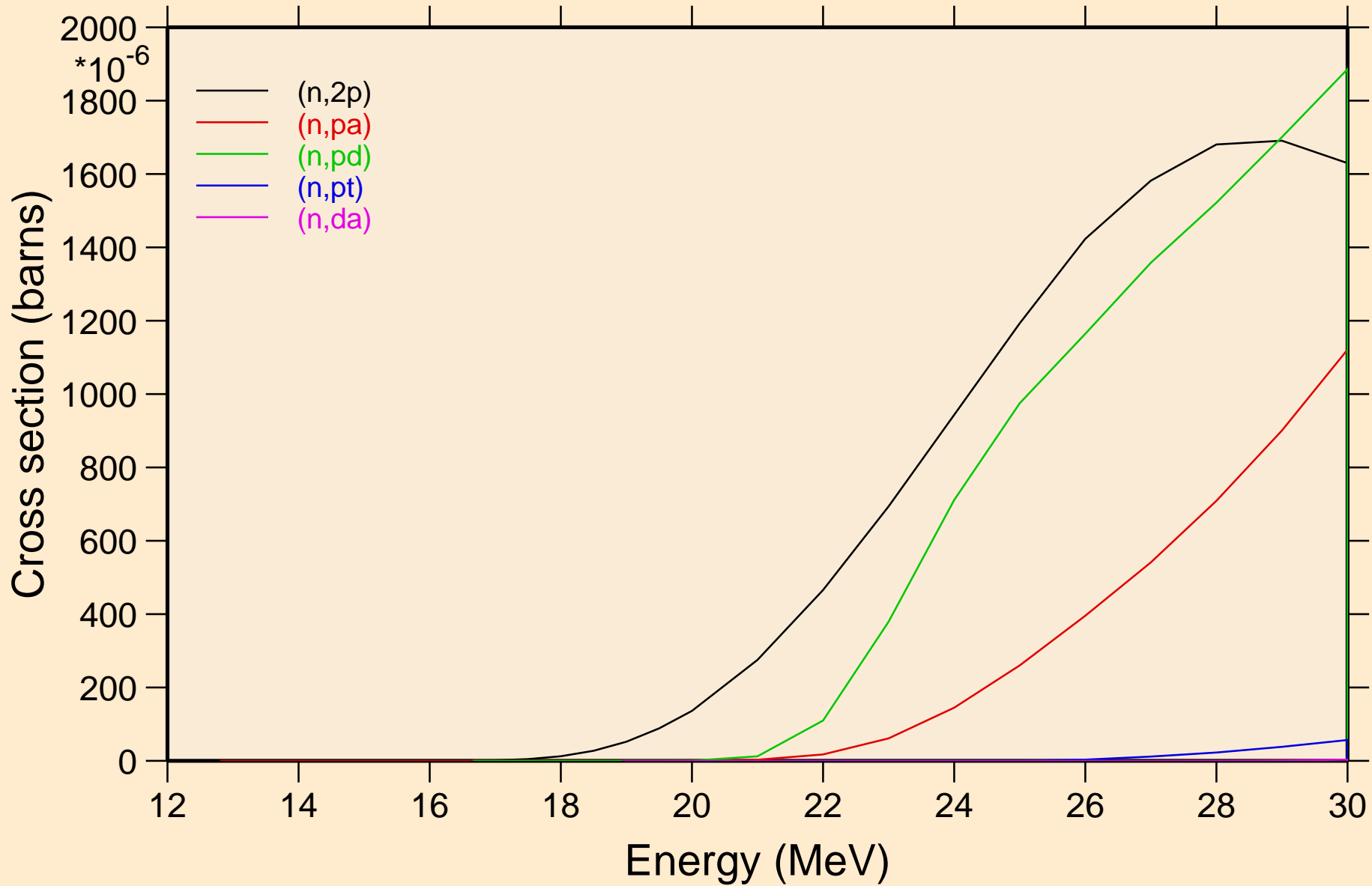

# CR052 NEUTRON ACER TENDL-2023 LIBRARY; T=0.K

## Threshold reactions

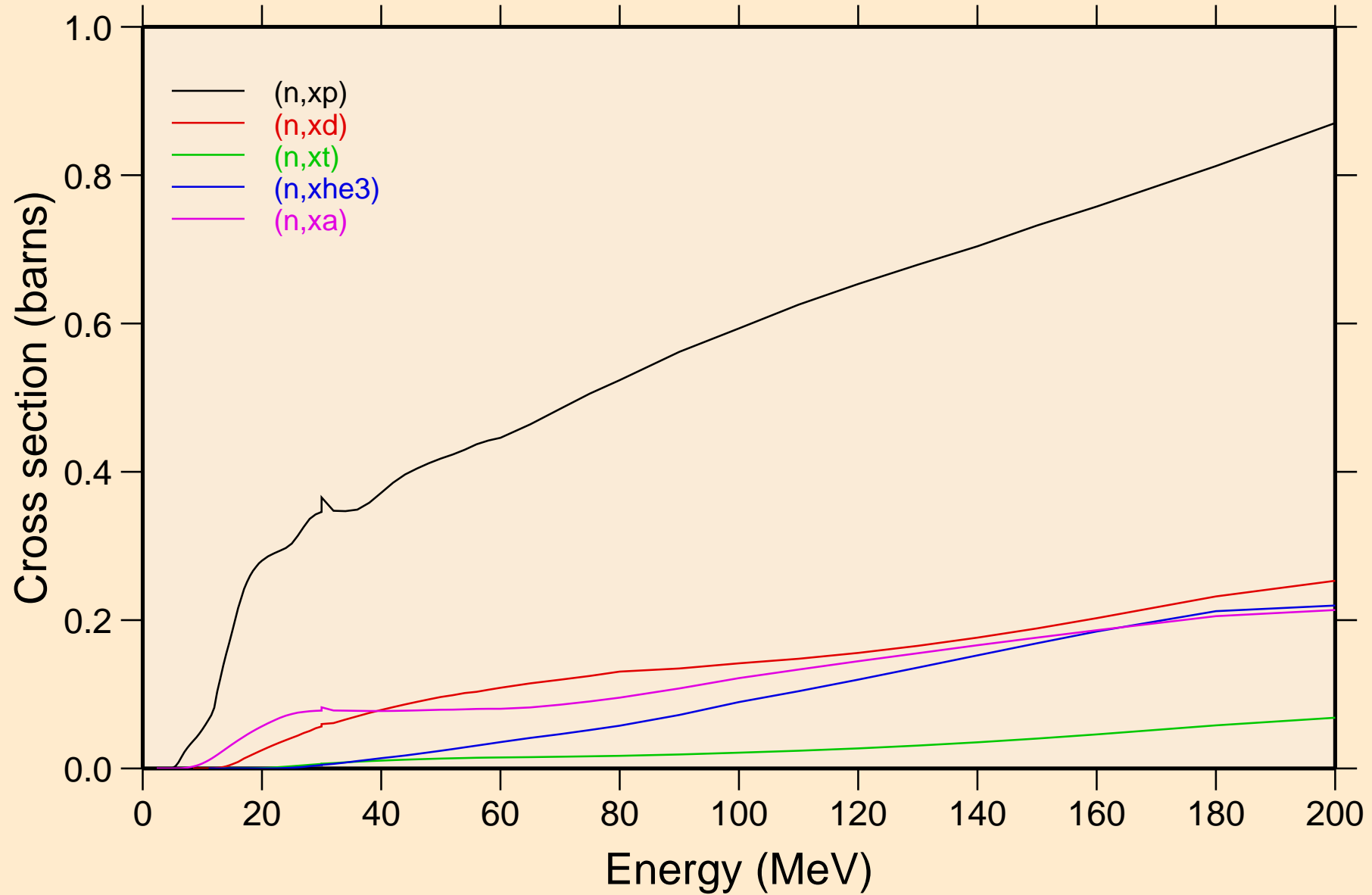

CR052 NEUTRON ACER TENDL-2023 LIBRARY; T=0.K  
angular distribution for elastic

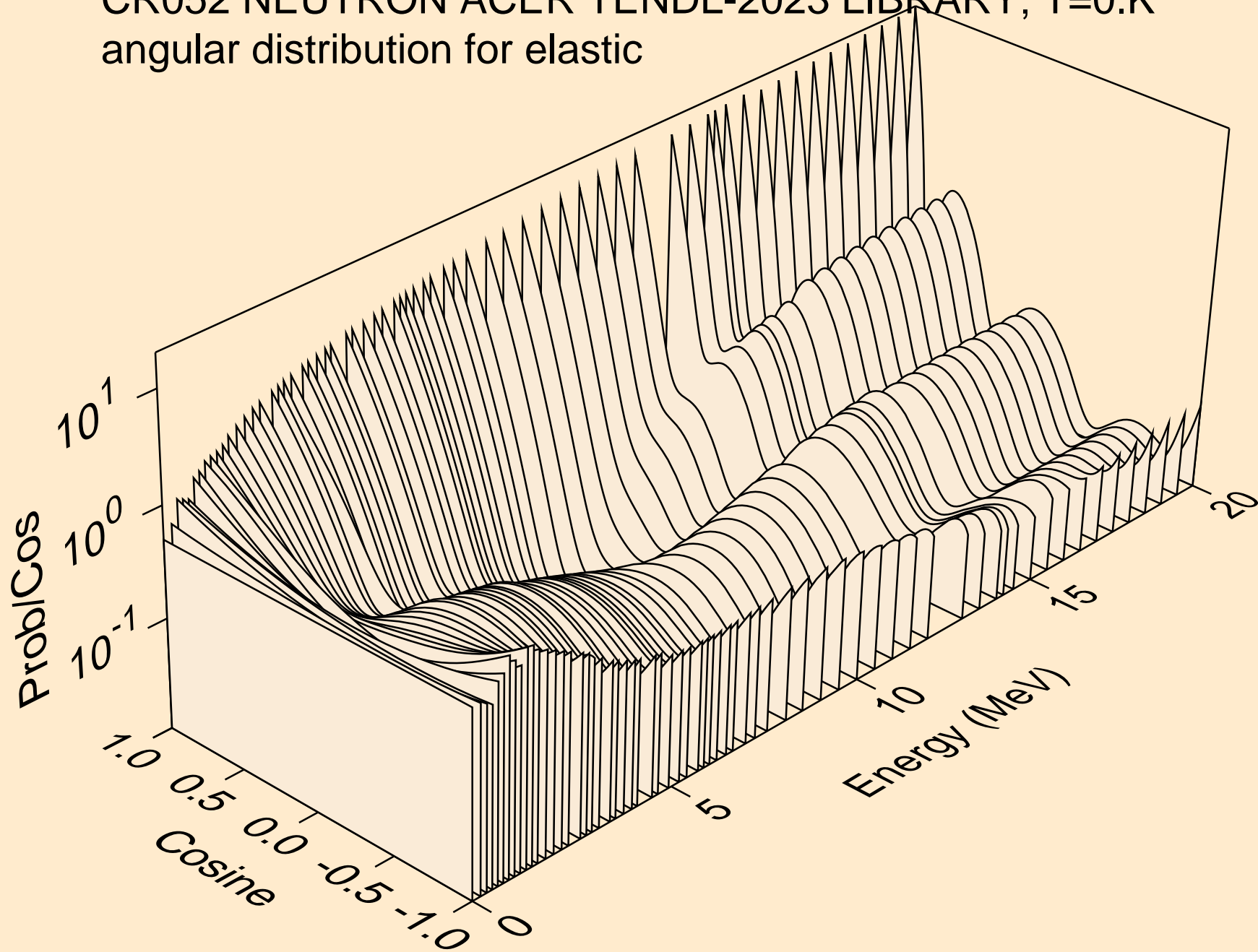

CR052 NEUTRON ACER TENDL-2023 LIBRARY; T=0.K  
angular distribution for elastic

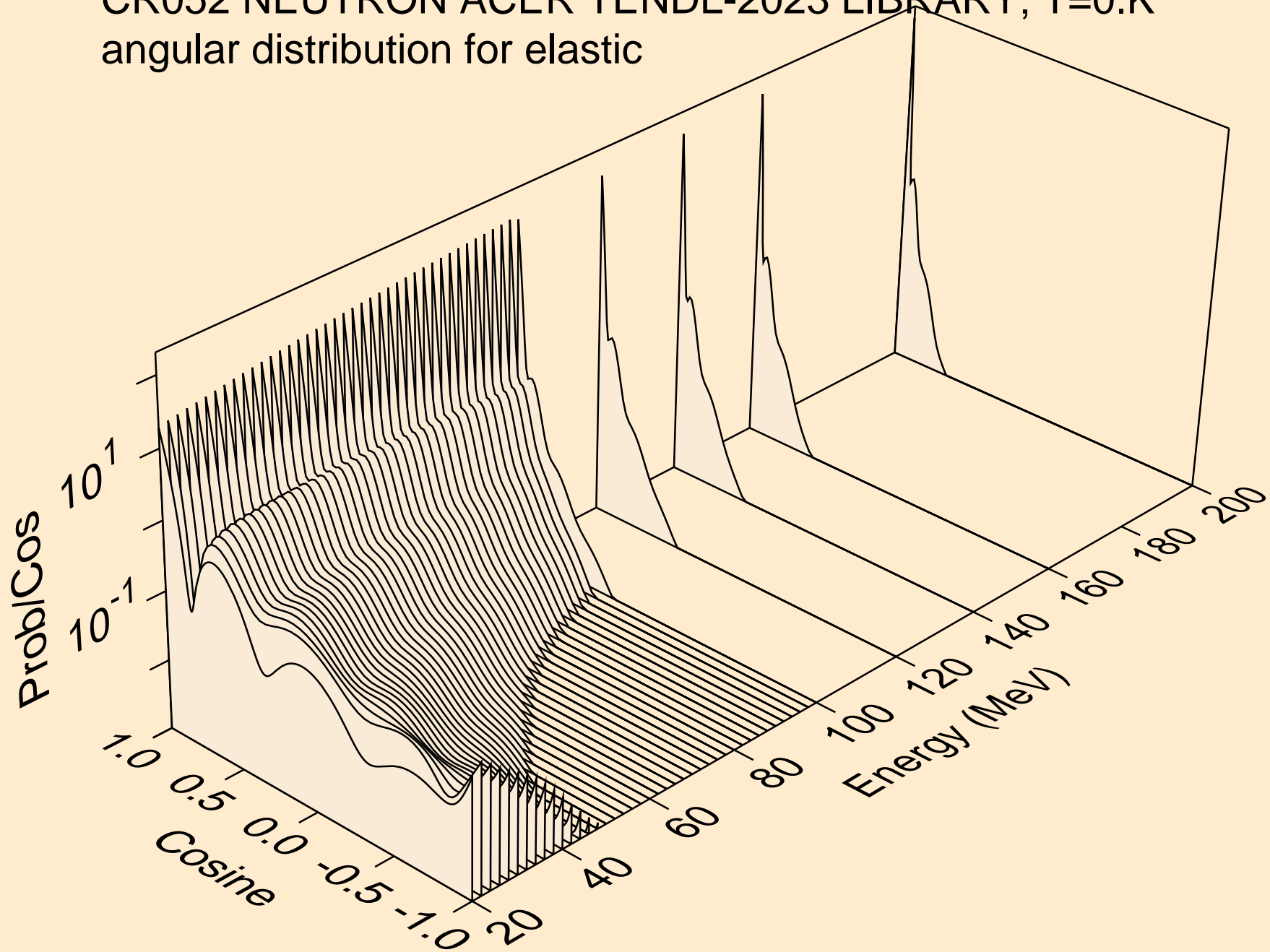

CR052 NEUTRON ACER TENDL-2023 LIBRARY; T=0.K  
angular distribution for (n,n\*1)

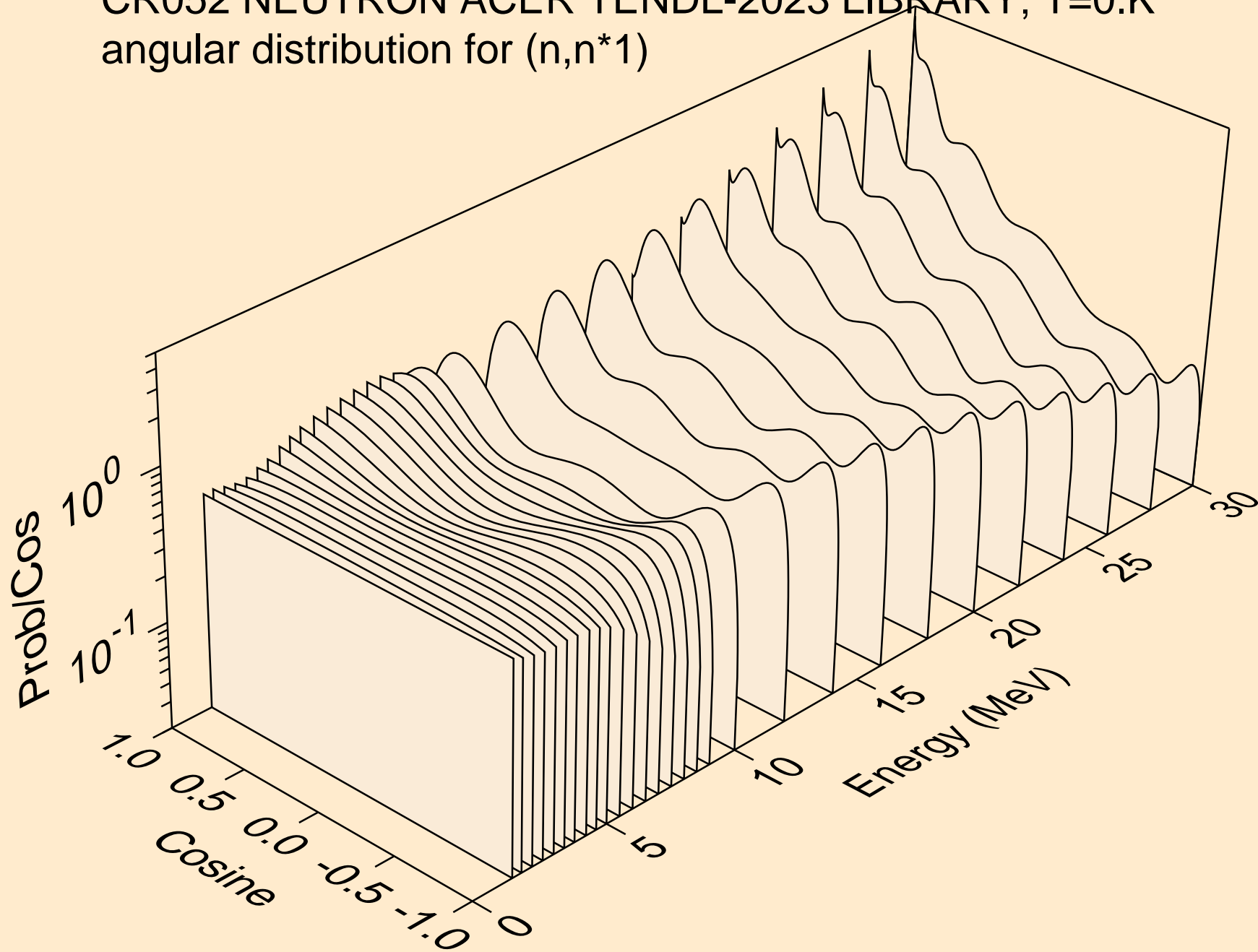

CR052 NEUTRON ACER TENDL-2023 LIBRARY; T=0.K  
angular distribution for (n,n\*2)

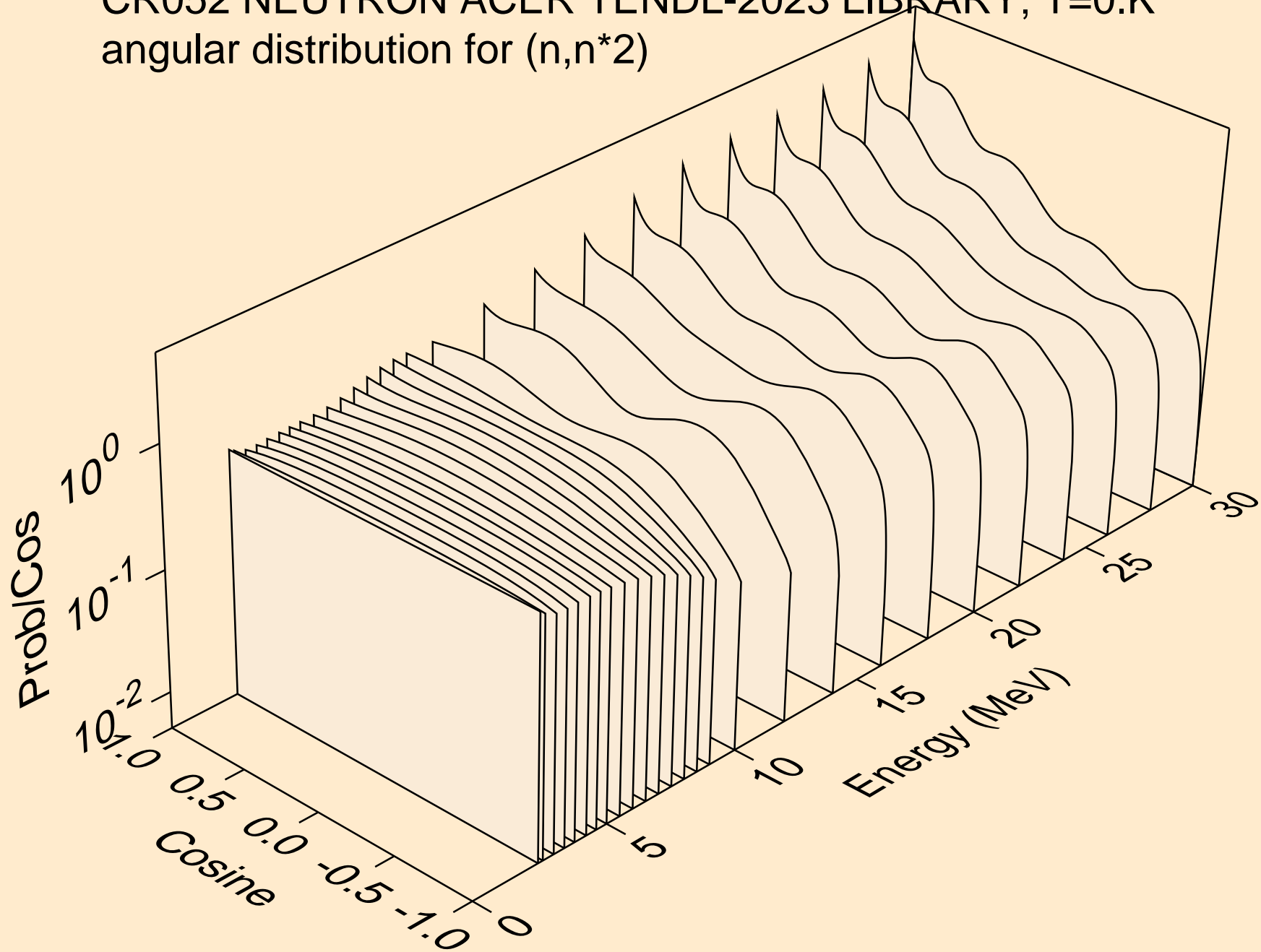

CR052 NEUTRON ACER TENDL-2023 LIBRARY; T=0.K  
angular distribution for (n,n\*3)

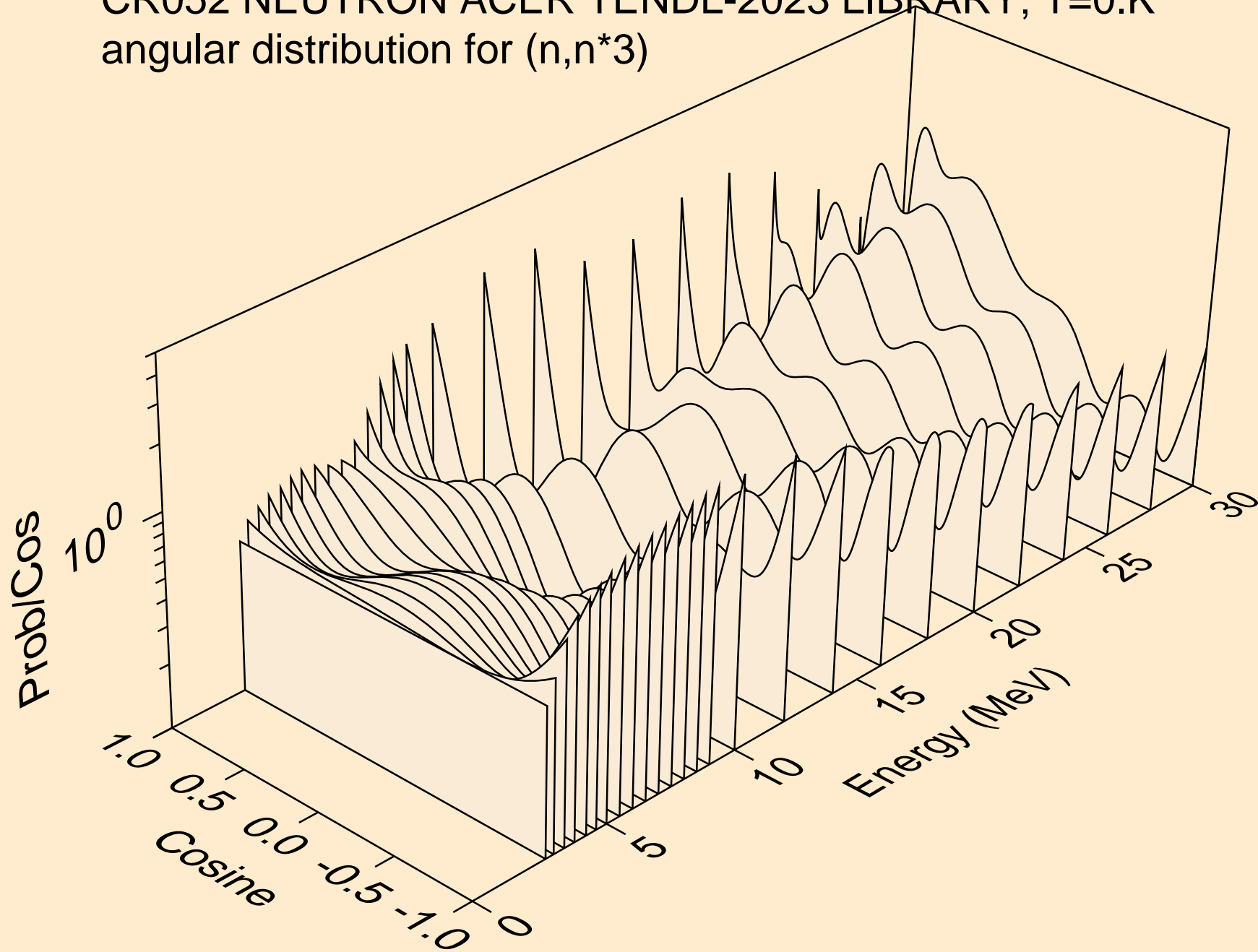

CR052 NEUTRON ACER TENDL-2023 LIBRARY; T=0.K  
angular distribution for (n,n\*4)

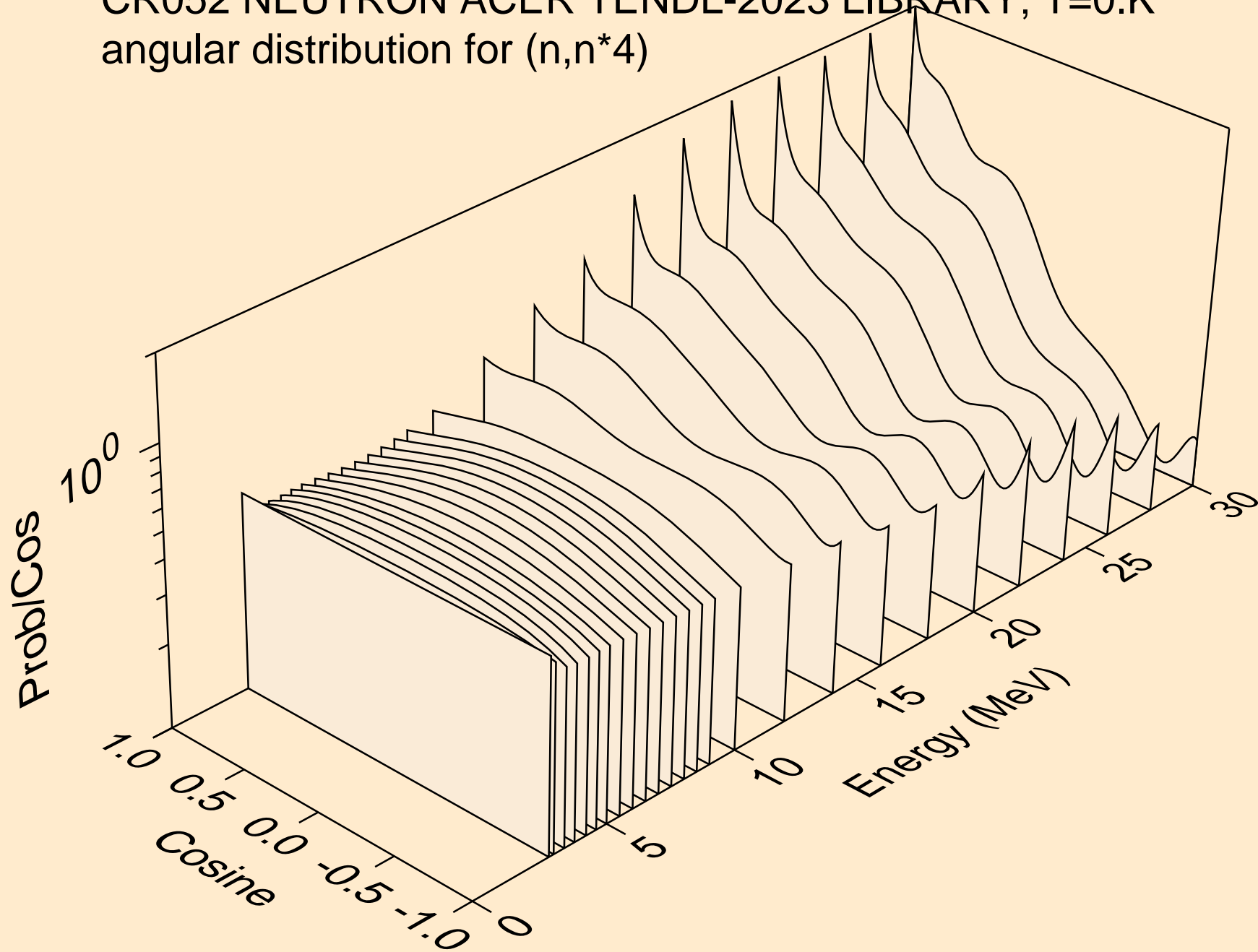



CR052 NEUTRON ACER TENDL-2023 LIBRARY; T=0.K  
angular distribution for (n,n\*5)

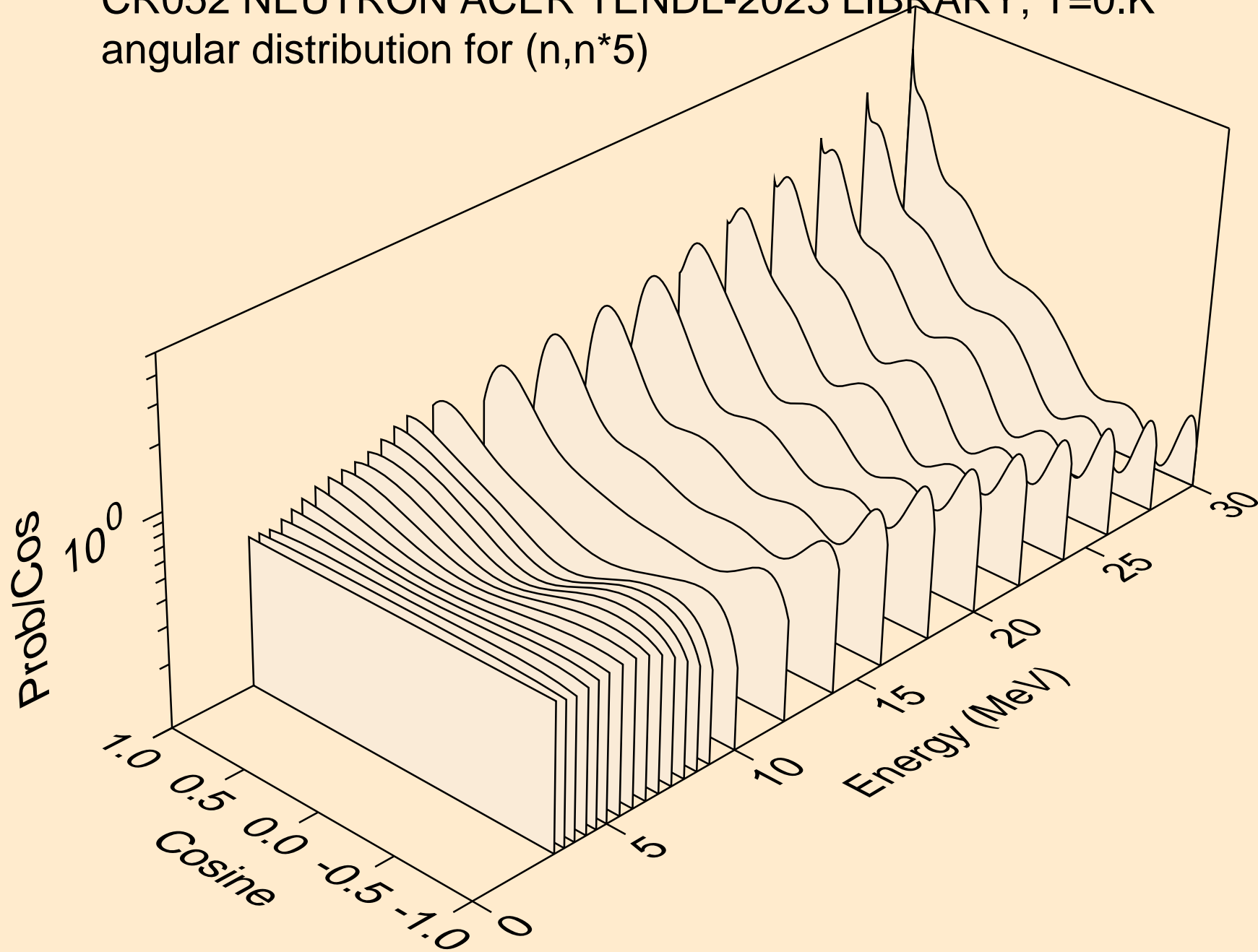

CR052 NEUTRON ACER TENDL-2023 LIBRARY; T=0.K  
angular distribution for (n,n\*6)

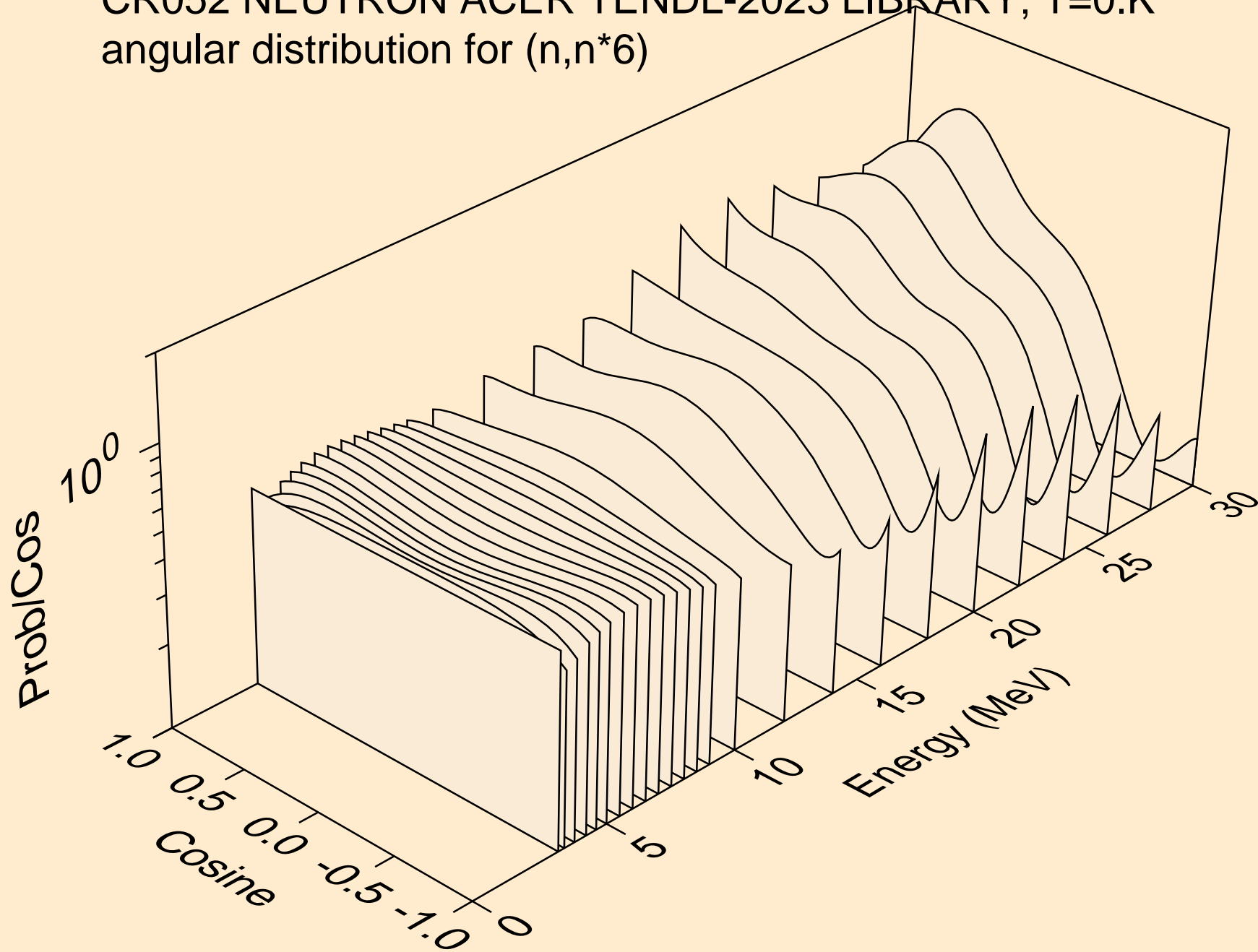

CR052 NEUTRON ACER TENDL-2023 LIBRARY; T=0.K  
angular distribution for (n,n\*7)

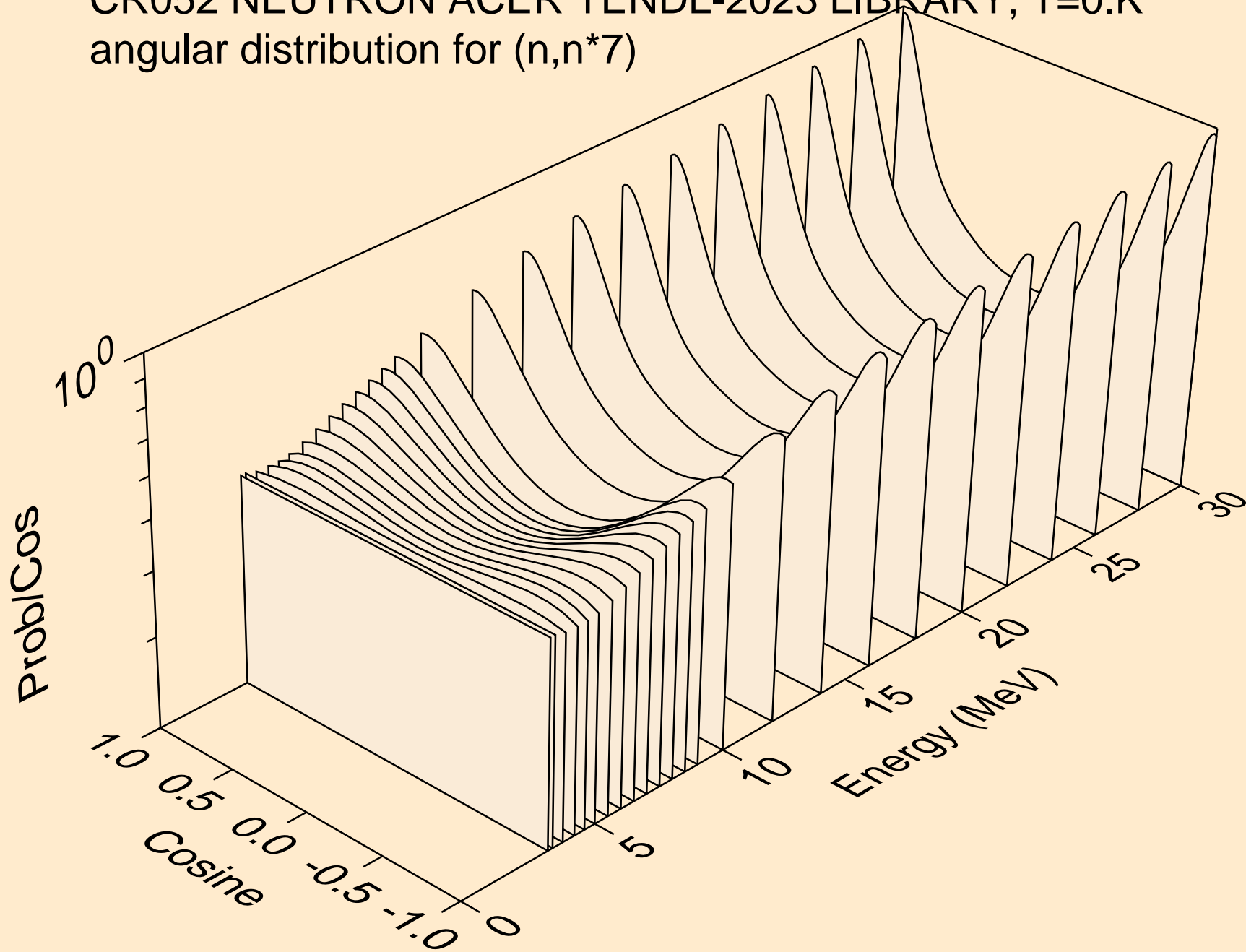

CR052 NEUTRON ACER TENDL-2023 LIBRARY; T=0.K  
angular distribution for (n,n\*8)

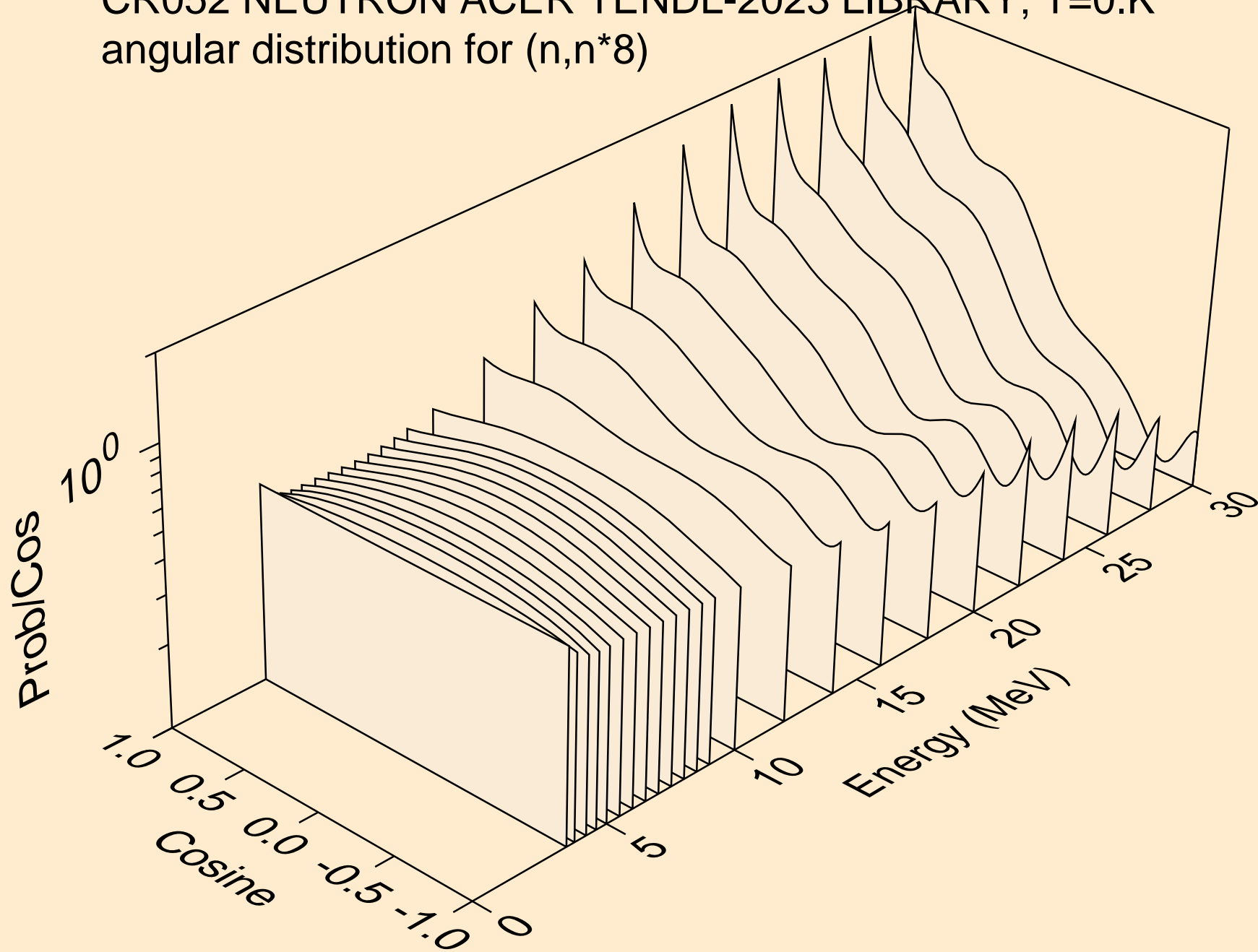

CR052 NEUTRON ACER TENDL-2023 LIBRARY; T=0.K  
angular distribution for (n,n\*9)

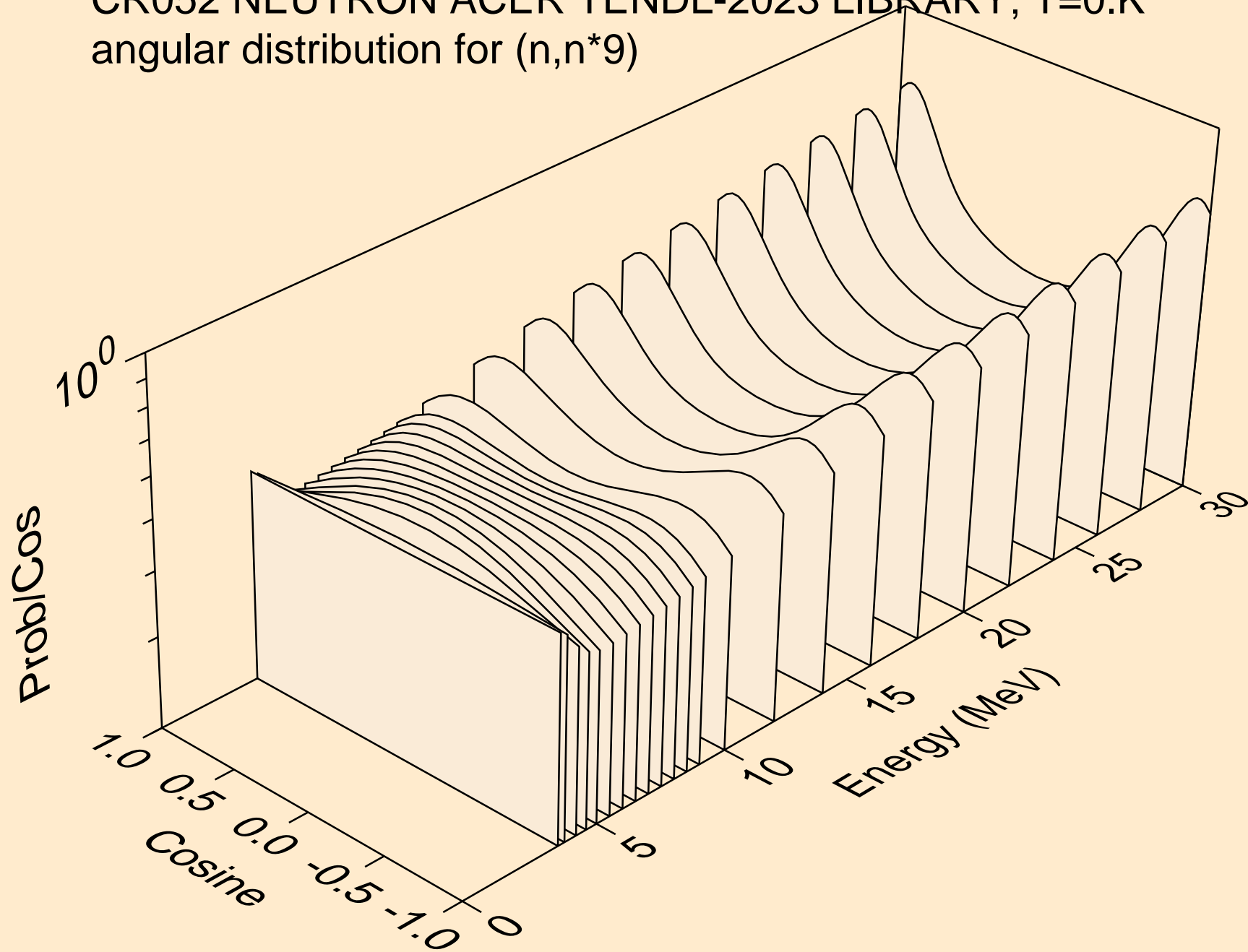

CR052 NEUTRON ACER TENDL-2023 LIBRARY; T=0.K  
angular distribution for (n,n\*10)

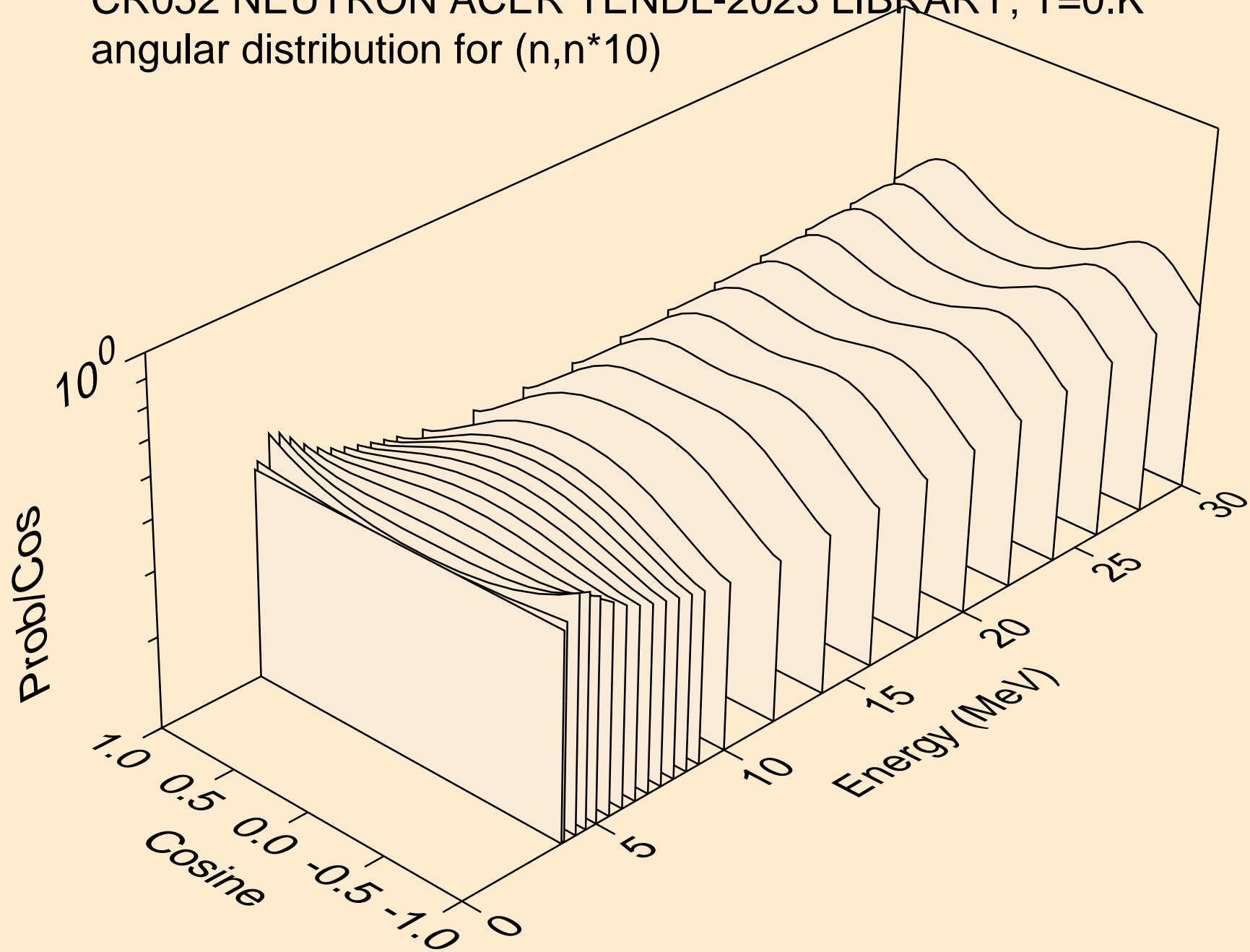

CR052 NEUTRON ACER TENDL-2023 LIBRARY; T=0.K  
angular distribution for (n,n\*11)

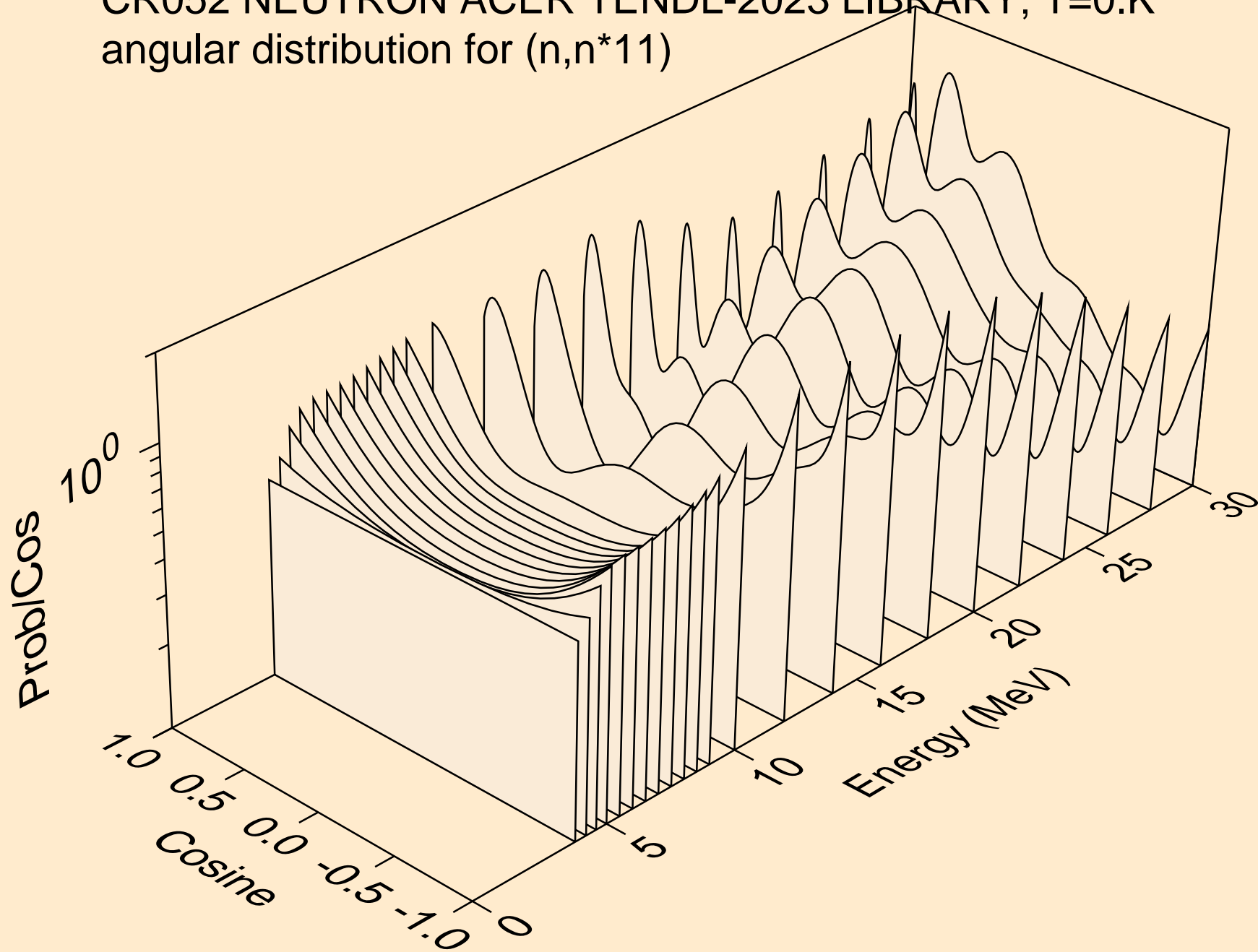

CR052 NEUTRON ACER TENDL-2023 LIBRARY; T=0.K  
angular distribution for (n,n\*12)

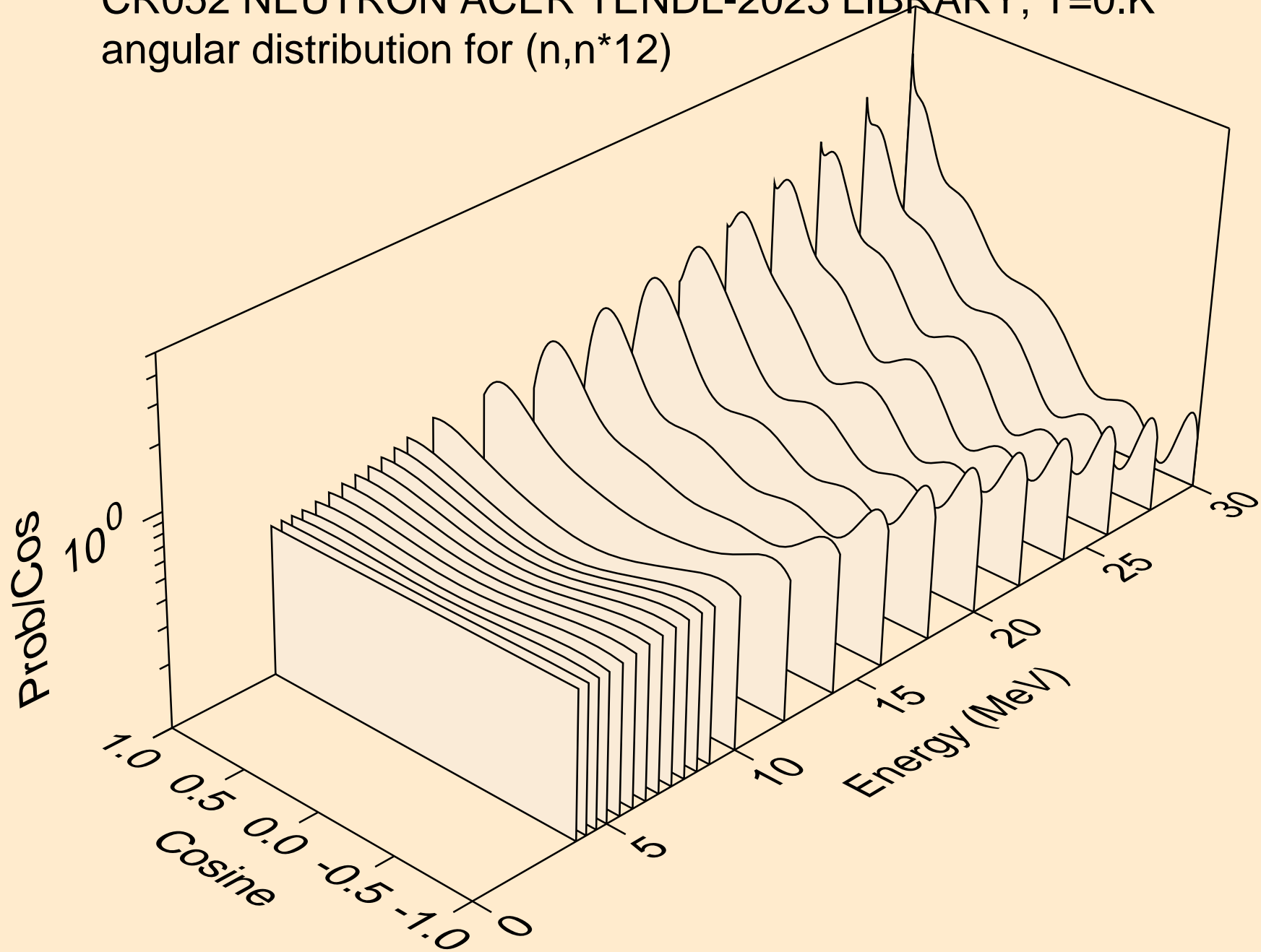



CR052 NEUTRON ACER TENDL-2023 LIBRARY; T=0.K  
angular distribution for (n,n\*13)

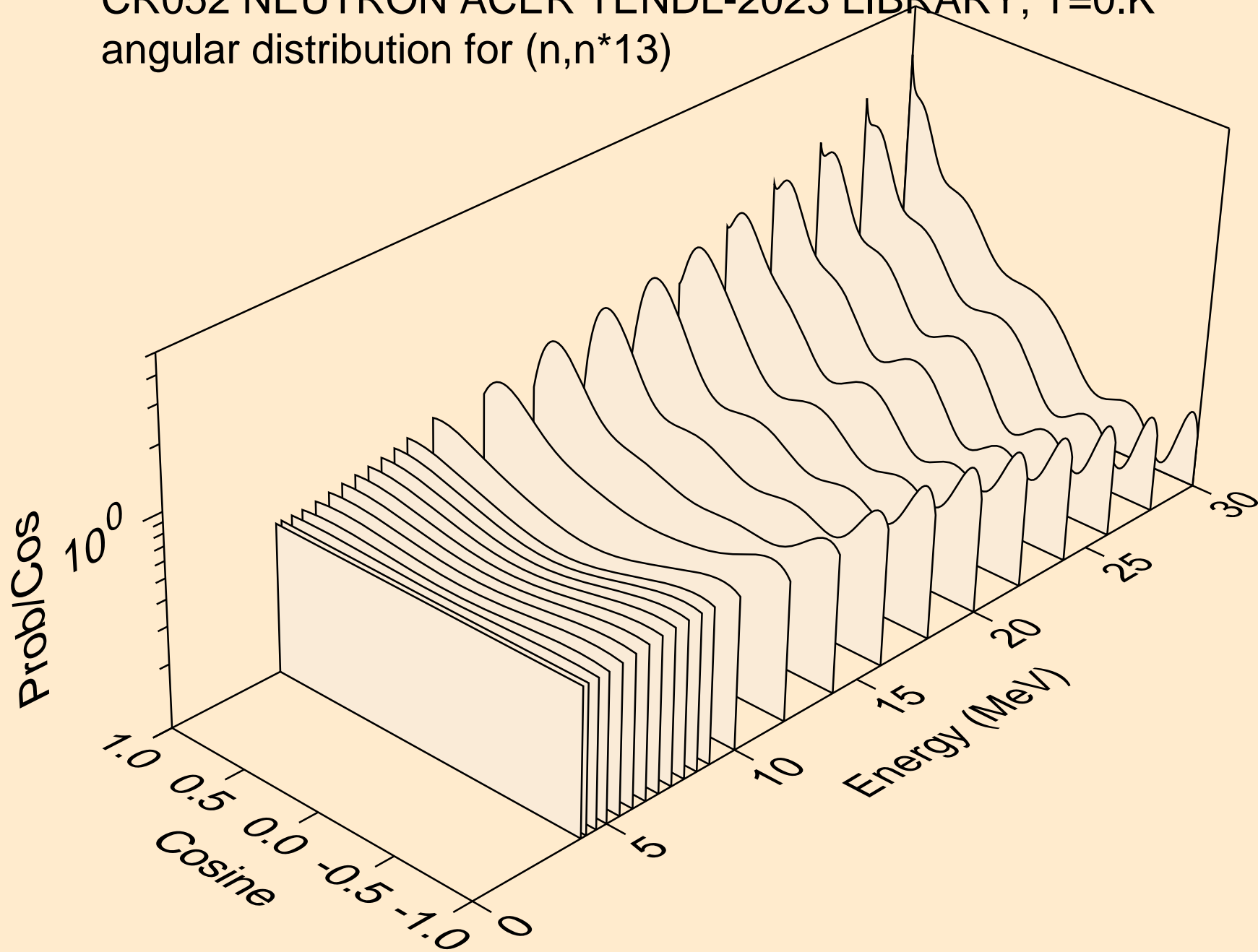

CR052 NEUTRON ACER TENDL-2023 LIBRARY; T=0.K  
angular distribution for (n,n\*14)

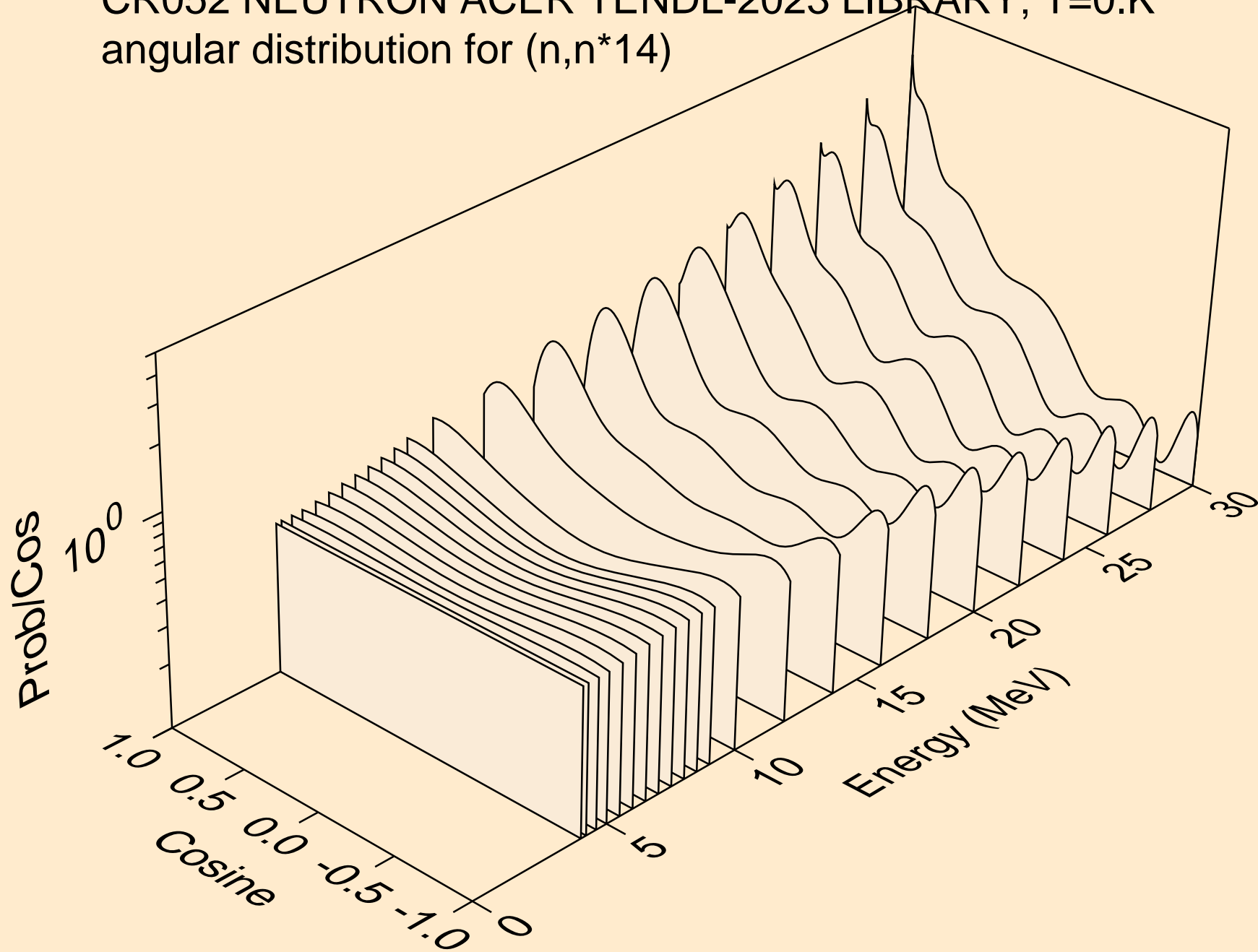

CR052 NEUTRON ACER TENDL-2023 LIBRARY; T=0.K  
angular distribution for (n,n\*15)

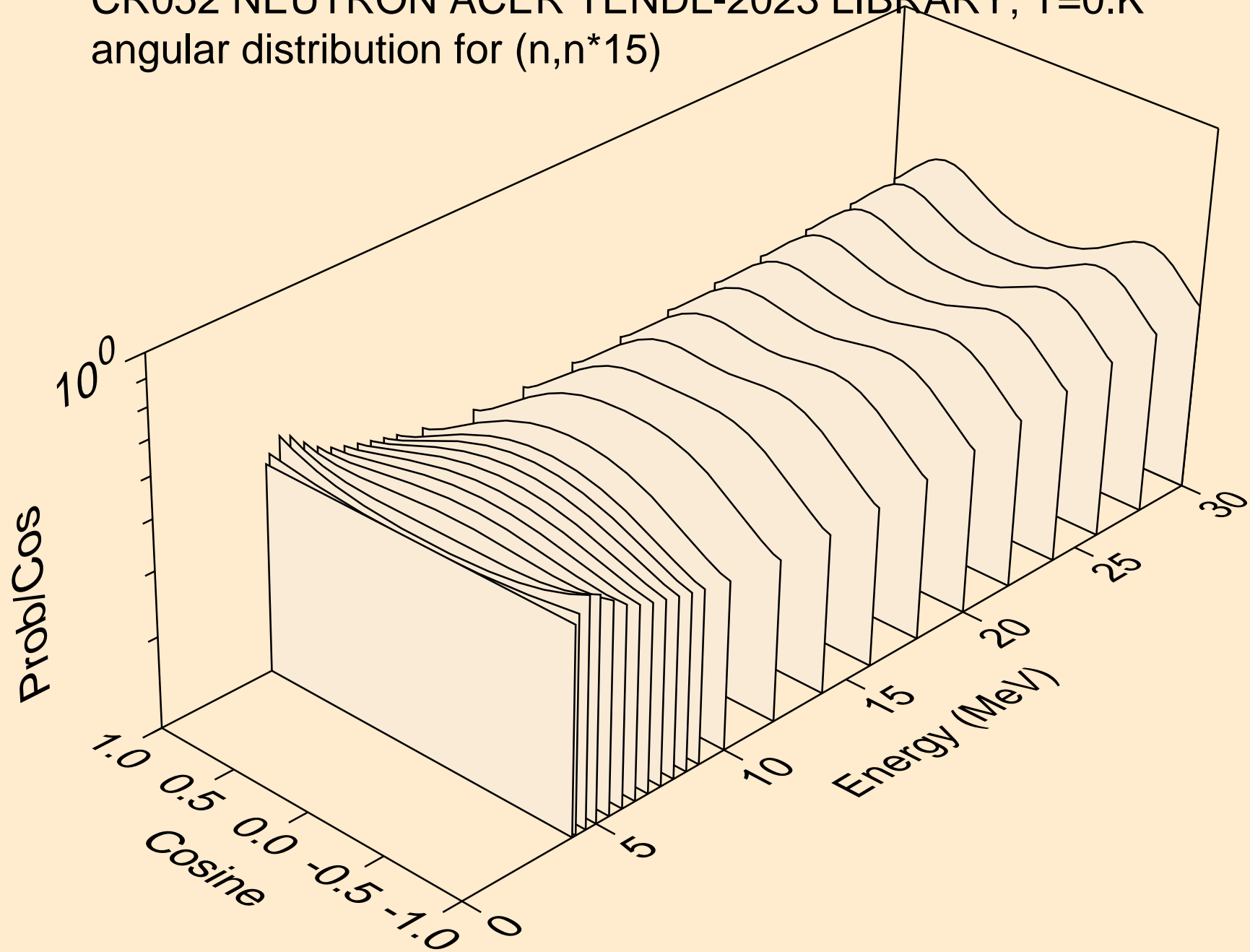

CR052 NEUTRON ACER TENDL-2023 LIBRARY; T=0.K  
angular distribution for (n,n\*16)

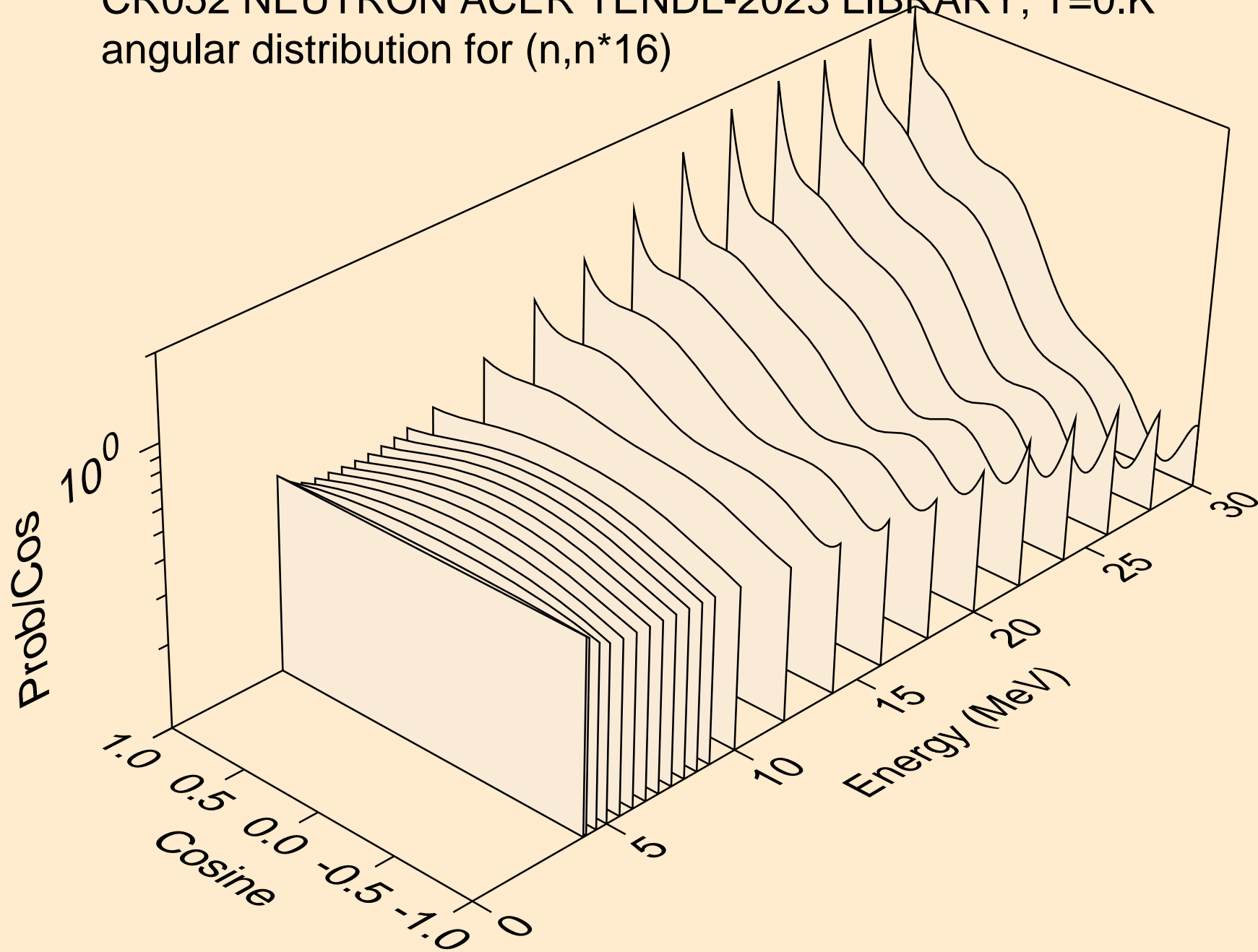

CR052 NEUTRON ACER TENDL-2023 LIBRARY; T=0.K  
Neutron emission for (n,x)

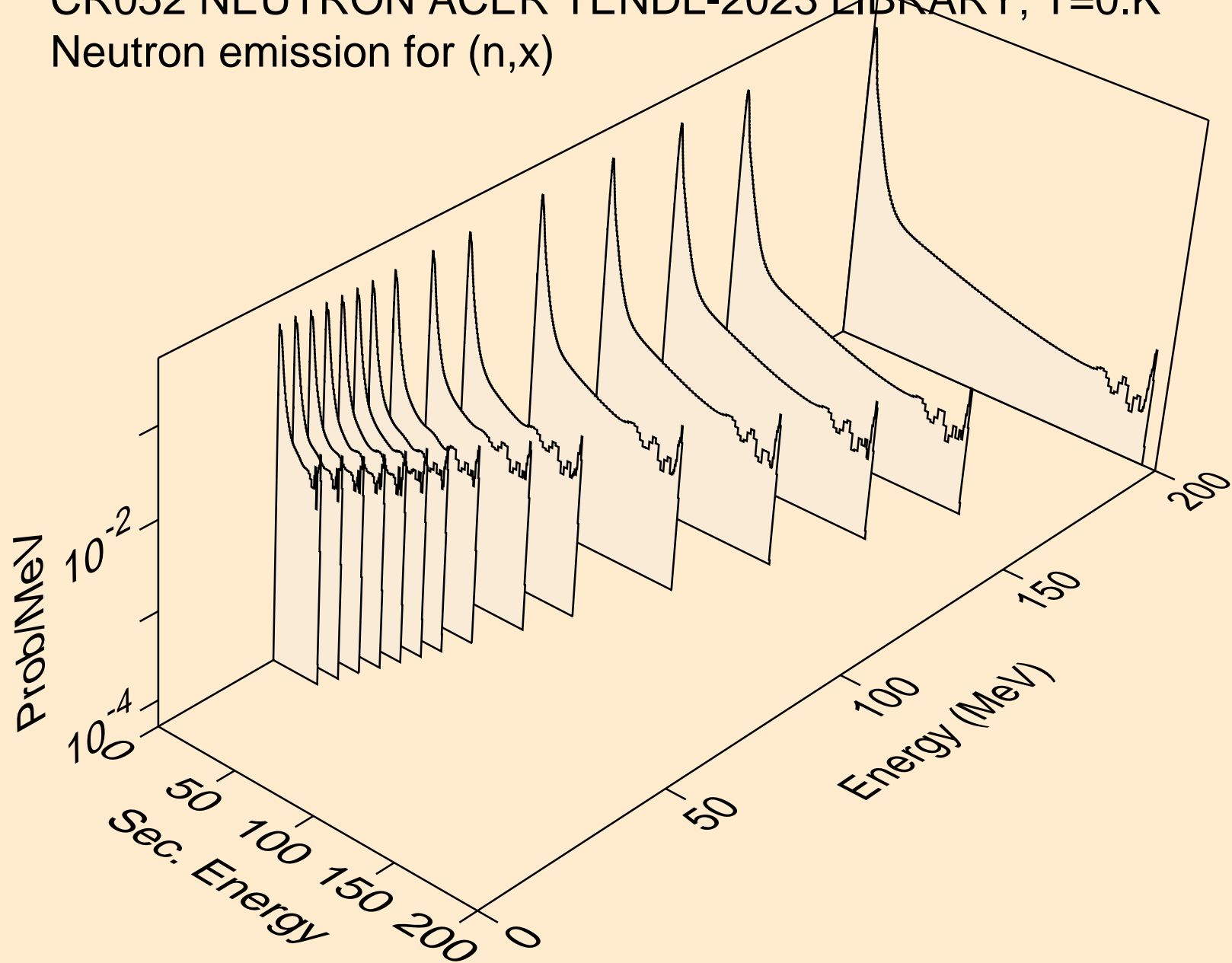

CR052 NEUTRON ACER TENDL-2023 LIBRARY; T=0.K  
Neutron emission for (n,2n)

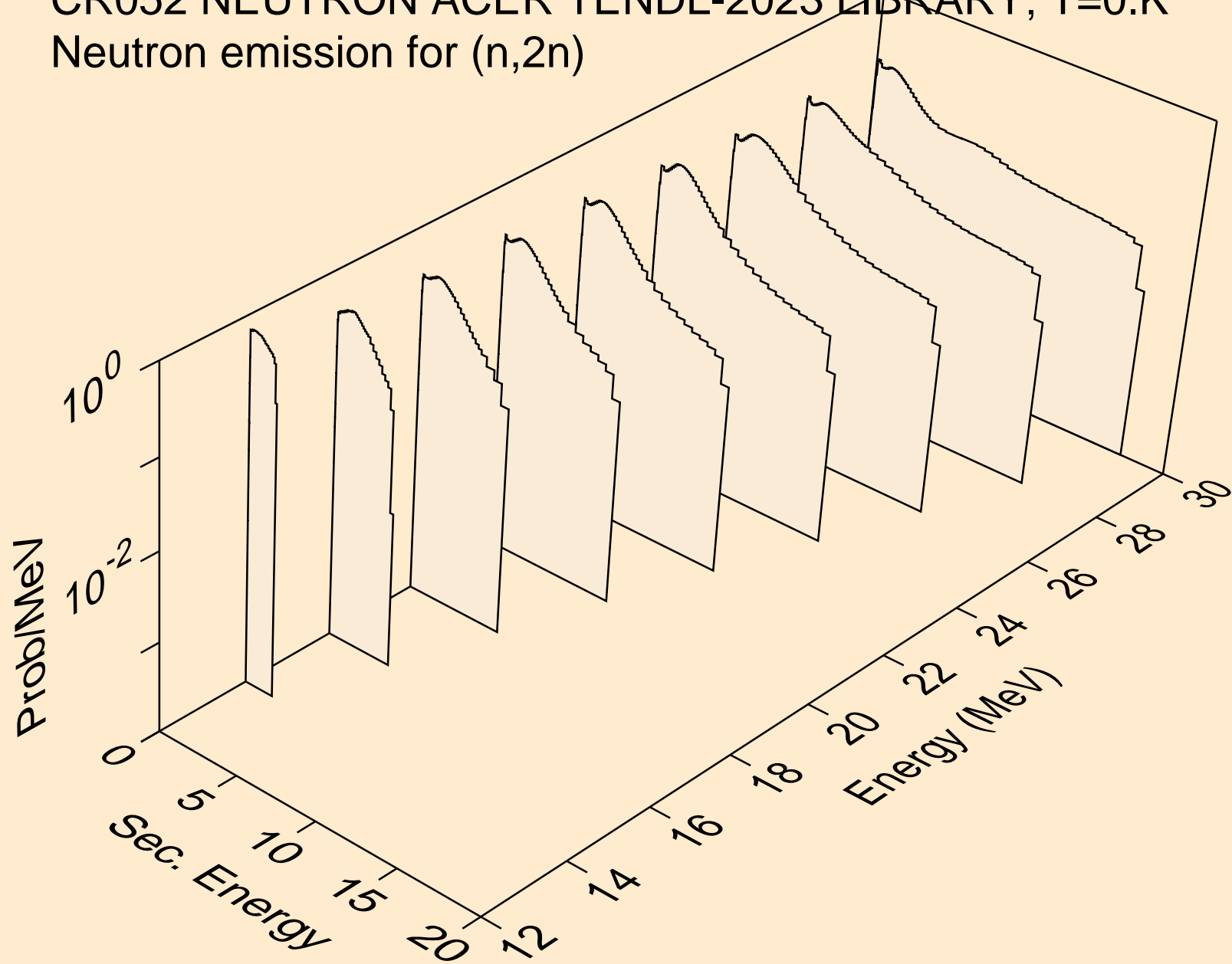

CR052 NEUTRON ACER TENDL-2023 LIBRARY; T=0.K  
Neutron emission for (n,3n)

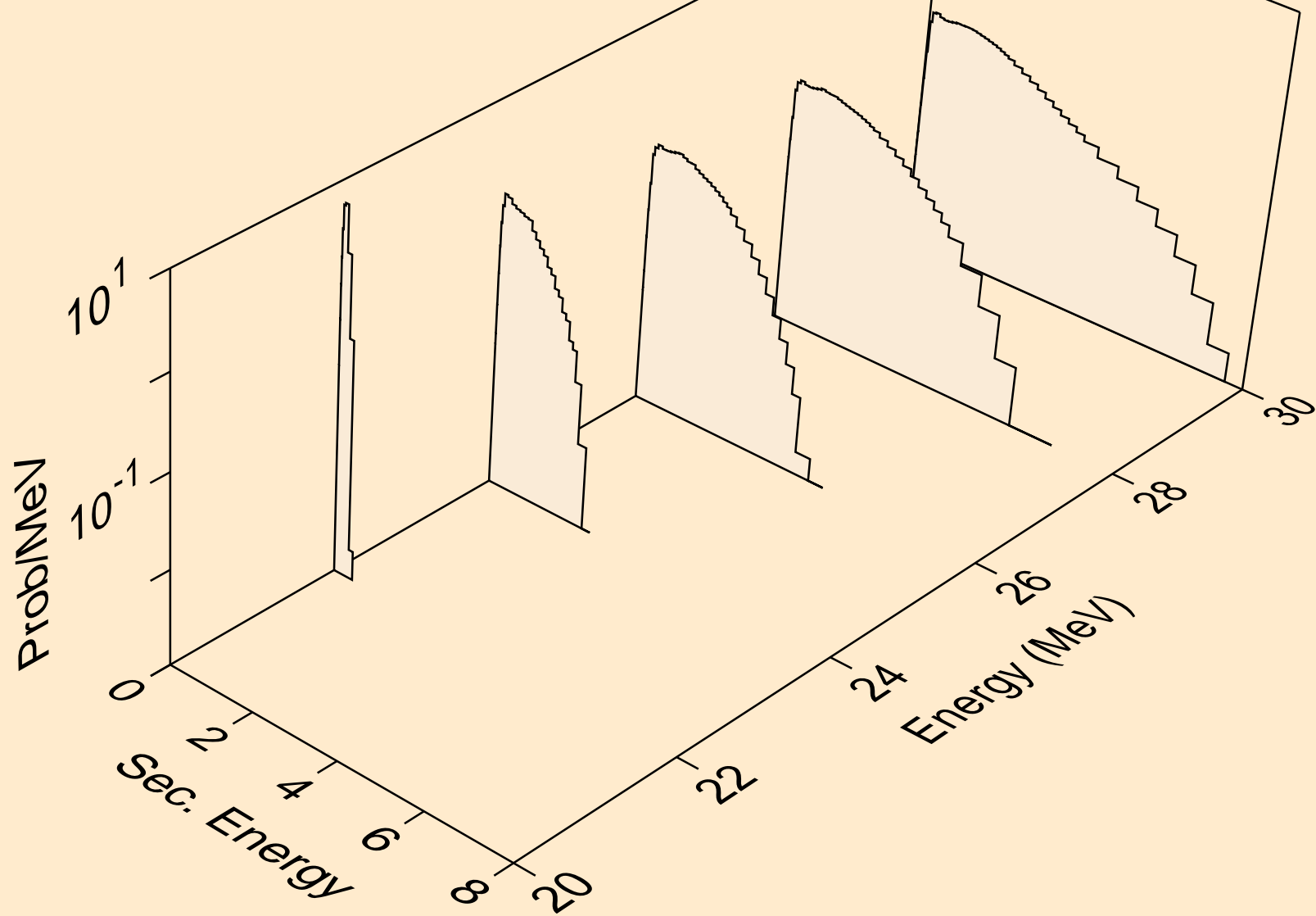

CR052 NEUTRON ACER TENDL-2023 LIBRARY; T=0.K  
Neutron emission for (n,n\*)a

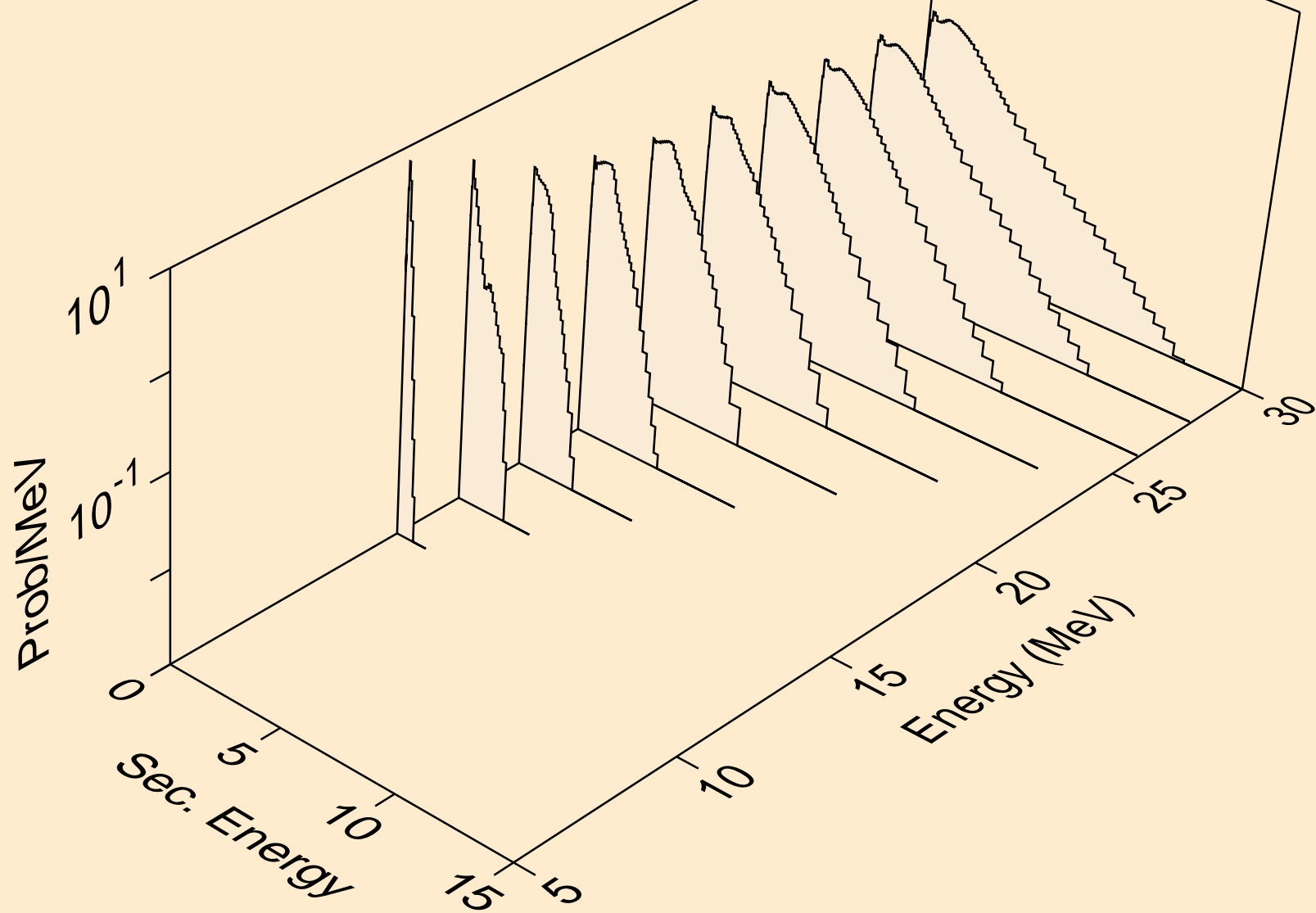



CR052 NEUTRON ACER TENDL-2023 LIBRARY; T=0.K  
Neutron emission for (n,2n)a

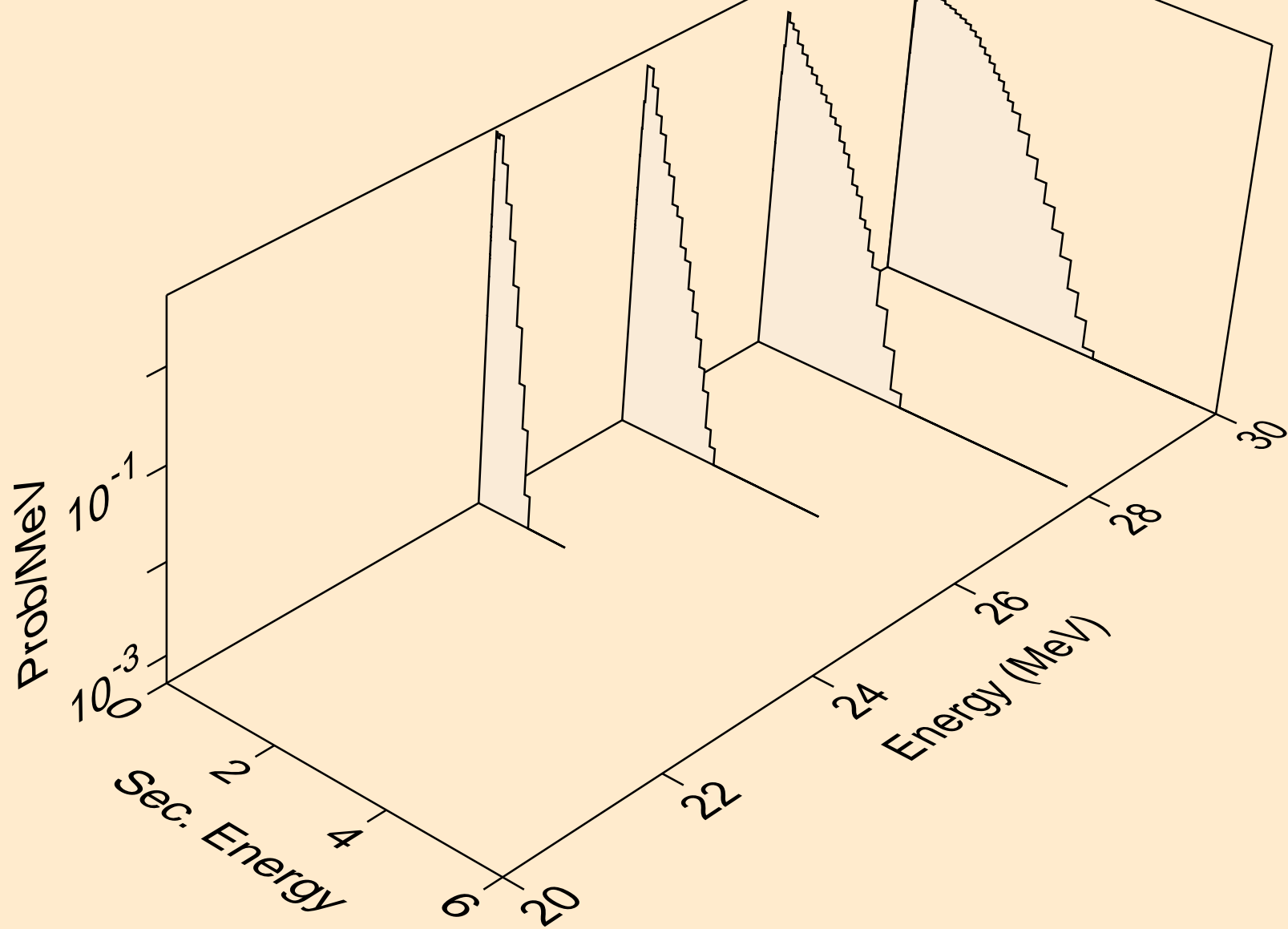

CR052 NEUTRON ACER TENDL-2023 LIBRARY; T=0.K  
Neutron emission for (n,n\*)p

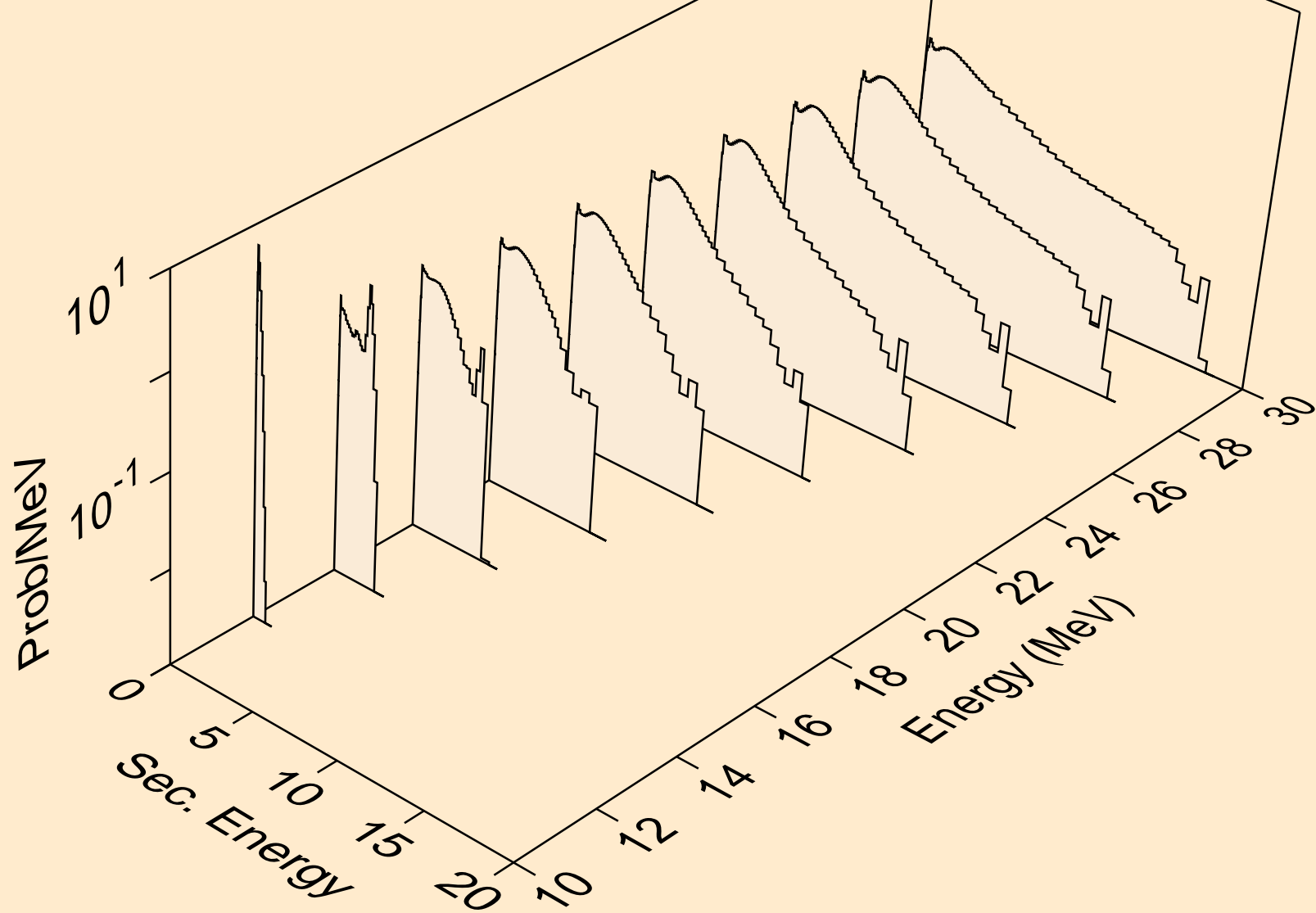

CR052 NEUTRON ACER TENDL-2023 LIBRARY; T=0.K  
Neutron emission for (n,n\*)2a

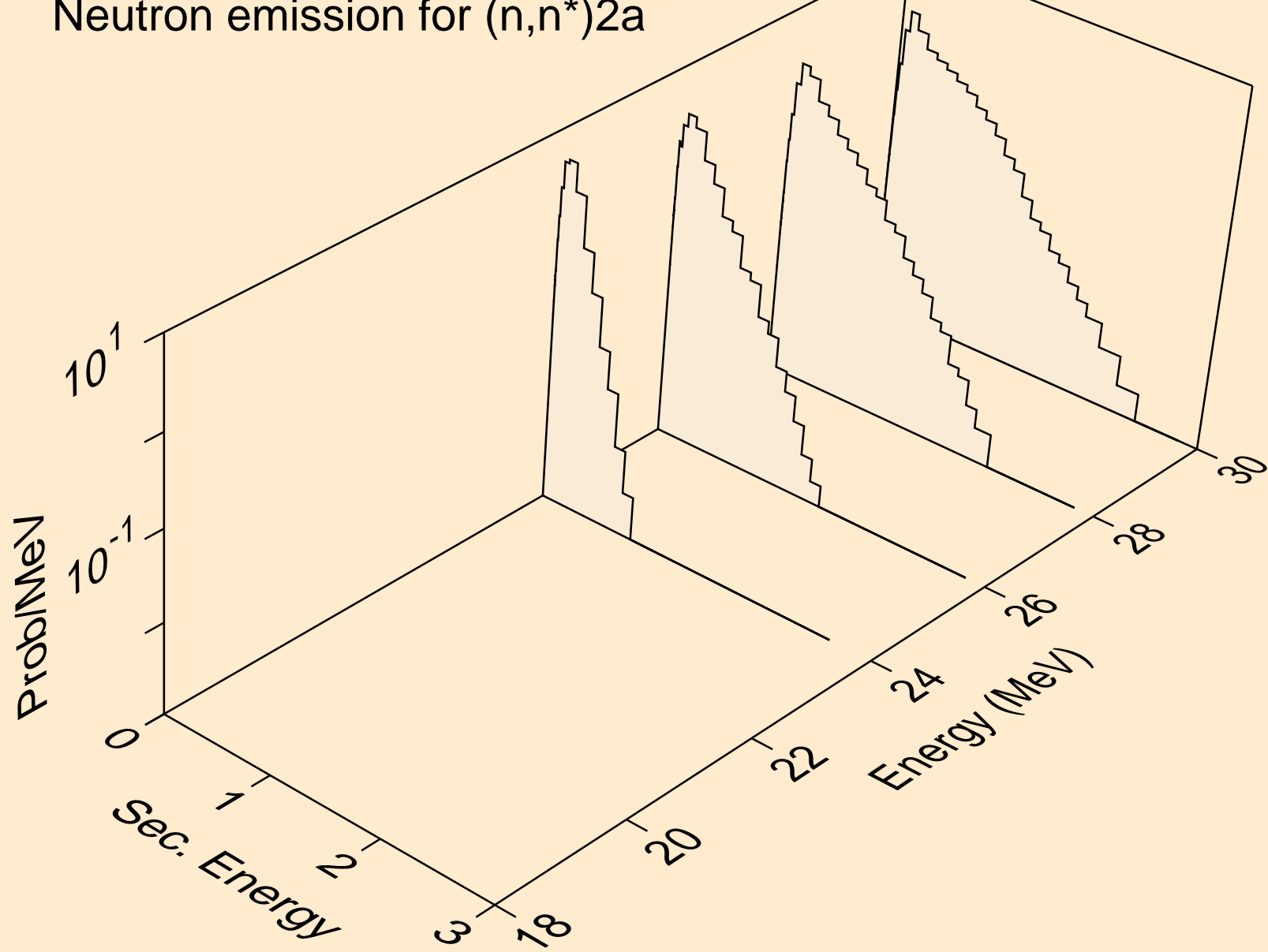

CR052 NEUTRON ACER TENDL-2023 LIBRARY; T=0.K  
Neutron emission for (n,n\*)d

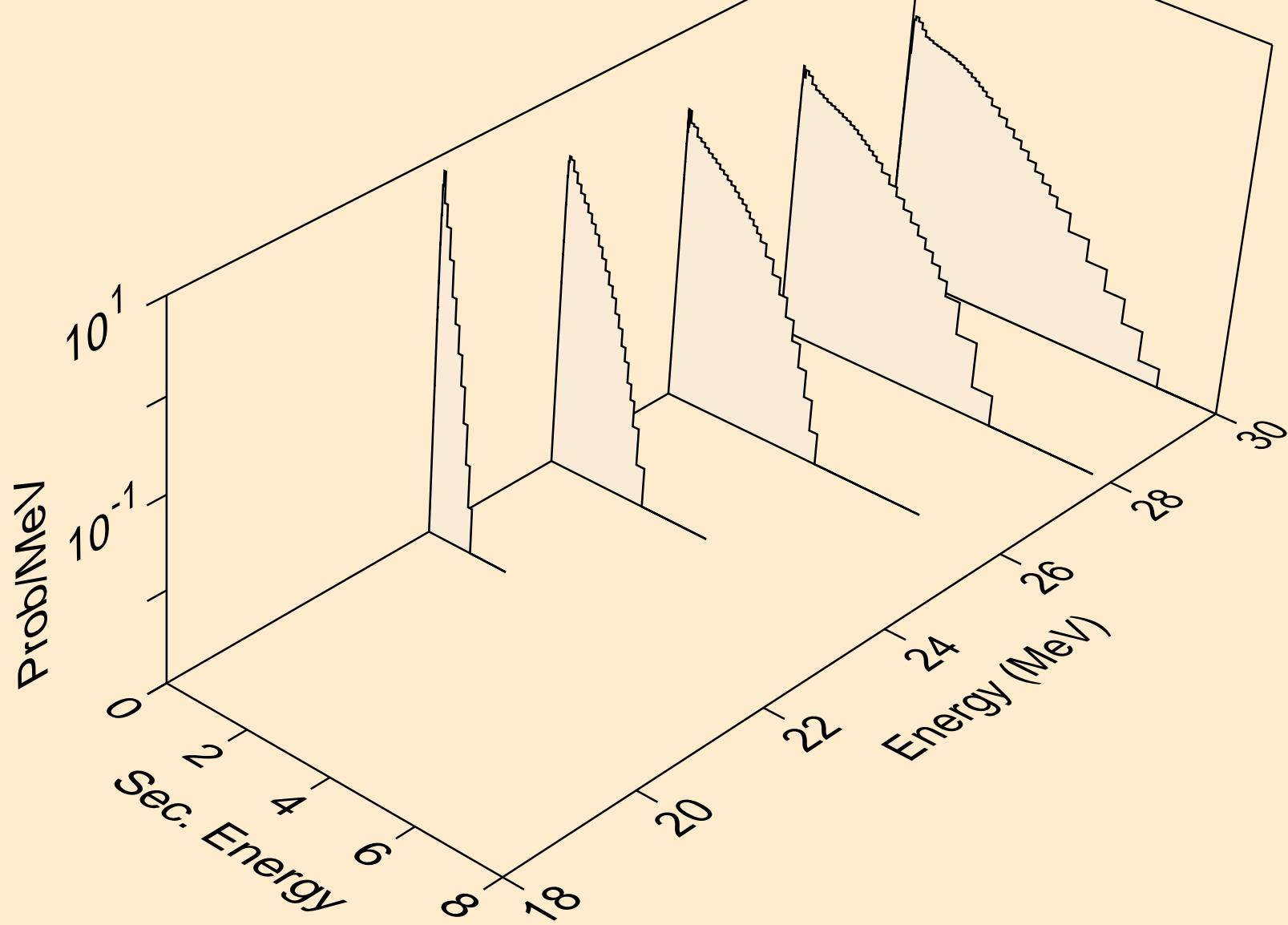

CR052 NEUTRON ACER TENDL-2023 LIBRARY; T=0.K  
Neutron emission for (n,n\*)t

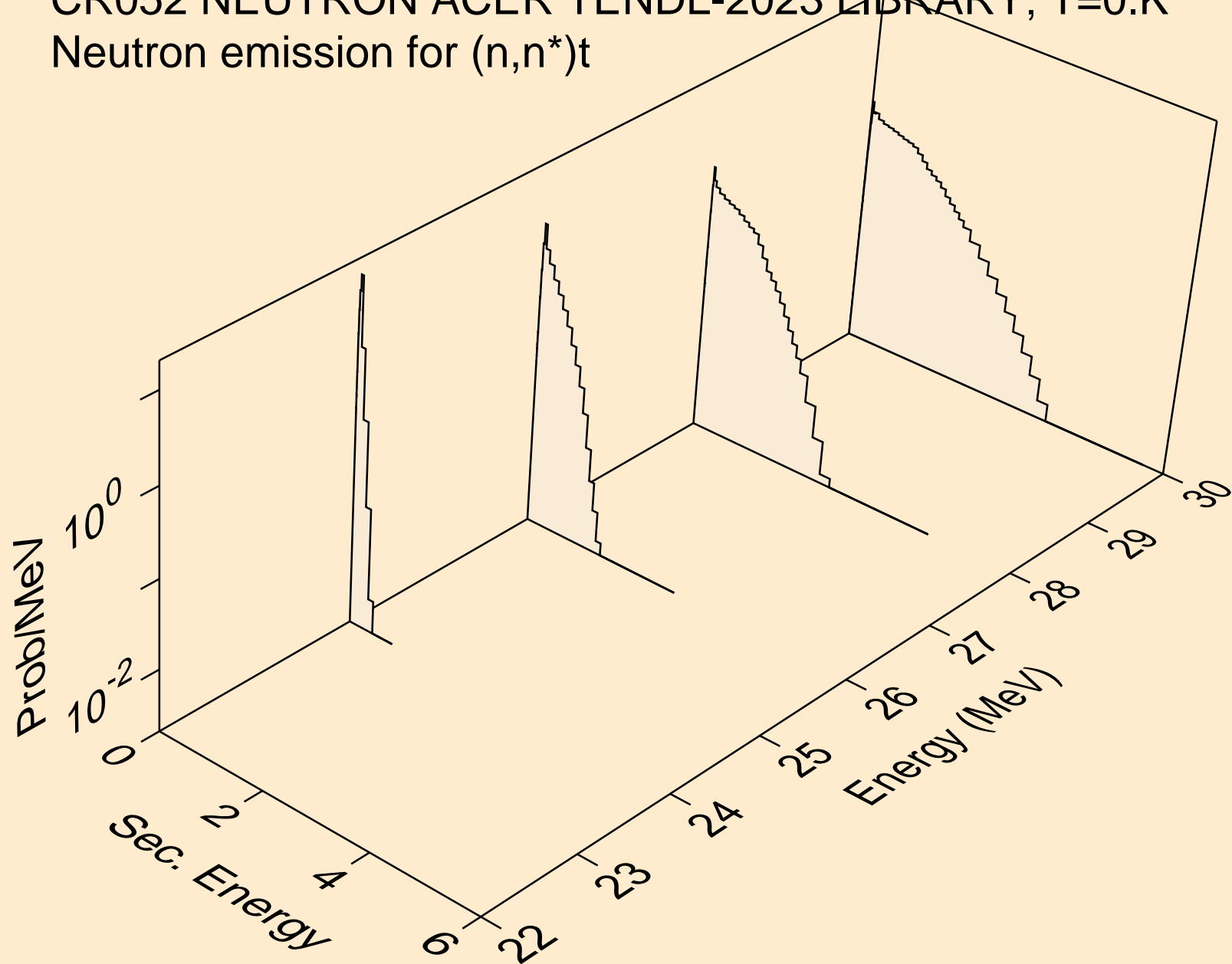

CR052 NEUTRON ACER TENDL-2023 LIBRARY; T=0.K  
Neutron emission for (n,n\*)he3

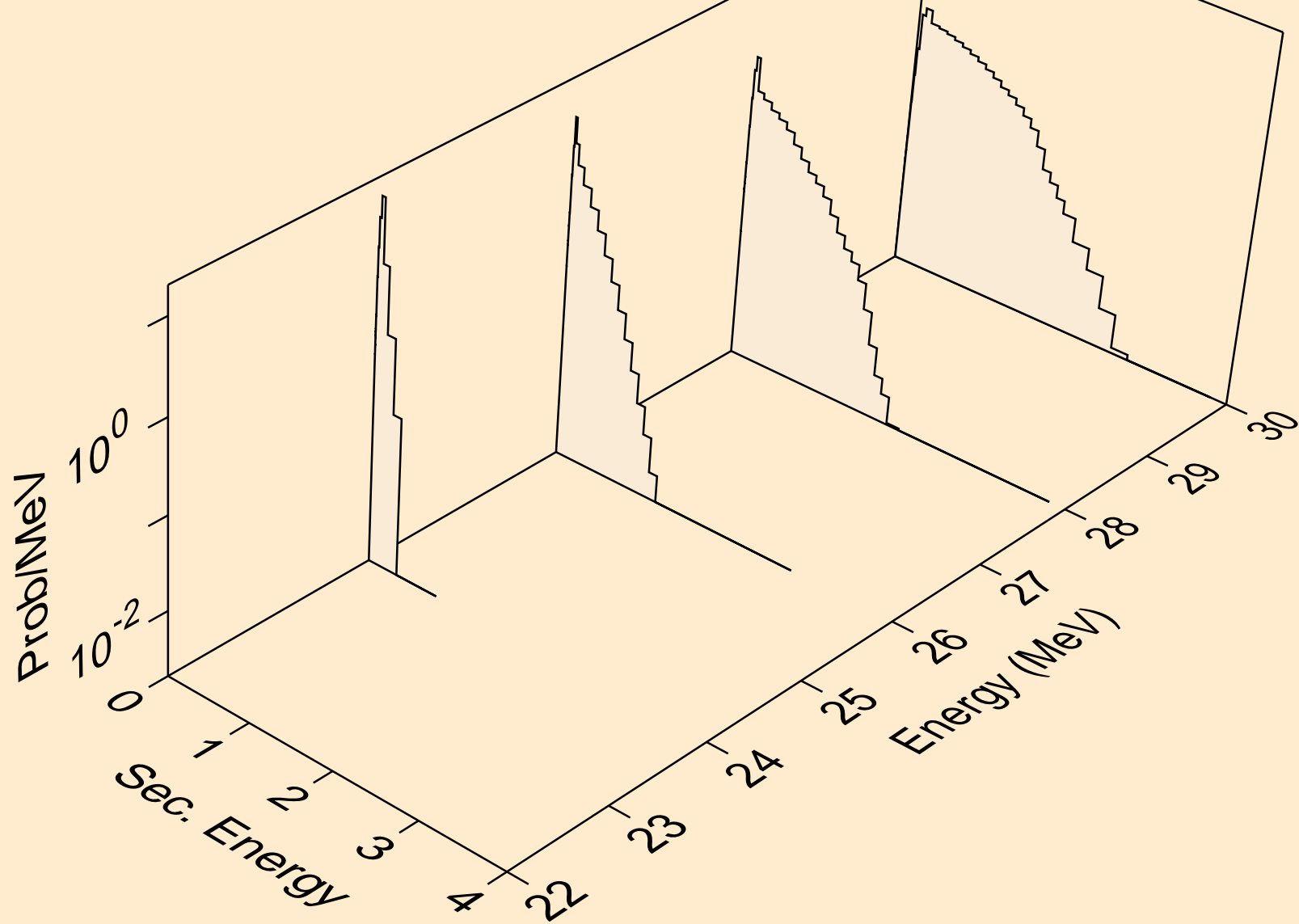

CR052 NEUTRON ACER TENDL-2023 LIBRARY; T=0.K  
Neutron emission for (n,2np)

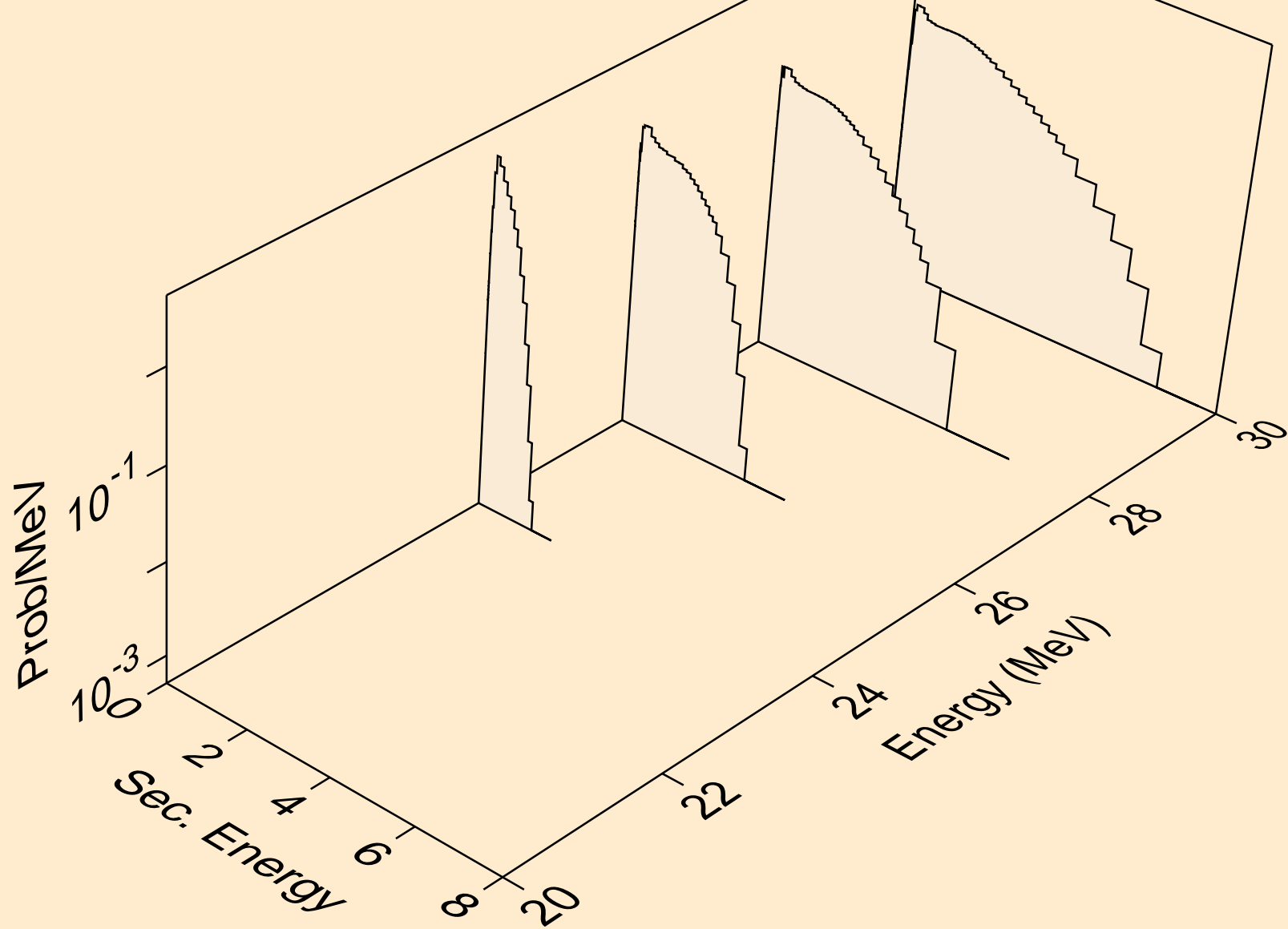

CR052 NEUTRON ACER TENDL-2023 LIBRARY; T=0.K  
Neutron emission for (n,n2p)

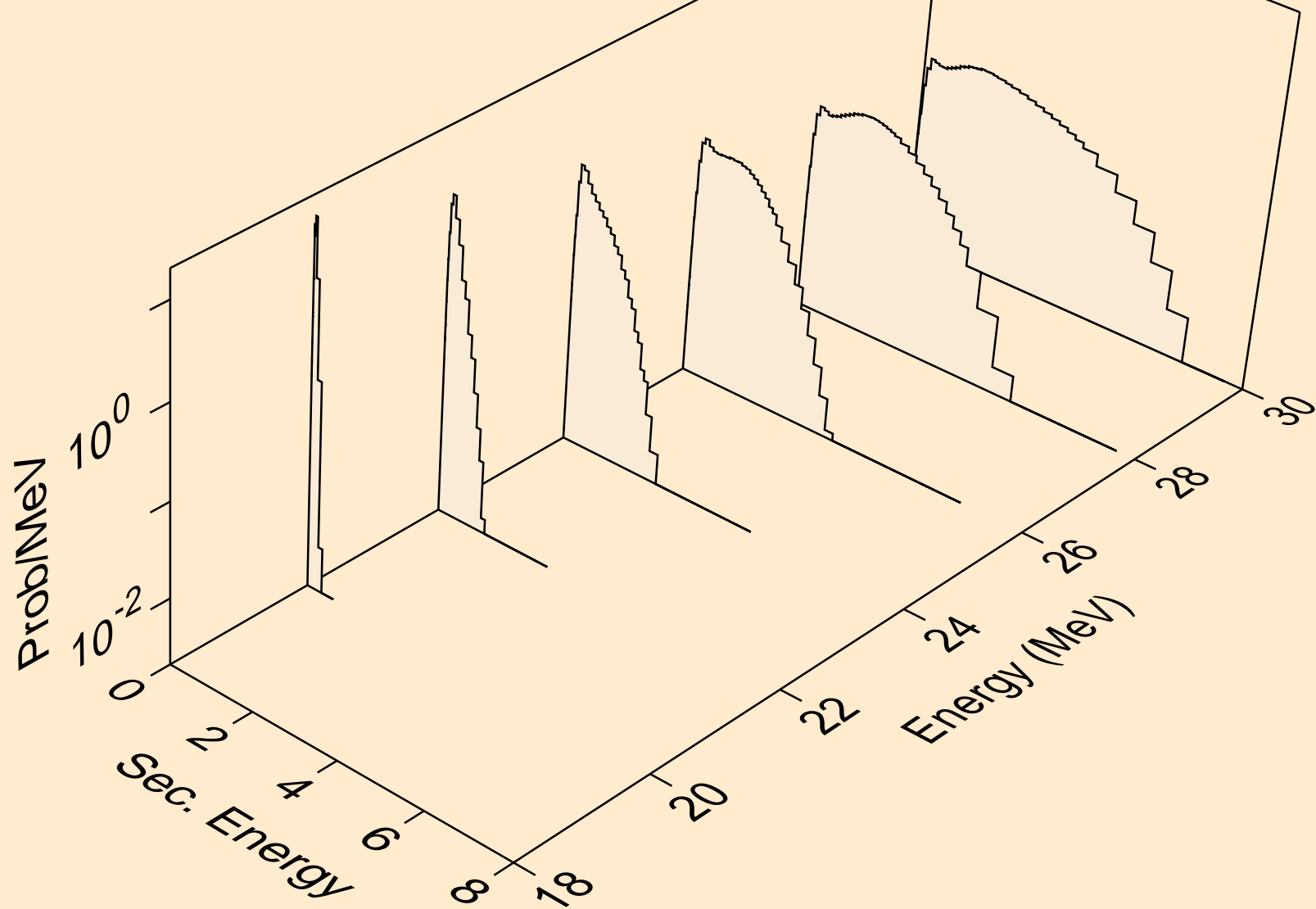



CR052 NEUTRON ACER TENDL-2023 LIBRARY; T=0.K  
Neutron emission for (n,npa)

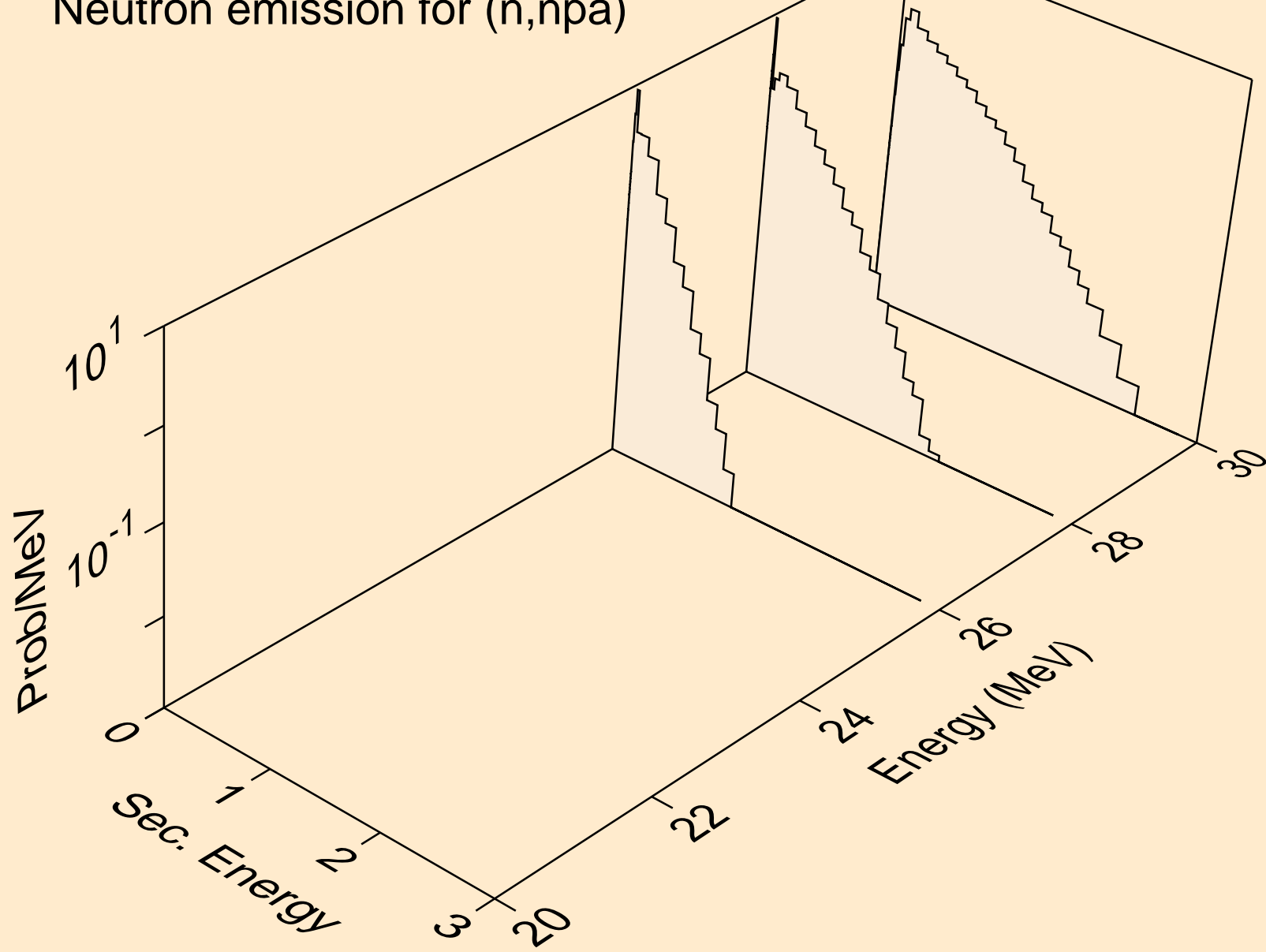

CR052 NEUTRON ACER TENDL-2023 LIBRARY; T=0.K  
Neutron emission for (n,n\*c)

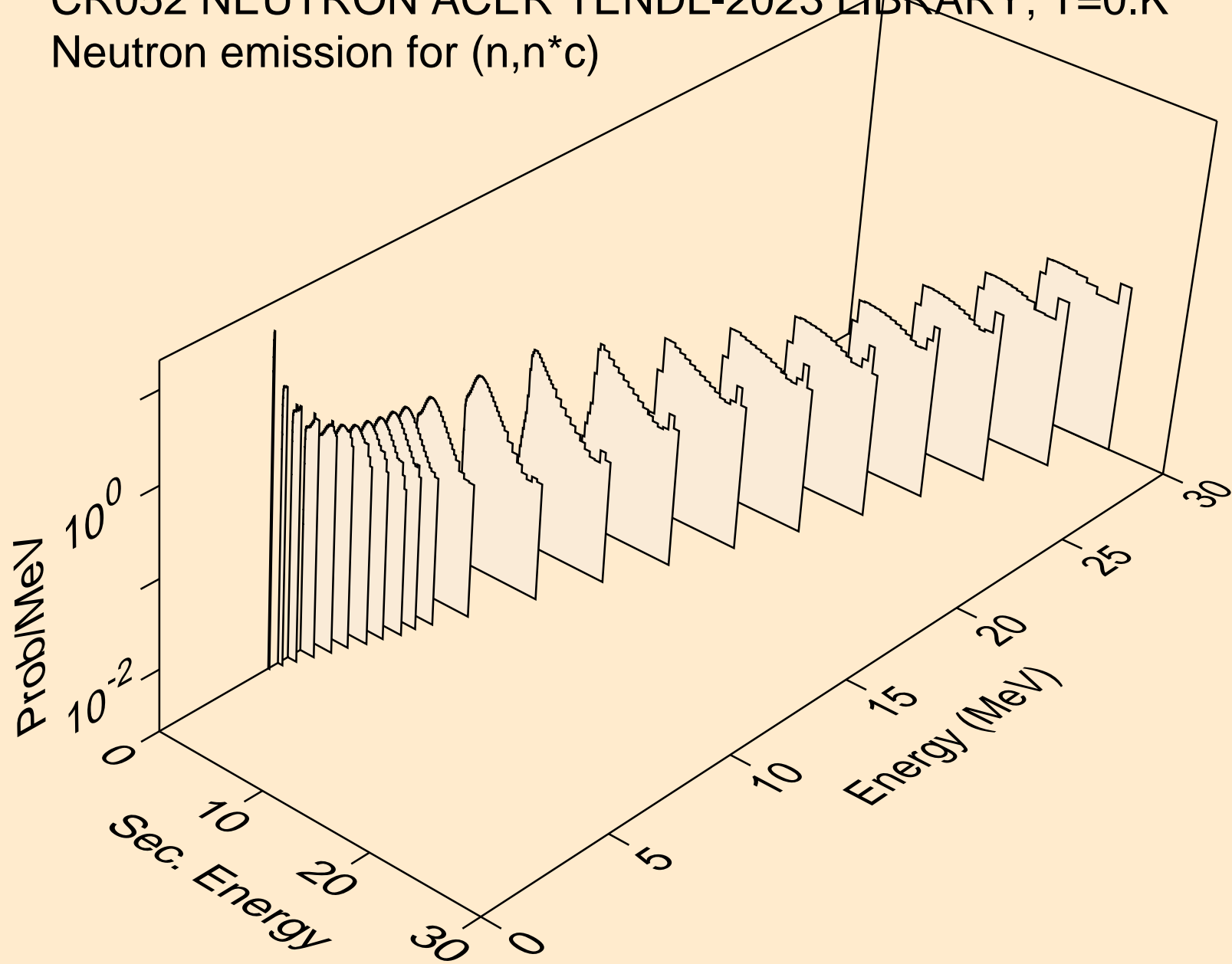

CR052 NEUTRON ACER TENDL-2023 LIBRARY; T=0.K  
Photon emission for (n,x)

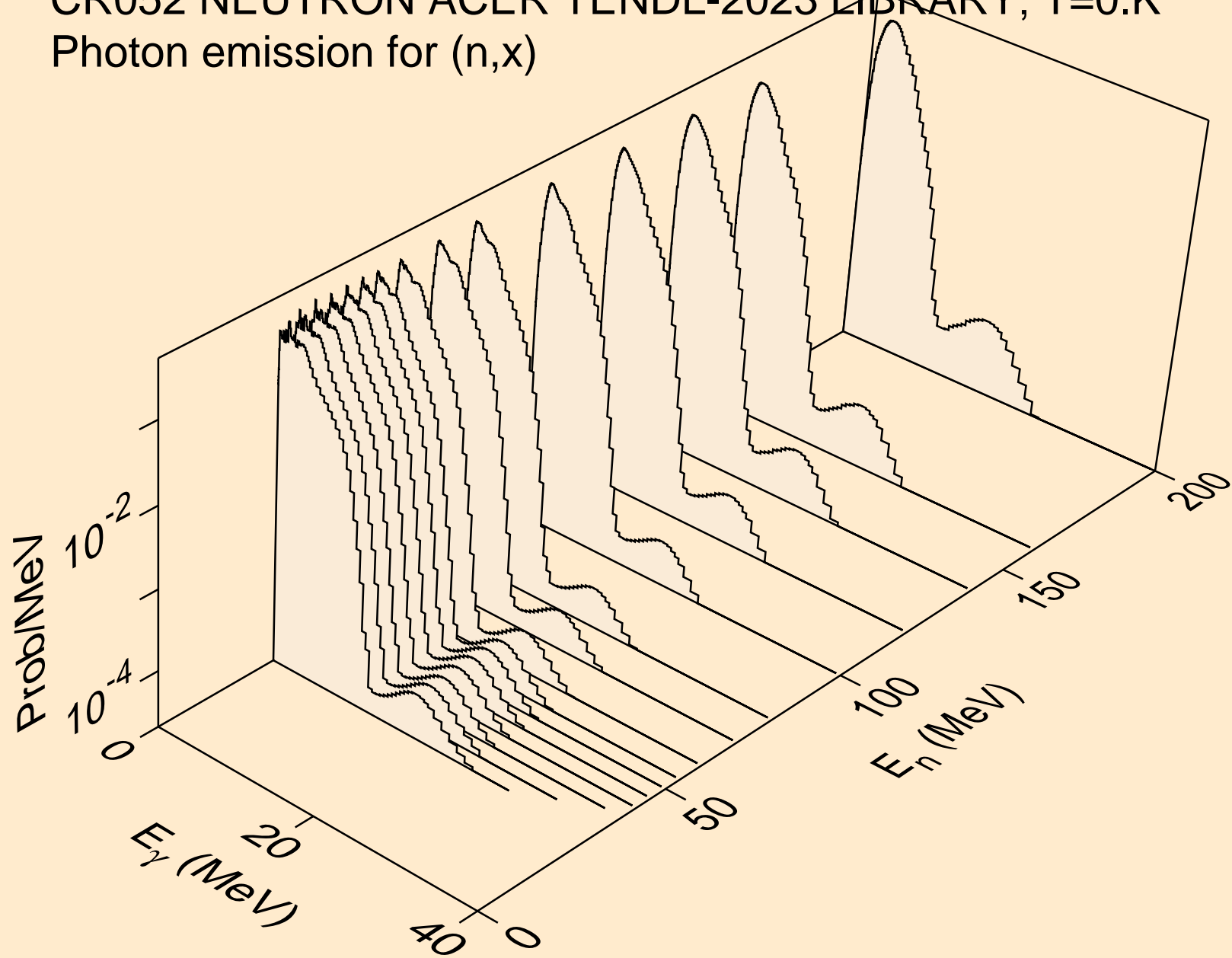

CR052 NEUTRON ACER TENDL-2023 LIBRARY; T=0.K  
Photon emission for (n,2n)

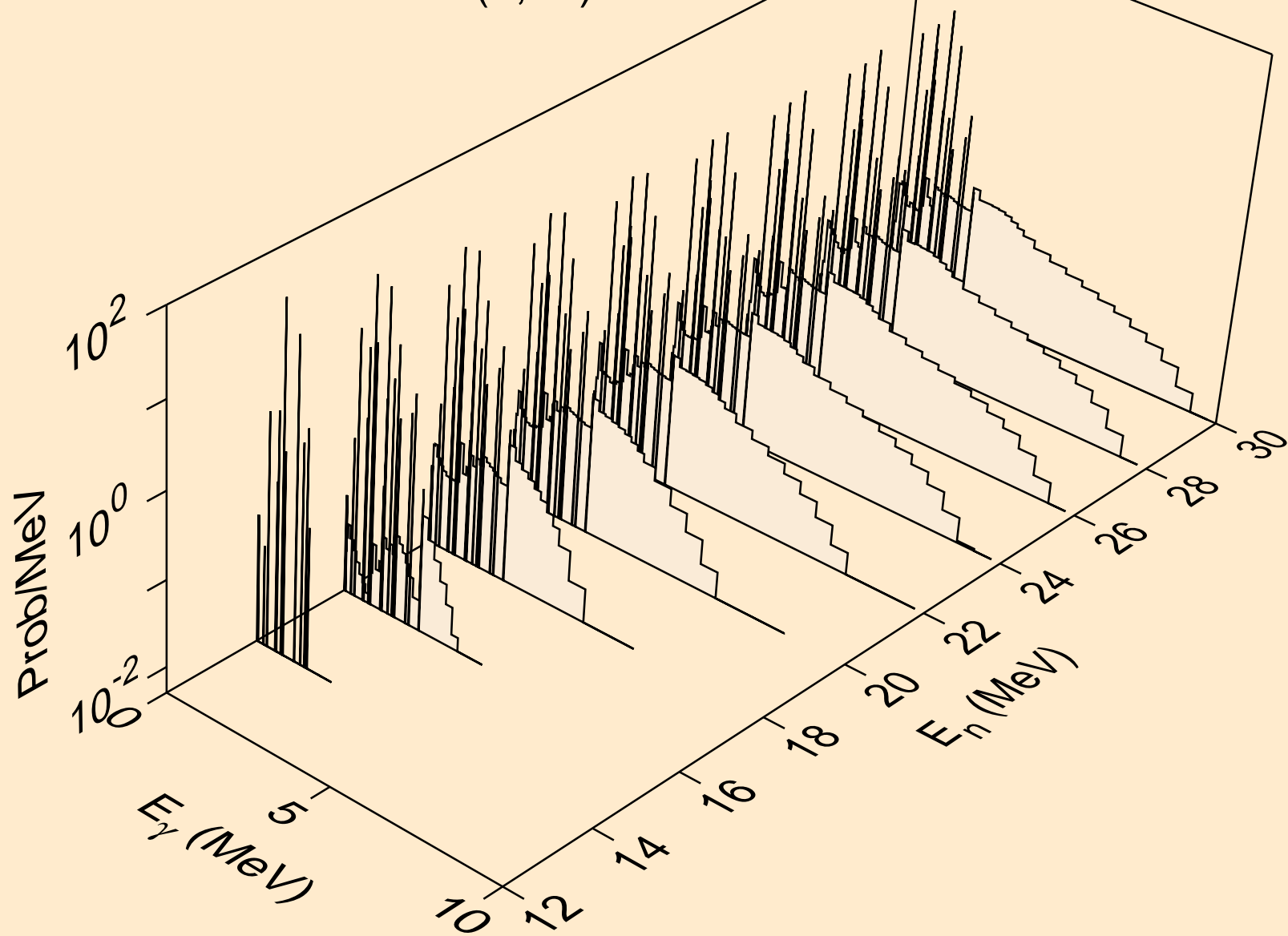

CR052 NEUTRON ACER TENDL-2023 LIBRARY; T=0.K  
Photon emission for (n,3n)

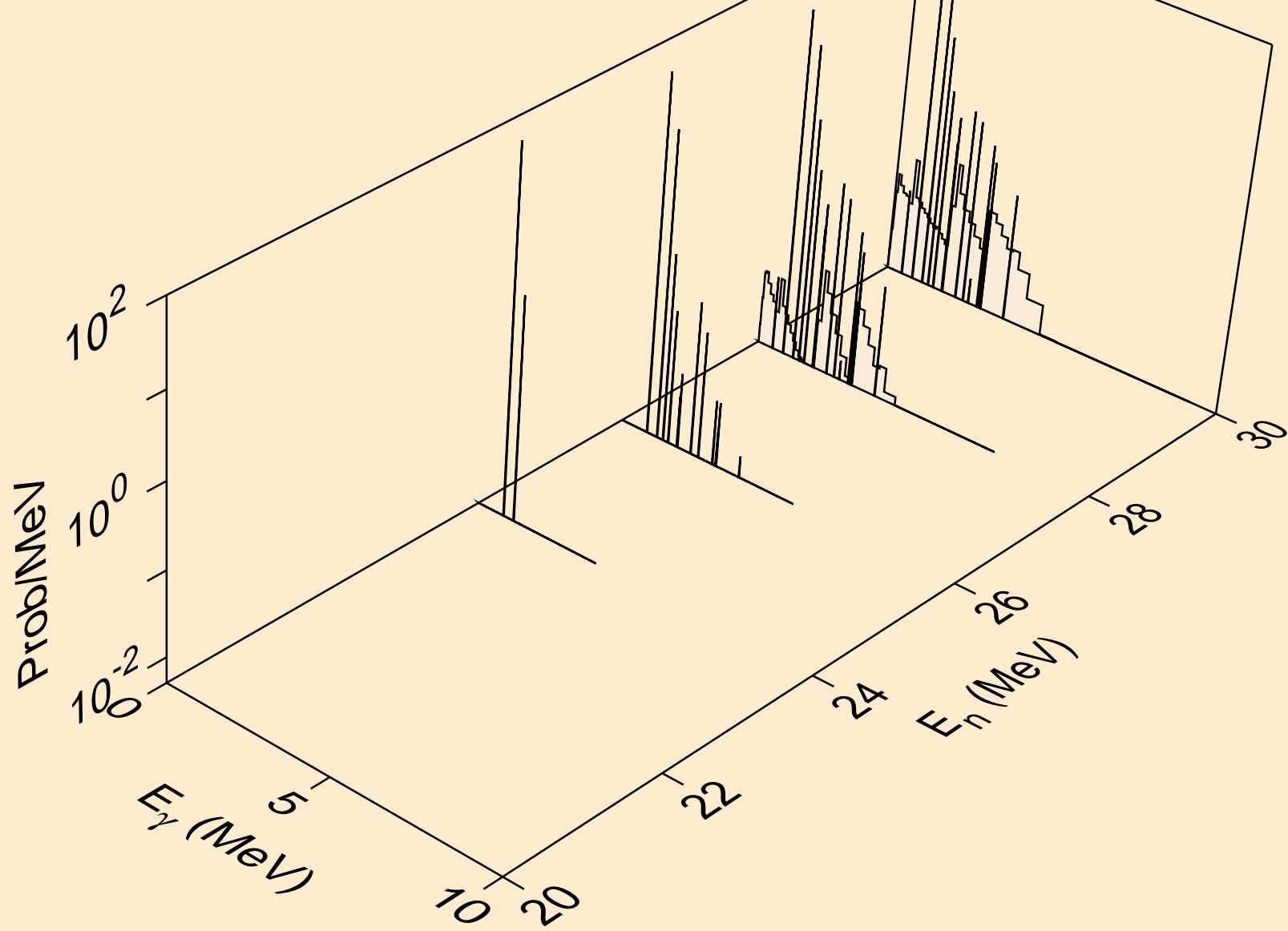

CR052 NEUTRON ACER TENDL-2023 LIBRARY; T=0.K  
Photon emission for (n,n\*)a

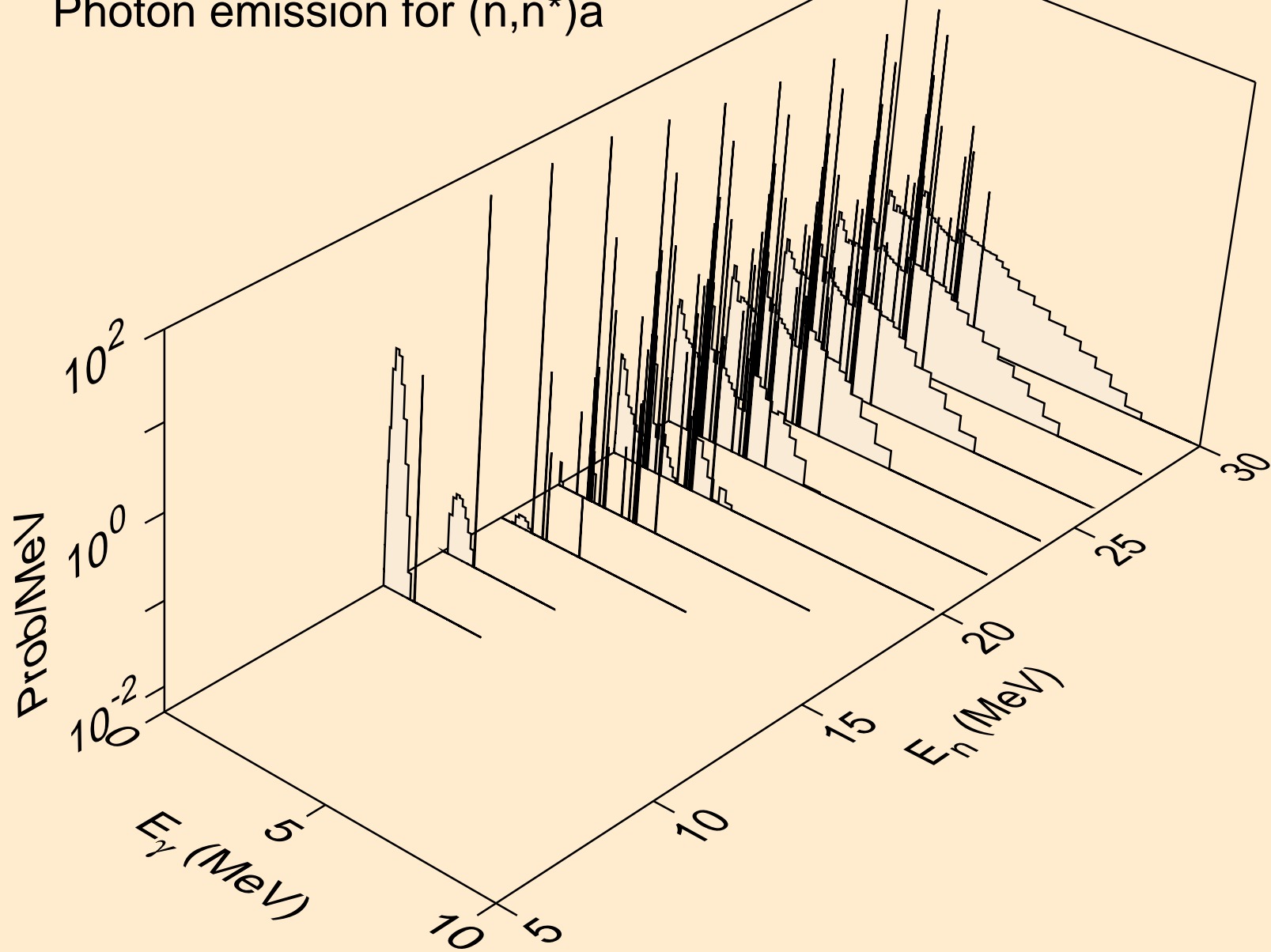

CR052 NEUTRON ACER TENDL-2023 LIBRARY; T=0.K  
Photon emission for (n,2n)a

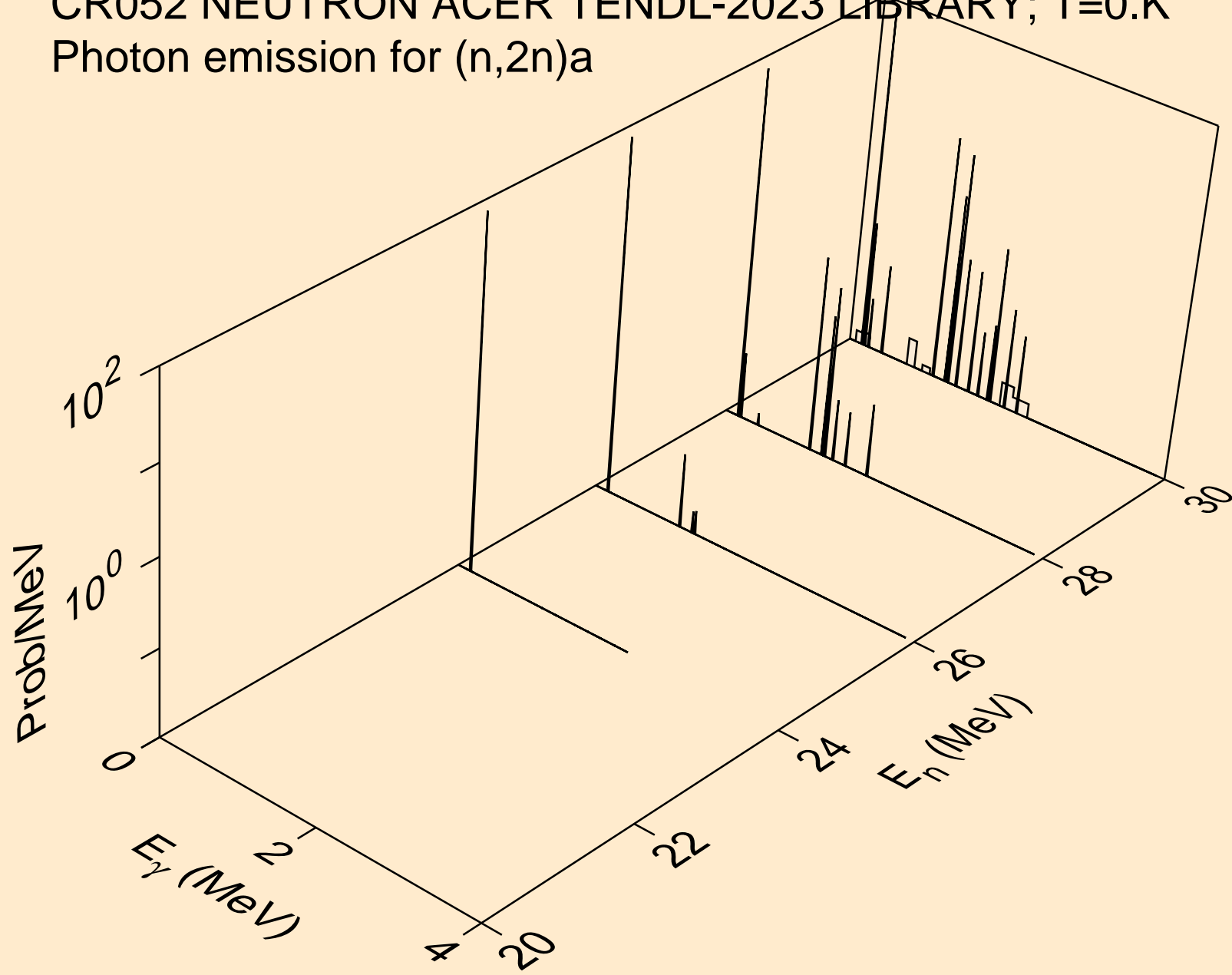

CR052 NEUTRON ACER TENDL-2023 LIBRARY; T=0.K  
Photon emission for (n,n\*)p

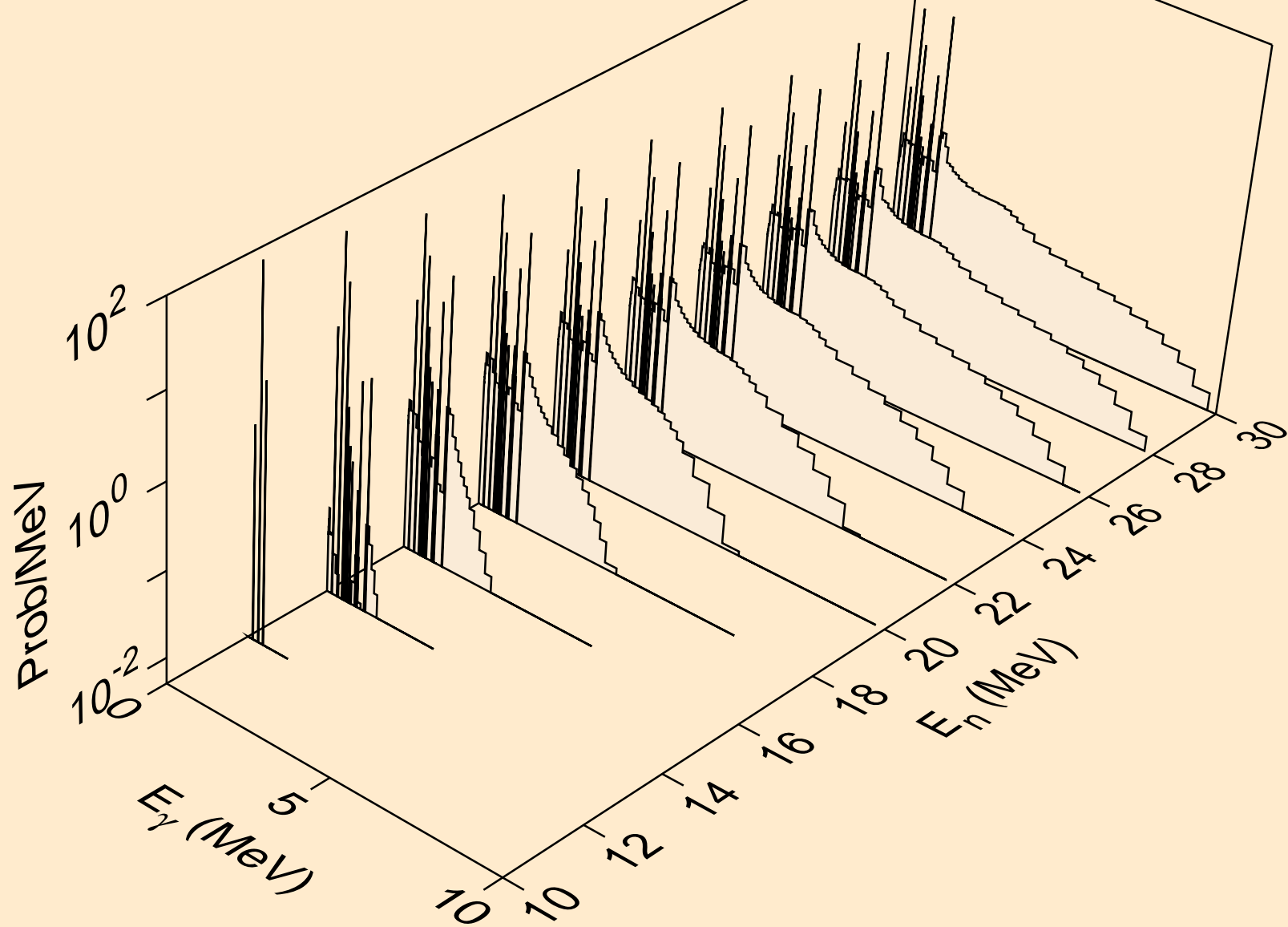



CR052 NEUTRON ACER TENDL-2023 LIBRARY; T=0.K  
Photon emission for (n,n\*)2a

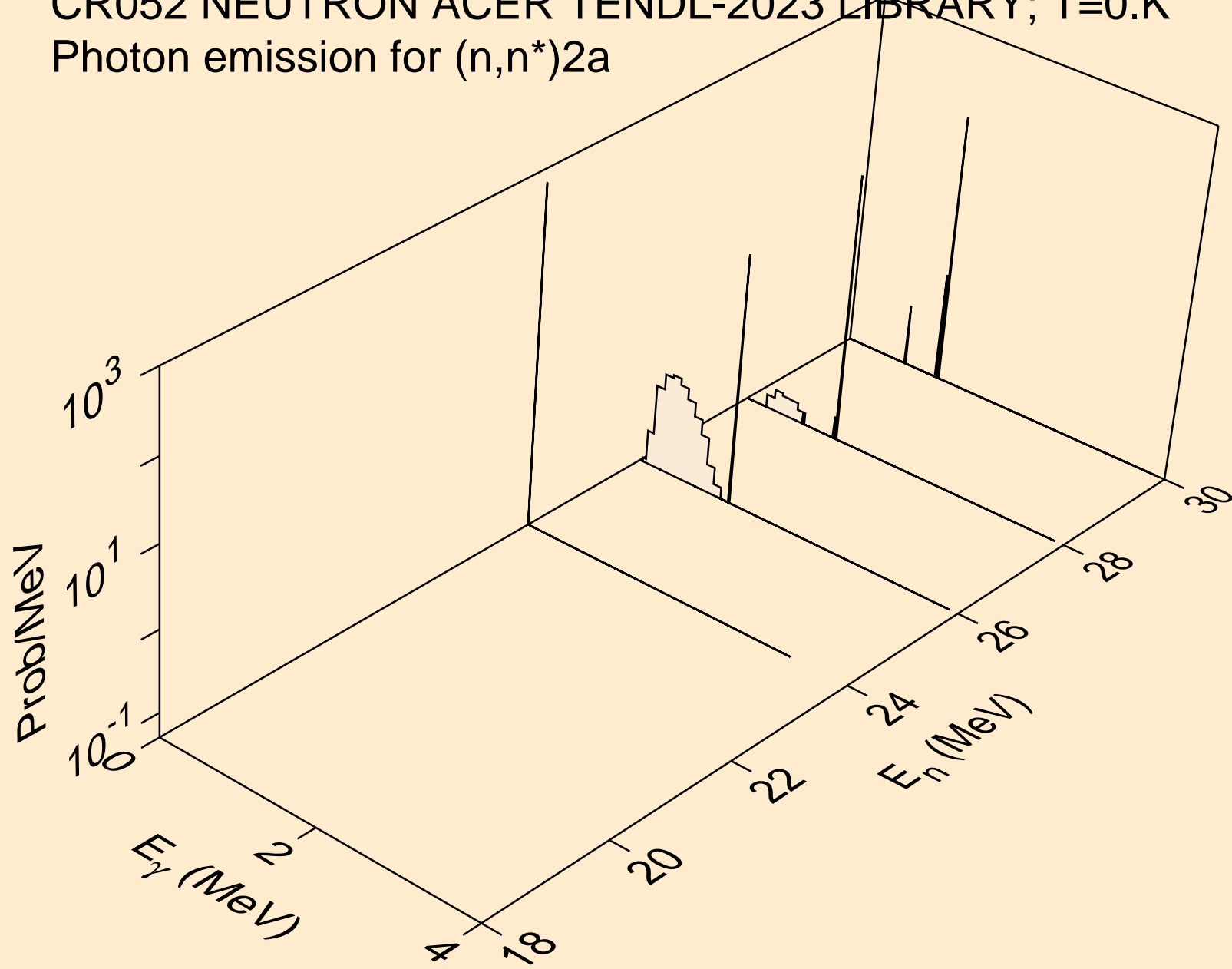

CR052 NEUTRON ACER TENDL-2023 LIBRARY; T=0.K  
Photon emission for (n,n\*)d

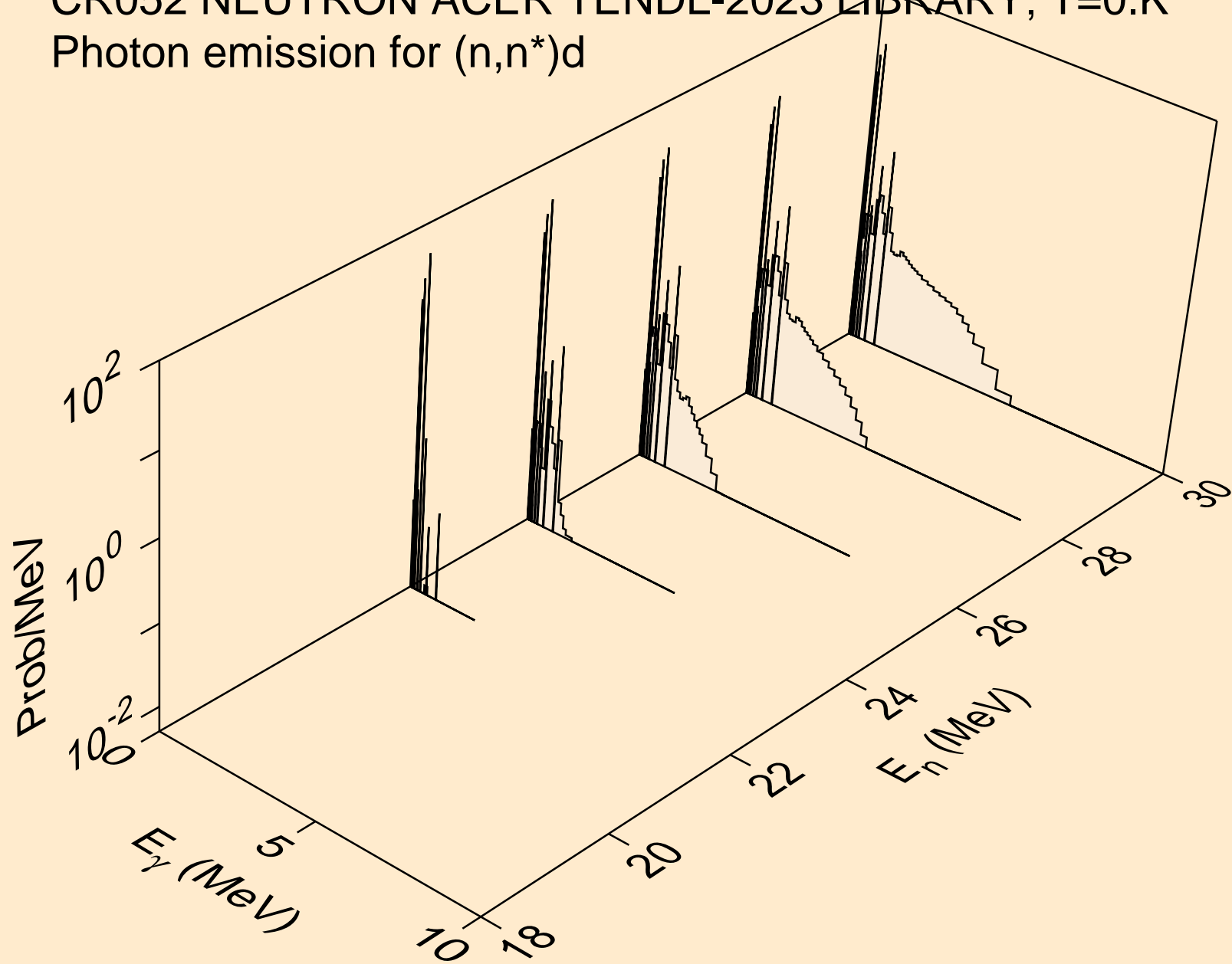

CR052 NEUTRON ACER TENDL-2023 LIBRARY; T=0.K  
Photon emission for (n,n\*)t

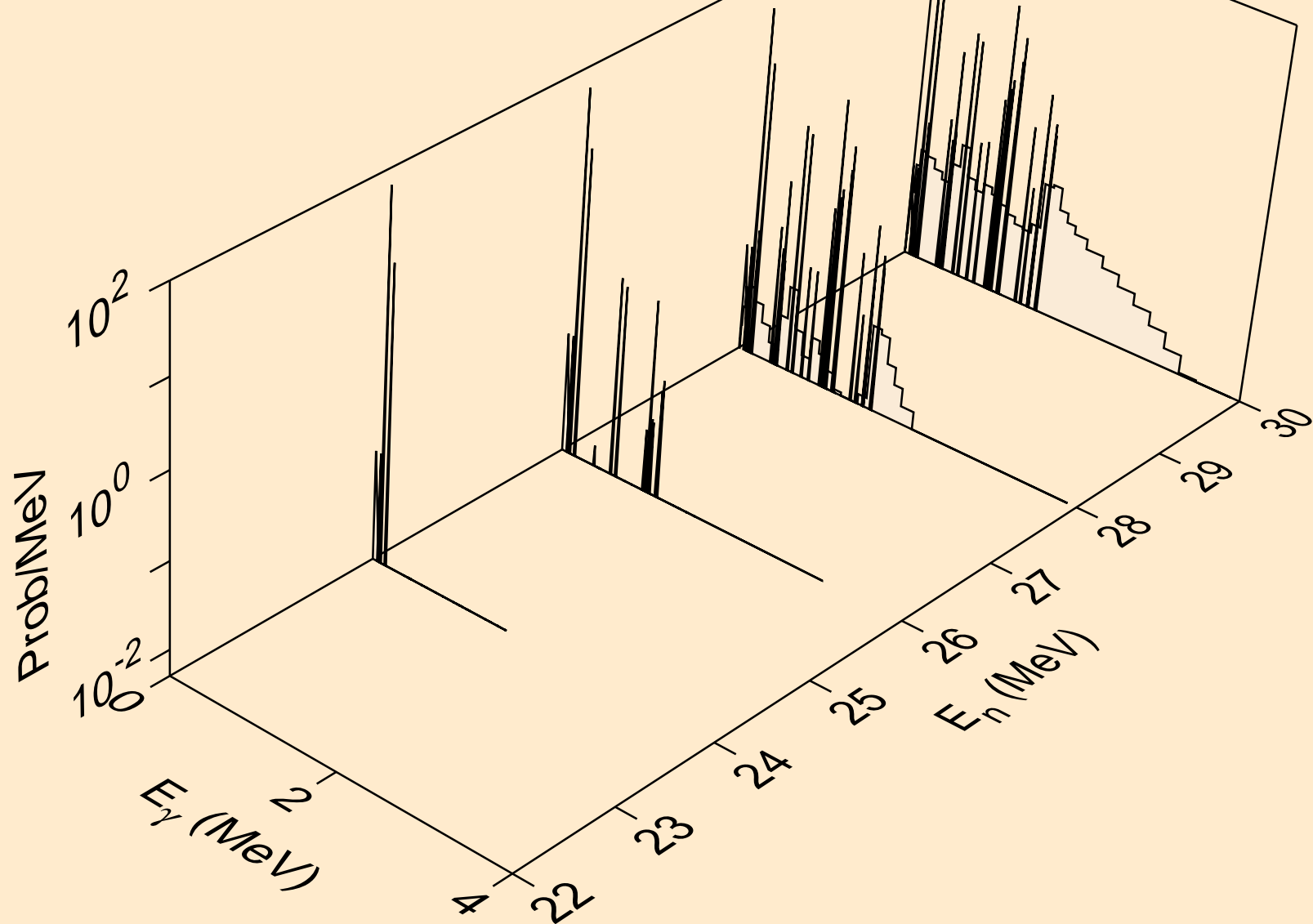

CR052 NEUTRON ACER TENDL-2023 LIBRARY; T=0.K  
Photon emission for (n,n\*)he3

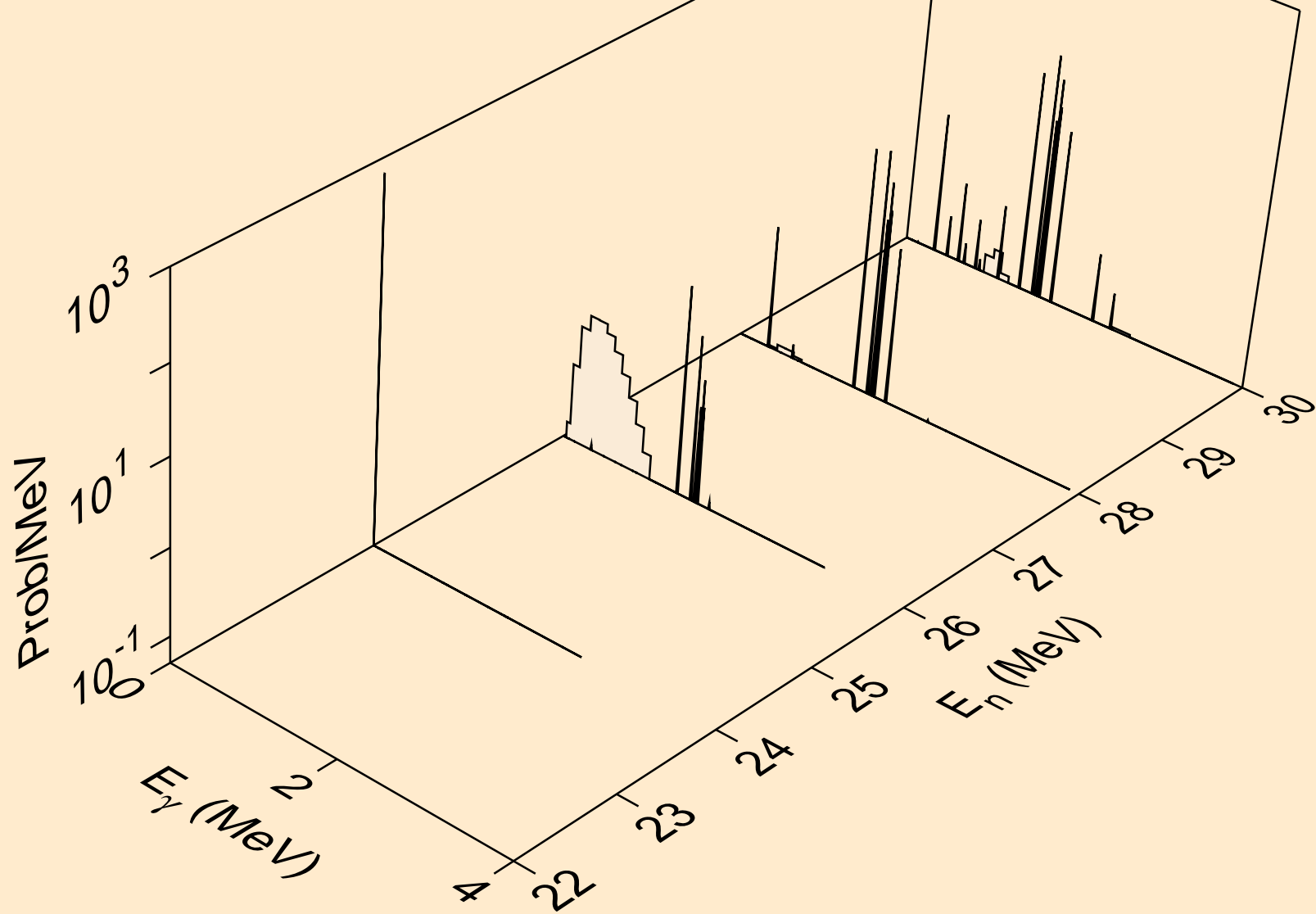

CR052 NEUTRON ACER TENDL-2023 LIBRARY; T=0.K  
Photon emission for (n,2np)

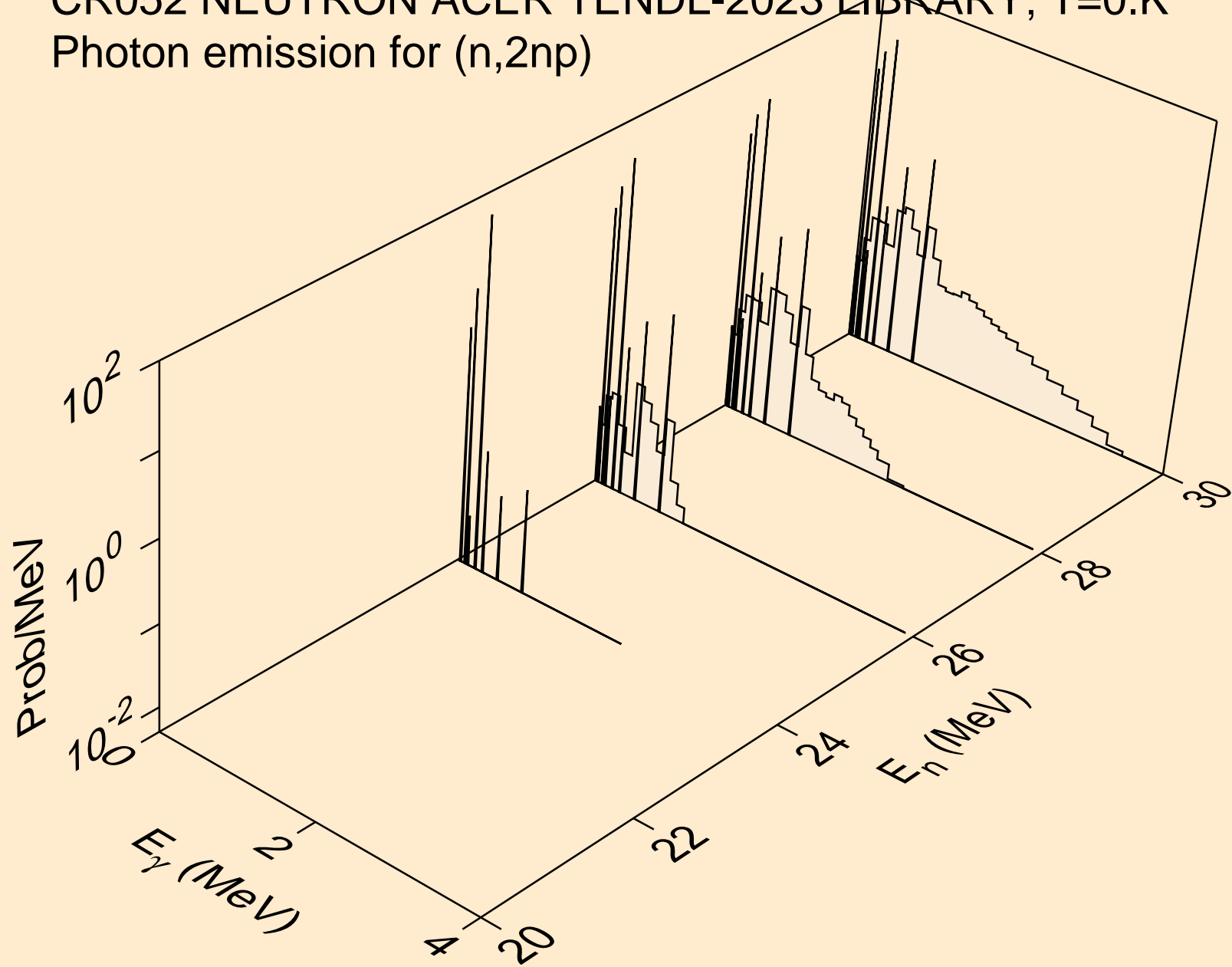

CR052 NEUTRON ACER TENDL-2023 LIBRARY; T=0.K  
Photon emission for (n,n2p)

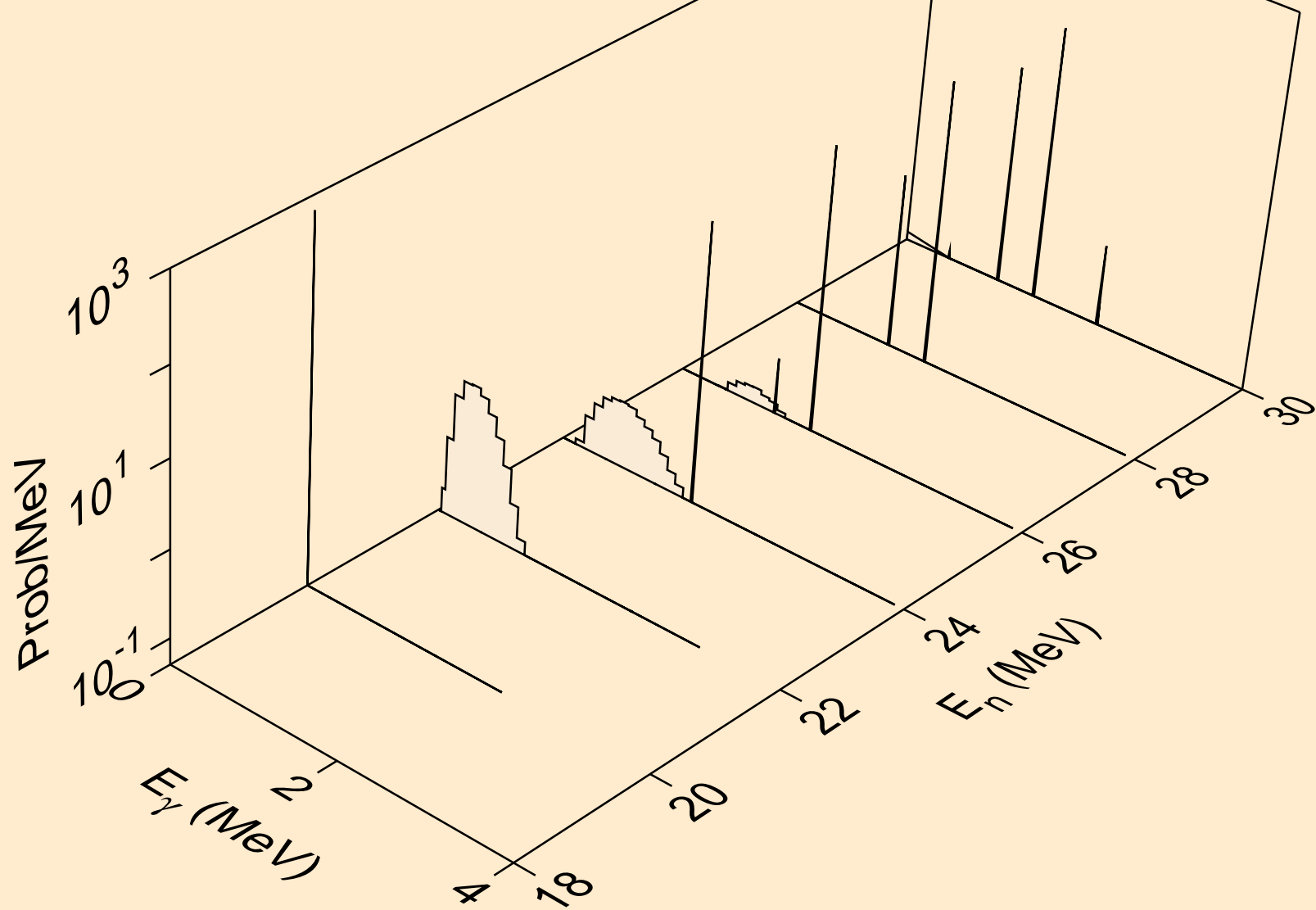

CR052 NEUTRON ACER TENDL-2023 LIBRARY; T=0.K  
Photon emission for (n,npa)

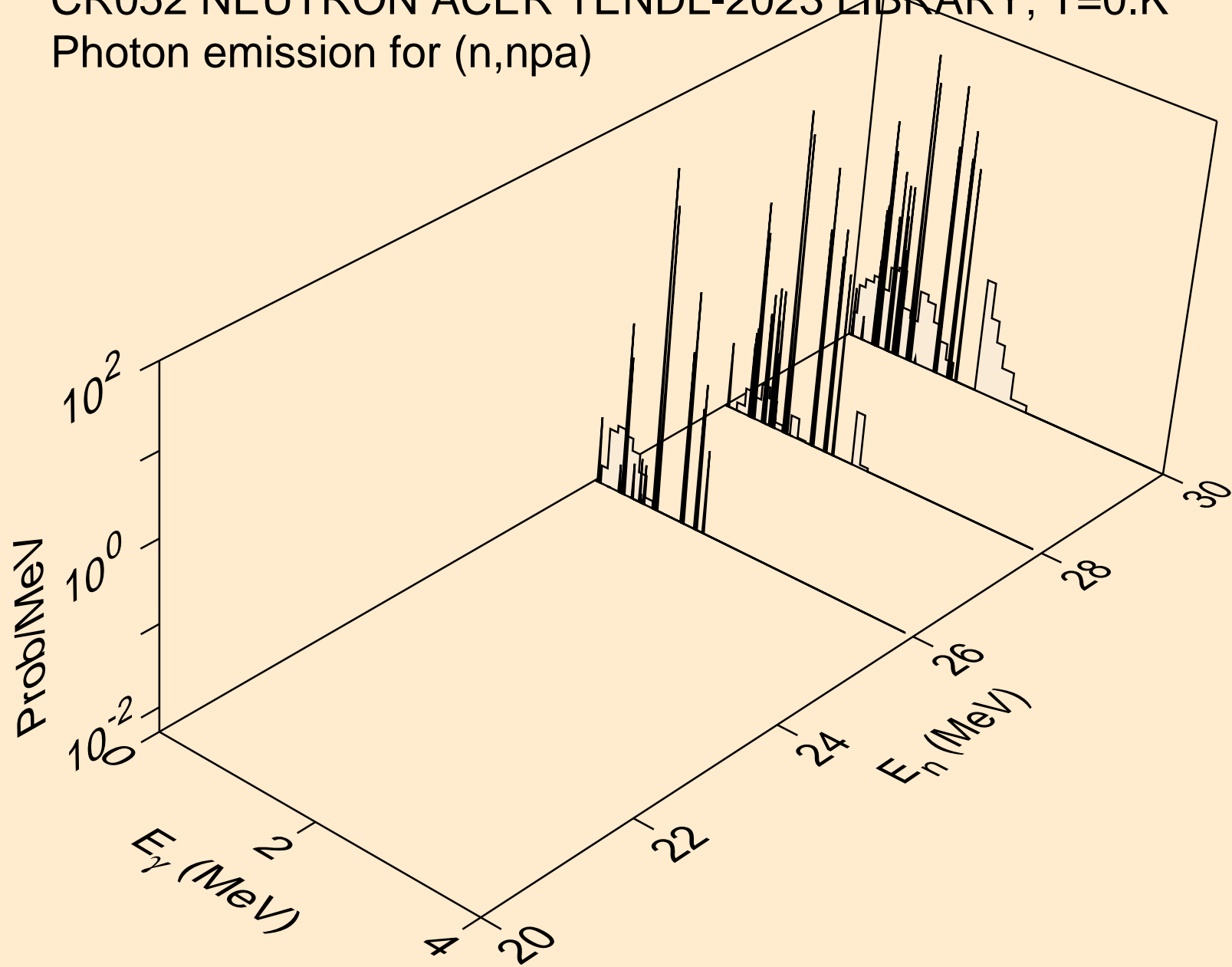

CR052 NEUTRON ACER TENDL-2023 LIBRARY; T=0.K  
Photon emission for (n,n\*c)

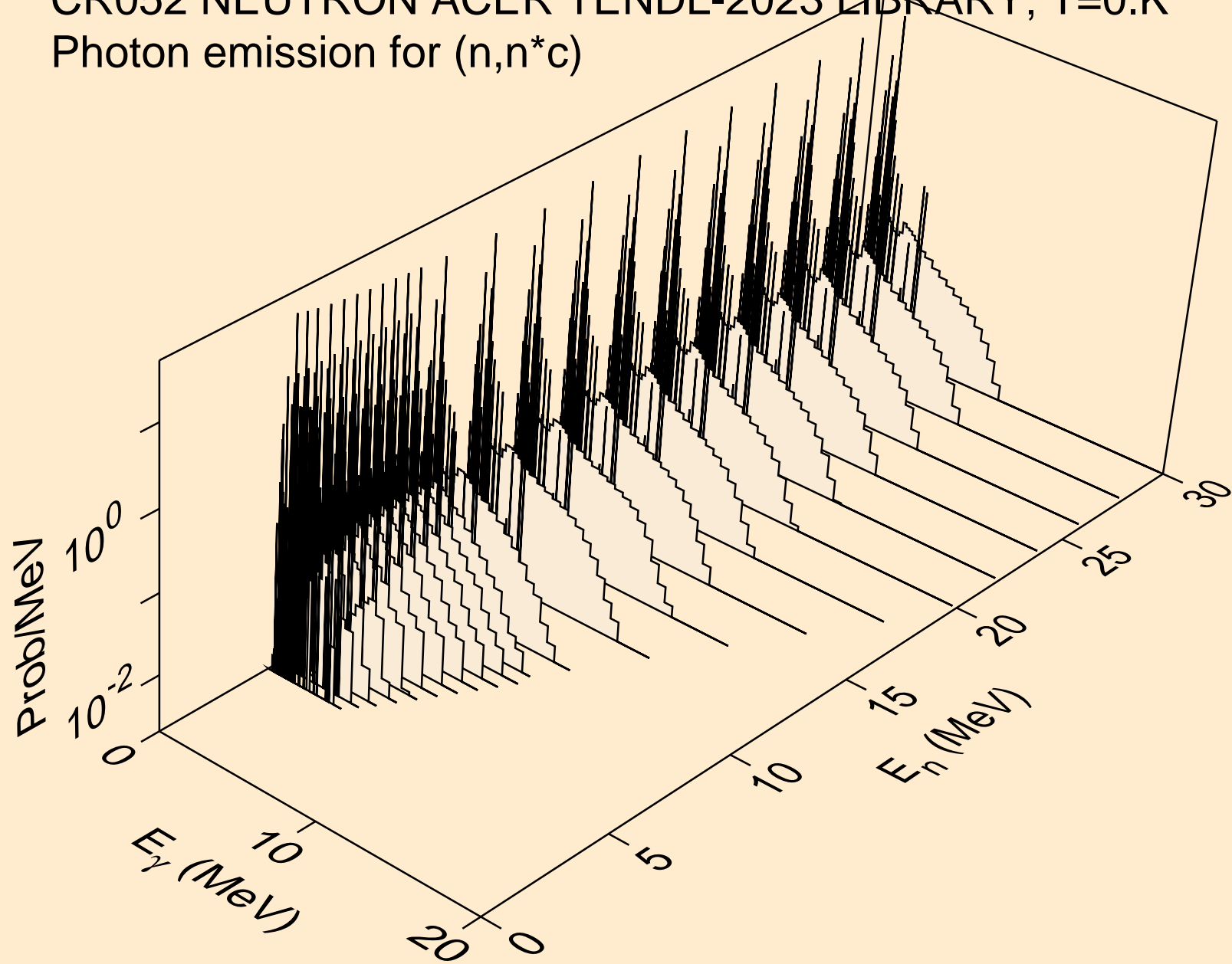



CR052 NEUTRON ACER TENDL-2023 LIBRARY; T=0.K  
Photon emission for (n,gma)

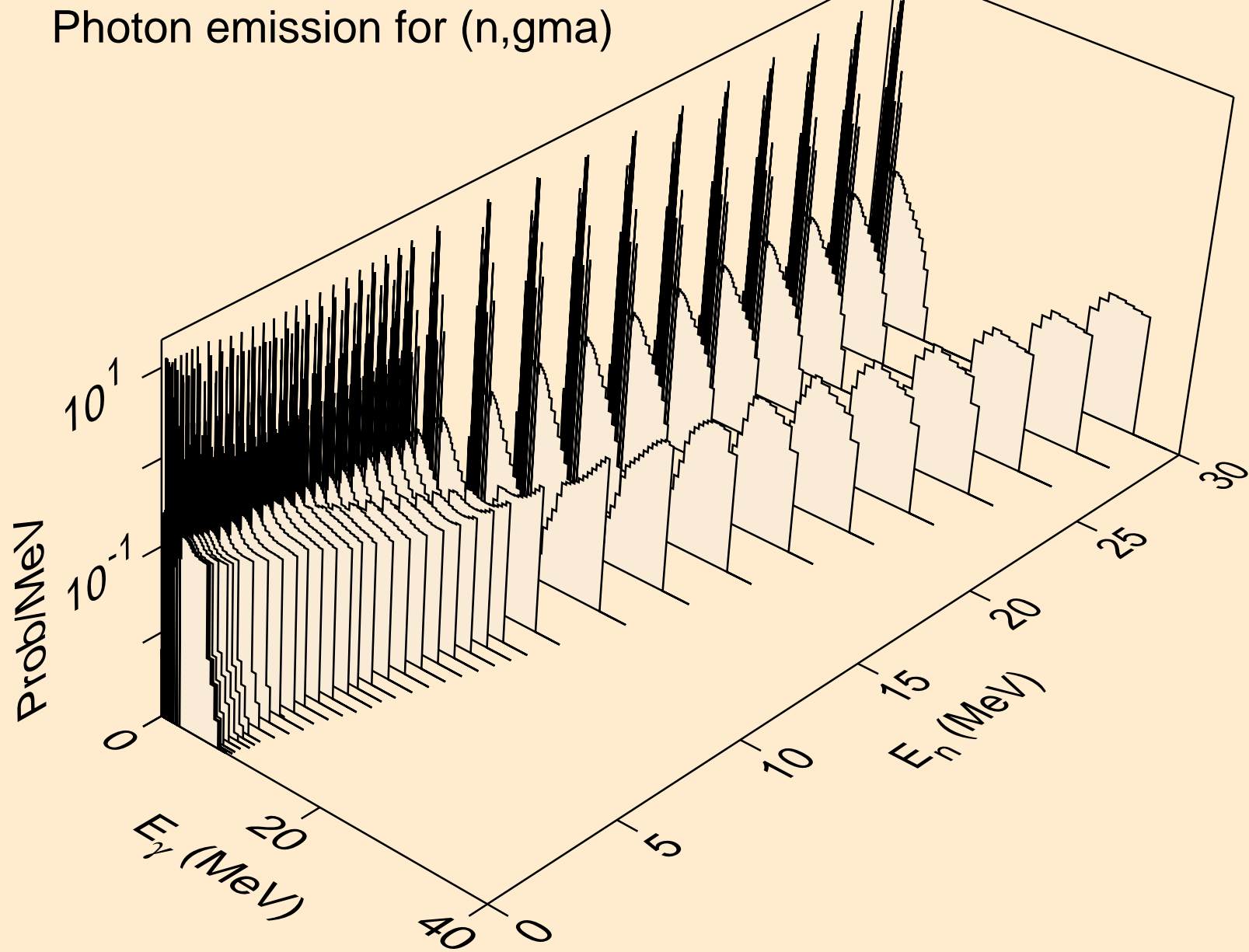

CR052 NEUTRON ACER TENDL-2023 LIBRARY; T=0.K  
Photon emission for (n,p)

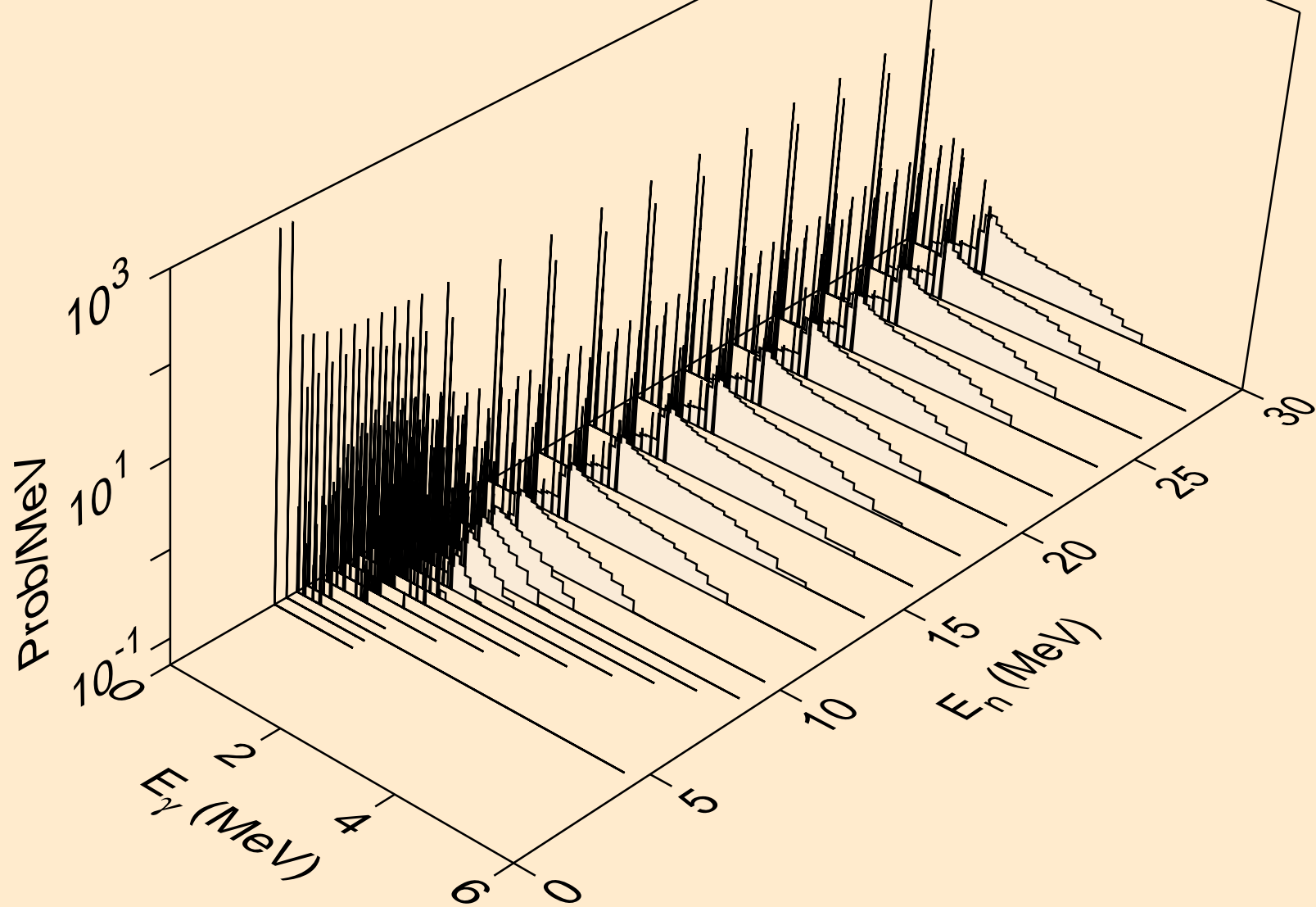

CR052 NEUTRON ACER TENDL-2023 LIBRARY; T=0.K  
Photon emission for (n,d)

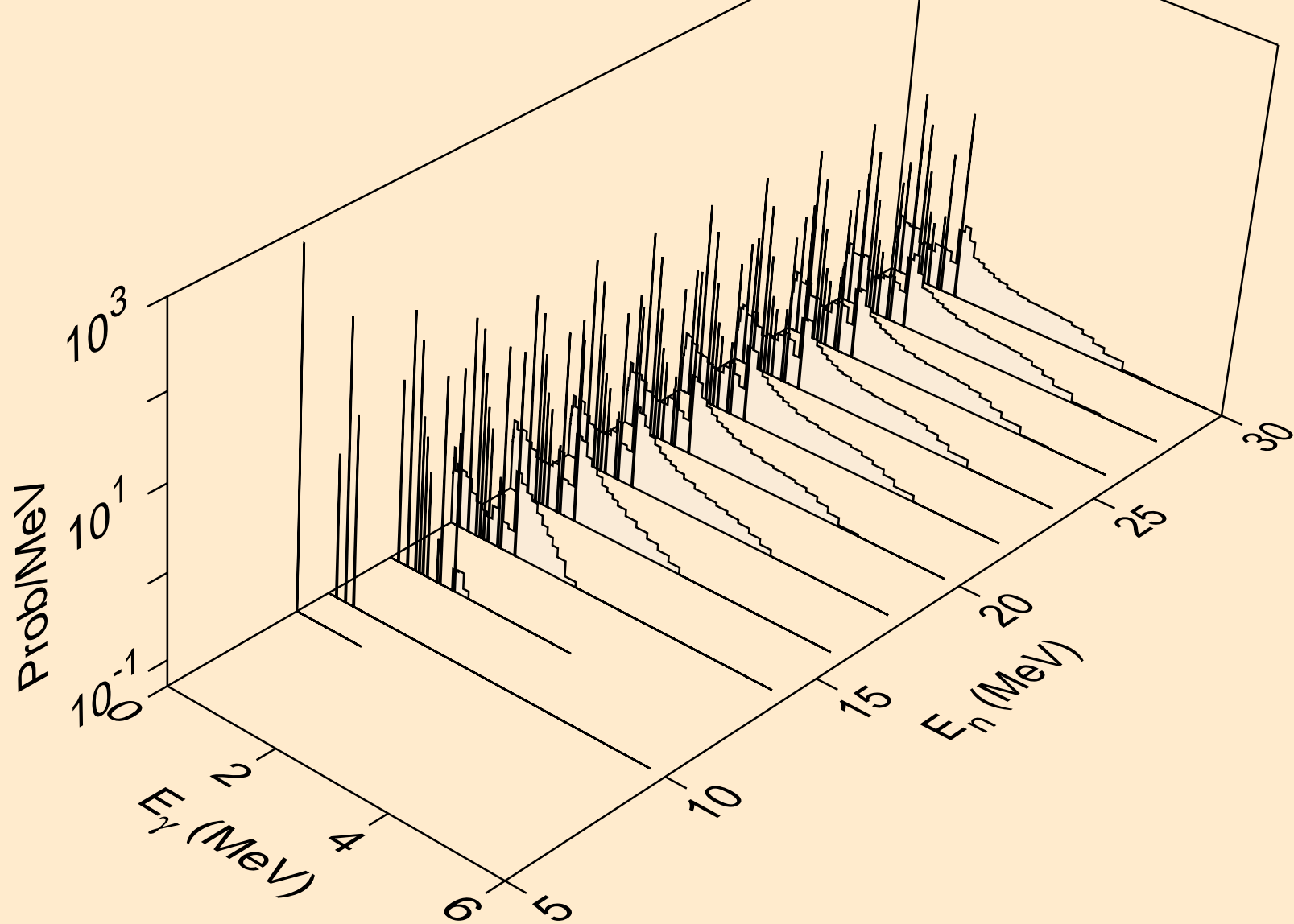

CR052 NEUTRON ACER TENDL-2023 LIBRARY; T=0.K  
Photon emission for (n,t)

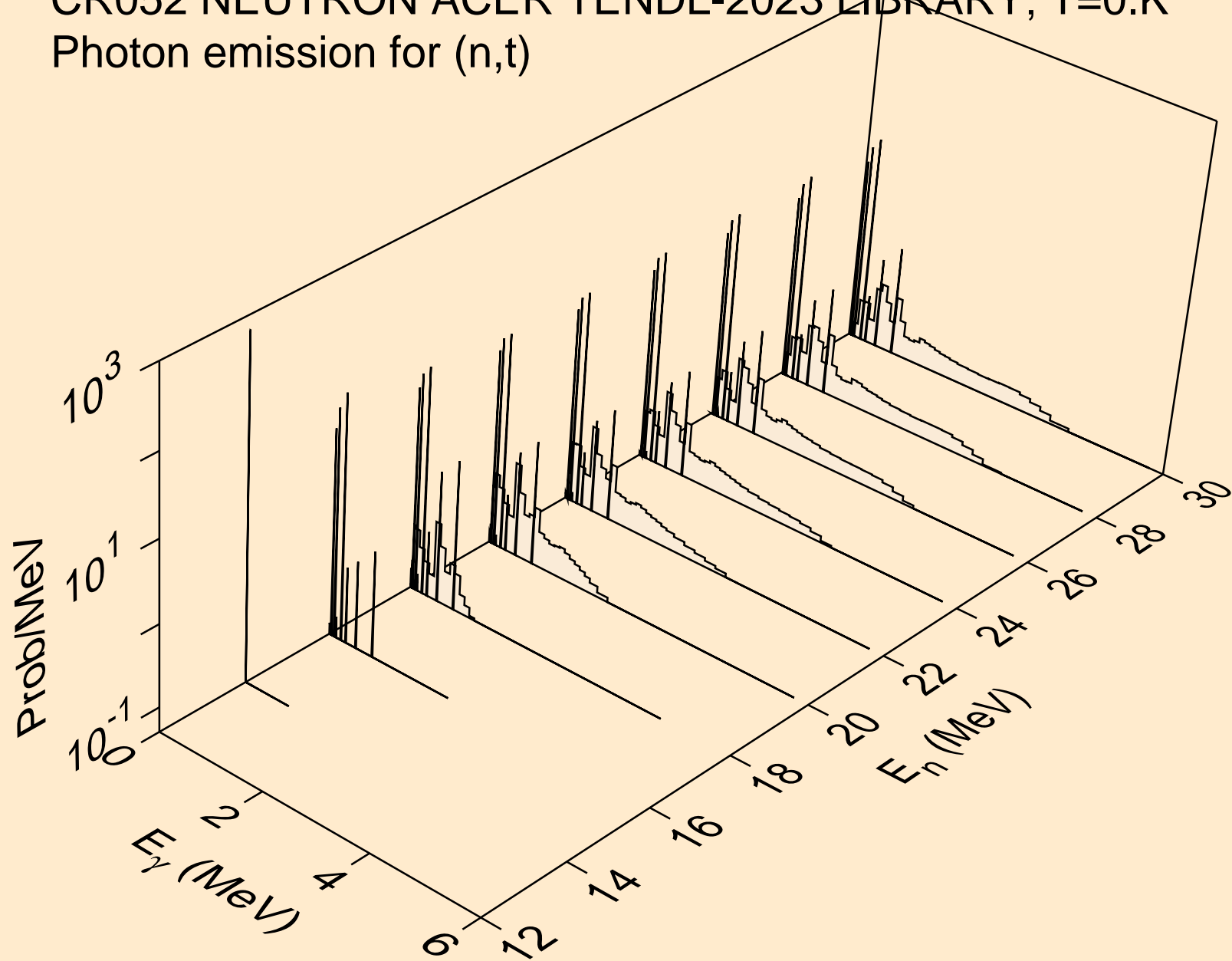

CR052 NEUTRON ACER TENDL-2023 LIBRARY; T=0.K  
Photon emission for (n,he3)

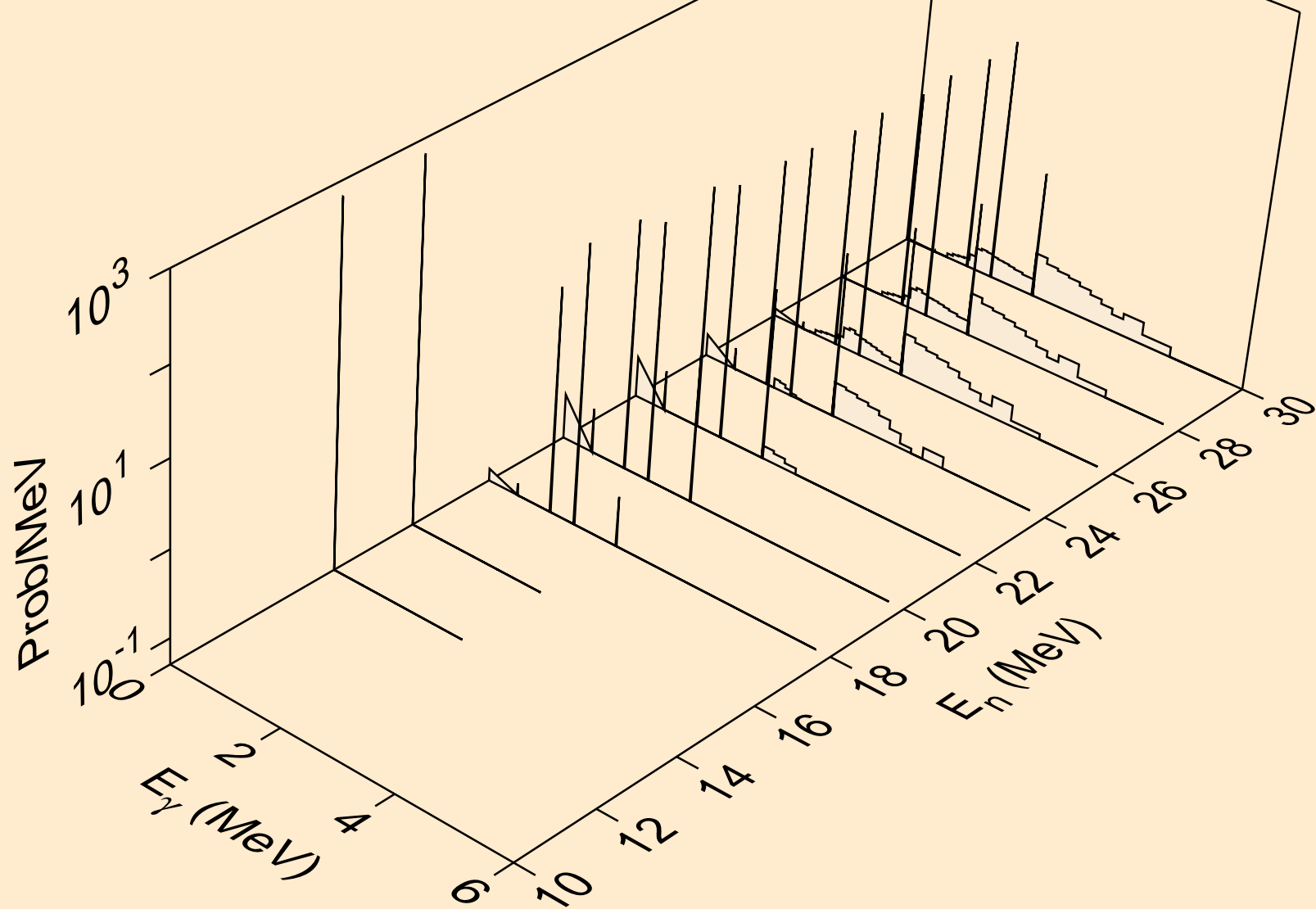

CR052 NEUTRON ACER TENDL-2023 LIBRARY; T=0.K  
Photon emission for (n,a)

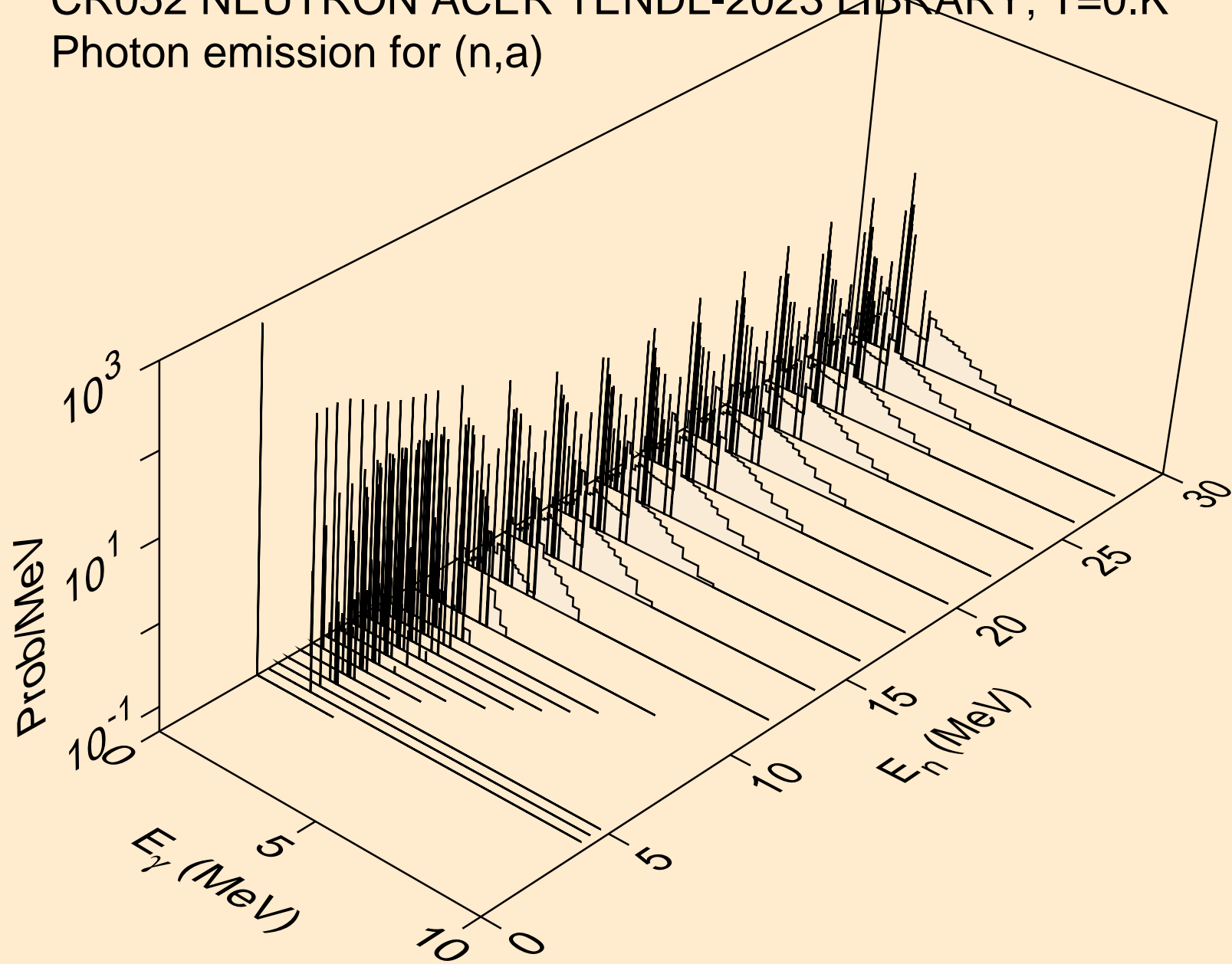

CR052 NEUTRON ACER TENDL-2023 LIBRARY; T=0.K  
Photon emission for (n,2a)

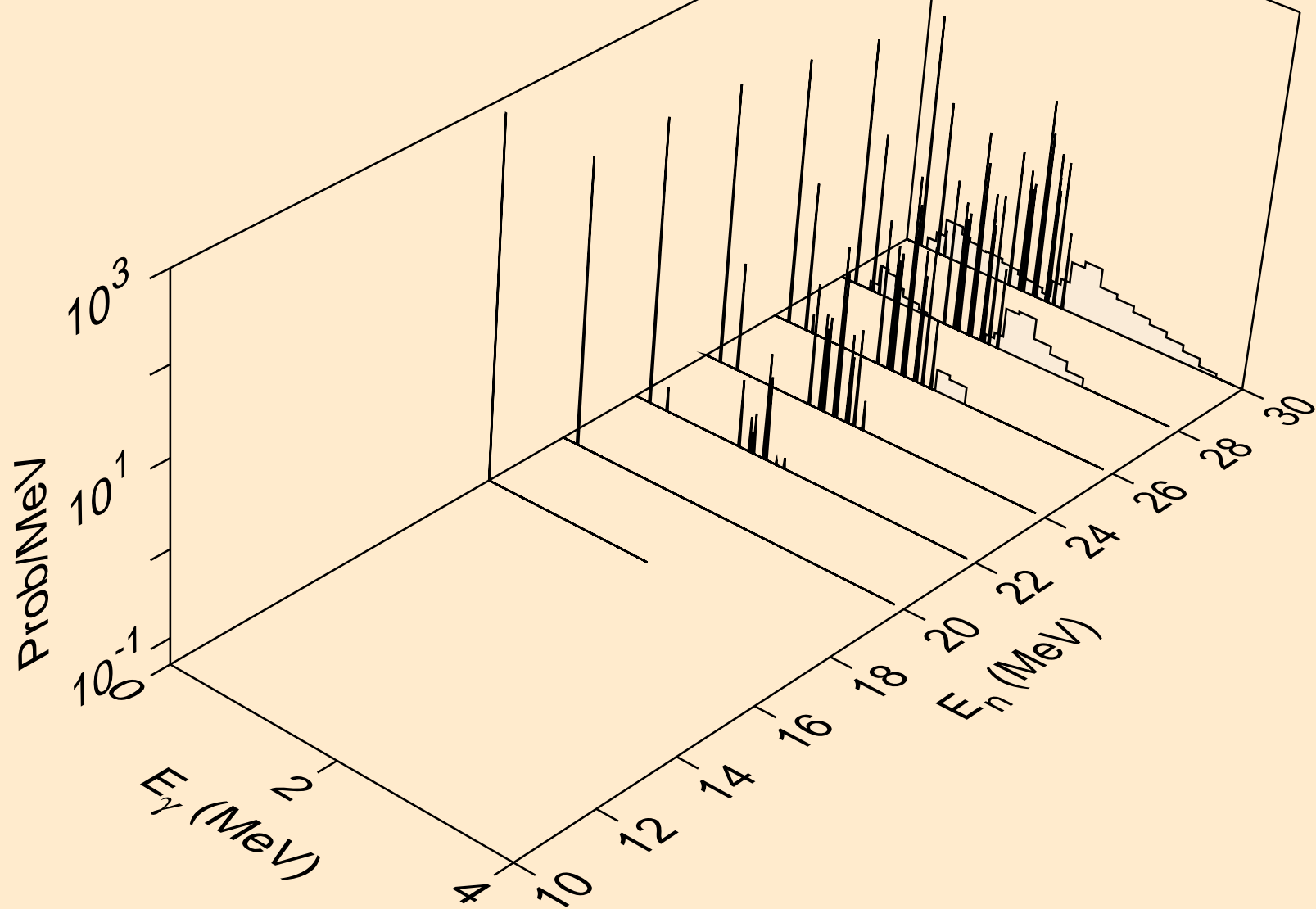

CR052 NEUTRON ACER TENDL-2023 LIBRARY; T=0.K  
Photon emission for (n,2p)

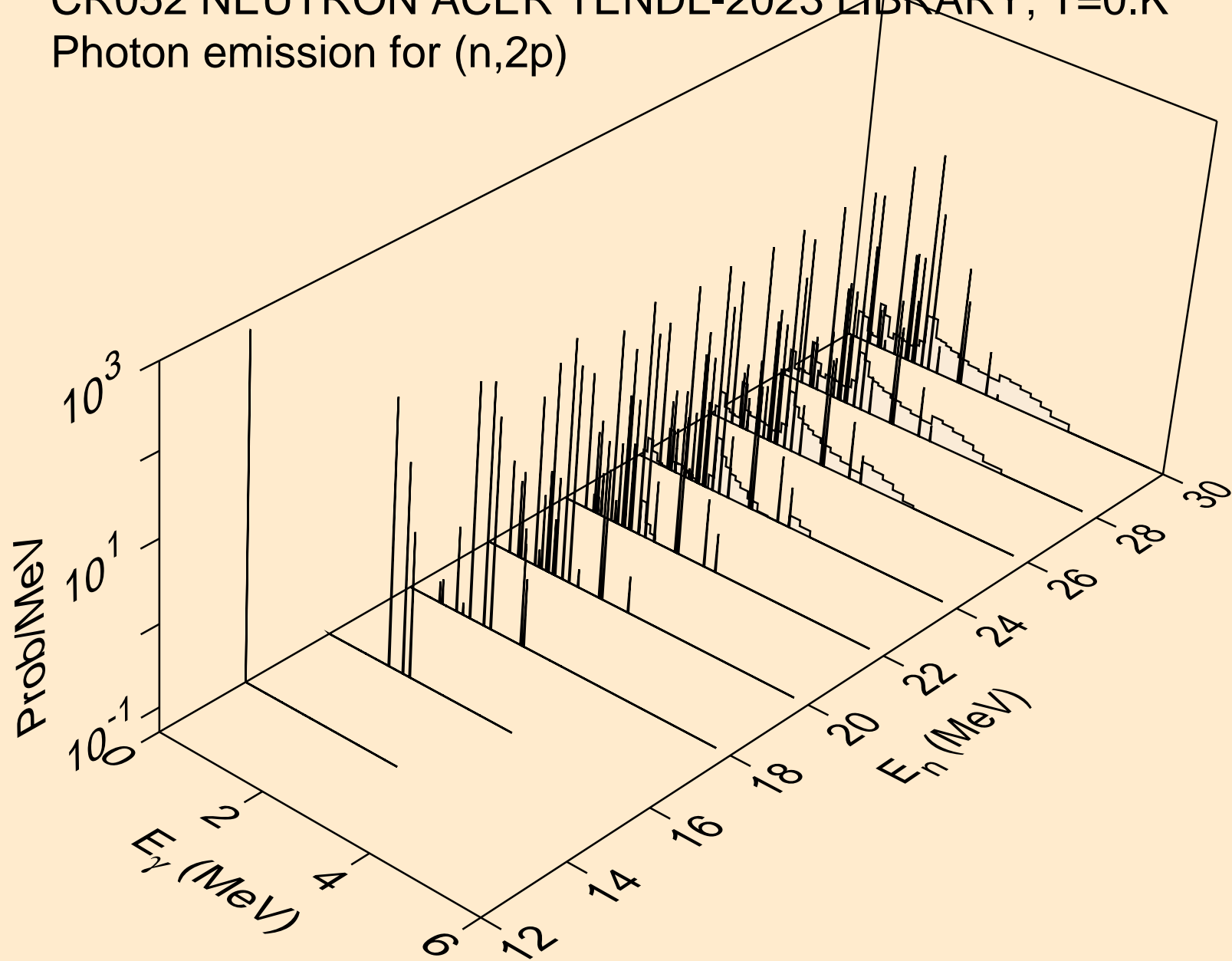



CR052 NEUTRON ACER TENDL-2023 LIBRARY; T=0.K  
Photon emission for (n,p $\alpha$ )

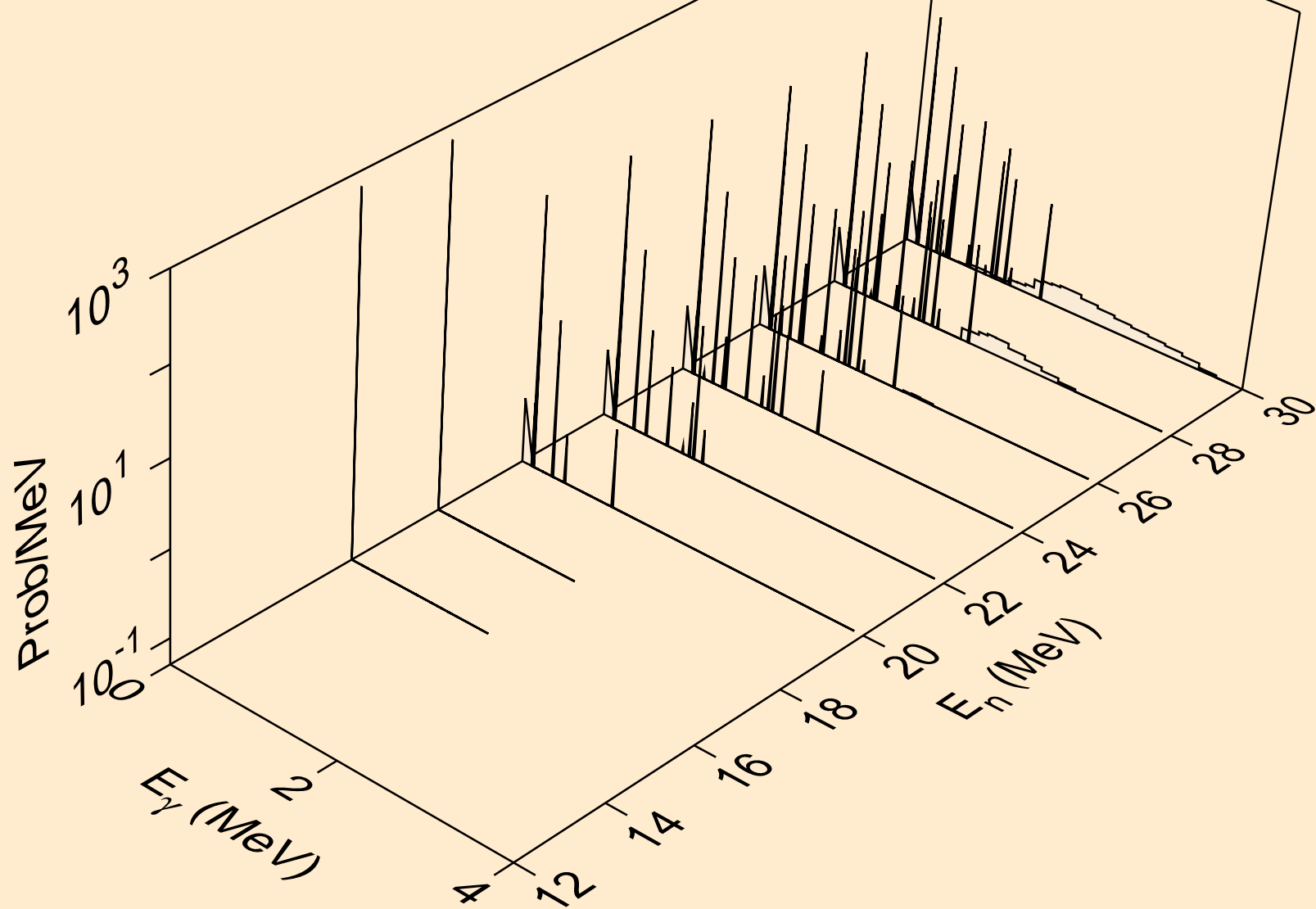

CR052 NEUTRON ACER TENDL-2023 LIBRARY; T=0.K  
Photon emission for (n,pd)

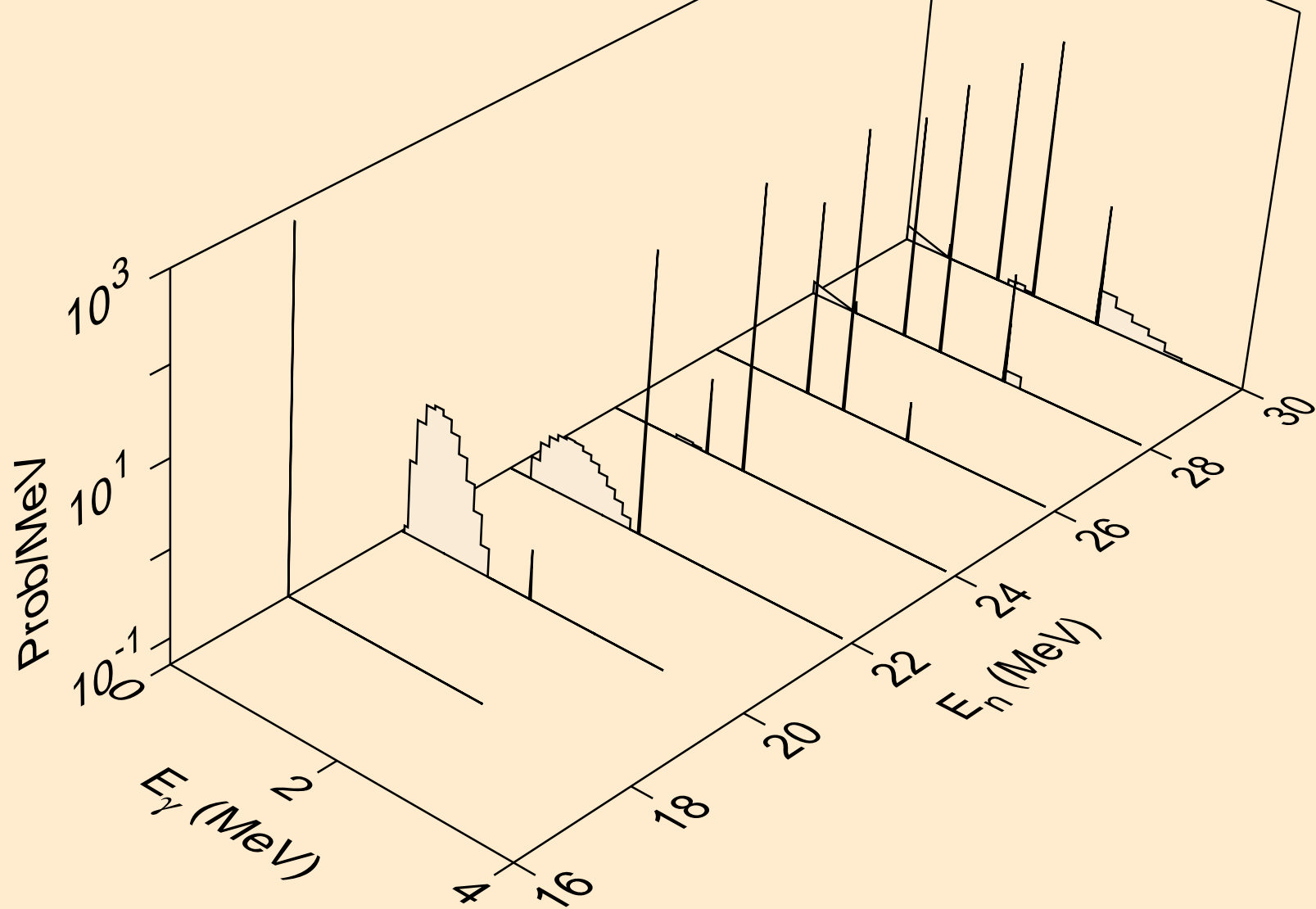

CR052 NEUTRON ACER TENDL-2023 LIBRARY; T=0.K  
Photon emission for (n,pt)

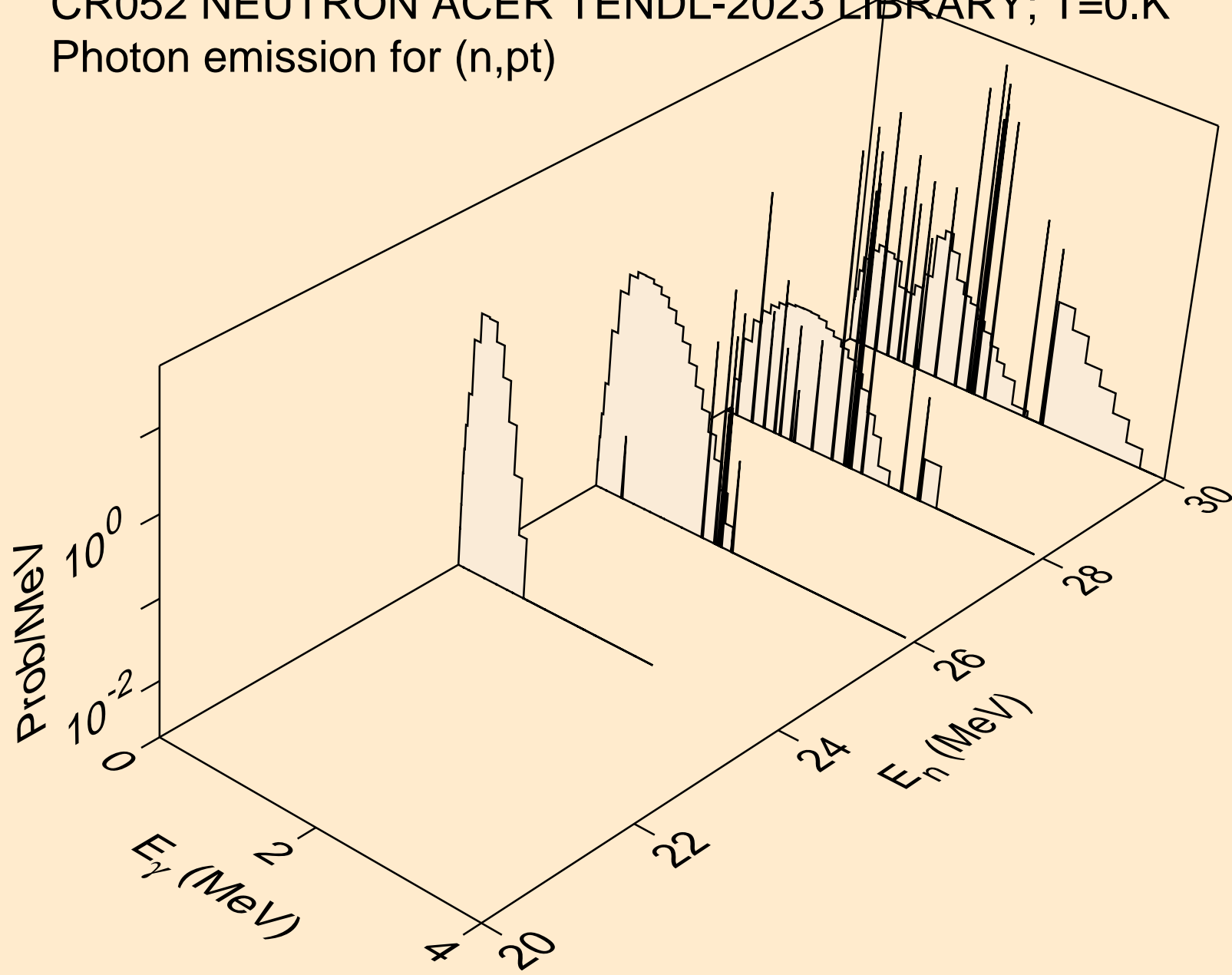

CR052 NEUTRON ACER TENDL-2023 LIBRARY; T=0.K  
Photon emission for (n,da)

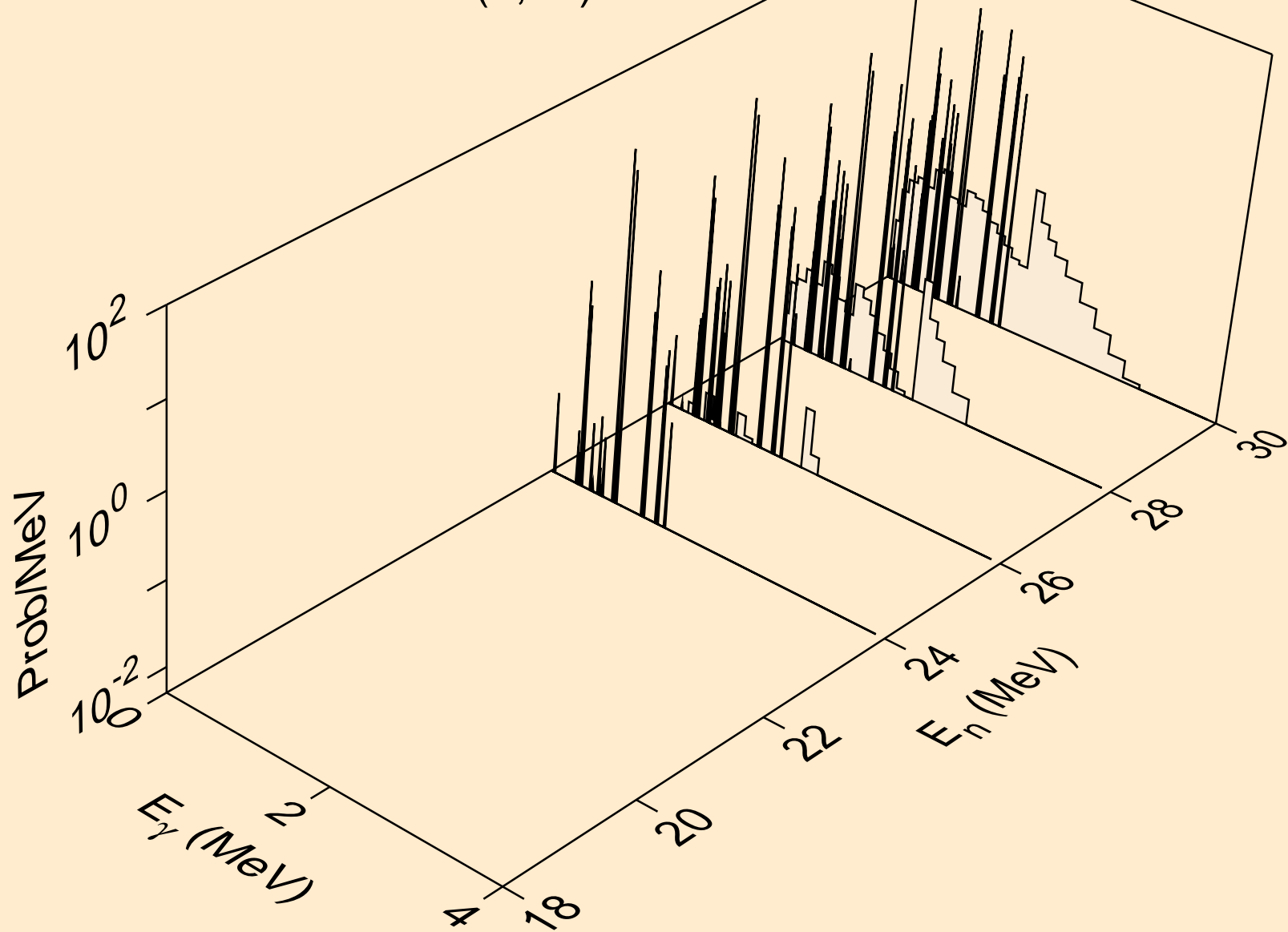

CR052 NEUTRON ACER TENDL-2023 LIBRARY; T=0.K  
thermal capture photon spectrum

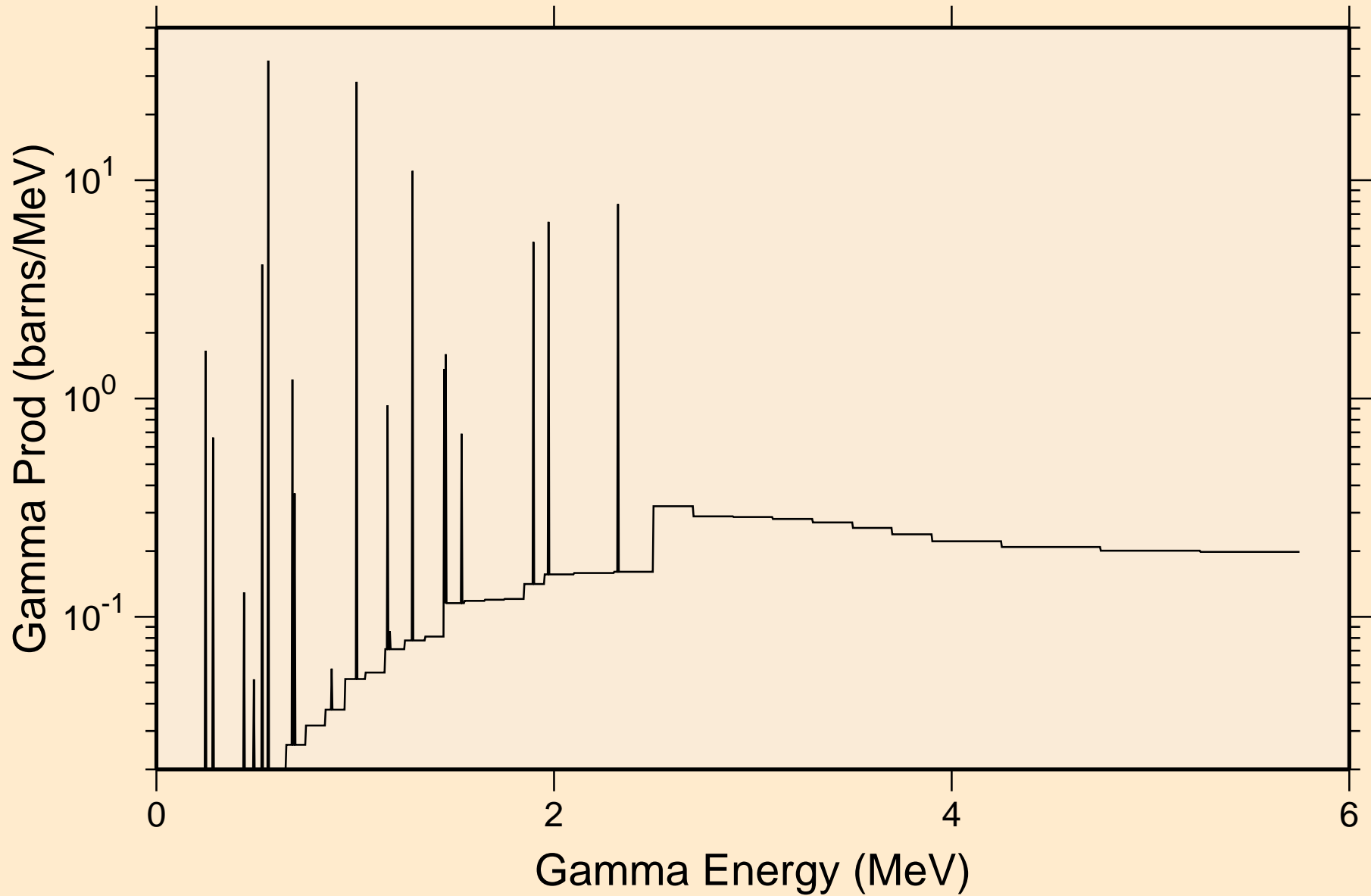

CR052 NEUTRON ACER TENDL-2023 LIBRARY; T=0.K  
14 MeV photon spectrum

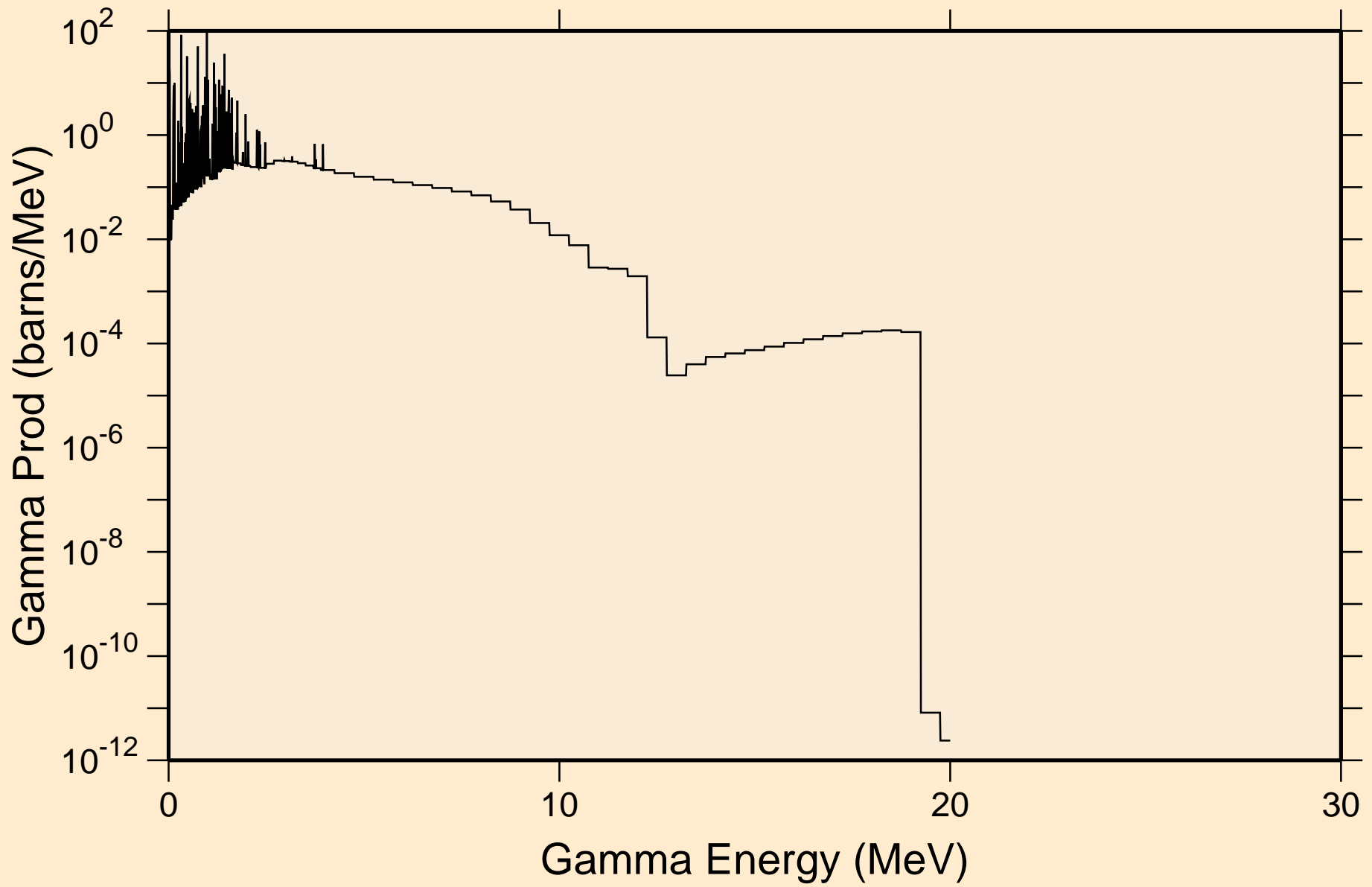

# CR052 NEUTRON ACER TENDL-2023 LIBRARY; T=0.K

## Particle heating contributions

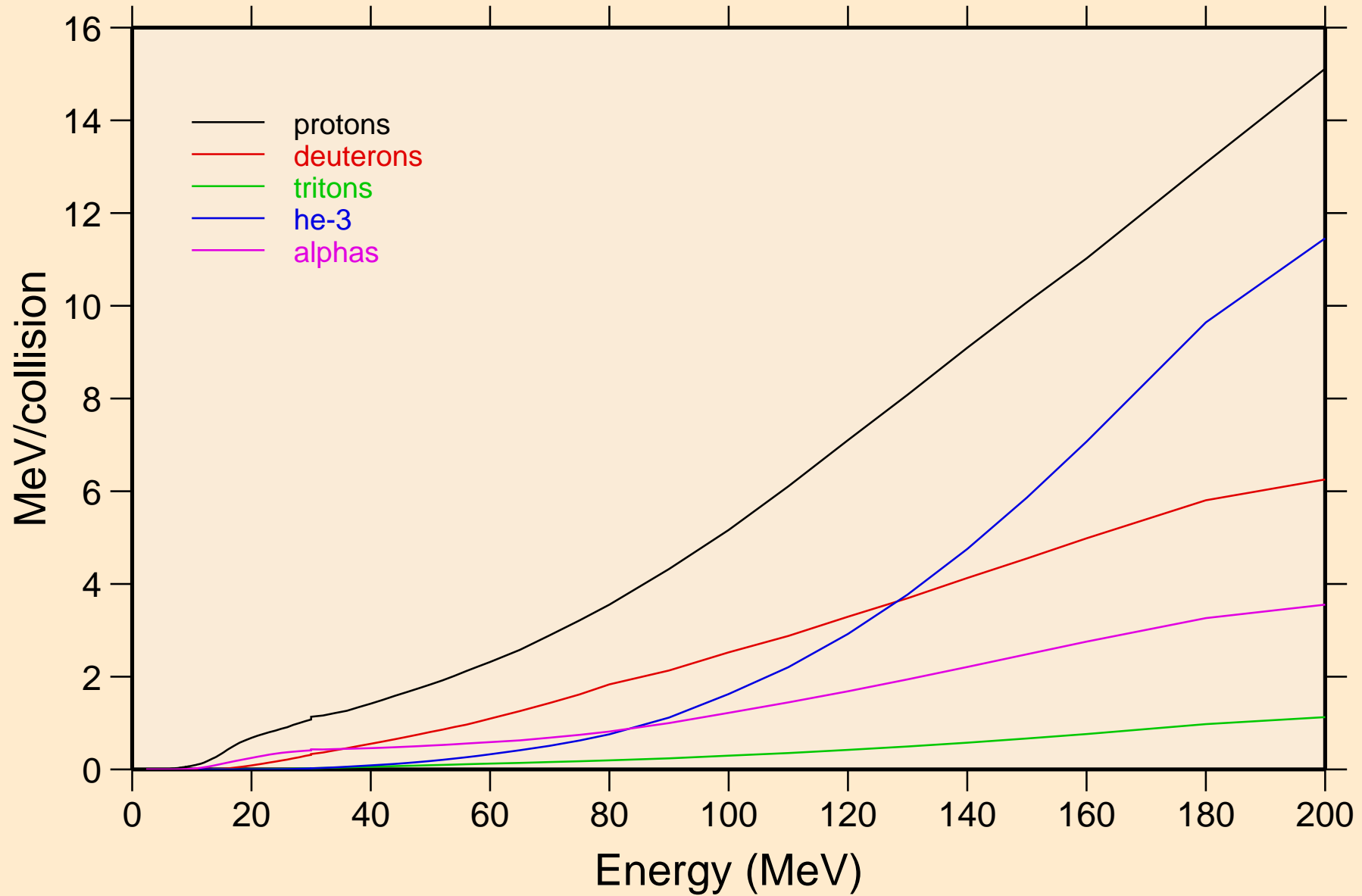

CR052 NEUTRON ACER TENDL-2023 LIBRARY; T=0.K  
Recoil Heating

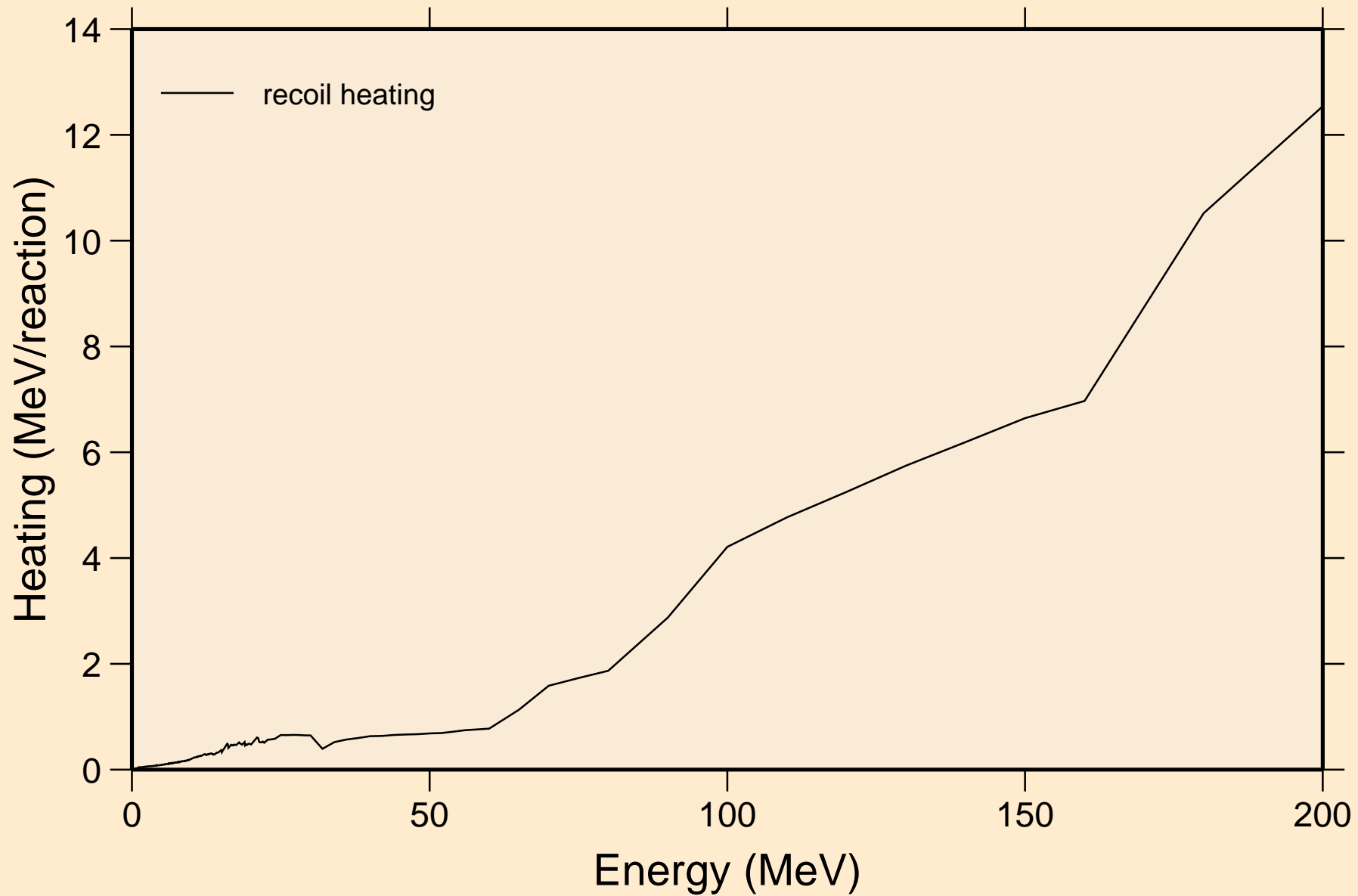



CR052 NEUTRON ACER TENDL-2023 LIBRARY; T=0.K  
Particle production cross sections

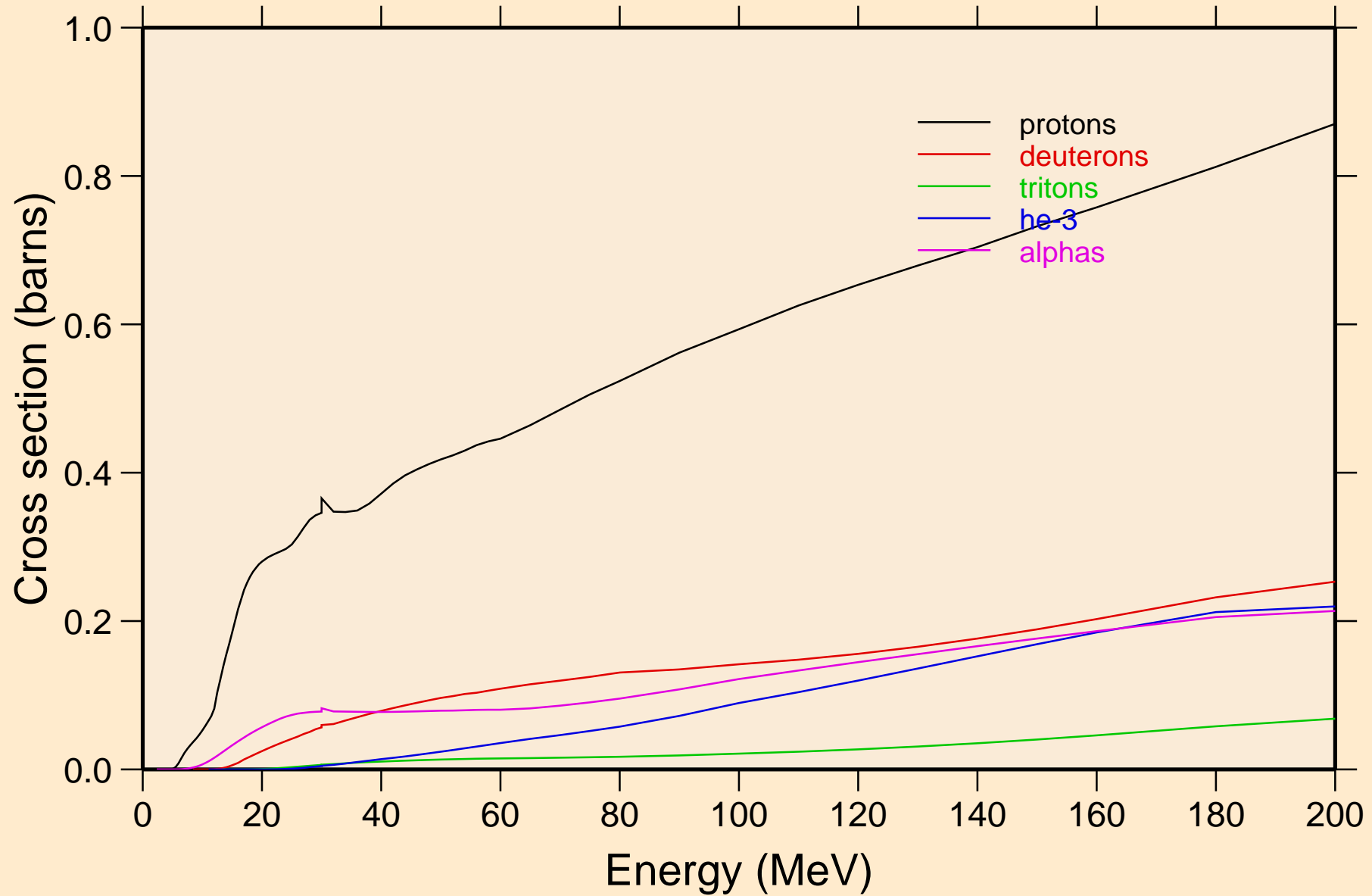

CR052 NEUTRON ACER TENDL-2023 LIBRARY; T=0.K  
protons from (n,x)

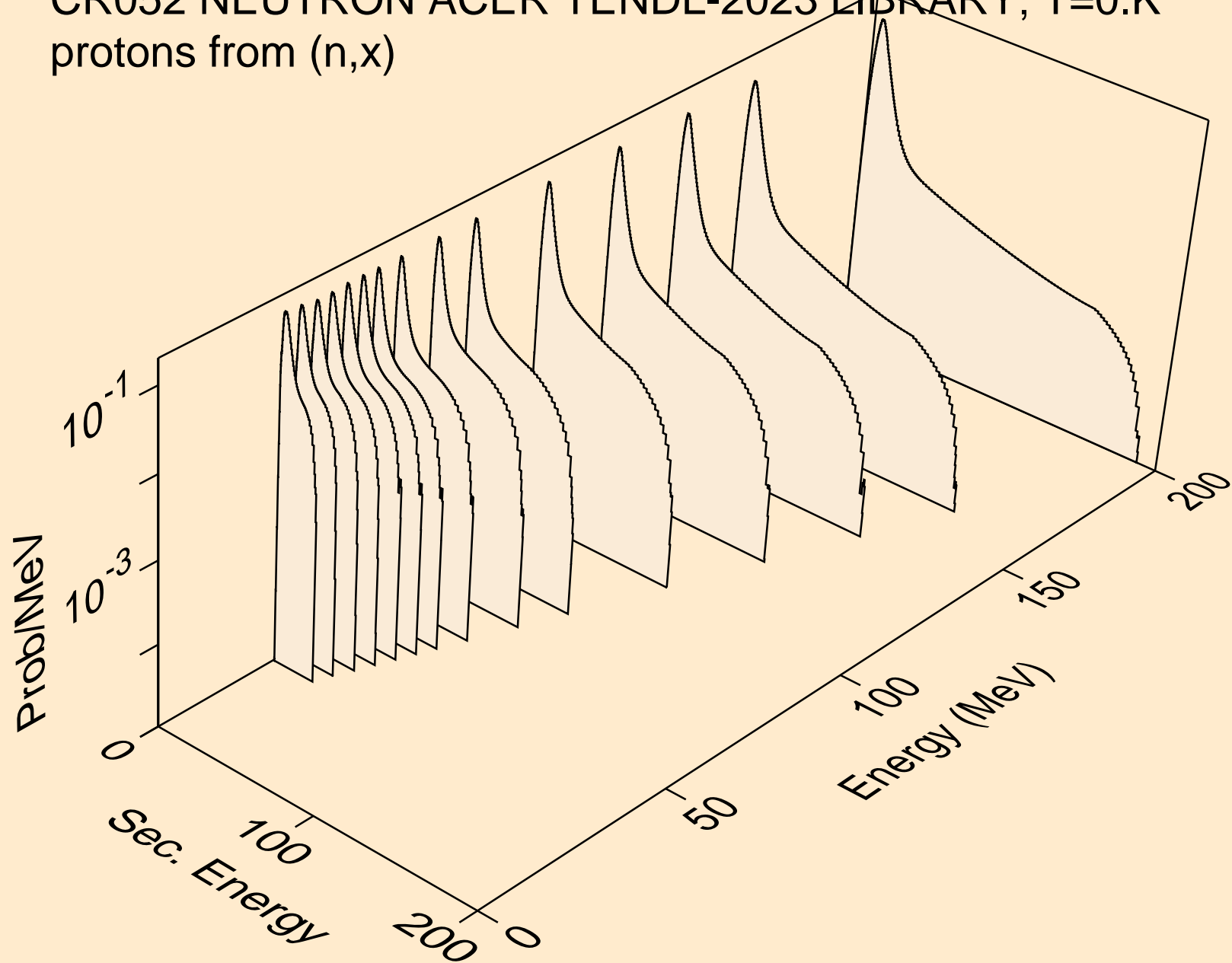

CR052 NEUTRON ACER TENDL-2023 LIBRARY; T=0.K  
protons from (n,n\*)p

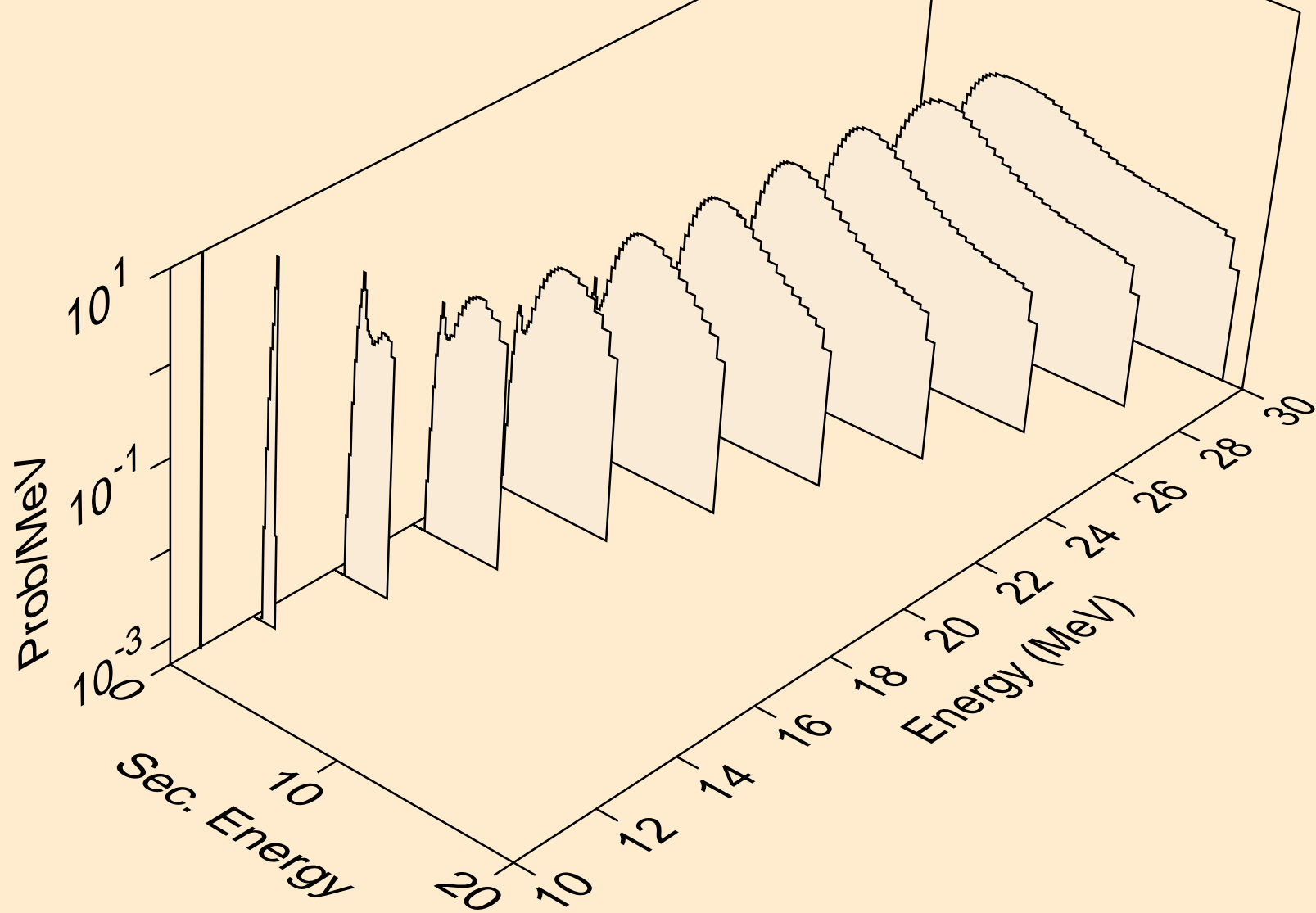

CR052 NEUTRON ACER TENDL-2023 LIBRARY; T=0.K  
protons from (n,2np)

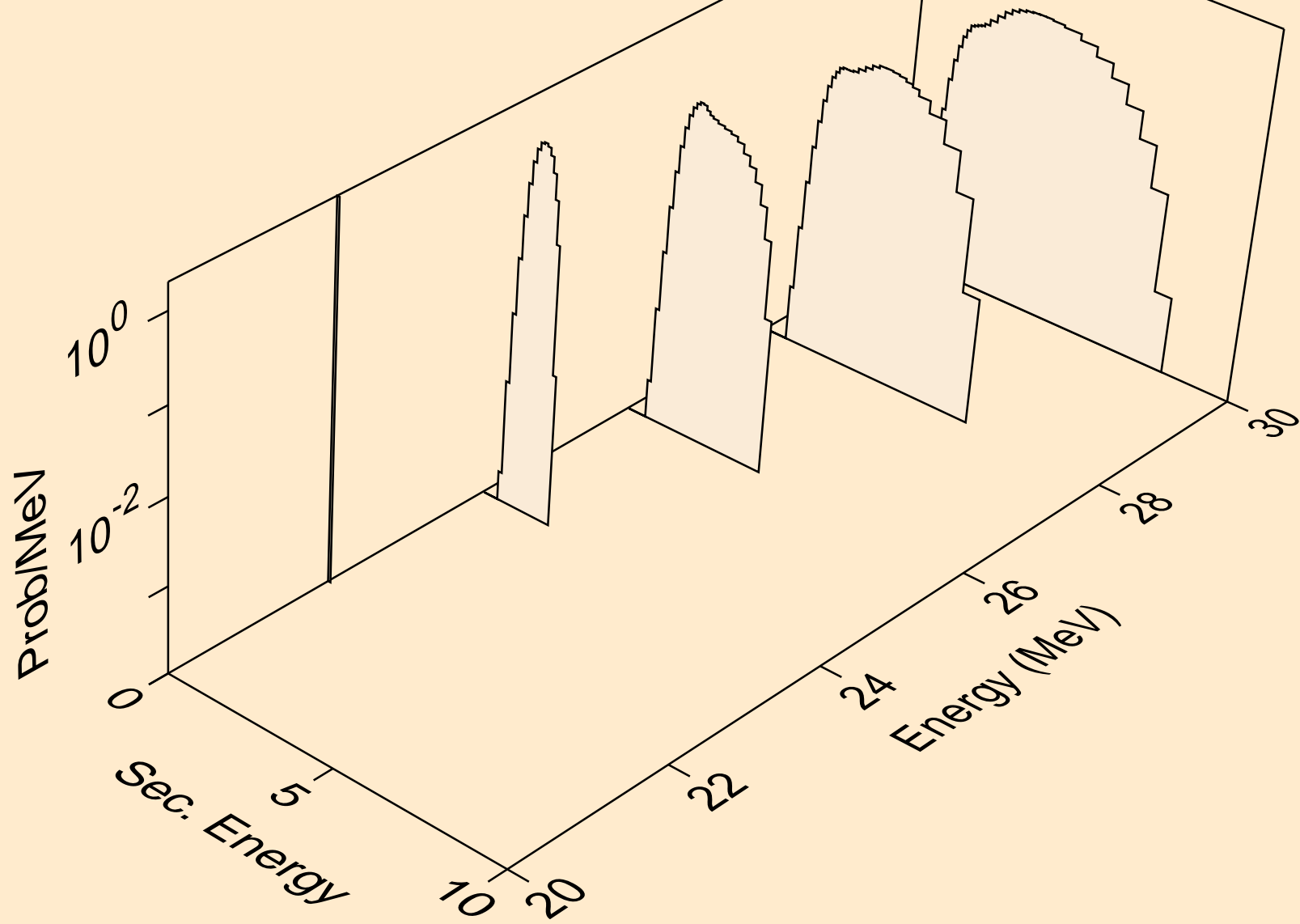

CR052 NEUTRON ACER TENDL-2023 LIBRARY; T=0.K  
protons from (n,n2p)

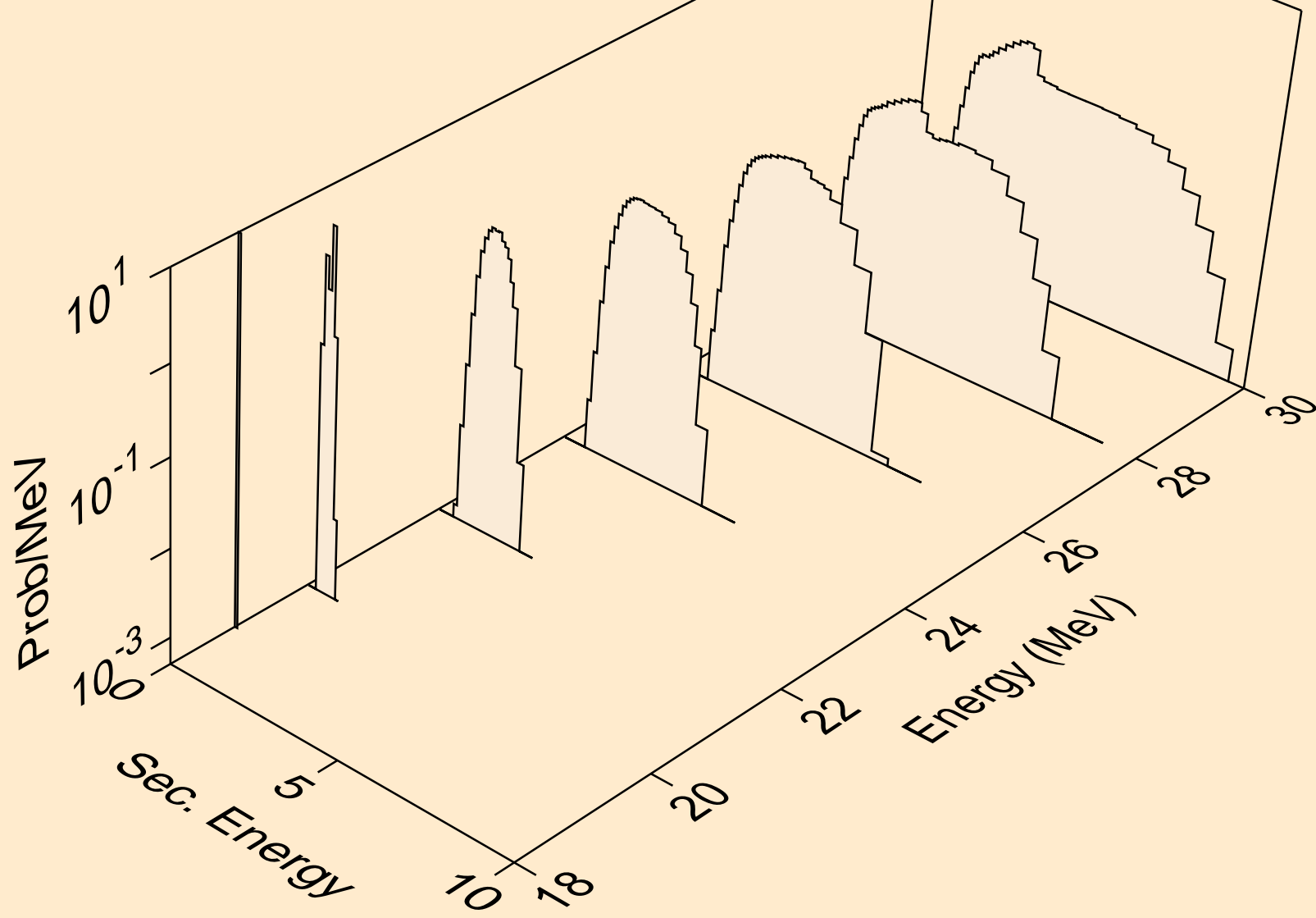

CR052 NEUTRON ACER TENDL-2023 LIBRARY; T=0.K  
protons from (n,npa)

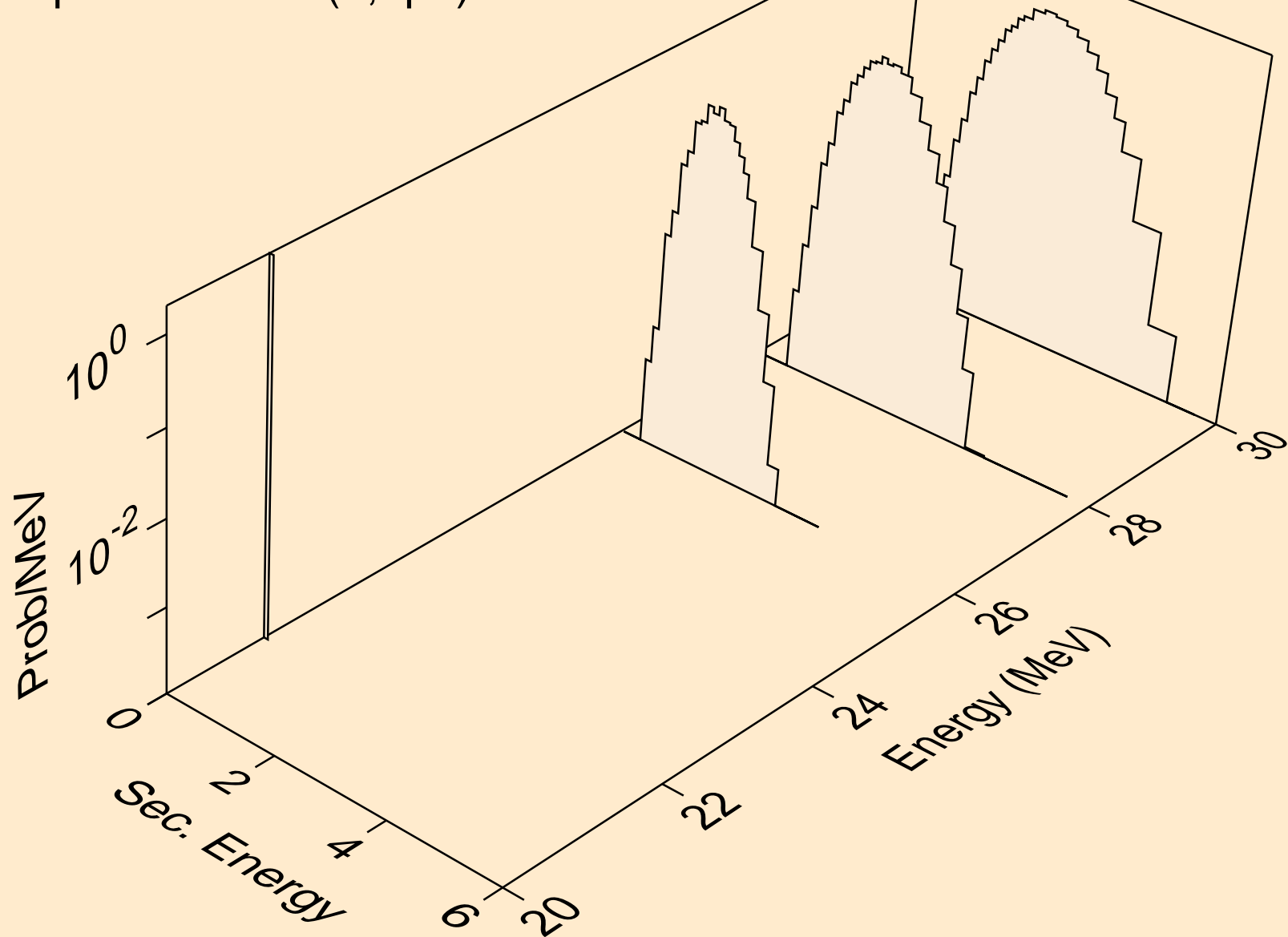

CR052 NEUTRON ACER TENDL-2023 LIBRARY; T=0.K  
protons from (n,p)

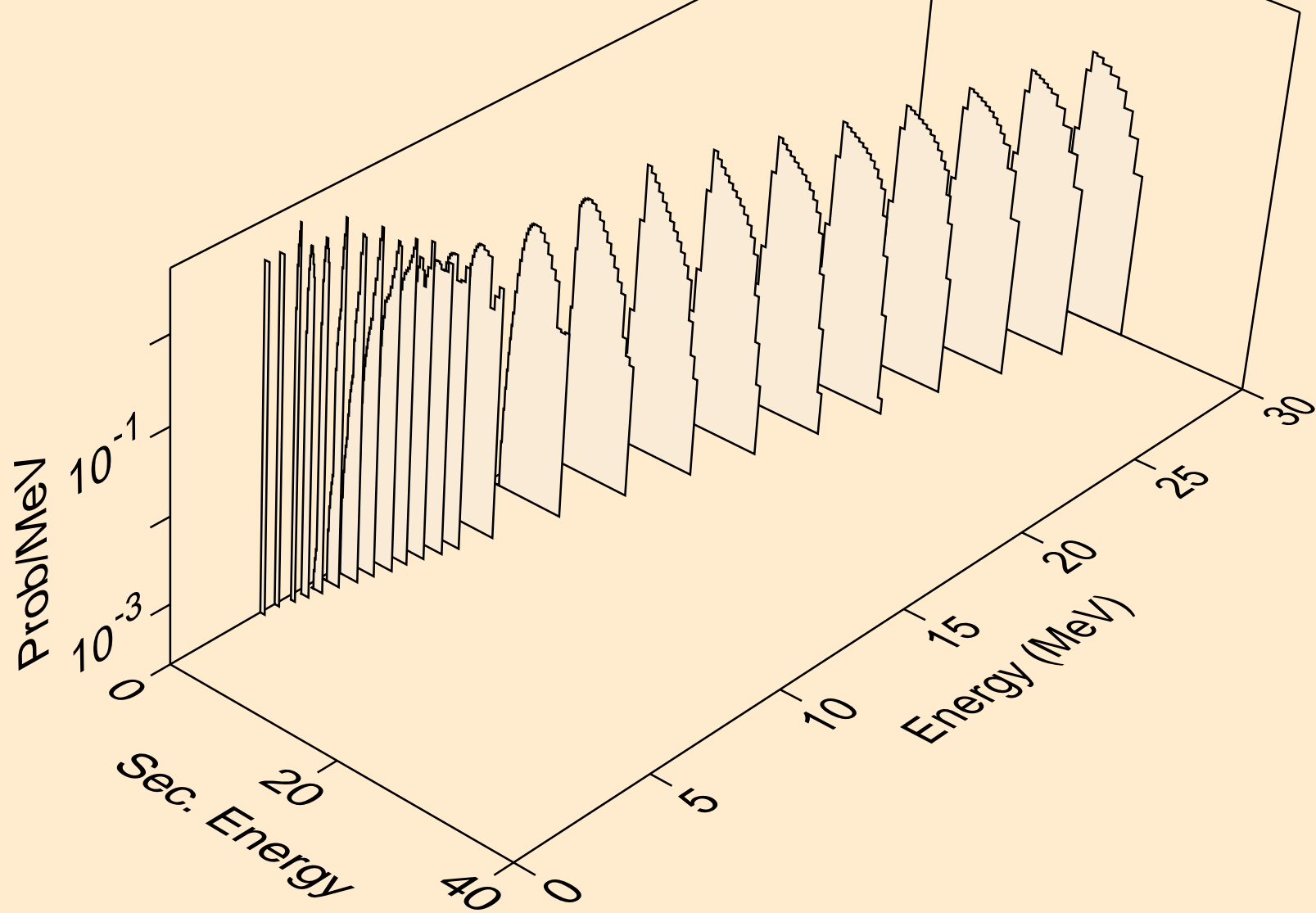

CR052 NEUTRON ACER TENDL-2023 LIBRARY; T=0.K  
protons from (n,2p)

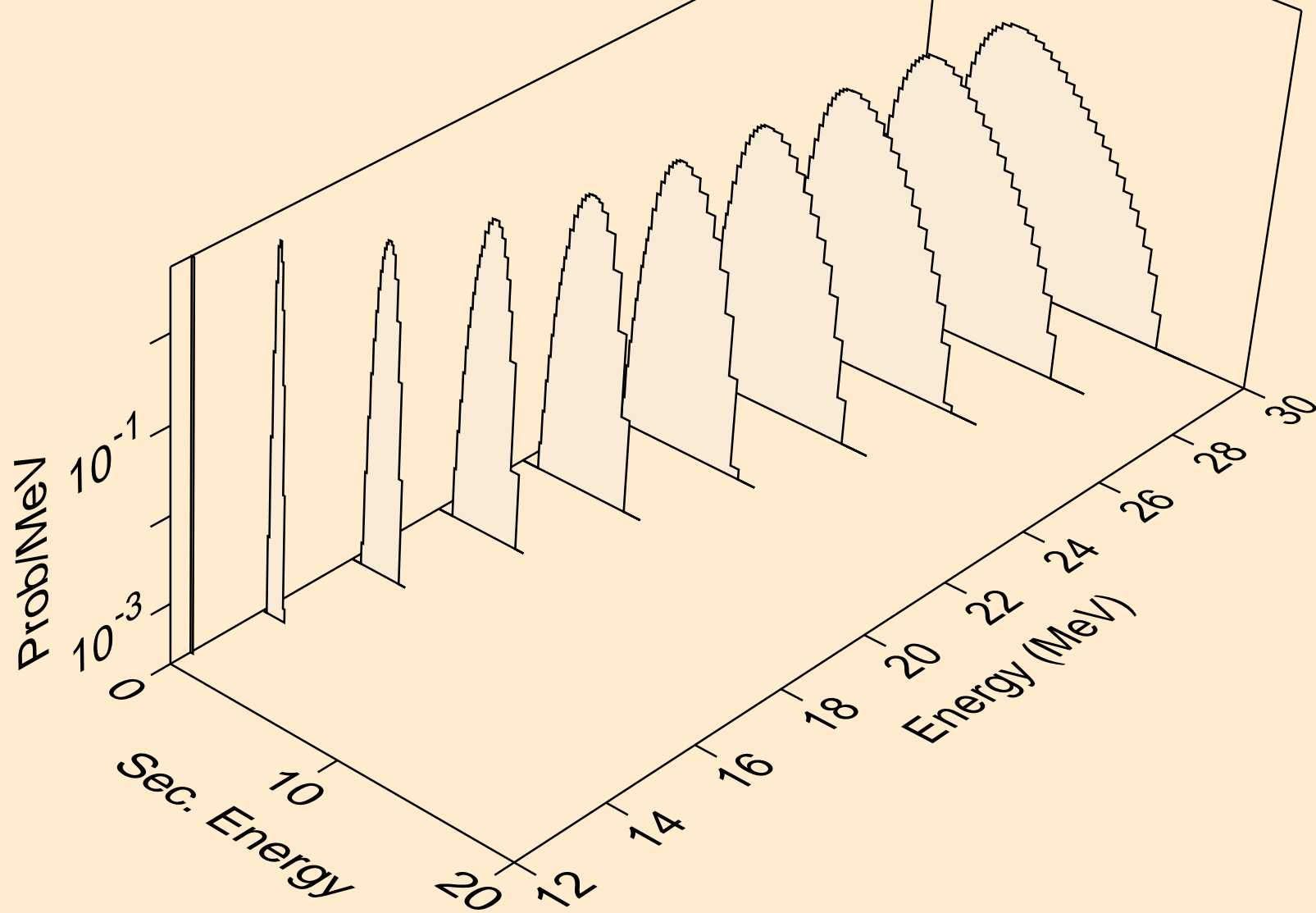



CR052 NEUTRON ACER TENDL-2023 LIBRARY; T=0.K  
protons from (n,p)

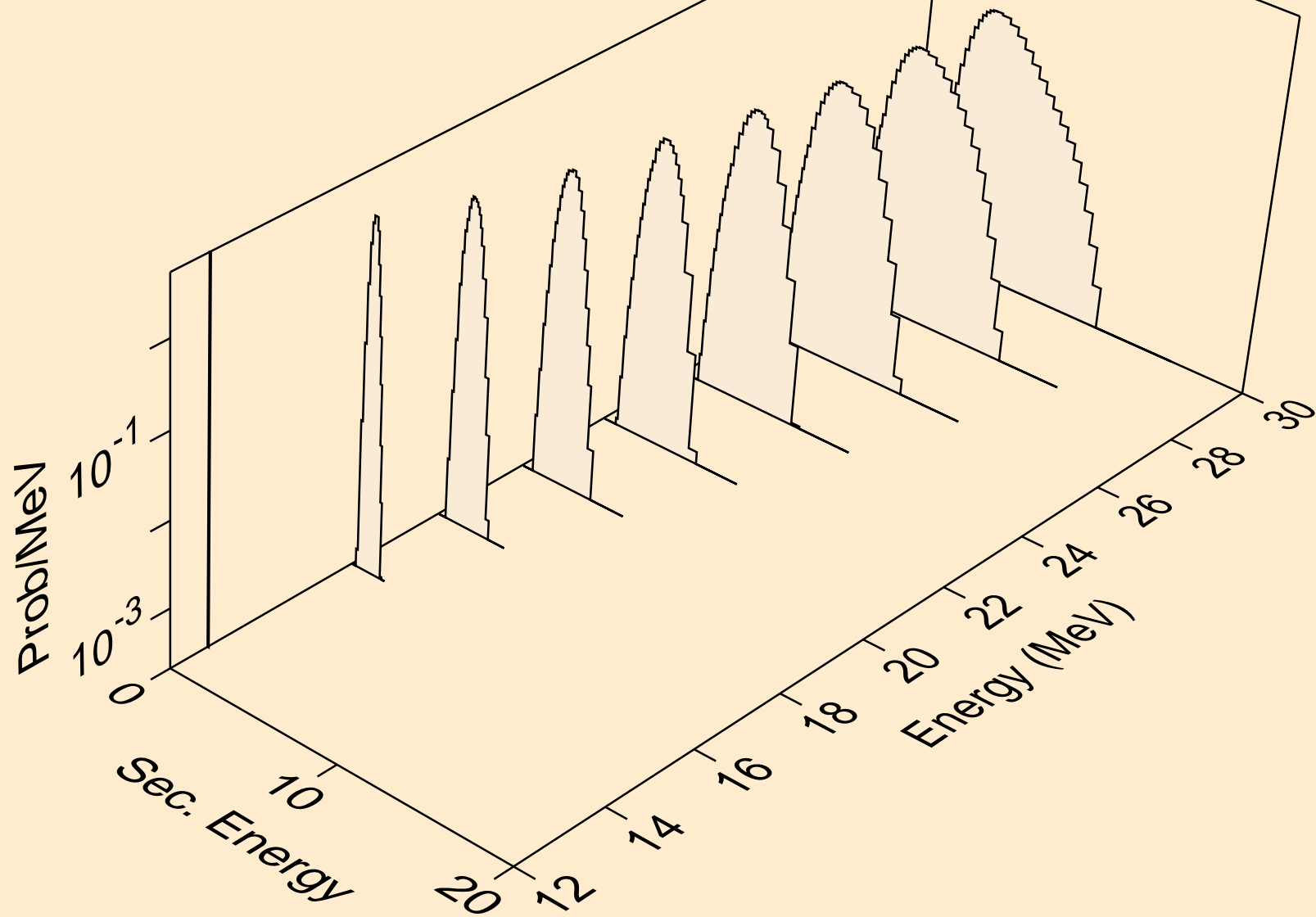

CR052 NEUTRON ACER TENDL-2023 LIBRARY; T=0.K  
protons from (n,pd)

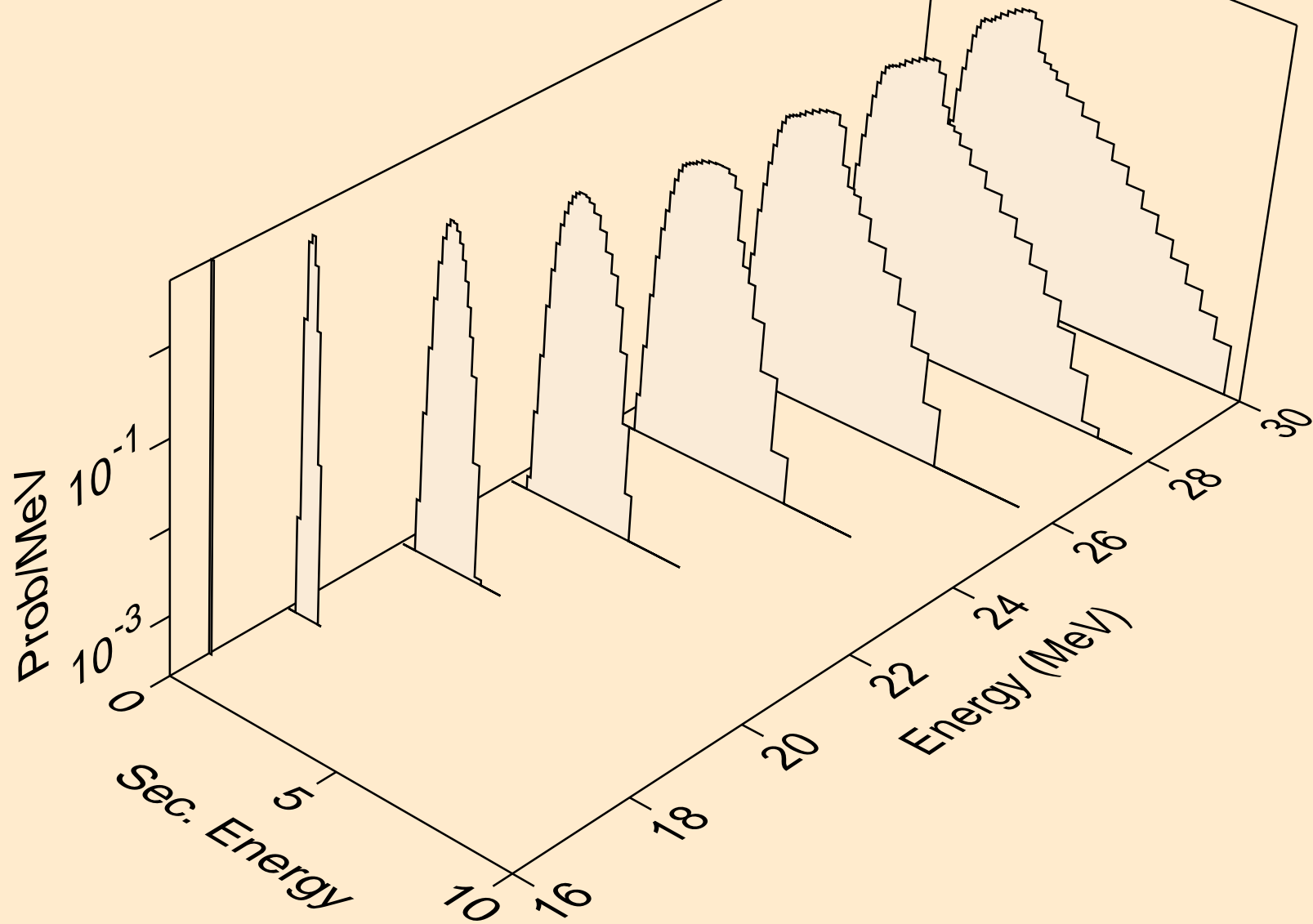

CR052 NEUTRON ACER TENDL-2023 LIBRARY; T=0.K  
protons from (n,pt)

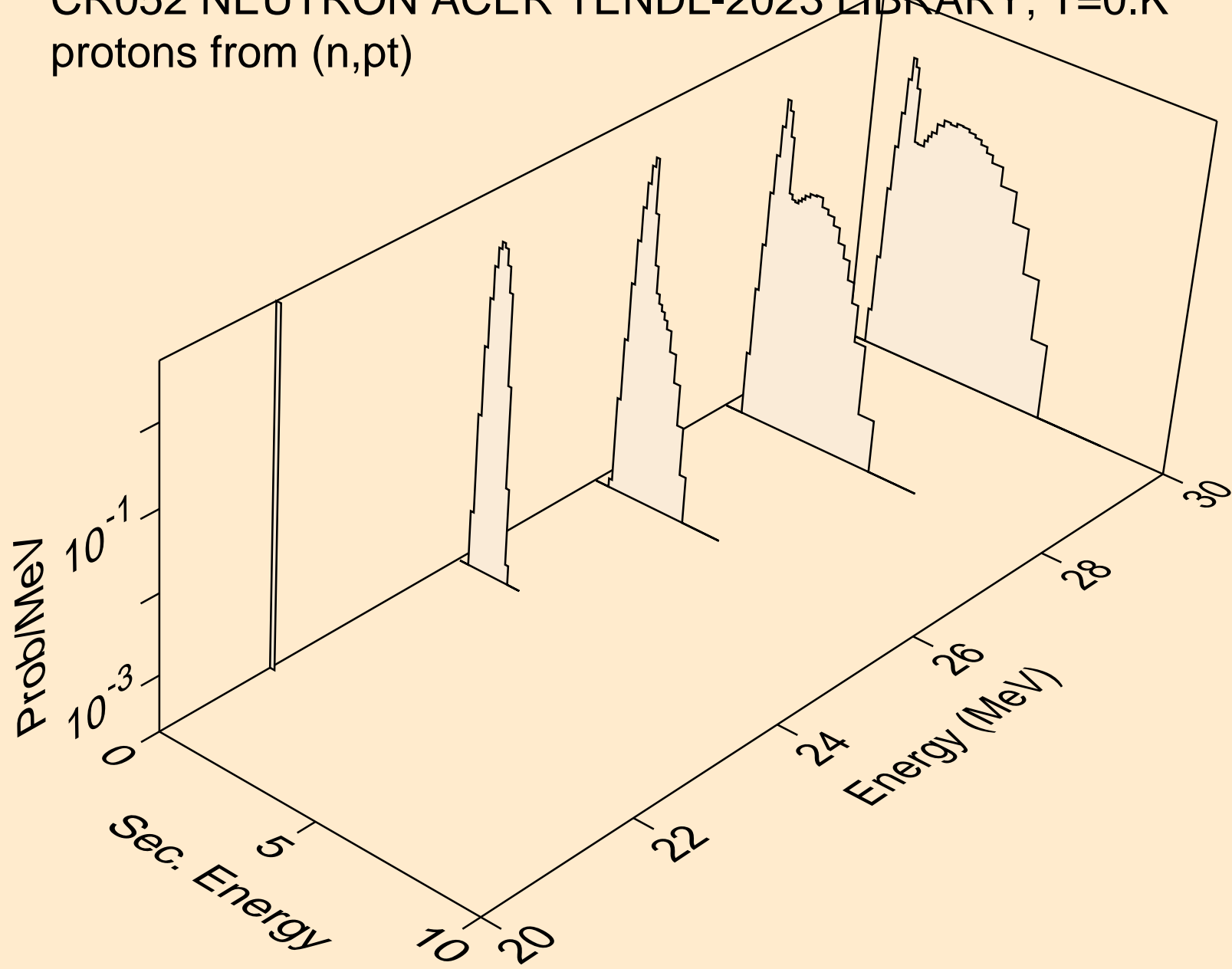

CR052 NEUTRON ACER TENDL-2023 LIBRARY; T=0.K  
deuterons from (n,x)

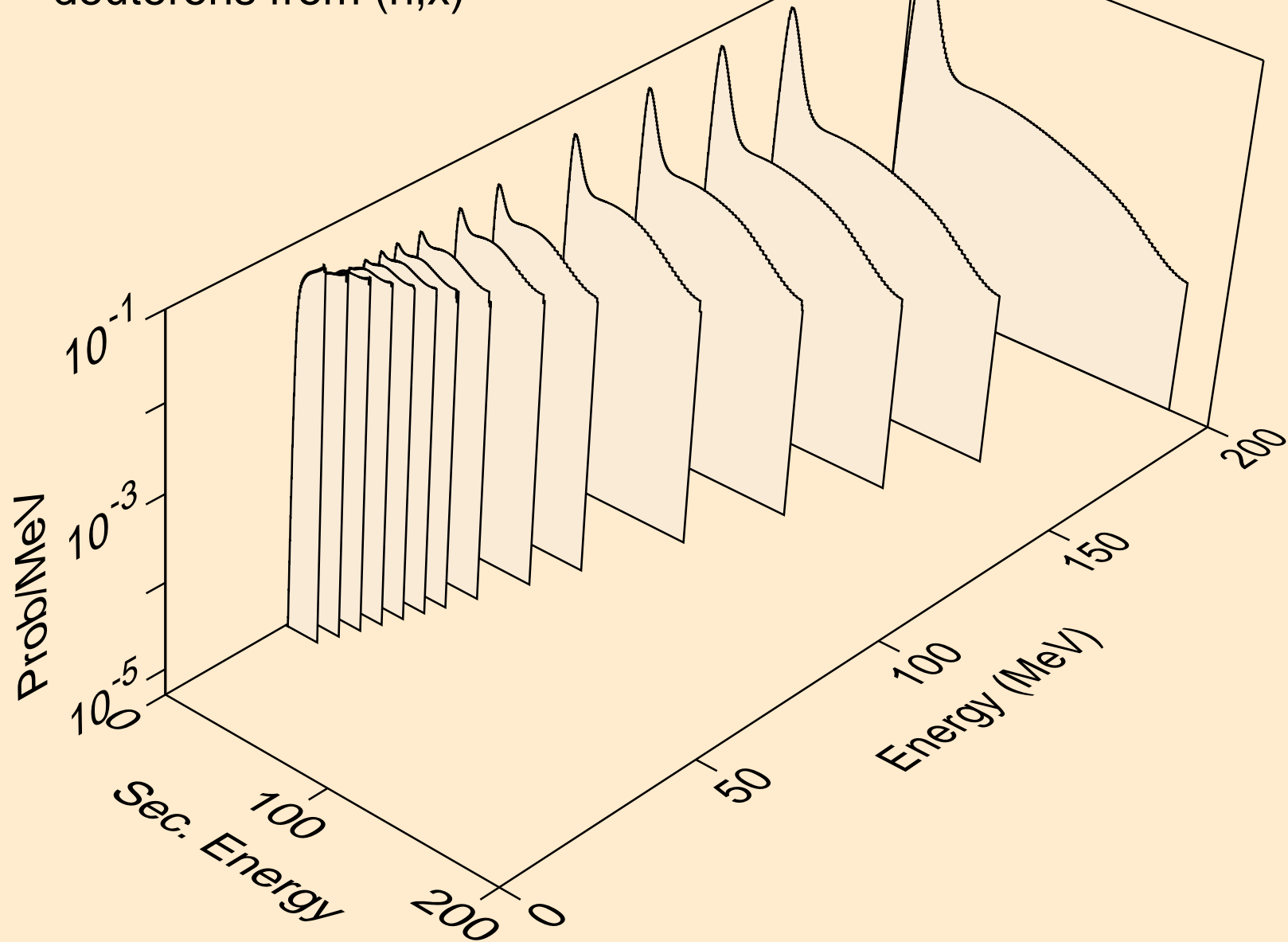

CR052 NEUTRON ACER TENDL-2023 LIBRARY; T=0.K  
deuterons from (n,n\*)d

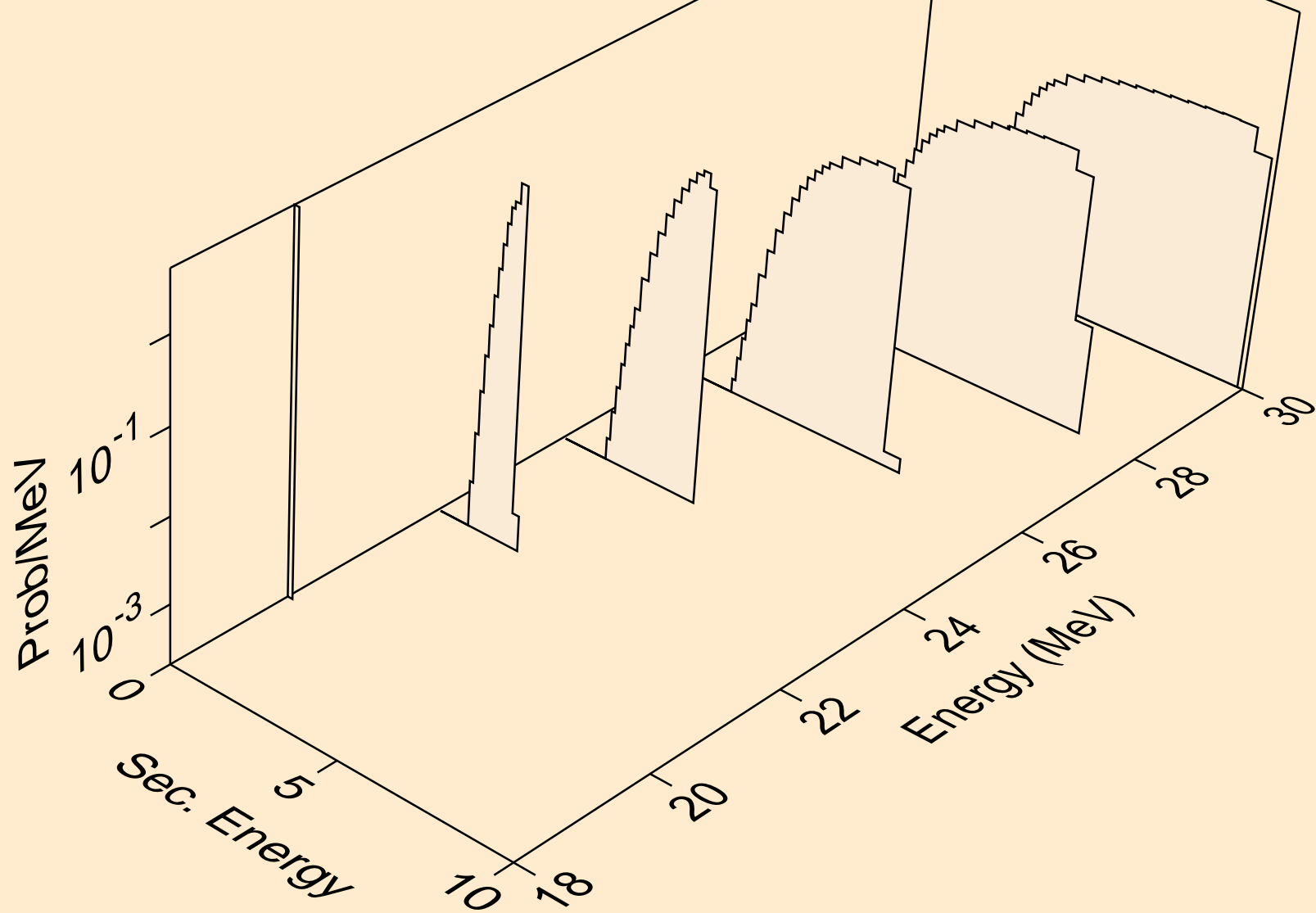

CR052 NEUTRON ACER TENDL-2023 LIBRARY; T=0.K  
deuterons from (n,d)

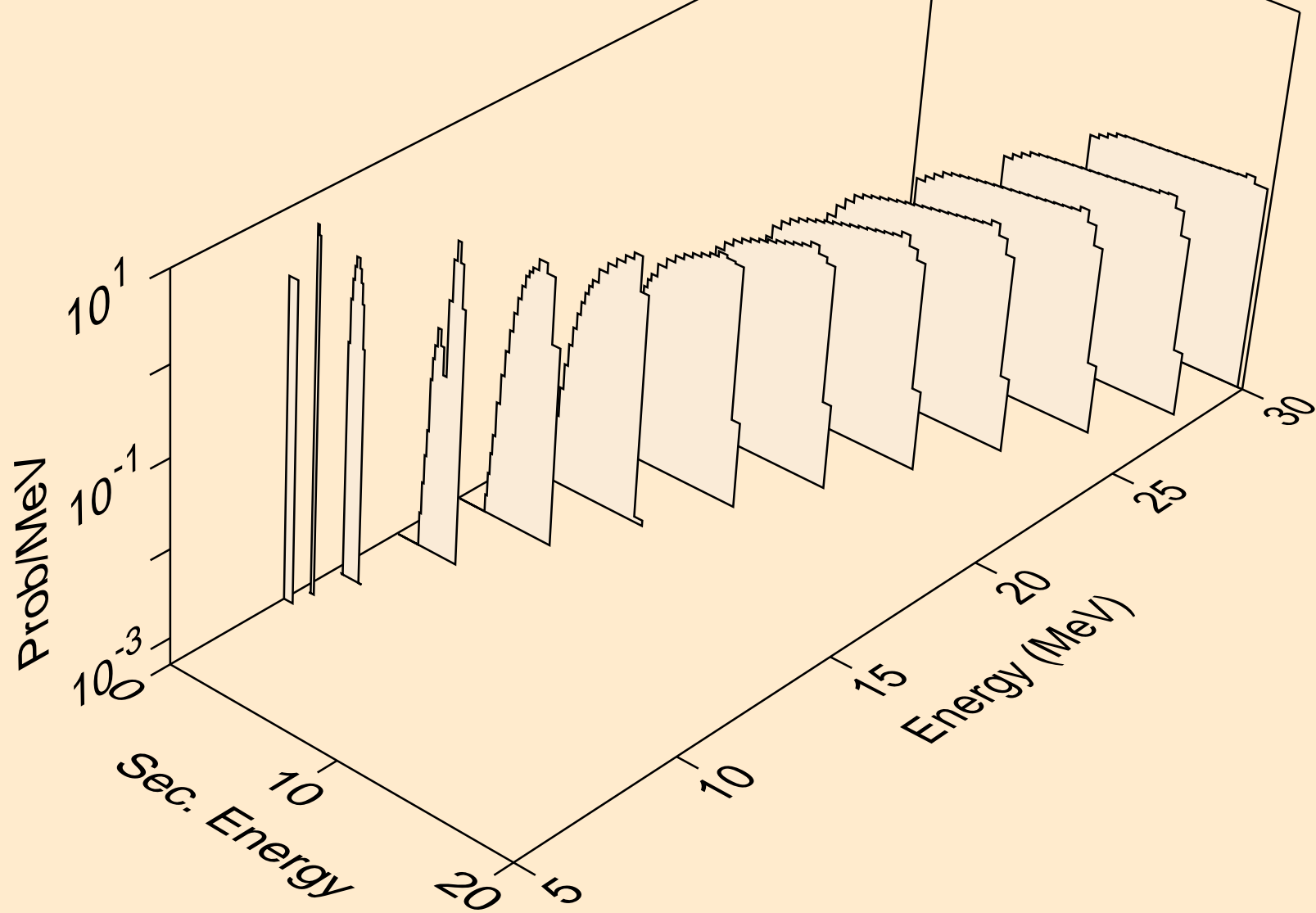

CR052 NEUTRON ACER TENDL-2023 LIBRARY; T=0.K  
deuterons from (n,pd)

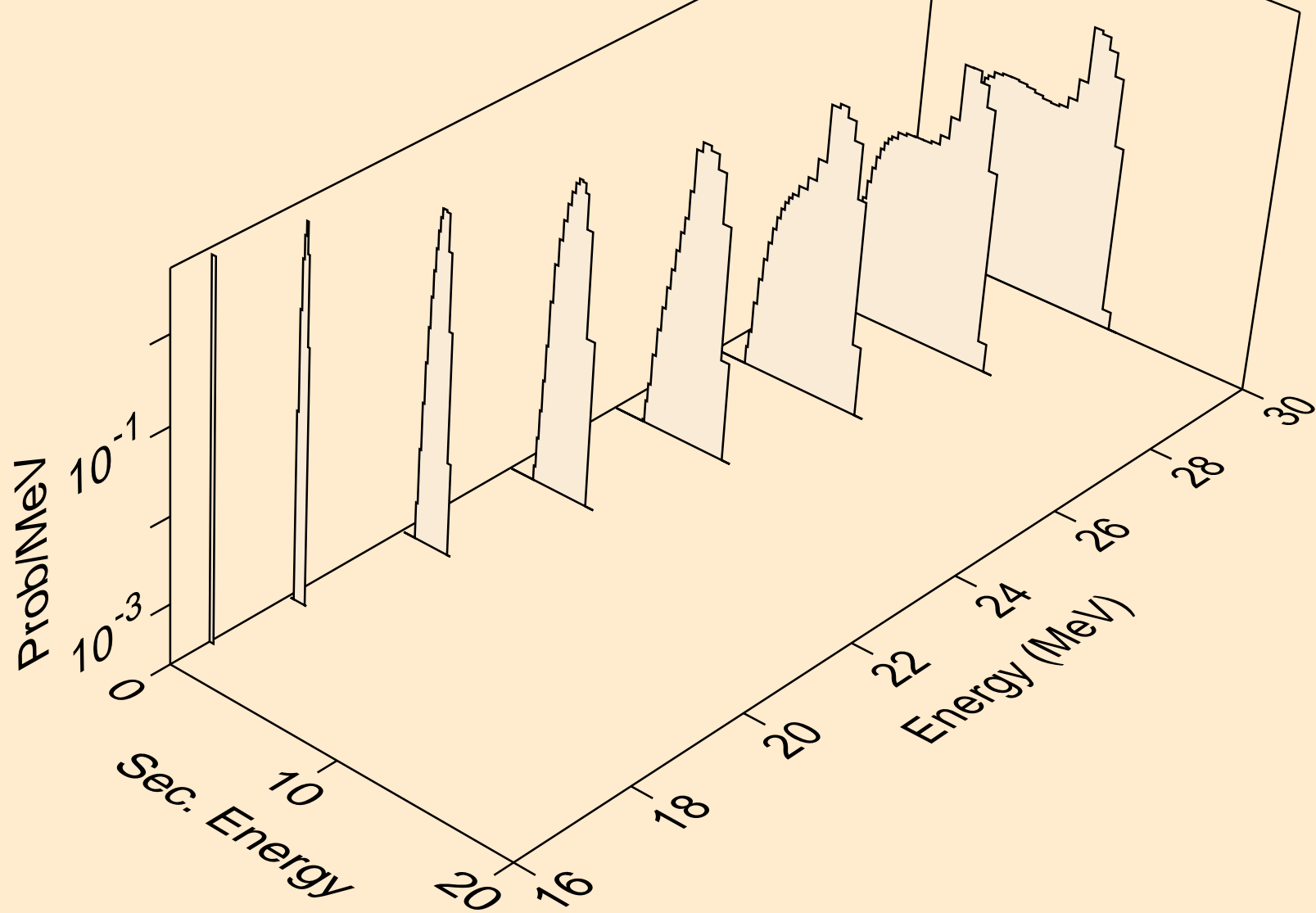

CR052 NEUTRON ACER TENDL-2023 LIBRARY; T=0.K  
deuterons from (n,da)

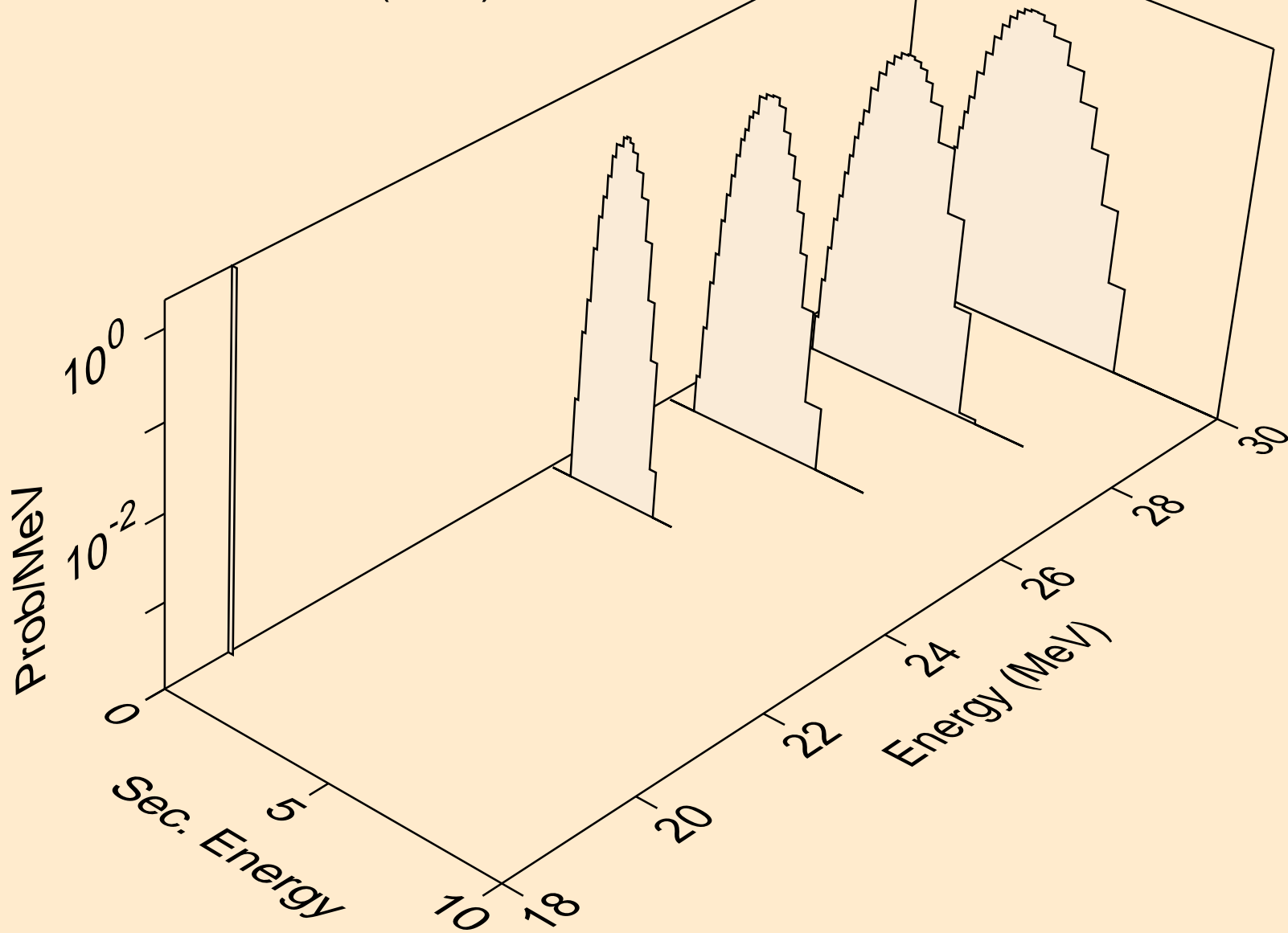



CR052 NEUTRON ACER TENDL-2023 LIBRARY; T=0.K  
tritons from (n,x)

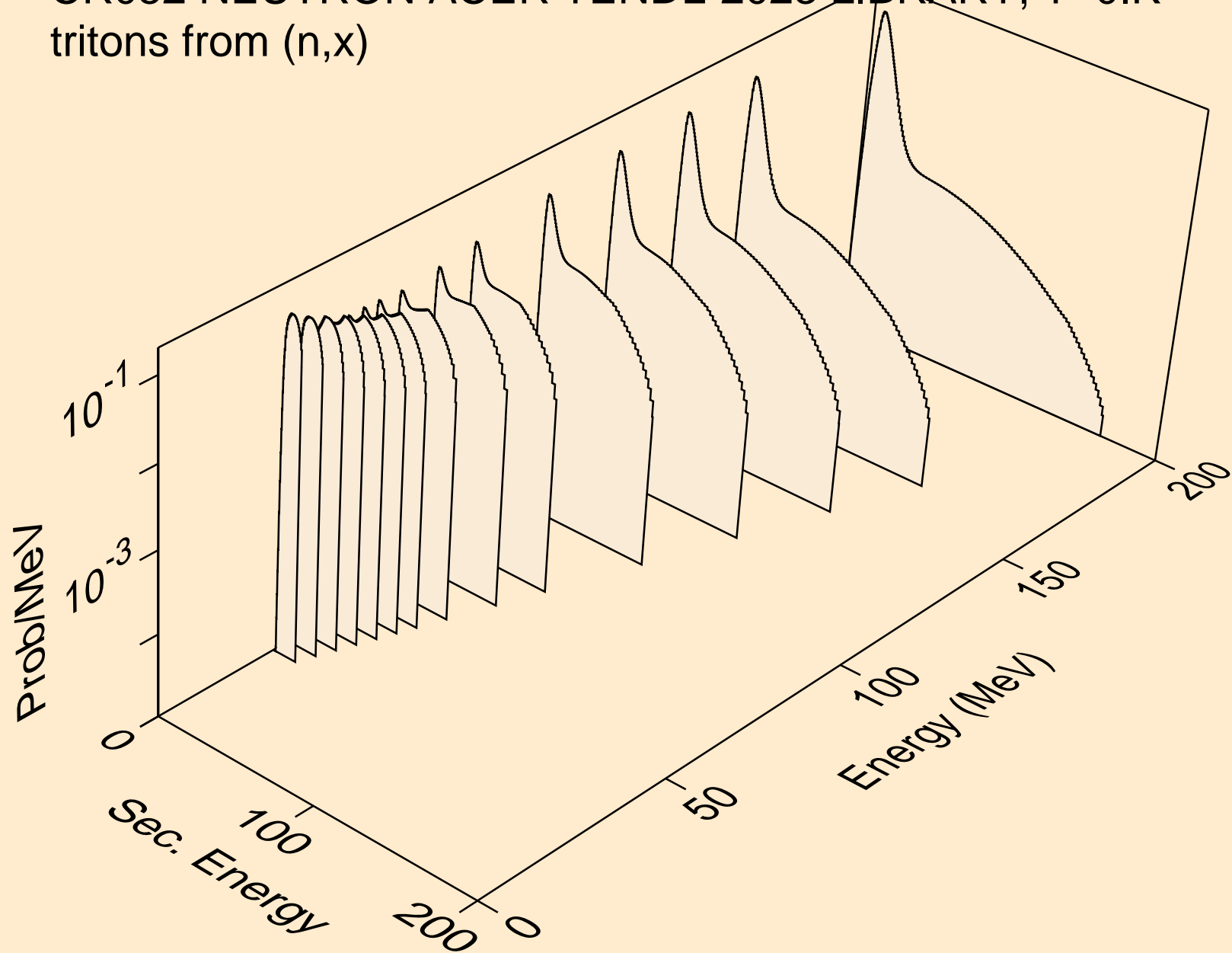

CR052 NEUTRON ACER TENDL-2023 LIBRARY; T=0.K  
tritons from (n,n\*)t

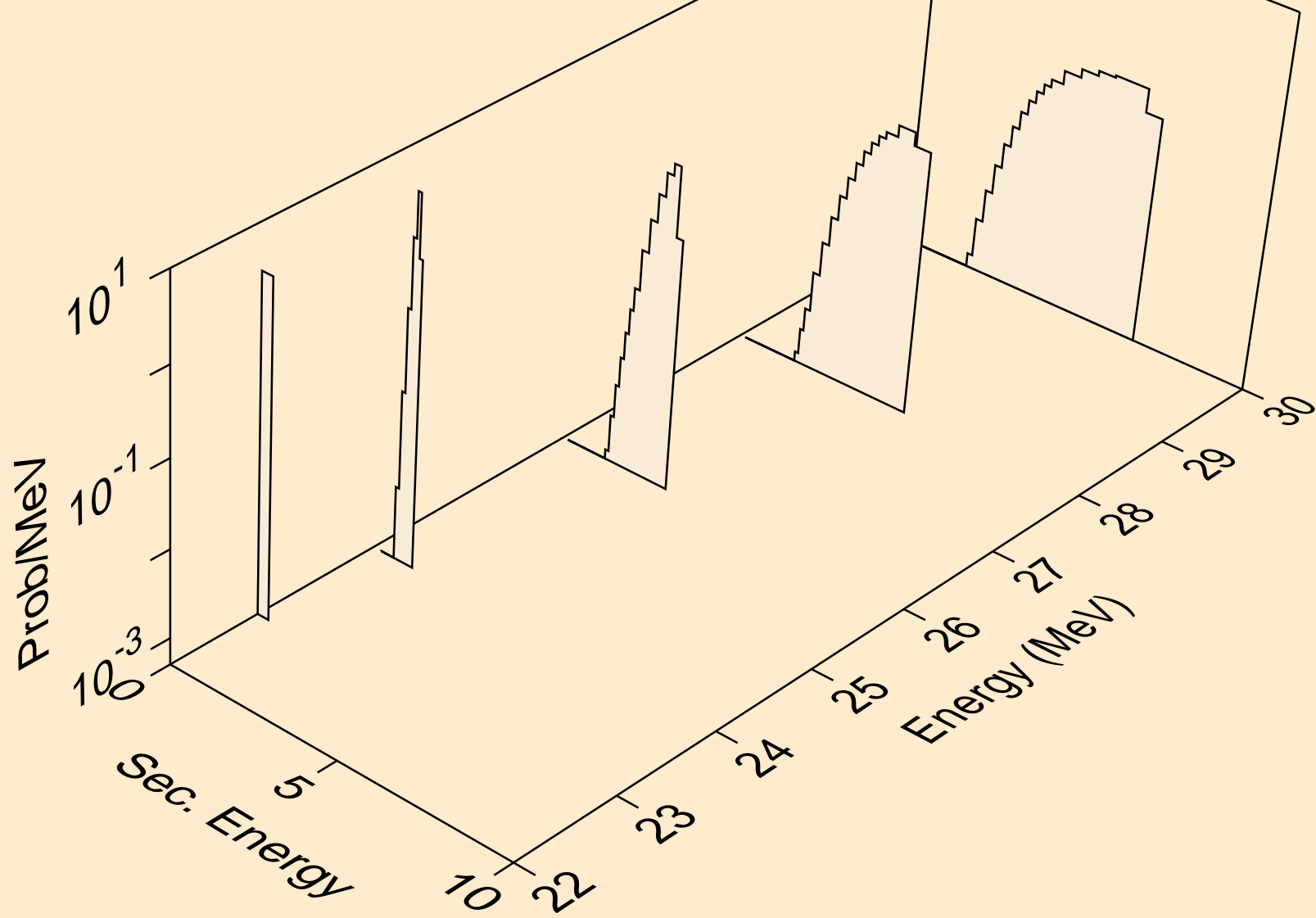

CR052 NEUTRON ACER TENDL-2023 LIBRARY; T=0.K  
tritons from (n,t)

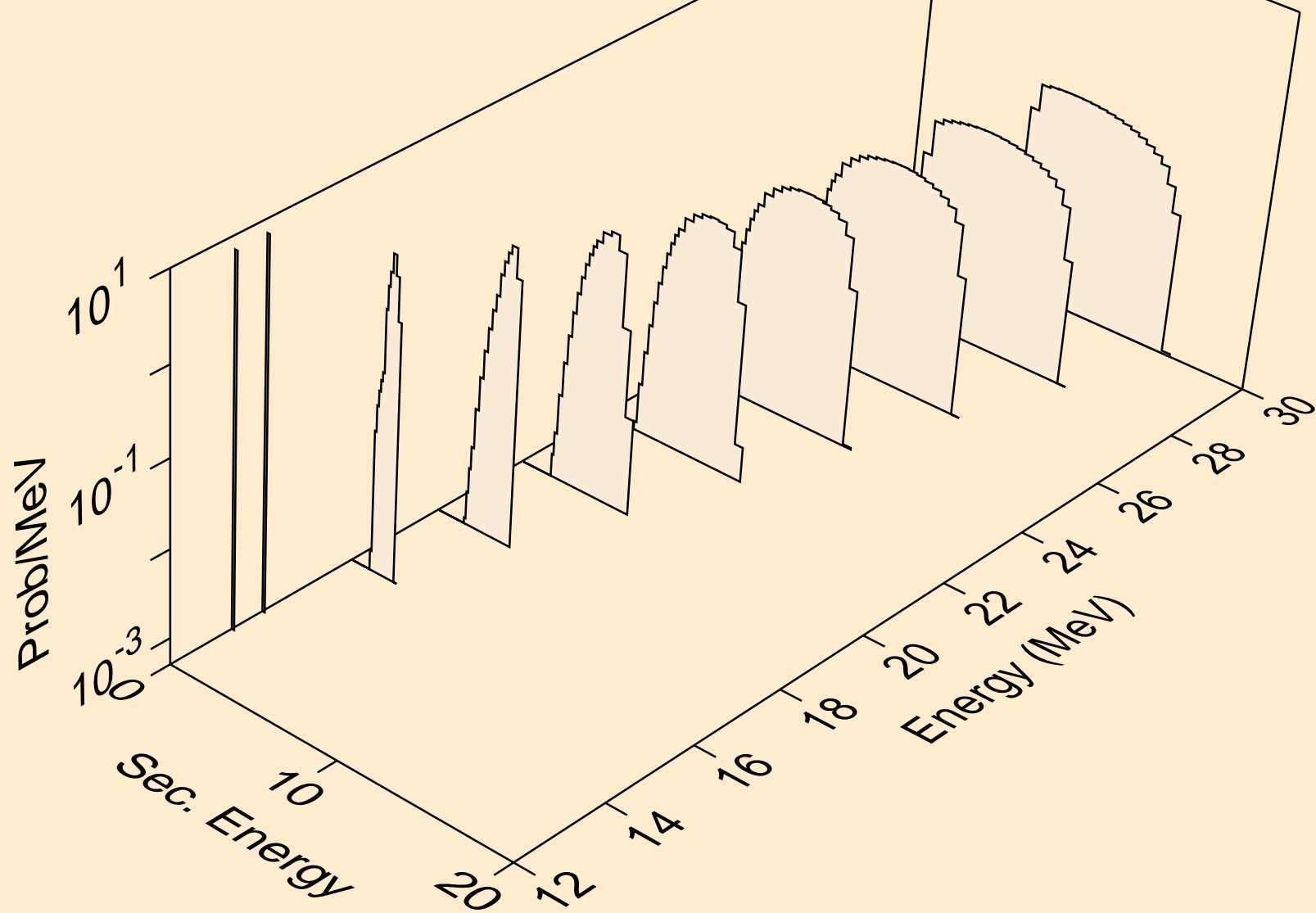

CR052 NEUTRON ACER TENDL-2023 LIBRARY; T=0.K  
tritons from (n,pt)

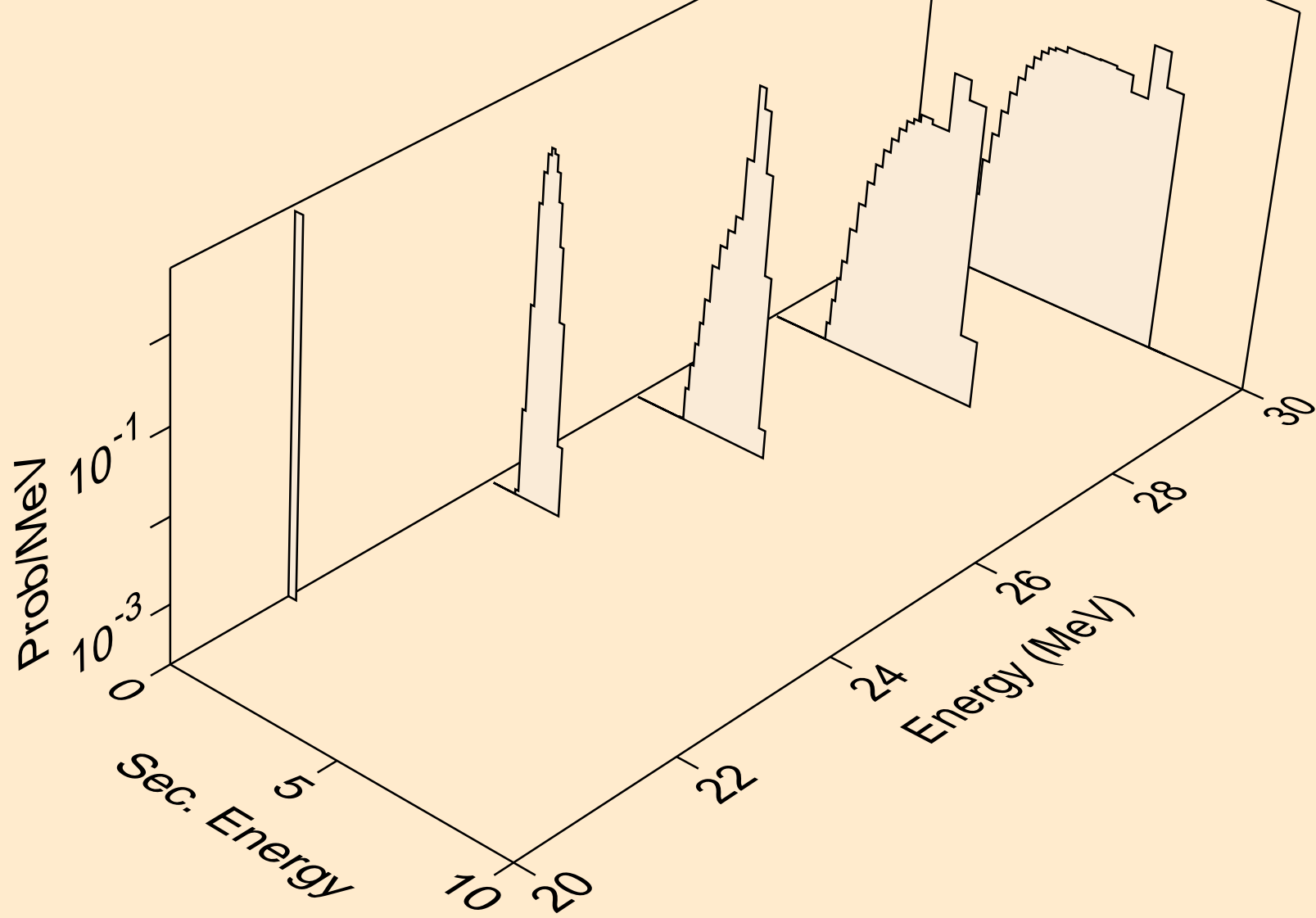

CR052 NEUTRON ACER TENDL-2023 LIBRARY; T=0.K  
he3s from (n,x)

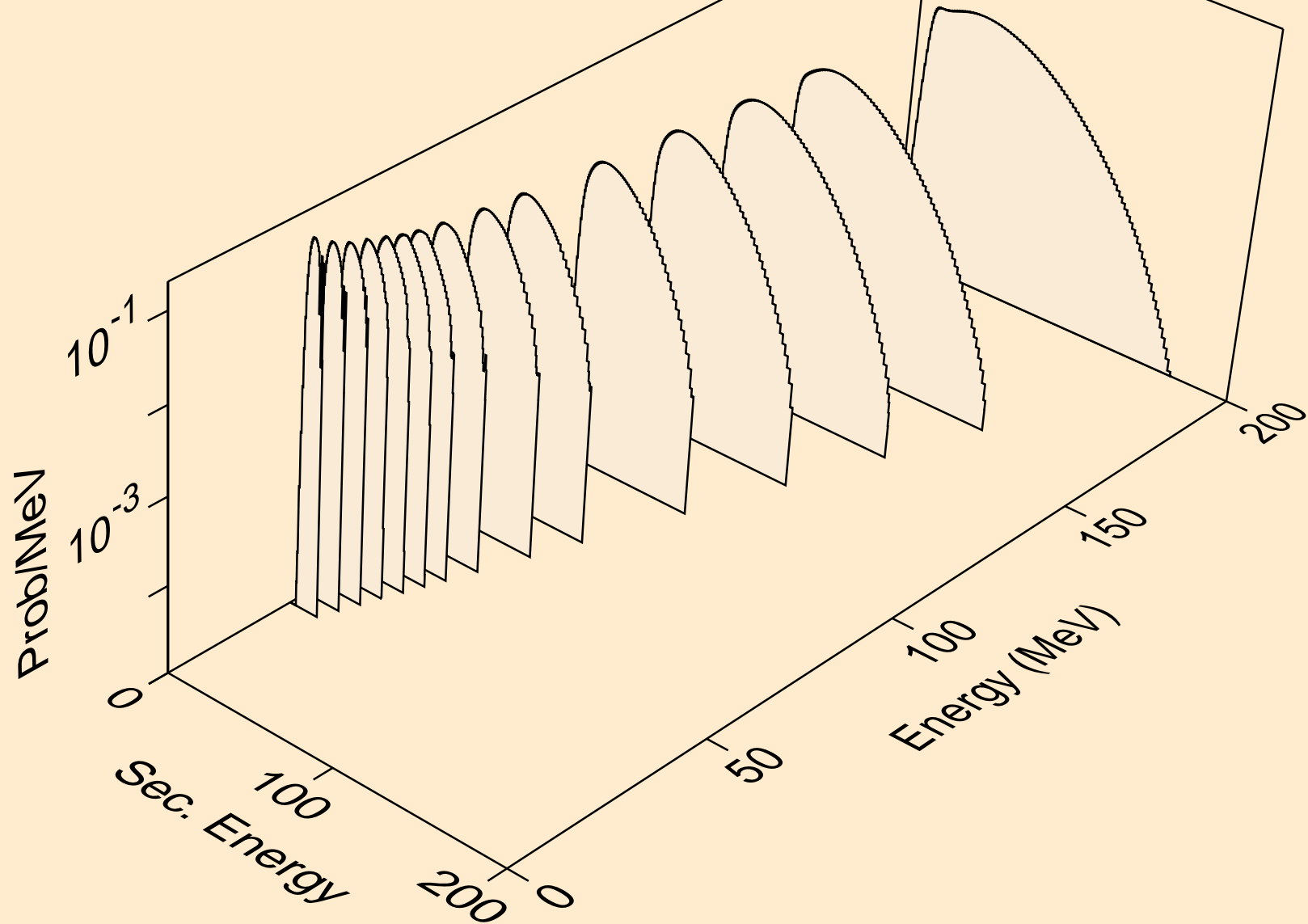

CR052 NEUTRON ACER TENDL-2023 LIBRARY; T=0.K  
he3s from (n,n\*)he3

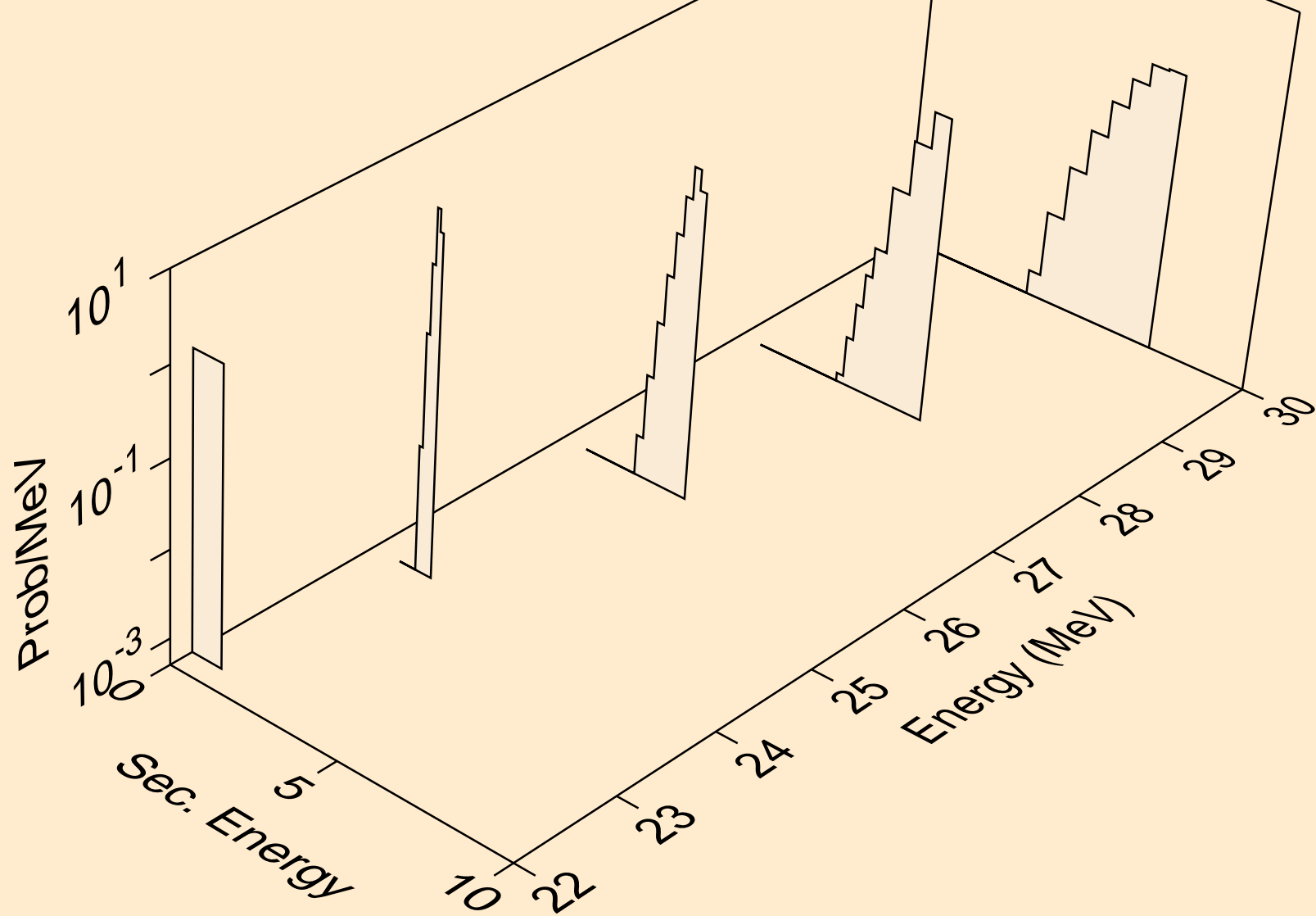

CR052 NEUTRON ACER TENDL-2023 LIBRARY; T=0.K  
he3s from (n,he3)

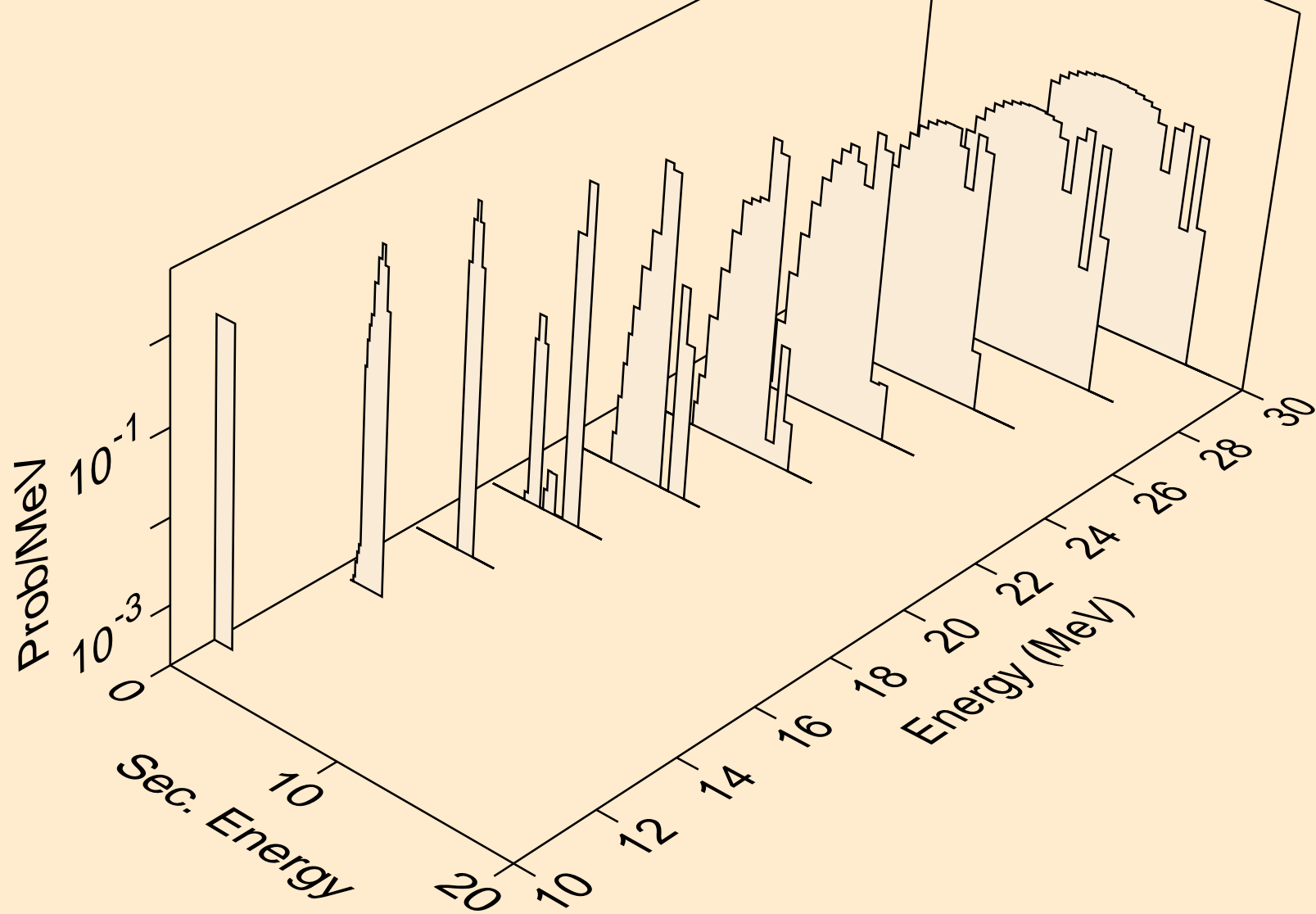

CR052 NEUTRON ACER TENDL-2023 LIBRARY; T=0.K  
alphas from (n,x)

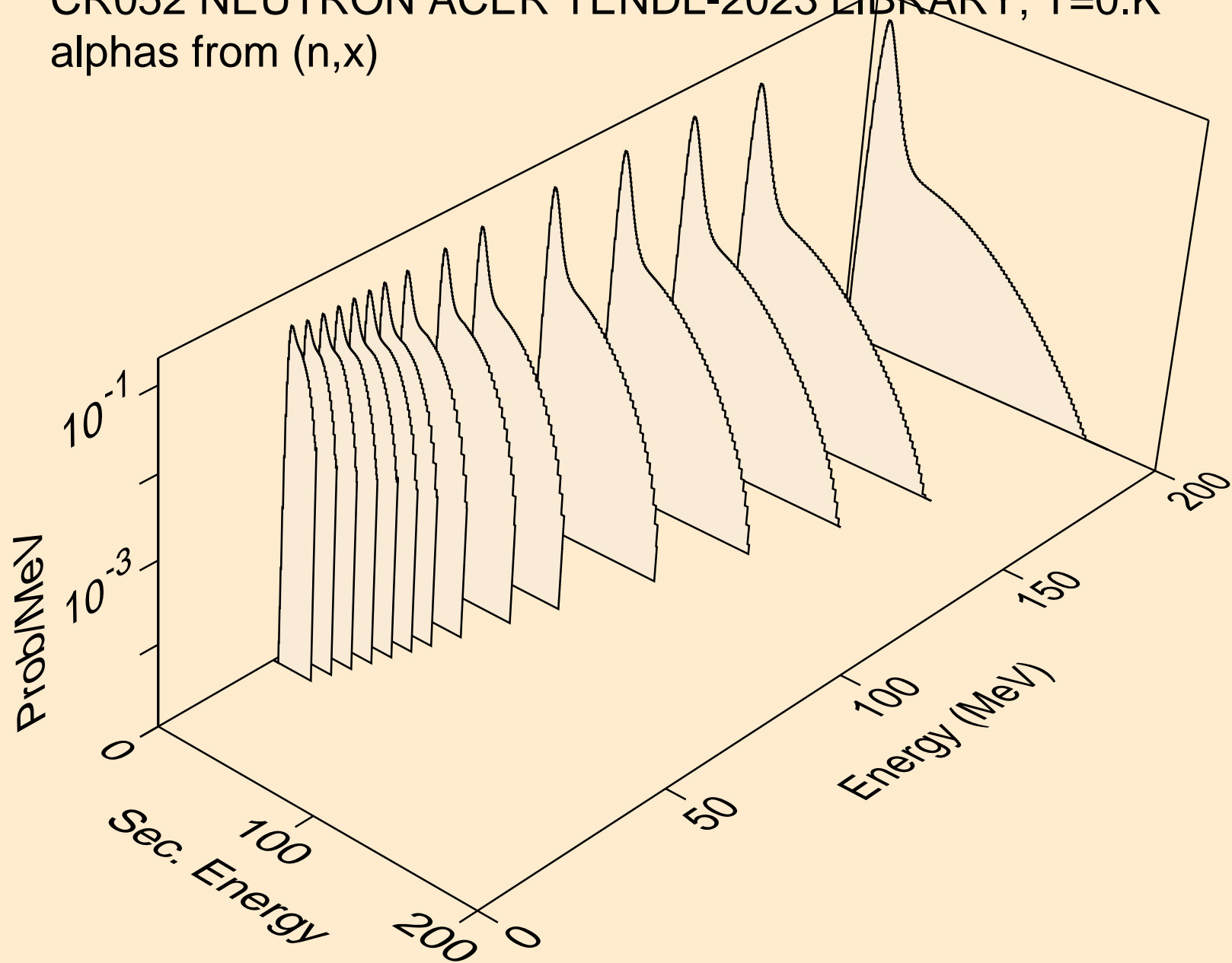



CR052 NEUTRON ACER TENDL-2023 LIBRARY; T=0.K  
alphas from (n,n\*)a

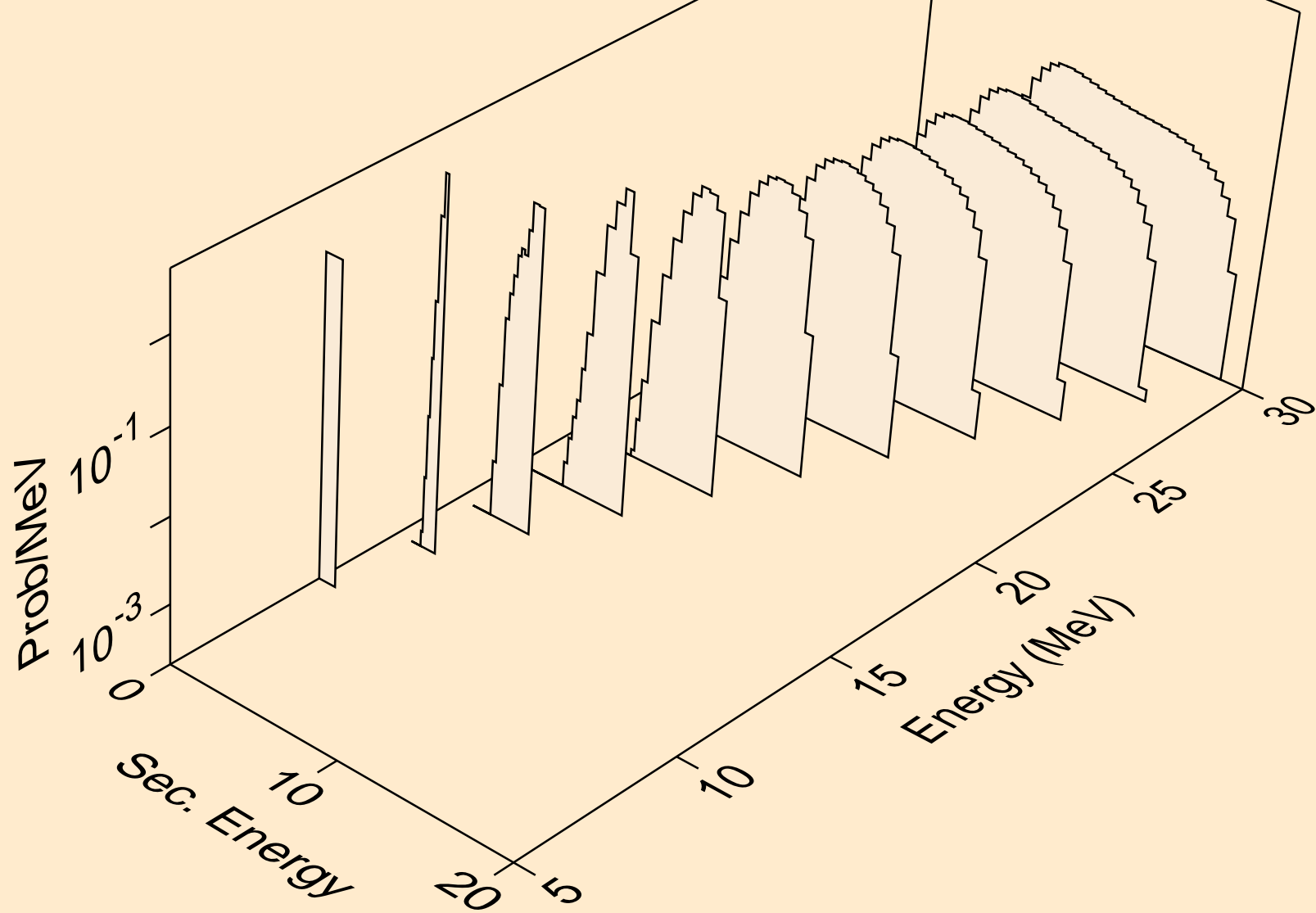

CR052 NEUTRON ACER TENDL-2023 LIBRARY; T=0.K  
alphas from (n,2n)a

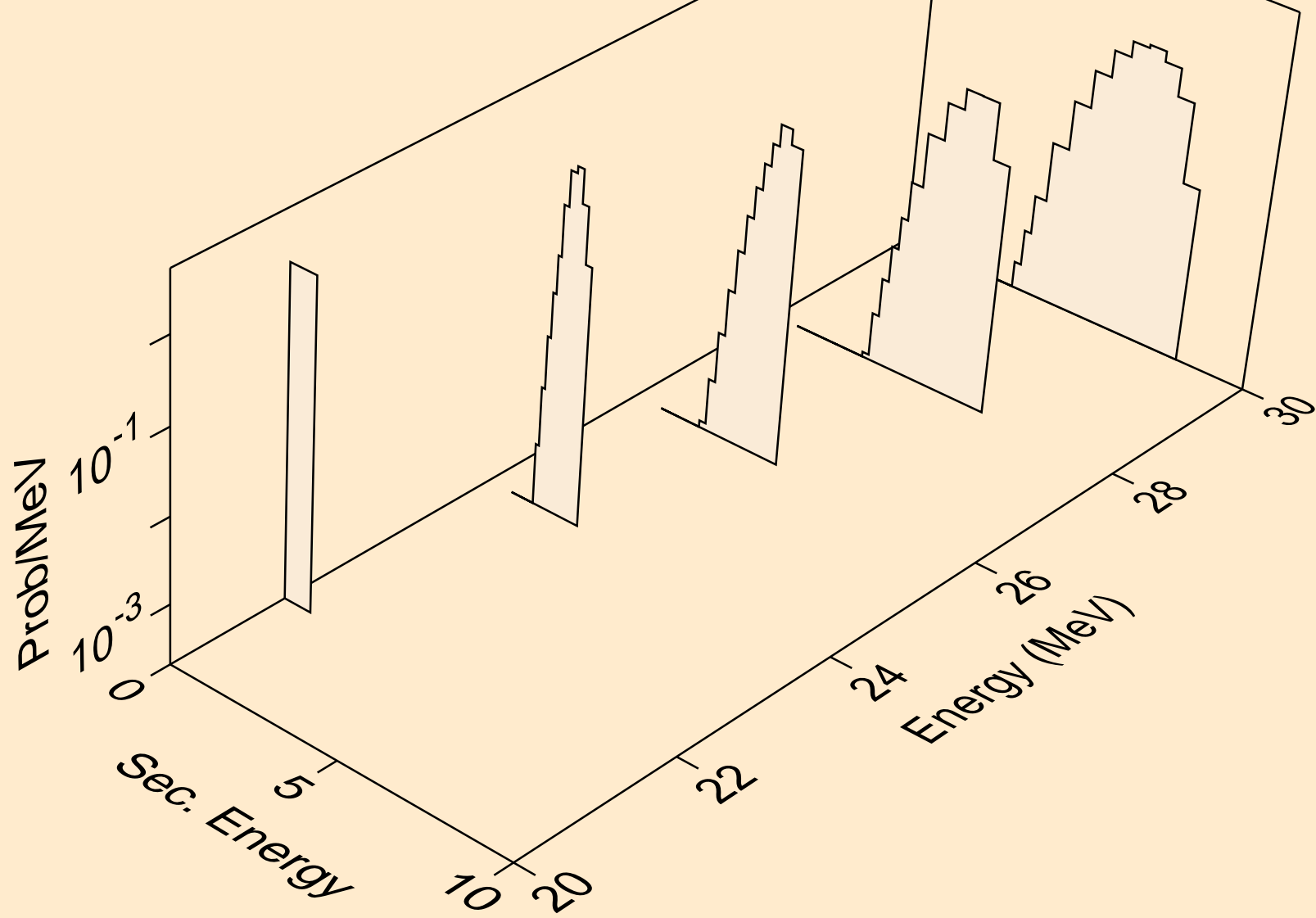

CR052 NEUTRON ACER TENDL-2023 LIBRARY; T=0.K  
alphas from (n,n\*)2a

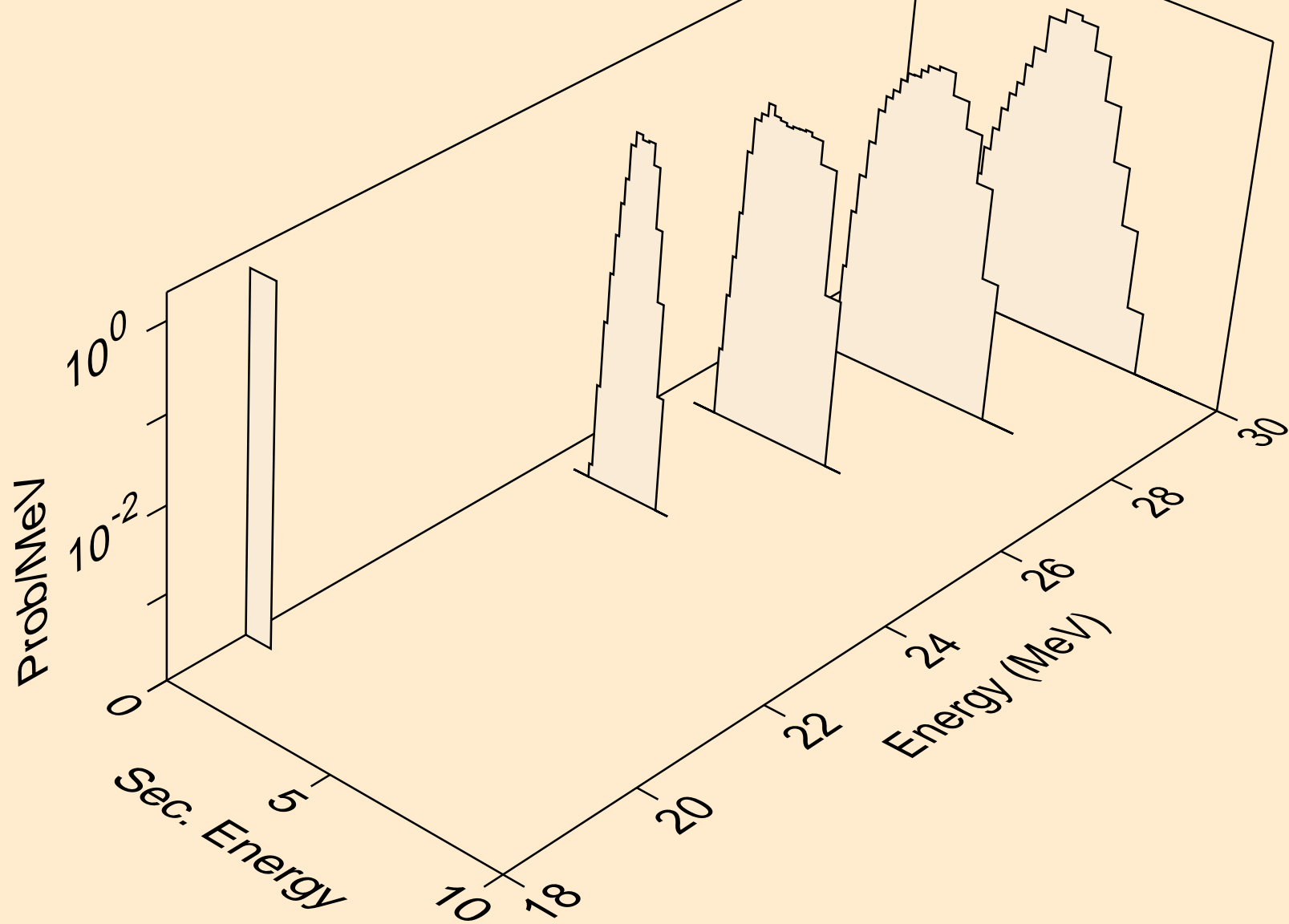

CR052 NEUTRON ACER TENDL-2023 LIBRARY; T=0.K  
alphas from (n,npa)

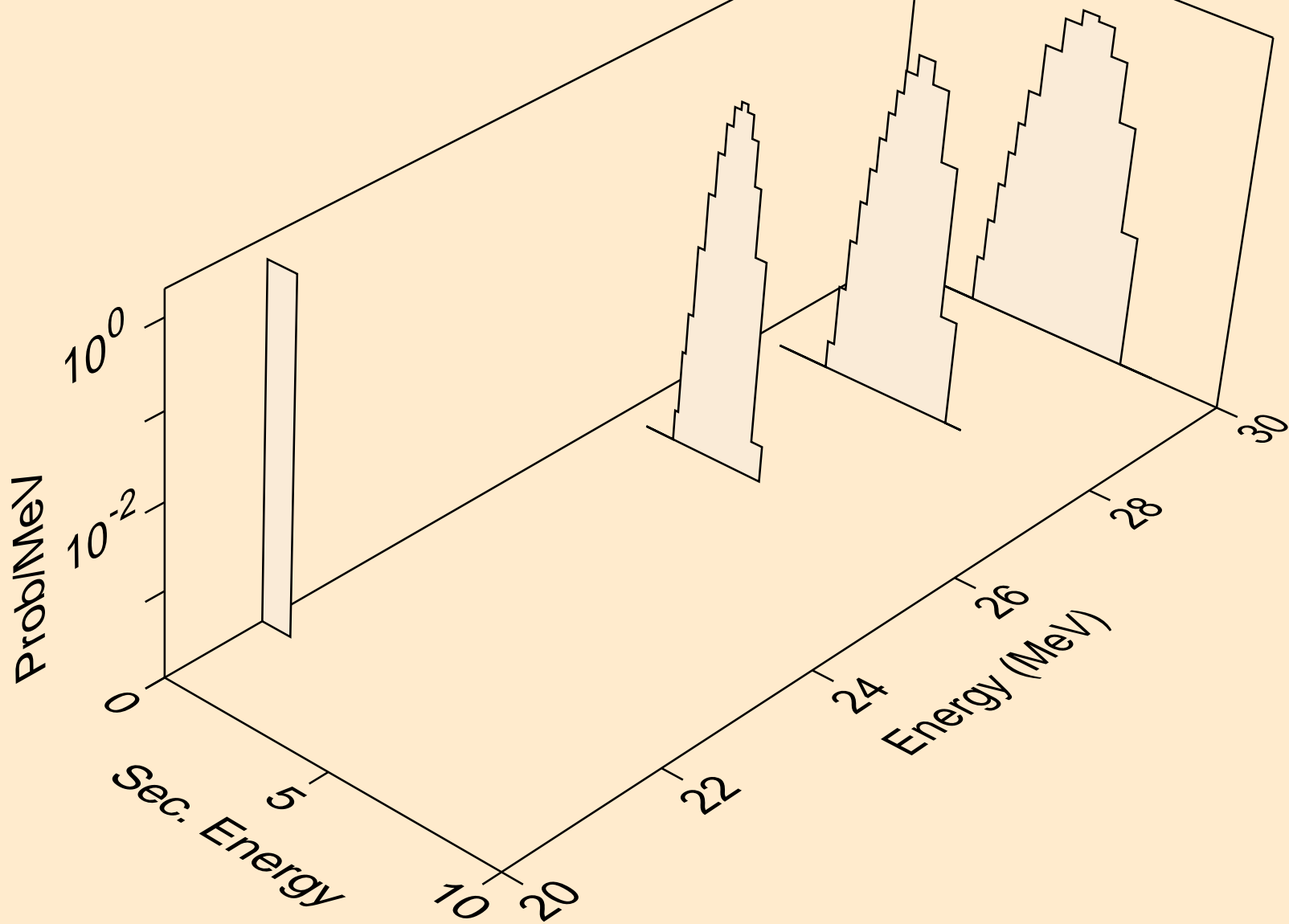

CR052 NEUTRON ACER TENDL-2023 LIBRARY; T=0.K  
alphas from (n,a)

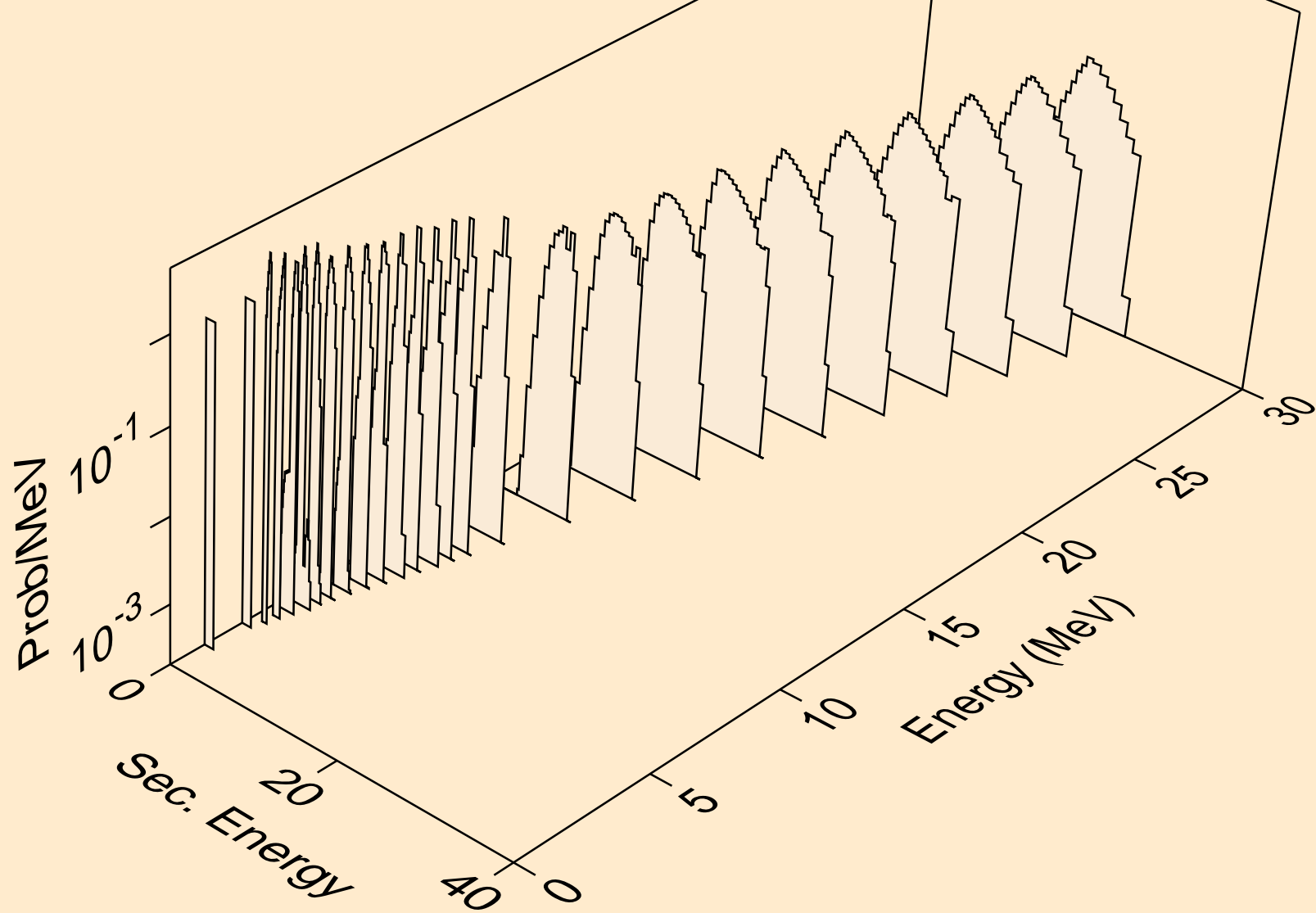

CR052 NEUTRON ACER TENDL-2023 LIBRARY; T=0.K  
alphas from (n,2a)

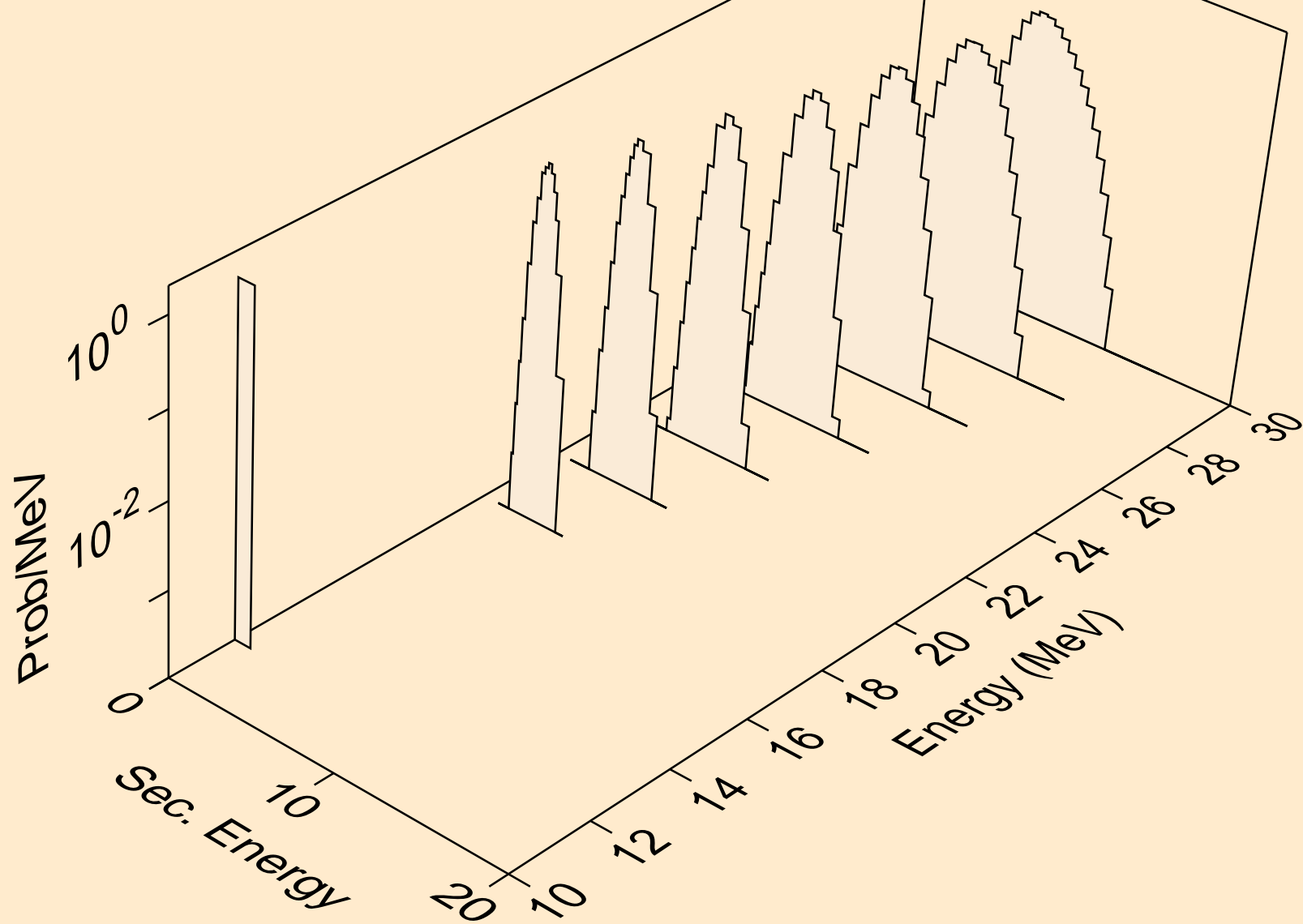

CR052 NEUTRON ACER TENDL-2023 LIBRARY; T=0.K  
alphas from (n,pa)

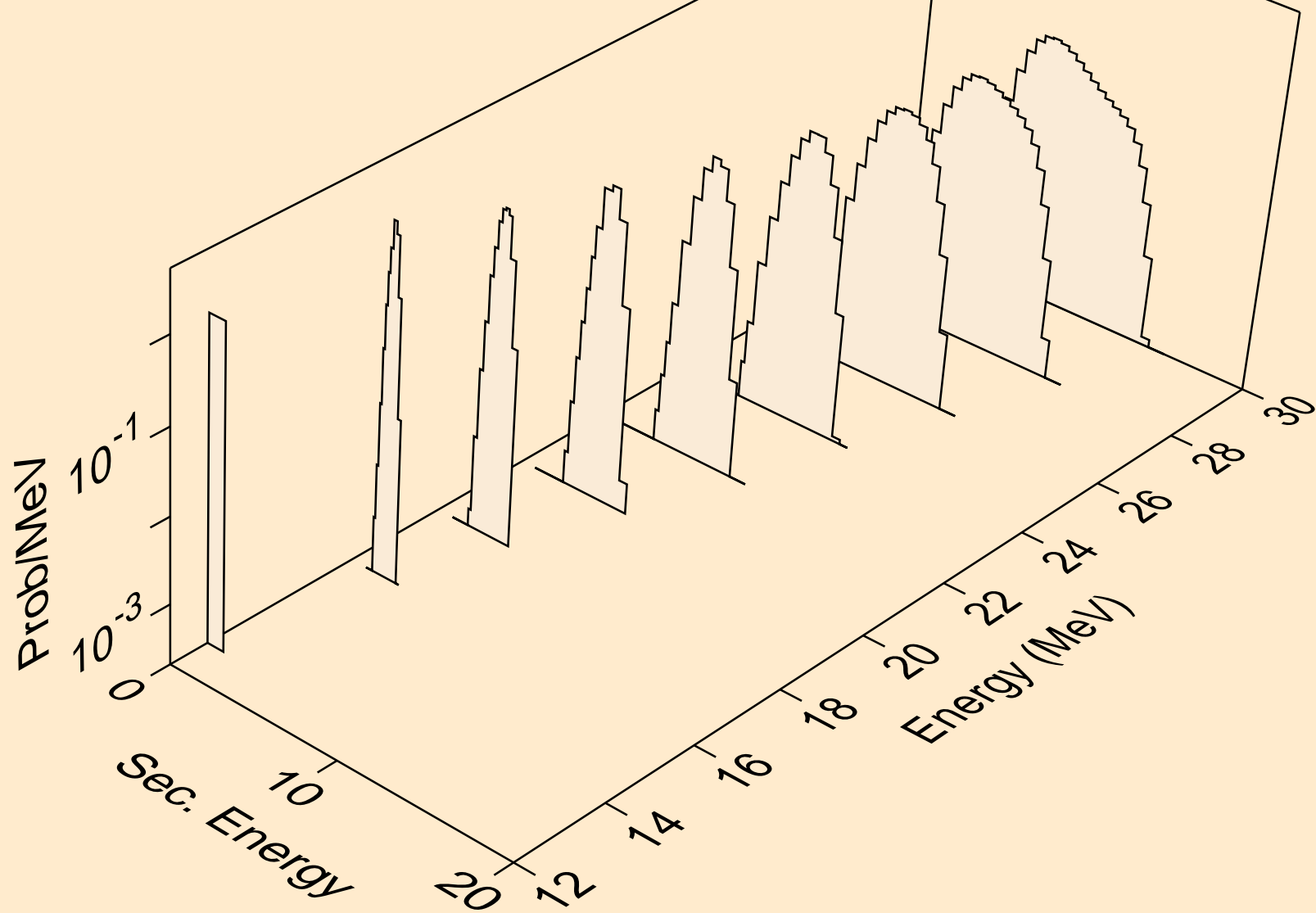

CR052 NEUTRON ACER TENDL-2023 LIBRARY; T=0.K  
alphas from (n,da)

