

CS135 NEUTRON ACER TENDL-2023 LIBRARY; T=0.K

Principal cross sections

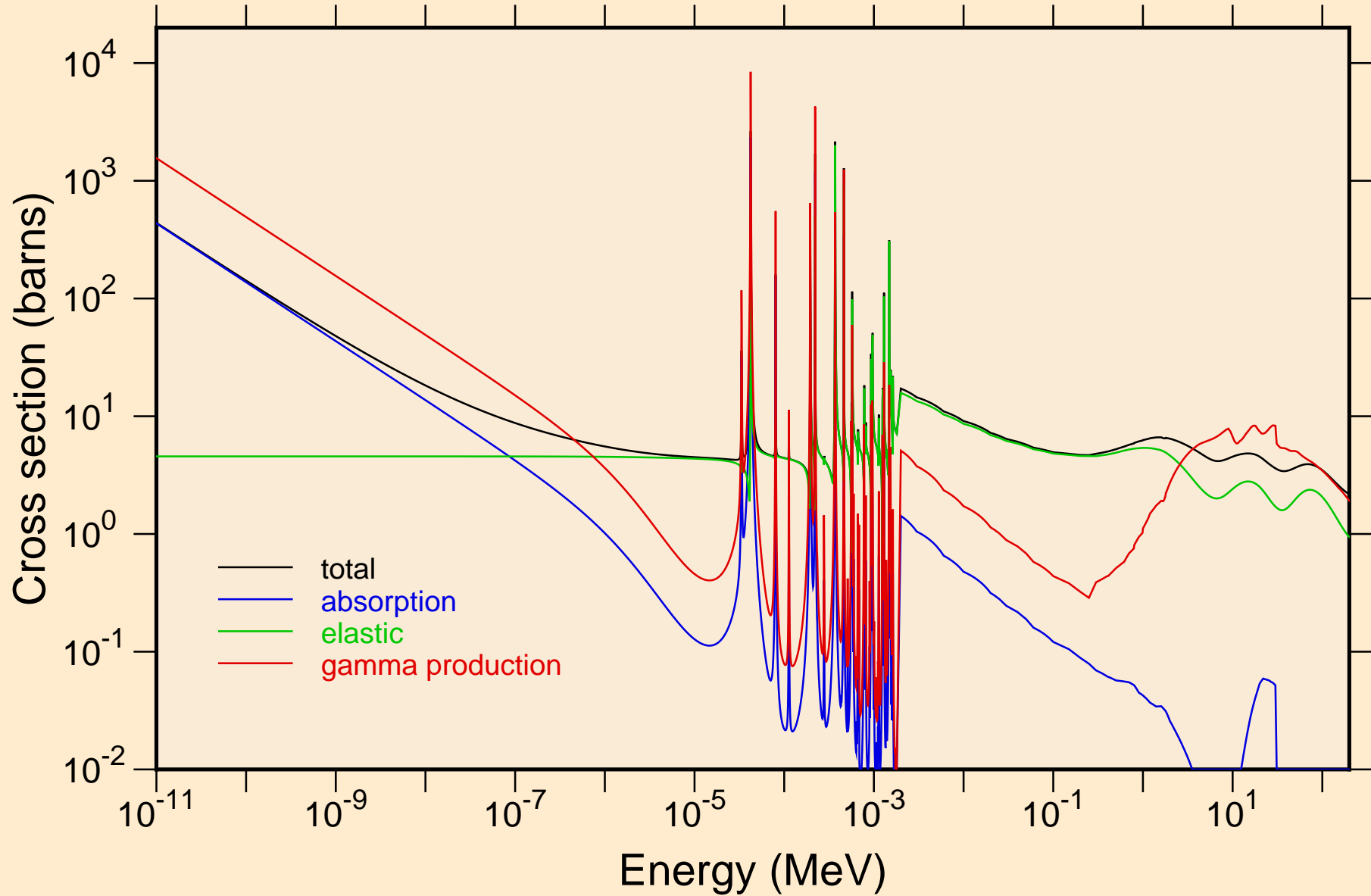

CS135 NEUTRON ACER TENDL-2023 LIBRARY; T=0.K
resonance total cross section

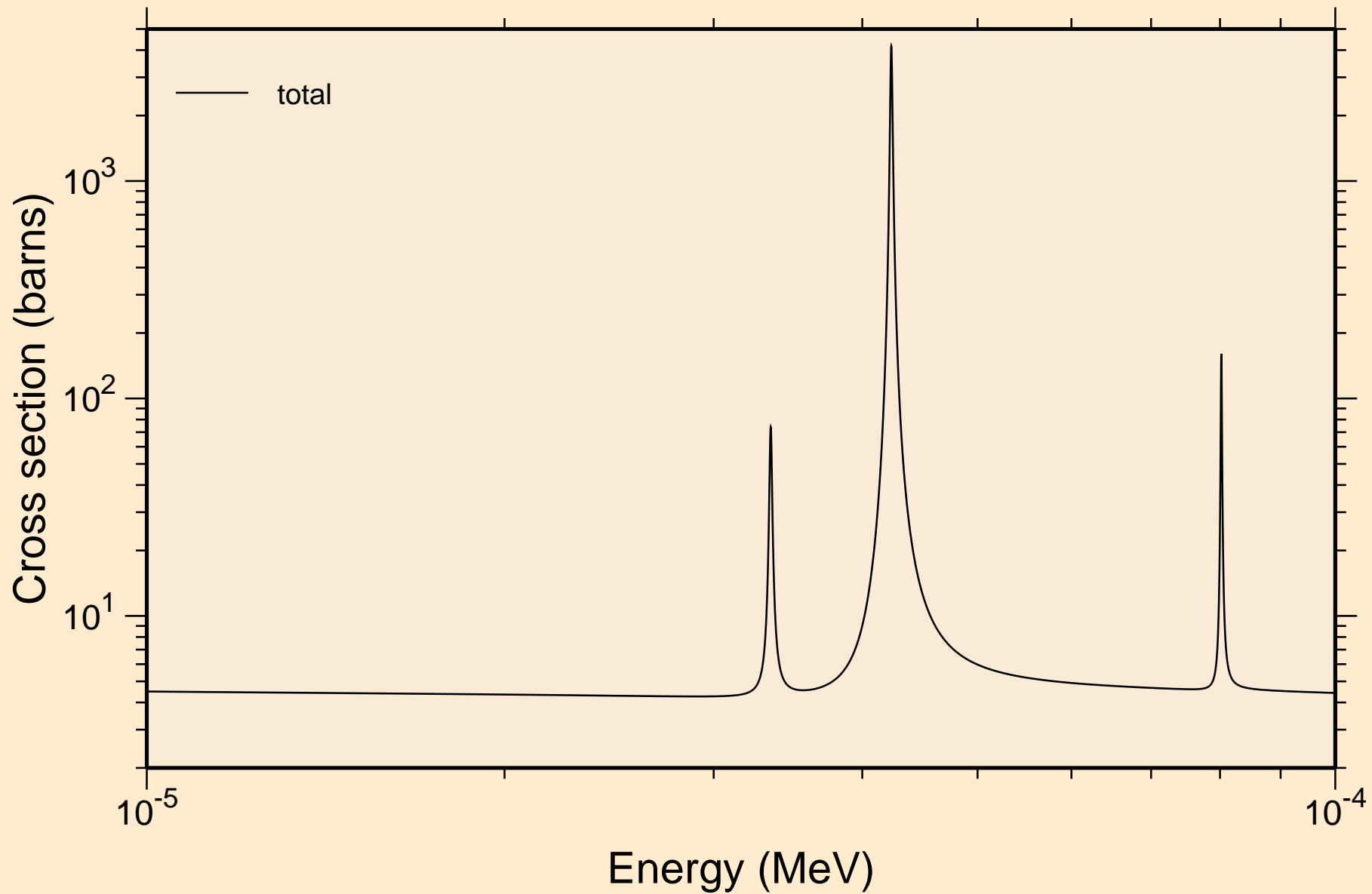

CS135 NEUTRON ACER TENDL-2023 LIBRARY; T=0.K
resonance total cross section

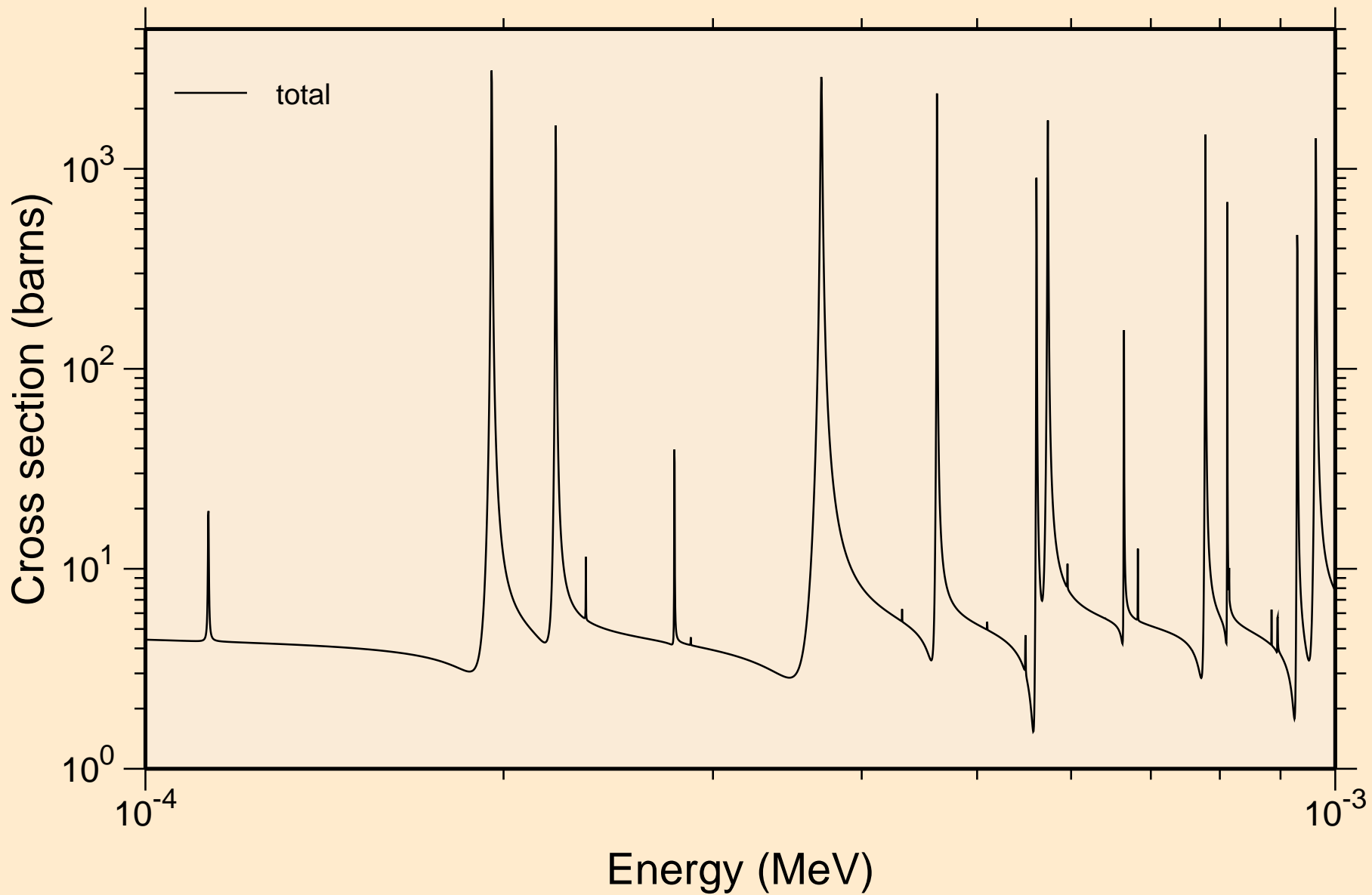

CS135 NEUTRON ACER TENDL-2023 LIBRARY; T=0.K
resonance total cross section

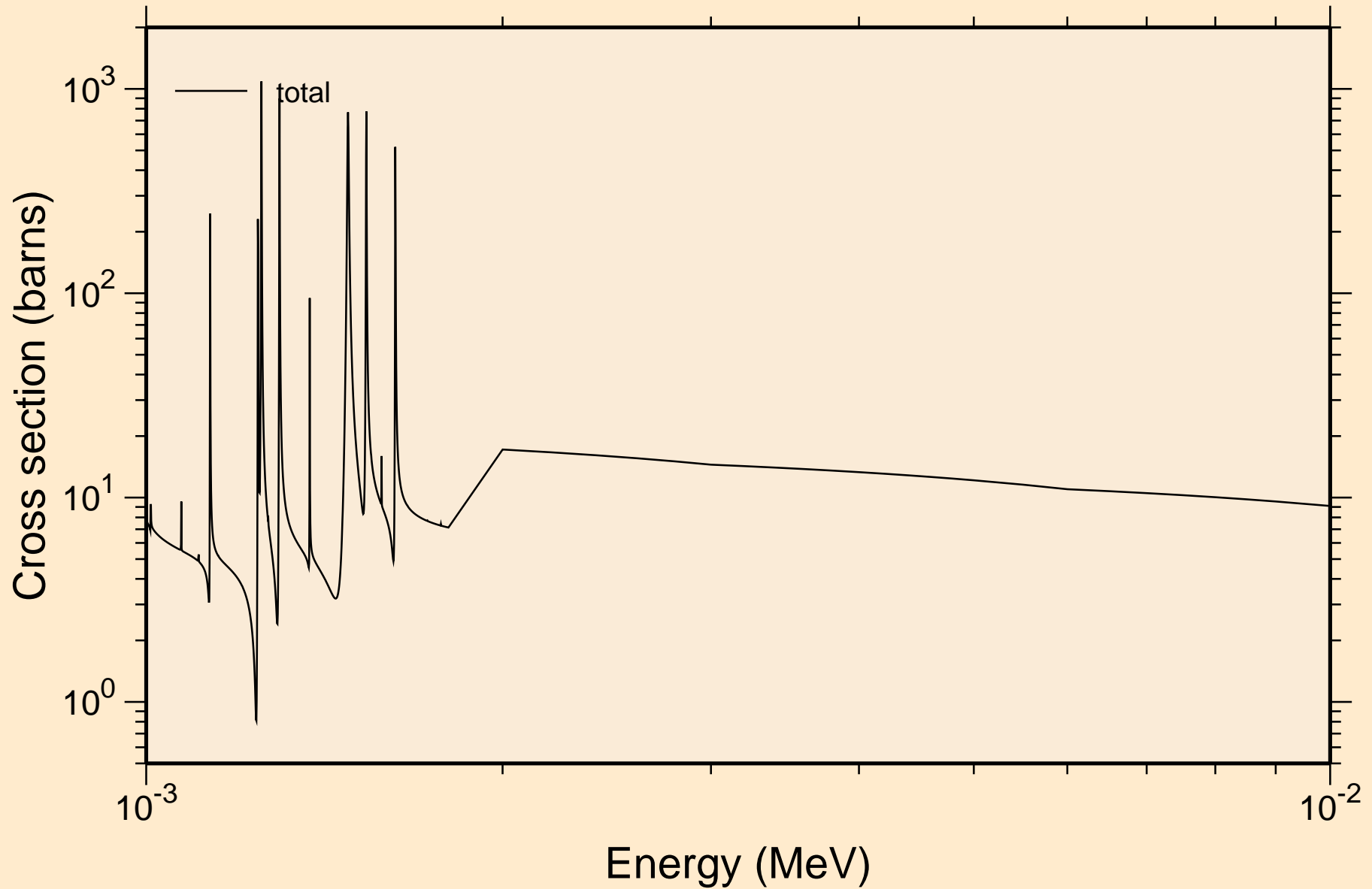

CS135 NEUTRON ACER TENDL-2023 LIBRARY; T=0.K
resonance total cross section

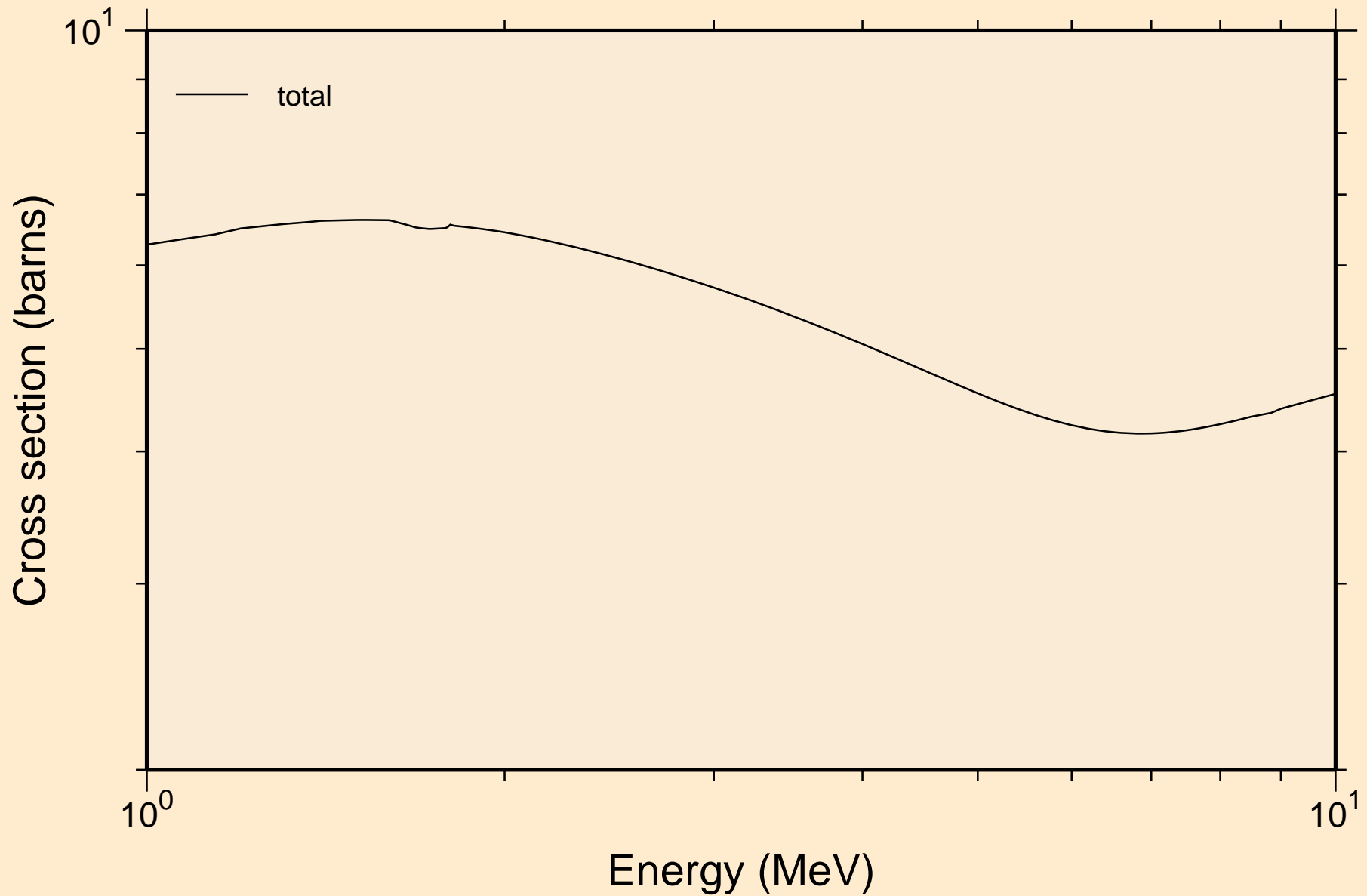

CS135 NEUTRON ACER TENDL-2023 LIBRARY; T=0.K
resonance absorption cross sections

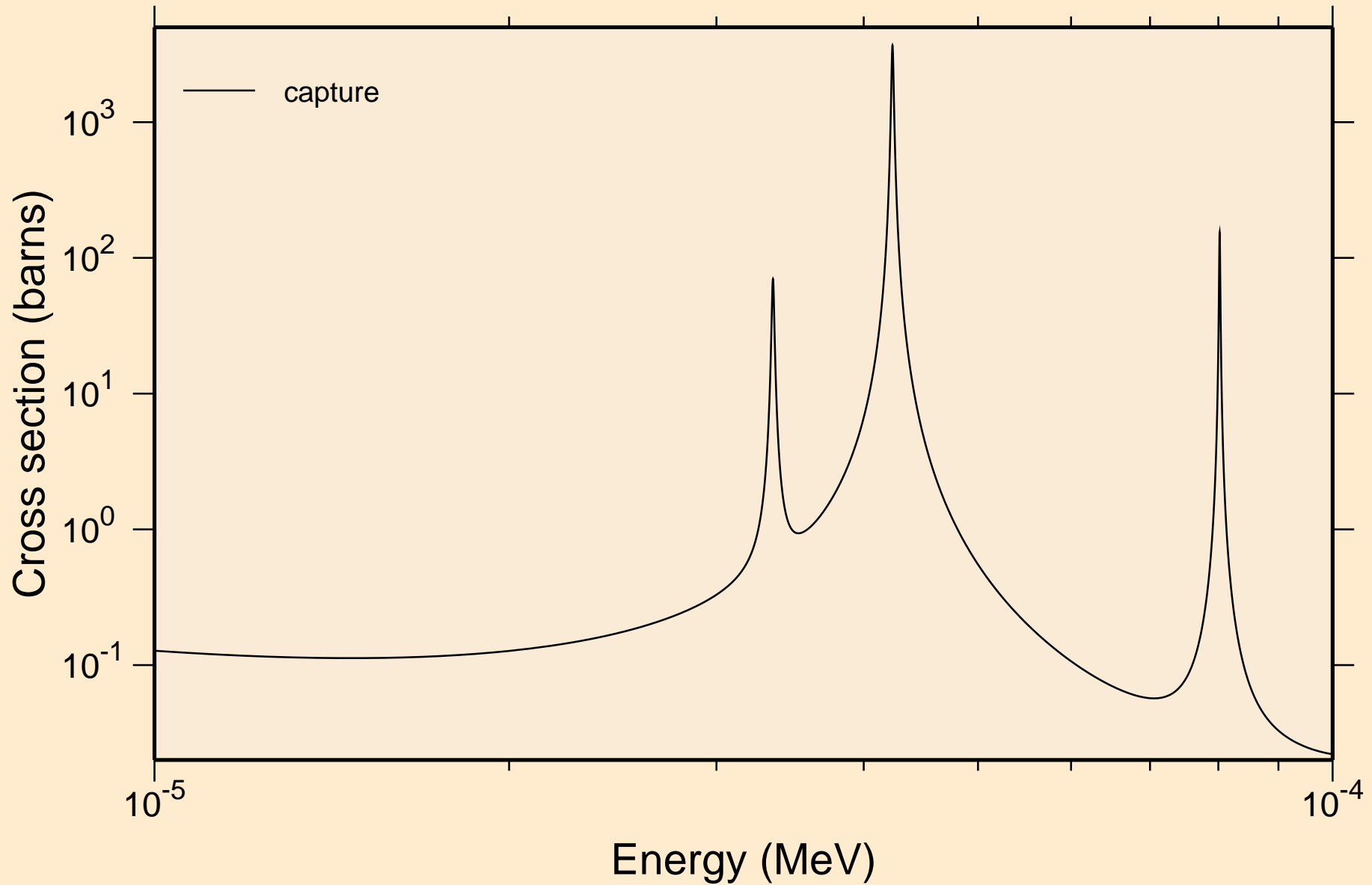

CS135 NEUTRON ACER TENDL-2023 LIBRARY; T=0.K
resonance absorption cross sections

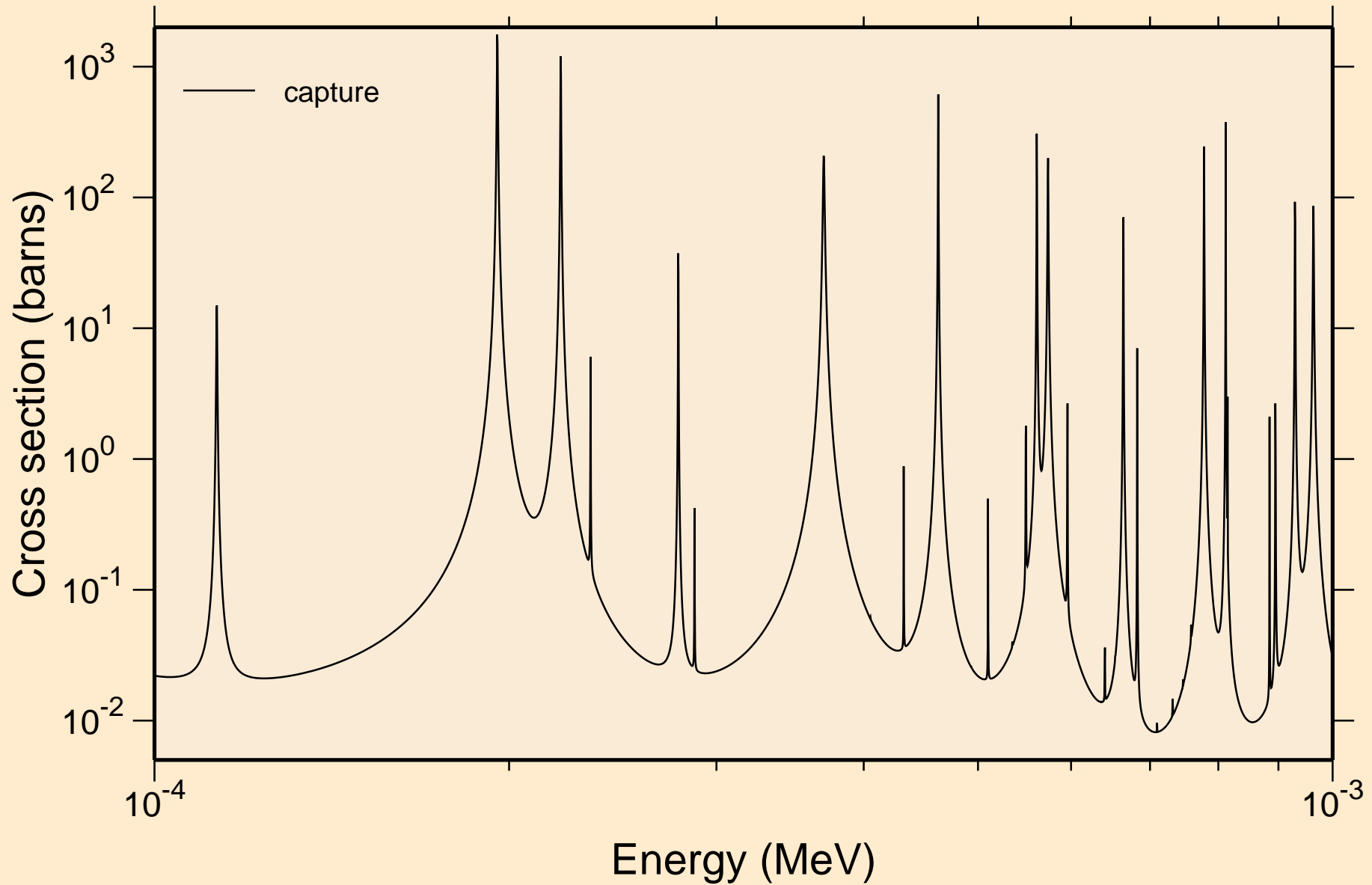

CS135 NEUTRON ACER TENDL-2023 LIBRARY; T=0.K
resonance absorption cross sections

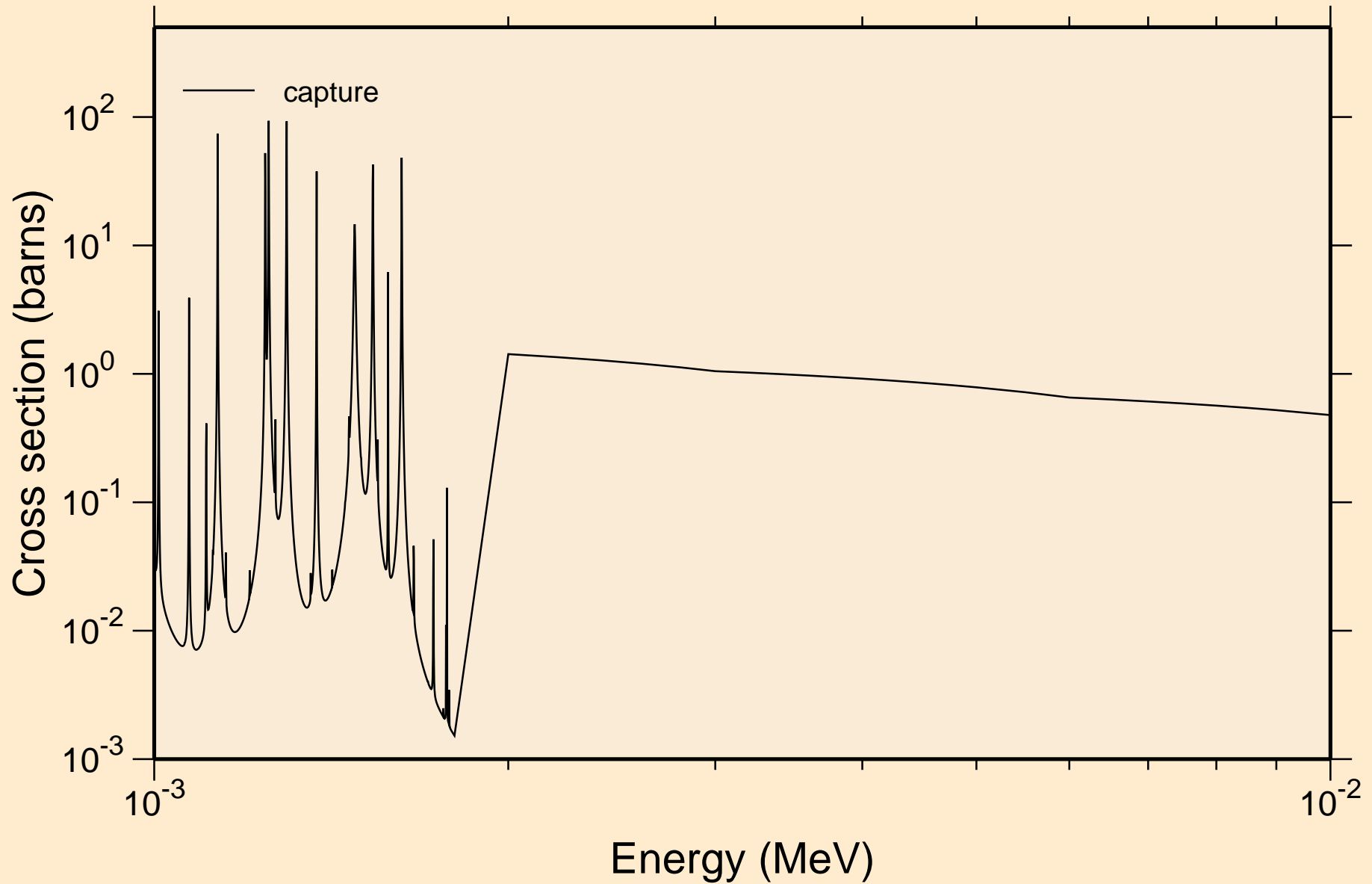

CS135 NEUTRON ACER TENDL-2023 LIBRARY; T=0.K
resonance absorption cross sections

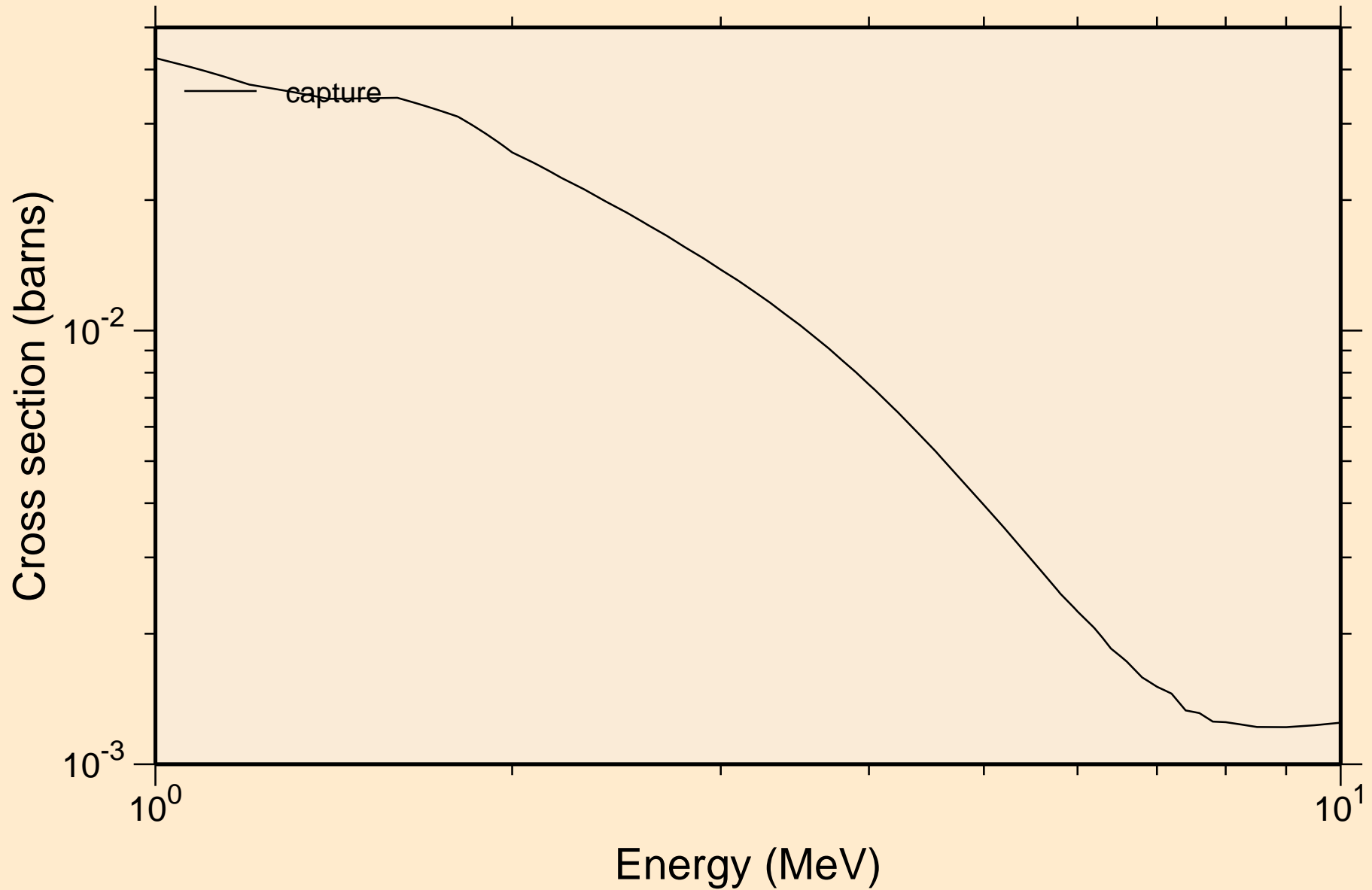

CS135 NEUTRON ACER TENDL-2023 LIBRARY; T=0.K

Heating

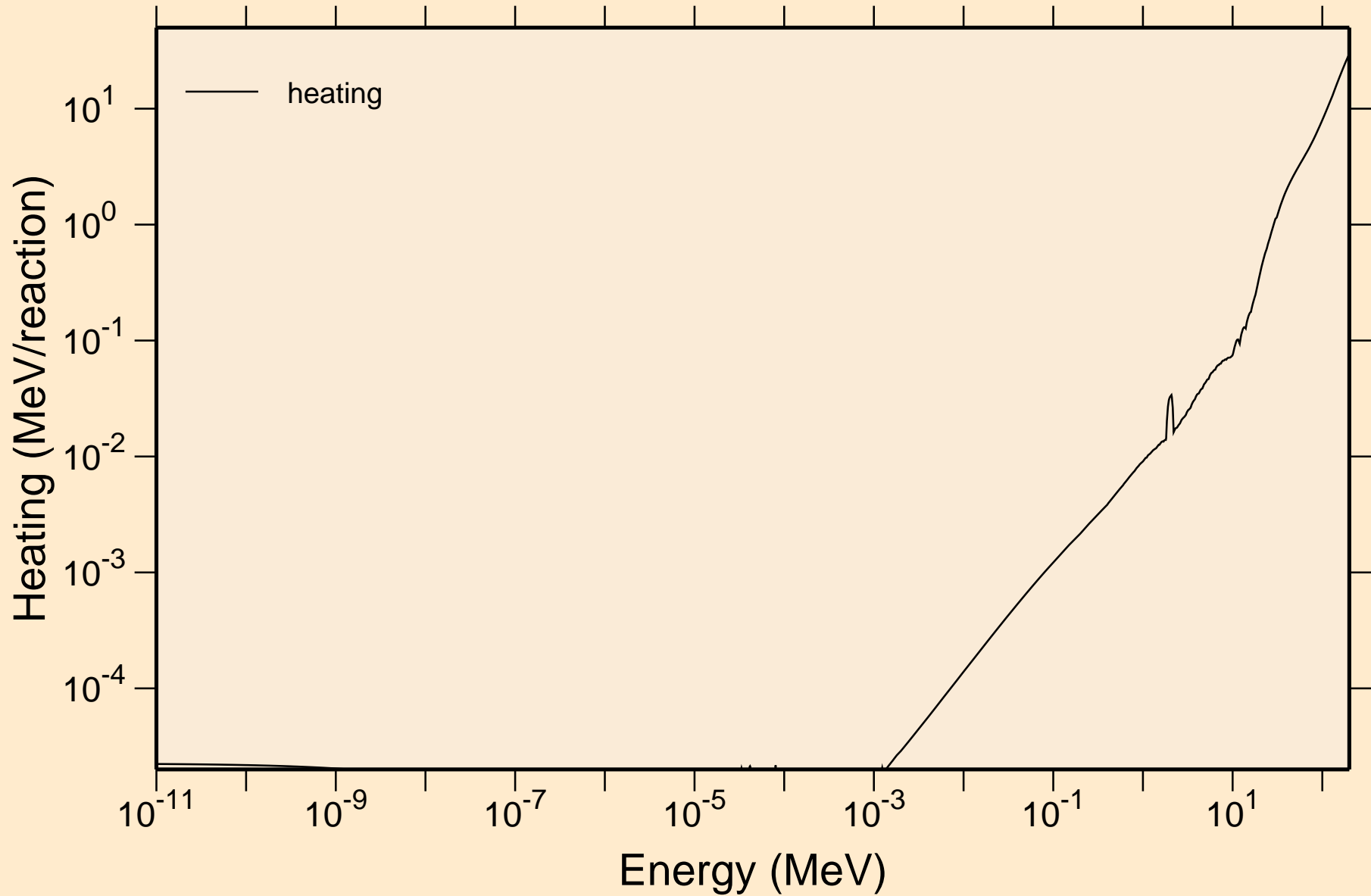

CS135 NEUTRON ACER TENDL-2023 LIBRARY; T=0.K

Damage

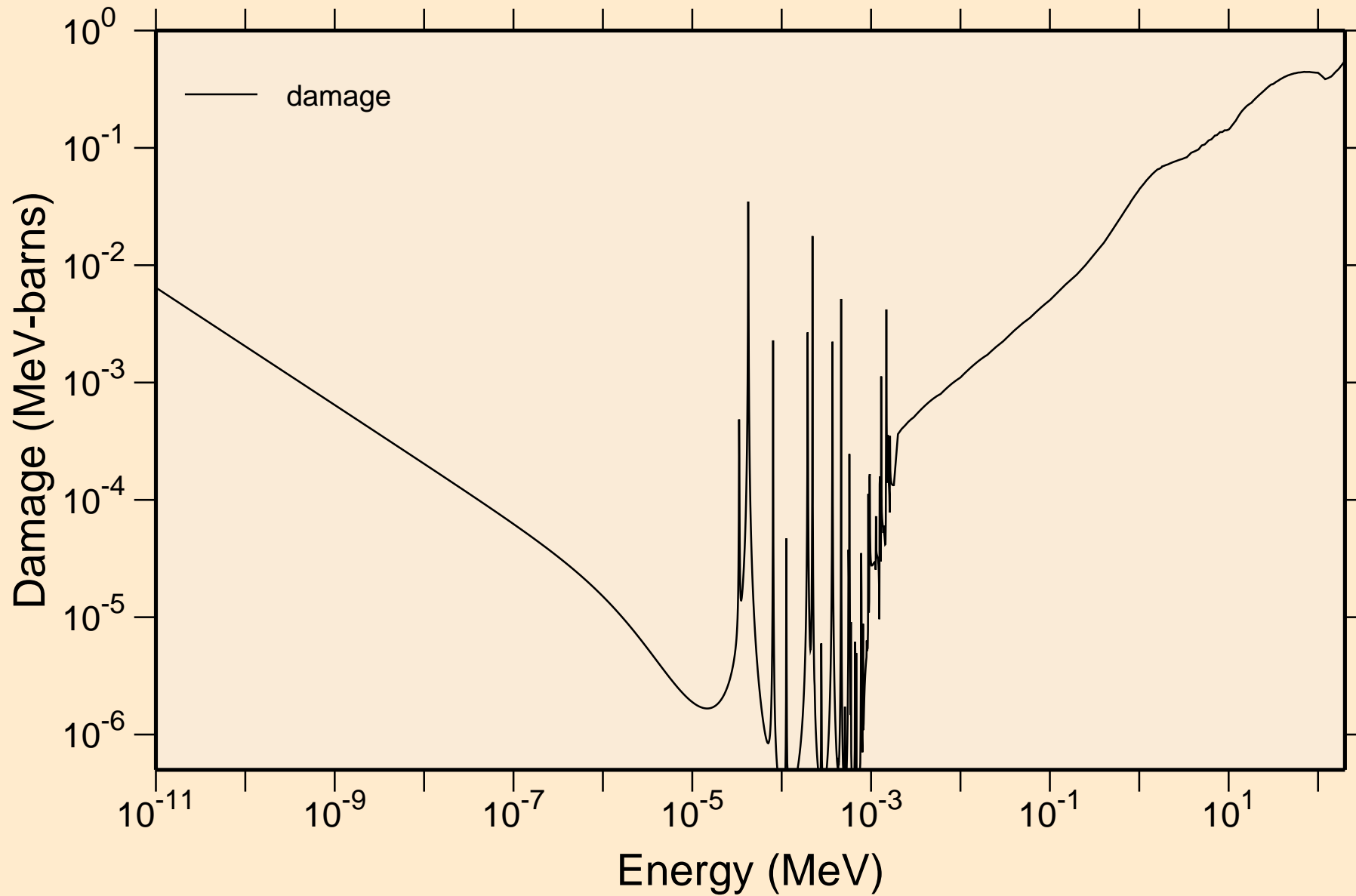

CS135 NEUTRON ACER TENDL-2023 LIBRARY; T=0.K

Non-threshold reactions

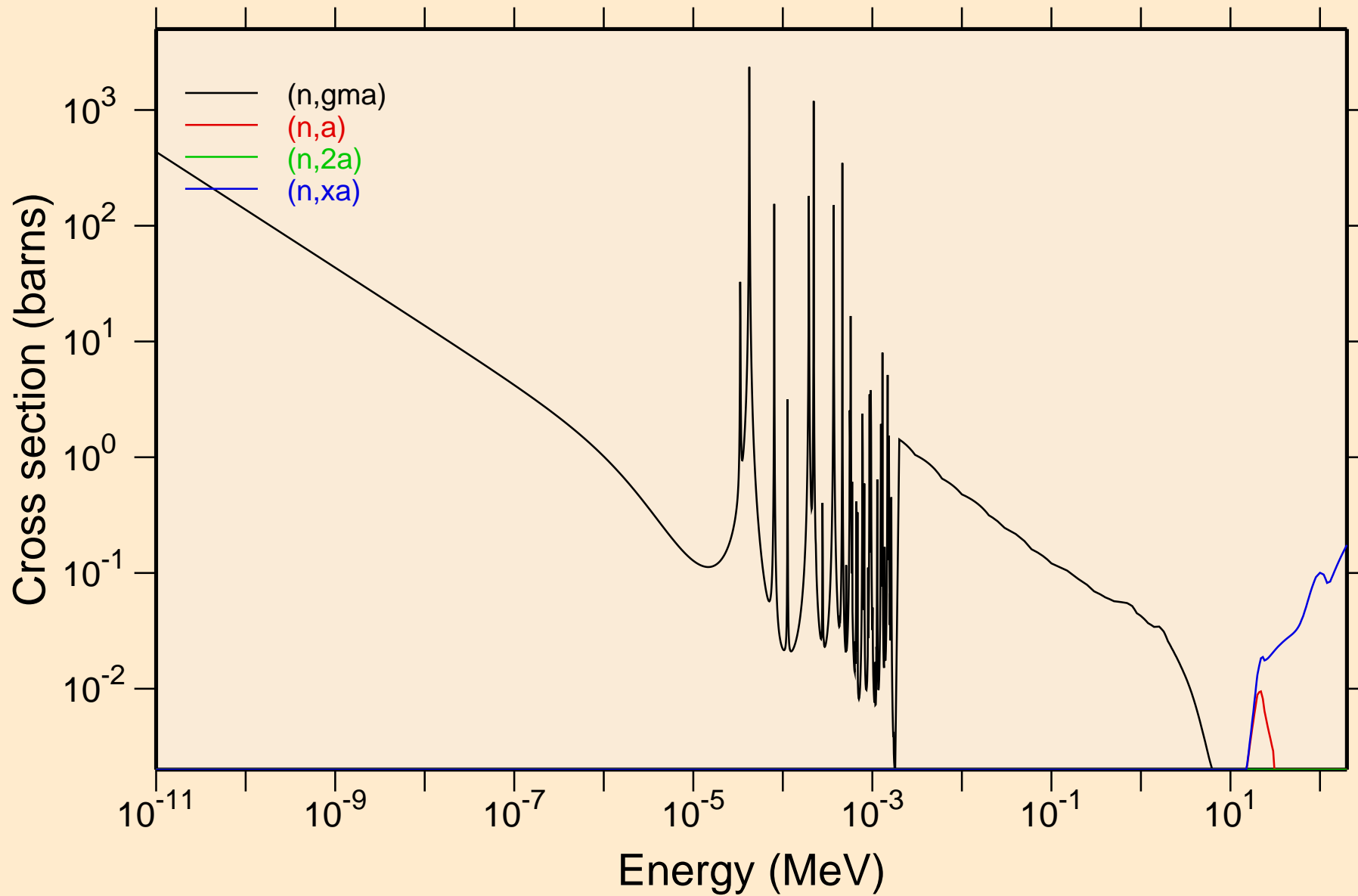

CS135 NEUTRON ACER TENDL-2023 LIBRARY; T=0.K

Principal cross sections

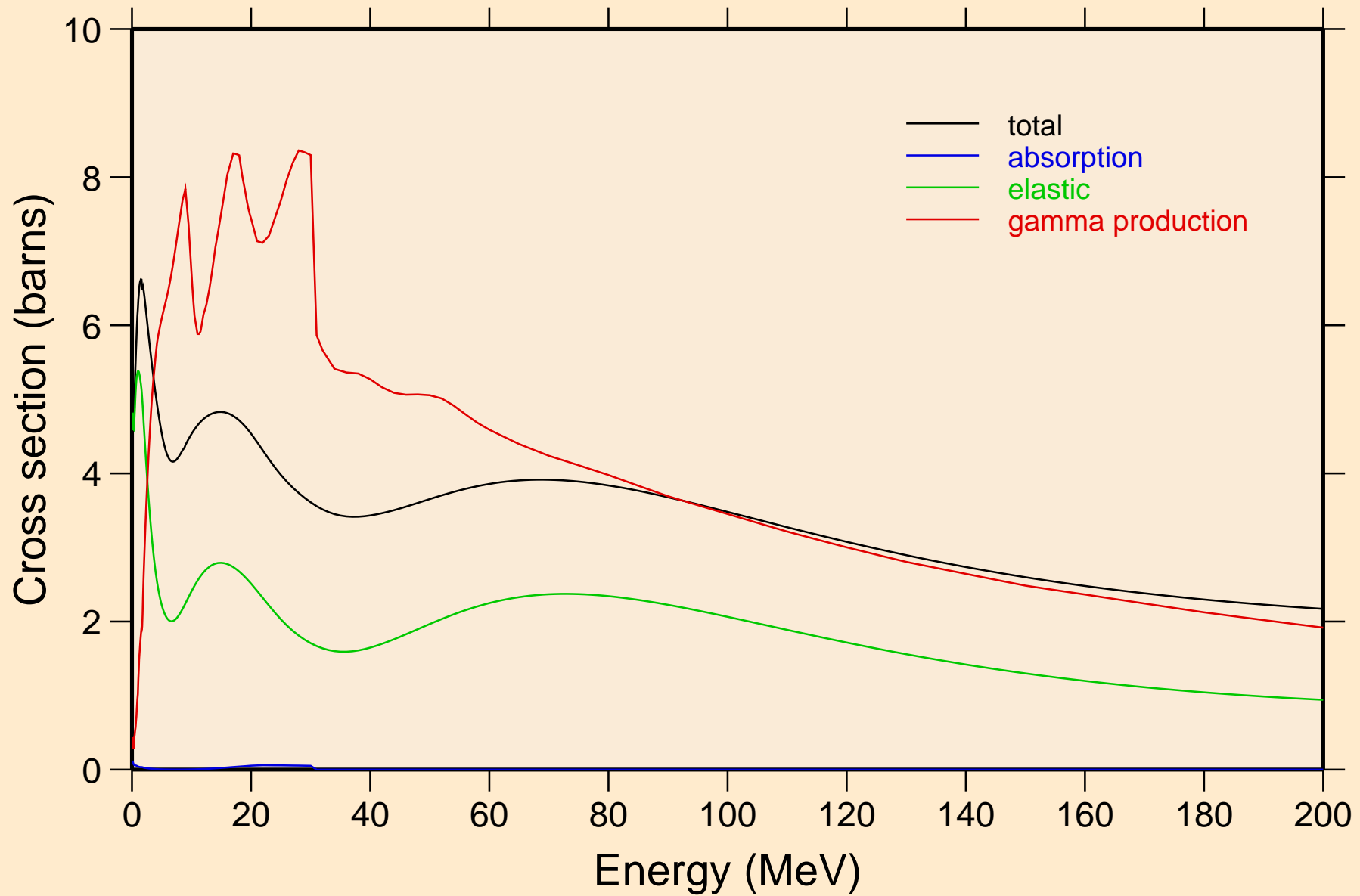

CS135 NEUTRON ACER TENDL-2023 LIBRARY; T=0.K

Heating

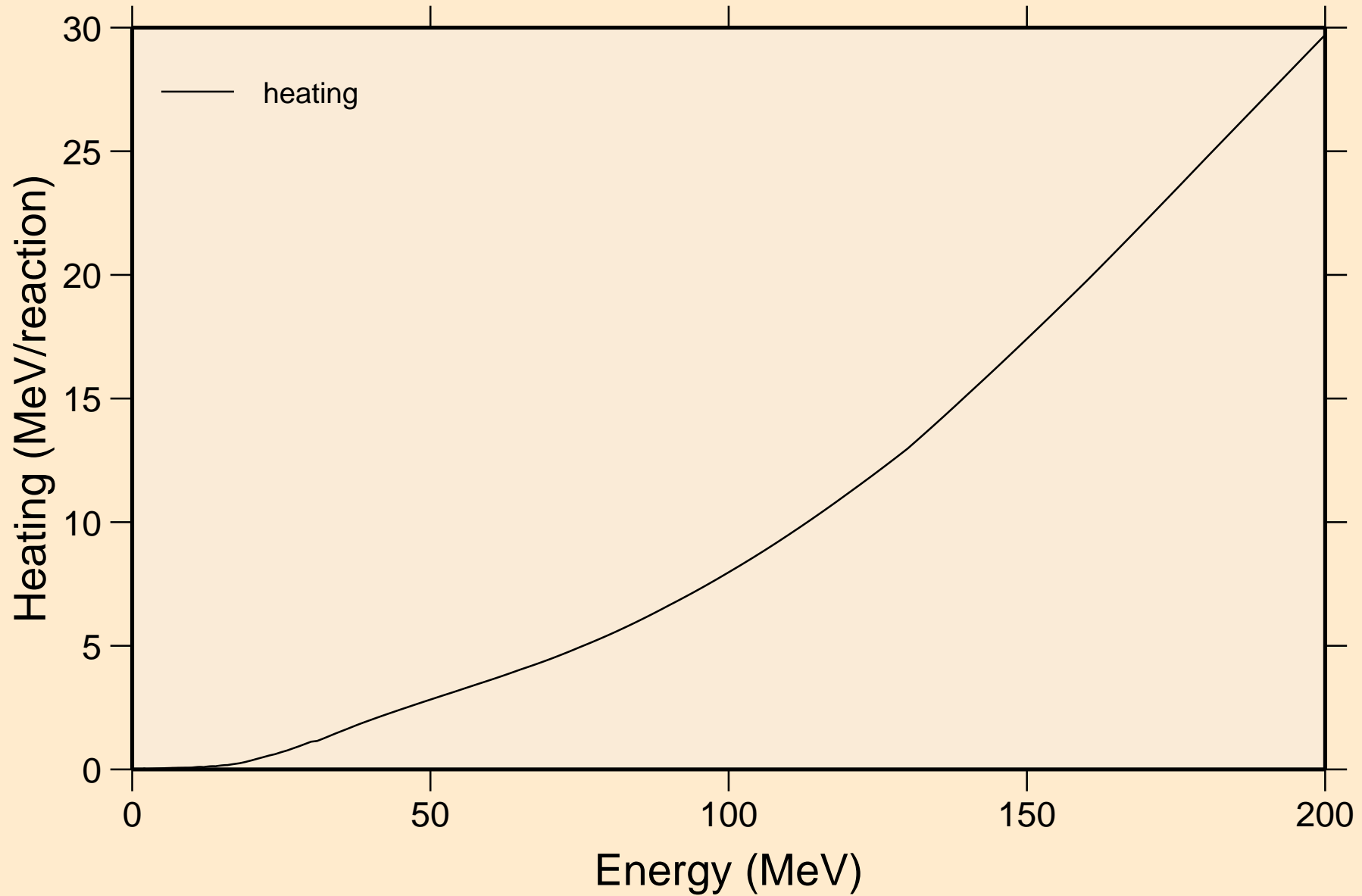

CS135 NEUTRON ACER TENDL-2023 LIBRARY; T=0.K

Damage

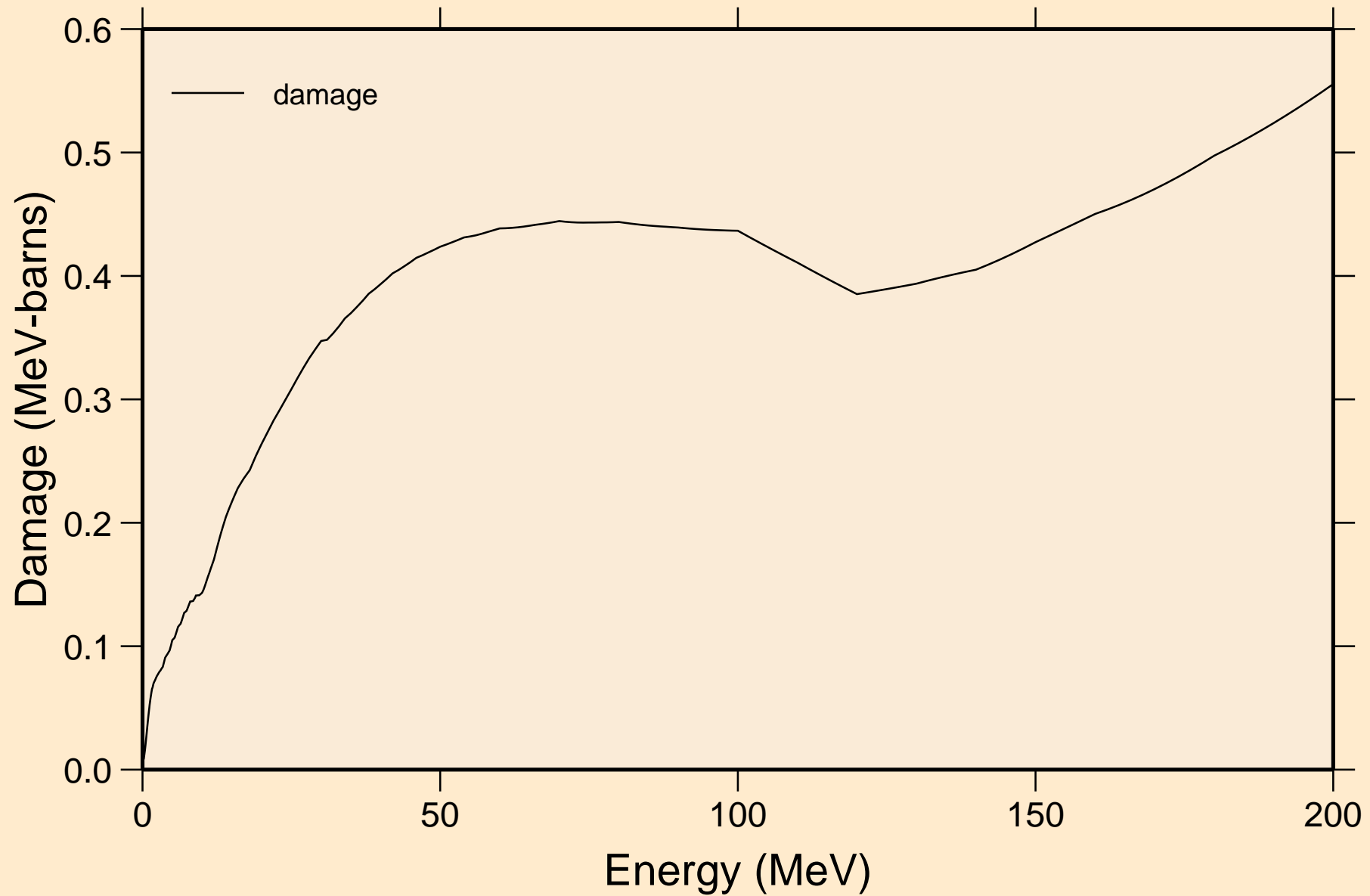

CS135 NEUTRON ACER TENDL-2023 LIBRARY; T=0.K

Non-threshold reactions

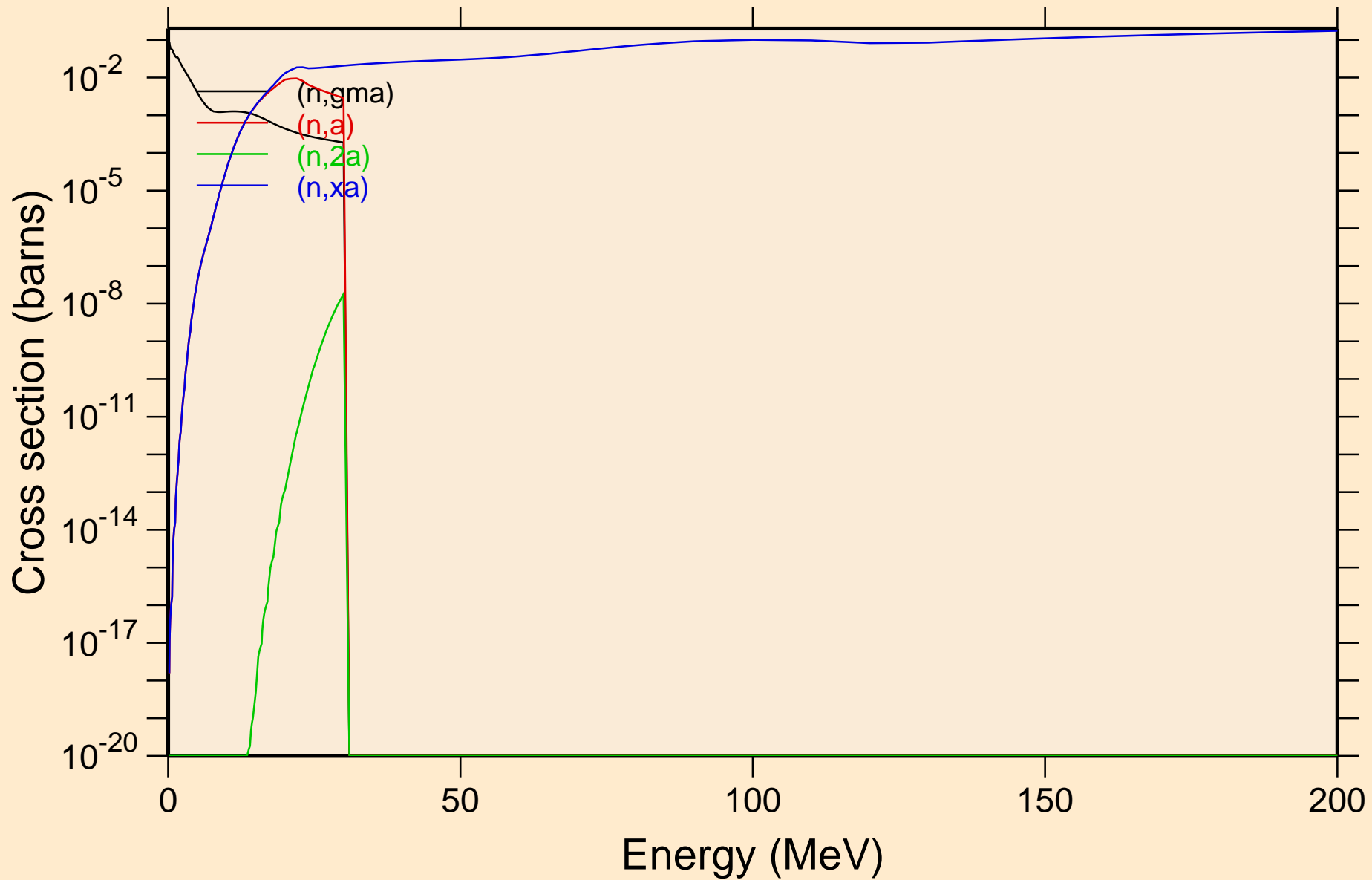

CS135 NEUTRON ACER TENDL-2023 LIBRARY; T=0.K

Inelastic levels

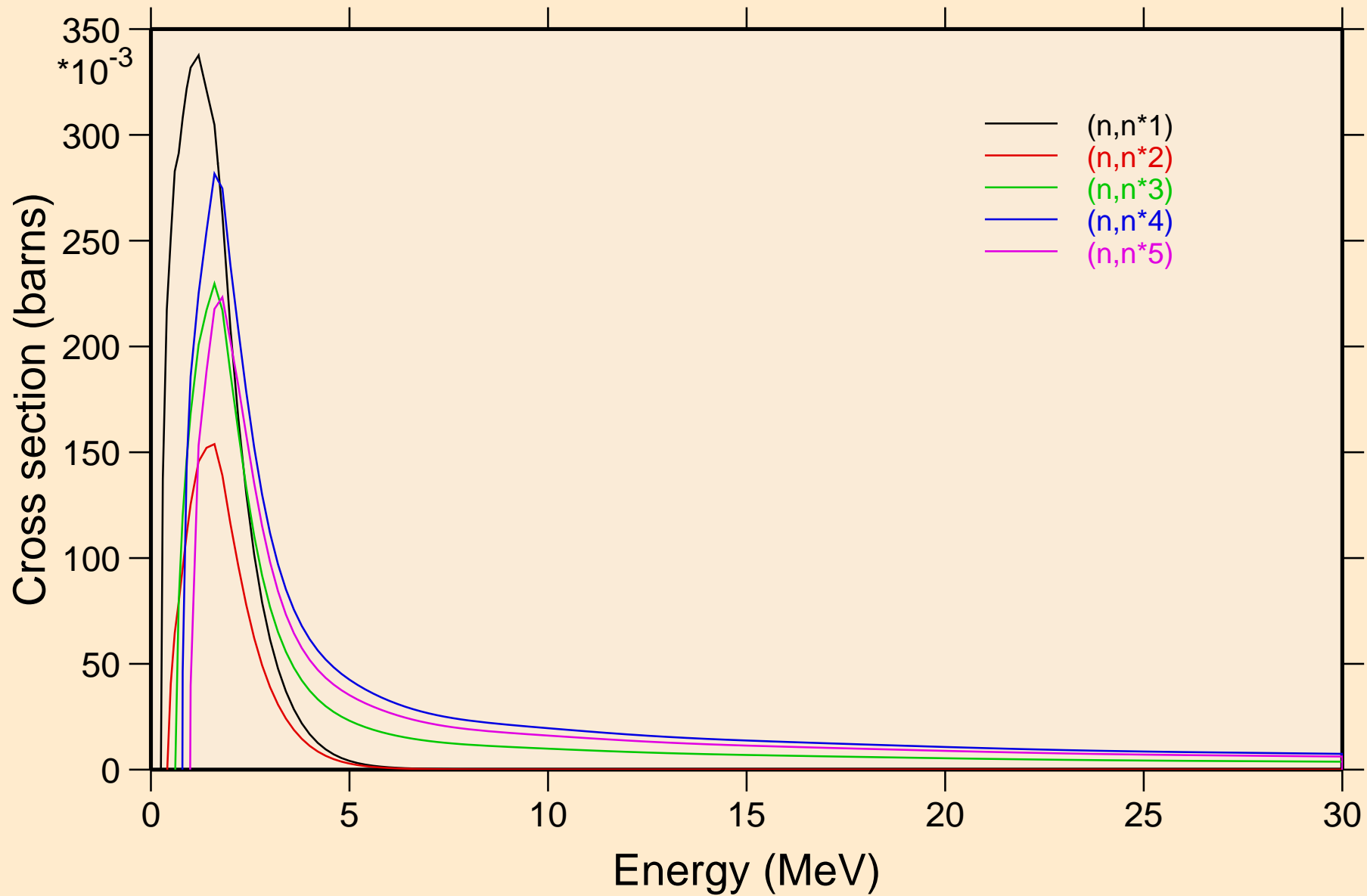

CS135 NEUTRON ACER TENDL-2023 LIBRARY; T=0.K

Inelastic levels

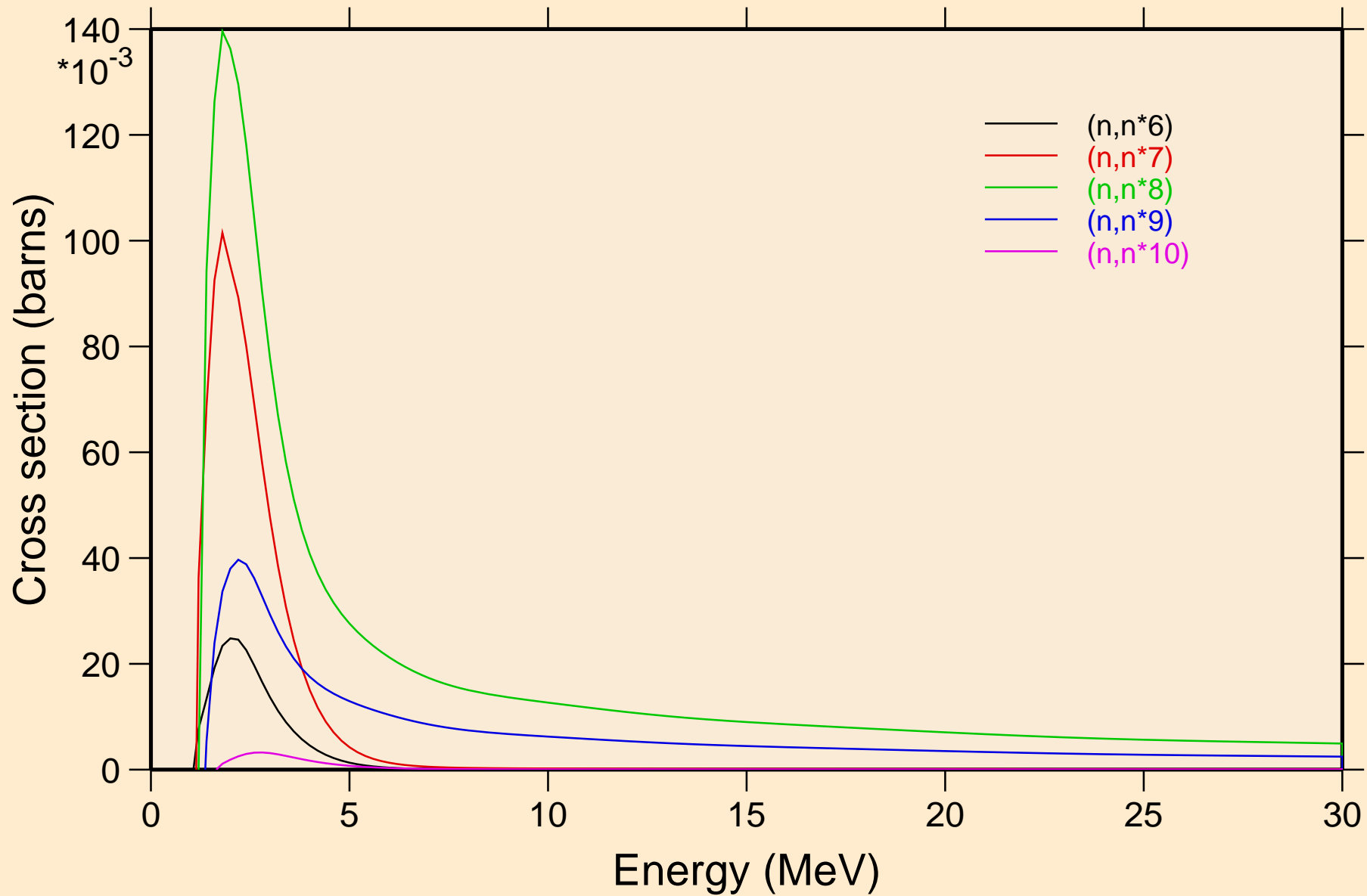

CS135 NEUTRON ACER TENDL-2023 LIBRARY; T=0.K

Inelastic levels

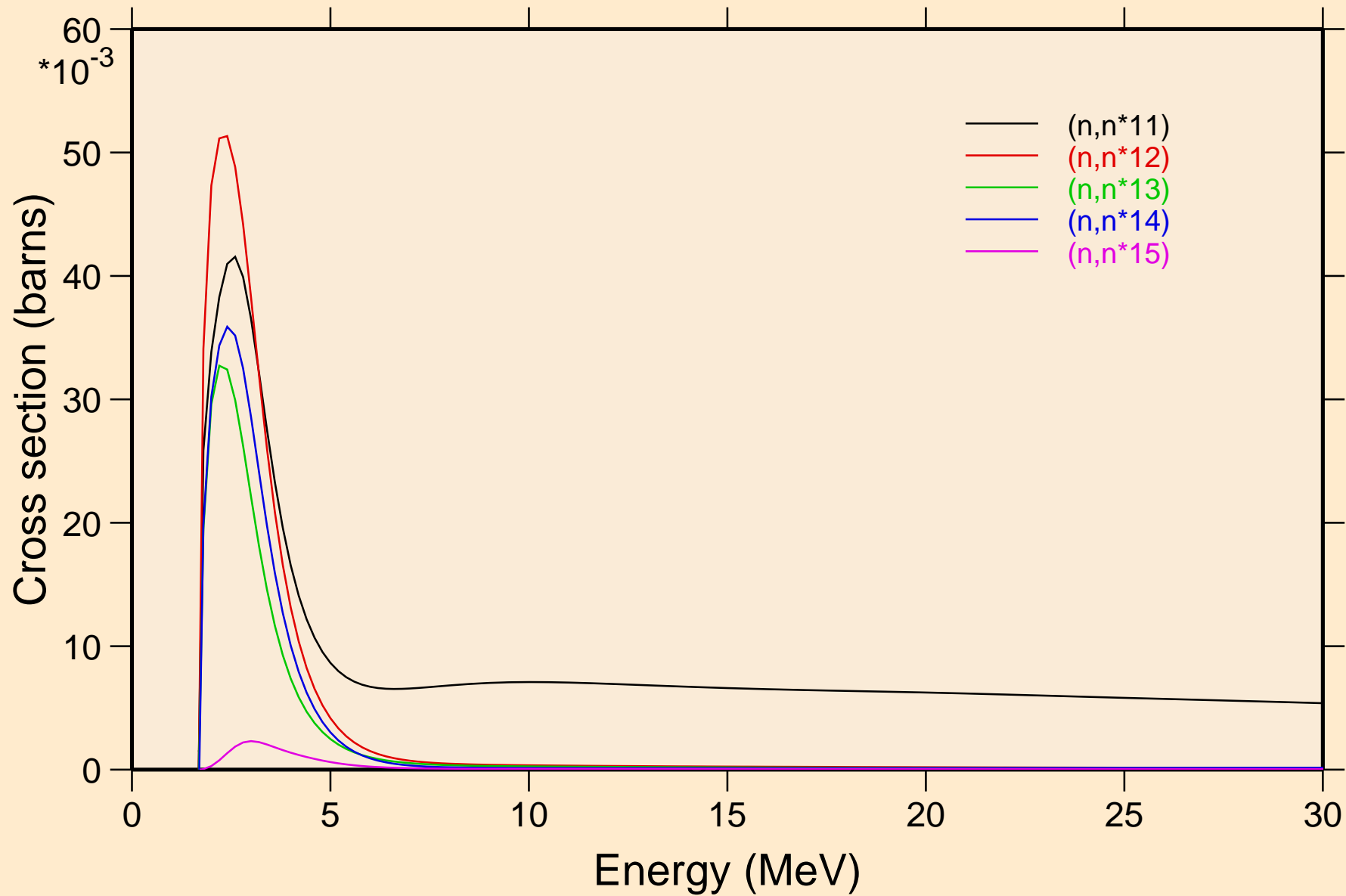

CS135 NEUTRON ACER TENDL-2023 LIBRARY; T=0.K

Inelastic levels

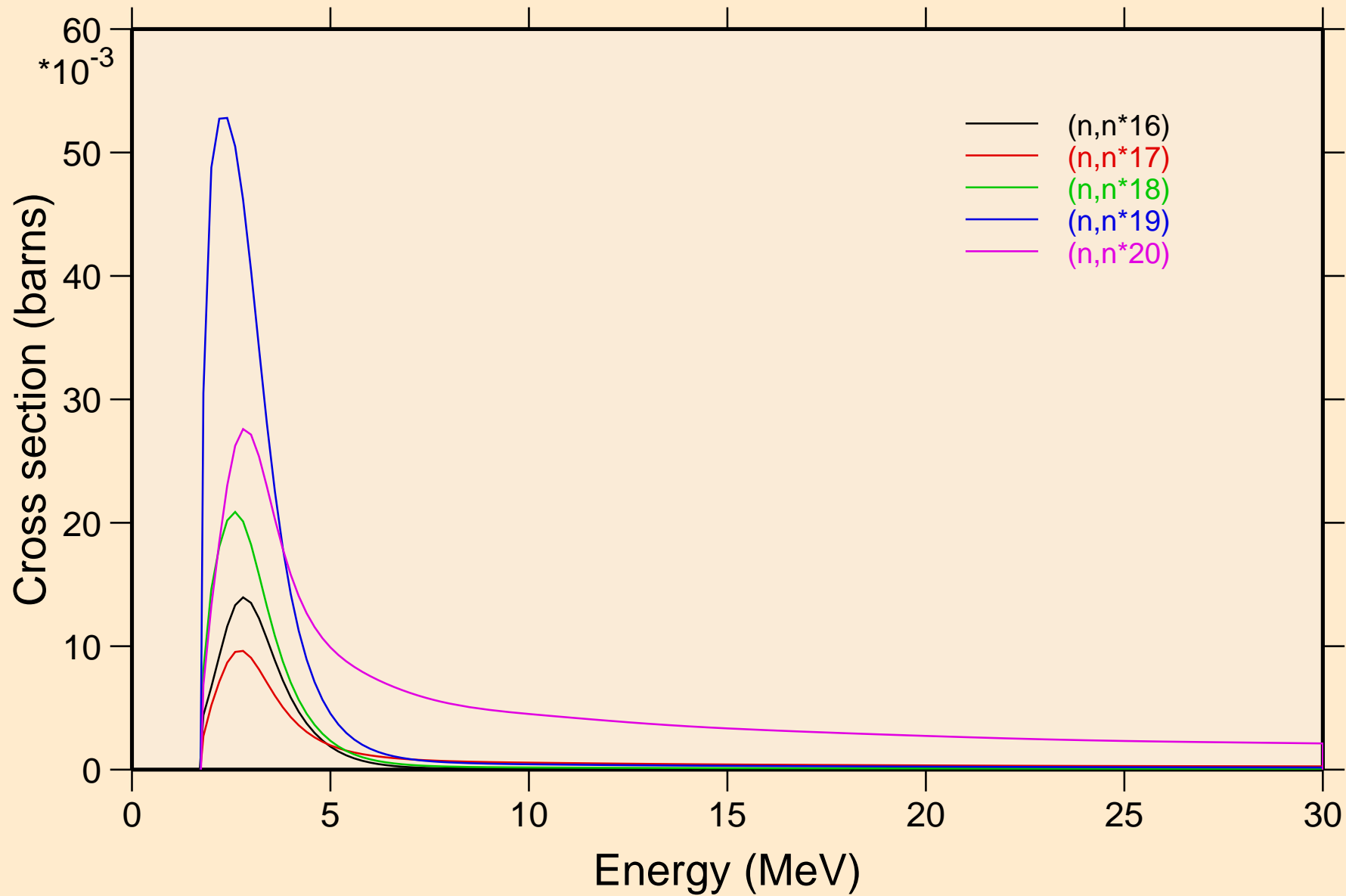

CS135 NEUTRON ACER TENDL-2023 LIBRARY; T=0.K

Inelastic levels

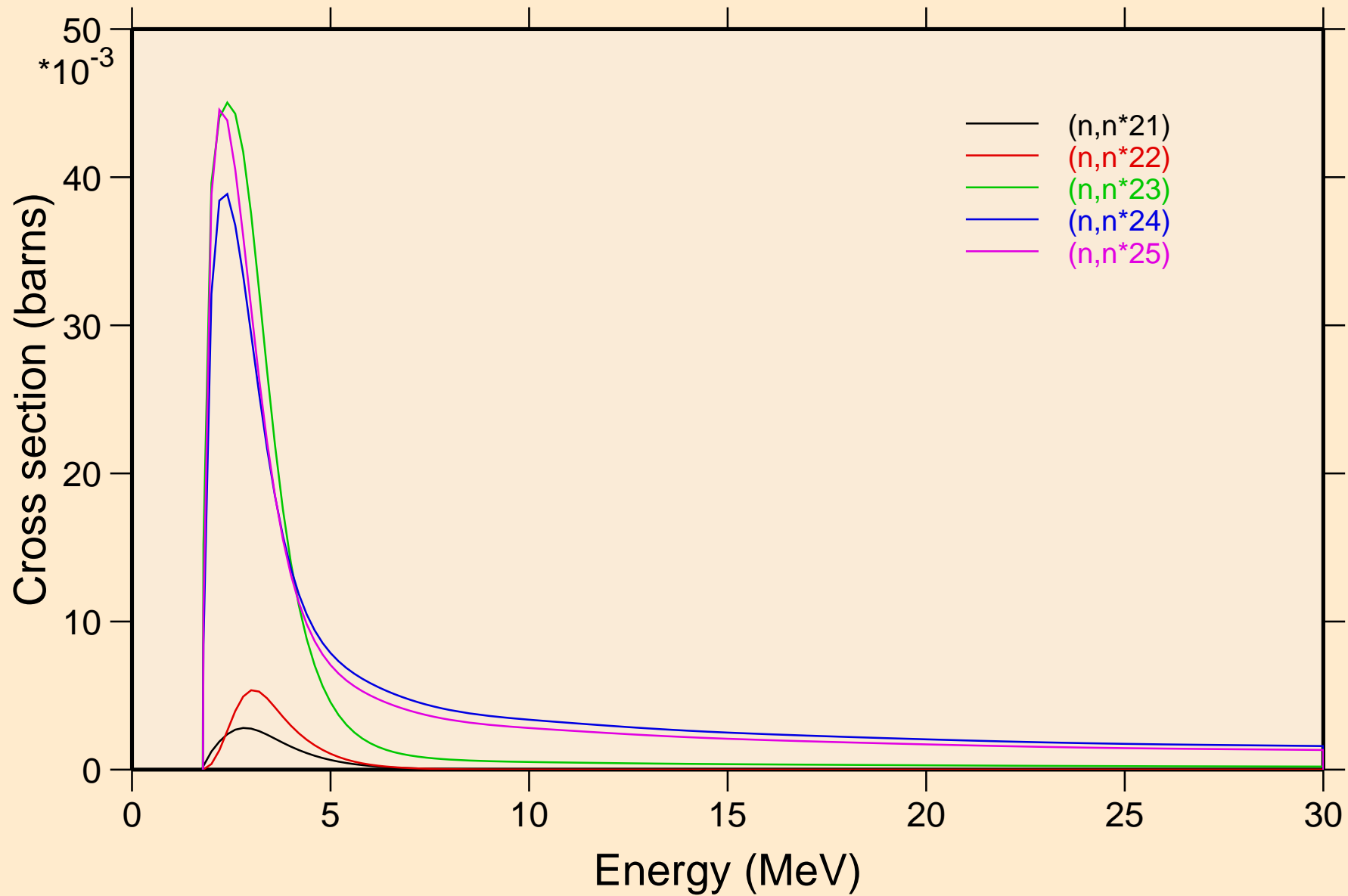

CS135 NEUTRON ACER TENDL-2023 LIBRARY; T=0.K
Inelastic levels

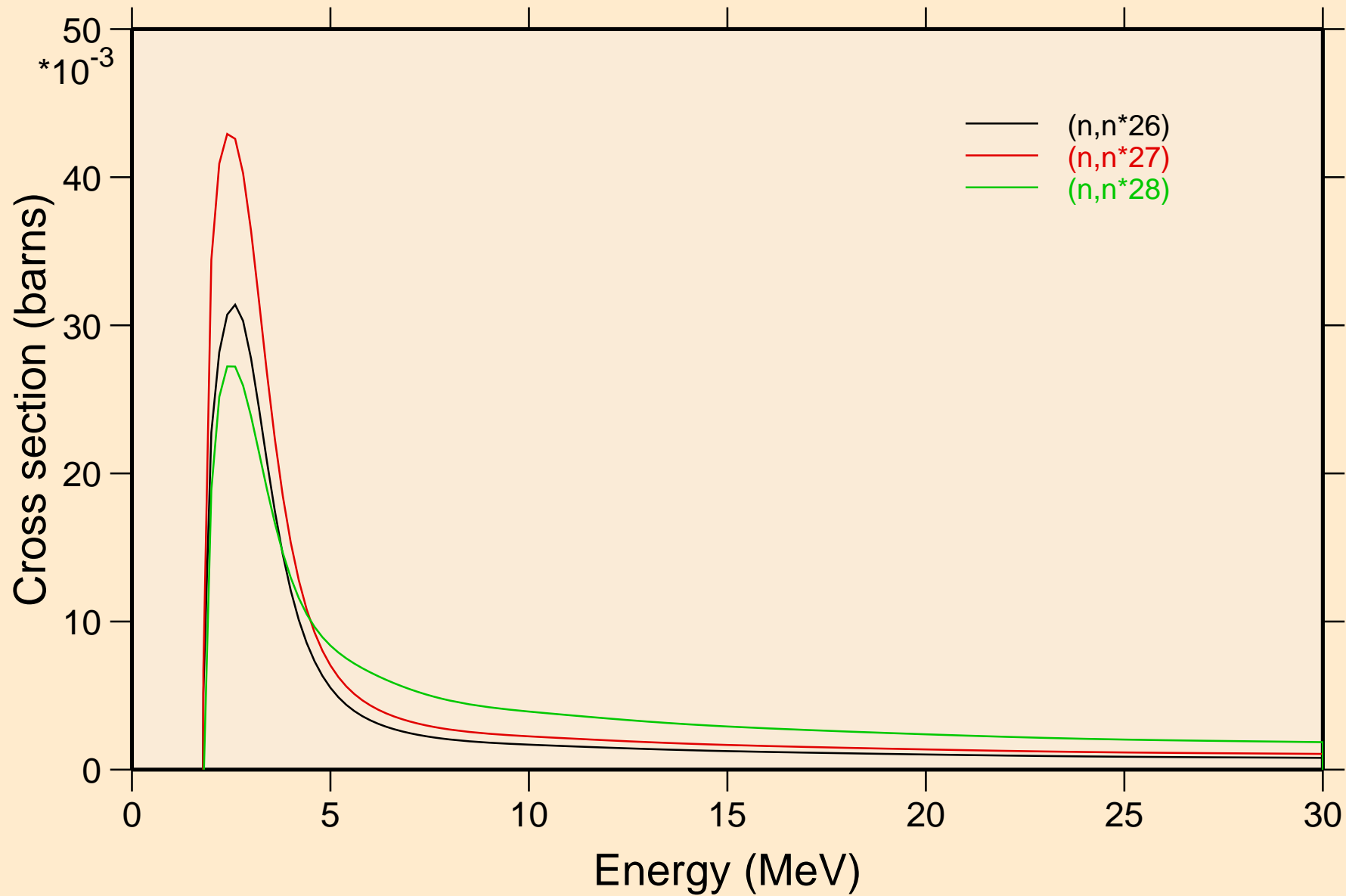

CS135 NEUTRON ACER TENDL-2023 LIBRARY; T=0.K

Threshold reactions

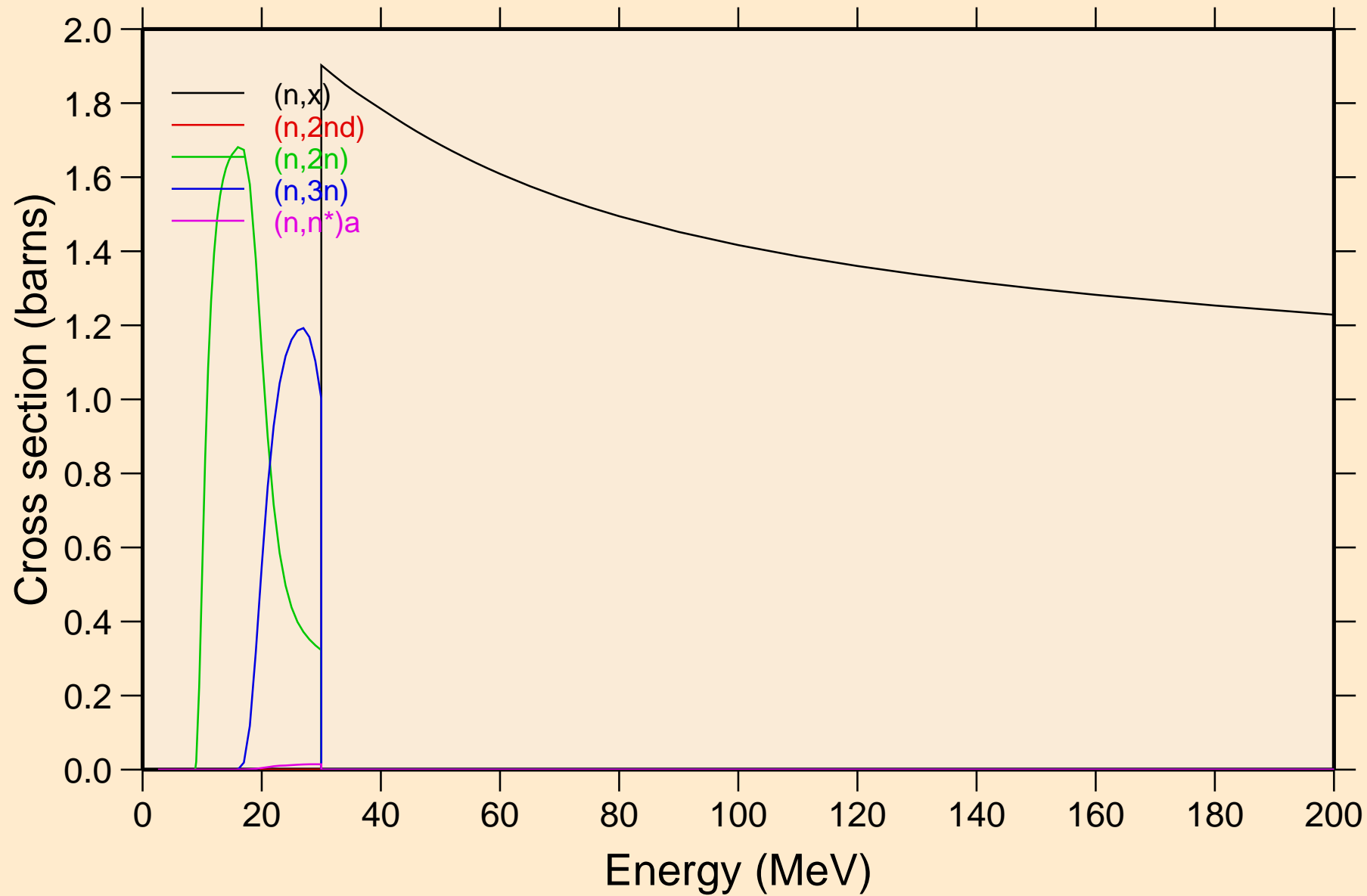

CS135 NEUTRON ACER TENDL-2023 LIBRARY; T=0.K

Threshold reactions

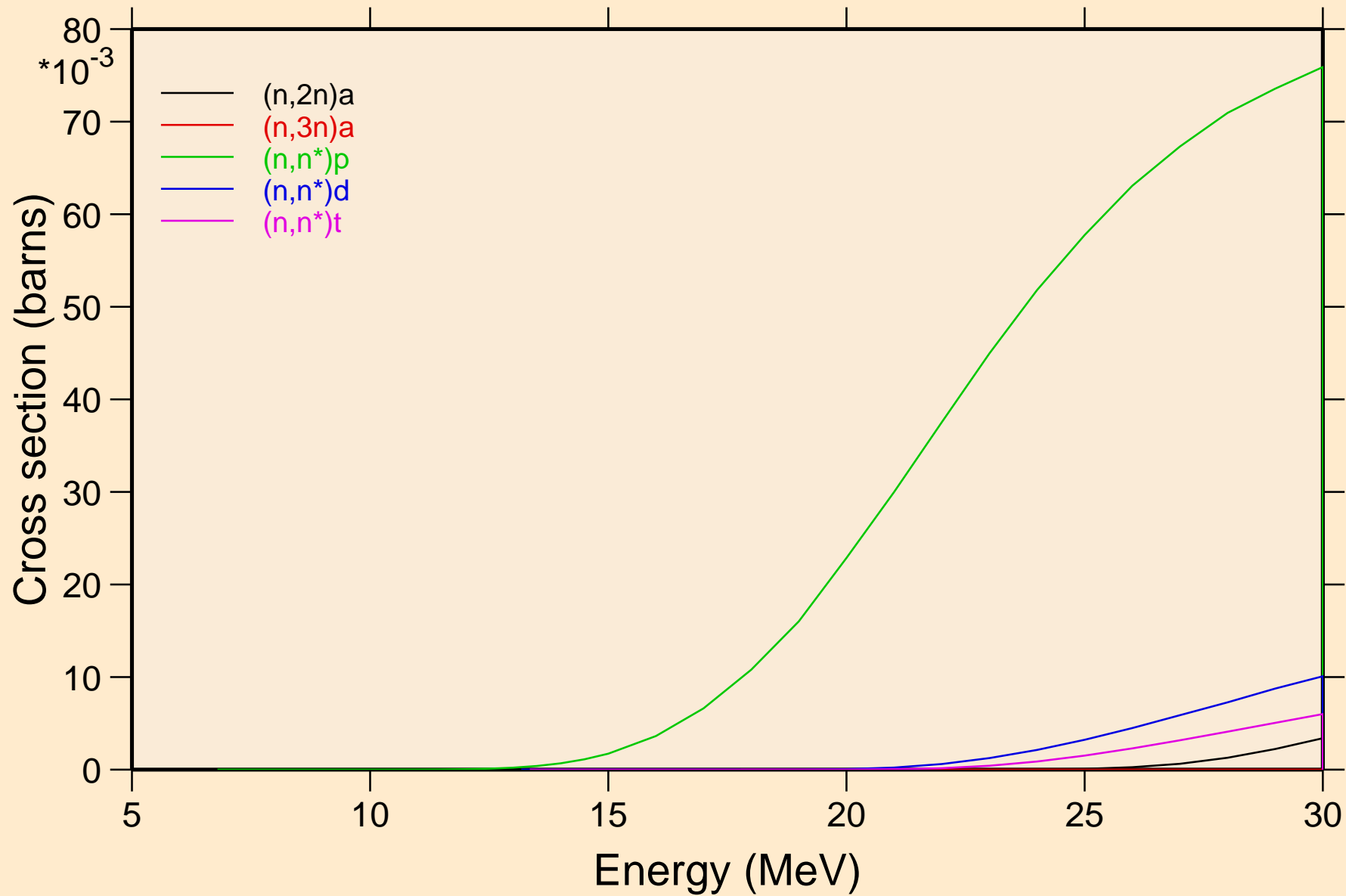

CS135 NEUTRON ACER TENDL-2023 LIBRARY; T=0.K

Threshold reactions

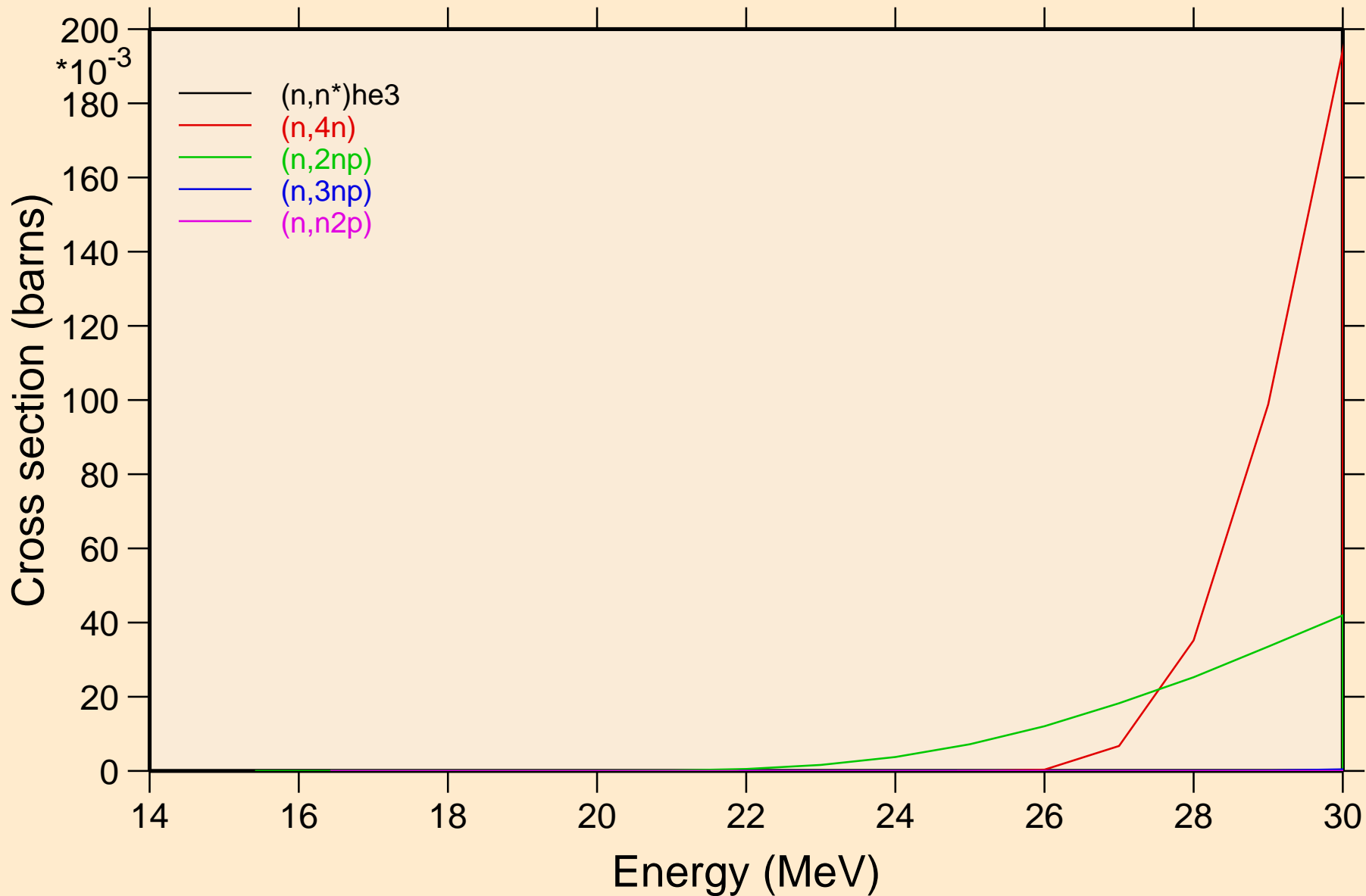

CS135 NEUTRON ACER TENDL-2023 LIBRARY; T=0.K

Threshold reactions

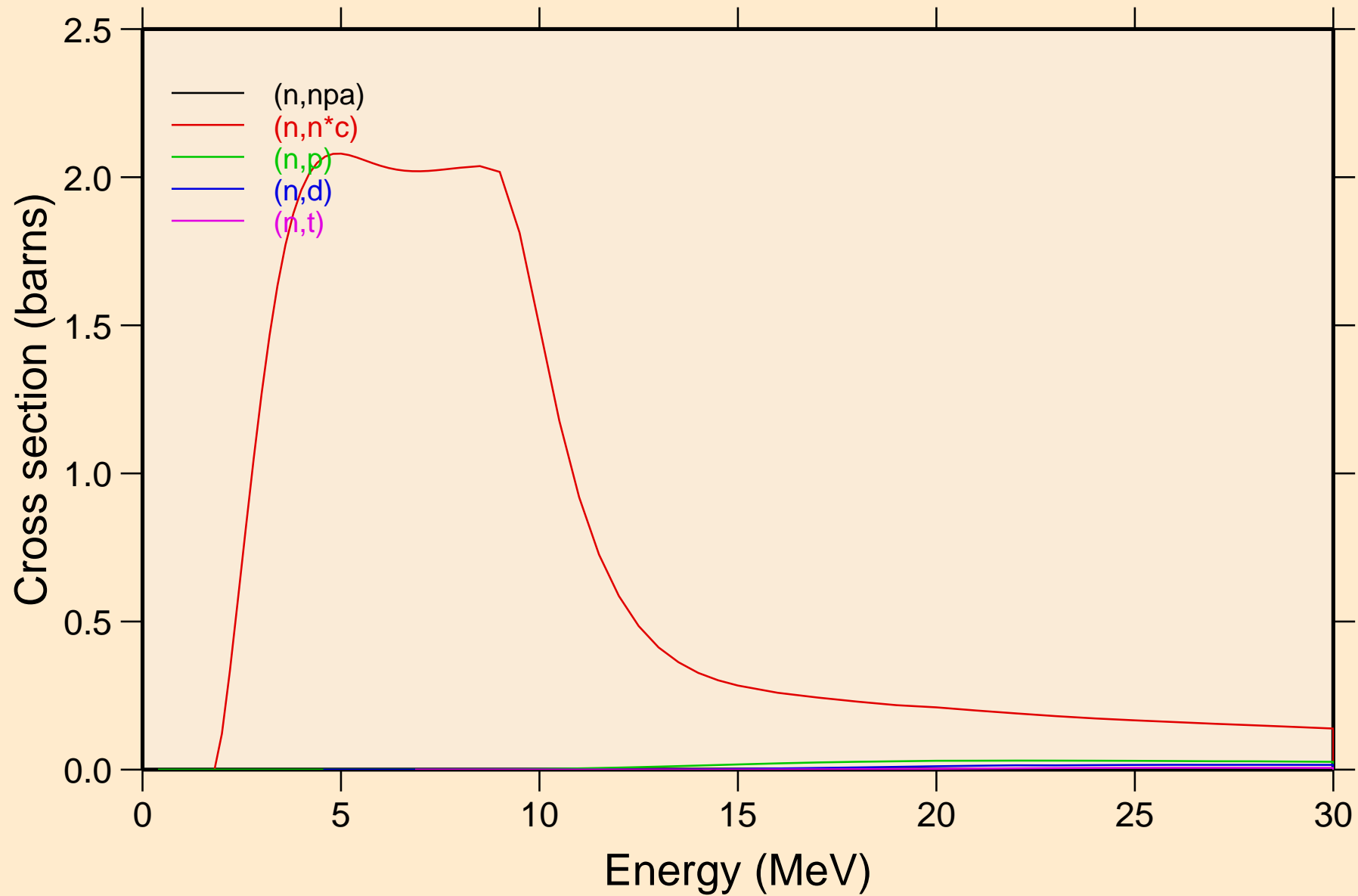

CS135 NEUTRON ACER TENDL-2023 LIBRARY; T=0.K

Threshold reactions

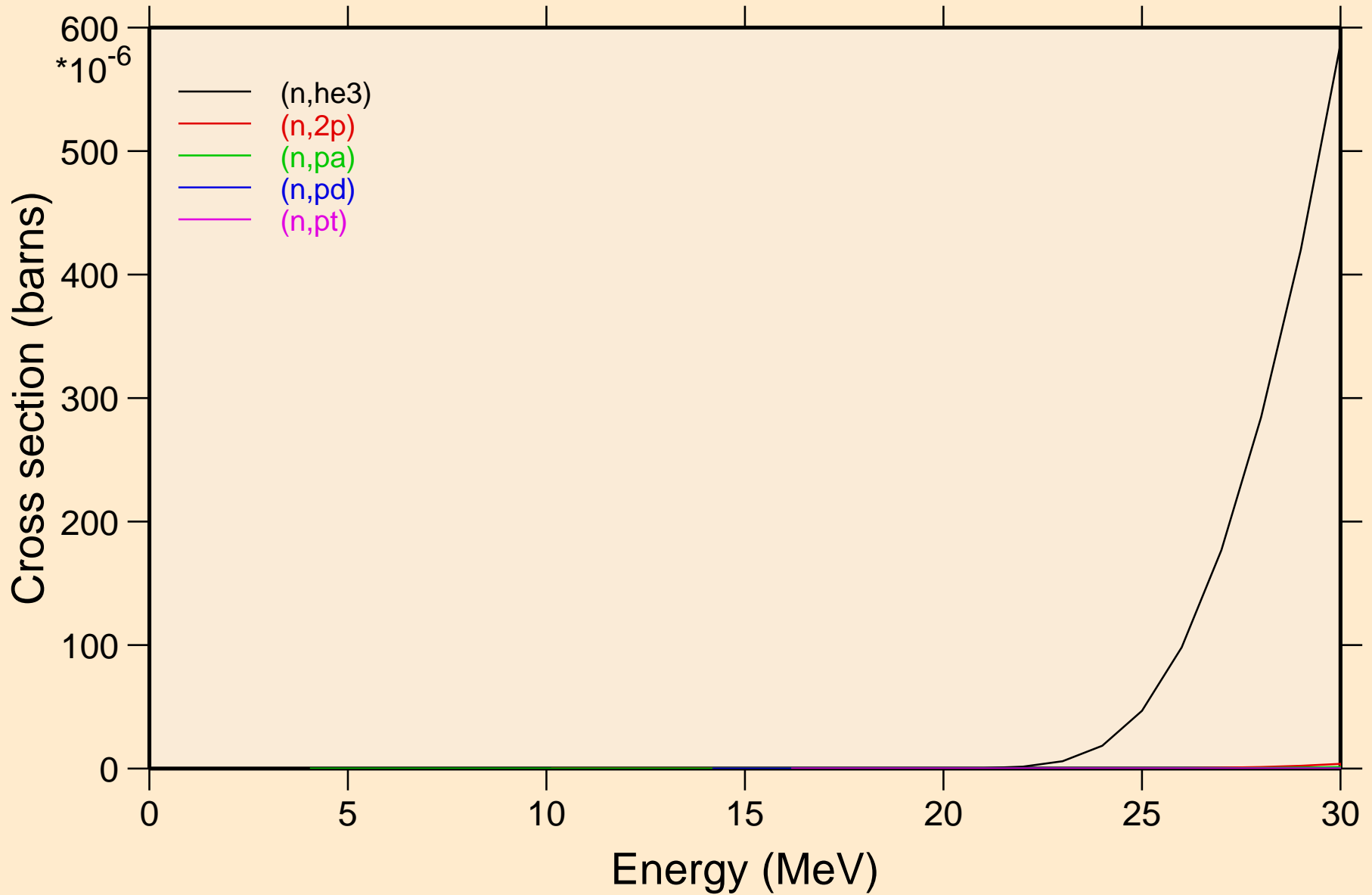

CS135 NEUTRON ACER TENDL-2023 LIBRARY; T=0.K
Threshold reactions

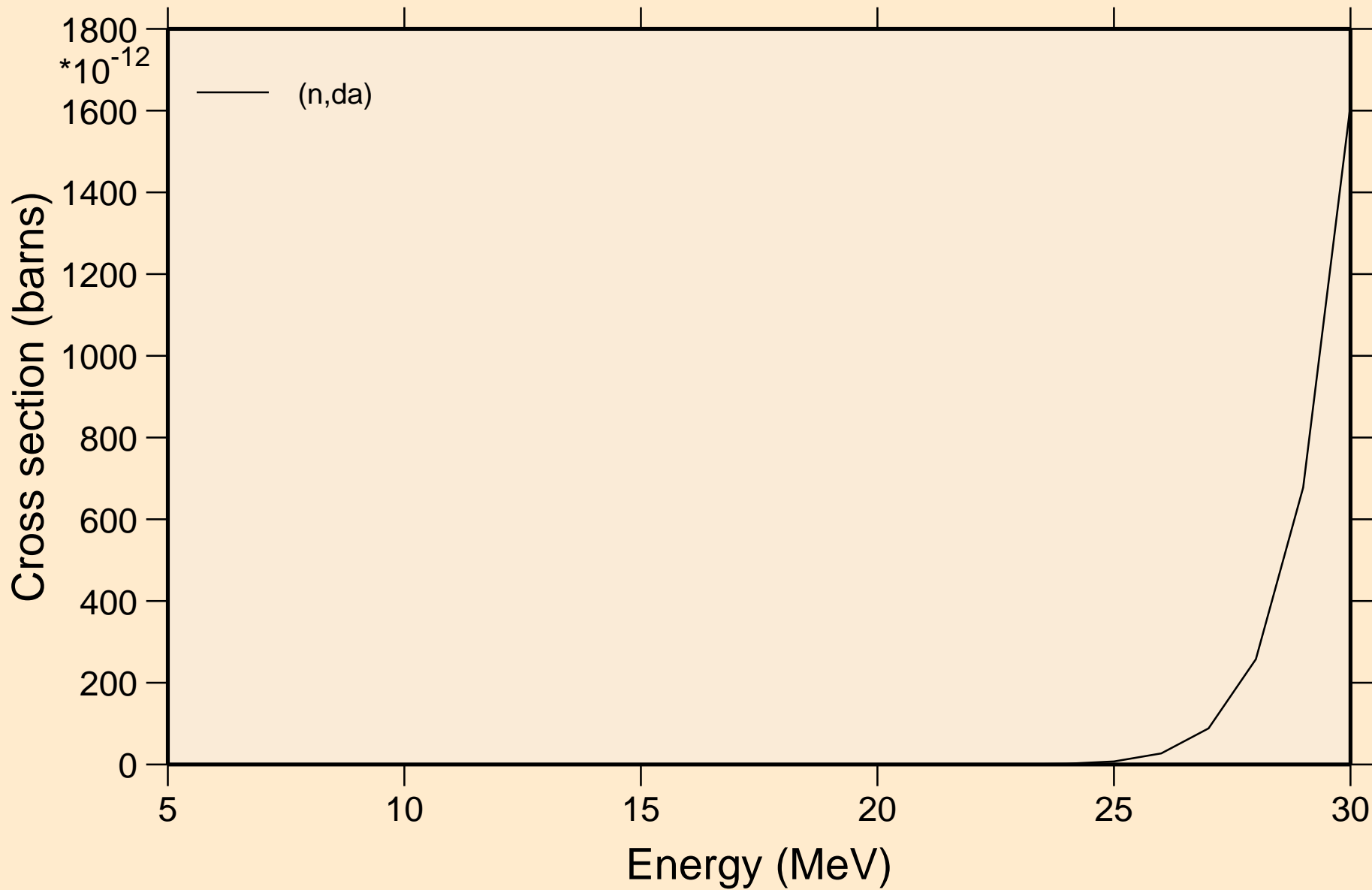

CS135 NEUTRON ACER TENDL-2023 LIBRARY; T=0.K

Threshold reactions

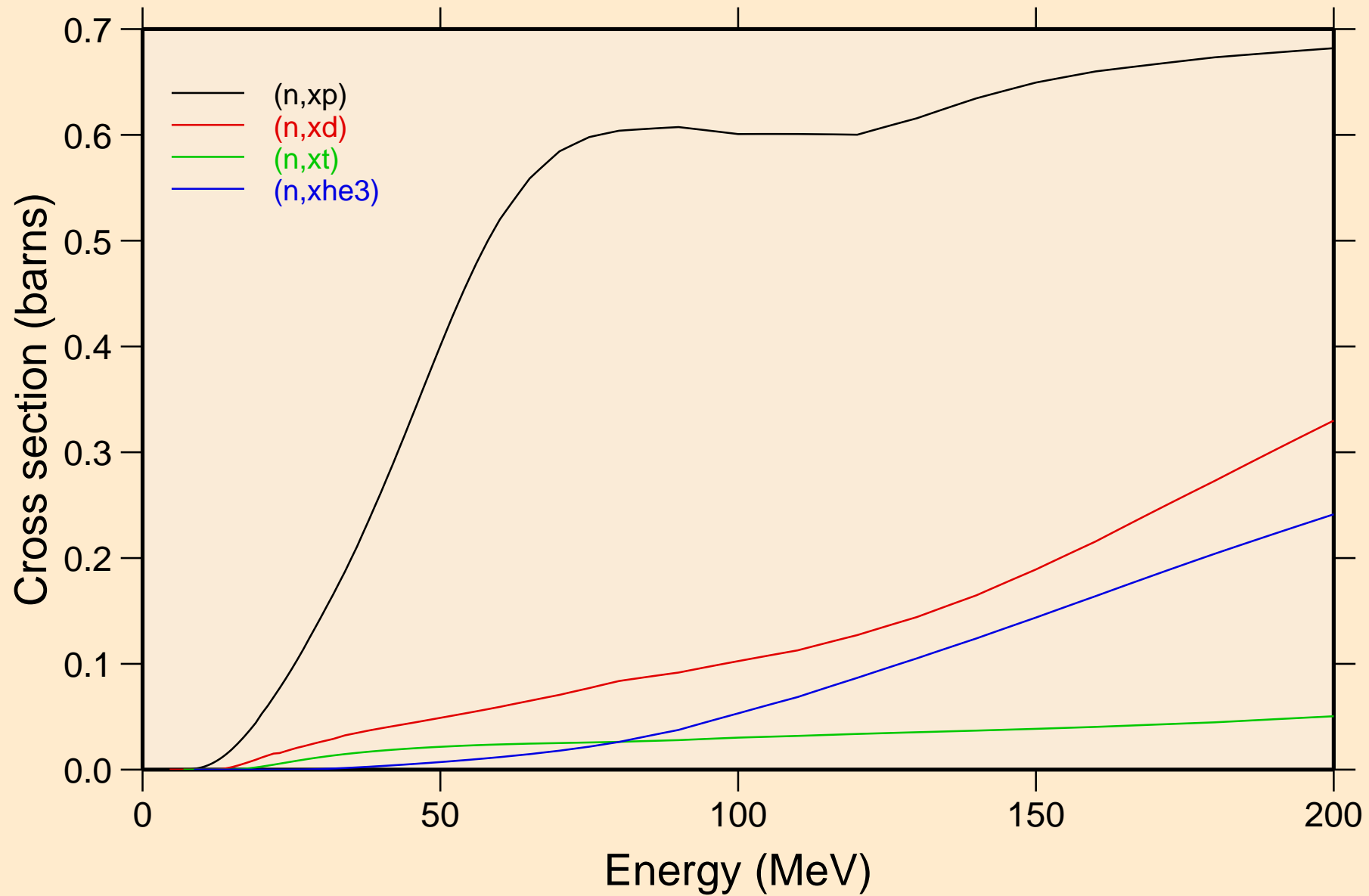

CS135 NEUTRON ACER TENDL-2023 LIBRARY; T=0.K
angular distribution for elastic

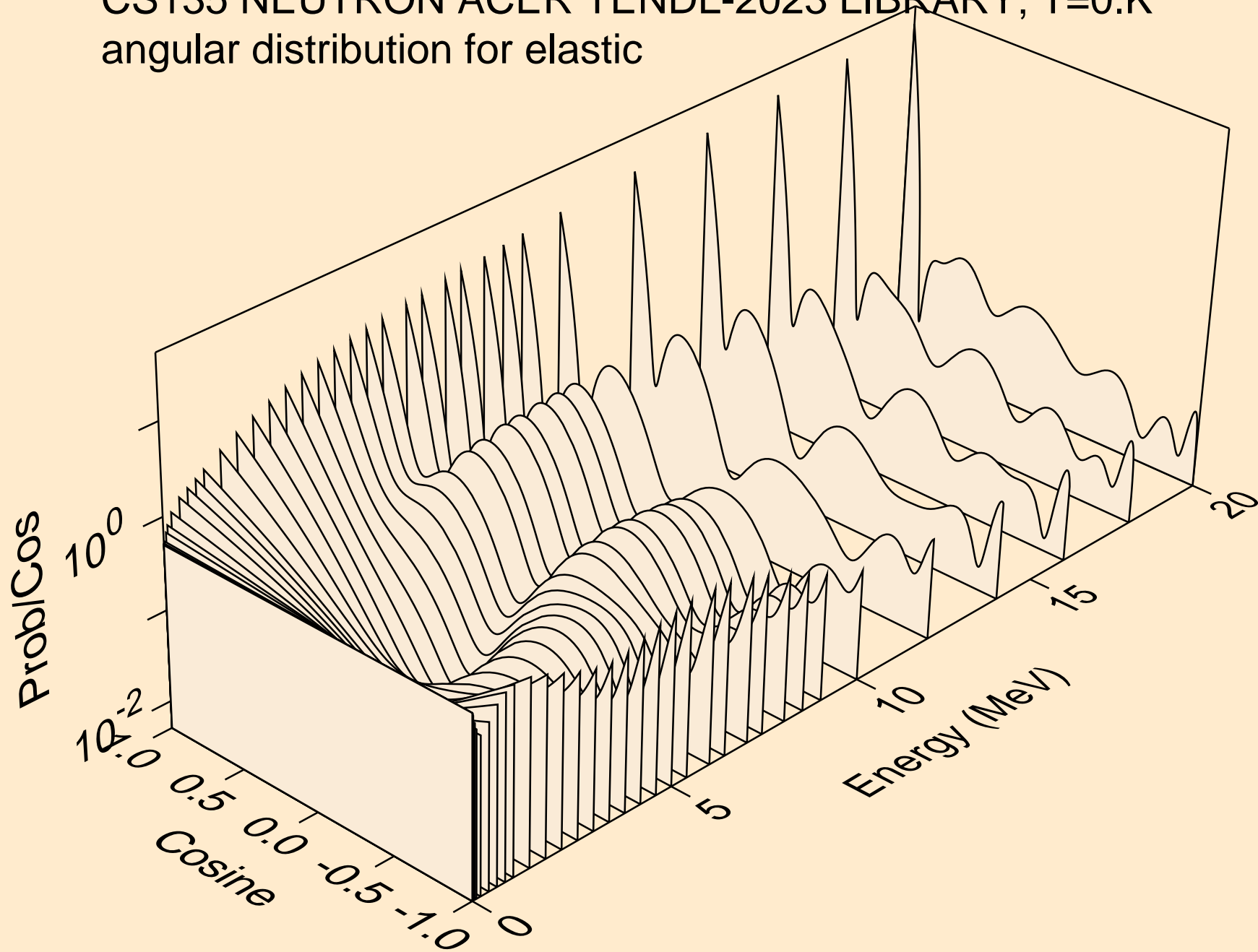

CS135 NEUTRON ACER TENDL-2023 LIBRARY; T=0.K
angular distribution for elastic

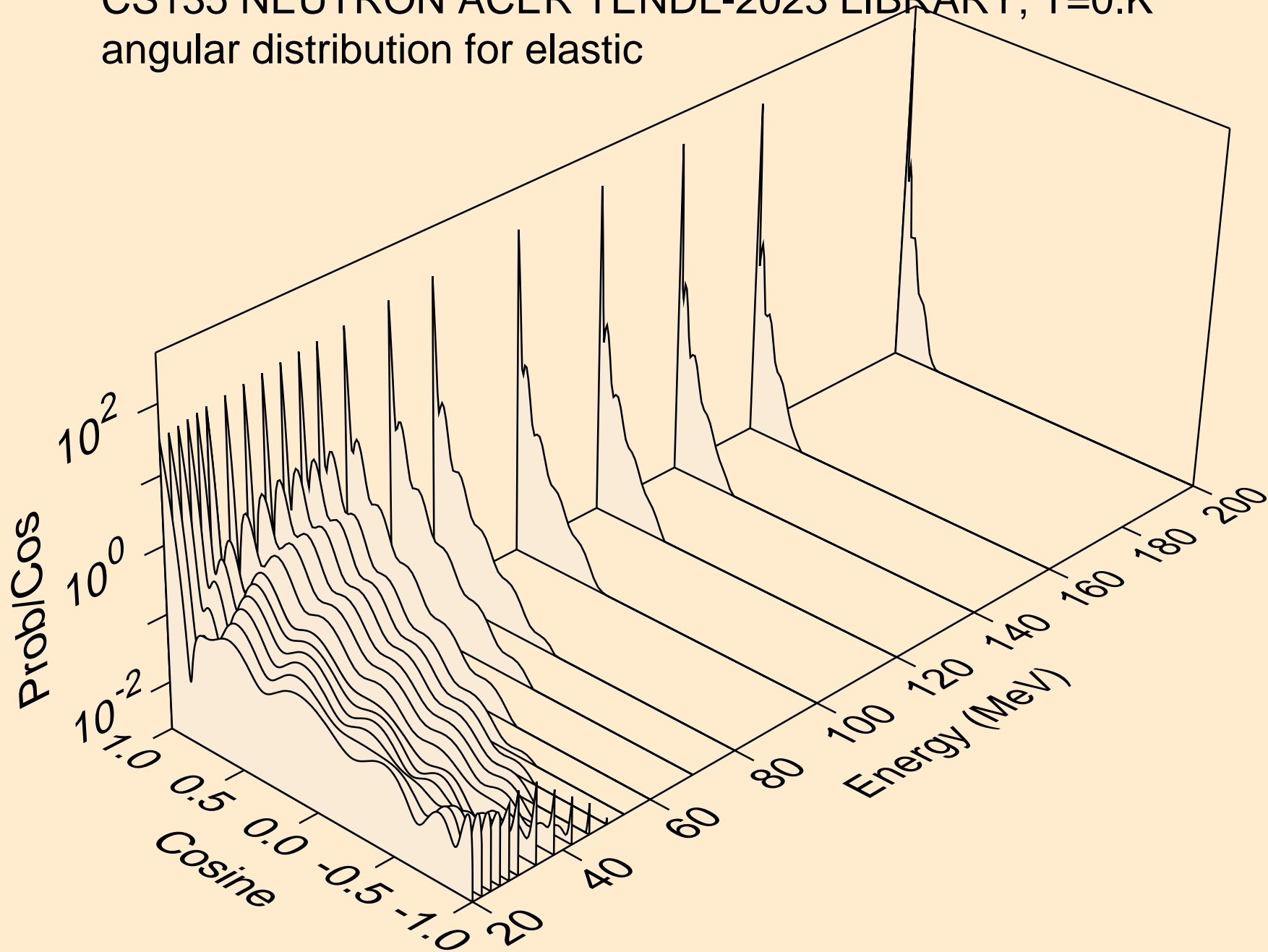

CS135 NEUTRON ACER TENDL-2023 LIBRARY; T=0.K
angular distribution for (n,n*1)

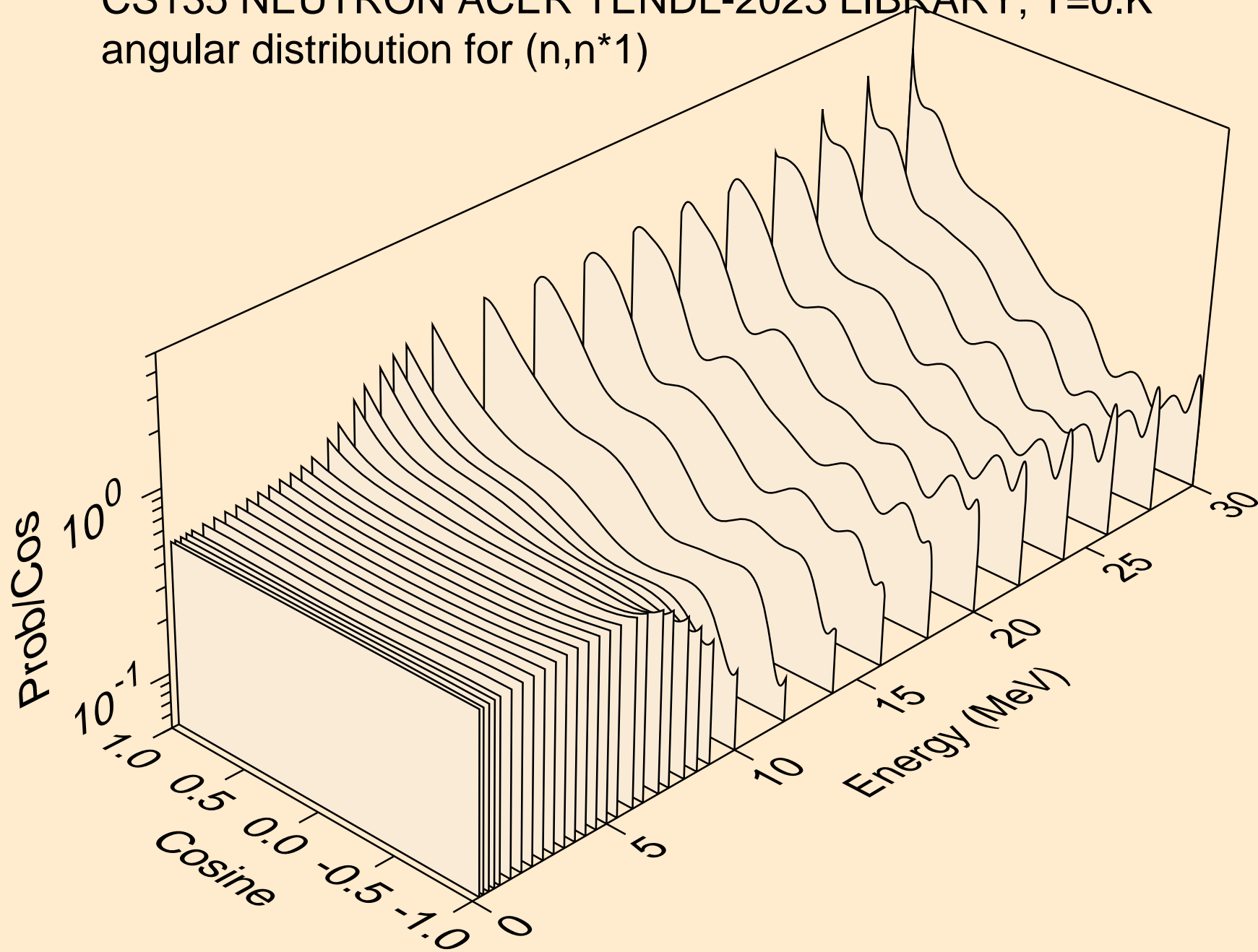

CS135 NEUTRON ACER TENDL-2023 LIBRARY; T=0.K
angular distribution for (n,n*2)

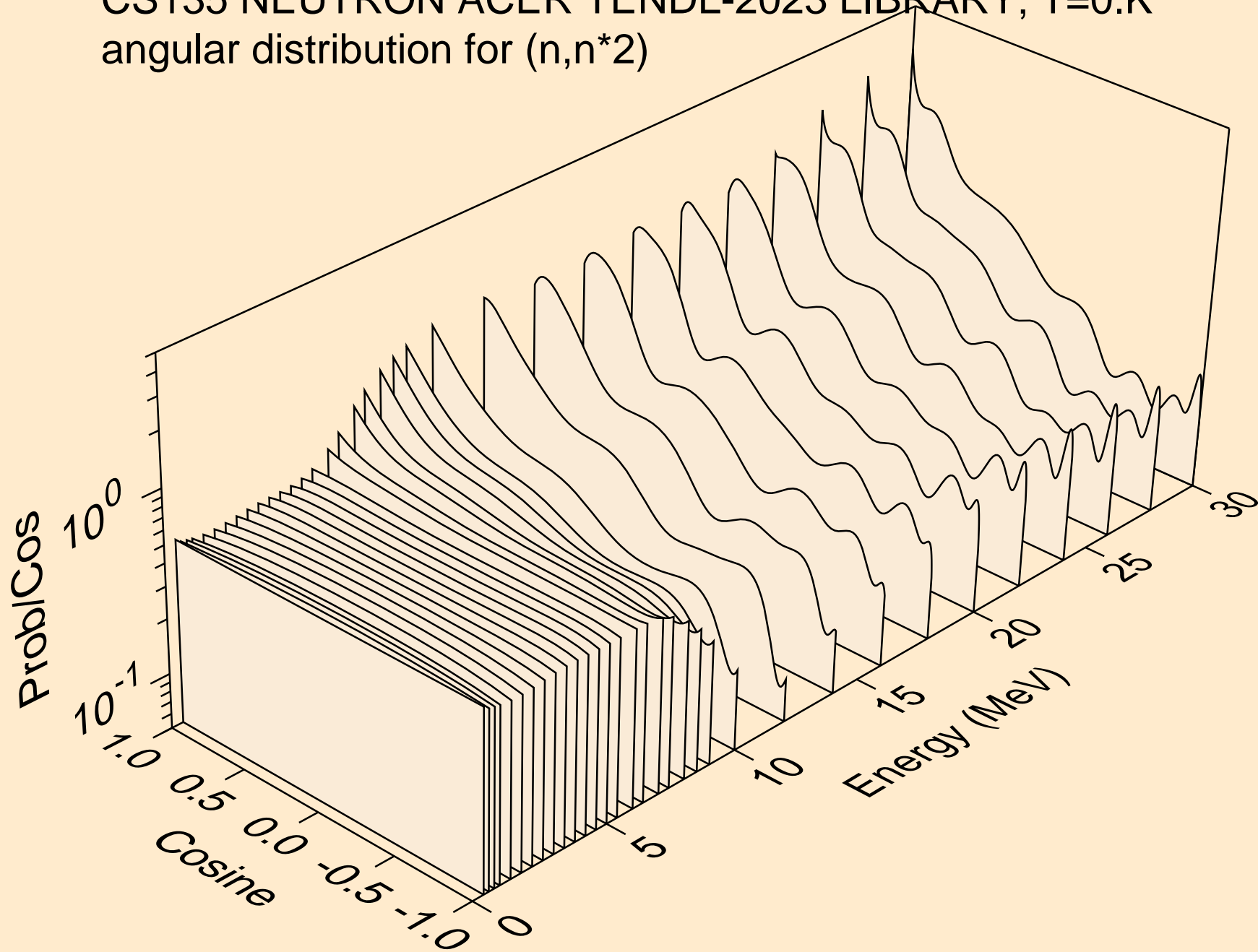

CS135 NEUTRON ACER TENDL-2023 LIBRARY; T=0.K
angular distribution for (n,n*3)

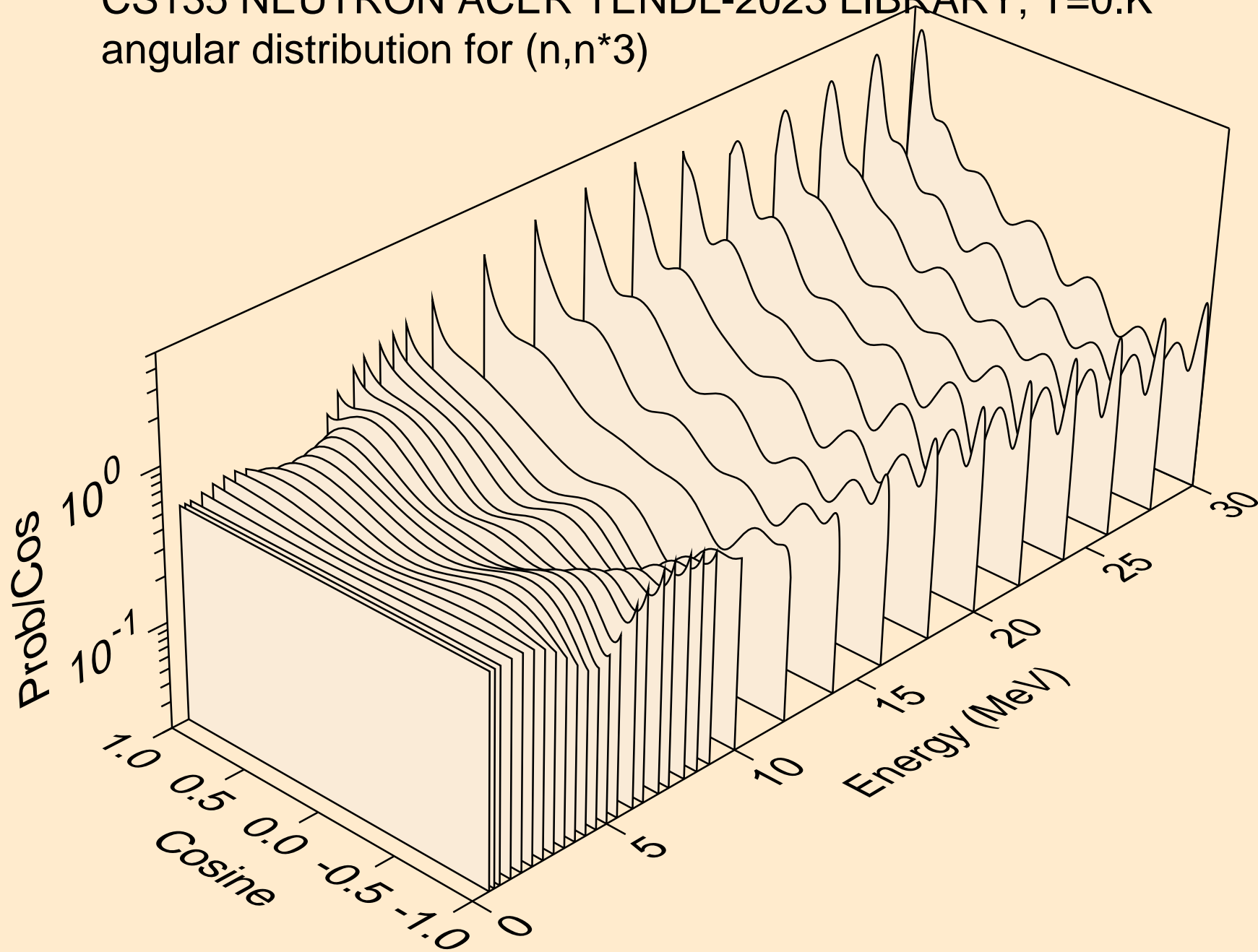

CS135 NEUTRON ACER TENDL-2023 LIBRARY; T=0.K
angular distribution for (n,n*4)

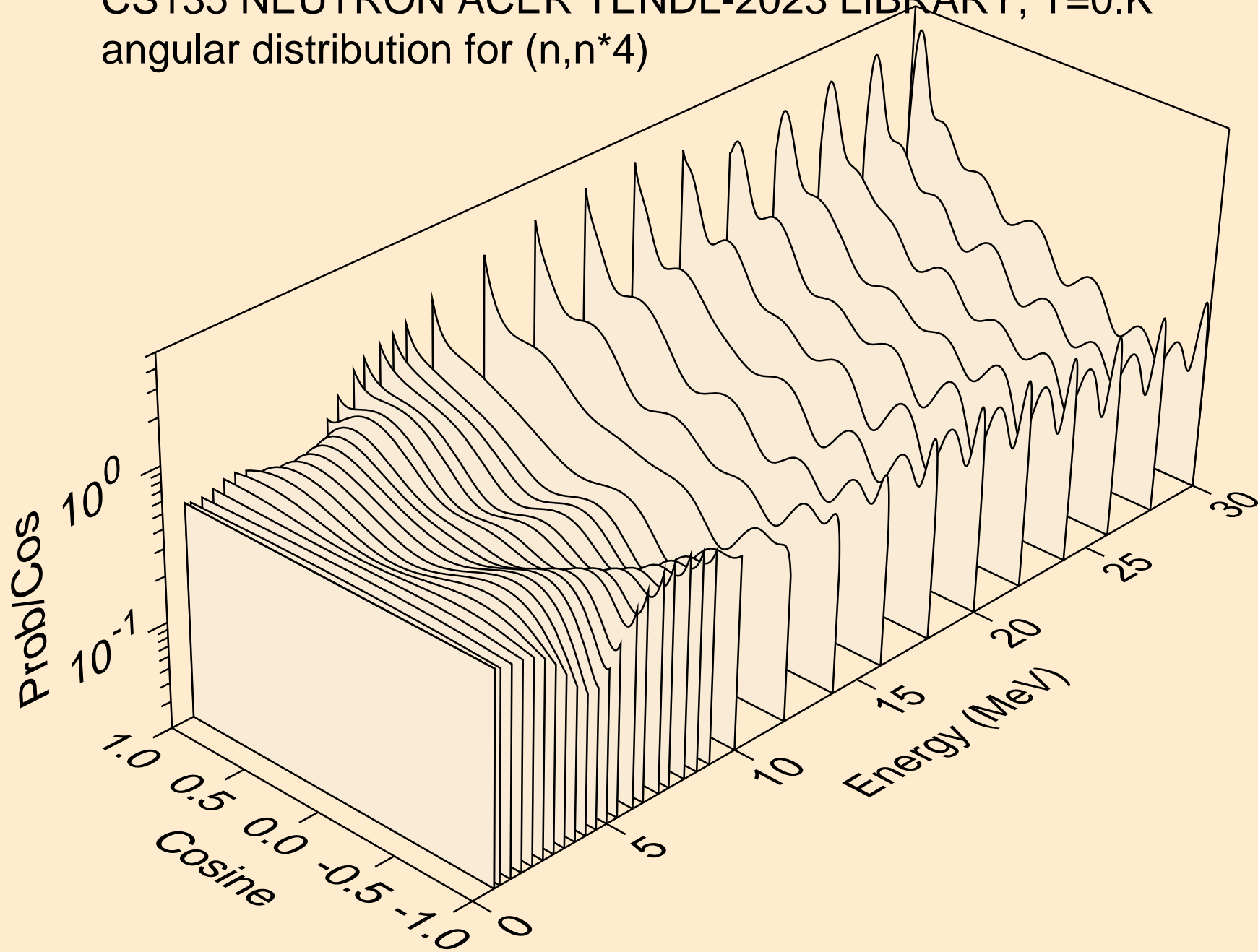

CS135 NEUTRON ACER TENDL-2023 LIBRARY; T=0.K
angular distribution for (n,n*5)

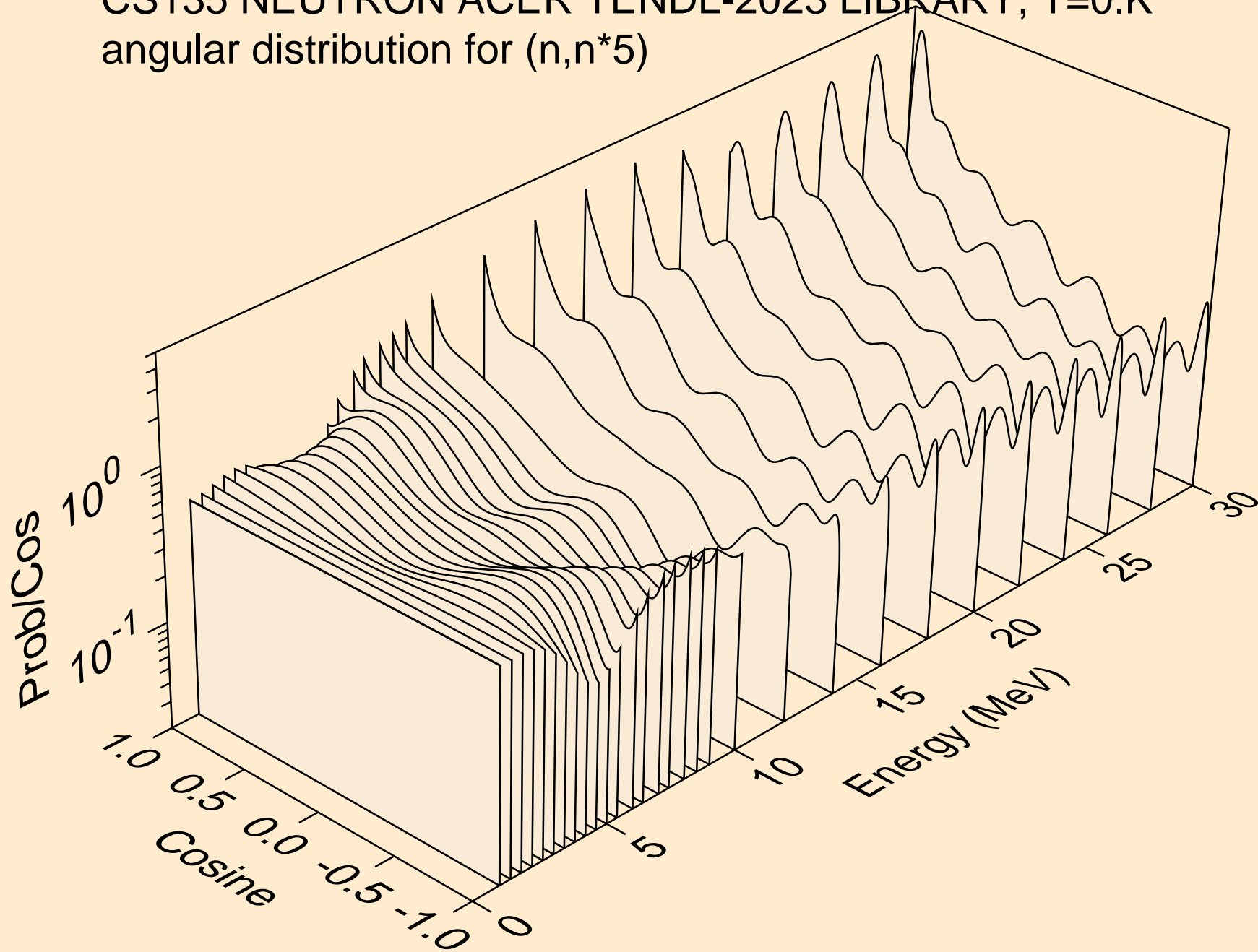

CS135 NEUTRON ACER TENDL-2023 LIBRARY; T=0.K
angular distribution for (n,n*6)

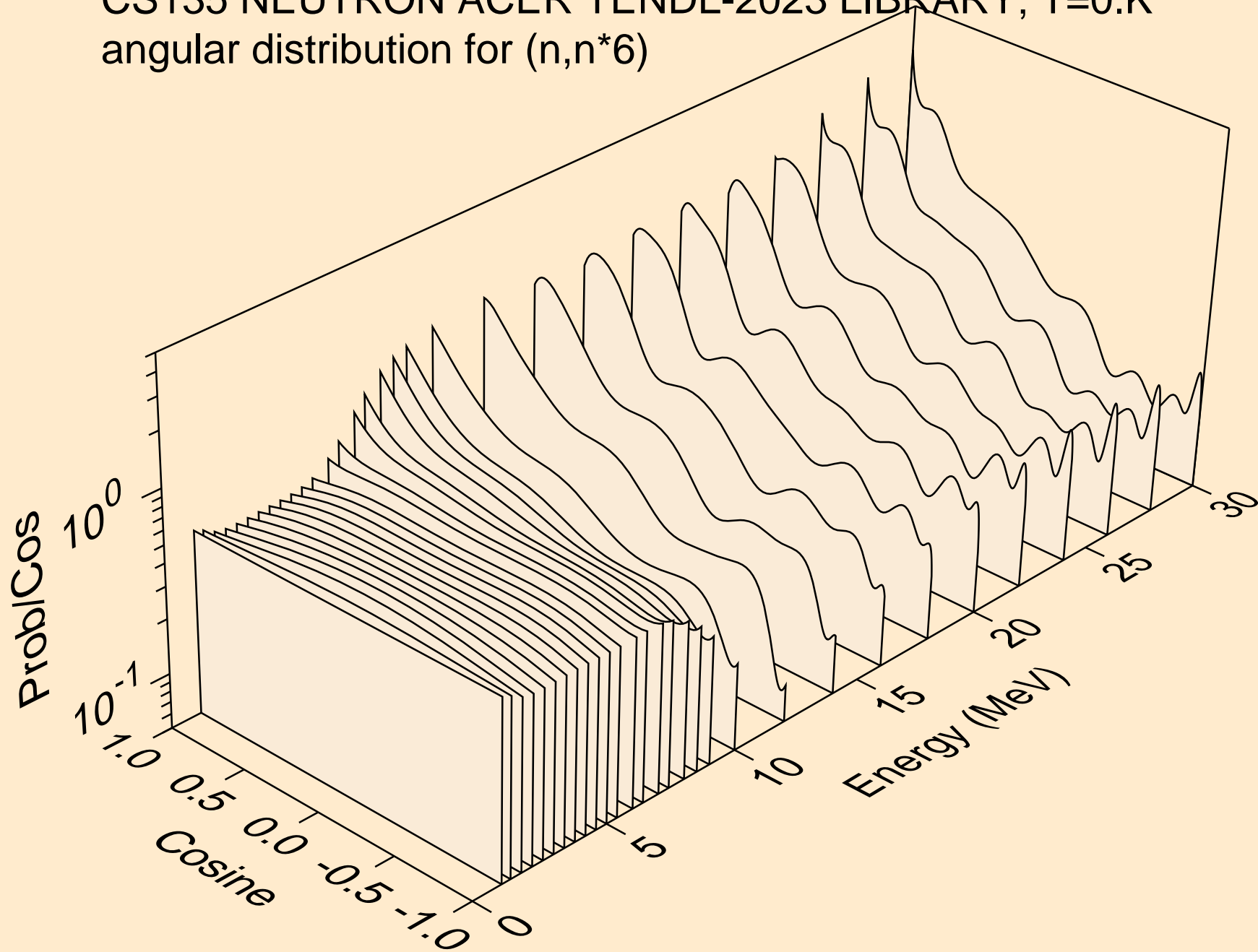

CS135 NEUTRON ACER TENDL-2023 LIBRARY; T=0.K
angular distribution for (n,n*7)

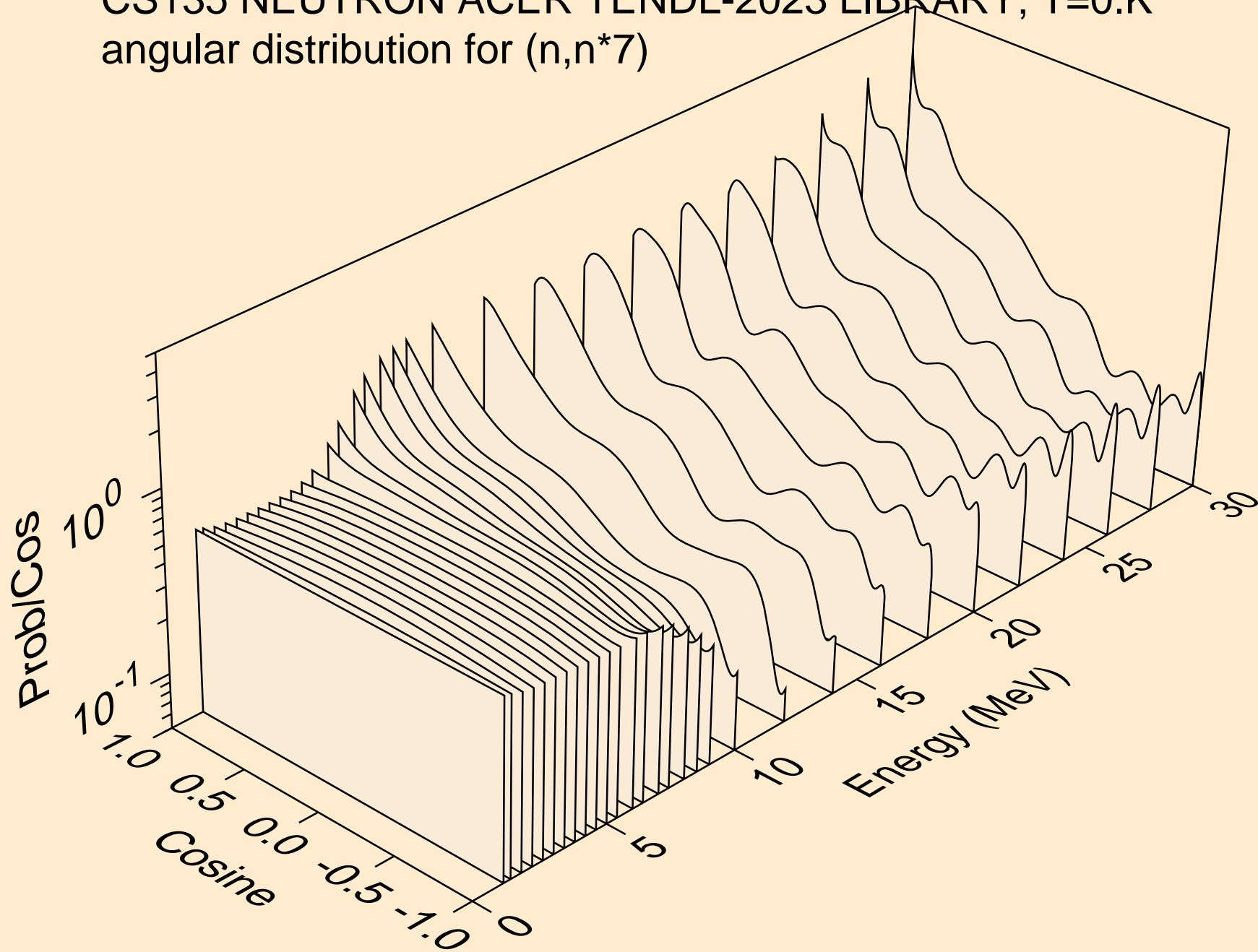

CS135 NEUTRON ACER TENDL-2023 LIBRARY; T=0.K
angular distribution for (n,n*8)

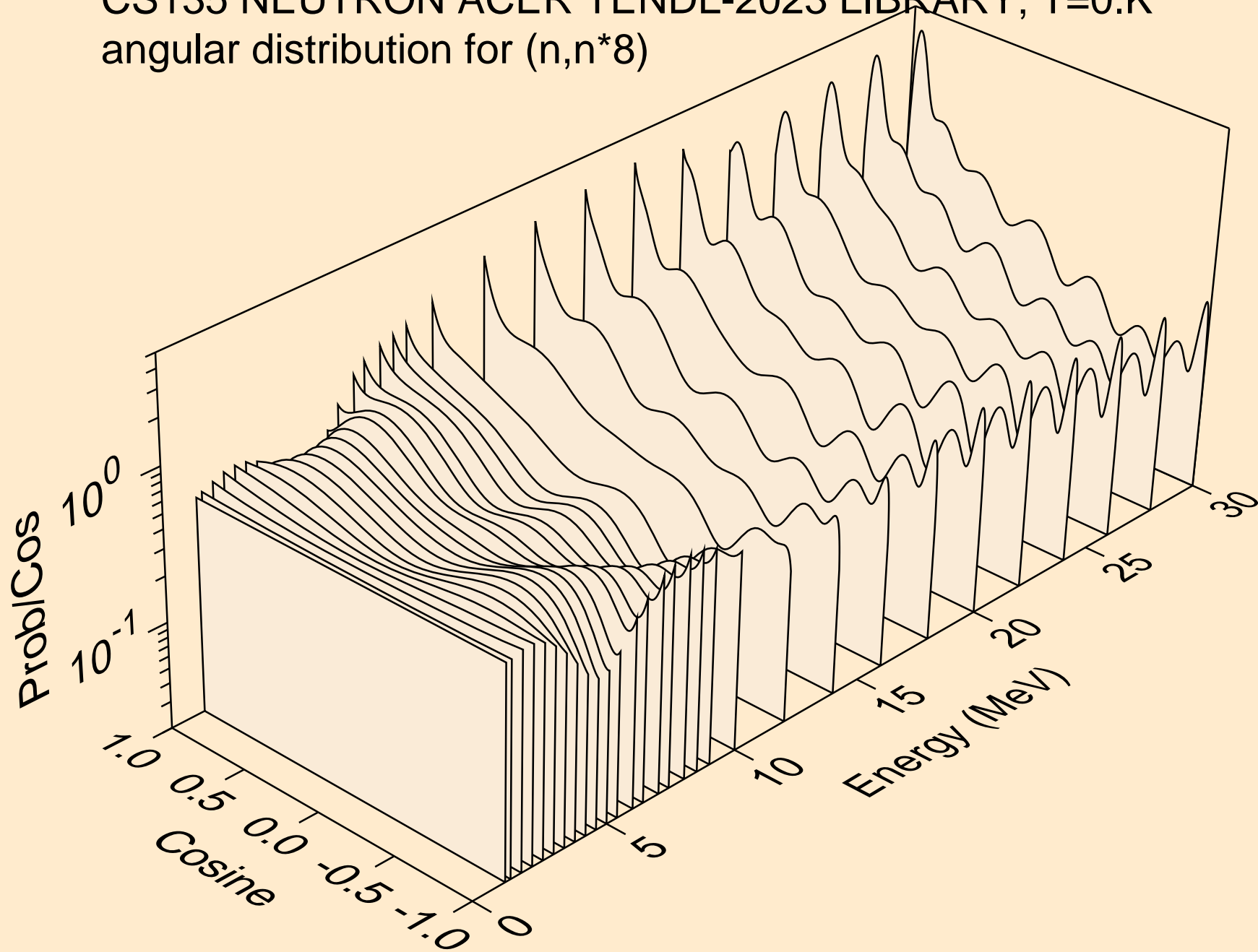

CS135 NEUTRON ACER TENDL-2023 LIBRARY; T=0.K
angular distribution for (n,n*9)

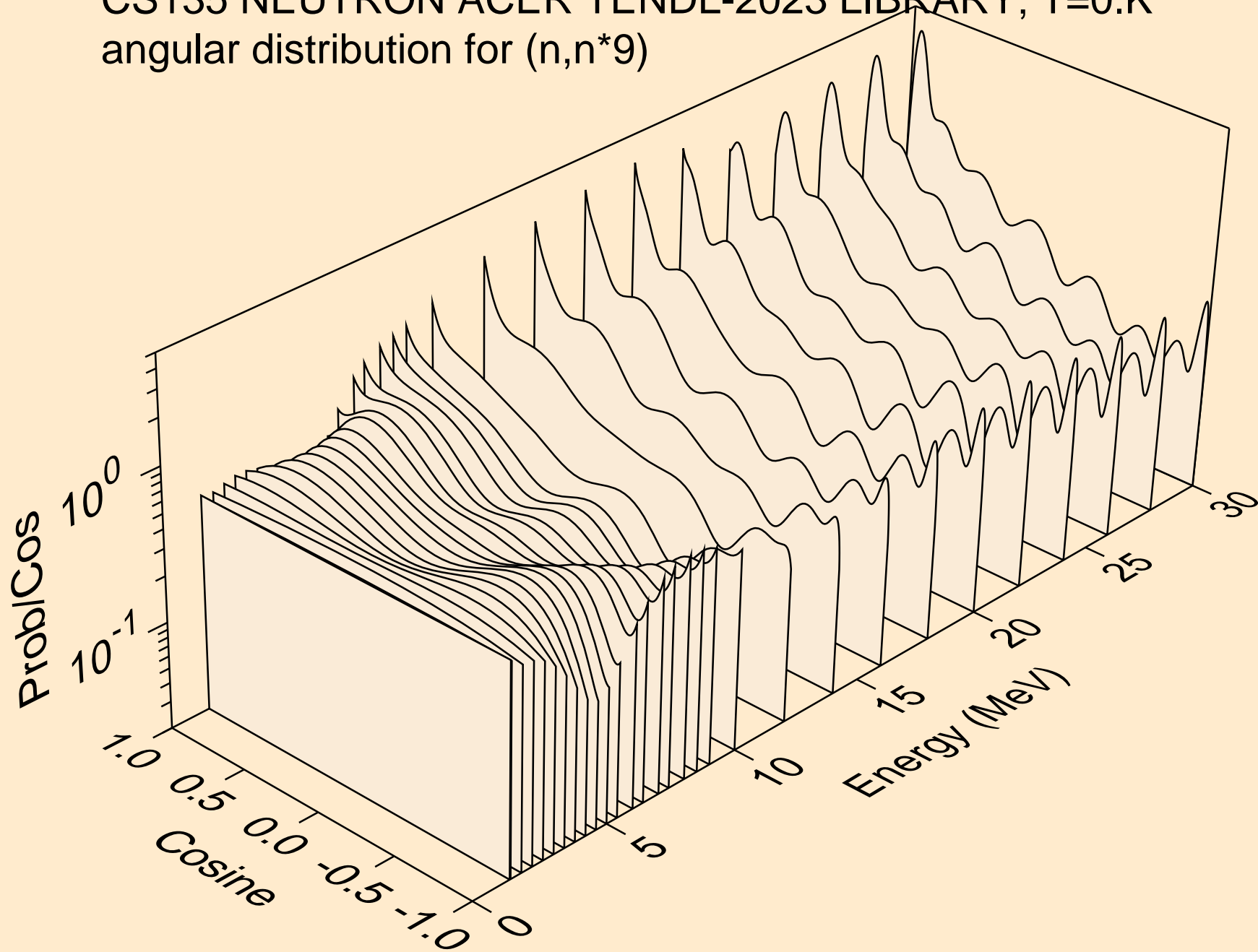

CS135 NEUTRON ACER TENDL-2023 LIBRARY; T=0.K
angular distribution for (n,n*10)

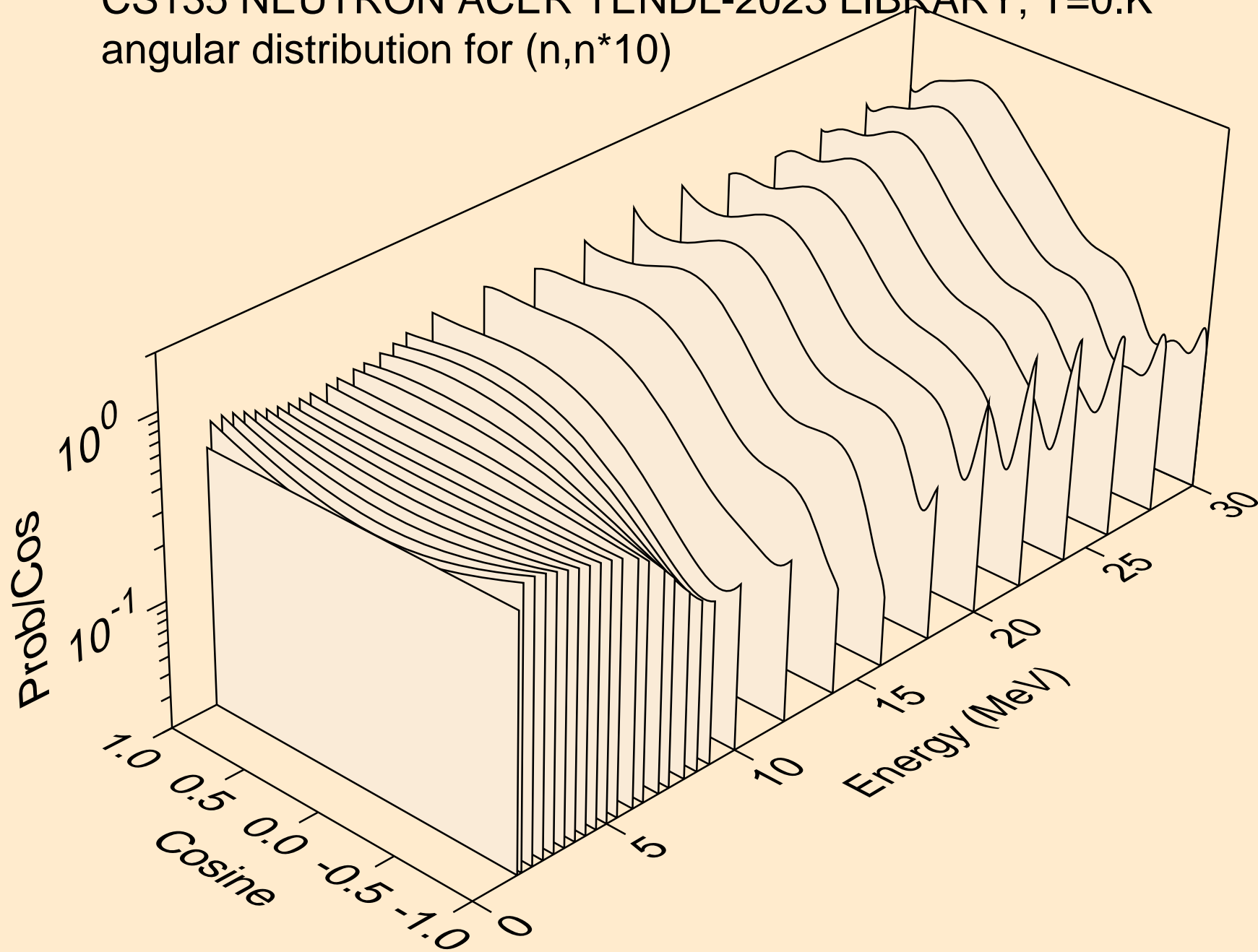

CS135 NEUTRON ACER TENDL-2023 LIBRARY; T=0.K
angular distribution for (n,n*11)

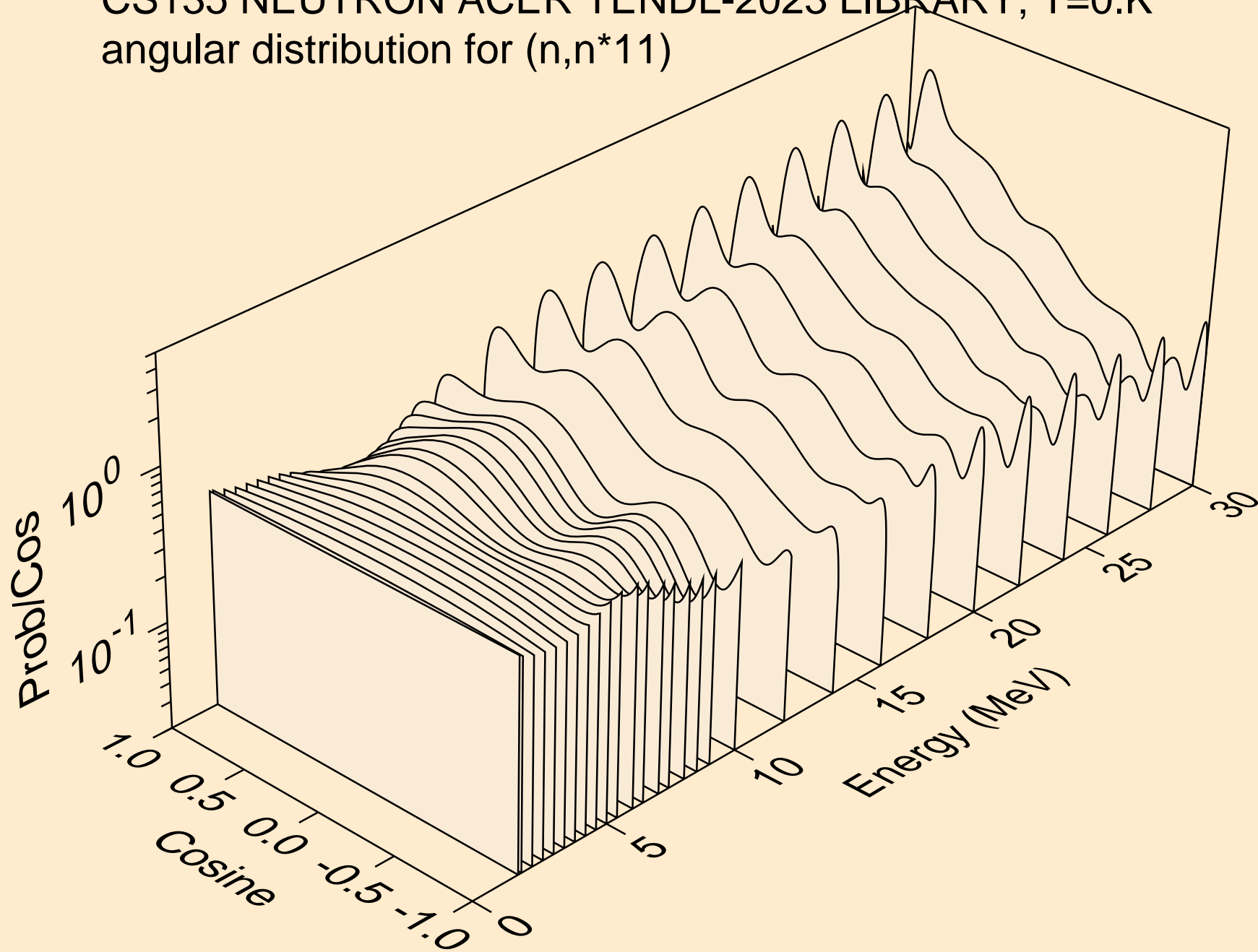

CS135 NEUTRON ACER TENDL-2023 LIBRARY; T=0.K
angular distribution for (n,n*12)

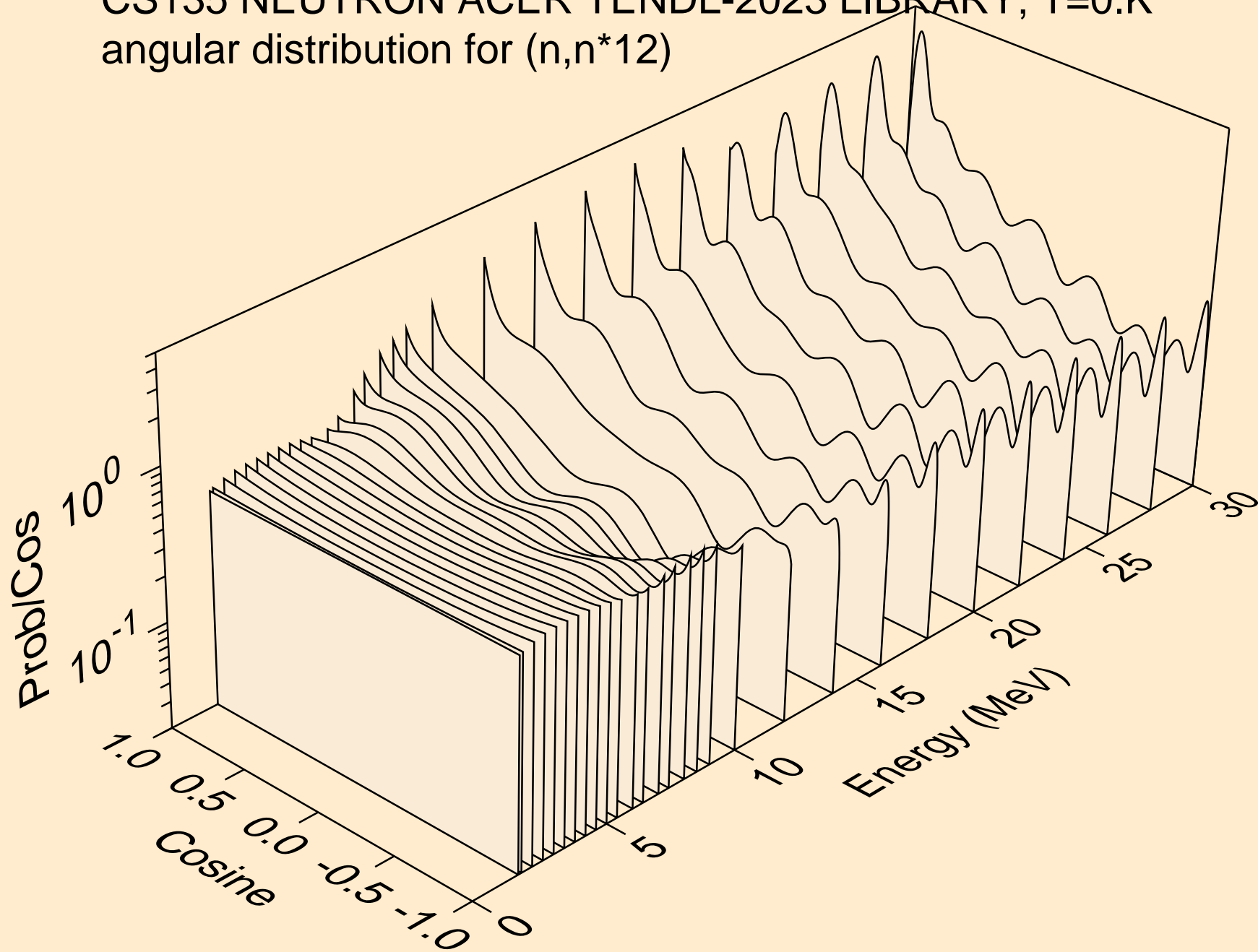

CS135 NEUTRON ACER TENDL-2023 LIBRARY; T=0.K
angular distribution for (n,n*13)

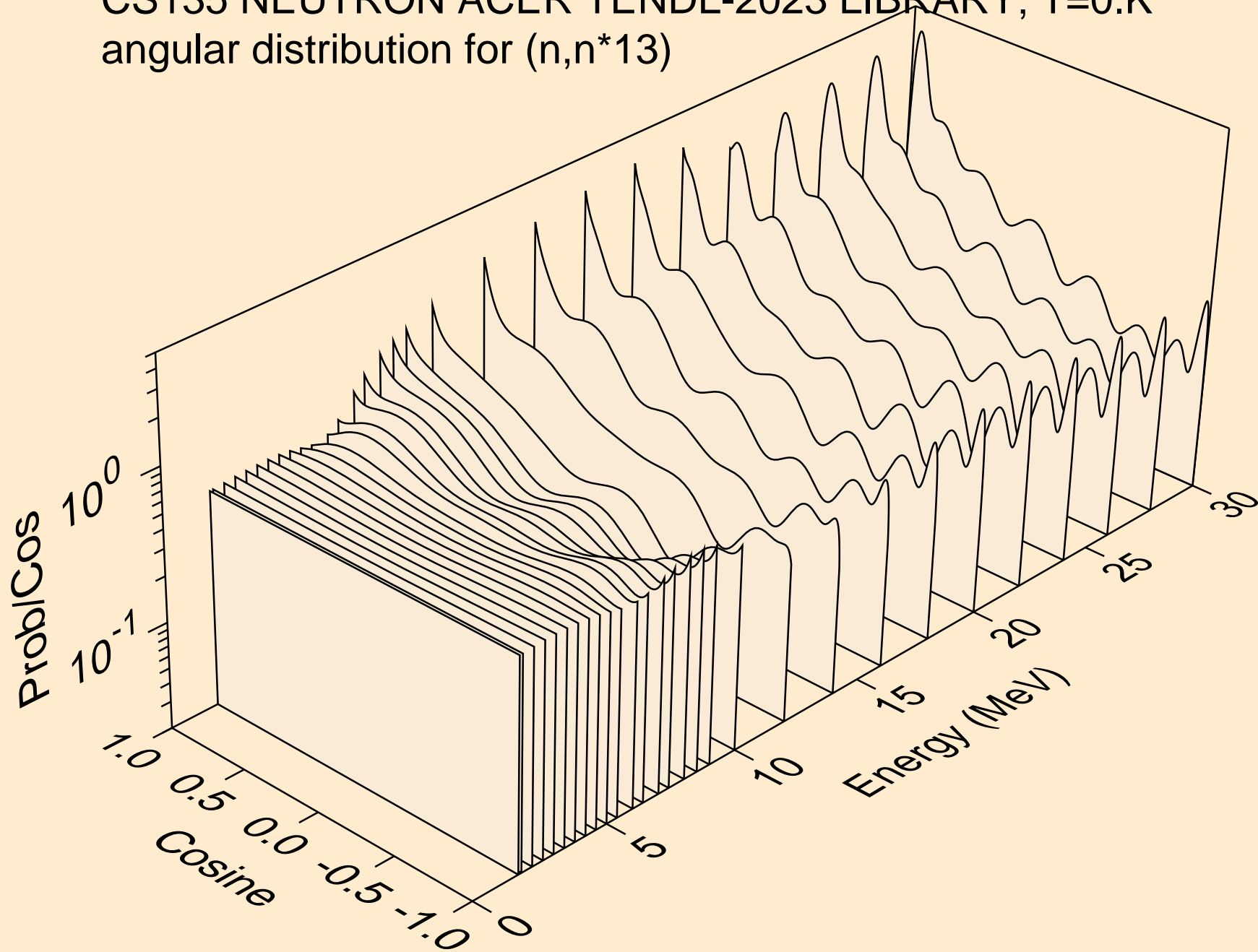

CS135 NEUTRON ACER TENDL-2023 LIBRARY; T=0.K
angular distribution for (n,n*14)

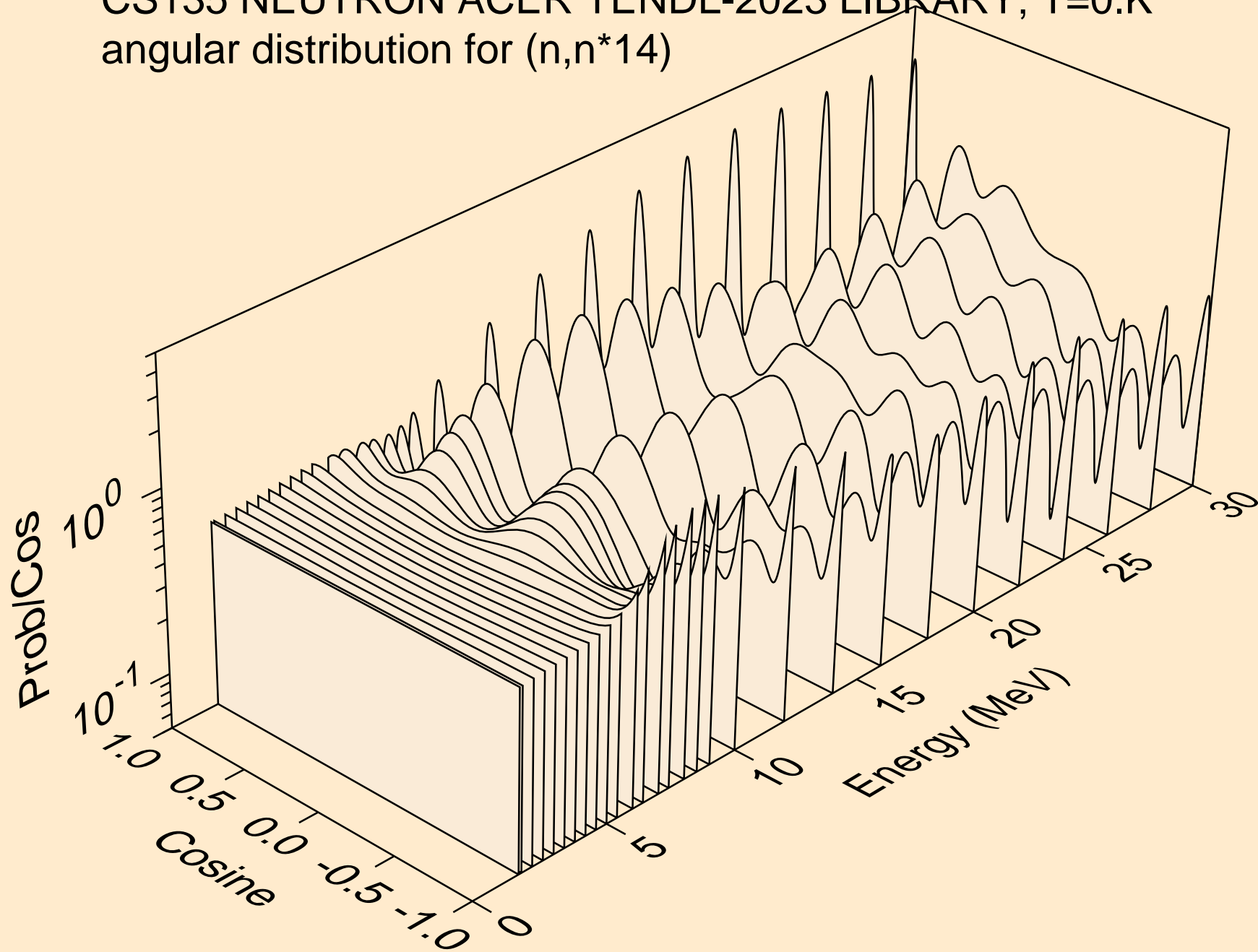

CS135 NEUTRON ACER TENDL-2023 LIBRARY; T=0.K
angular distribution for (n,n*15)

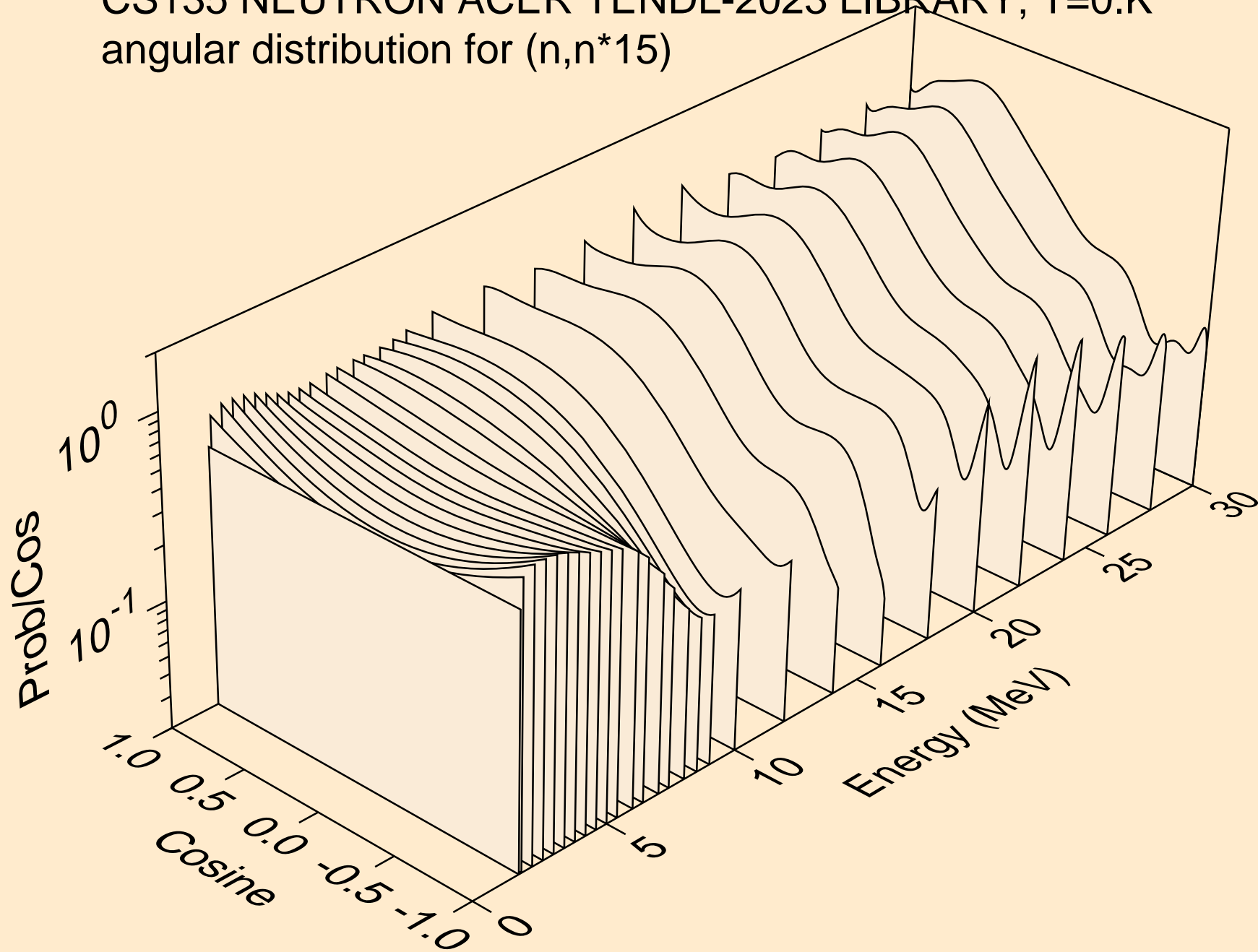

CS135 NEUTRON ACER TENDL-2023 LIBRARY; T=0.K
angular distribution for (n,n*16)

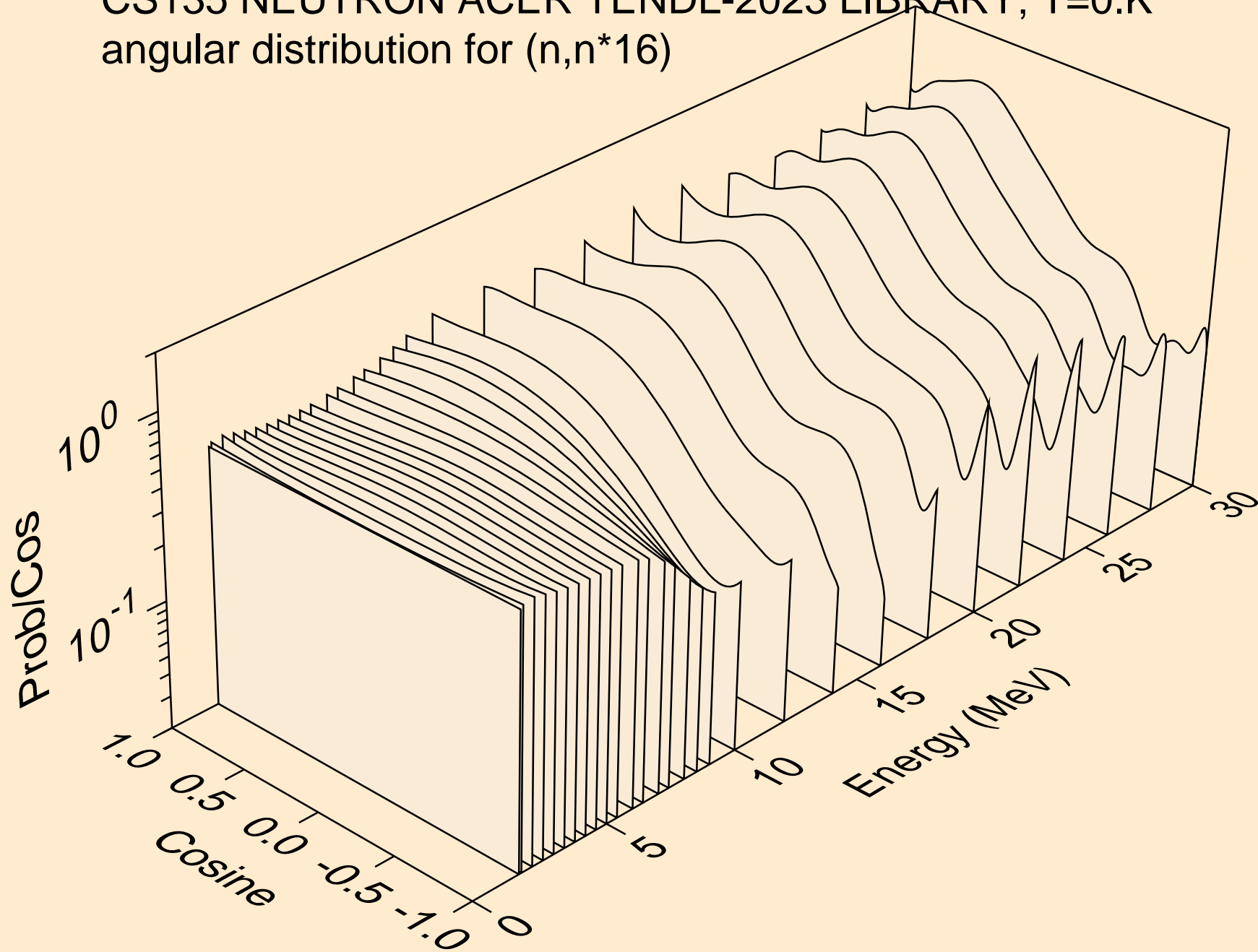

CS135 NEUTRON ACER TENDL-2023 LIBRARY; T=0.K
angular distribution for (n,n*17)

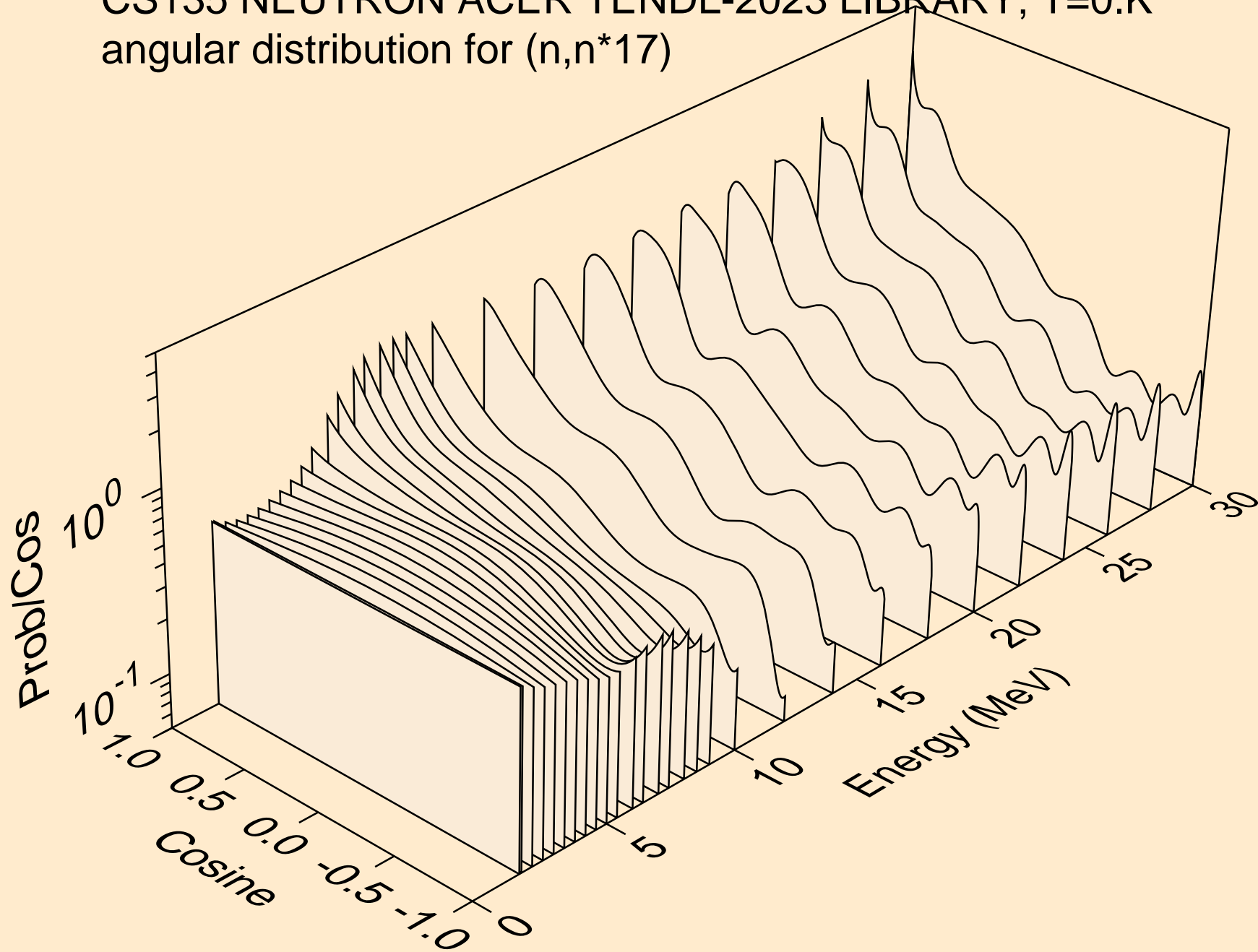

CS135 NEUTRON ACER TENDL-2023 LIBRARY; T=0.K
angular distribution for (n,n*18)

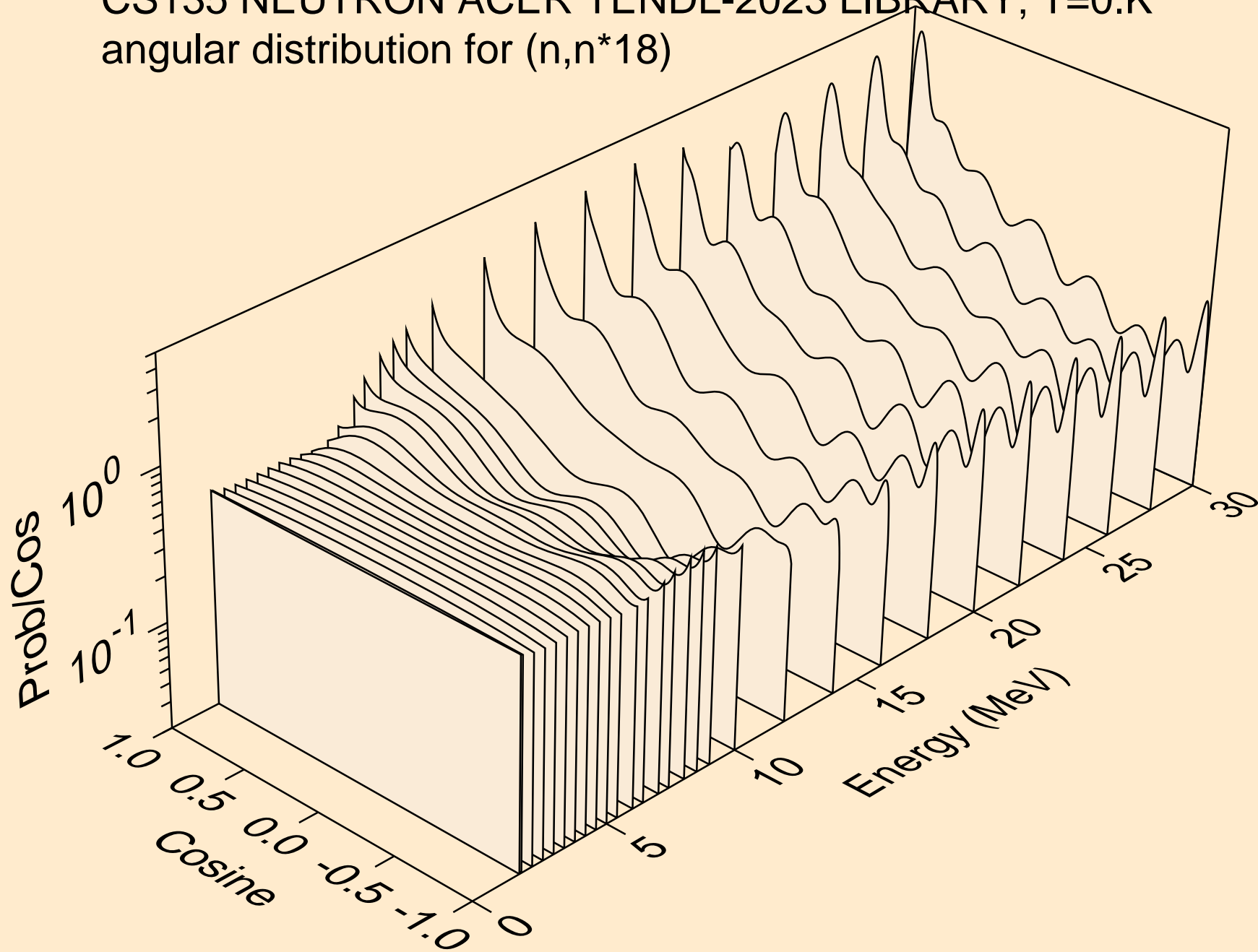

CS135 NEUTRON ACER TENDL-2023 LIBRARY; T=0.K
angular distribution for (n,n*19)

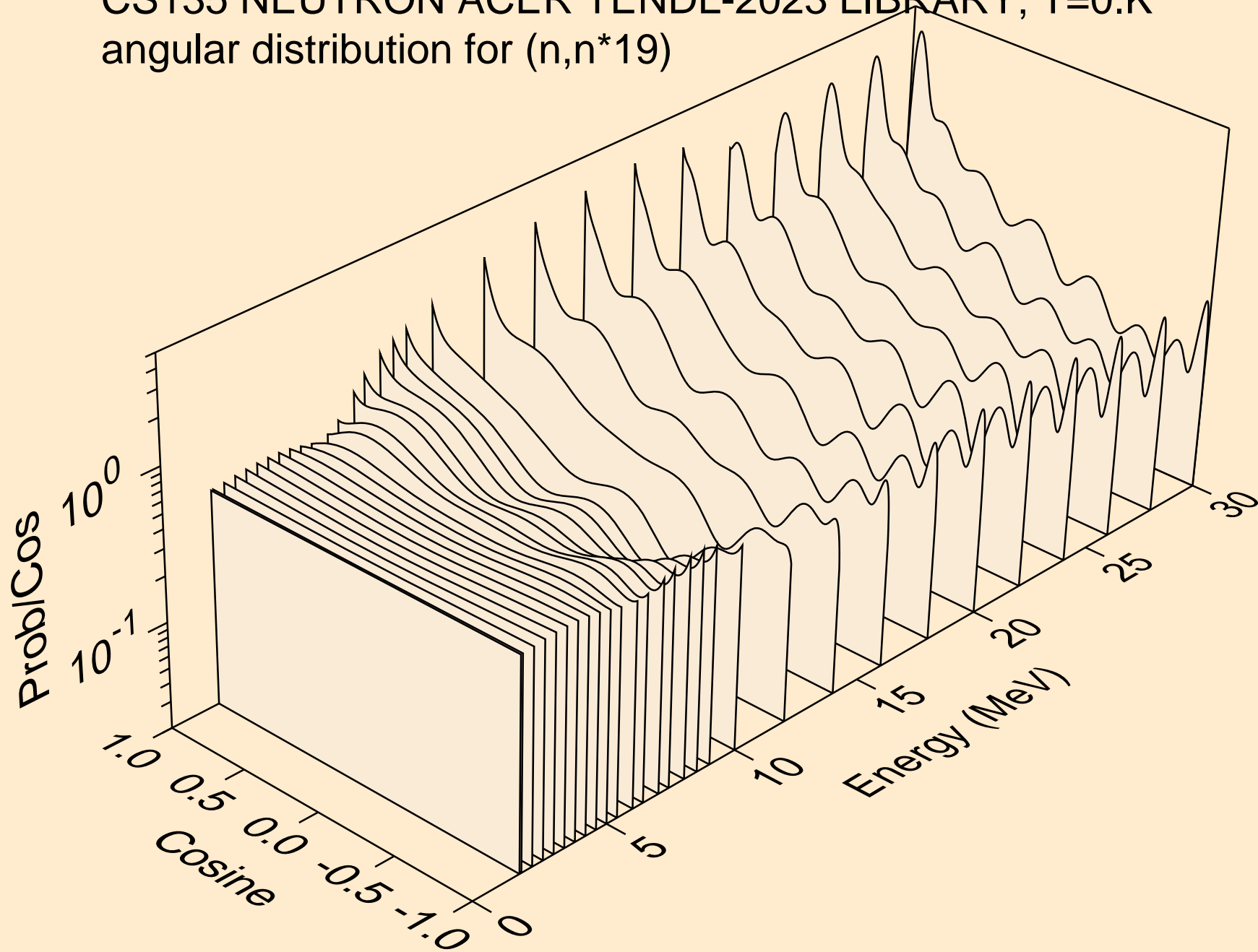

CS135 NEUTRON ACER TENDL-2023 LIBRARY; T=0.K
angular distribution for (n,n*20)

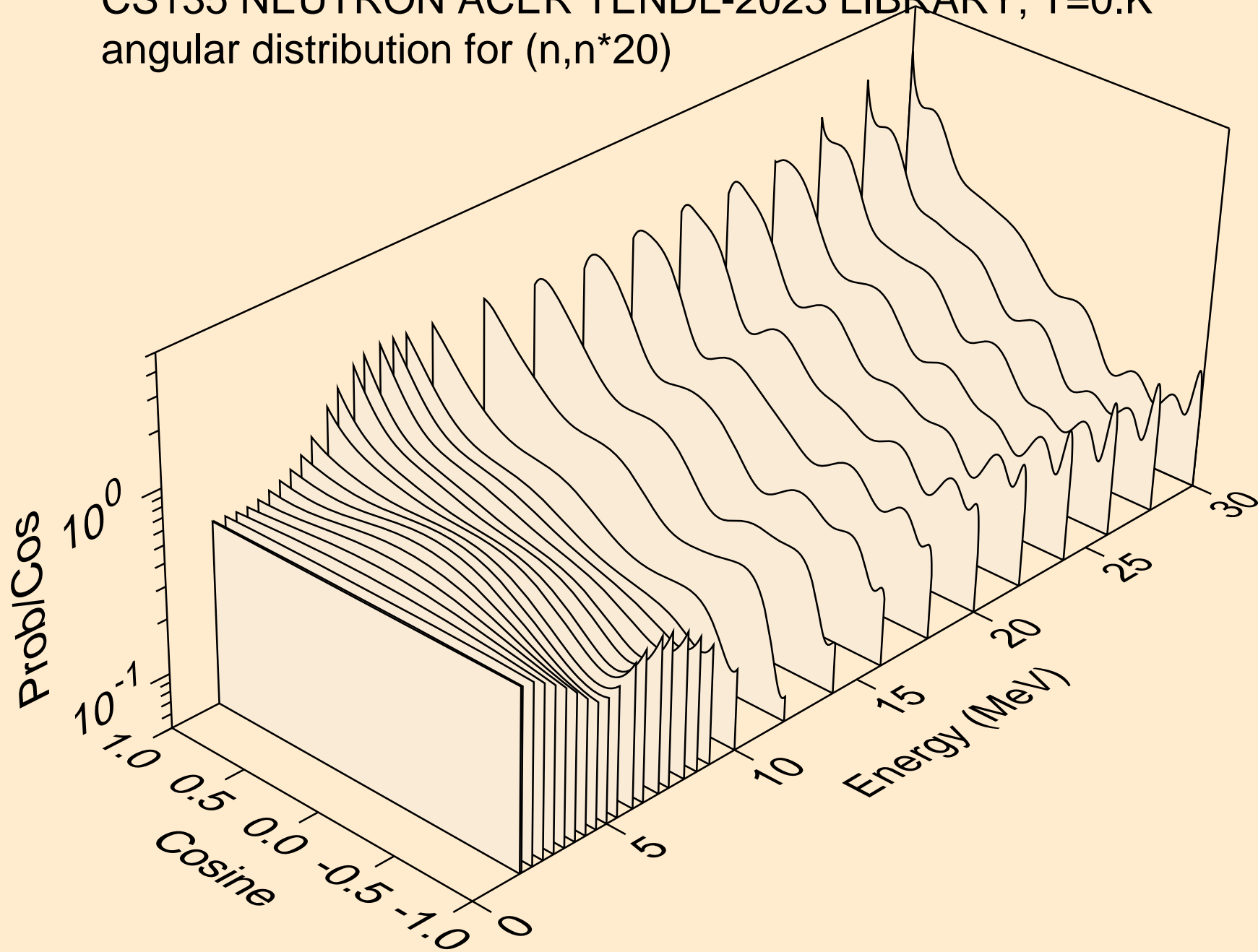

CS135 NEUTRON ACER TENDL-2023 LIBRARY; T=0.K
angular distribution for (n,n*21)

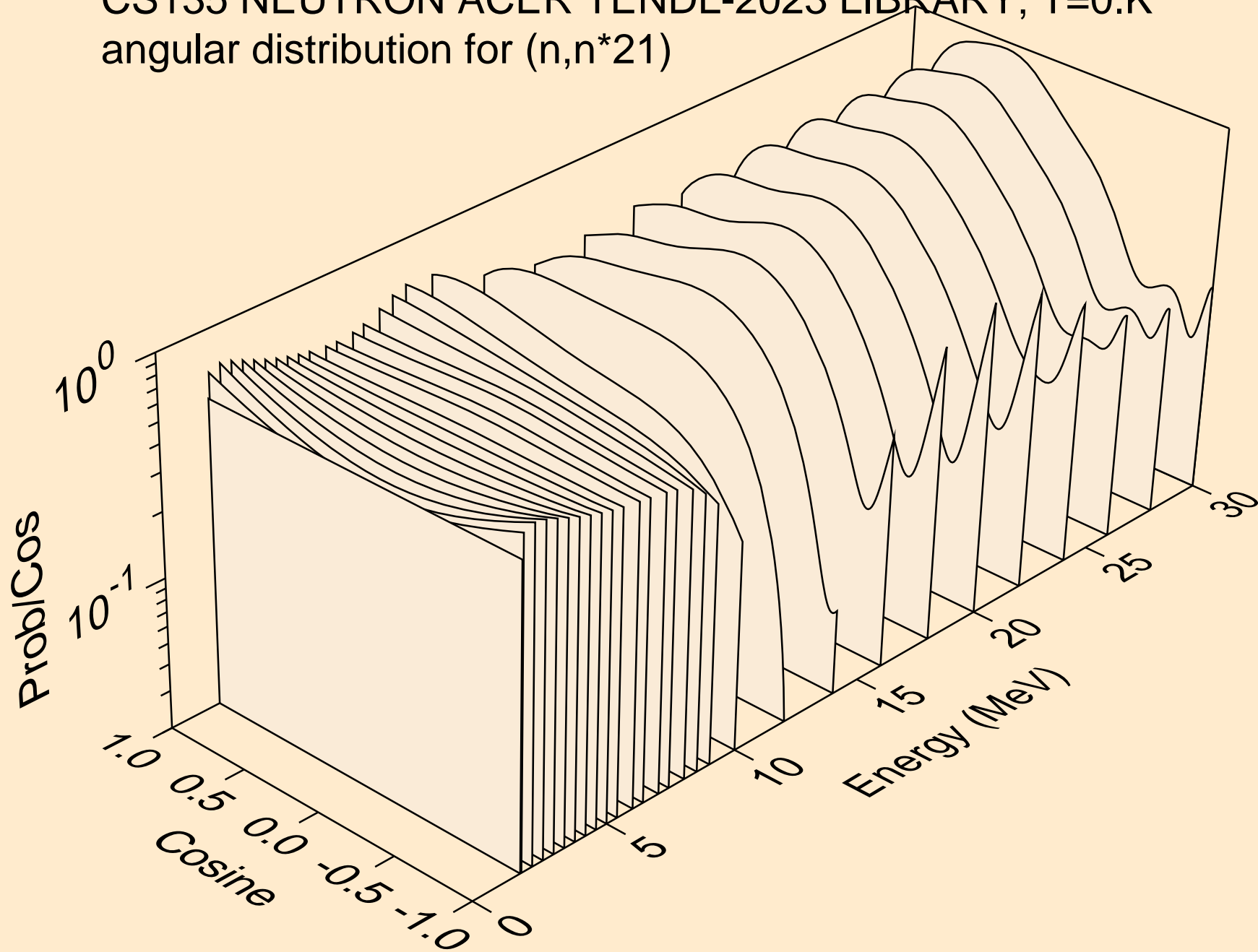

CS135 NEUTRON ACER TENDL-2023 LIBRARY; T=0.K
angular distribution for (n,n*22)

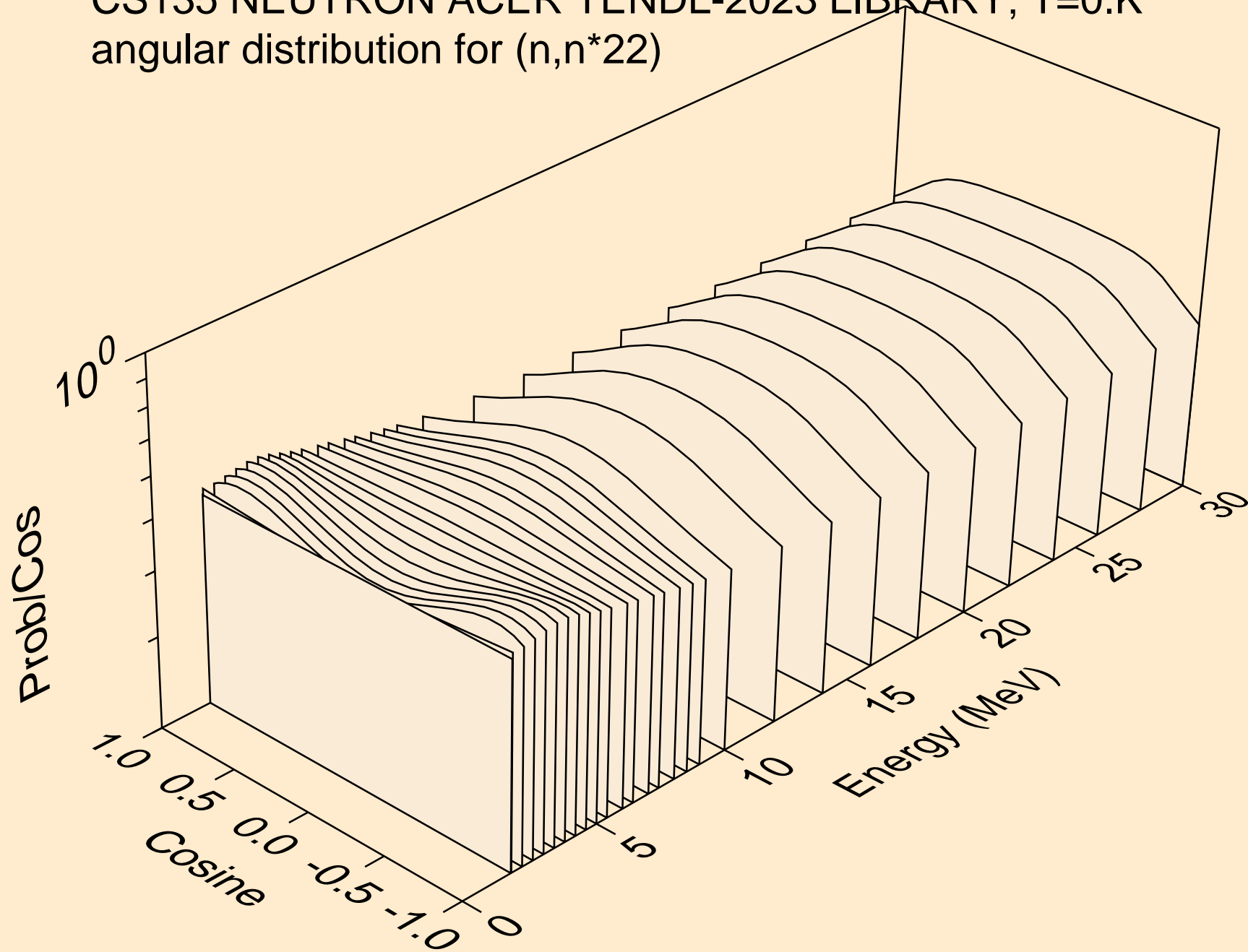

CS135 NEUTRON ACER TENDL-2023 LIBRARY; T=0.K
angular distribution for (n,n*23)

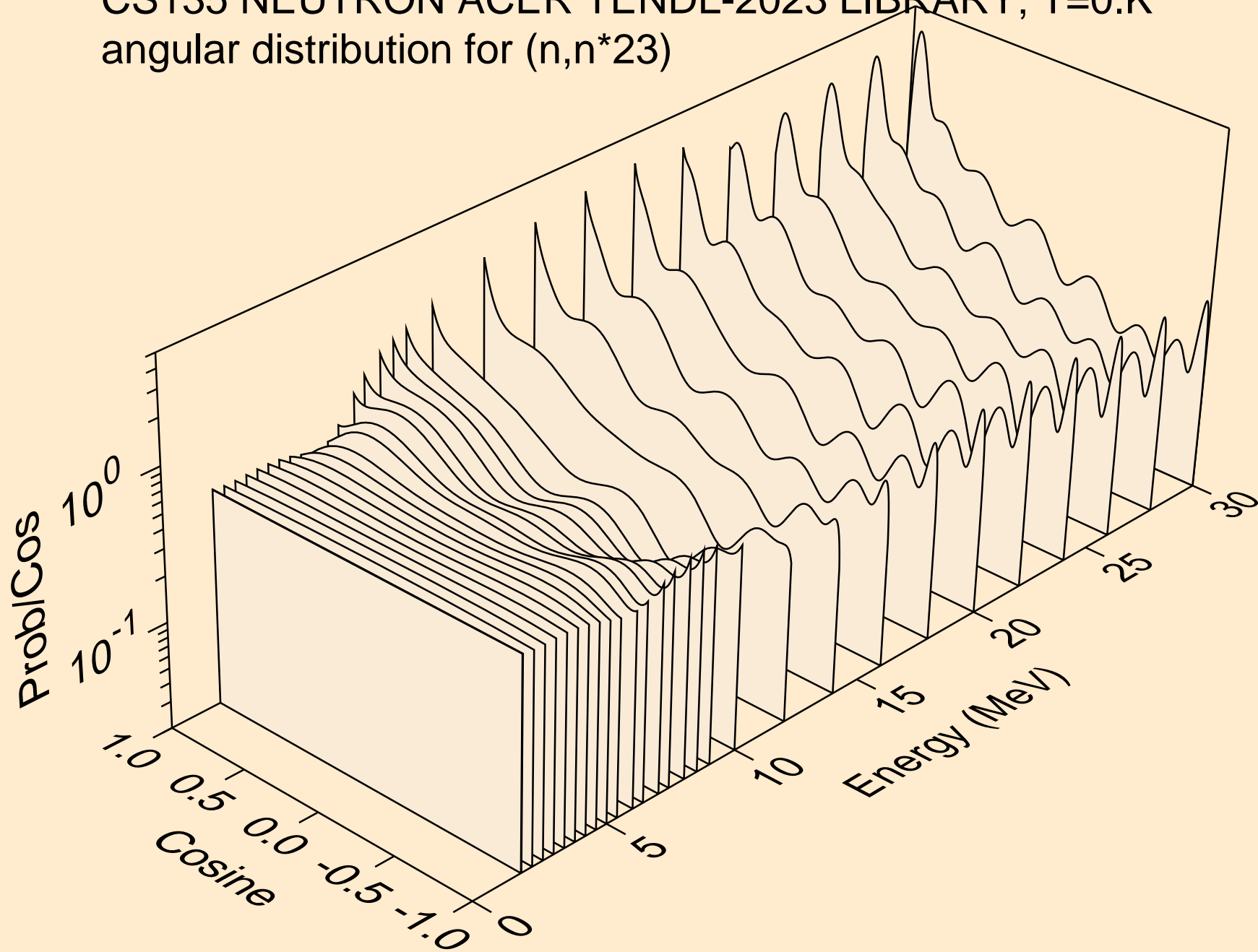

CS135 NEUTRON ACER TENDL-2023 LIBRARY; T=0.K
angular distribution for (n,n*24)

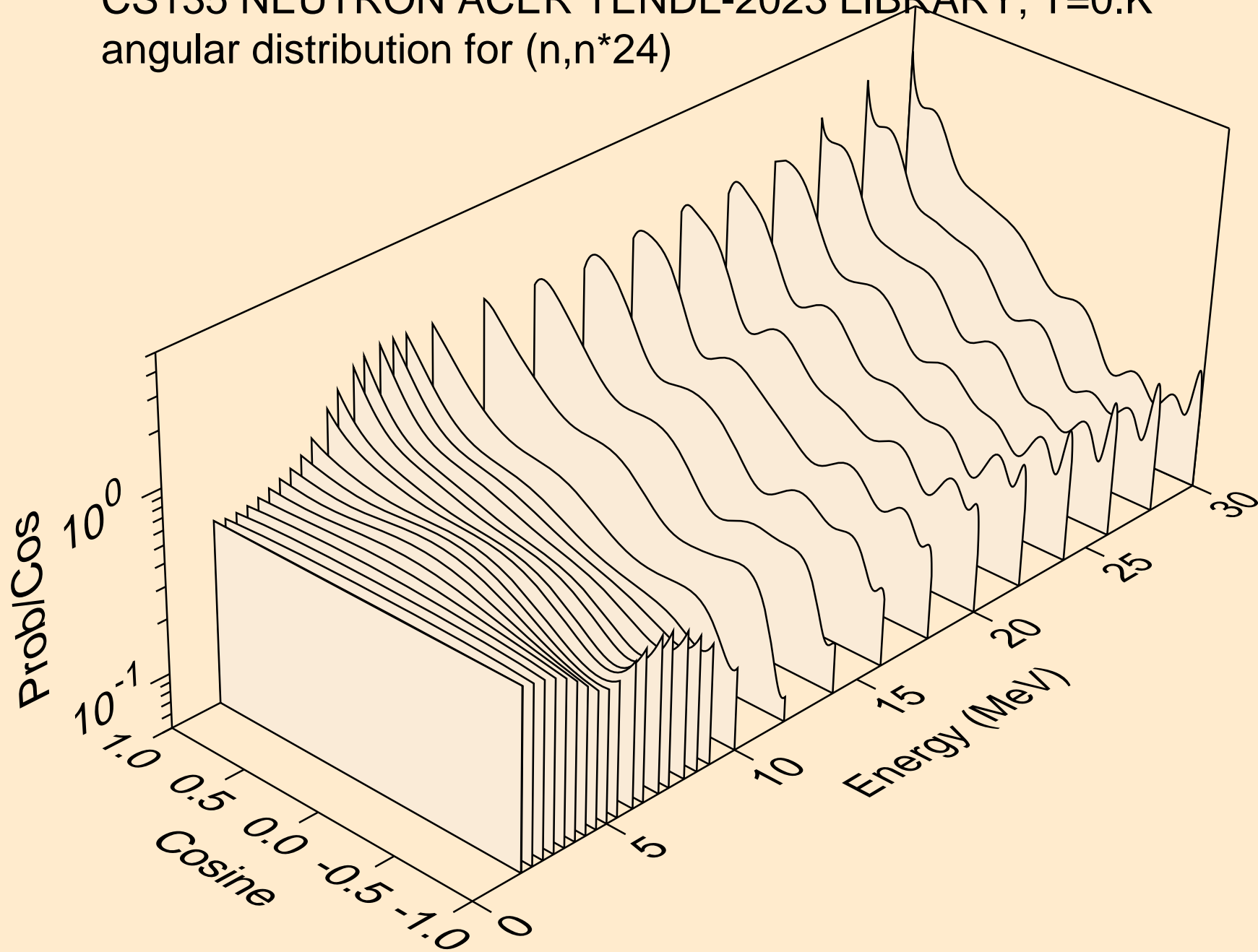

CS135 NEUTRON ACER TENDL-2023 LIBRARY; T=0.K
angular distribution for (n,n*25)

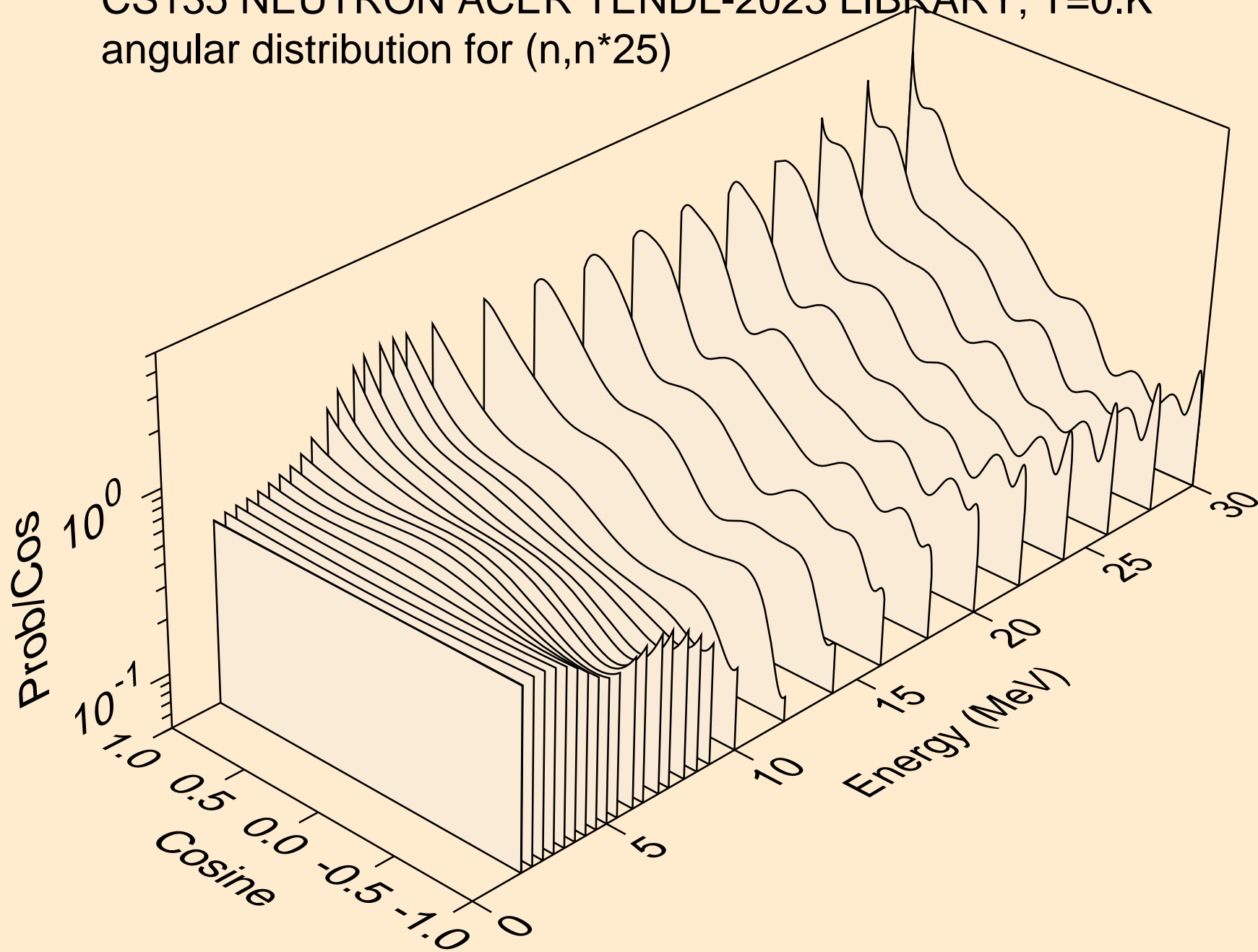

CS135 NEUTRON ACER TENDL-2023 LIBRARY; T=0.K
angular distribution for (n,n*26)

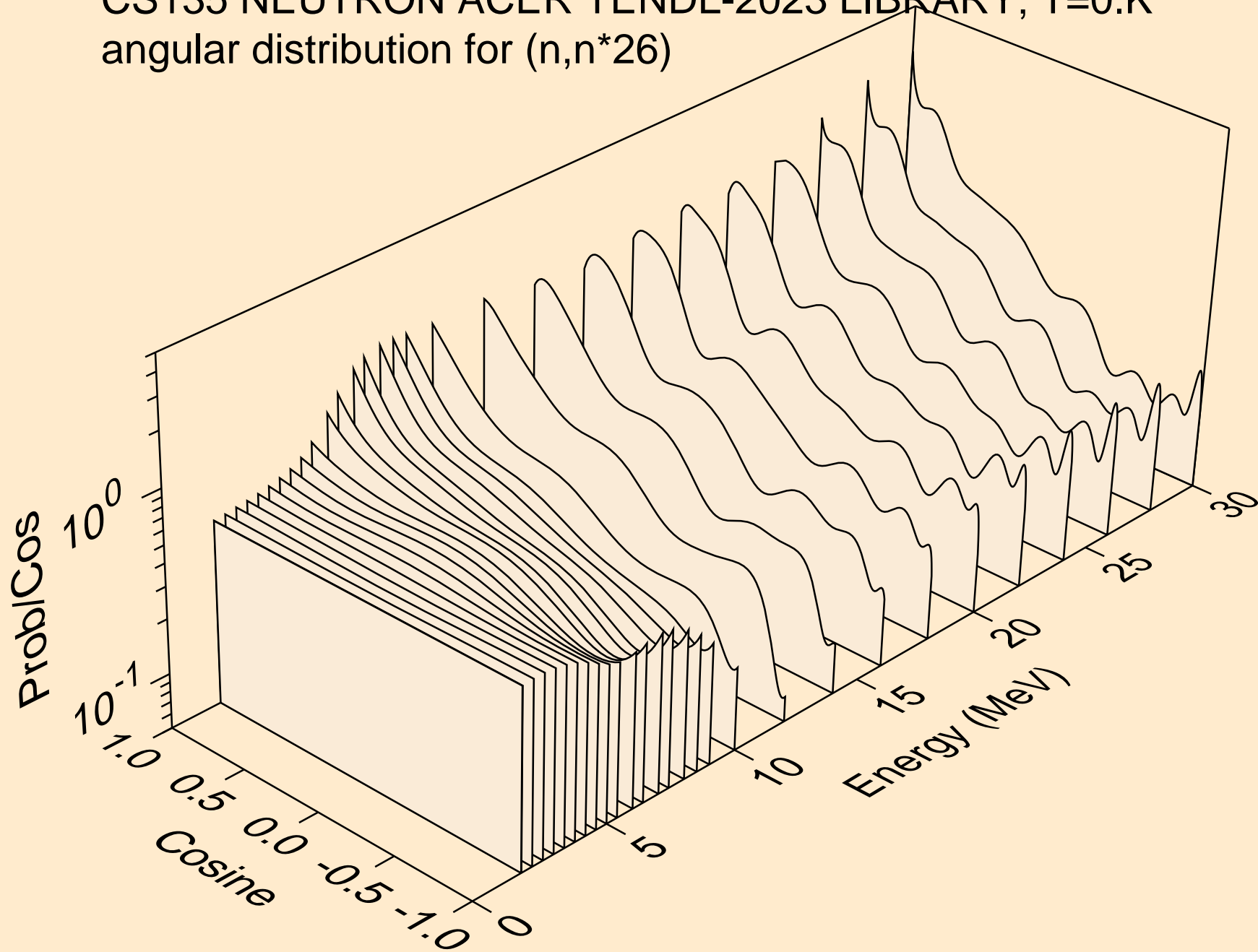

CS135 NEUTRON ACER TENDL-2023 LIBRARY; T=0.K
angular distribution for (n,n*27)

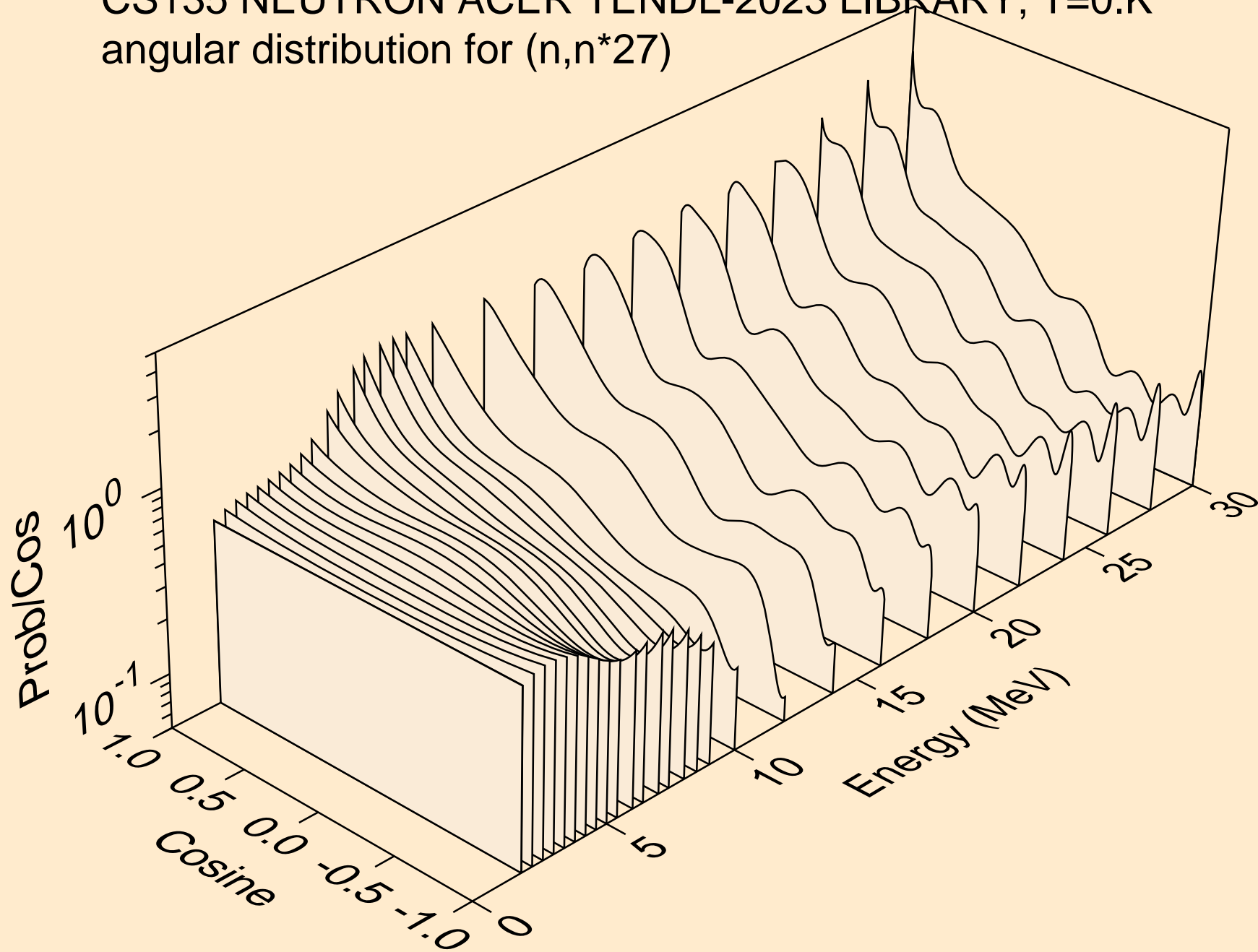

CS135 NEUTRON ACER TENDL-2023 LIBRARY; T=0.K
angular distribution for (n,n*28)

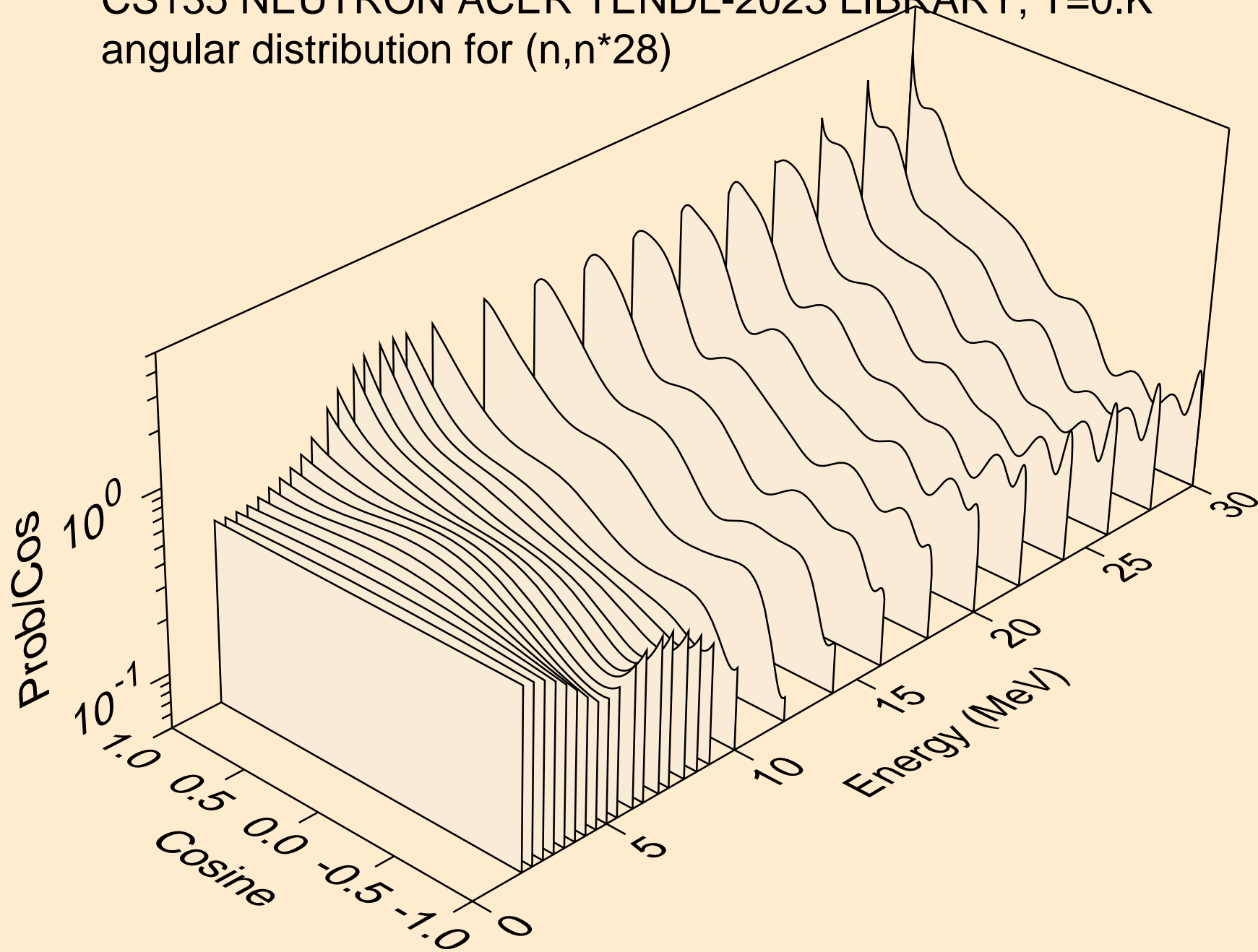

CS135 NEUTRON ACER TENDL-2023 LIBRARY; T=0.K
Neutron emission for (n,x)

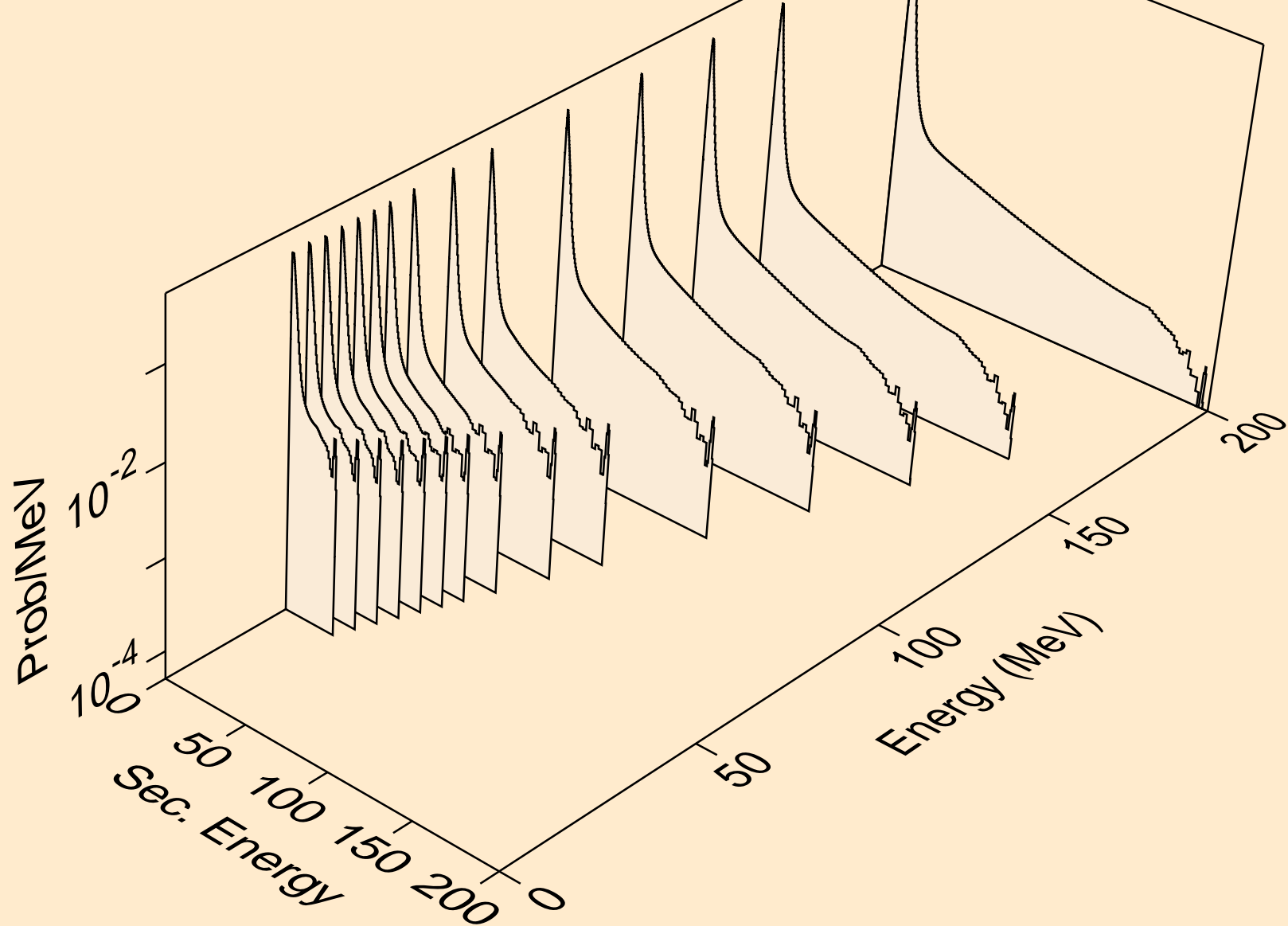

CS135 NEUTRON ACER TENDL-2023 LIBRARY; T=0.K
Neutron emission for (n,2nd)

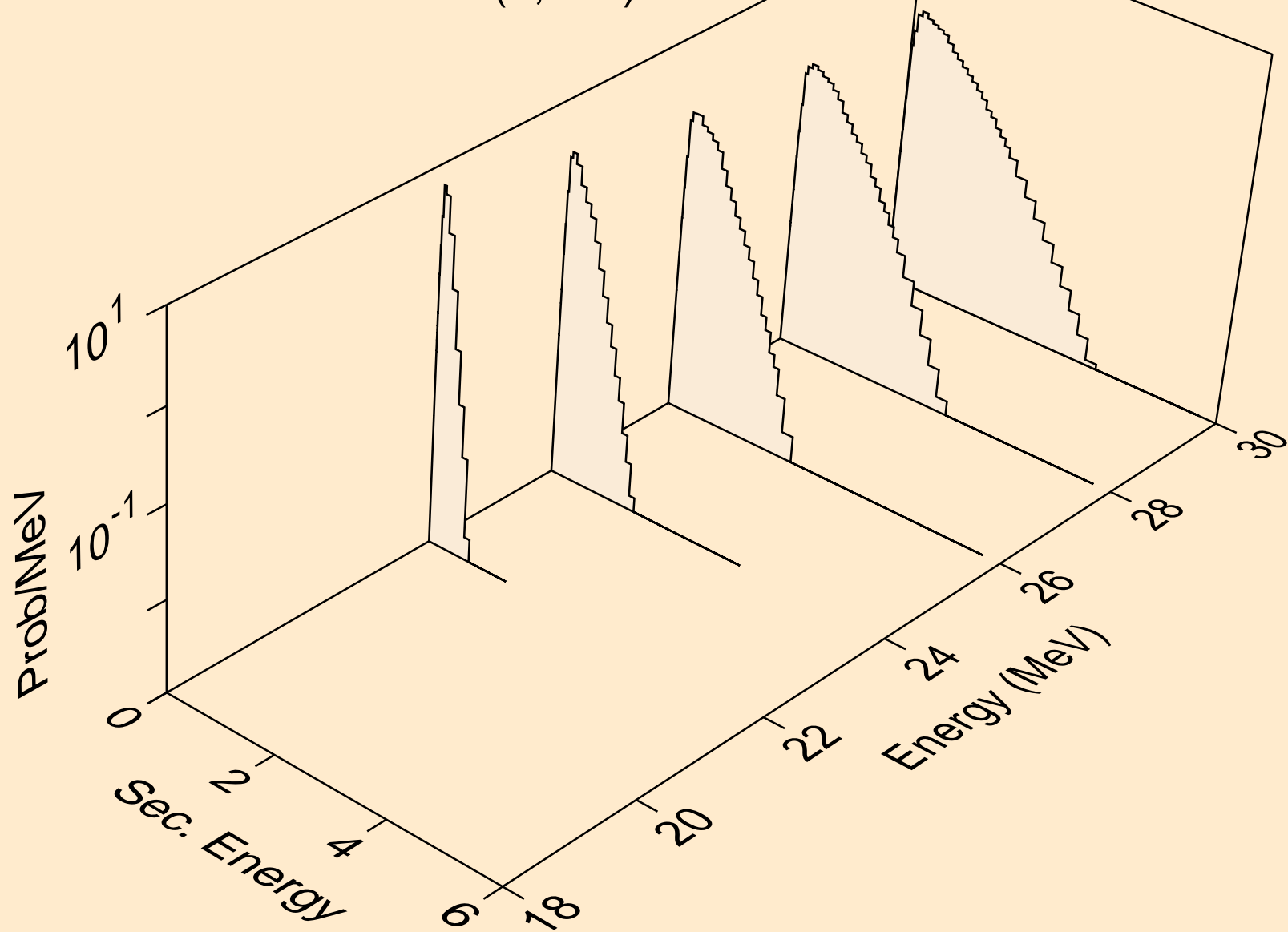

CS135 NEUTRON ACER TENDL-2023 LIBRARY; T=0.K
Neutron emission for (n,2n)

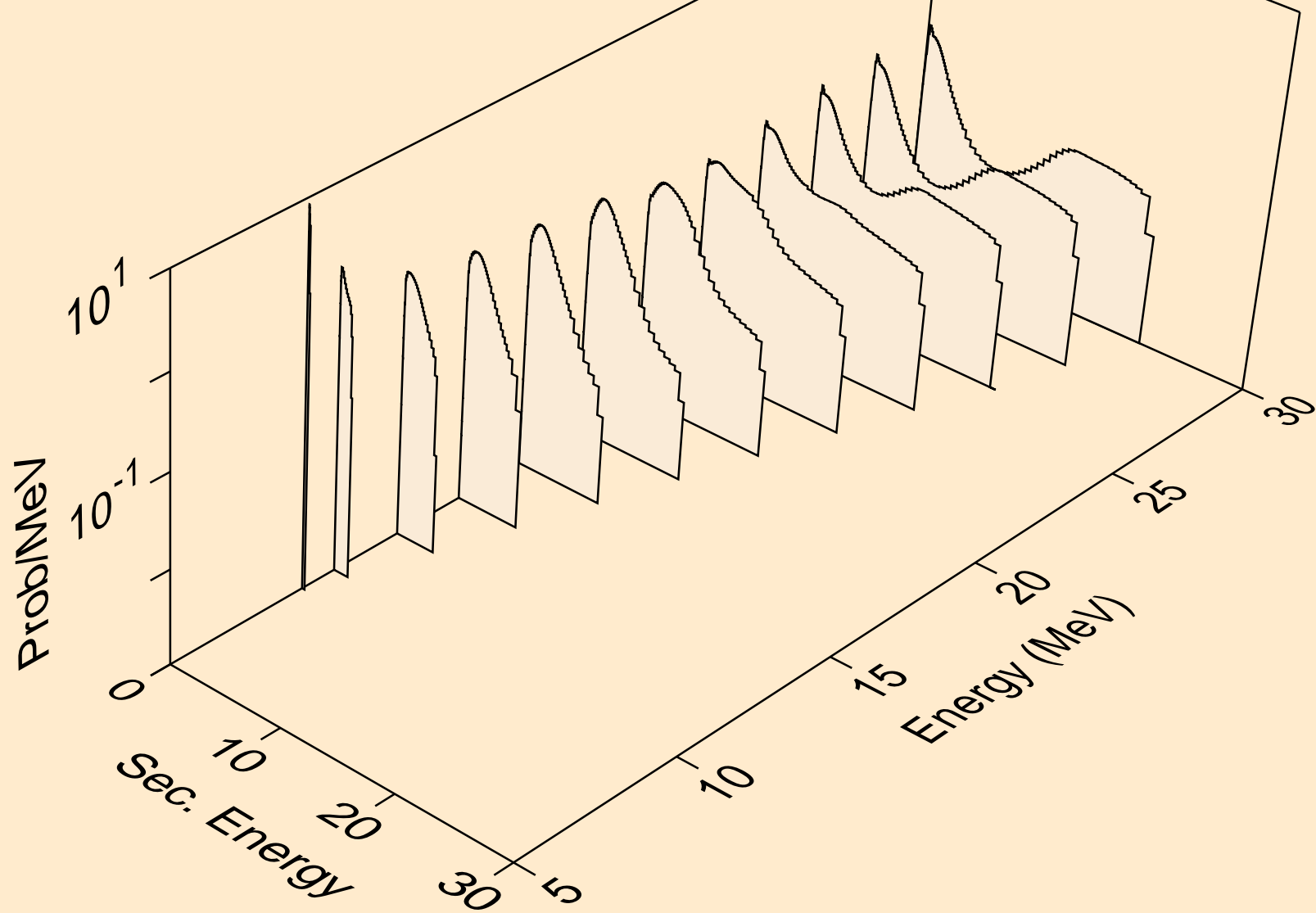

CS135 NEUTRON ACER TENDL-2023 LIBRARY; T=0.K
Neutron emission for (n,3n)

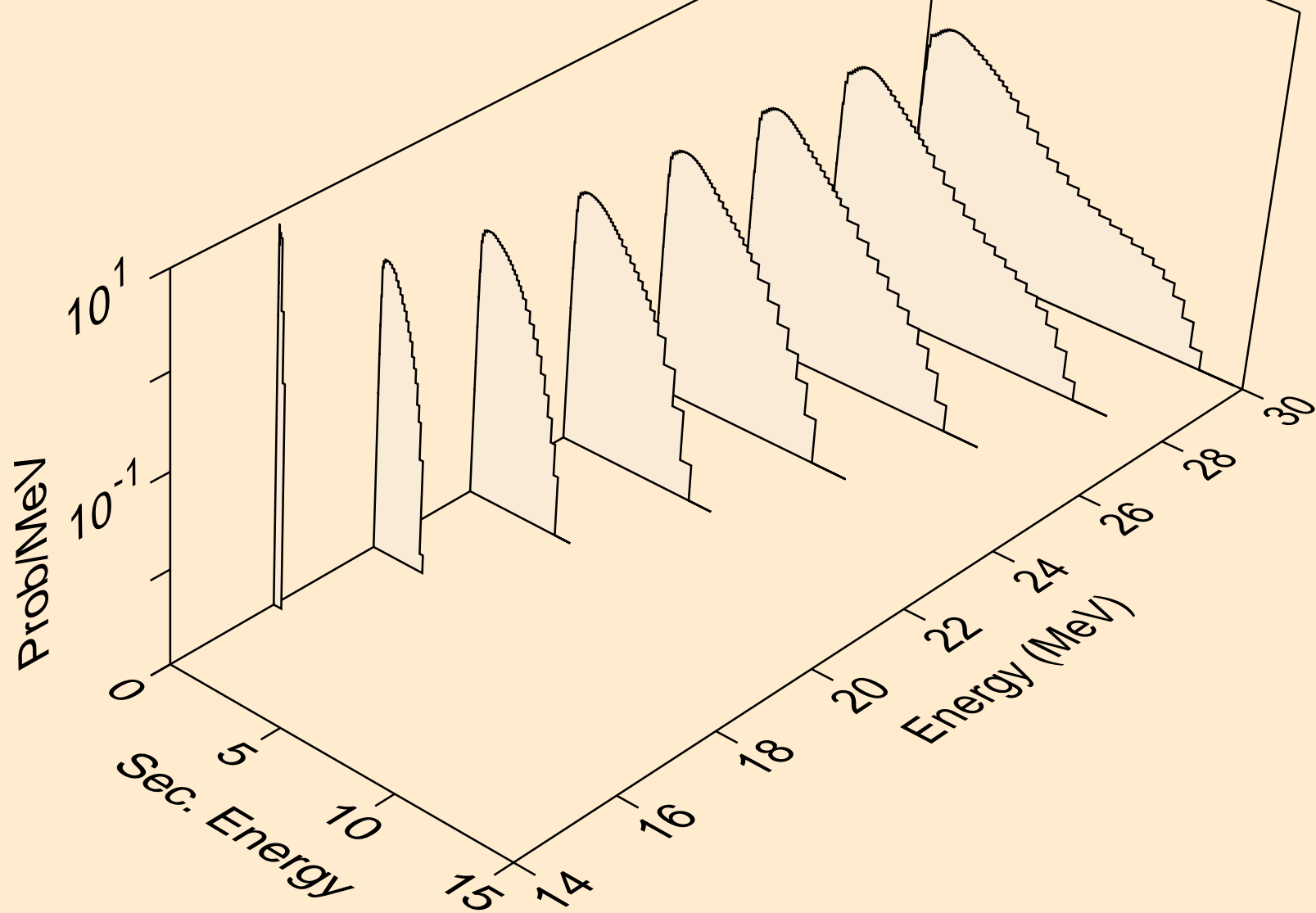

CS135 NEUTRON ACER TENDL-2023 LIBRARY; T=0.K
Neutron emission for (n,n*)a

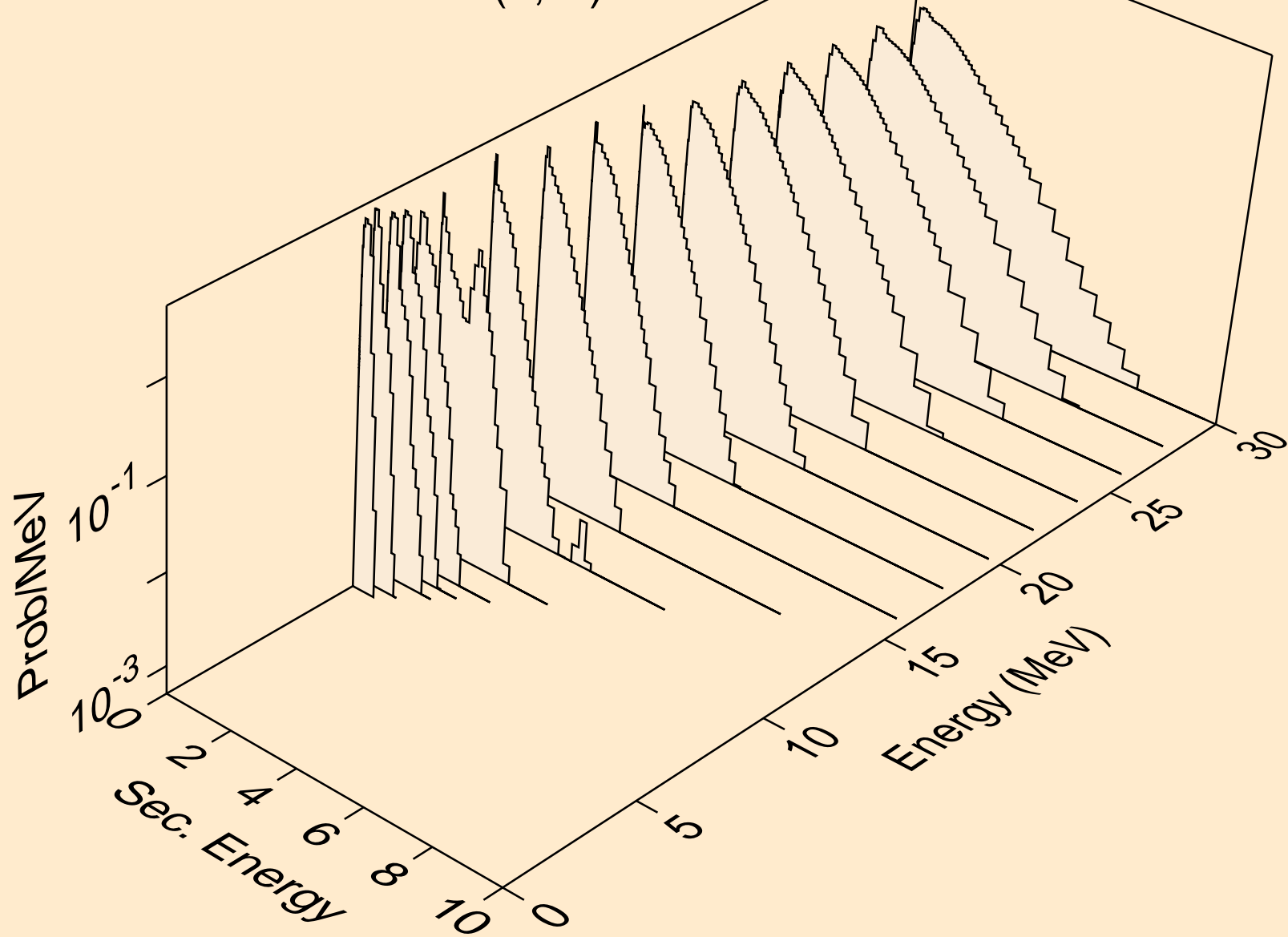

CS135 NEUTRON ACER TENDL-2023 LIBRARY; T=0.K
Neutron emission for (n,2n)a

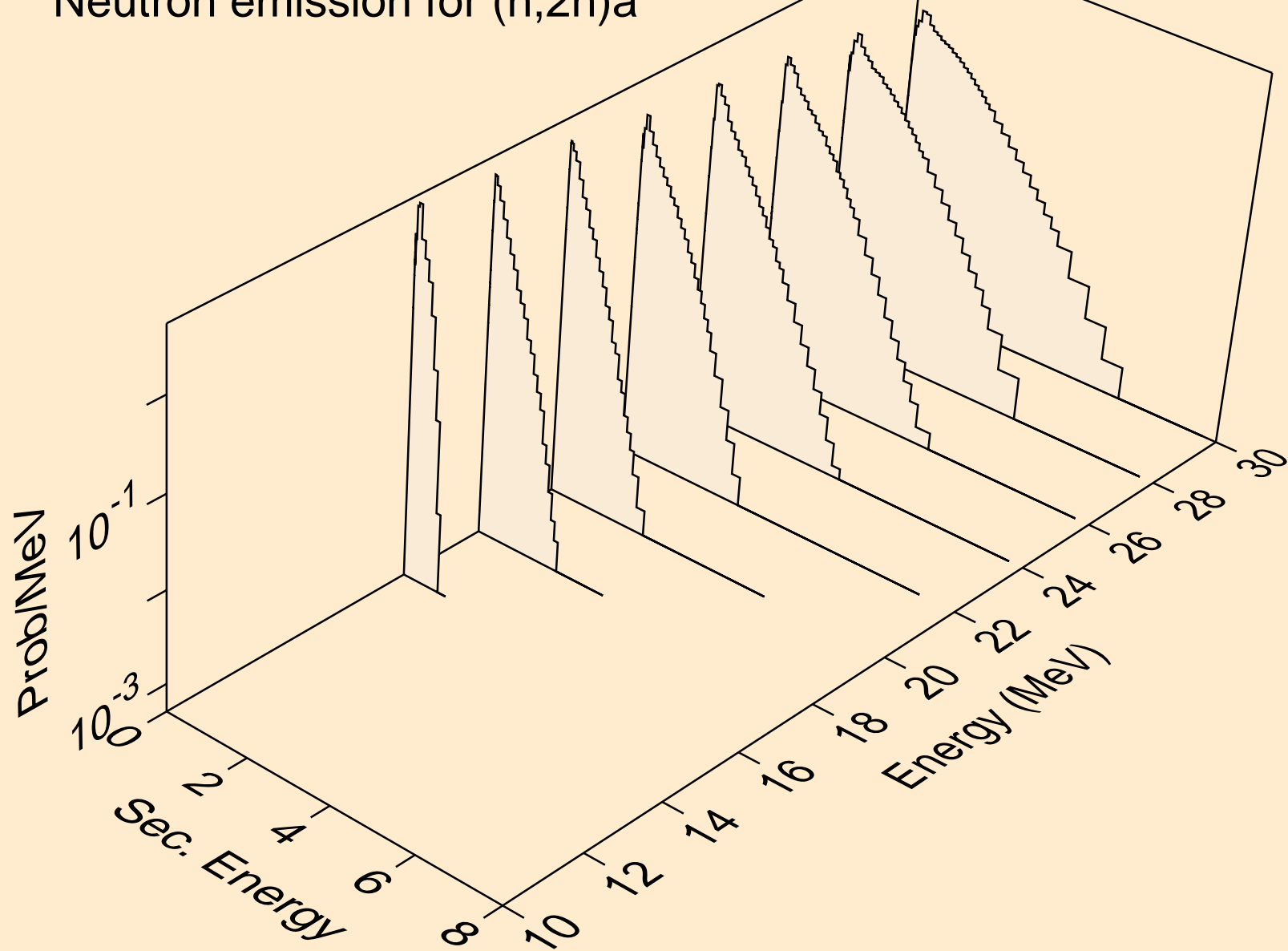

CS135 NEUTRON ACER TENDL-2023 LIBRARY; T=0.K
Neutron emission for (n,3n)a

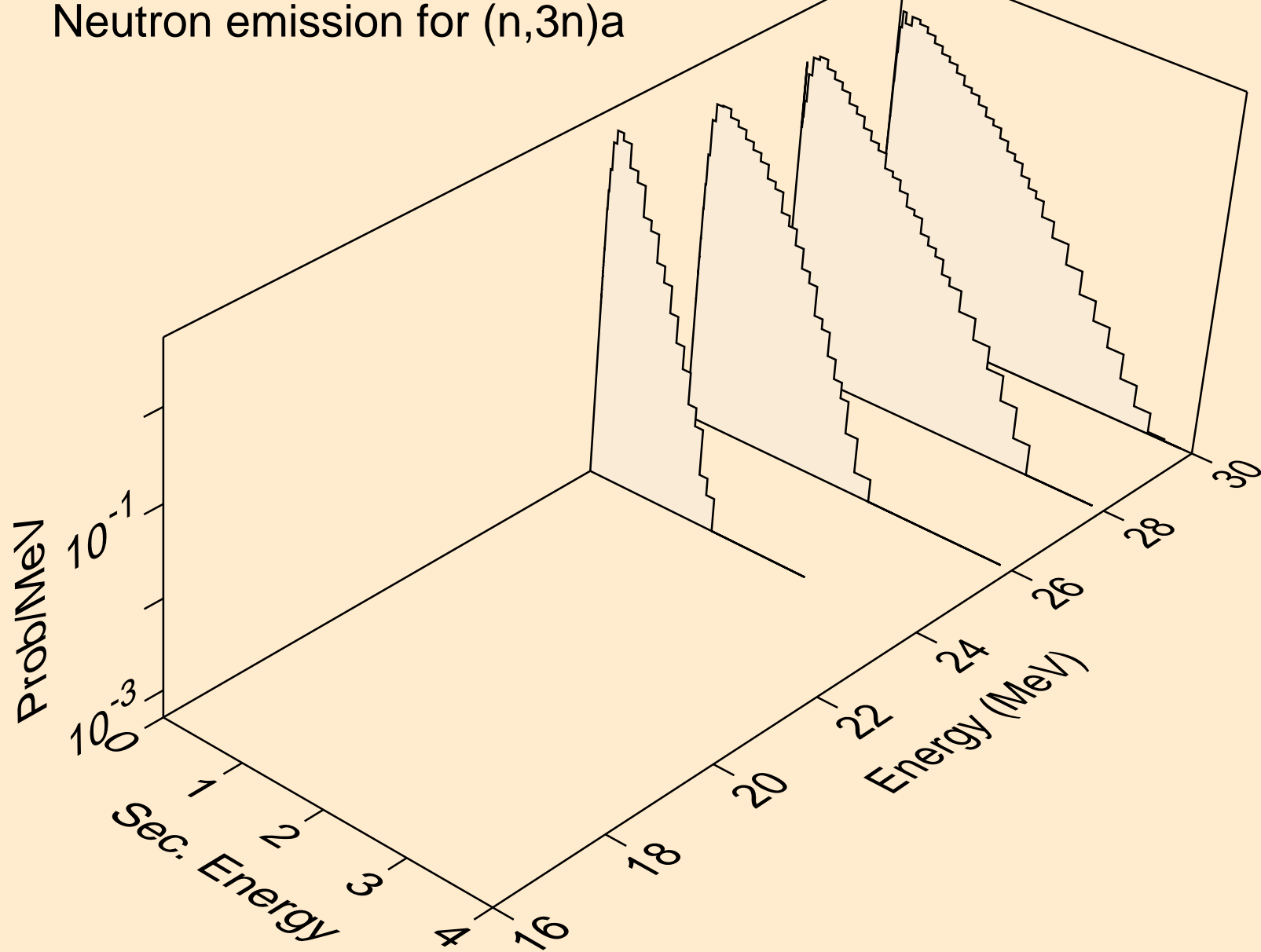

CS135 NEUTRON ACER TENDL-2023 LIBRARY; T=0.K
Neutron emission for (n,n*)p

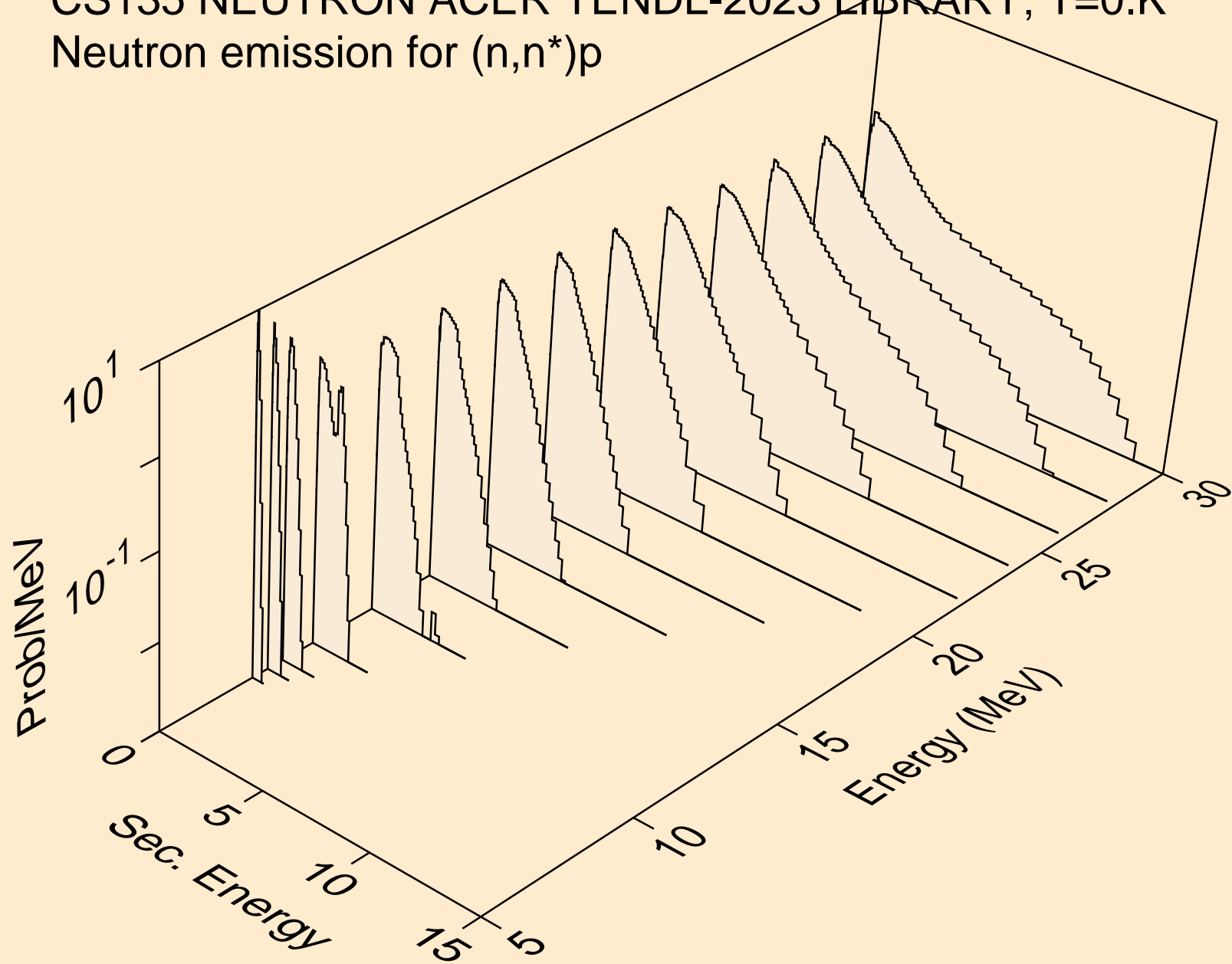

CS135 NEUTRON ACER TENDL-2023 LIBRARY; T=0.K
Neutron emission for (n,n*)d

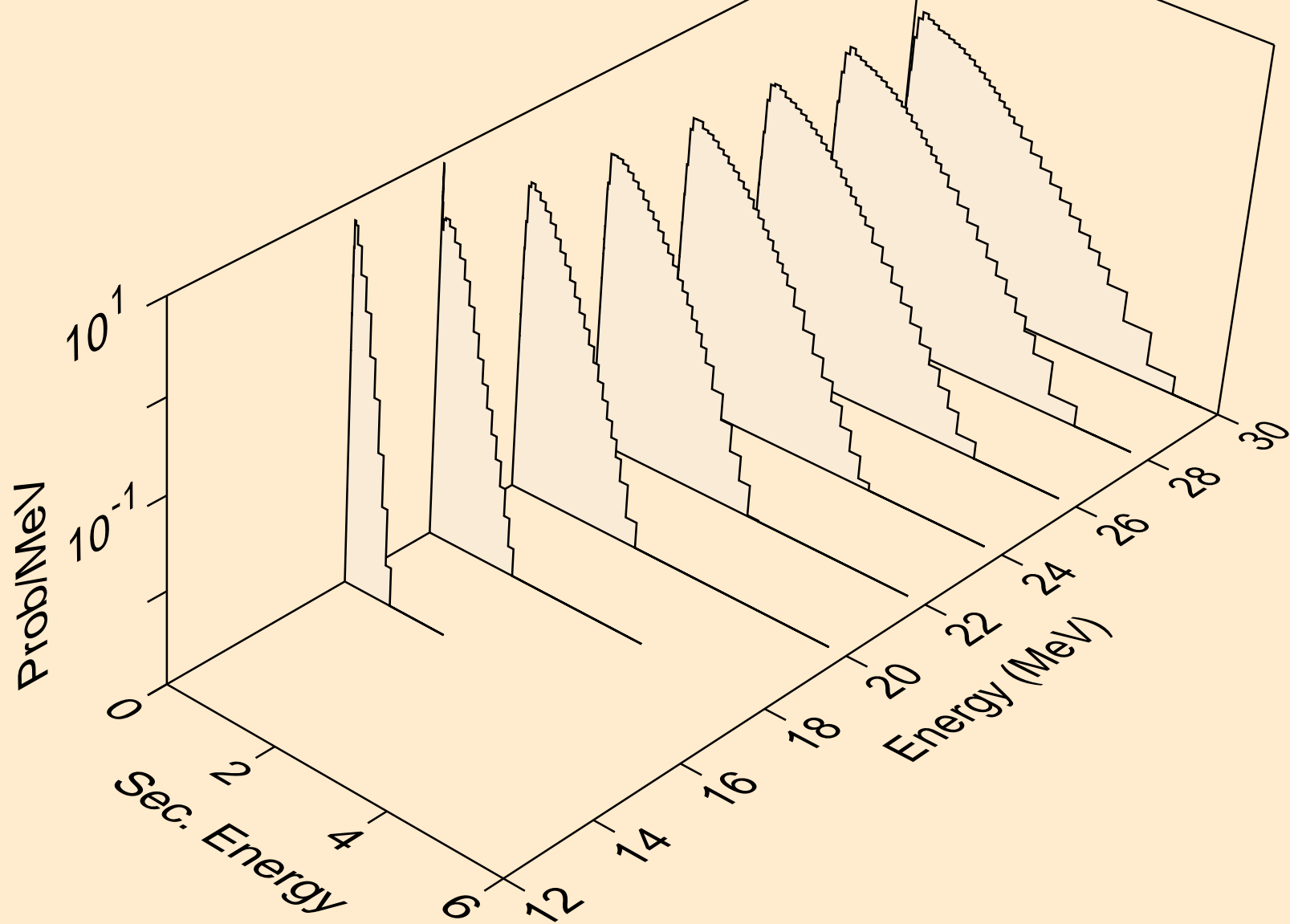

CS135 NEUTRON ACER TENDL-2023 LIBRARY; T=0.K
Neutron emission for (n,n*)t

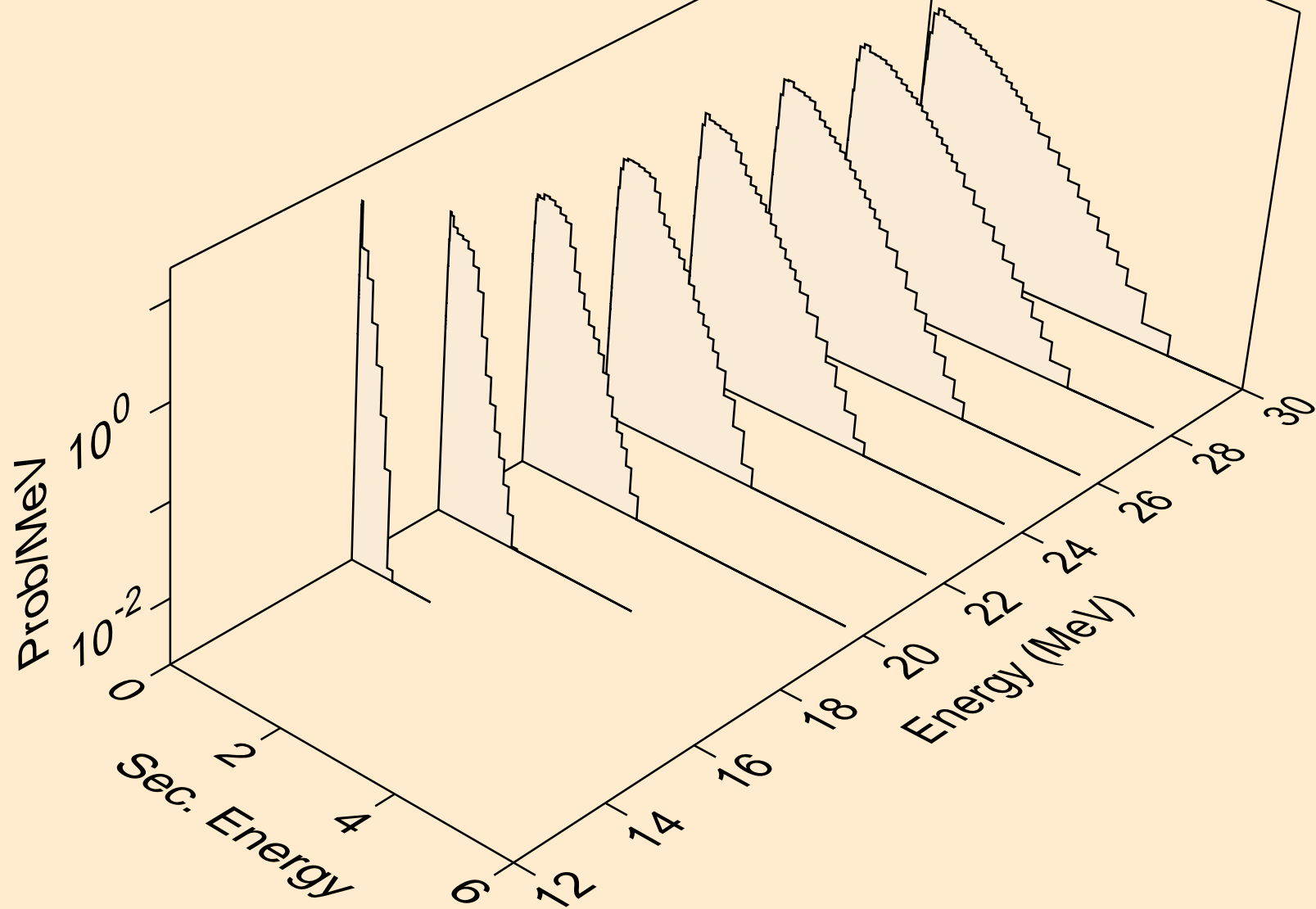

CS135 NEUTRON ACER TENDL-2023 LIBRARY; T=0.K
Neutron emission for (n,n*)he3

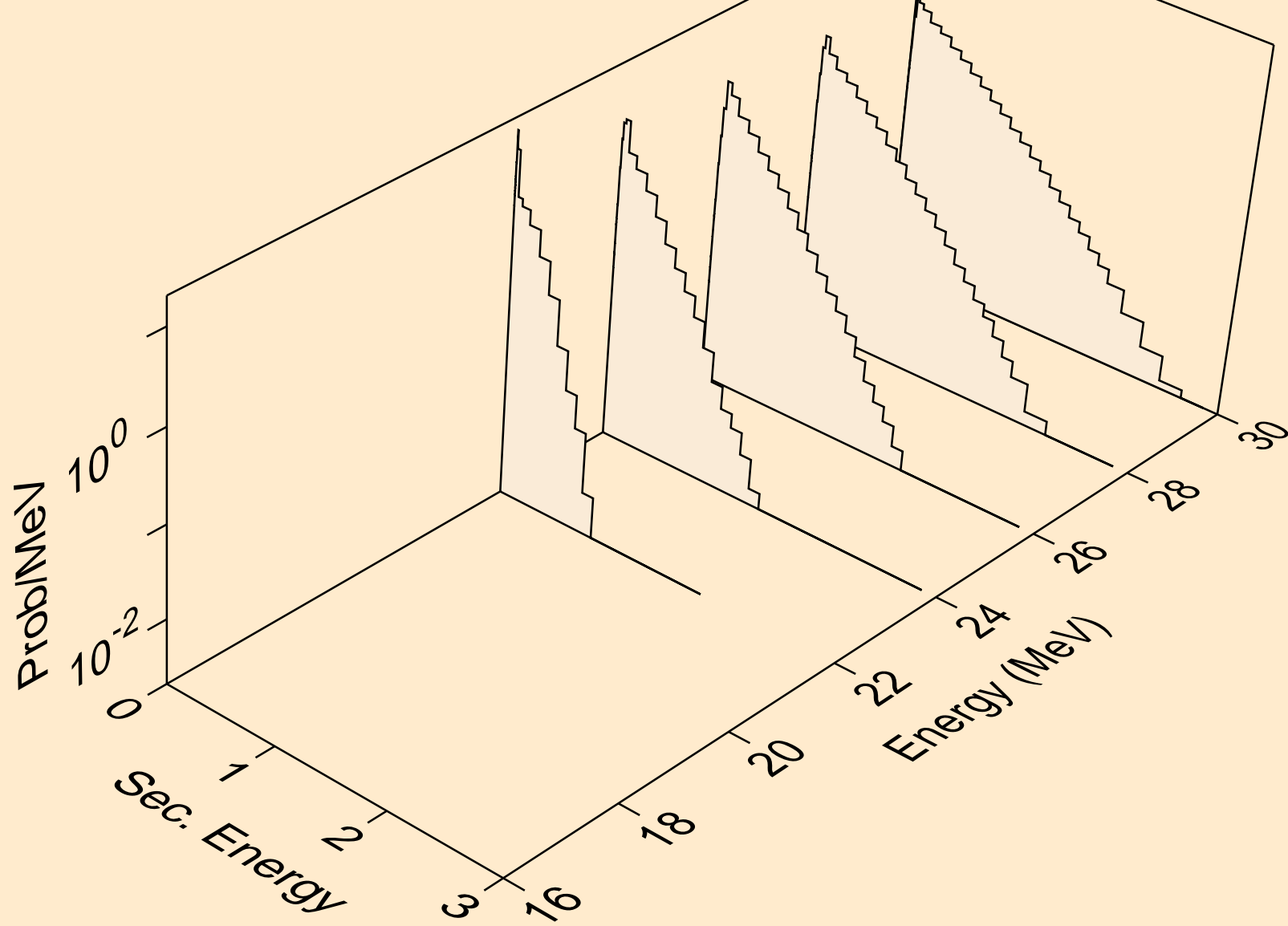

CS135 NEUTRON ACER TENDL-2023 LIBRARY; T=0.K
Neutron emission for (n,4n)

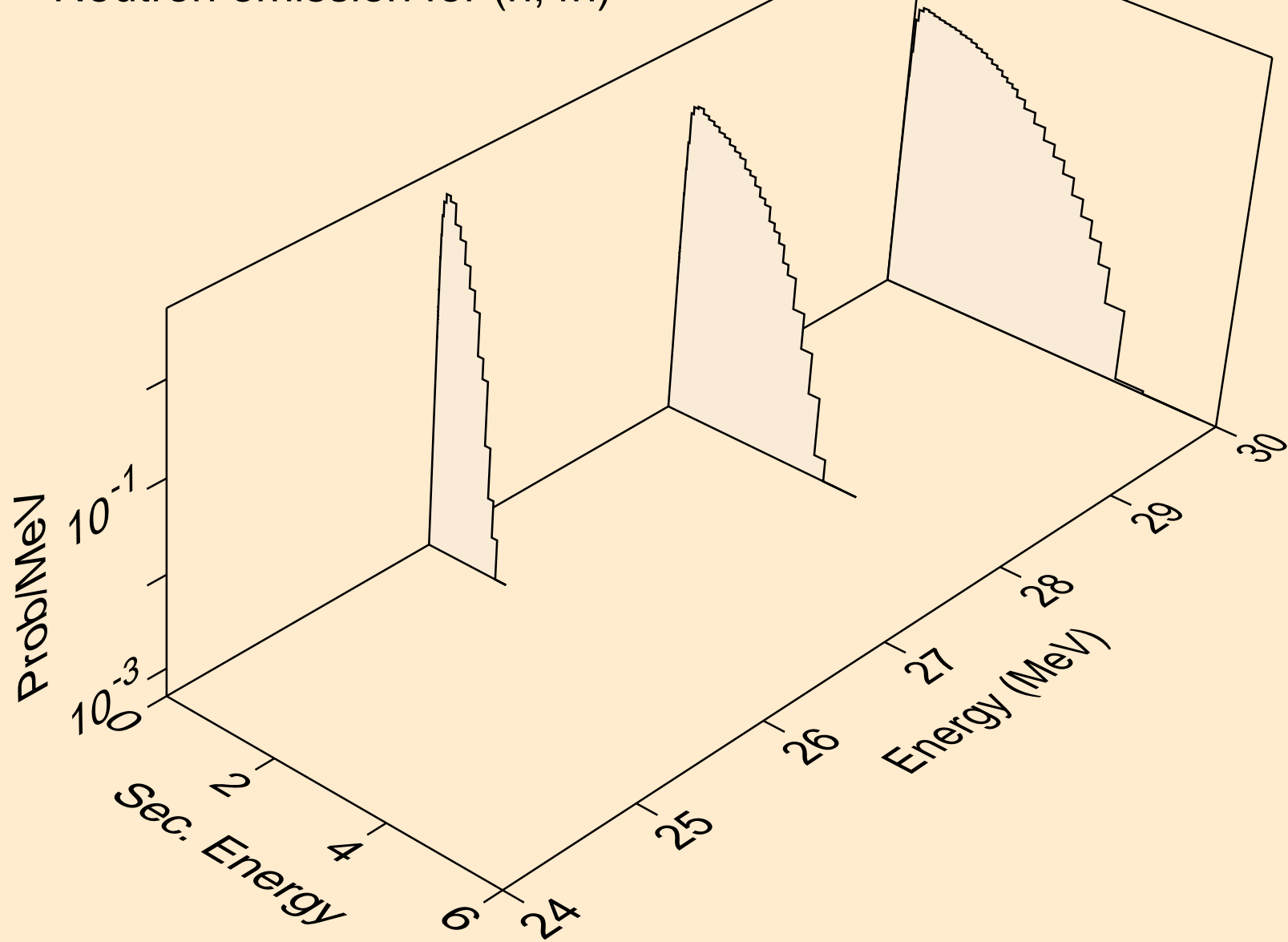

CS135 NEUTRON ACER TENDL-2023 LIBRARY; T=0.K
Neutron emission for (n,2np)

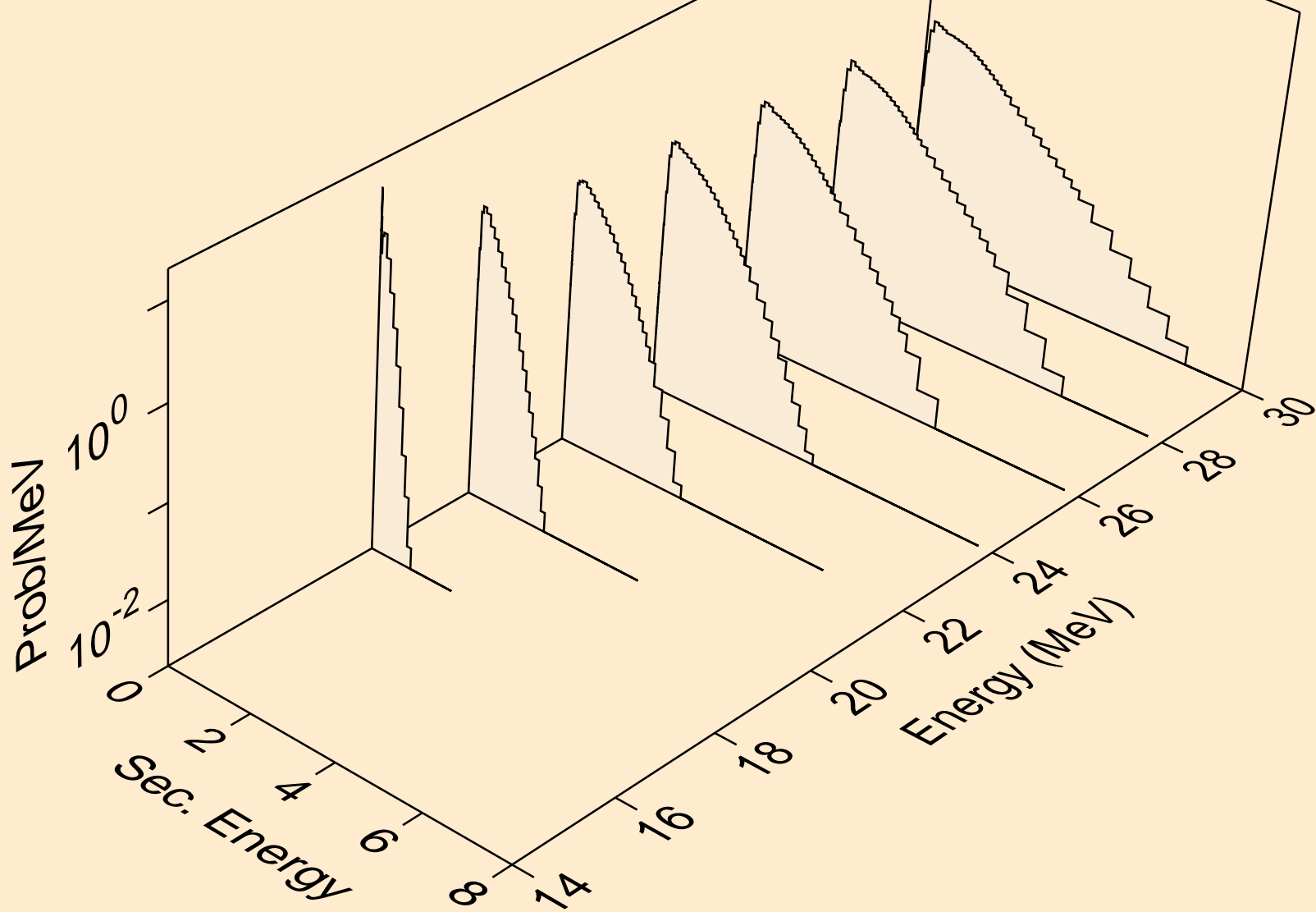

CS135 NEUTRON ACER TENDL-2023 LIBRARY; T=0.K
Neutron emission for (n,3np)

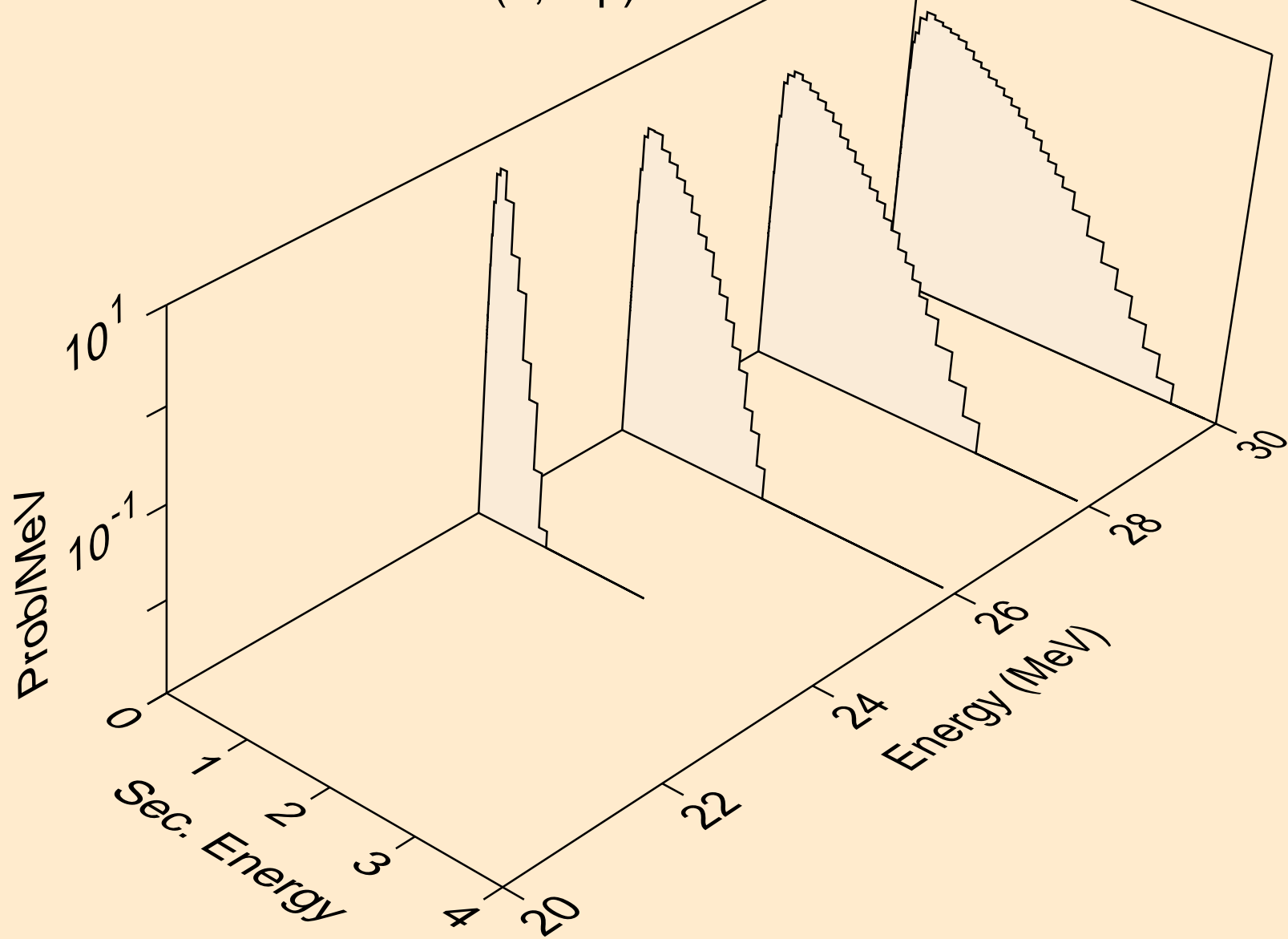

CS135 NEUTRON ACER TENDL-2023 LIBRARY; T=0.K
Neutron emission for (n,n2p)

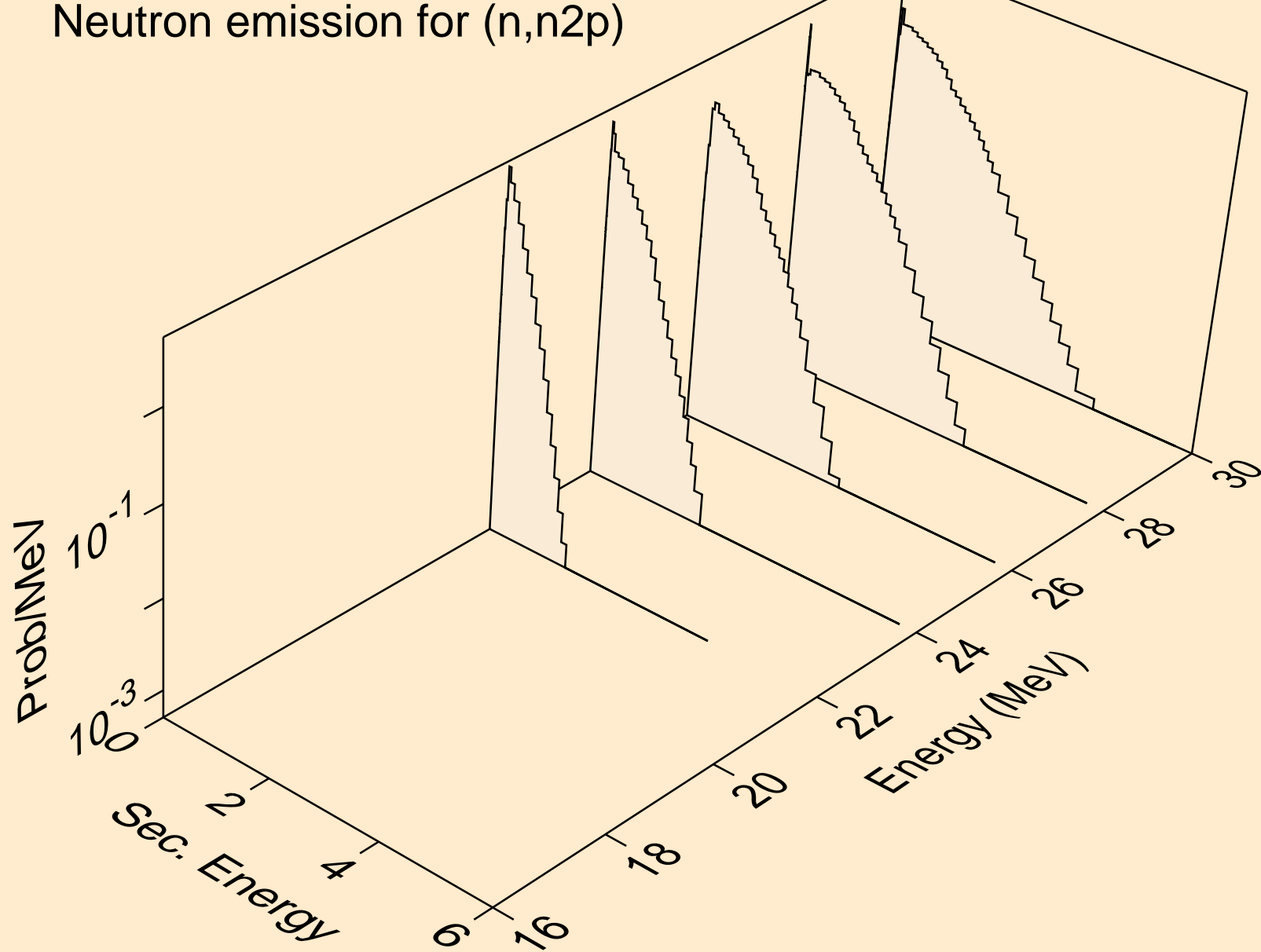

CS135 NEUTRON ACER TENDL-2023 LIBRARY; T=0.K
Neutron emission for (n,npa)

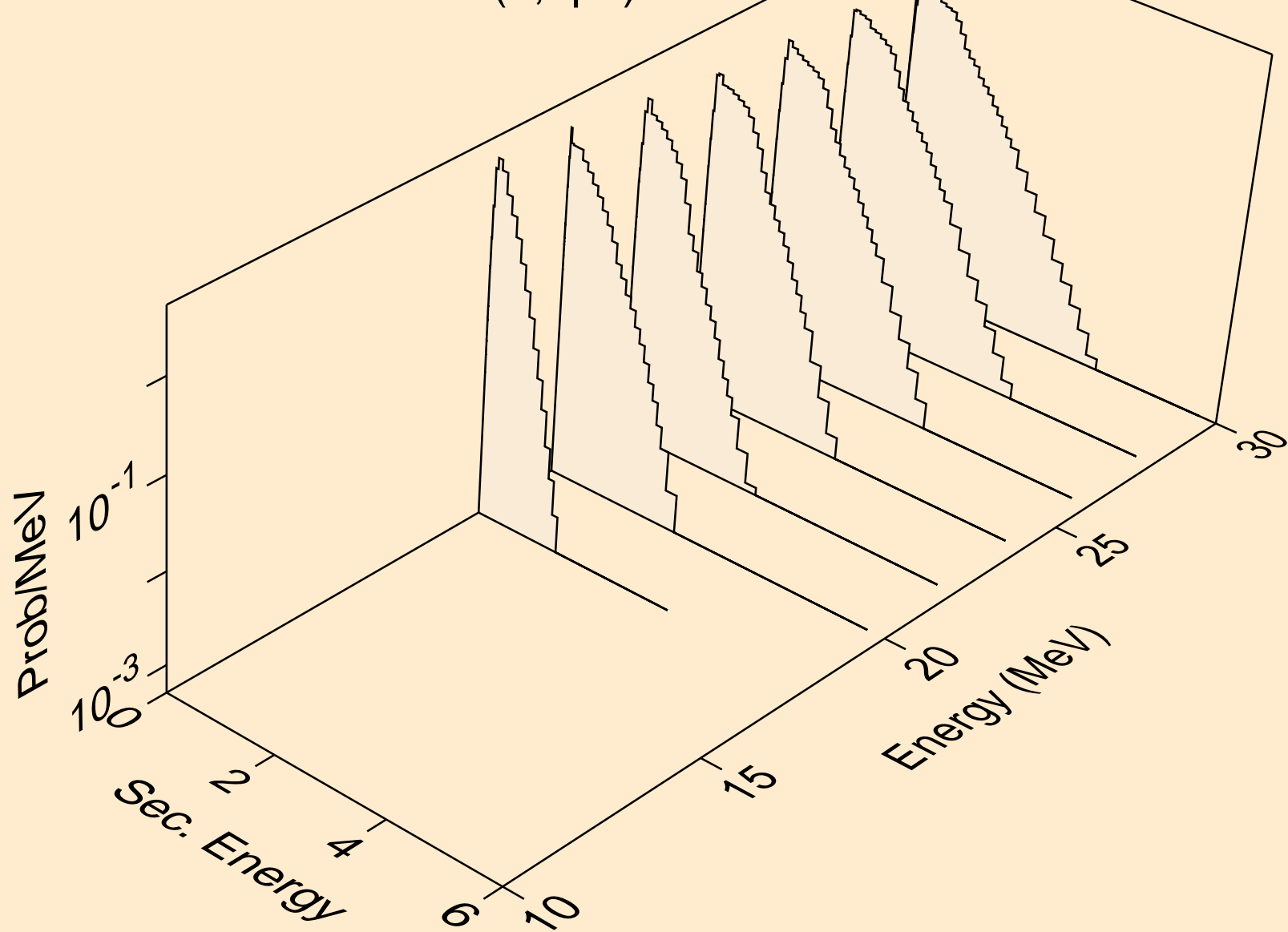

CS135 NEUTRON ACER TENDL-2023 LIBRARY; T=0.K
Neutron emission for (n,n*c)

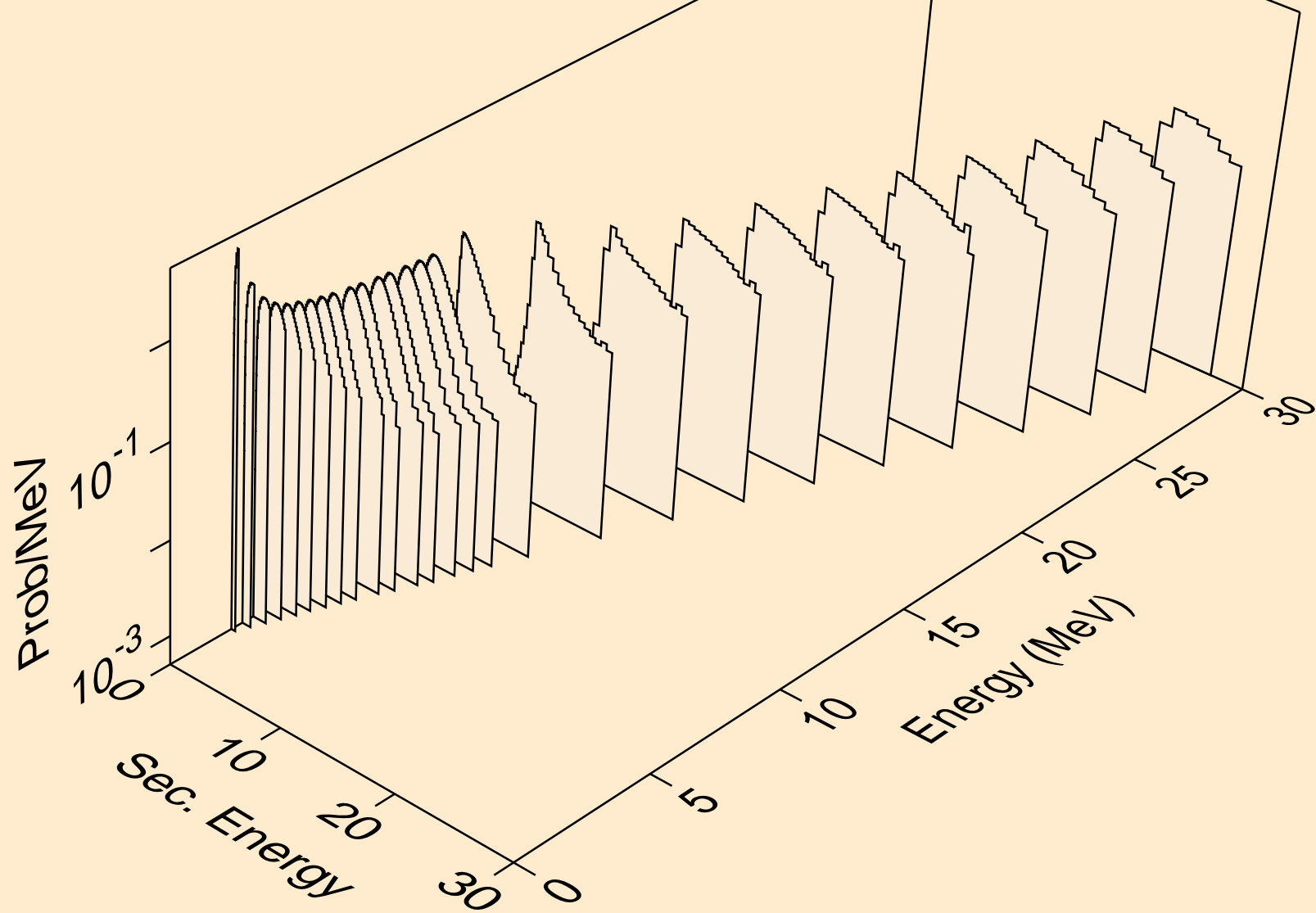

CS135 NEUTRON ACER TENDL-2023 LIBRARY; T=0.K
Photon emission for (n,x)

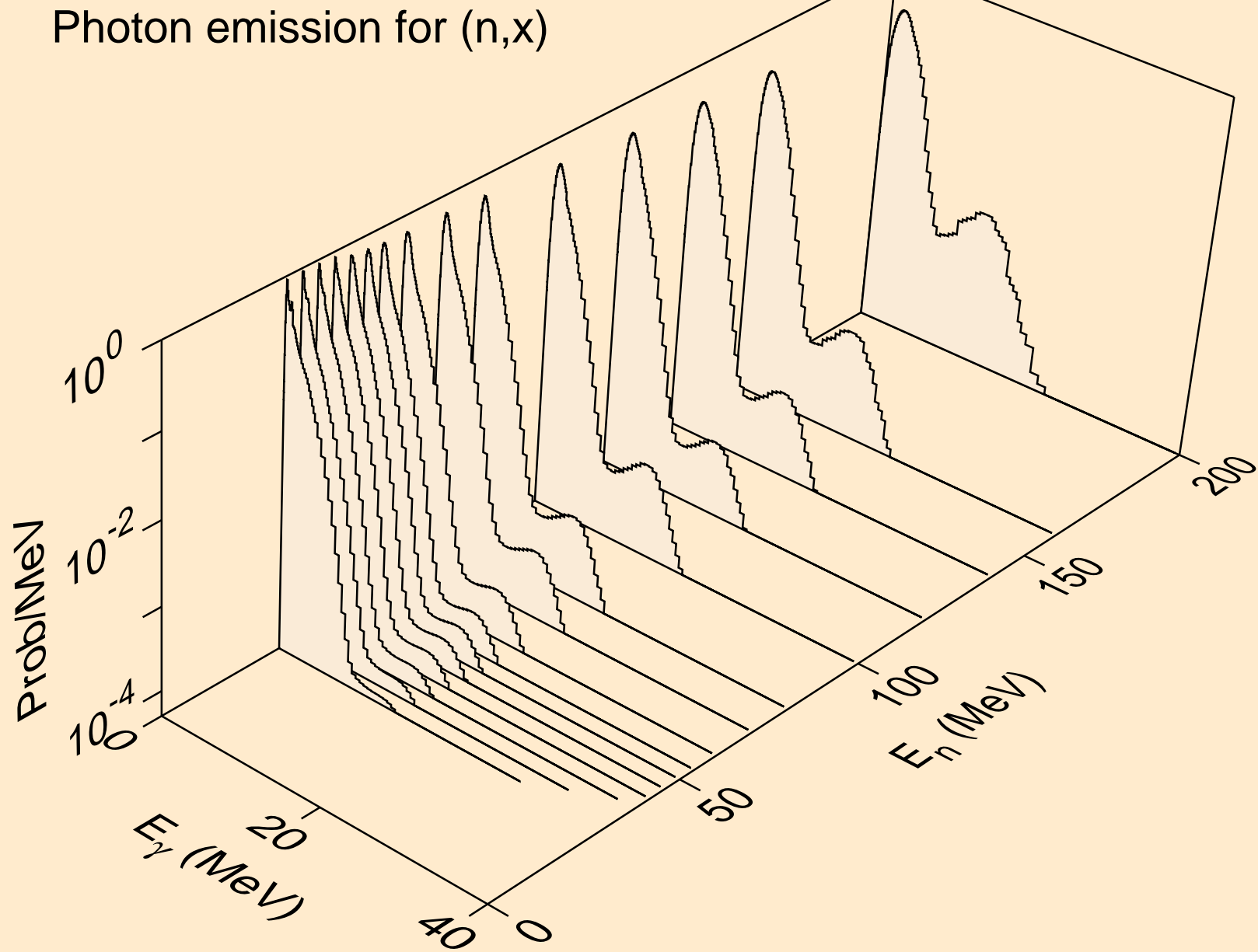

CS135 NEUTRON ACER TENDL-2023 LIBRARY; T=0.K
Photon emission for (n,2nd)

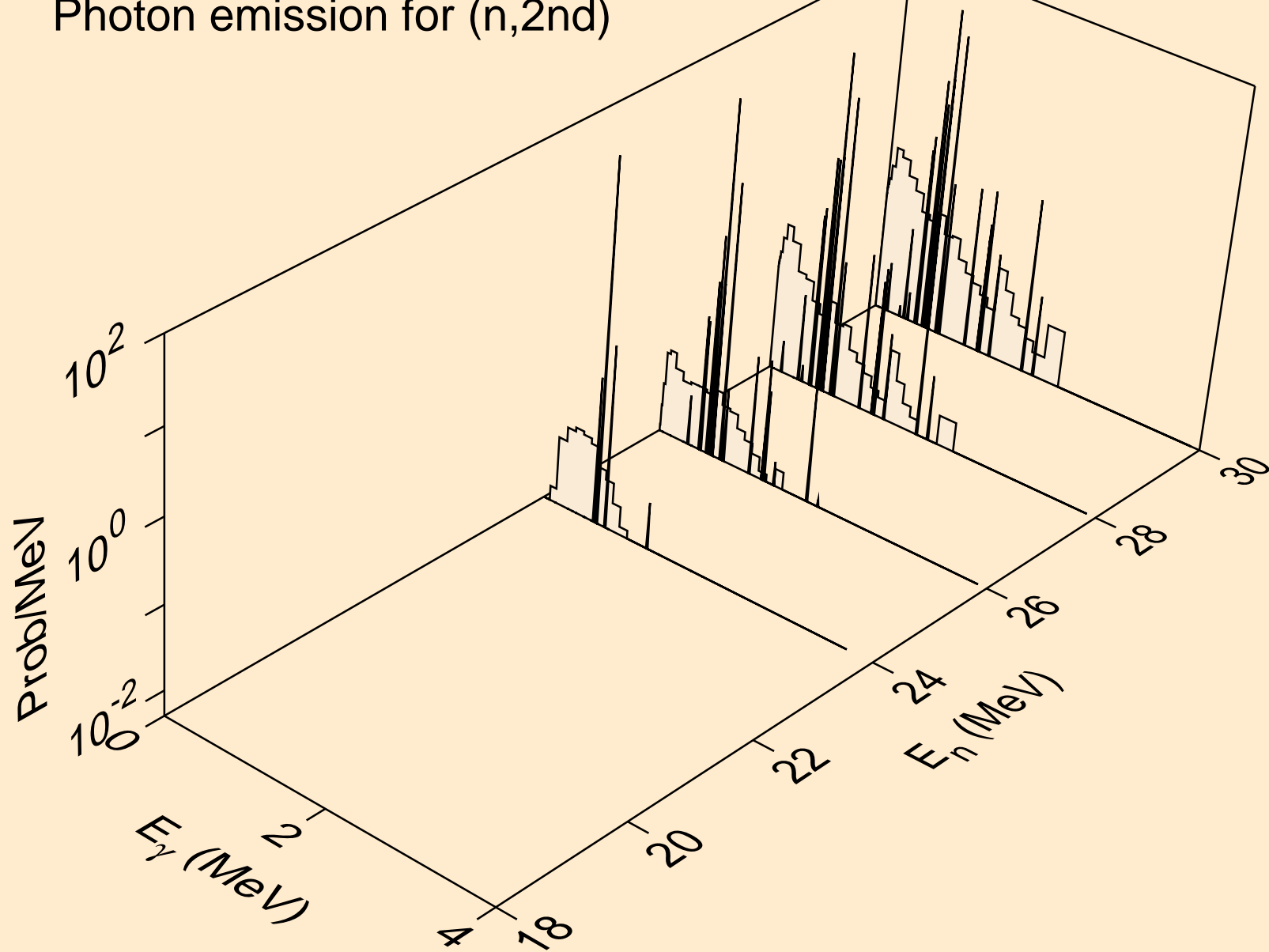

CS135 NEUTRON ACER TENDL-2023 LIBRARY; T=0.K
Photon emission for (n,2n)

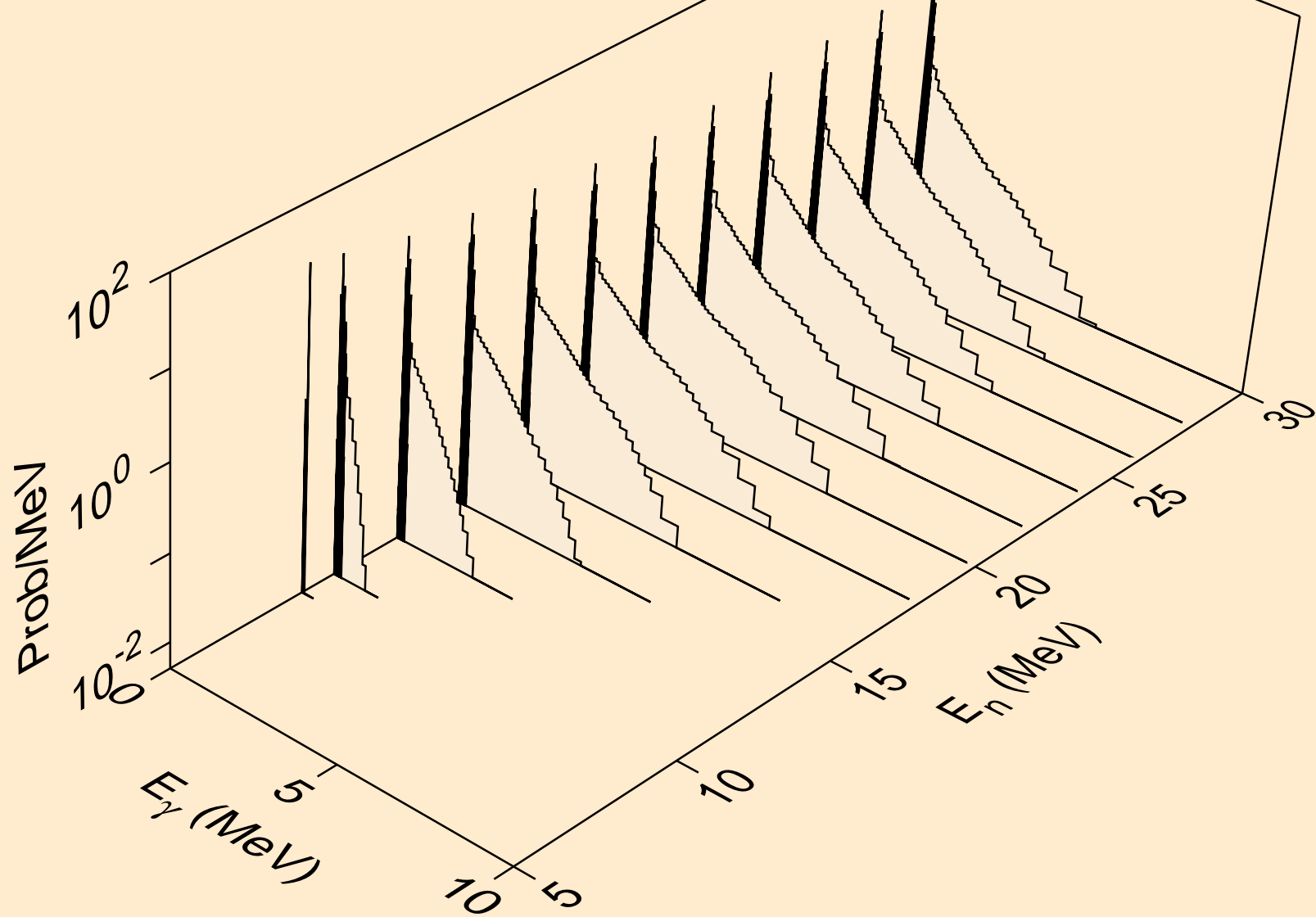

CS135 NEUTRON ACER TENDL-2023 LIBRARY; T=0.K
Photon emission for (n,3n)

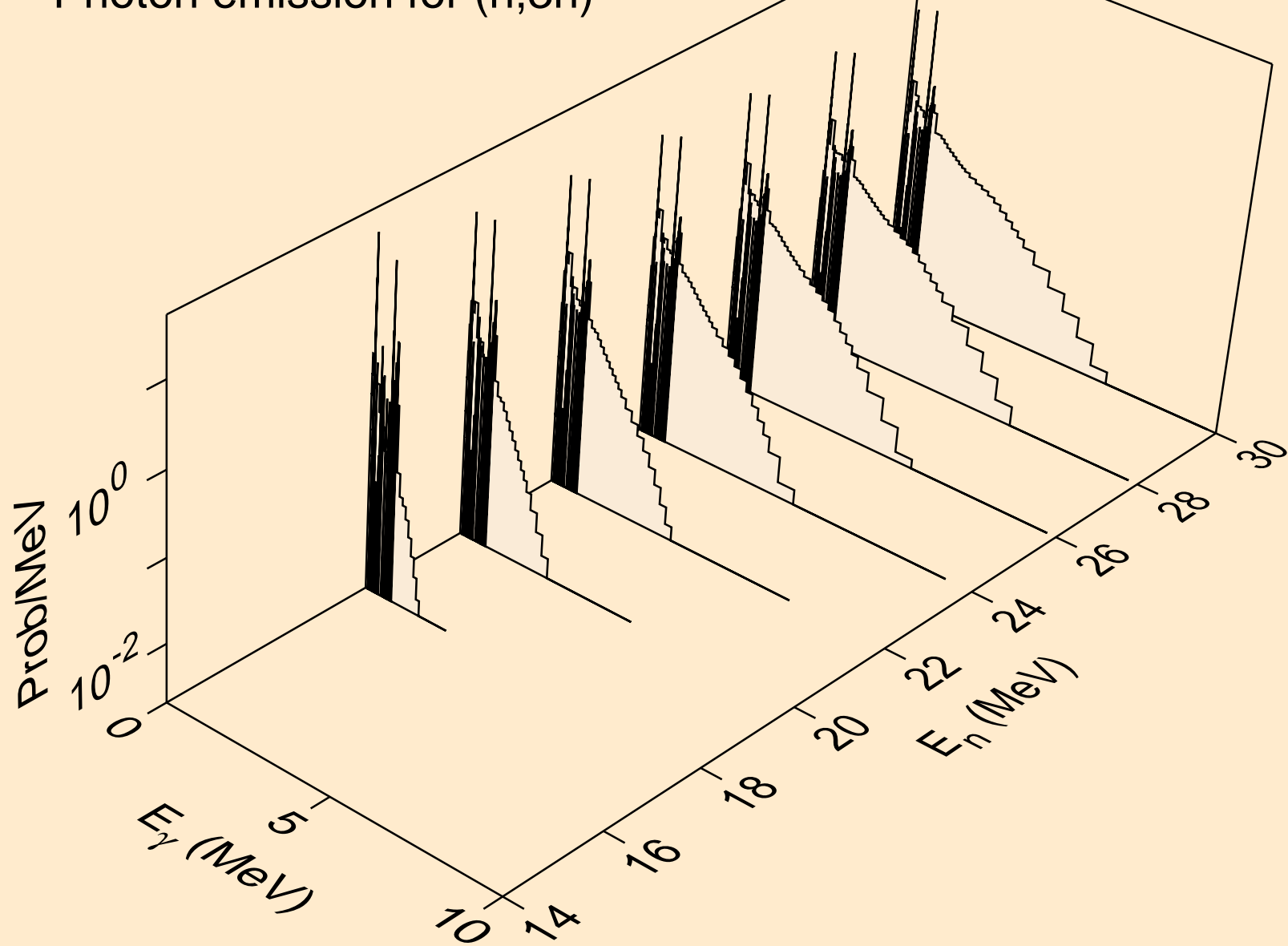

CS135 NEUTRON ACER TENDL-2023 LIBRARY; T=0.K
Photon emission for (n,n*)a

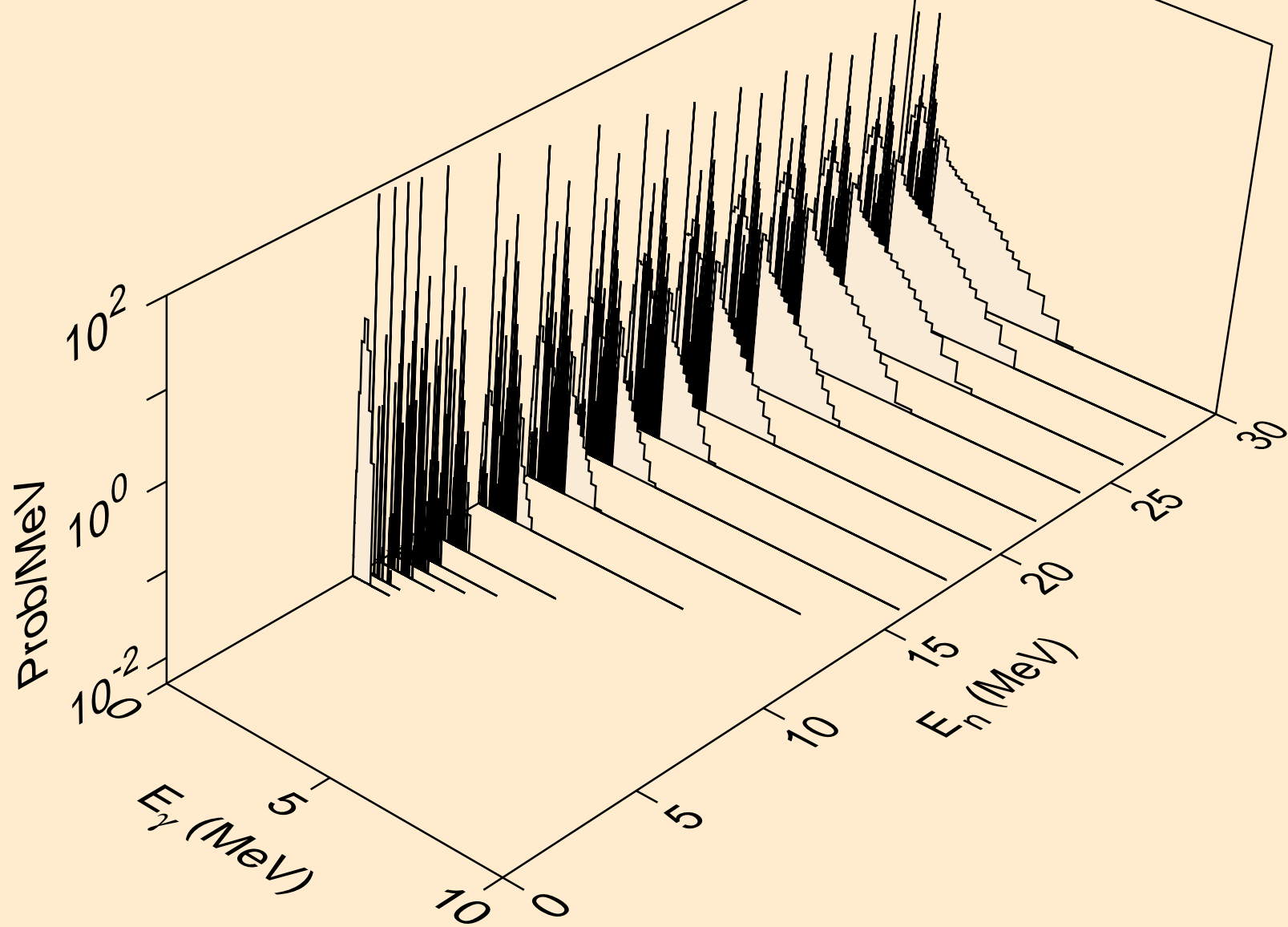

CS135 NEUTRON ACER TENDL-2023 LIBRARY; T=0.K
Photon emission for (n,2n)a

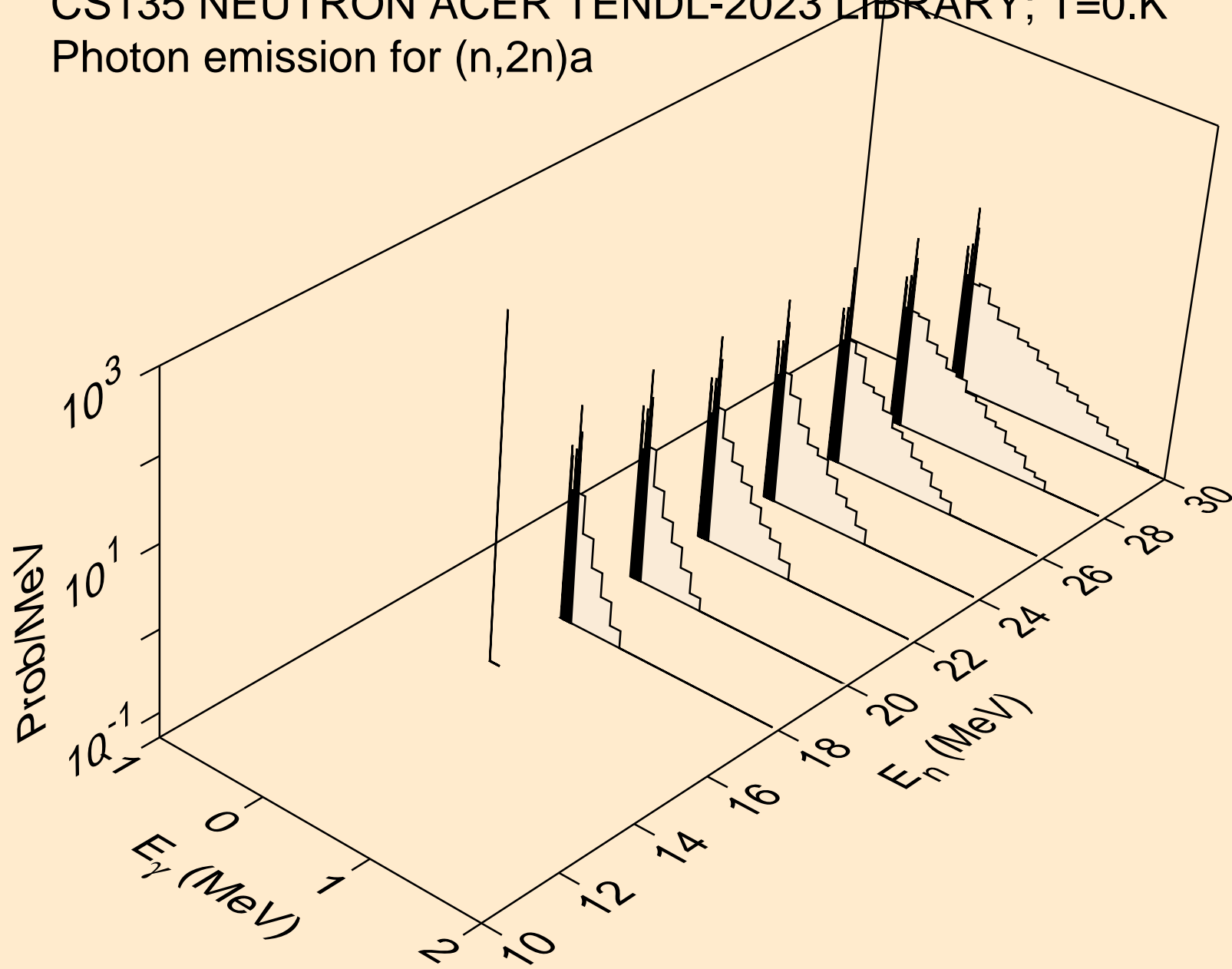

CS135 NEUTRON ACER TENDL-2023 LIBRARY; T=0.K
Photon emission for (n,3n)a

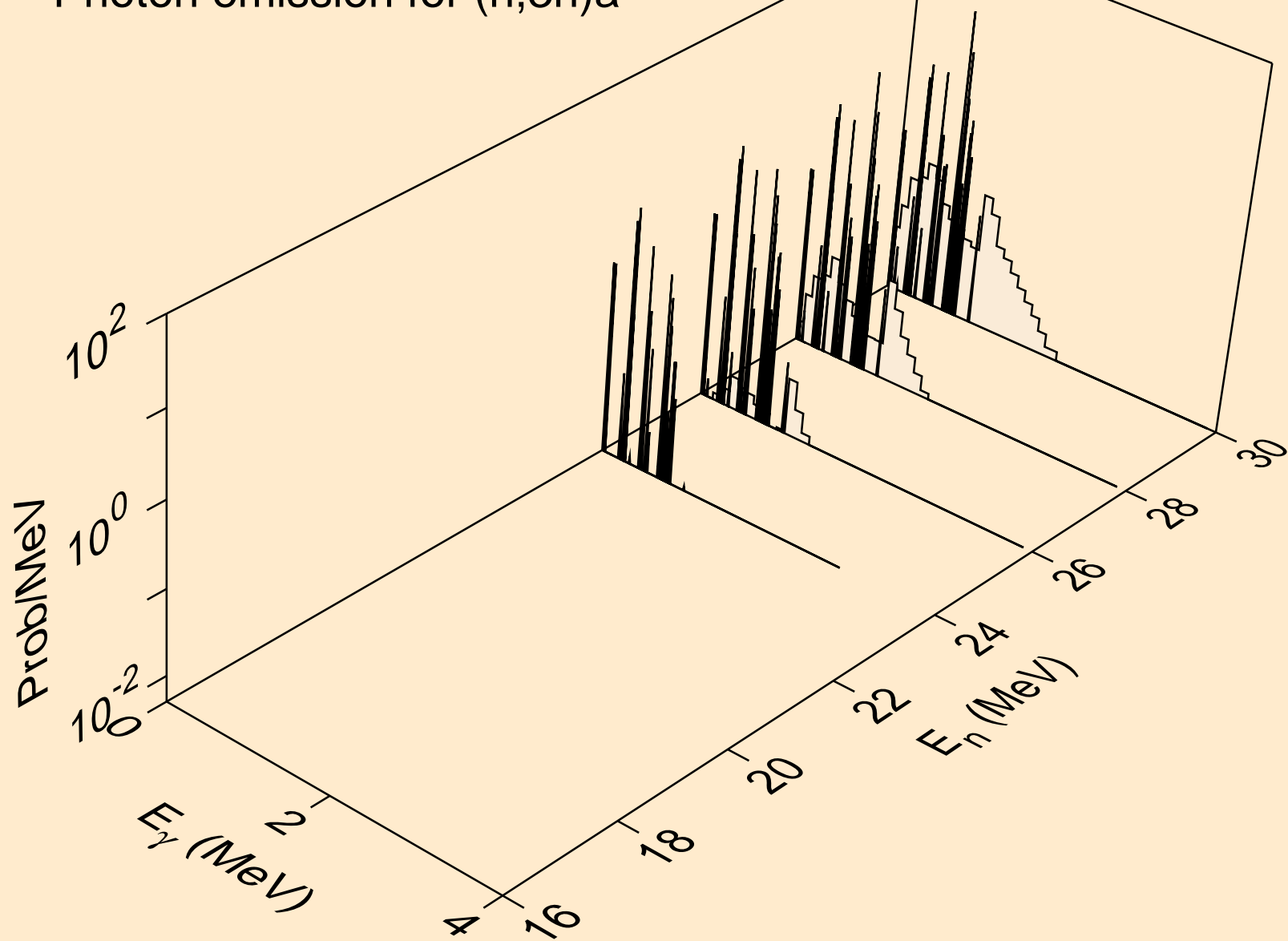

CS135 NEUTRON ACER TENDL-2023 LIBRARY; T=0.K
Photon emission for (n,n*)p

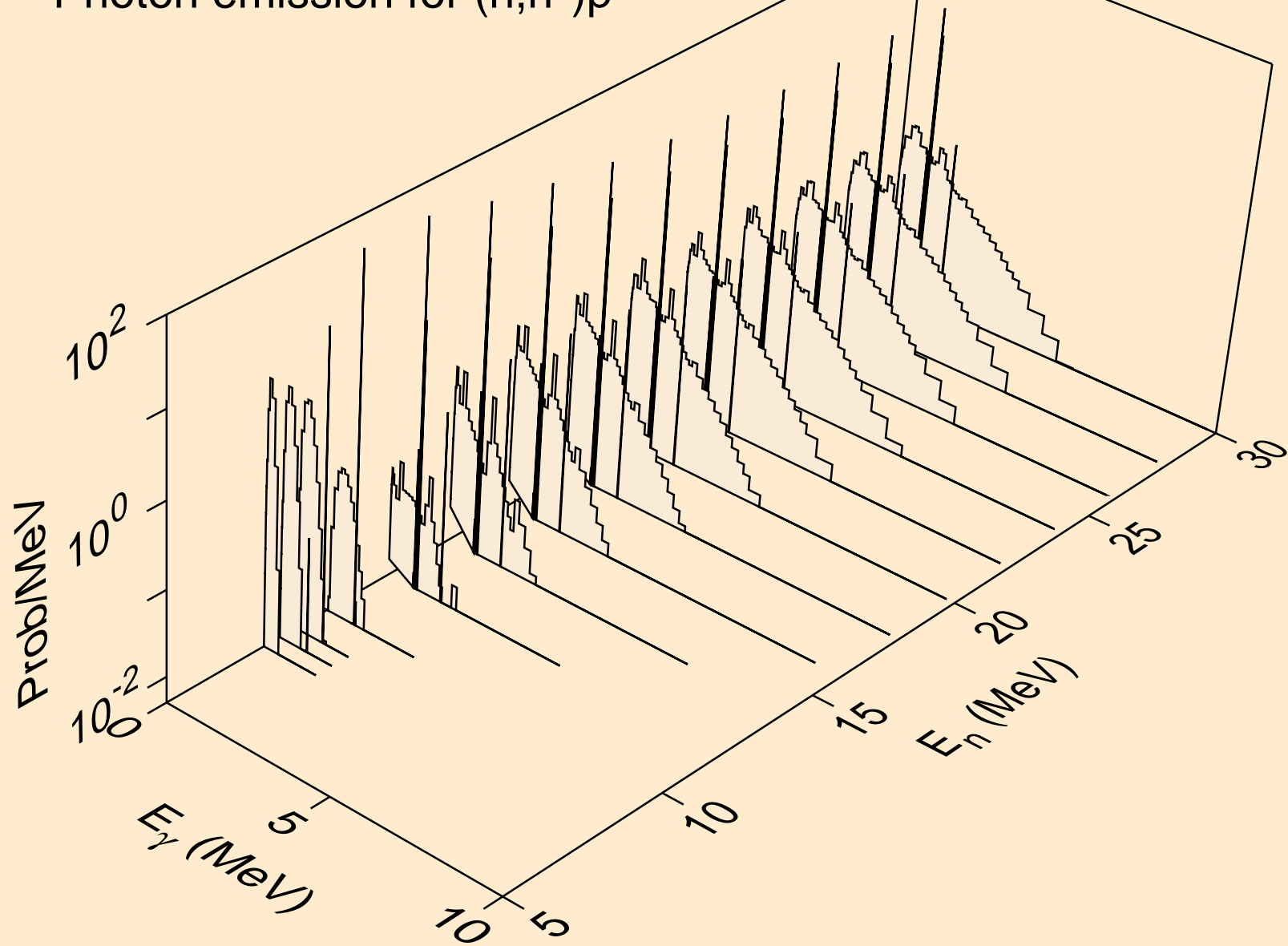

CS135 NEUTRON ACER TENDL-2023 LIBRARY; T=0.K
Photon emission for (n,n*)d

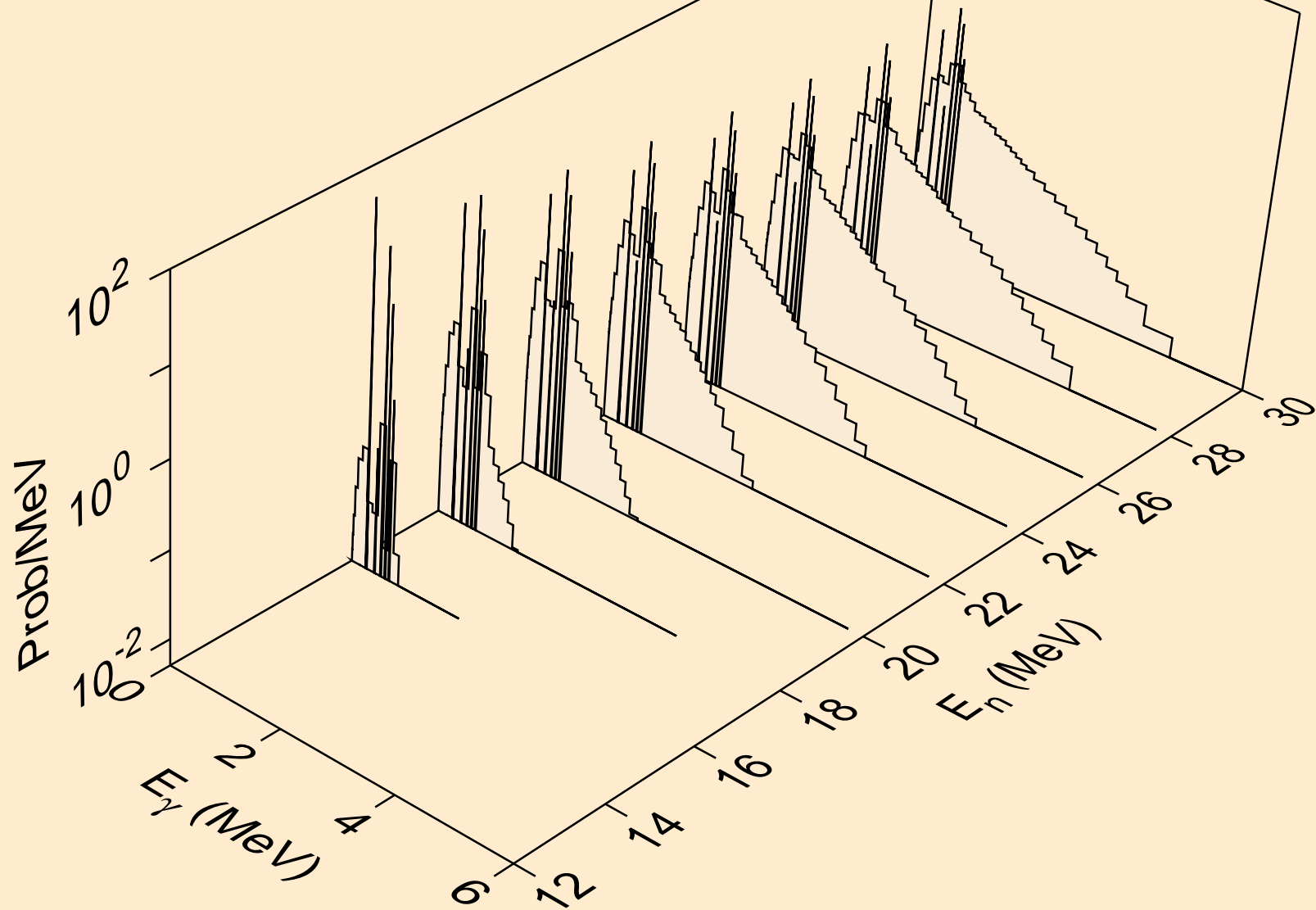

CS135 NEUTRON ACER TENDL-2023 LIBRARY; T=0.K
Photon emission for (n,n*)t

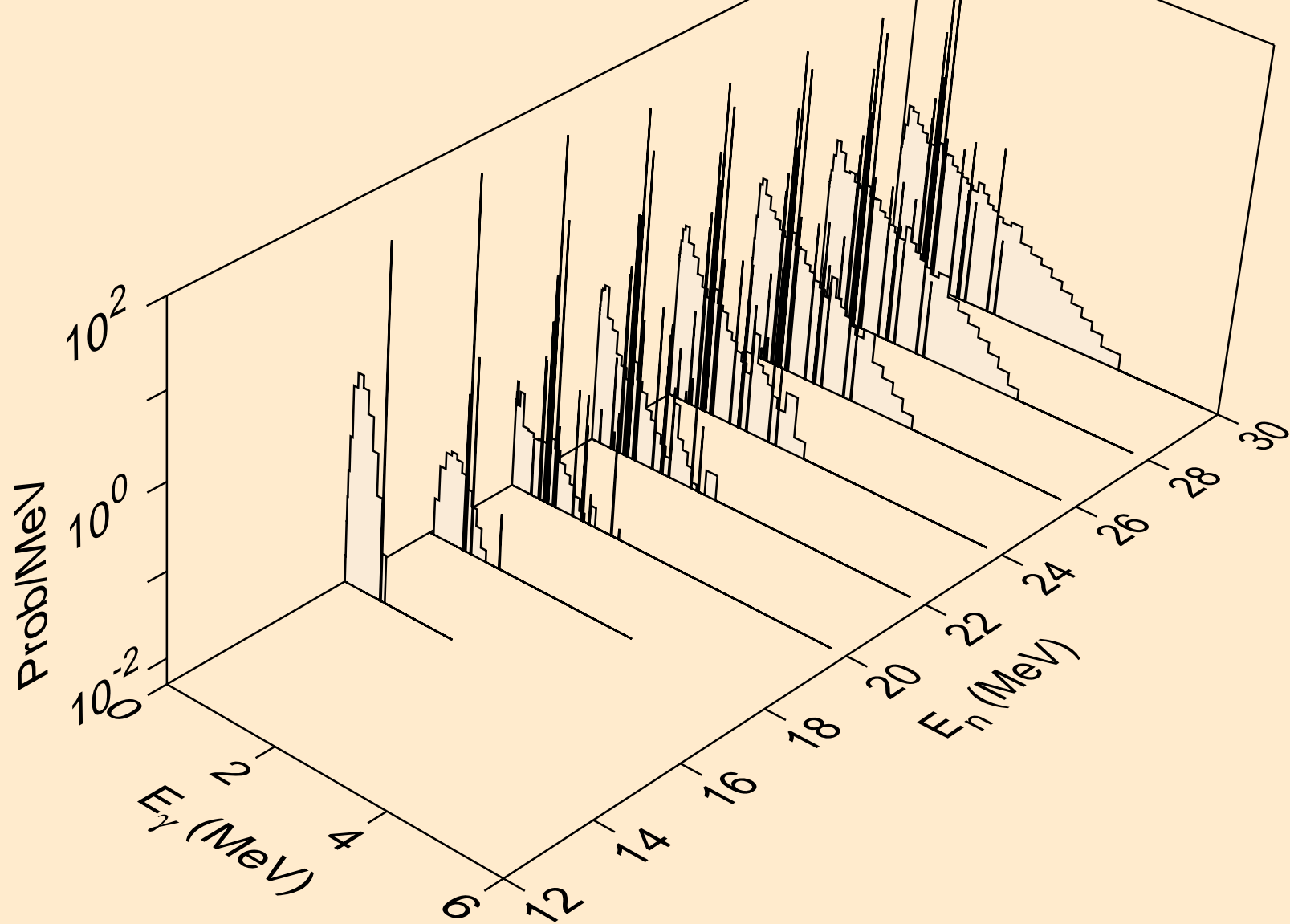

CS135 NEUTRON ACER TENDL-2023 LIBRARY; T=0.K
Photon emission for (n,n*)he3

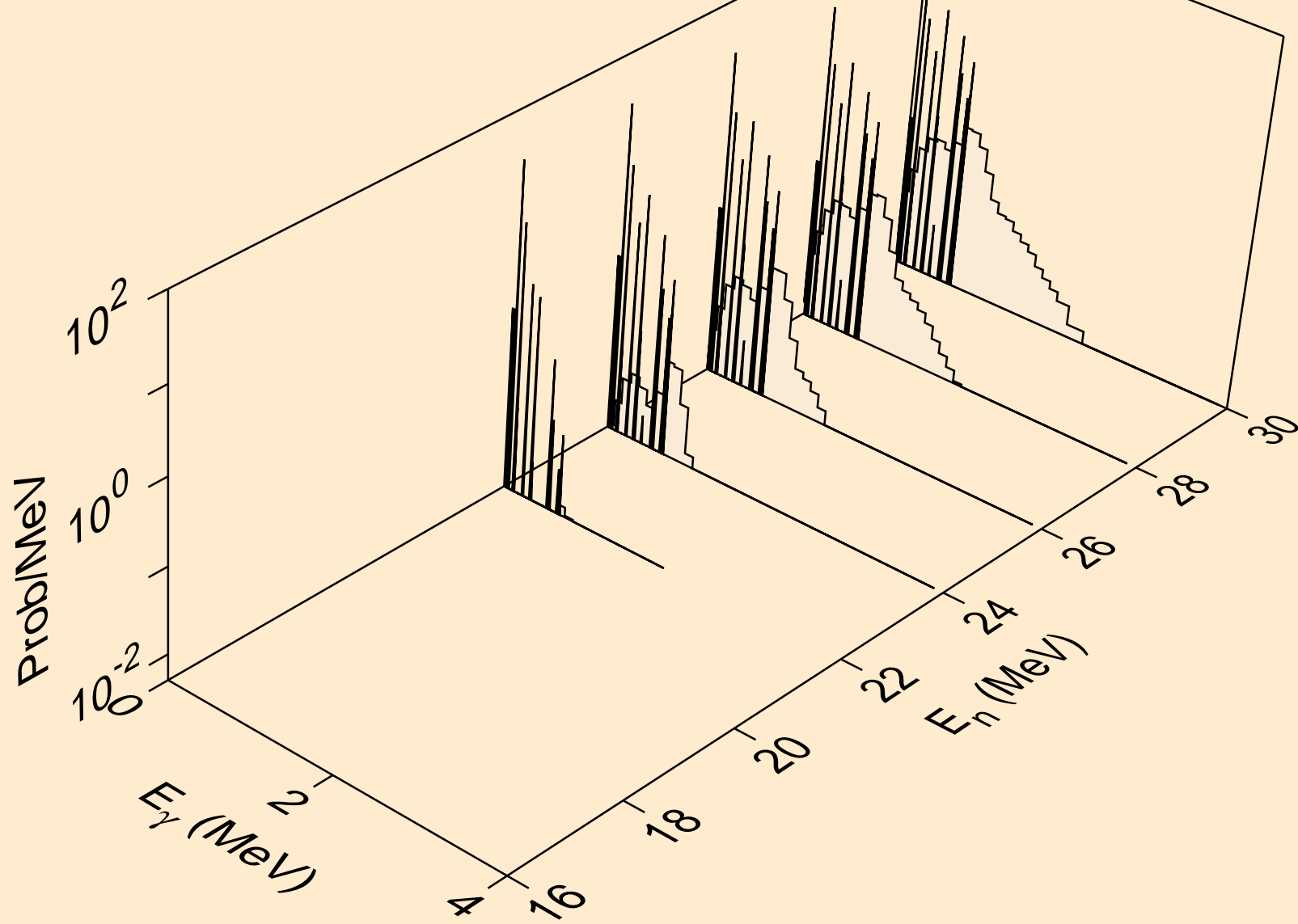

CS135 NEUTRON ACER TENDL-2023 LIBRARY; T=0.K
Photon emission for (n,4n)

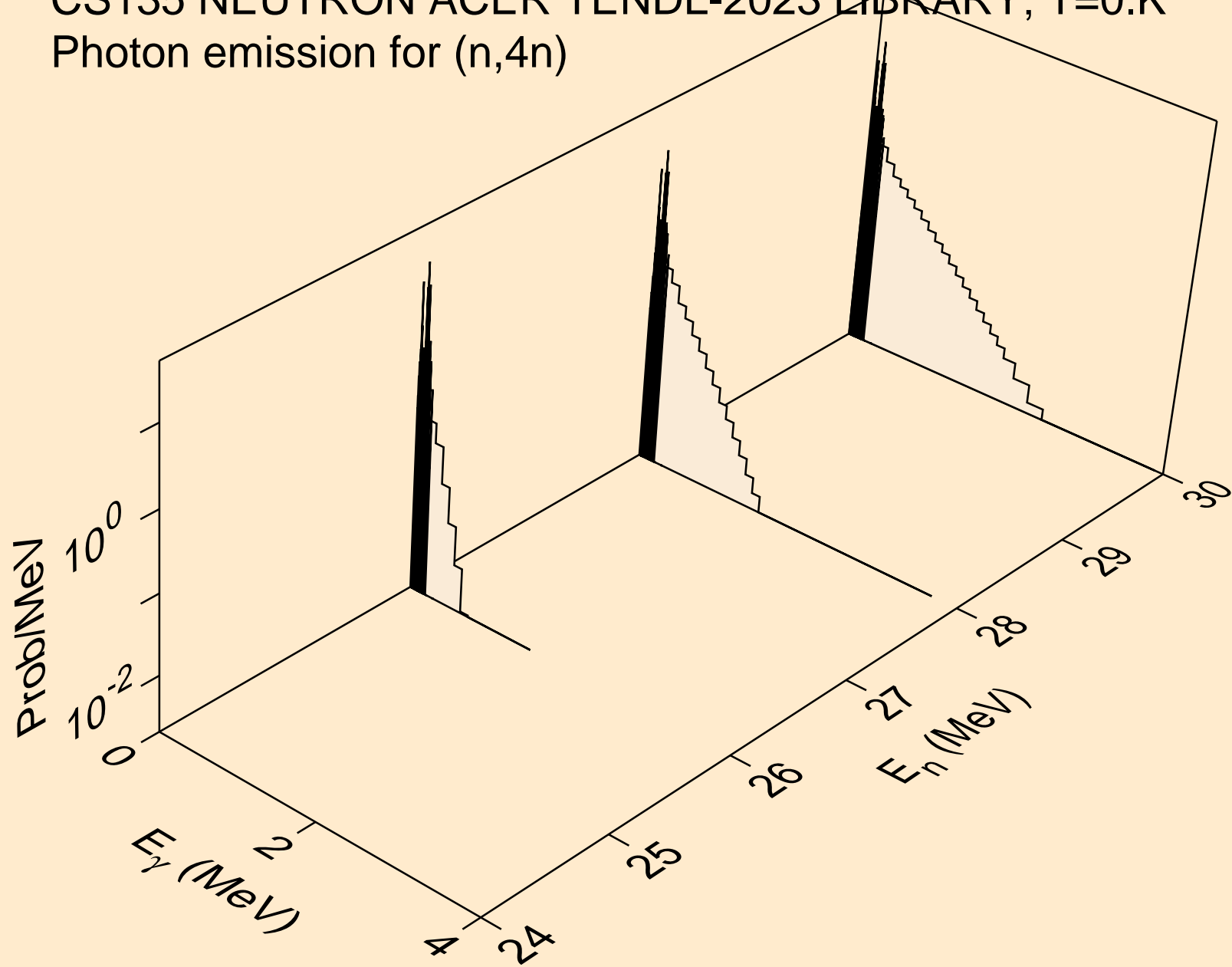

CS135 NEUTRON ACER TENDL-2023 LIBRARY; T=0.K
Photon emission for (n,2np)

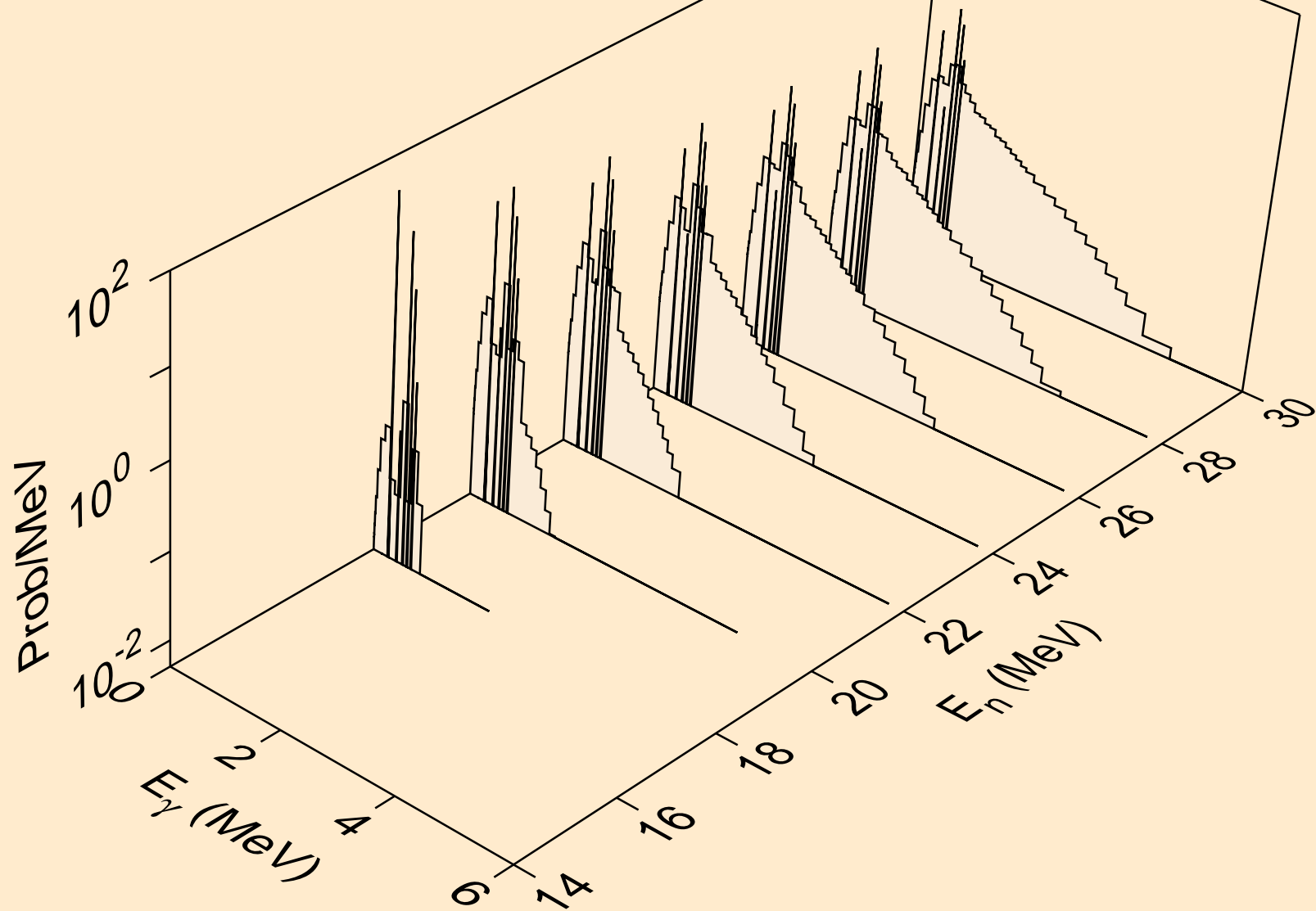

CS135 NEUTRON ACER TENDL-2023 LIBRARY; T=0.K
Photon emission for (n,3np)

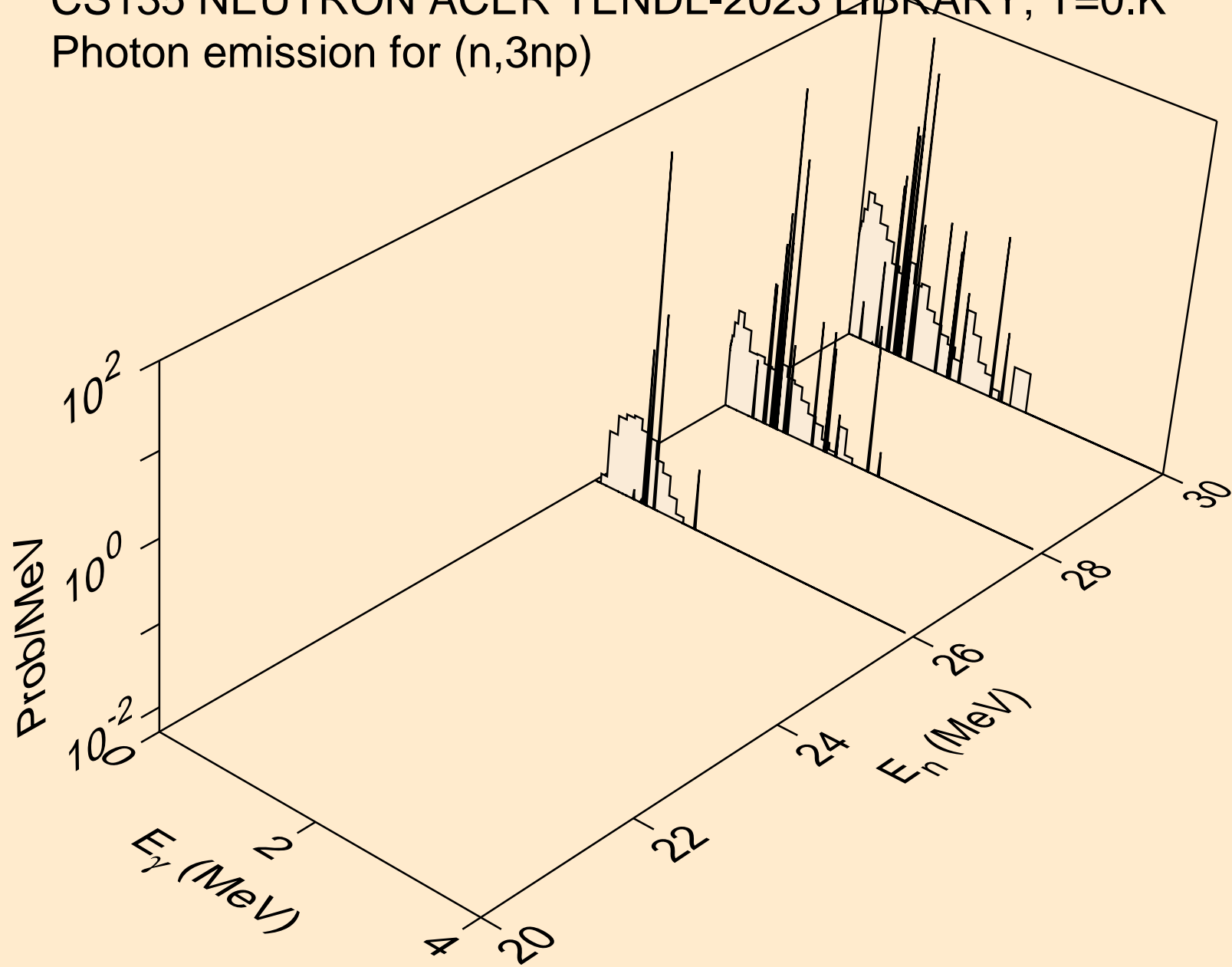

CS135 NEUTRON ACER TENDL-2023 LIBRARY; T=0.K
Photon emission for (n,n2p)

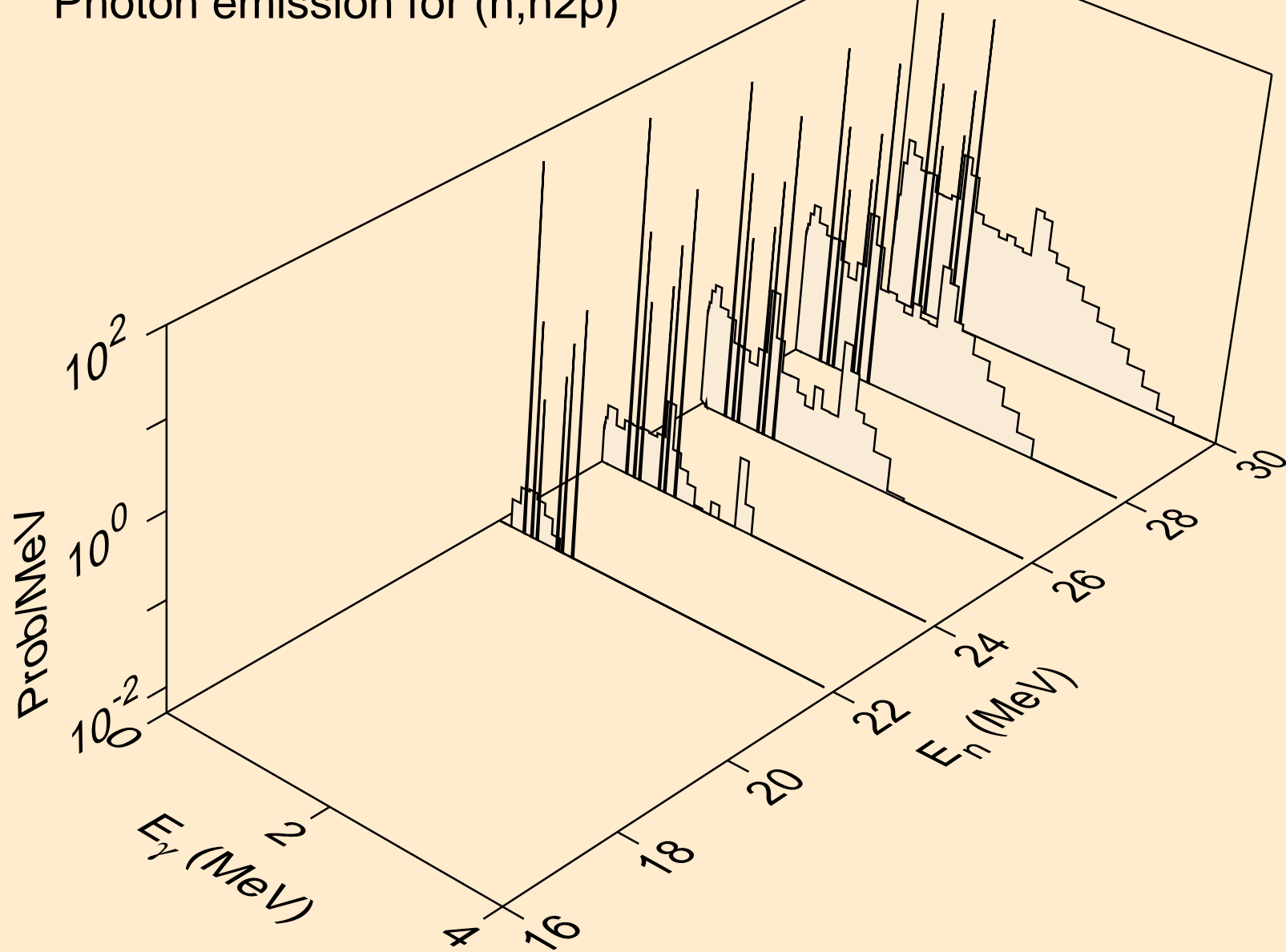

CS135 NEUTRON ACER TENDL-2023 LIBRARY; T=0.K
Photon emission for (n,npa)

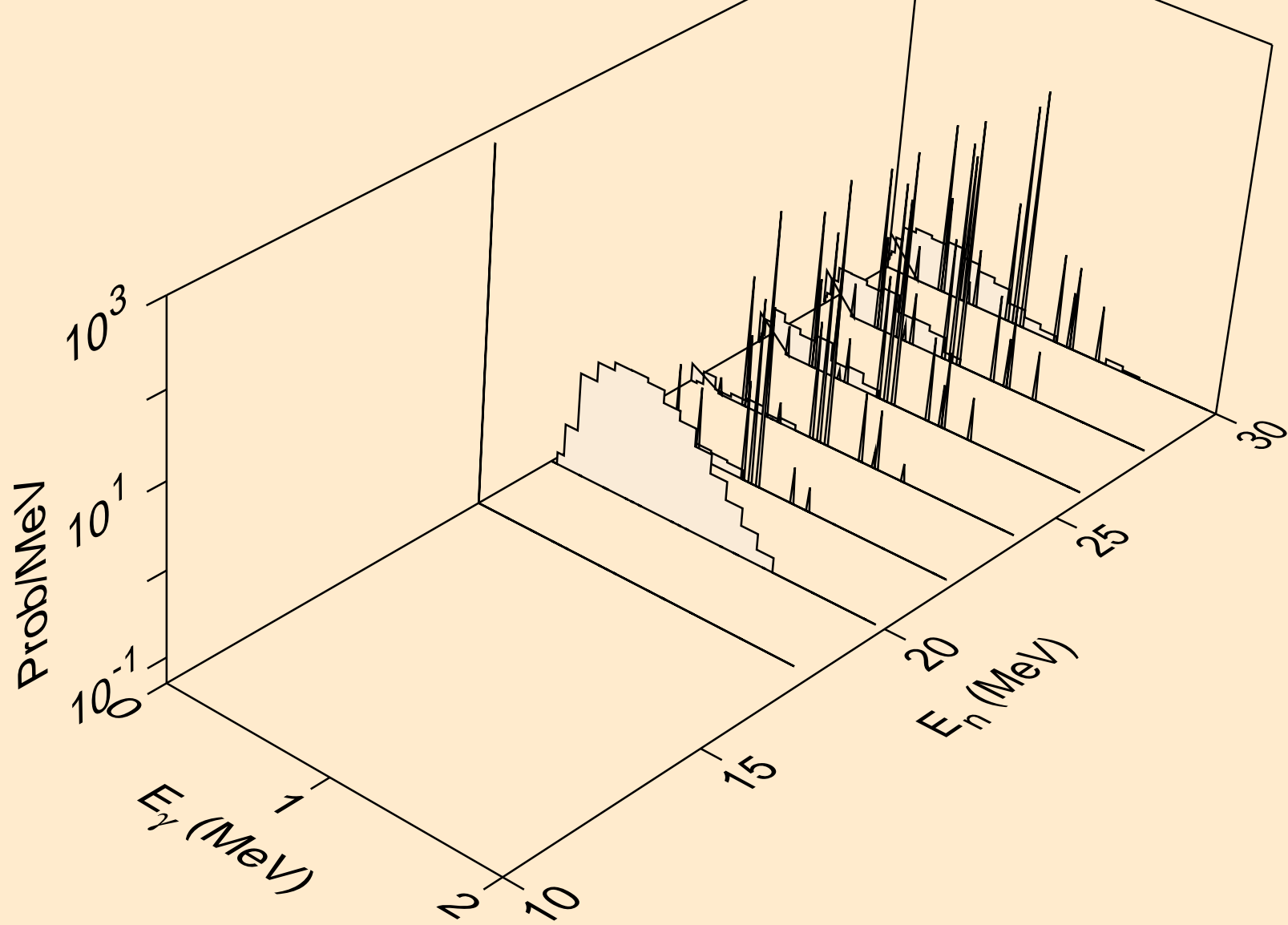

CS135 NEUTRON ACER TENDL-2023 LIBRARY; T=0.K
Photon emission for (n,n*c)

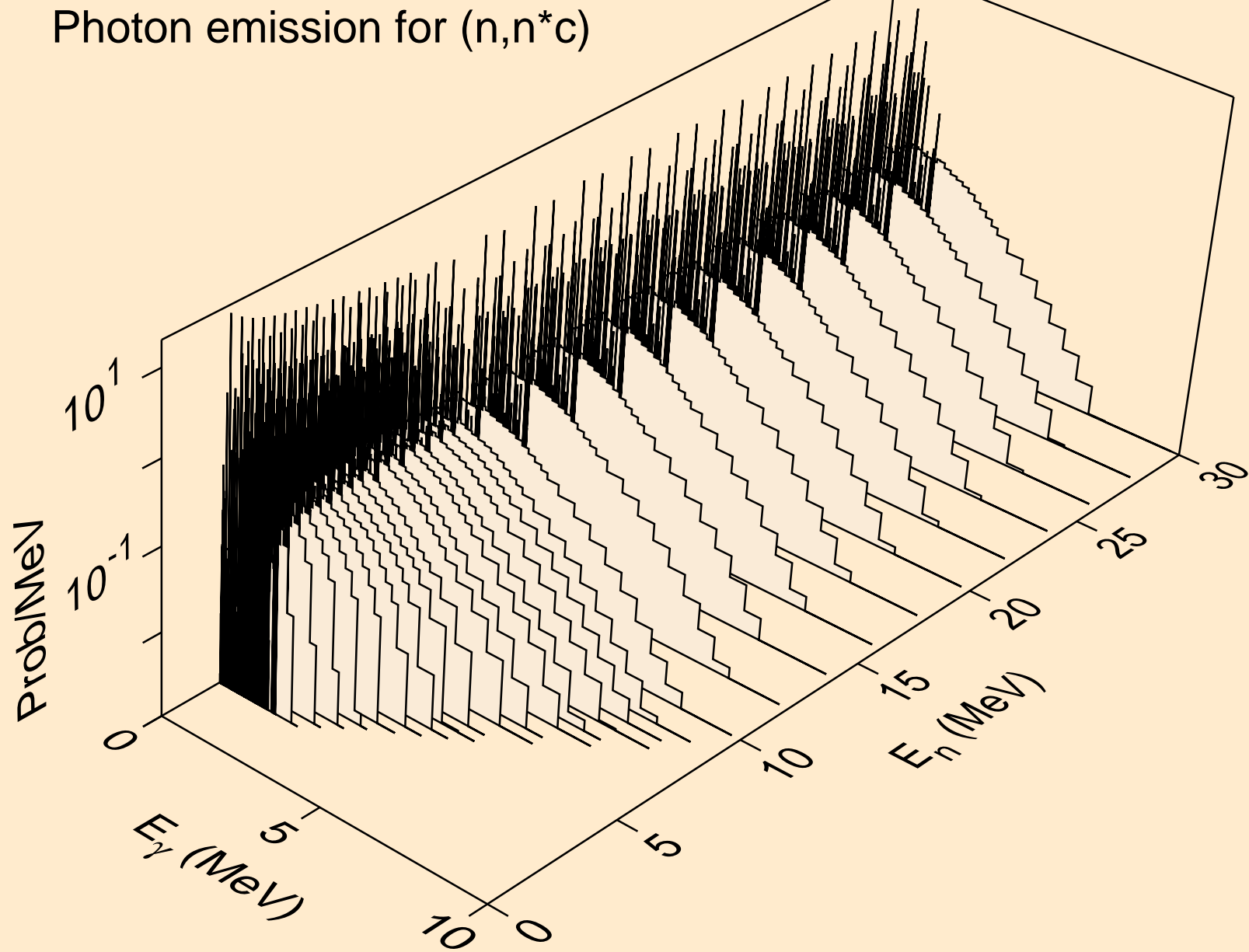

CS135 NEUTRON ACER TENDL-2023 LIBRARY; T=0.K
Photon emission for (n,gma)

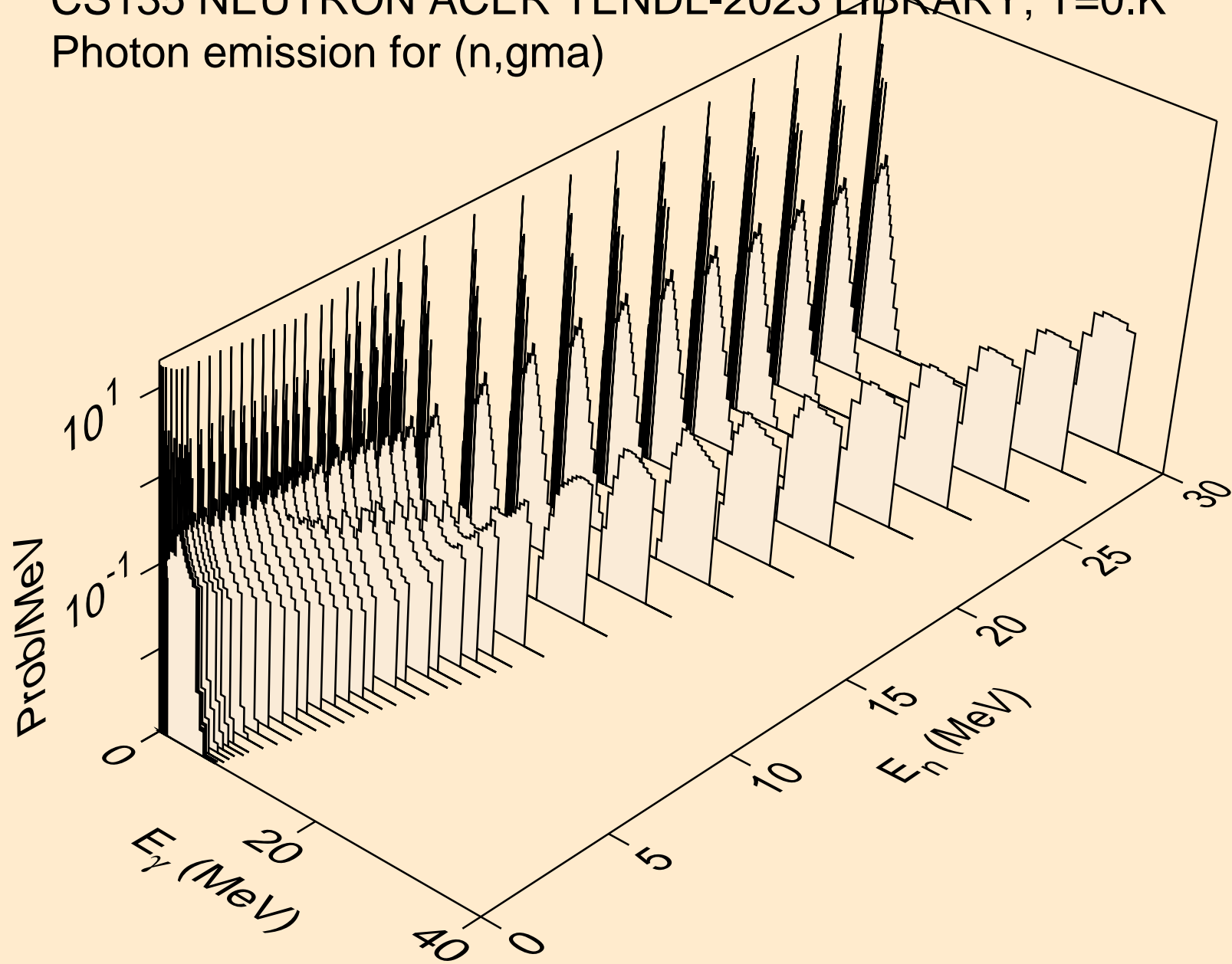

CS135 NEUTRON ACER TENDL-2023 LIBRARY; T=0.K
Photon emission for (n,p)

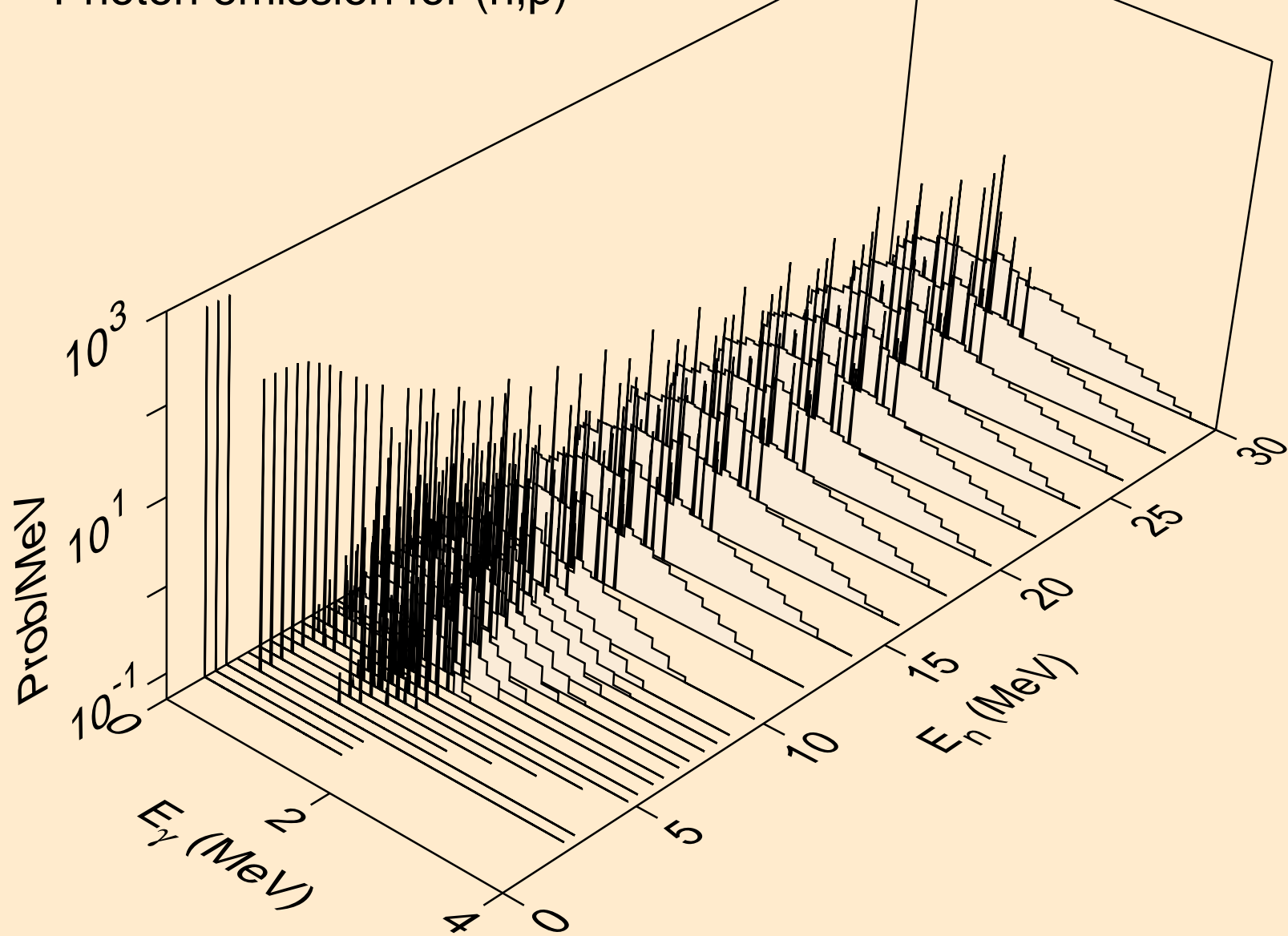

CS135 NEUTRON ACER TENDL-2023 LIBRARY; T=0.K
Photon emission for (n,d)

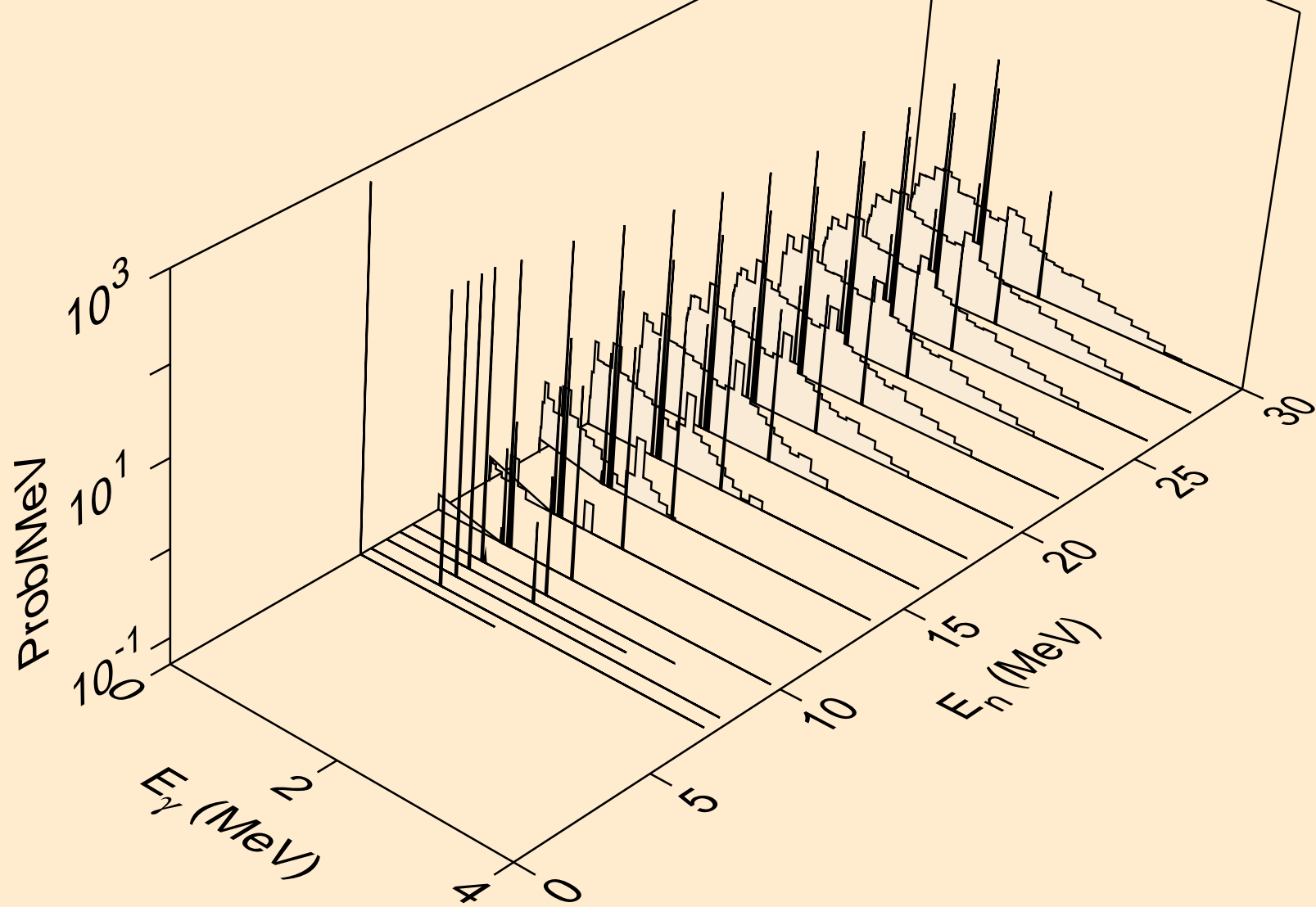

CS135 NEUTRON ACER TENDL-2023 LIBRARY; T=0.K
Photon emission for (n,t)

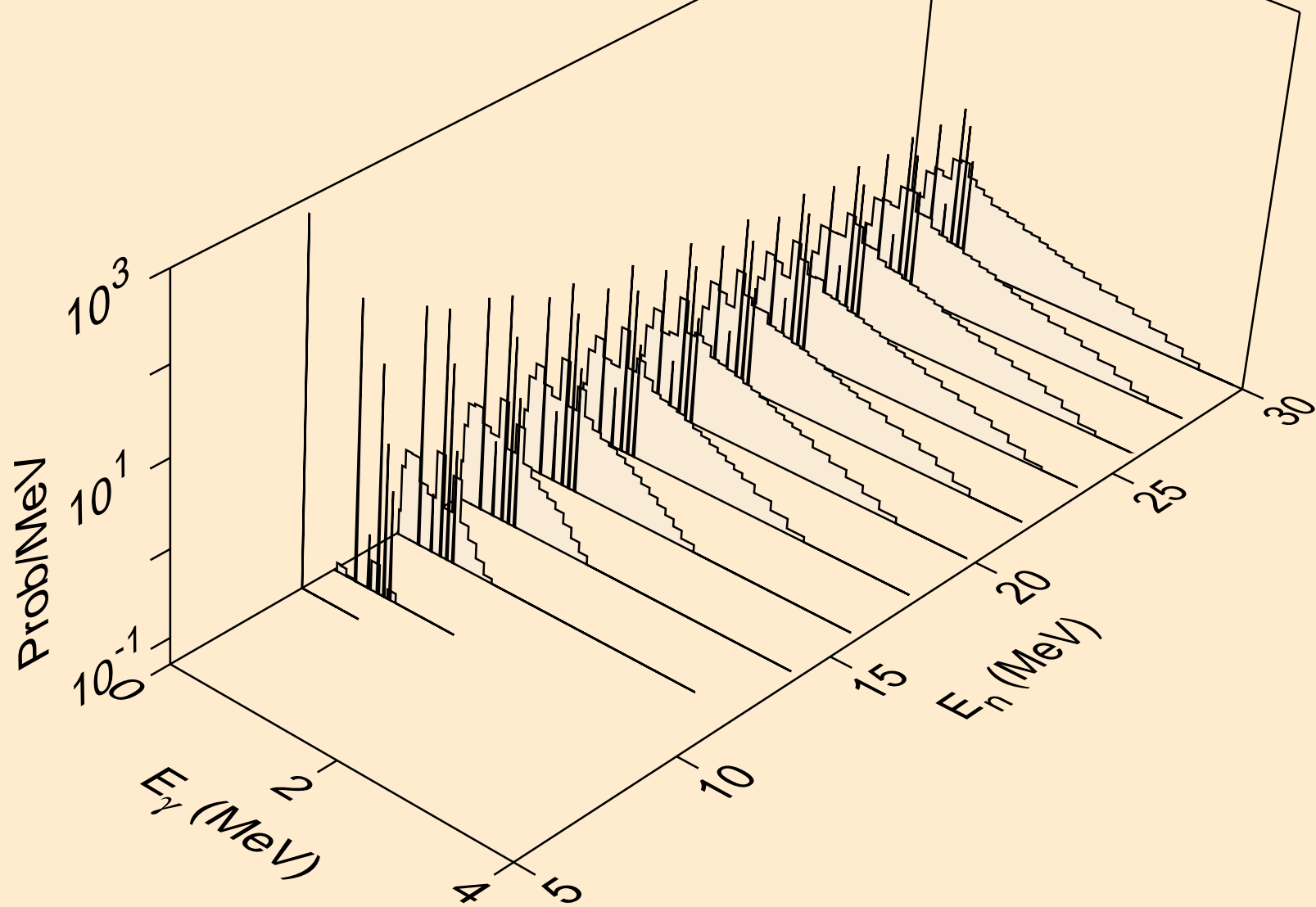

CS135 NEUTRON ACER TENDL-2023 LIBRARY; T=0.K
Photon emission for (n,he3)

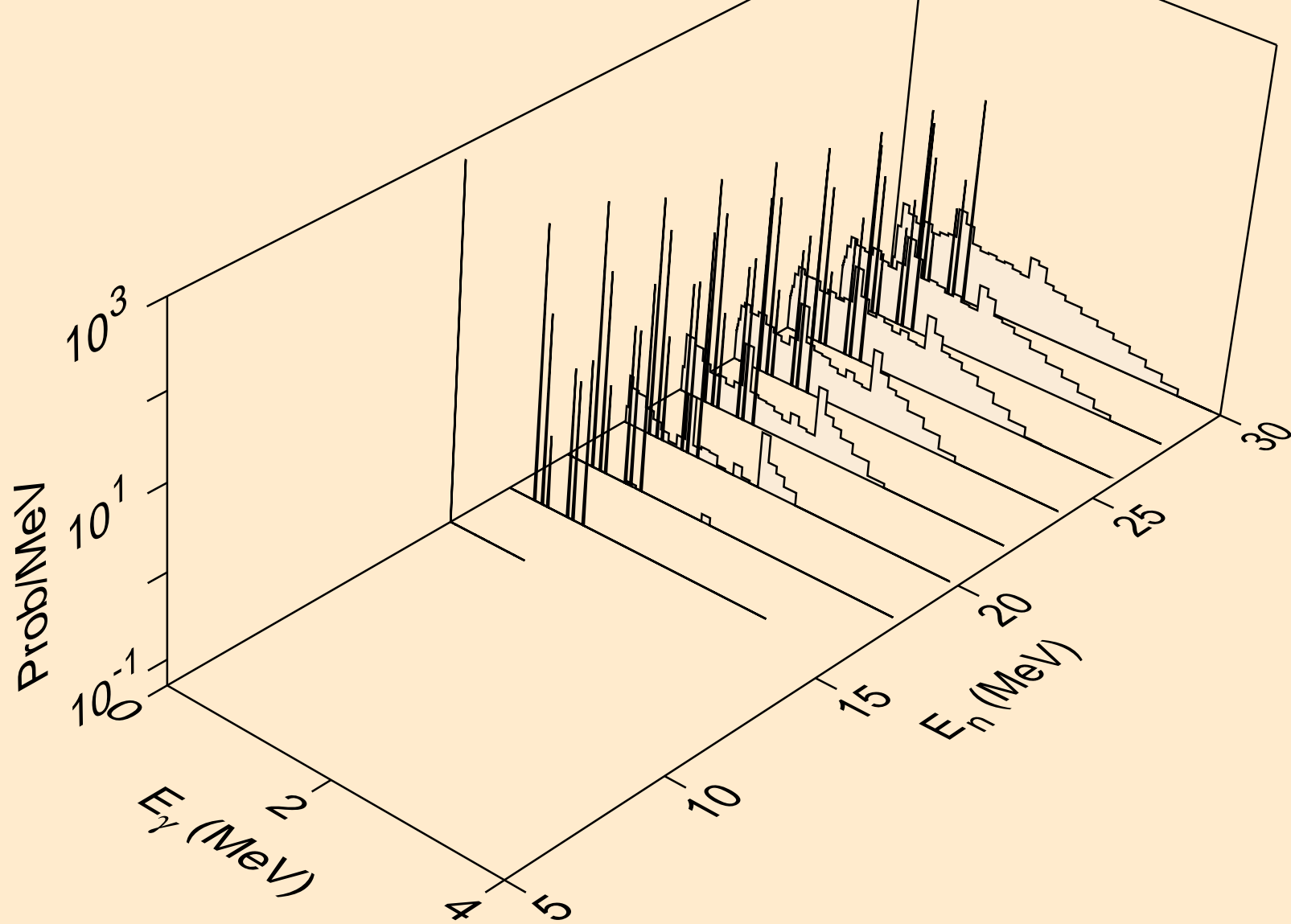

CS135 NEUTRON ACER TENDL-2023 LIBRARY; T=0.K
Photon emission for (n,a)

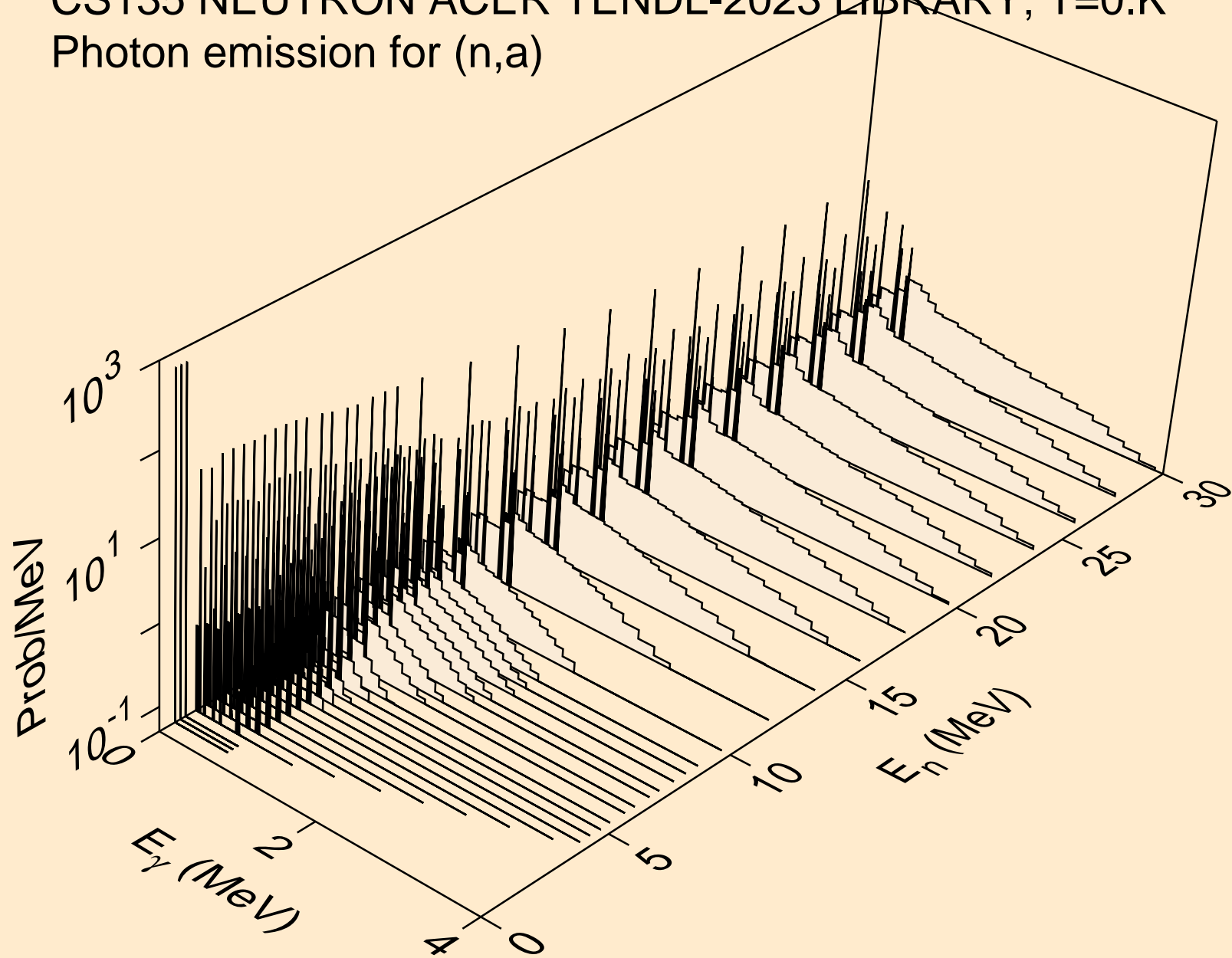

CS135 NEUTRON ACER TENDL-2023 LIBRARY; T=0.K
Photon emission for (n,2a)

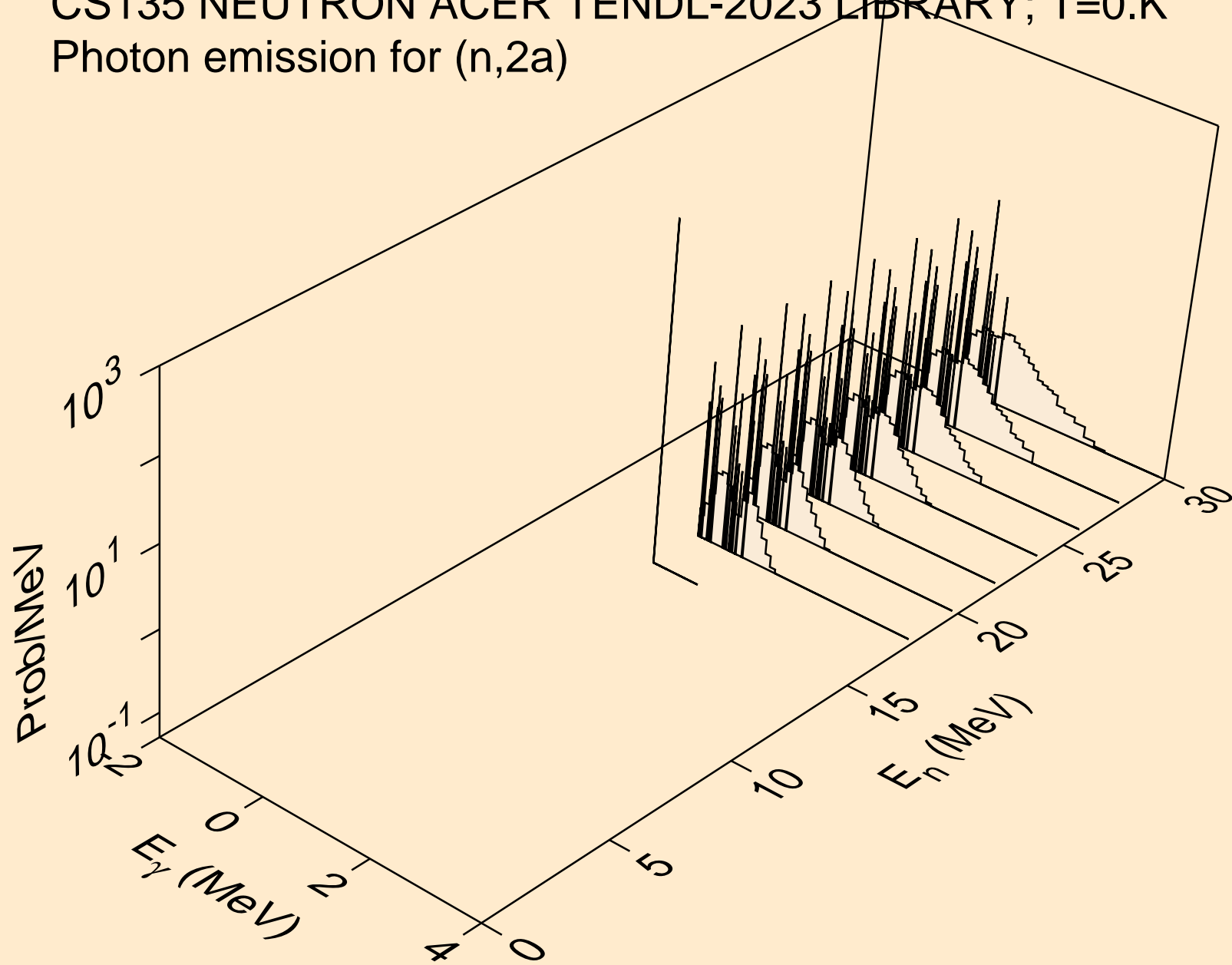

CS135 NEUTRON ACER TENDL-2023 LIBRARY; T=0.K
Photon emission for (n,2p)

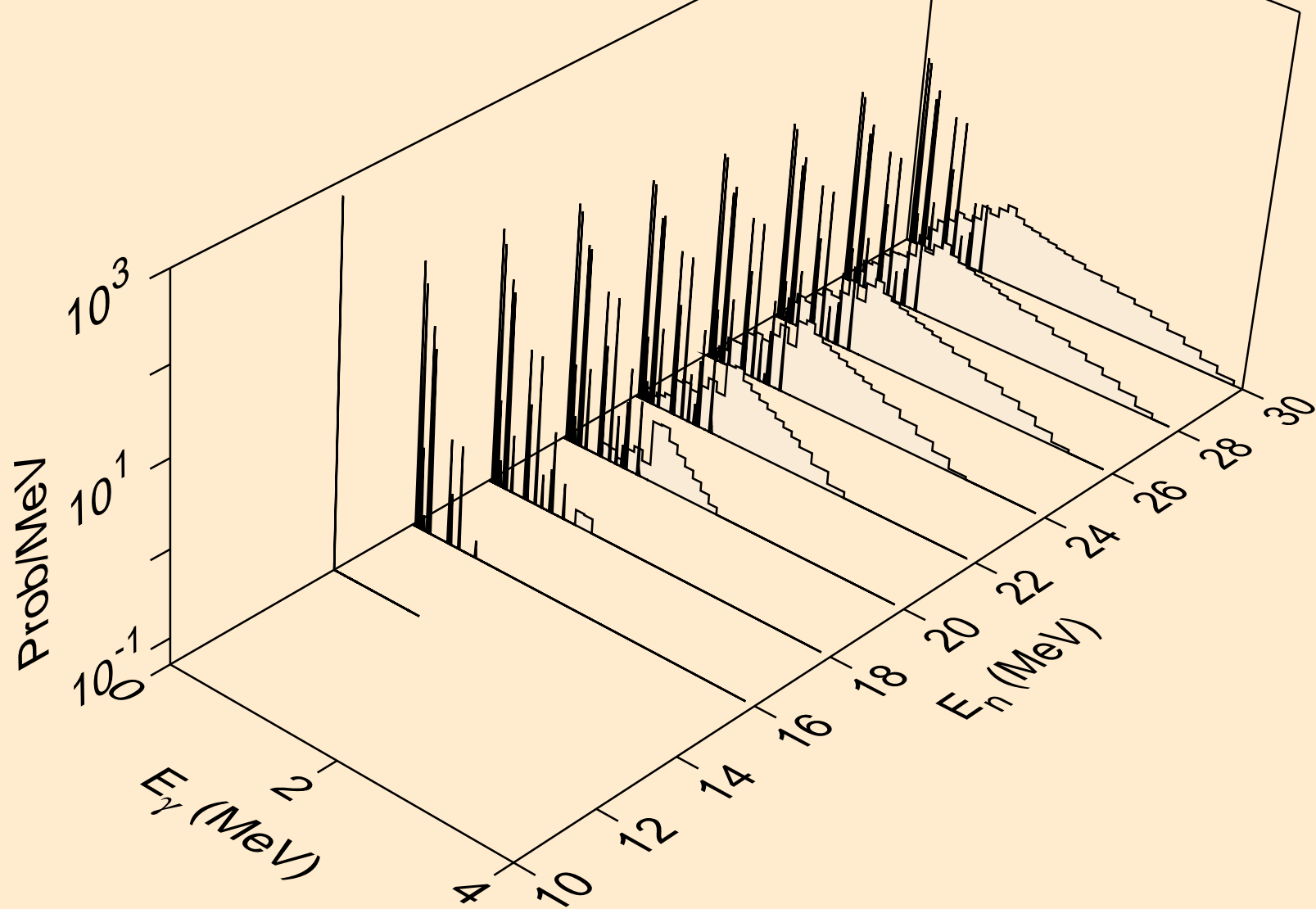

CS135 NEUTRON ACER TENDL-2023 LIBRARY; T=0.K
Photon emission for (n,p α)

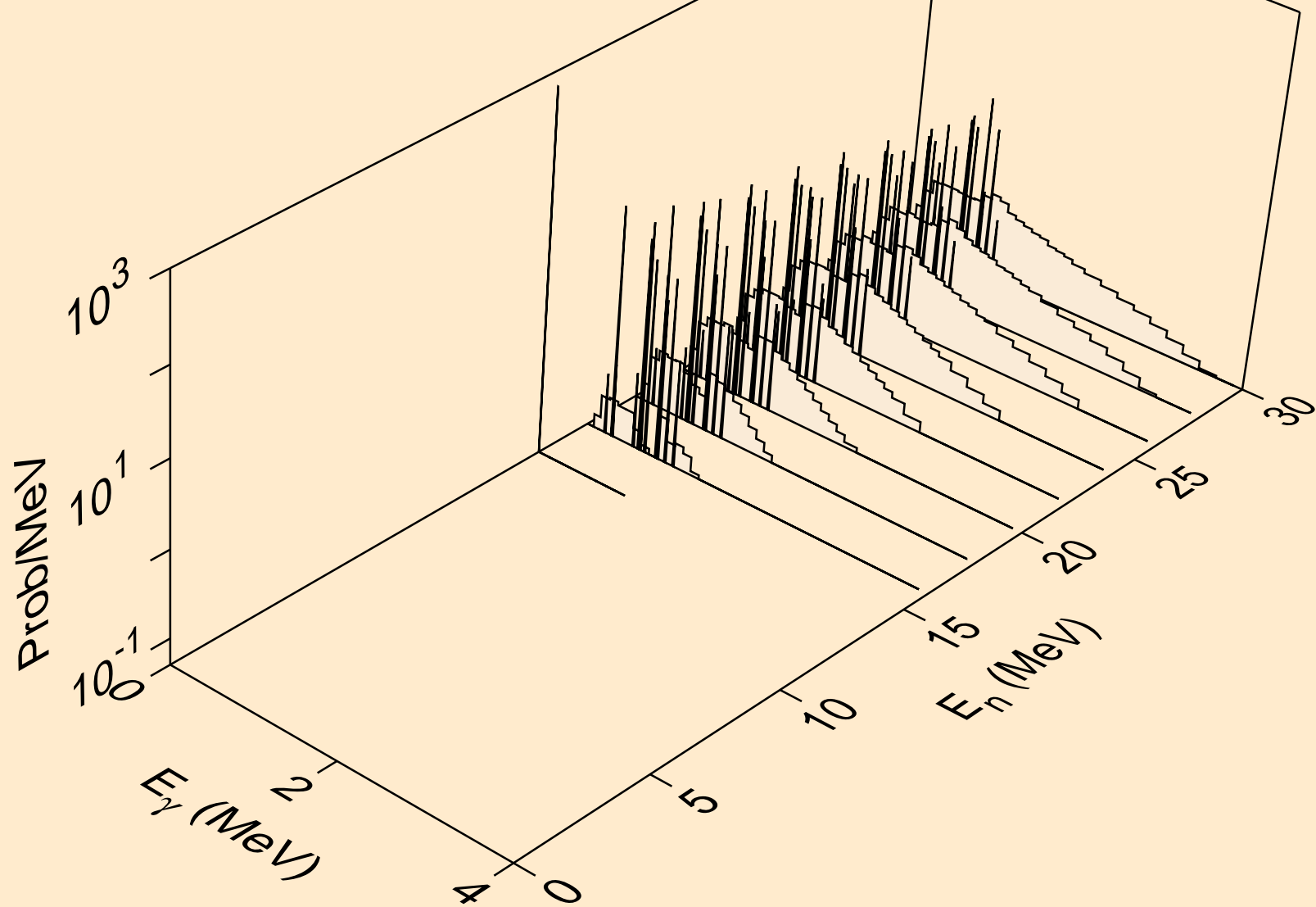

CS135 NEUTRON ACER TENDL-2023 LIBRARY; T=0.K
Photon emission for (n,pd)

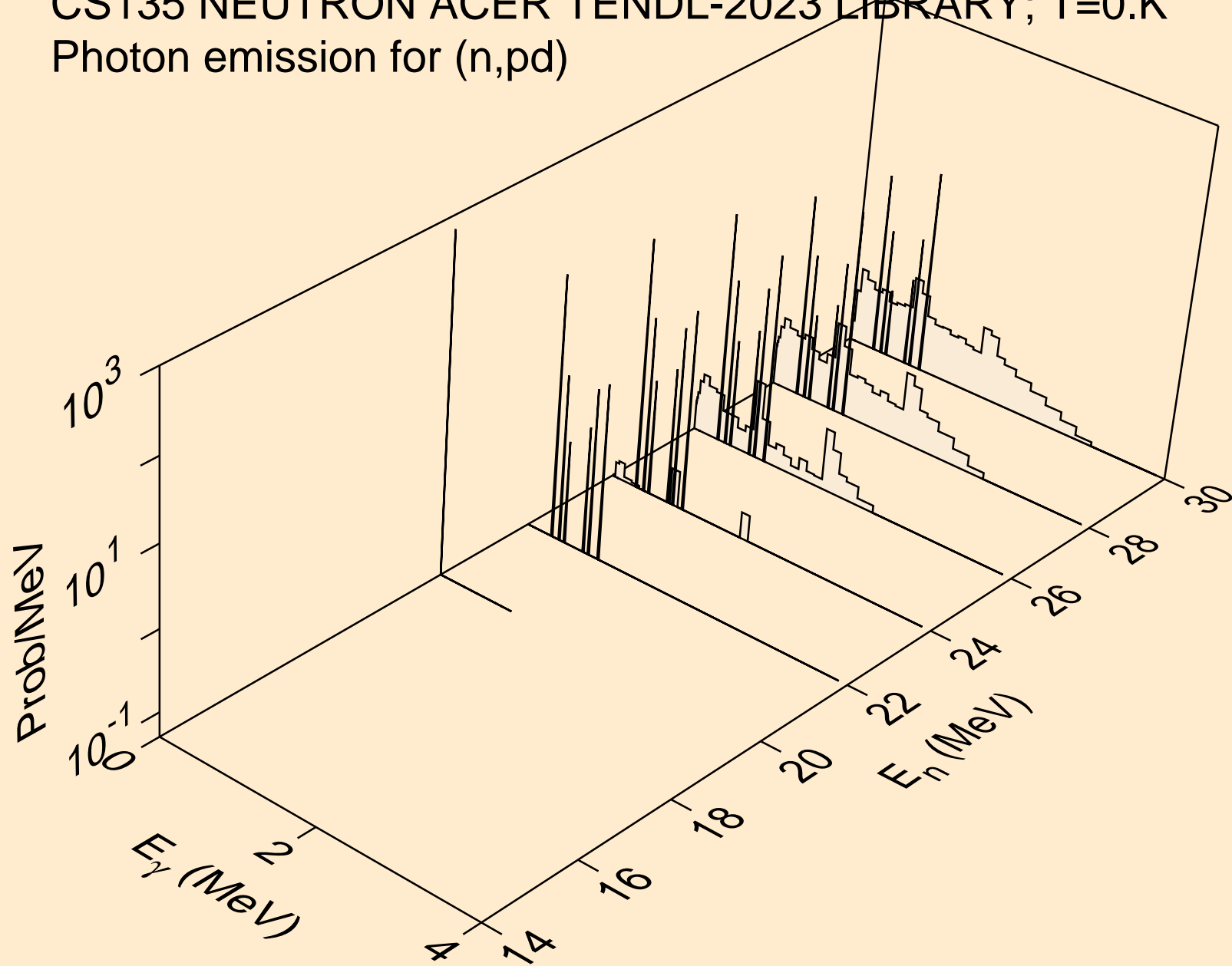

CS135 NEUTRON ACER TENDL-2023 LIBRARY; T=0.K
Photon emission for (n,pt)

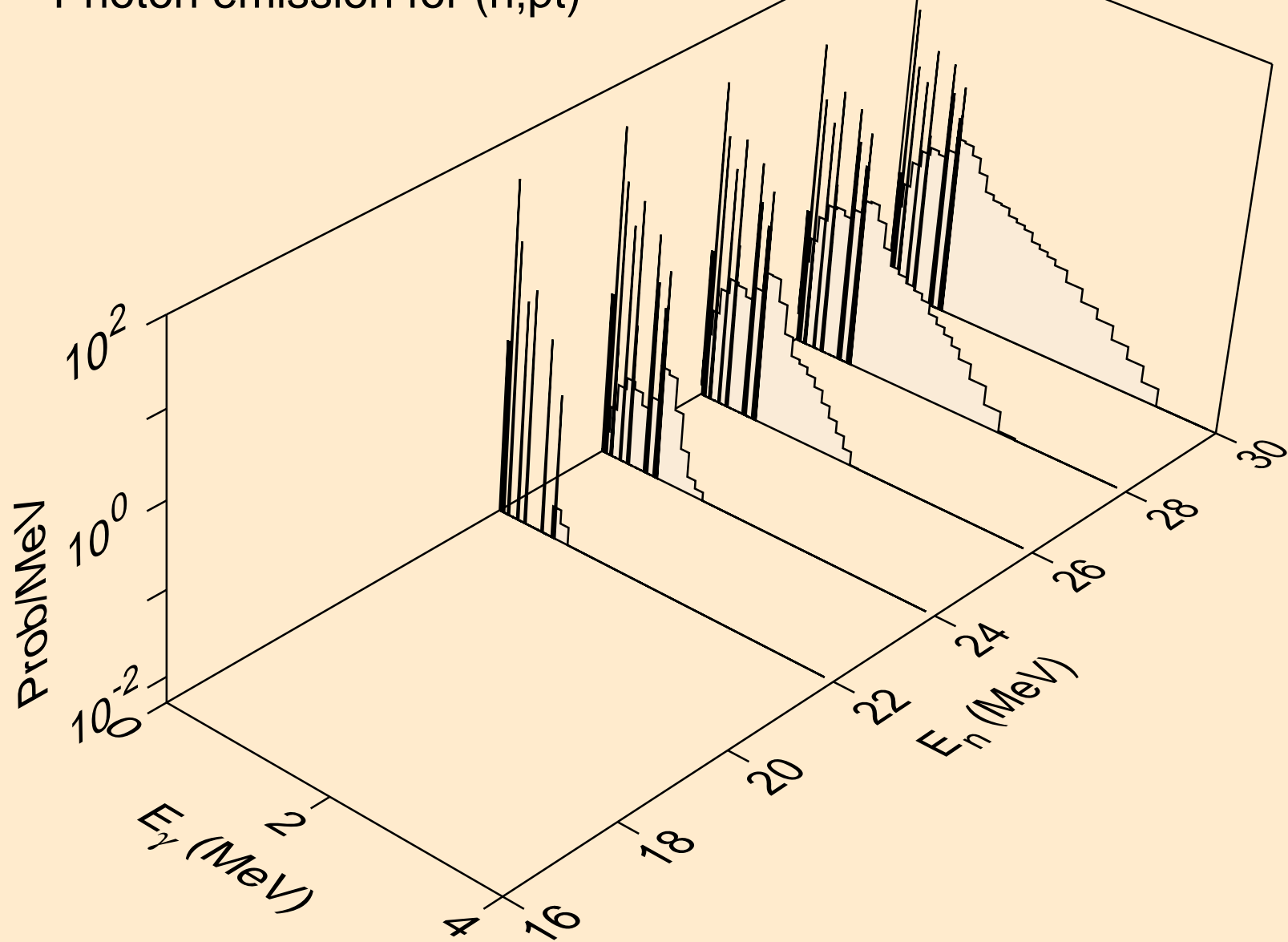

CS135 NEUTRON ACER TENDL-2023 LIBRARY; T=0.K
Photon emission for (n,da)

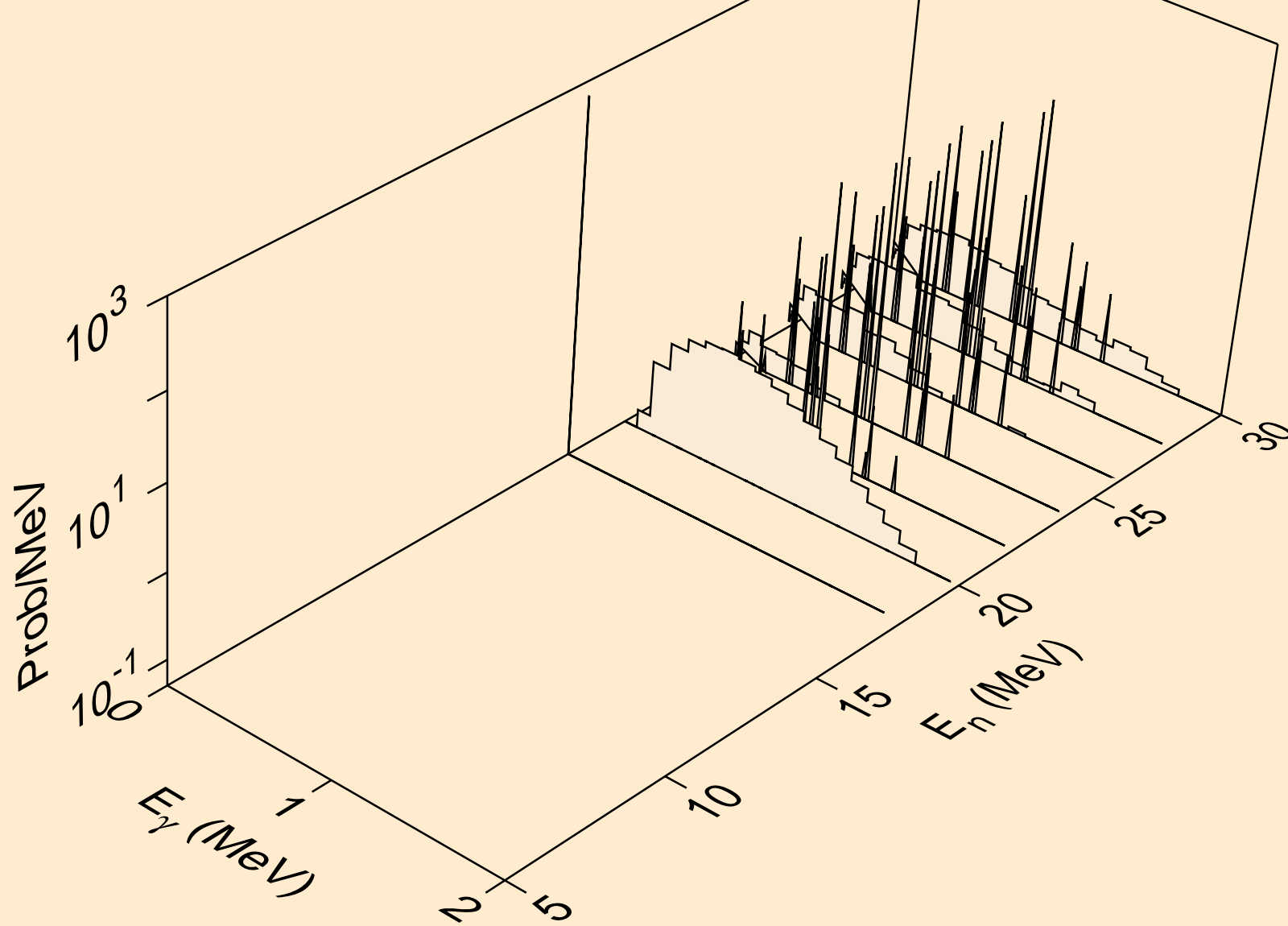

CS135 NEUTRON ACER TENDL-2023 LIBRARY; T=0.K
thermal capture photon spectrum

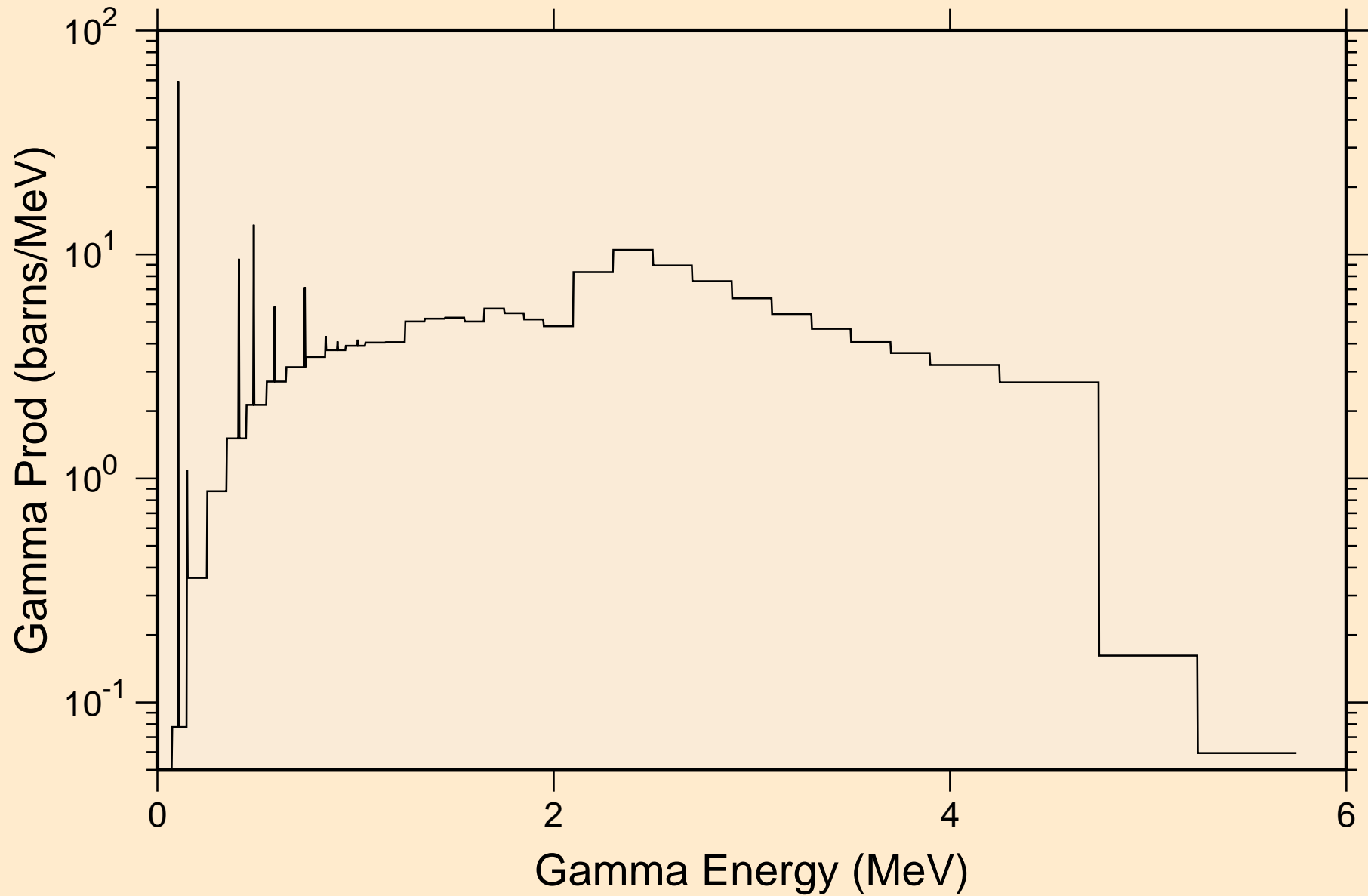

CS135 NEUTRON ACER TENDL-2023 LIBRARY; T=0.K
14 MeV photon spectrum

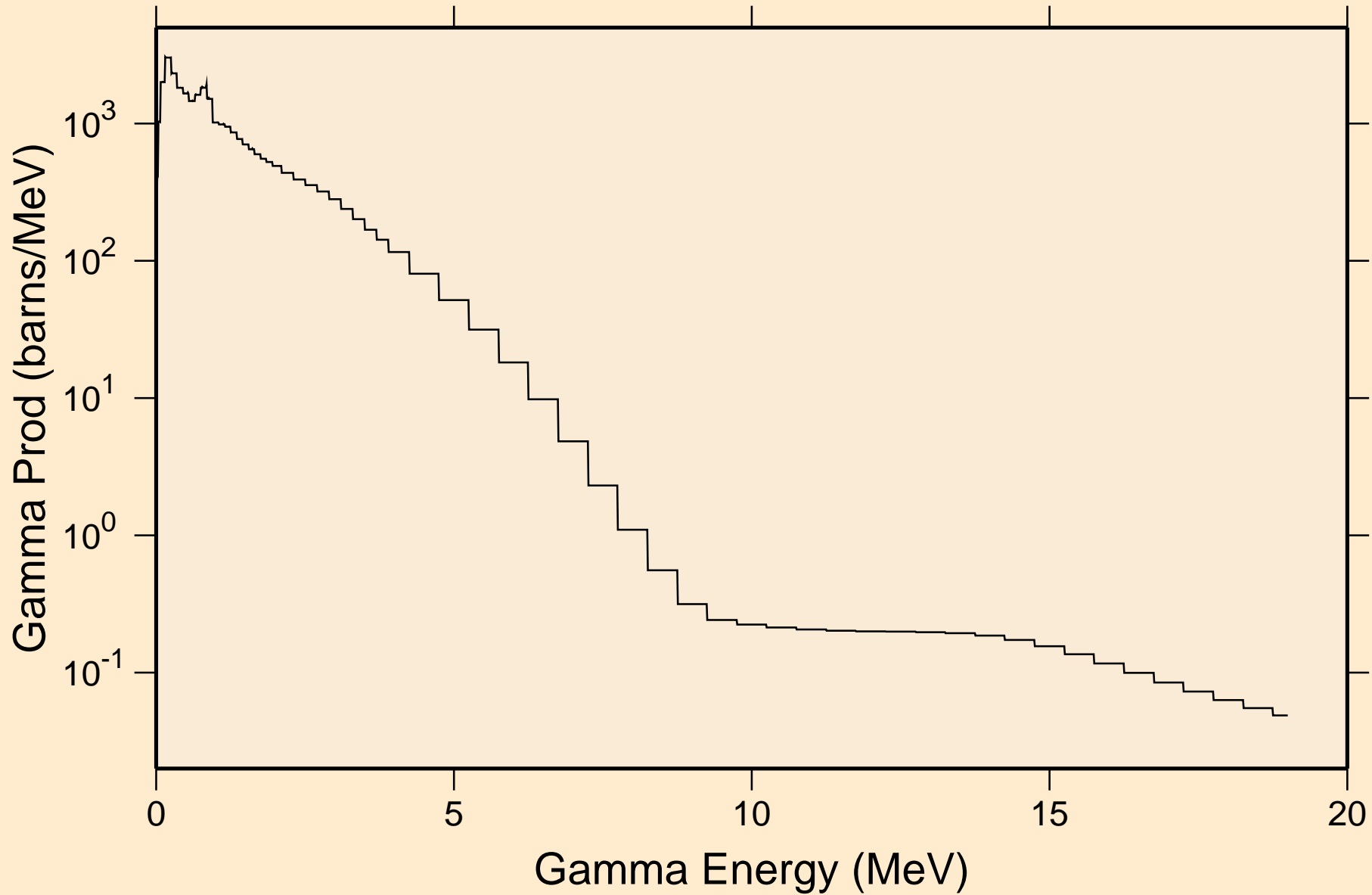

CS135 NEUTRON ACER TENDL-2023 LIBRARY; T=0.K

Particle heating contributions

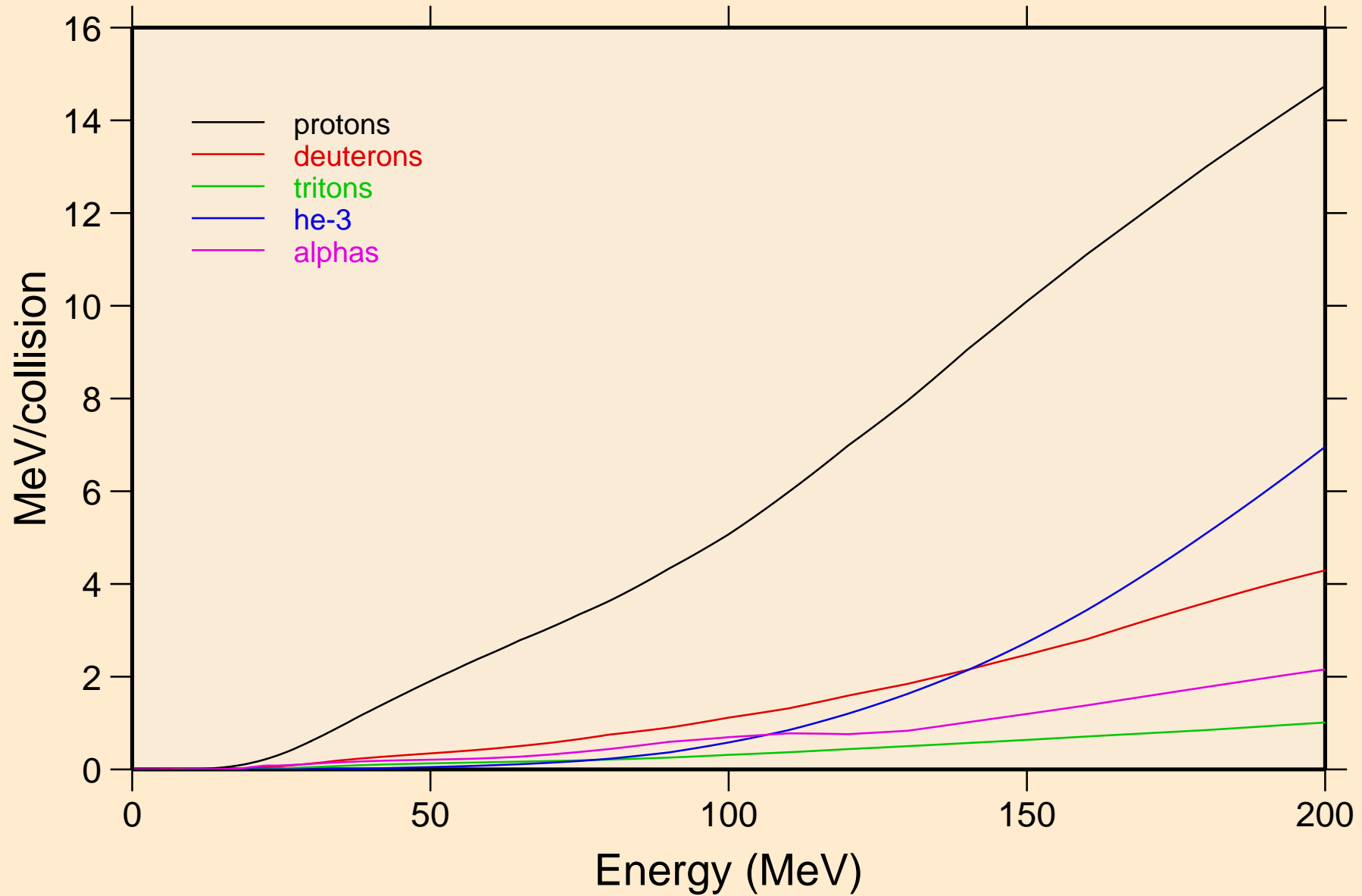

CS135 NEUTRON ACER TENDL-2023 LIBRARY; T=0.K

Recoil Heating

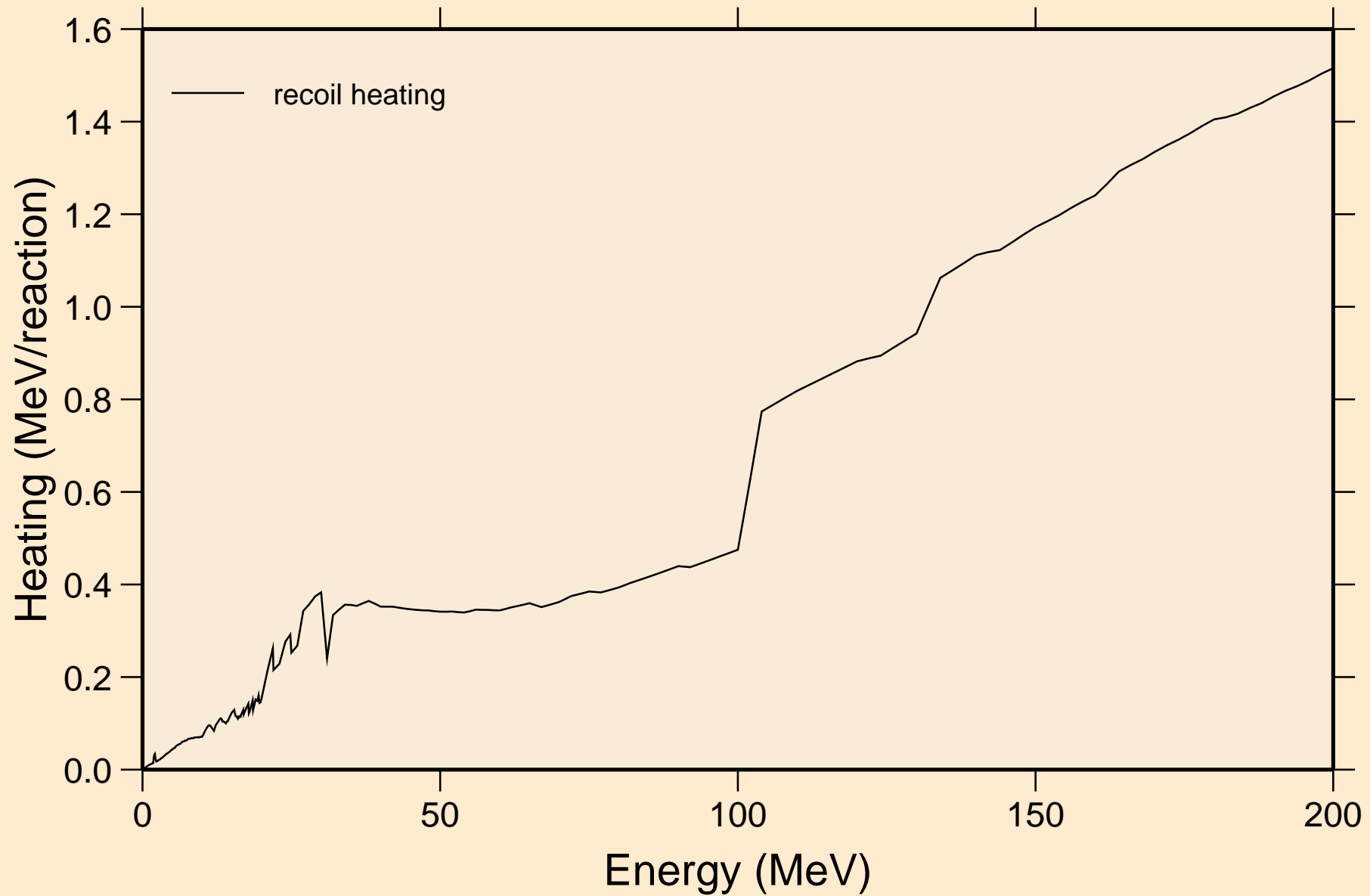

CS135 NEUTRON ACER TENDL-2023 LIBRARY; T=0.K

Particle production cross sections

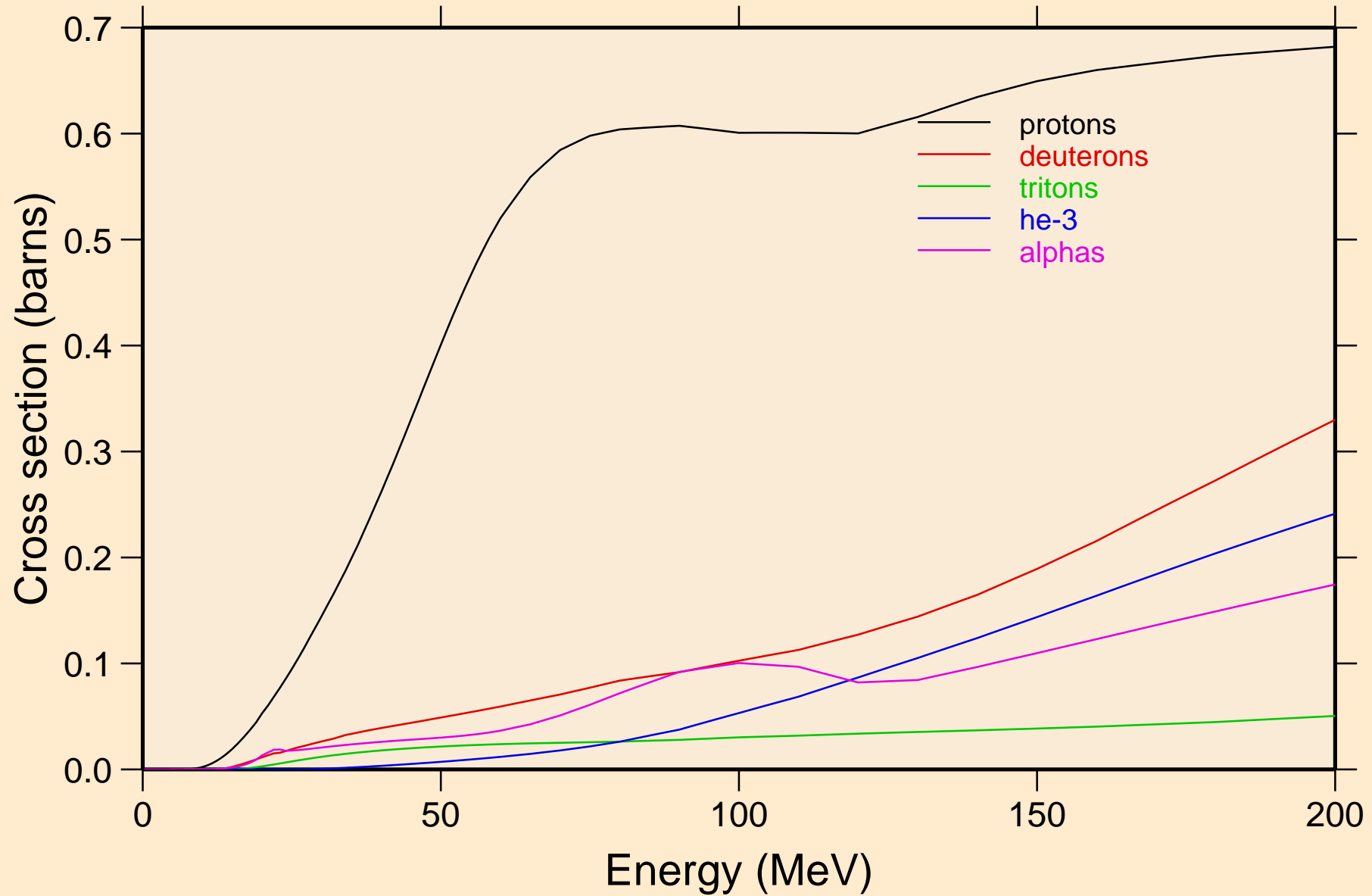

CS135 NEUTRON ACER TENDL-2023 LIBRARY; T=0.K
protons from (n,x)

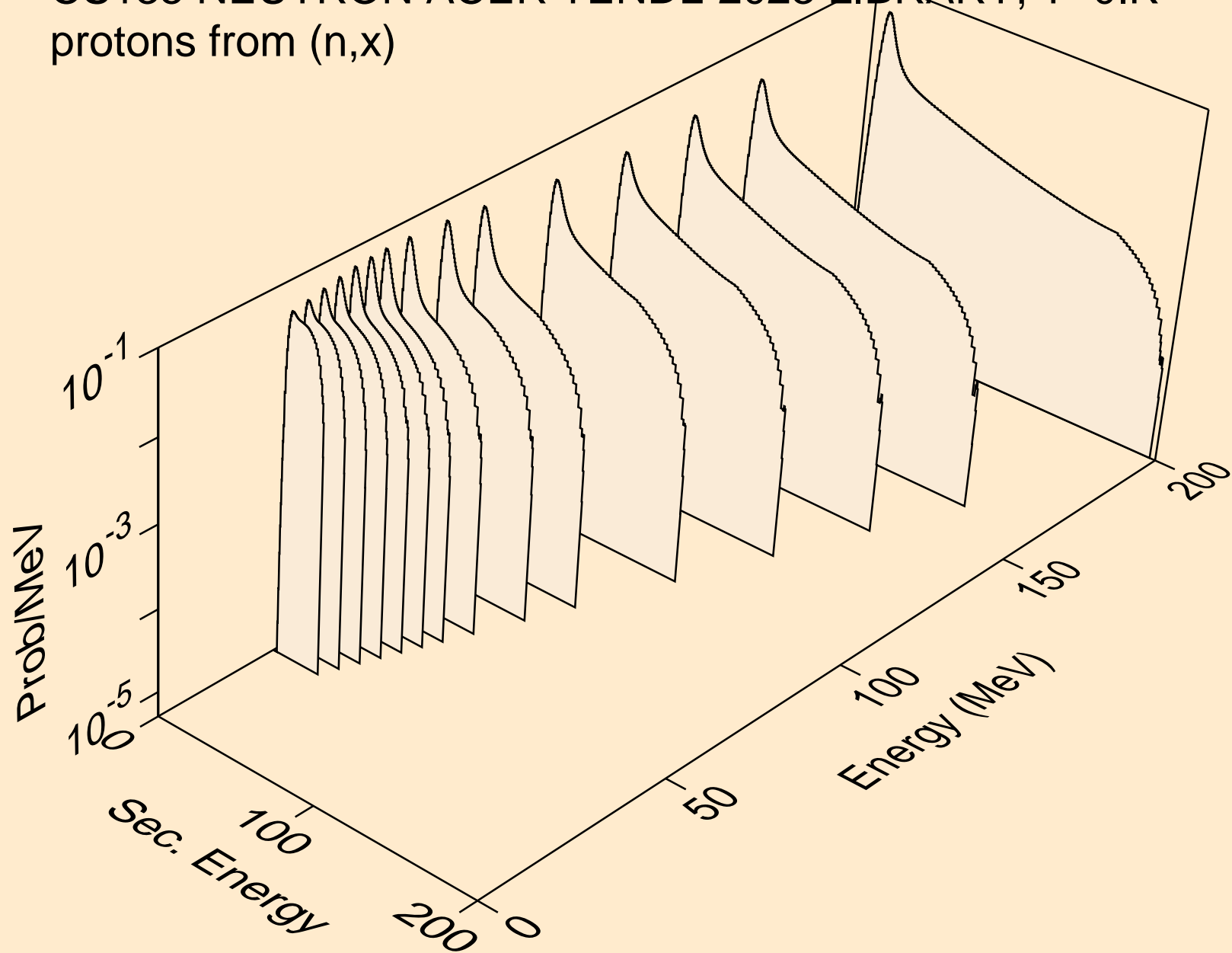

CS135 NEUTRON ACER TENDL-2023 LIBRARY; T=0.K
protons from (n,n*)p

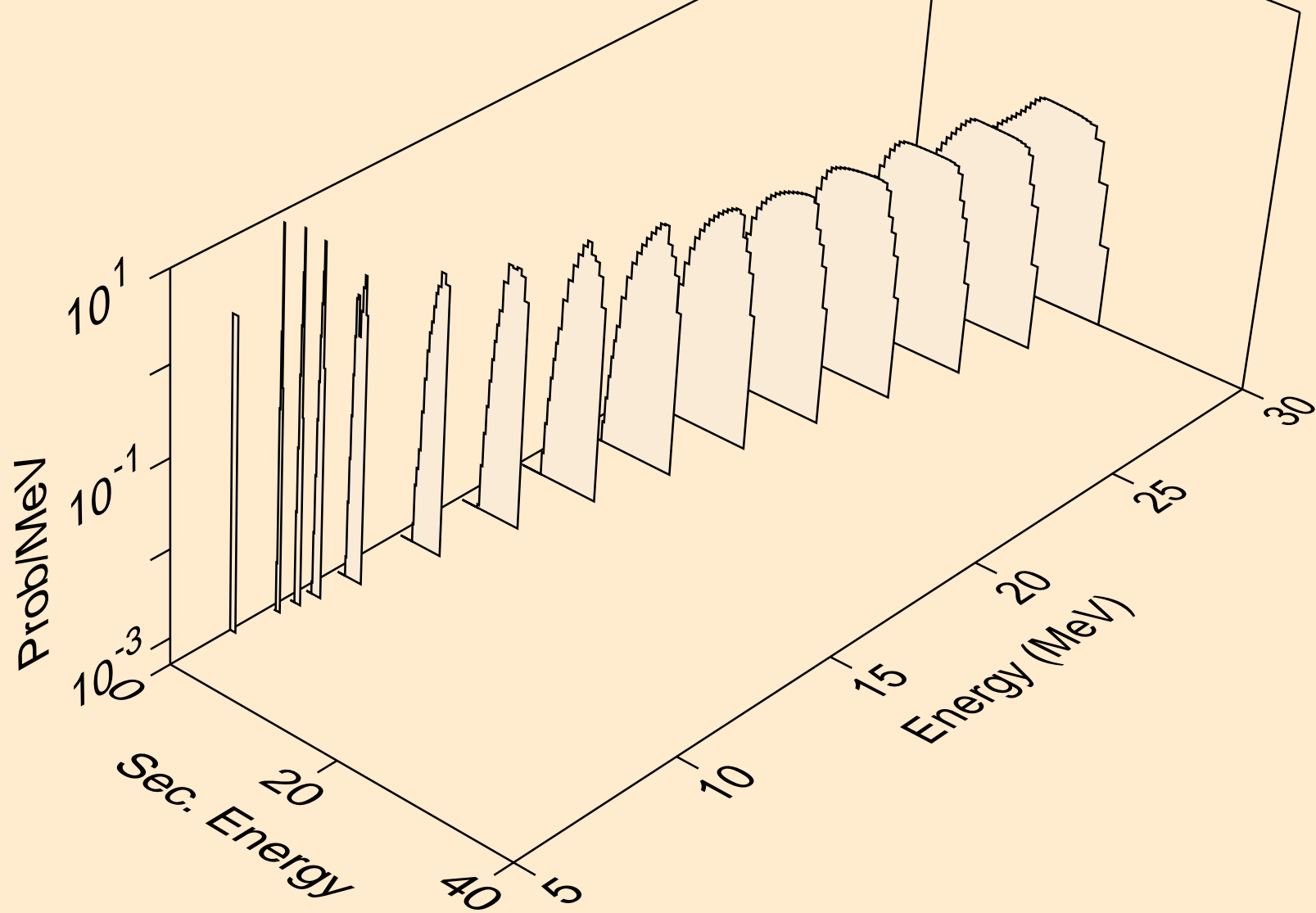

CS135 NEUTRON ACER TENDL-2023 LIBRARY; T=0.K
protons from (n,2np)

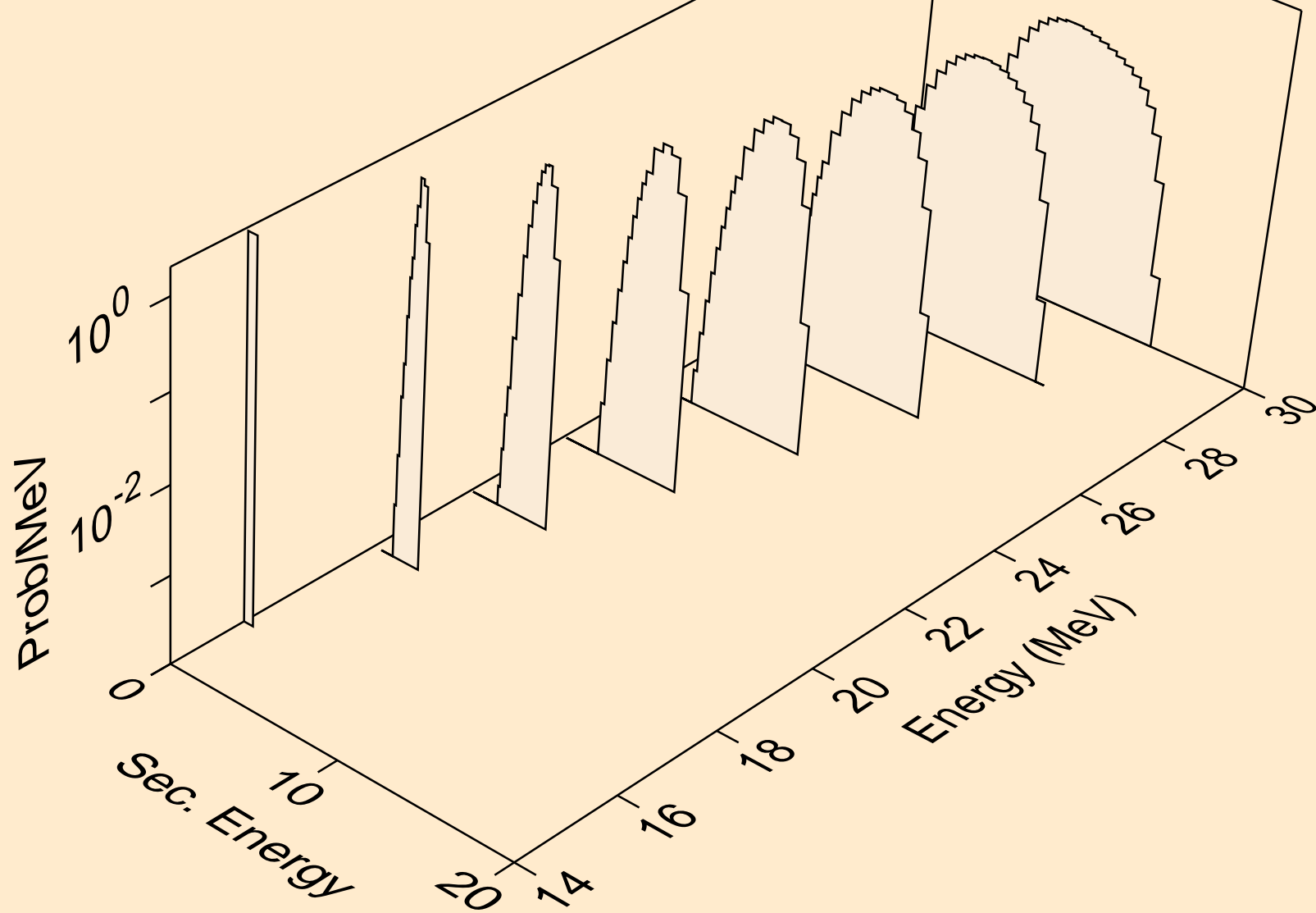

CS135 NEUTRON ACER TENDL-2023 LIBRARY; T=0.K
protons from (n,3np)

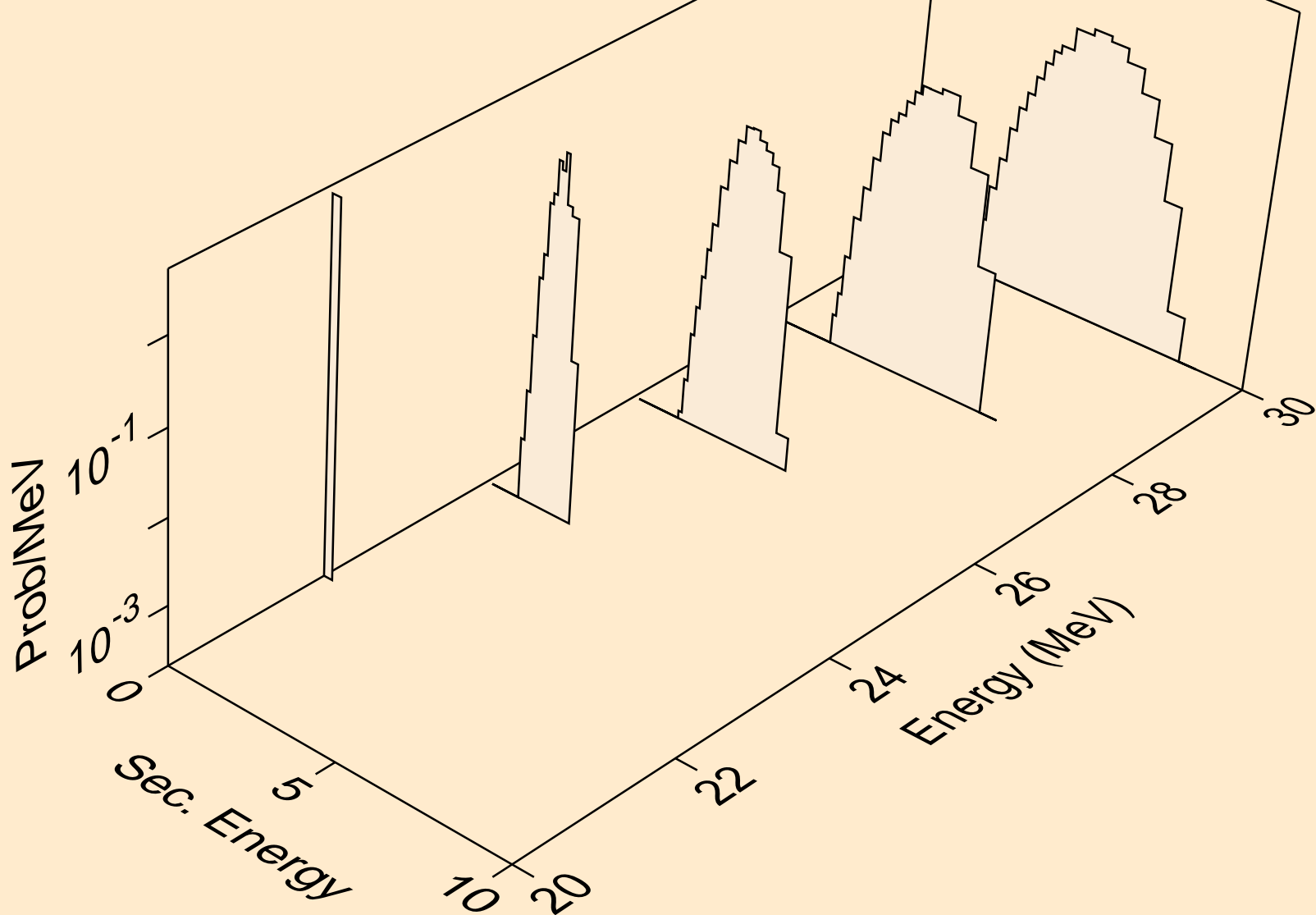

CS135 NEUTRON ACER TENDL-2023 LIBRARY; T=0.K
protons from (n,n2p)

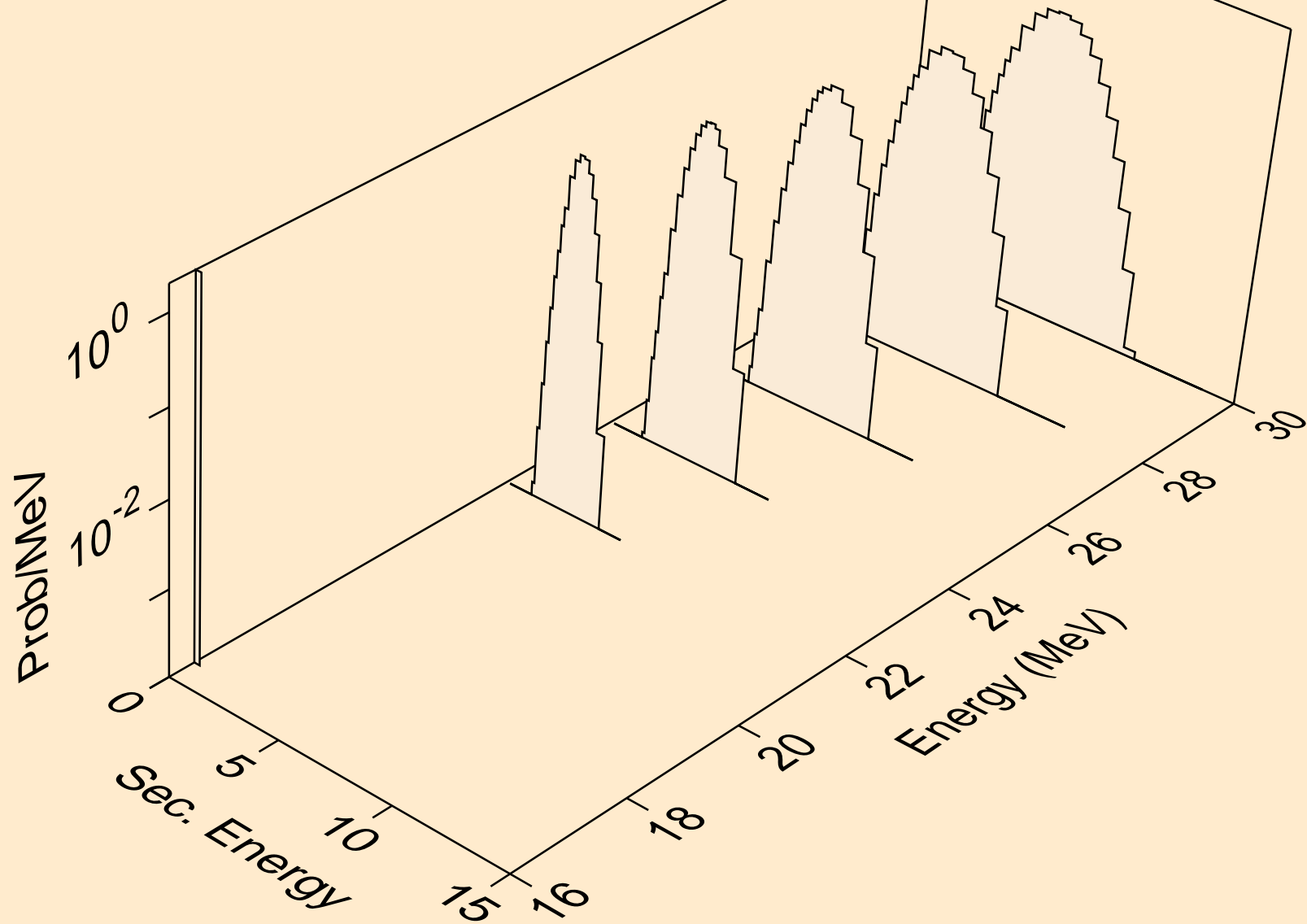

CS135 NEUTRON ACER TENDL-2023 LIBRARY; T=0.K
protons from (n,npa)

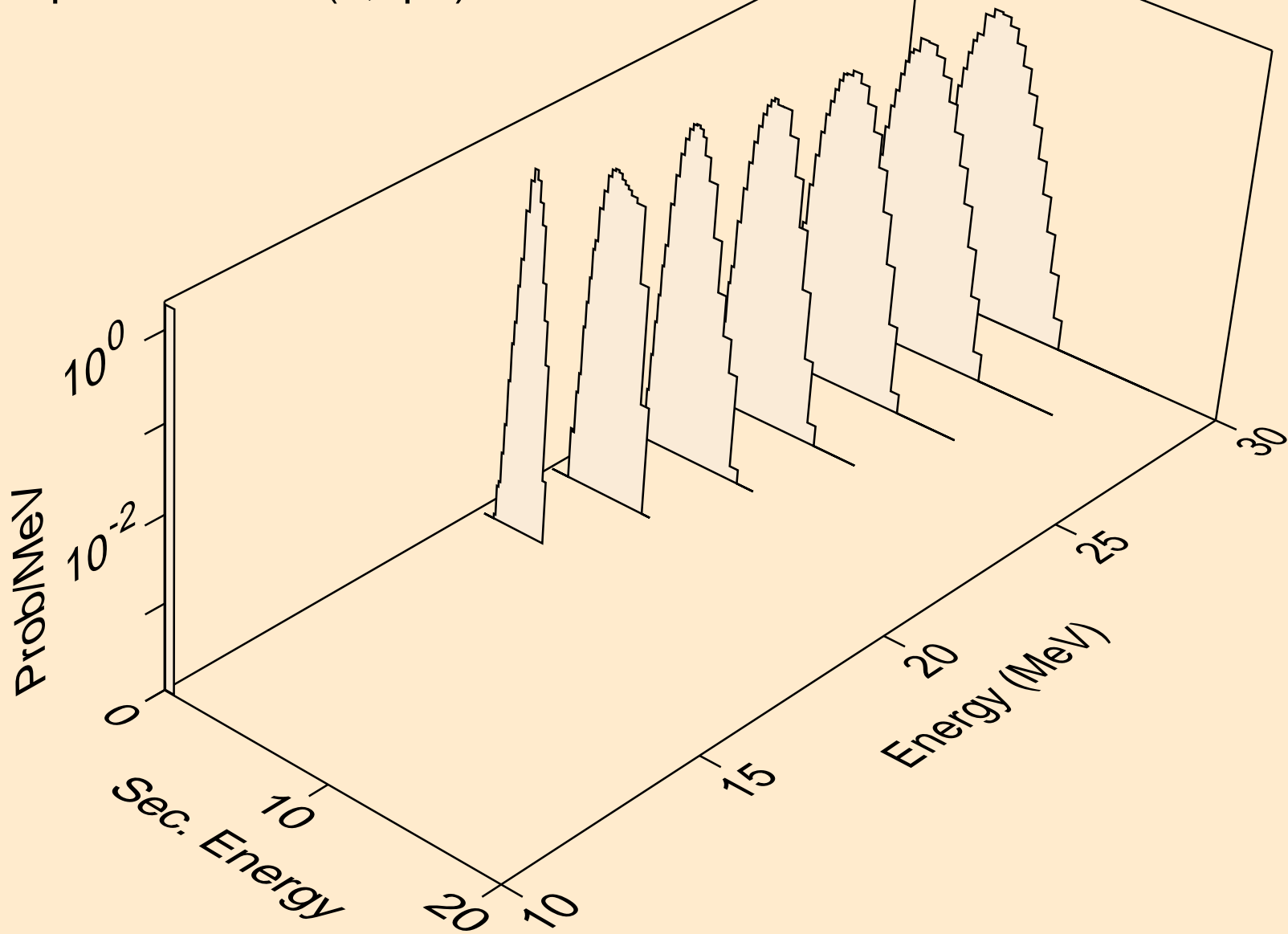

CS135 NEUTRON ACER TENDL-2023 LIBRARY; T=0.K
protons from (n,p)

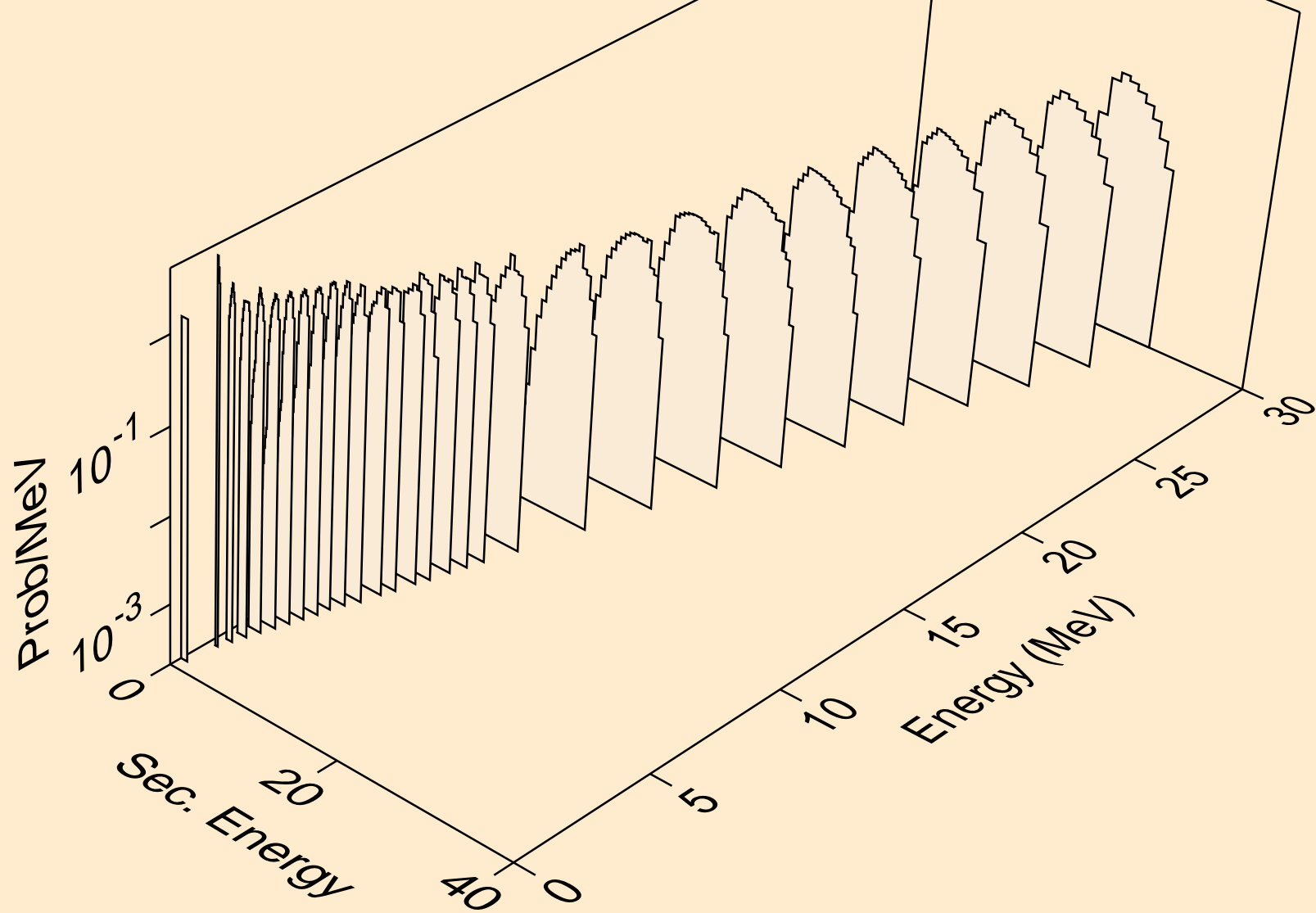

CS135 NEUTRON ACER TENDL-2023 LIBRARY; T=0.K
protons from (n,2p)

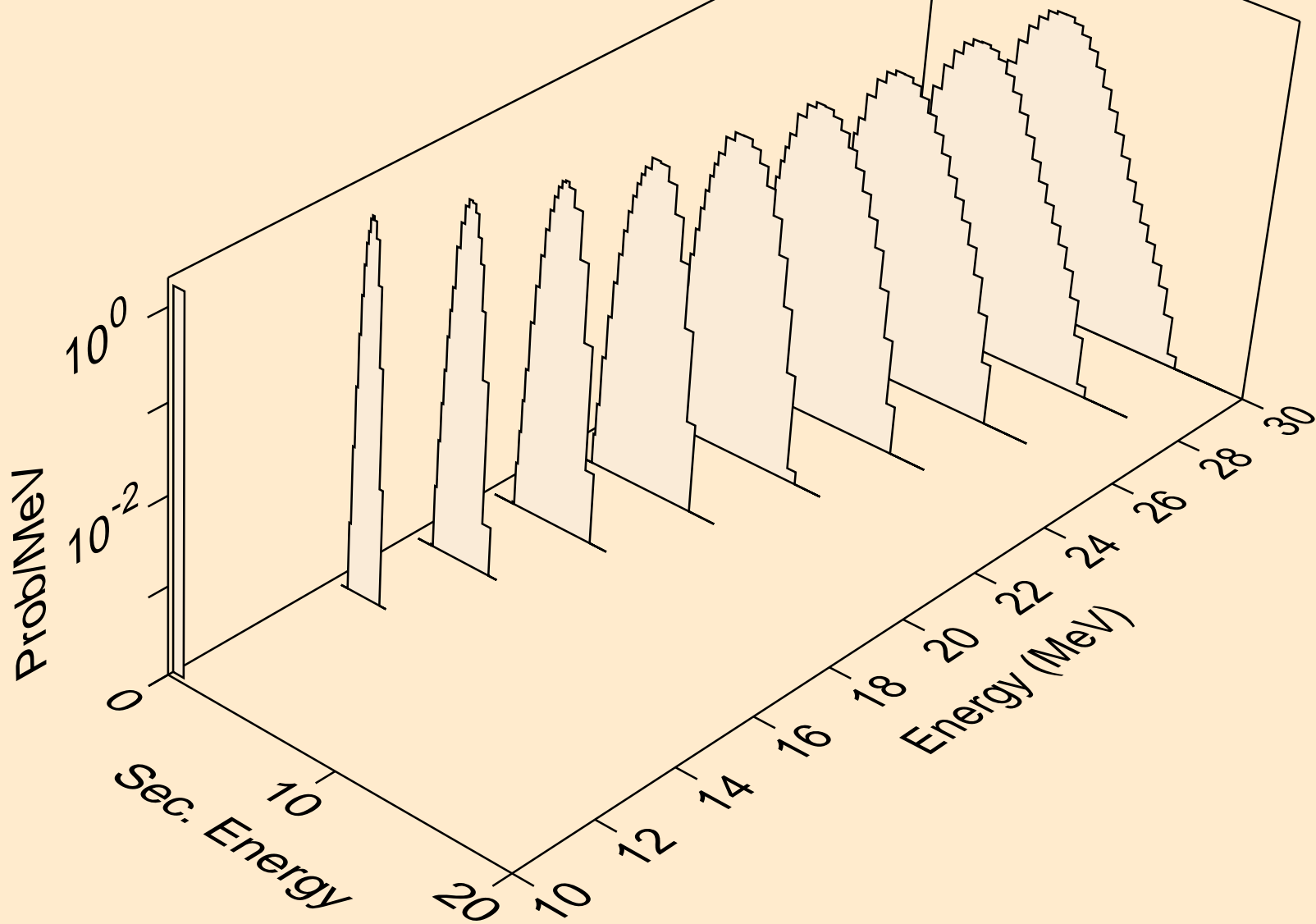

CS135 NEUTRON ACER TENDL-2023 LIBRARY; T=0.K
protons from (n,pa)

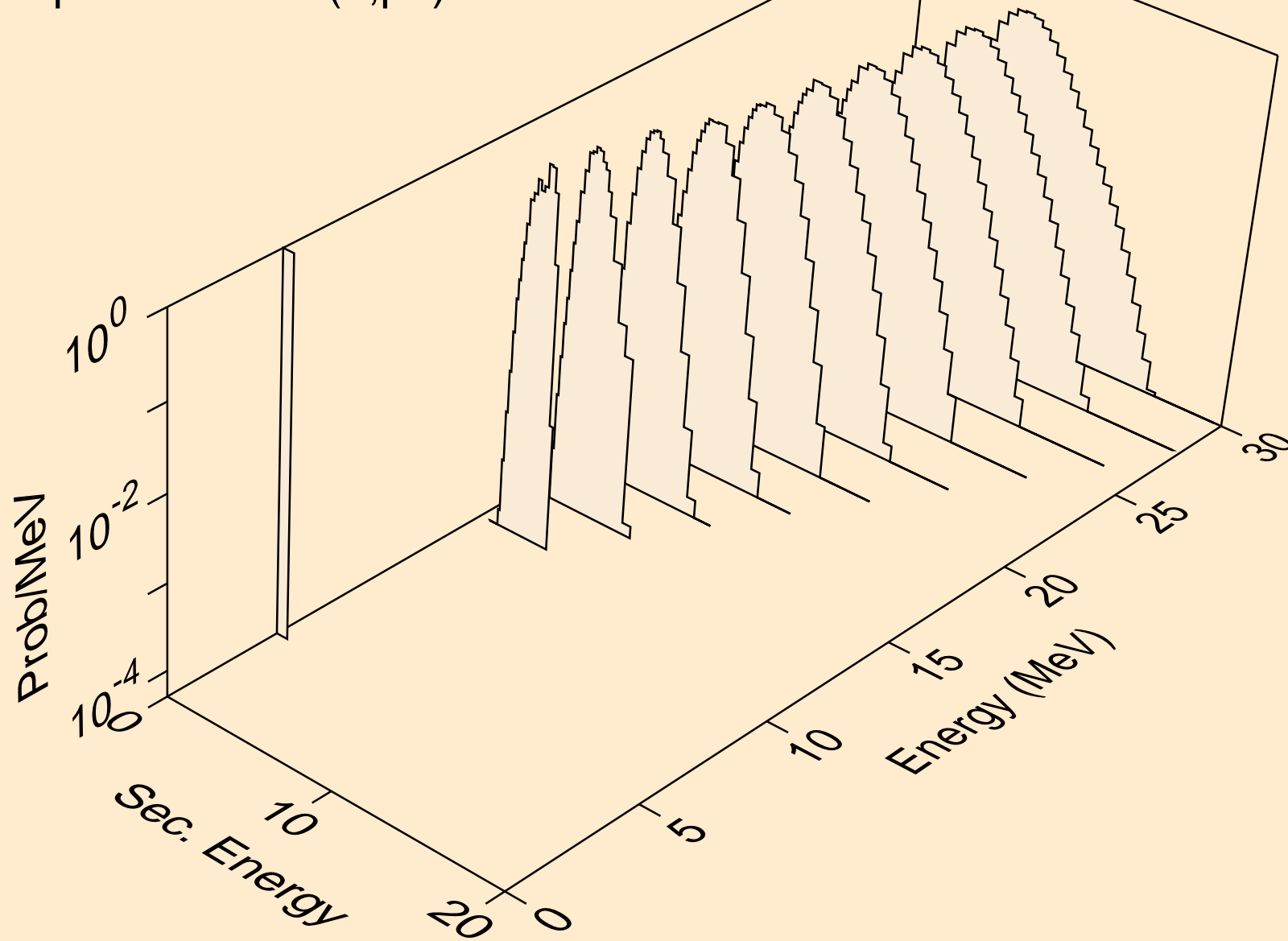

CS135 NEUTRON ACER TENDL-2023 LIBRARY; T=0.K
protons from (n,pd)

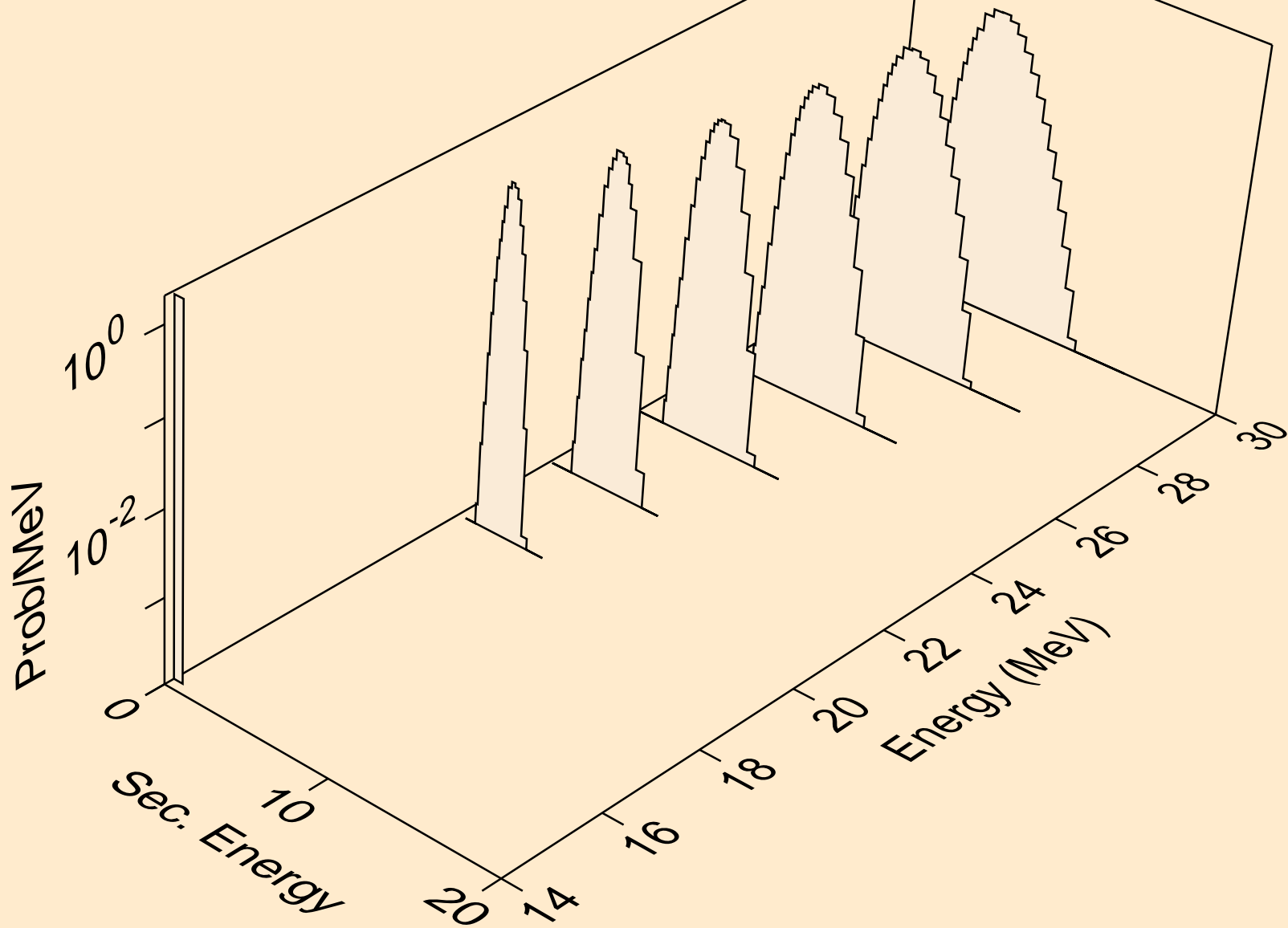

CS135 NEUTRON ACER TENDL-2023 LIBRARY; T=0.K
protons from (n,pt)

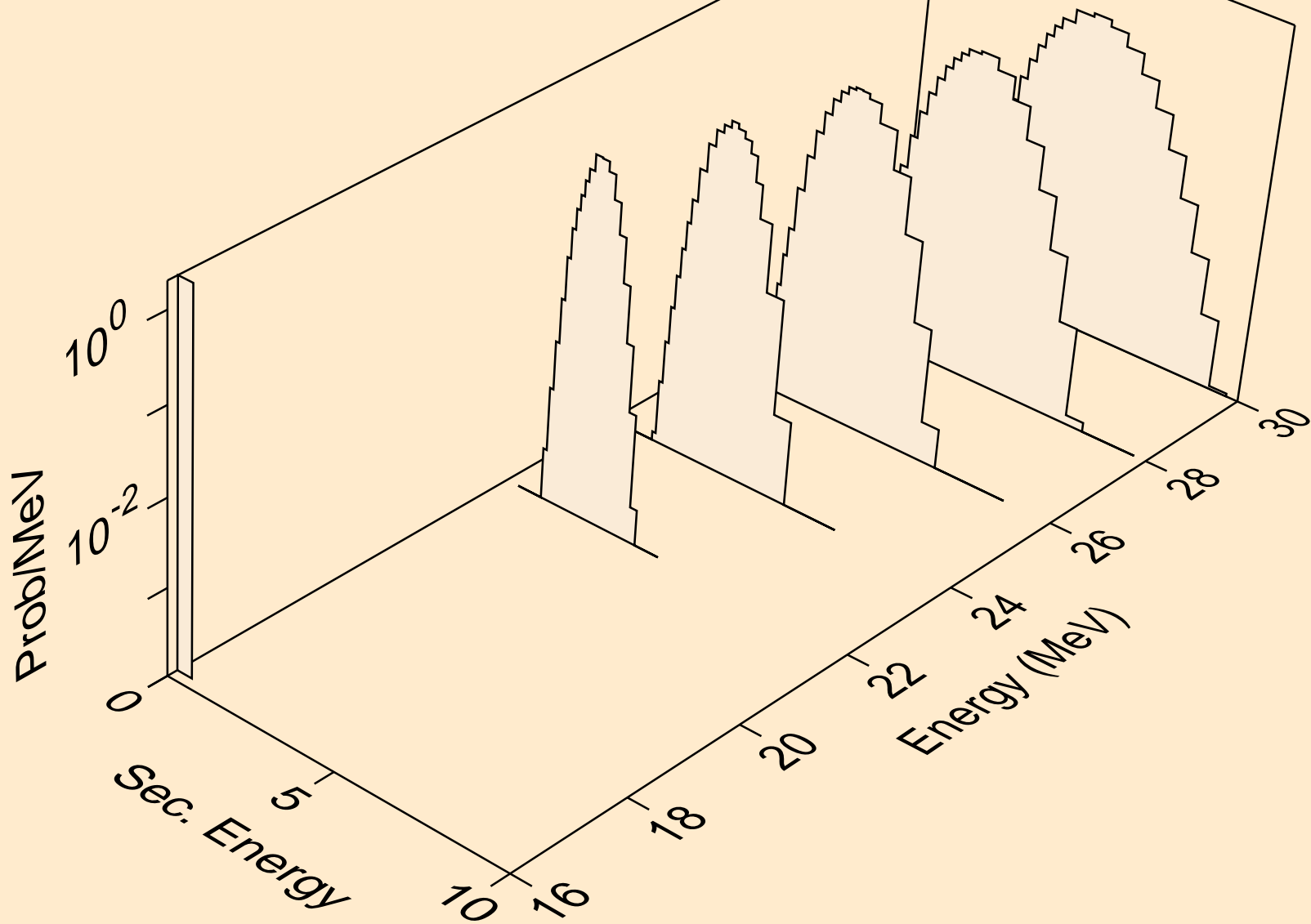

CS135 NEUTRON ACER TENDL-2023 LIBRARY; T=0.K
deuterons from (n,x)

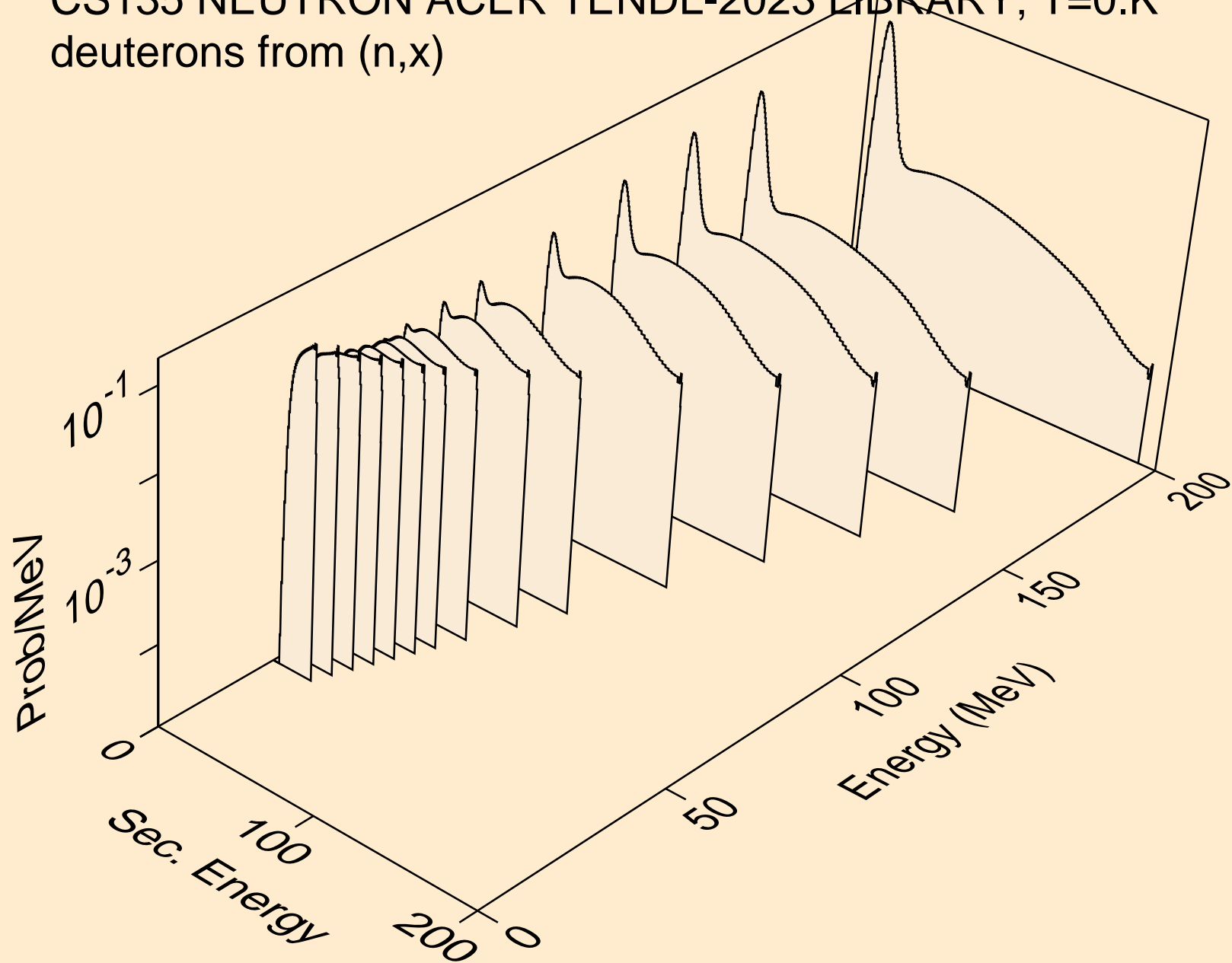

CS135 NEUTRON ACER TENDL-2023 LIBRARY; T=0.K
deuterons from (n,2nd)

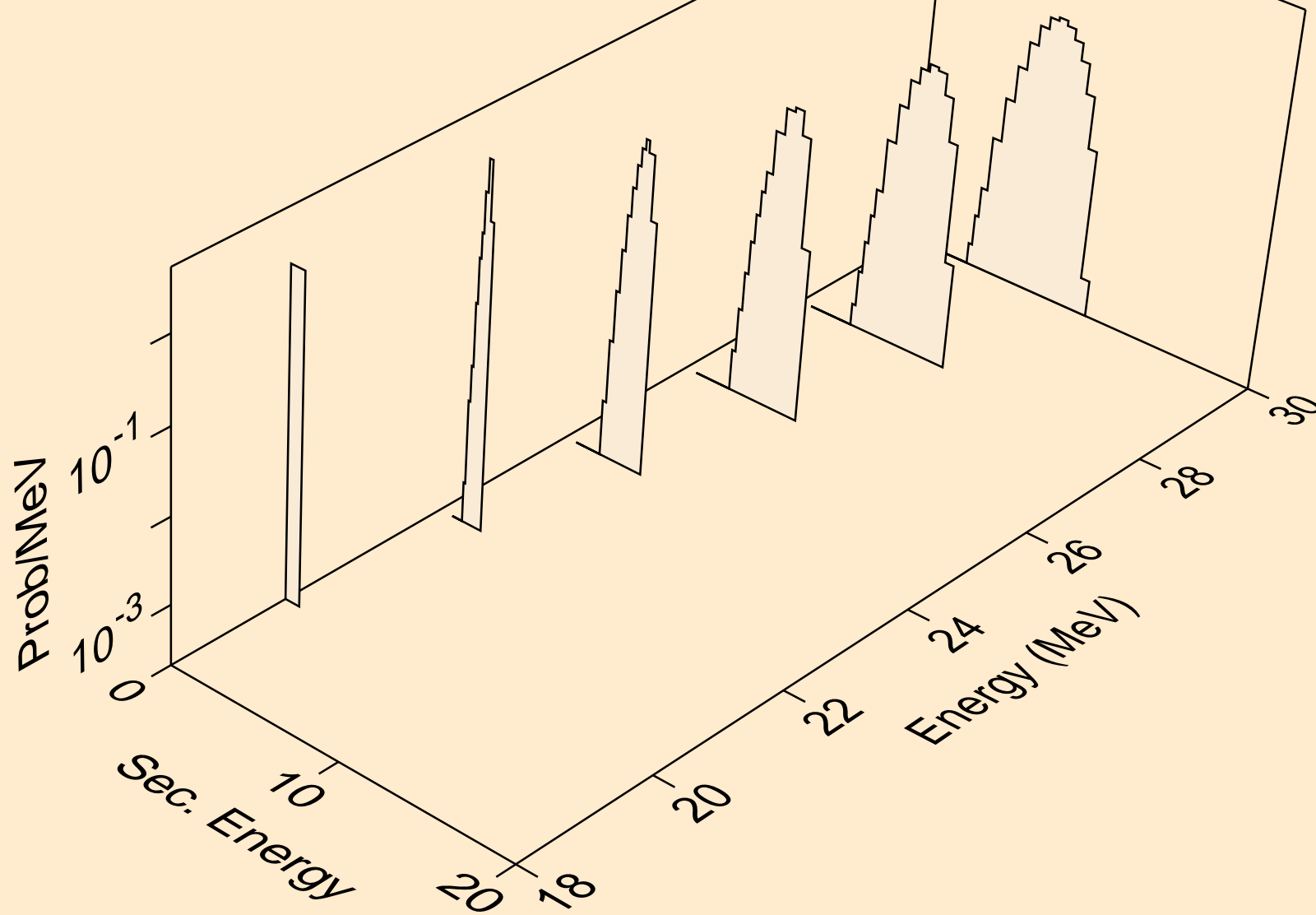

CS135 NEUTRON ACER TENDL-2023 LIBRARY; T=0.K
deuterons from (n,n*)d

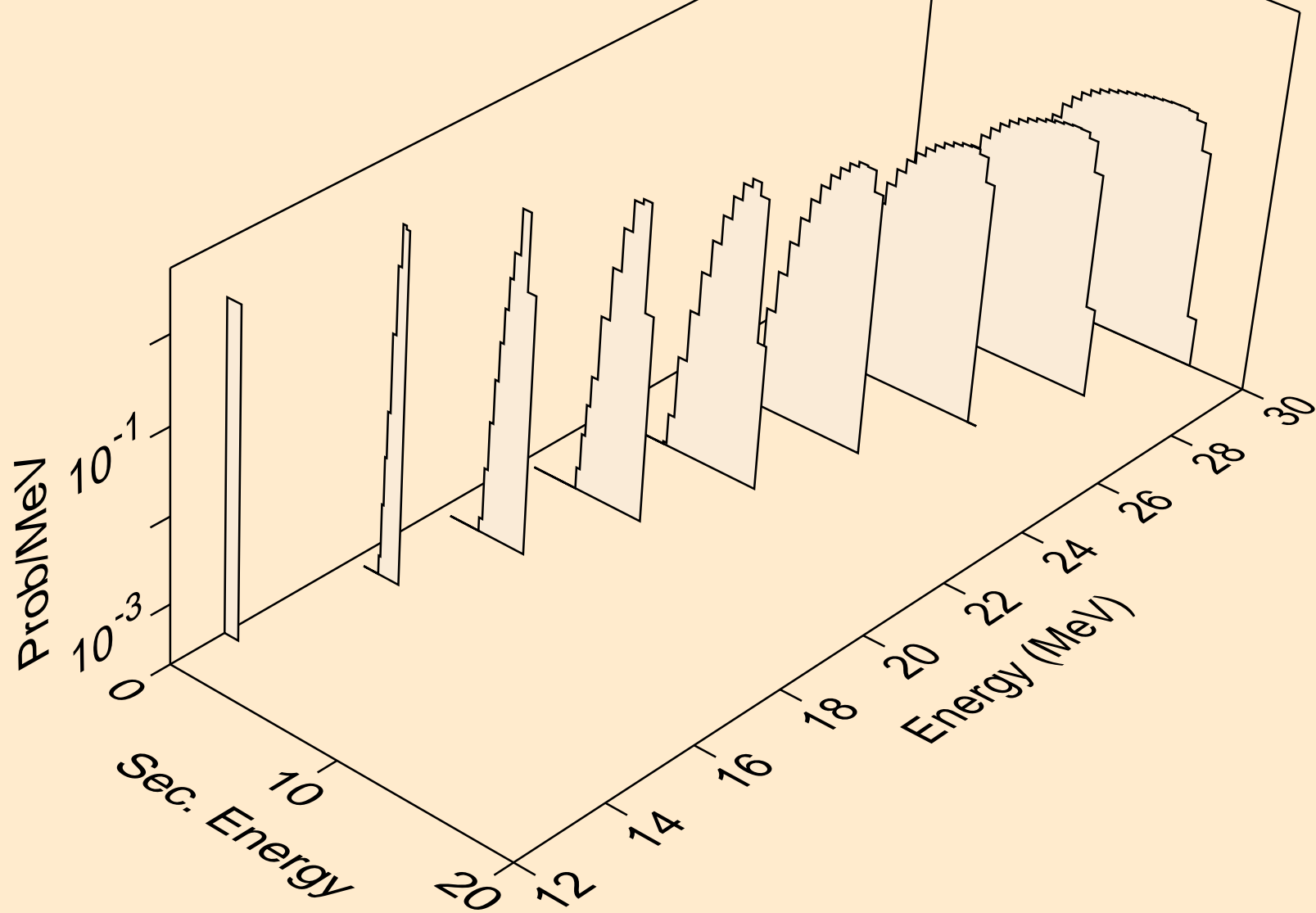

CS135 NEUTRON ACER TENDL-2023 LIBRARY; T=0.K
deuterons from (n,d)

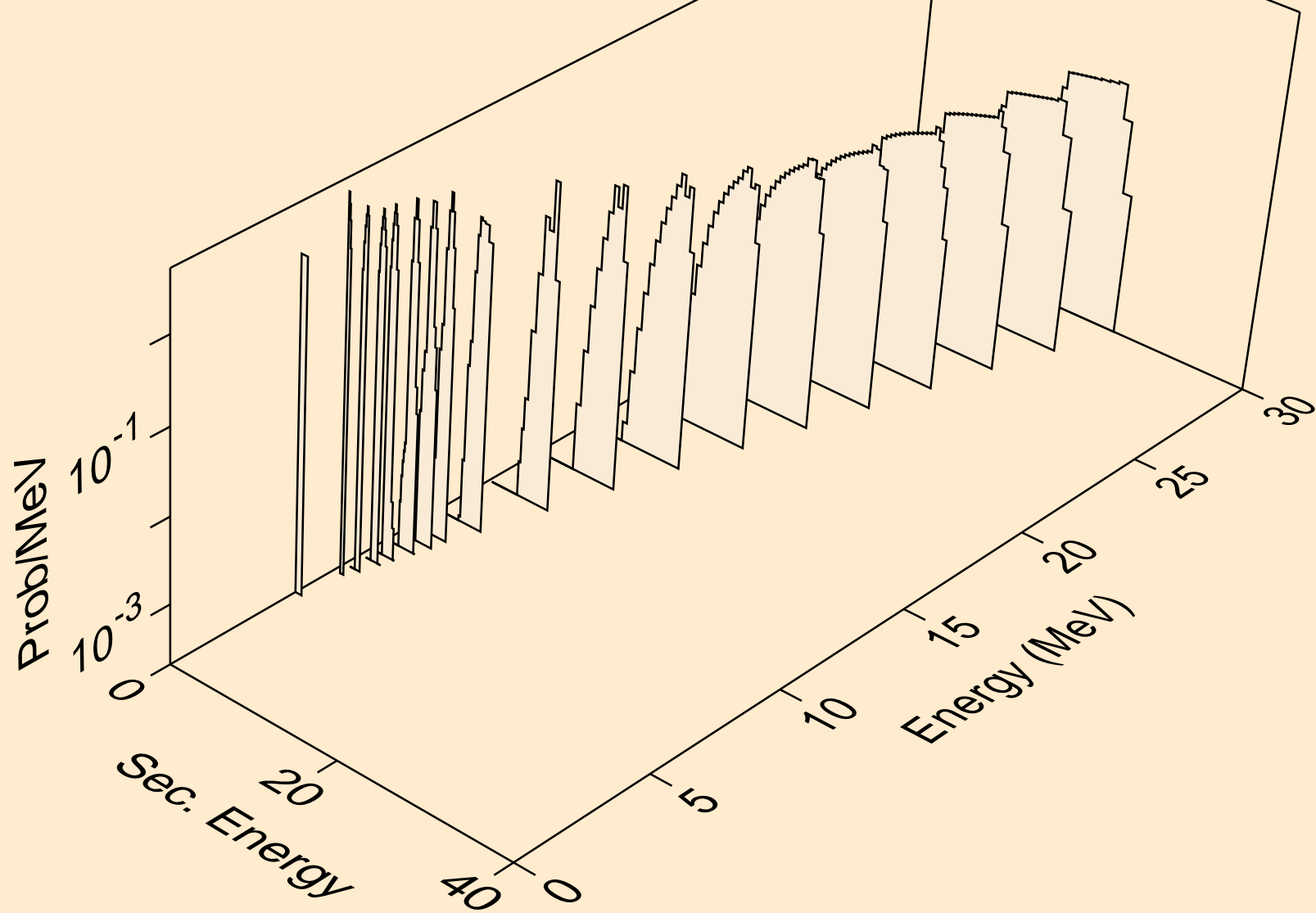

CS135 NEUTRON ACER TENDL-2023 LIBRARY; T=0.K
deuterons from (n,pd)

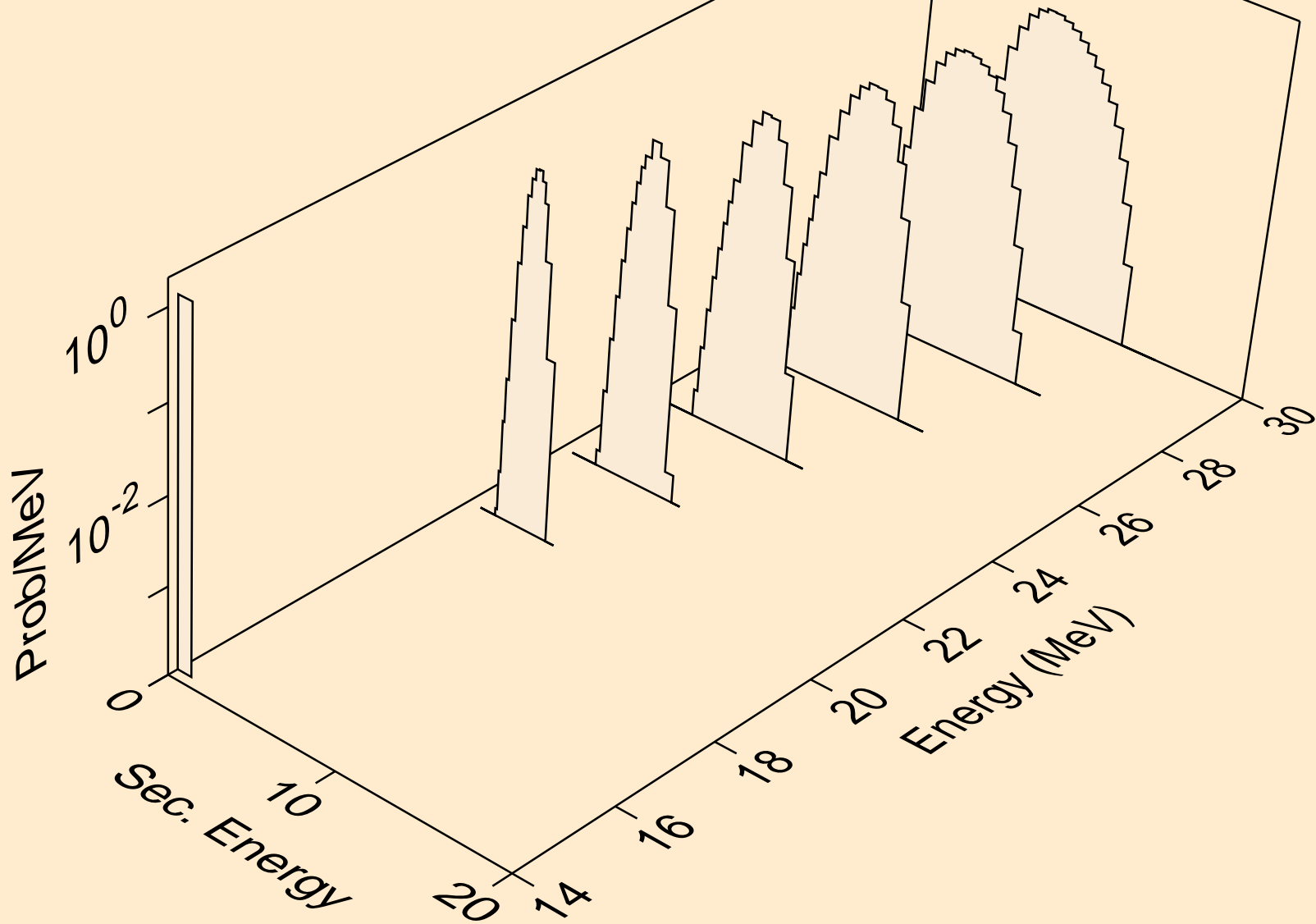

CS135 NEUTRON ACER TENDL-2023 LIBRARY; T=0.K
deuterons from (n,da)

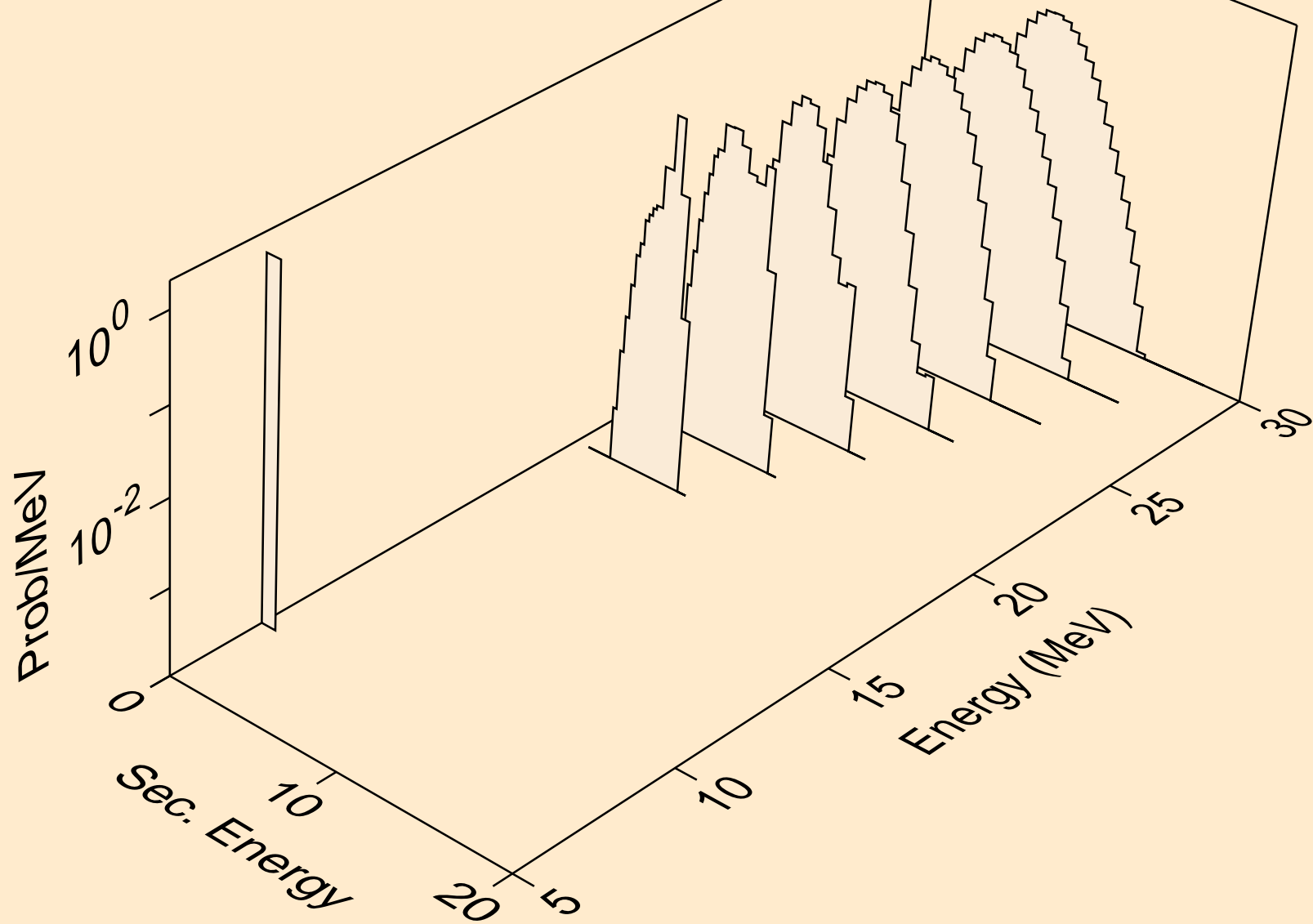

CS135 NEUTRON ACER TENDL-2023 LIBRARY; T=0.K
tritons from (n,x)

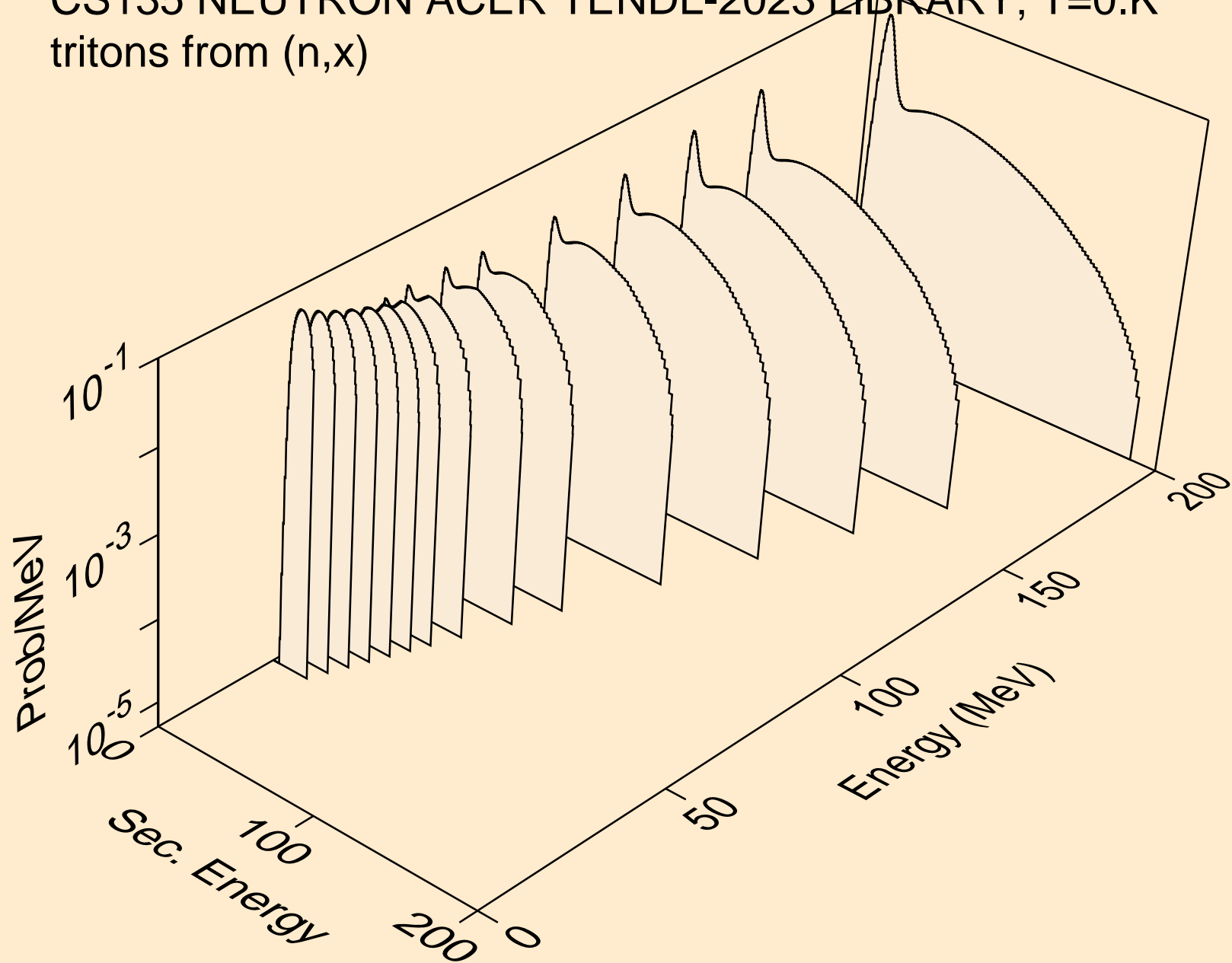

CS135 NEUTRON ACER TENDL-2023 LIBRARY; T=0.K
tritons from (n,n*)t

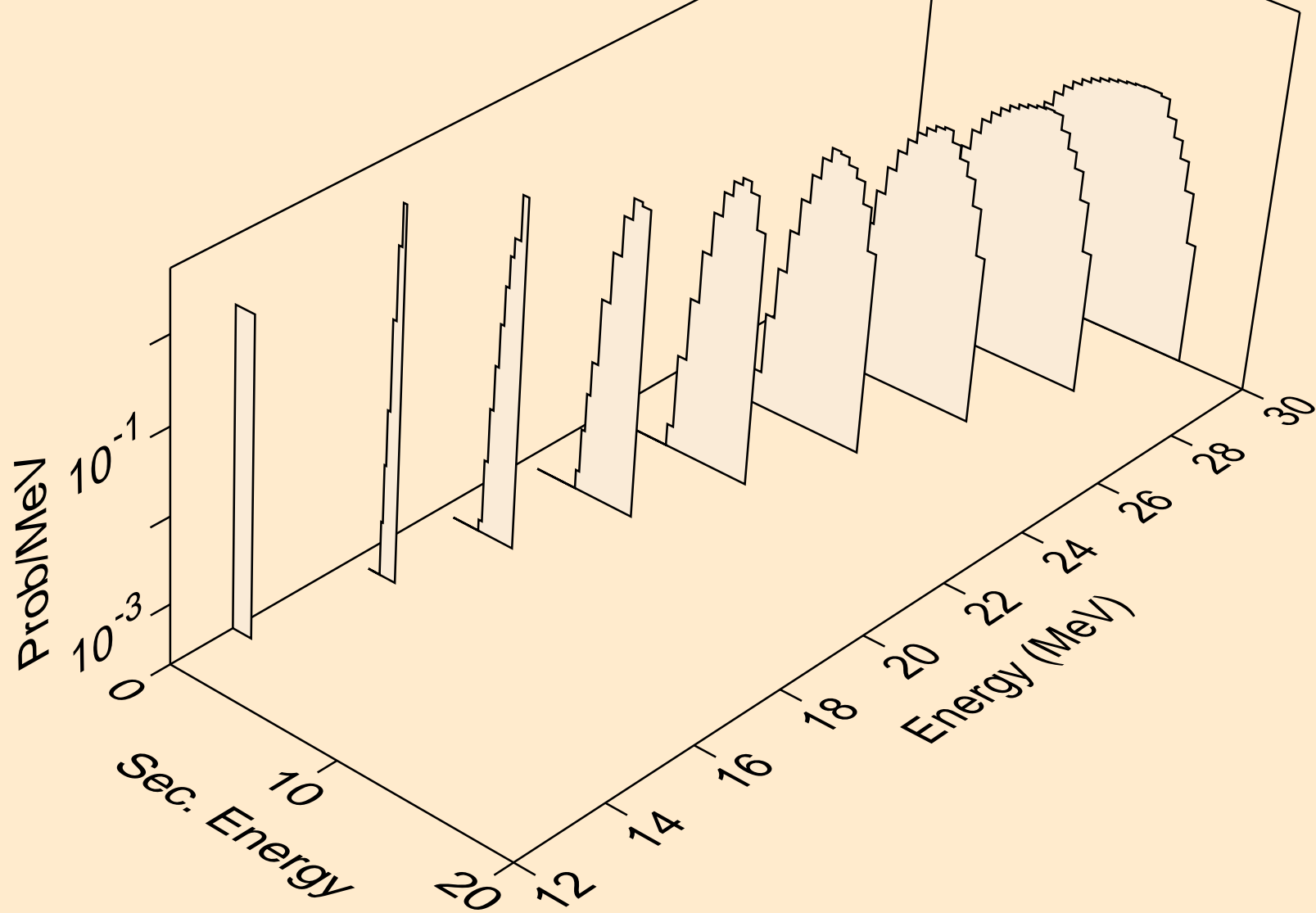

CS135 NEUTRON ACER TENDL-2023 LIBRARY; T=0.K
tritons from (n,t)

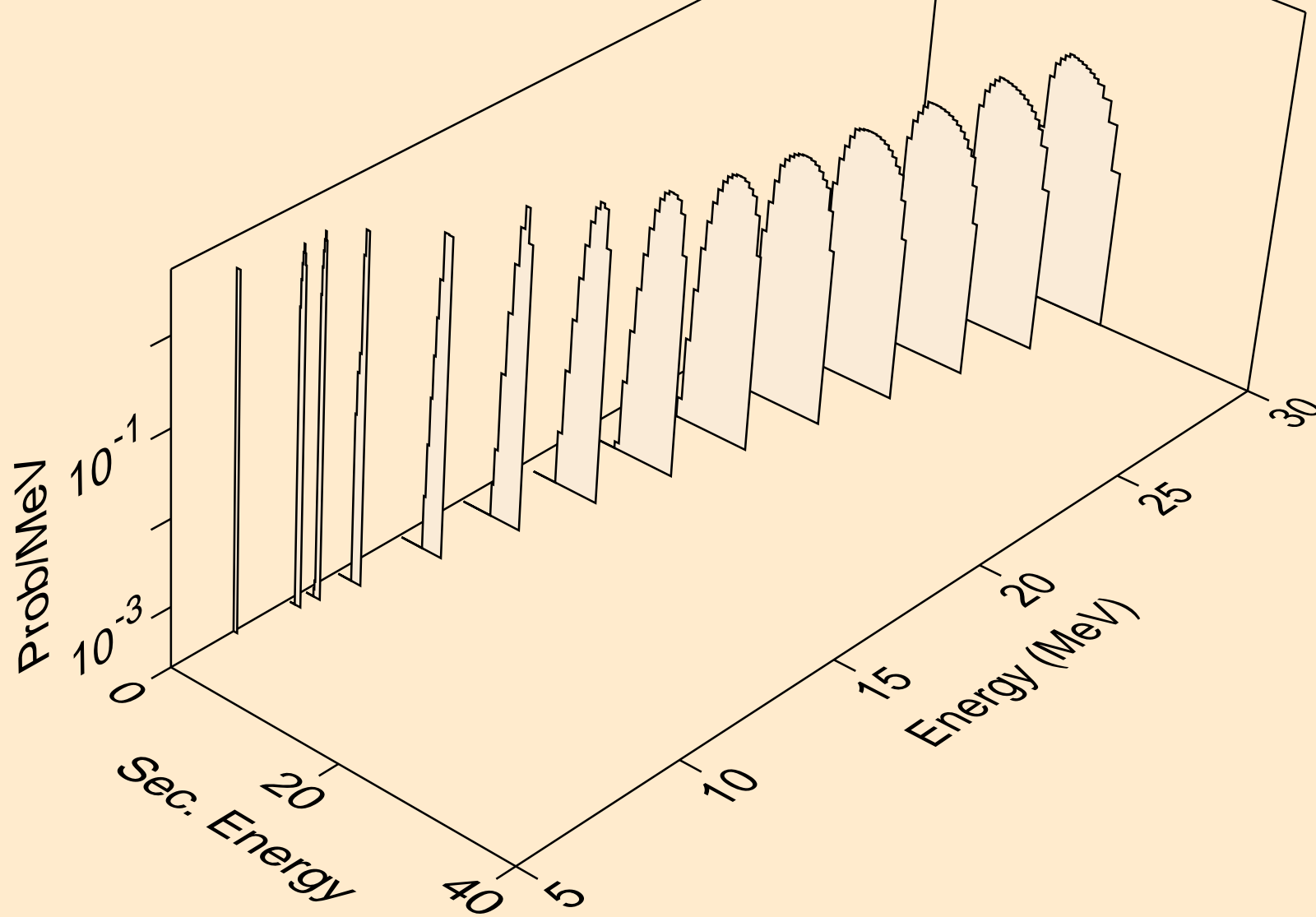

CS135 NEUTRON ACER TENDL-2023 LIBRARY; T=0.K
tritons from (n,pt)

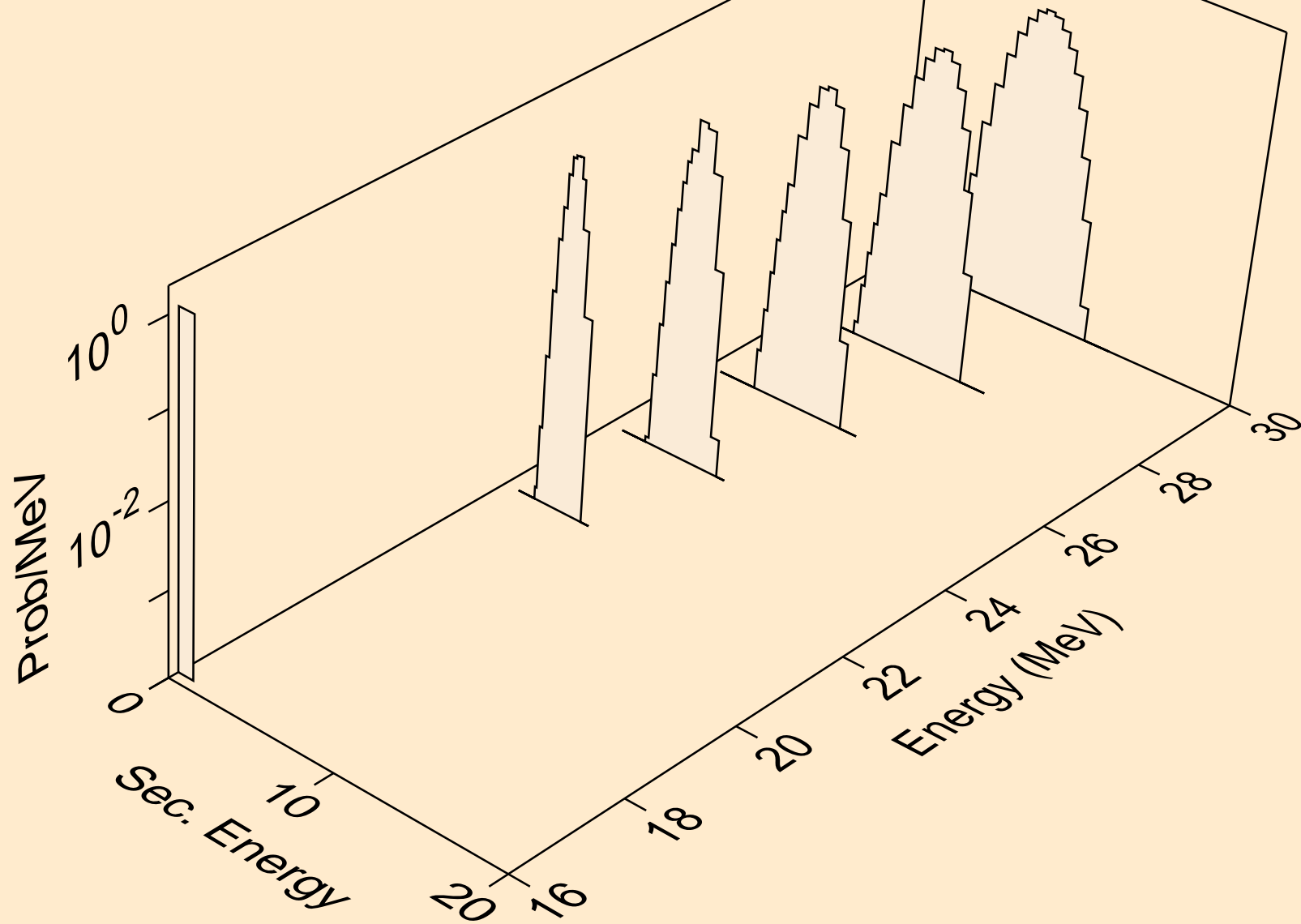

CS135 NEUTRON ACER TENDL-2023 LIBRARY; T=0.K
he3s from (n,x)

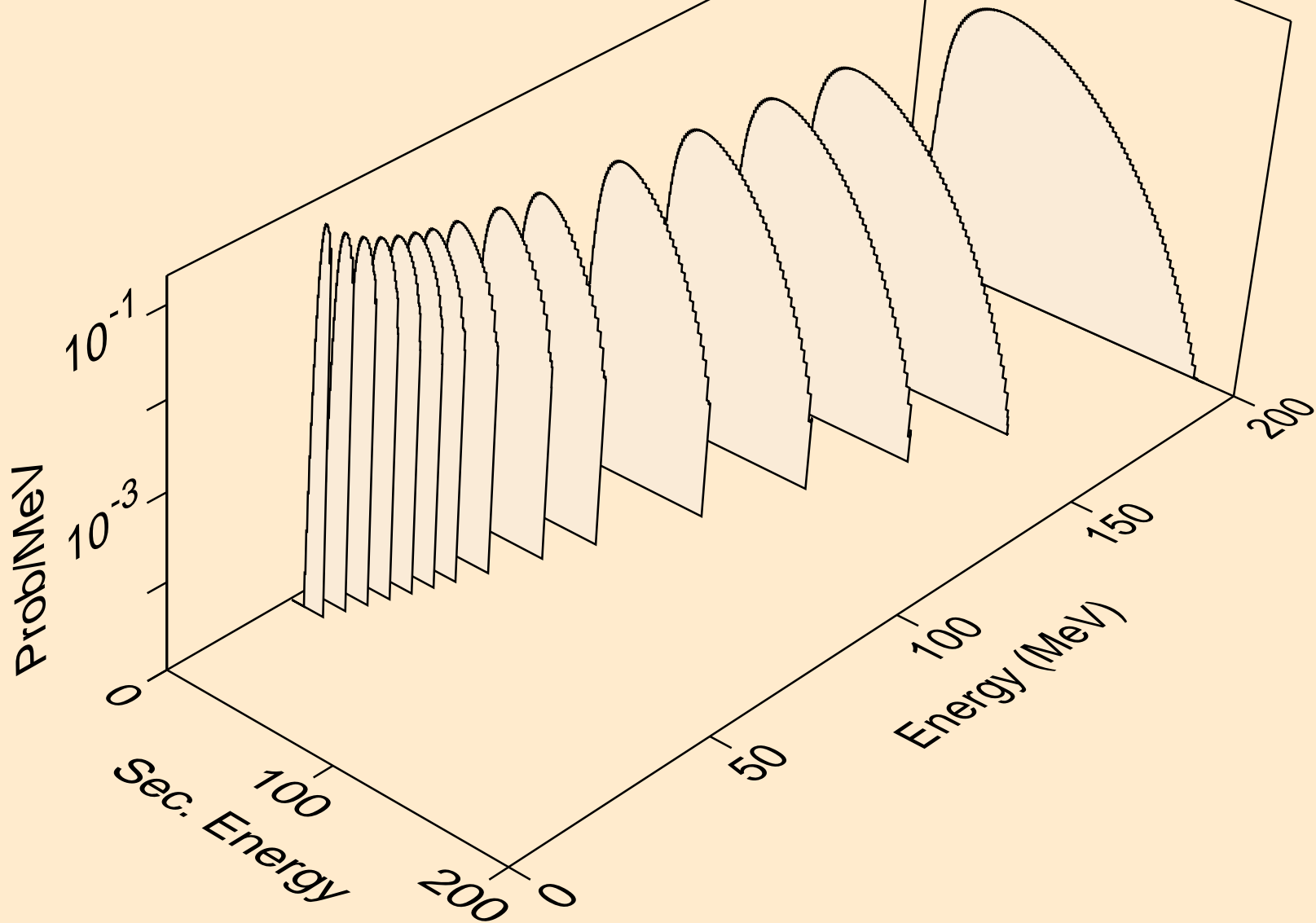

CS135 NEUTRON ACER TENDL-2023 LIBRARY; T=0.K
he3s from (n,n*)he3

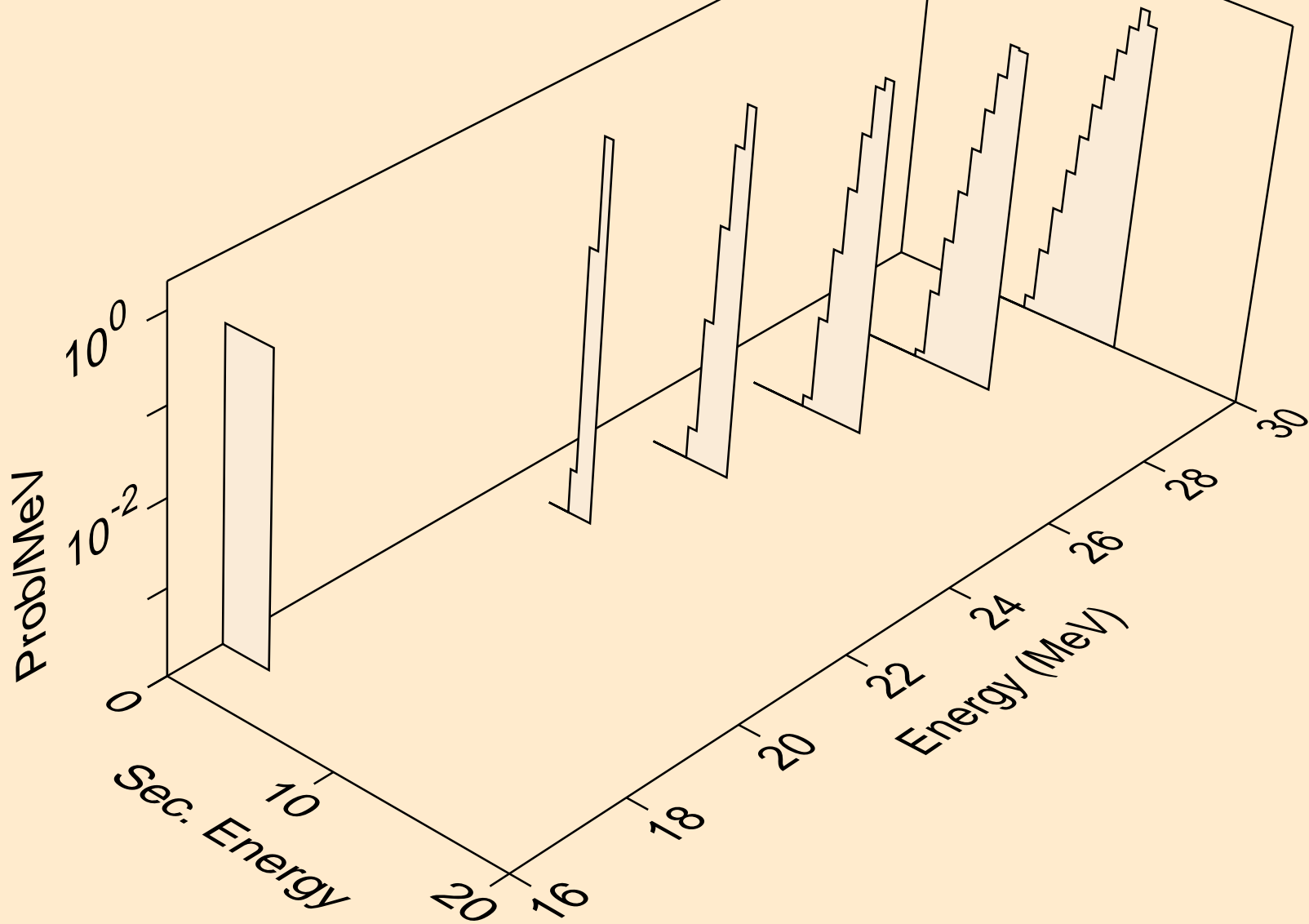

CS135 NEUTRON ACER TENDL-2023 LIBRARY; T=0.K
he3s from (n,he3)

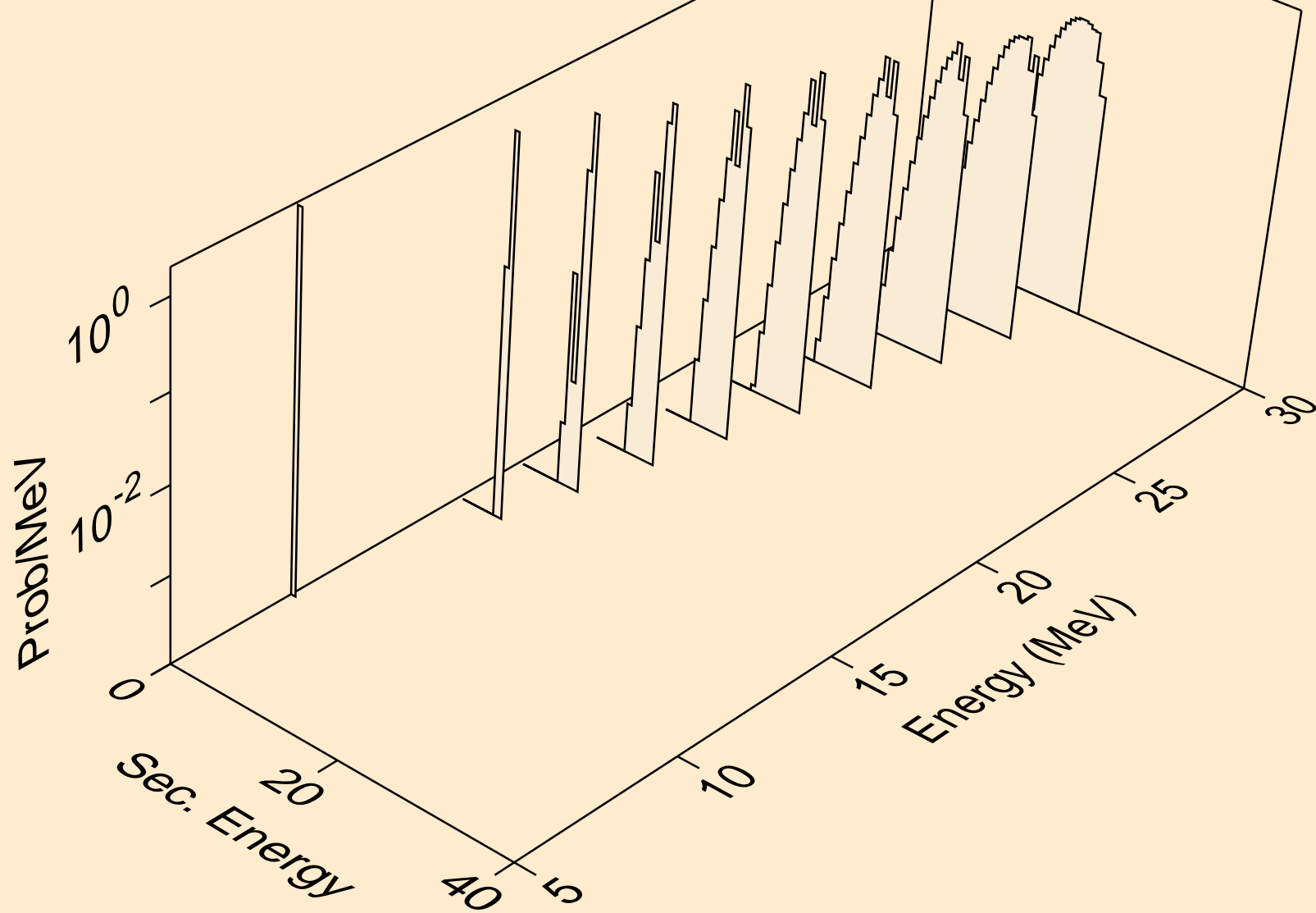

CS135 NEUTRON ACER TENDL-2023 LIBRARY; T=0.K
alphas from (n,x)

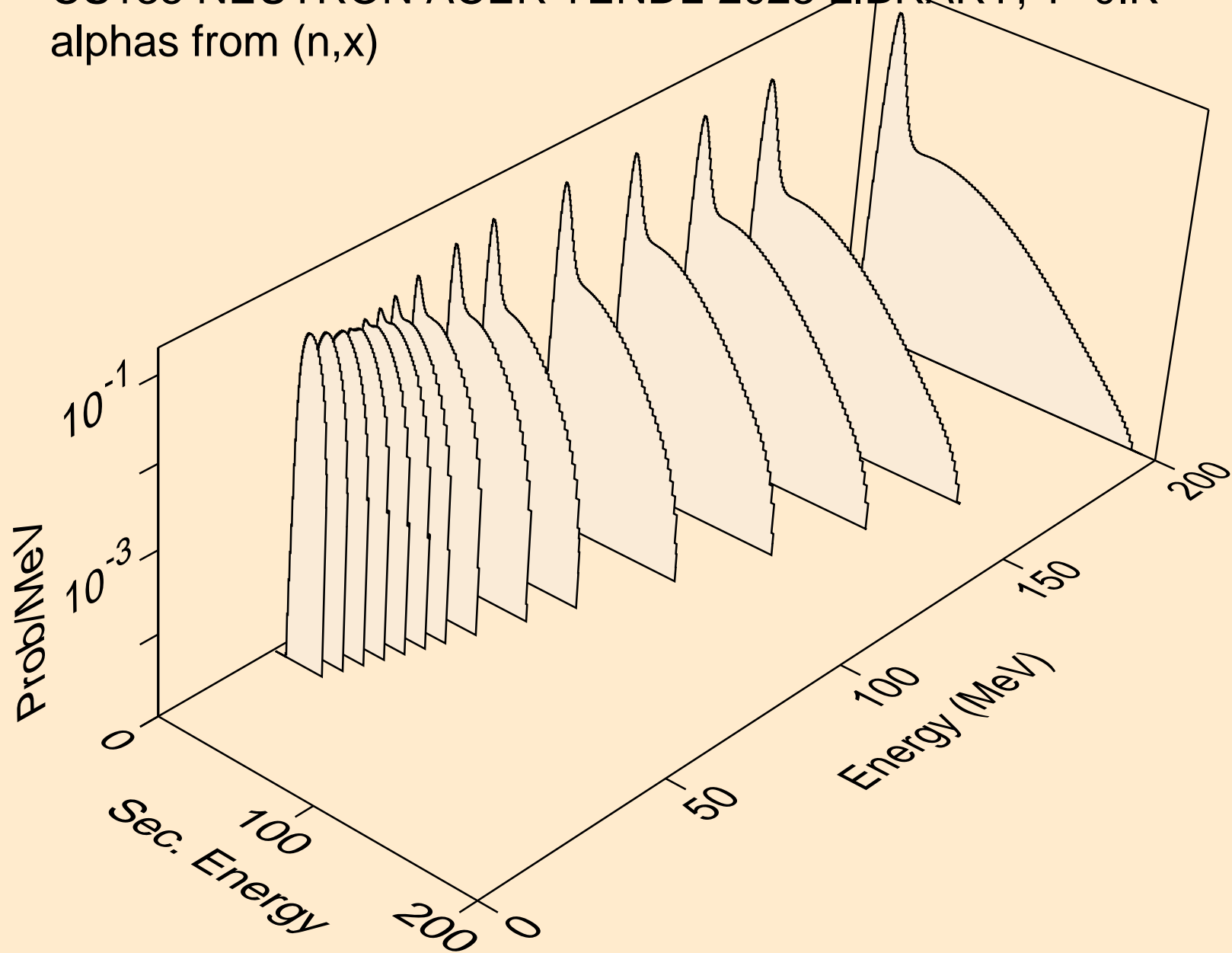

CS135 NEUTRON ACER TENDL-2023 LIBRARY; T=0.K
alphas from (n,n*)a

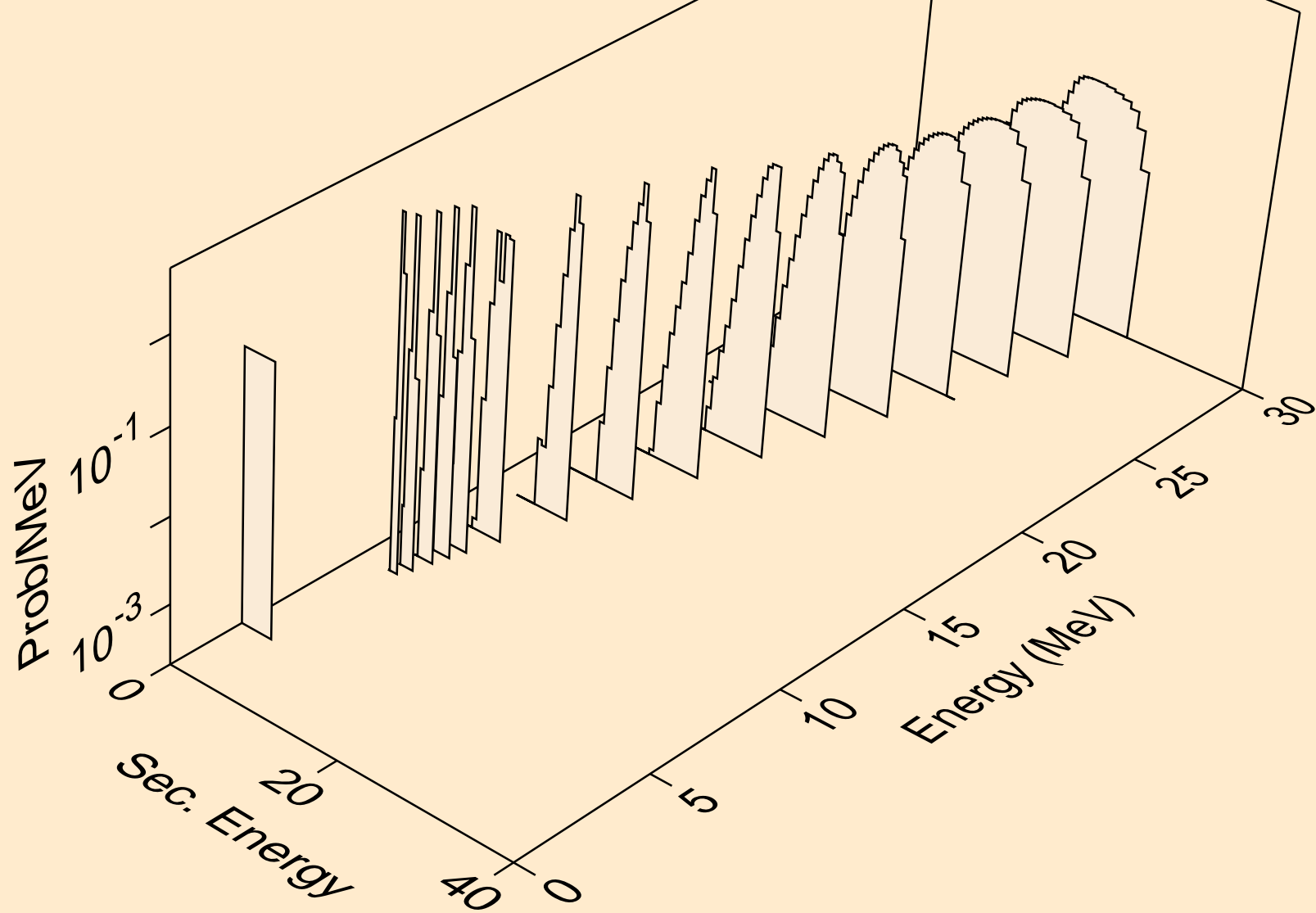

CS135 NEUTRON ACER TENDL-2023 LIBRARY; T=0.K
alphas from (n,2n)a

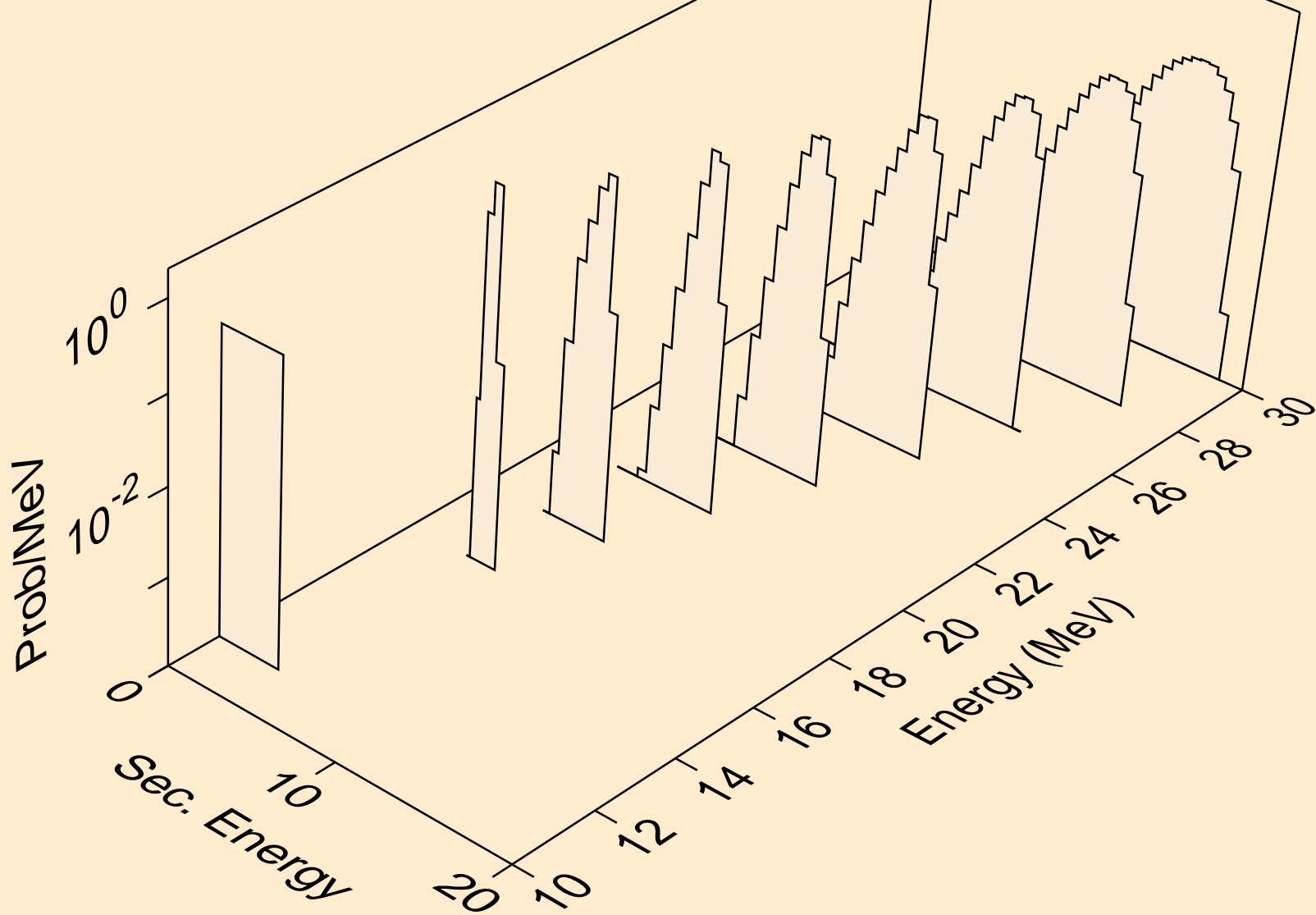

CS135 NEUTRON ACER TENDL-2023 LIBRARY; T=0.K
alphas from (n,3n)a

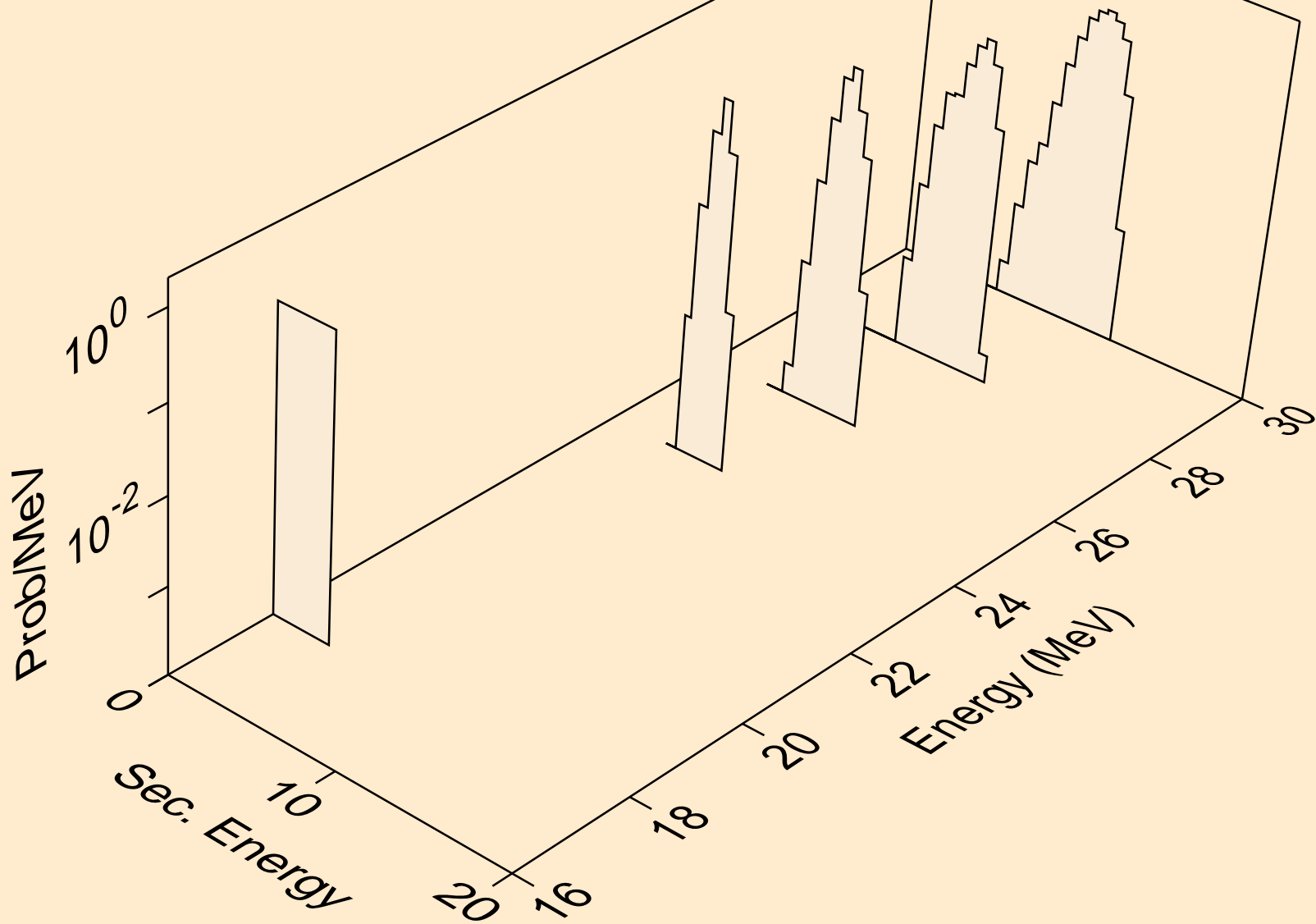

CS135 NEUTRON ACER TENDL-2023 LIBRARY; T=0.K
alphas from (n,npa)

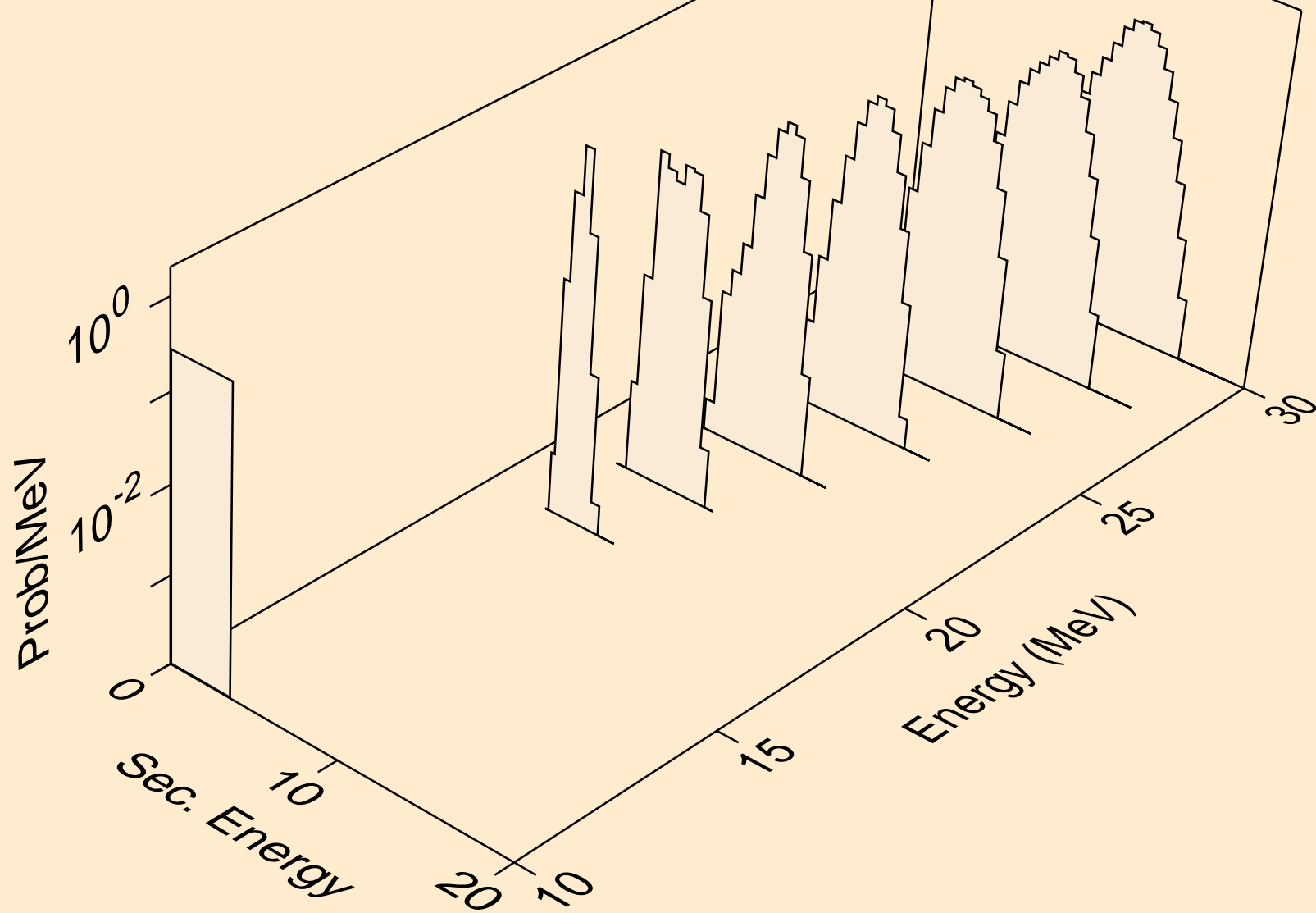

CS135 NEUTRON ACER TENDL-2023 LIBRARY; T=0.K
alphas from (n,a)

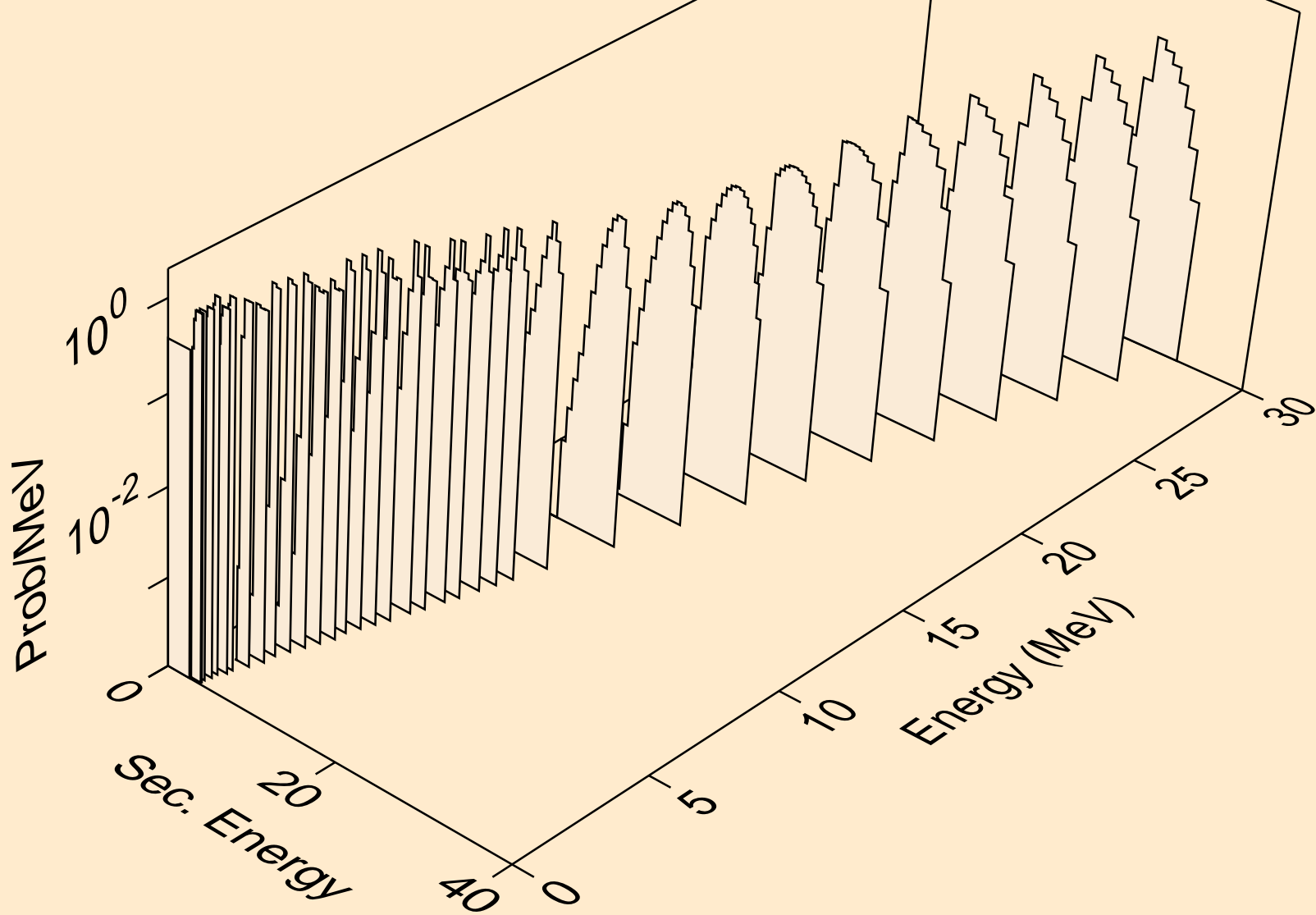

CS135 NEUTRON ACER TENDL-2023 LIBRARY; T=0.K
alphas from (n,2a)

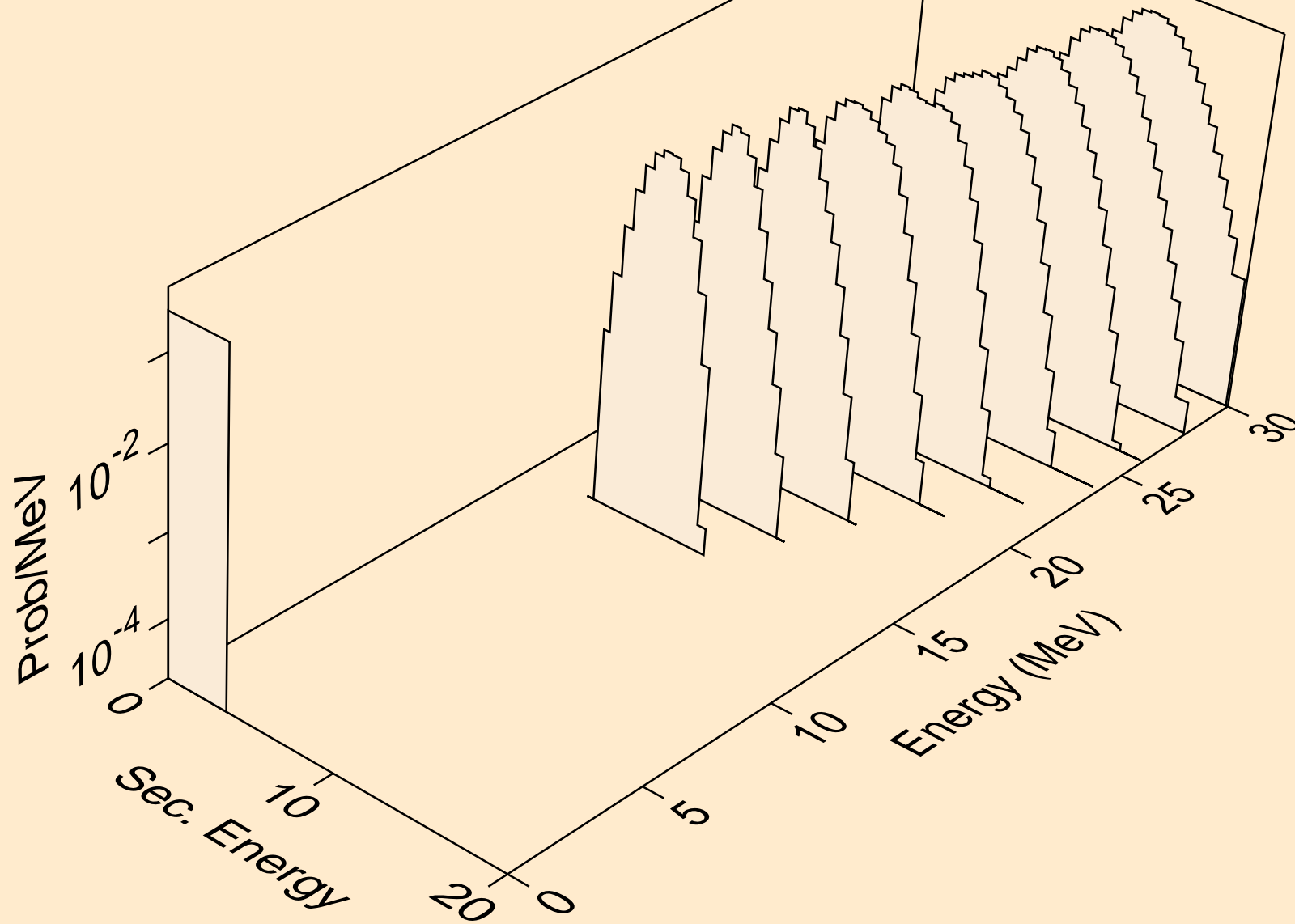

CS135 NEUTRON ACER TENDL-2023 LIBRARY; T=0.K
alphas from (n,pa)

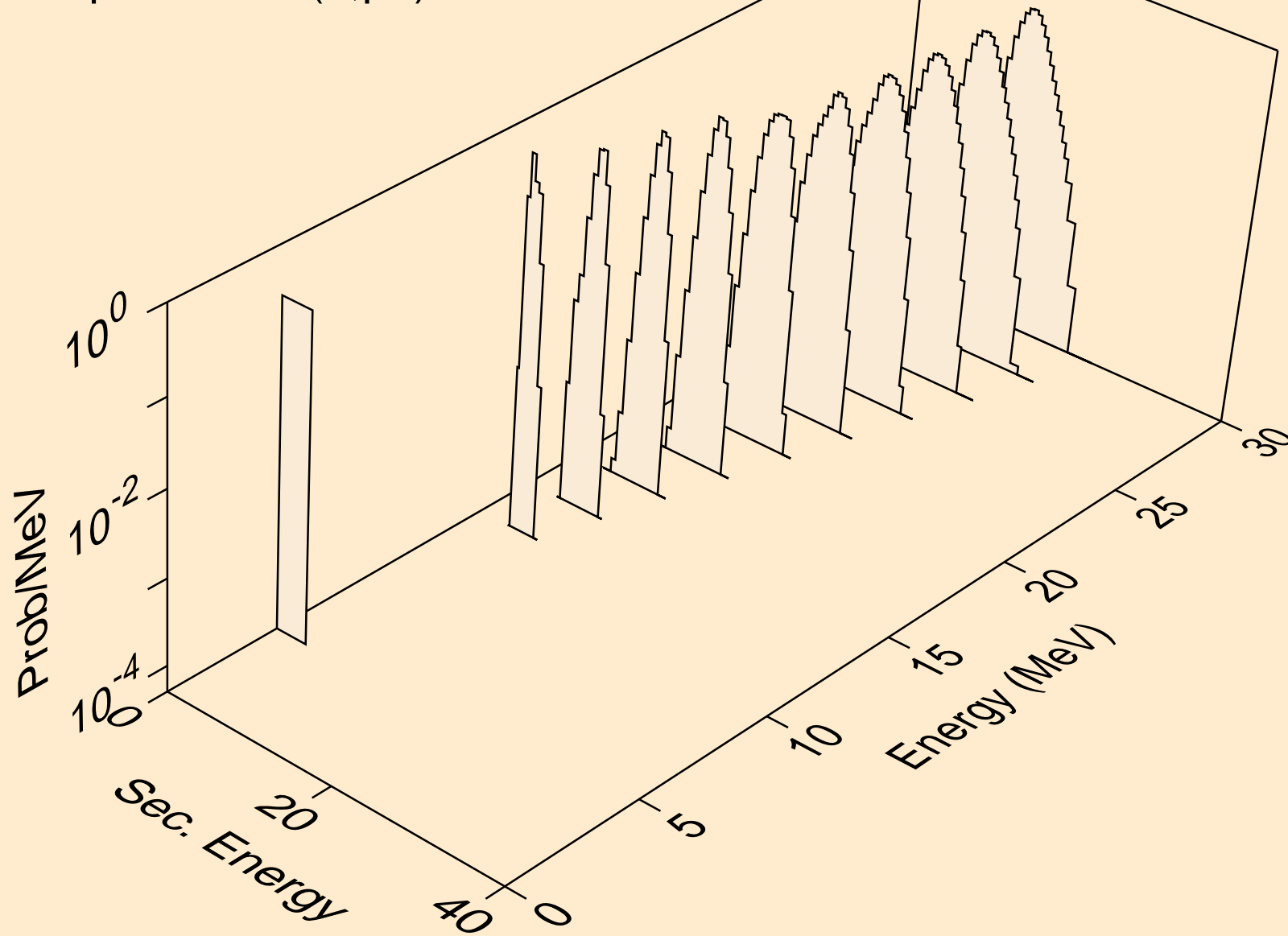

CS135 NEUTRON ACER TENDL-2023 LIBRARY; T=0.K
alphas from (n,da)

