

# CU062 NEUTRON ACER TENDL-2023 LIBRARY; T=0.K

## Principal cross sections

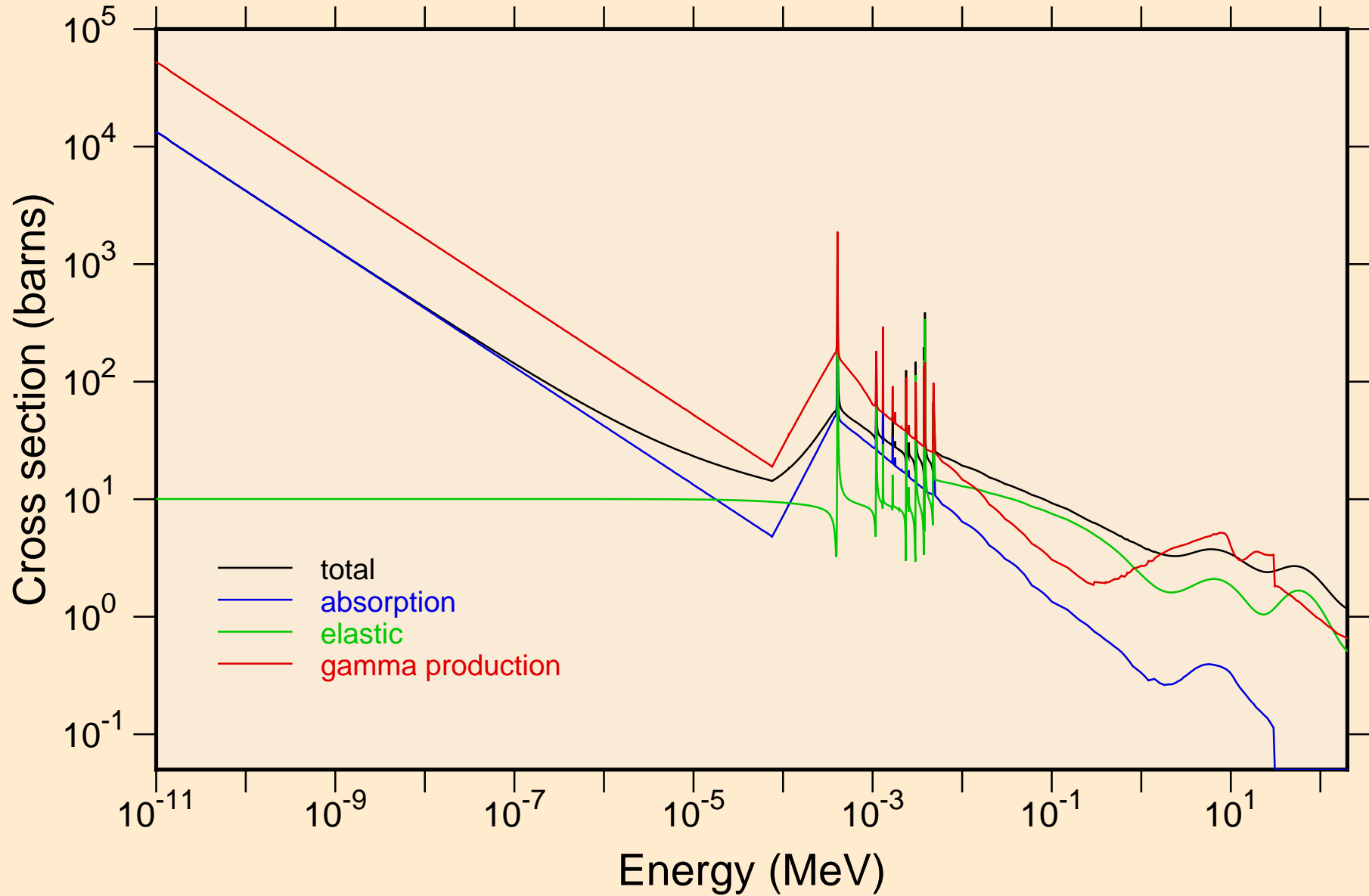

CU062 NEUTRON ACER TENDL-2023 LIBRARY; T=0.K  
resonance total cross section

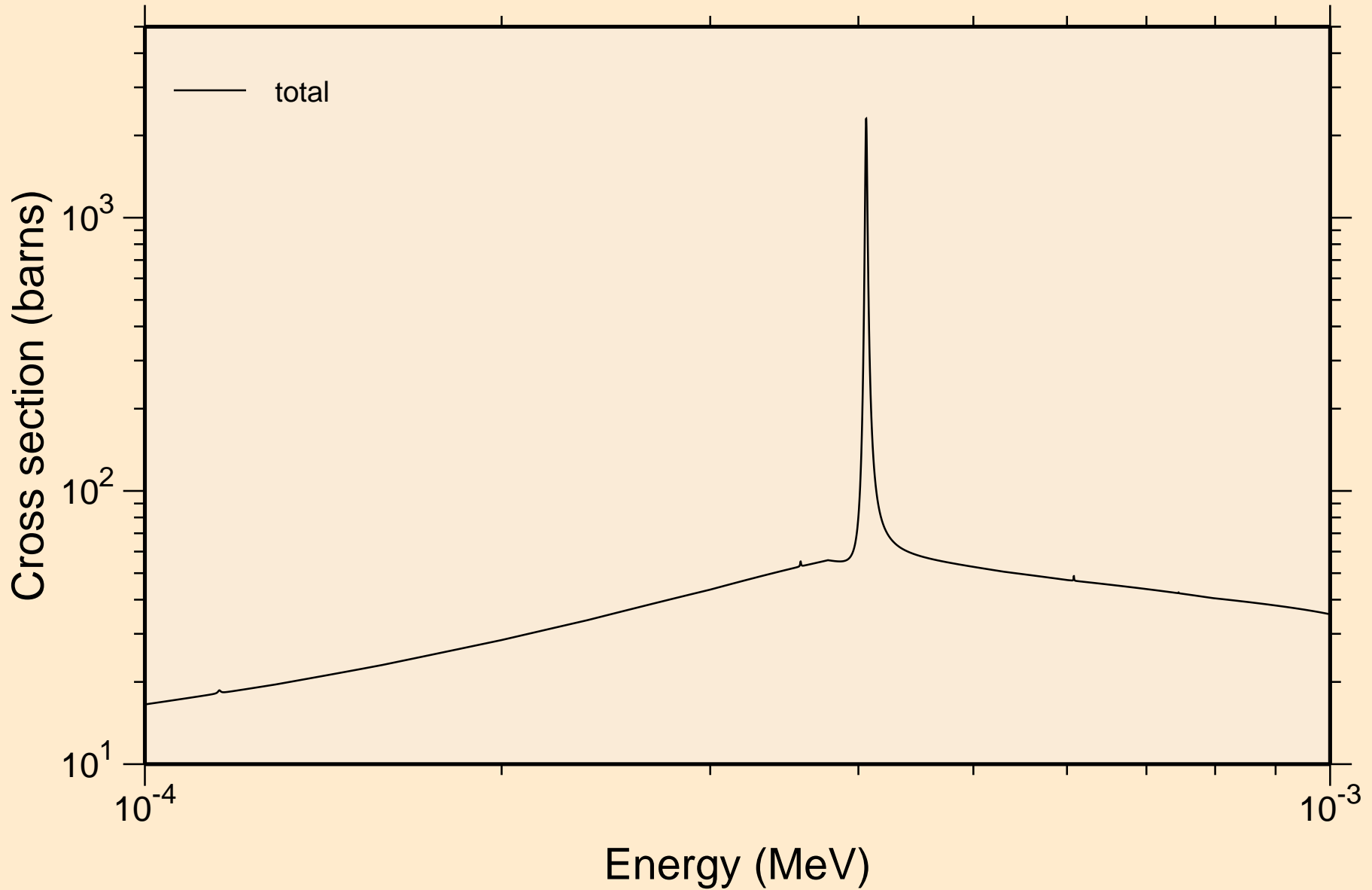

CU062 NEUTRON ACER TENDL-2023 LIBRARY; T=0.K  
resonance total cross section

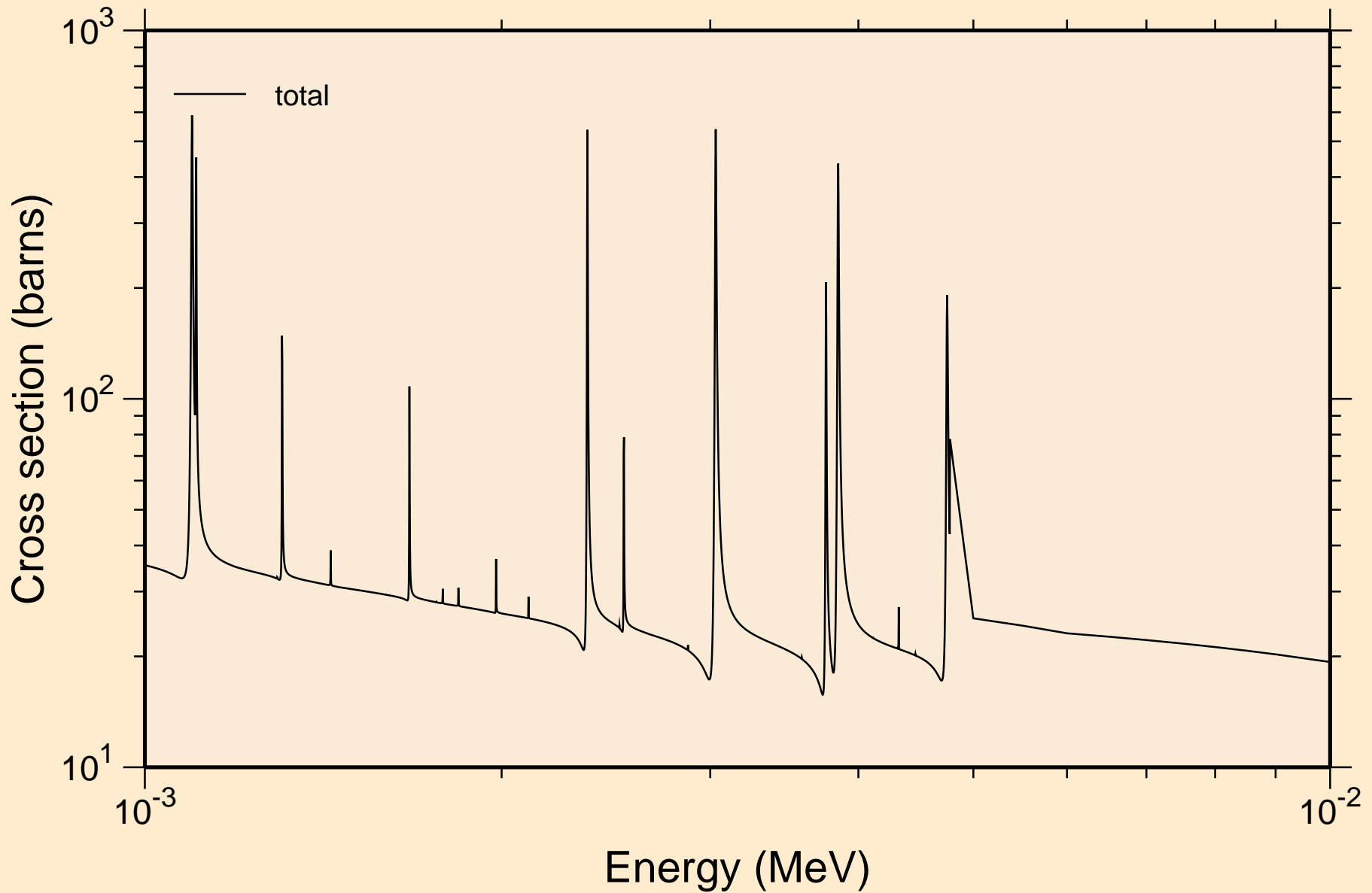

CU062 NEUTRON ACER TENDL-2023 LIBRARY; T=0.K  
resonance total cross section

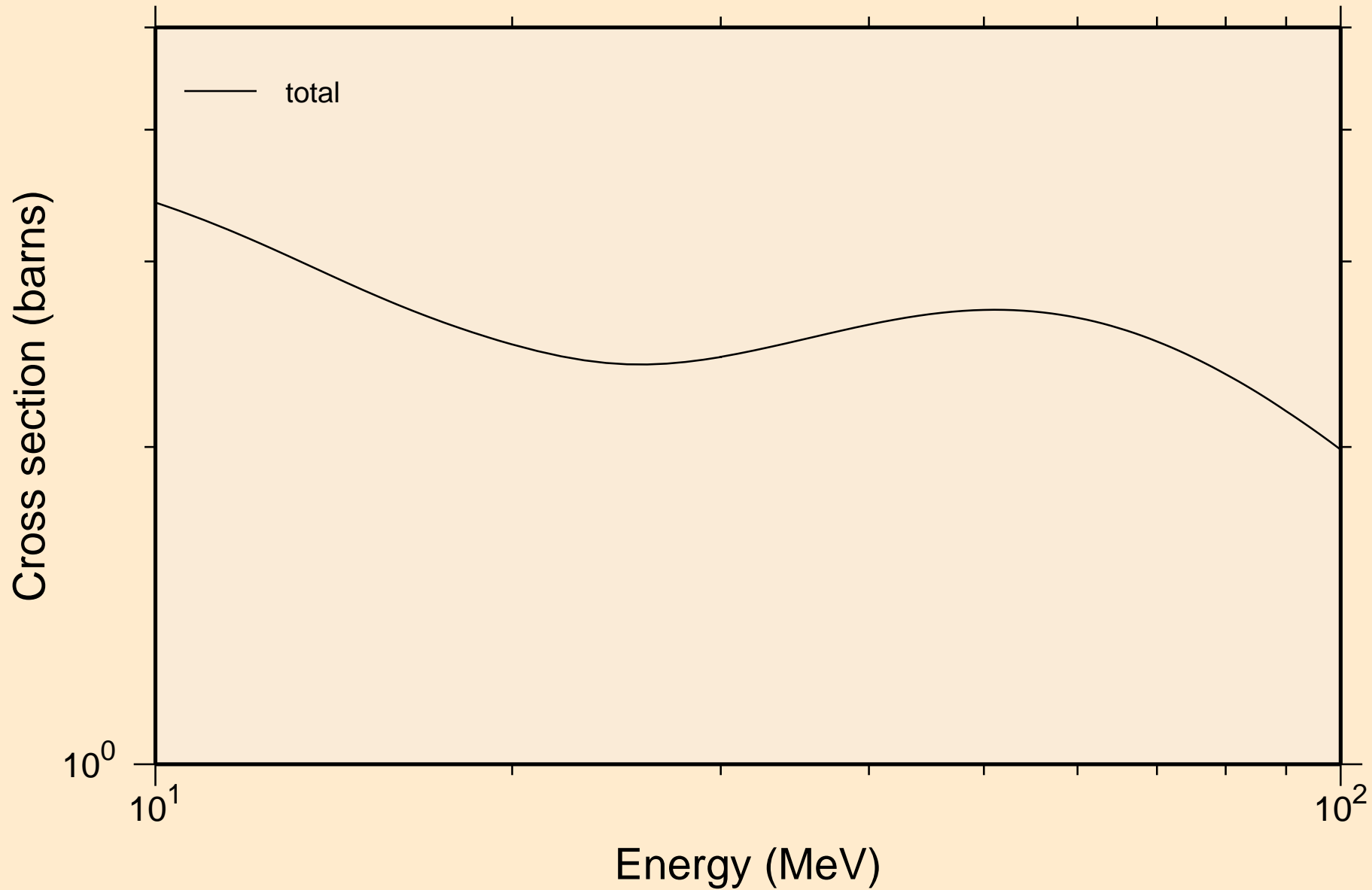

CU062 NEUTRON ACER TENDL-2023 LIBRARY; T=0.K  
resonance absorption cross sections

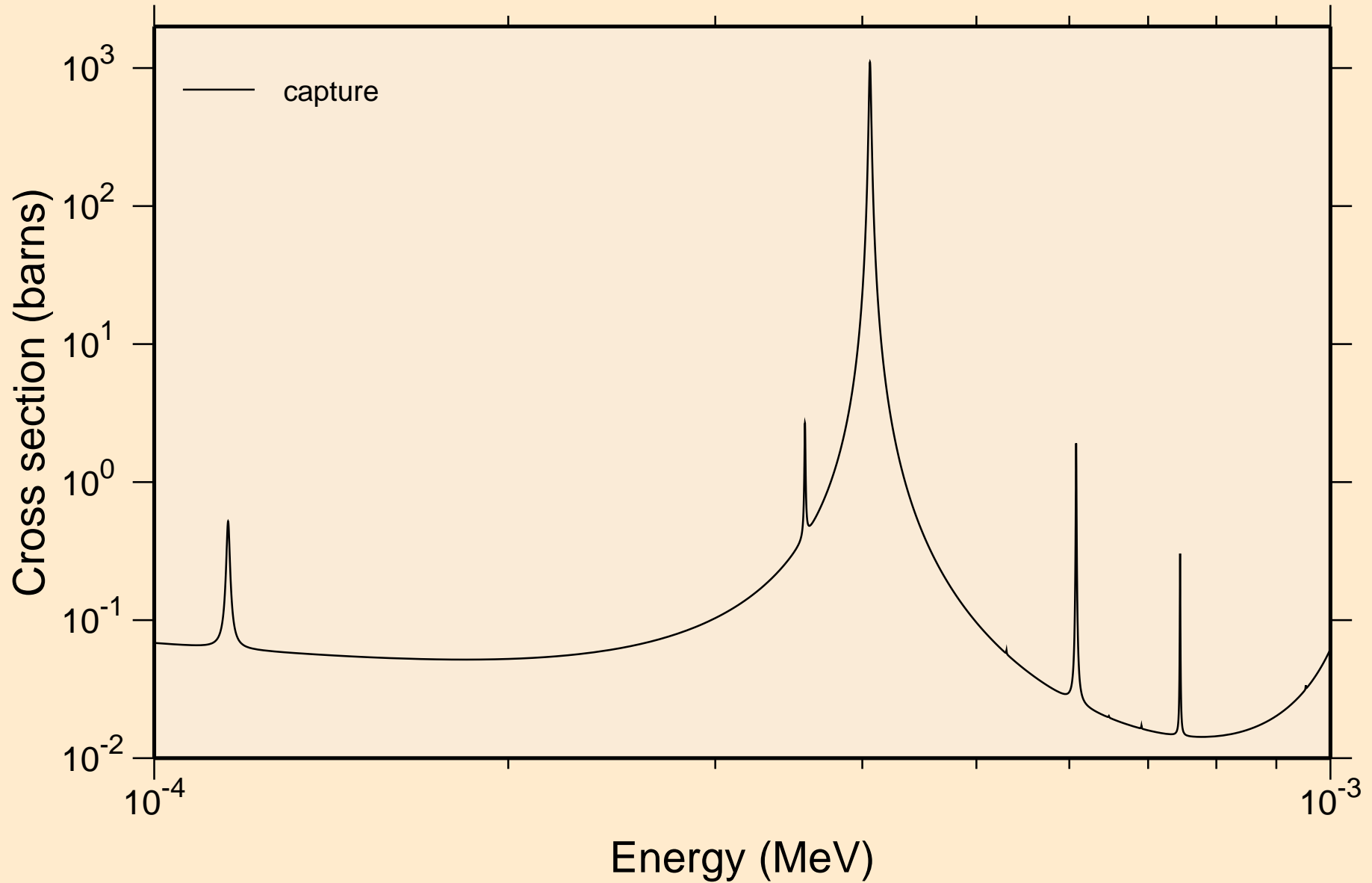

CU062 NEUTRON ACER TENDL-2023 LIBRARY; T=0.K  
resonance absorption cross sections

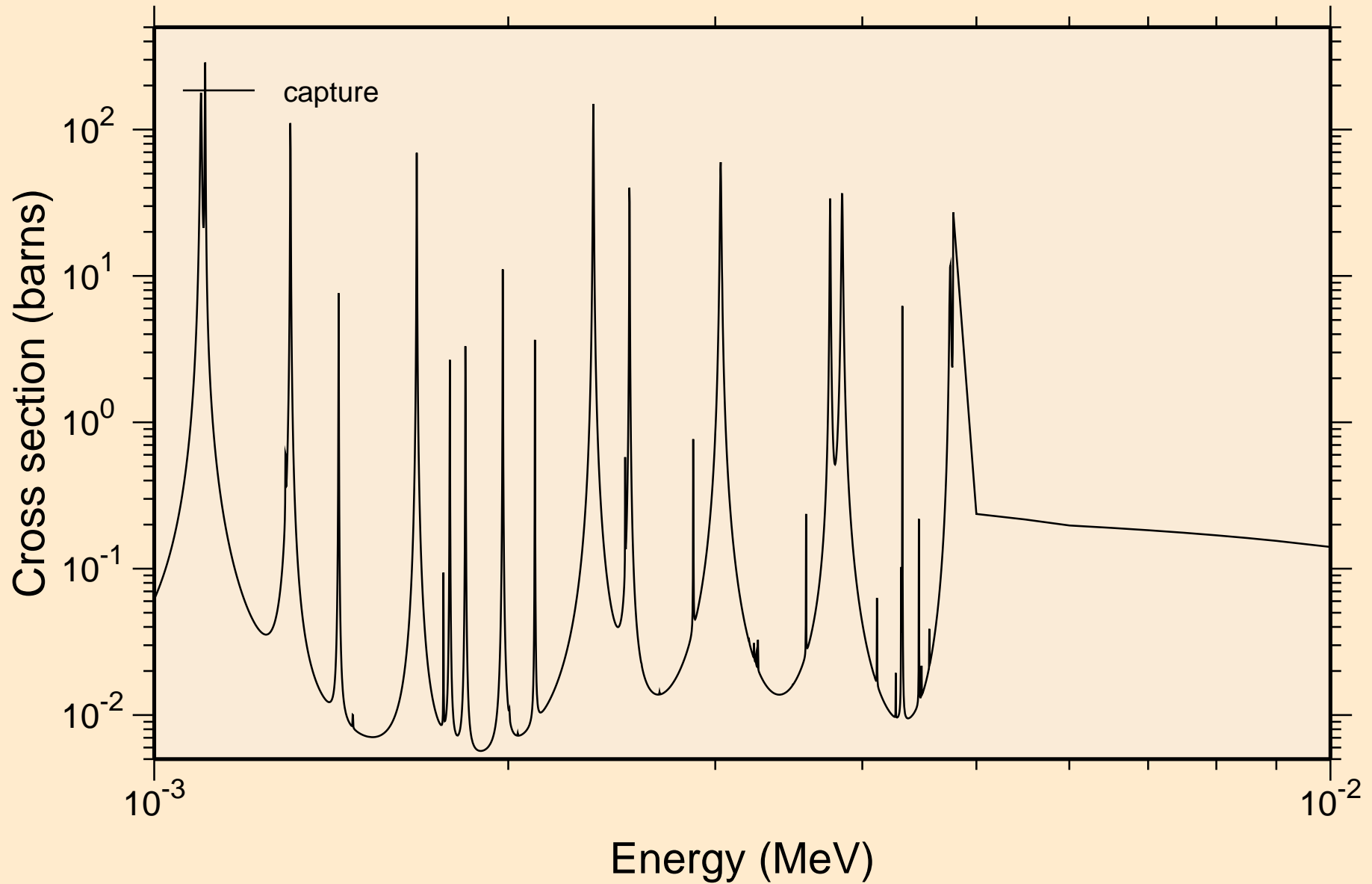

CU062 NEUTRON ACER TENDL-2023 LIBRARY; T=0.K  
resonance absorption cross sections

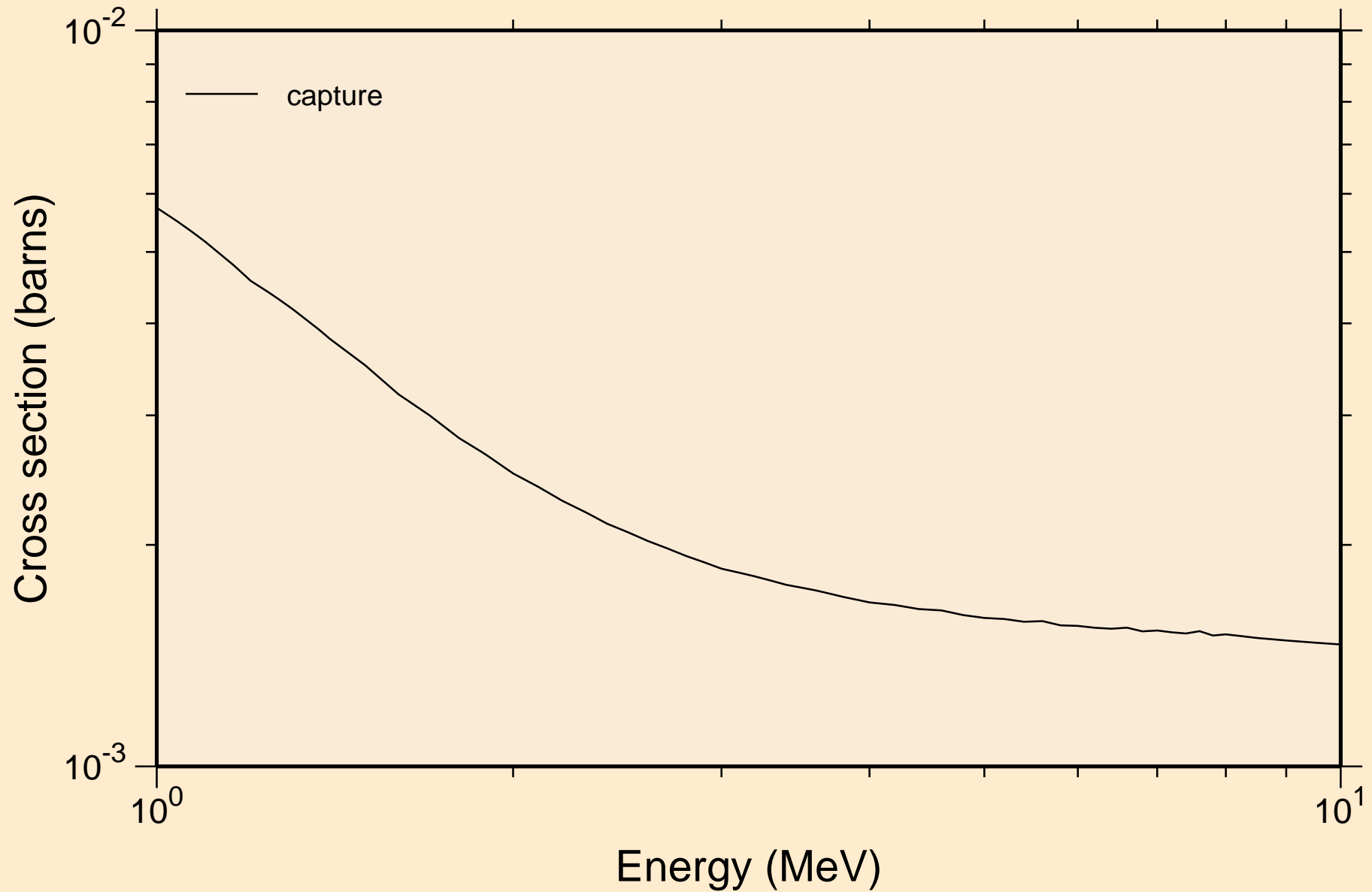

CU062 NEUTRON ACER TENDL-2023 LIBRARY; T=0.K  
Heating

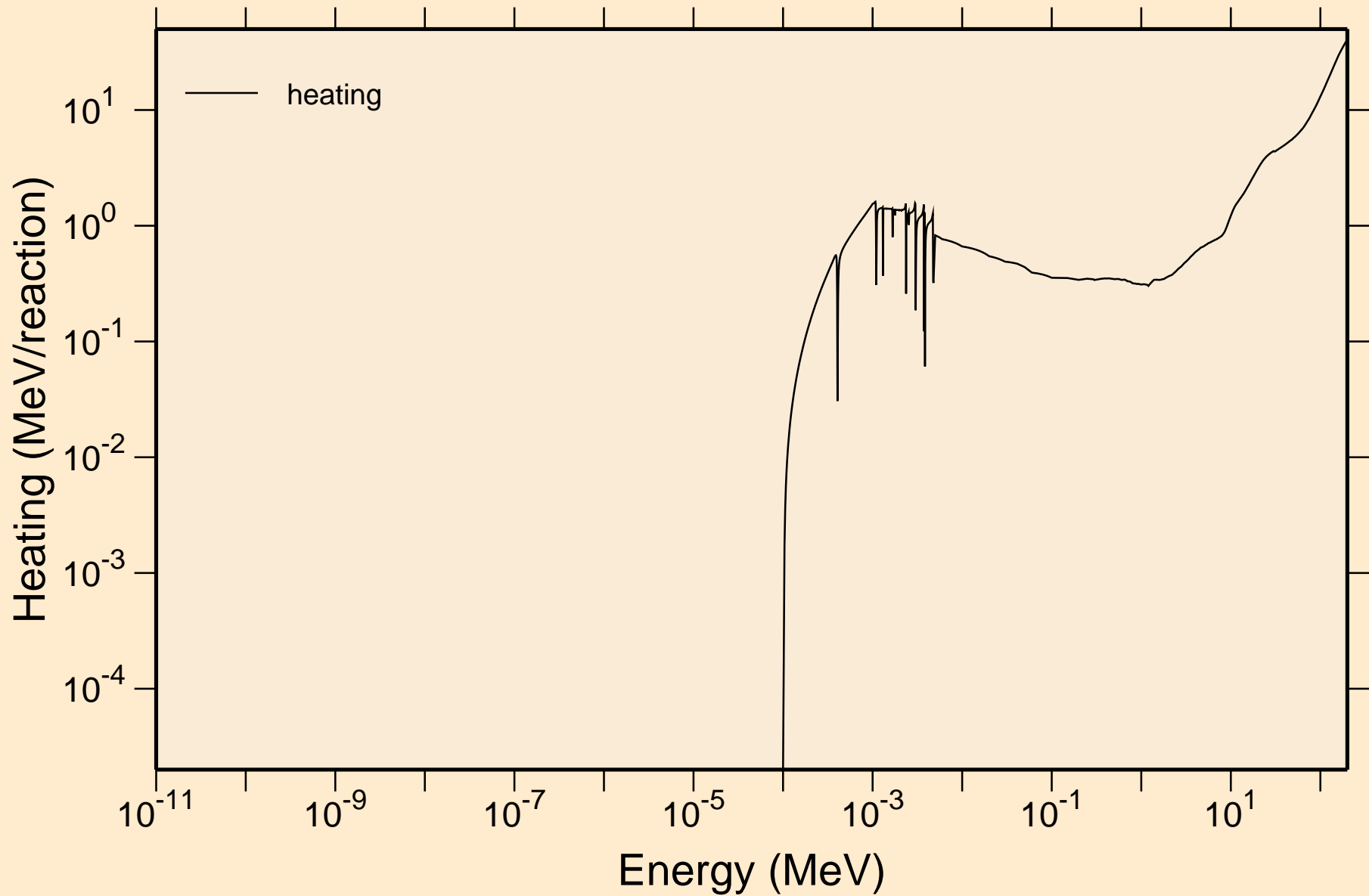



CU062 NEUTRON ACER TENDL-2023 LIBRARY; T=0.K  
Damage

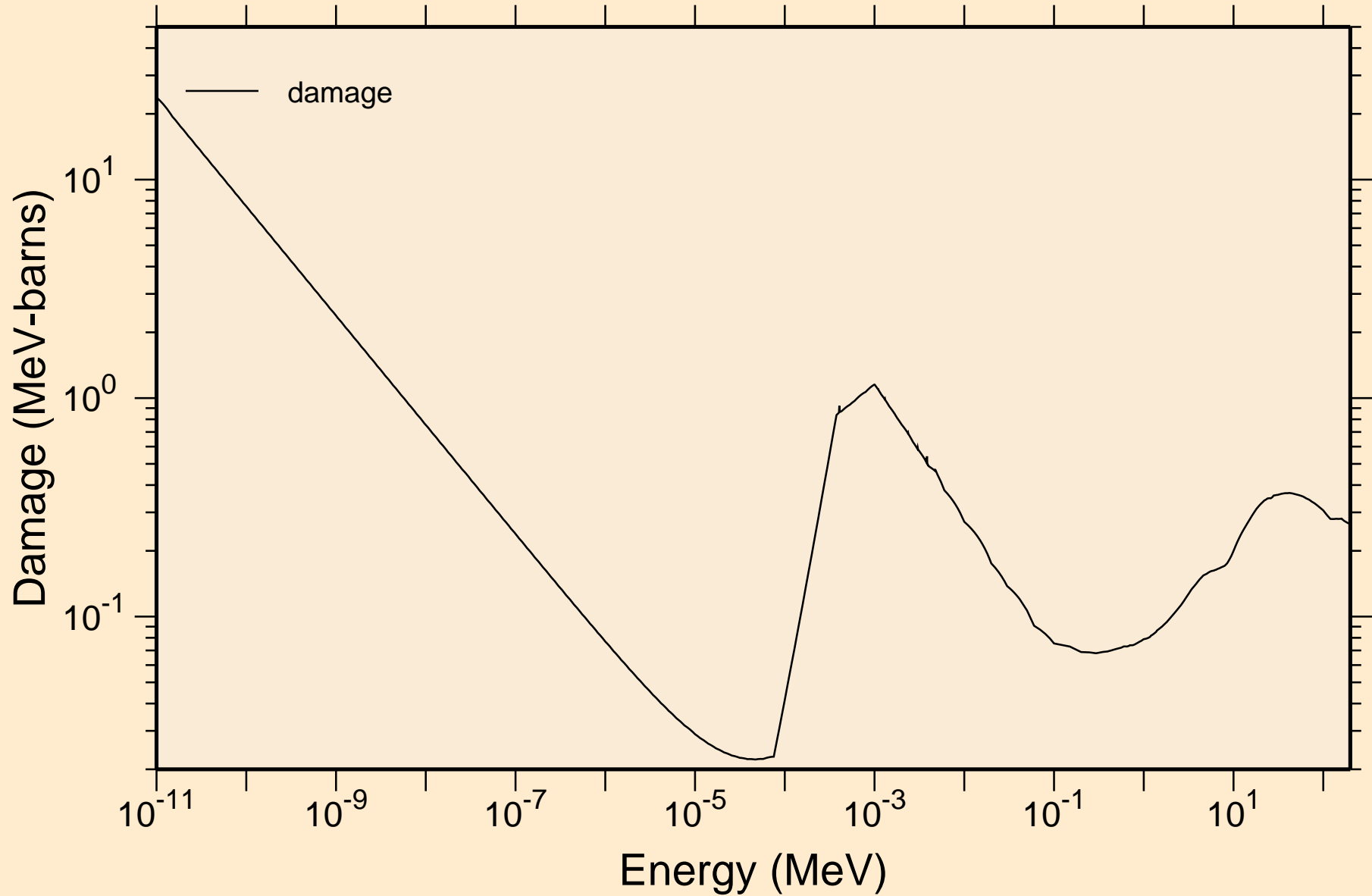

# CU062 NEUTRON ACER TENDL-2023 LIBRARY; T=0.K

## Non-threshold reactions

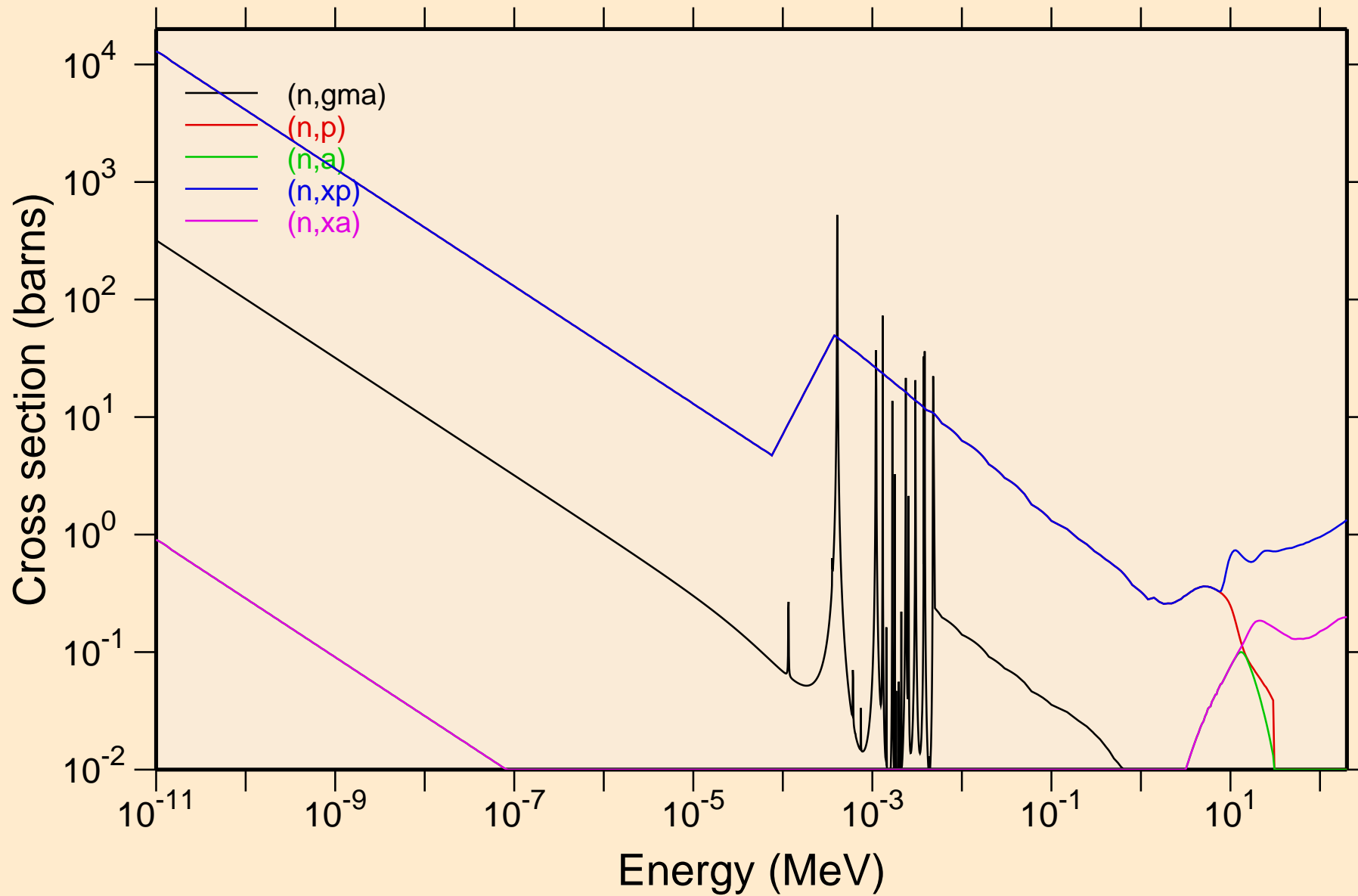

# CU062 NEUTRON ACER TENDL-2023 LIBRARY; T=0.K

## Principal cross sections

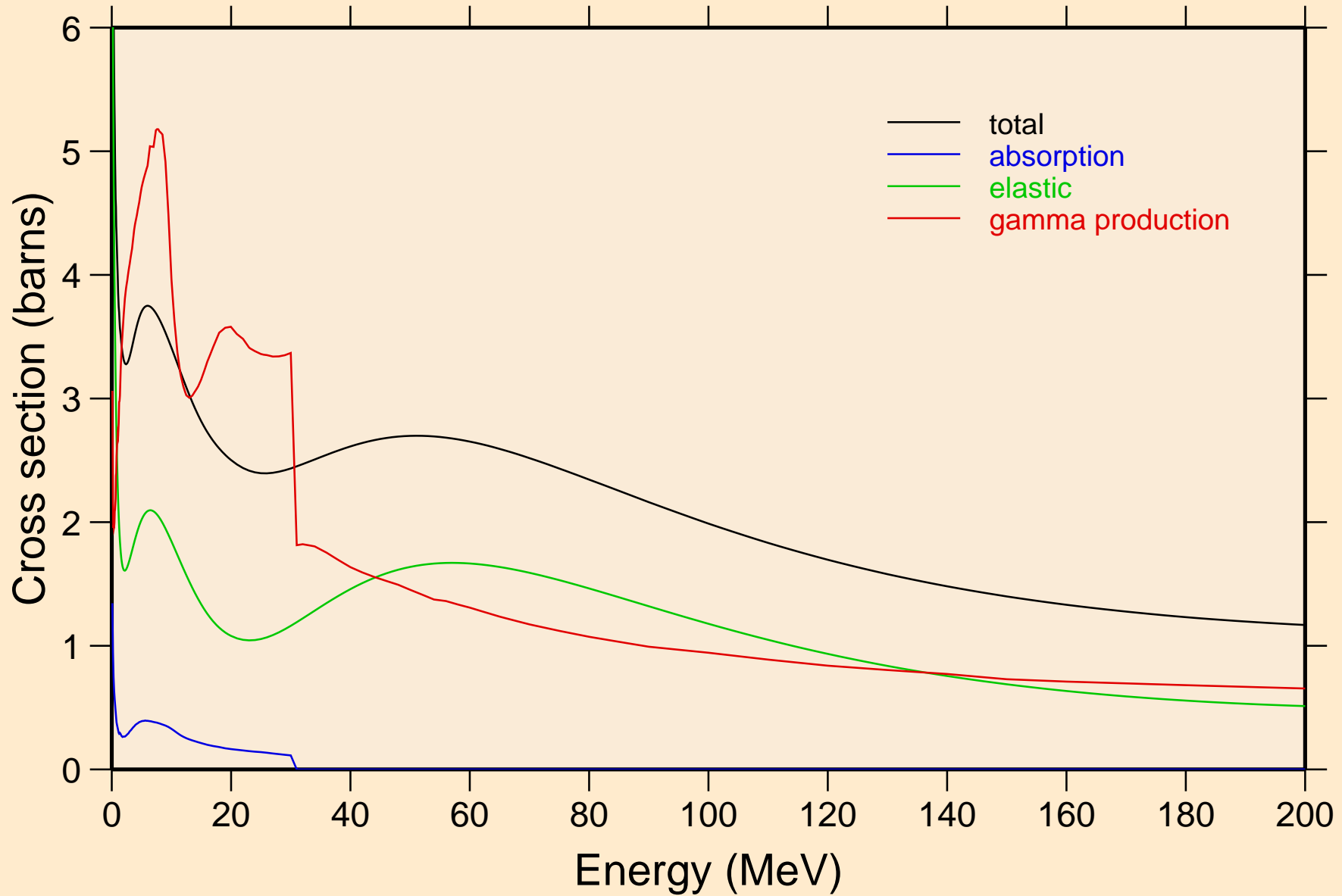

# CU062 NEUTRON ACER TENDL-2023 LIBRARY; T=0.K

## Heating

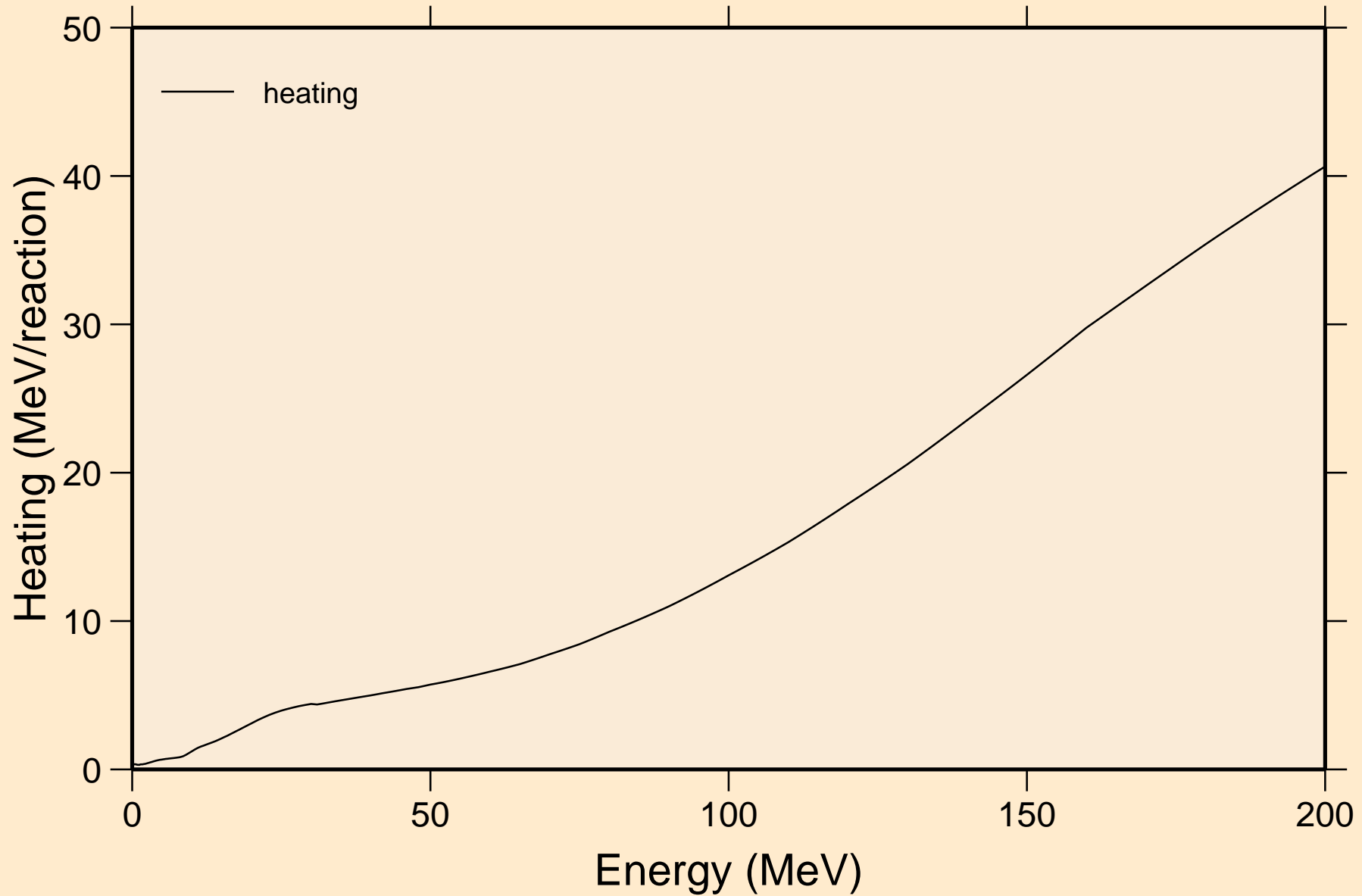

CU062 NEUTRON ACER TENDL-2023 LIBRARY; T=0.K  
Damage

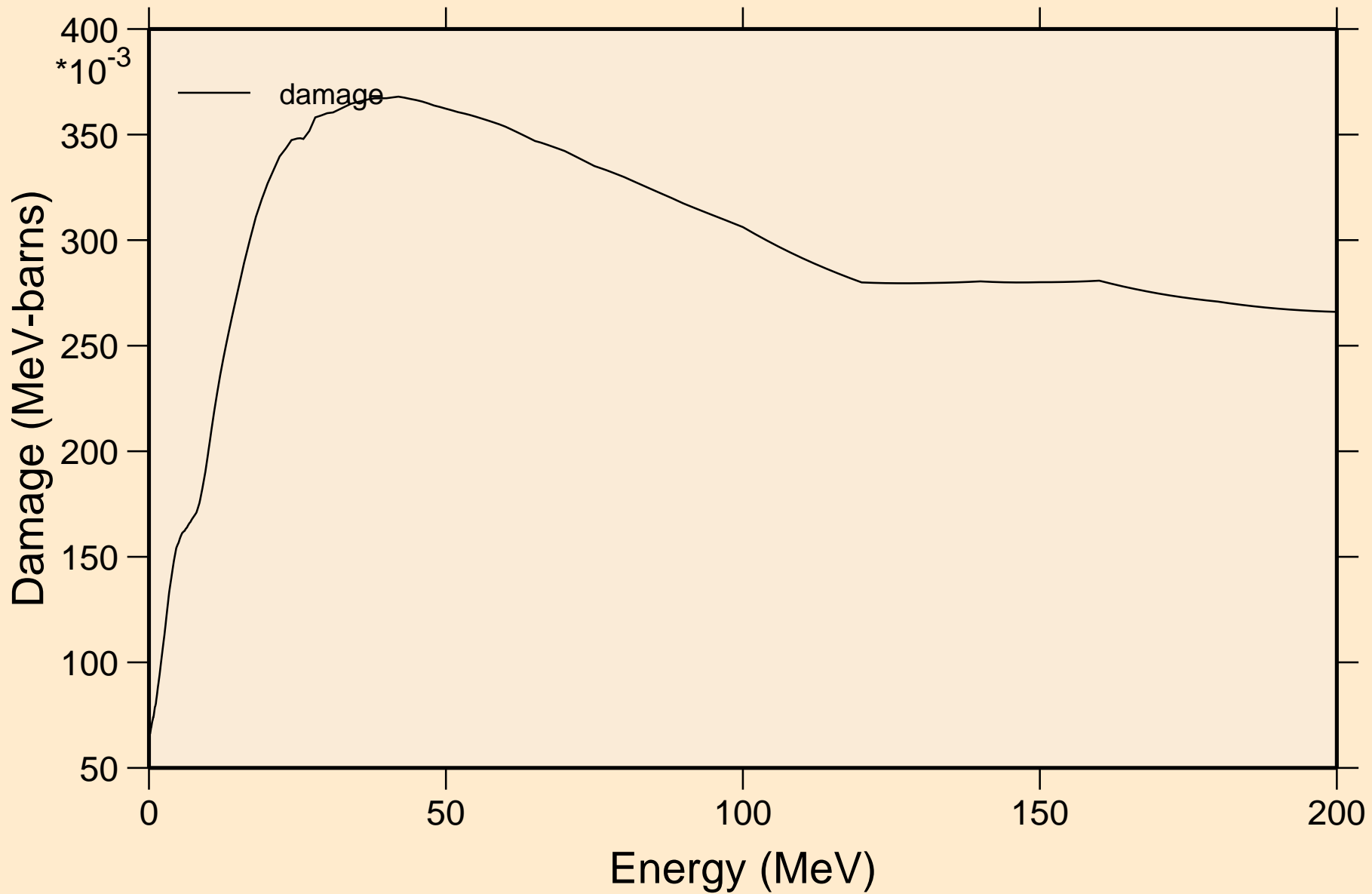

CU062 NEUTRON ACER TENDL-2023 LIBRARY; T=0.K  
Non-threshold reactions

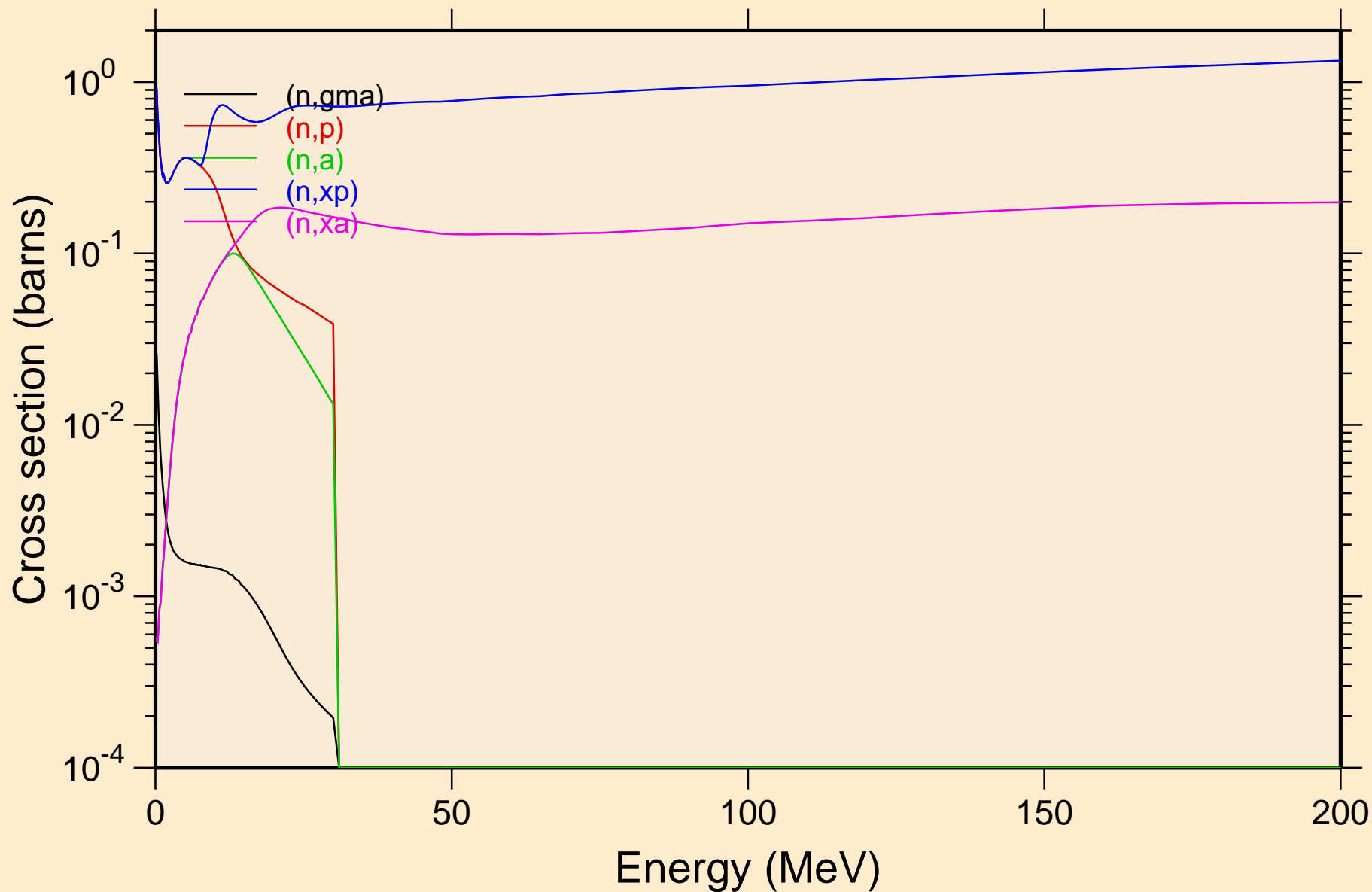

CU062 NEUTRON ACER TENDL-2023 LIBRARY; T=0.K  
Inelastic levels

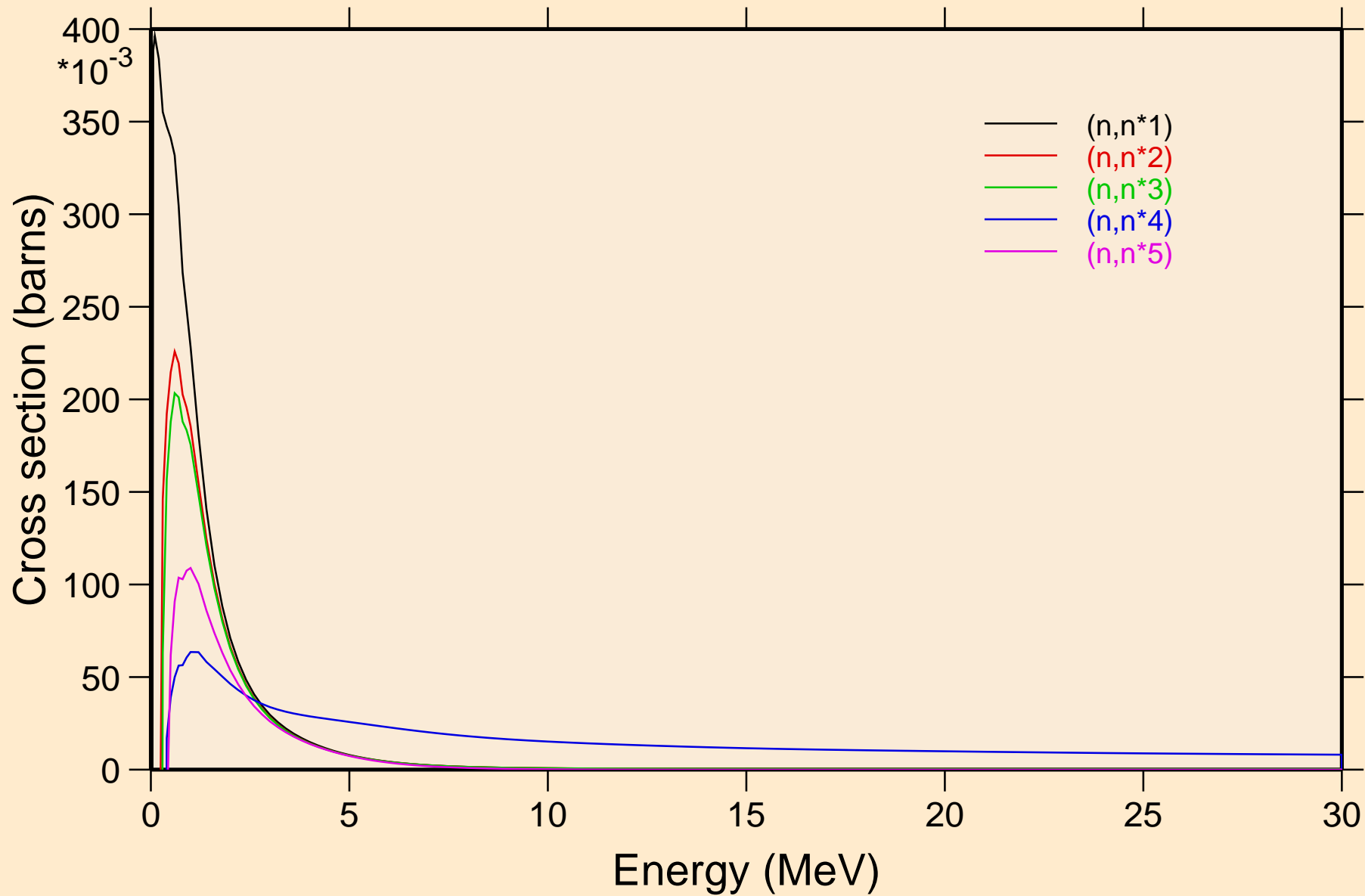

CU062 NEUTRON ACER TENDL-2023 LIBRARY; T=0.K  
Inelastic levels

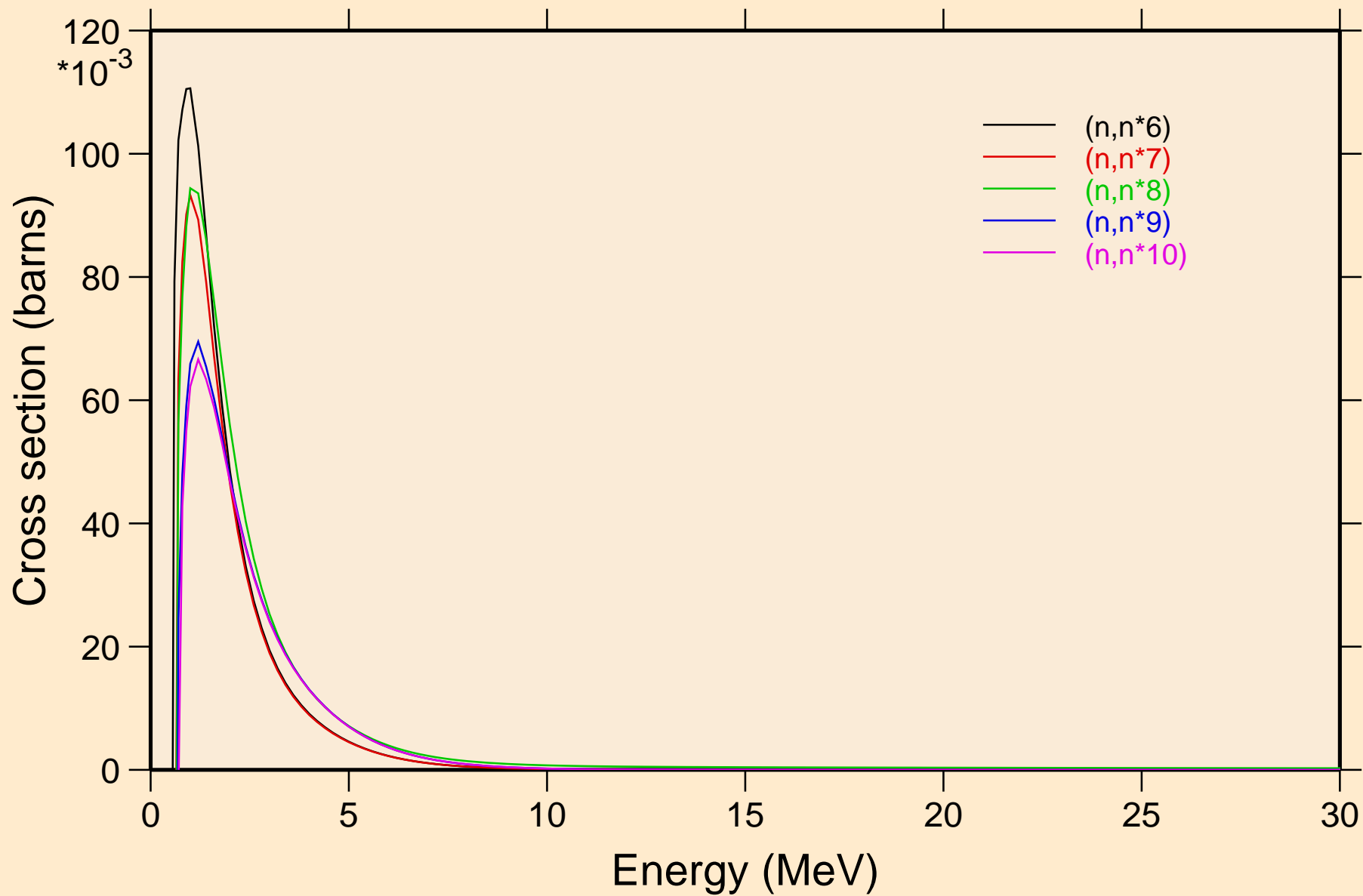



CU062 NEUTRON ACER TENDL-2023 LIBRARY; T=0.K  
Inelastic levels

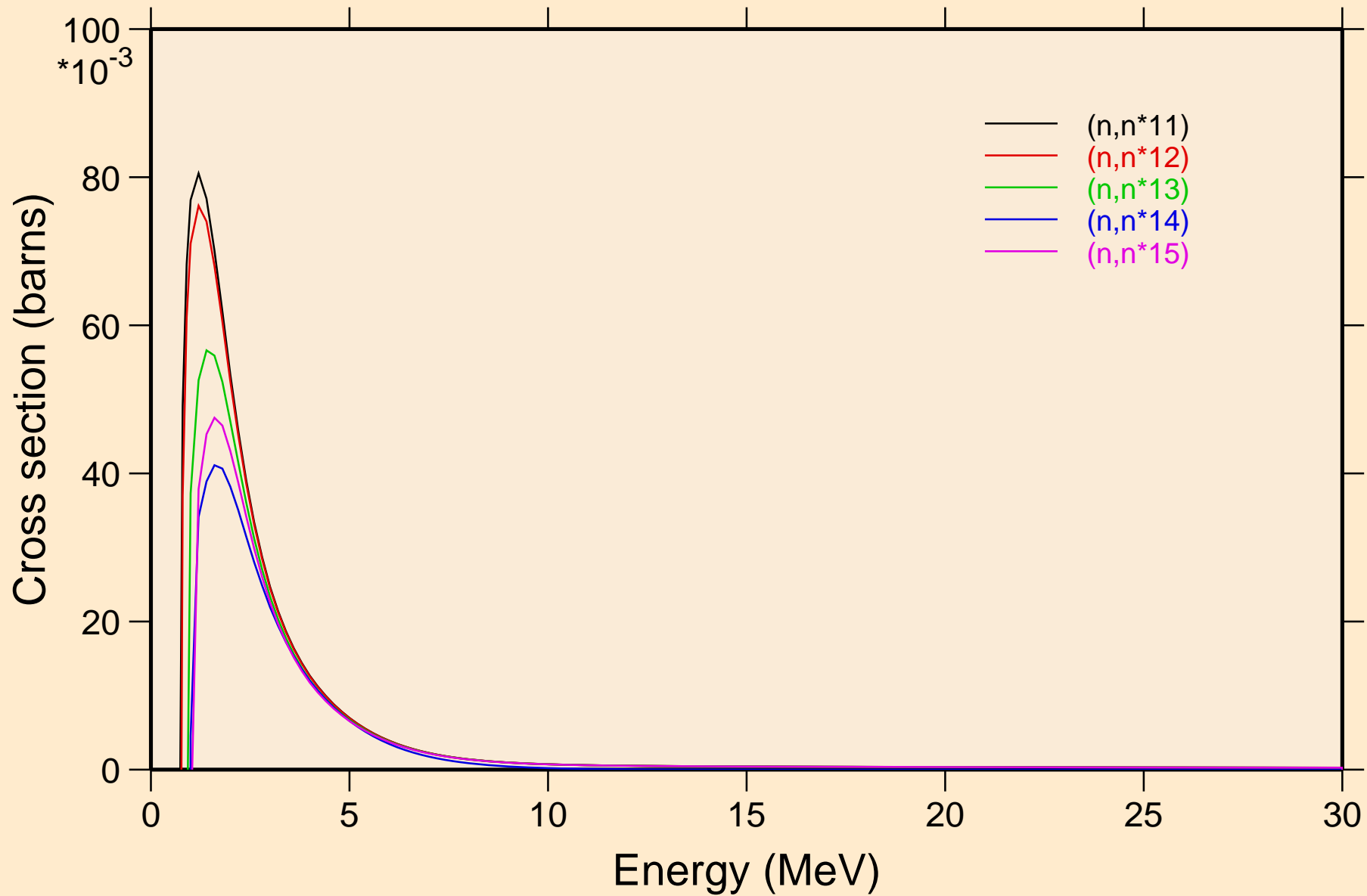

CU062 NEUTRON ACER TENDL-2023 LIBRARY; T=0.K  
Inelastic levels

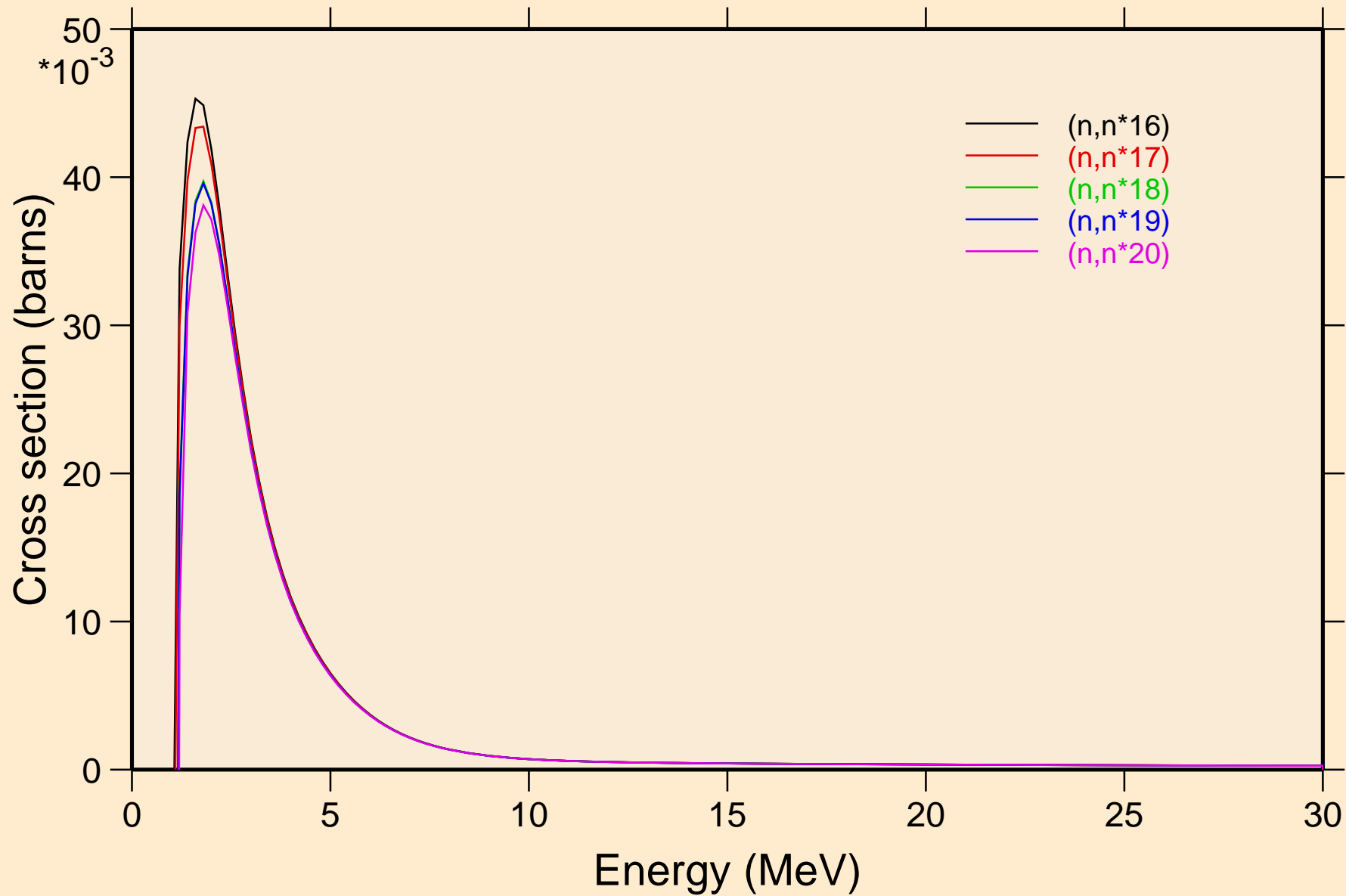

CU062 NEUTRON ACER TENDL-2023 LIBRARY; T=0.K  
Inelastic levels

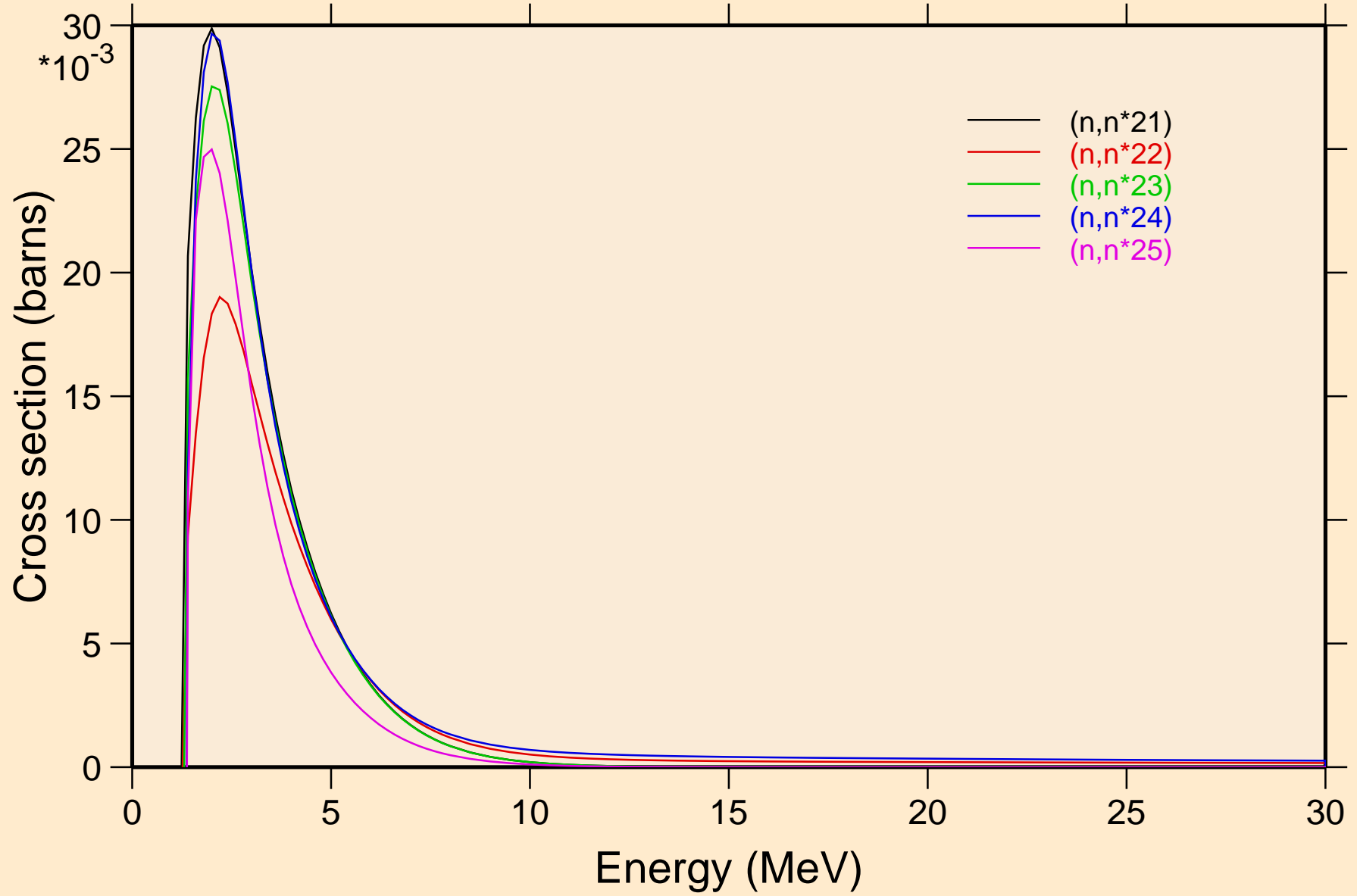

CU062 NEUTRON ACER TENDL-2023 LIBRARY; T=0.K  
Inelastic levels

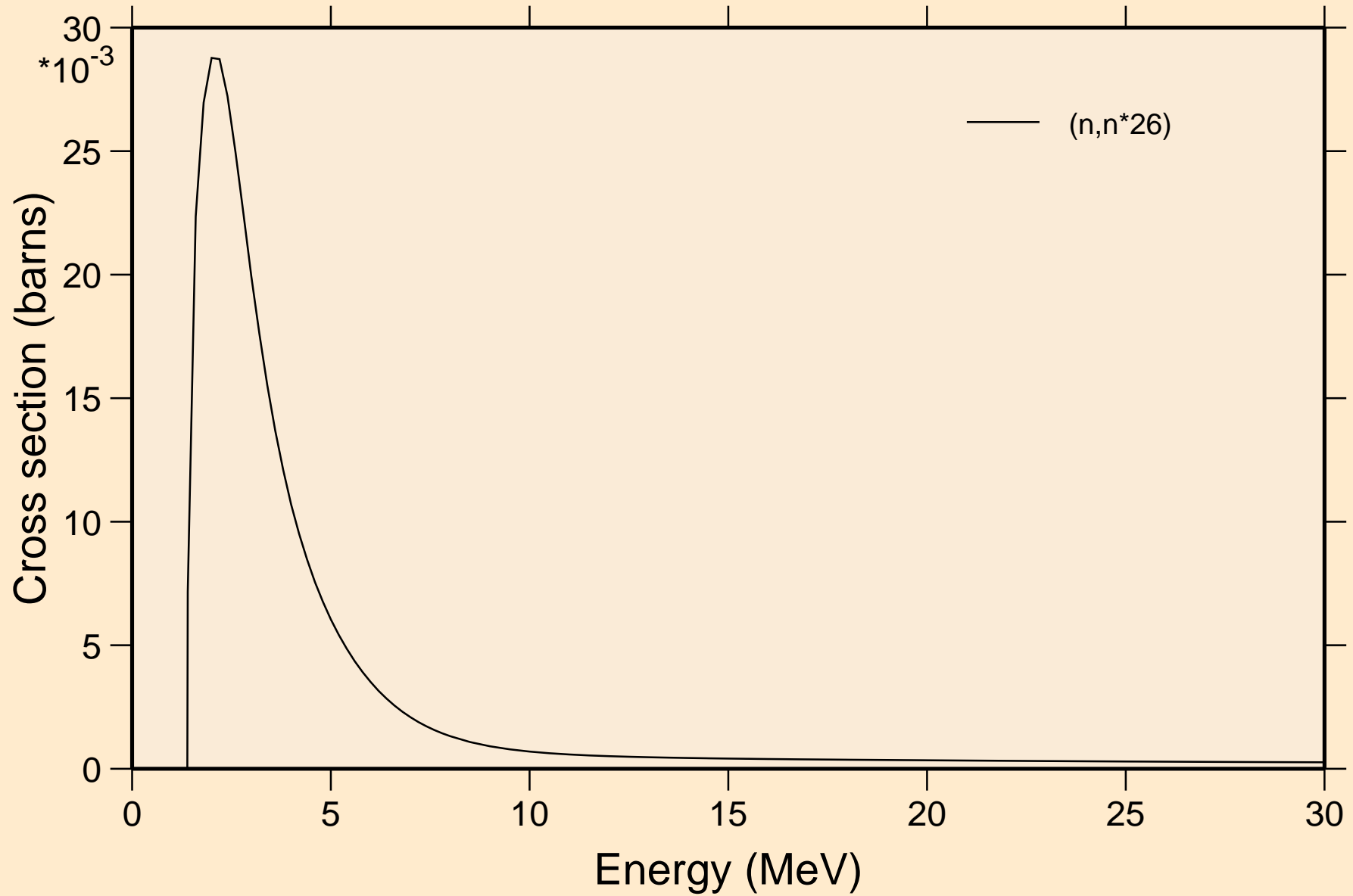

CU062 NEUTRON ACER TENDL-2023 LIBRARY; T=0.K  
Threshold reactions

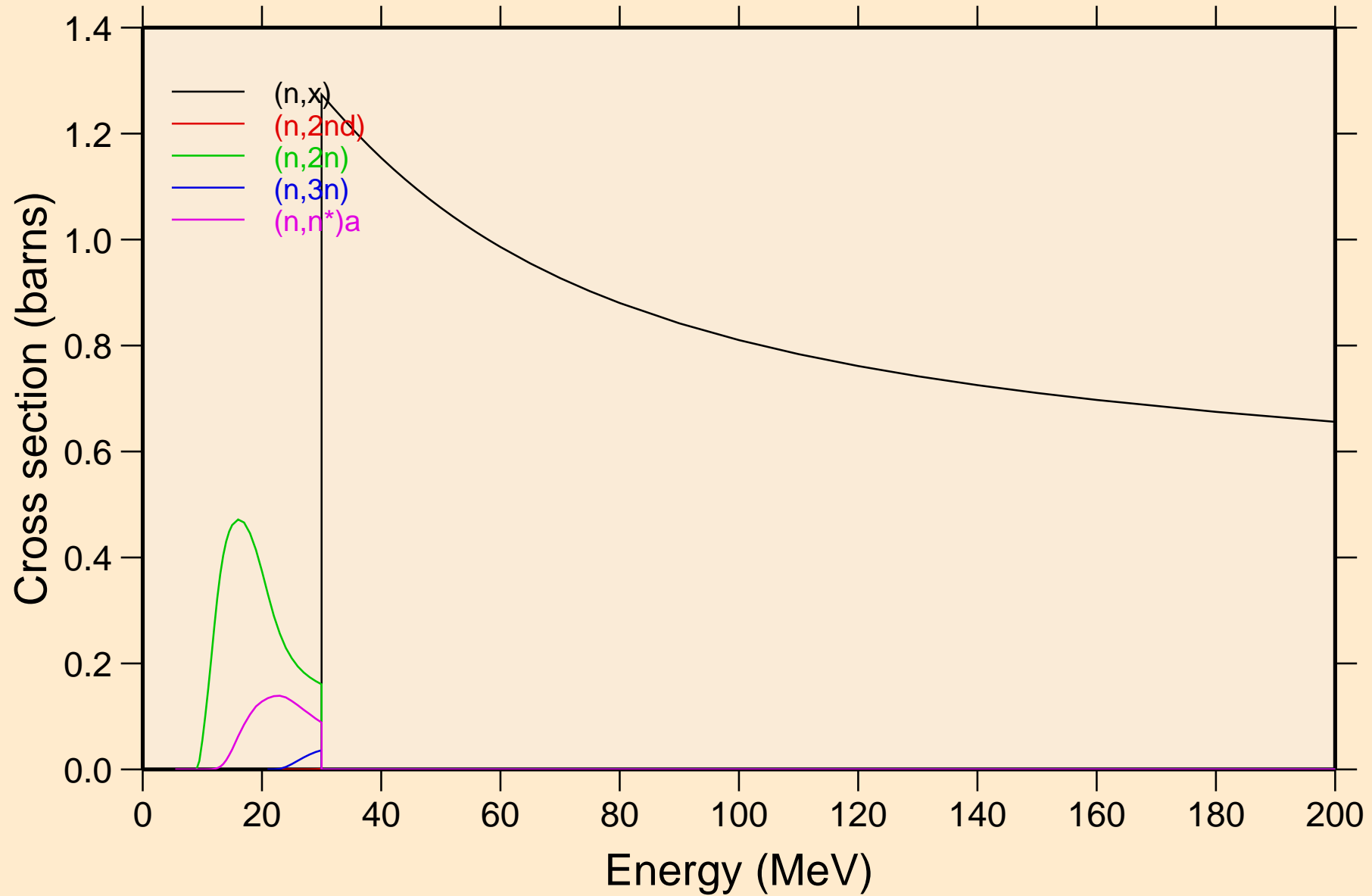

# CU062 NEUTRON ACER TENDL-2023 LIBRARY; T=0.K

## Threshold reactions

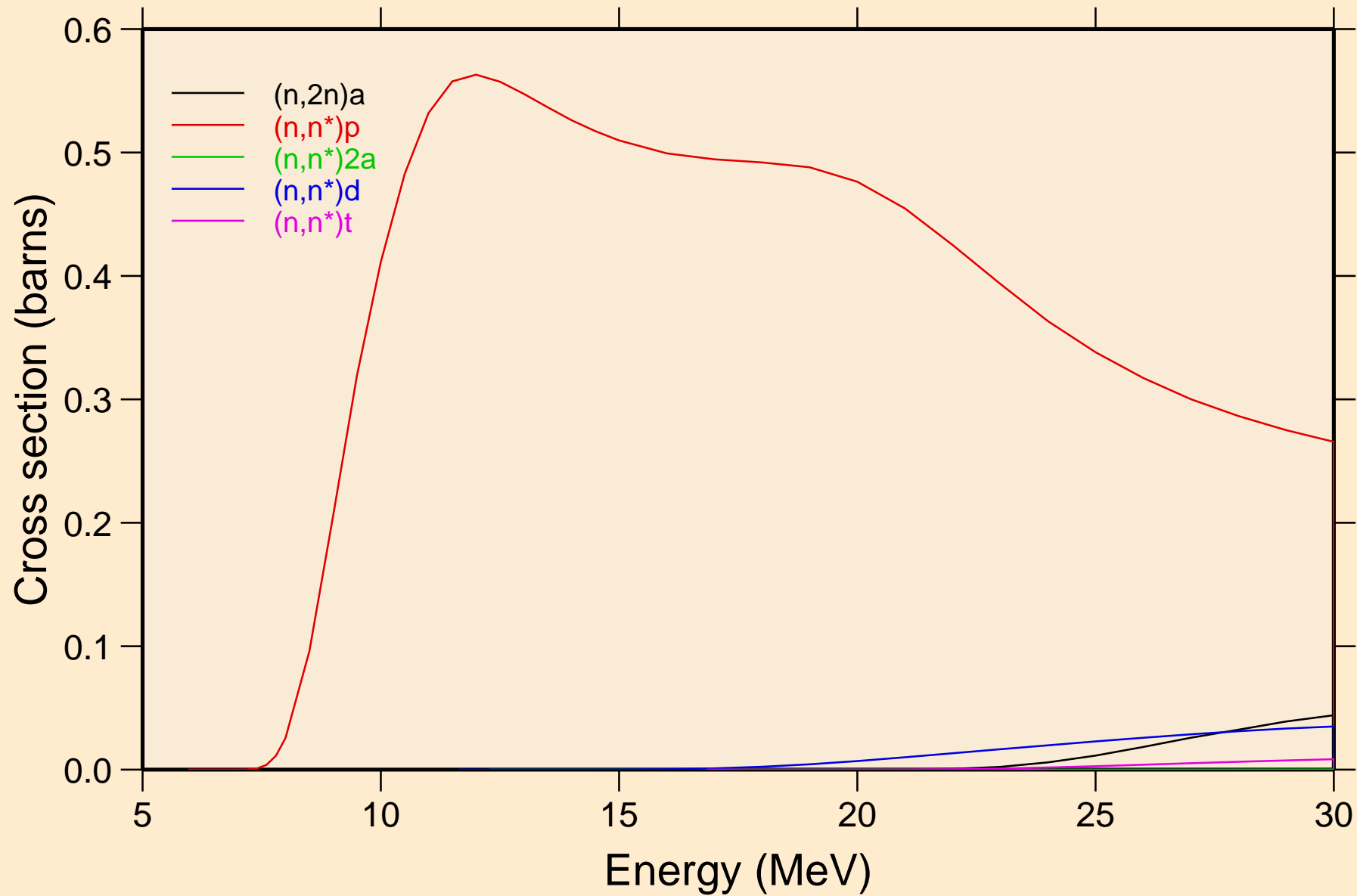

# CU062 NEUTRON ACER TENDL-2023 LIBRARY; T=0.K

## Threshold reactions

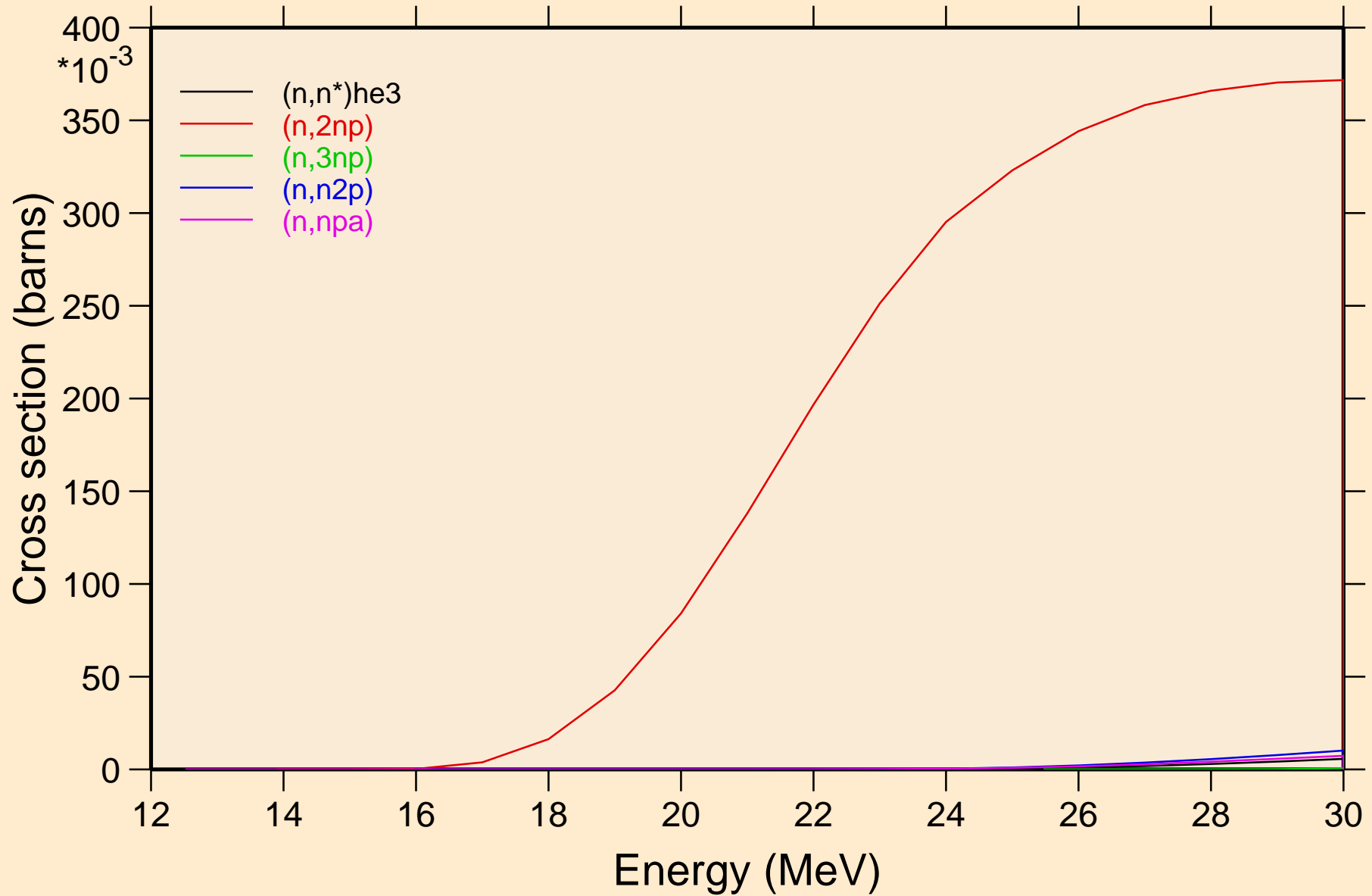

CU062 NEUTRON ACER TENDL-2023 LIBRARY; T=0.K  
Threshold reactions

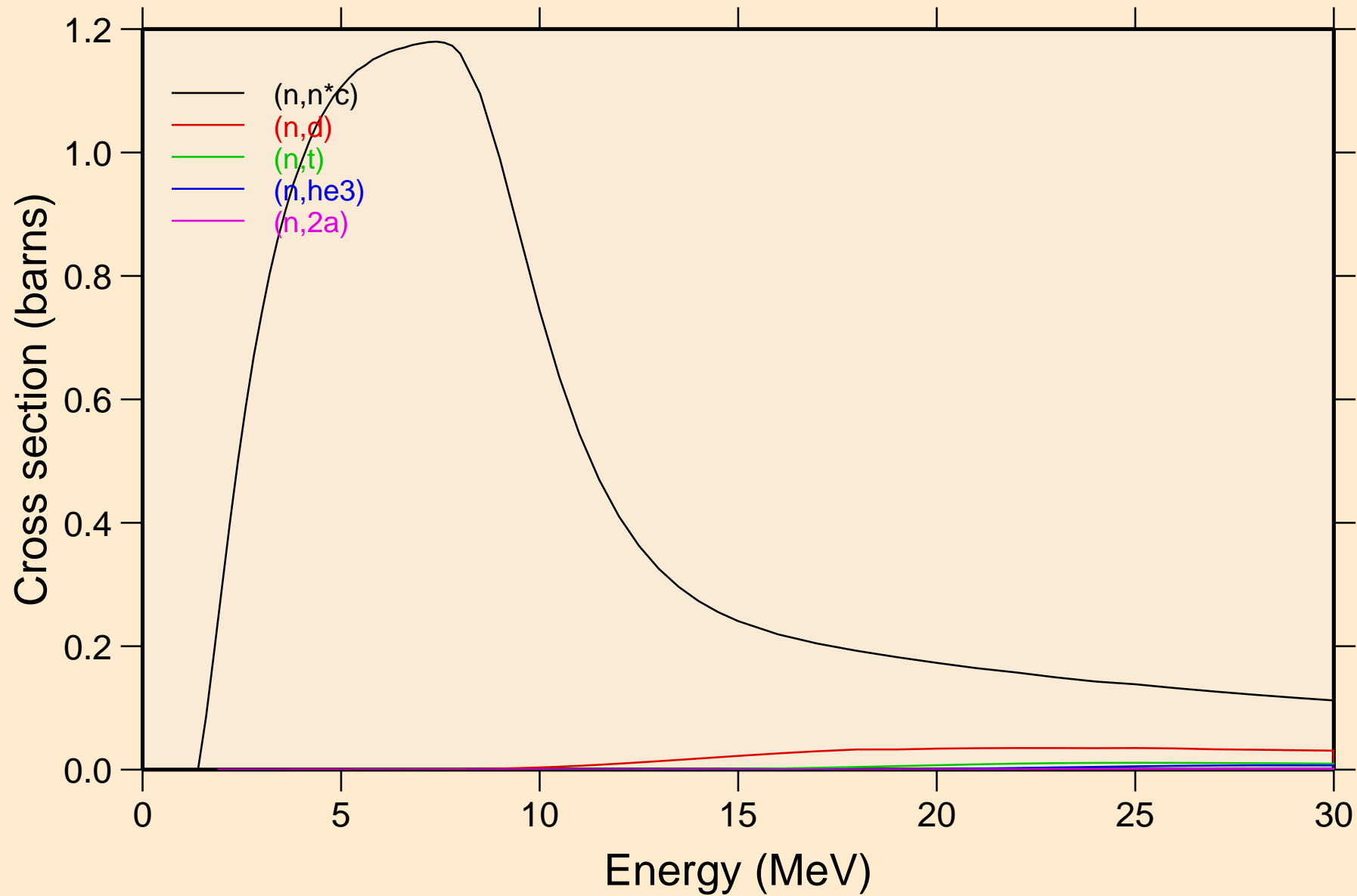



# CU062 NEUTRON ACER TENDL-2023 LIBRARY; T=0.K

## Threshold reactions

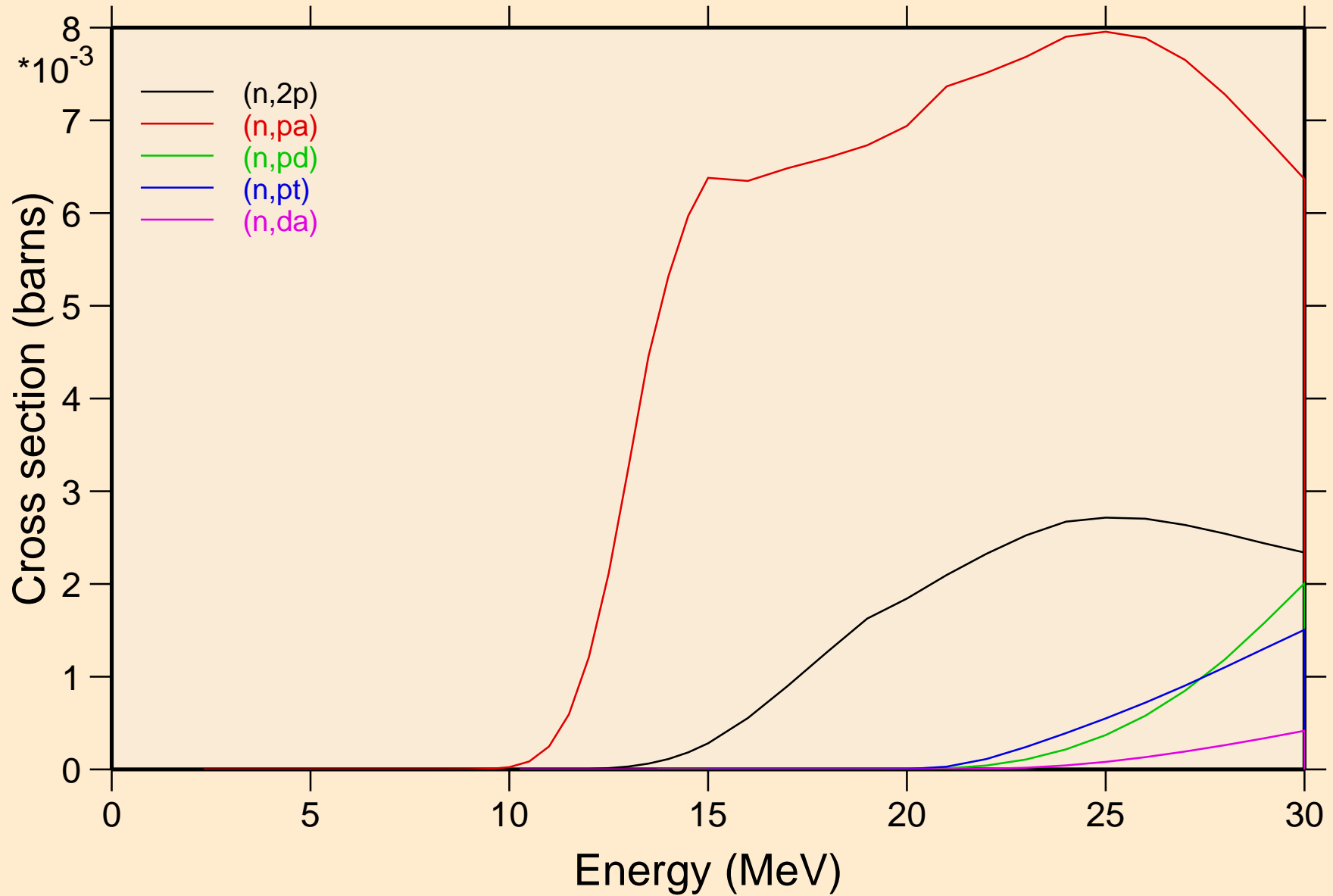

# CU062 NEUTRON ACER TENDL-2023 LIBRARY; T=0.K

## Threshold reactions

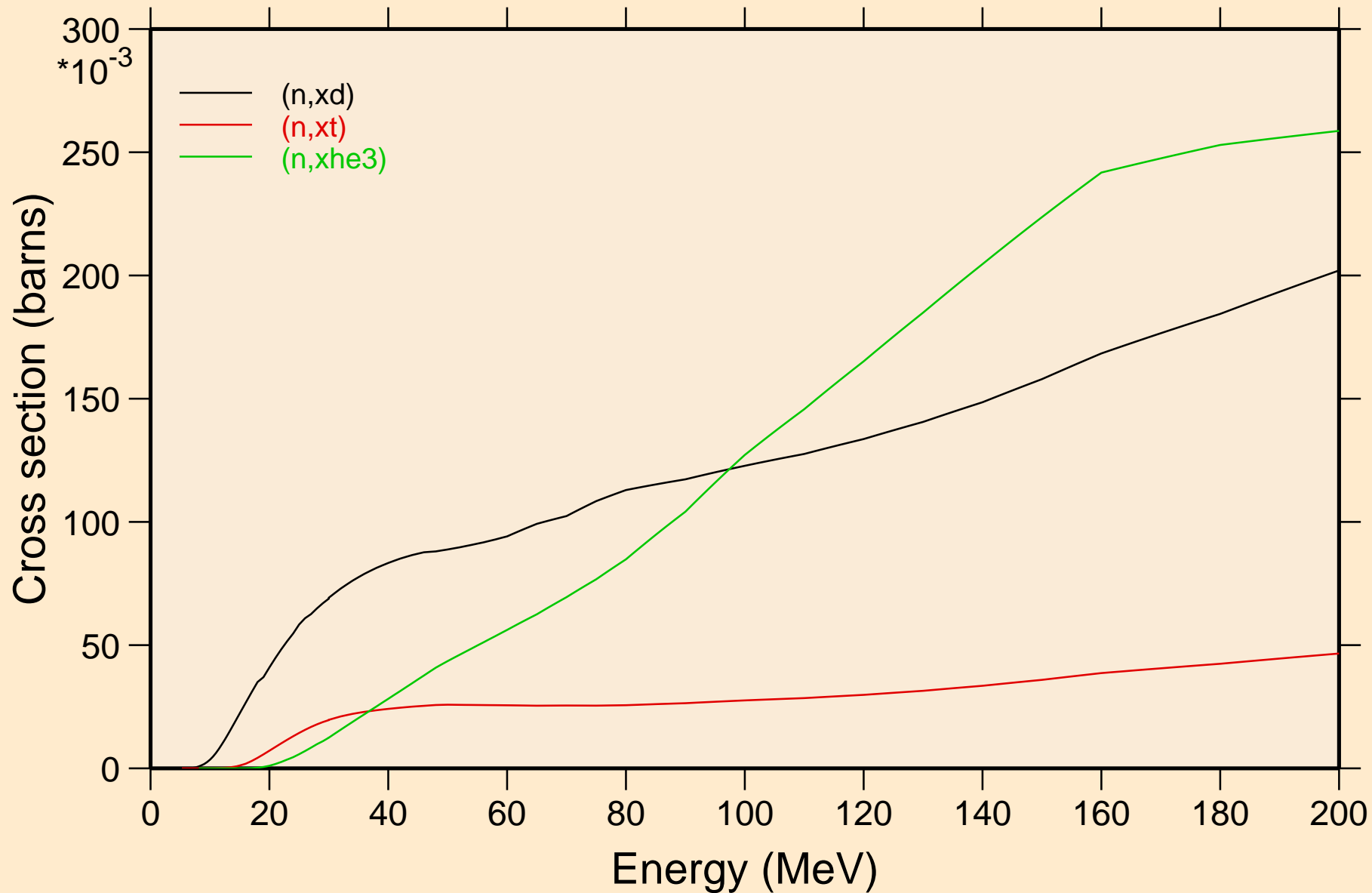

CU062 NEUTRON ACER TENDL-2023 LIBRARY; T=0.K  
angular distribution for elastic

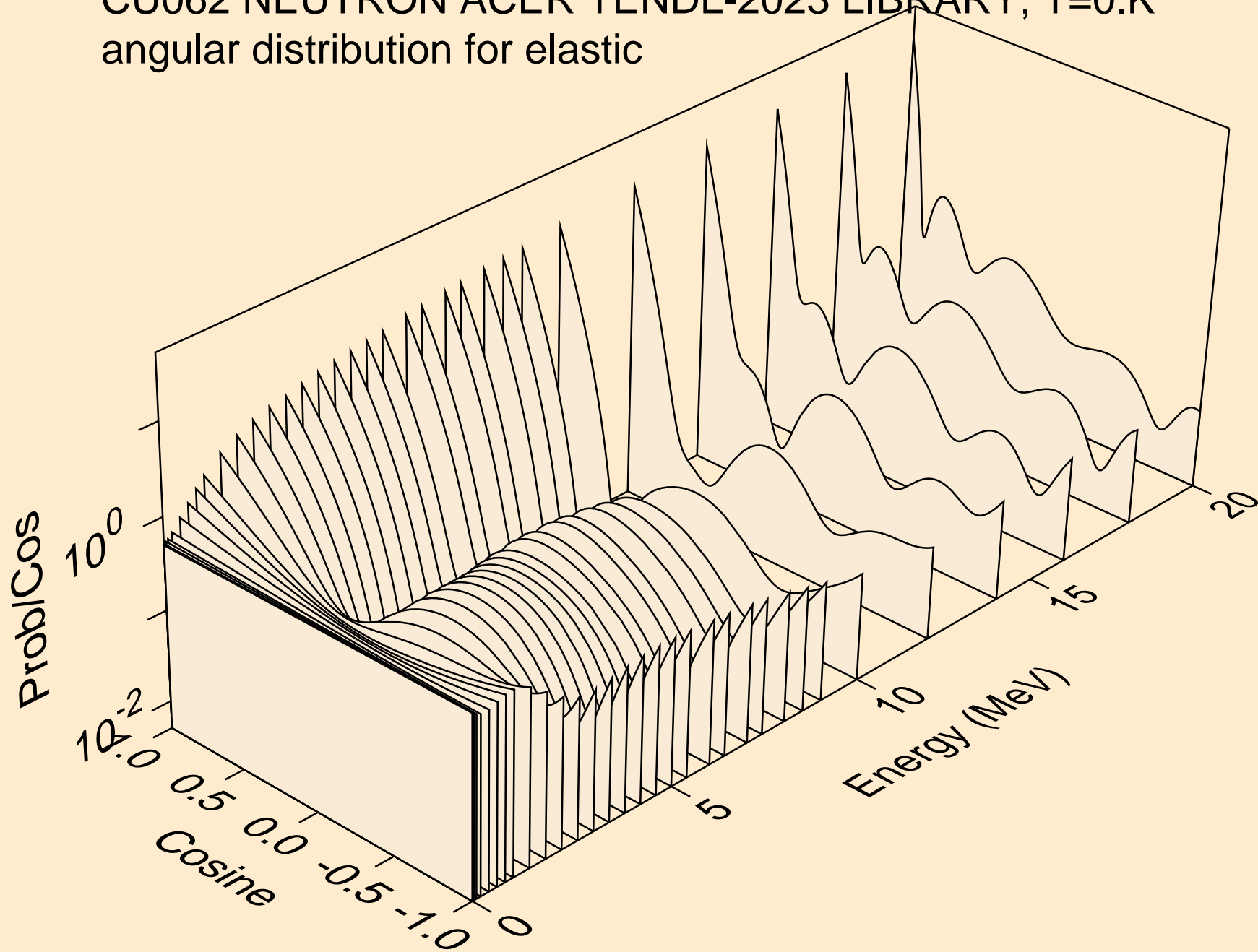

CU062 NEUTRON ACER TENDL-2023 LIBRARY; T=0.K  
angular distribution for elastic

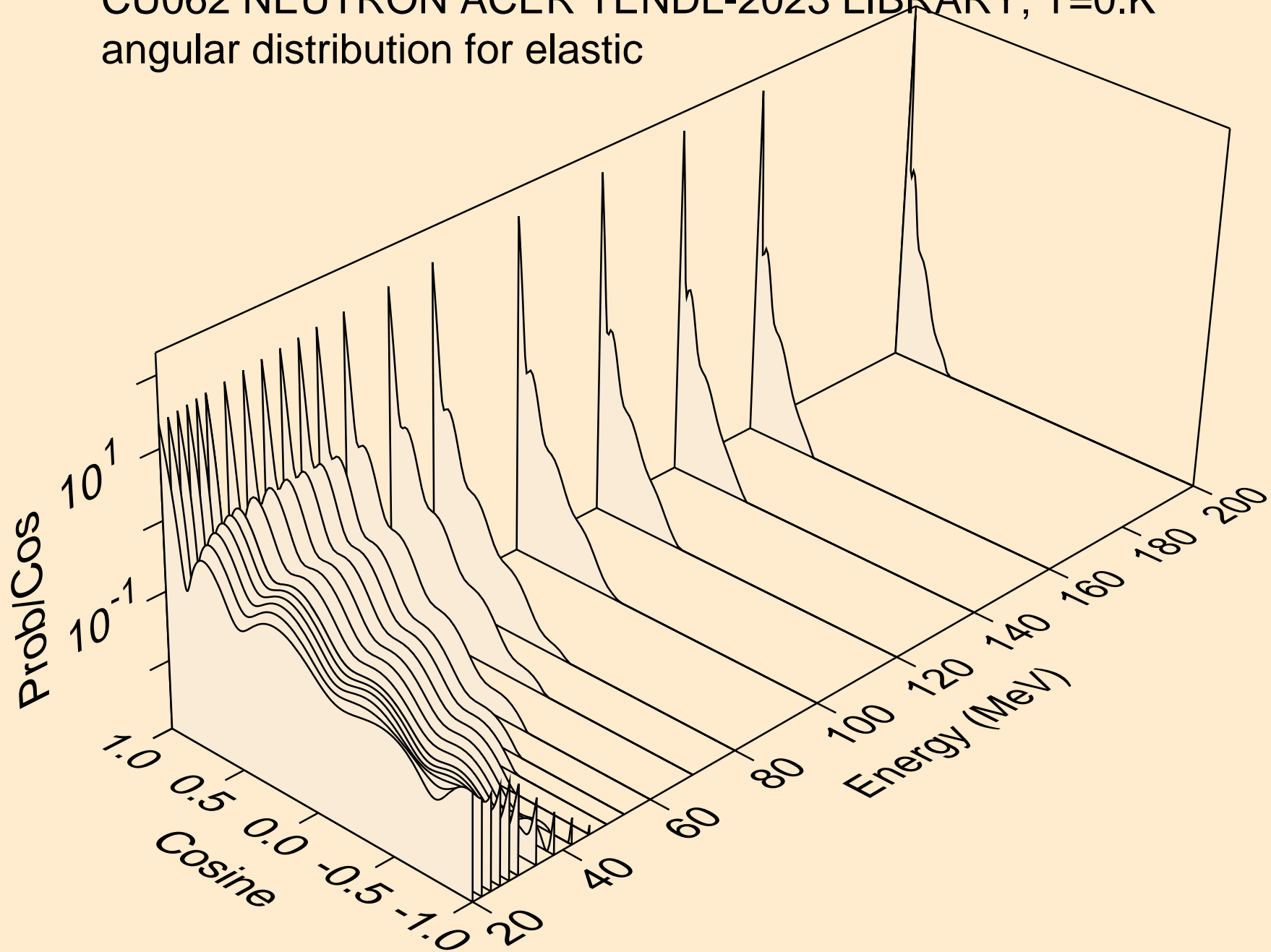

CU062 NEUTRON ACER TENDL-2023 LIBRARY; T=0.K  
angular distribution for (n,n\*1)

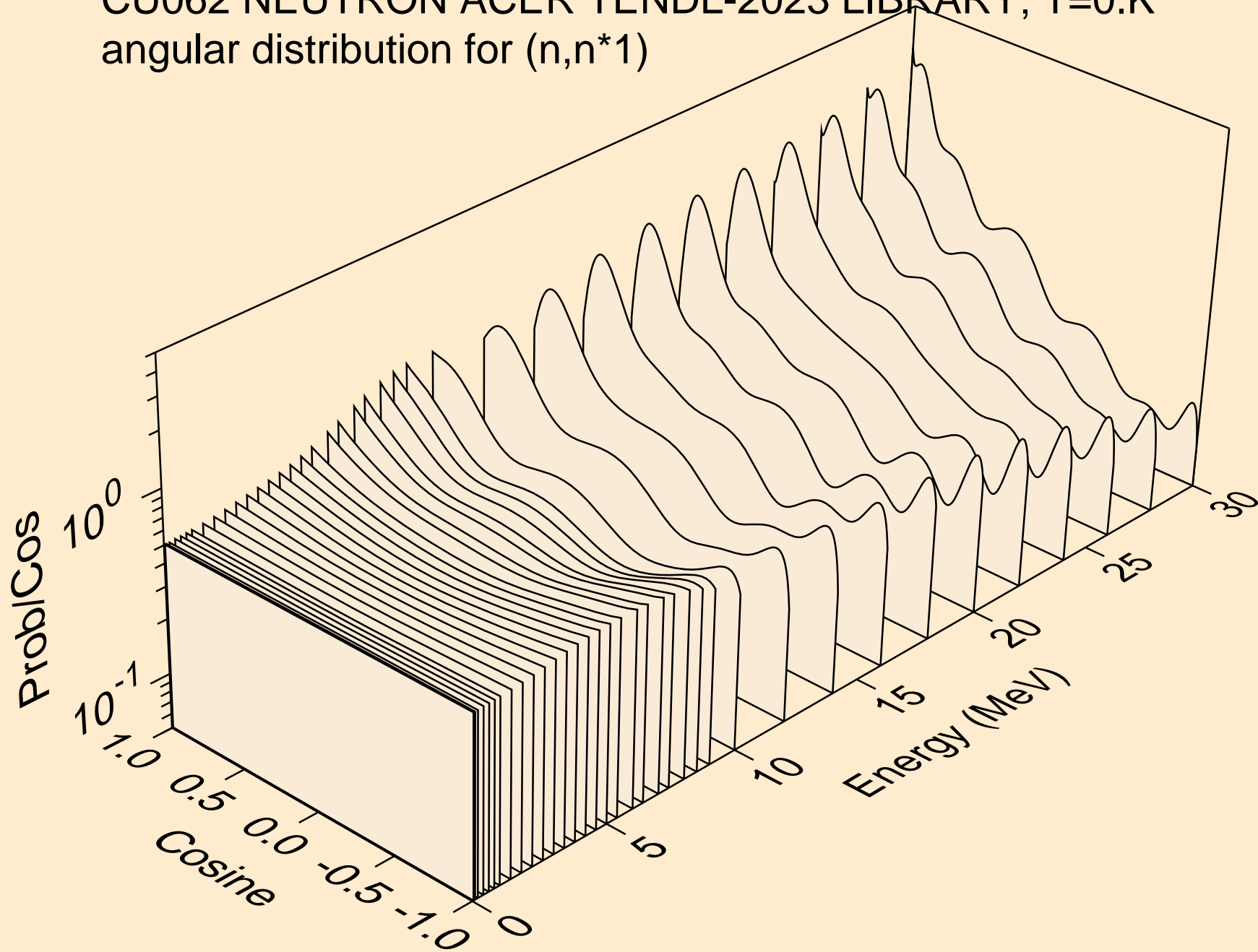

CU062 NEUTRON ACER TENDL-2023 LIBRARY; T=0.K  
angular distribution for (n,n\*2)

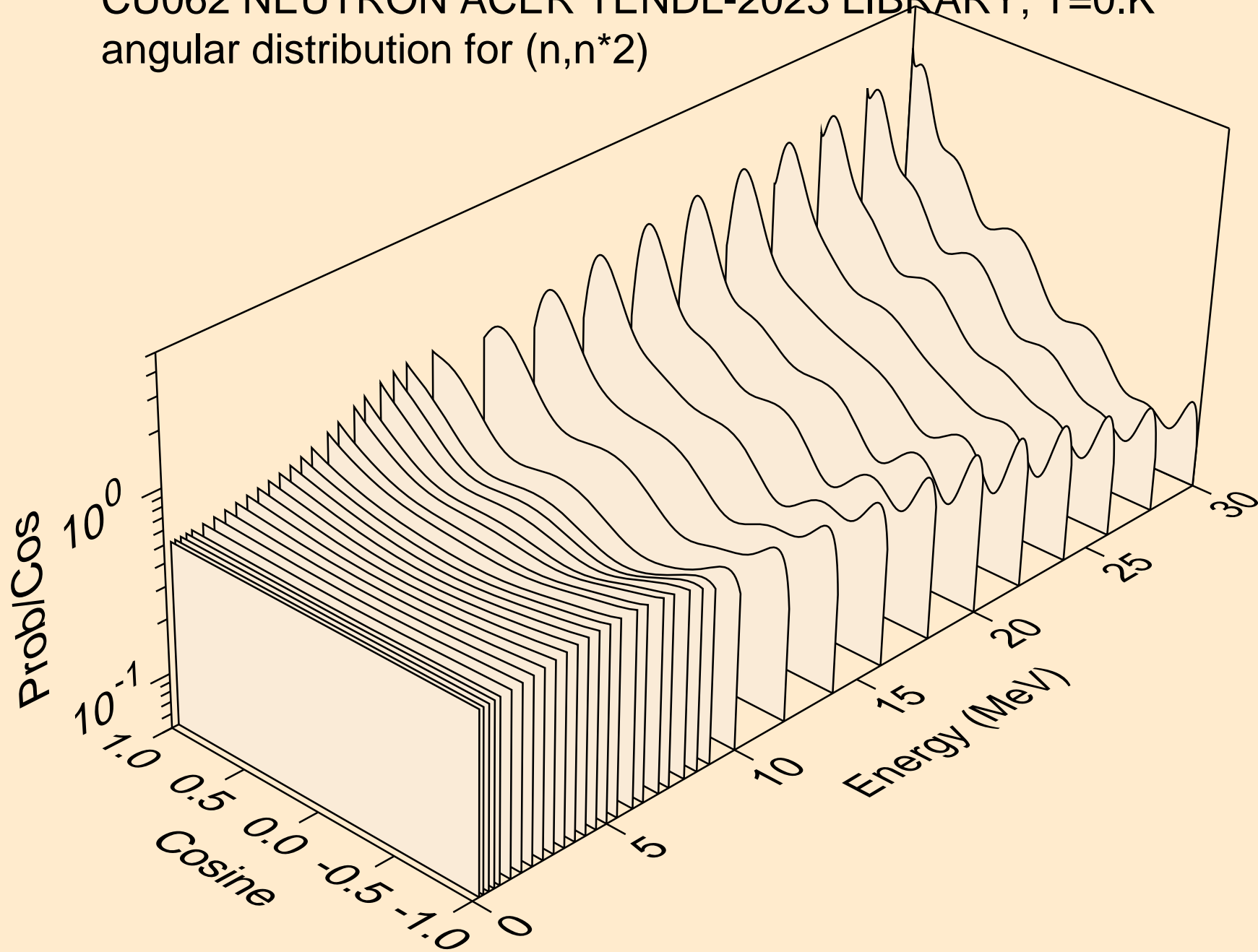

CU062 NEUTRON ACER TENDL-2023 LIBRARY; T=0.K  
angular distribution for (n,n\*3)

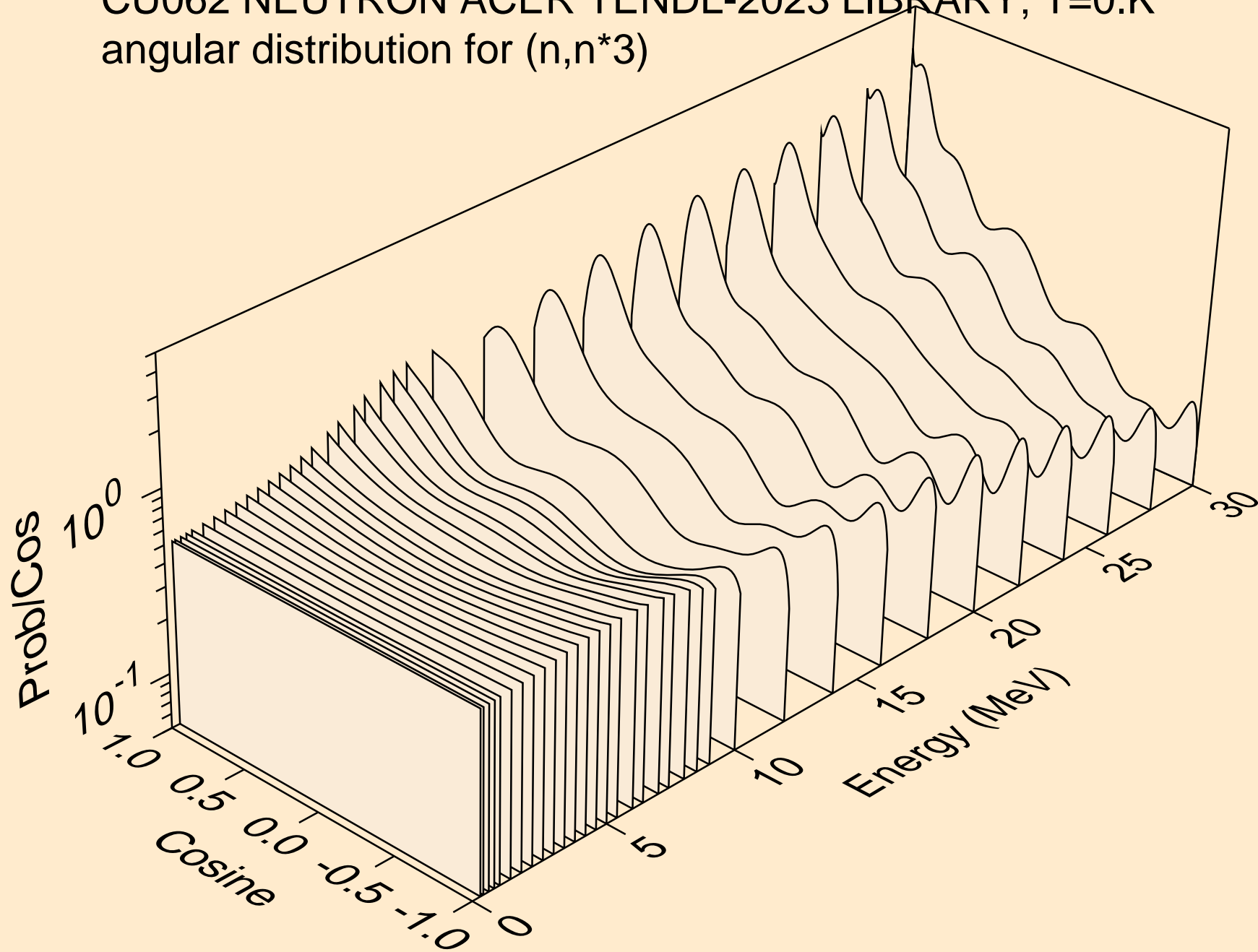

CU062 NEUTRON ACER TENDL-2023 LIBRARY; T=0.K  
angular distribution for (n,n\*4)

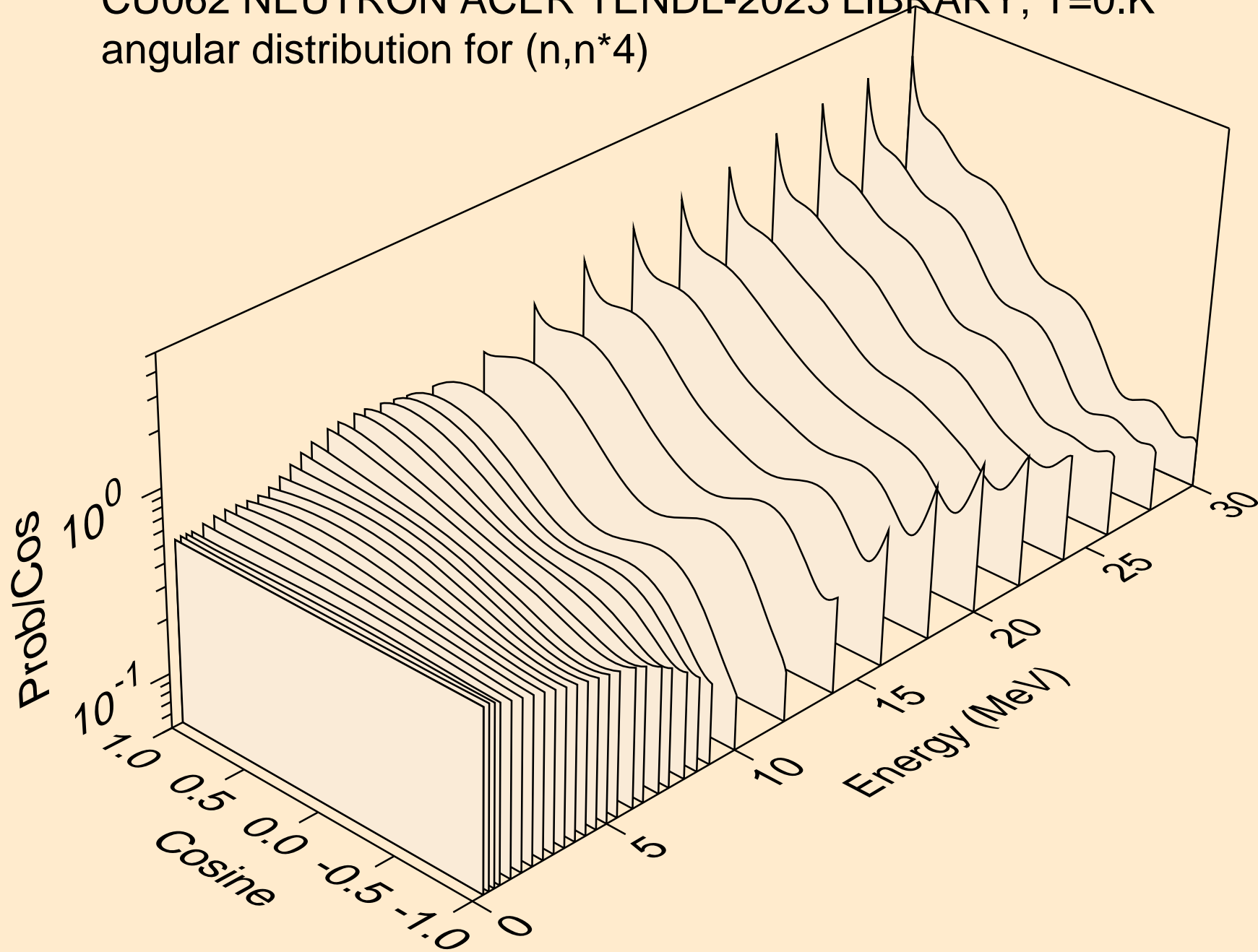



CU062 NEUTRON ACER TENDL-2023 LIBRARY; T=0.K  
angular distribution for (n,n\*5)

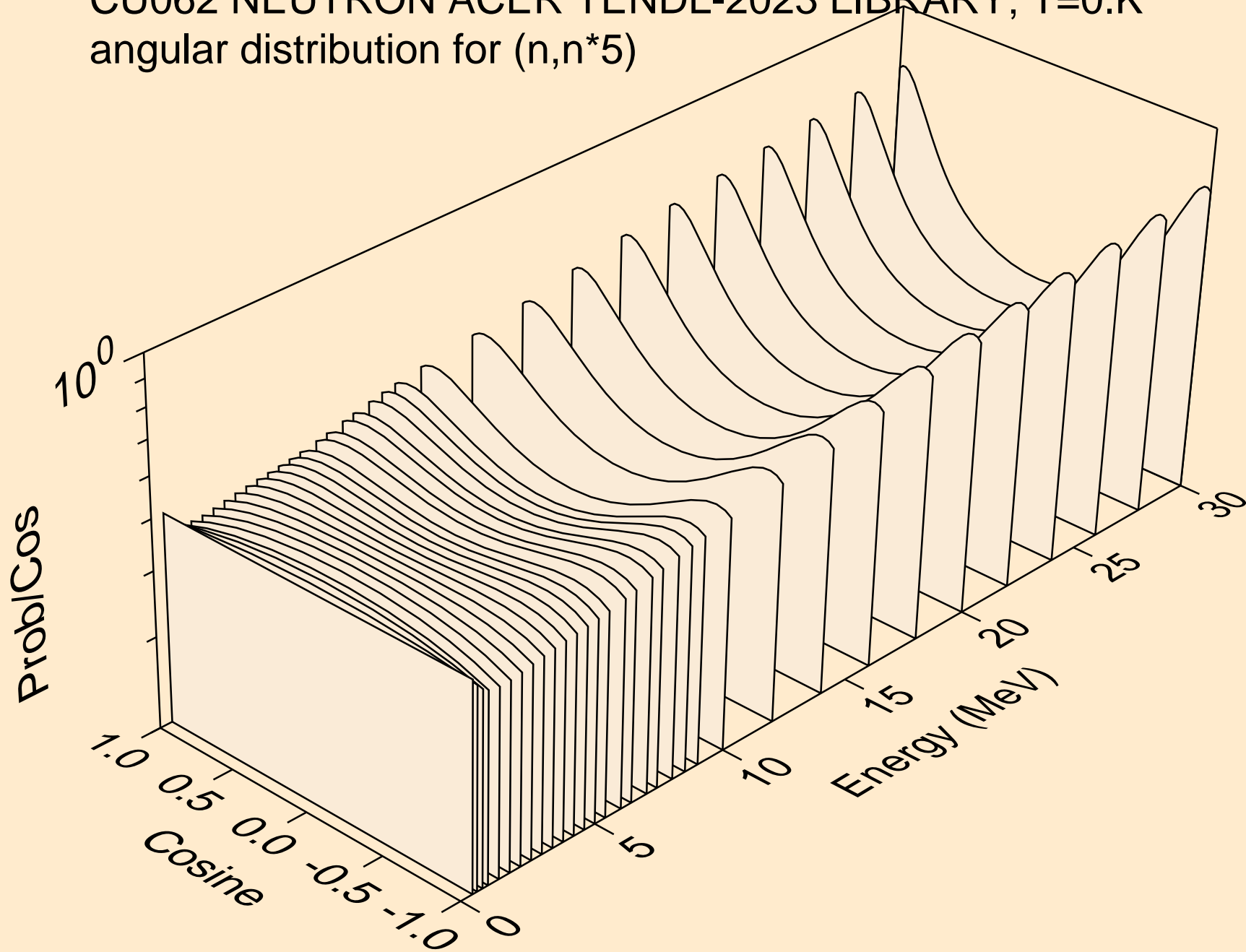

CU062 NEUTRON ACER TENDL-2023 LIBRARY; T=0.K  
angular distribution for (n,n\*6)

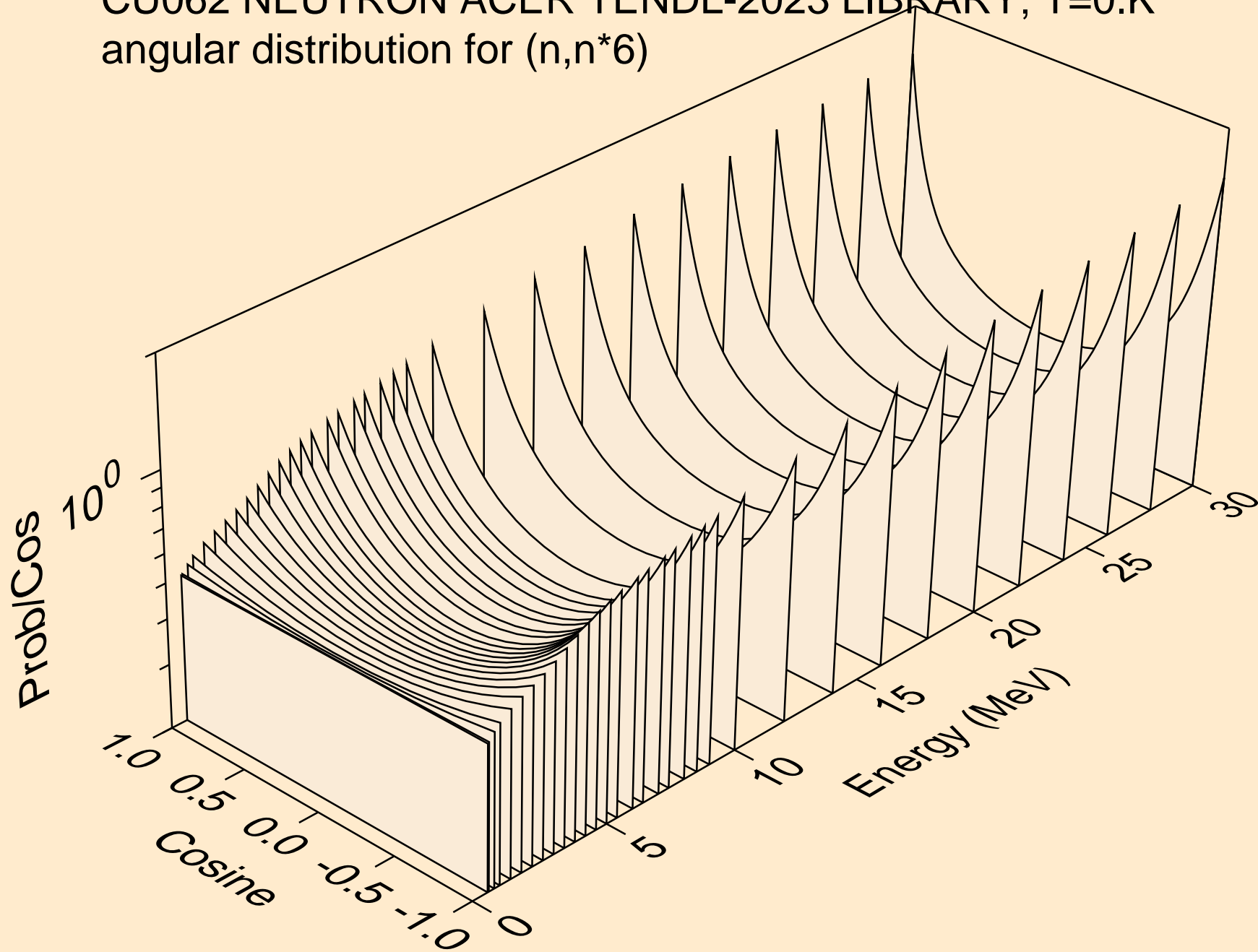

CU062 NEUTRON ACER TENDL-2023 LIBRARY; T=0.K  
angular distribution for (n,n\*7)

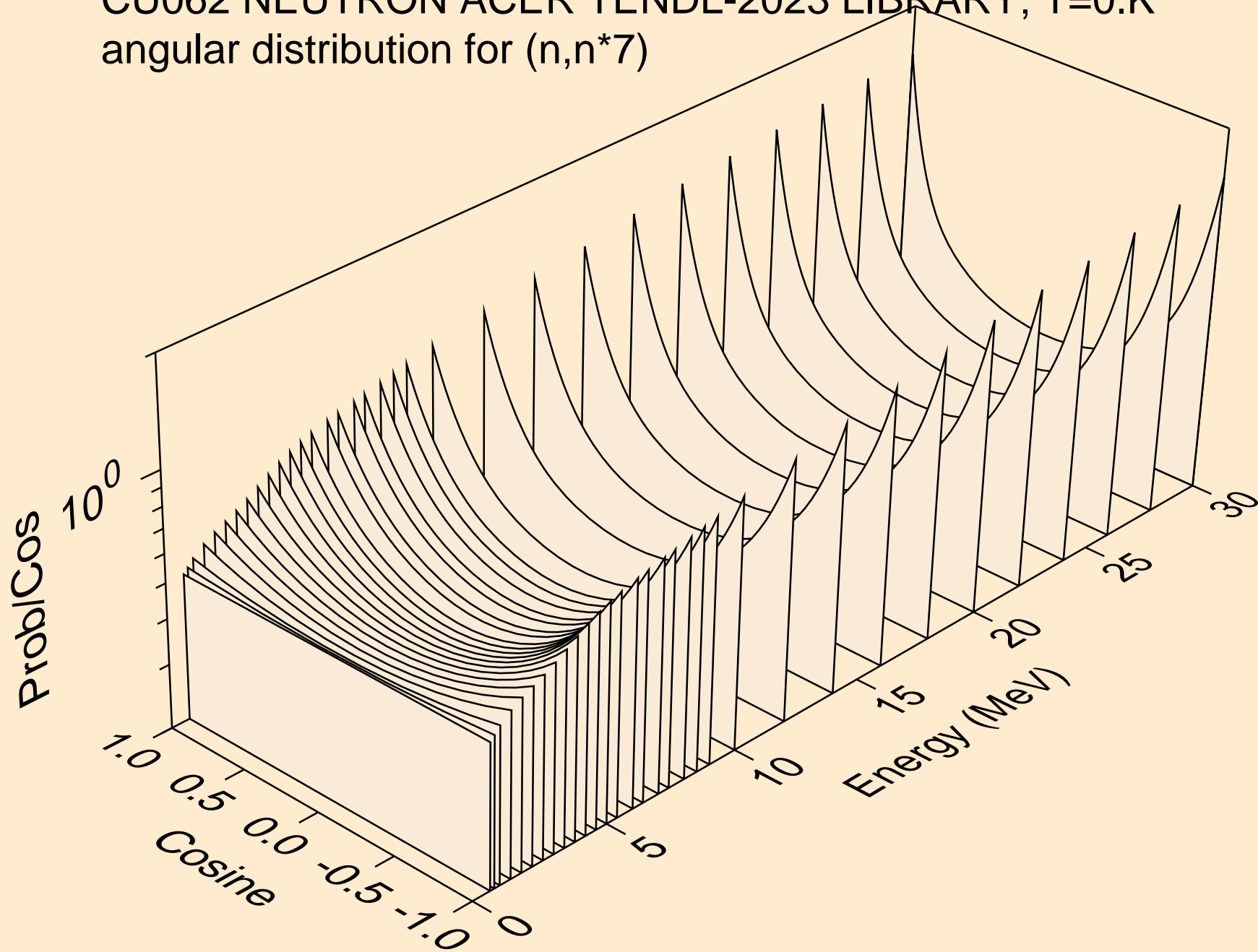

CU062 NEUTRON ACER TENDL-2023 LIBRARY; T=0.K  
angular distribution for (n,n\*8)

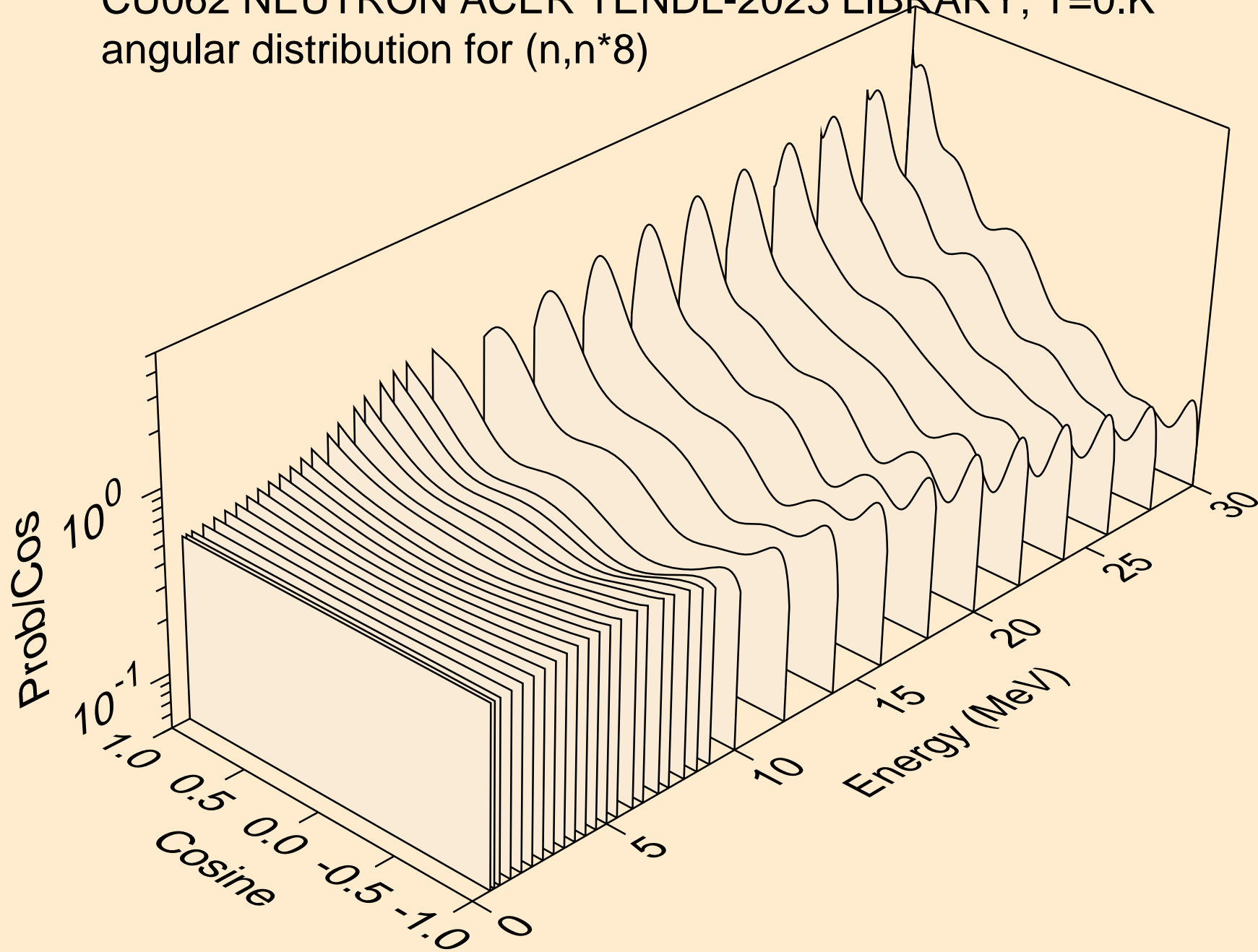

CU062 NEUTRON ACER TENDL-2023 LIBRARY; T=0.K  
angular distribution for (n,n\*9)

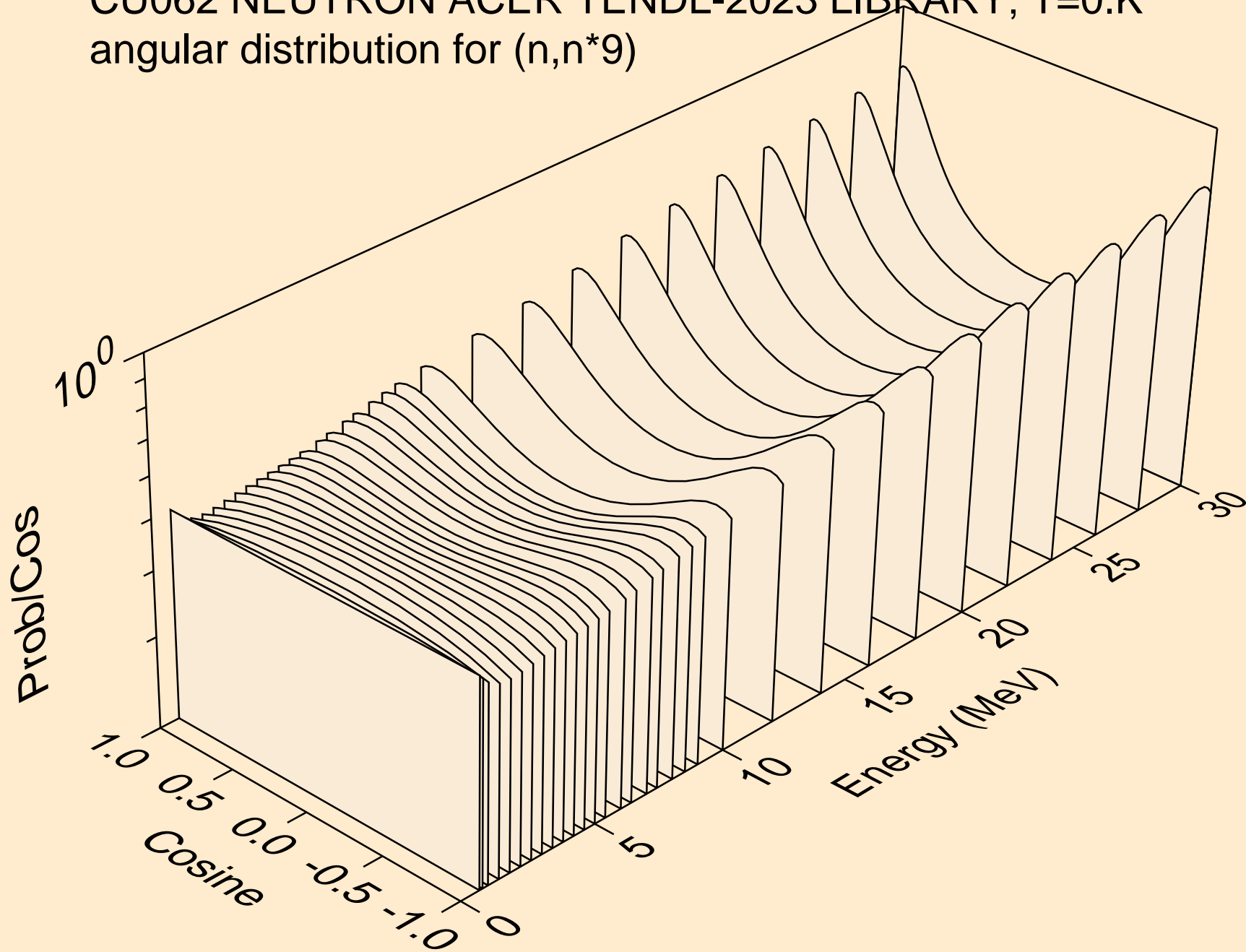

CU062 NEUTRON ACER TENDL-2023 LIBRARY; T=0.K  
angular distribution for (n,n\*10)

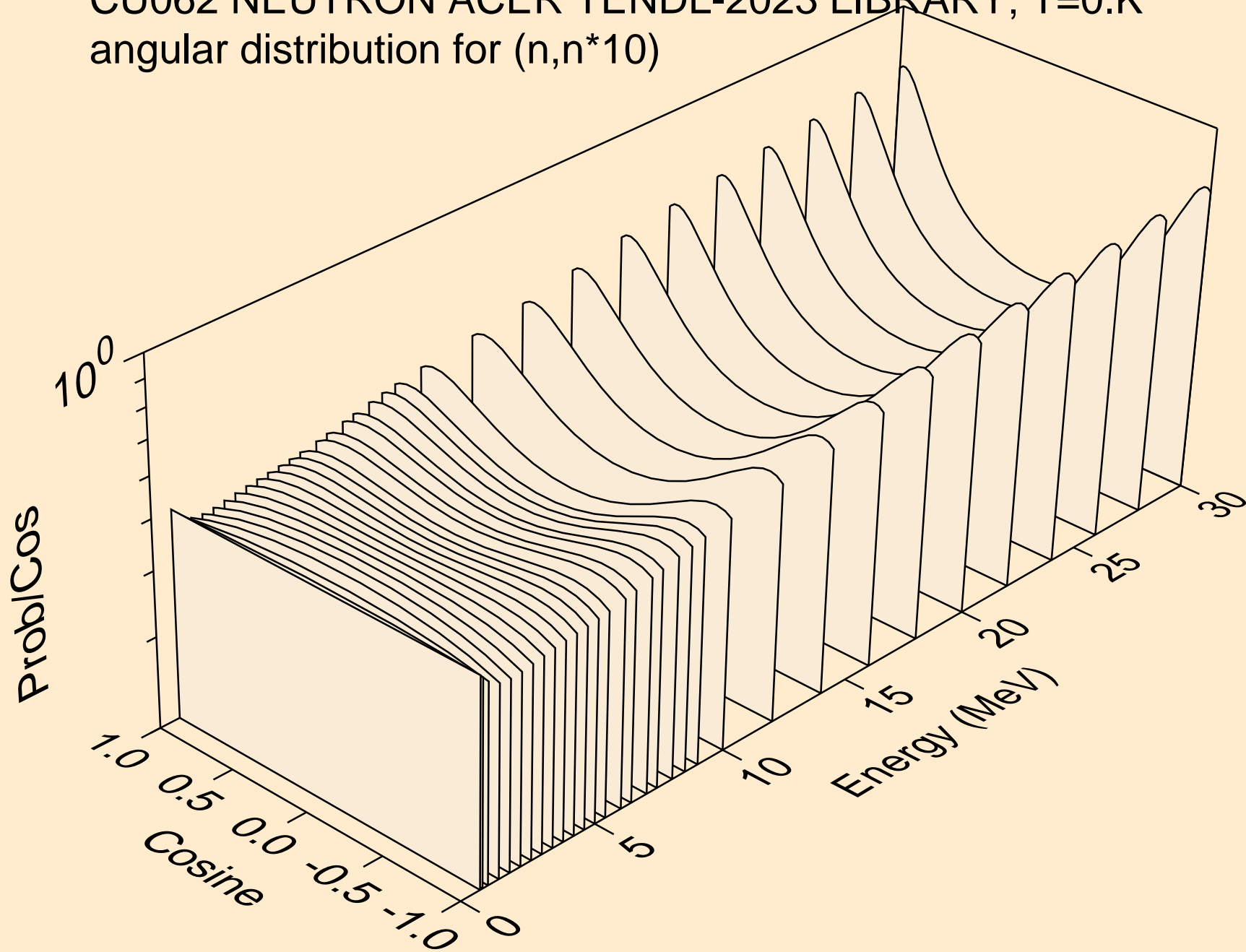

CU062 NEUTRON ACER TENDL-2023 LIBRARY; T=0.K  
angular distribution for (n,n\*11)

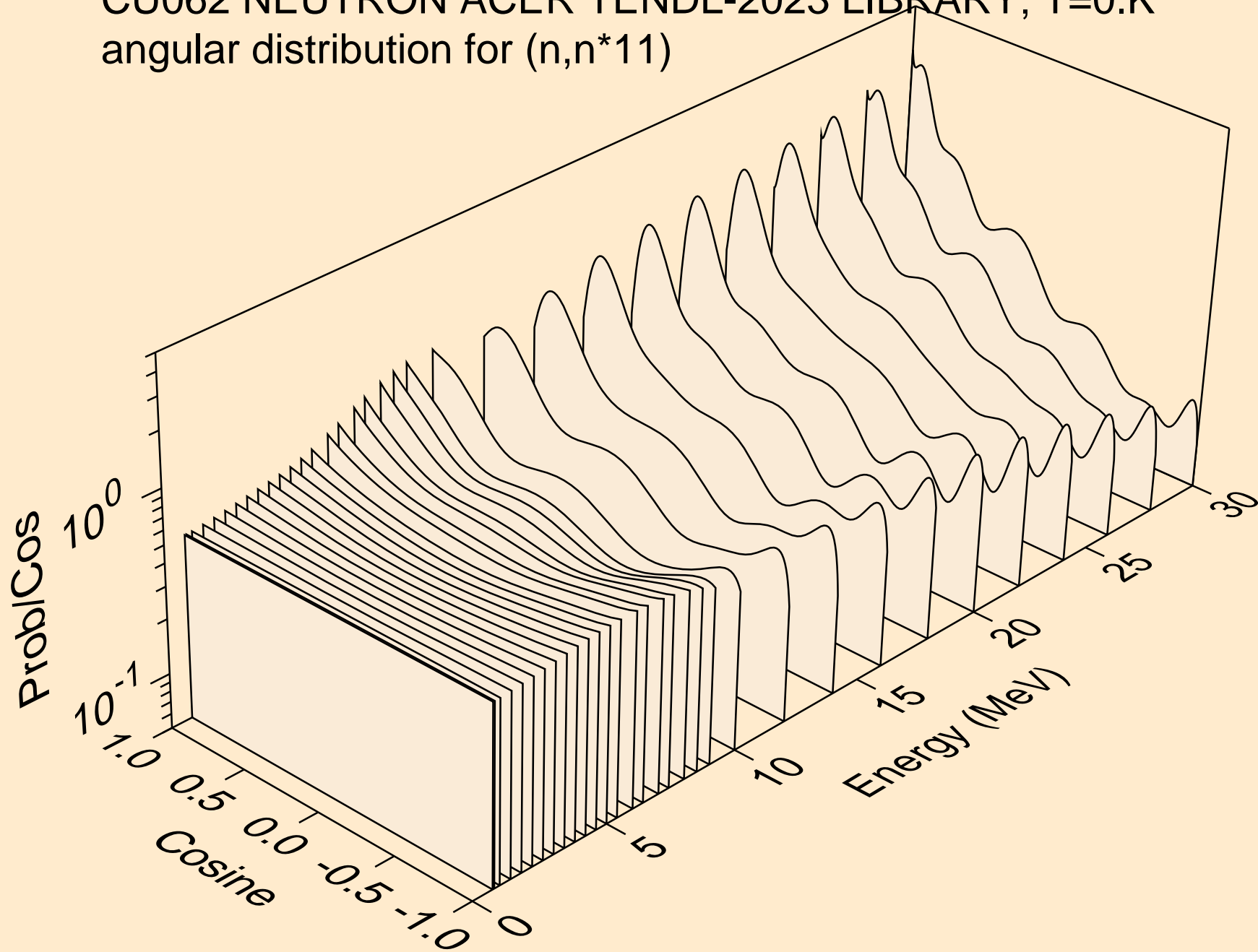

CU062 NEUTRON ACER TENDL-2023 LIBRARY; T=0.K  
angular distribution for (n,n\*12)

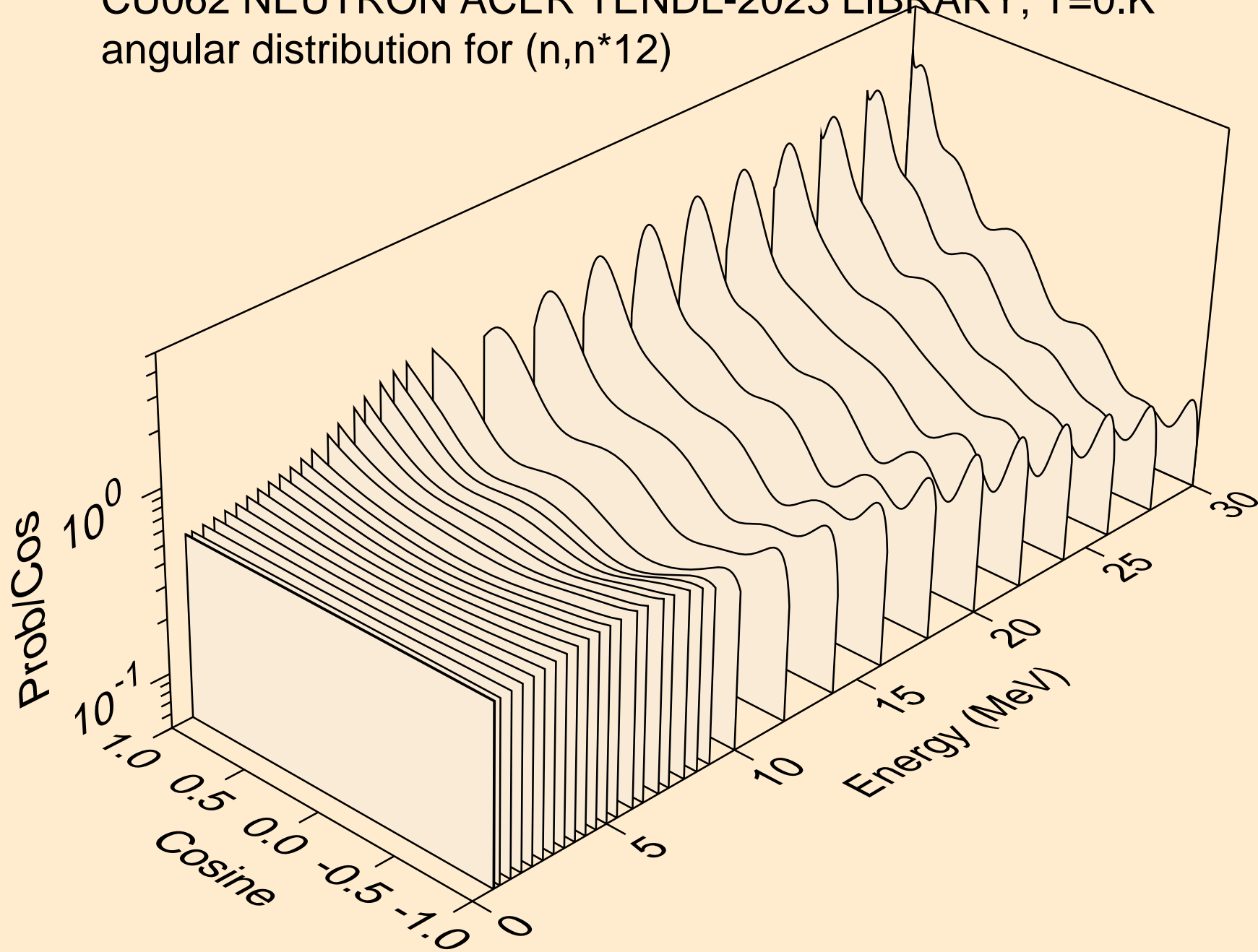



CU062 NEUTRON ACER TENDL-2023 LIBRARY; T=0.K  
angular distribution for (n,n\*13)

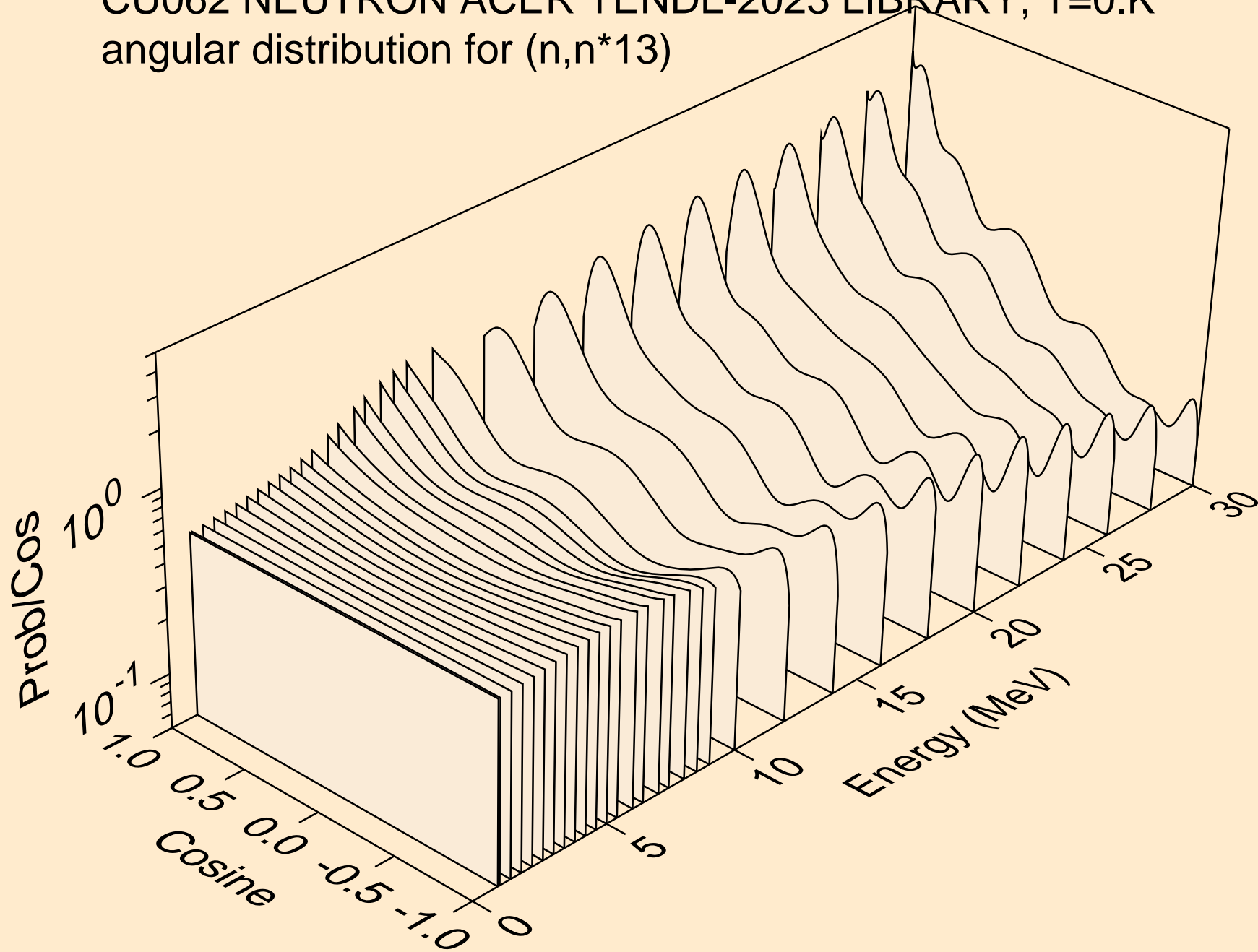

CU062 NEUTRON ACER TENDL-2023 LIBRARY; T=0.K  
angular distribution for (n,n\*14)

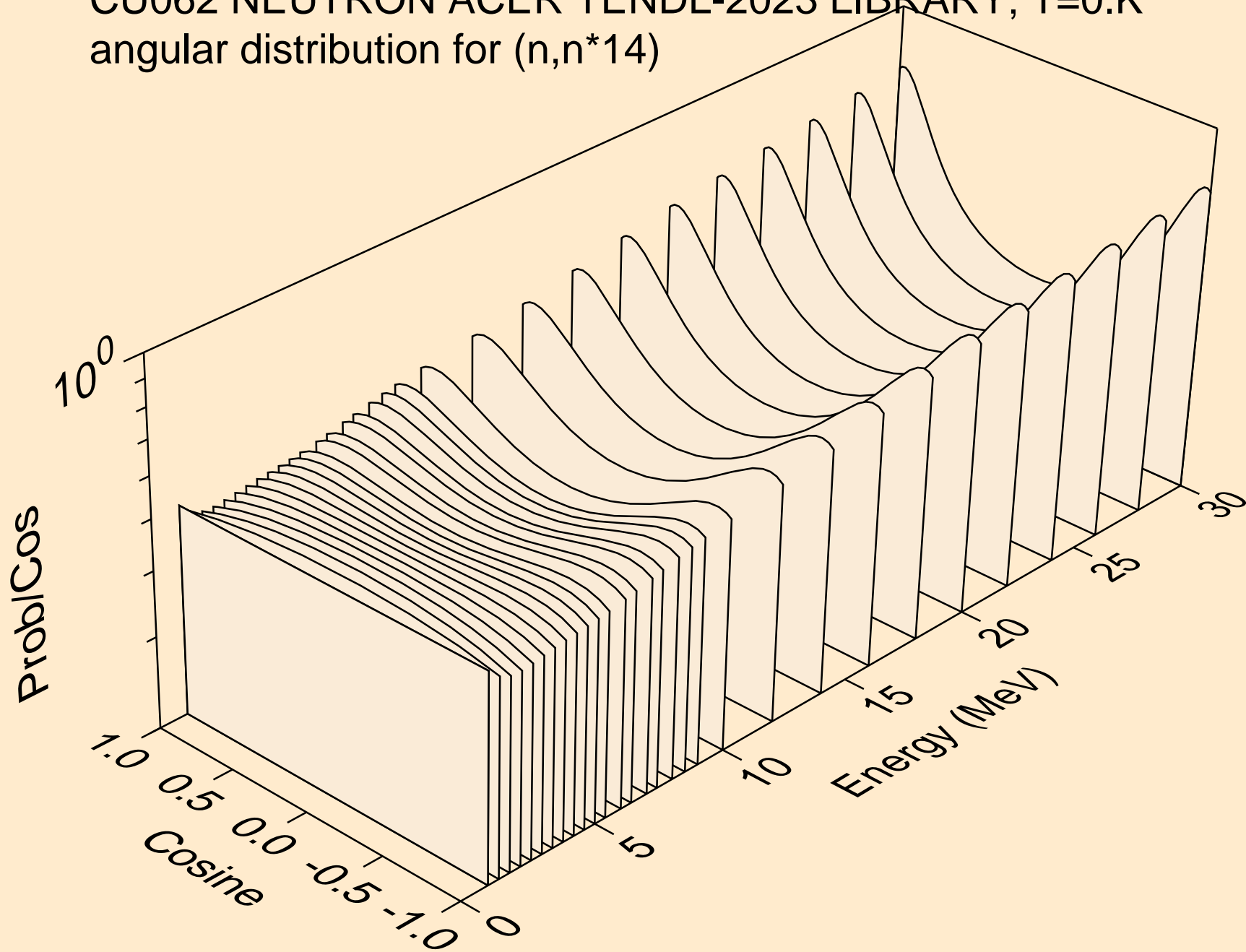

CU062 NEUTRON ACER TENDL-2023 LIBRARY; T=0.K  
angular distribution for (n,n\*15)

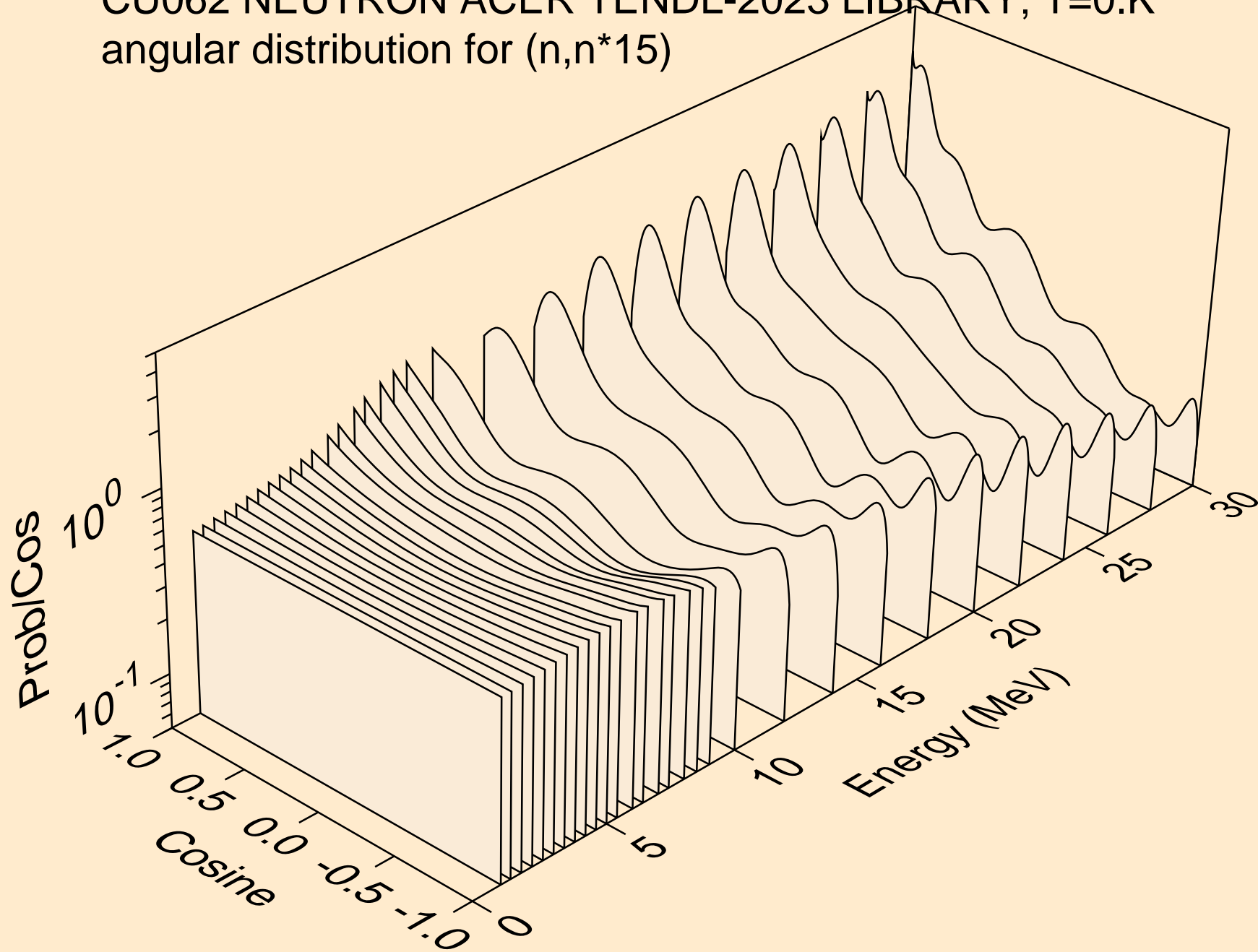

CU062 NEUTRON ACER TENDL-2023 LIBRARY; T=0.K  
angular distribution for (n,n\*16)

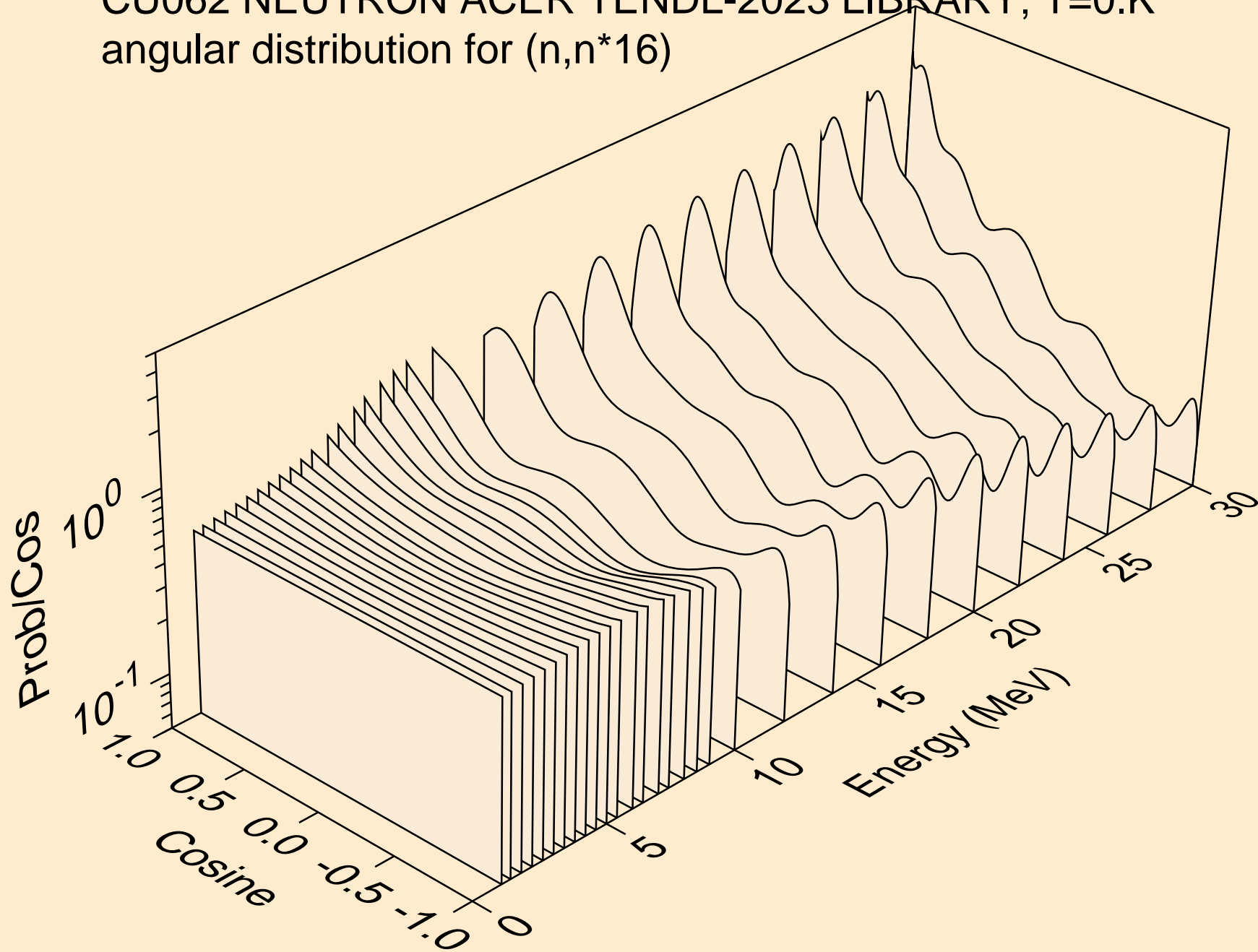

CU062 NEUTRON ACER TENDL-2023 LIBRARY; T=0.K  
angular distribution for (n,n\*17)

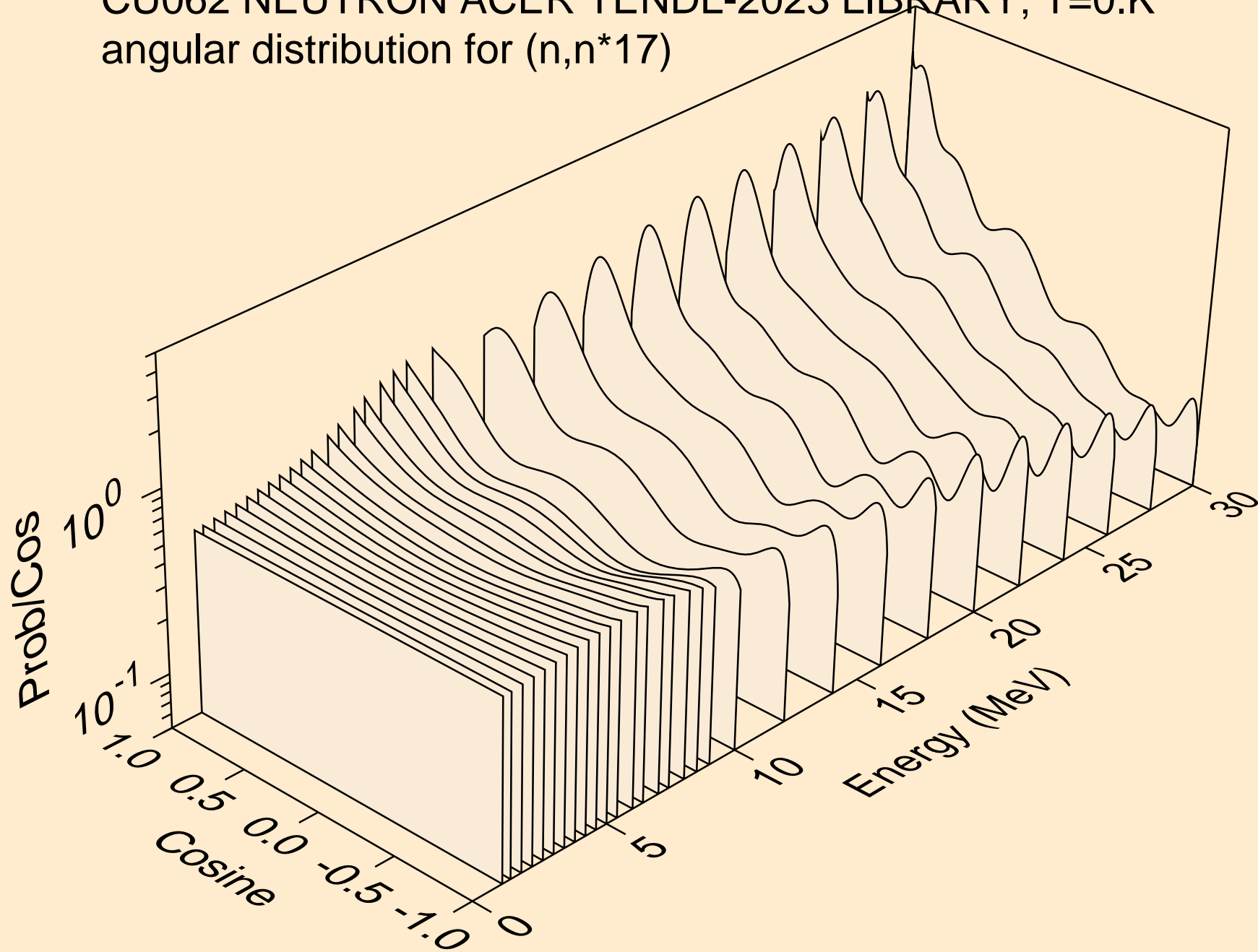

CU062 NEUTRON ACER TENDL-2023 LIBRARY; T=0.K  
angular distribution for (n,n\*18)

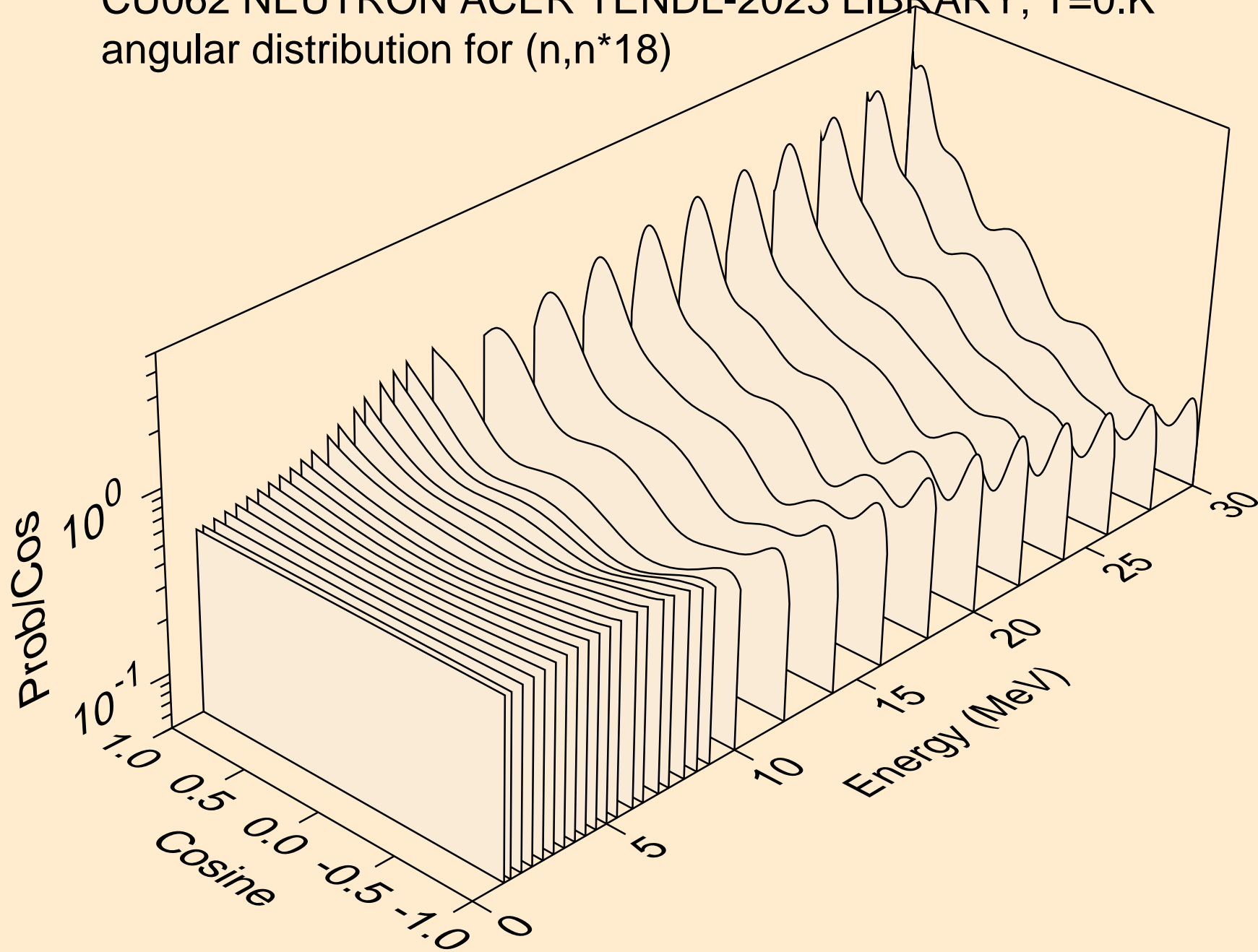

CU062 NEUTRON ACER TENDL-2023 LIBRARY; T=0.K  
angular distribution for (n,n\*19)

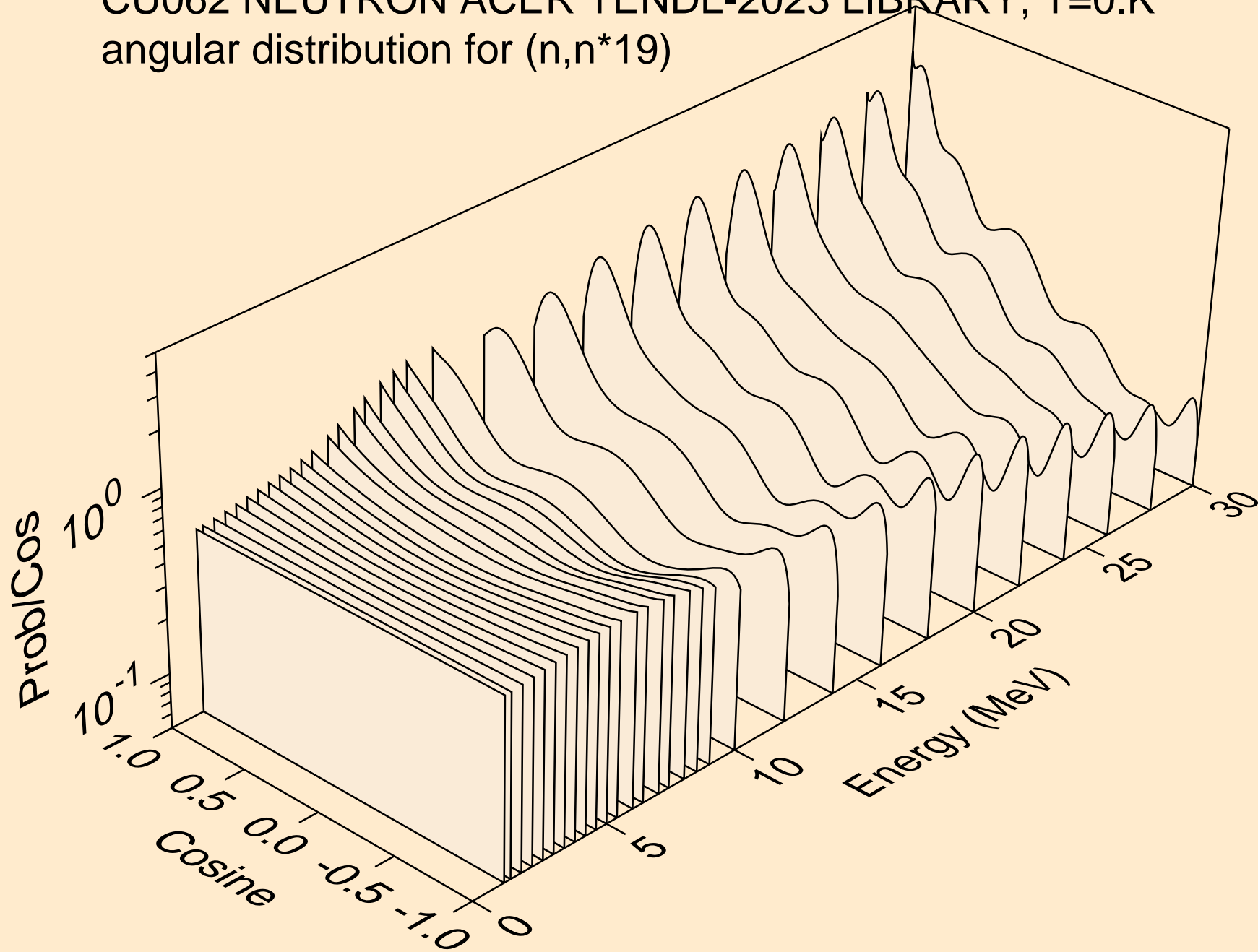

CU062 NEUTRON ACER TENDL-2023 LIBRARY; T=0.K  
angular distribution for (n,n\*20)

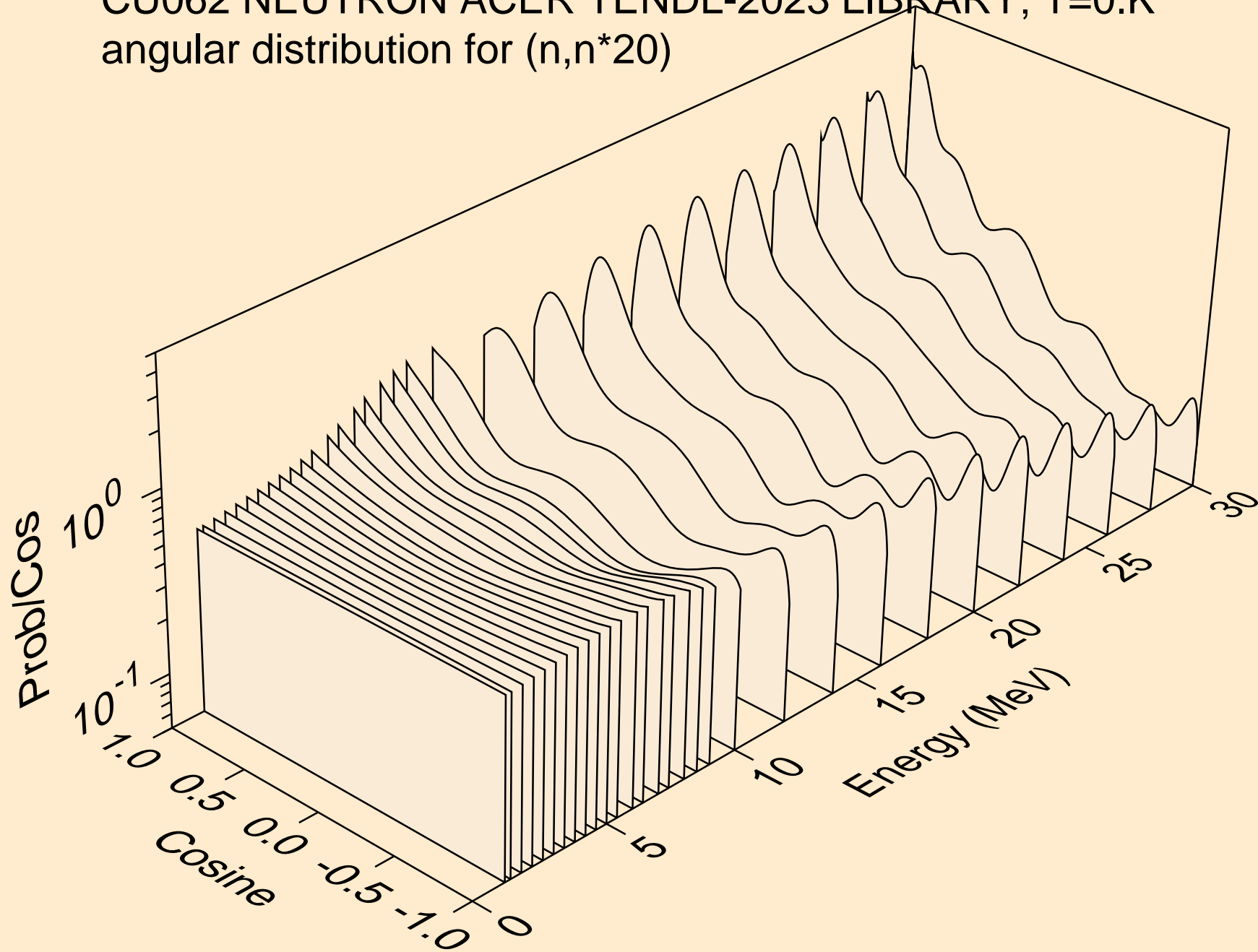



CU062 NEUTRON ACER TENDL-2023 LIBRARY; T=0.K  
angular distribution for (n,n\*21)

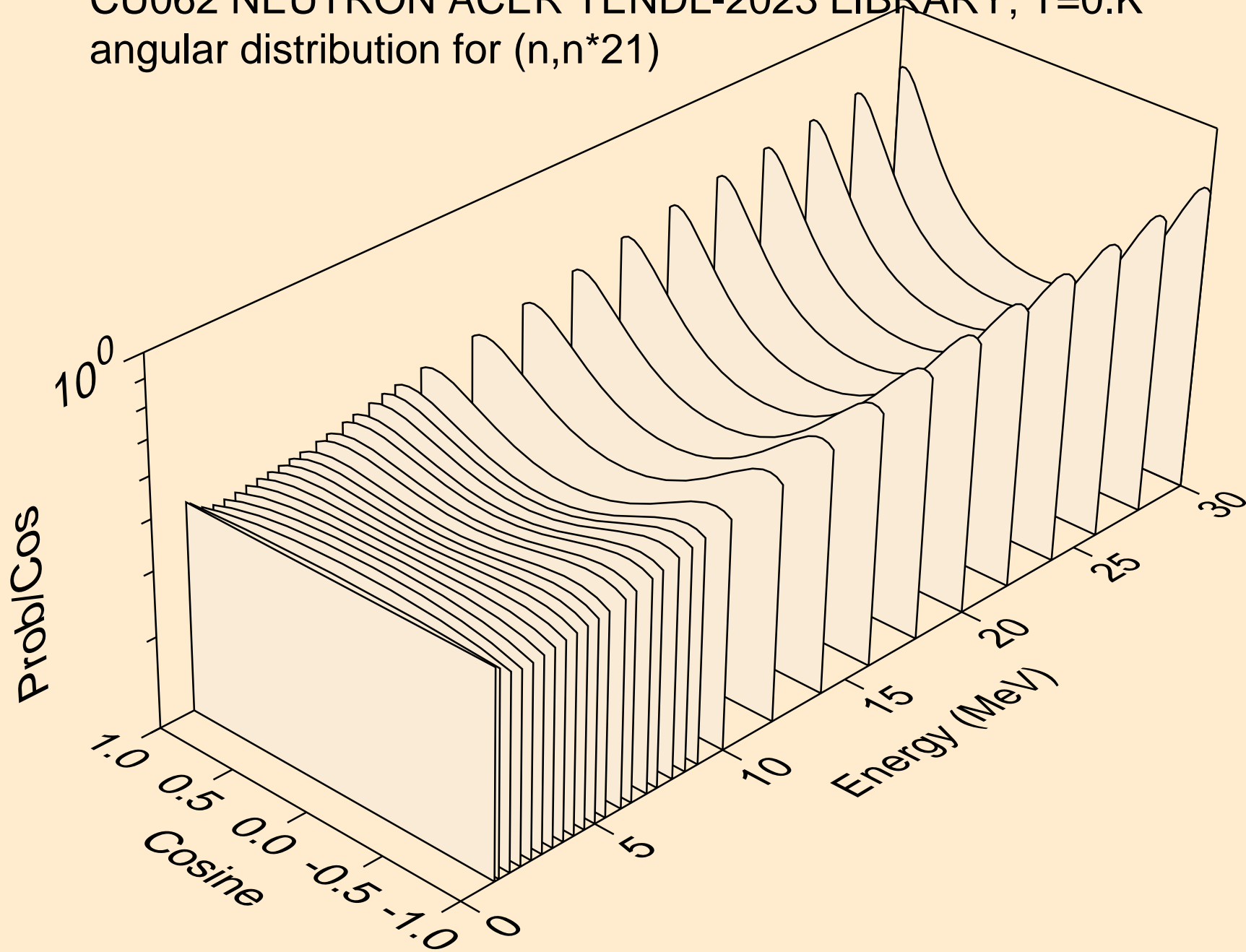

CU062 NEUTRON ACER TENDL-2023 LIBRARY; T=0.K  
angular distribution for (n,n\*22)

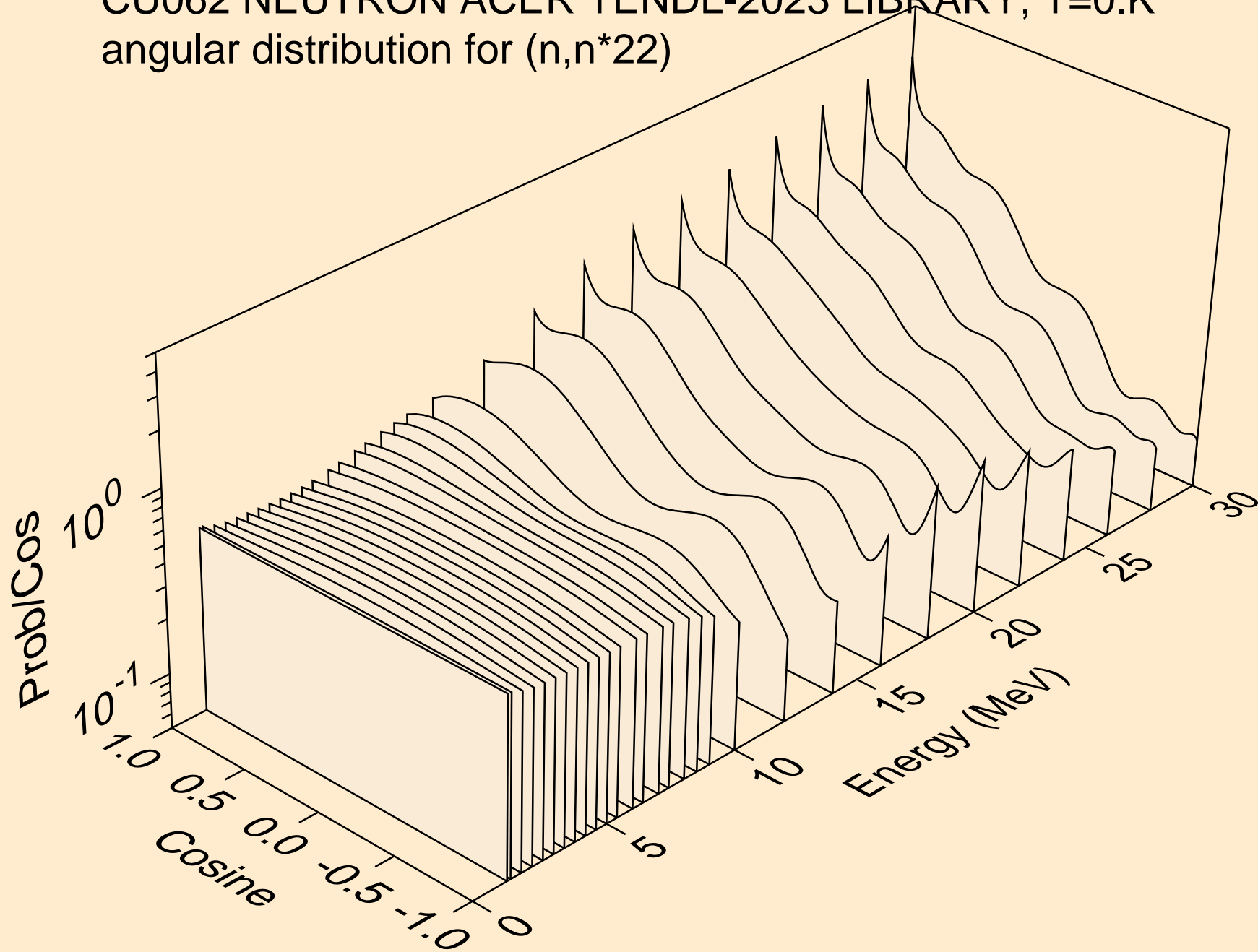

CU062 NEUTRON ACER TENDL-2023 LIBRARY; T=0.K  
angular distribution for (n,n\*23)

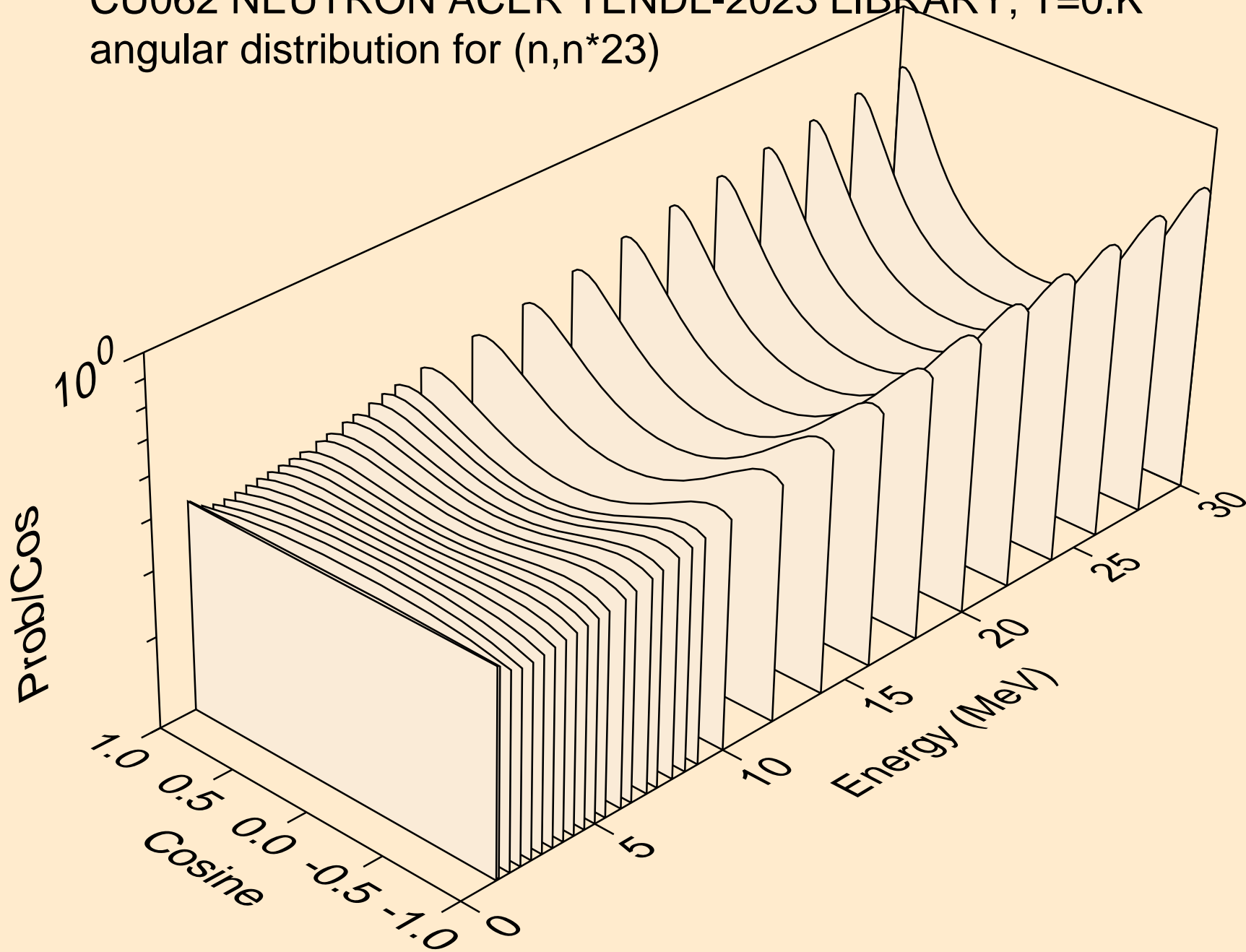

CU062 NEUTRON ACER TENDL-2023 LIBRARY; T=0.K  
angular distribution for (n,n\*24)

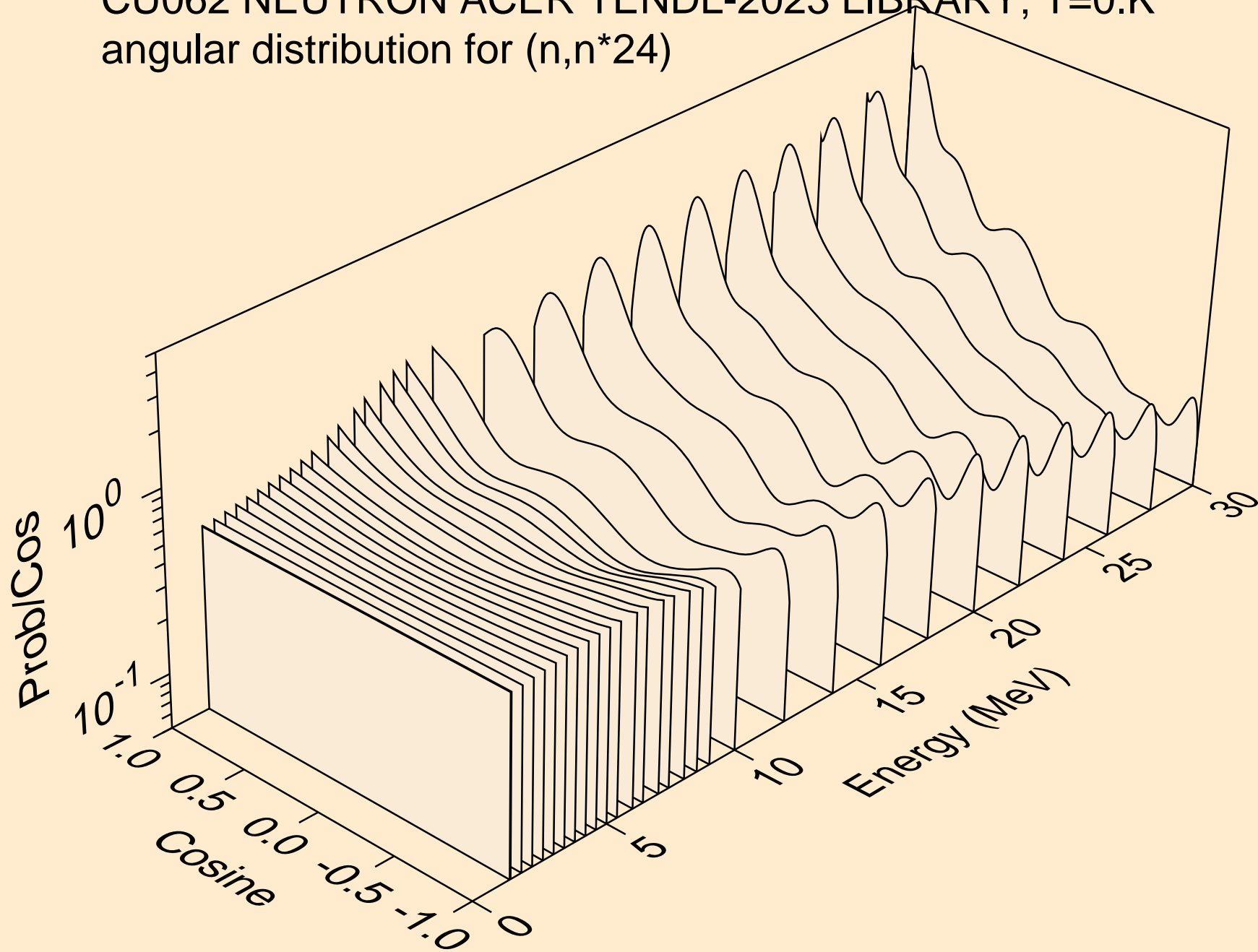

CU062 NEUTRON ACER TENDL-2023 LIBRARY; T=0.K  
angular distribution for (n,n\*25)

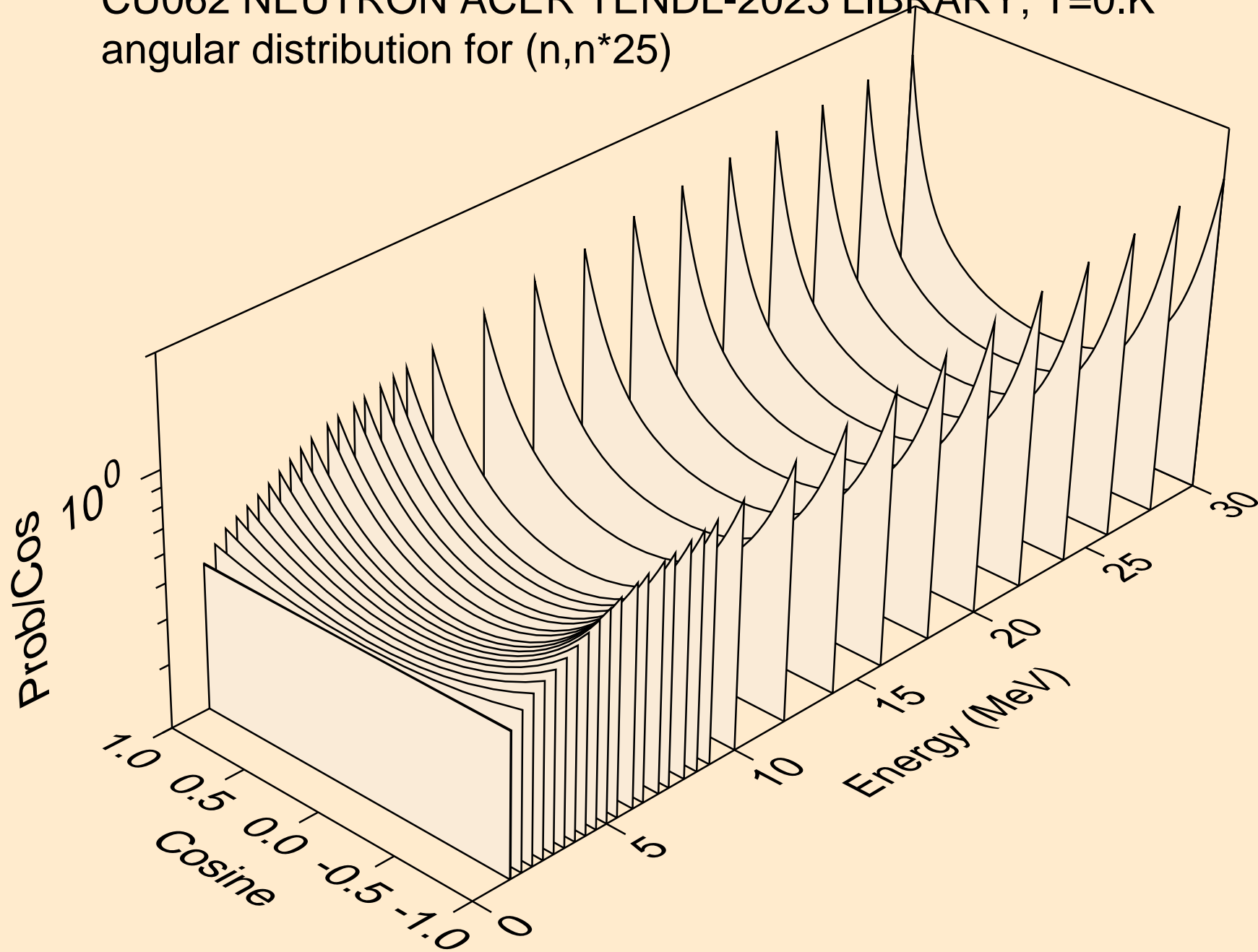

CU062 NEUTRON ACER TENDL-2023 LIBRARY; T=0.K  
angular distribution for (n,n\*26)

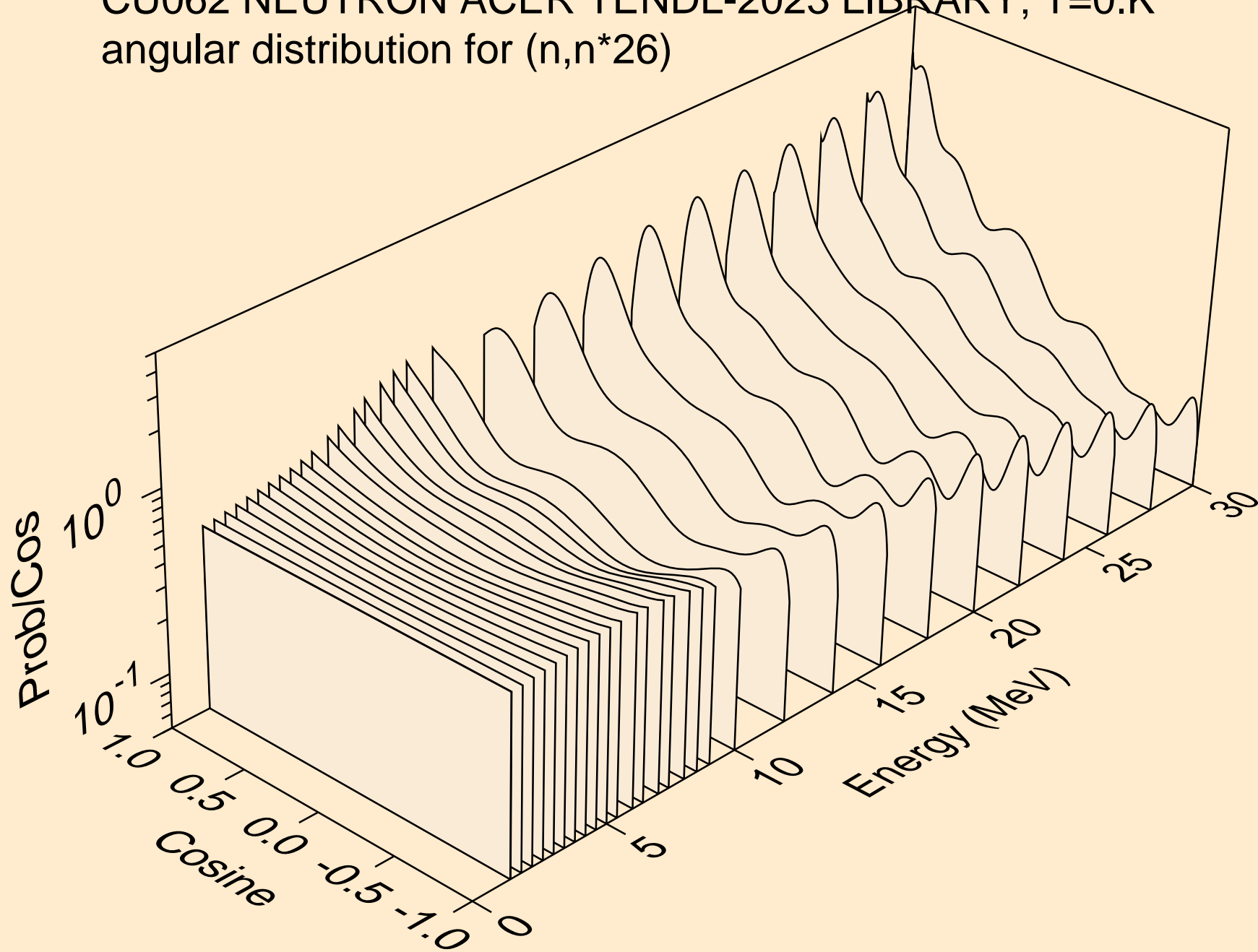

CU062 NEUTRON ACER TENDL-2023 LIBRARY; T=0.K  
Neutron emission for (n,x)

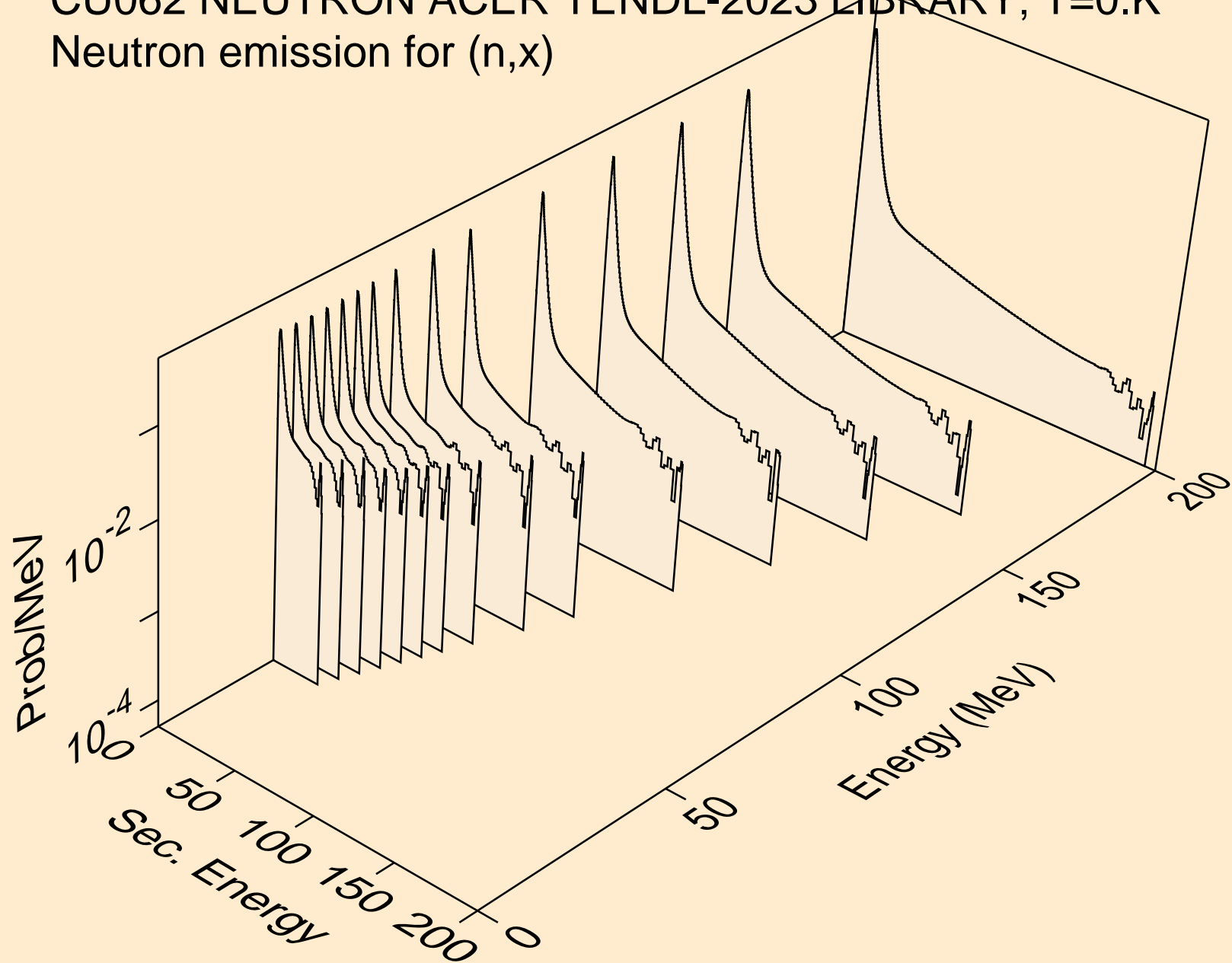

CU062 NEUTRON ACER TENDL-2023 LIBRARY; T=0.K  
Neutron emission for (n,2nd)

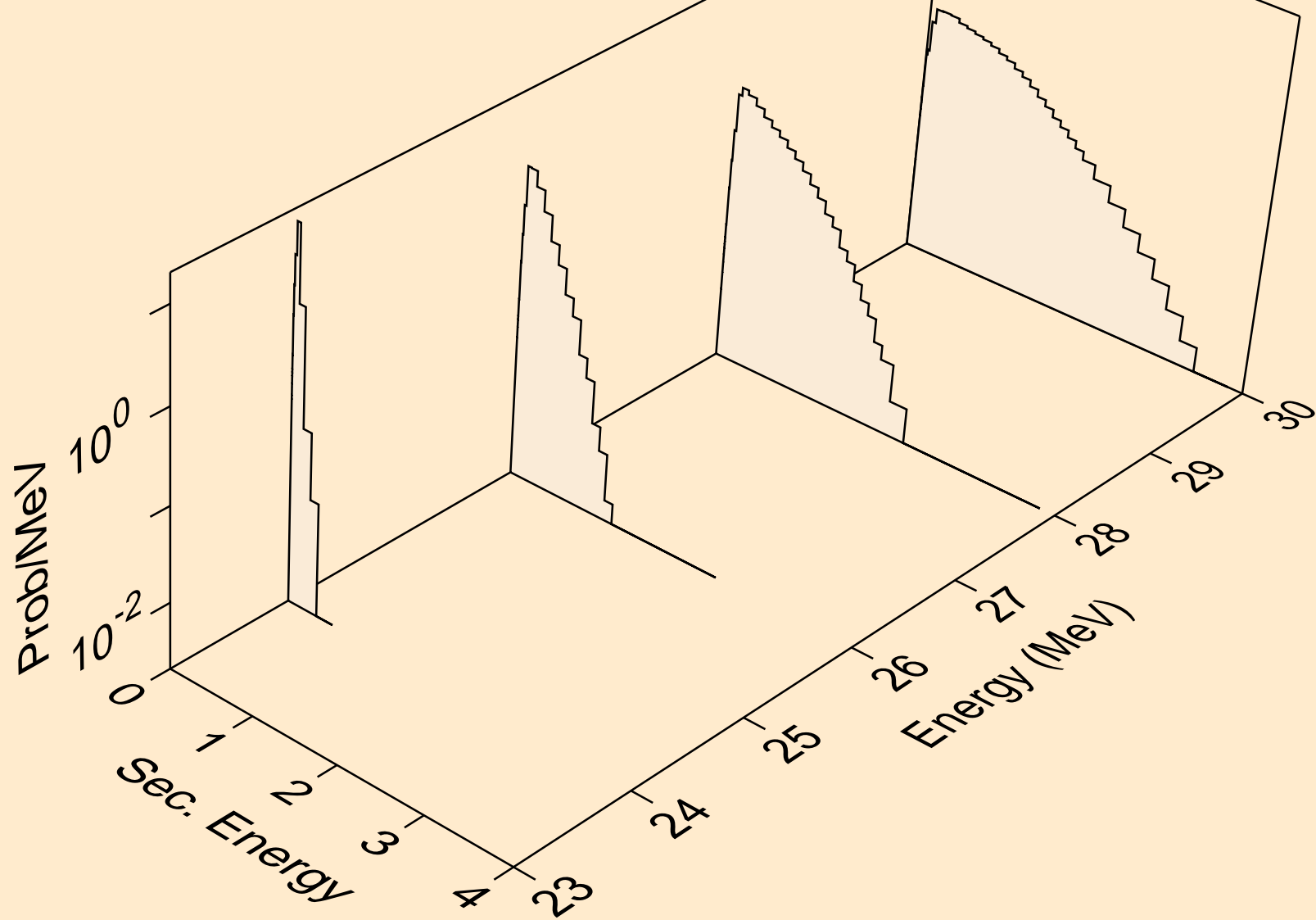



CU062 NEUTRON ACER TENDL-2023 LIBRARY; T=0.K  
Neutron emission for (n,2n)

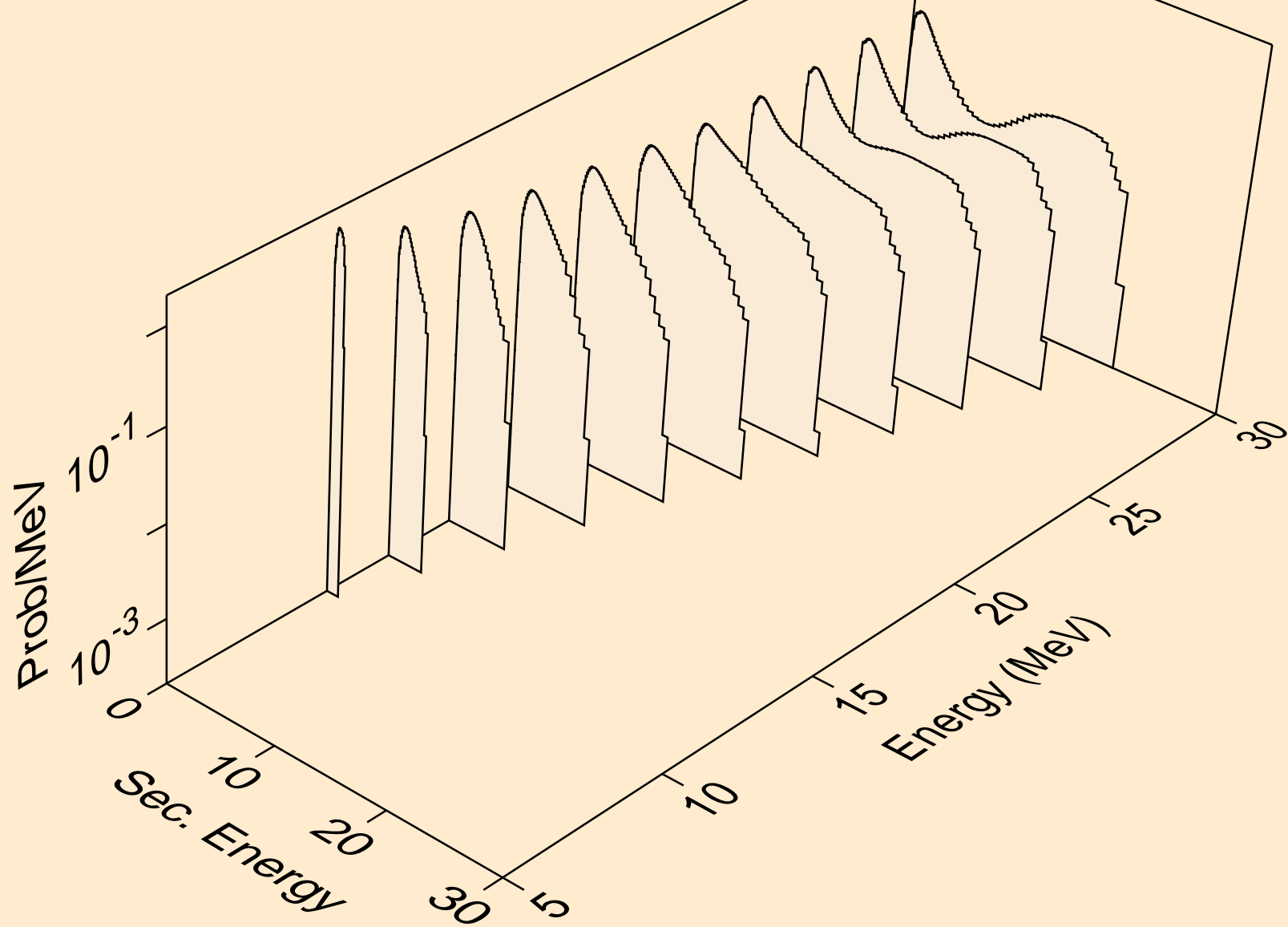

CU062 NEUTRON ACER TENDL-2023 LIBRARY; T=0.K  
Neutron emission for (n,3n)

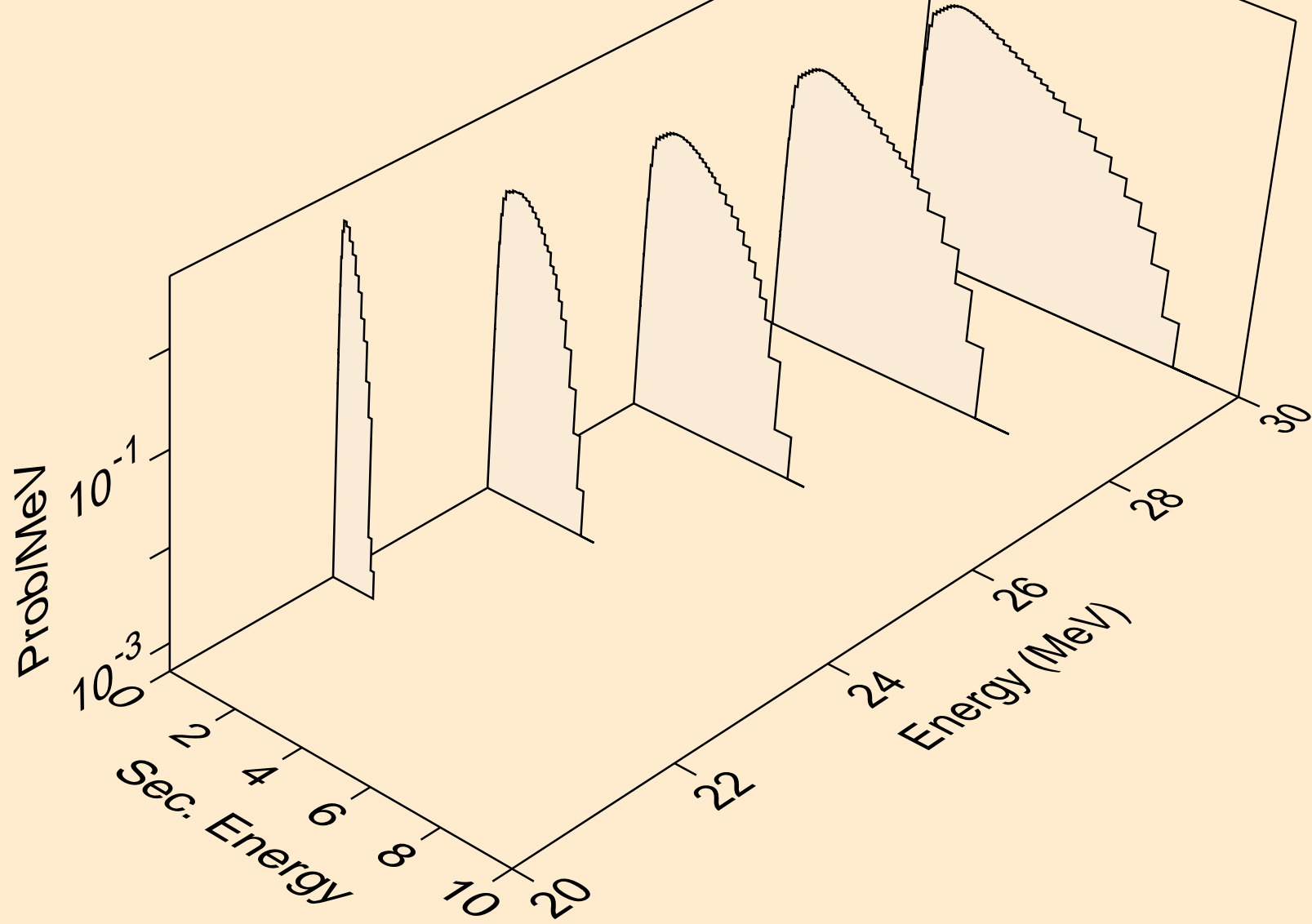

CU062 NEUTRON ACER TENDL-2023 LIBRARY; T=0.K  
Neutron emission for (n,n\*)a

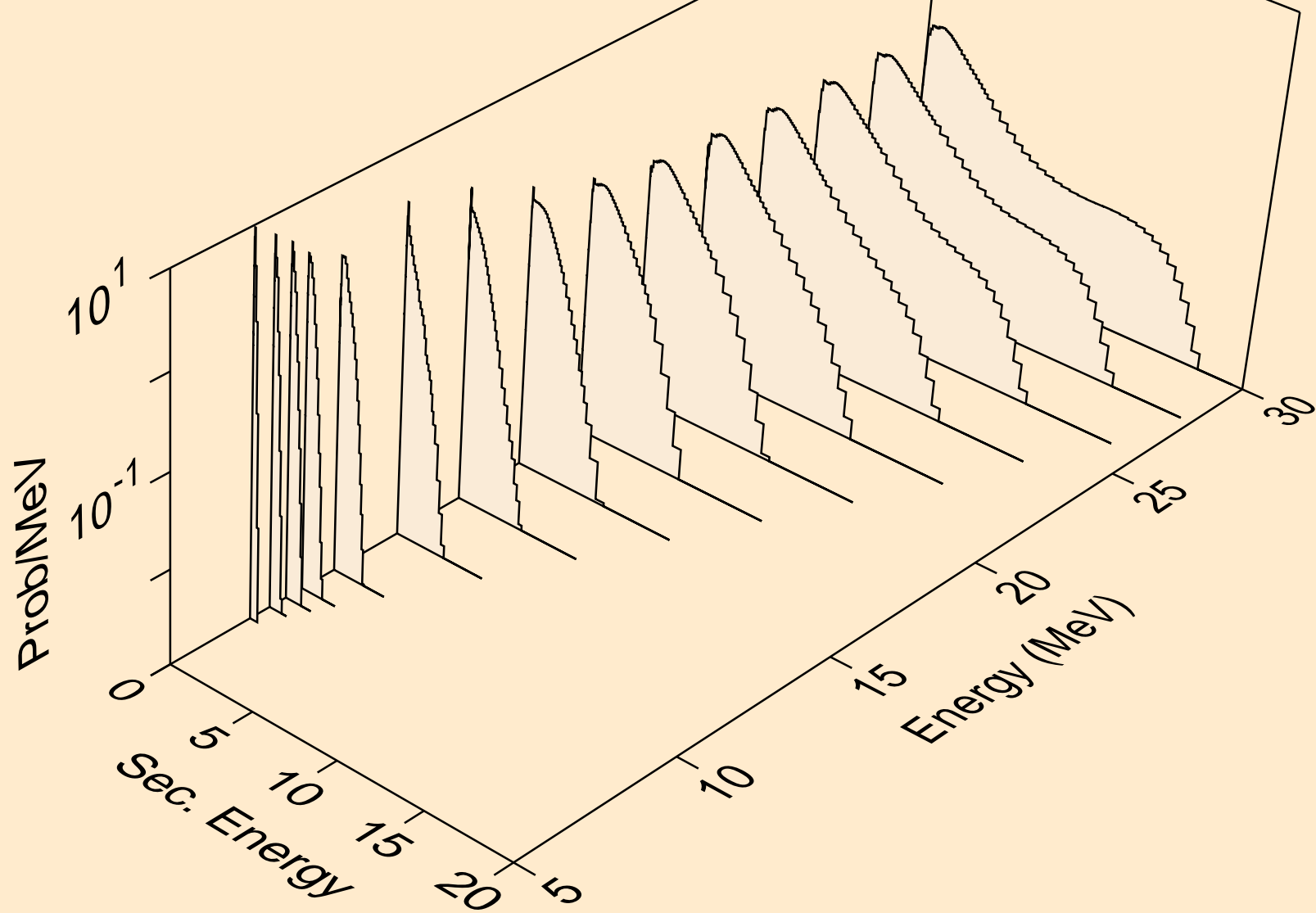

CU062 NEUTRON ACER TENDL-2023 LIBRARY; T=0.K  
Neutron emission for (n,2n)a

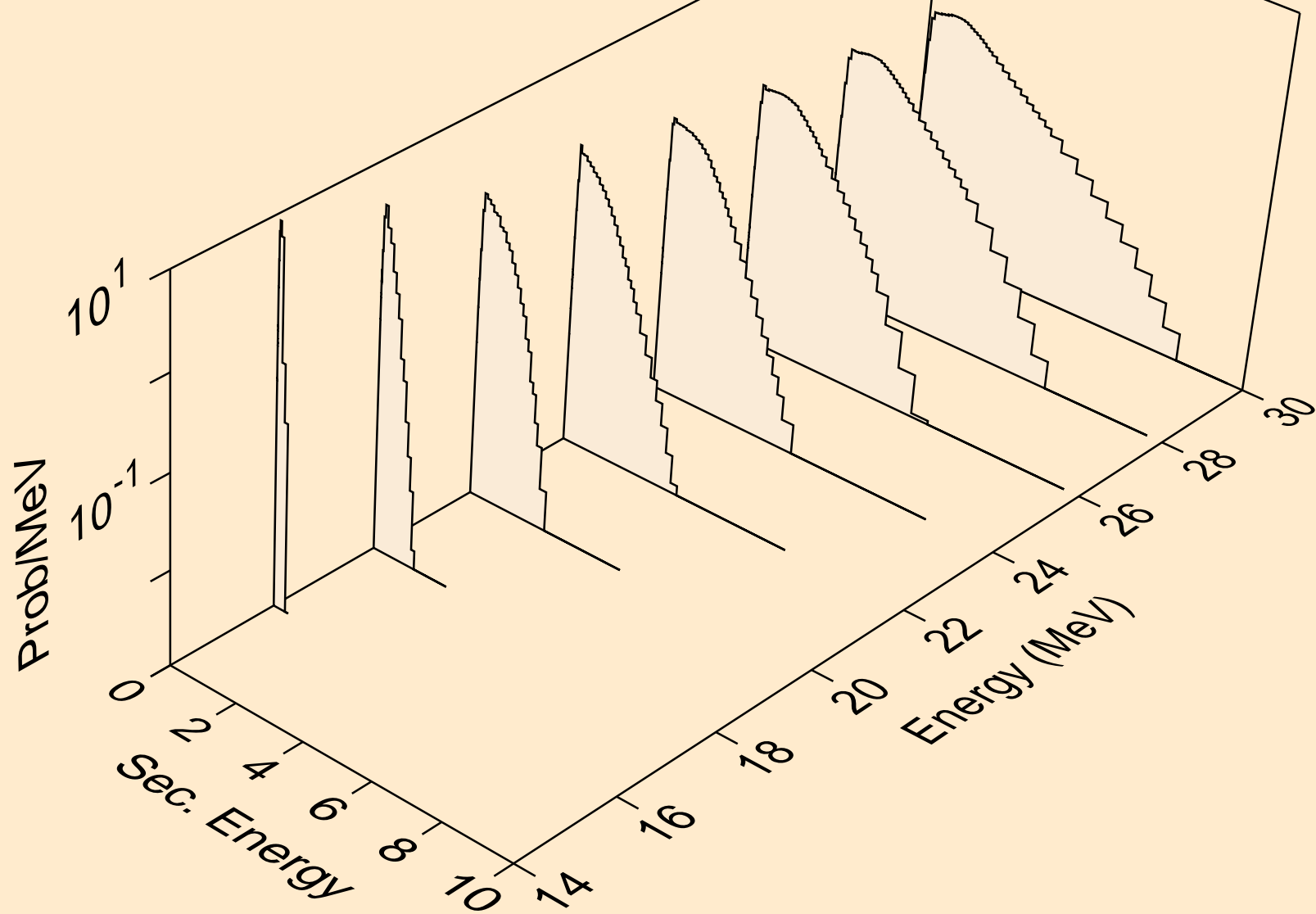

CU062 NEUTRON ACER TENDL-2023 LIBRARY; T=0.K  
Neutron emission for (n,n\*)p

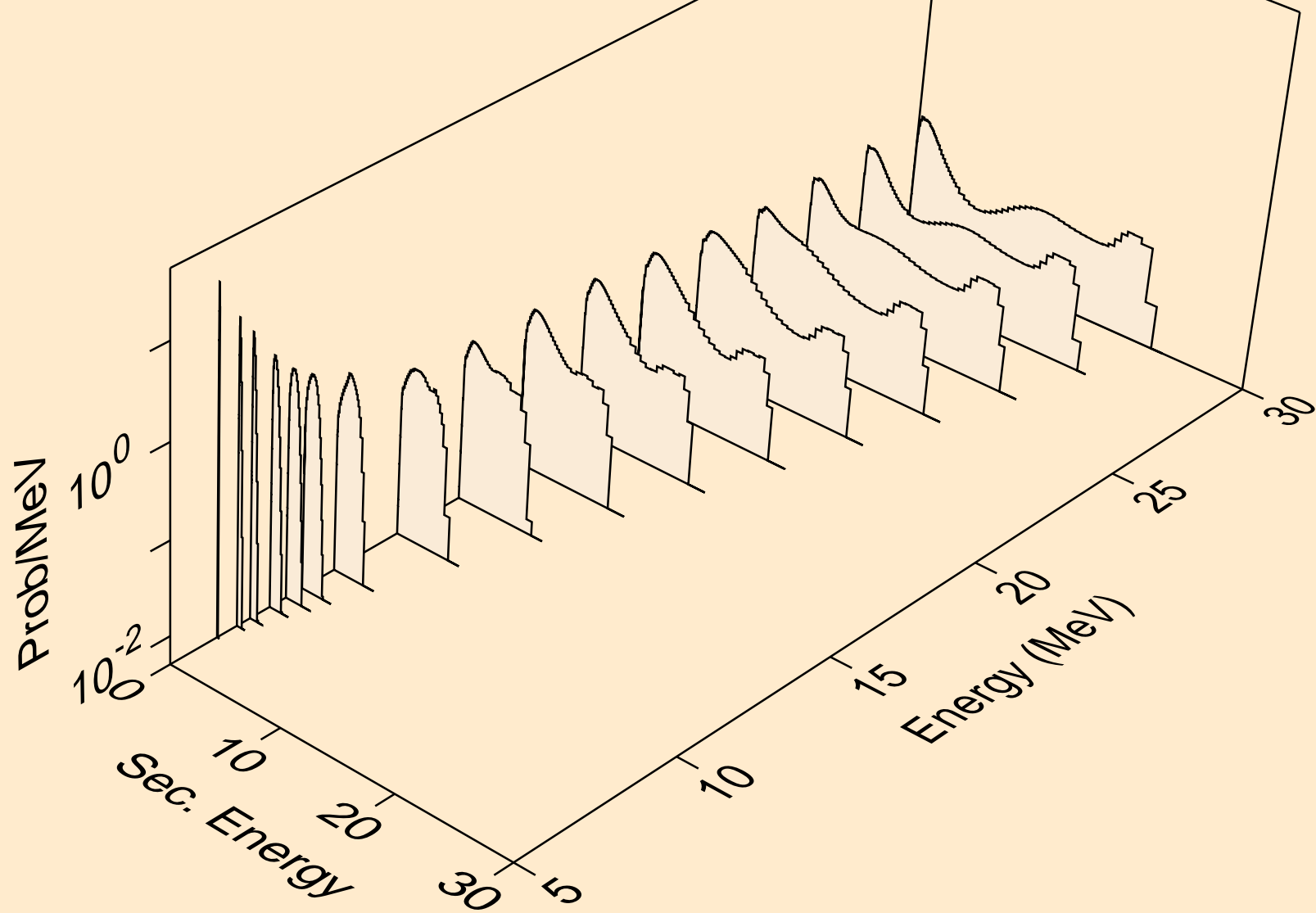

CU062 NEUTRON ACER TENDL-2023 LIBRARY; T=0.K  
Neutron emission for (n,n\*)2a

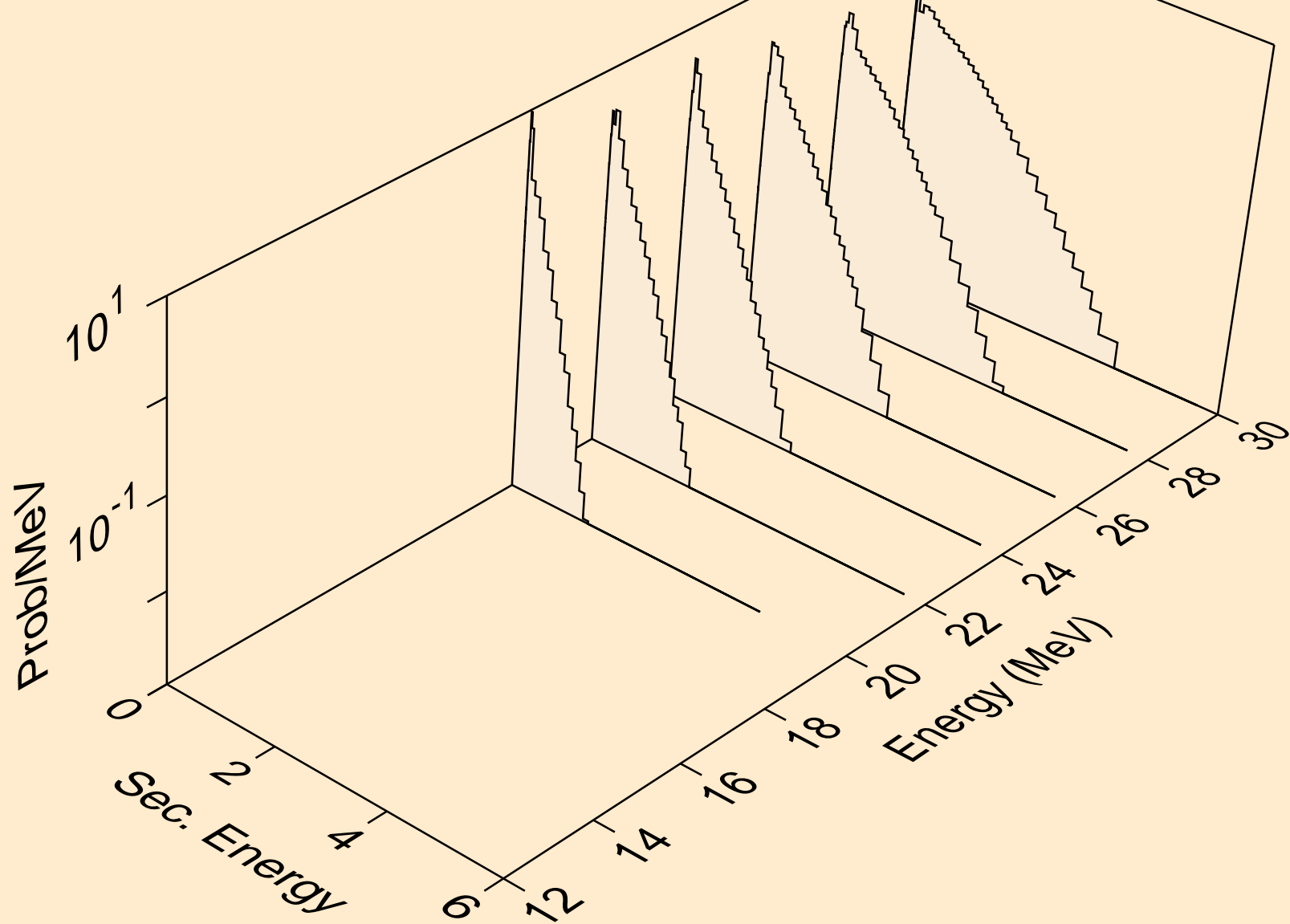

CU062 NEUTRON ACER TENDL-2023 LIBRARY; T=0.K  
Neutron emission for (n,n\*)d

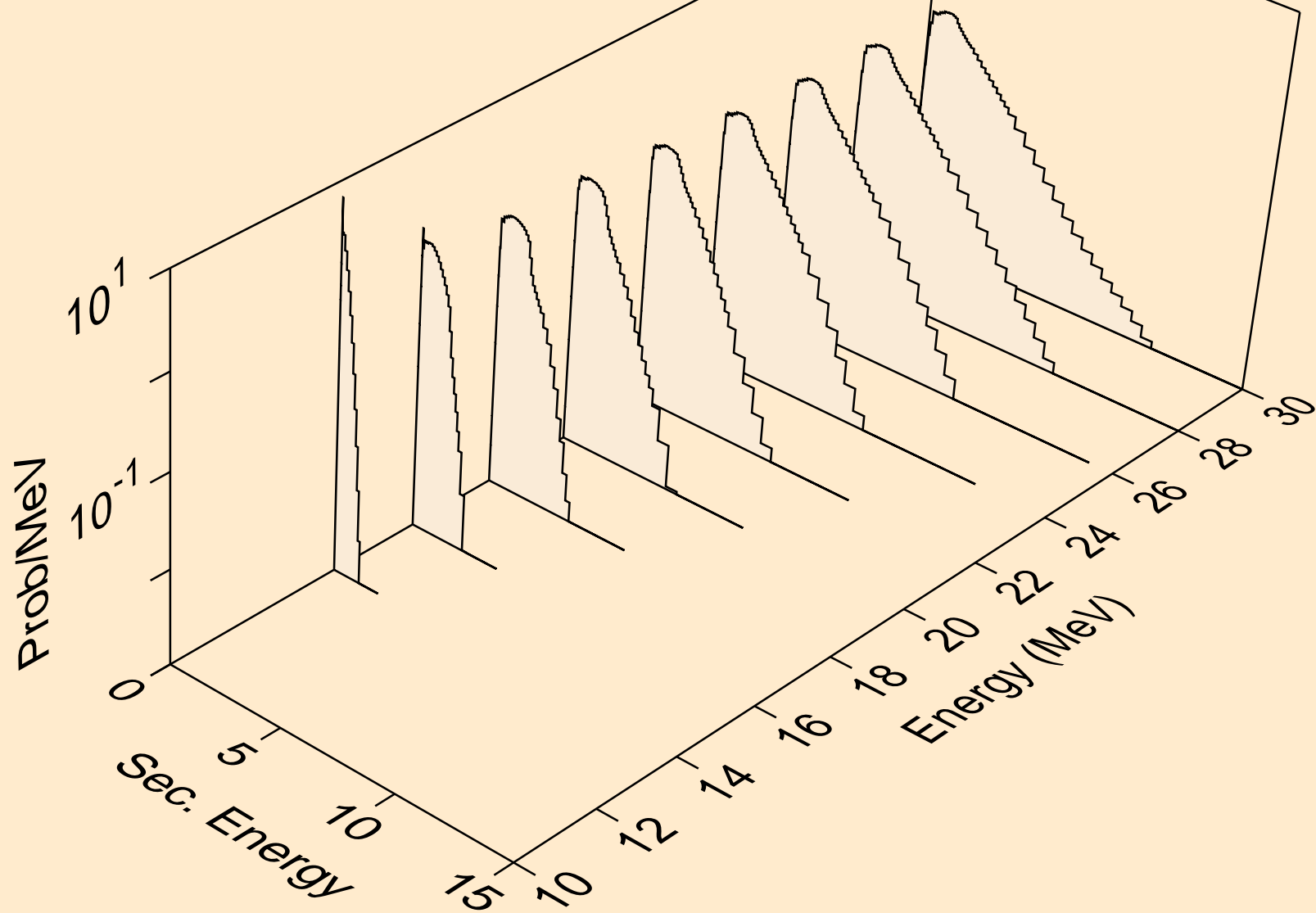

CU062 NEUTRON ACER TENDL-2023 LIBRARY; T=0.K  
Neutron emission for (n,n\*)t

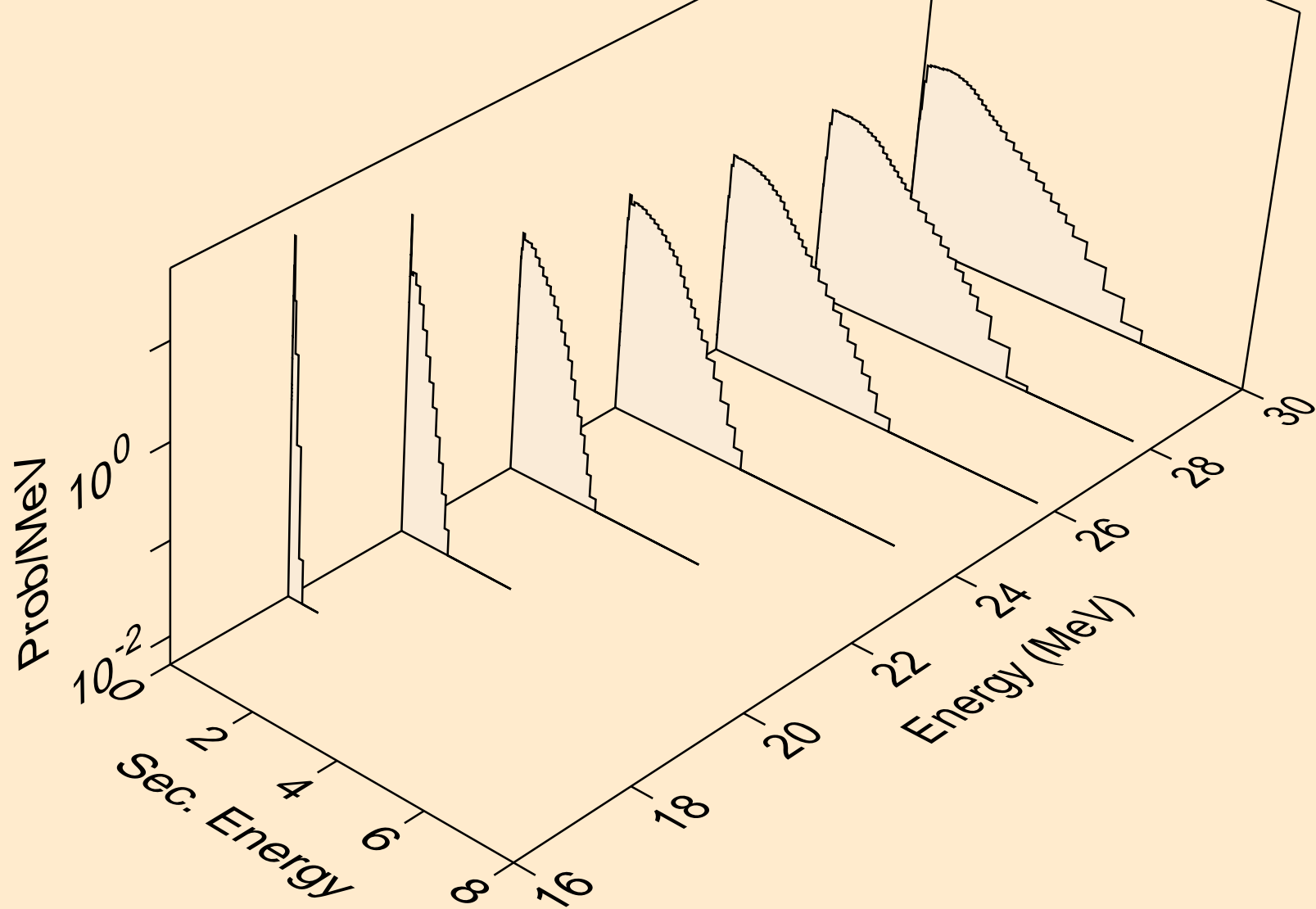



CU062 NEUTRON ACER TENDL-2023 LIBRARY; T=0.K  
Neutron emission for (n,n\*)he3

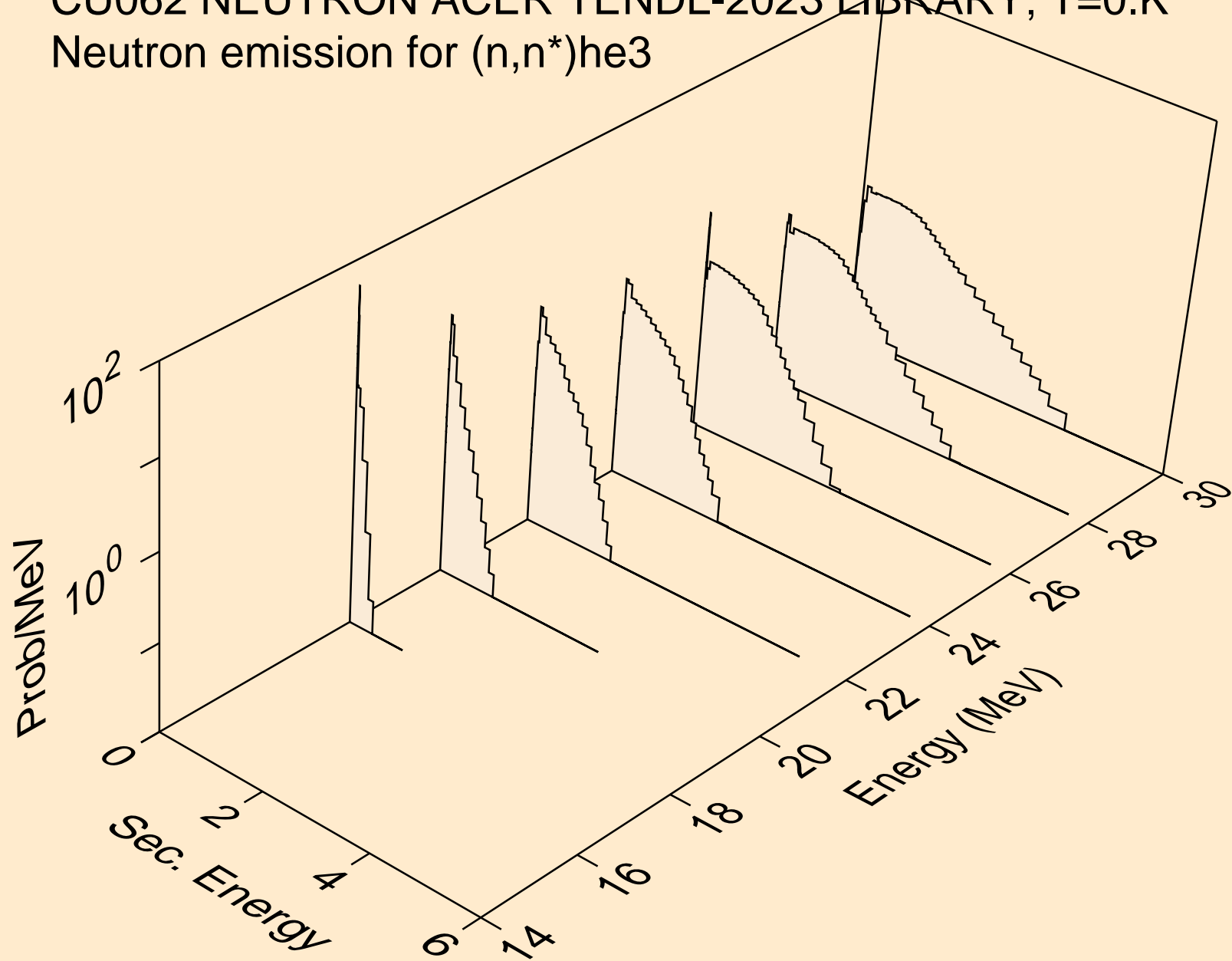

CU062 NEUTRON ACER TENDL-2023 LIBRARY; T=0.K  
Neutron emission for (n,2np)

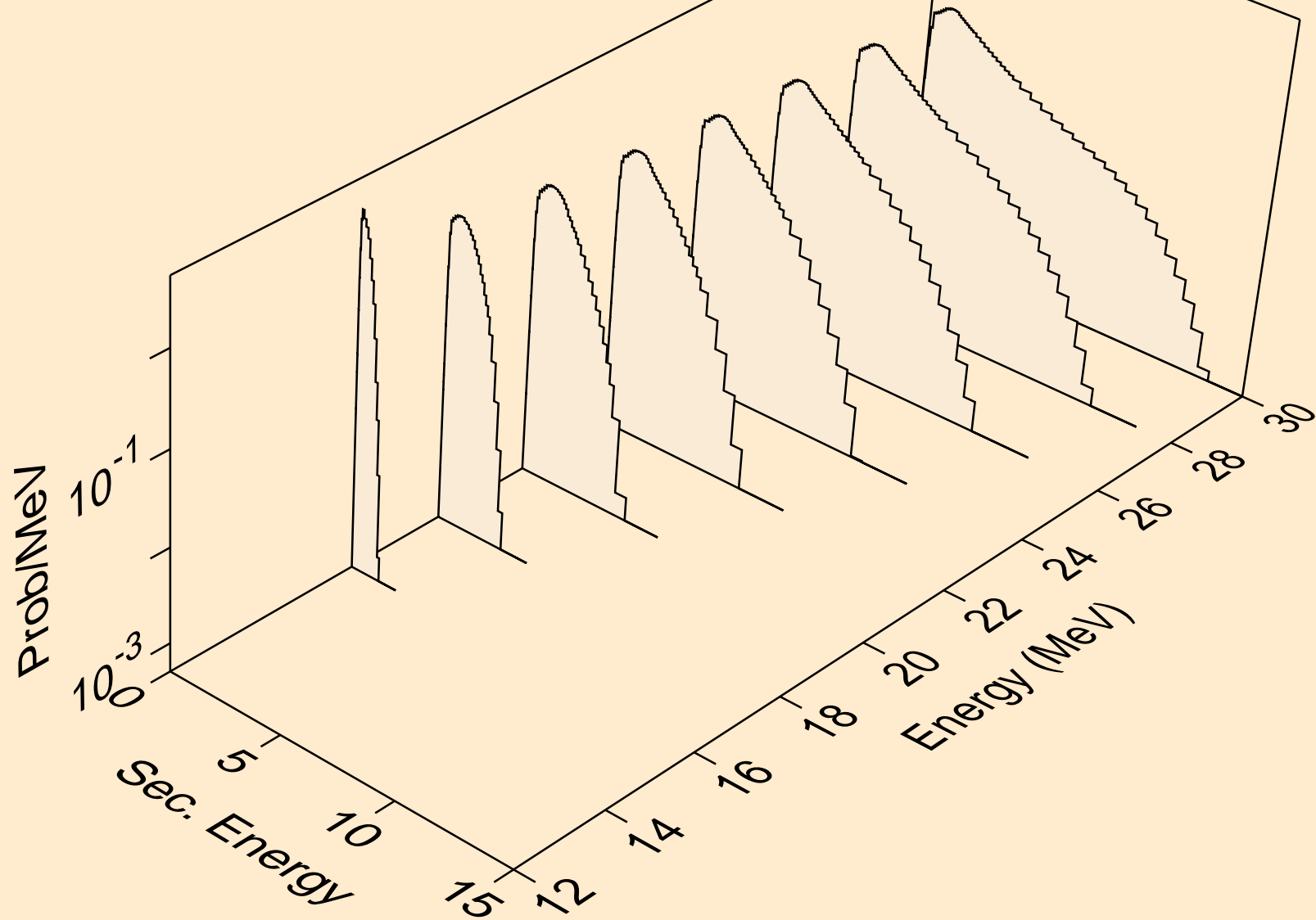

CU062 NEUTRON ACER TENDL-2023 LIBRARY; T=0.K  
Neutron emission for (n,3np)

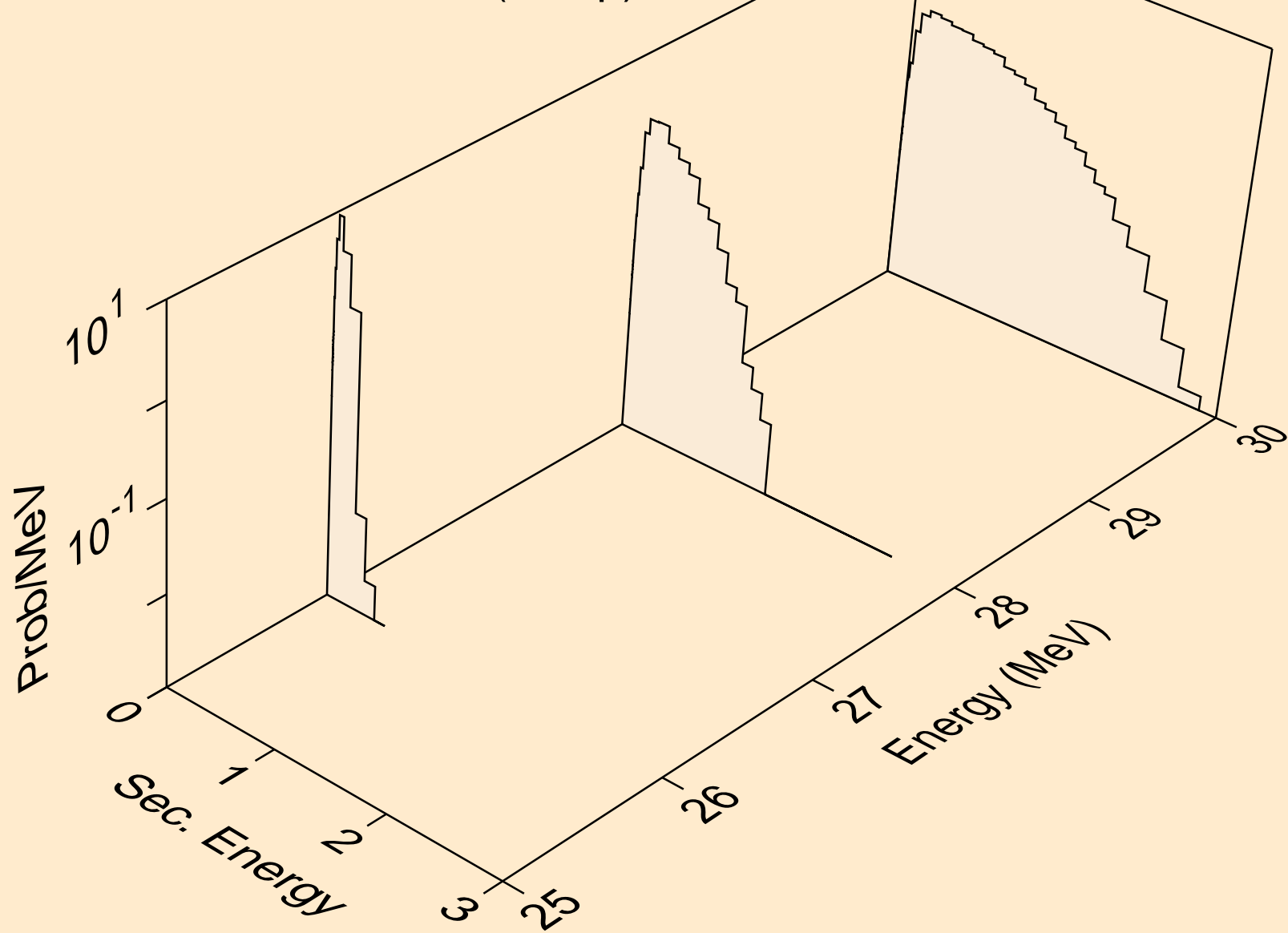

CU062 NEUTRON ACER TENDL-2023 LIBRARY; T=0.K  
Neutron emission for (n,n2p)

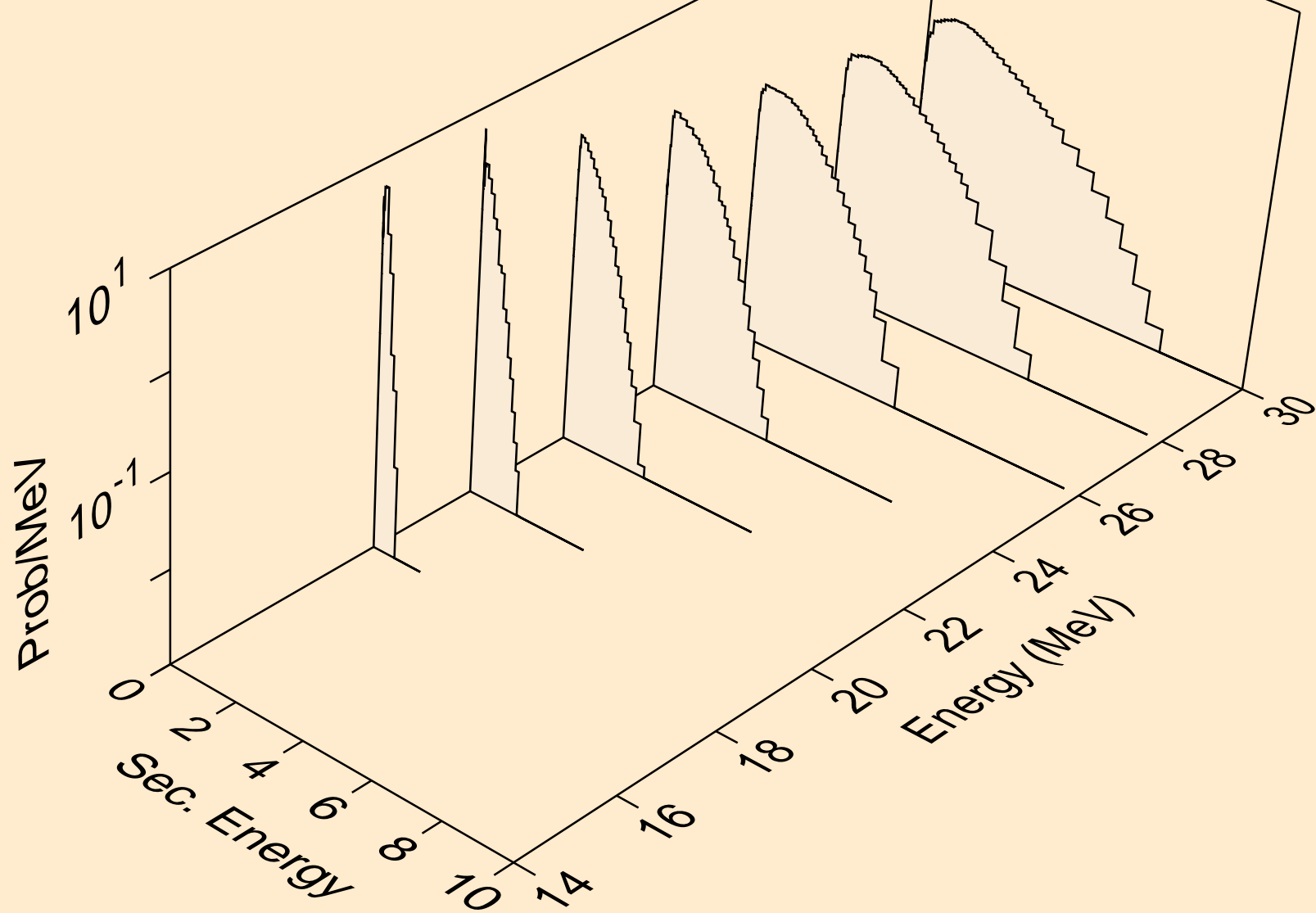

CU062 NEUTRON ACER TENDL-2023 LIBRARY; T=0.K  
Neutron emission for (n,npa)

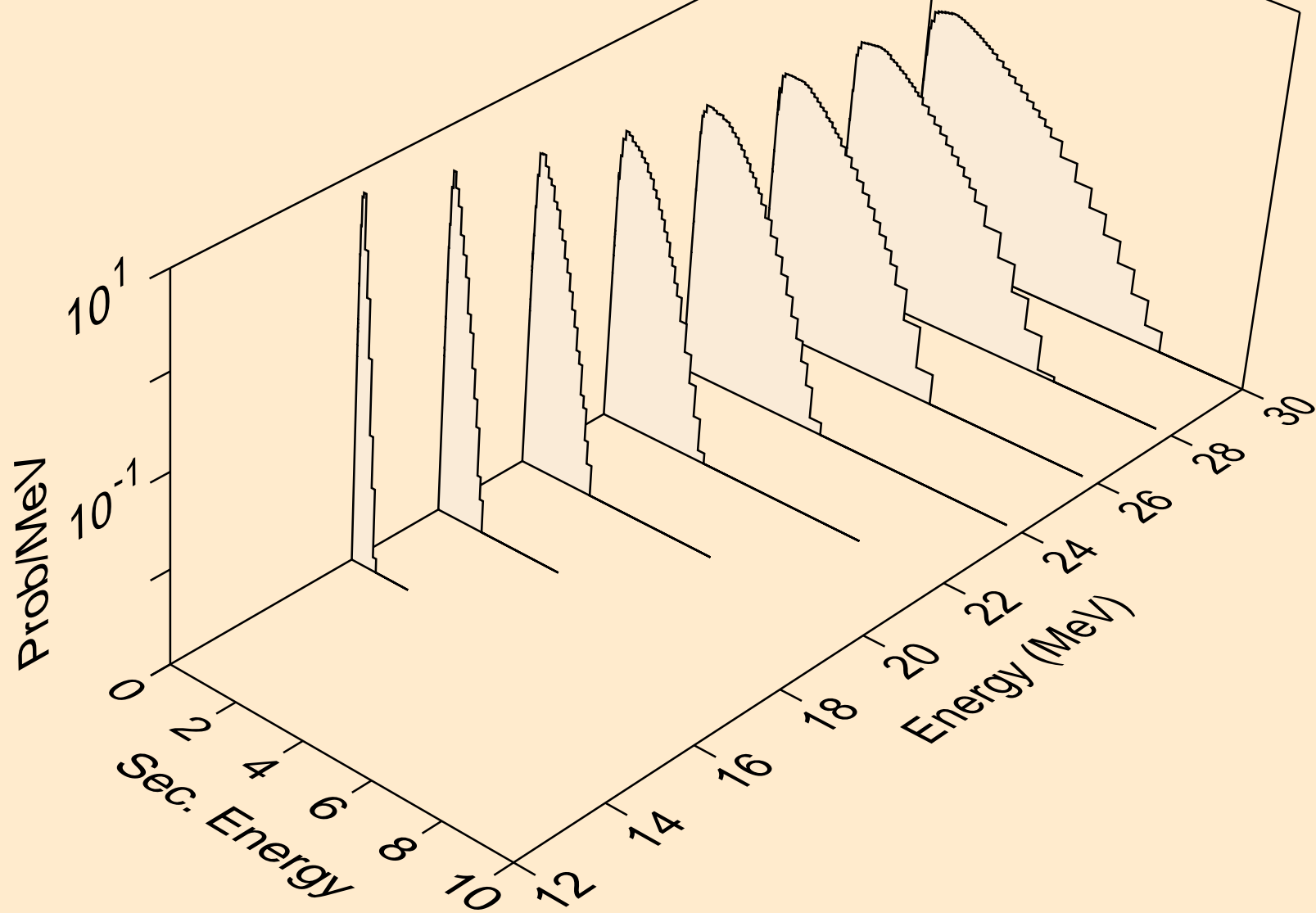

CU062 NEUTRON ACER TENDL-2023 LIBRARY; T=0.K  
Neutron emission for (n,n\*c)

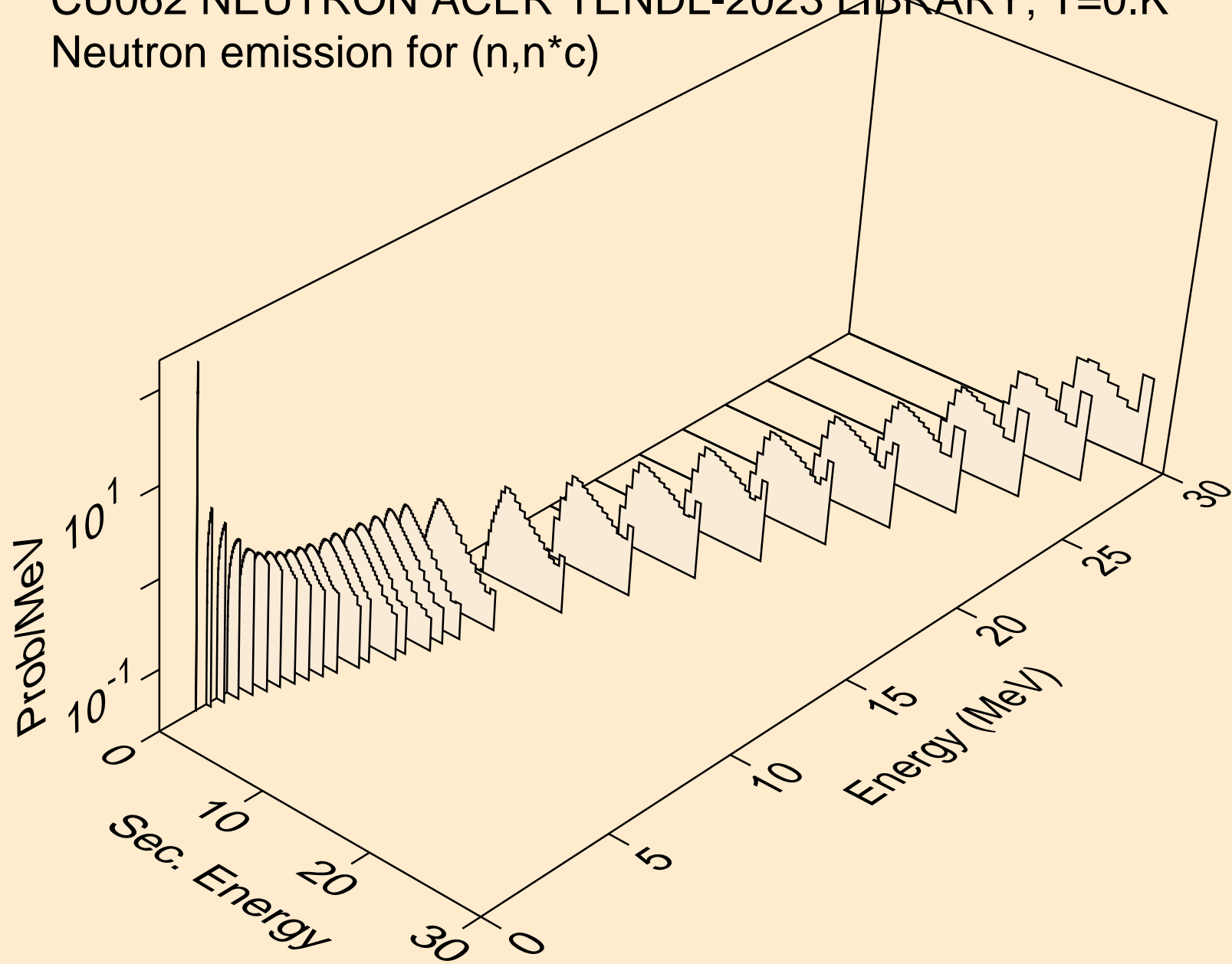

CU062 NEUTRON ACER TENDL-2023 LIBRARY; T=0.K  
Photon emission for (n,x)

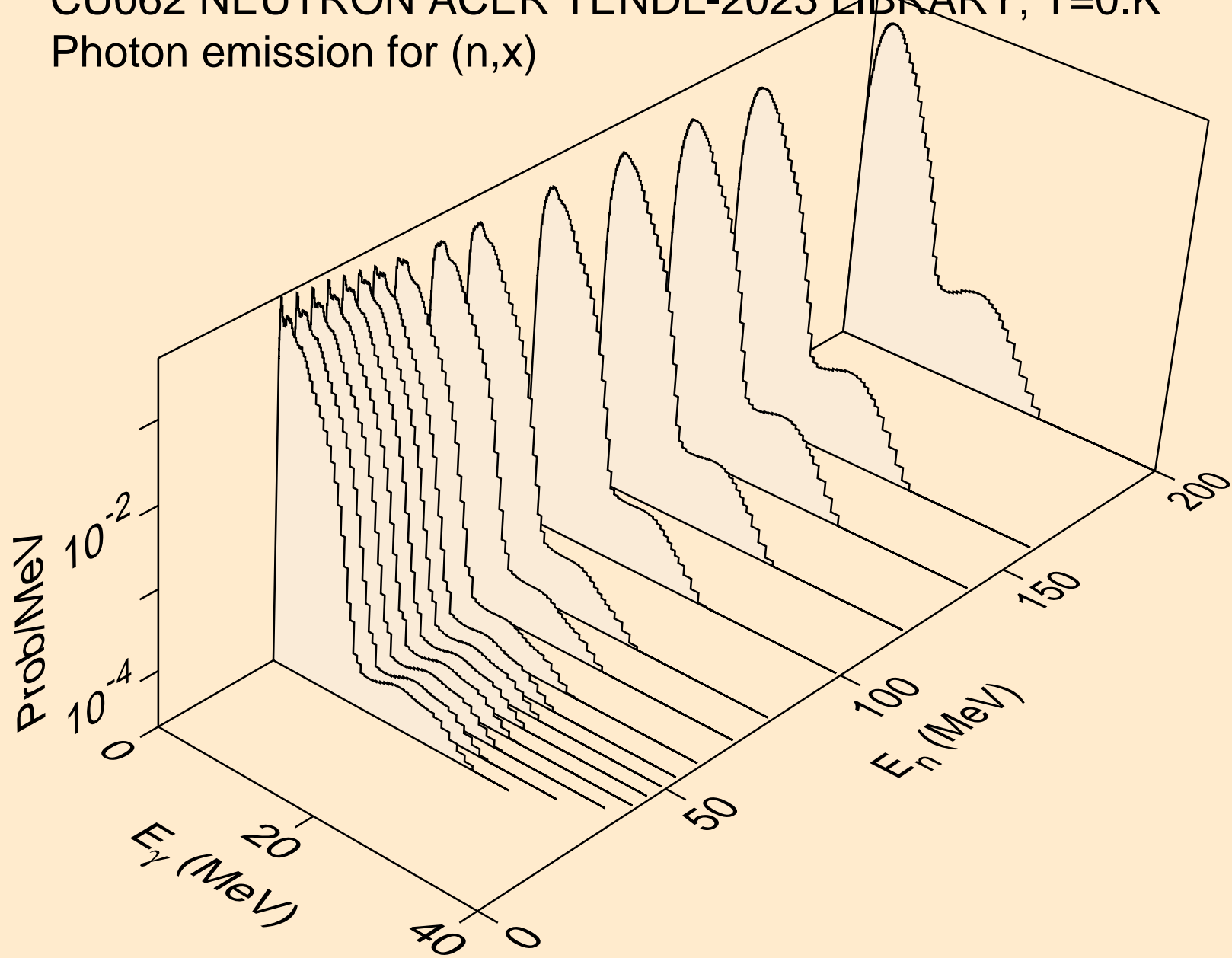

CU062 NEUTRON ACER TENDL-2023 LIBRARY; T=0.K  
Photon emission for (n,2nd)

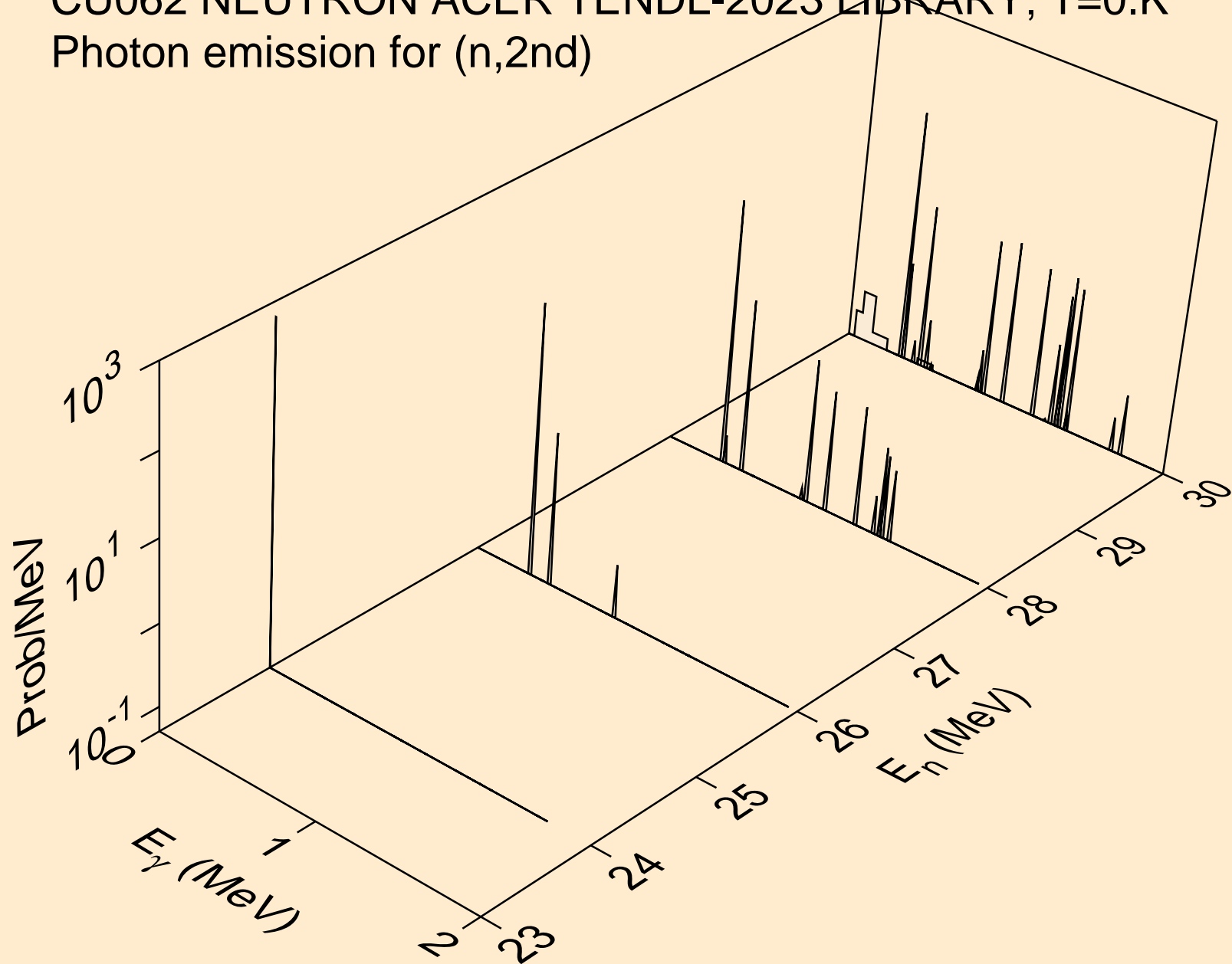



CU062 NEUTRON ACER TENDL-2023 LIBRARY; T=0.K  
Photon emission for (n,2n)

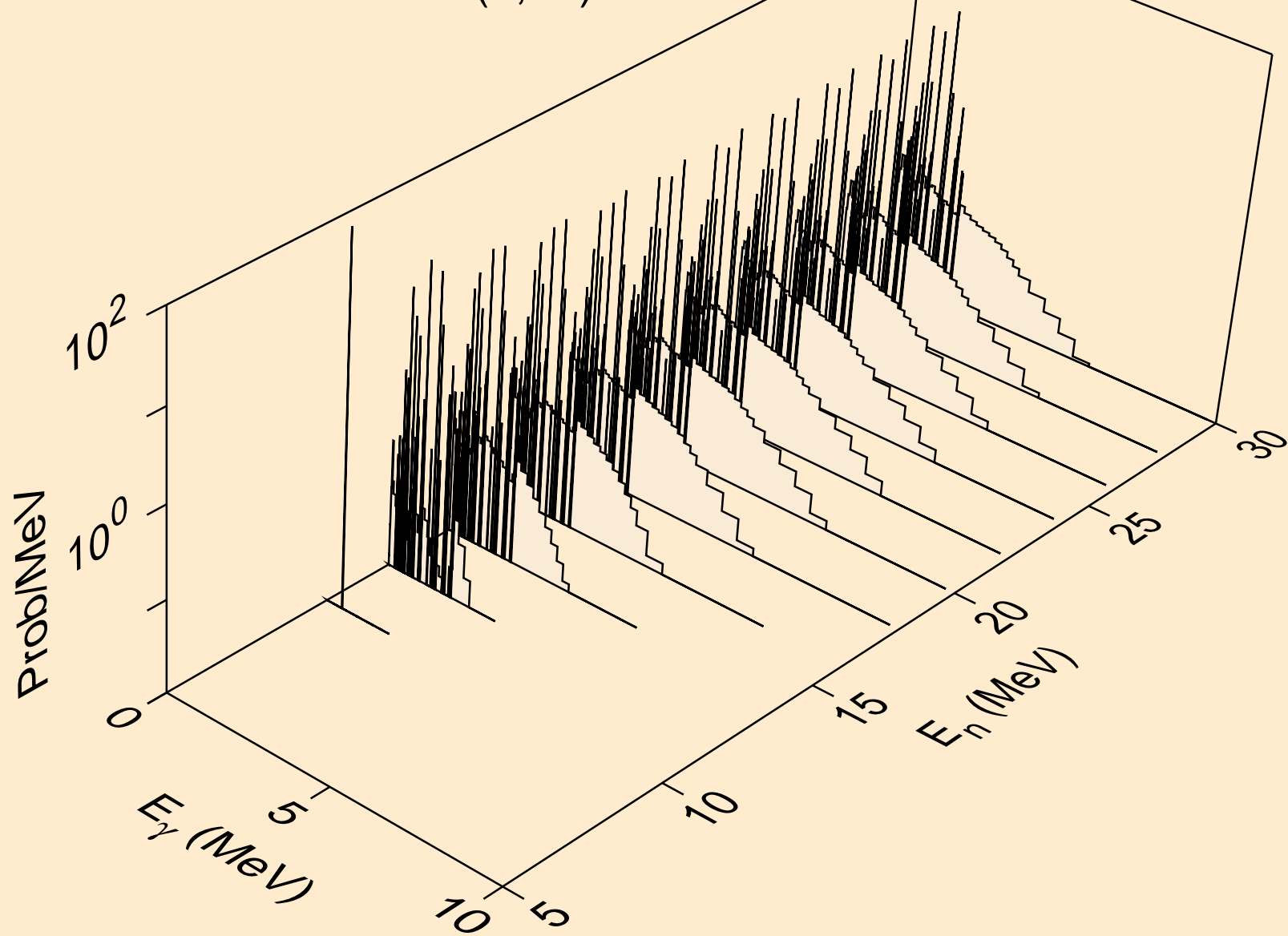

CU062 NEUTRON ACER TENDL-2023 LIBRARY; T=0.K  
Photon emission for (n,3n)

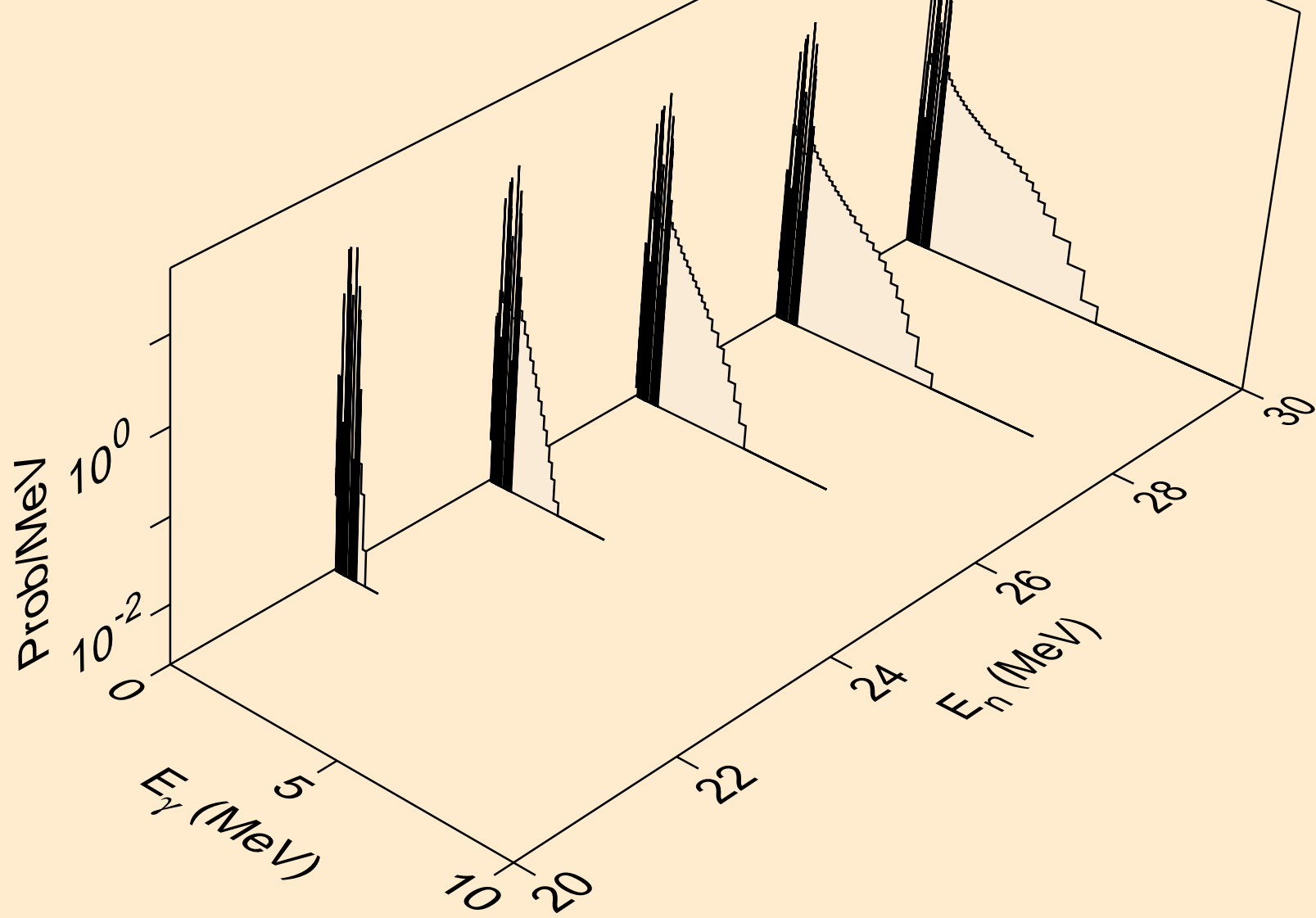

CU062 NEUTRON ACER TENDL-2023 LIBRARY; T=0.K  
Photon emission for (n,n\*)a

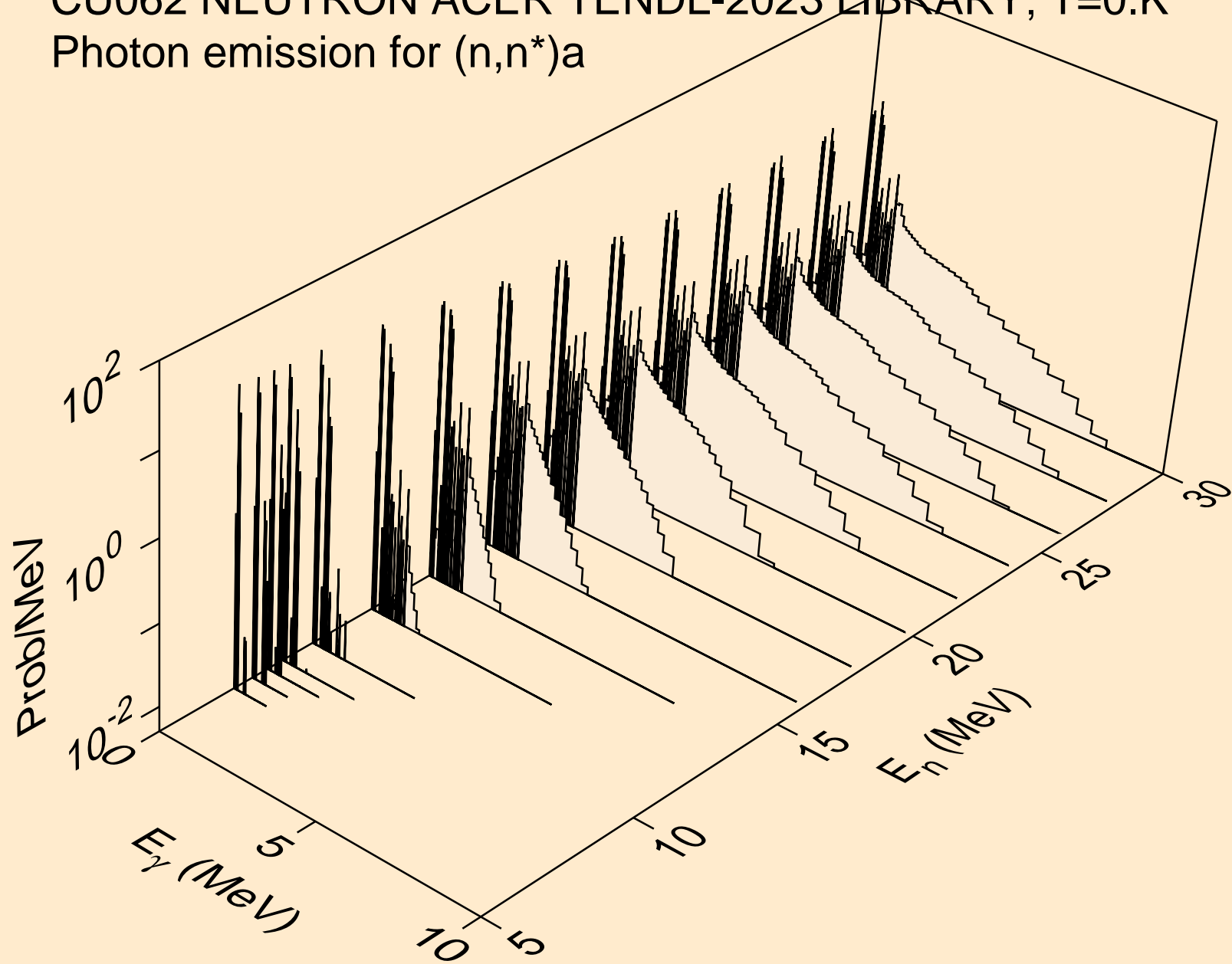

CU062 NEUTRON ACER TENDL-2023 LIBRARY; T=0.K  
Photon emission for (n,2n)a

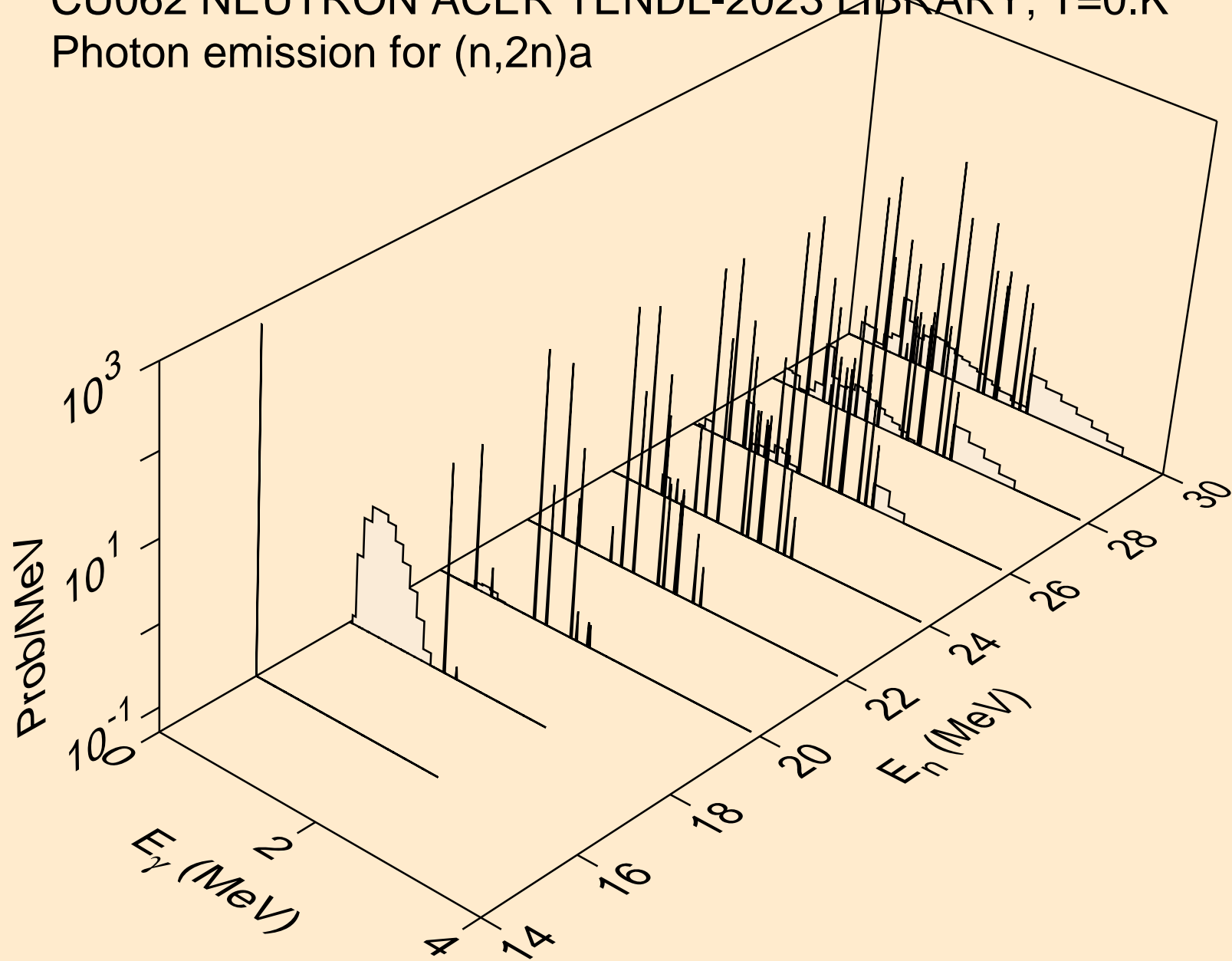

CU062 NEUTRON ACER TENDL-2023 LIBRARY; T=0.K  
Photon emission for (n,n\*)p

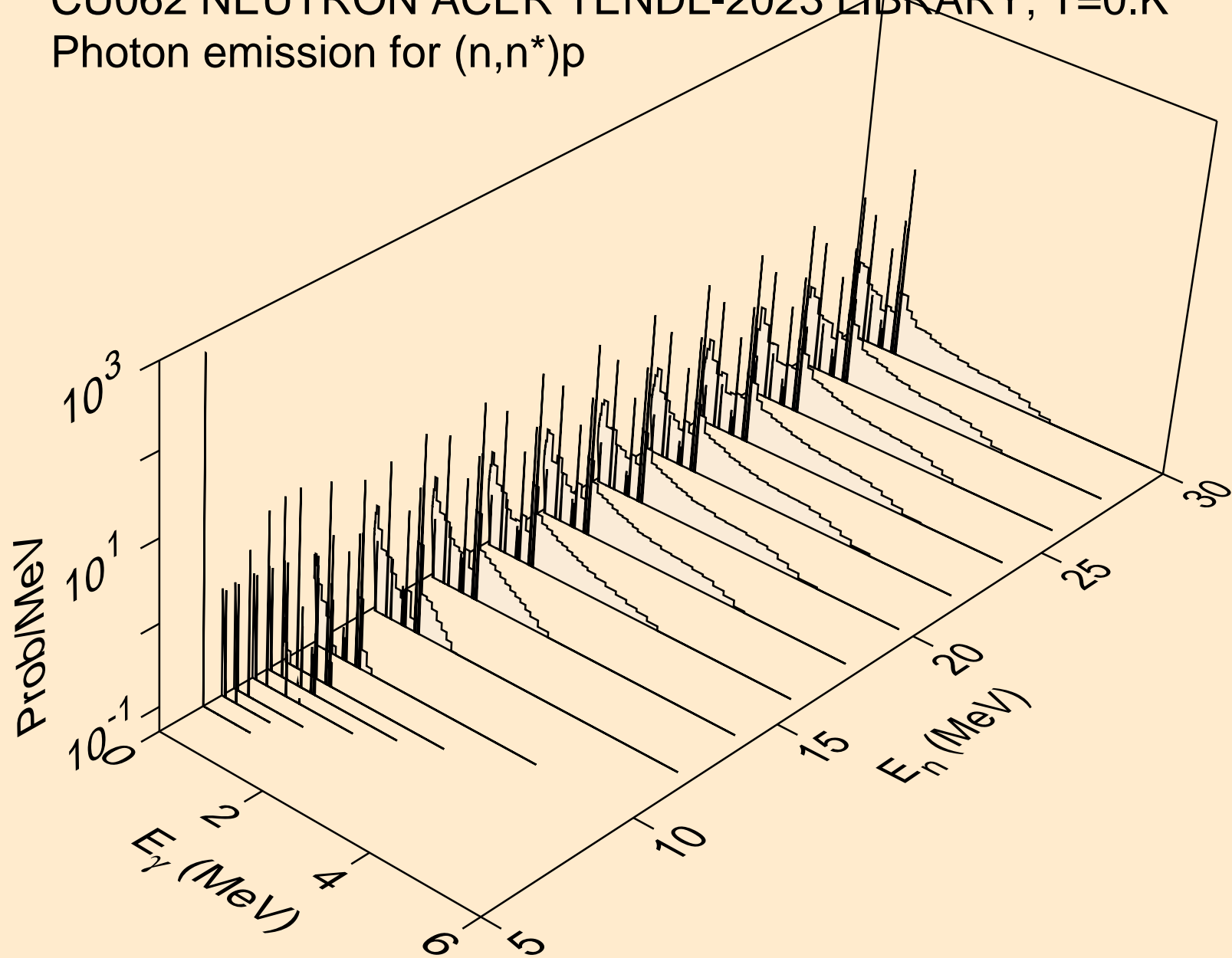

CU062 NEUTRON ACER TENDL-2023 LIBRARY; T=0.K  
Photon emission for (n,n\*)2a

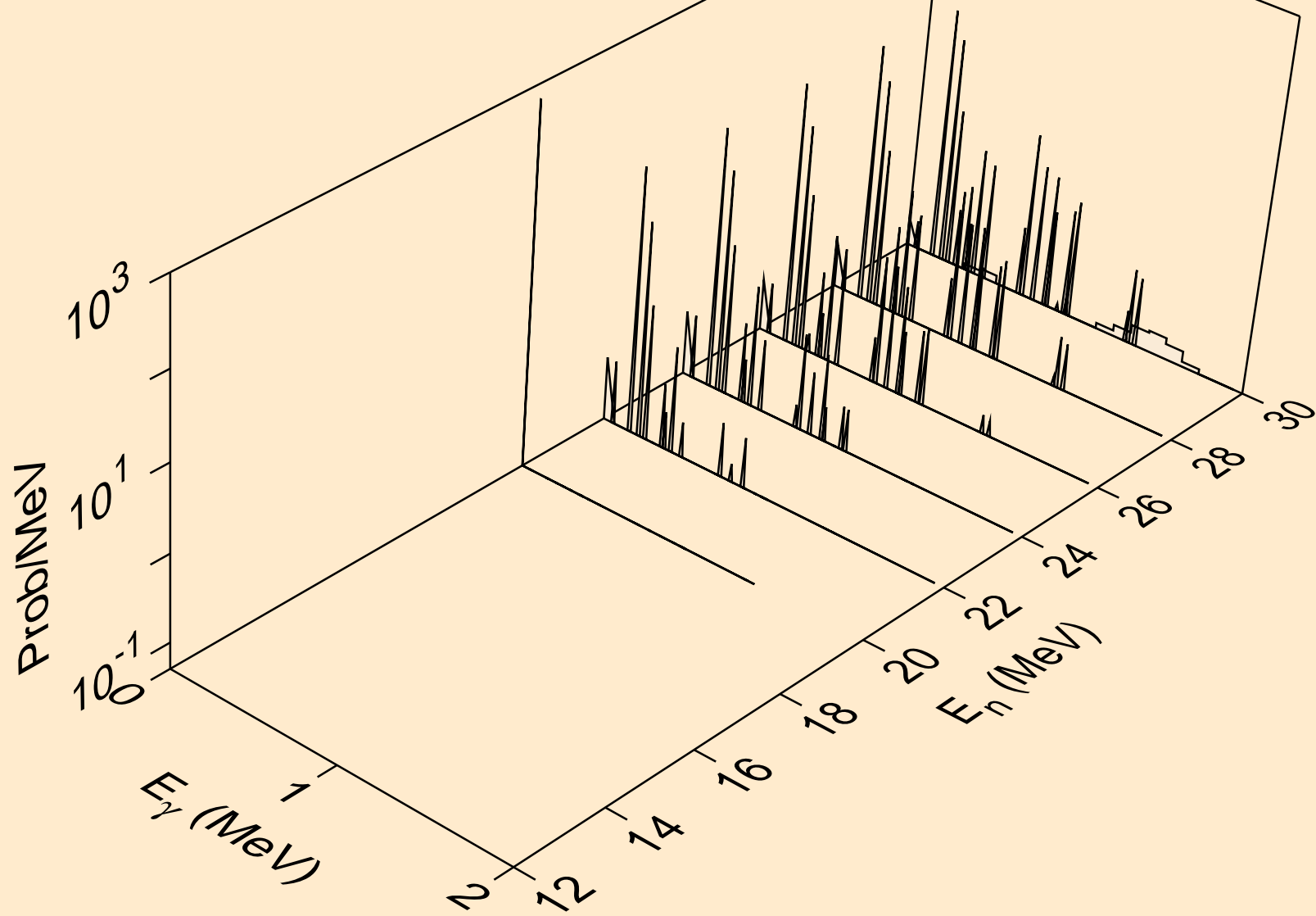

CU062 NEUTRON ACER TENDL-2023 LIBRARY; T=0.K  
Photon emission for (n,n\*)d

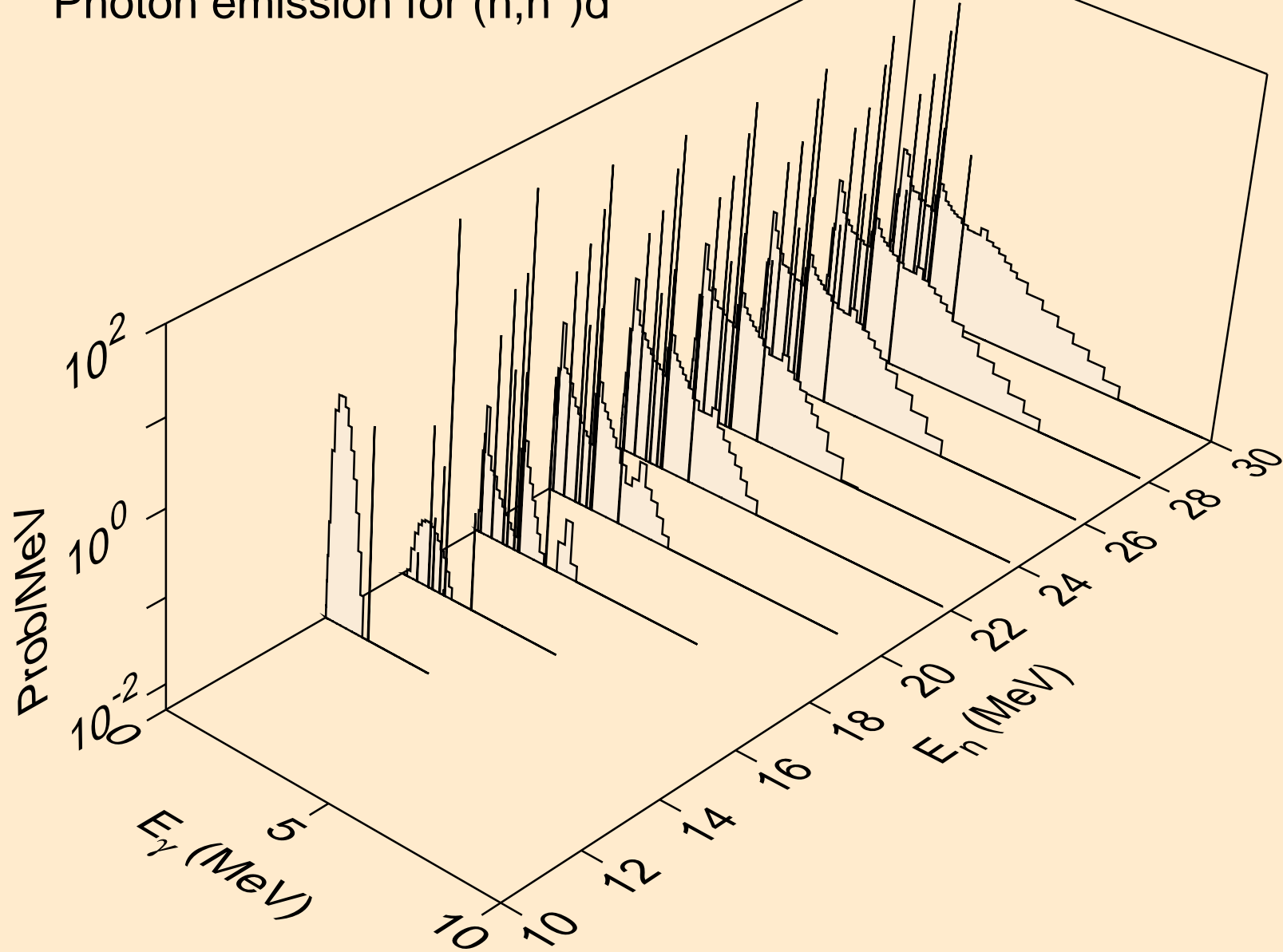

CU062 NEUTRON ACER TENDL-2023 LIBRARY; T=0.K  
Photon emission for (n,n\*)t

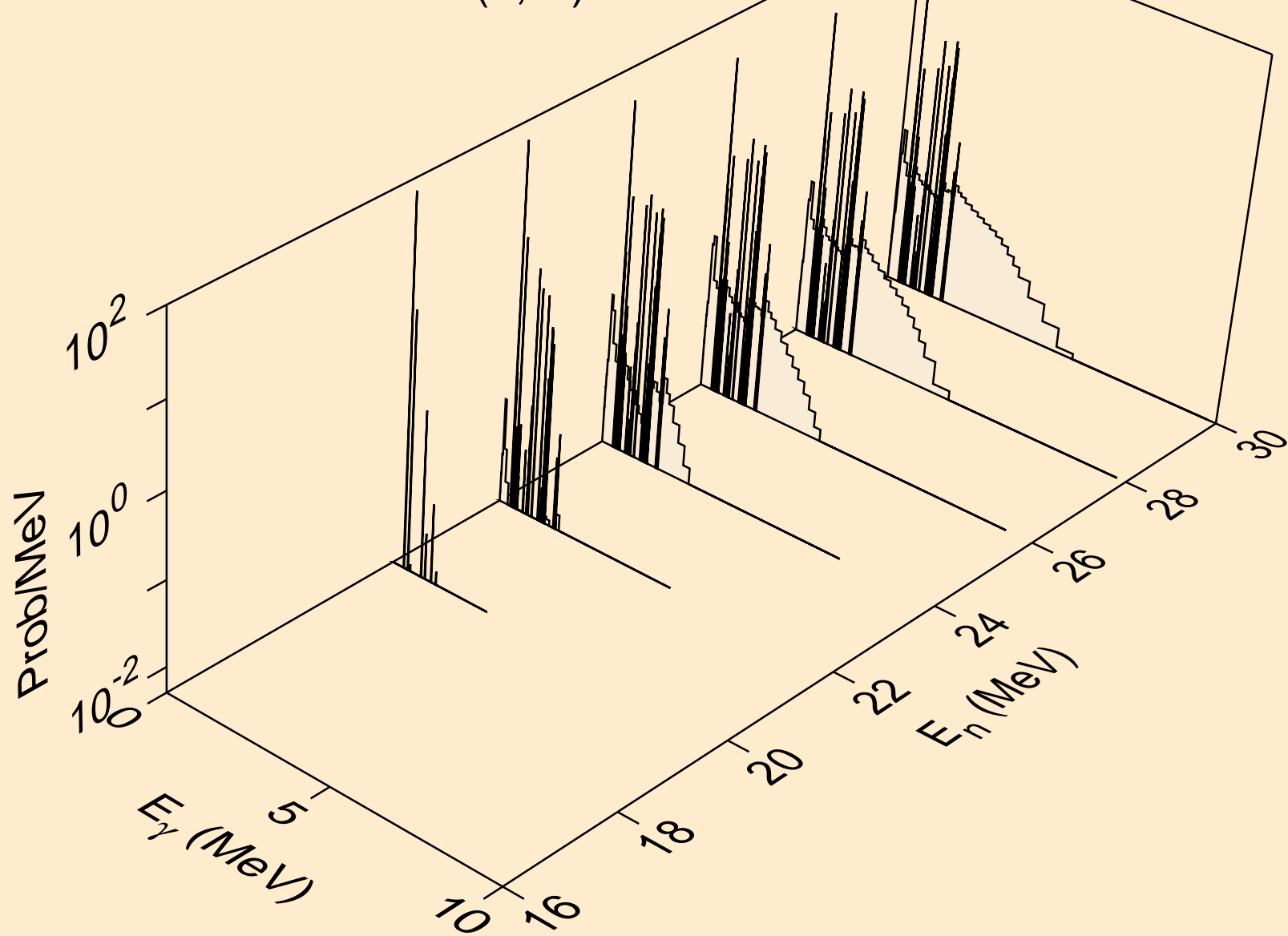



CU062 NEUTRON ACER TENDL-2023 LIBRARY; T=0.K  
Photon emission for (n,n\*)he3

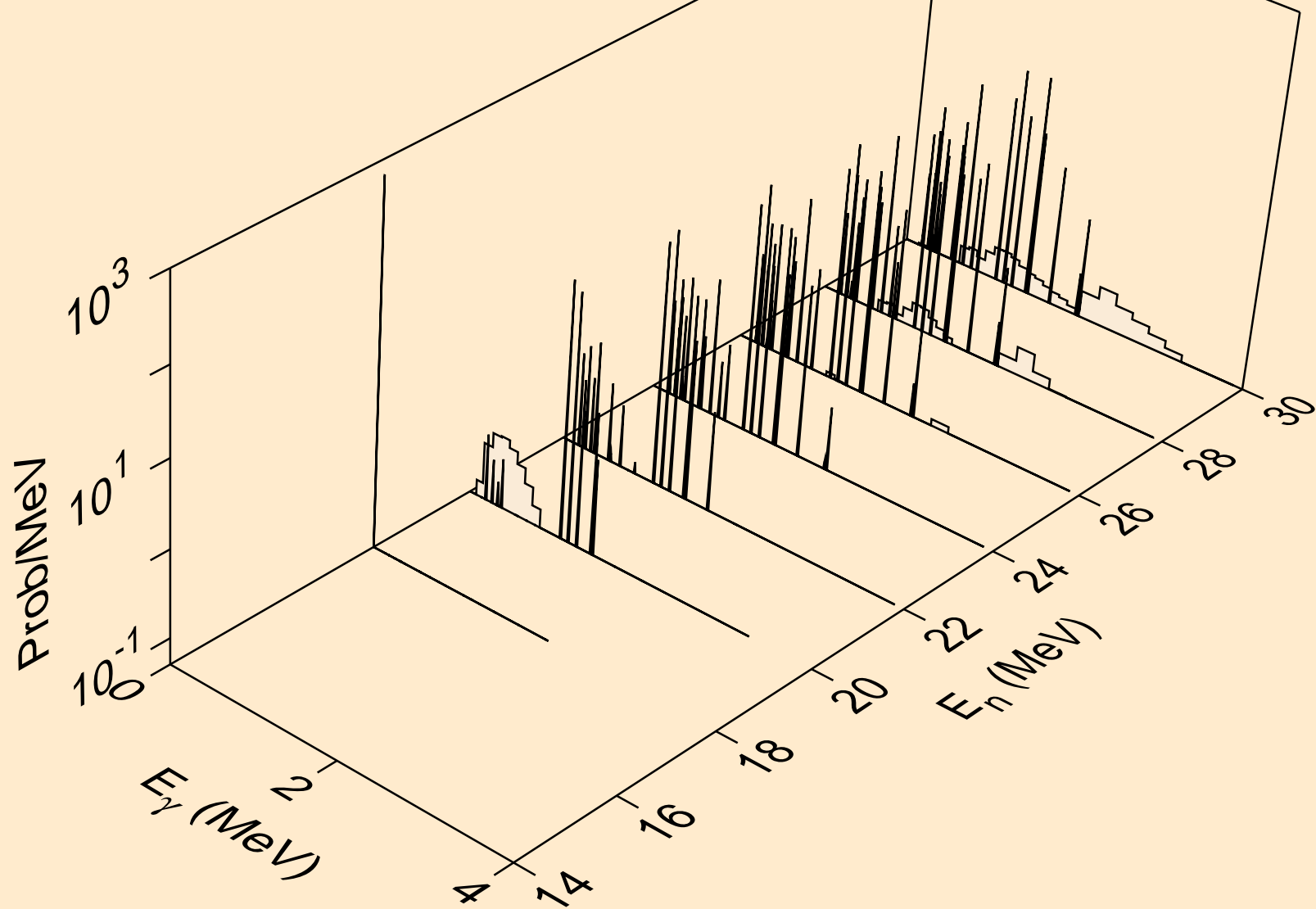

CU062 NEUTRON ACER TENDL-2023 LIBRARY; T=0.K  
Photon emission for (n,2np)

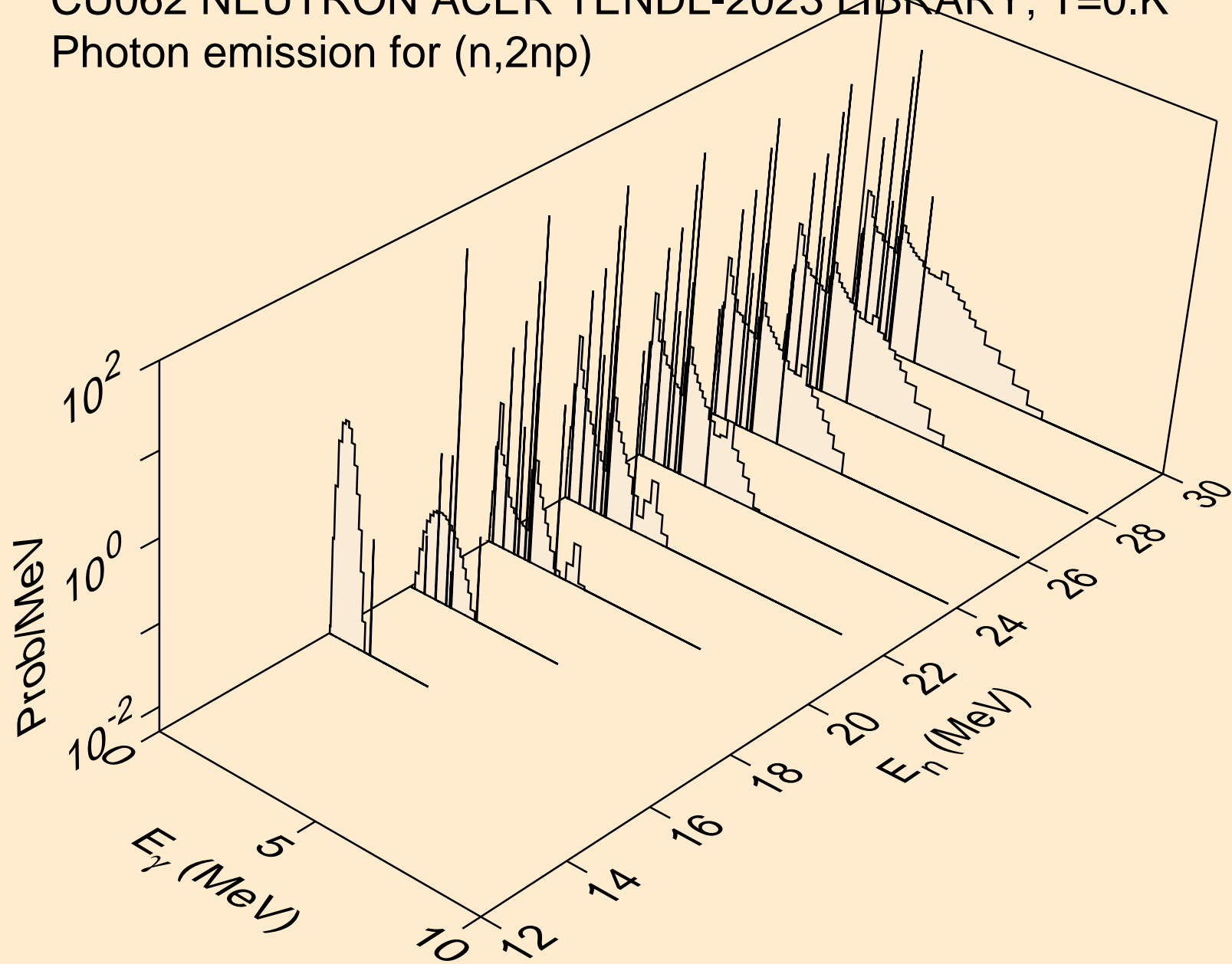

CU062 NEUTRON ACER TENDL-2023 LIBRARY; T=0.K  
Photon emission for (n,3np)

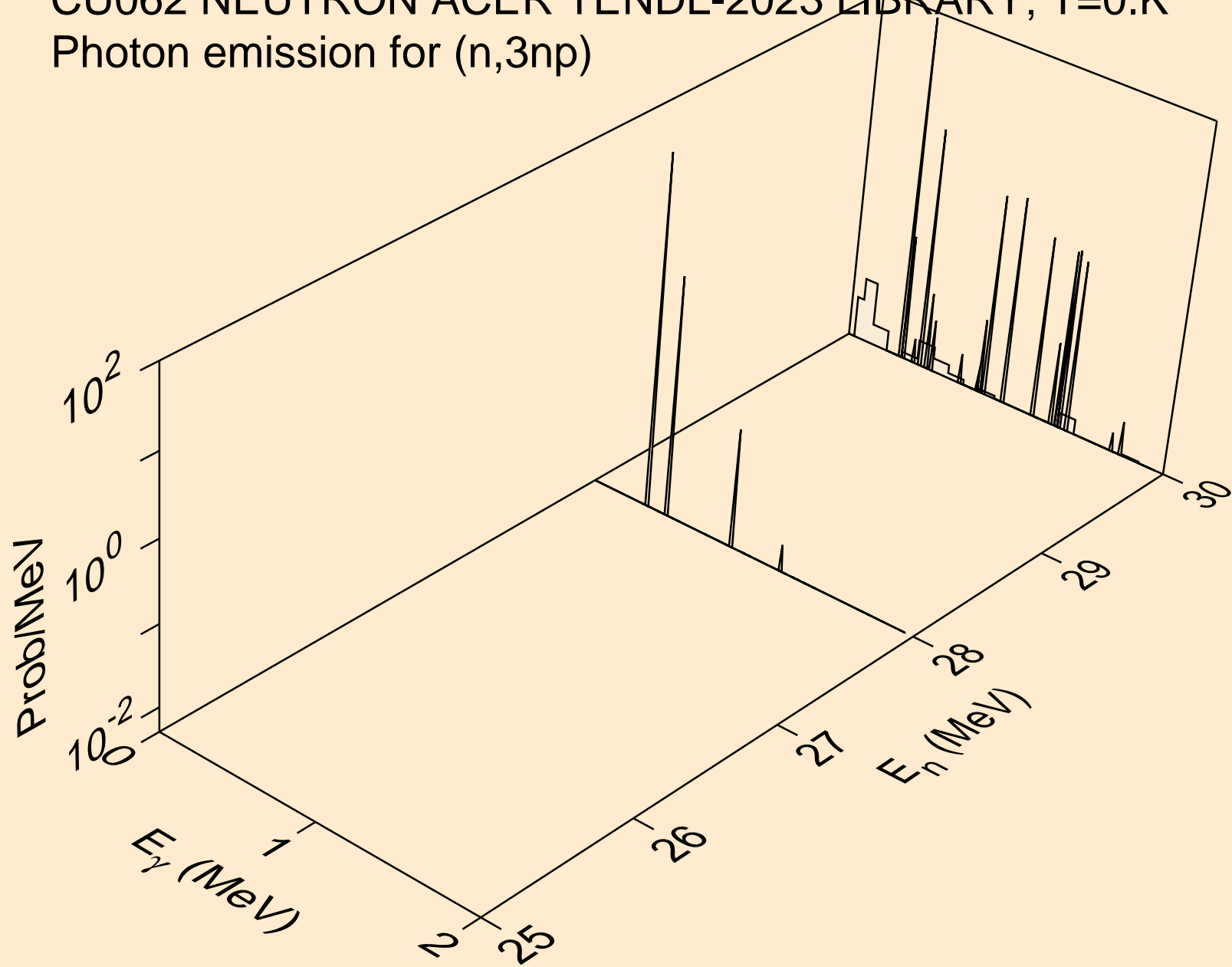

CU062 NEUTRON ACER TENDL-2023 LIBRARY; T=0.K  
Photon emission for (n,n2p)

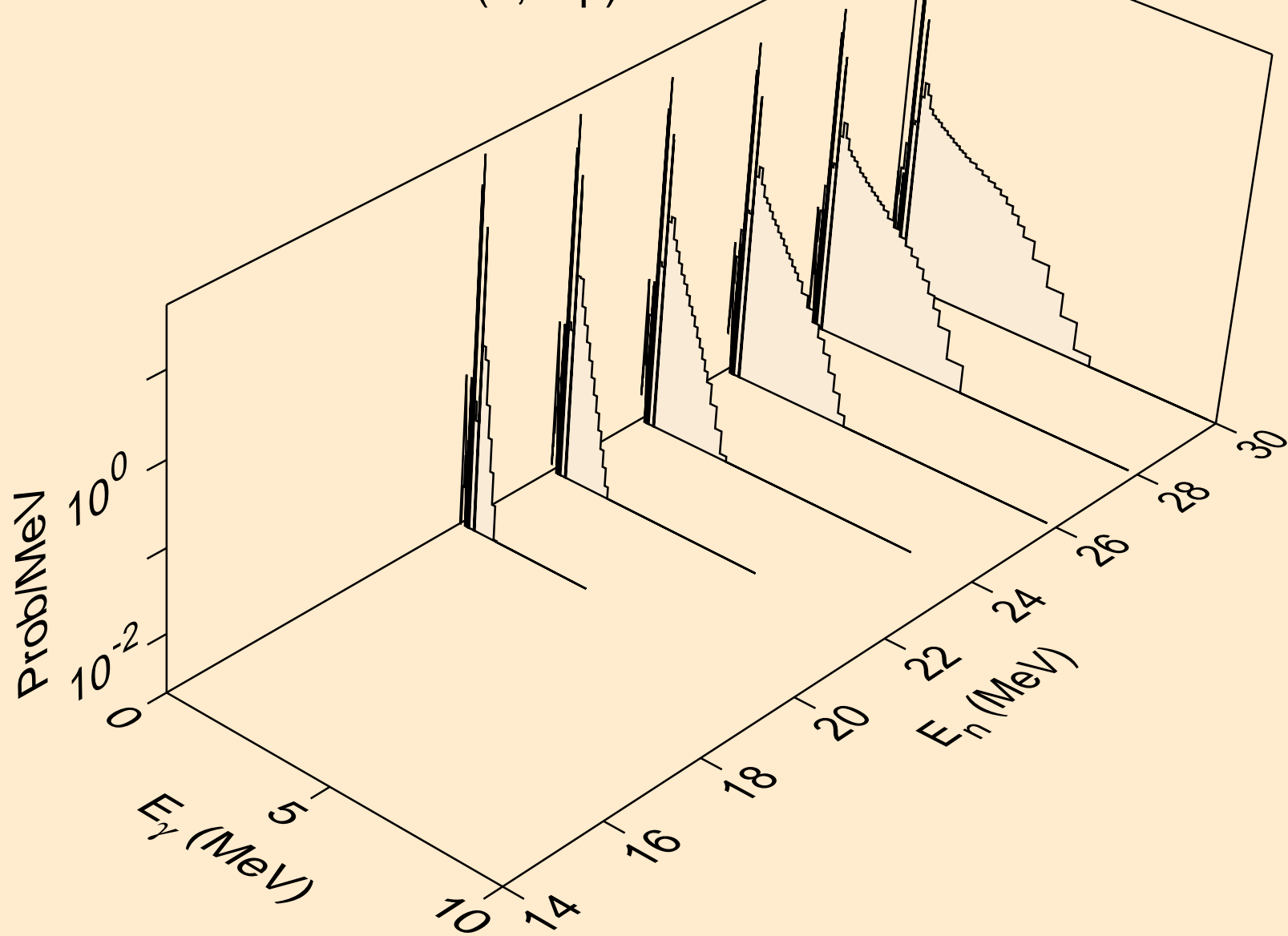

CU062 NEUTRON ACER TENDL-2023 LIBRARY; T=0.K  
Photon emission for (n,npa)

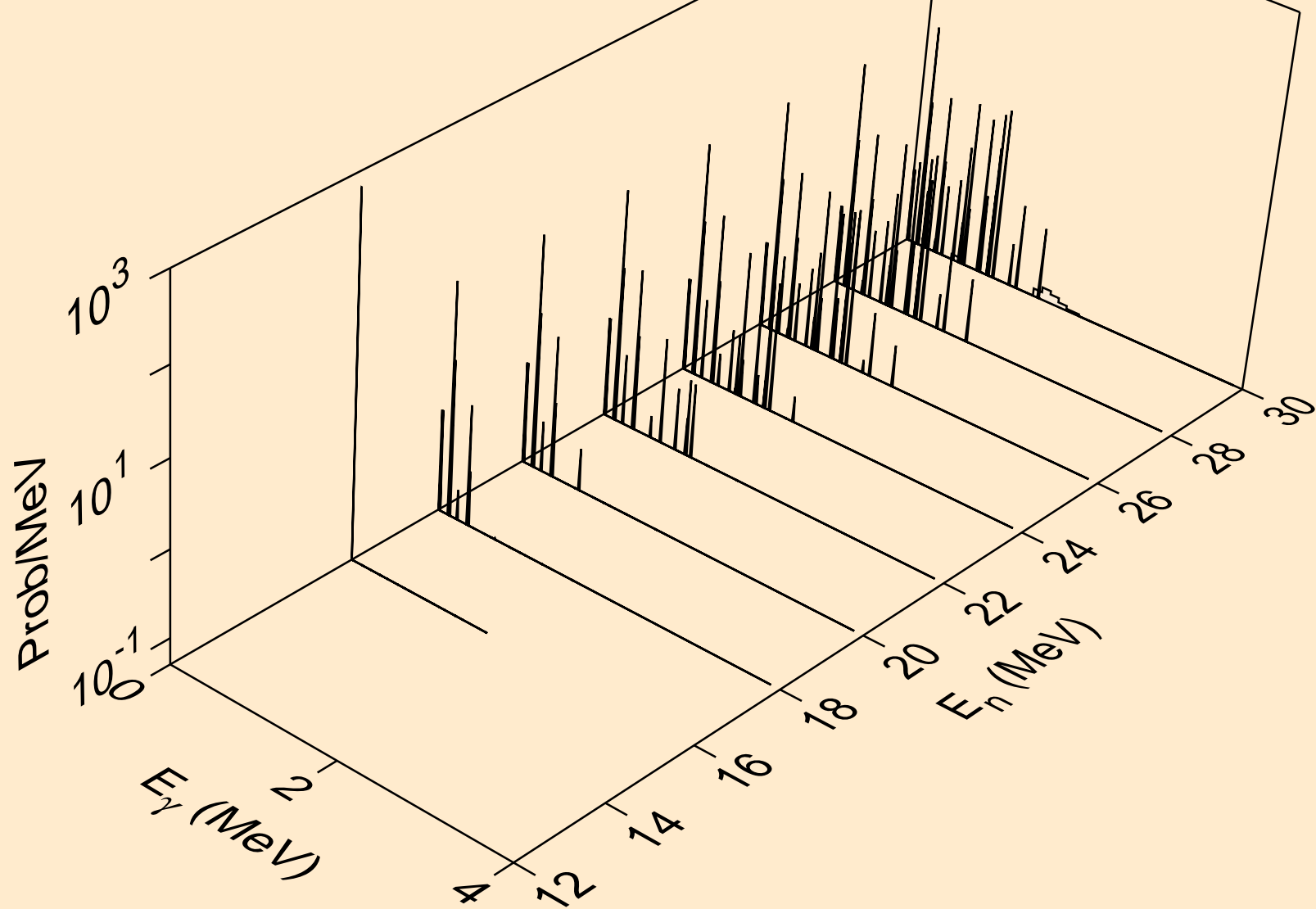

CU062 NEUTRON ACER TENDL-2023 LIBRARY; T=0.K  
Photon emission for (n,n\*c)

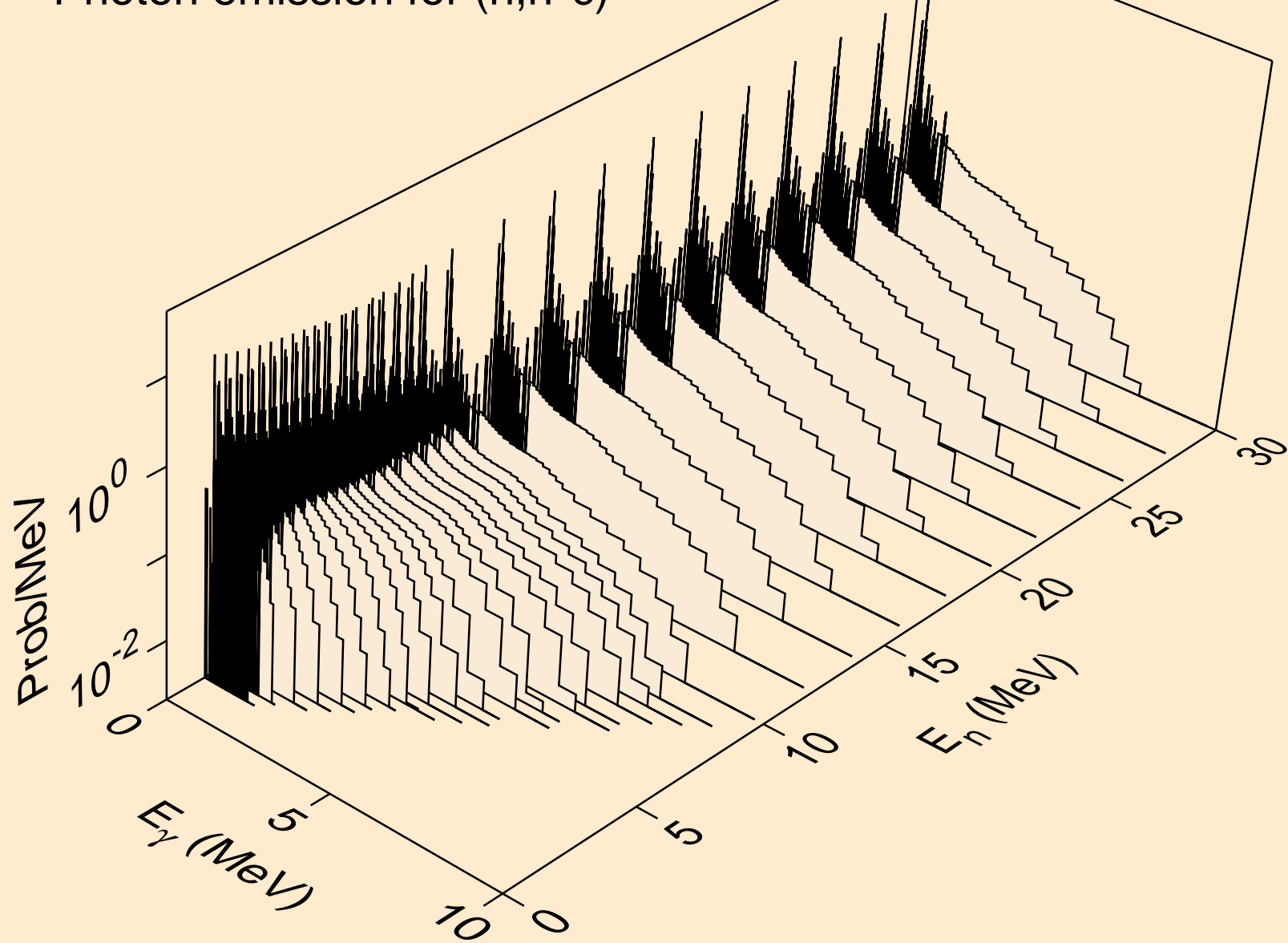

CU062 NEUTRON ACER TENDL-2023 LIBRARY; T=0.K  
Photon emission for (n,gma)

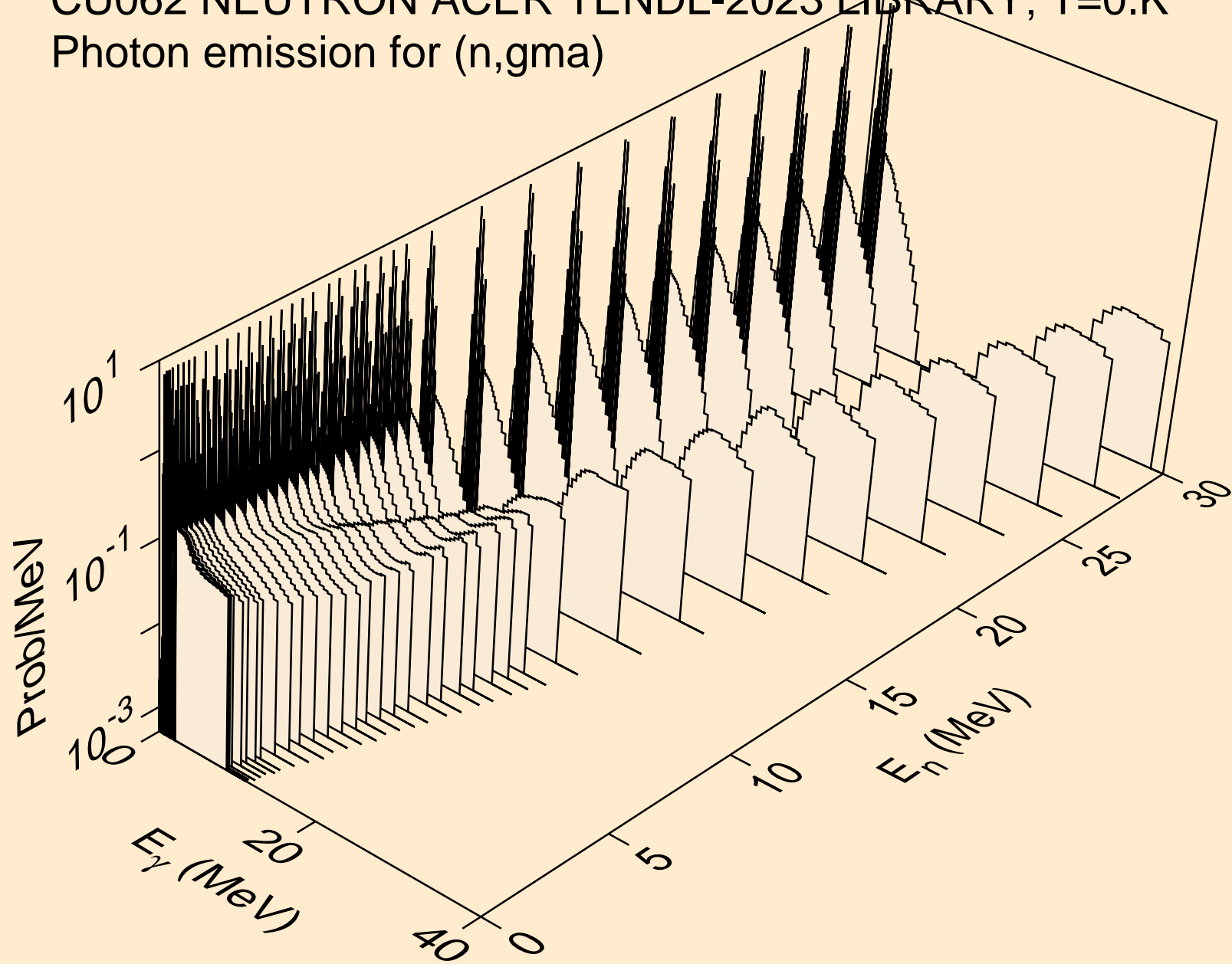

CU062 NEUTRON ACER TENDL-2023 LIBRARY; T=0.K  
Photon emission for (n,p)

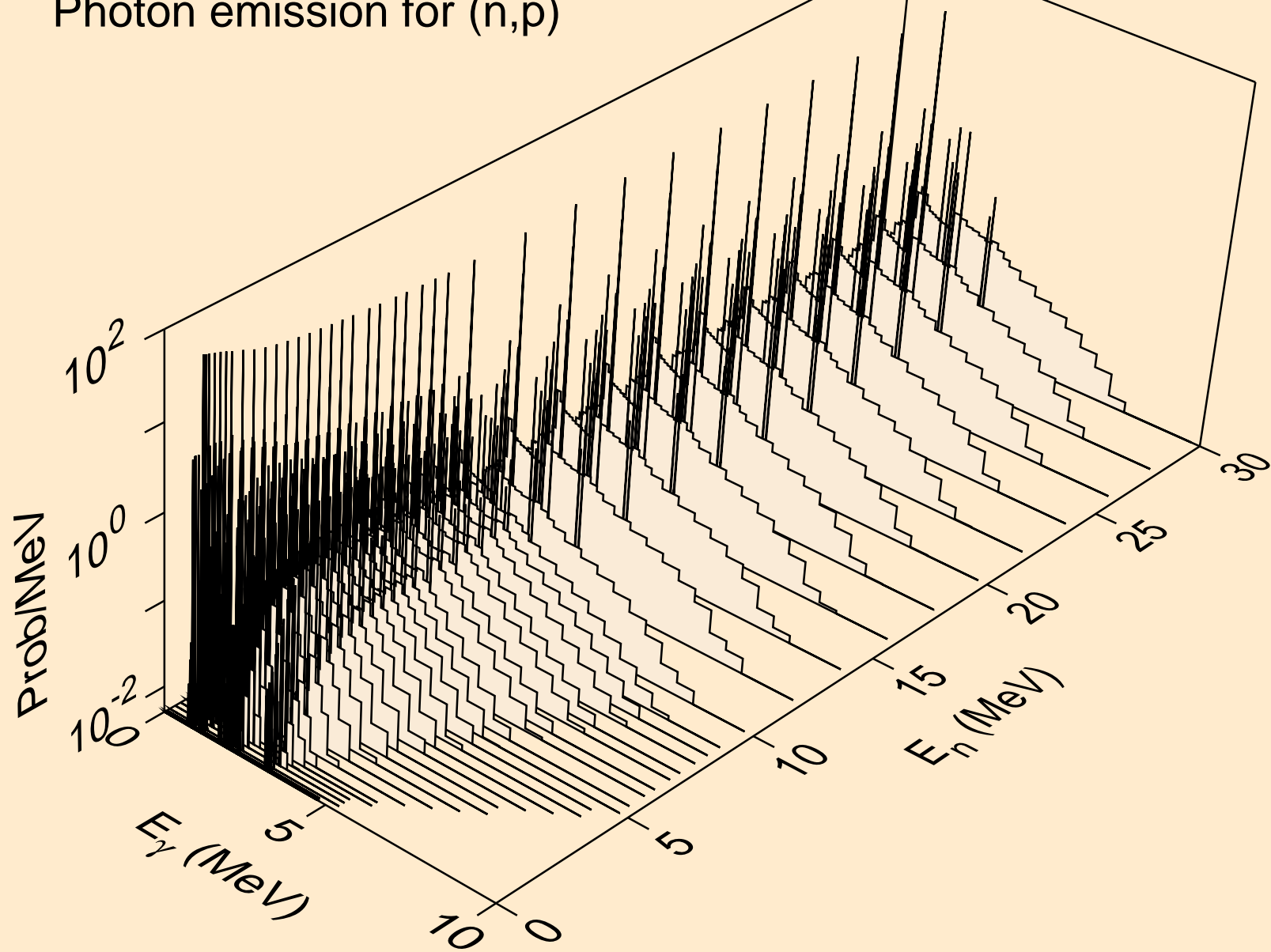



CU062 NEUTRON ACER TENDL-2023 LIBRARY; T=0.K  
Photon emission for (n,d)

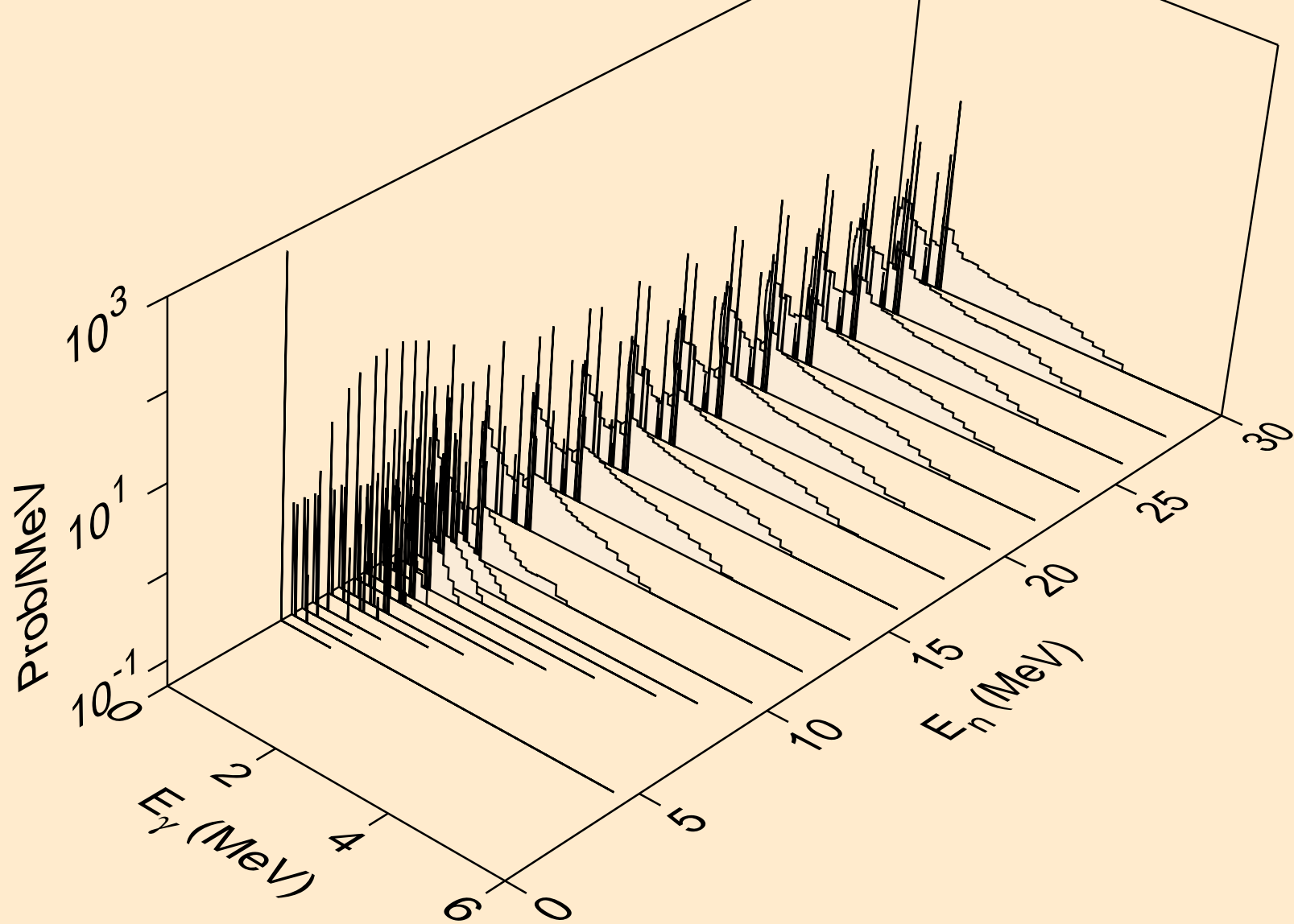

CU062 NEUTRON ACER TENDL-2023 LIBRARY; T=0.K  
Photon emission for (n,t)

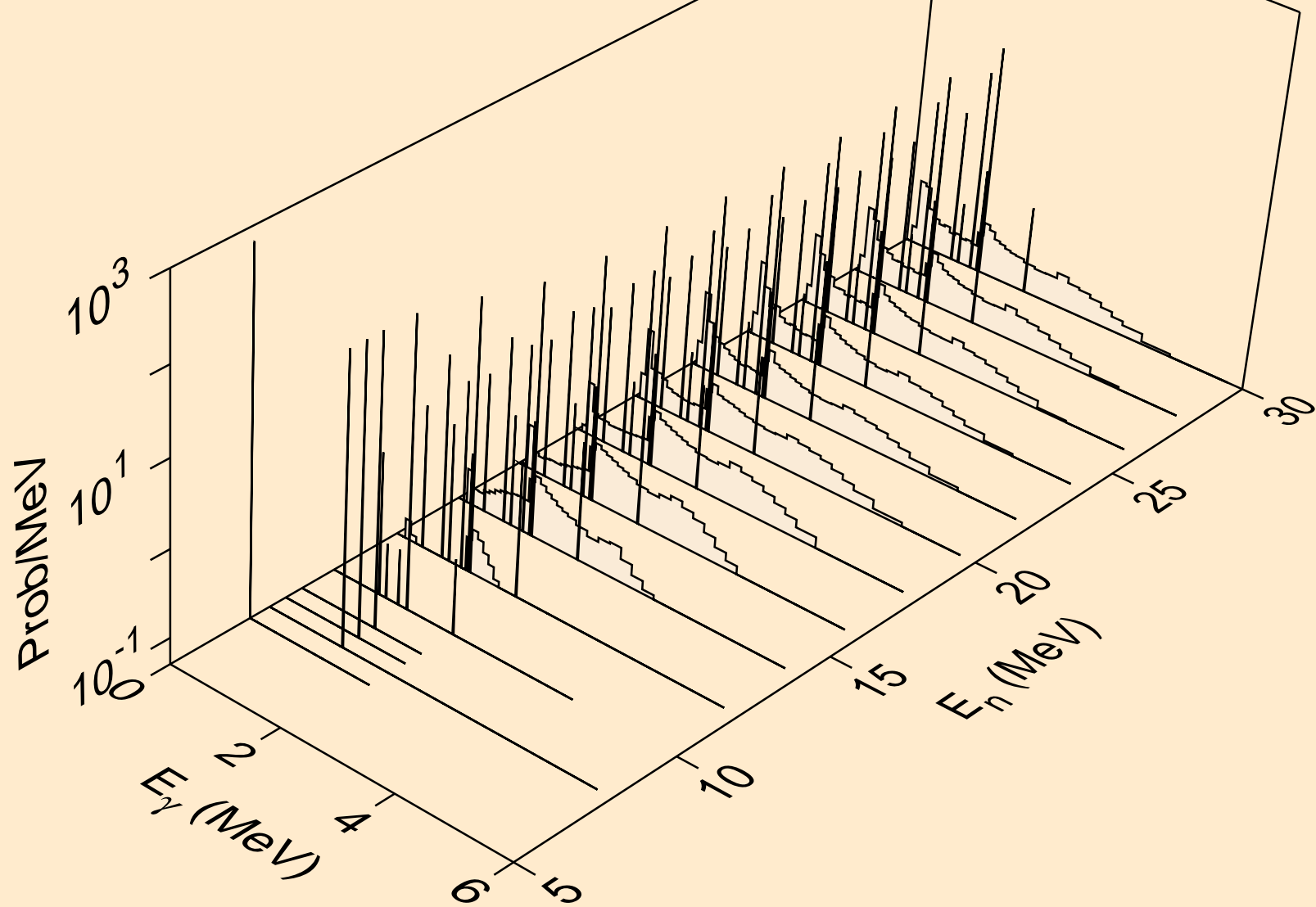

CU062 NEUTRON ACER TENDL-2023 LIBRARY; T=0.K  
Photon emission for (n,he3)

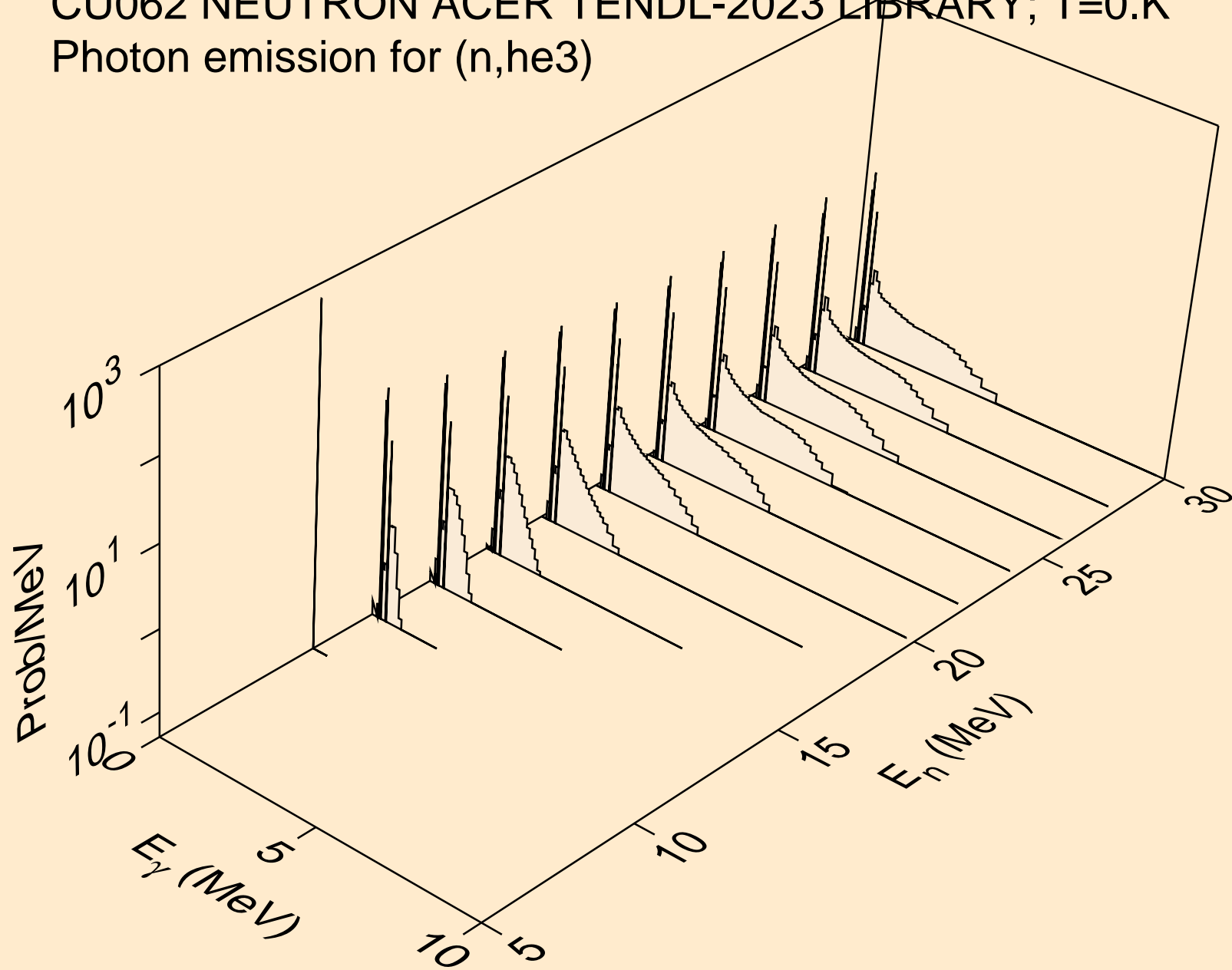

CU062 NEUTRON ACER TENDL-2023 LIBRARY; T=0.K  
Photon emission for (n,a)

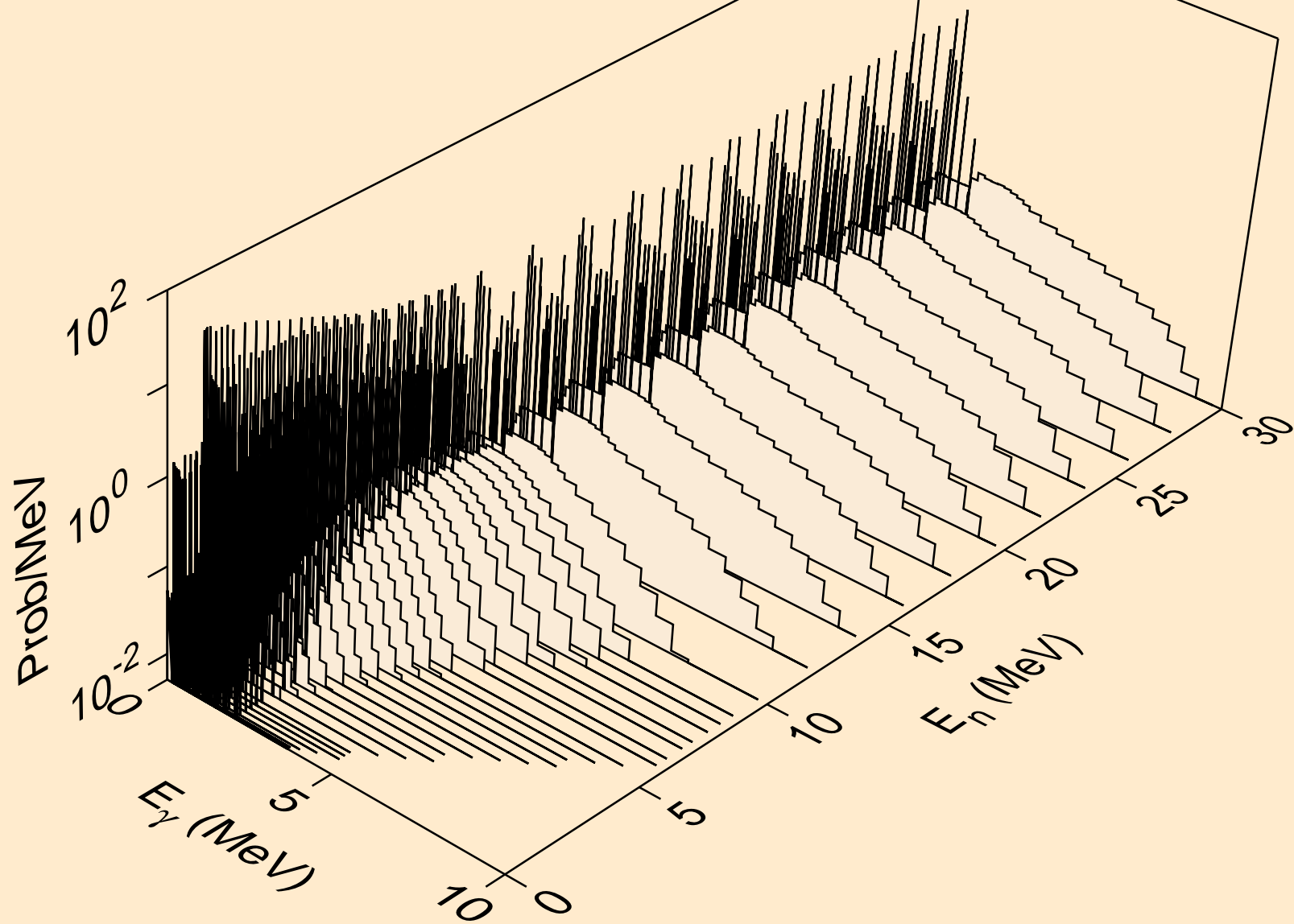

CU062 NEUTRON ACER TENDL-2023 LIBRARY; T=0.K  
Photon emission for (n,2a)

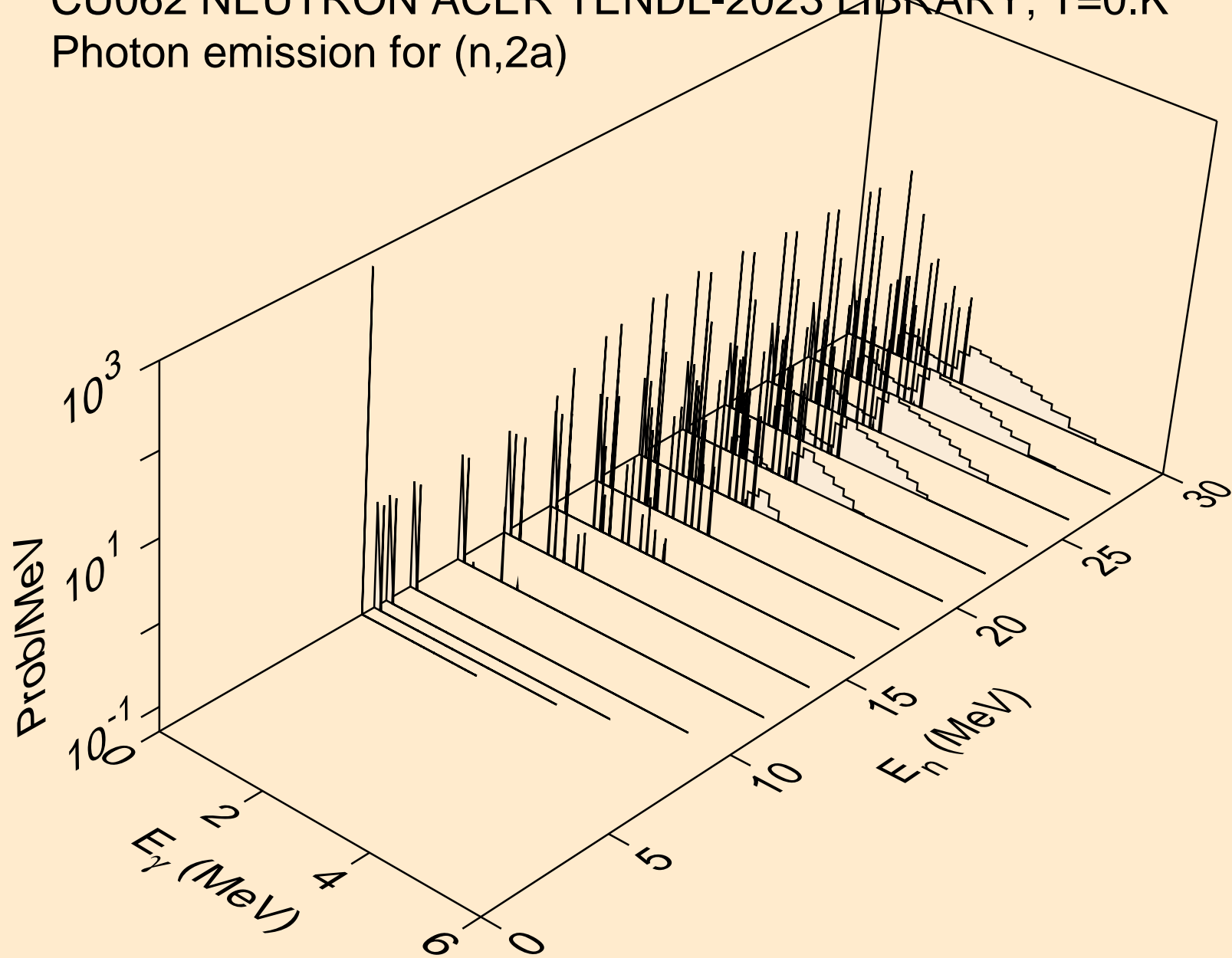

CU062 NEUTRON ACER TENDL-2023 LIBRARY; T=0.K  
Photon emission for (n,2p)

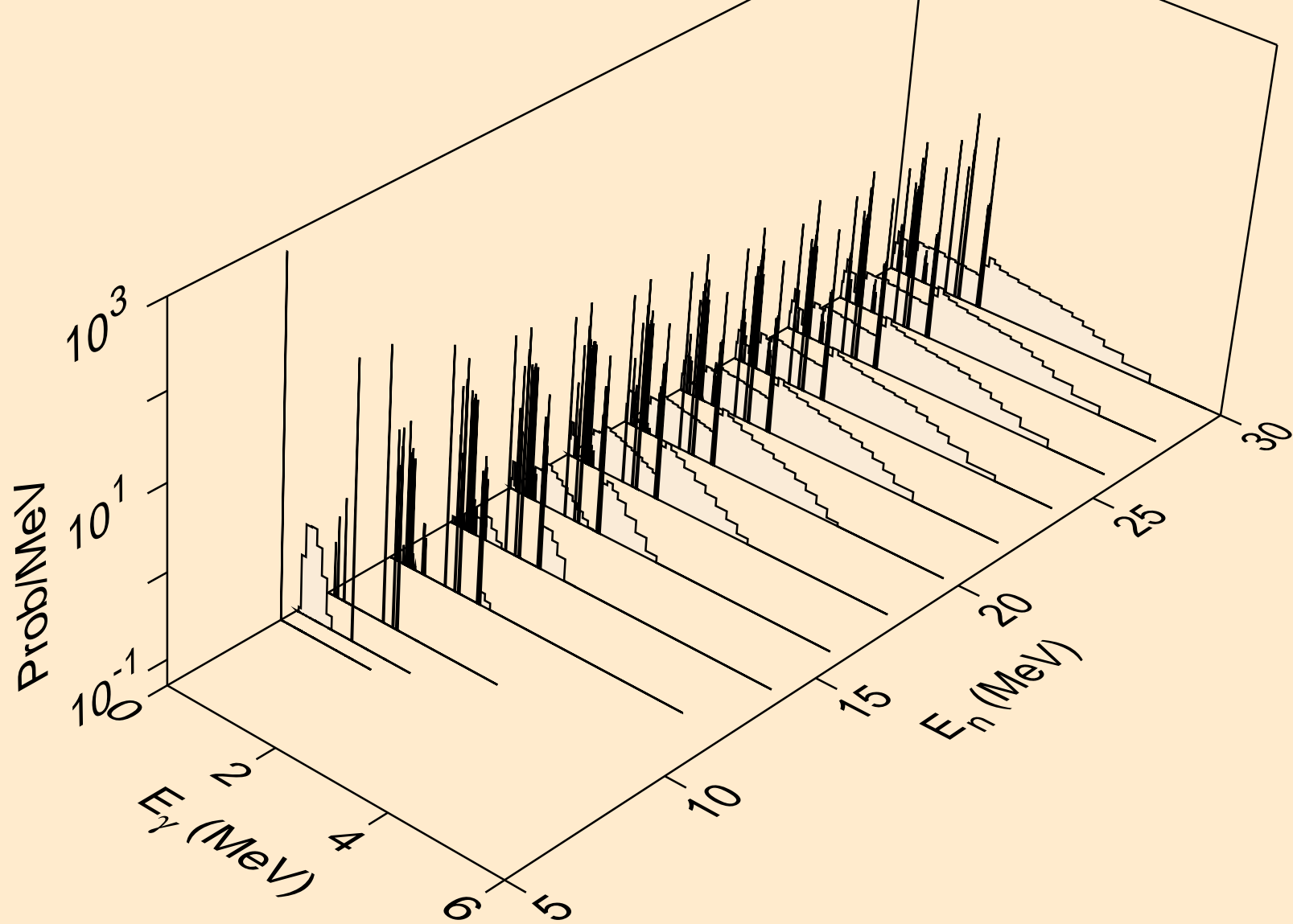

CU062 NEUTRON ACER TENDL-2023 LIBRARY; T=0.K  
Photon emission for (n,p $\alpha$ )

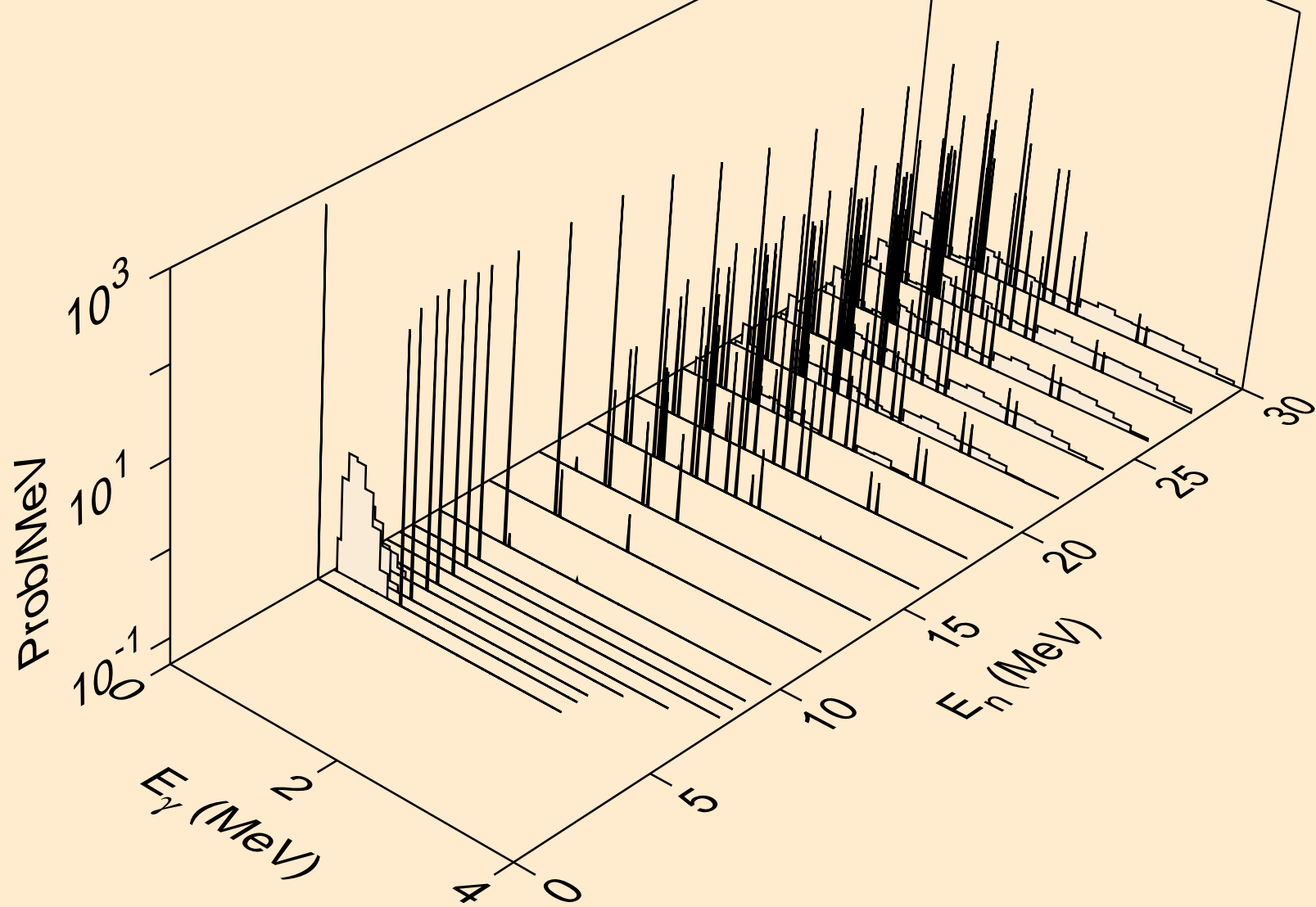

CU062 NEUTRON ACER TENDL-2023 LIBRARY; T=0.K  
Photon emission for (n,pd)

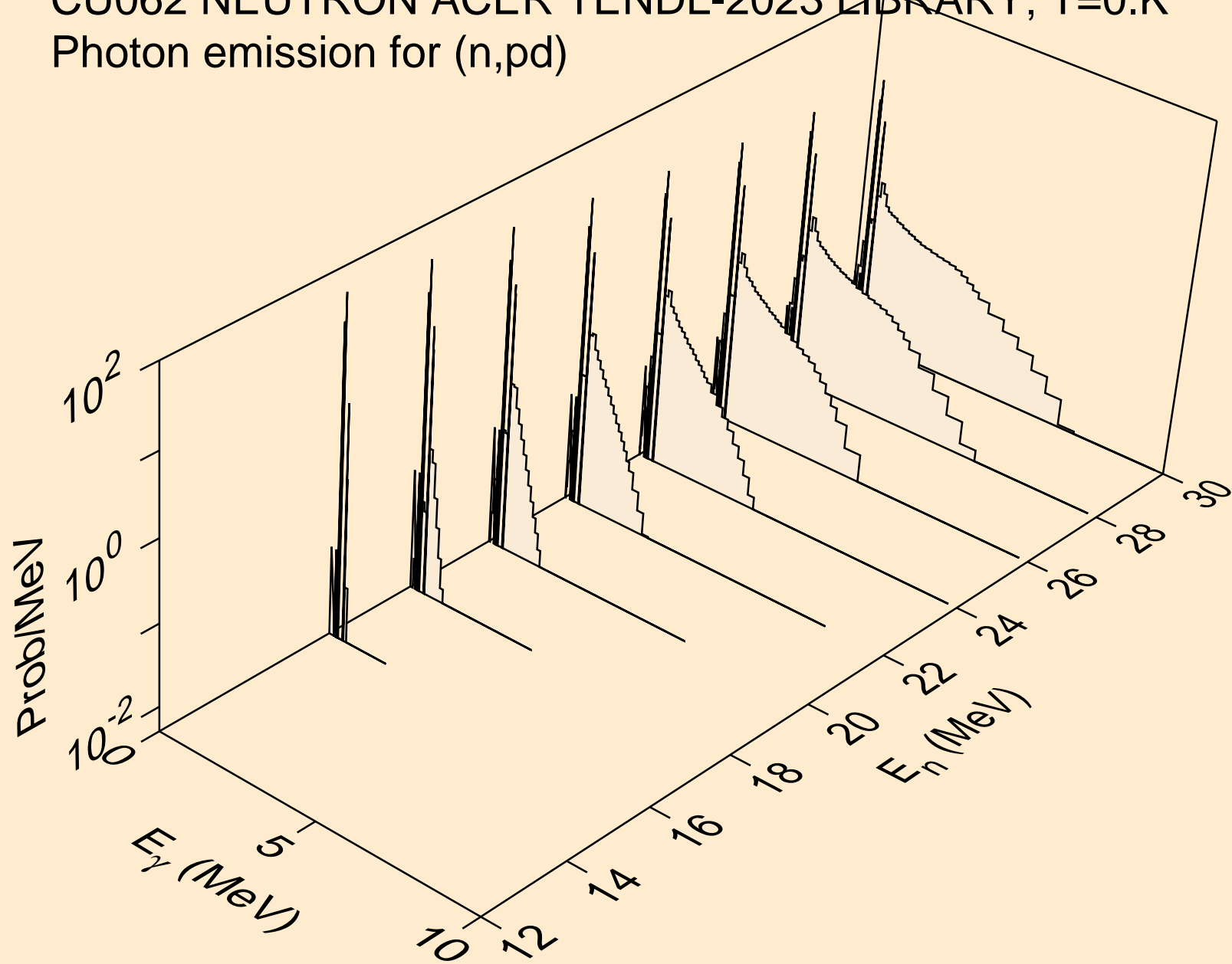



CU062 NEUTRON ACER TENDL-2023 LIBRARY; T=0.K  
Photon emission for (n,pt)

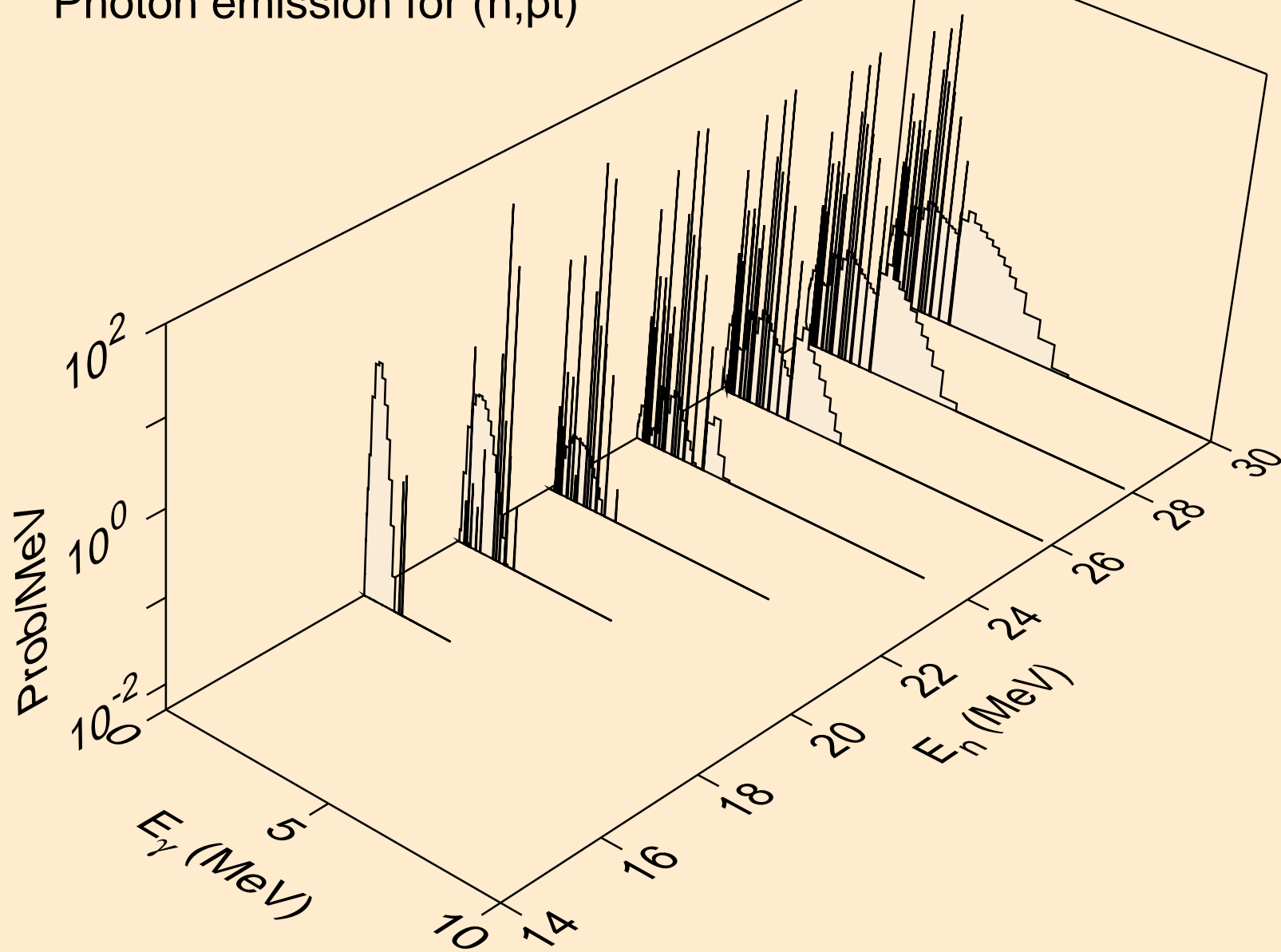

CU062 NEUTRON ACER TENDL-2023 LIBRARY; T=0.K  
Photon emission for (n,da)

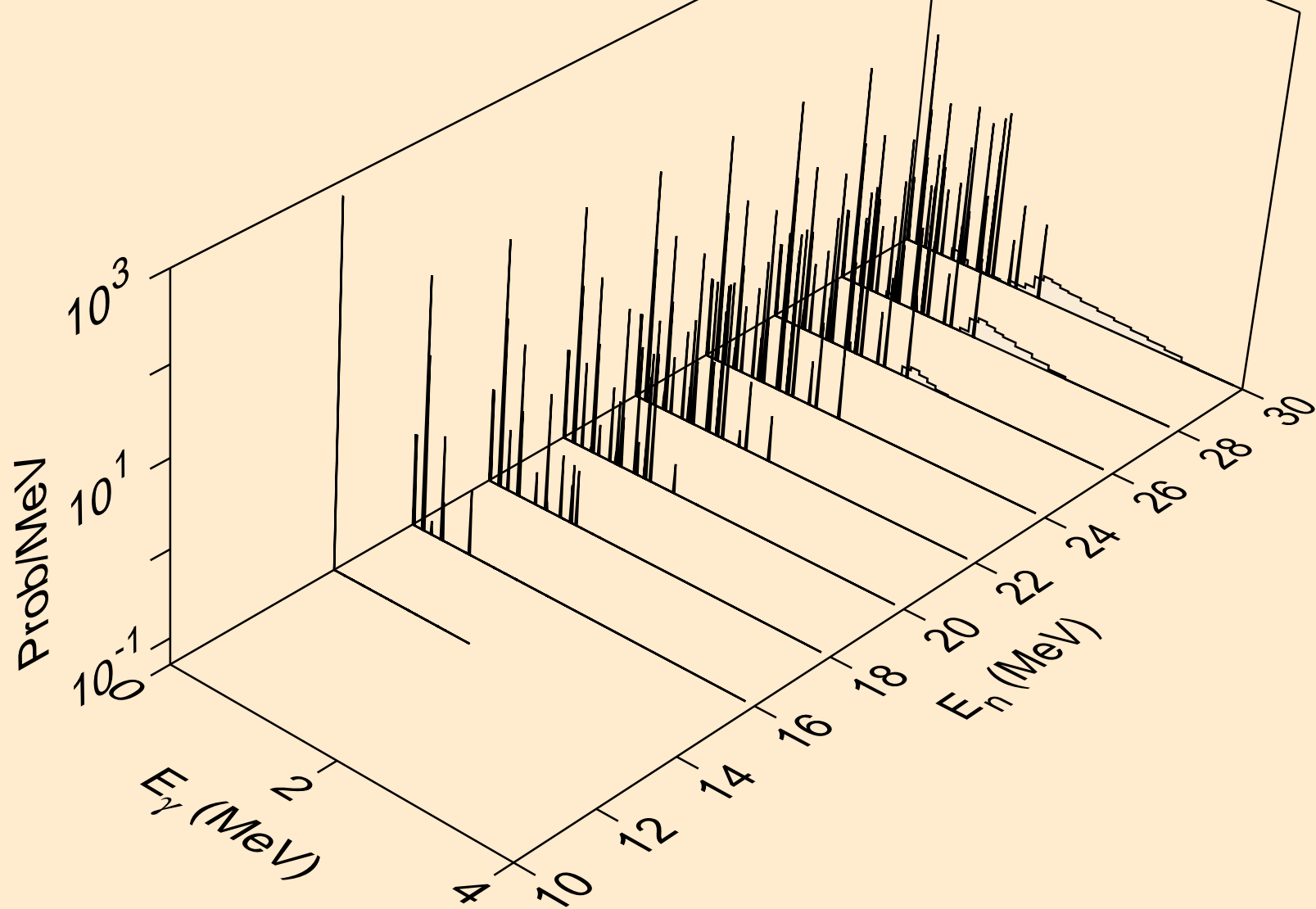

CU062 NEUTRON ACER TENDL-2023 LIBRARY; T=0.K  
thermal capture photon spectrum

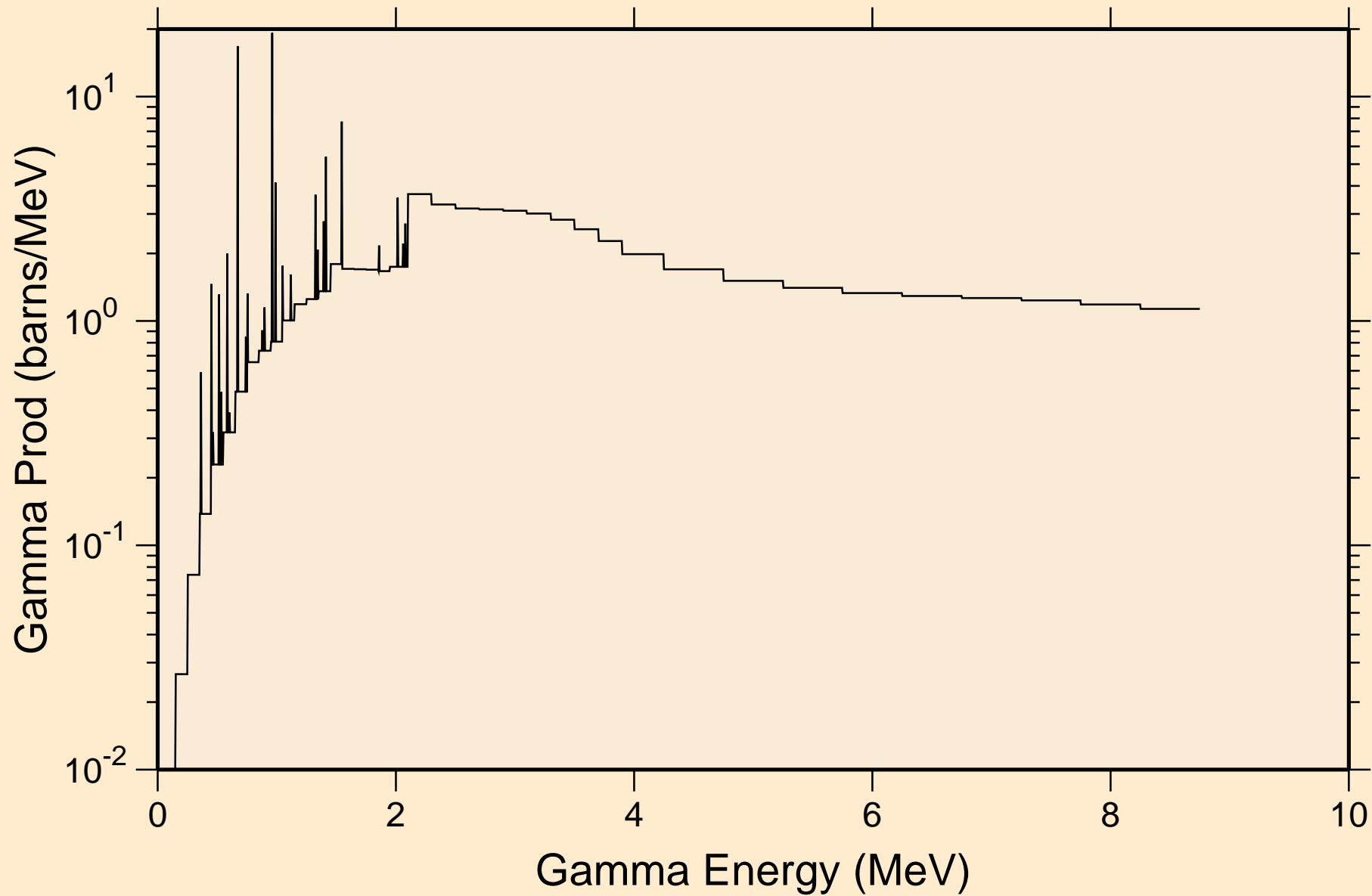

CU062 NEUTRON ACER TENDL-2023 LIBRARY; T=0.K  
14 MeV photon spectrum

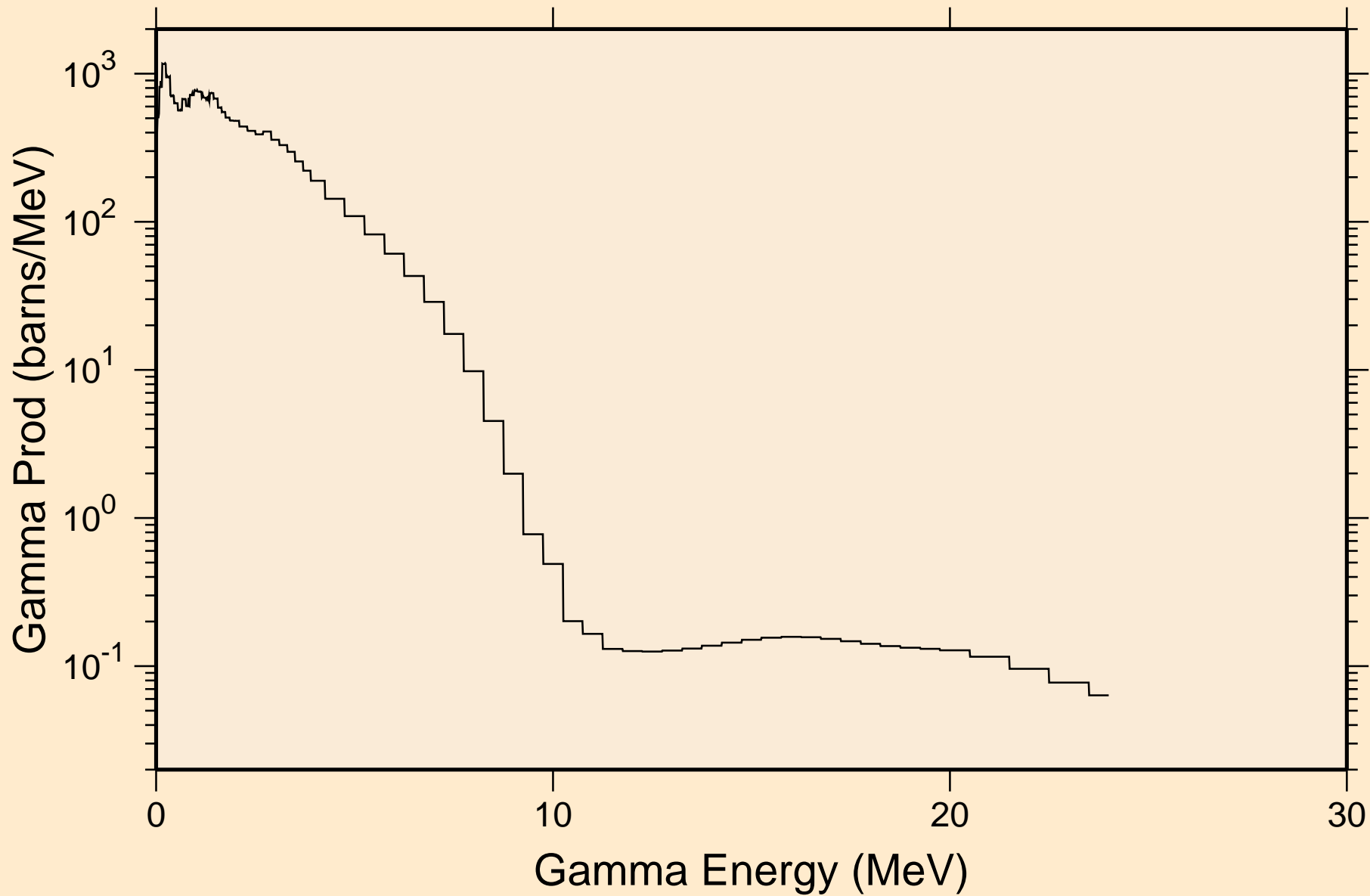

# CU062 NEUTRON ACER TENDL-2023 LIBRARY; T=0.K

## Particle heating contributions

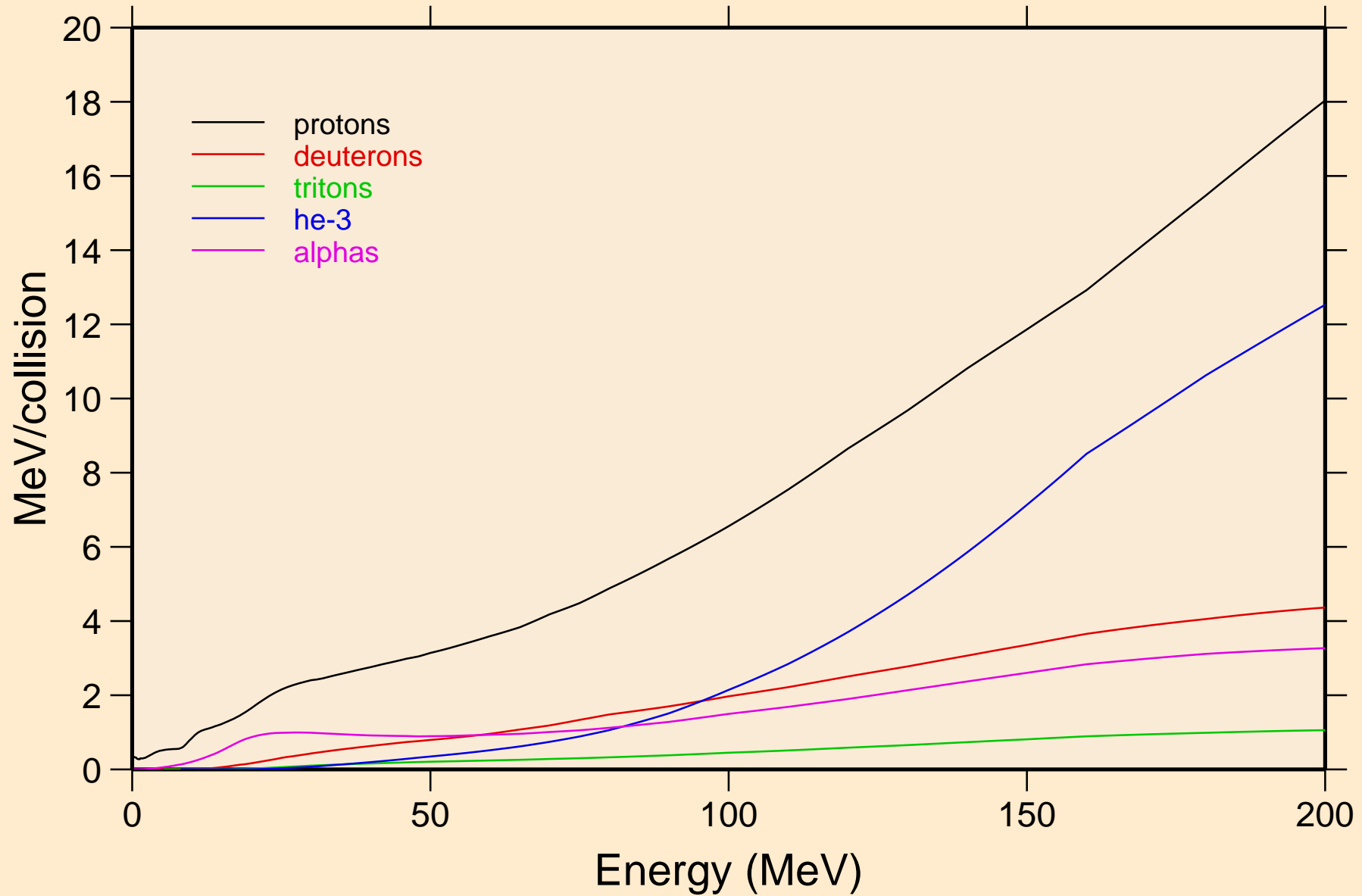

CU062 NEUTRON ACER TENDL-2023 LIBRARY; T=0.K  
Recoil Heating

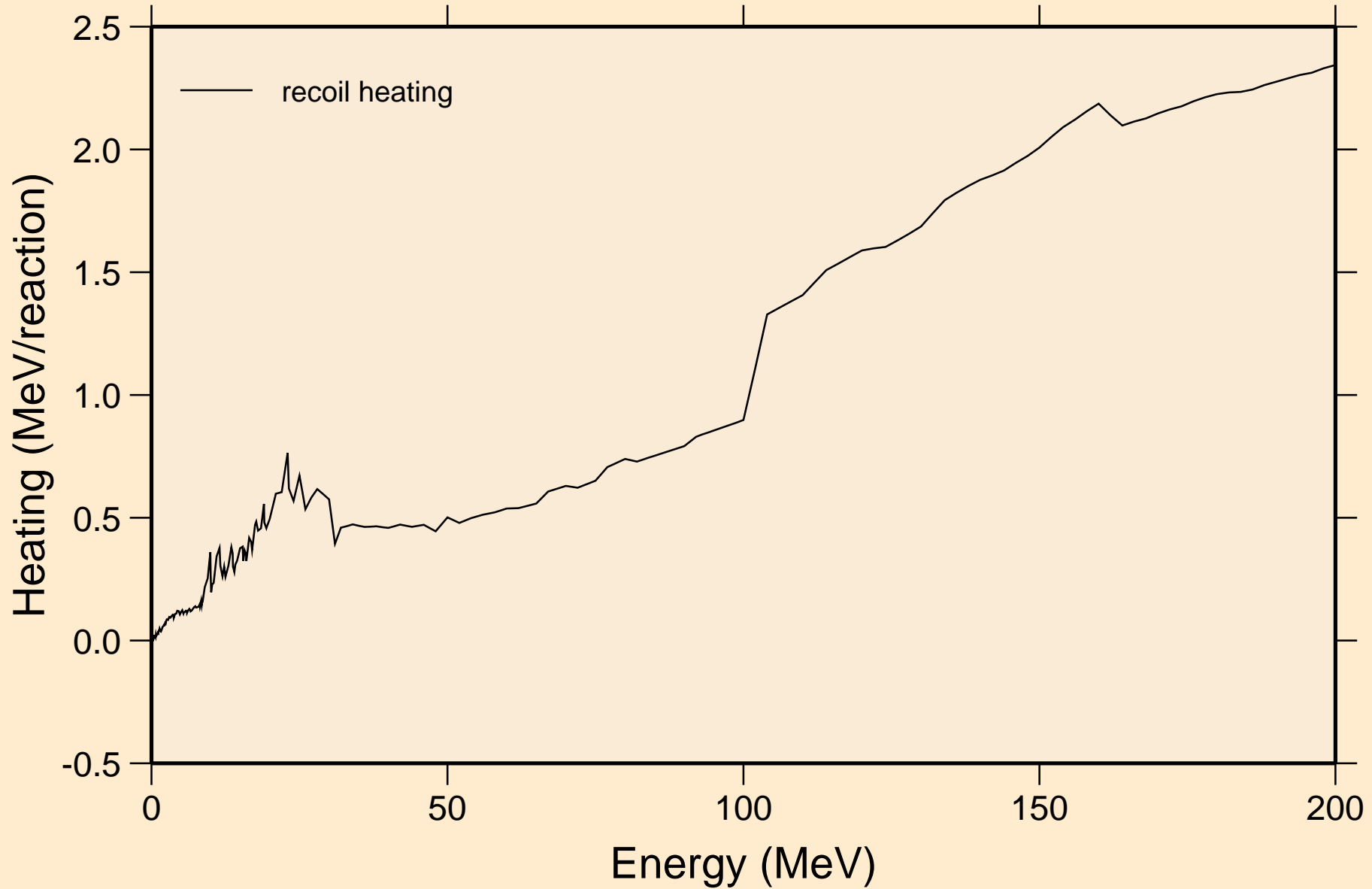

# CU062 NEUTRON ACER TENDL-2023 LIBRARY; T=0.K

## Particle production cross sections

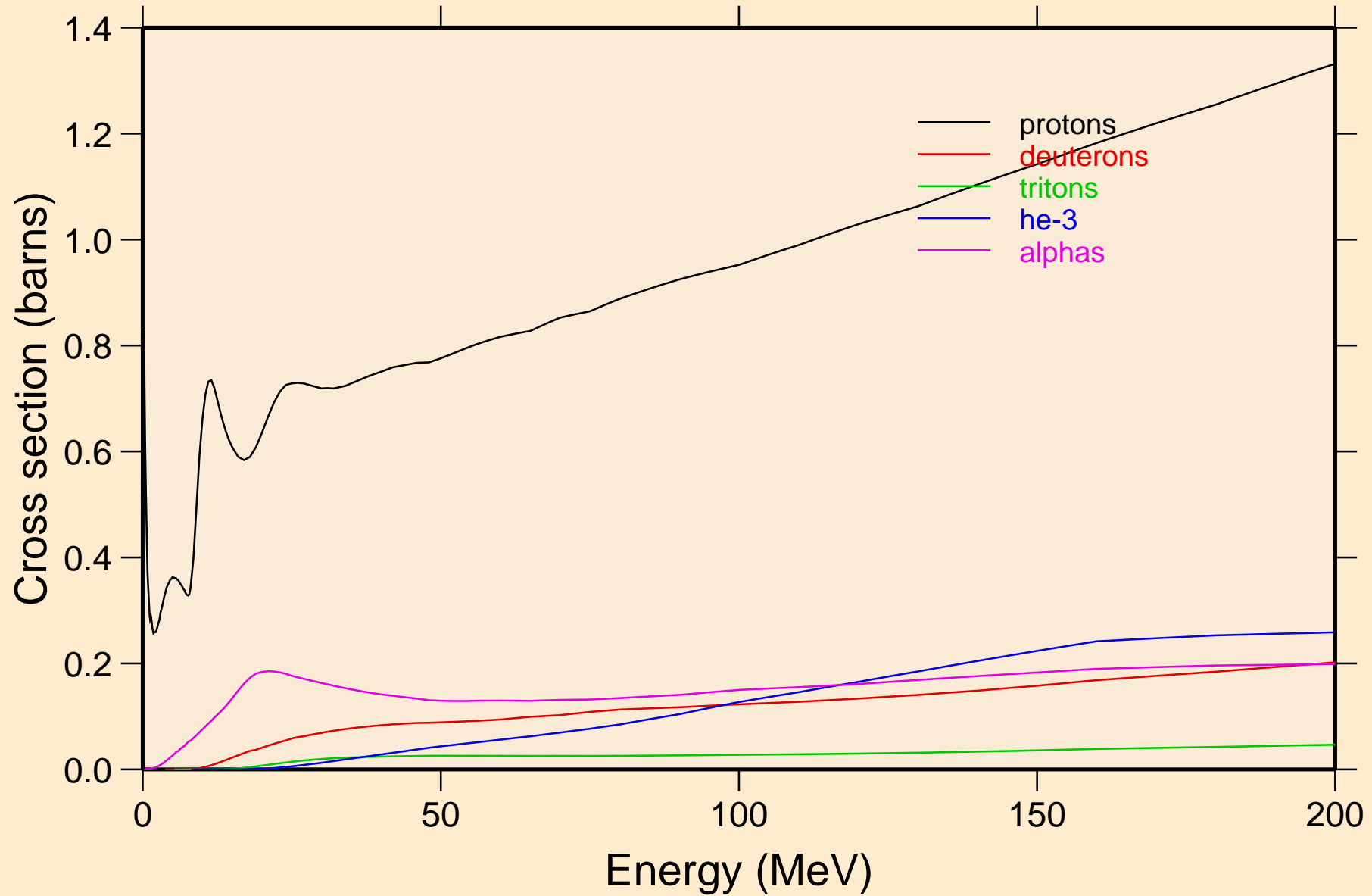

CU062 NEUTRON ACER TENDL-2023 LIBRARY; T=0.K  
protons from (n,x)

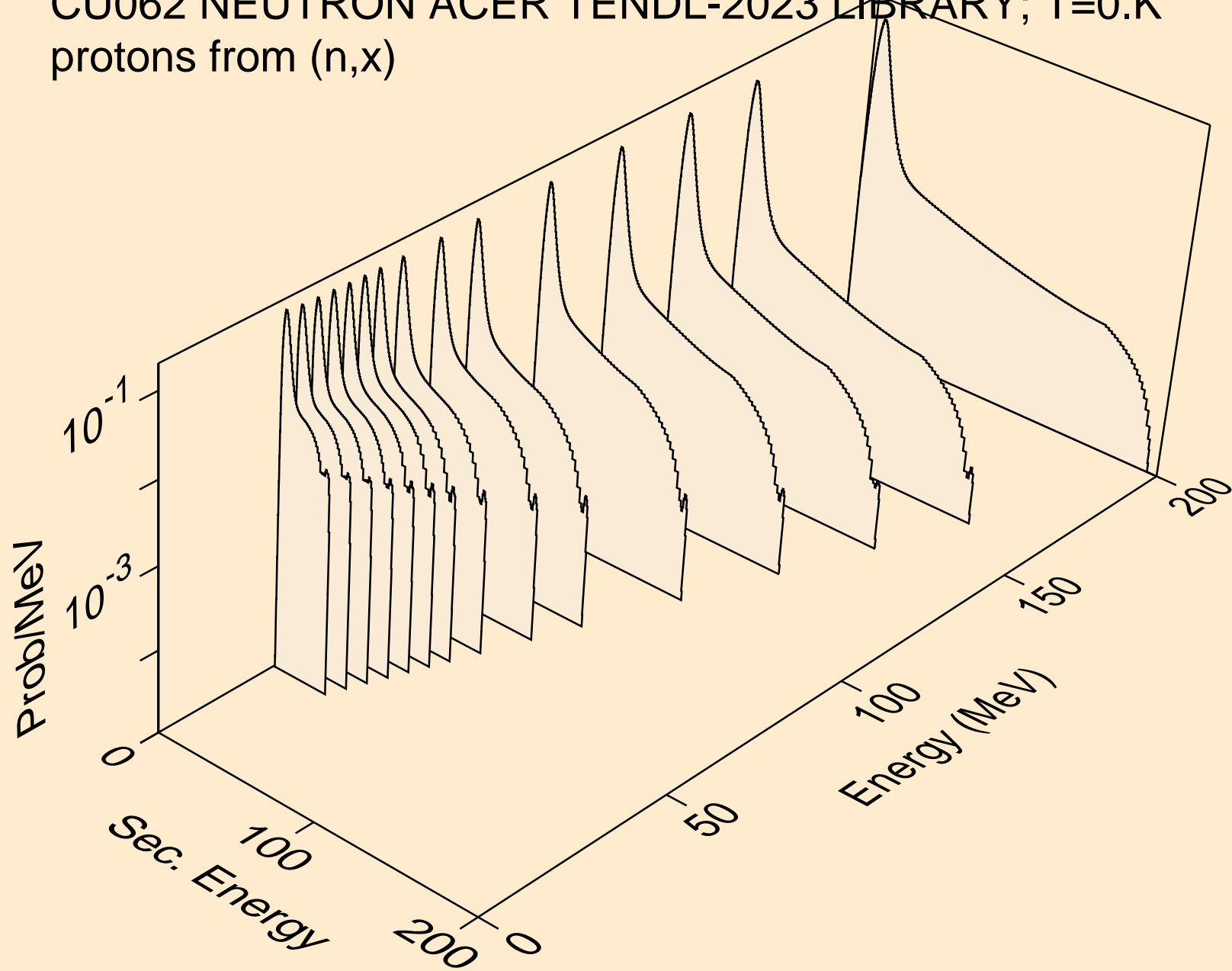



CU062 NEUTRON ACER TENDL-2023 LIBRARY; T=0.K  
protons from (n,n\*)p

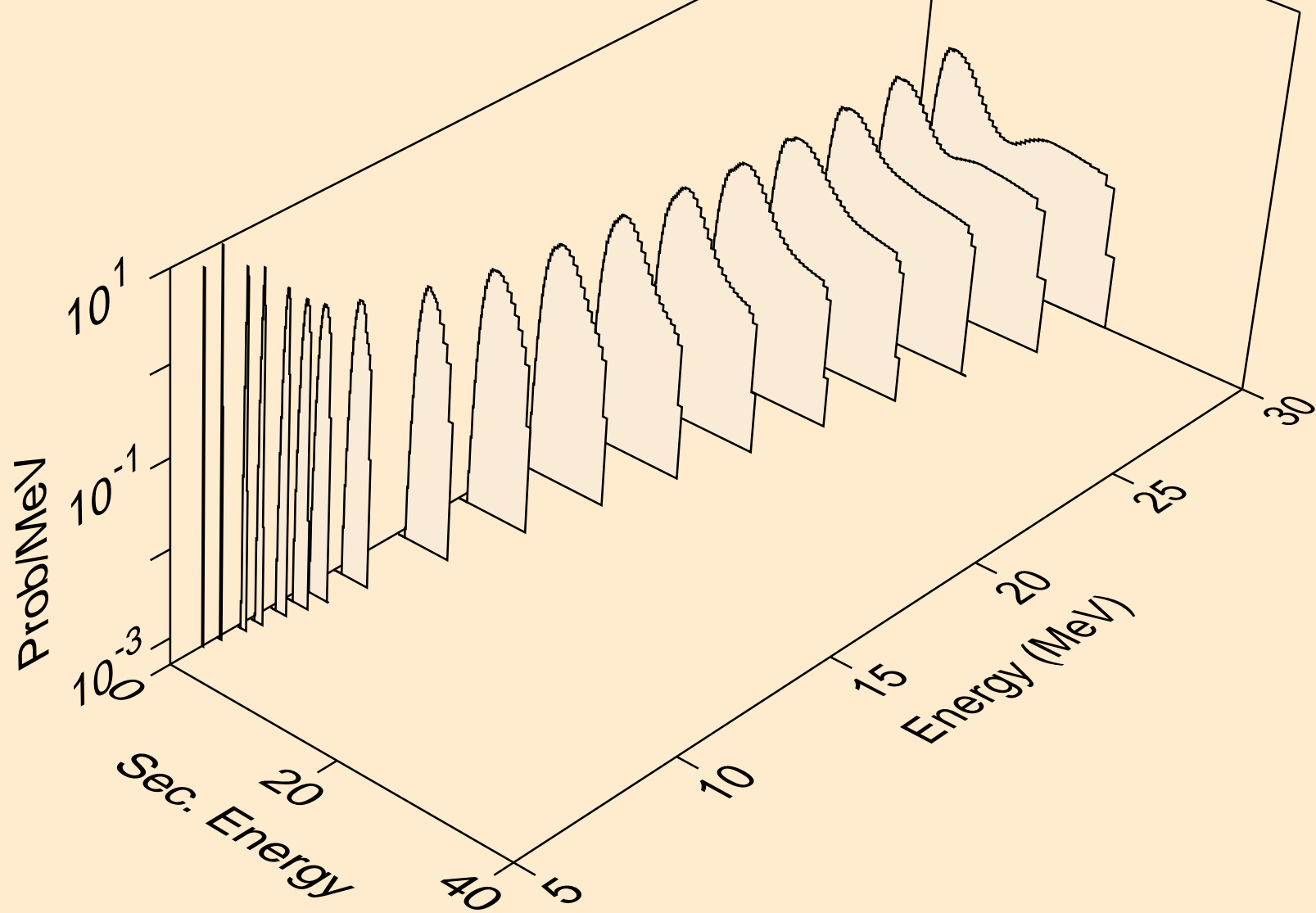

CU062 NEUTRON ACER TENDL-2023 LIBRARY; T=0.K  
protons from (n,2np)

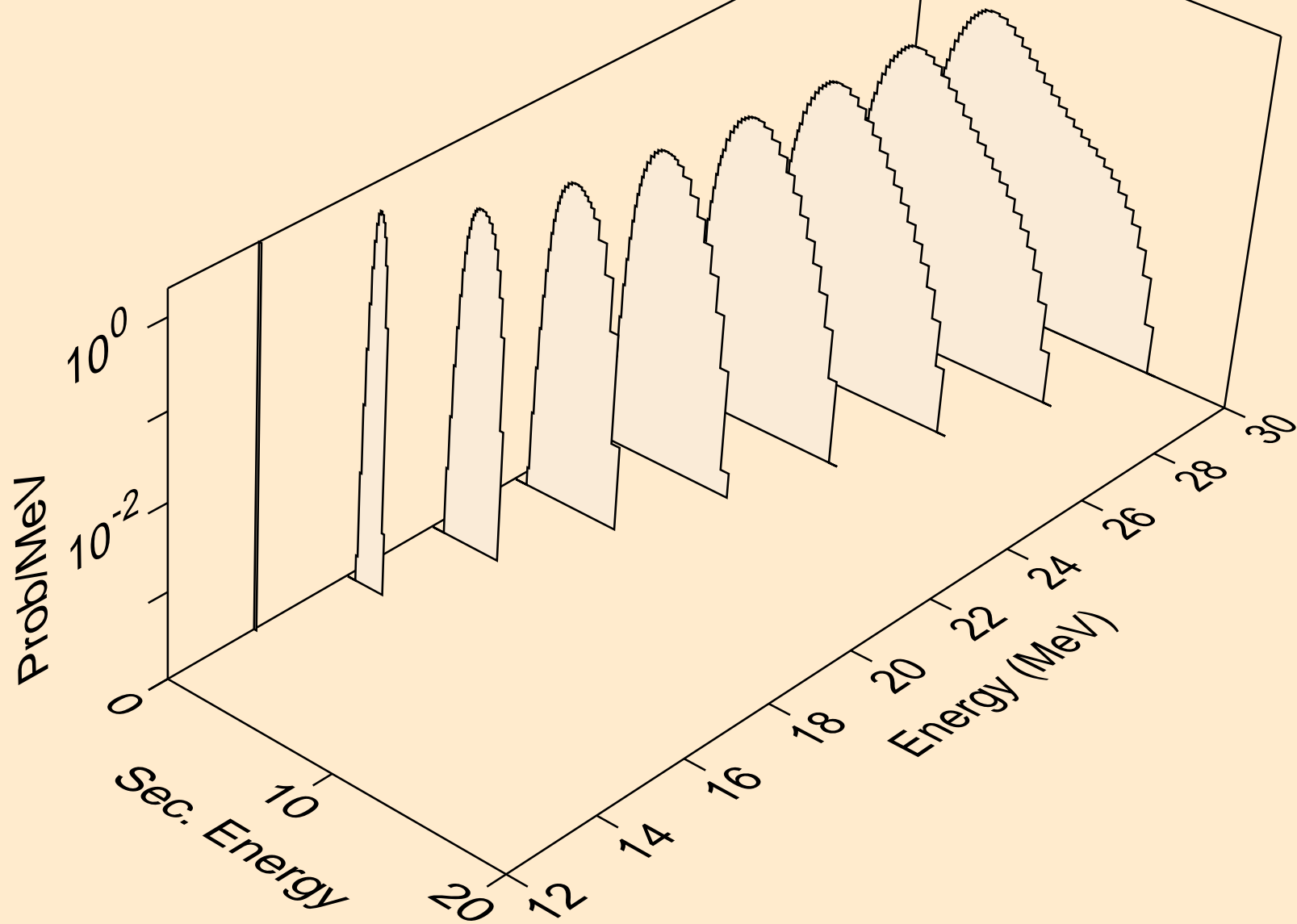

CU062 NEUTRON ACER TENDL-2023 LIBRARY; T=0.K  
protons from (n,3np)

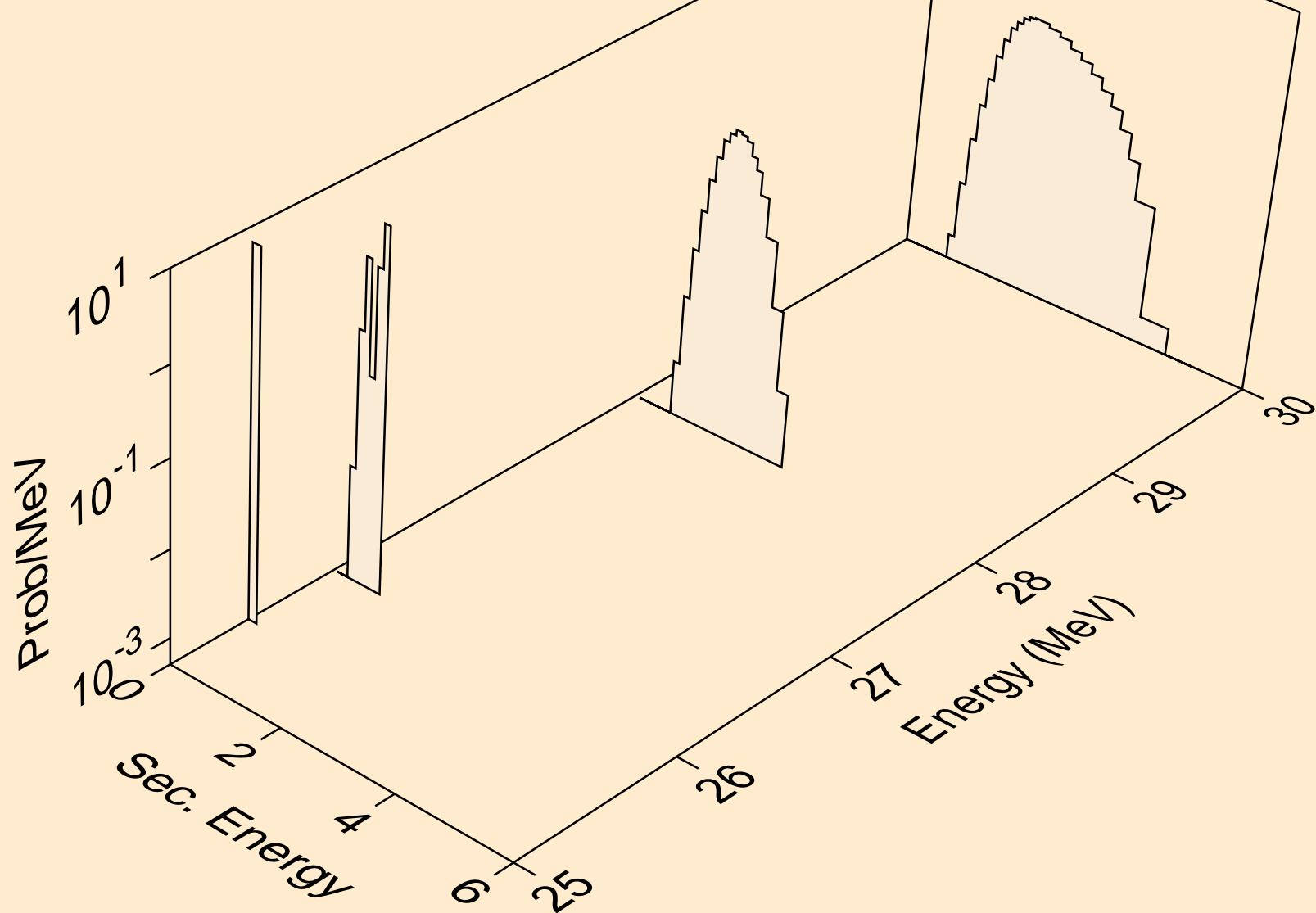

CU062 NEUTRON ACER TENDL-2023 LIBRARY; T=0.K  
protons from (n,n2p)

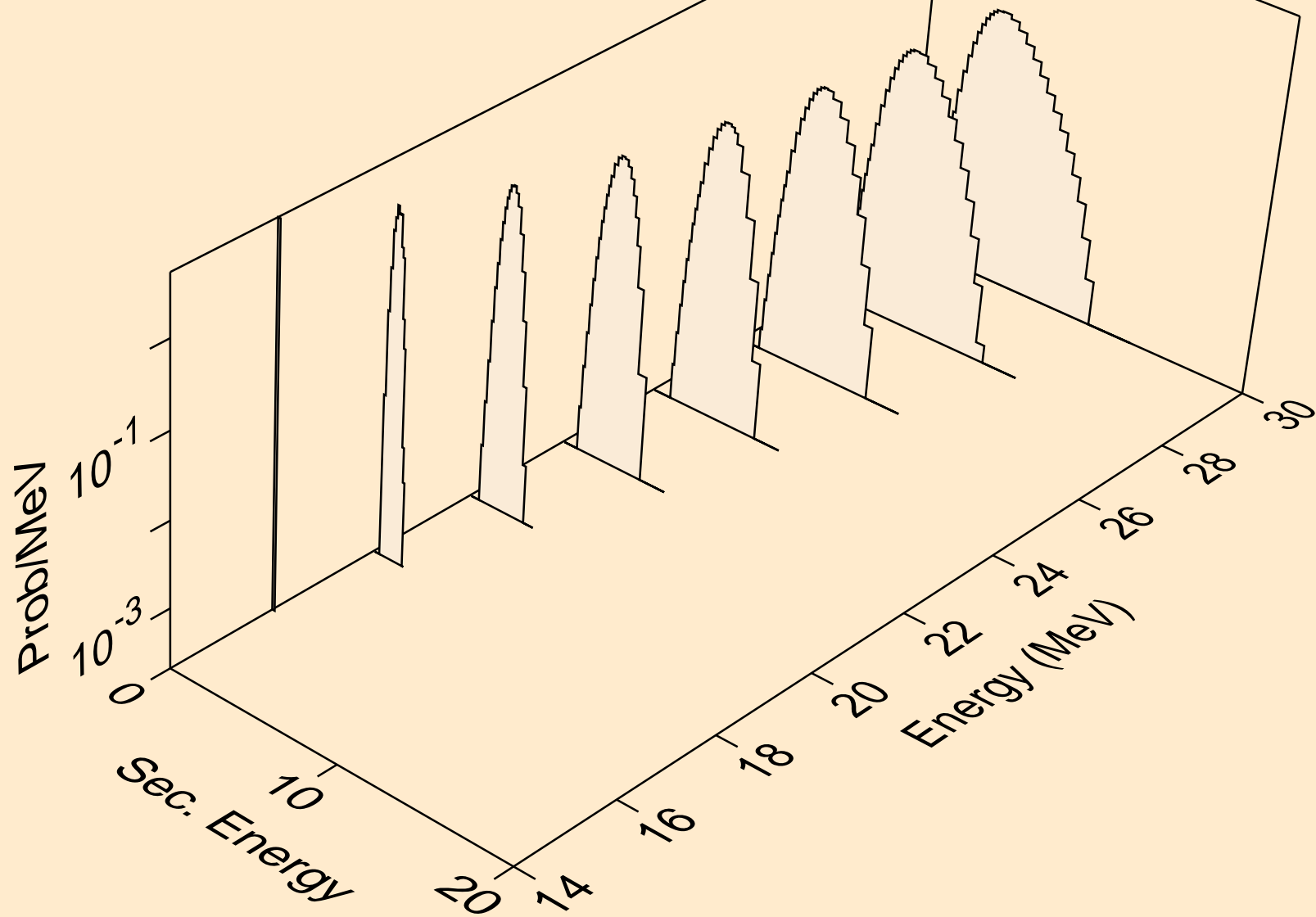

CU062 NEUTRON ACER TENDL-2023 LIBRARY; T=0.K  
protons from (n,npa)

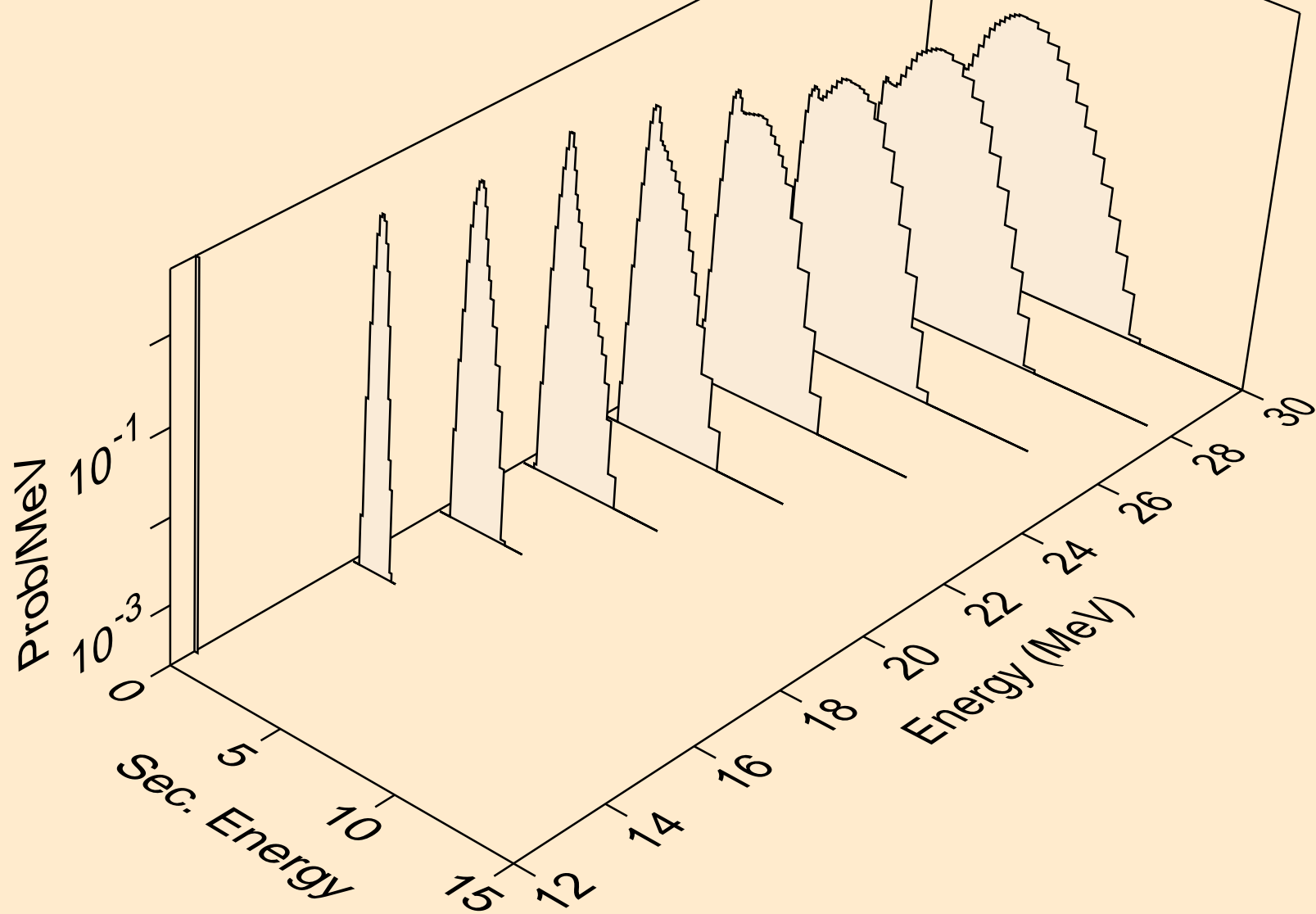

CU062 NEUTRON ACER TENDL-2023 LIBRARY; T=0.K  
protons from (n,p)

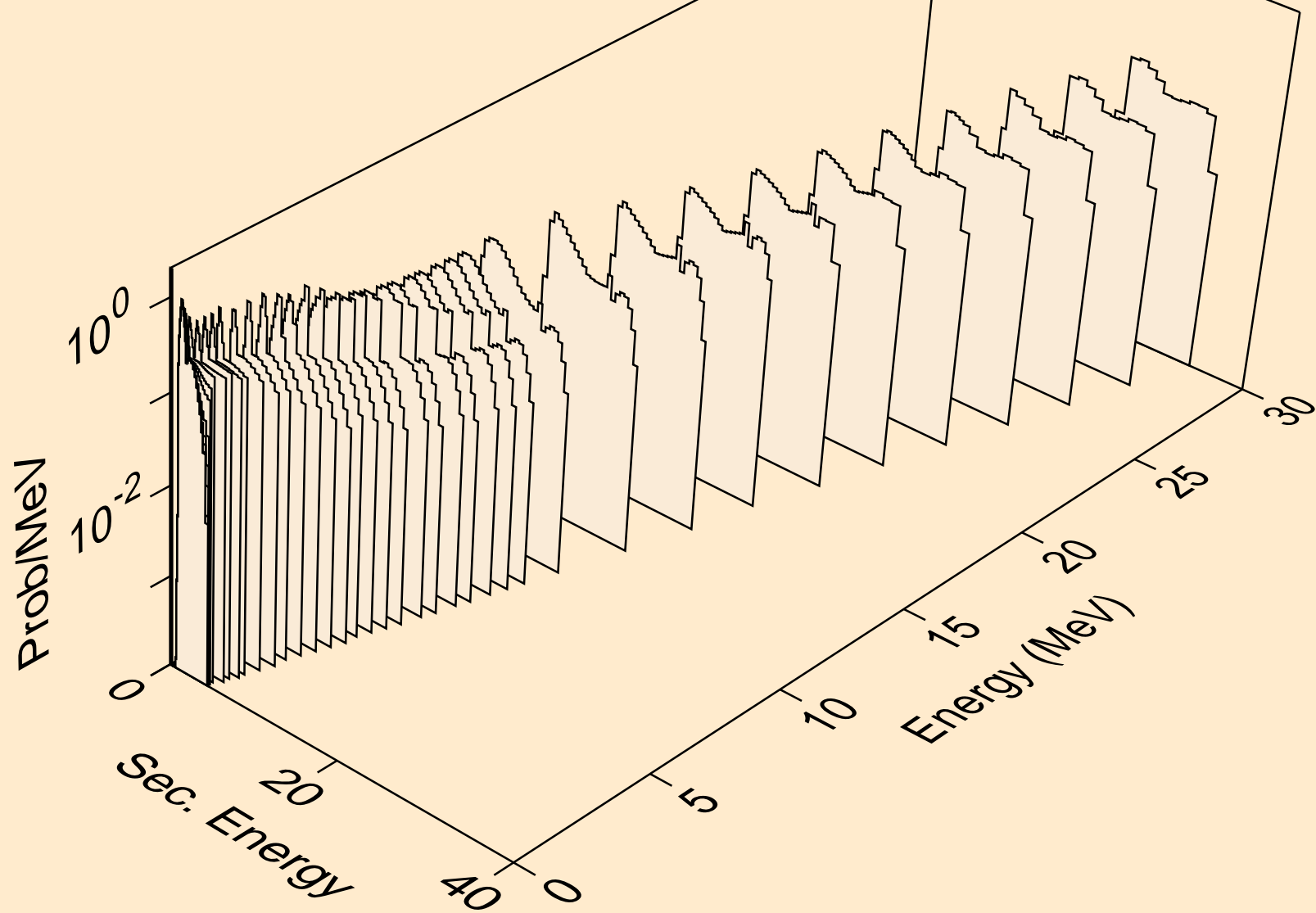

CU062 NEUTRON ACER TENDL-2023 LIBRARY; T=0.K  
protons from (n,2p)

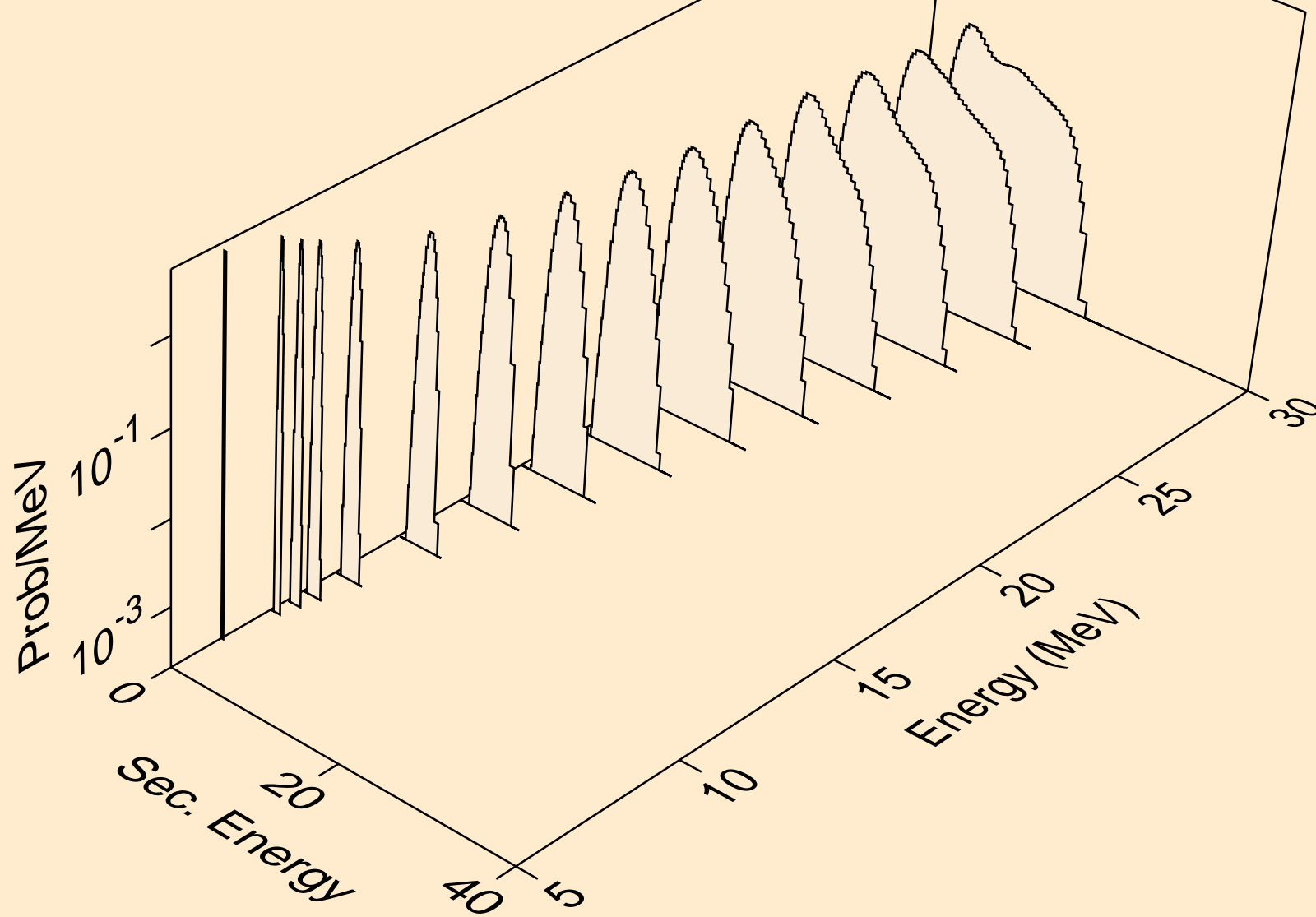

CU062 NEUTRON ACER TENDL-2023 LIBRARY; T=0.K  
protons from (n,p)

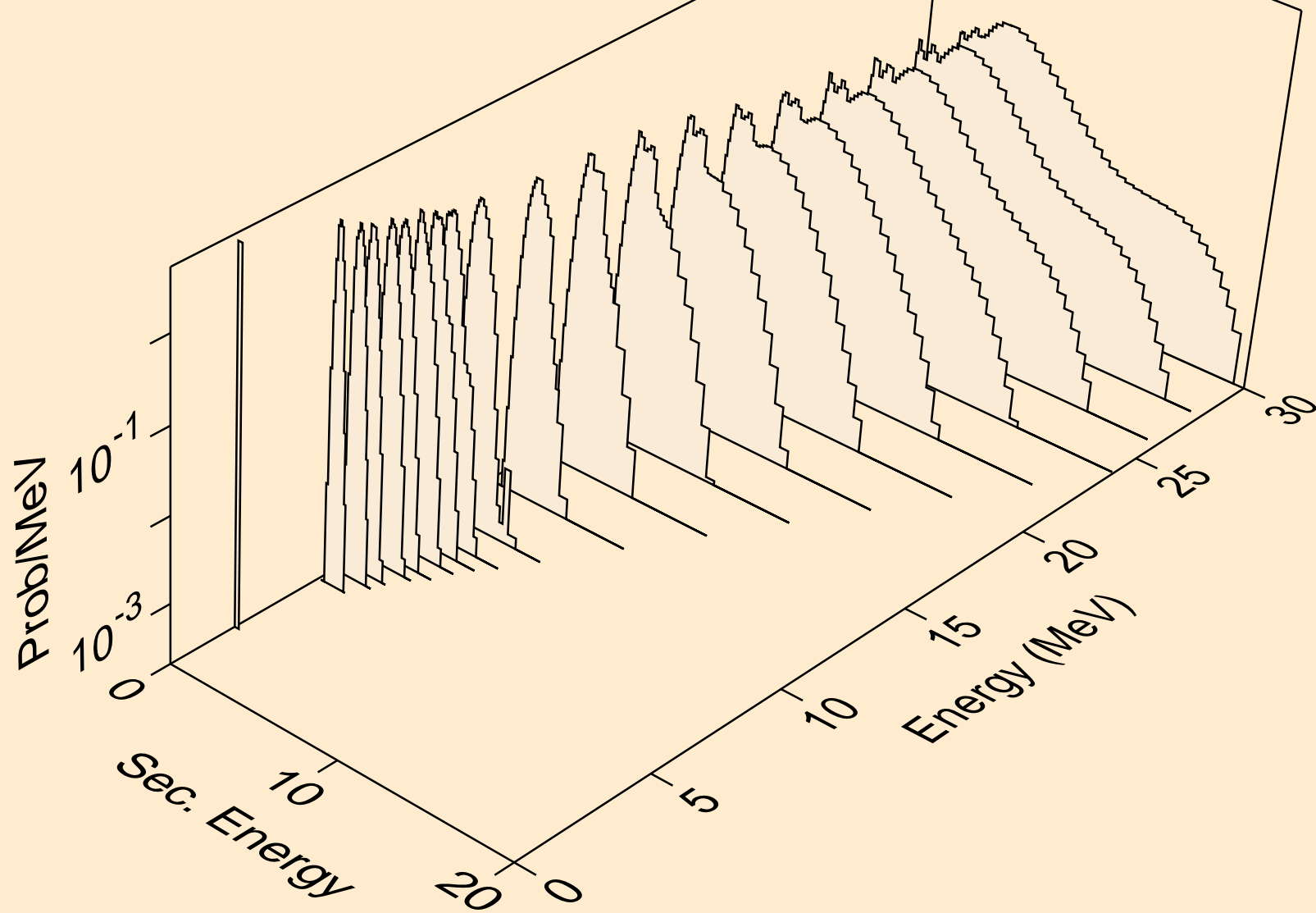



CU062 NEUTRON ACER TENDL-2023 LIBRARY; T=0.K  
protons from (n,pd)

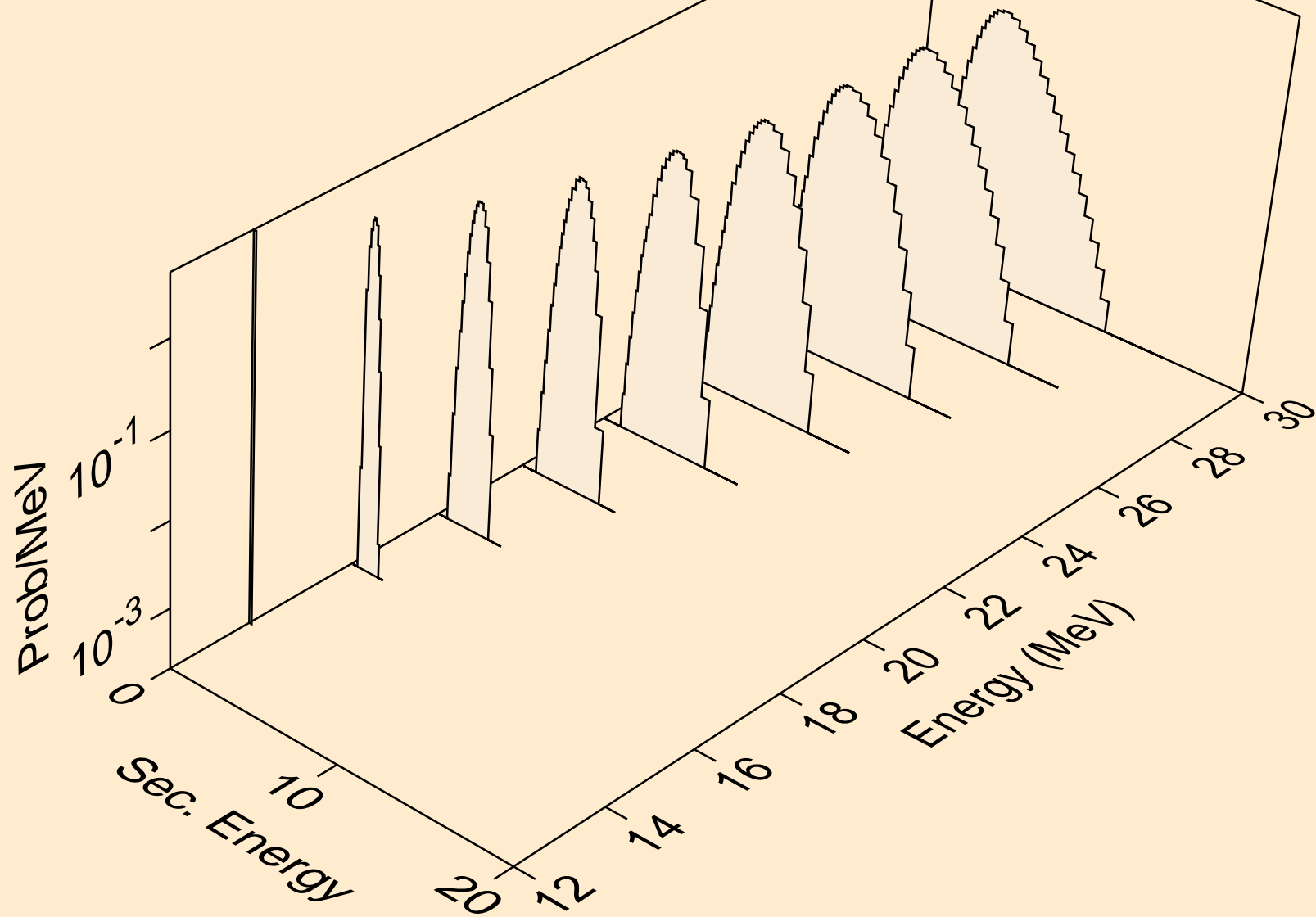

CU062 NEUTRON ACER TENDL-2023 LIBRARY; T=0.K  
protons from (n,pt)

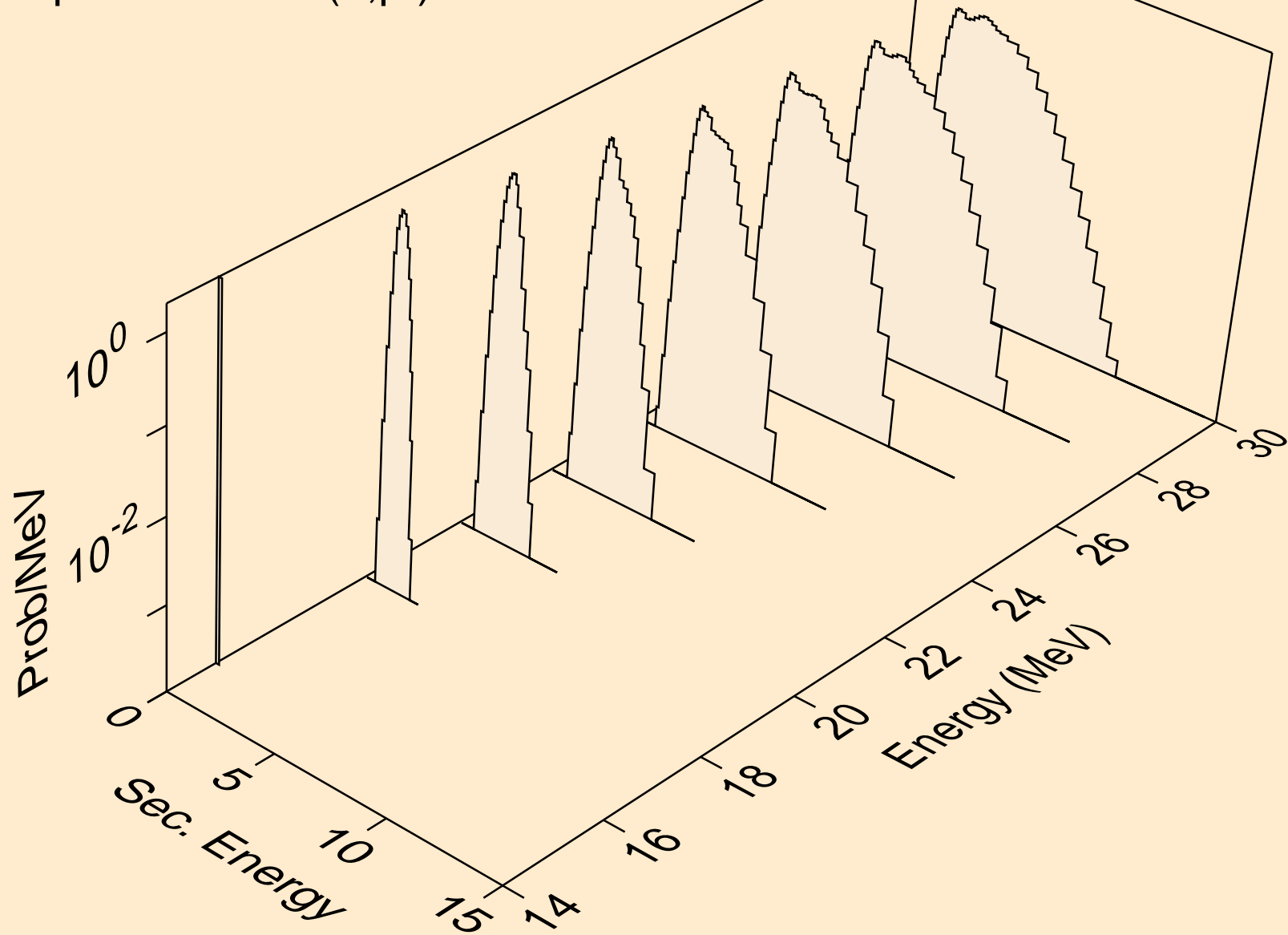

CU062 NEUTRON ACER TENDL-2023 LIBRARY; T=0.K  
deuterons from (n,x)

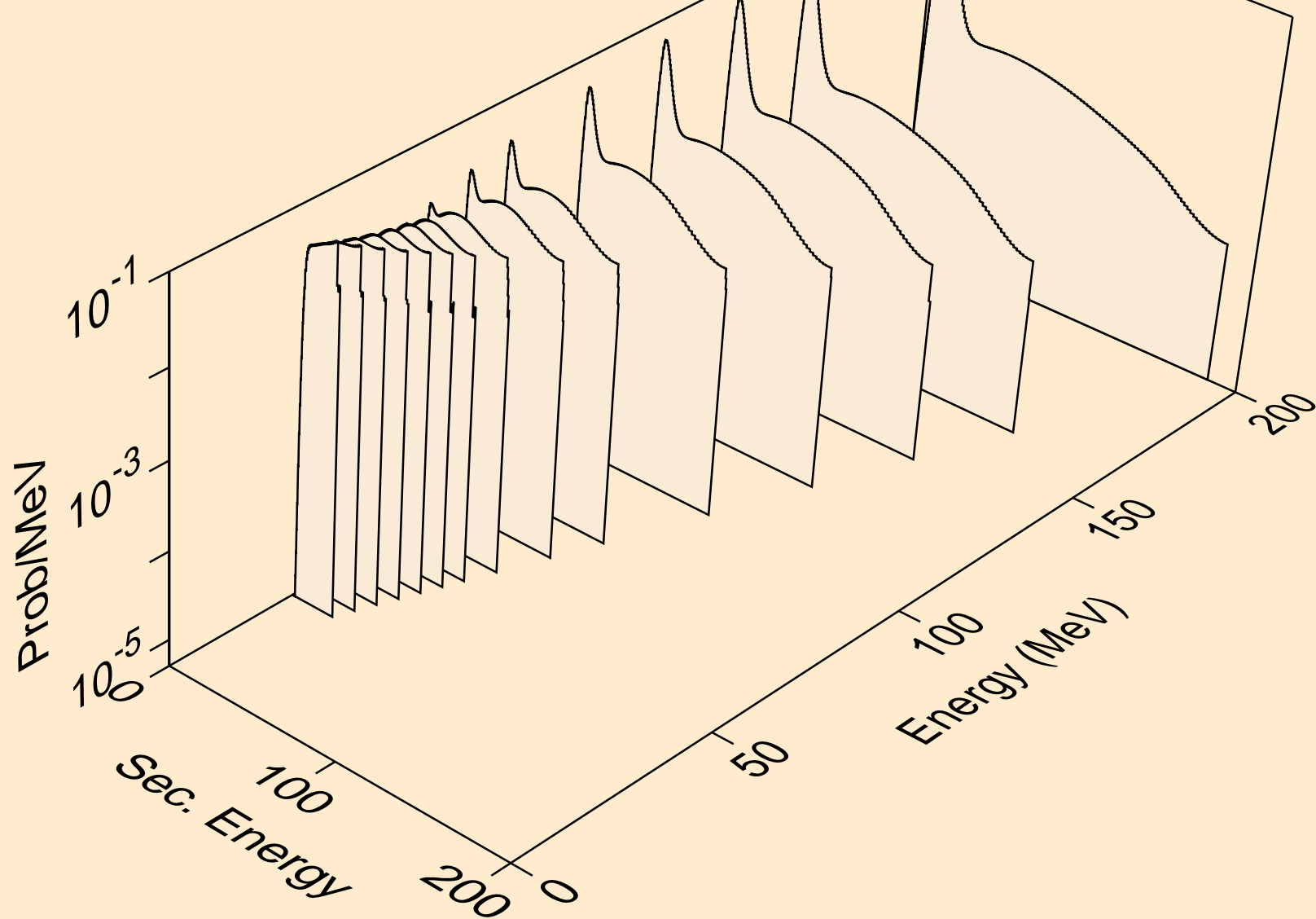

CU062 NEUTRON ACER TENDL-2023 LIBRARY; T=0.K  
deuterons from (n,2nd)

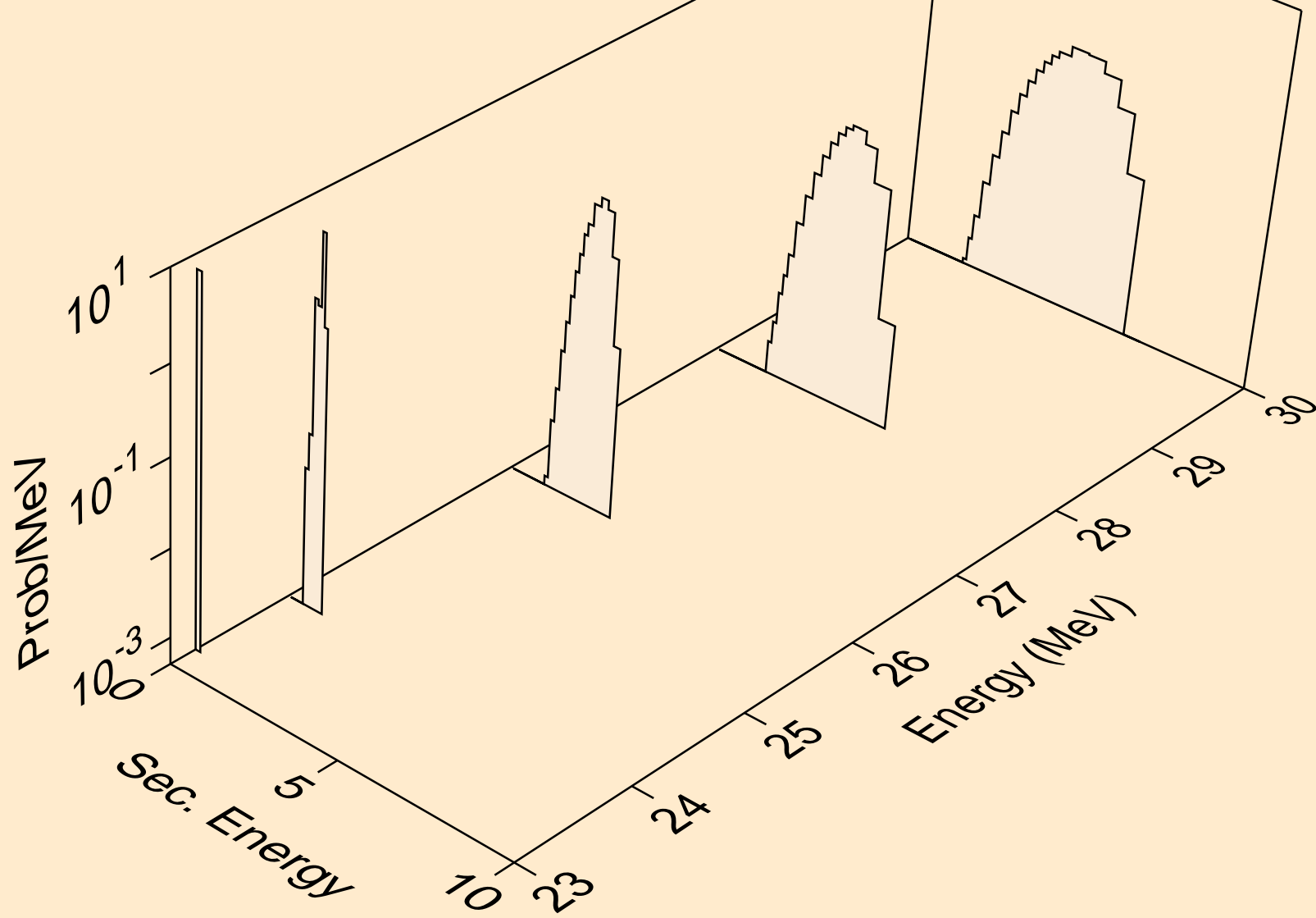

CU062 NEUTRON ACER TENDL-2023 LIBRARY; T=0.K  
deuterons from (n,n\*)d

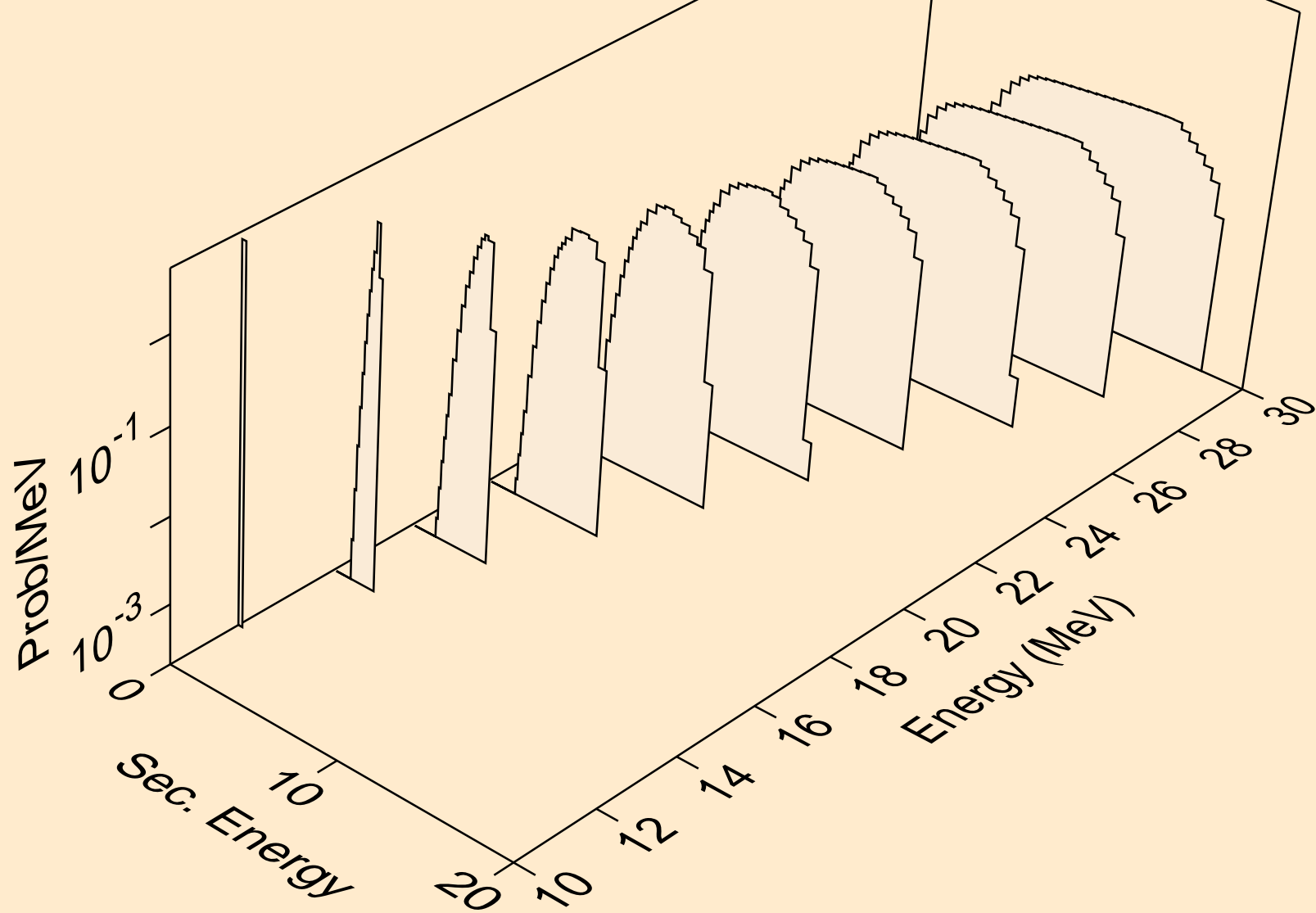

CU062 NEUTRON ACER TENDL-2023 LIBRARY; T=0.K  
deuterons from (n,d)

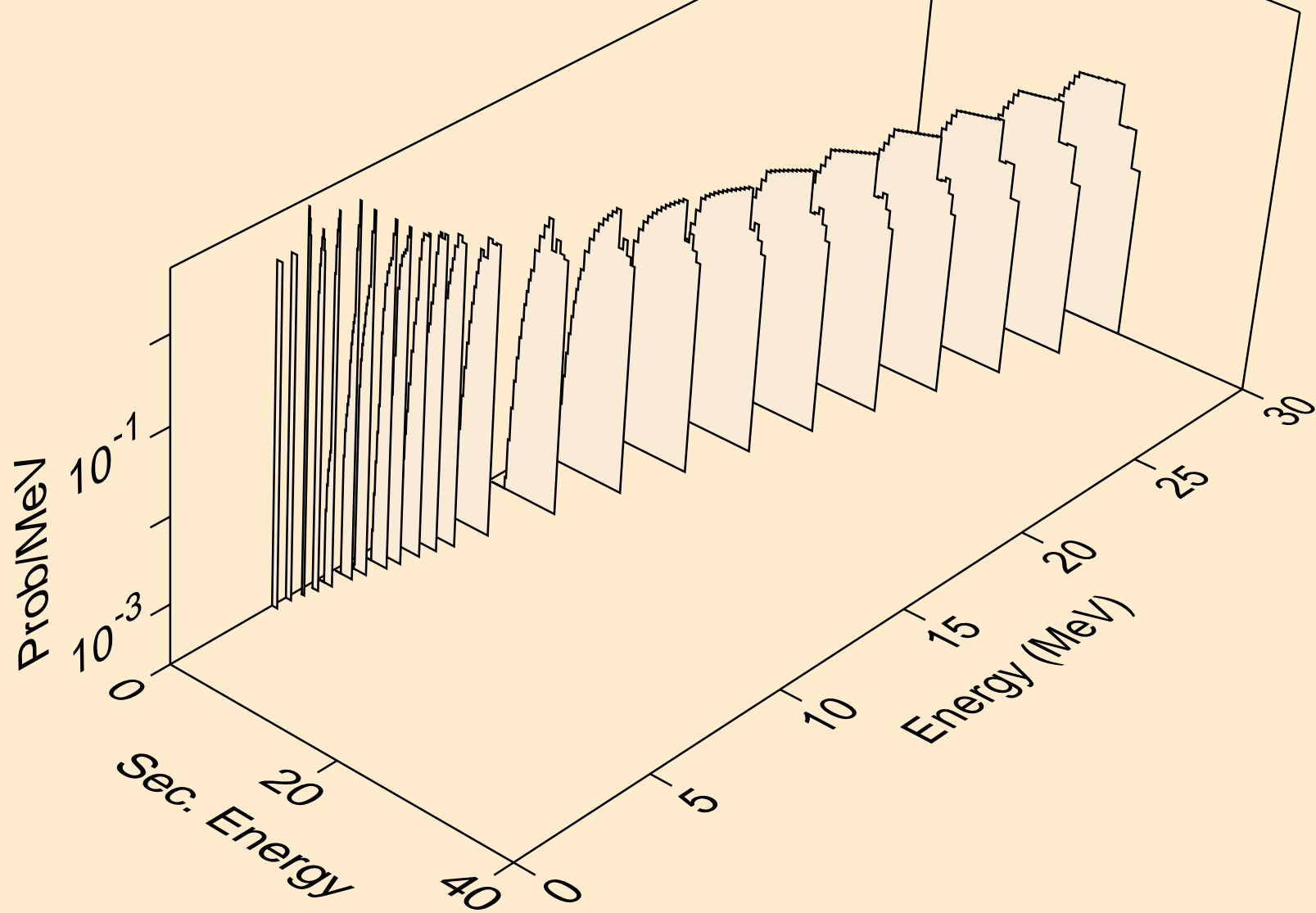

CU062 NEUTRON ACER TENDL-2023 LIBRARY; T=0.K  
deuterons from (n,pd)

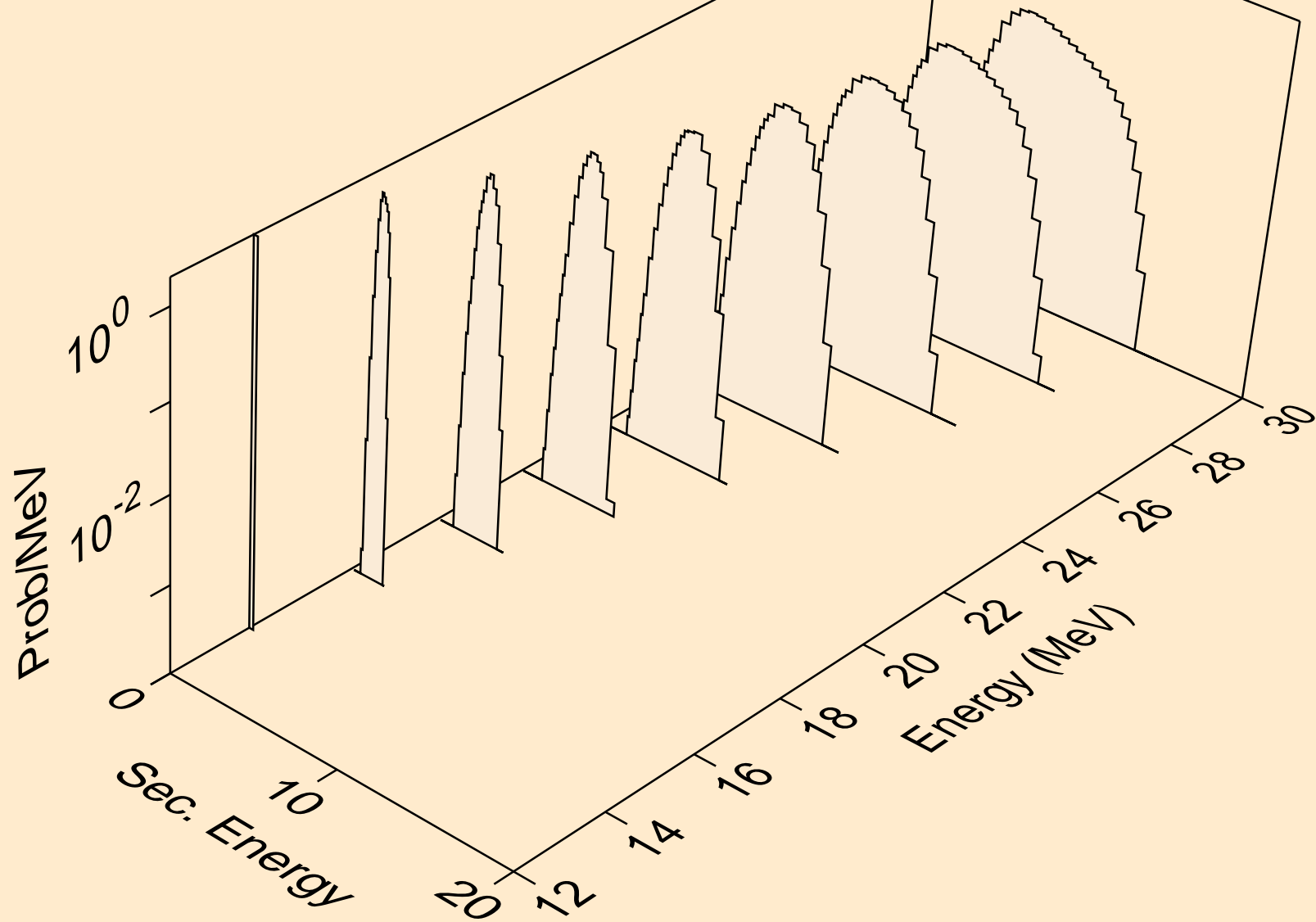

CU062 NEUTRON ACER TENDL-2023 LIBRARY; T=0.K  
deuterons from (n,da)

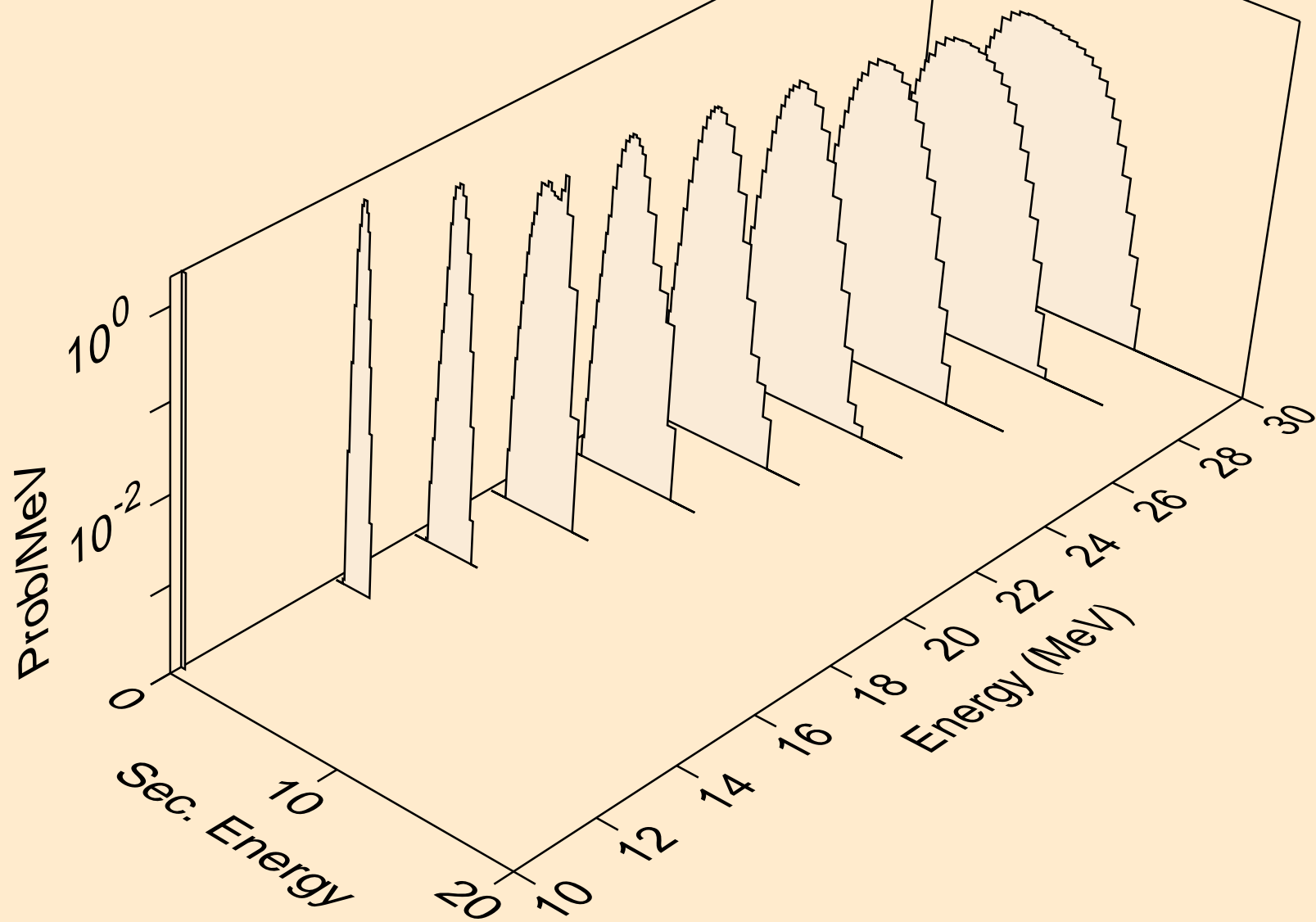



CU062 NEUTRON ACER TENDL-2023 LIBRARY; T=0.K  
tritons from (n,x)

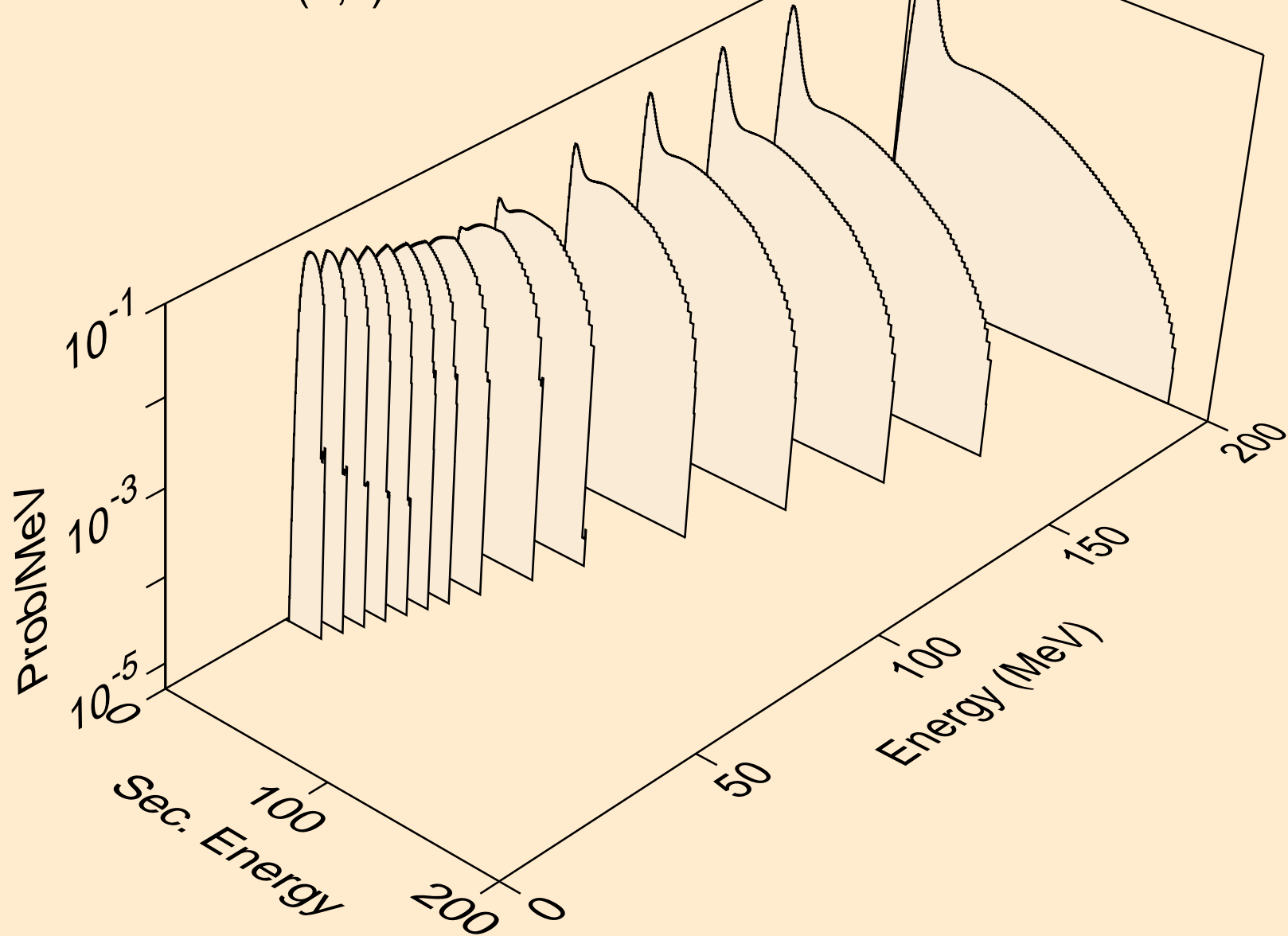

CU062 NEUTRON ACER TENDL-2023 LIBRARY; T=0.K  
tritons from (n,n\*)t

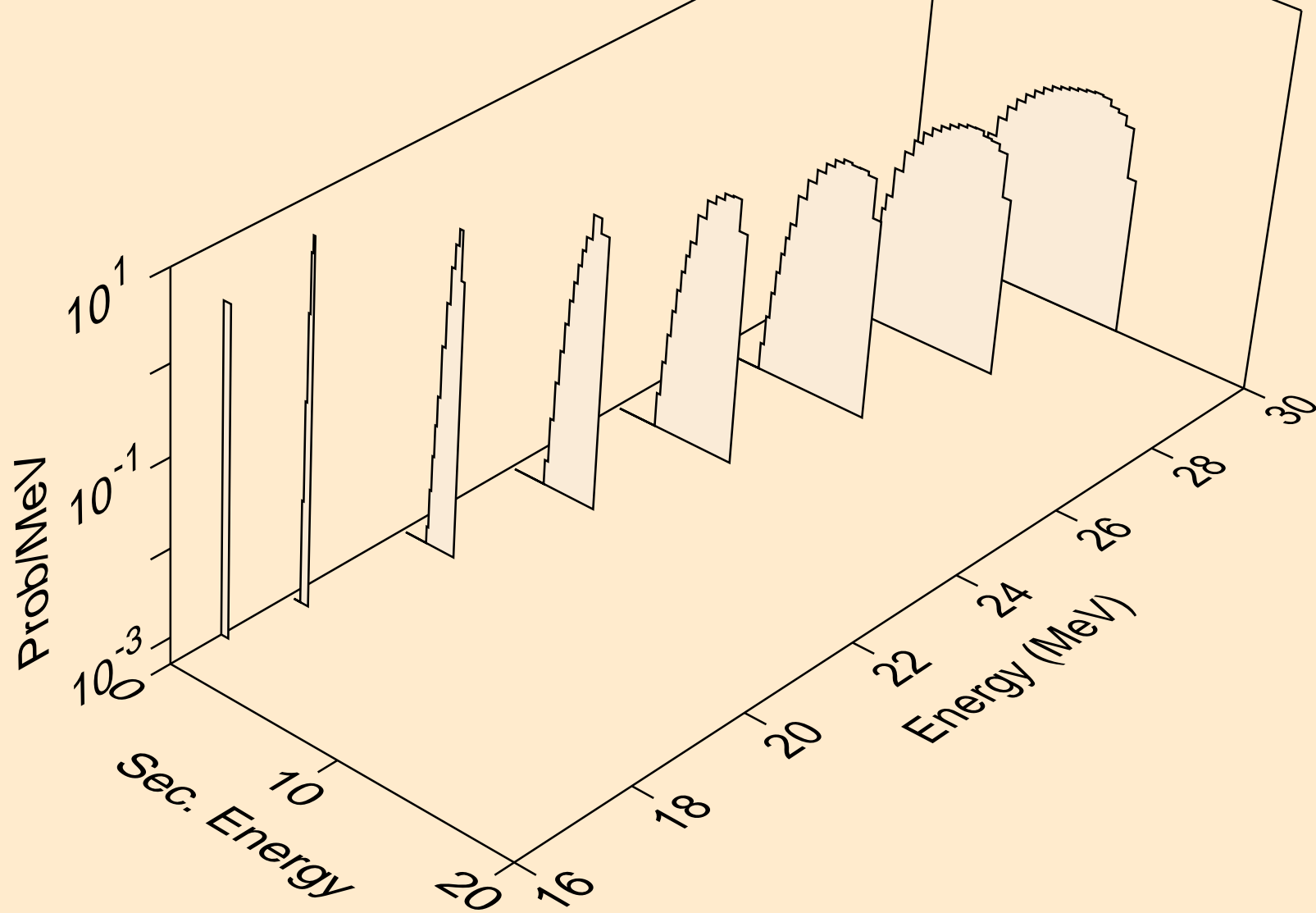

CU062 NEUTRON ACER TENDL-2023 LIBRARY; T=0.K  
tritons from (n,t)

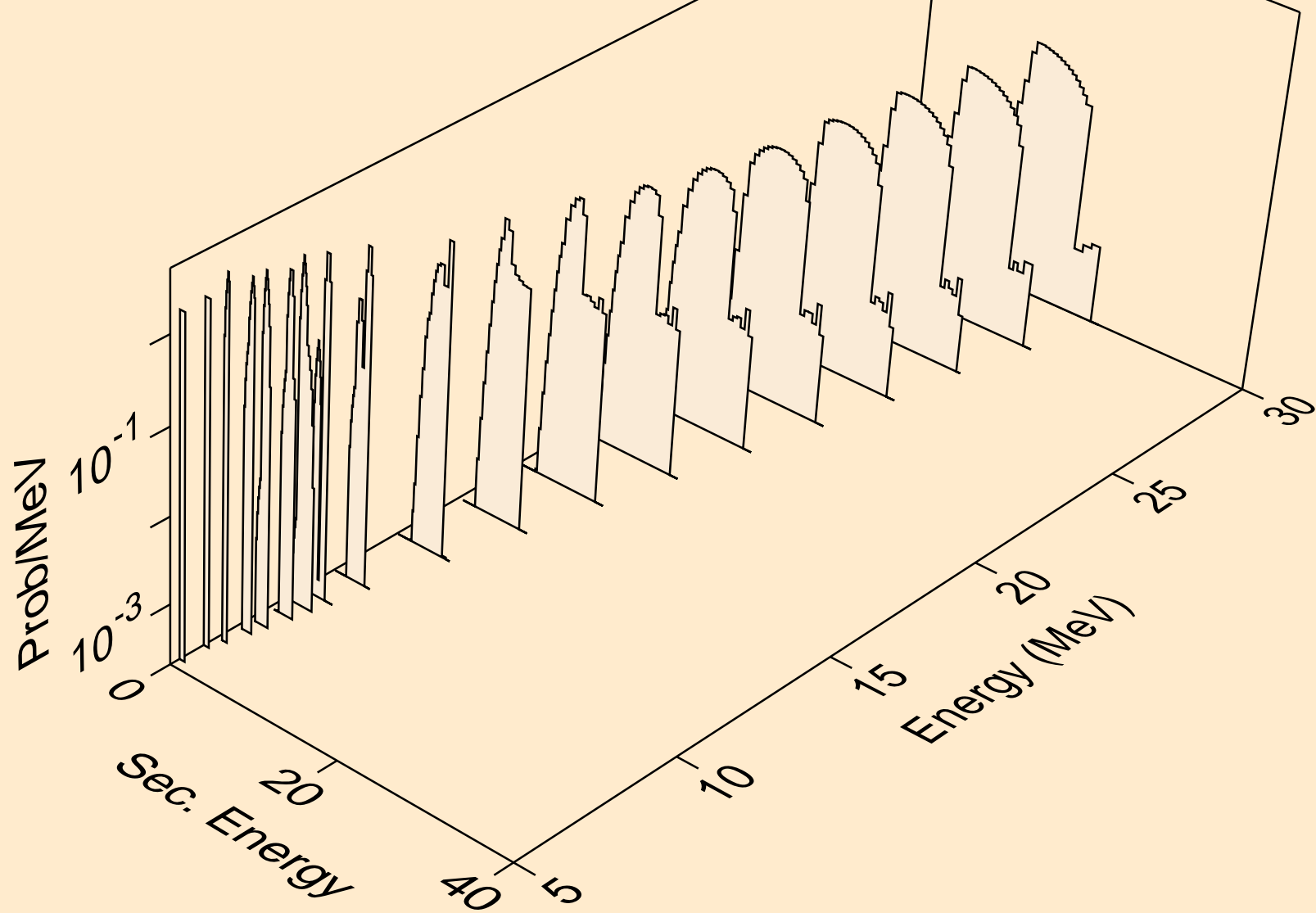

CU062 NEUTRON ACER TENDL-2023 LIBRARY; T=0.K  
tritons from (n,pt)

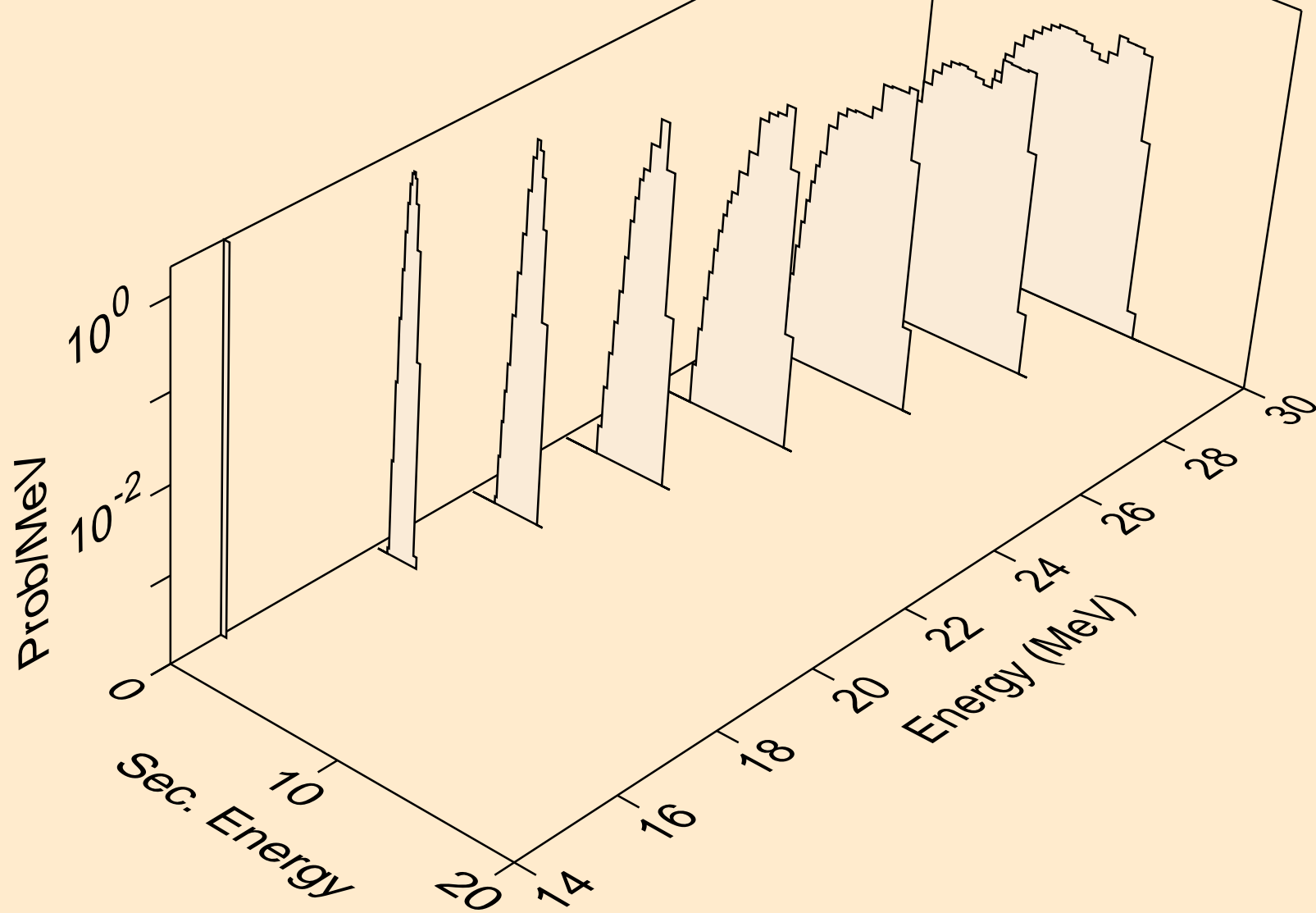

CU062 NEUTRON ACER TENDL-2023 LIBRARY; T=0.K  
he3s from (n,x)

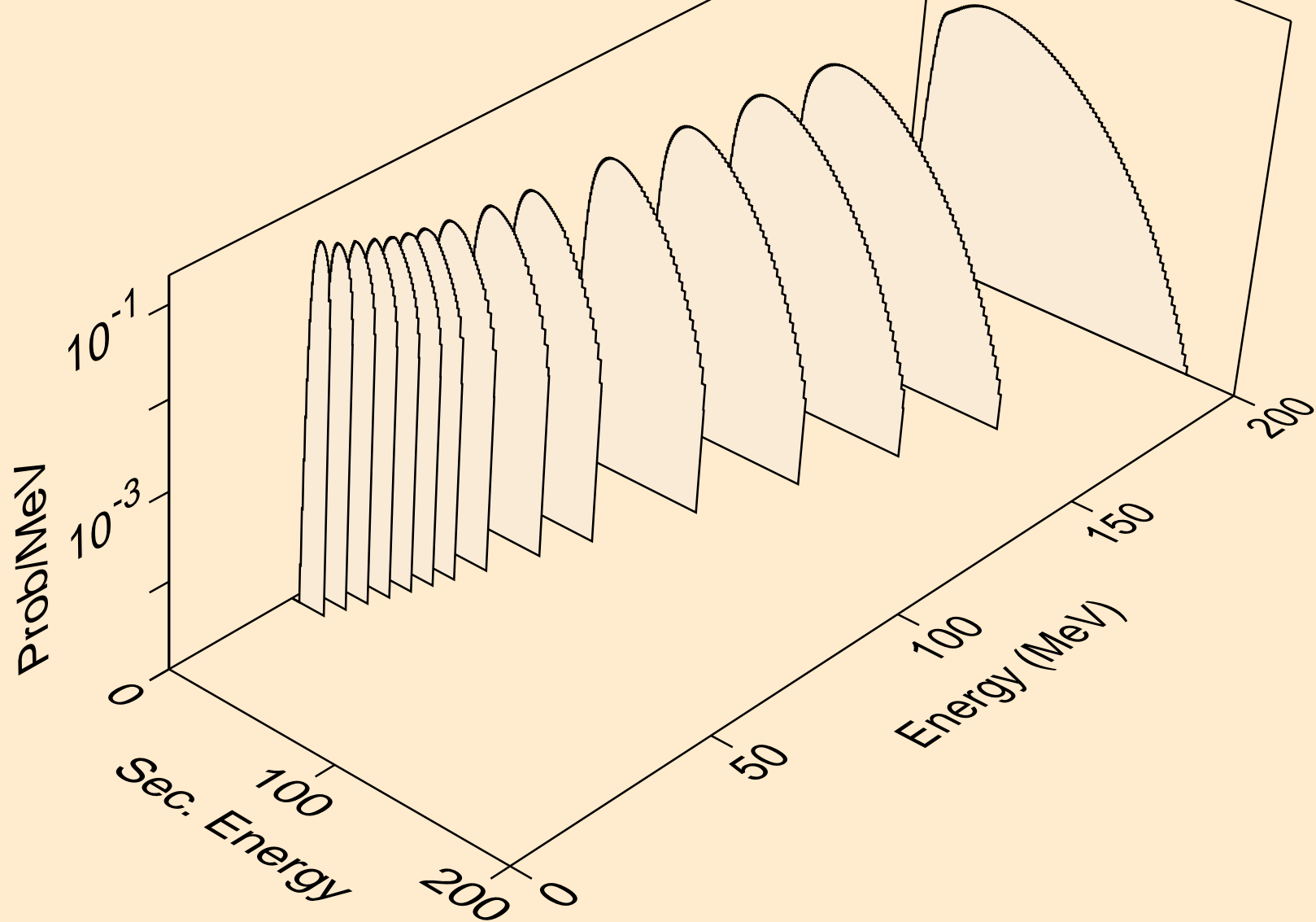

CU062 NEUTRON ACER TENDL-2023 LIBRARY; T=0.K  
he3s from (n,n\*)he3

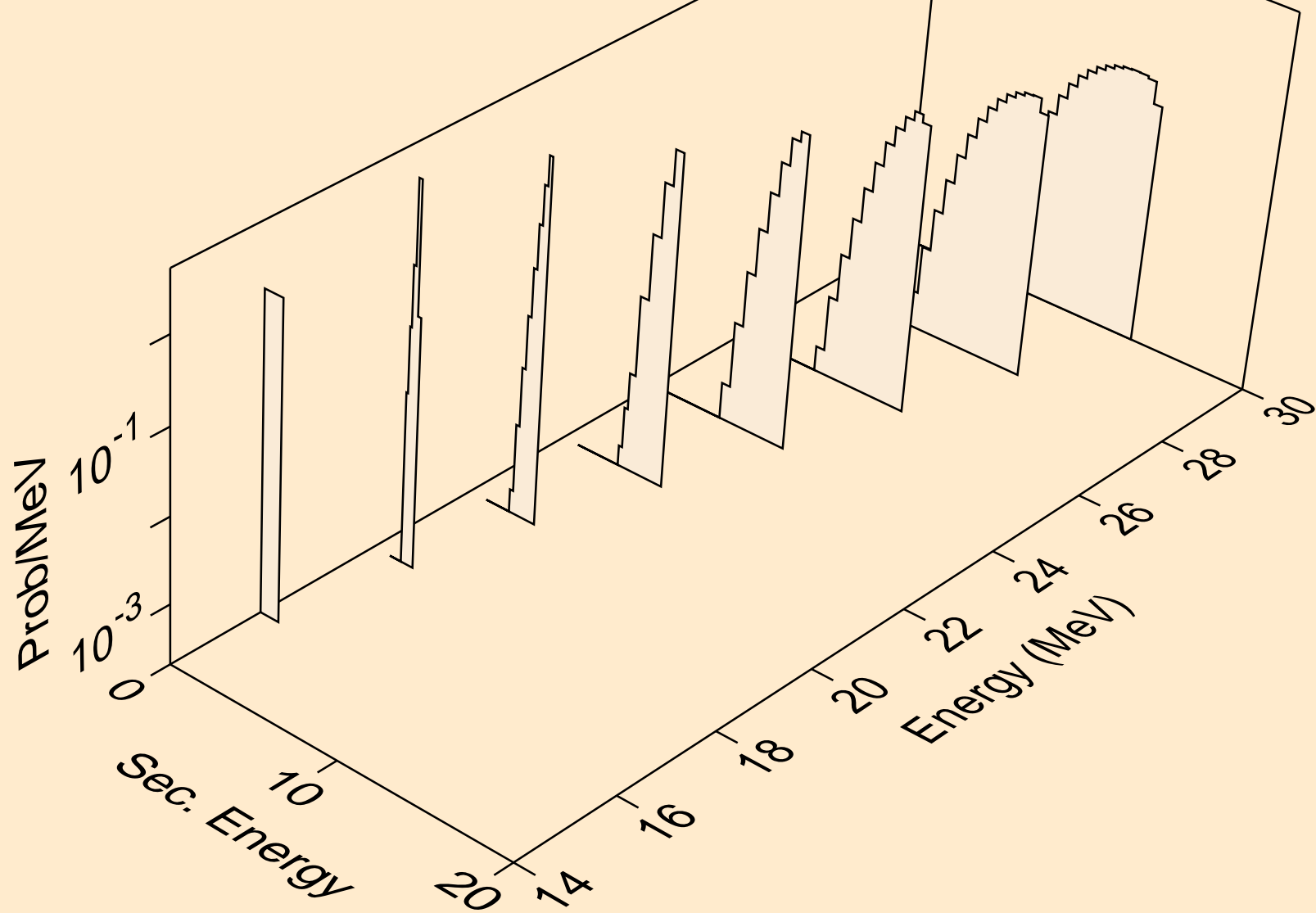

CU062 NEUTRON ACER TENDL-2023 LIBRARY; T=0.K  
he3s from (n,he3)

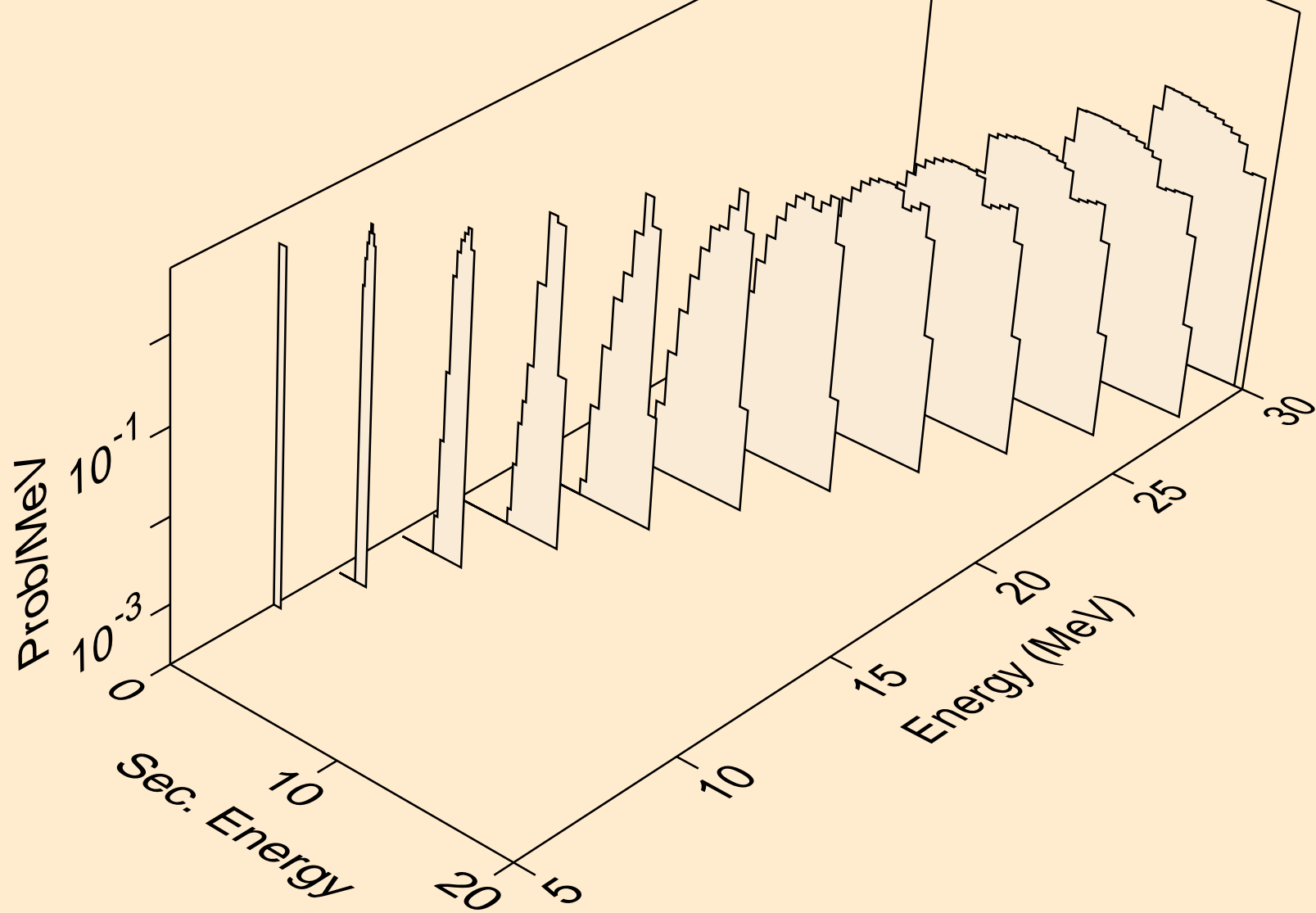

CU062 NEUTRON ACER TENDL-2023 LIBRARY; T=0.K  
alphas from (n,x)

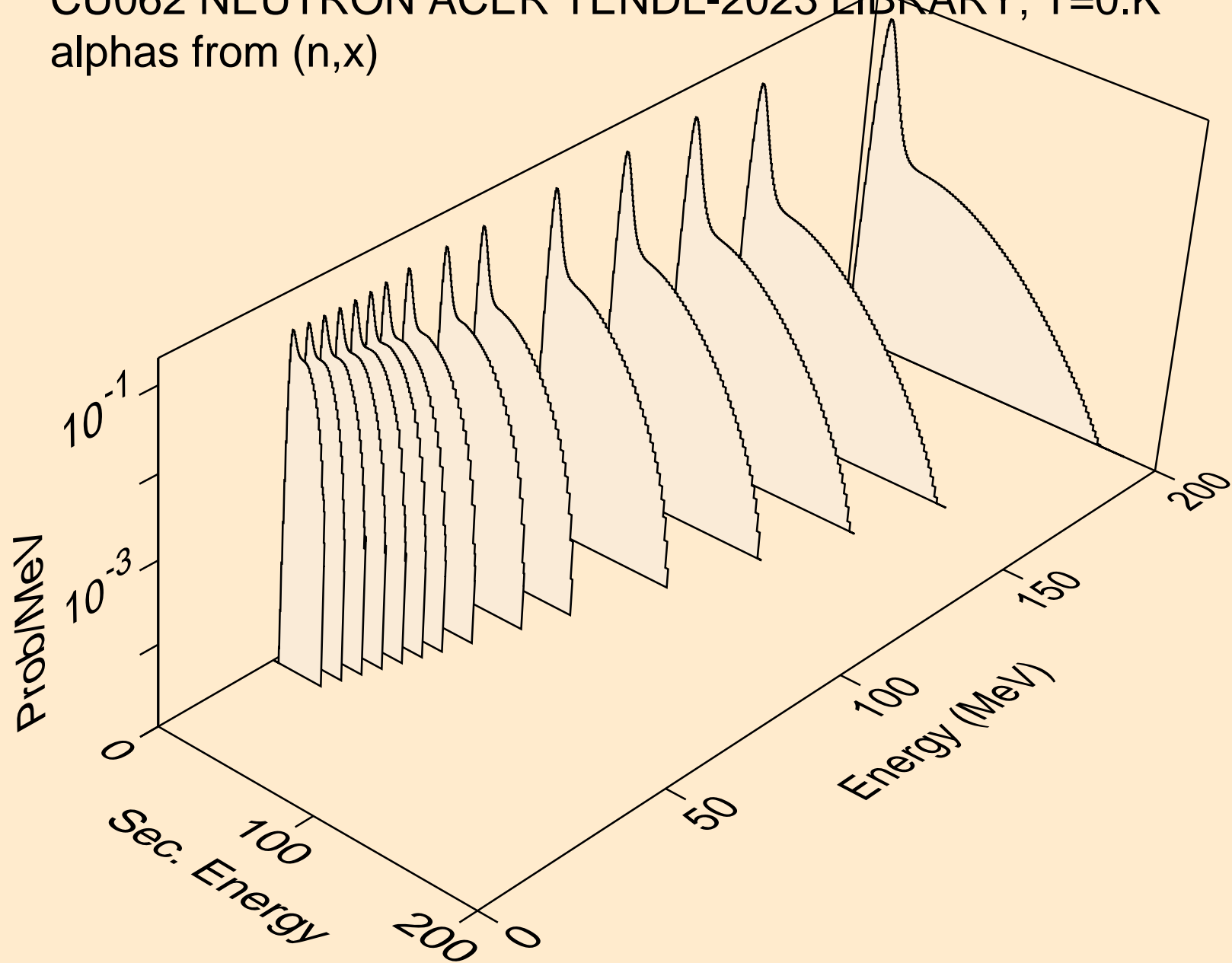



CU062 NEUTRON ACER TENDL-2023 LIBRARY; T=0.K  
alphas from (n,n\*)a

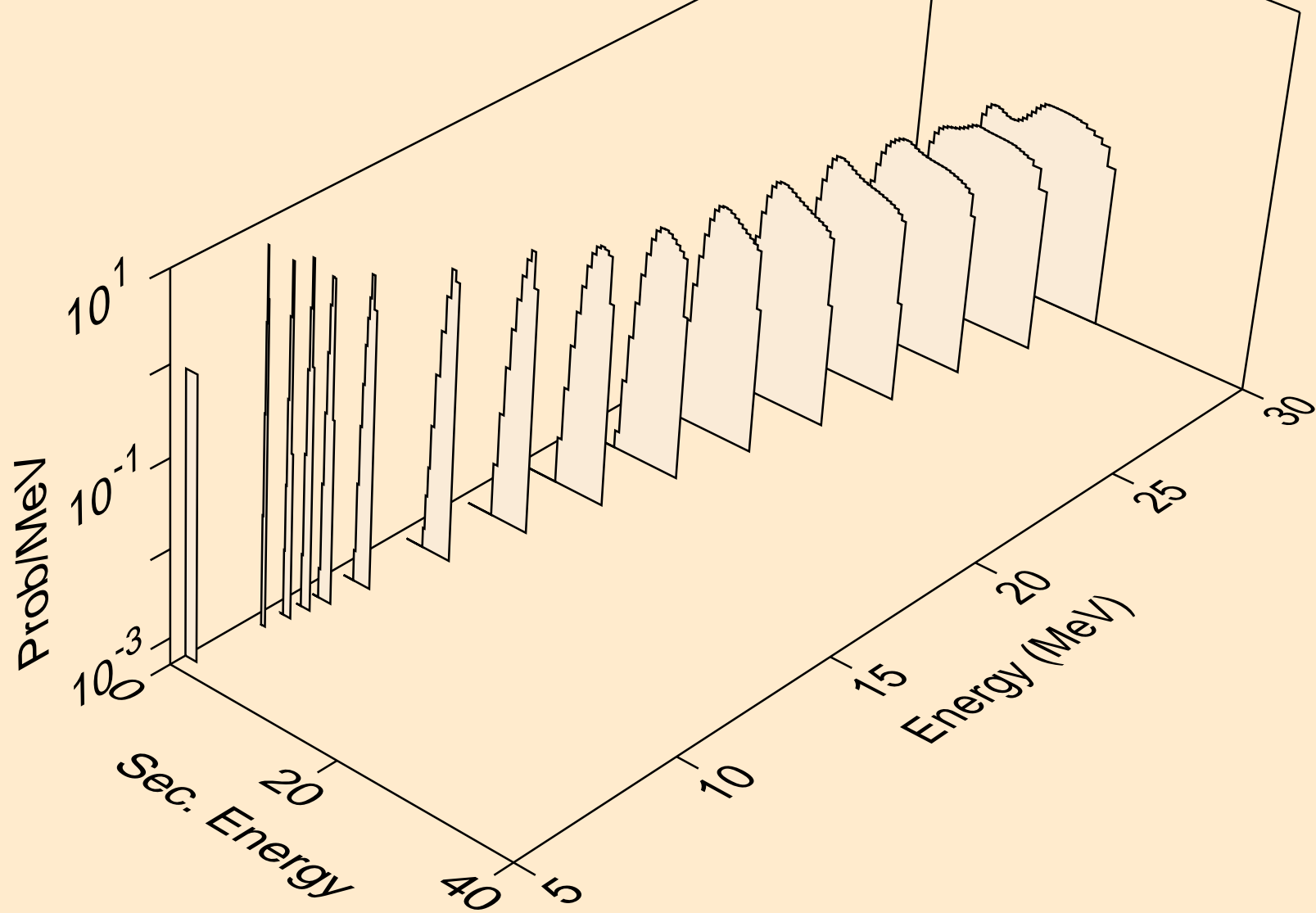

CU062 NEUTRON ACER TENDL-2023 LIBRARY; T=0.K  
alphas from (n,2n)a

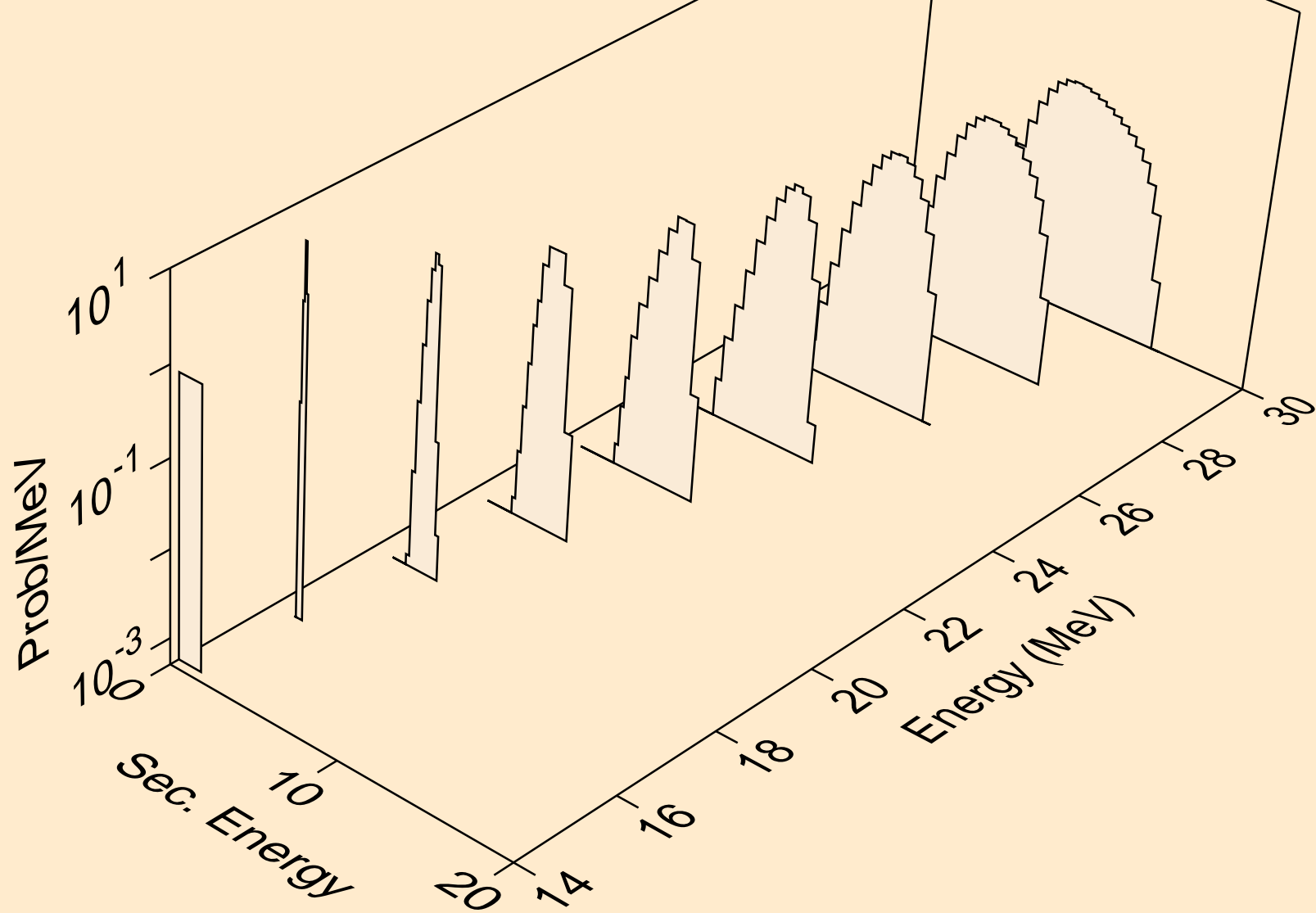

CU062 NEUTRON ACER TENDL-2023 LIBRARY; T=0.K  
alphas from (n,n\*)2a

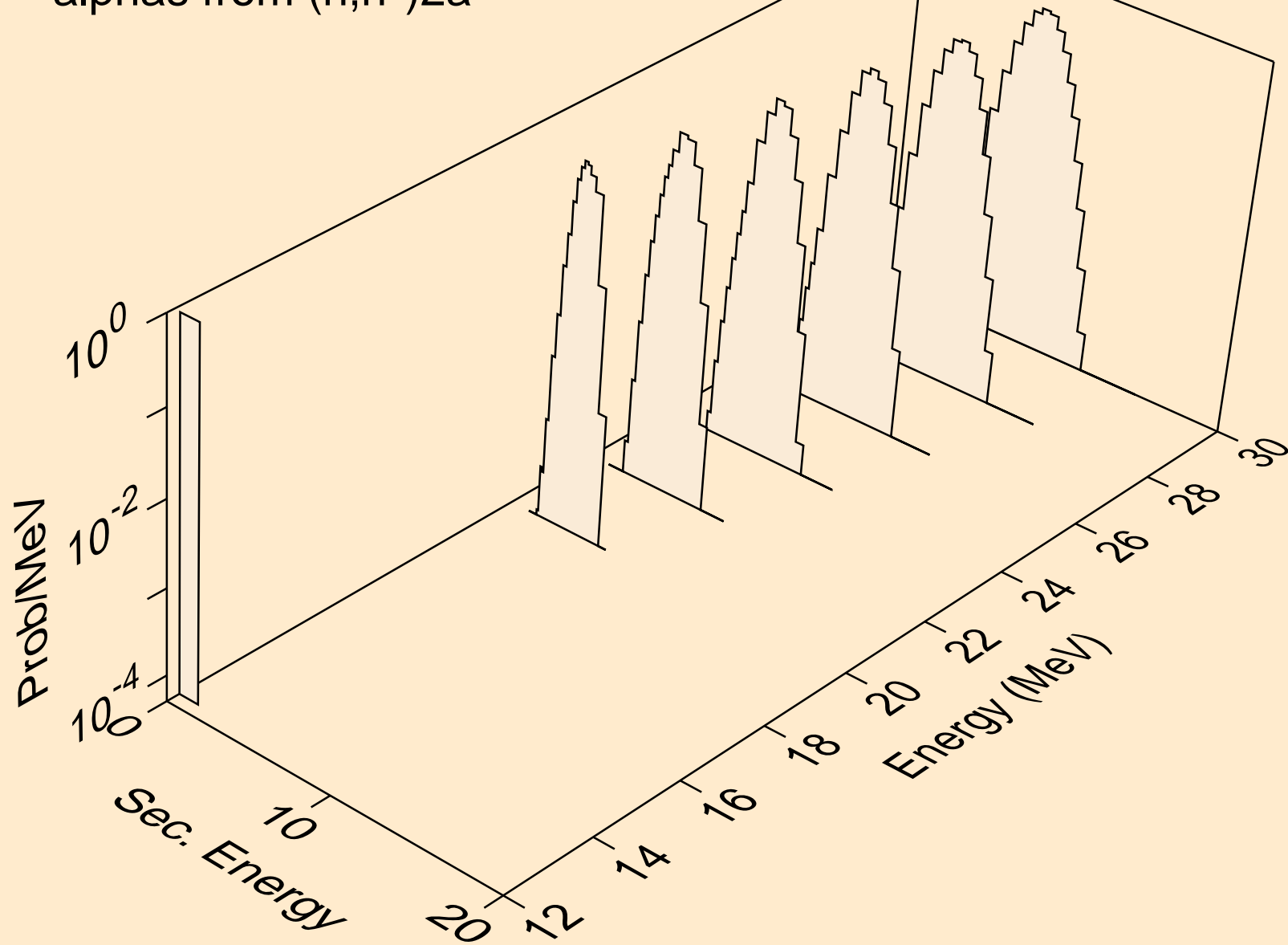

CU062 NEUTRON ACER TENDL-2023 LIBRARY; T=0.K  
alphas from (n,npa)

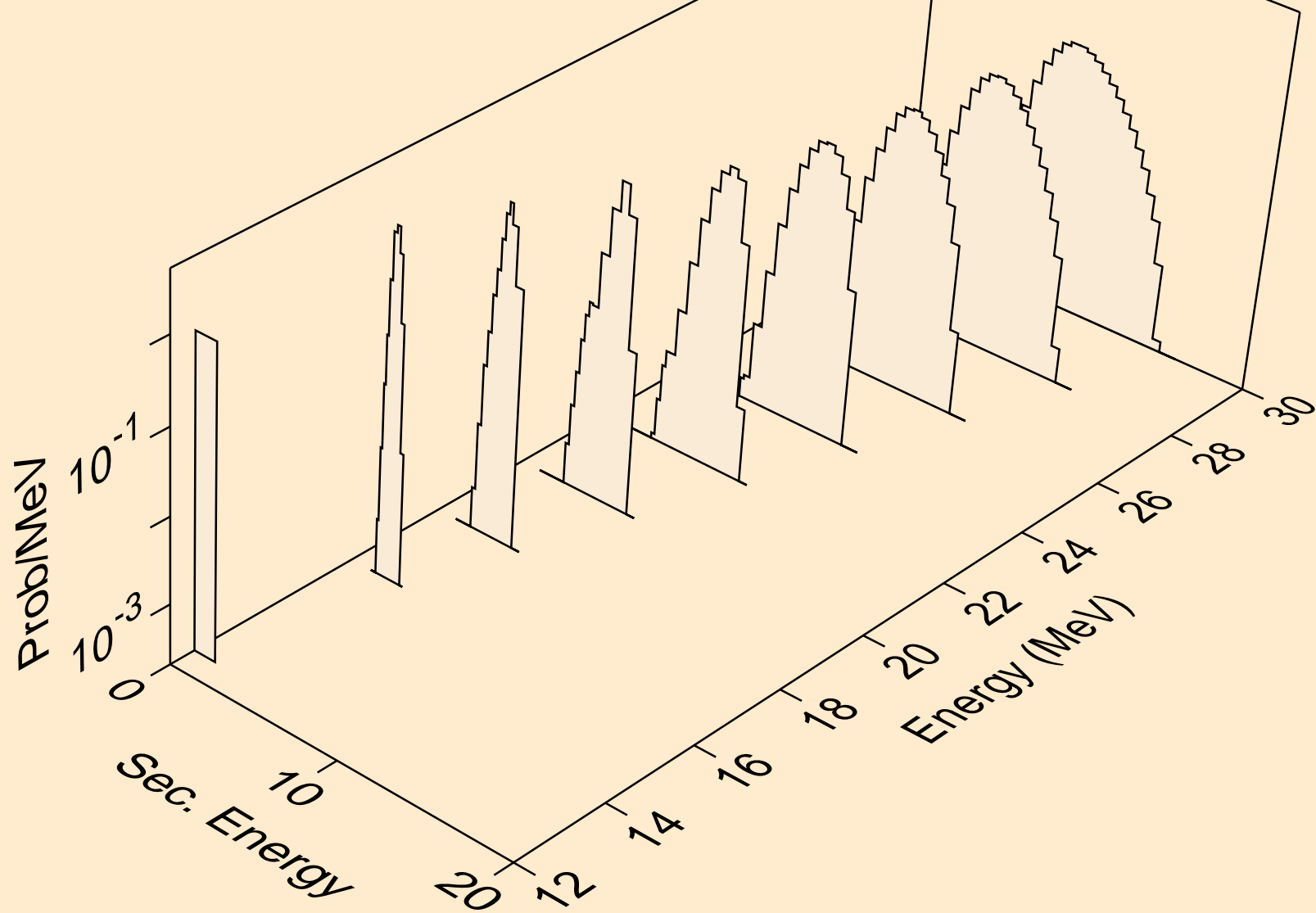

CU062 NEUTRON ACER TENDL-2023 LIBRARY; T=0.K  
alphas from (n,a)

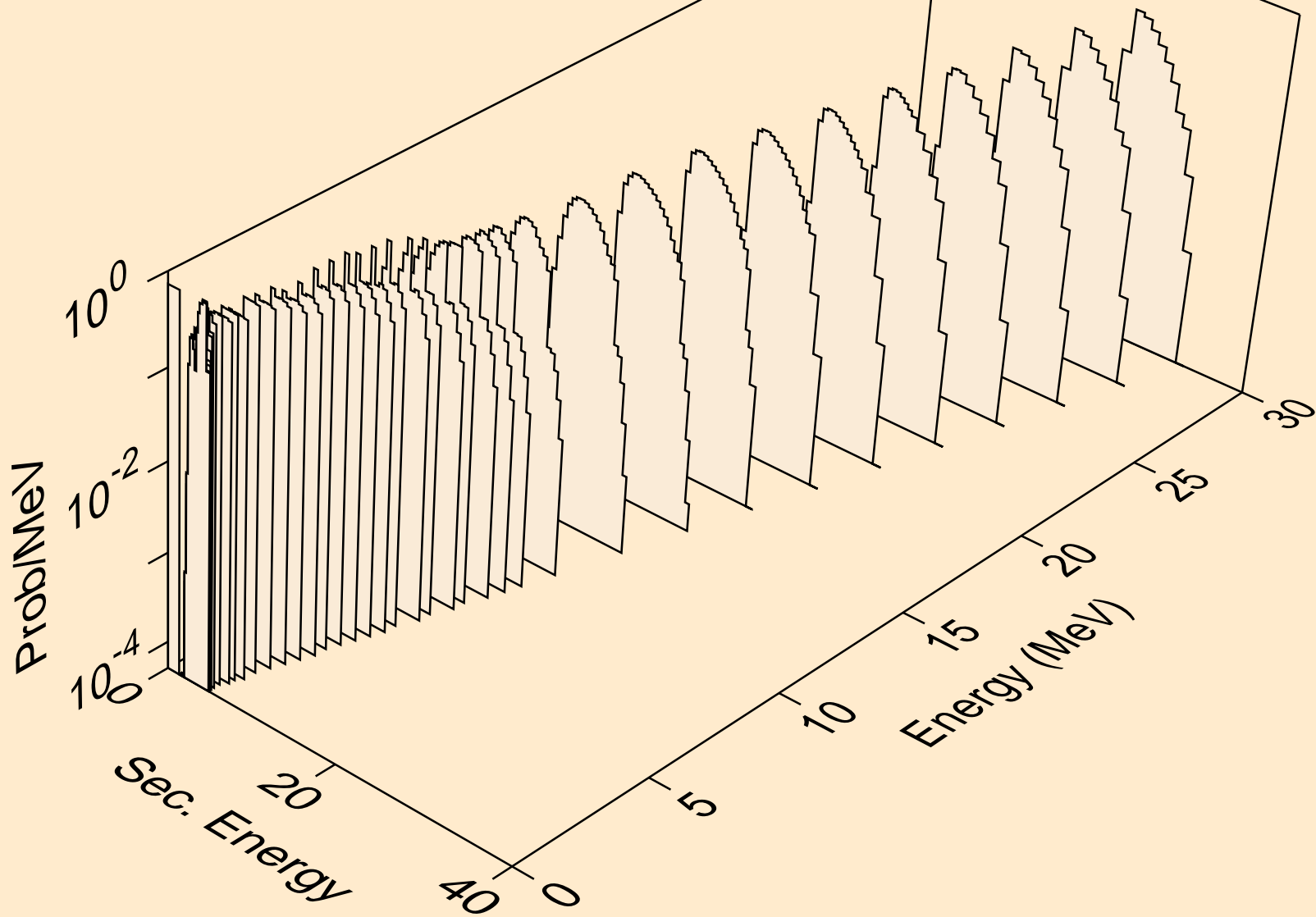

CU062 NEUTRON ACER TENDL-2023 LIBRARY; T=0.K  
alphas from (n,2a)

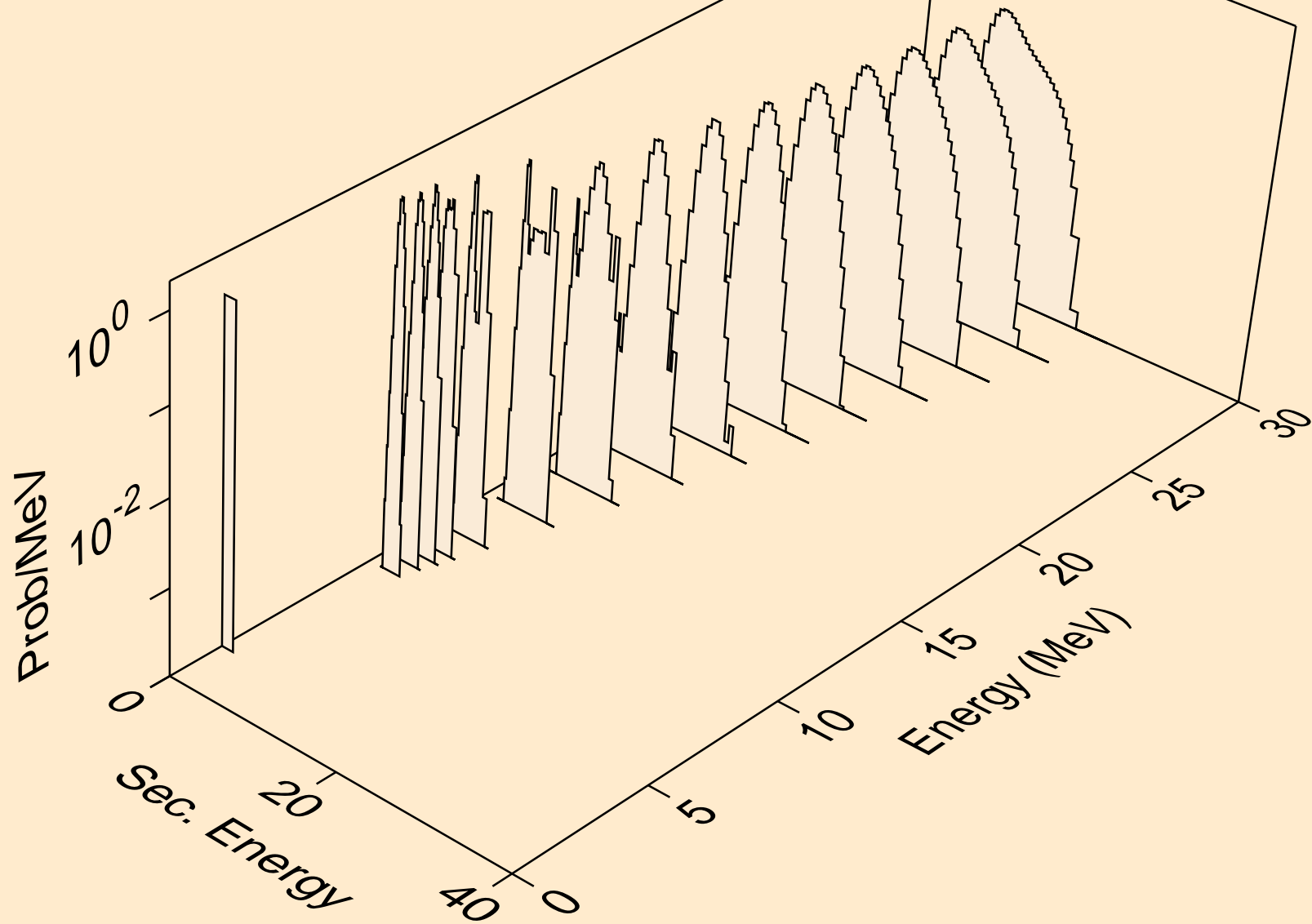

CU062 NEUTRON ACER TENDL-2023 LIBRARY; T=0.K  
alphas from (n,pa)

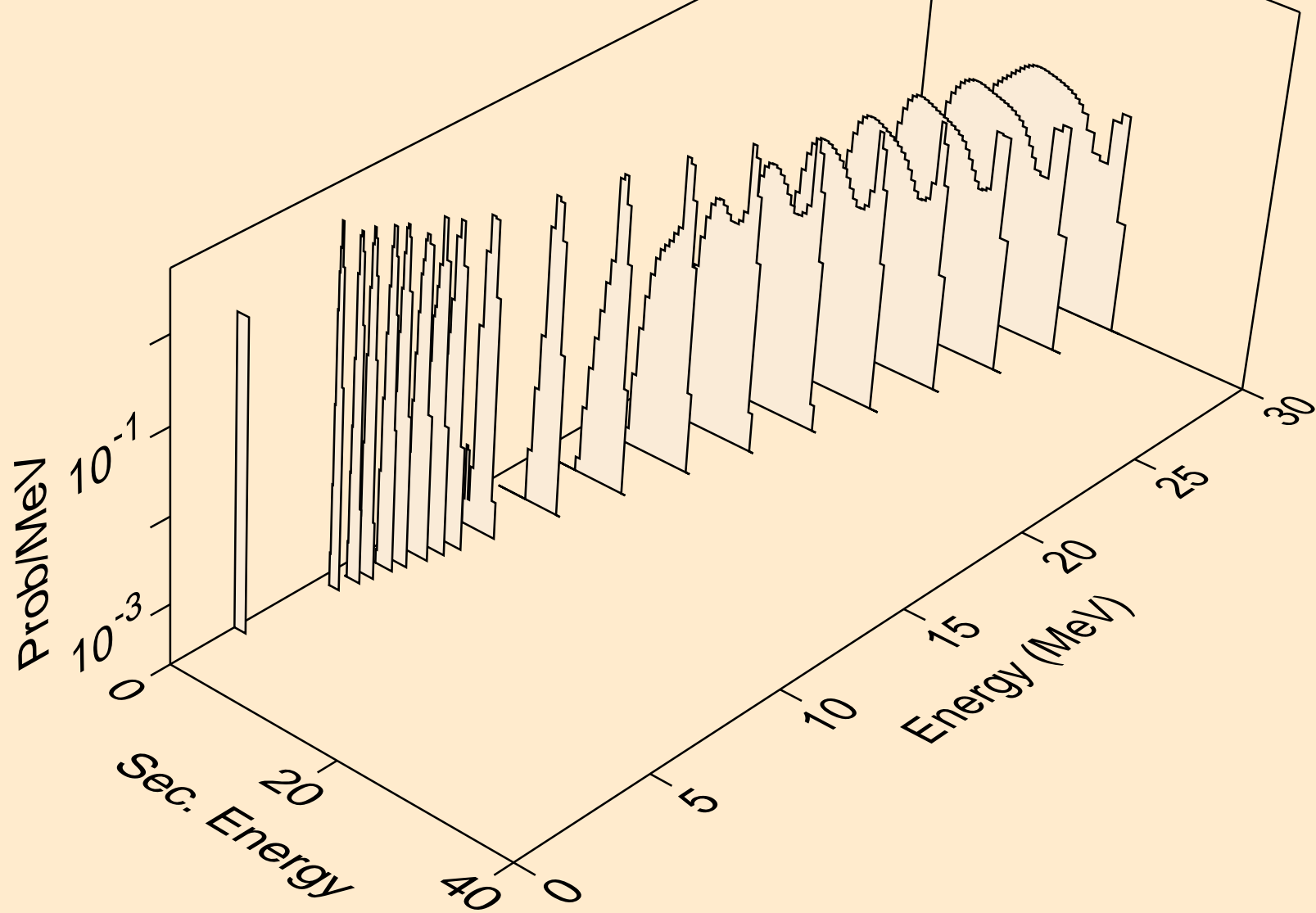

CU062 NEUTRON ACER TENDL-2023 LIBRARY; T=0.K  
alphas from (n,da)

