

CU068 NEUTRON ACER TENDL-2023 LIBRARY; T=0.K

Principal cross sections

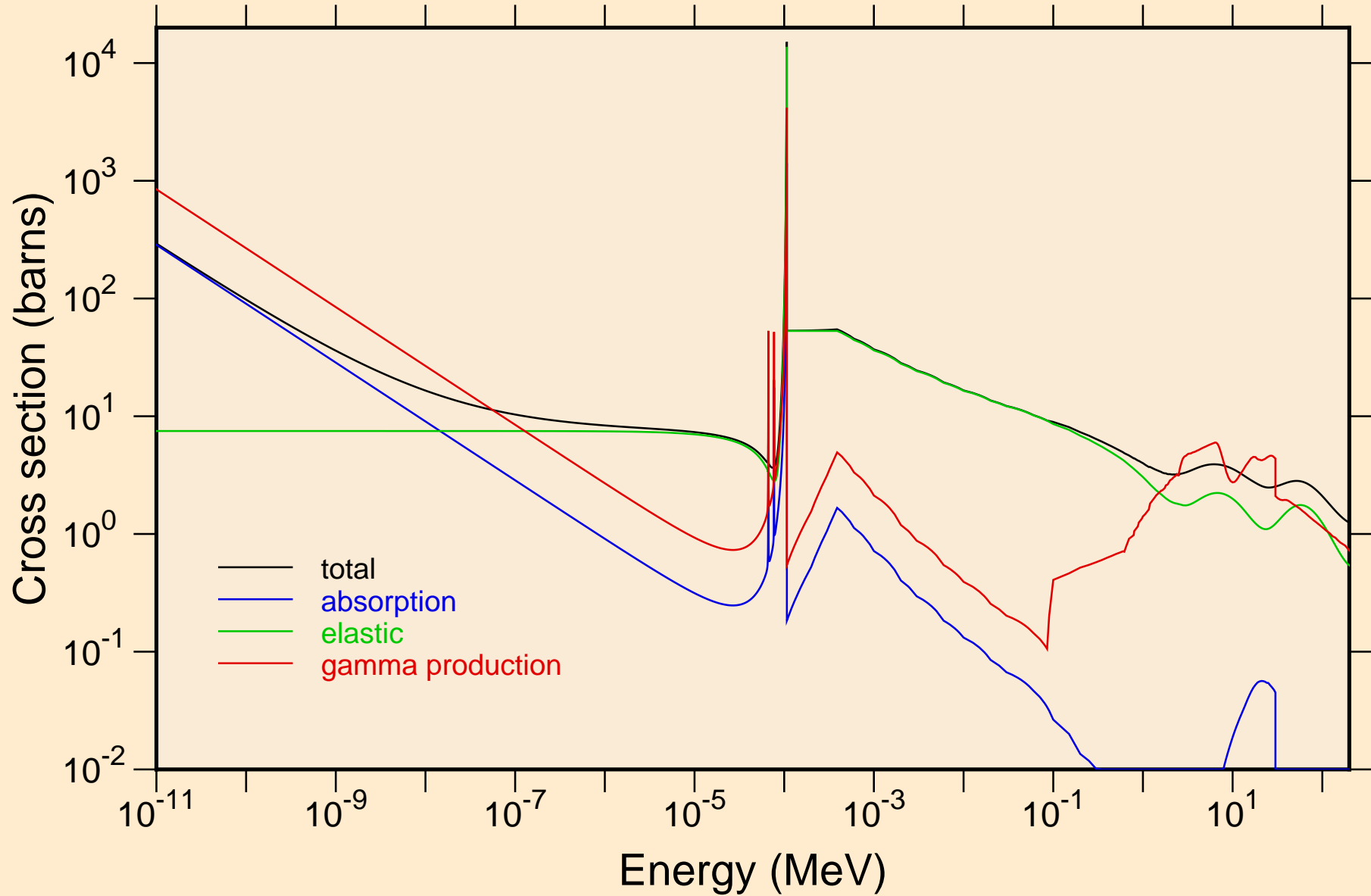

CU068 NEUTRON ACER TENDL-2023 LIBRARY; T=0.K
Heating

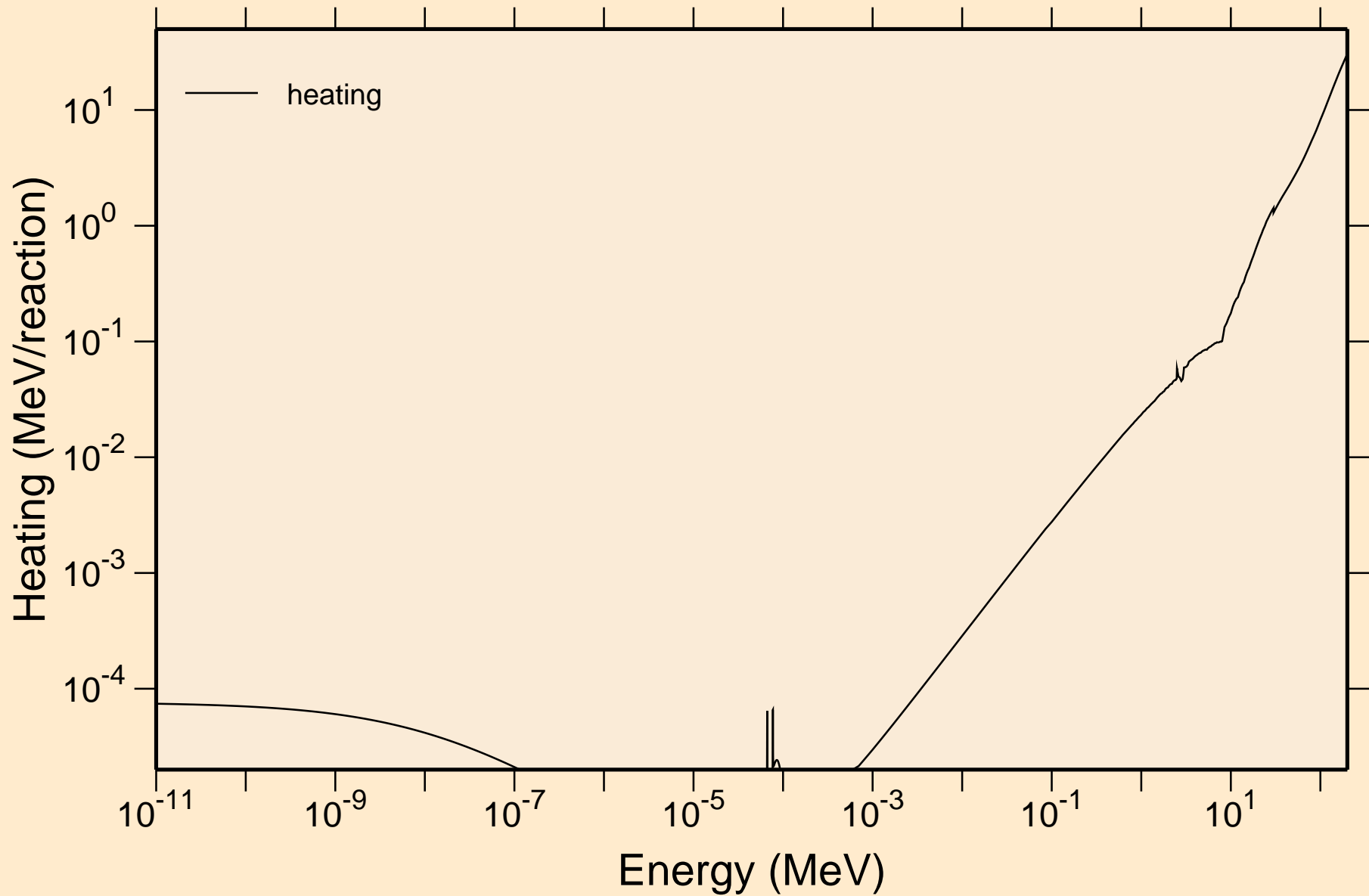

CU068 NEUTRON ACER TENDL-2023 LIBRARY; T=0.K
Damage

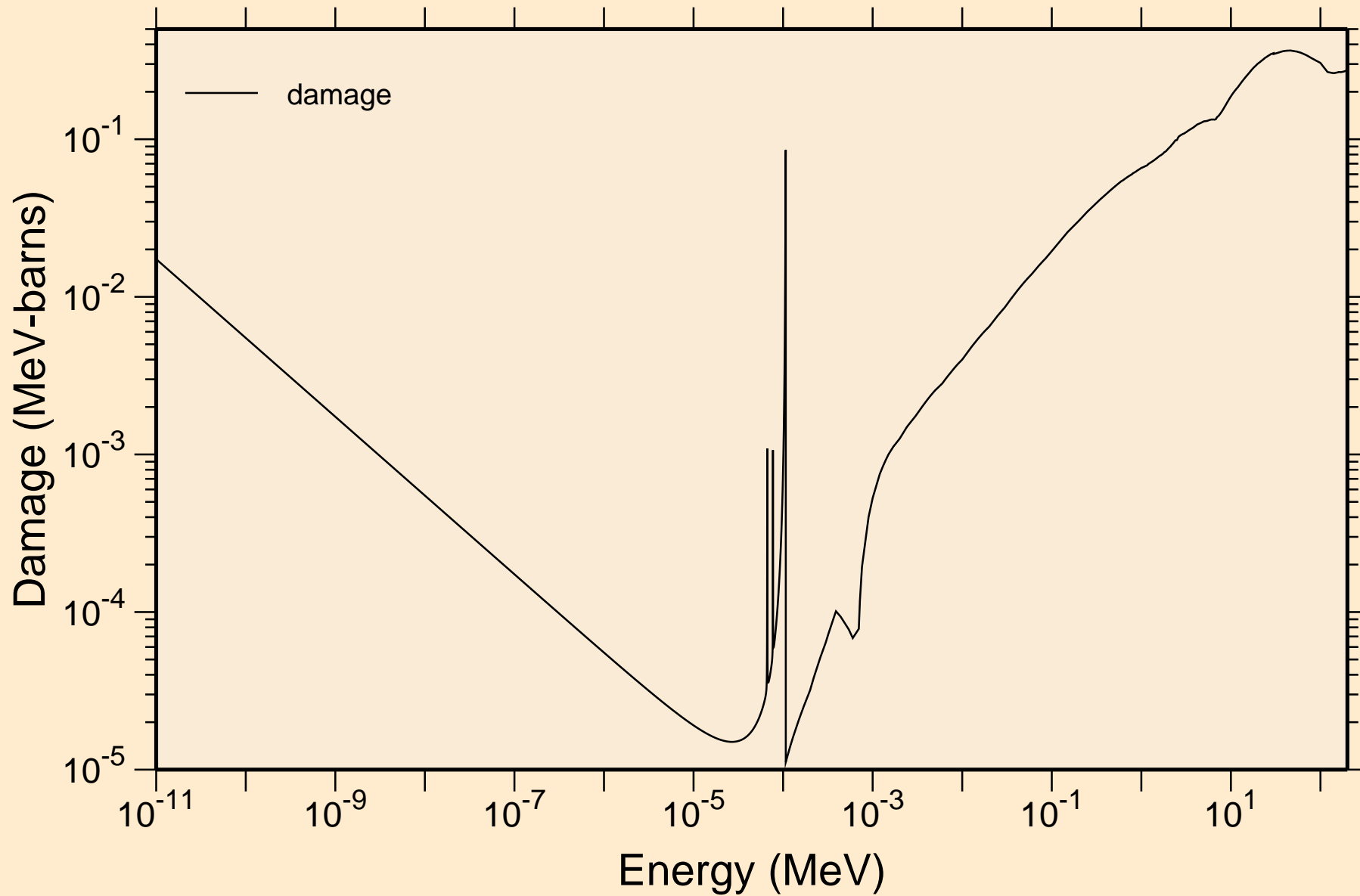

CU068 NEUTRON ACER TENDL-2023 LIBRARY; T=0.K
Non-threshold reactions

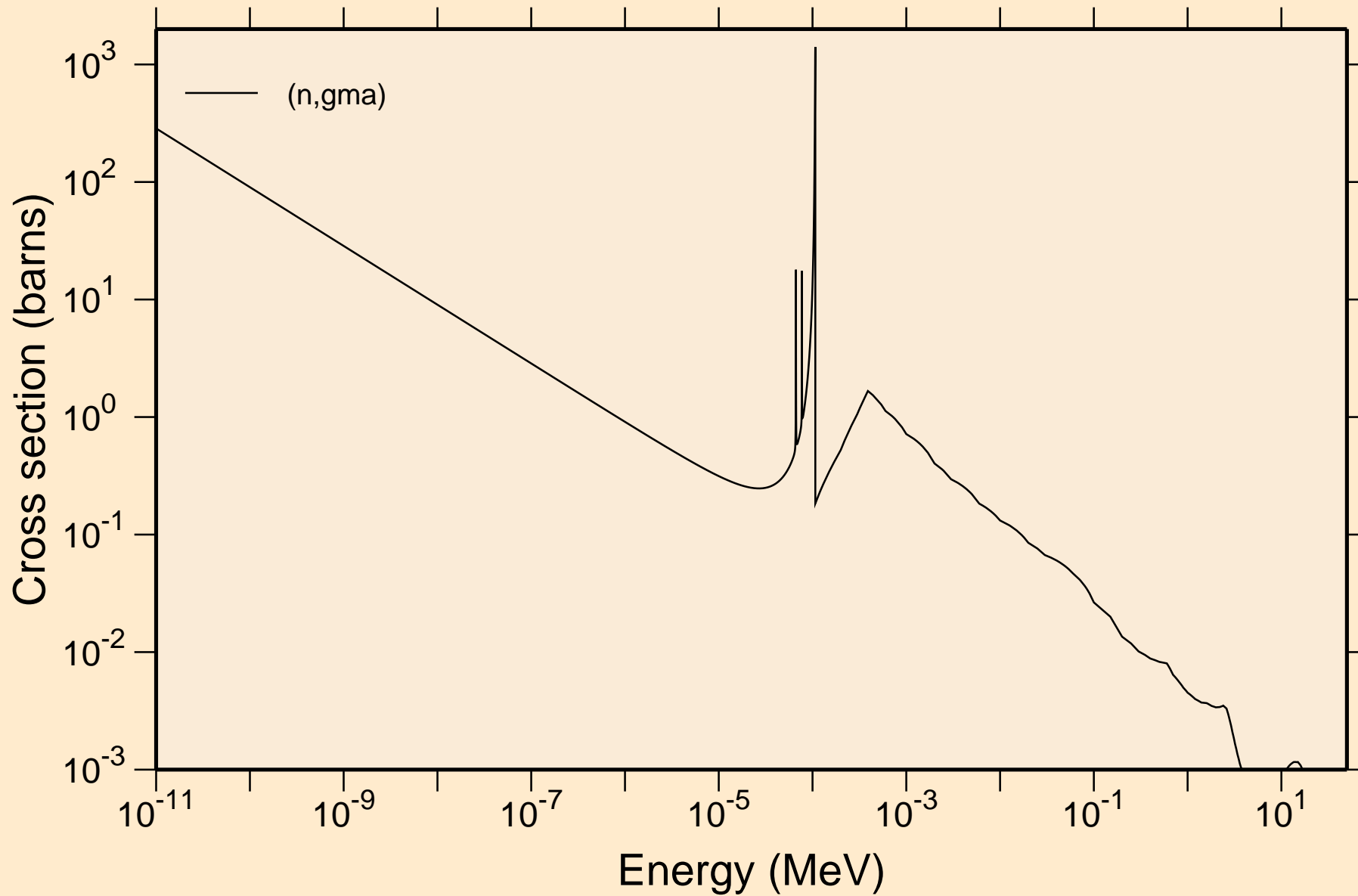

CU068 NEUTRON ACER TENDL-2023 LIBRARY; T=0.K

Principal cross sections

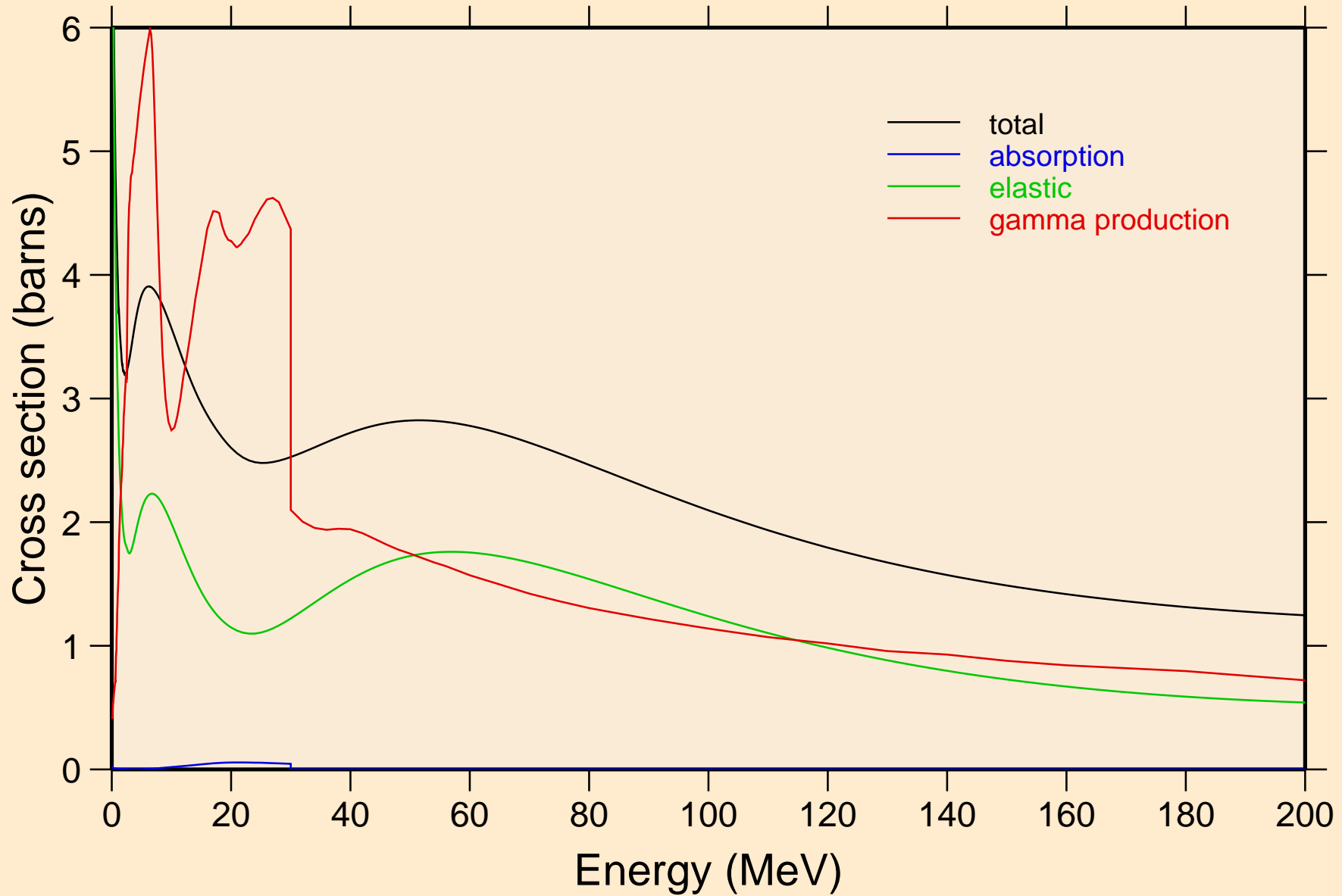

CU068 NEUTRON ACER TENDL-2023 LIBRARY; T=0.K

Heating

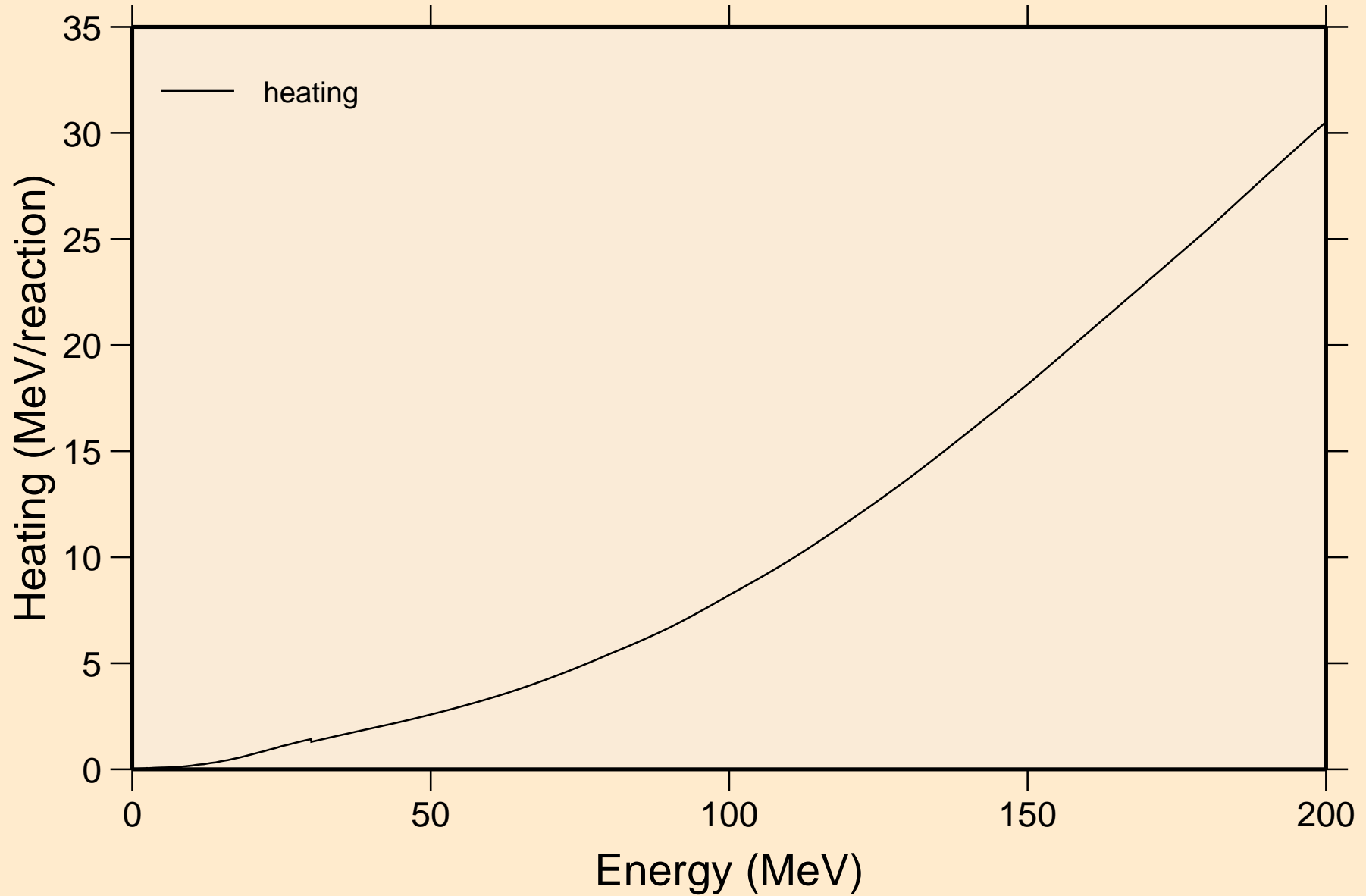

CU068 NEUTRON ACER TENDL-2023 LIBRARY; T=0.K

Damage

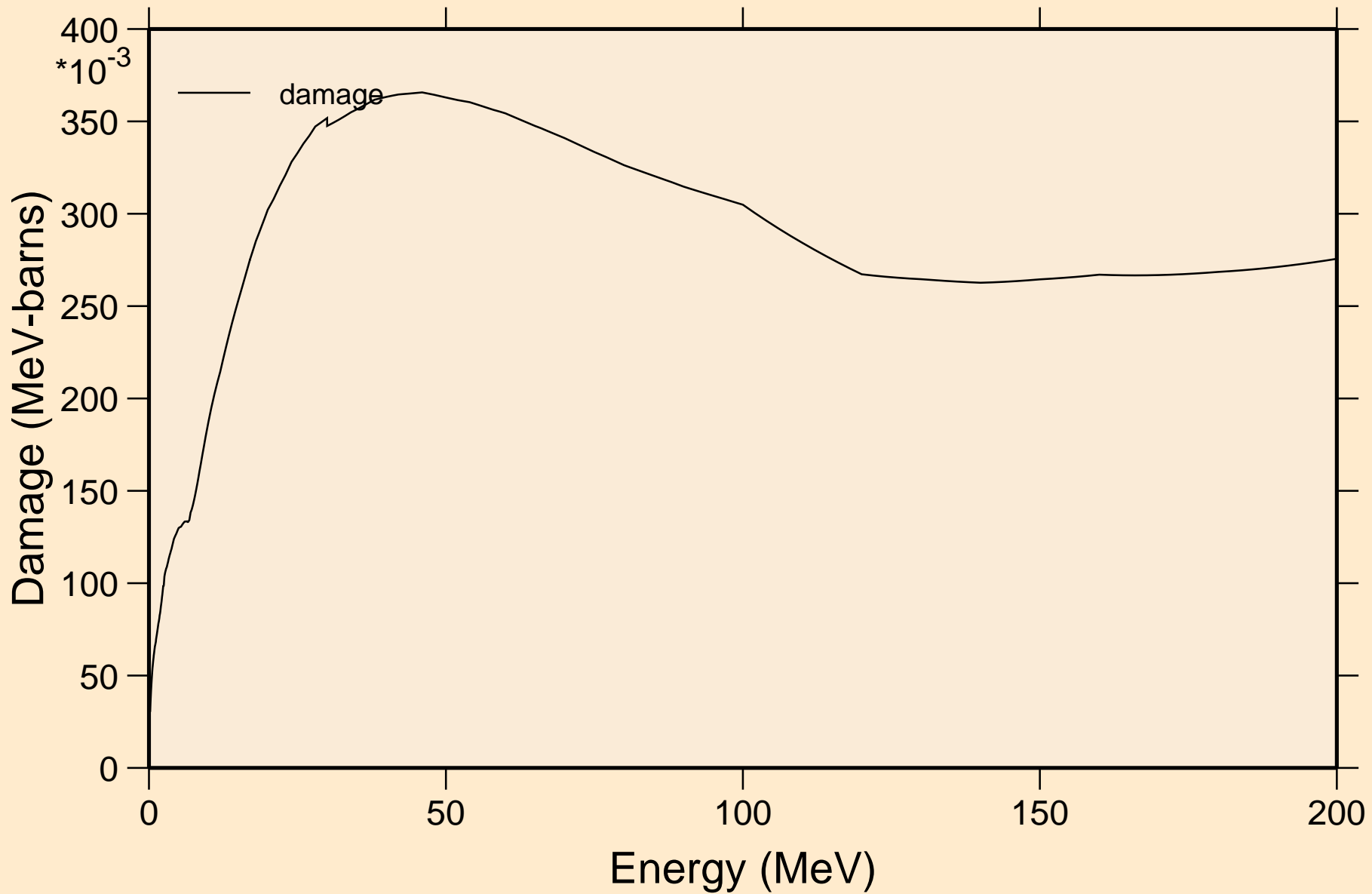

CU068 NEUTRON ACER TENDL-2023 LIBRARY; T=0.K
Non-threshold reactions

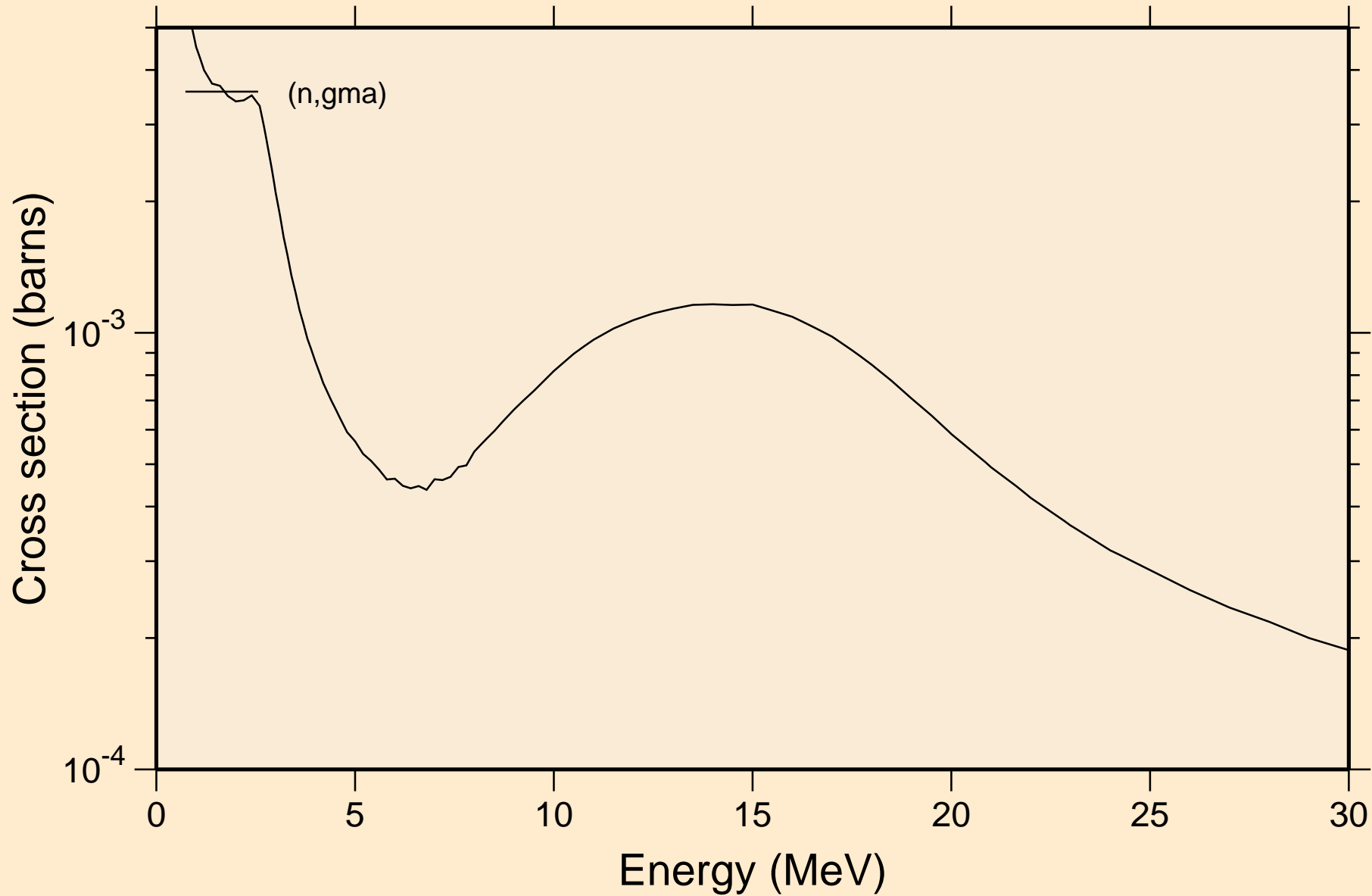

CU068 NEUTRON ACER TENDL-2023 LIBRARY; T=0.K
Inelastic levels

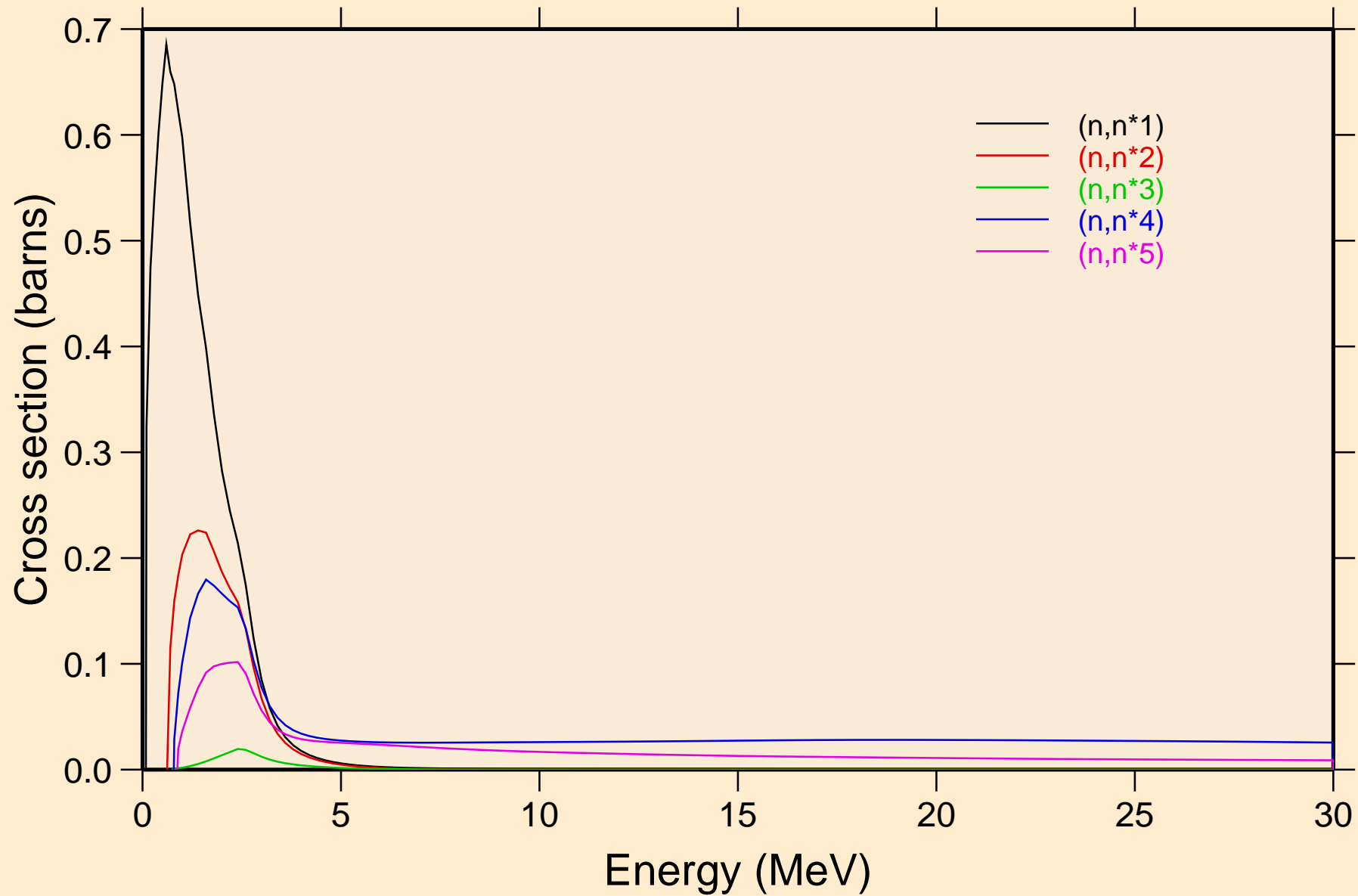

CU068 NEUTRON ACER TENDL-2023 LIBRARY; T=0.K
Inelastic levels

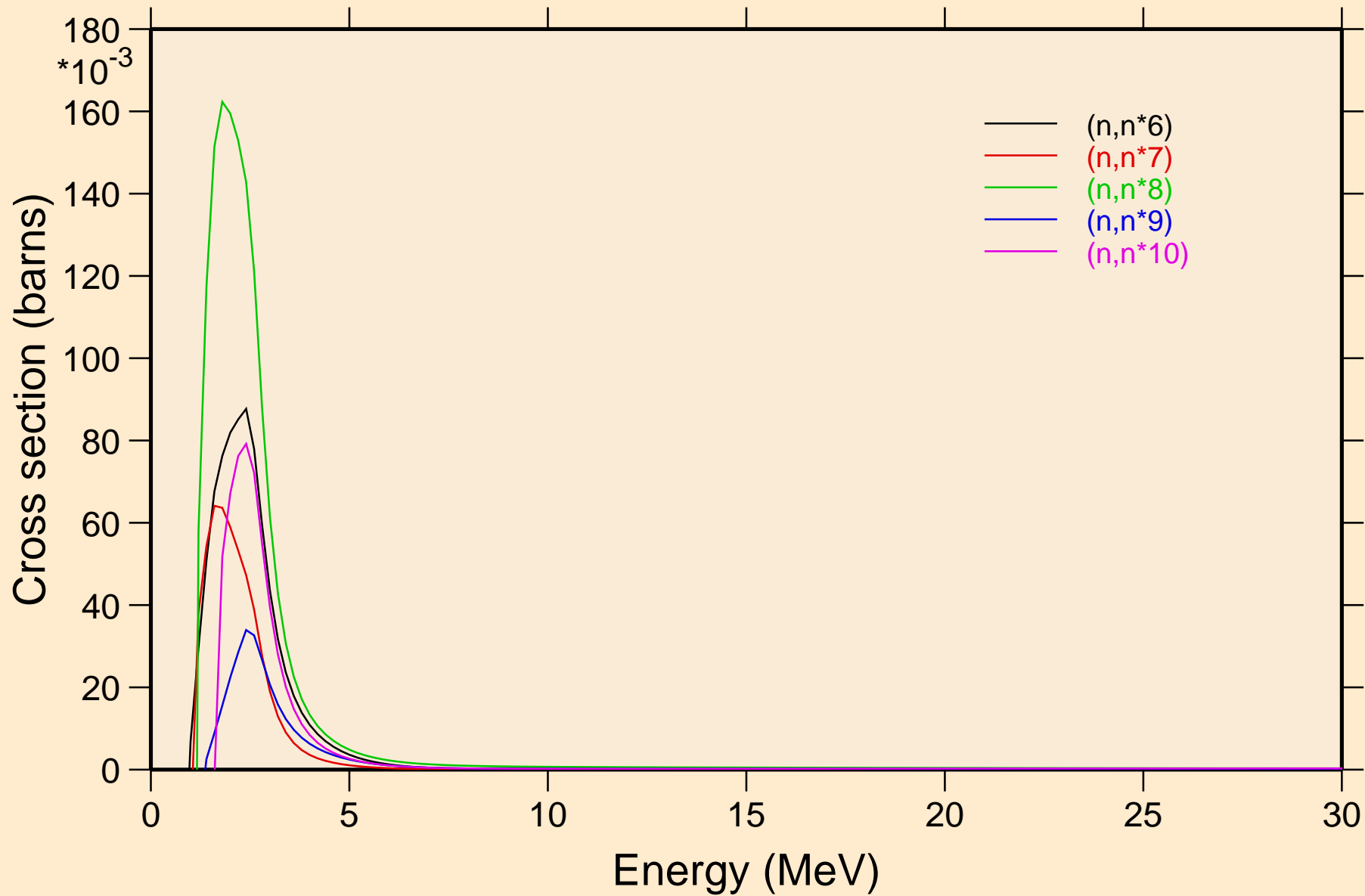

CU068 NEUTRON ACER TENDL-2023 LIBRARY; T=0.K
Inelastic levels

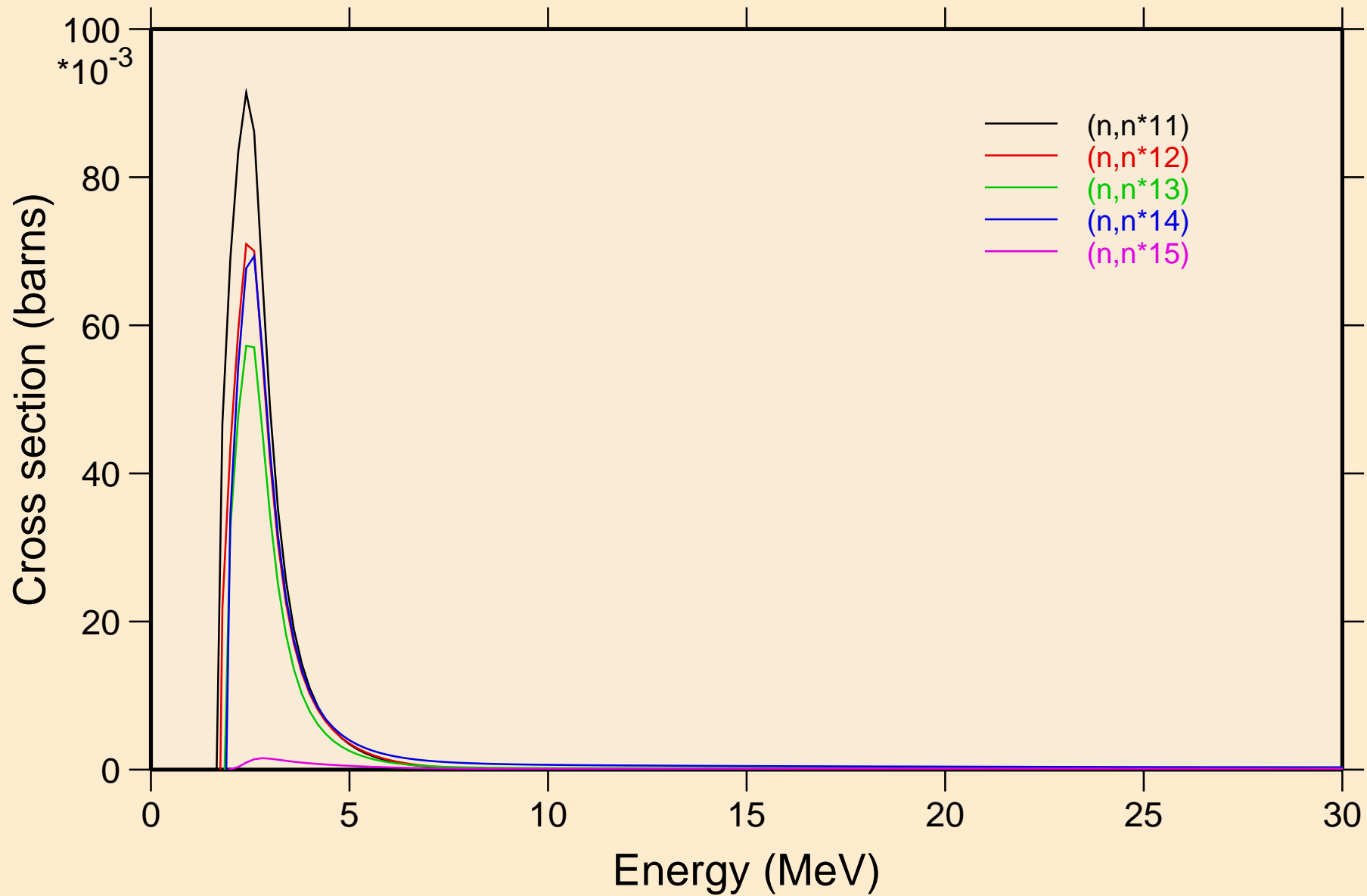

CU068 NEUTRON ACER TENDL-2023 LIBRARY; T=0.K
Inelastic levels

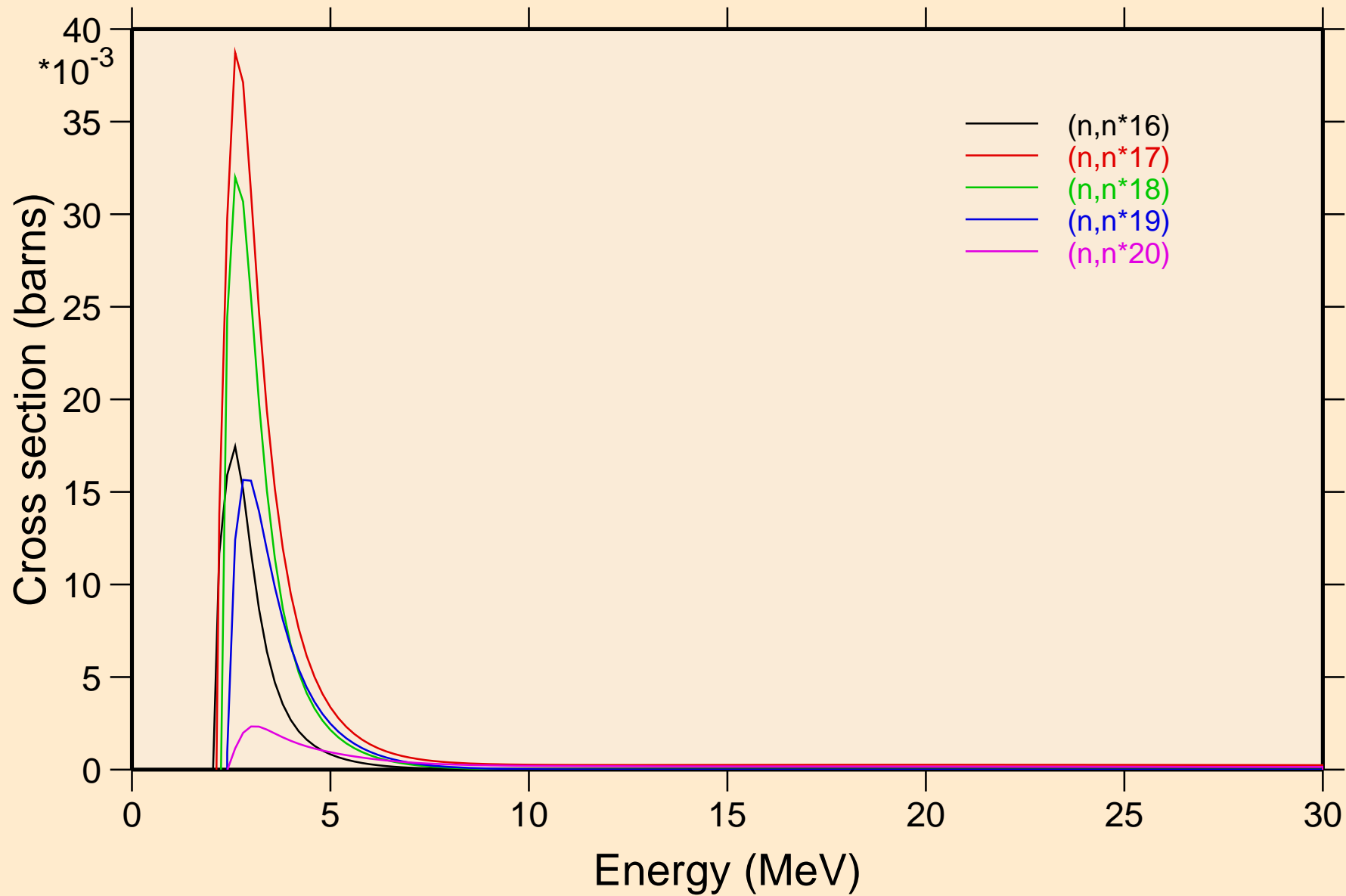

CU068 NEUTRON ACER TENDL-2023 LIBRARY; T=0.K
Inelastic levels

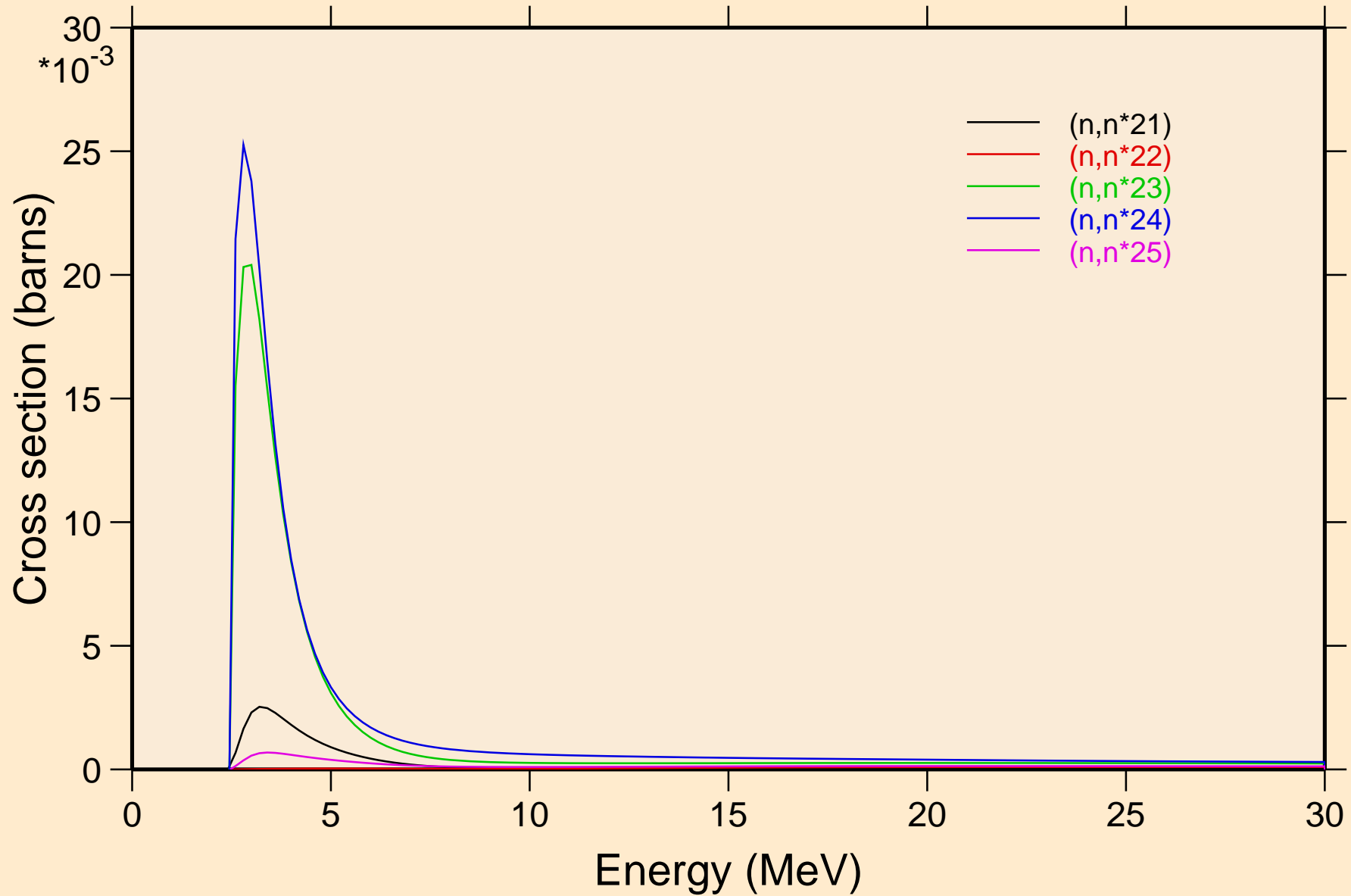

CU068 NEUTRON ACER TENDL-2023 LIBRARY; T=0.K
Inelastic levels

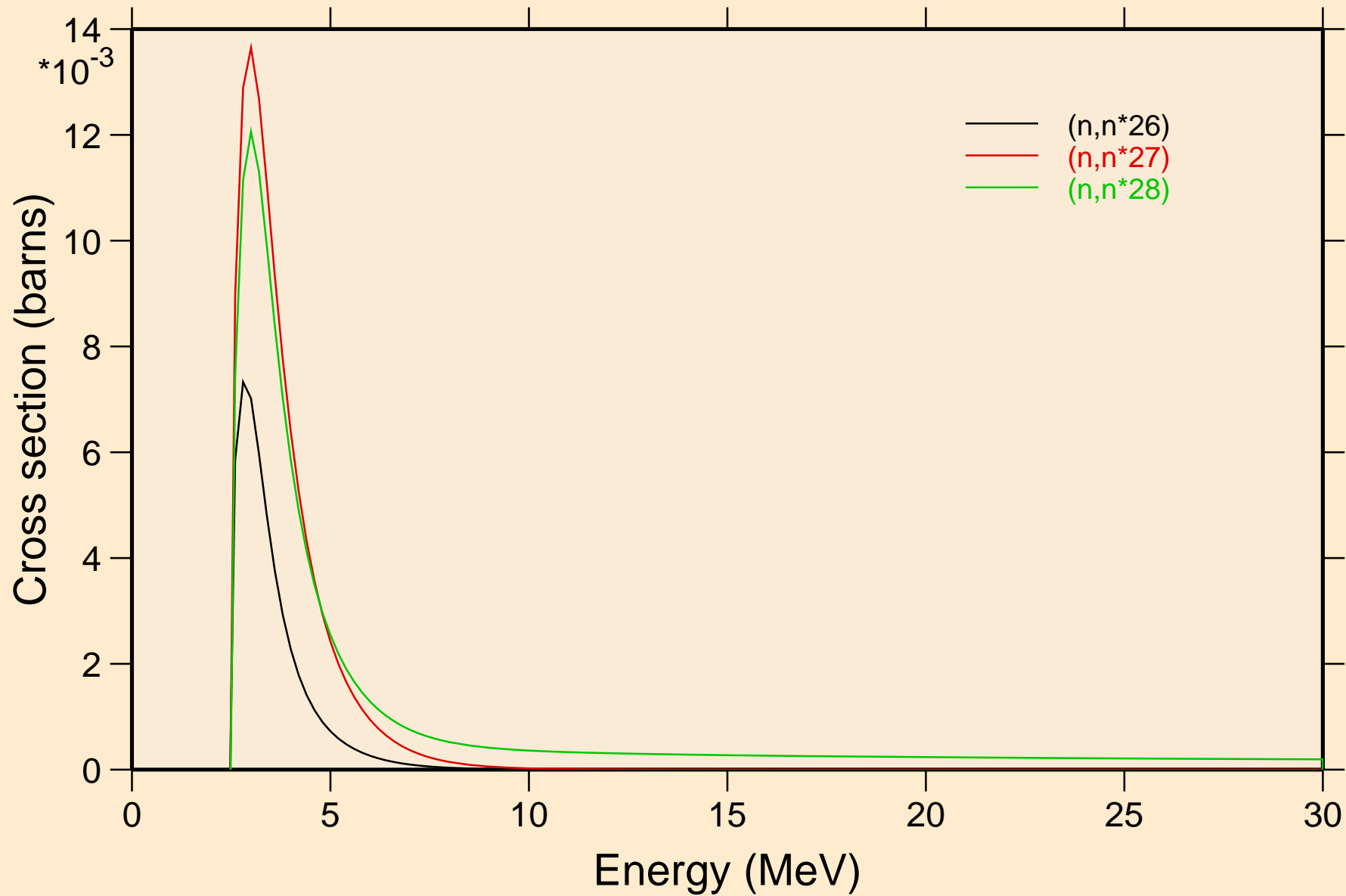

CU068 NEUTRON ACER TENDL-2023 LIBRARY; T=0.K
Threshold reactions

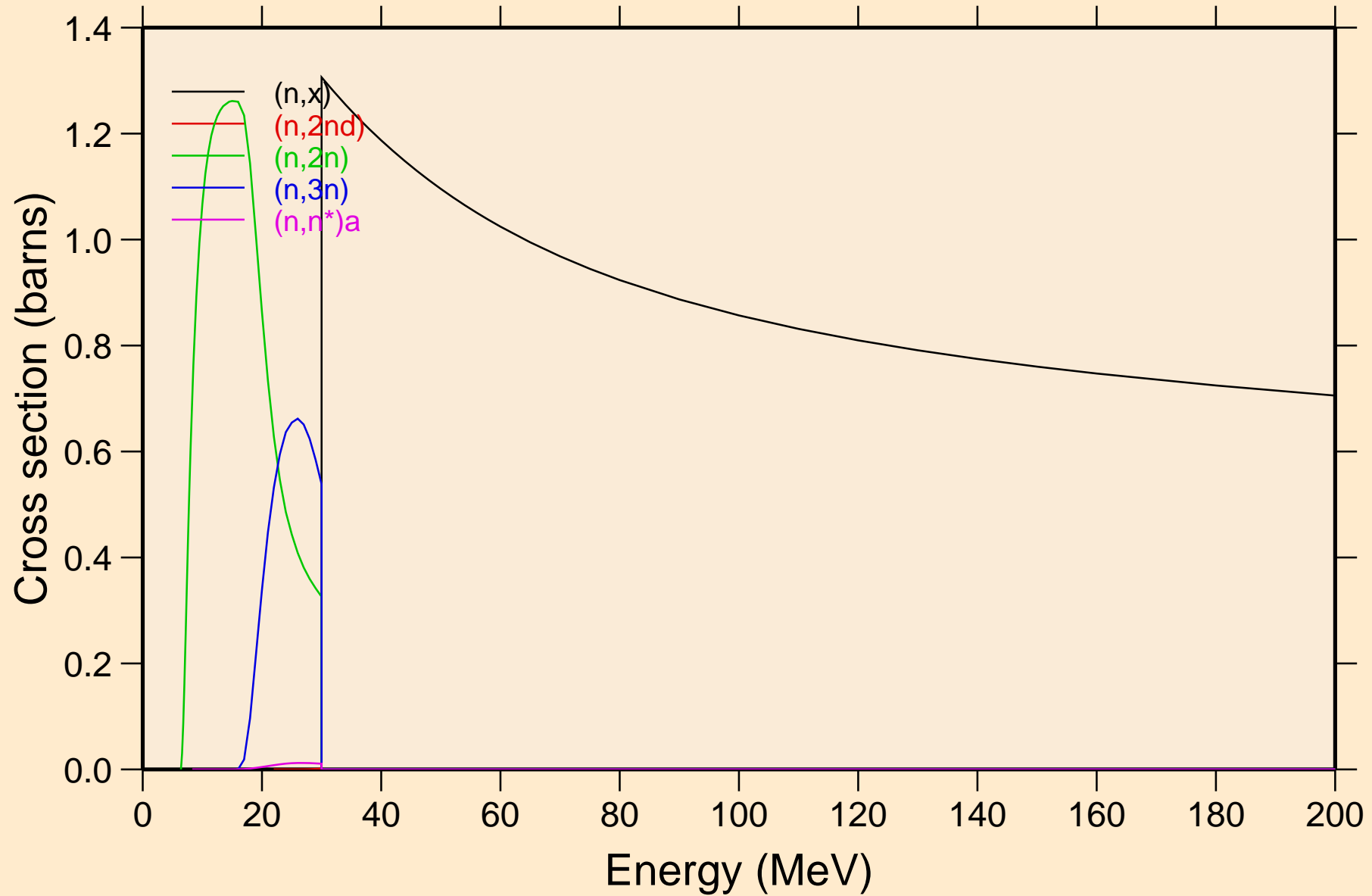

CU068 NEUTRON ACER TENDL-2023 LIBRARY; T=0.K

Threshold reactions

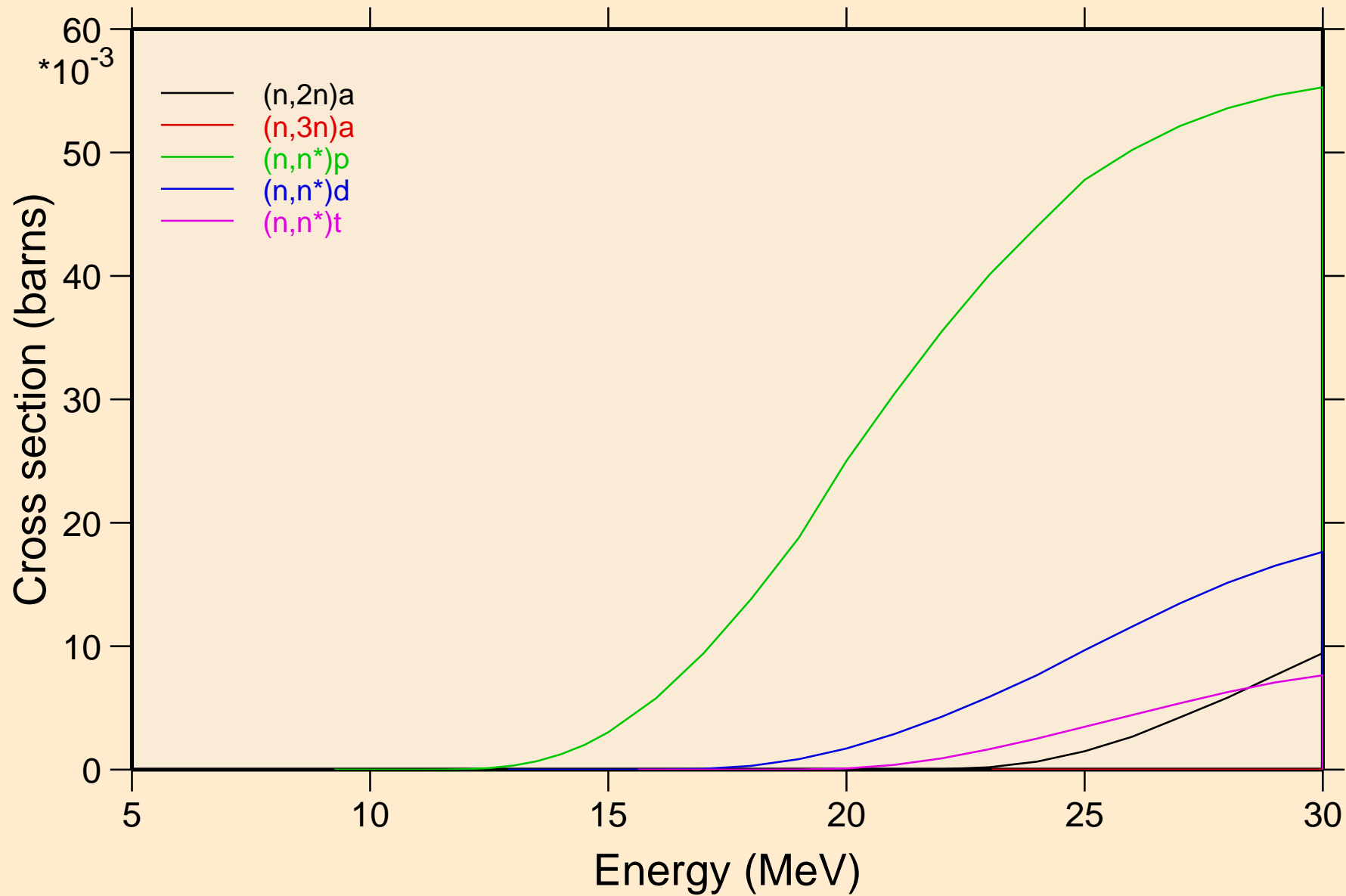

CU068 NEUTRON ACER TENDL-2023 LIBRARY; T=0.K

Threshold reactions

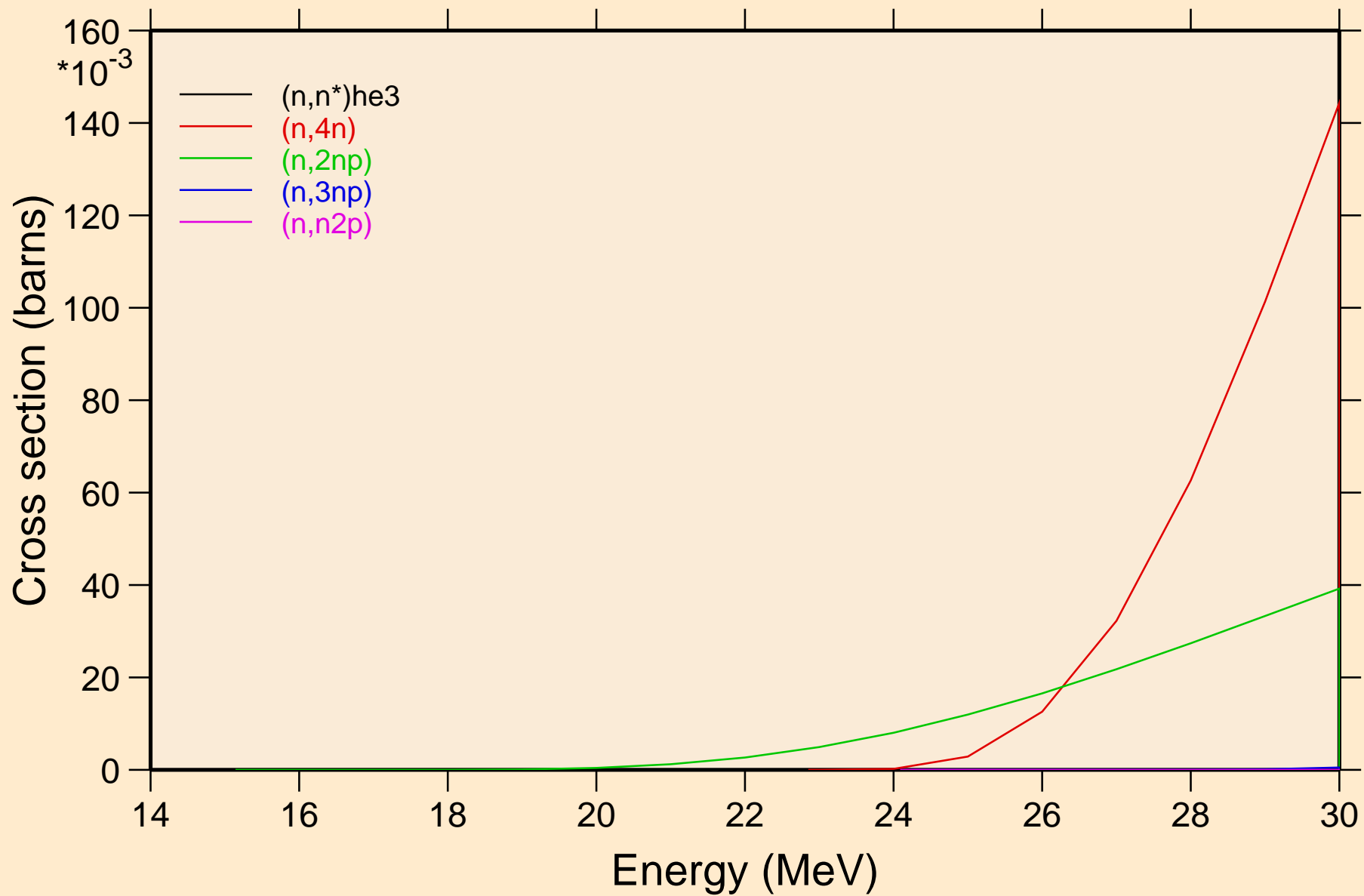

CU068 NEUTRON ACER TENDL-2023 LIBRARY; T=0.K

Threshold reactions

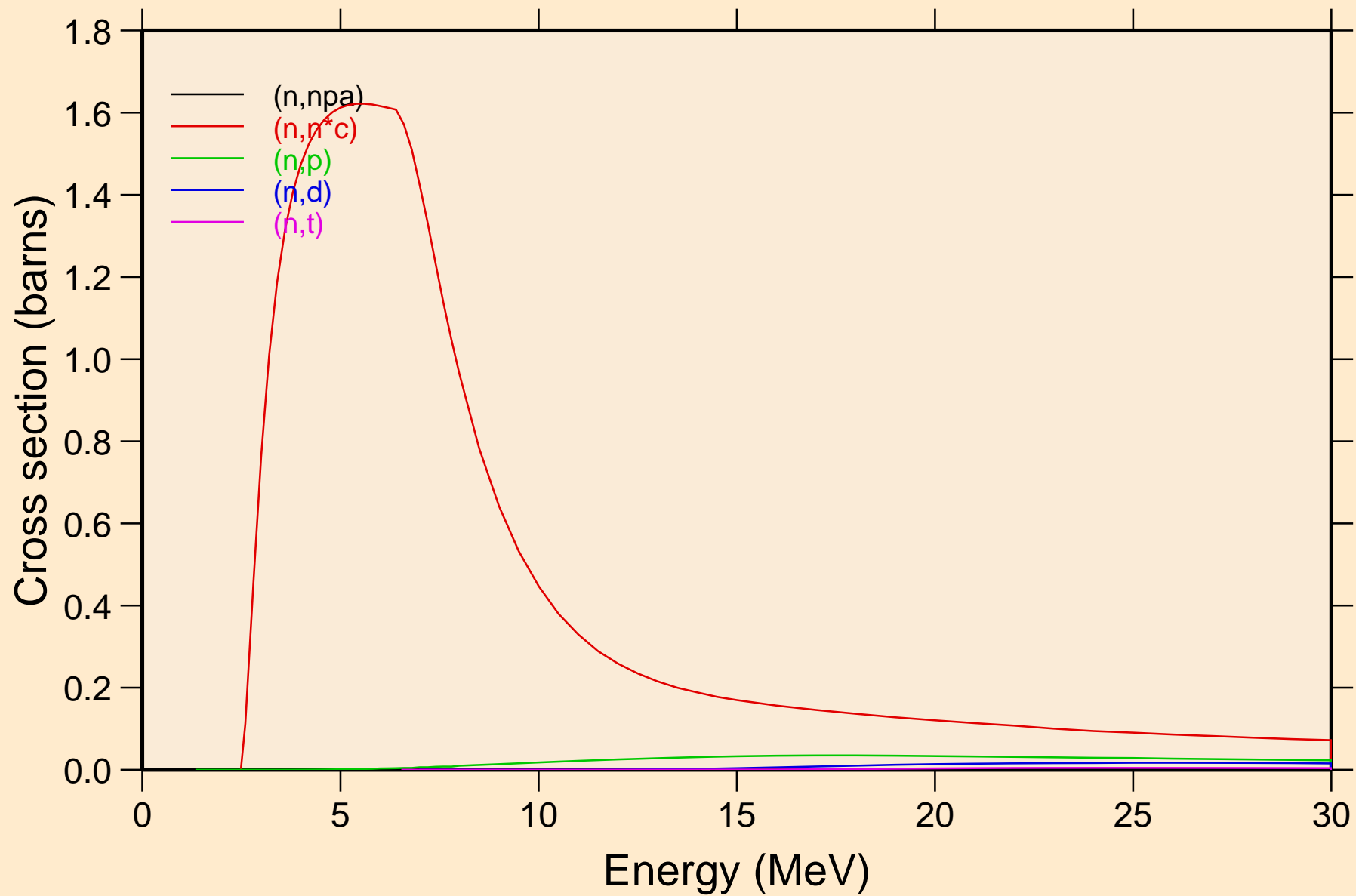

CU068 NEUTRON ACER TENDL-2023 LIBRARY; T=0.K

Threshold reactions

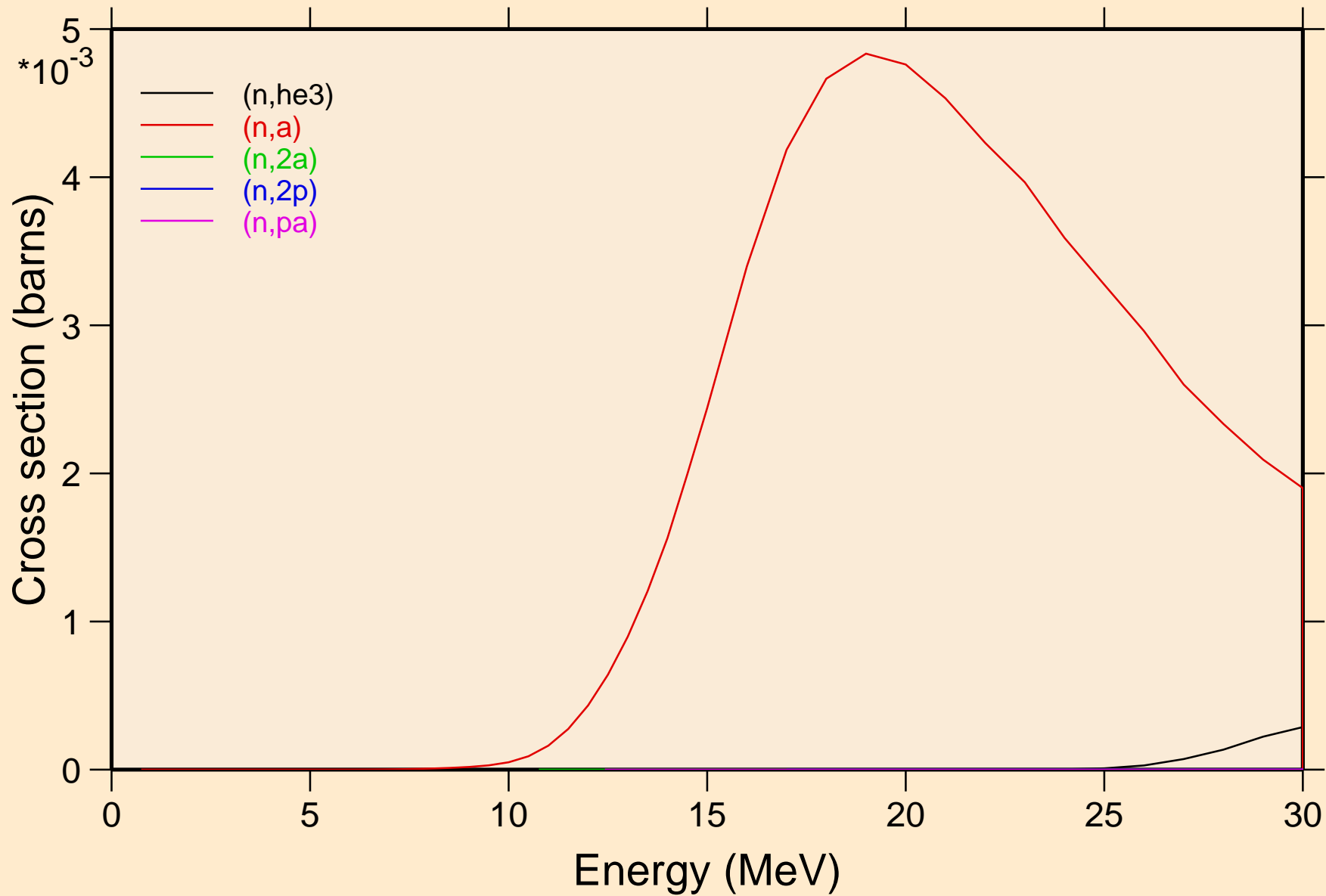

CU068 NEUTRON ACER TENDL-2023 LIBRARY; T=0.K
Threshold reactions

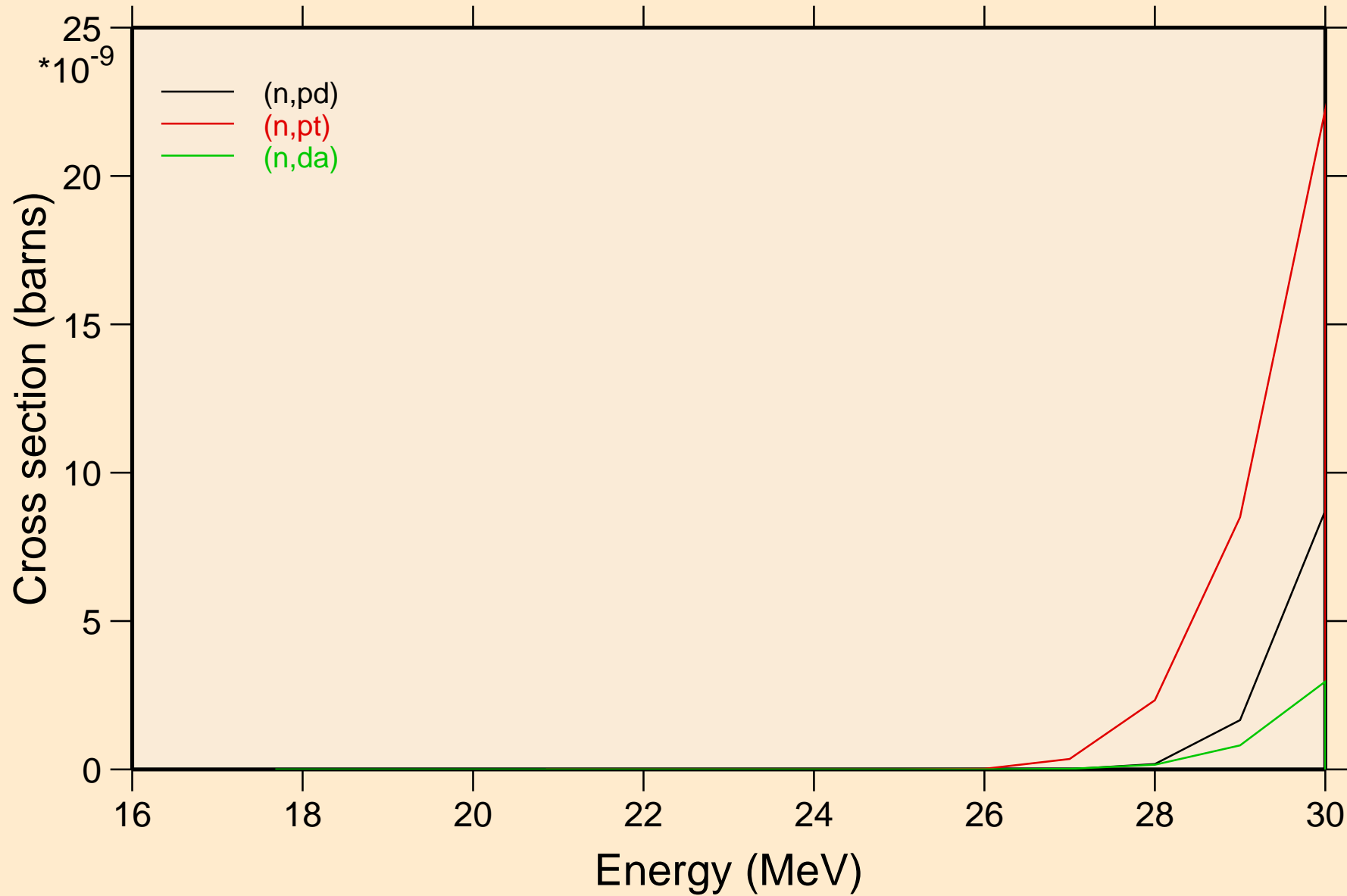

CU068 NEUTRON ACER TENDL-2023 LIBRARY; T=0.K

Threshold reactions

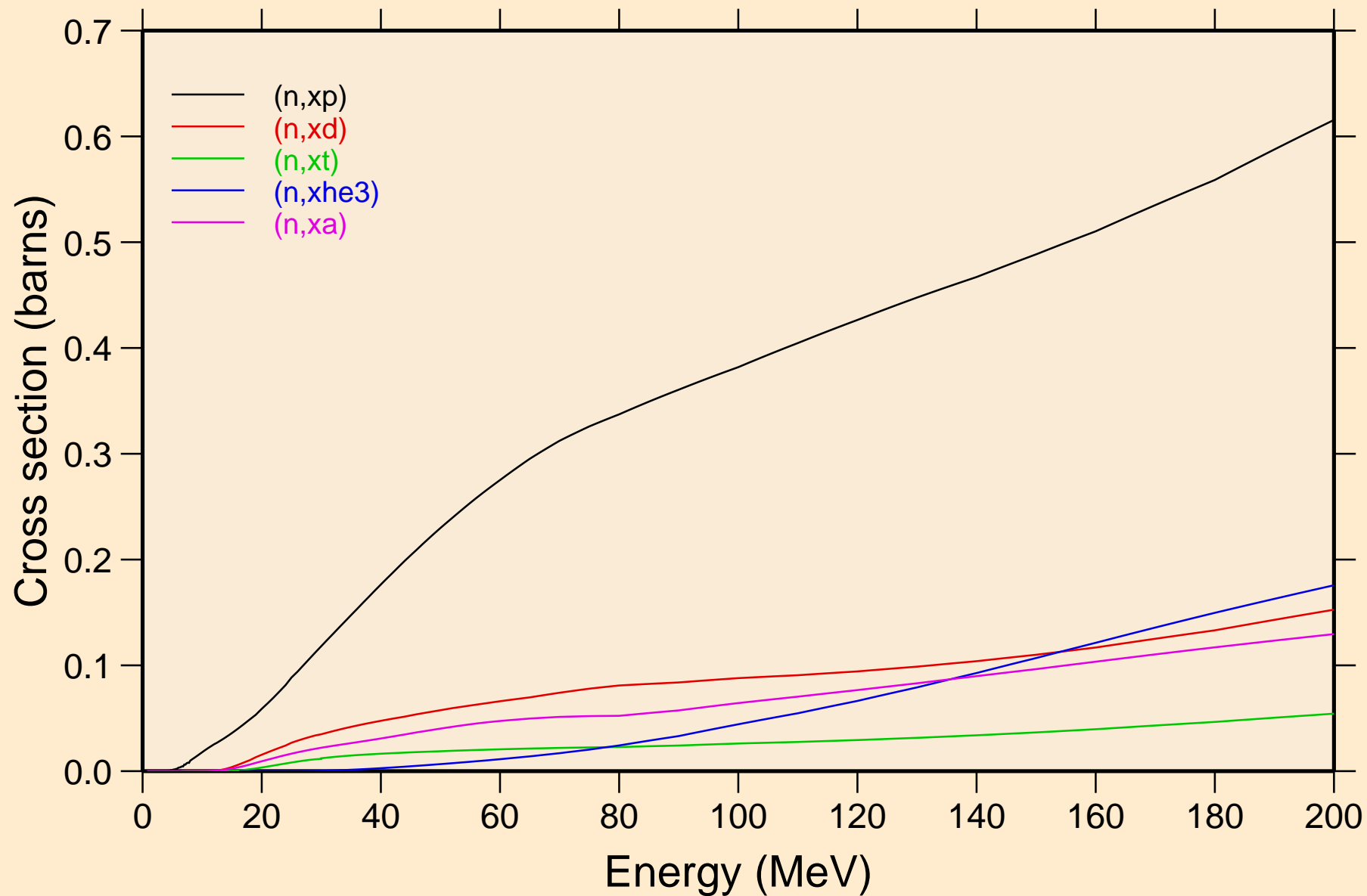

CU068 NEUTRON ACER TENDL-2023 LIBRARY; T=0.K
angular distribution for elastic

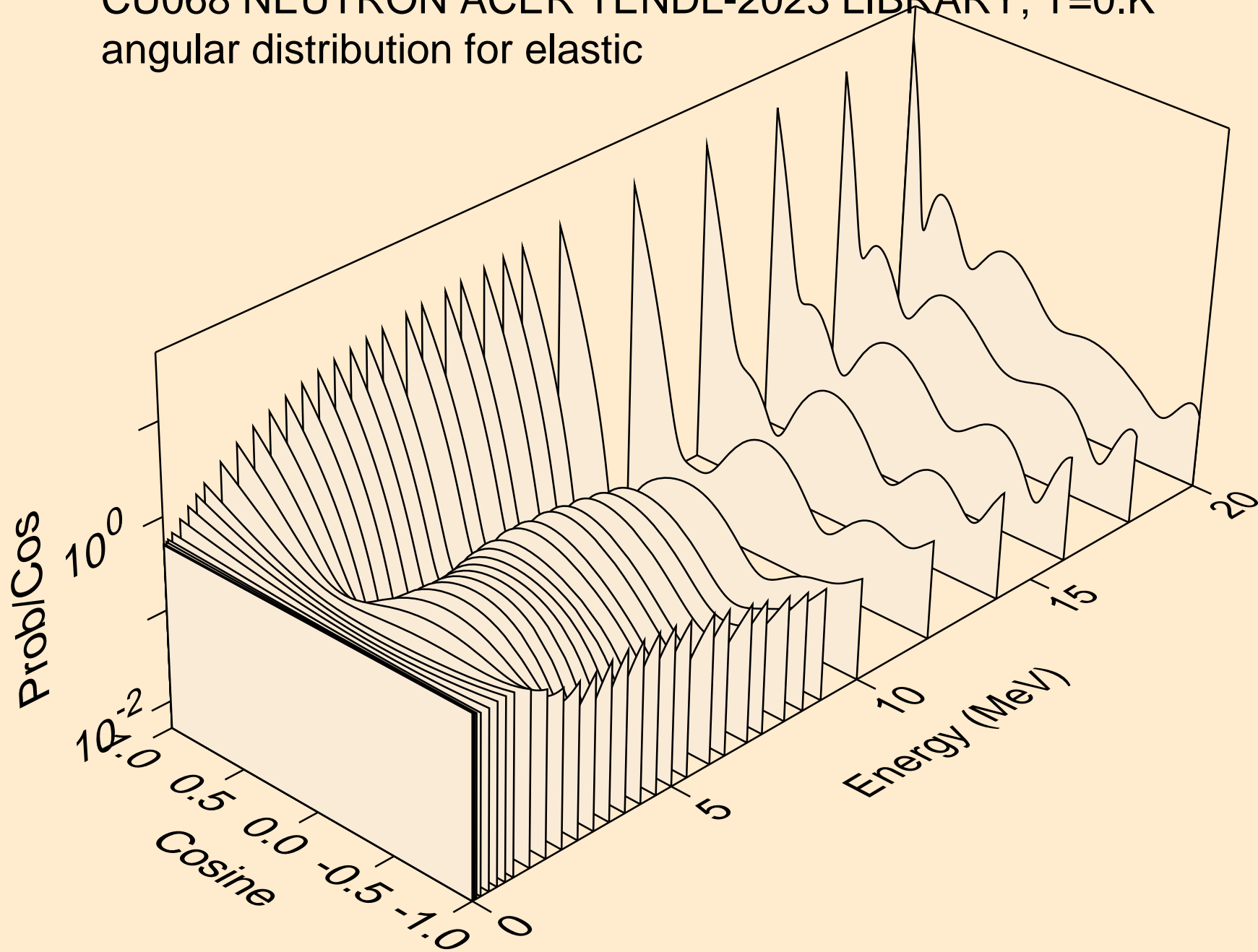

CU068 NEUTRON ACER TENDL-2023 LIBRARY; T=0.K
angular distribution for elastic

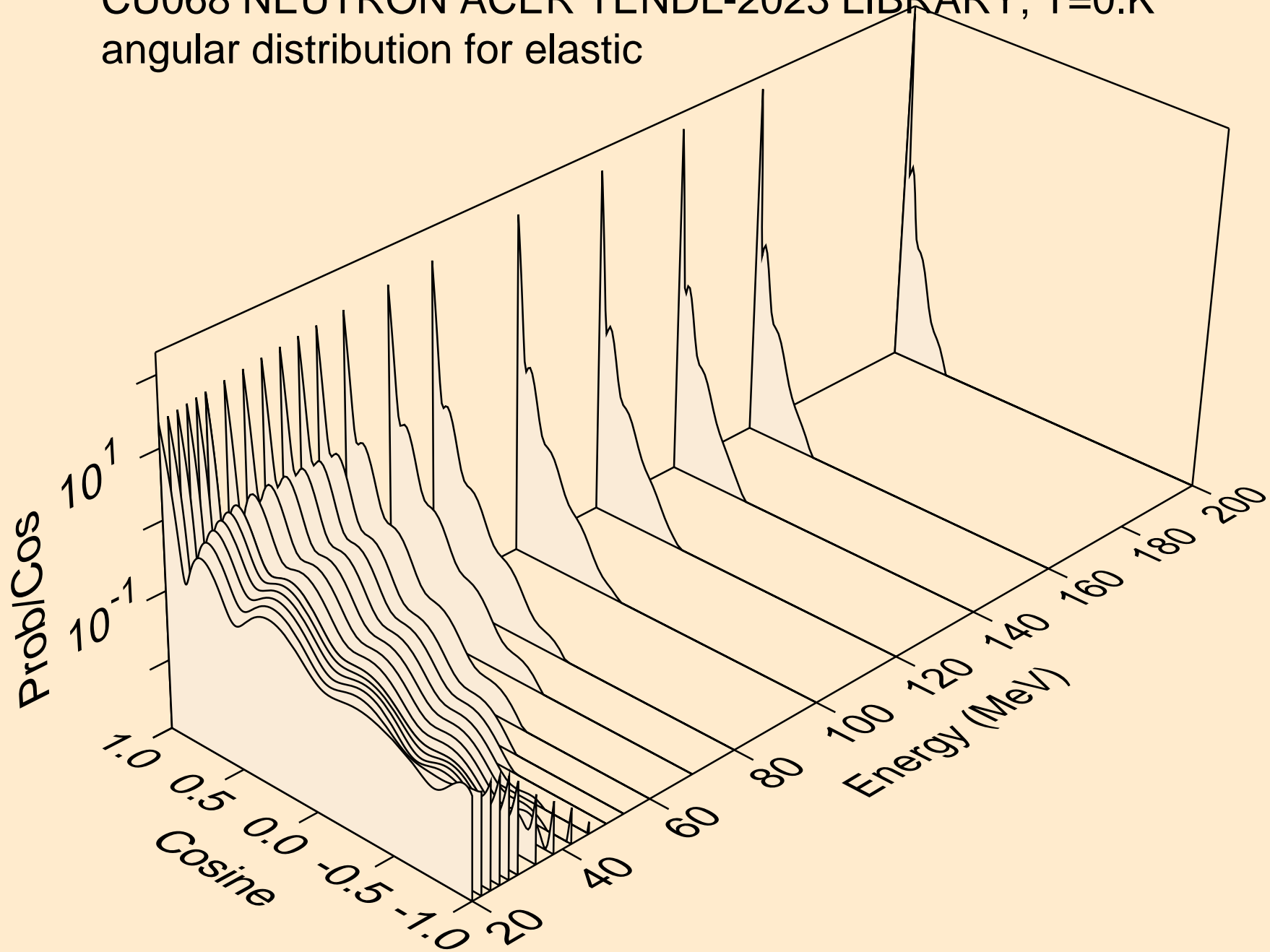

CU068 NEUTRON ACER TENDL-2023 LIBRARY; T=0.K
angular distribution for (n,n*1)

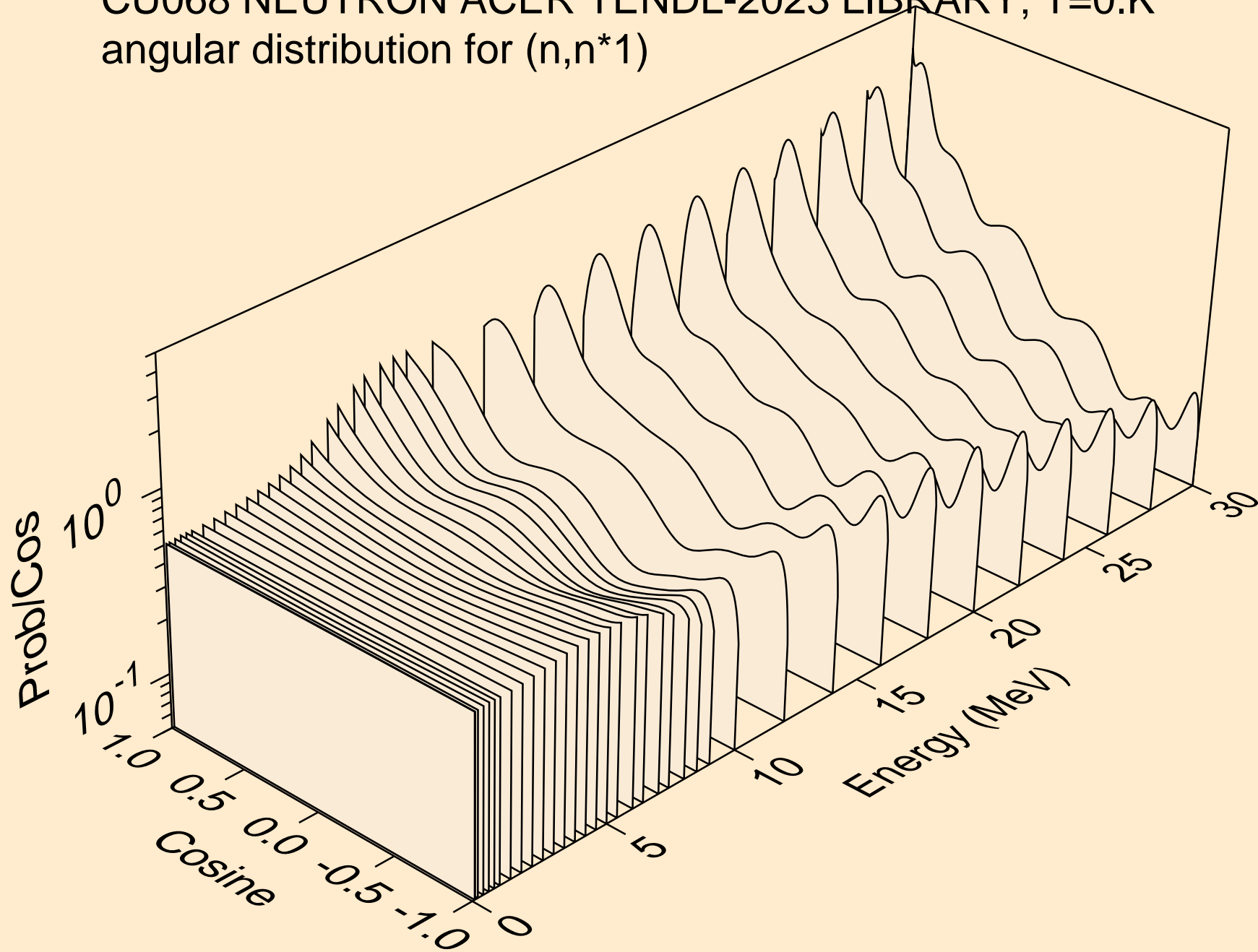

CU068 NEUTRON ACER TENDL-2023 LIBRARY; T=0.K
angular distribution for (n,n*2)

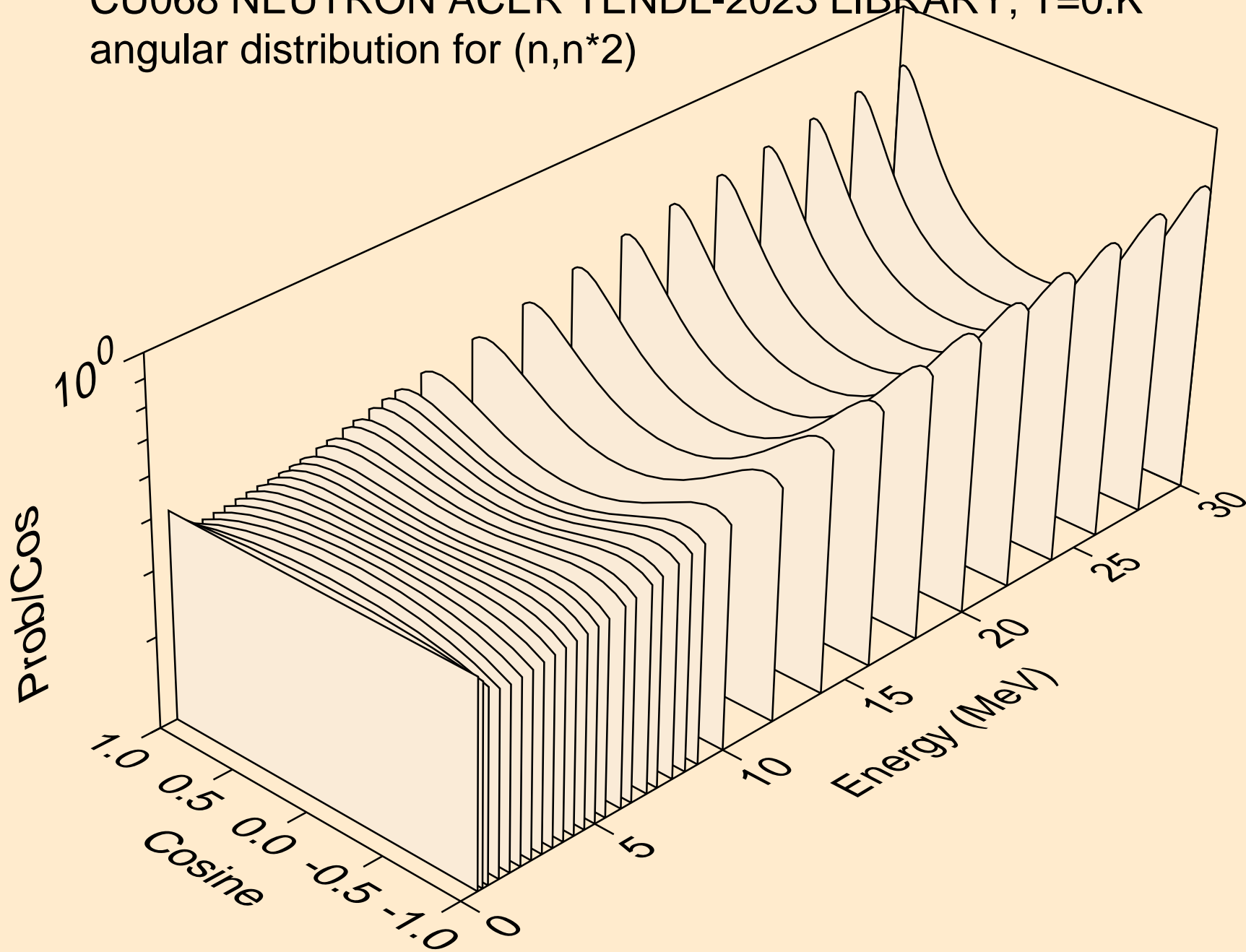

CU068 NEUTRON ACER TENDL-2023 LIBRARY; T=0.K
angular distribution for (n,n*3)

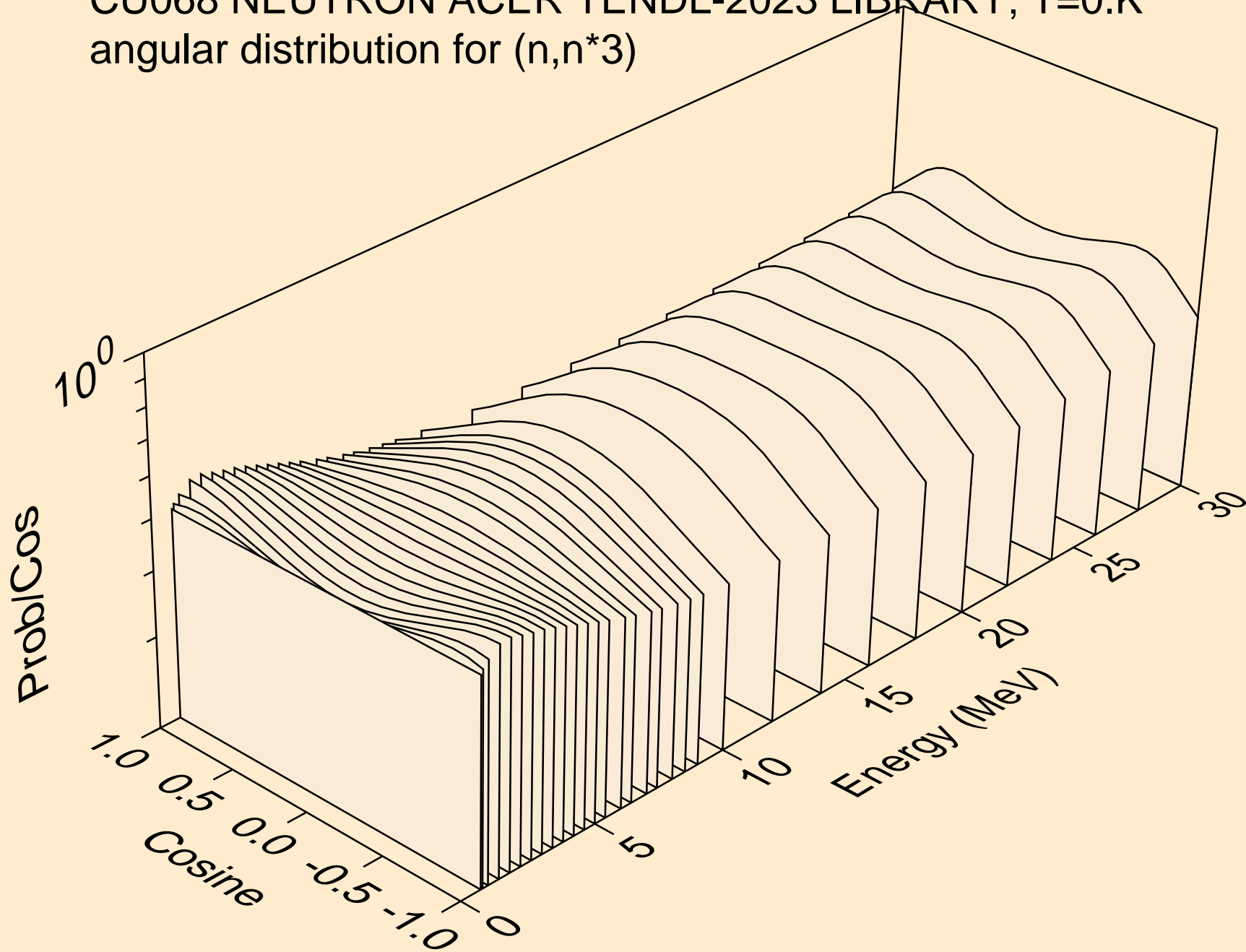

CU068 NEUTRON ACER TENDL-2023 LIBRARY; T=0.K
angular distribution for (n,n*4)

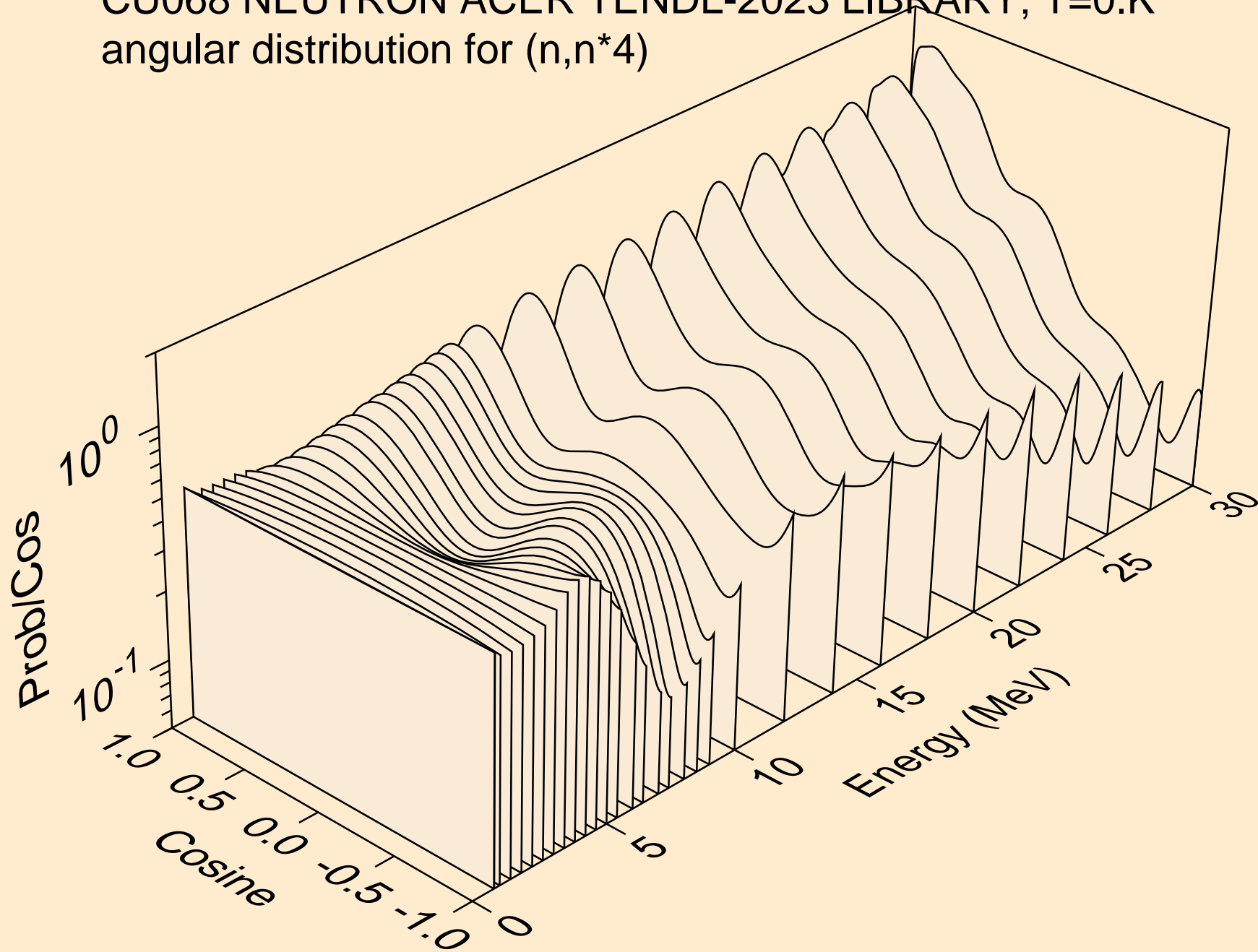

CU068 NEUTRON ACER TENDL-2023 LIBRARY; T=0.K
angular distribution for (n,n*5)

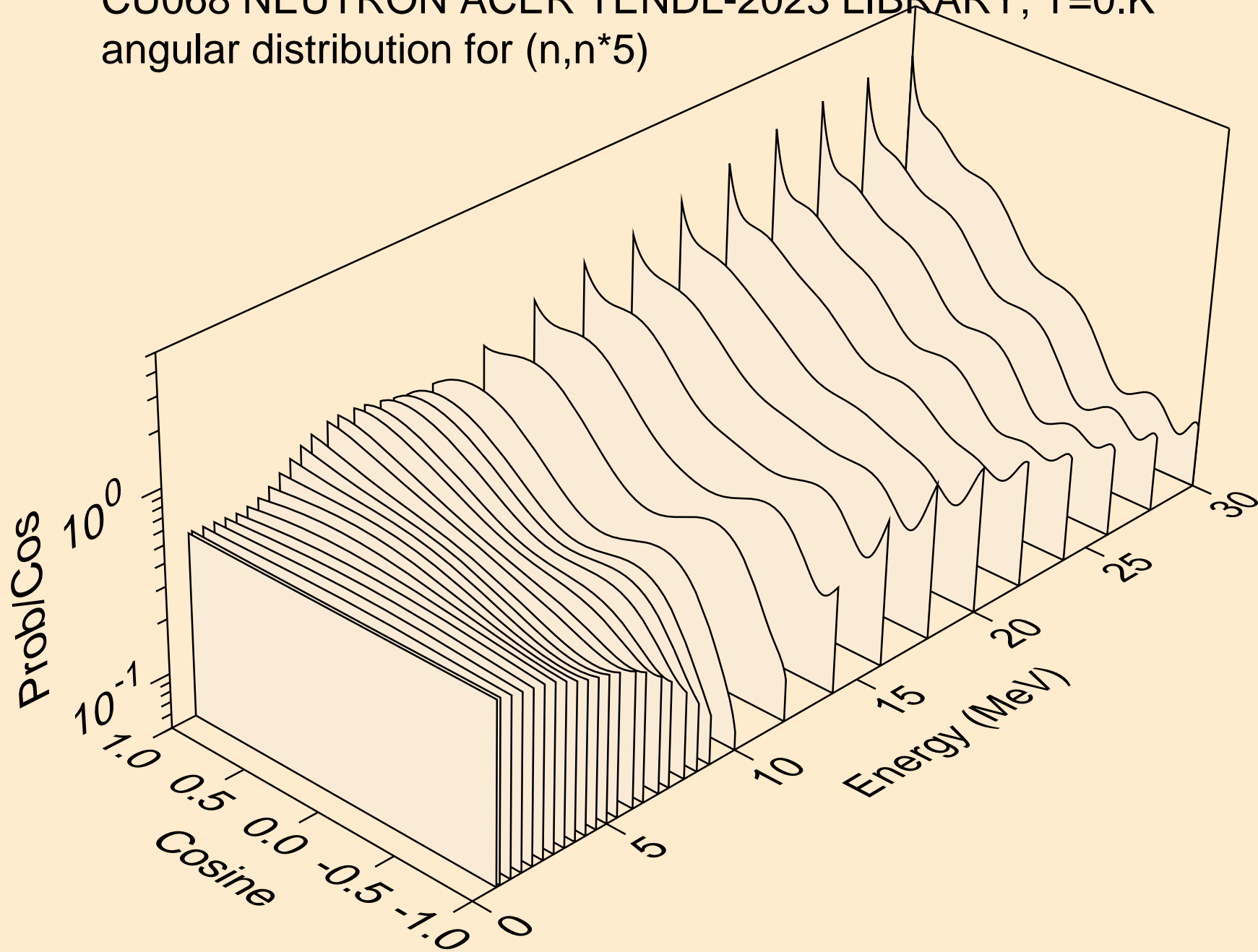

CU068 NEUTRON ACER TENDL-2023 LIBRARY; T=0.K
angular distribution for (n,n*6)

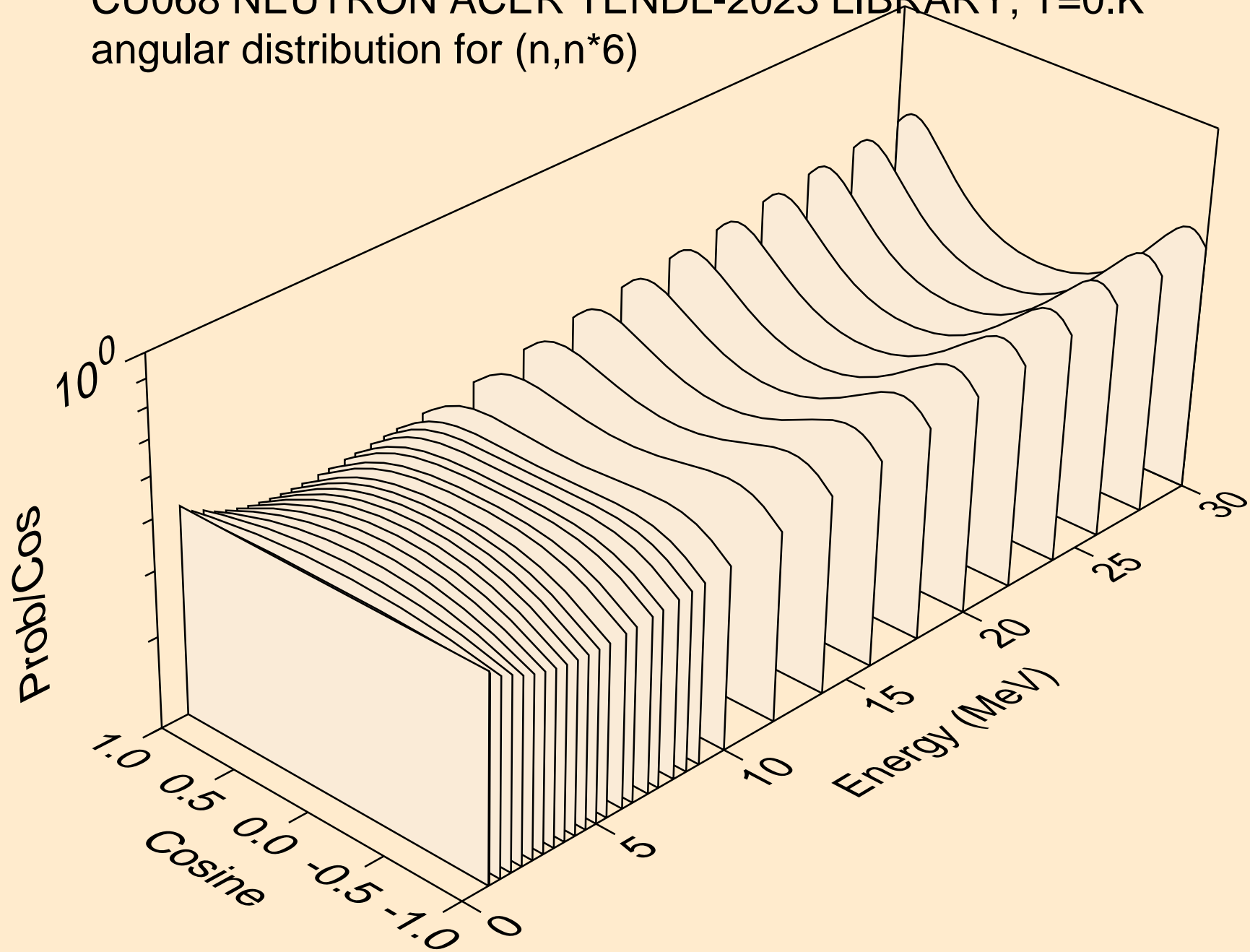

CU068 NEUTRON ACER TENDL-2023 LIBRARY; T=0.K
angular distribution for (n,n*7)

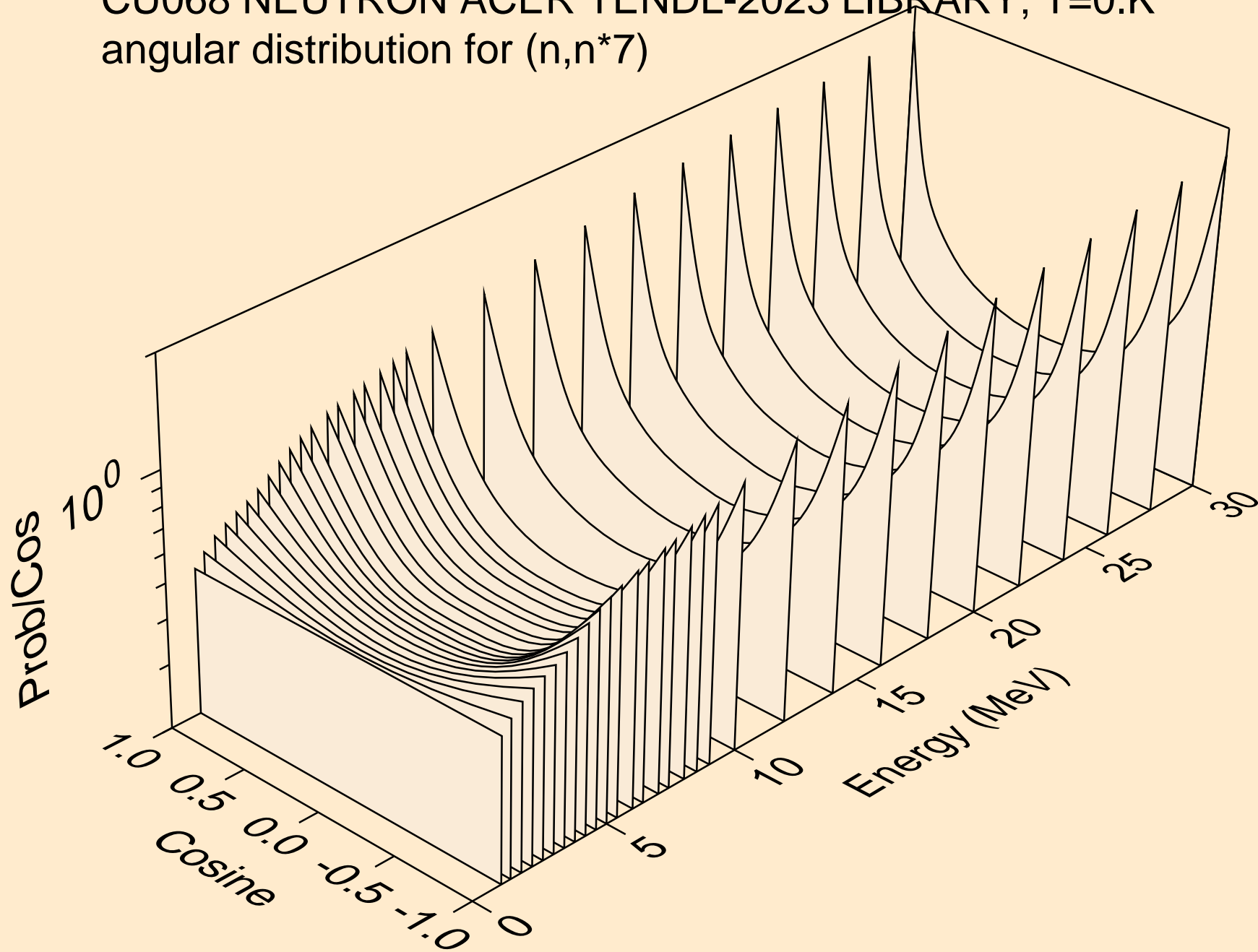

CU068 NEUTRON ACER TENDL-2023 LIBRARY; T=0.K
angular distribution for (n,n*8)

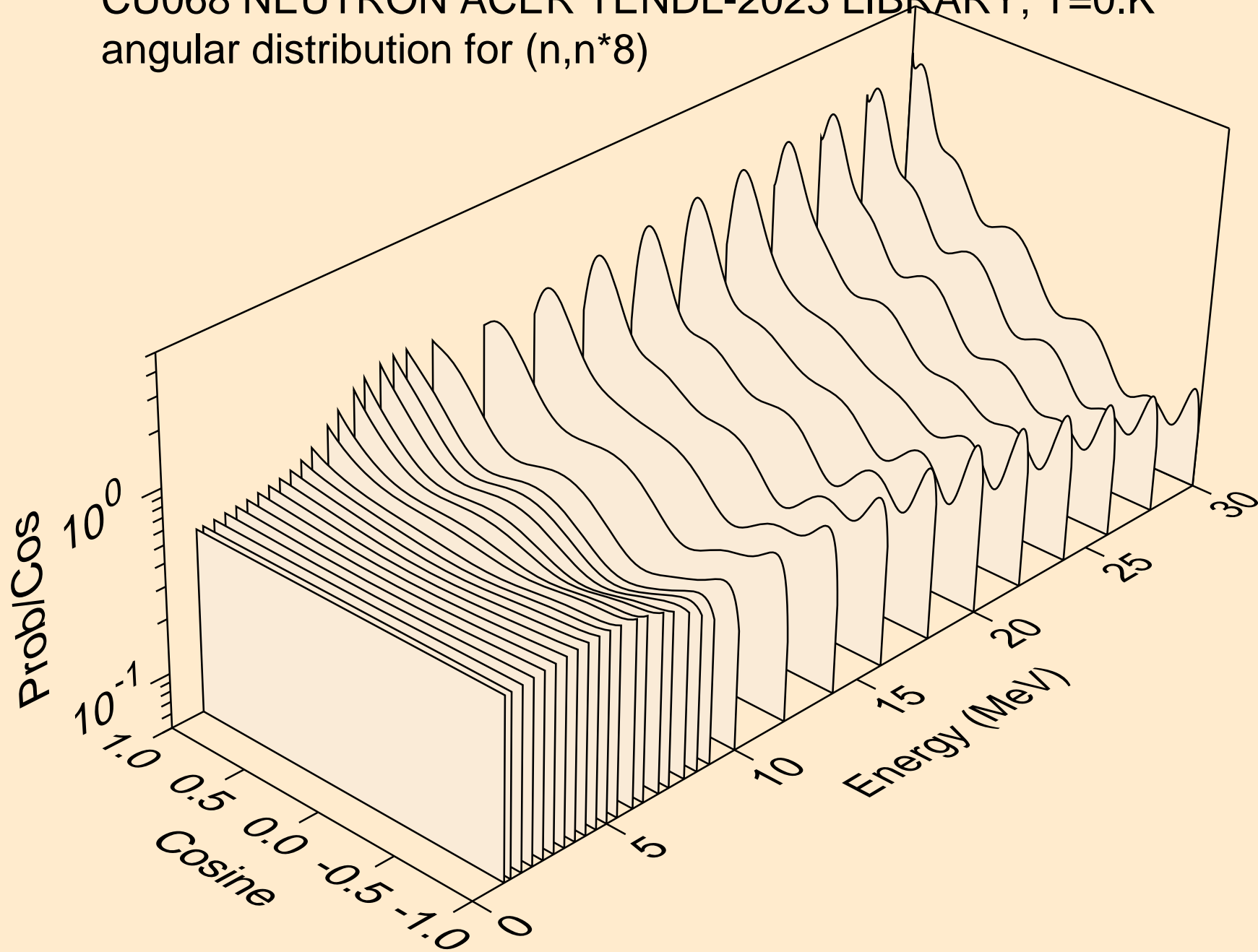

CU068 NEUTRON ACER TENDL-2023 LIBRARY; T=0.K
angular distribution for (n,n*9)

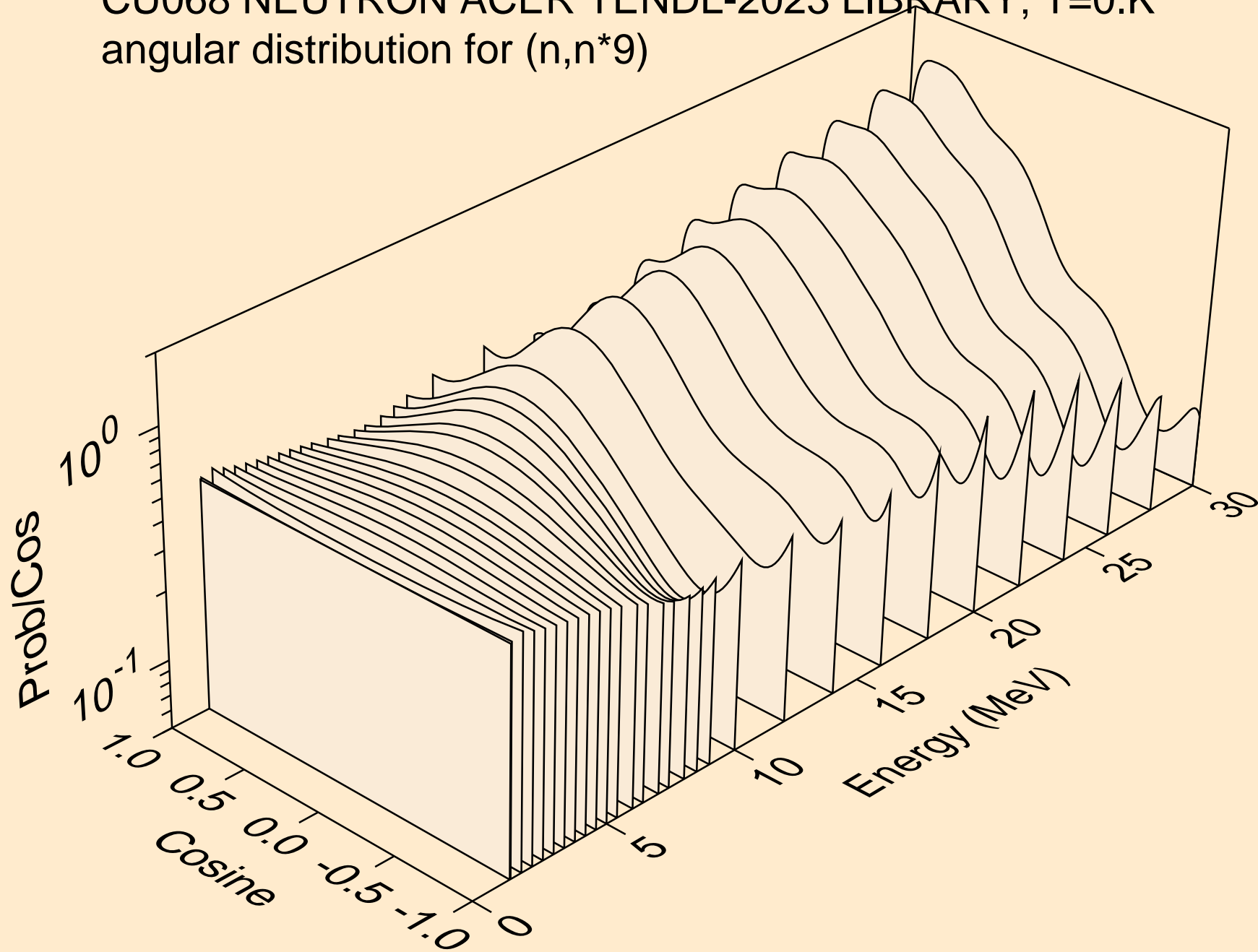

CU068 NEUTRON ACER TENDL-2023 LIBRARY; T=0.K
angular distribution for (n,n*10)

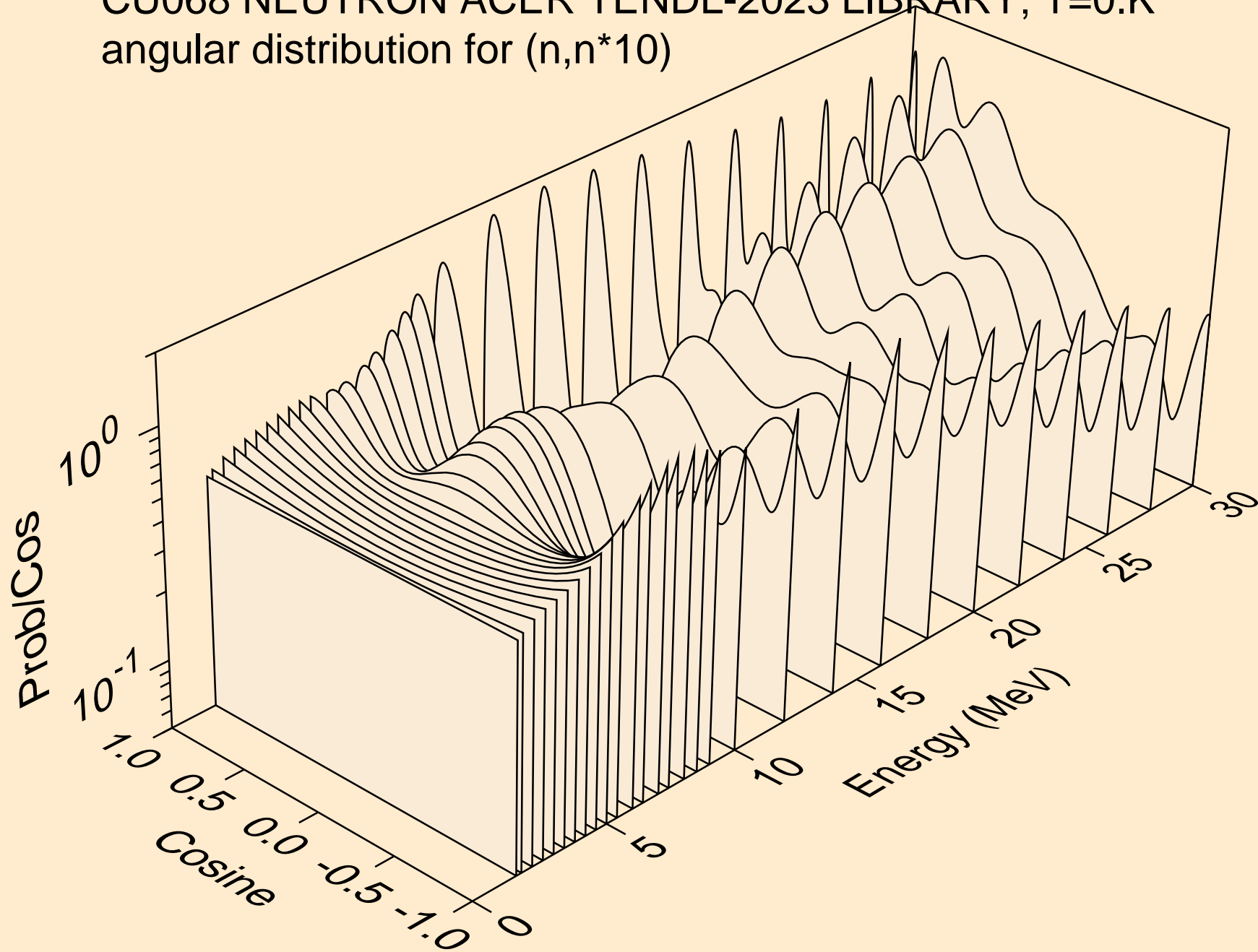

CU068 NEUTRON ACER TENDL-2023 LIBRARY; T=0.K
angular distribution for (n,n*11)

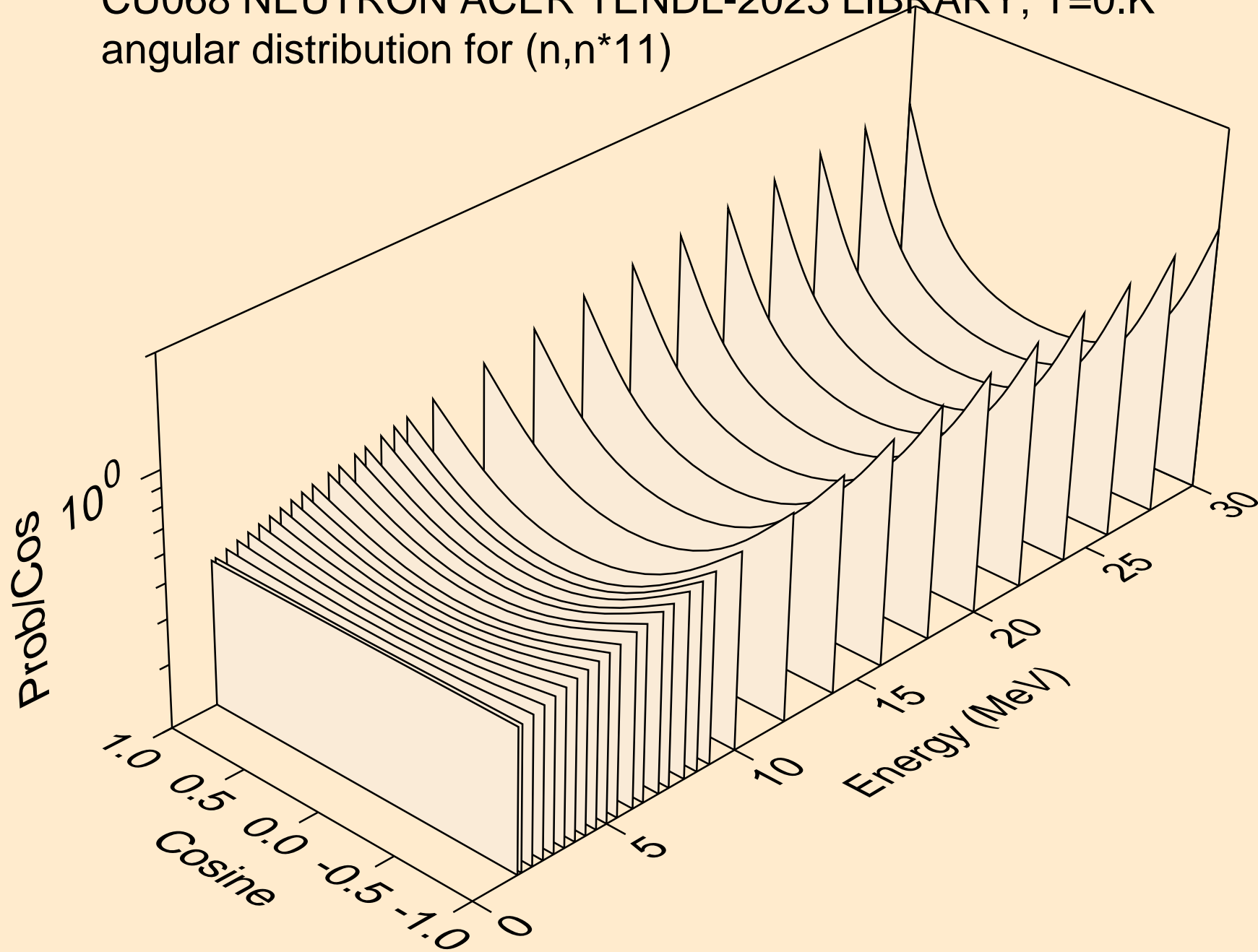

CU068 NEUTRON ACER TENDL-2023 LIBRARY; T=0.K
angular distribution for (n,n*12)

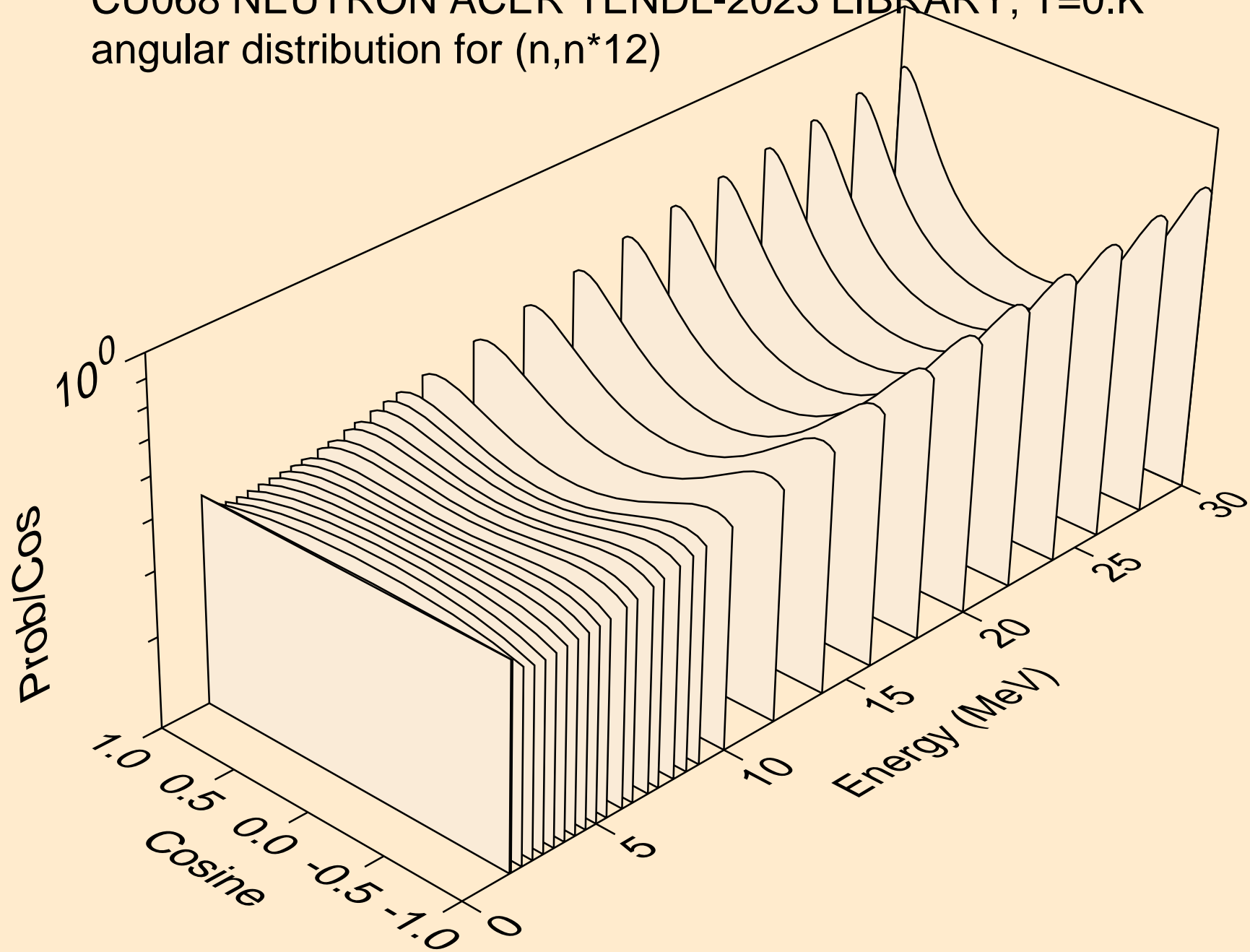

CU068 NEUTRON ACER TENDL-2023 LIBRARY; T=0.K
angular distribution for (n,n*13)

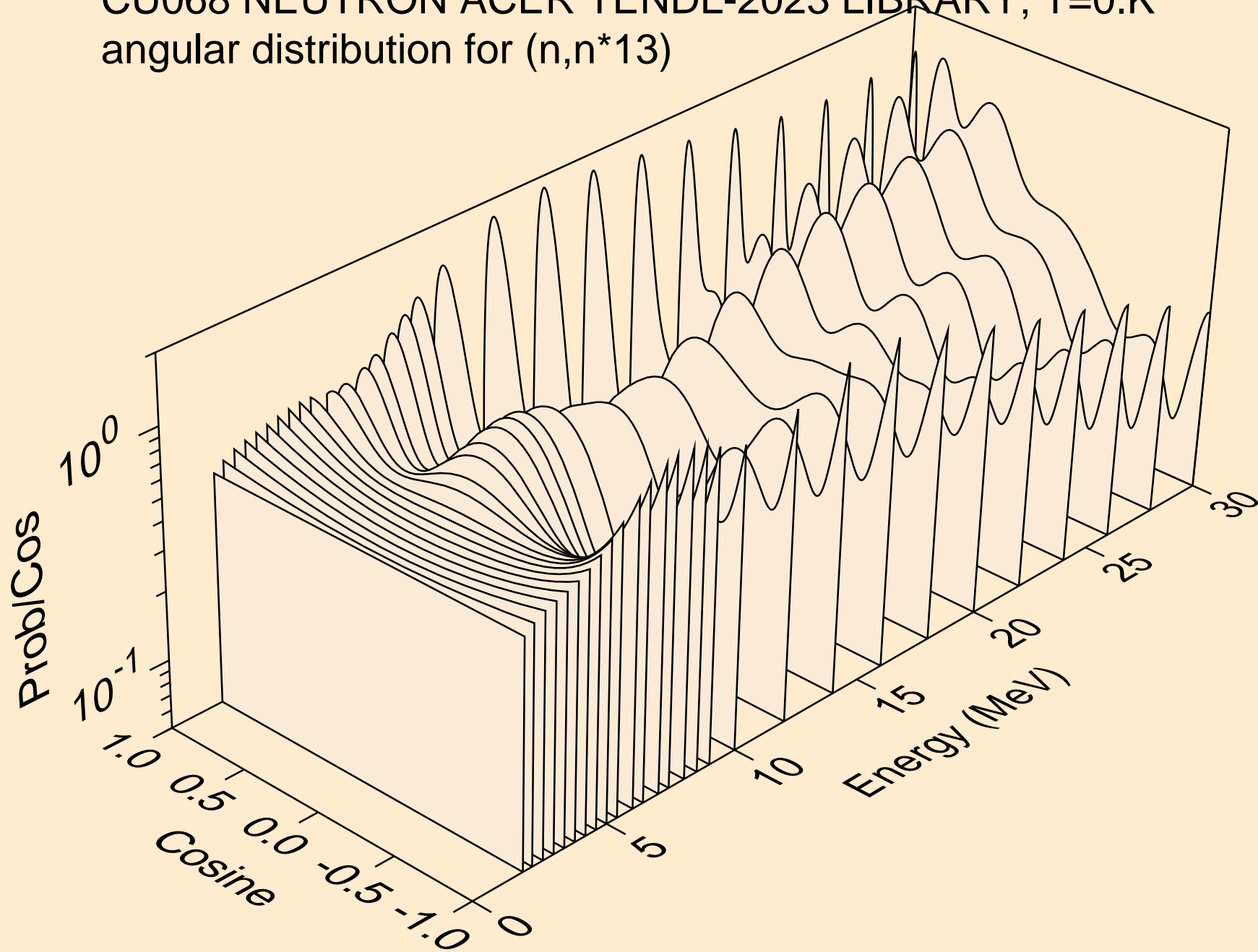

CU068 NEUTRON ACER TENDL-2023 LIBRARY; T=0.K
angular distribution for (n,n*14)

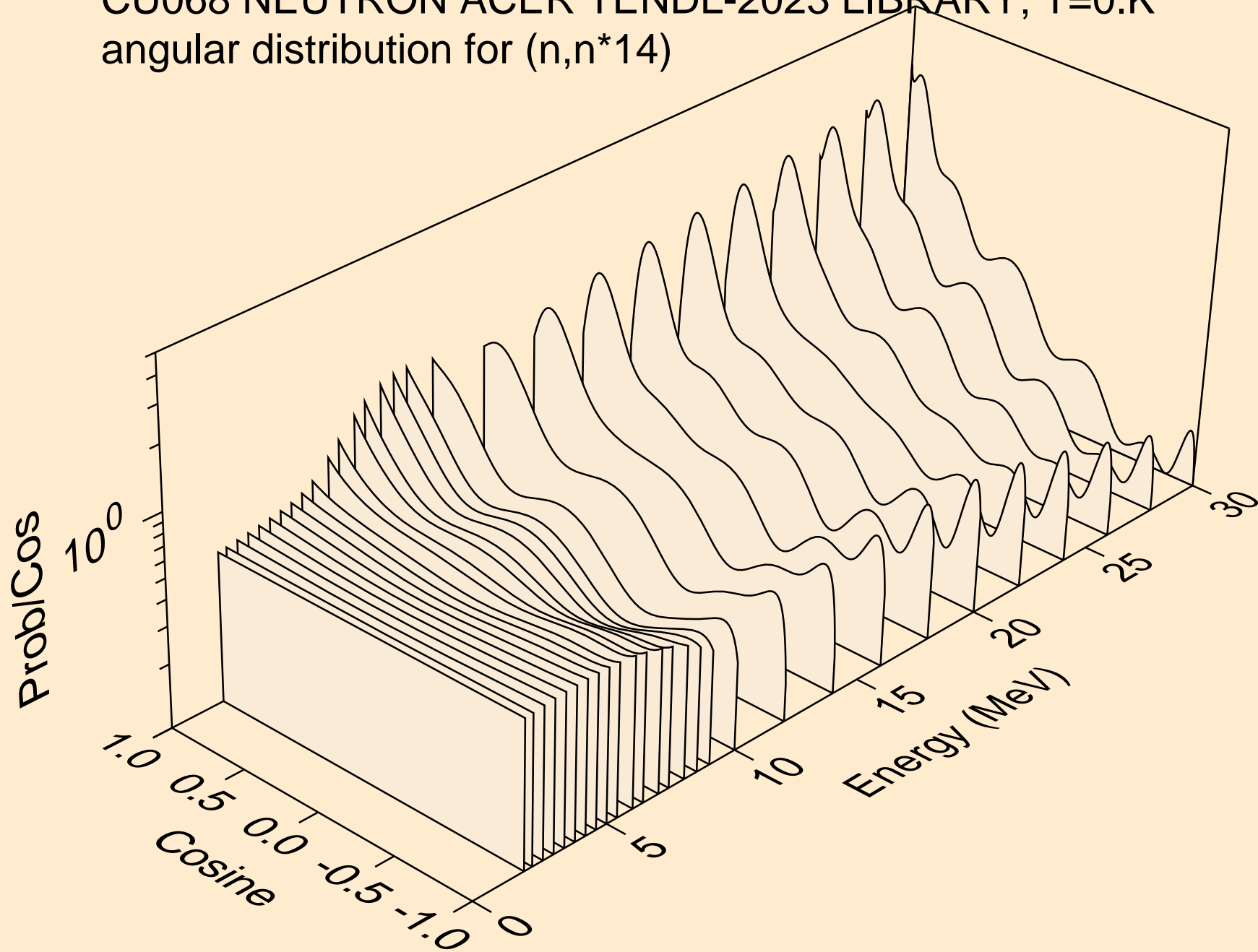

CU068 NEUTRON ACER TENDL-2023 LIBRARY; T=0.K
angular distribution for (n,n*15)

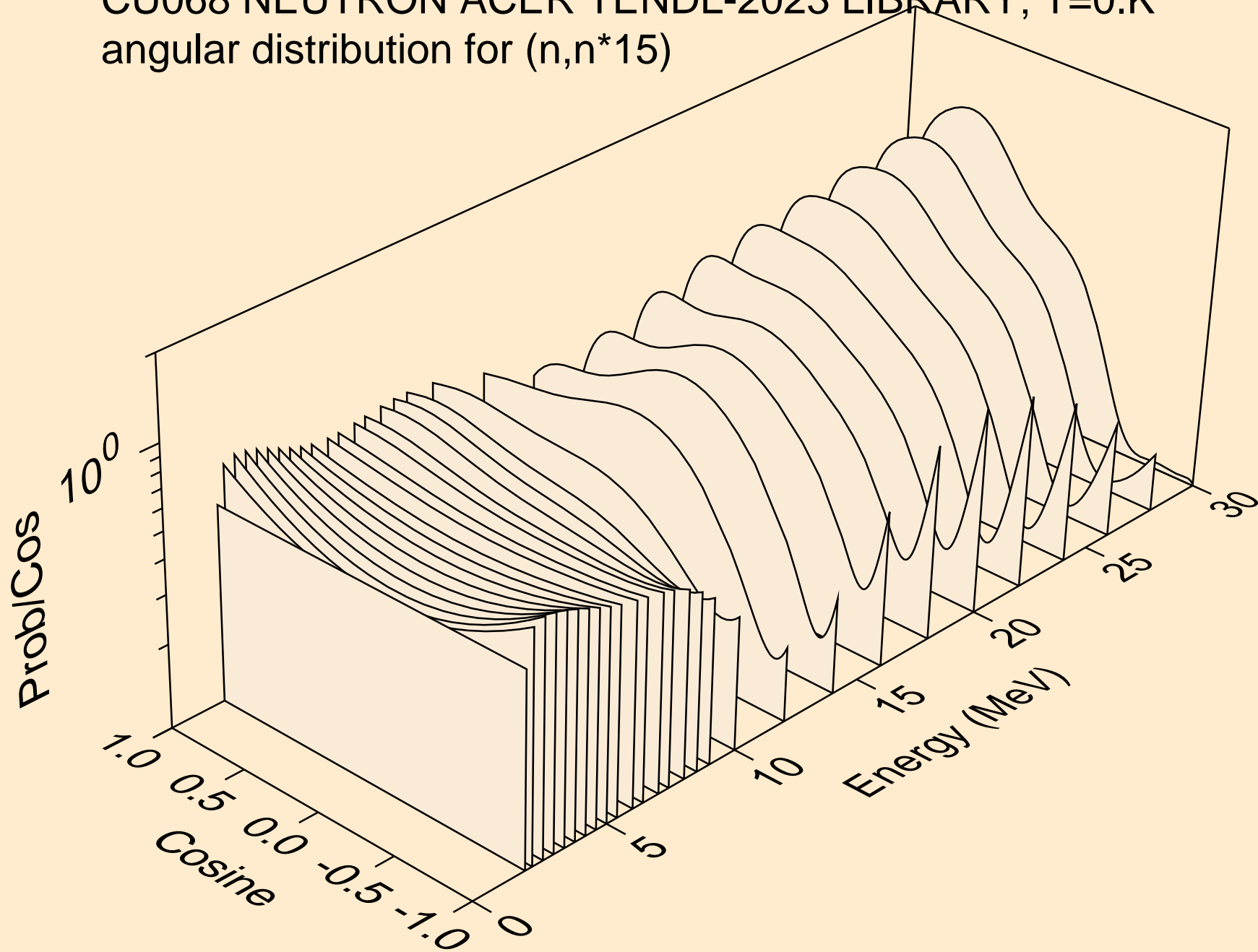

CU068 NEUTRON ACER TENDL-2023 LIBRARY; T=0.K
angular distribution for (n,n*16)

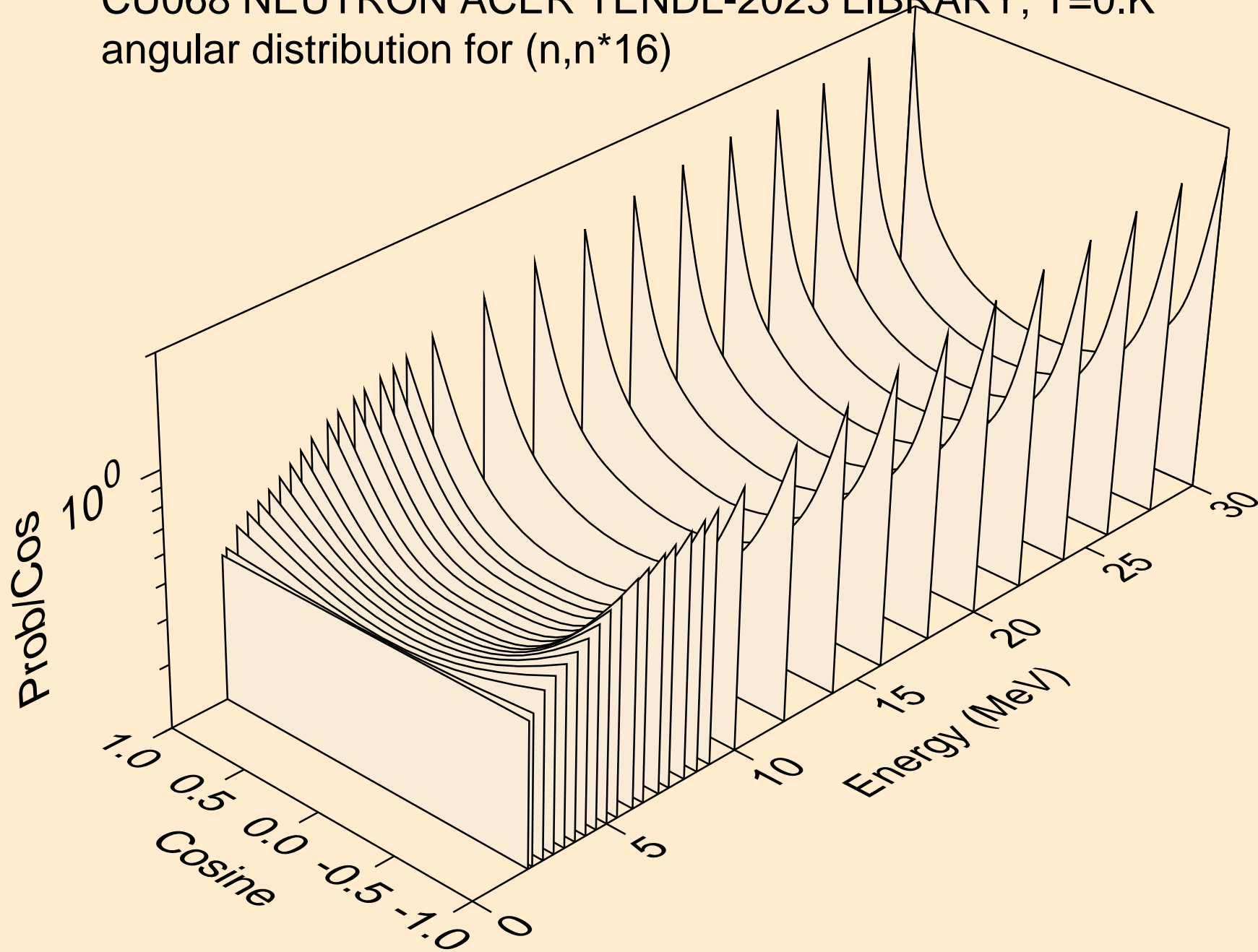

CU068 NEUTRON ACER TENDL-2023 LIBRARY; T=0.K
angular distribution for (n,n*17)

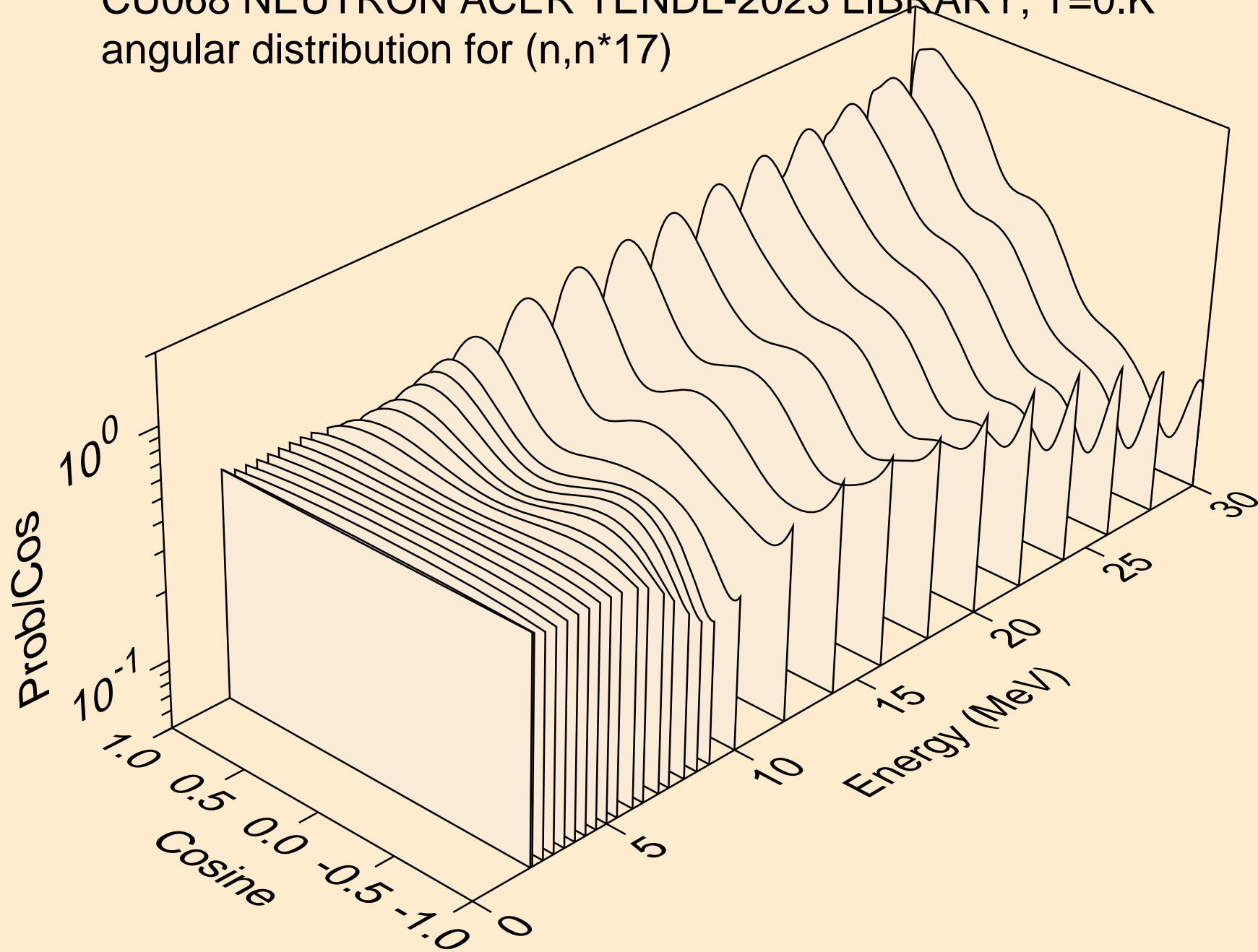

CU068 NEUTRON ACER TENDL-2023 LIBRARY; T=0.K
angular distribution for (n,n*18)

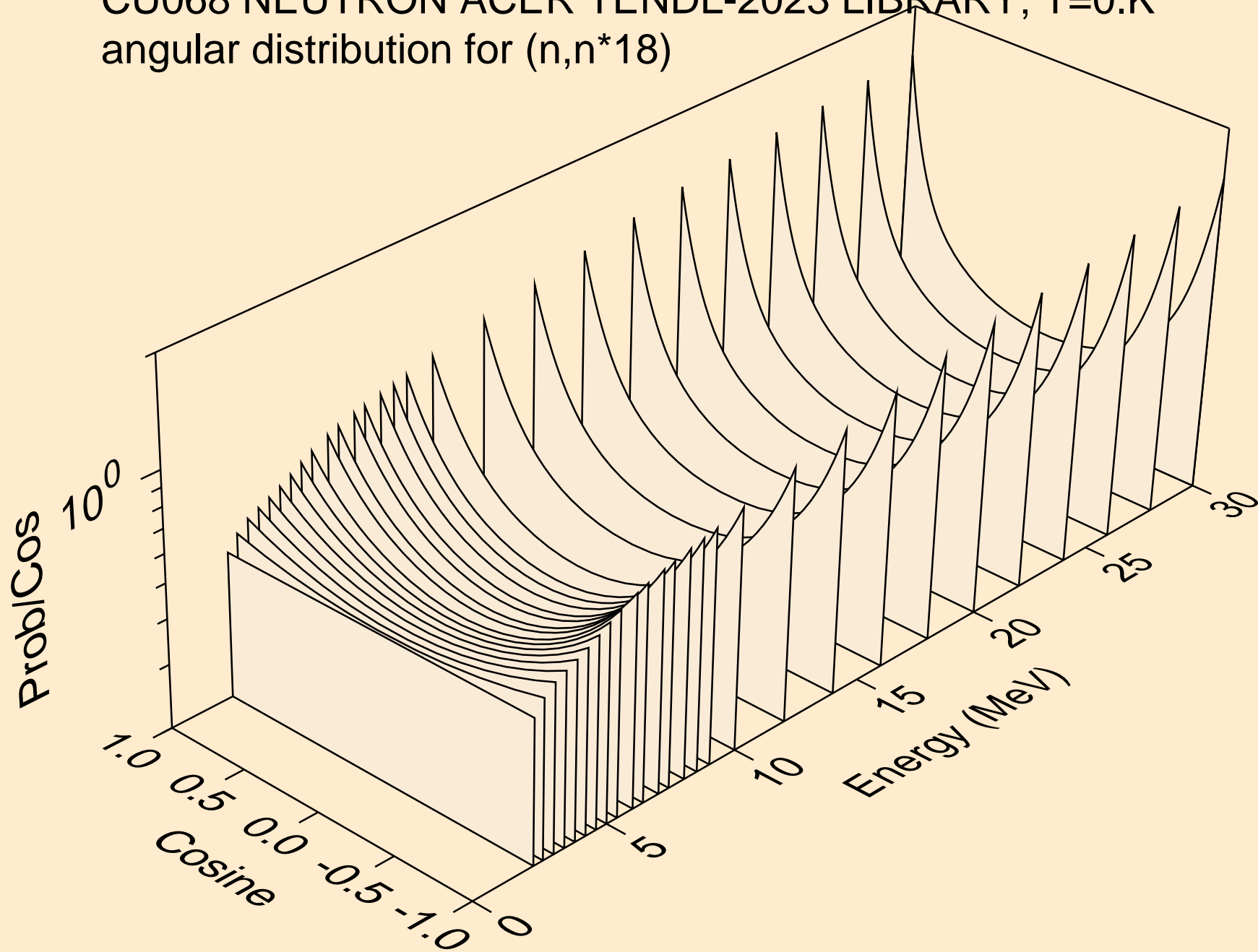

CU068 NEUTRON ACER TENDL-2023 LIBRARY; T=0.K
angular distribution for (n,n*19)

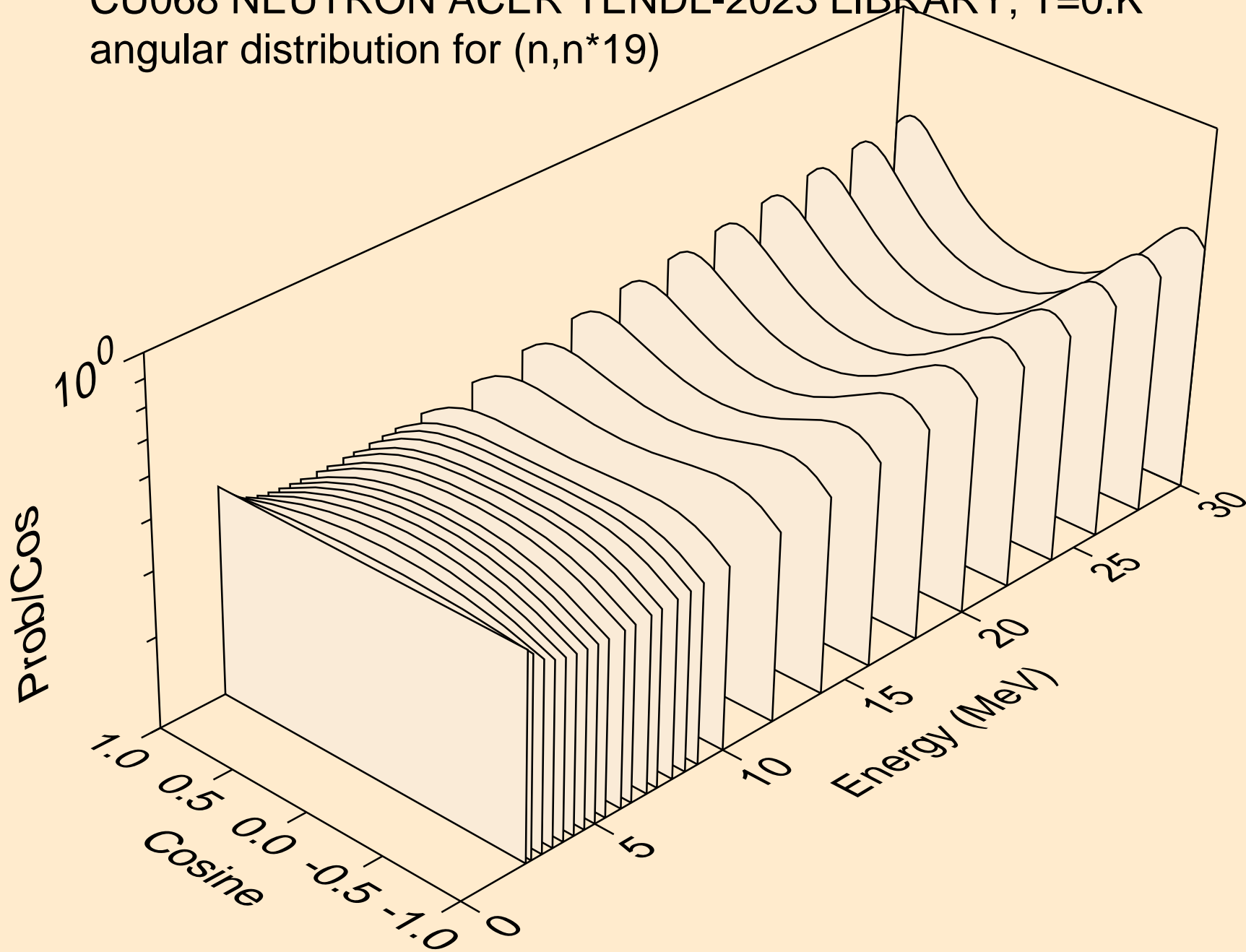

CU068 NEUTRON ACER TENDL-2023 LIBRARY; T=0.K
angular distribution for (n,n*20)

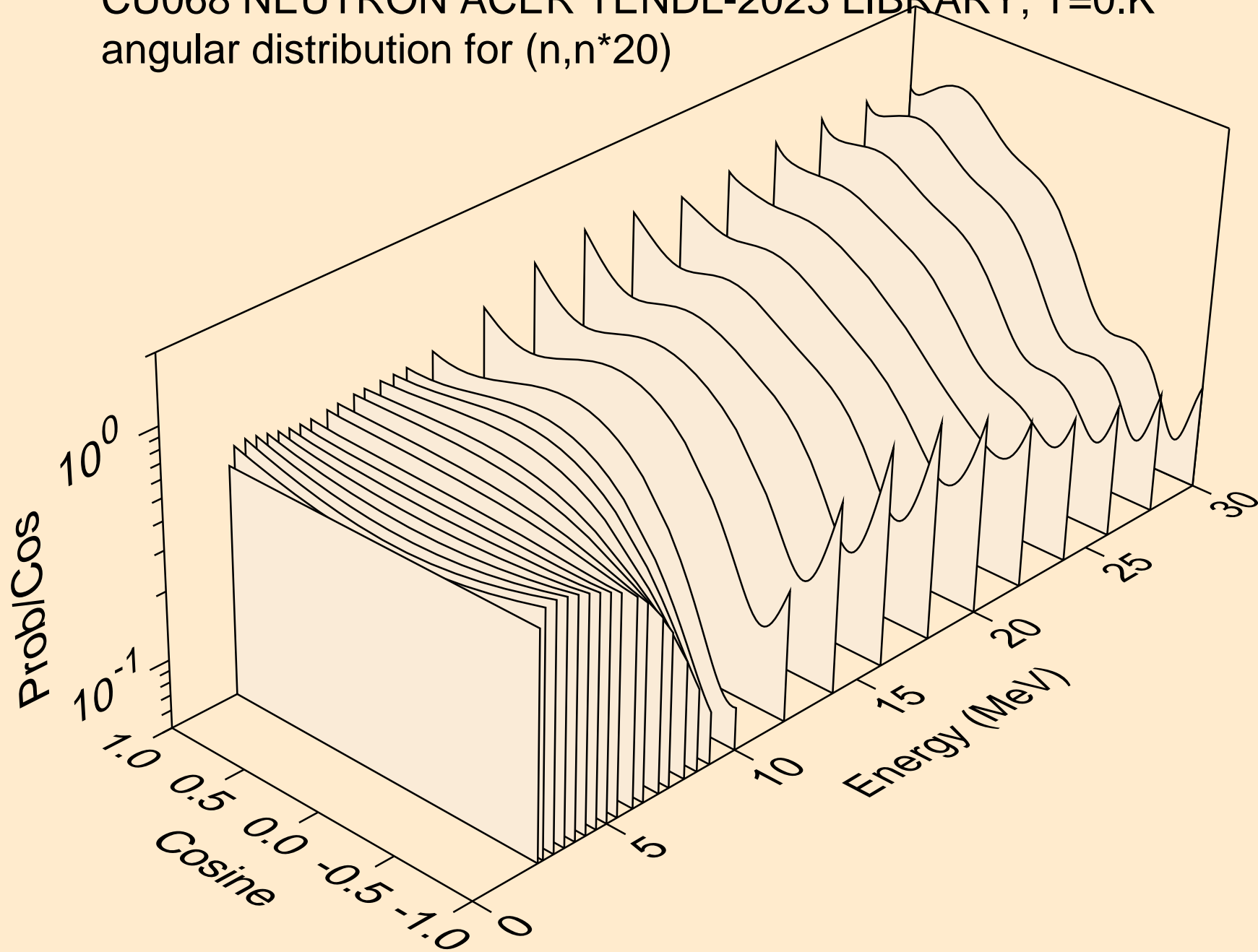

CU068 NEUTRON ACER TENDL-2023 LIBRARY; T=0.K
angular distribution for (n,n*21)

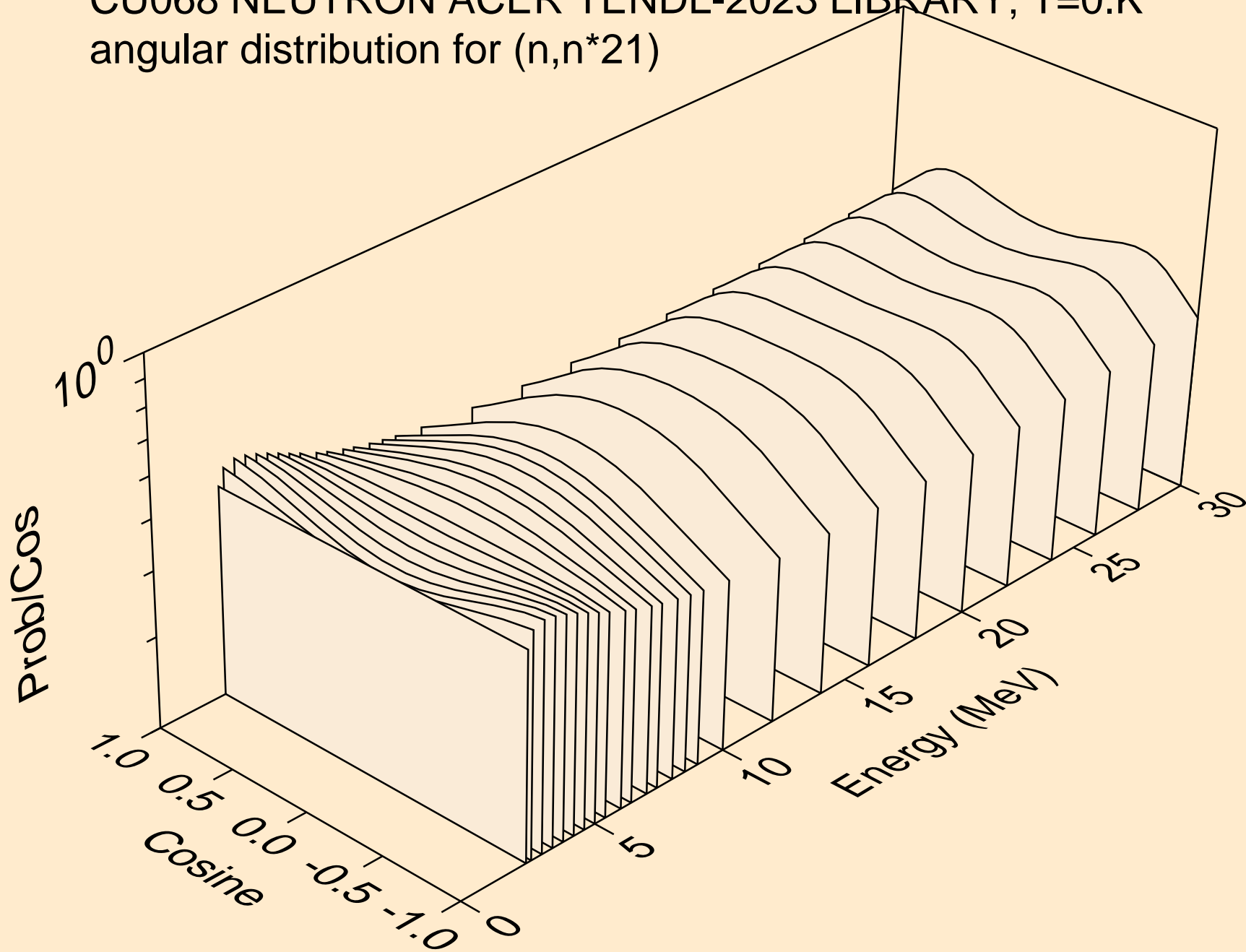

CU068 NEUTRON ACER TENDL-2023 LIBRARY; T=0.K
angular distribution for (n,n*22)

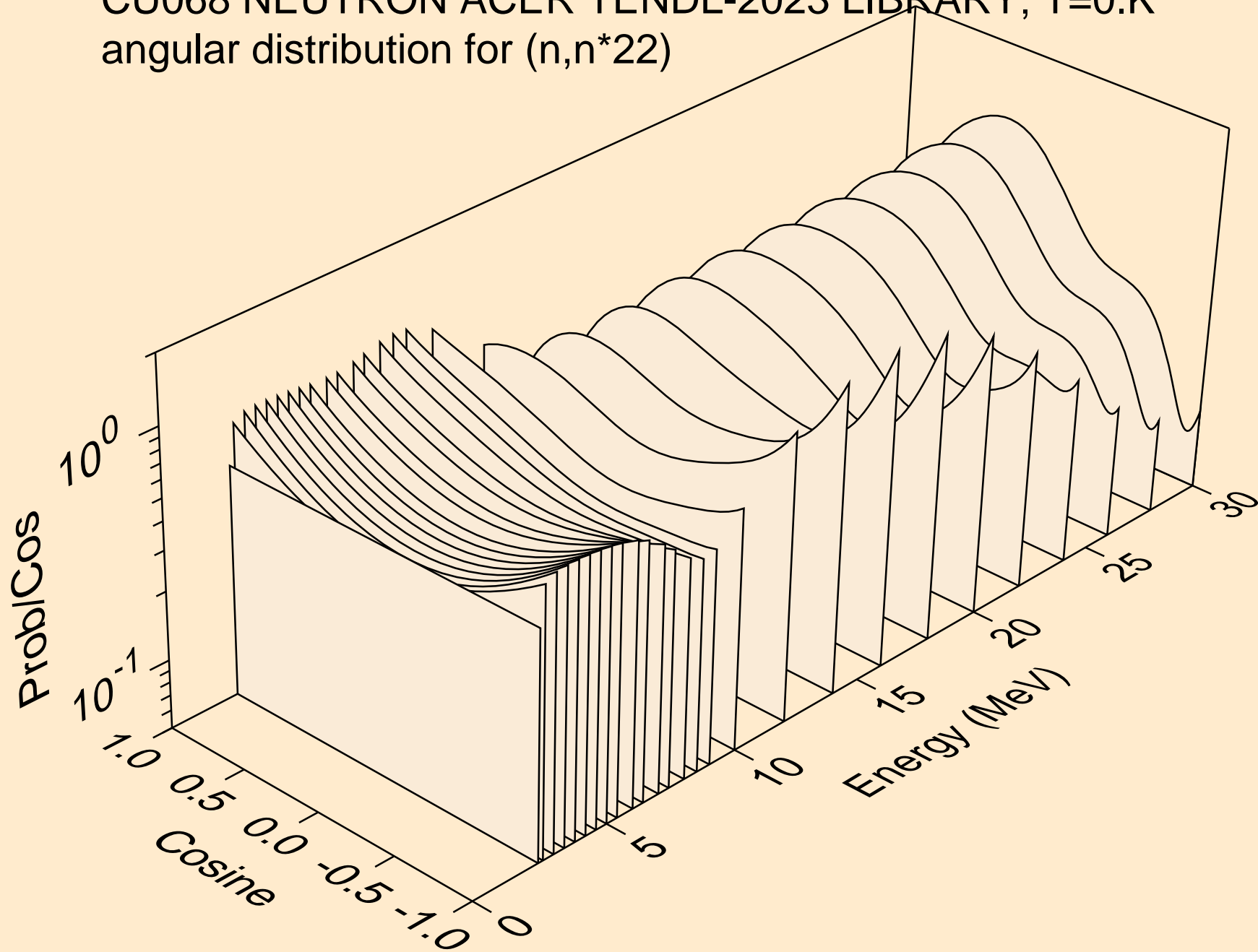

CU068 NEUTRON ACER TENDL-2023 LIBRARY; T=0.K
angular distribution for (n,n*23)

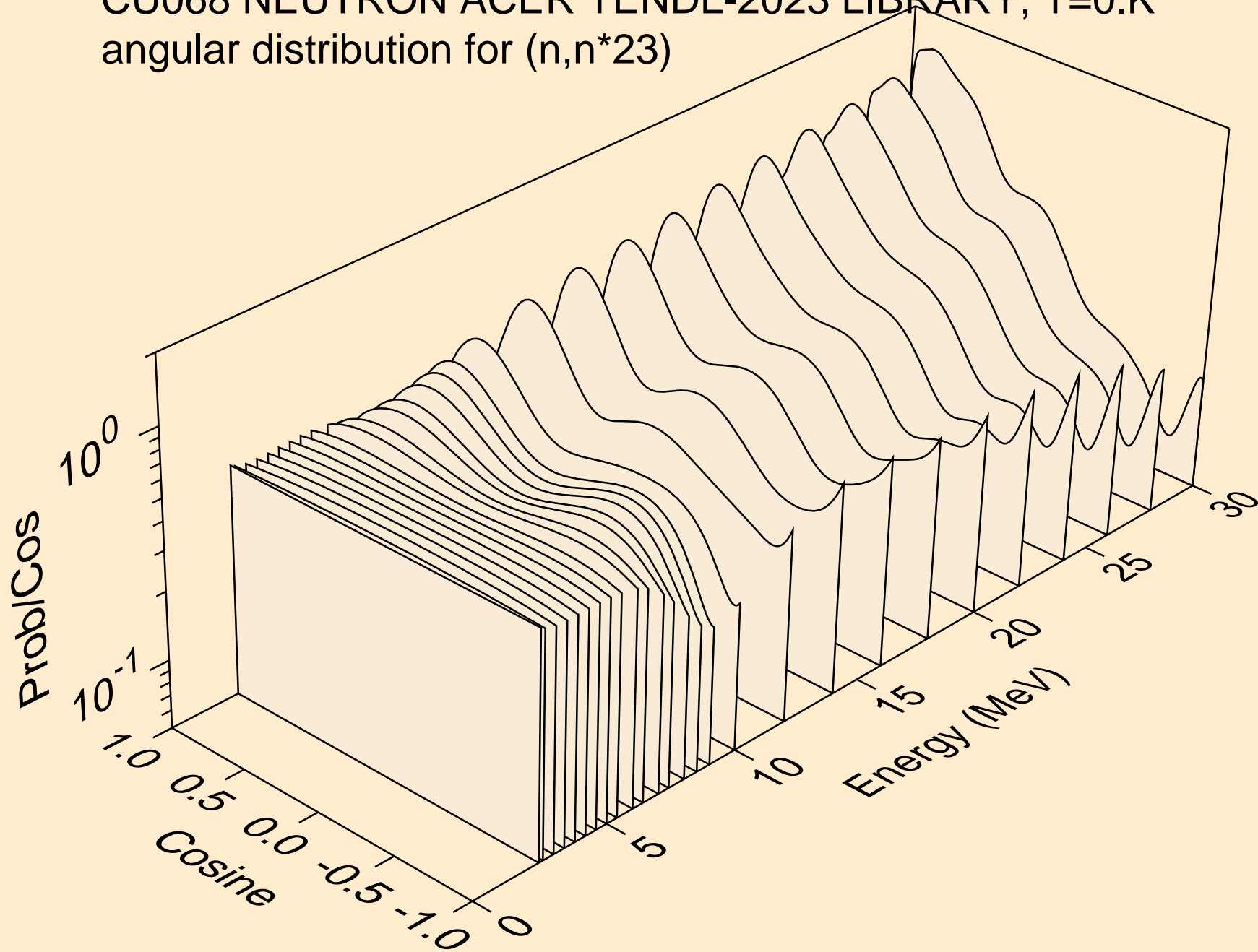

CU068 NEUTRON ACER TENDL-2023 LIBRARY; T=0.K
angular distribution for (n,n*24)

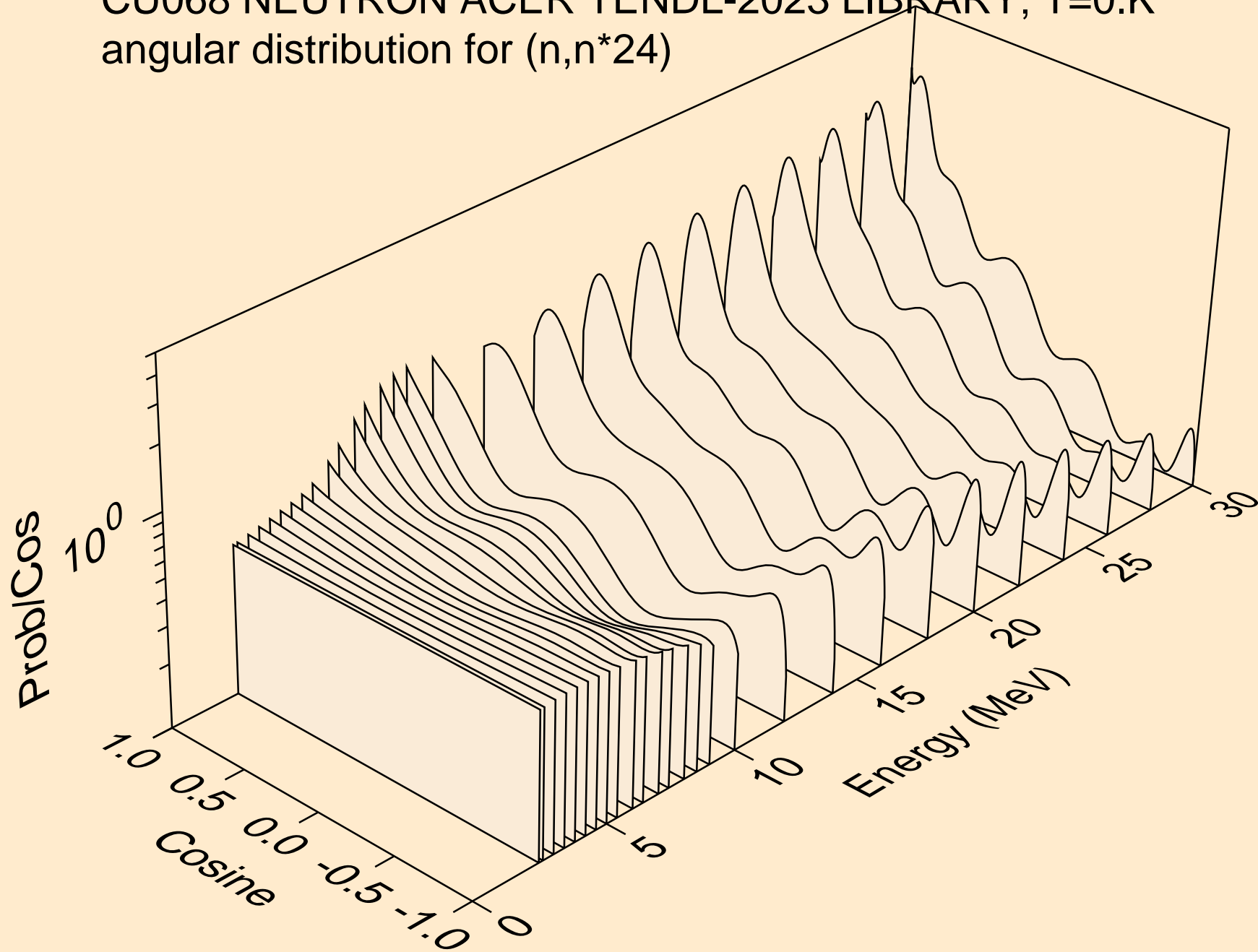

CU068 NEUTRON ACER TENDL-2023 LIBRARY; T=0.K
angular distribution for (n,n*25)

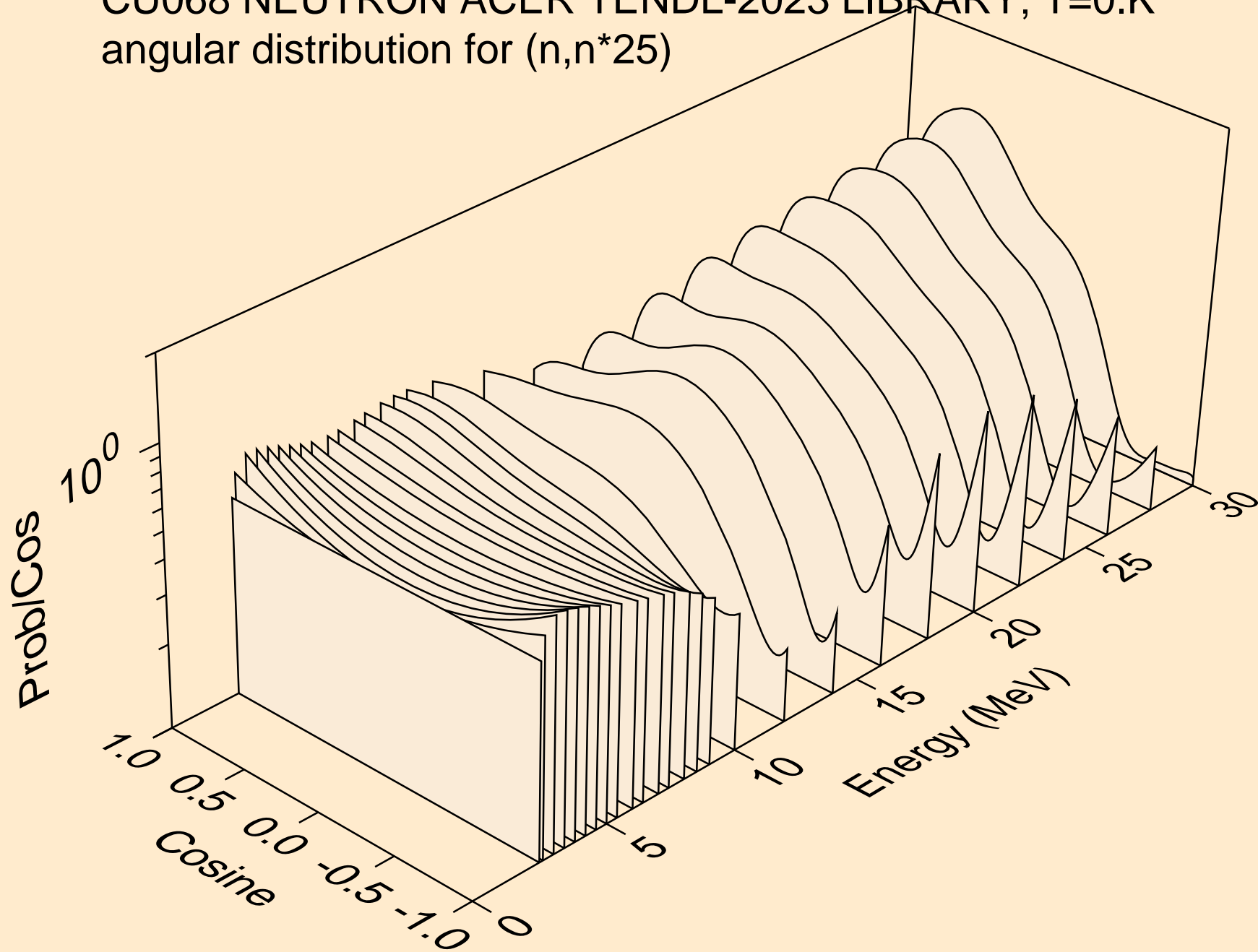

CU068 NEUTRON ACER TENDL-2023 LIBRARY; T=0.K
angular distribution for (n,n*26)

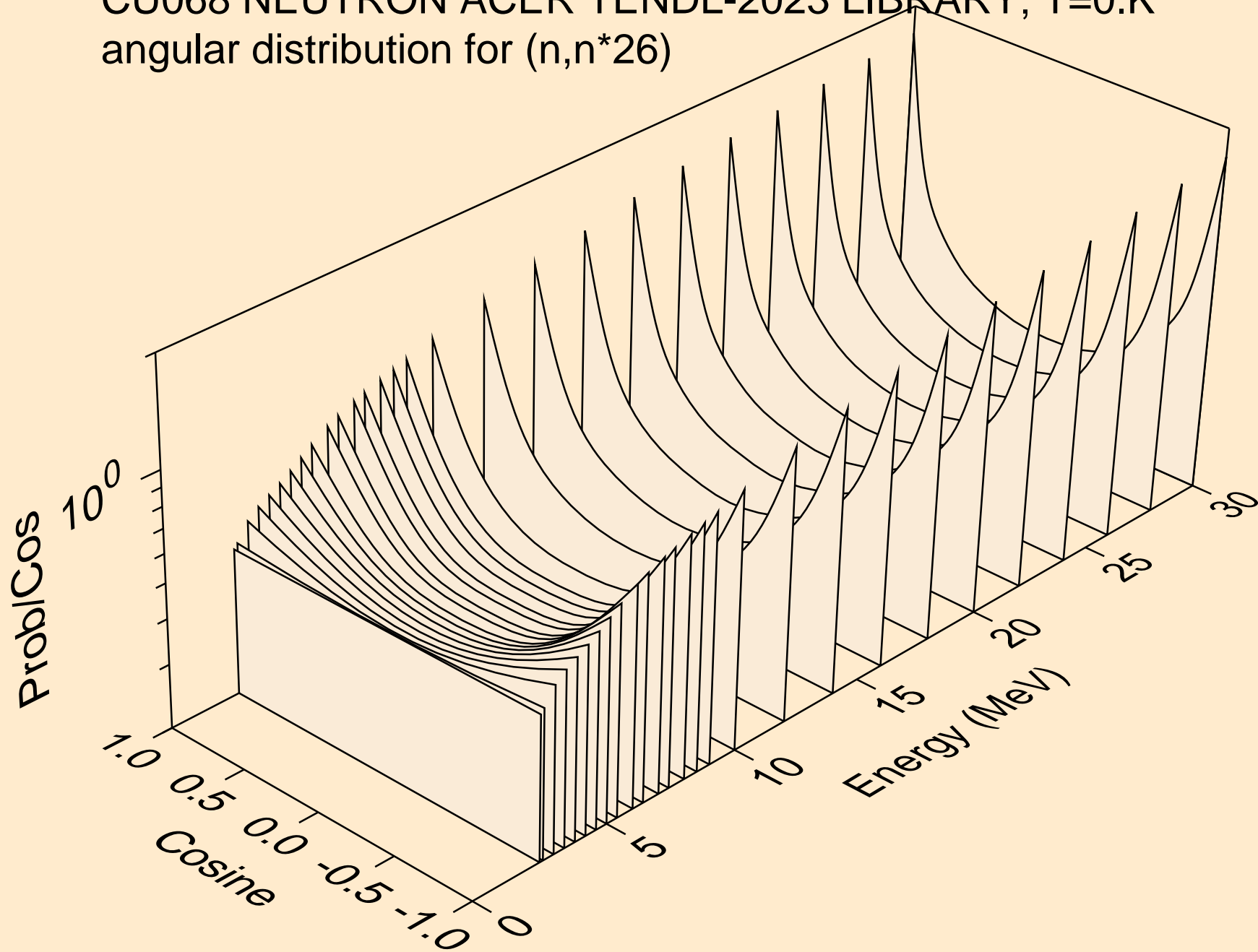

CU068 NEUTRON ACER TENDL-2023 LIBRARY; T=0.K
angular distribution for (n,n*27)

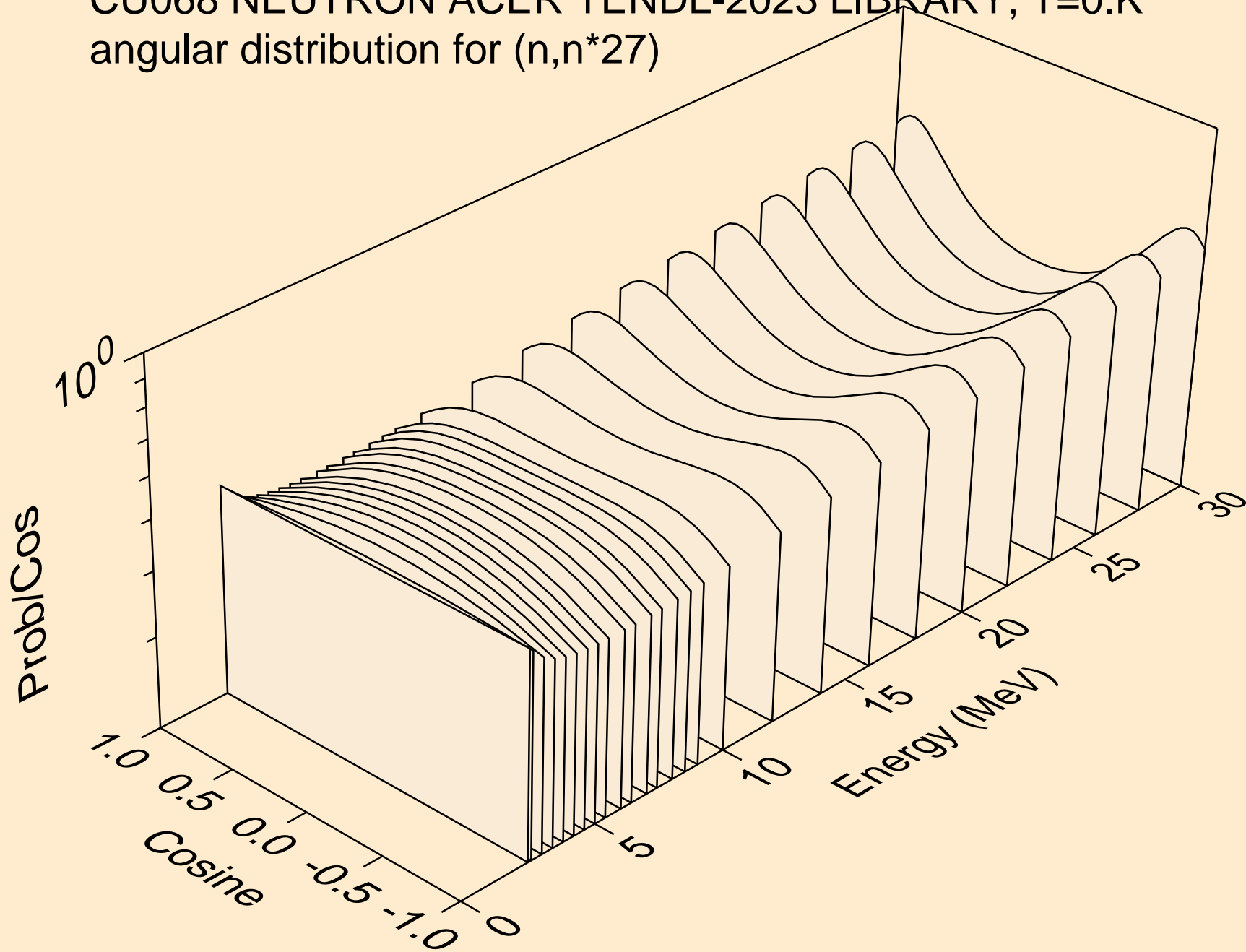

CU068 NEUTRON ACER TENDL-2023 LIBRARY; T=0.K
angular distribution for (n,n*28)

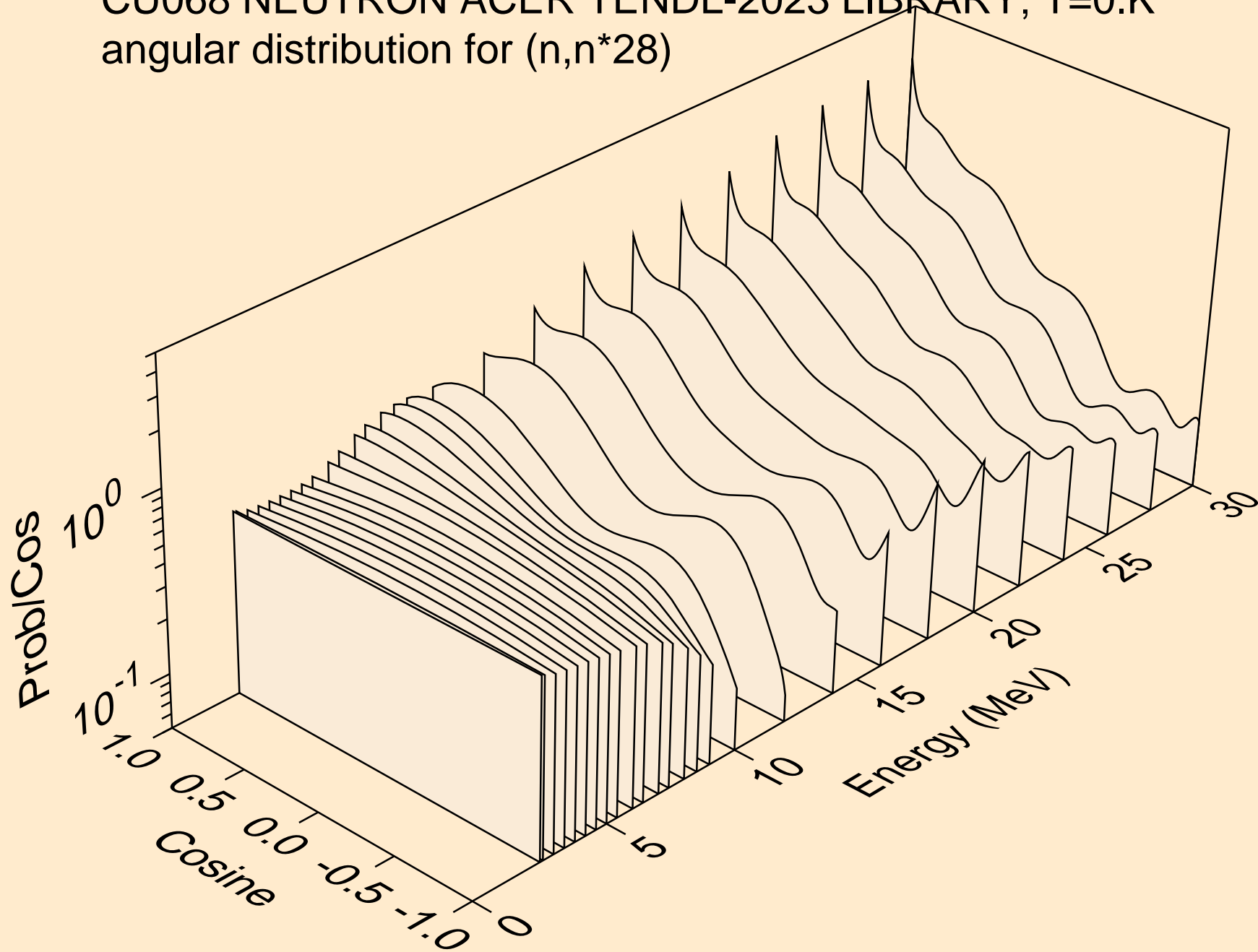

CU068 NEUTRON ACER TENDL-2023 LIBRARY; T=0.K
Neutron emission for (n,x)

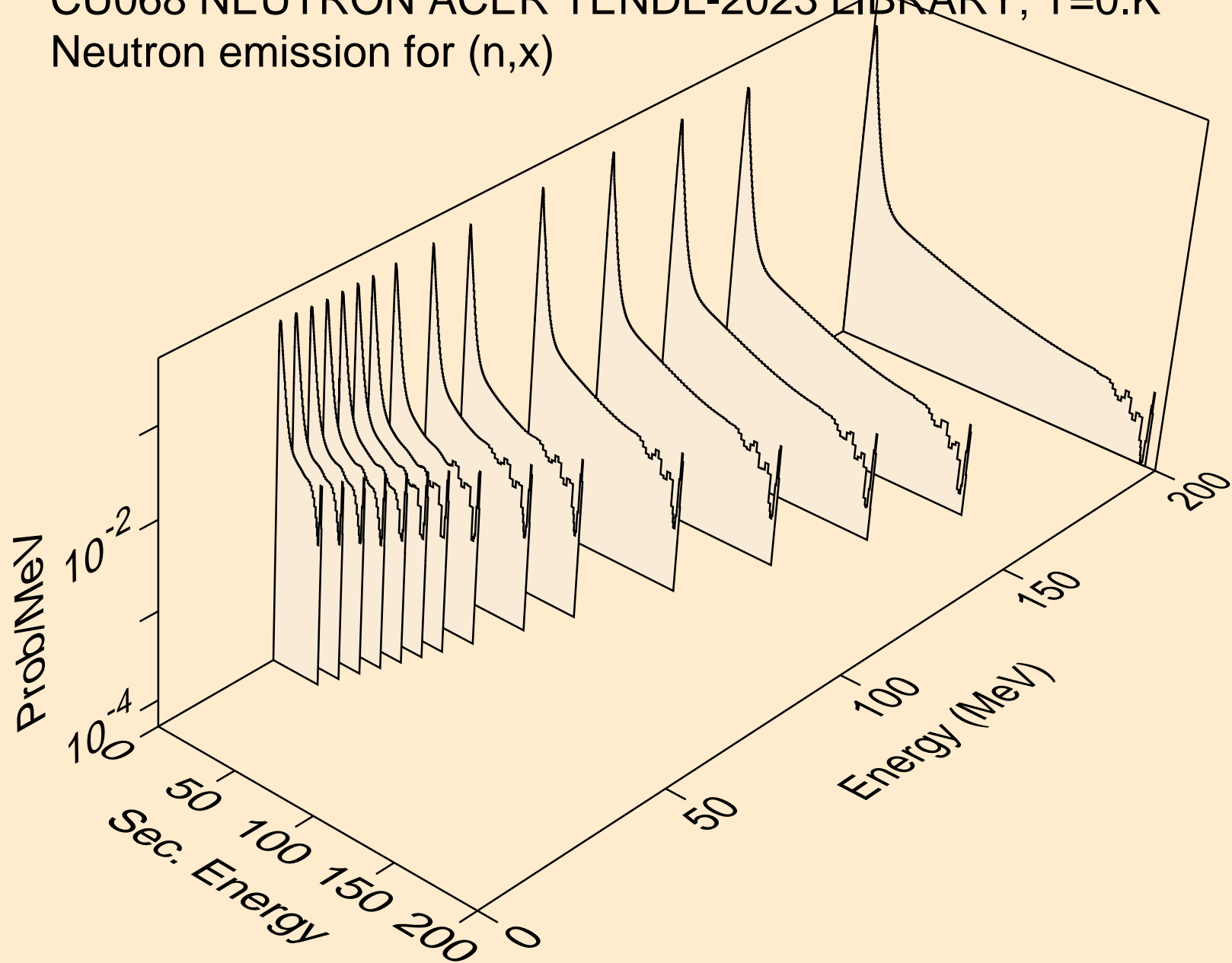

CU068 NEUTRON ACER TENDL-2023 LIBRARY; T=0.K
Neutron emission for (n,2nd)

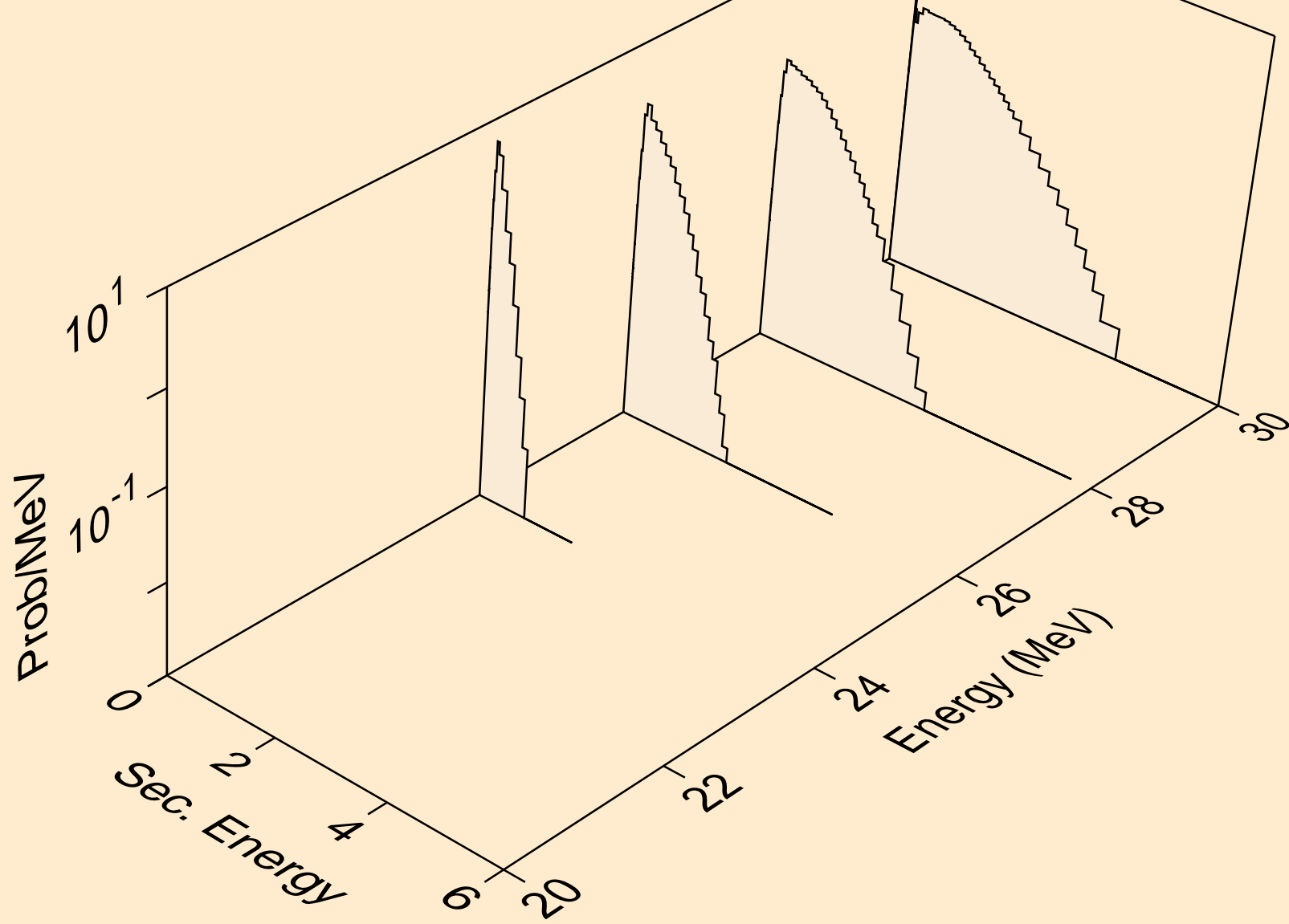

CU068 NEUTRON ACER TENDL-2023 LIBRARY; T=0.K
Neutron emission for (n,2n)

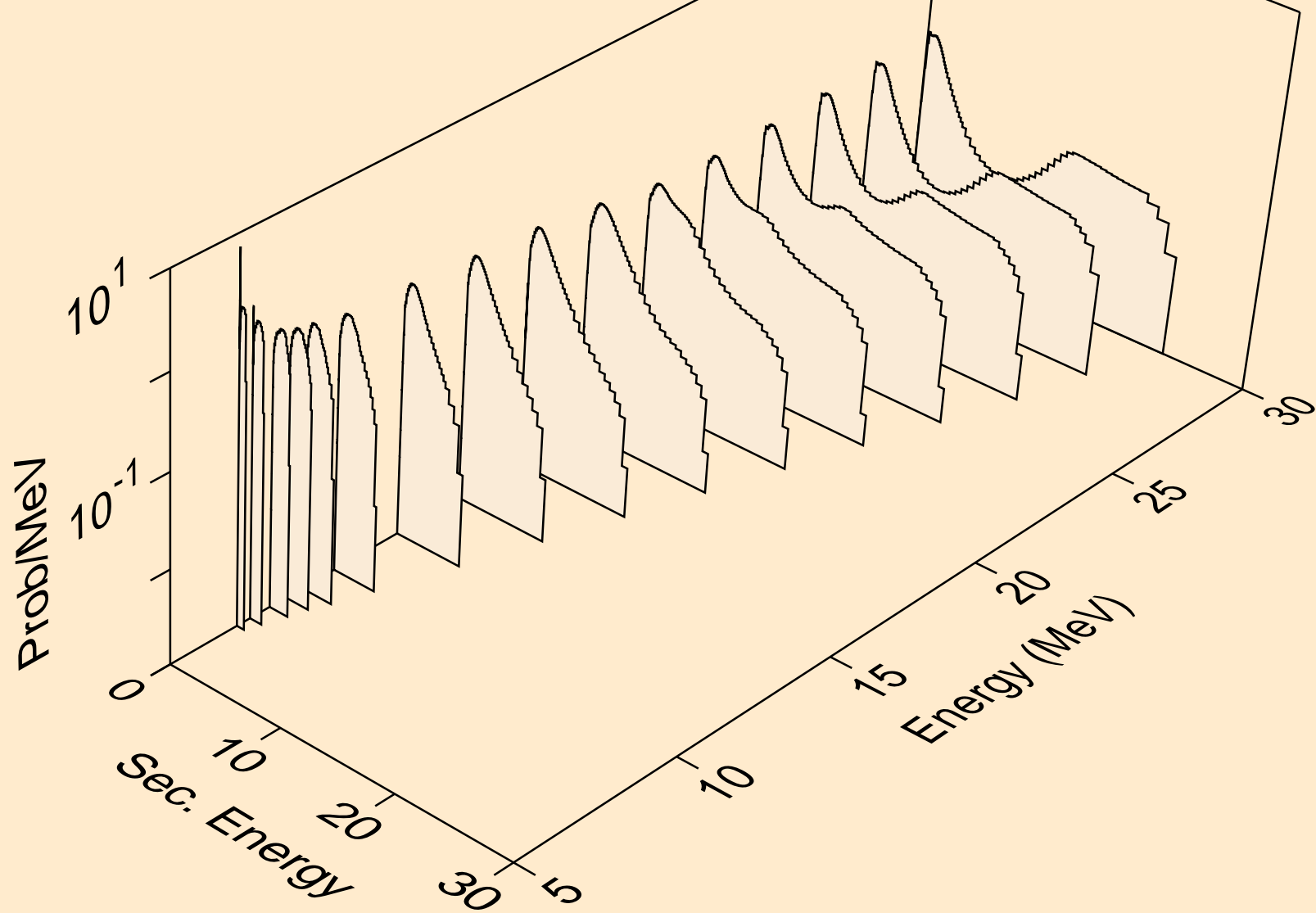

CU068 NEUTRON ACER TENDL-2023 LIBRARY; T=0.K
Neutron emission for (n,3n)

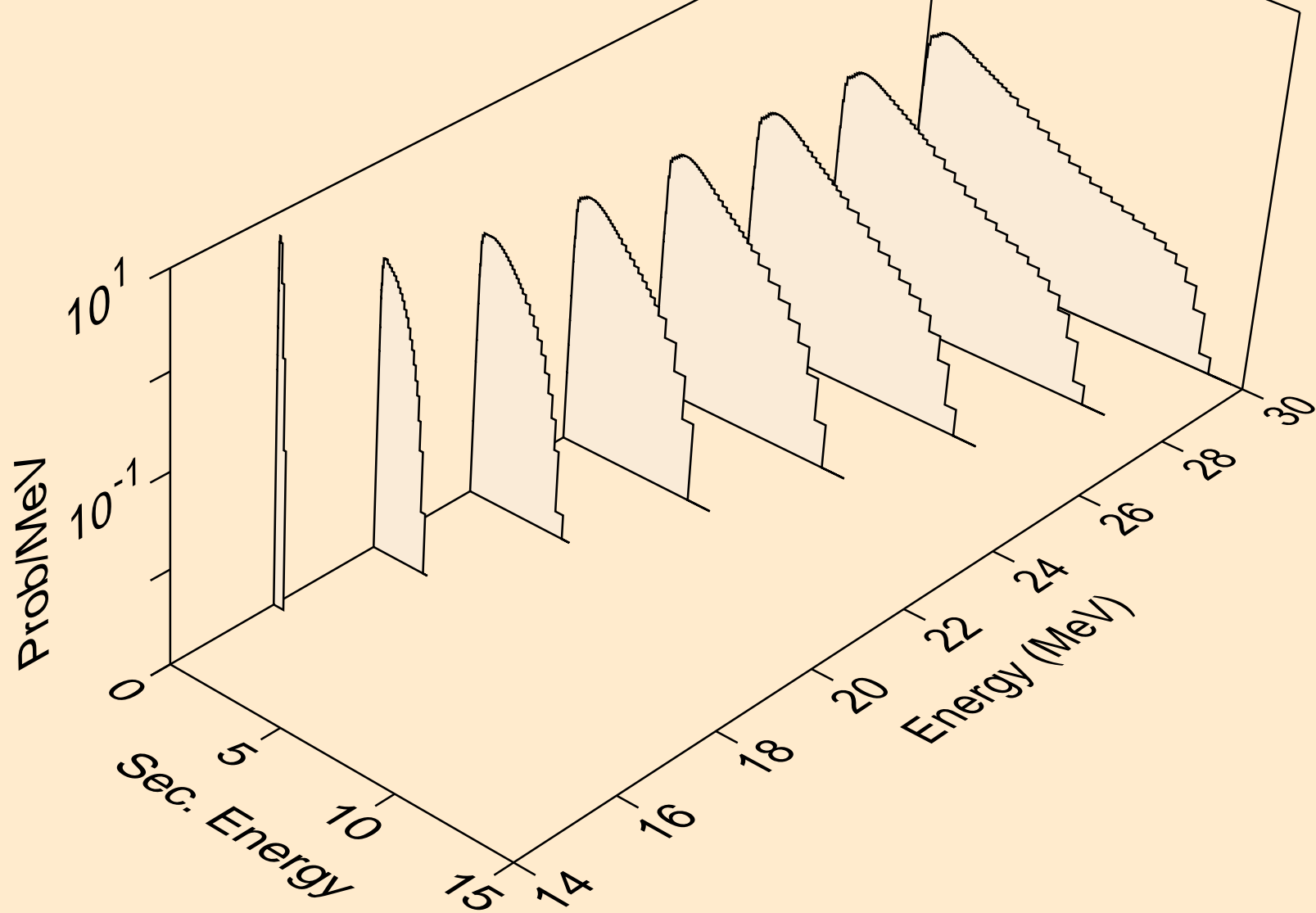

CU068 NEUTRON ACER TENDL-2023 LIBRARY; T=0.K
Neutron emission for (n,n*)a

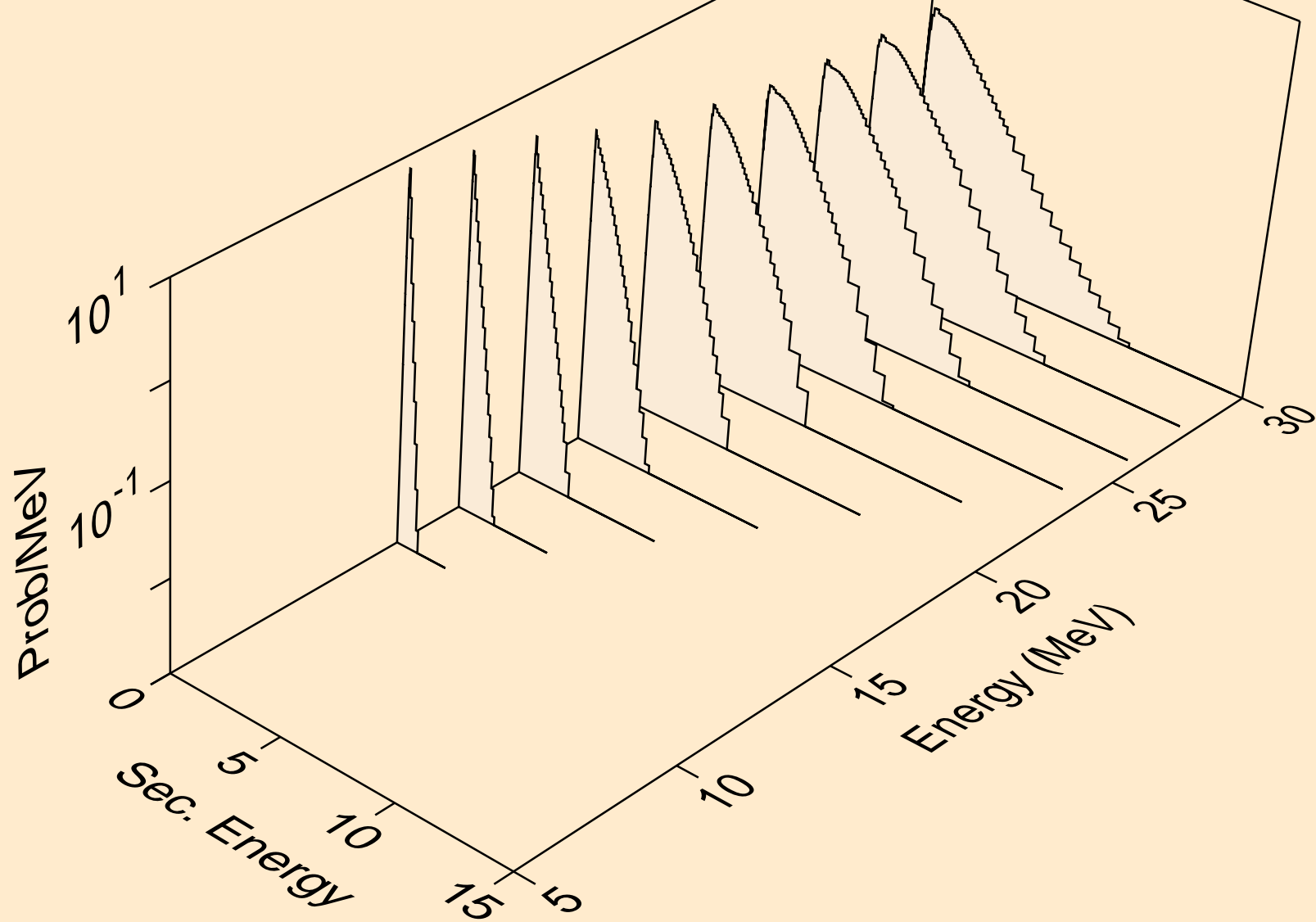

CU068 NEUTRON ACER TENDL-2023 LIBRARY; T=0.K
Neutron emission for (n,2n)a

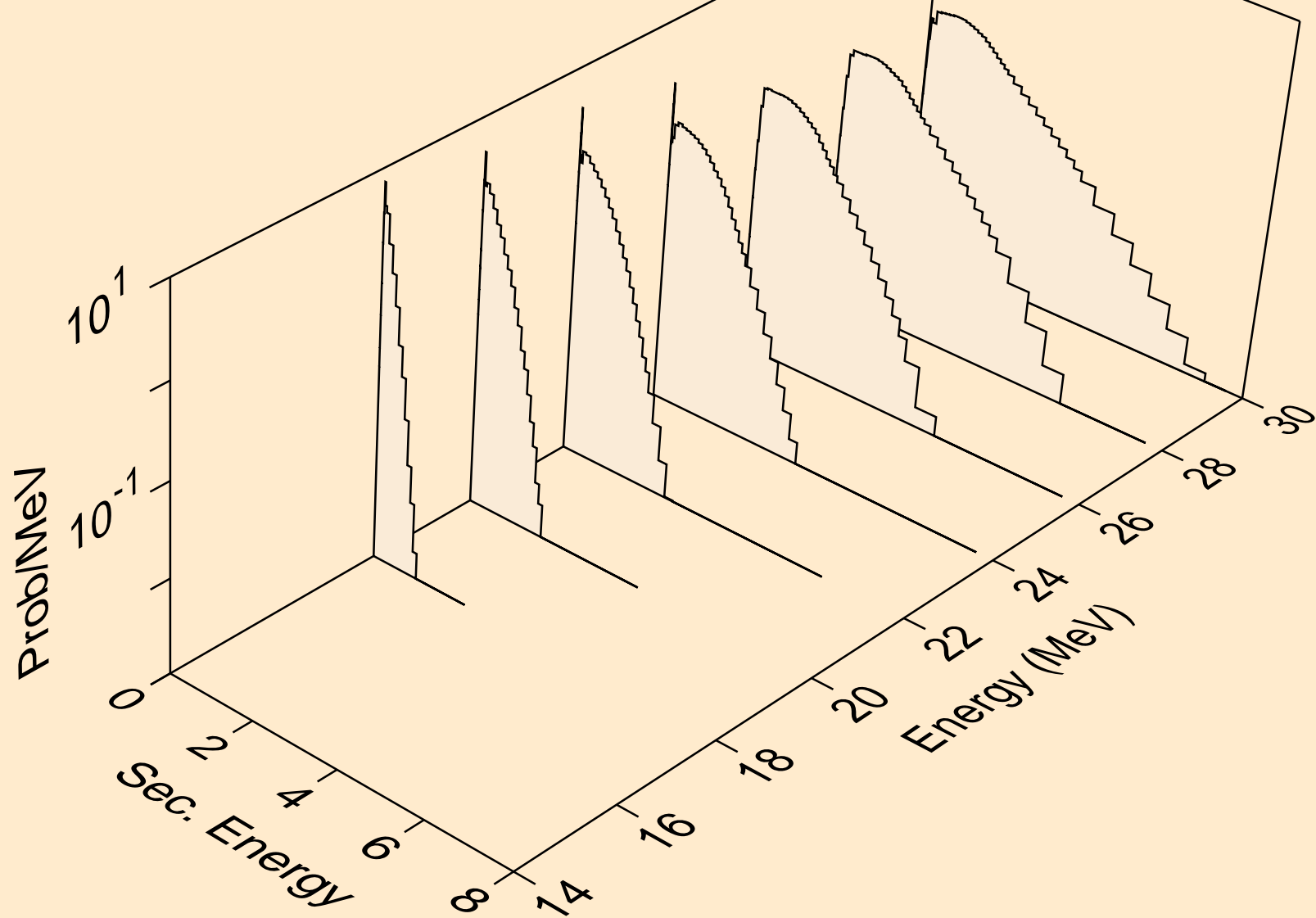

CU068 NEUTRON ACER TENDL-2023 LIBRARY; T=0.K
Neutron emission for (n,3n)a

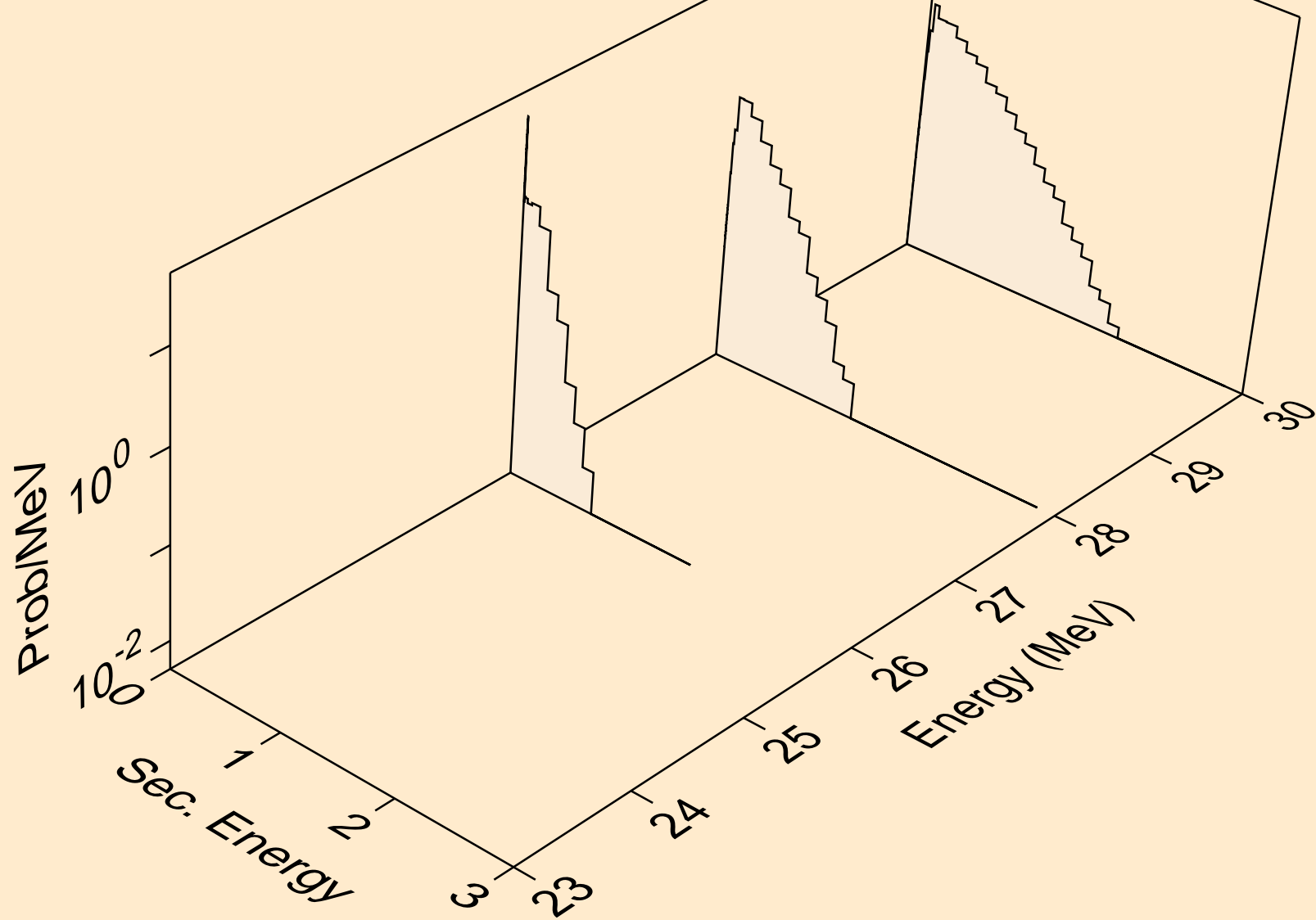

CU068 NEUTRON ACER TENDL-2023 LIBRARY; T=0.K
Neutron emission for (n,n*)p

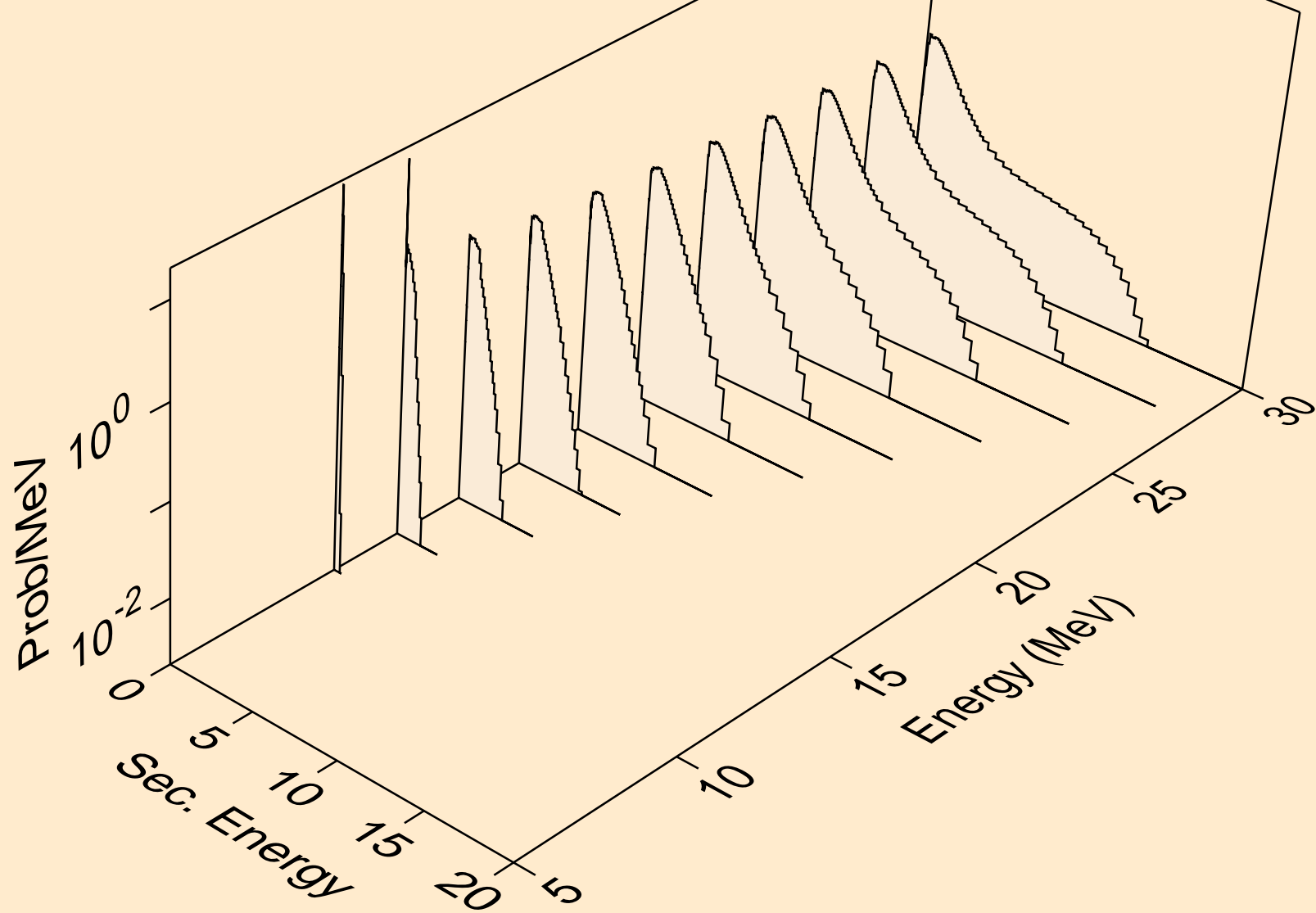

CU068 NEUTRON ACER TENDL-2023 LIBRARY; T=0.K
Neutron emission for (n,n*)d

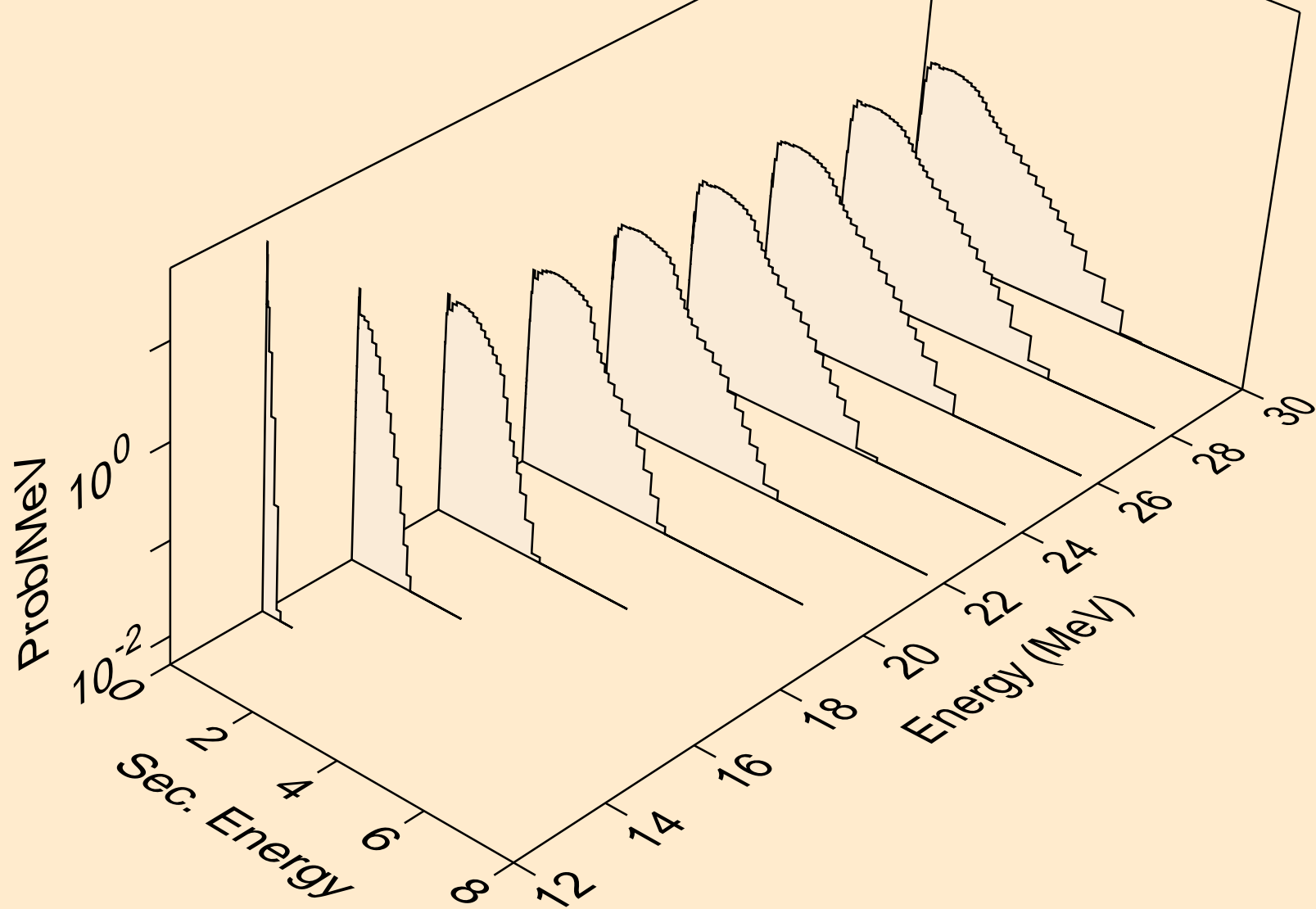

CU068 NEUTRON ACER TENDL-2023 LIBRARY; T=0.K
Neutron emission for (n,n*)t

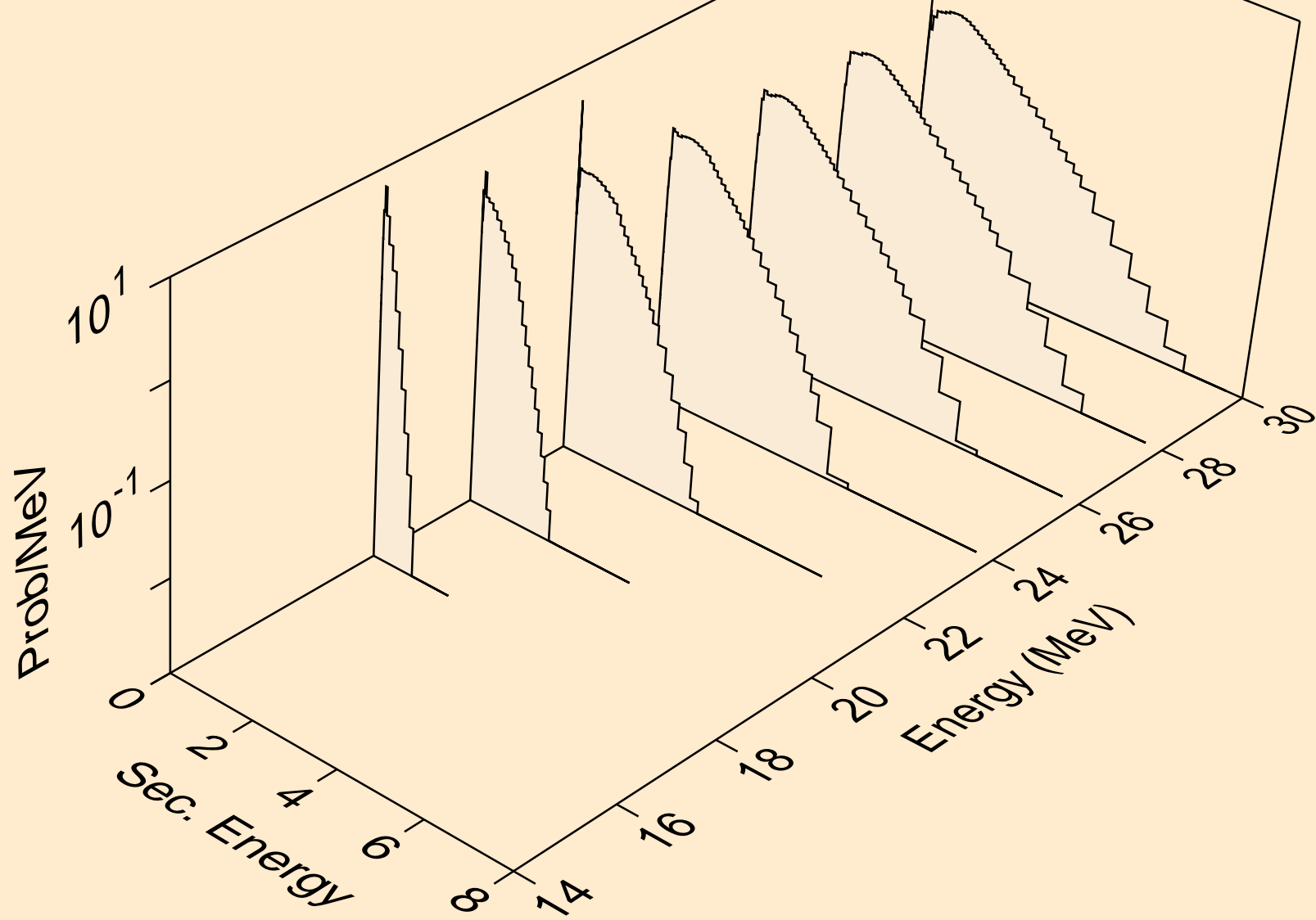

CU068 NEUTRON ACER TENDL-2023 LIBRARY; T=0.K
Neutron emission for (n,n*)he3

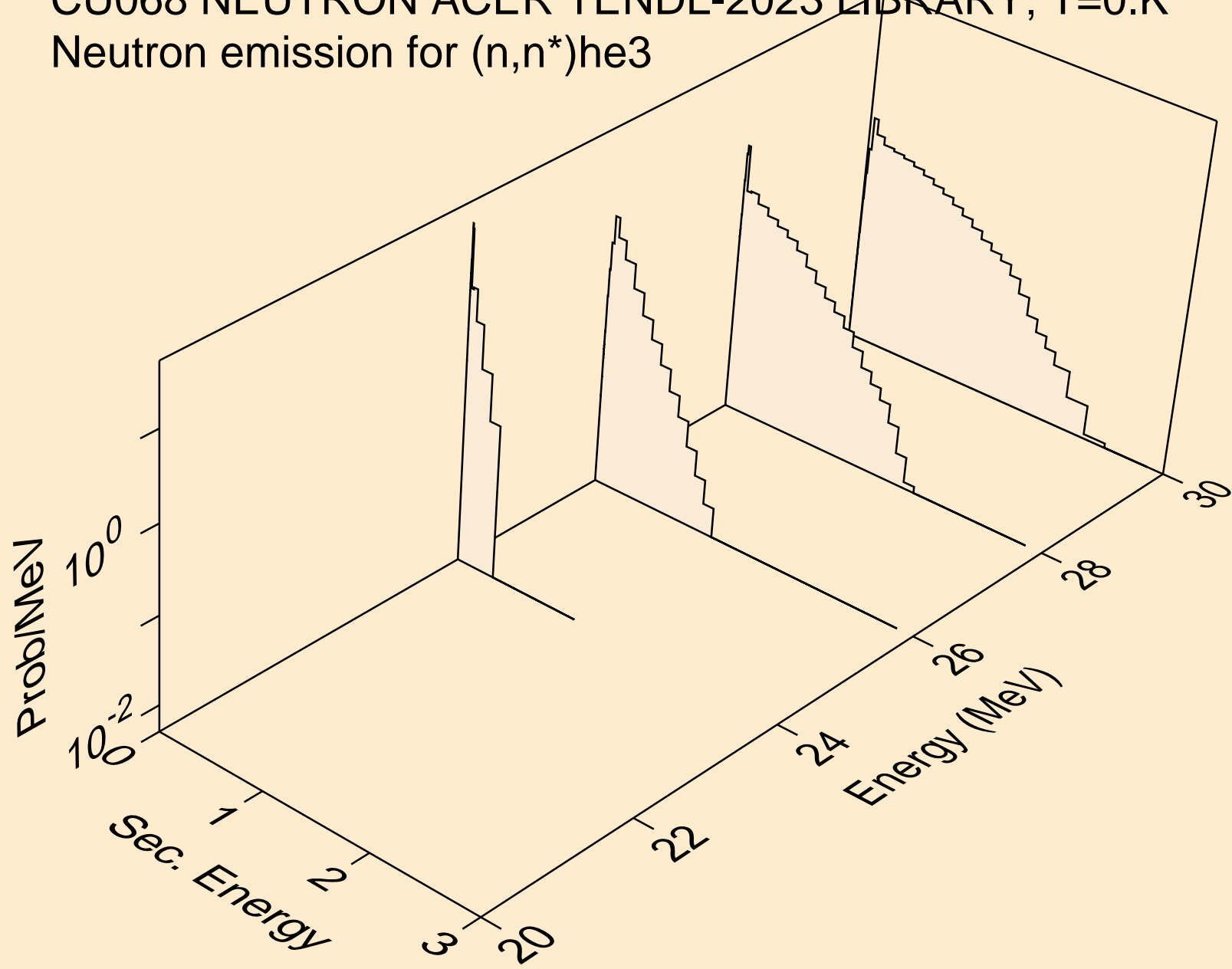

CU068 NEUTRON ACER TENDL-2023 LIBRARY; T=0.K
Neutron emission for (n,4n)

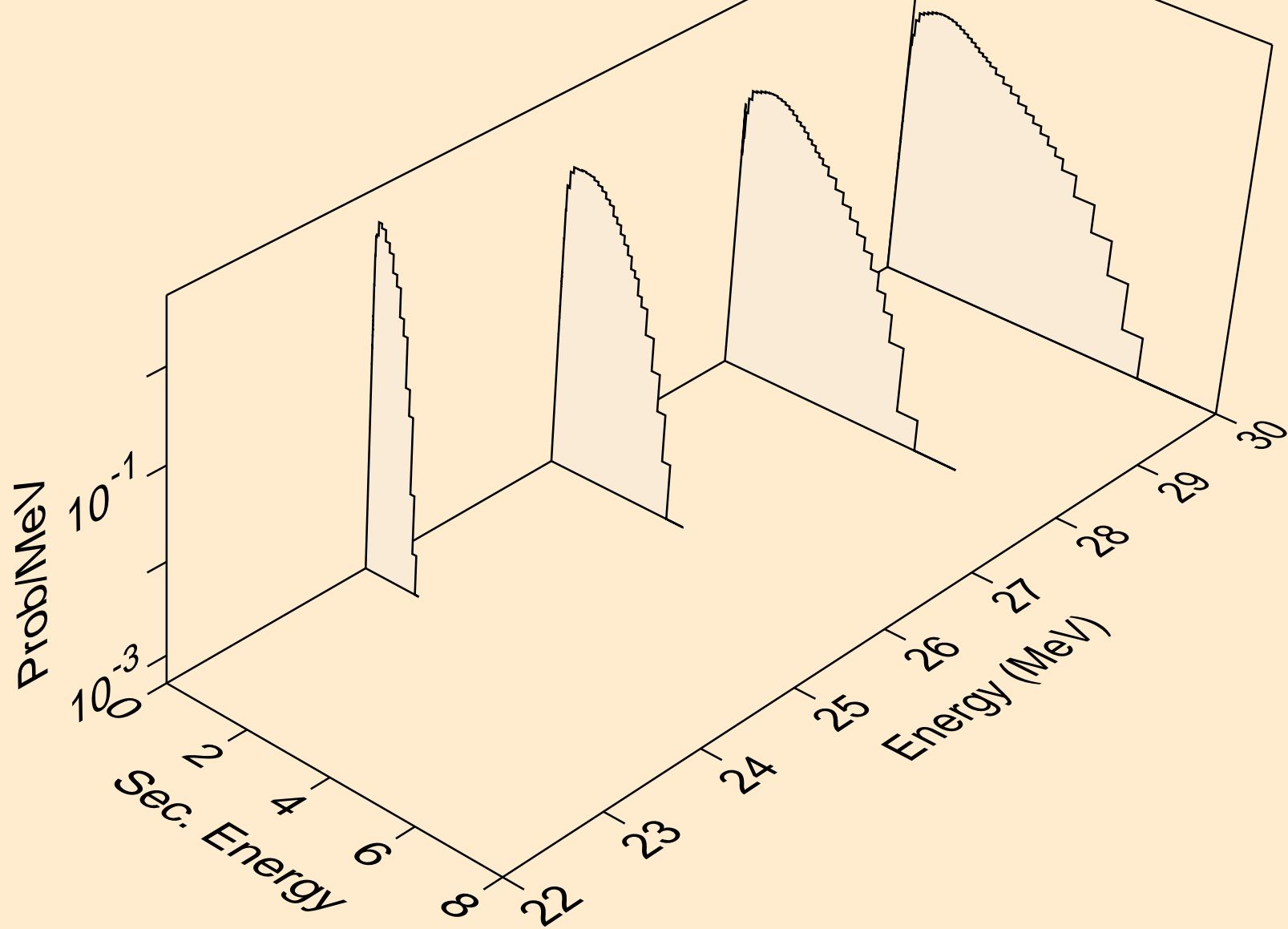

CU068 NEUTRON ACER TENDL-2023 LIBRARY; T=0.K
Neutron emission for (n,2np)

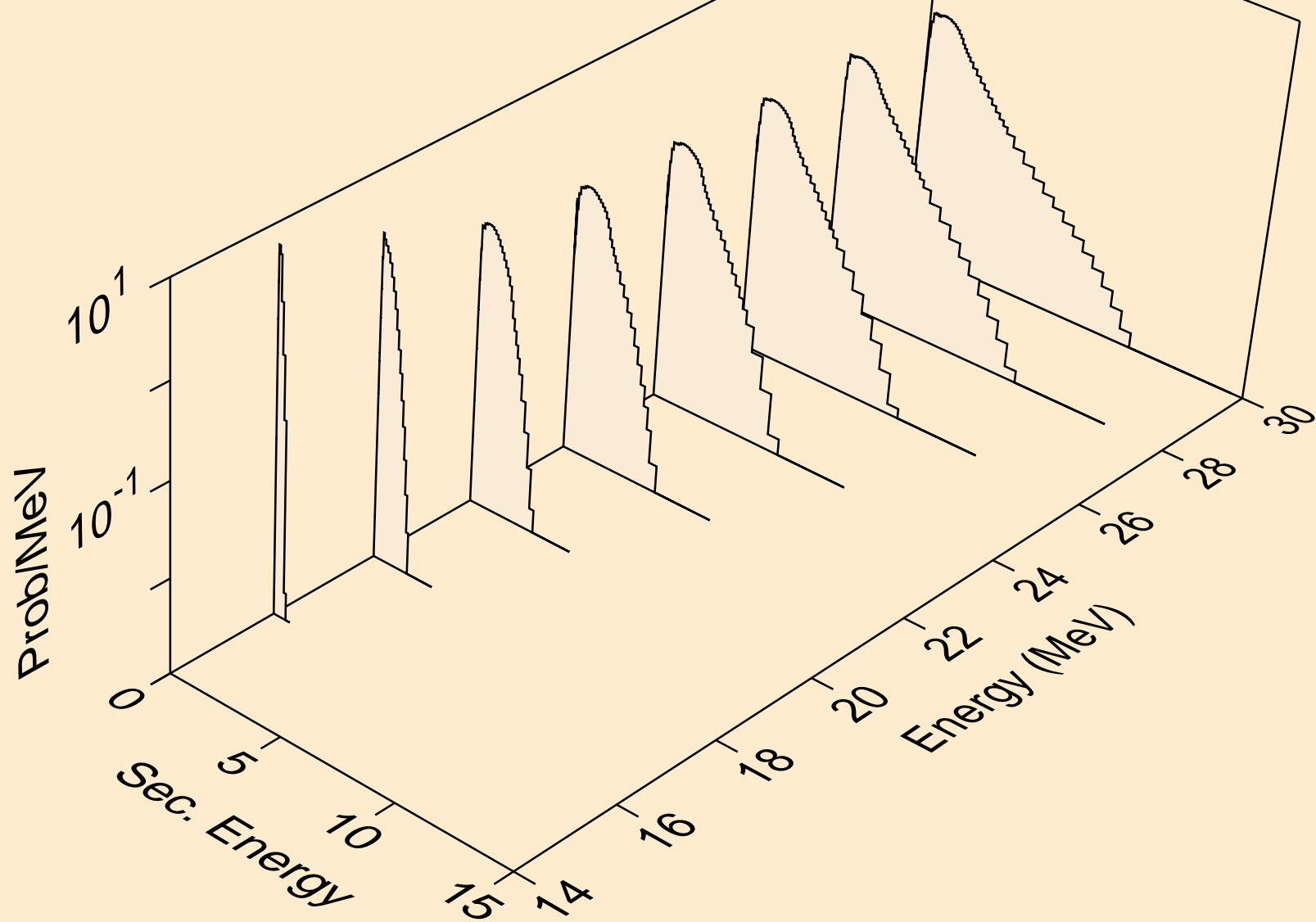

CU068 NEUTRON ACER TENDL-2023 LIBRARY; T=0.K
Neutron emission for (n,3np)

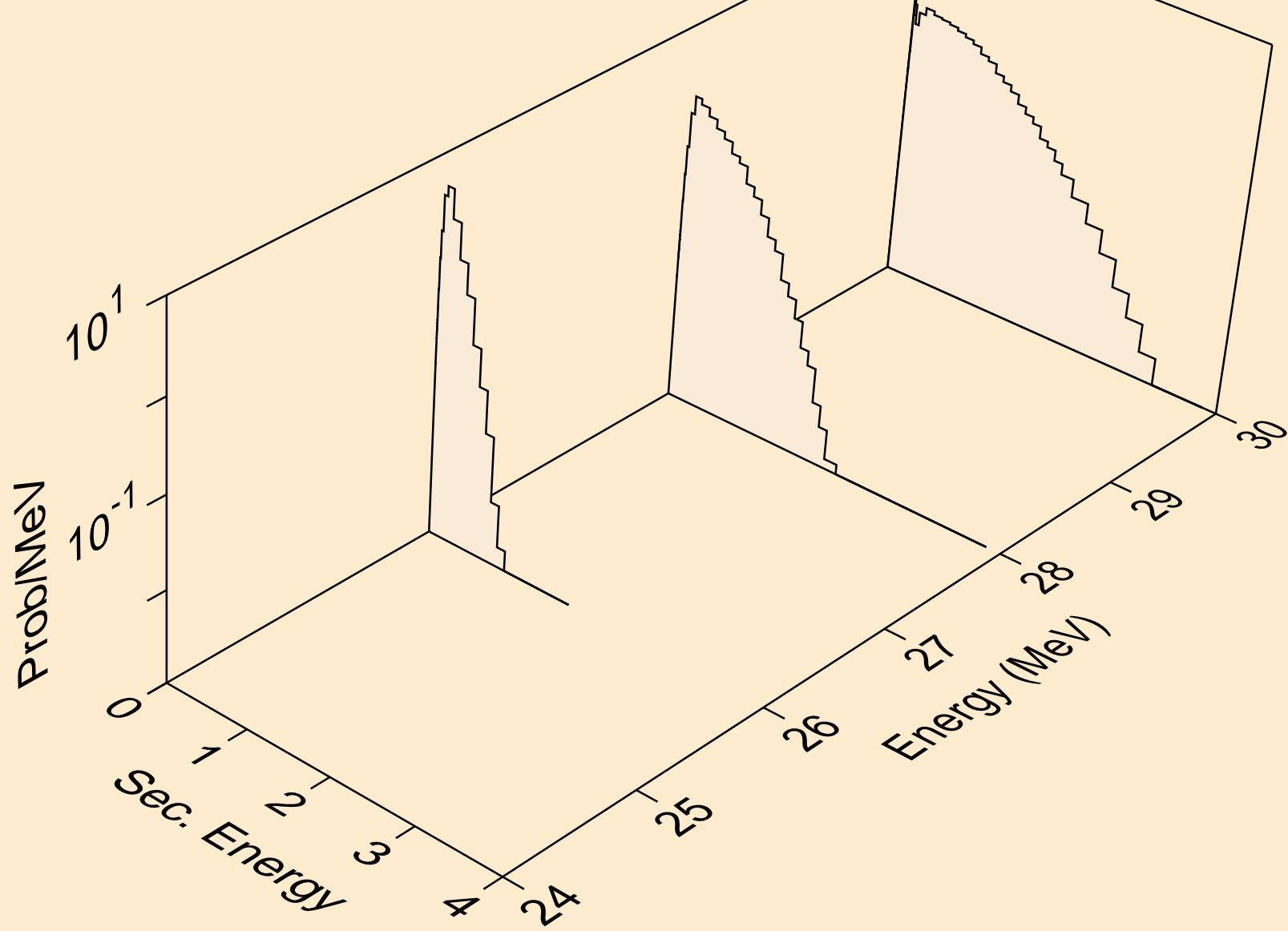

CU068 NEUTRON ACER TENDL-2023 LIBRARY; T=0.K
Neutron emission for (n,n2p)

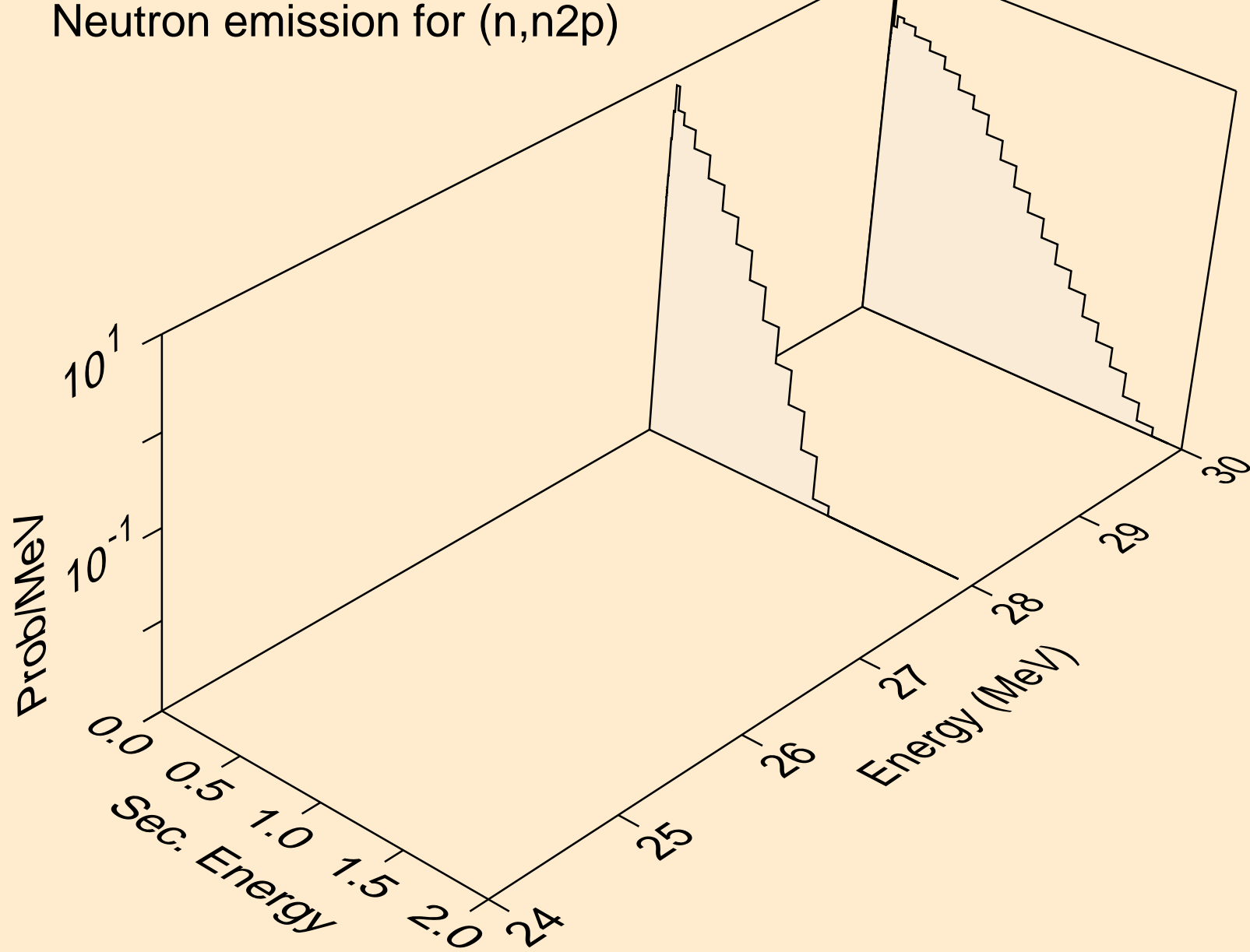

CU068 NEUTRON ACER TENDL-2023 LIBRARY; T=0.K
Neutron emission for (n,npa)

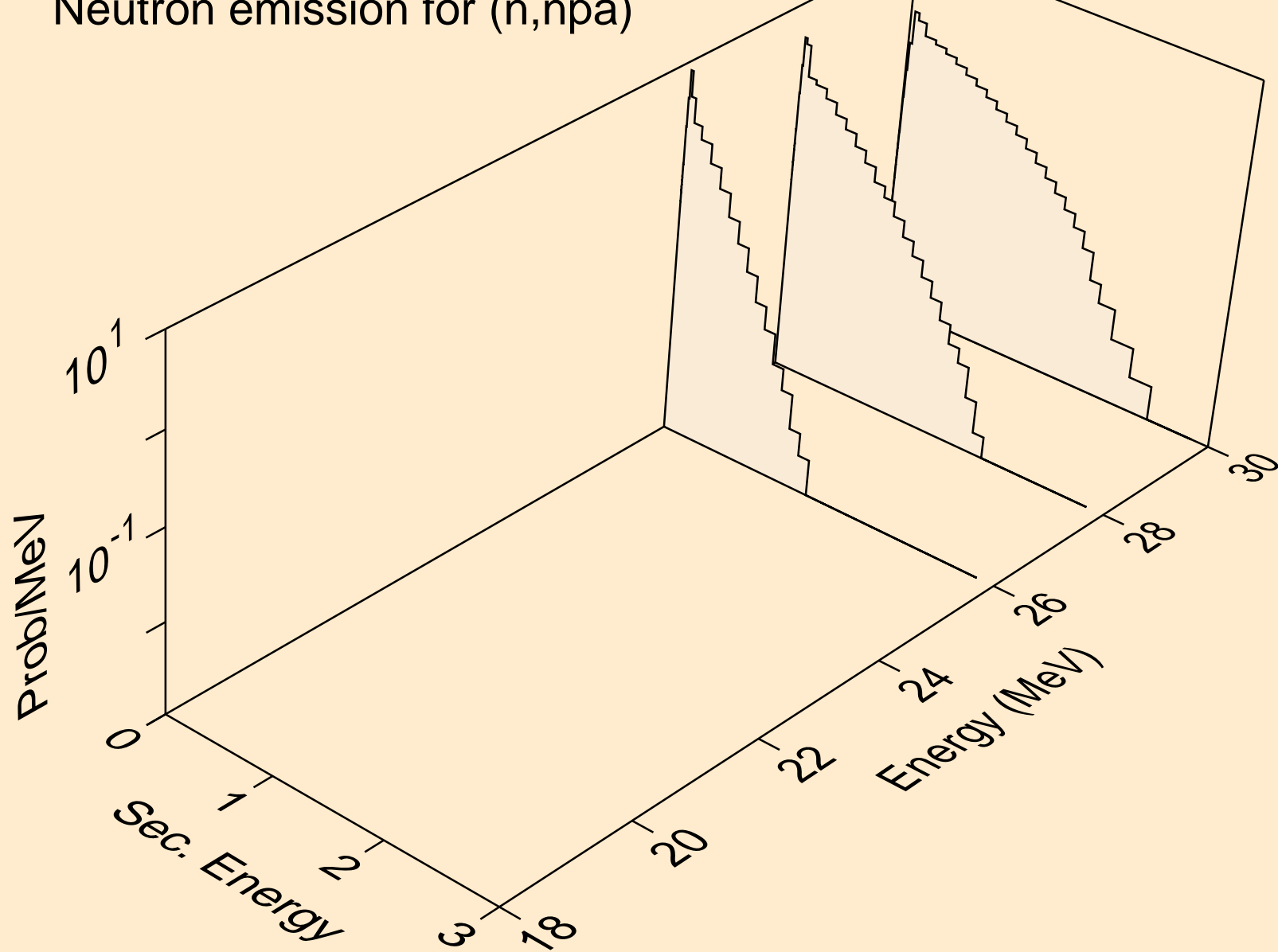

CU068 NEUTRON ACER TENDL-2023 LIBRARY; T=0.K
Neutron emission for (n,n*c)

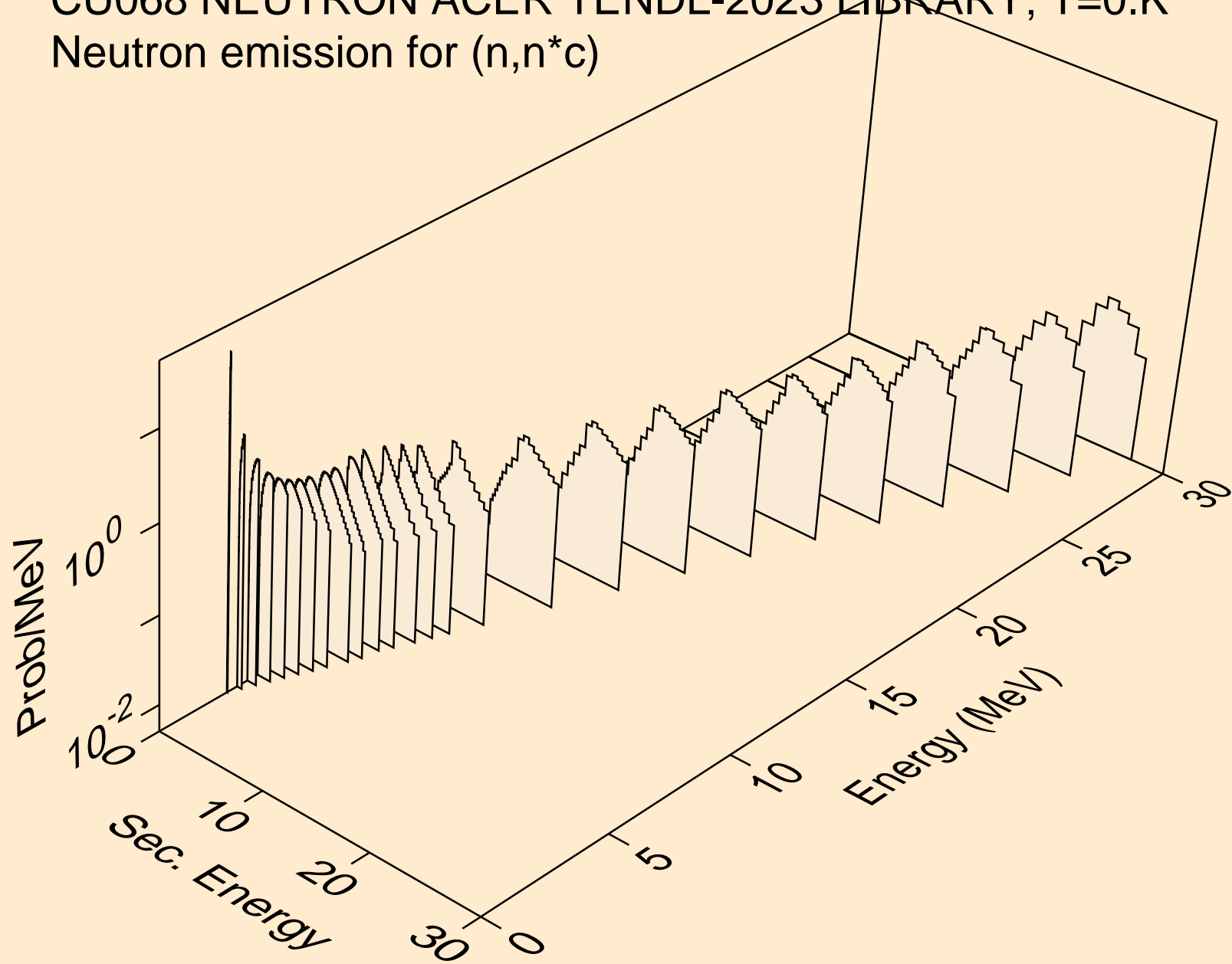

CU068 NEUTRON ACER TENDL-2023 LIBRARY; T=0.K
Photon emission for (n,x)

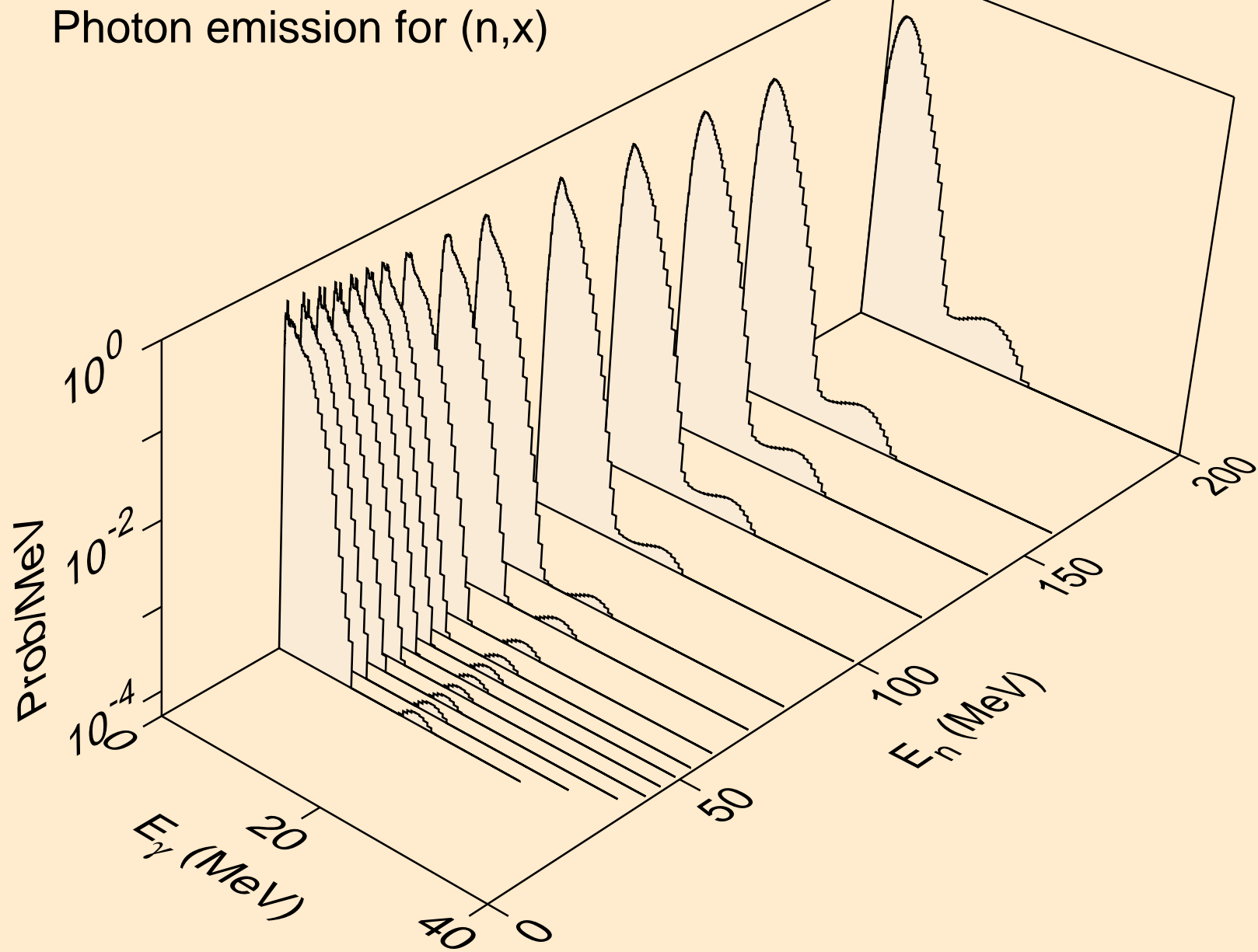

CU068 NEUTRON ACER TENDL-2023 LIBRARY; T=0.K
Photon emission for (n,2nd)

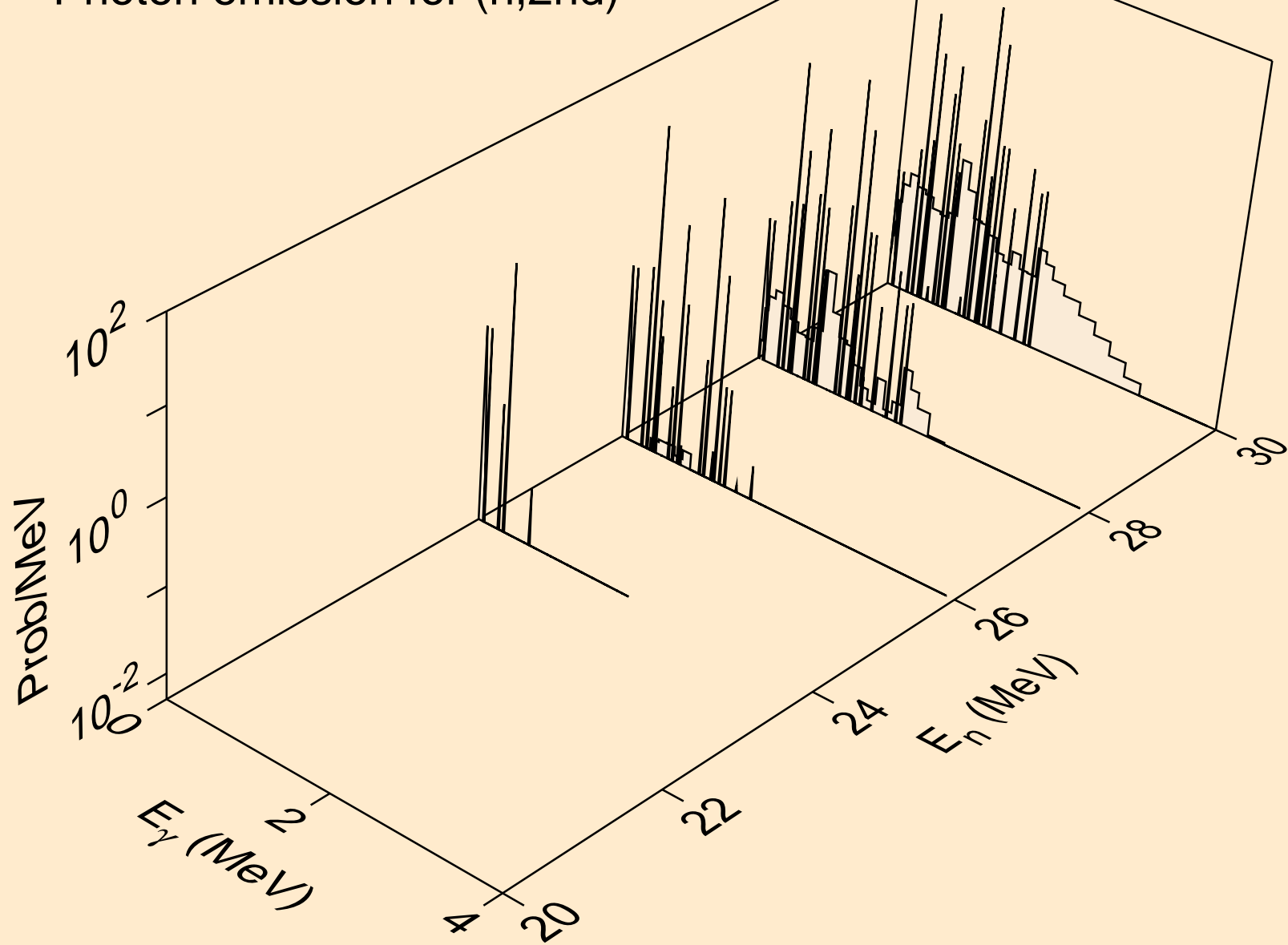

CU068 NEUTRON ACER TENDL-2023 LIBRARY; T=0.K
Photon emission for (n,2n)

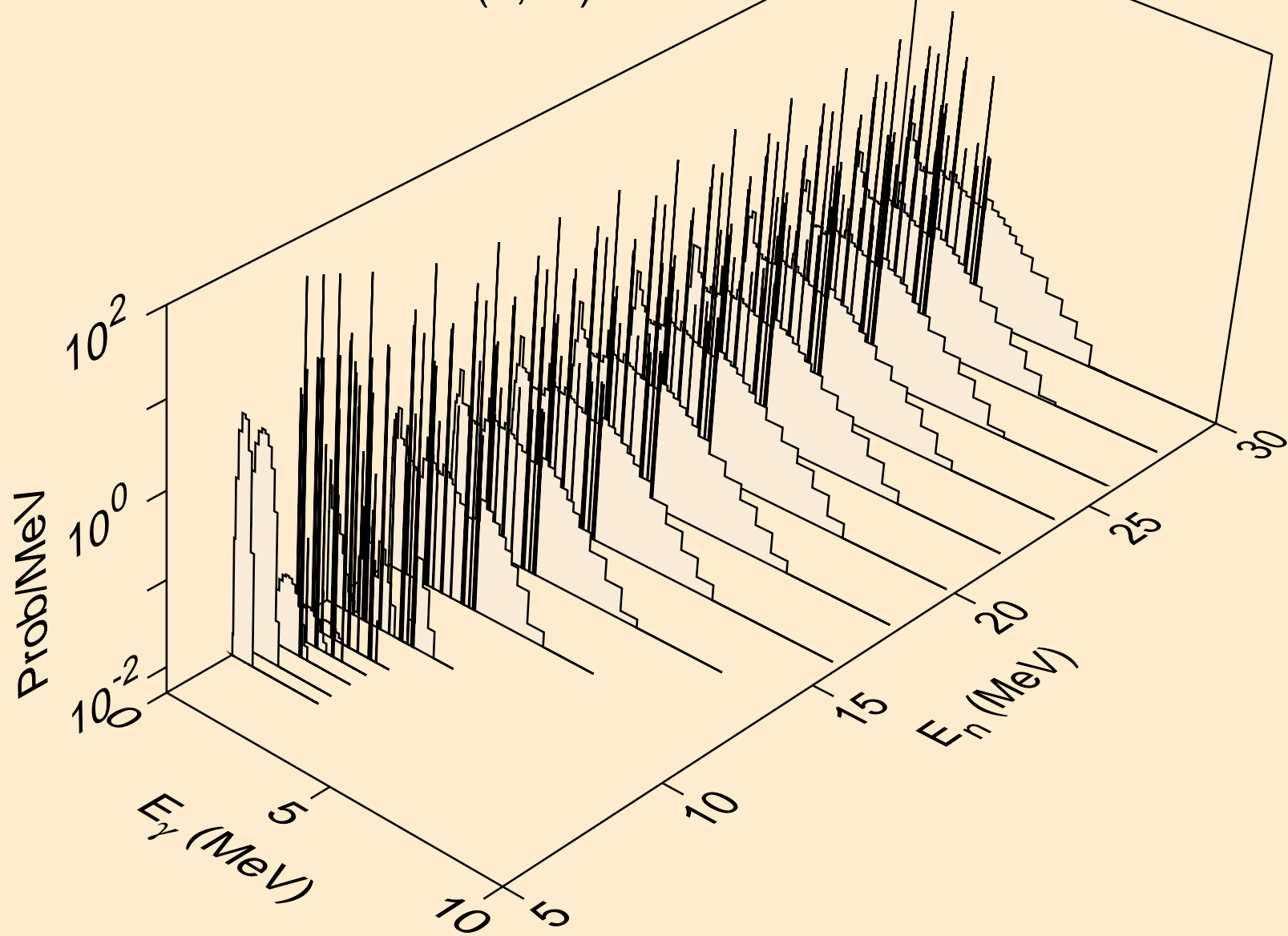

CU068 NEUTRON ACER TENDL-2023 LIBRARY; T=0.K
Photon emission for (n,3n)

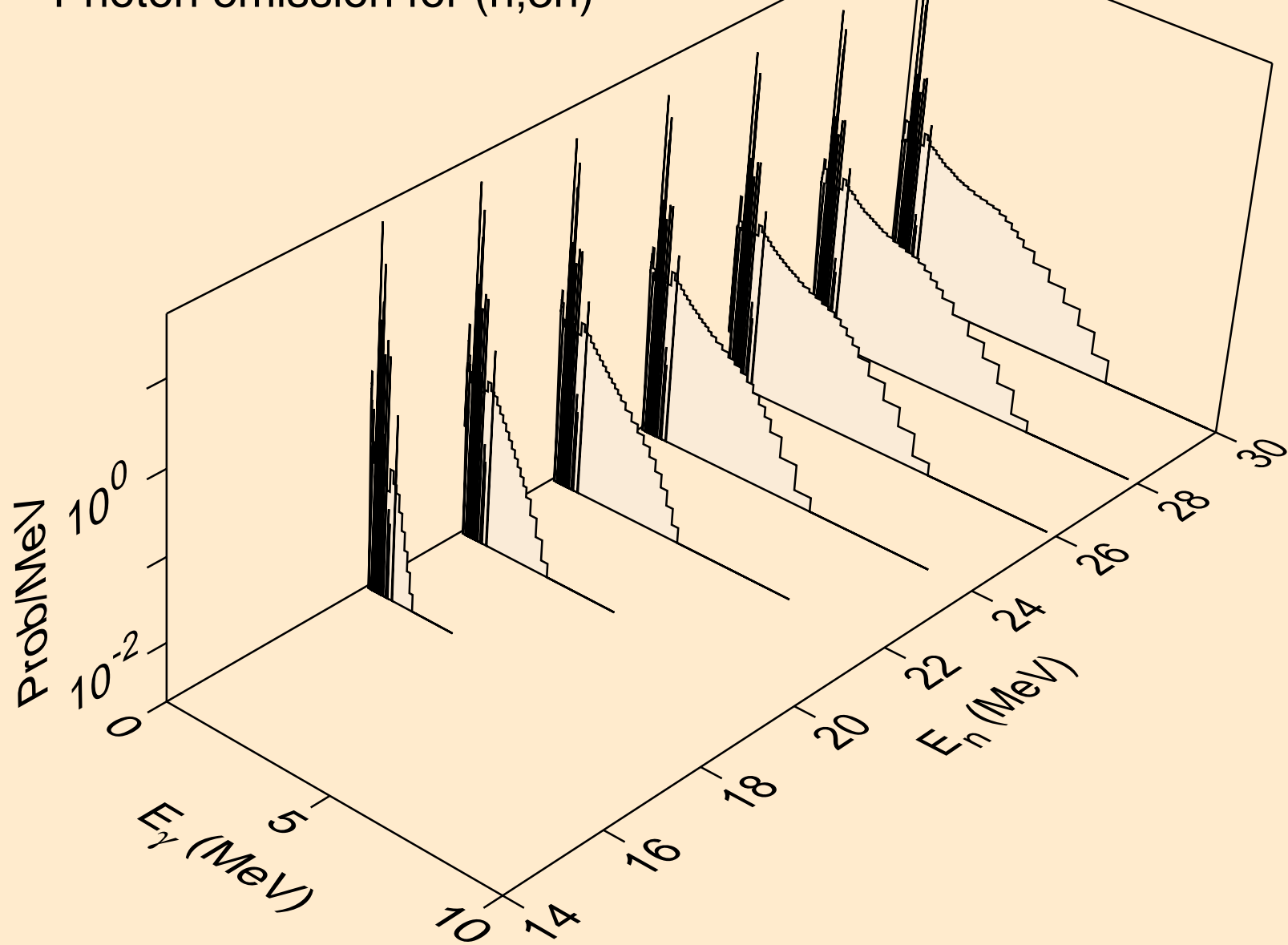

CU068 NEUTRON ACER TENDL-2023 LIBRARY; T=0.K
Photon emission for (n,n*)a

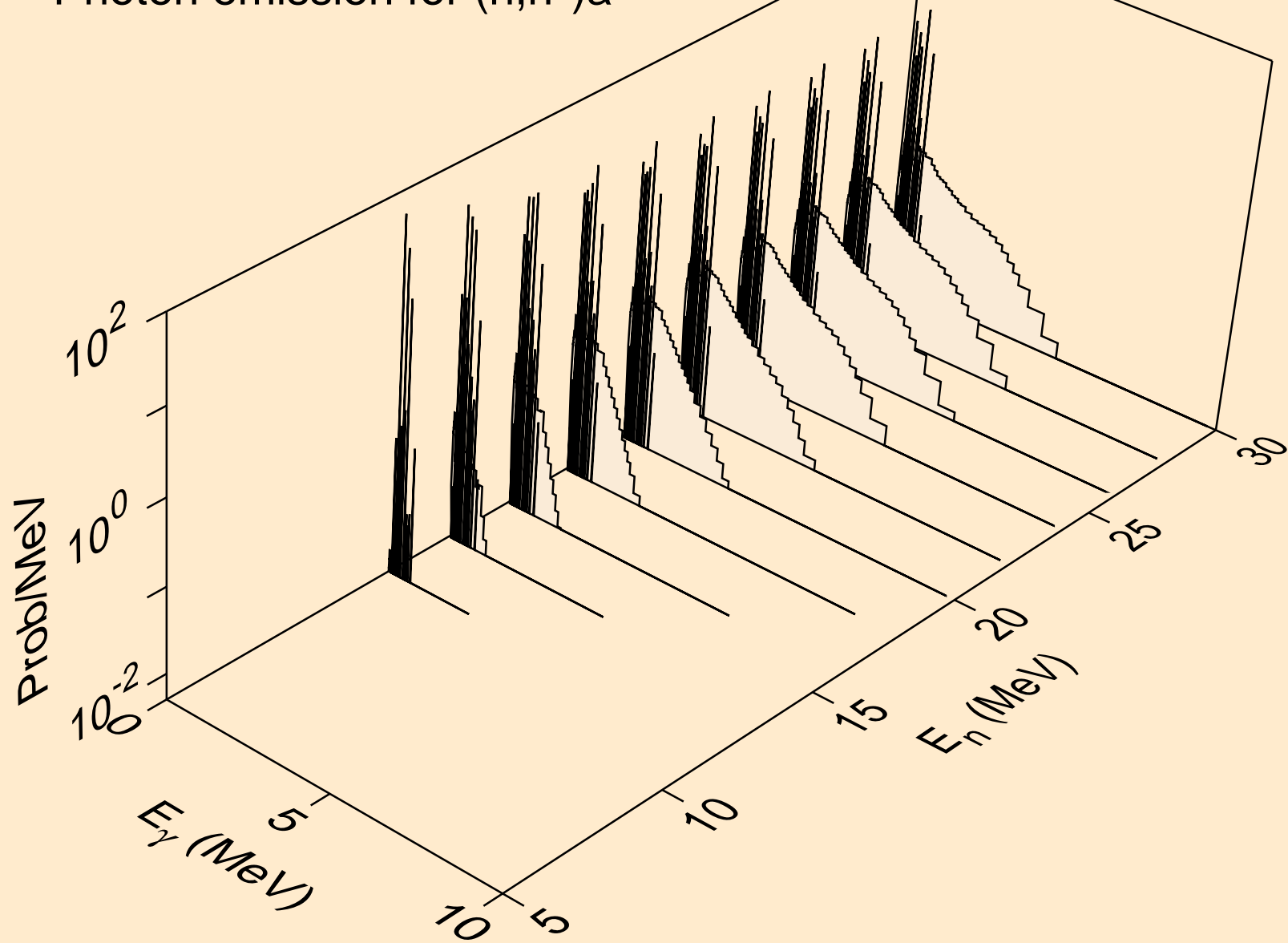

CU068 NEUTRON ACER TENDL-2023 LIBRARY; T=0.K
Photon emission for (n,2n)a

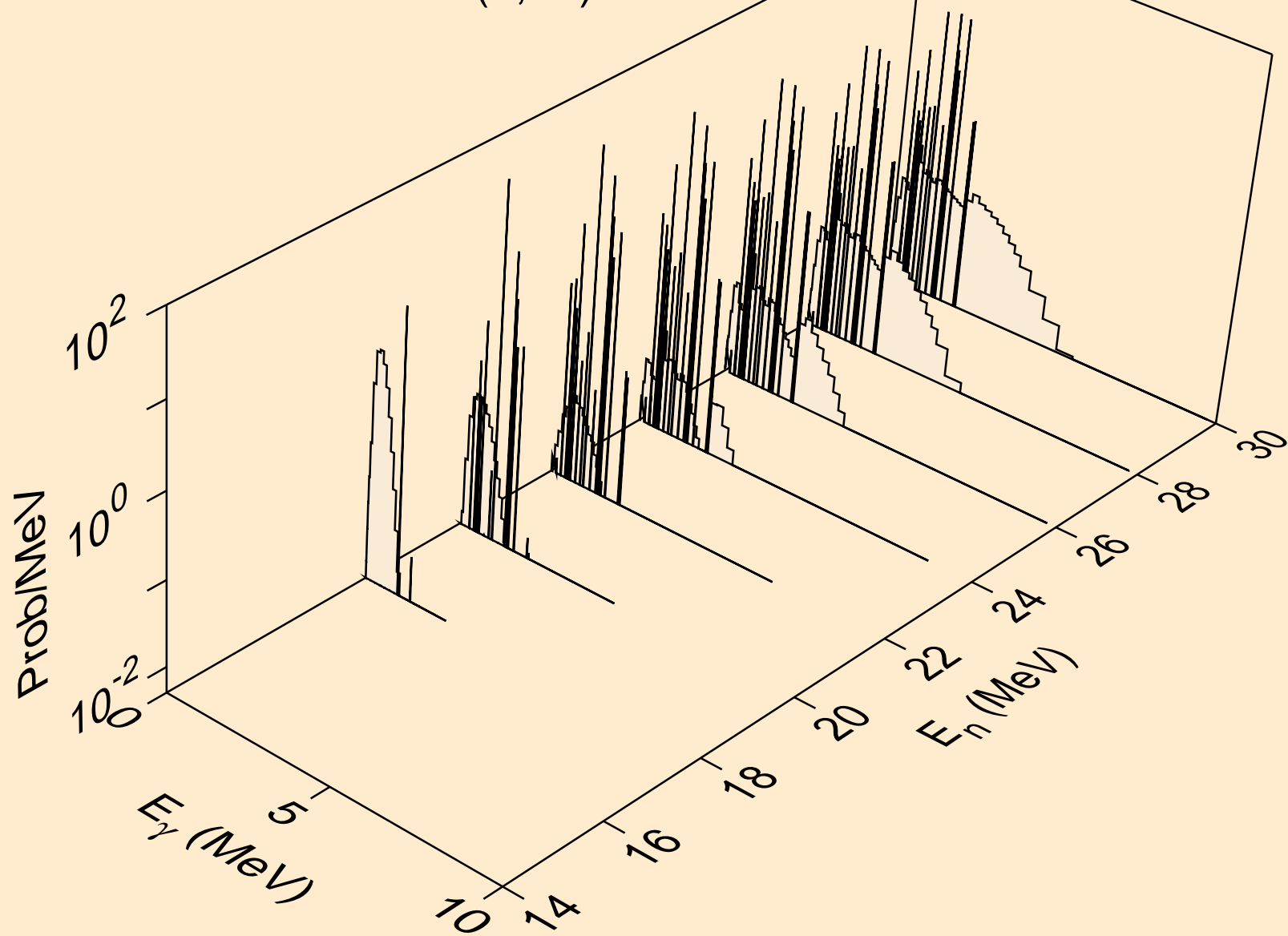

CU068 NEUTRON ACER TENDL-2023 LIBRARY; T=0.K
Photon emission for (n,3n)a

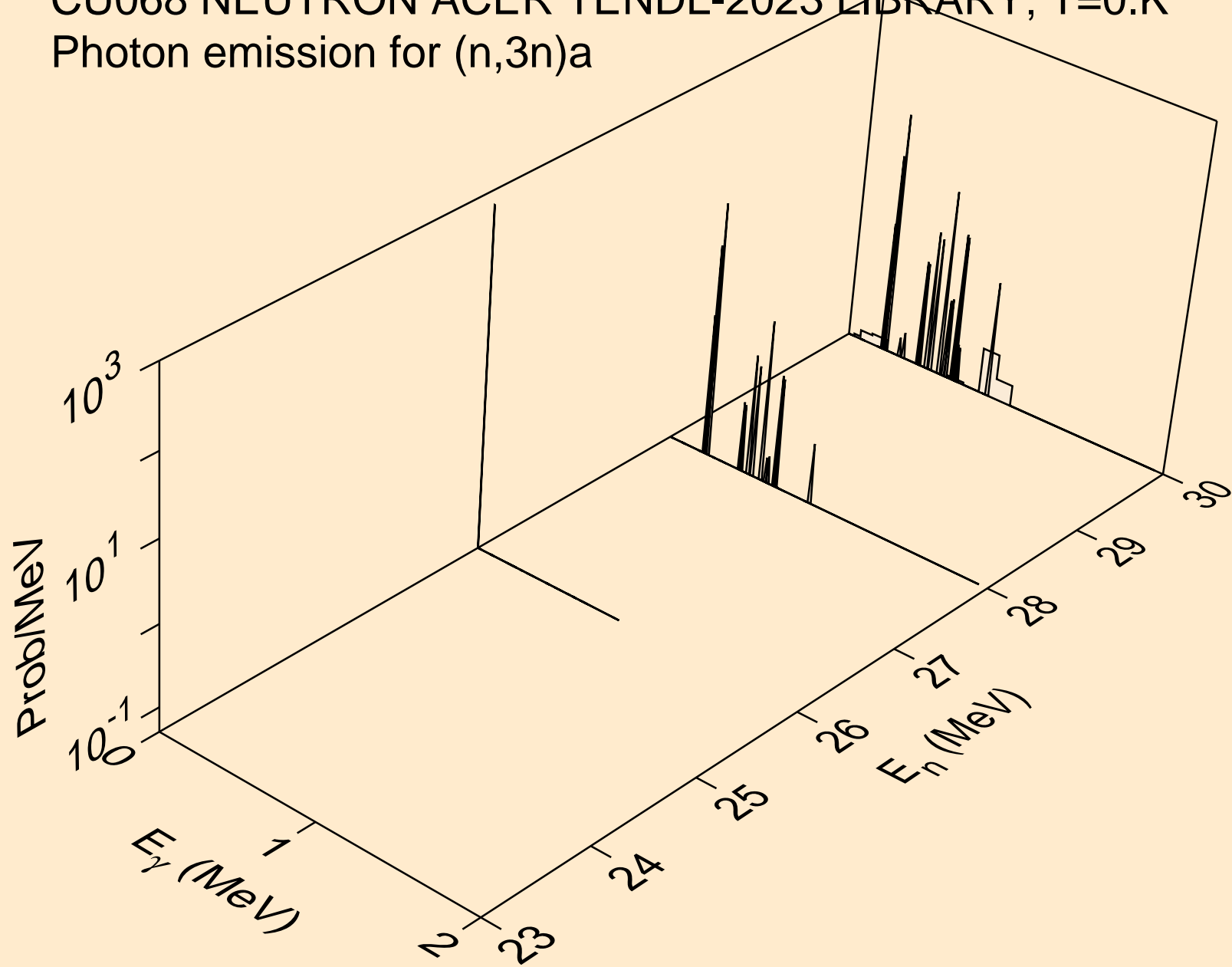

CU068 NEUTRON ACER TENDL-2023 LIBRARY; T=0.K
Photon emission for (n,n*)p

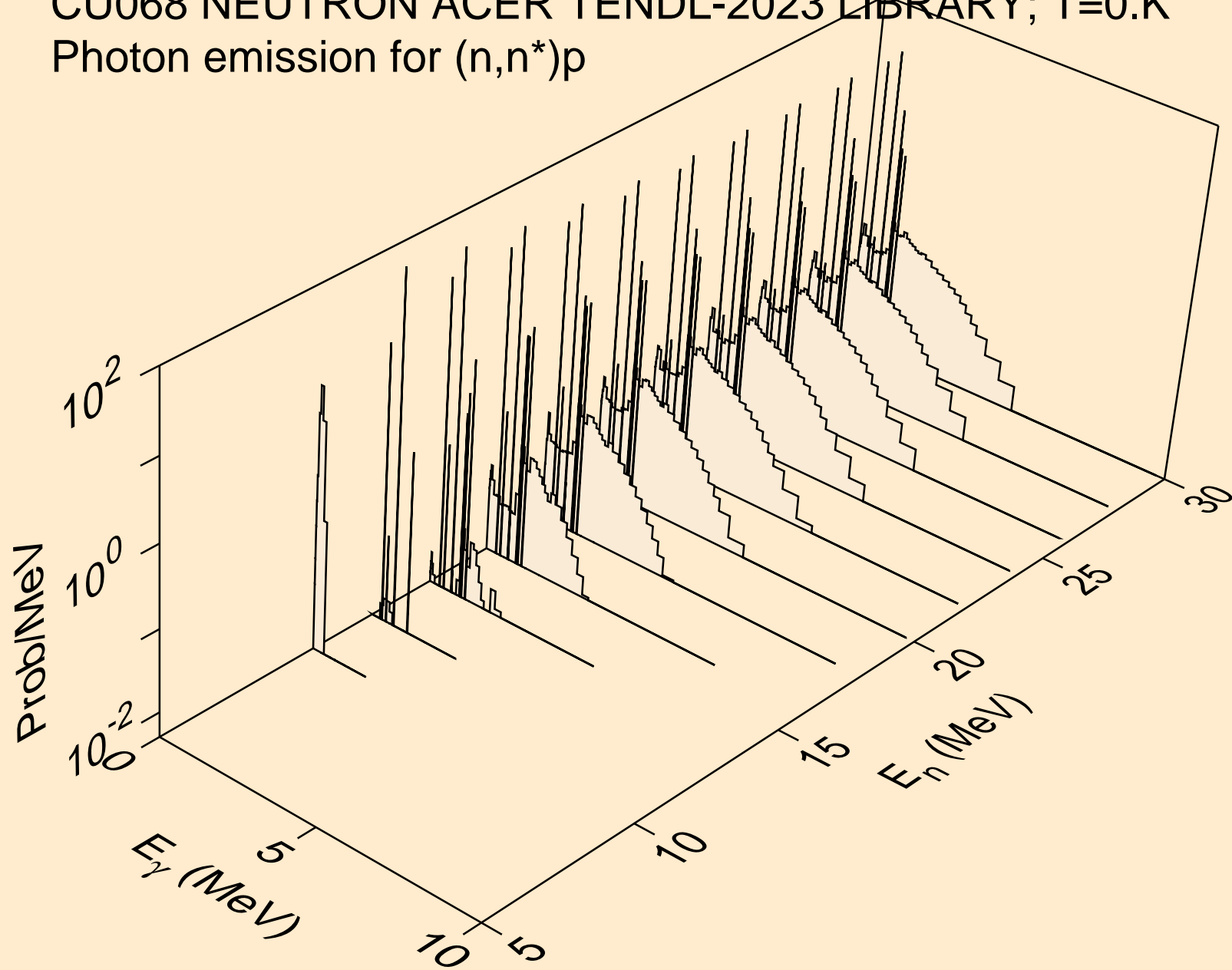

CU068 NEUTRON ACER TENDL-2023 LIBRARY; T=0.K
Photon emission for (n,n*)d

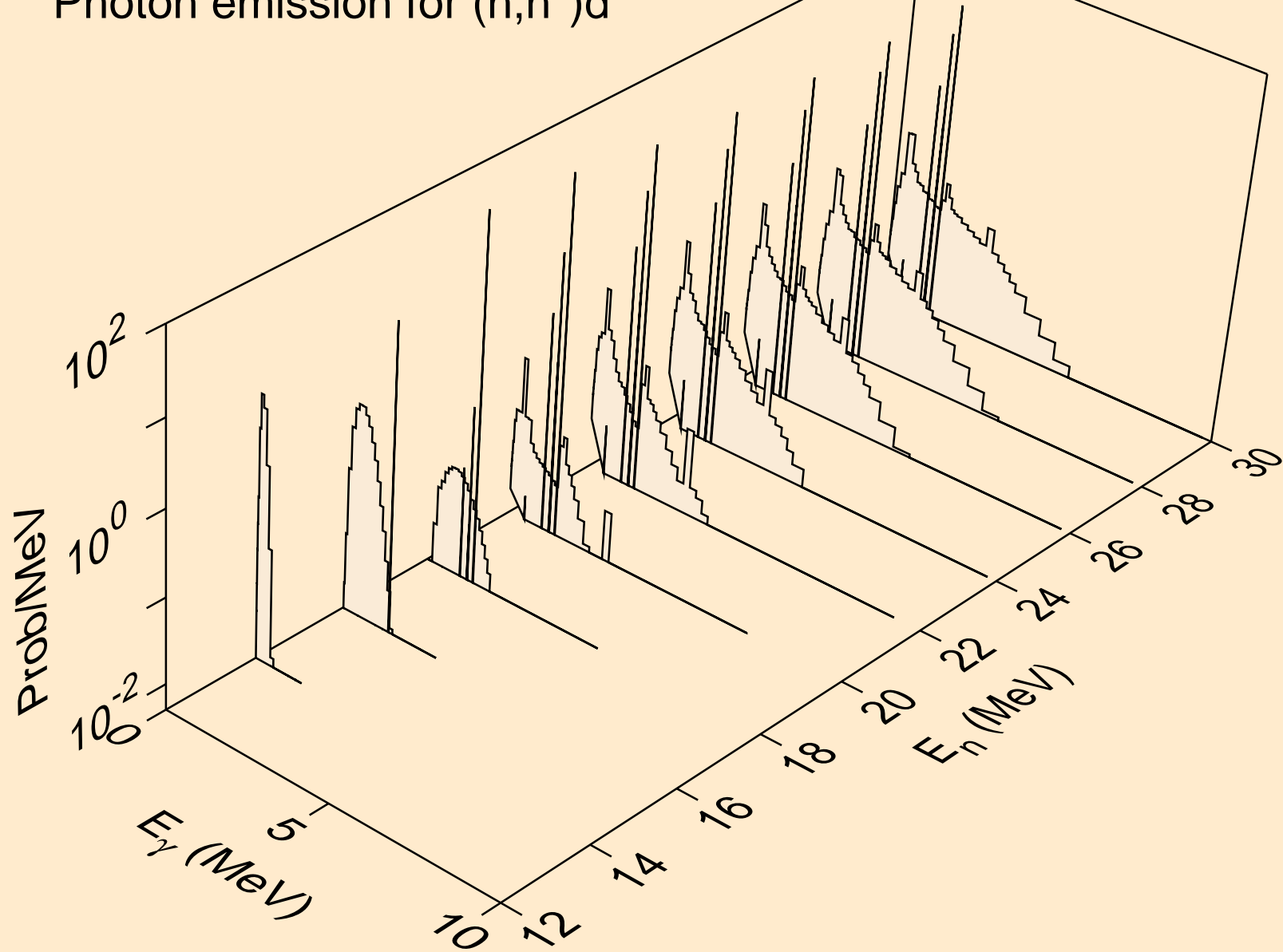

CU068 NEUTRON ACER TENDL-2023 LIBRARY; T=0.K
Photon emission for (n,n*)t

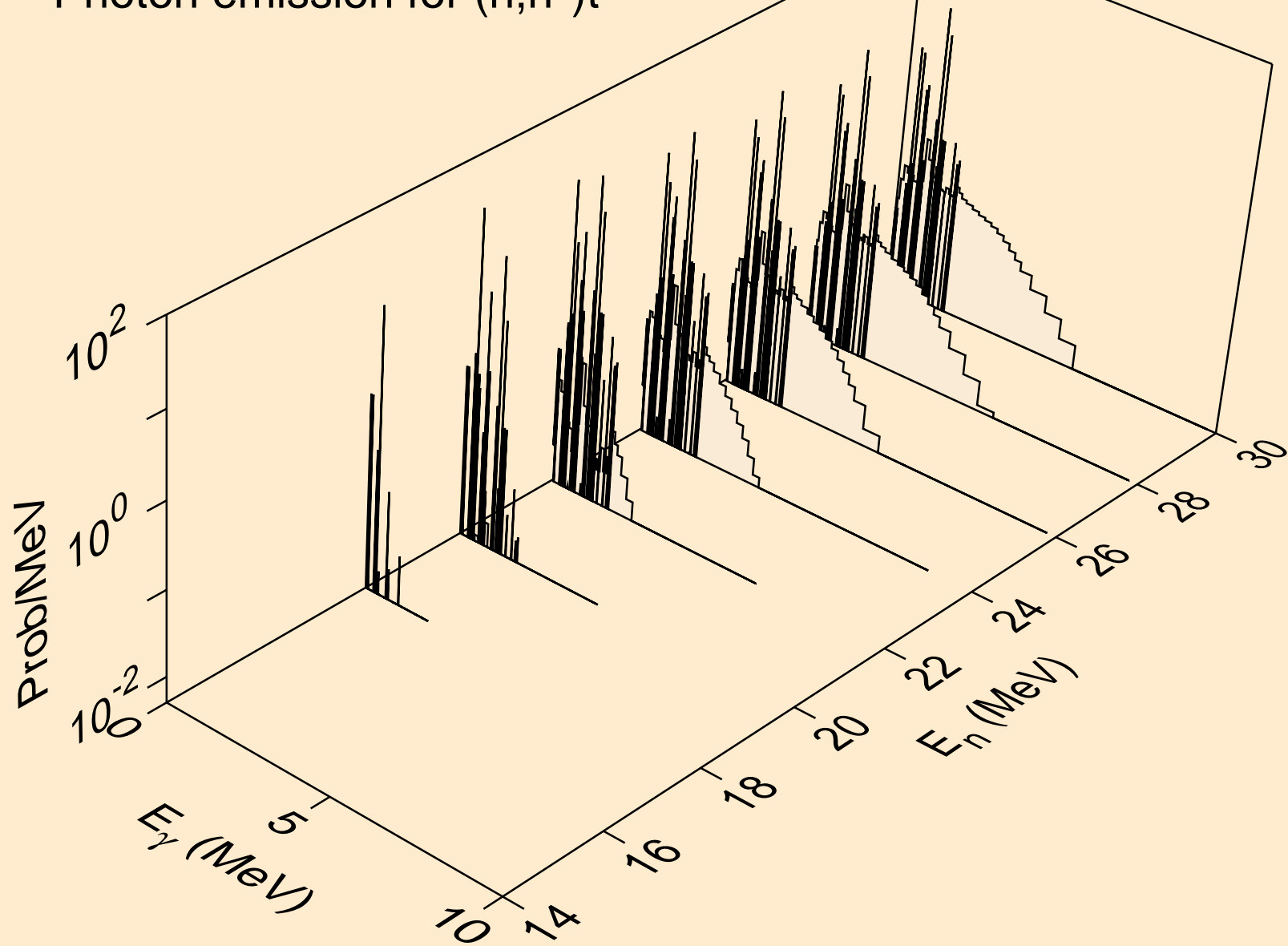

CU068 NEUTRON ACER TENDL-2023 LIBRARY; T=0.K
Photon emission for (n,n*)he3

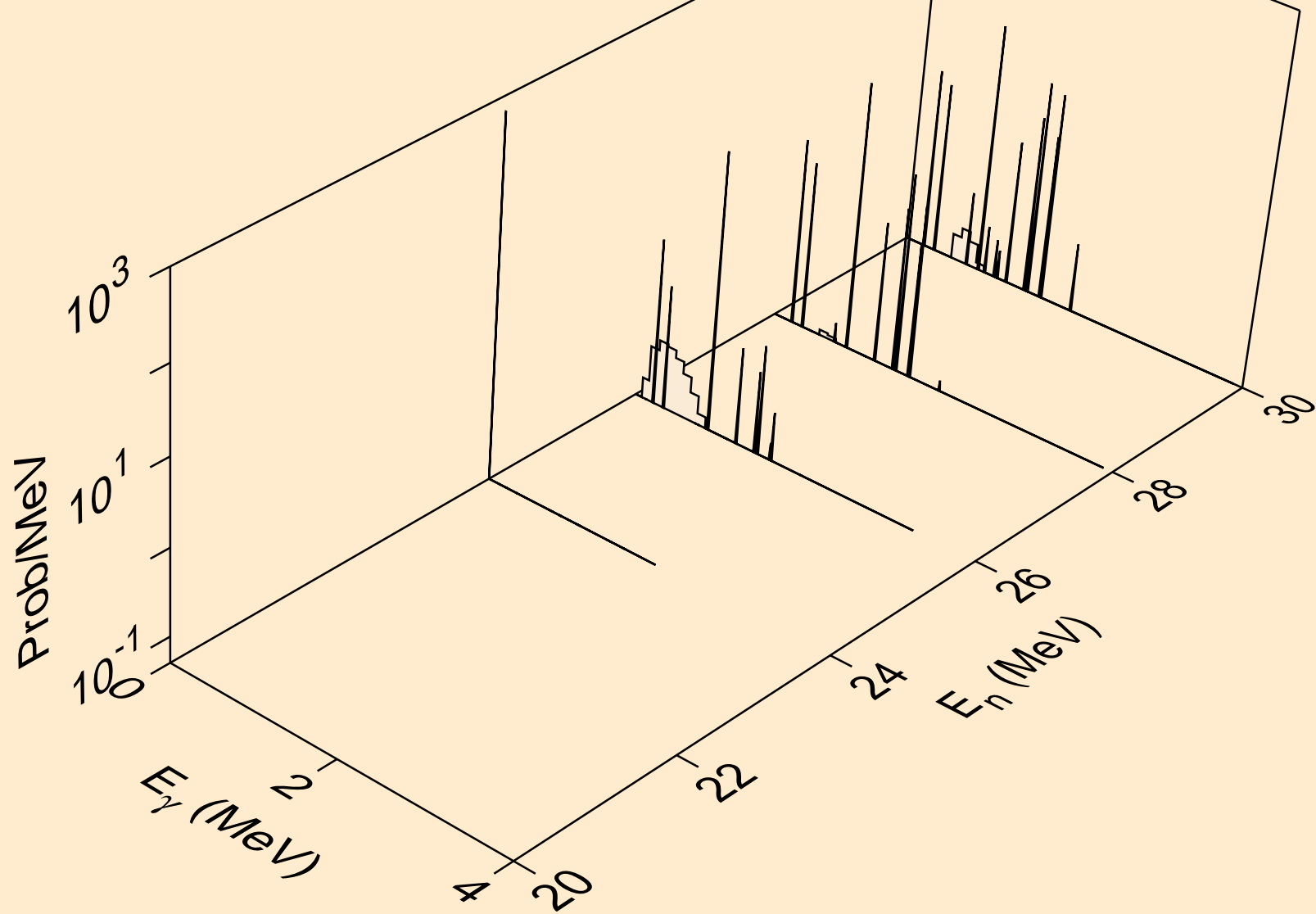

CU068 NEUTRON ACER TENDL-2023 LIBRARY; T=0.K
Photon emission for (n,4n)

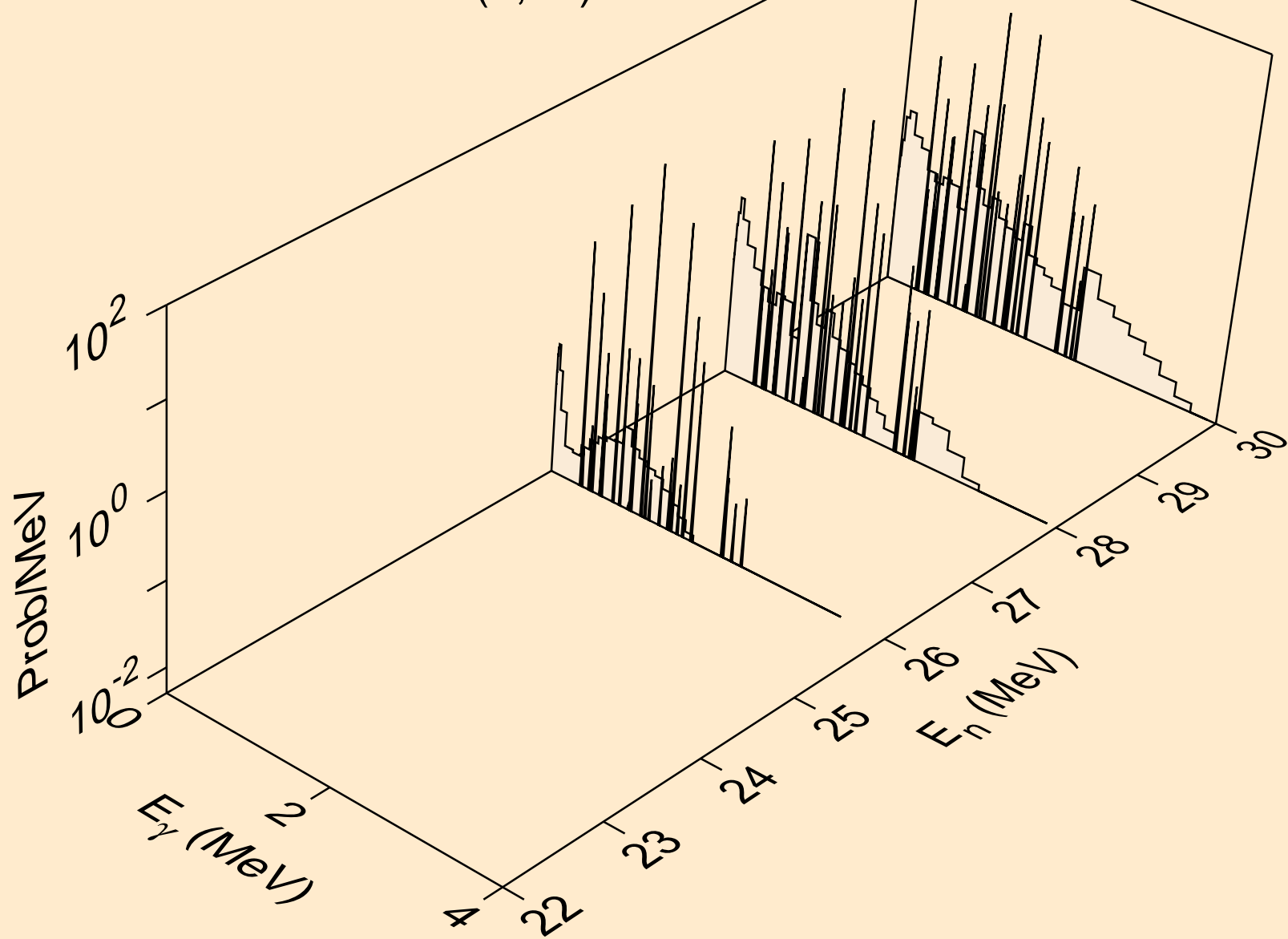

CU068 NEUTRON ACER TENDL-2023 LIBRARY; T=0.K
Photon emission for (n,2np)

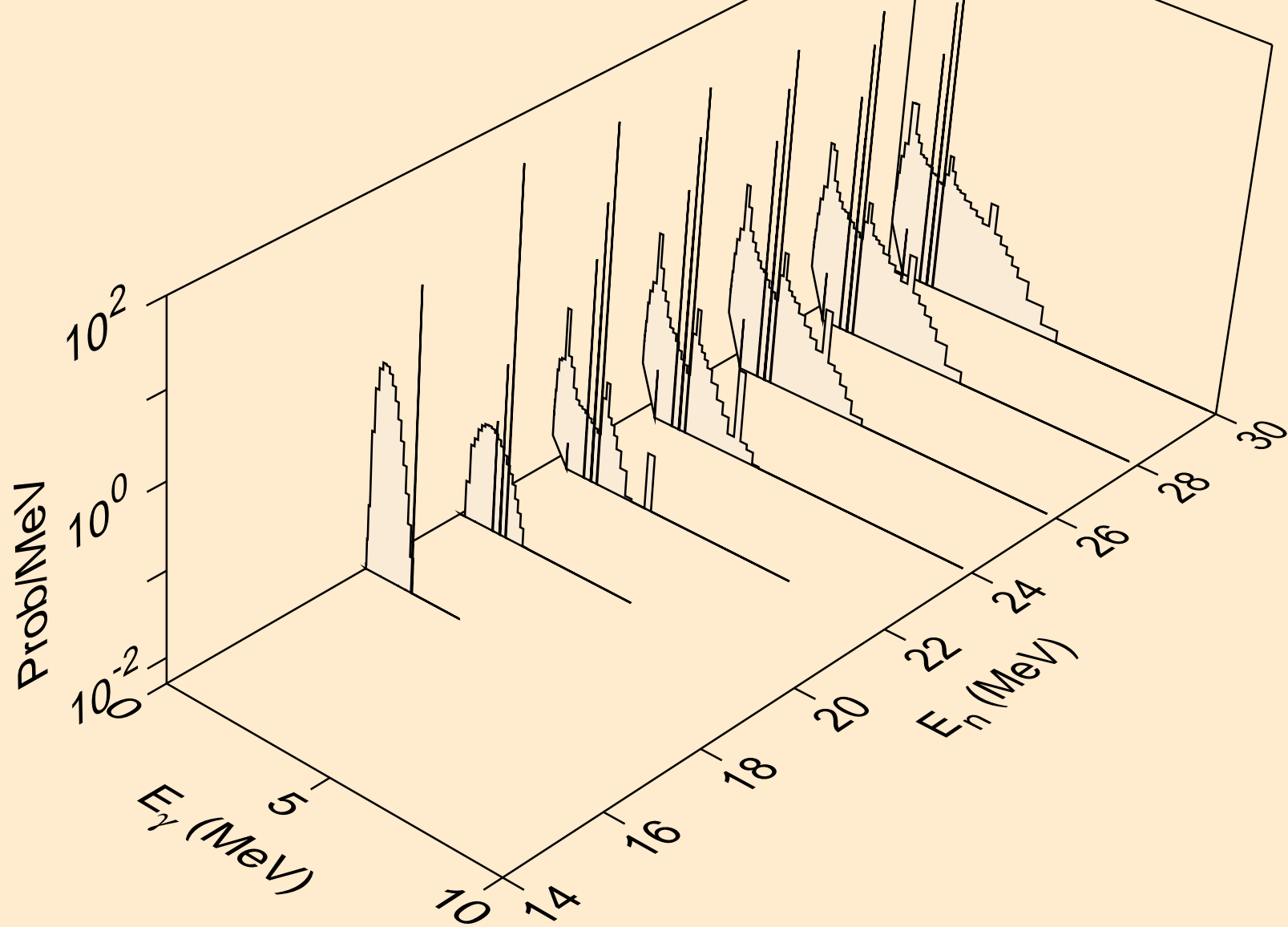

CU068 NEUTRON ACER TENDL-2023 LIBRARY; T=0.K
Photon emission for (n,3np)

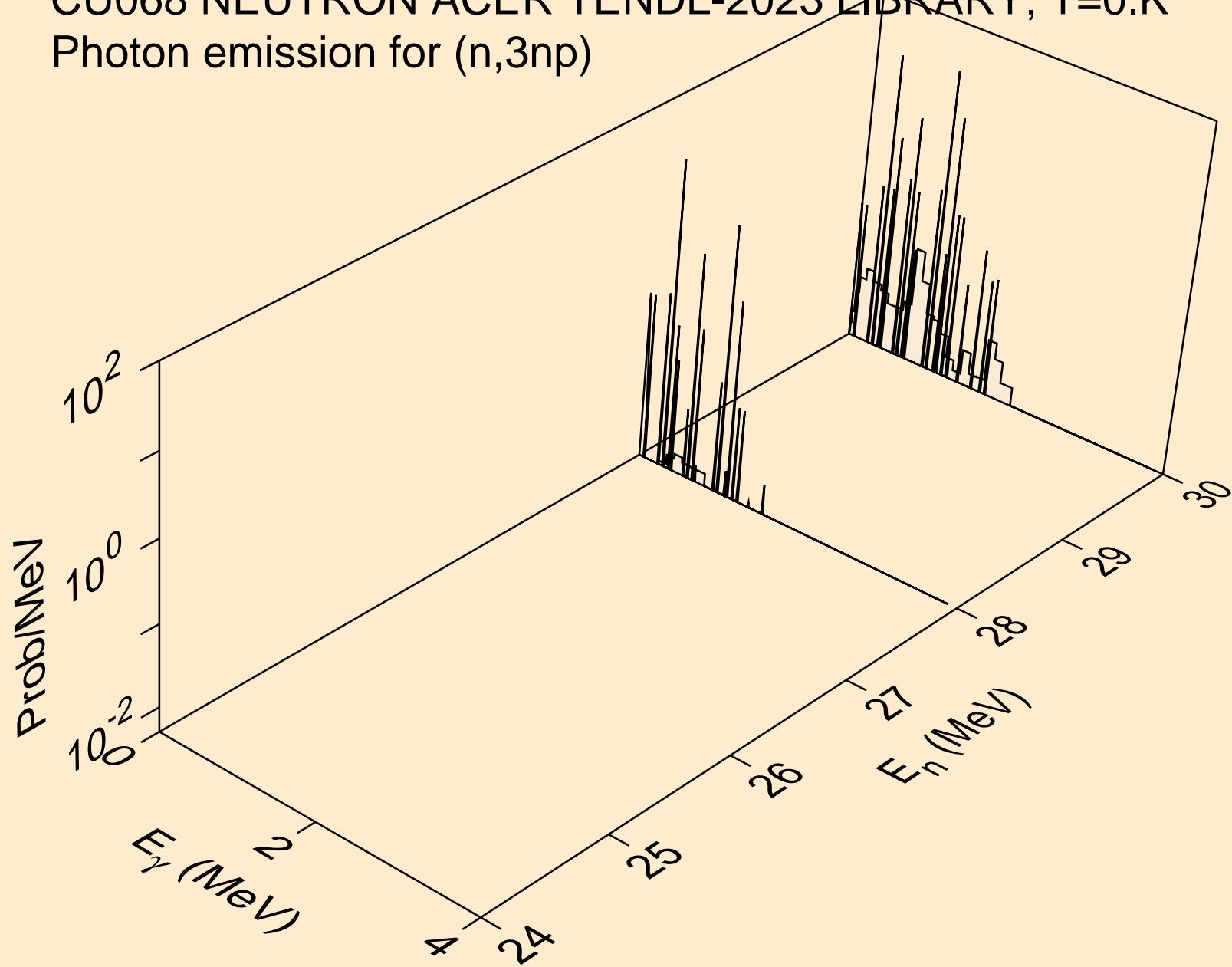

CU068 NEUTRON ACER TENDL-2023 LIBRARY; T=0.K
Photon emission for (n,n2p)

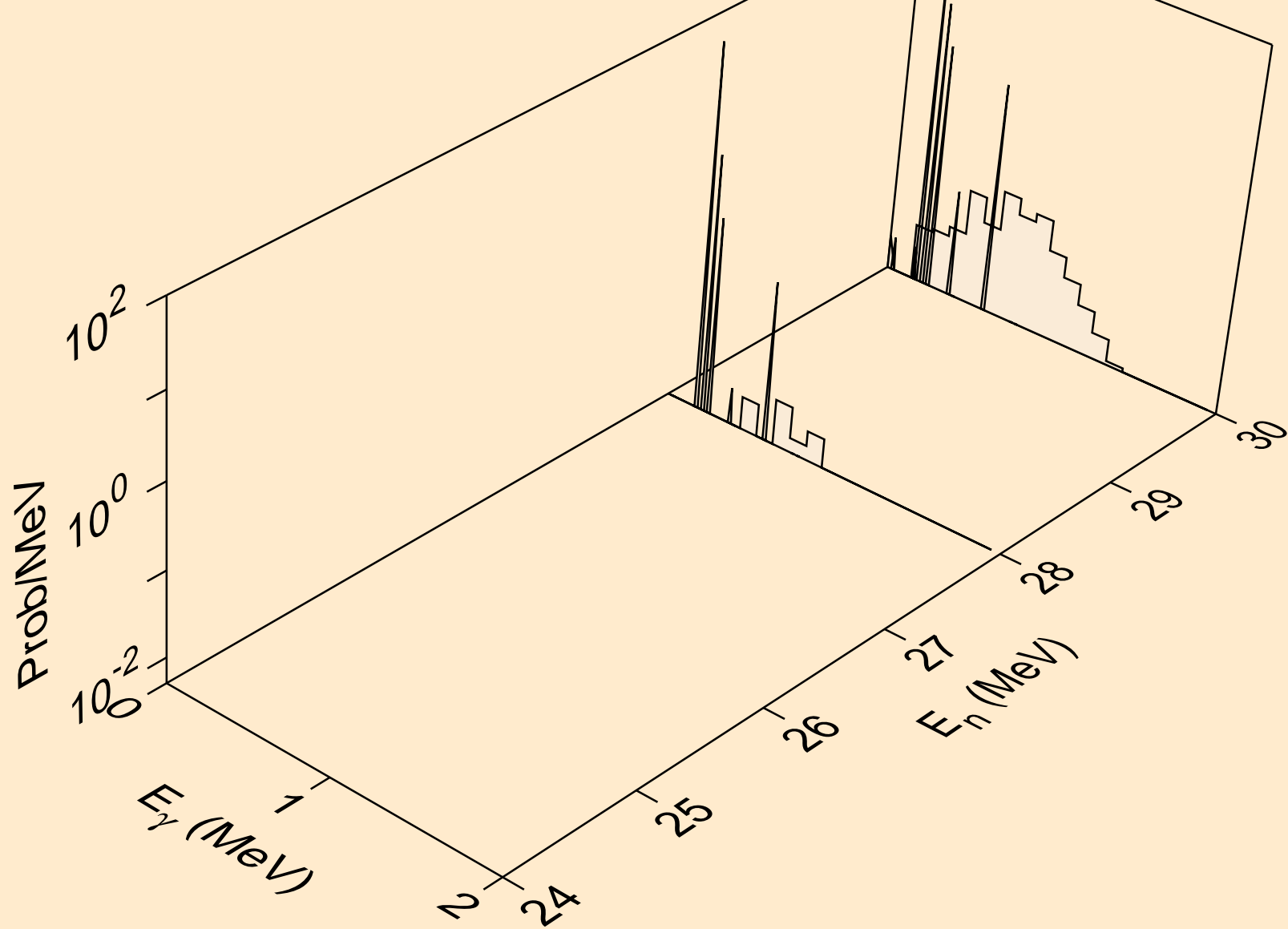

CU068 NEUTRON ACER TENDL-2023 LIBRARY; T=0.K
Photon emission for (n,npa)

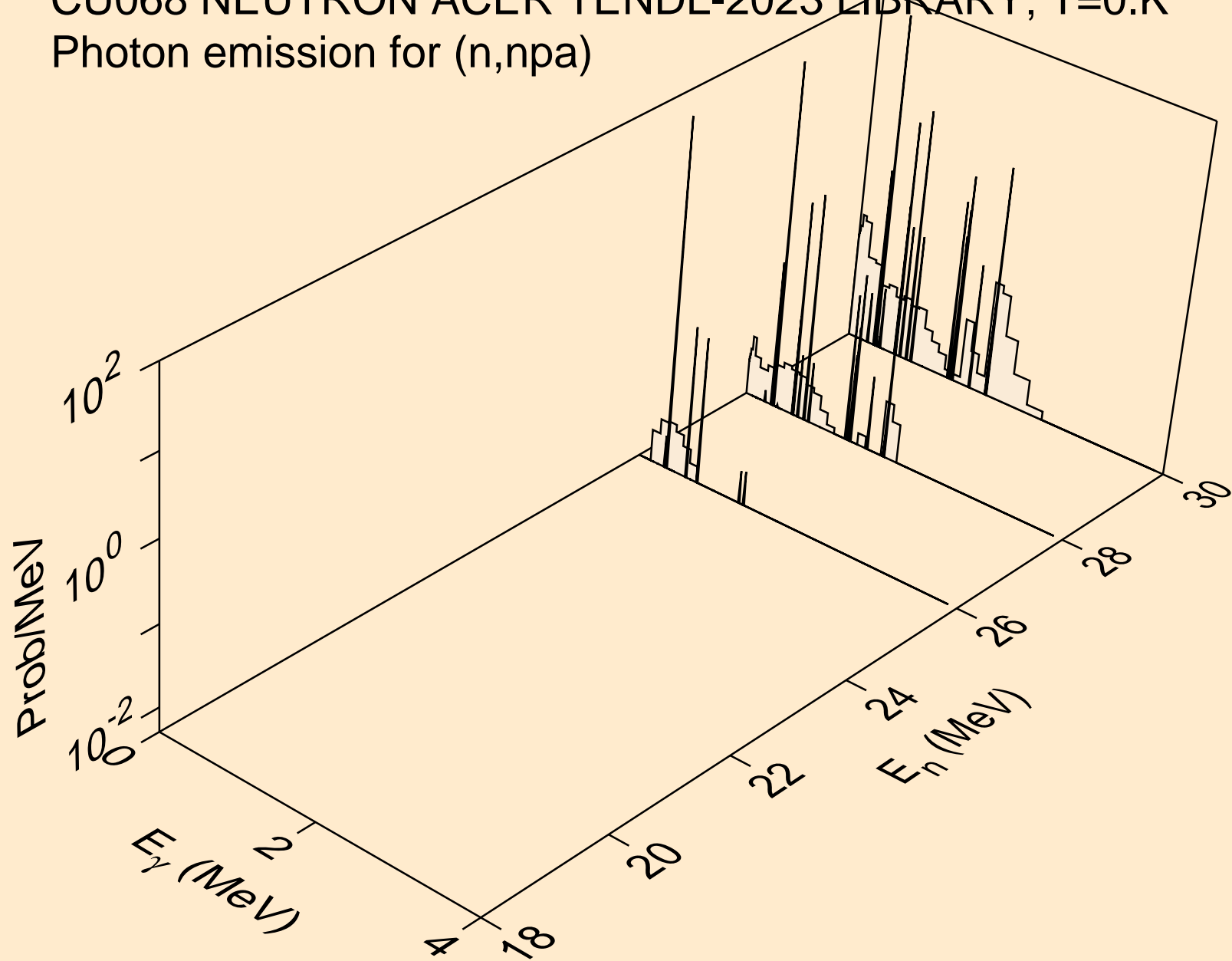

CU068 NEUTRON ACER TENDL-2023 LIBRARY; T=0.K
Photon emission for (n,n*c)

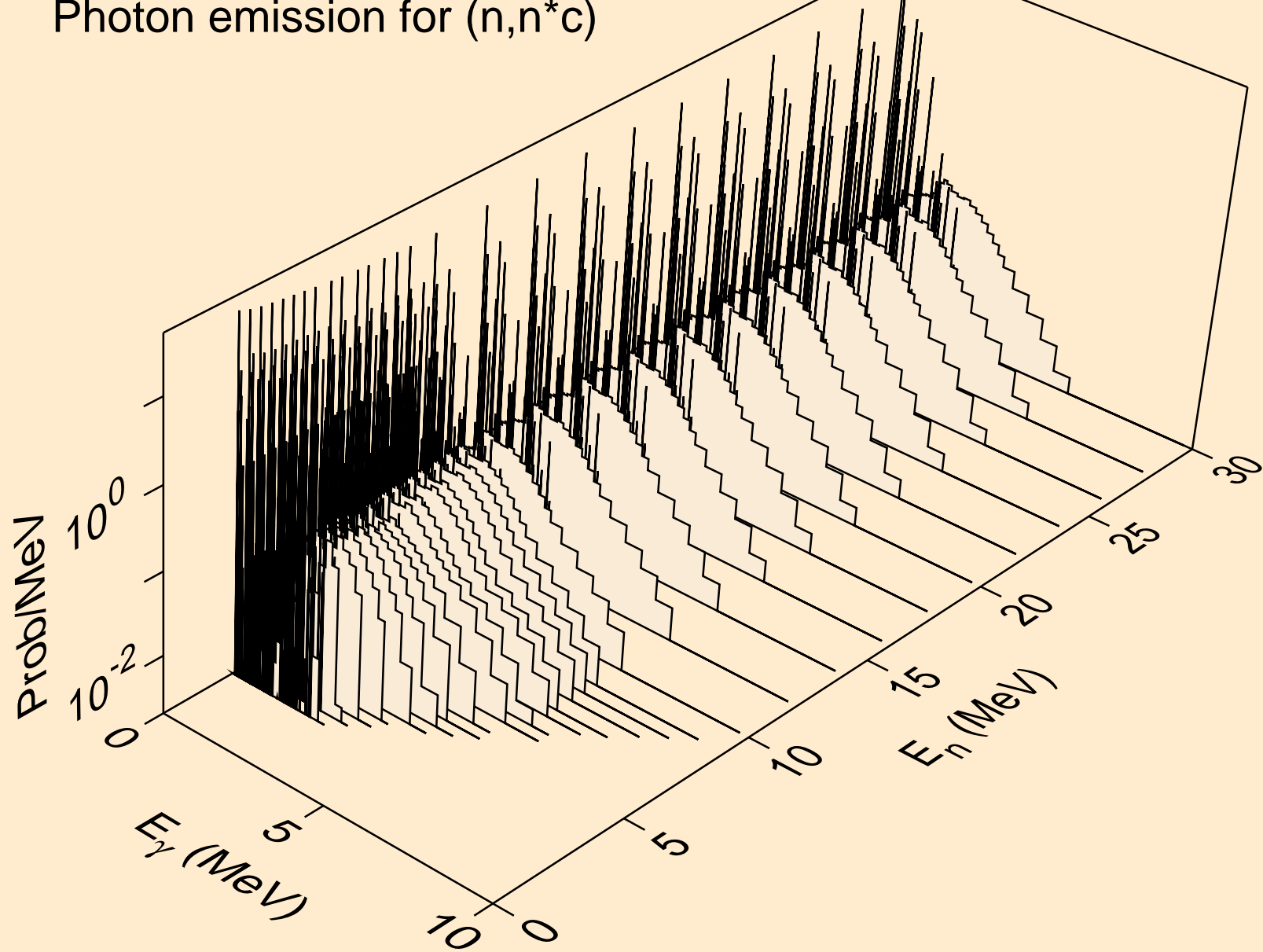

CU068 NEUTRON ACER TENDL-2023 LIBRARY; T=0.K
Photon emission for (n,gma)

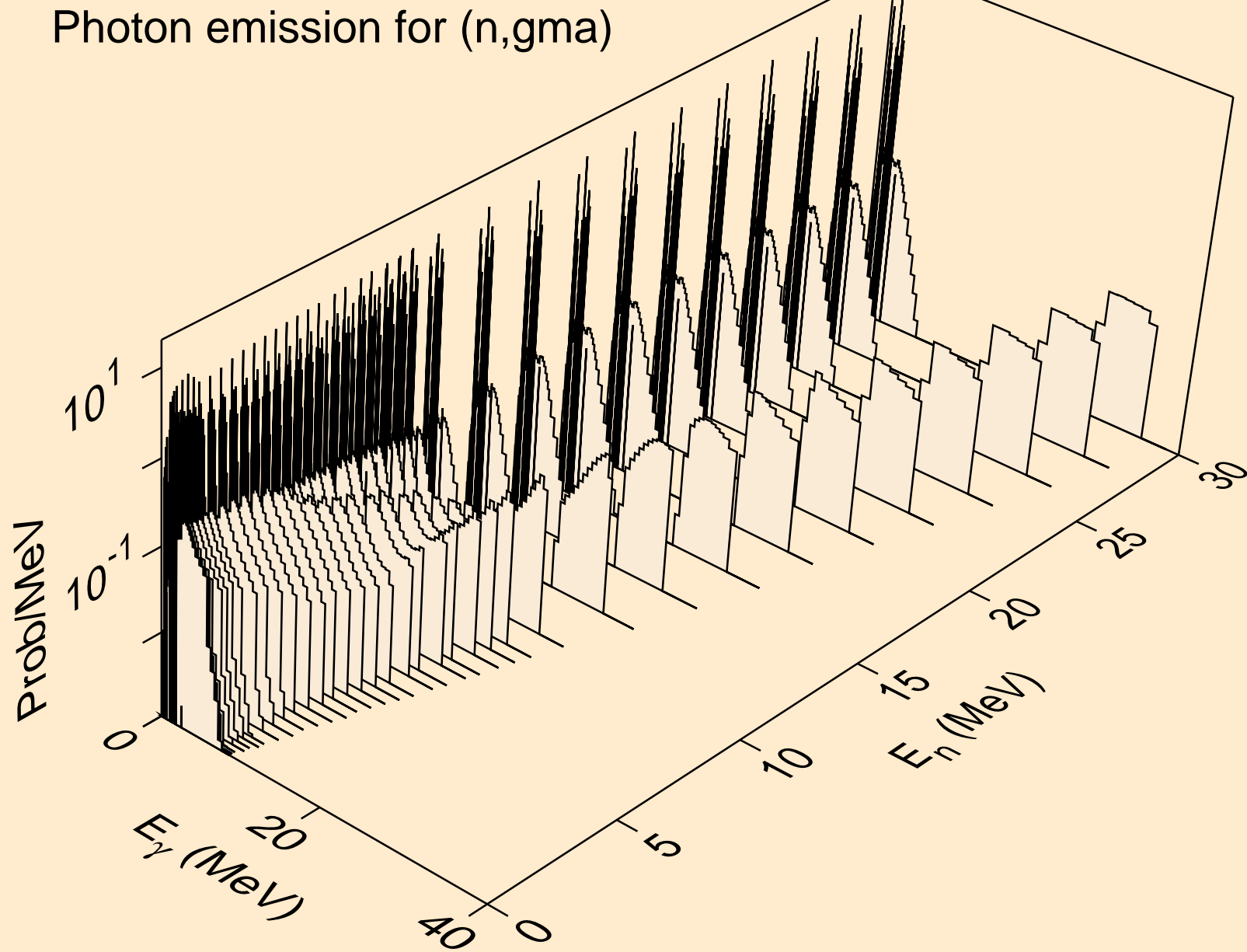

CU068 NEUTRON ACER TENDL-2023 LIBRARY; T=0.K
Photon emission for (n,p)

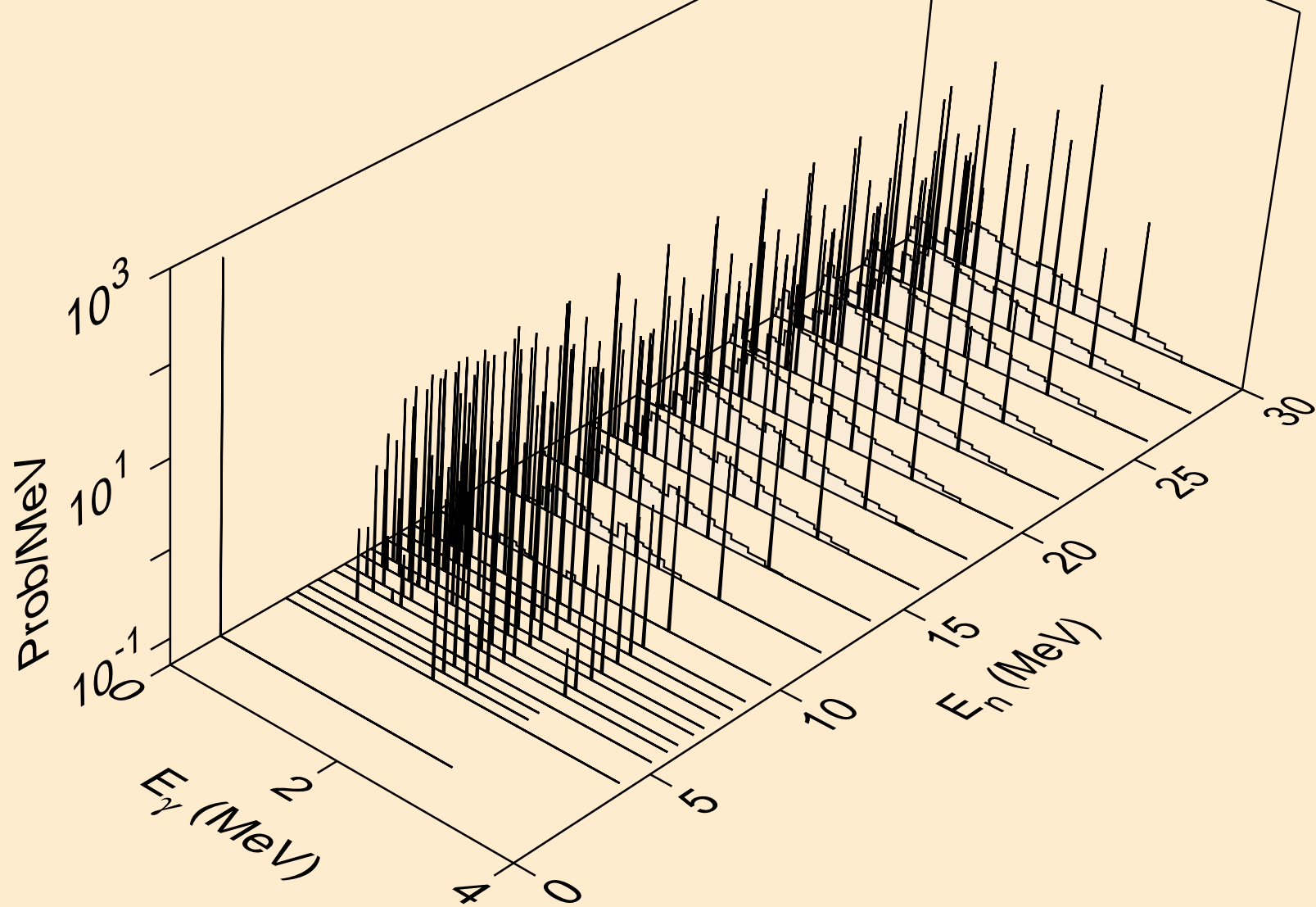

CU068 NEUTRON ACER TENDL-2023 LIBRARY; T=0.K
Photon emission for (n,d)

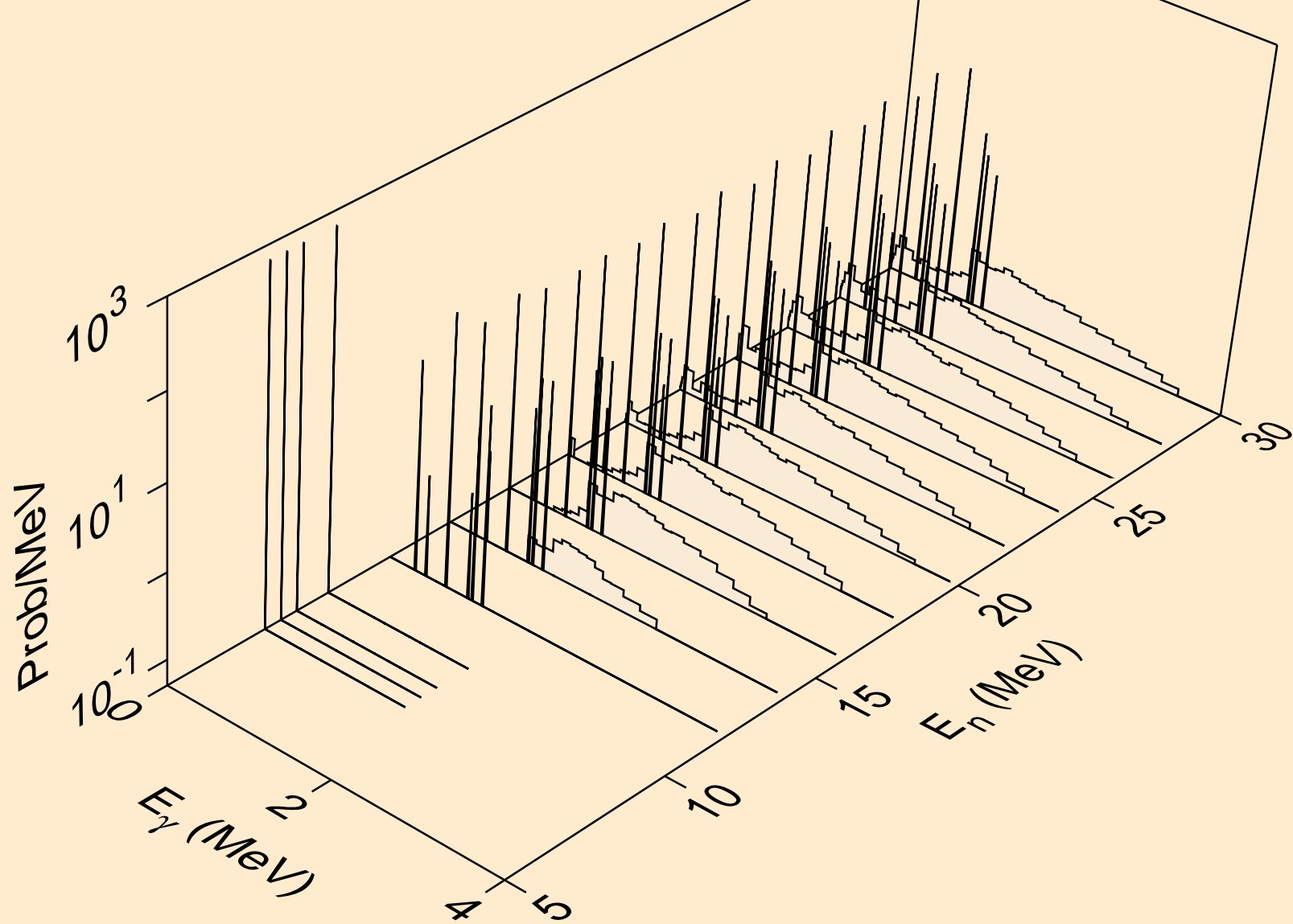

CU068 NEUTRON ACER TENDL-2023 LIBRARY; T=0.K
Photon emission for (n,t)

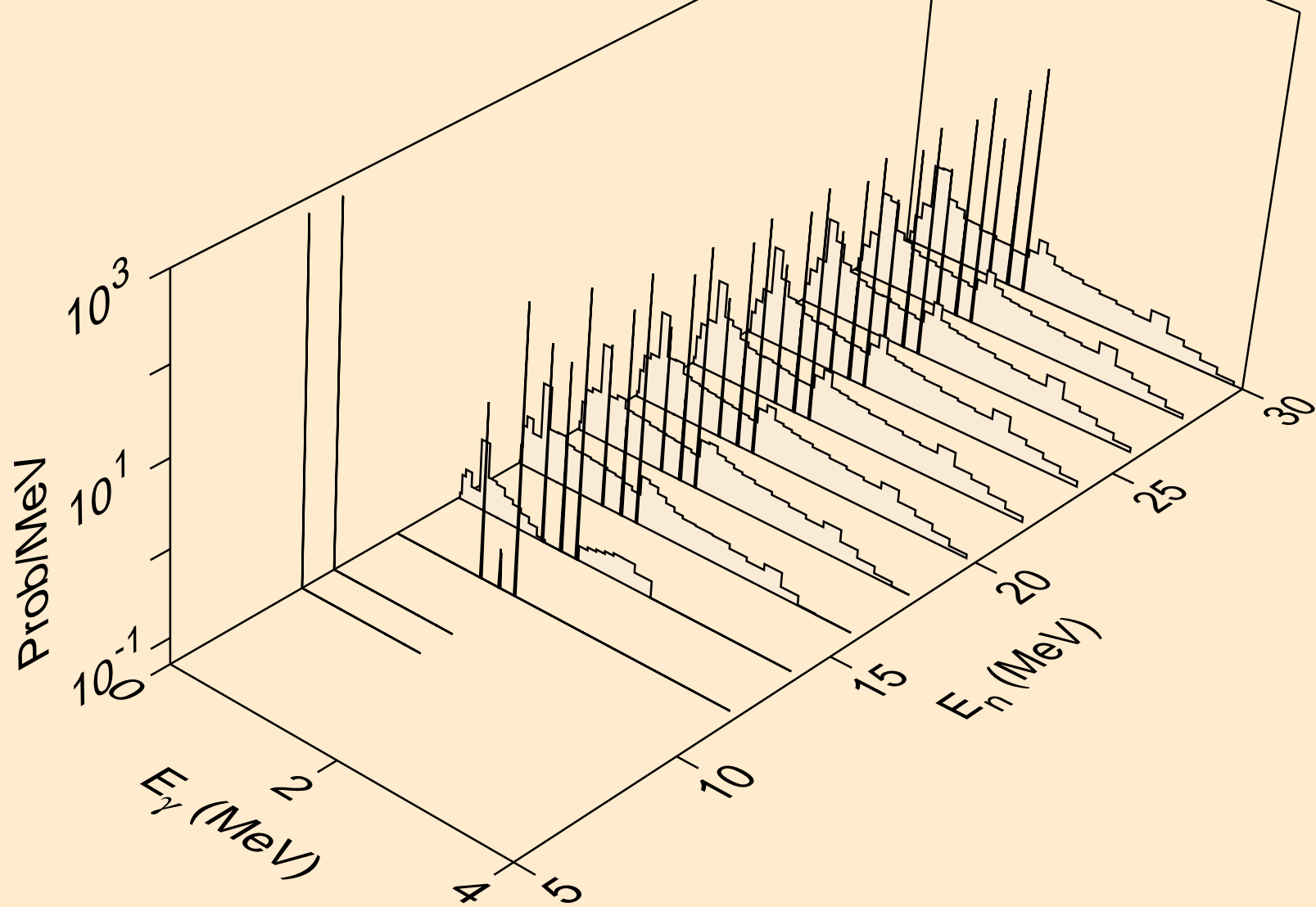

CU068 NEUTRON ACER TENDL-2023 LIBRARY; T=0.K
Photon emission for (n,he3)

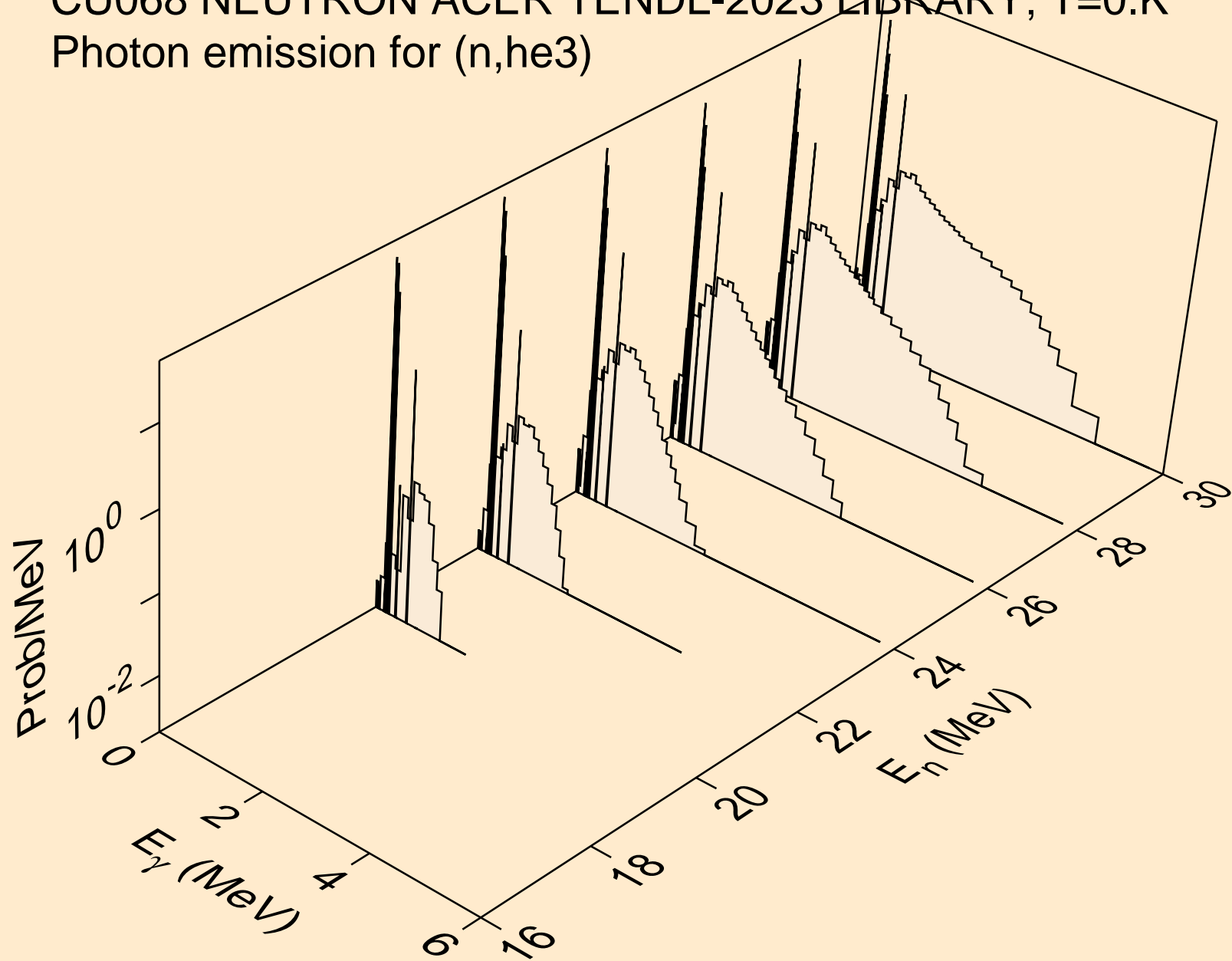

CU068 NEUTRON ACER TENDL-2023 LIBRARY; T=0.K
Photon emission for (n,a)

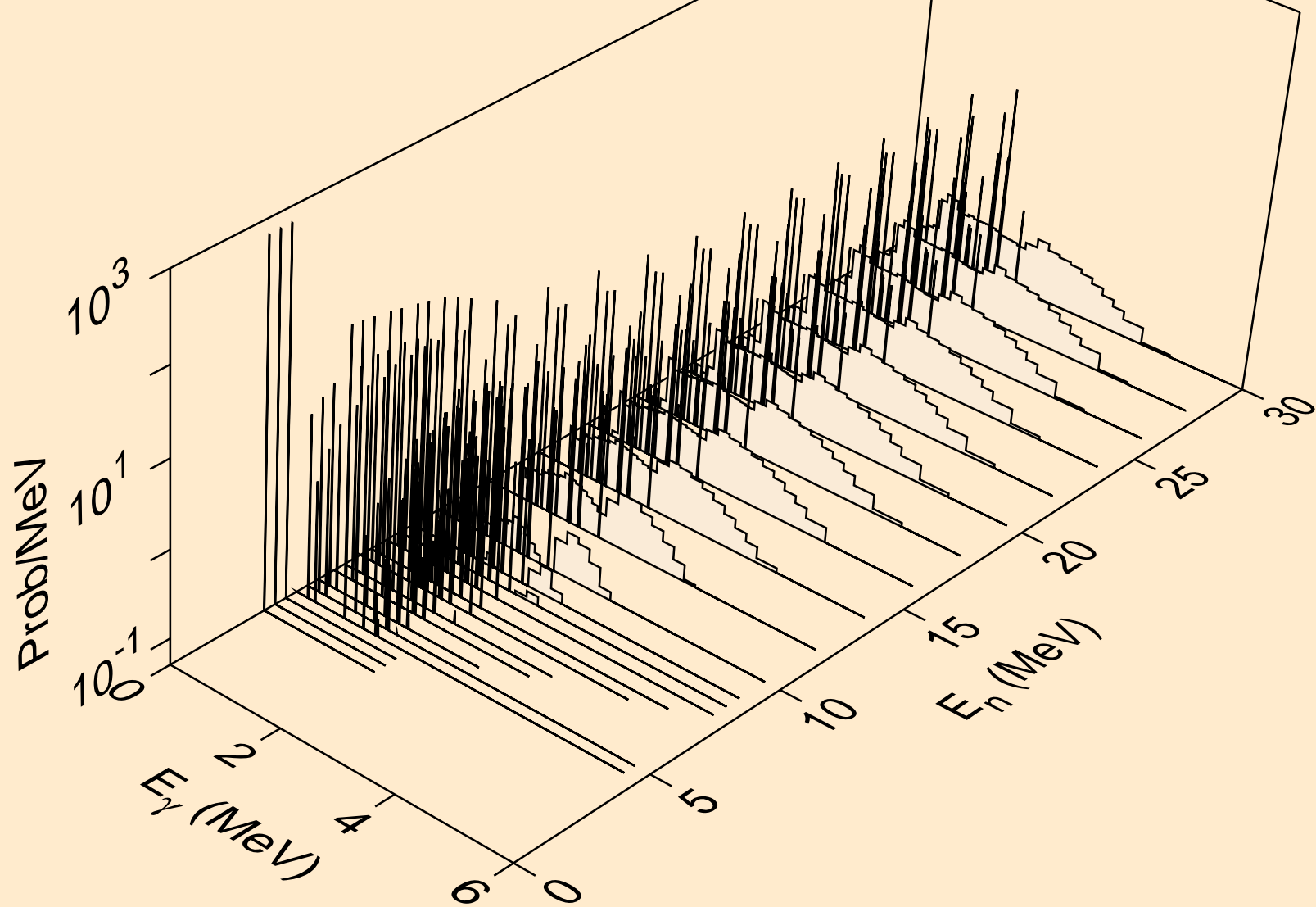

CU068 NEUTRON ACER TENDL-2023 LIBRARY; T=0.K
Photon emission for (n,2a)

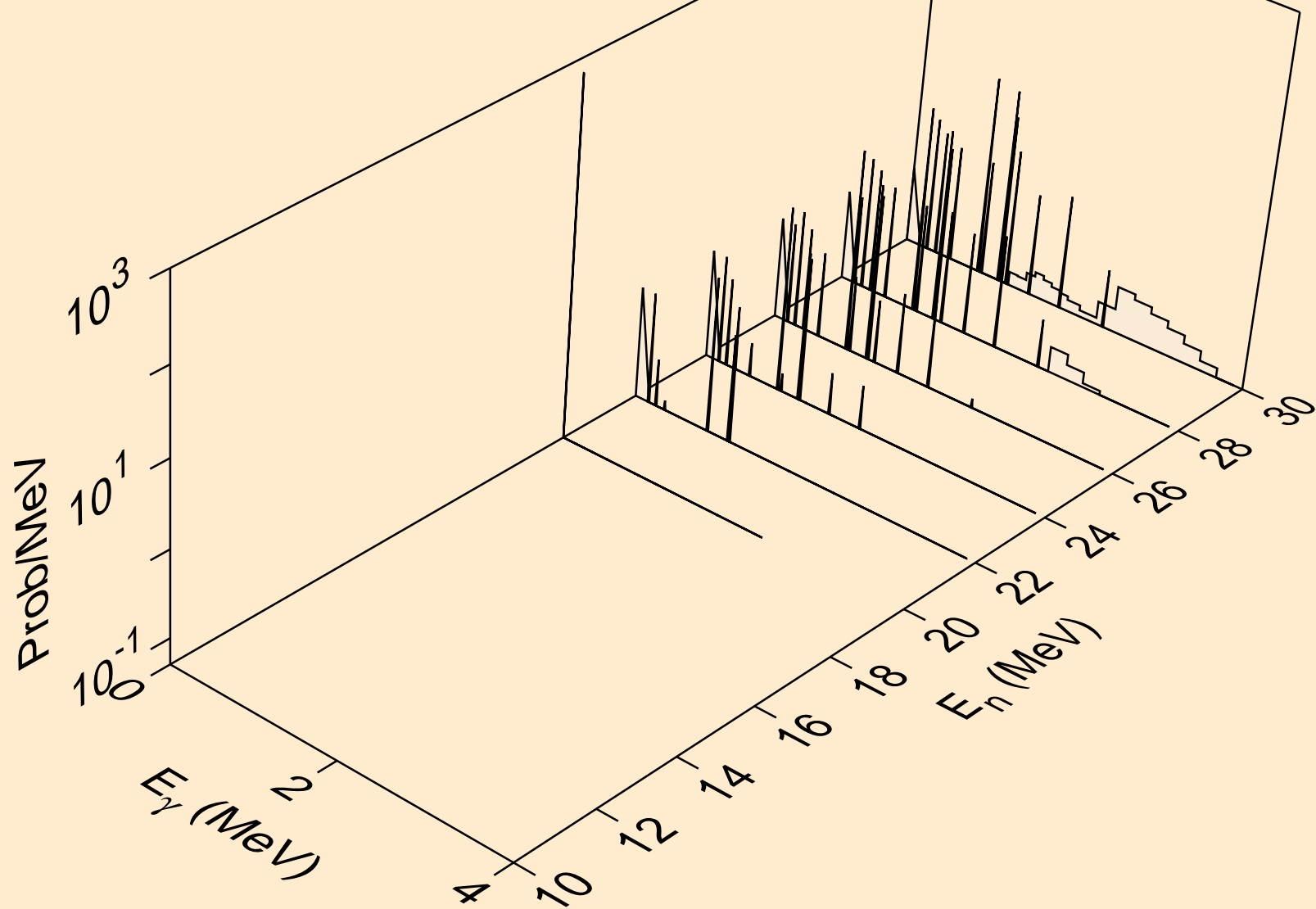

CU068 NEUTRON ACER TENDL-2023 LIBRARY; T=0.K
Photon emission for (n,2p)

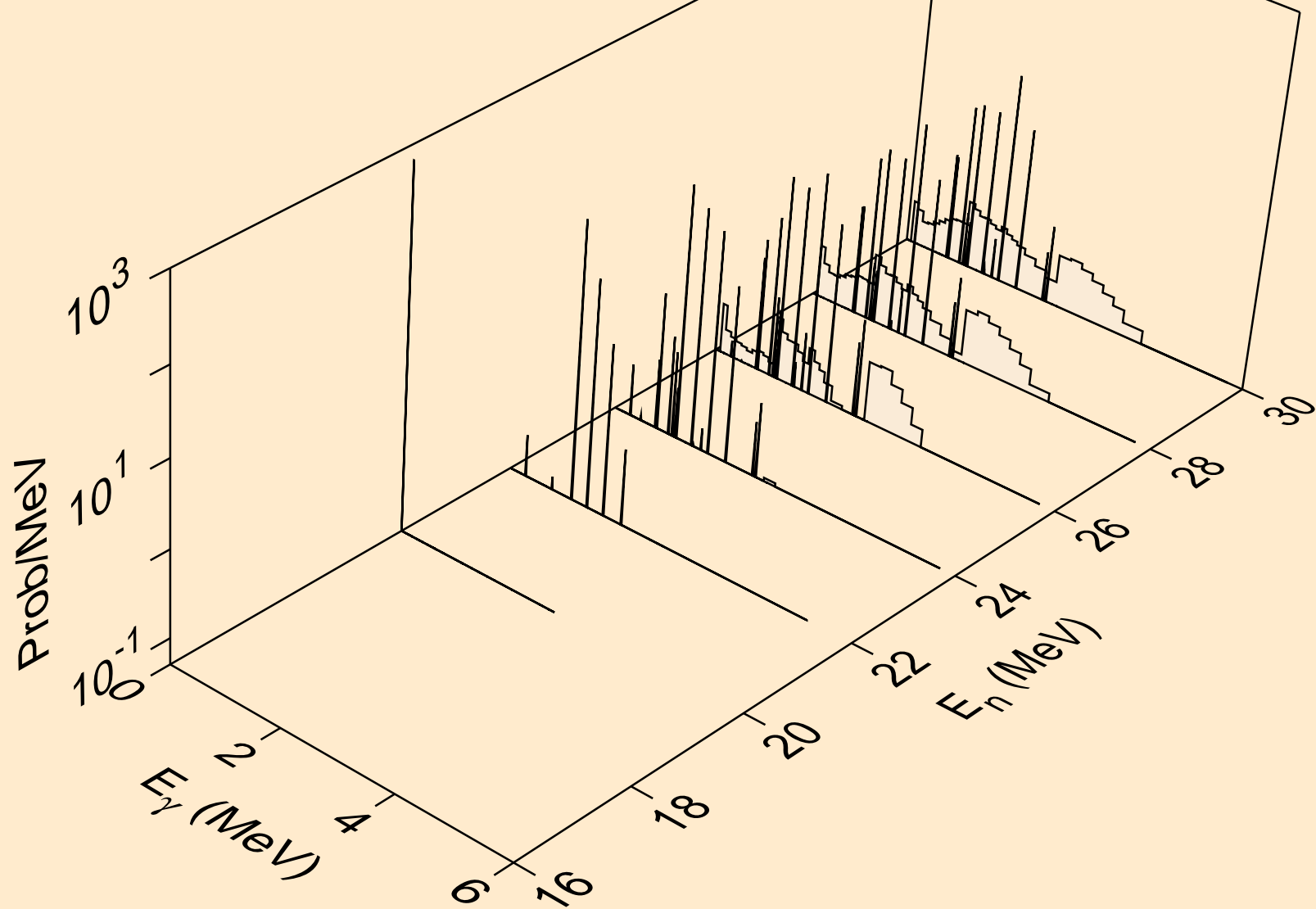

CU068 NEUTRON ACER TENDL-2023 LIBRARY; T=0.K
Photon emission for (n,p)

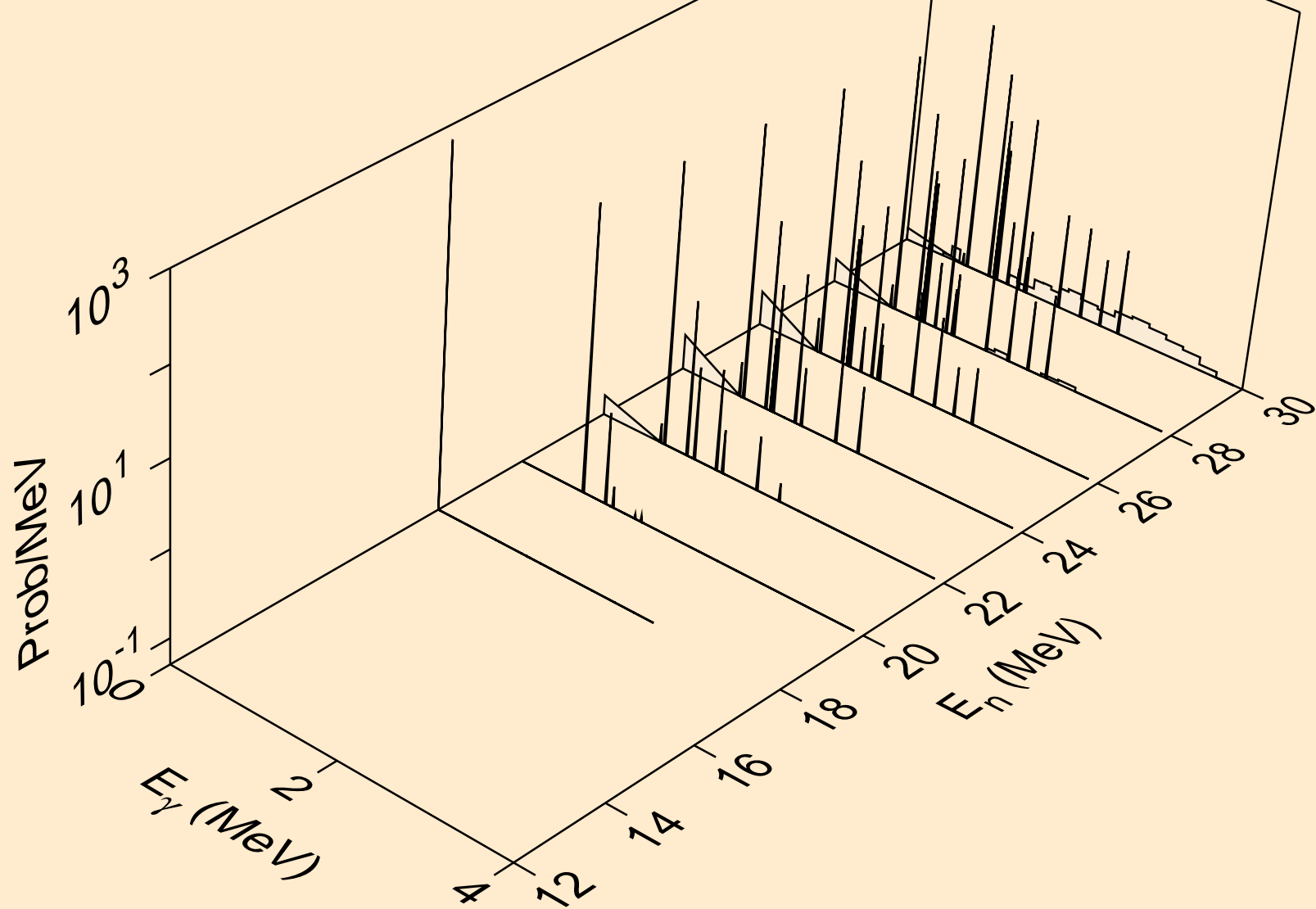

CU068 NEUTRON ACER TENDL-2023 LIBRARY; T=0.K
Photon emission for (n,pd)

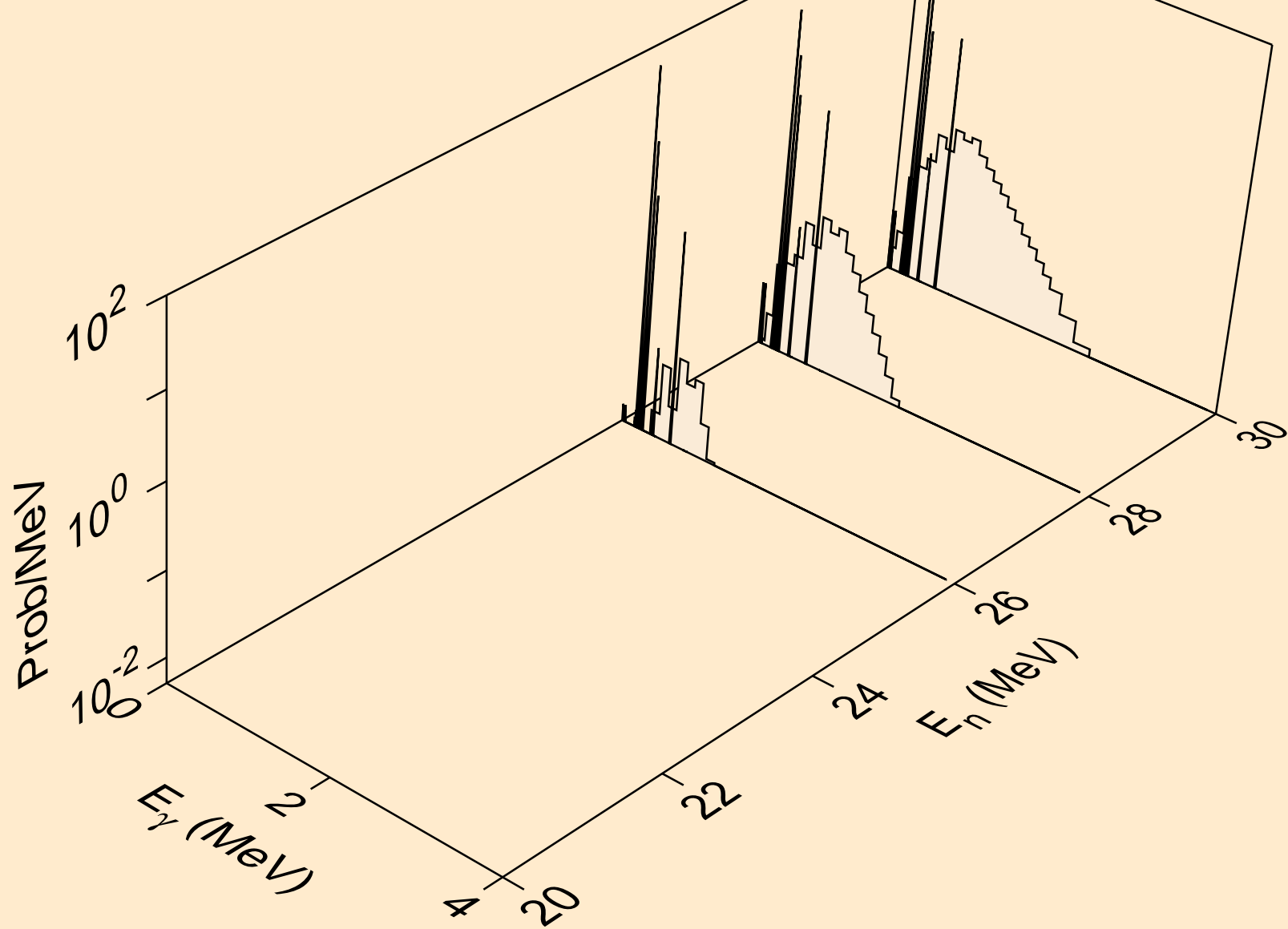

CU068 NEUTRON ACER TENDL-2023 LIBRARY; T=0.K
Photon emission for (n,pt)

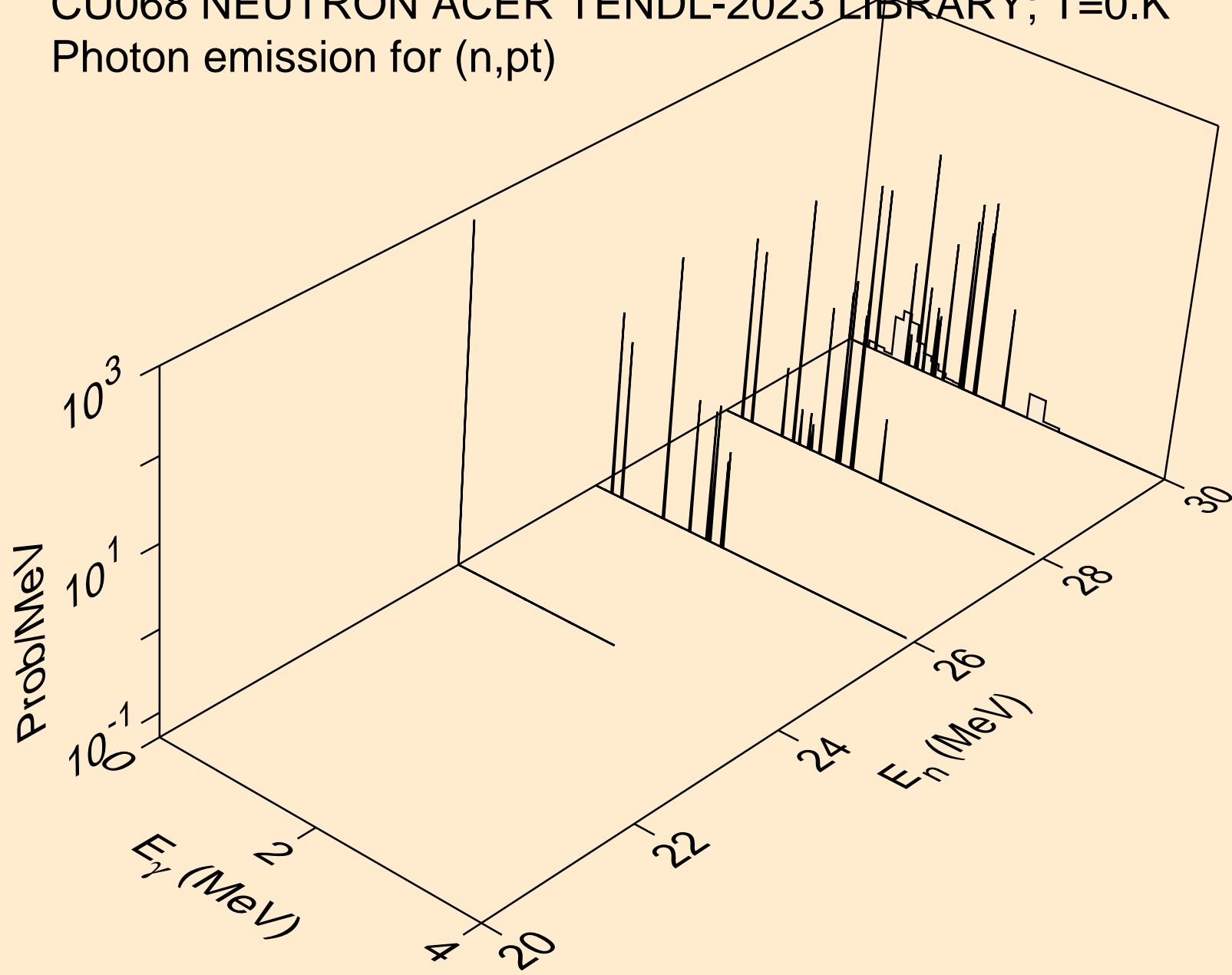

CU068 NEUTRON ACER TENDL-2023 LIBRARY; T=0.K
Photon emission for (n,da)

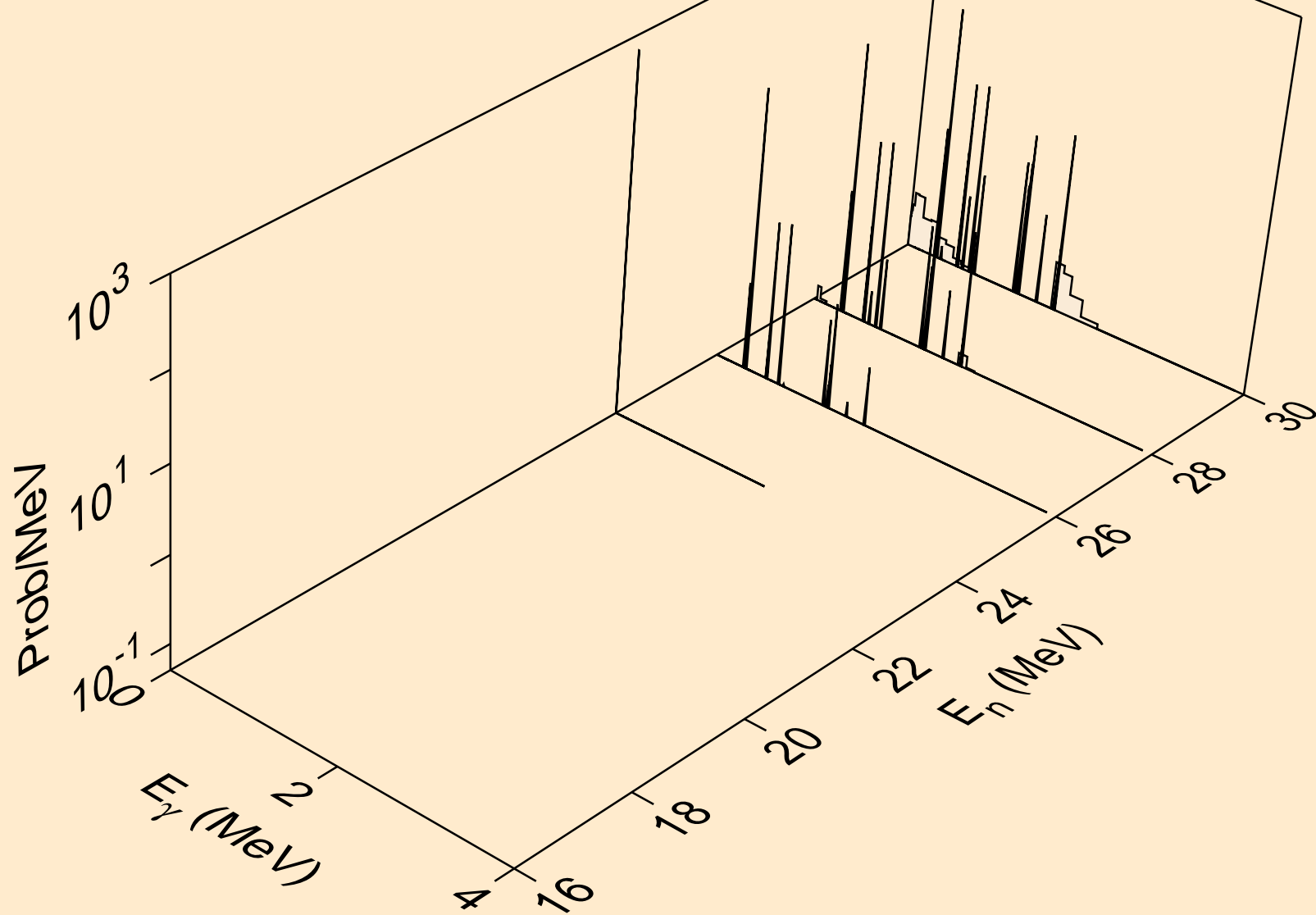

CU068 NEUTRON ACER TENDL-2023 LIBRARY; T=0.K
thermal capture photon spectrum

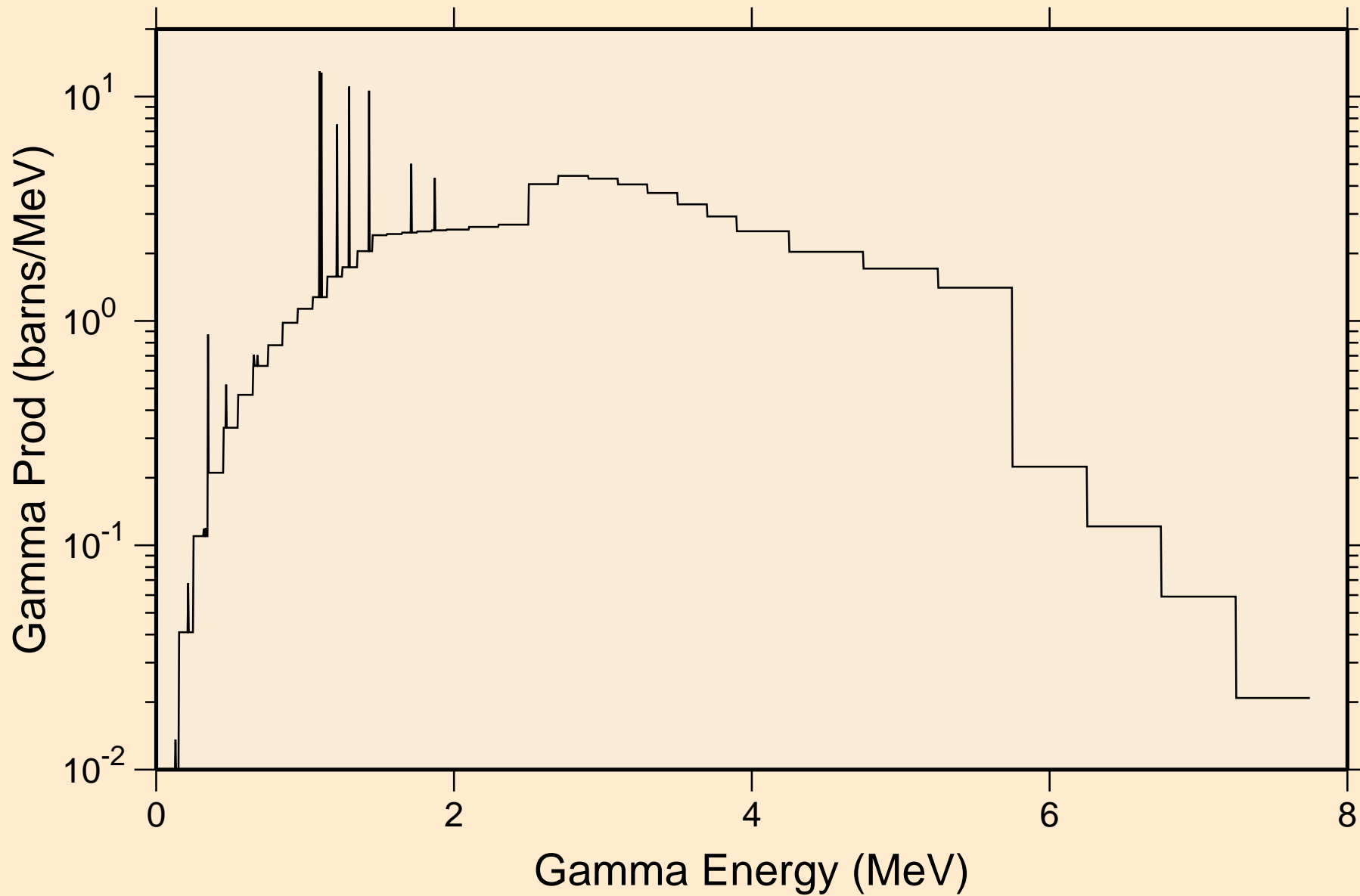

CU068 NEUTRON ACER TENDL-2023 LIBRARY; T=0.K
14 MeV photon spectrum

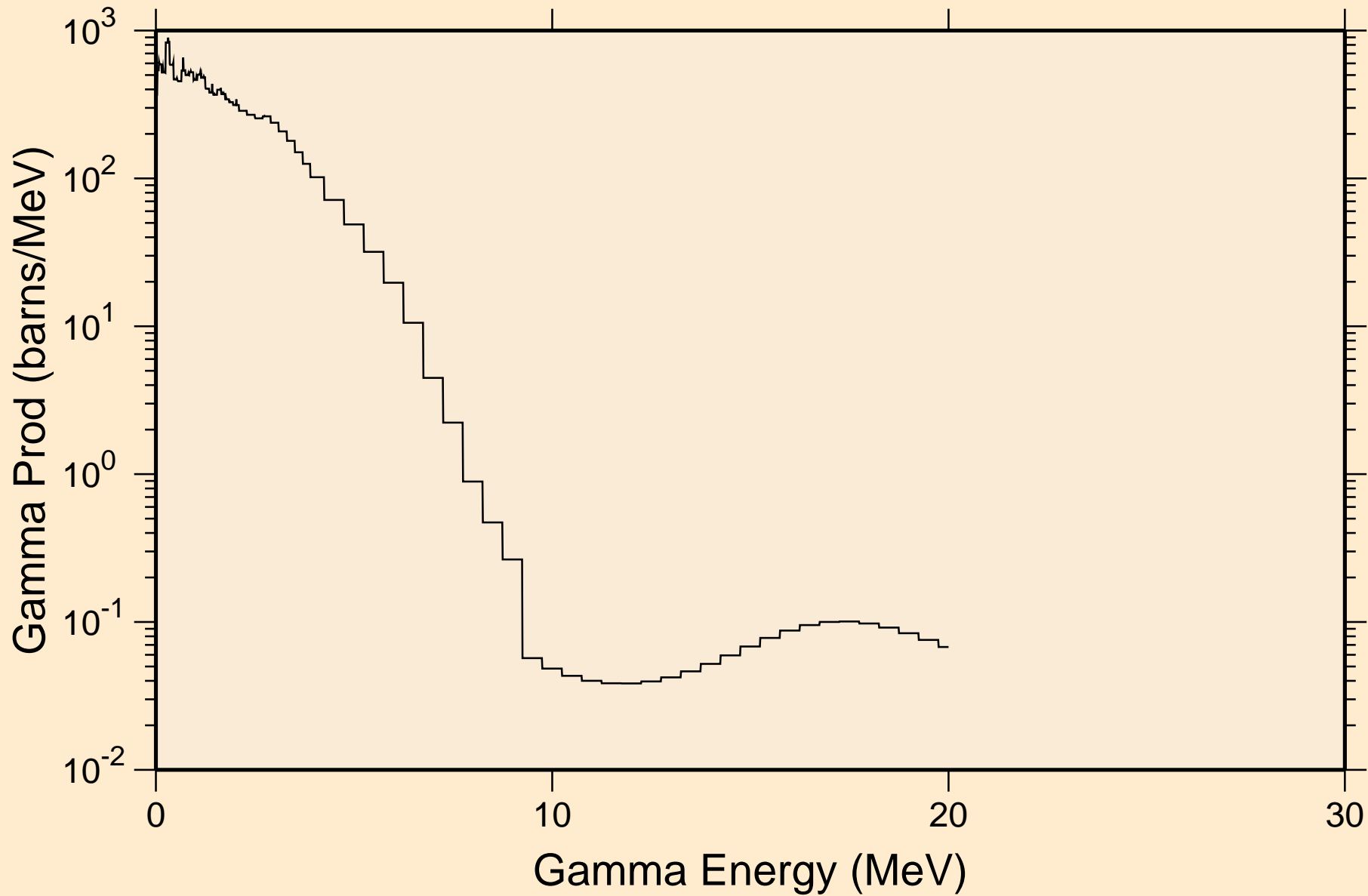

CU068 NEUTRON ACER TENDL-2023 LIBRARY; T=0.K

Particle heating contributions

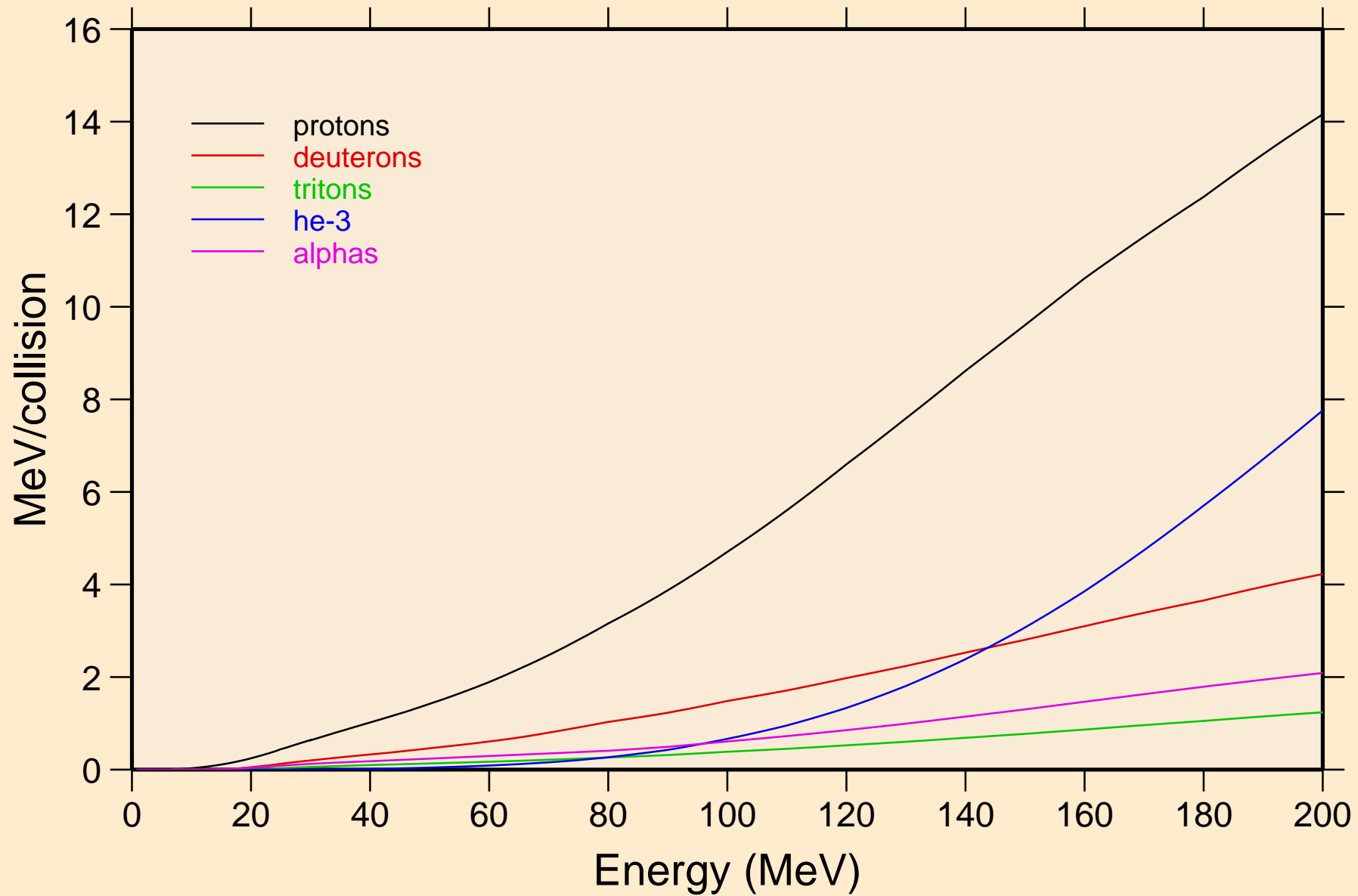

CU068 NEUTRON ACER TENDL-2023 LIBRARY; T=0.K
Recoil Heating

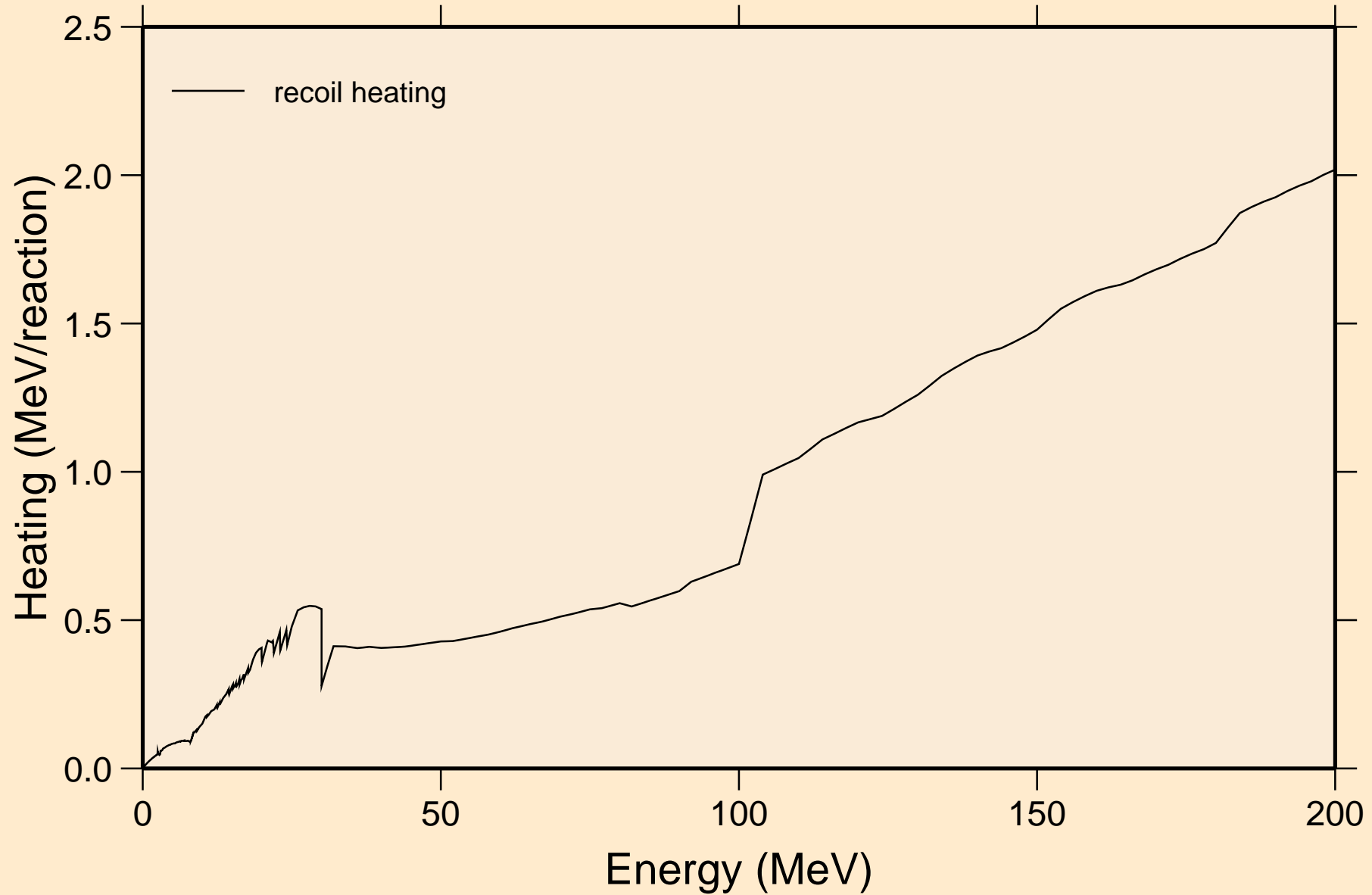

CU068 NEUTRON ACER TENDL-2023 LIBRARY; T=0.K
Particle production cross sections

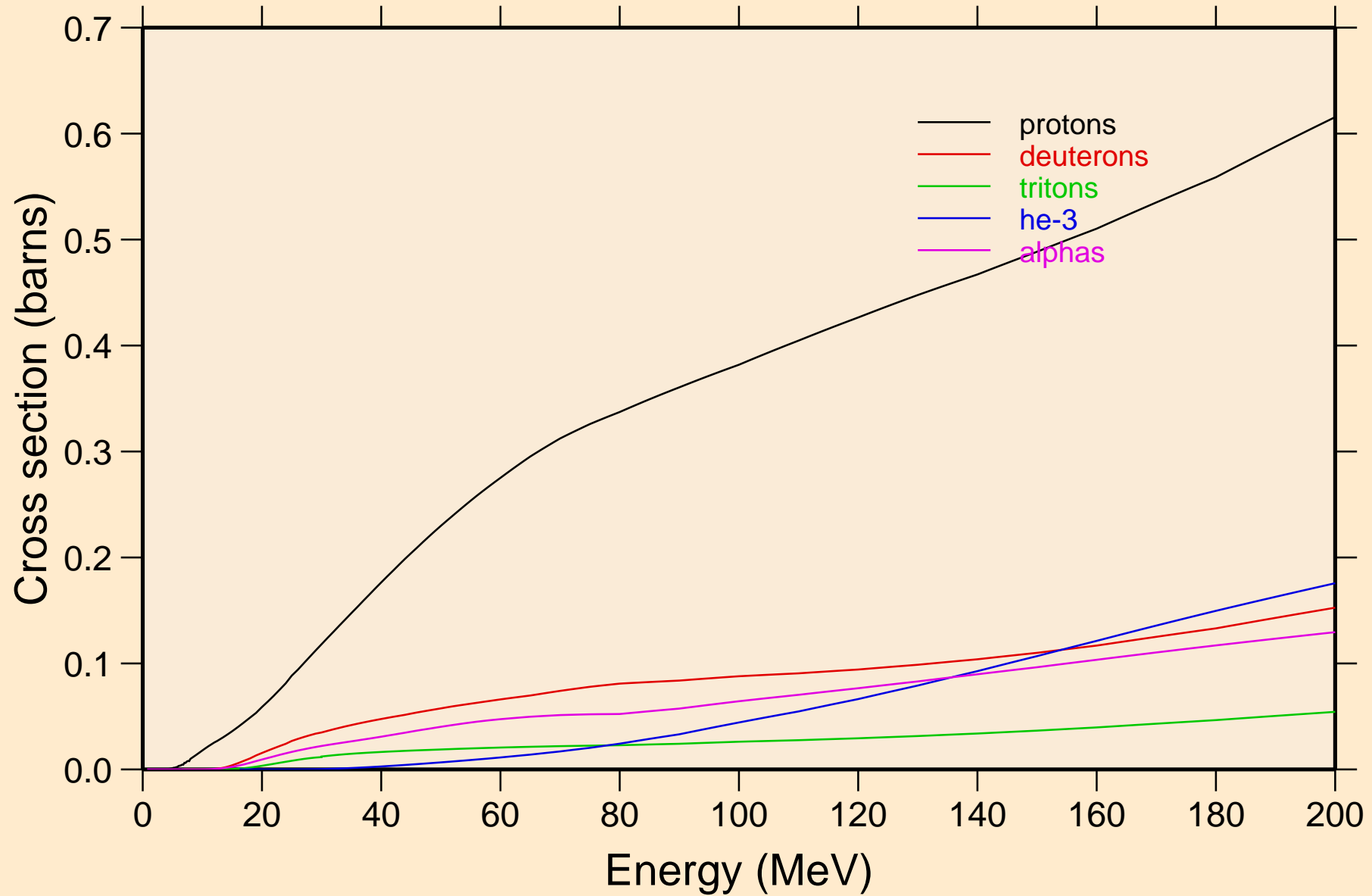

CU068 NEUTRON ACER TENDL-2023 LIBRARY; T=0.K
protons from (n,x)

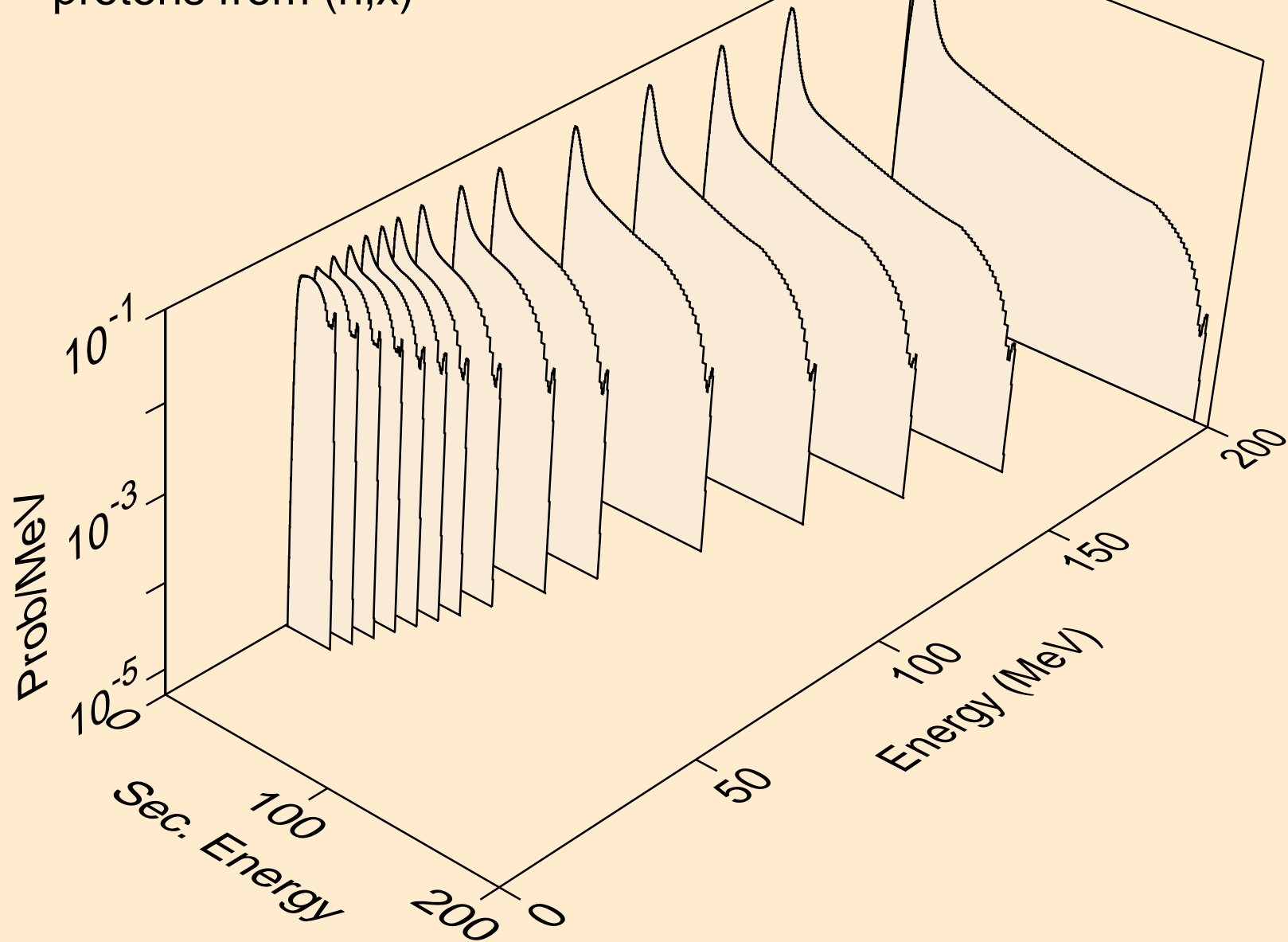

CU068 NEUTRON ACER TENDL-2023 LIBRARY; T=0.K
protons from (n,n*)p

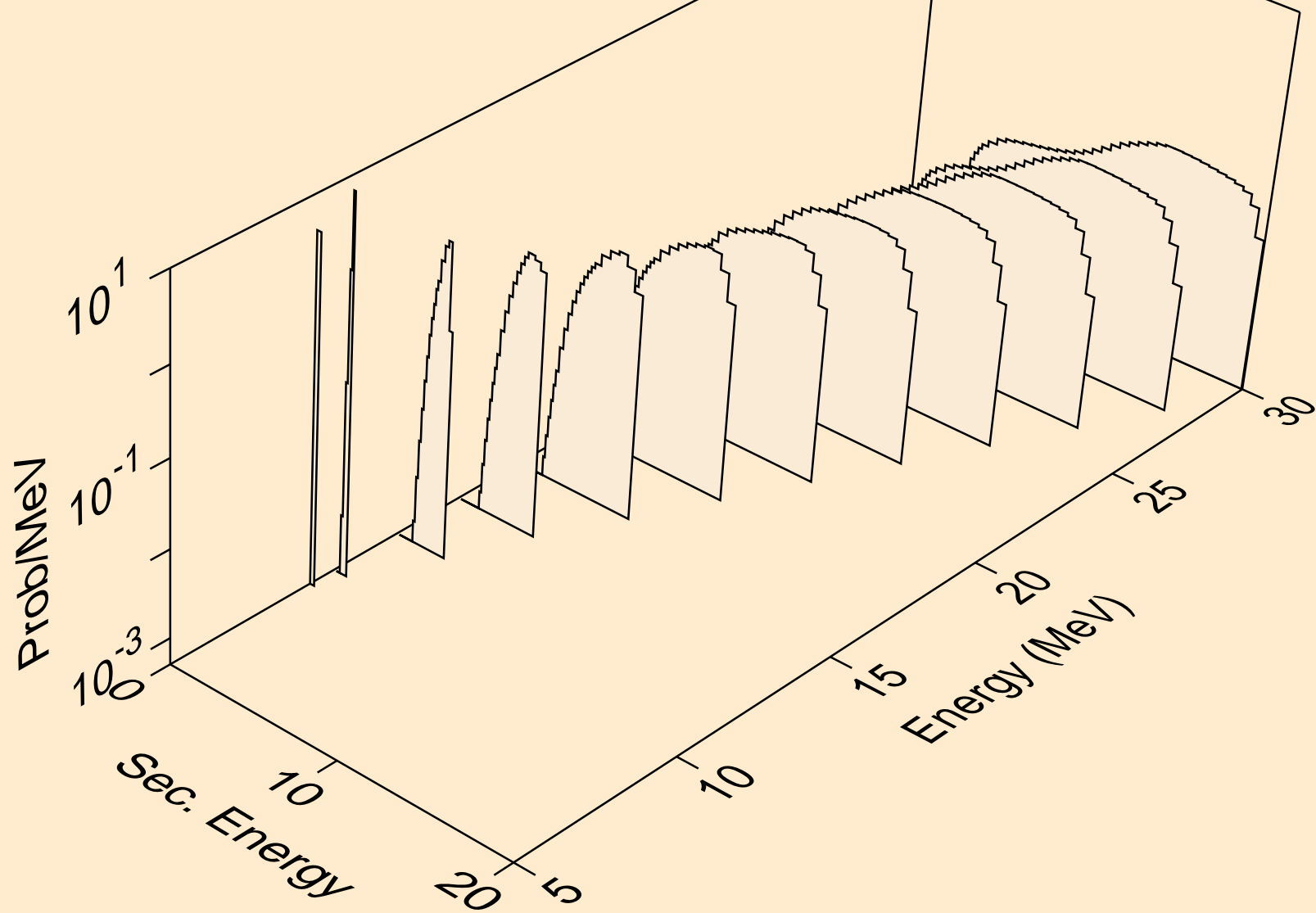

CU068 NEUTRON ACER TENDL-2023 LIBRARY; T=0.K
protons from (n,2np)

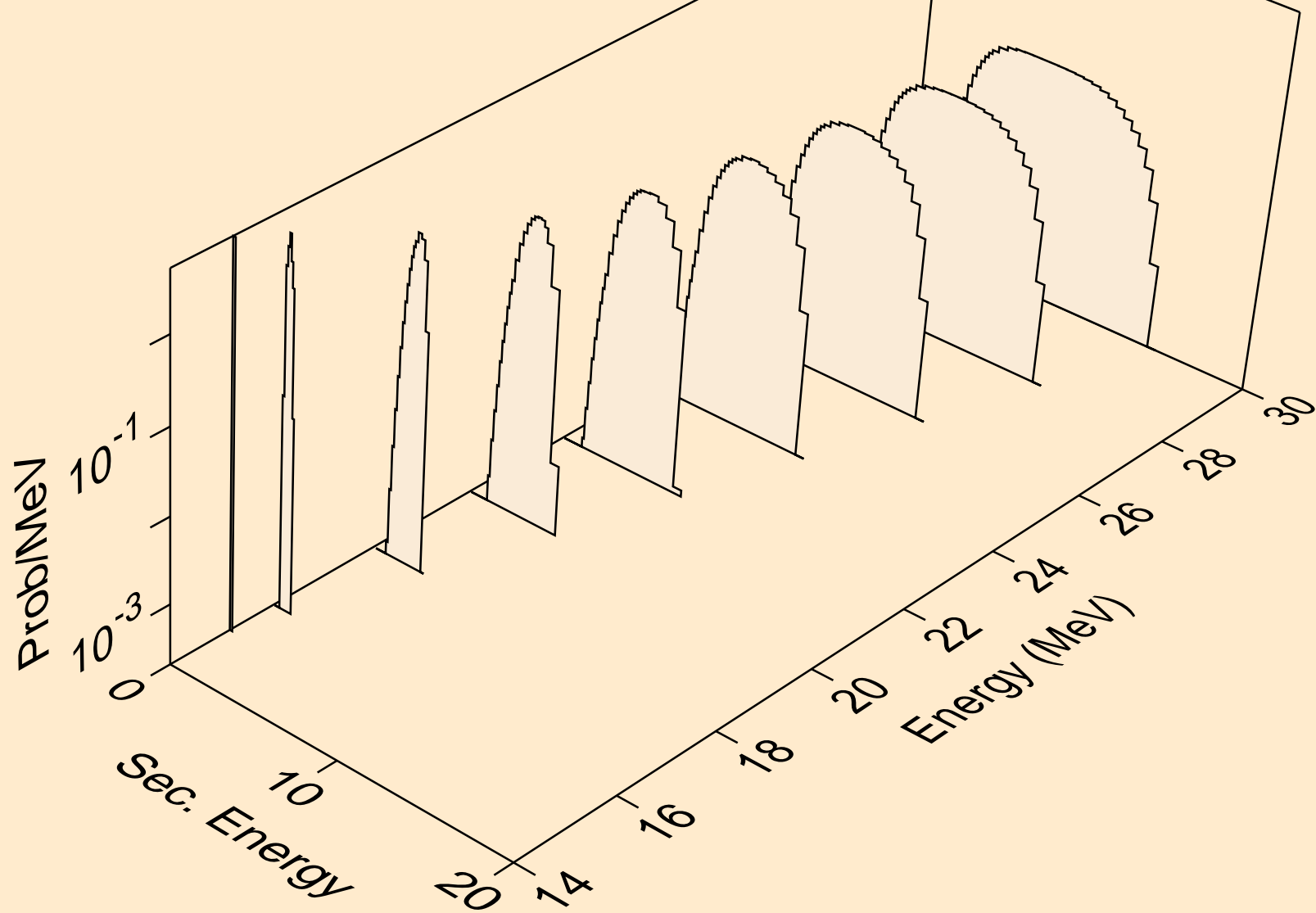

CU068 NEUTRON ACER TENDL-2023 LIBRARY; T=0.K
protons from (n,3np)

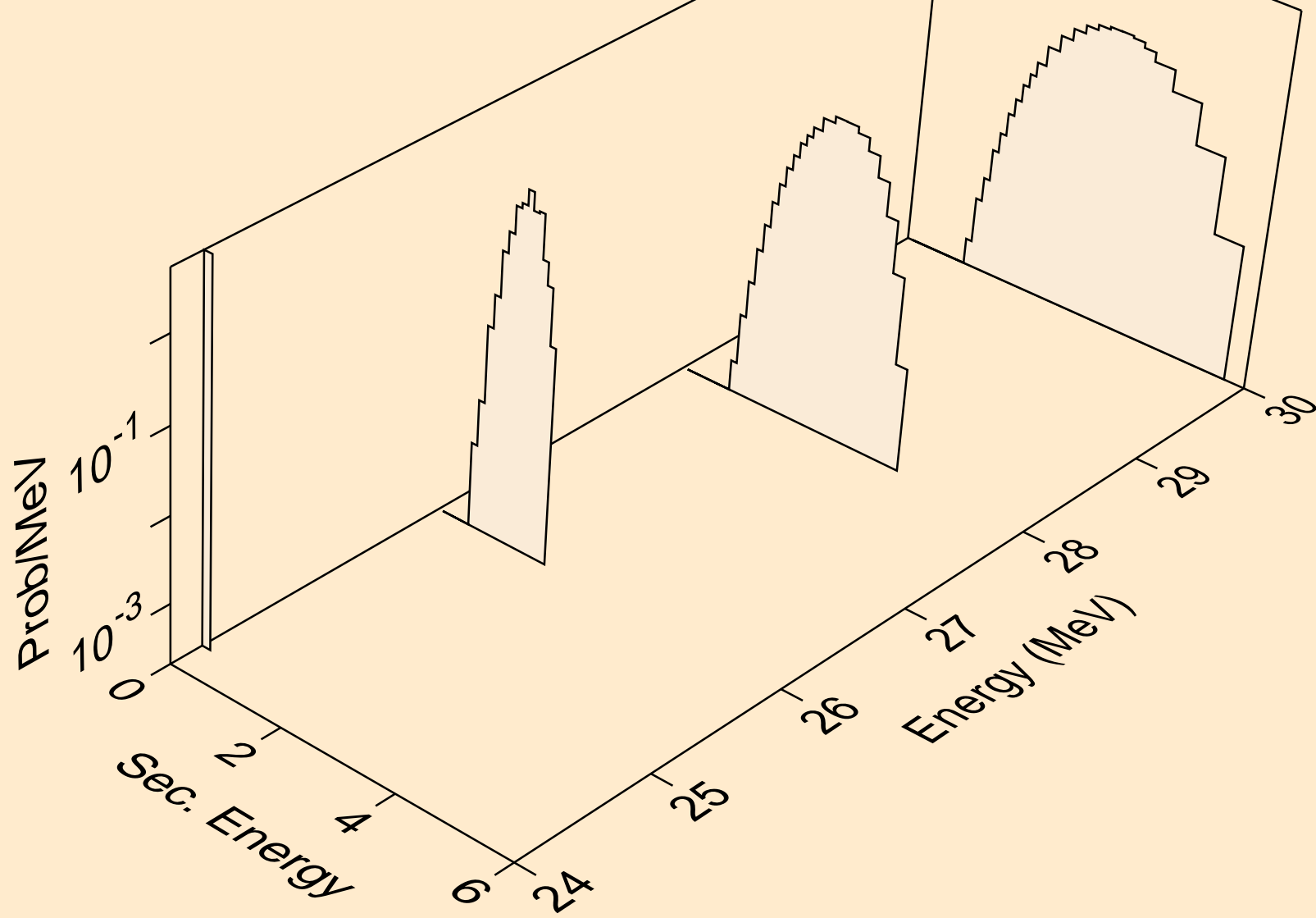

CU068 NEUTRON ACER TENDL-2023 LIBRARY; T=0.K
protons from (n,n2p)

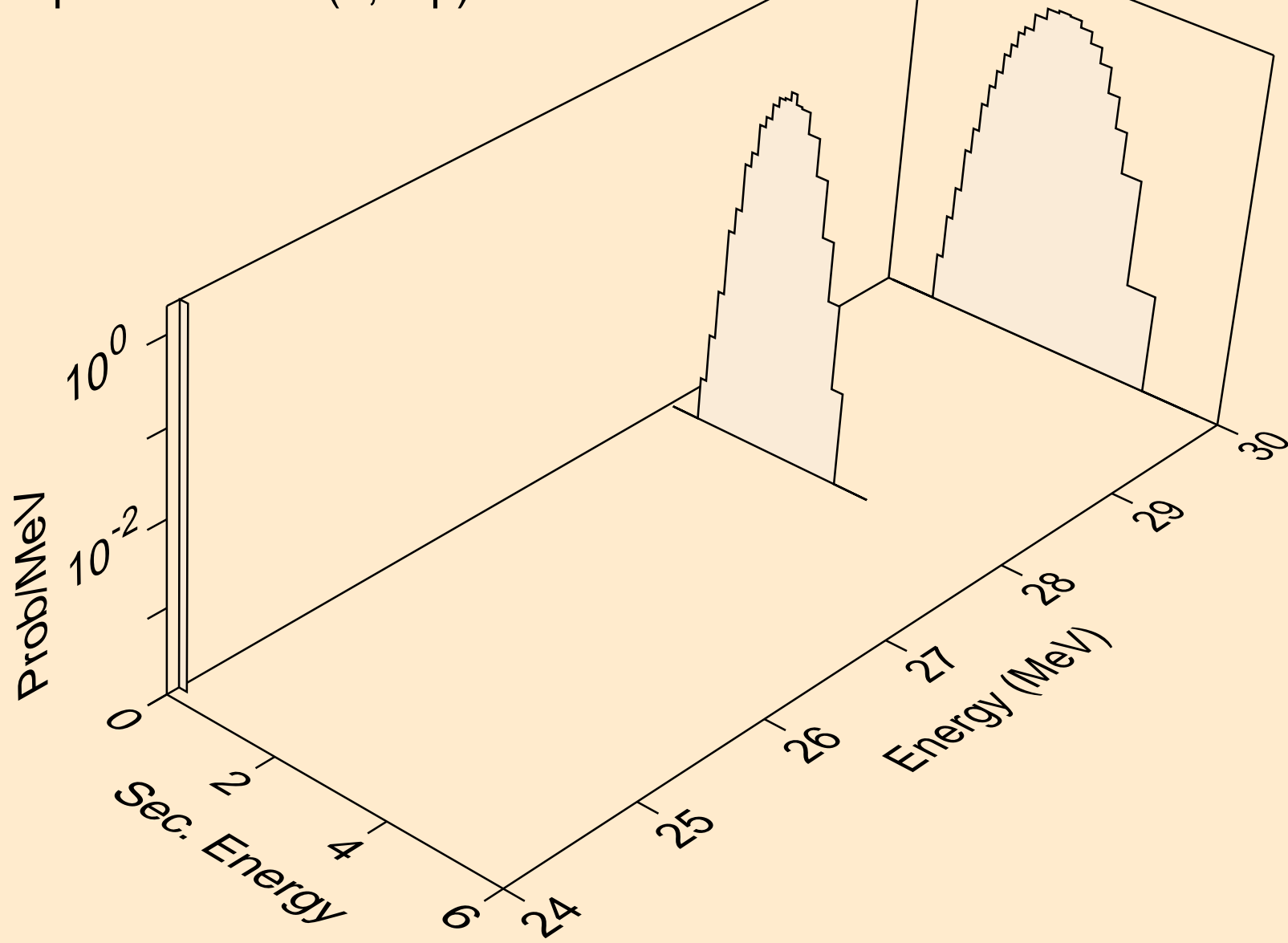

CU068 NEUTRON ACER TENDL-2023 LIBRARY; T=0.K
protons from (n,npa)

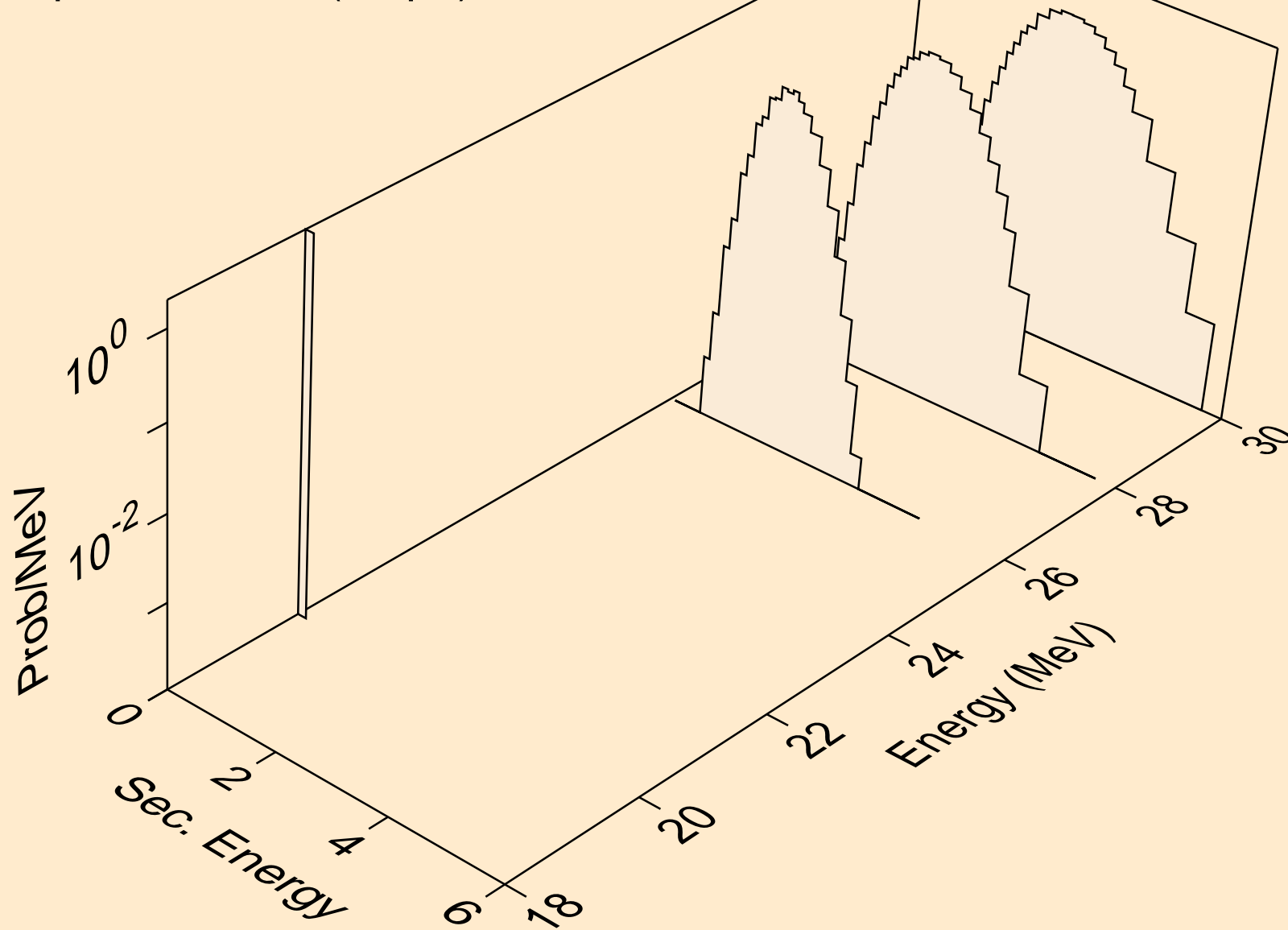

CU068 NEUTRON ACER TENDL-2023 LIBRARY; T=0.K
protons from (n,p)

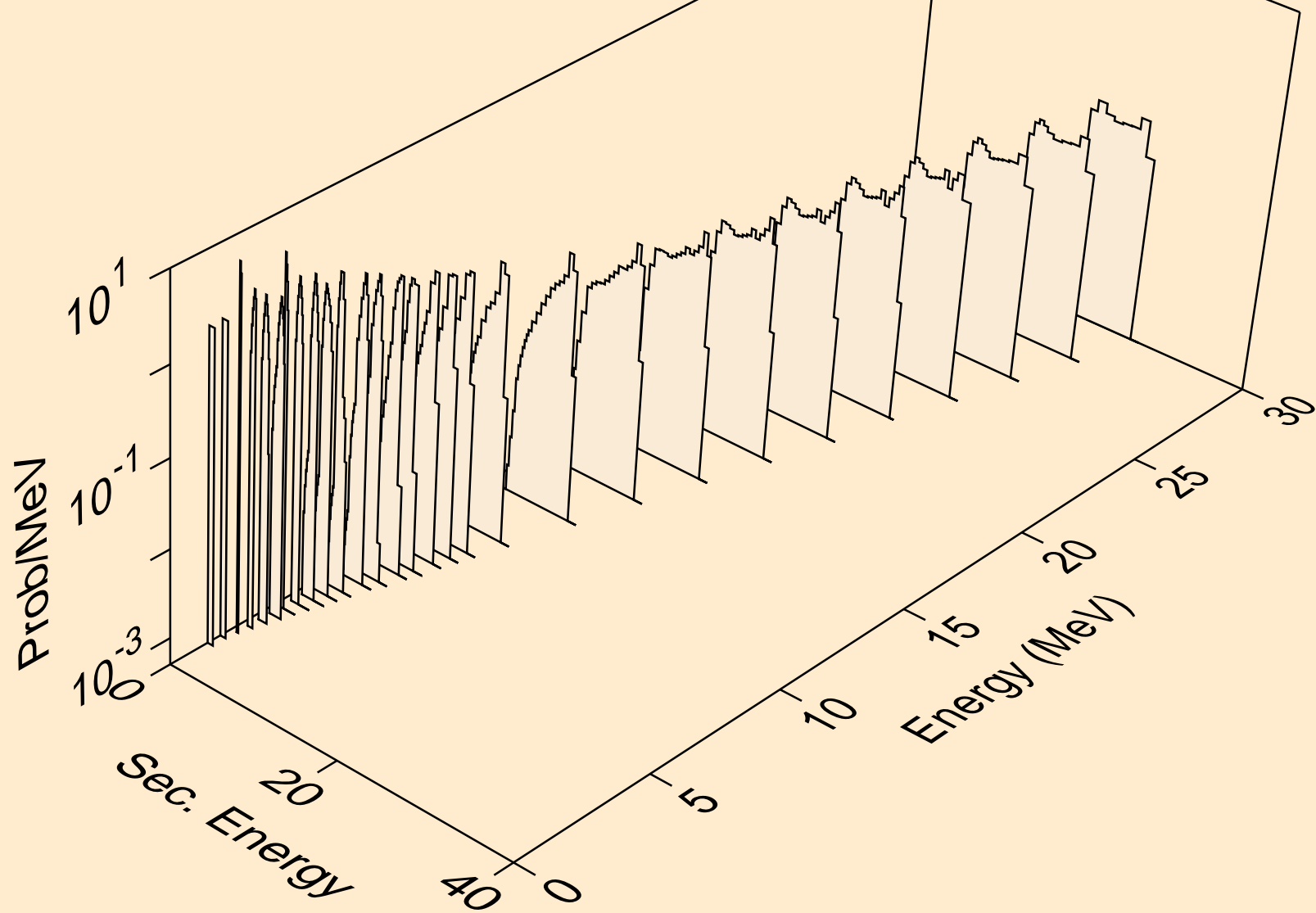

CU068 NEUTRON ACER TENDL-2023 LIBRARY; T=0.K
protons from (n,2p)

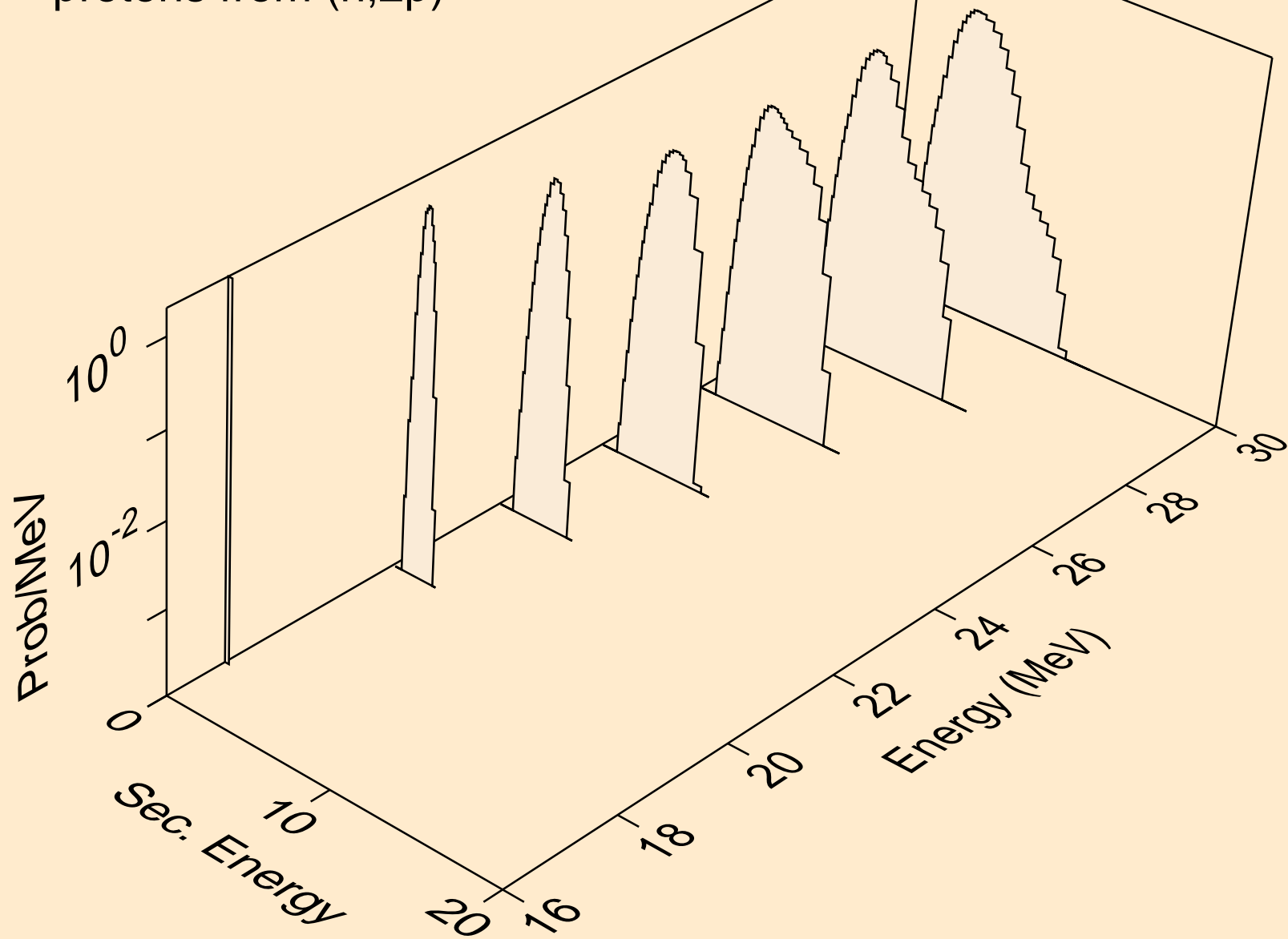

CU068 NEUTRON ACER TENDL-2023 LIBRARY; T=0.K
protons from (n,p)

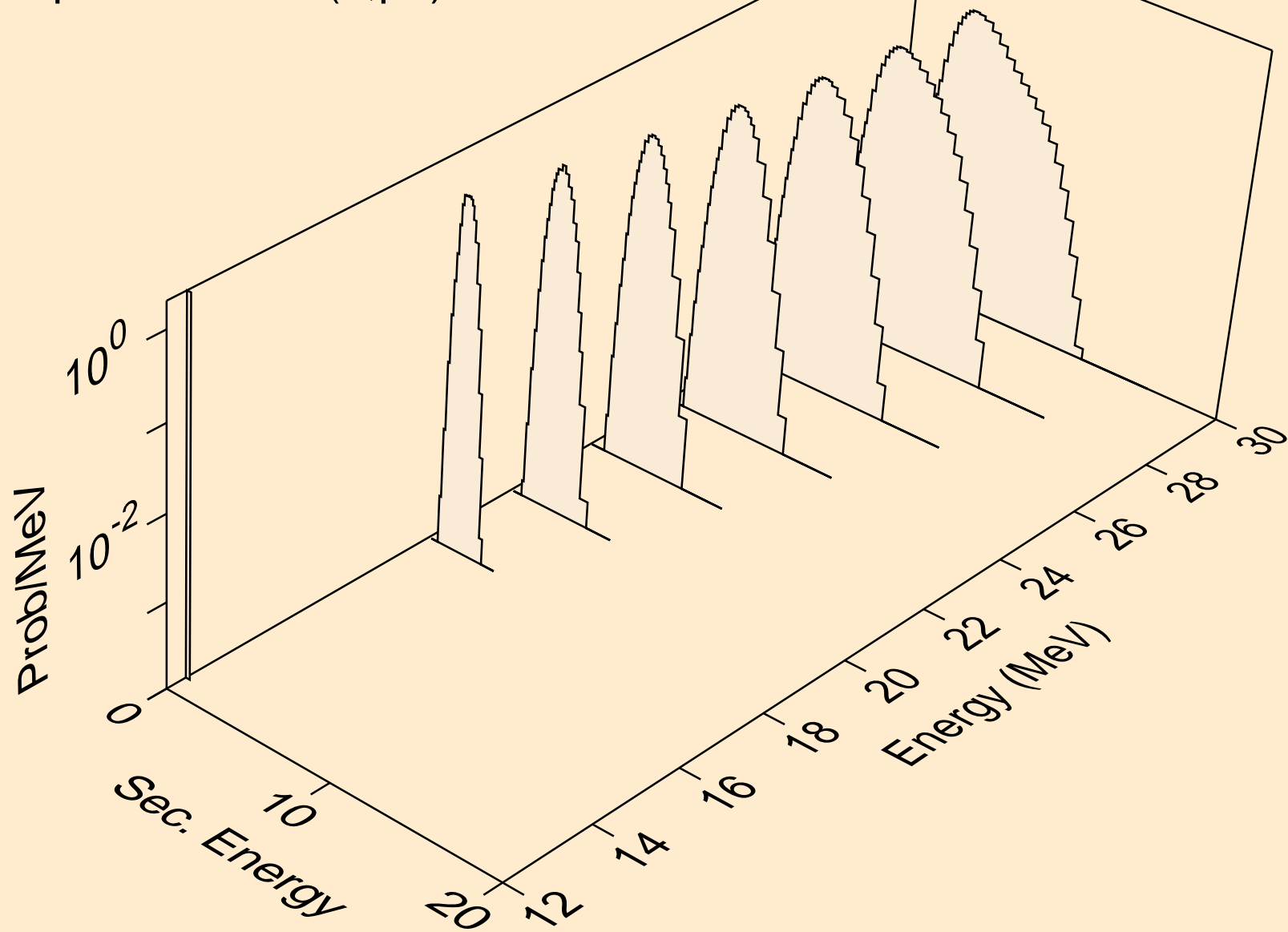

CU068 NEUTRON ACER TENDL-2023 LIBRARY; T=0.K
protons from (n,pd)

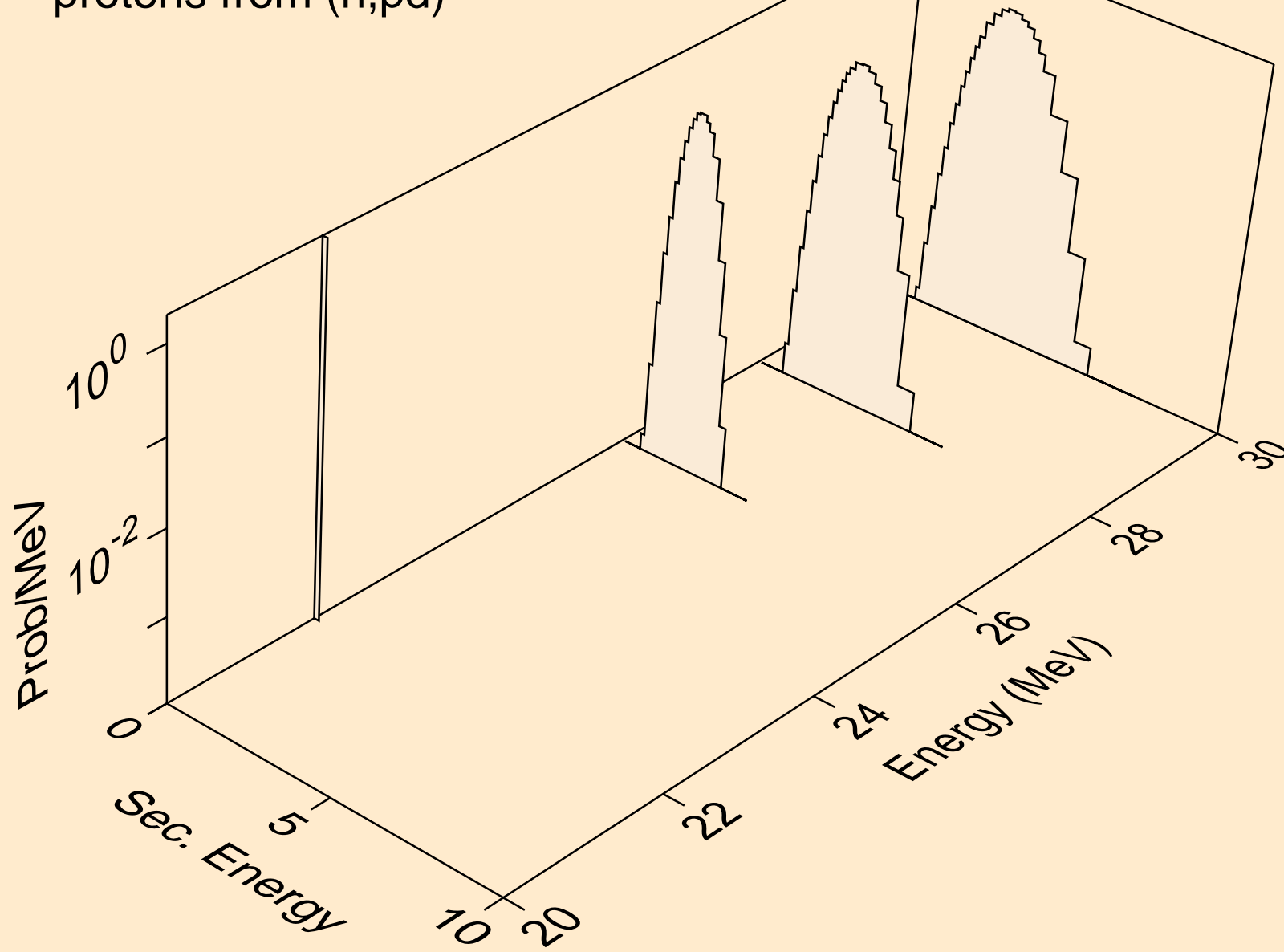

CU068 NEUTRON ACER TENDL-2023 LIBRARY; T=0.K
protons from (n,pt)

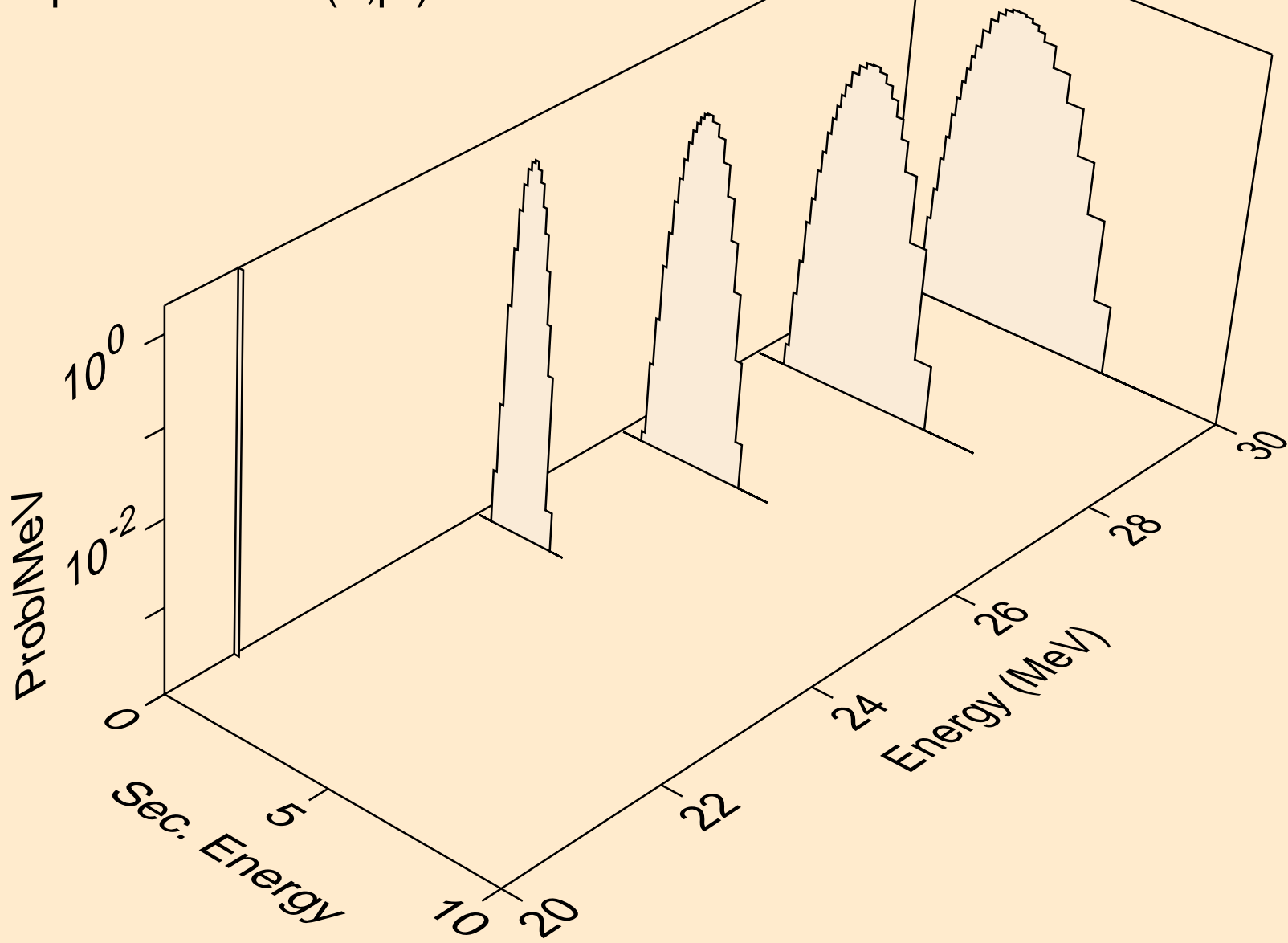

CU068 NEUTRON ACER TENDL-2023 LIBRARY; T=0.K
deuterons from (n,x)

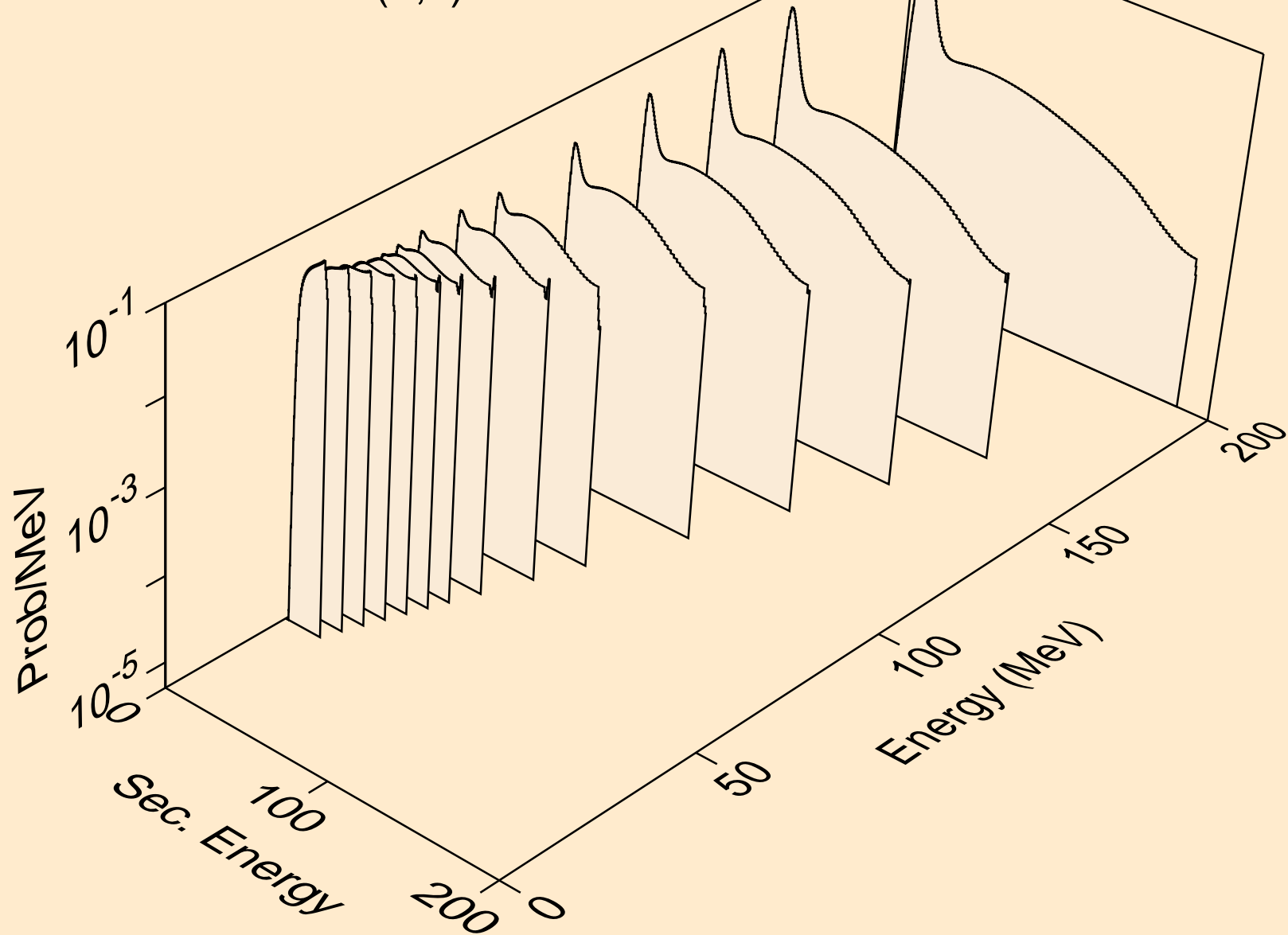

CU068 NEUTRON ACER TENDL-2023 LIBRARY; T=0.K
deuterons from (n,2nd)

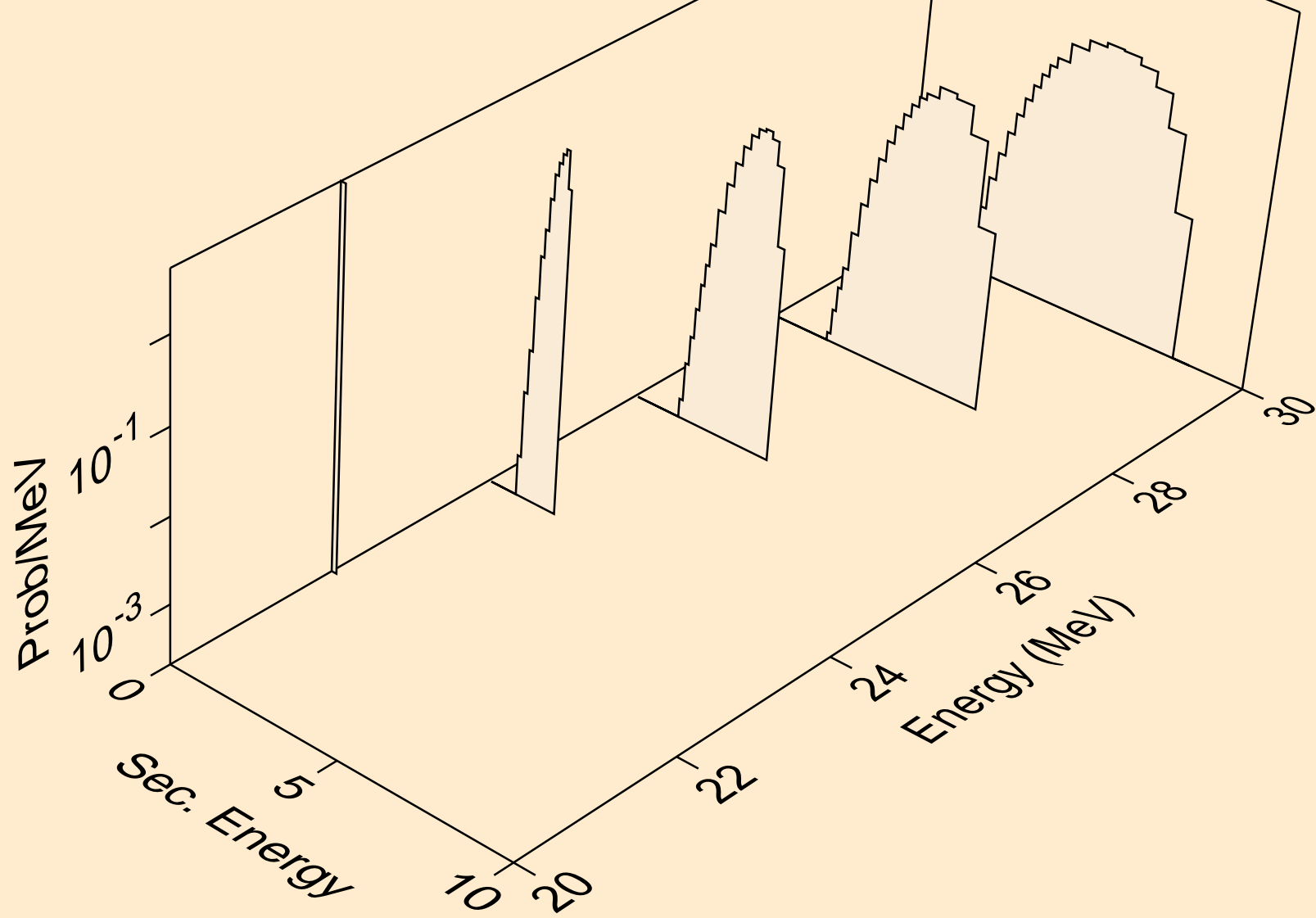

CU068 NEUTRON ACER TENDL-2023 LIBRARY; T=0.K
deuterons from (n,n*)d

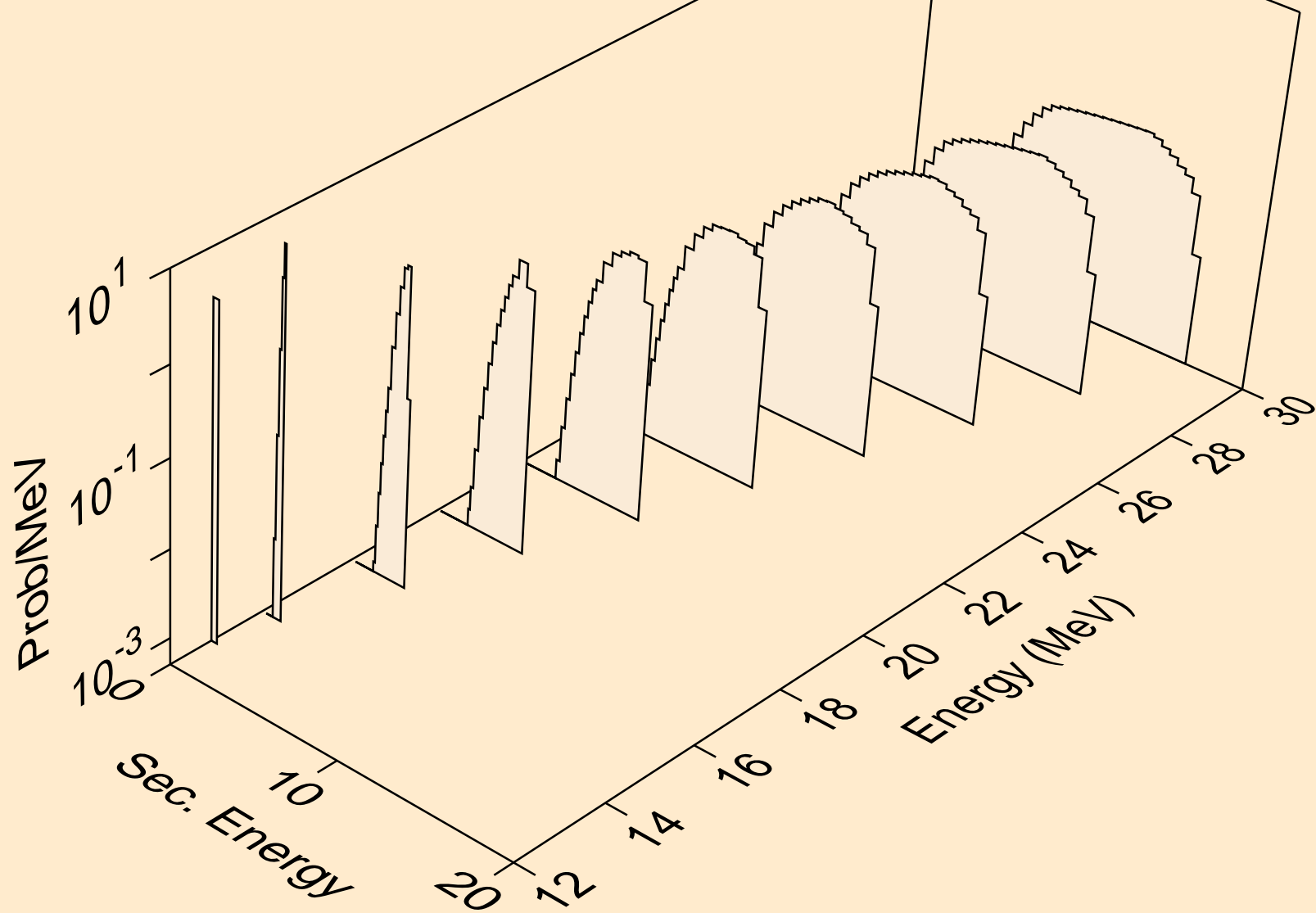

CU068 NEUTRON ACER TENDL-2023 LIBRARY; T=0.K
deuterons from (n,d)

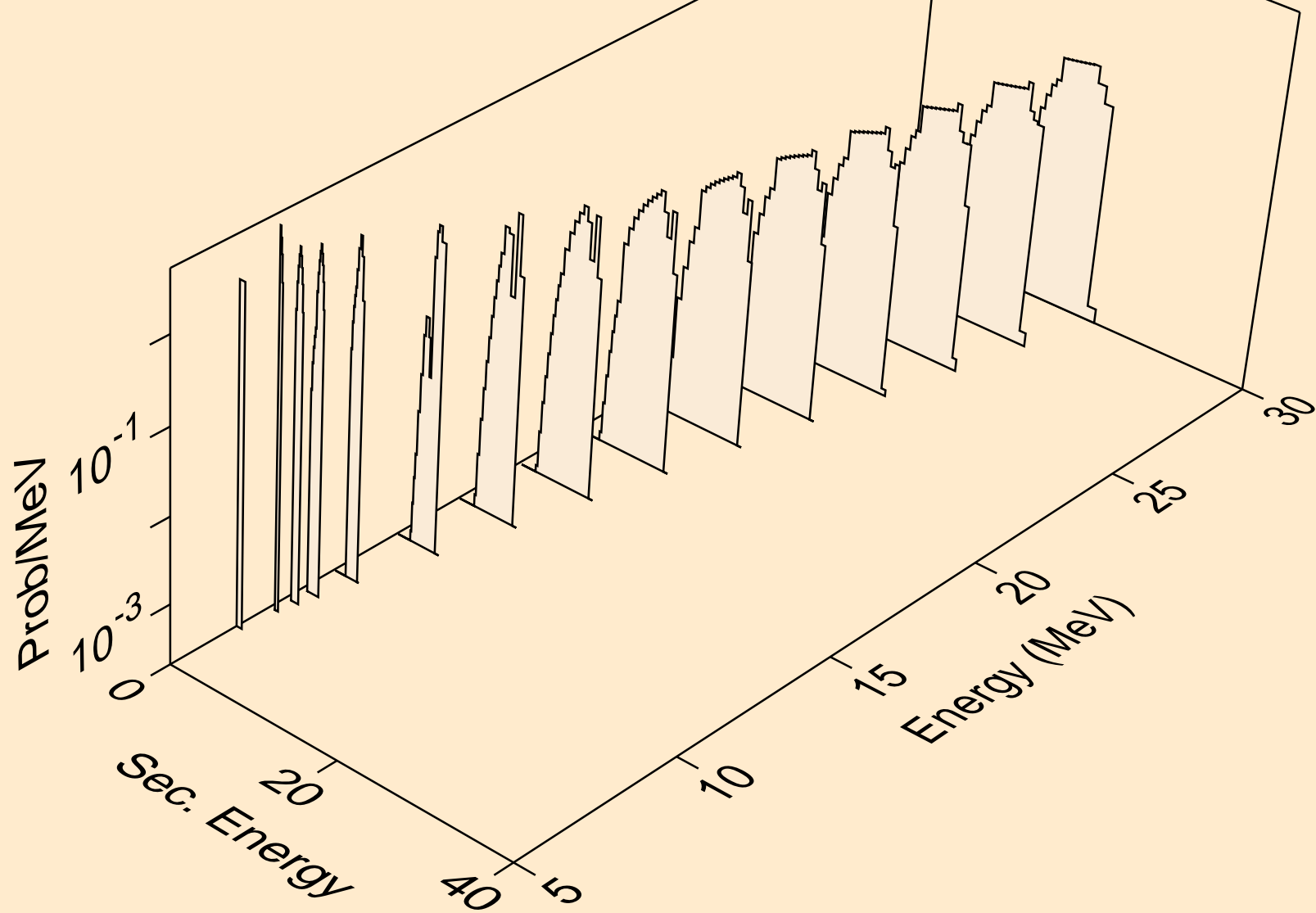

CU068 NEUTRON ACER TENDL-2023 LIBRARY; T=0.K
deuterons from (n,pd)

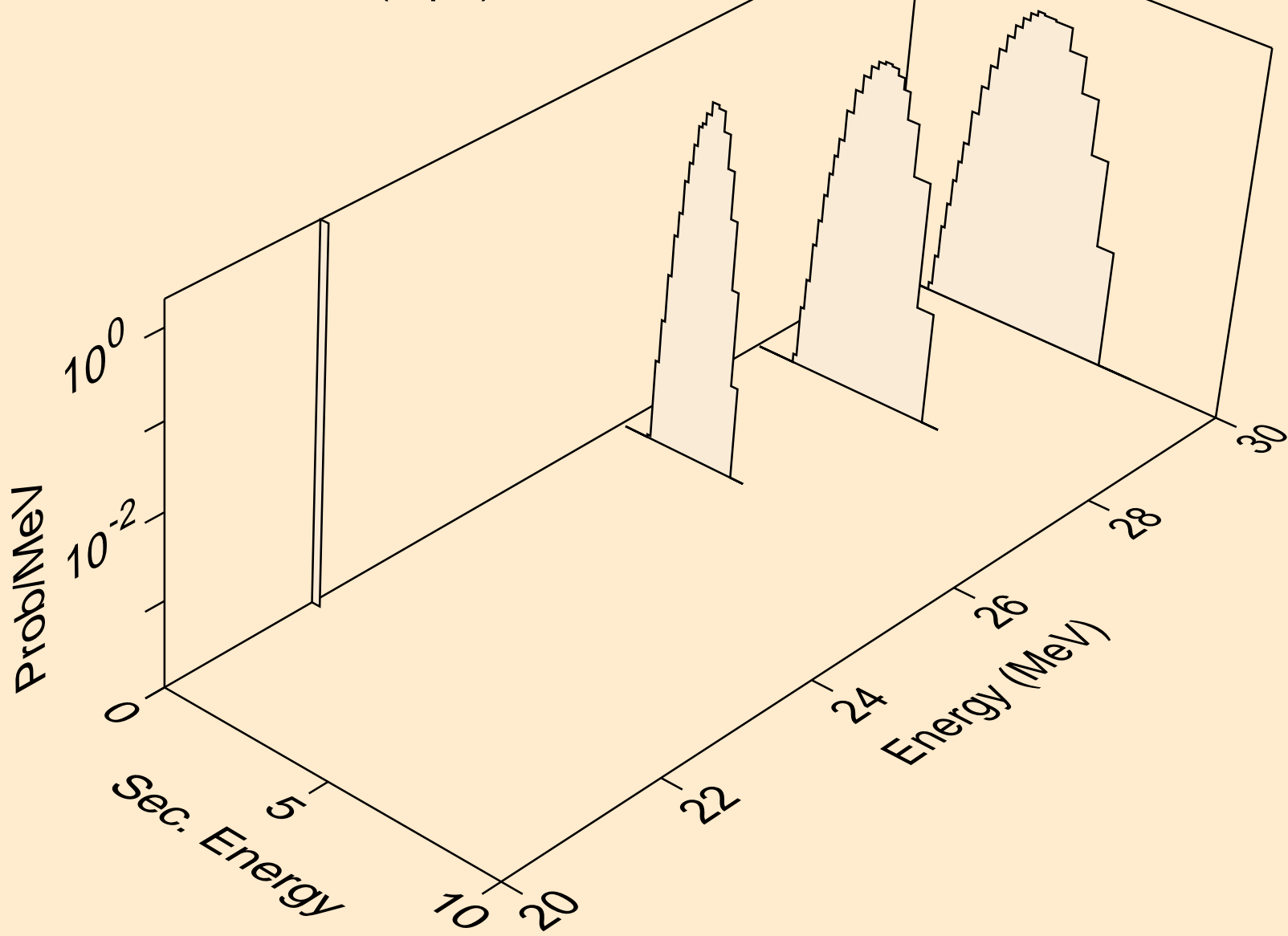

CU068 NEUTRON ACER TENDL-2023 LIBRARY; T=0.K
deuterons from (n,da)

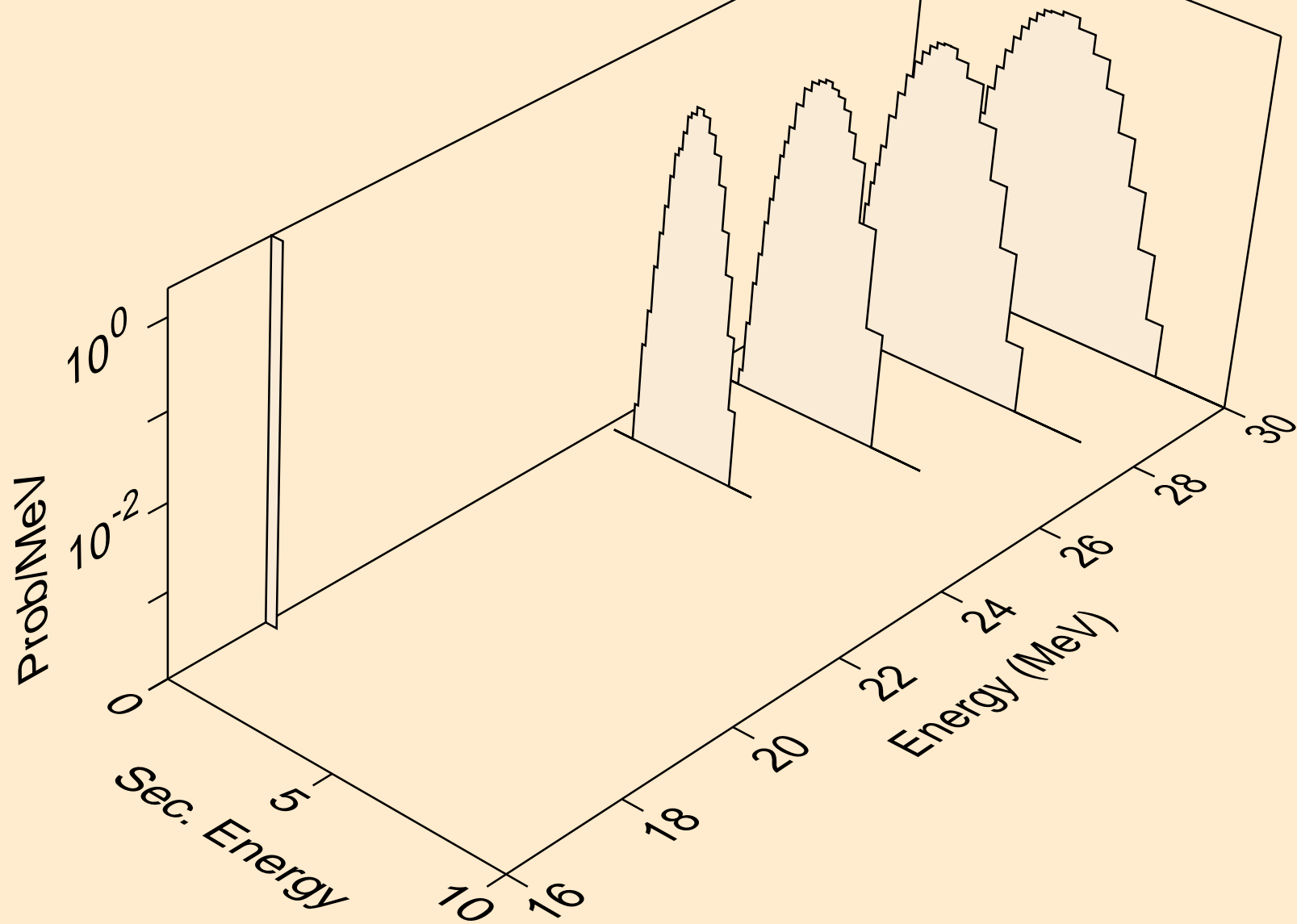

CU068 NEUTRON ACER TENDL-2023 LIBRARY; T=0.K
tritons from (n,x)

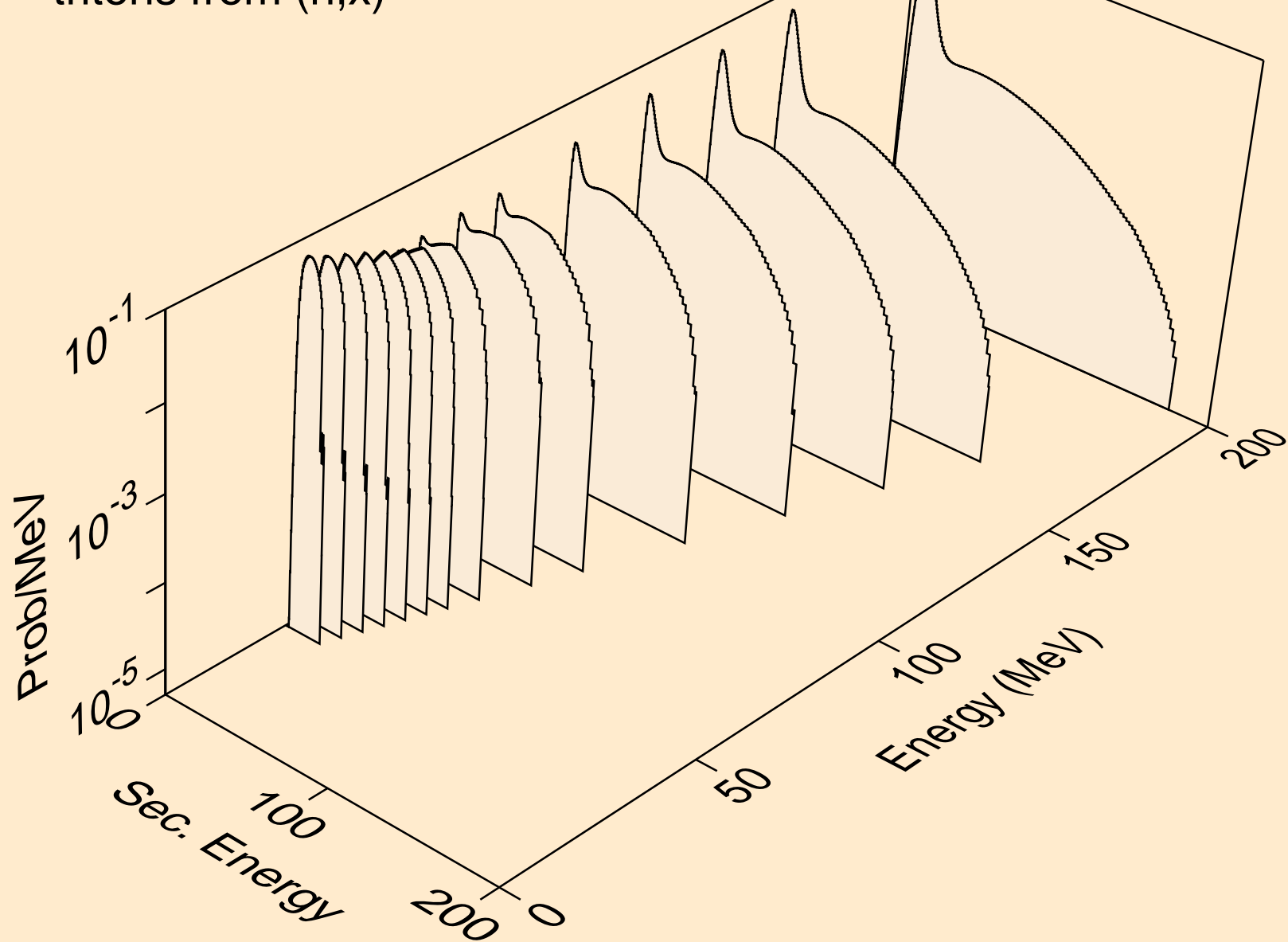

CU068 NEUTRON ACER TENDL-2023 LIBRARY; T=0.K
tritons from (n,n*)t

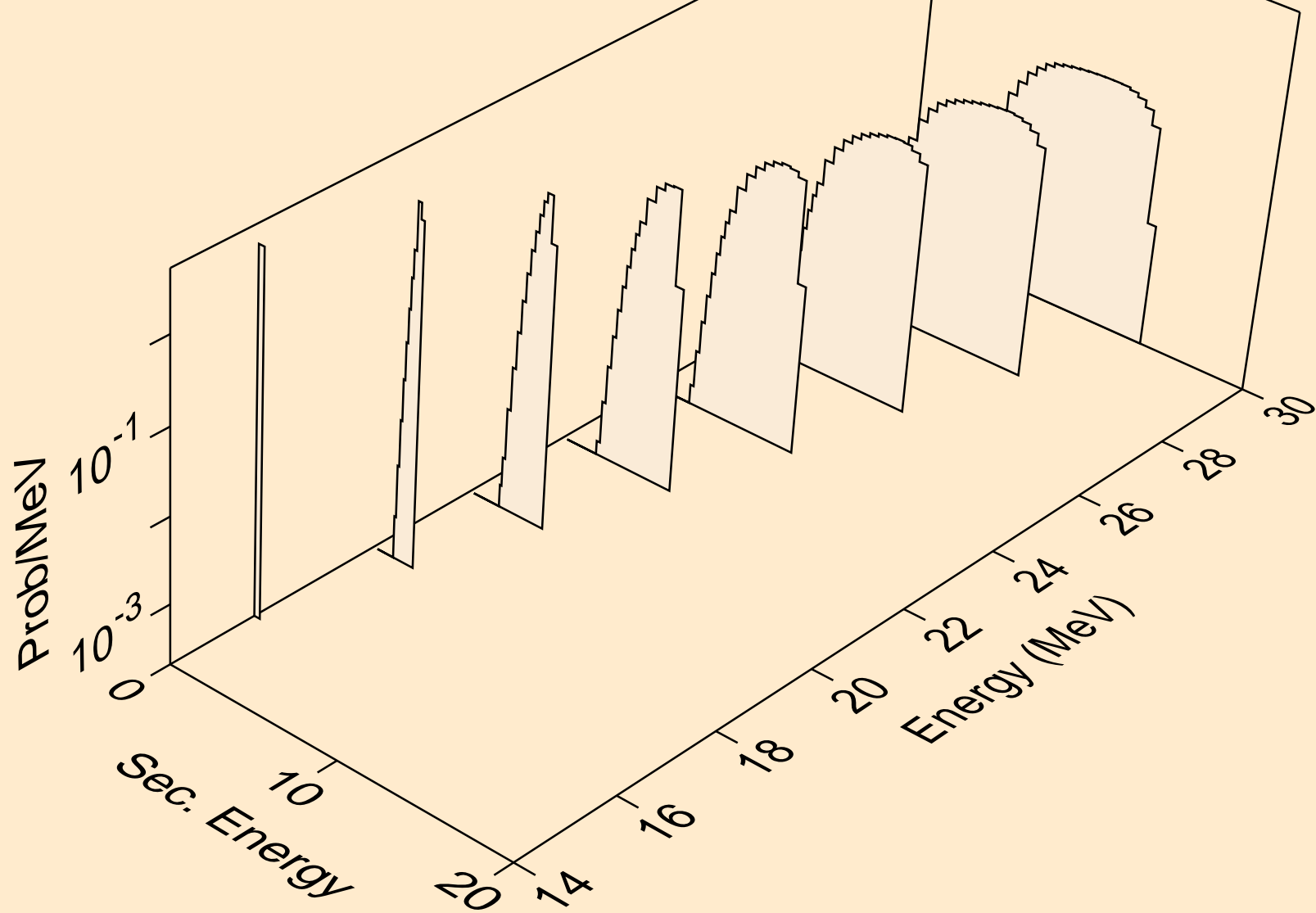

CU068 NEUTRON ACER TENDL-2023 LIBRARY; T=0.K
tritons from (n,t)

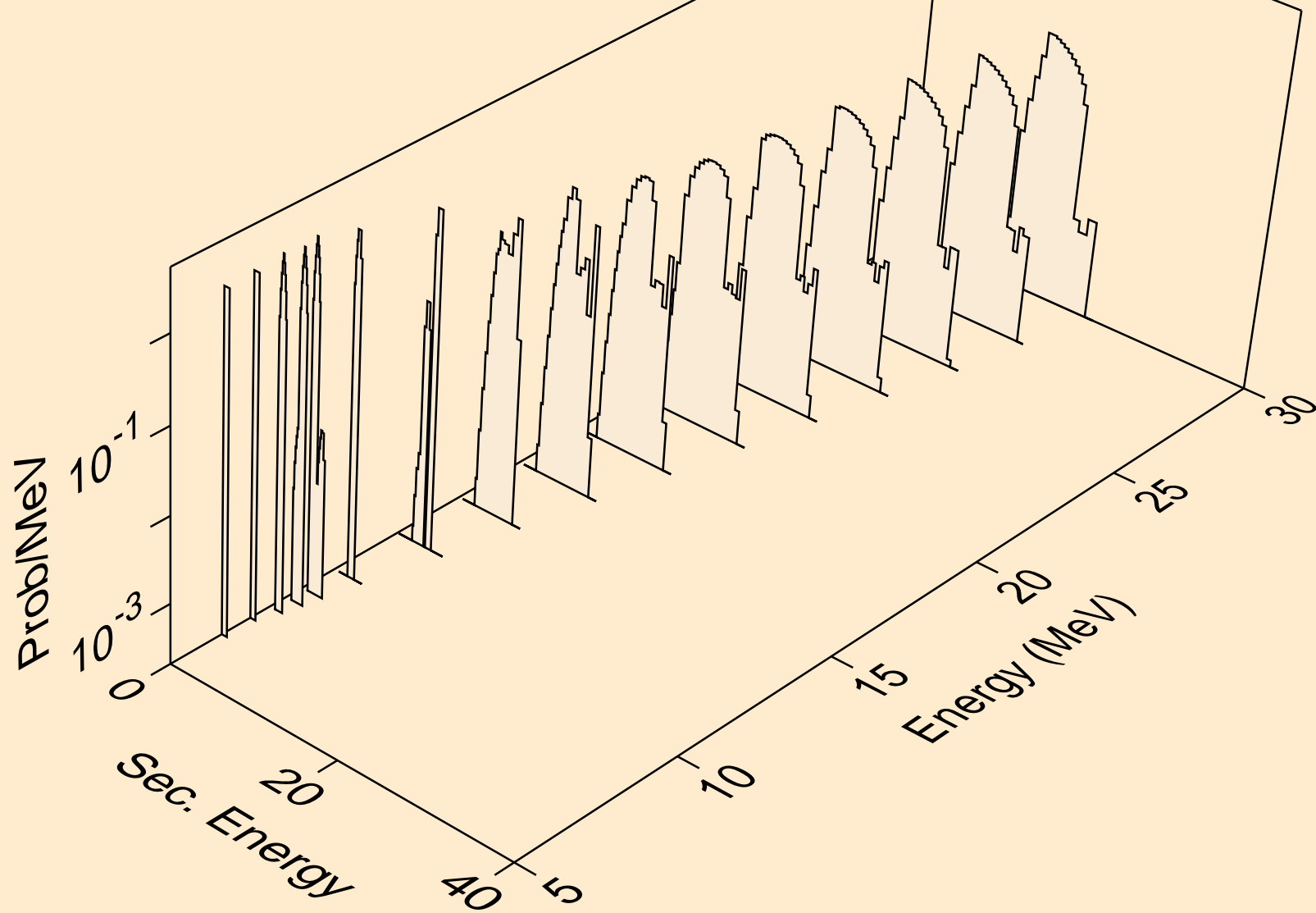

CU068 NEUTRON ACER TENDL-2023 LIBRARY; T=0.K
tritons from (n,pt)

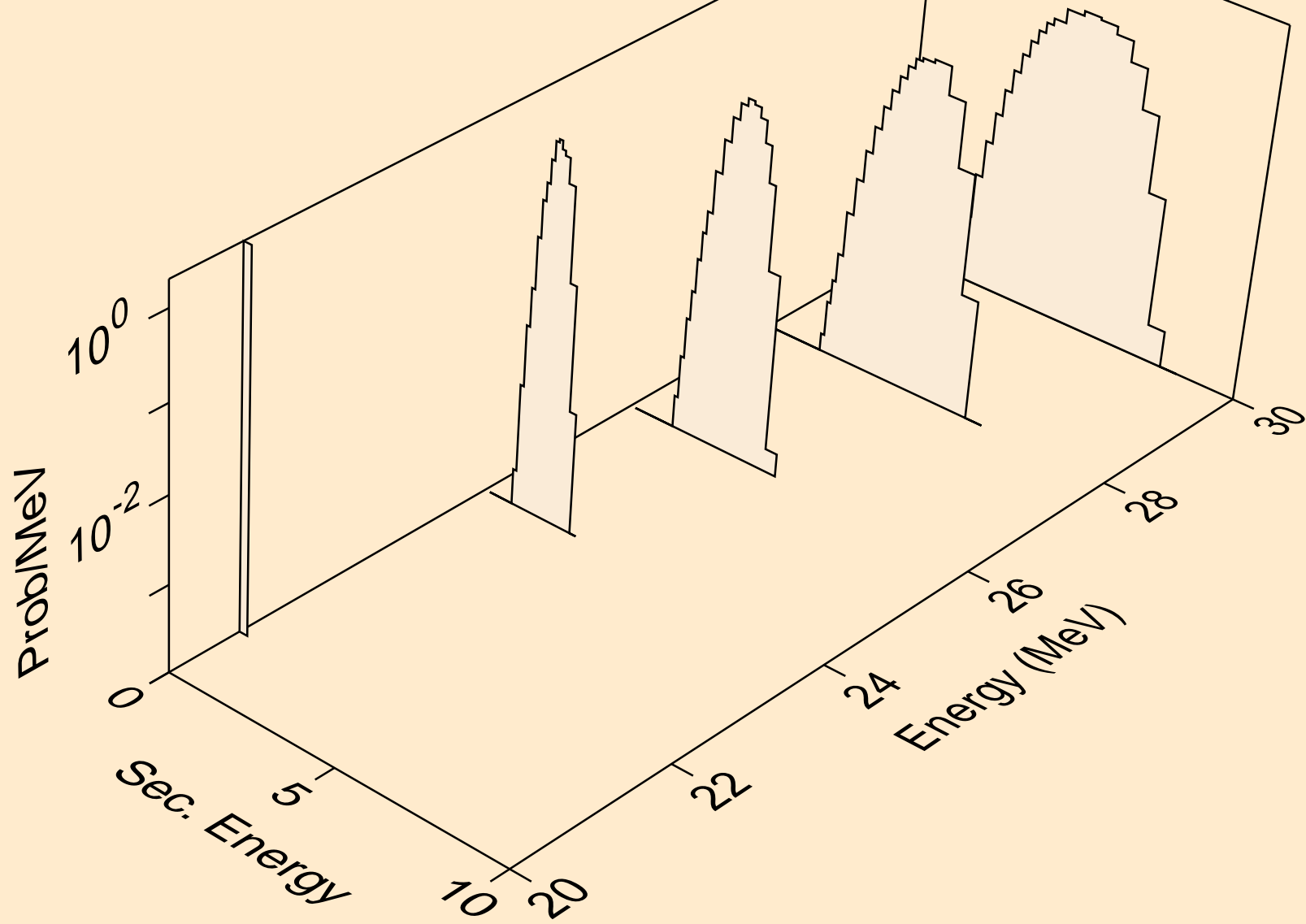

CU068 NEUTRON ACER TENDL-2023 LIBRARY; T=0.K
he3s from (n,x)

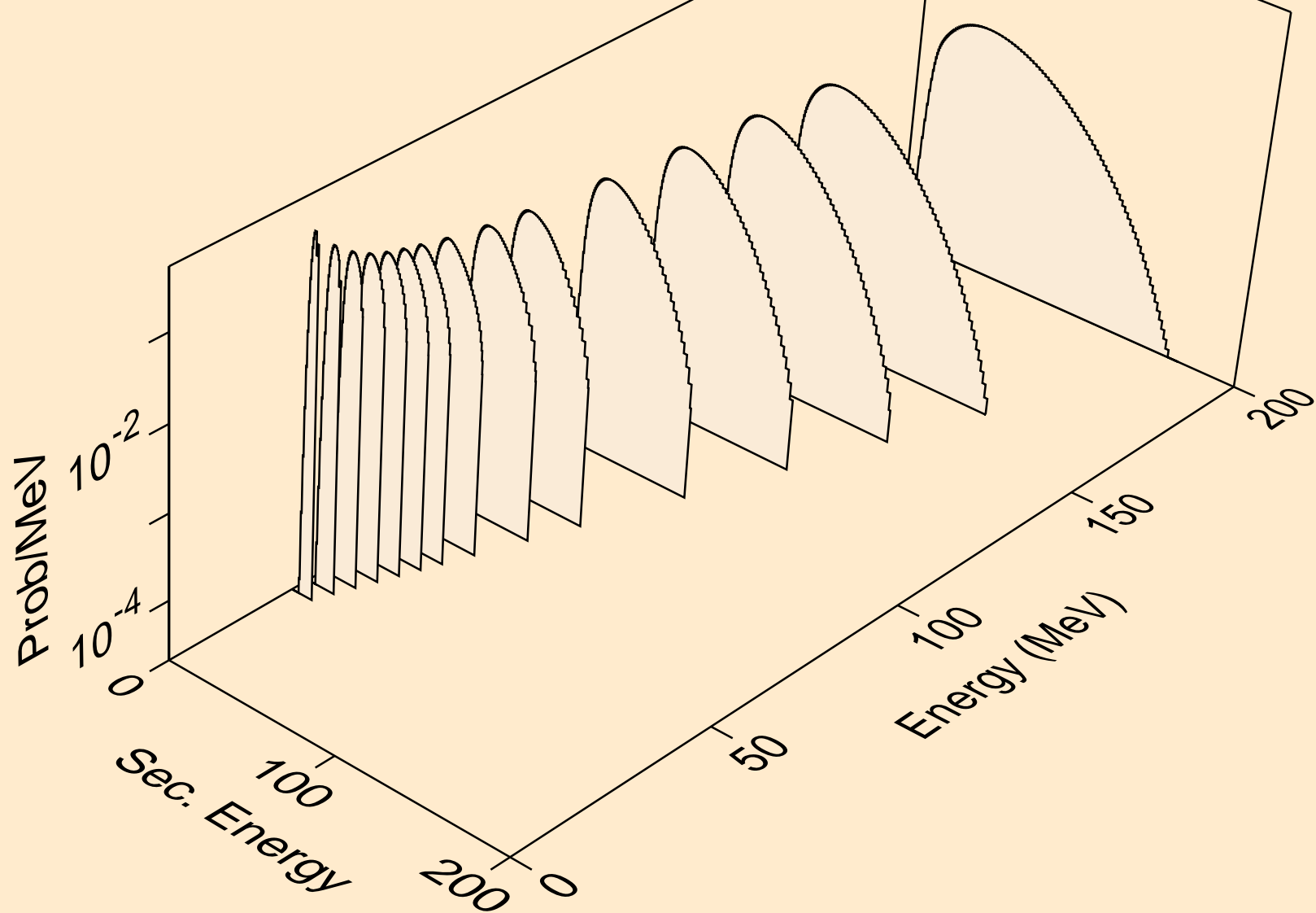

CU068 NEUTRON ACER TENDL-2023 LIBRARY; T=0.K
he3s from (n,n*)he3

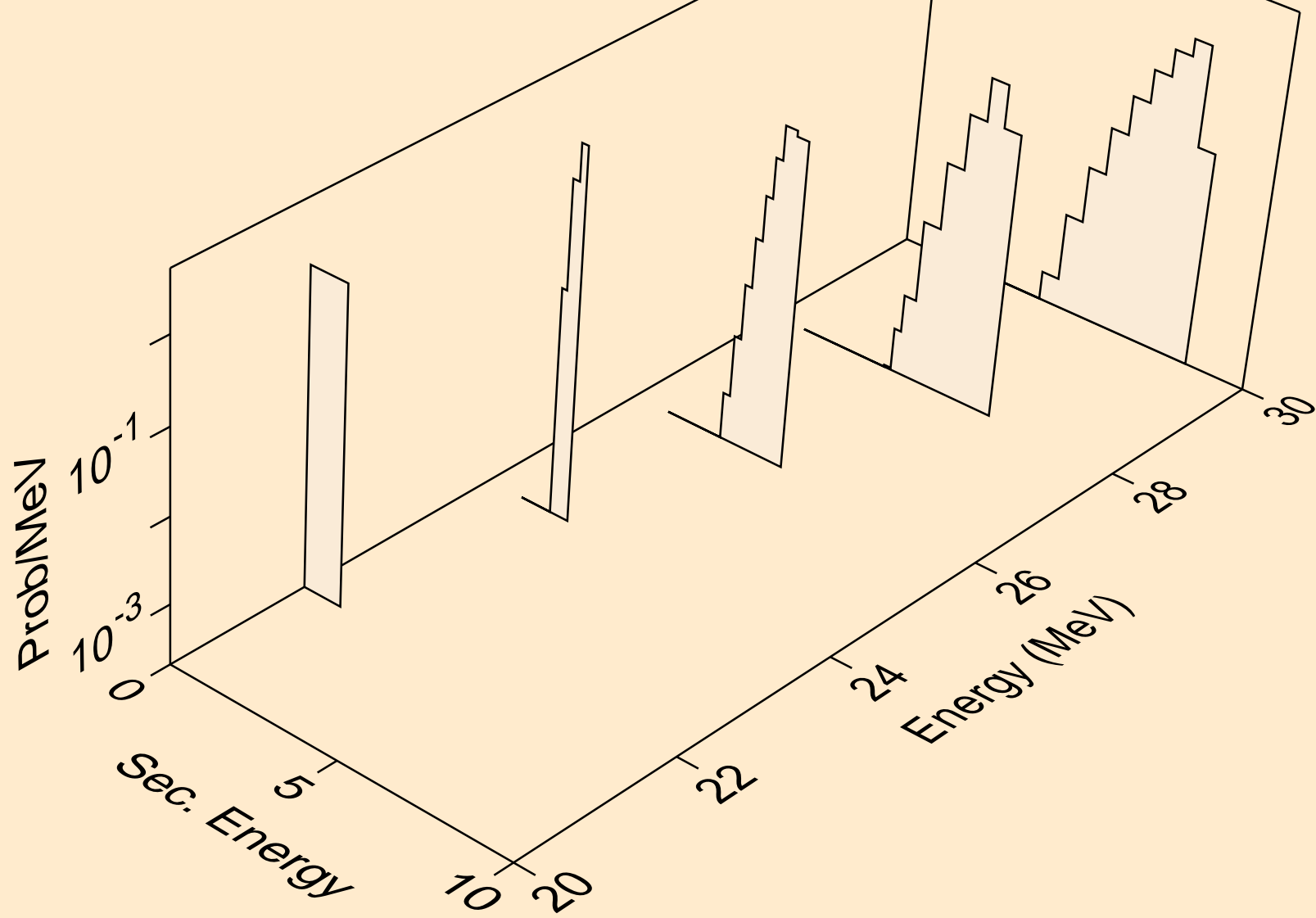

CU068 NEUTRON ACER TENDL-2023 LIBRARY; T=0.K
he3s from (n,he3)

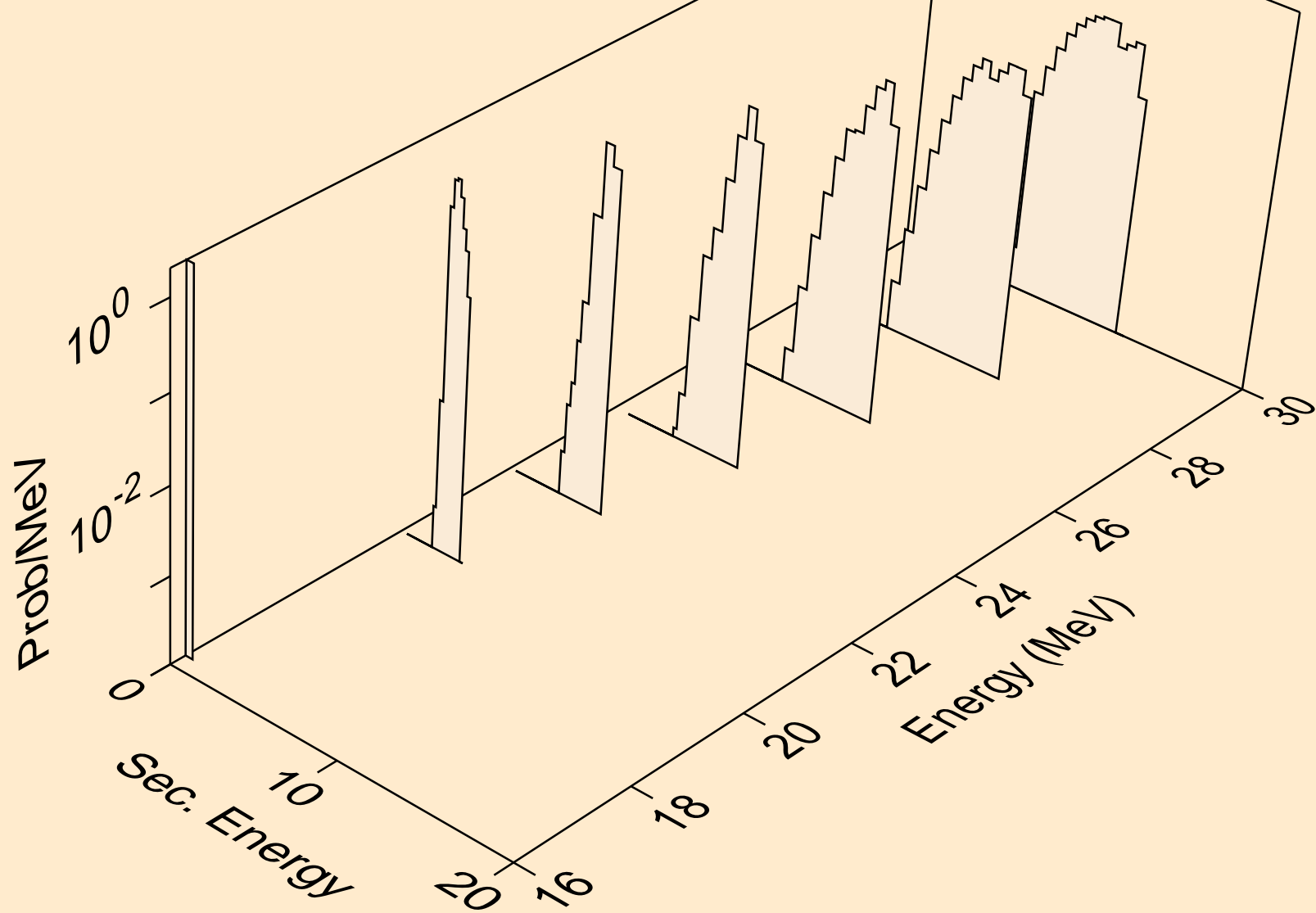

CU068 NEUTRON ACER TENDL-2023 LIBRARY; T=0.K
alphas from (n,x)

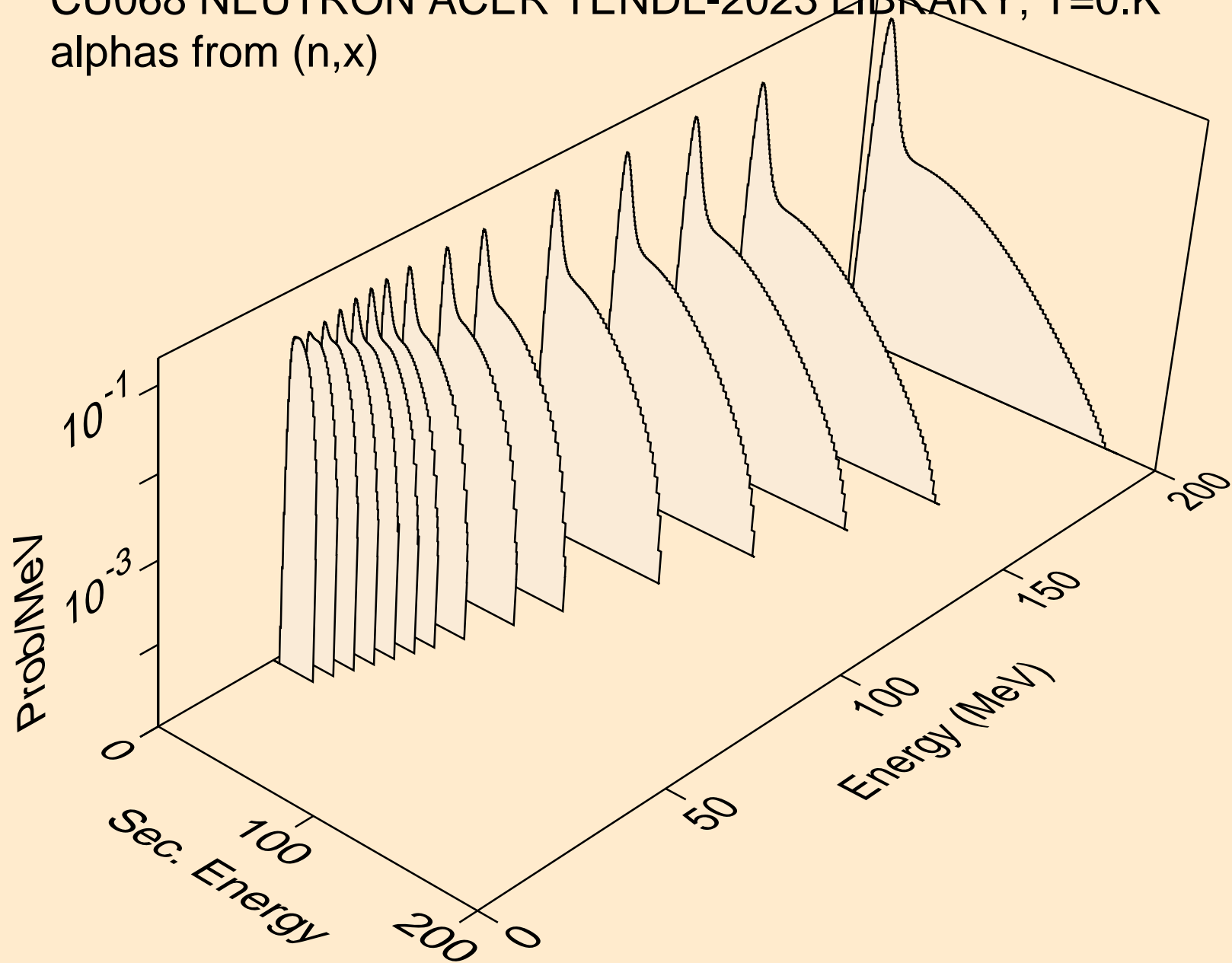

CU068 NEUTRON ACER TENDL-2023 LIBRARY; T=0.K
alphas from (n,n*)a

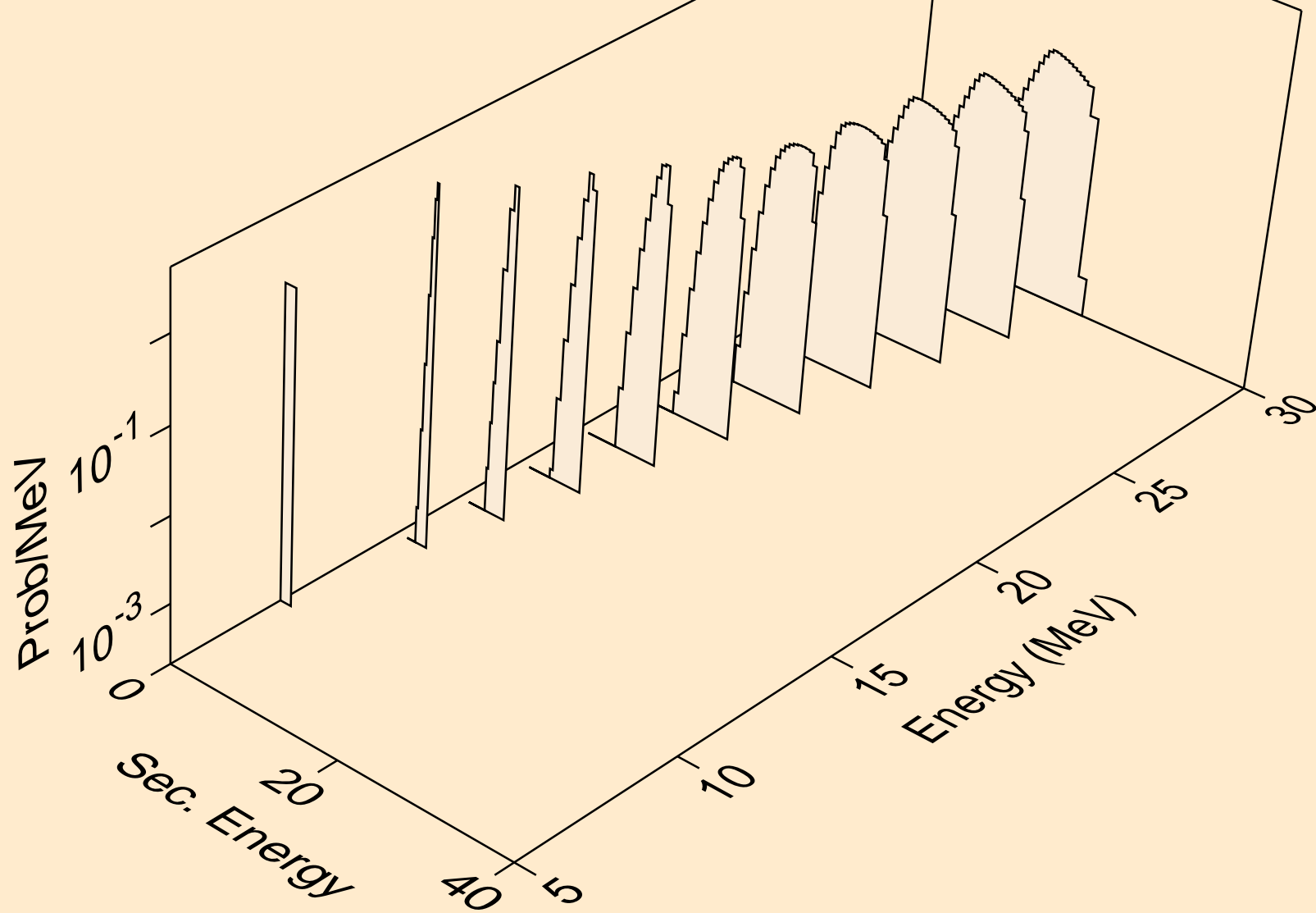

CU068 NEUTRON ACER TENDL-2023 LIBRARY; T=0.K
alphas from (n,2n)a

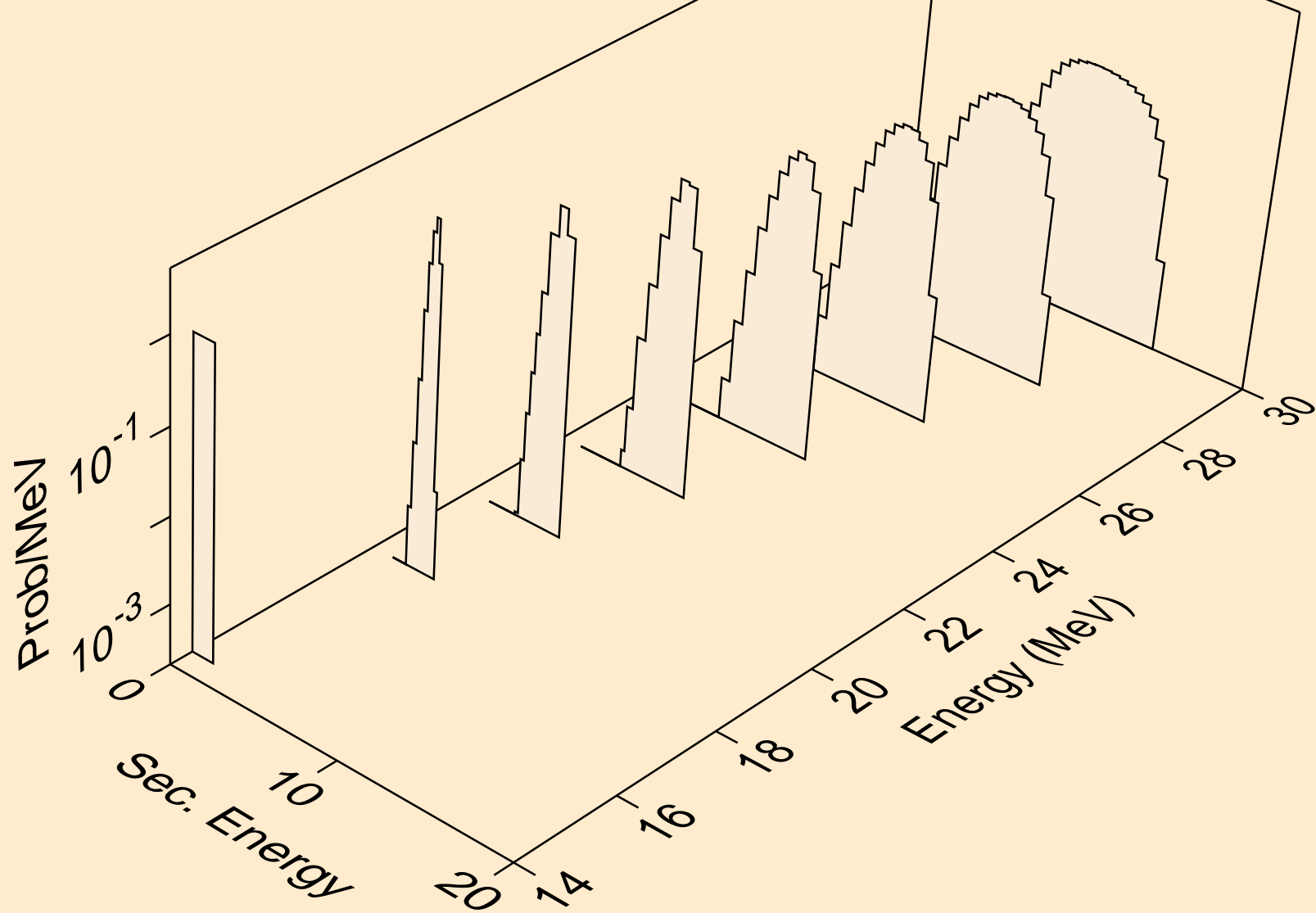

CU068 NEUTRON ACER TENDL-2023 LIBRARY; T=0.K
alphas from (n,3n)a

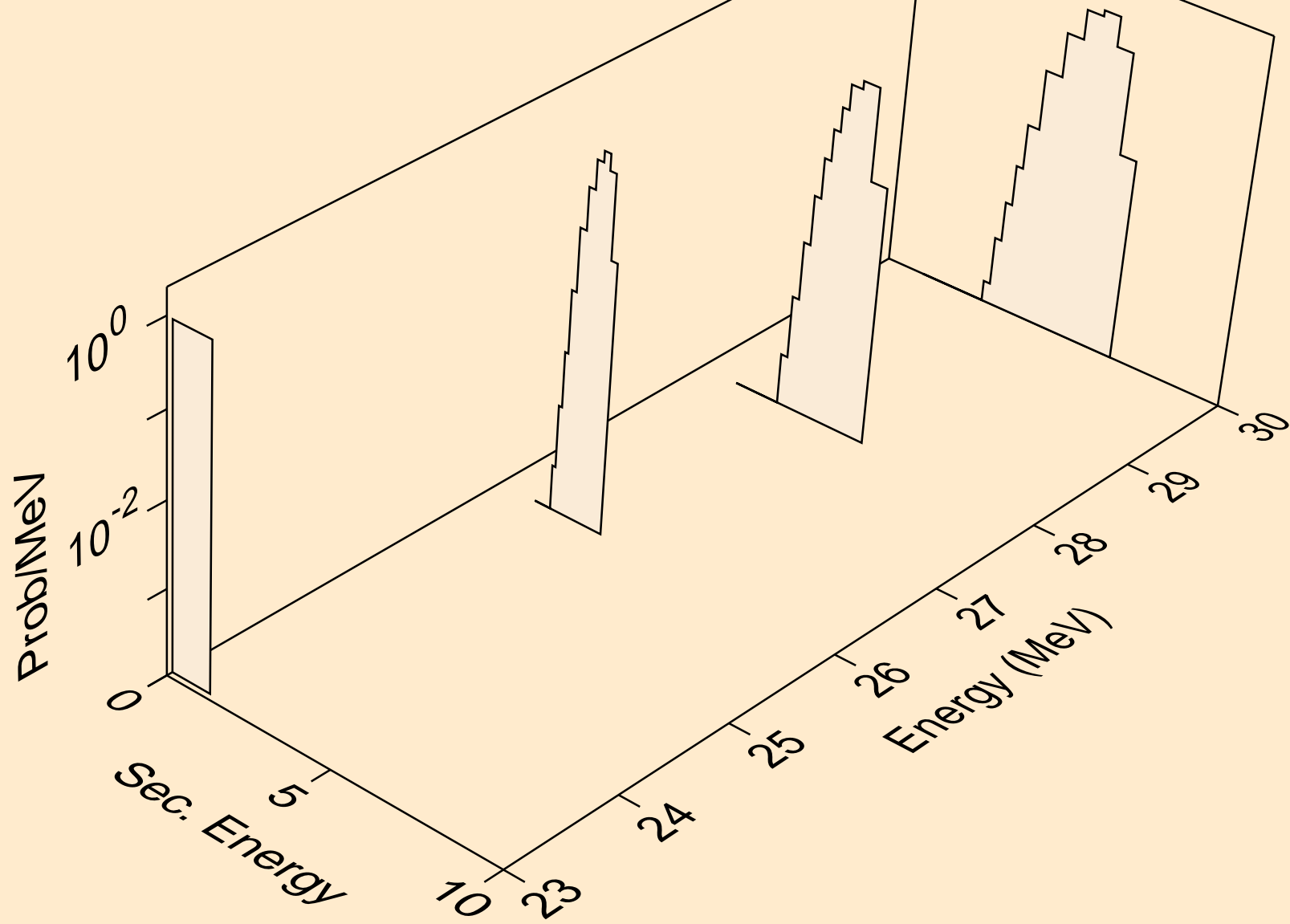

CU068 NEUTRON ACER TENDL-2023 LIBRARY; T=0.K
alphas from (n,npa)

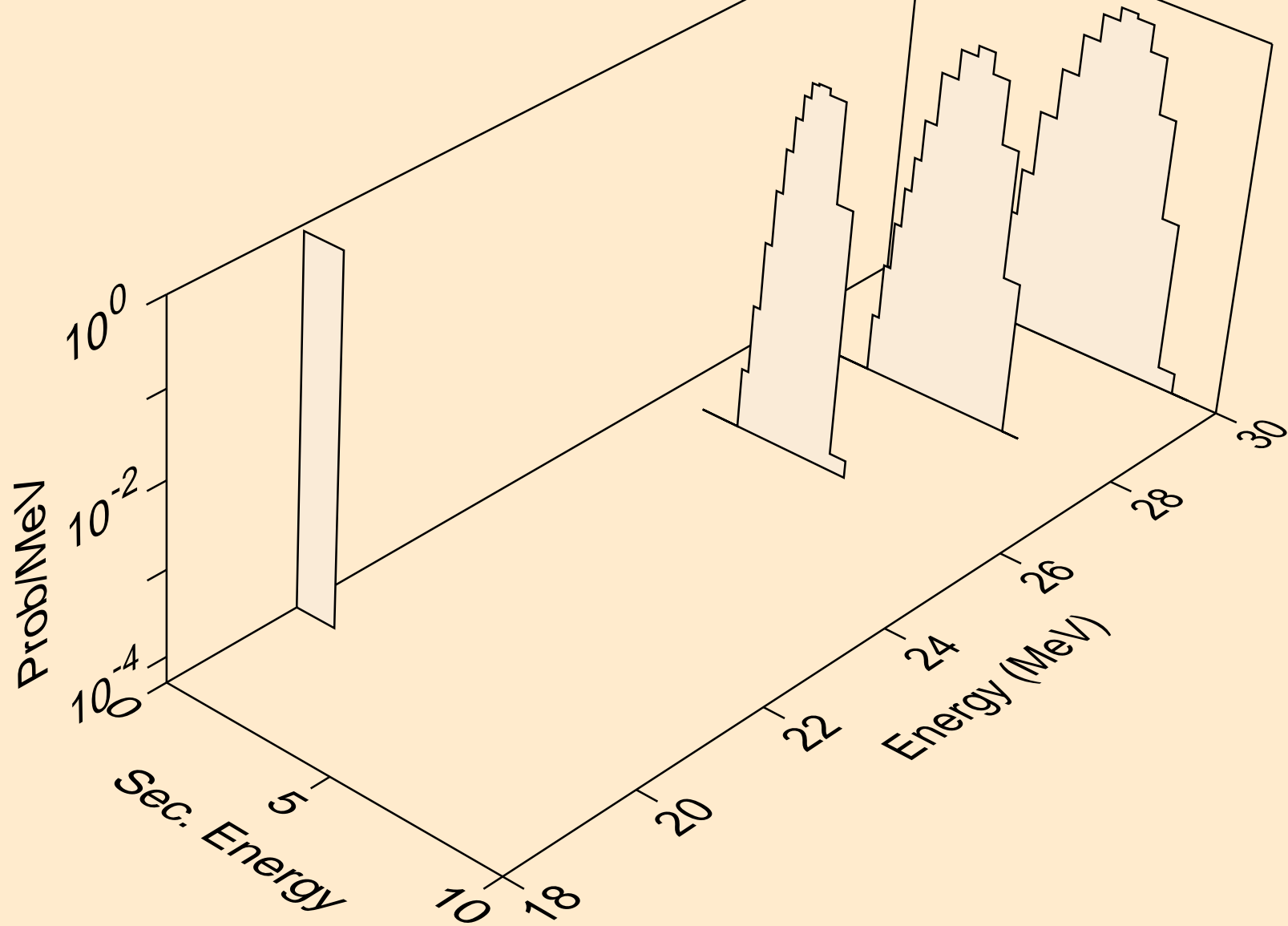

CU068 NEUTRON ACER TENDL-2023 LIBRARY; T=0.K
alphas from (n,a)

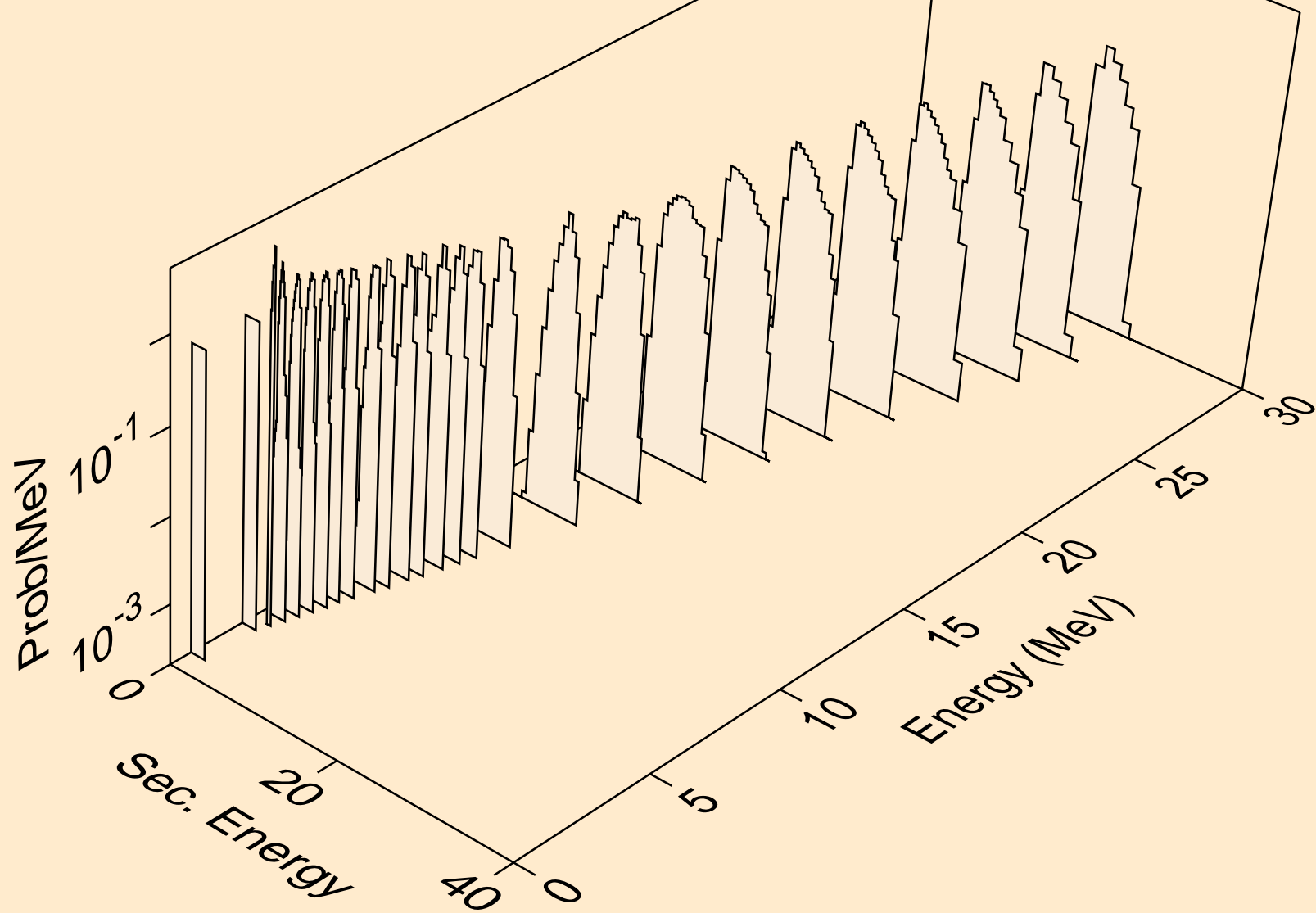

CU068 NEUTRON ACER TENDL-2023 LIBRARY; T=0.K
alphas from (n,2a)

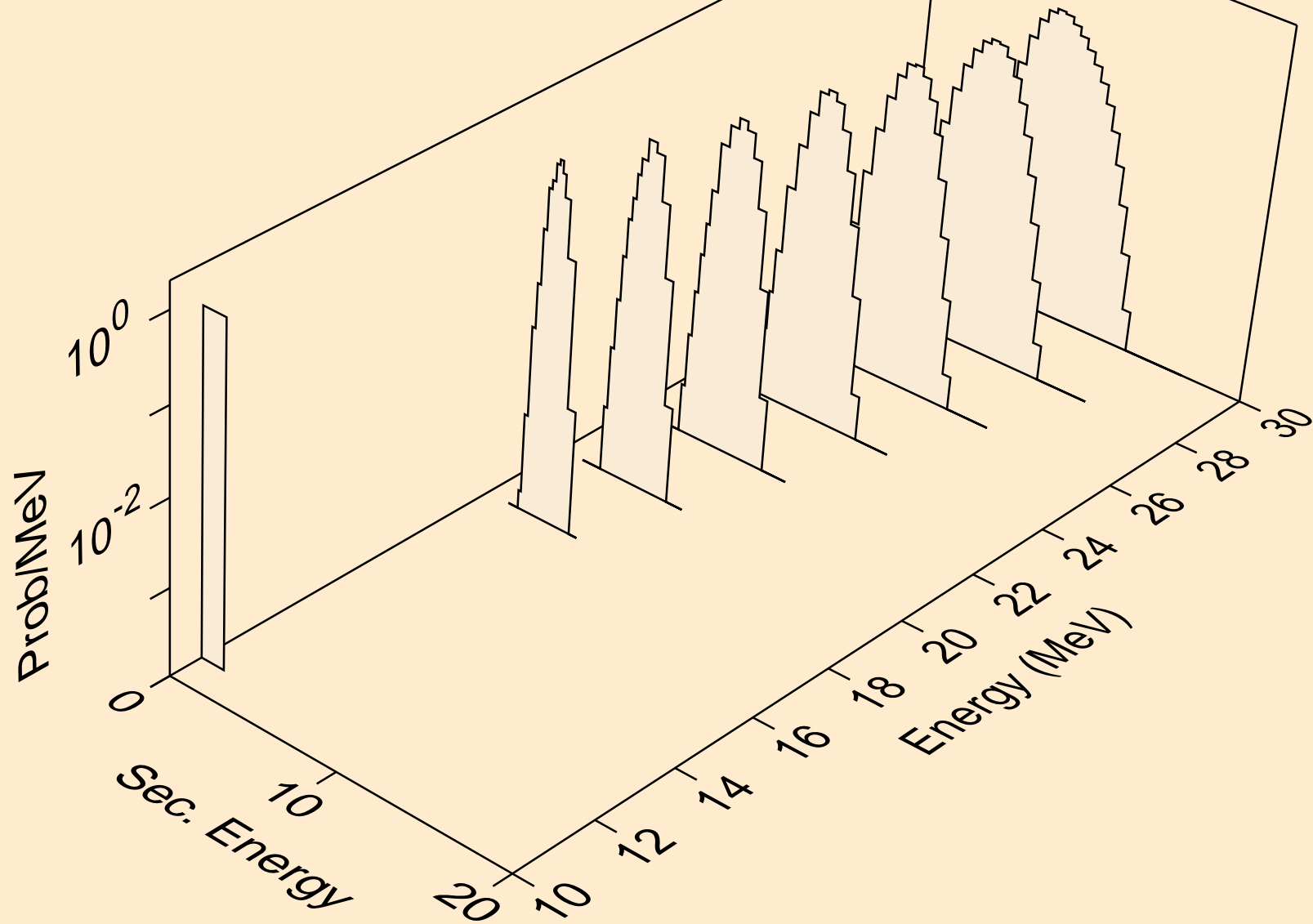

CU068 NEUTRON ACER TENDL-2023 LIBRARY; T=0.K
alphas from (n,pa)

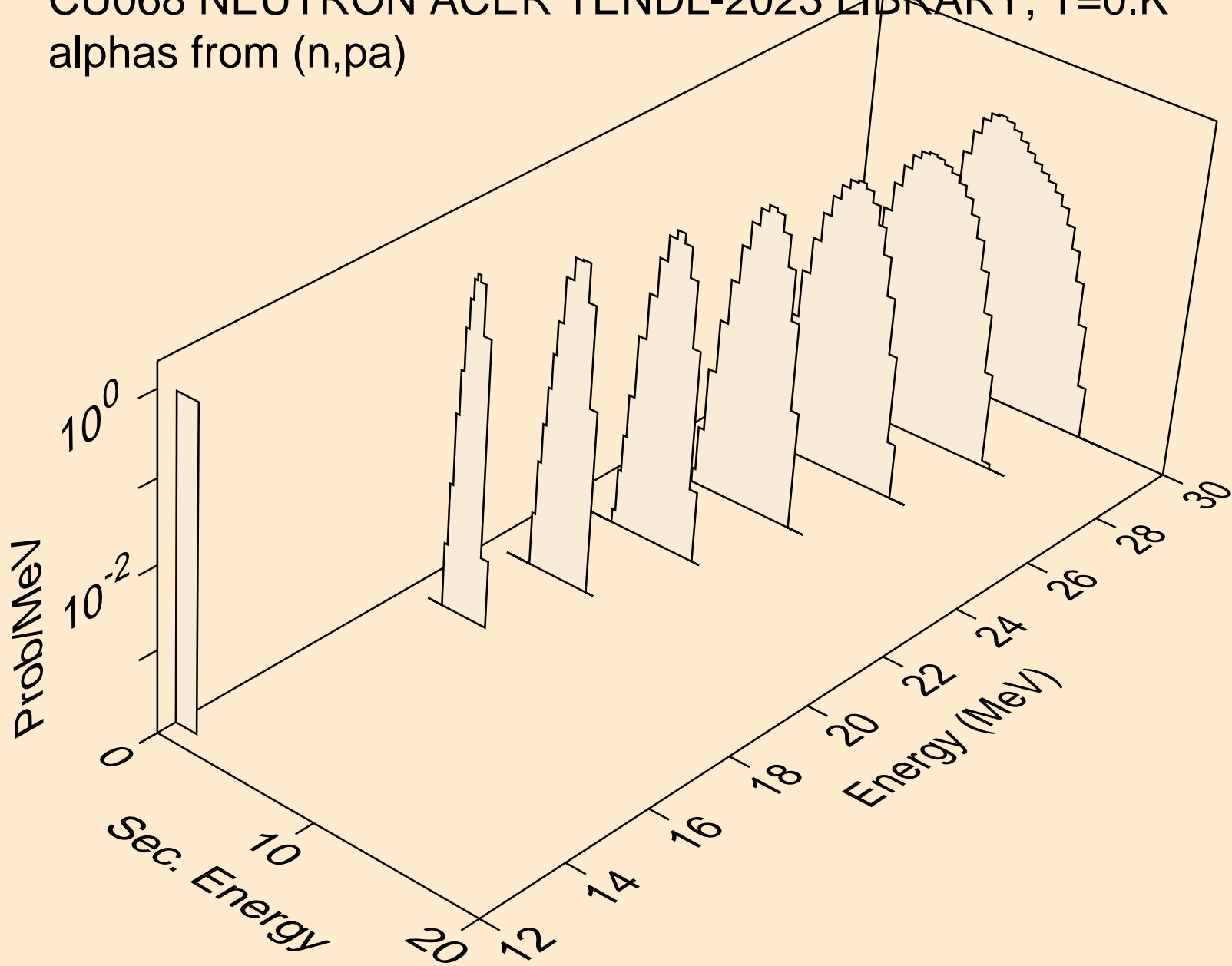

CU068 NEUTRON ACER TENDL-2023 LIBRARY; T=0.K
alphas from (n,da)

