

DY144 NEUTRON ACER TENDL-2023 LIBRARY; T=0.K

Principal cross sections

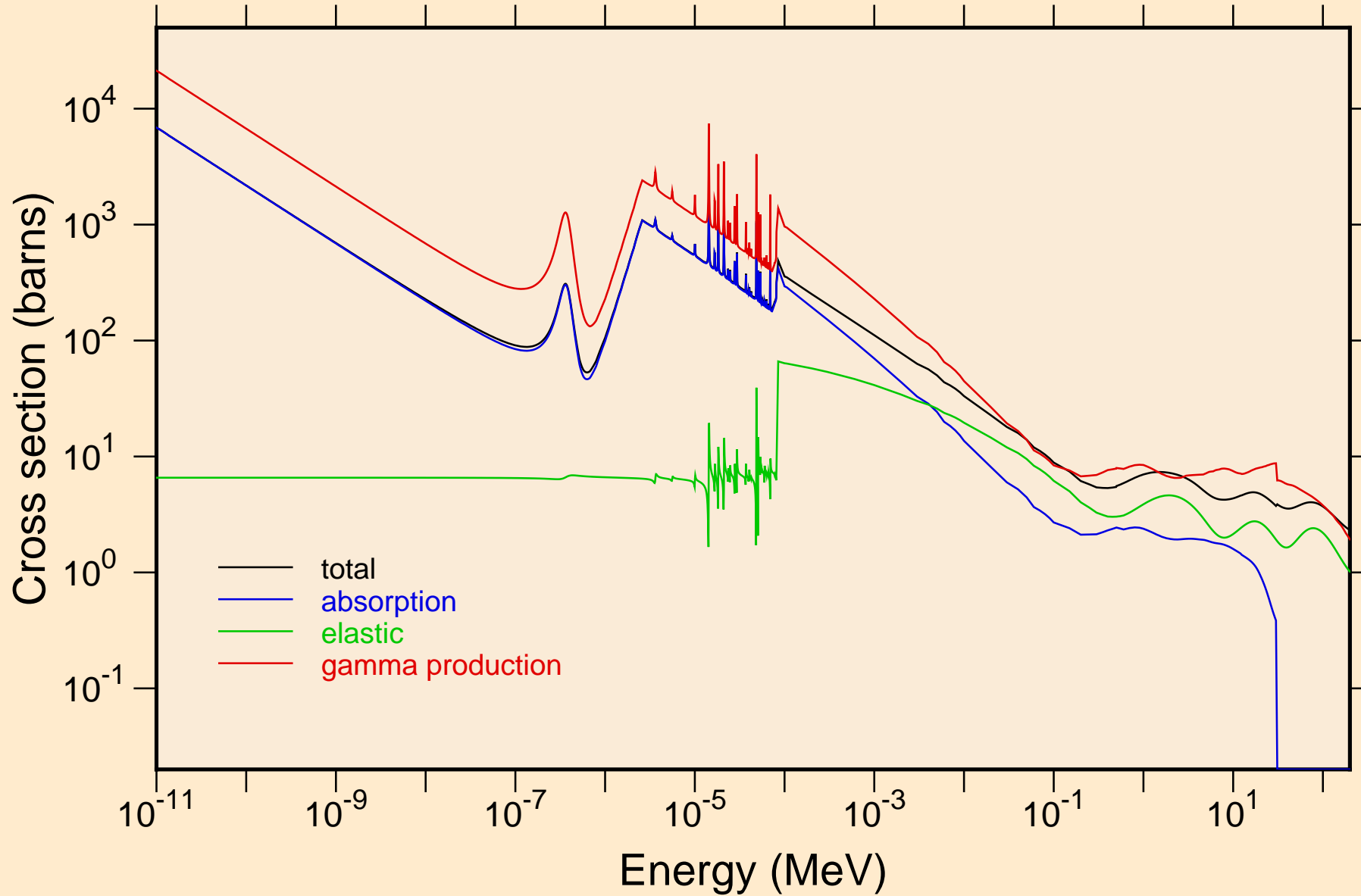

DY144 NEUTRON ACER TENDL-2023 LIBRARY; T=0.K
resonance total cross section

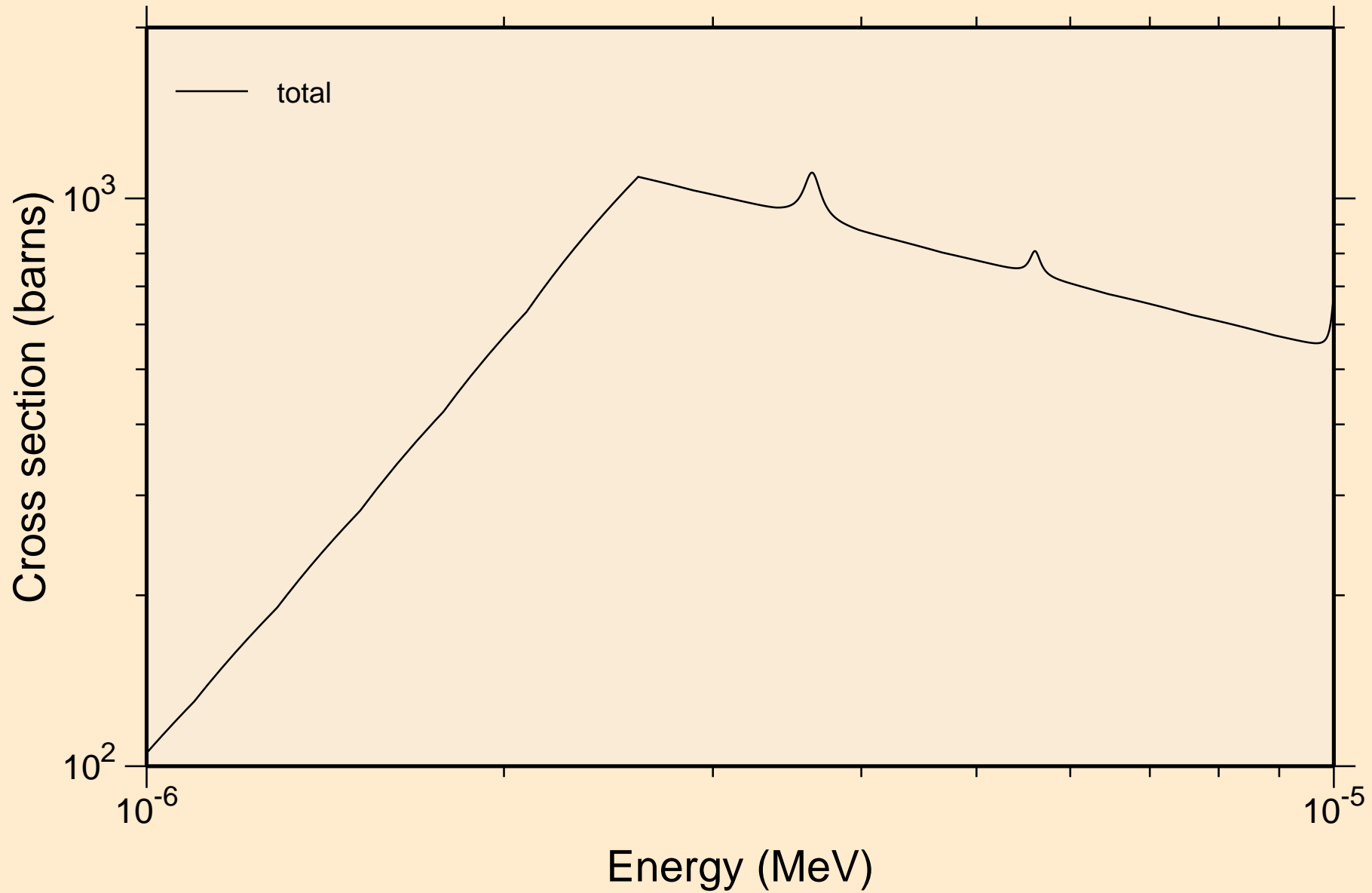

DY144 NEUTRON ACER TENDL-2023 LIBRARY; T=0.K
resonance total cross section

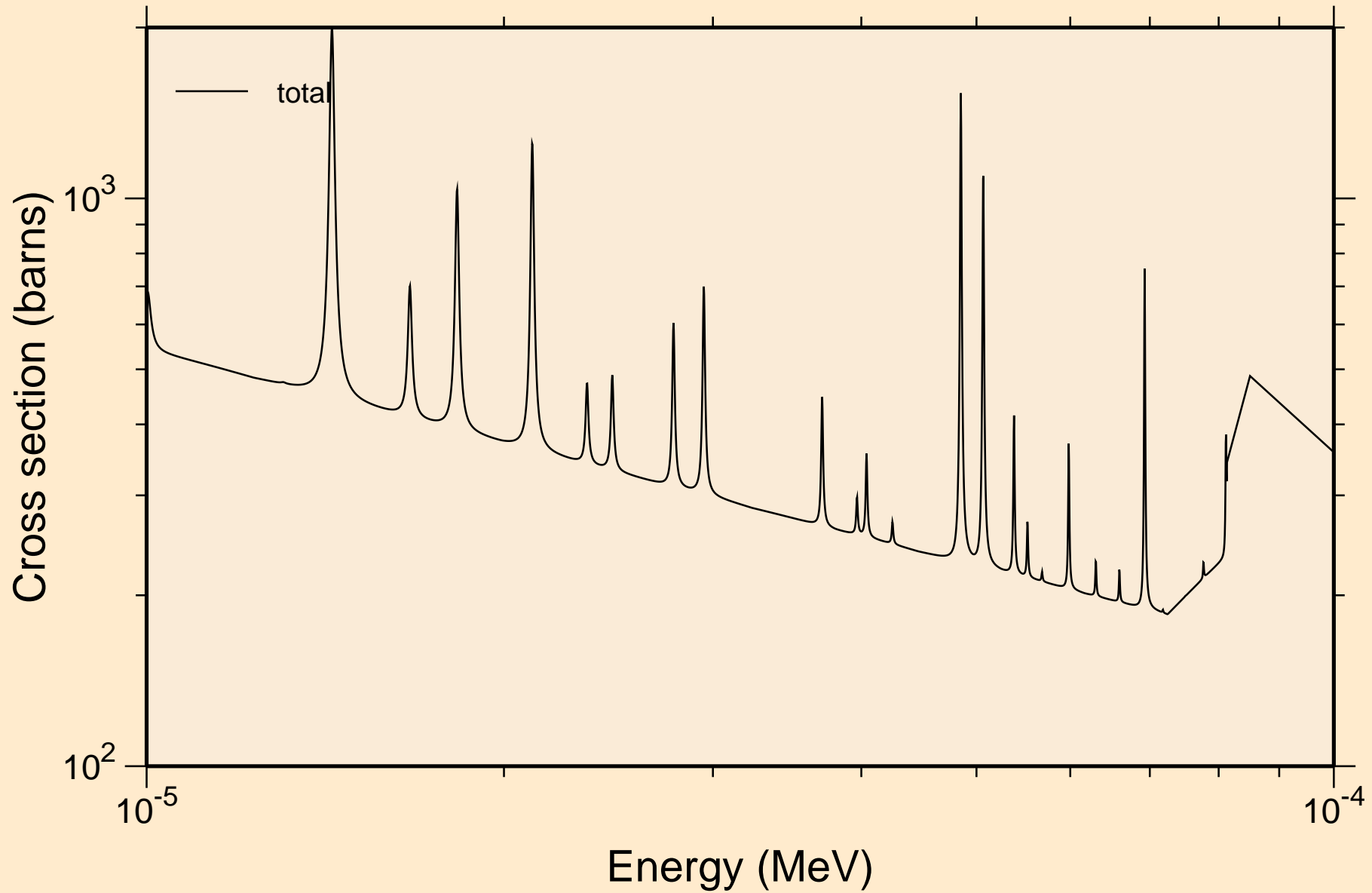

DY144 NEUTRON ACER TENDL-2023 LIBRARY; T=0.K
resonance total cross section

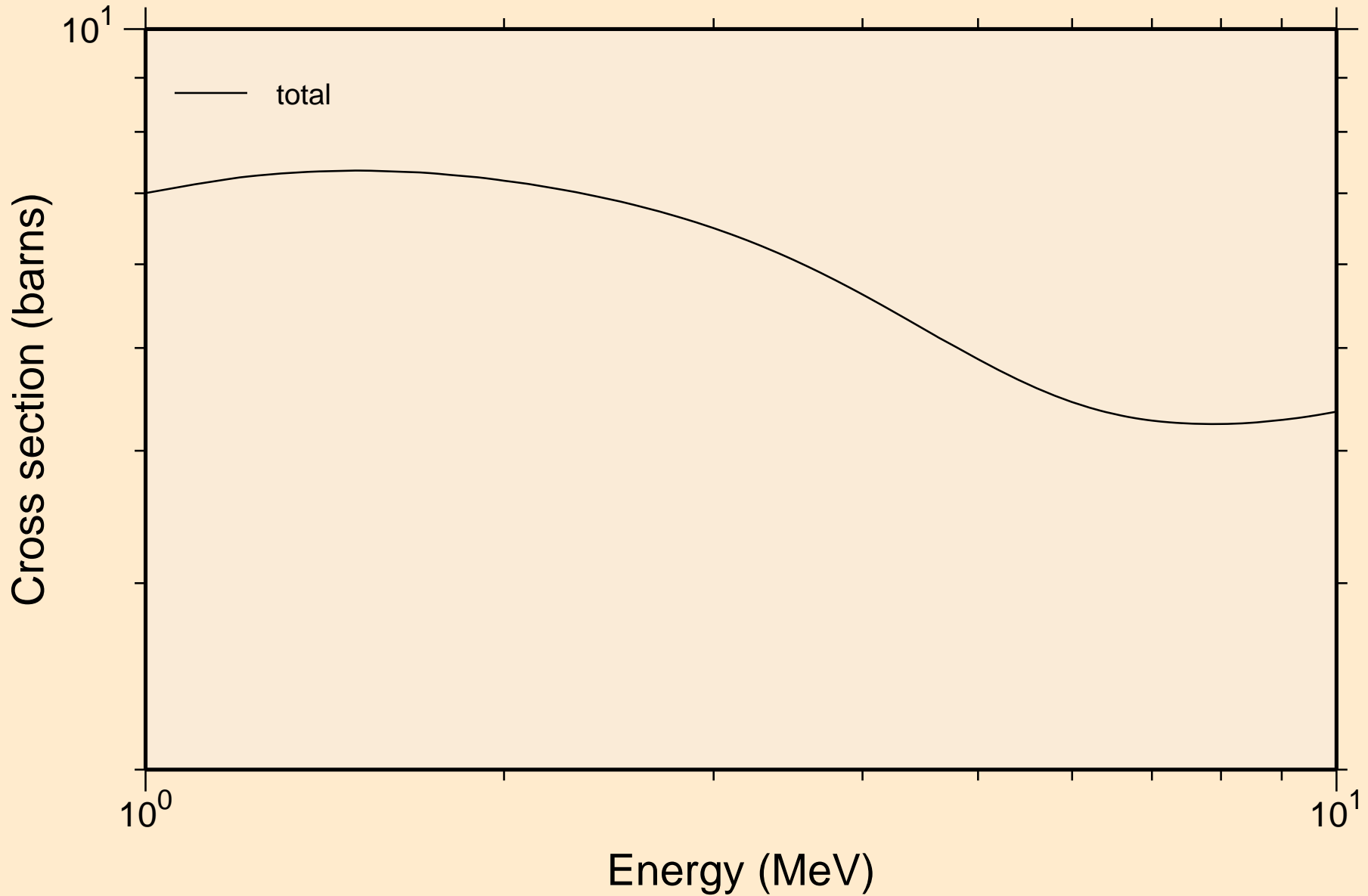

DY144 NEUTRON ACER TENDL-2023 LIBRARY; T=0.K
resonance absorption cross sections

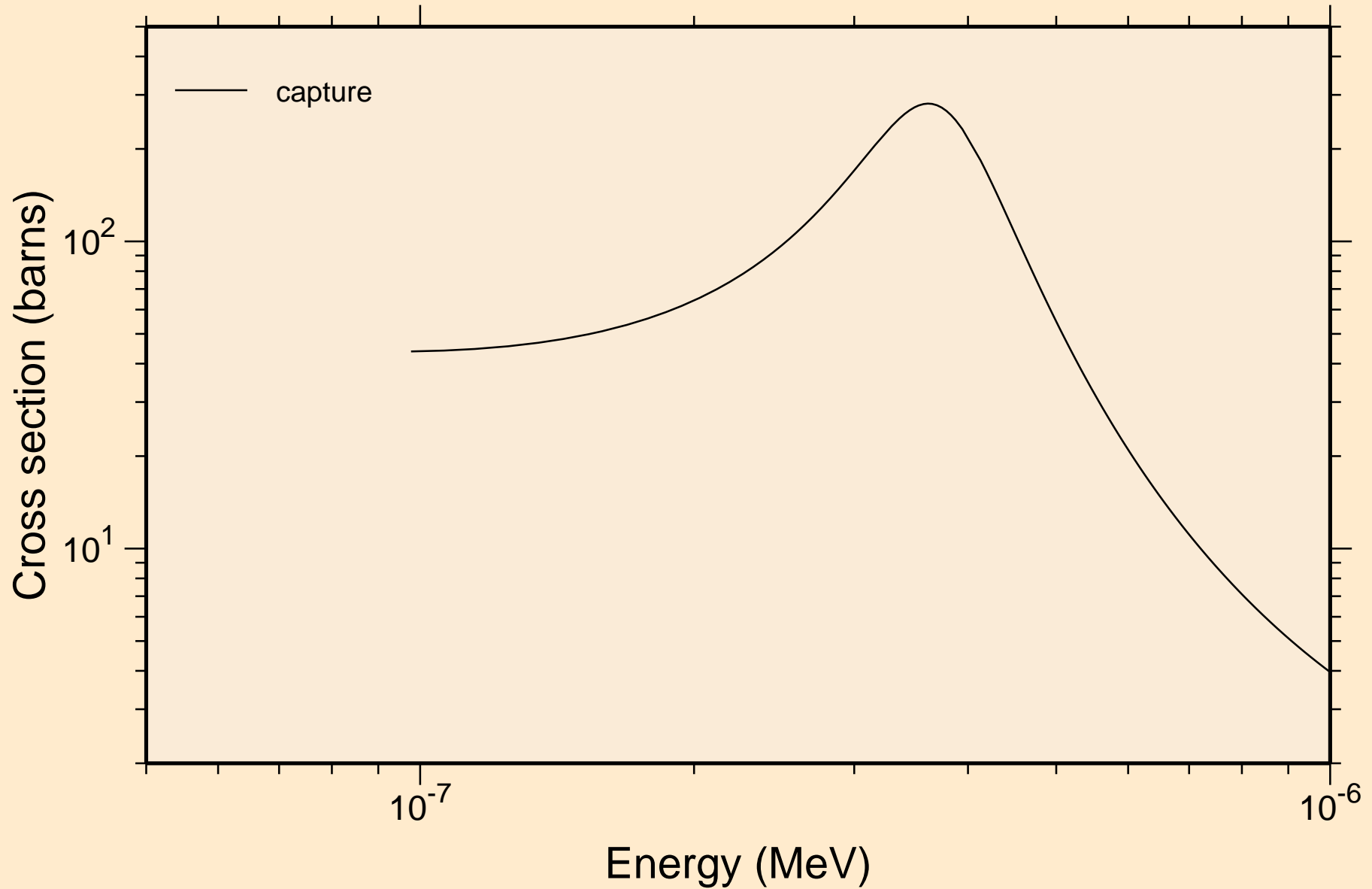

DY144 NEUTRON ACER TENDL-2023 LIBRARY; T=0.K
resonance absorption cross sections

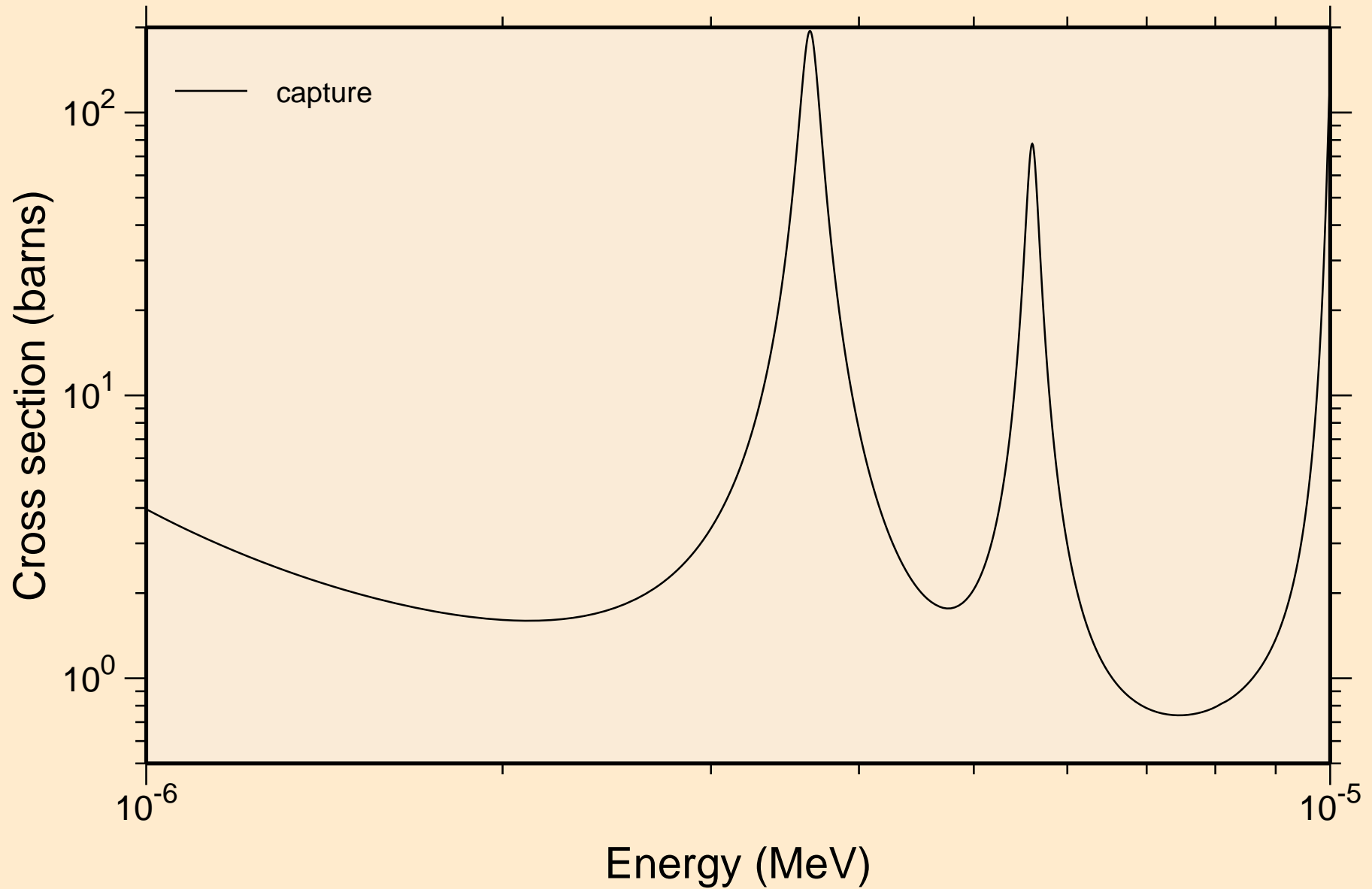

DY144 NEUTRON ACER TENDL-2023 LIBRARY; T=0.K
resonance absorption cross sections

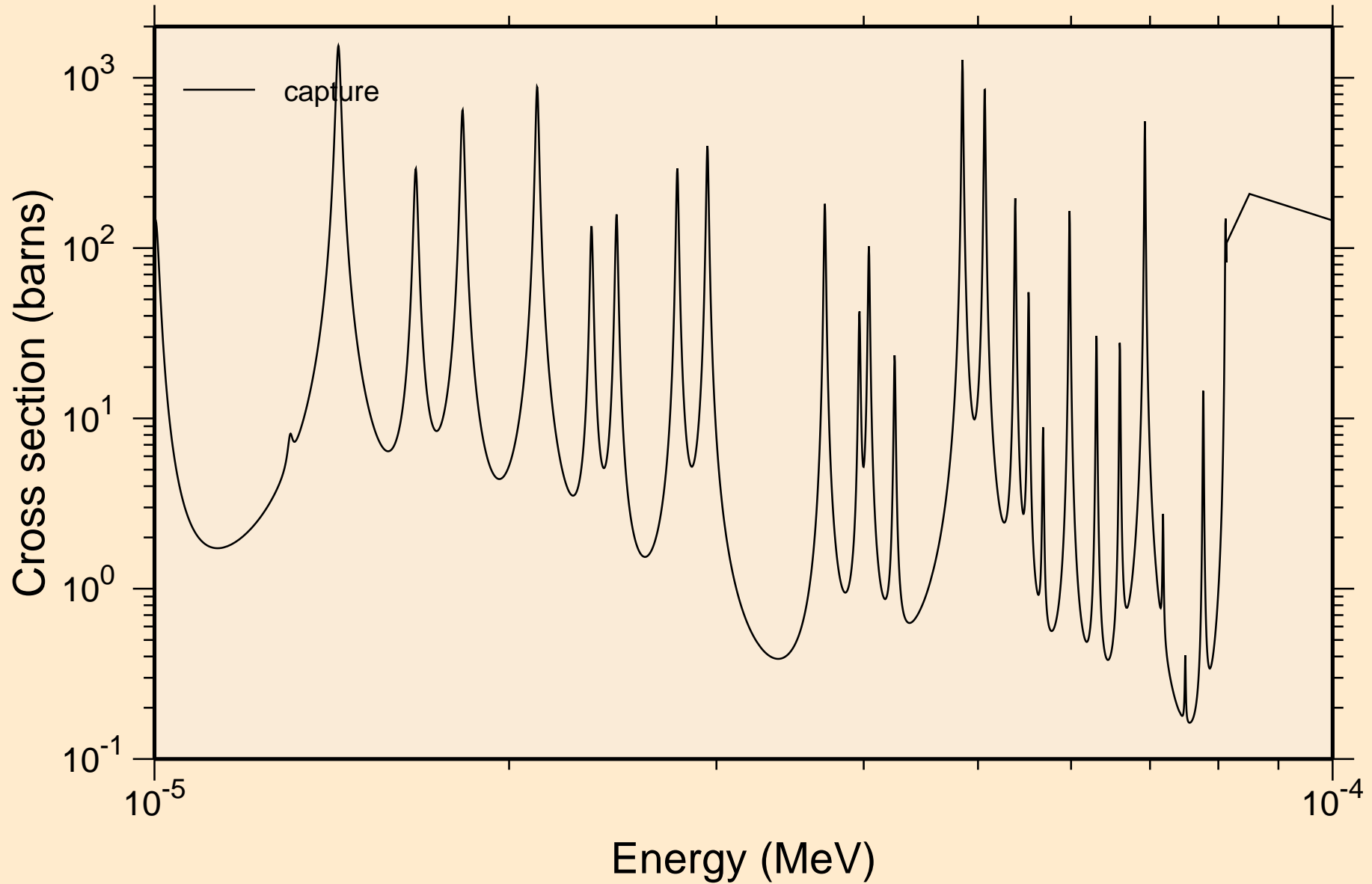

DY144 NEUTRON ACER TENDL-2023 LIBRARY; T=0.K
resonance absorption cross sections

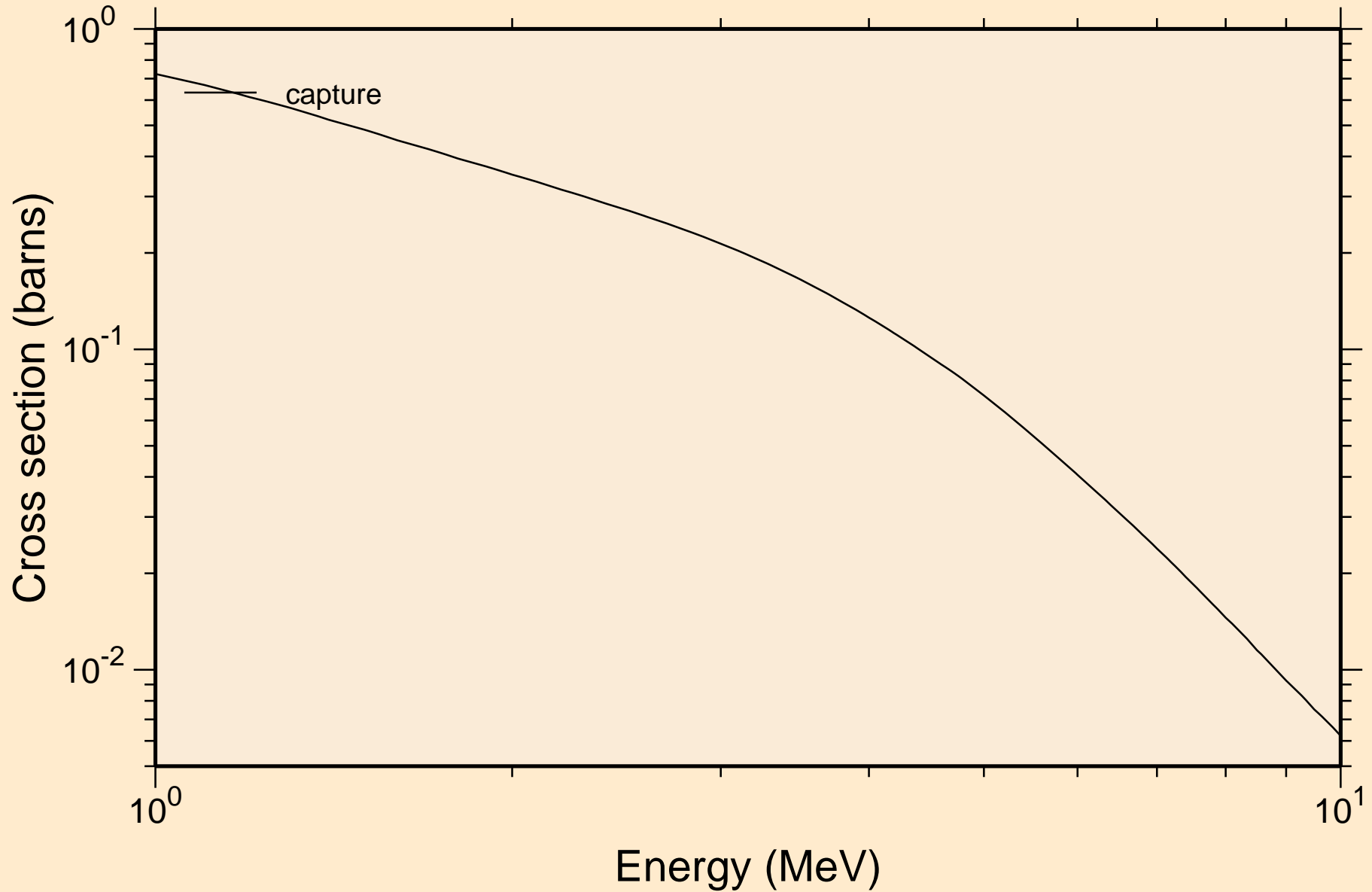

DY144 NEUTRON ACER TENDL-2023 LIBRARY; T=0.K

Heating

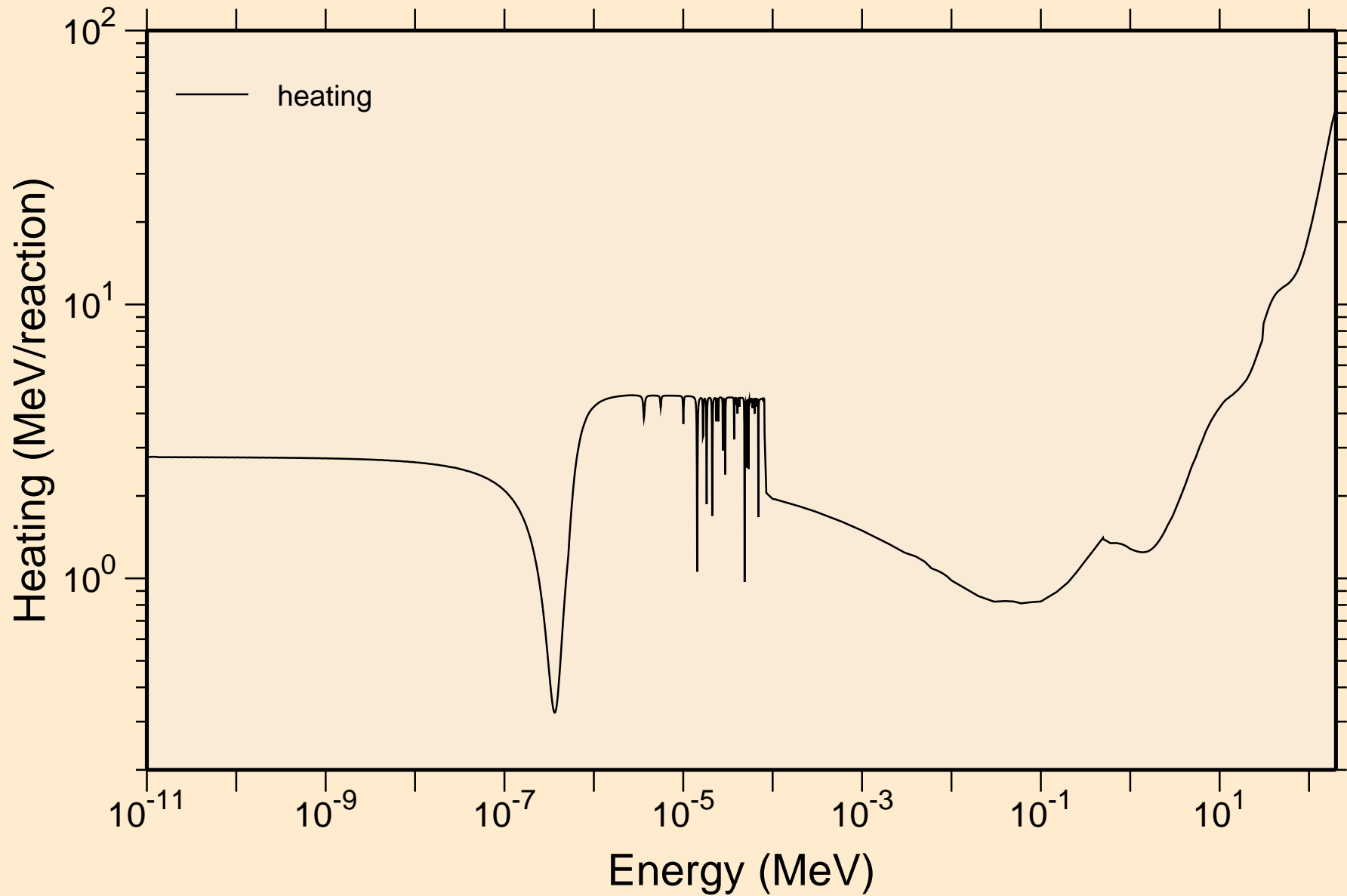

DY144 NEUTRON ACER TENDL-2023 LIBRARY; T=0.K
Damage

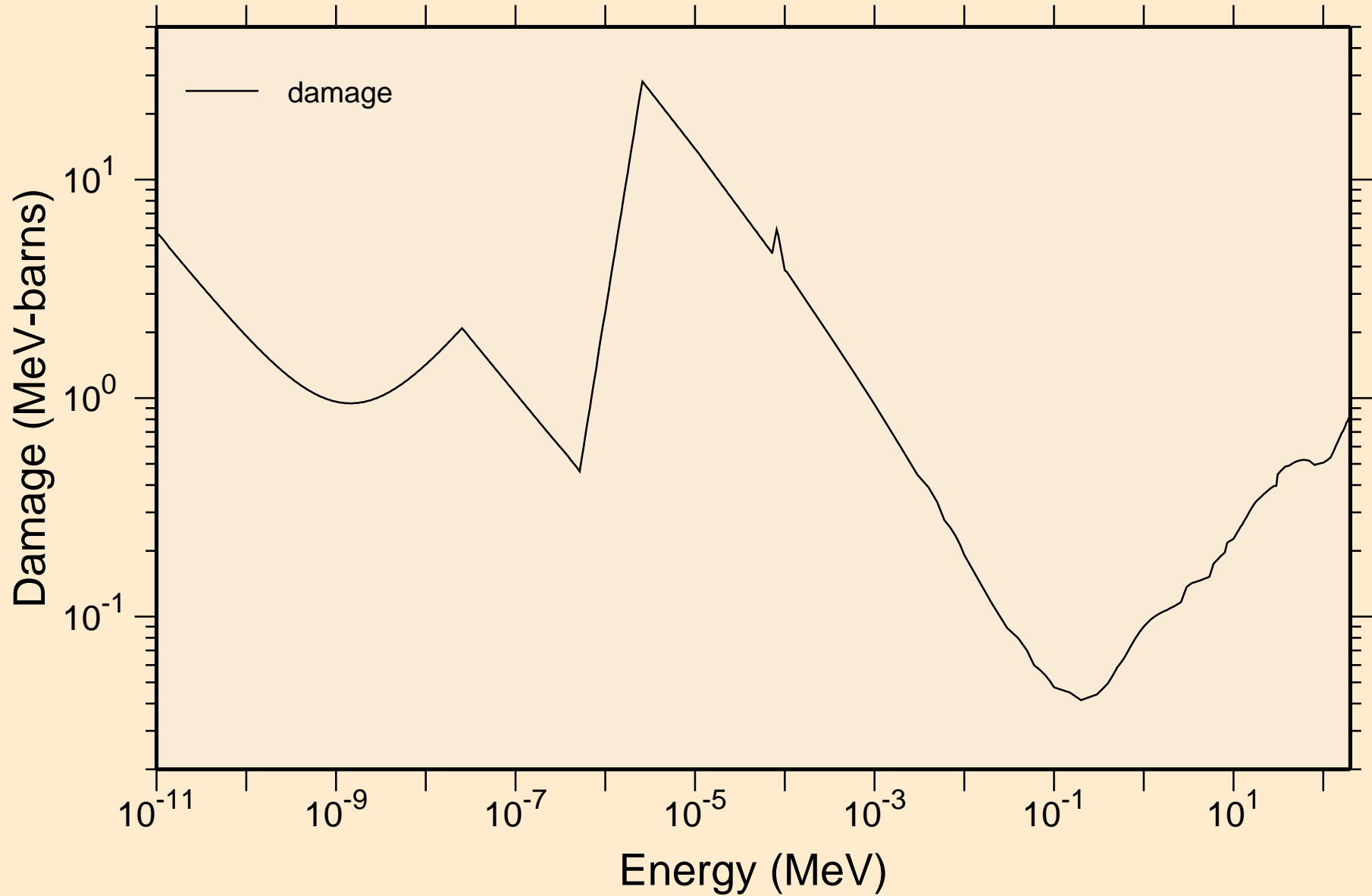

DY144 NEUTRON ACER TENDL-2023 LIBRARY; T=0.K

Non-threshold reactions

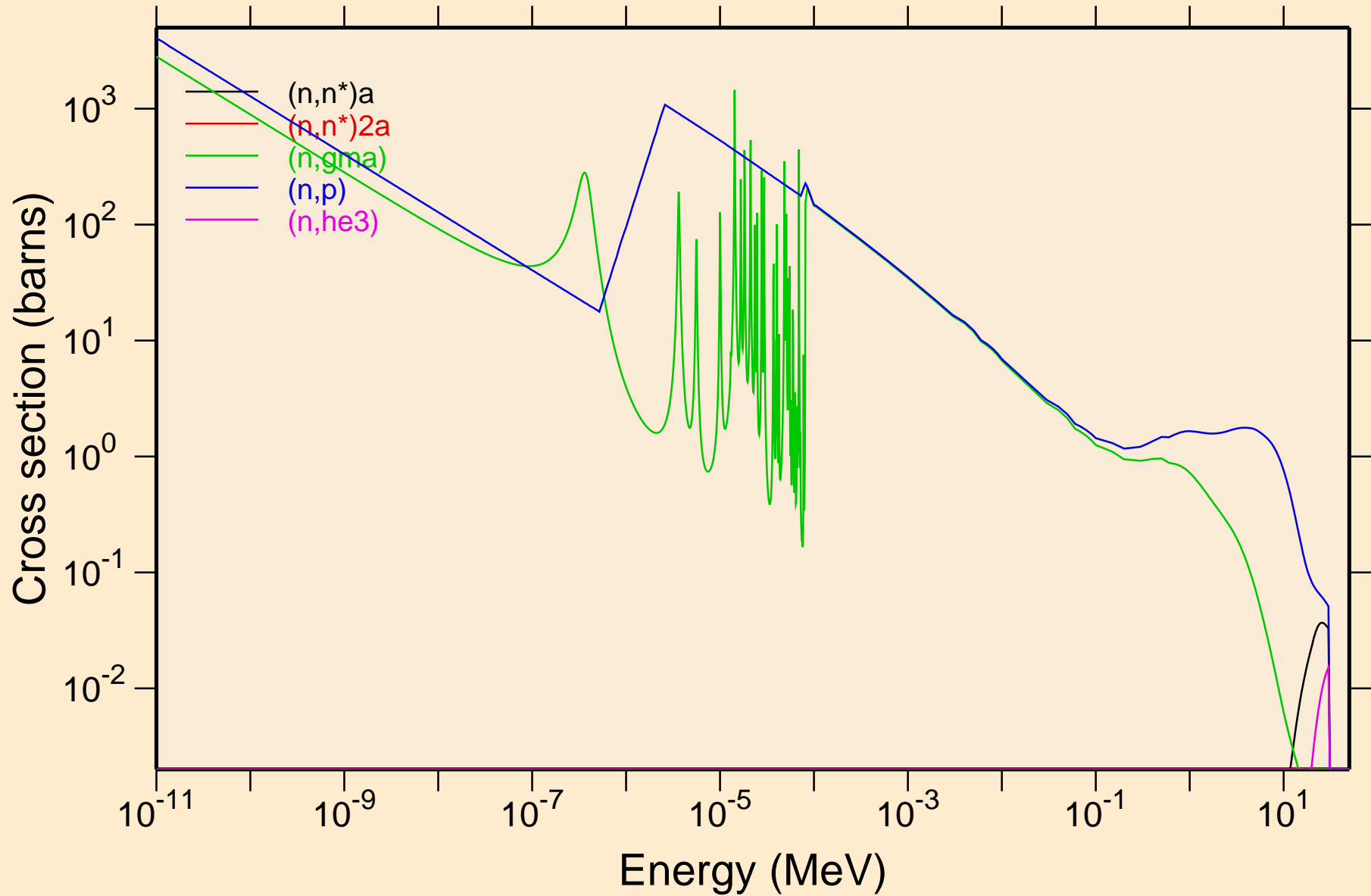

DY144 NEUTRON ACER TENDL-2023 LIBRARY; T=0.K
Non-threshold reactions

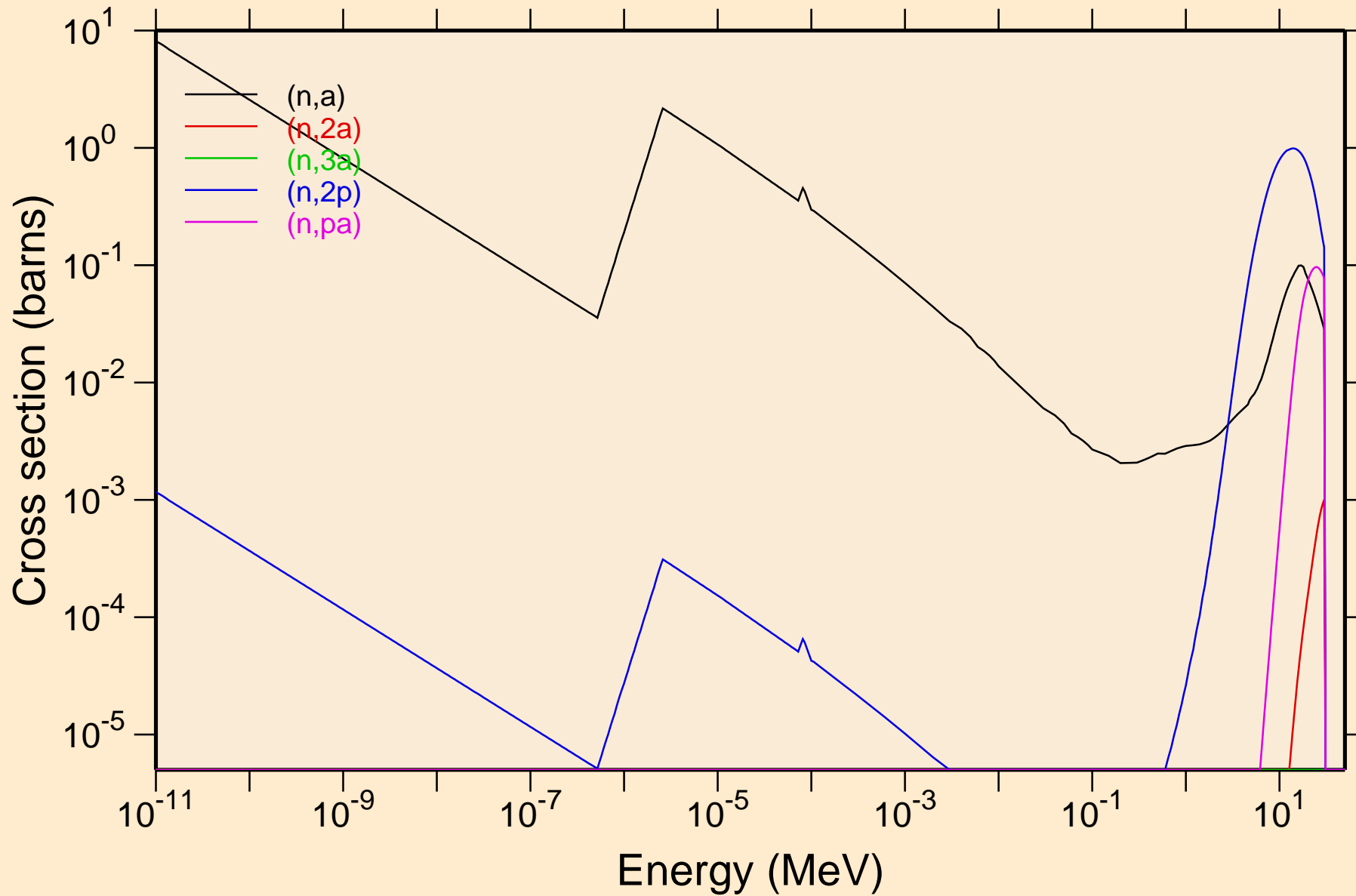

DY144 NEUTRON ACER TENDL-2023 LIBRARY; T=0.K
Non-threshold reactions

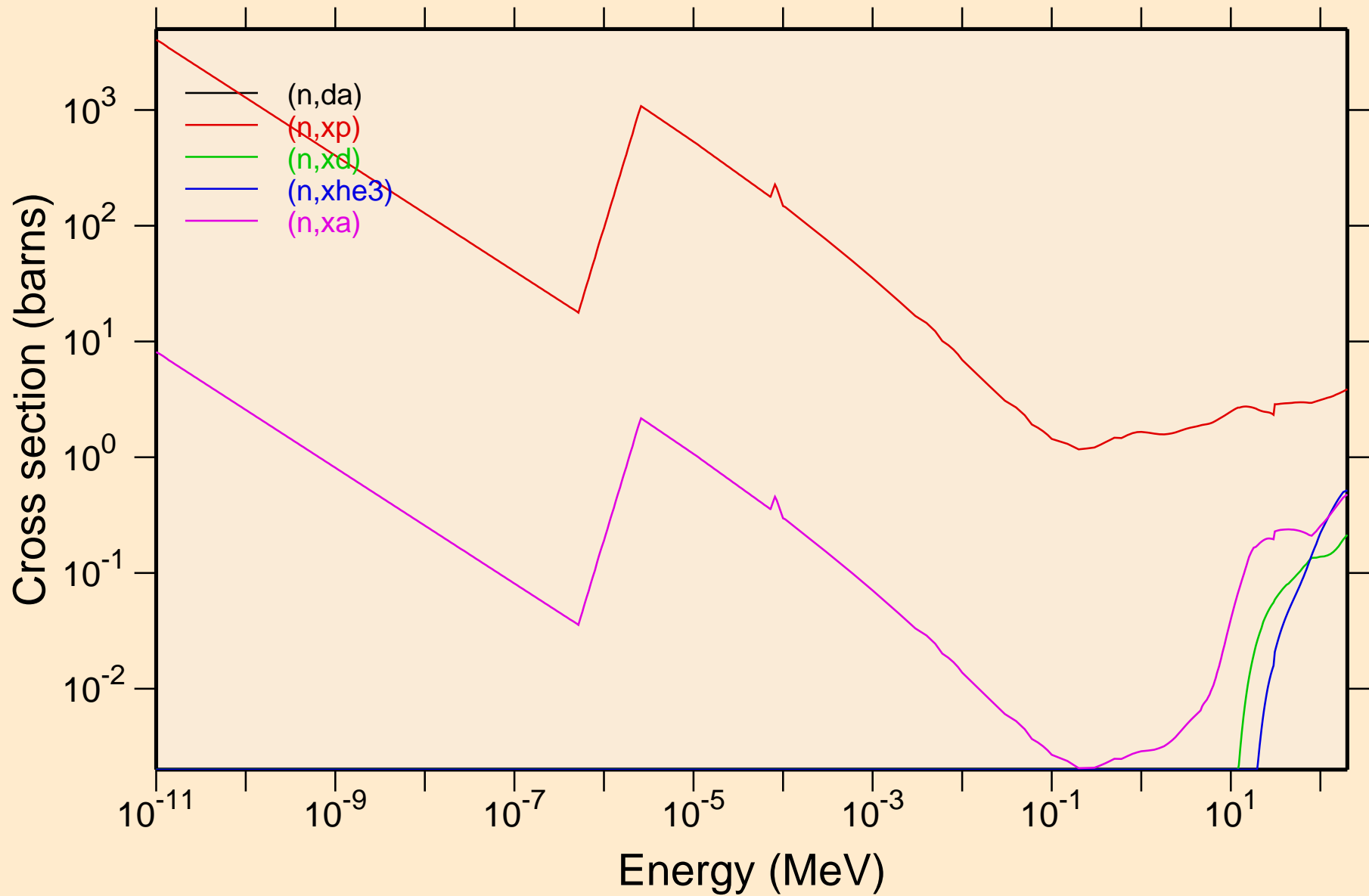

DY144 NEUTRON ACER TENDL-2023 LIBRARY; T=0.K

Principal cross sections

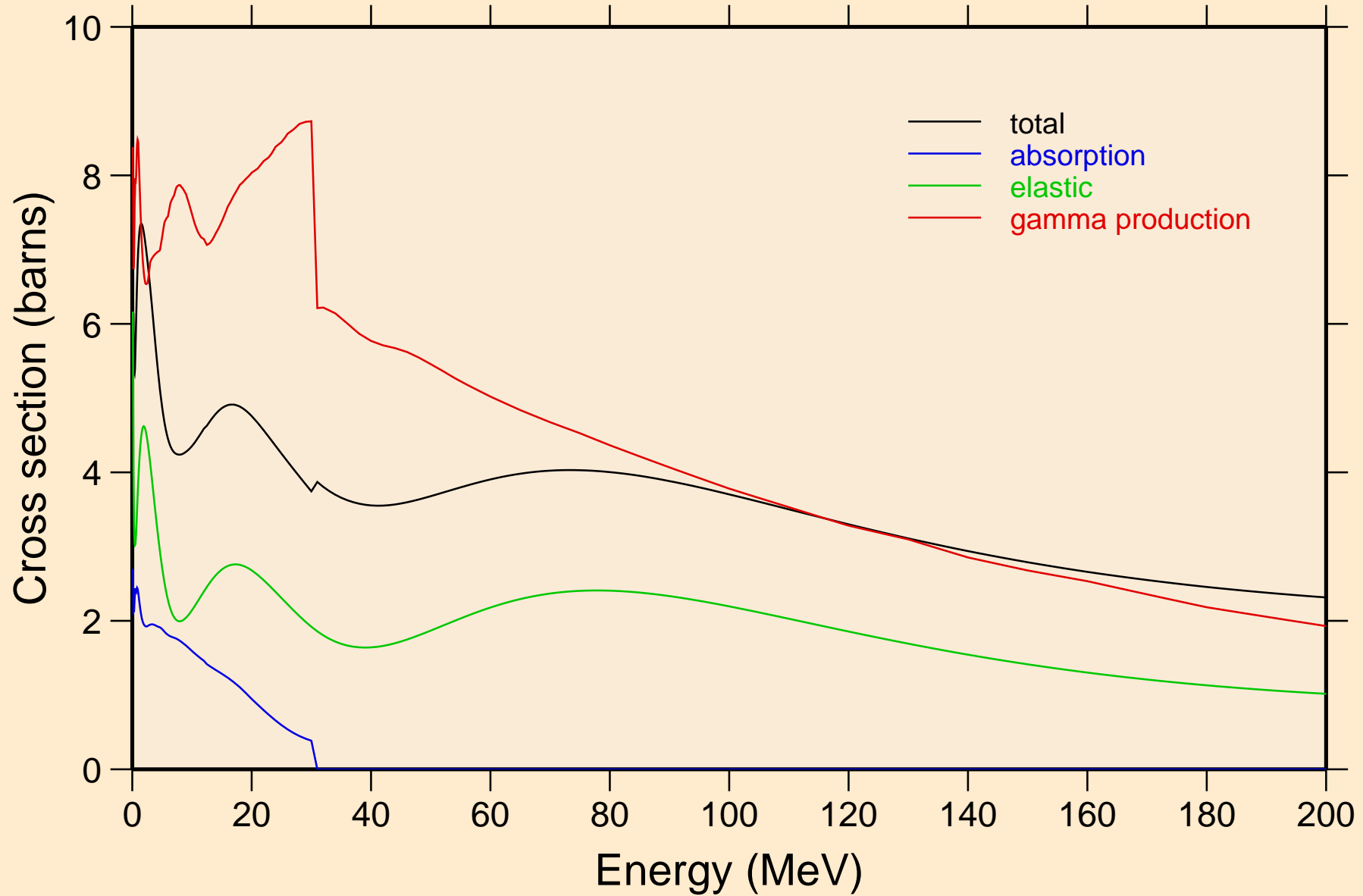

DY144 NEUTRON ACER TENDL-2023 LIBRARY; T=0.K

Heating

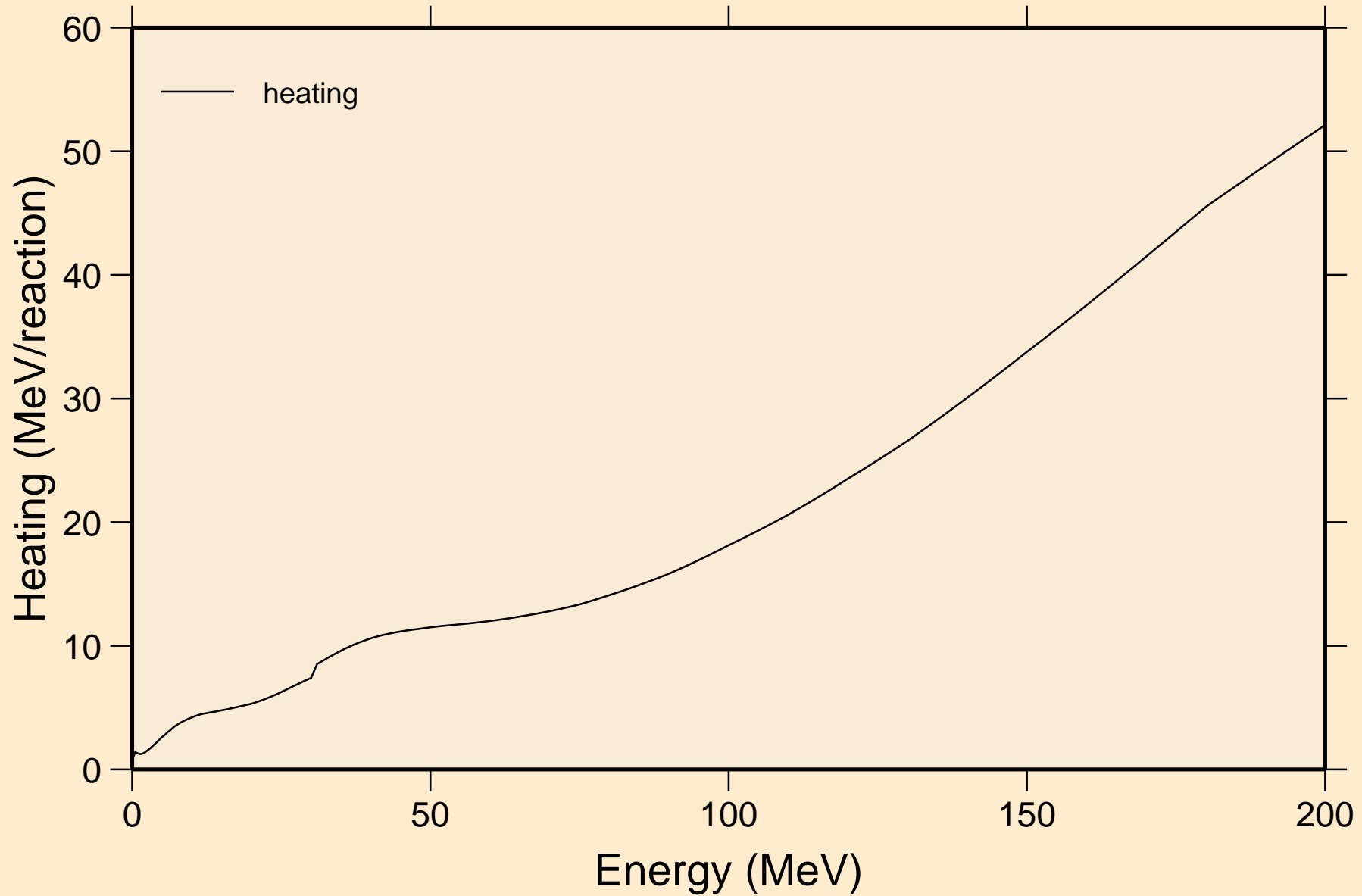

DY144 NEUTRON ACER TENDL-2023 LIBRARY; T=0.K
Damage

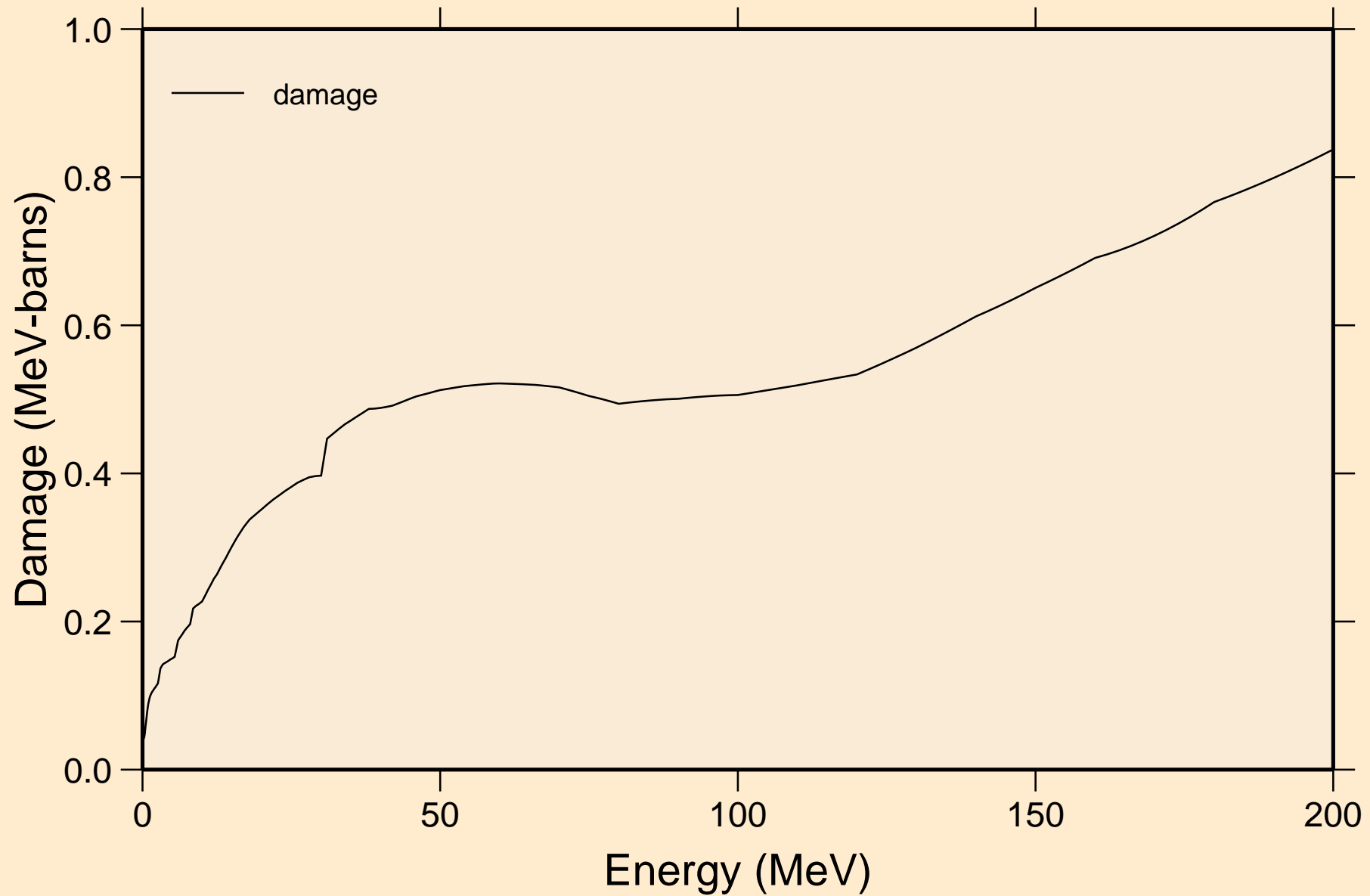

DY144 NEUTRON ACER TENDL-2023 LIBRARY; T=0.K
Non-threshold reactions

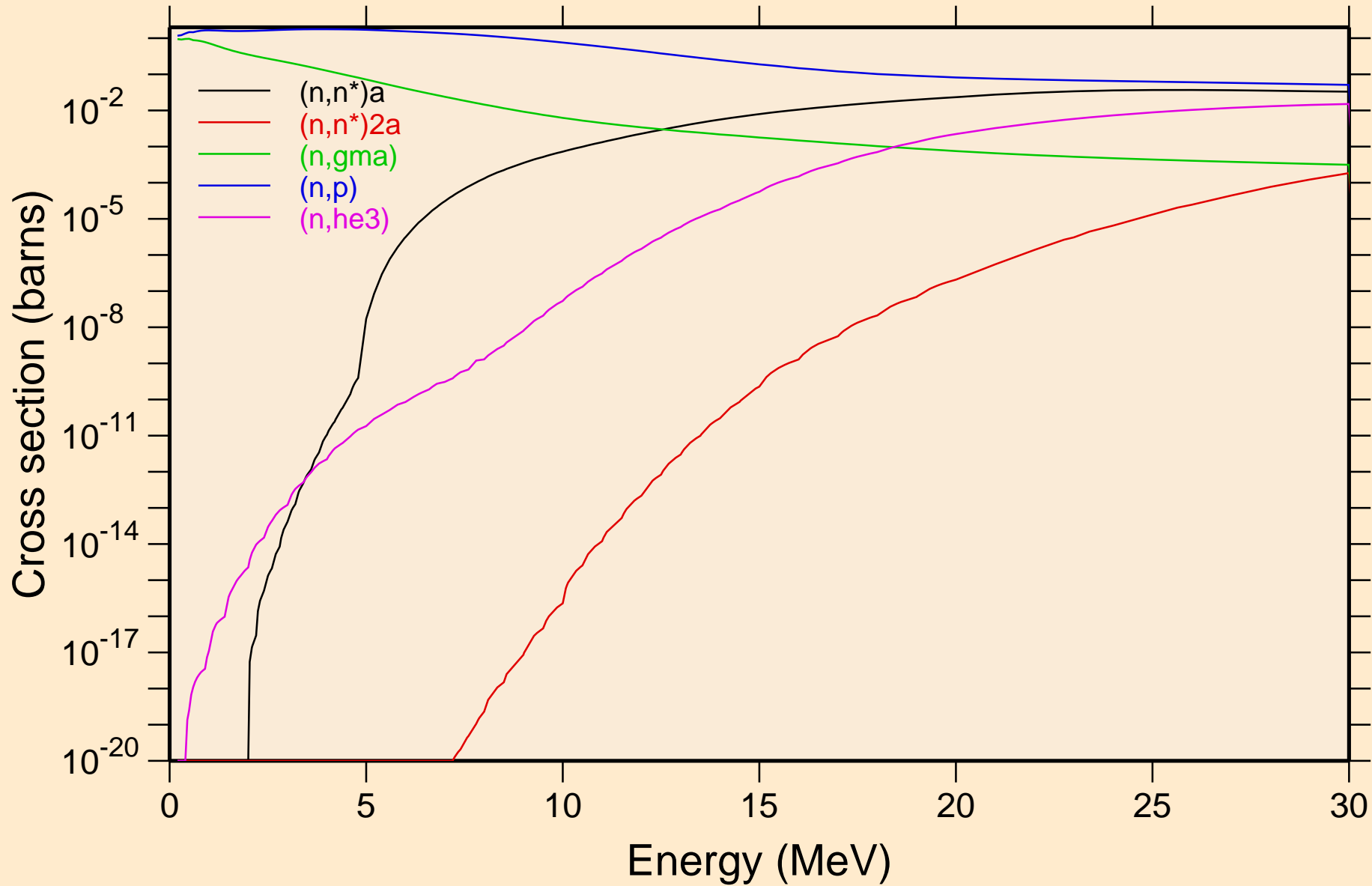

DY144 NEUTRON ACER TENDL-2023 LIBRARY; T=0.K
Non-threshold reactions

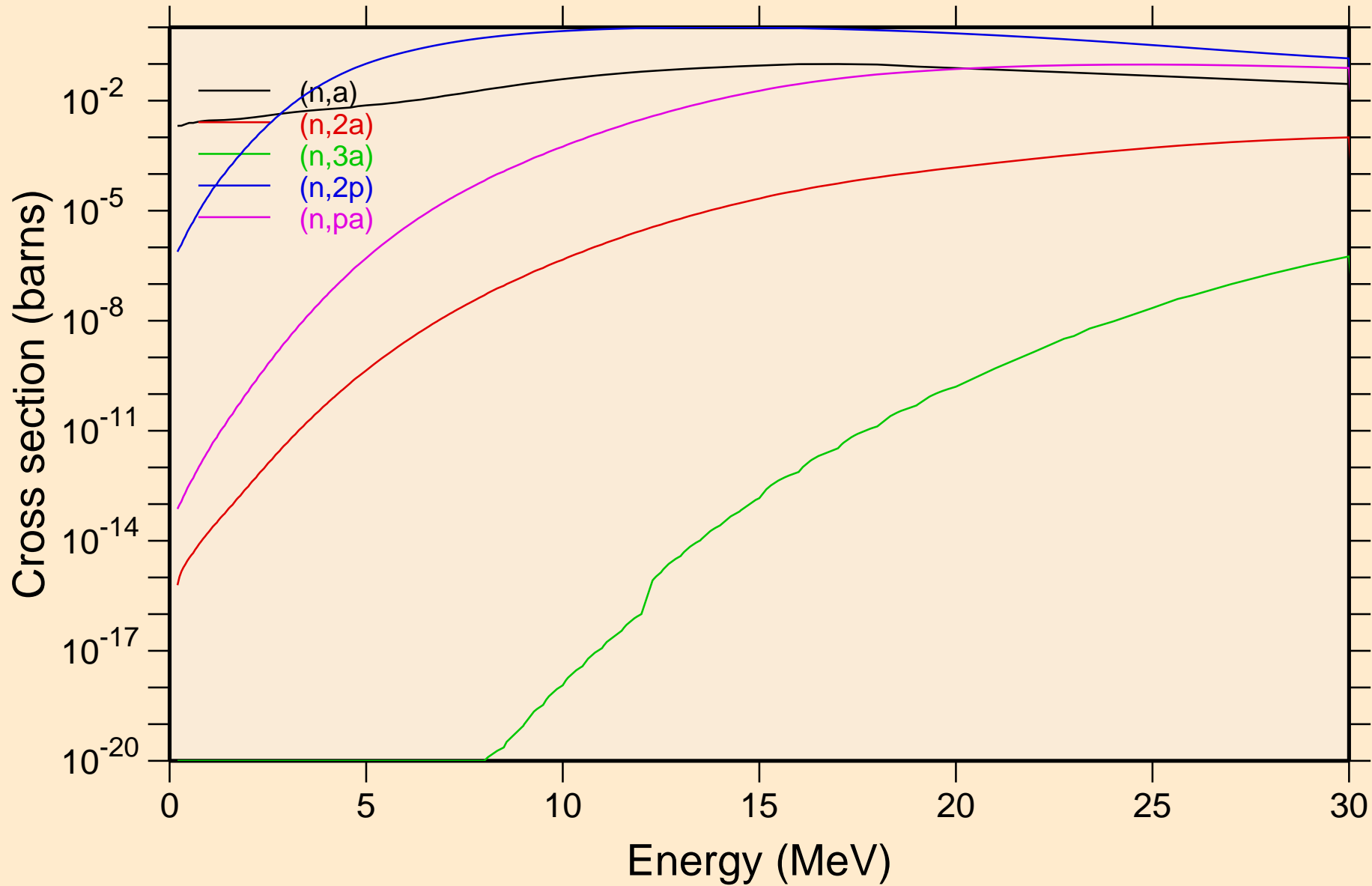

DY144 NEUTRON ACER TENDL-2023 LIBRARY; T=0.K
Non-threshold reactions

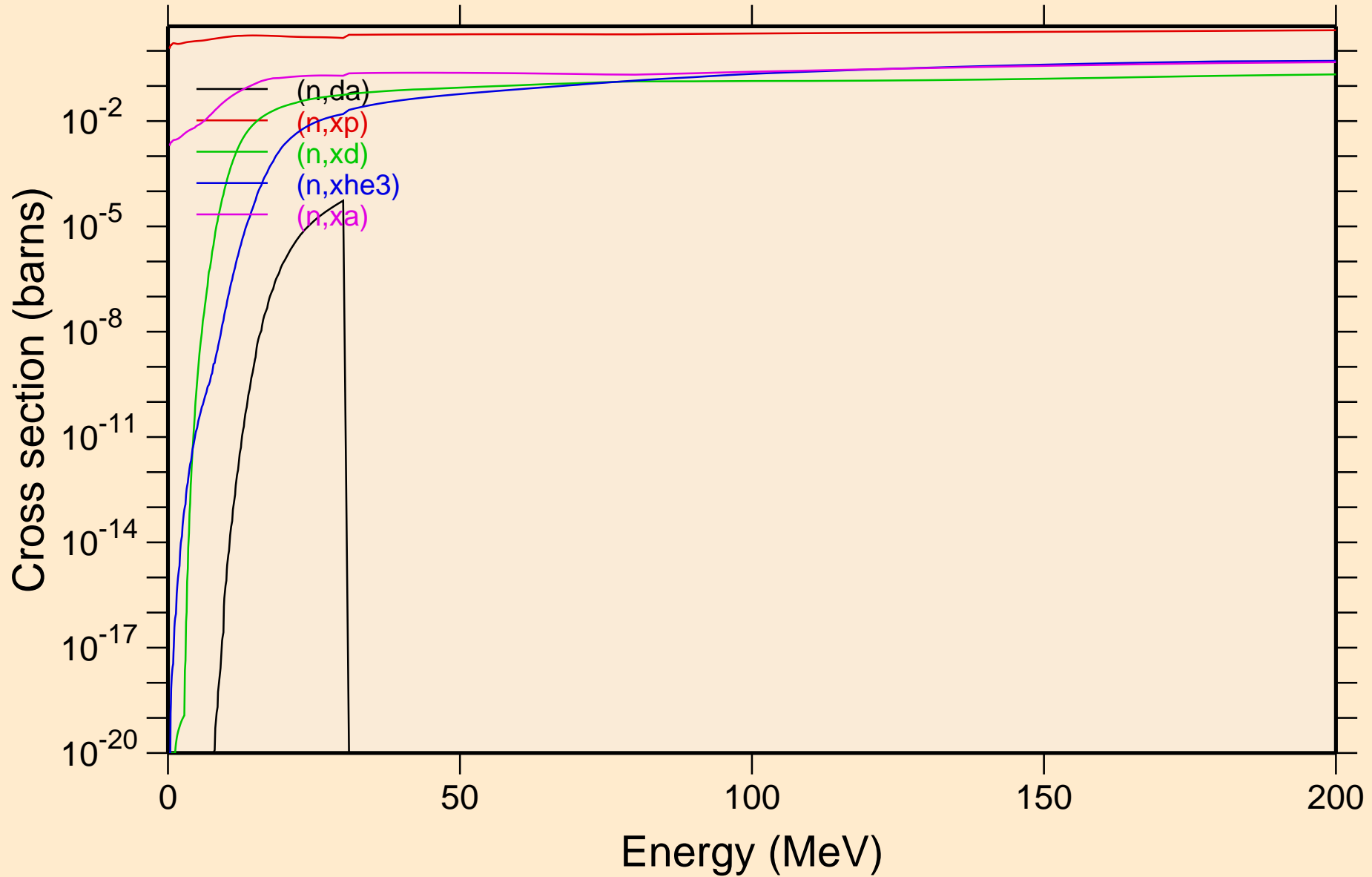

DY144 NEUTRON ACER TENDL-2023 LIBRARY; T=0.K
Inelastic levels

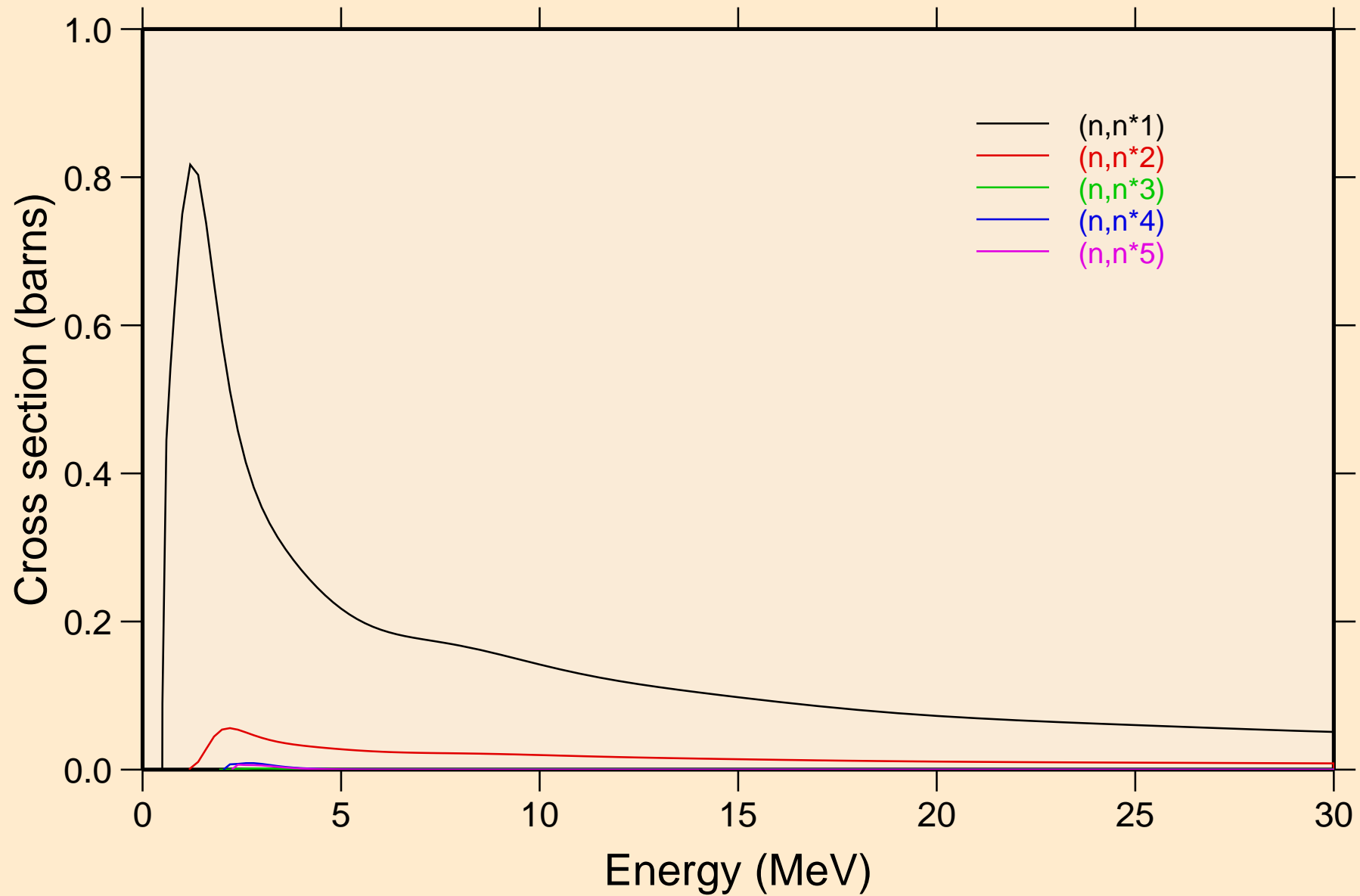

DY144 NEUTRON ACER TENDL-2023 LIBRARY; T=0.K
Inelastic levels

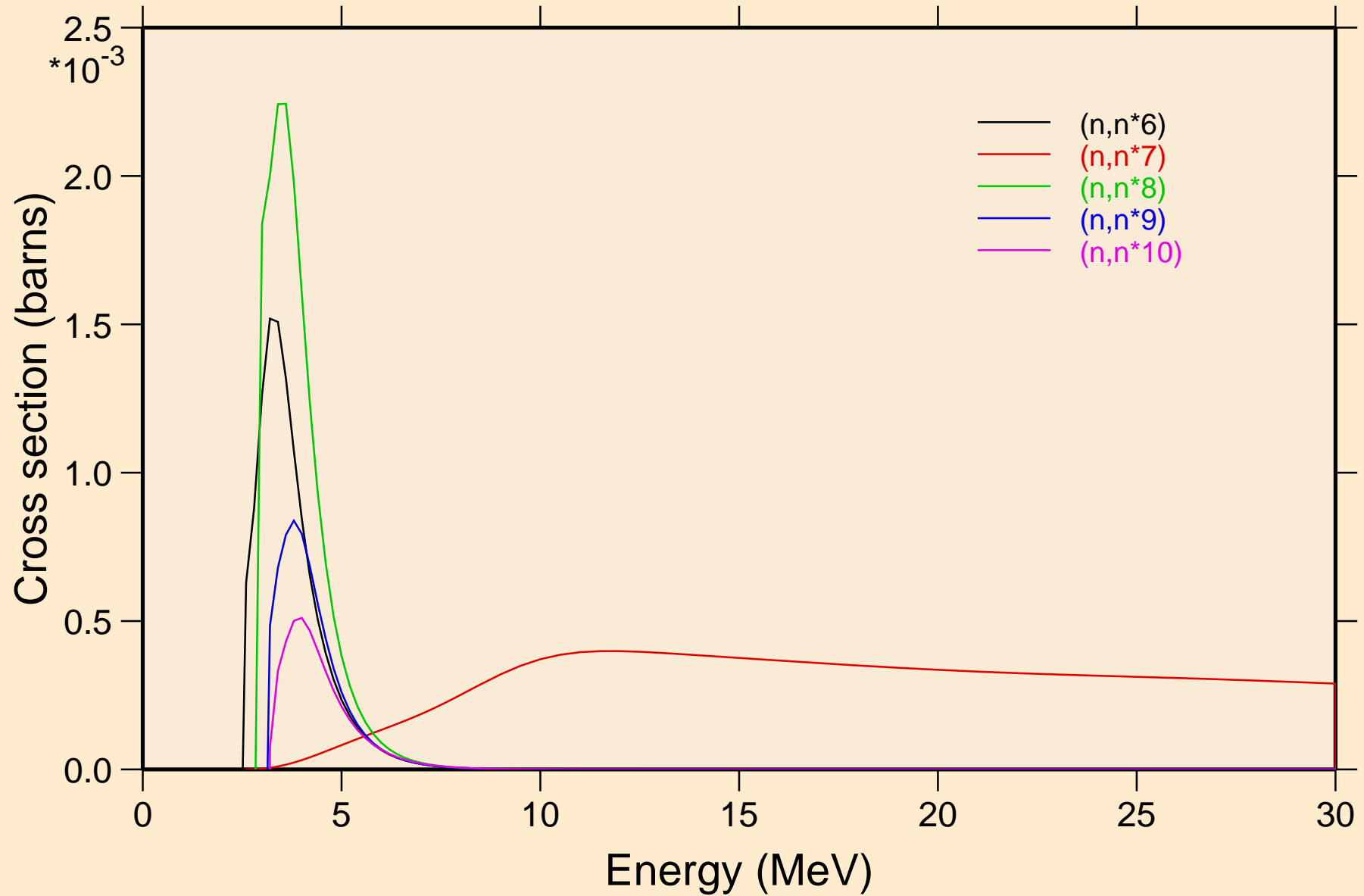

DY144 NEUTRON ACER TENDL-2023 LIBRARY; T=0.K
Inelastic levels

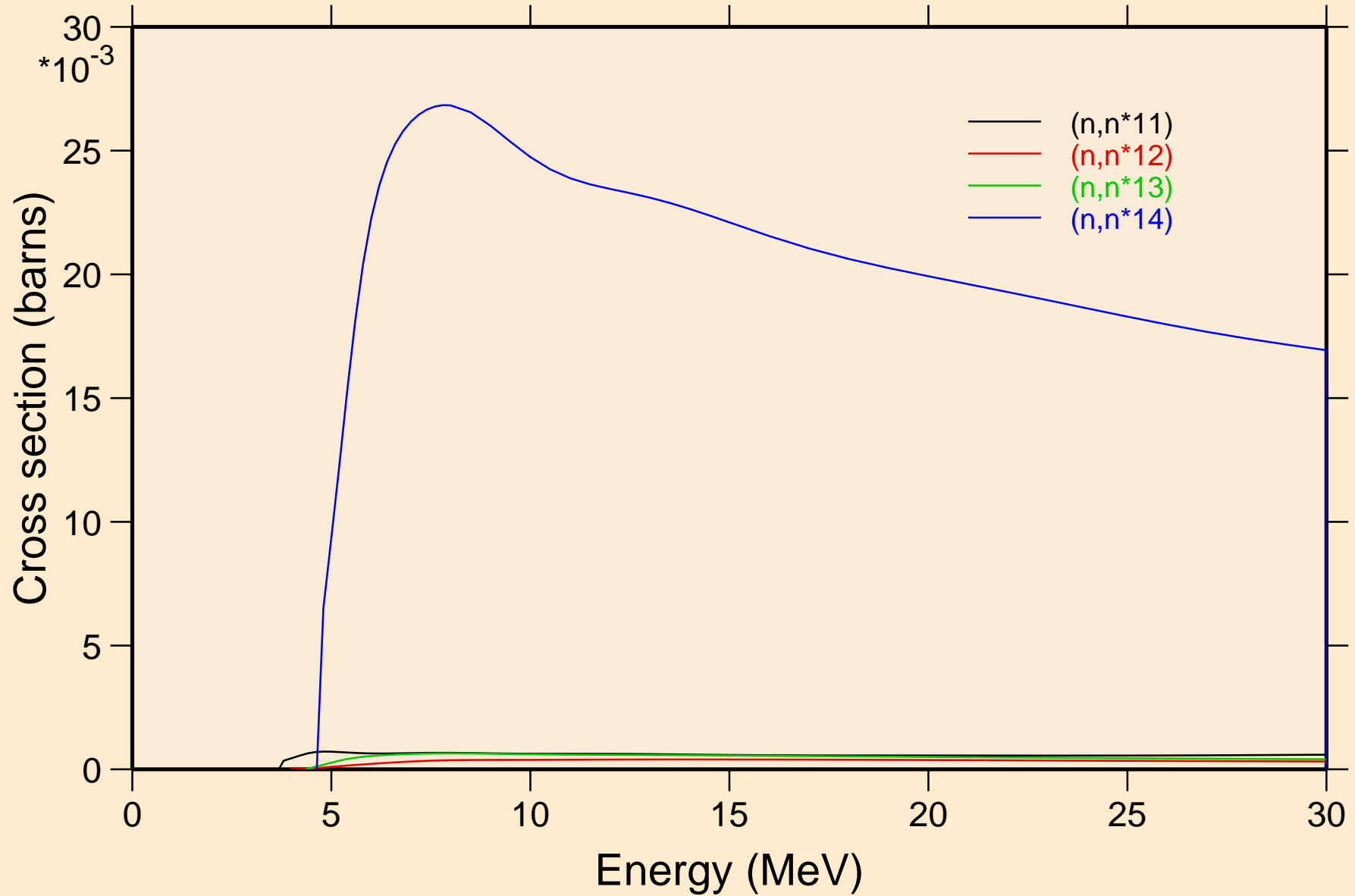

DY144 NEUTRON ACER TENDL-2023 LIBRARY; T=0.K
Threshold reactions

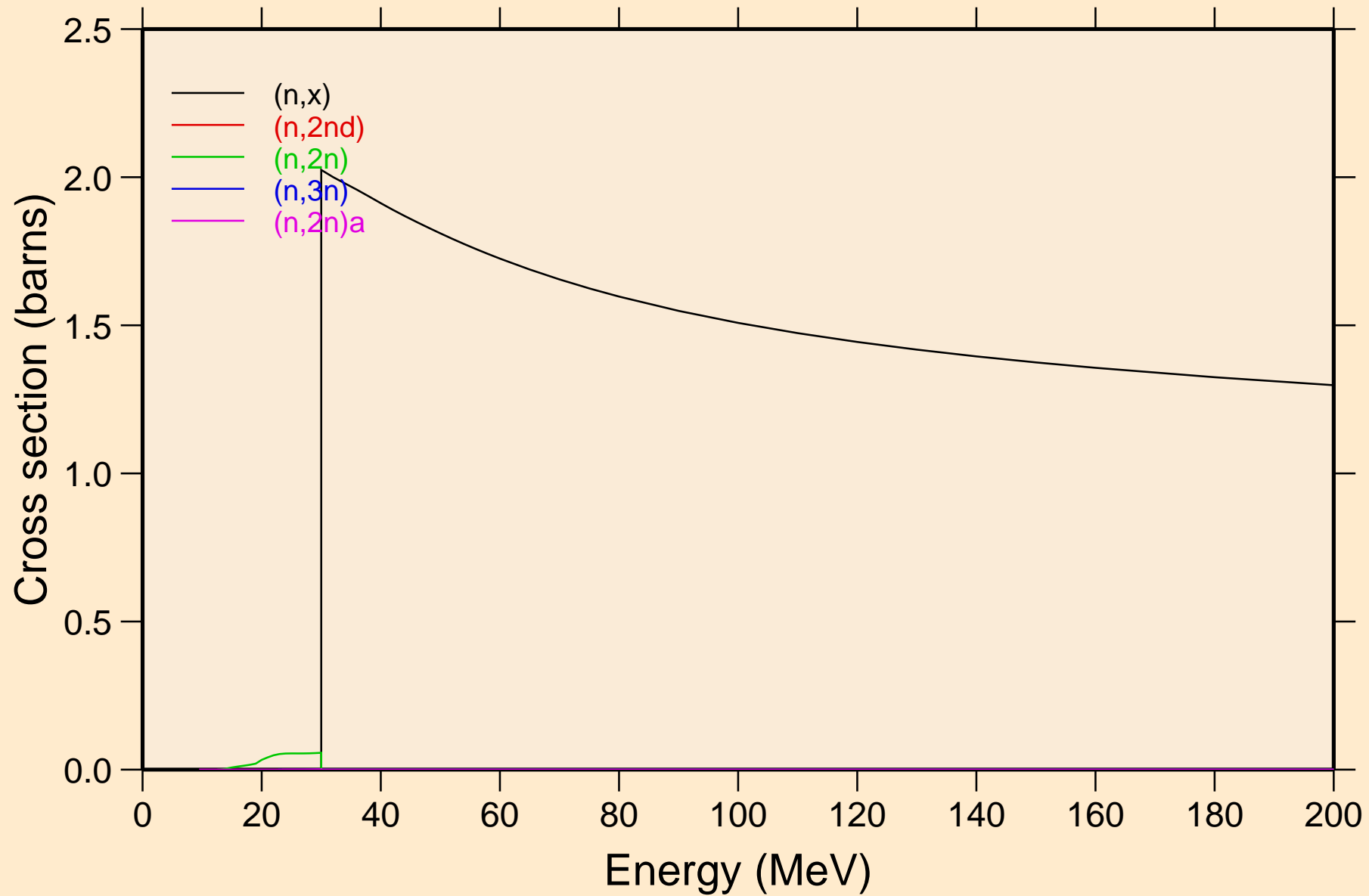

DY144 NEUTRON ACER TENDL-2023 LIBRARY; T=0.K
Threshold reactions

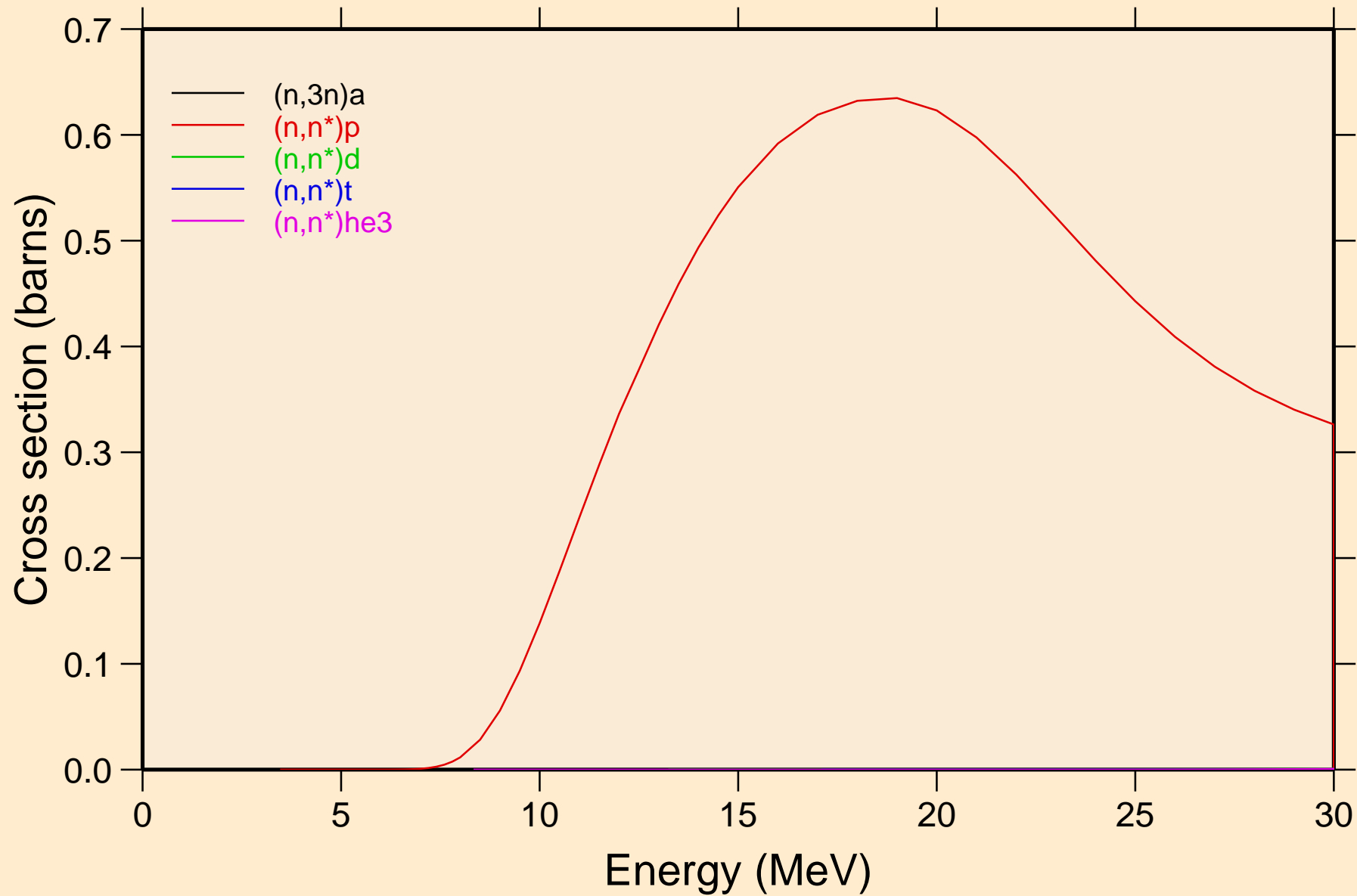

DY144 NEUTRON ACER TENDL-2023 LIBRARY; T=0.K
Threshold reactions

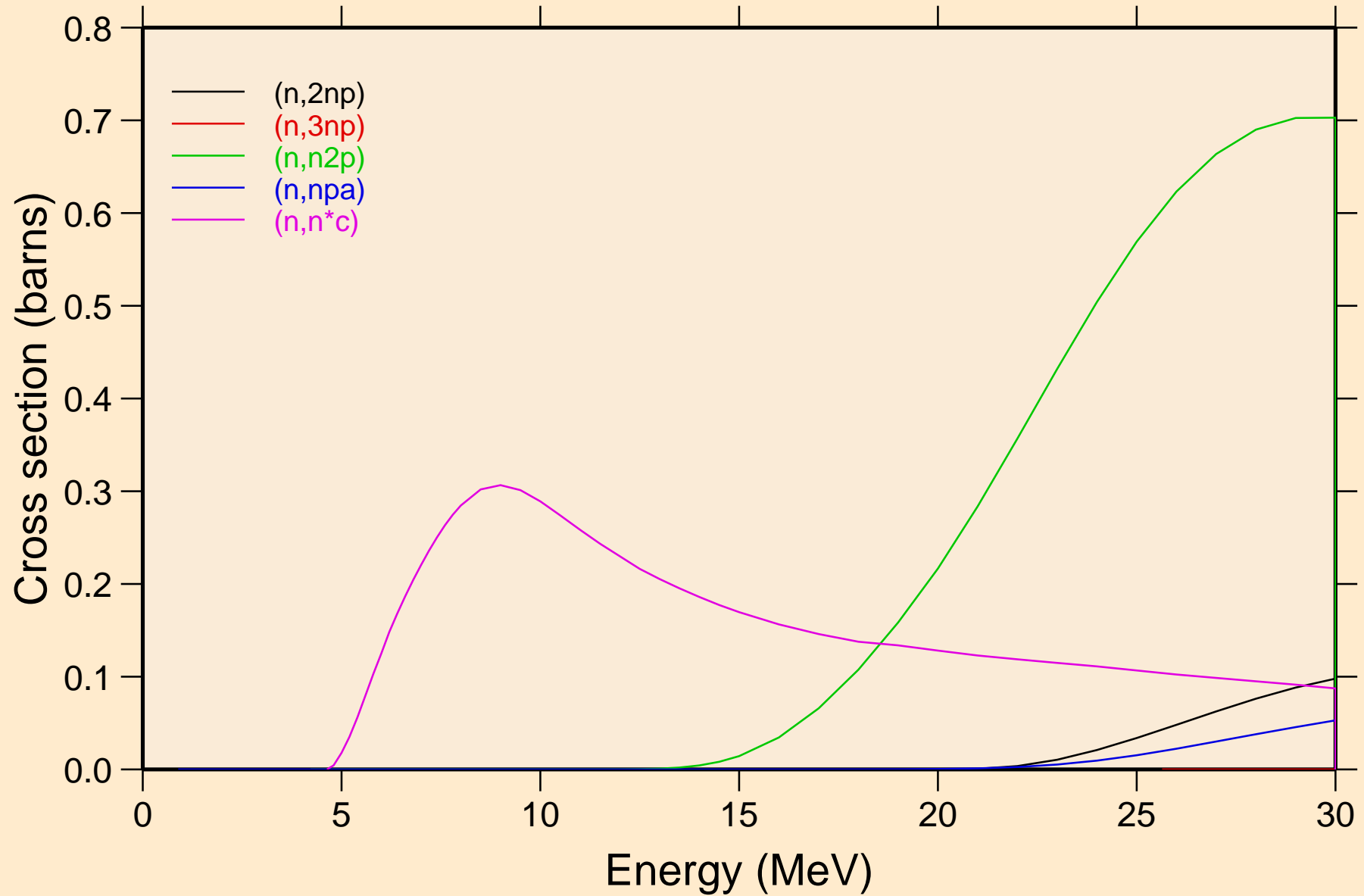

DY144 NEUTRON ACER TENDL-2023 LIBRARY; T=0.K

Threshold reactions

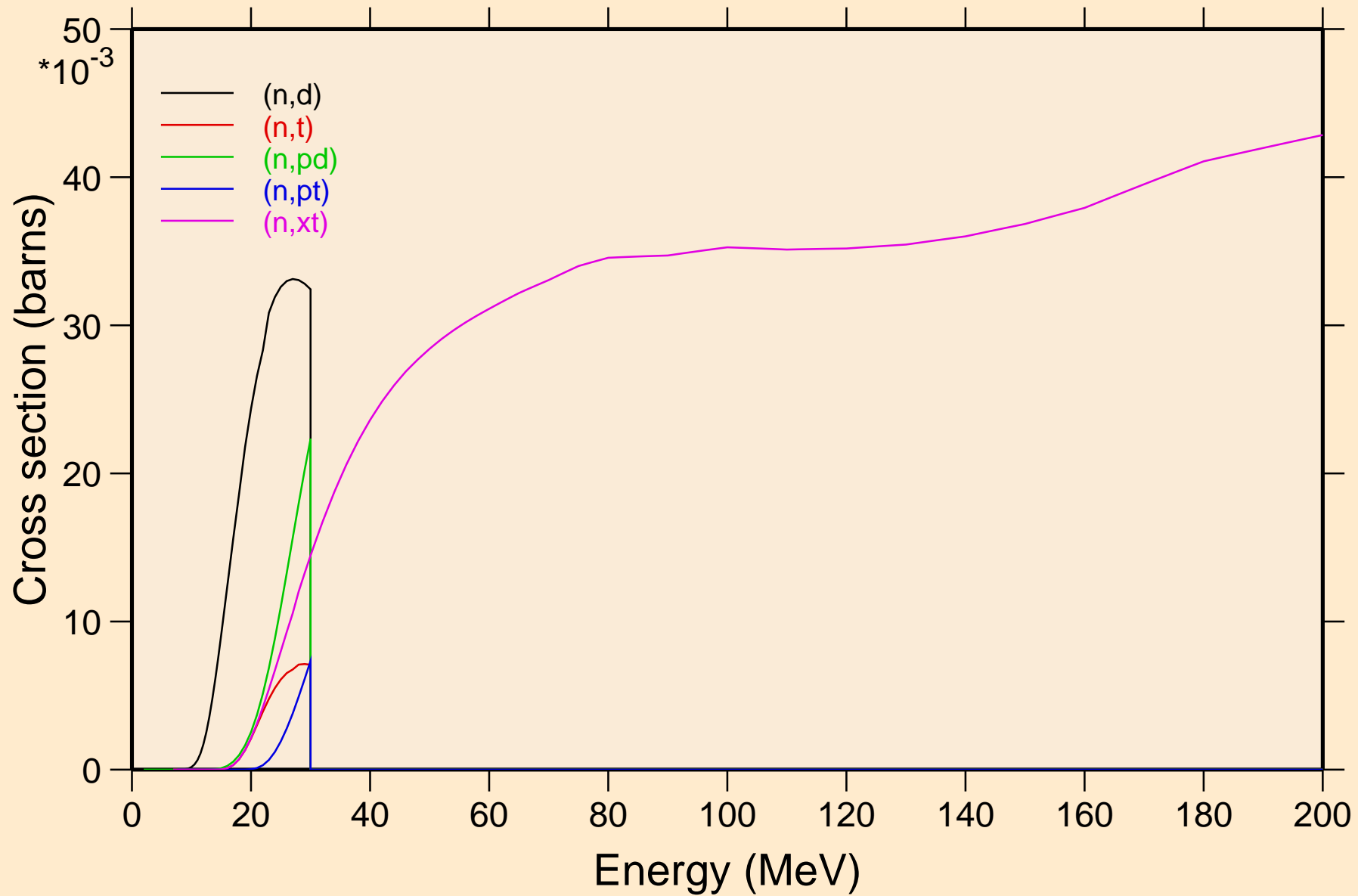

DY144 NEUTRON ACER TENDL-2023 LIBRARY; T=0.K
angular distribution for elastic

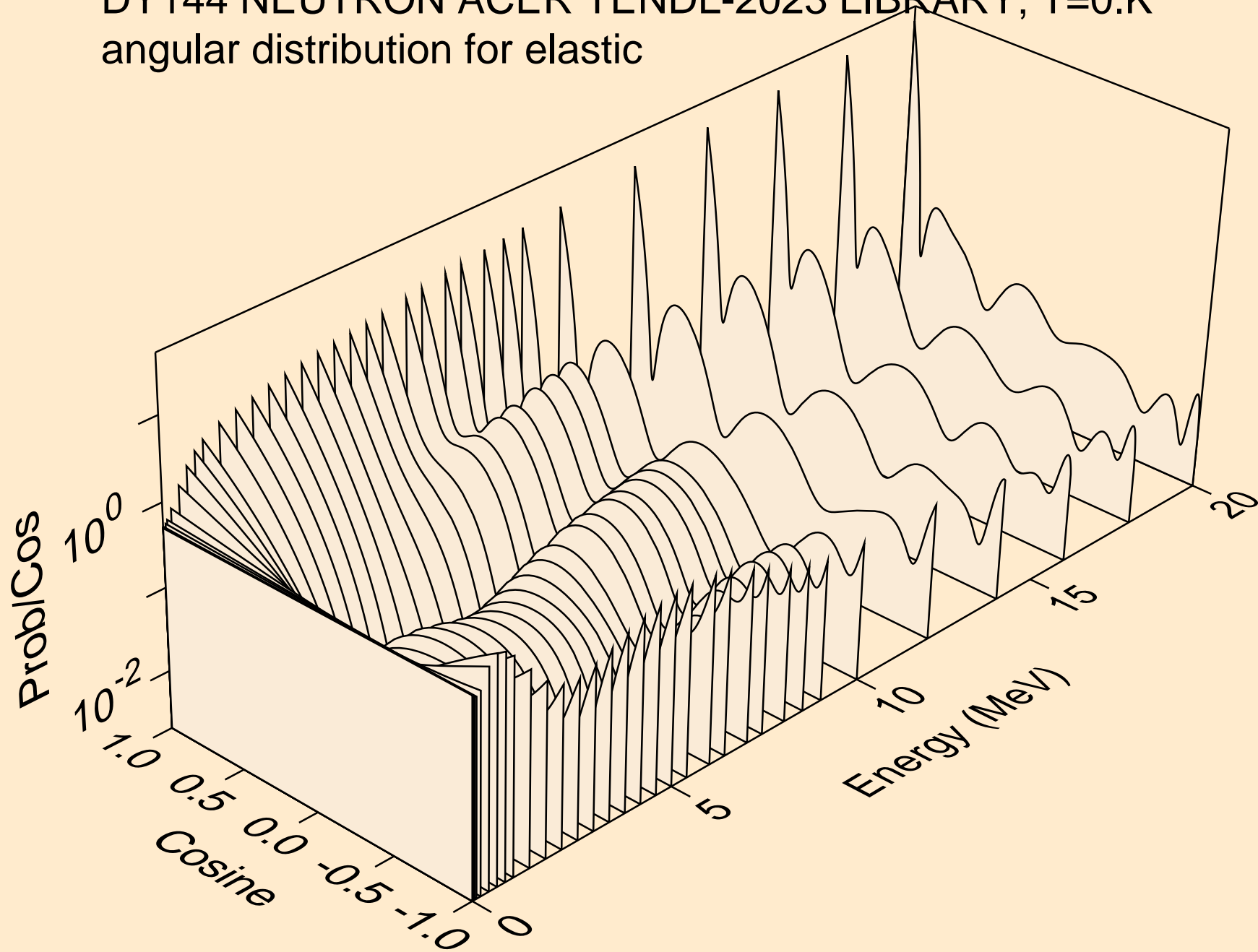

DY144 NEUTRON ACER TENDL-2023 LIBRARY; T=0.K
angular distribution for elastic

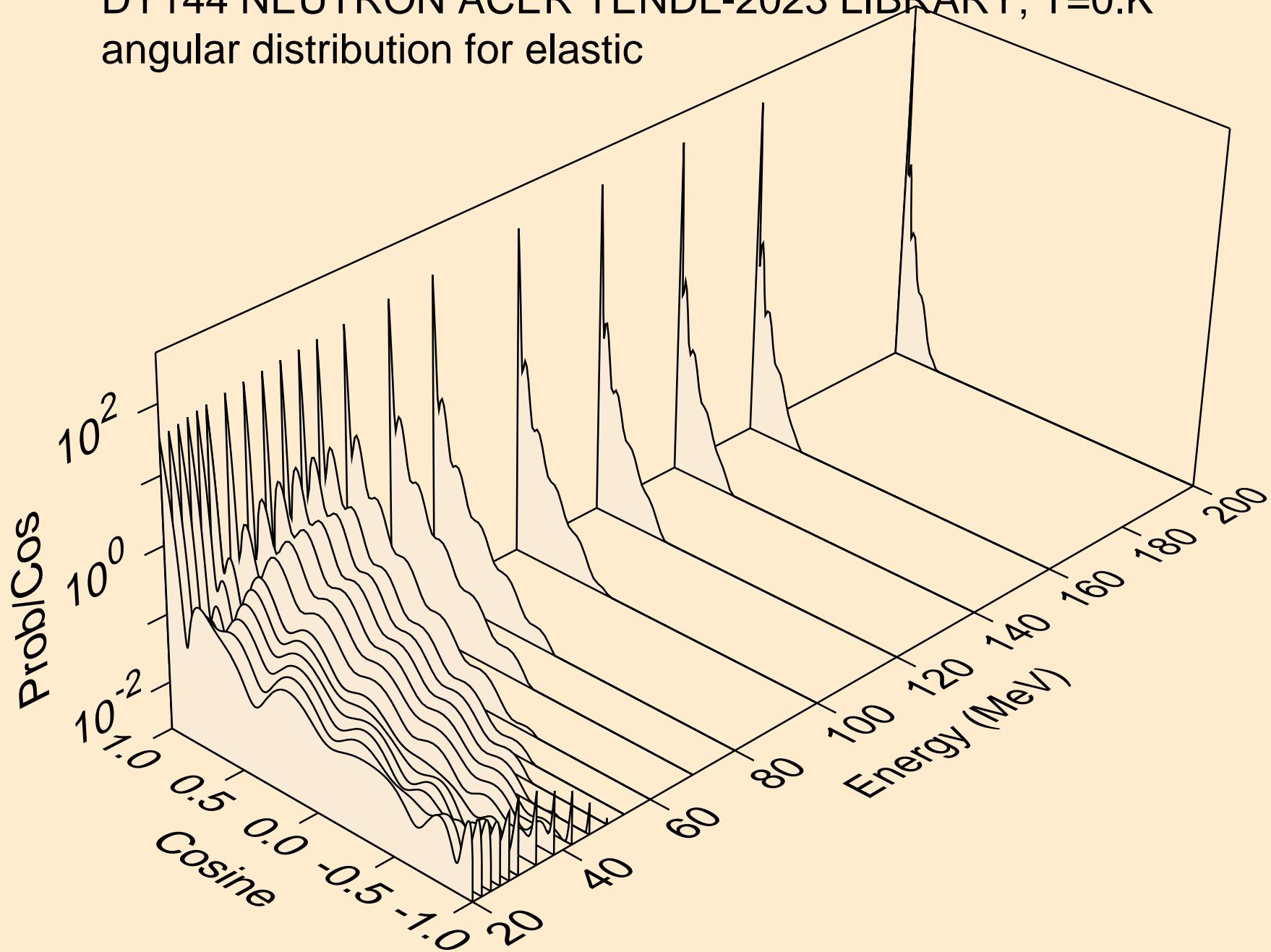

DY144 NEUTRON ACER TENDL-2023 LIBRARY; T=0.K
angular distribution for (n,n*1)

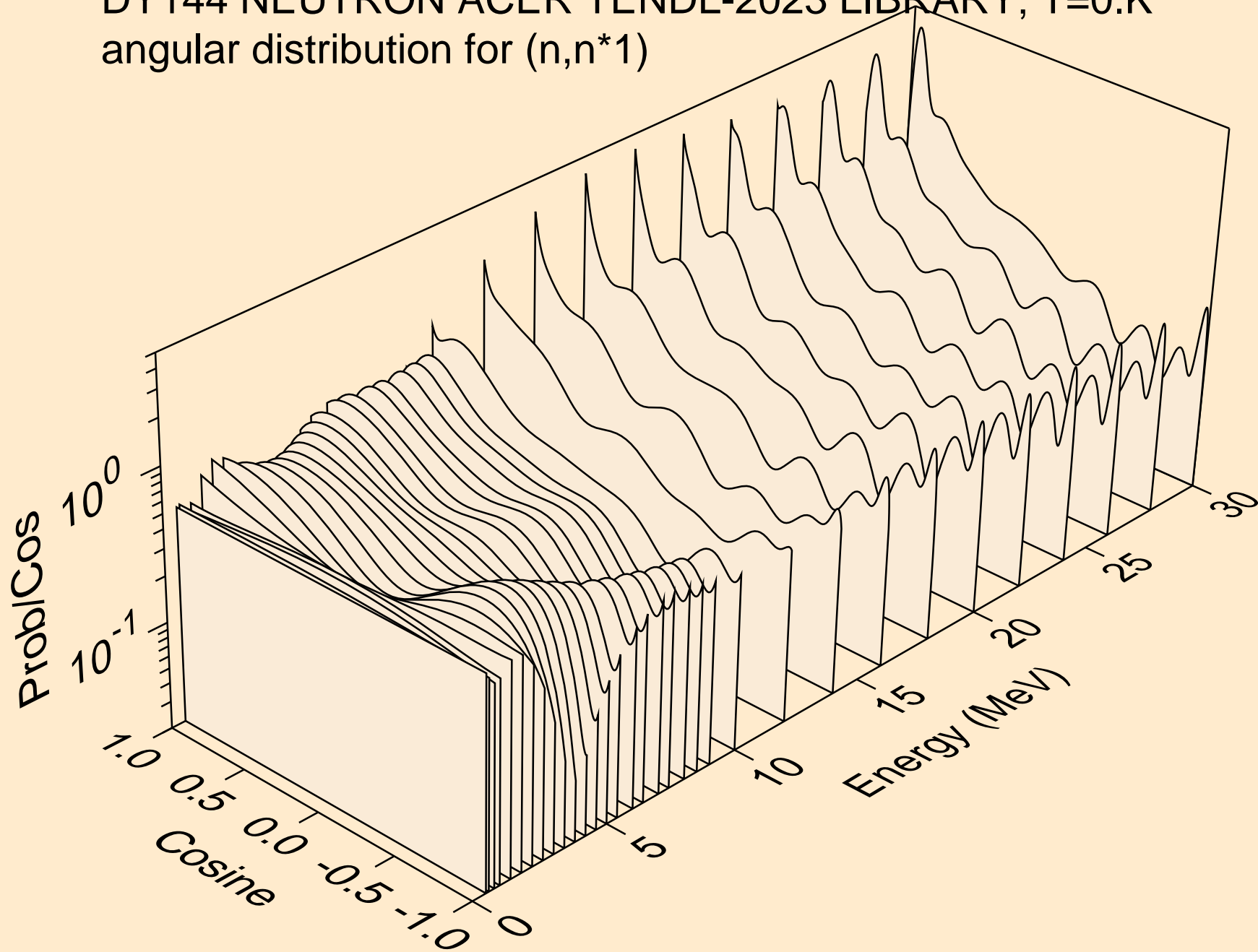

DY144 NEUTRON ACER TENDL-2023 LIBRARY; T=0.K
angular distribution for (n,n*2)

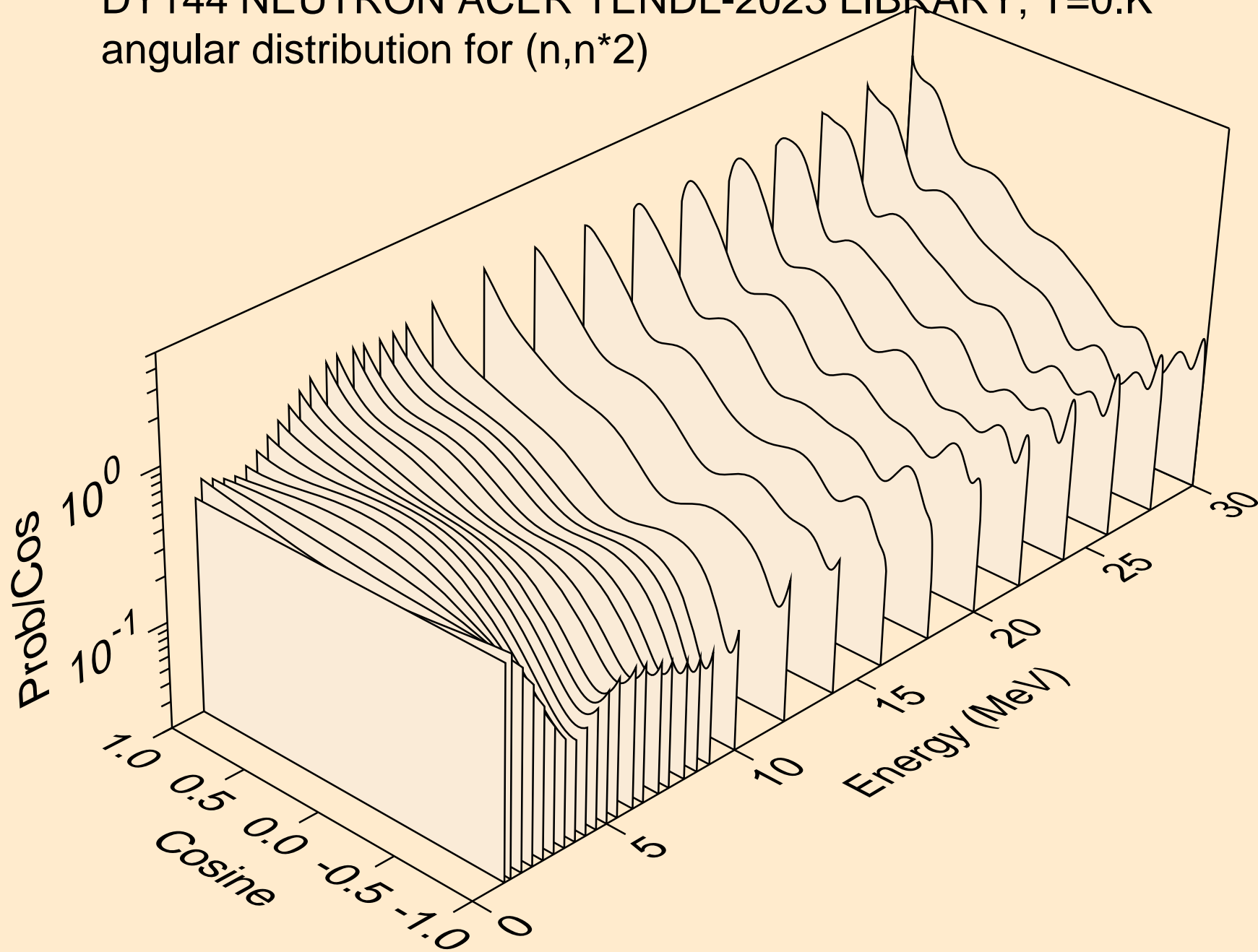

DY144 NEUTRON ACER TENDL-2023 LIBRARY; T=0.K
angular distribution for (n,n*3)

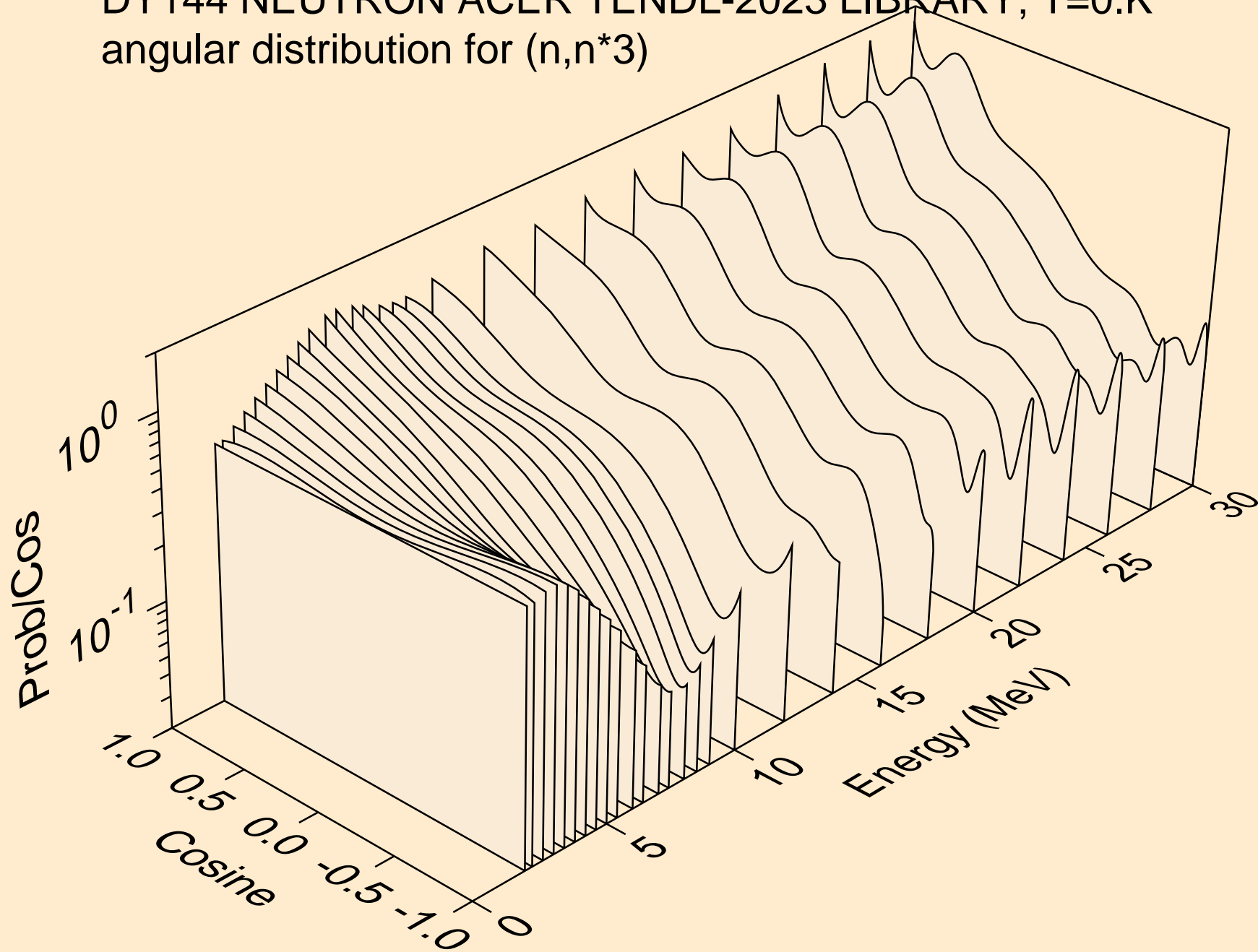

DY144 NEUTRON ACER TENDL-2023 LIBRARY; T=0.K
angular distribution for (n,n*4)

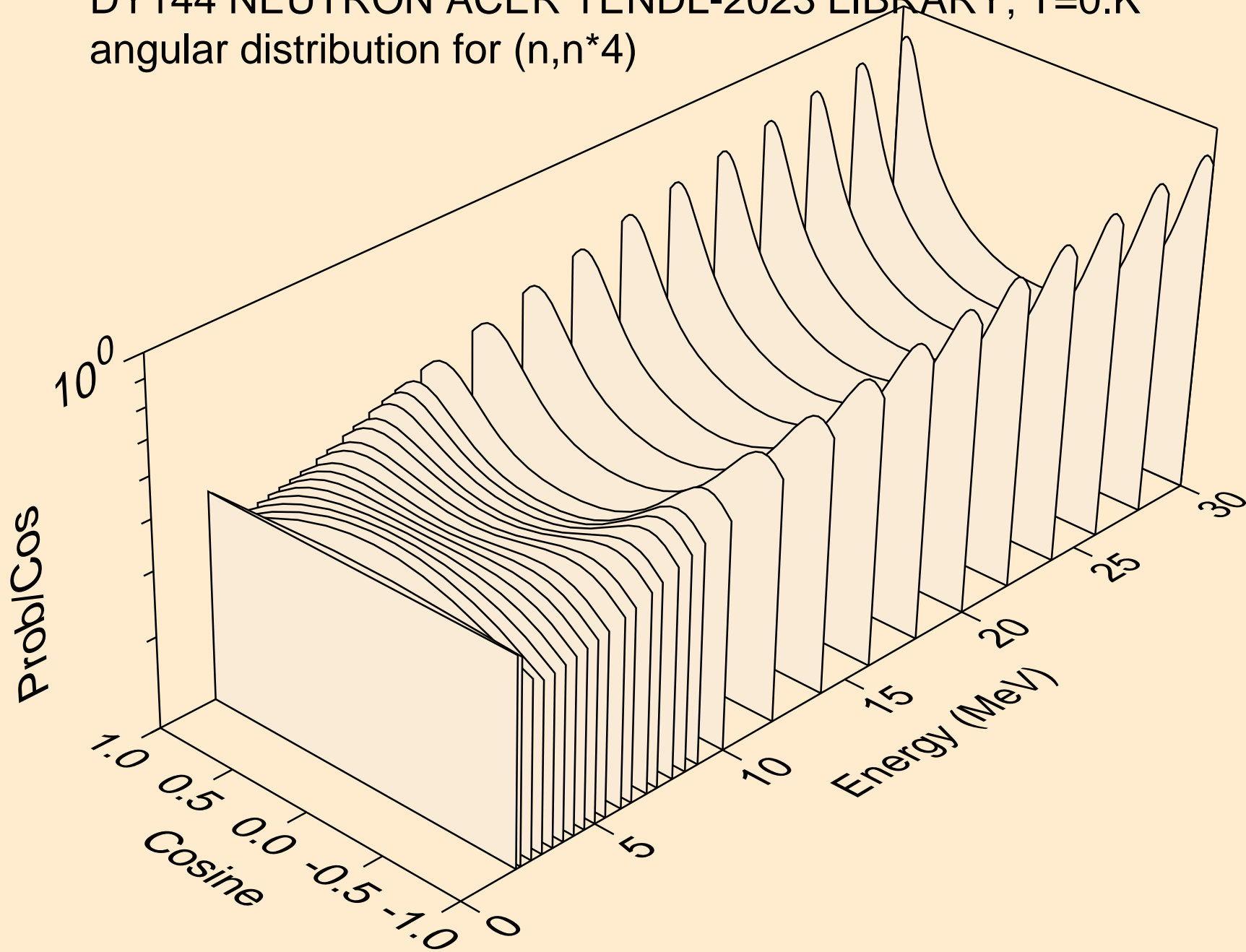

DY144 NEUTRON ACER TENDL-2023 LIBRARY; T=0.K
angular distribution for (n,n*5)

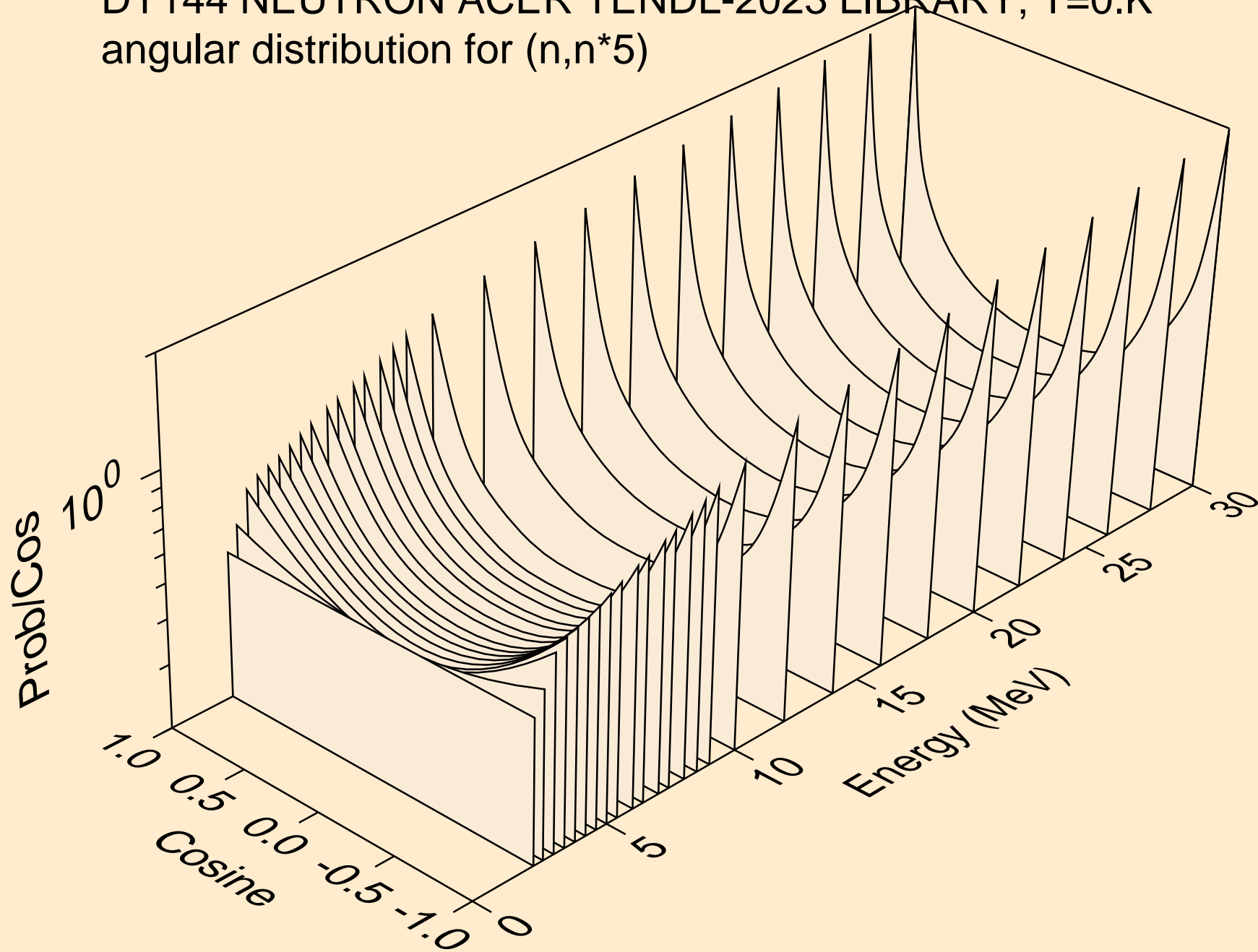

DY144 NEUTRON ACER TENDL-2023 LIBRARY; T=0.K
angular distribution for (n,n*6)

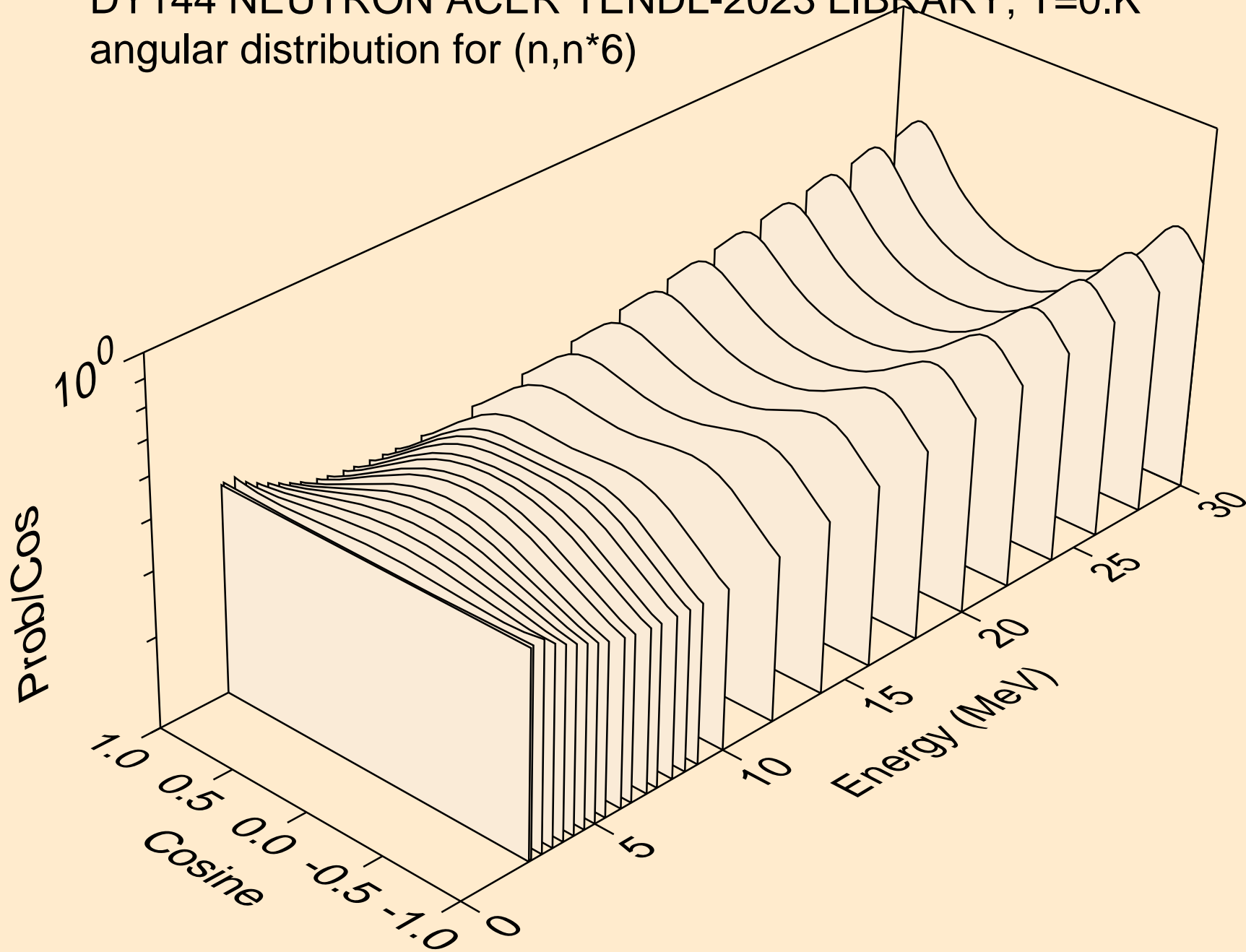

DY144 NEUTRON ACER TENDL-2023 LIBRARY; T=0.K
angular distribution for (n,n*7)

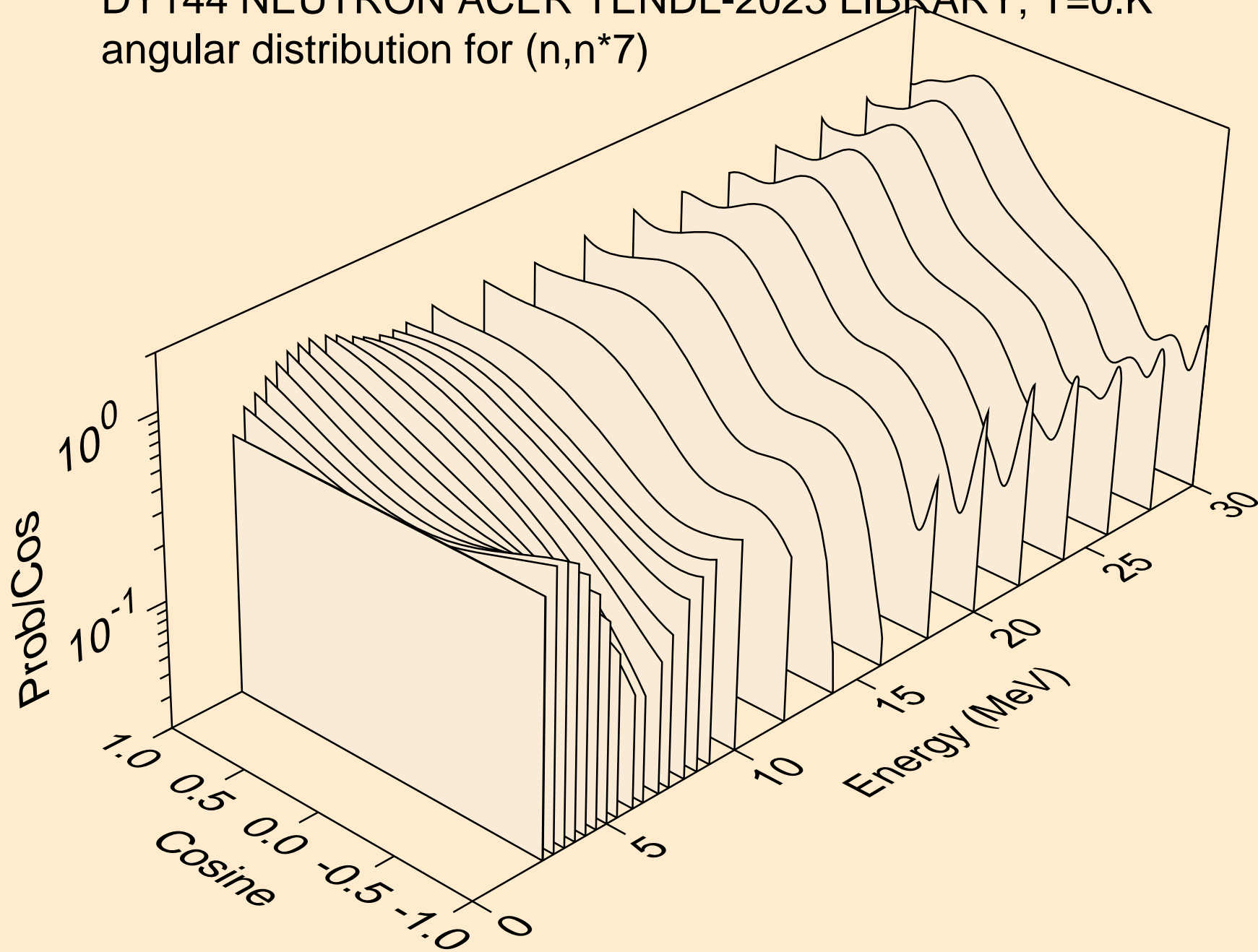

DY144 NEUTRON ACER TENDL-2023 LIBRARY; T=0.K
angular distribution for (n,n*8)

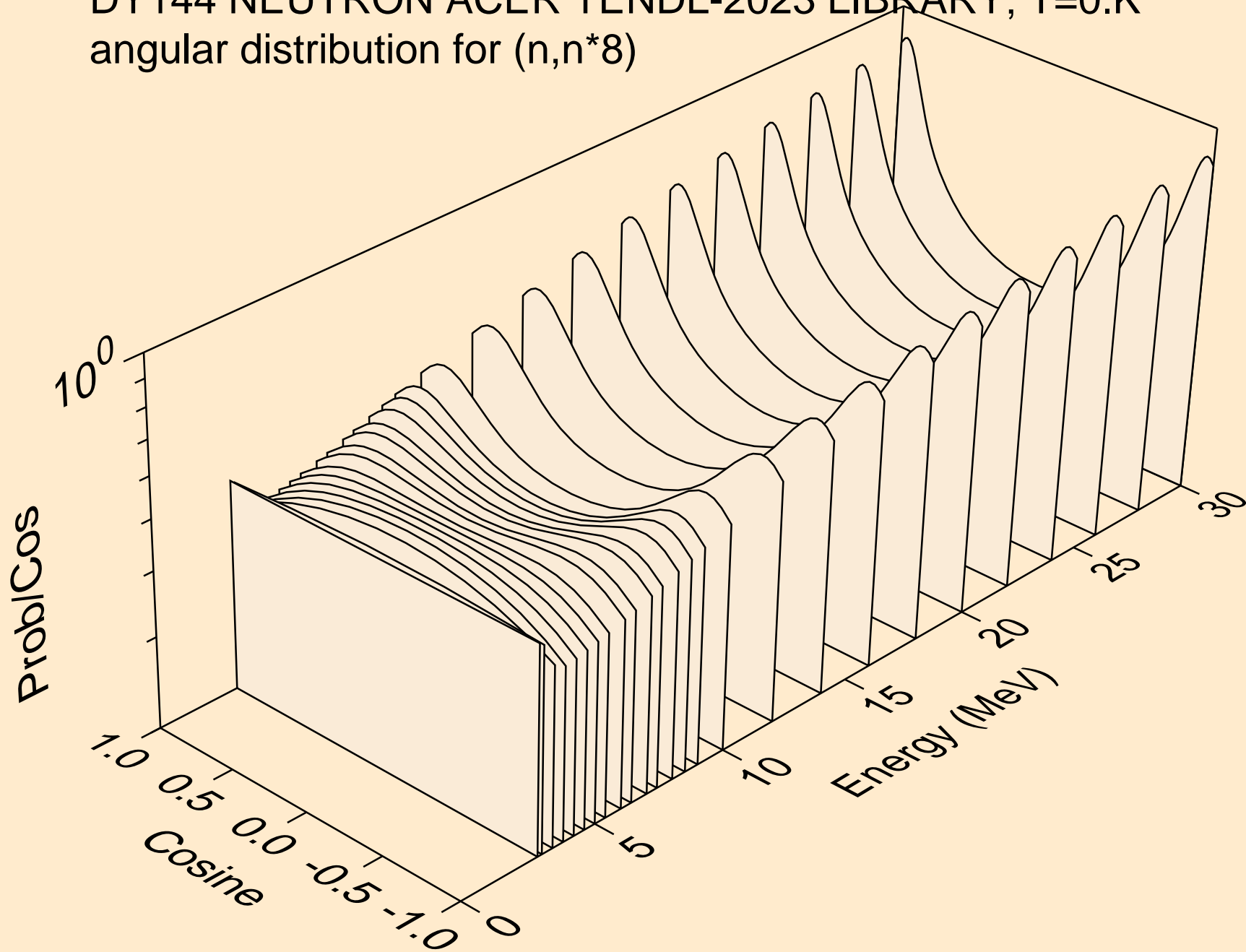

DY144 NEUTRON ACER TENDL-2023 LIBRARY; T=0.K
angular distribution for (n,n*9)

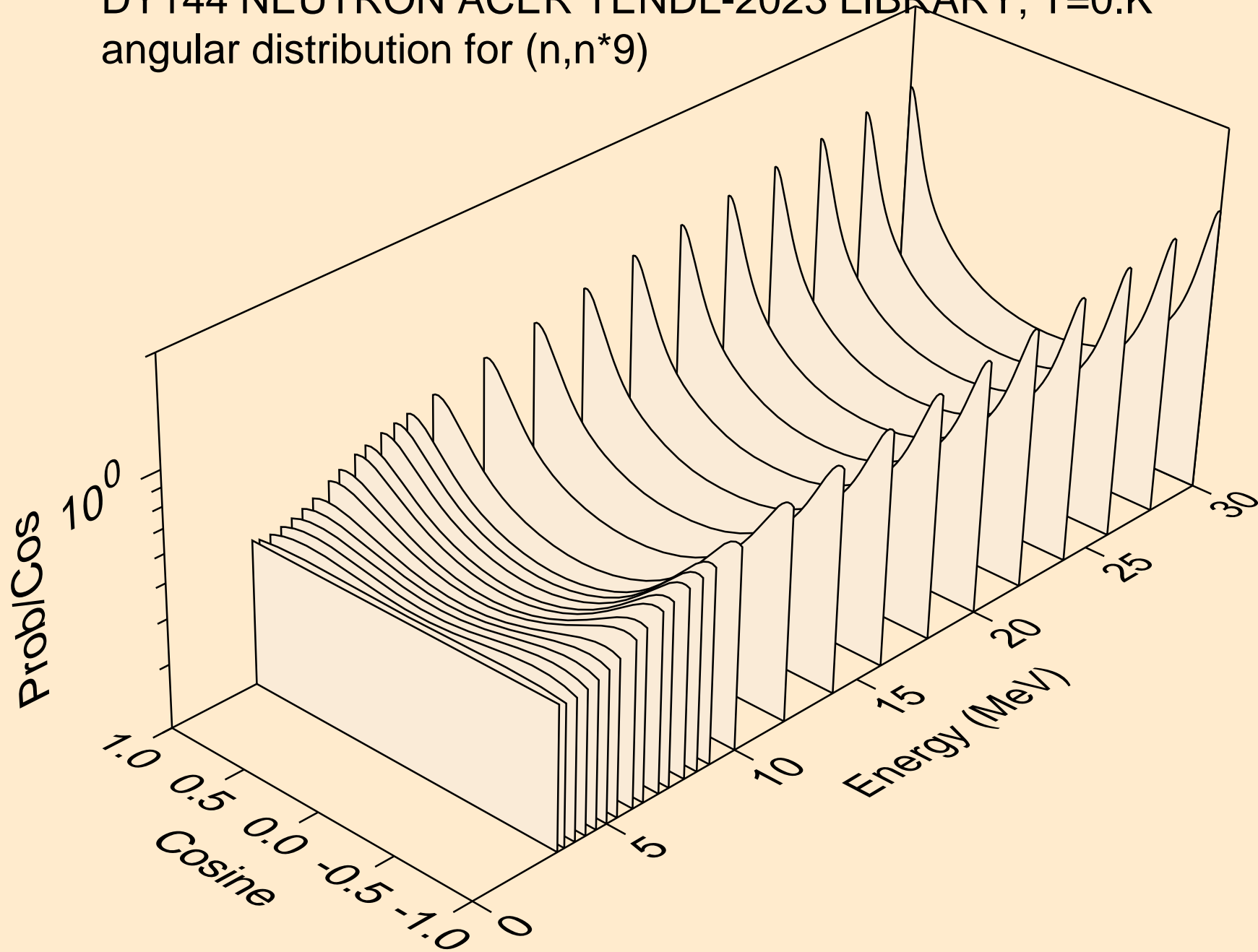

DY144 NEUTRON ACER TENDL-2023 LIBRARY; T=0.K
angular distribution for (n,n*10)

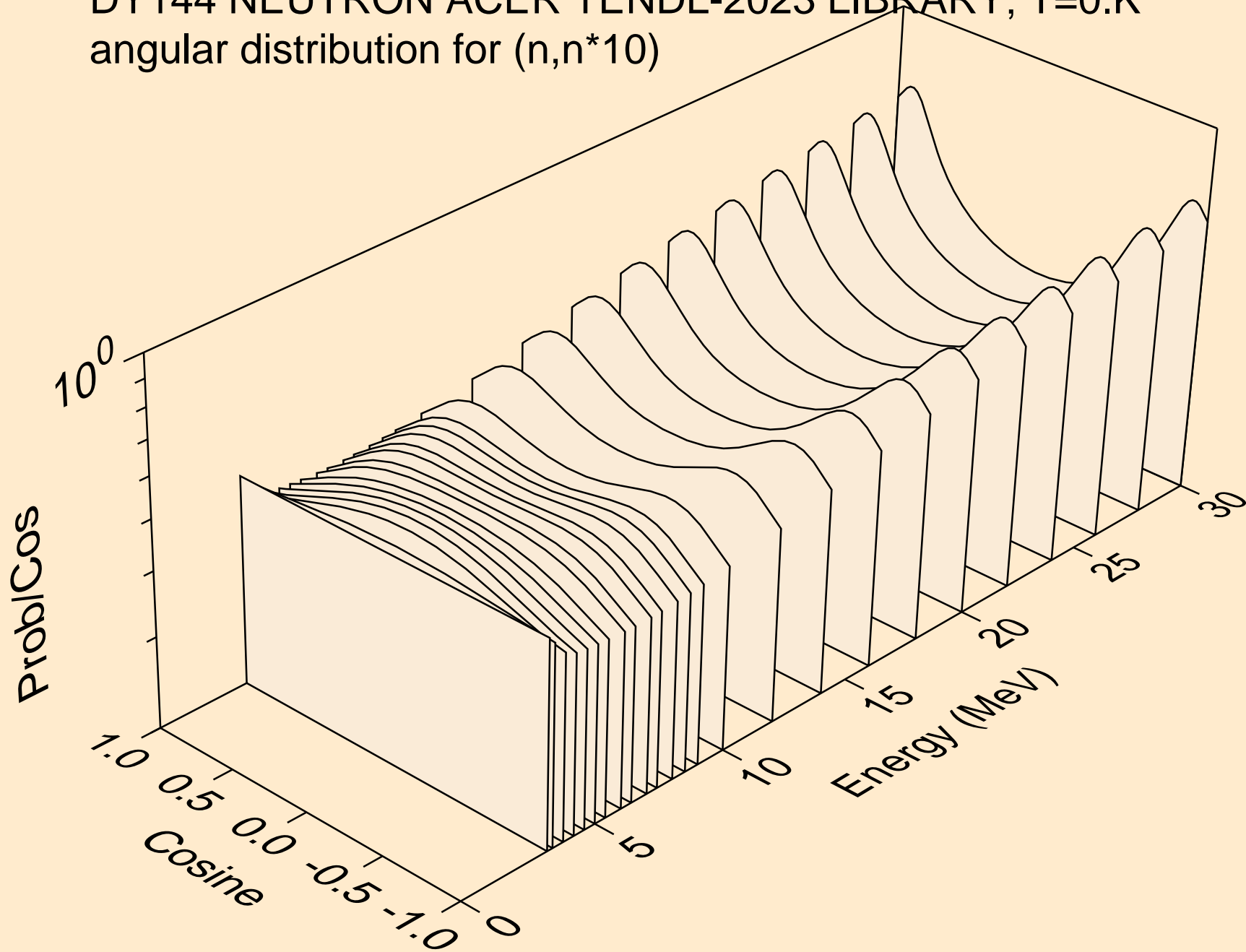

DY144 NEUTRON ACER TENDL-2023 LIBRARY; T=0.K
angular distribution for (n,n*11)

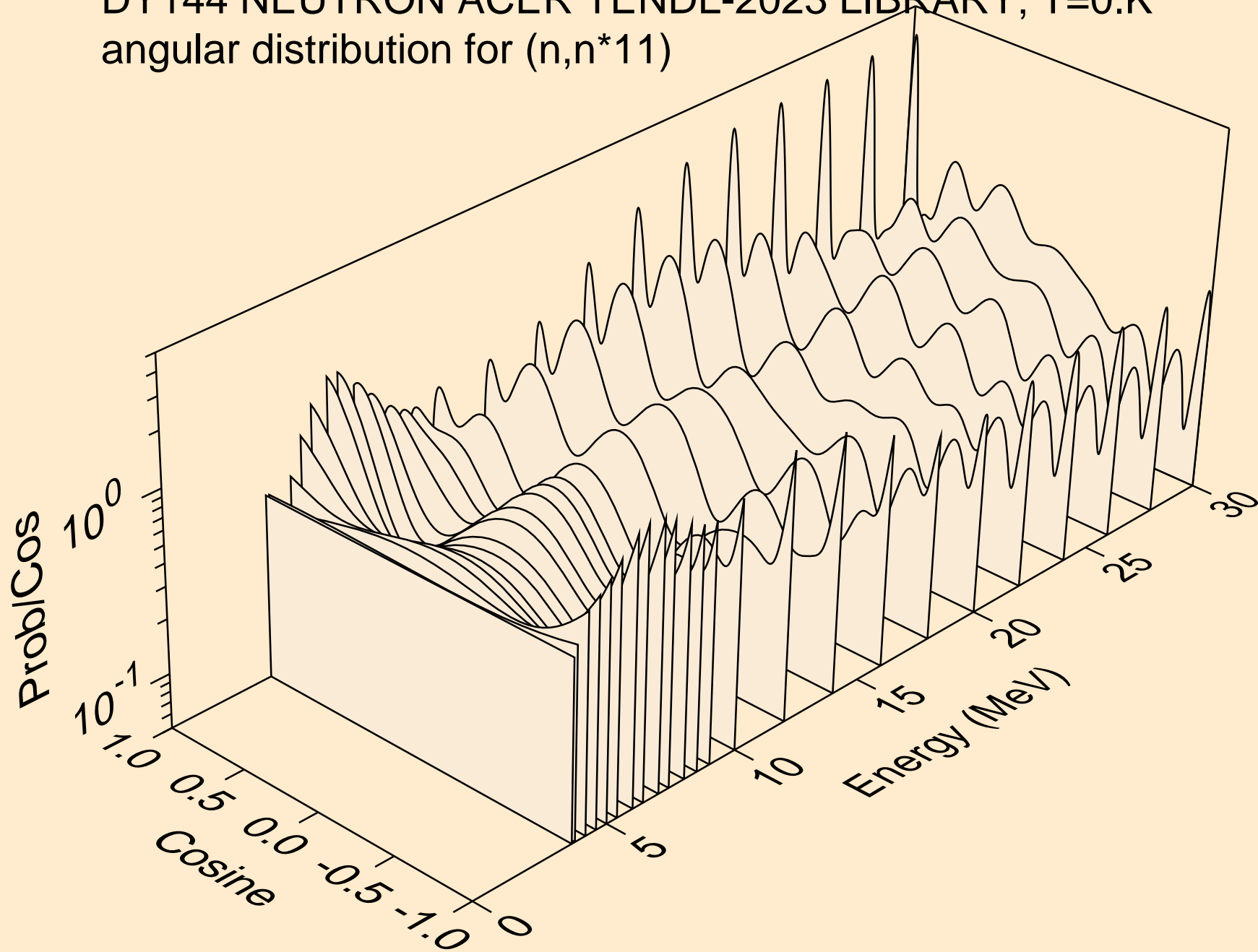

DY144 NEUTRON ACER TENDL-2023 LIBRARY; T=0.K
angular distribution for (n,n*12)

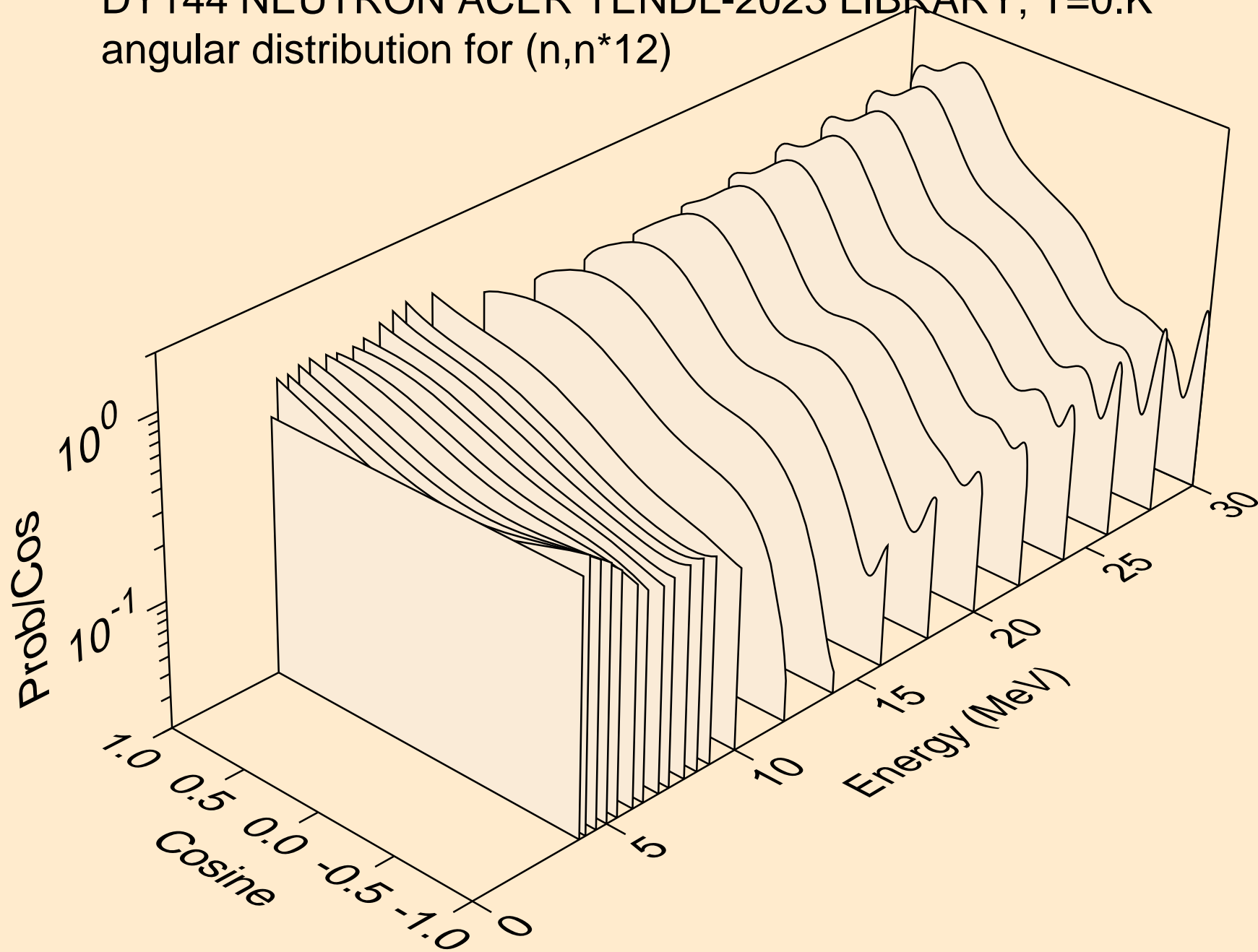

DY144 NEUTRON ACER TENDL-2023 LIBRARY; T=0.K
angular distribution for (n,n*13)

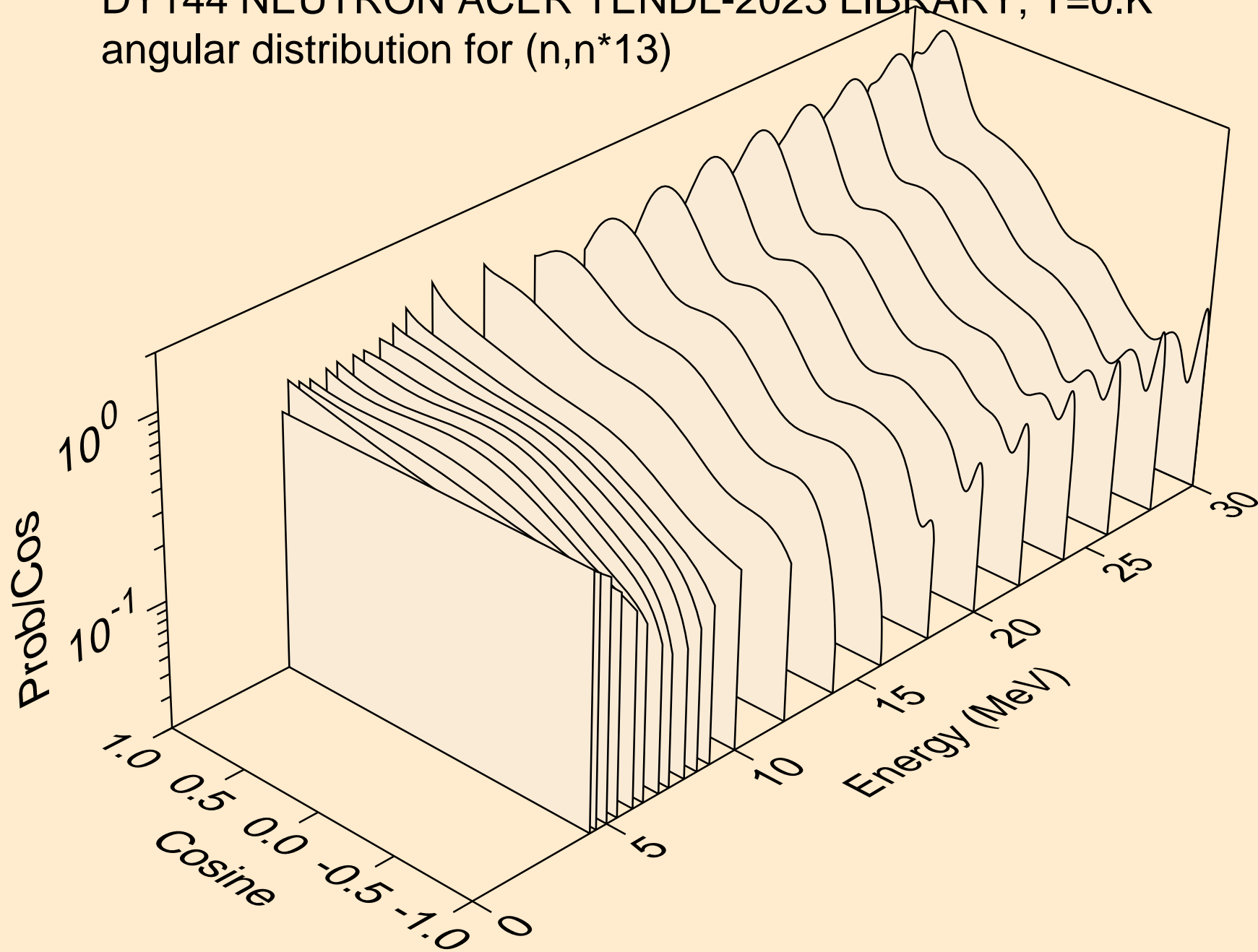

DY144 NEUTRON ACER TENDL-2023 LIBRARY; T=0.K
angular distribution for (n,n*14)

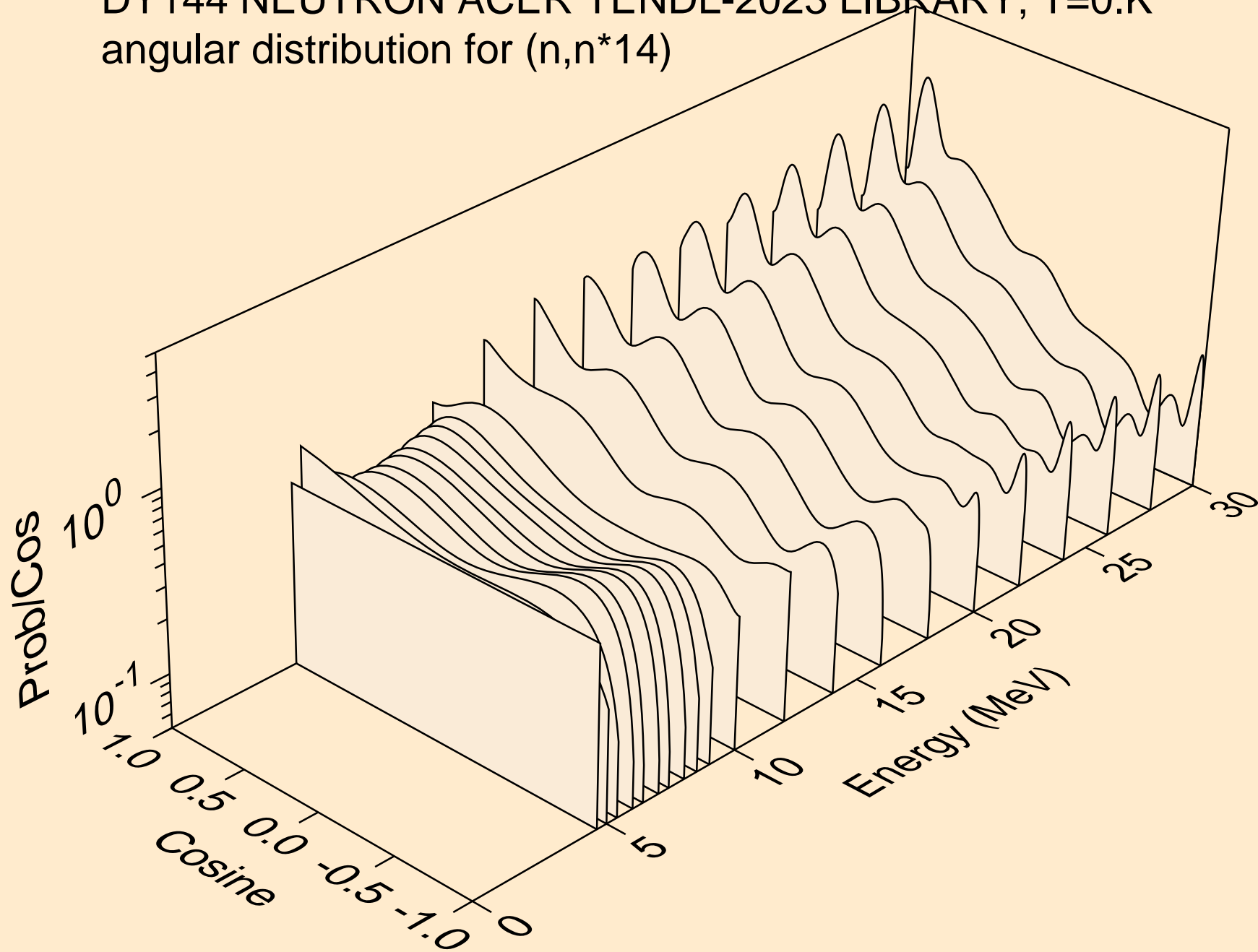

DY144 NEUTRON ACER TENDL-2023 LIBRARY; T=0.K
Neutron emission for (n,x)

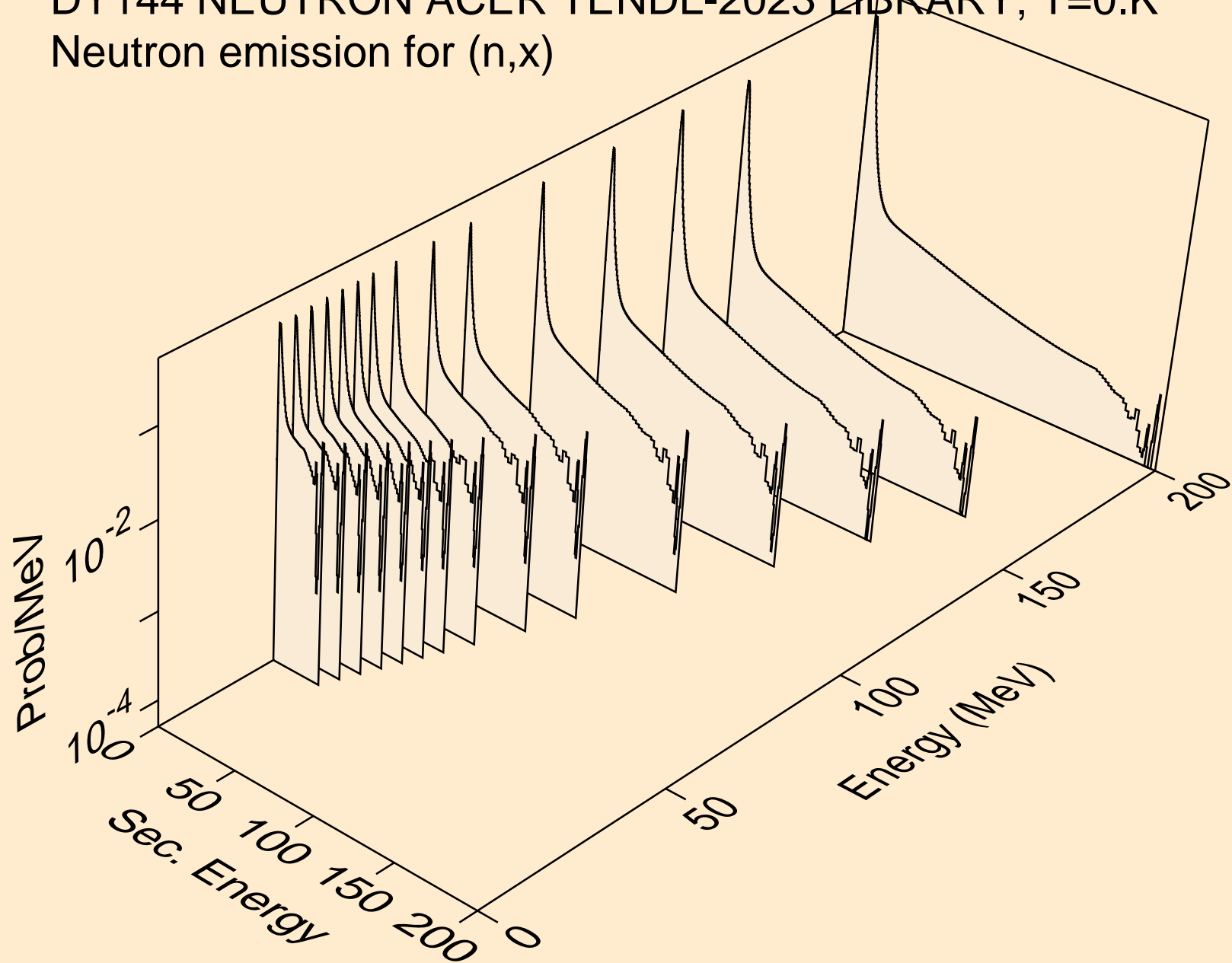

DY144 NEUTRON ACER TENDL-2023 LIBRARY; T=0.K
Neutron emission for (n,2nd)

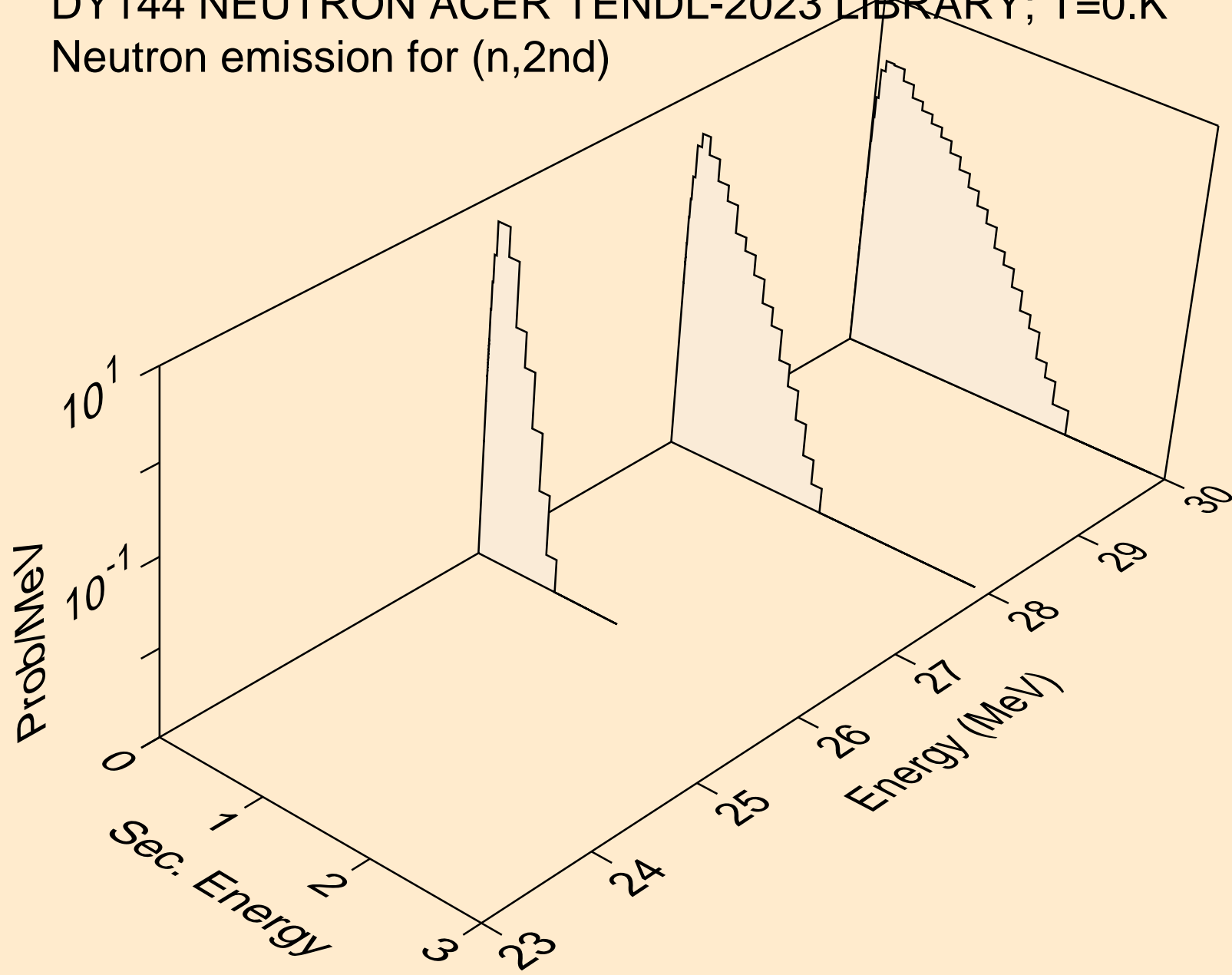

DY144 NEUTRON ACER TENDL-2023 LIBRARY; T=0.K
Neutron emission for (n,2n)

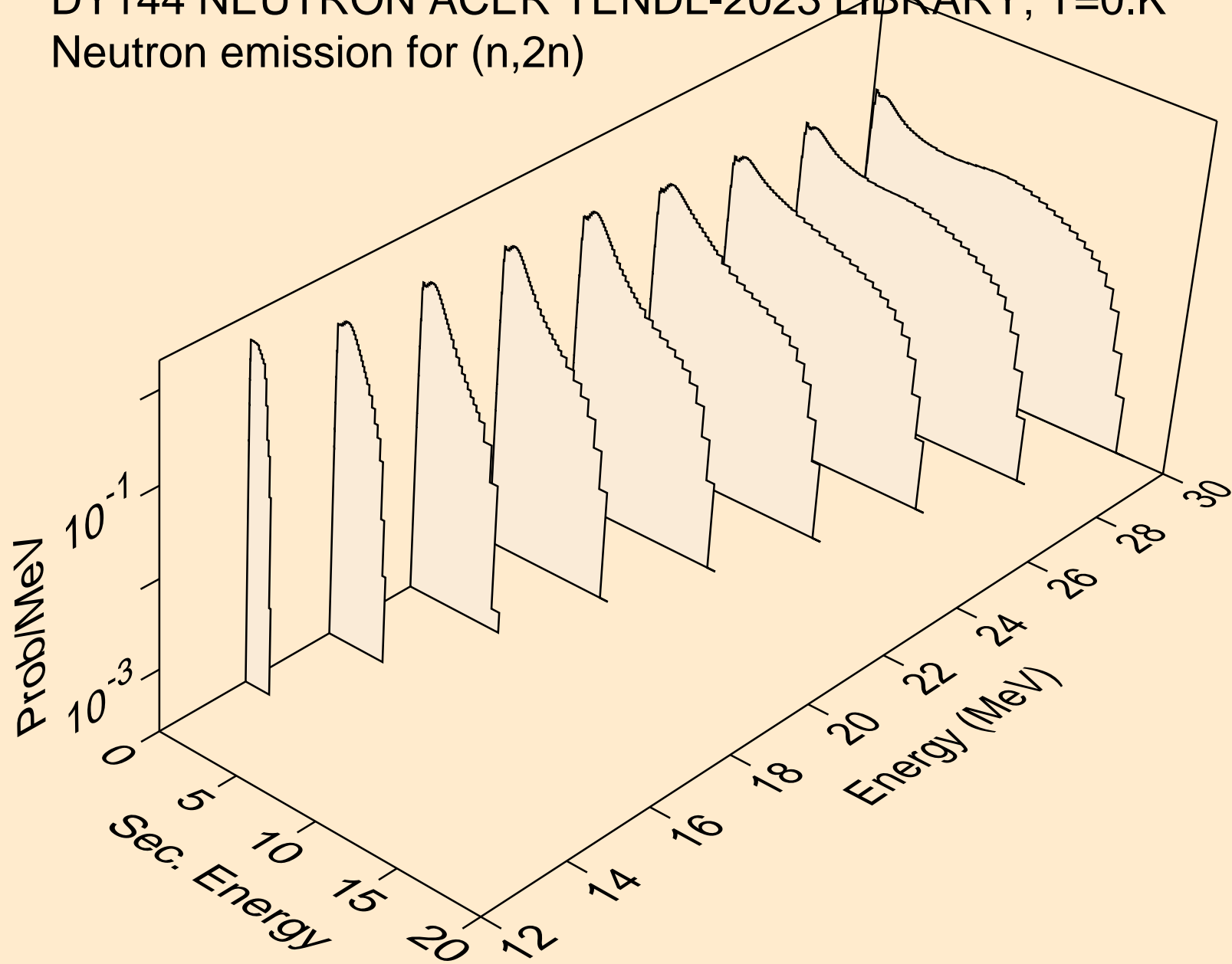

DY144 NEUTRON ACER TENDL-2023 LIBRARY; T=0.K
Neutron emission for (n,3n)

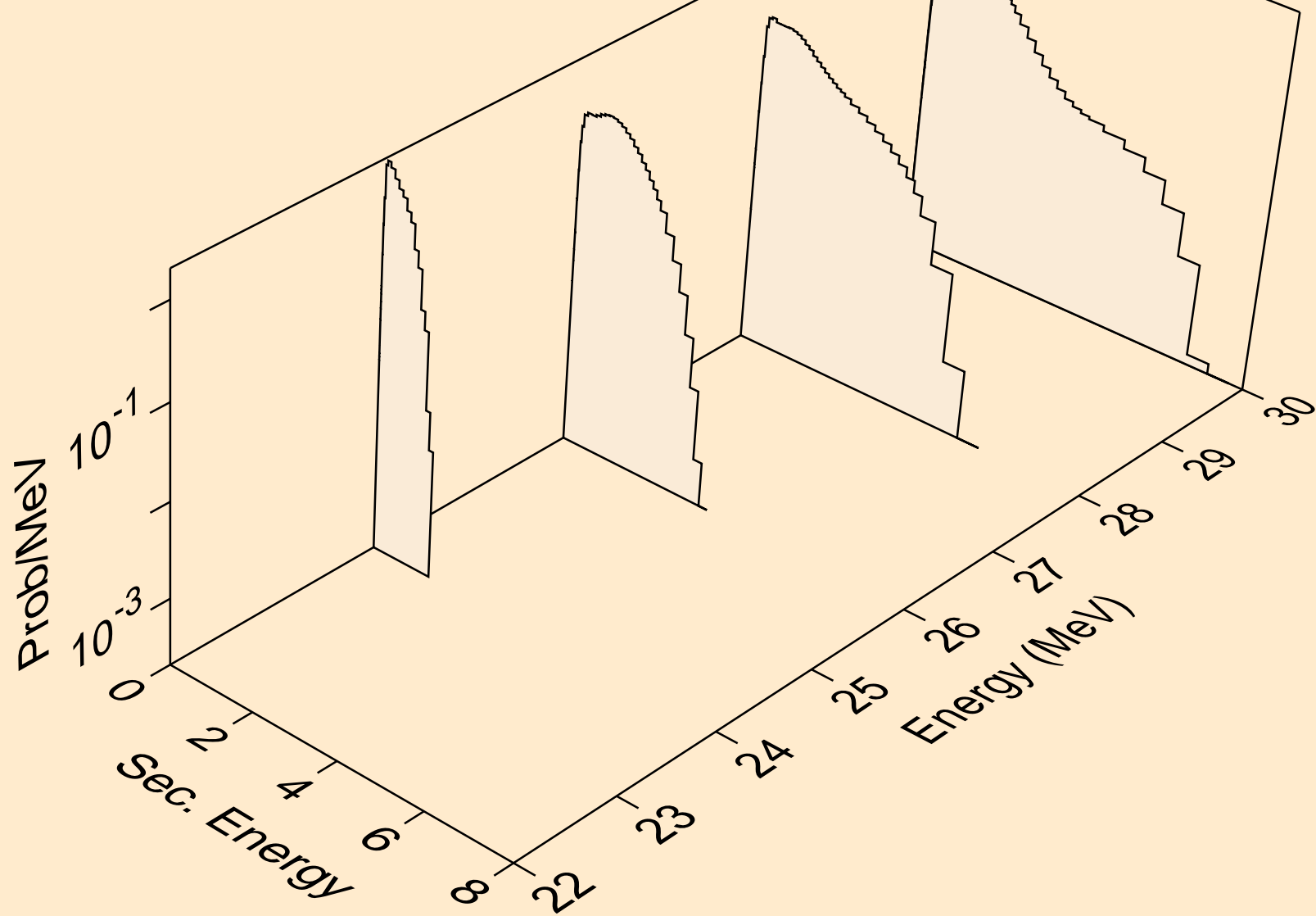

DY144 NEUTRON ACER TENDL-2023 LIBRARY; T=0.K
Neutron emission for (n,n*)a

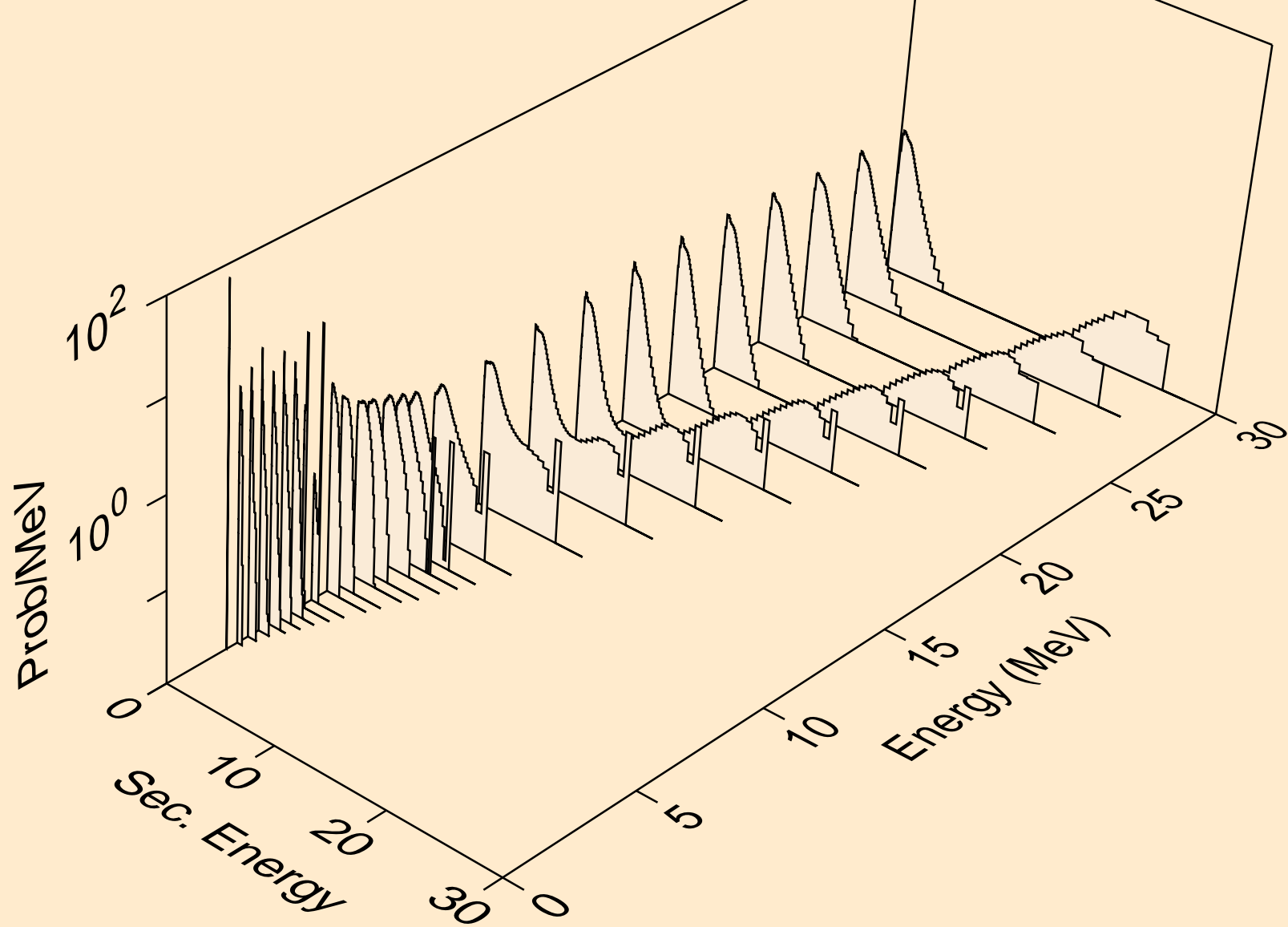

DY144 NEUTRON ACER TENDL-2023 LIBRARY; T=0.K
Neutron emission for (n,2n)a

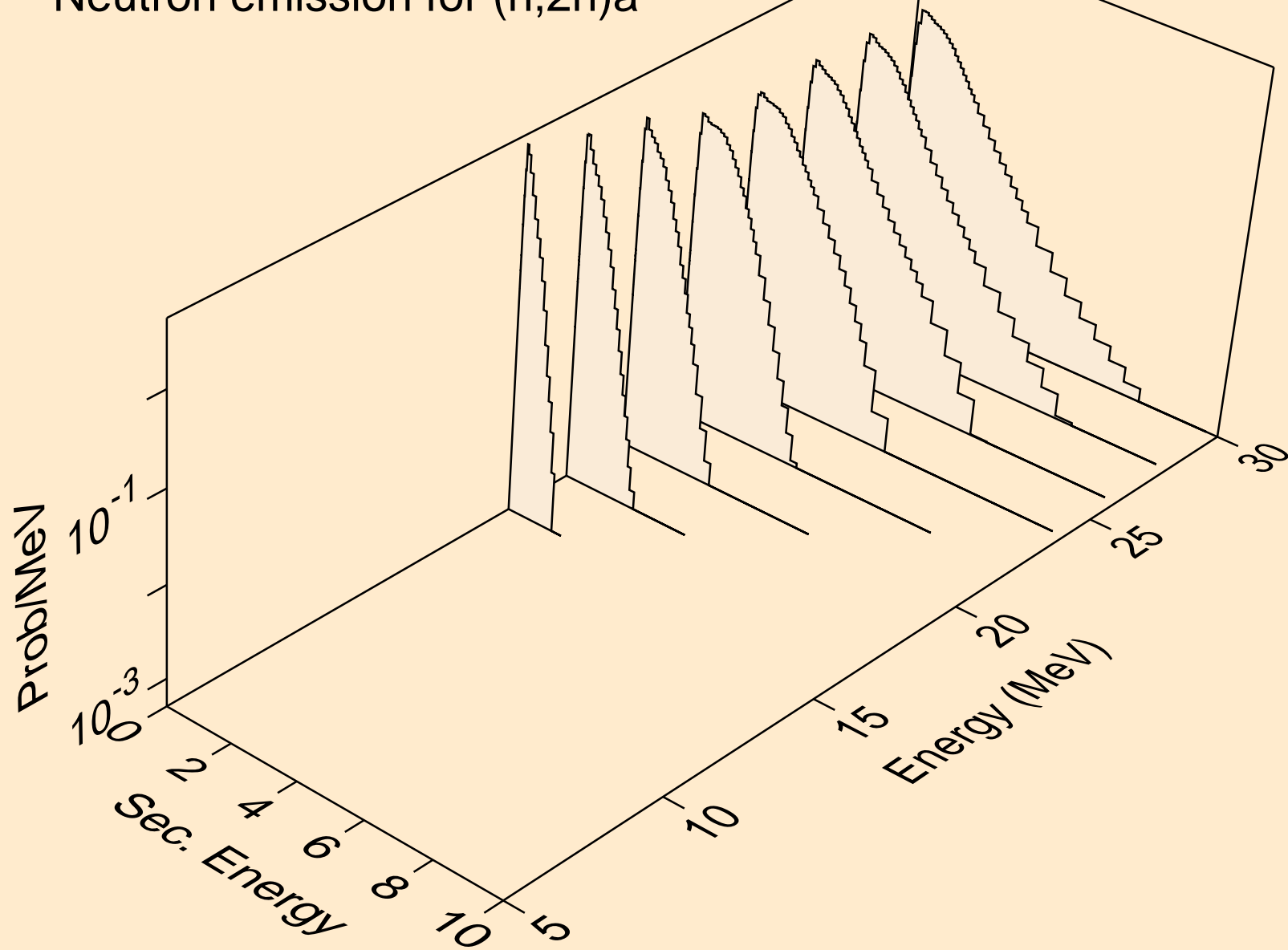

DY144 NEUTRON ACER TENDL-2023 LIBRARY; T=0.K
Neutron emission for (n,3n)a

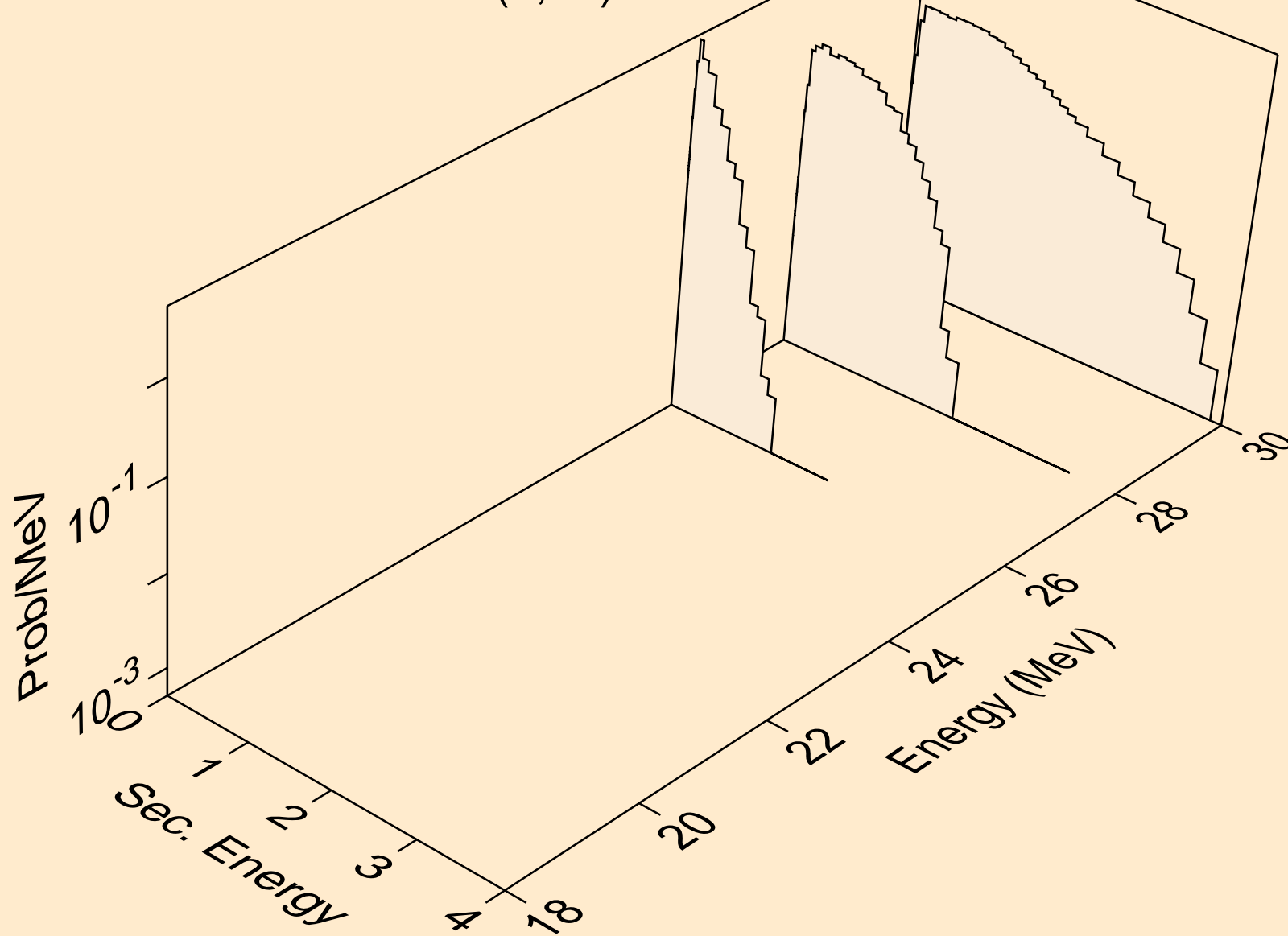

DY144 NEUTRON ACER TENDL-2023 LIBRARY; T=0.K
Neutron emission for (n,n*)p

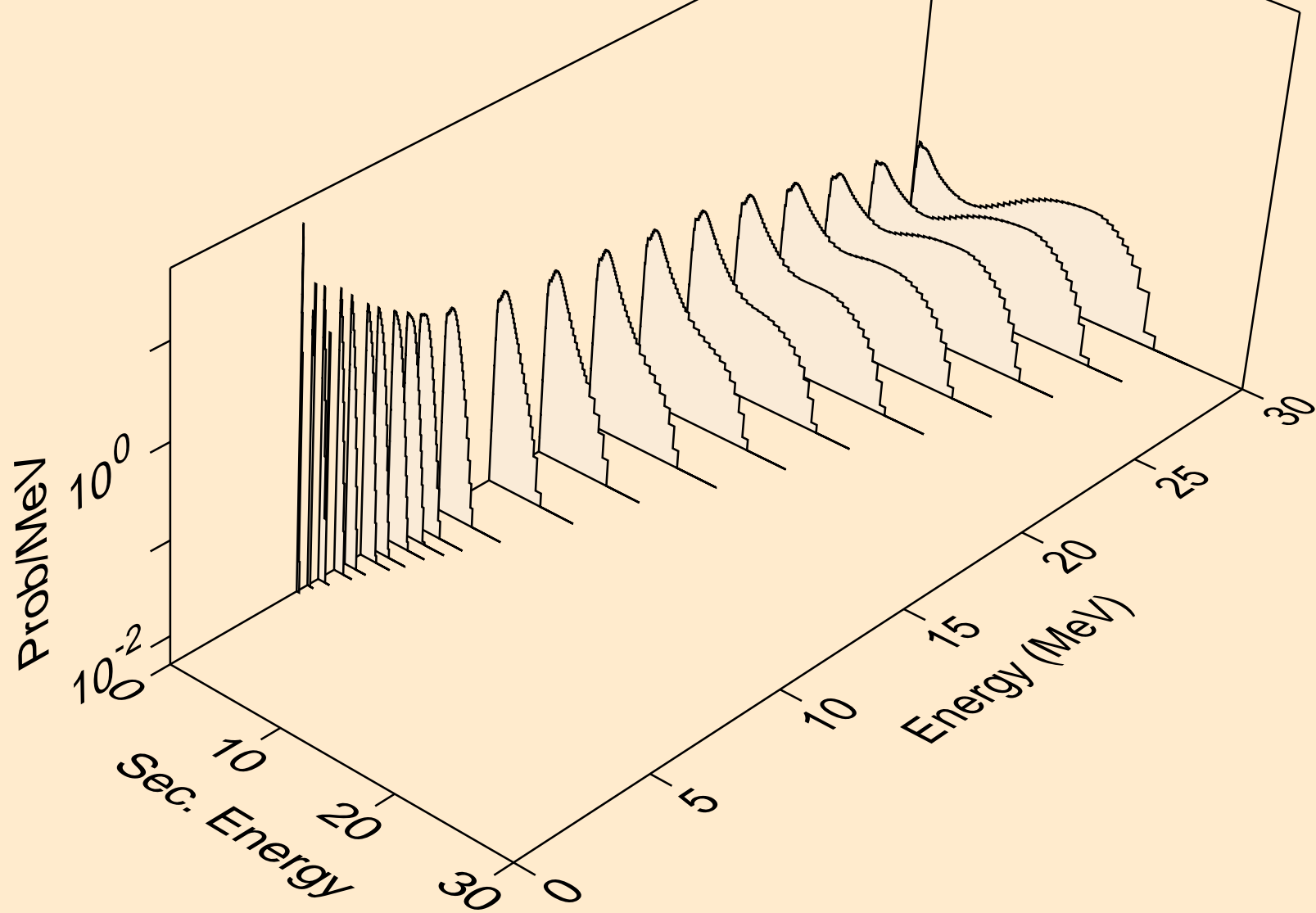

DY144 NEUTRON ACER TENDL-2023 LIBRARY; T=0.K
Neutron emission for (n,n*)2a

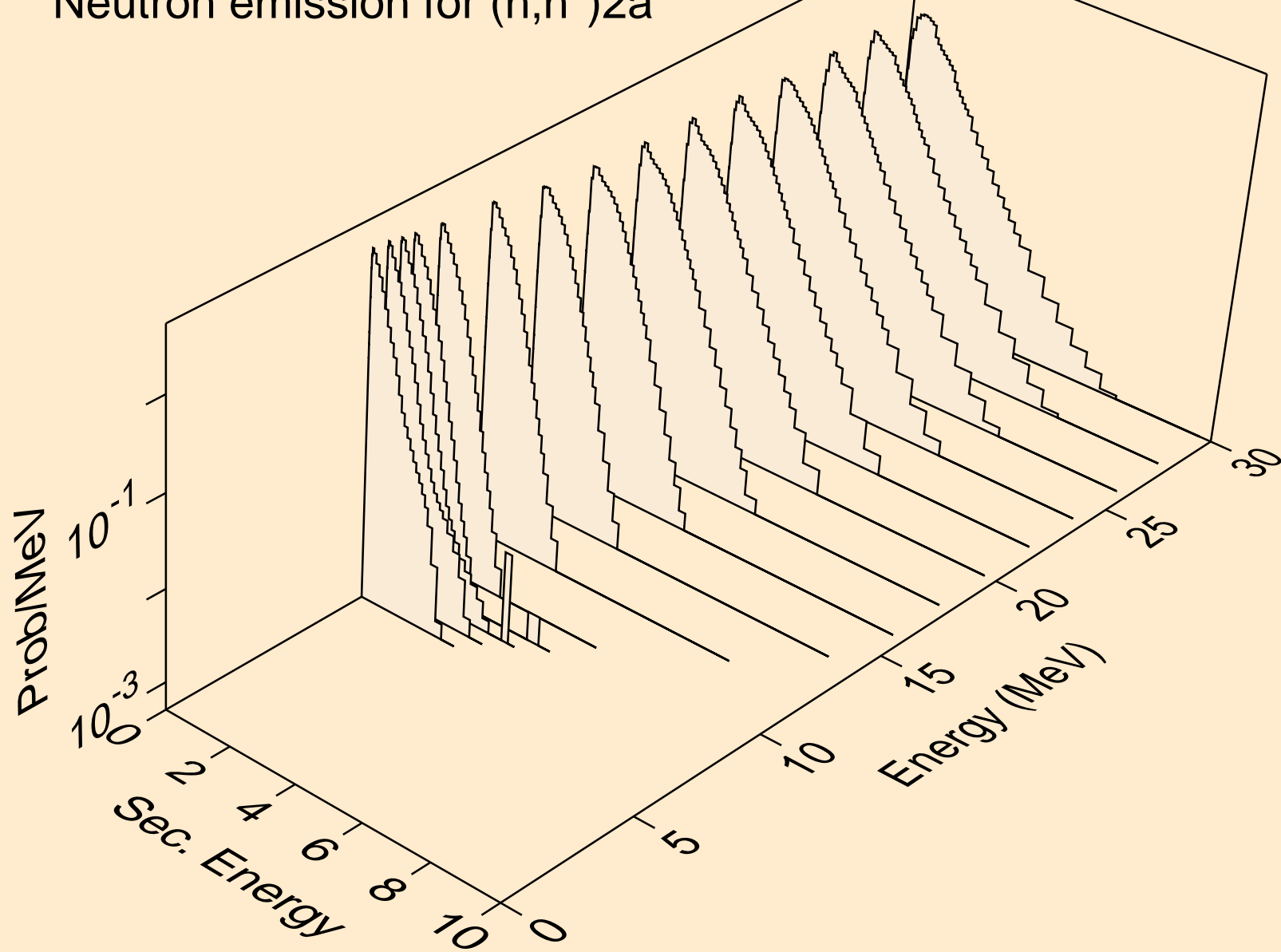

DY144 NEUTRON ACER TENDL-2023 LIBRARY; T=0.K
Neutron emission for (n,n*)d

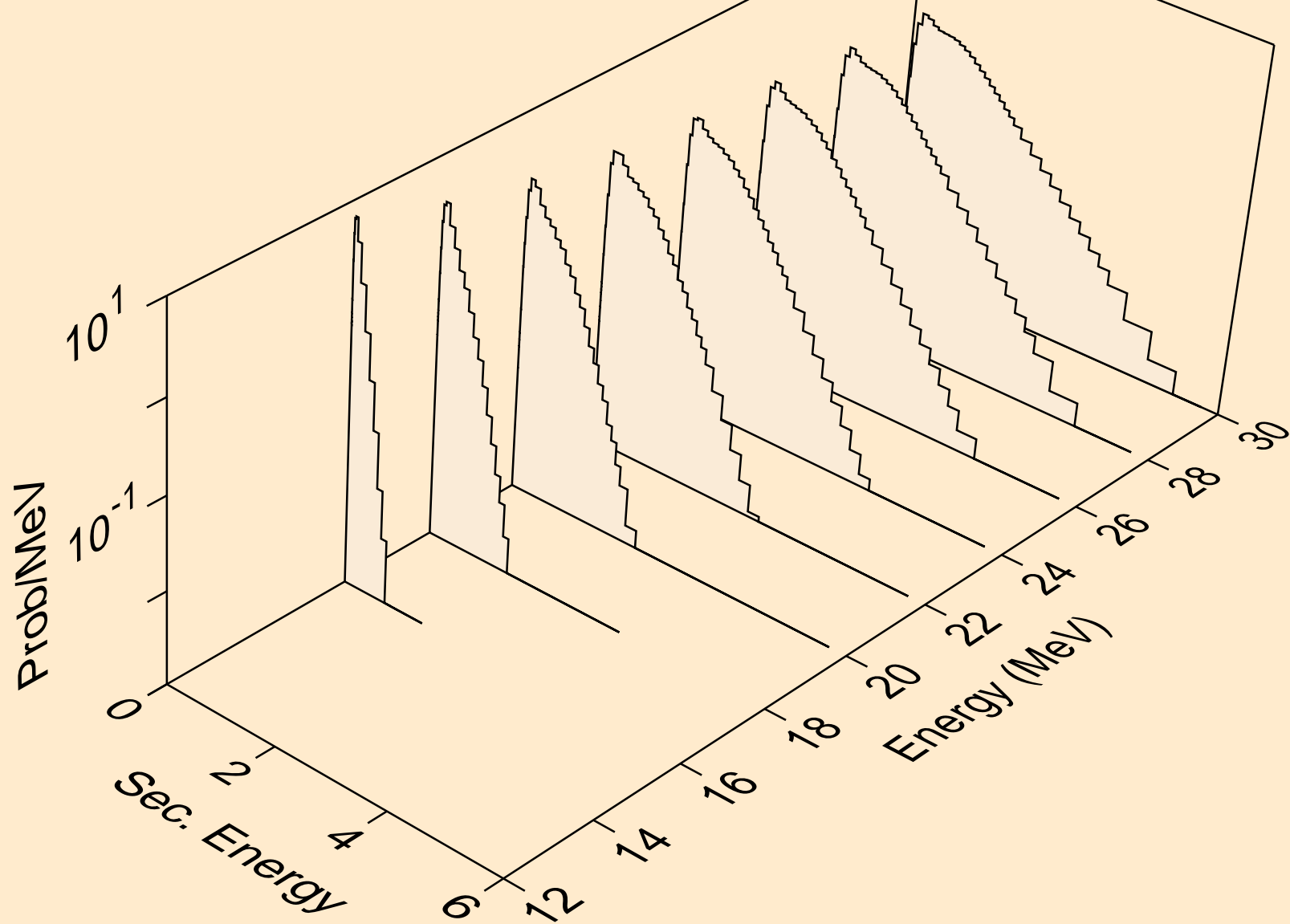

DY144 NEUTRON ACER TENDL-2023 LIBRARY; T=0.K
Neutron emission for (n,n*)t

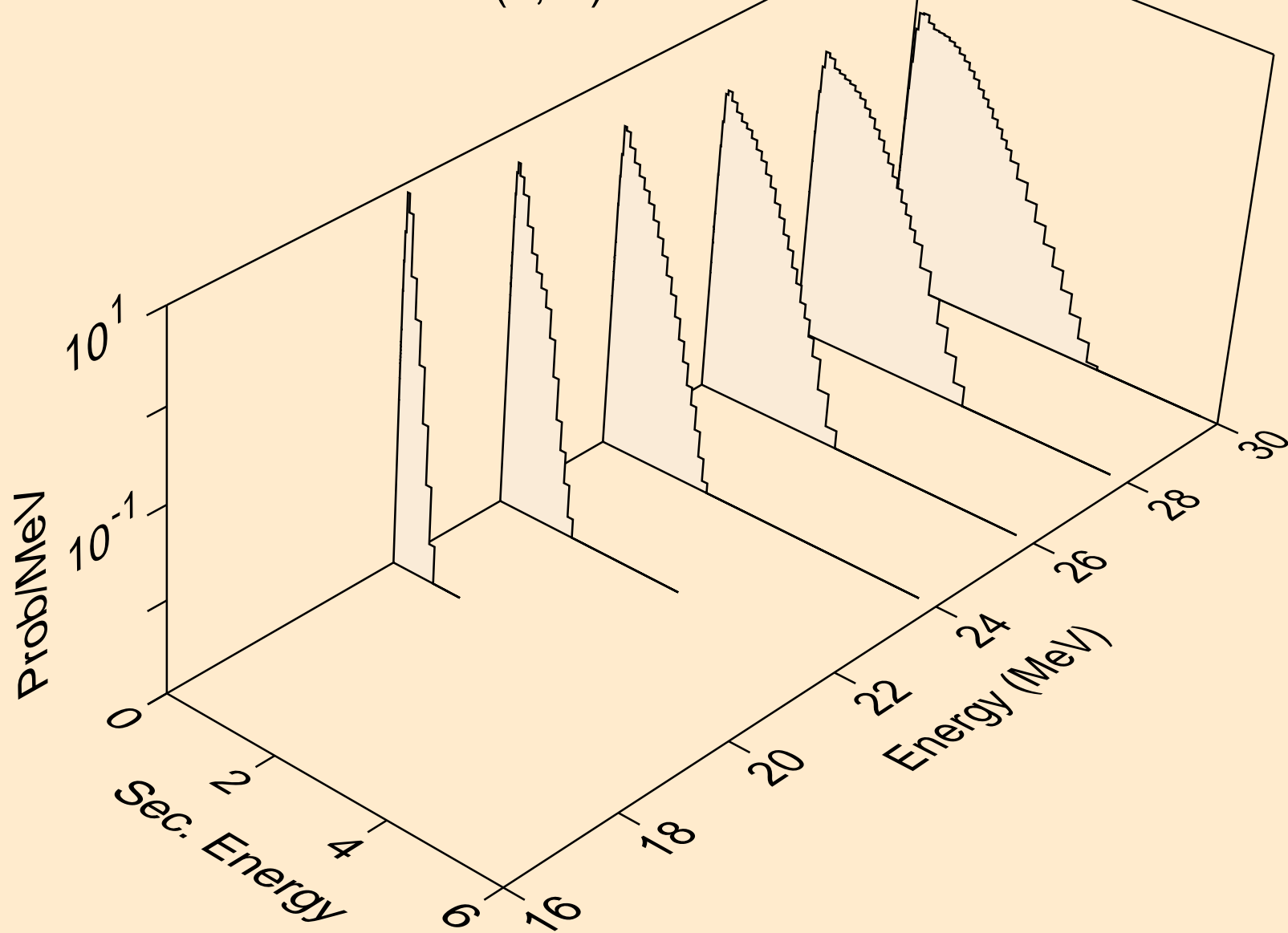

DY144 NEUTRON ACER TENDL-2023 LIBRARY; T=0.K
Neutron emission for (n,n*)he3

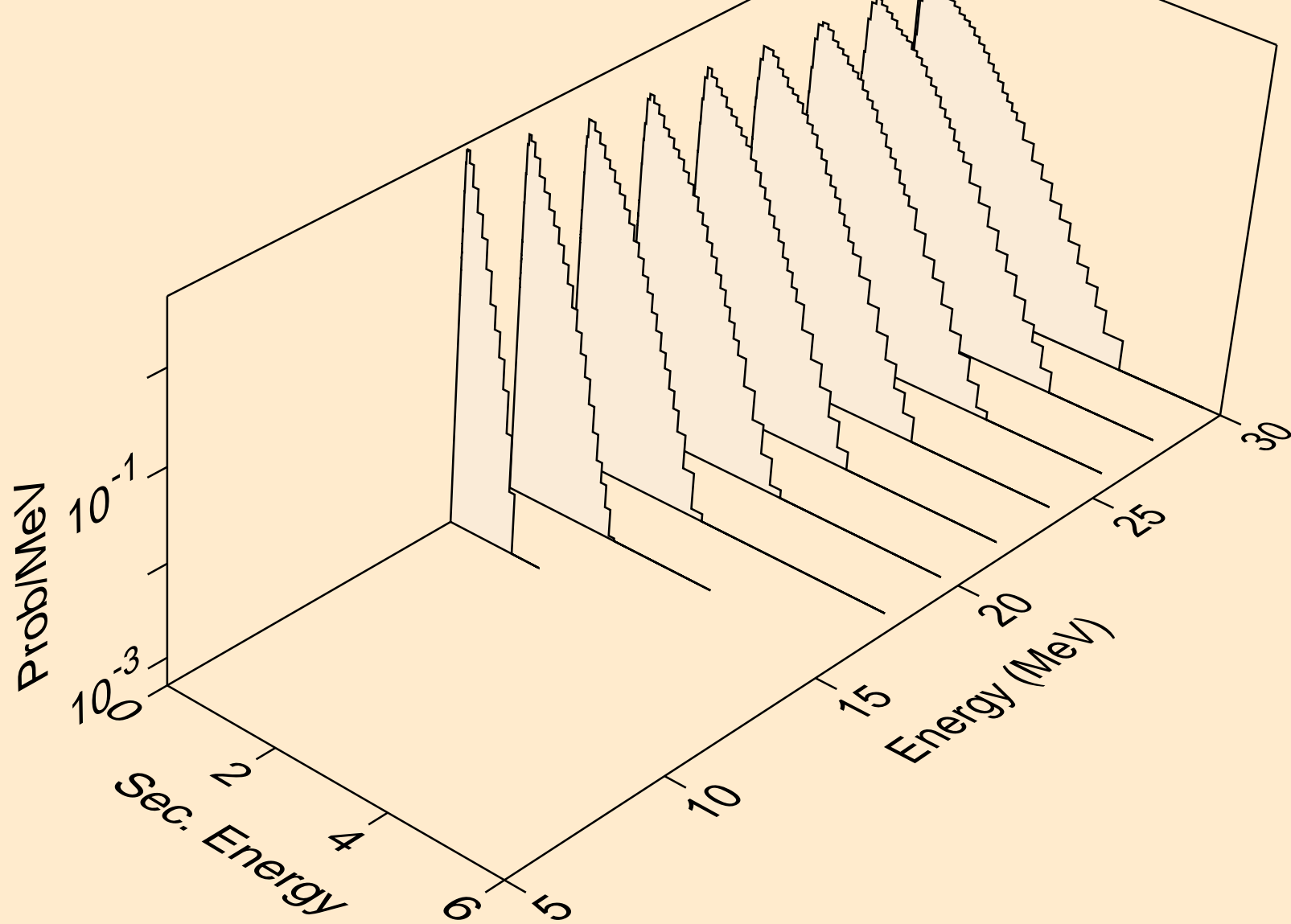

DY144 NEUTRON ACER TENDL-2023 LIBRARY; T=0.K
Neutron emission for (n,2np)

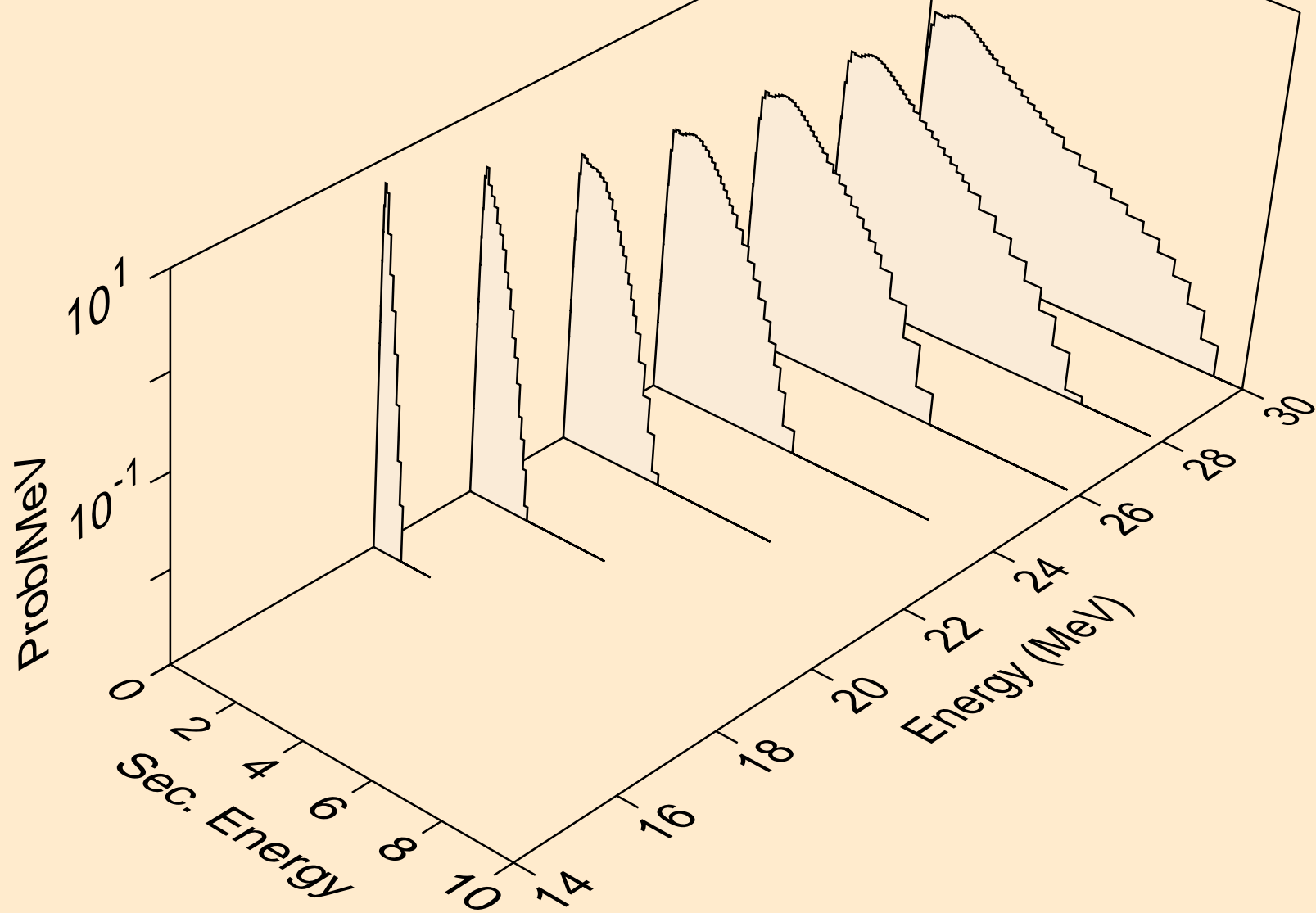

DY144 NEUTRON ACER TENDL-2023 LIBRARY; T=0.K
Neutron emission for (n,3np)

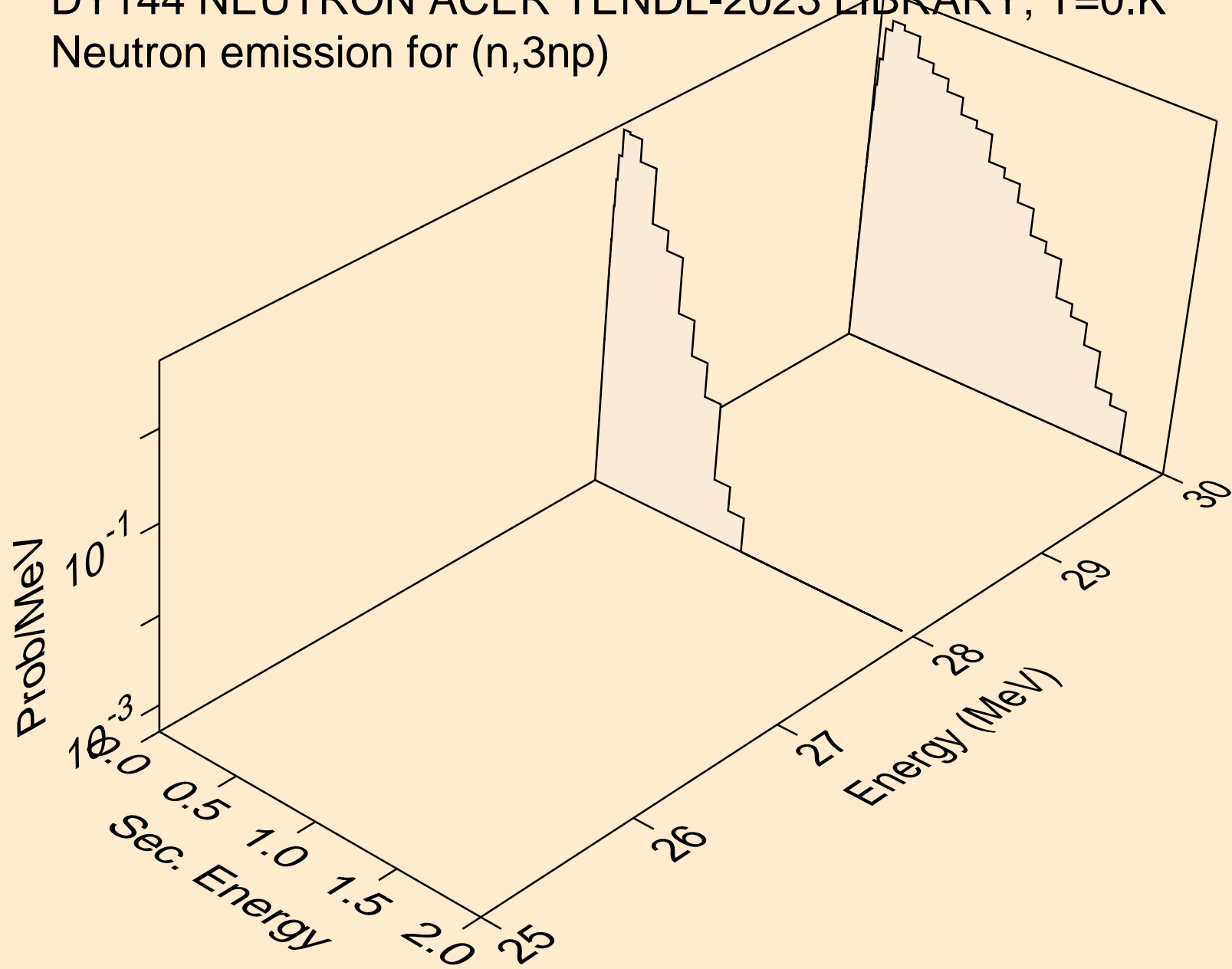

DY144 NEUTRON ACER TENDL-2023 LIBRARY; T=0.K
Neutron emission for (n,n2p)

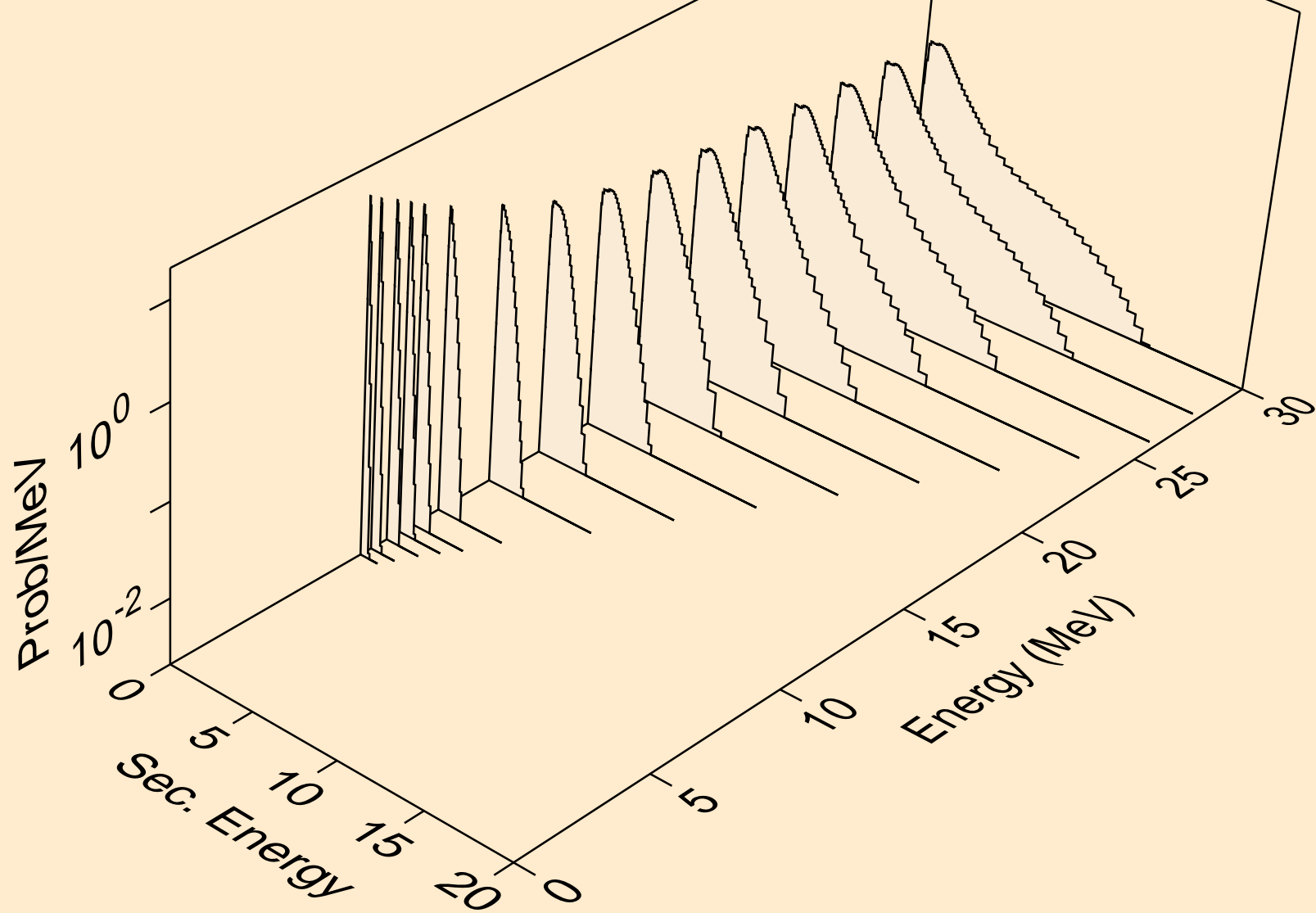

DY144 NEUTRON ACER TENDL-2023 LIBRARY; T=0.K
Neutron emission for (n,npa)

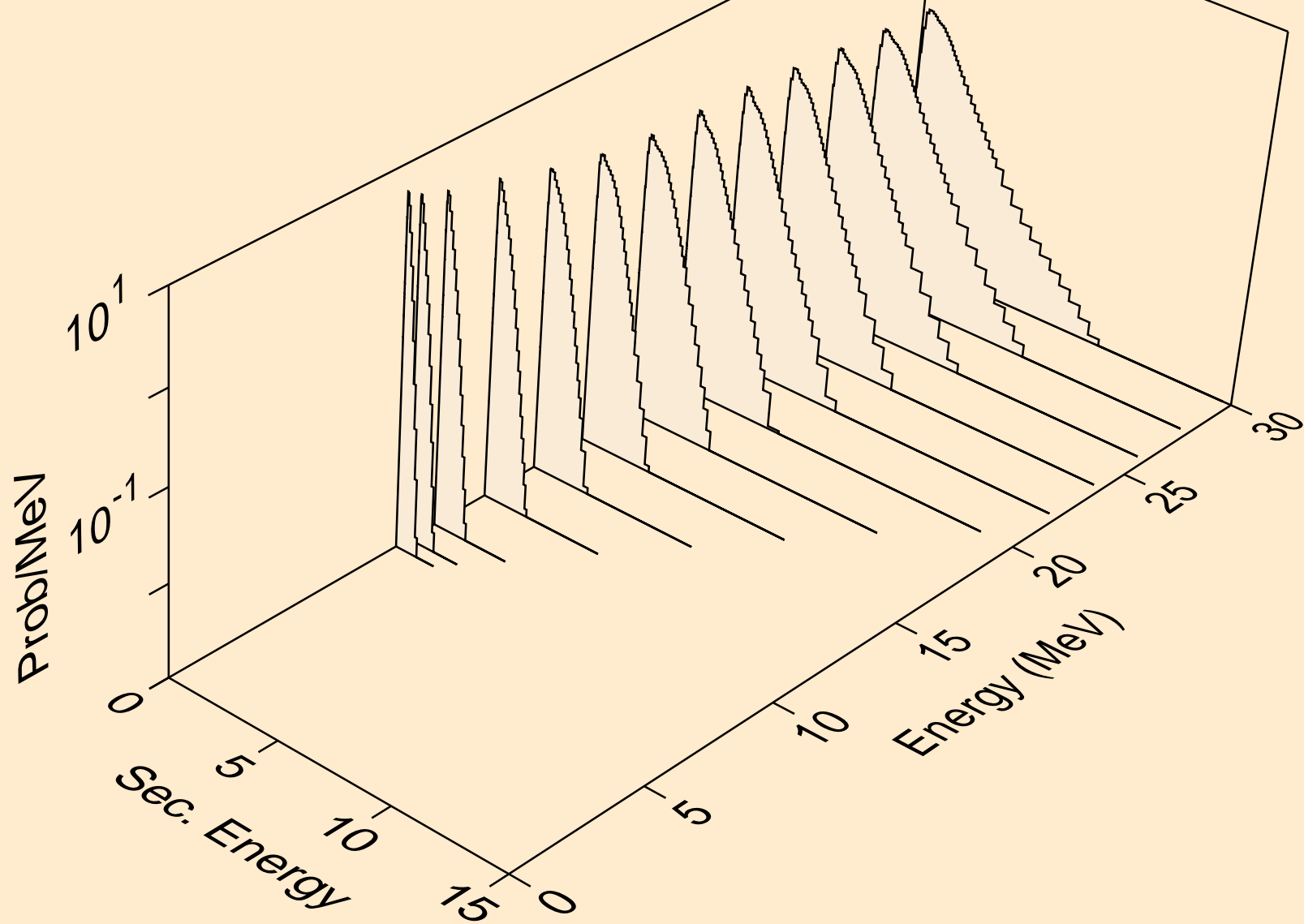

DY144 NEUTRON ACER TENDL-2023 LIBRARY; T=0.K
Neutron emission for (n,n*c)

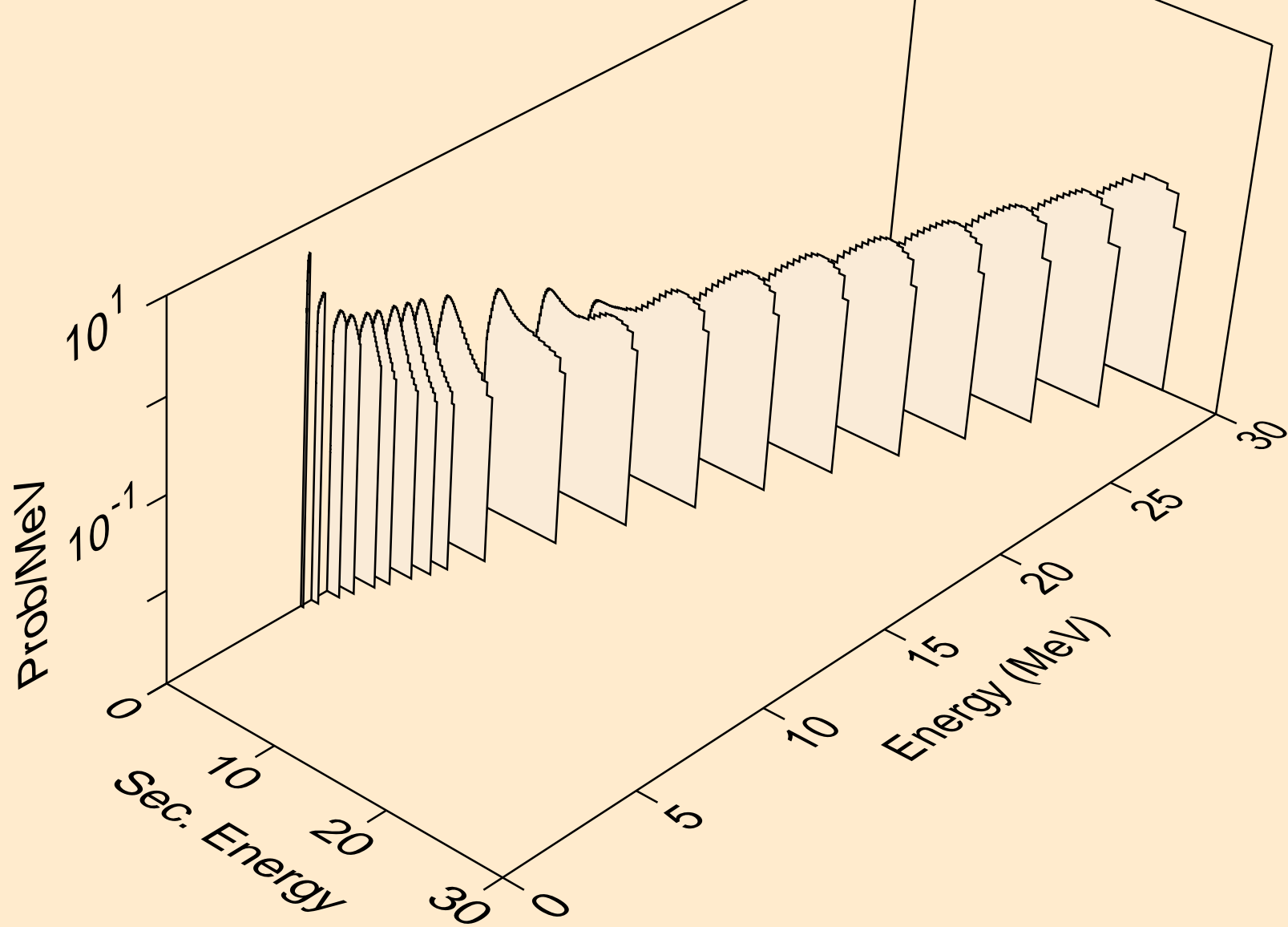

DY144 NEUTRON ACER TENDL-2023 LIBRARY; T=0.K
Photon emission for (n,x)

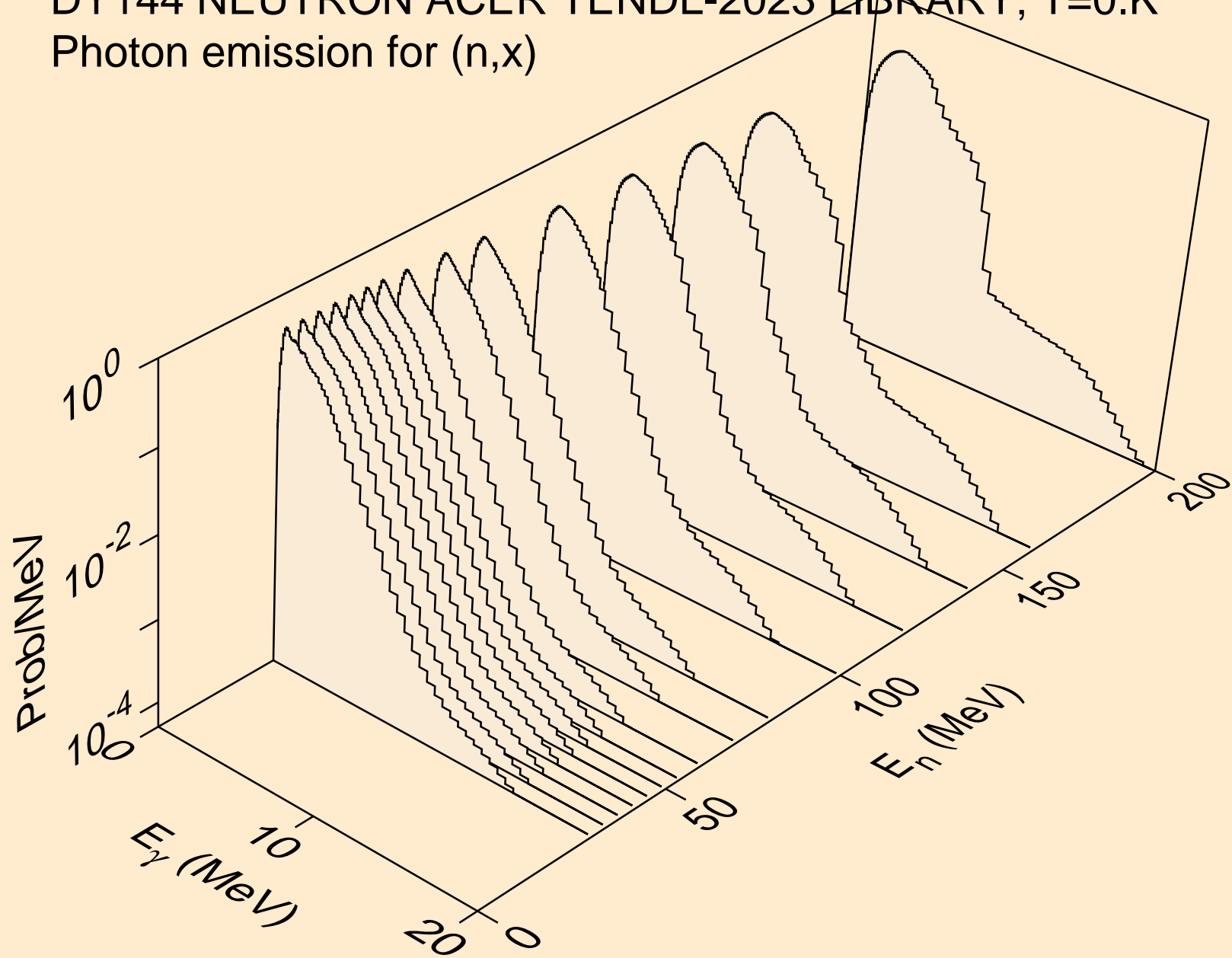

DY144 NEUTRON ACER TENDL-2023 LIBRARY; T=0.K
Photon emission for (n,2nd)

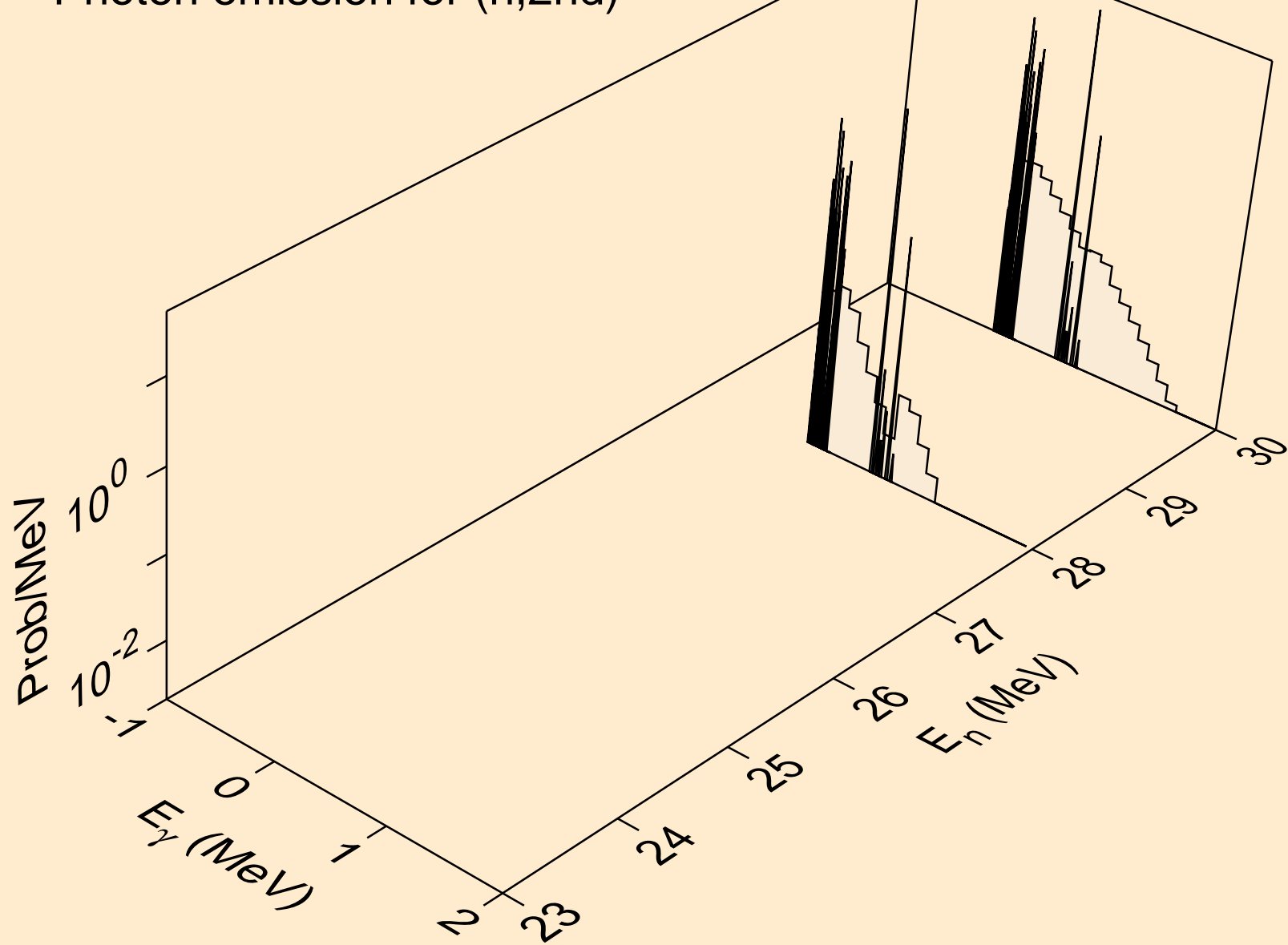

DY144 NEUTRON ACER TENDL-2023 LIBRARY; T=0.K
Photon emission for (n,2n)

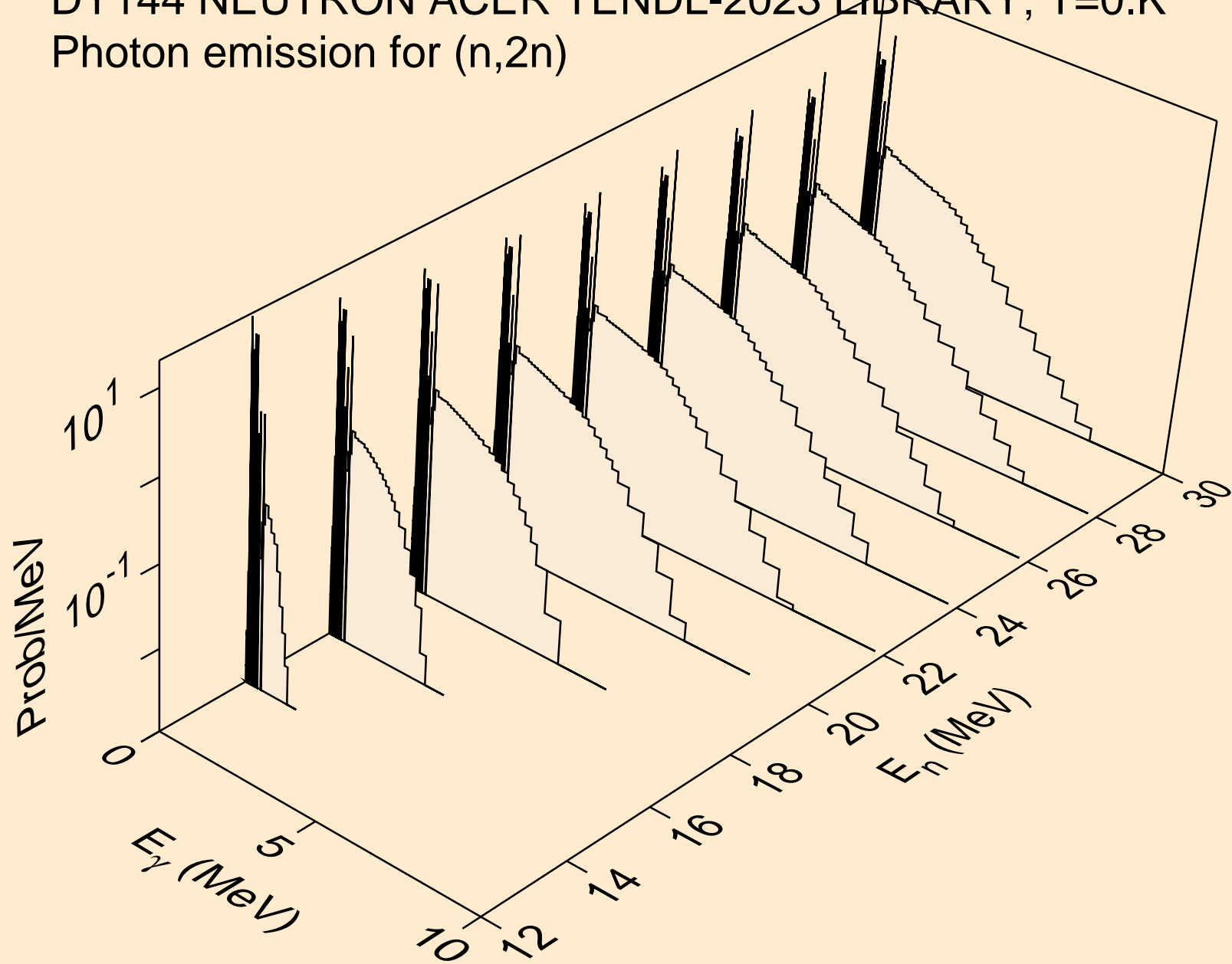

DY144 NEUTRON ACER TENDL-2023 LIBRARY; T=0.K
Photon emission for (n,3n)

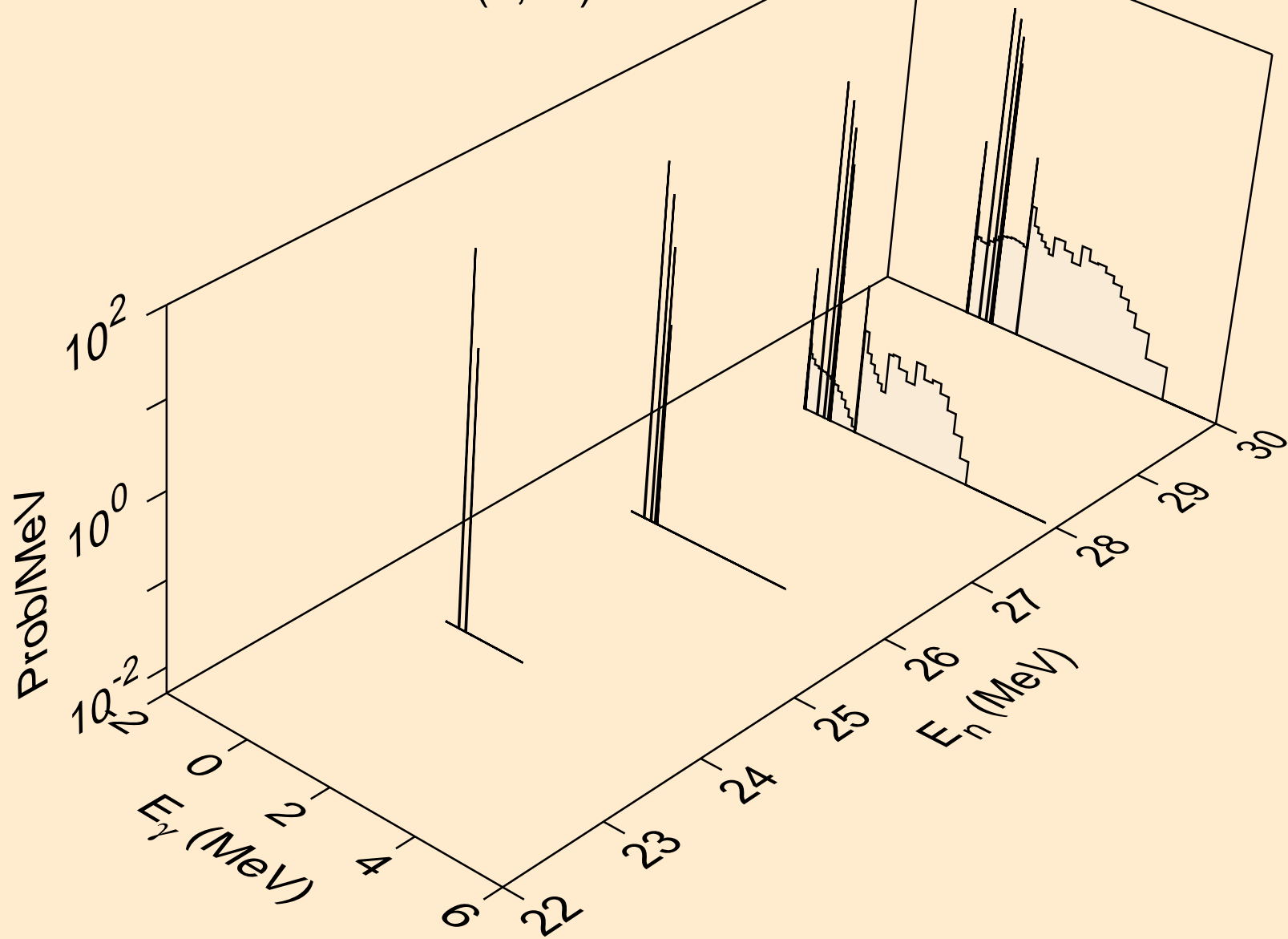

DY144 NEUTRON ACER TENDL-2023 LIBRARY; T=0.K
Photon emission for (n,n*)a

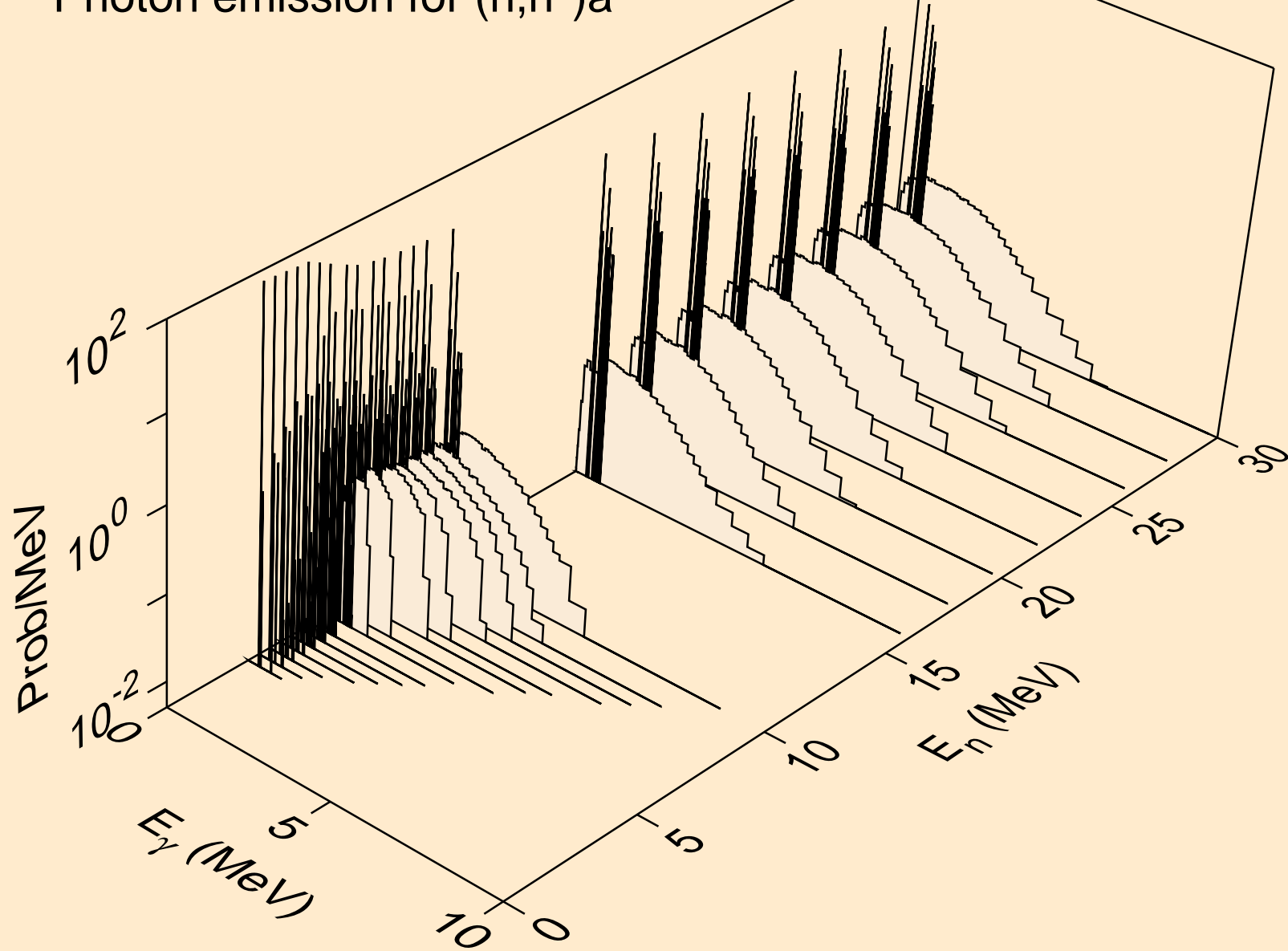

DY144 NEUTRON ACER TENDL-2023 LIBRARY; T=0.K
Photon emission for (n,2n)a

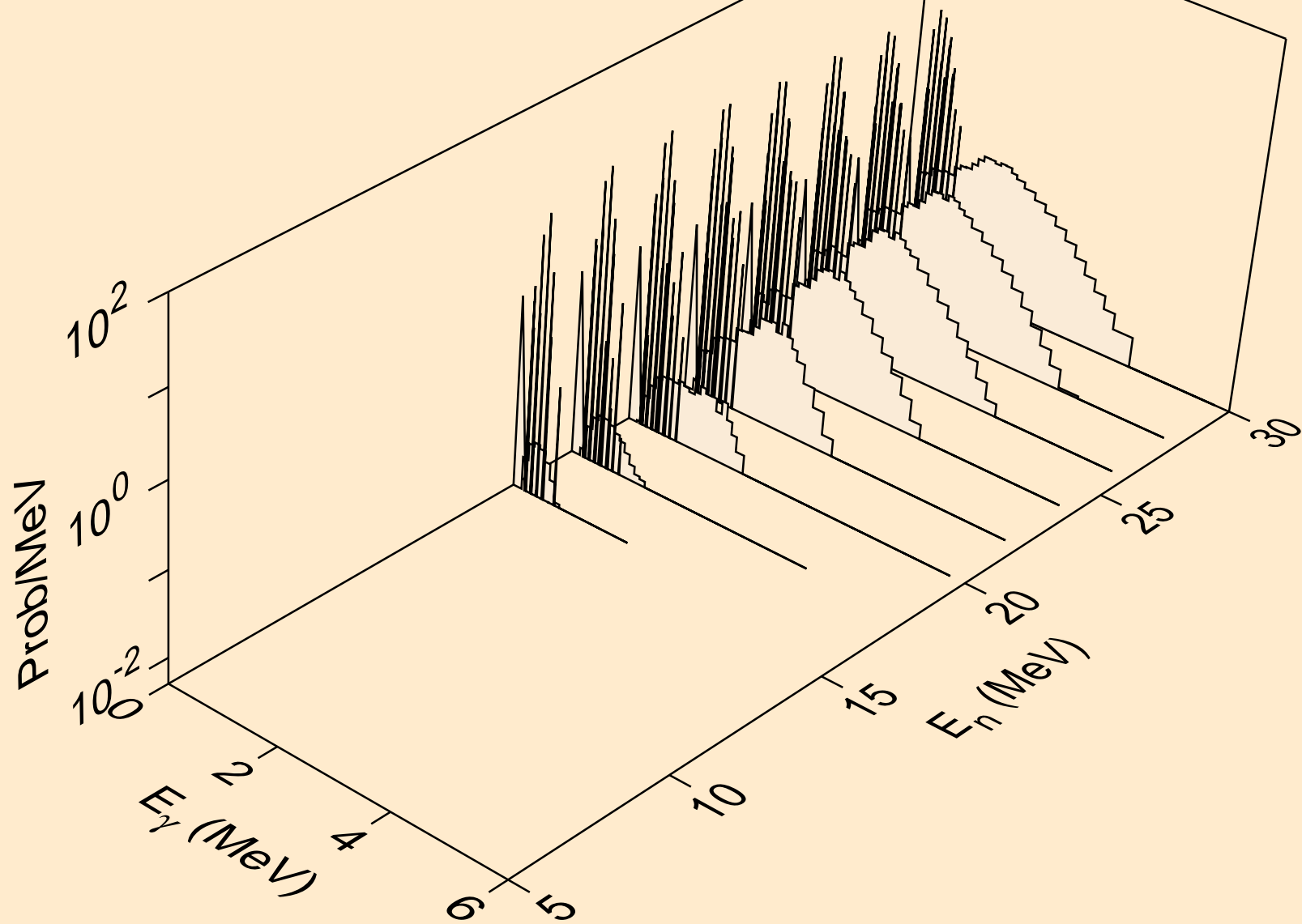

DY144 NEUTRON ACER TENDL-2023 LIBRARY; T=0.K
Photon emission for (n,3n)a

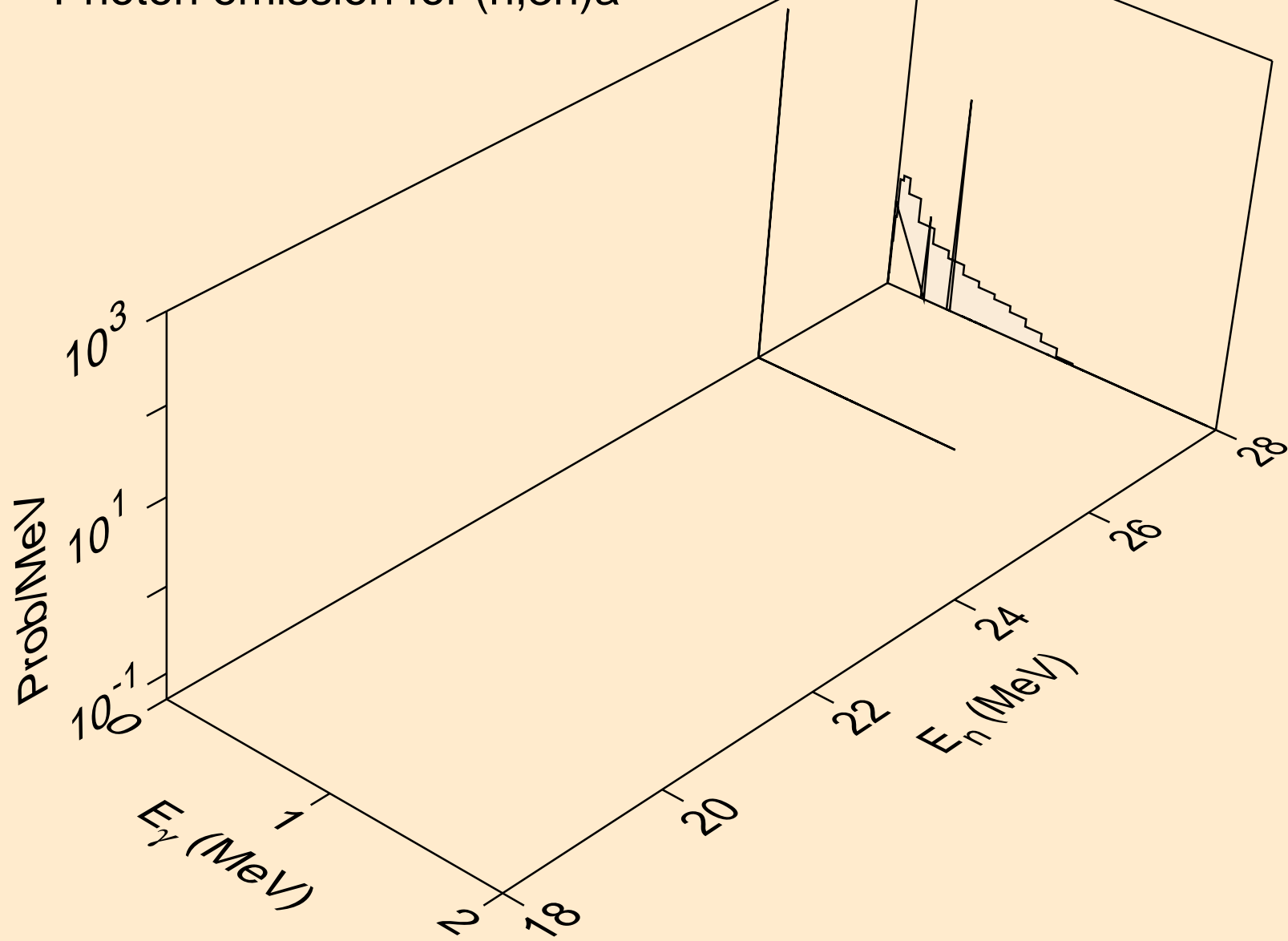

DY144 NEUTRON ACER TENDL-2023 LIBRARY; T=0.K
Photon emission for (n,n*)p

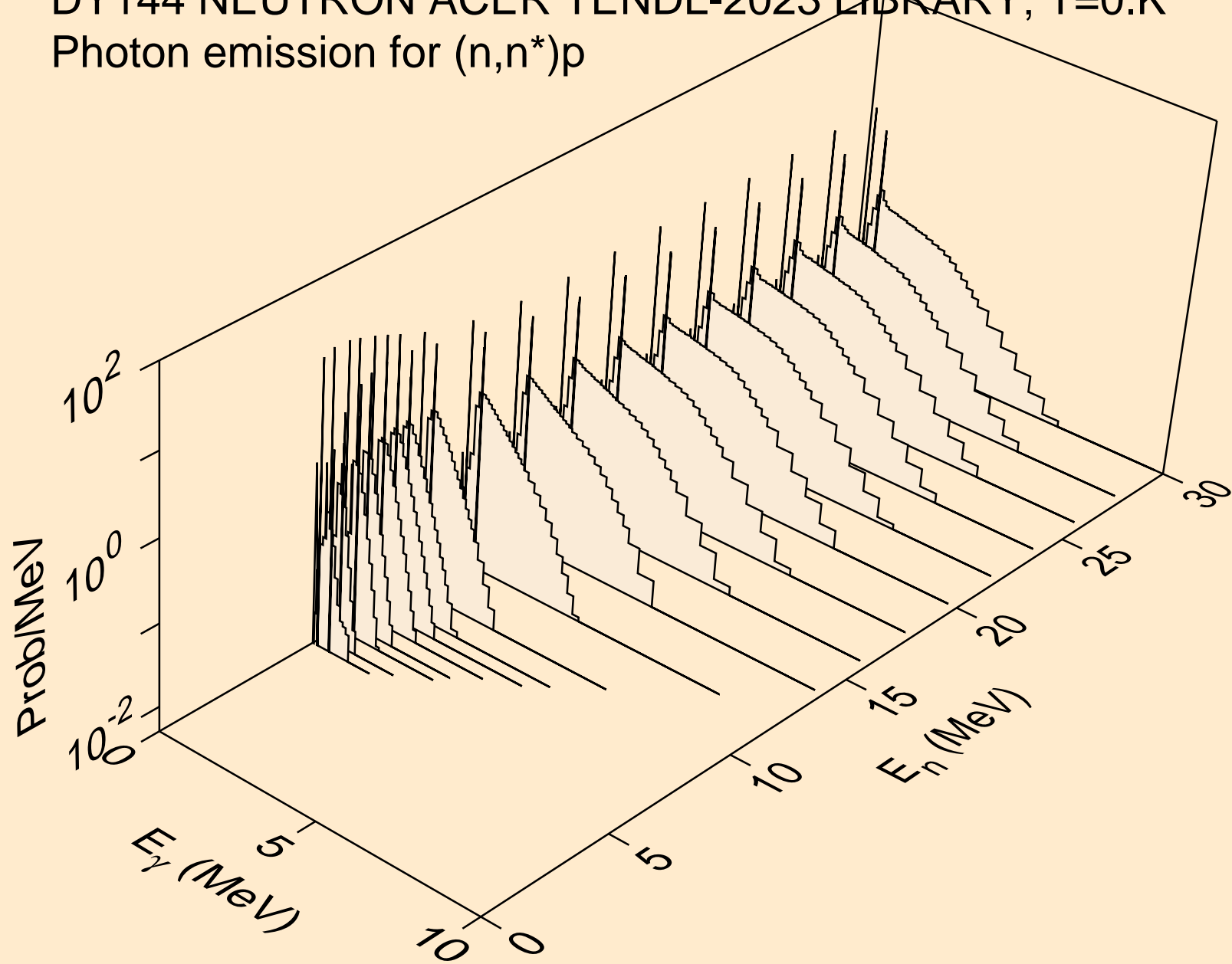

DY144 NEUTRON ACER TENDL-2023 LIBRARY; T=0.K
Photon emission for (n,n*)2a

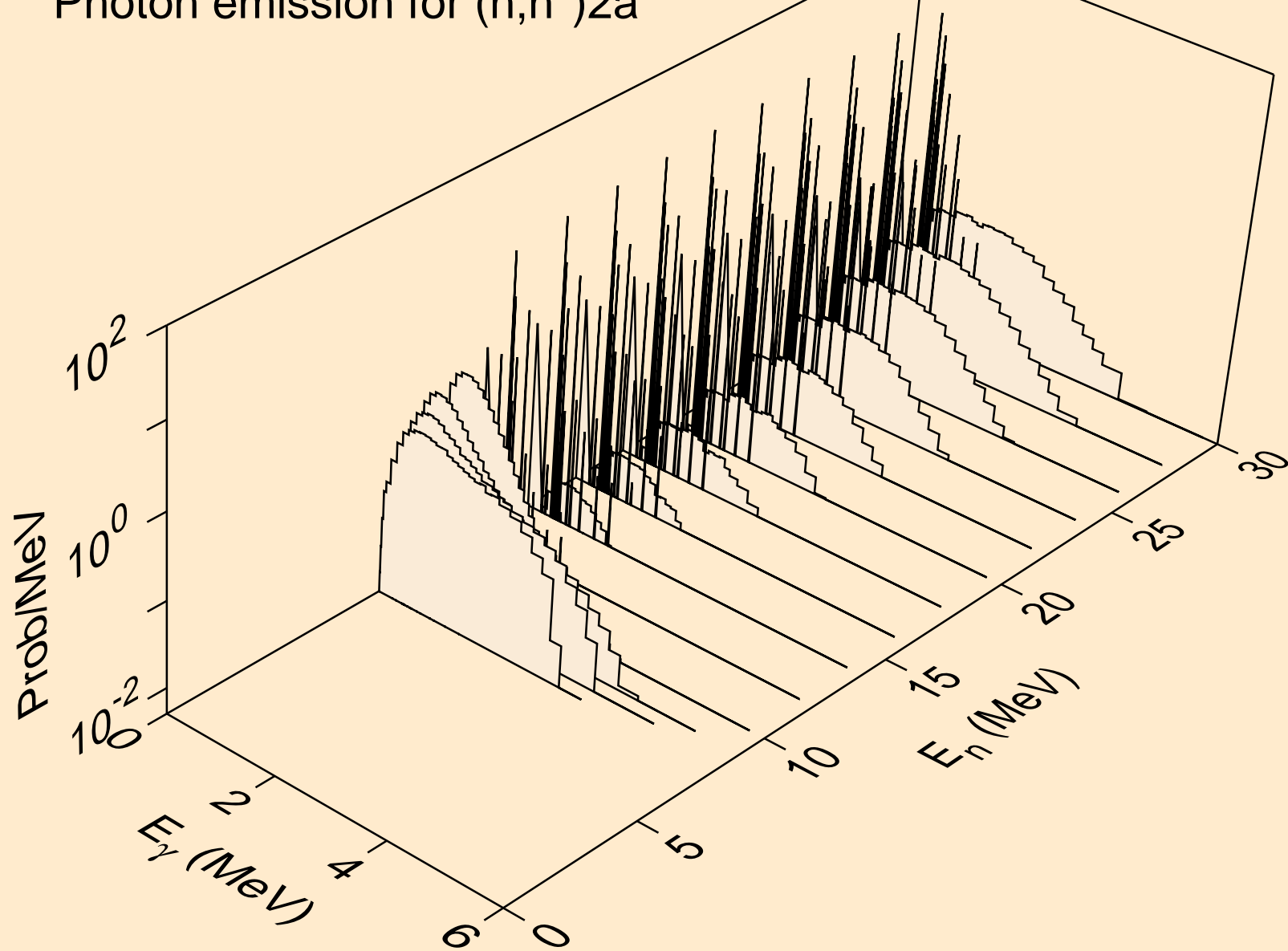

DY144 NEUTRON ACER TENDL-2023 LIBRARY; T=0.K
Photon emission for (n,n*)d

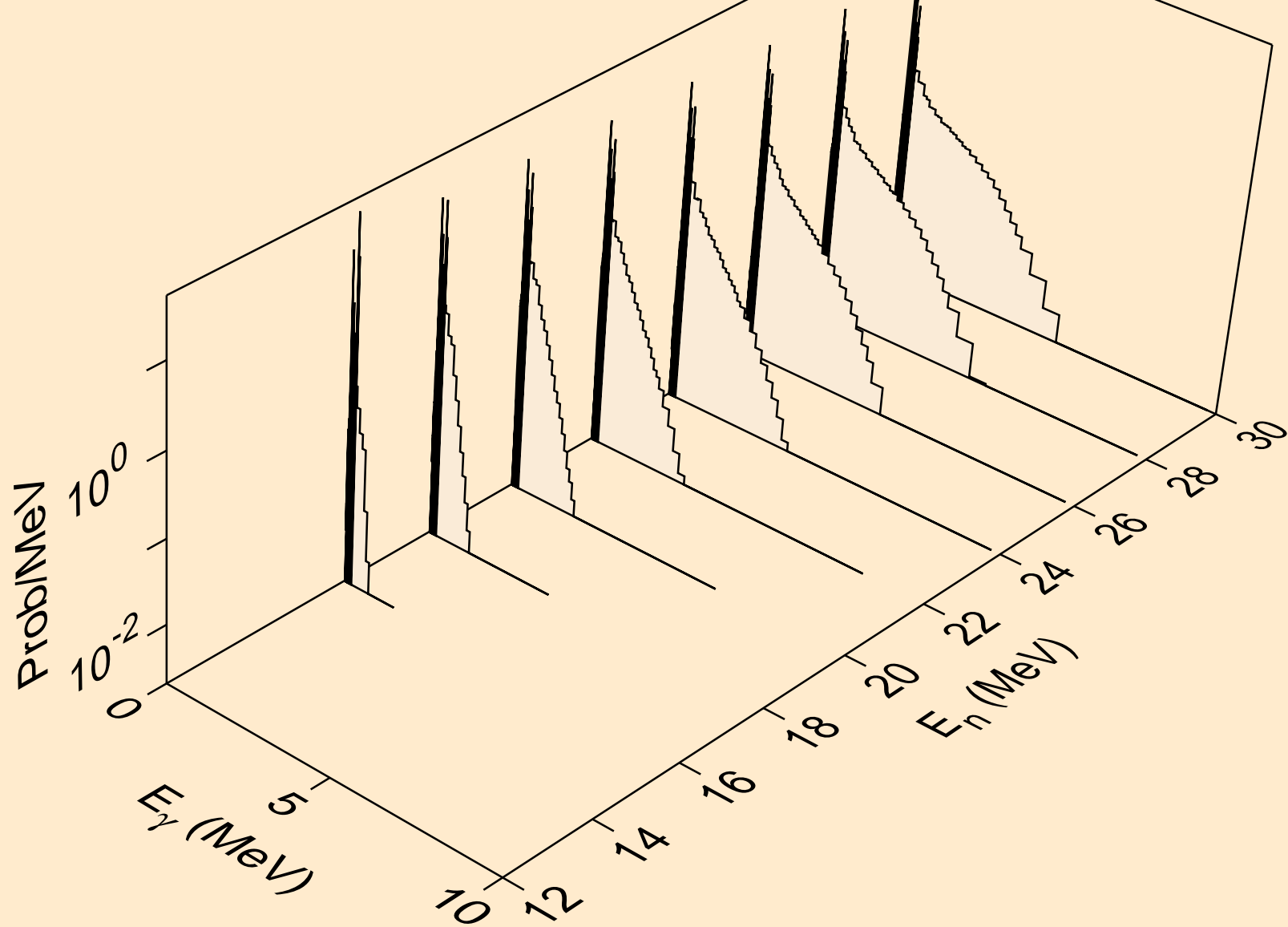

DY144 NEUTRON ACER TENDL-2023 LIBRARY; T=0.K
Photon emission for (n,n*)t

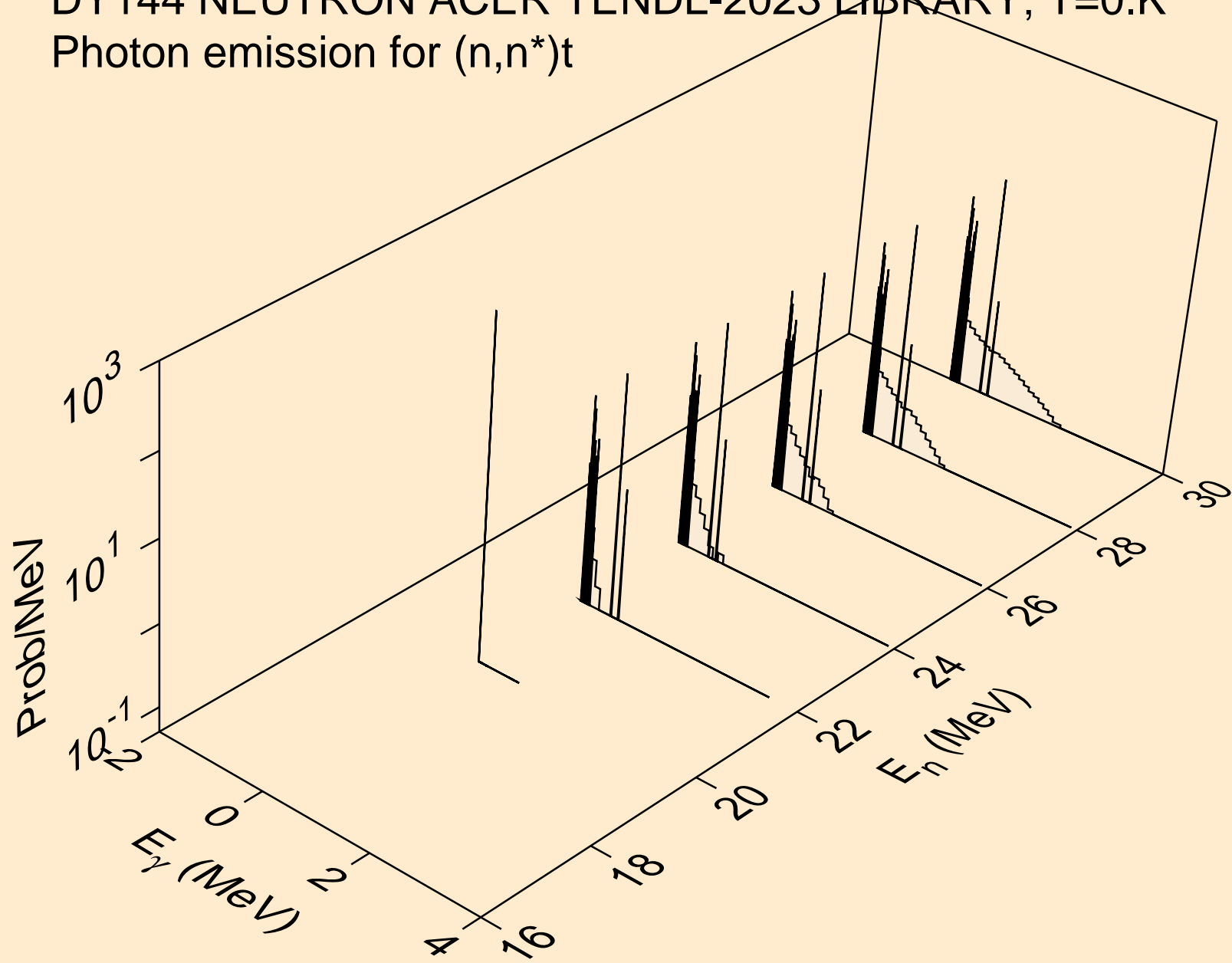

DY144 NEUTRON ACER TENDL-2023 LIBRARY; T=0.K
Photon emission for (n,n*)he3

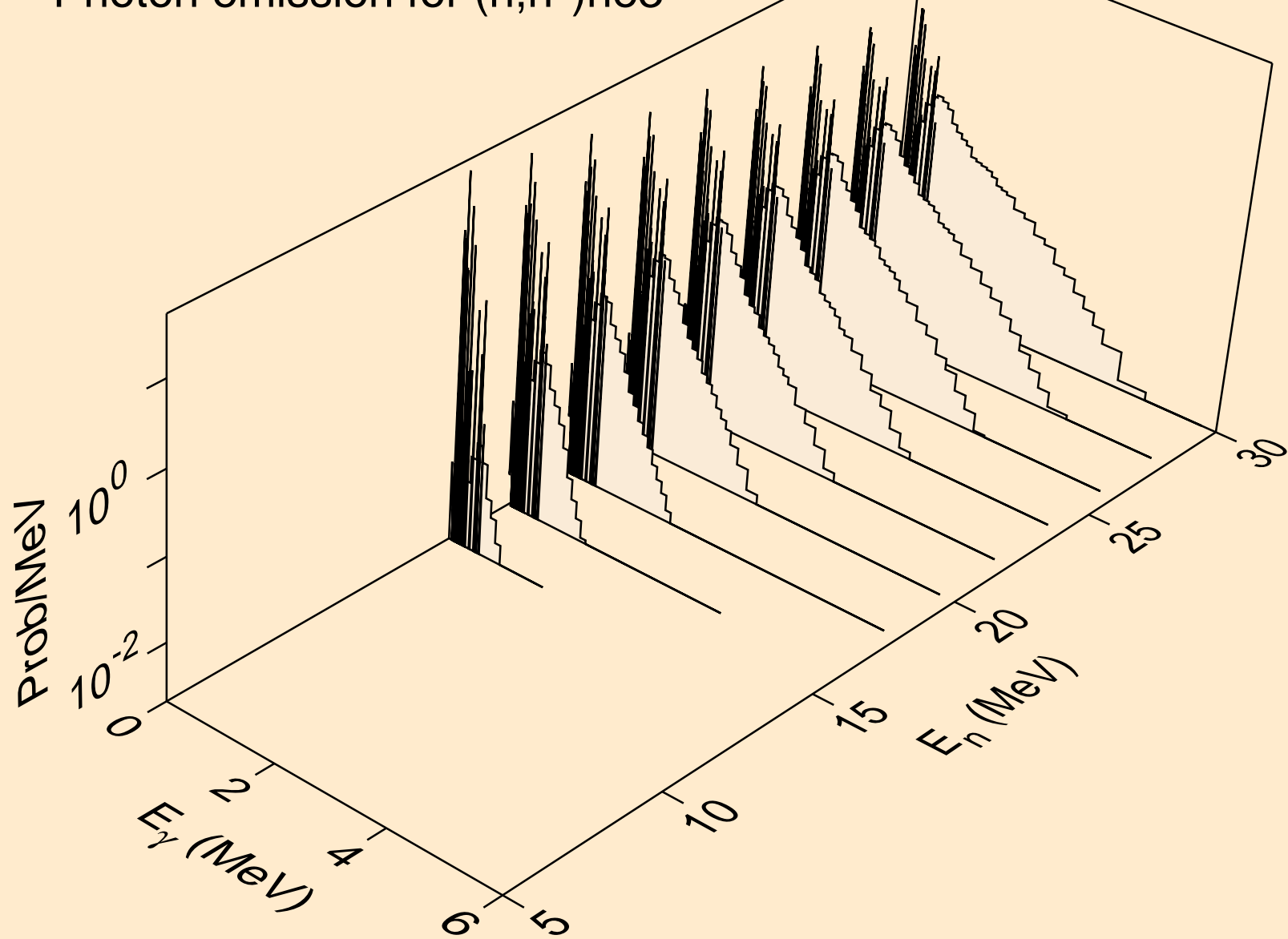

DY144 NEUTRON ACER TENDL-2023 LIBRARY; T=0.K
Photon emission for (n,2np)

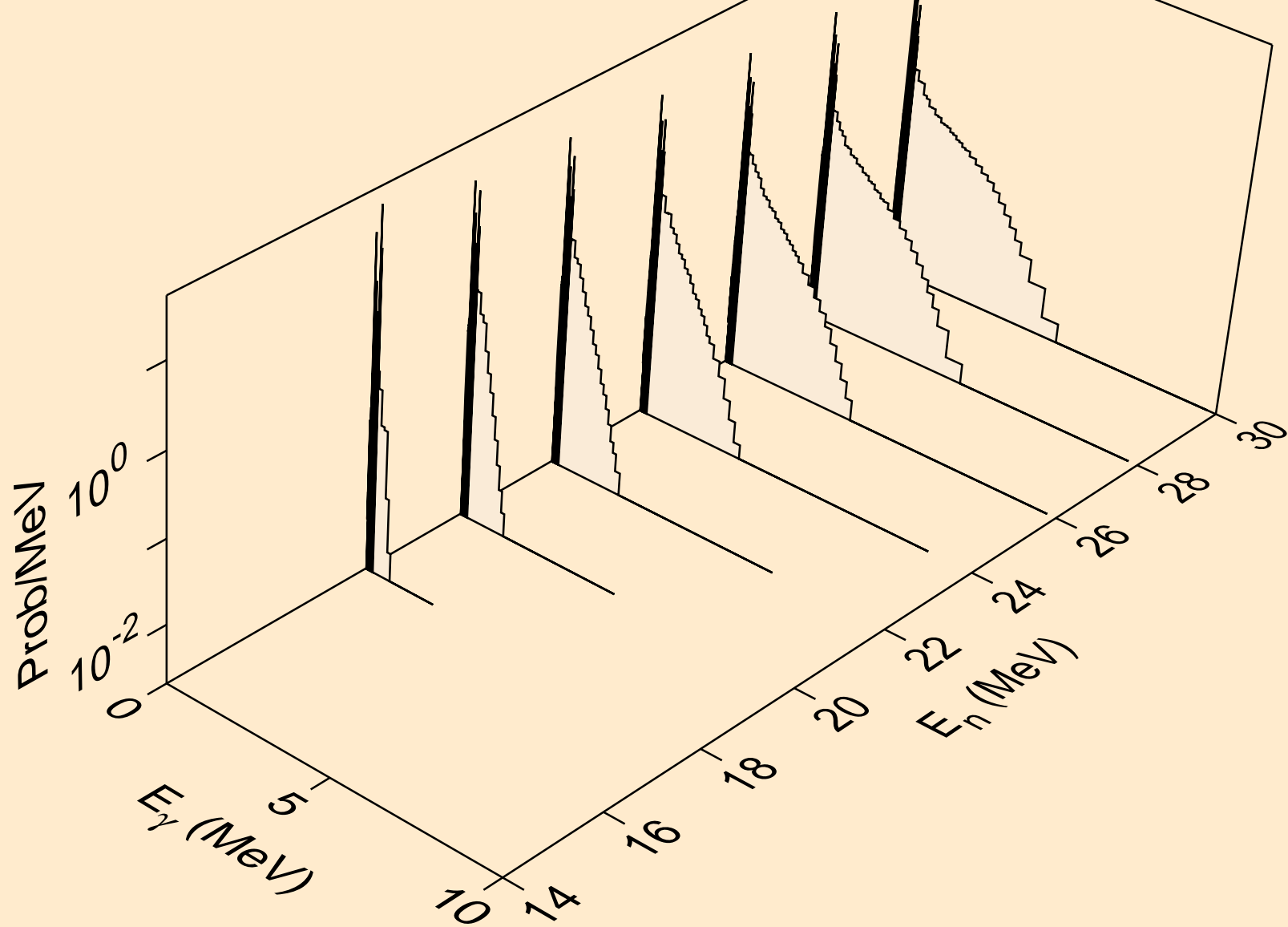

DY144 NEUTRON ACER TENDL-2023 LIBRARY; T=0.K
Photon emission for (n,3np)

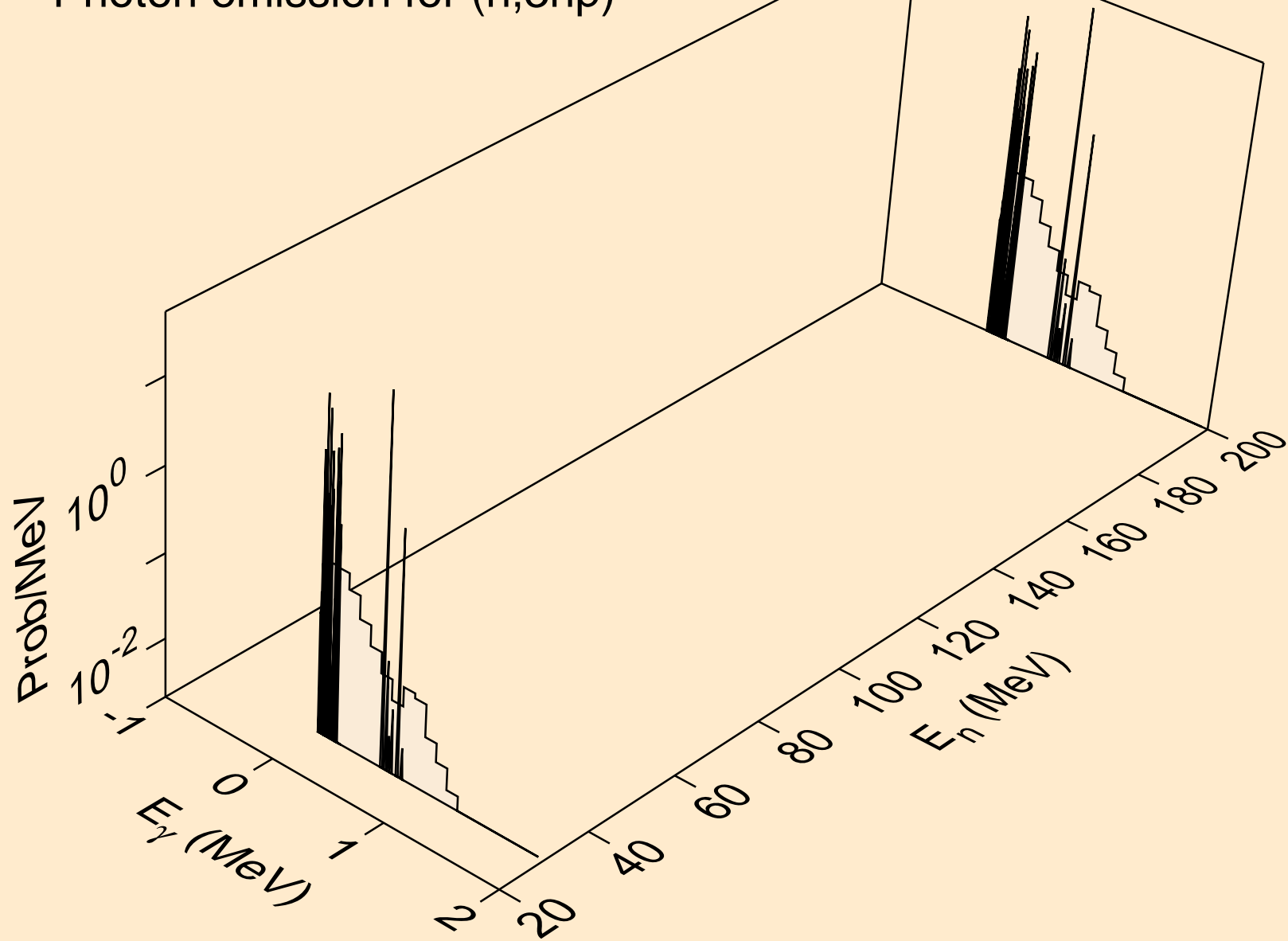

DY144 NEUTRON ACER TENDL-2023 LIBRARY; T=0.K
Photon emission for (n,n2p)

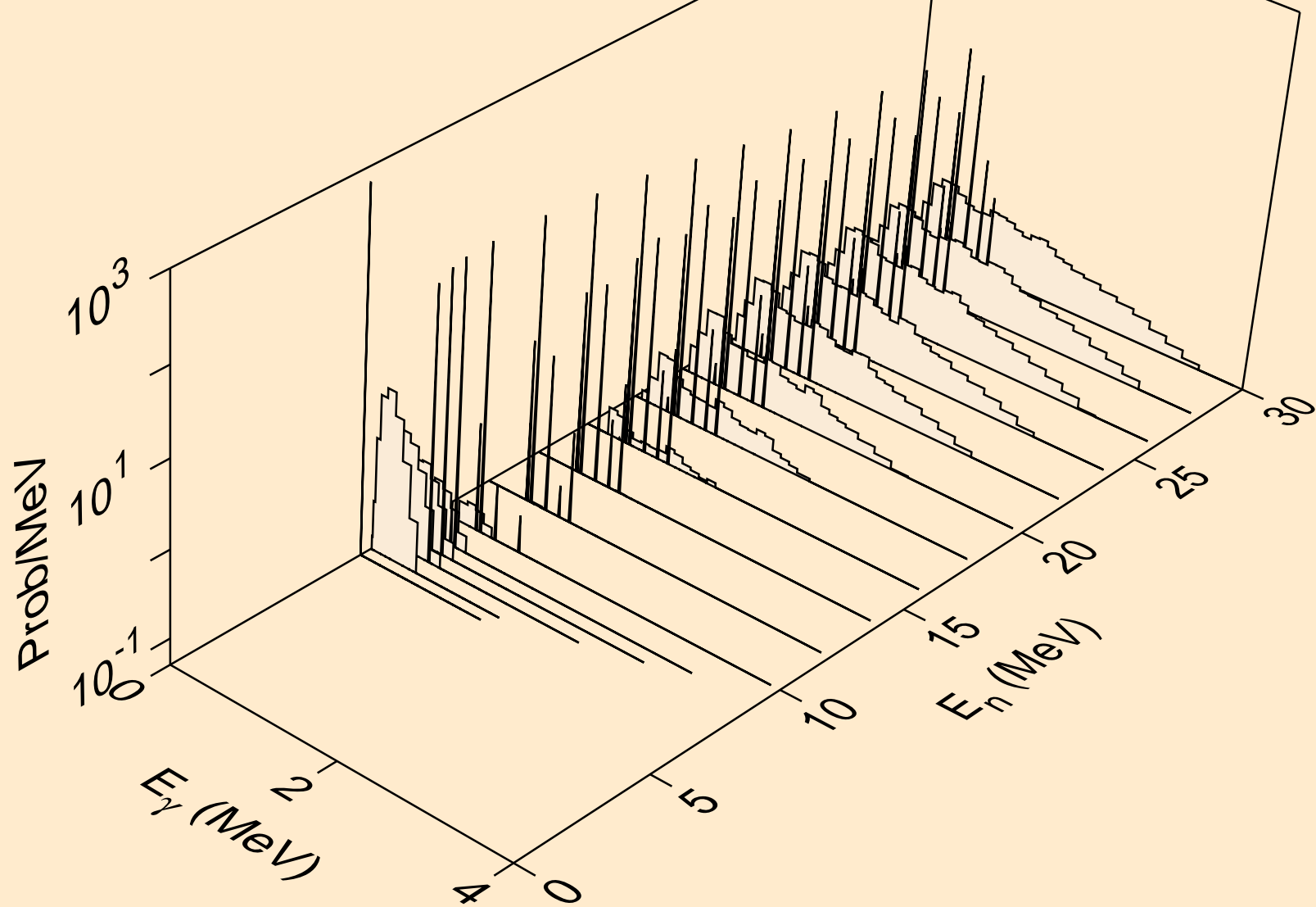

DY144 NEUTRON ACER TENDL-2023 LIBRARY; T=0.K
Photon emission for (n,npa)

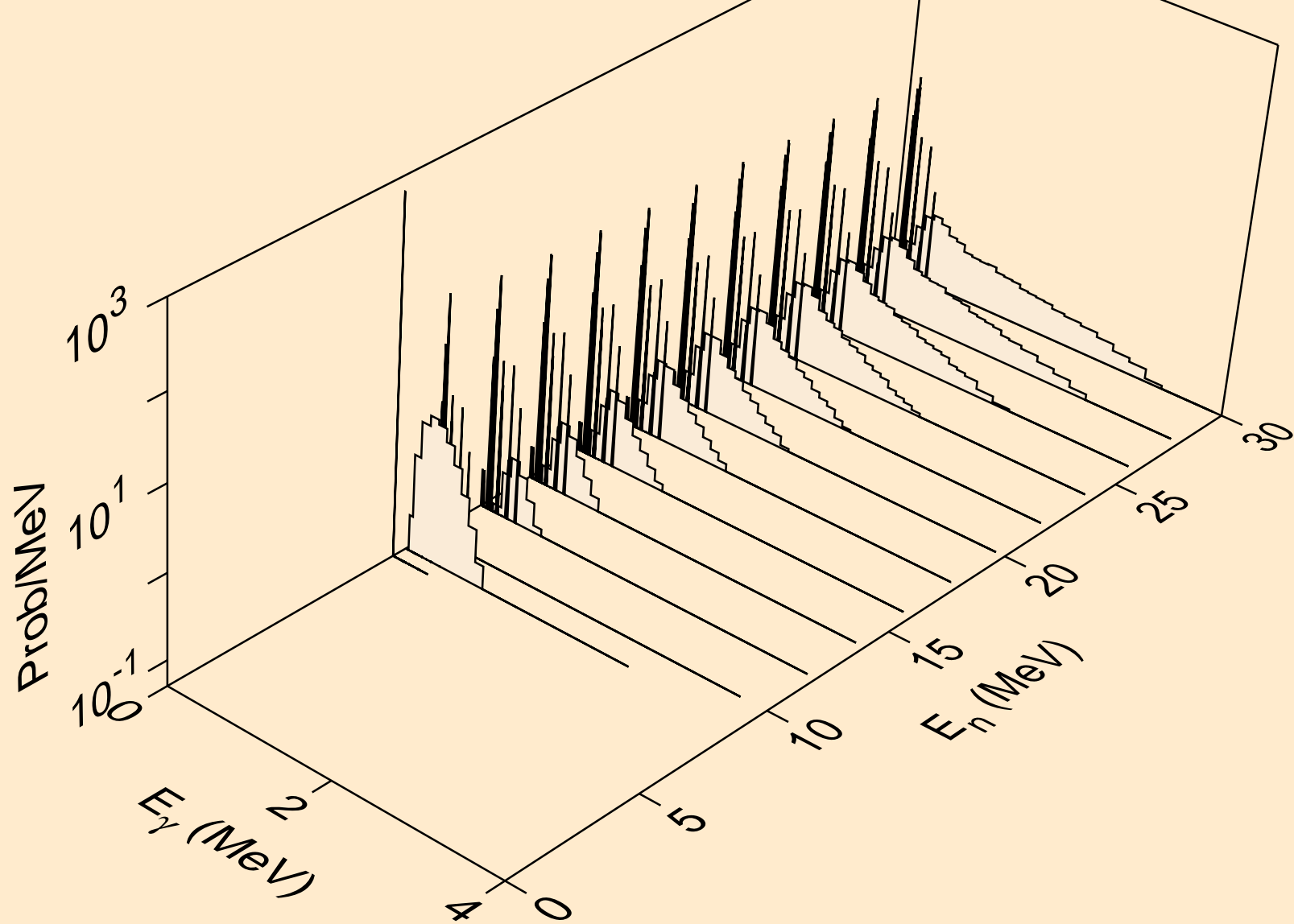

DY144 NEUTRON ACER TENDL-2023 LIBRARY; T=0.K
Photon emission for (n,n*c)

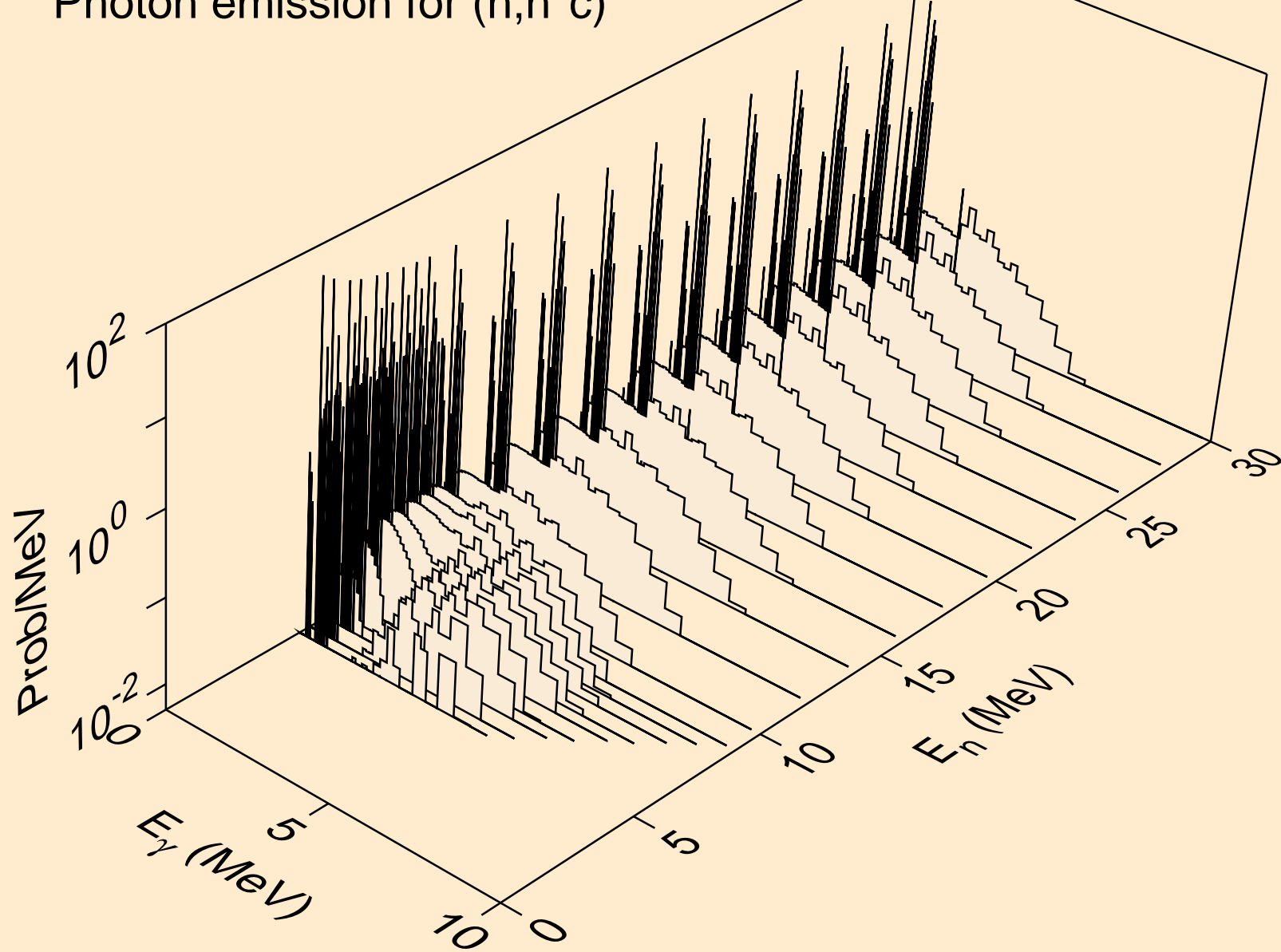

DY144 NEUTRON ACER TENDL-2023 LIBRARY; T=0.K
Photon emission for (n,gma)

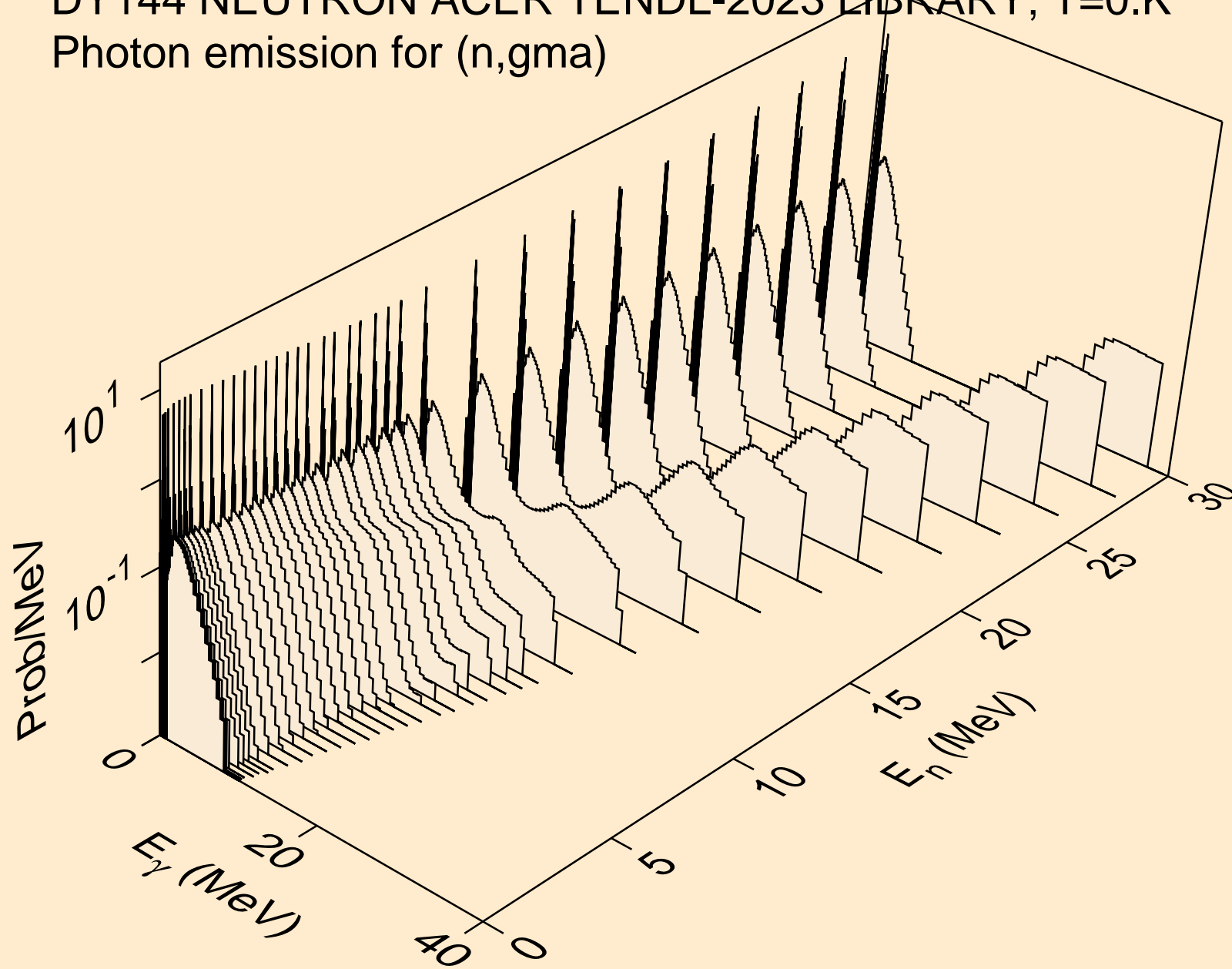

DY144 NEUTRON ACER TENDL-2023 LIBRARY; T=0.K
Photon emission for (n,p)

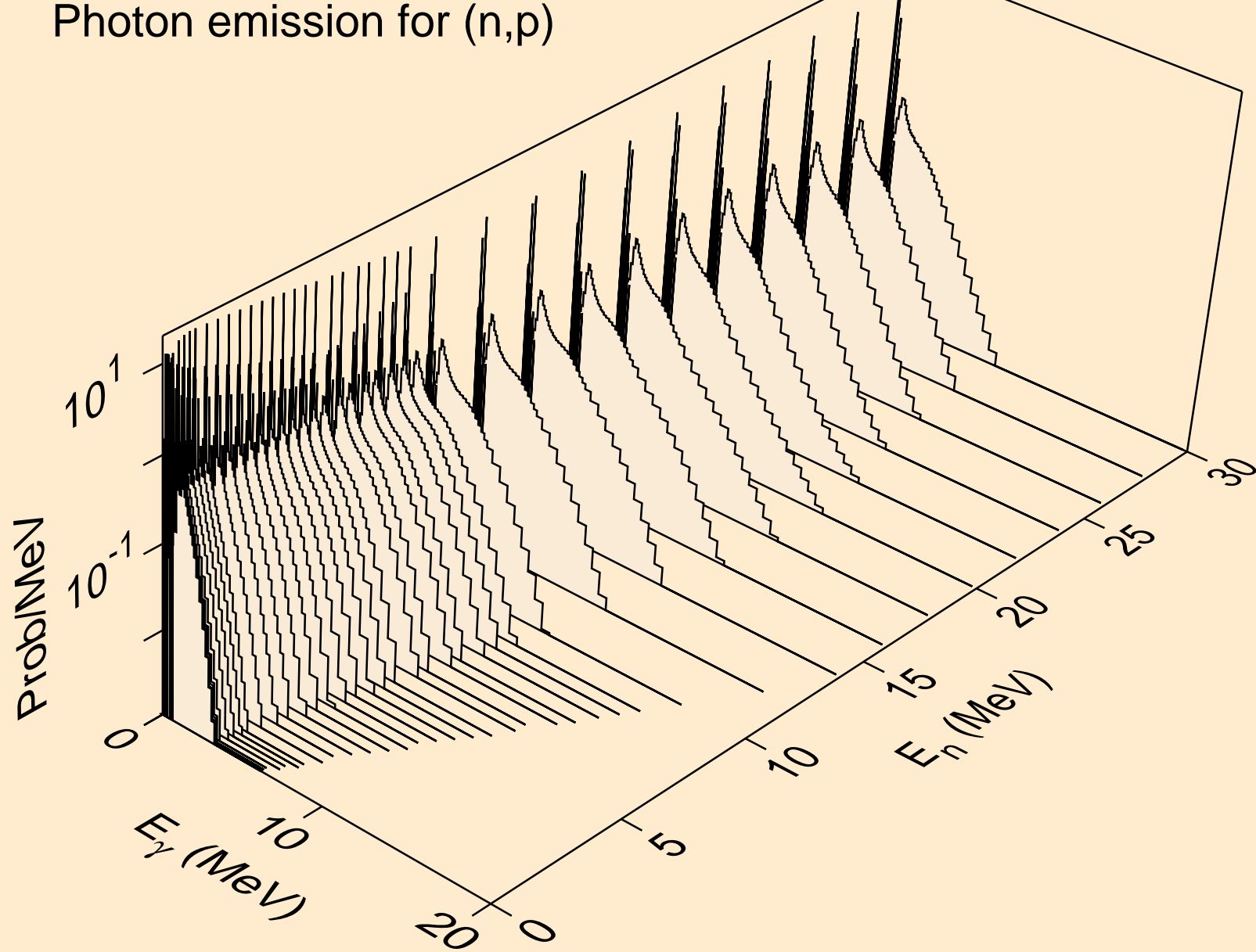

DY144 NEUTRON ACER TENDL-2023 LIBRARY; T=0.K
Photon emission for (n,d)

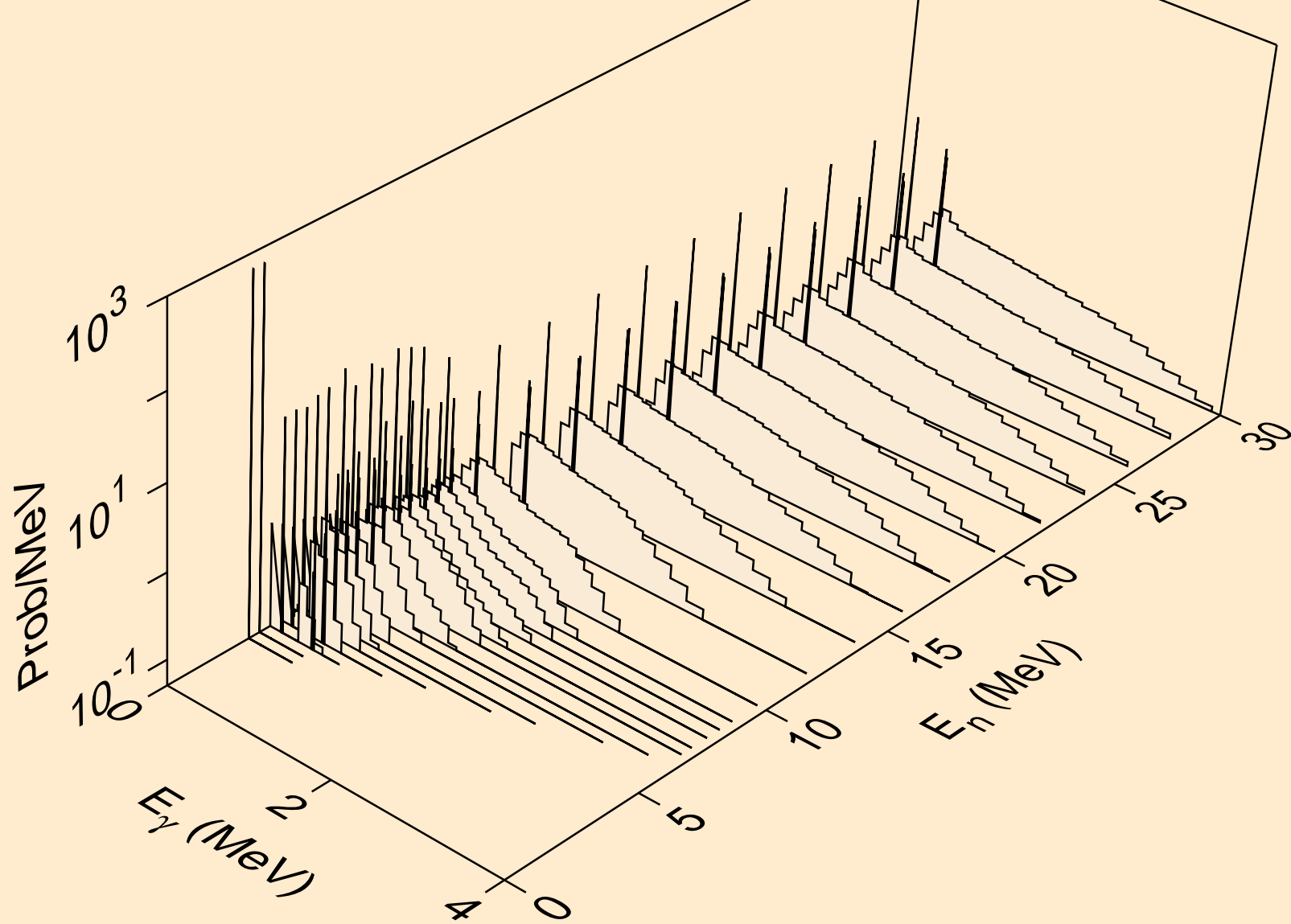

DY144 NEUTRON ACER TENDL-2023 LIBRARY; T=0.K
Photon emission for (n,t)

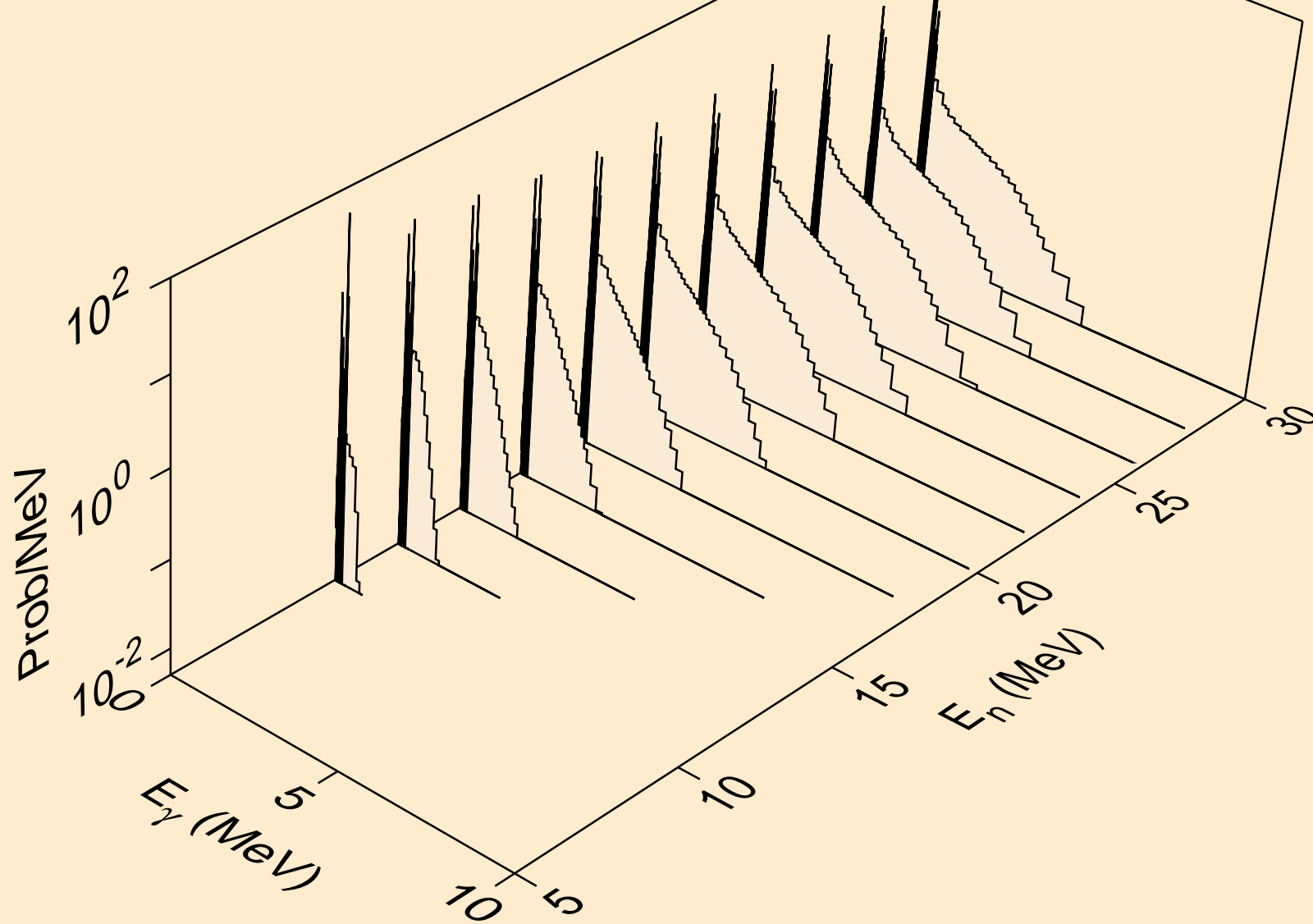

DY144 NEUTRON ACER TENDL-2023 LIBRARY; T=0.K
Photon emission for (n,he3)

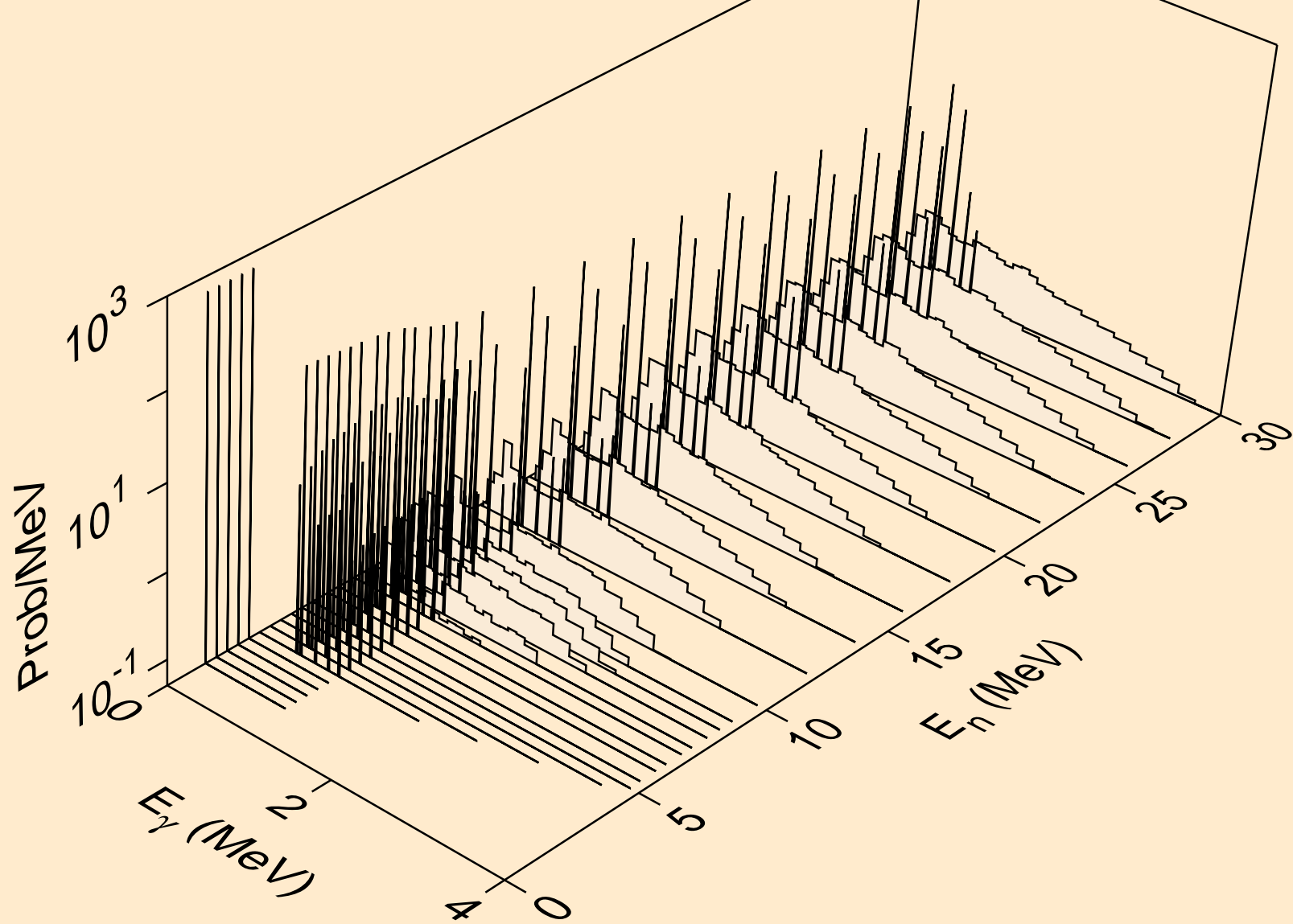

DY144 NEUTRON ACER TENDL-2023 LIBRARY; T=0.K
Photon emission for (n,a)

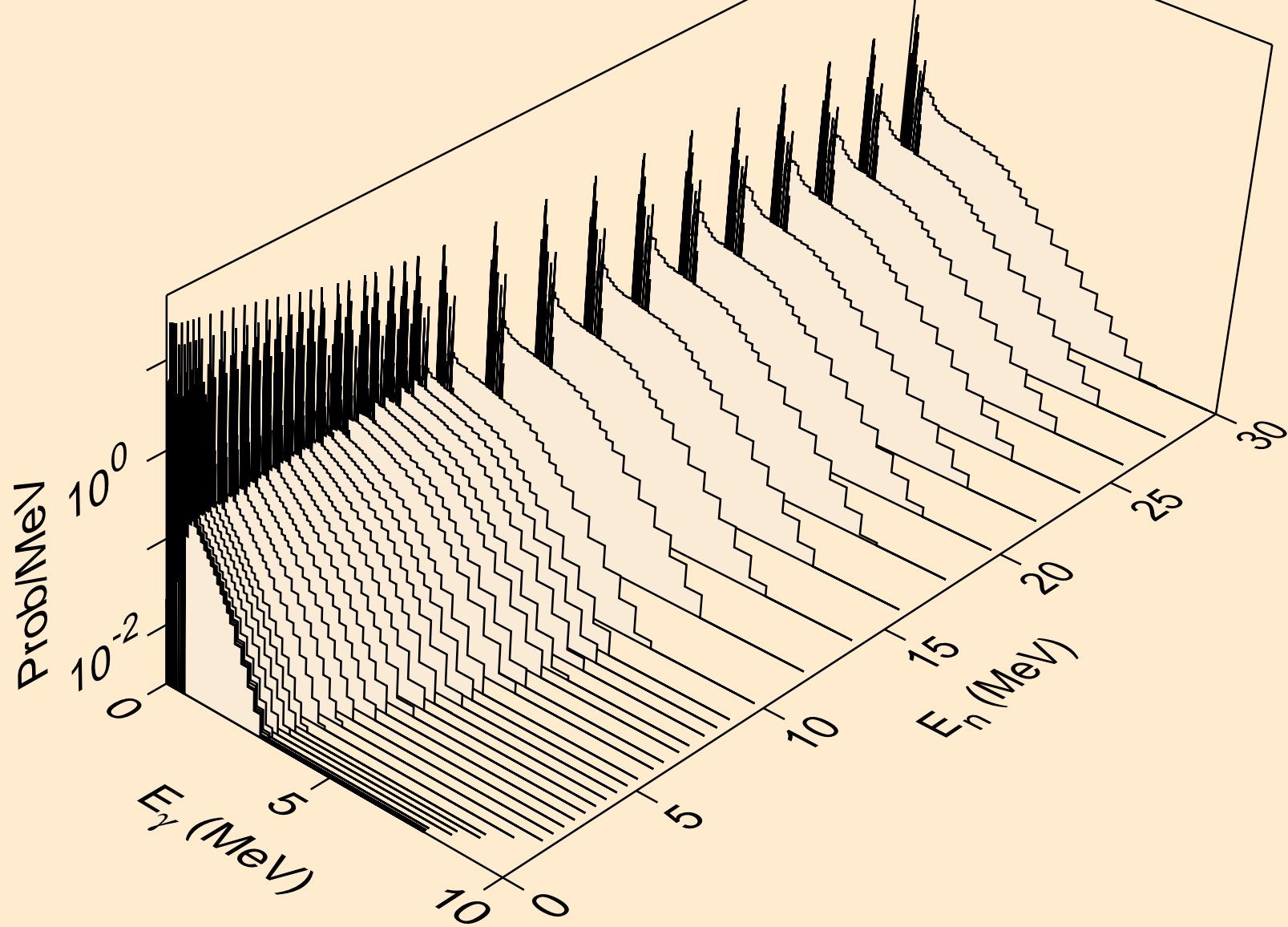

DY144 NEUTRON ACER TENDL-2023 LIBRARY; T=0.K
Photon emission for (n,2a)

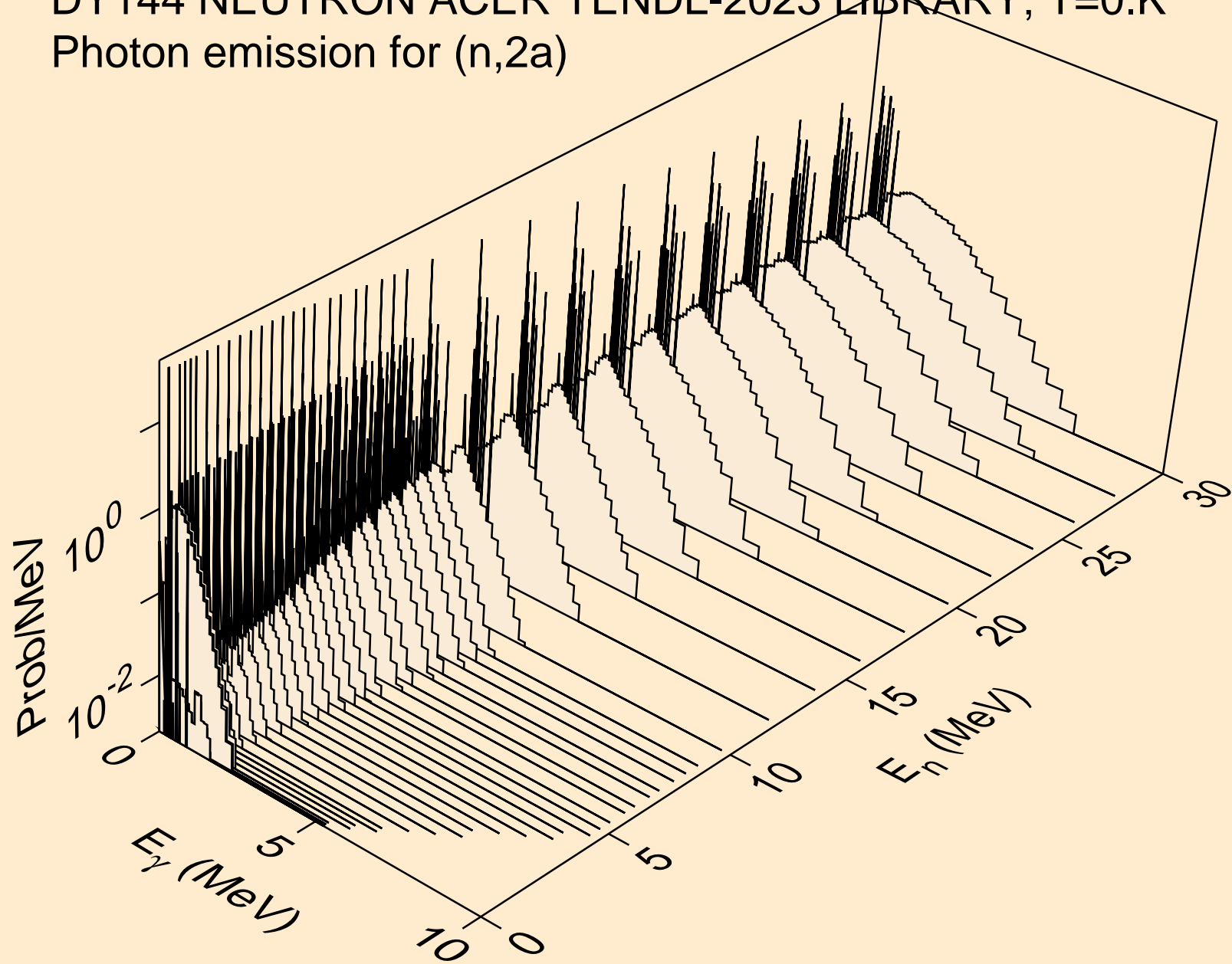

DY144 NEUTRON ACER TENDL-2023 LIBRARY; T=0.K
Photon emission for (n,3a)

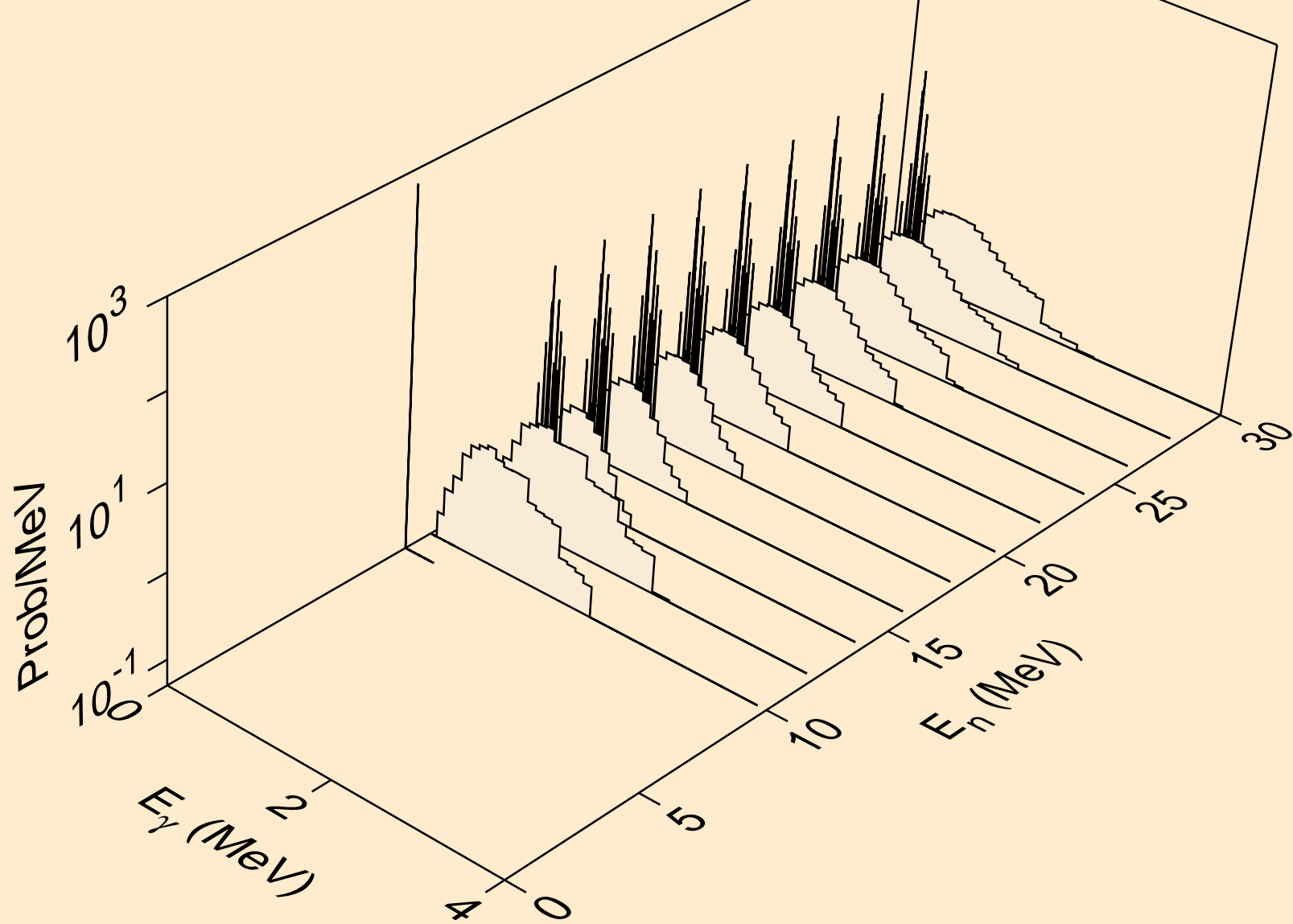

DY144 NEUTRON ACER TENDL-2023 LIBRARY; T=0.K
Photon emission for (n,2p)

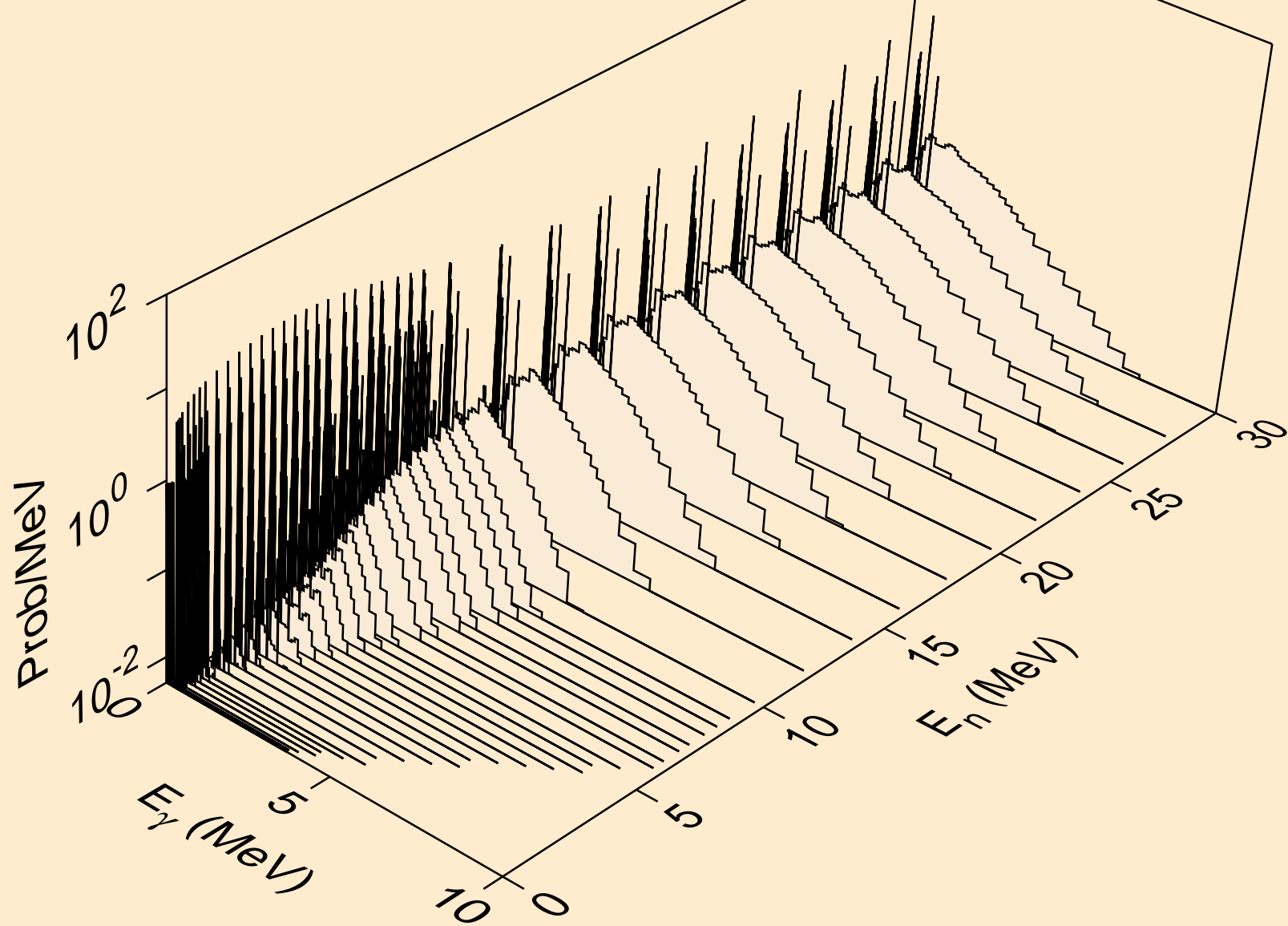

DY144 NEUTRON ACER TENDL-2023 LIBRARY; T=0.K
Photon emission for (n,p α)

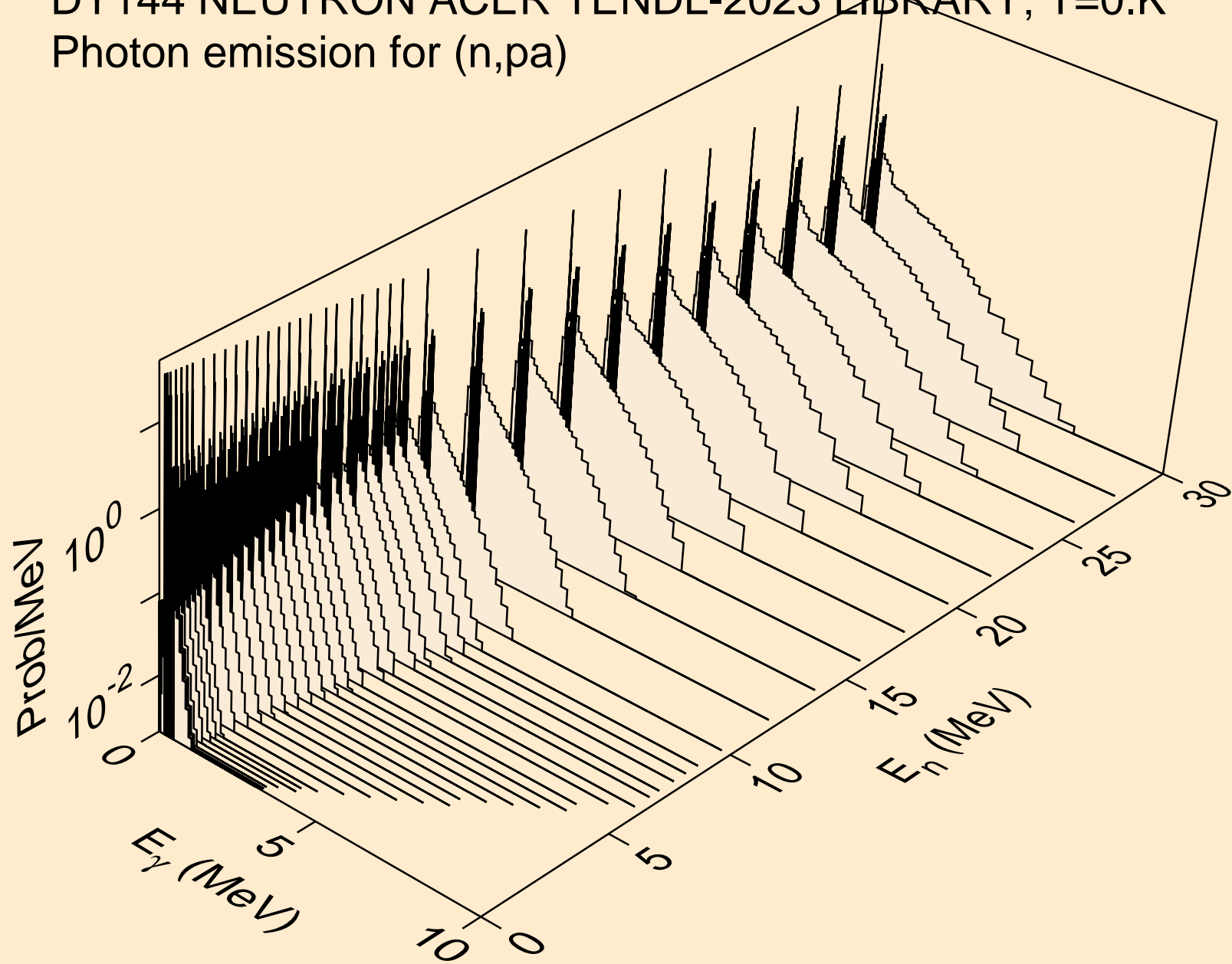

DY144 NEUTRON ACER TENDL-2023 LIBRARY; T=0.K
Photon emission for (n,pd)

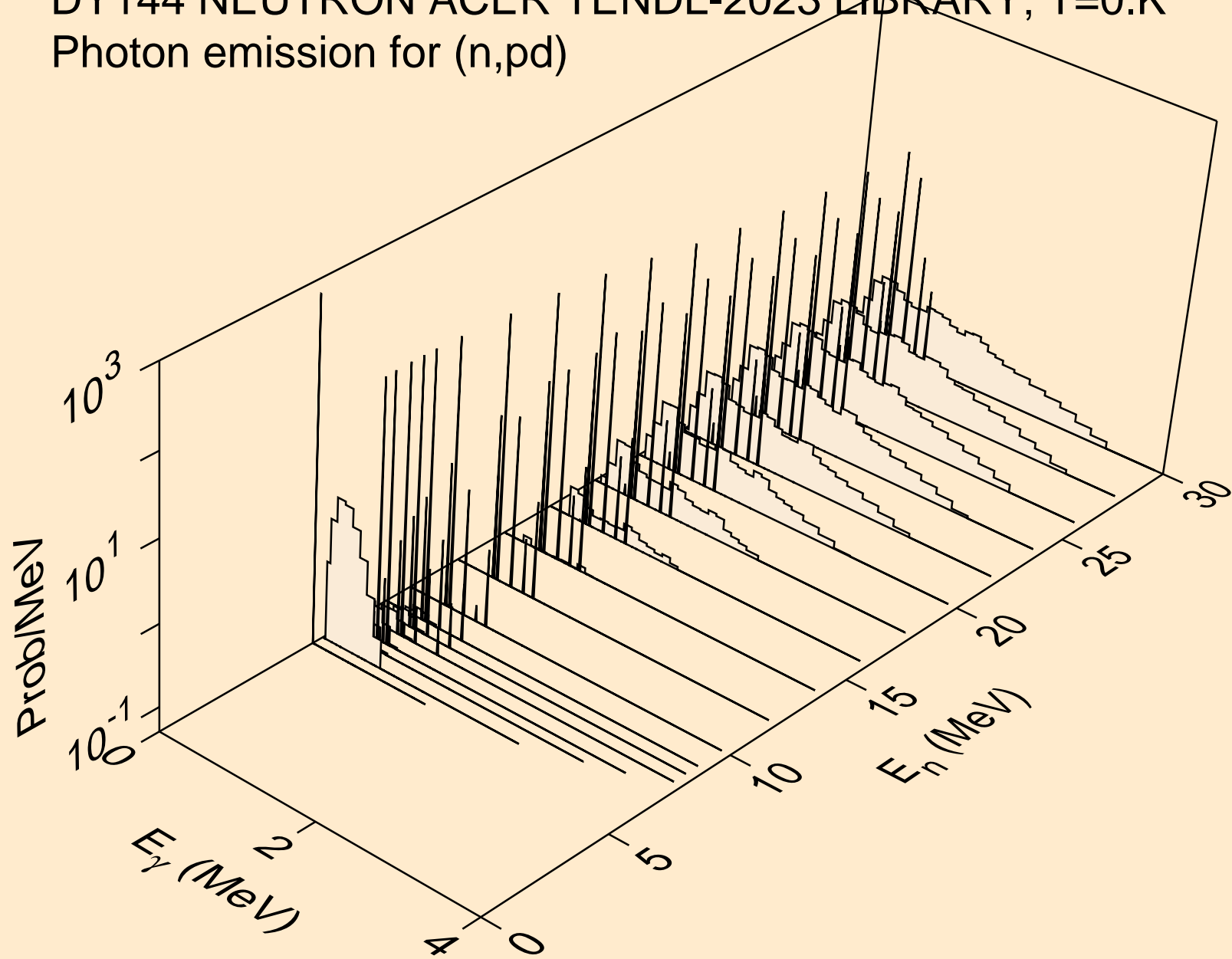

DY144 NEUTRON ACER TENDL-2023 LIBRARY; T=0.K
Photon emission for (n,pt)

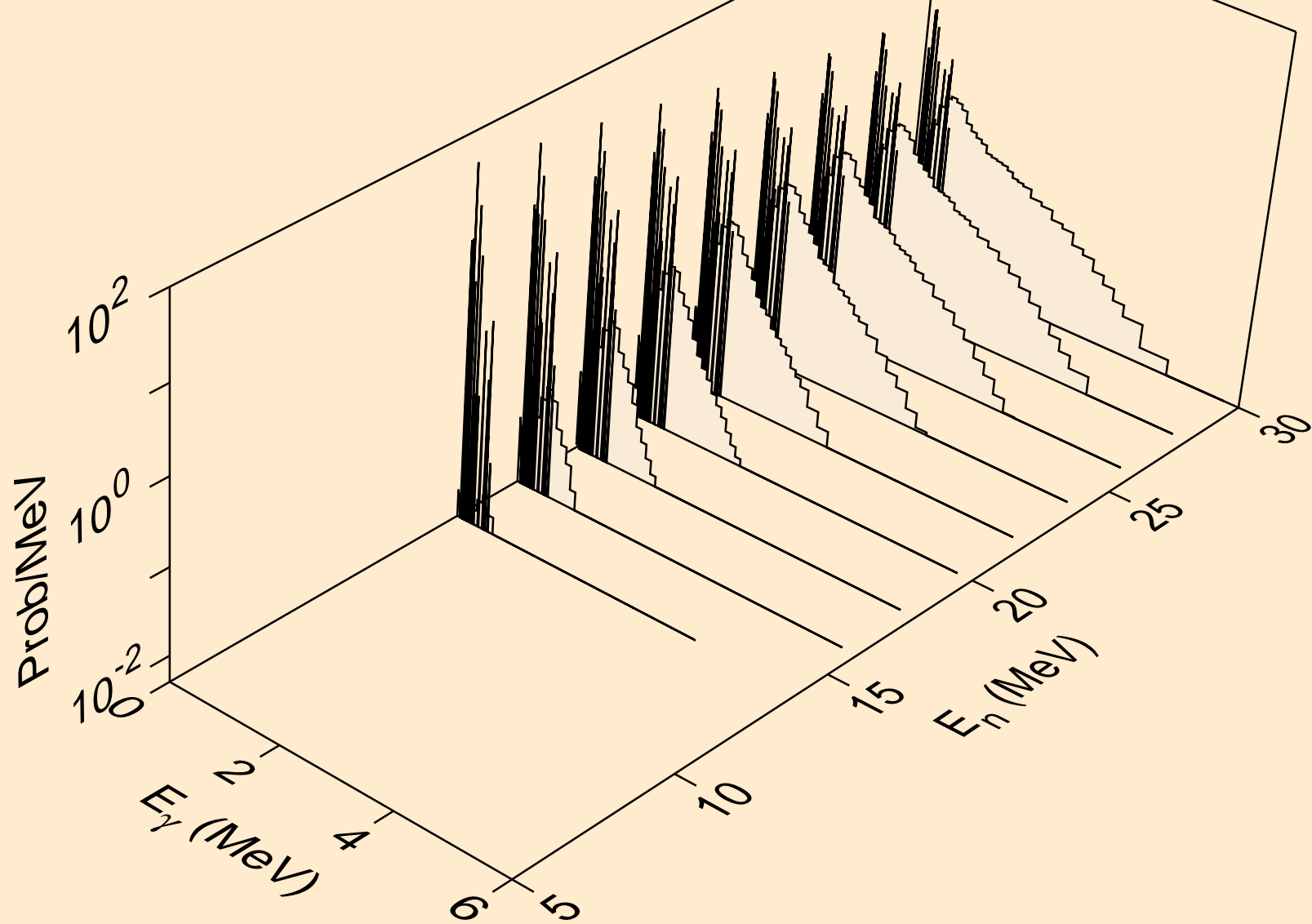

DY144 NEUTRON ACER TENDL-2023 LIBRARY; T=0.K
Photon emission for (n,da)

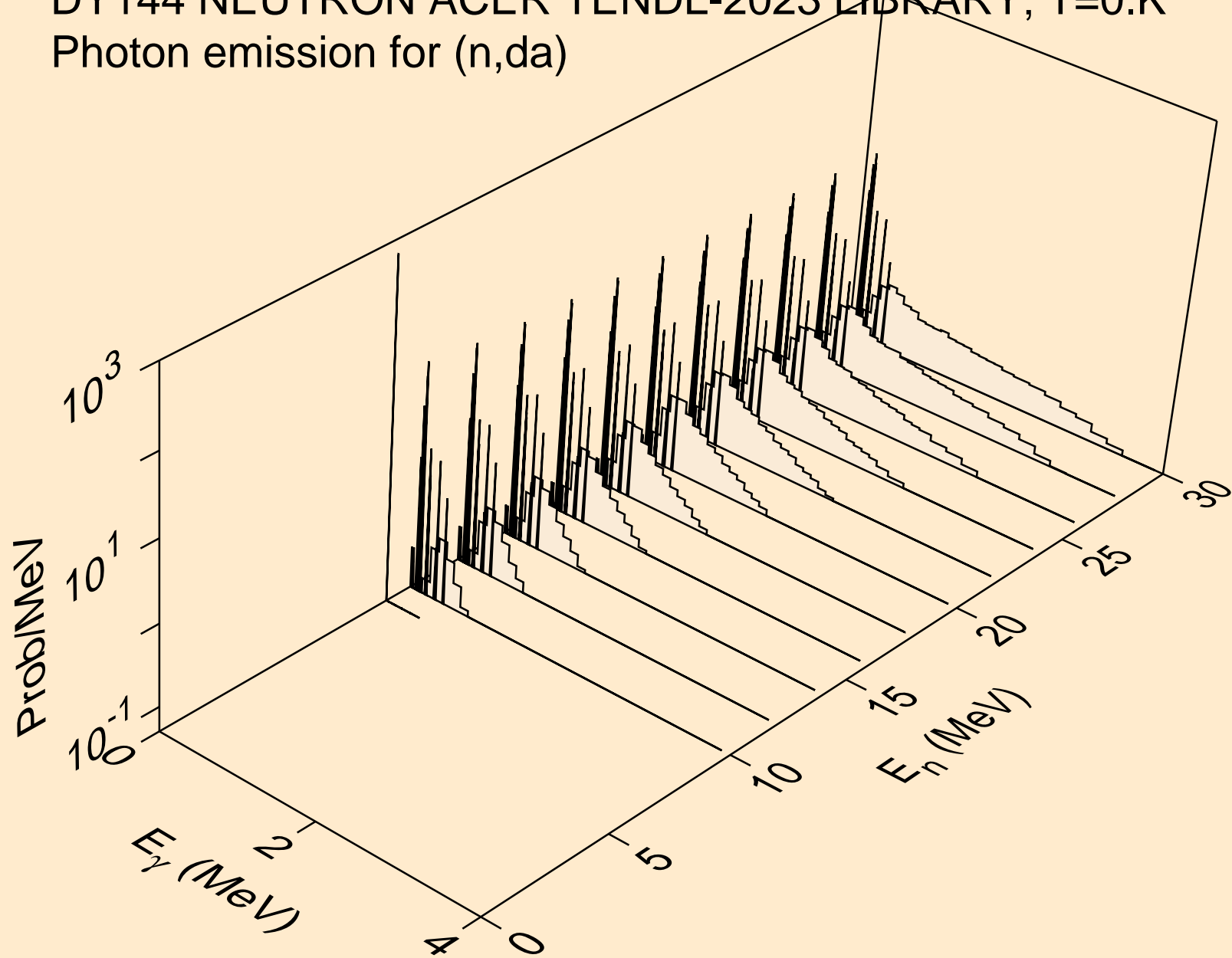

DY144 NEUTRON ACER TENDL-2023 LIBRARY; T=0.K
thermal capture photon spectrum

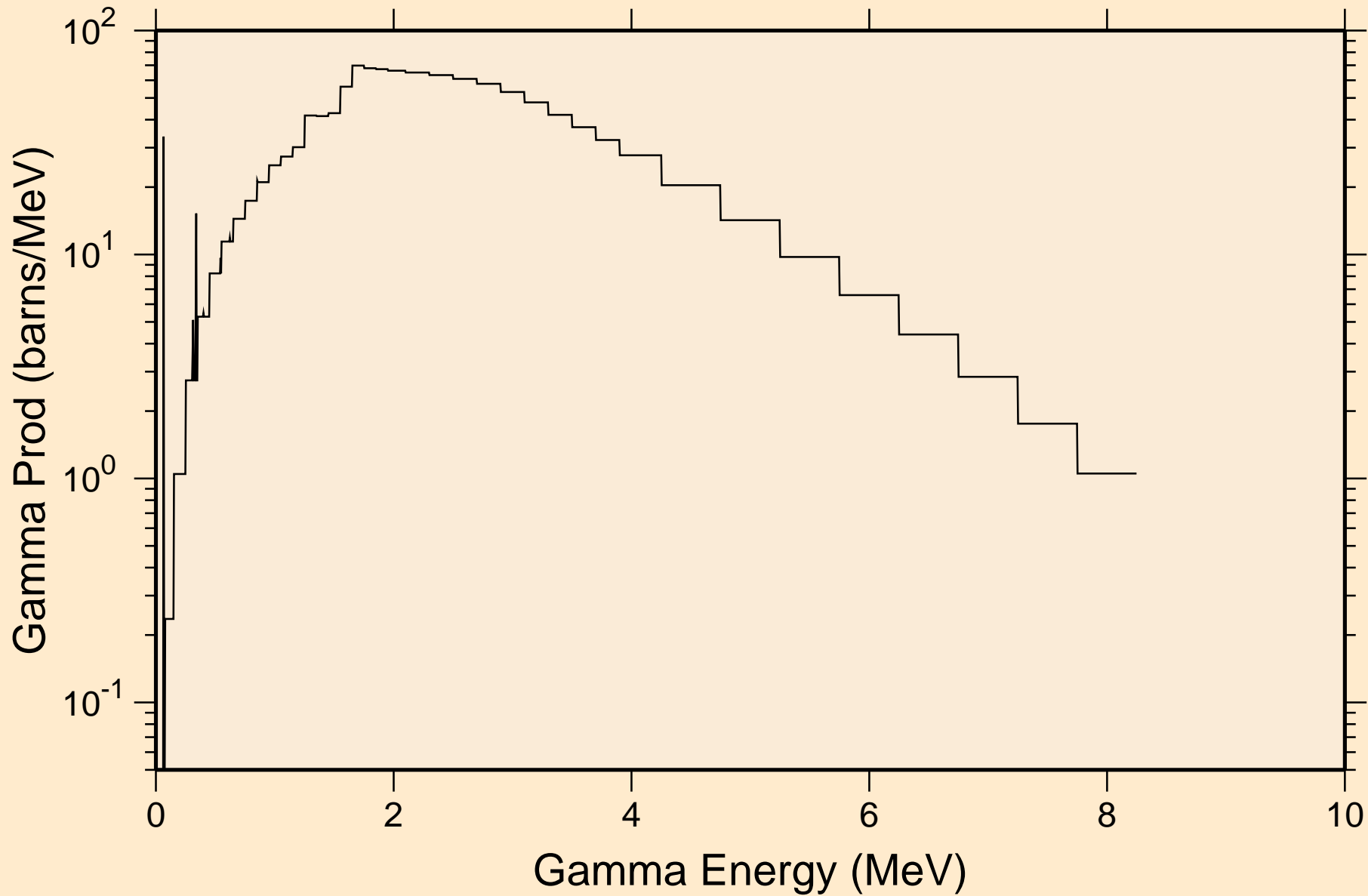

DY144 NEUTRON ACER TENDL-2023 LIBRARY; T=0.K
14 MeV photon spectrum

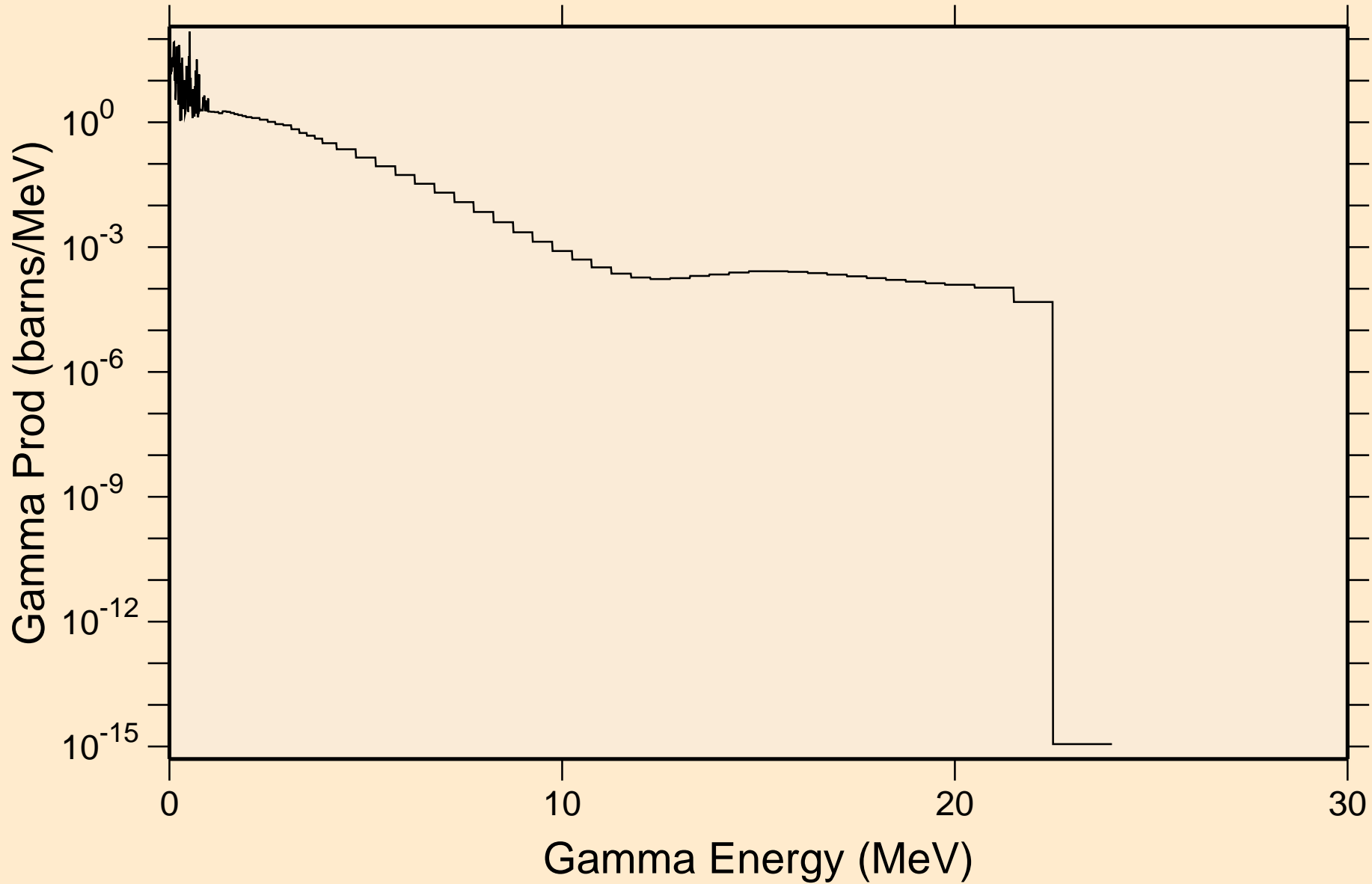

DY144 NEUTRON ACER TENDL-2023 LIBRARY; T=0.K

Particle heating contributions

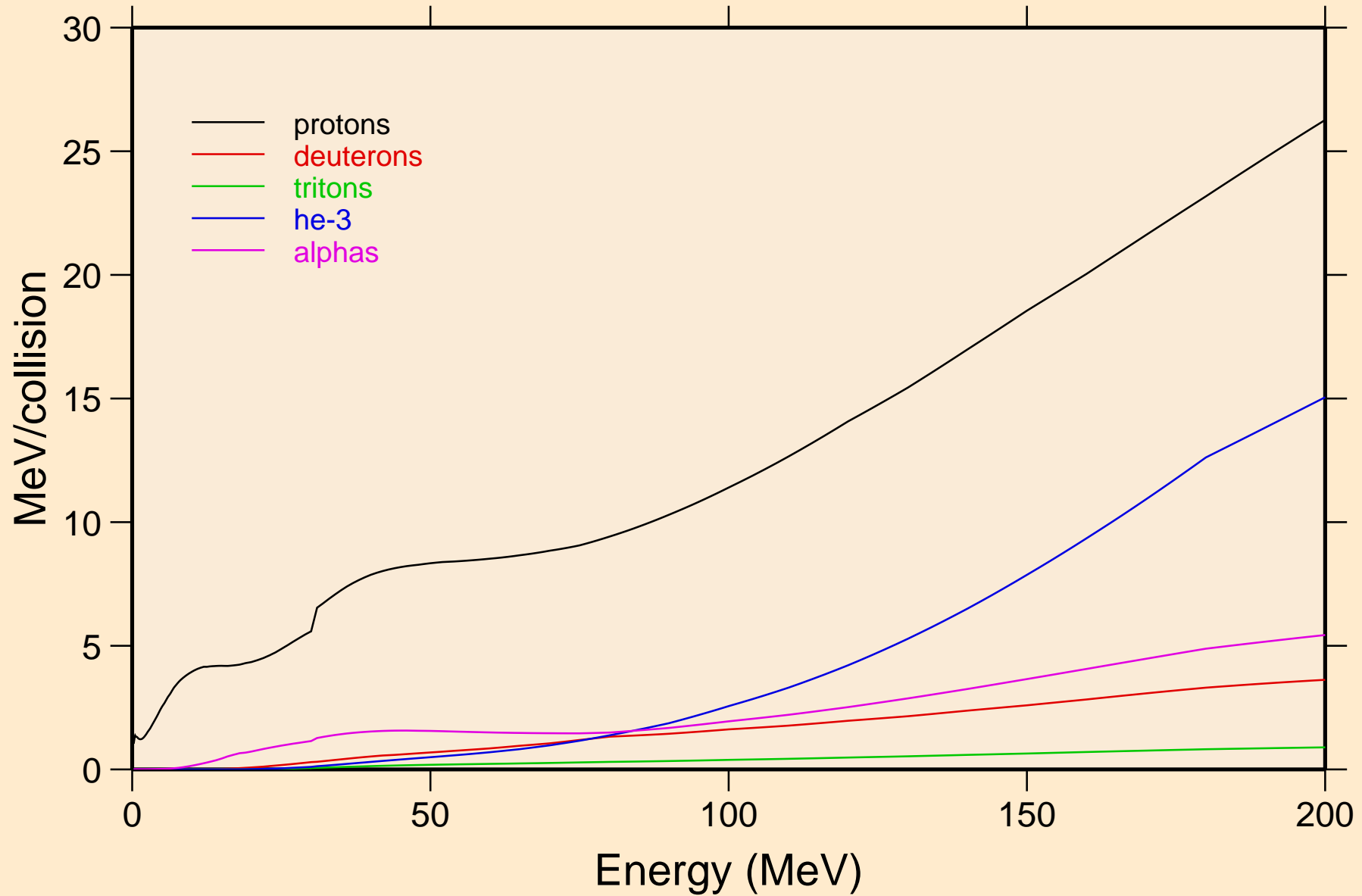

DY144 NEUTRON ACER TENDL-2023 LIBRARY; T=0.K
Recoil Heating

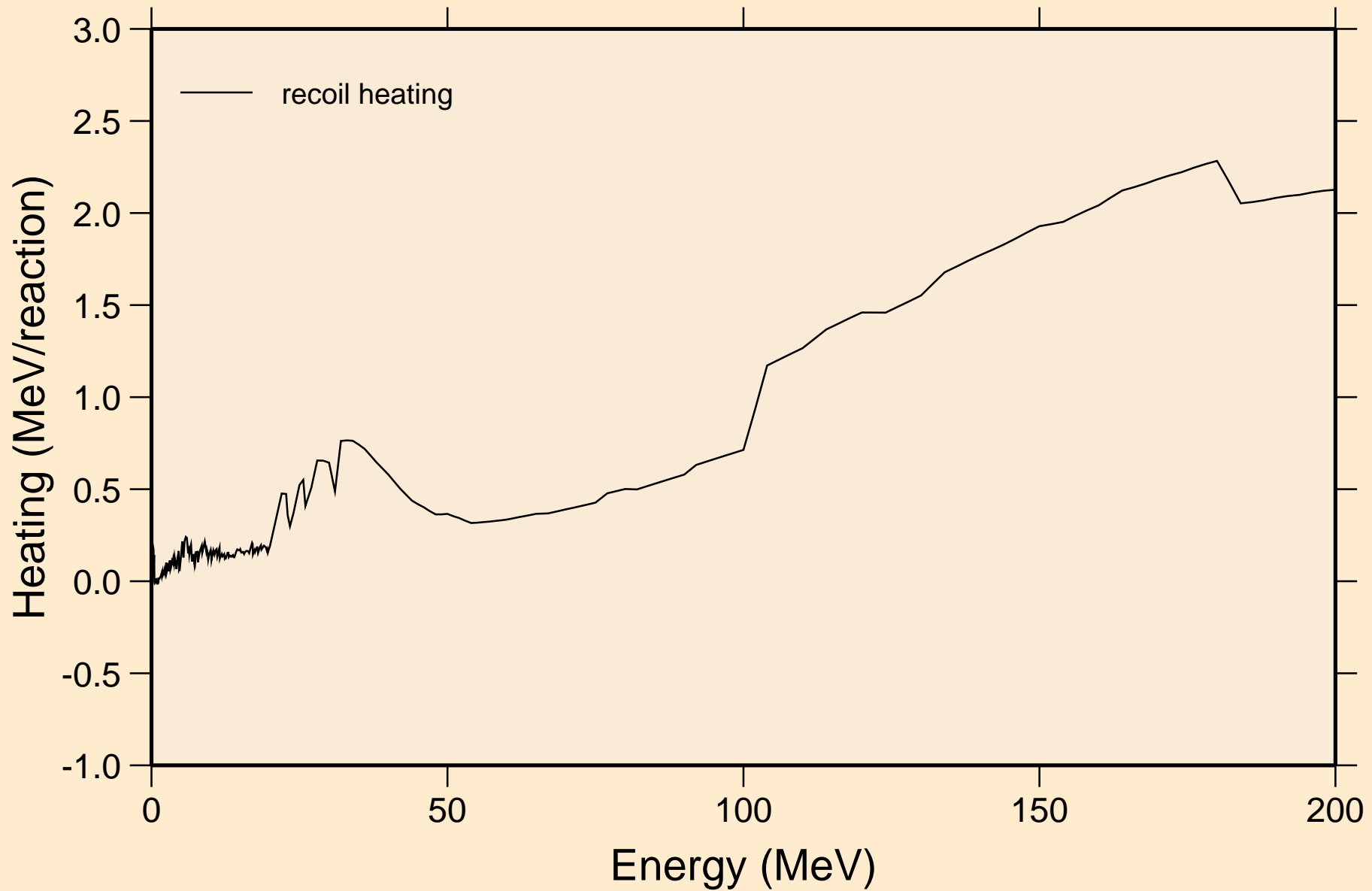

DY144 NEUTRON ACER TENDL-2023 LIBRARY; T=0.K

Particle production cross sections

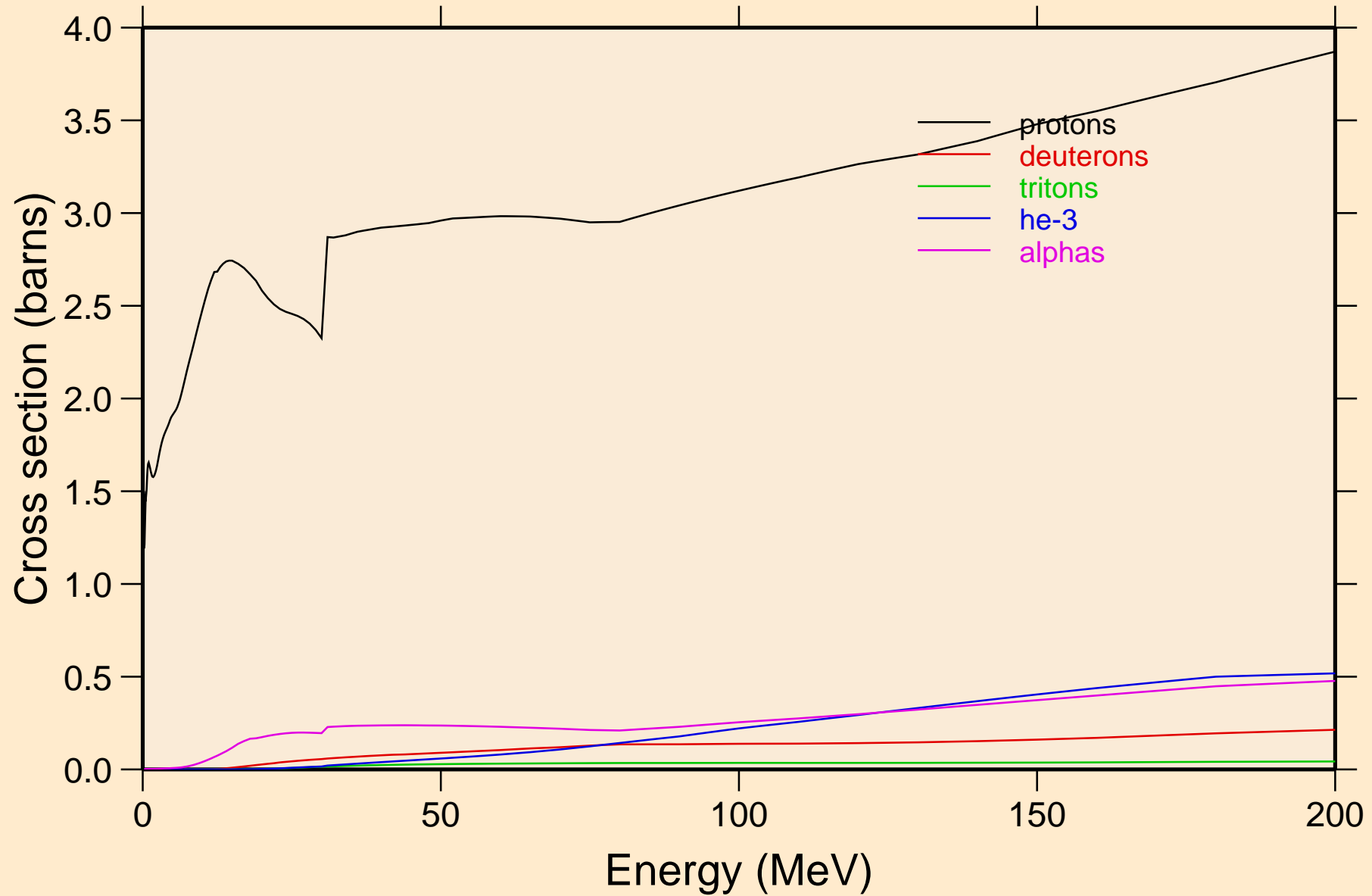

DY144 NEUTRON ACER TENDL-2023 LIBRARY; T=0.K
protons from (n,x)

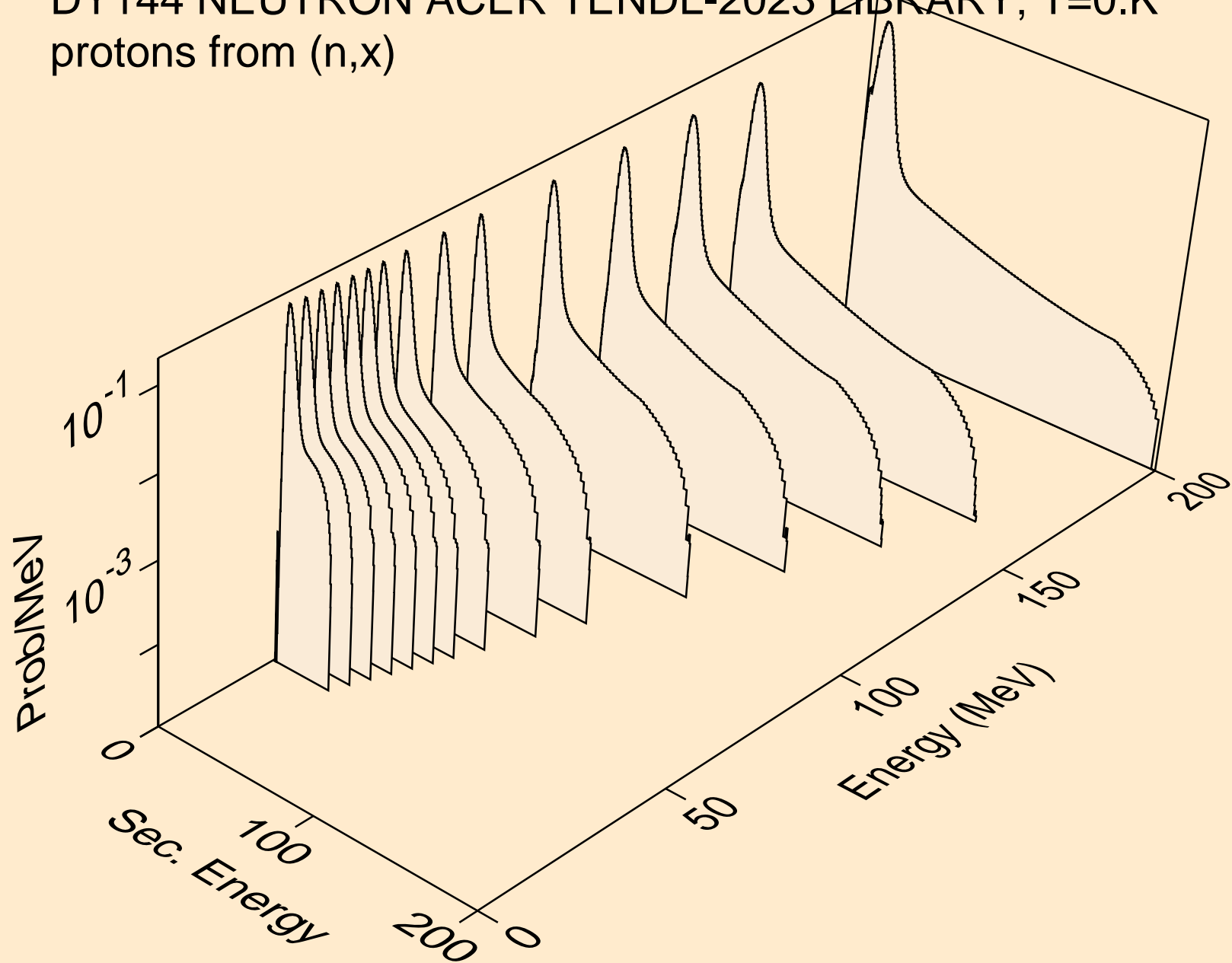

DY144 NEUTRON ACER TENDL-2023 LIBRARY; T=0.K
protons from (n,n*)p

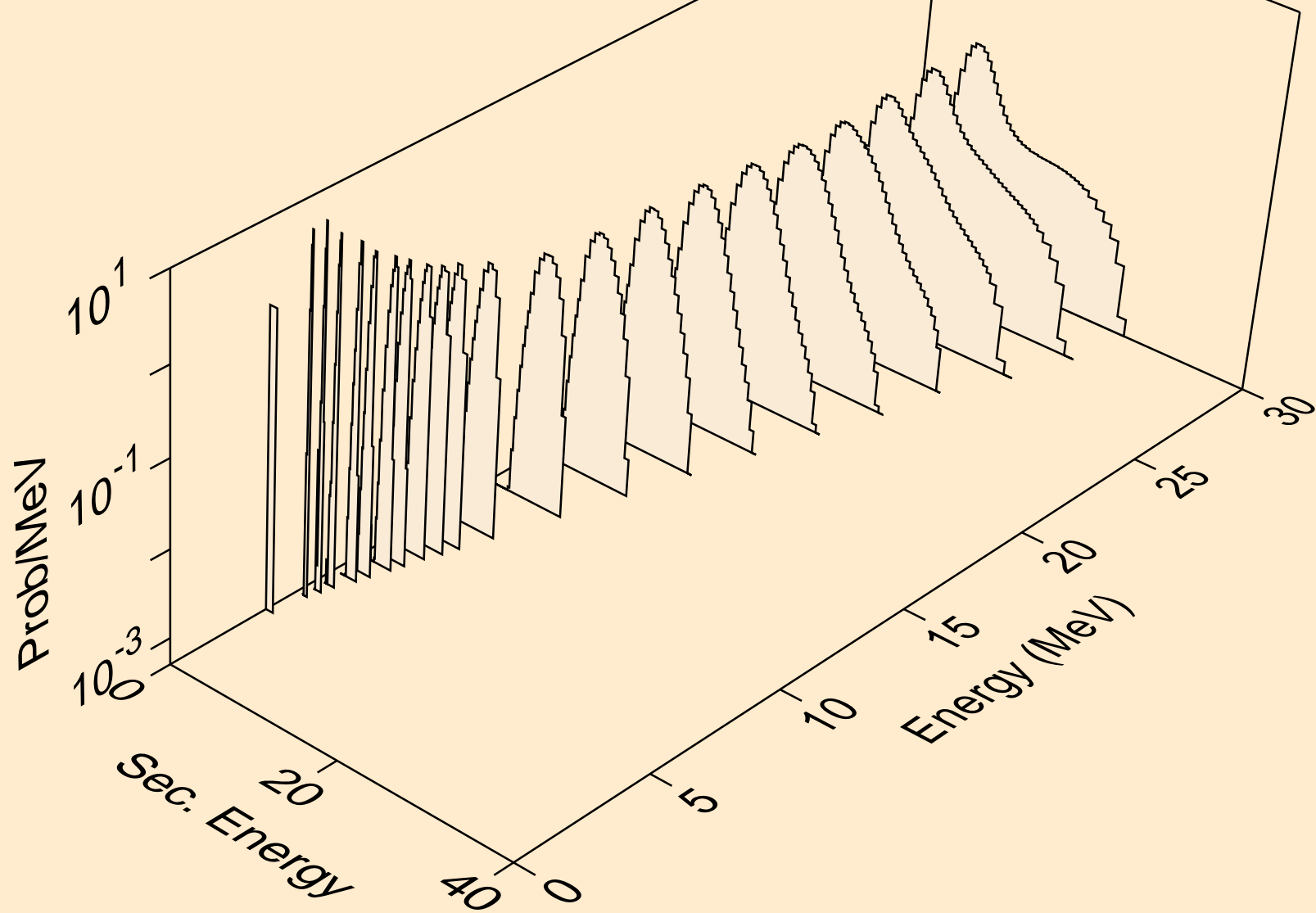

DY144 NEUTRON ACER TENDL-2023 LIBRARY; T=0.K
protons from (n,2np)

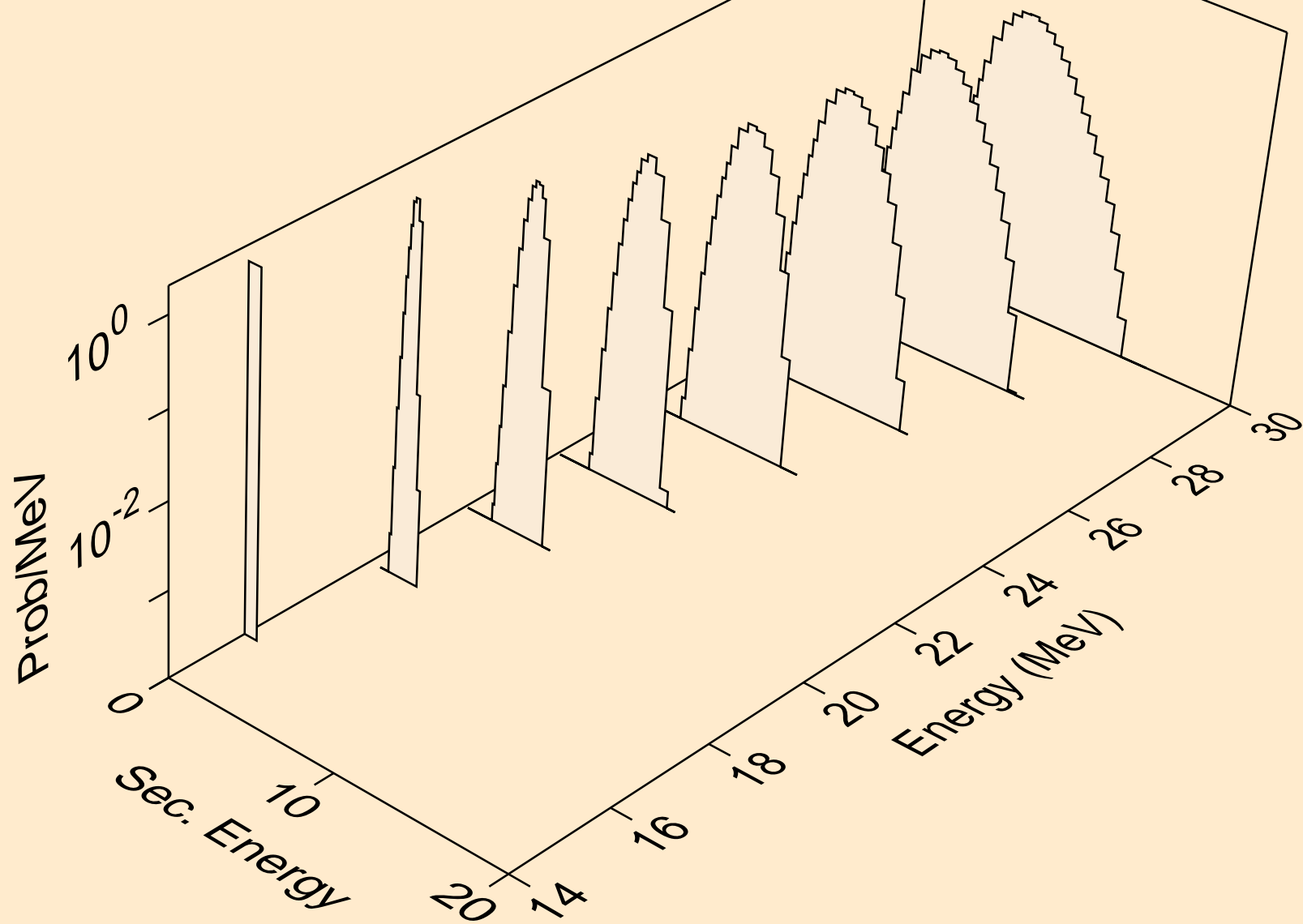

DY144 NEUTRON ACER TENDL-2023 LIBRARY; T=0.K
protons from (n,3np)

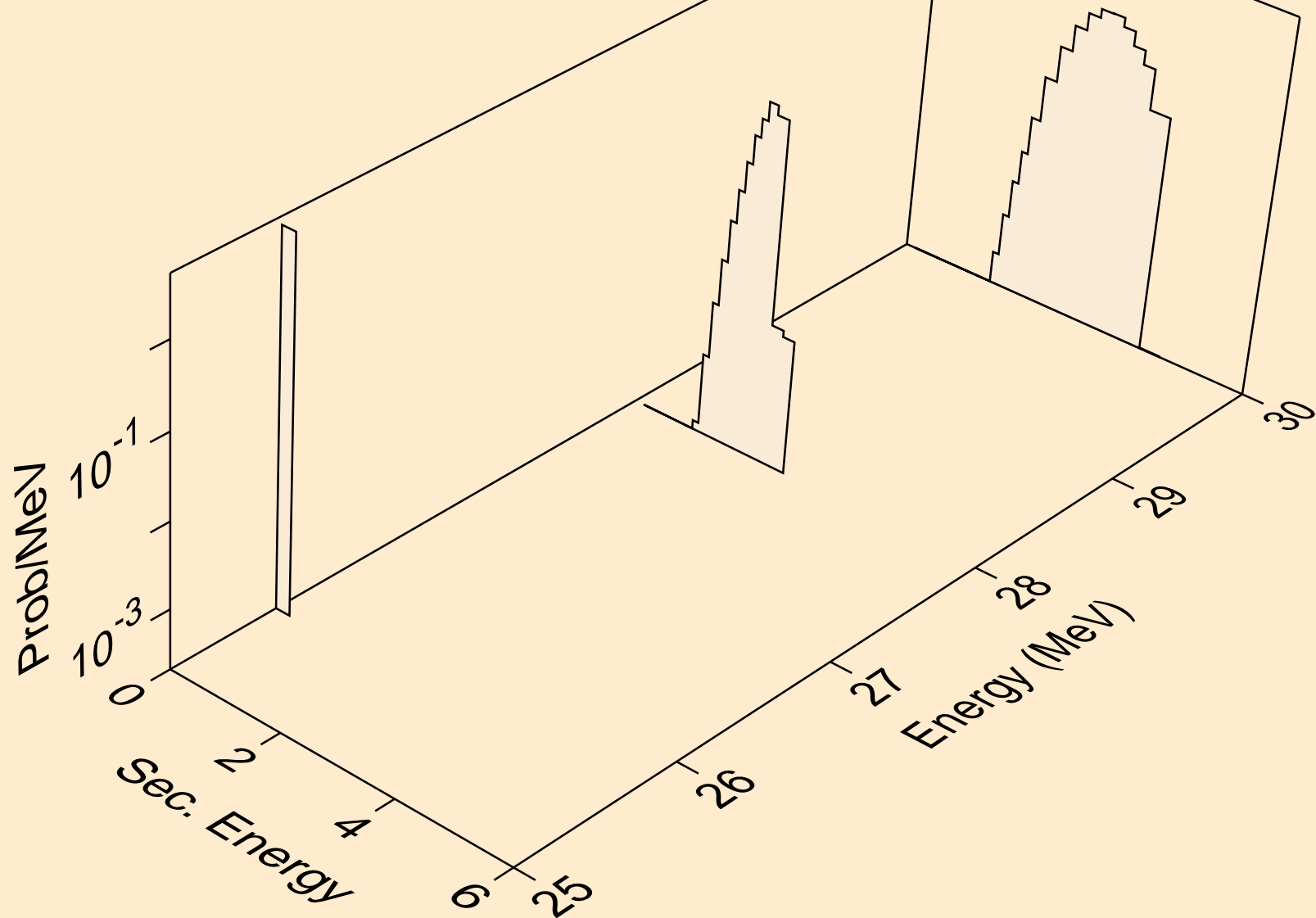

DY144 NEUTRON ACER TENDL-2023 LIBRARY; T=0.K
protons from (n,n2p)

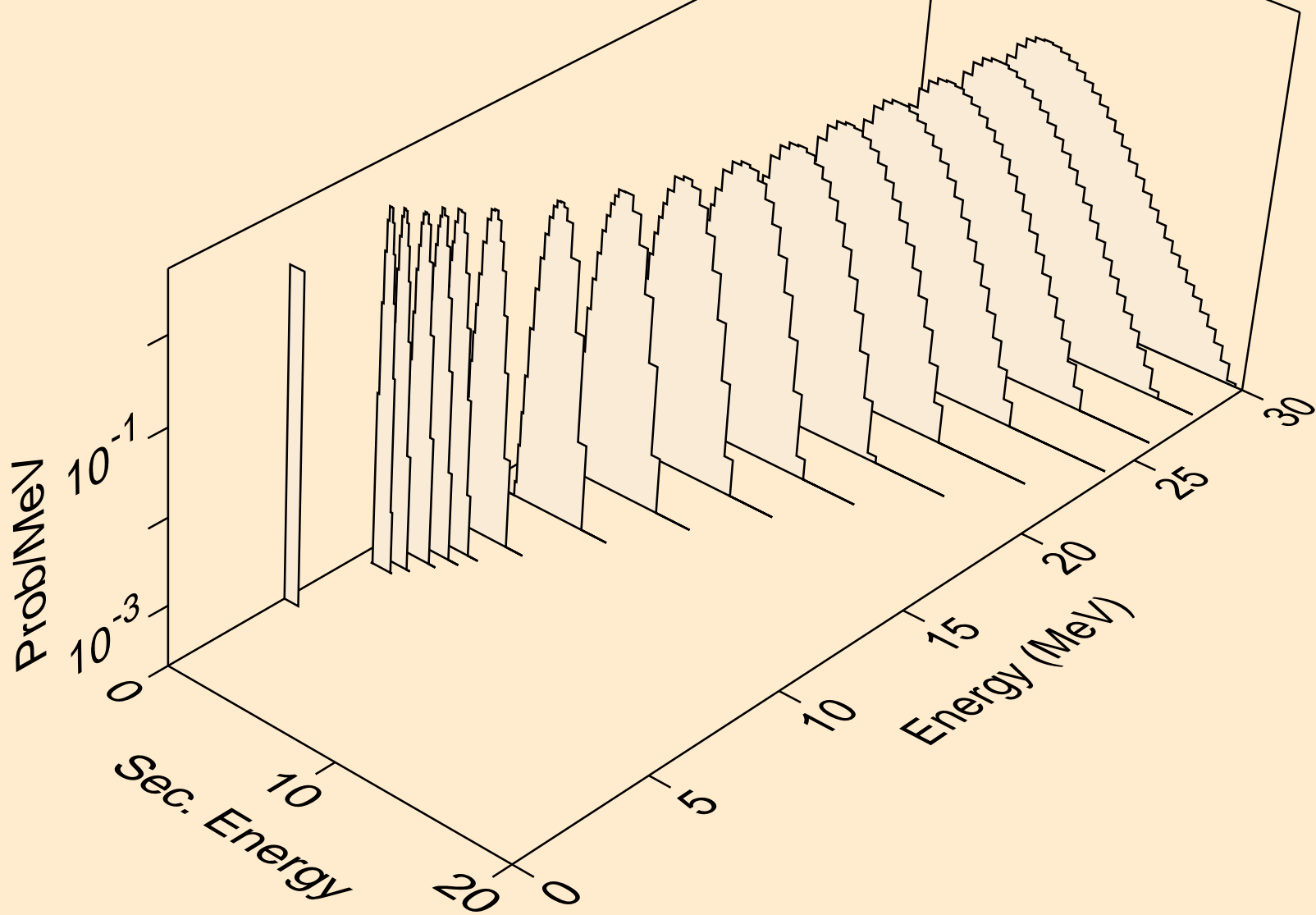

DY144 NEUTRON ACER TENDL-2023 LIBRARY; T=0.K
protons from (n,npa)

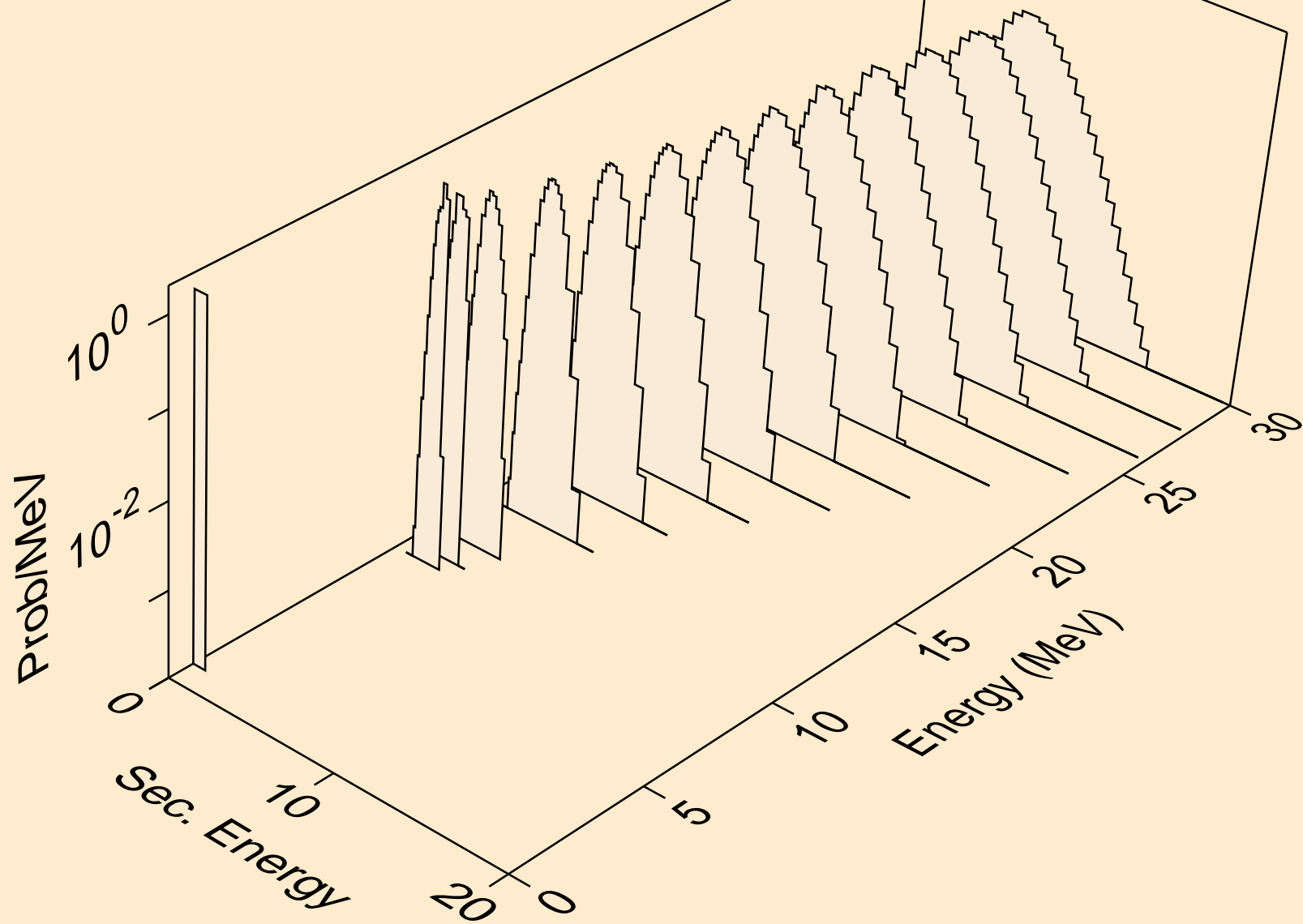

DY144 NEUTRON ACER TENDL-2023 LIBRARY; T=0.K
protons from (n,p)

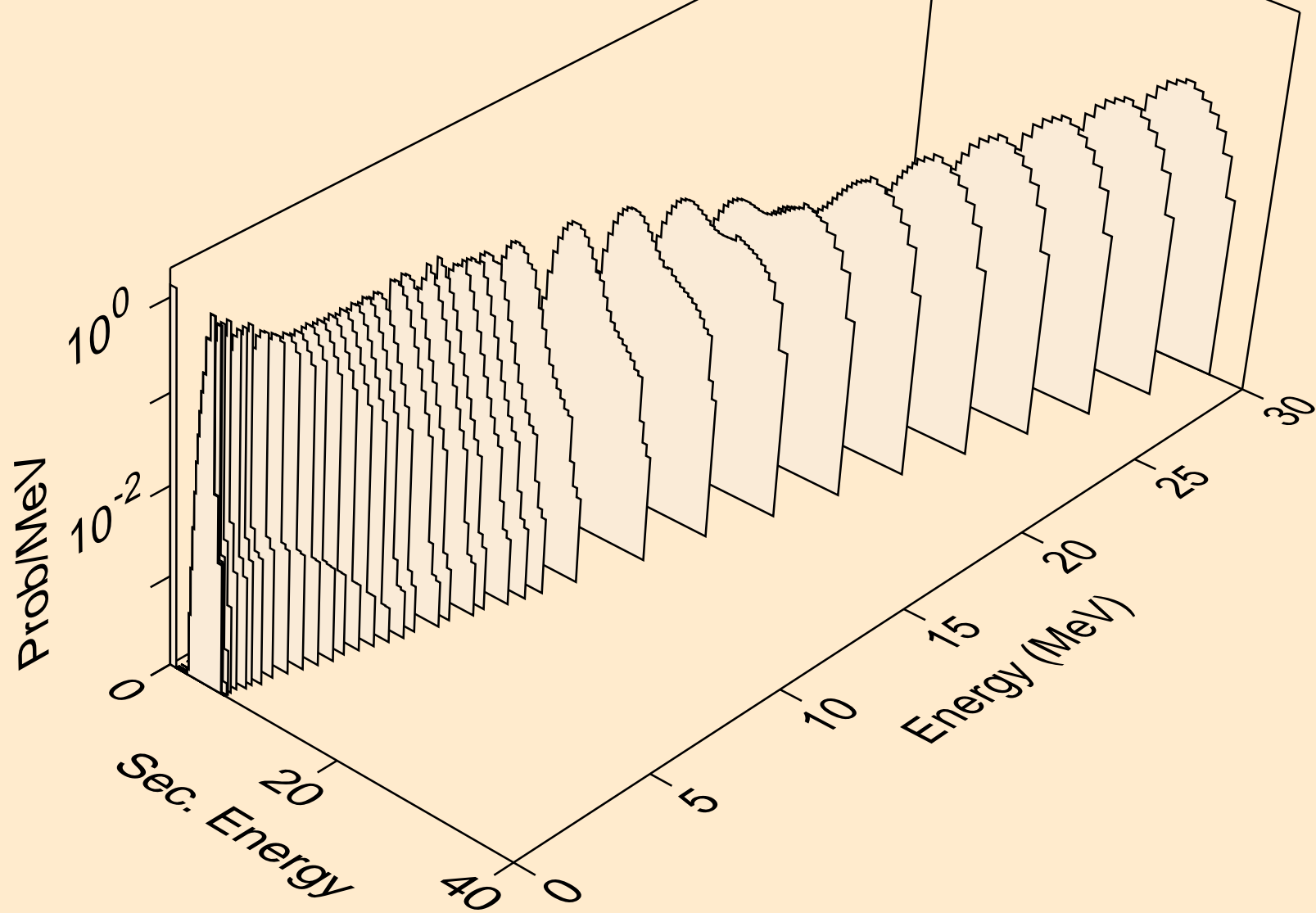

DY144 NEUTRON ACER TENDL-2023 LIBRARY; T=0.K
protons from (n,2p)

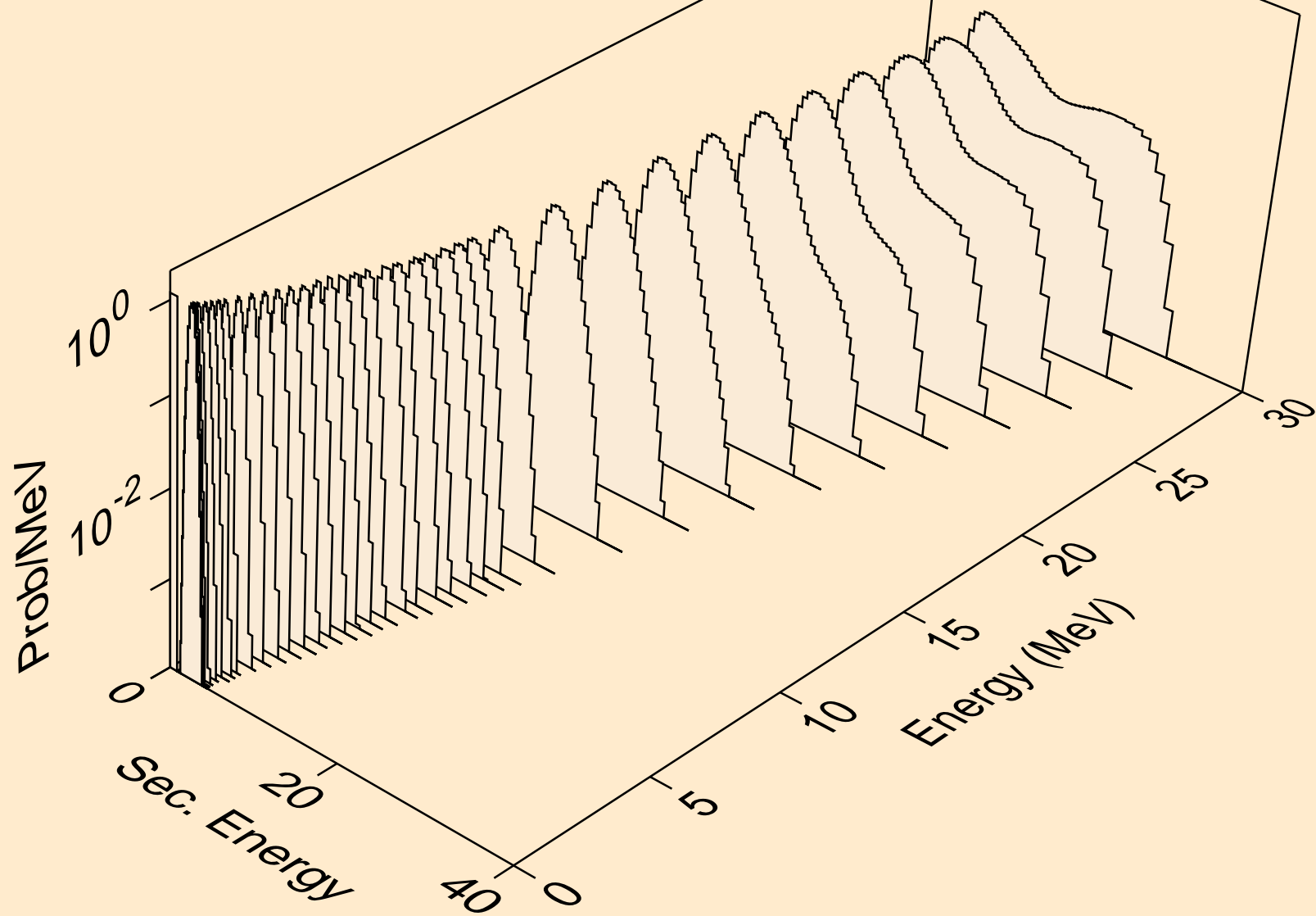

DY144 NEUTRON ACER TENDL-2023 LIBRARY; T=0.K
protons from (n,p)

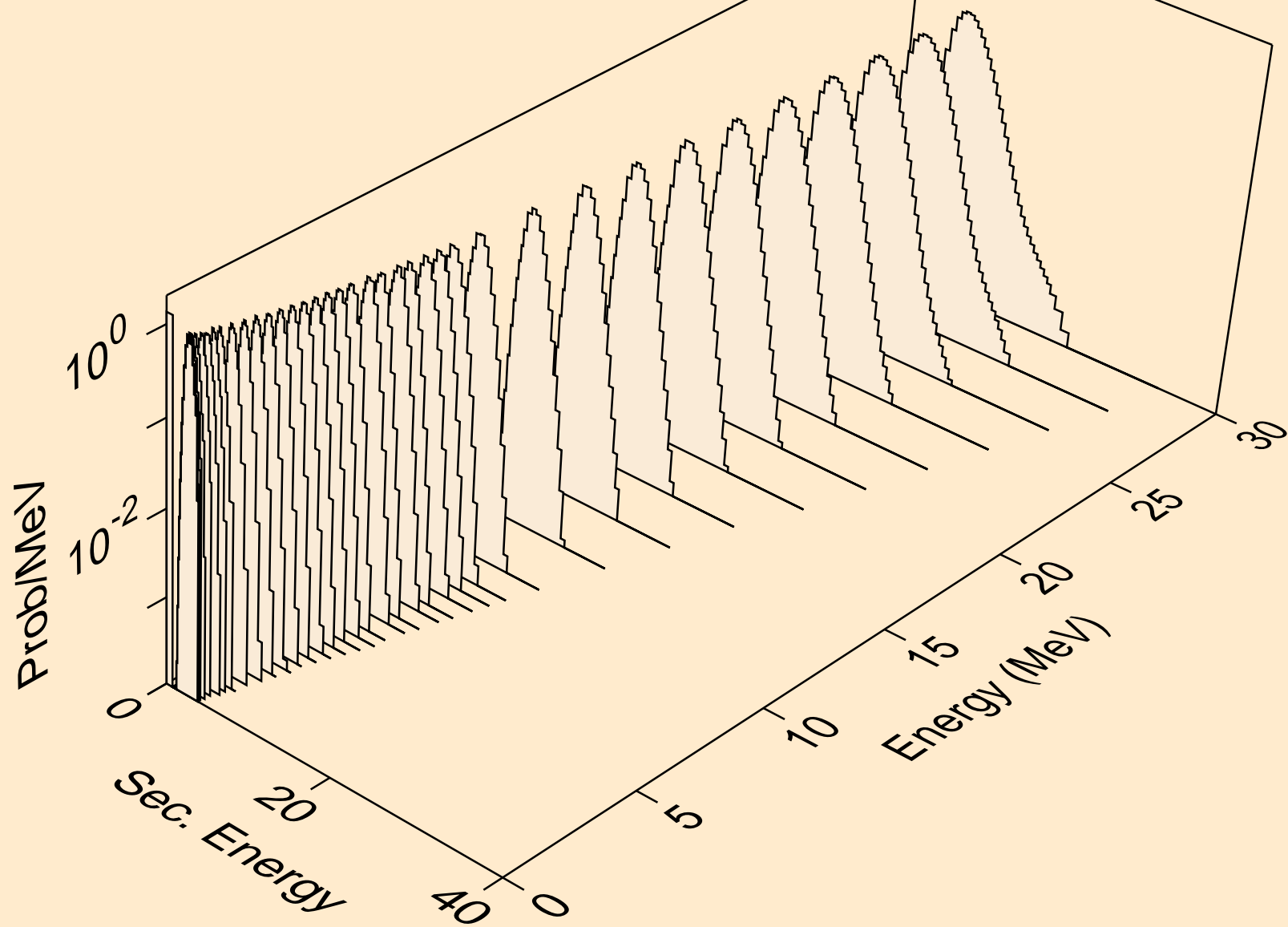

DY144 NEUTRON ACER TENDL-2023 LIBRARY; T=0.K
protons from (n,pd)

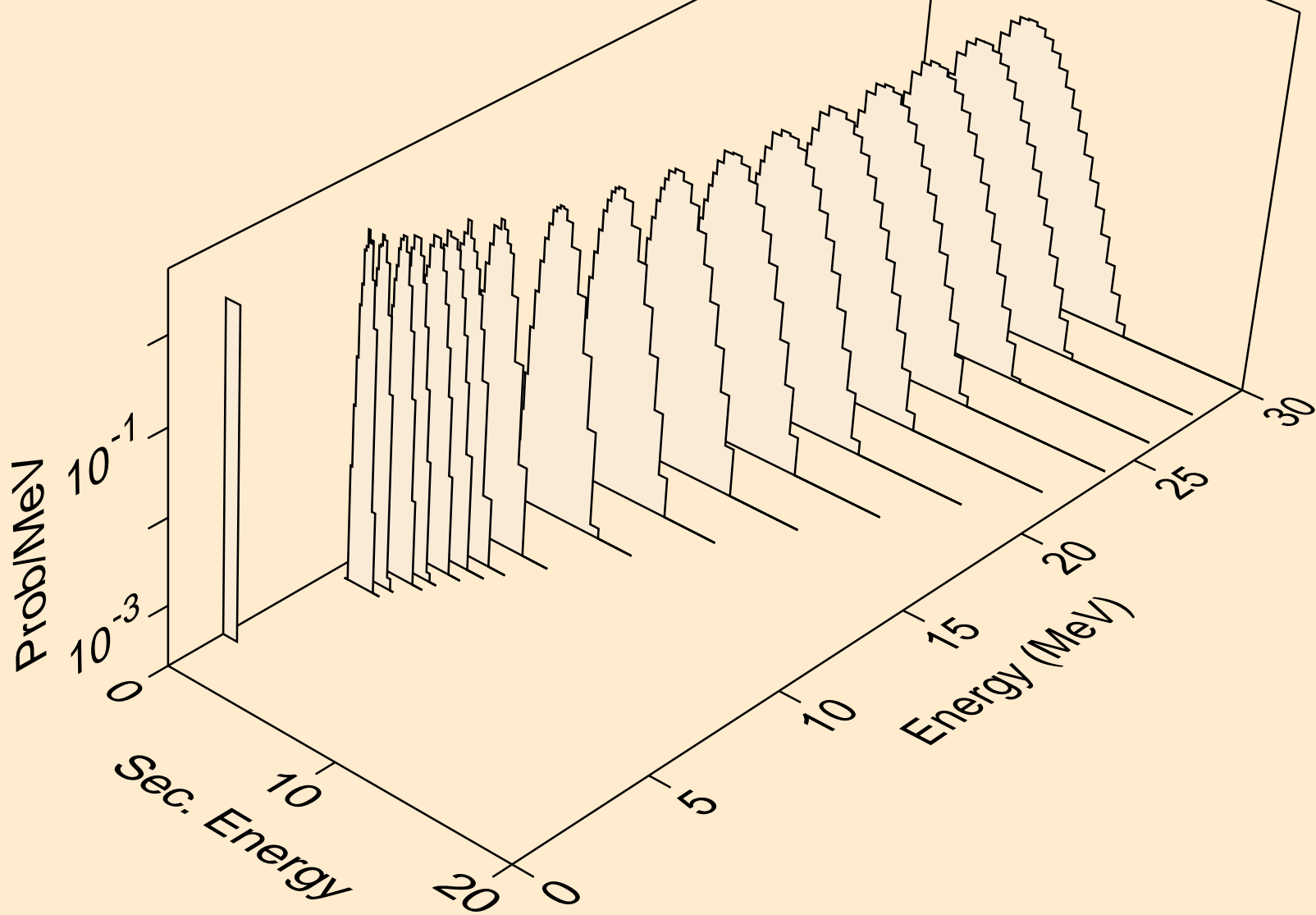

DY144 NEUTRON ACER TENDL-2023 LIBRARY; T=0.K
protons from (n,pt)

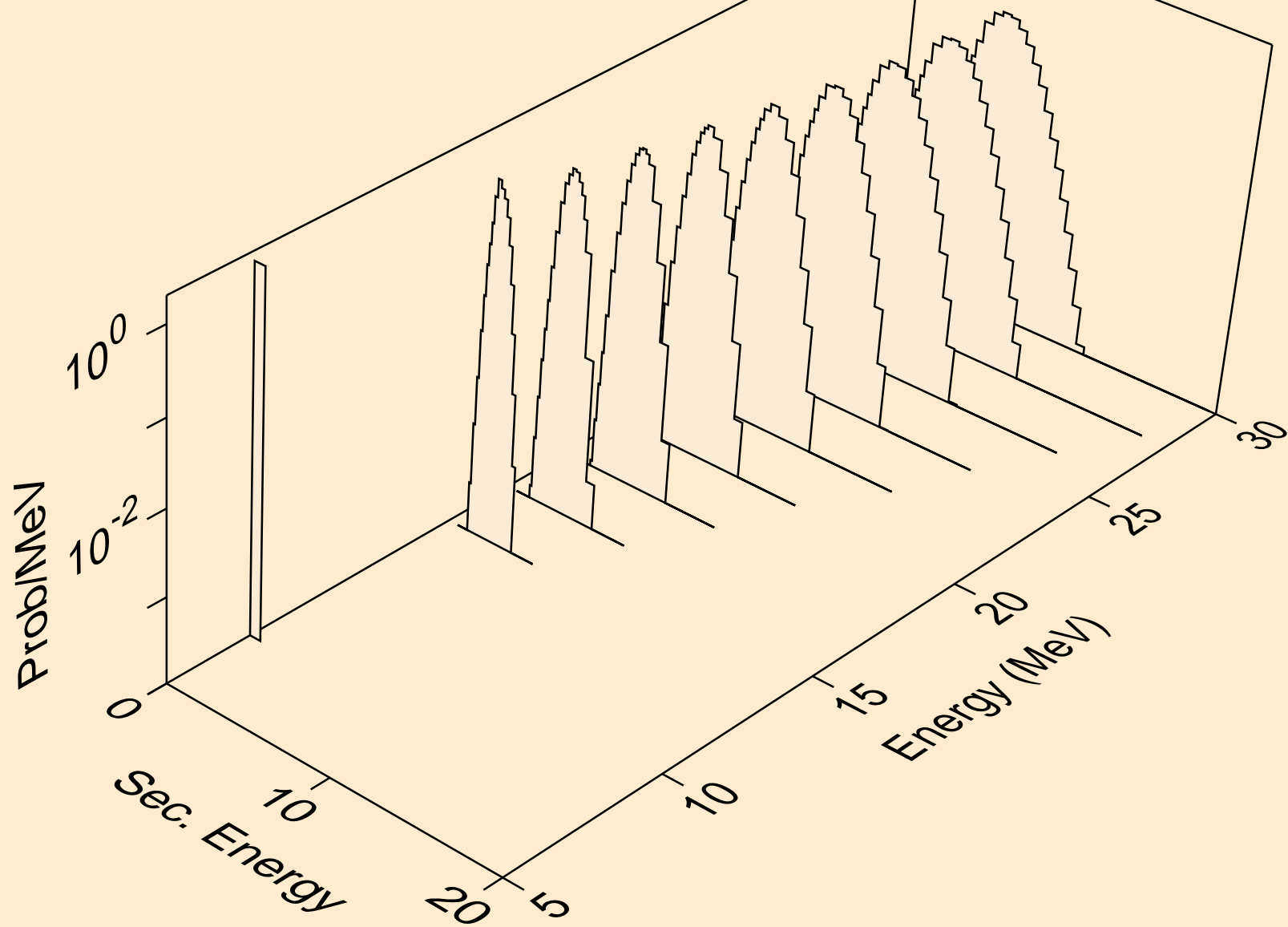

DY144 NEUTRON ACER TENDL-2023 LIBRARY; T=0.K
deuterons from (n,x)

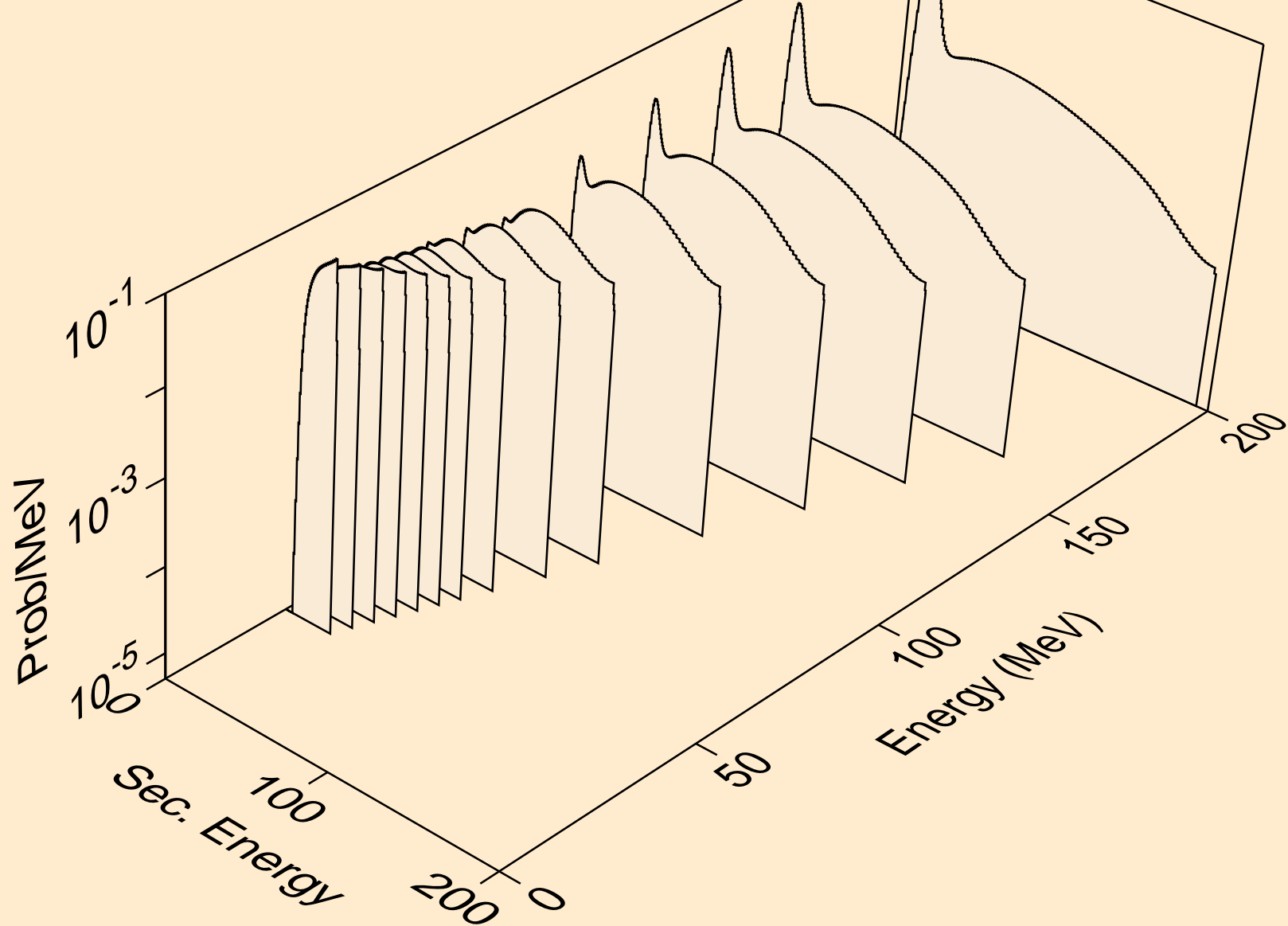

DY144 NEUTRON ACER TENDL-2023 LIBRARY; T=0.K
deuterons from (n,2nd)

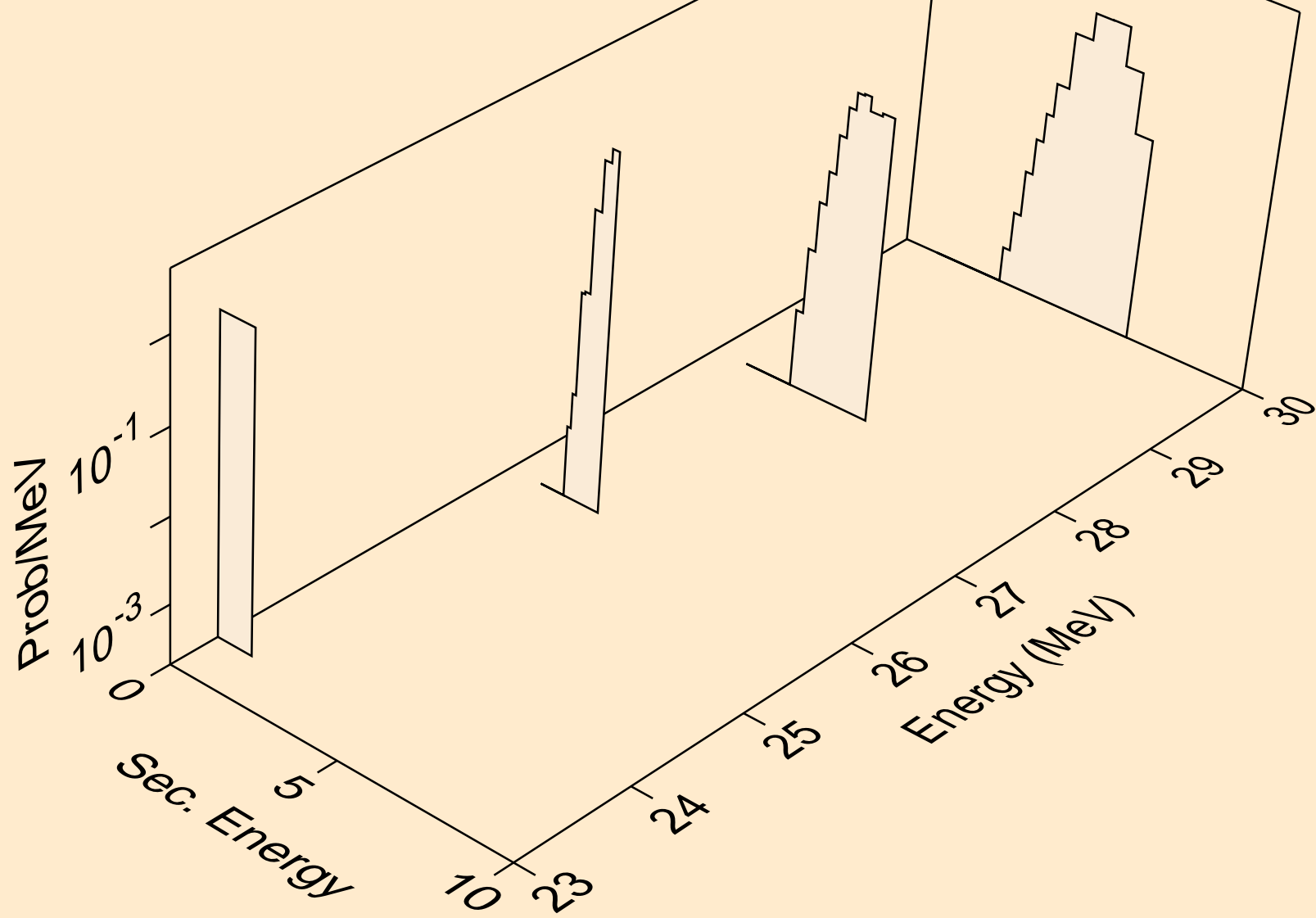

DY144 NEUTRON ACER TENDL-2023 LIBRARY; T=0.K
deuterons from (n,n*)d

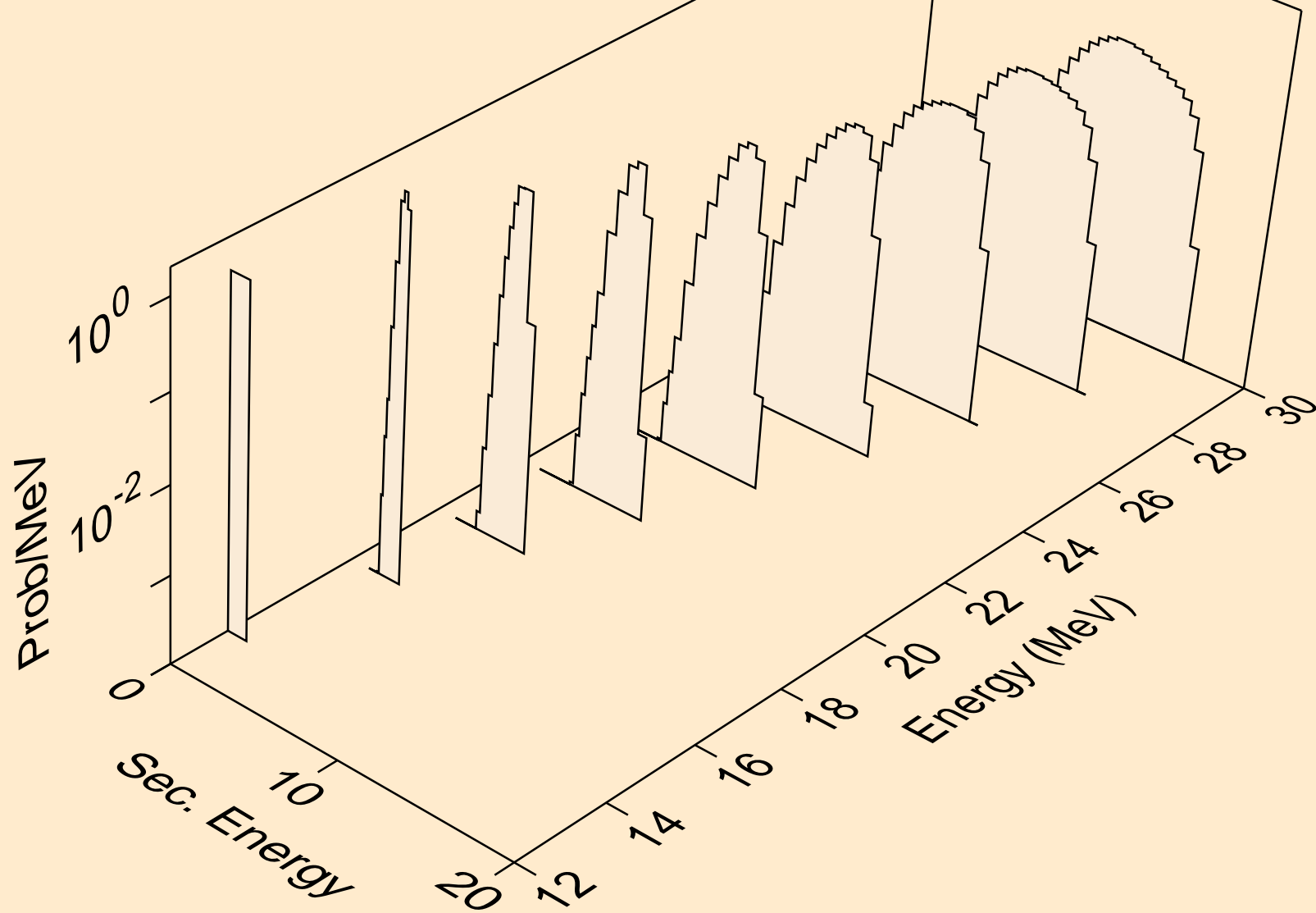

DY144 NEUTRON ACER TENDL-2023 LIBRARY; T=0.K
deuterons from (n,d)

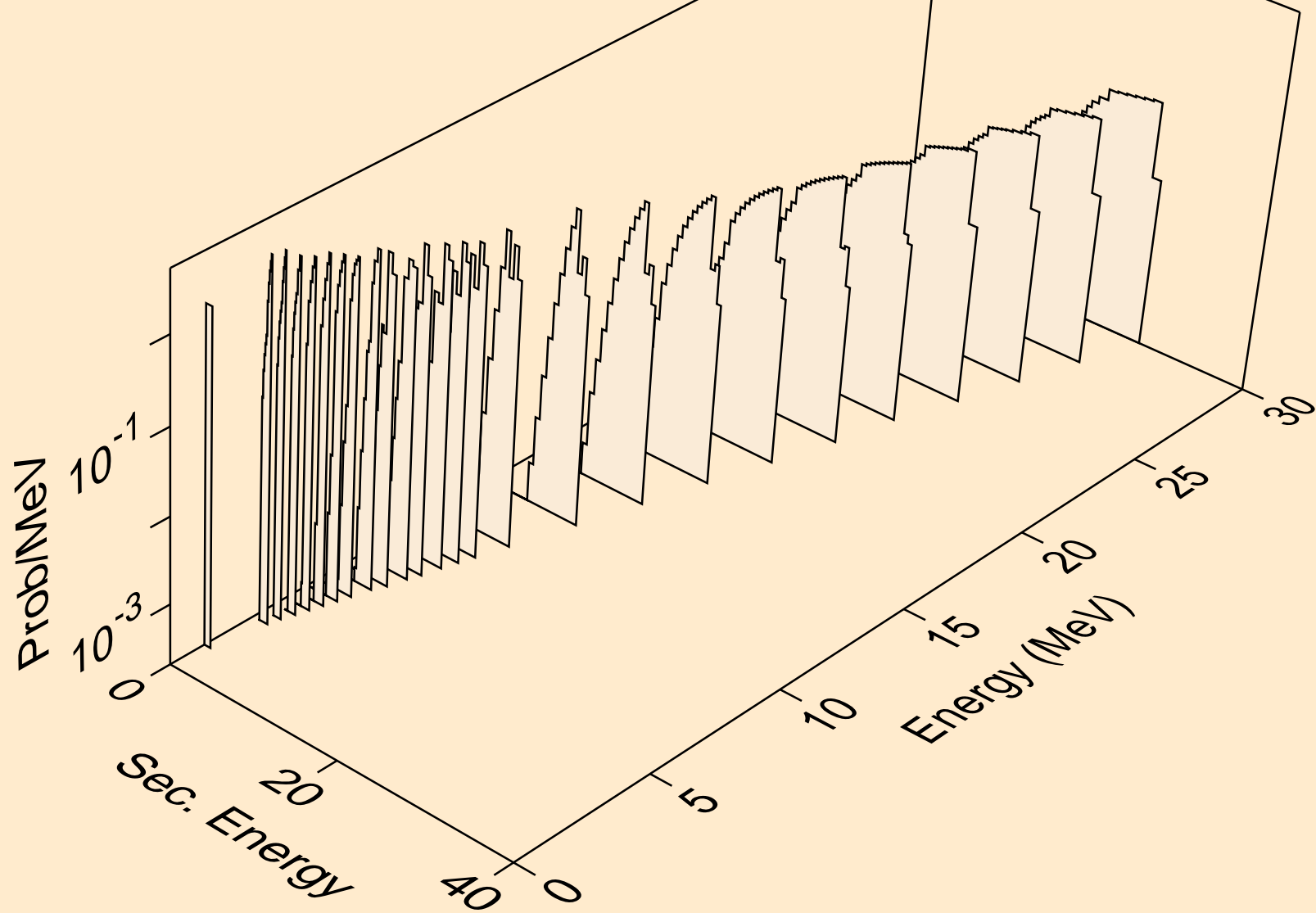

DY144 NEUTRON ACER TENDL-2023 LIBRARY; T=0.K
deuterons from (n,pd)

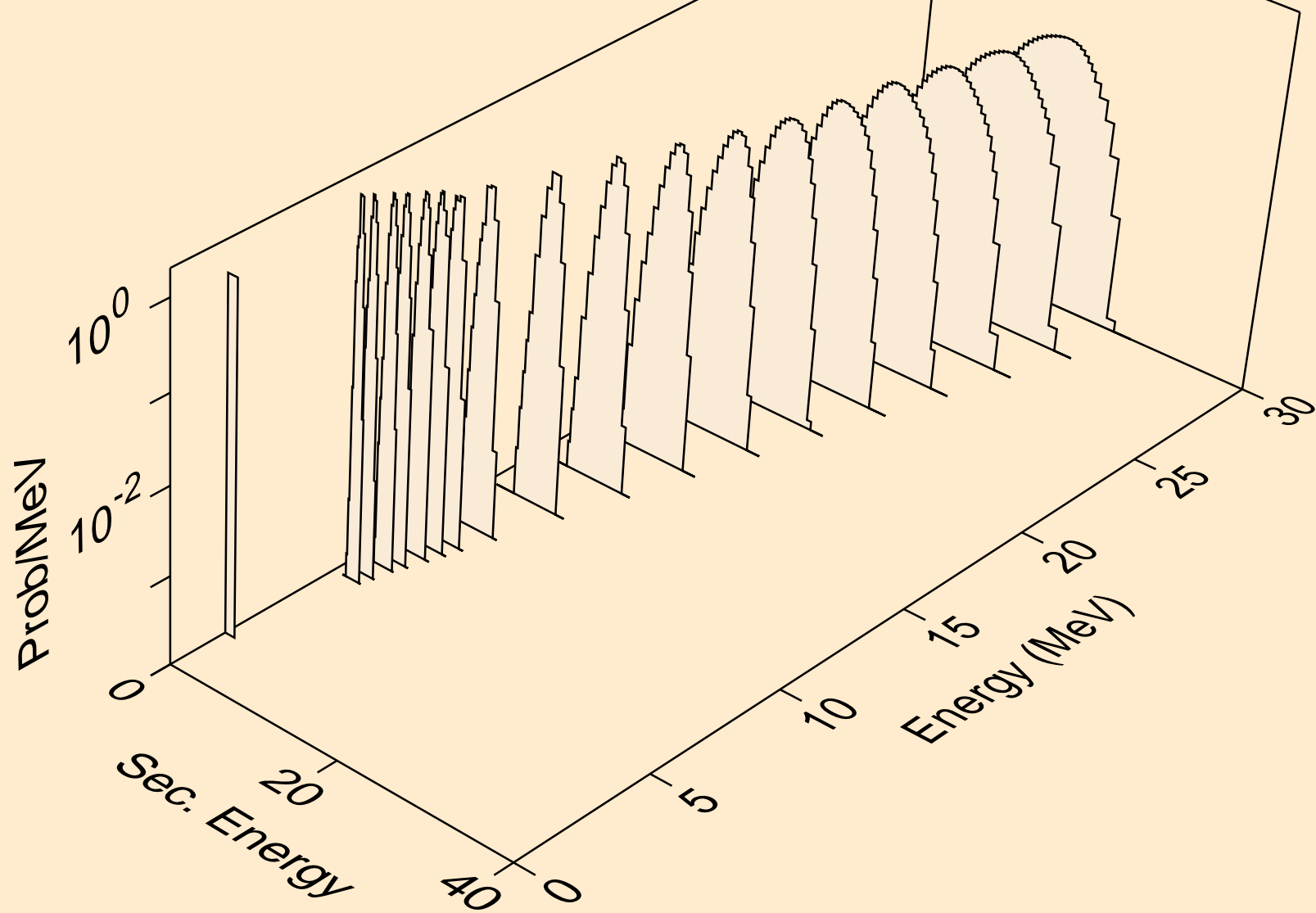

DY144 NEUTRON ACER TENDL-2023 LIBRARY; T=0.K
deuterons from (n,da)

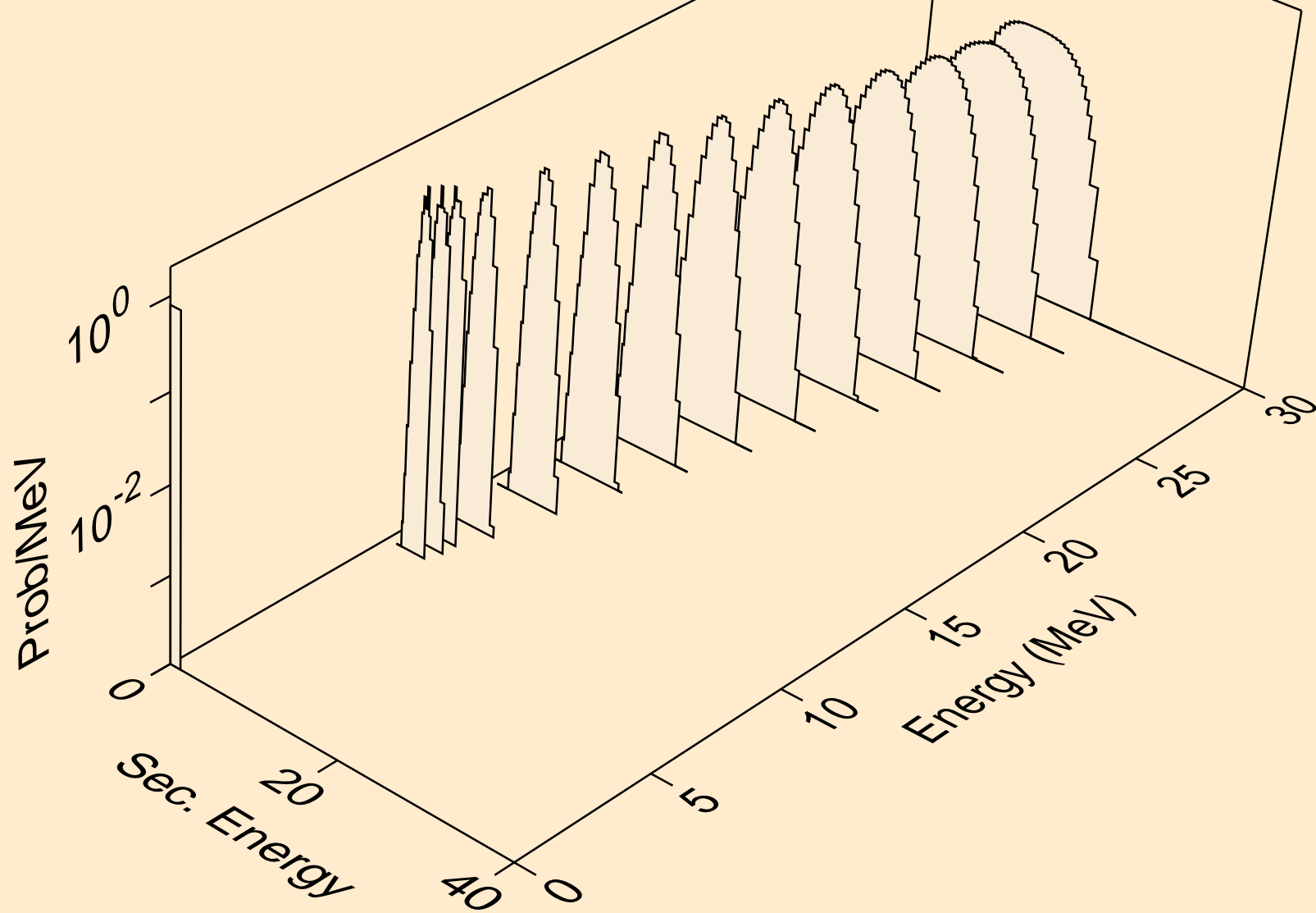

DY144 NEUTRON ACER TENDL-2023 LIBRARY; T=0.K
tritons from (n,x)

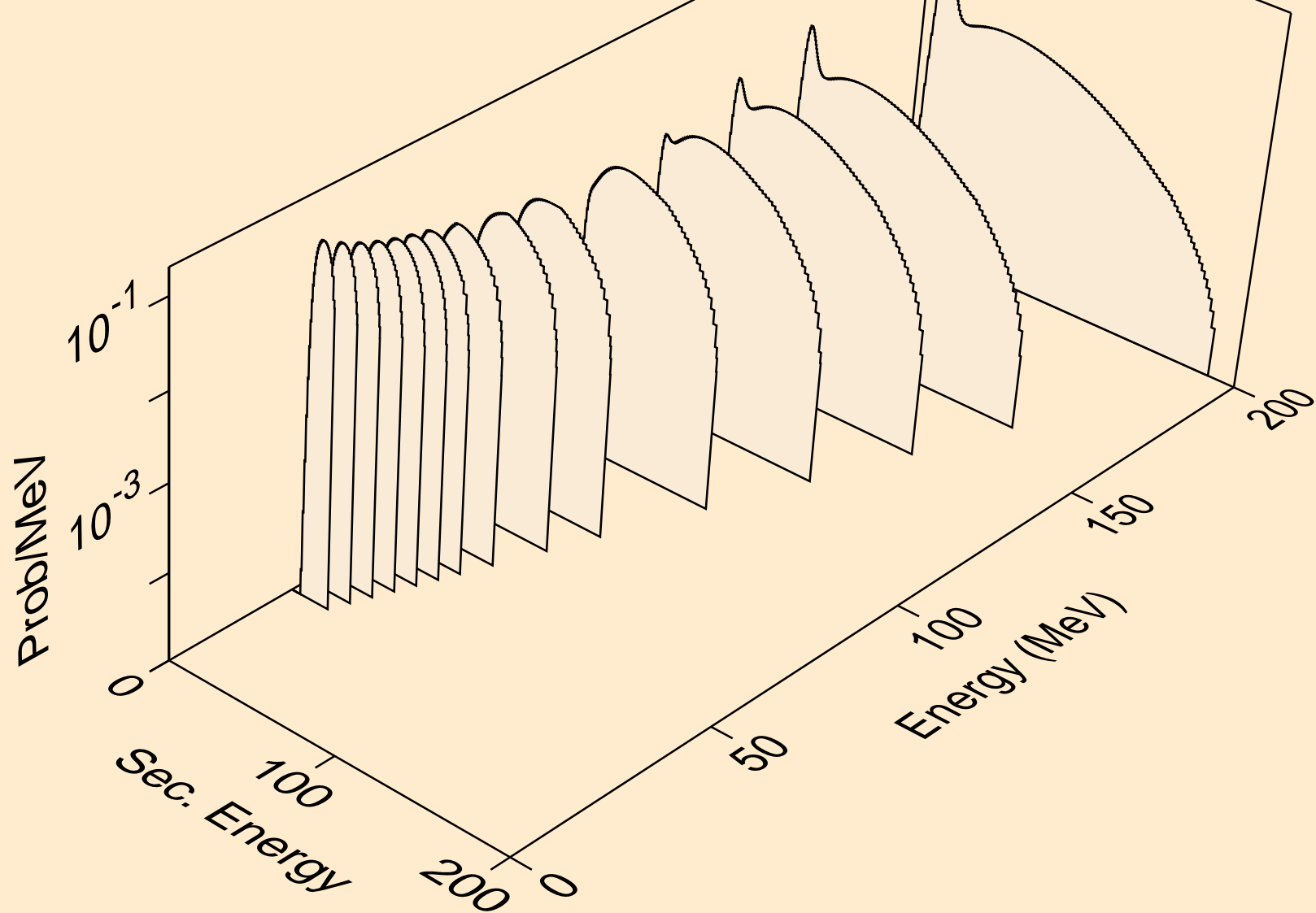

DY144 NEUTRON ACER TENDL-2023 LIBRARY; T=0.K
tritons from (n,n*)t

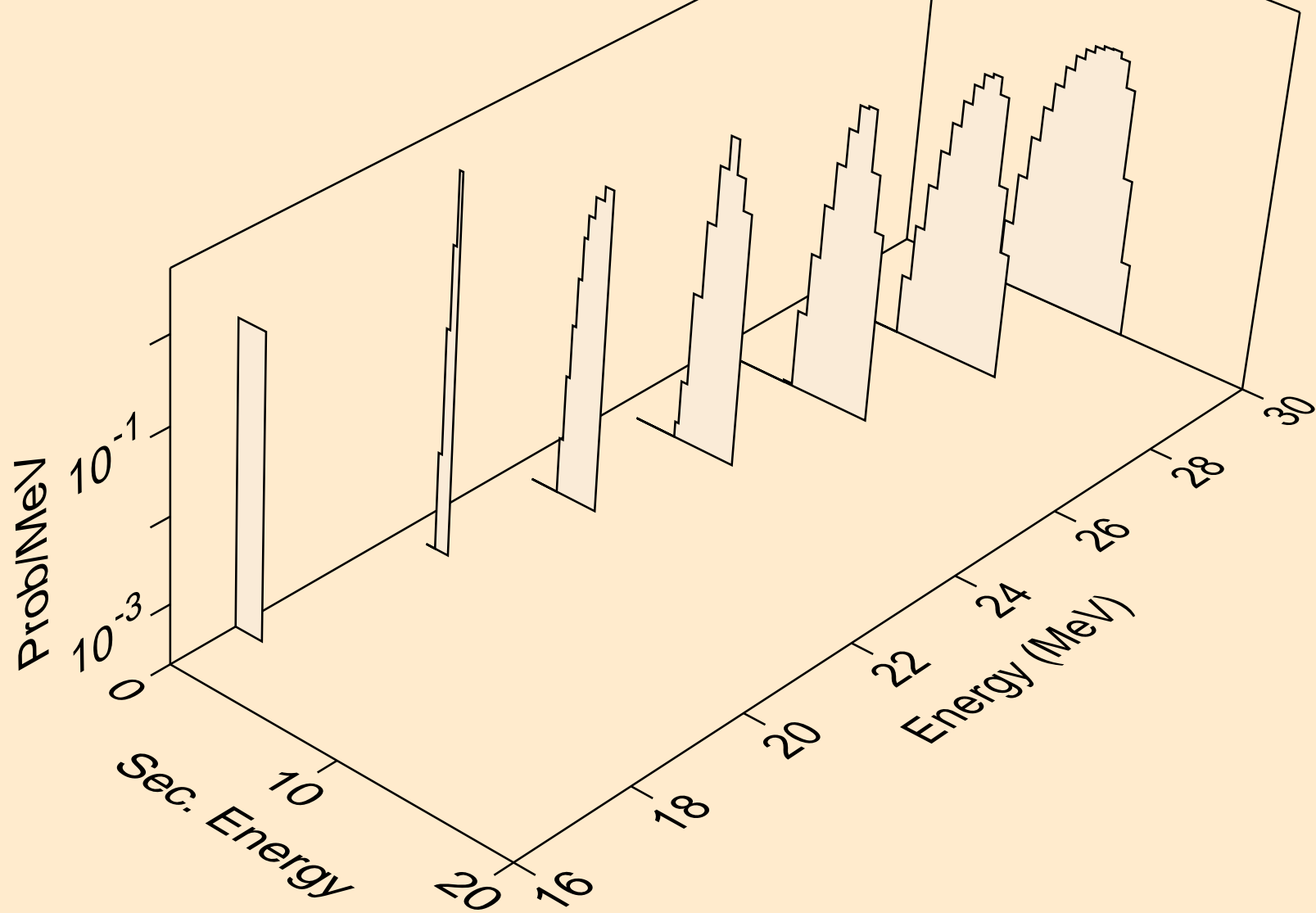

DY144 NEUTRON ACER TENDL-2023 LIBRARY; T=0.K
tritons from (n,t)

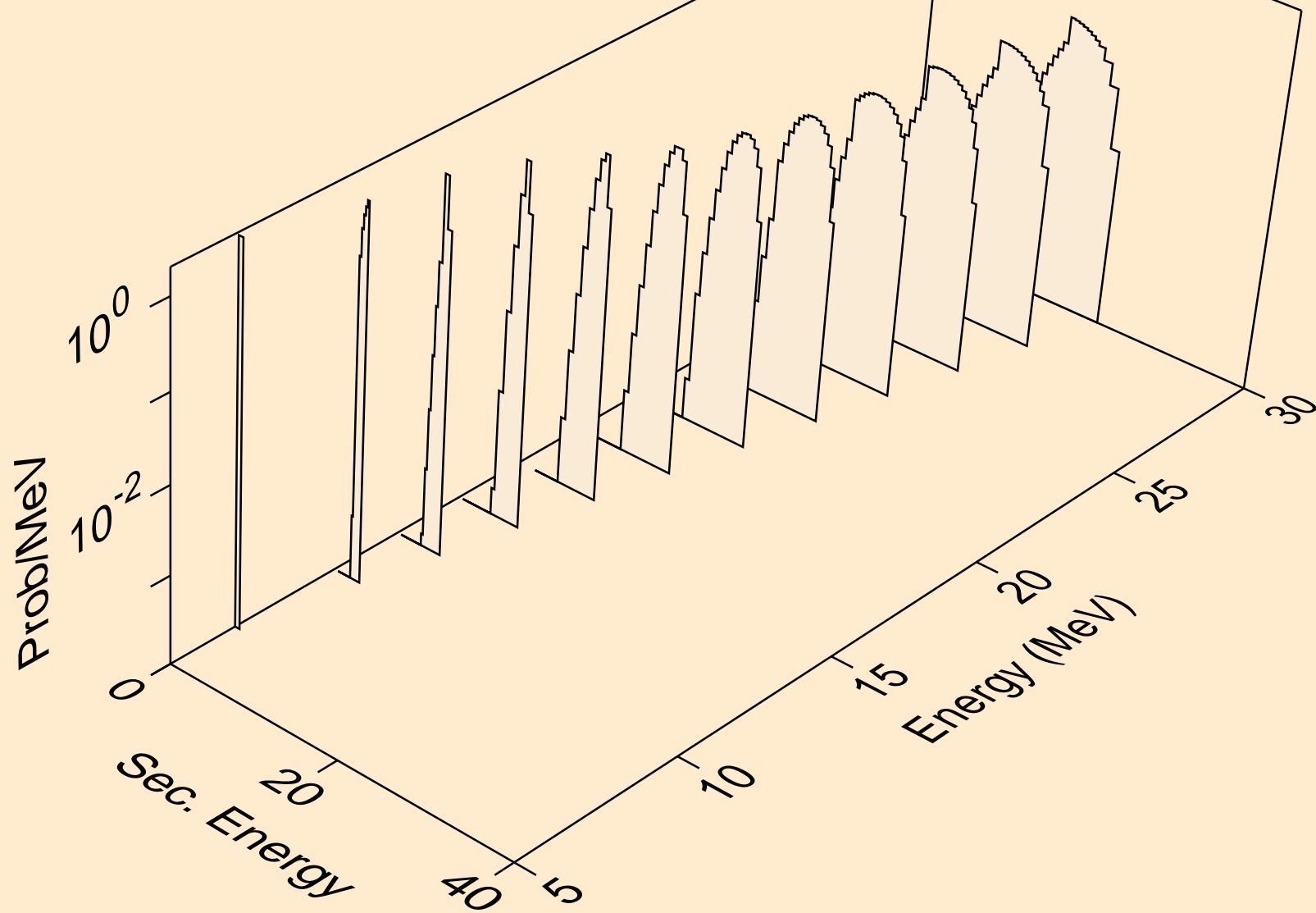

DY144 NEUTRON ACER TENDL-2023 LIBRARY; T=0.K
tritons from (n,pt)

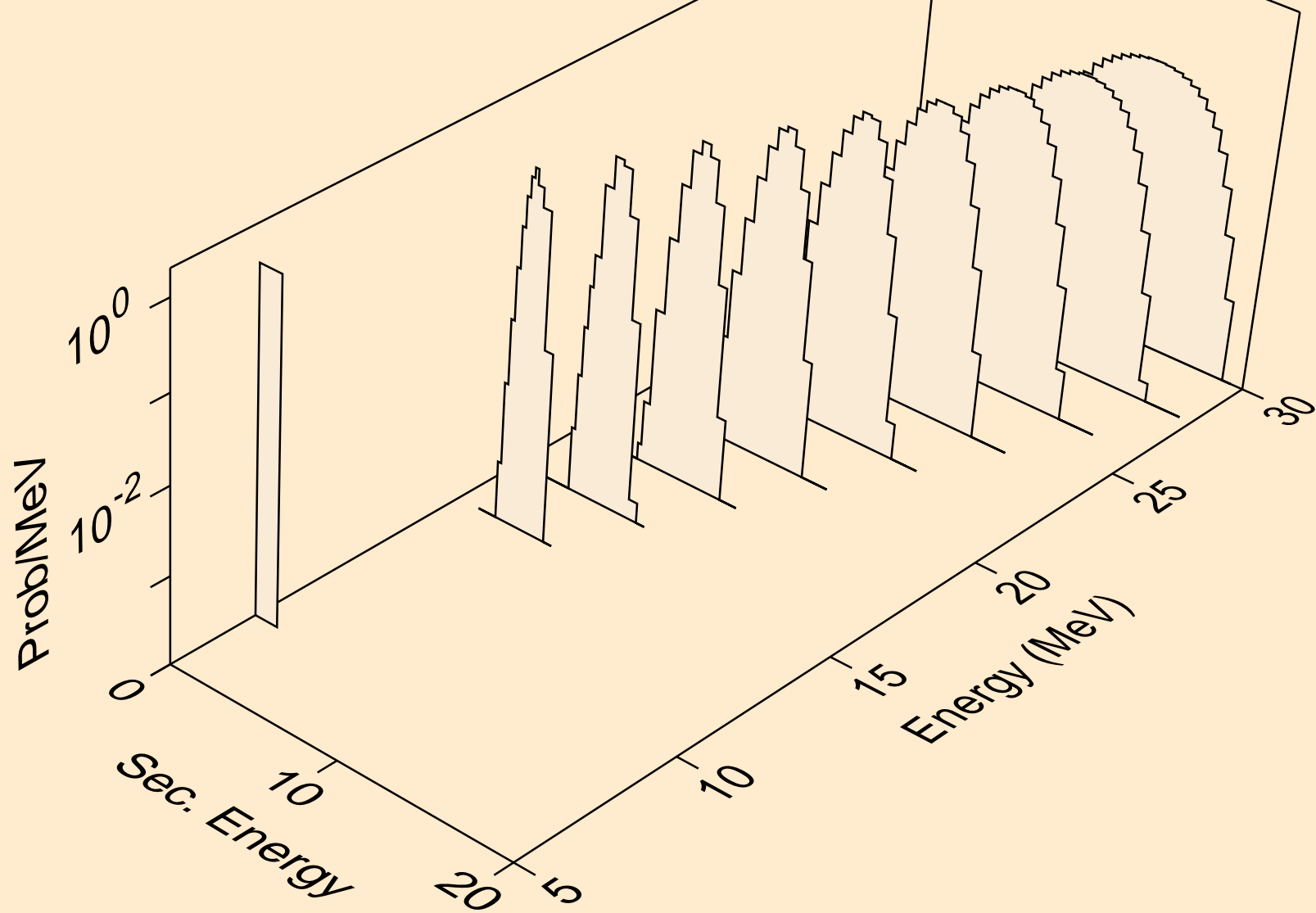

DY144 NEUTRON ACER TENDL-2023 LIBRARY; T=0.K
he3s from (n,x)

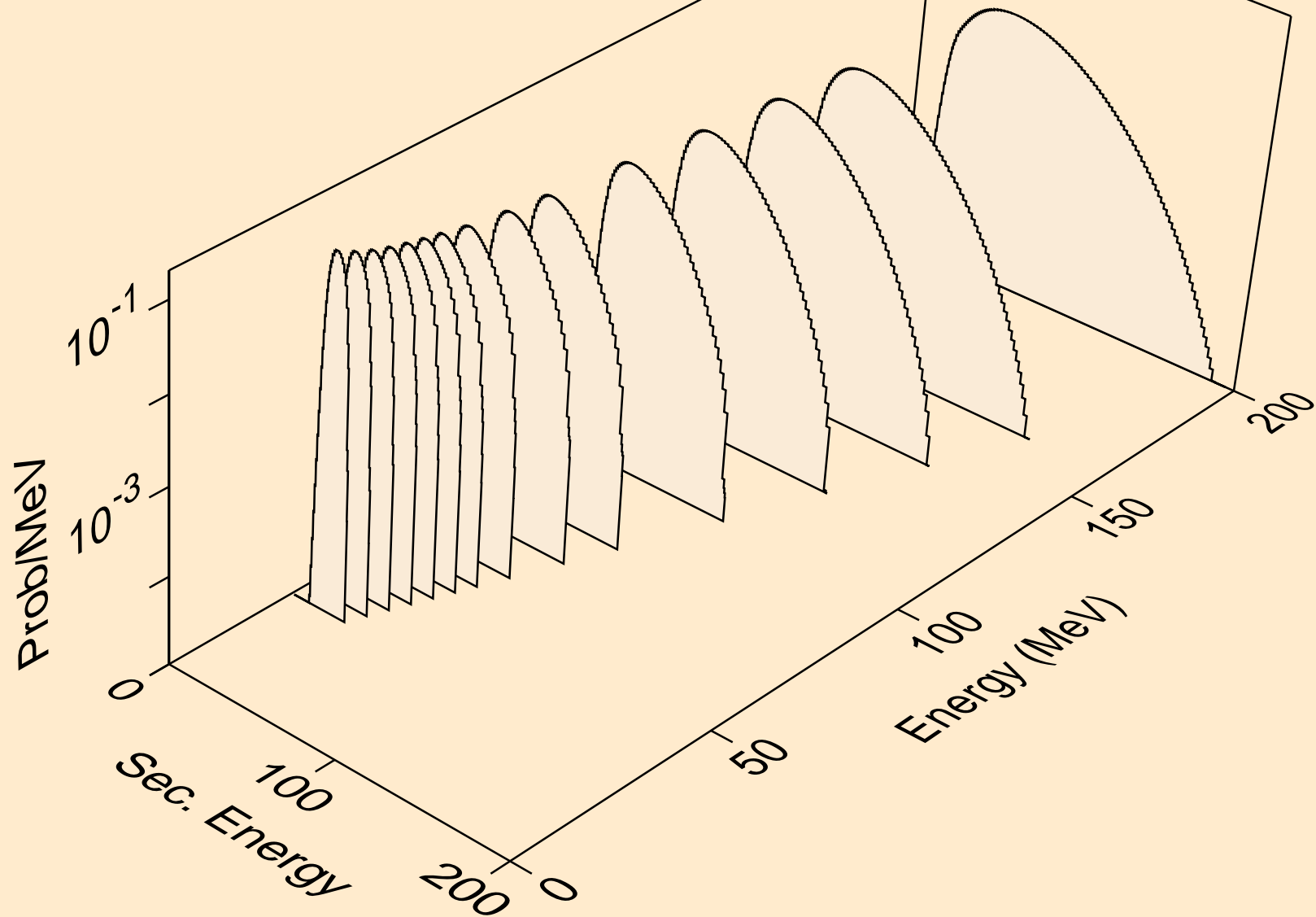

DY144 NEUTRON ACER TENDL-2023 LIBRARY; T=0.K
he3s from (n,n*)he3

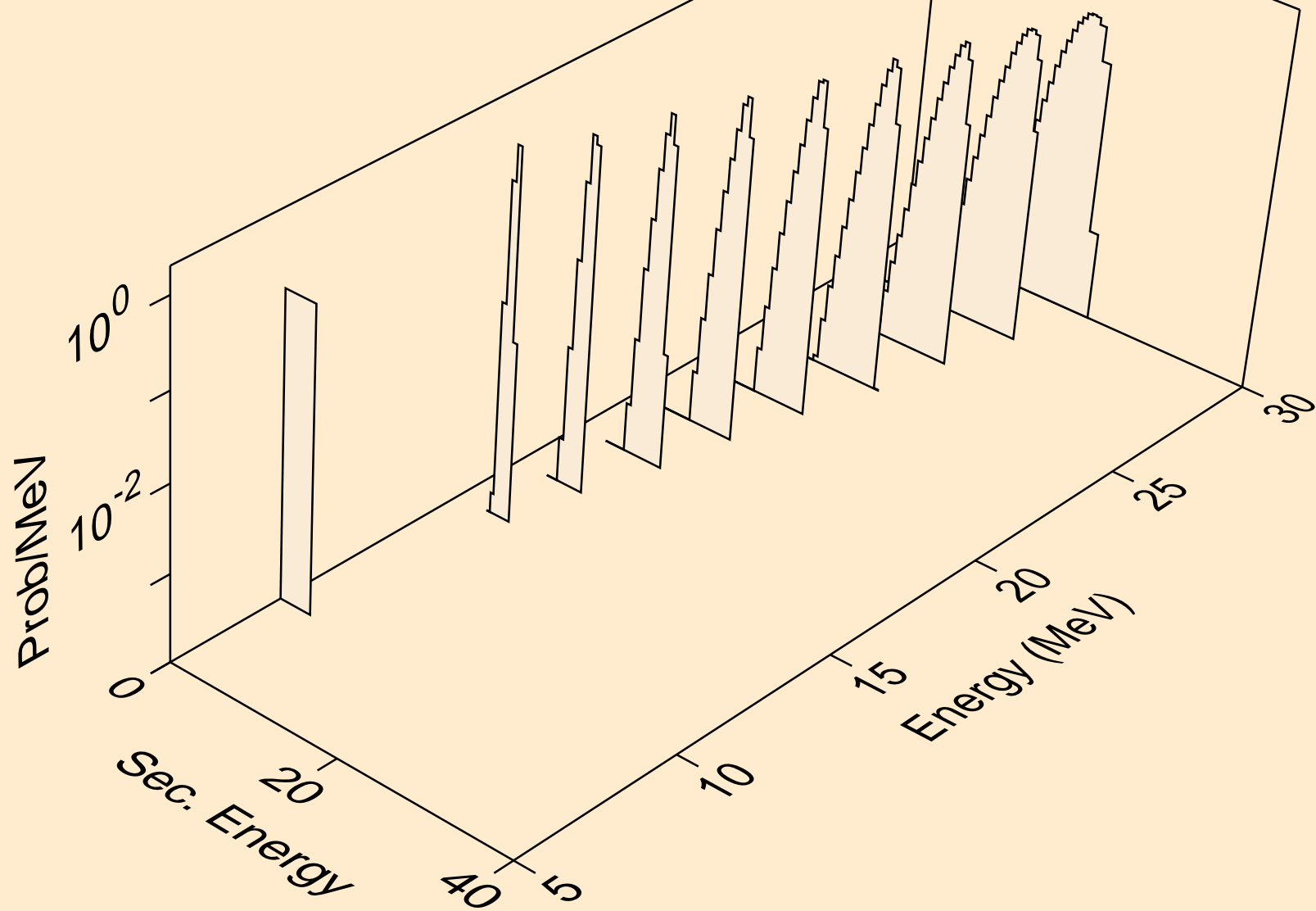

DY144 NEUTRON ACER TENDL-2023 LIBRARY; T=0.K
he3s from (n,he3)

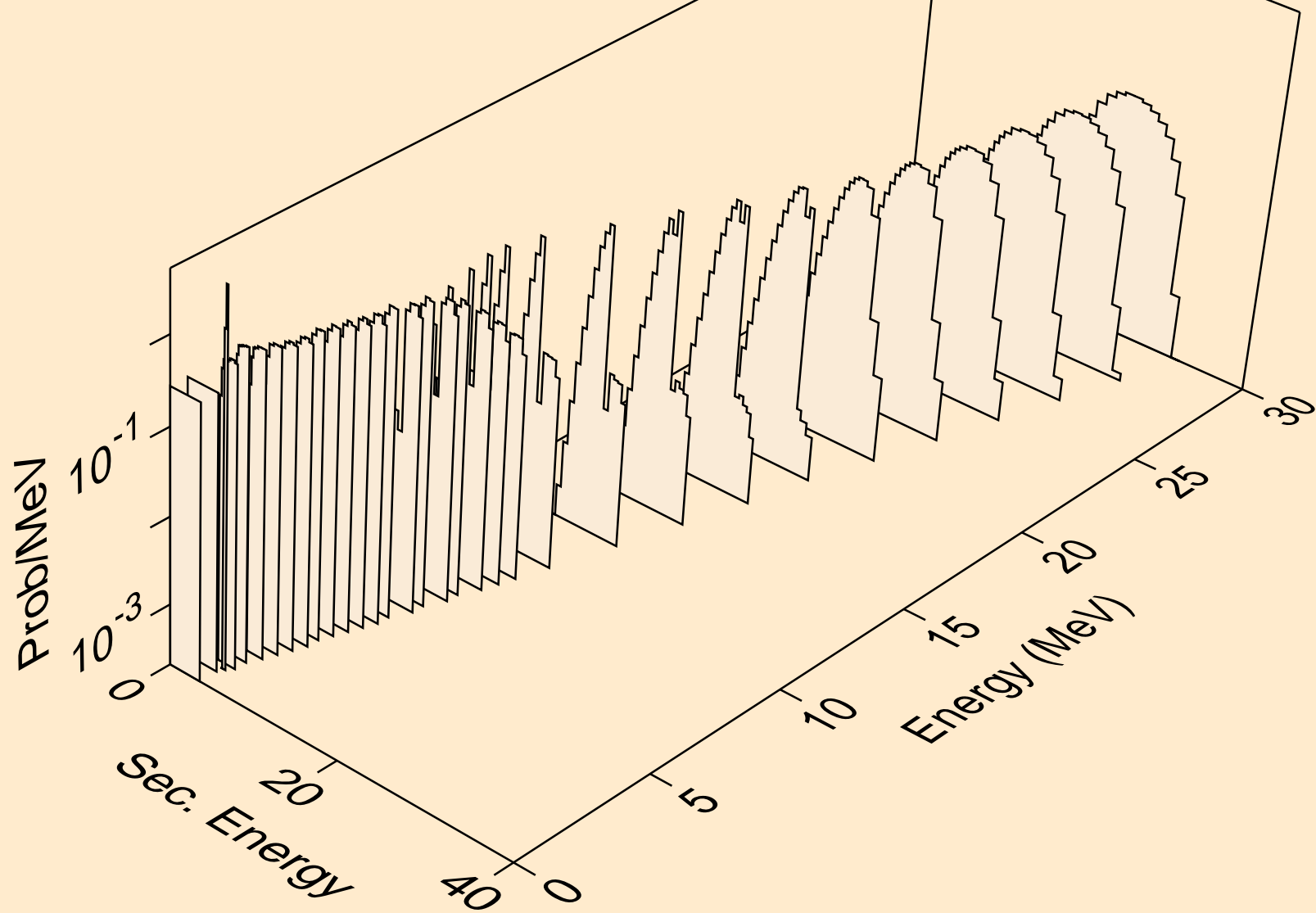

DY144 NEUTRON ACER TENDL-2023 LIBRARY; T=0.K
alphas from (n,x)

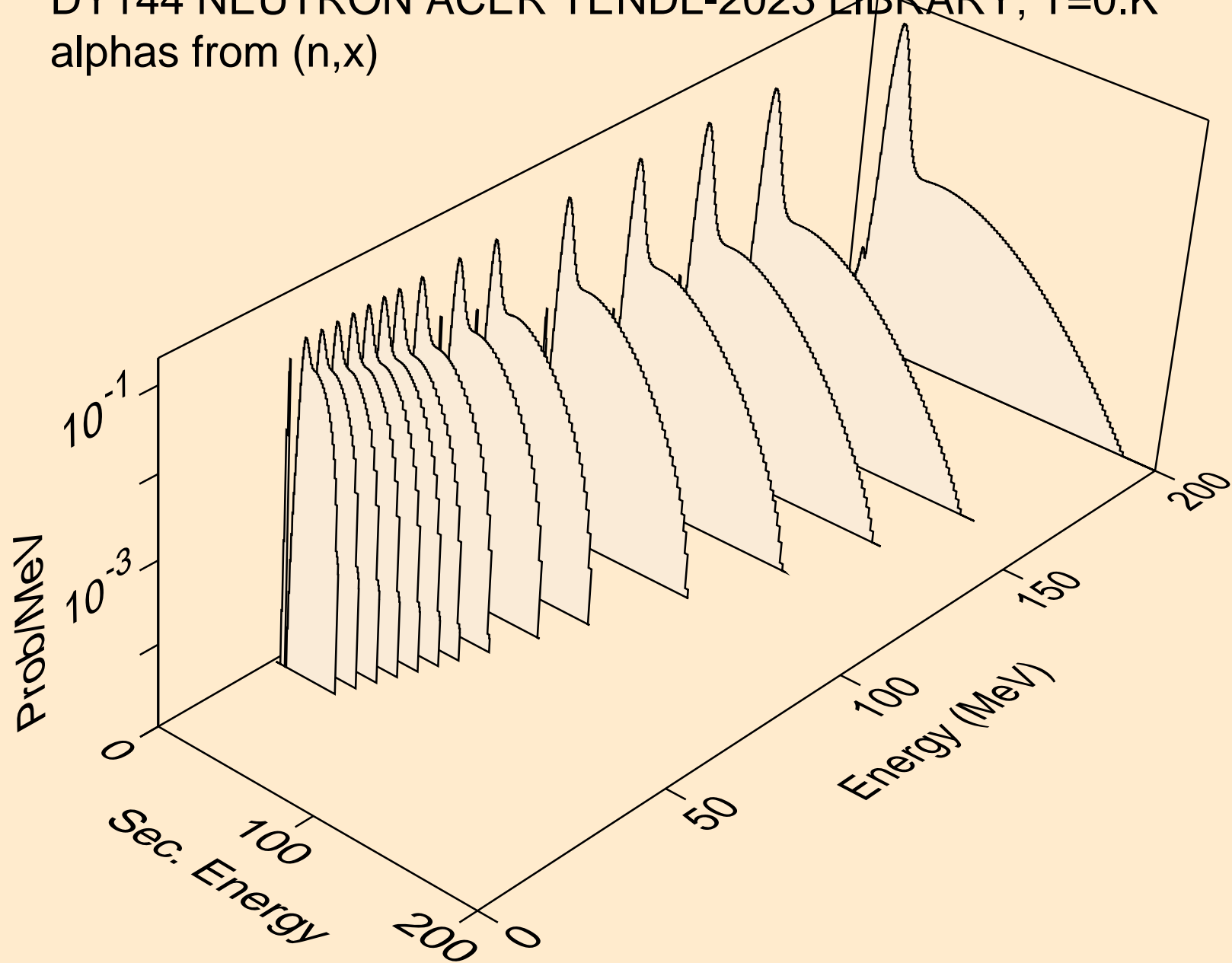

DY144 NEUTRON ACER TENDL-2023 LIBRARY; T=0.K
alphas from (n,n*)a

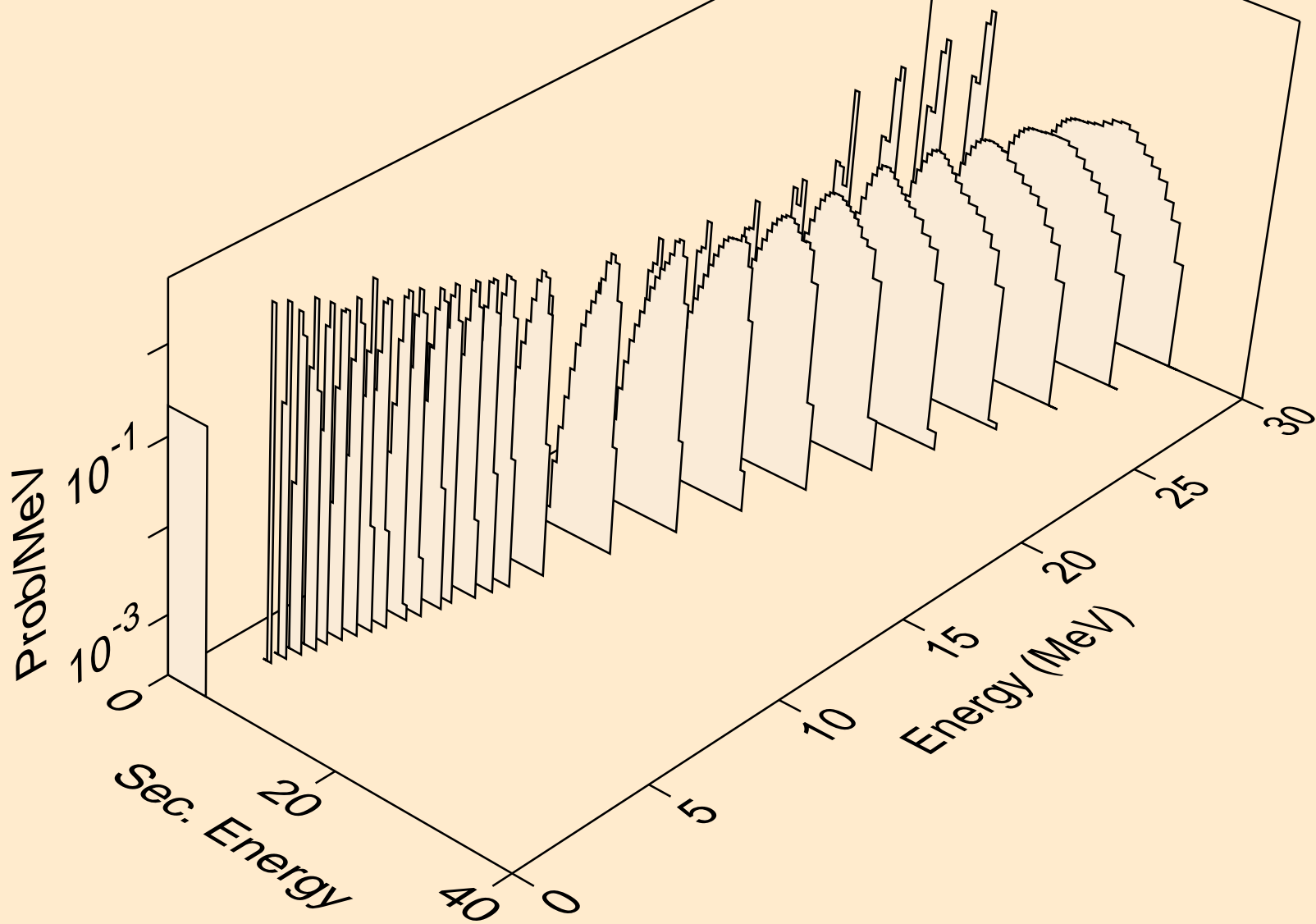

DY144 NEUTRON ACER TENDL-2023 LIBRARY; T=0.K
alphas from (n,2n)a

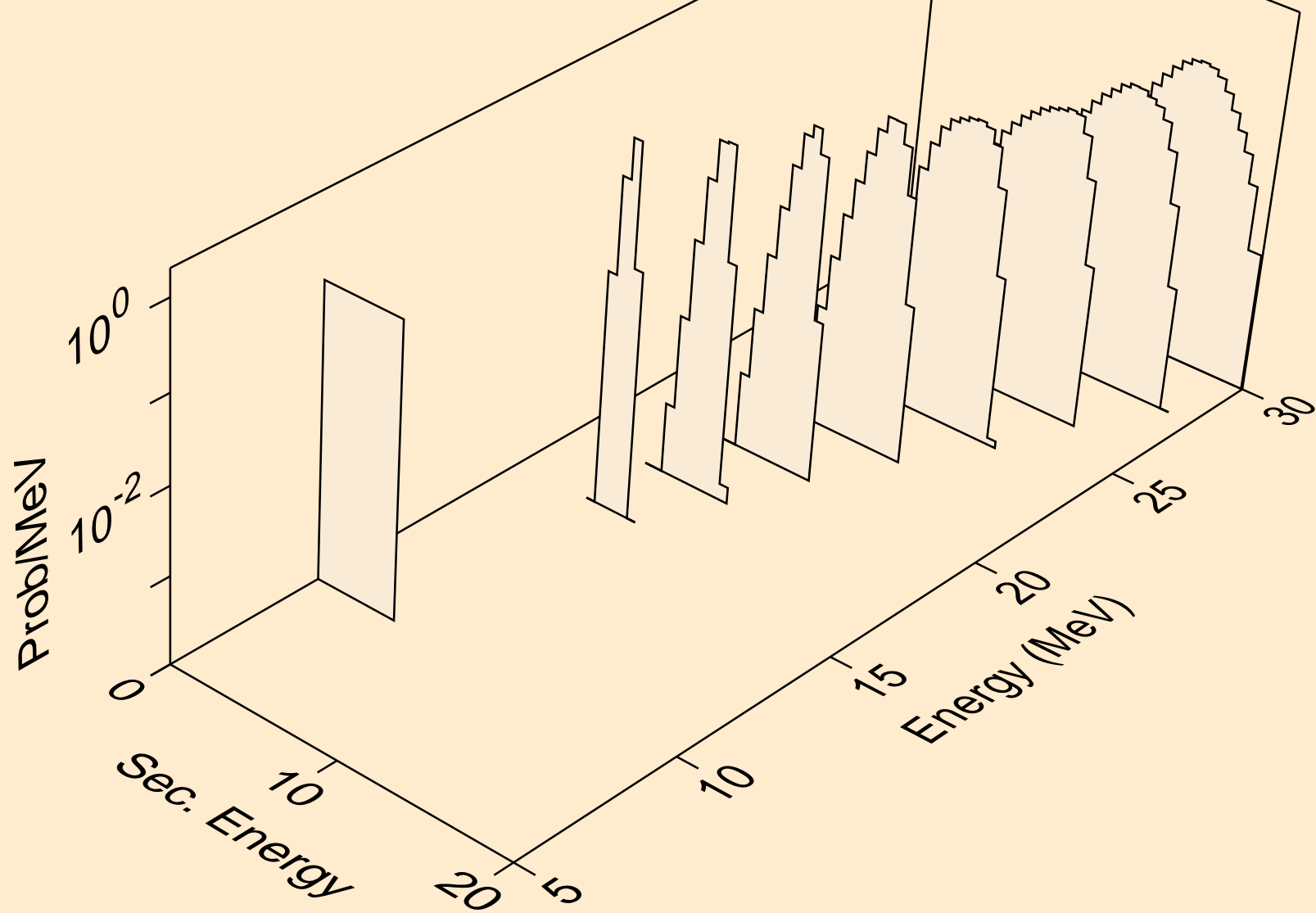

DY144 NEUTRON ACER TENDL-2023 LIBRARY; T=0.K
alphas from (n,3n)a

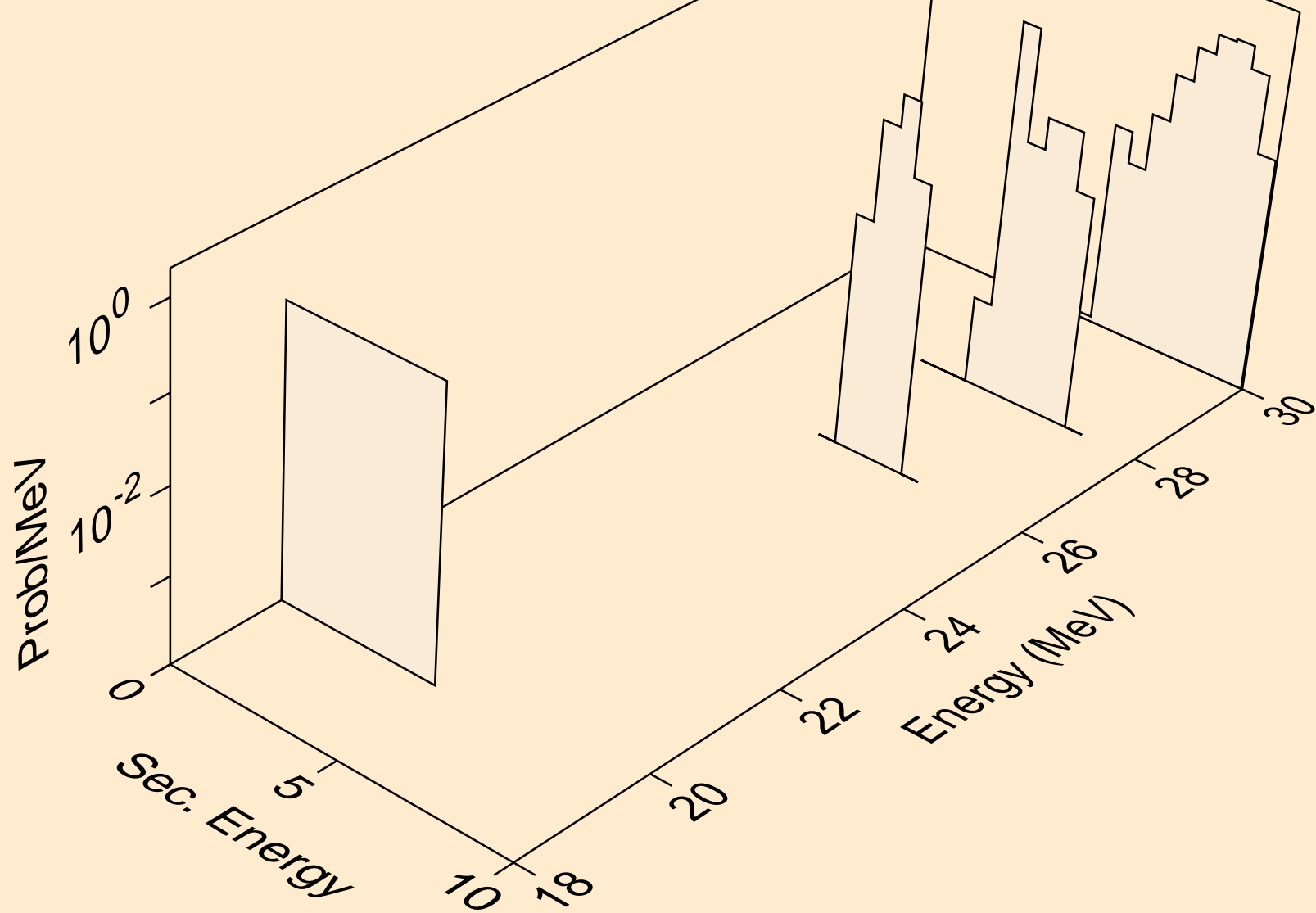

DY144 NEUTRON ACER TENDL-2023 LIBRARY; T=0.K
alphas from (n,n*)2a

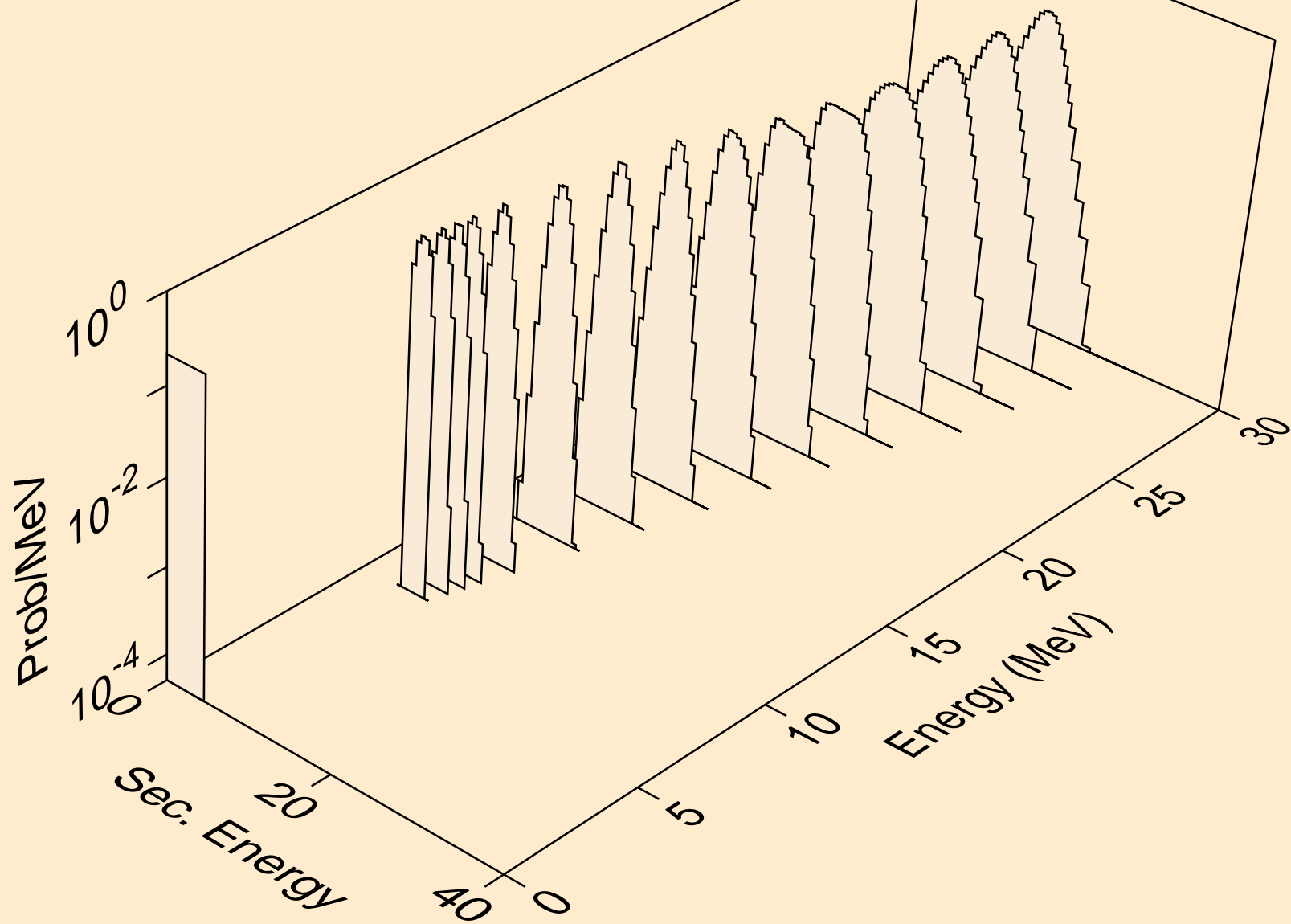

DY144 NEUTRON ACER TENDL-2023 LIBRARY; T=0.K
alphas from (n,npa)

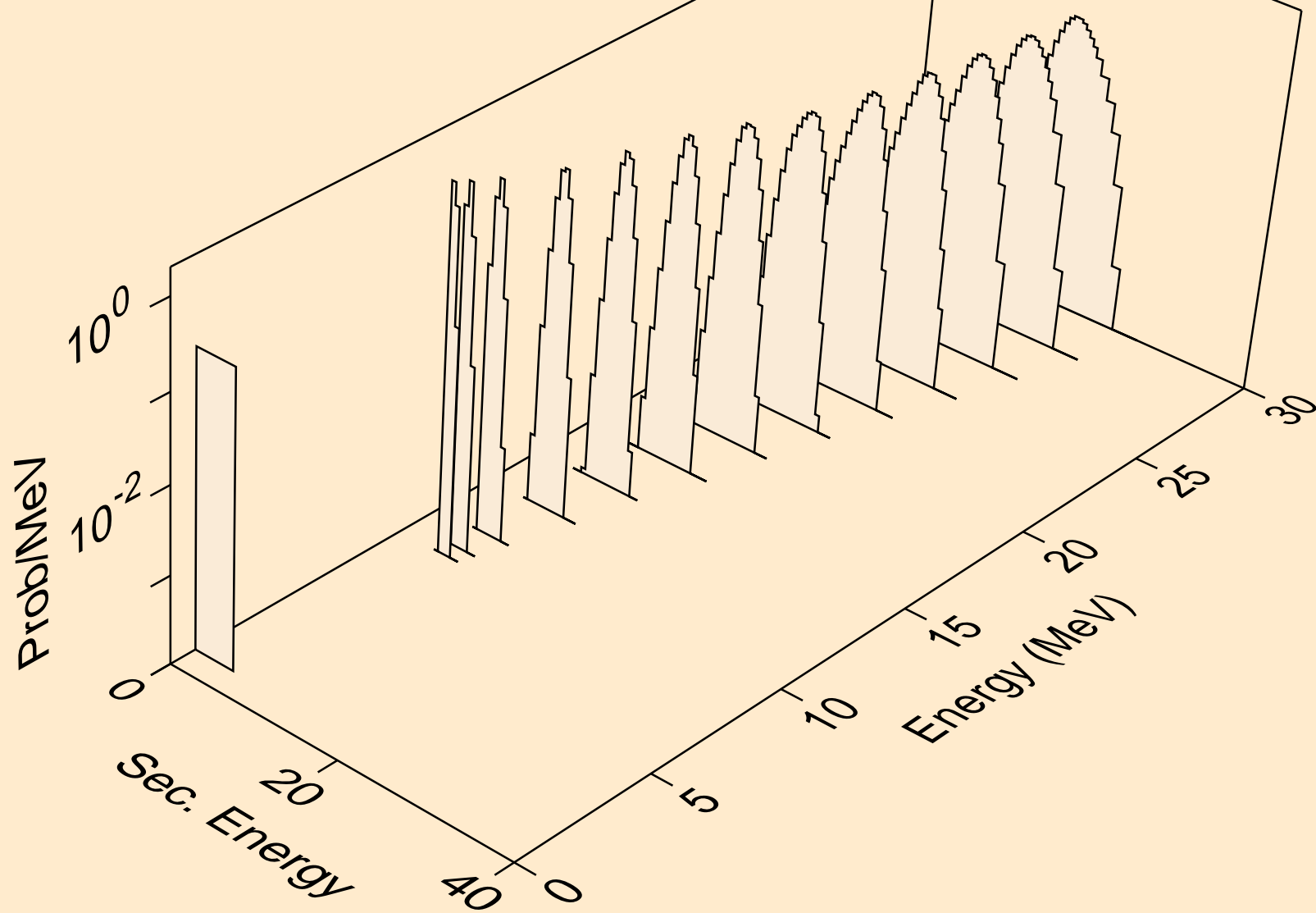

DY144 NEUTRON ACER TENDL-2023 LIBRARY; T=0.K
alphas from (n,a)

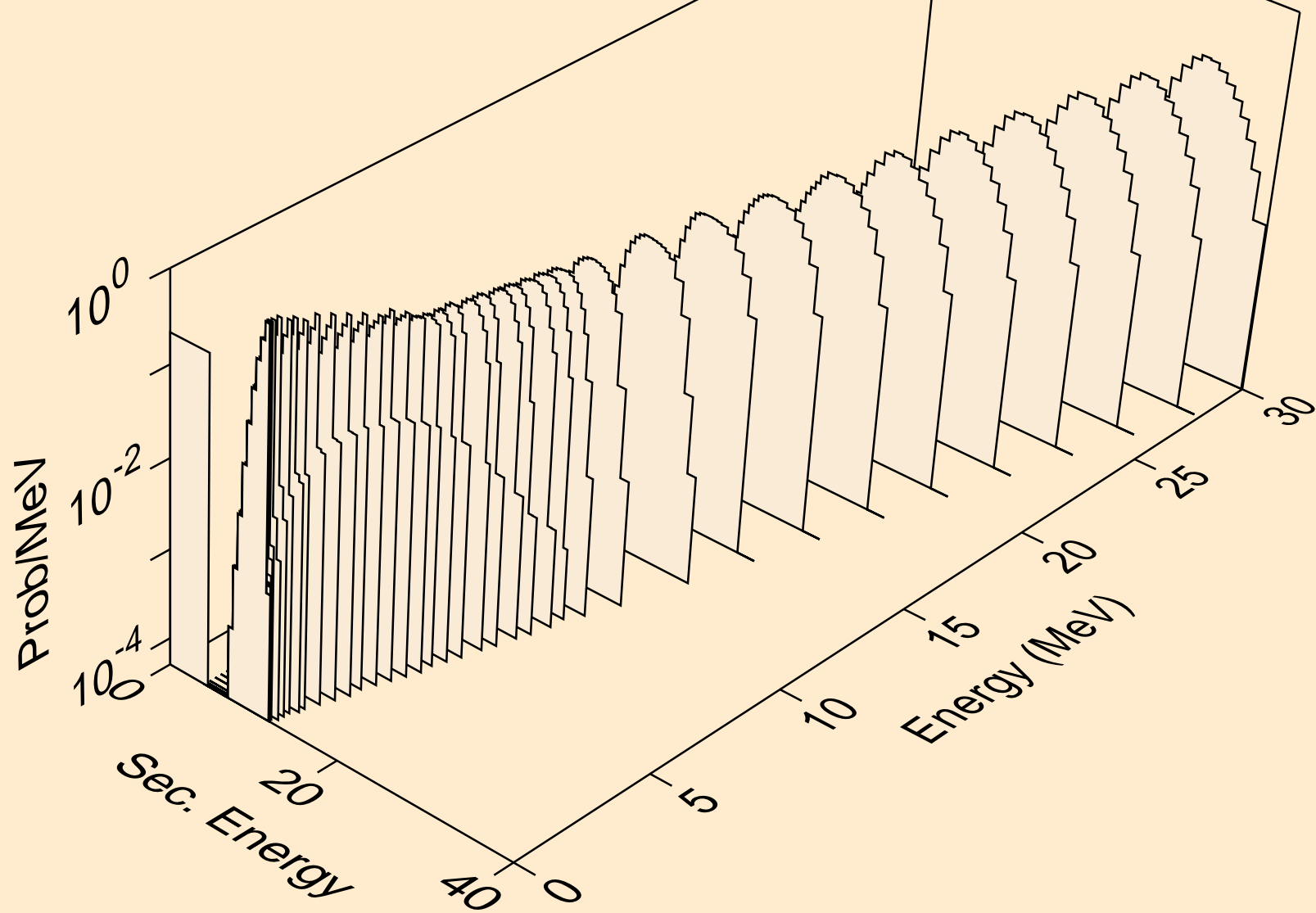

DY144 NEUTRON ACER TENDL-2023 LIBRARY; T=0.K
alphas from (n,2a)

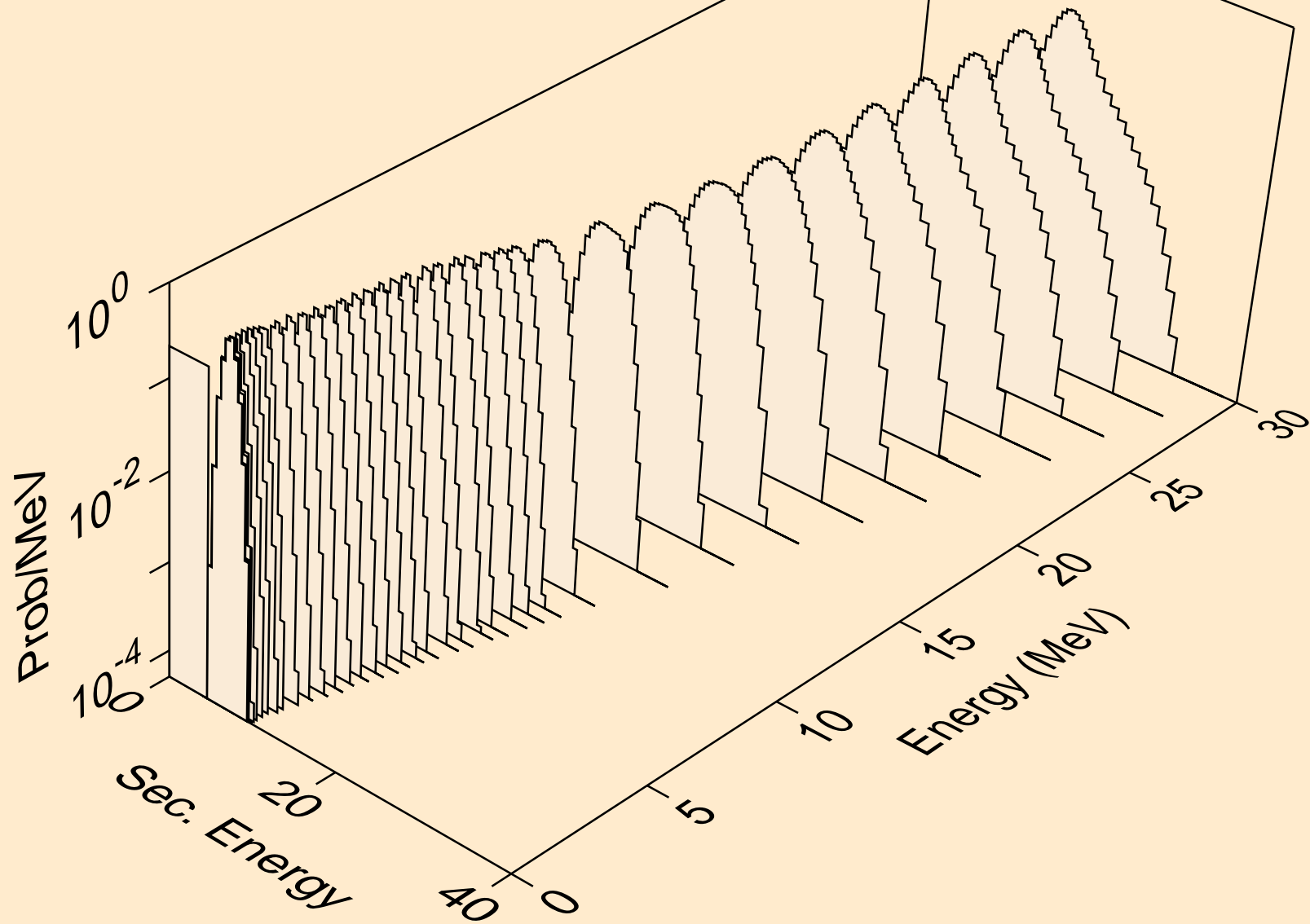

DY144 NEUTRON ACER TENDL-2023 LIBRARY; T=0.K
alphas from (n,3a)

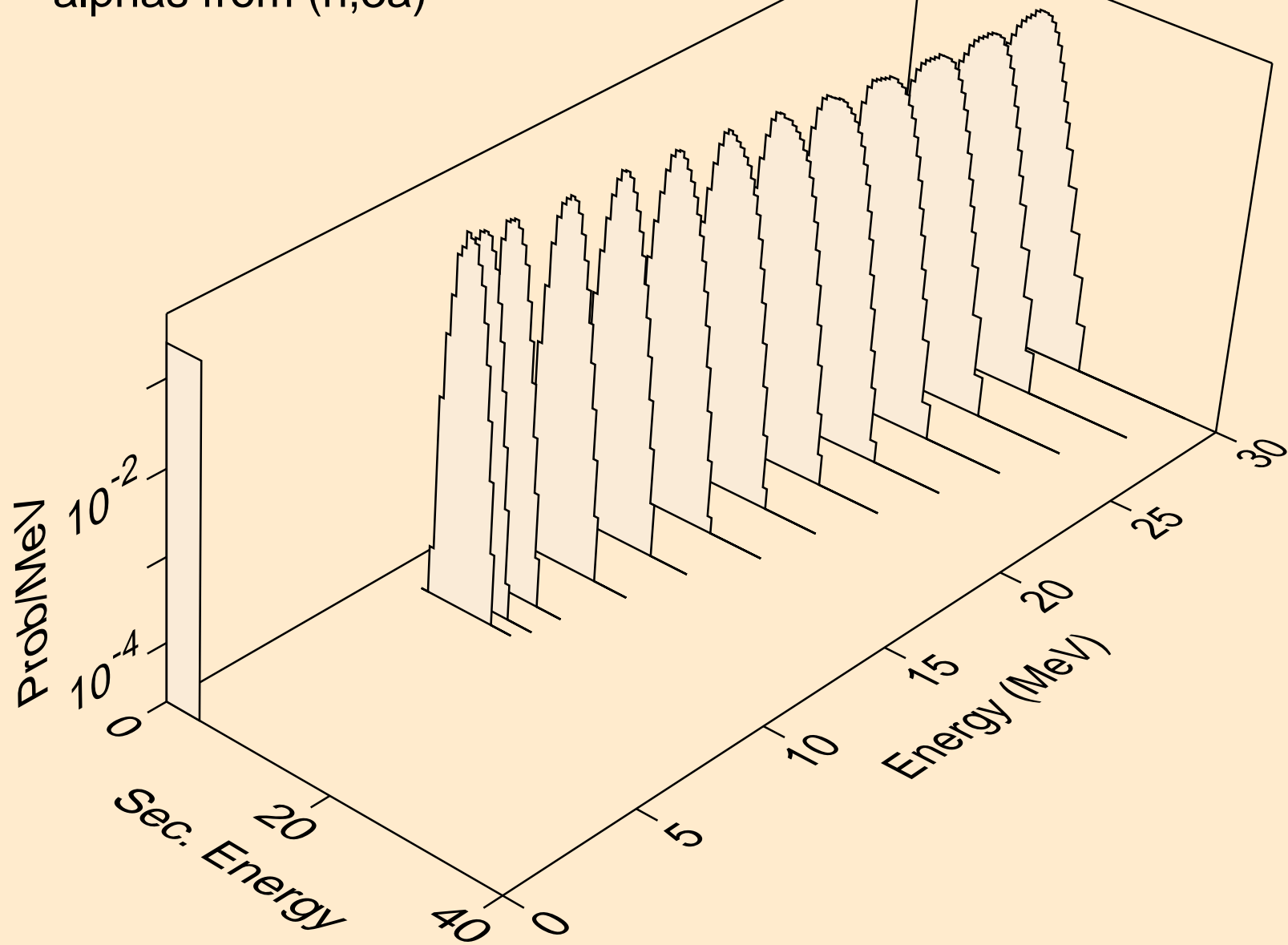

DY144 NEUTRON ACER TENDL-2023 LIBRARY; T=0.K
alphas from (n,pa)

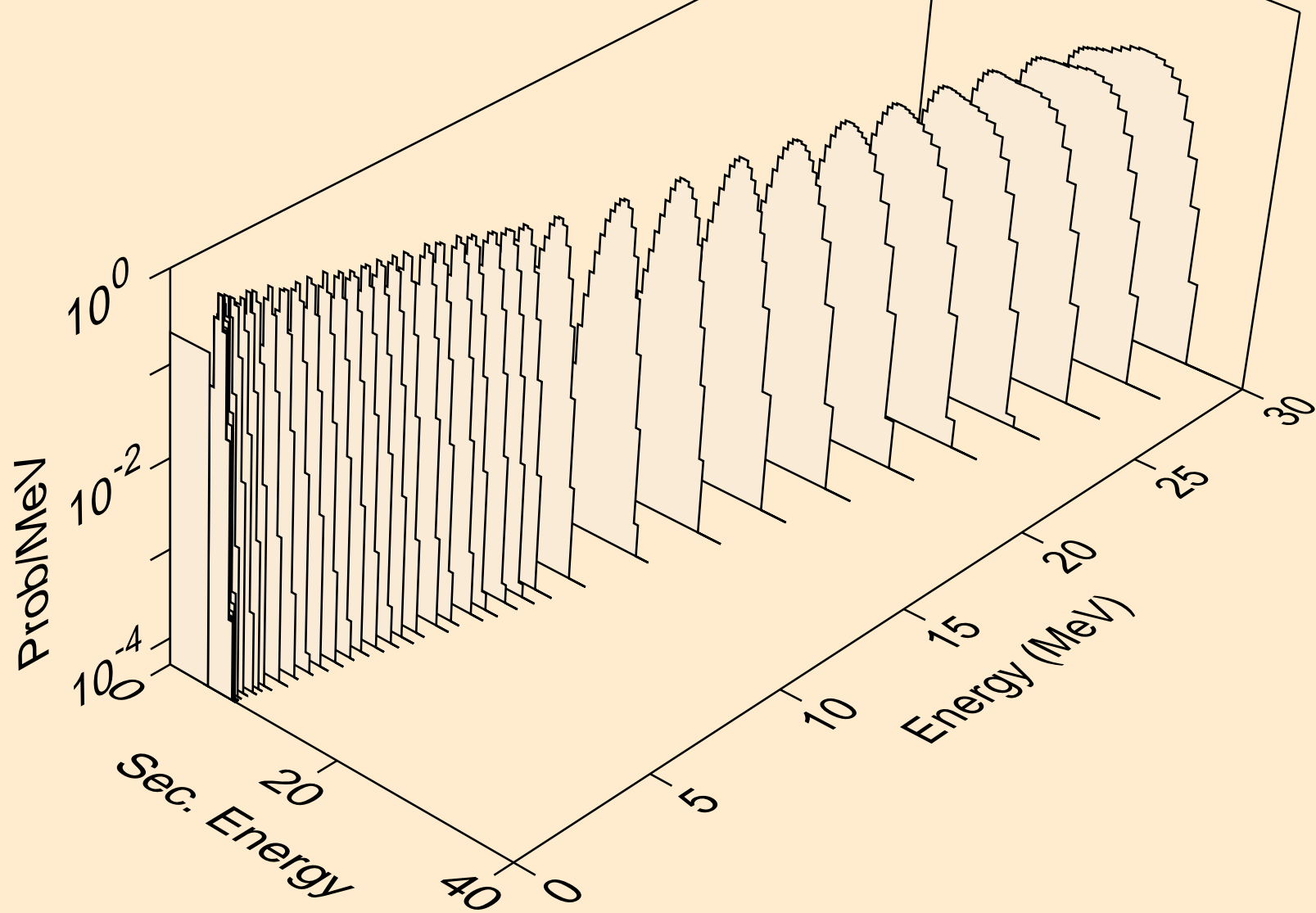

DY144 NEUTRON ACER TENDL-2023 LIBRARY; T=0.K
alphas from (n,da)

