

# DY145 NEUTRON ACER TENDL-2023 LIBRARY; T=0.K

## Principal cross sections

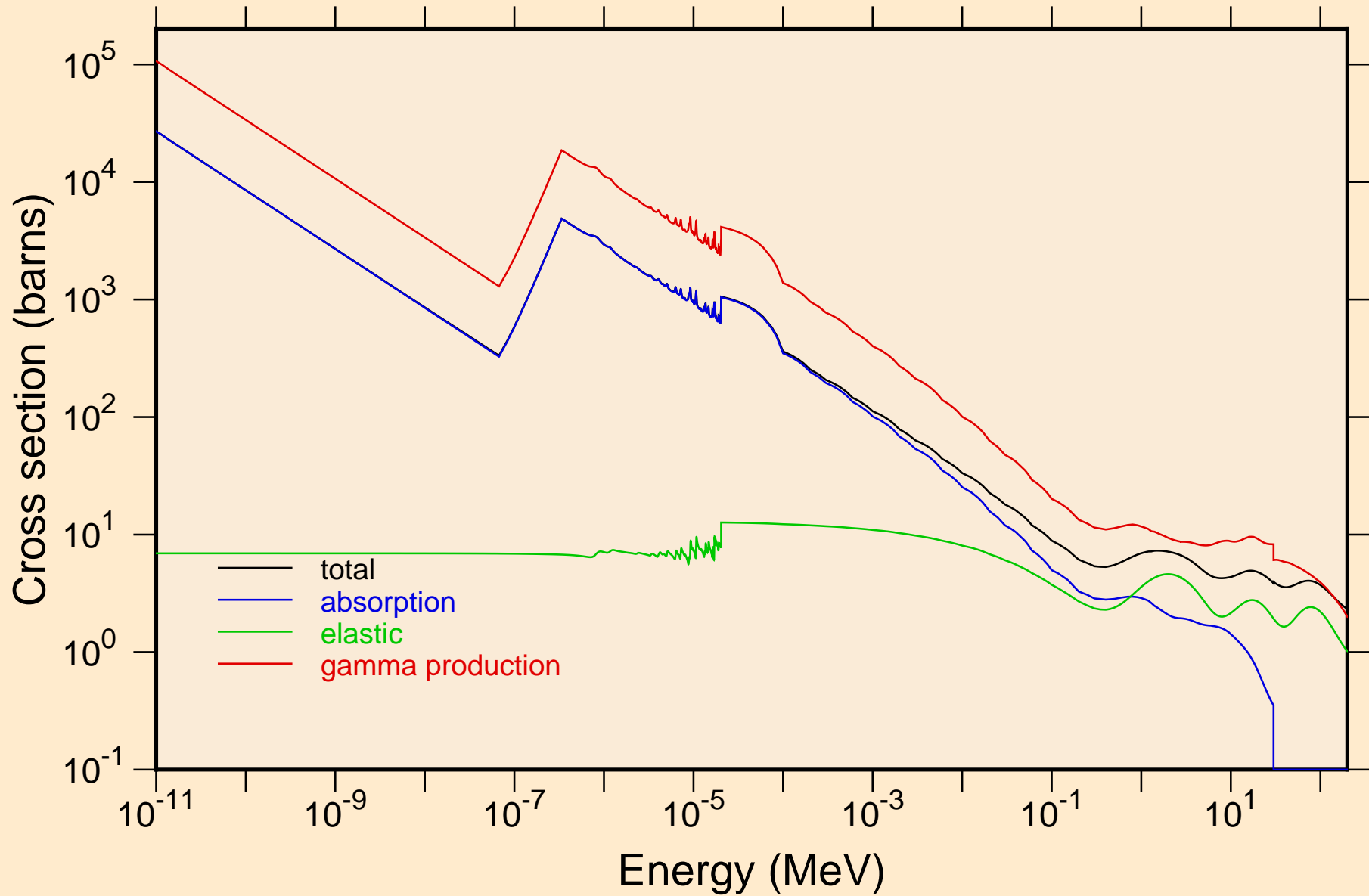

DY145 NEUTRON ACER TENDL-2023 LIBRARY; T=0.K  
resonance total cross section

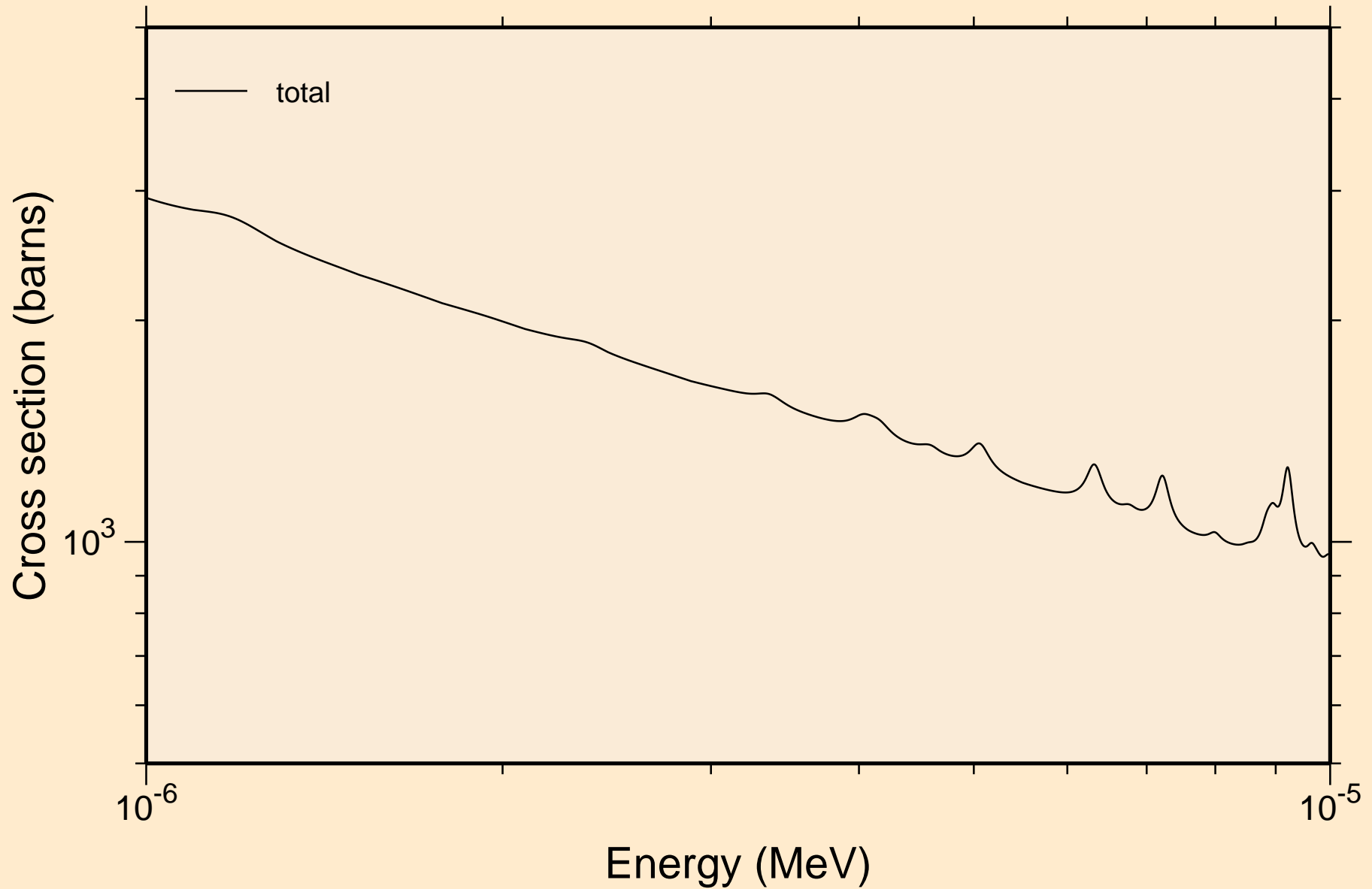

DY145 NEUTRON ACER TENDL-2023 LIBRARY; T=0.K  
resonance total cross section

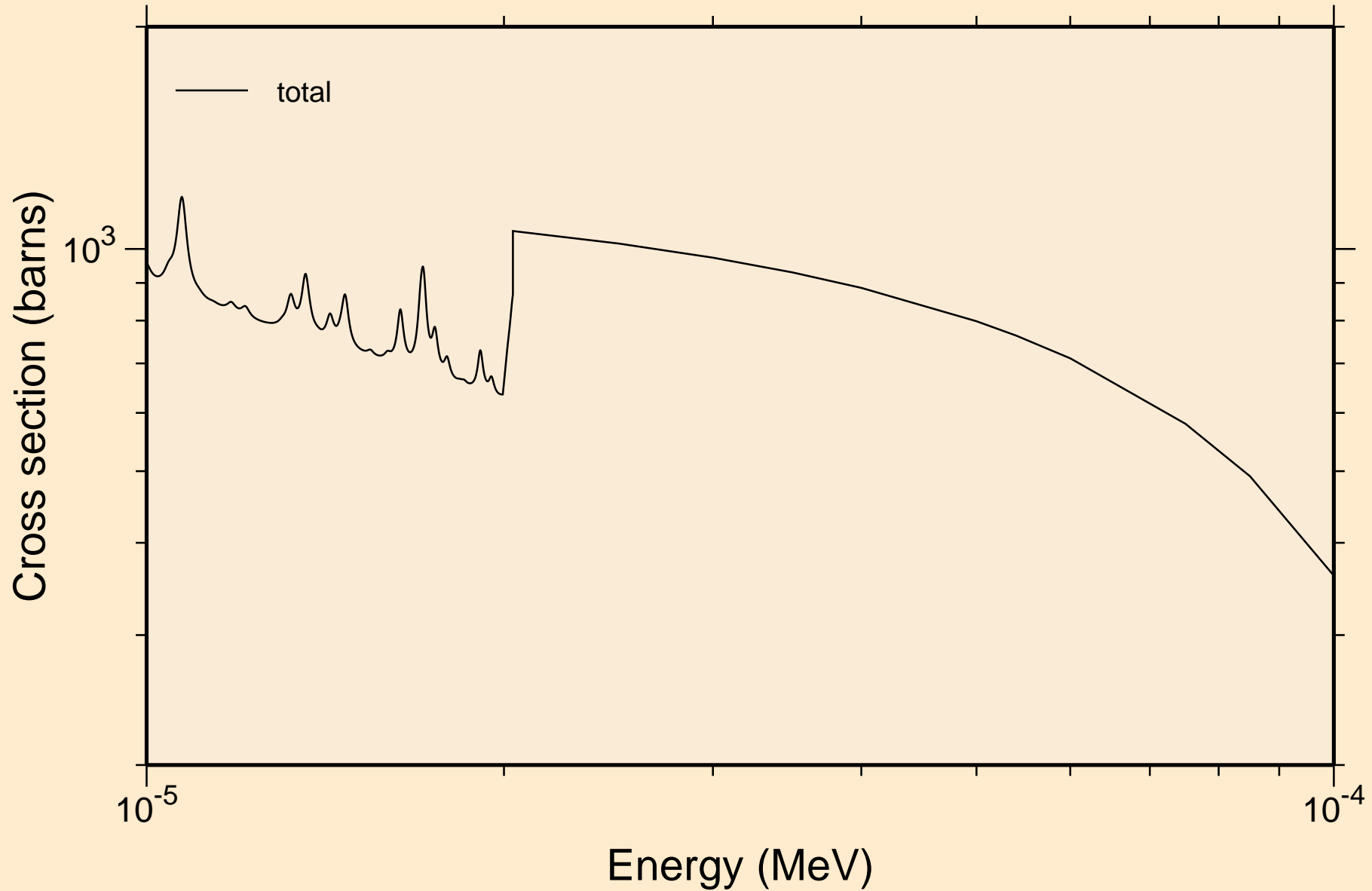

DY145 NEUTRON ACER TENDL-2023 LIBRARY; T=0.K  
resonance total cross section

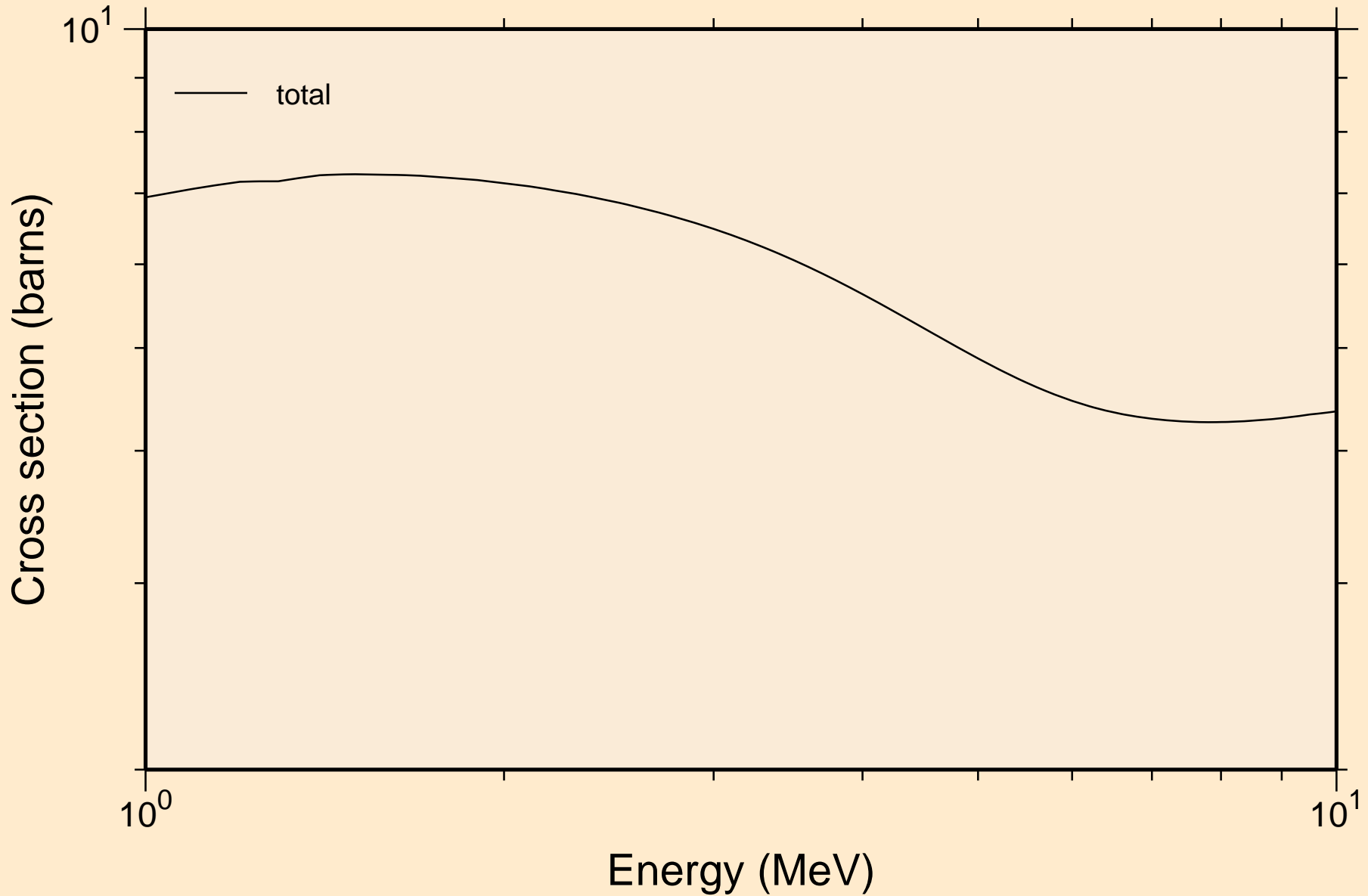

DY145 NEUTRON ACER TENDL-2023 LIBRARY; T=0.K  
resonance absorption cross sections

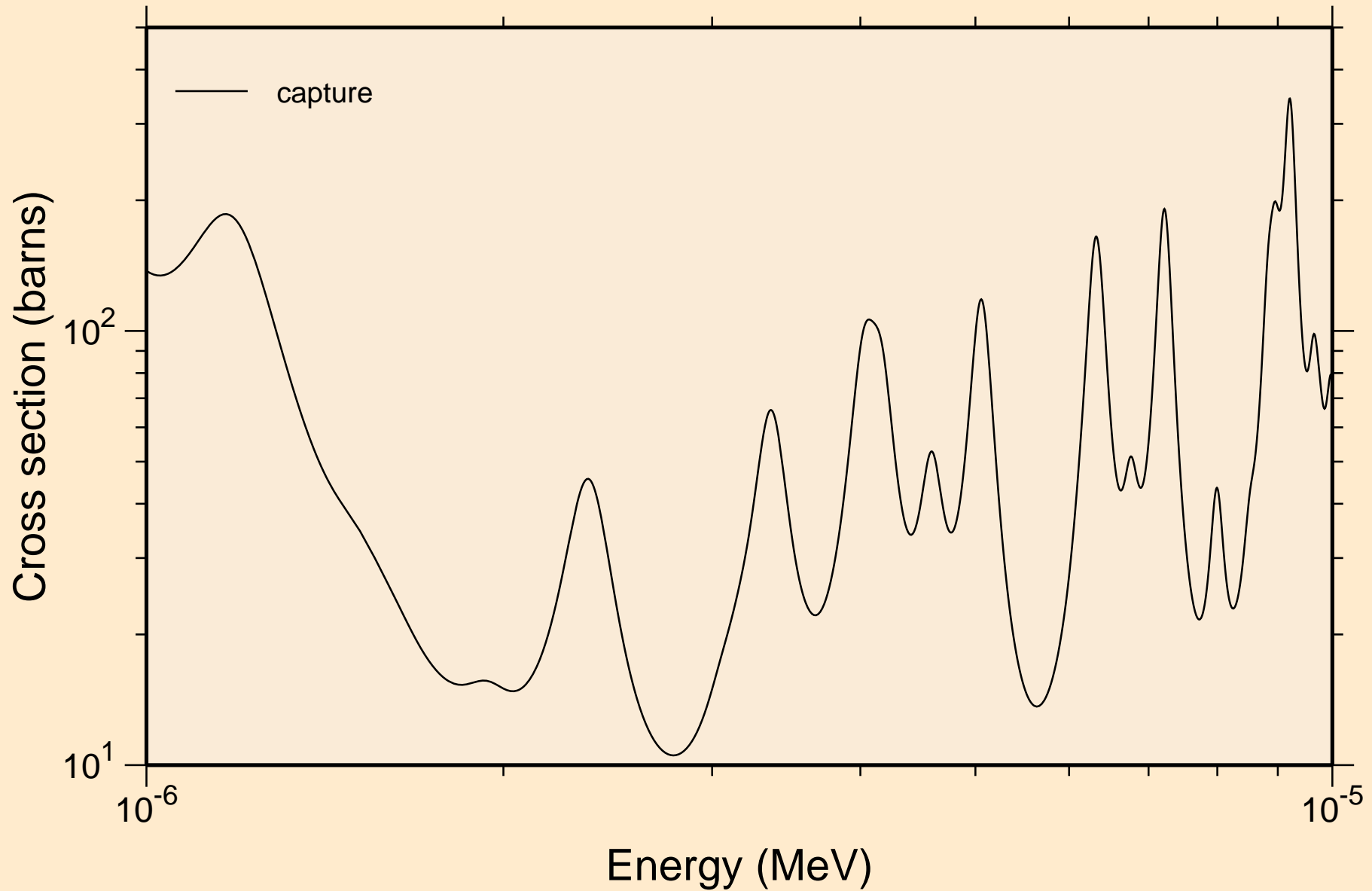

DY145 NEUTRON ACER TENDL-2023 LIBRARY; T=0.K  
resonance absorption cross sections

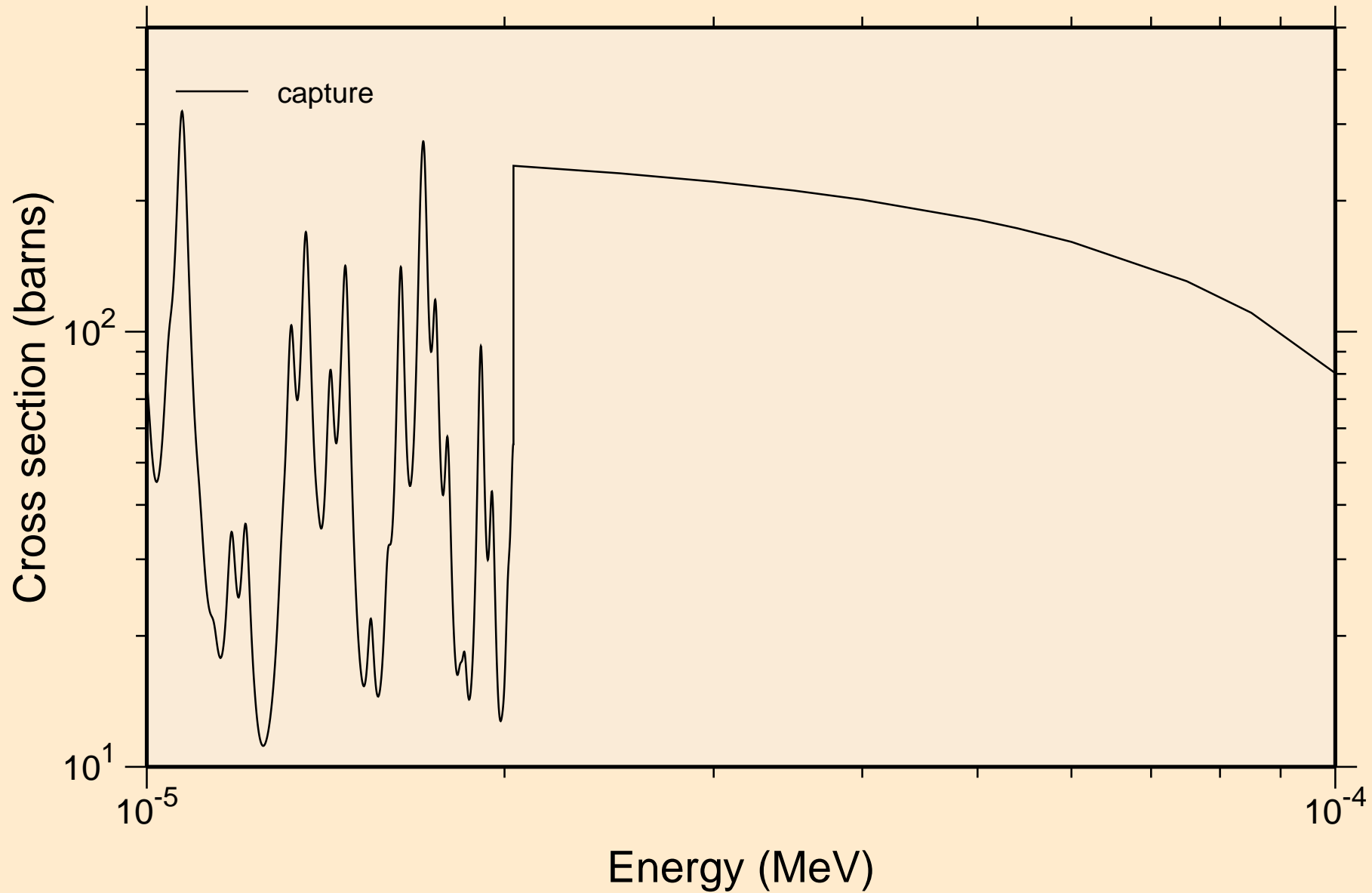

DY145 NEUTRON ACER TENDL-2023 LIBRARY; T=0.K  
resonance absorption cross sections

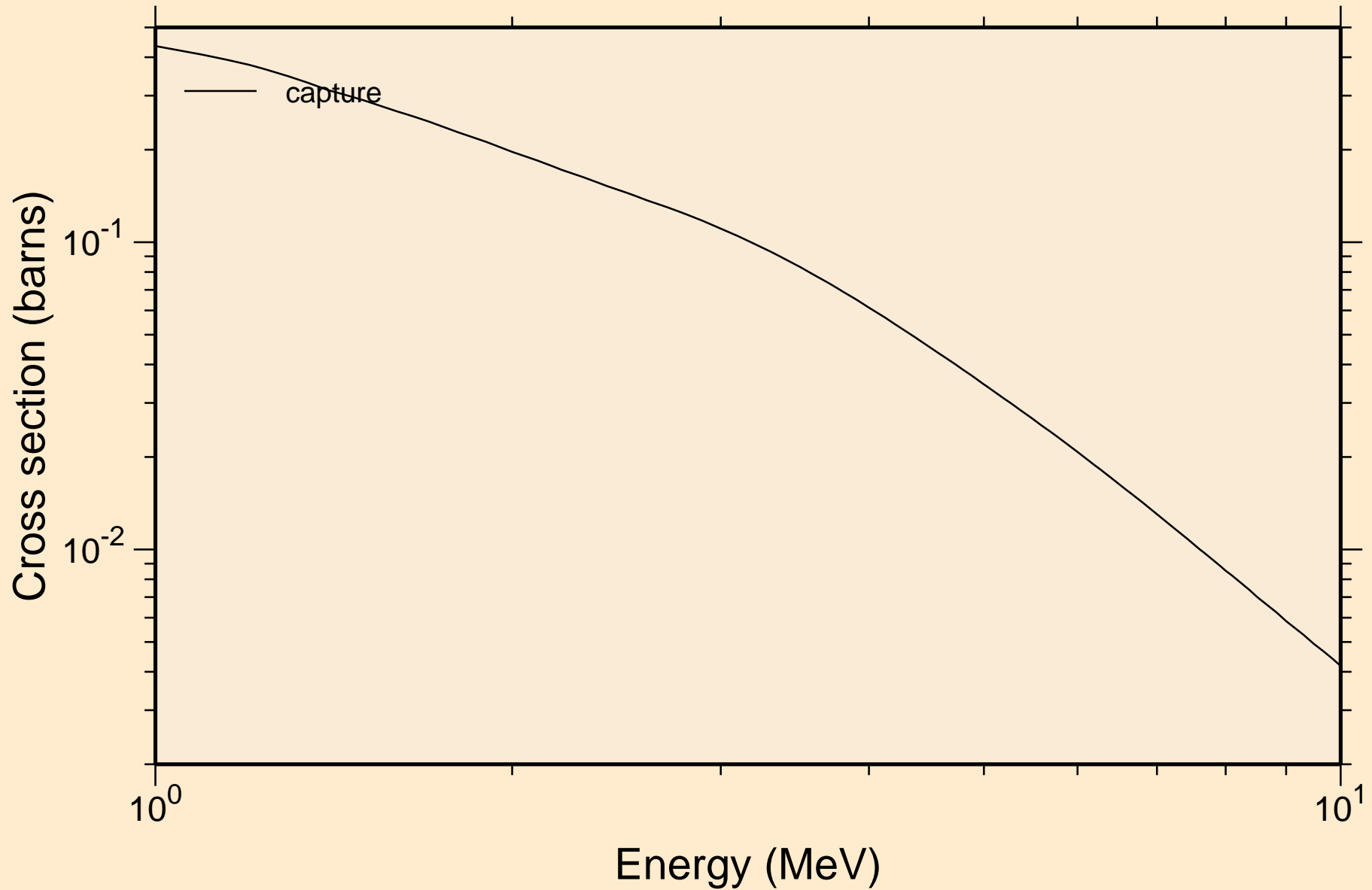

# DY145 NEUTRON ACER TENDL-2023 LIBRARY; T=0.K

## Heating

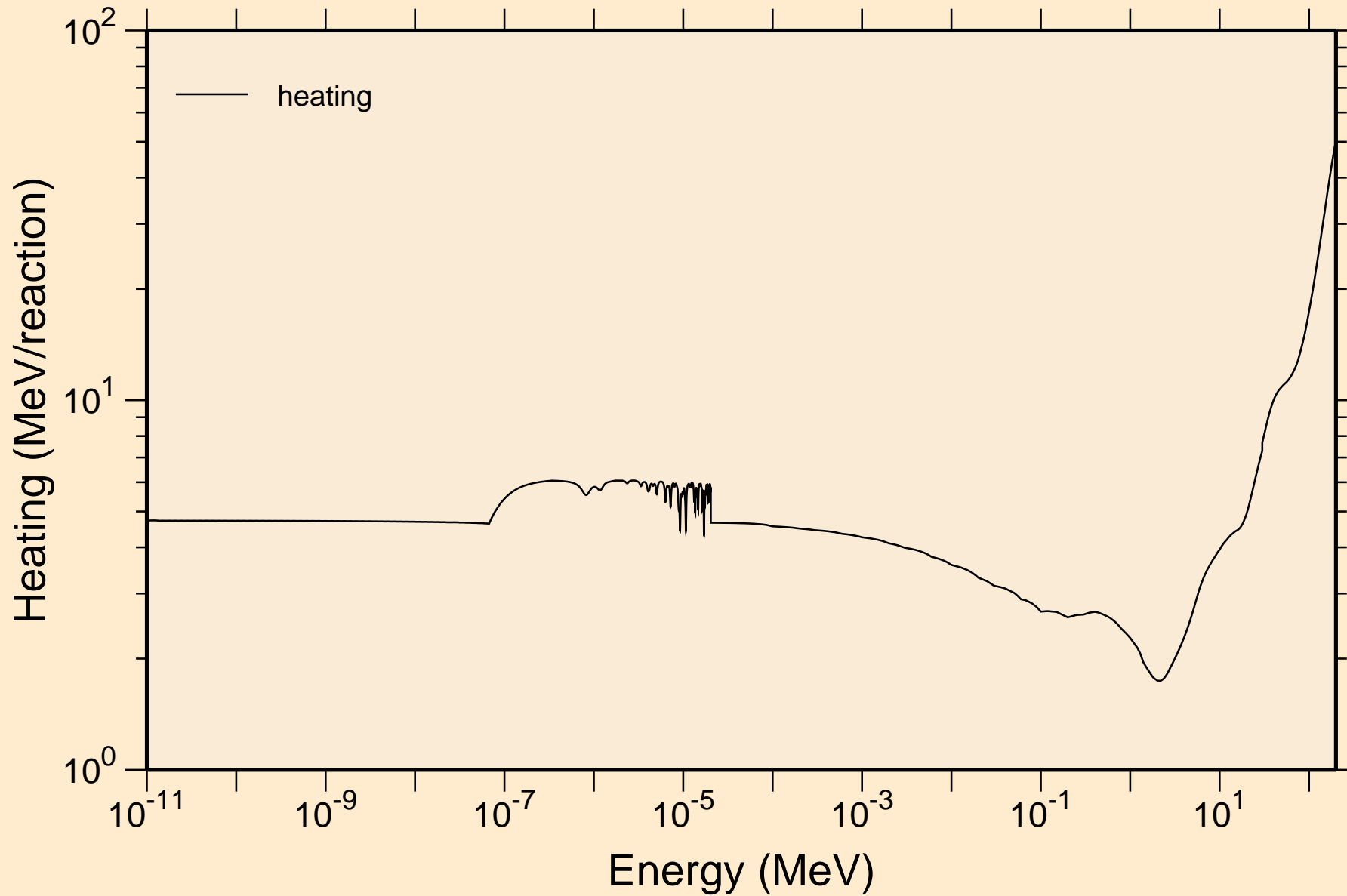



DY145 NEUTRON ACER TENDL-2023 LIBRARY; T=0.K  
Damage

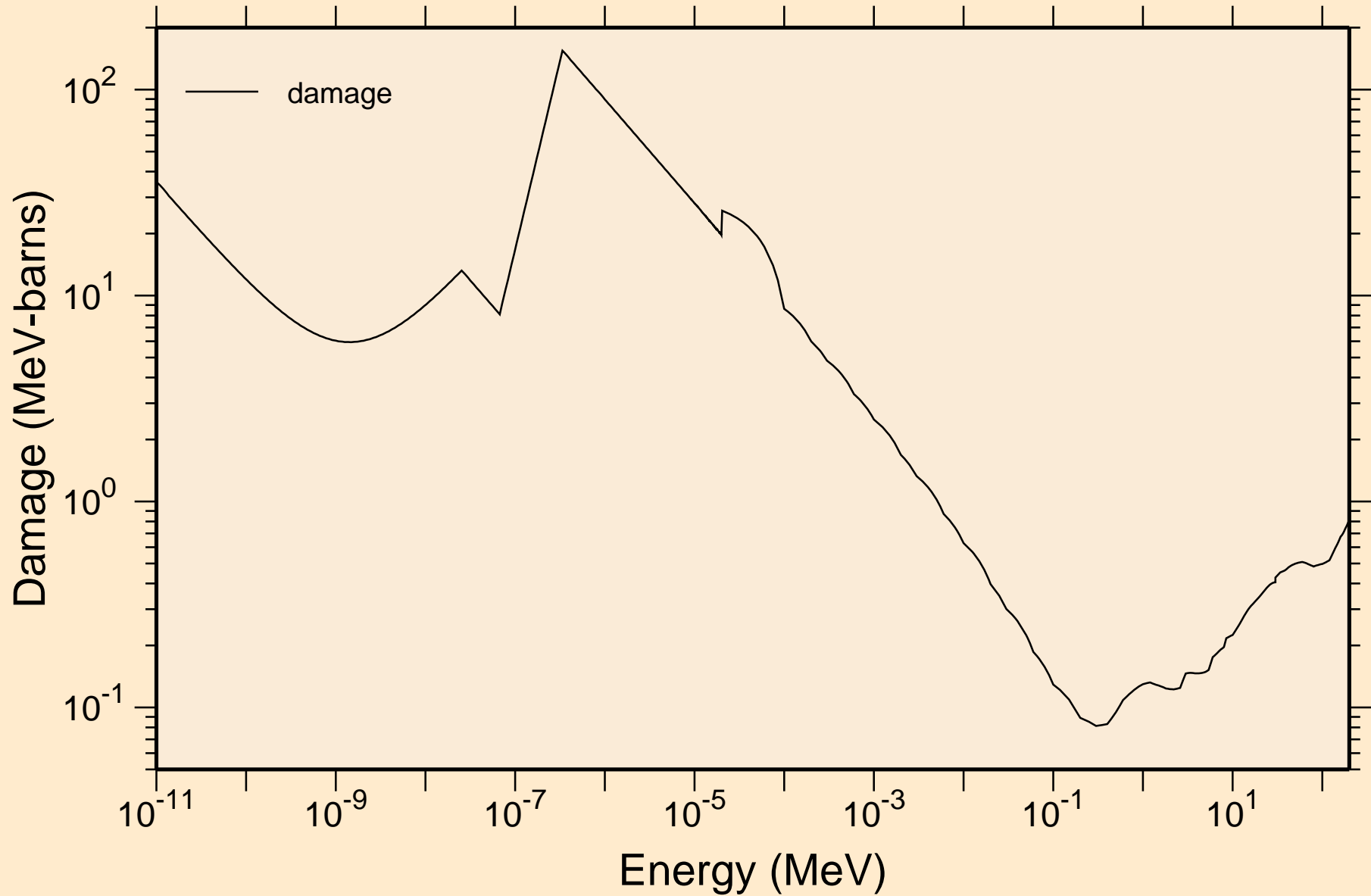

# DY145 NEUTRON ACER TENDL-2023 LIBRARY; T=0.K

## Non-threshold reactions

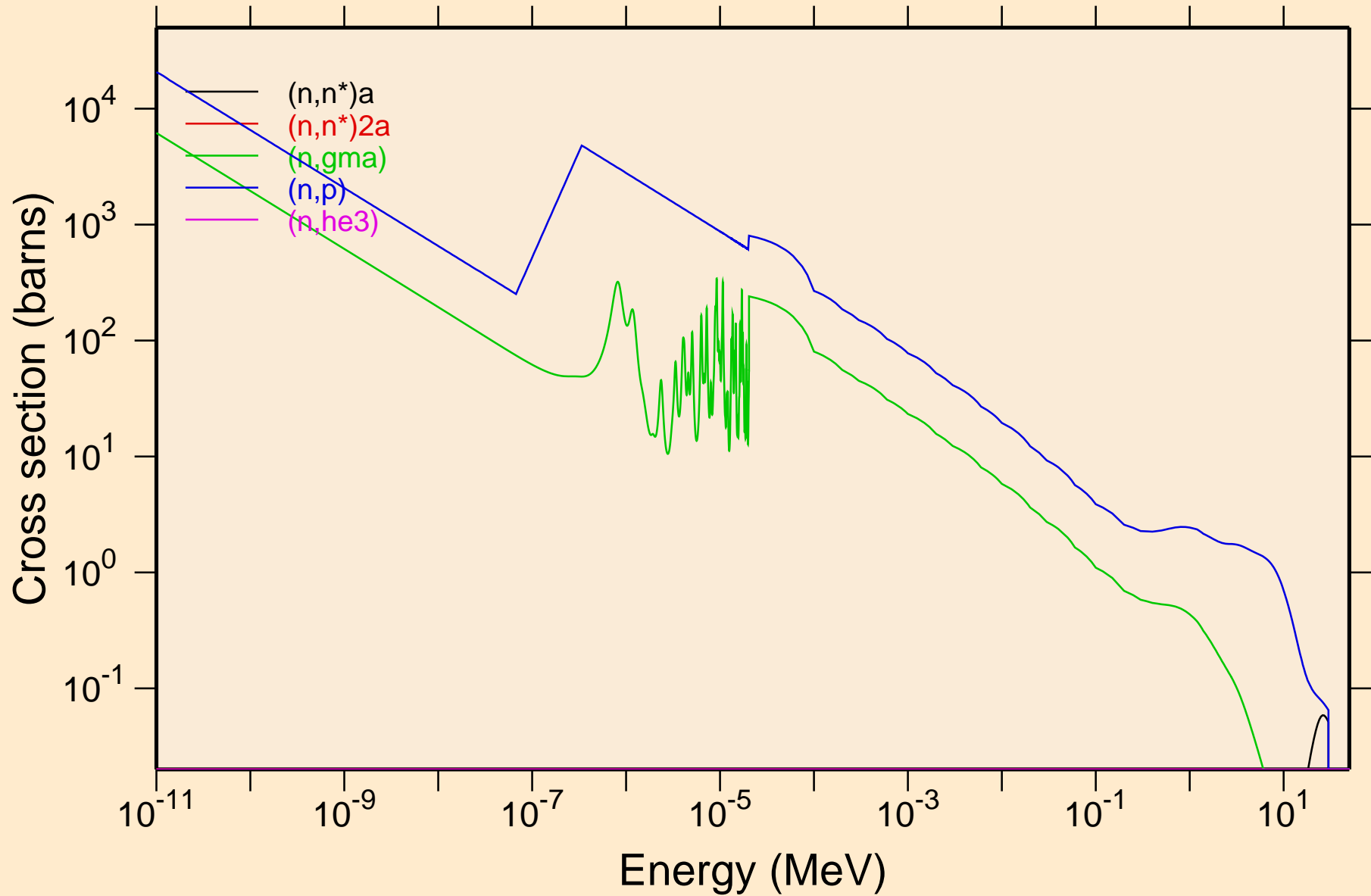

DY145 NEUTRON ACER TENDL-2023 LIBRARY; T=0.K  
Non-threshold reactions

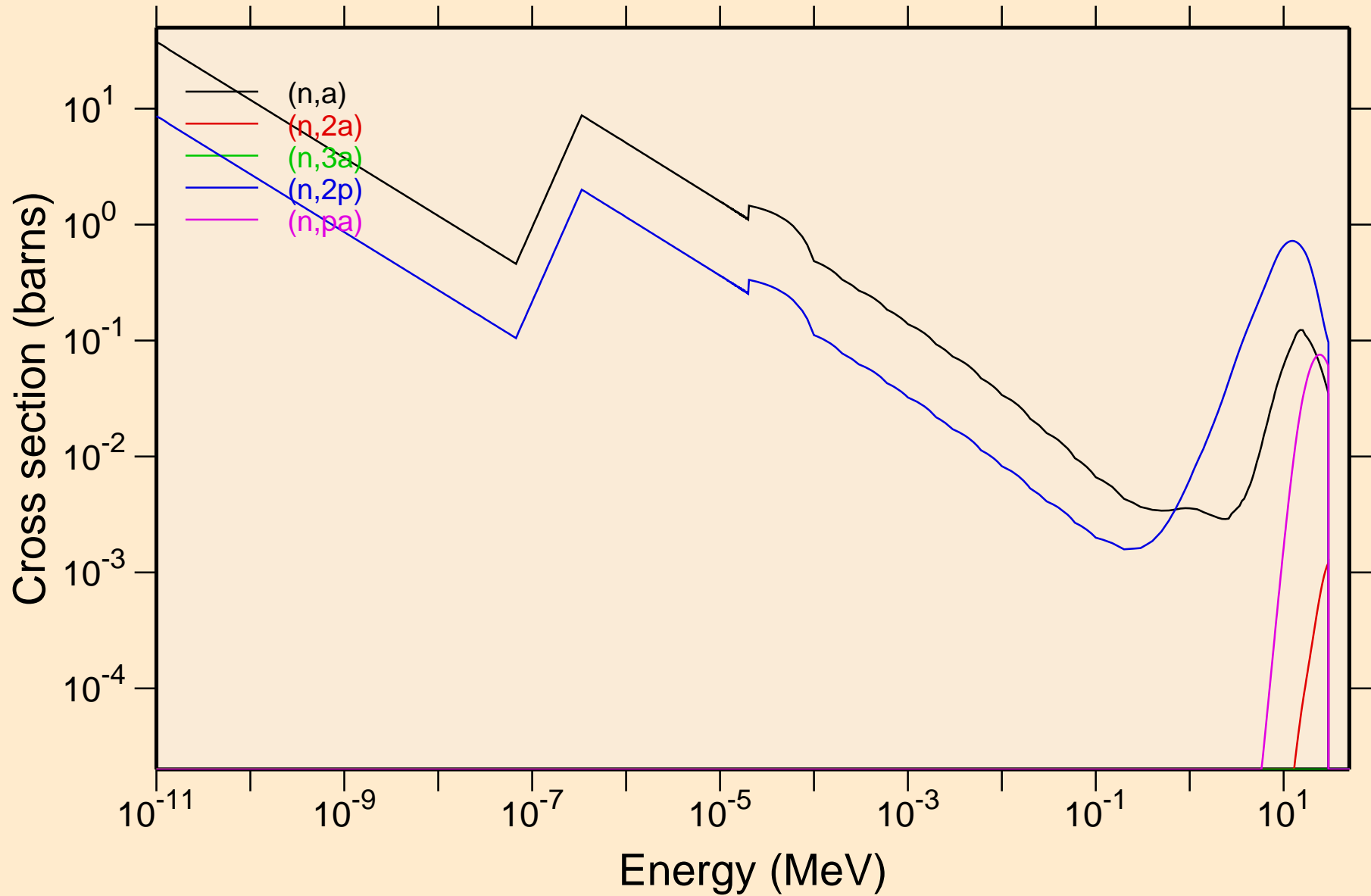

# DY145 NEUTRON ACER TENDL-2023 LIBRARY; T=0.K

## Non-threshold reactions

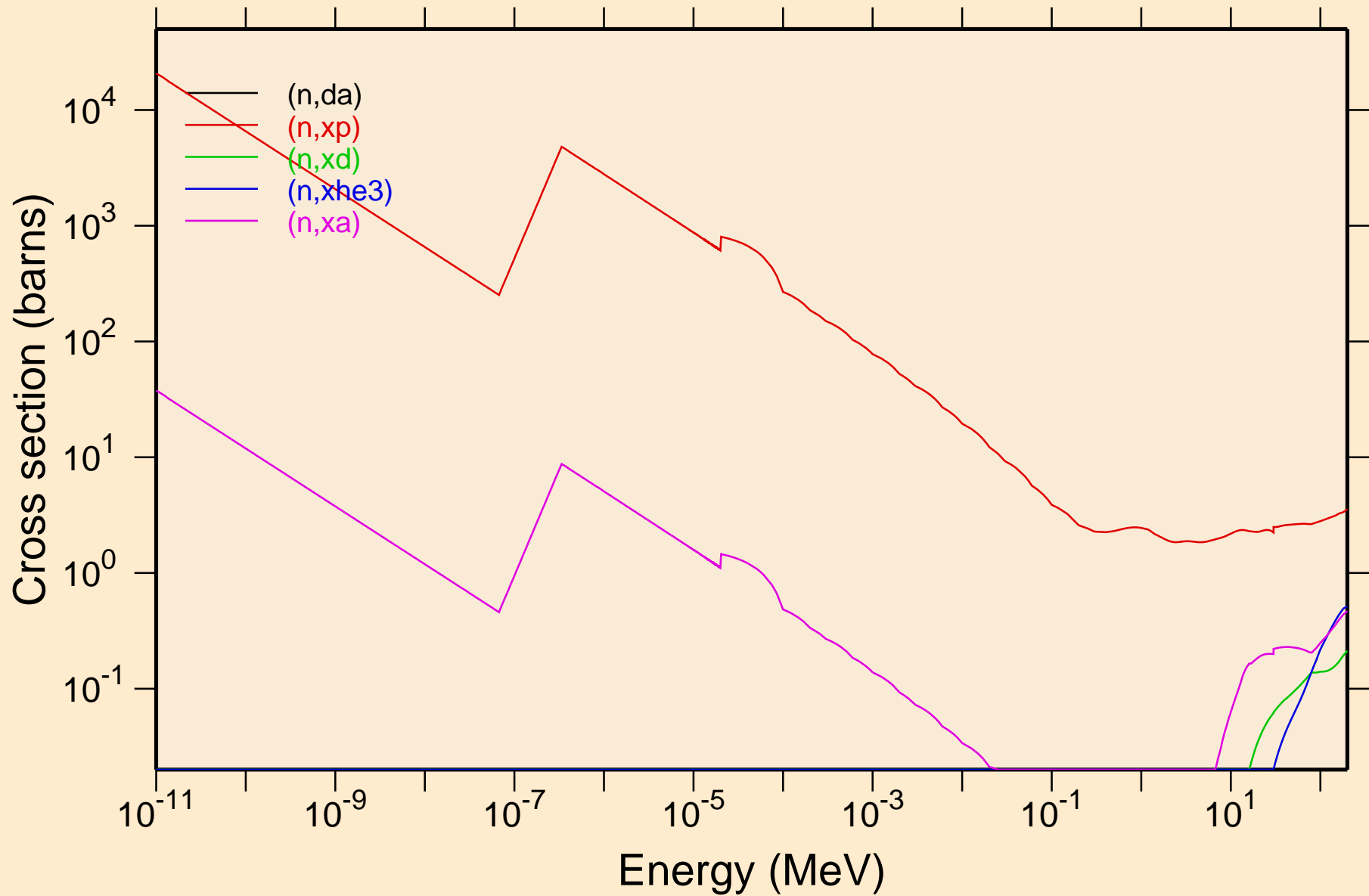

# DY145 NEUTRON ACER TENDL-2023 LIBRARY; T=0.K

## Principal cross sections

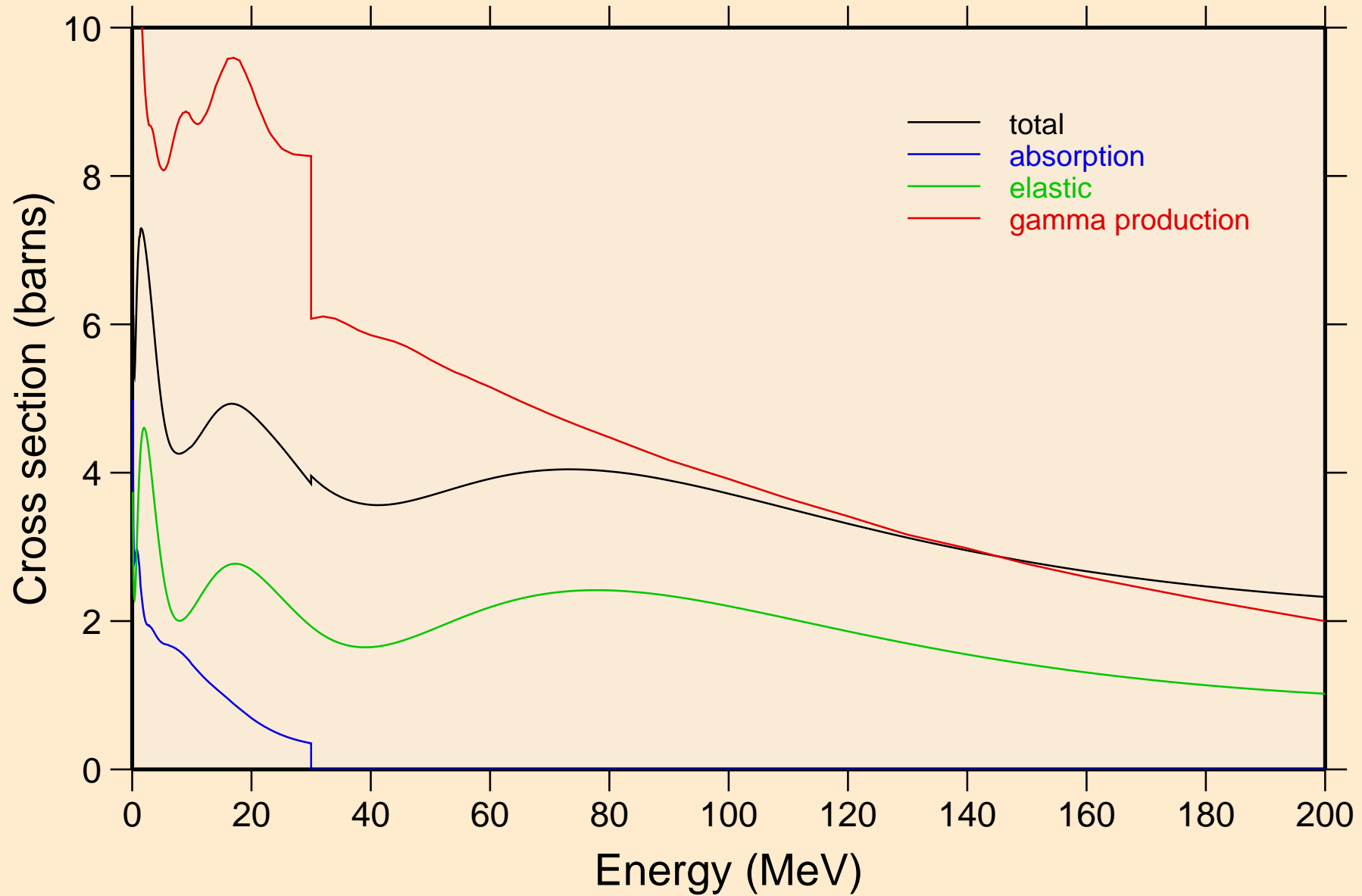

# DY145 NEUTRON ACER TENDL-2023 LIBRARY; T=0.K

## Heating

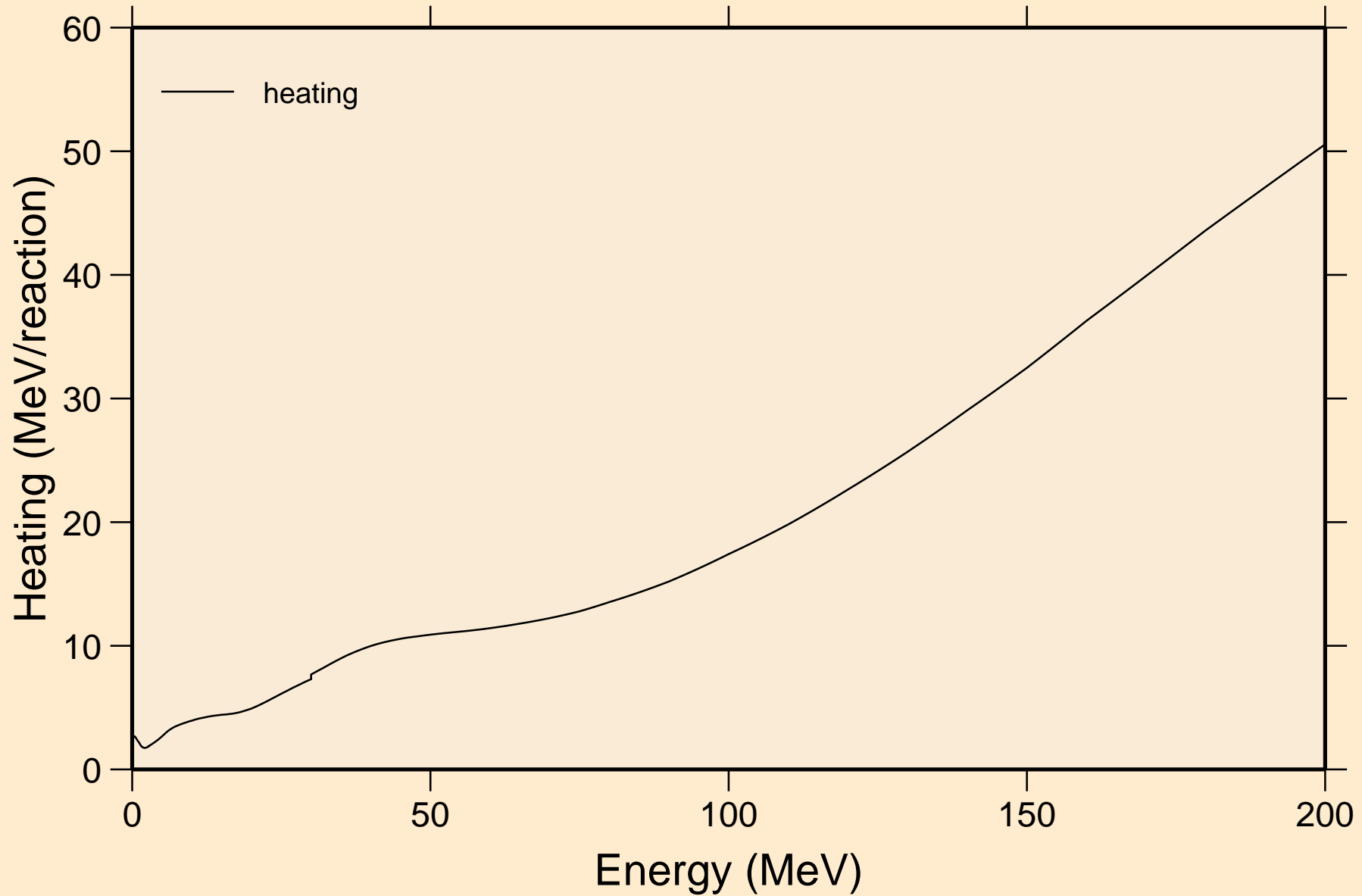

# DY145 NEUTRON ACER TENDL-2023 LIBRARY; T=0.K

## Damage

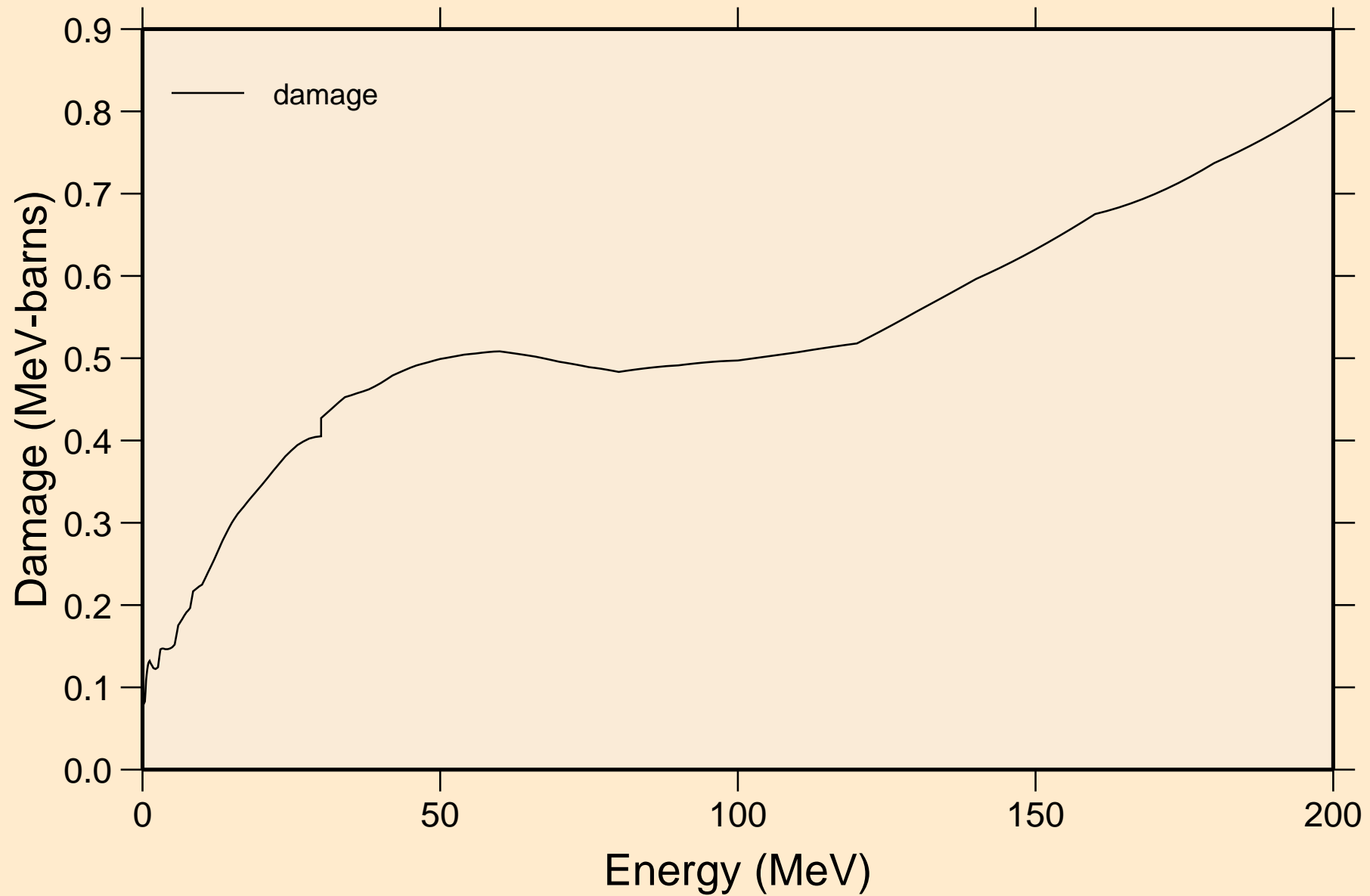

DY145 NEUTRON ACER TENDL-2023 LIBRARY; T=0.K  
Non-threshold reactions

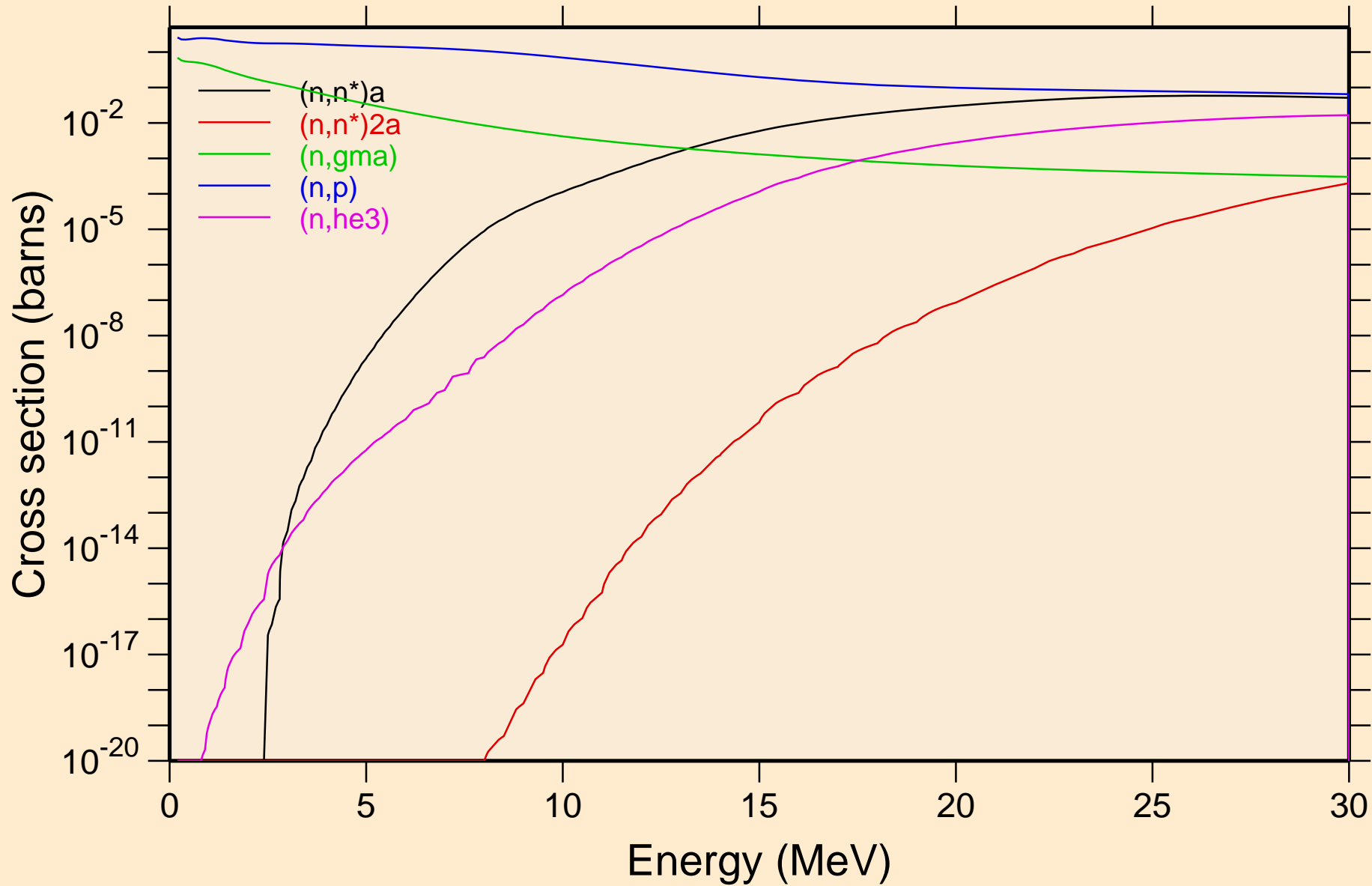



DY145 NEUTRON ACER TENDL-2023 LIBRARY; T=0.K  
Non-threshold reactions

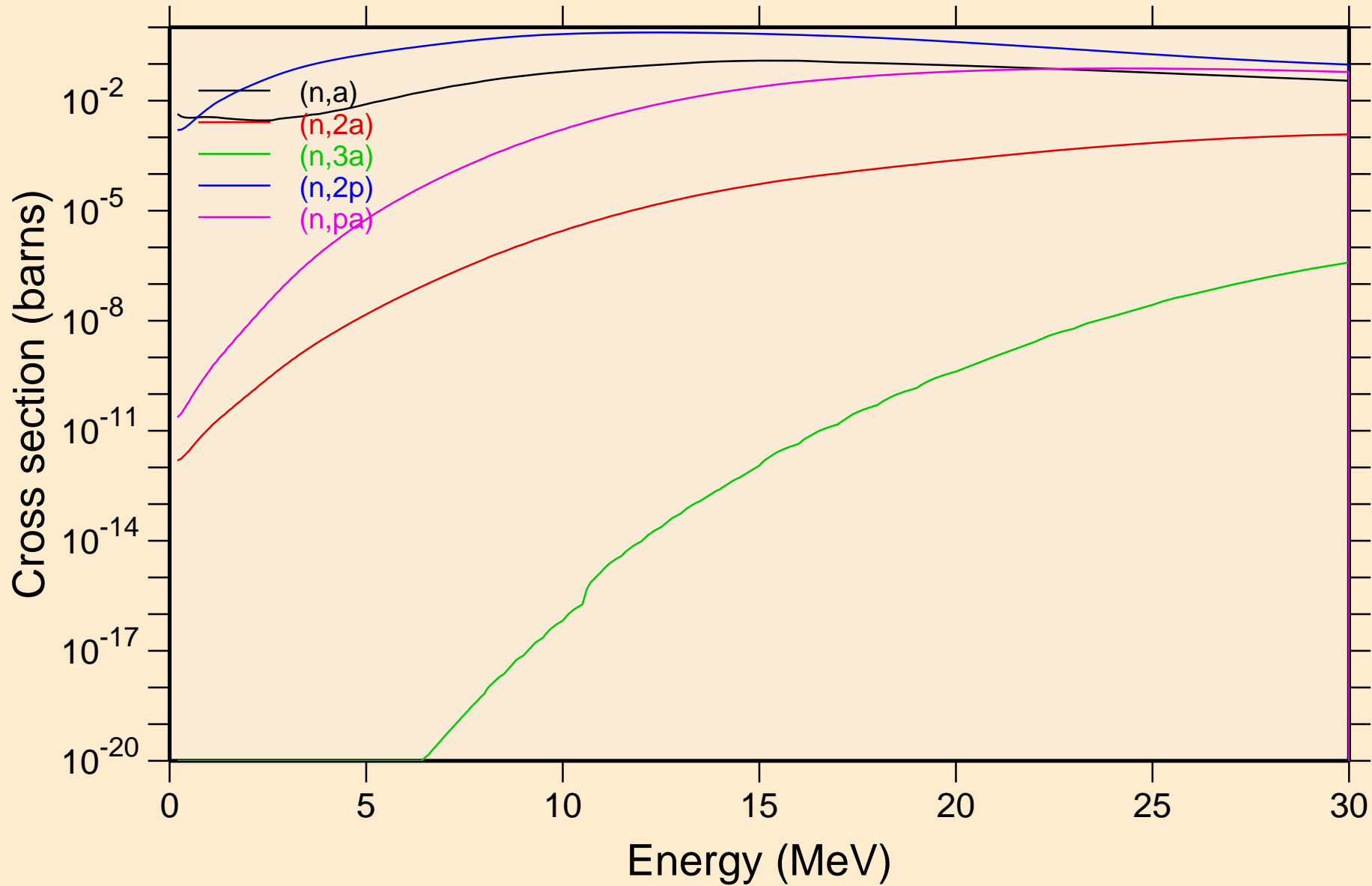

DY145 NEUTRON ACER TENDL-2023 LIBRARY; T=0.K  
Non-threshold reactions

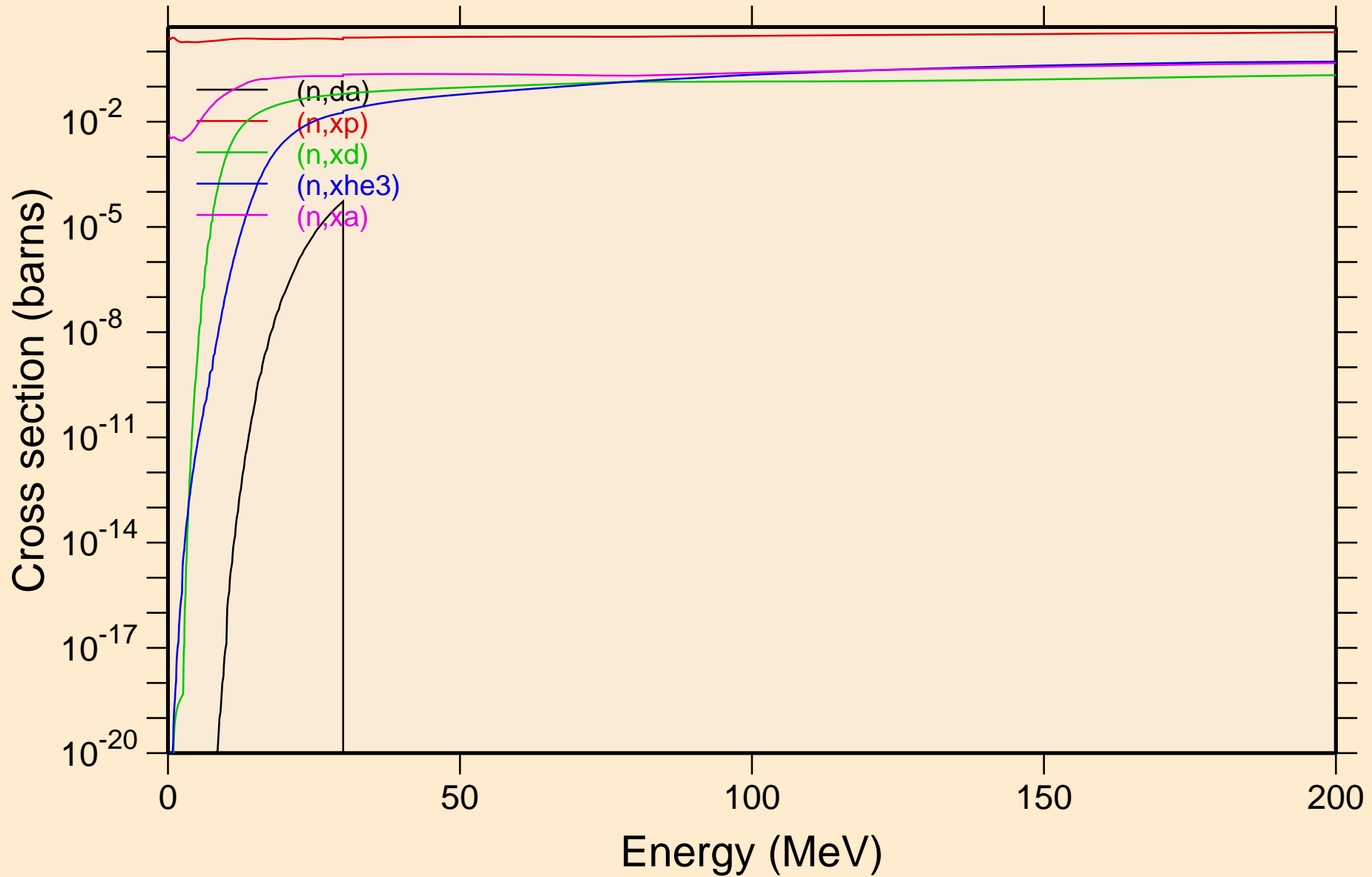

DY145 NEUTRON ACER TENDL-2023 LIBRARY; T=0.K  
Inelastic levels

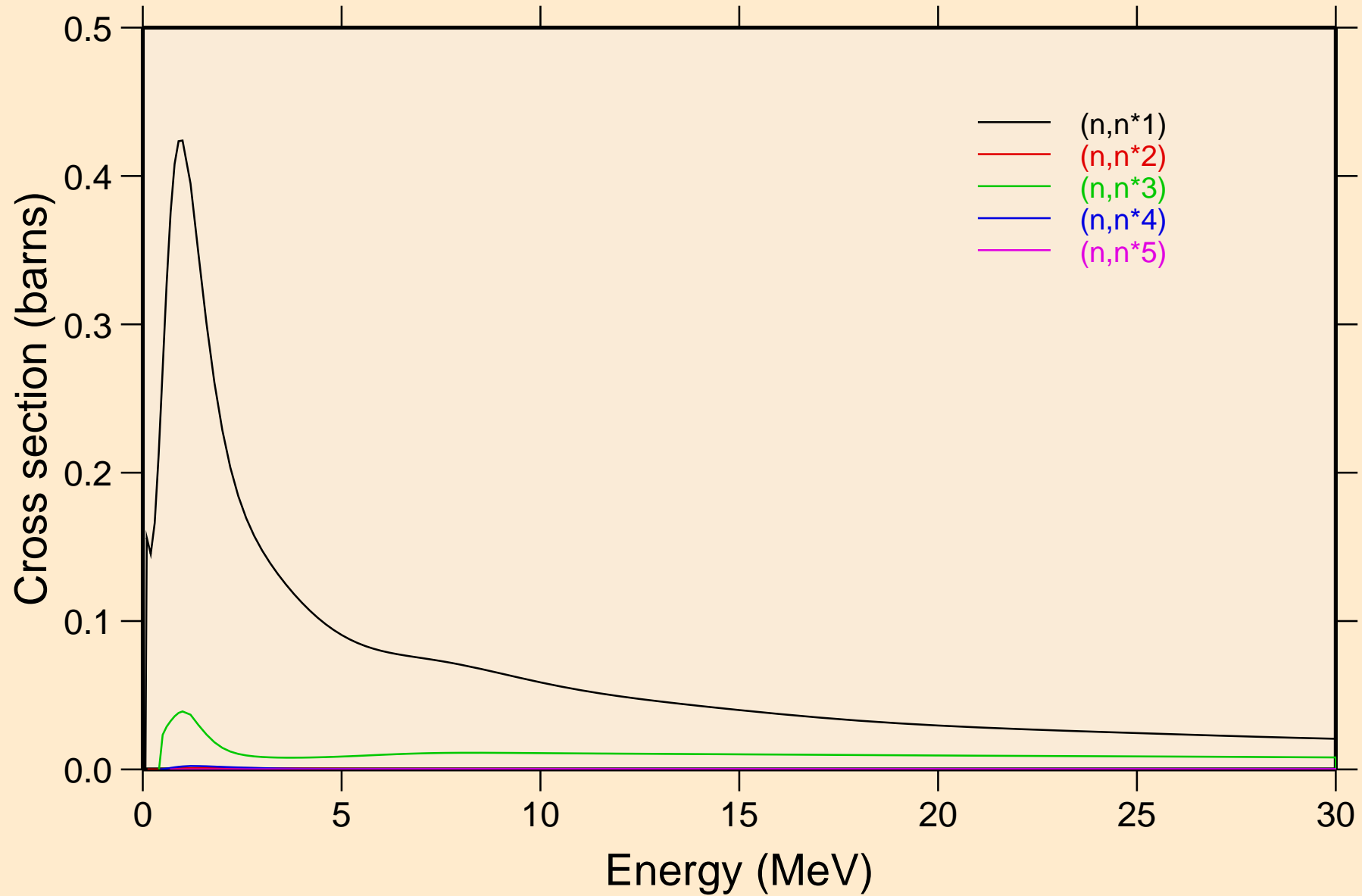

# DY145 NEUTRON ACER TENDL-2023 LIBRARY; T=0.K

## Inelastic levels

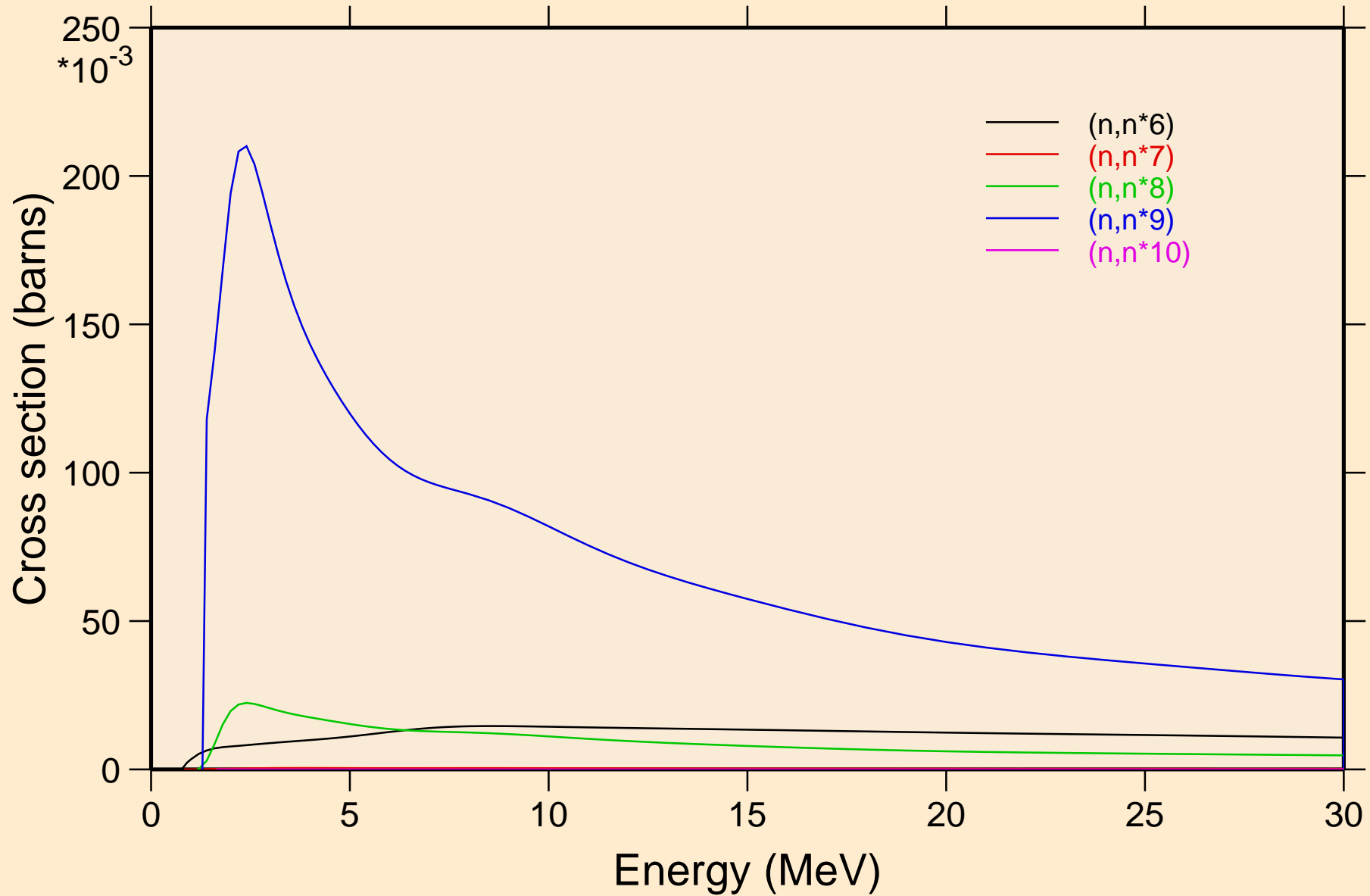

DY145 NEUTRON ACER TENDL-2023 LIBRARY; T=0.K  
Inelastic levels

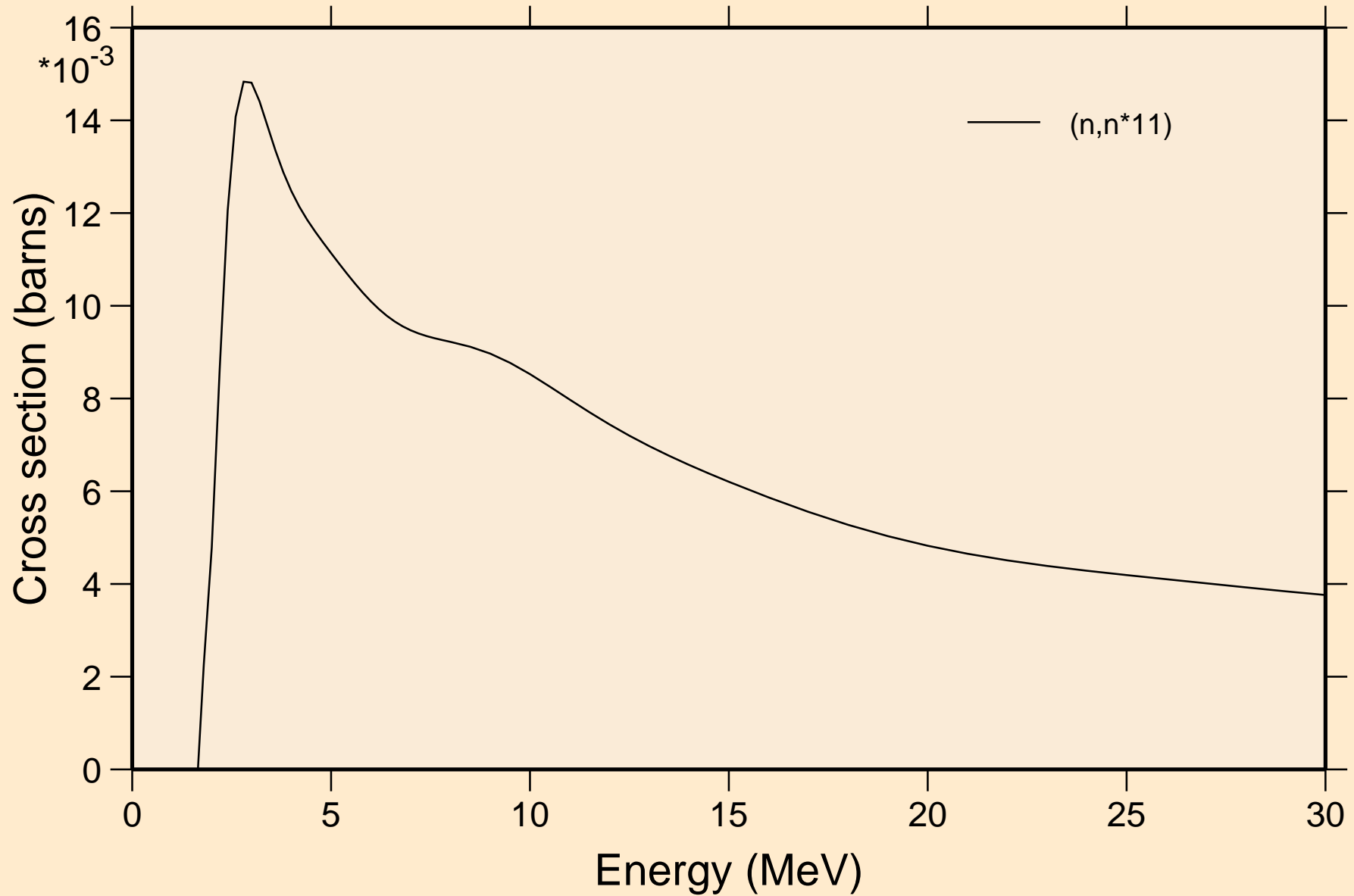

DY145 NEUTRON ACER TENDL-2023 LIBRARY; T=0.K  
Threshold reactions

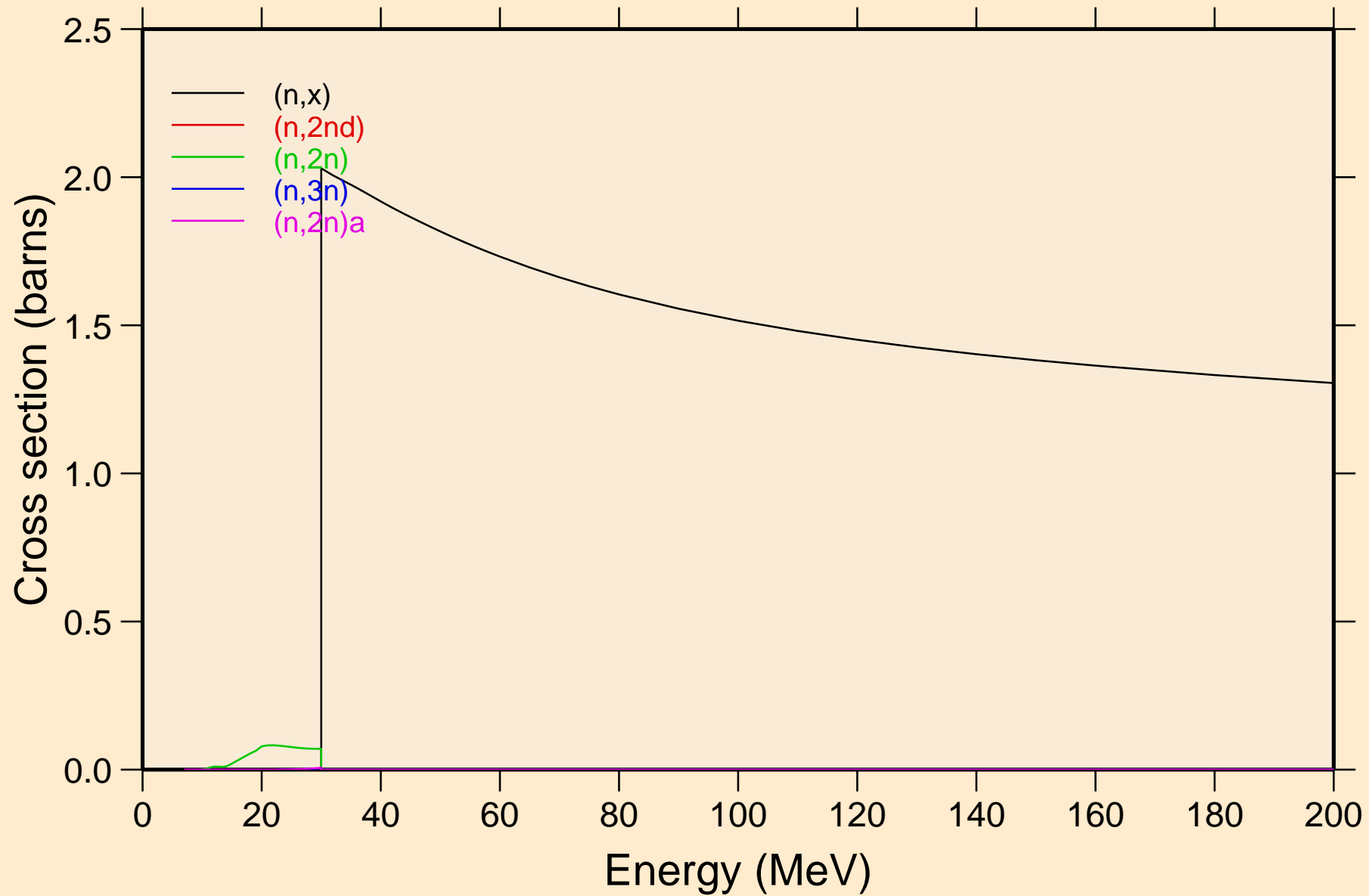

DY145 NEUTRON ACER TENDL-2023 LIBRARY; T=0.K  
Threshold reactions

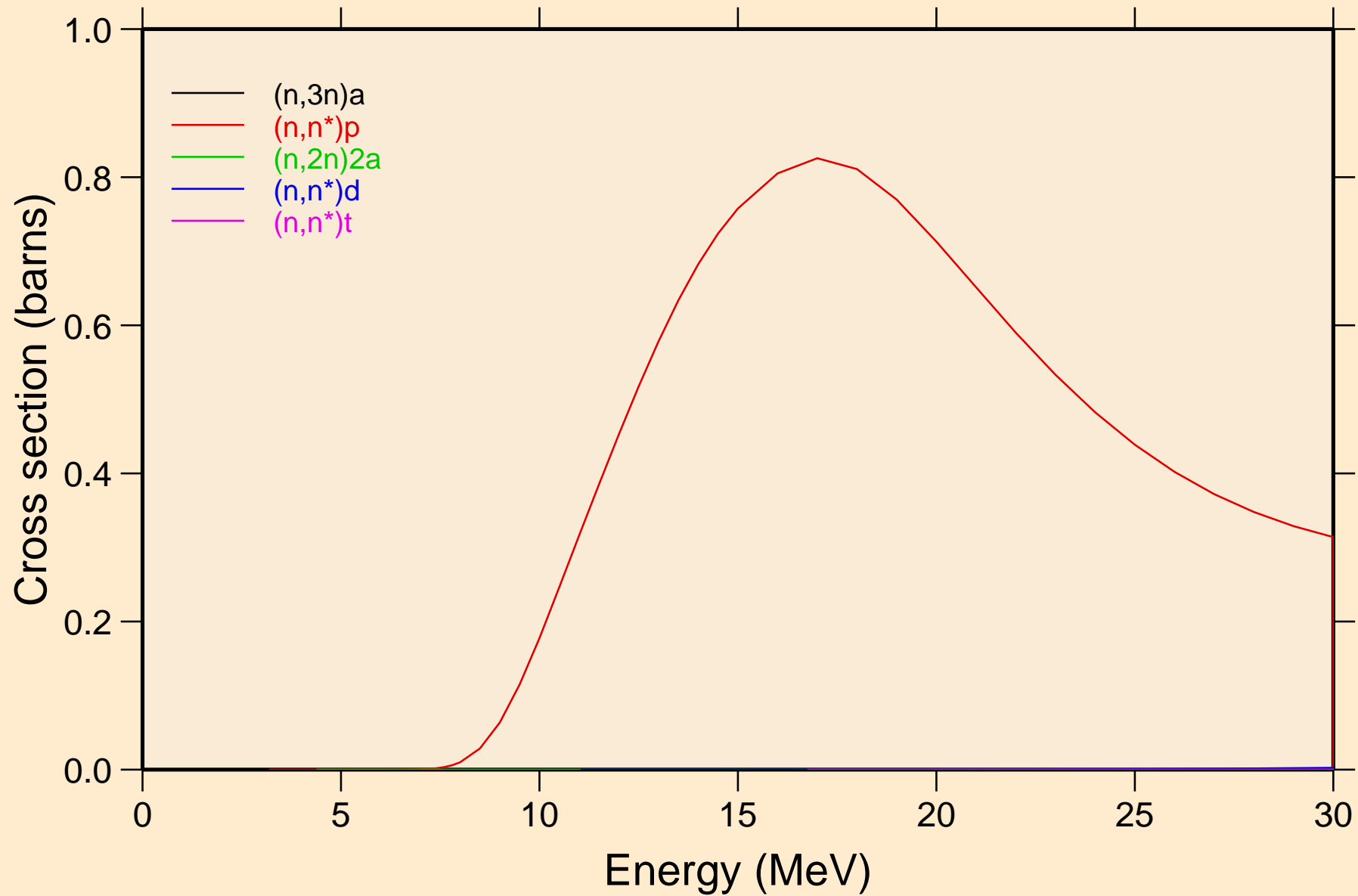

DY145 NEUTRON ACER TENDL-2023 LIBRARY; T=0.K  
Threshold reactions

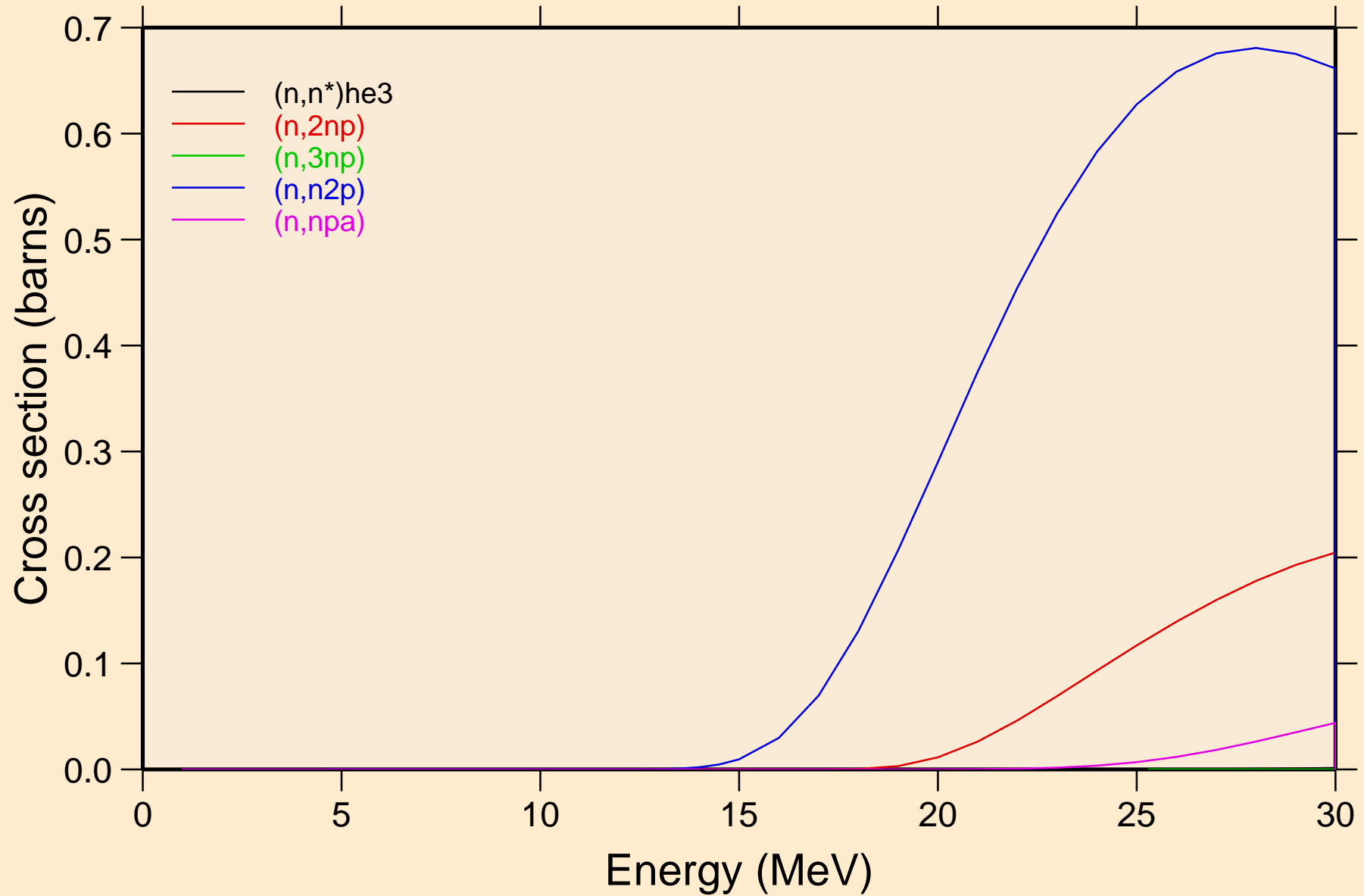



# DY145 NEUTRON ACER TENDL-2023 LIBRARY; T=0.K

## Threshold reactions

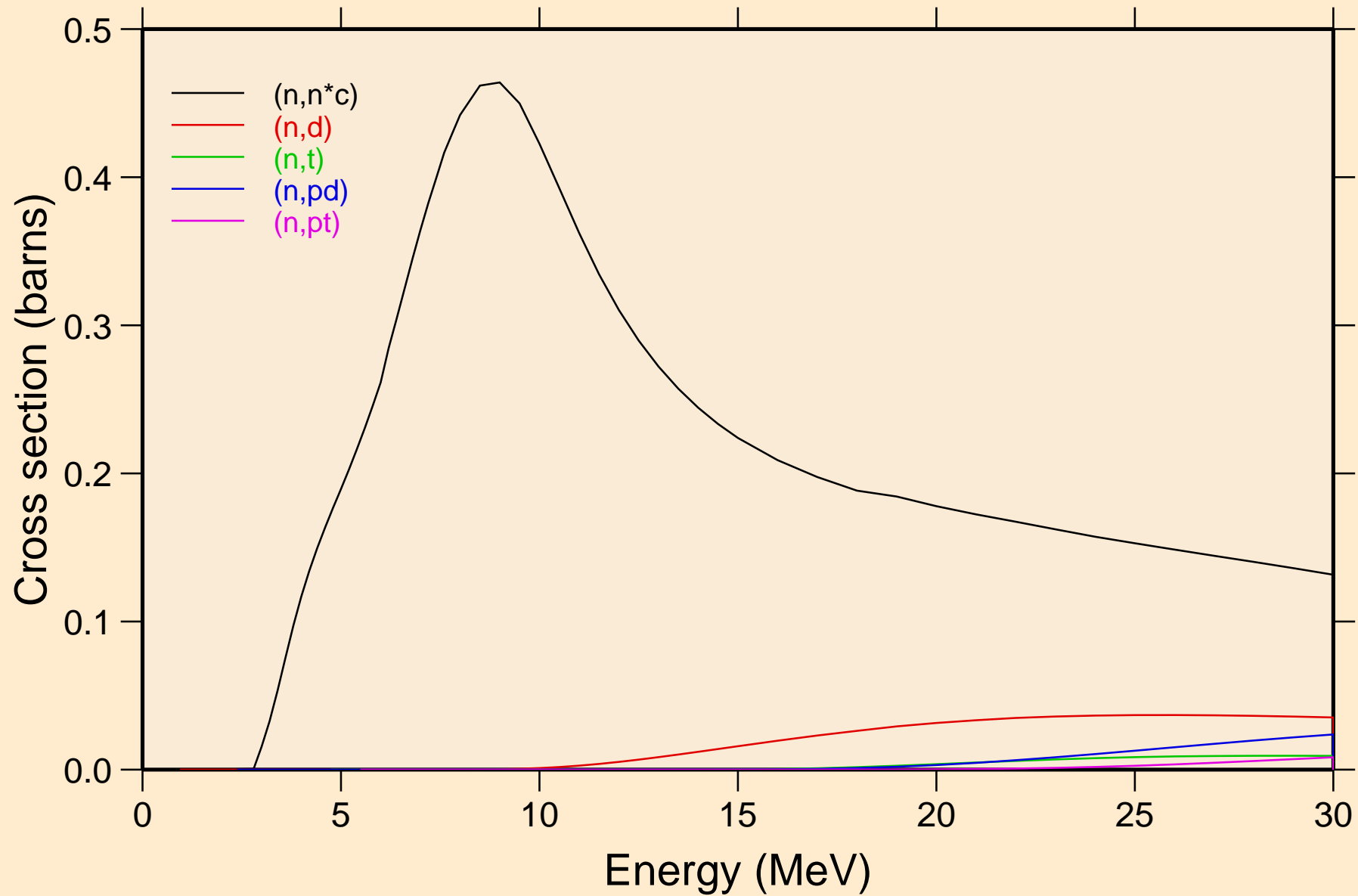

DY145 NEUTRON ACER TENDL-2023 LIBRARY; T=0.K  
Threshold reactions

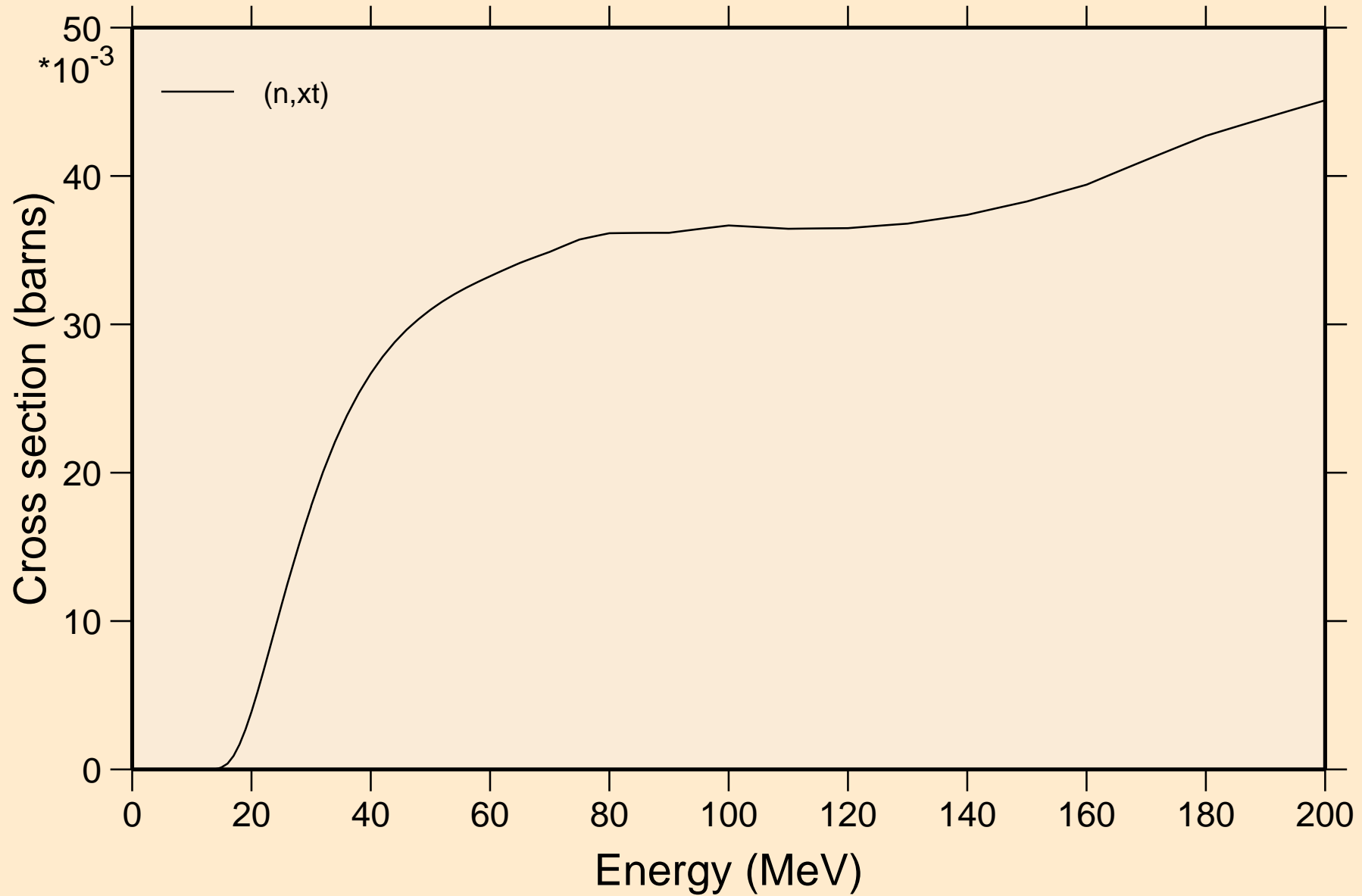

DY145 NEUTRON ACER TENDL-2023 LIBRARY; T=0.K  
angular distribution for elastic

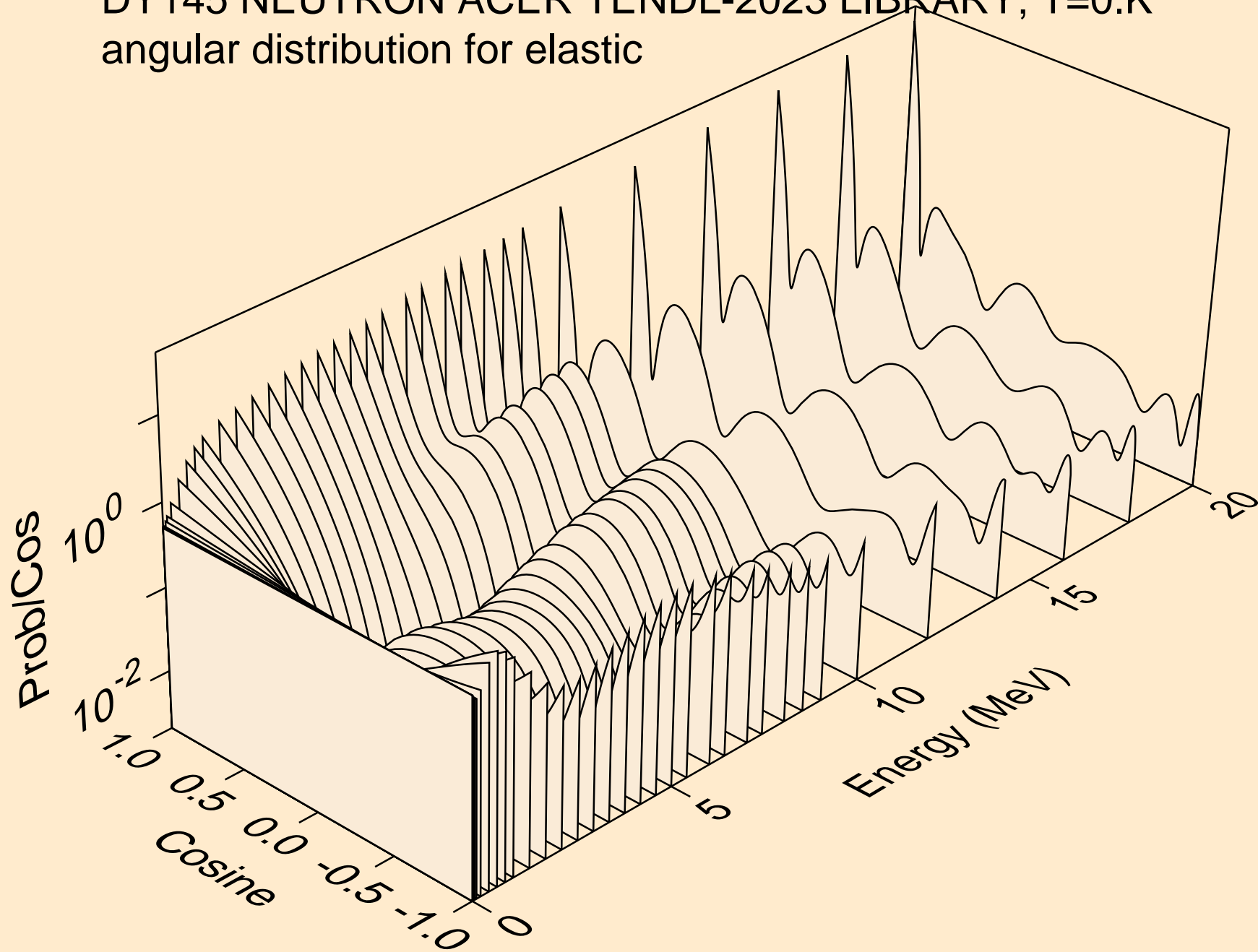

DY145 NEUTRON ACER TENDL-2023 LIBRARY; T=0.K  
angular distribution for elastic

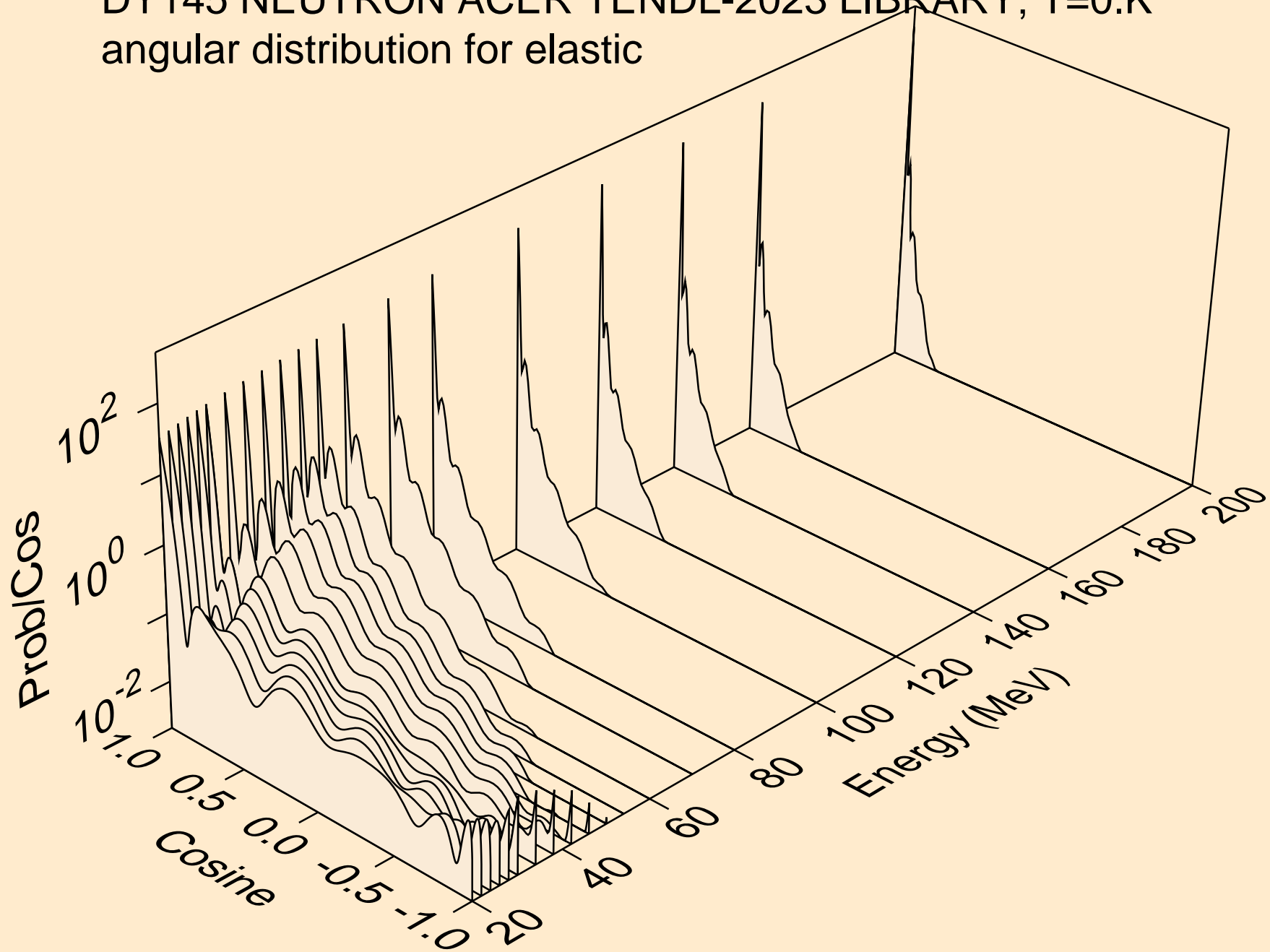

DY145 NEUTRON ACER TENDL-2023 LIBRARY; T=0.K  
angular distribution for (n,n\*1)

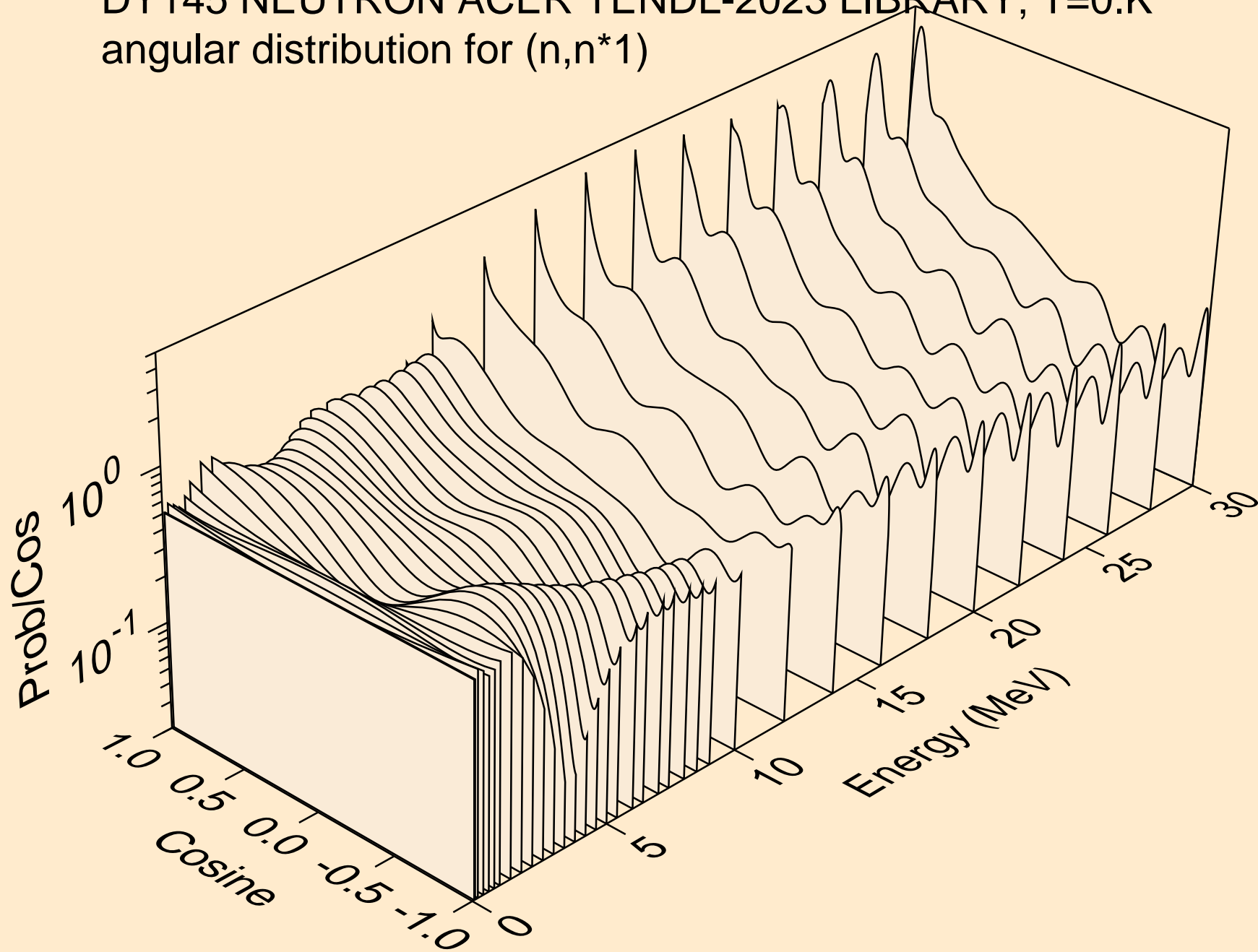

DY145 NEUTRON ACER TENDL-2023 LIBRARY; T=0.K  
angular distribution for (n,n\*2)

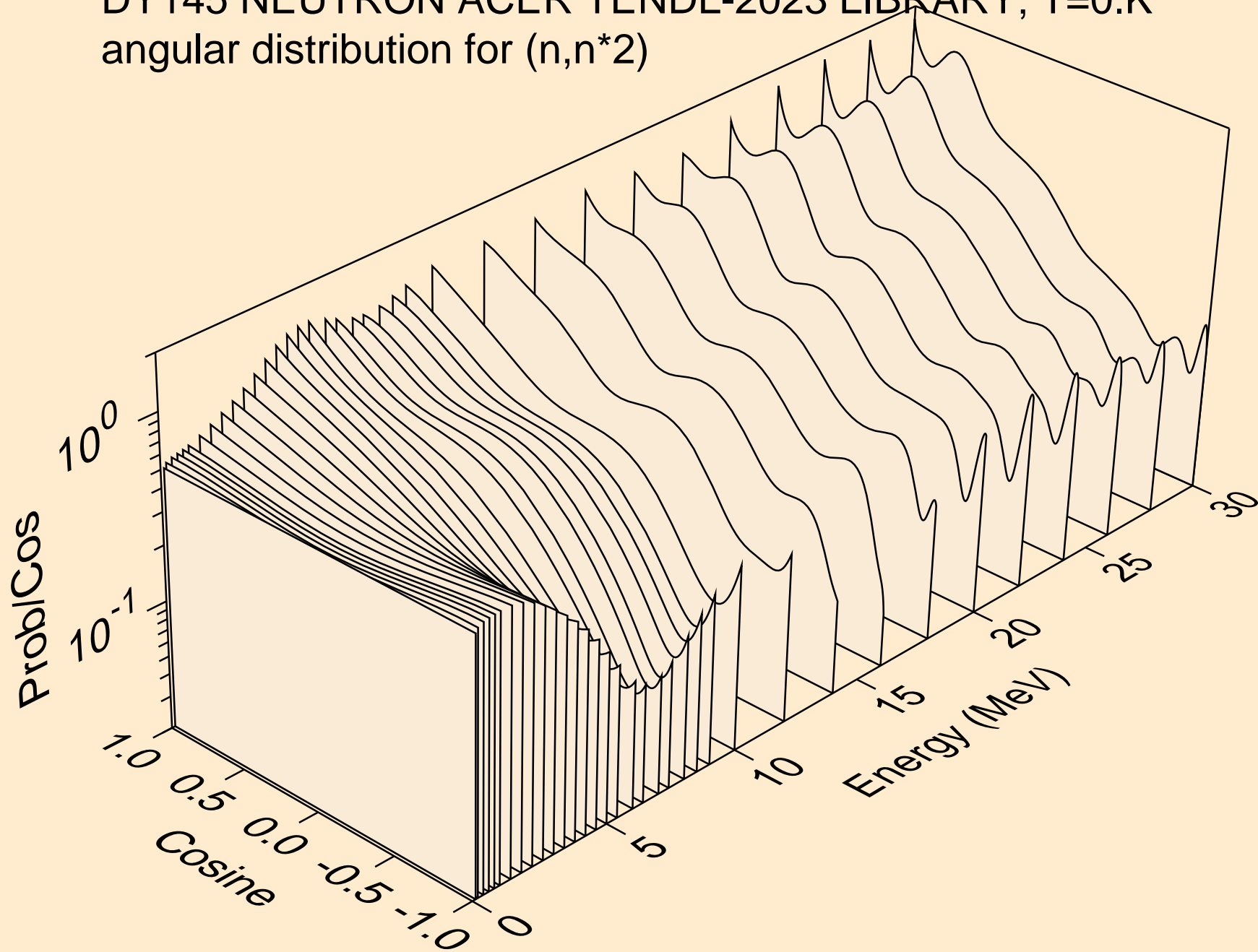

DY145 NEUTRON ACER TENDL-2023 LIBRARY; T=0.K  
angular distribution for (n,n\*3)

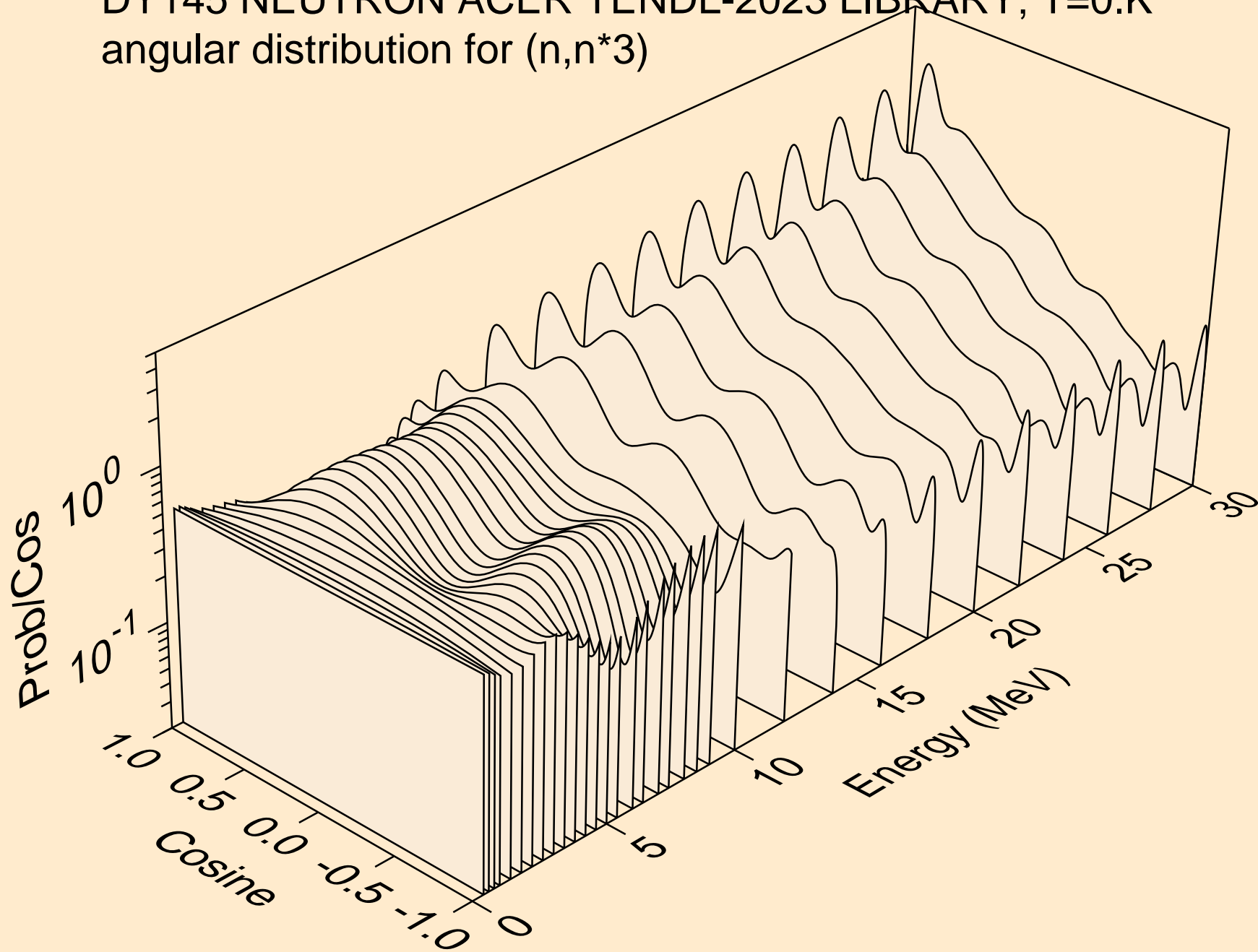

DY145 NEUTRON ACER TENDL-2023 LIBRARY; T=0.K  
angular distribution for (n,n\*4)

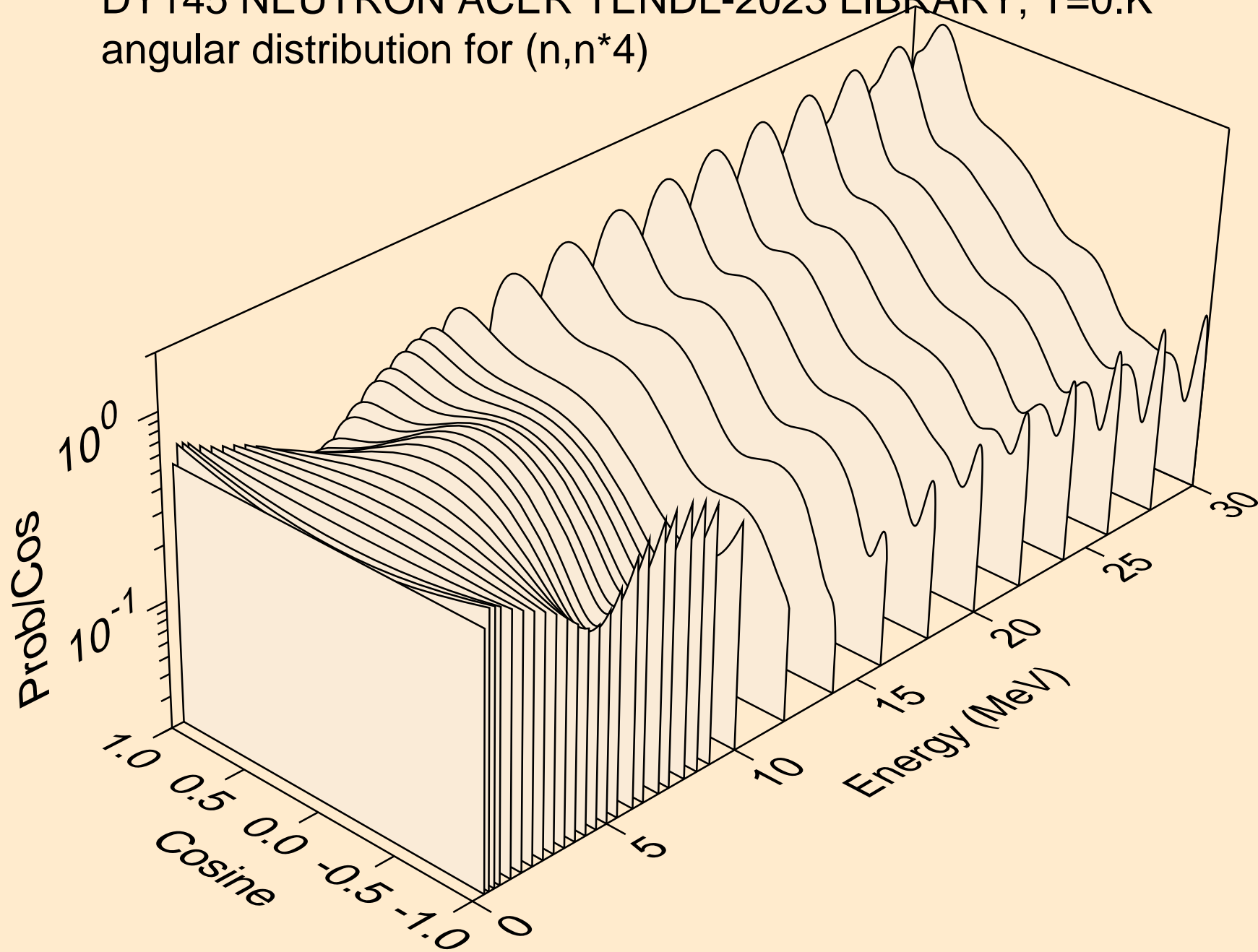



DY145 NEUTRON ACER TENDL-2023 LIBRARY; T=0.K  
angular distribution for (n,n\*5)

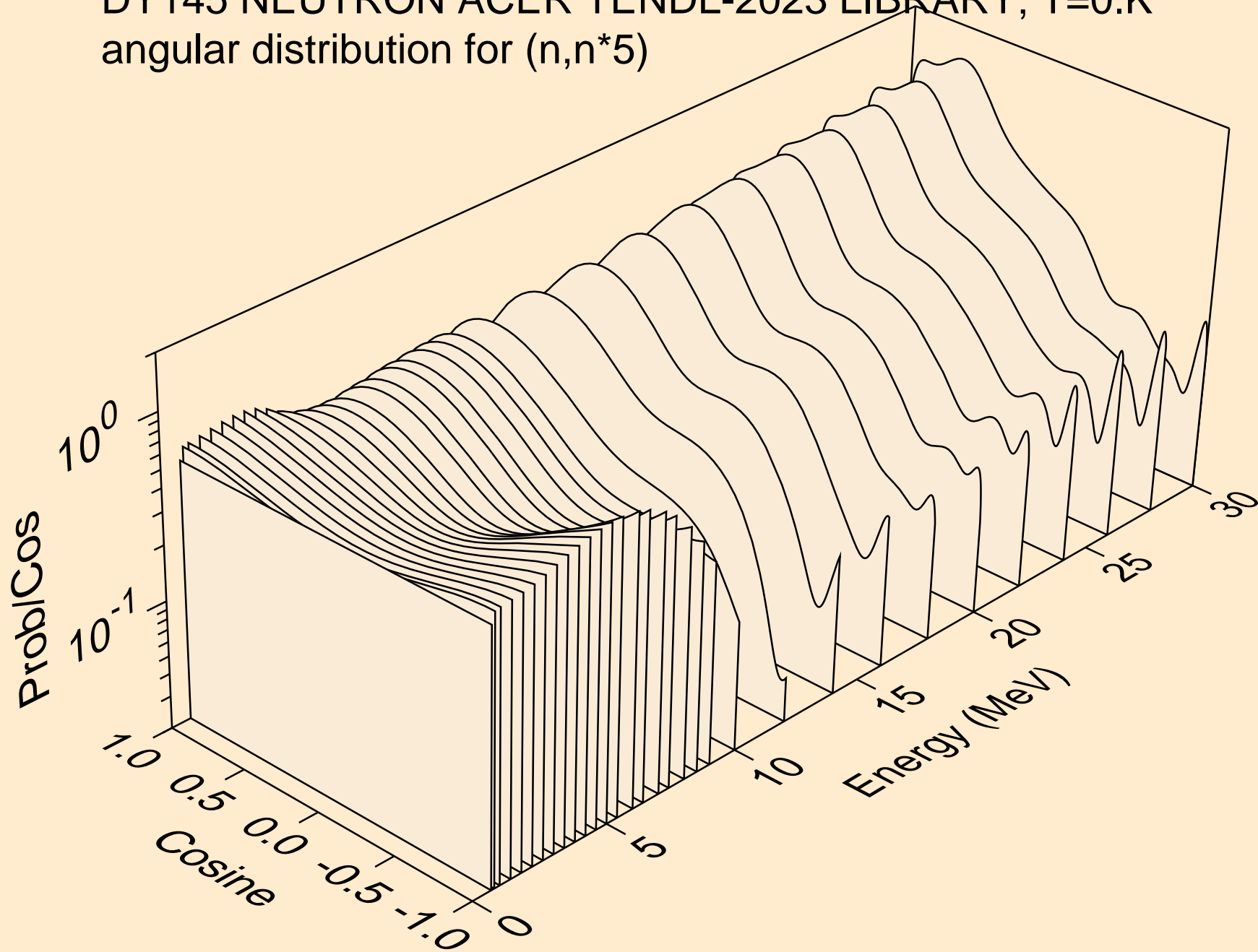

DY145 NEUTRON ACER TENDL-2023 LIBRARY; T=0.K  
angular distribution for (n,n\*6)

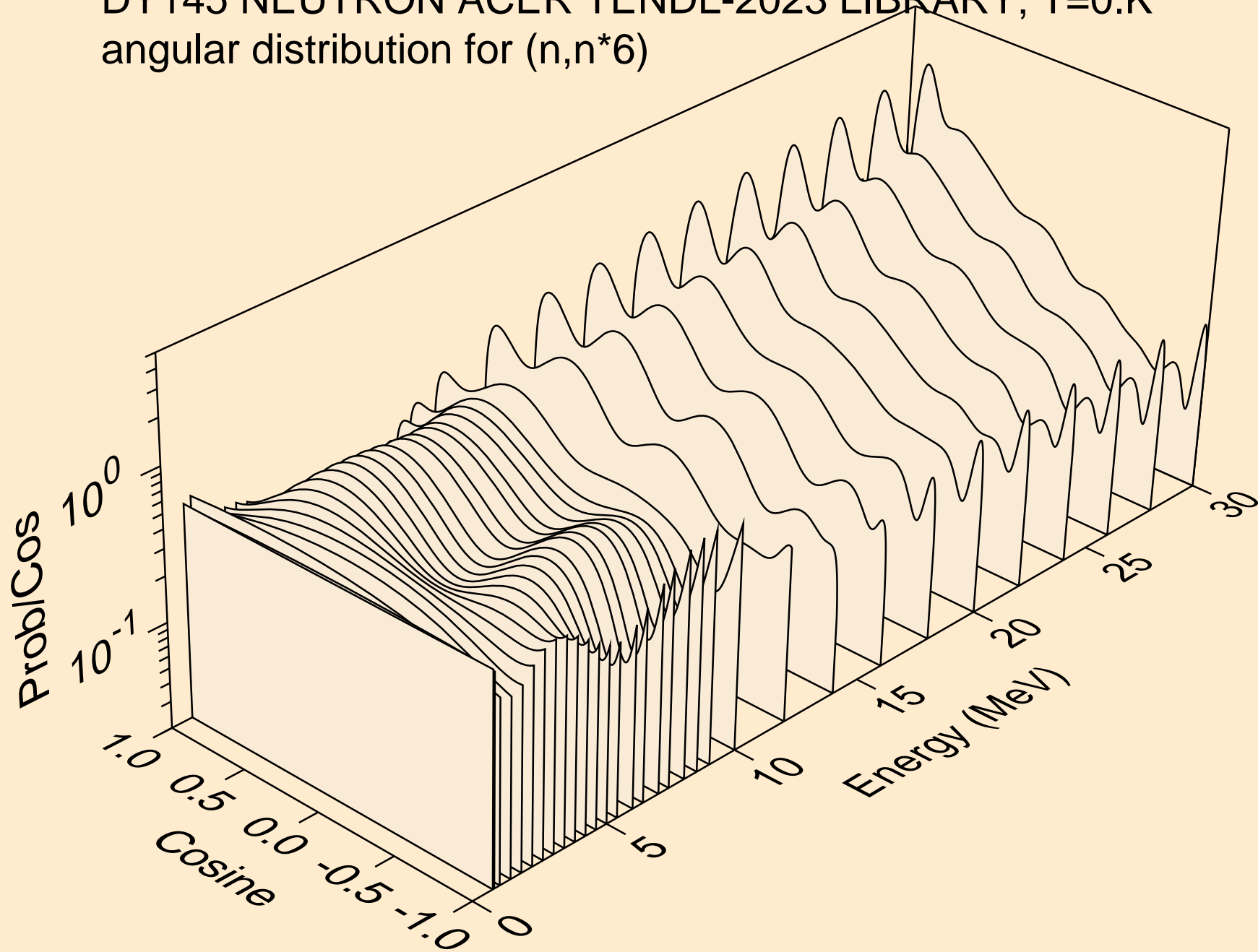

DY145 NEUTRON ACER TENDL-2023 LIBRARY; T=0.K  
angular distribution for (n,n\*7)

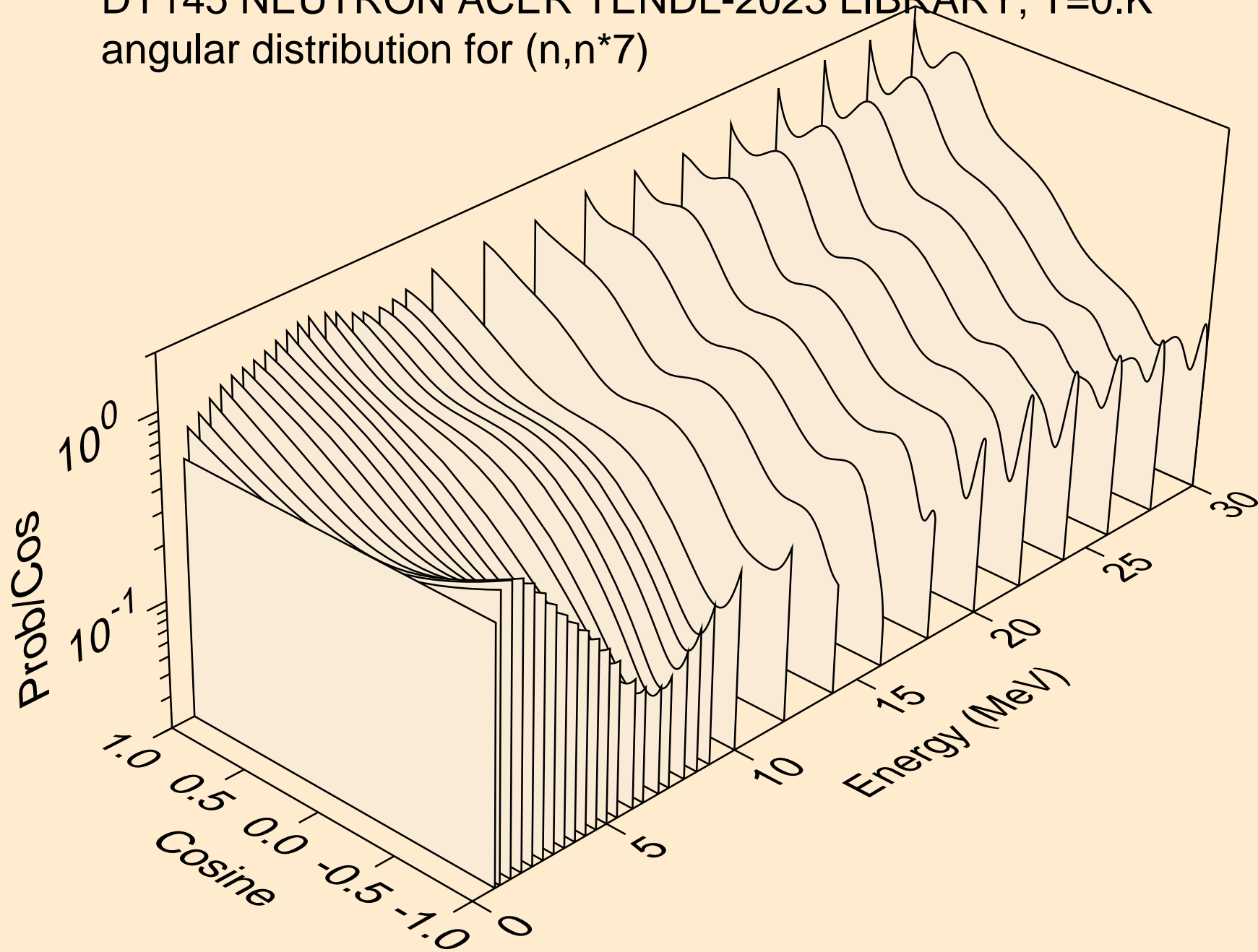

DY145 NEUTRON ACER TENDL-2023 LIBRARY; T=0.K  
angular distribution for (n,n\*8)

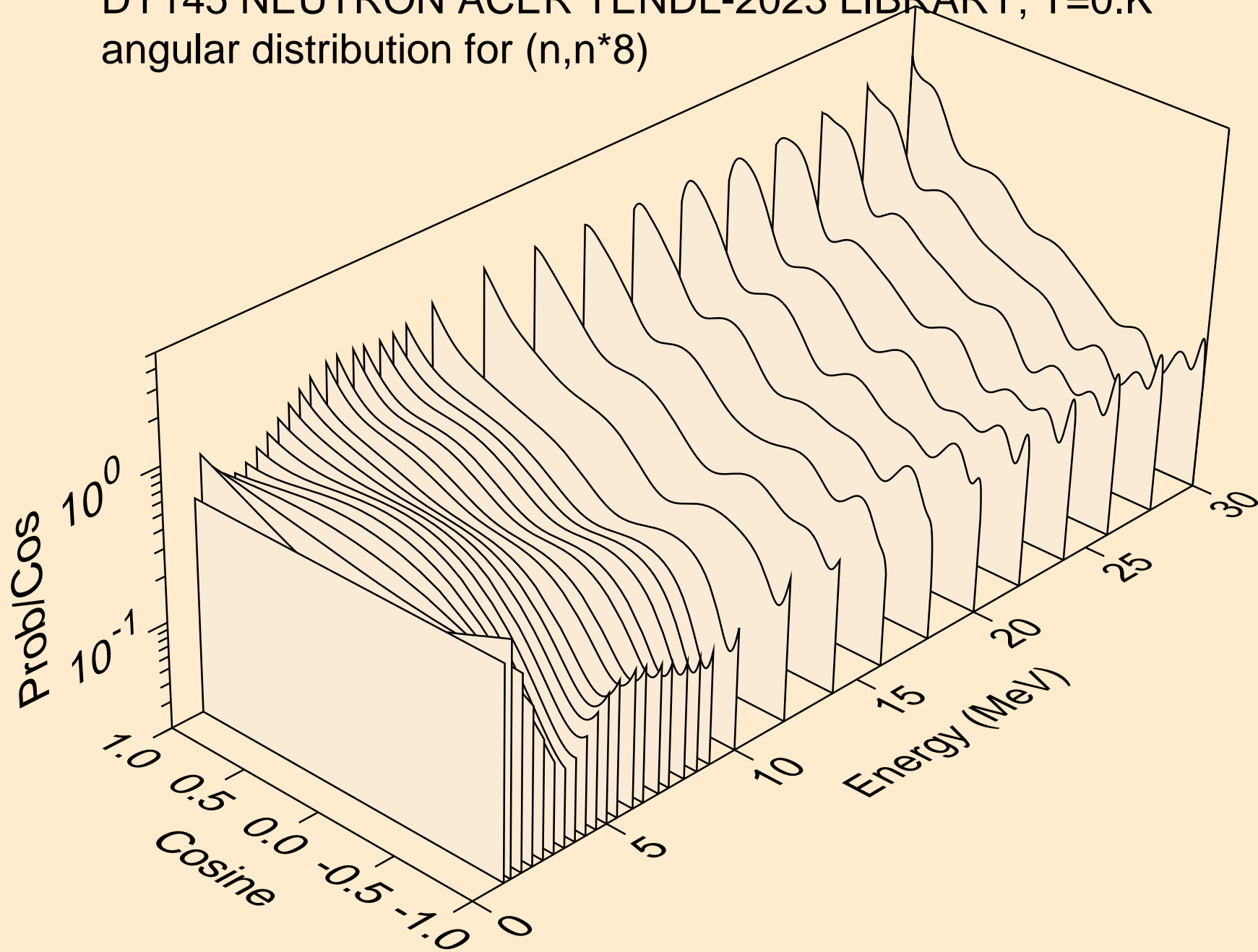

DY145 NEUTRON ACER TENDL-2023 LIBRARY; T=0.K  
angular distribution for (n,n\*9)

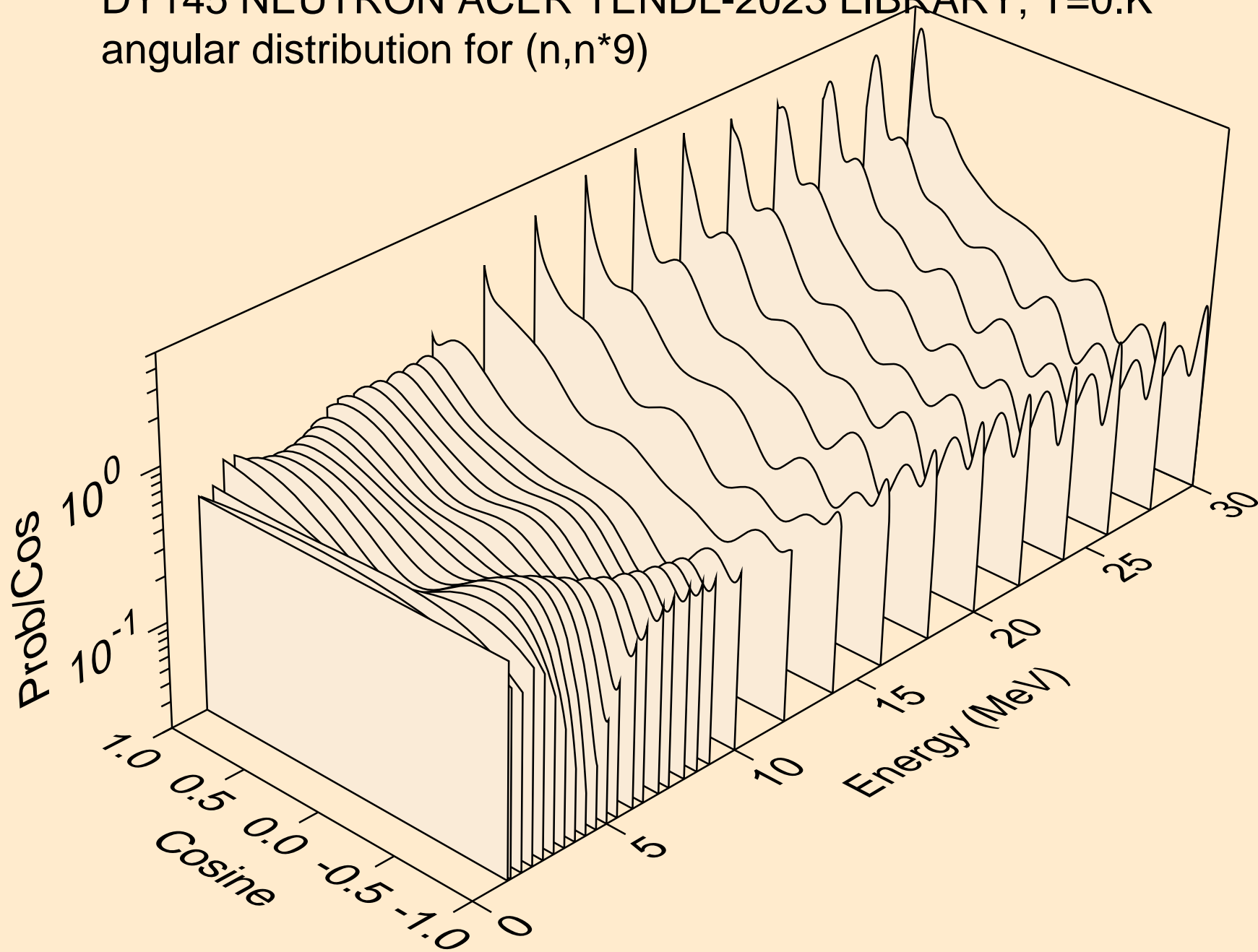

DY145 NEUTRON ACER TENDL-2023 LIBRARY; T=0.K  
angular distribution for (n,n\*10)

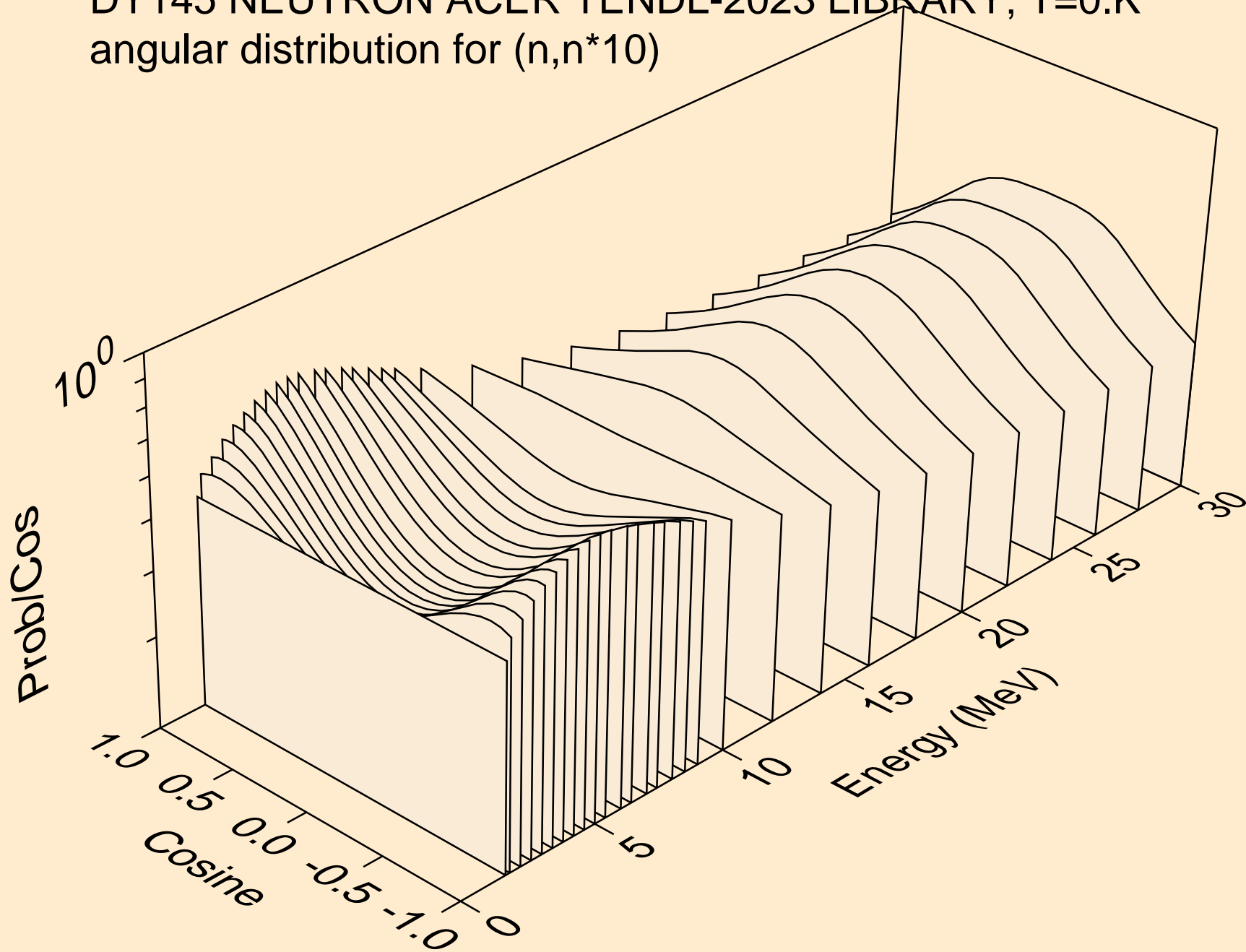

DY145 NEUTRON ACER TENDL-2023 LIBRARY; T=0.K  
angular distribution for (n,n\*11)

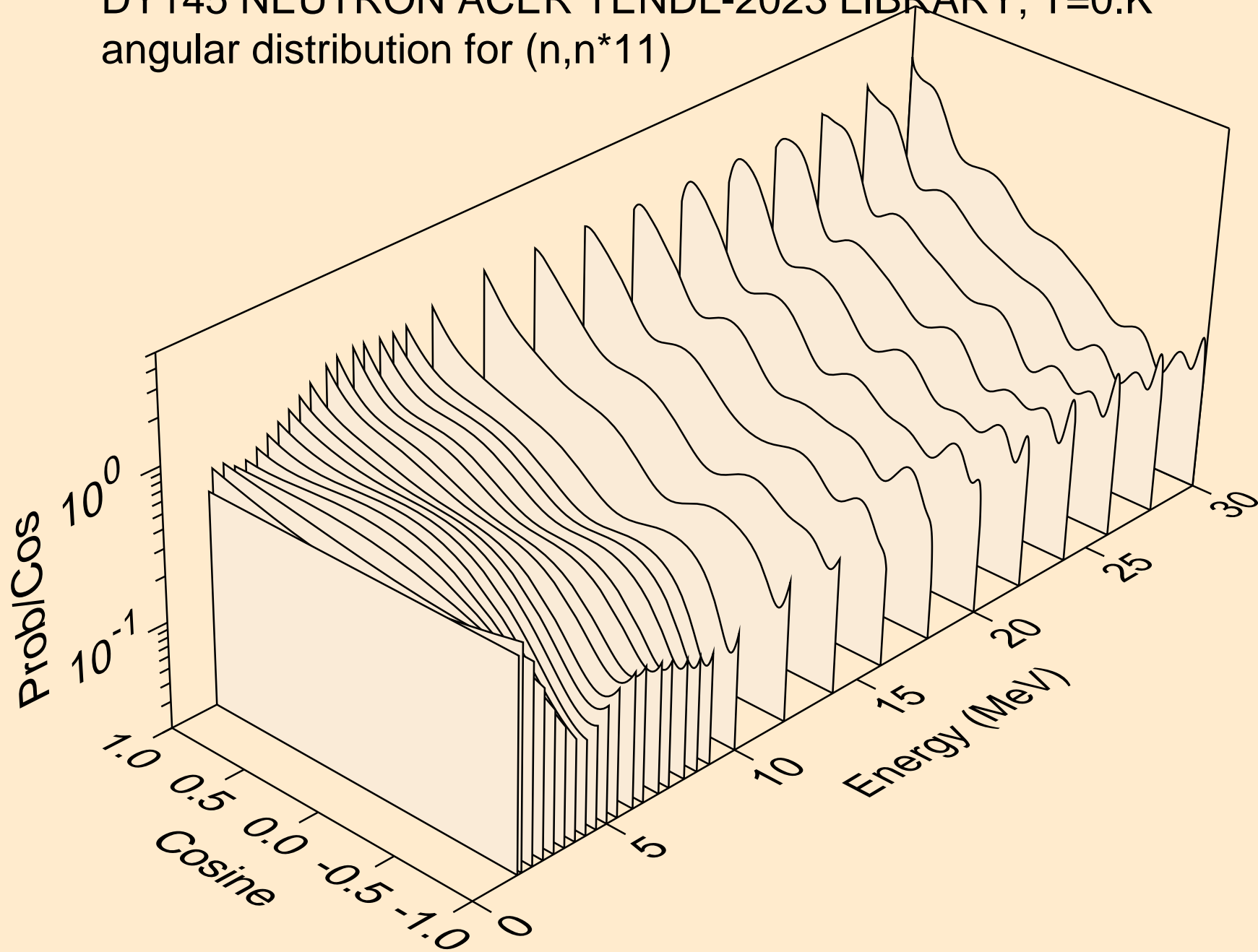

DY145 NEUTRON ACER TENDL-2023 LIBRARY; T=0.K  
Neutron emission for (n,x)

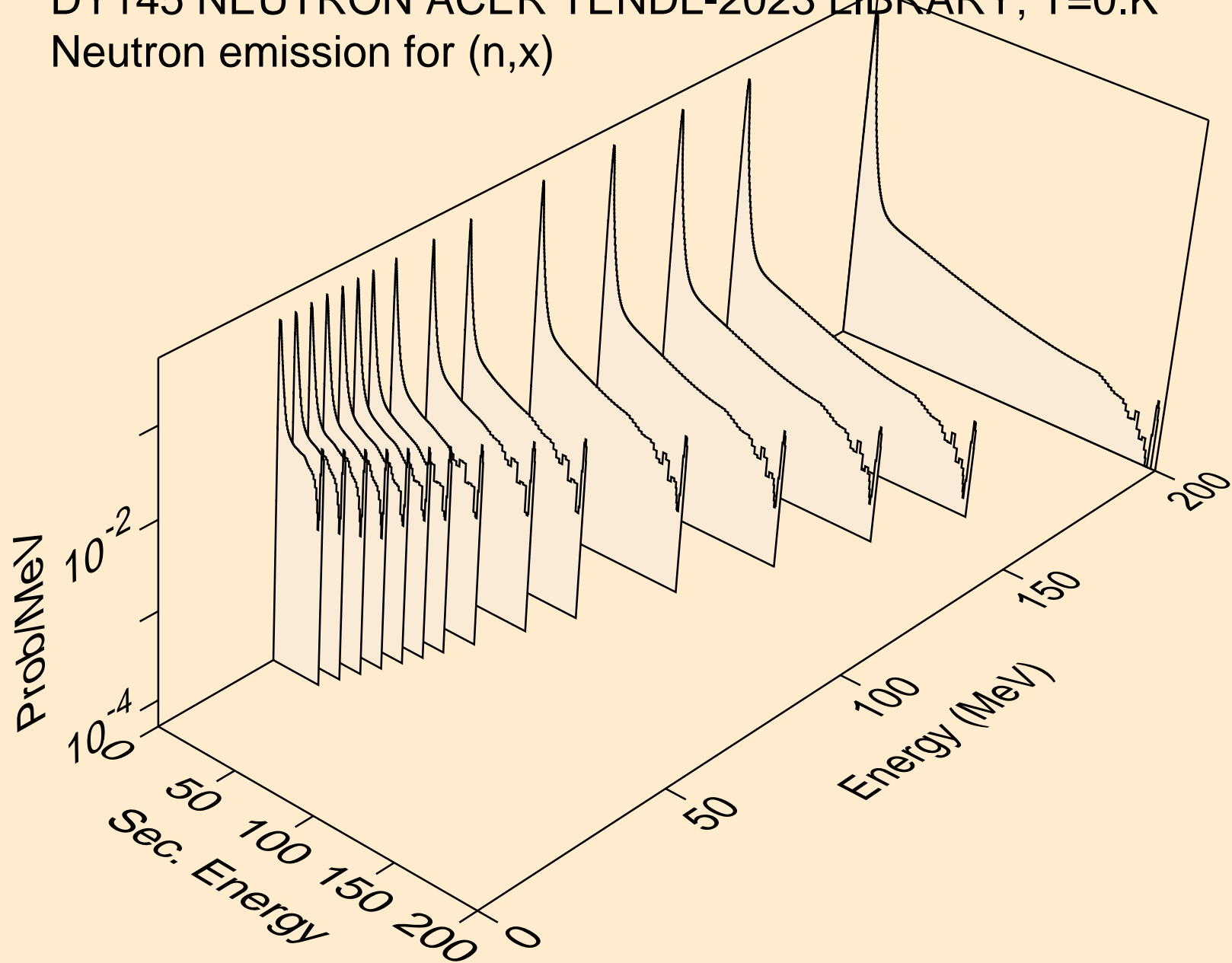



DY145 NEUTRON ACER TENDL-2023 LIBRARY; T=0.K  
Neutron emission for (n,2nd)

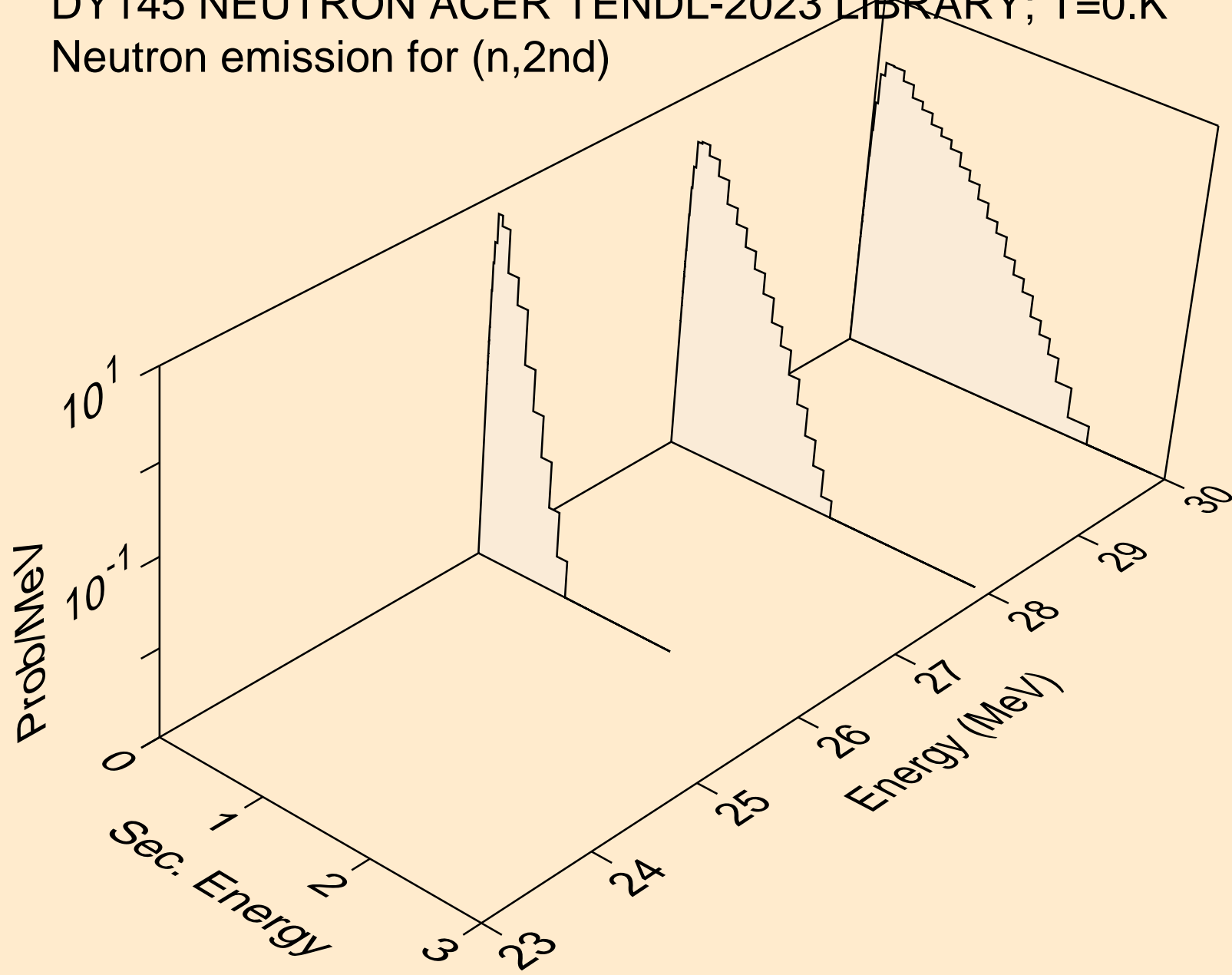

DY145 NEUTRON ACER TENDL-2023 LIBRARY; T=0.K  
Neutron emission for (n,2n)

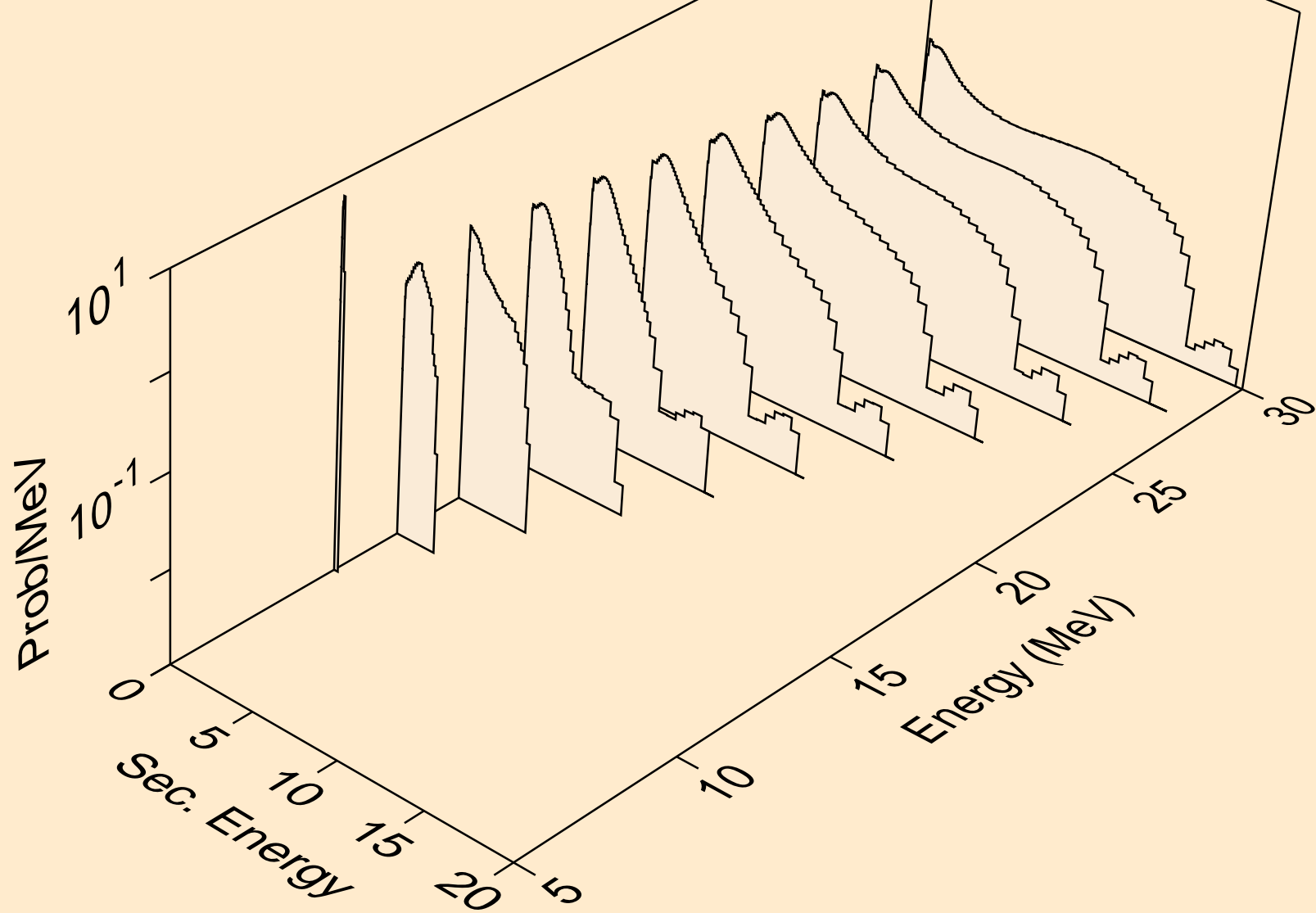

DY145 NEUTRON ACER TENDL-2023 LIBRARY; T=0.K  
Neutron emission for (n,3n)

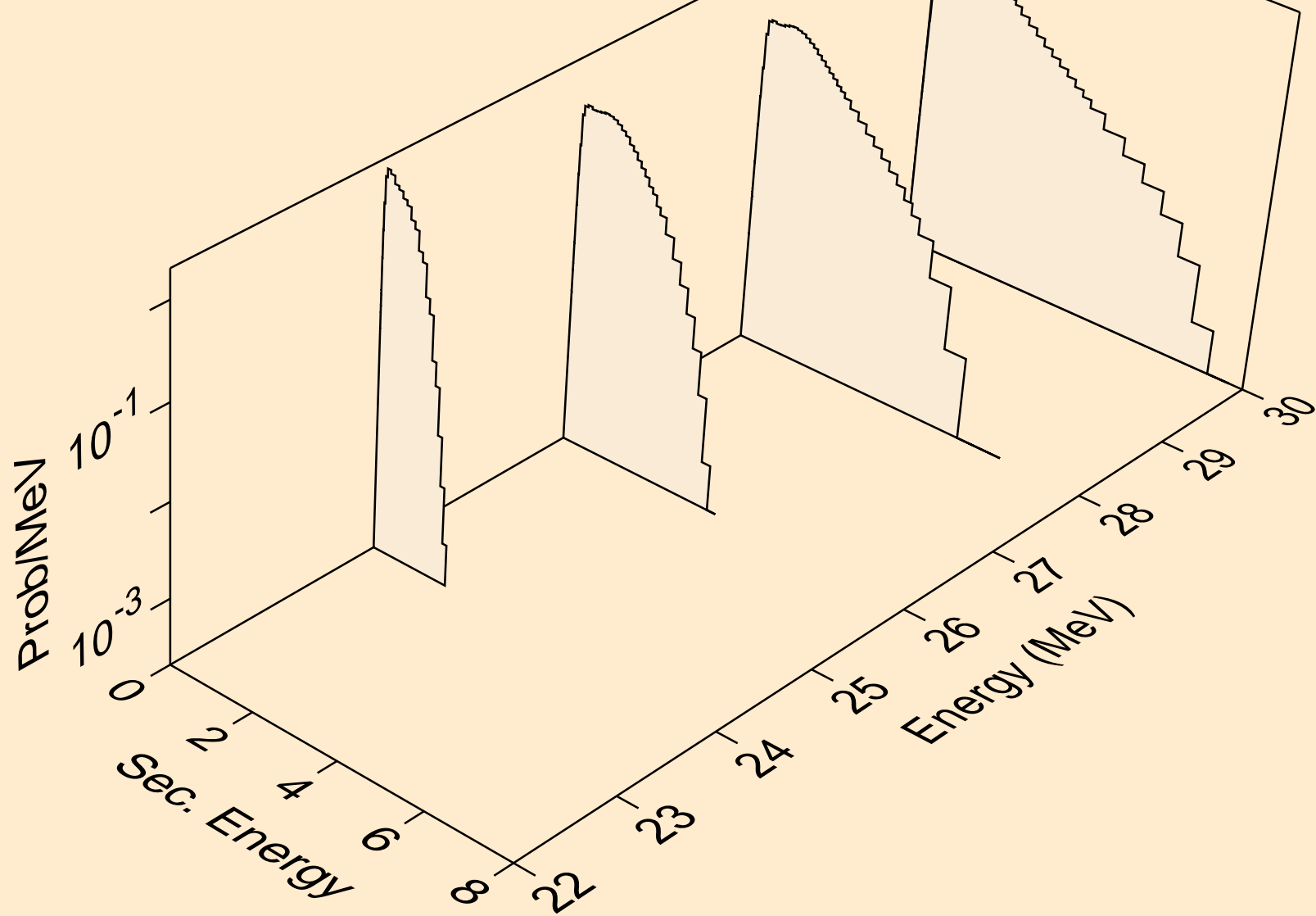

DY145 NEUTRON ACER TENDL-2023 LIBRARY; T=0.K  
Neutron emission for (n,n\*)a

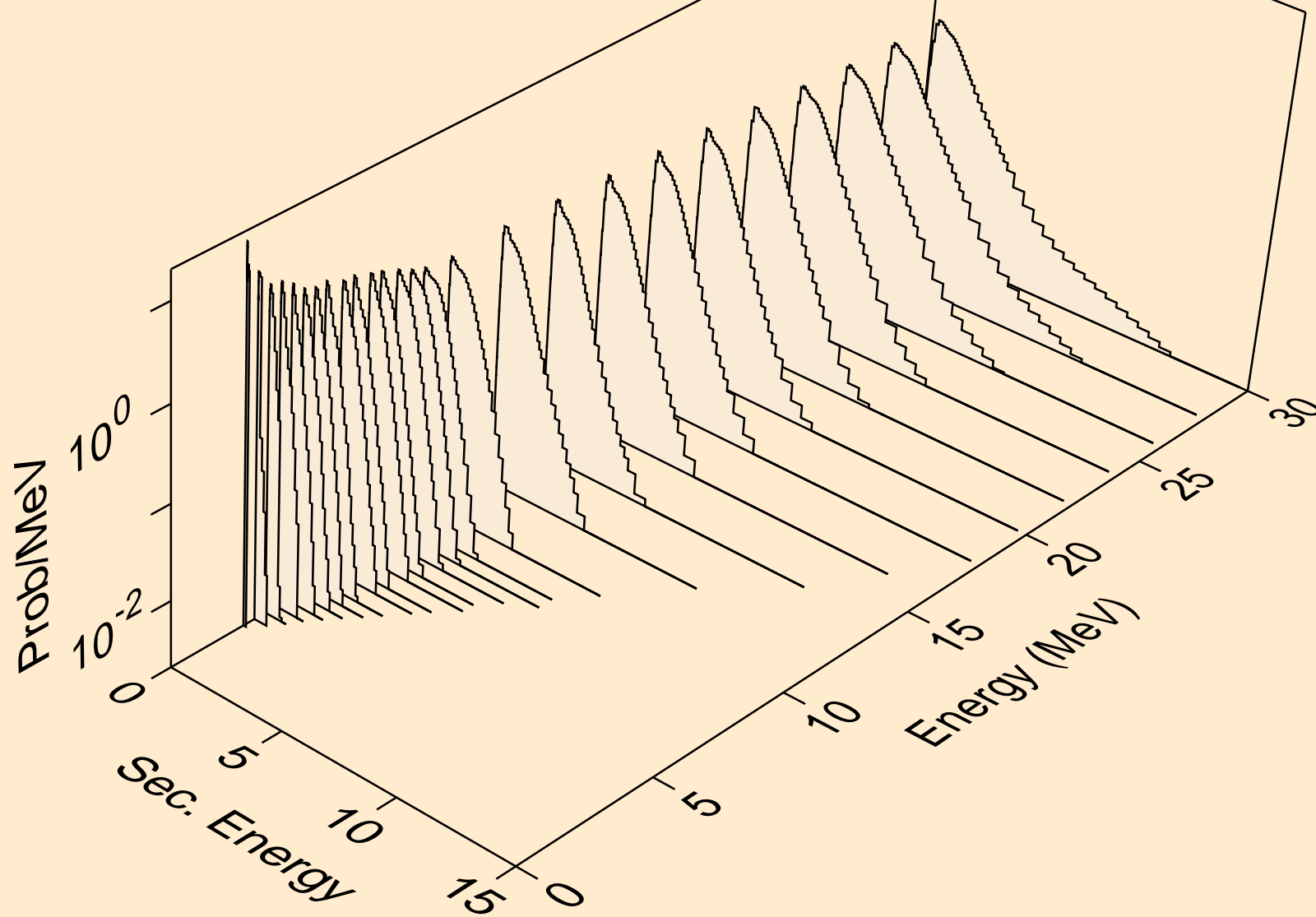

DY145 NEUTRON ACER TENDL-2023 LIBRARY; T=0.K  
Neutron emission for (n,2n)a

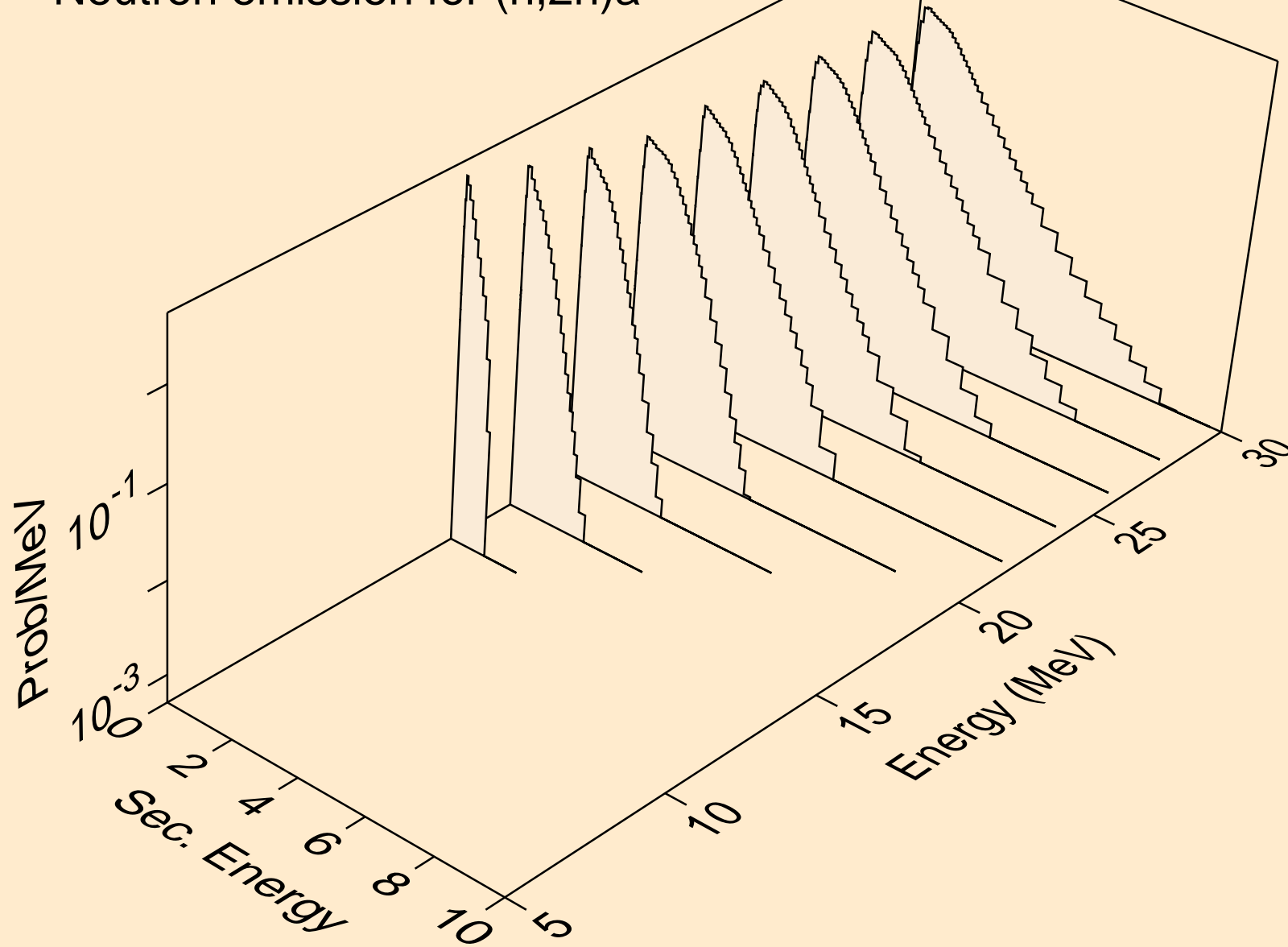

DY145 NEUTRON ACER TENDL-2023 LIBRARY; T=0.K  
Neutron emission for (n,3n)a

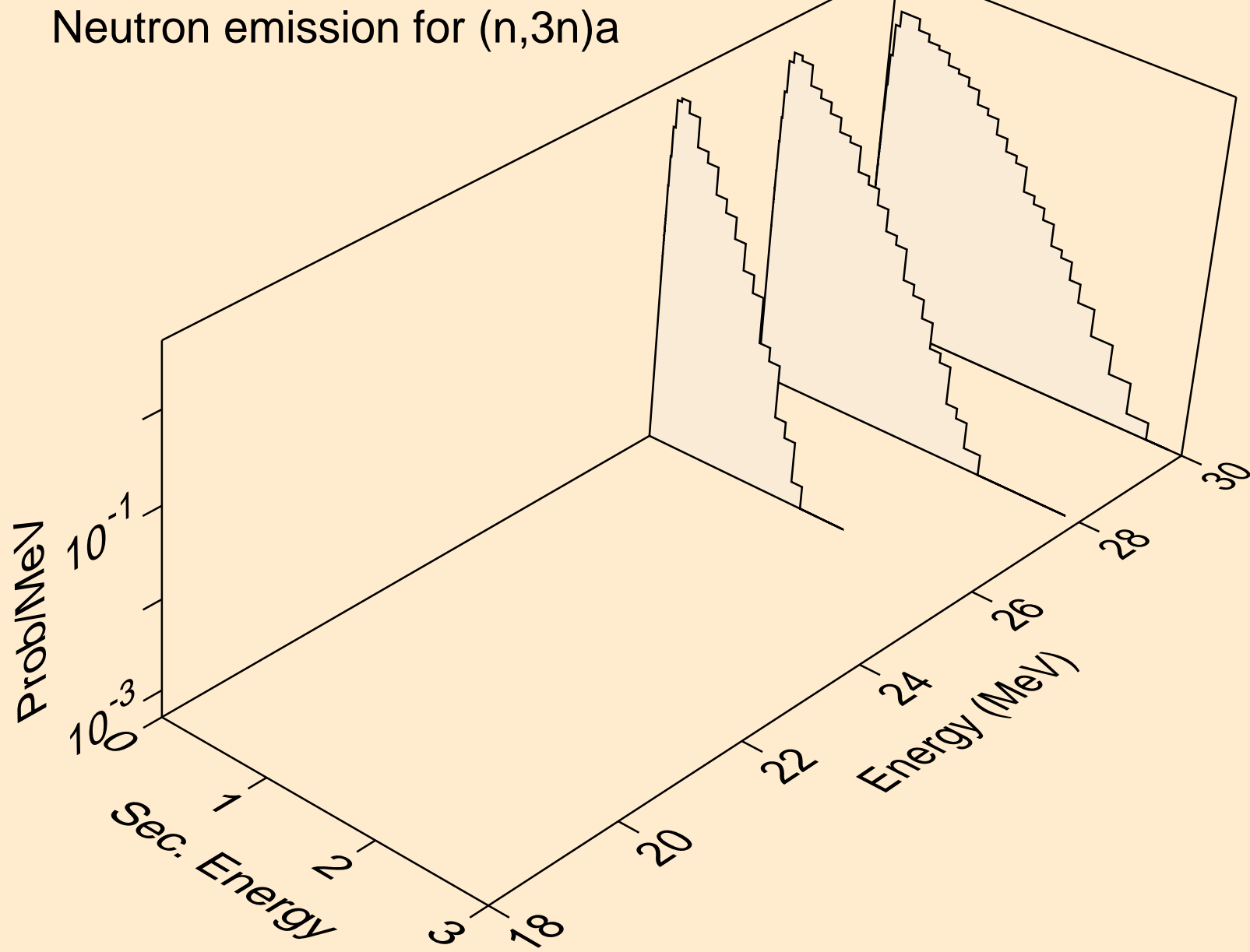

DY145 NEUTRON ACER TENDL-2023 LIBRARY; T=0.K  
Neutron emission for (n,n\*)p

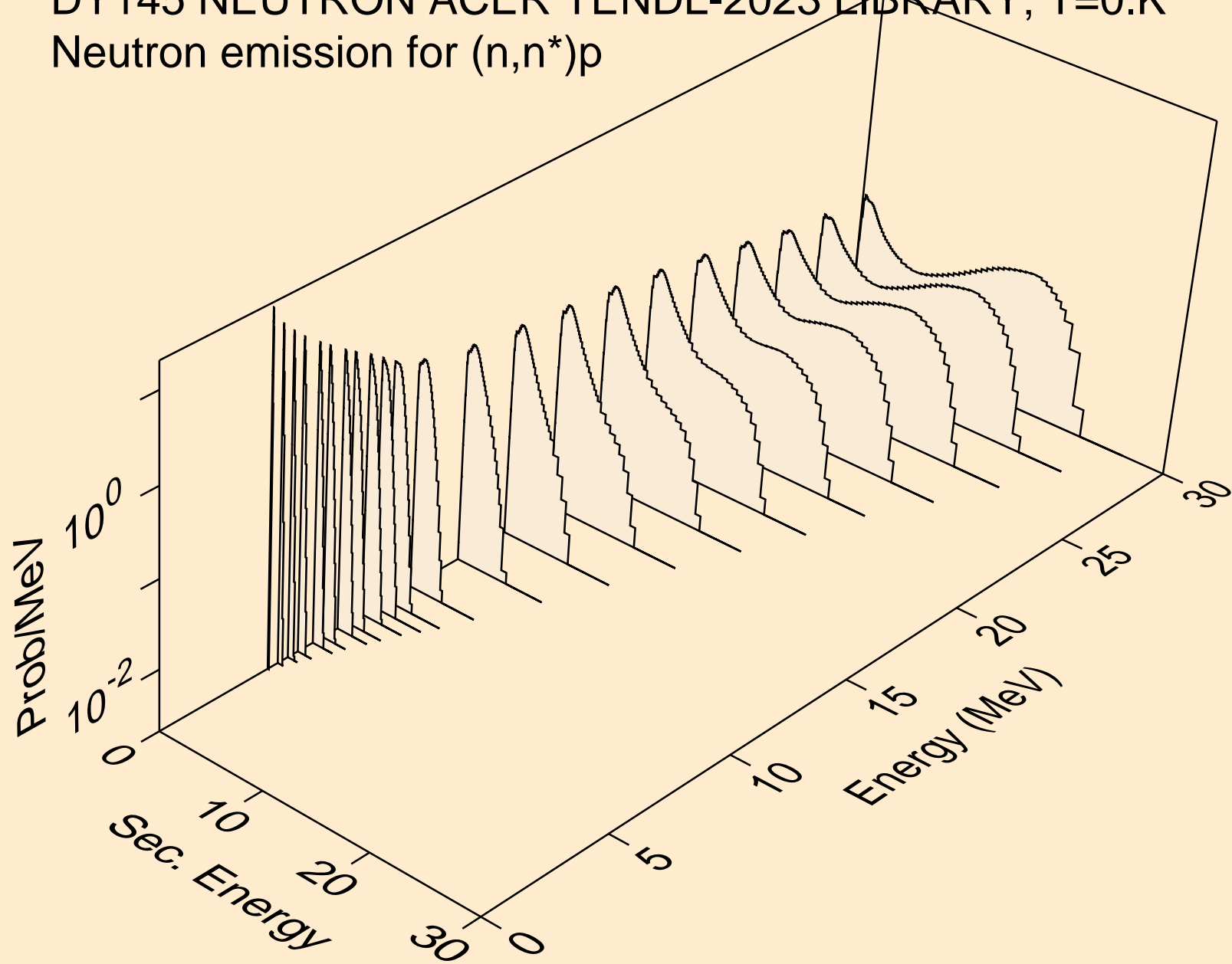

DY145 NEUTRON ACER TENDL-2023 LIBRARY; T=0.K  
Neutron emission for (n,n\*)2a

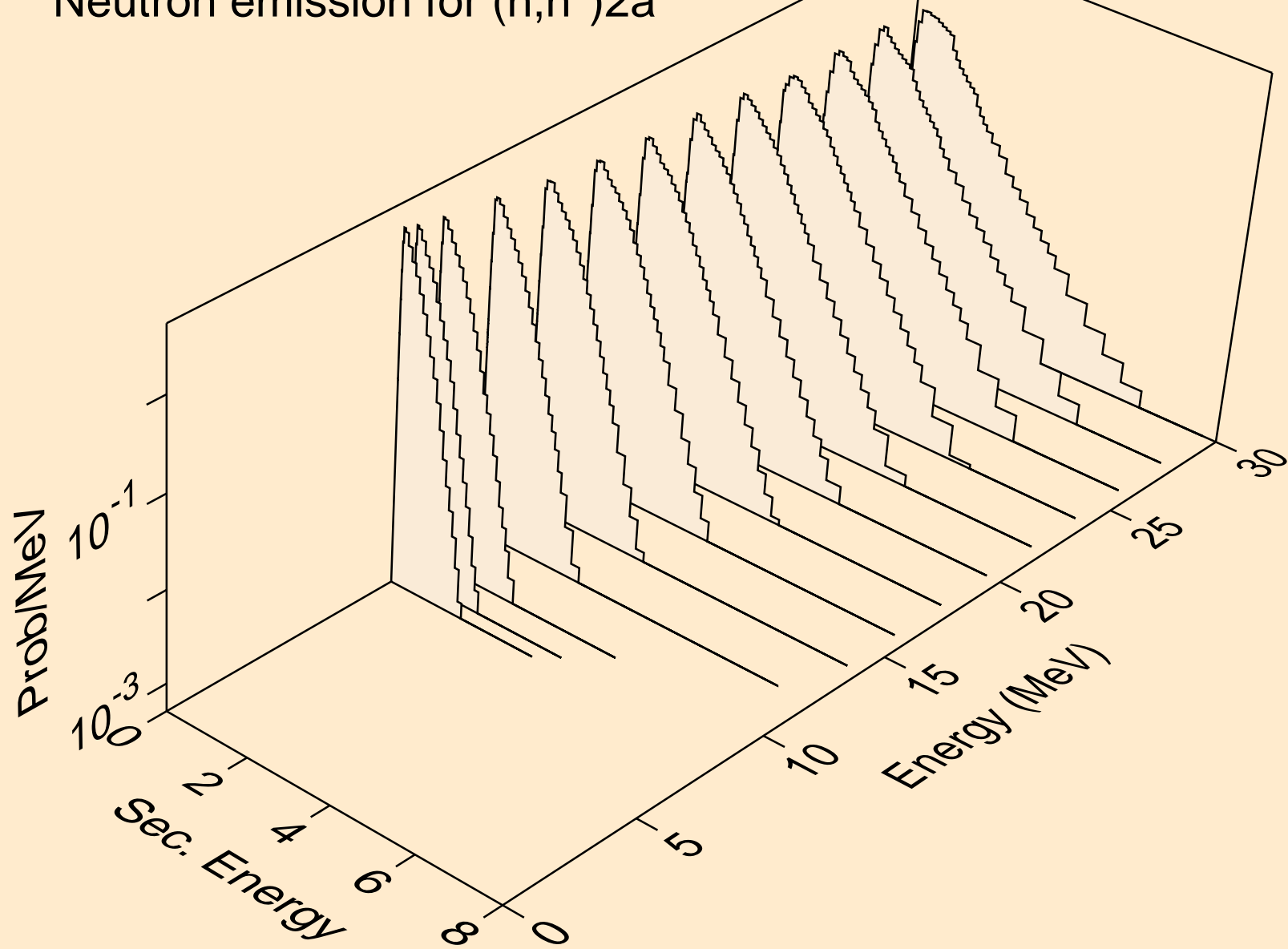



DY145 NEUTRON ACER TENDL-2023 LIBRARY; T=0.K  
Neutron emission for (n,2n)2a

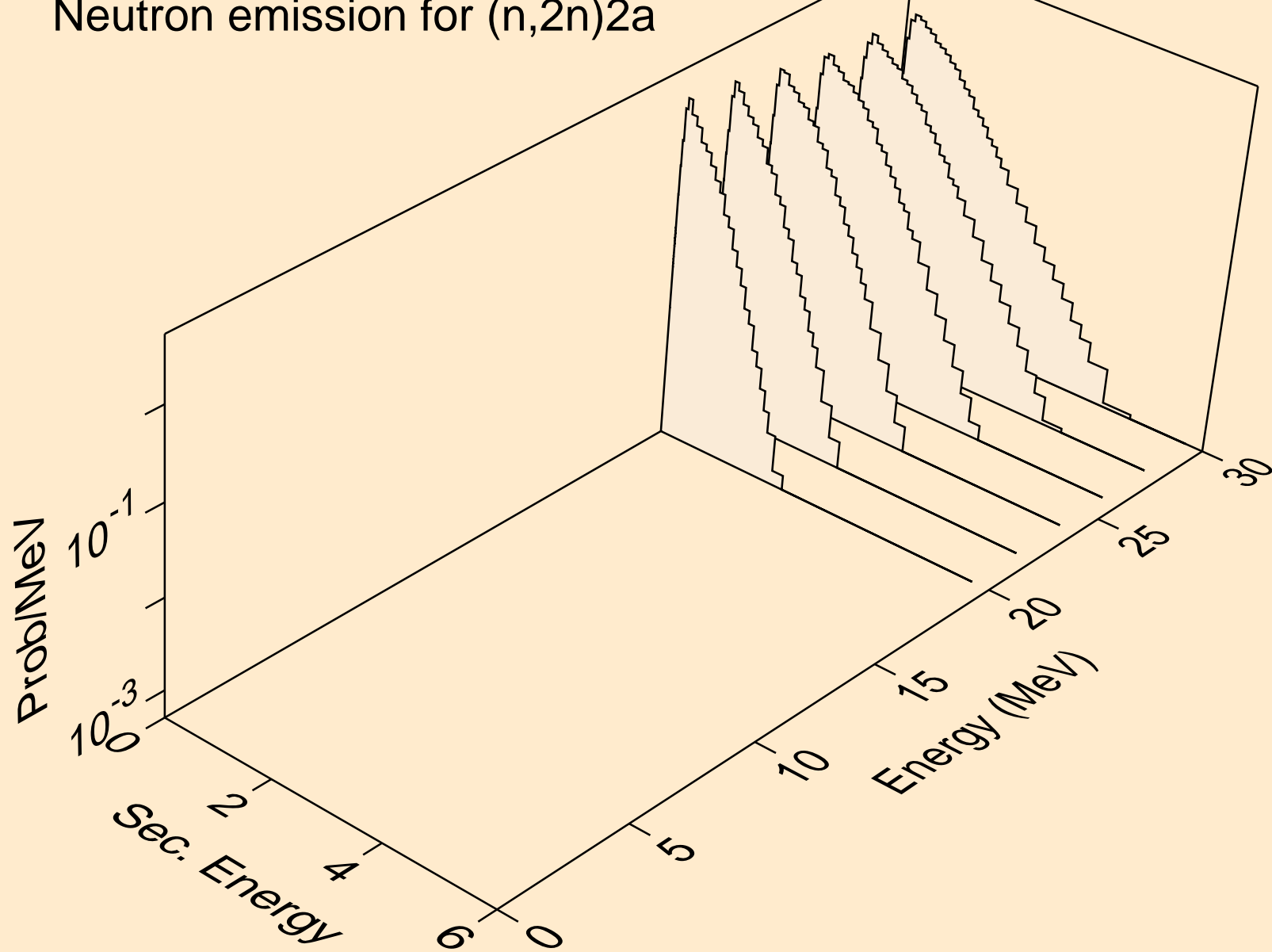

DY145 NEUTRON ACER TENDL-2023 LIBRARY; T=0.K  
Neutron emission for (n,n\*)d

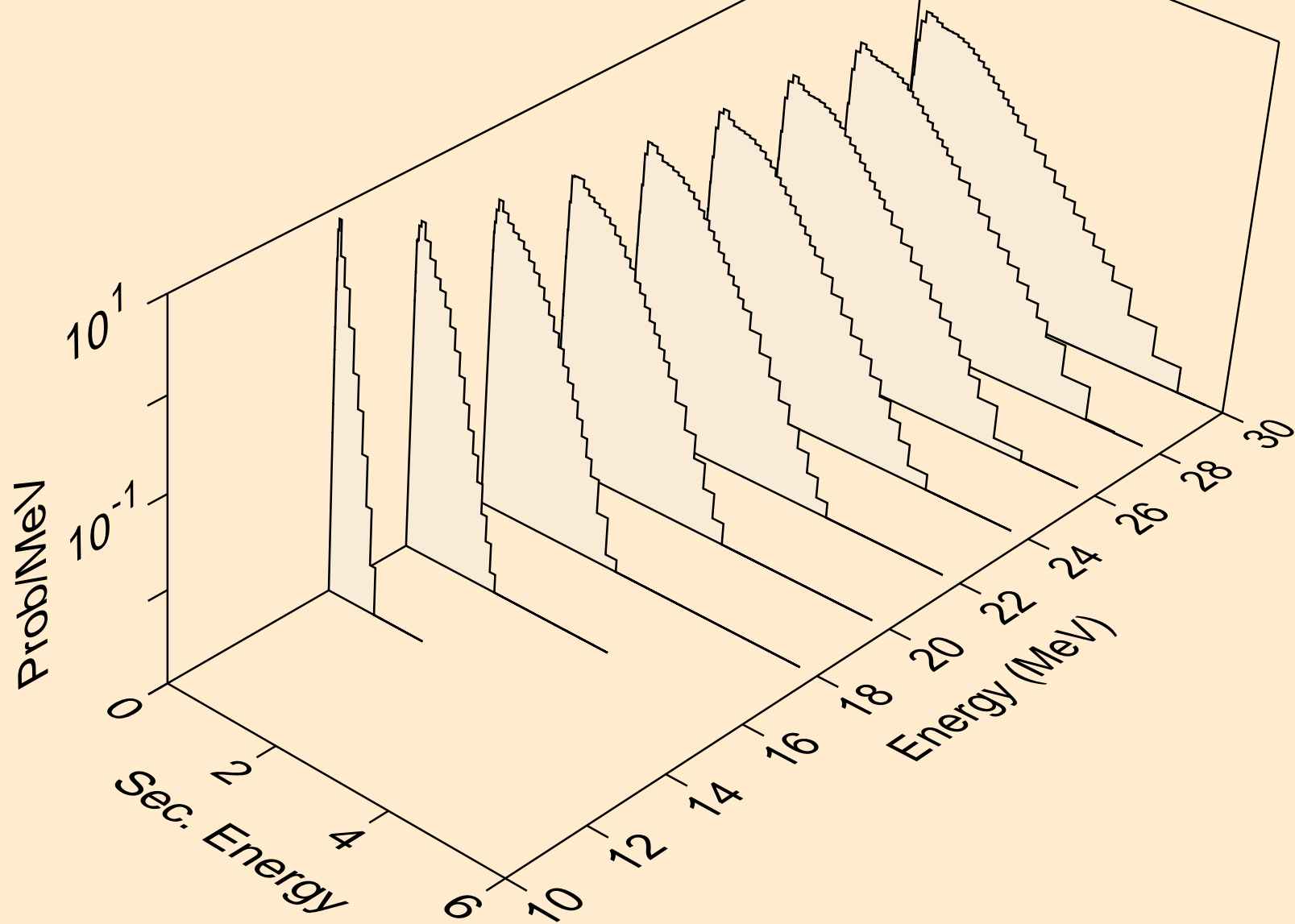

DY145 NEUTRON ACER TENDL-2023 LIBRARY; T=0.K  
Neutron emission for (n,n\*)t

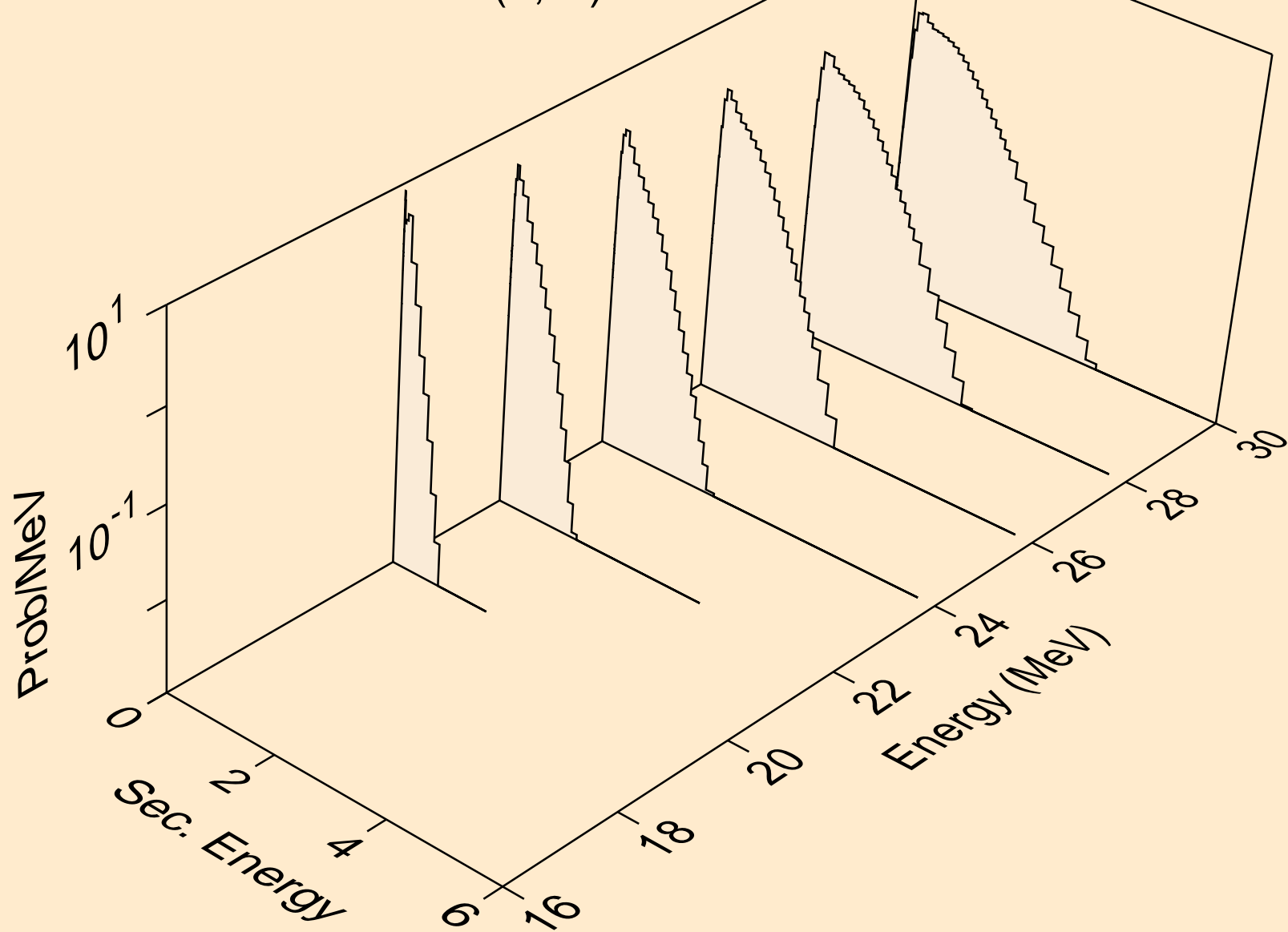

DY145 NEUTRON ACER TENDL-2023 LIBRARY; T=0.K  
Neutron emission for (n,n\*)he3

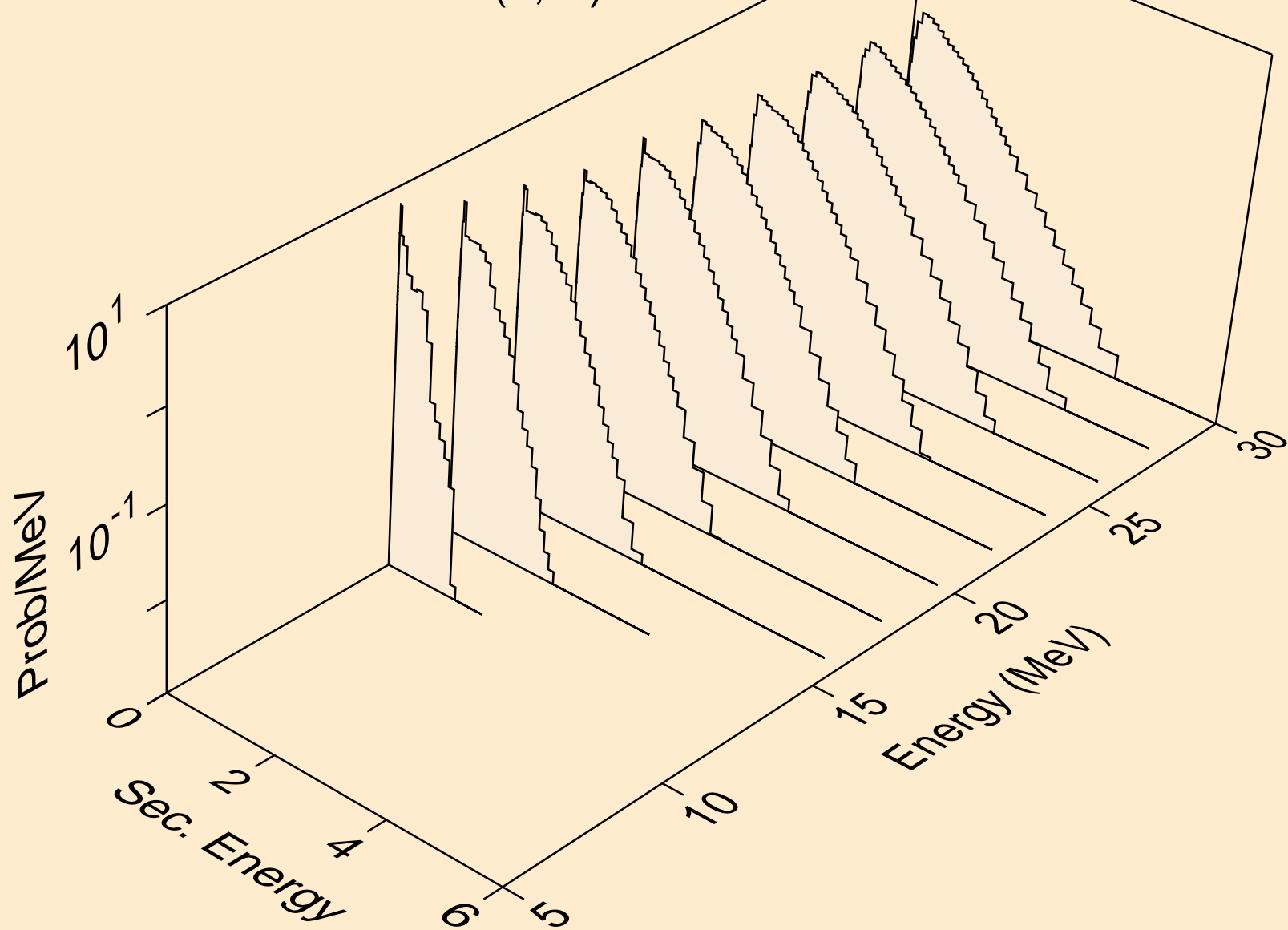

DY145 NEUTRON ACER TENDL-2023 LIBRARY; T=0.K  
Neutron emission for (n,2np)

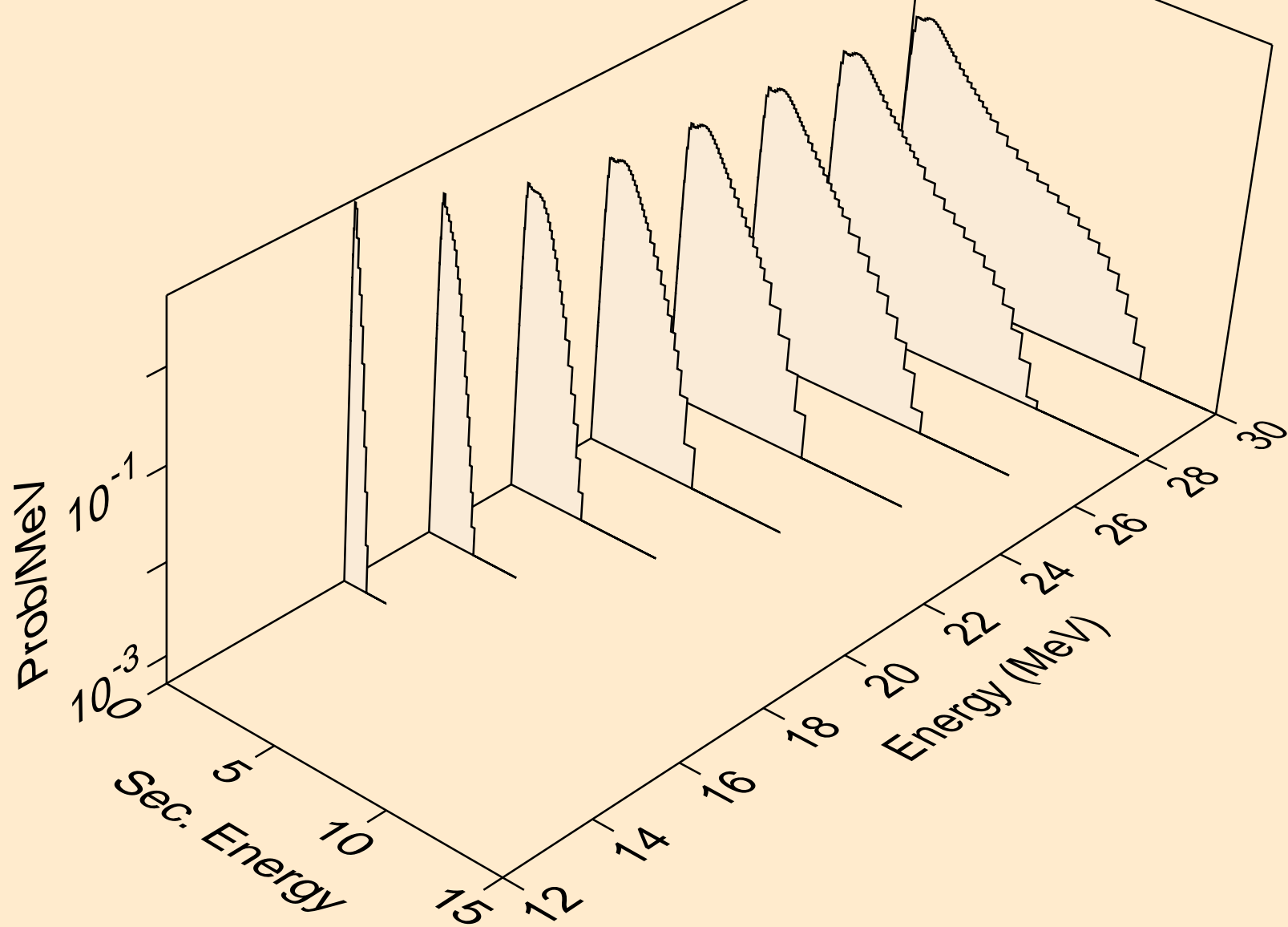

DY145 NEUTRON ACER TENDL-2023 LIBRARY; T=0.K  
Neutron emission for (n,3np)

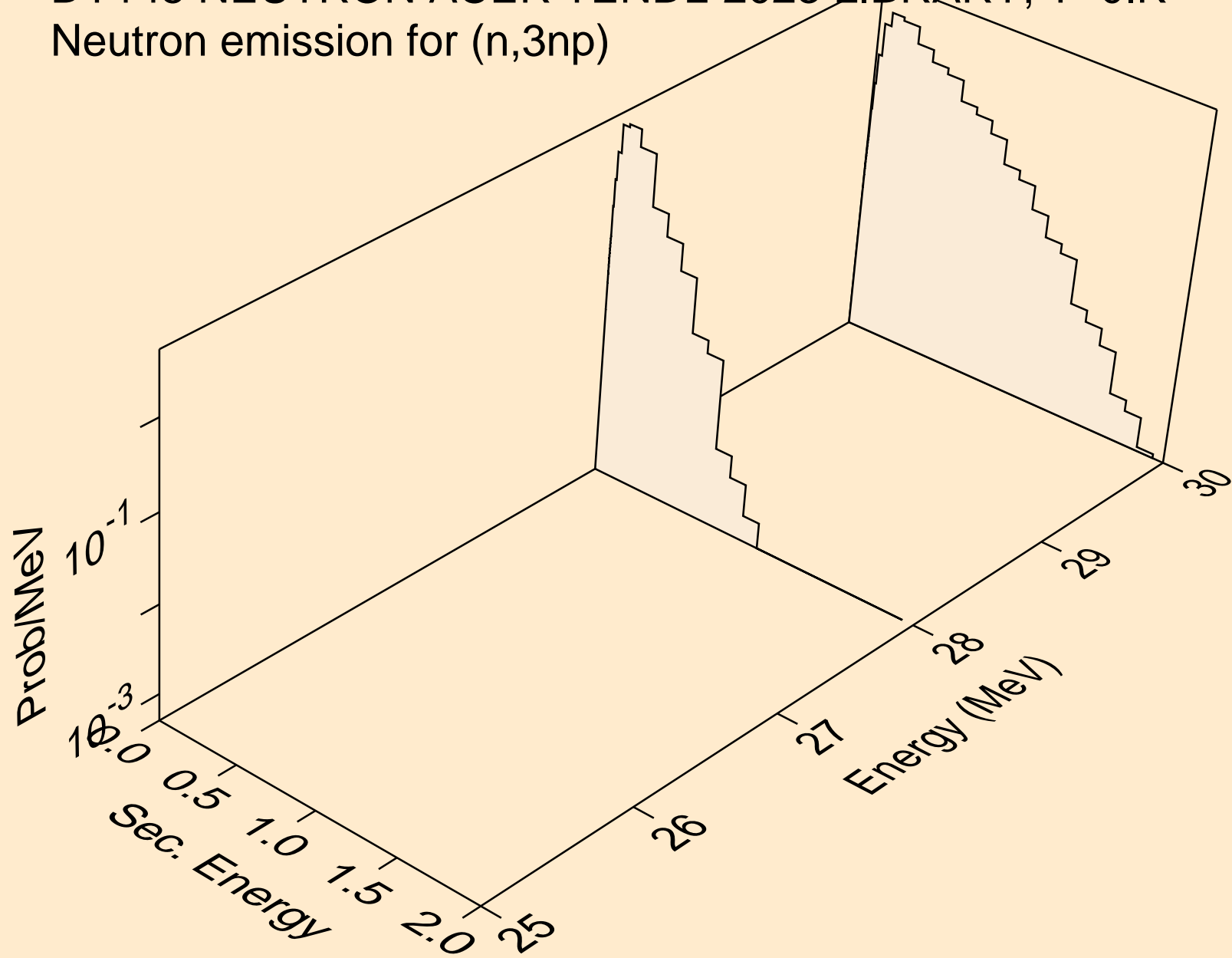

DY145 NEUTRON ACER TENDL-2023 LIBRARY; T=0.K  
Neutron emission for (n,n2p)

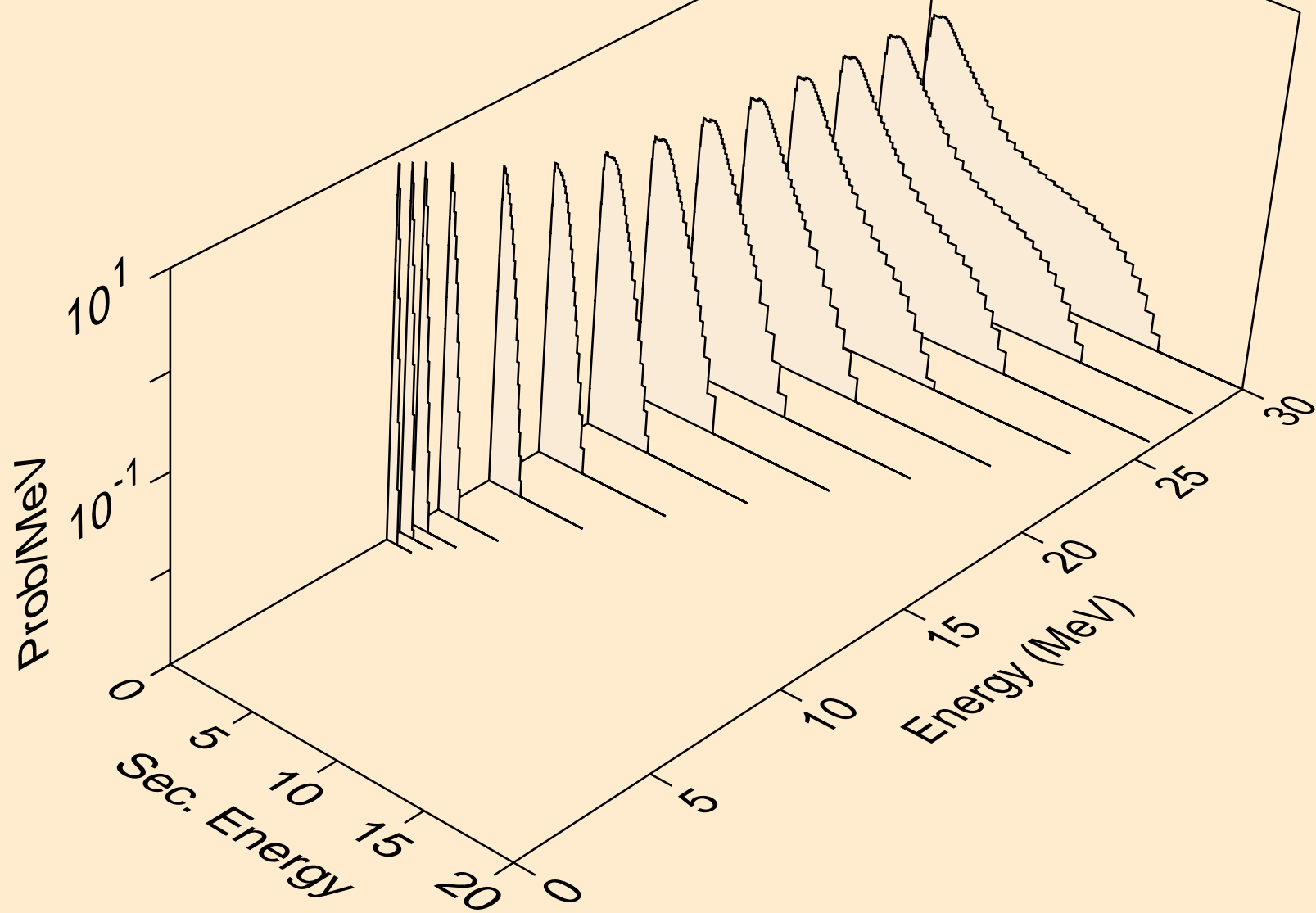

DY145 NEUTRON ACER TENDL-2023 LIBRARY; T=0.K  
Neutron emission for (n,npa)

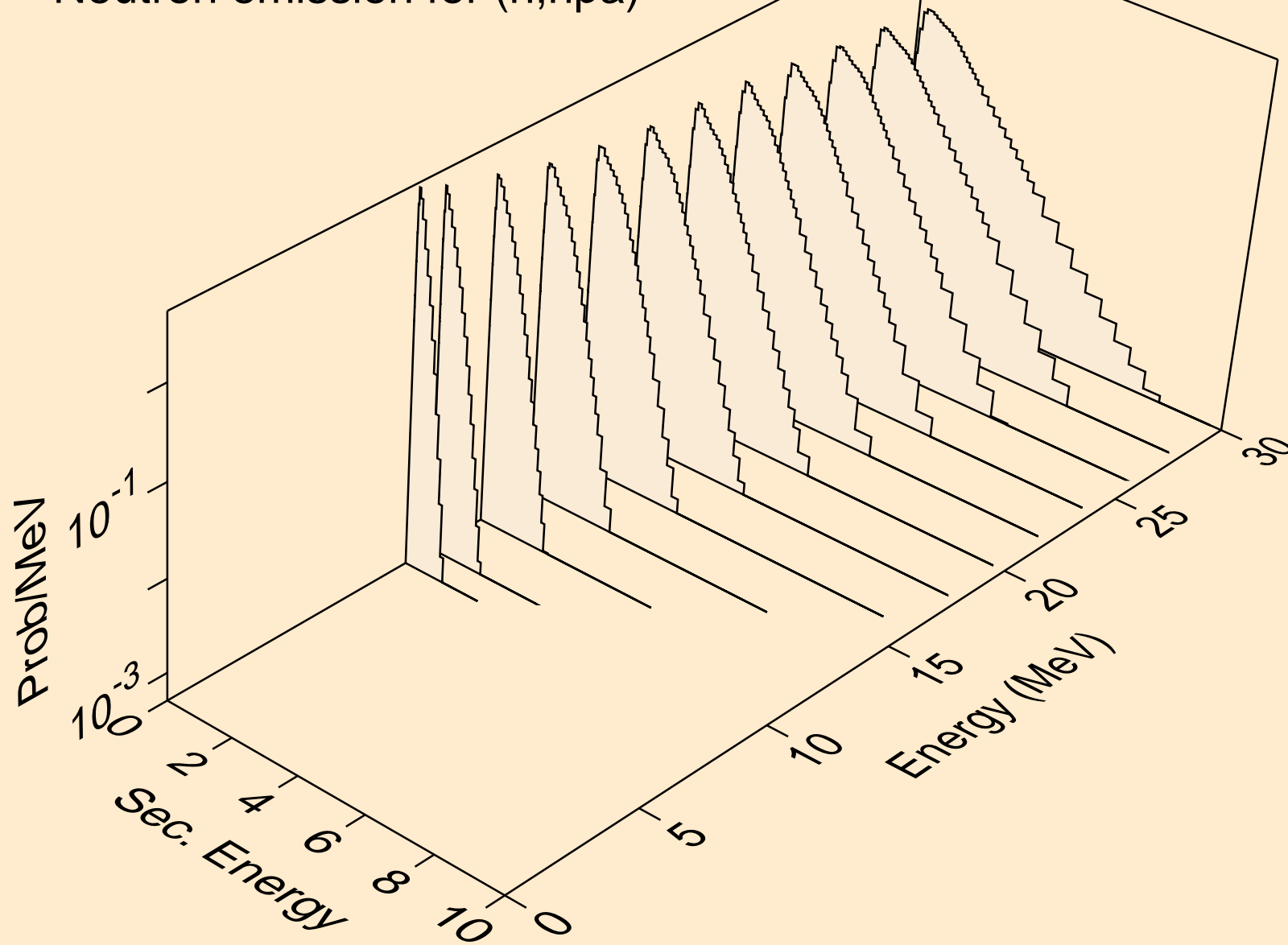



DY145 NEUTRON ACER TENDL-2023 LIBRARY; T=0.K  
Neutron emission for (n,n\*c)

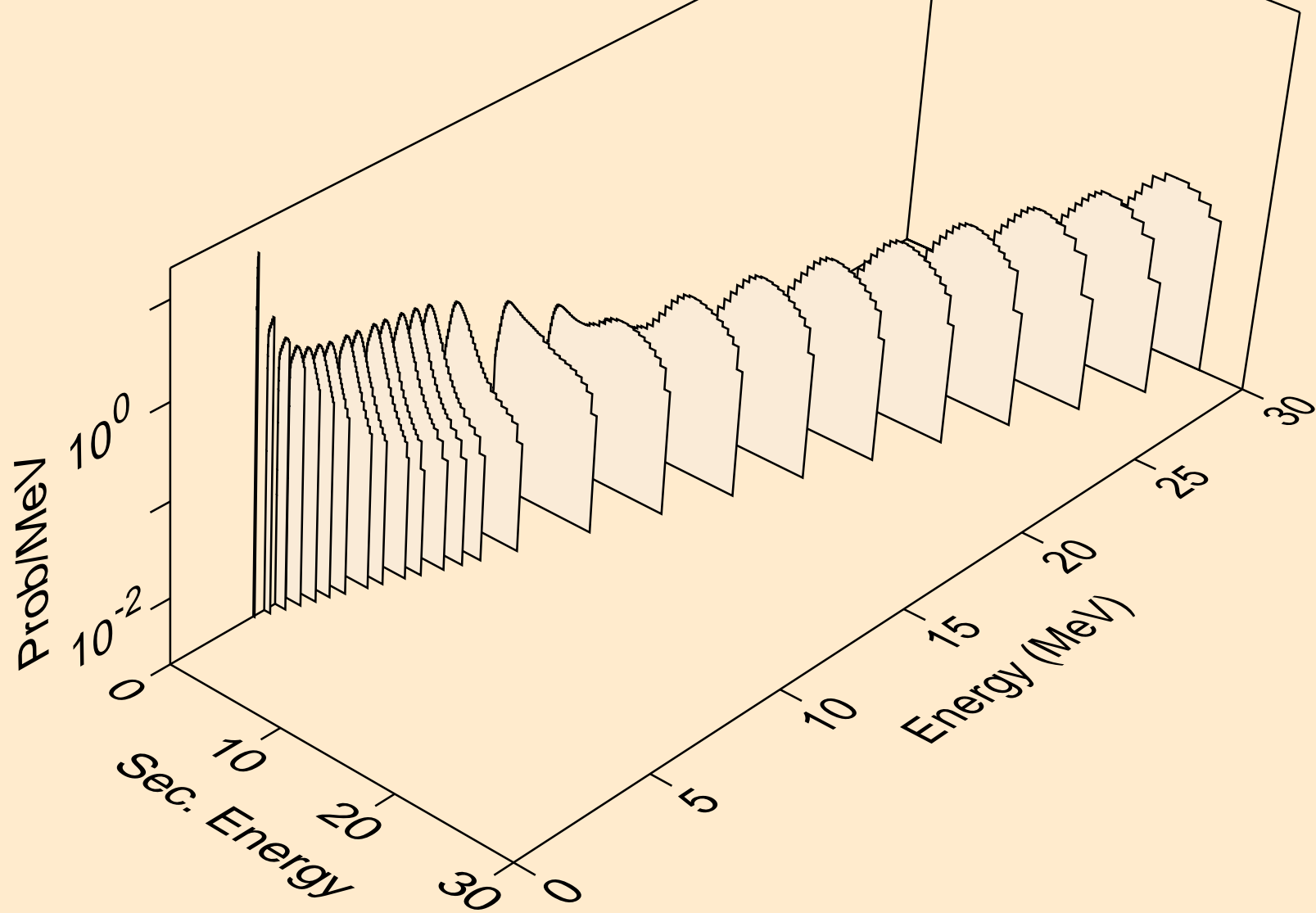

DY145 NEUTRON ACER TENDL-2023 LIBRARY; T=0.K  
Photon emission for (n,x)

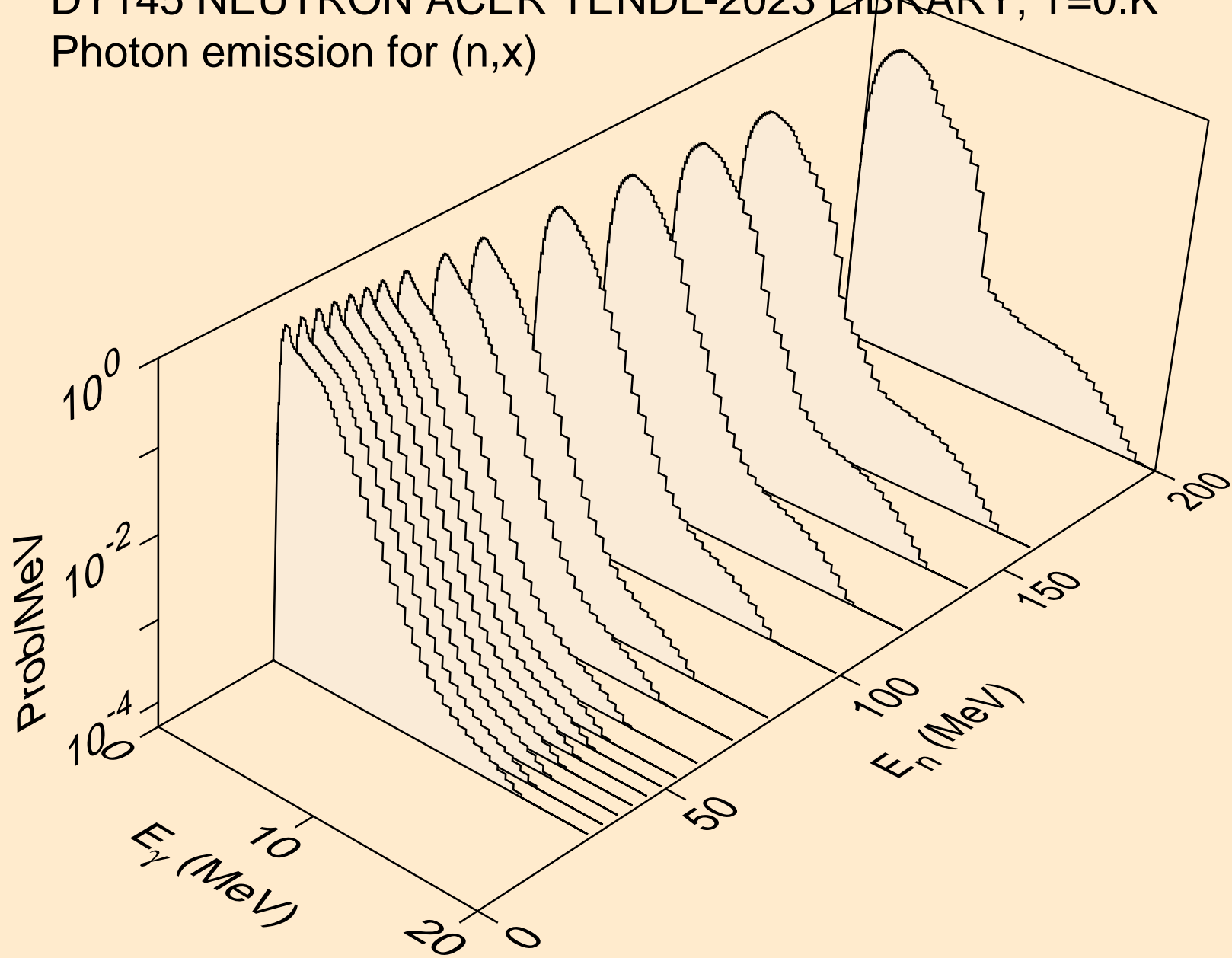

DY145 NEUTRON ACER TENDL-2023 LIBRARY; T=0.K  
Photon emission for (n,2nd)

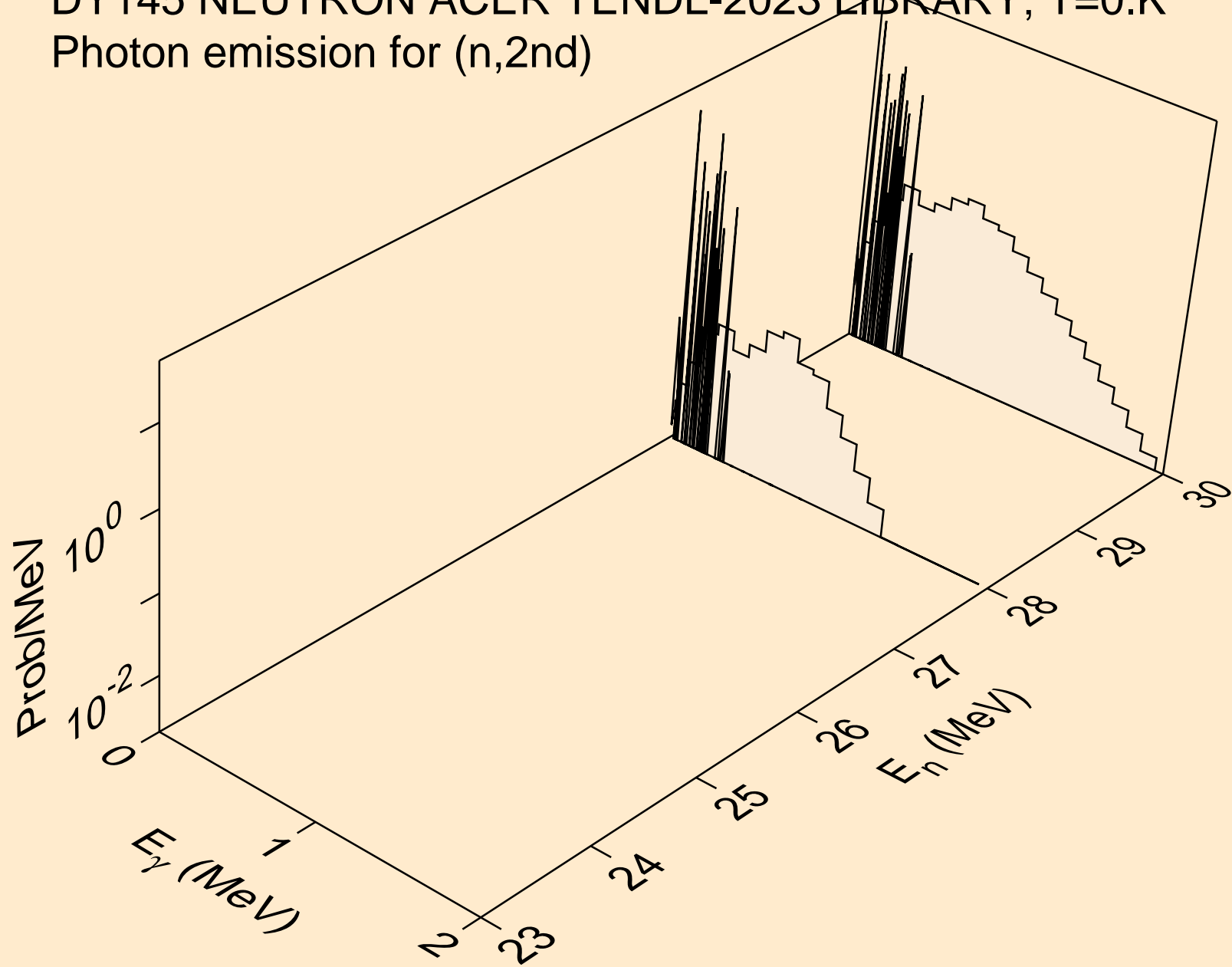

DY145 NEUTRON ACER TENDL-2023 LIBRARY; T=0.K  
Photon emission for (n,2n)

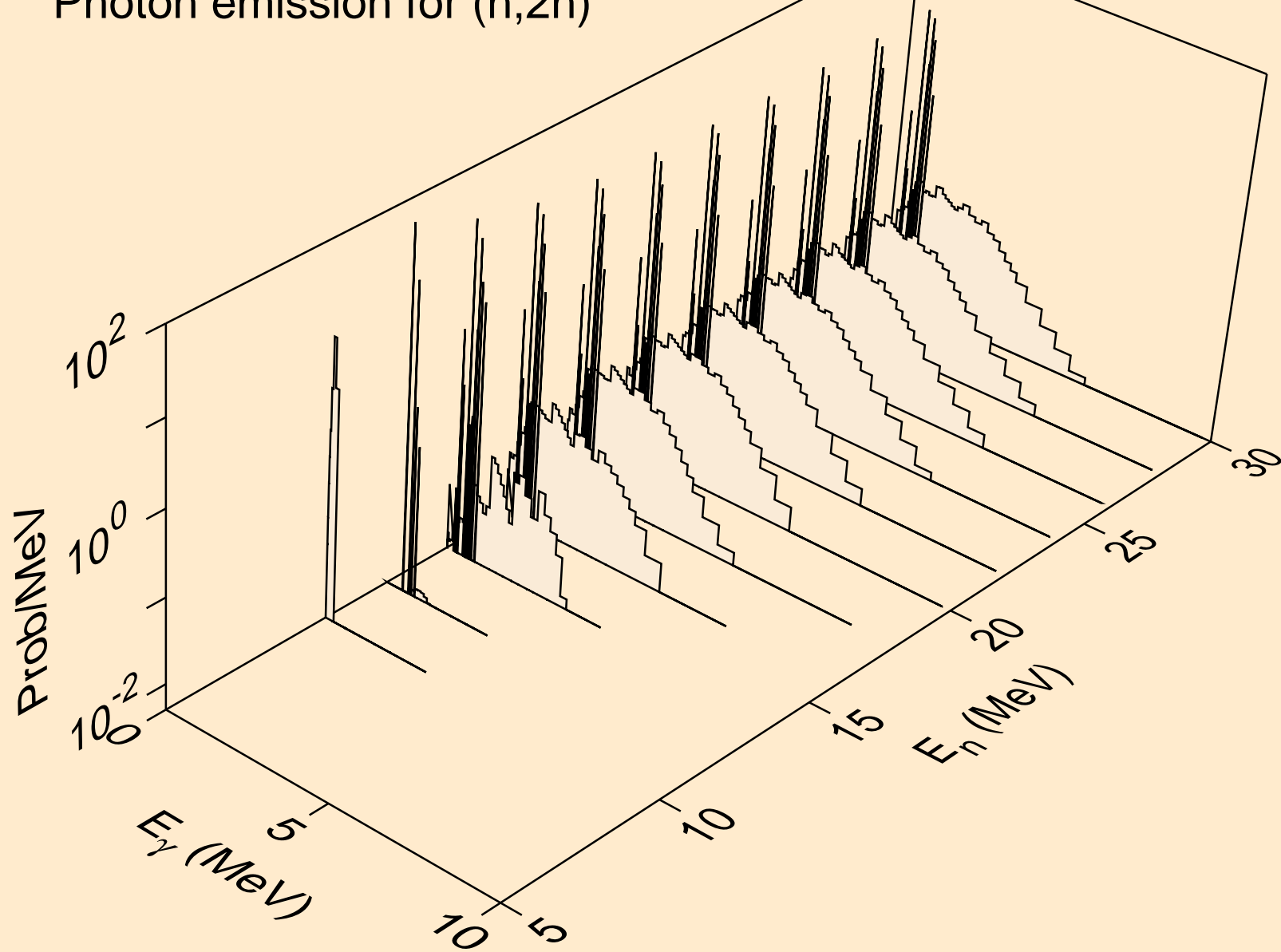

DY145 NEUTRON ACER TENDL-2023 LIBRARY; T=0.K  
Photon emission for (n,3n)

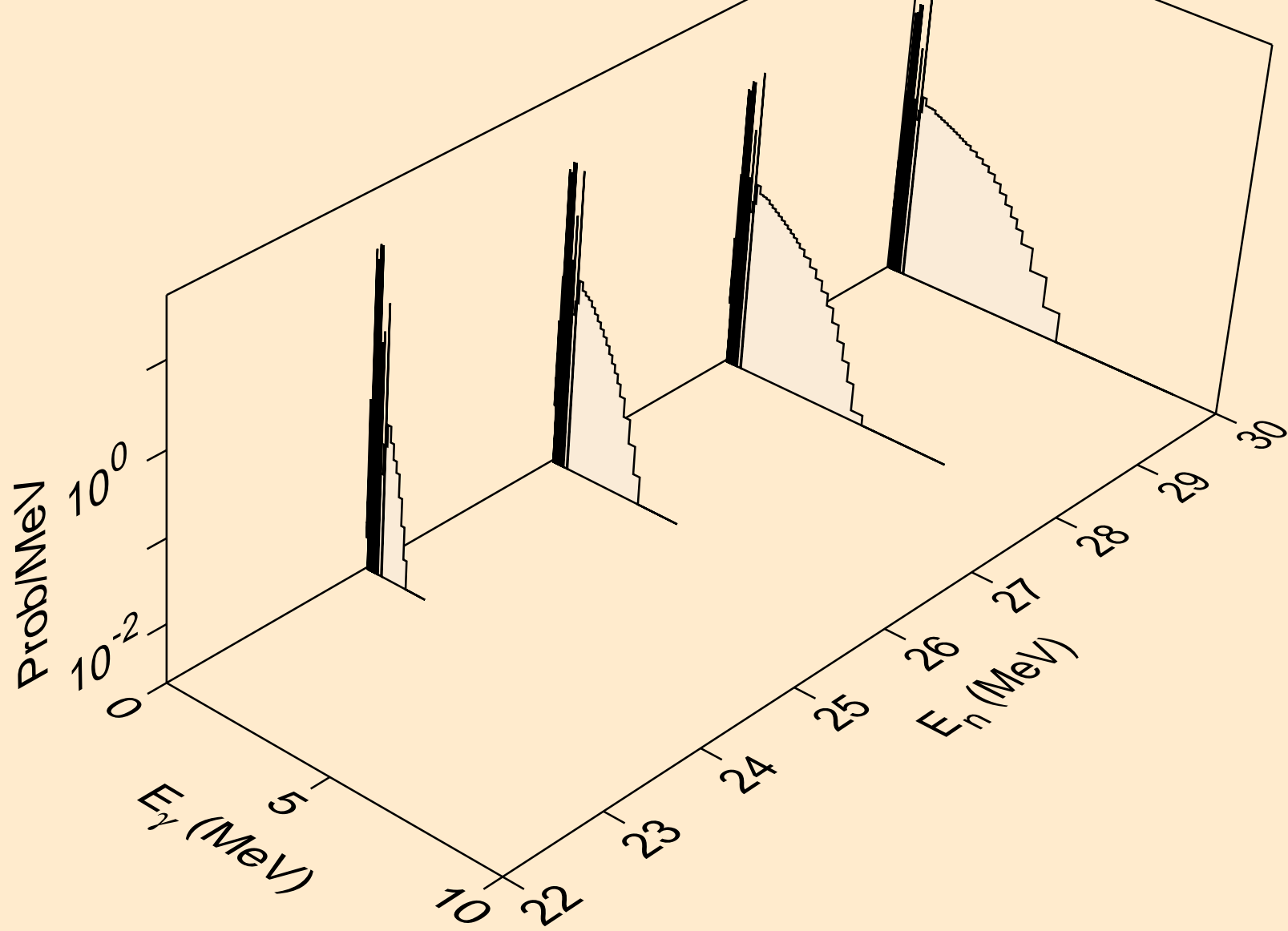

DY145 NEUTRON ACER TENDL-2023 LIBRARY; T=0.K  
Photon emission for (n,n\*)a

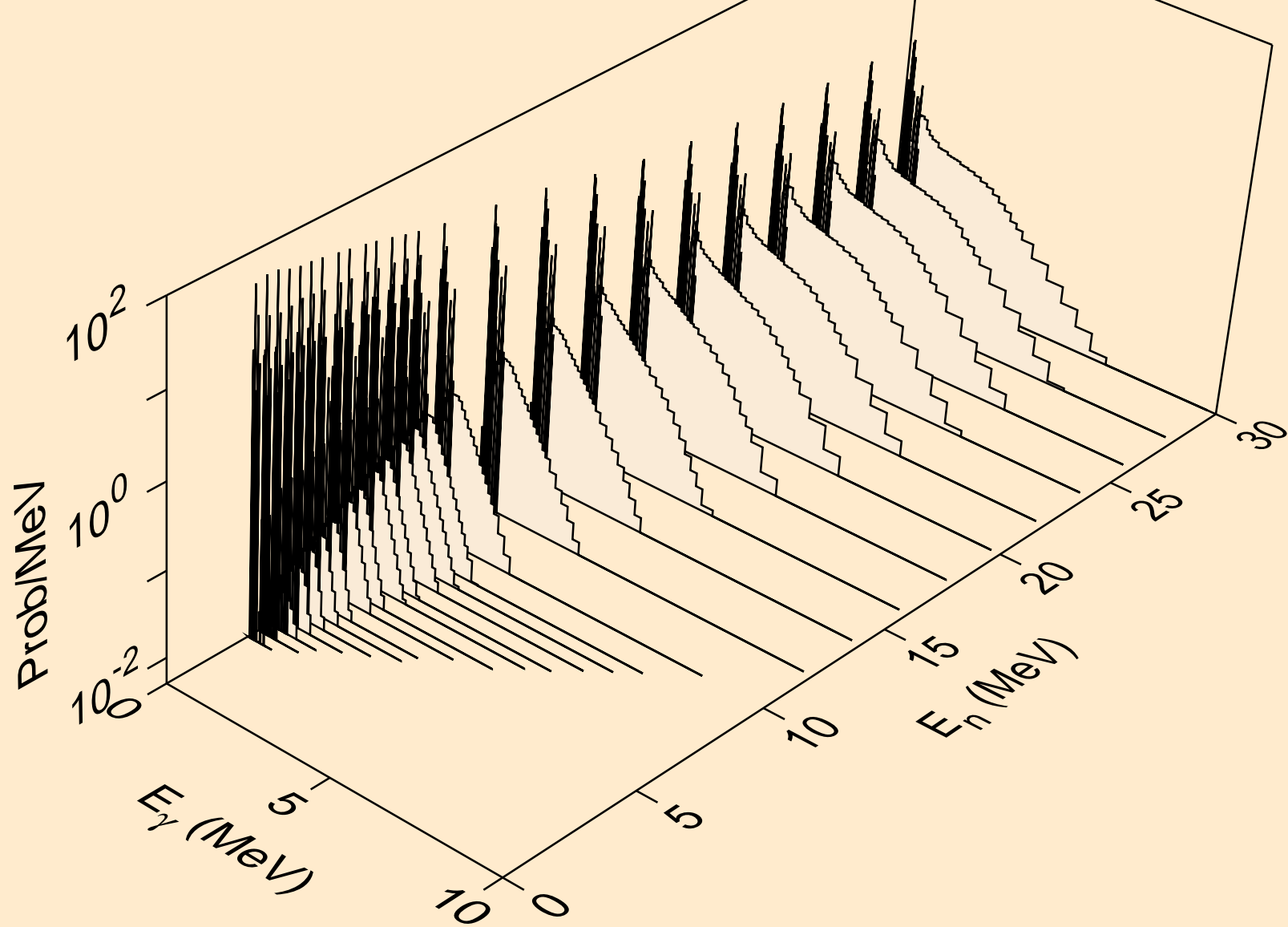

DY145 NEUTRON ACER TENDL-2023 LIBRARY; T=0.K  
Photon emission for (n,2n)a

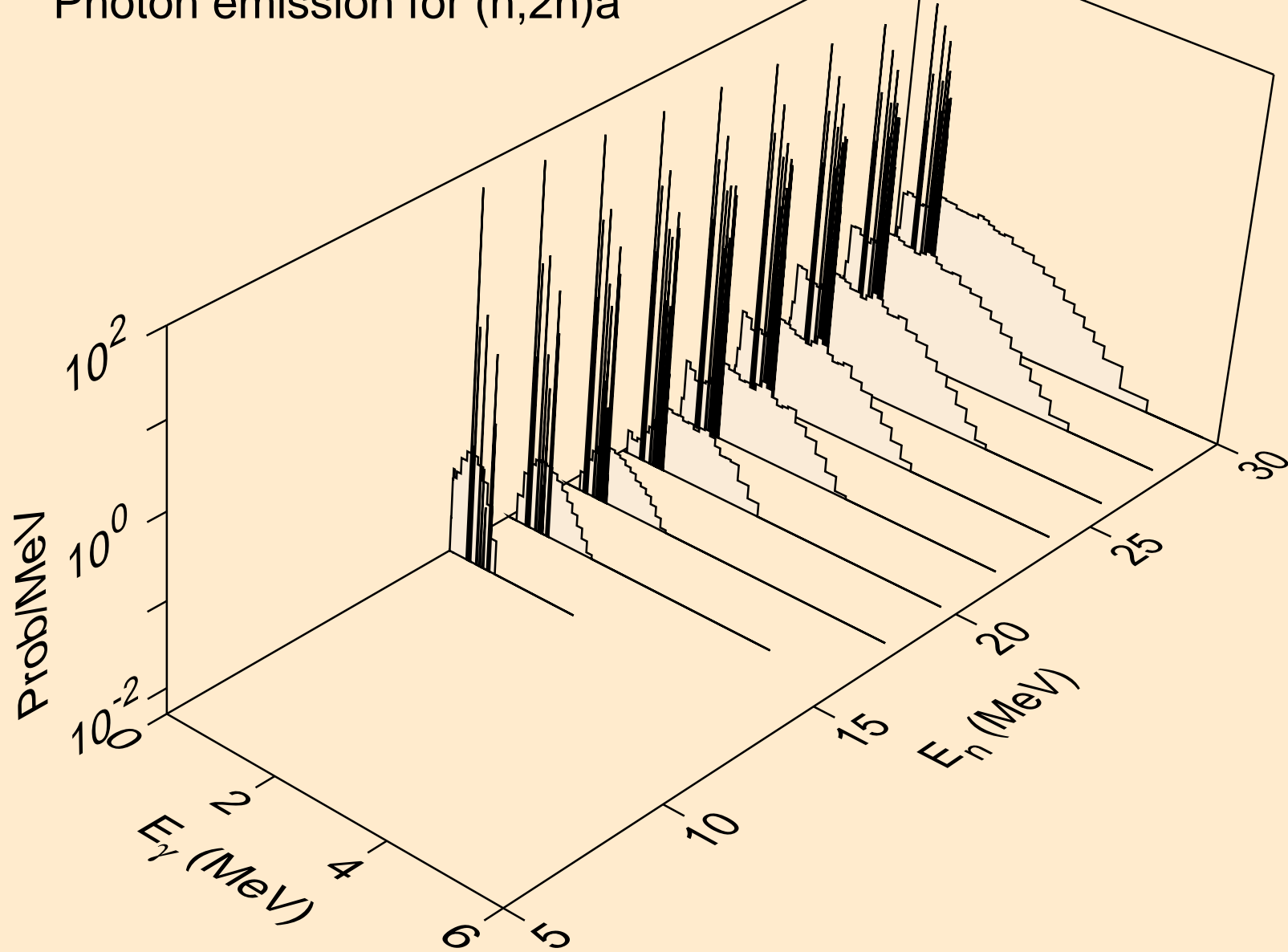

DY145 NEUTRON ACER TENDL-2023 LIBRARY; T=0.K  
Photon emission for (n,3n)a

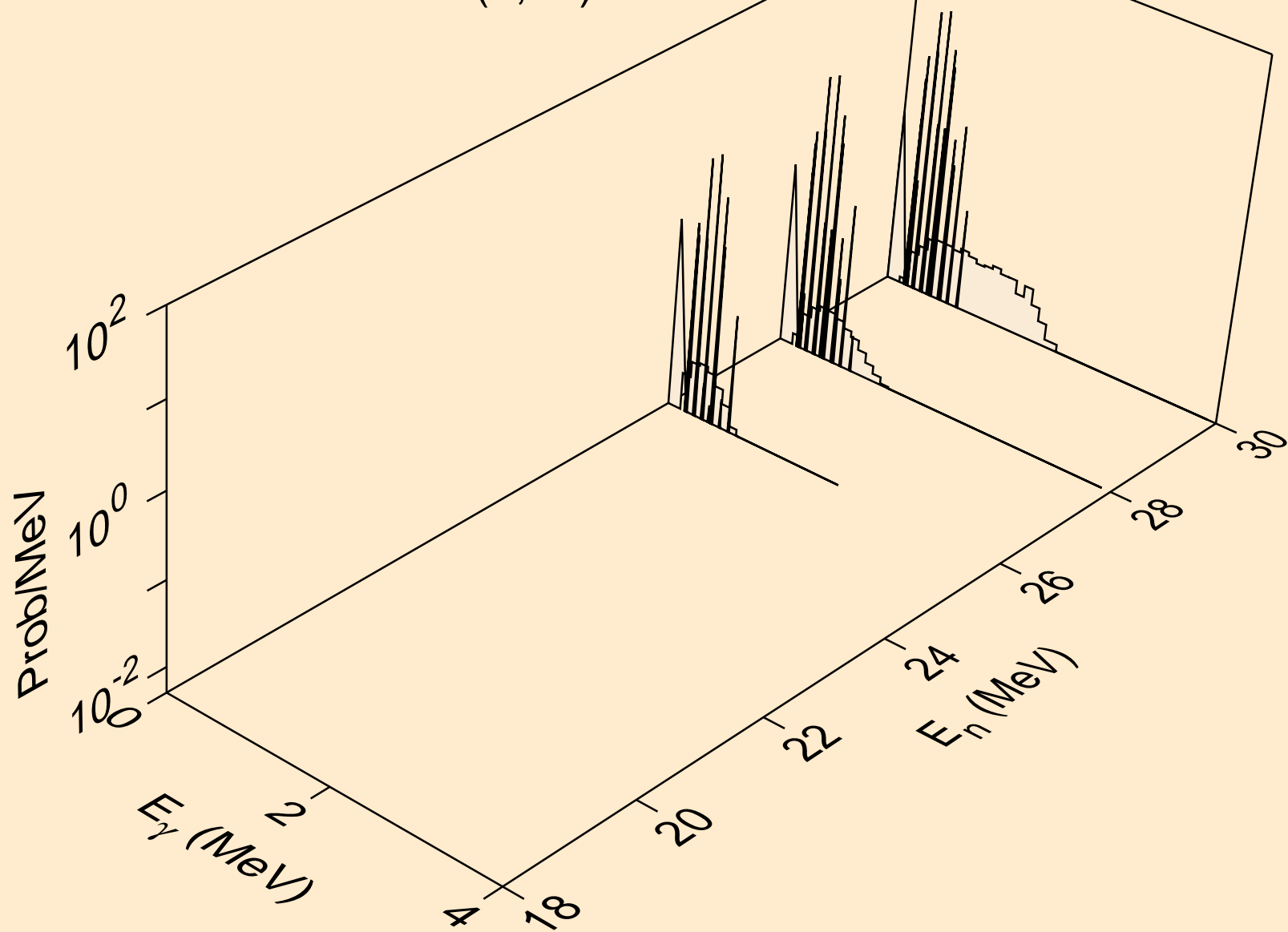



DY145 NEUTRON ACER TENDL-2023 LIBRARY; T=0.K  
Photon emission for (n,n\*)p

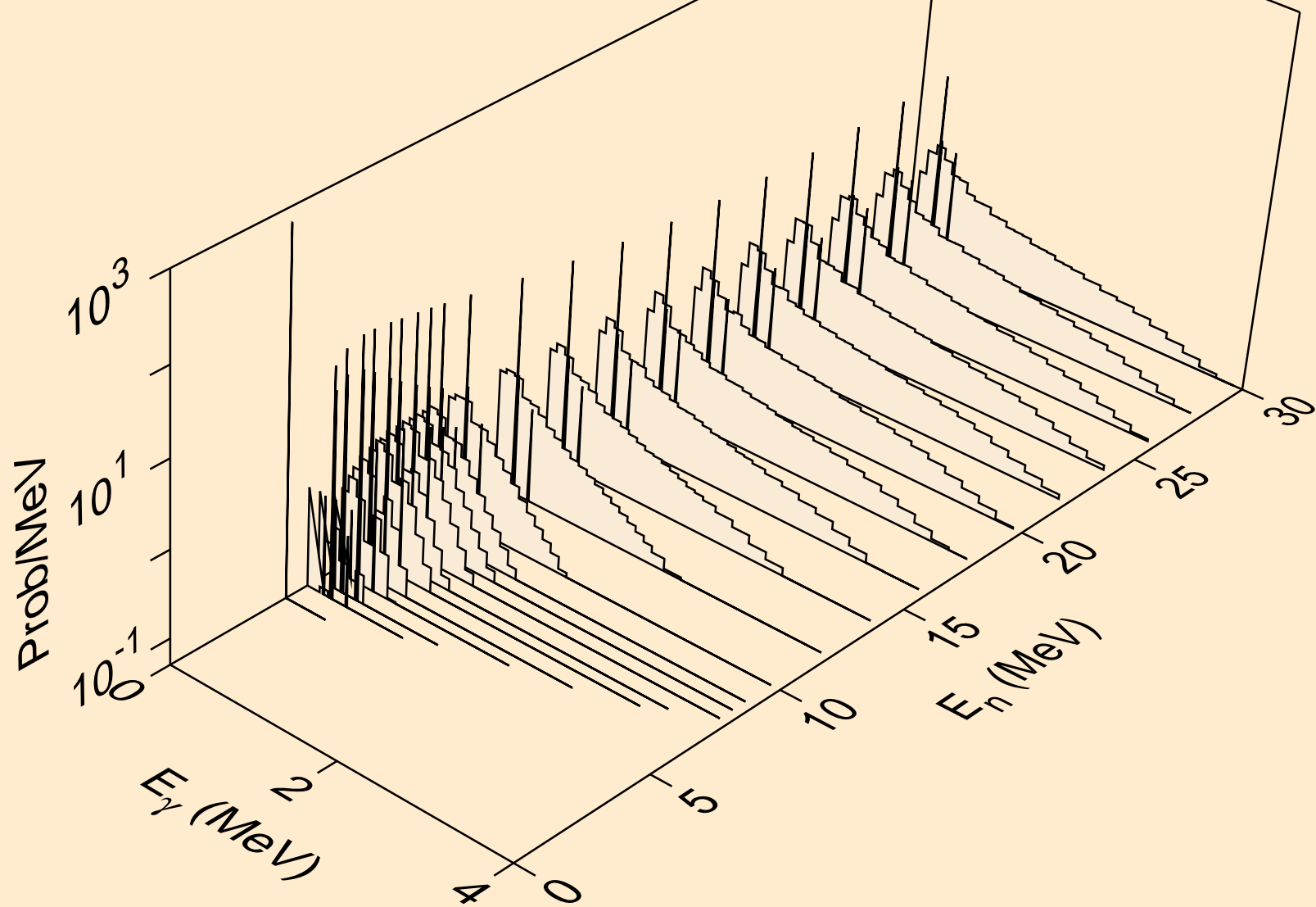

DY145 NEUTRON ACER TENDL-2023 LIBRARY; T=0.K  
Photon emission for (n,n\*)2a

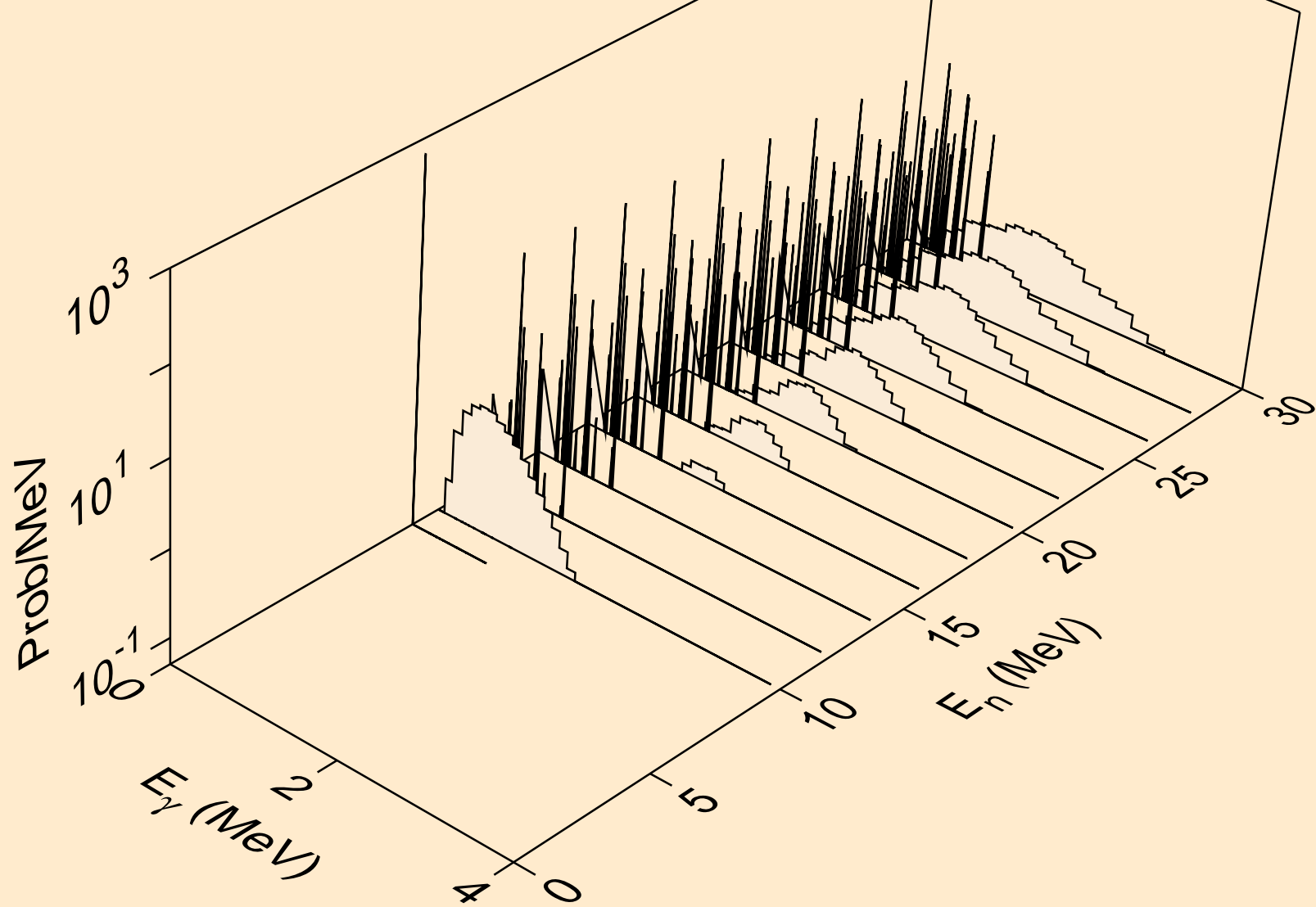

DY145 NEUTRON ACER TENDL-2023 LIBRARY; T=0.K  
Photon emission for (n,2n)2a

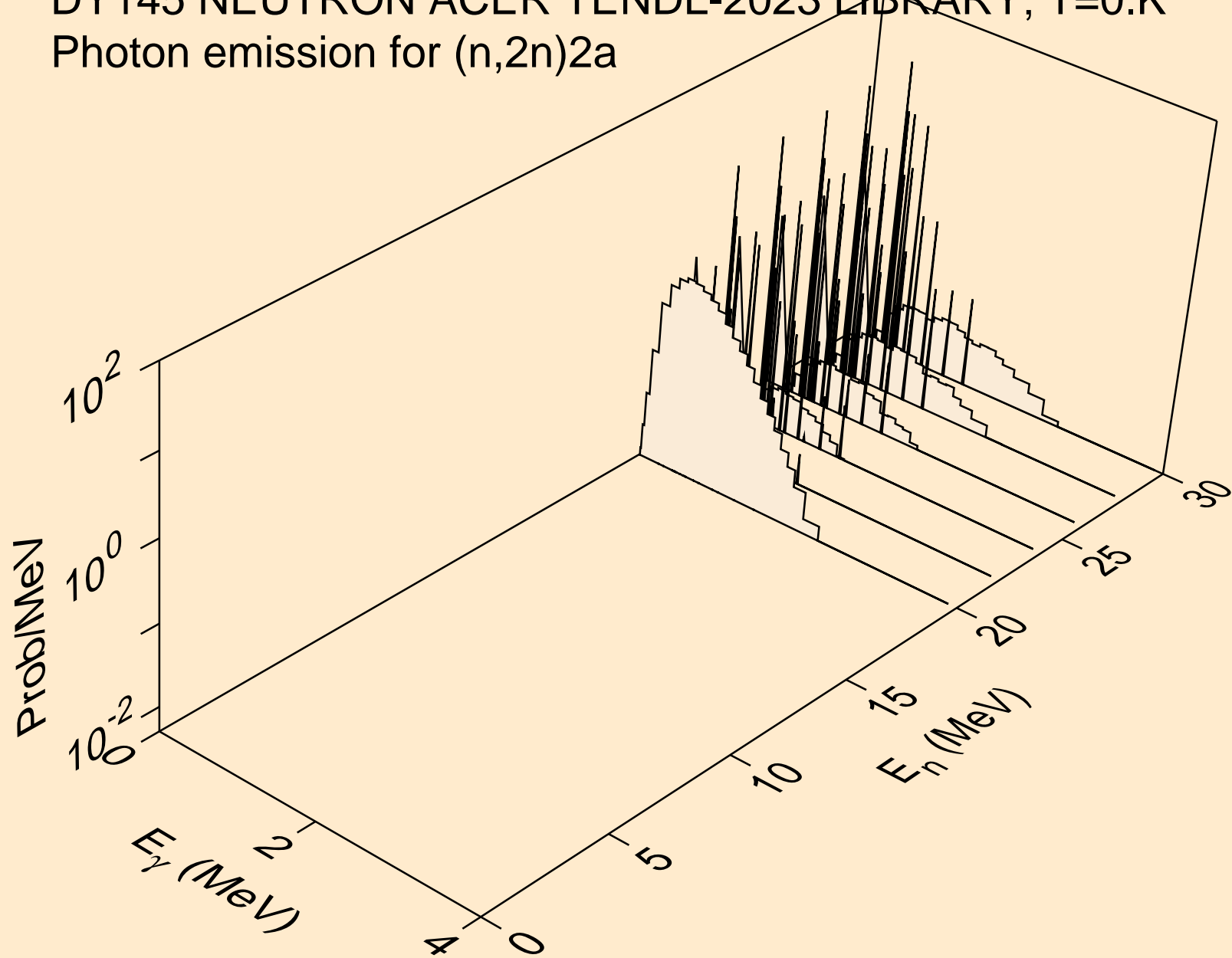

DY145 NEUTRON ACER TENDL-2023 LIBRARY; T=0.K  
Photon emission for (n,n\*)d

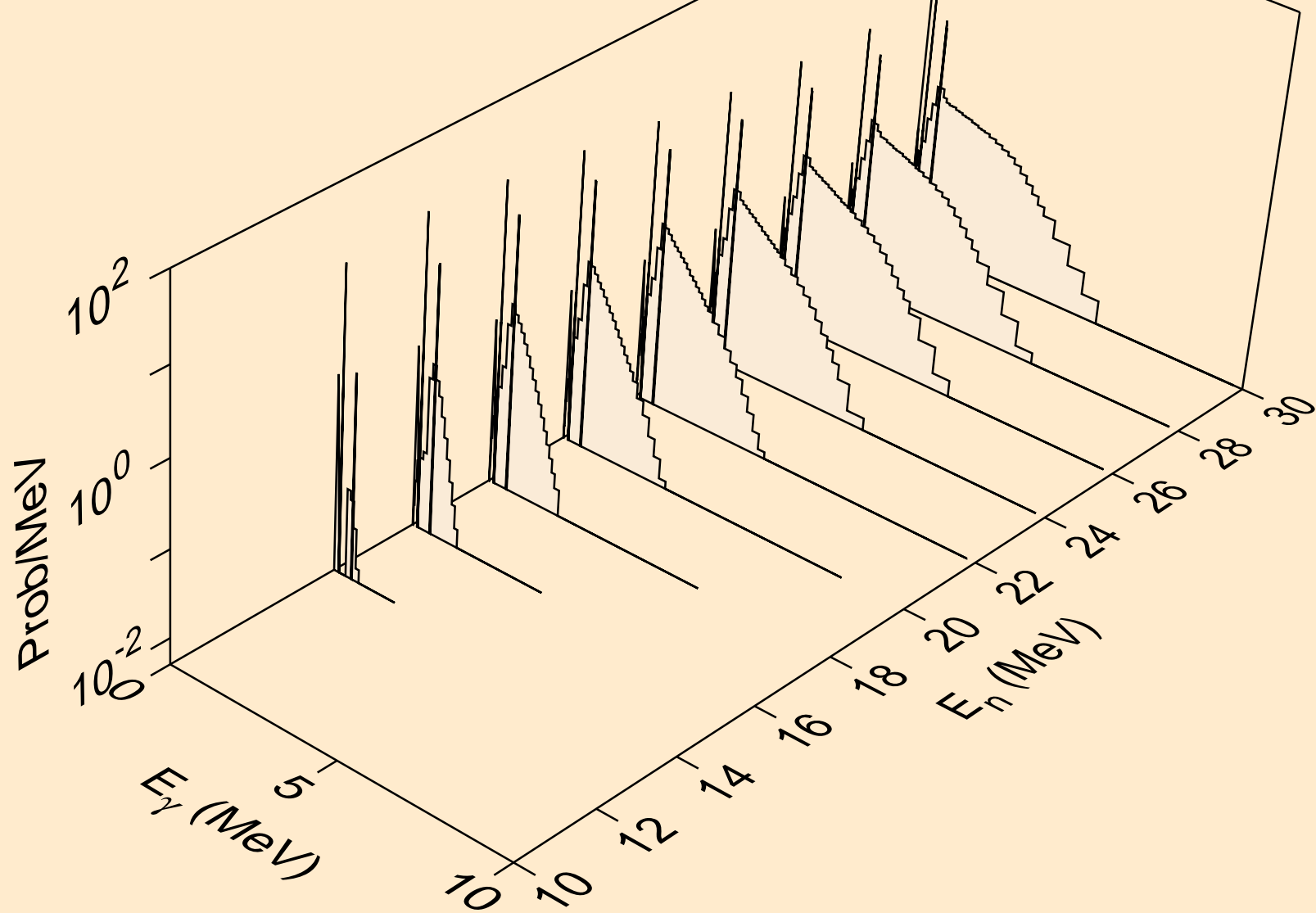

DY145 NEUTRON ACER TENDL-2023 LIBRARY; T=0.K  
Photon emission for (n,n\*)t

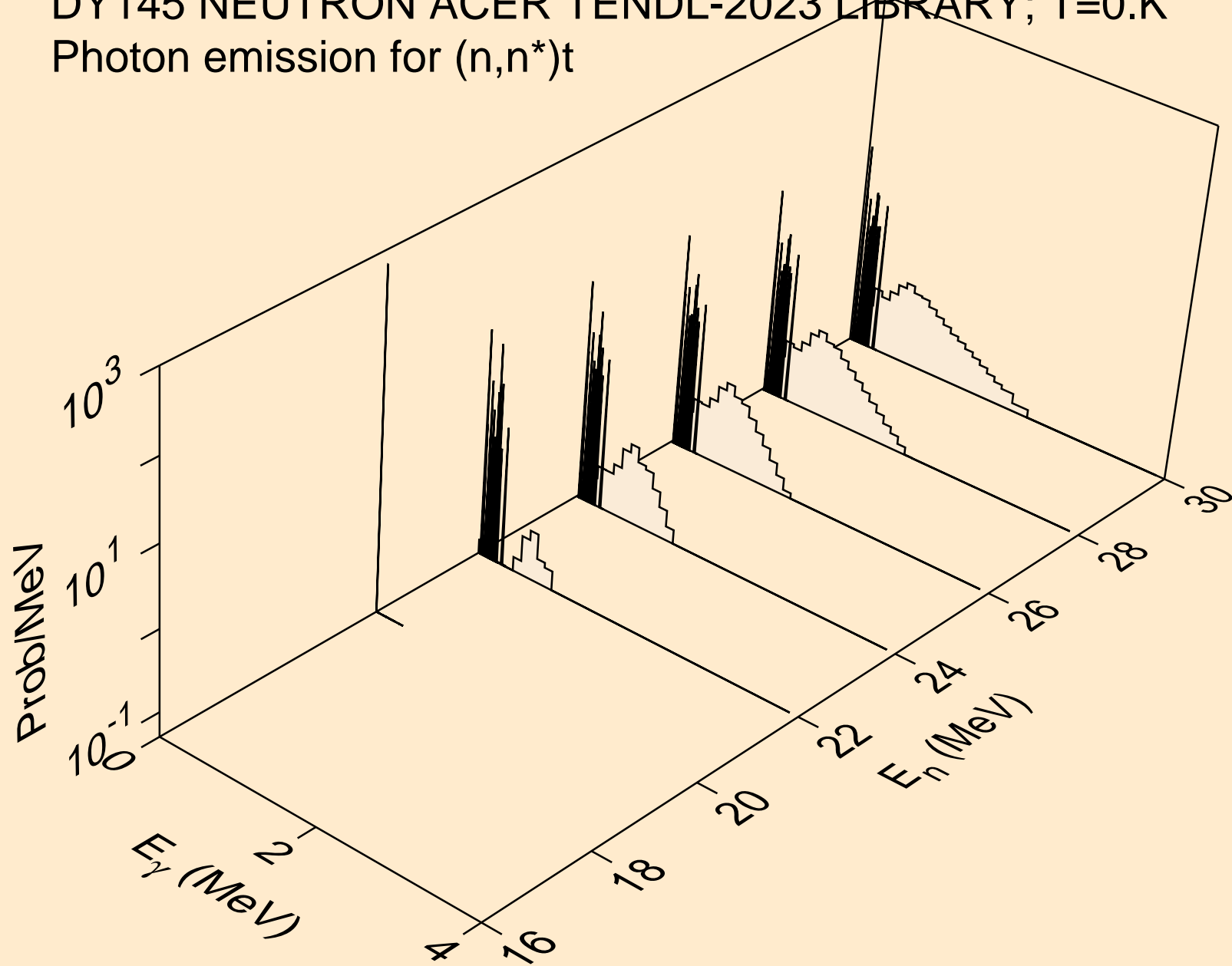

DY145 NEUTRON ACER TENDL-2023 LIBRARY; T=0.K  
Photon emission for (n,n\*)he3

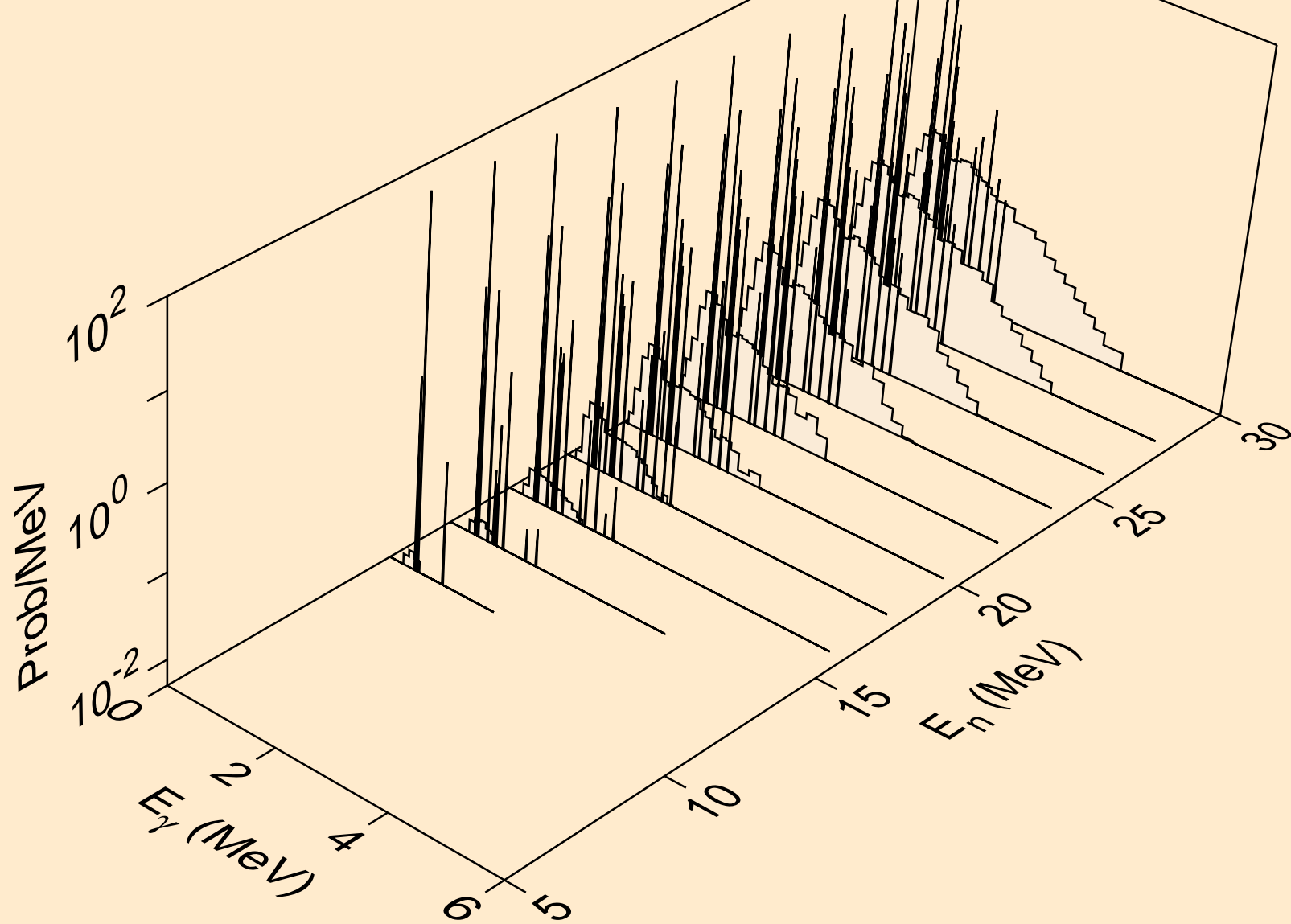

DY145 NEUTRON ACER TENDL-2023 LIBRARY; T=0.K  
Photon emission for (n,2np)

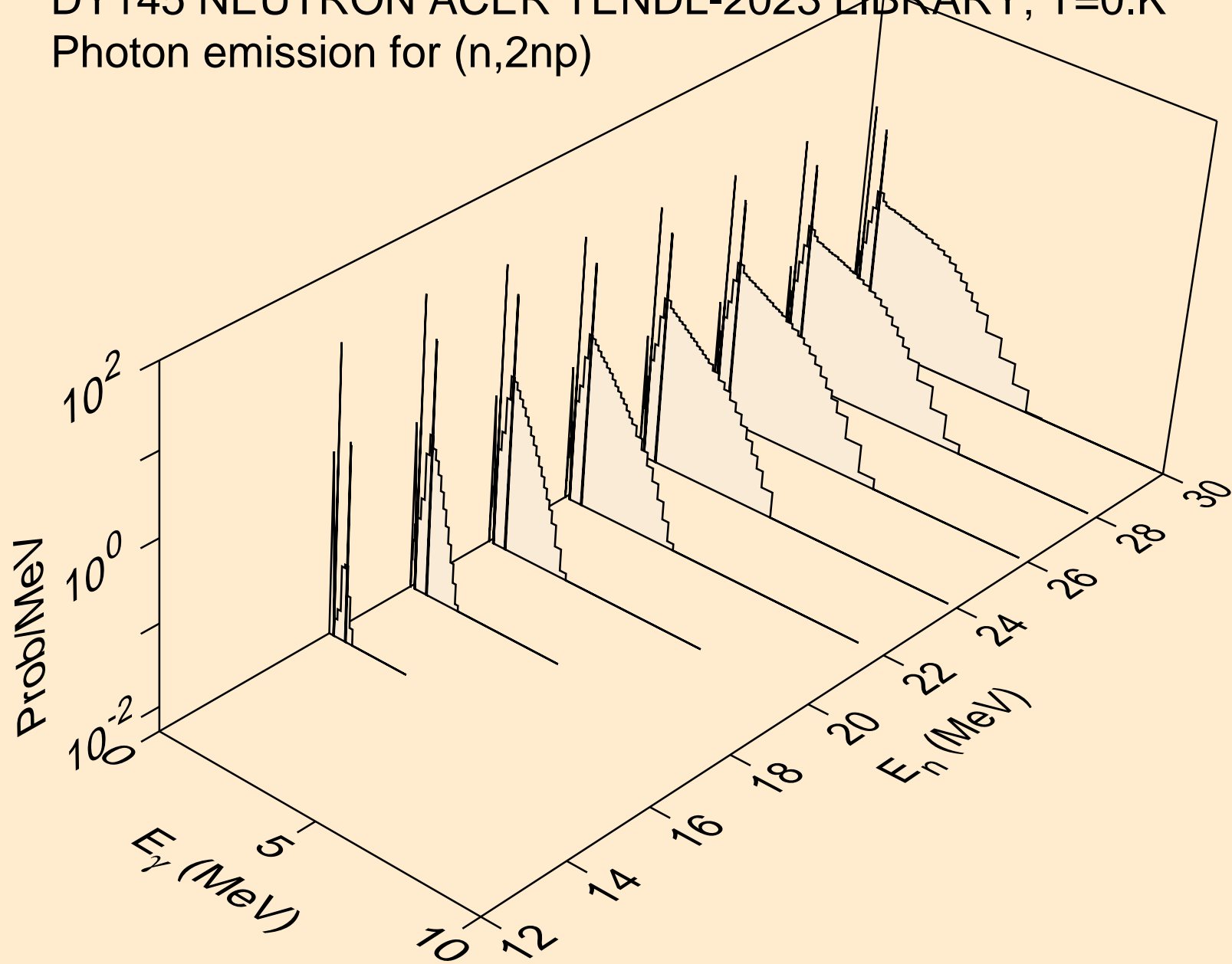

DY145 NEUTRON ACER TENDL-2023 LIBRARY; T=0.K  
Photon emission for (n,3np)

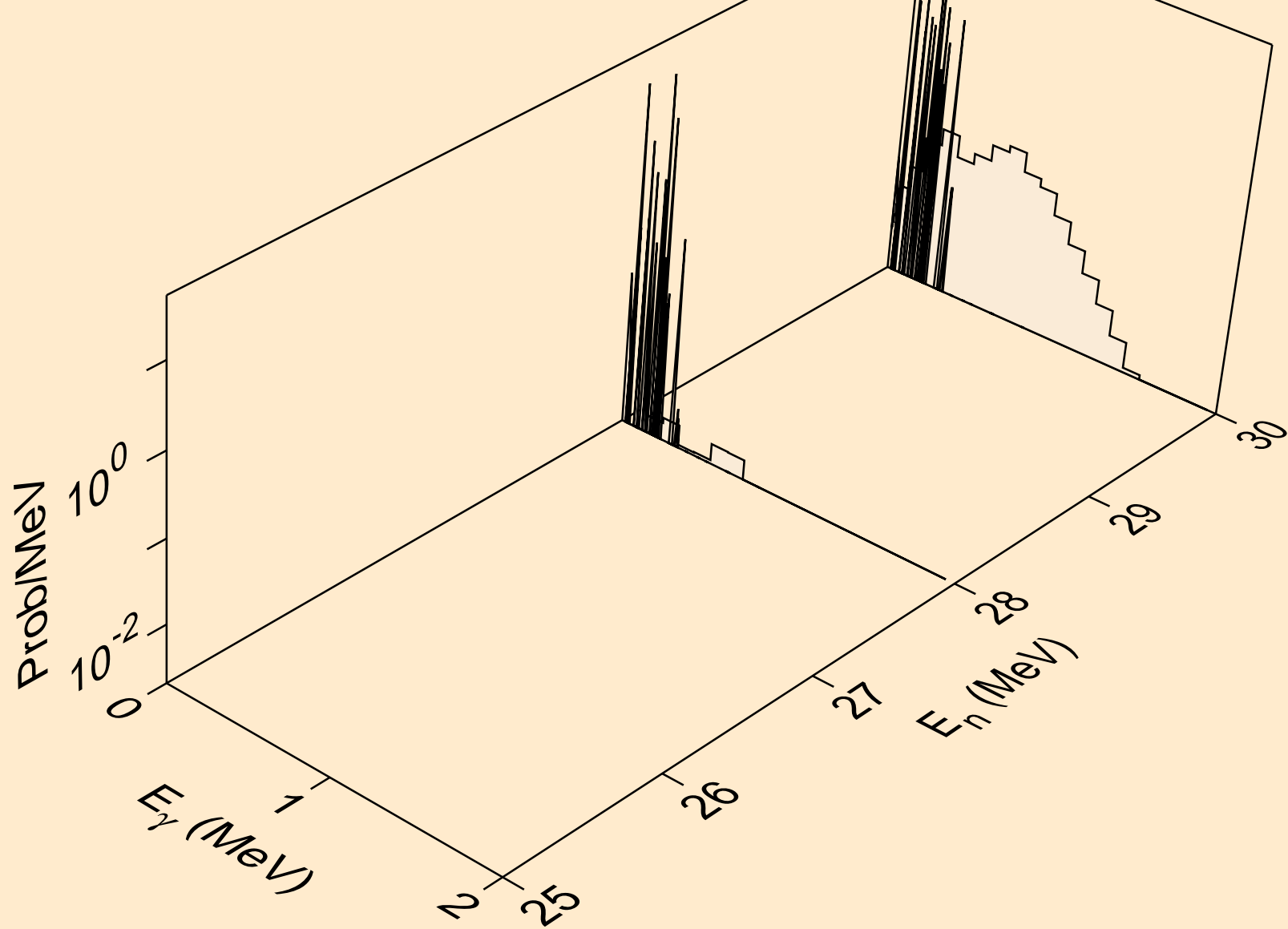



DY145 NEUTRON ACER TENDL-2023 LIBRARY; T=0.K  
Photon emission for (n,n2p)

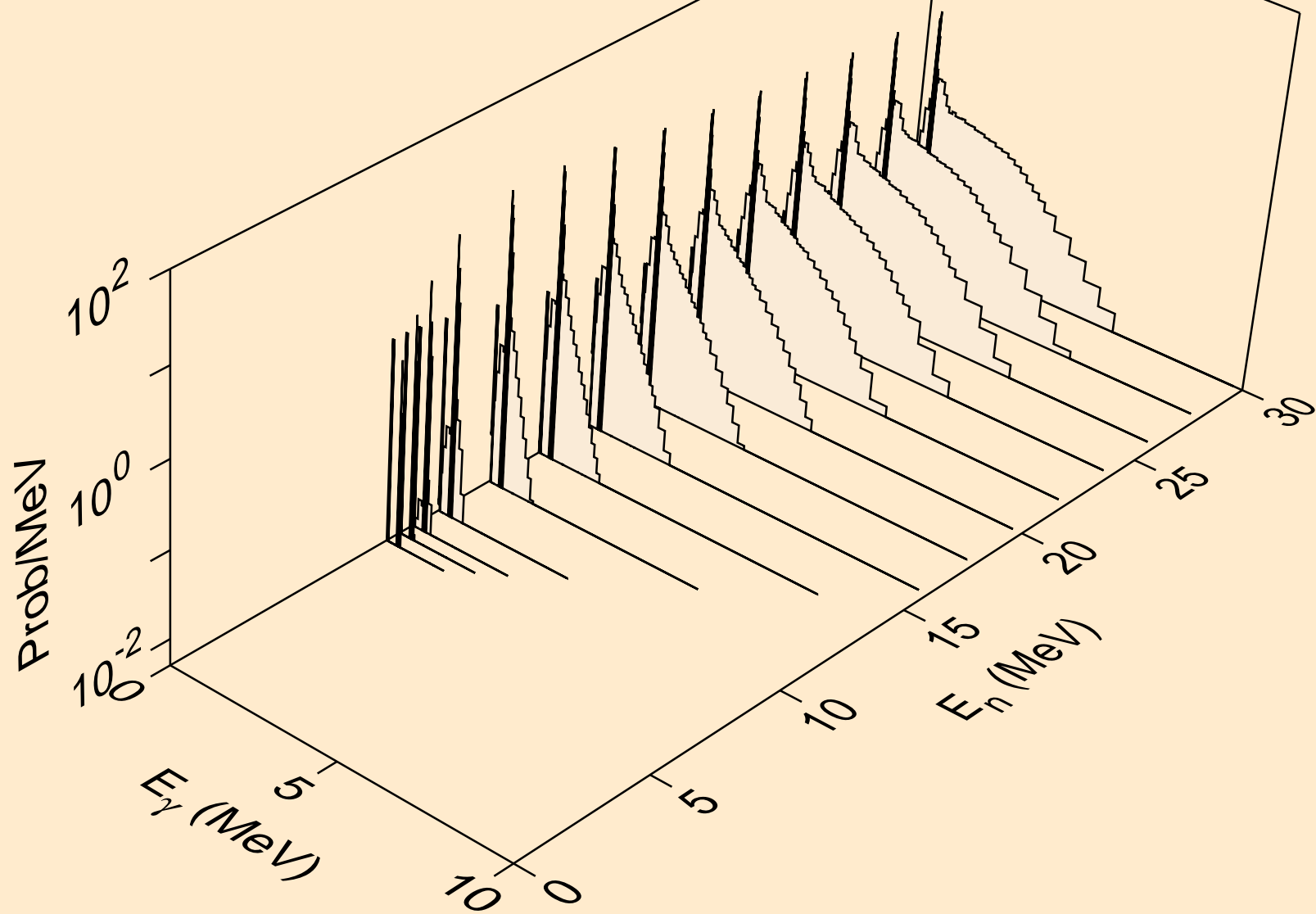

DY145 NEUTRON ACER TENDL-2023 LIBRARY; T=0.K  
Photon emission for (n,npa)

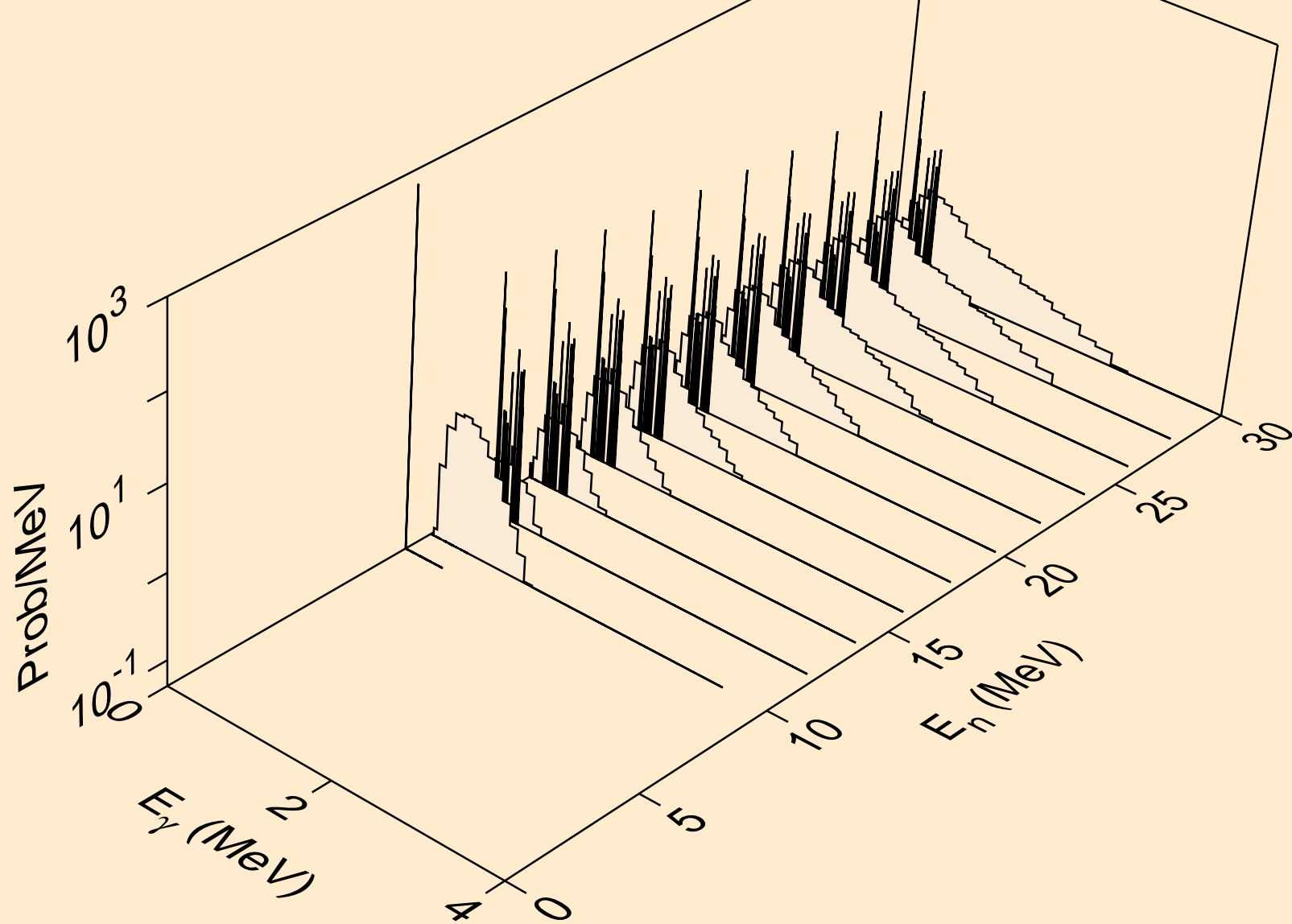

DY145 NEUTRON ACER TENDL-2023 LIBRARY; T=0.K  
Photon emission for (n,n\*c)

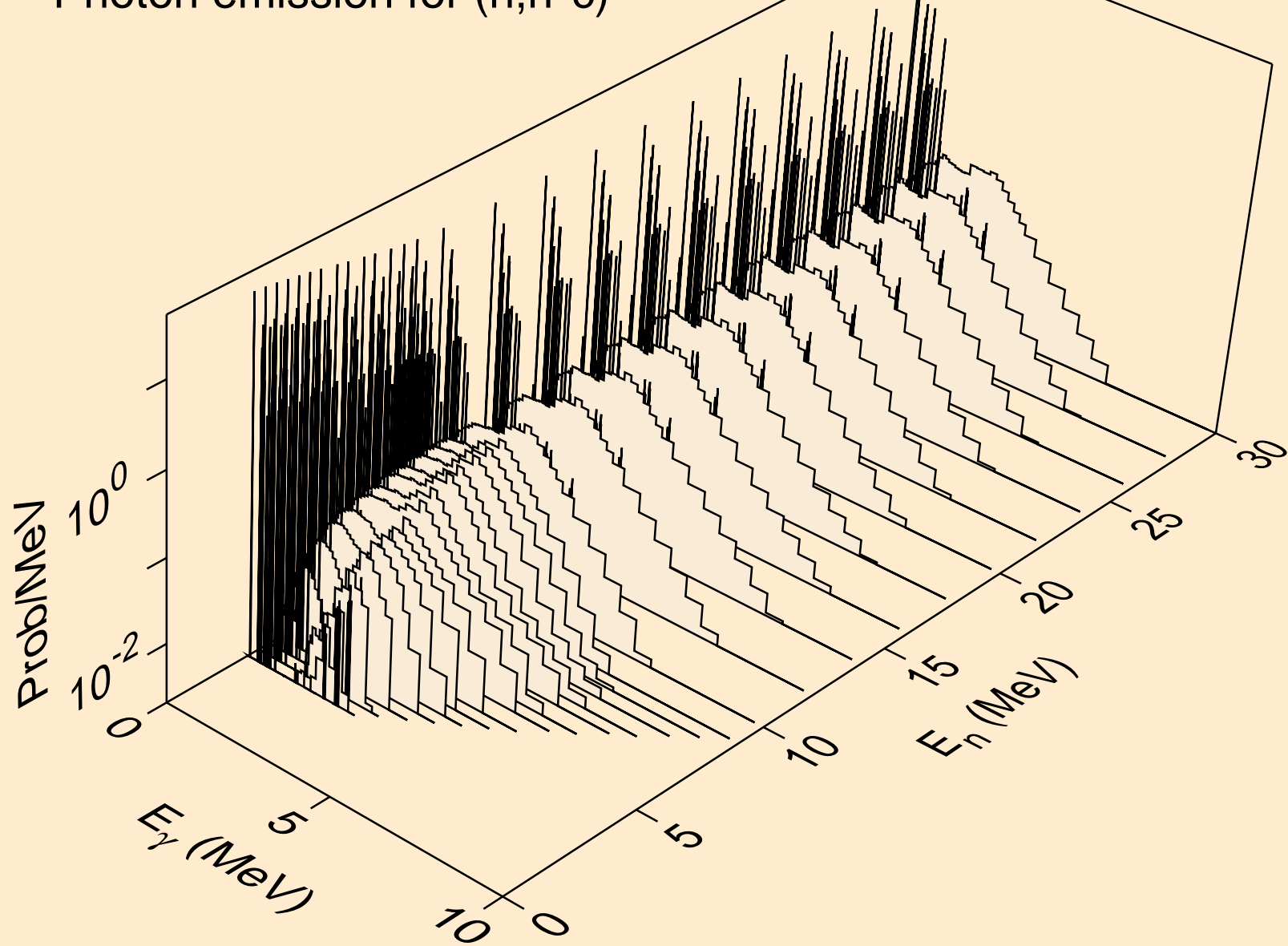

DY145 NEUTRON ACER TENDL-2023 LIBRARY; T=0.K  
Photon emission for (n,gma)

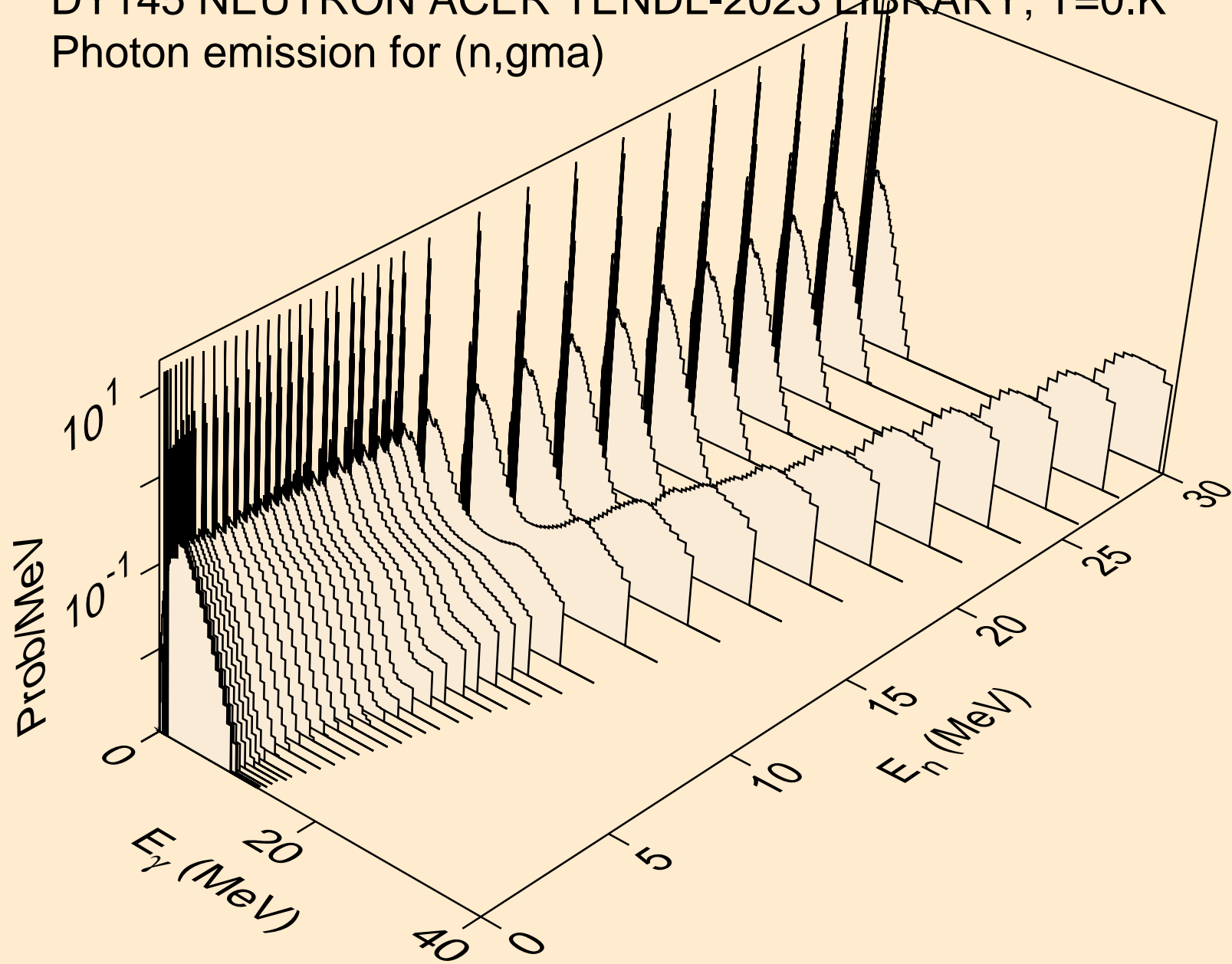

DY145 NEUTRON ACER TENDL-2023 LIBRARY; T=0.K  
Photon emission for (n,p)

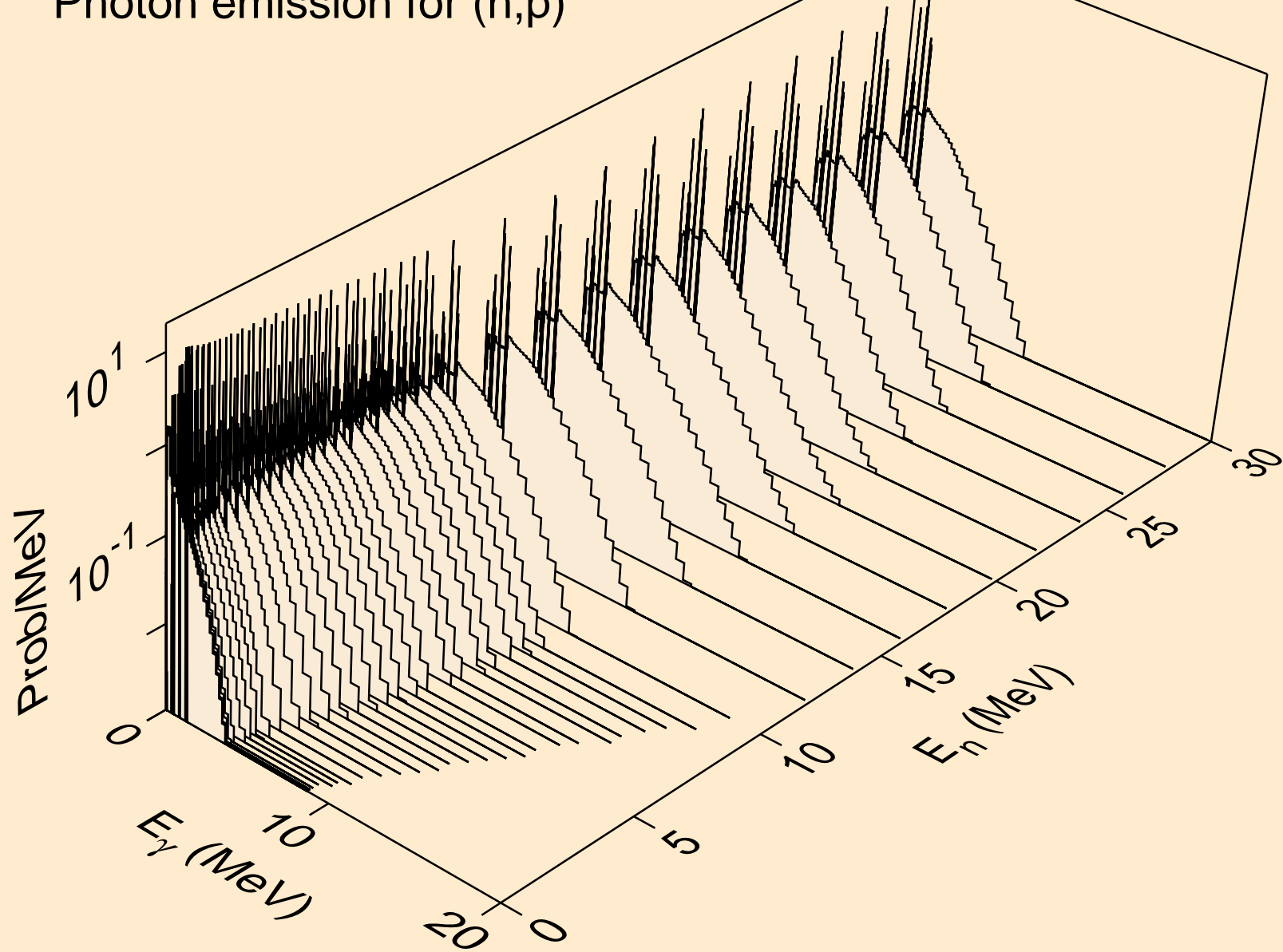

DY145 NEUTRON ACER TENDL-2023 LIBRARY; T=0.K  
Photon emission for (n,d)

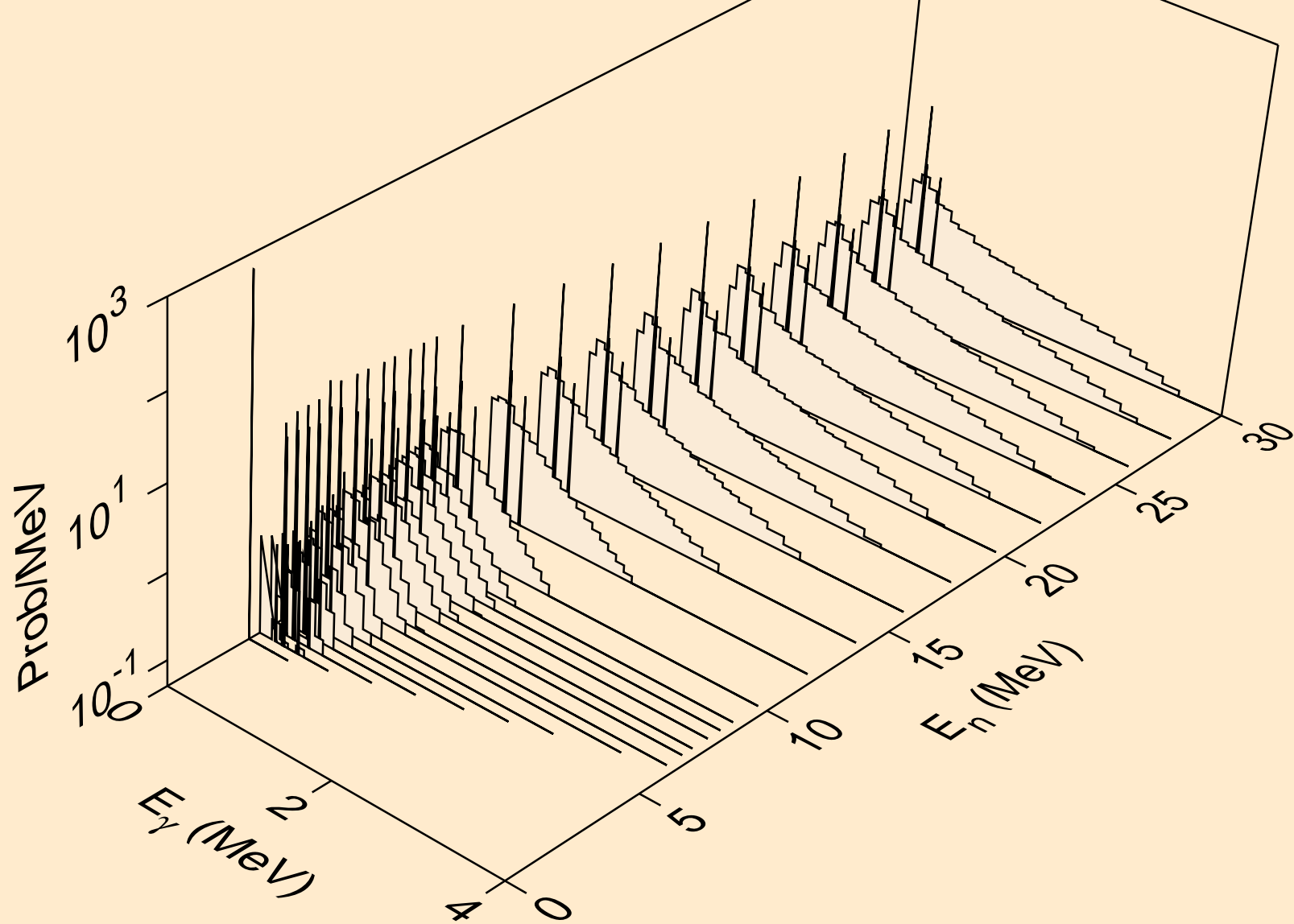

DY145 NEUTRON ACER TENDL-2023 LIBRARY; T=0.K  
Photon emission for (n,t)

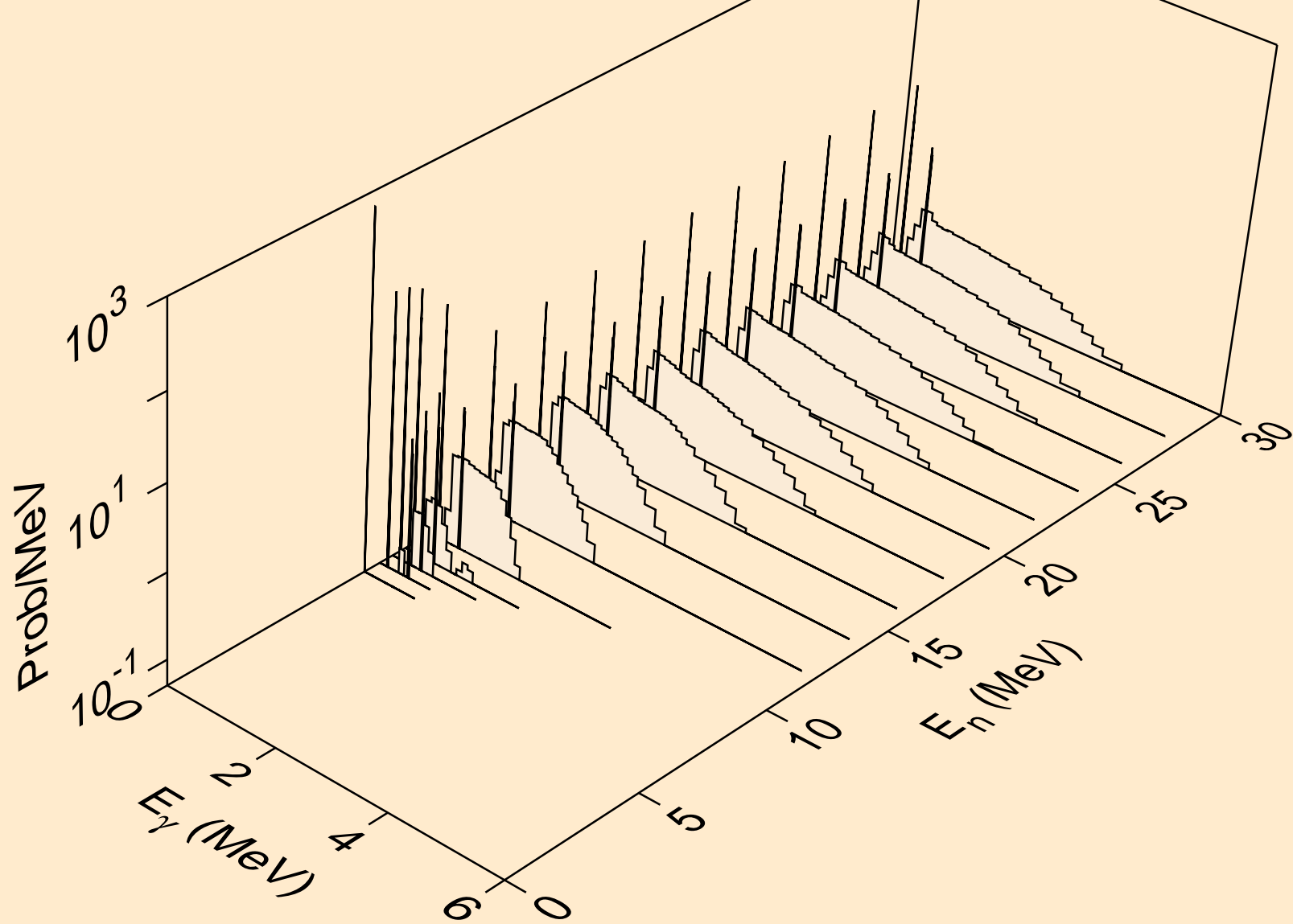

DY145 NEUTRON ACER TENDL-2023 LIBRARY; T=0.K  
Photon emission for (n,he3)

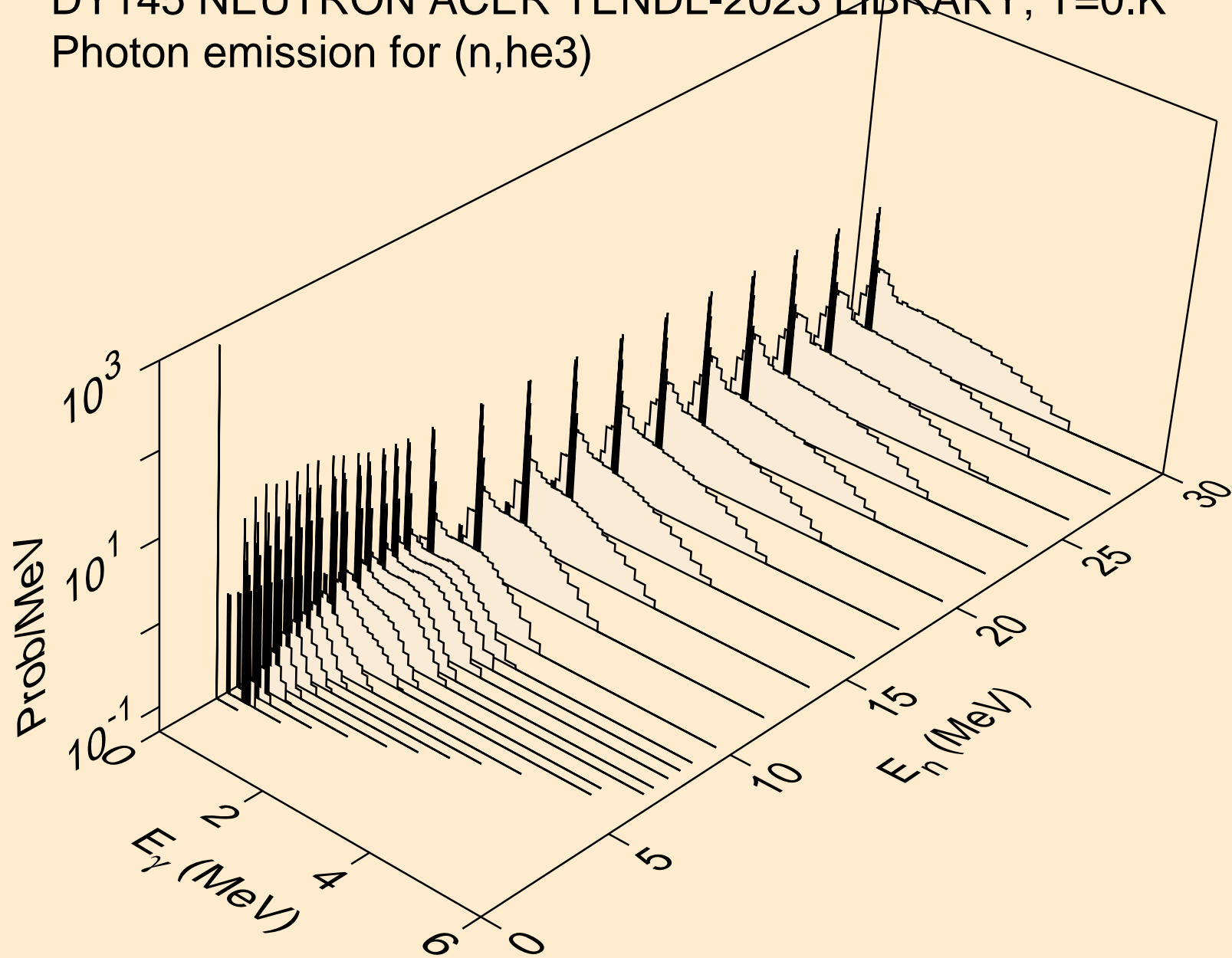



DY145 NEUTRON ACER TENDL-2023 LIBRARY; T=0.K  
Photon emission for (n,a)

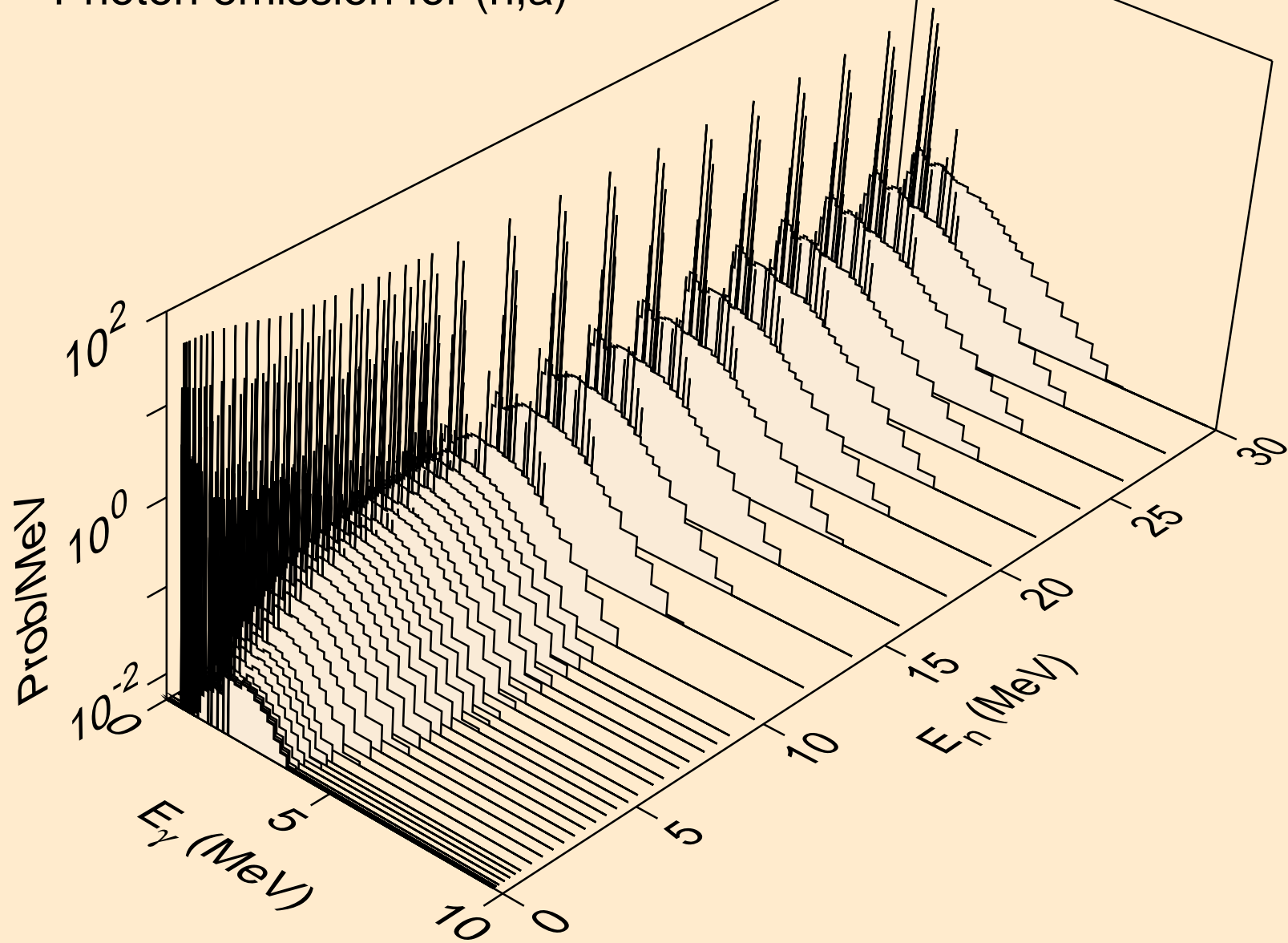

DY145 NEUTRON ACER TENDL-2023 LIBRARY; T=0.K  
Photon emission for (n,2a)

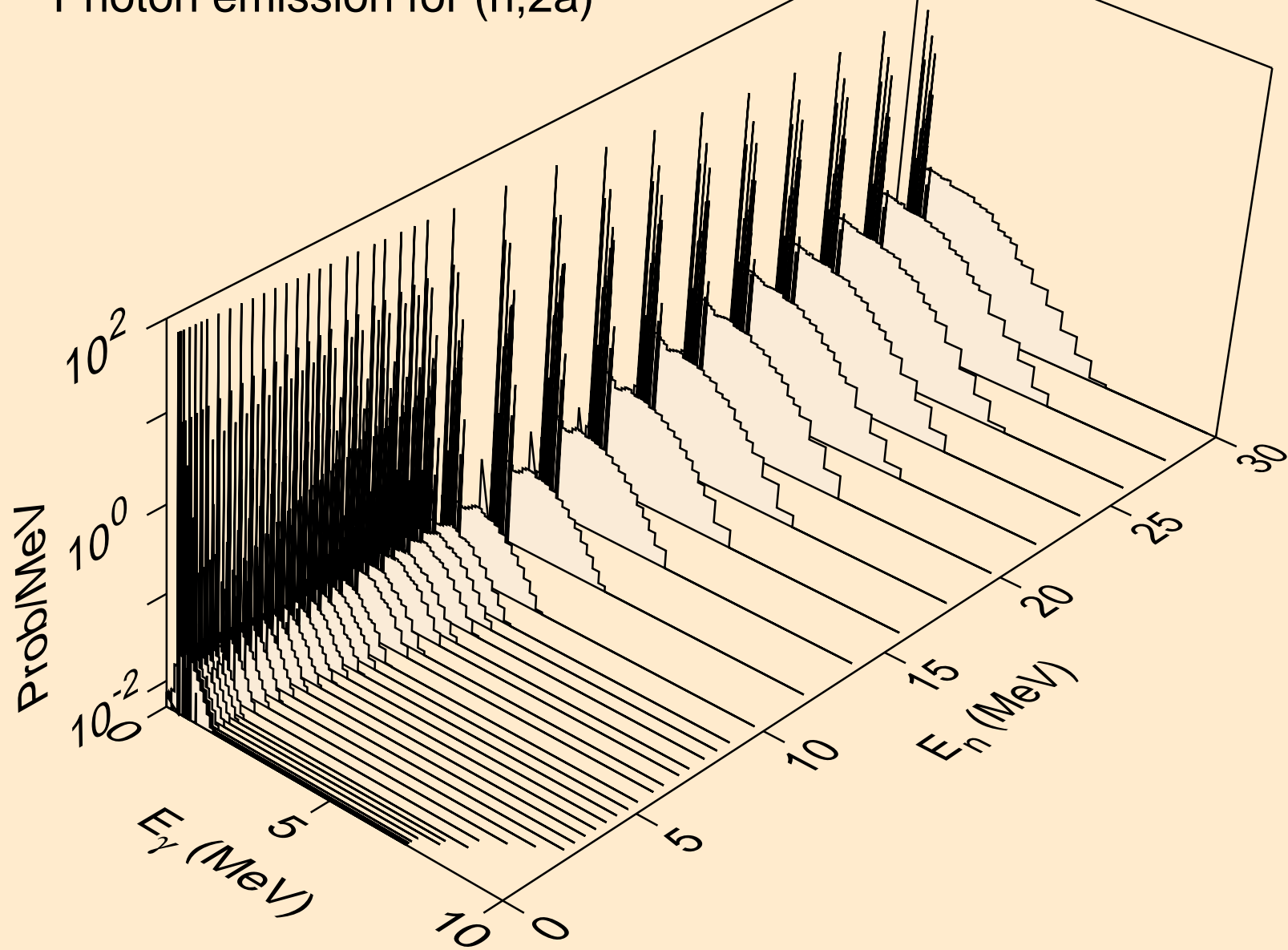

DY145 NEUTRON ACER TENDL-2023 LIBRARY; T=0.K  
Photon emission for (n,3a)

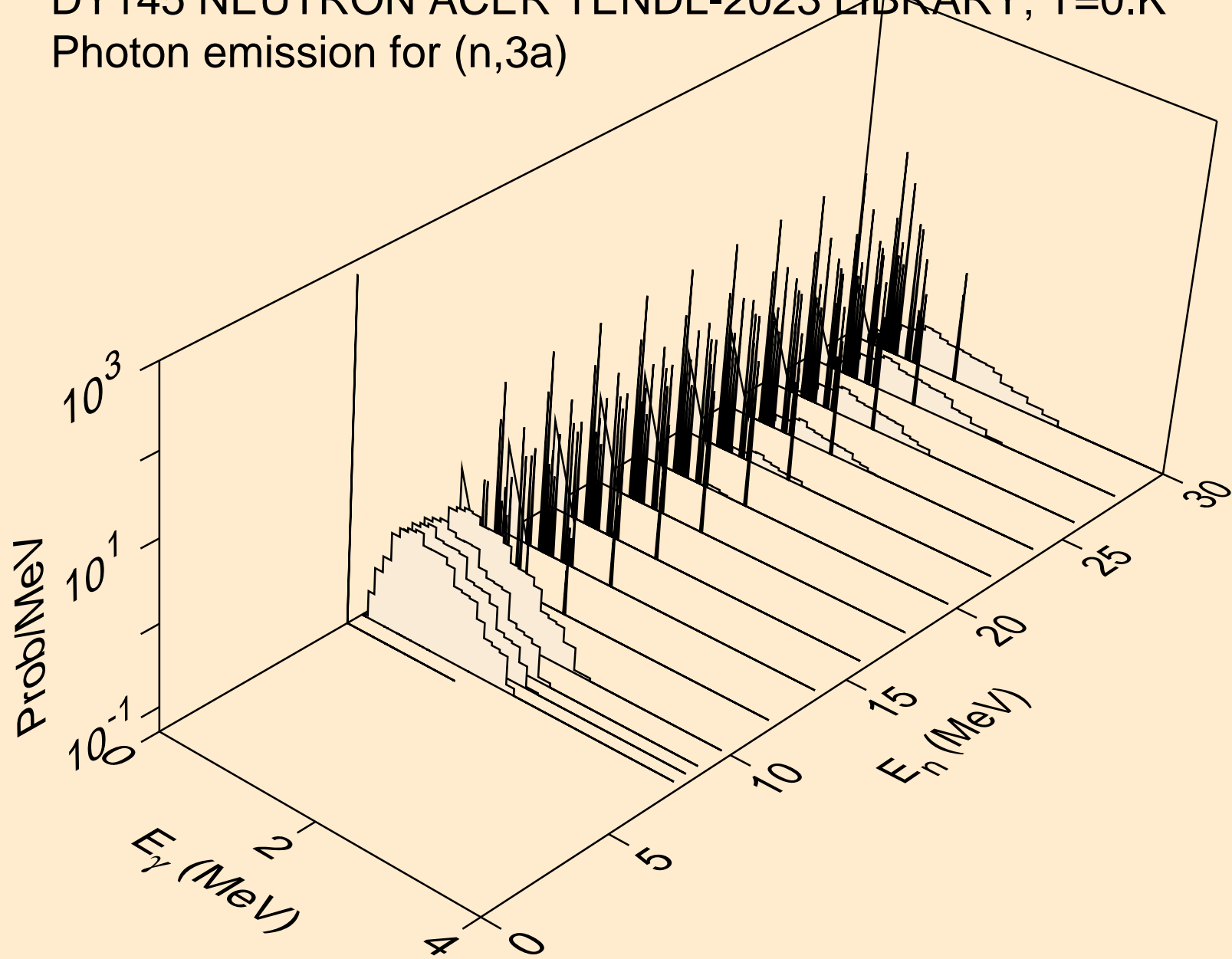

DY145 NEUTRON ACER TENDL-2023 LIBRARY; T=0.K  
Photon emission for (n,2p)

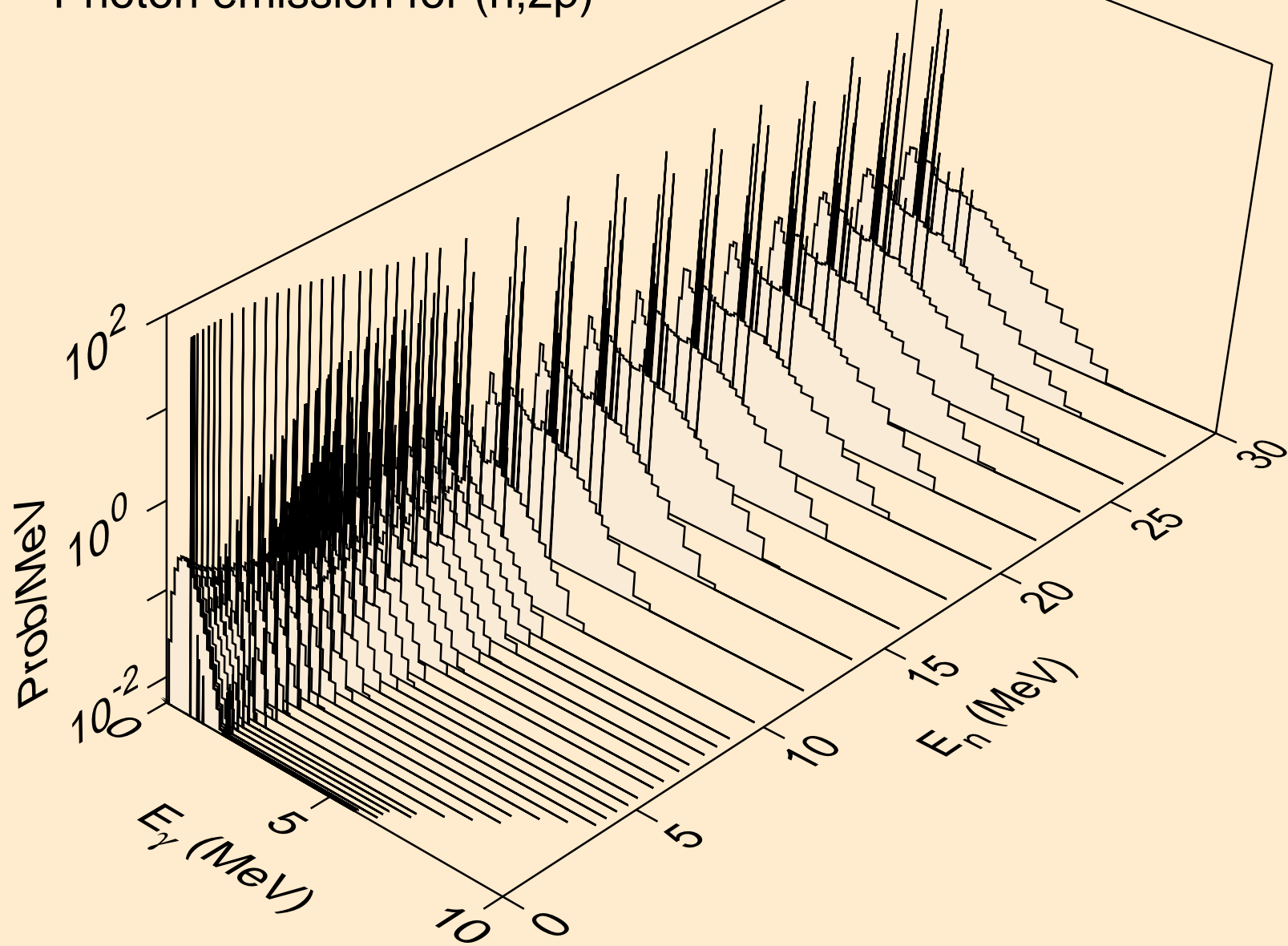

DY145 NEUTRON ACER TENDL-2023 LIBRARY; T=0.K  
Photon emission for (n,p)

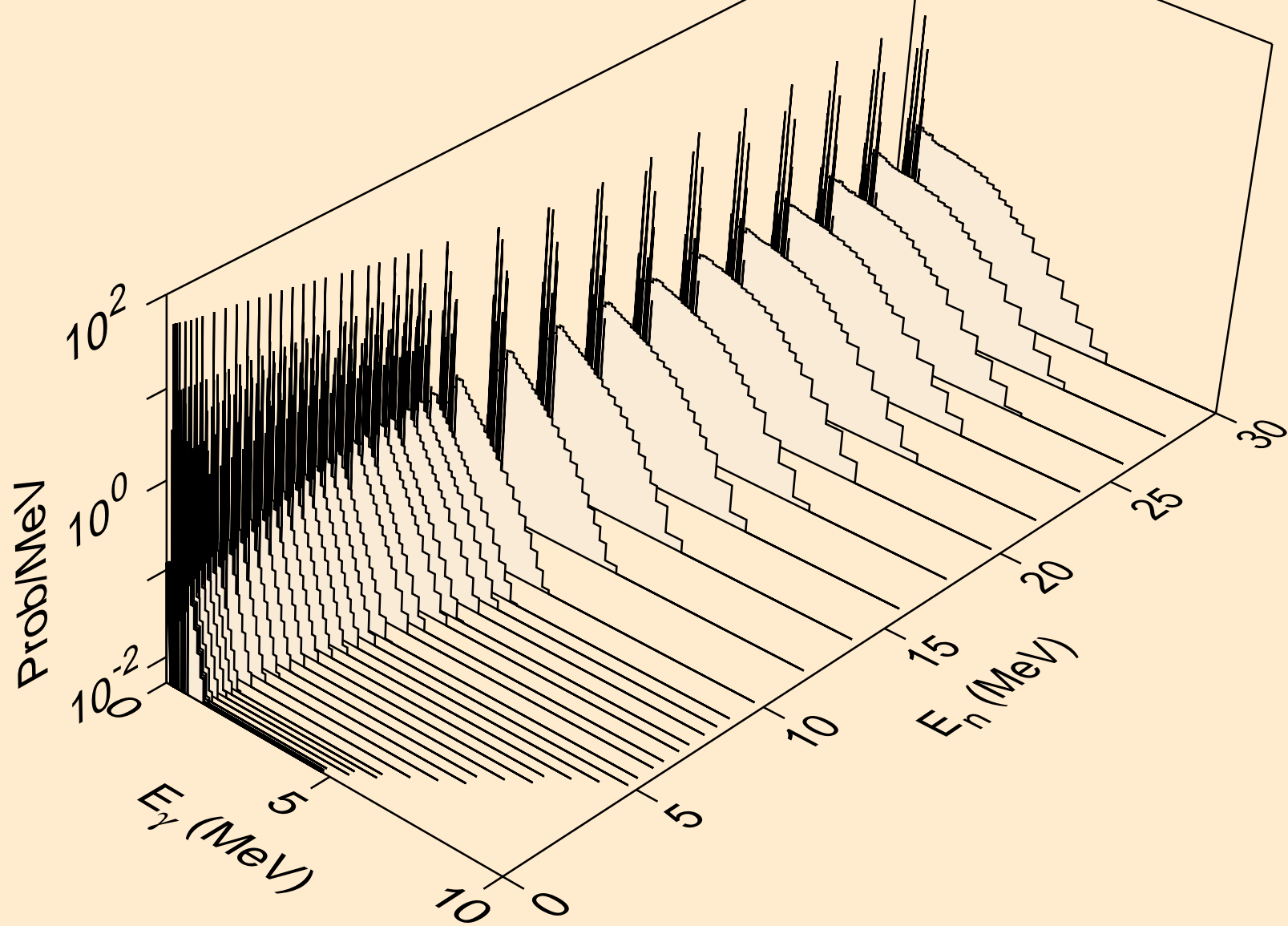

DY145 NEUTRON ACER TENDL-2023 LIBRARY; T=0.K  
Photon emission for (n,pd)

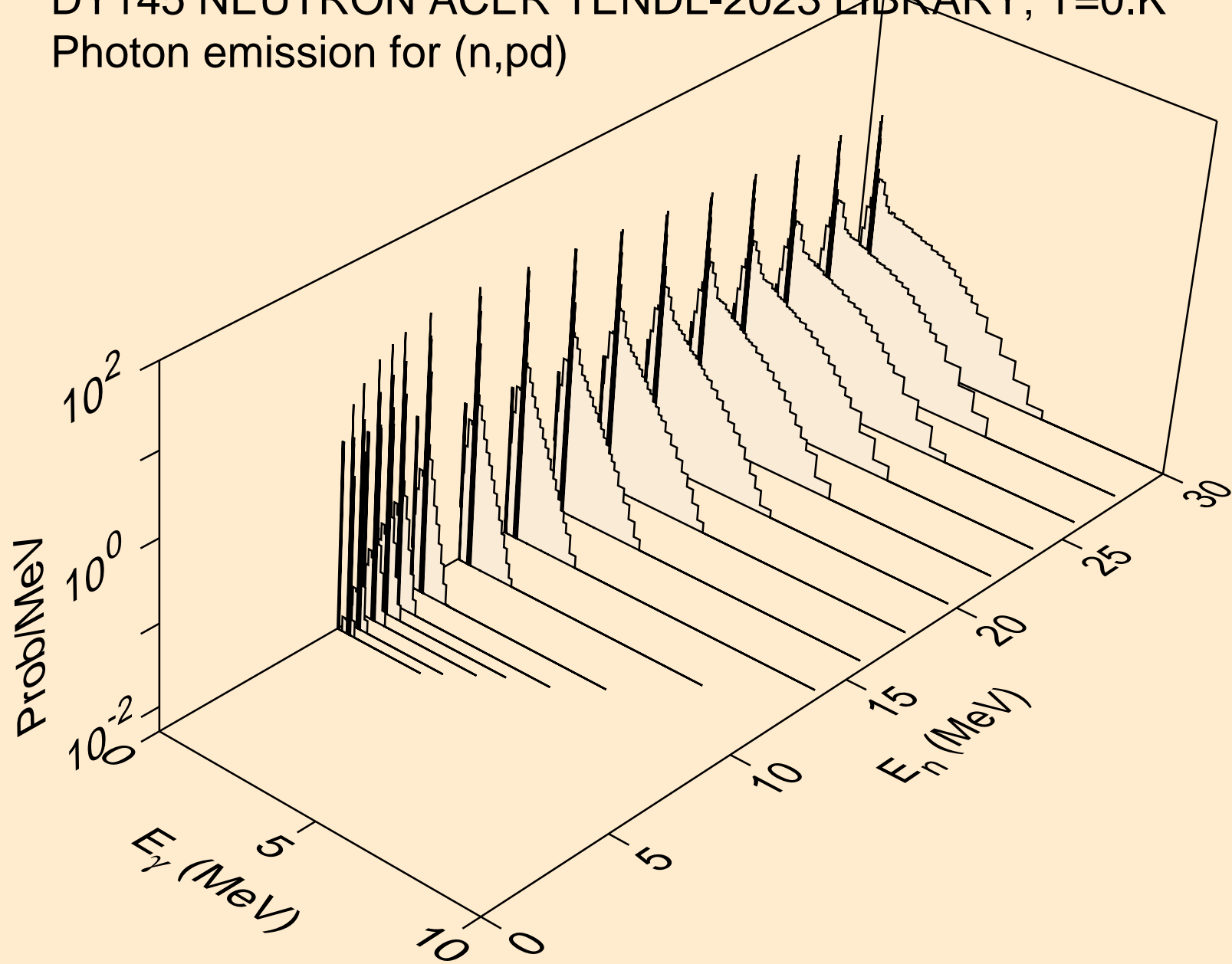

DY145 NEUTRON ACER TENDL-2023 LIBRARY; T=0.K  
Photon emission for (n,pt)

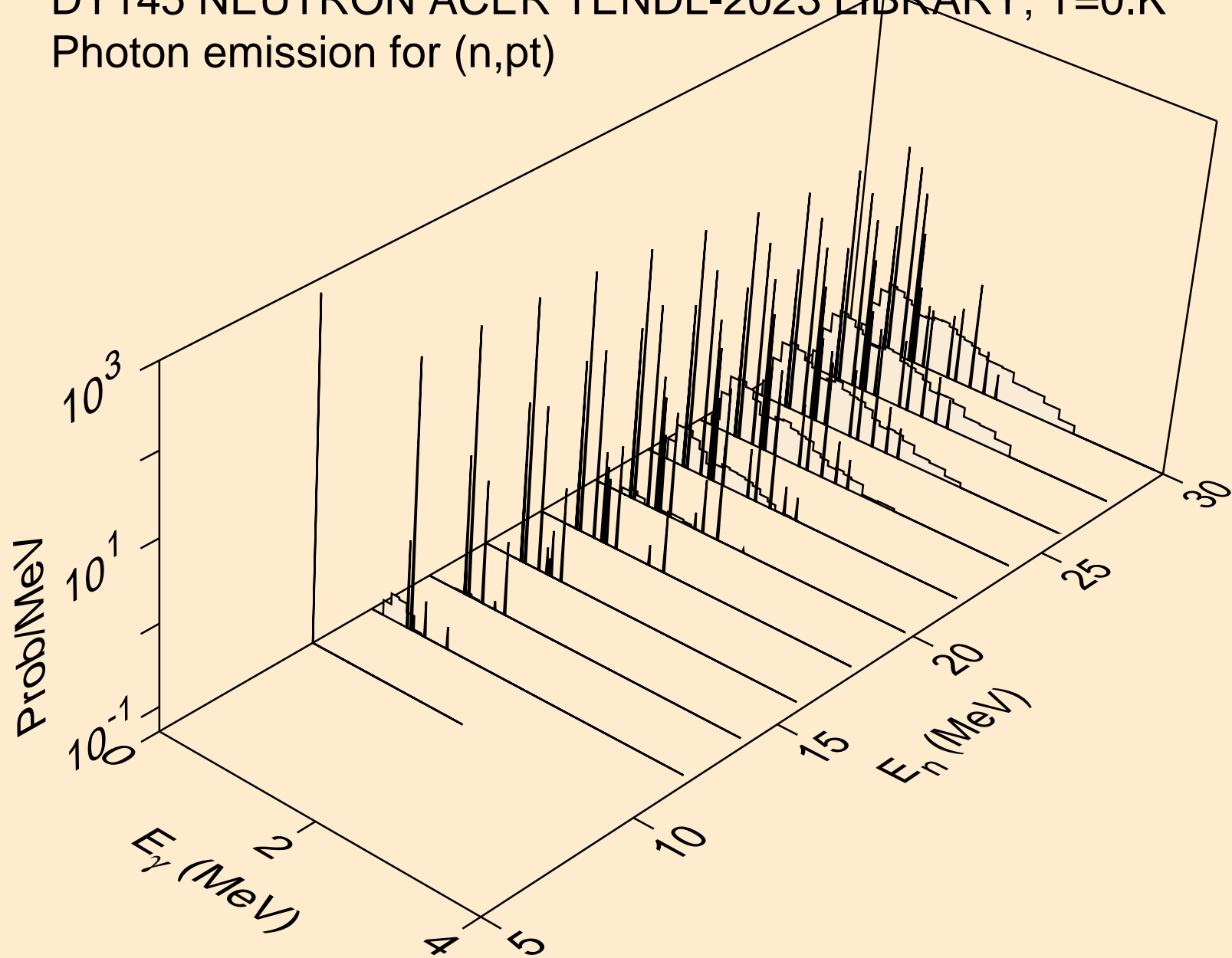

DY145 NEUTRON ACER TENDL-2023 LIBRARY; T=0.K  
Photon emission for (n,da)

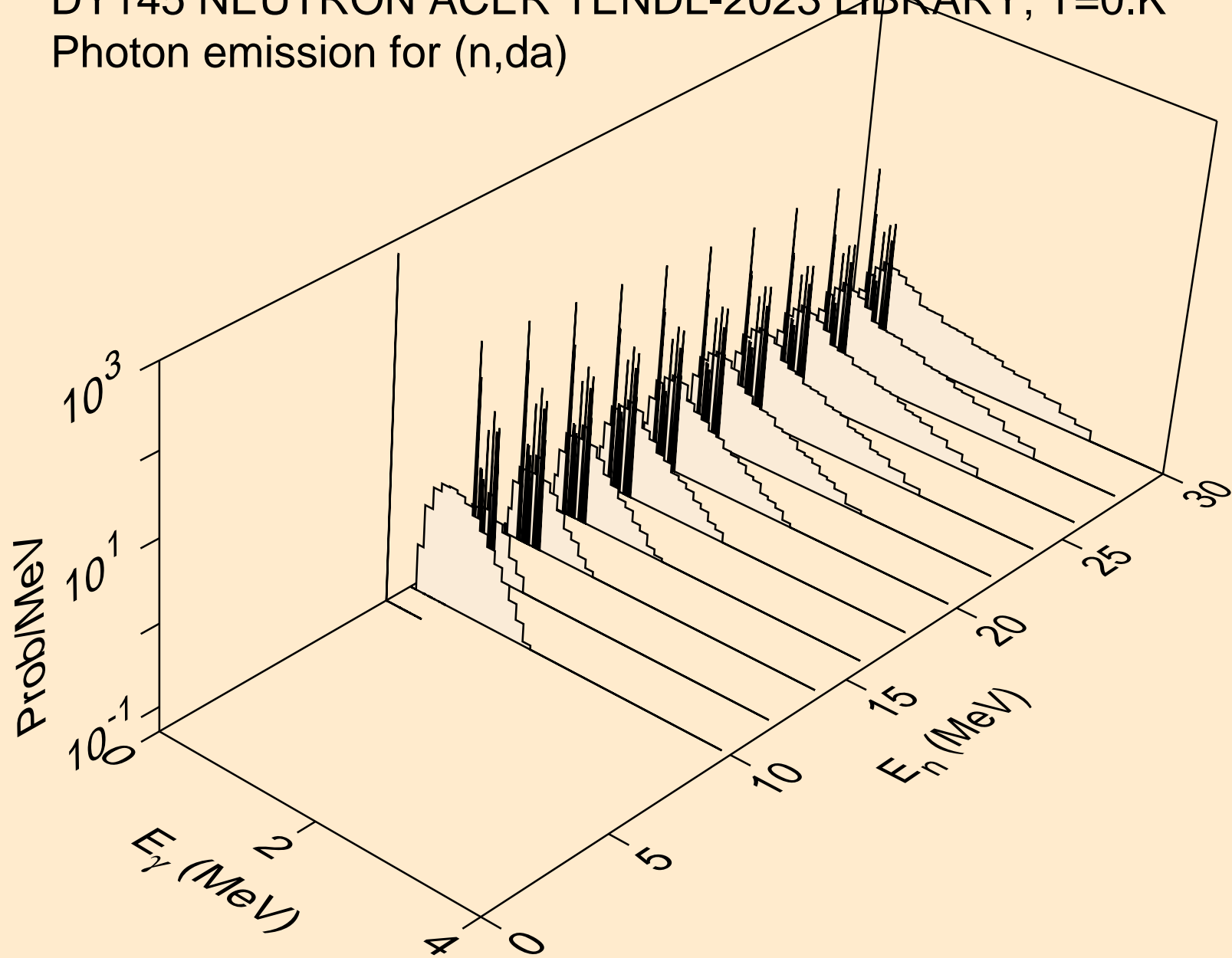



DY145 NEUTRON ACER TENDL-2023 LIBRARY; T=0.K  
thermal capture photon spectrum

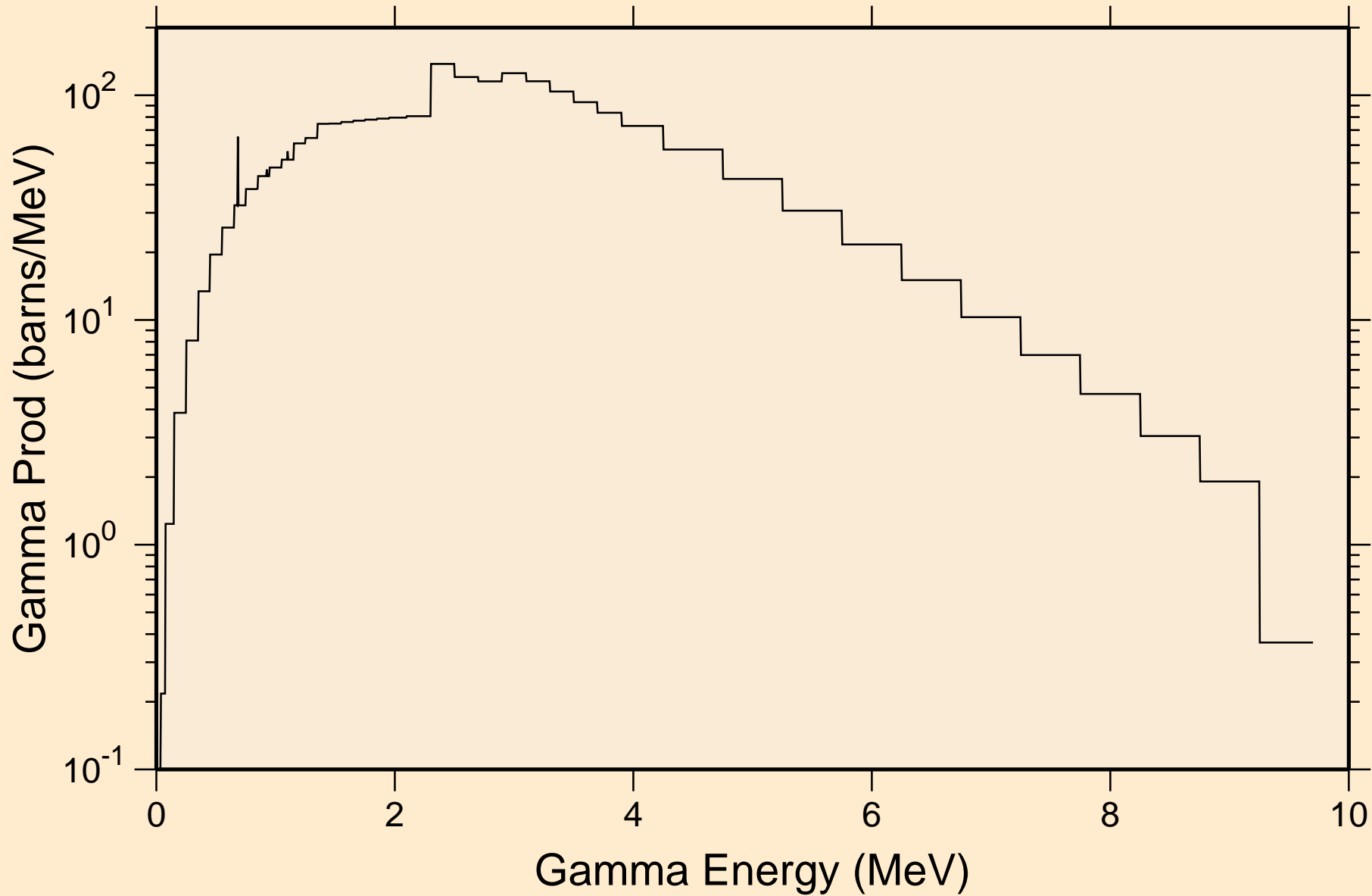

DY145 NEUTRON ACER TENDL-2023 LIBRARY; T=0.K  
14 MeV photon spectrum

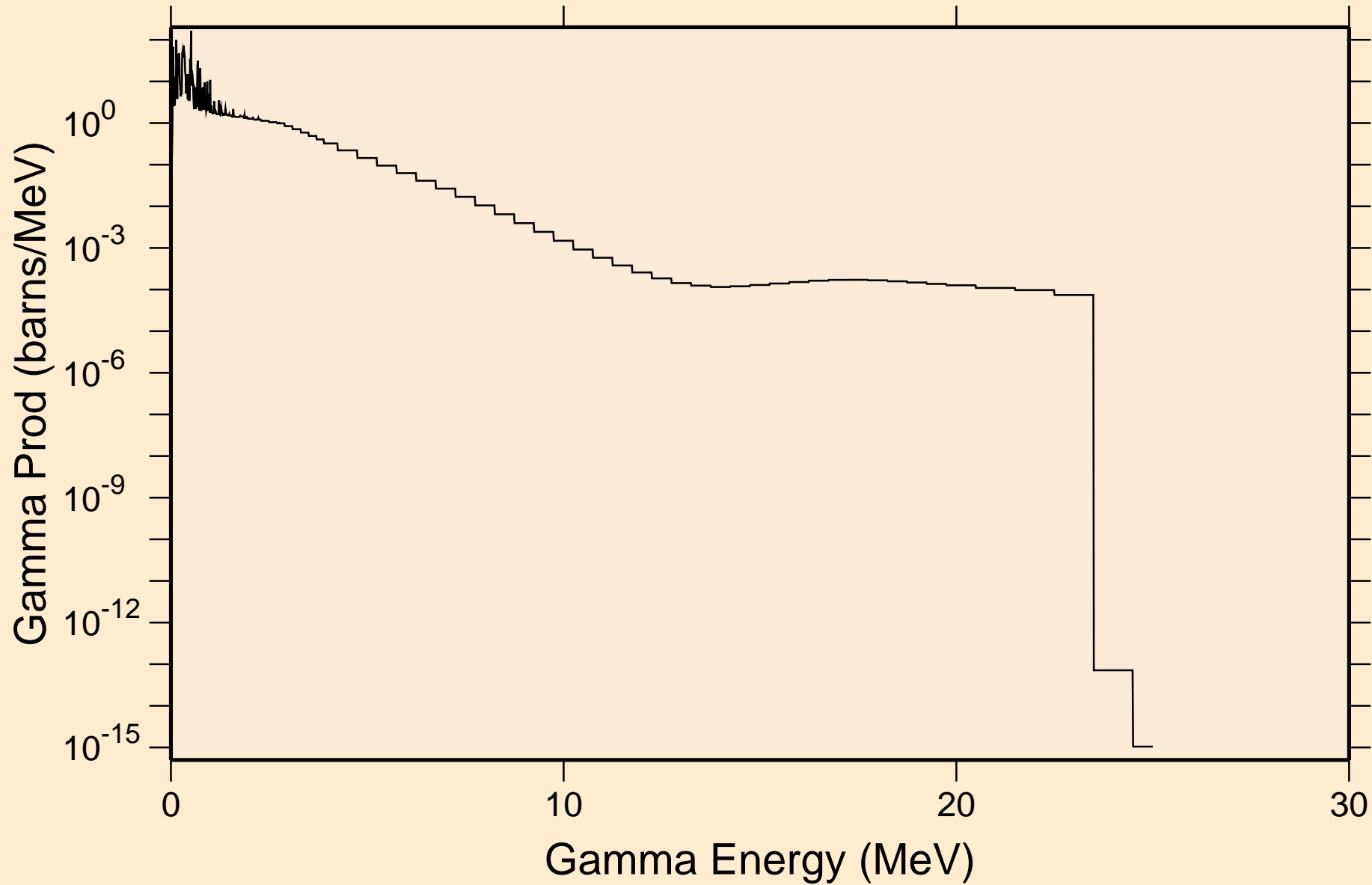

# DY145 NEUTRON ACER TENDL-2023 LIBRARY; T=0.K

## Particle heating contributions

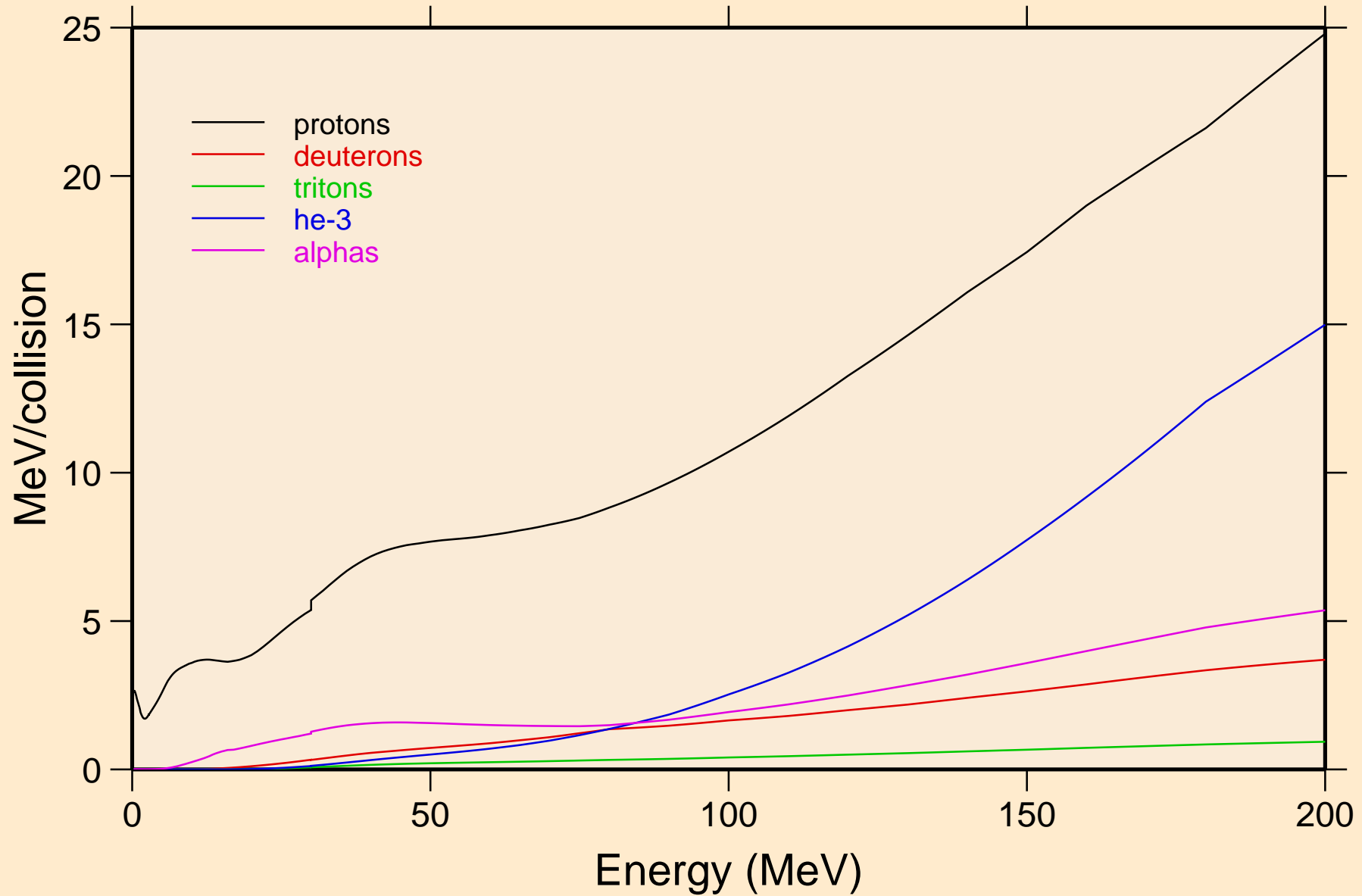

DY145 NEUTRON ACER TENDL-2023 LIBRARY; T=0.K  
Recoil Heating

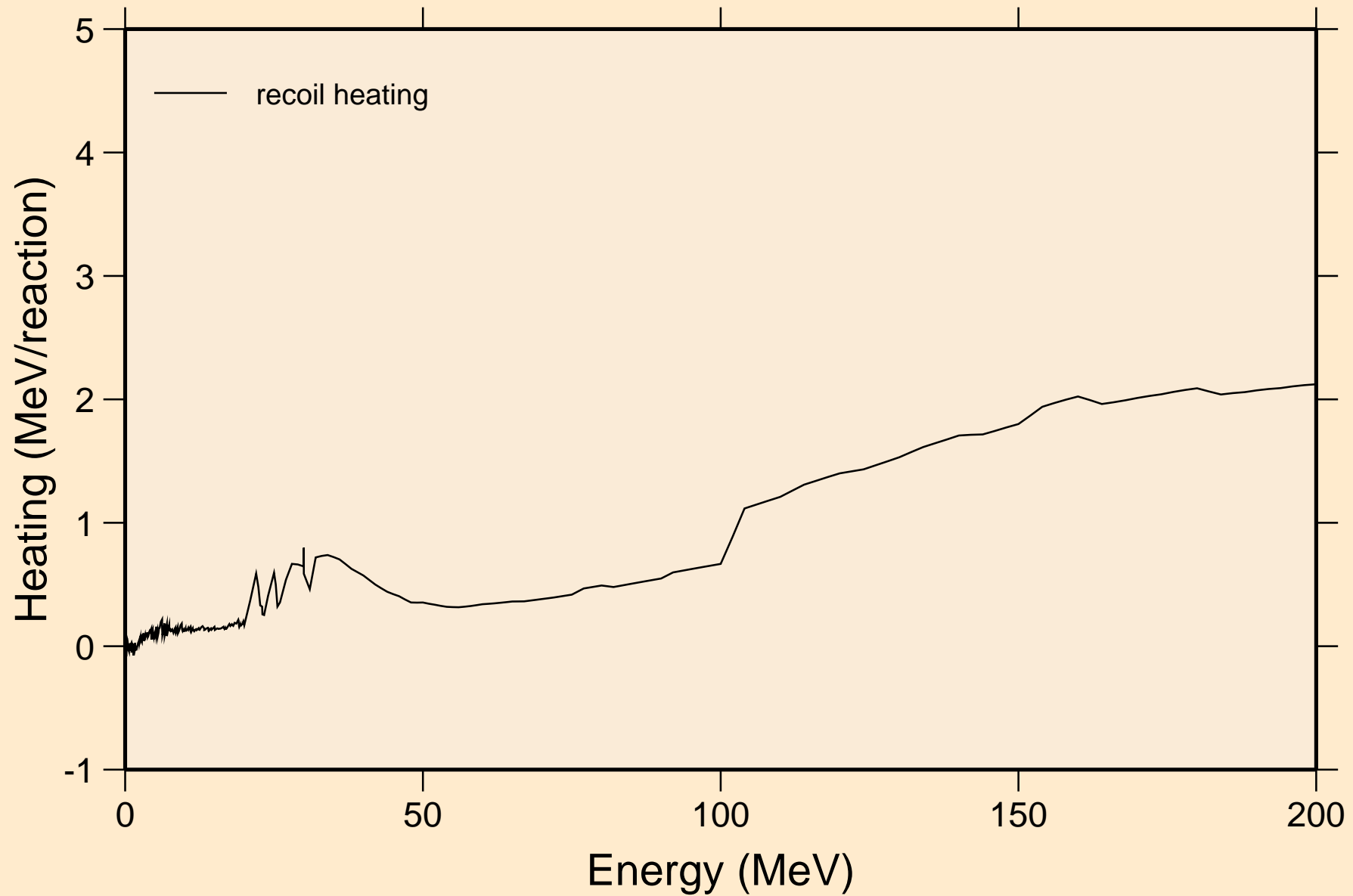

# DY145 NEUTRON ACER TENDL-2023 LIBRARY; T=0.K

## Particle production cross sections

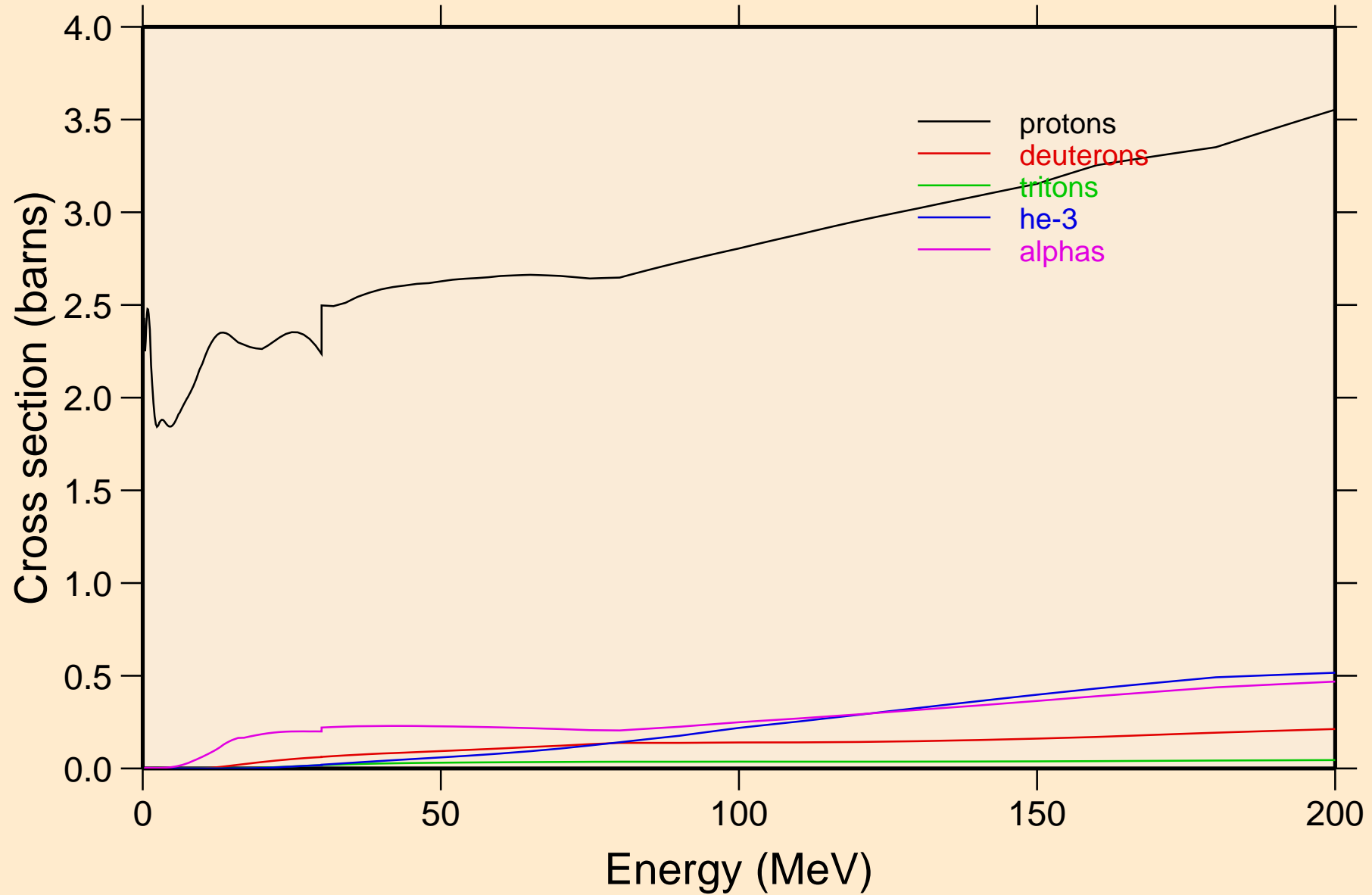

DY145 NEUTRON ACER TENDL-2023 LIBRARY; T=0.K  
protons from (n,x)

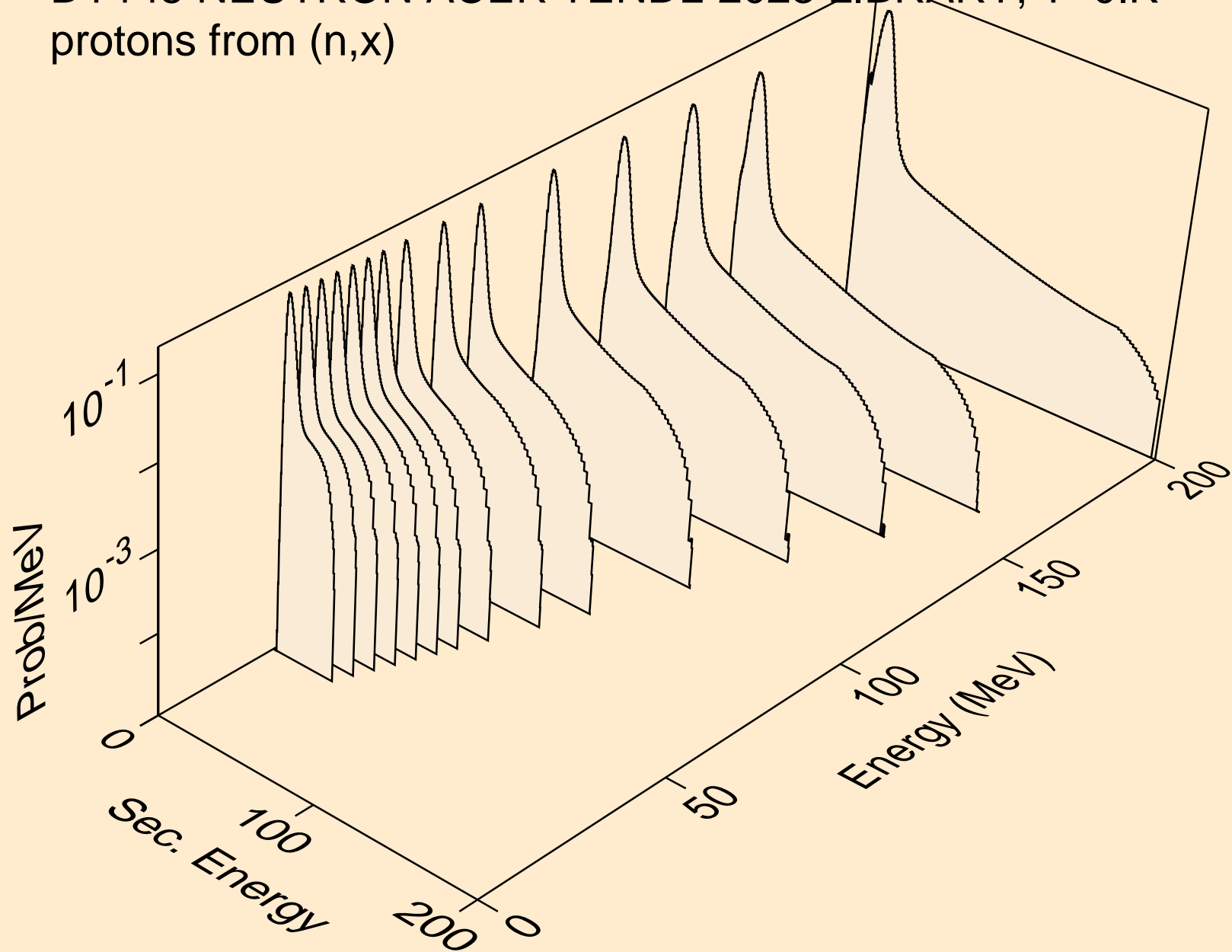

DY145 NEUTRON ACER TENDL-2023 LIBRARY; T=0.K  
protons from (n,n\*)p

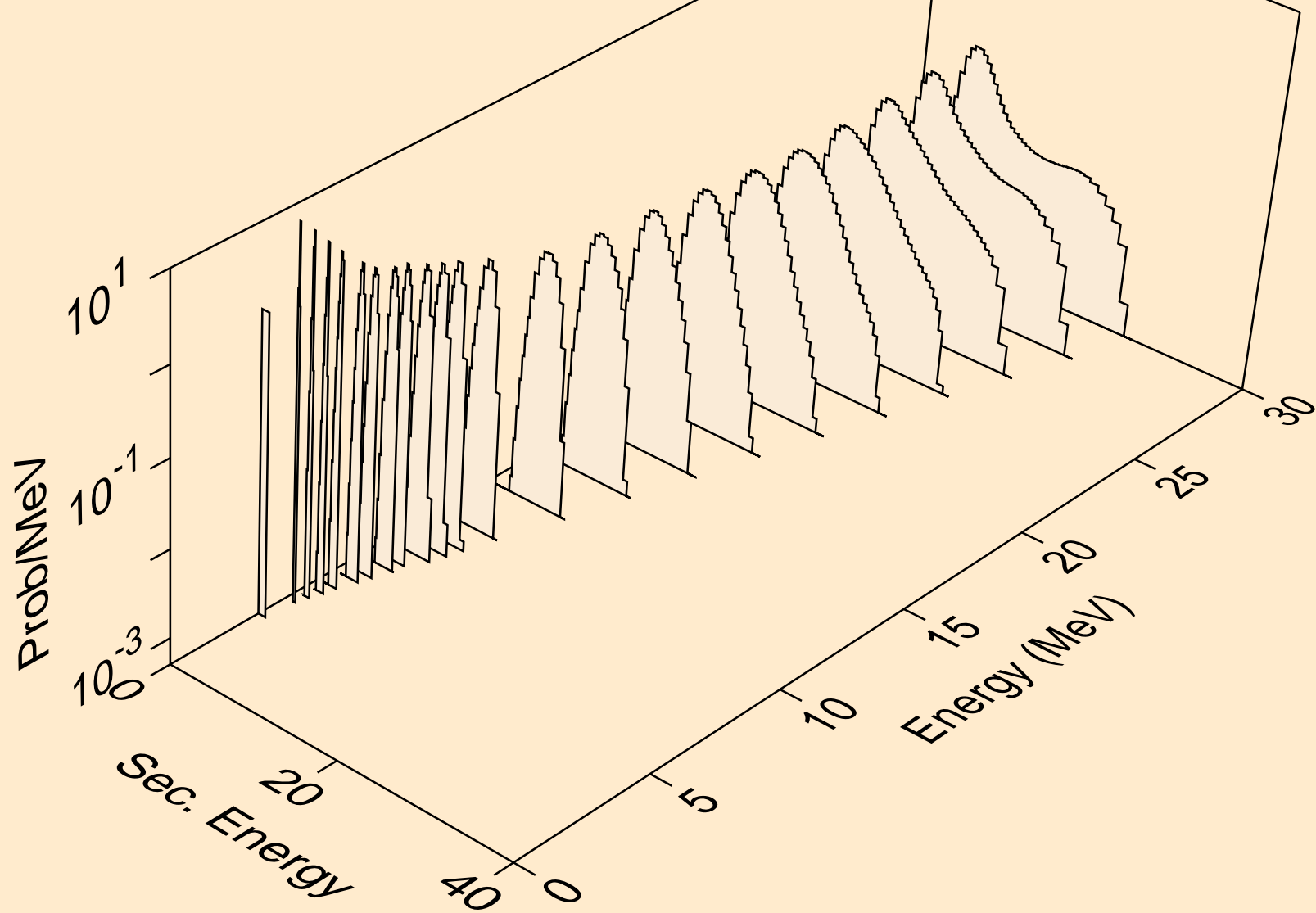

DY145 NEUTRON ACER TENDL-2023 LIBRARY; T=0.K  
protons from (n,2np)

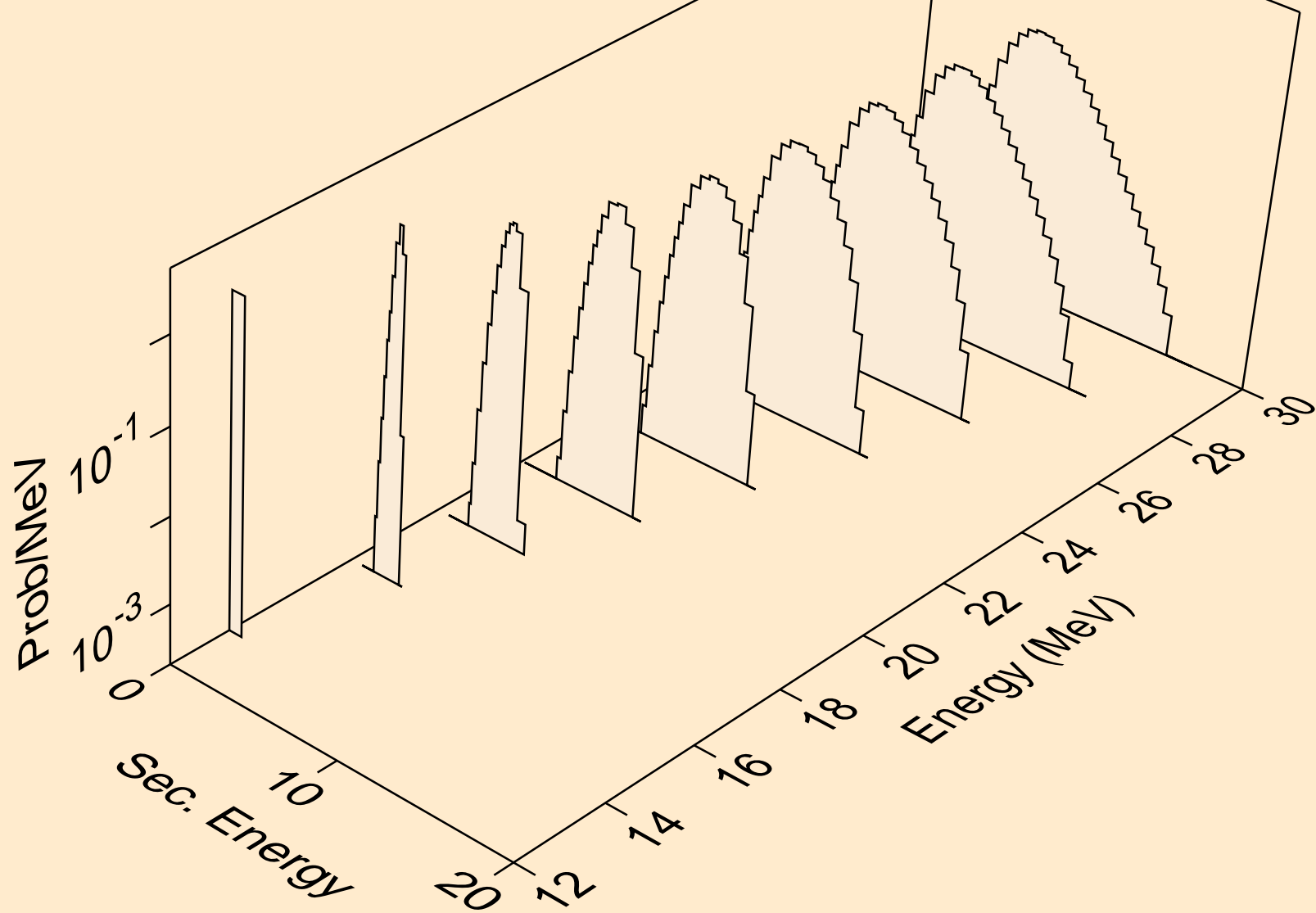



DY145 NEUTRON ACER TENDL-2023 LIBRARY; T=0.K  
protons from (n,3np)

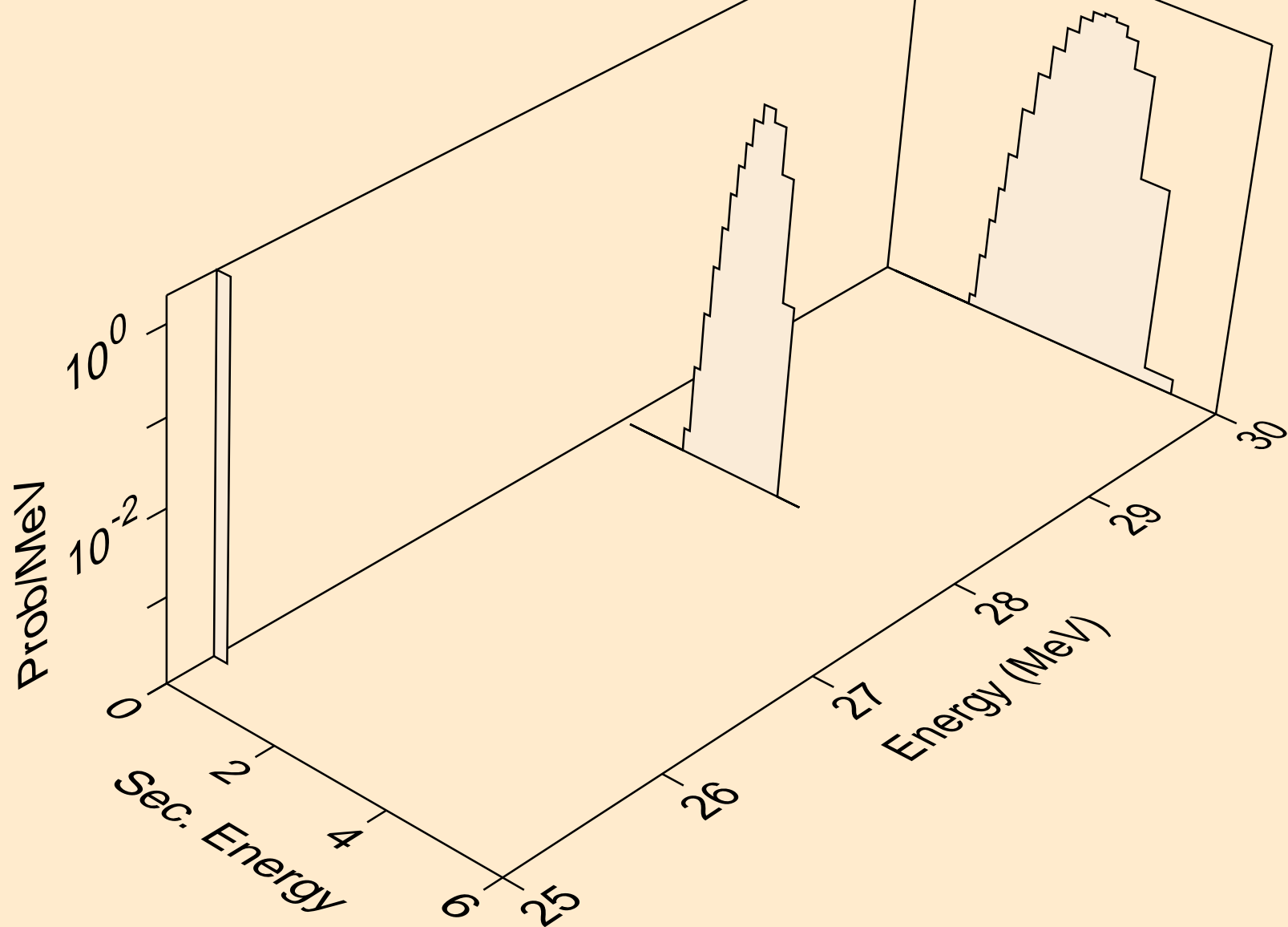

DY145 NEUTRON ACER TENDL-2023 LIBRARY; T=0.K  
protons from (n,n2p)

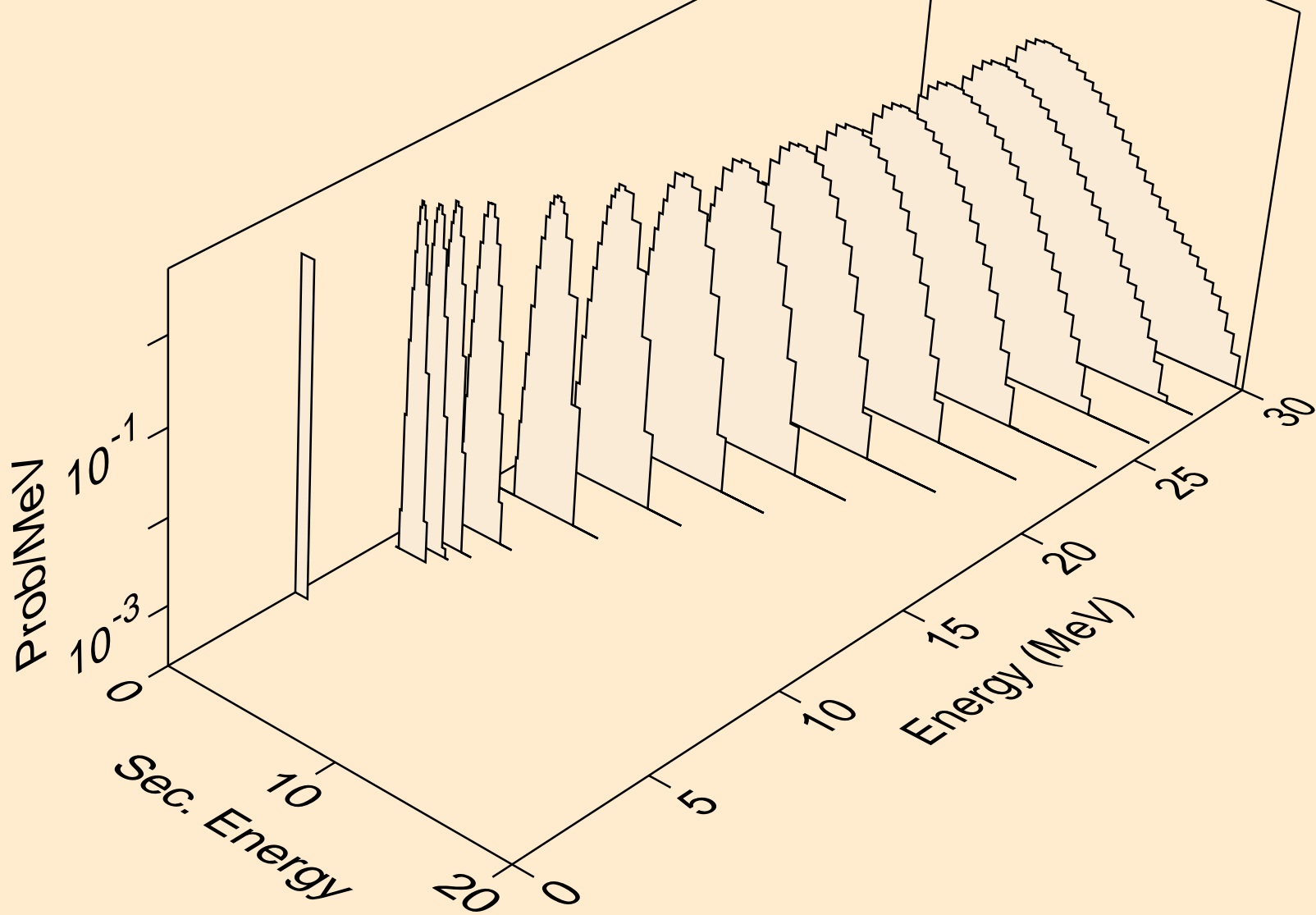

DY145 NEUTRON ACER TENDL-2023 LIBRARY; T=0.K  
protons from (n,npa)

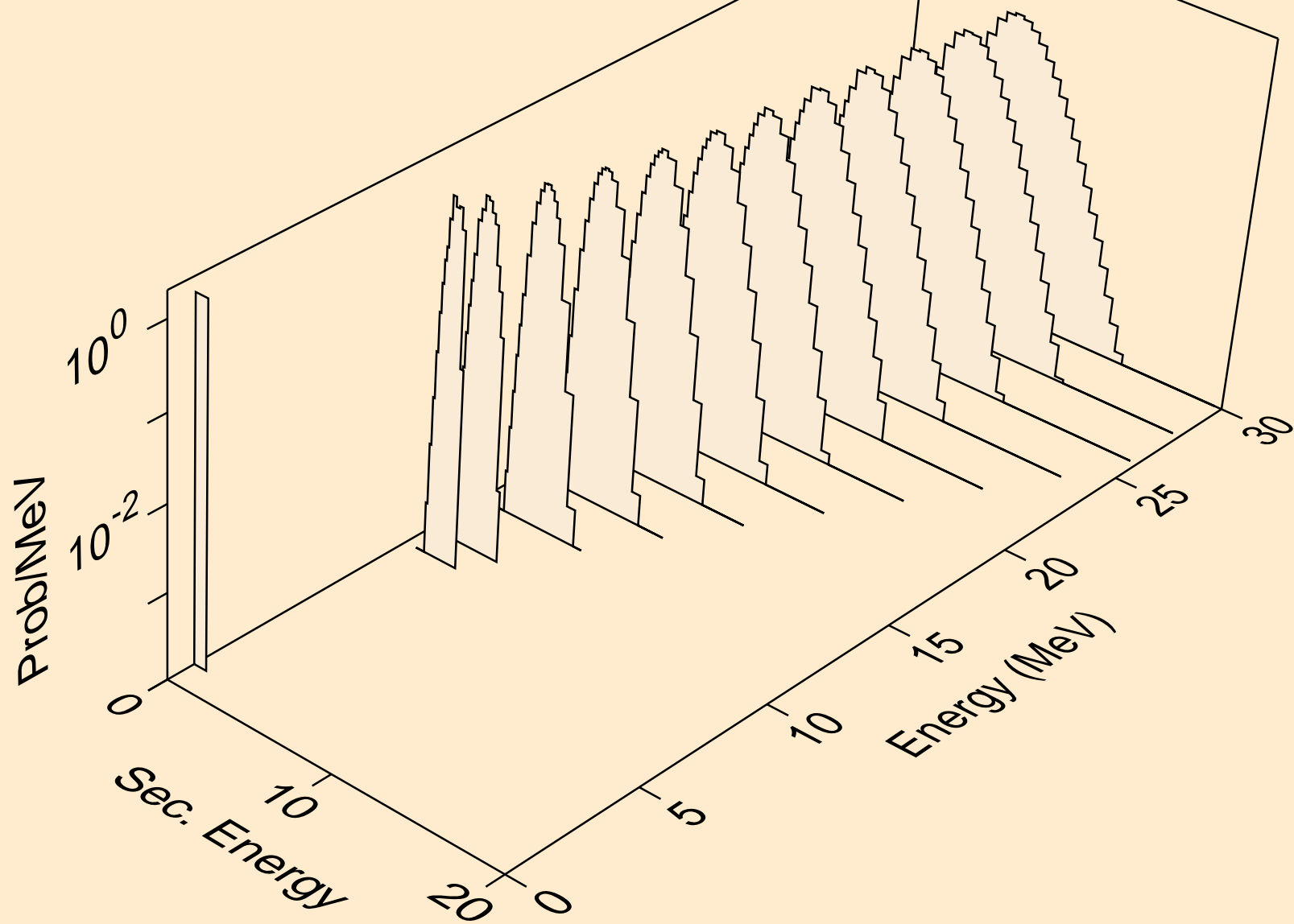

DY145 NEUTRON ACER TENDL-2023 LIBRARY; T=0.K  
protons from (n,p)

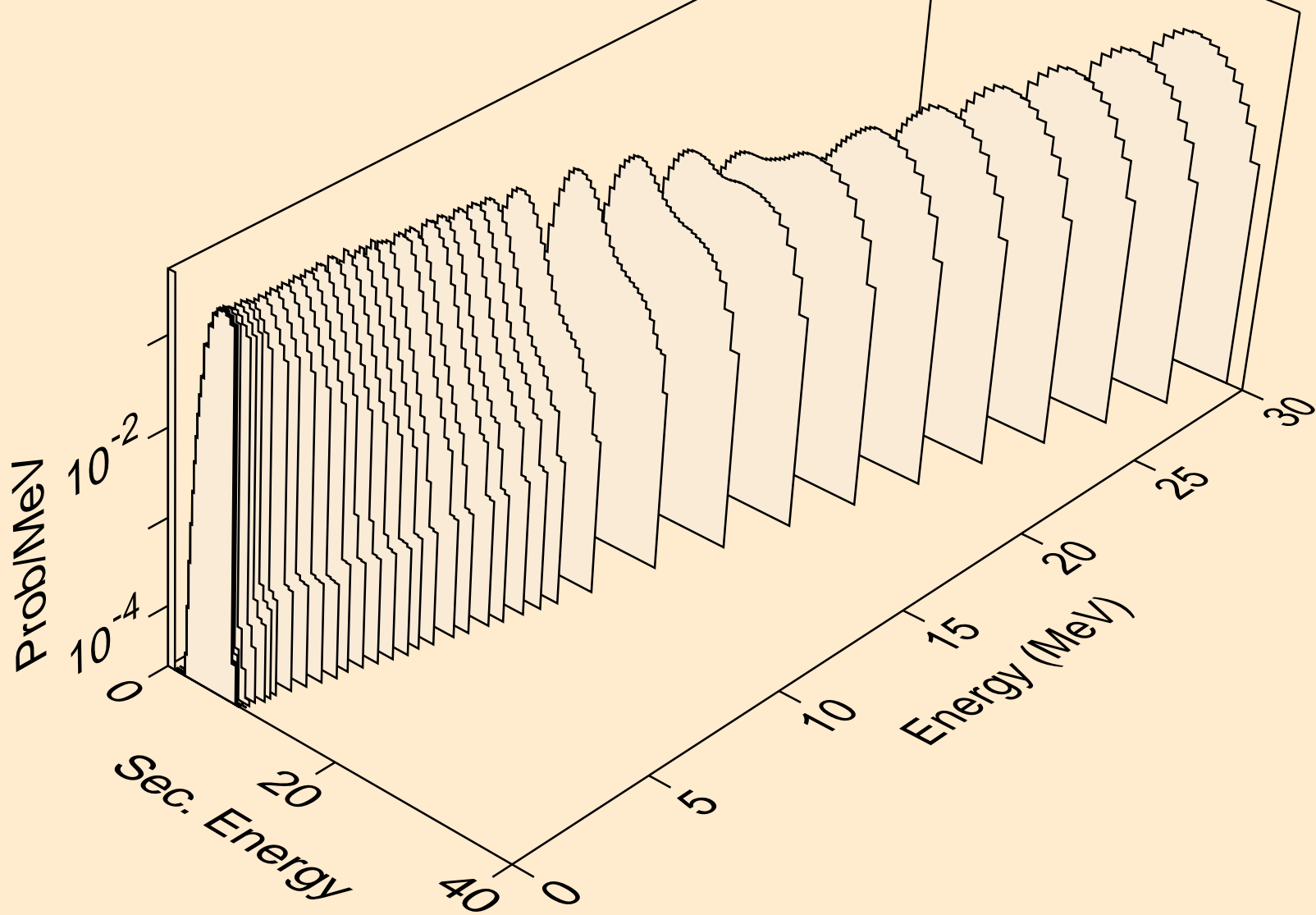

DY145 NEUTRON ACER TENDL-2023 LIBRARY; T=0.K  
protons from (n,2p)

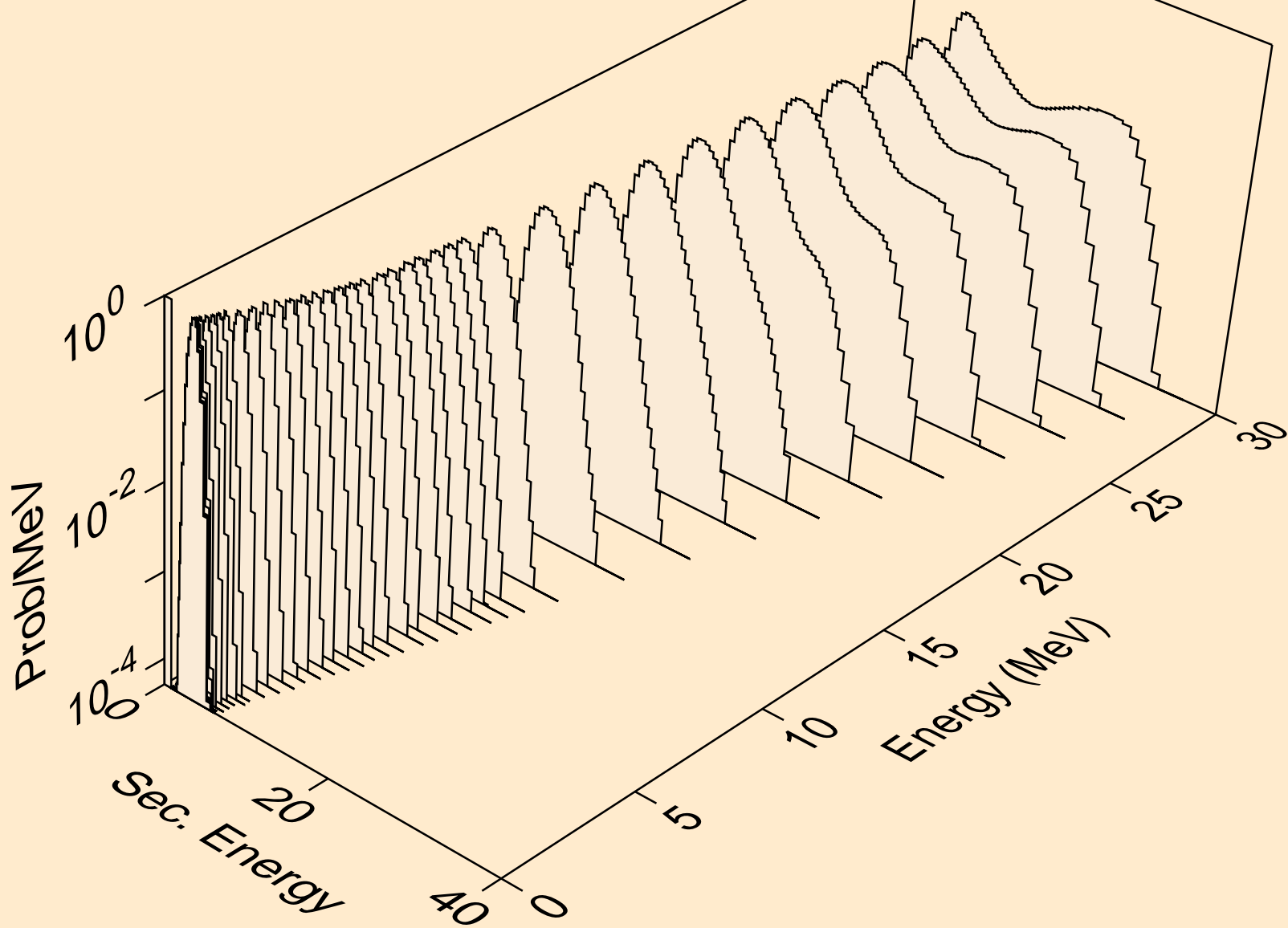

DY145 NEUTRON ACER TENDL-2023 LIBRARY; T=0.K  
protons from (n,p)

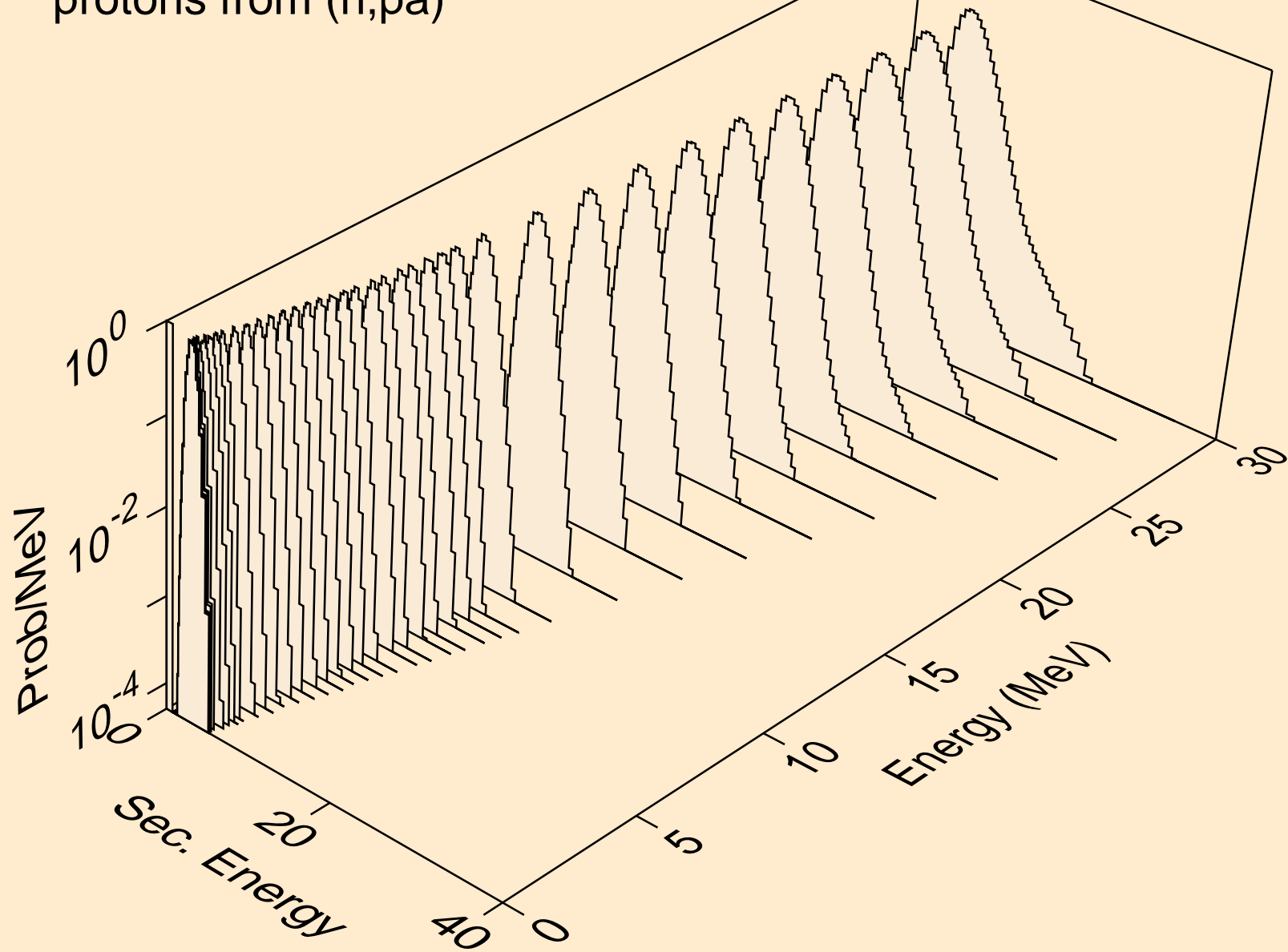

DY145 NEUTRON ACER TENDL-2023 LIBRARY; T=0.K  
protons from (n,pd)

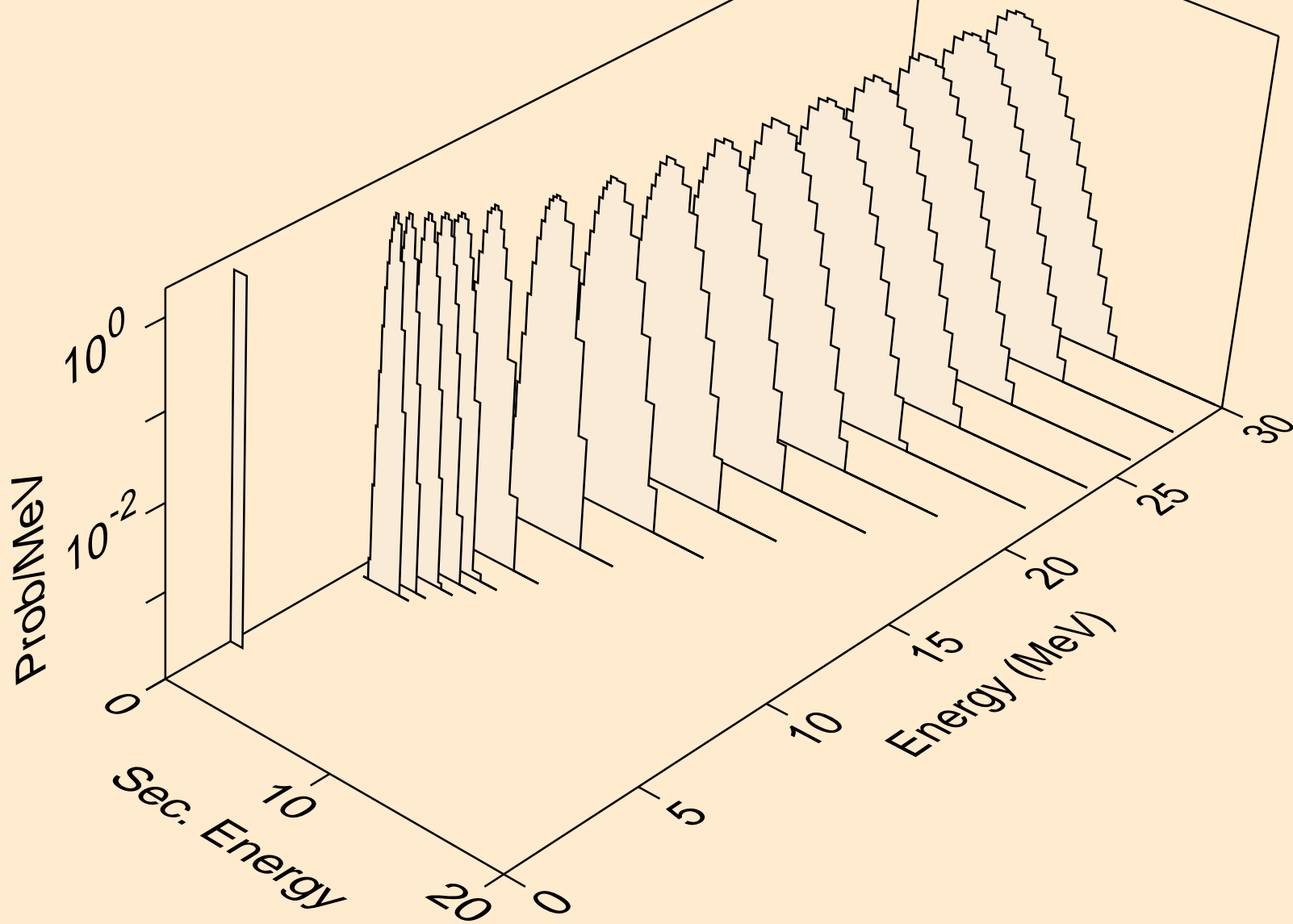

DY145 NEUTRON ACER TENDL-2023 LIBRARY; T=0.K  
protons from (n,pt)

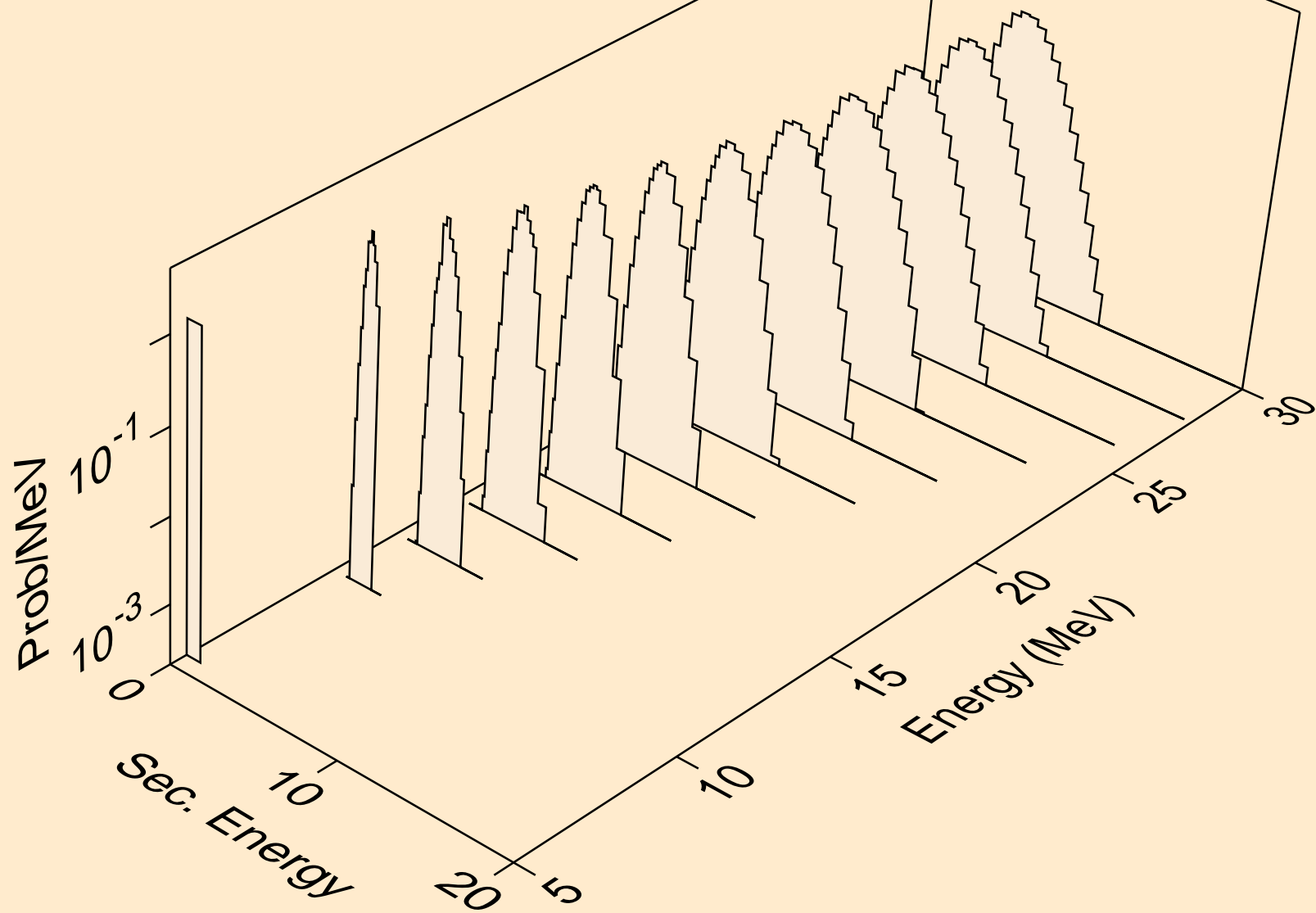



DY145 NEUTRON ACER TENDL-2023 LIBRARY; T=0.K  
deuterons from (n,x)

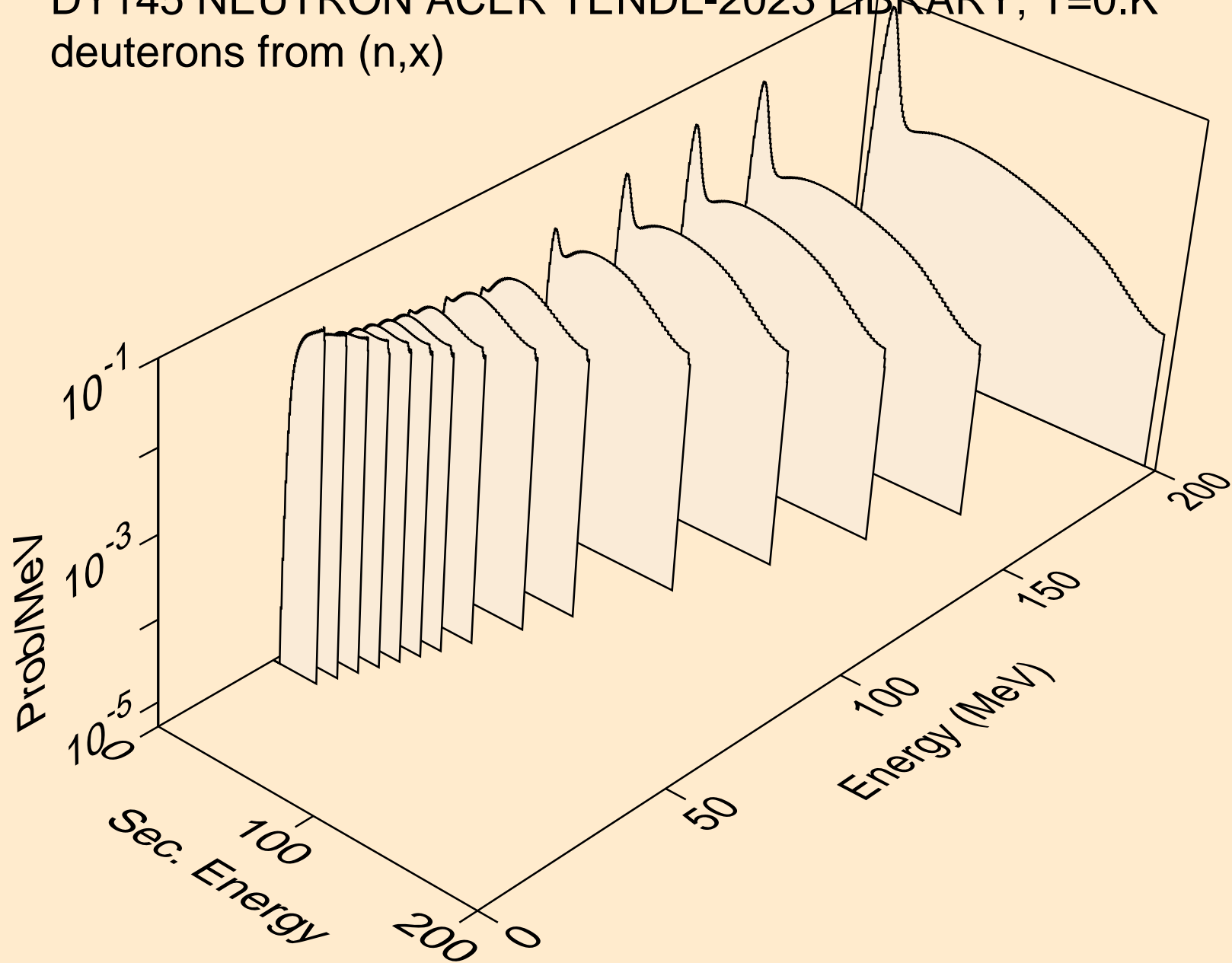

DY145 NEUTRON ACER TENDL-2023 LIBRARY; T=0.K  
deuterons from (n,2nd)

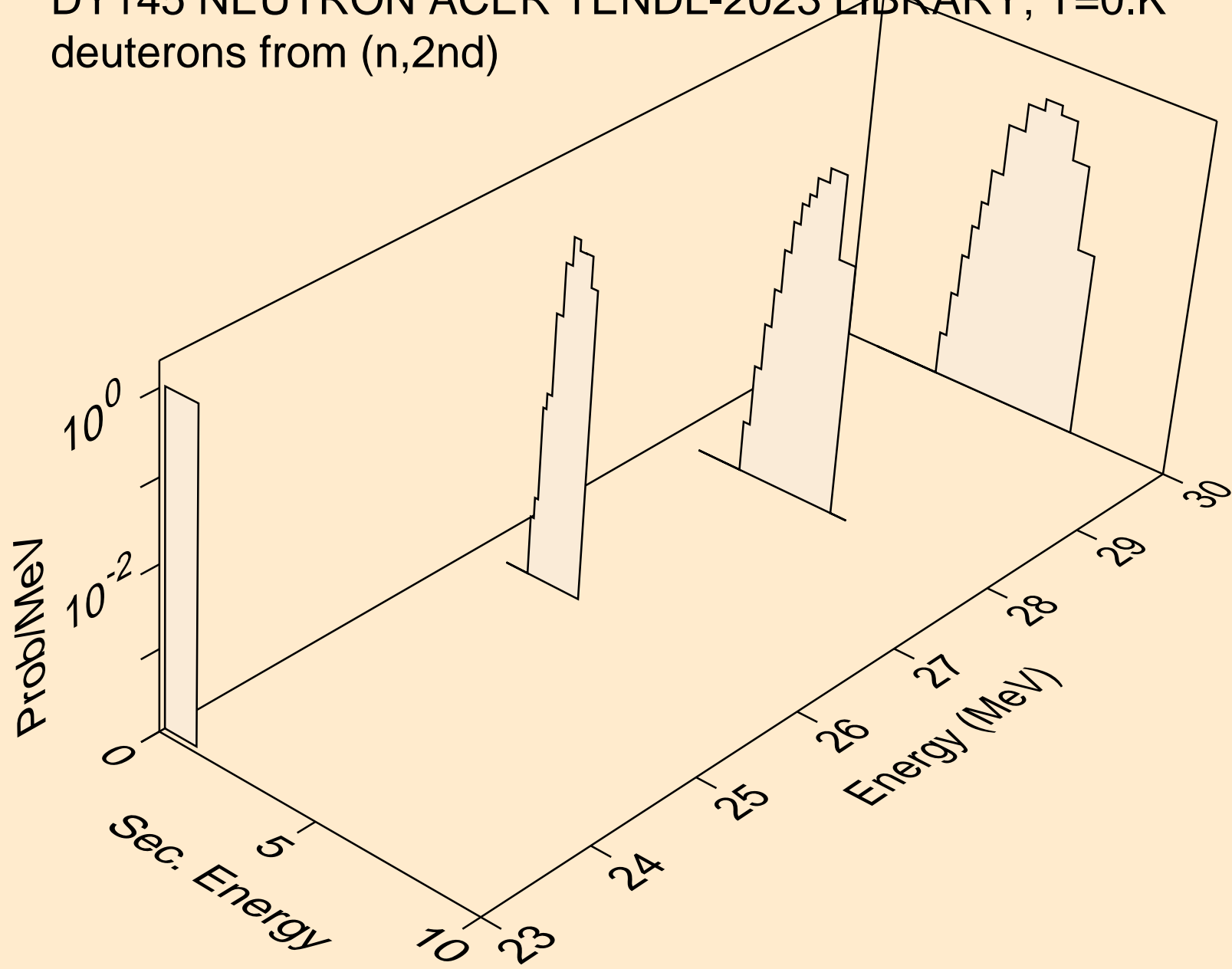

DY145 NEUTRON ACER TENDL-2023 LIBRARY; T=0.K  
deuterons from (n,n\*)d

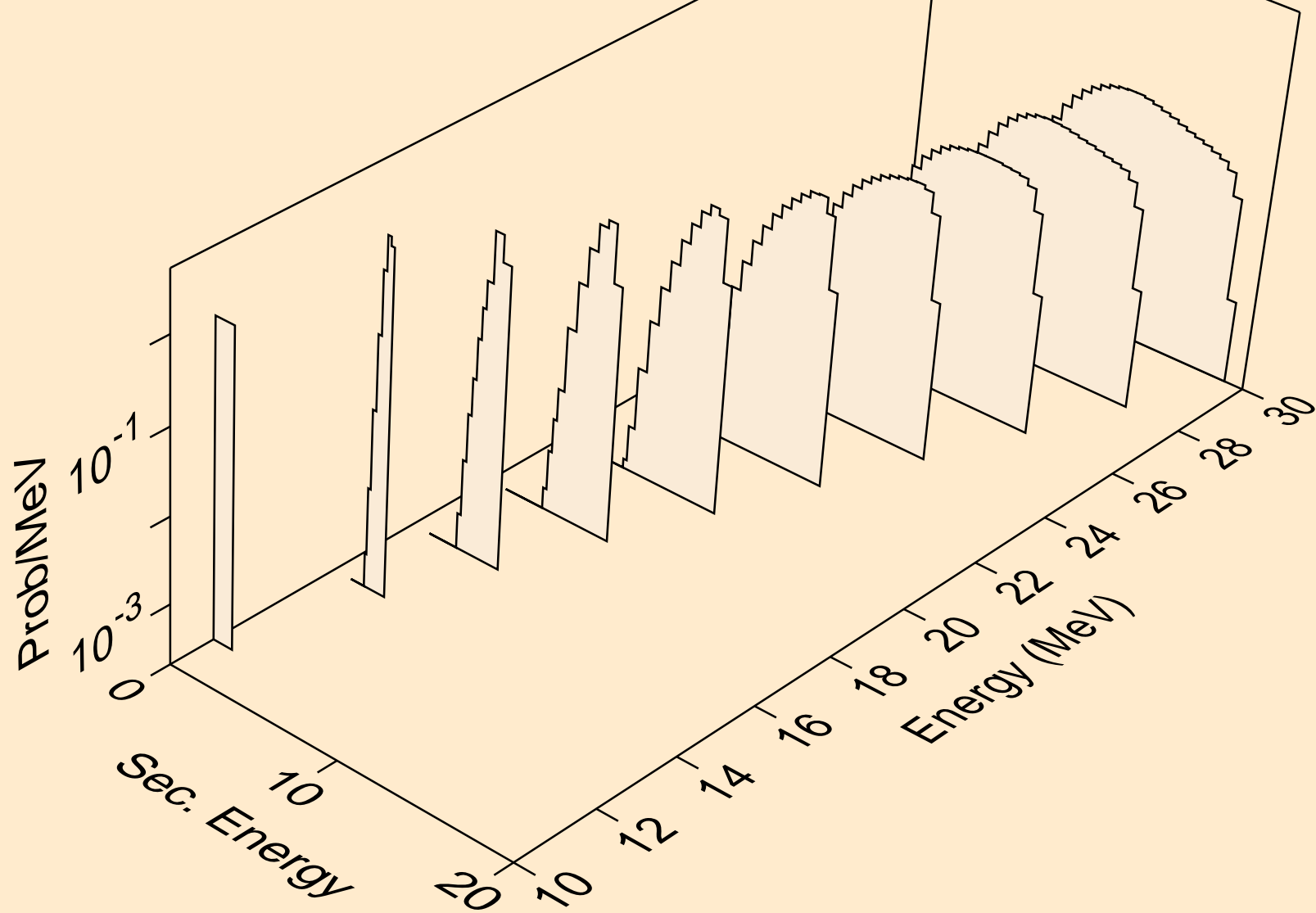

DY145 NEUTRON ACER TENDL-2023 LIBRARY; T=0.K  
deuterons from (n,d)

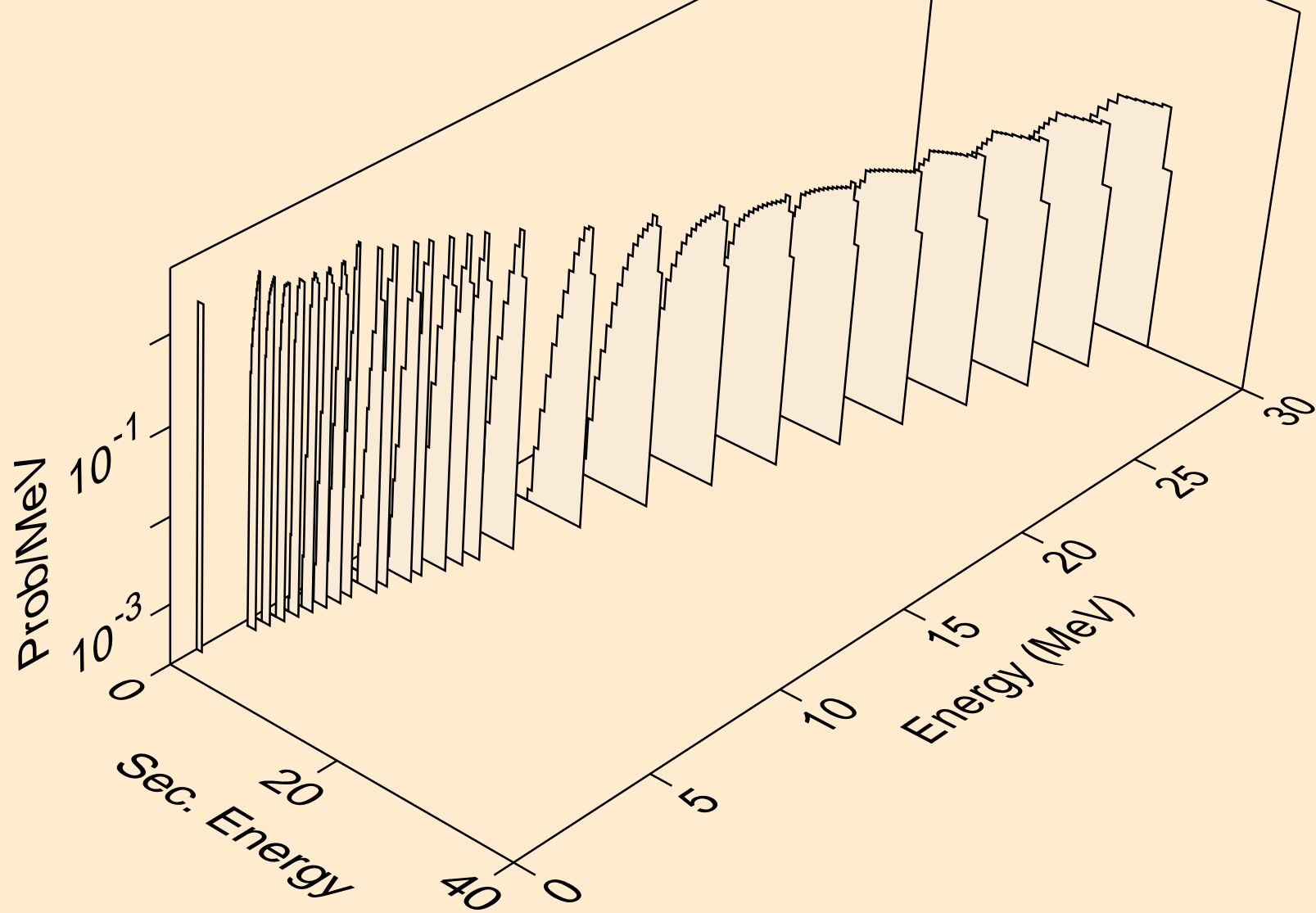

DY145 NEUTRON ACER TENDL-2023 LIBRARY; T=0.K  
deuterons from (n,pd)

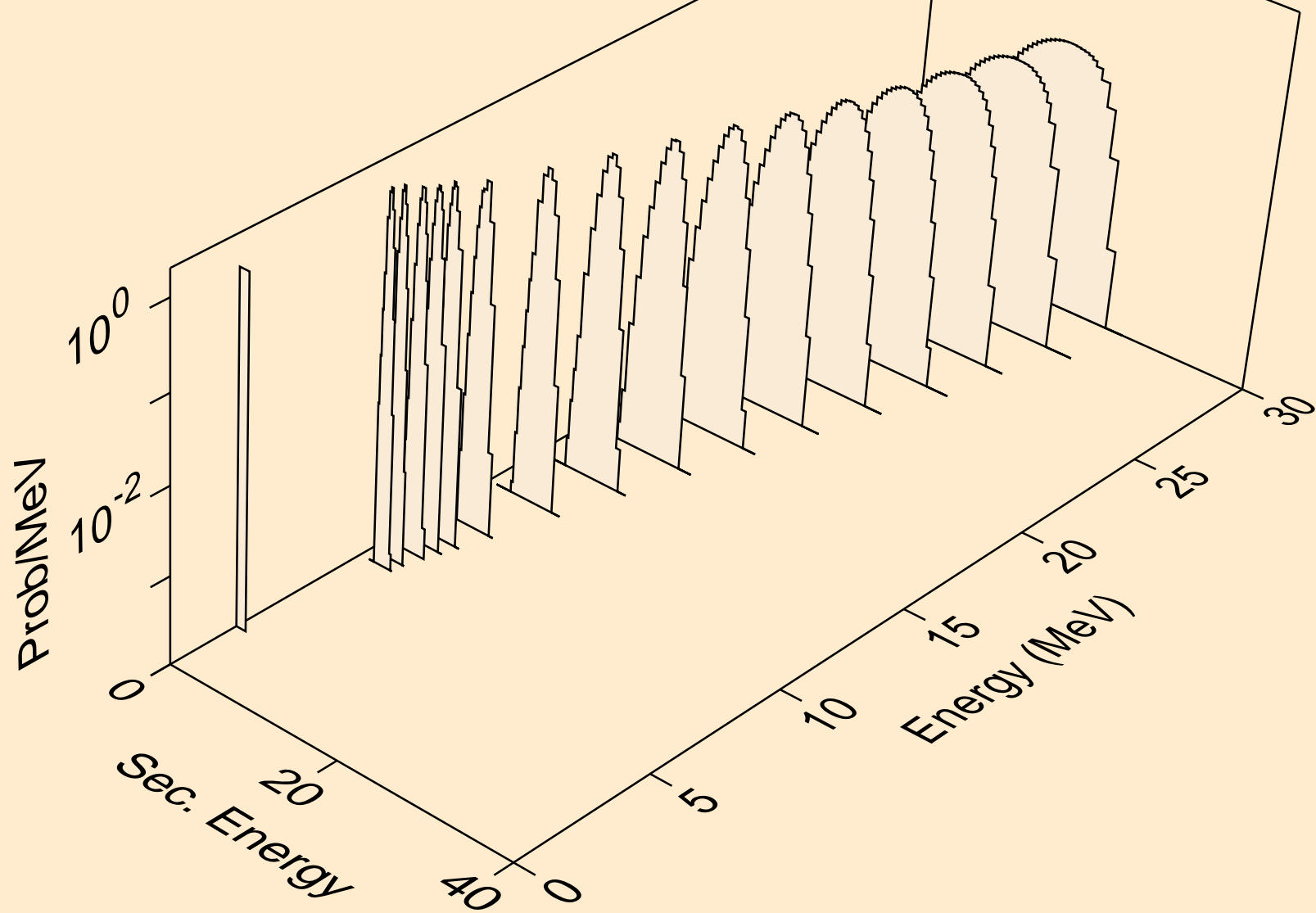

DY145 NEUTRON ACER TENDL-2023 LIBRARY; T=0.K  
deuterons from (n,da)

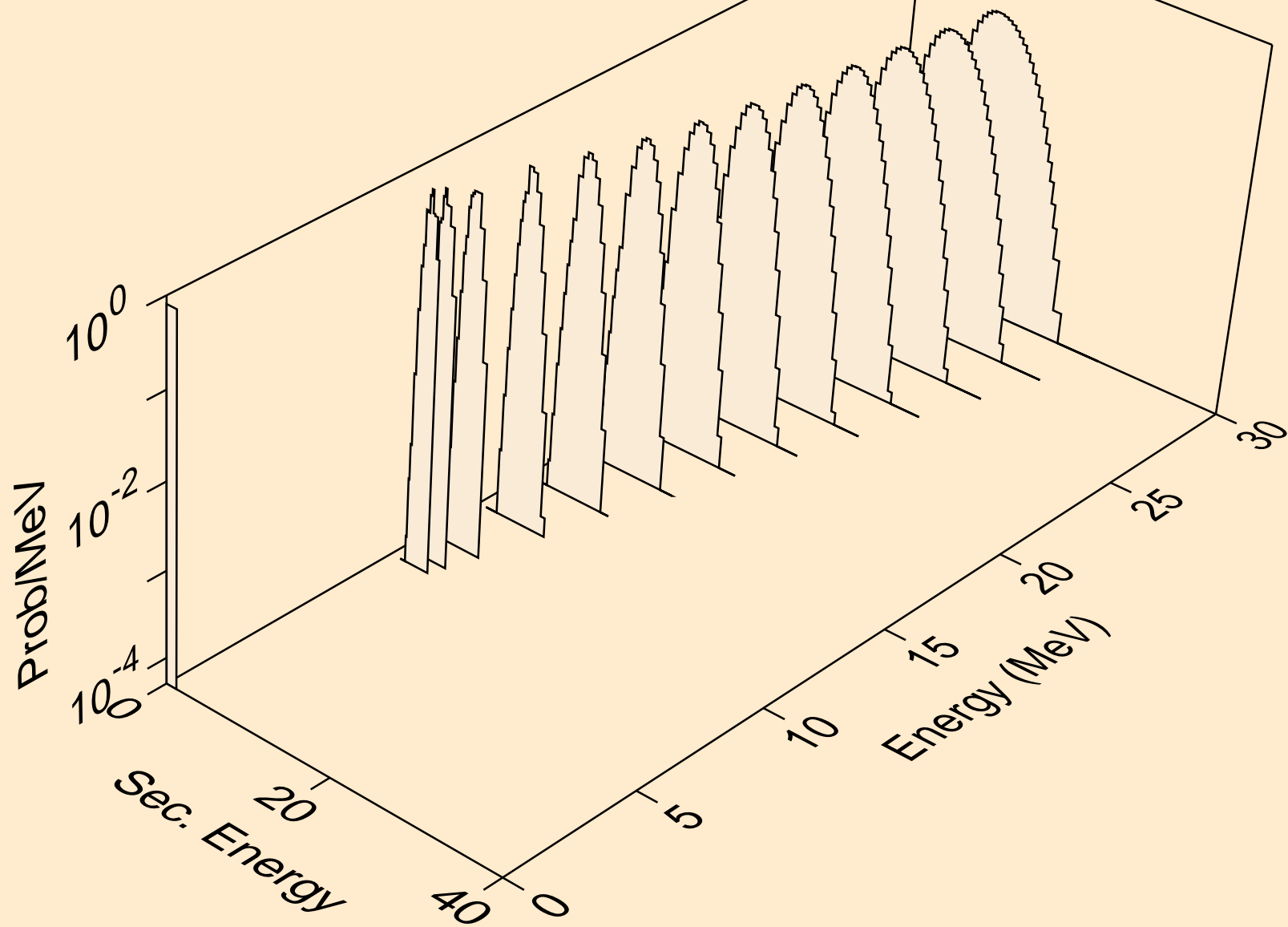

DY145 NEUTRON ACER TENDL-2023 LIBRARY; T=0.K  
tritons from (n,x)

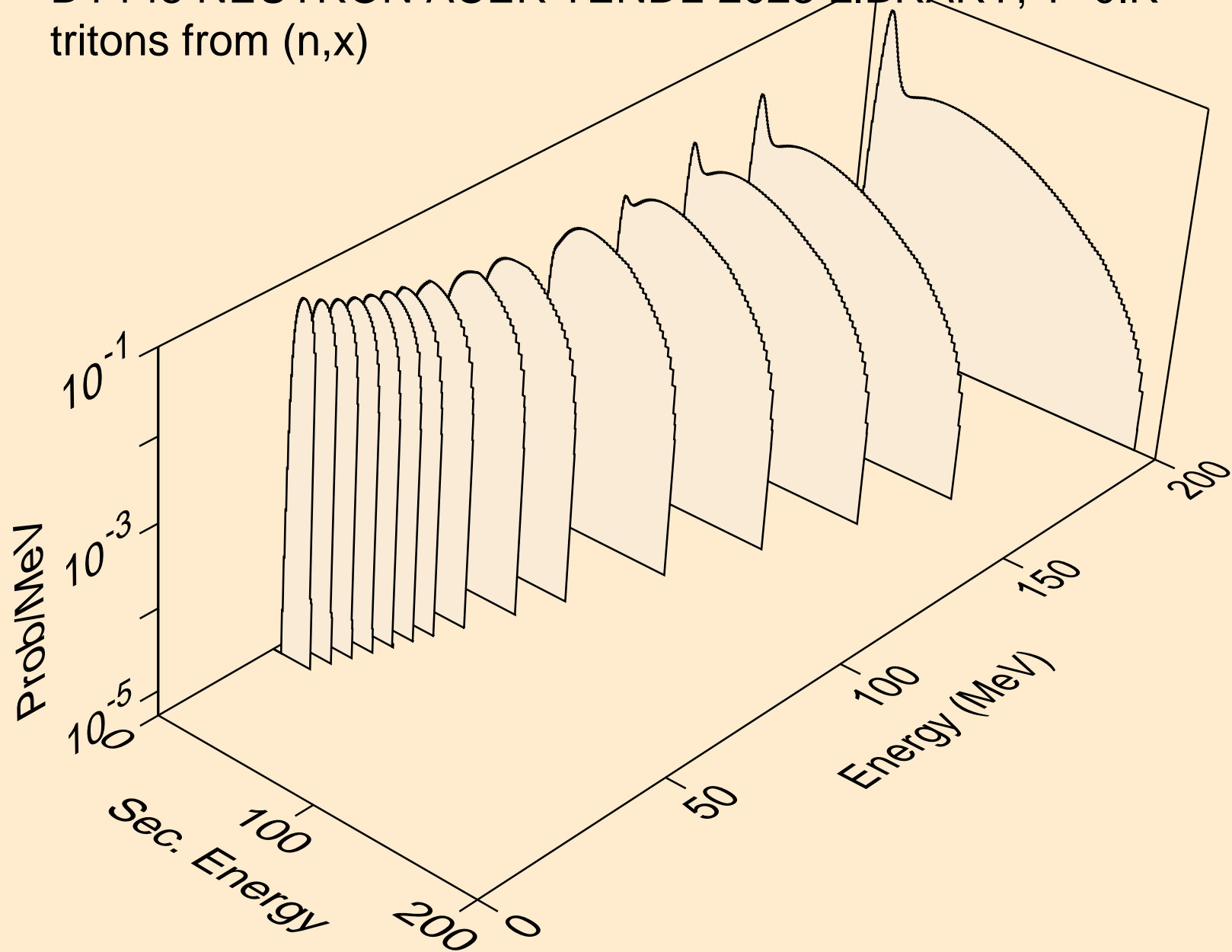

DY145 NEUTRON ACER TENDL-2023 LIBRARY; T=0.K  
tritons from (n,n\*)t

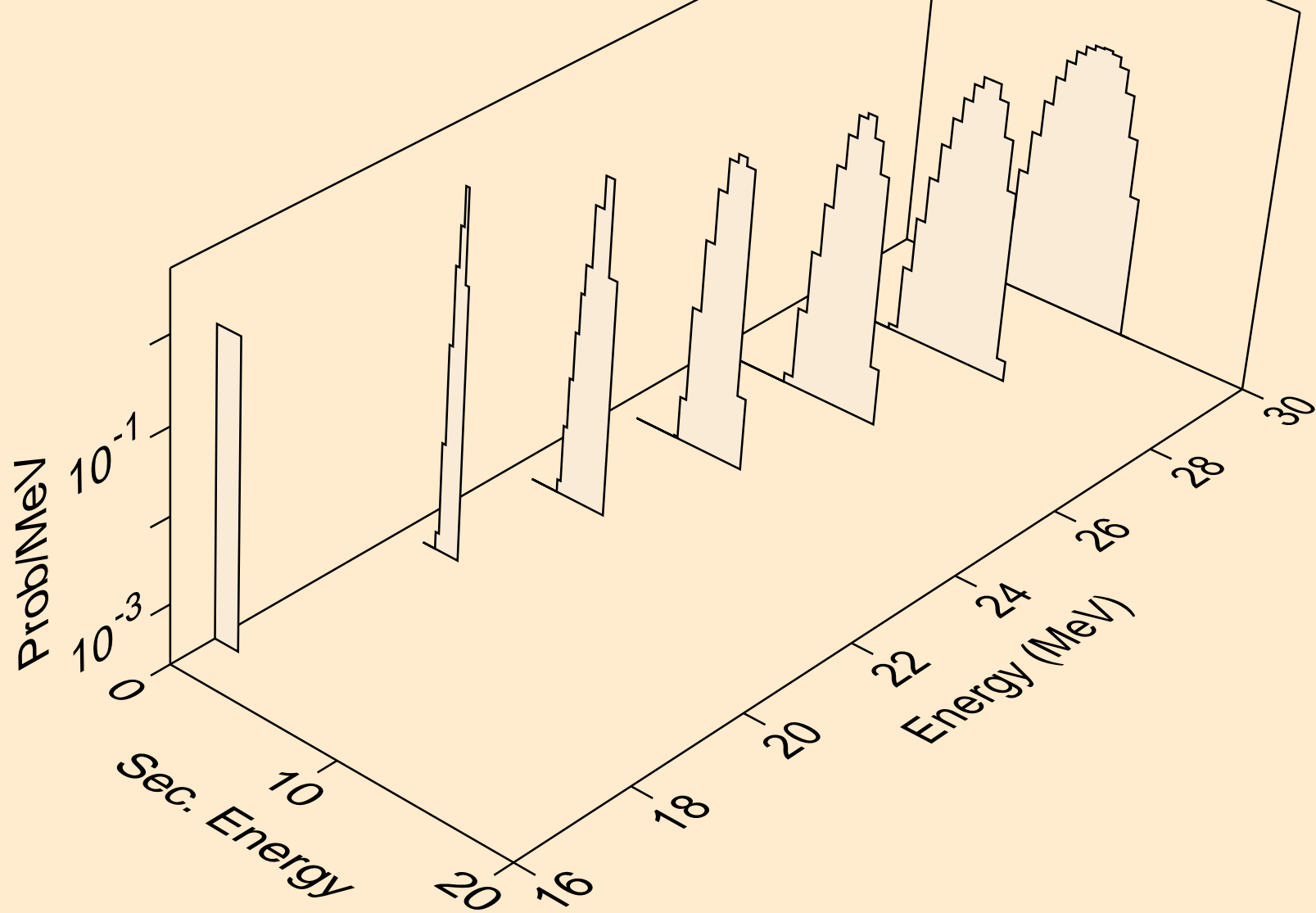



DY145 NEUTRON ACER TENDL-2023 LIBRARY; T=0.K  
tritons from (n,t)

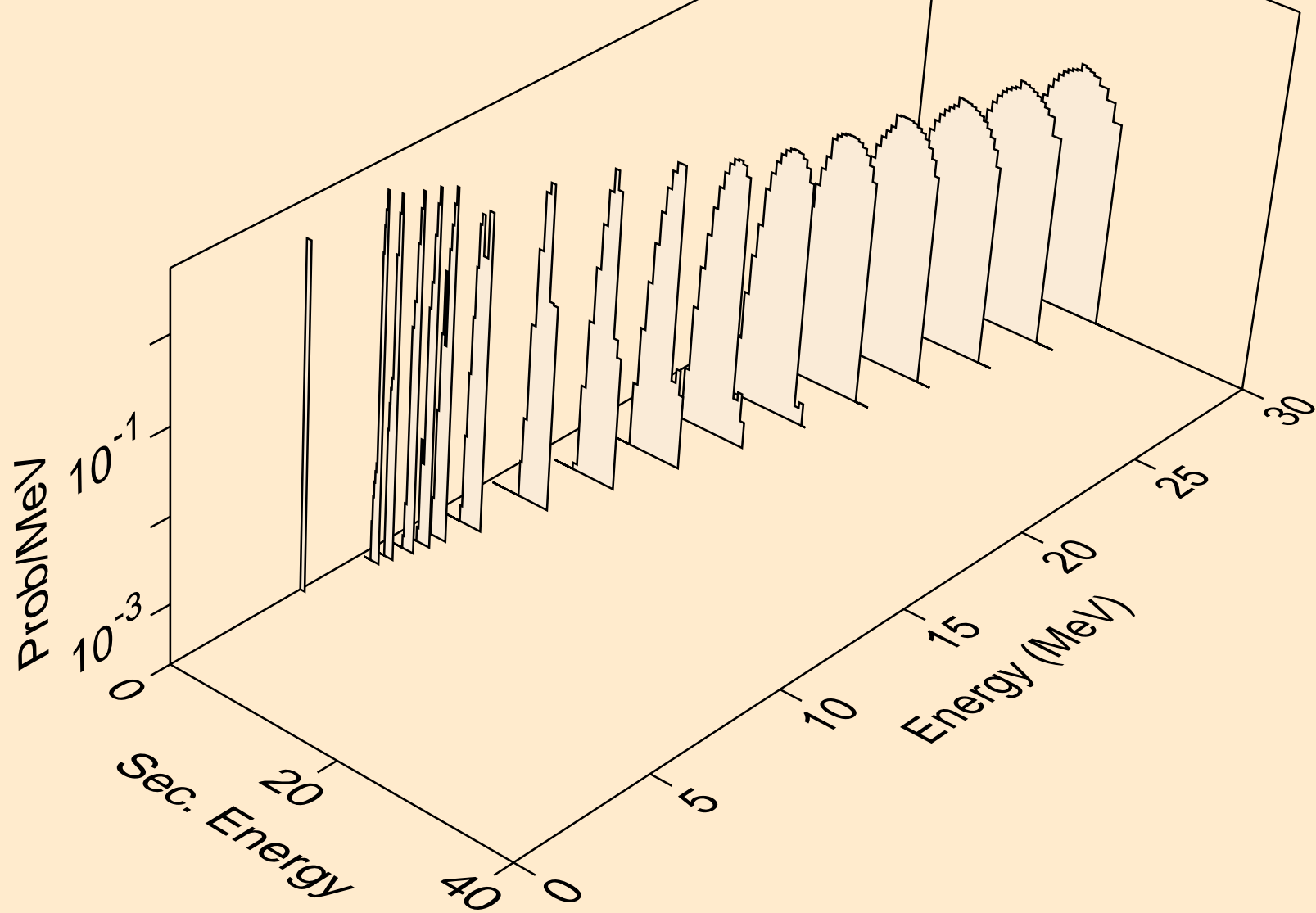

DY145 NEUTRON ACER TENDL-2023 LIBRARY; T=0.K  
tritons from (n,pt)

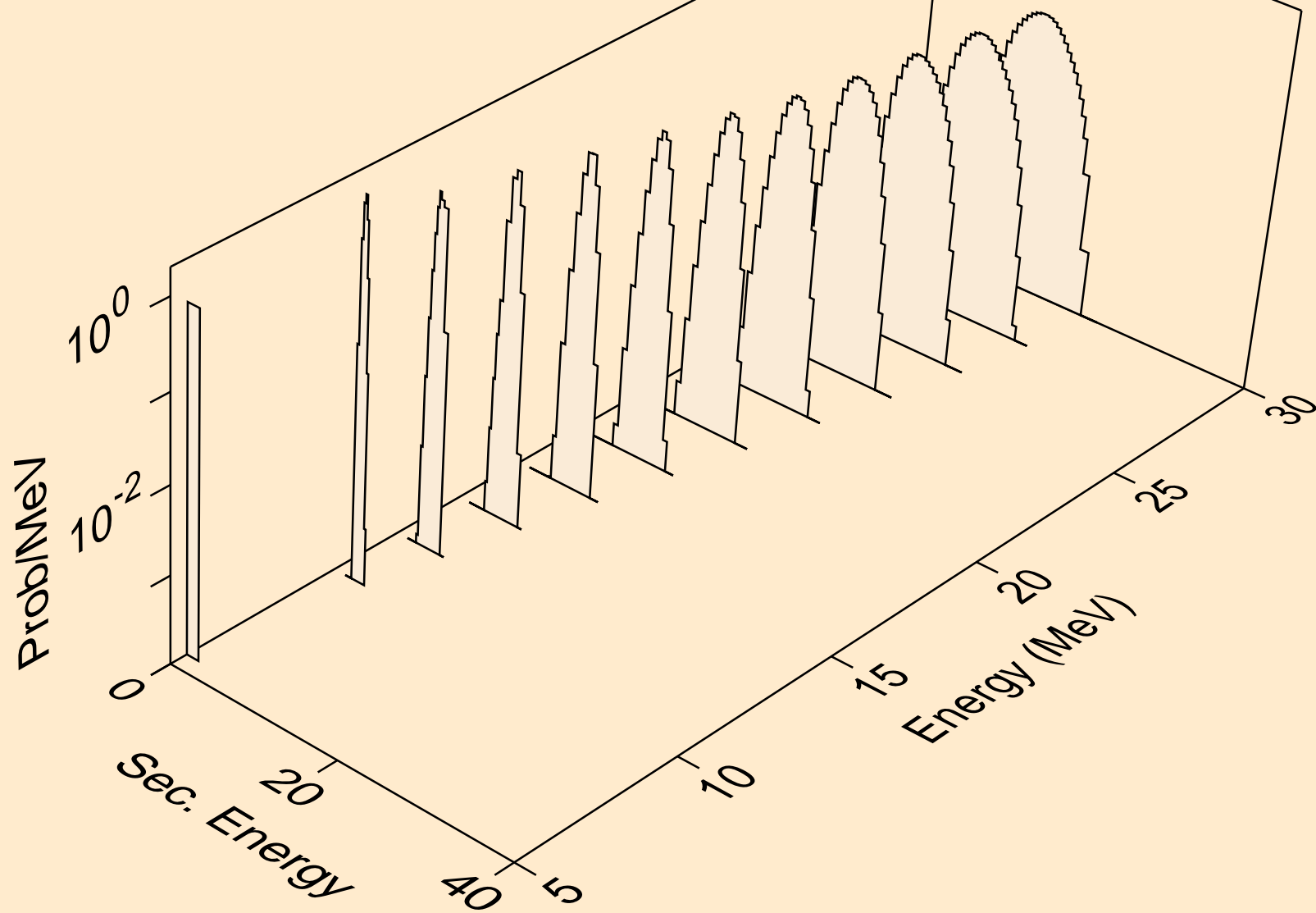

DY145 NEUTRON ACER TENDL-2023 LIBRARY; T=0.K  
he3s from (n,x)

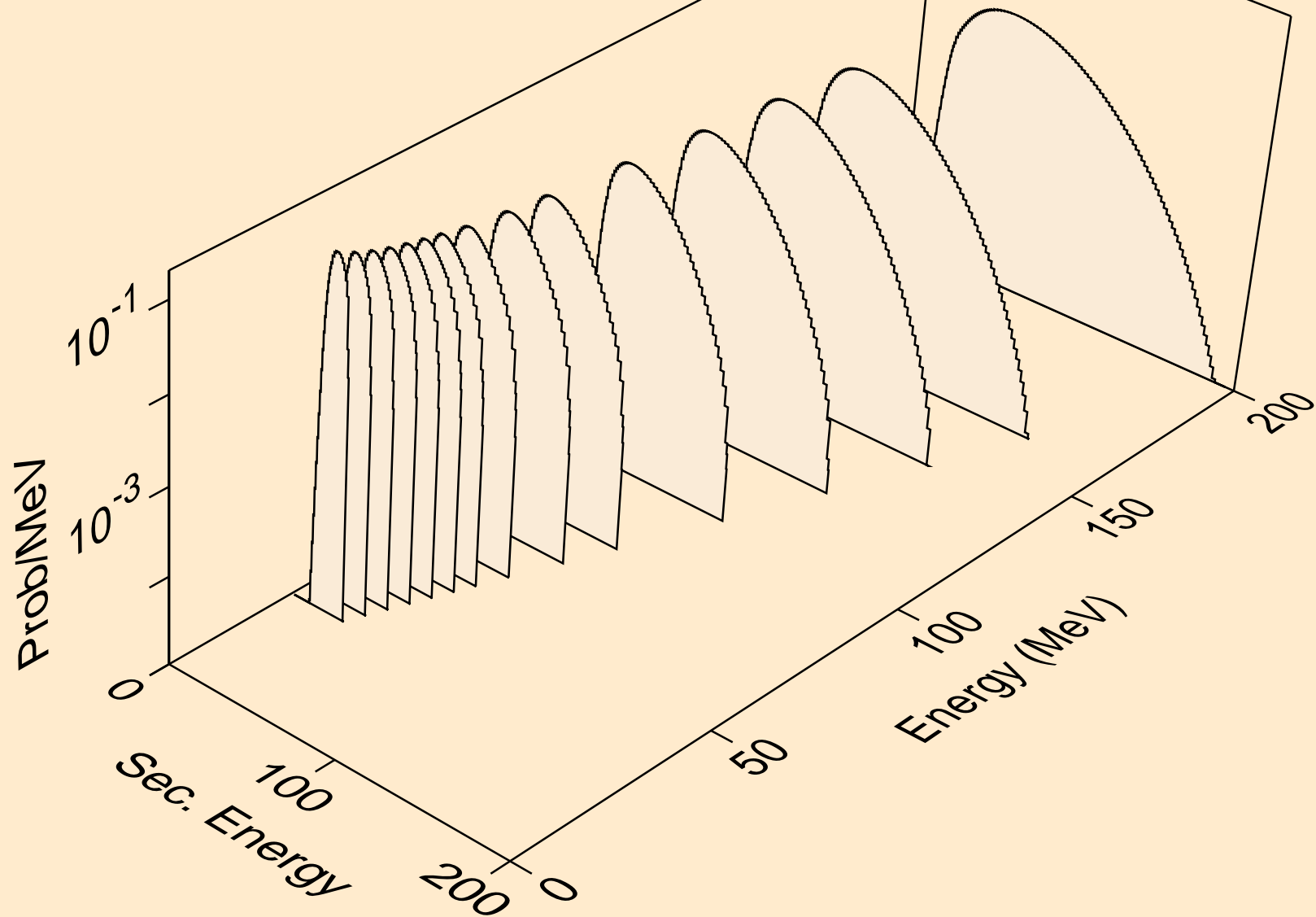

DY145 NEUTRON ACER TENDL-2023 LIBRARY; T=0.K  
he3s from (n,n\*)he3

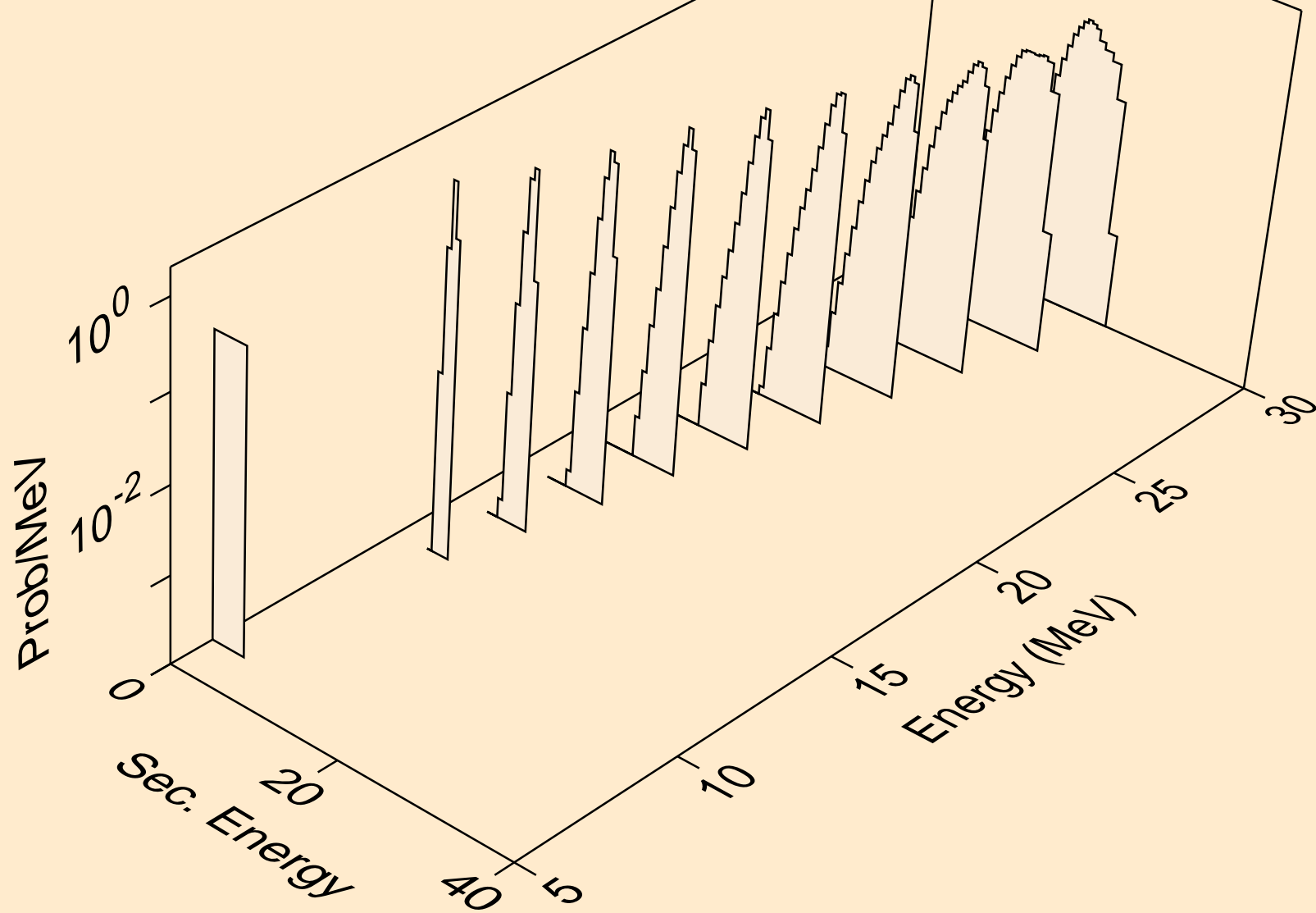

DY145 NEUTRON ACER TENDL-2023 LIBRARY; T=0.K  
he3s from (n,he3)

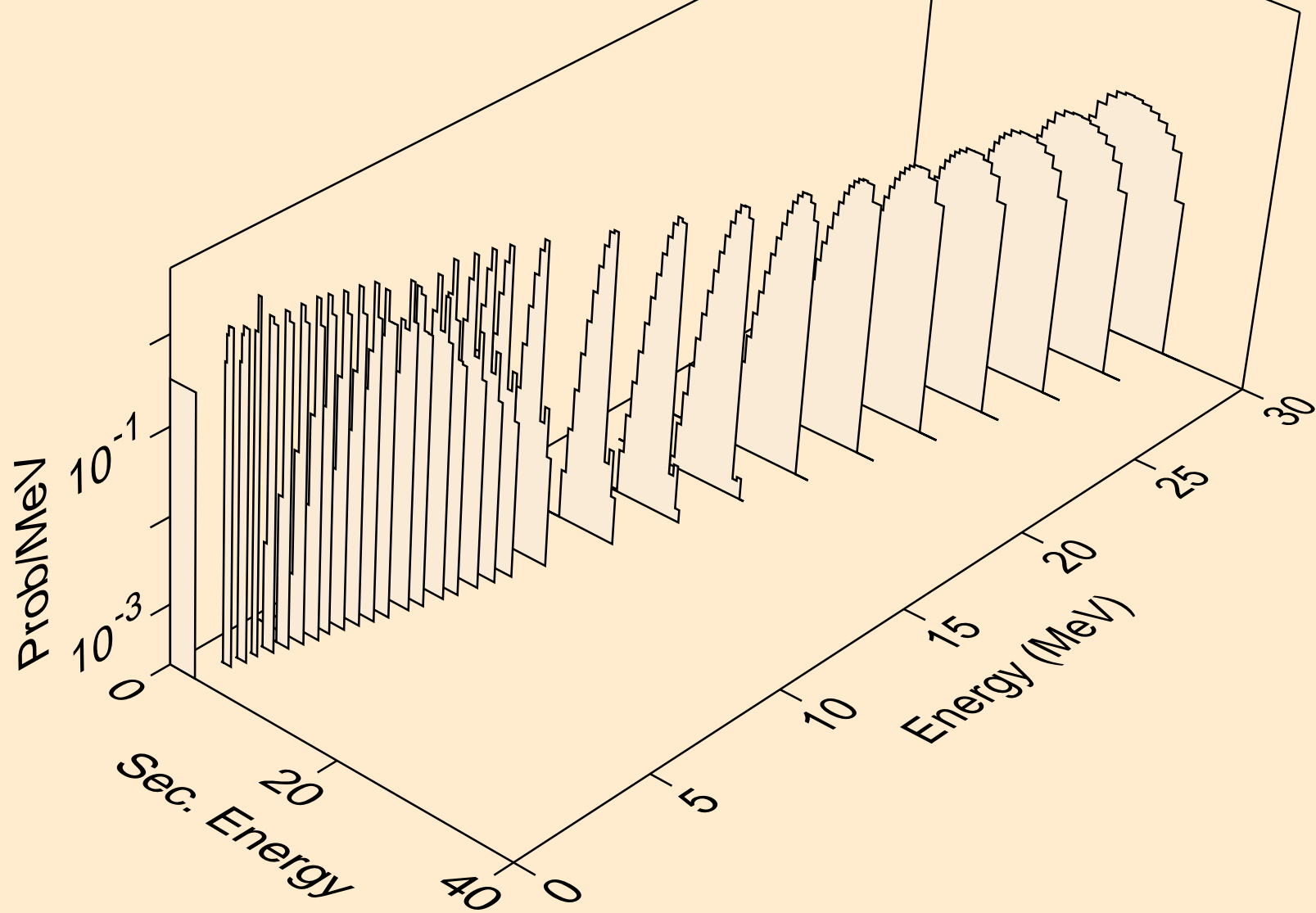

DY145 NEUTRON ACER TENDL-2023 LIBRARY; T=0.K  
alphas from (n,x)

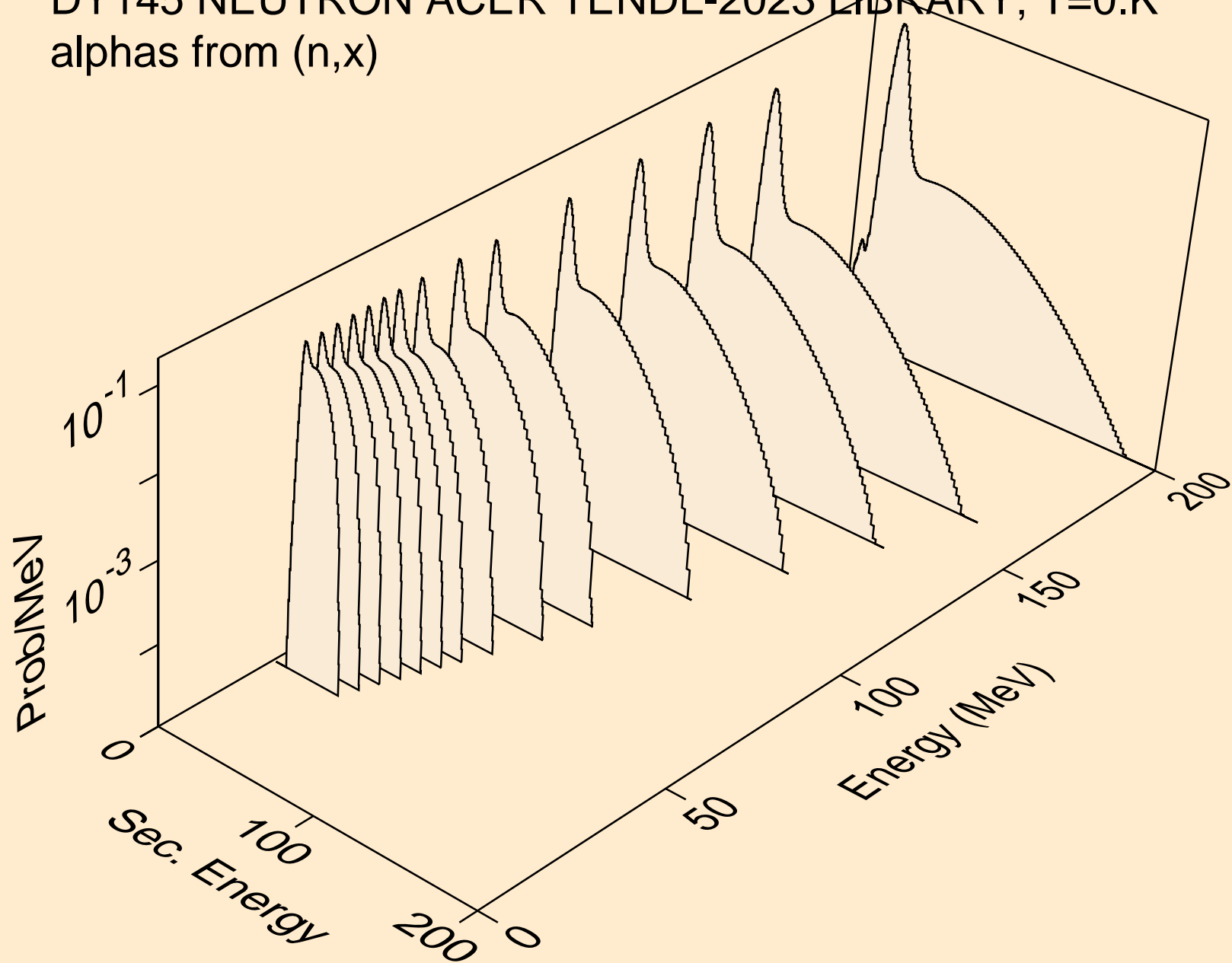

DY145 NEUTRON ACER TENDL-2023 LIBRARY; T=0.K  
alphas from (n,n\*)a

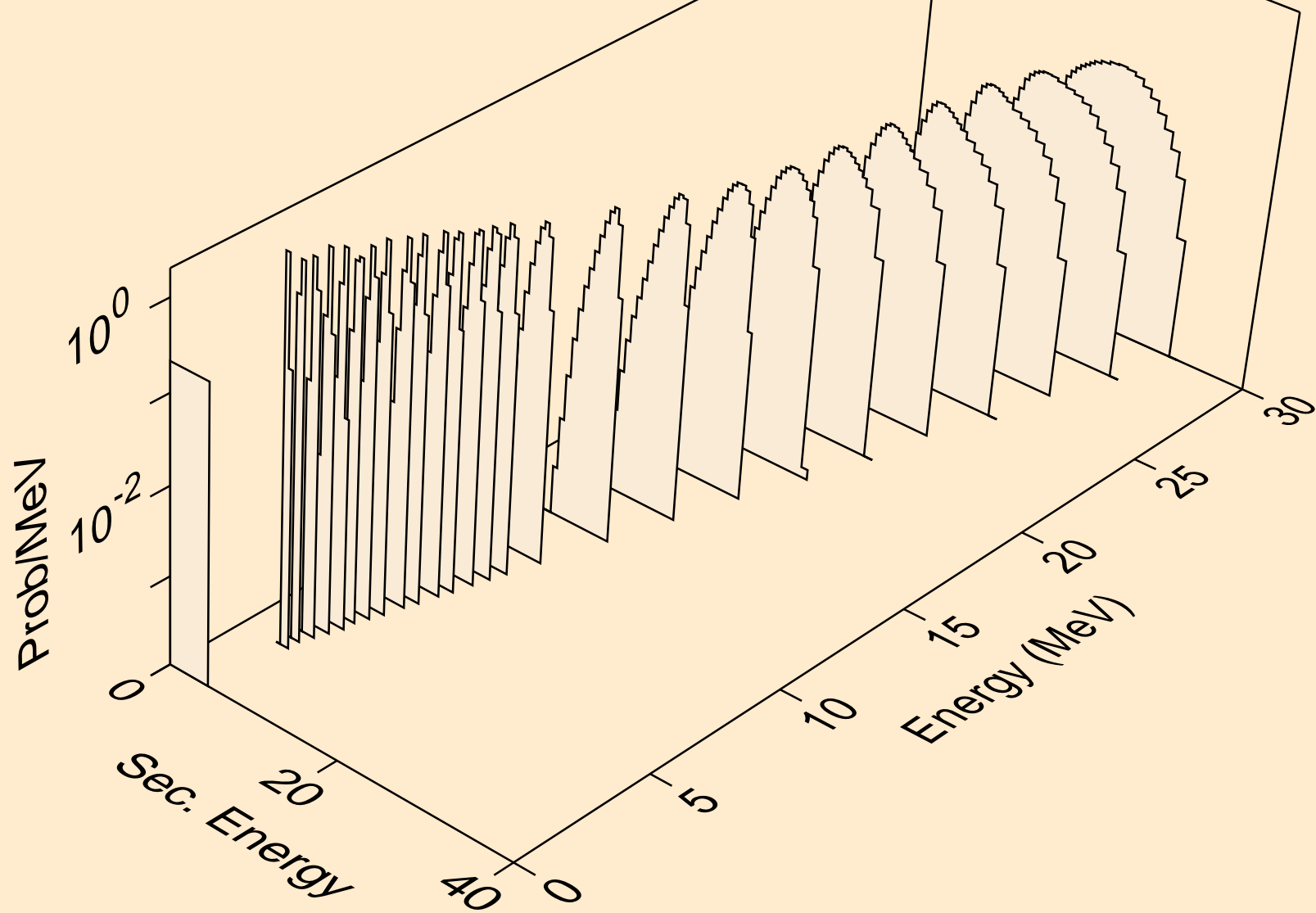

DY145 NEUTRON ACER TENDL-2023 LIBRARY; T=0.K  
alphas from (n,2n)a

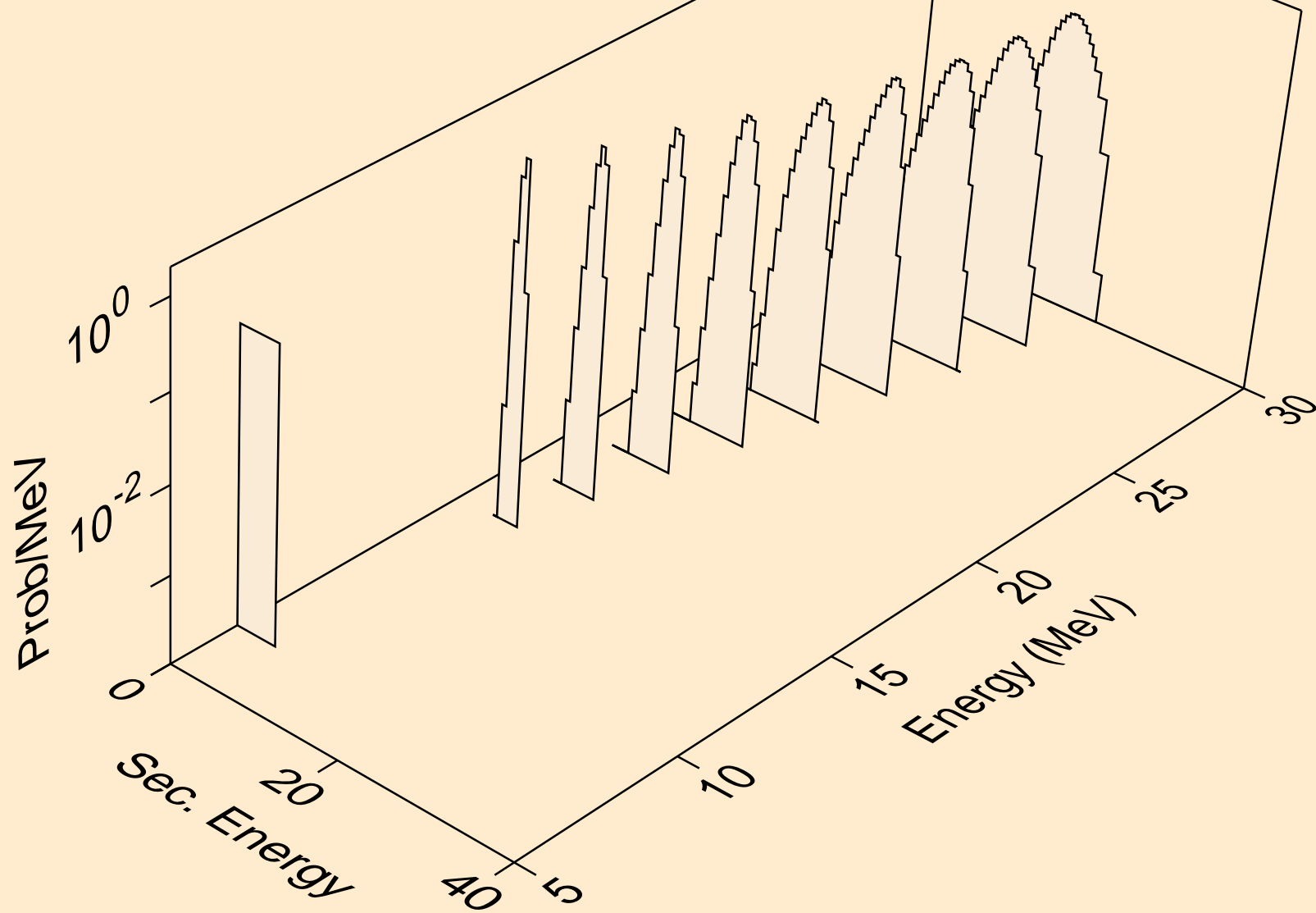



DY145 NEUTRON ACER TENDL-2023 LIBRARY; T=0.K  
alphas from (n,3n)a

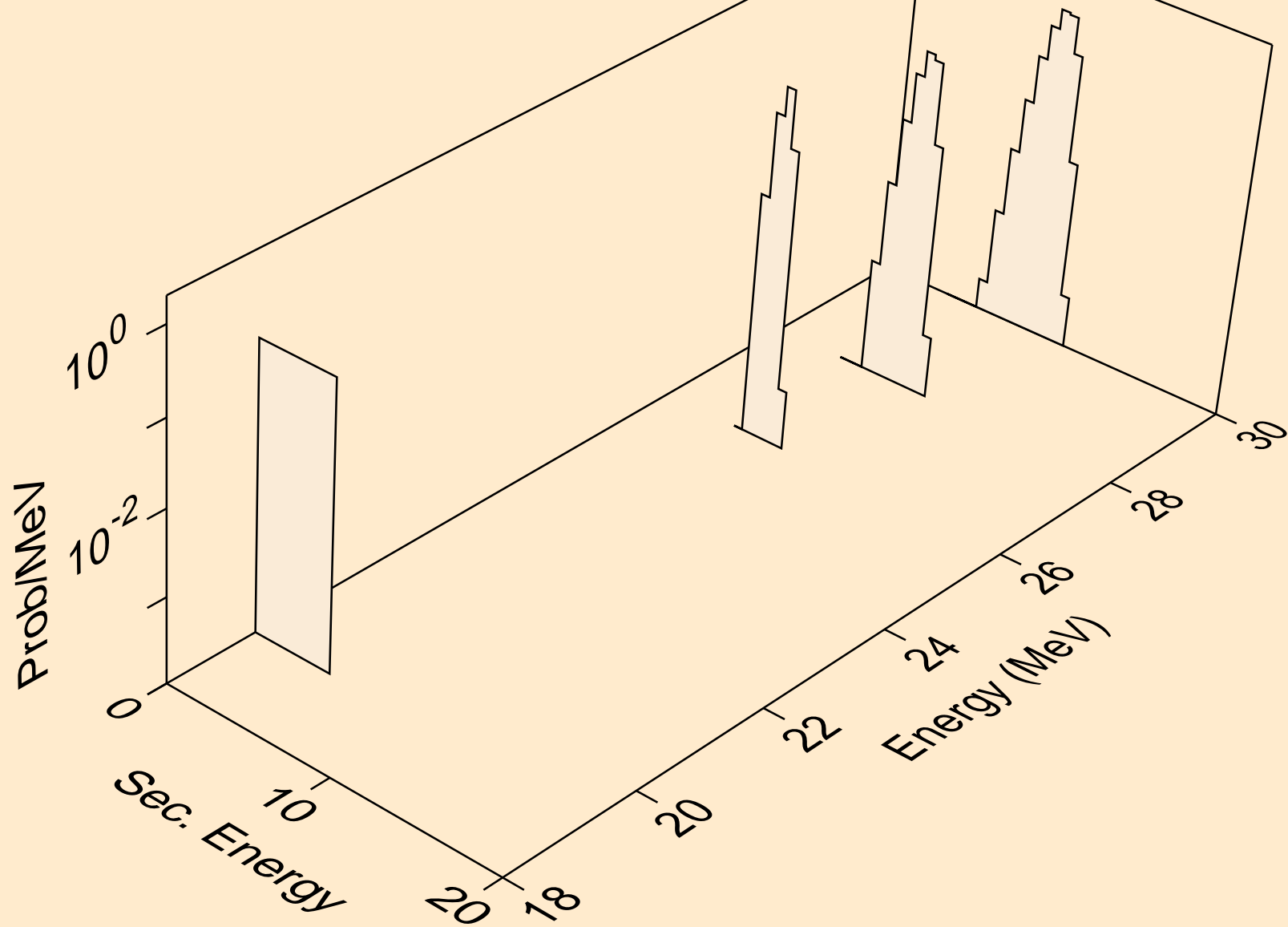

DY145 NEUTRON ACER TENDL-2023 LIBRARY; T=0.K  
alphas from (n,n\*)2a

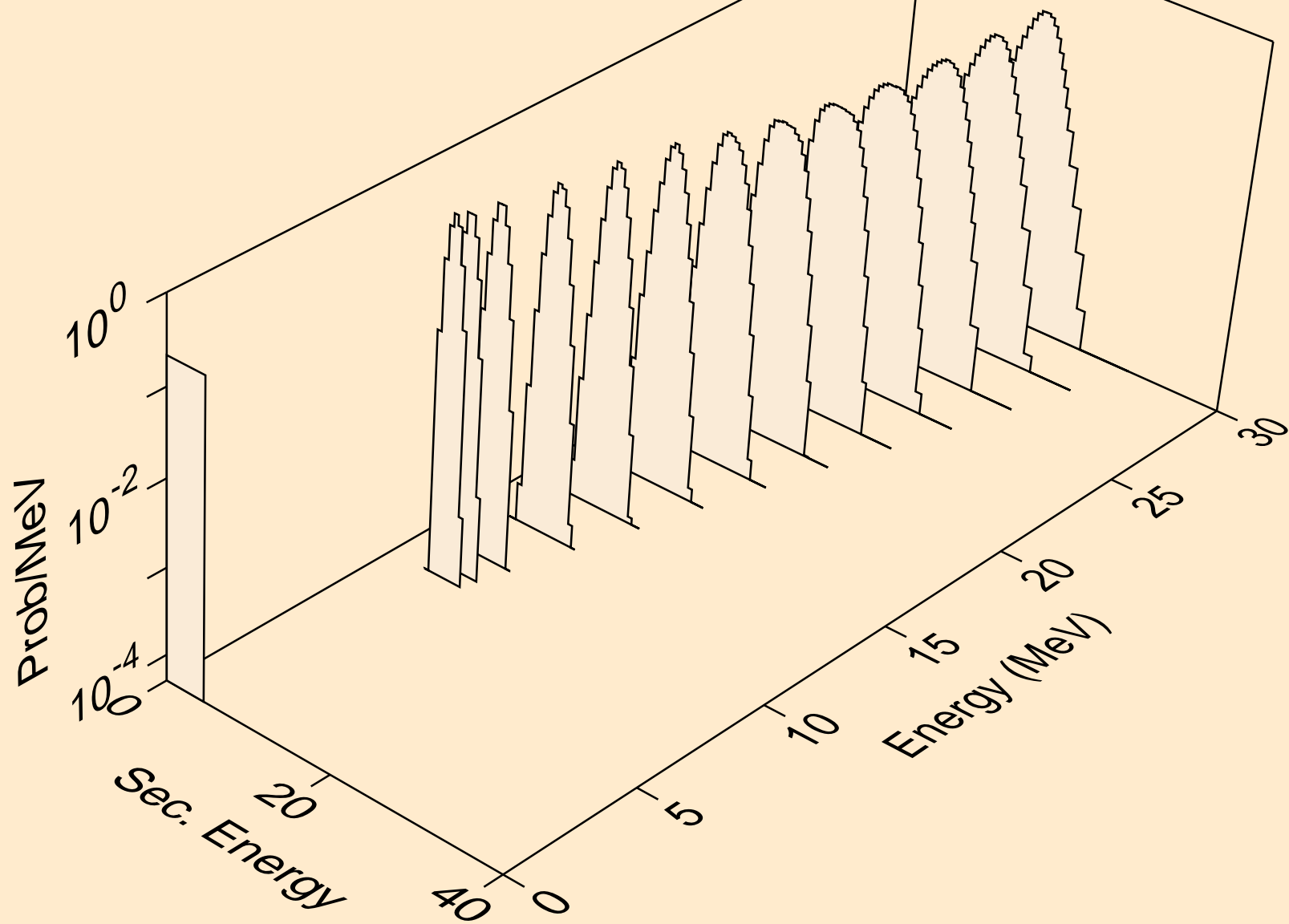

DY145 NEUTRON ACER TENDL-2023 LIBRARY; T=0.K  
alphas from (n,2n)2a

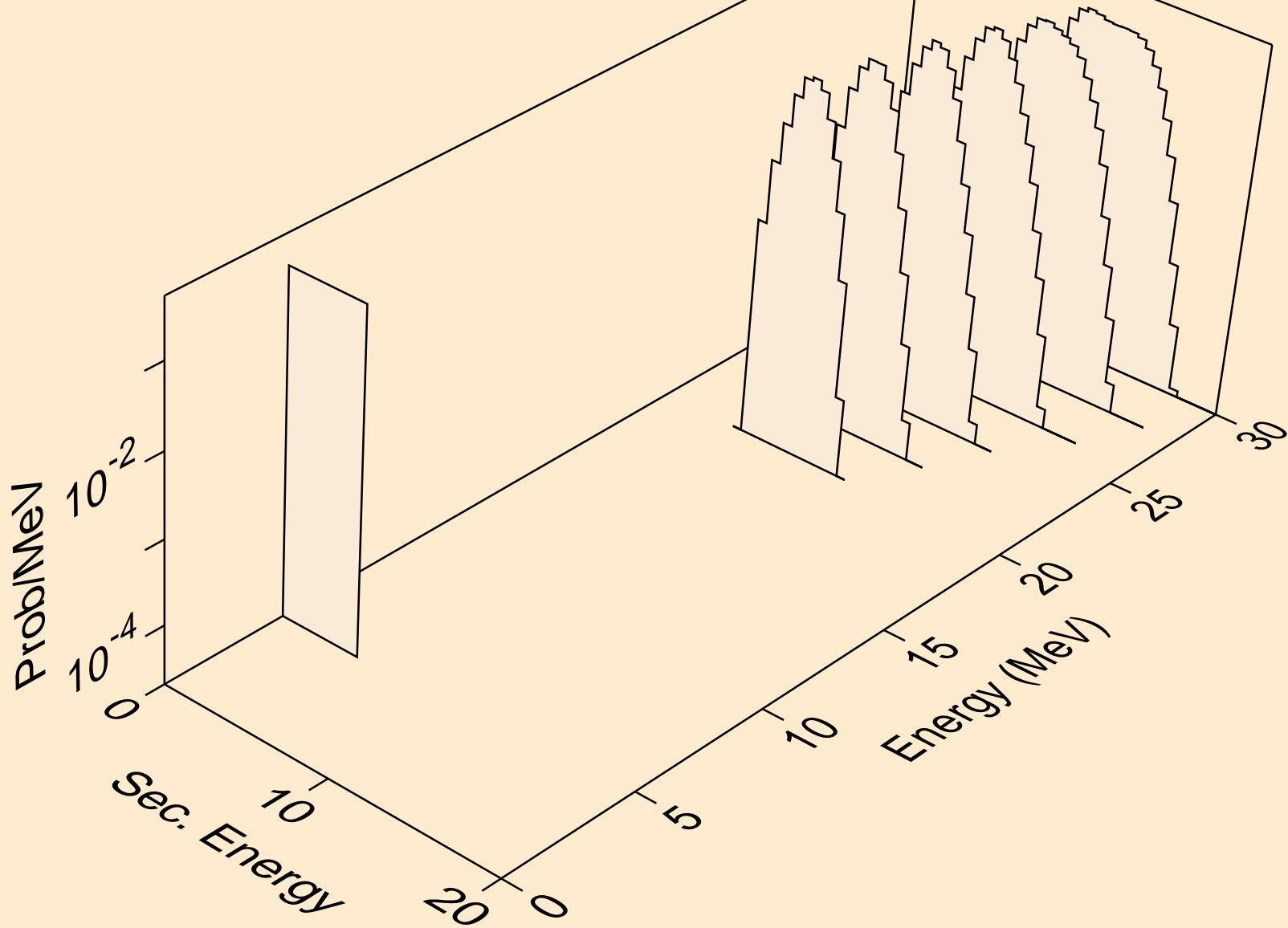

DY145 NEUTRON ACER TENDL-2023 LIBRARY; T=0.K  
alphas from (n,npa)

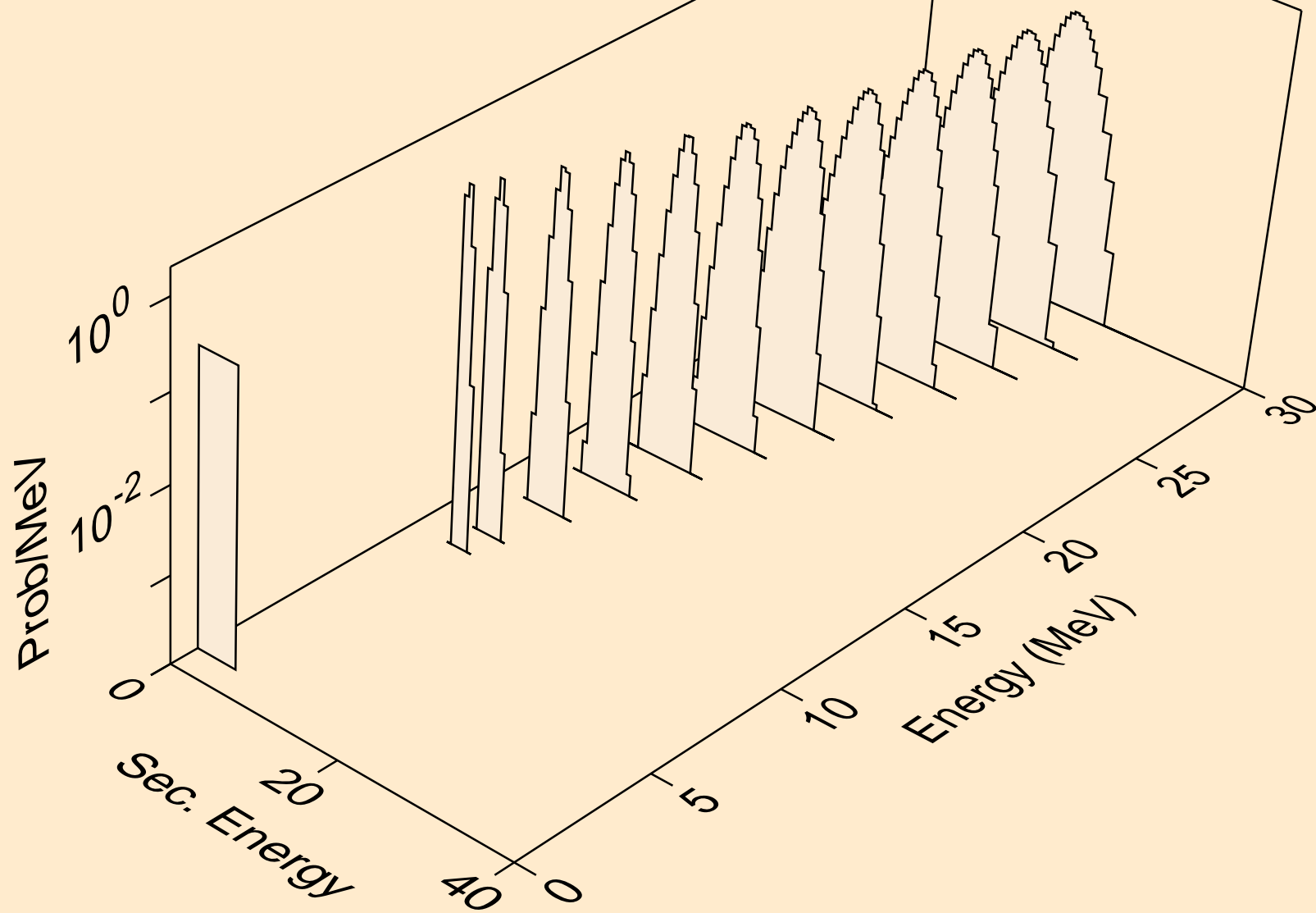

DY145 NEUTRON ACER TENDL-2023 LIBRARY; T=0.K  
alphas from (n,a)

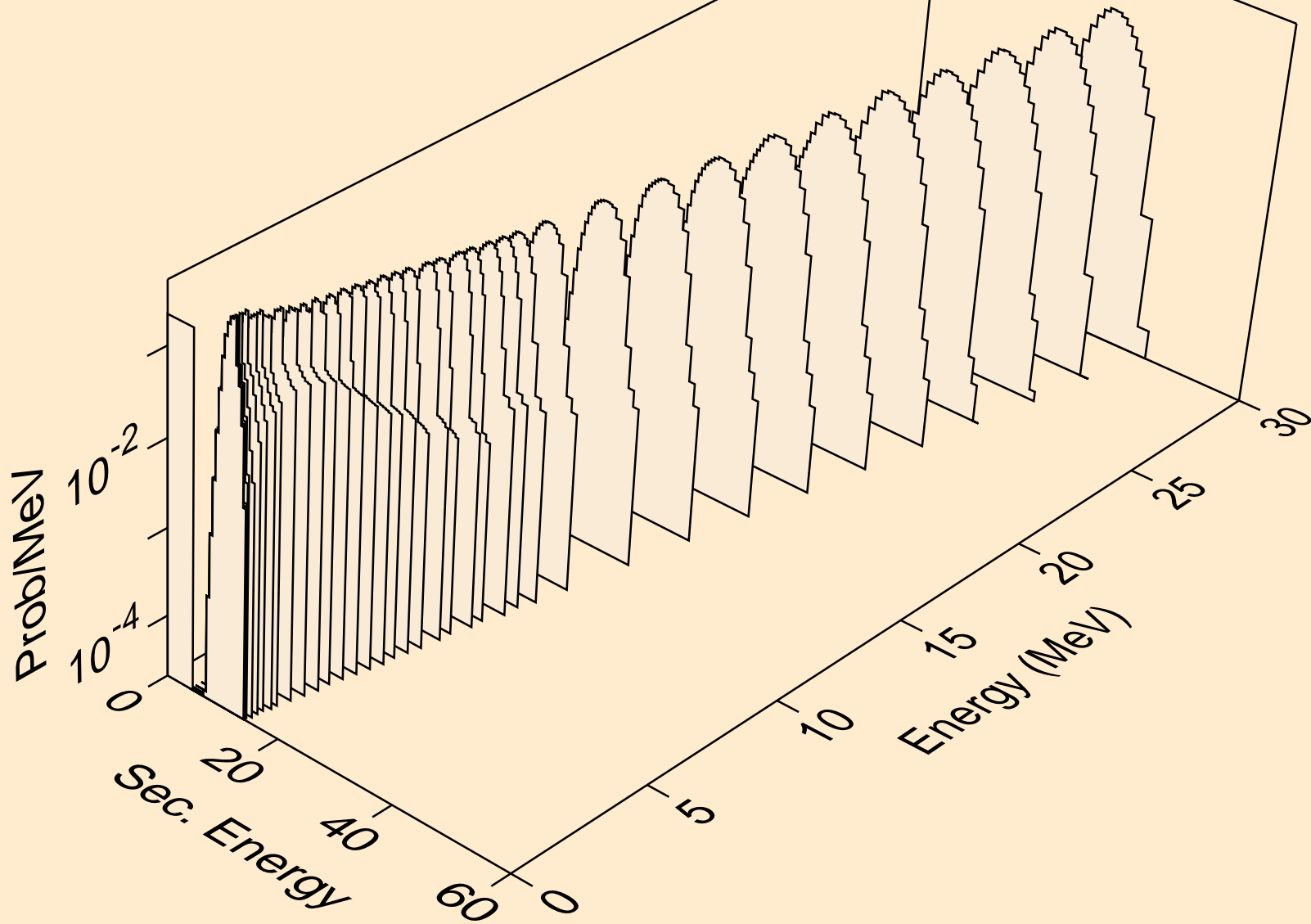

DY145 NEUTRON ACER TENDL-2023 LIBRARY; T=0.K  
alphas from (n,2a)

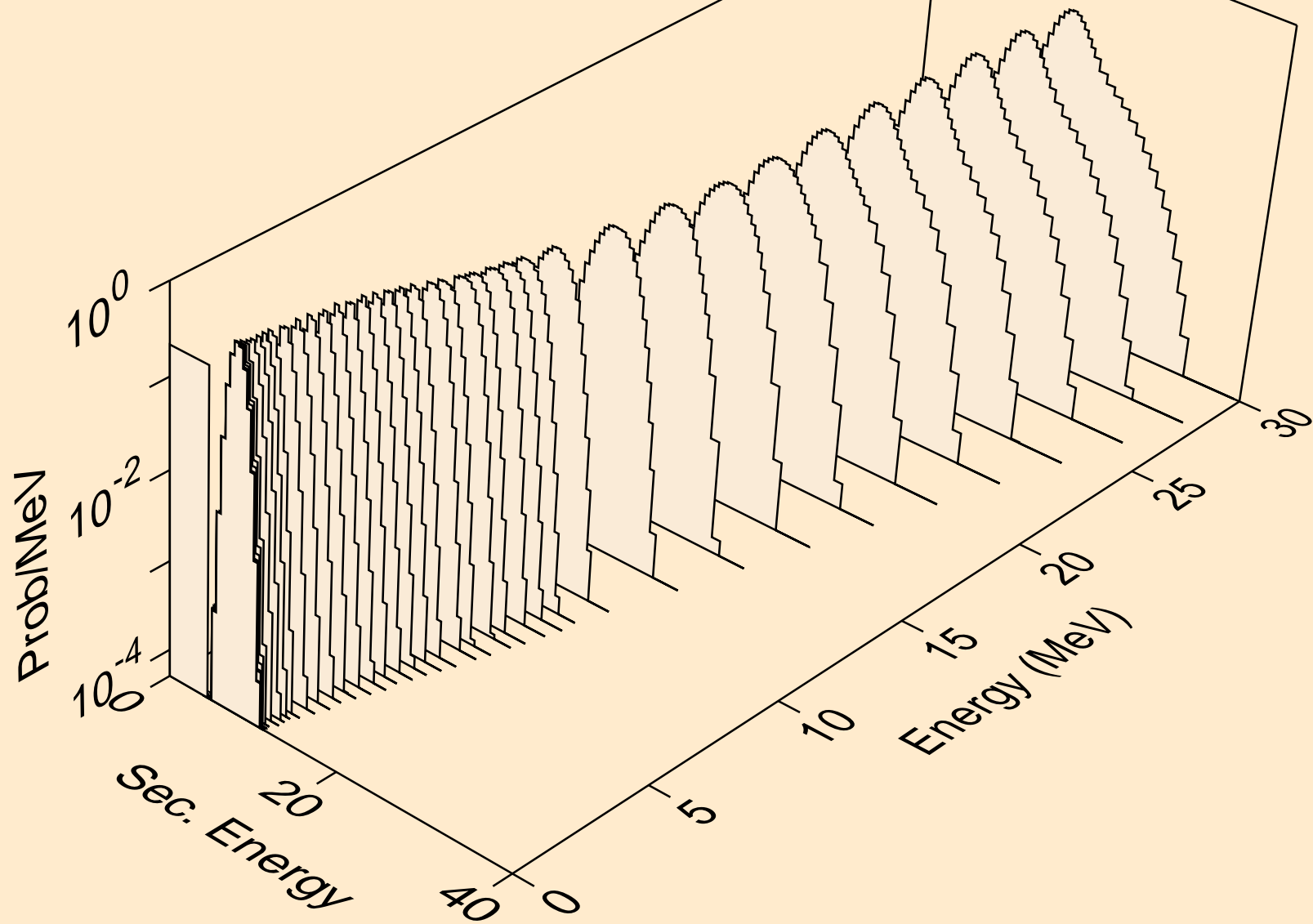

DY145 NEUTRON ACER TENDL-2023 LIBRARY; T=0.K  
alphas from (n,3a)

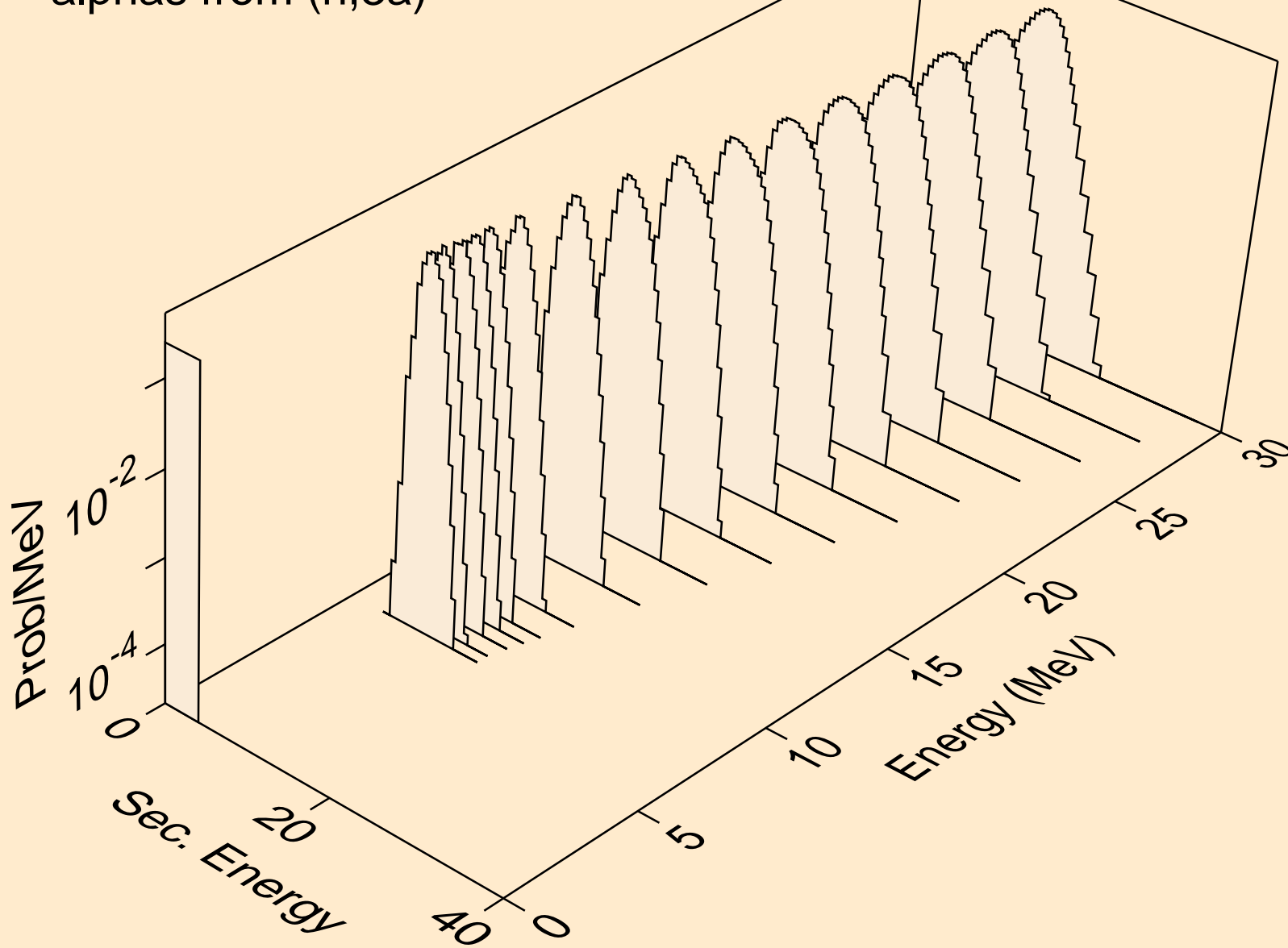

DY145 NEUTRON ACER TENDL-2023 LIBRARY; T=0.K  
alphas from (n,pa)

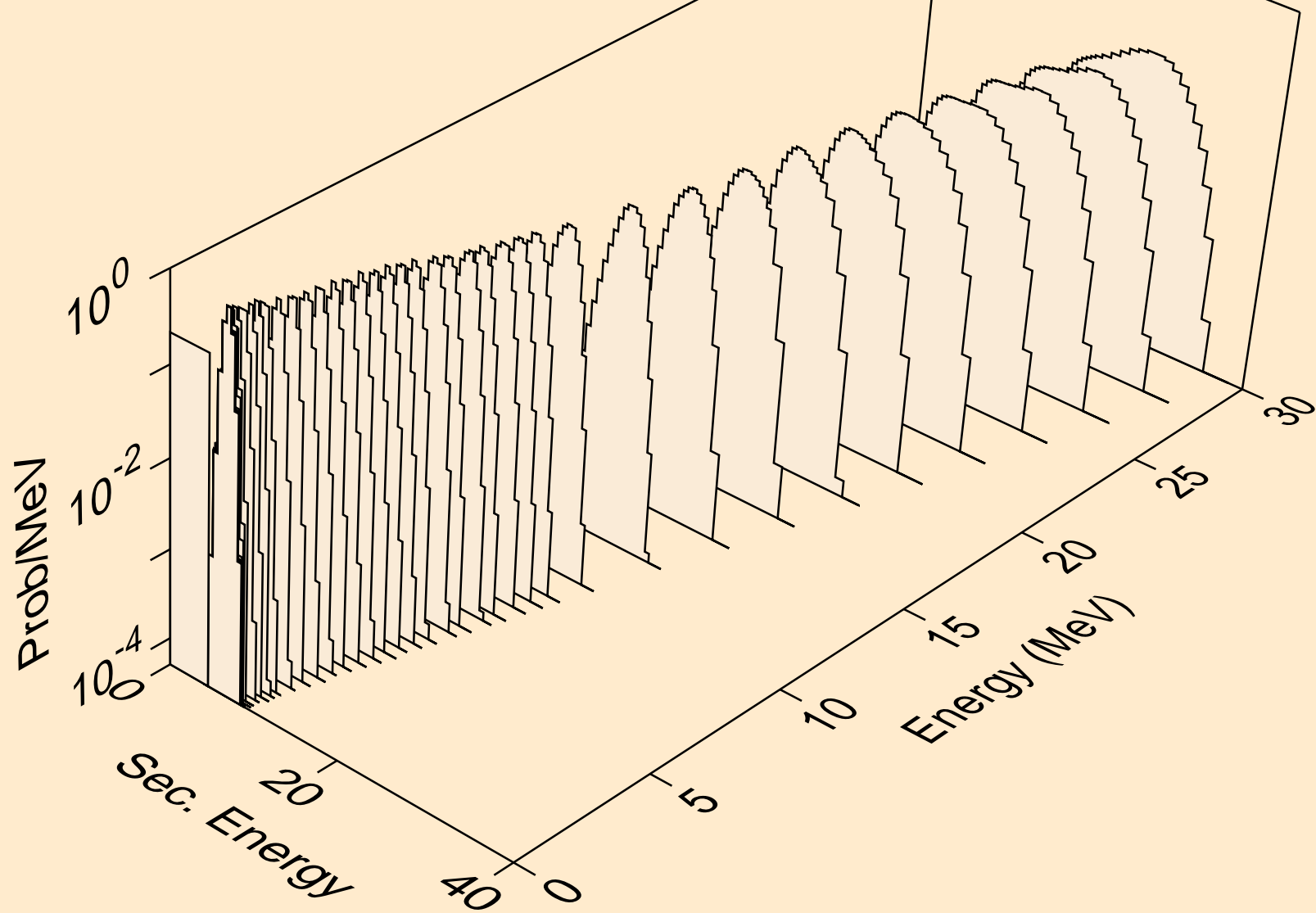



DY145 NEUTRON ACER TENDL-2023 LIBRARY; T=0.K  
alphas from (n,da)

