

ER167M NEUTRON ACER TENDL-2023 LIBRARY; T=0.K

Principal cross sections

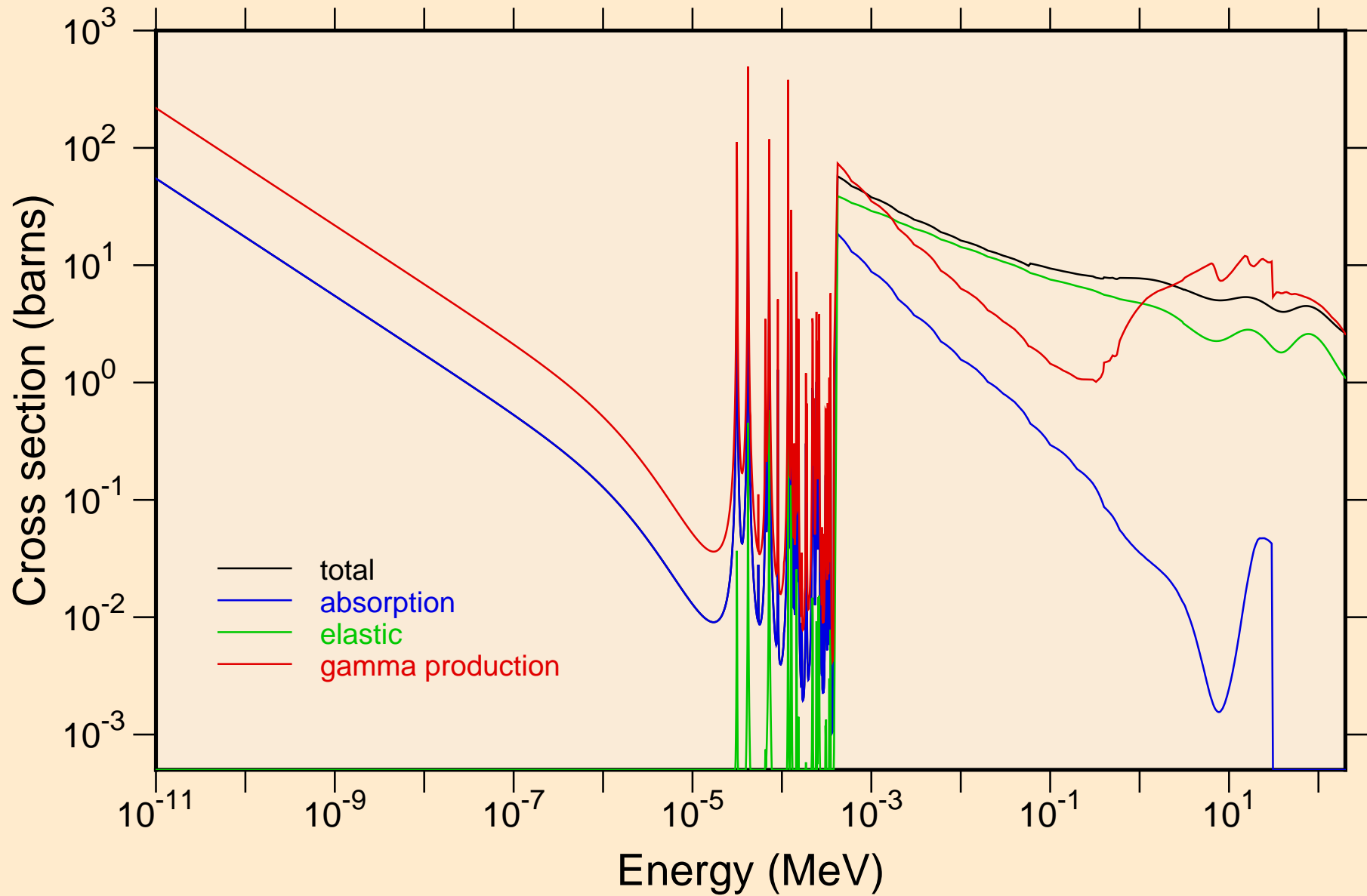

ER167M NEUTRON ACER TENDL-2023 LIBRARY; T=0.K
resonance total cross section

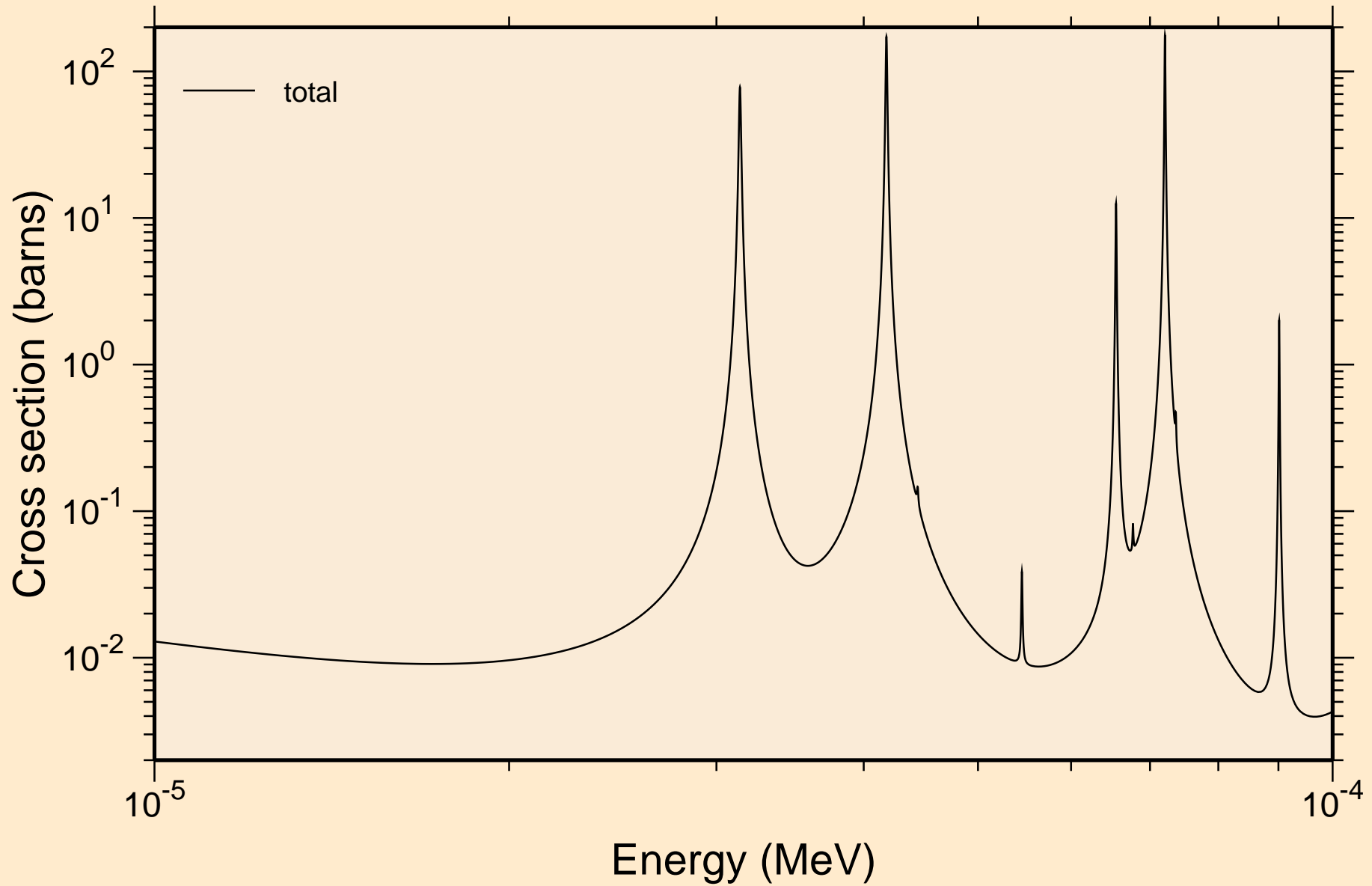

ER167M NEUTRON ACER TENDL-2023 LIBRARY; T=0.K
resonance total cross section

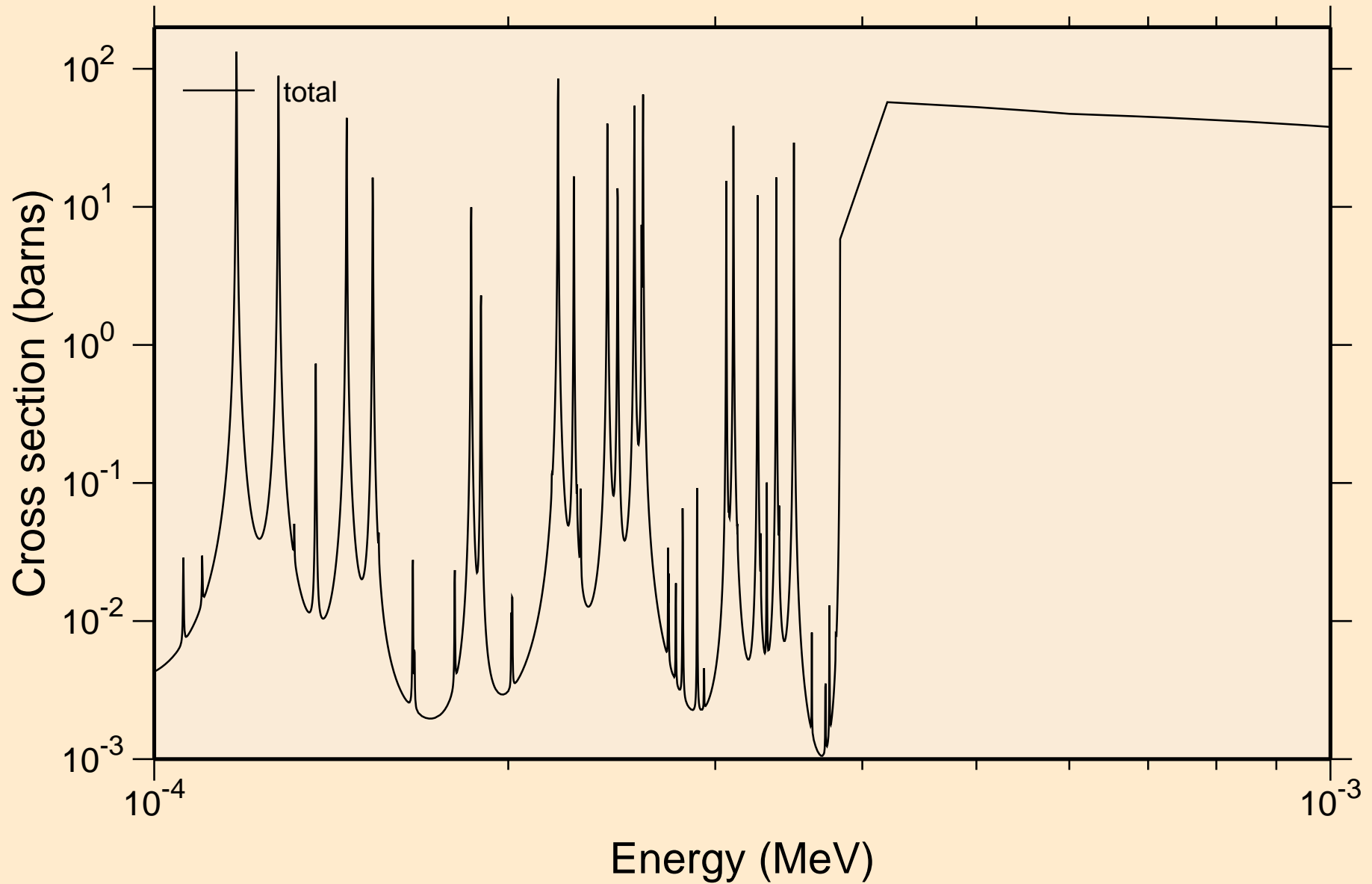

ER167M NEUTRON ACER TENDL-2023 LIBRARY; T=0.K
resonance total cross section

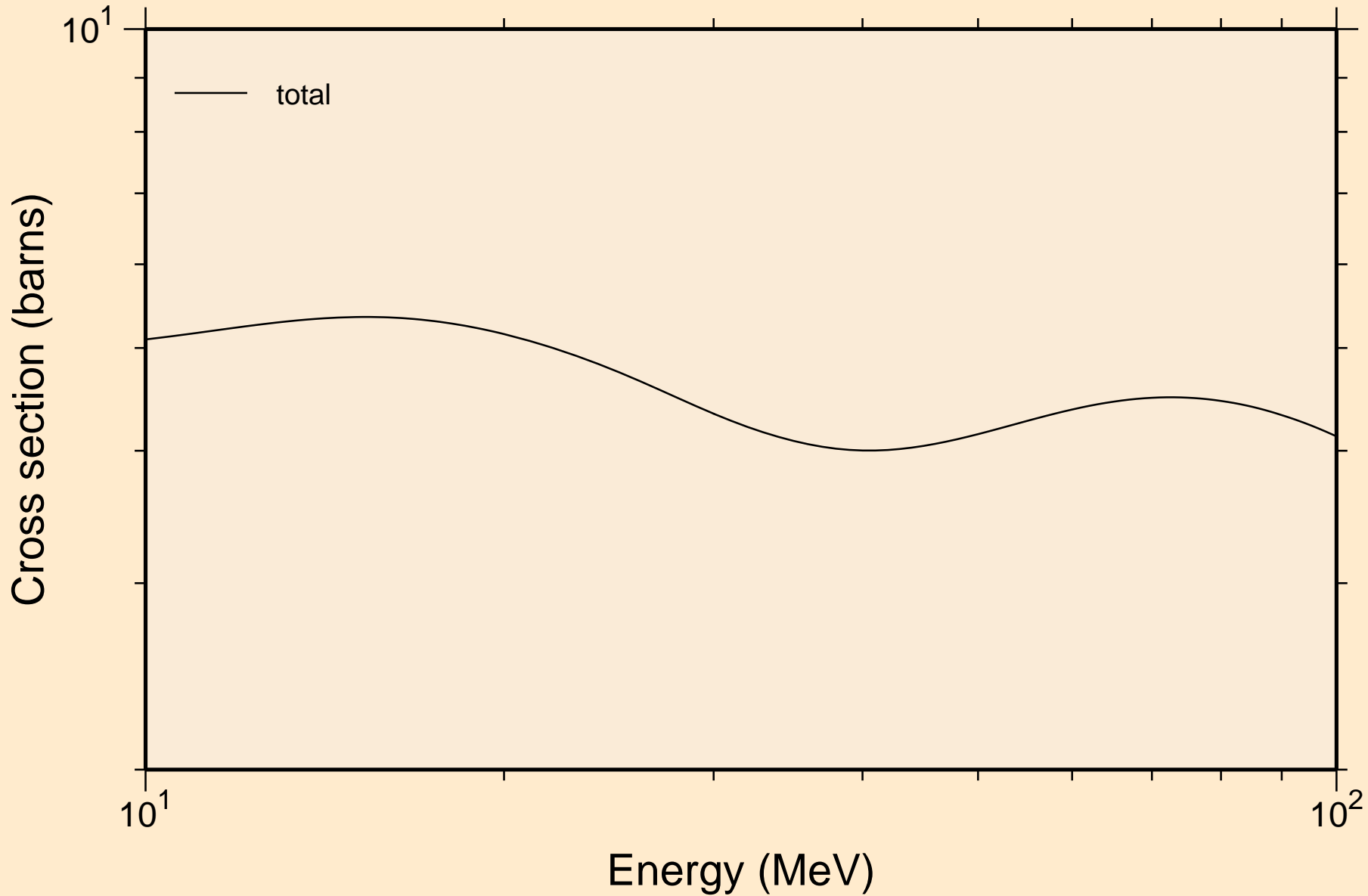

ER167M NEUTRON ACER TENDL-2023 LIBRARY; T=0.K
resonance absorption cross sections

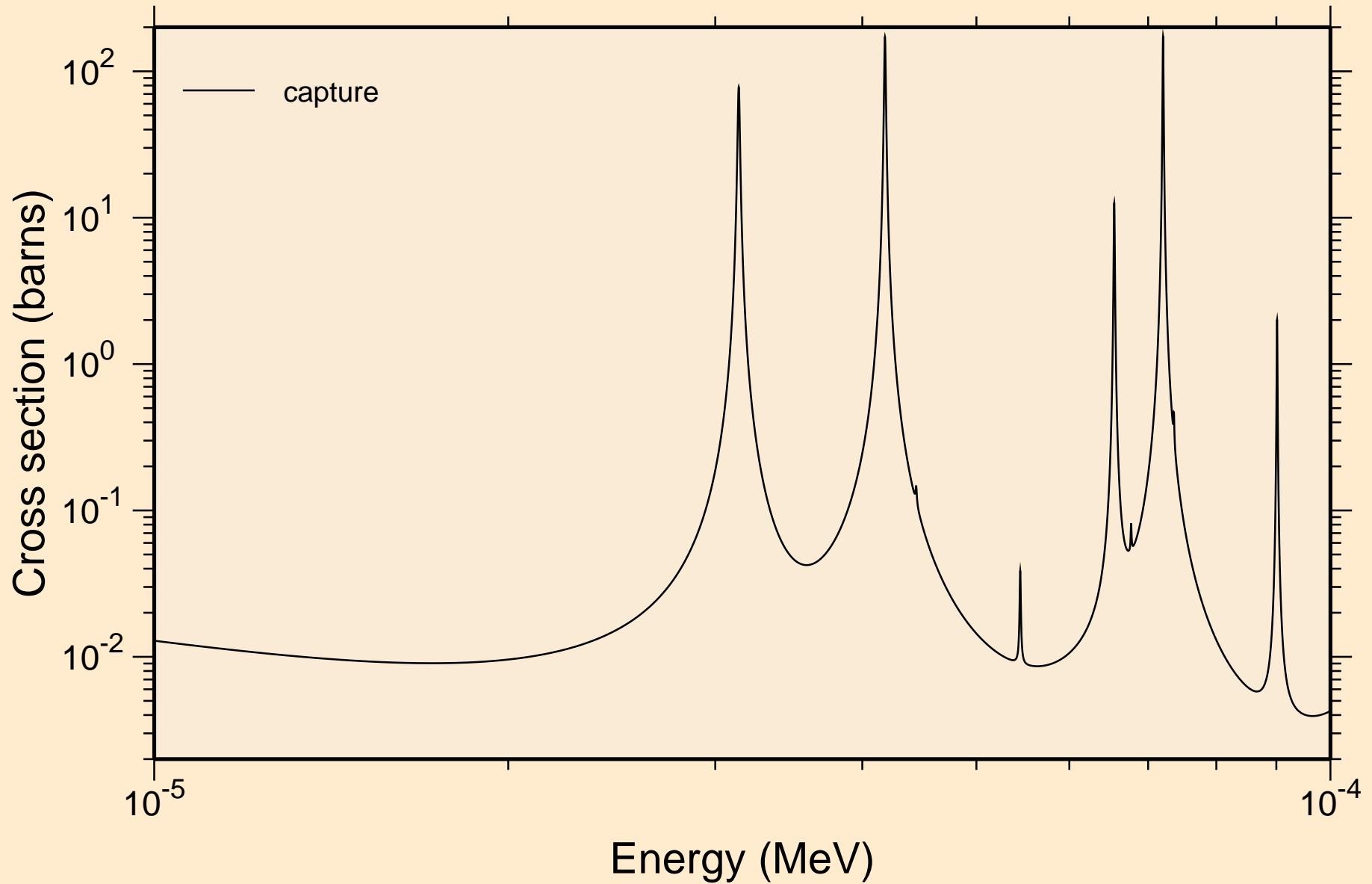

ER167M NEUTRON ACER TENDL-2023 LIBRARY; T=0.K
resonance absorption cross sections

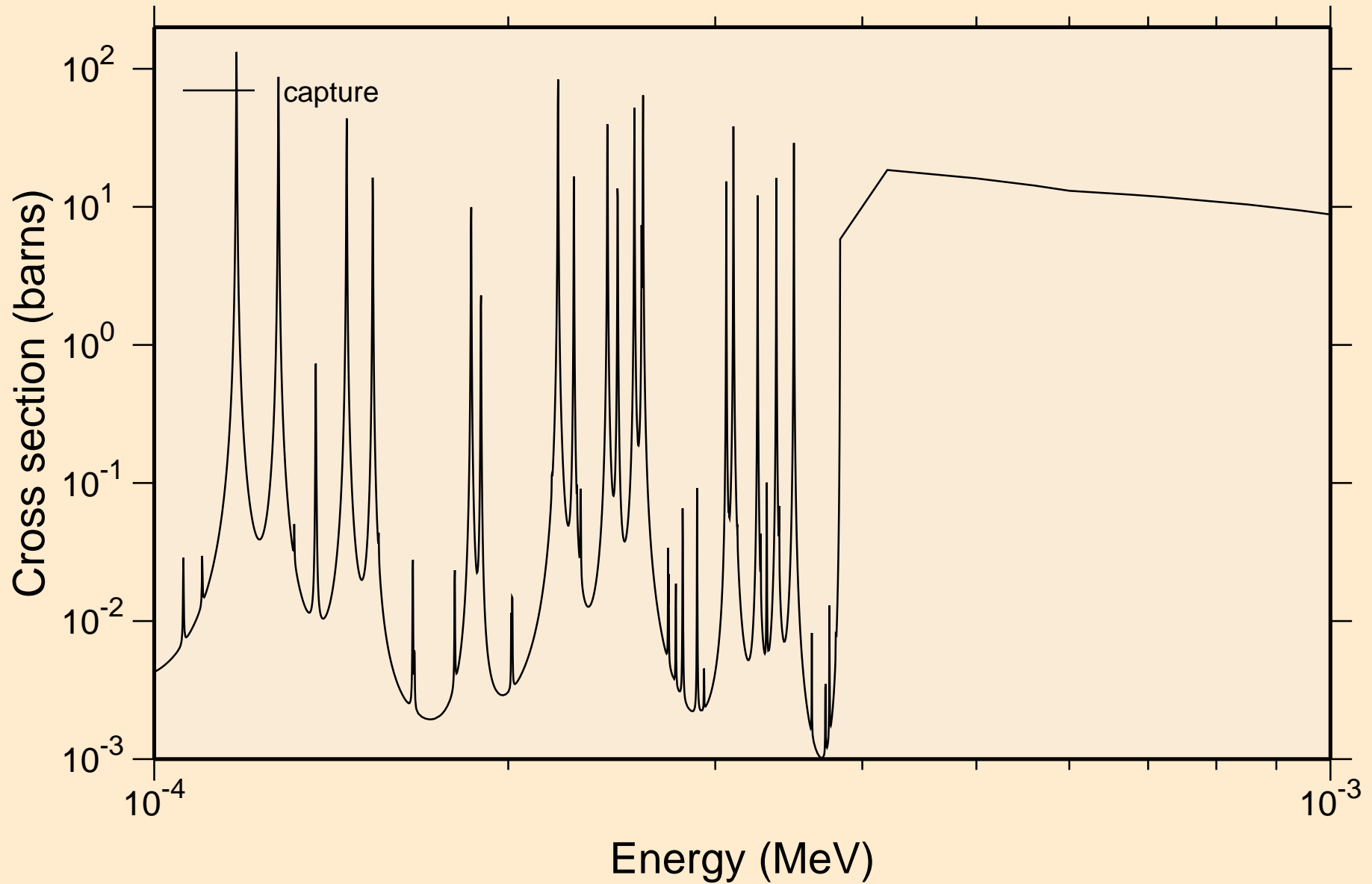

ER167M NEUTRON ACER TENDL-2023 LIBRARY; T=0.K
resonance absorption cross sections

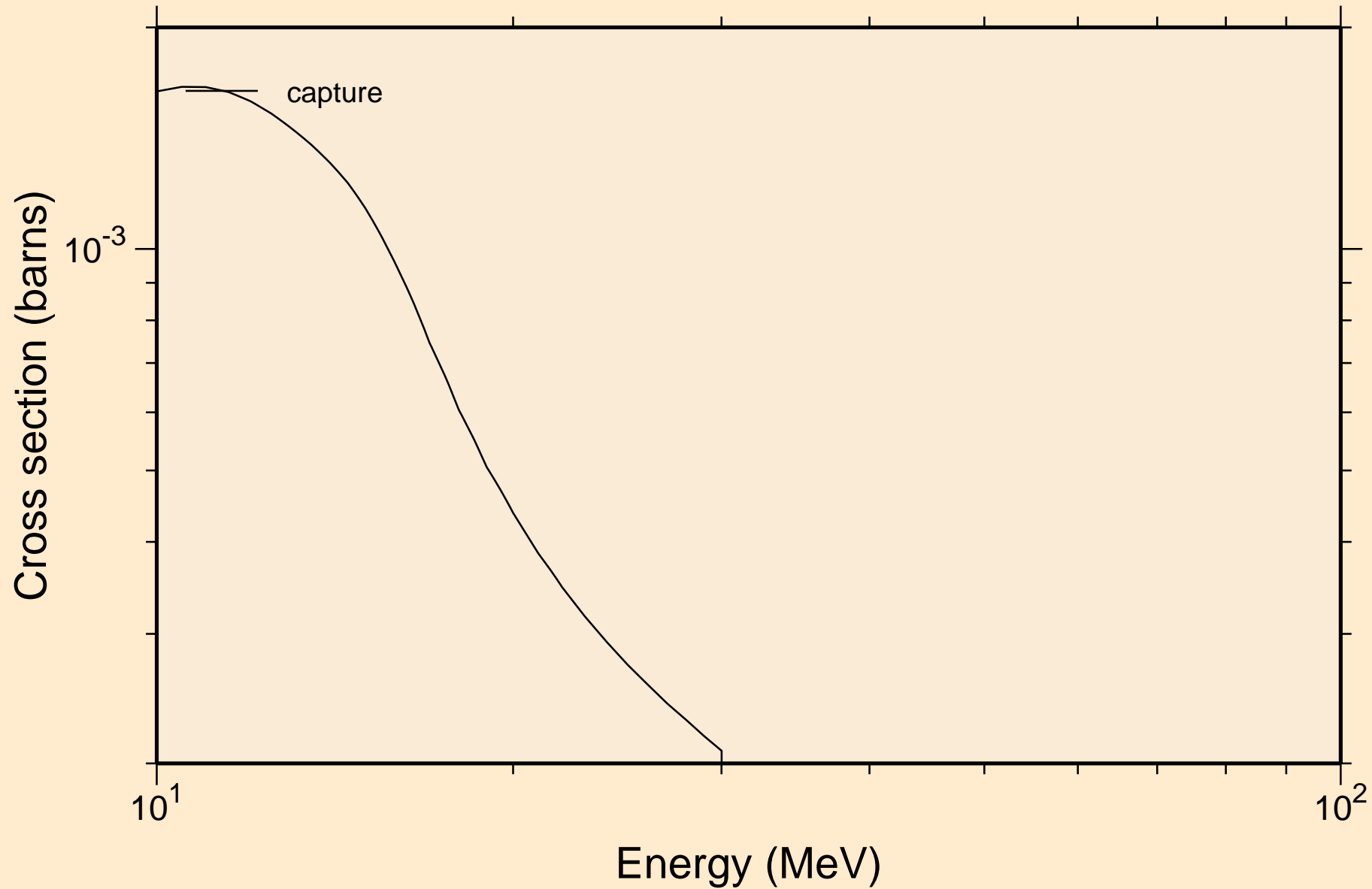

ER167M NEUTRON ACER TENDL-2023 LIBRARY; T=0.K
Heating

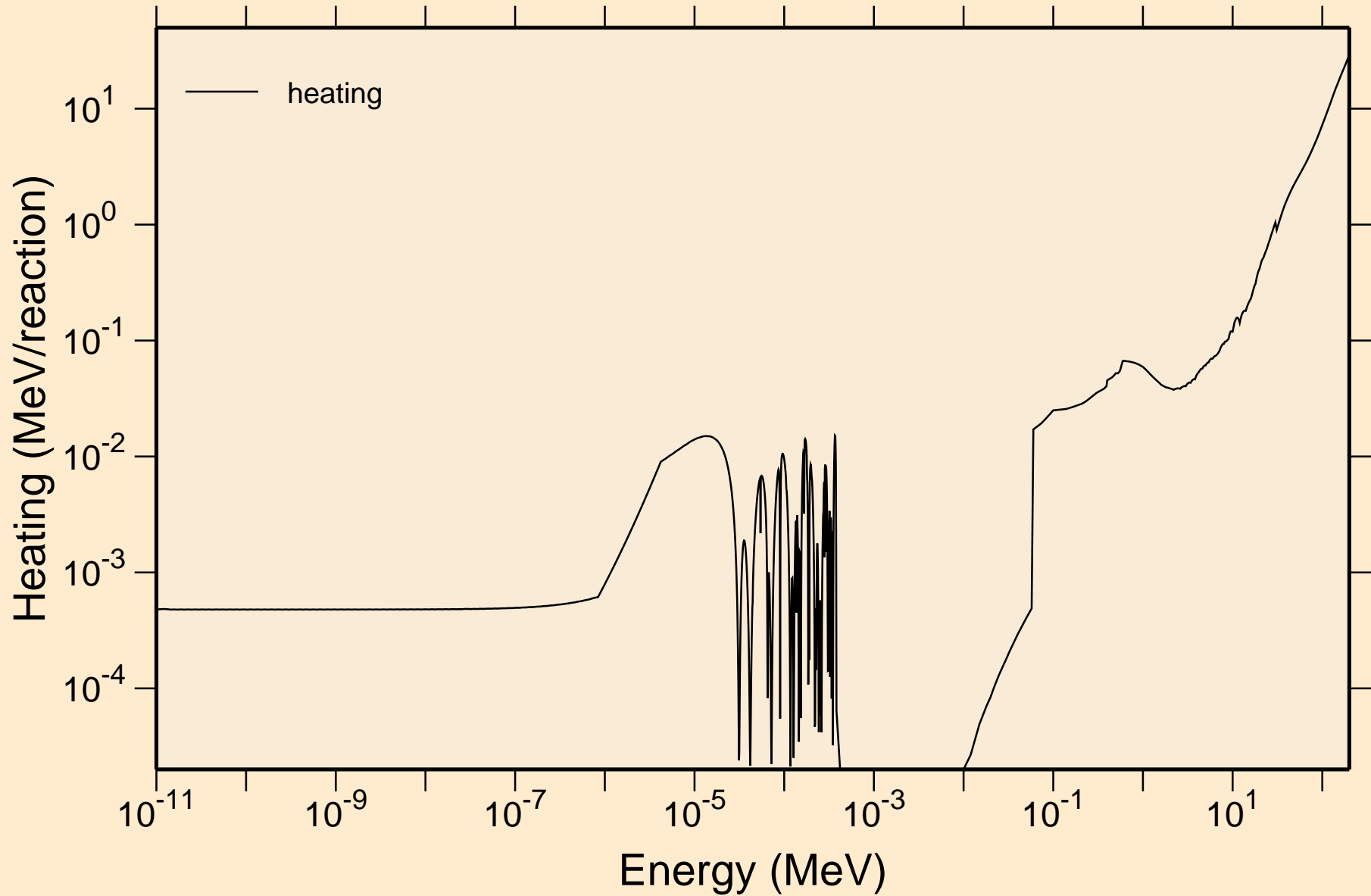

ER167M NEUTRON ACER TENDL-2023 LIBRARY; T=0.K
Damage

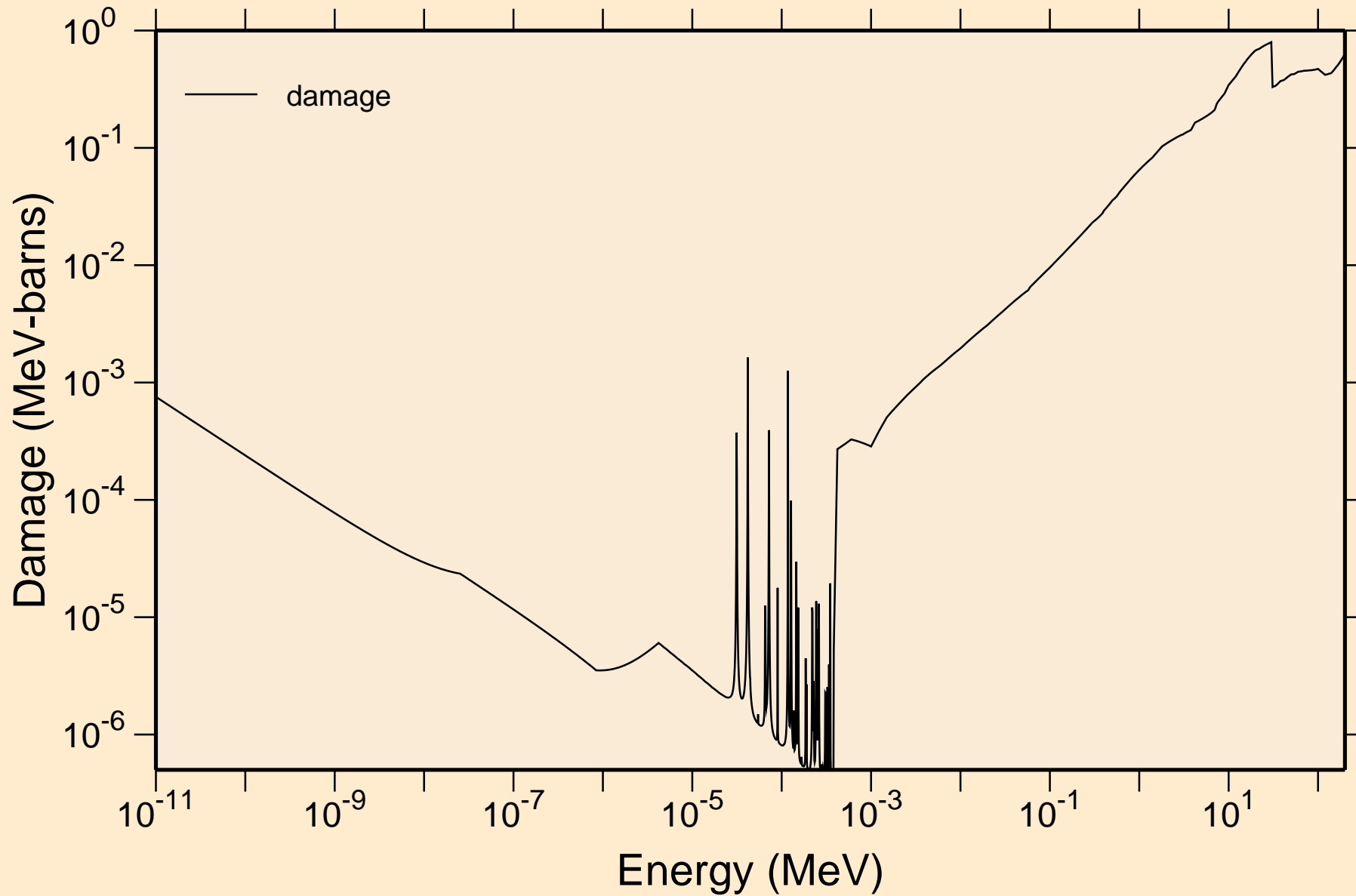

ER167M NEUTRON ACER TENDL-2023 LIBRARY; T=0.K

Non-threshold reactions

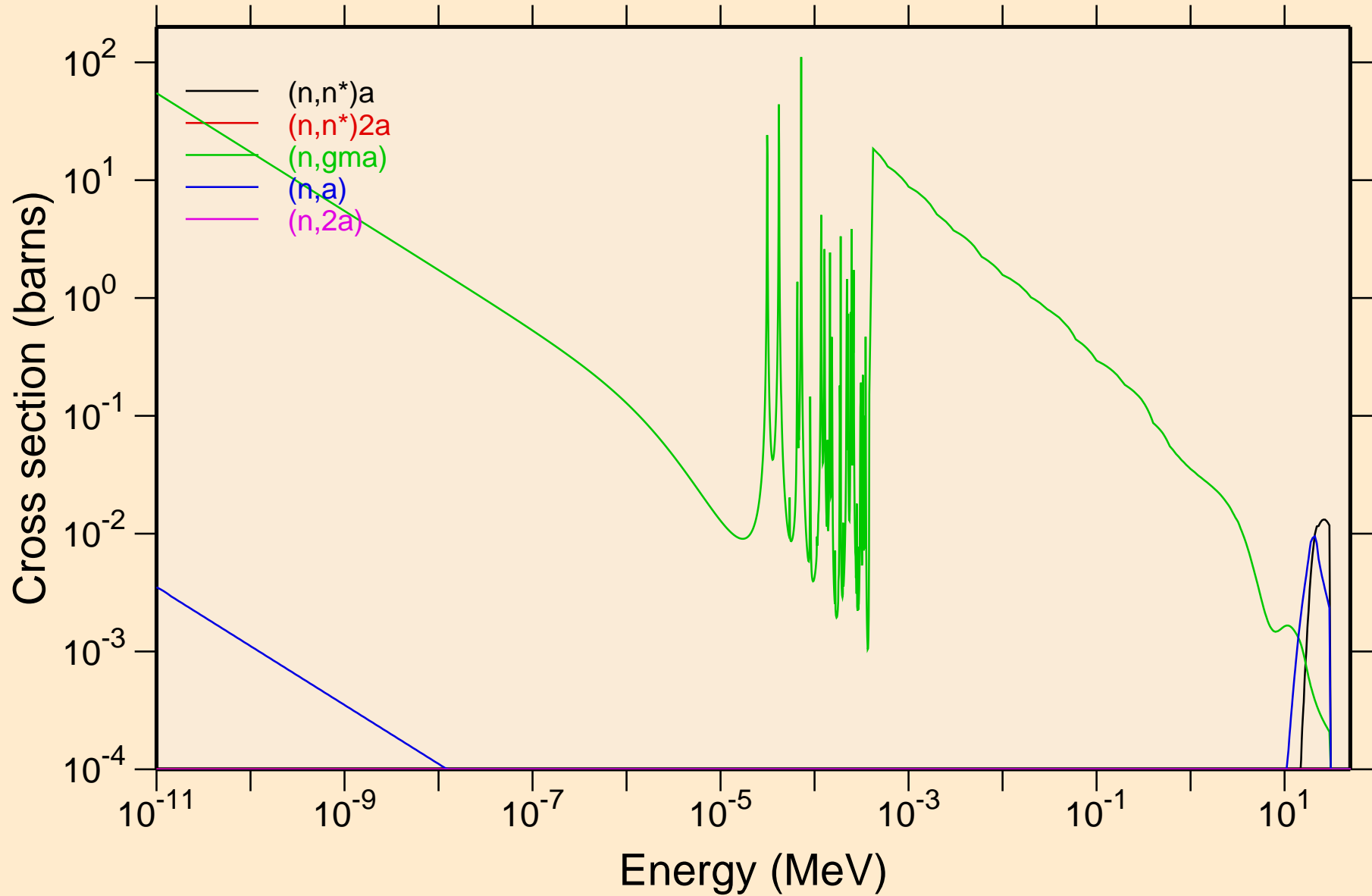

ER167M NEUTRON ACER TENDL-2023 LIBRARY; T=0.K
Non-threshold reactions

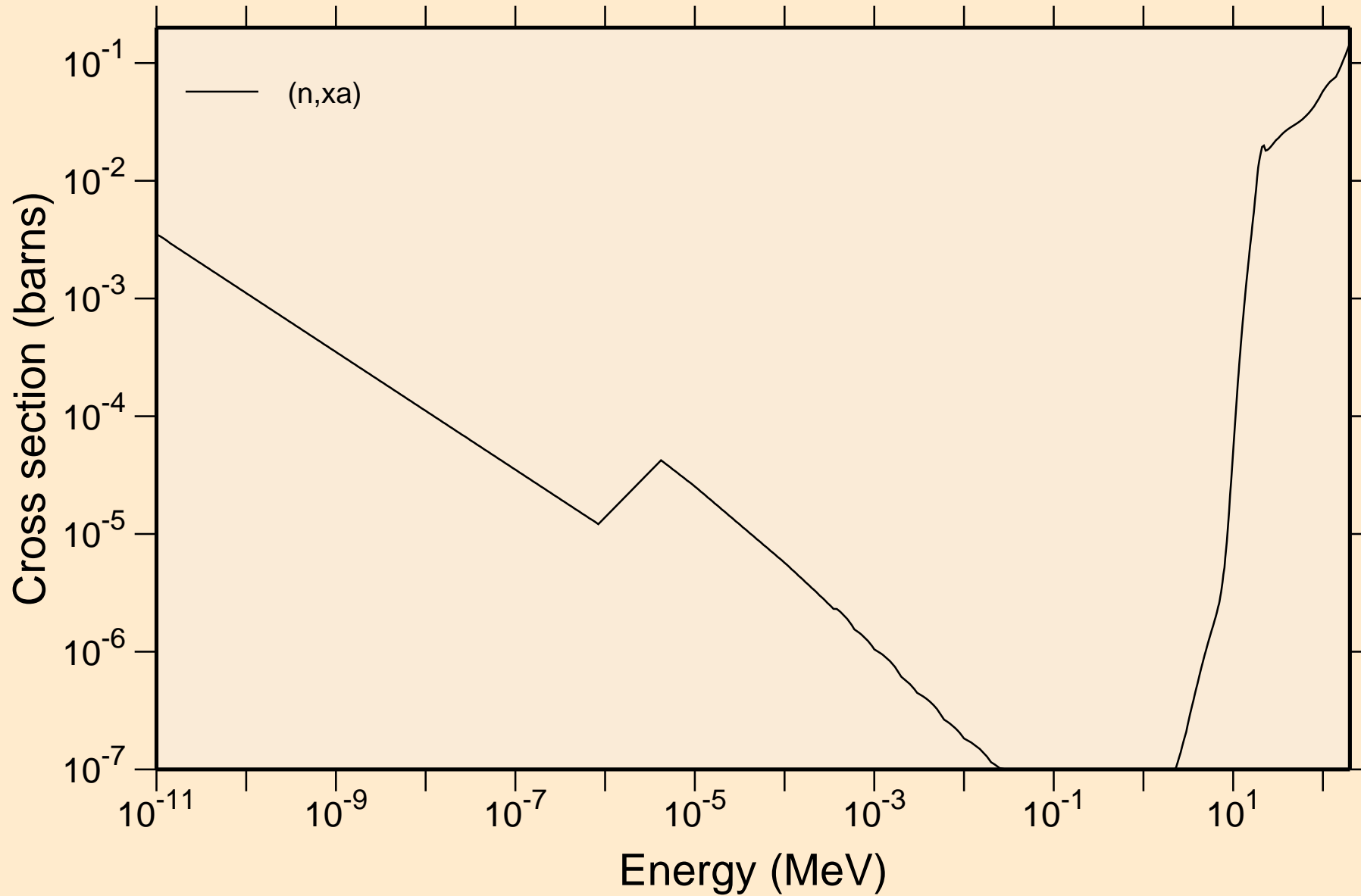

ER167M NEUTRON ACER TENDL-2023 LIBRARY; T=0.K

Principal cross sections

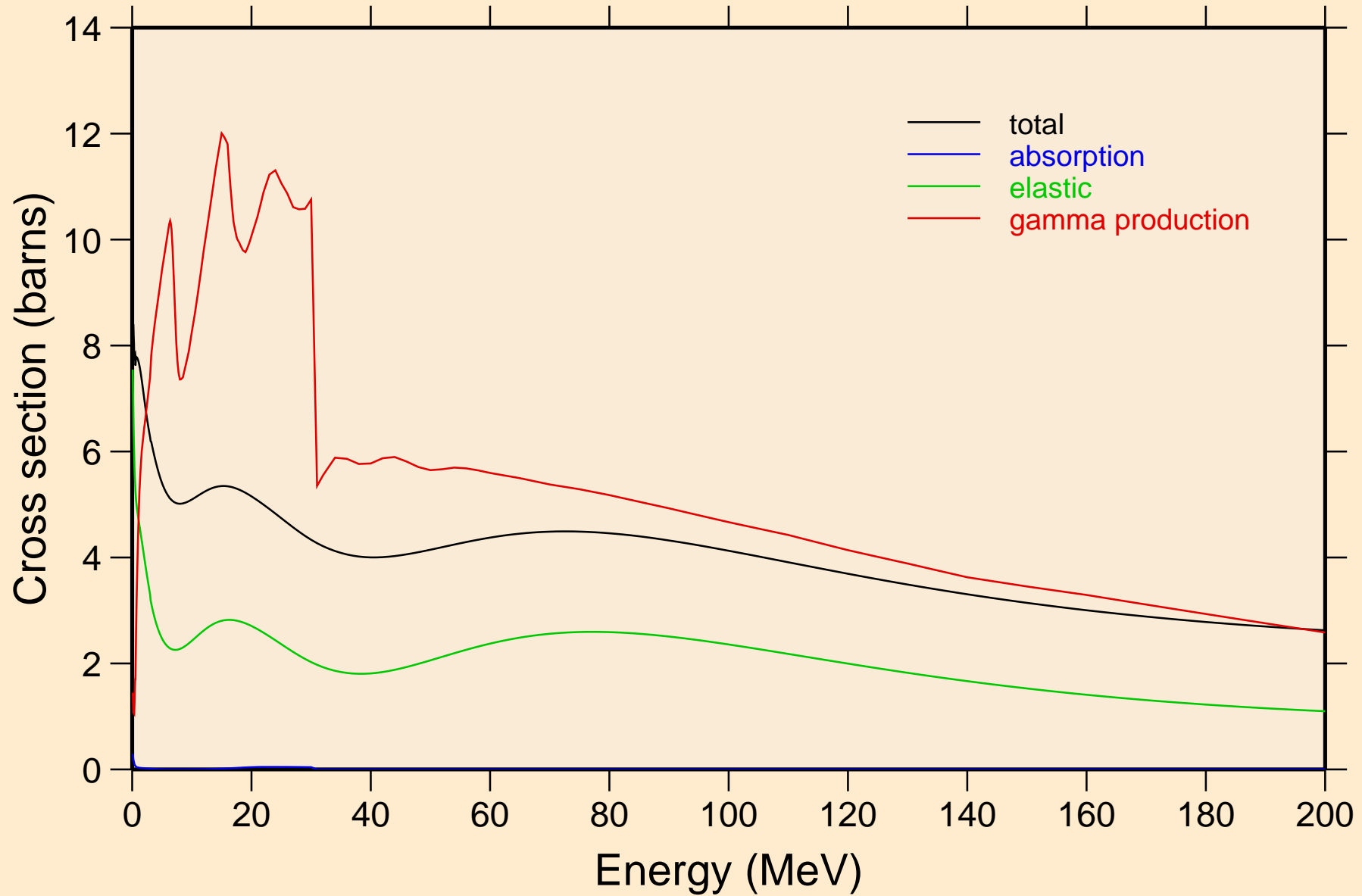

ER167M NEUTRON ACER TENDL-2023 LIBRARY; T=0.K

Heating

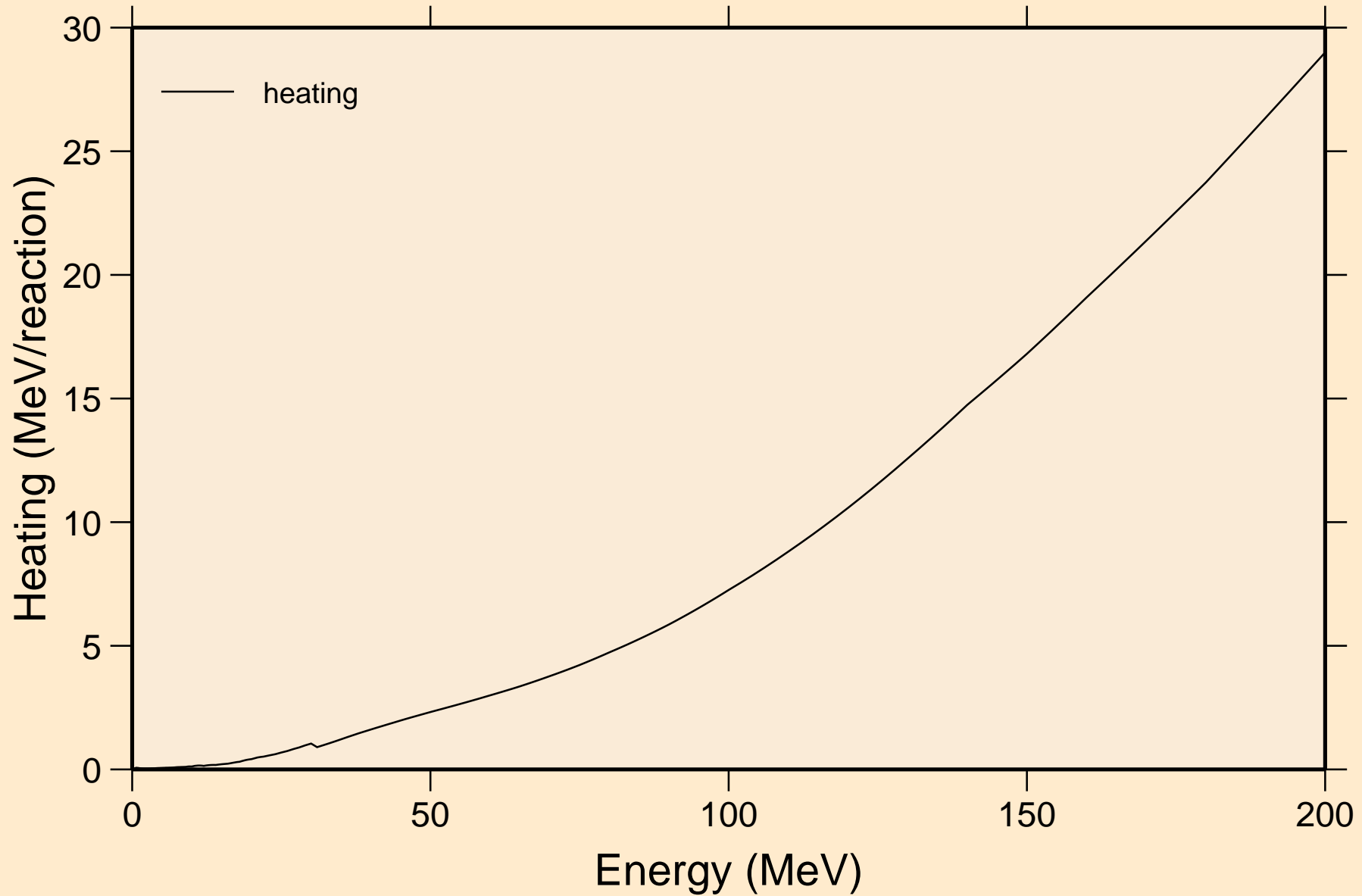

ER167M NEUTRON ACER TENDL-2023 LIBRARY; T=0.K
Damage

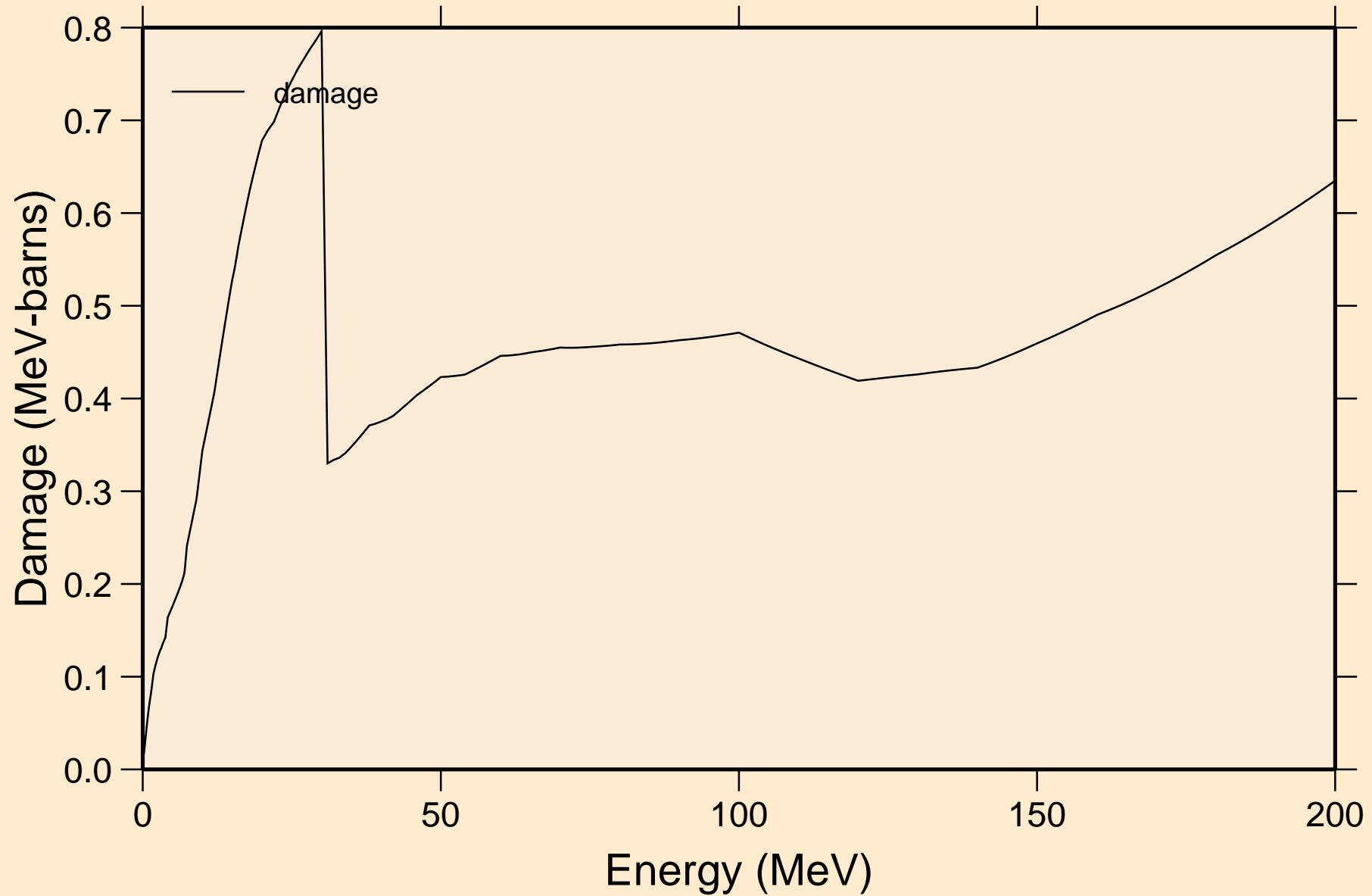

ER167M NEUTRON ACER TENDL-2023 LIBRARY; T=0.K

Non-threshold reactions

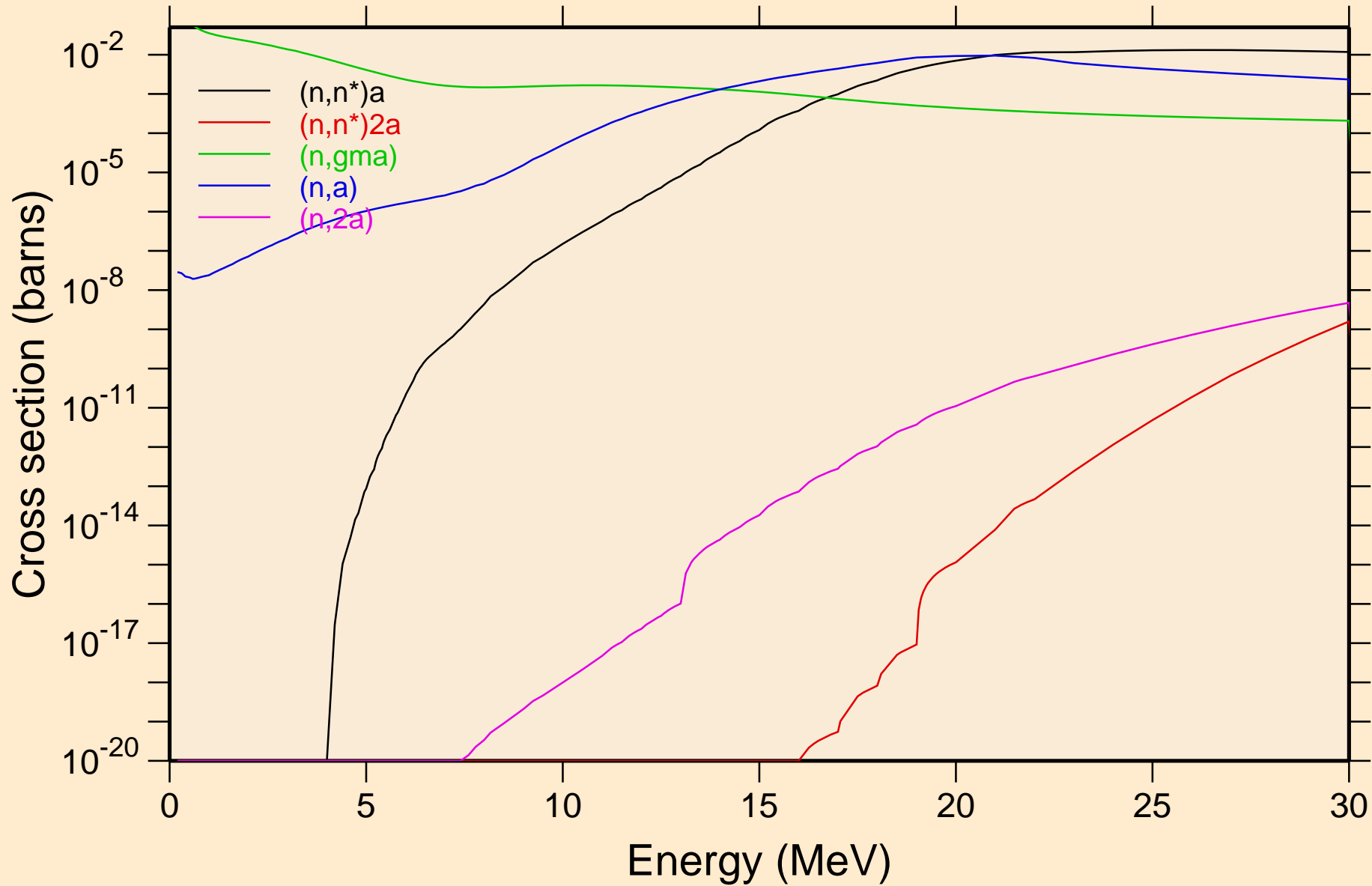

ER167M NEUTRON ACER TENDL-2023 LIBRARY; T=0.K
Non-threshold reactions

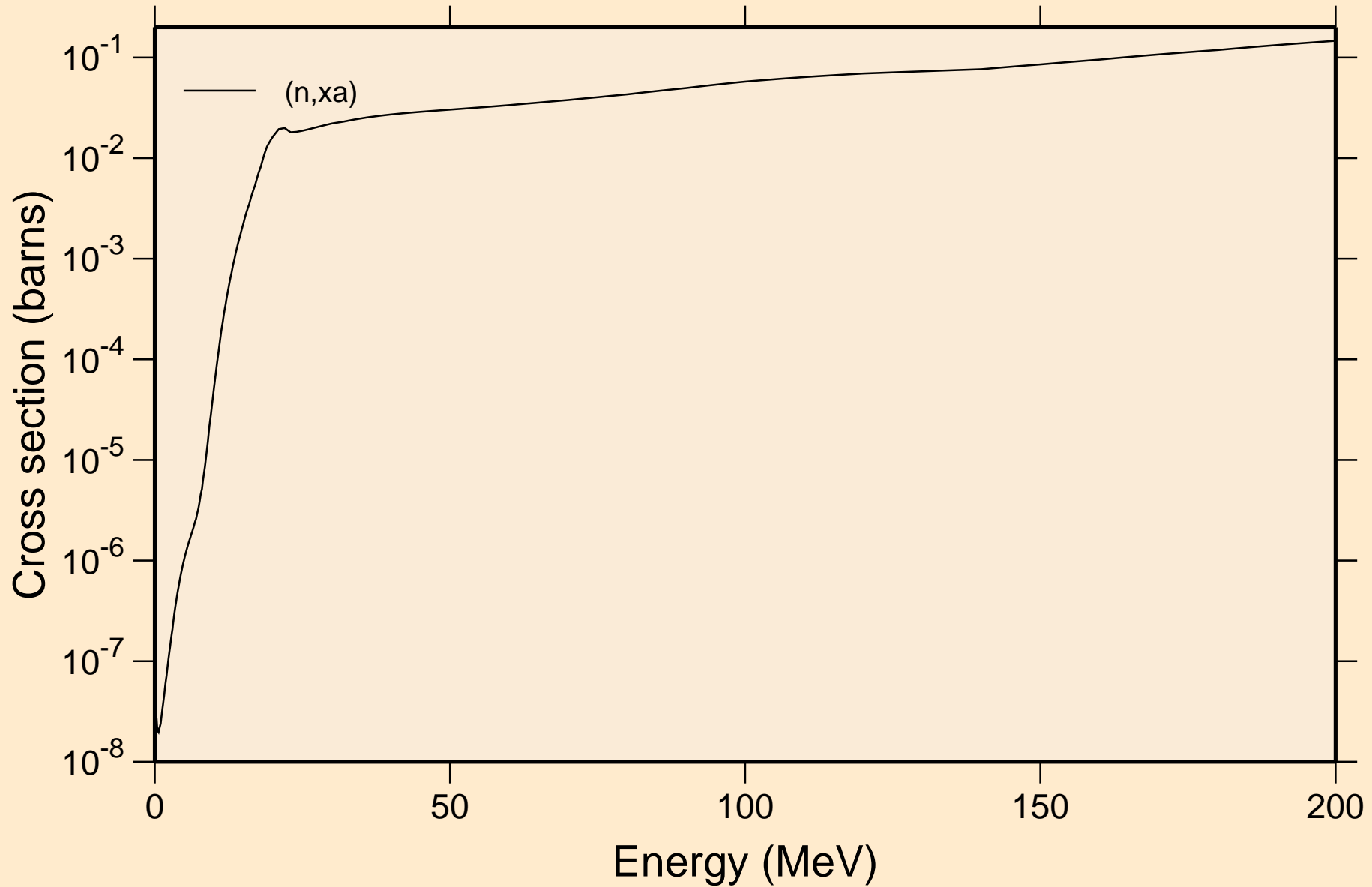

ER167M NEUTRON ACER TENDL-2023 LIBRARY; T=0.K
Inelastic levels

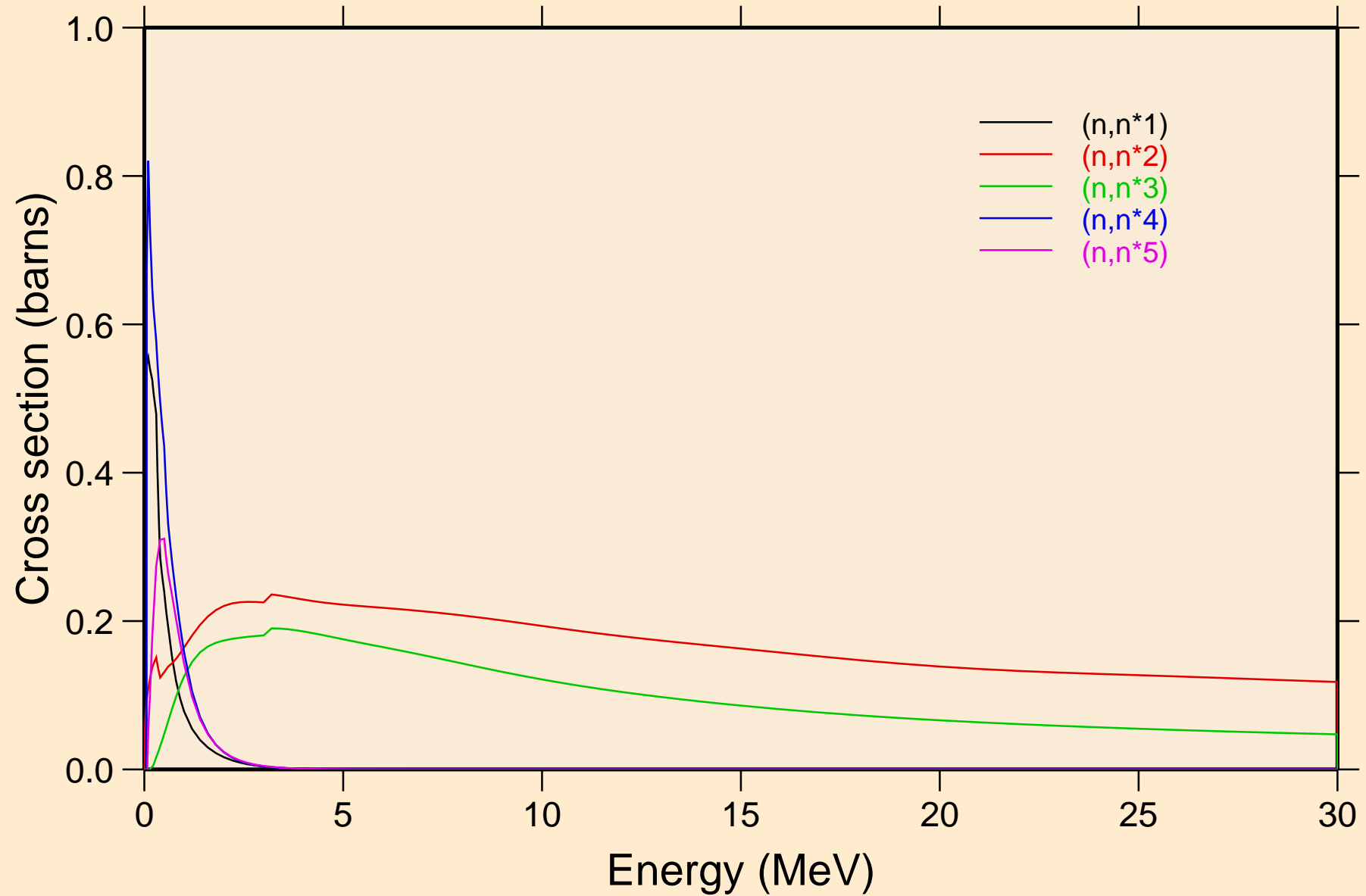

ER167M NEUTRON ACER TENDL-2023 LIBRARY; T=0.K
Inelastic levels

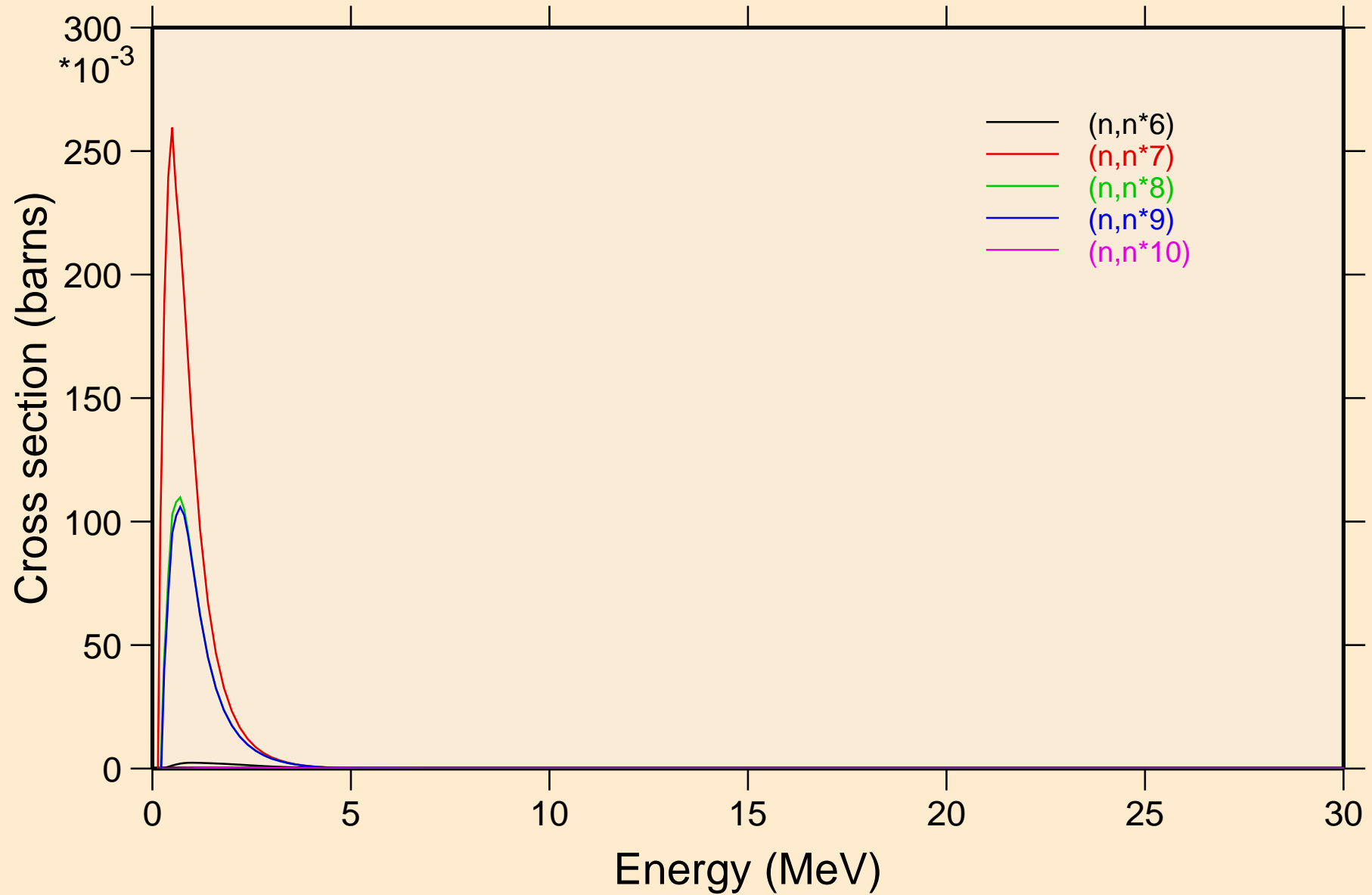

ER167M NEUTRON ACER TENDL-2023 LIBRARY; T=0.K
Inelastic levels

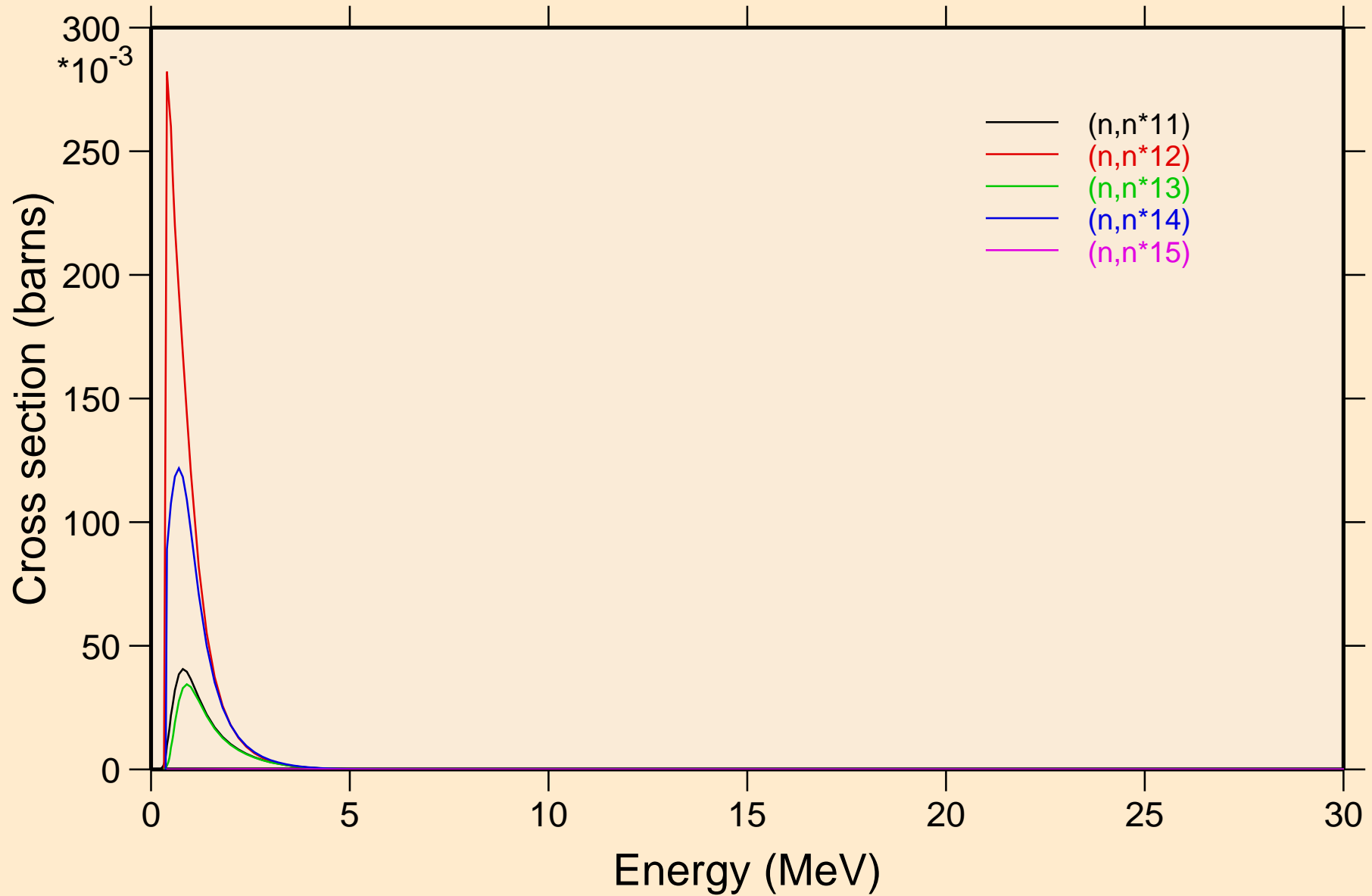

ER167M NEUTRON ACER TENDL-2023 LIBRARY; T=0.K
Inelastic levels

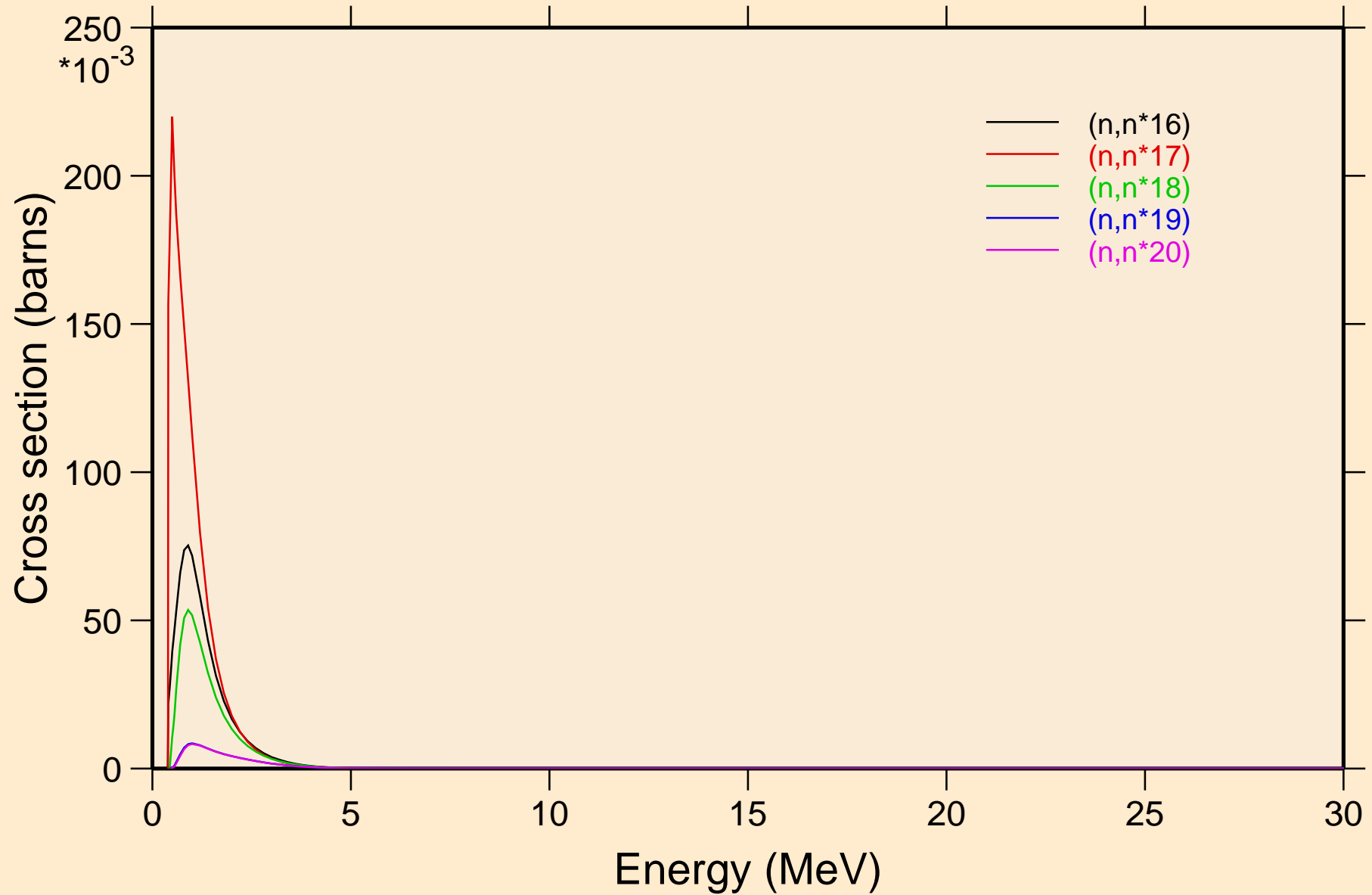

ER167M NEUTRON ACER TENDL-2023 LIBRARY; T=0.K
Inelastic levels

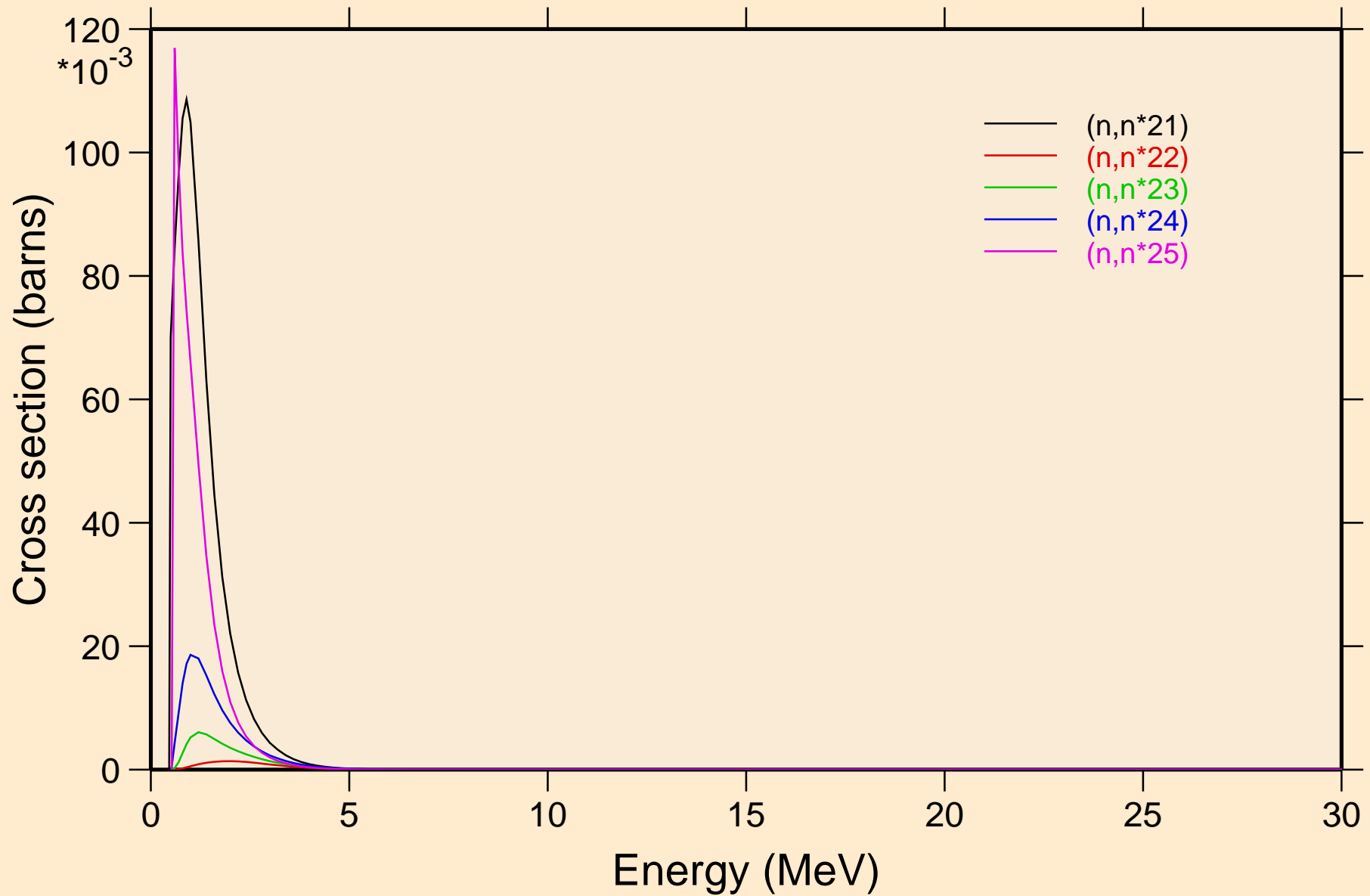

ER167M NEUTRON ACER TENDL-2023 LIBRARY; T=0.K
Inelastic levels

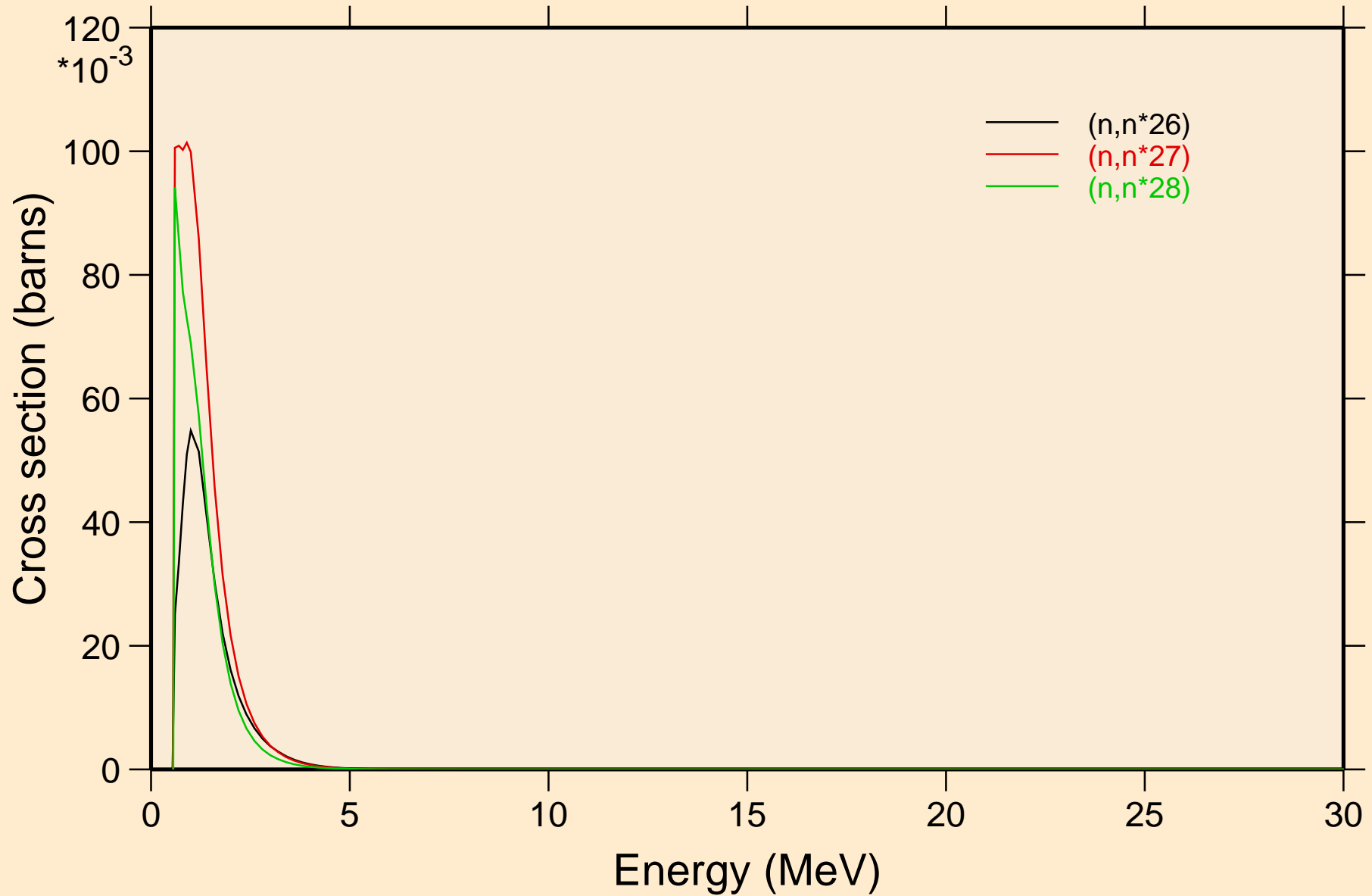

ER167M NEUTRON ACER TENDL-2023 LIBRARY; T=0.K

Threshold reactions

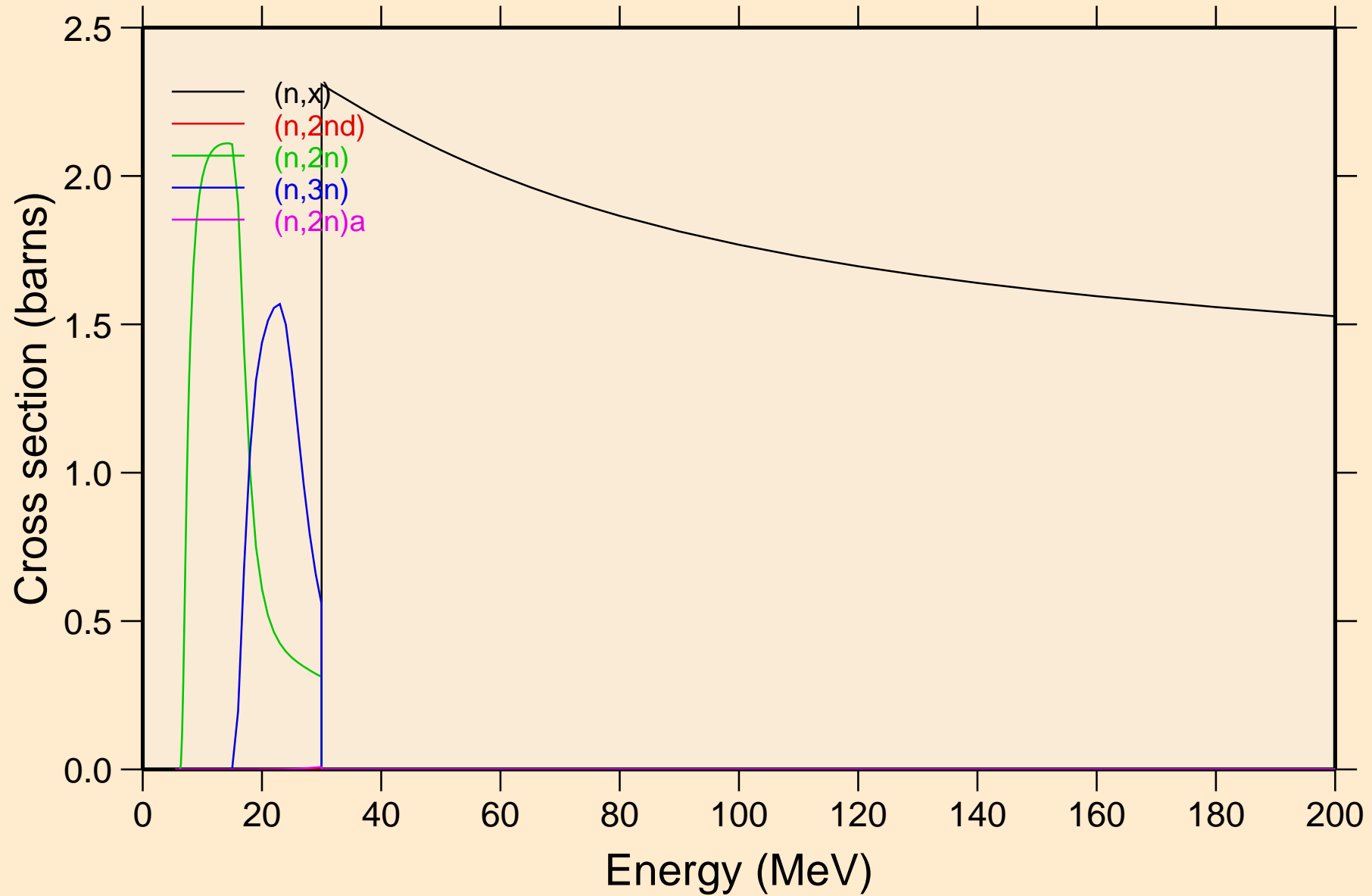

ER167M NEUTRON ACER TENDL-2023 LIBRARY; T=0.K
Threshold reactions

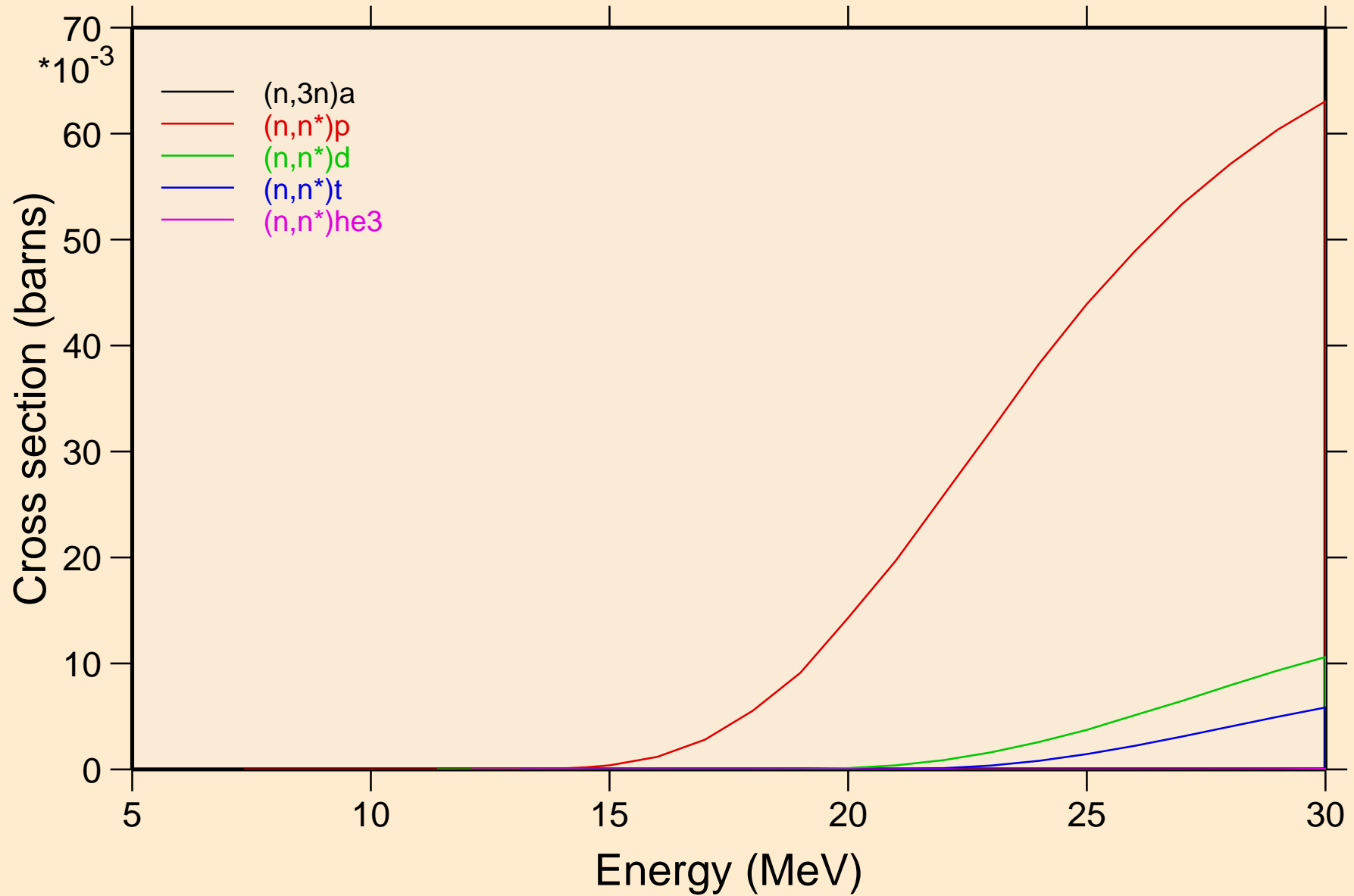

ER167M NEUTRON ACER TENDL-2023 LIBRARY; T=0.K
Threshold reactions

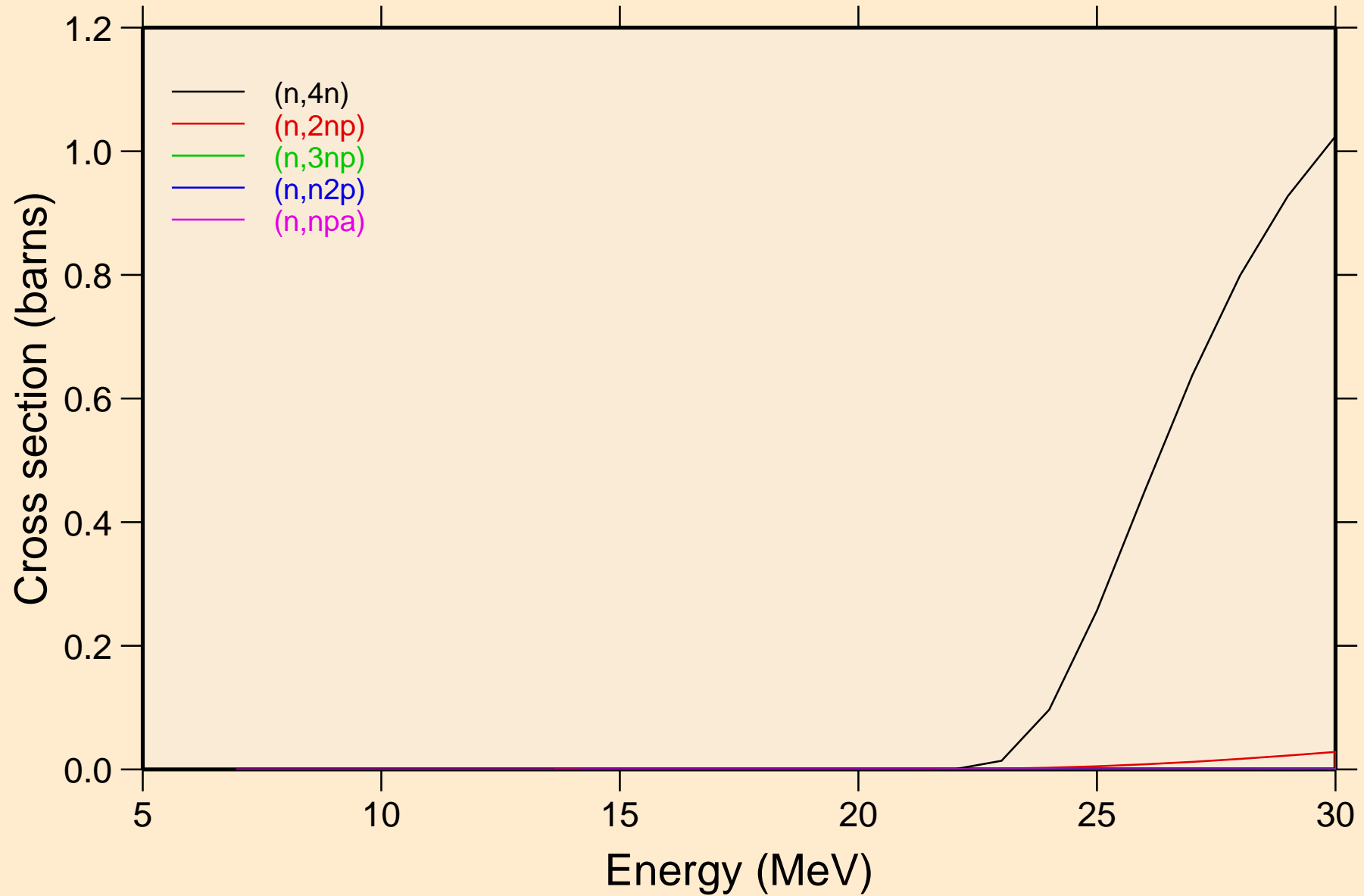

ER167M NEUTRON ACER TENDL-2023 LIBRARY; T=0.K
Threshold reactions

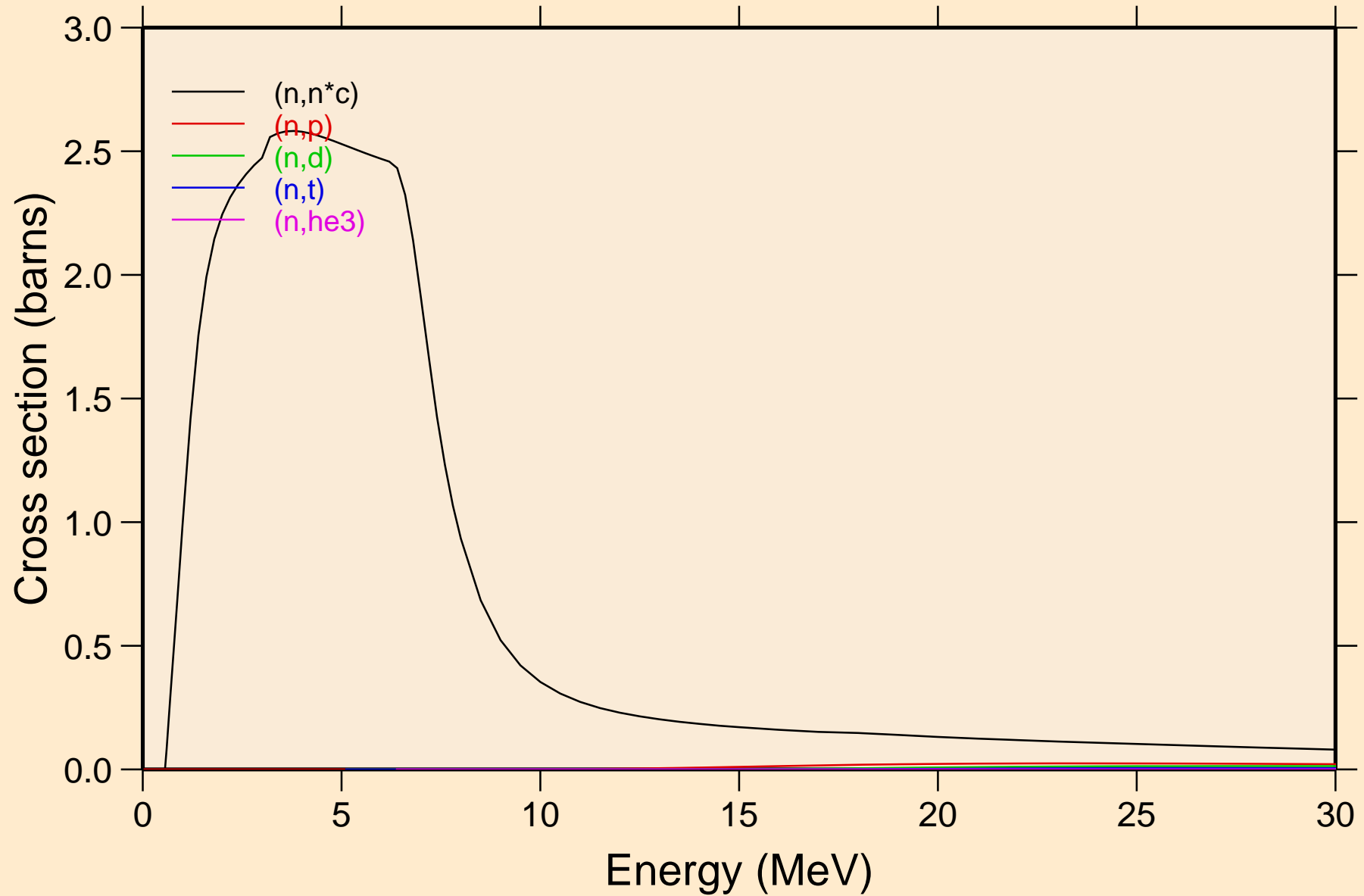

ER167M NEUTRON ACER TENDL-2023 LIBRARY; T=0.K
Threshold reactions

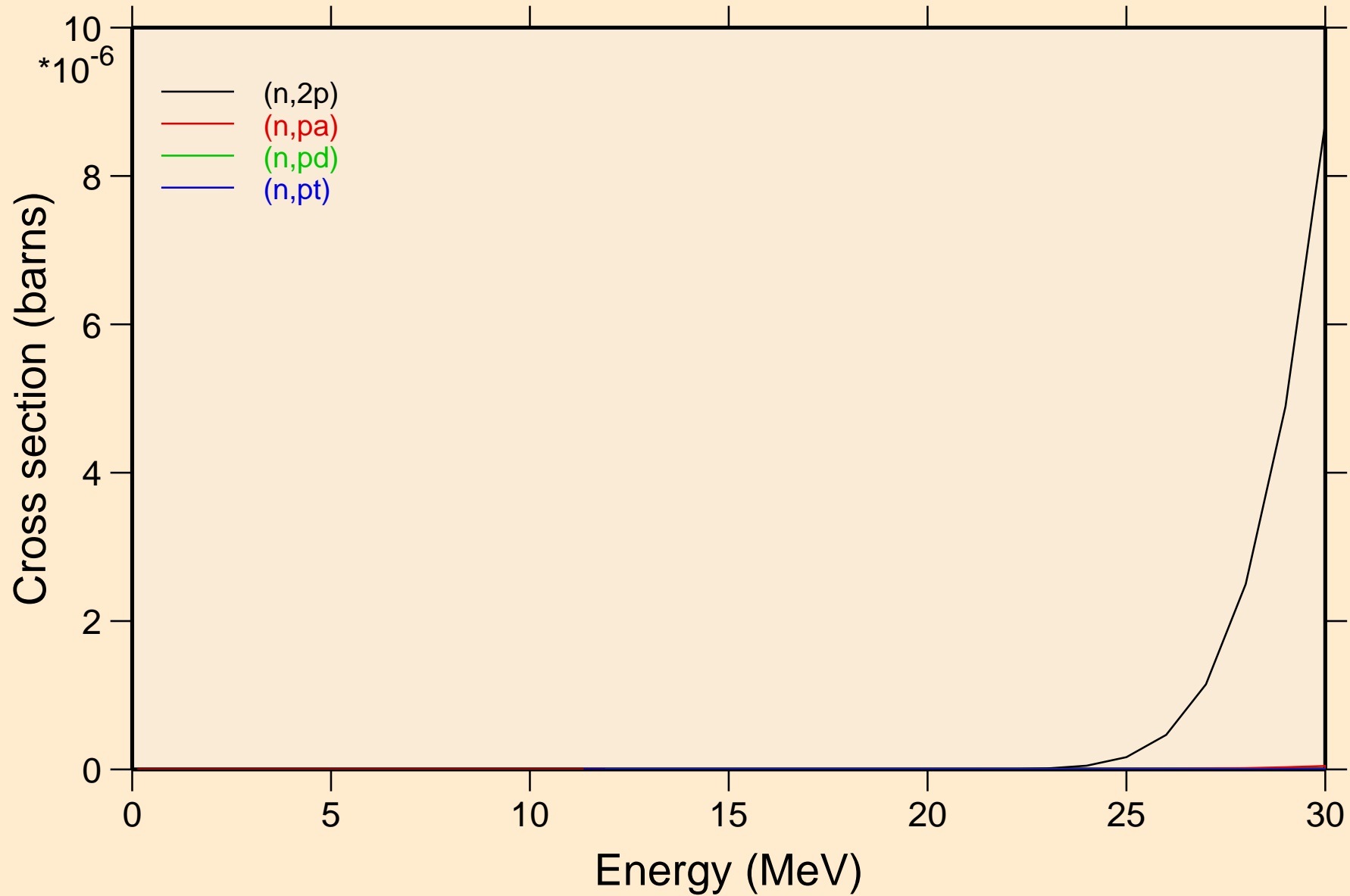

ER167M NEUTRON ACER TENDL-2023 LIBRARY; T=0.K
Threshold reactions

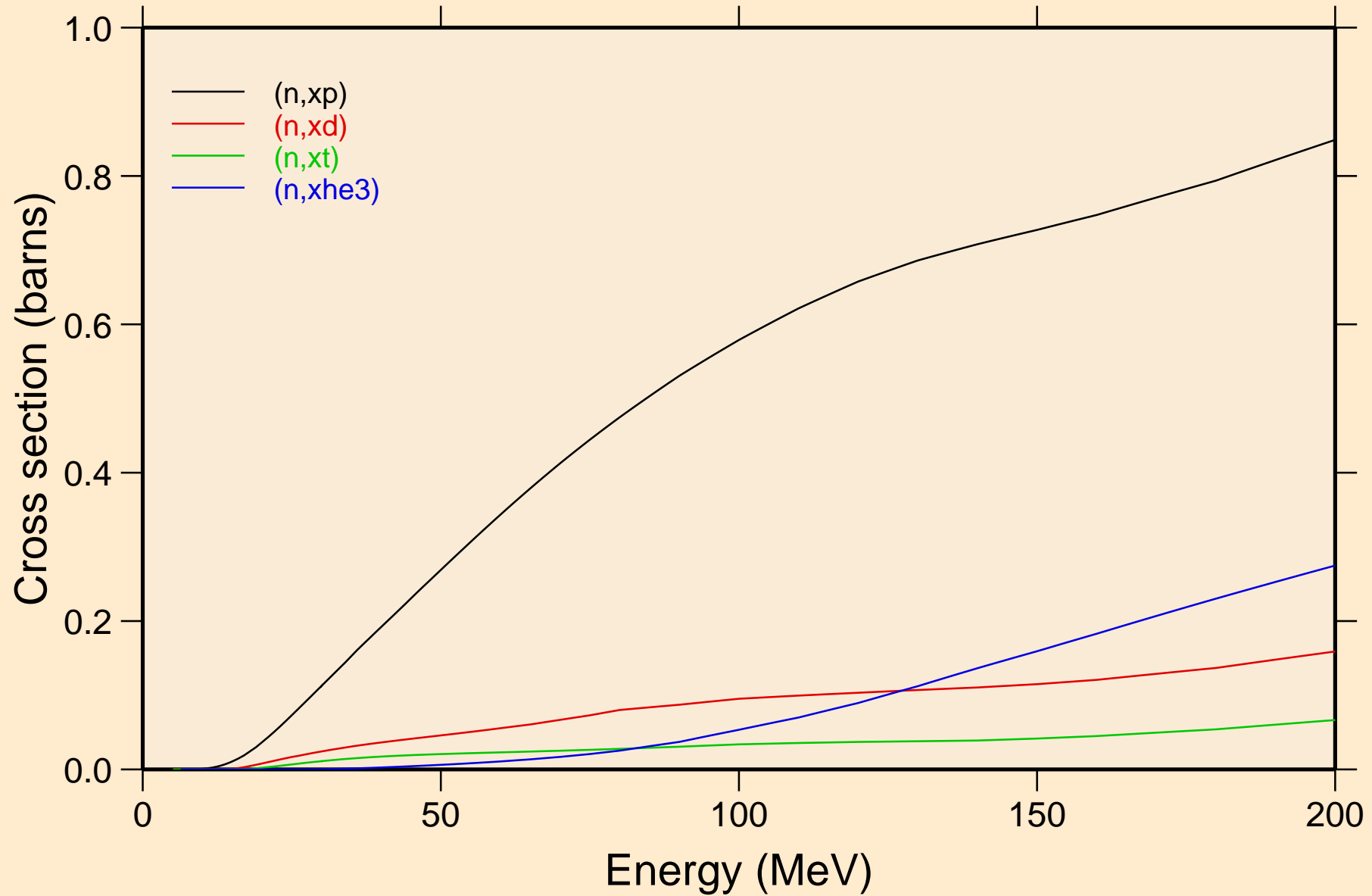

ER167M NEUTRON ACER TENDL-2023 LIBRARY; T=0.K
angular distribution for elastic

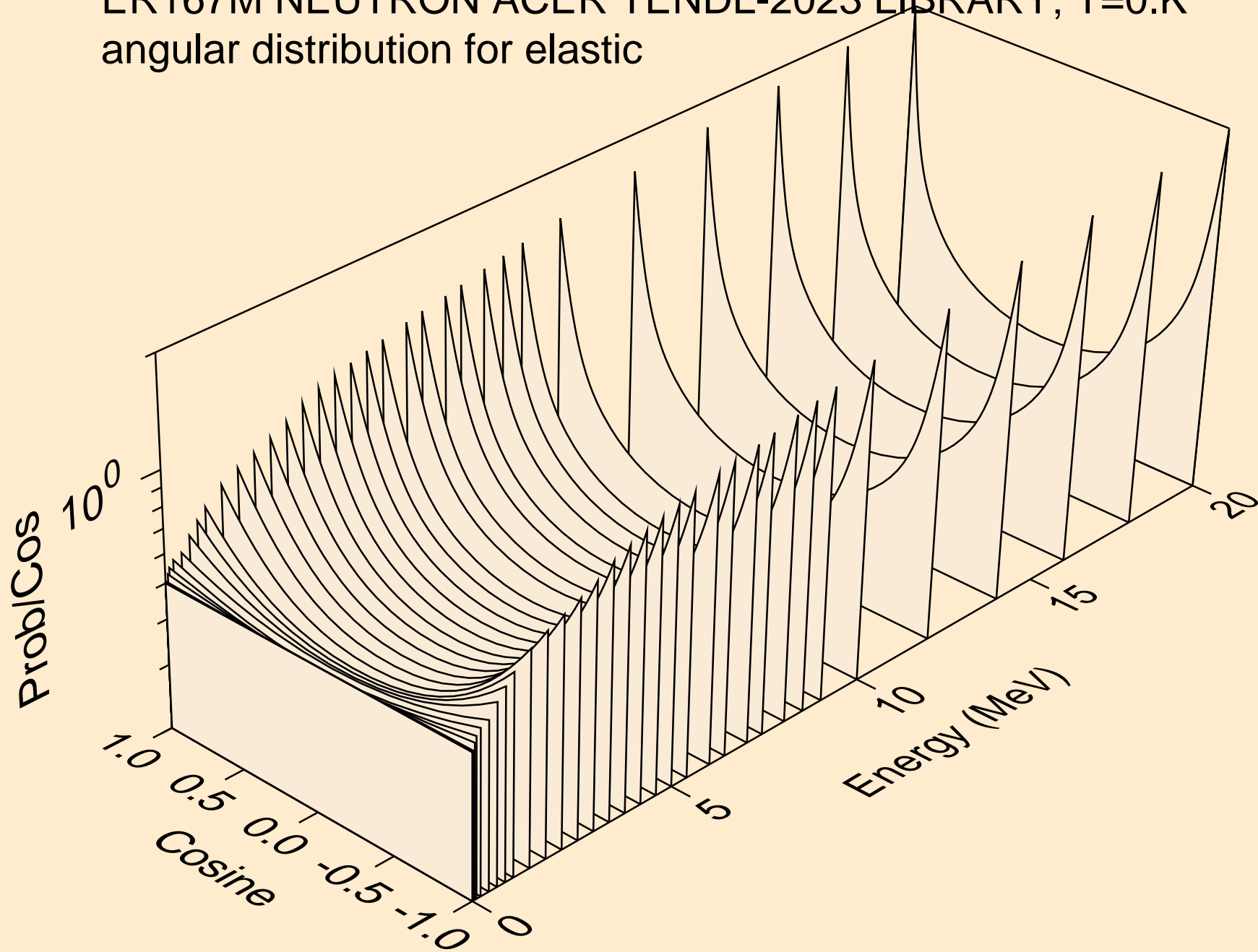

ER167M NEUTRON ACER TENDL-2023 LIBRARY; T=0.K
angular distribution for elastic

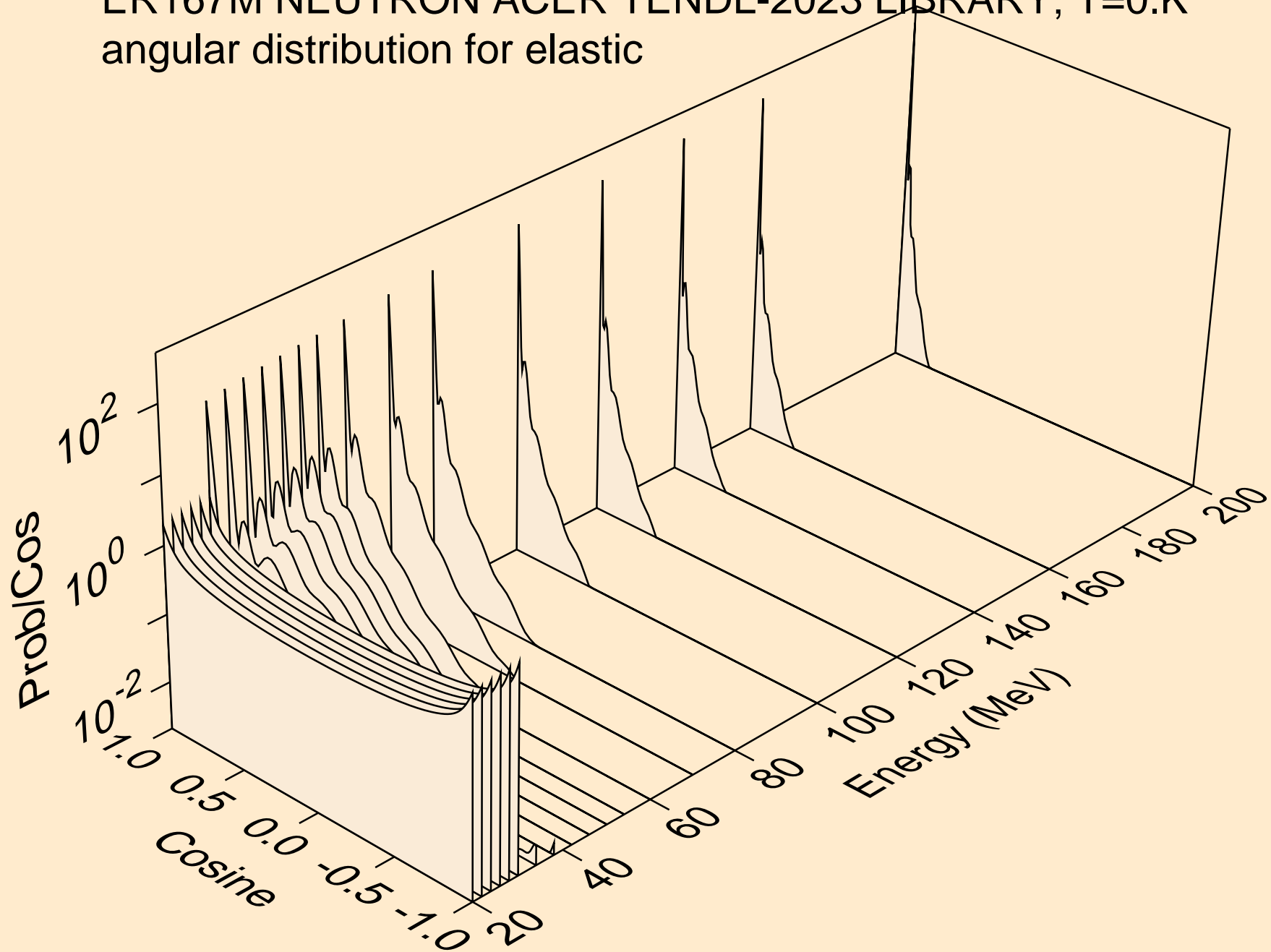

ER167M NEUTRON ACER TENDL-2023 LIBRARY; T=0.K
angular distribution for (n,n*1)

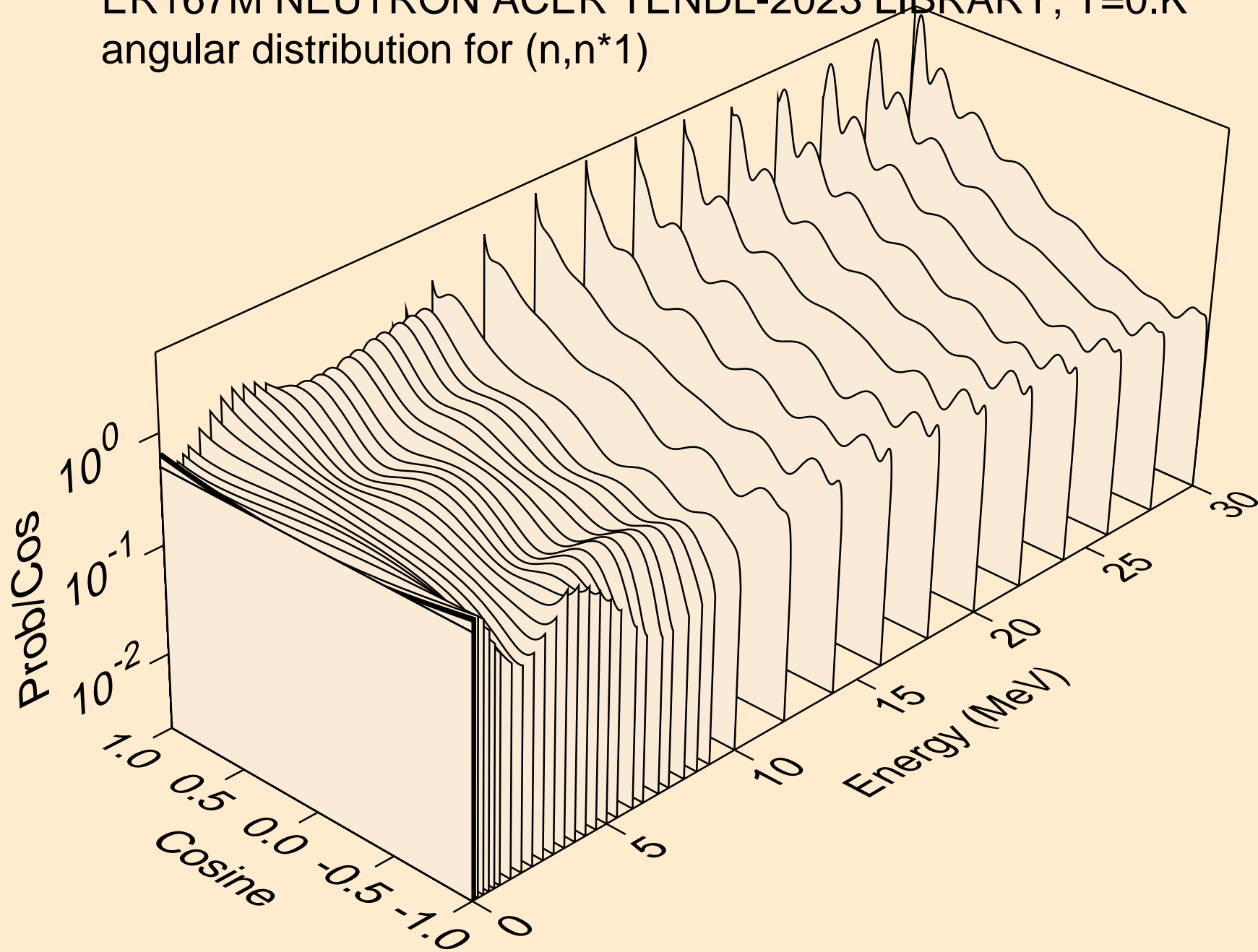

ER167M NEUTRON ACER TENDL-2023 LIBRARY; T=0.K
angular distribution for (n,n*2)

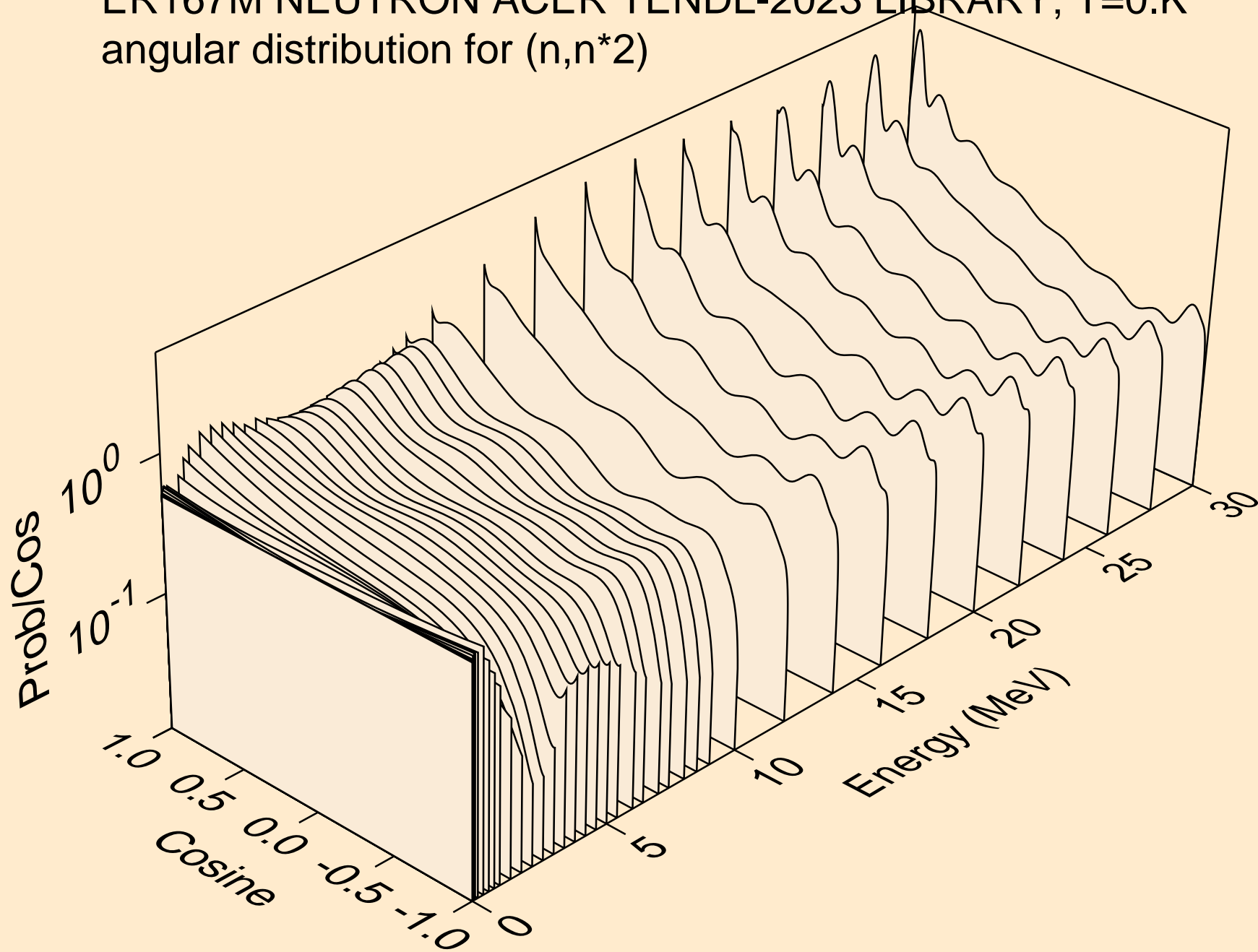

ER167M NEUTRON ACER TENDL-2023 LIBRARY; T=0.K
angular distribution for (n,n*3)

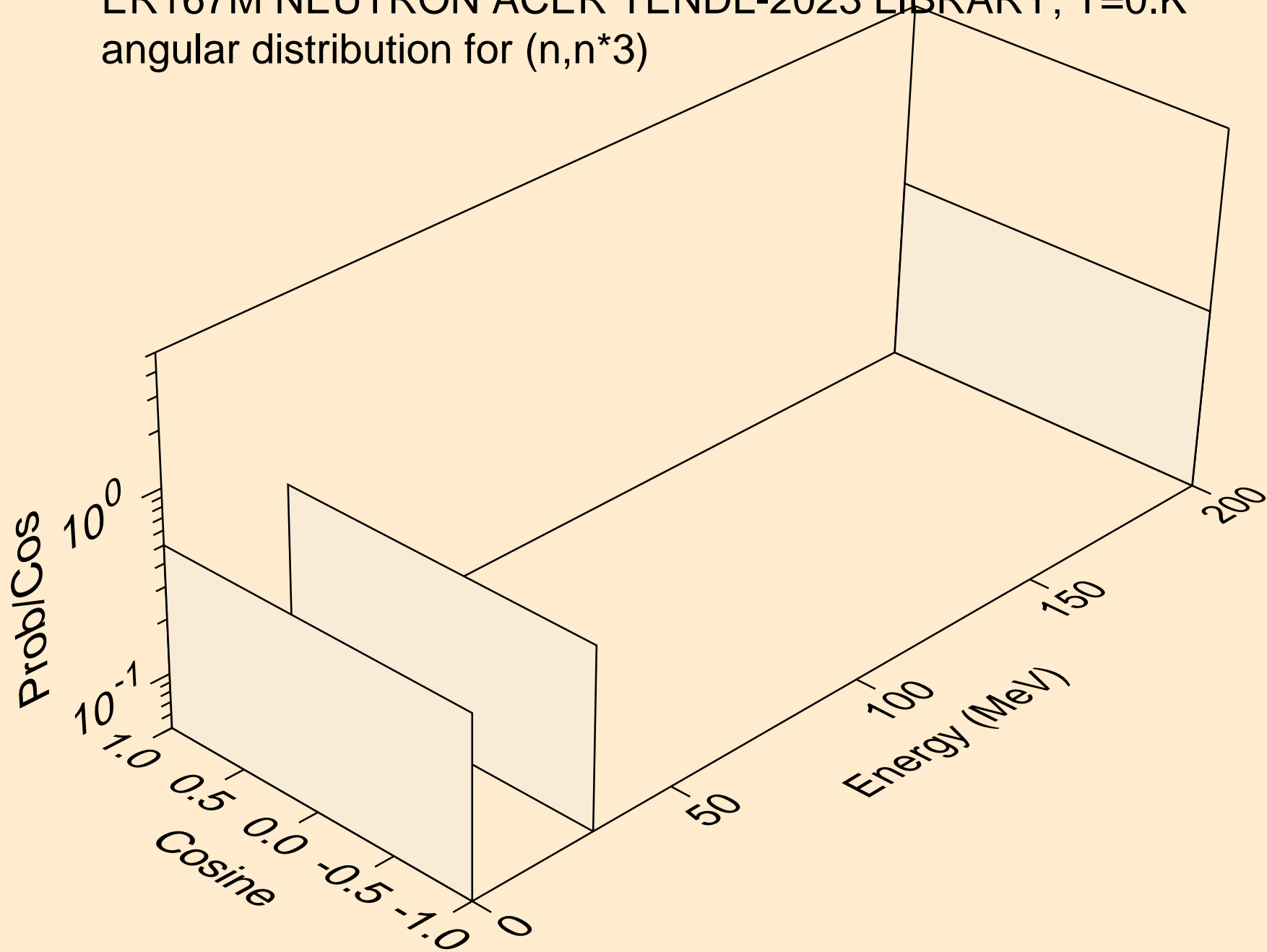

ER167M NEUTRON ACER TENDL-2023 LIBRARY; T=0.K
angular distribution for (n,n*4)

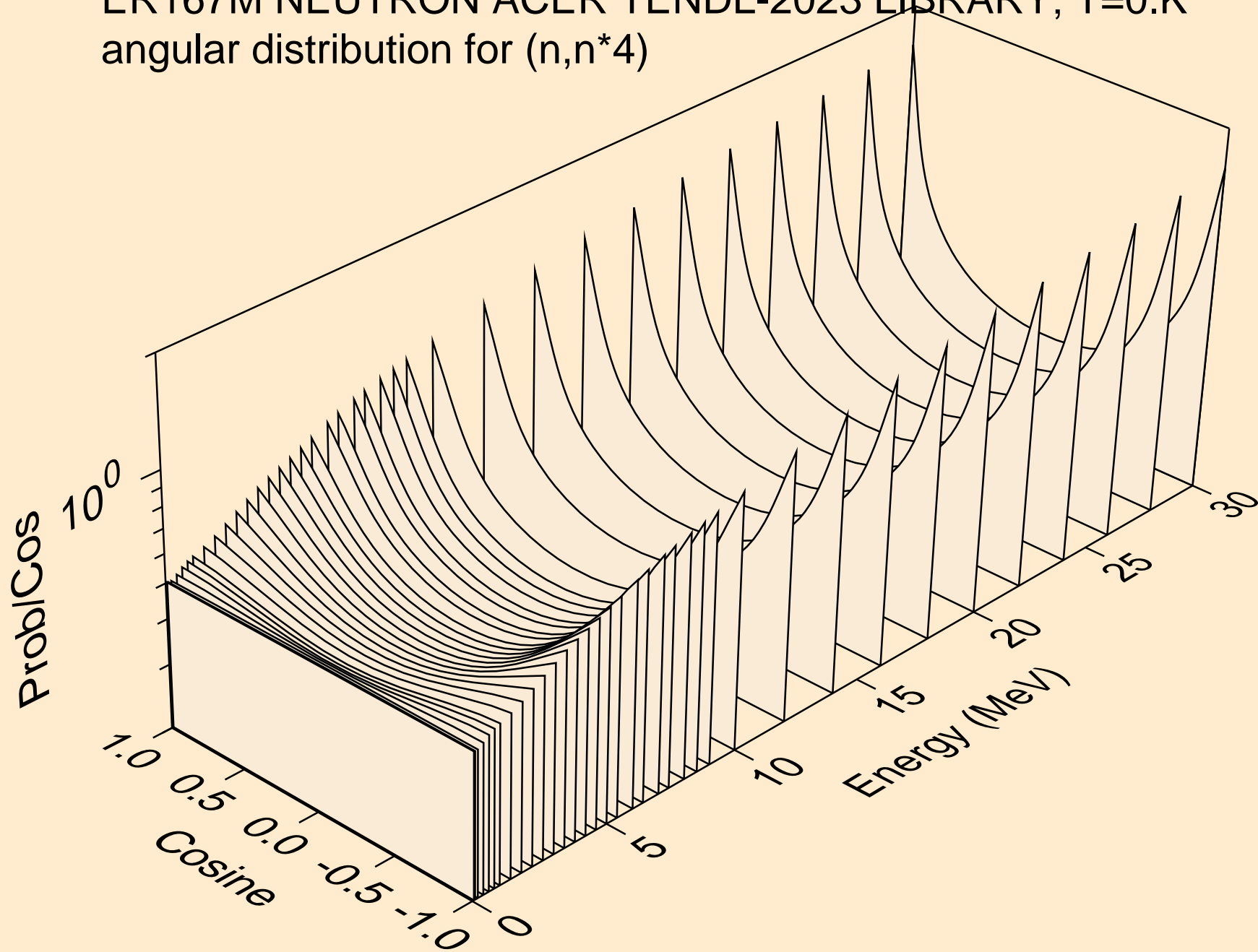

ER167M NEUTRON ACER TENDL-2023 LIBRARY; T=0.K
angular distribution for (n,n*5)

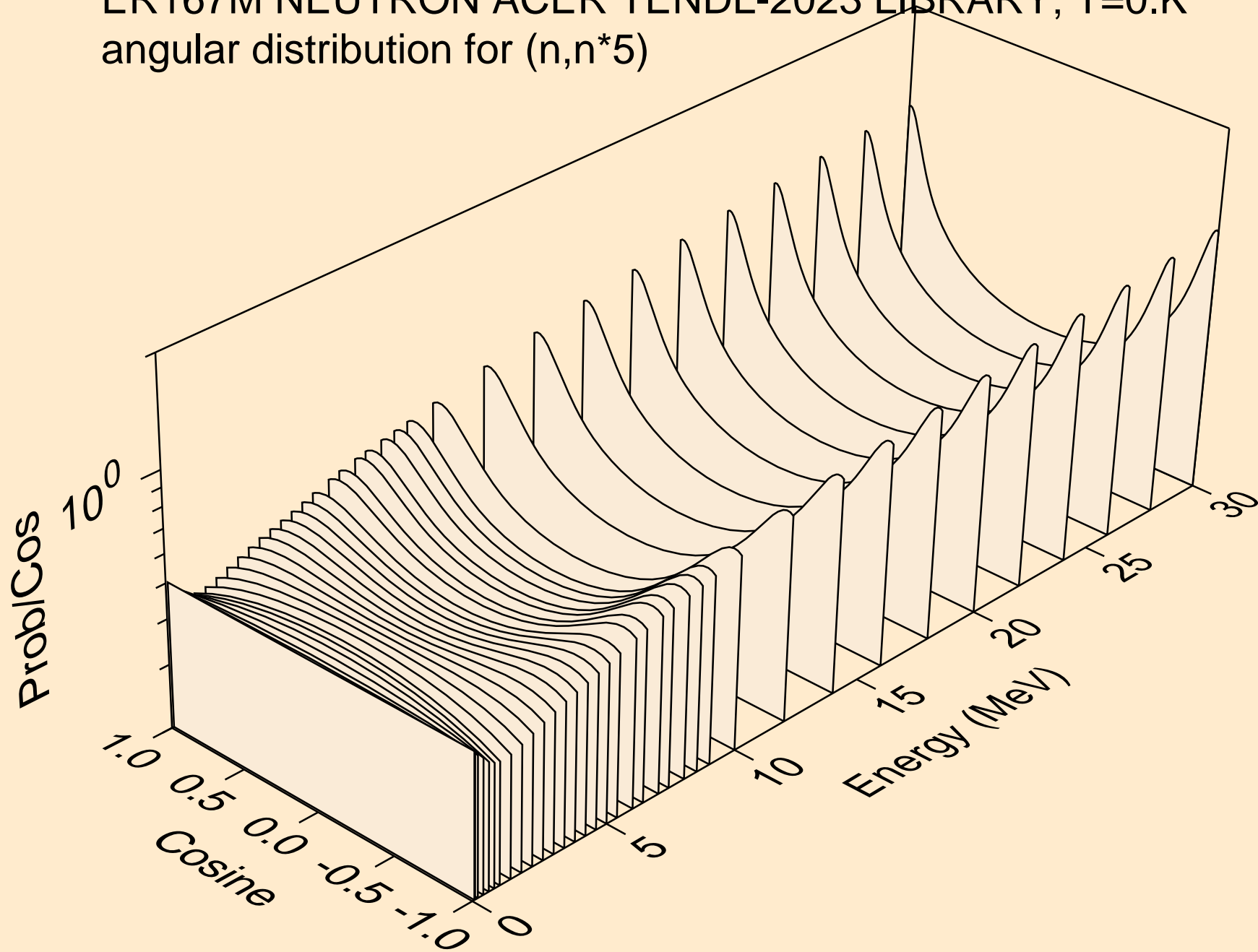

ER167M NEUTRON ACER TENDL-2023 LIBRARY; T=0.K
angular distribution for (n,n*6)

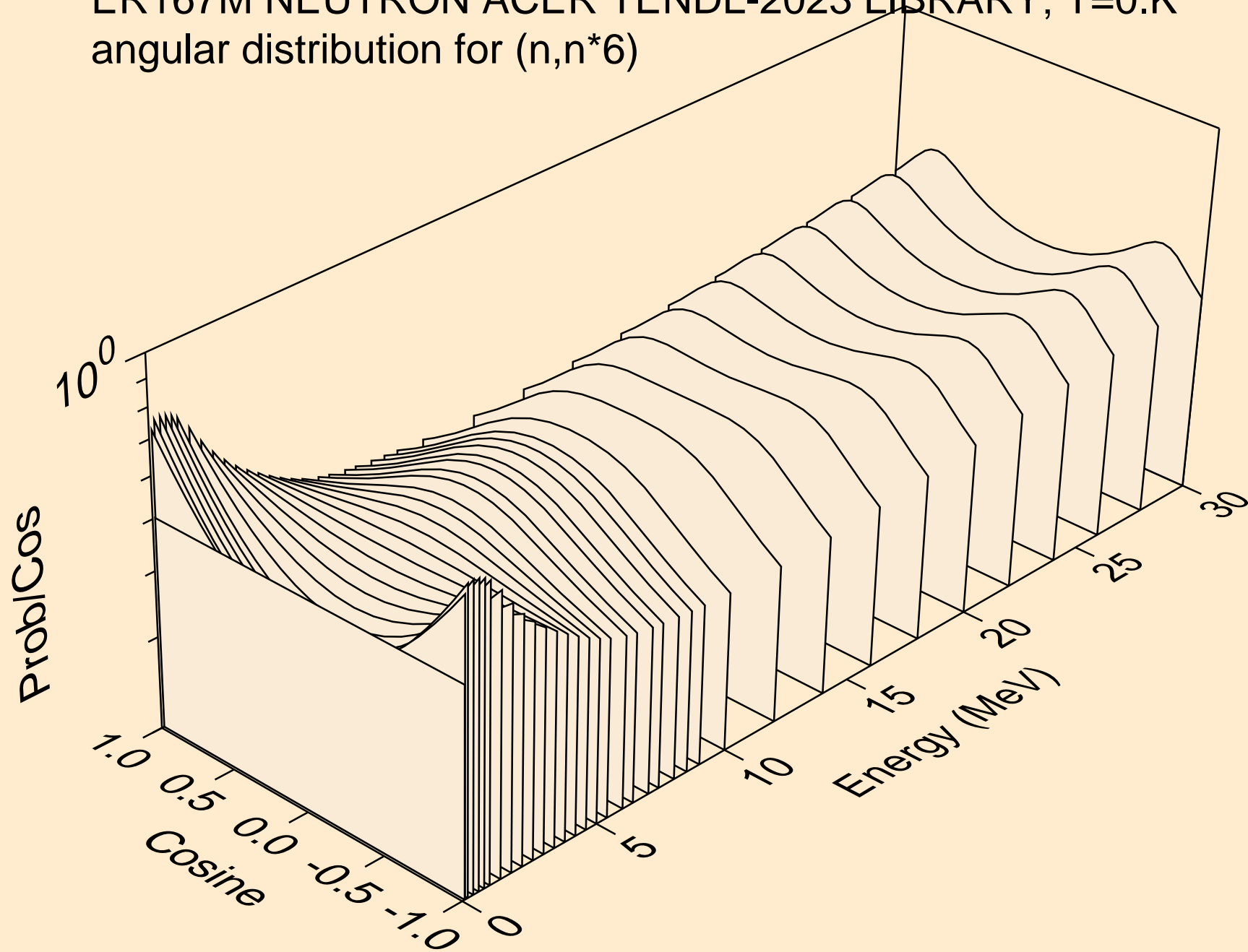

ER167M NEUTRON ACER TENDL-2023 LIBRARY; T=0.K
angular distribution for (n,n*7)

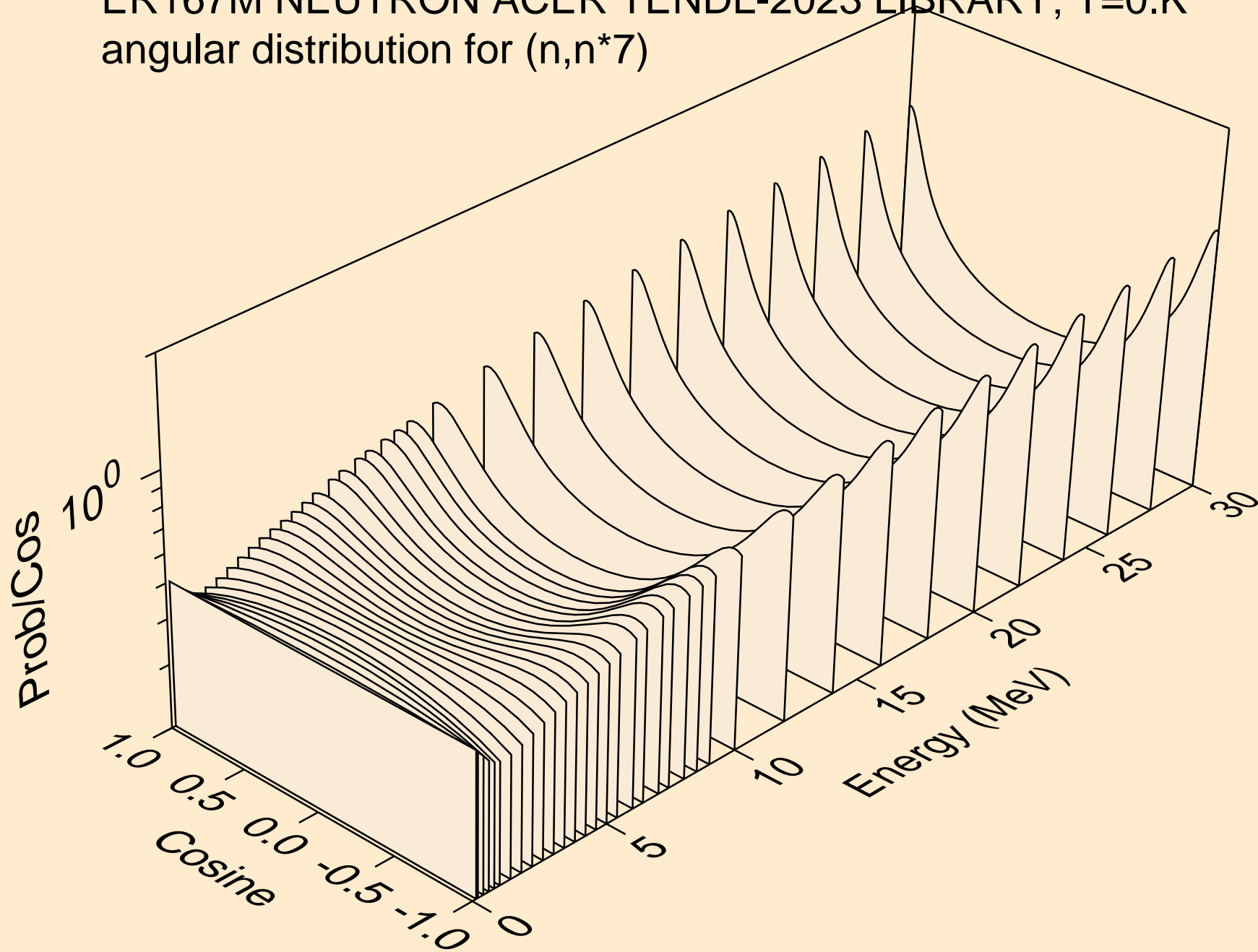

ER167M NEUTRON ACER TENDL-2023 LIBRARY; T=0.K
angular distribution for (n,n*8)

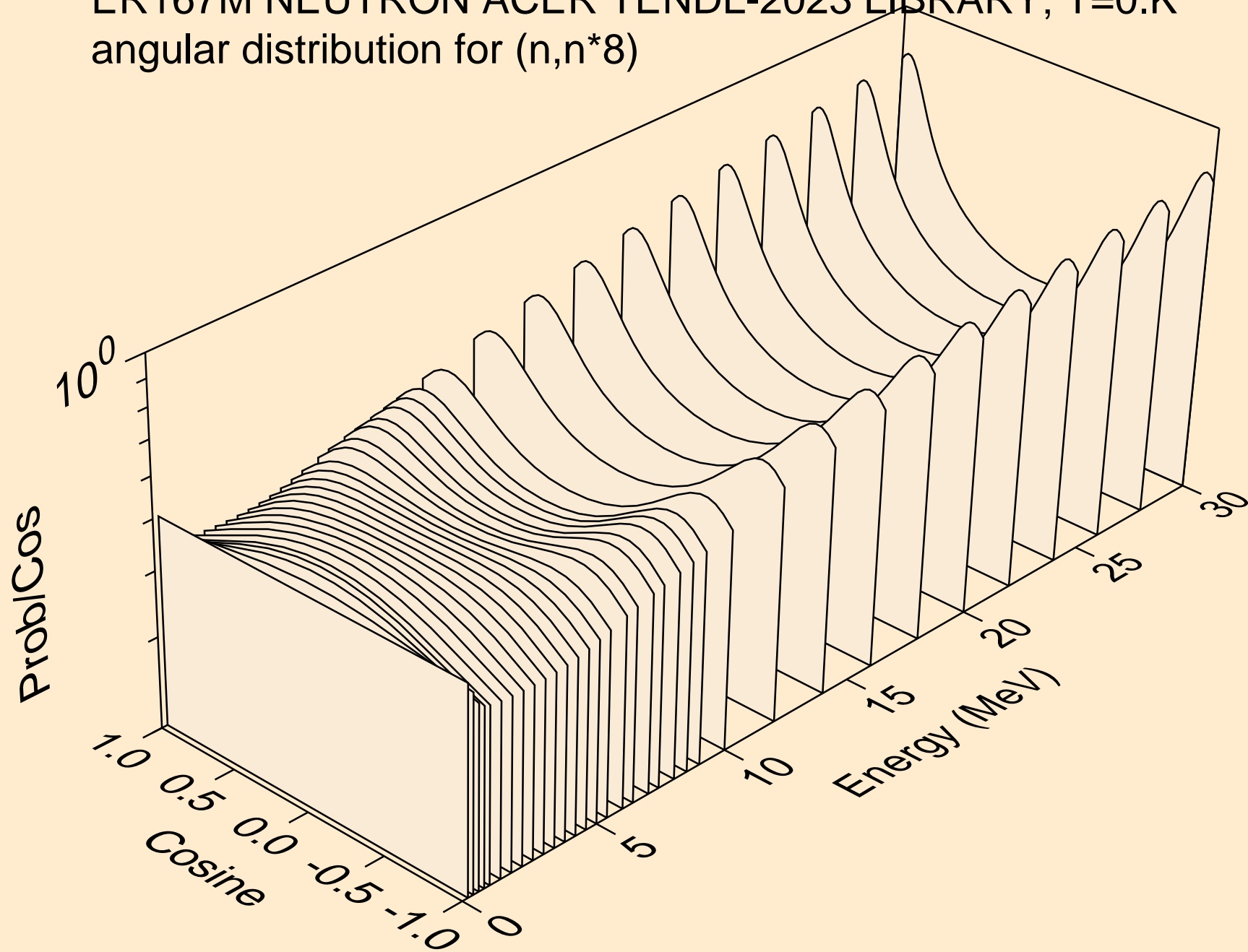

ER167M NEUTRON ACER TENDL-2023 LIBRARY; T=0.K
angular distribution for (n,n*9)

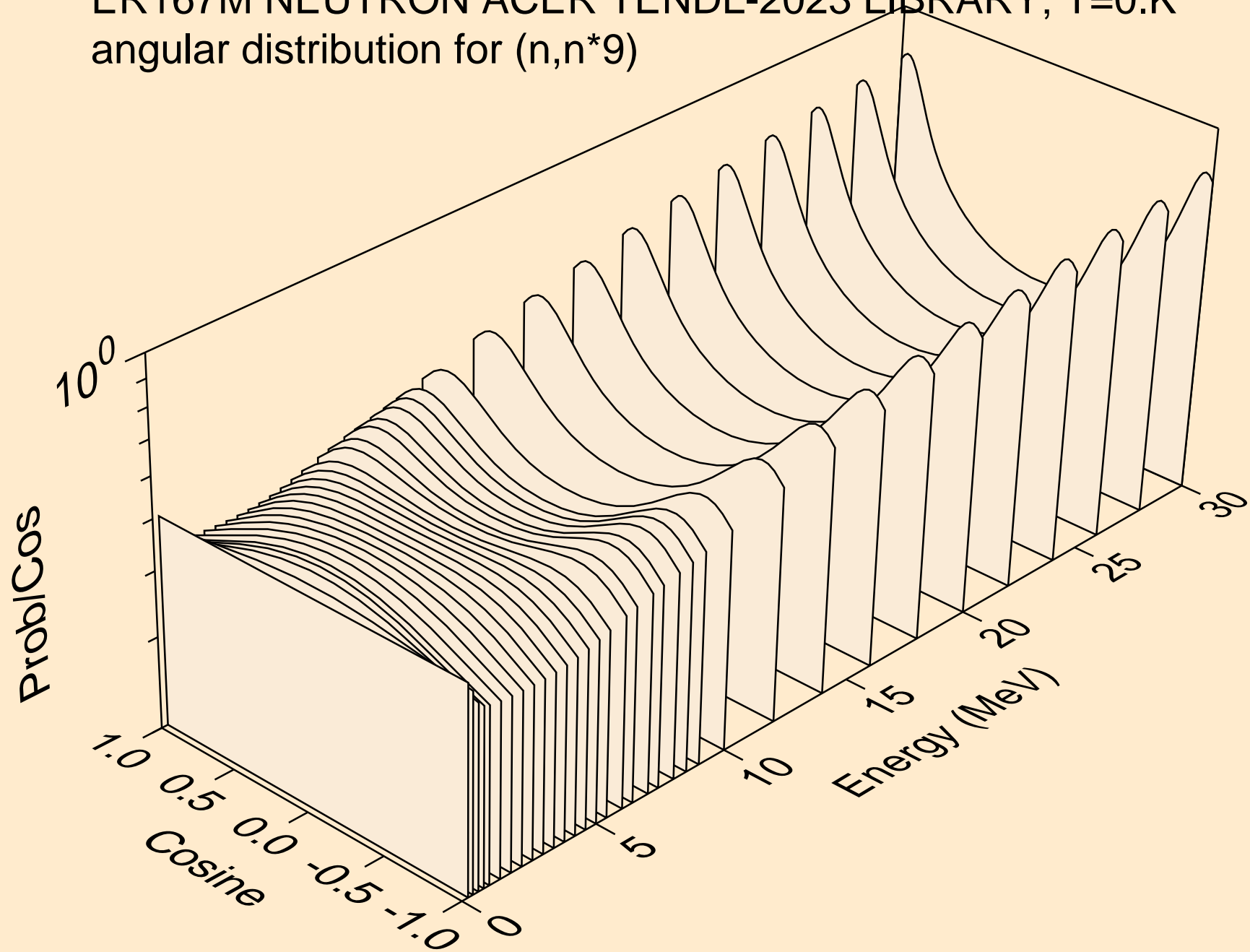

ER167M NEUTRON ACER TENDL-2023 LIBRARY; T=0.K
angular distribution for (n,n*10)

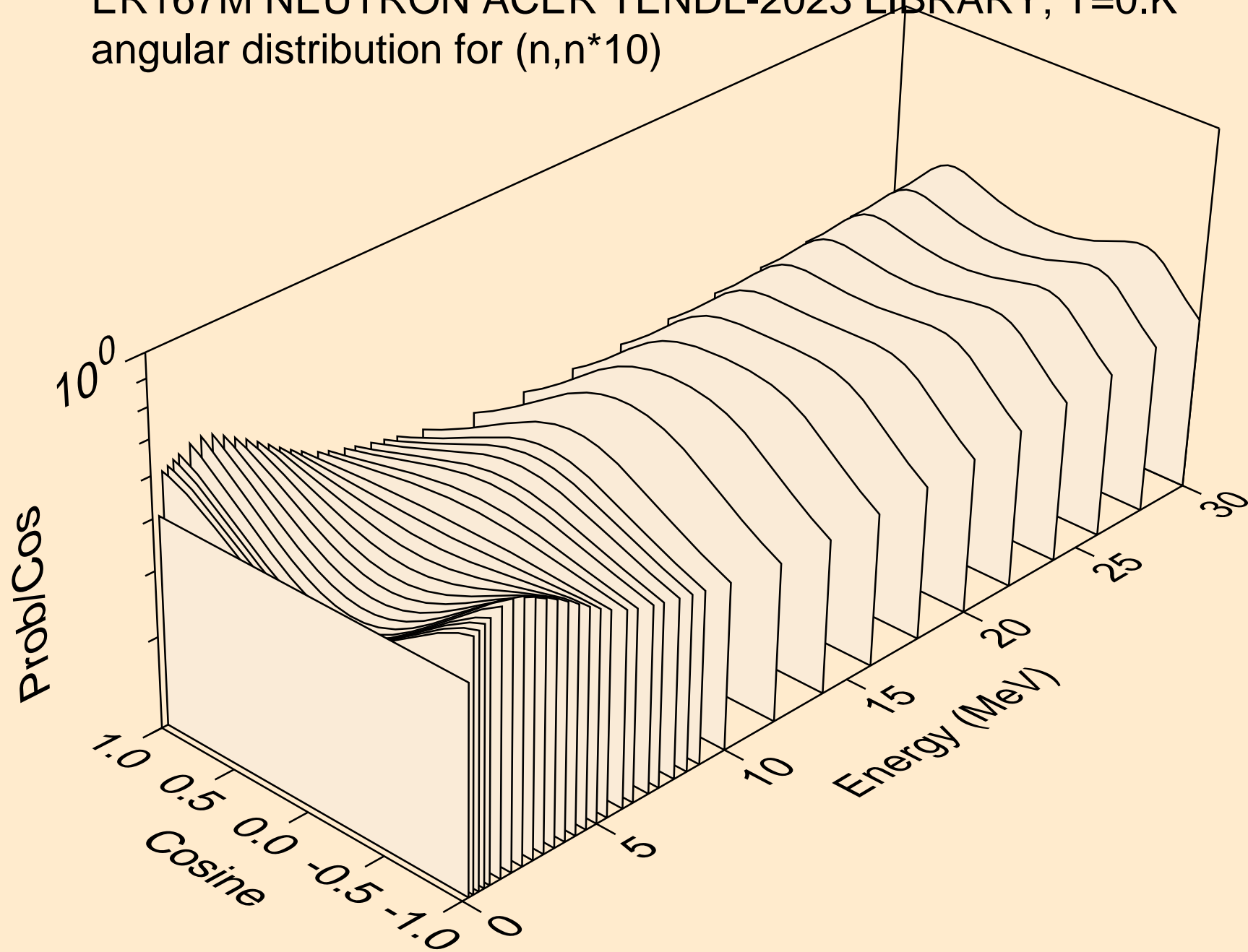

ER167M NEUTRON ACER TENDL-2023 LIBRARY; T=0.K
angular distribution for (n,n*11)

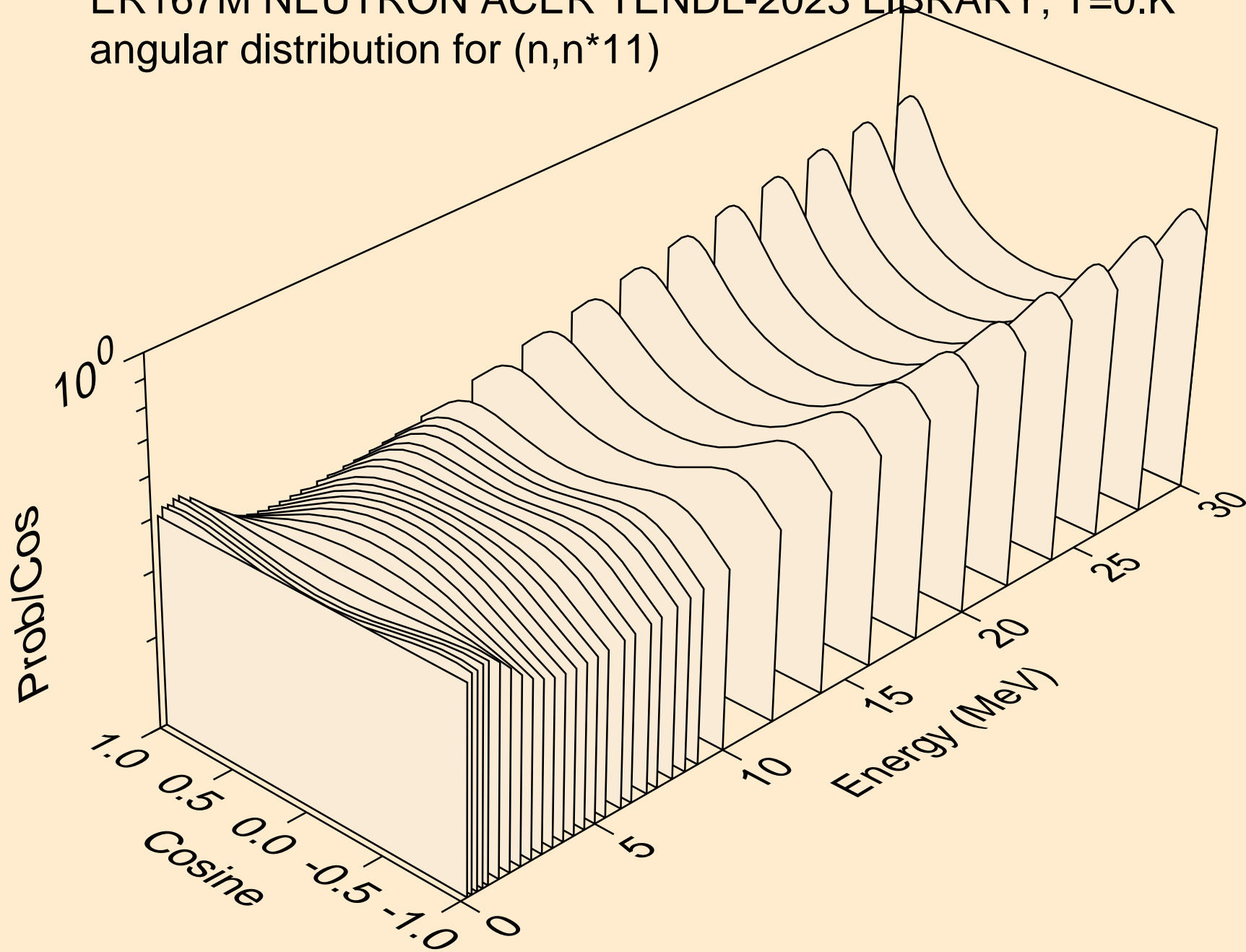

ER167M NEUTRON ACER TENDL-2023 LIBRARY; T=0.K
angular distribution for (n,n*12)

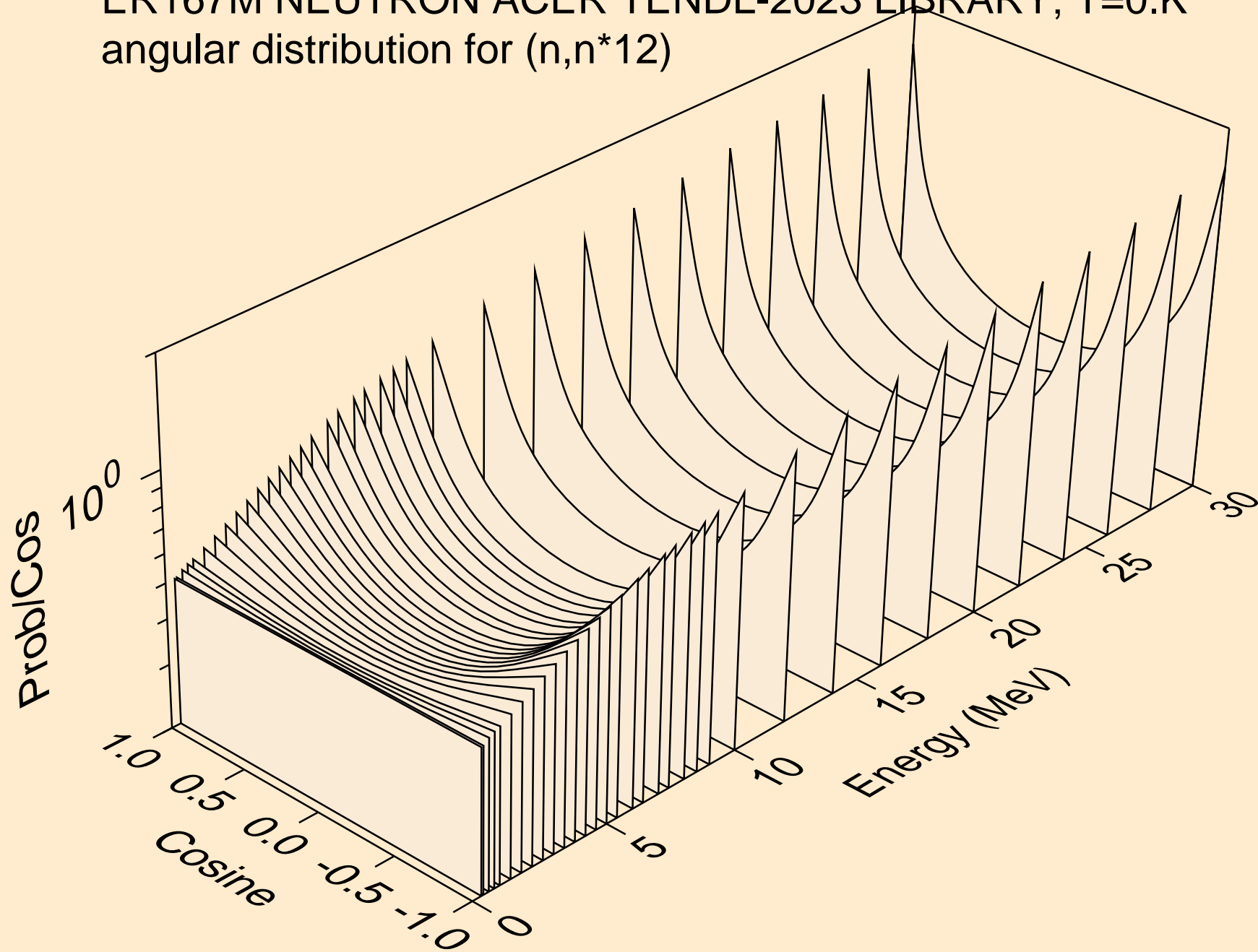

ER167M NEUTRON ACER TENDL-2023 LIBRARY; T=0.K
angular distribution for (n,n*13)

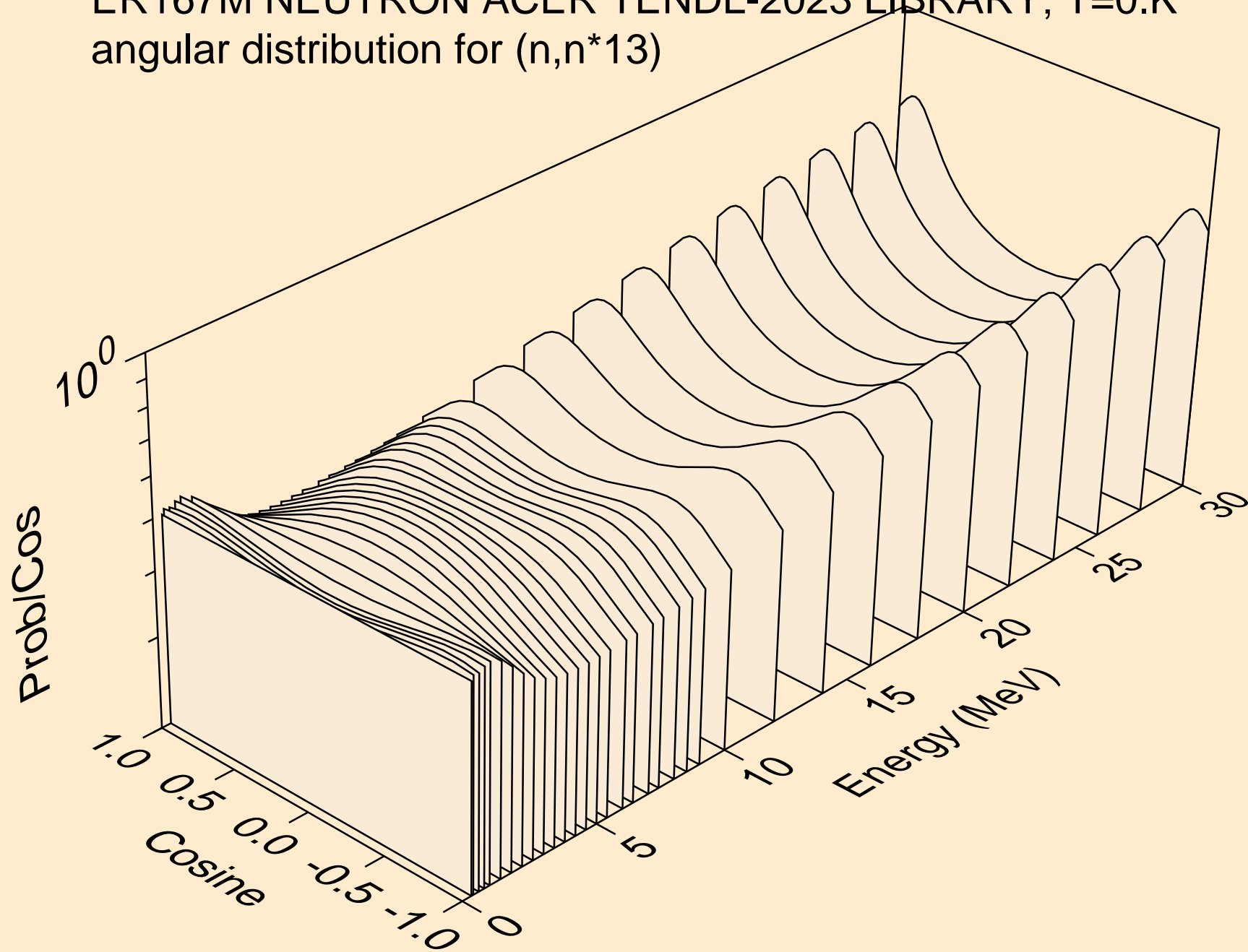

ER167M NEUTRON ACER TENDL-2023 LIBRARY; T=0.K
angular distribution for (n,n*14)

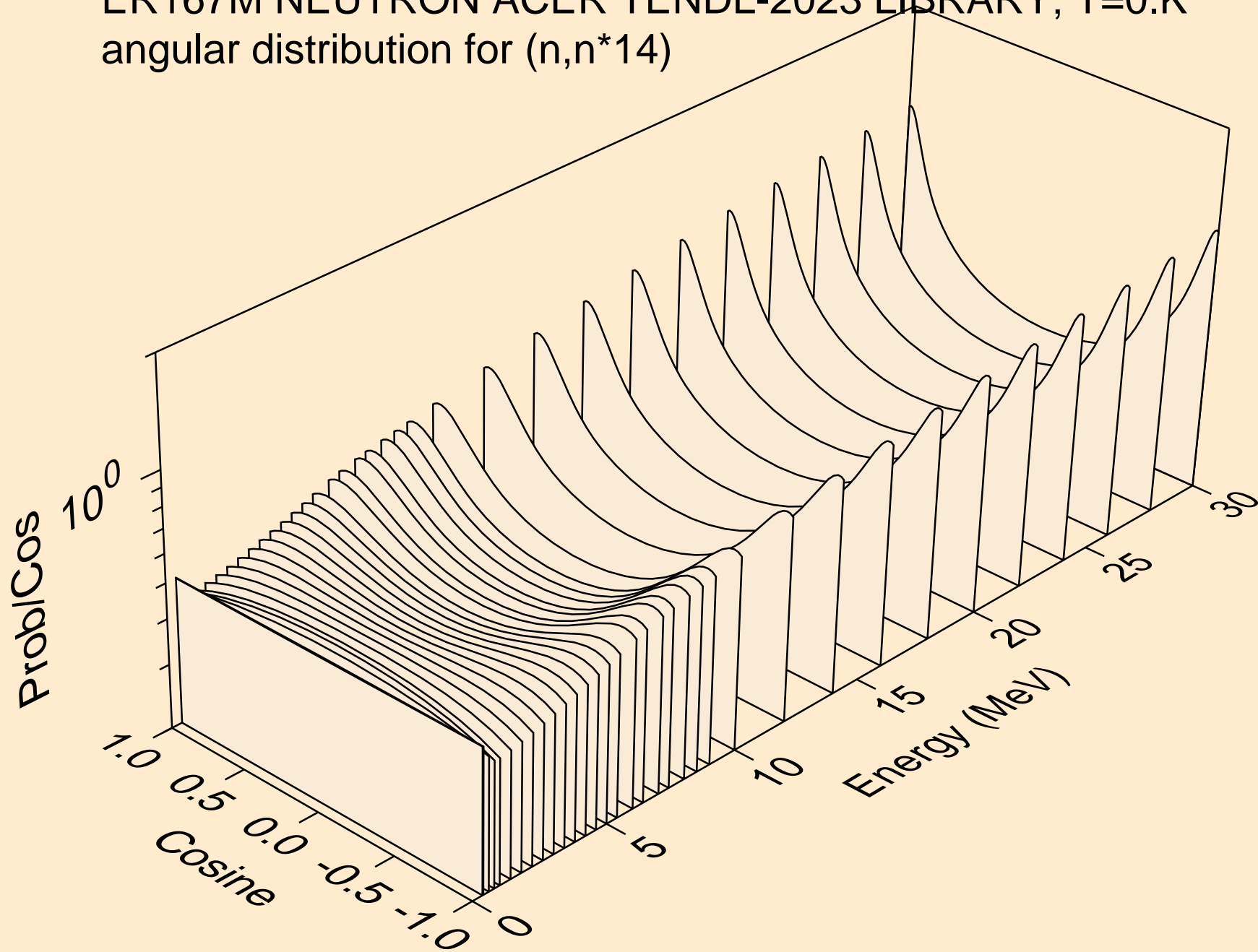

ER167M NEUTRON ACER TENDL-2023 LIBRARY; T=0.K
angular distribution for (n,n*15)

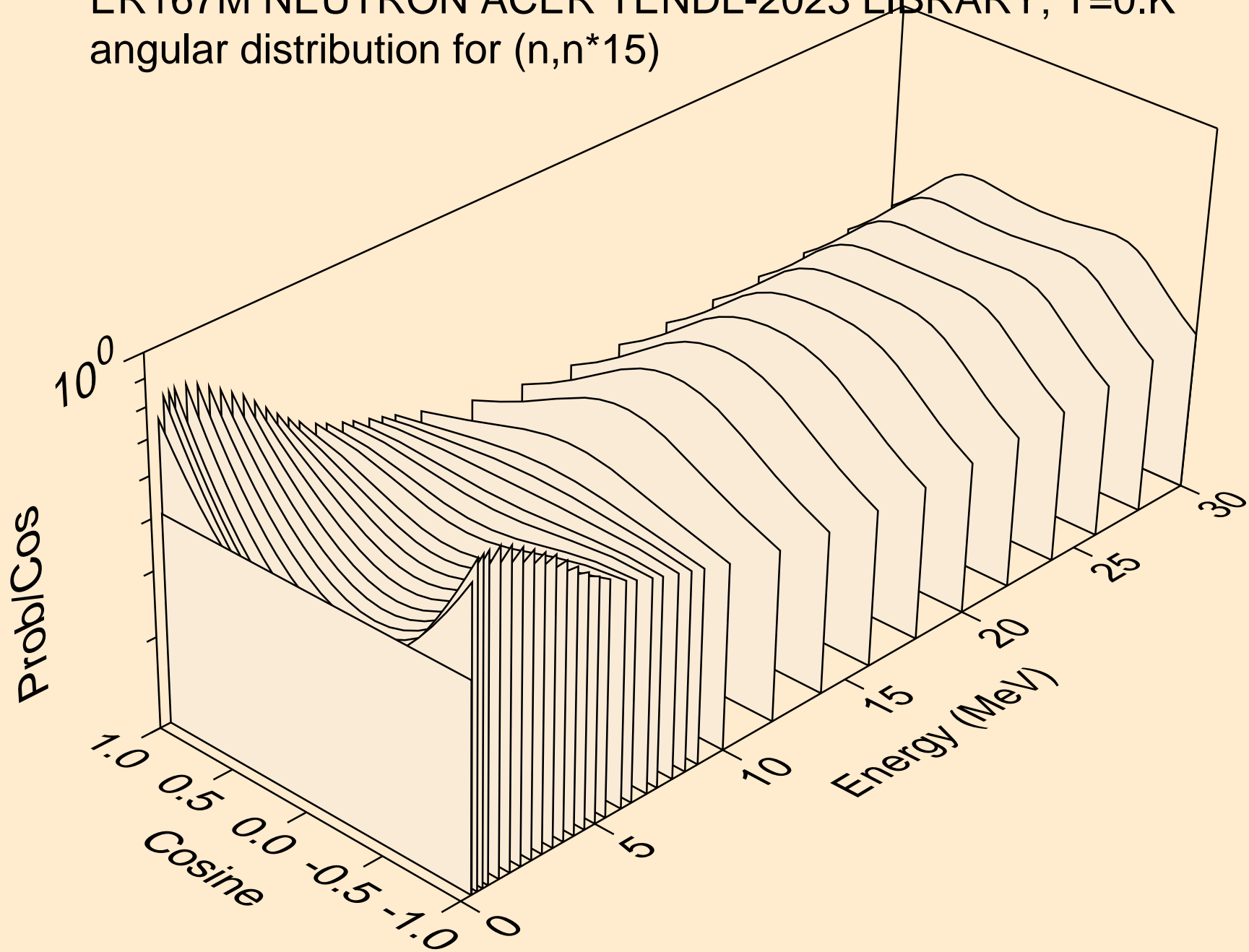

ER167M NEUTRON ACER TENDL-2023 LIBRARY; T=0.K
angular distribution for (n,n*16)

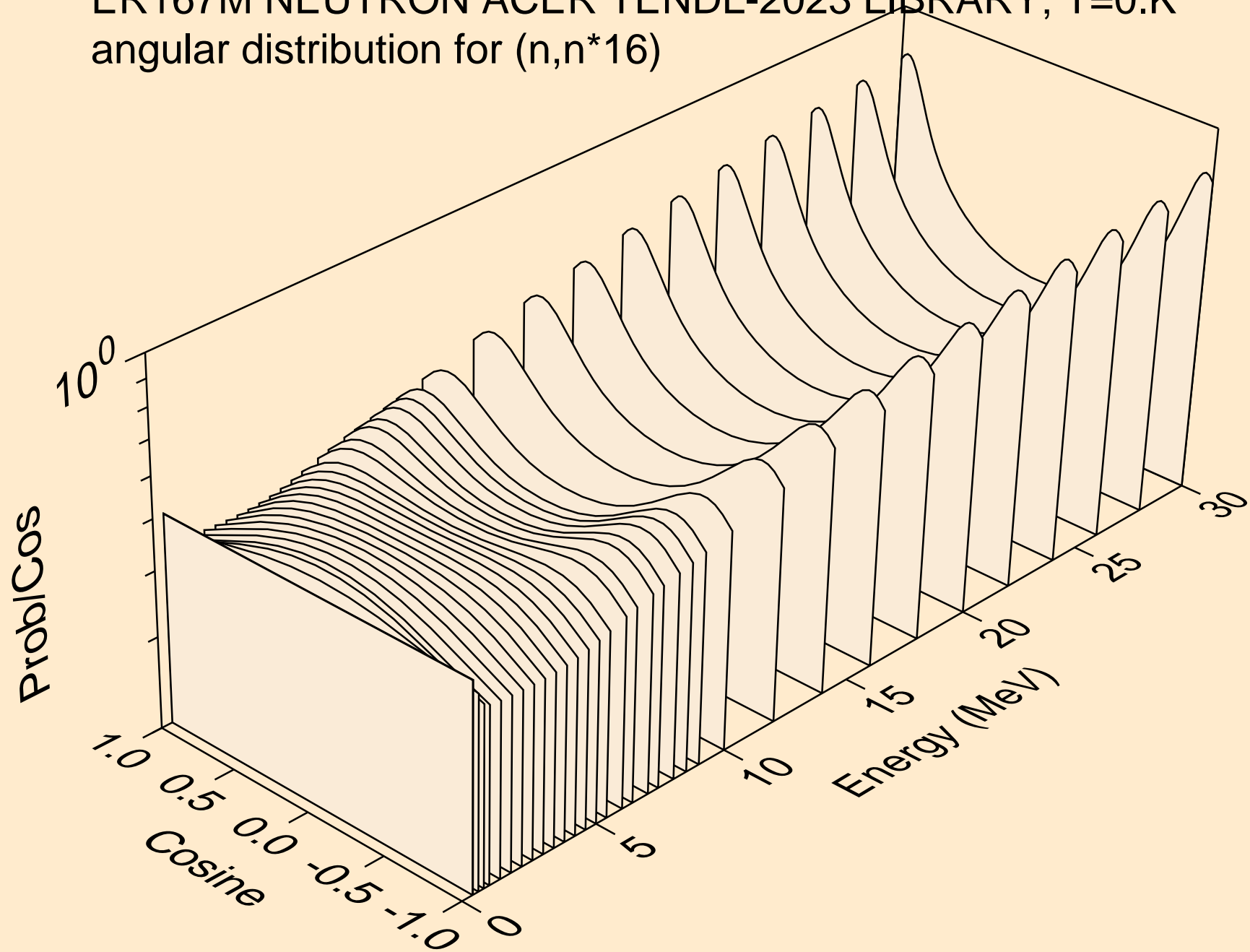

ER167M NEUTRON ACER TENDL-2023 LIBRARY; T=0.K
angular distribution for (n,n*17)

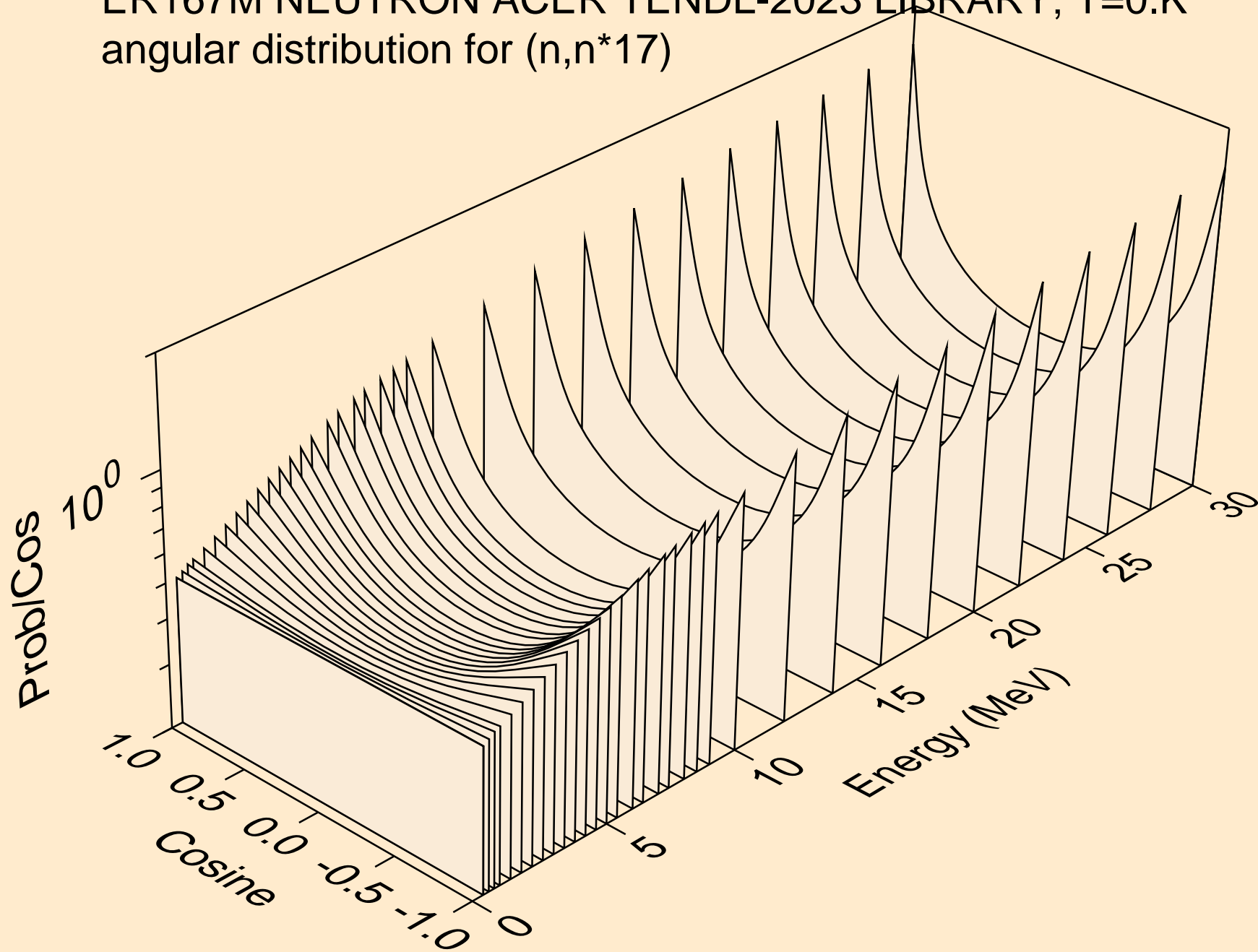

ER167M NEUTRON ACER TENDL-2023 LIBRARY; T=0.K
angular distribution for (n,n*18)

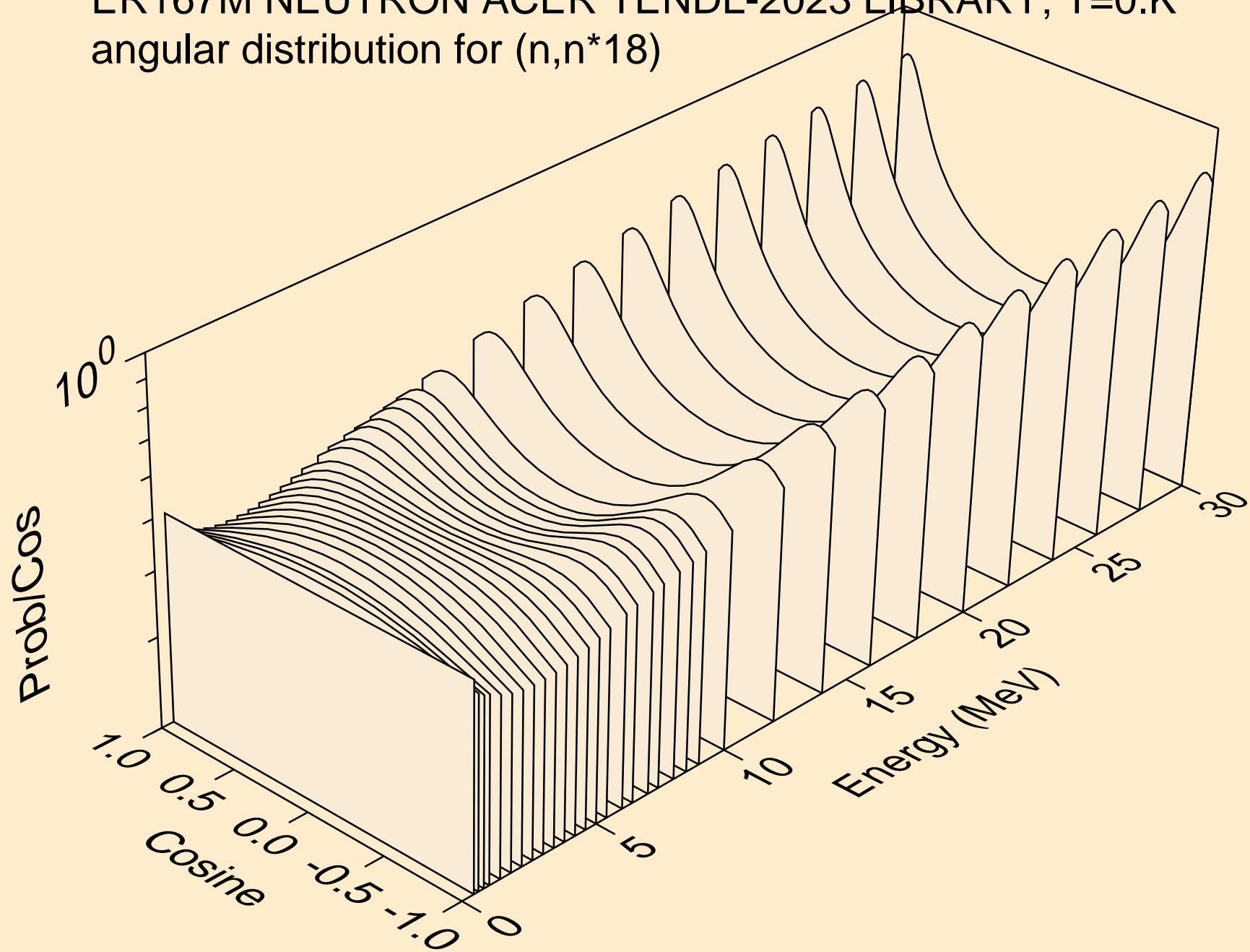

ER167M NEUTRON ACER TENDL-2023 LIBRARY; T=0.K
angular distribution for (n,n*19)

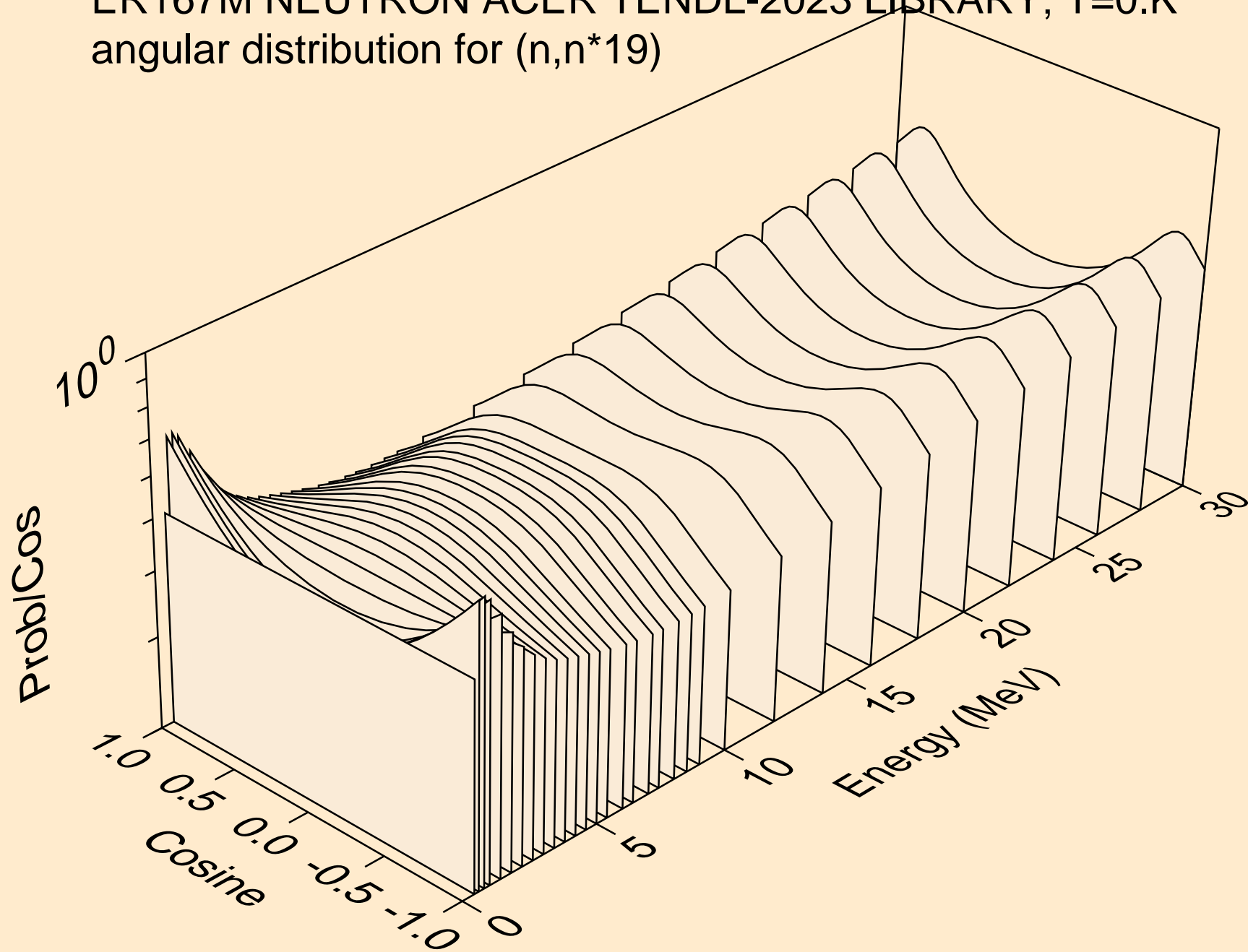

ER167M NEUTRON ACER TENDL-2023 LIBRARY; T=0.K
angular distribution for (n,n*20)

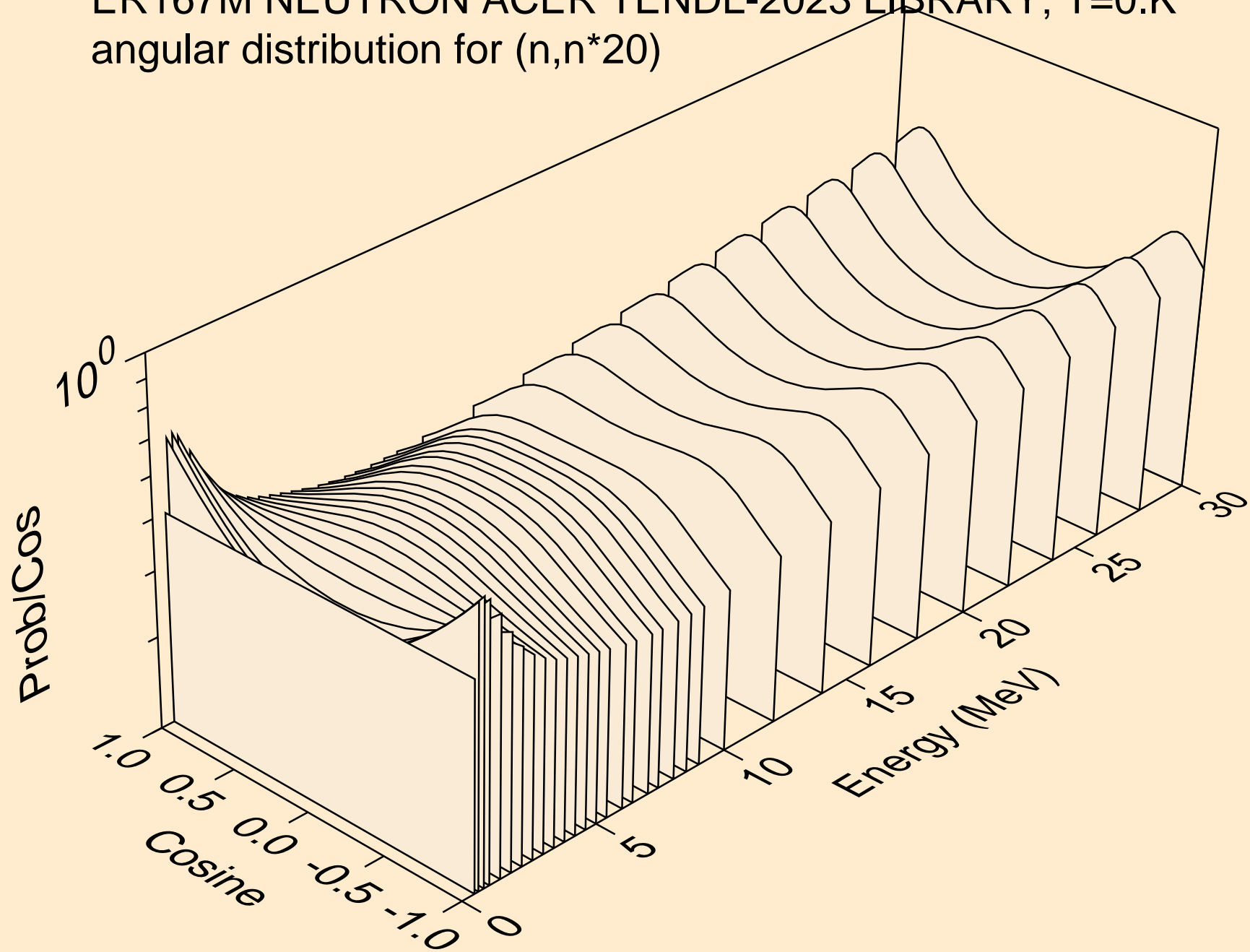

ER167M NEUTRON ACER TENDL-2023 LIBRARY; T=0.K
angular distribution for (n,n*21)

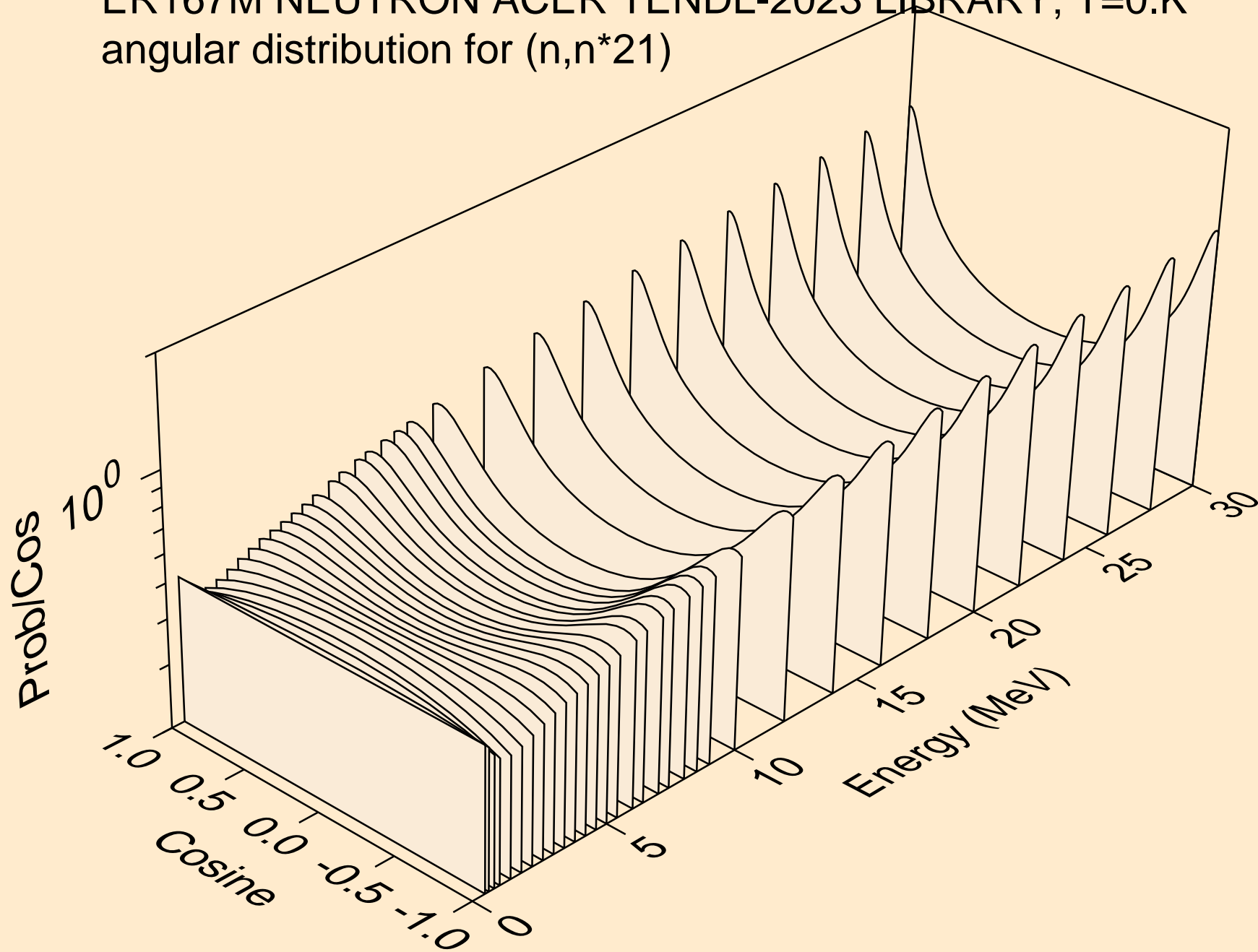

ER167M NEUTRON ACER TENDL-2023 LIBRARY; T=0.K
angular distribution for (n,n*22)

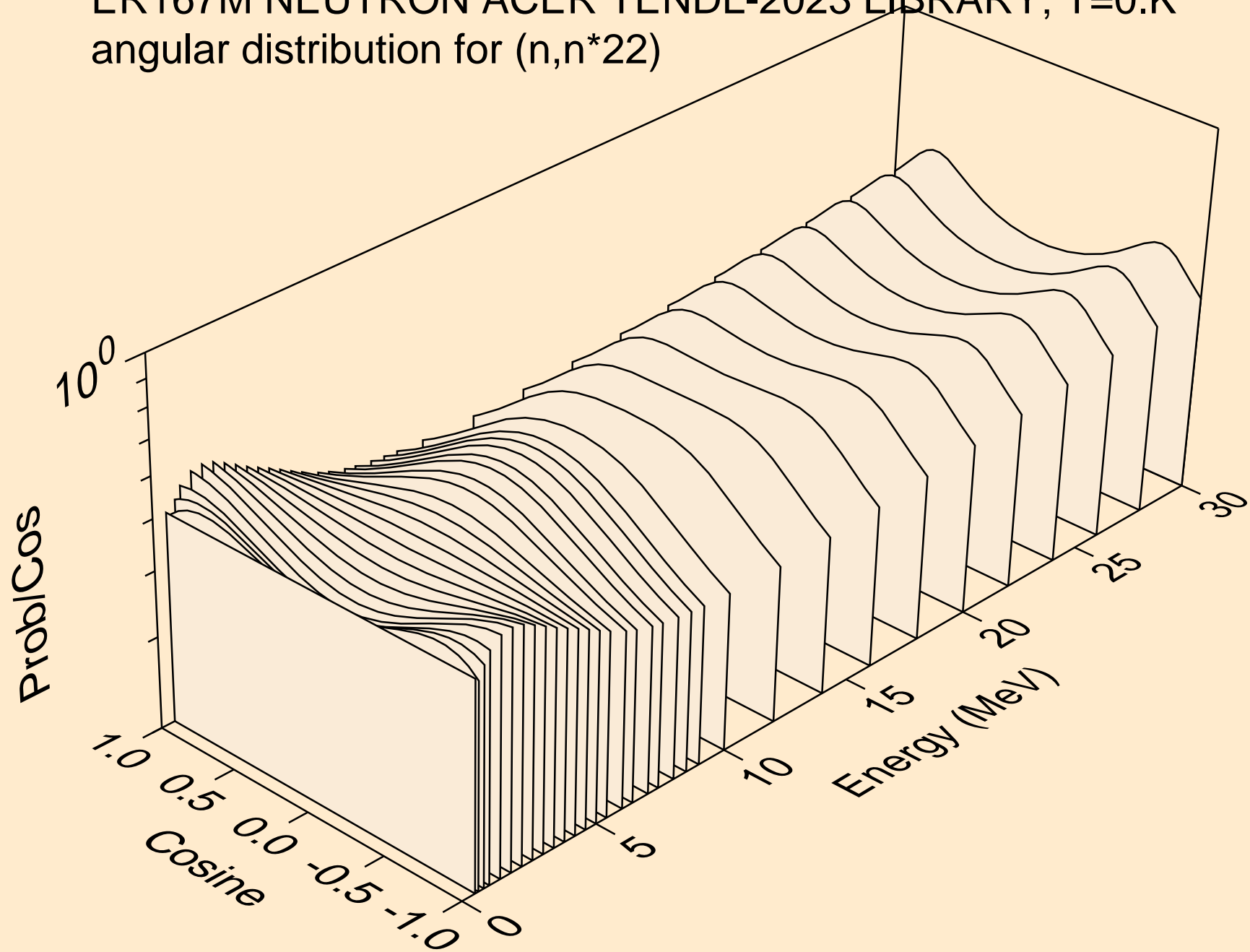

ER167M NEUTRON ACER TENDL-2023 LIBRARY; T=0.K
angular distribution for (n,n*23)

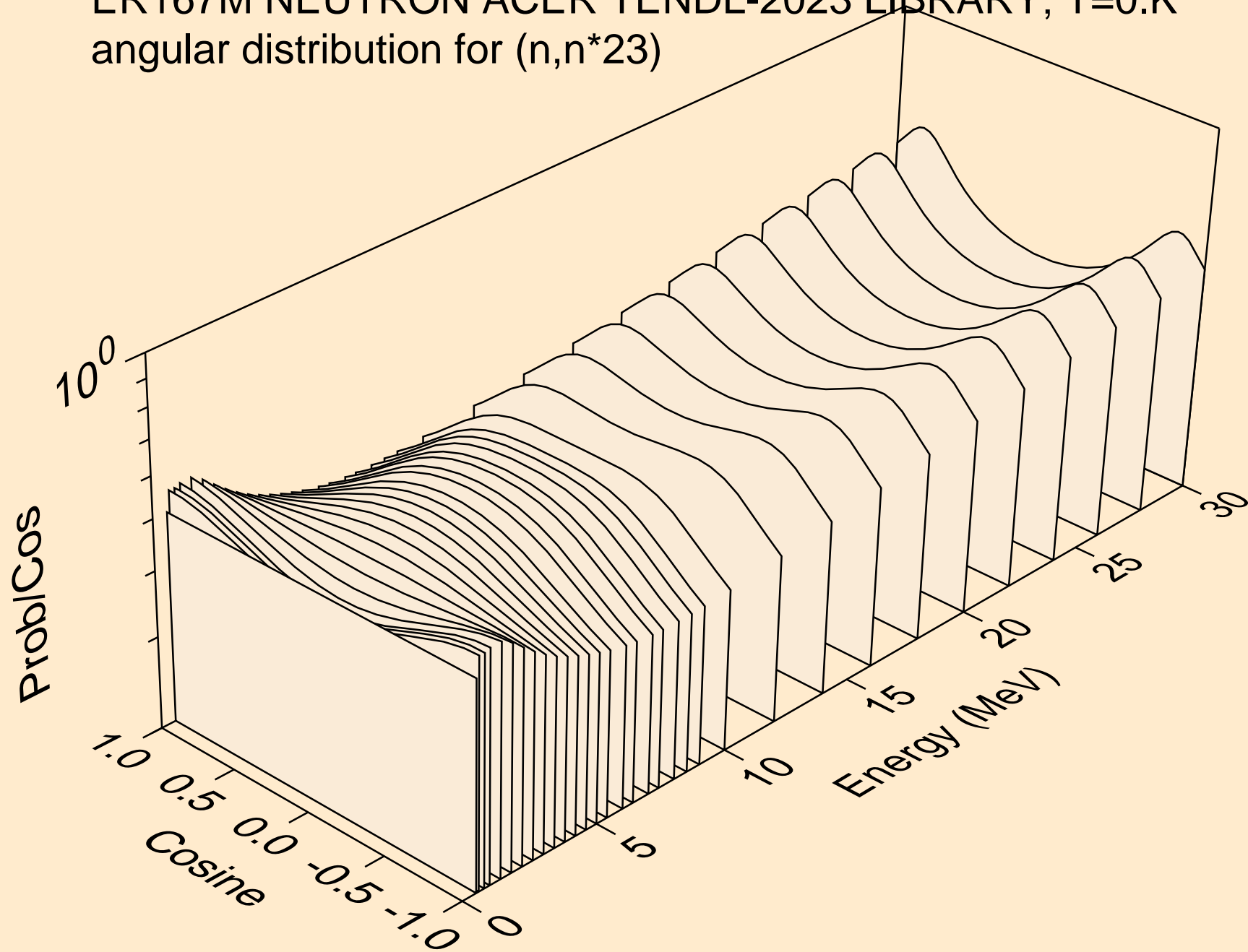

ER167M NEUTRON ACER TENDL-2023 LIBRARY; T=0.K
angular distribution for (n,n*24)

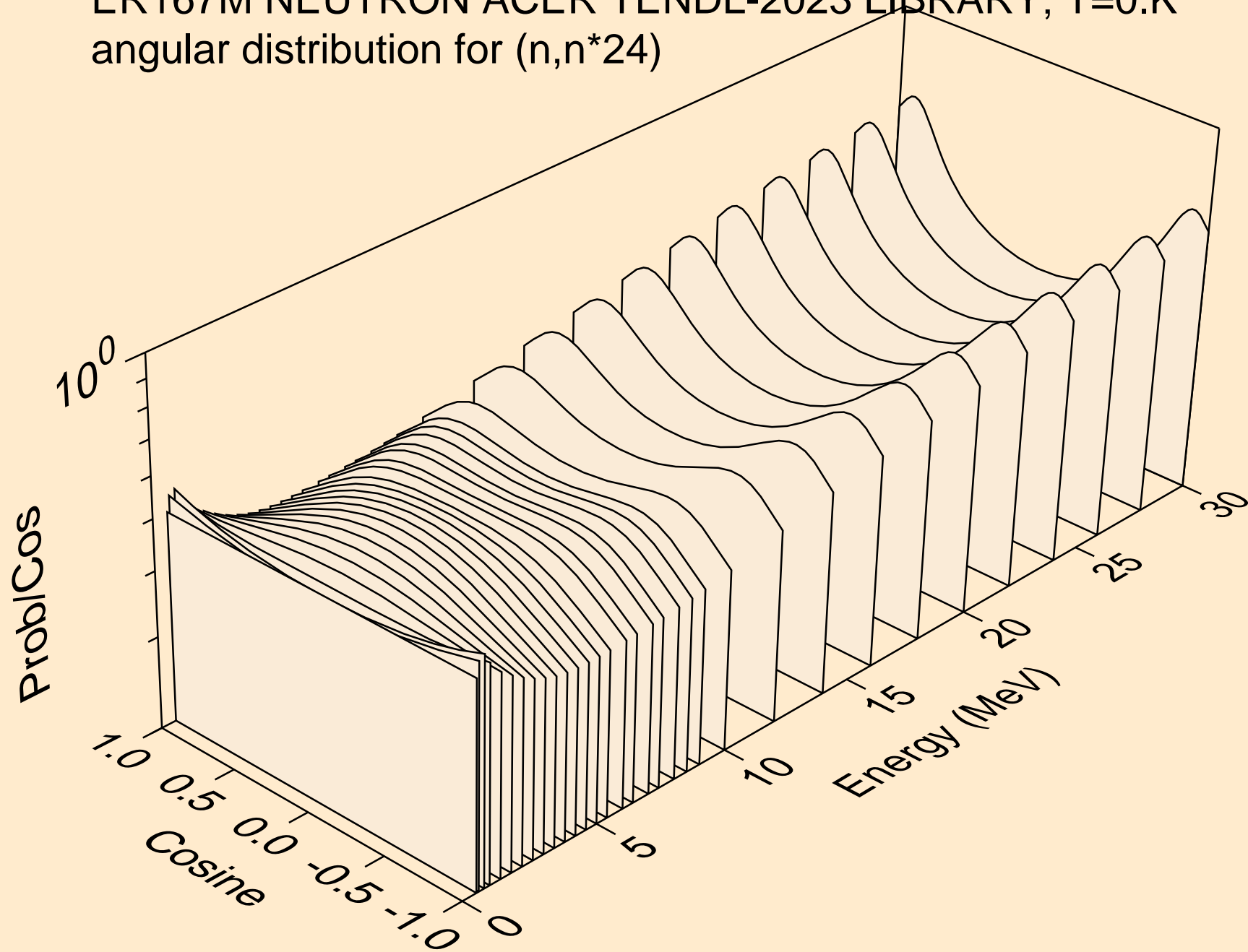

ER167M NEUTRON ACER TENDL-2023 LIBRARY; T=0.K
angular distribution for (n,n*25)

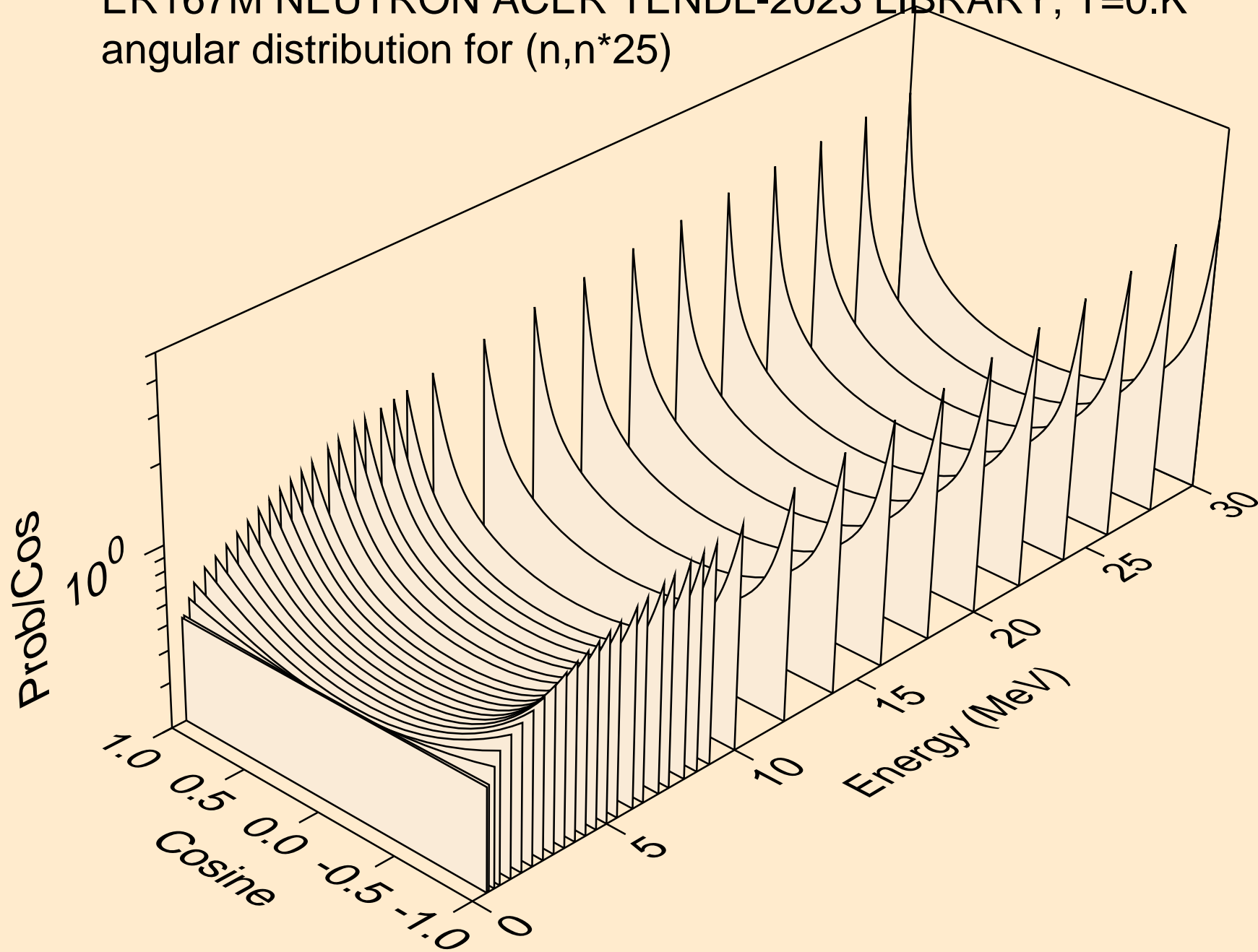

ER167M NEUTRON ACER TENDL-2023 LIBRARY; T=0.K
angular distribution for (n,n*26)

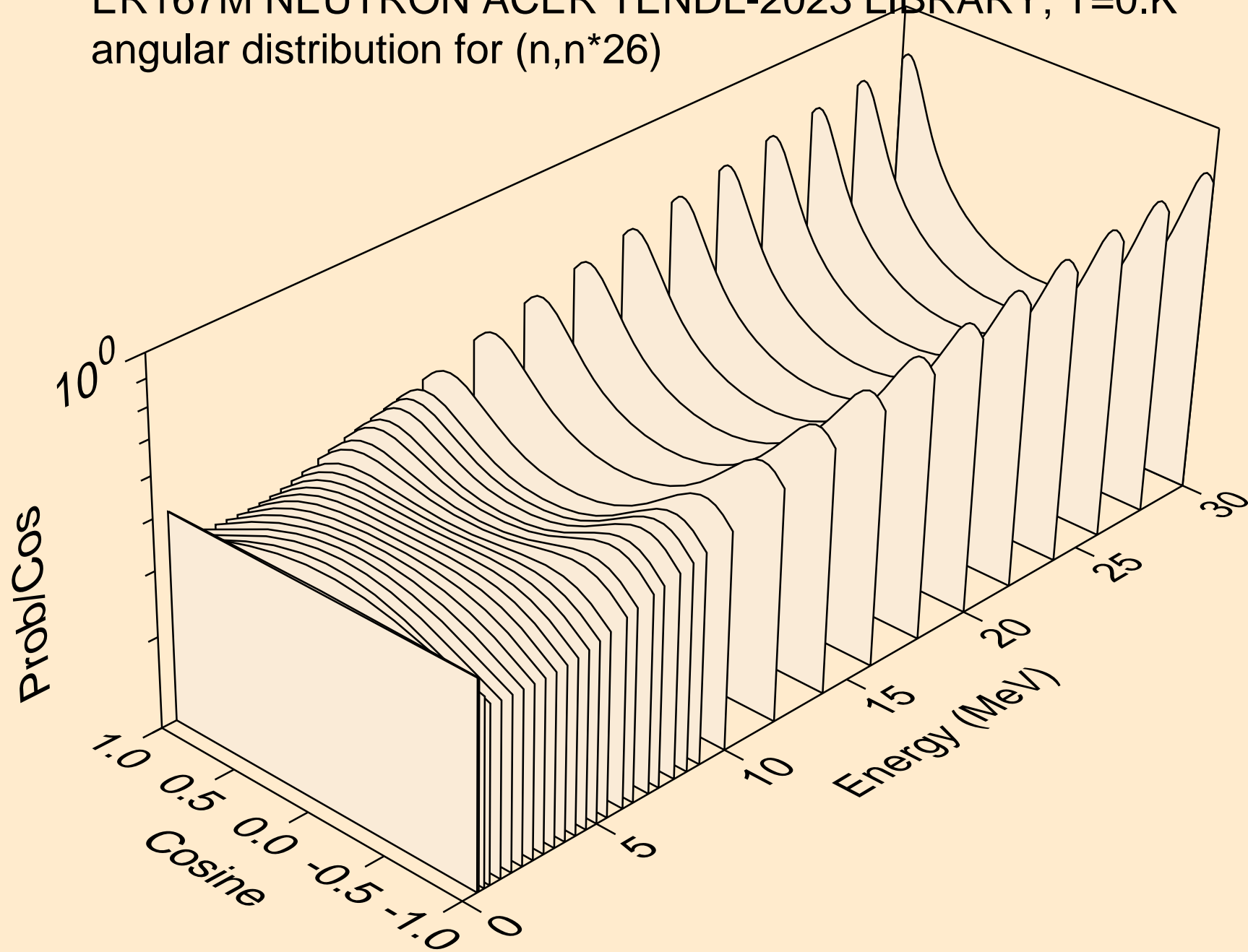

ER167M NEUTRON ACER TENDL-2023 LIBRARY; T=0.K
angular distribution for (n,n*27)

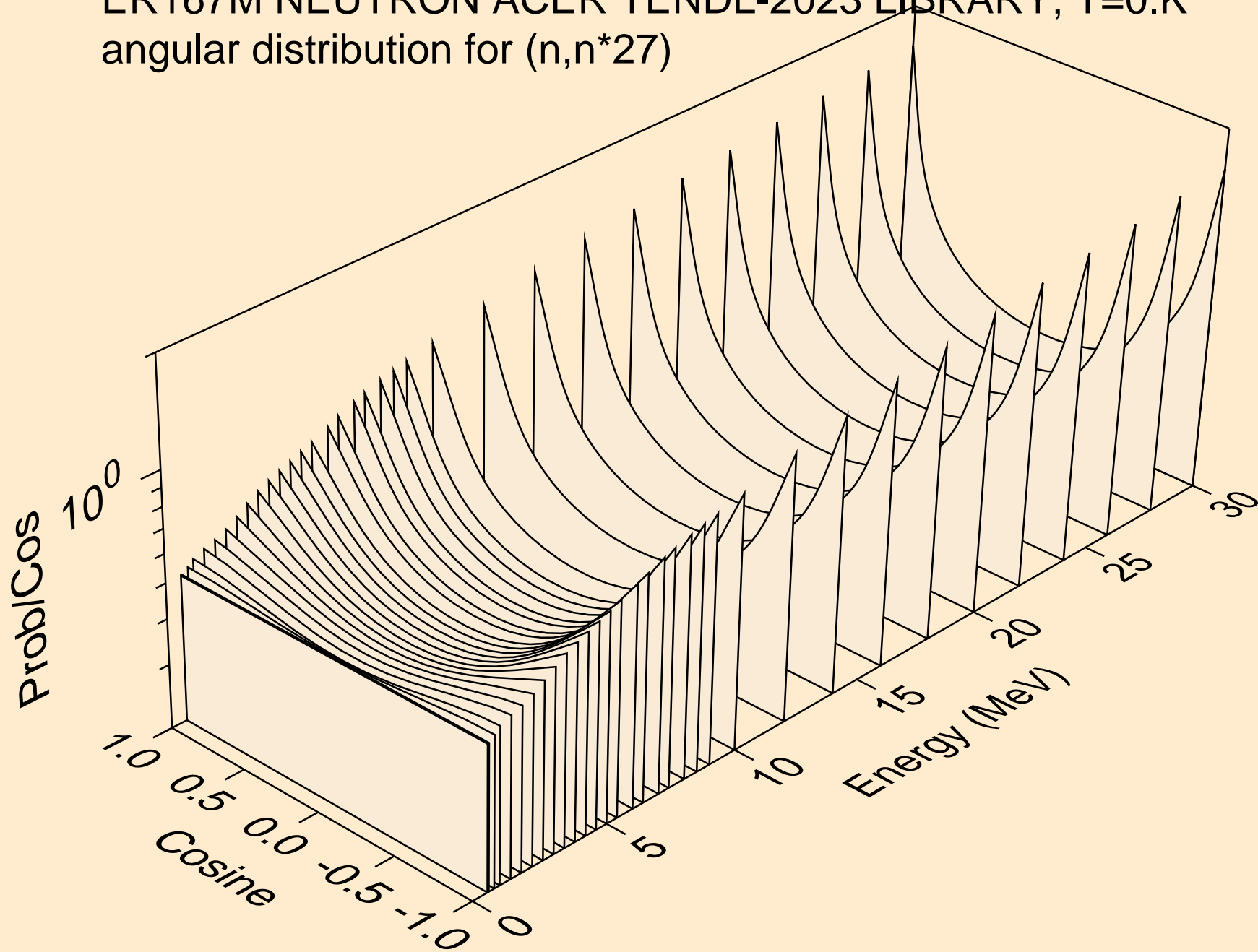

ER167M NEUTRON ACER TENDL-2023 LIBRARY; T=0.K
angular distribution for (n,n*28)

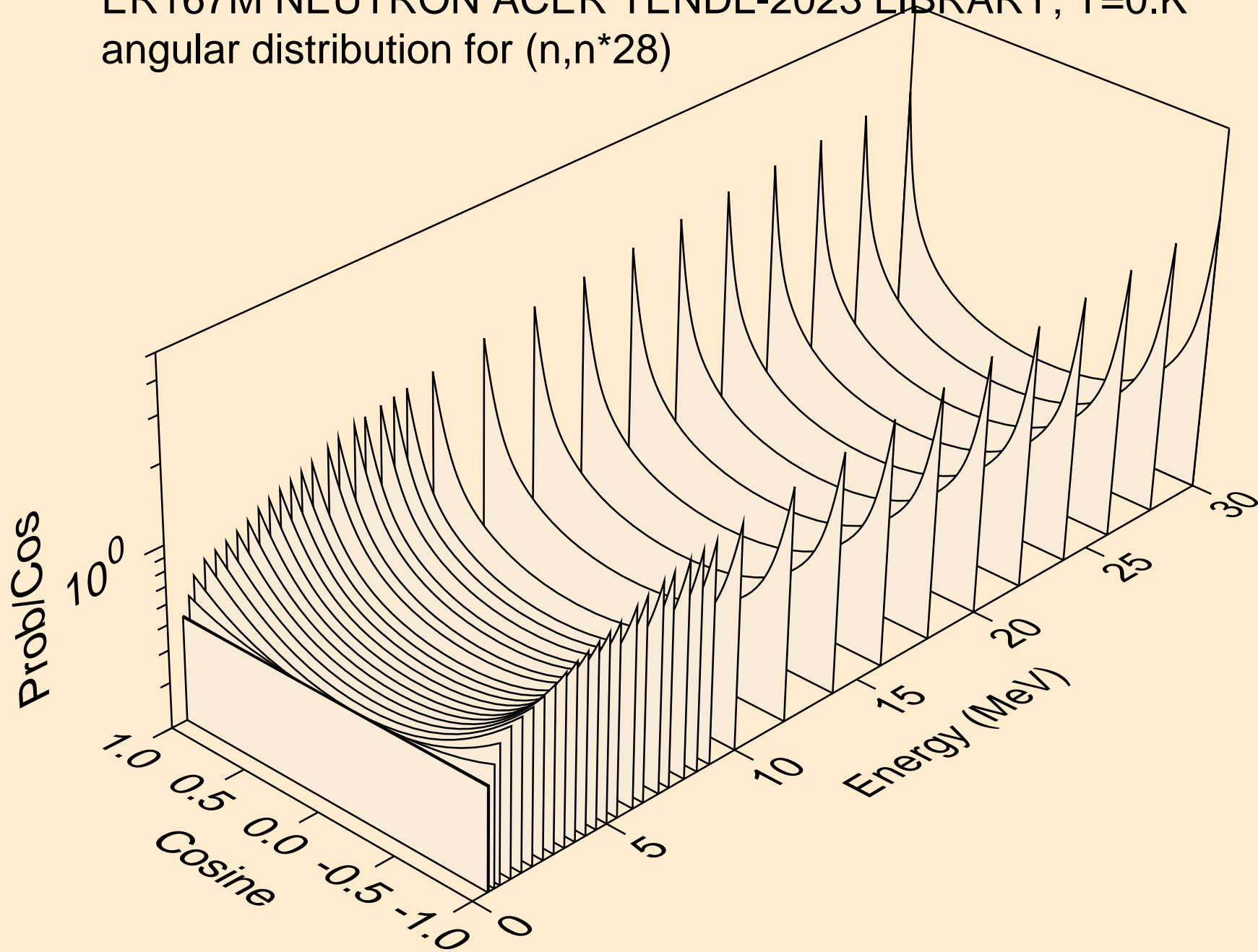

ER167M NEUTRON ACER TENDL-2023 LIBRARY; T=0.K
Neutron emission for (n,x)

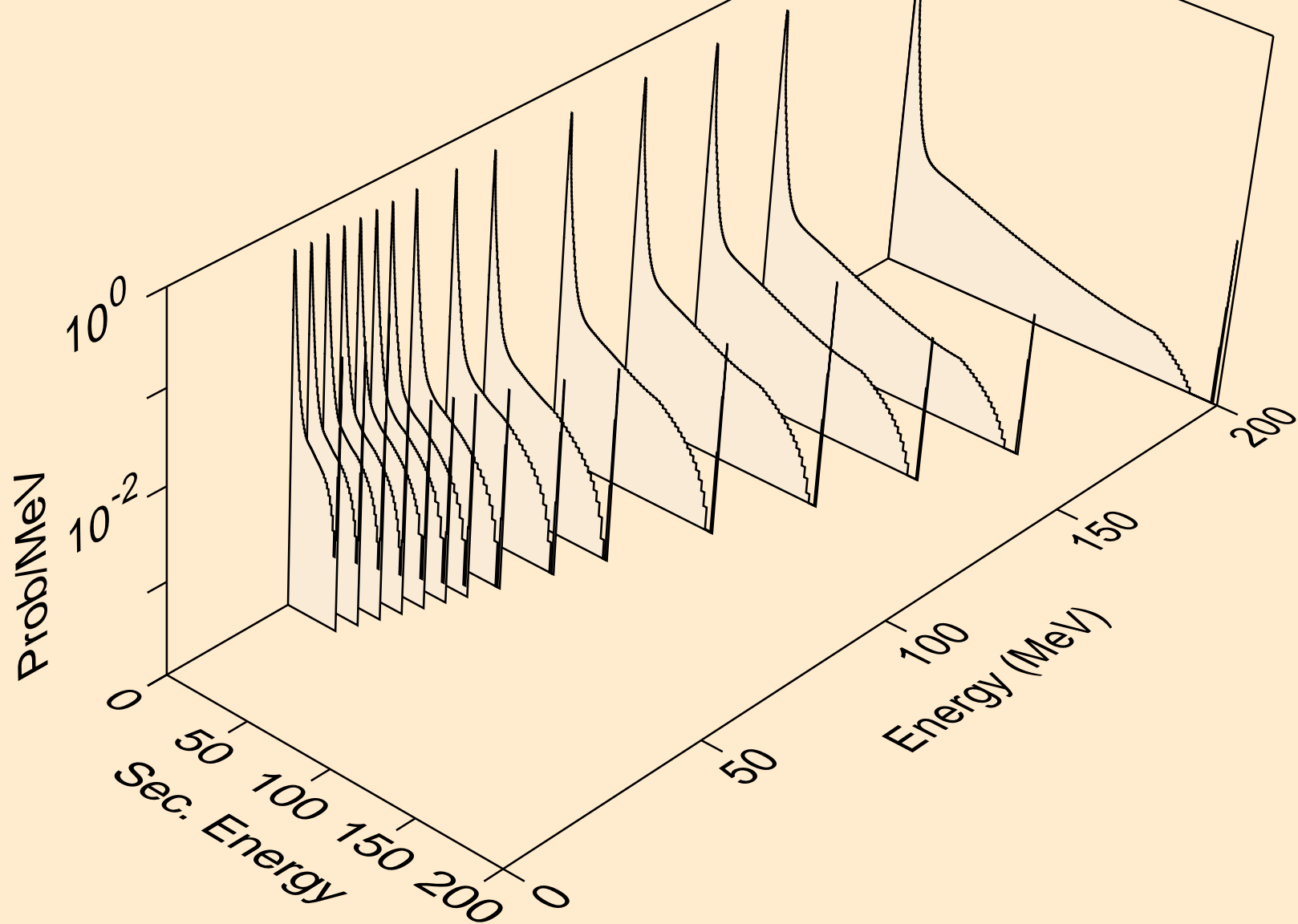

ER167M NEUTRON ACER TENDL-2023 LIBRARY; T=0.K
Neutron emission for (n,2nd)

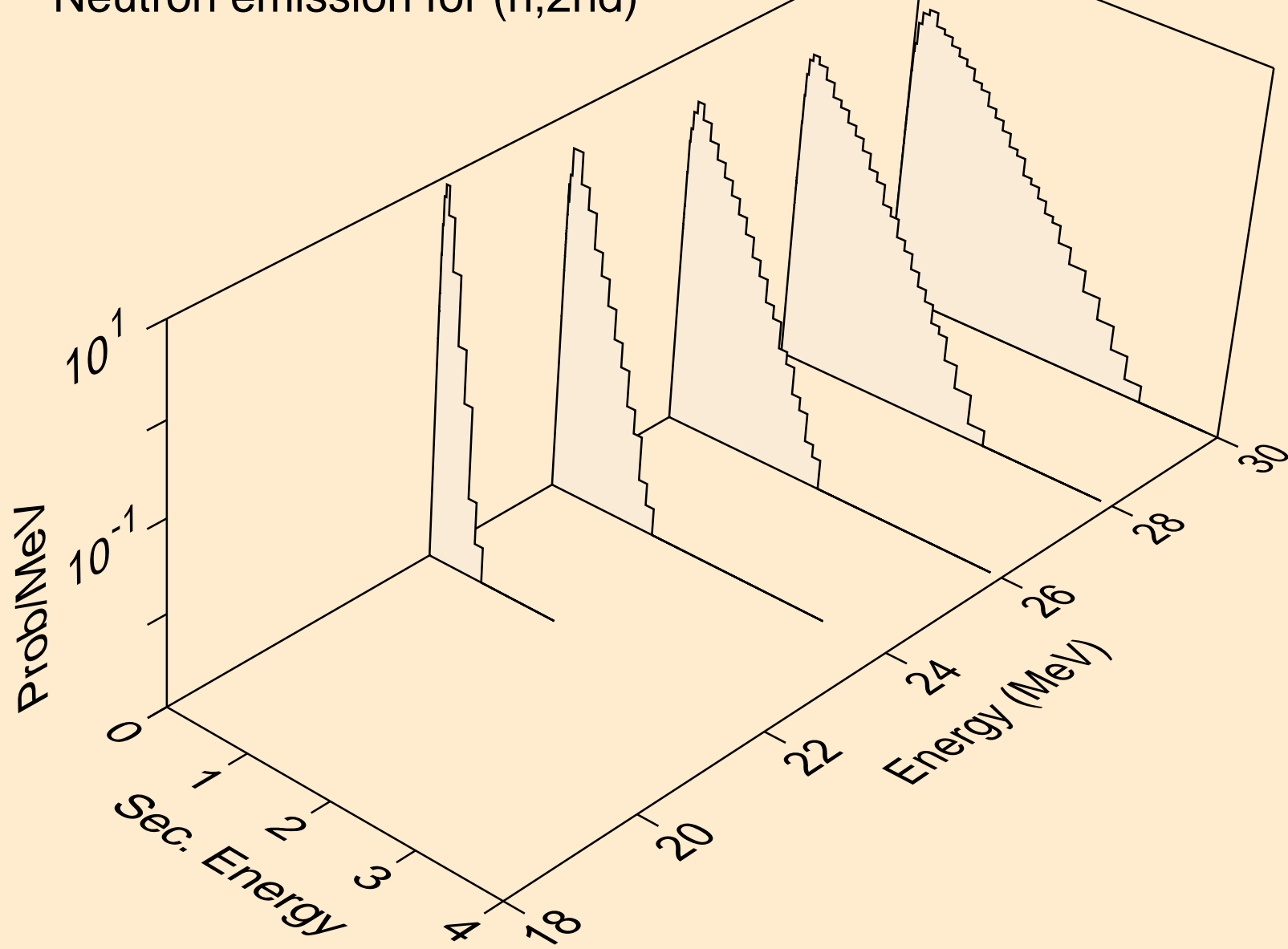

ER167M NEUTRON ACER TENDL-2023 LIBRARY; T=0.K
Neutron emission for (n,2n)

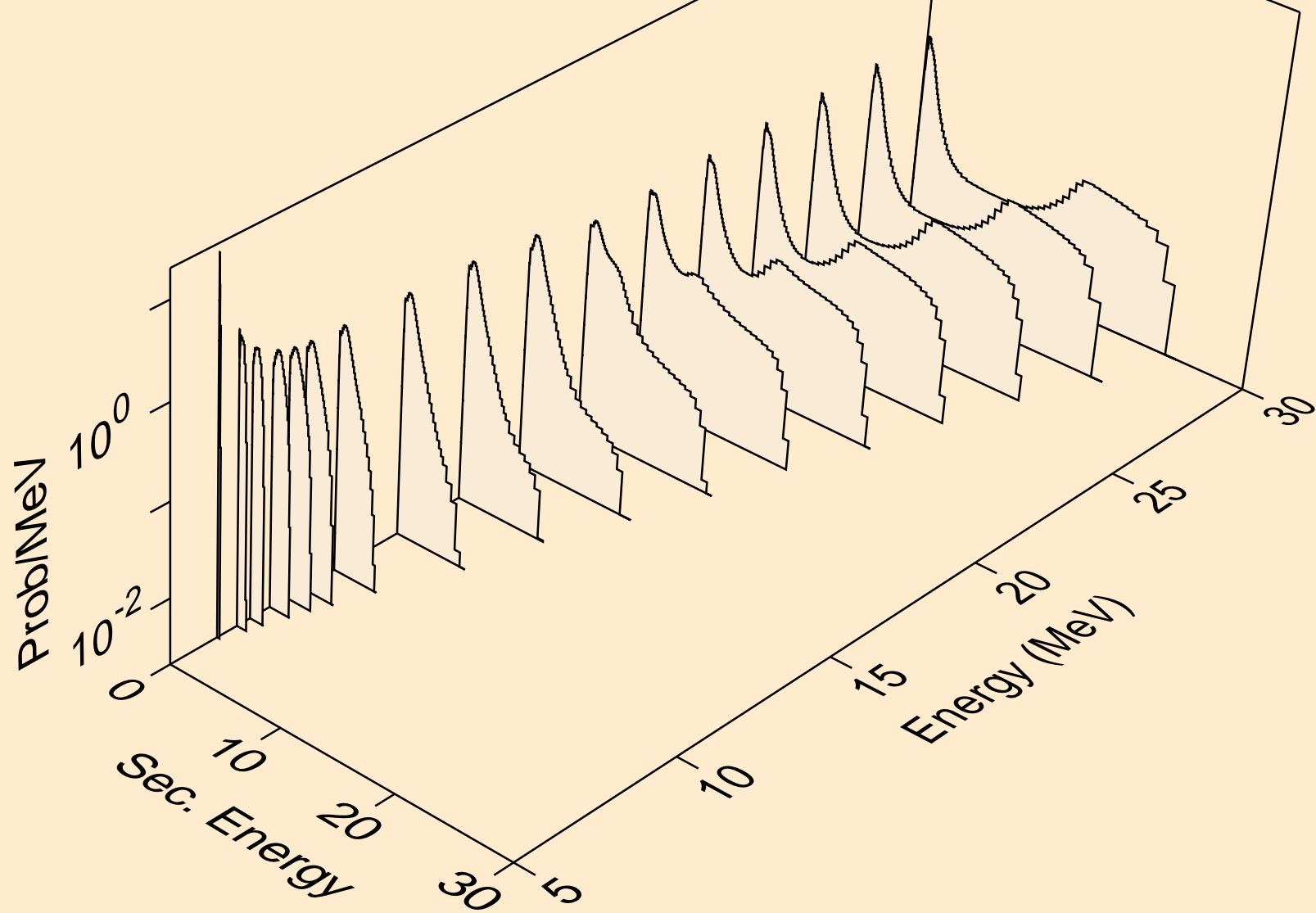

ER167M NEUTRON ACER TENDL-2023 LIBRARY; T=0.K
Neutron emission for (n,3n)

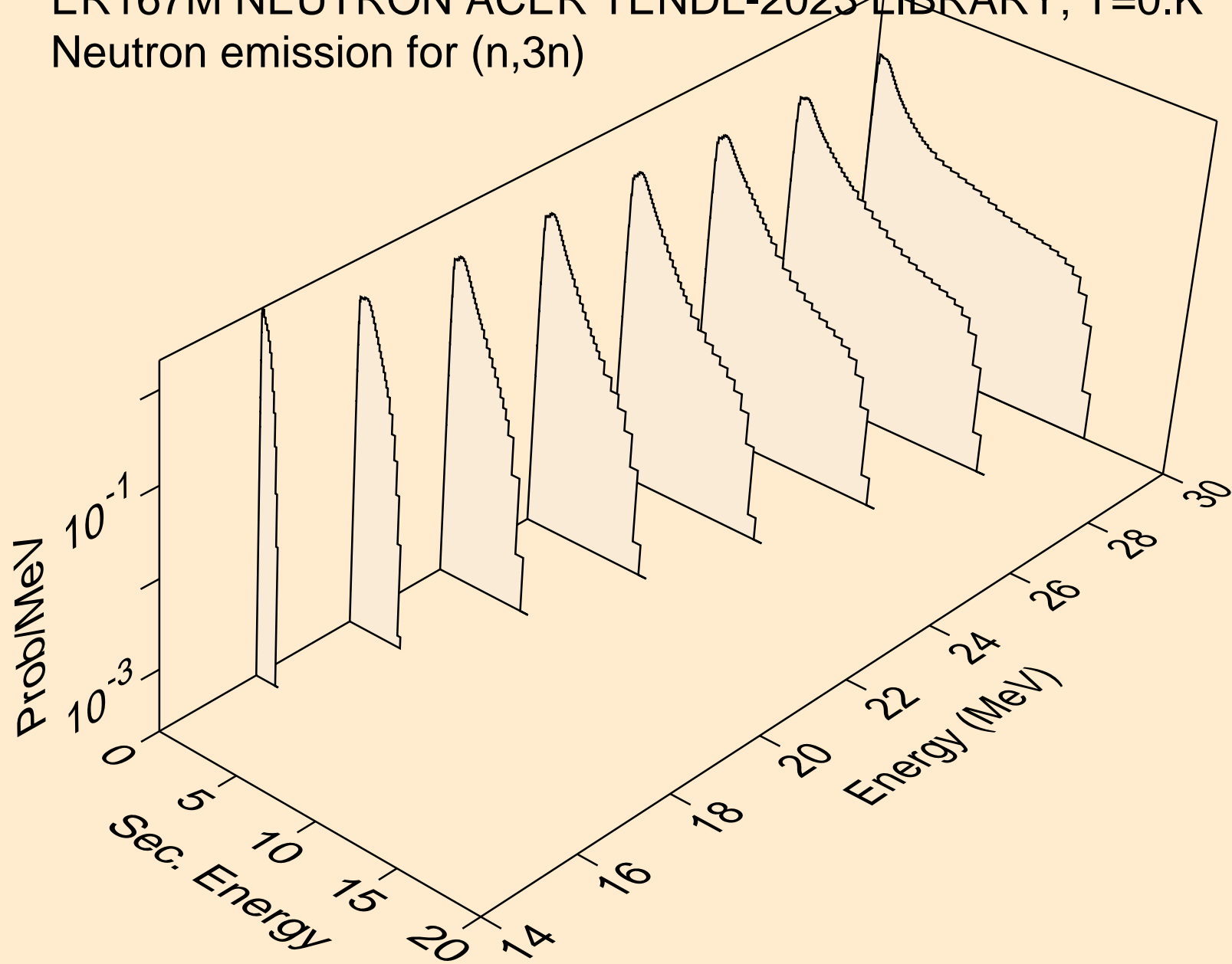

ER167M NEUTRON ACER TENDL-2023 LIBRARY; T=0.K
Neutron emission for (n,n*)a

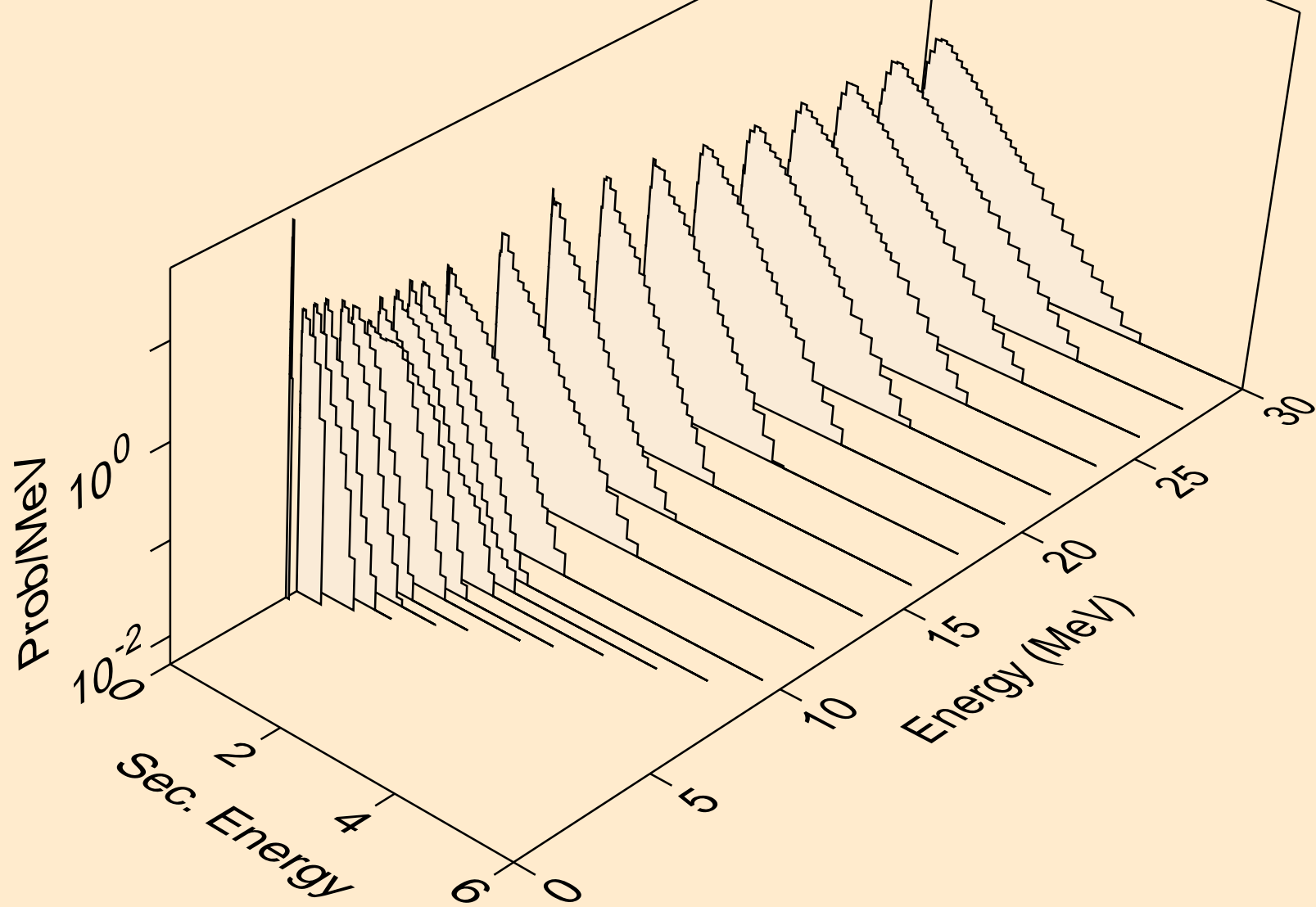

ER167M NEUTRON ACER TENDL-2023 LIBRARY; T=0.K
Neutron emission for (n,2n)a

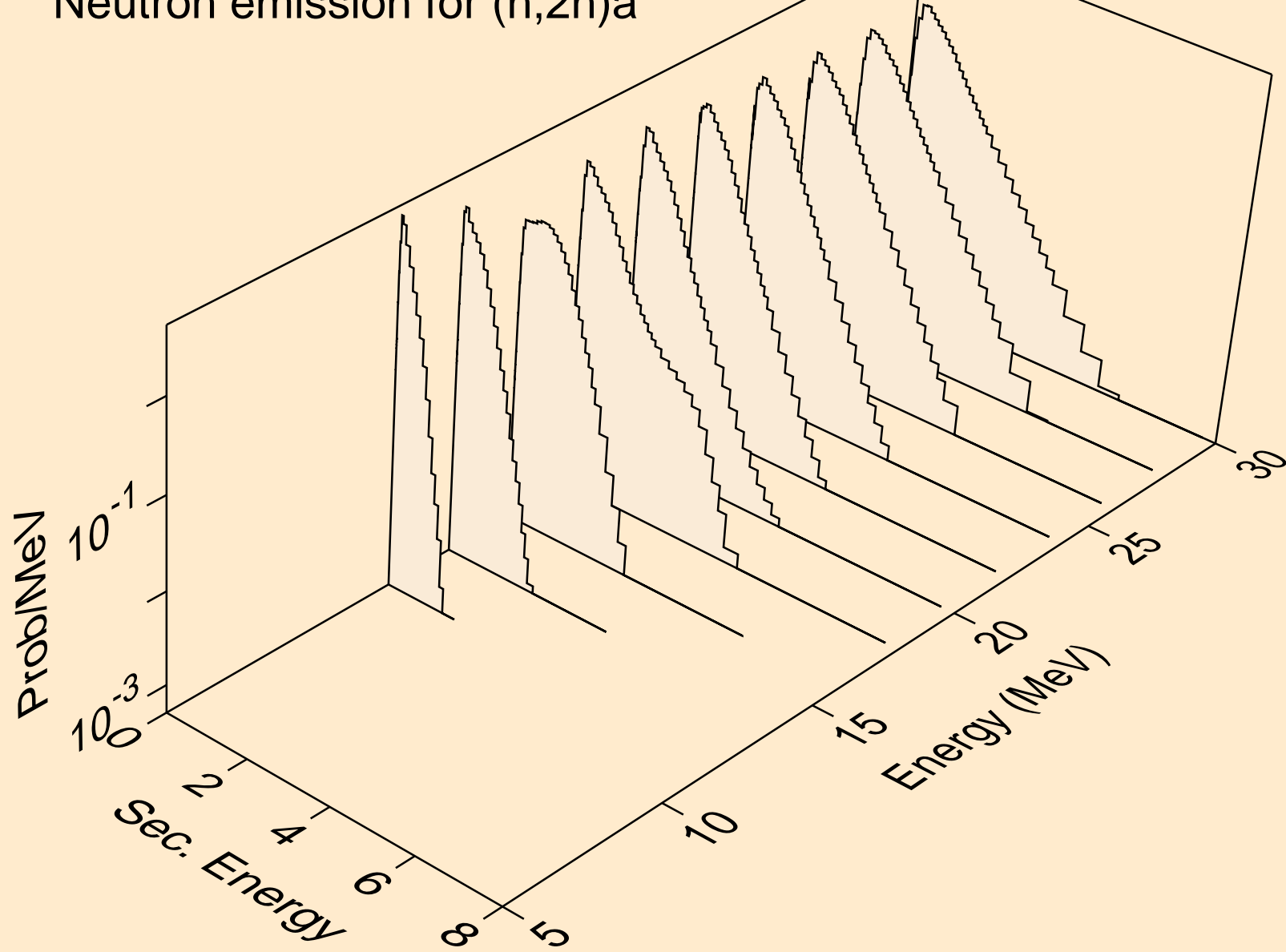

ER167M NEUTRON ACER TENDL-2023 LIBRARY; T=0.K
Neutron emission for (n,3n)a

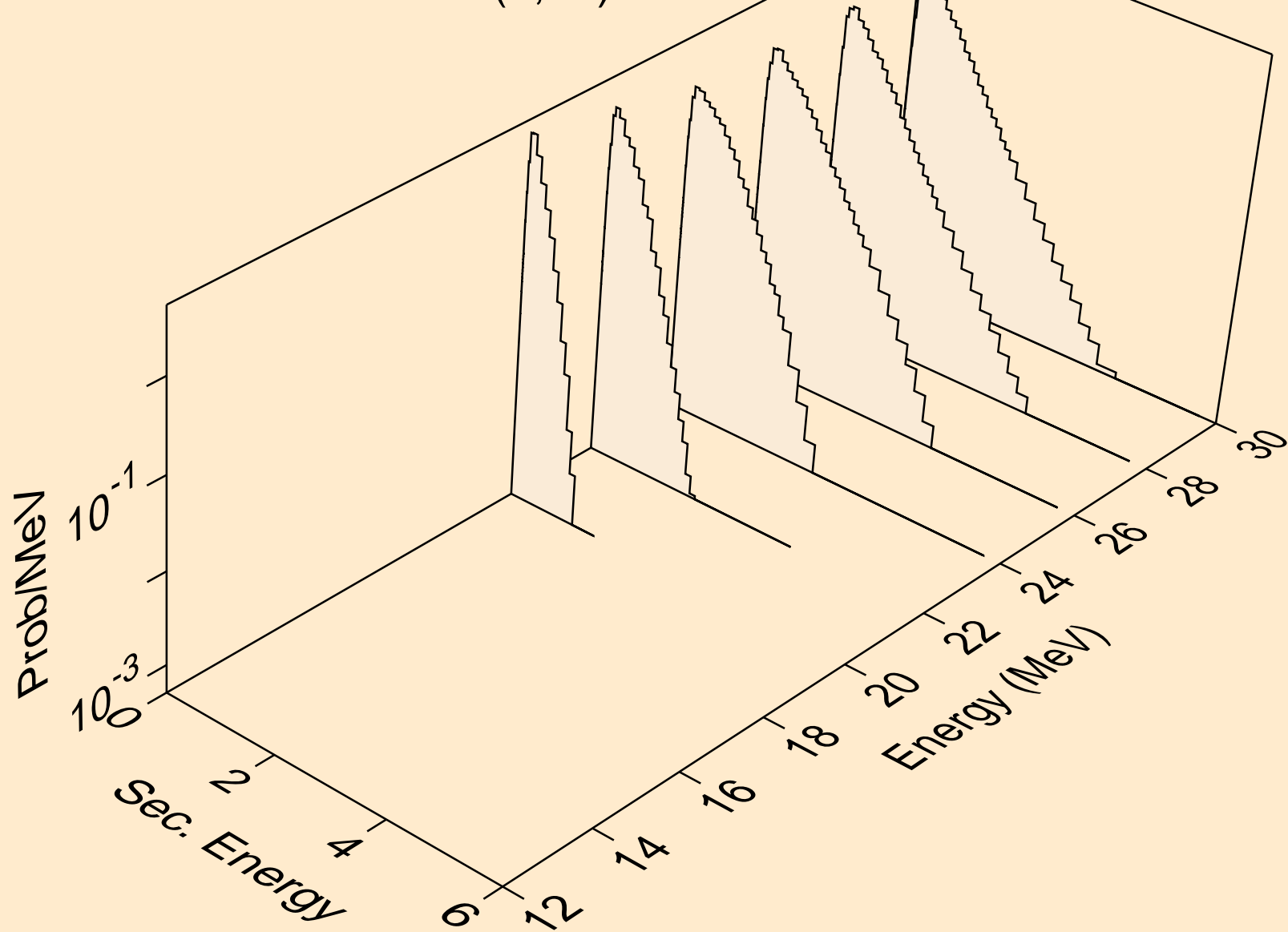

ER167M NEUTRON ACER TENDL-2023 LIBRARY; T=0.K
Neutron emission for (n,n*)p

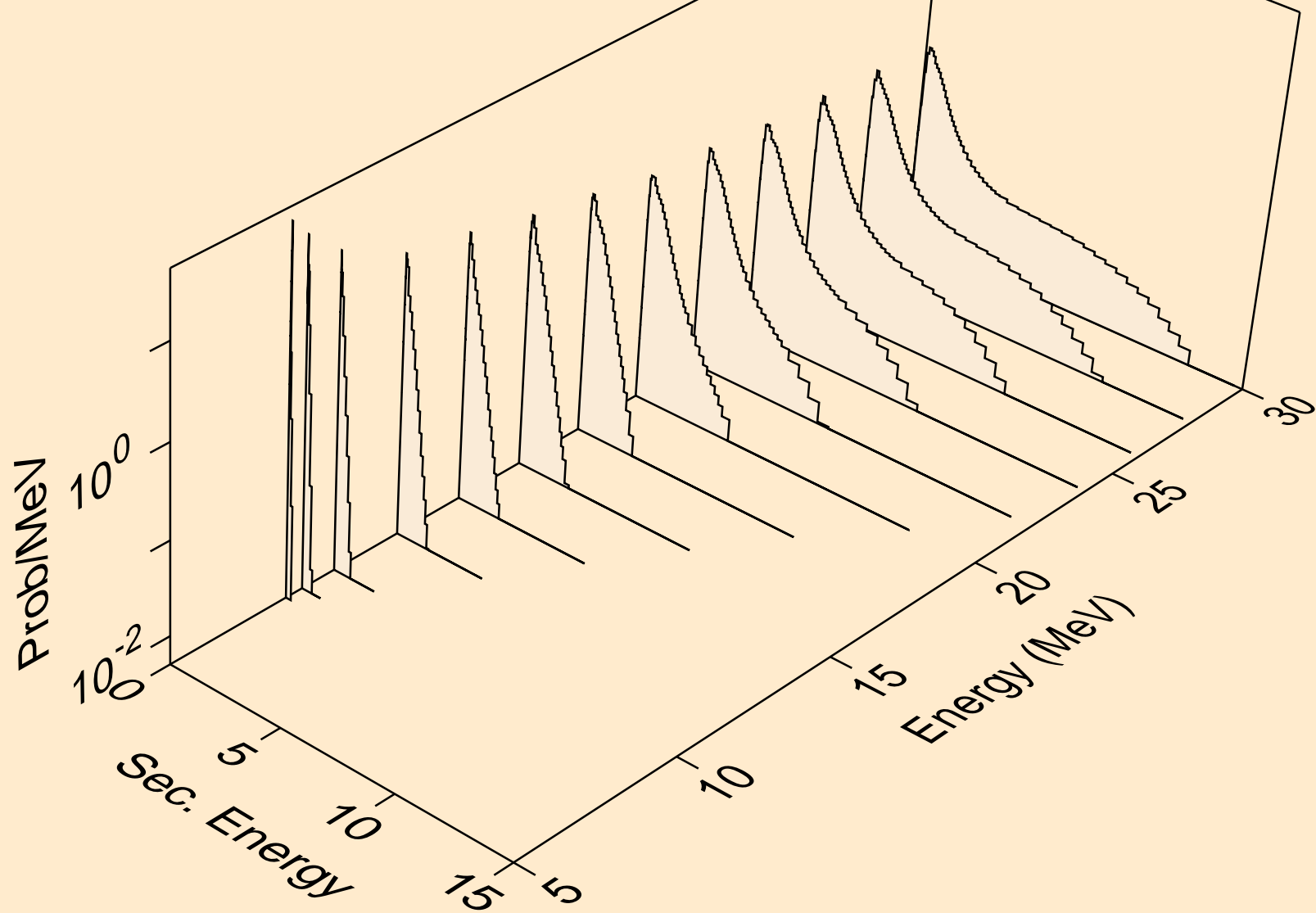

ER167M NEUTRON ACER TENDL-2023 LIBRARY; T=0.K
Neutron emission for (n,n*)2a

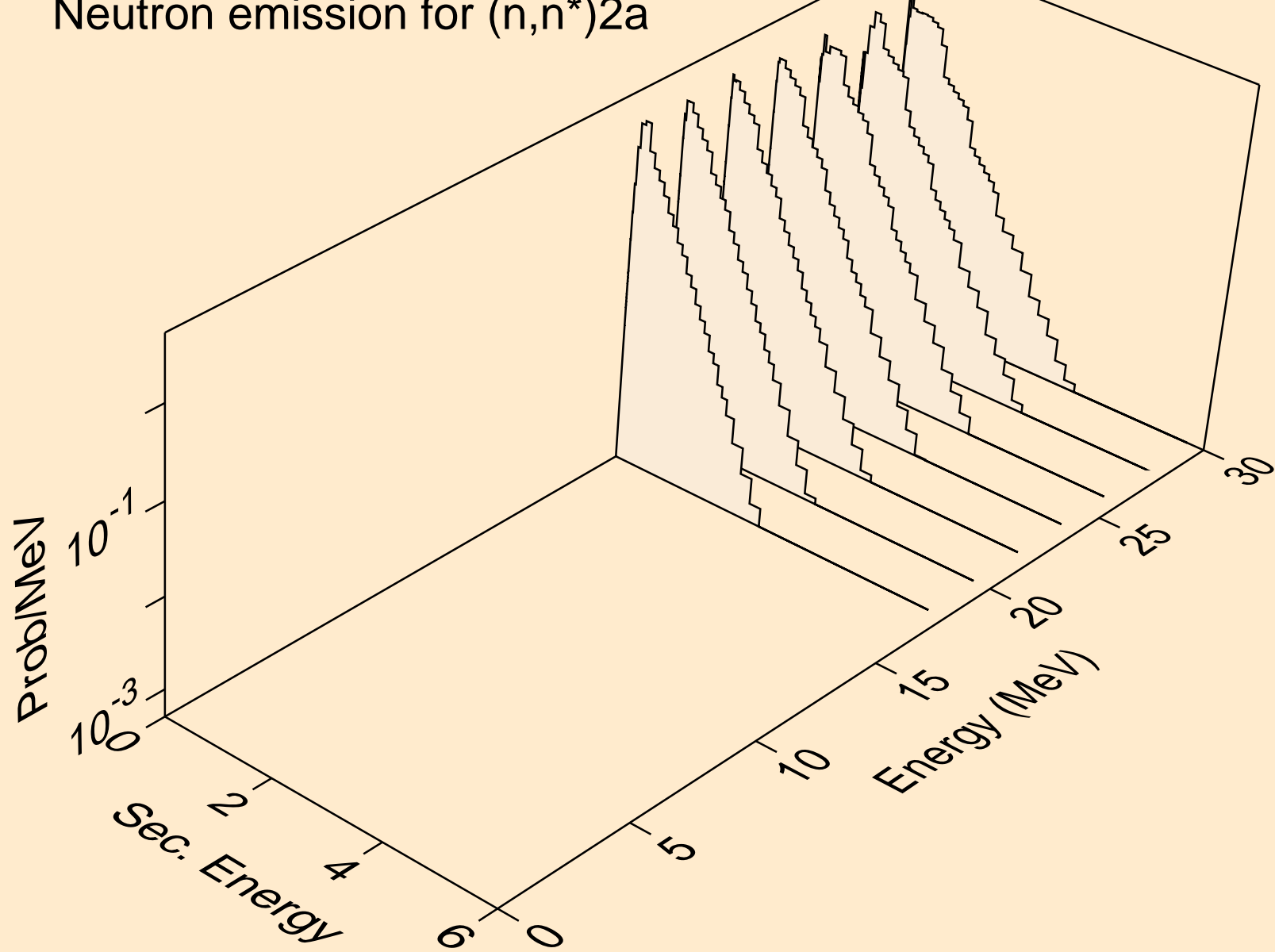

ER167M NEUTRON ACER TENDL-2023 LIBRARY; T=0.K
Neutron emission for (n,n*)d

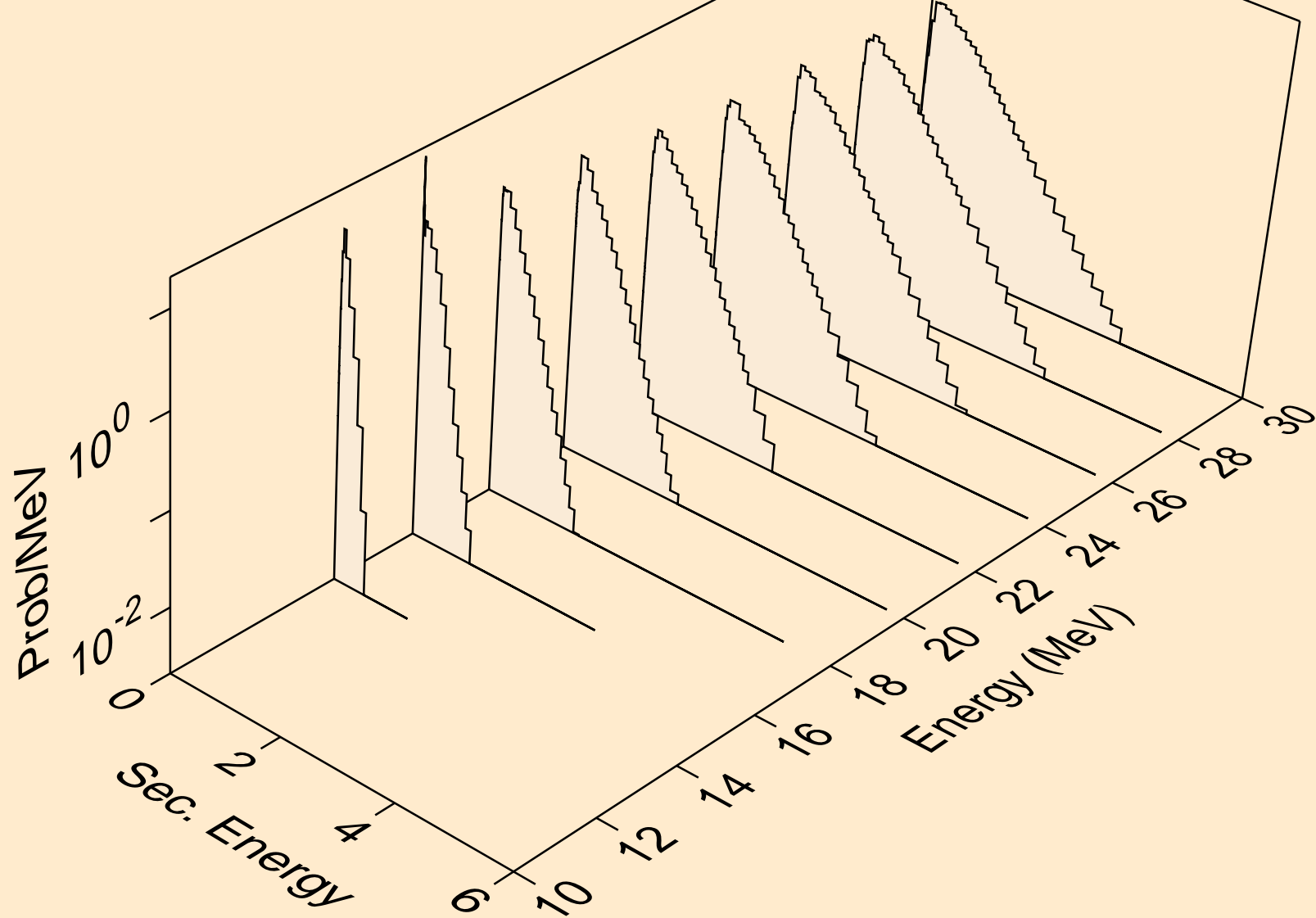

ER167M NEUTRON ACER TENDL-2023 LIBRARY; T=0.K
Neutron emission for (n,n*)t

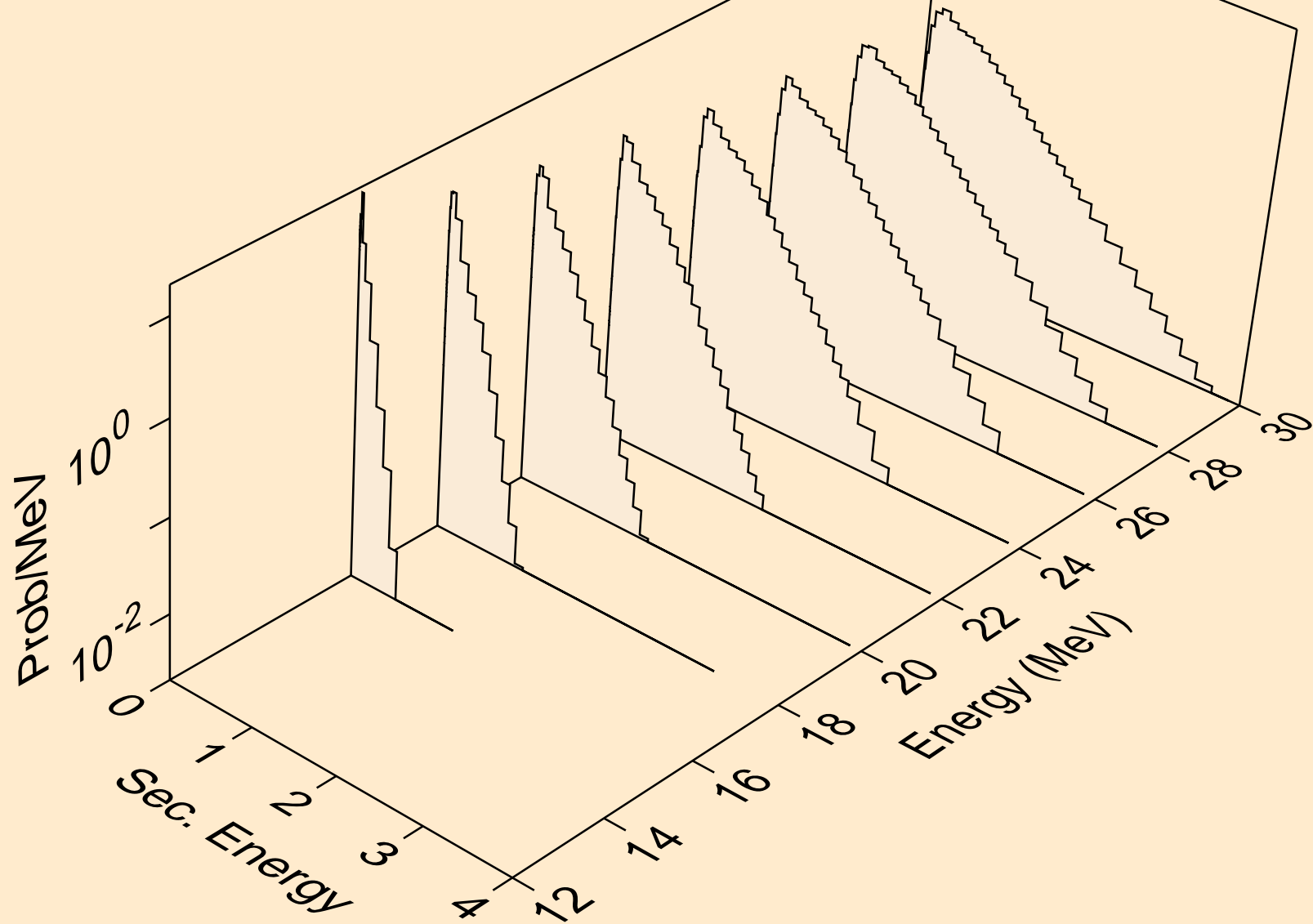

ER167M NEUTRON ACER TENDL-2023 LIBRARY; T=0.K
Neutron emission for (n,n*)he3

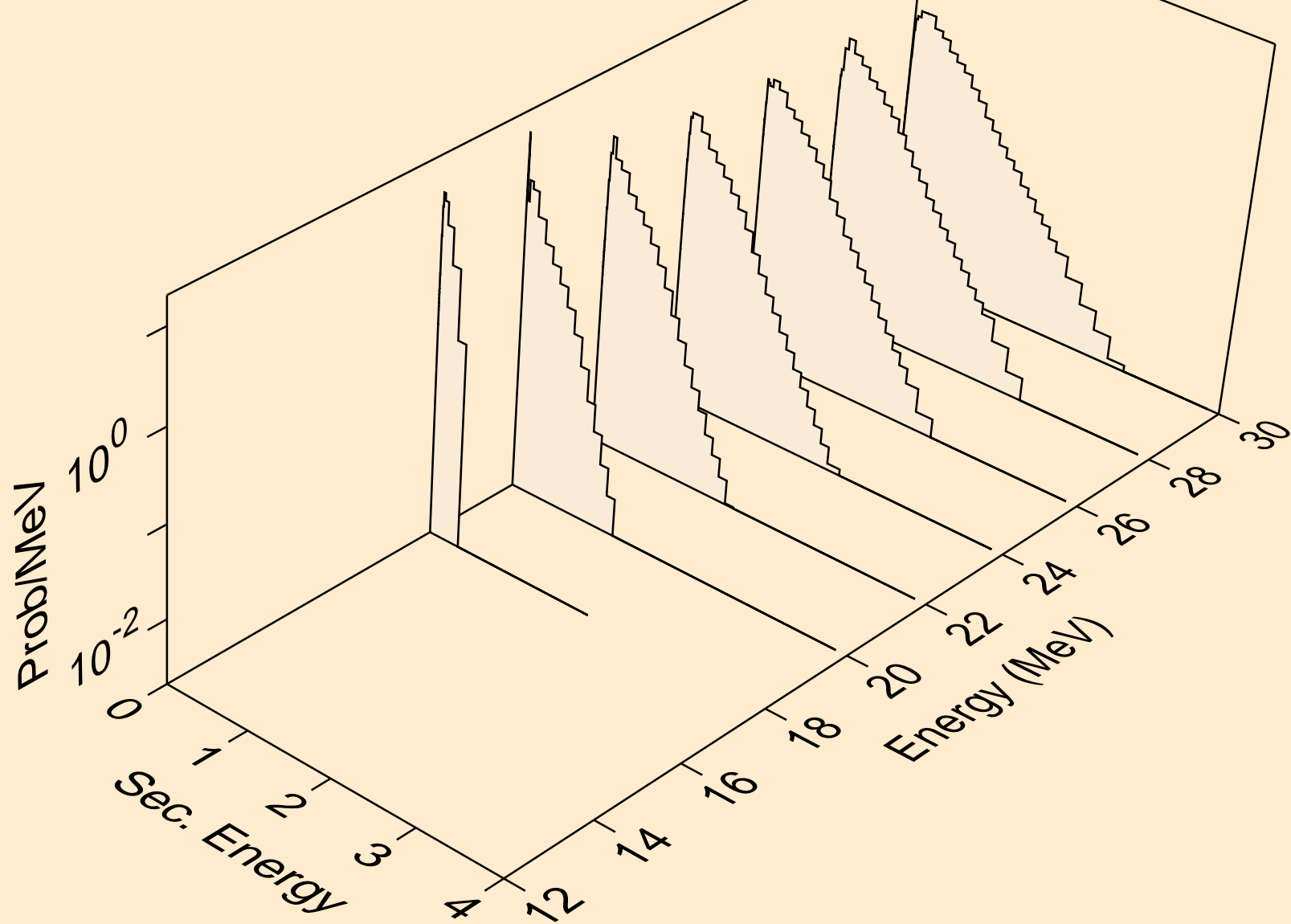

ER167M NEUTRON ACER TENDL-2023 LIBRARY; T=0.K
Neutron emission for (n,4n)

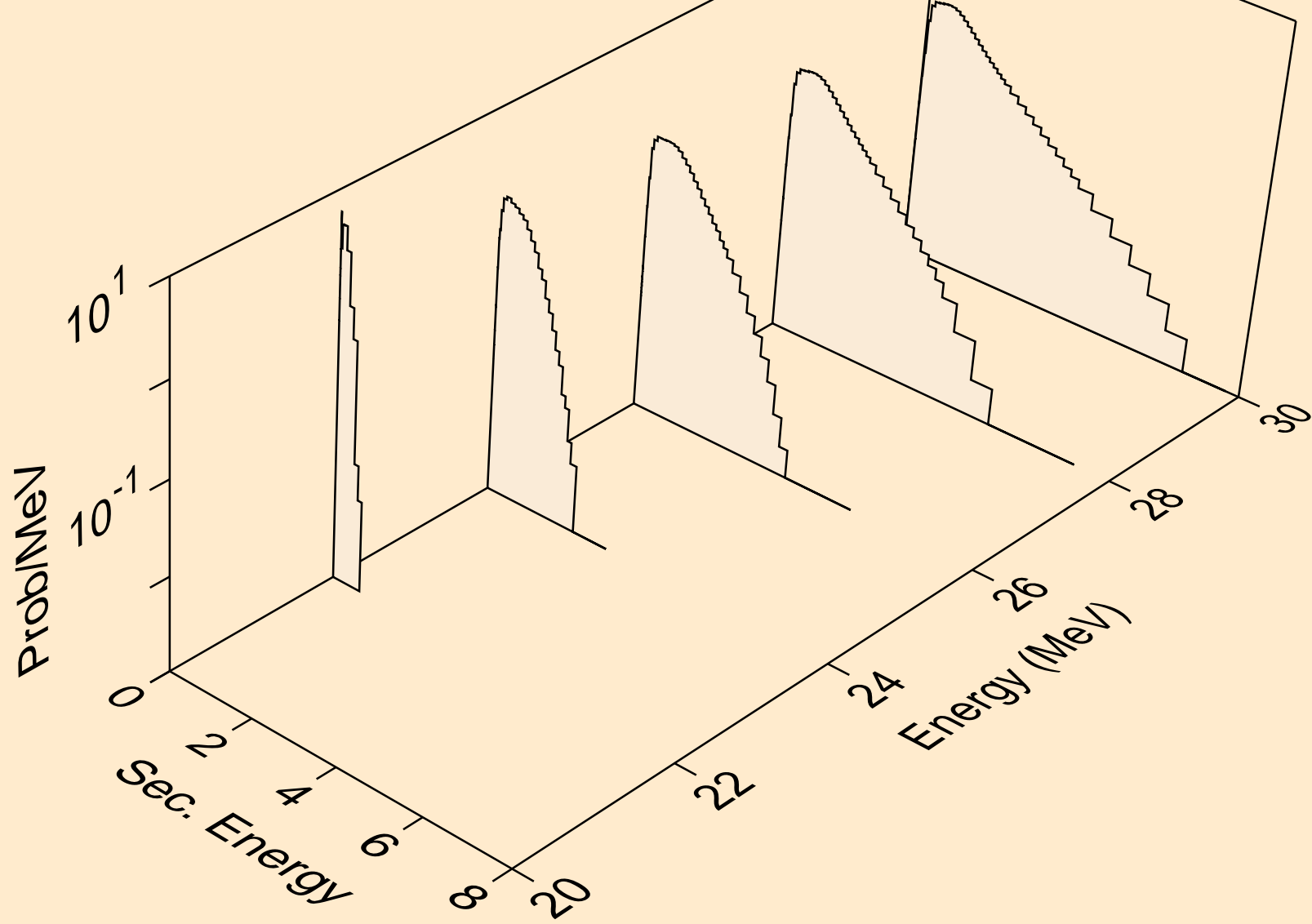

ER167M NEUTRON ACER TENDL-2023 LIBRARY; T=0.K
Neutron emission for (n,2np)

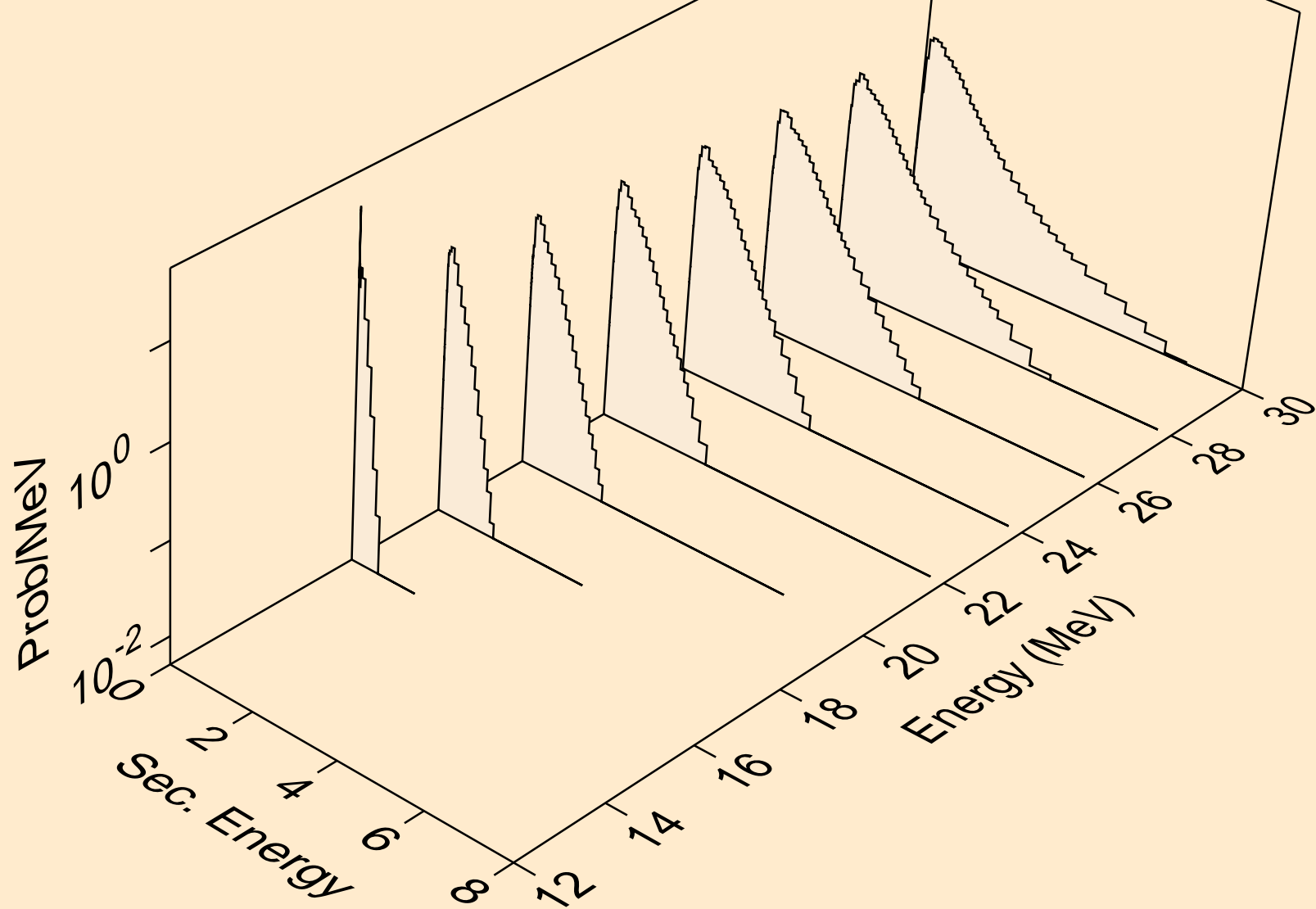

ER167M NEUTRON ACER TENDL-2023 LIBRARY; T=0.K
Neutron emission for (n,3np)

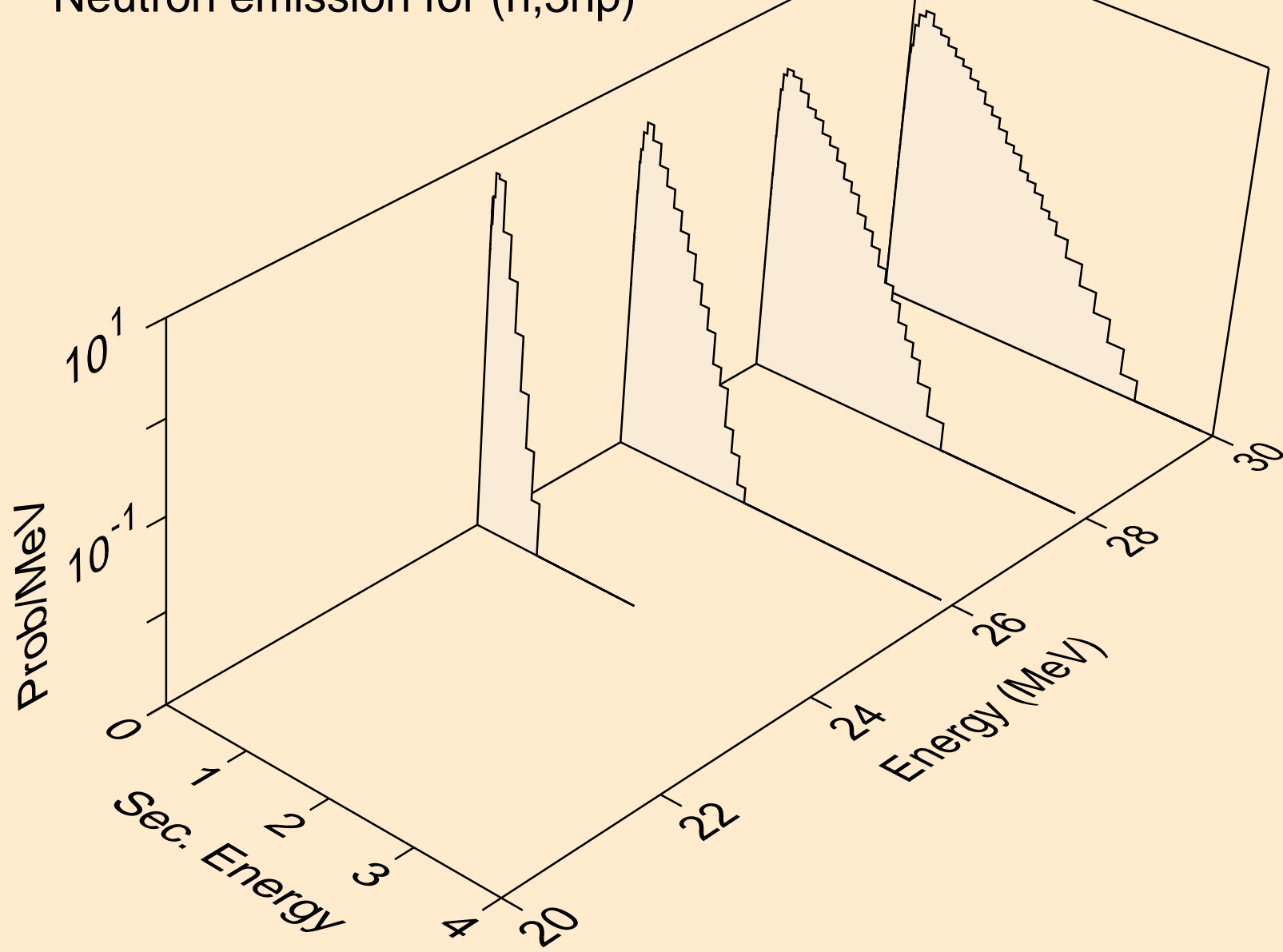

ER167M NEUTRON ACER TENDL-2023 LIBRARY; T=0.K
Neutron emission for (n,n2p)

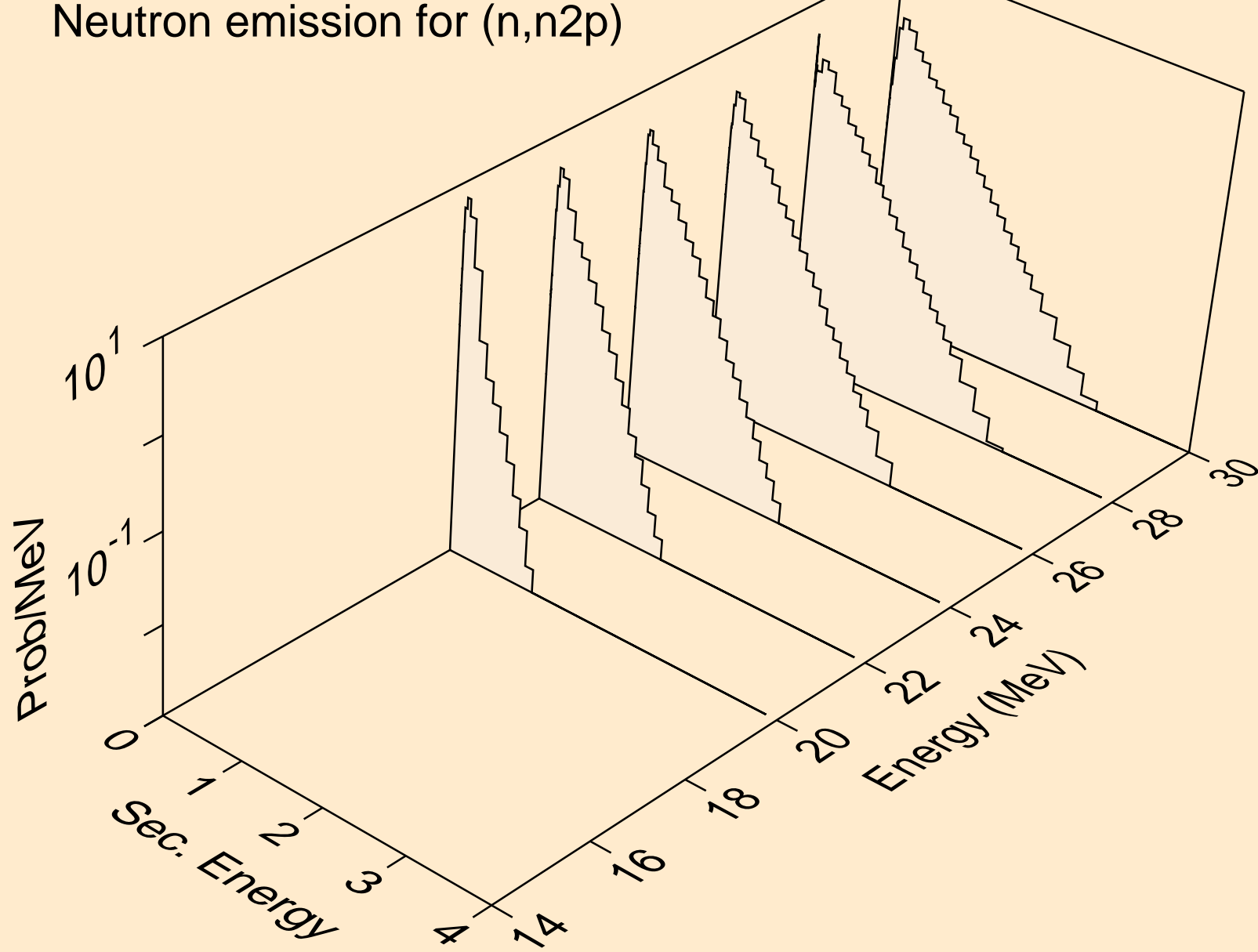

ER167M NEUTRON ACER TENDL-2023 LIBRARY; T=0.K
Neutron emission for (n,npa)

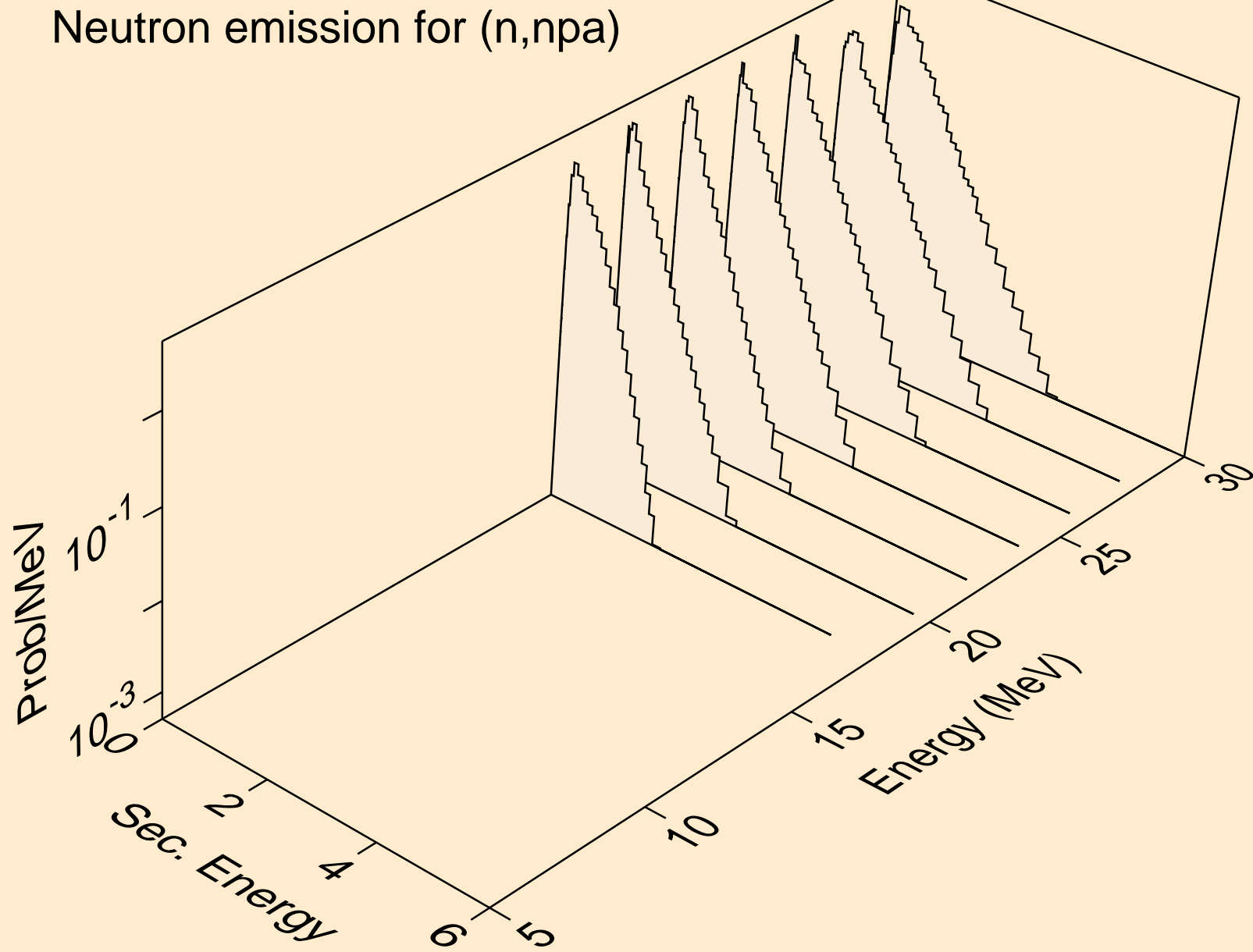

ER167M NEUTRON ACER TENDL-2023 LIBRARY; T=0.K
Neutron emission for (n,n*c)

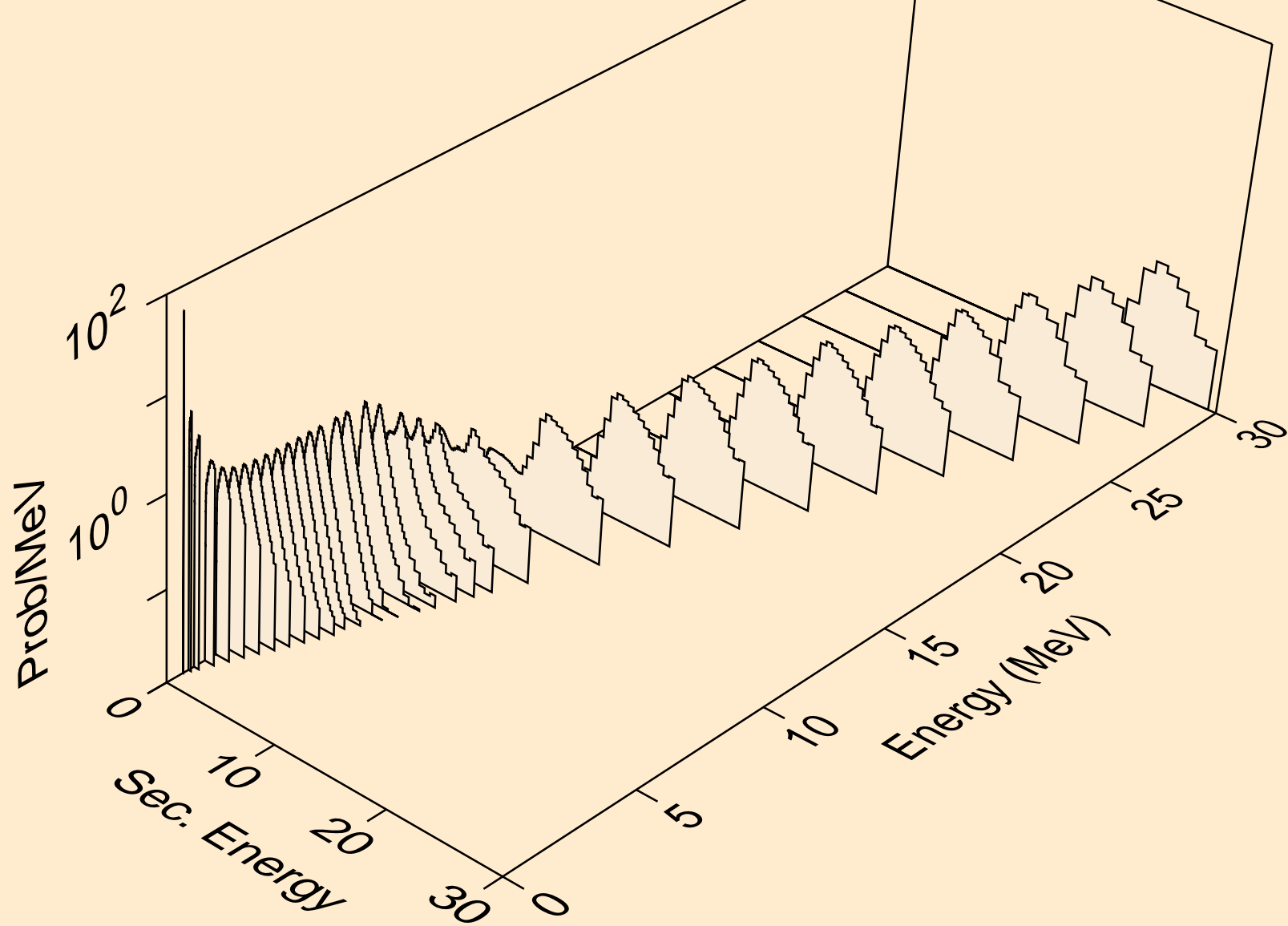

ER167M NEUTRON ACER TENDL-2023 LIBRARY; T=0.K
Photon emission for (n,x)

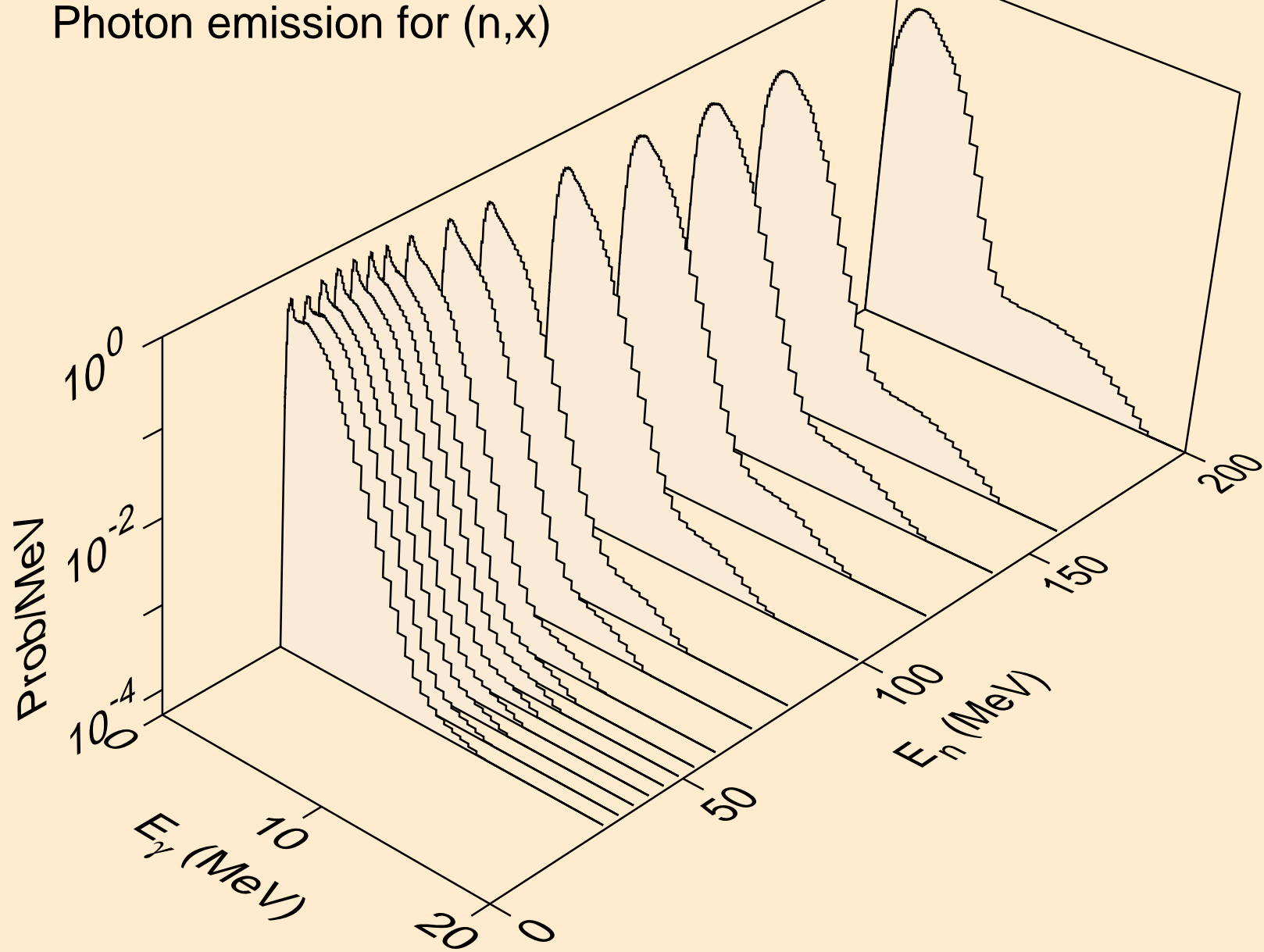

ER167M NEUTRON ACER TENDL-2023 LIBRARY; T=0.K
Photon emission for (n,2nd)

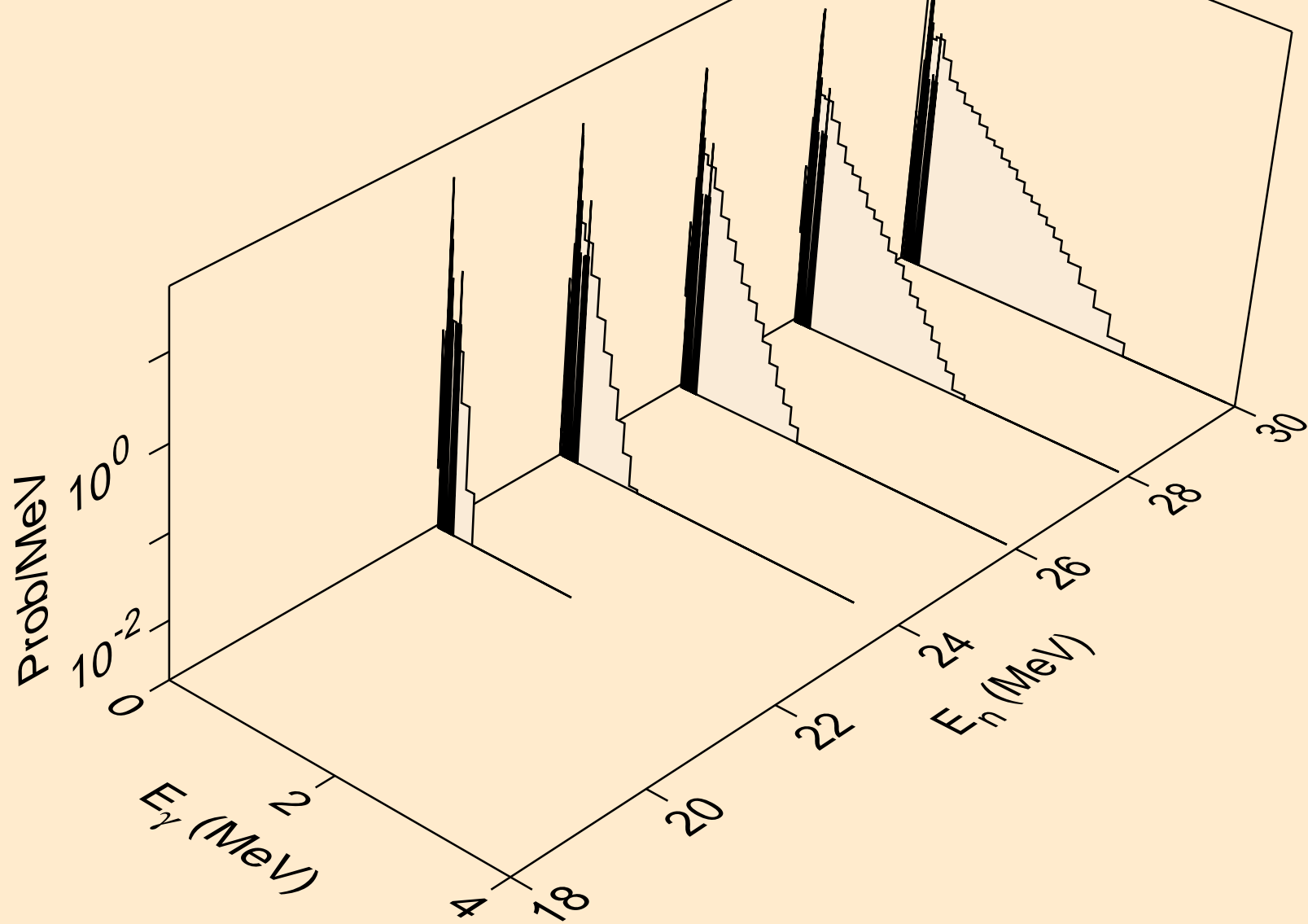

ER167M NEUTRON ACER TENDL-2023 LIBRARY; T=0.K
Photon emission for (n,2n)

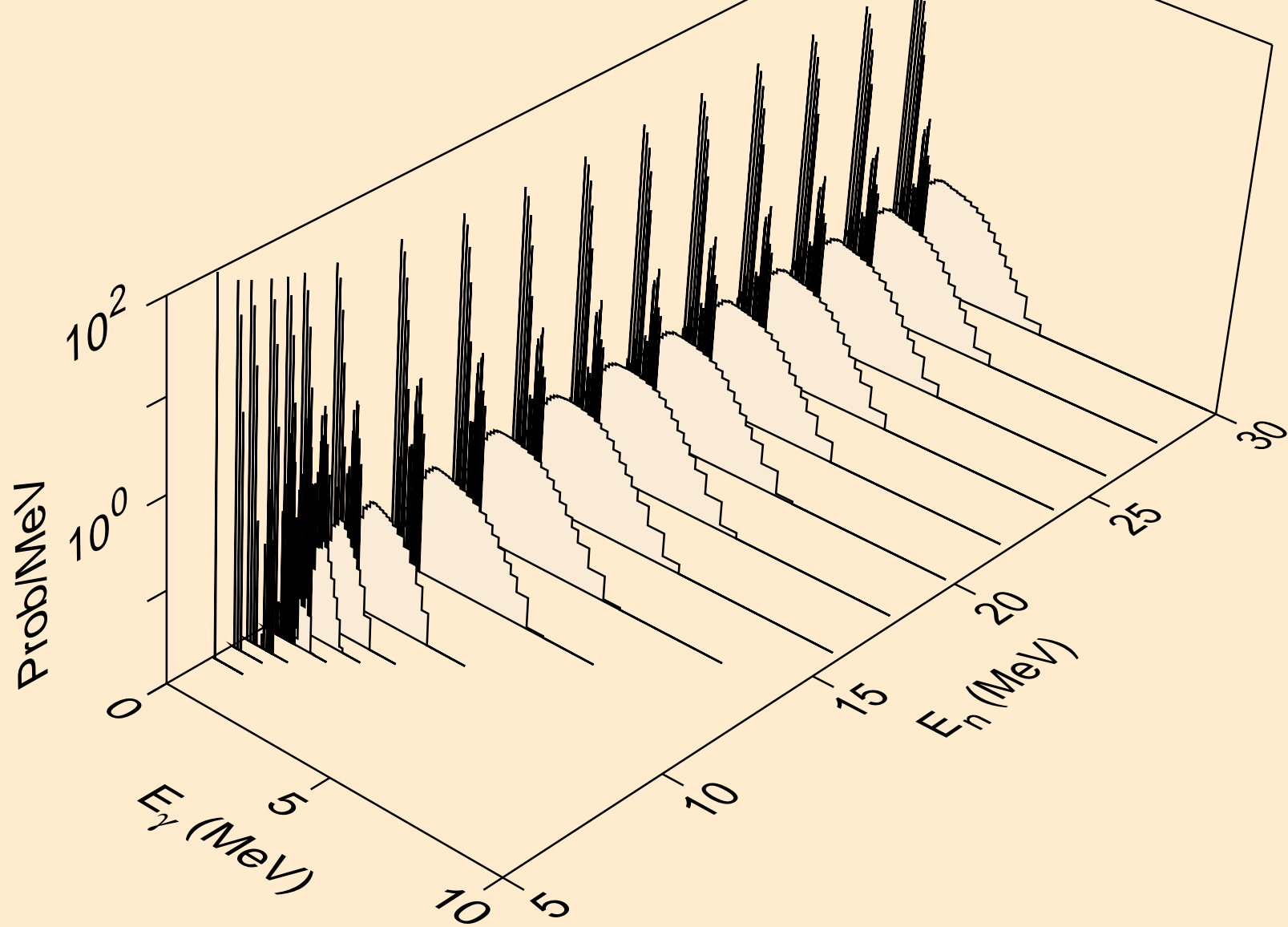

ER167M NEUTRON ACER TENDL-2023 LIBRARY; T=0.K
Photon emission for (n,3n)

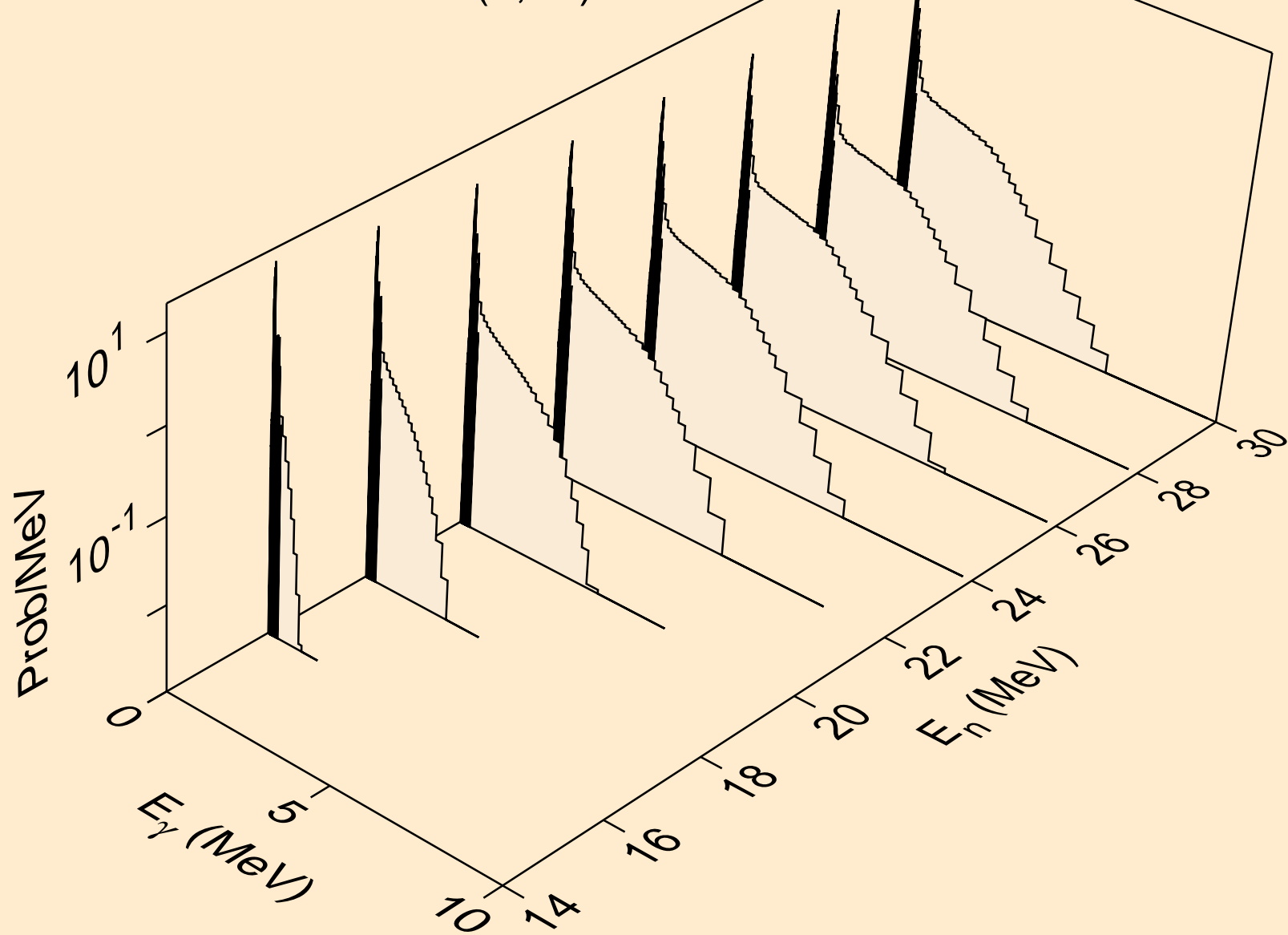

ER167M NEUTRON ACER TENDL-2023 LIBRARY; T=0.K
Photon emission for (n,n*)a

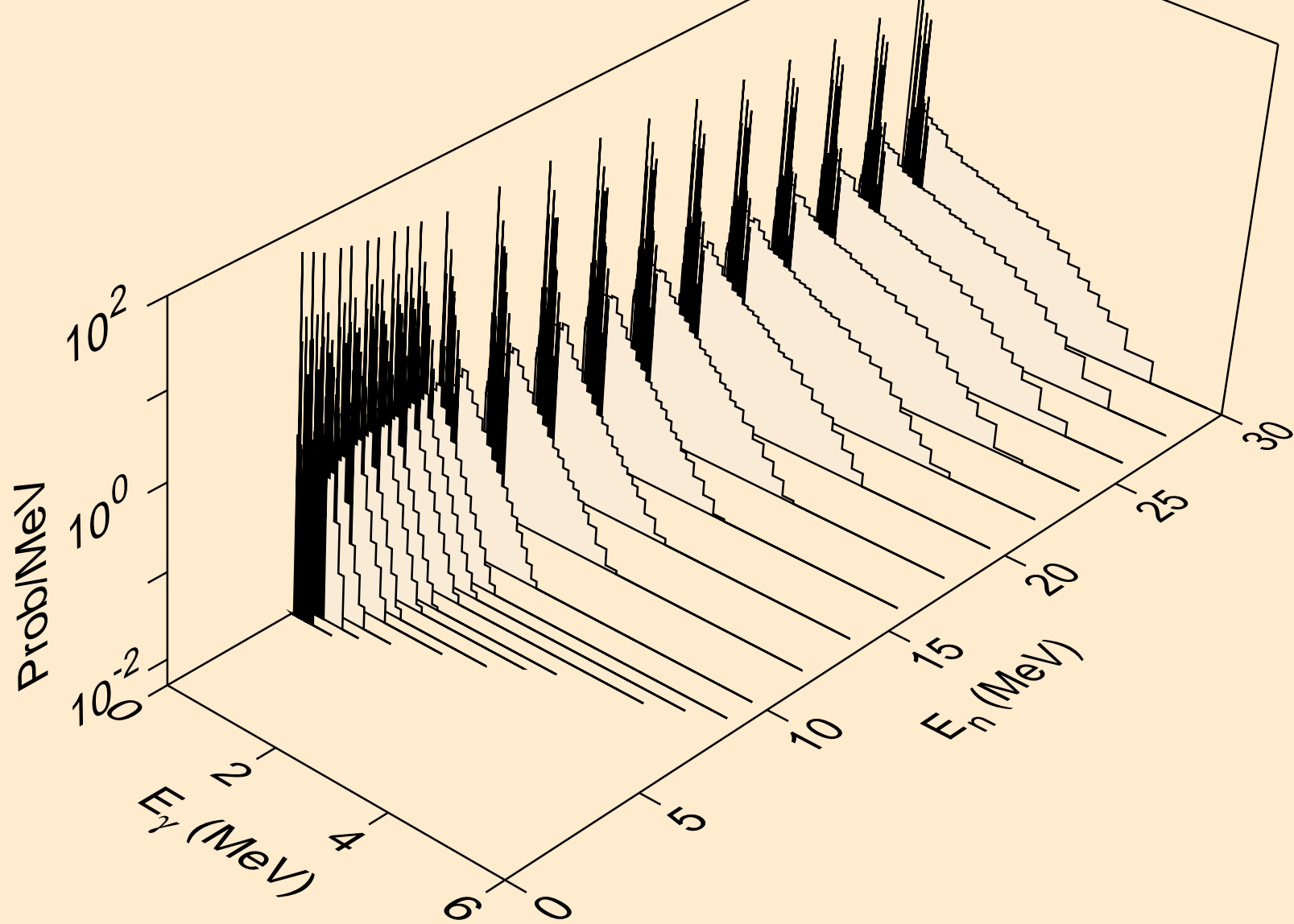

ER167M NEUTRON ACER TENDL-2023 LIBRARY; T=0.K
Photon emission for (n,2n)a

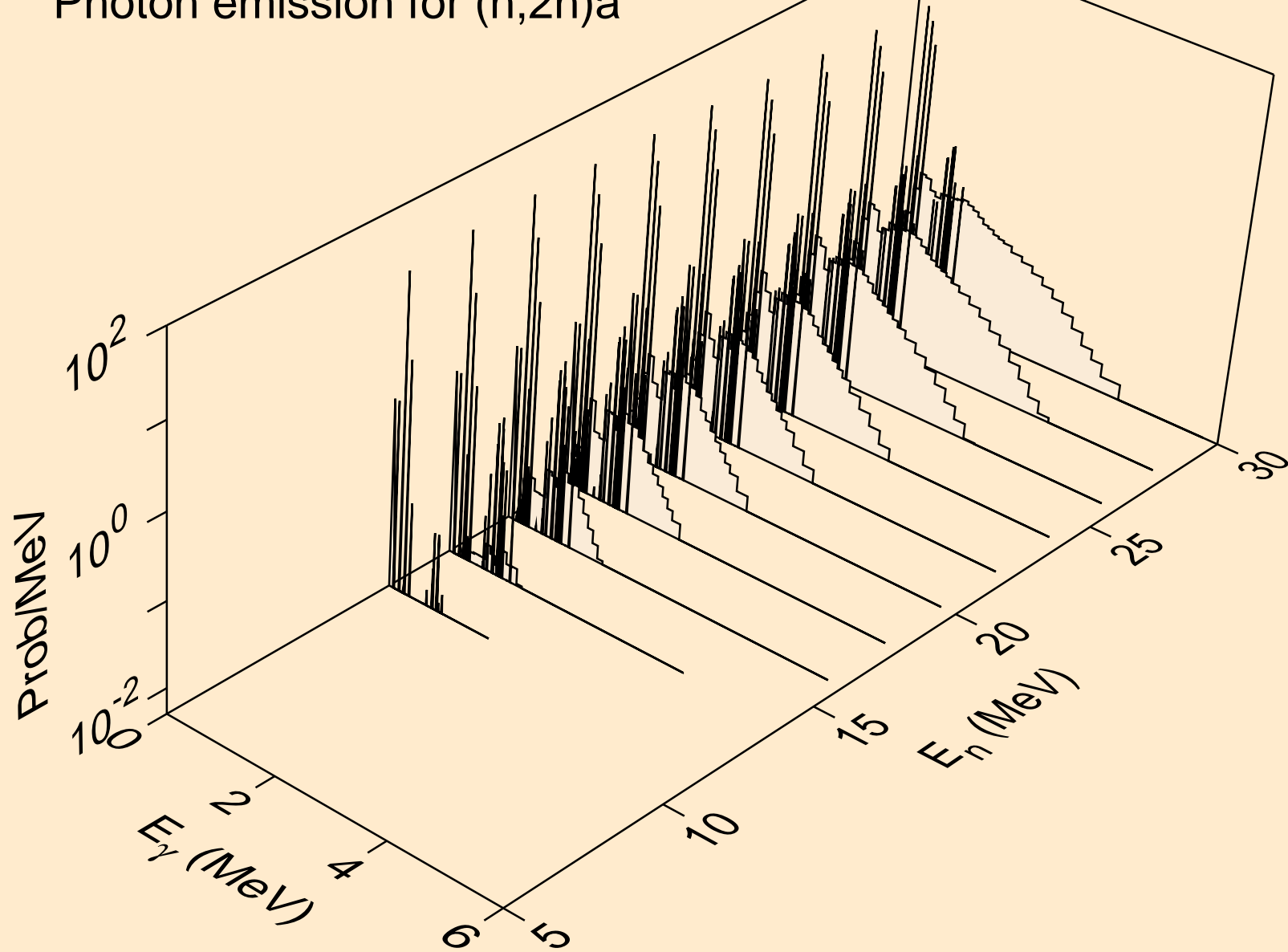

ER167M NEUTRON ACER TENDL-2023 LIBRARY; T=0.K
Photon emission for (n,3n)a

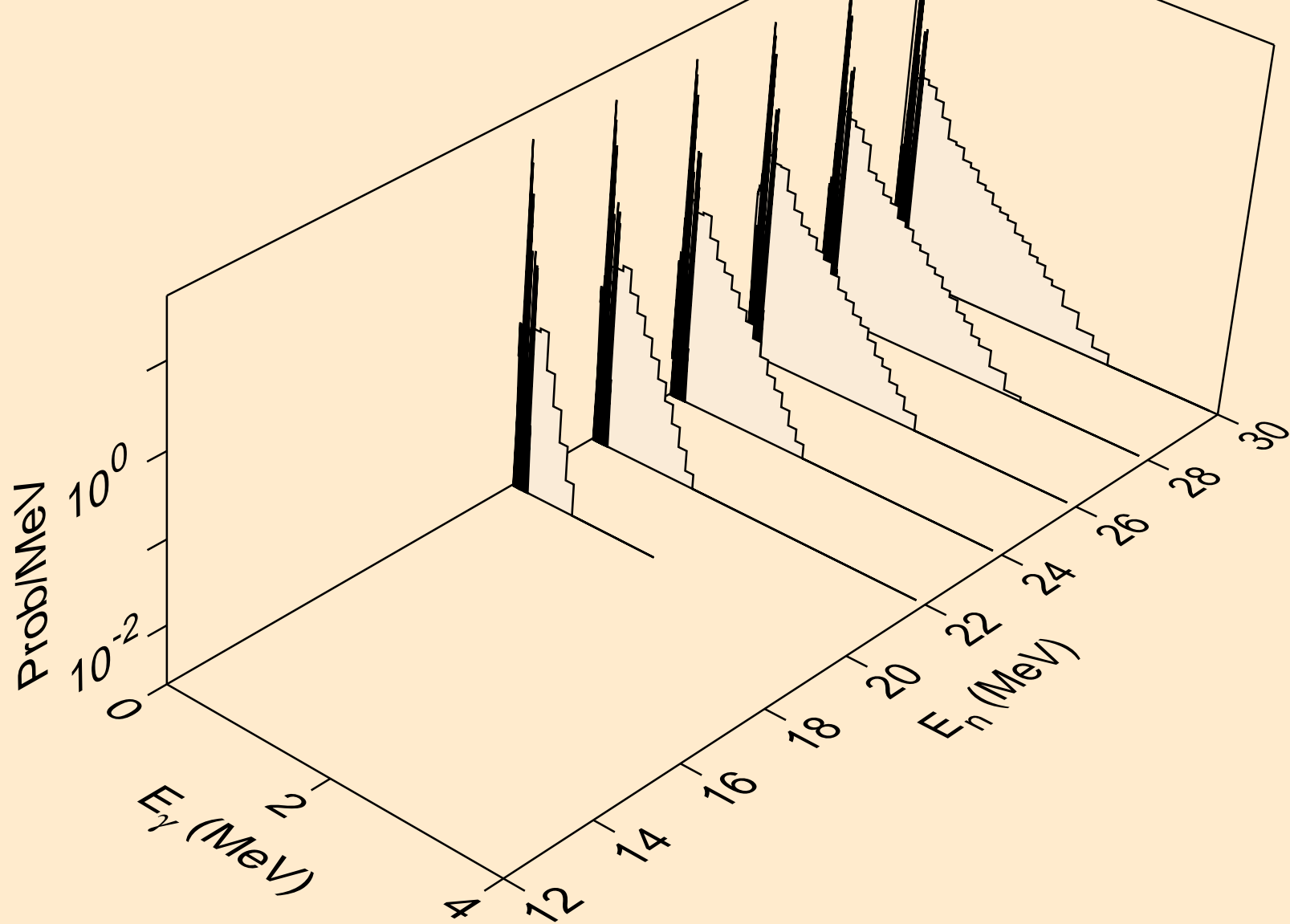

ER167M NEUTRON ACER TENDL-2023 LIBRARY; T=0.K
Photon emission for (n,n*)p

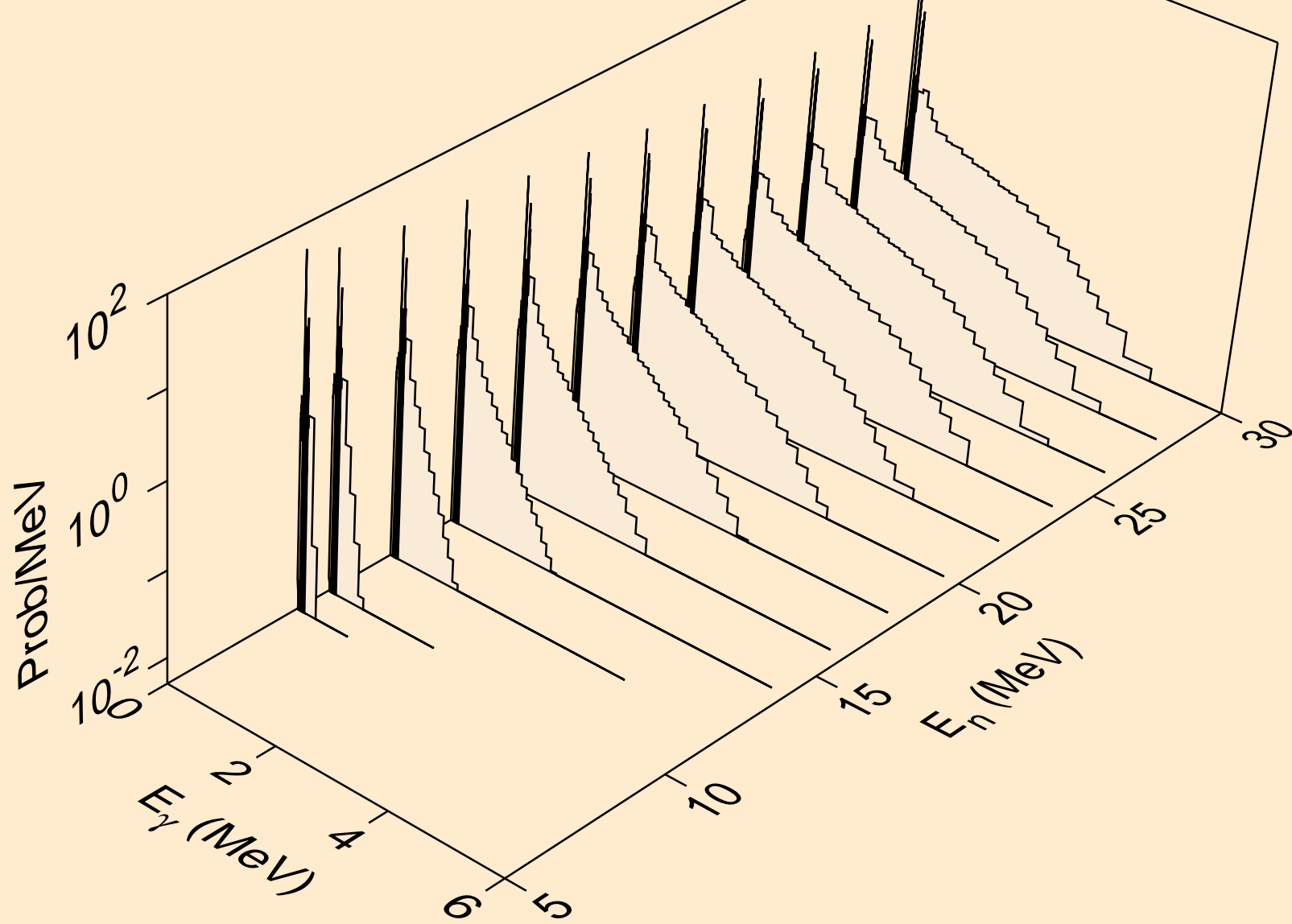

ER167M NEUTRON ACER TENDL-2023 LIBRARY; T=0.K
Photon emission for (n,n*)2a

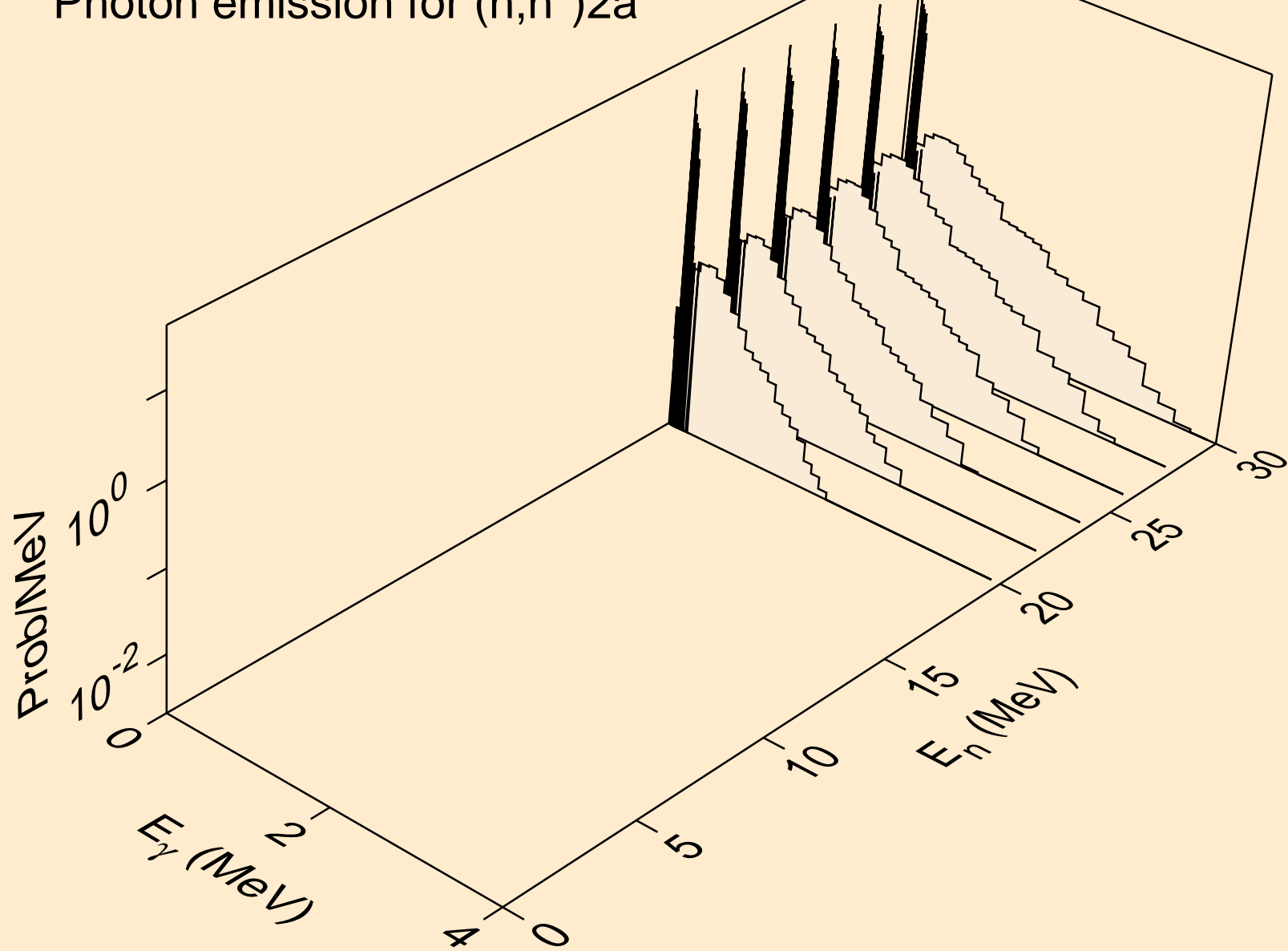

ER167M NEUTRON ACER TENDL-2023 LIBRARY; T=0.K
Photon emission for (n,n*)d

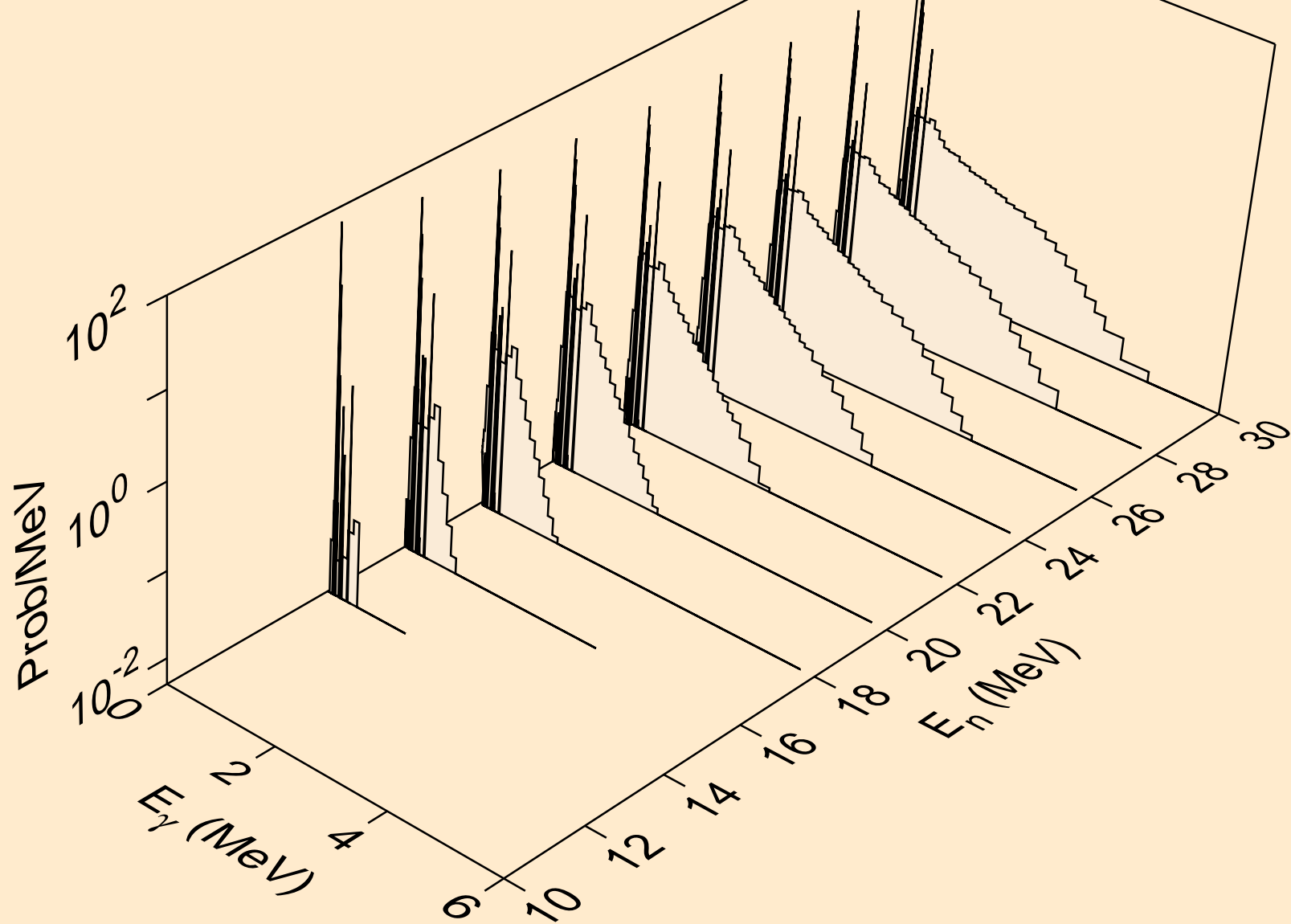

ER167M NEUTRON ACER TENDL-2023 LIBRARY; T=0.K
Photon emission for (n,n*)t

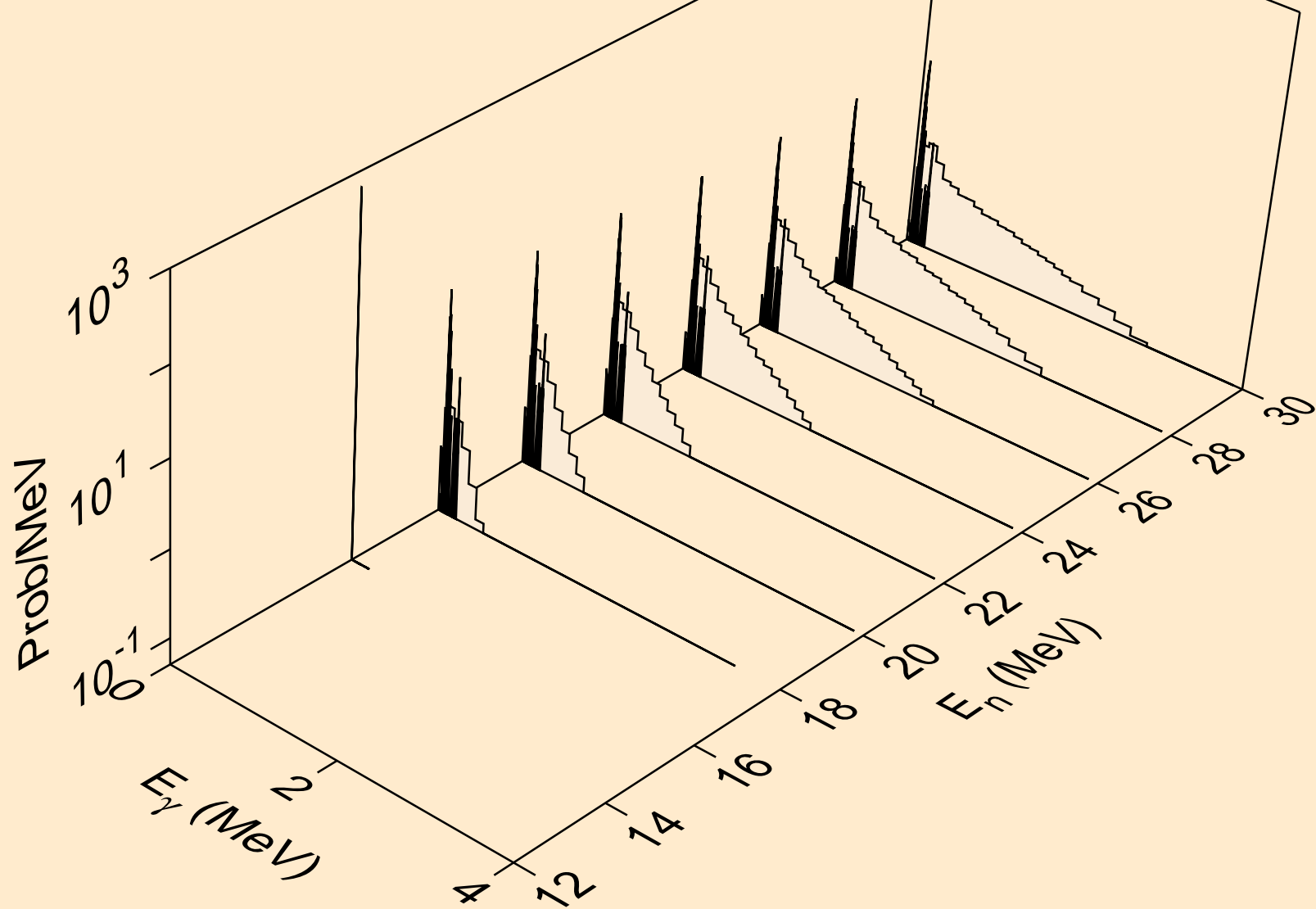

ER167M NEUTRON ACER TENDL-2023 LIBRARY; T=0.K
Photon emission for (n,n*)he3

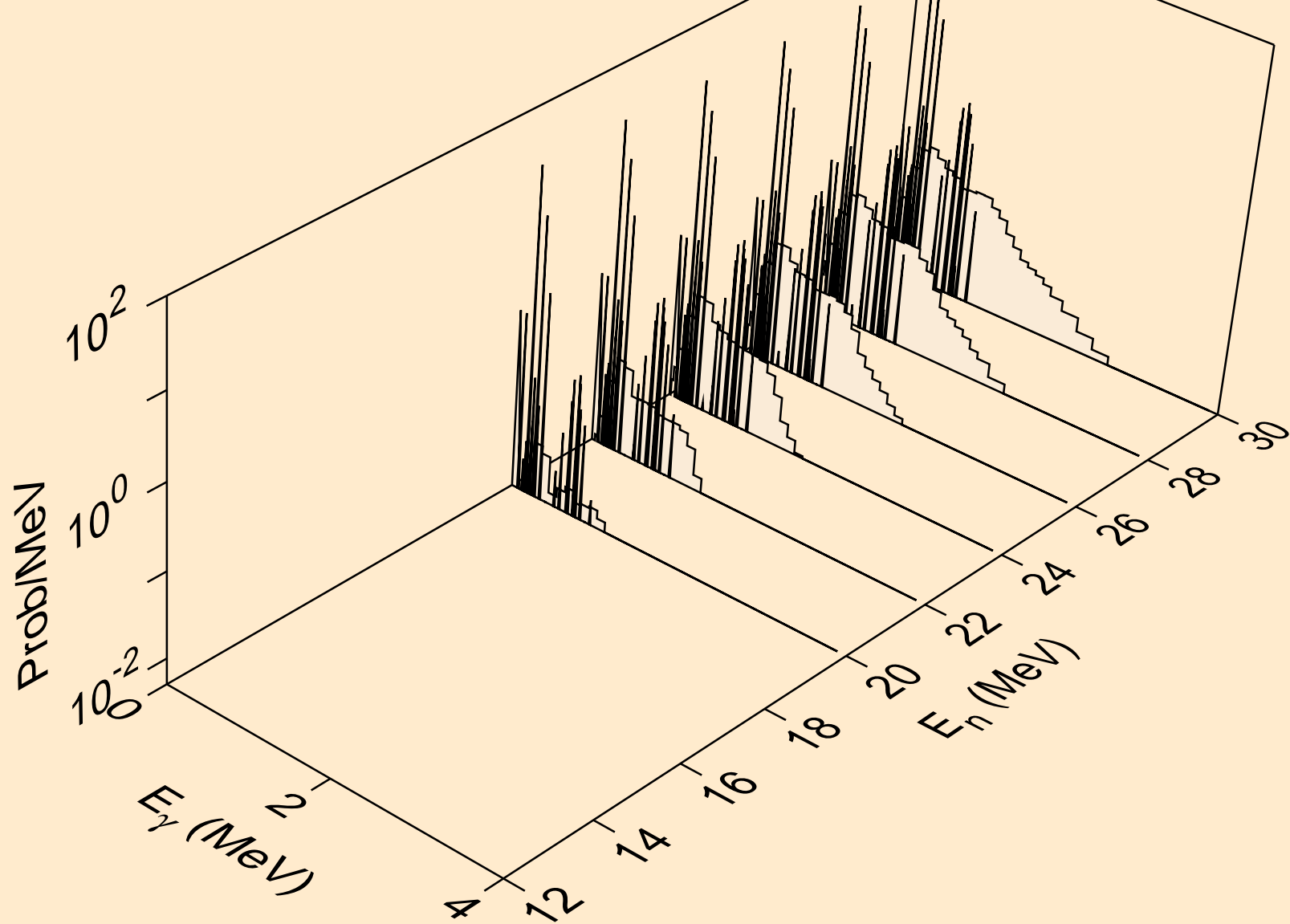

ER167M NEUTRON ACER TENDL-2023 LIBRARY; T=0.K
Photon emission for (n,4n)

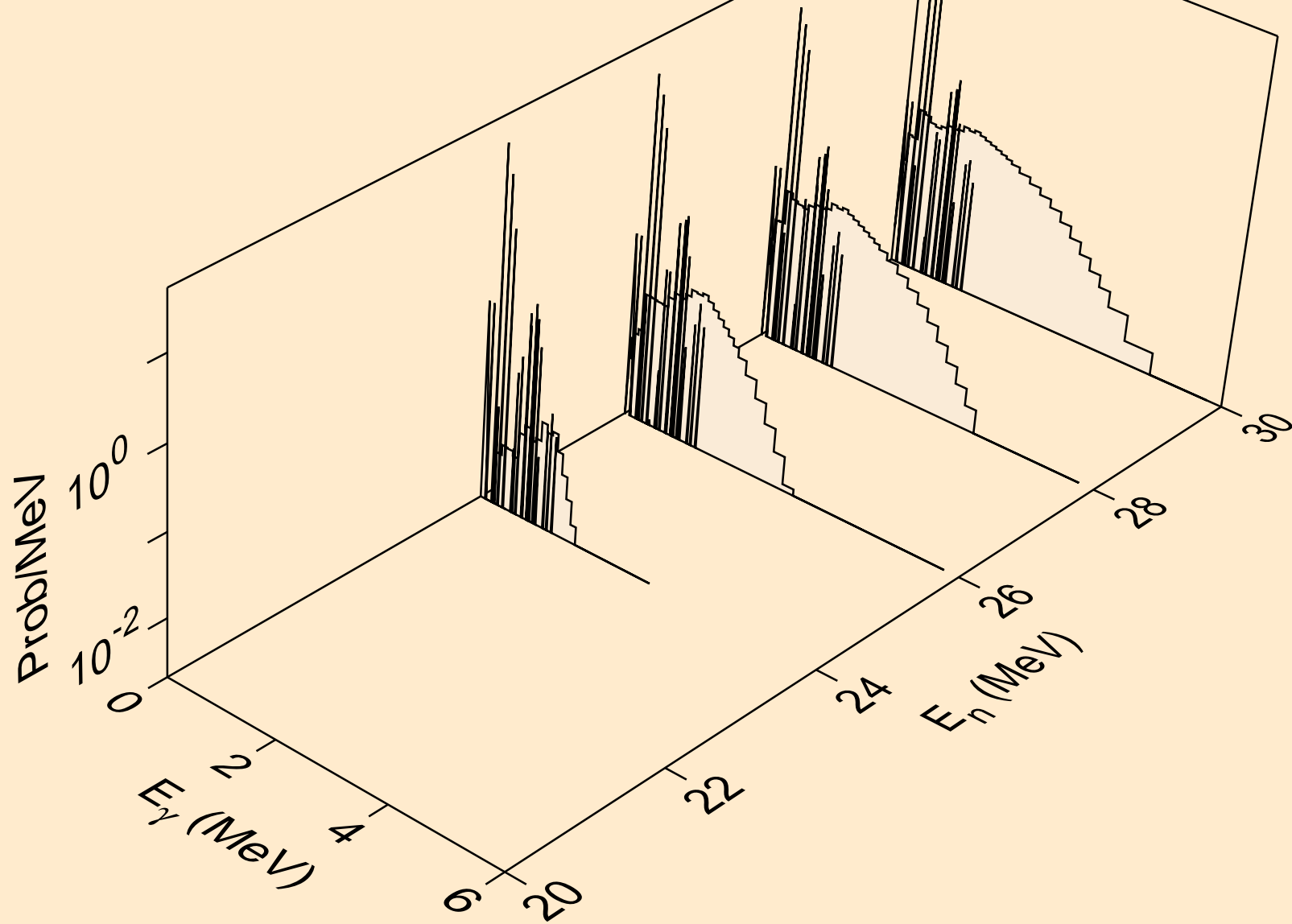

ER167M NEUTRON ACER TENDL-2023 LIBRARY; T=0.K
Photon emission for (n,2np)

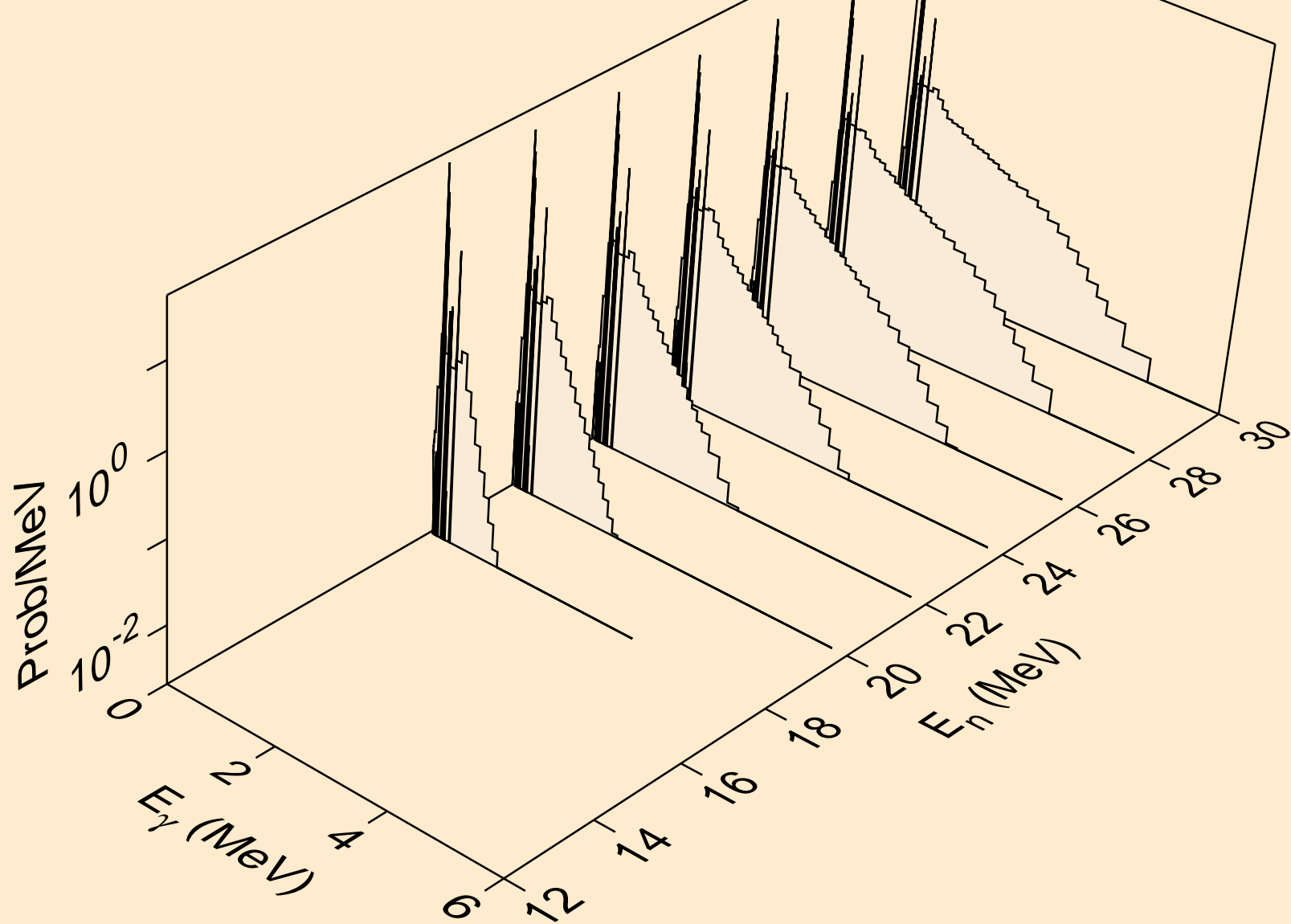

ER167M NEUTRON ACER TENDL-2023 LIBRARY; T=0.K
Photon emission for (n,3np)

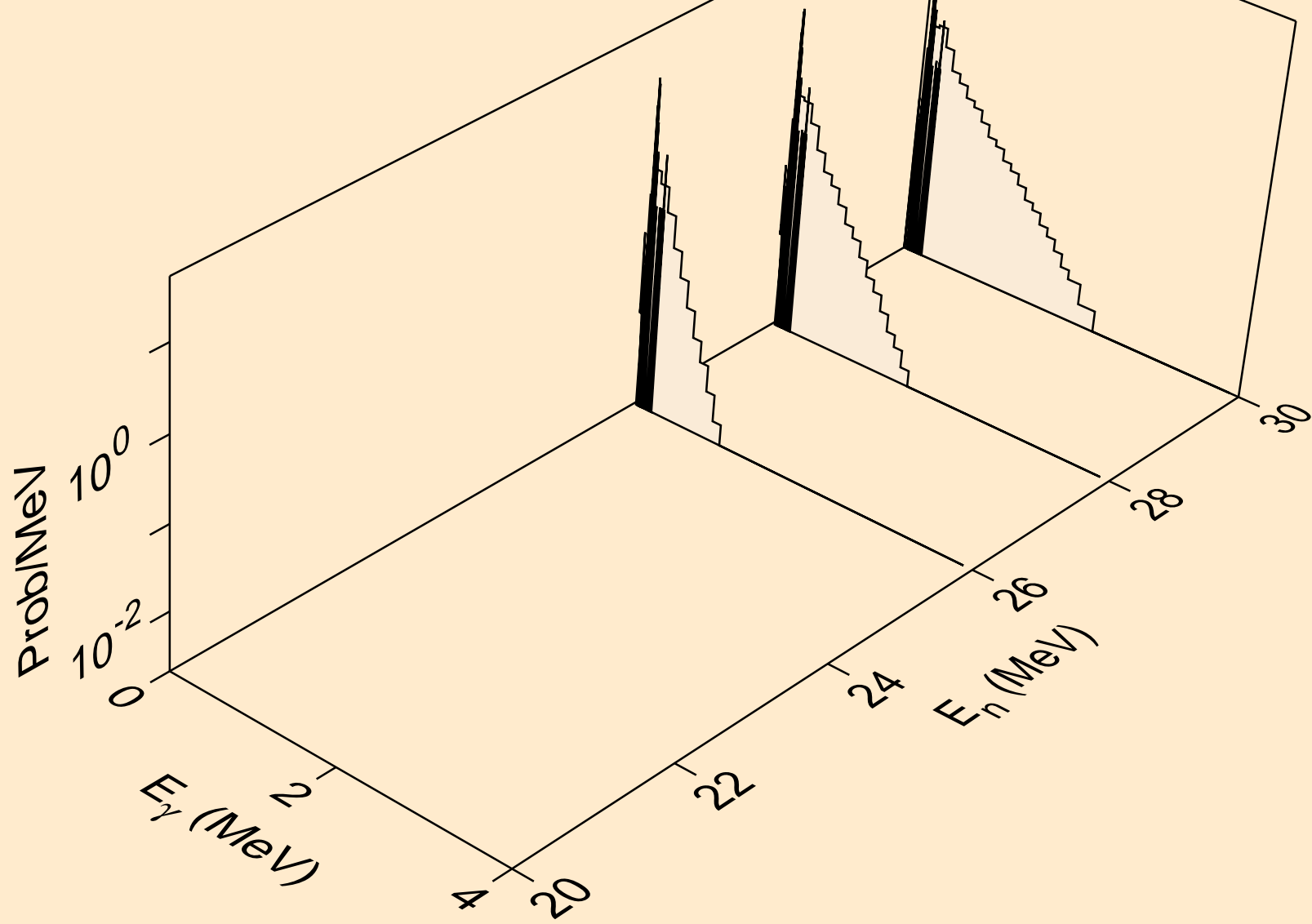

ER167M NEUTRON ACER TENDL-2023 LIBRARY; T=0.K
Photon emission for (n,n2p)

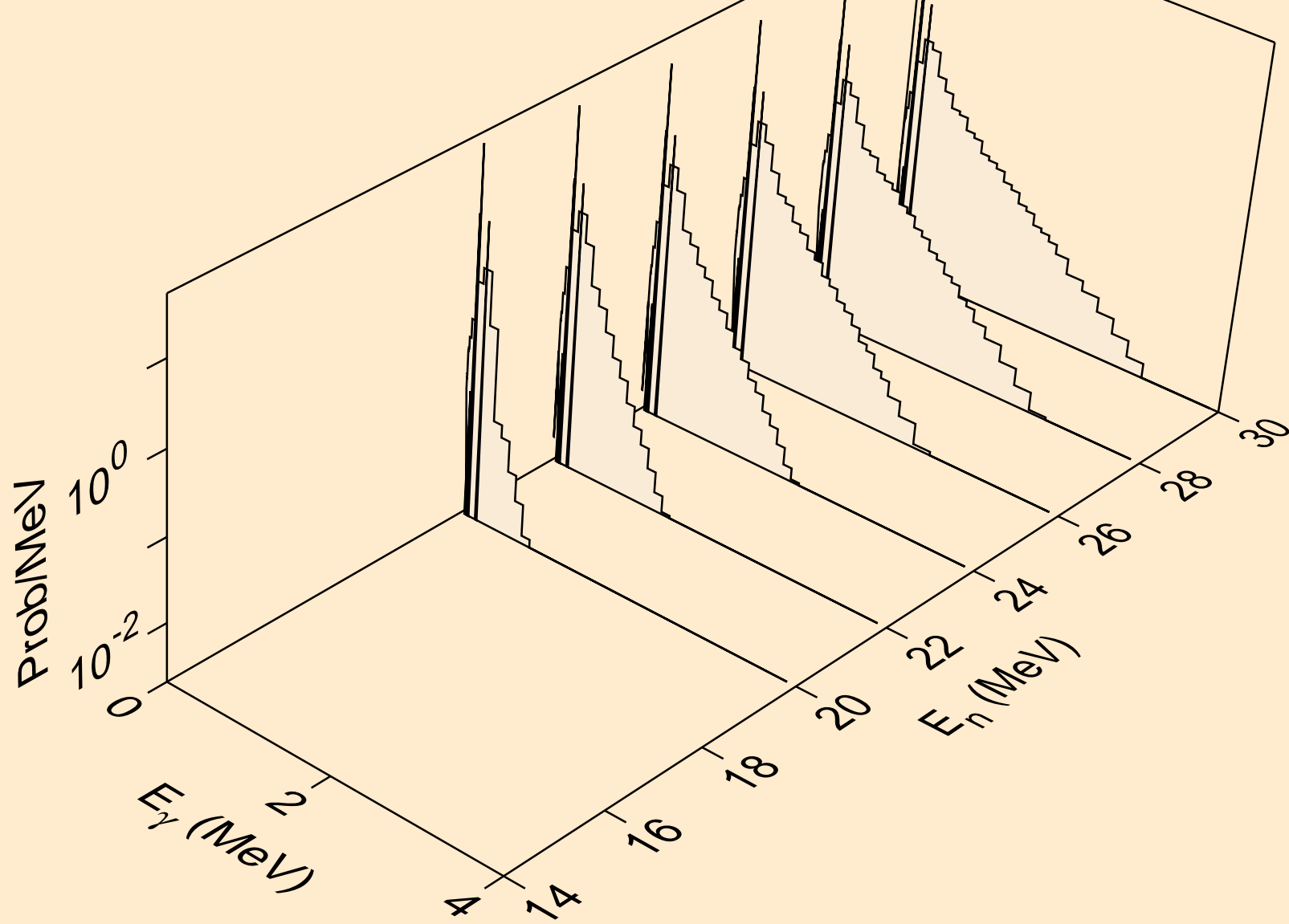

ER167M NEUTRON ACER TENDL-2023 LIBRARY; T=0.K
Photon emission for (n,npa)

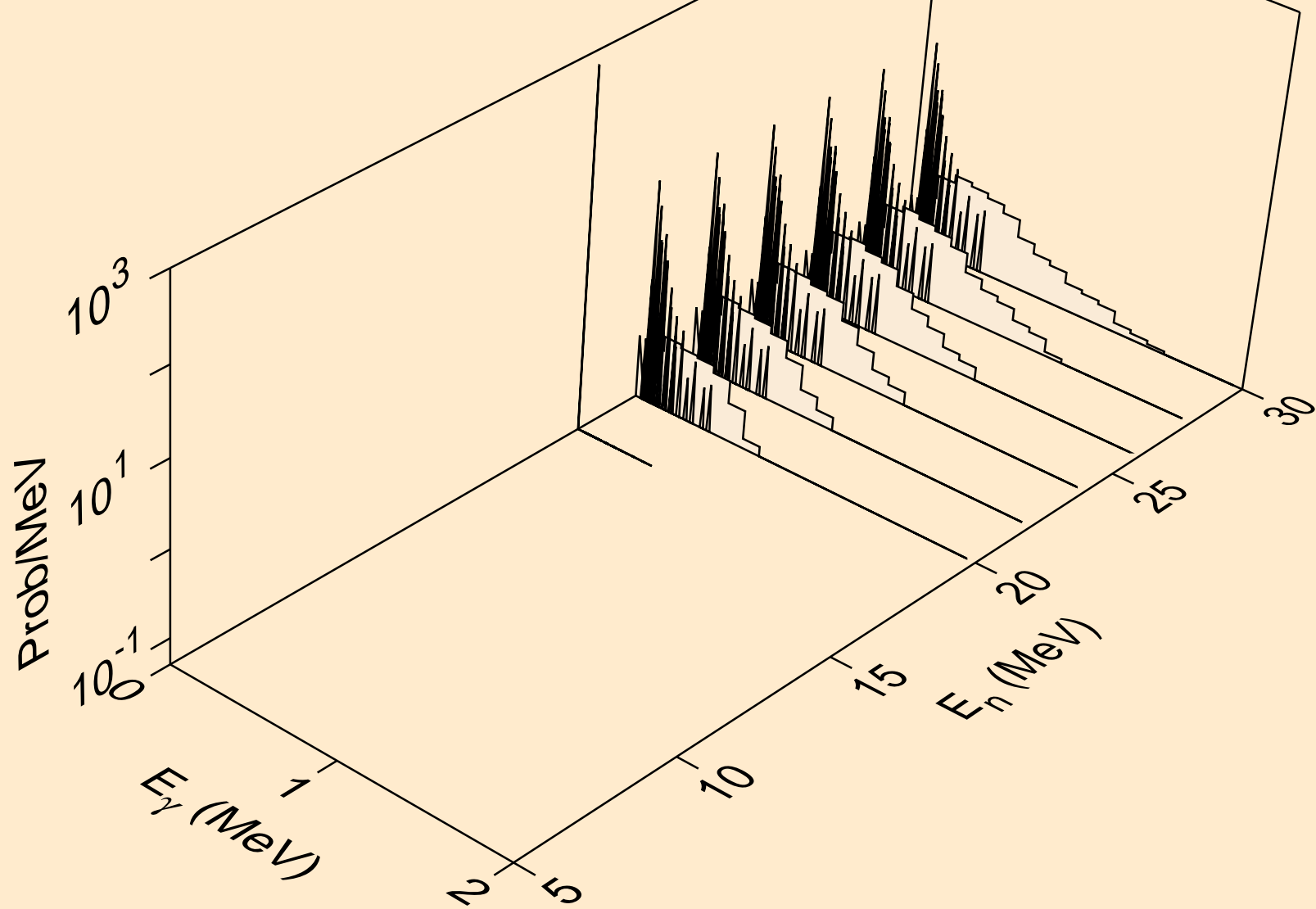

ER167M NEUTRON ACER TENDL-2023 LIBRARY; T=0.K
Photon emission for (n,n*1)

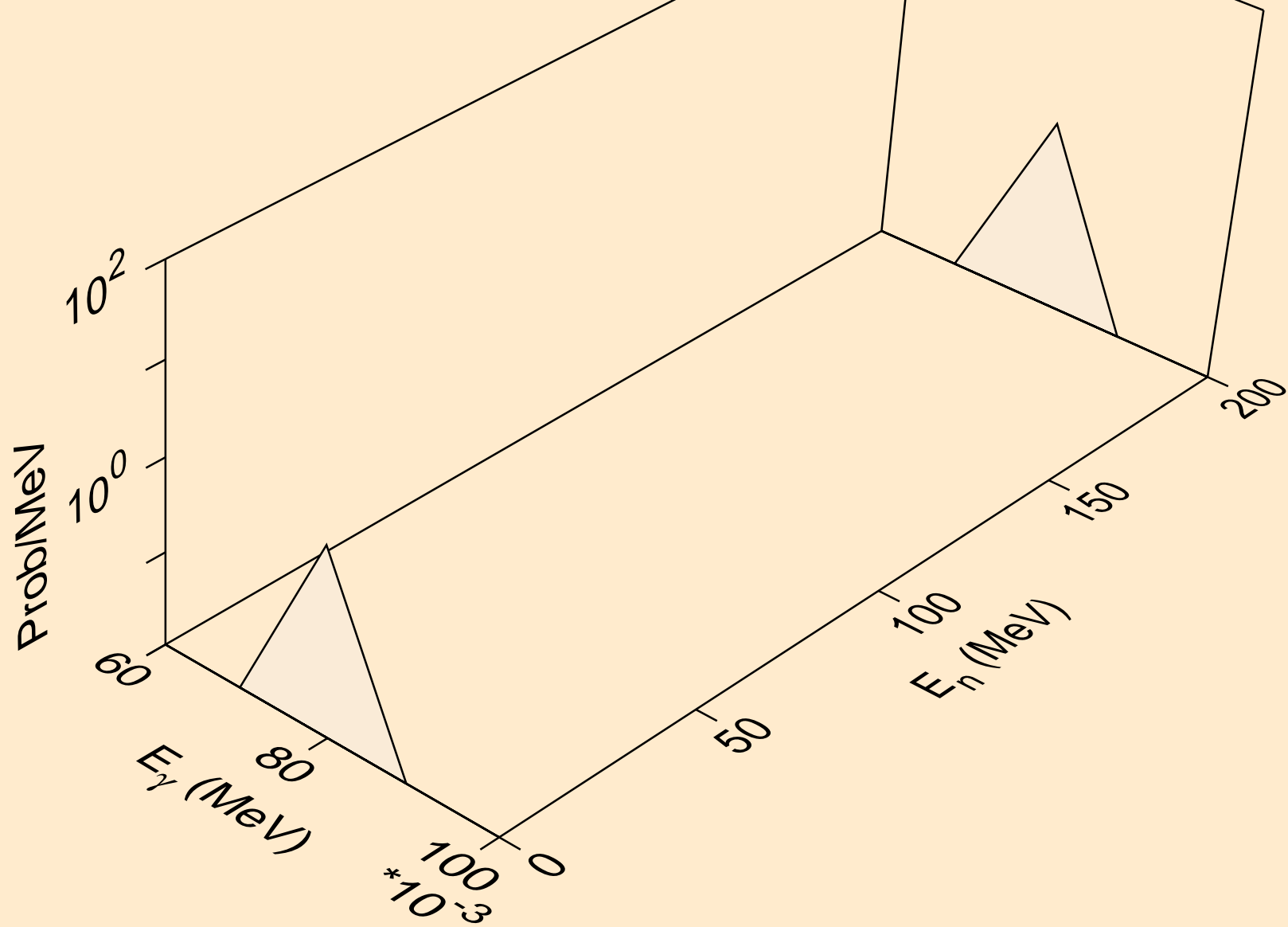

ER167M NEUTRON ACER TENDL-2023 LIBRARY; T=0.K
Photon emission for (n,n*2)

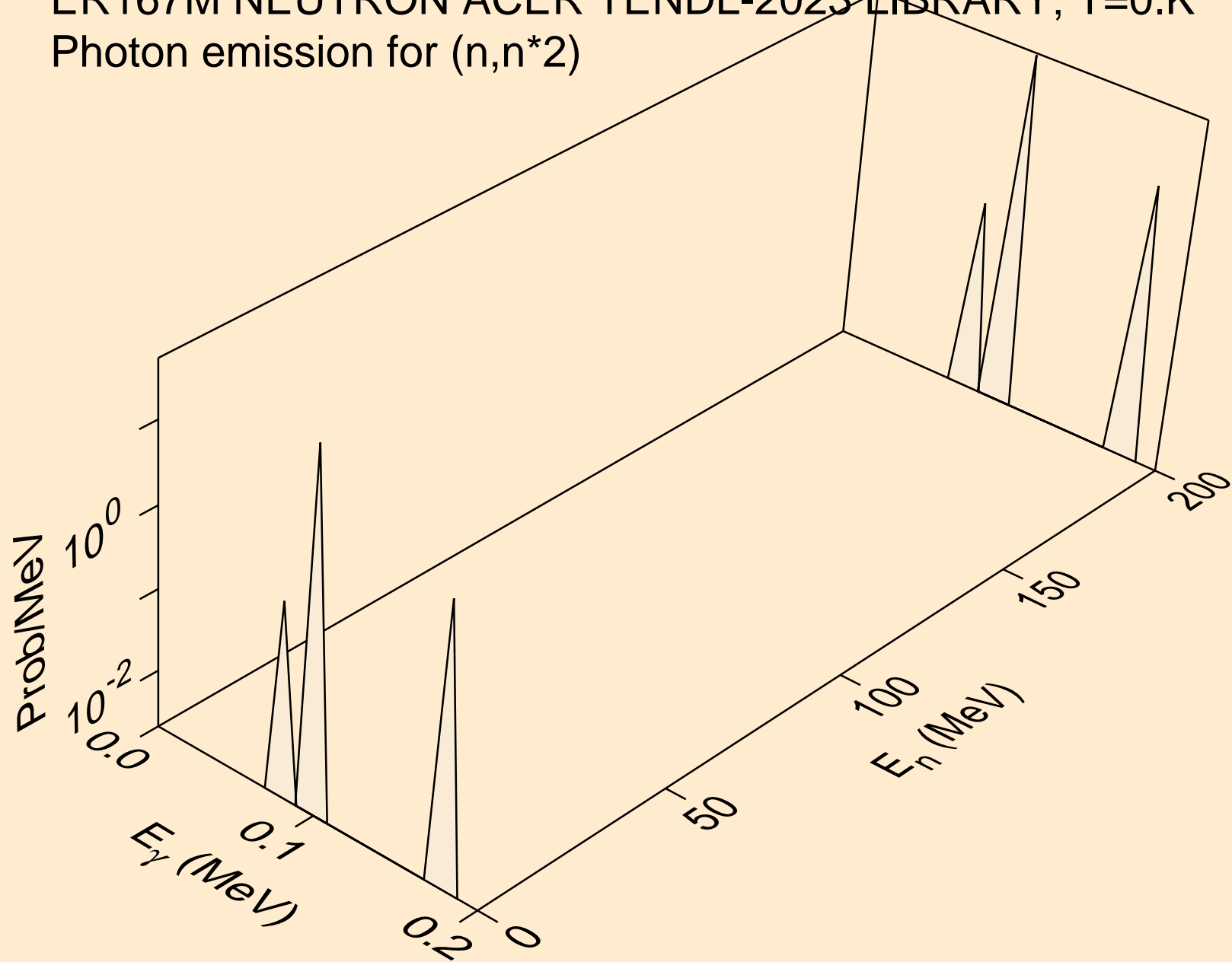

ER167M NEUTRON ACER TENDL-2023 LIBRARY; T=0.K
Photon emission for (n,n*4)

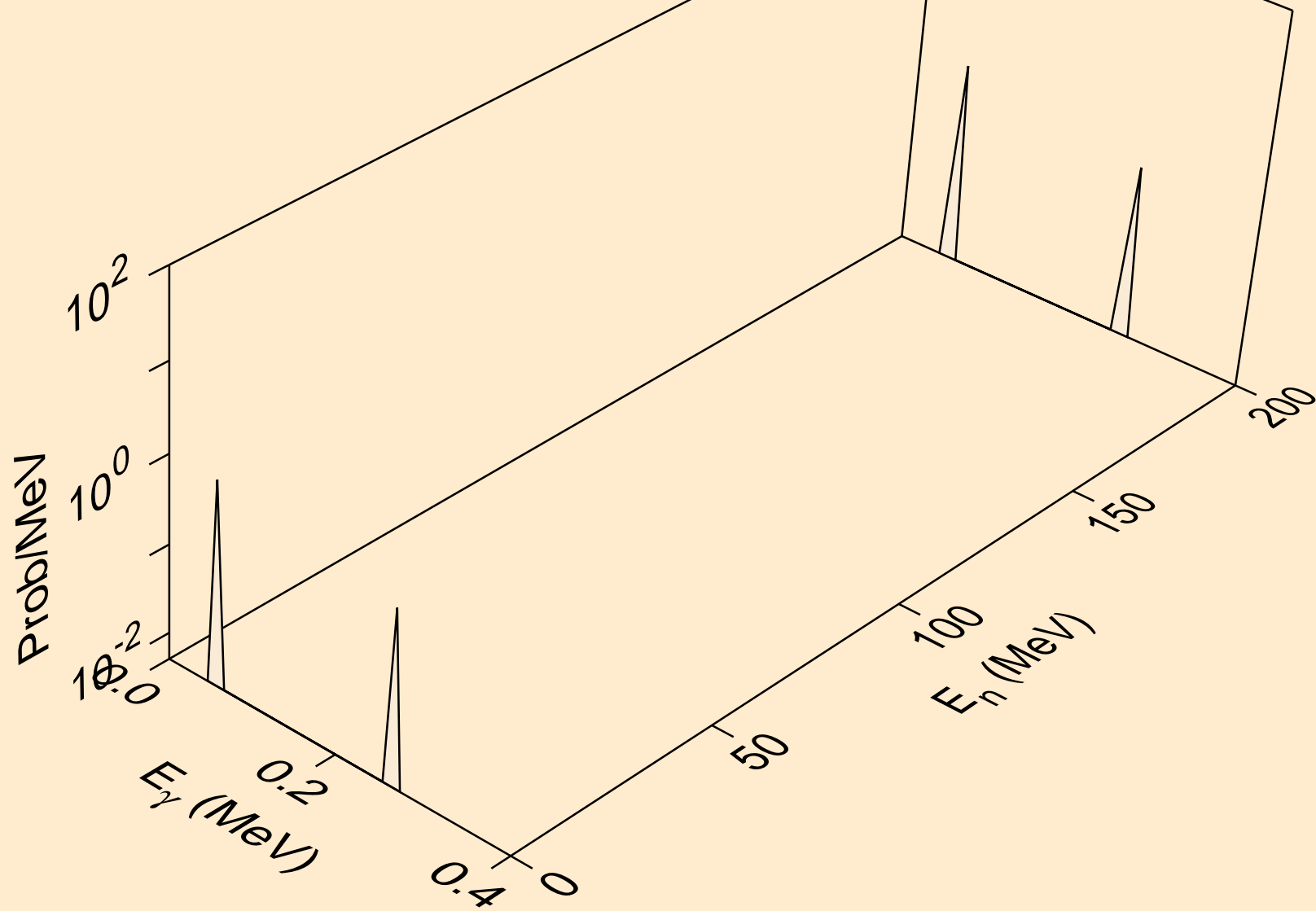

ER167M NEUTRON ACER TENDL-2023 LIBRARY; T=0.K
Photon emission for (n,n*5)

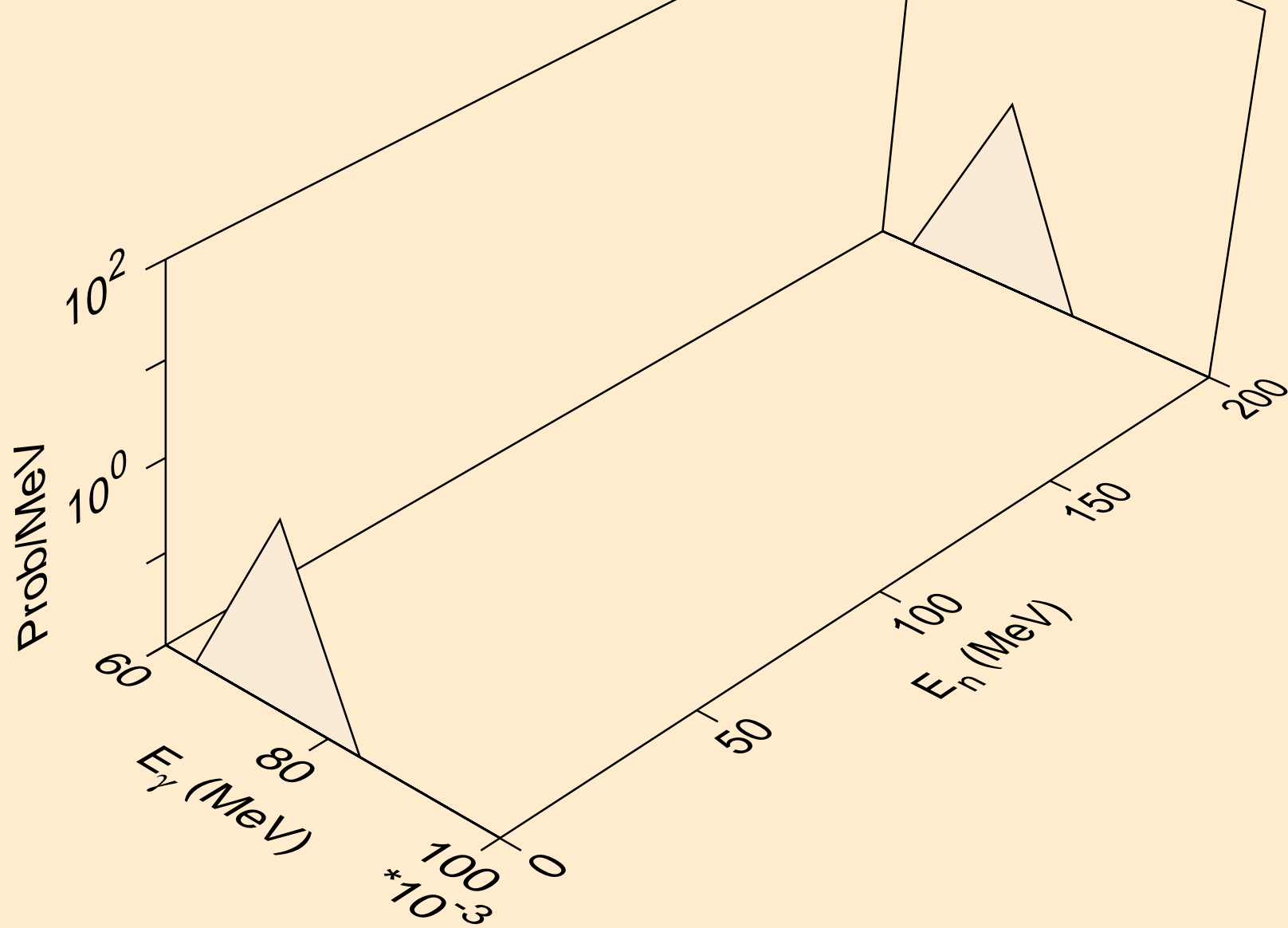

ER167M NEUTRON ACER TENDL-2023 LIBRARY; T=0.K
Photon emission for (n,n*6)

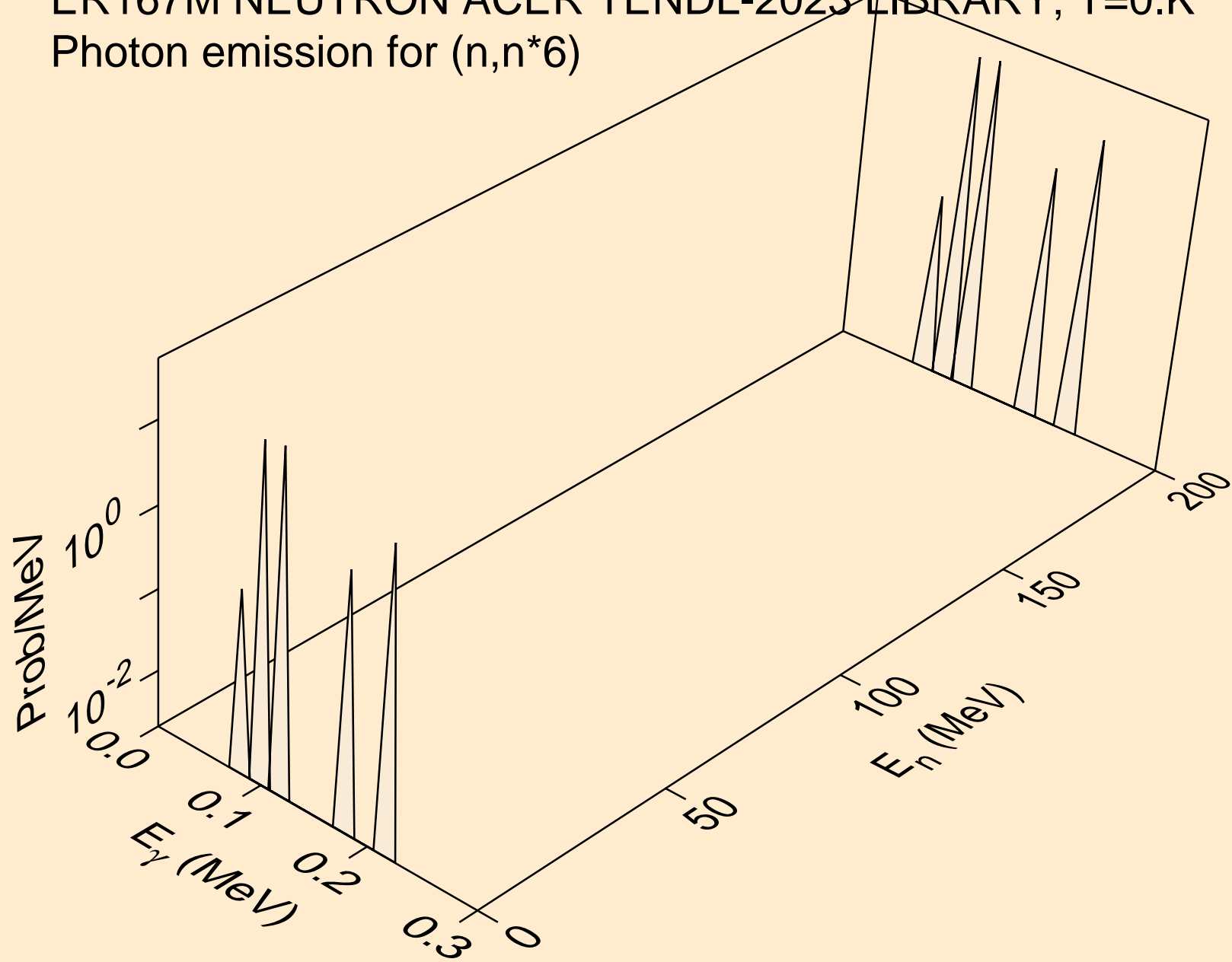

ER167M NEUTRON ACER TENDL-2023 LIBRARY; T=0.K
Photon emission for (n,n*7)

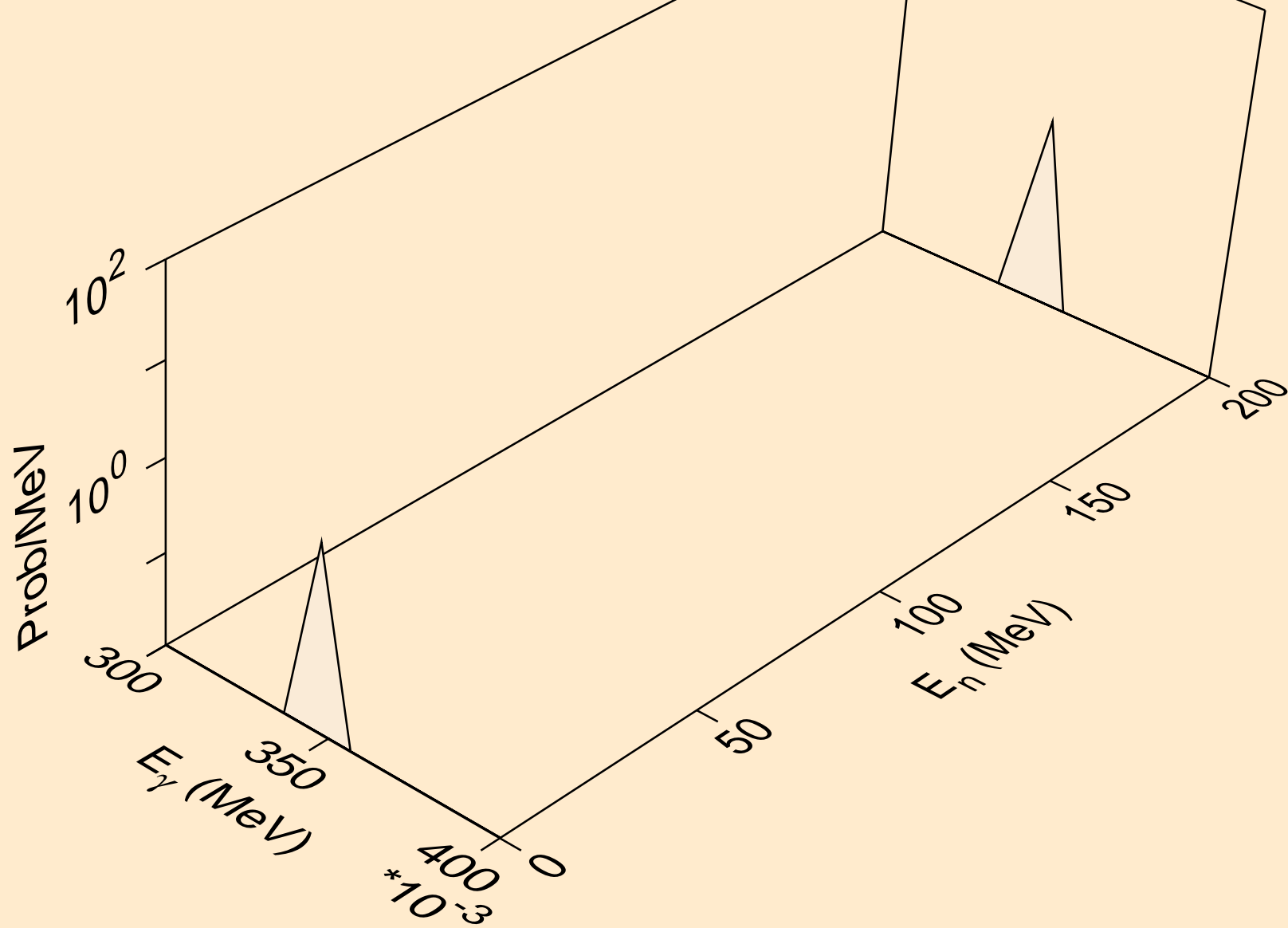

ER167M NEUTRON ACER TENDL-2023 LIBRARY; T=0.K
Photon emission for (n,n*8)

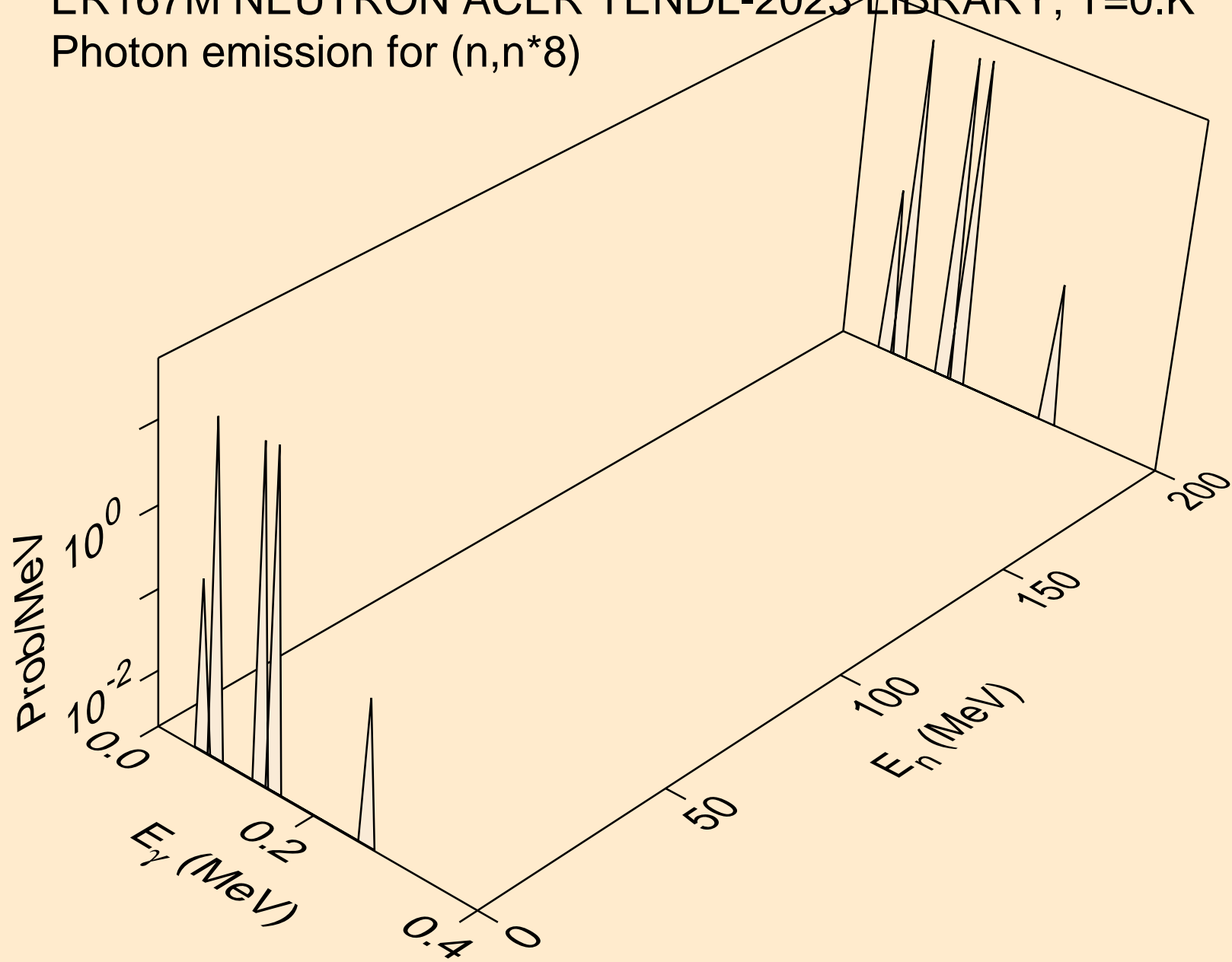

ER167M NEUTRON ACER TENDL-2023 LIBRARY; T=0.K
Photon emission for (n,n*9)

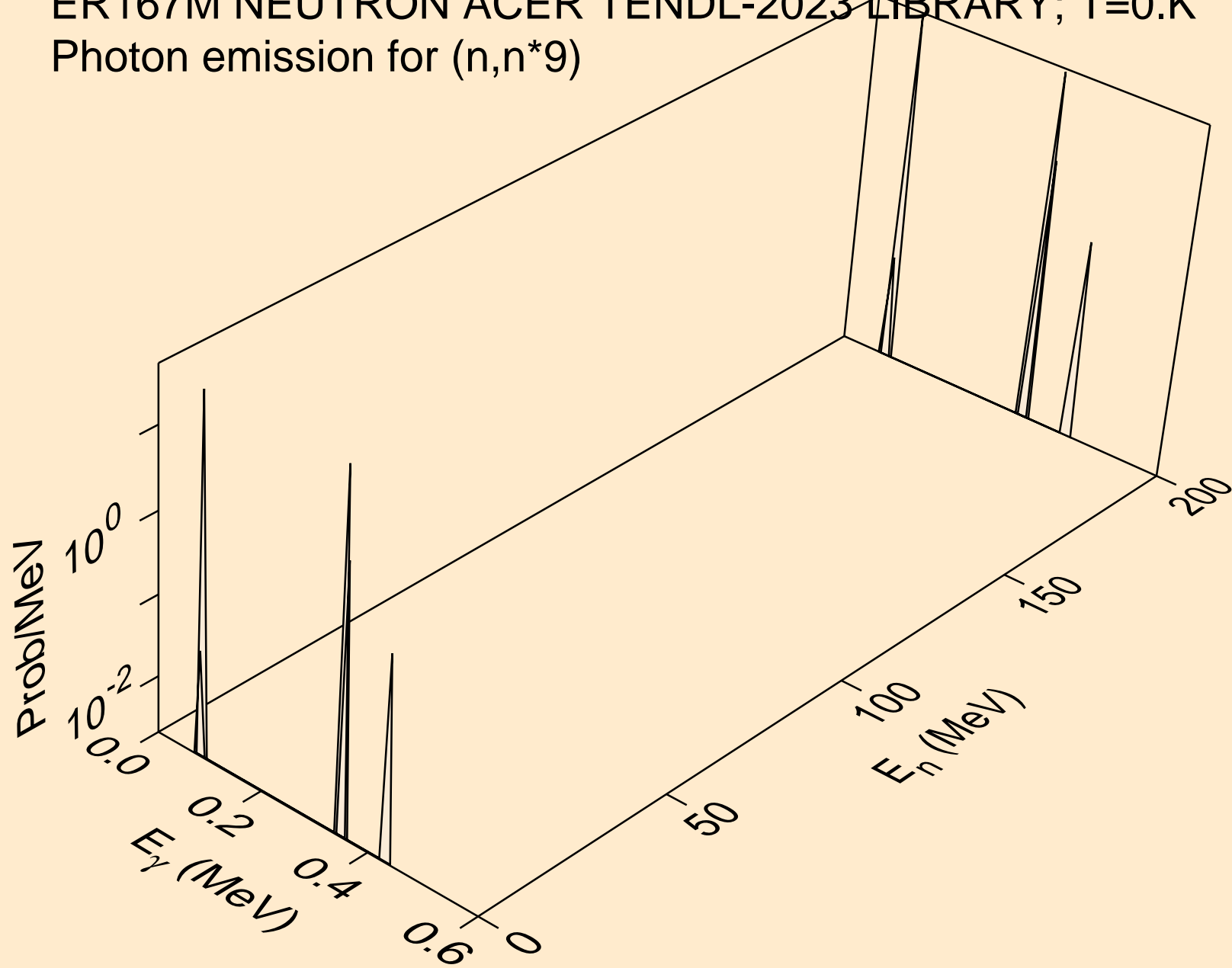

ER167M NEUTRON ACER TENDL-2023 LIBRARY; T=0.K
Photon emission for (n,n*10)

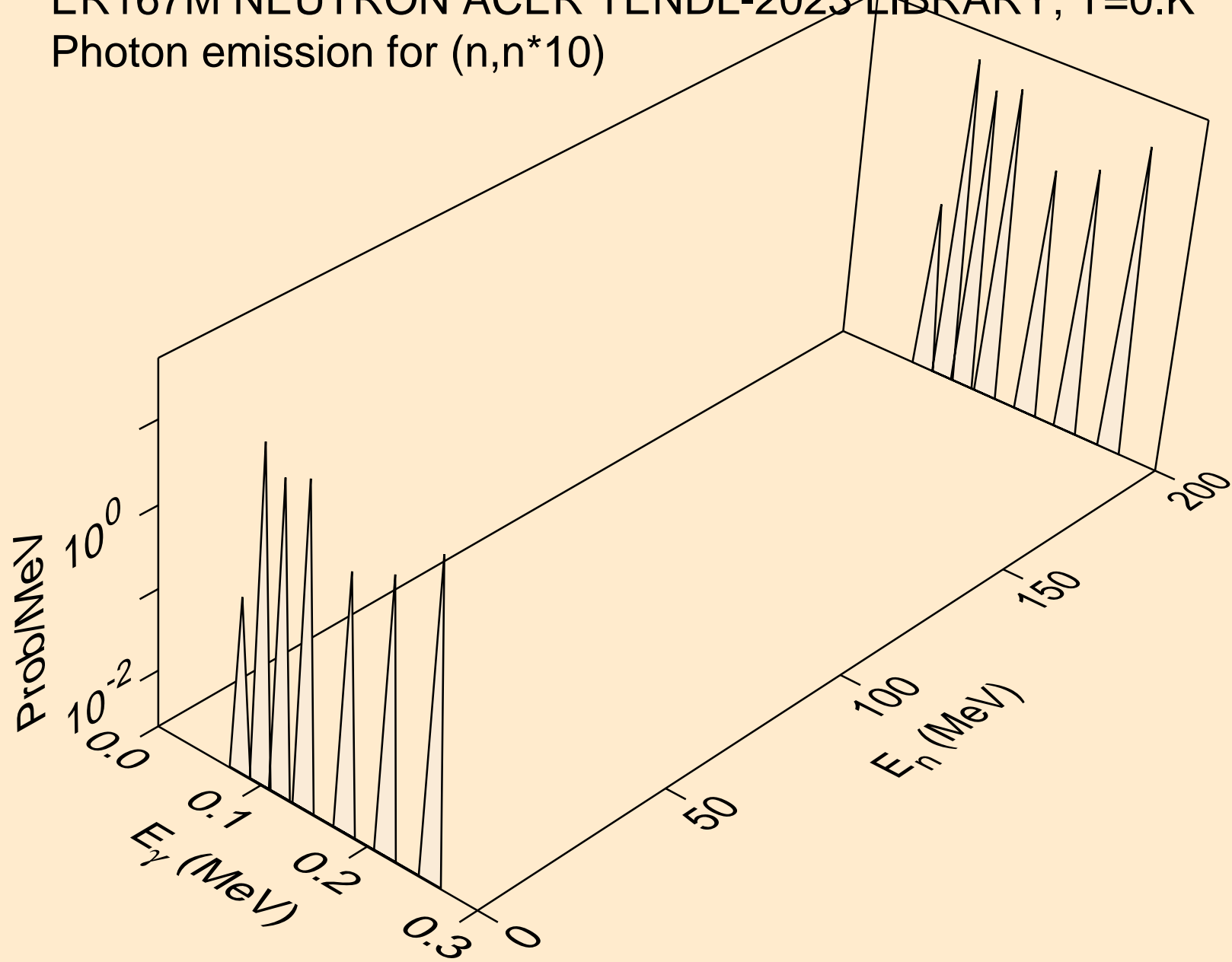

ER167M NEUTRON ACER TENDL-2023 LIBRARY; T=0.K
Photon emission for (n,n*11)

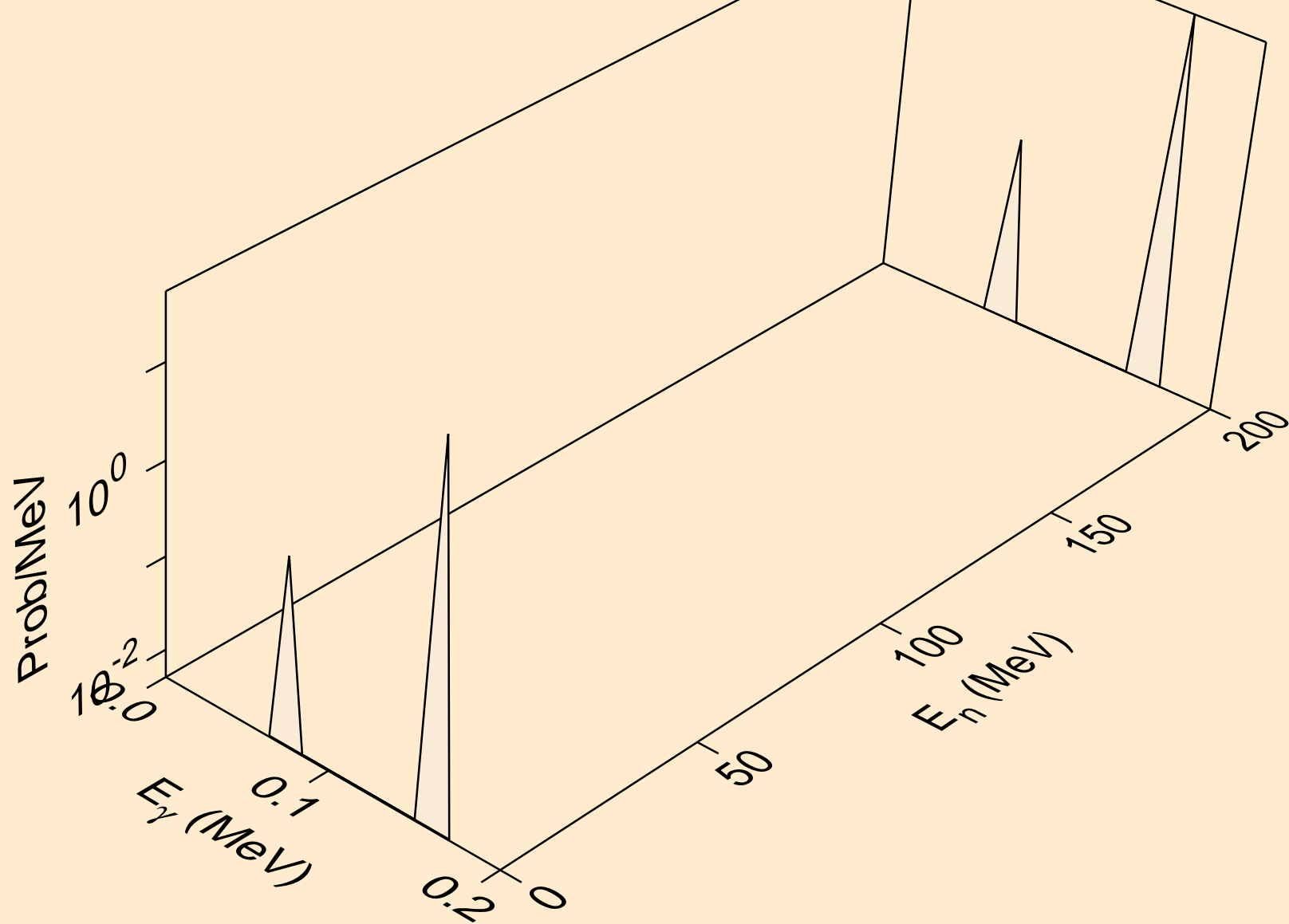

ER167M NEUTRON ACER TENDL-2023 LIBRARY; T=0.K
Photon emission for (n,n*12)

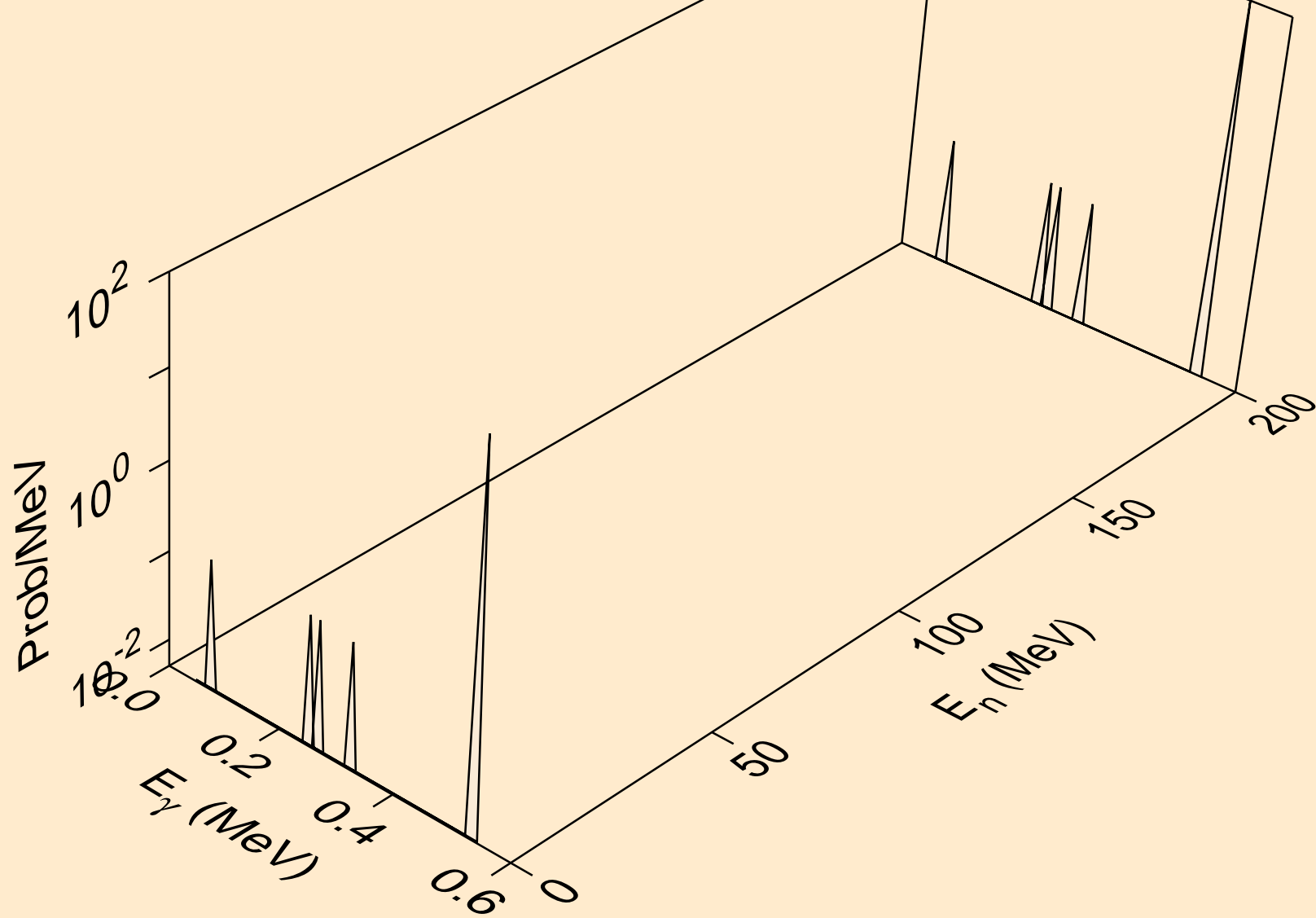

ER167M NEUTRON ACER TENDL-2023 LIBRARY; T=0.K
Photon emission for (n,n*13)

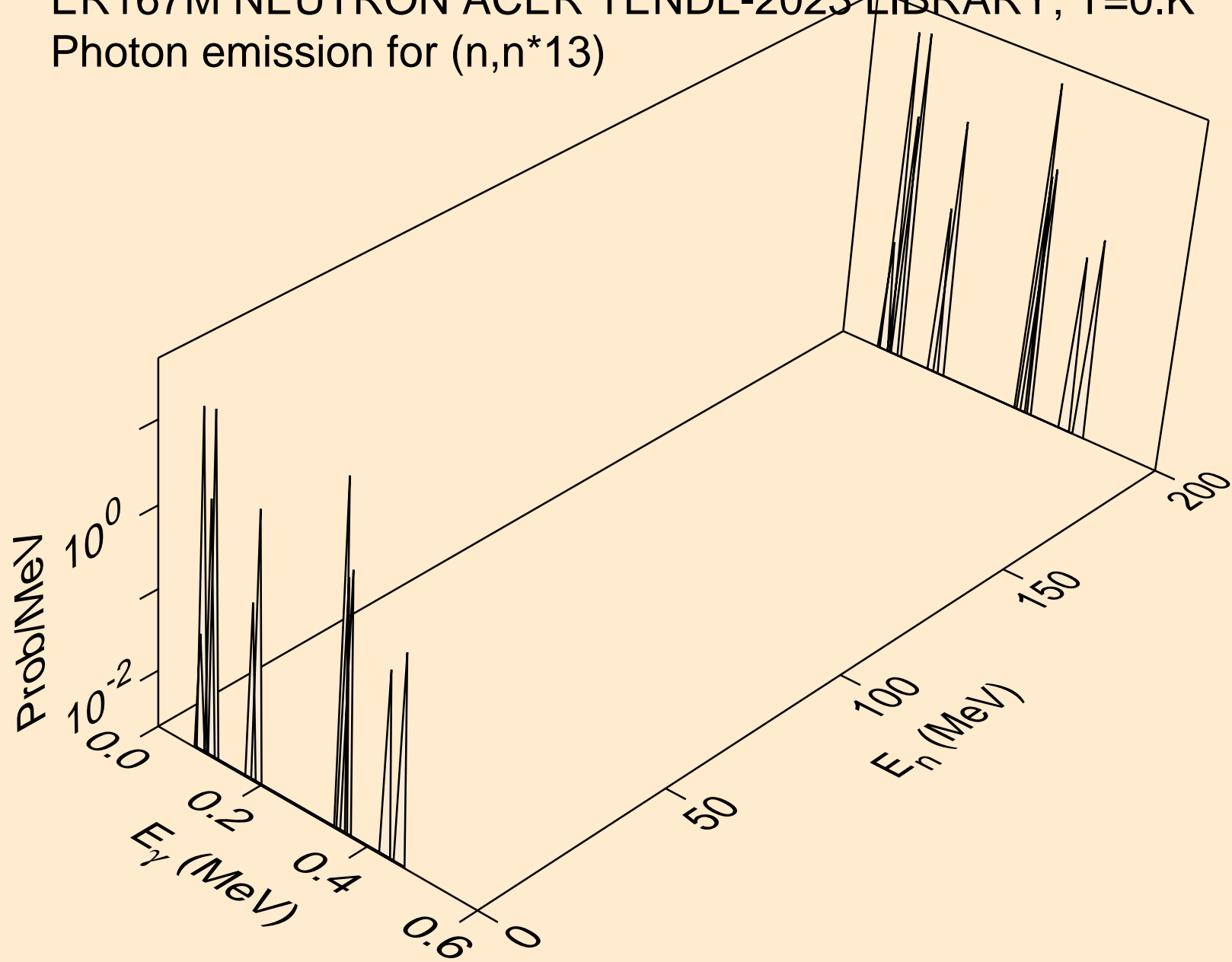

ER167M NEUTRON ACER TENDL-2023 LIBRARY; T=0.K
Photon emission for (n,n*14)

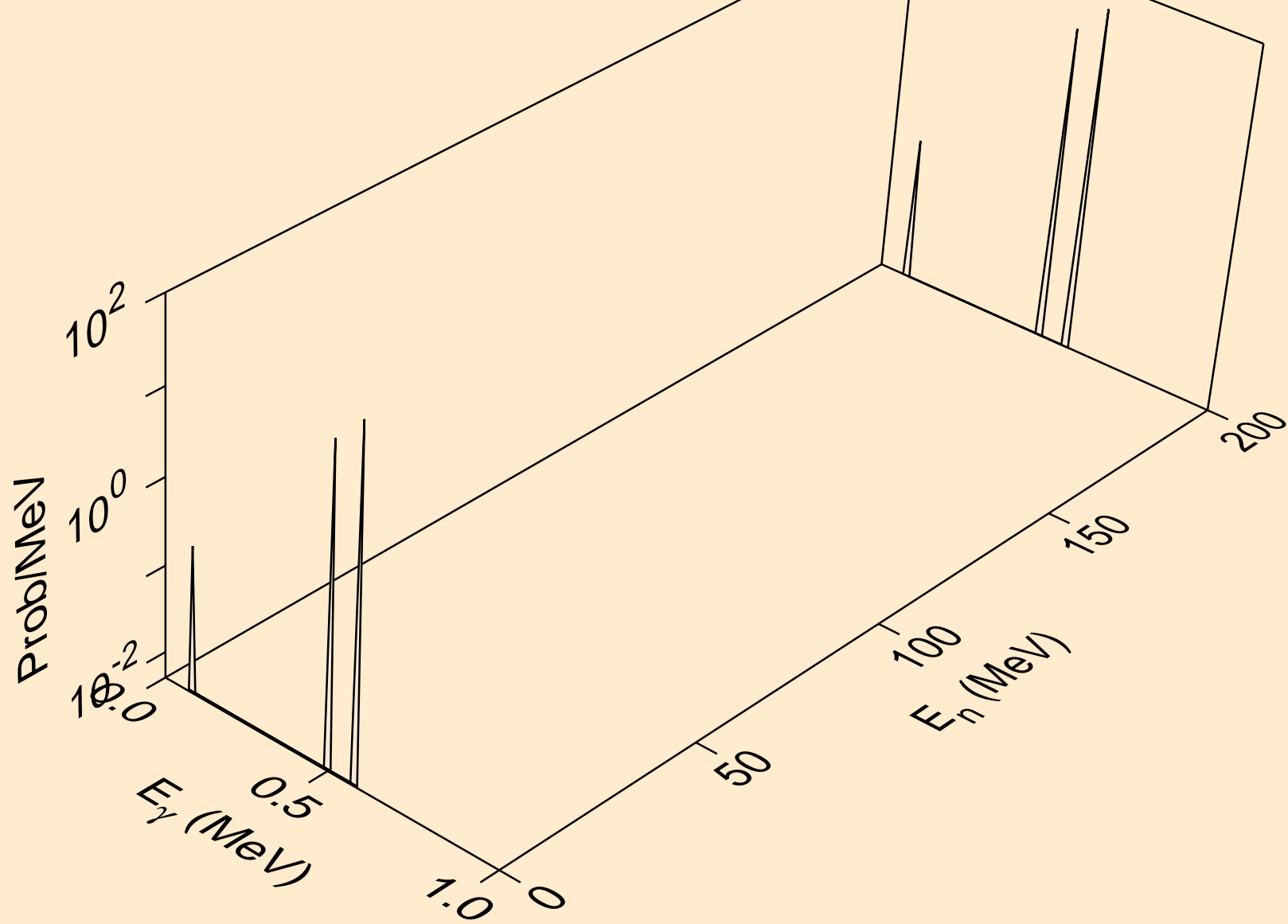

ER167M NEUTRON ACER TENDL-2023 LIBRARY; T=0.K
Photon emission for (n,n*15)

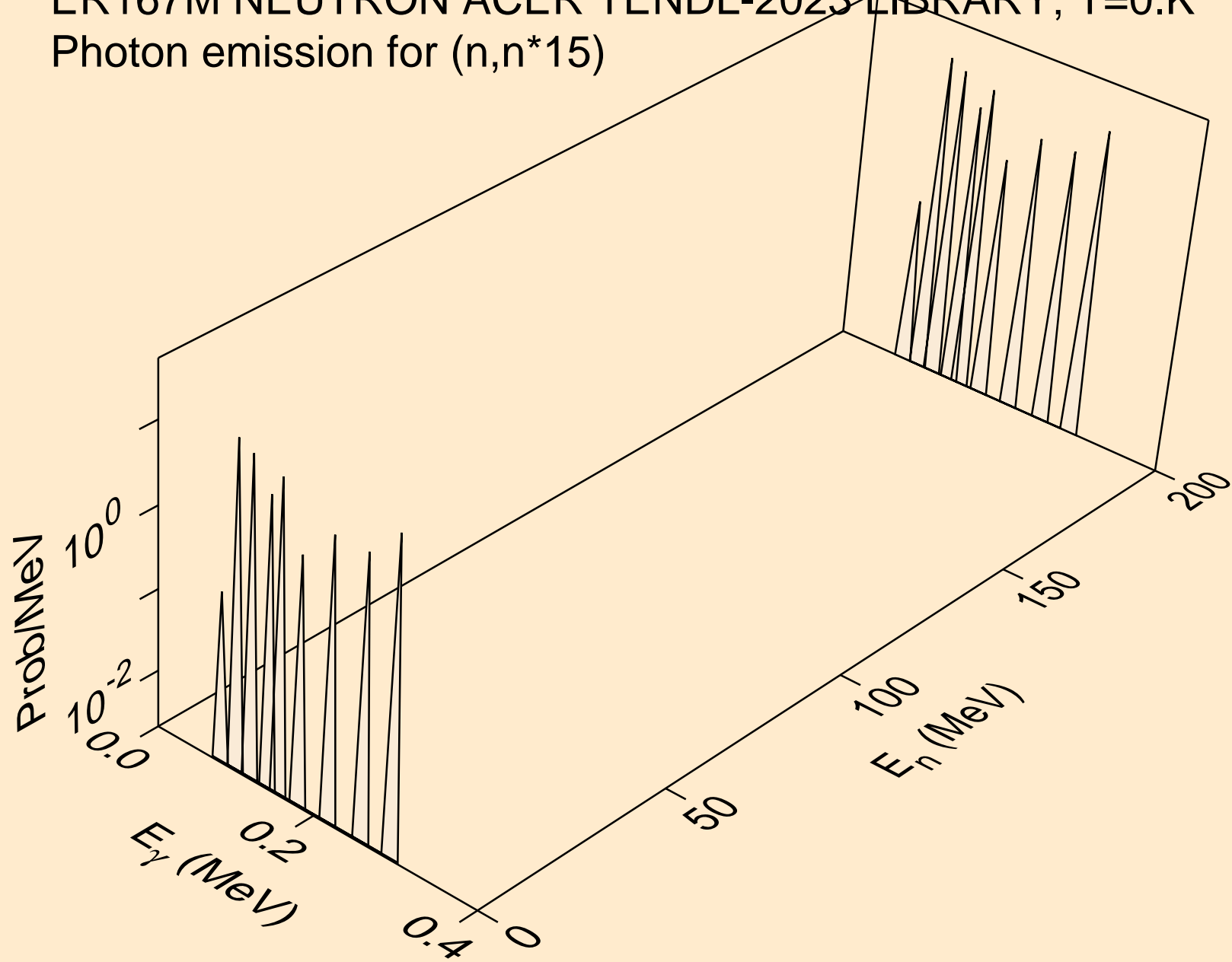

ER167M NEUTRON ACER TENDL-2023 LIBRARY; T=0.K
Photon emission for (n,n*16)

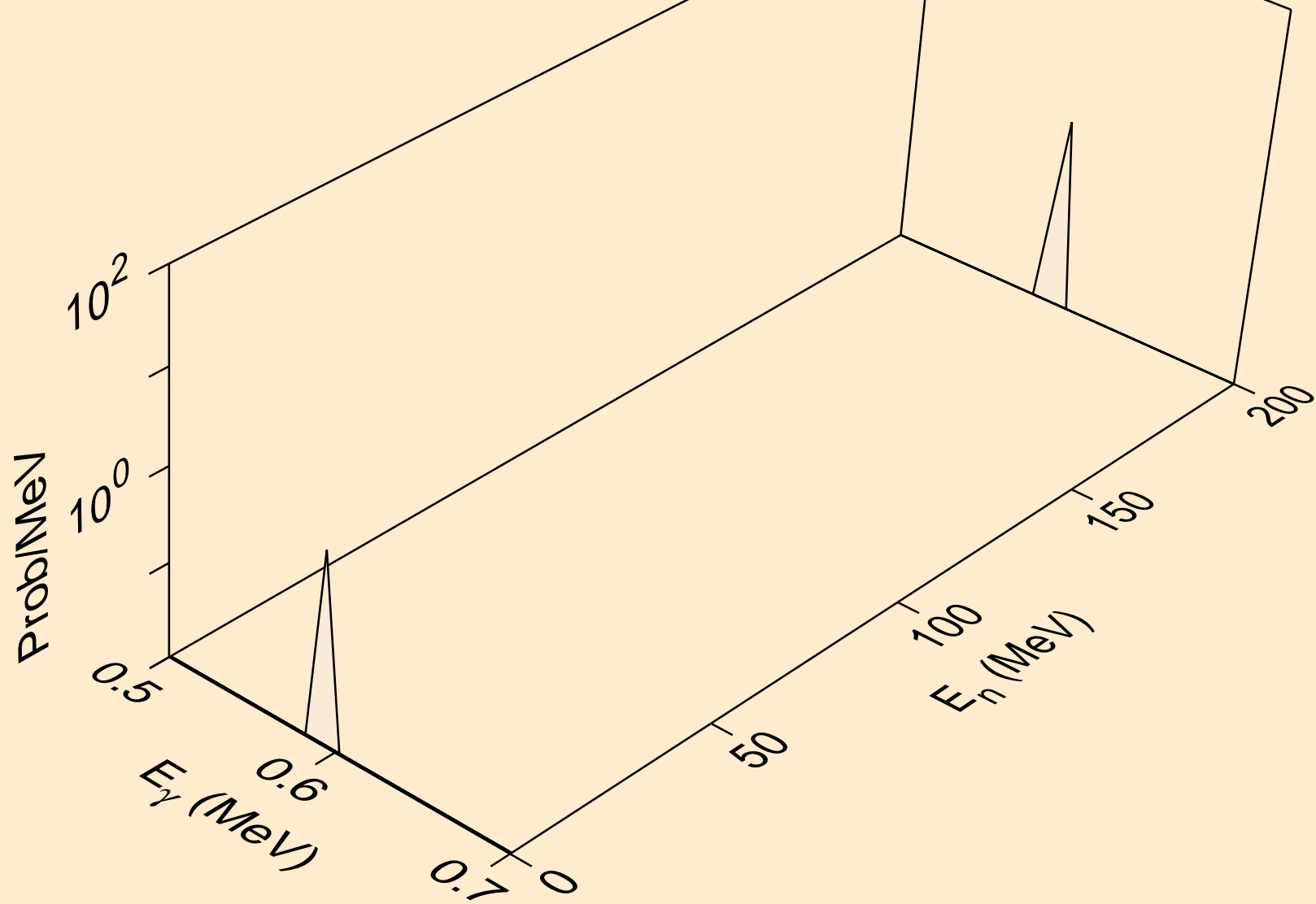

ER167M NEUTRON ACER TENDL-2023 LIBRARY; T=0.K
Photon emission for (n,n*17)

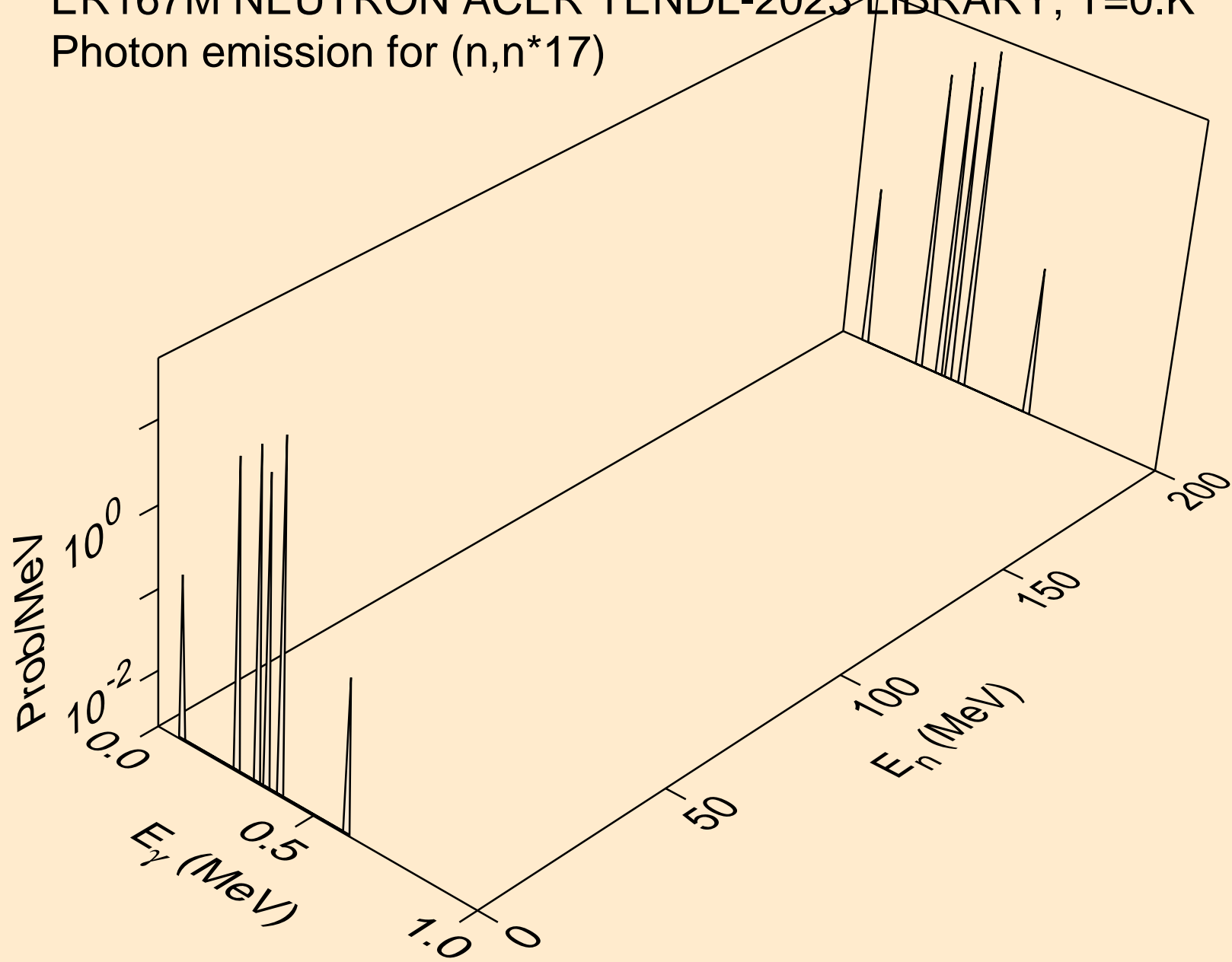

ER167M NEUTRON ACER TENDL-2023 LIBRARY; T=0.K
Photon emission for (n,n*18)

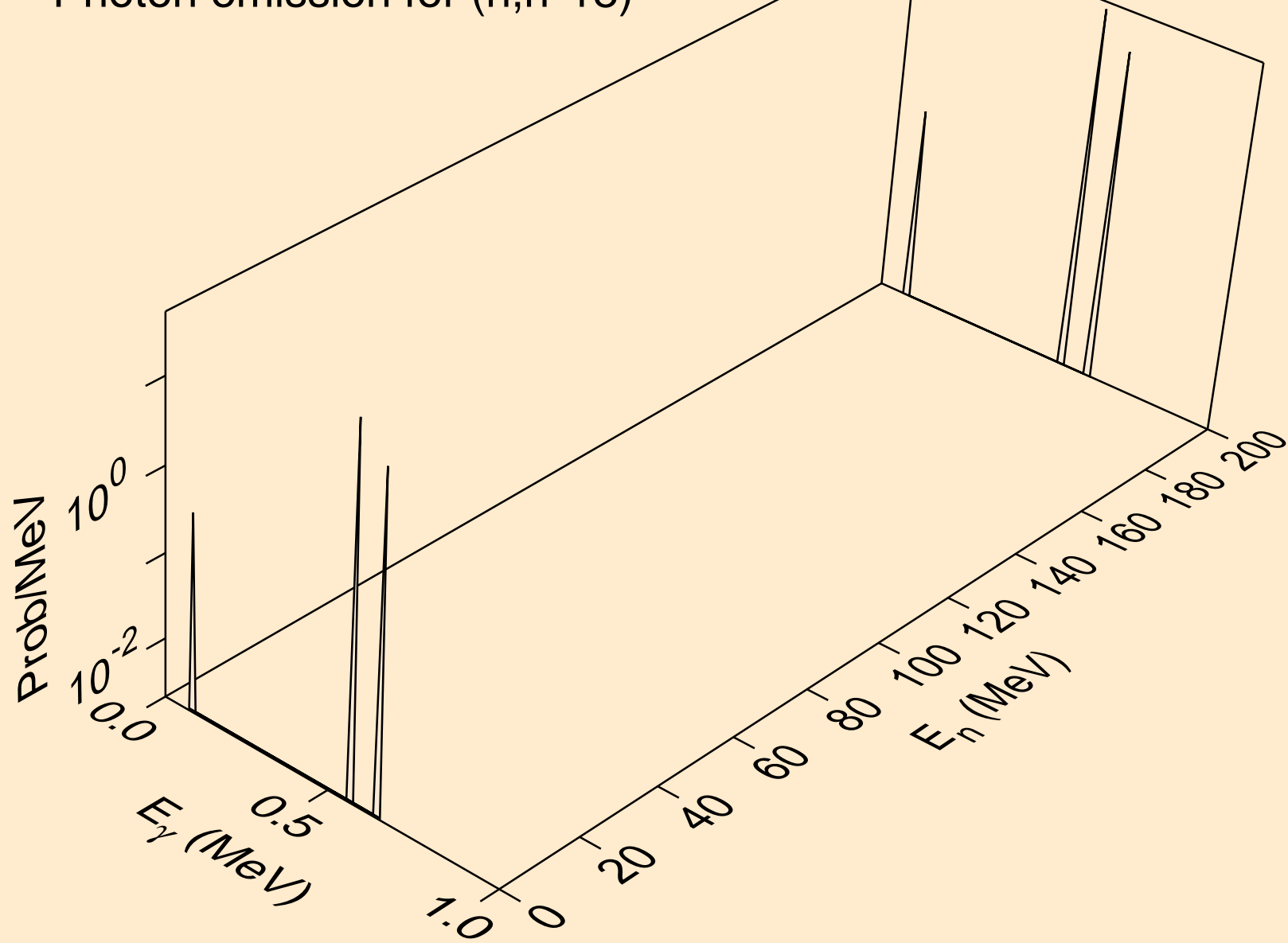

ER167M NEUTRON ACER TENDL-2023 LIBRARY; T=0.K
Photon emission for (n,n*19)

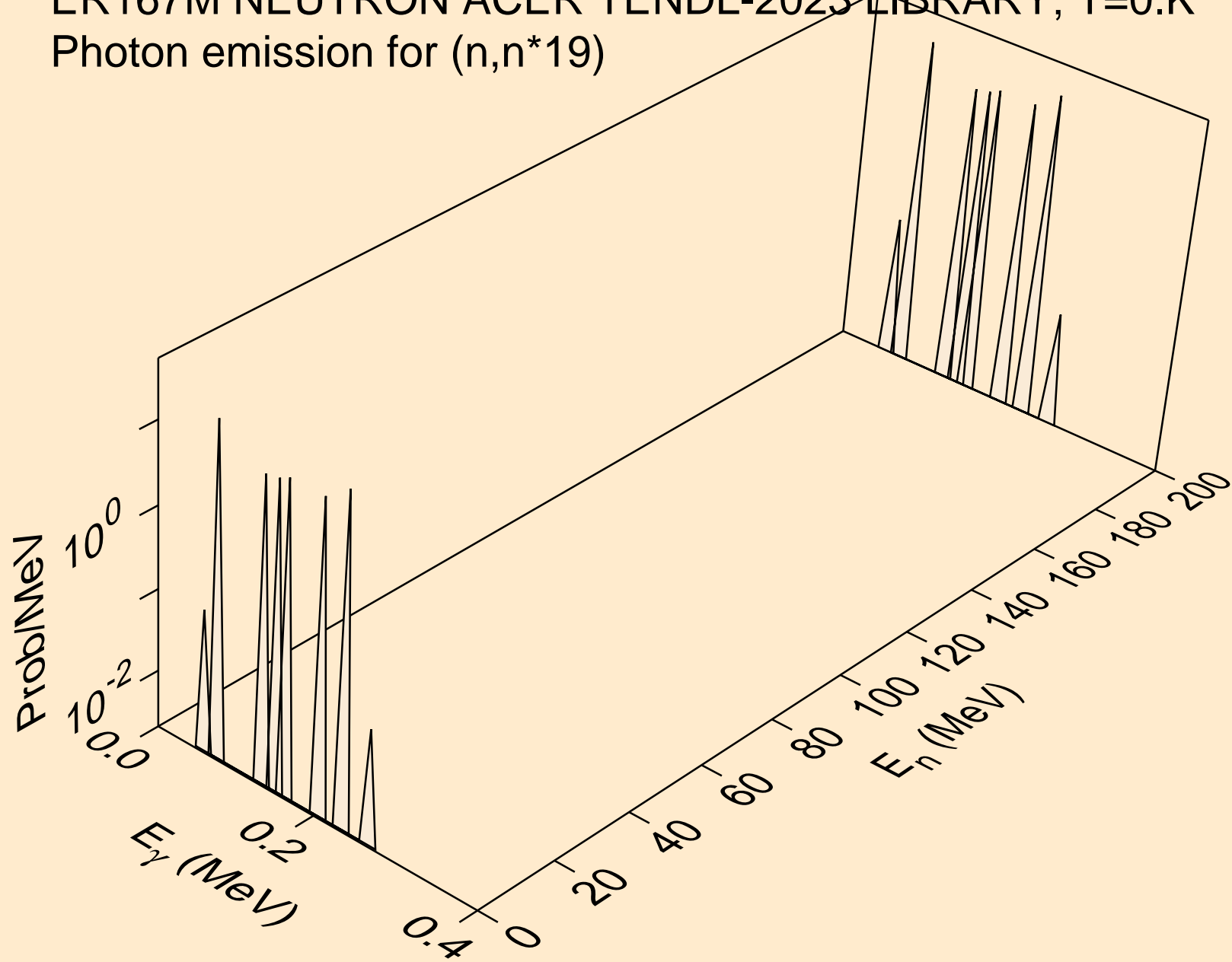

ER167M NEUTRON ACER TENDL-2023 LIBRARY; T=0.K
Photon emission for (n,n*20)

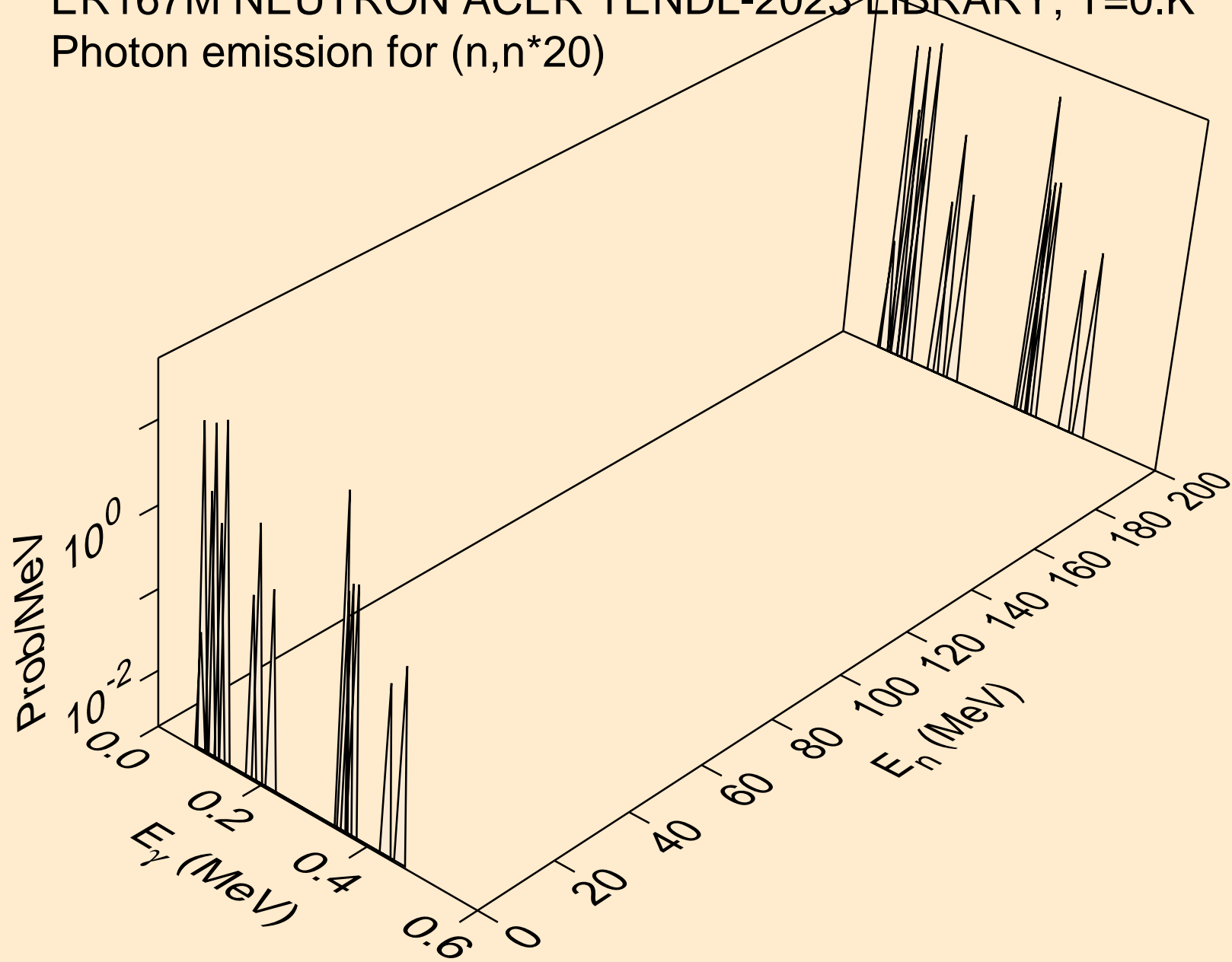

ER167M NEUTRON ACER TENDL-2023 LIBRARY; T=0.K
Photon emission for (n,n*21)

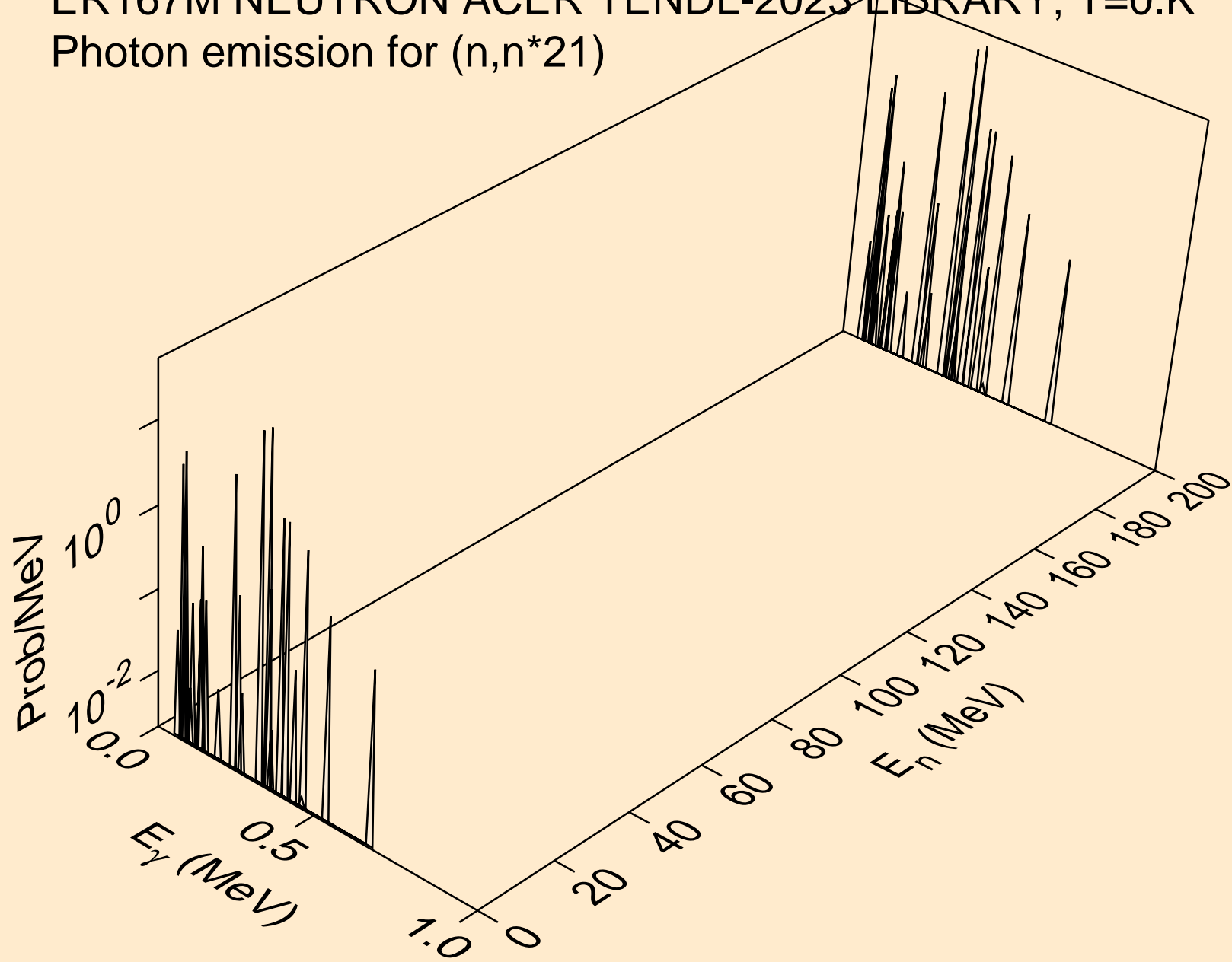

ER167M NEUTRON ACER TENDL-2023 LIBRARY; T=0.K
Photon emission for (n,n*22)

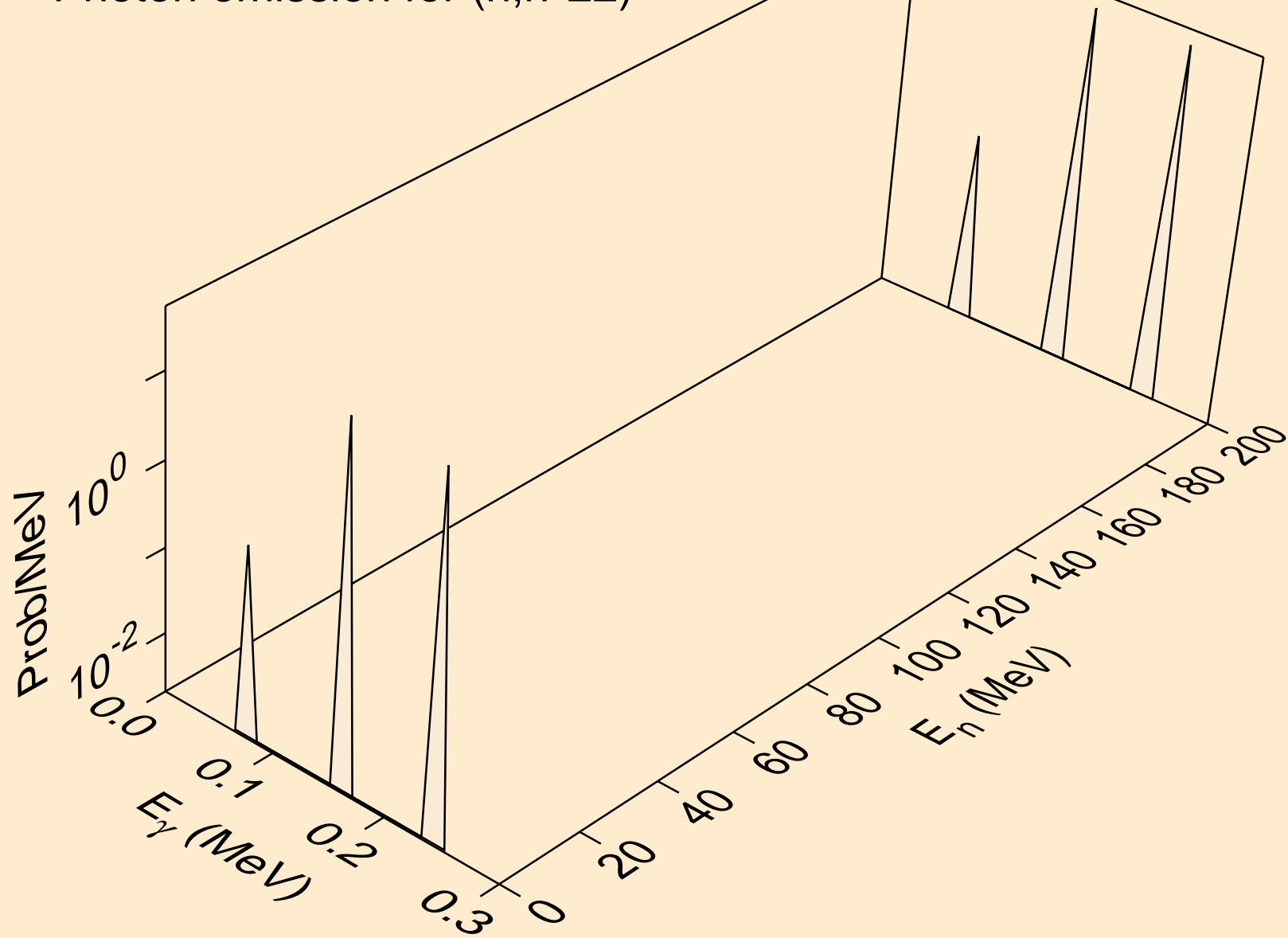

ER167M NEUTRON ACER TENDL-2023 LIBRARY; T=0.K
Photon emission for (n,n*23)

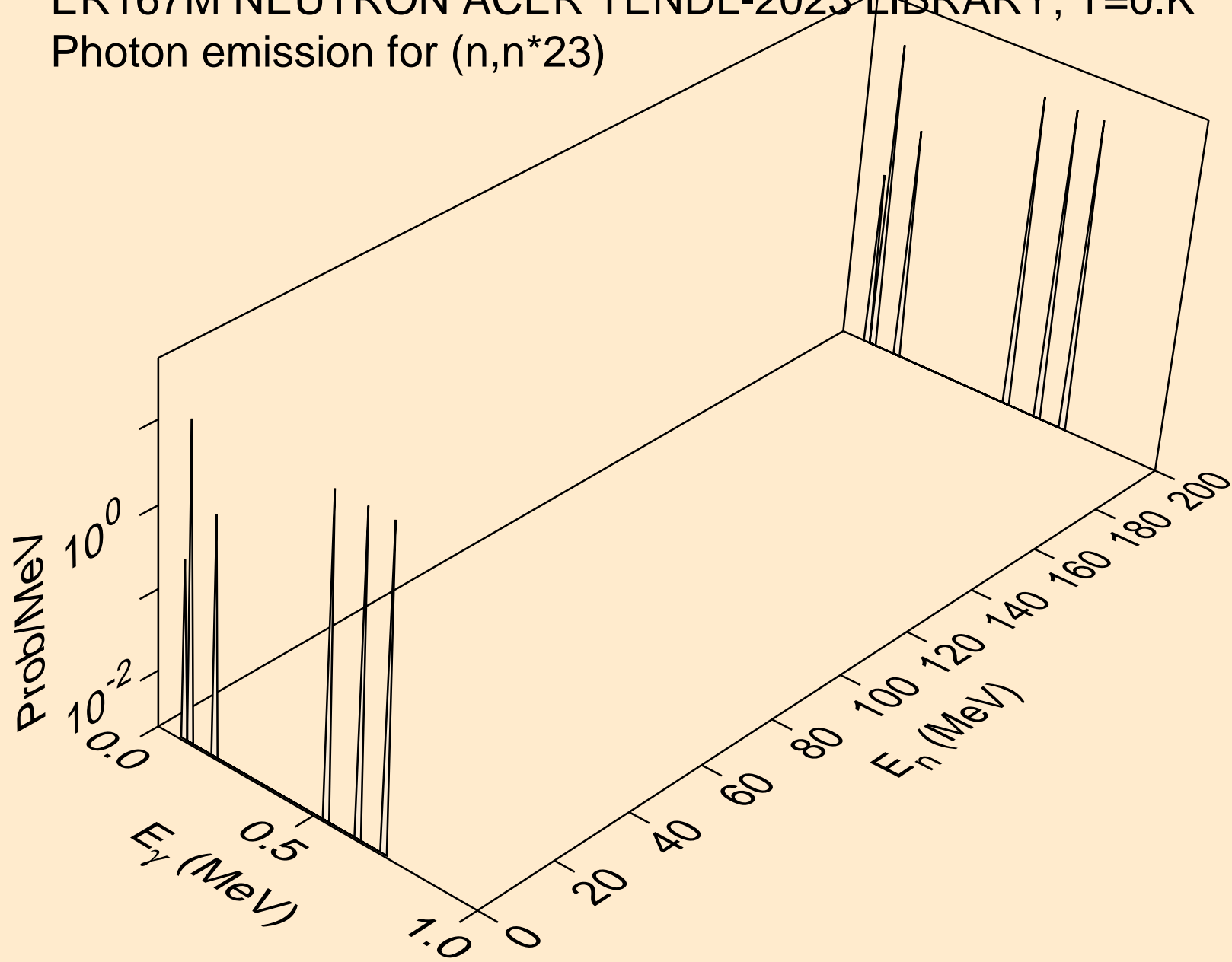

ER167M NEUTRON ACER TENDL-2023 LIBRARY; T=0.K
Photon emission for (n,n*24)

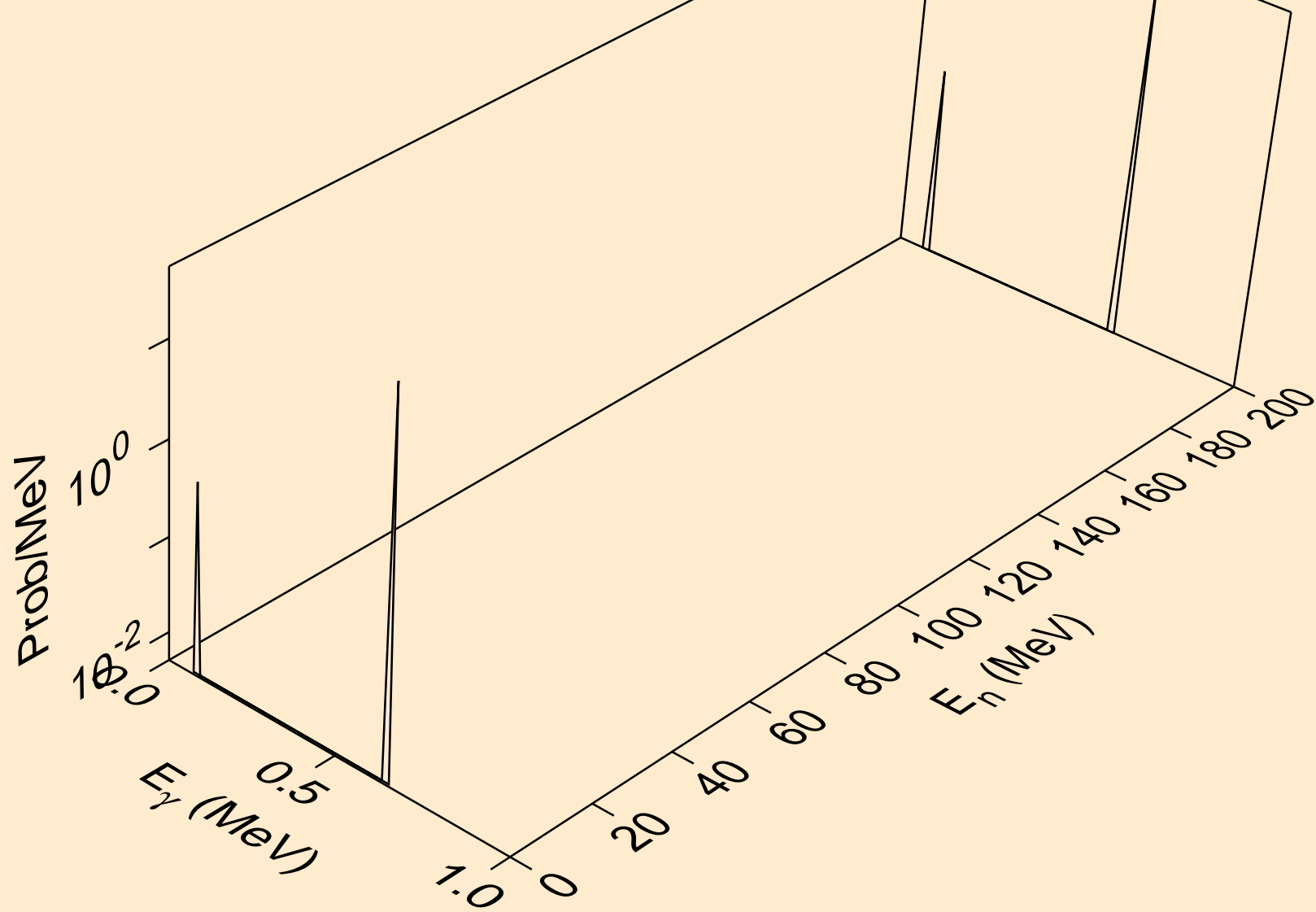

ER167M NEUTRON ACER TENDL-2023 LIBRARY; T=0.K
Photon emission for (n,n*25)

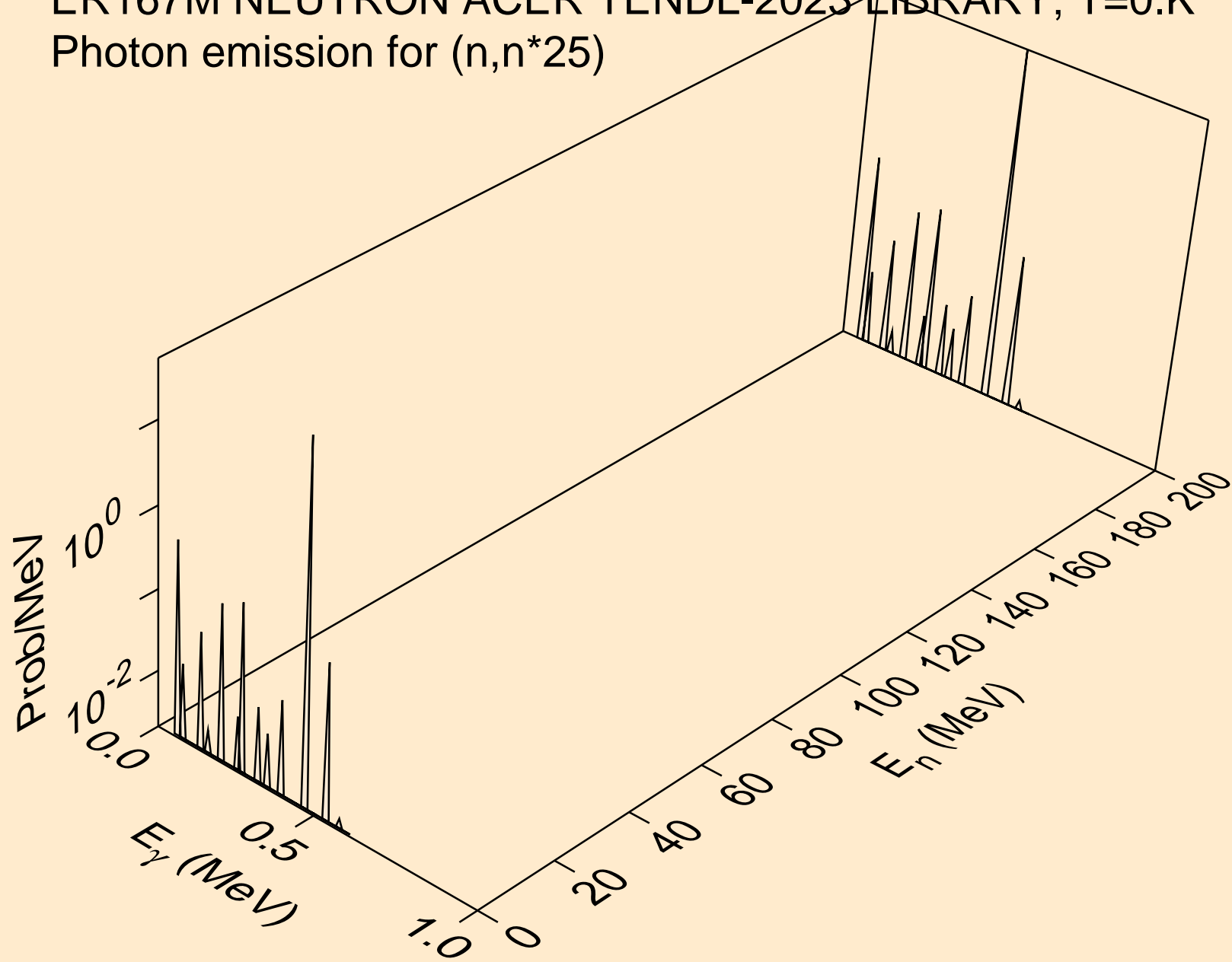

ER167M NEUTRON ACER TENDL-2023 LIBRARY; T=0.K
Photon emission for (n,n*26)

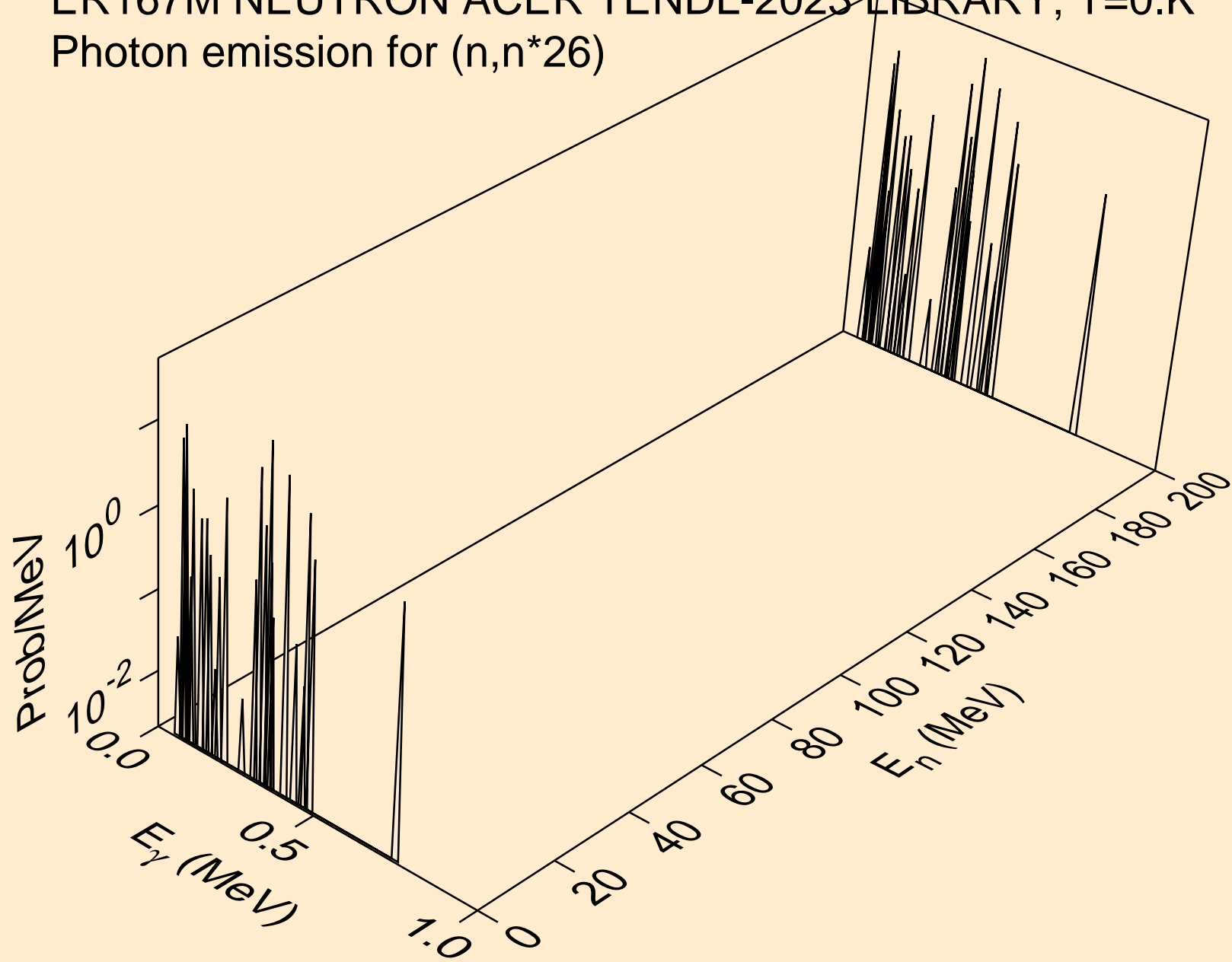

ER167M NEUTRON ACER TENDL-2023 LIBRARY; T=0.K
Photon emission for (n,n*27)

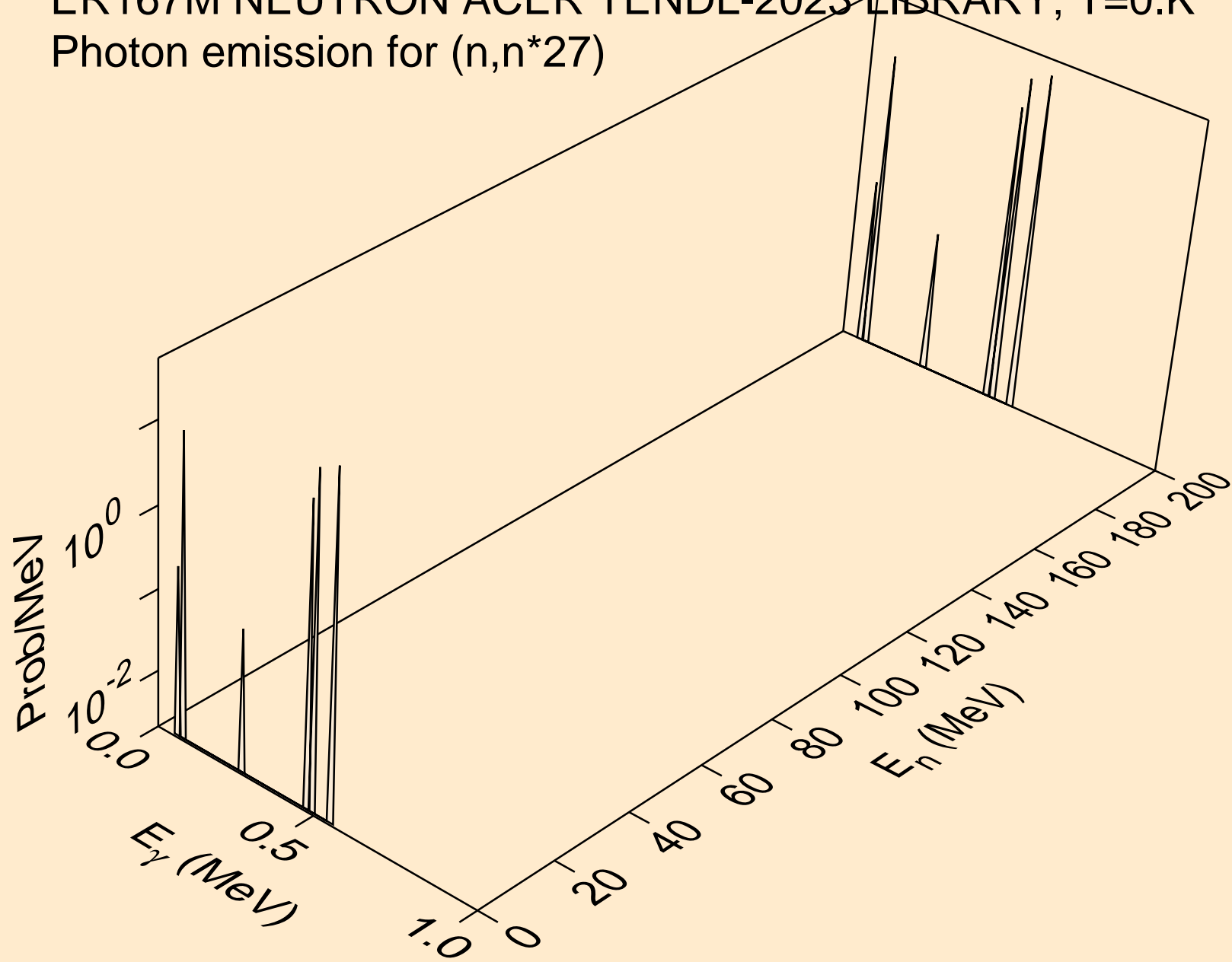

ER167M NEUTRON ACER TENDL-2023 LIBRARY; T=0.K
Photon emission for (n,n*28)

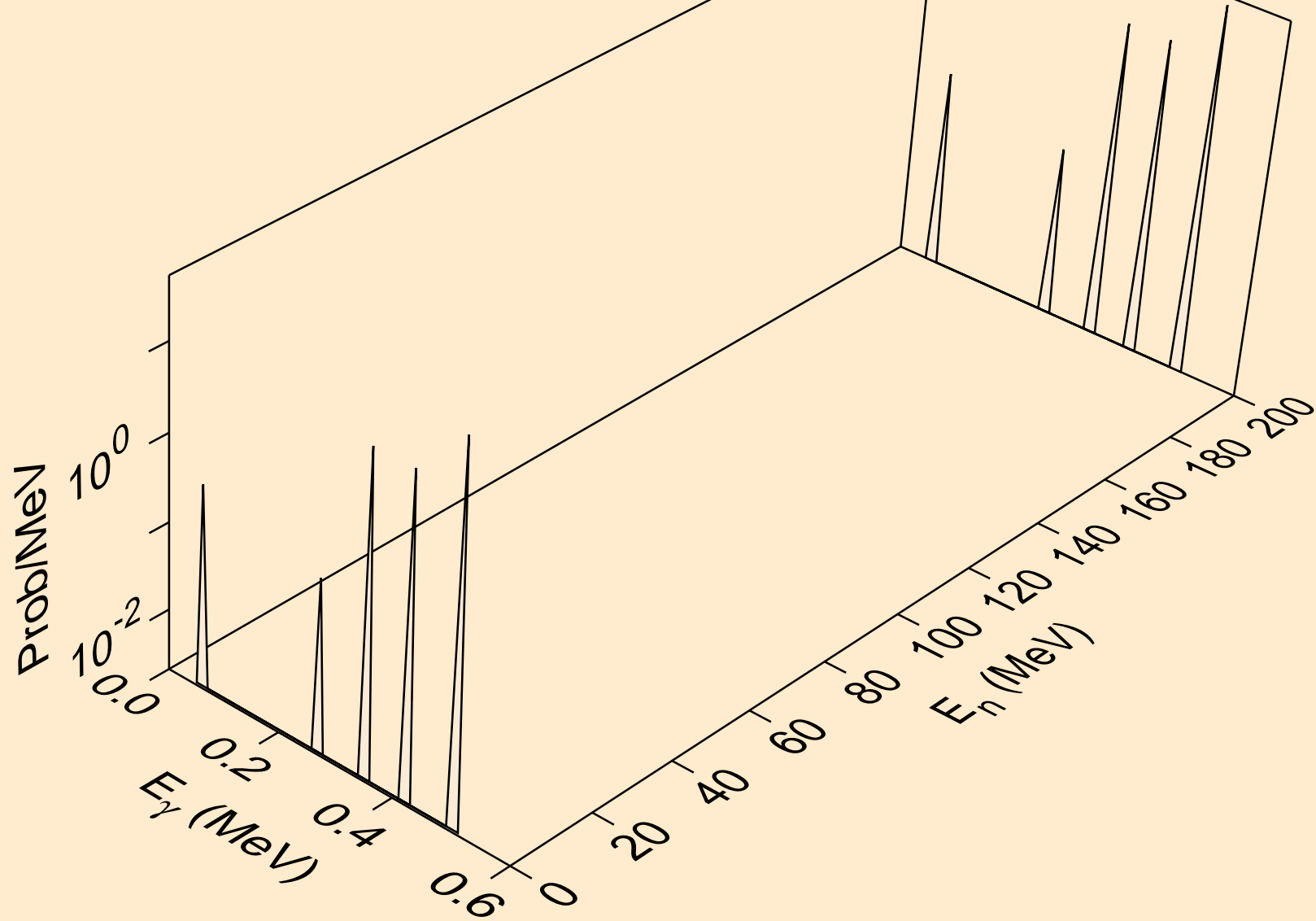

ER167M NEUTRON ACER TENDL-2023 LIBRARY; T=0.K
Photon emission for (n,n*c)

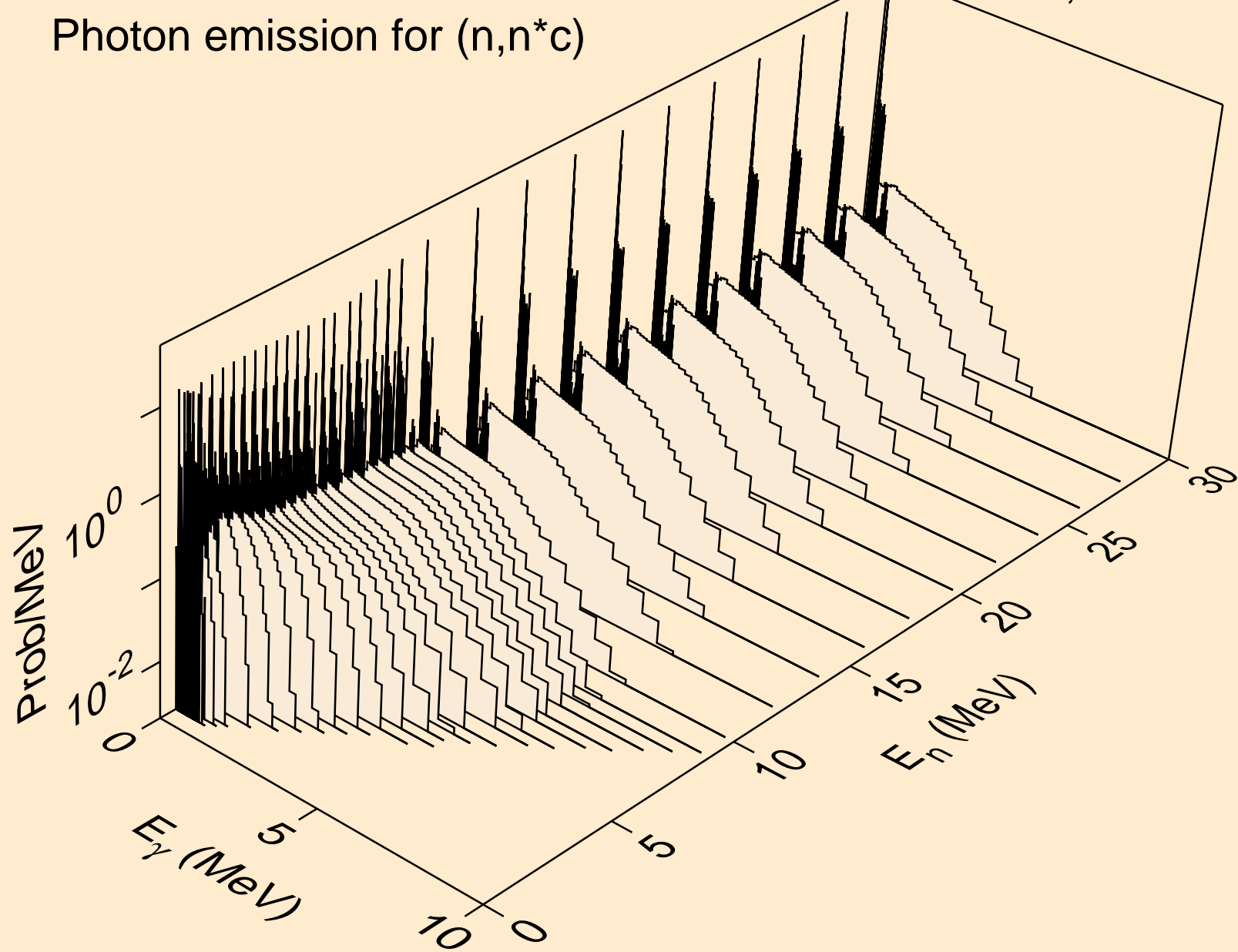

ER167M NEUTRON ACER TENDL-2023 LIBRARY; T=0.K
Photon emission for (n,gma)

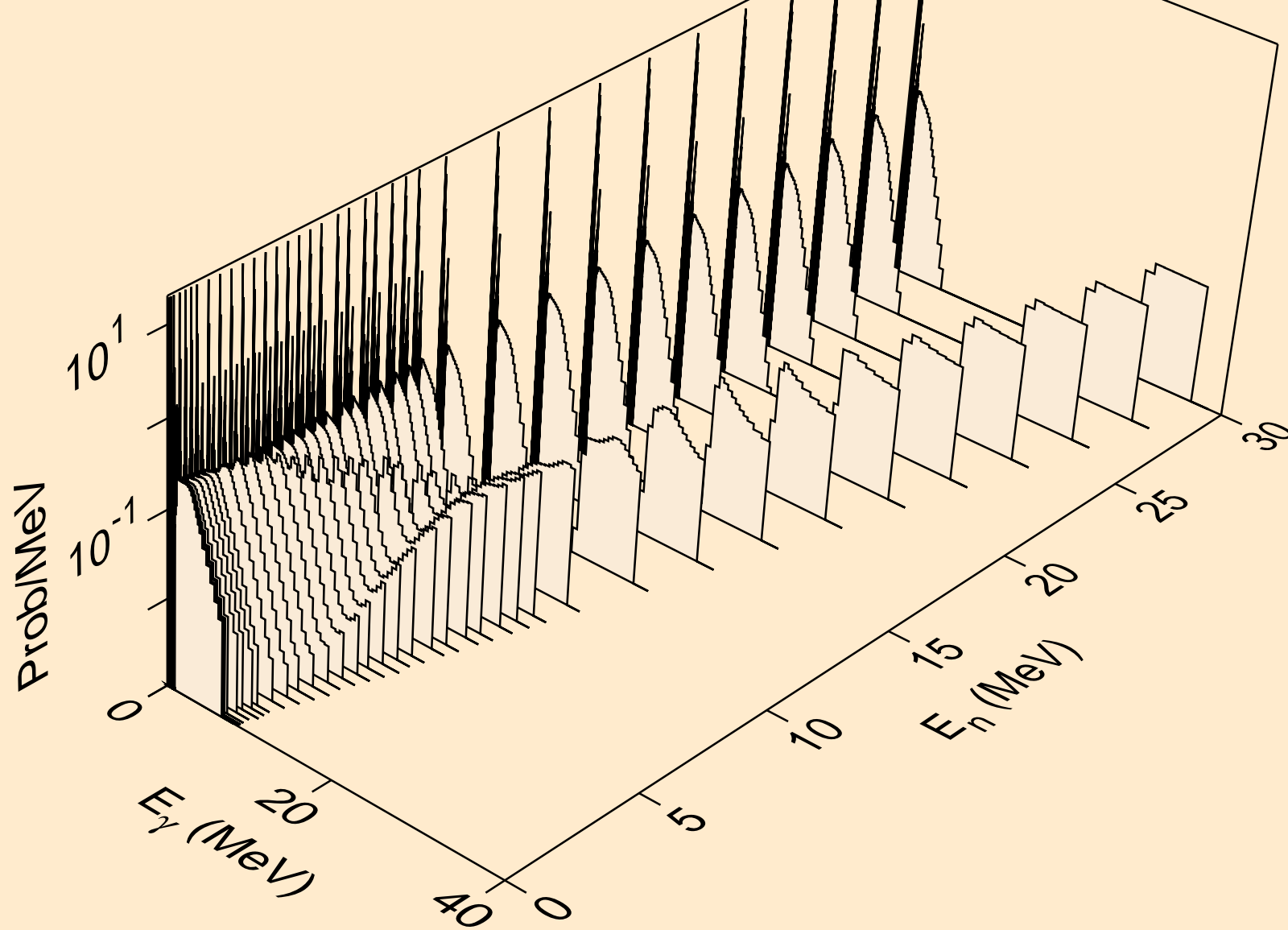

ER167M NEUTRON ACER TENDL-2023 LIBRARY; T=0.K
Photon emission for (n,p)

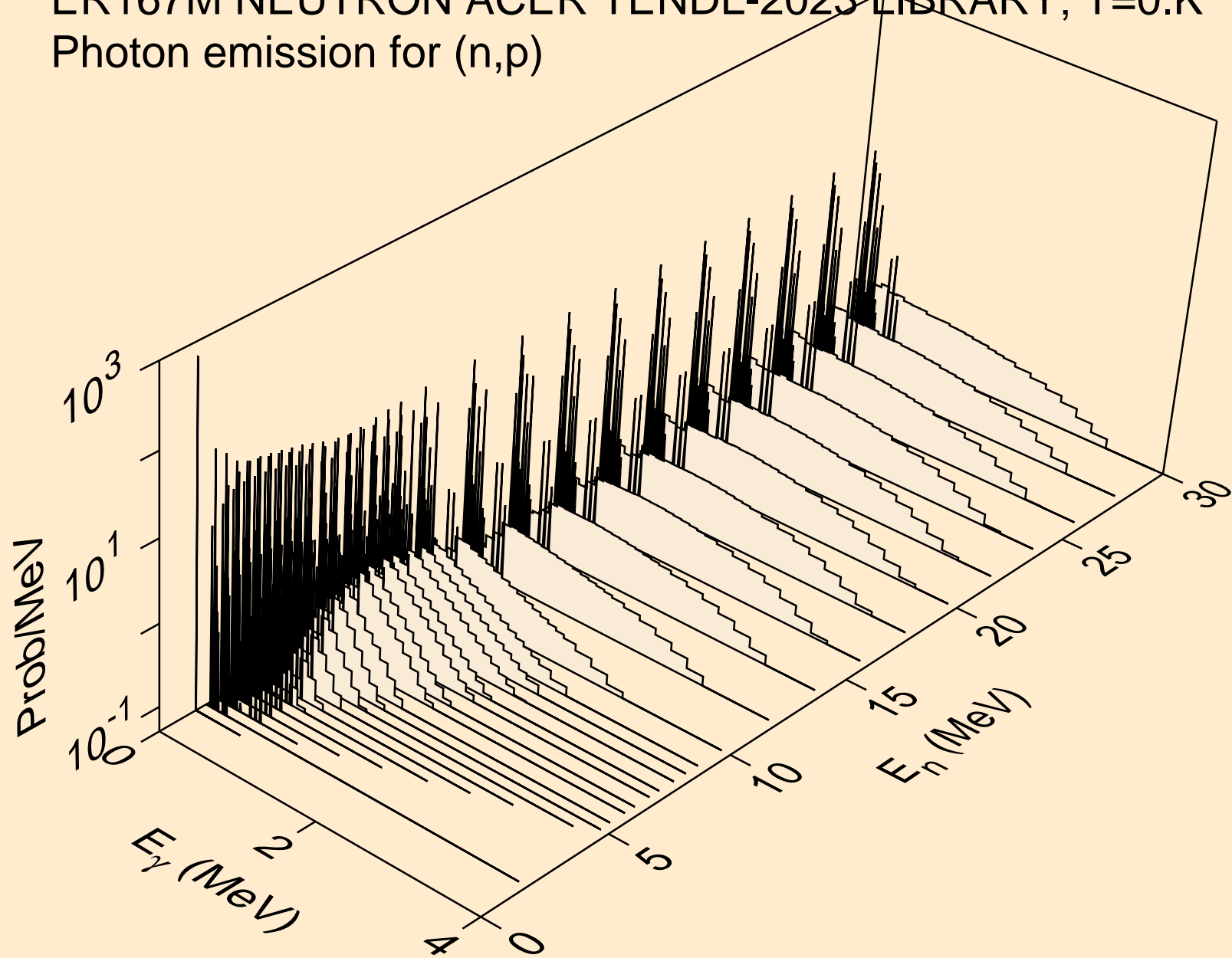

ER167M NEUTRON ACER TENDL-2023 LIBRARY; T=0.K
Photon emission for (n,d)

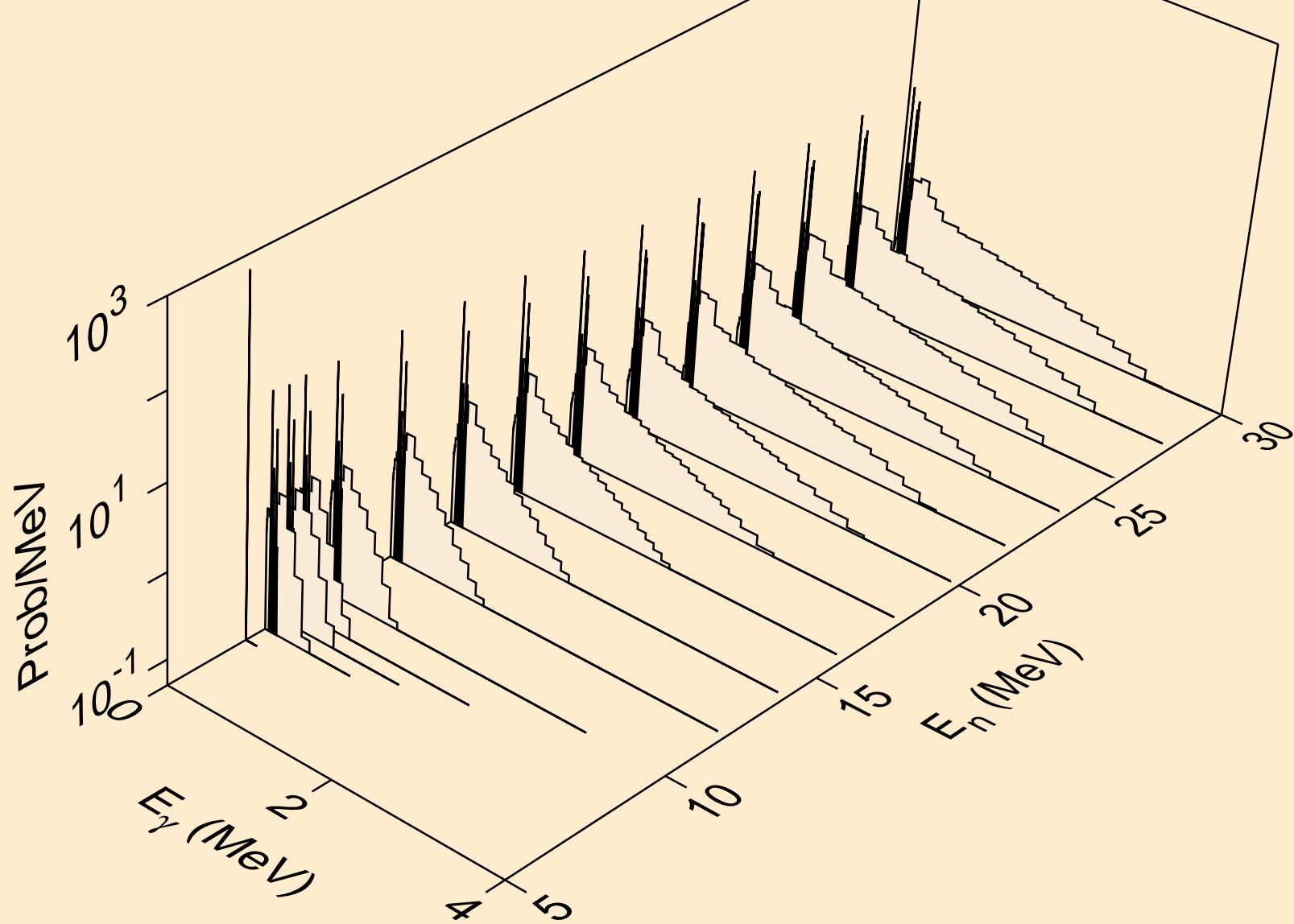

ER167M NEUTRON ACER TENDL-2023 LIBRARY; T=0.K
Photon emission for (n,t)

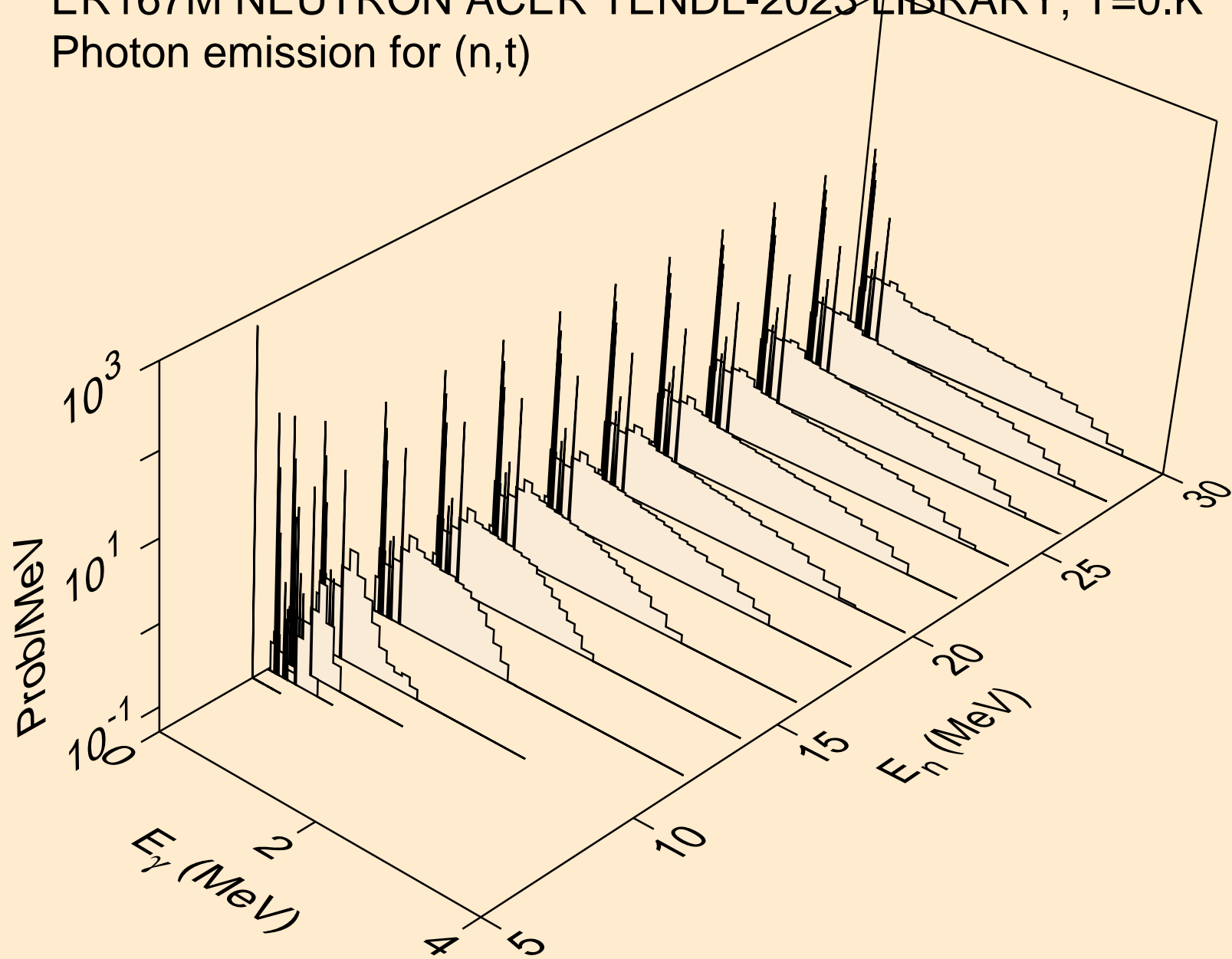

ER167M NEUTRON ACER TENDL-2023 LIBRARY; T=0.K
Photon emission for (n,he3)

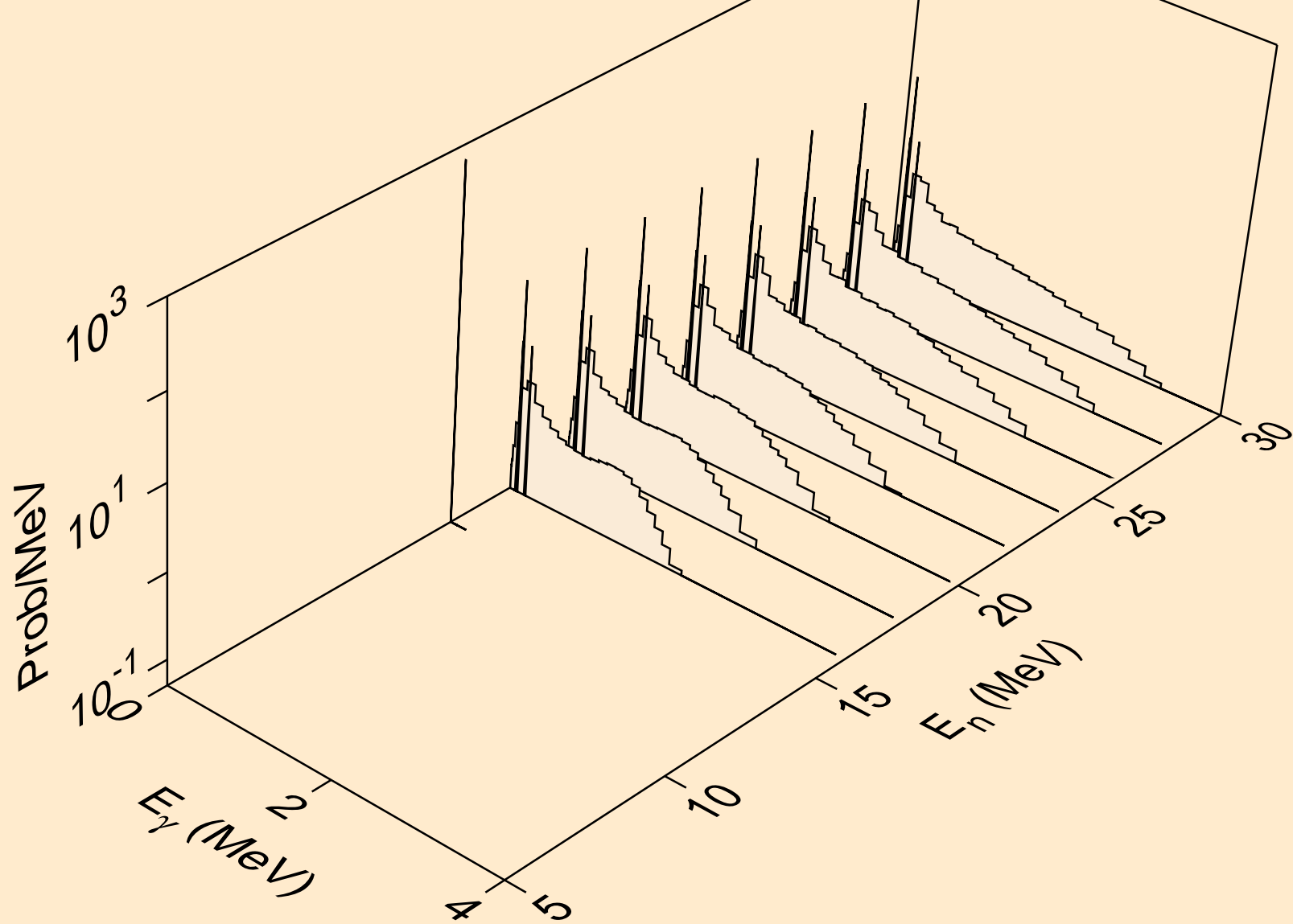

ER167M NEUTRON ACER TENDL-2023 LIBRARY; T=0.K
Photon emission for (n,a)

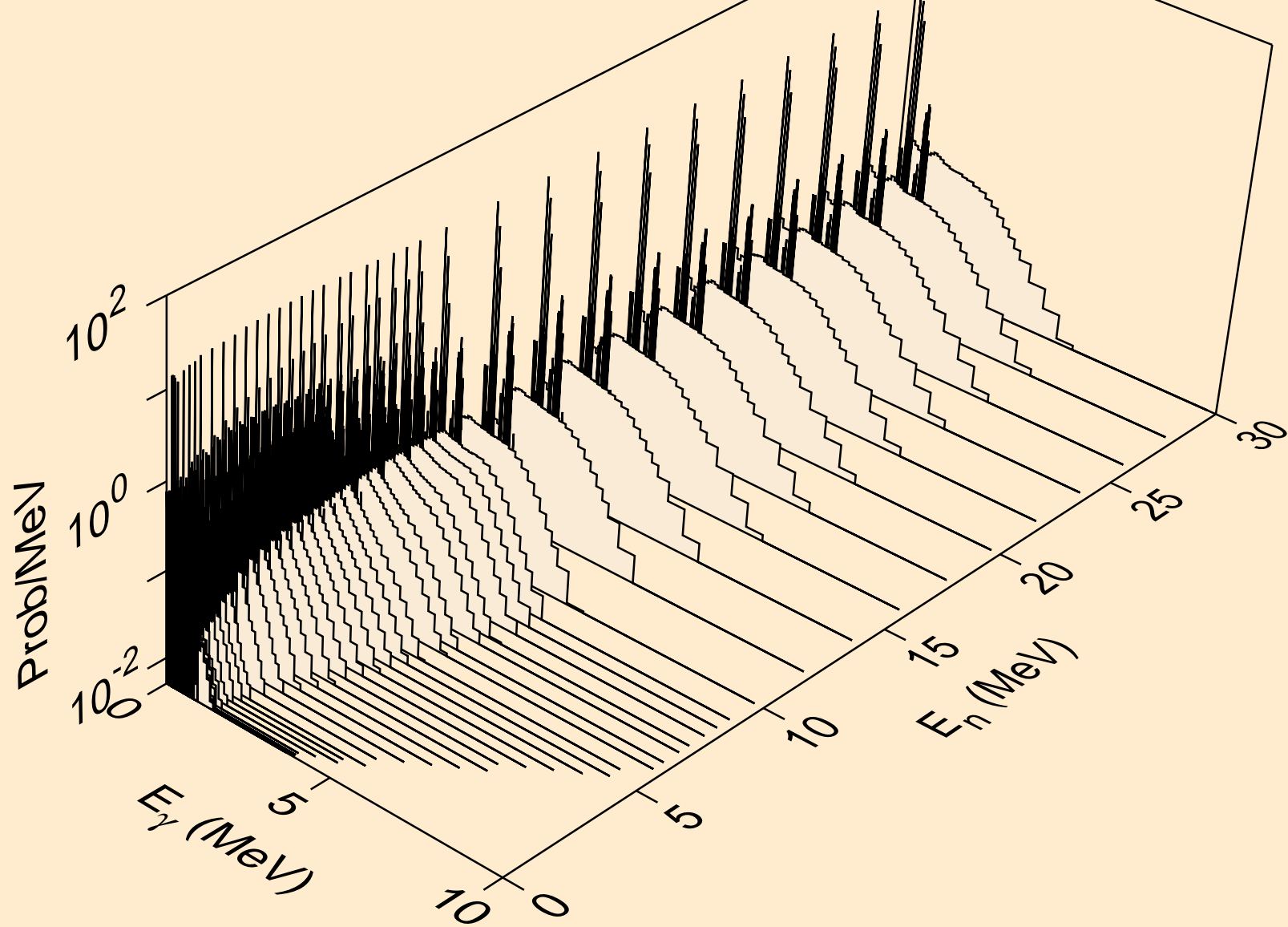

ER167M NEUTRON ACER TENDL-2023 LIBRARY; T=0.K
Photon emission for (n,2a)

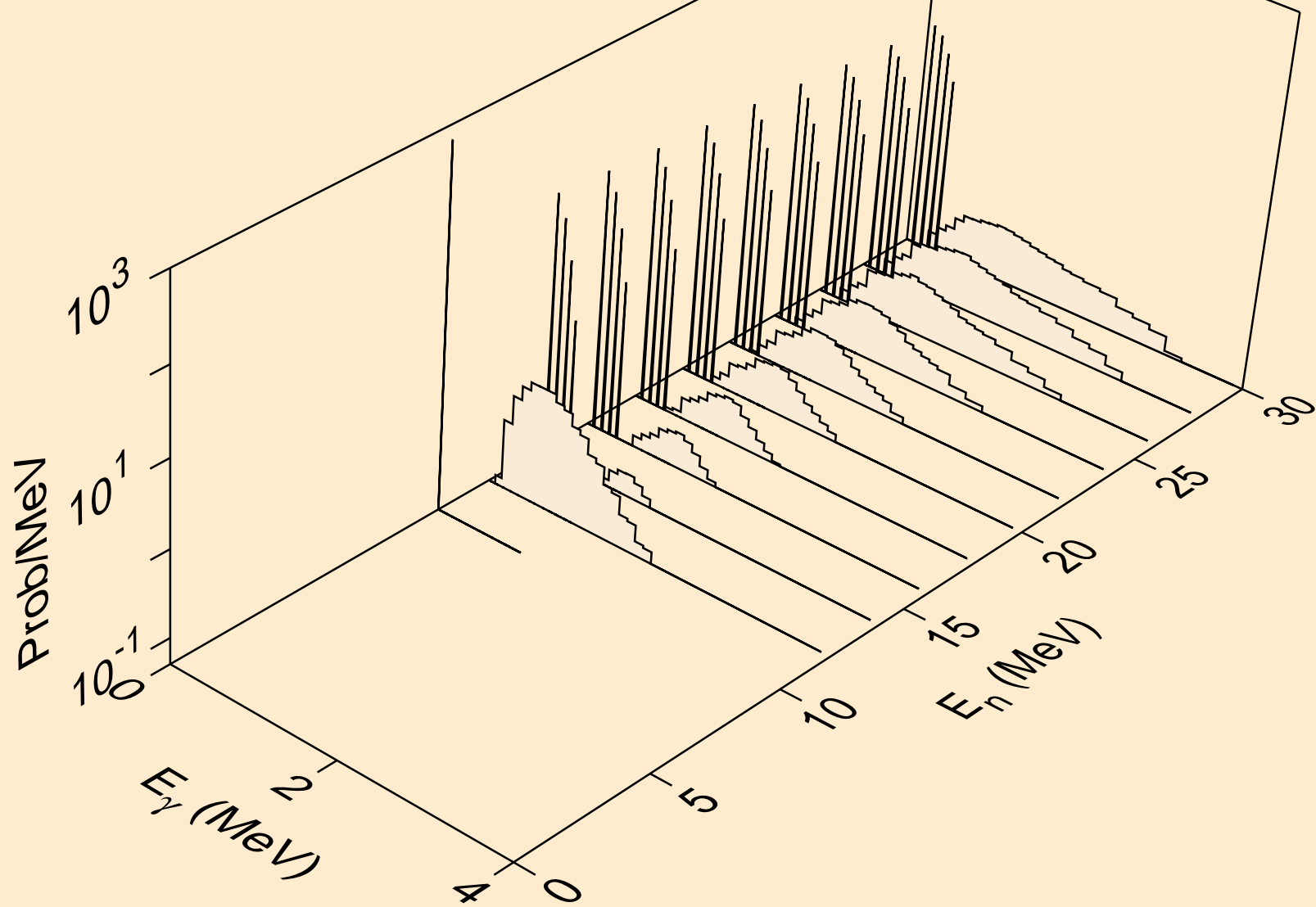

ER167M NEUTRON ACER TENDL-2023 LIBRARY; T=0.K
Photon emission for (n,2p)

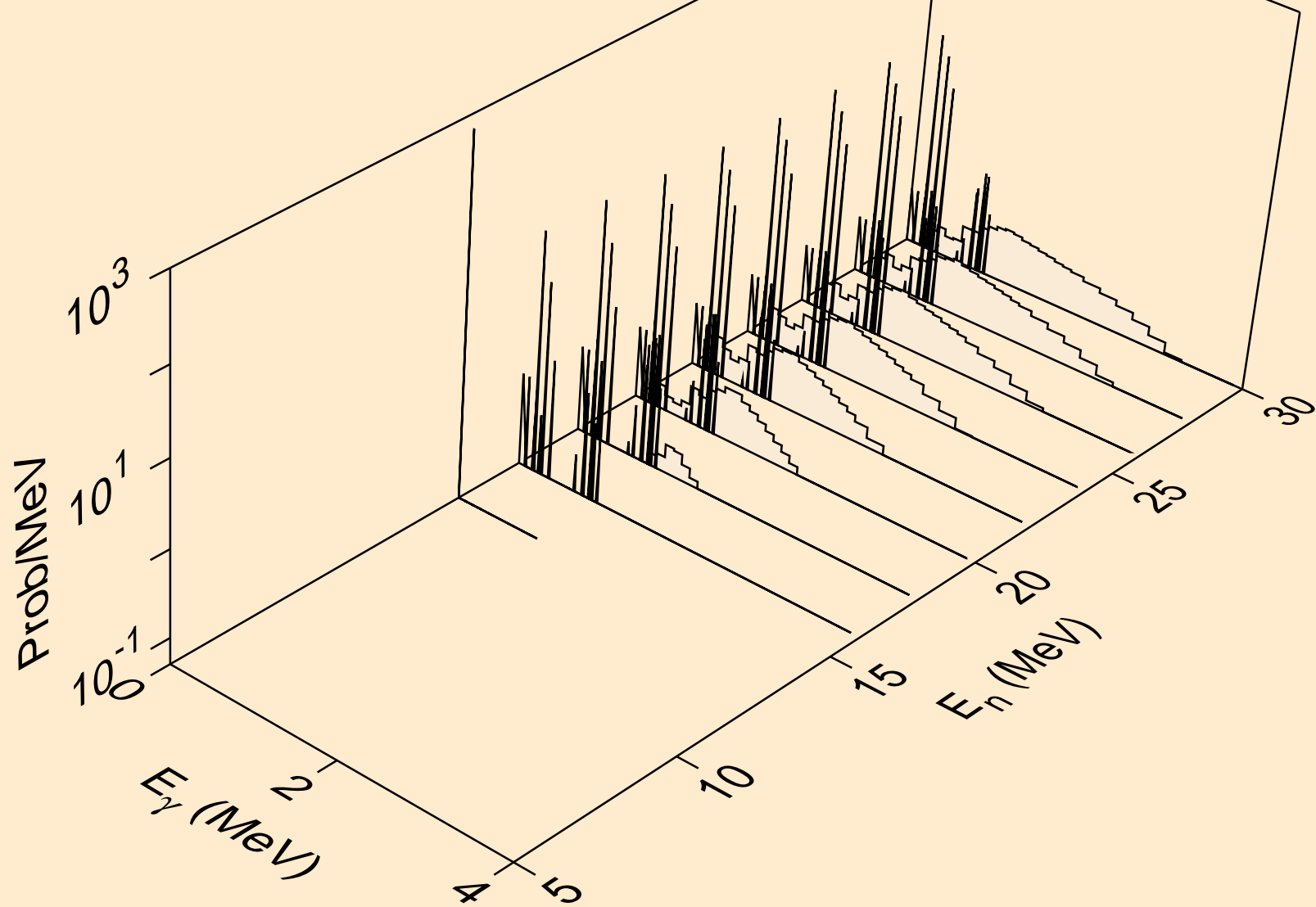

ER167M NEUTRON ACER TENDL-2023 LIBRARY; T=0.K
Photon emission for (n,p)

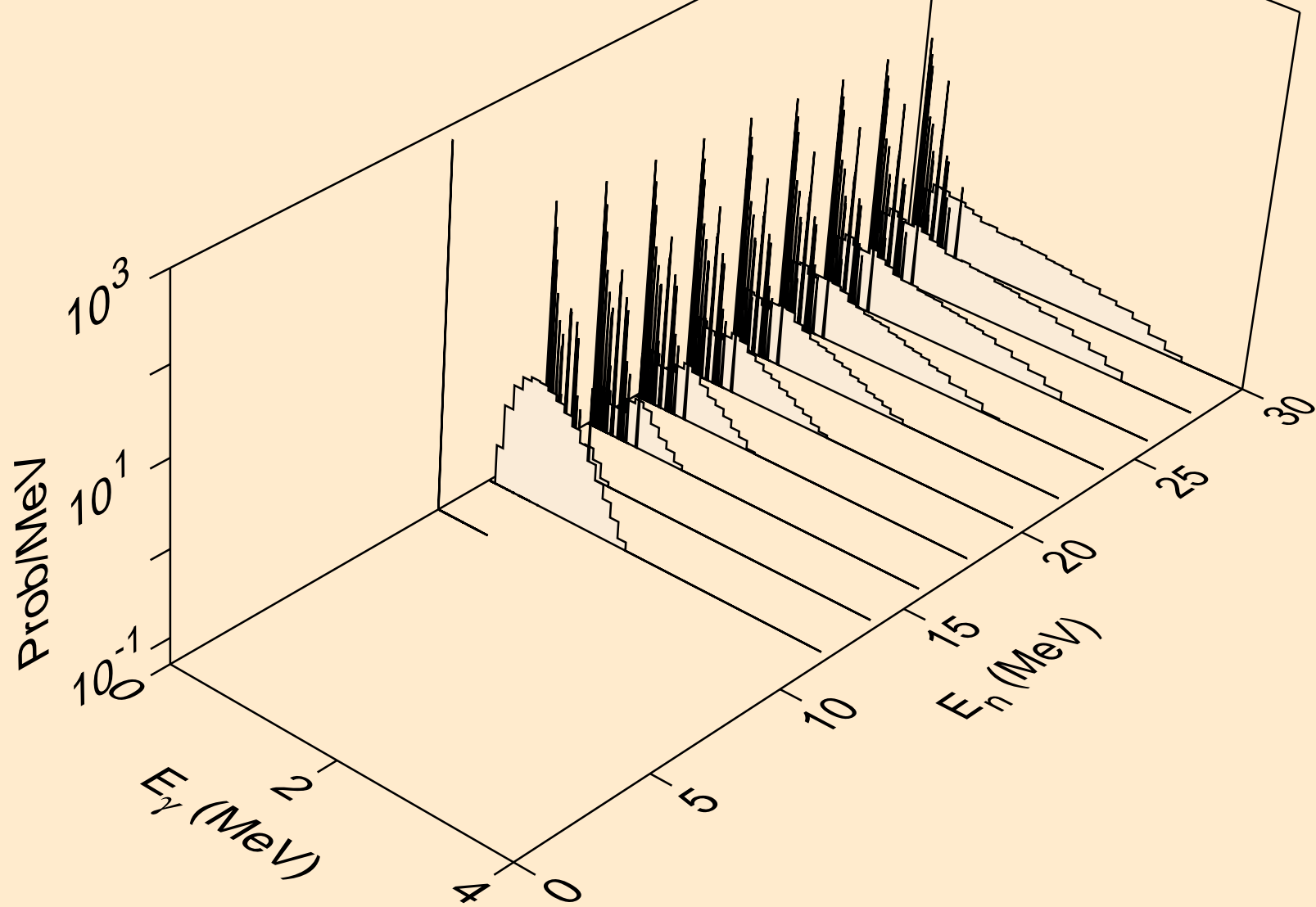

ER167M NEUTRON ACER TENDL-2023 LIBRARY; T=0.K
Photon emission for (n,pd)

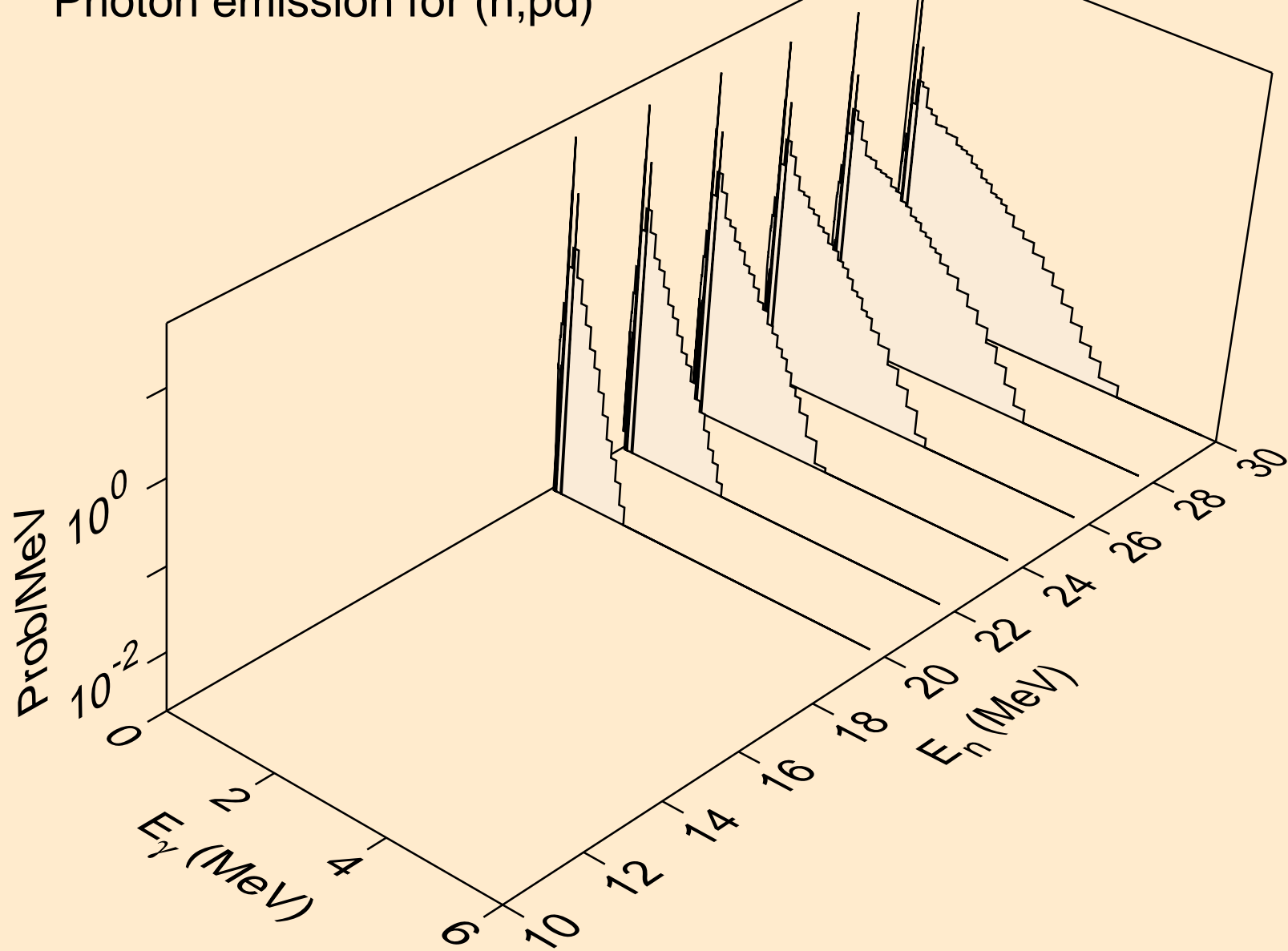

ER167M NEUTRON ACER TENDL-2023 LIBRARY; T=0.K
Photon emission for (n,pt)

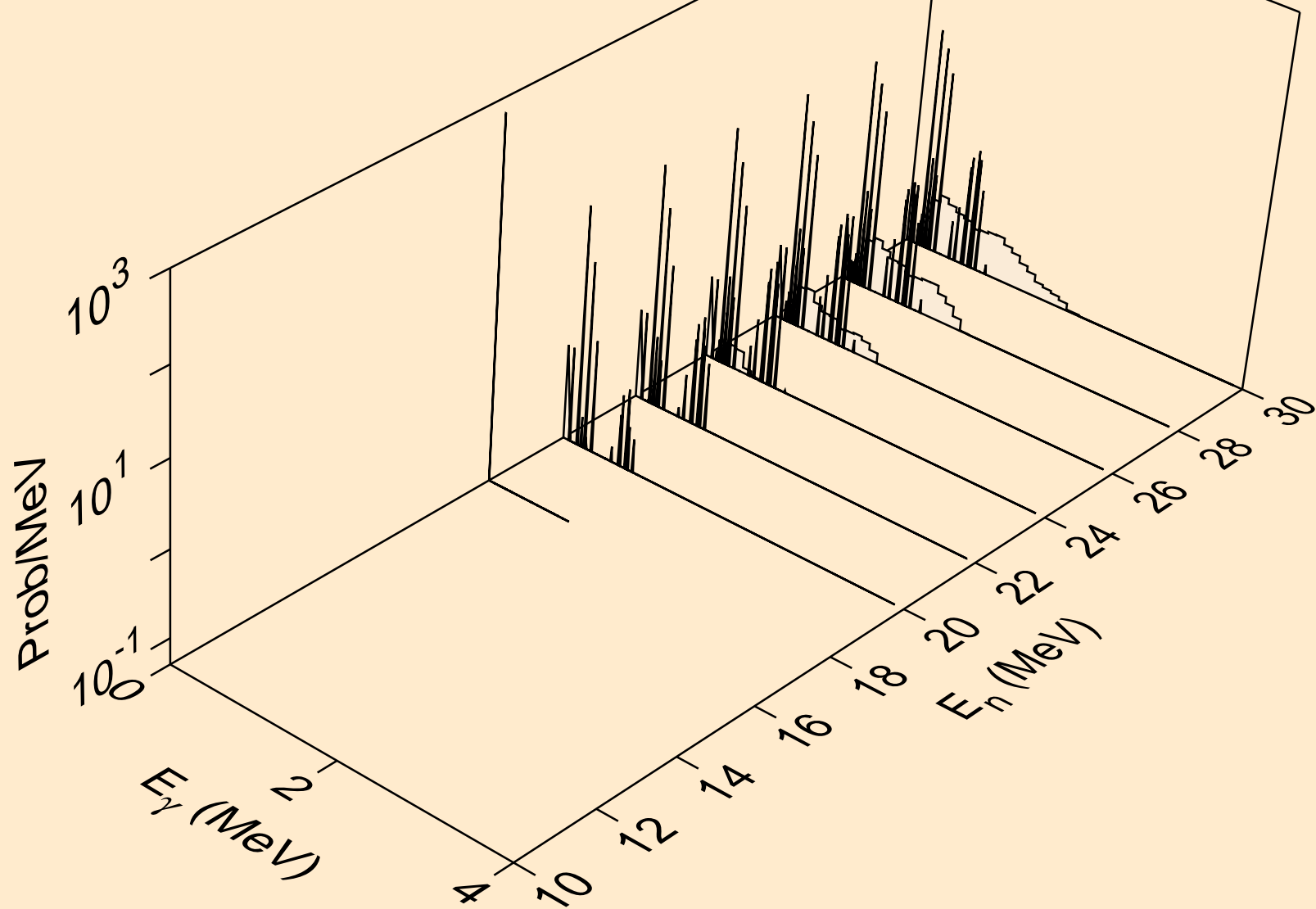

ER167M NEUTRON ACER TENDL-2023 LIBRARY; T=0.K
thermal capture photon spectrum

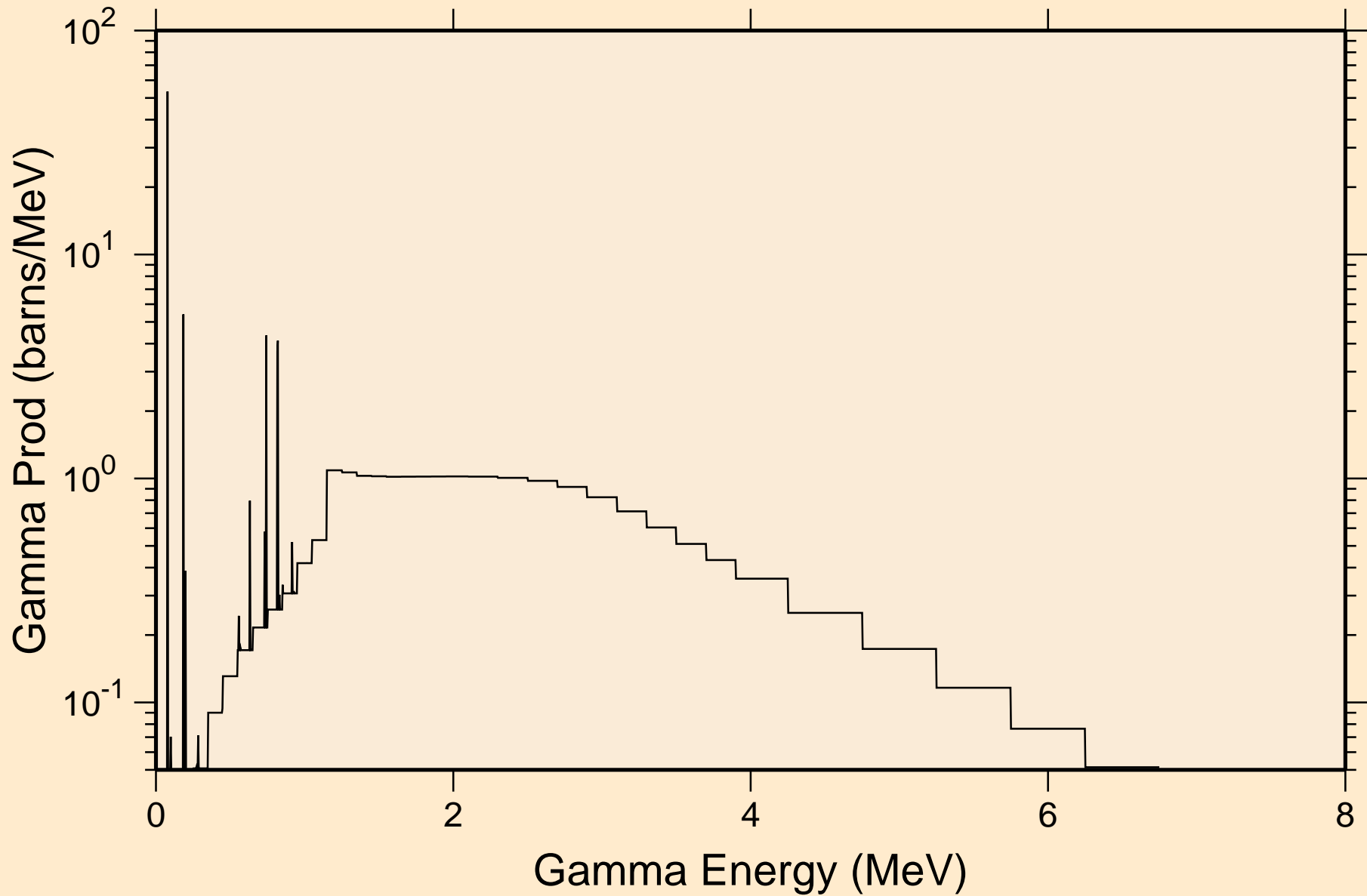

ER167M NEUTRON ACER TENDL-2023 LIBRARY; T=0.K
14 MeV photon spectrum

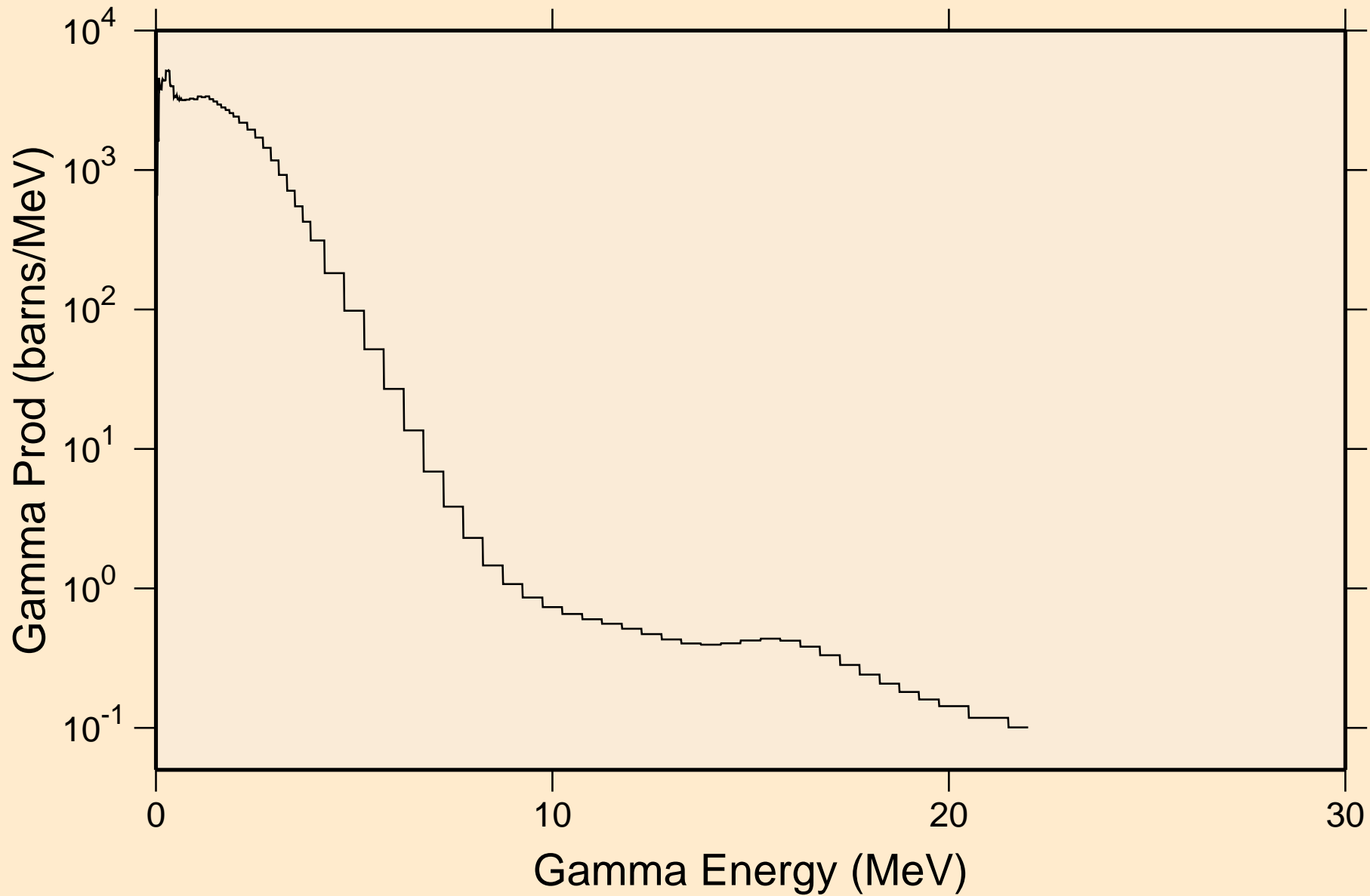

ER167M NEUTRON ACER TENDL-2023 LIBRARY; T=0.K
Particle heating contributions

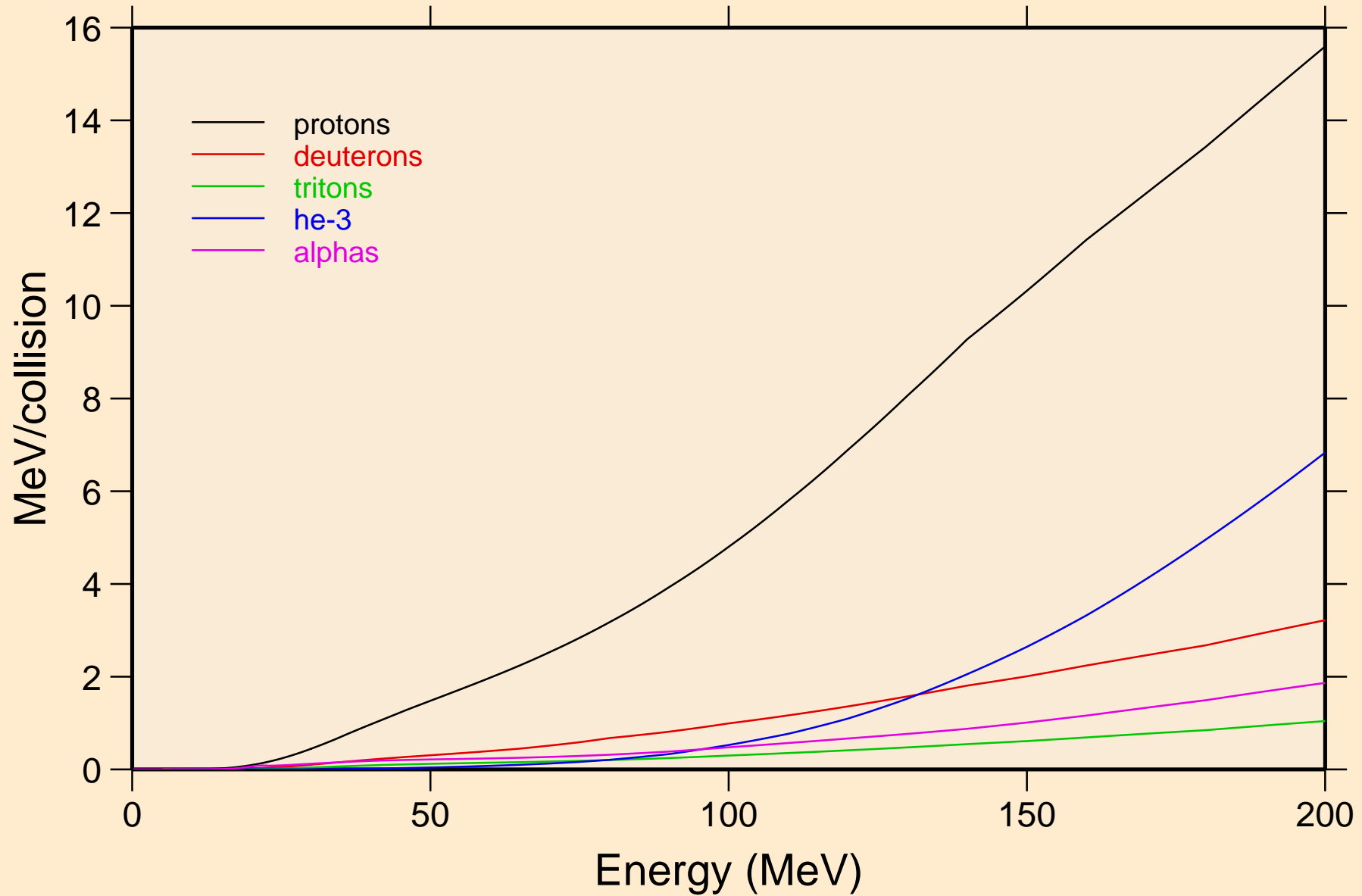

ER167M NEUTRON ACER TENDL-2023 LIBRARY; T=0.K
Recoil Heating

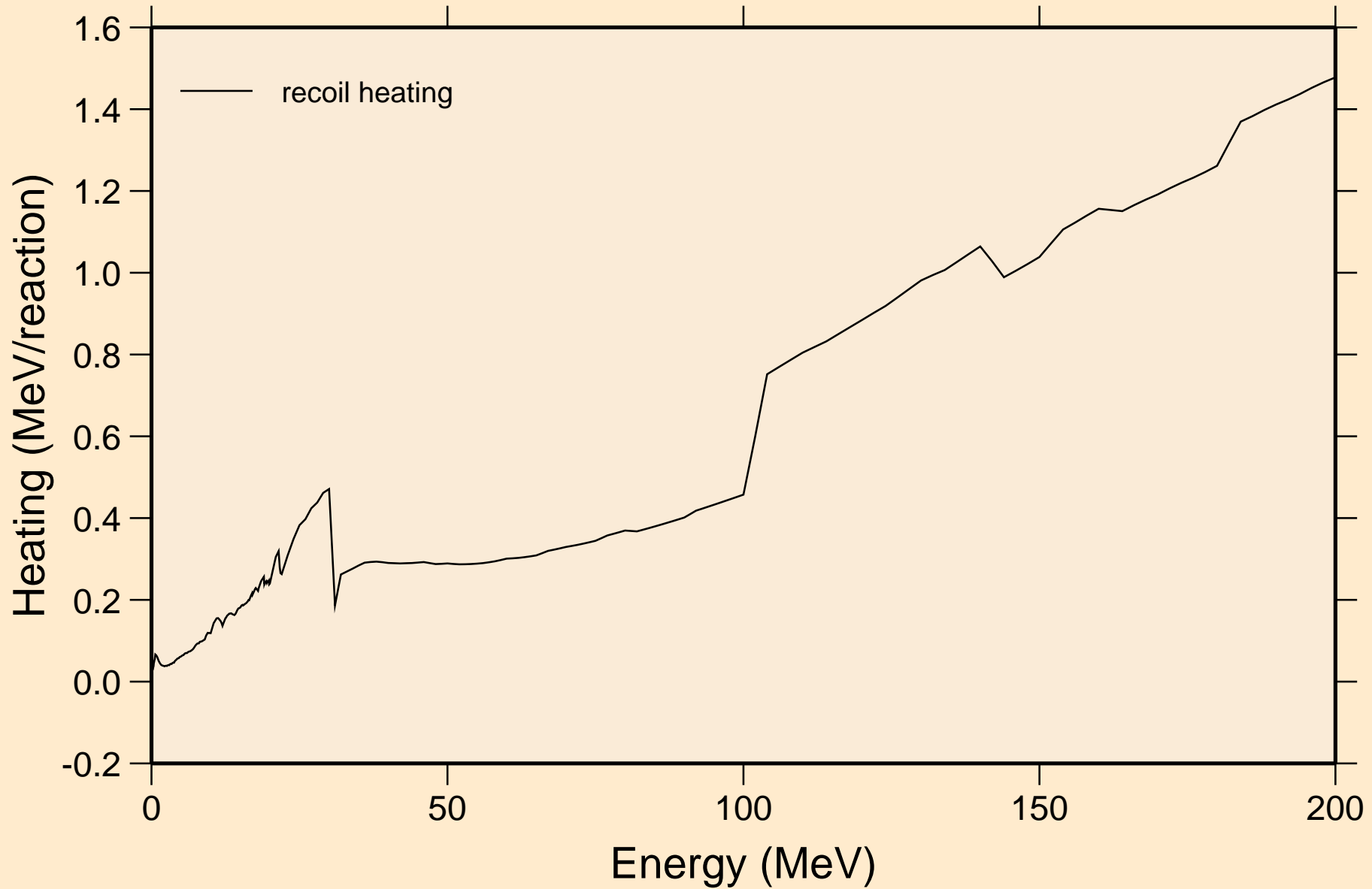

ER167M NEUTRON ACER TENDL-2023 LIBRARY; T=0.K
Particle production cross sections

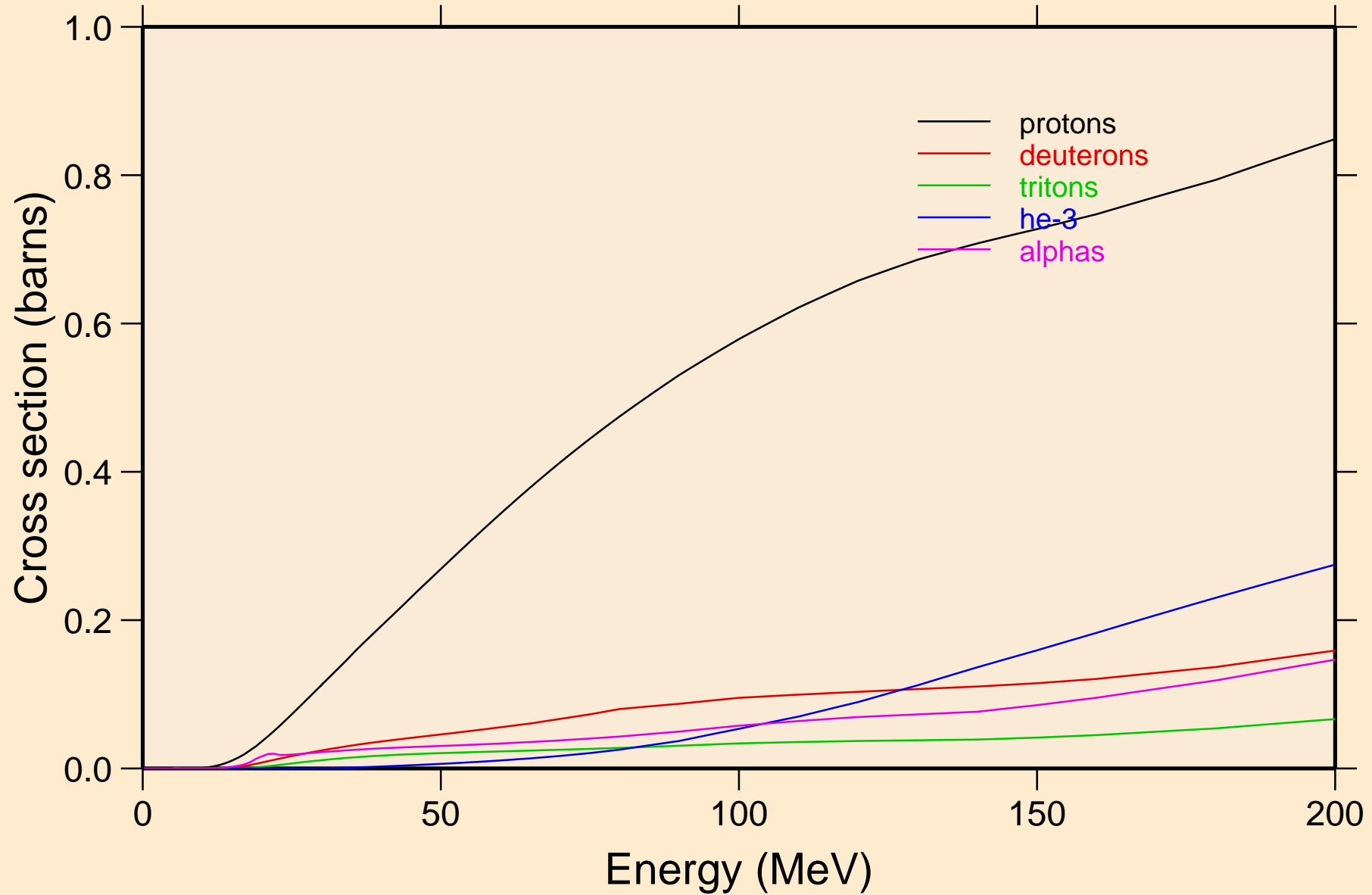

ER167M NEUTRON ACER TENDL-2023 LIBRARY; T=0.K
protons from (n,x)

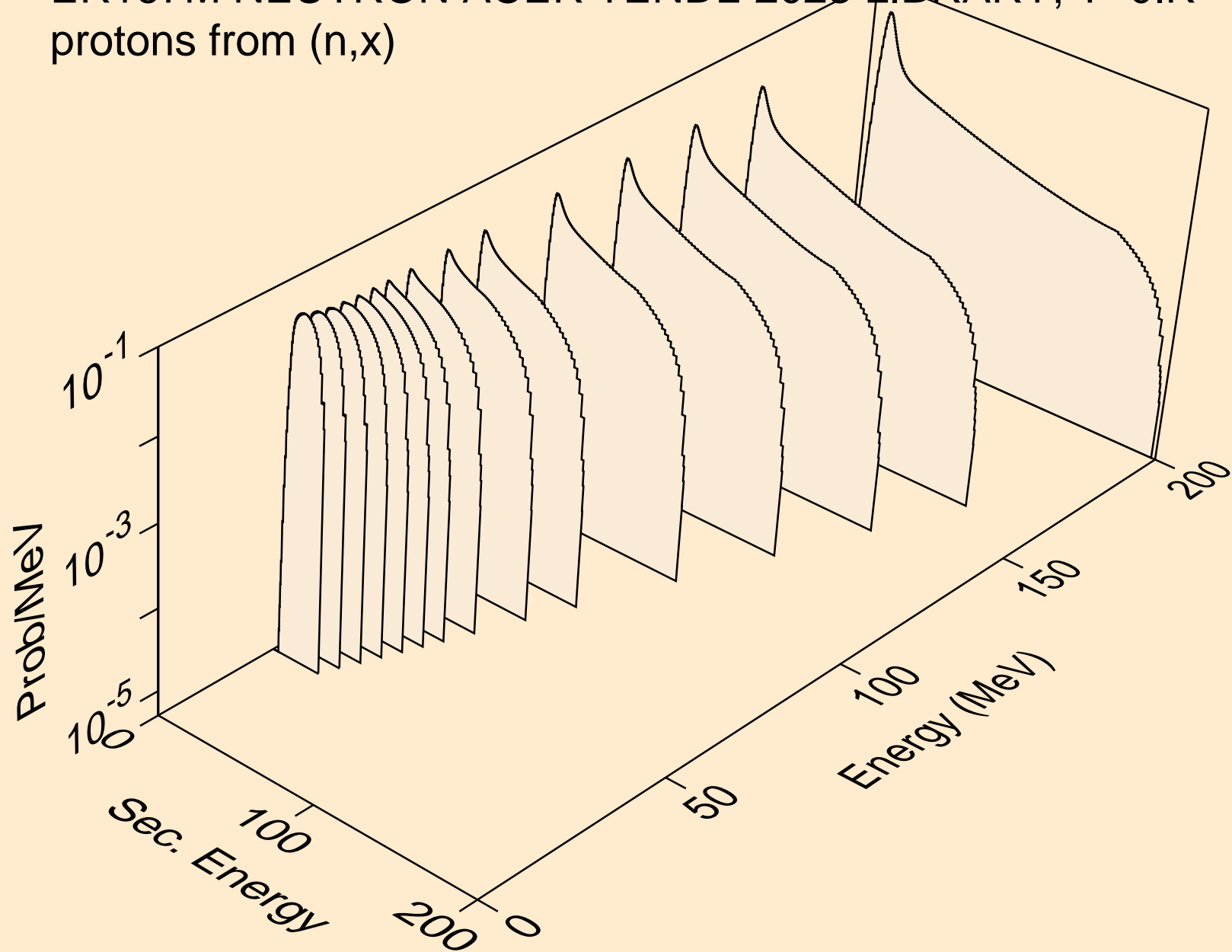

ER167M NEUTRON ACER TENDL-2023 LIBRARY; T=0.K
protons from (n,n*)p

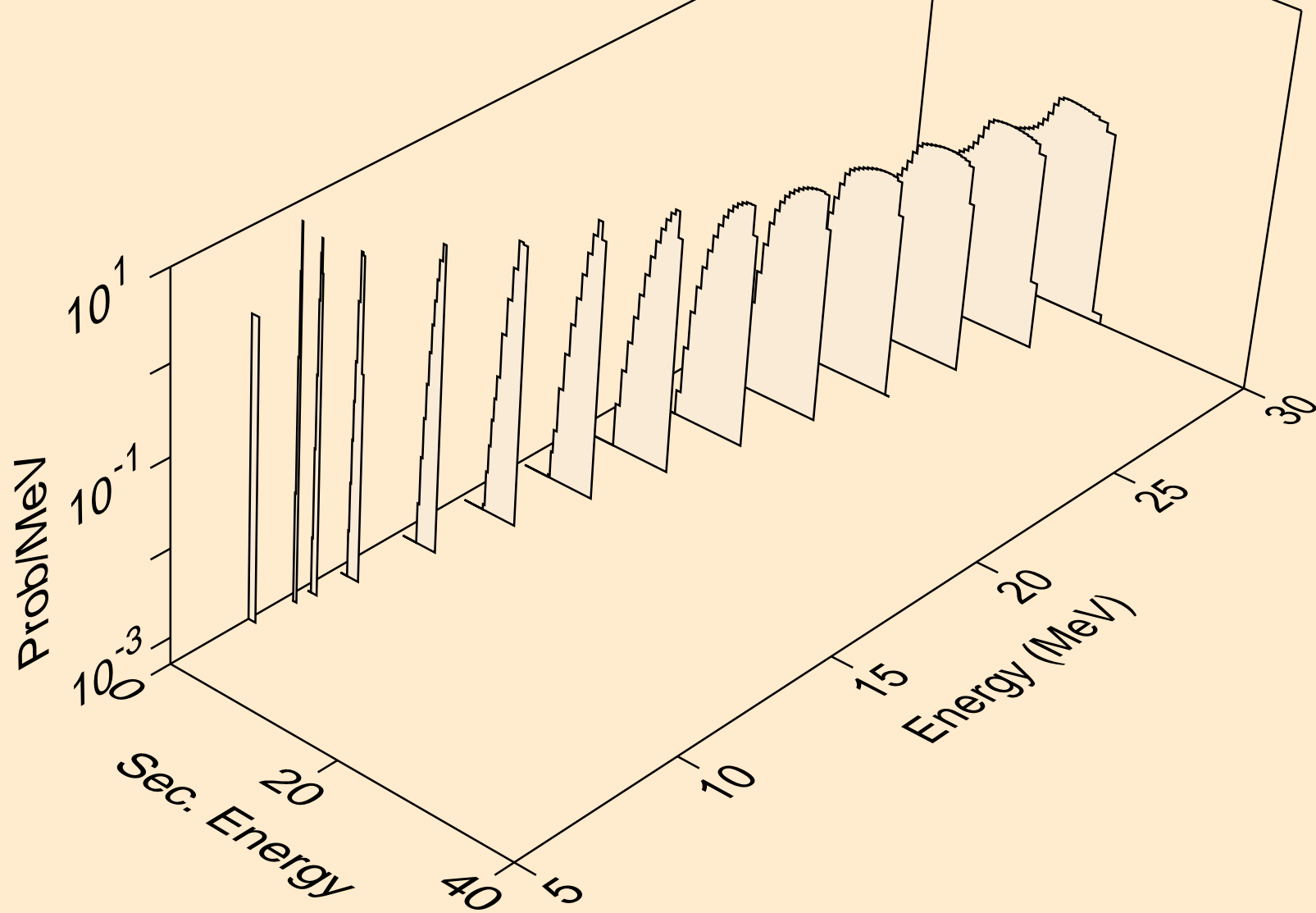

ER167M NEUTRON ACER TENDL-2023 LIBRARY; T=0.K
protons from (n,2np)

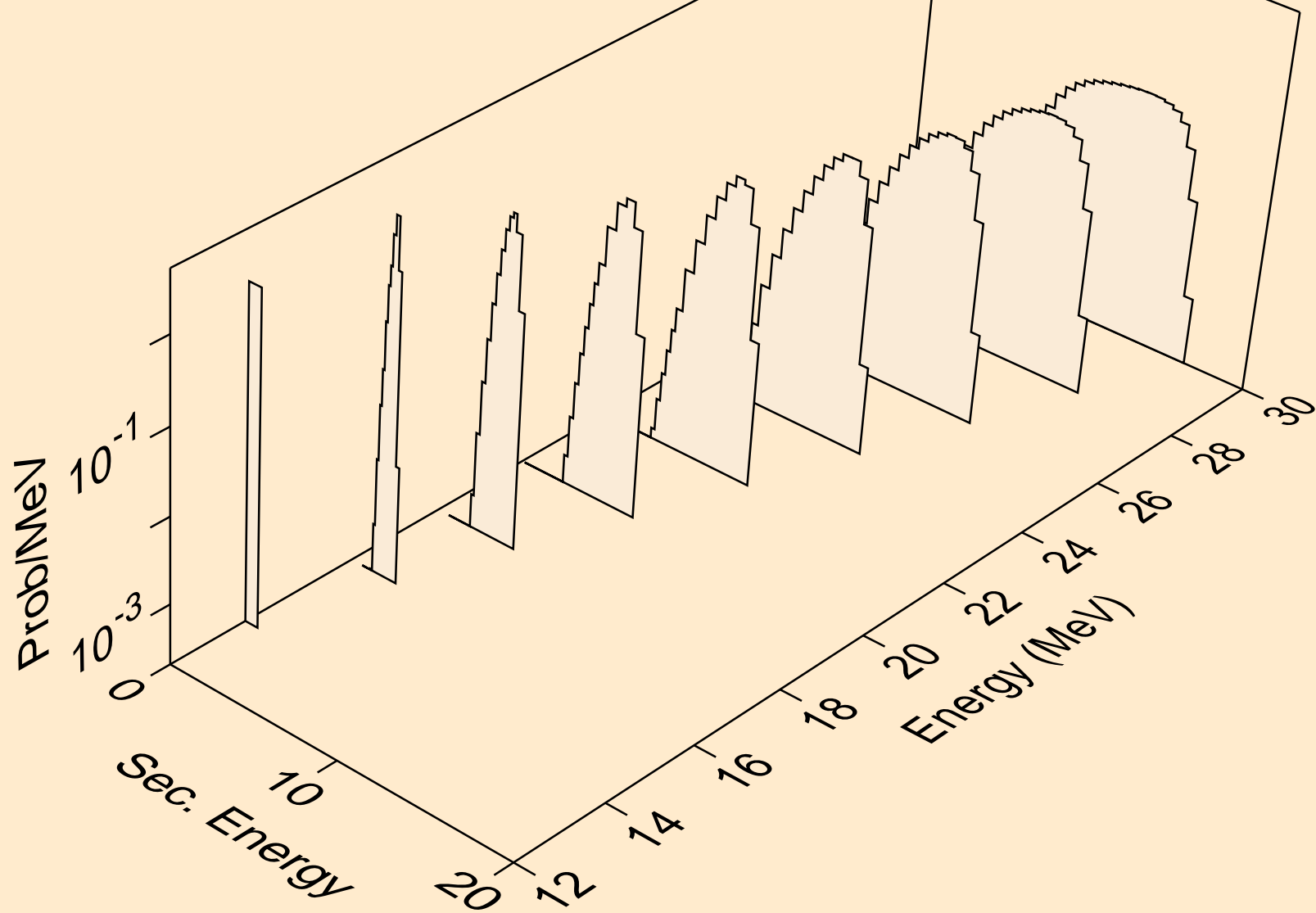

ER167M NEUTRON ACER TENDL-2023 LIBRARY; T=0.K
protons from (n,3np)

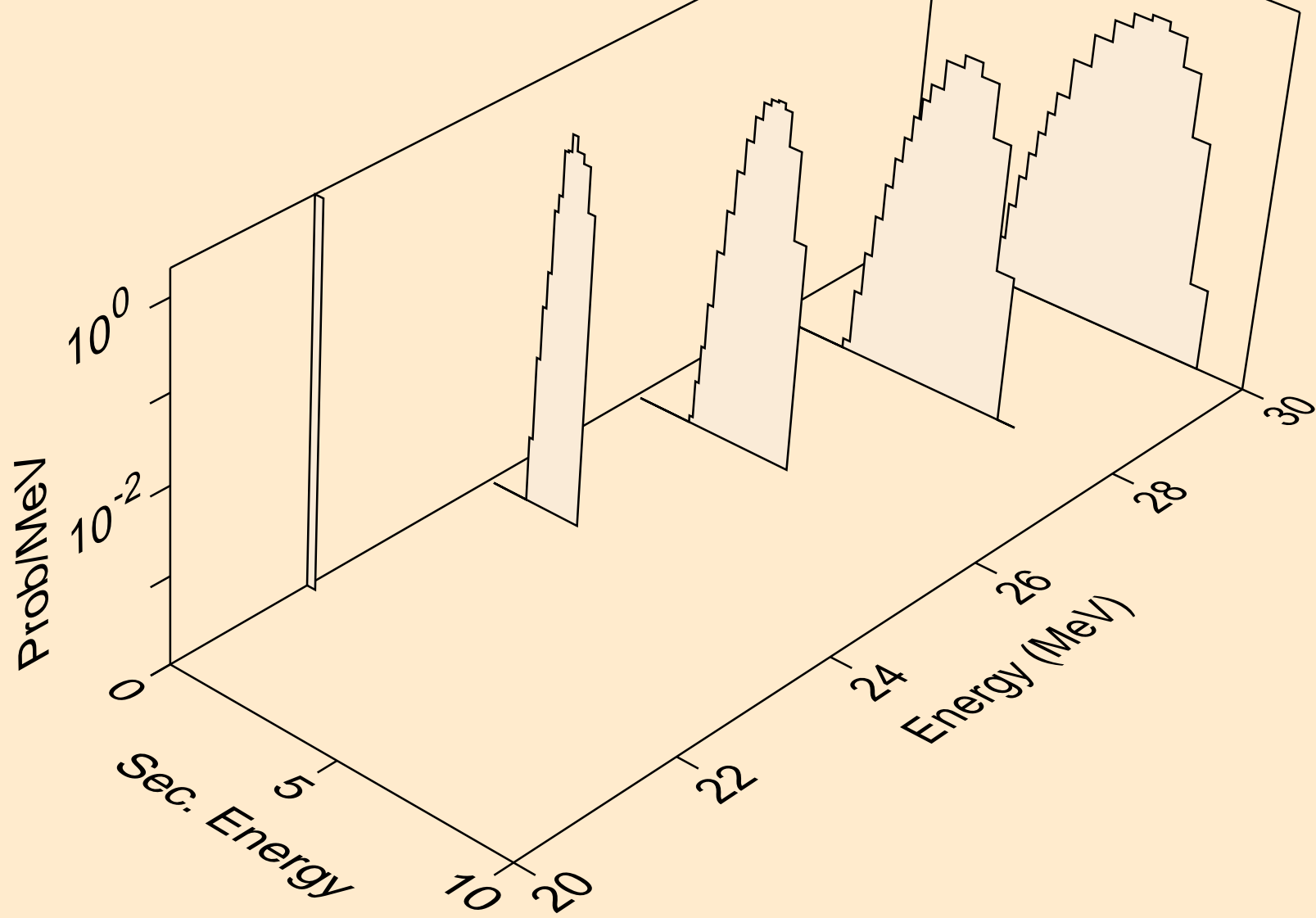

ER167M NEUTRON ACER TENDL-2023 LIBRARY; T=0.K
protons from (n,n2p)

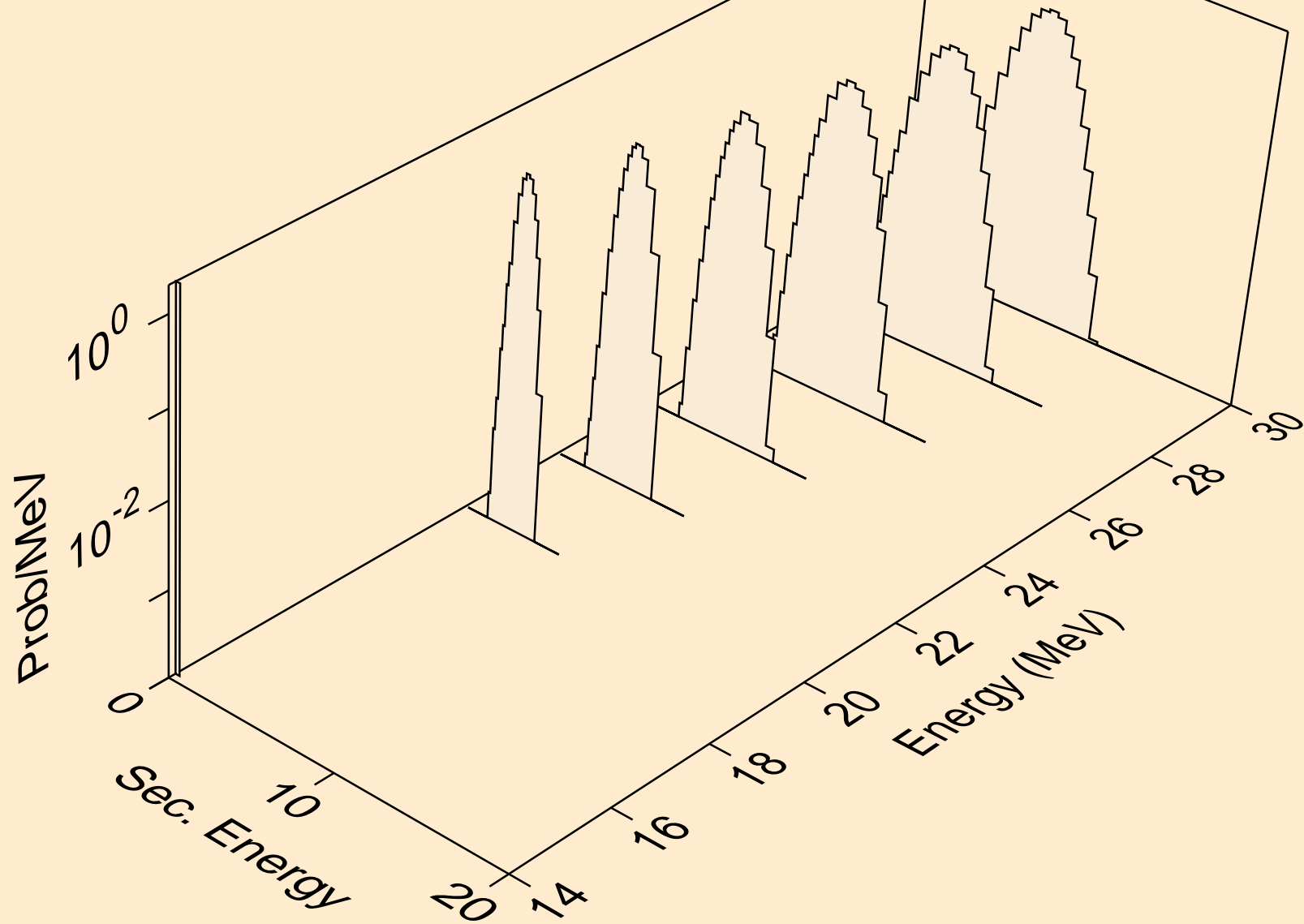

ER167M NEUTRON ACER TENDL-2023 LIBRARY; T=0.K
protons from (n,npa)

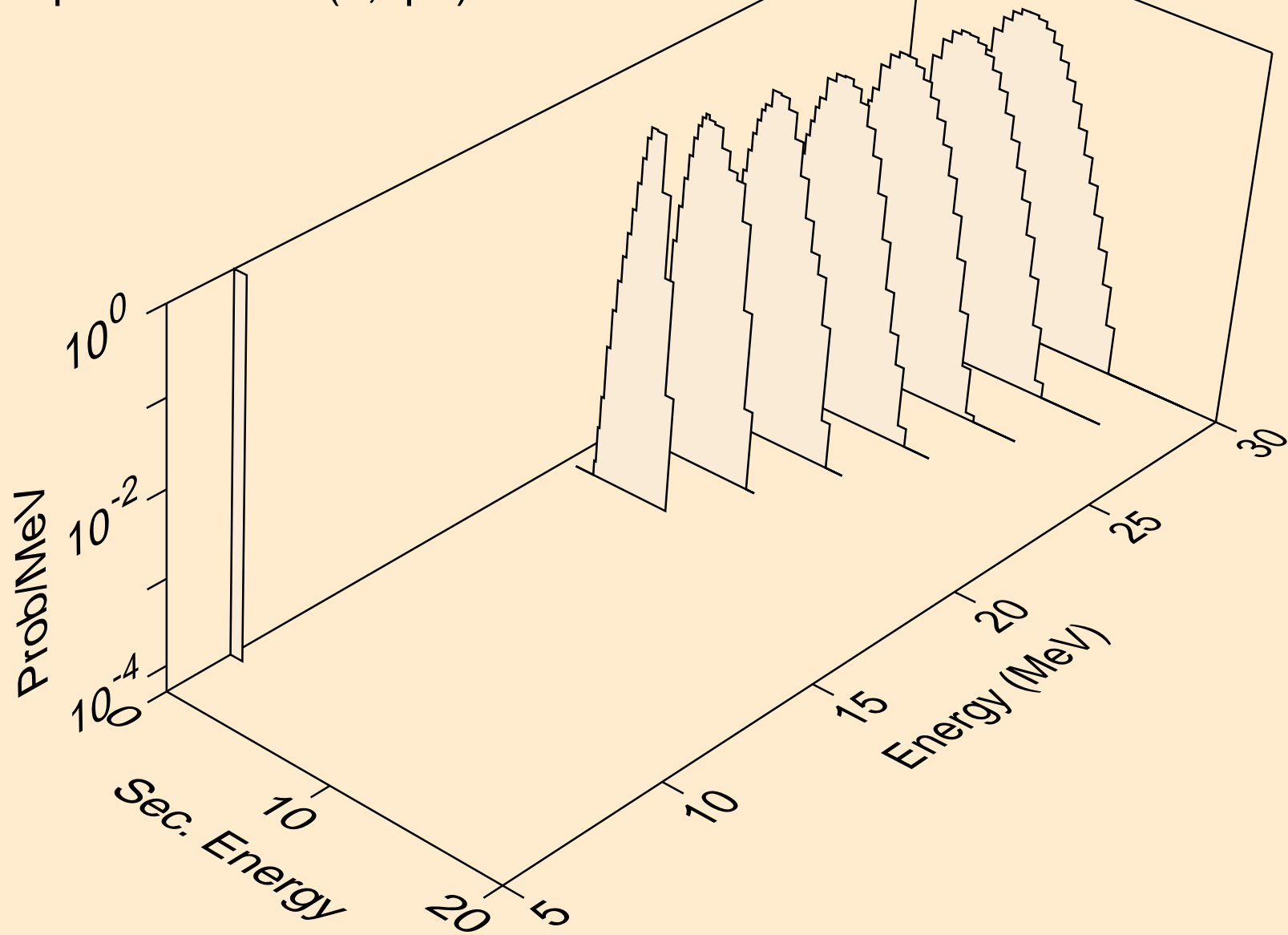

ER167M NEUTRON ACER TENDL-2023 LIBRARY; T=0.K
protons from (n,p)

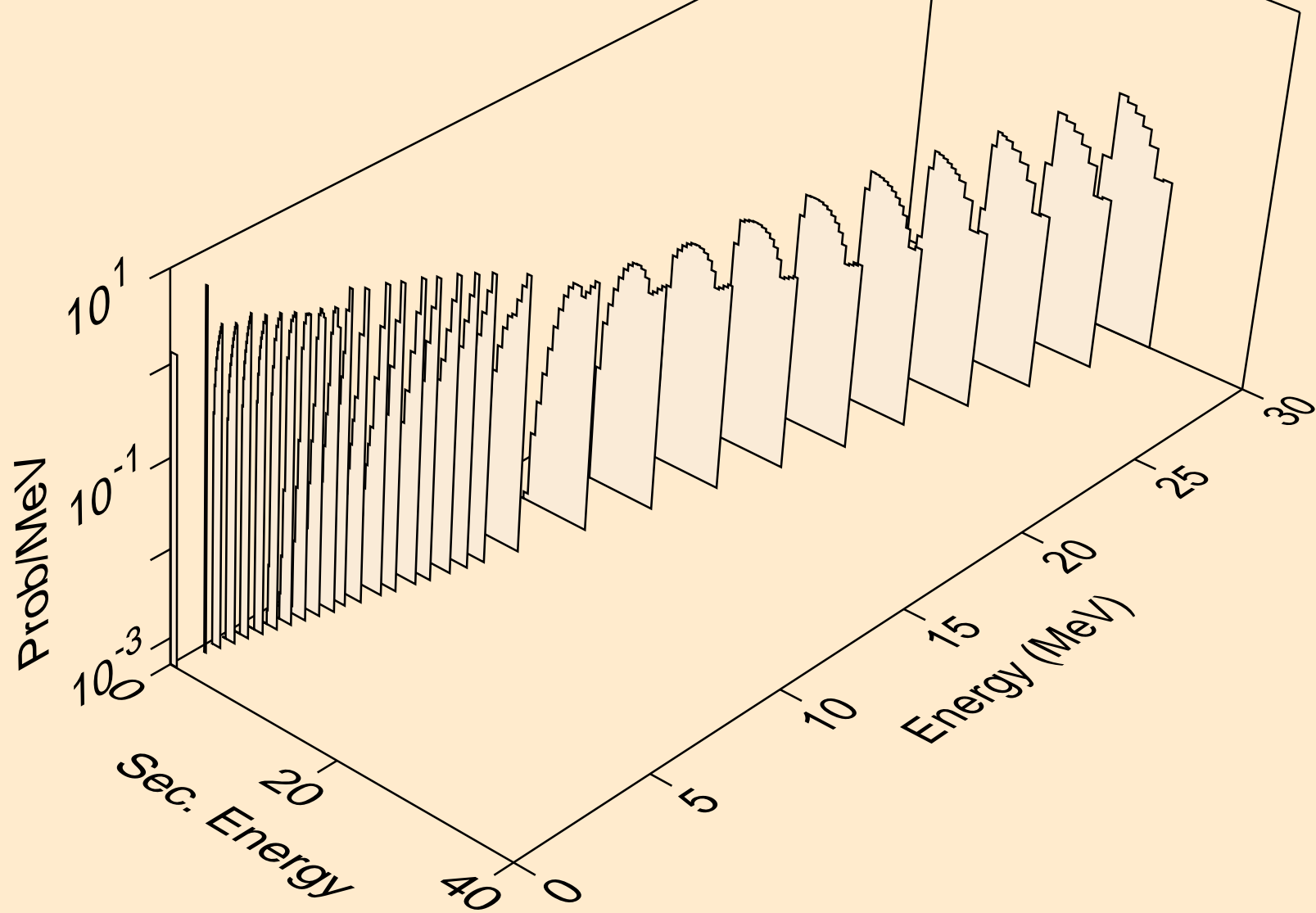

ER167M NEUTRON ACER TENDL-2023 LIBRARY; T=0.K
protons from (n,2p)

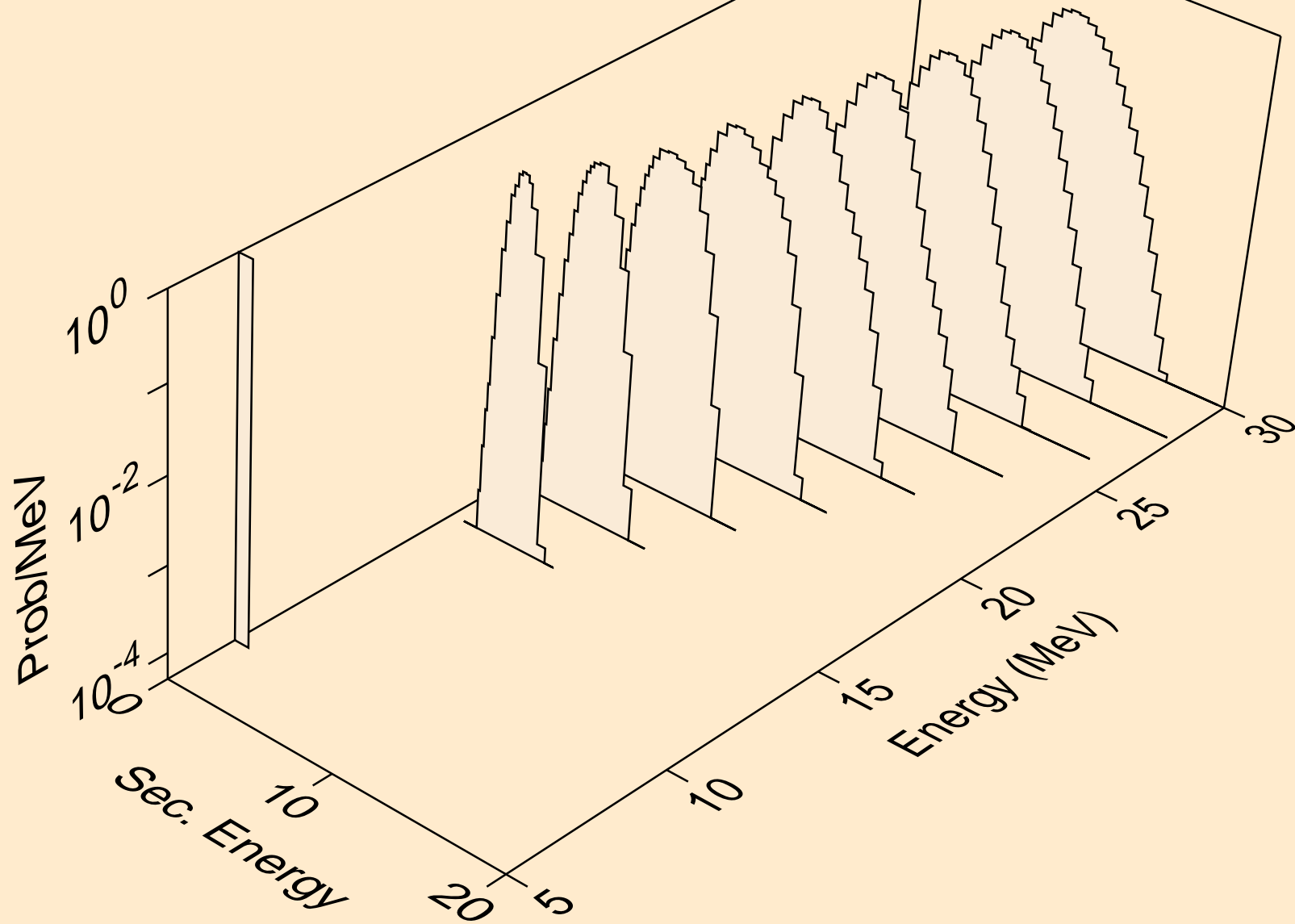

ER167M NEUTRON ACER TENDL-2023 LIBRARY; T=0.K
protons from (n,p)

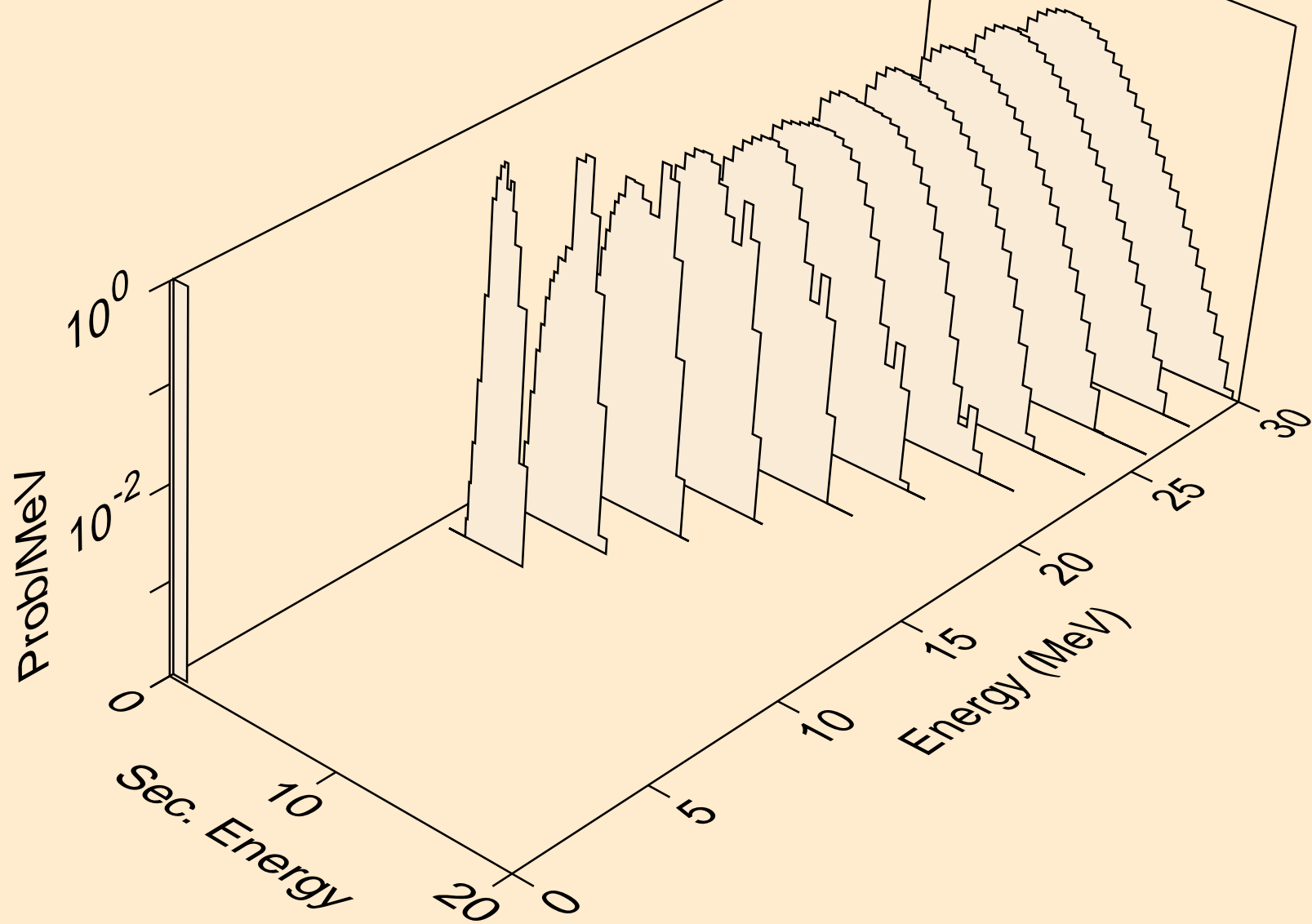

ER167M NEUTRON ACER TENDL-2023 LIBRARY; T=0.K
protons from (n,pd)

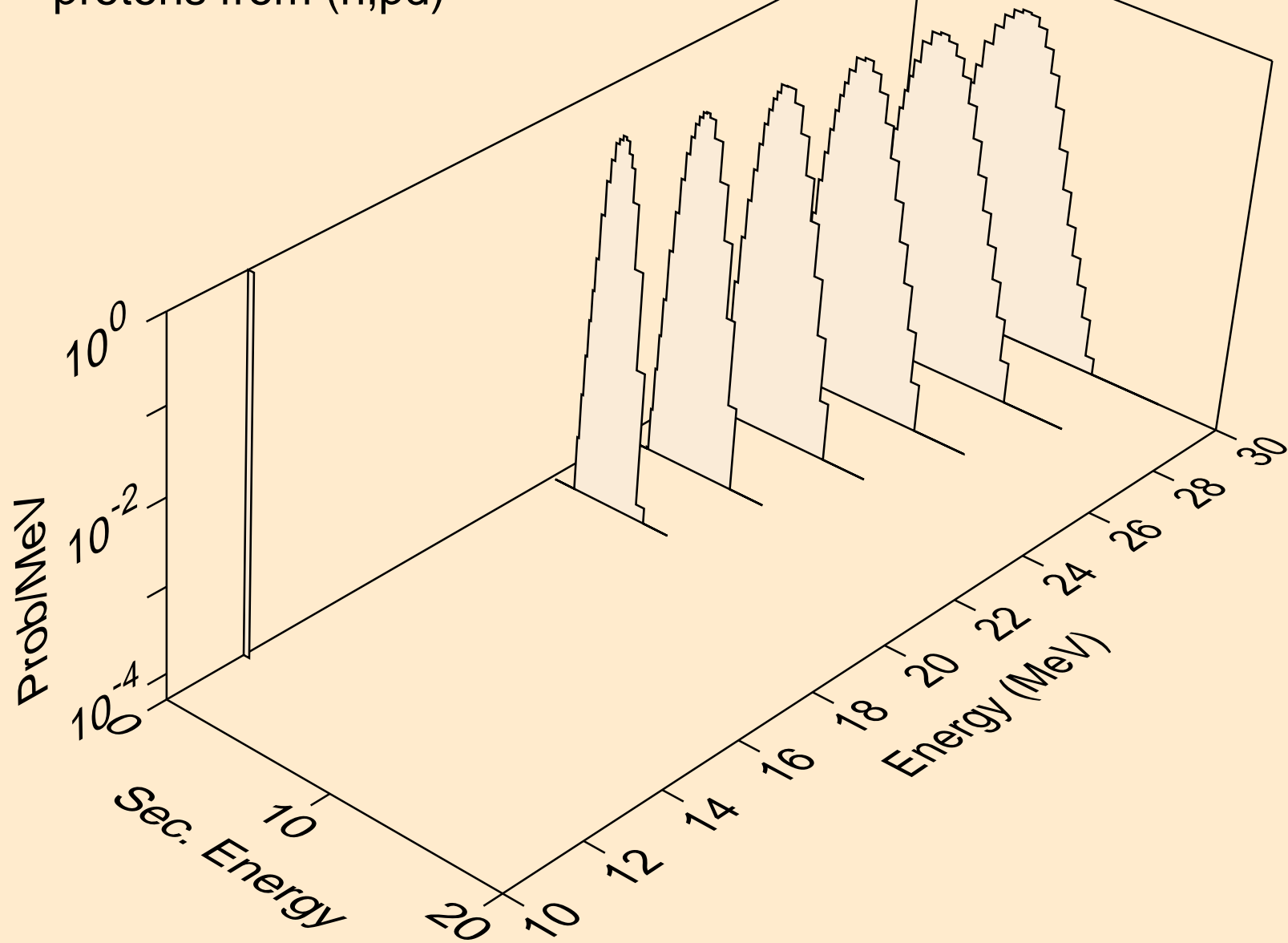

ER167M NEUTRON ACER TENDL-2023 LIBRARY; T=0.K
protons from (n,pt)

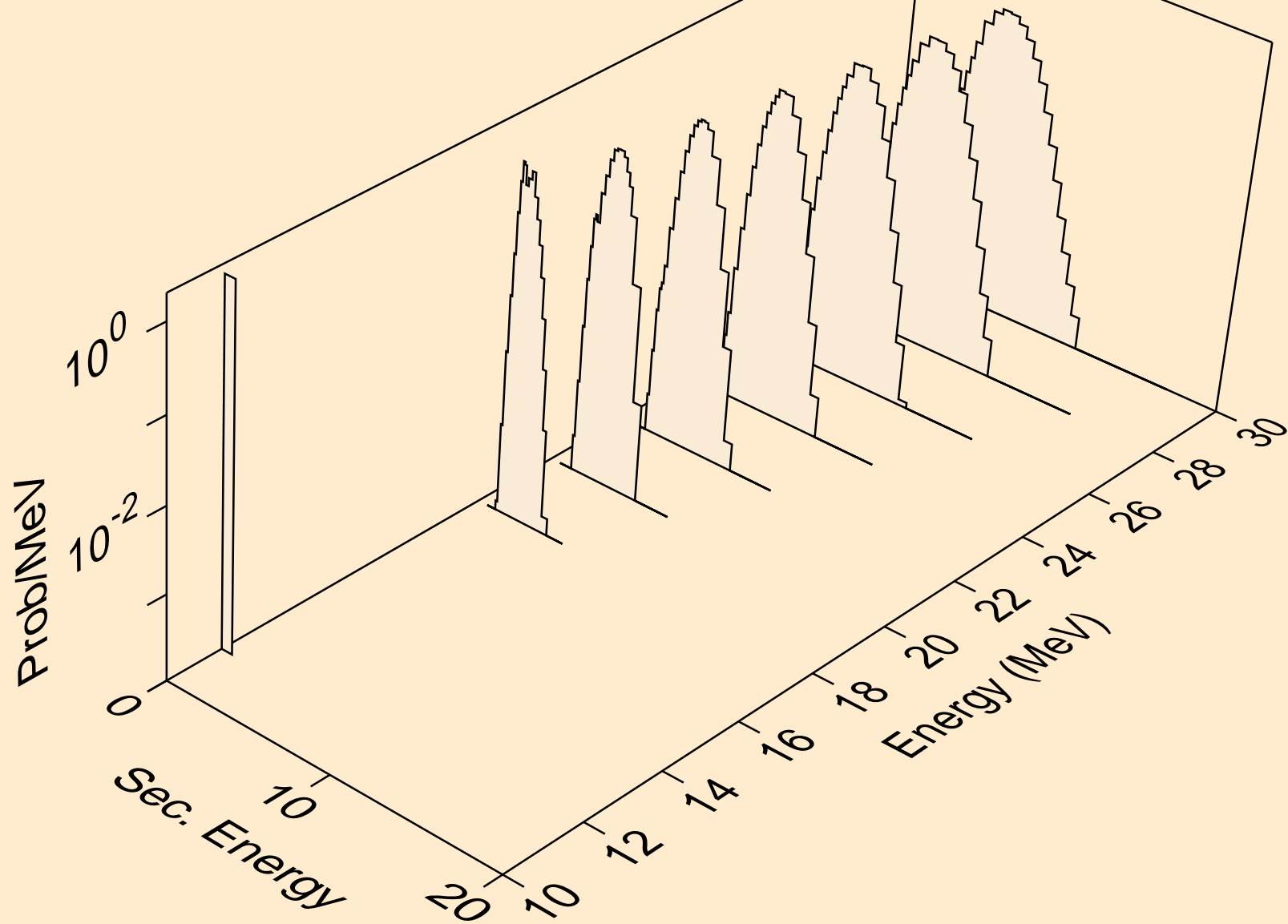

ER167M NEUTRON ACER TENDL-2023 LIBRARY; T=0.K
deuterons from (n,x)

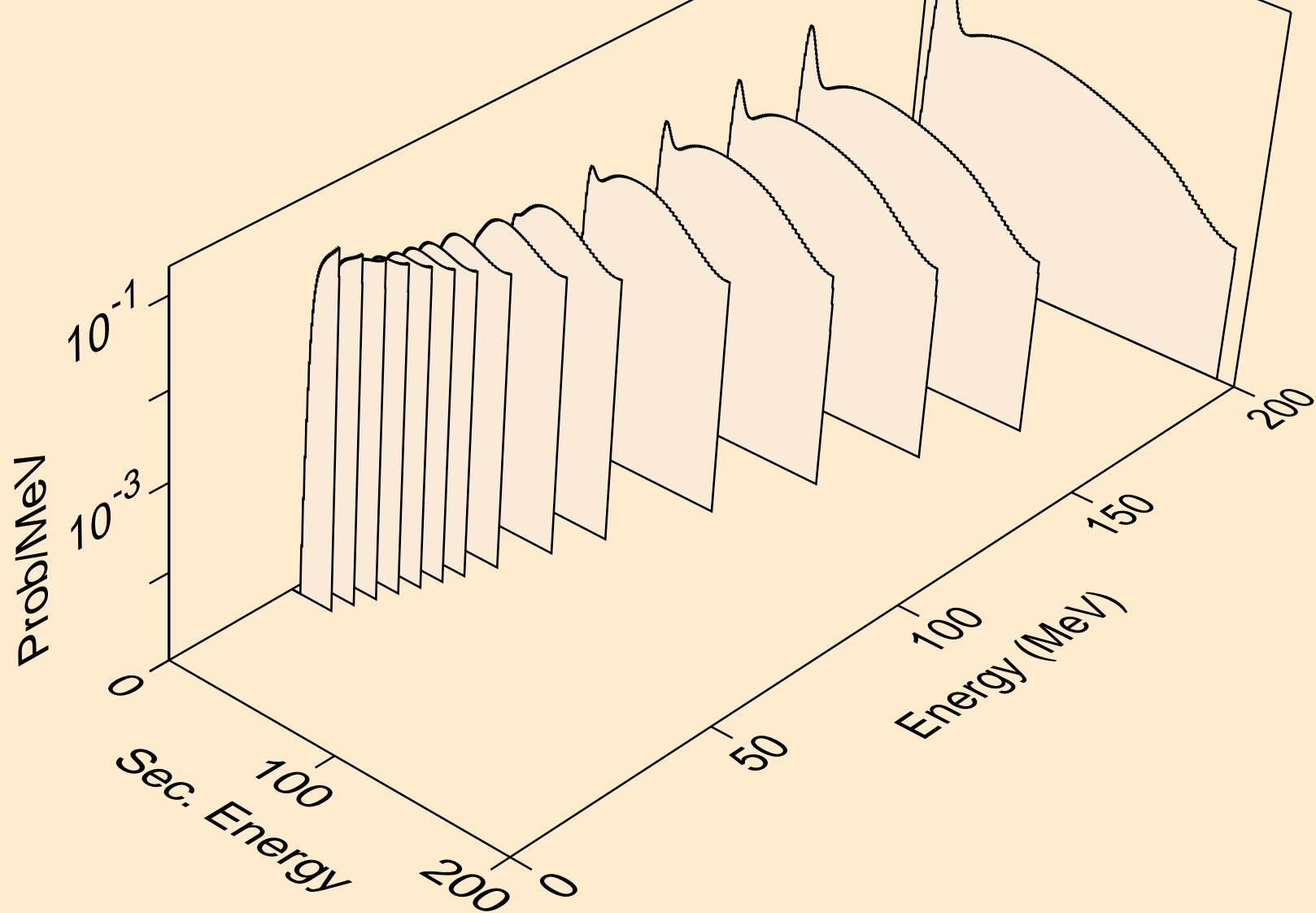

ER167M NEUTRON ACER TENDL-2023 LIBRARY; T=0.K
deuterons from (n,2nd)

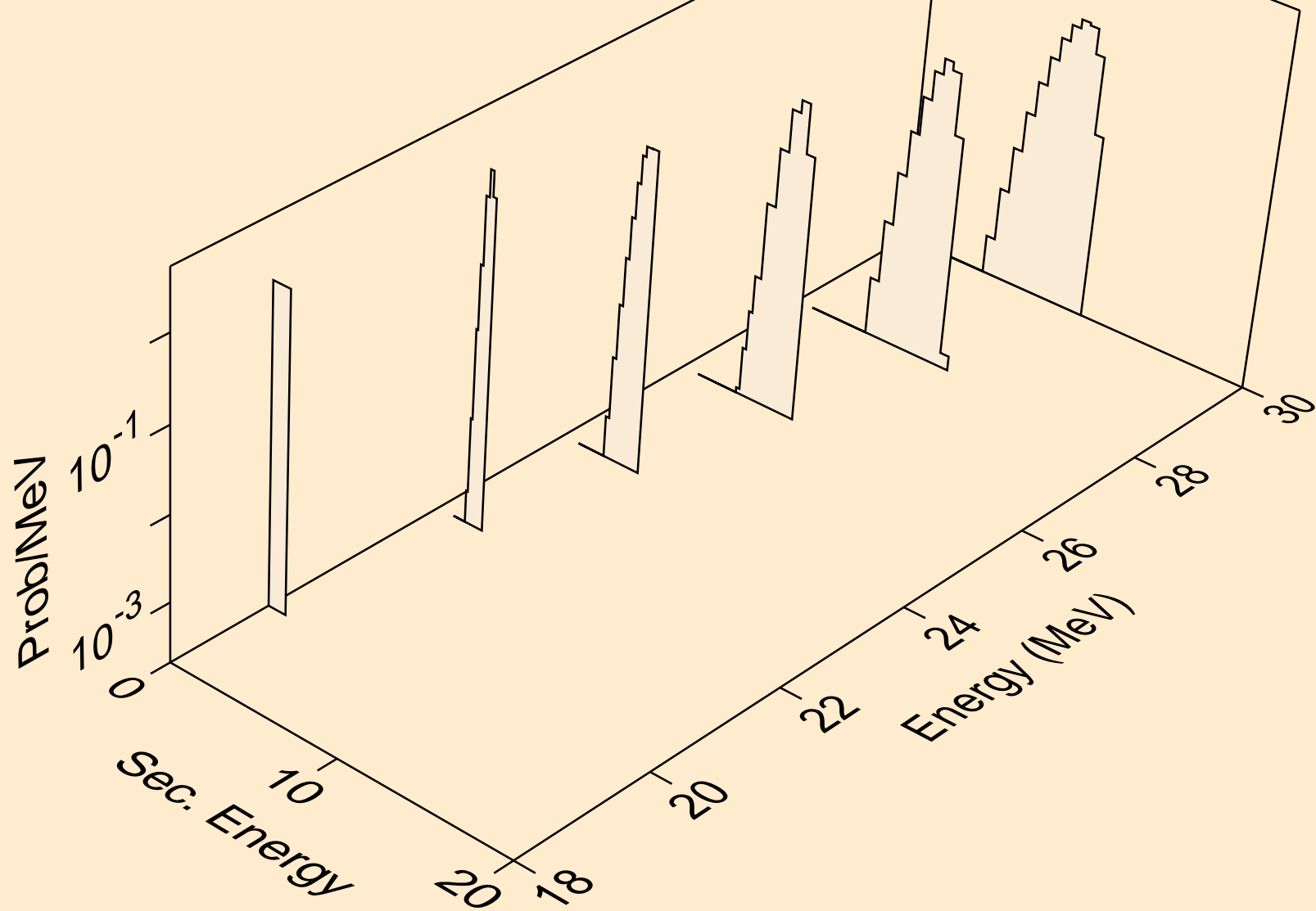

ER167M NEUTRON ACER TENDL-2023 LIBRARY; T=0.K
deuterons from (n,n*)d

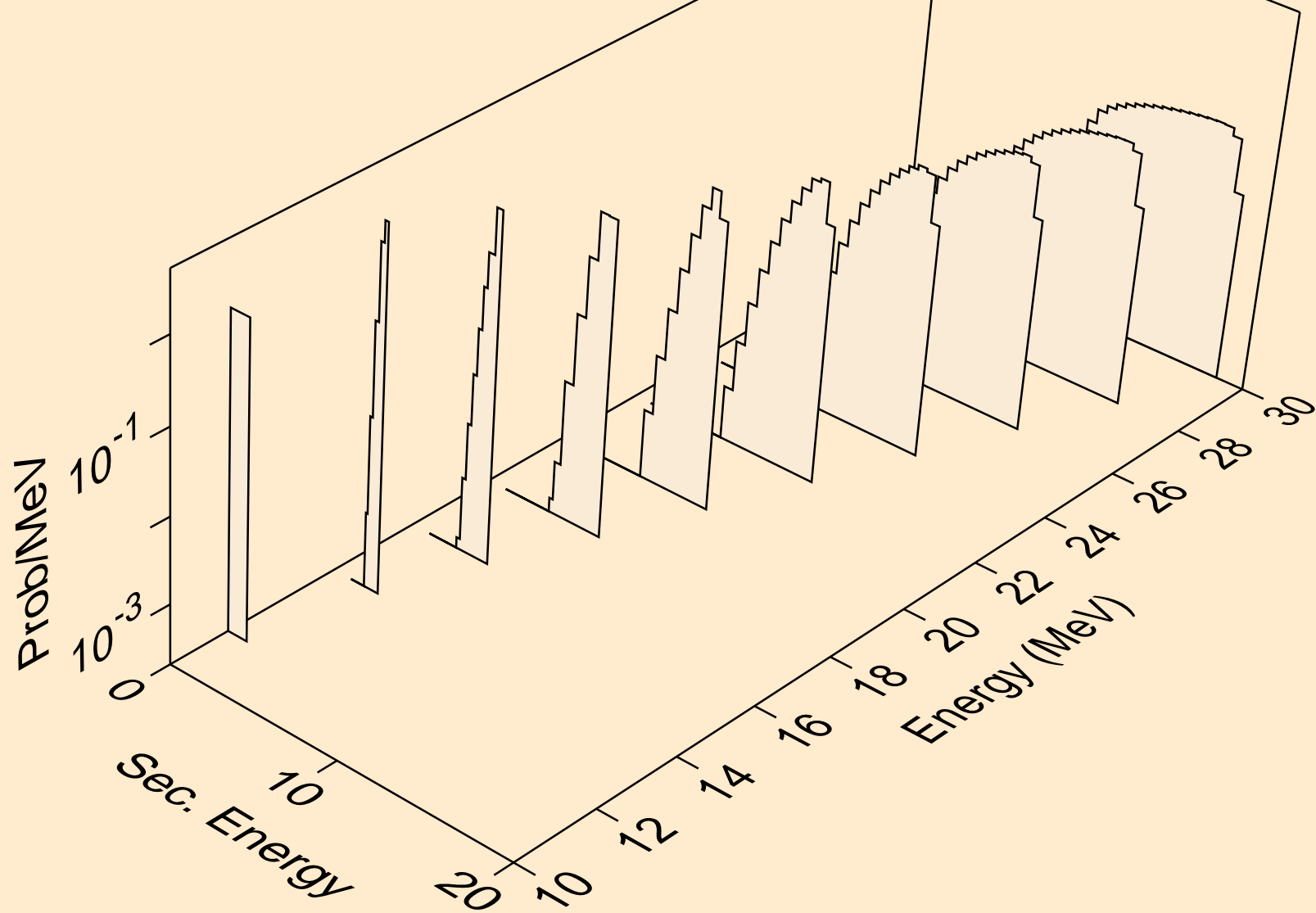

ER167M NEUTRON ACER TENDL-2023 LIBRARY; T=0.K
deuterons from (n,d)

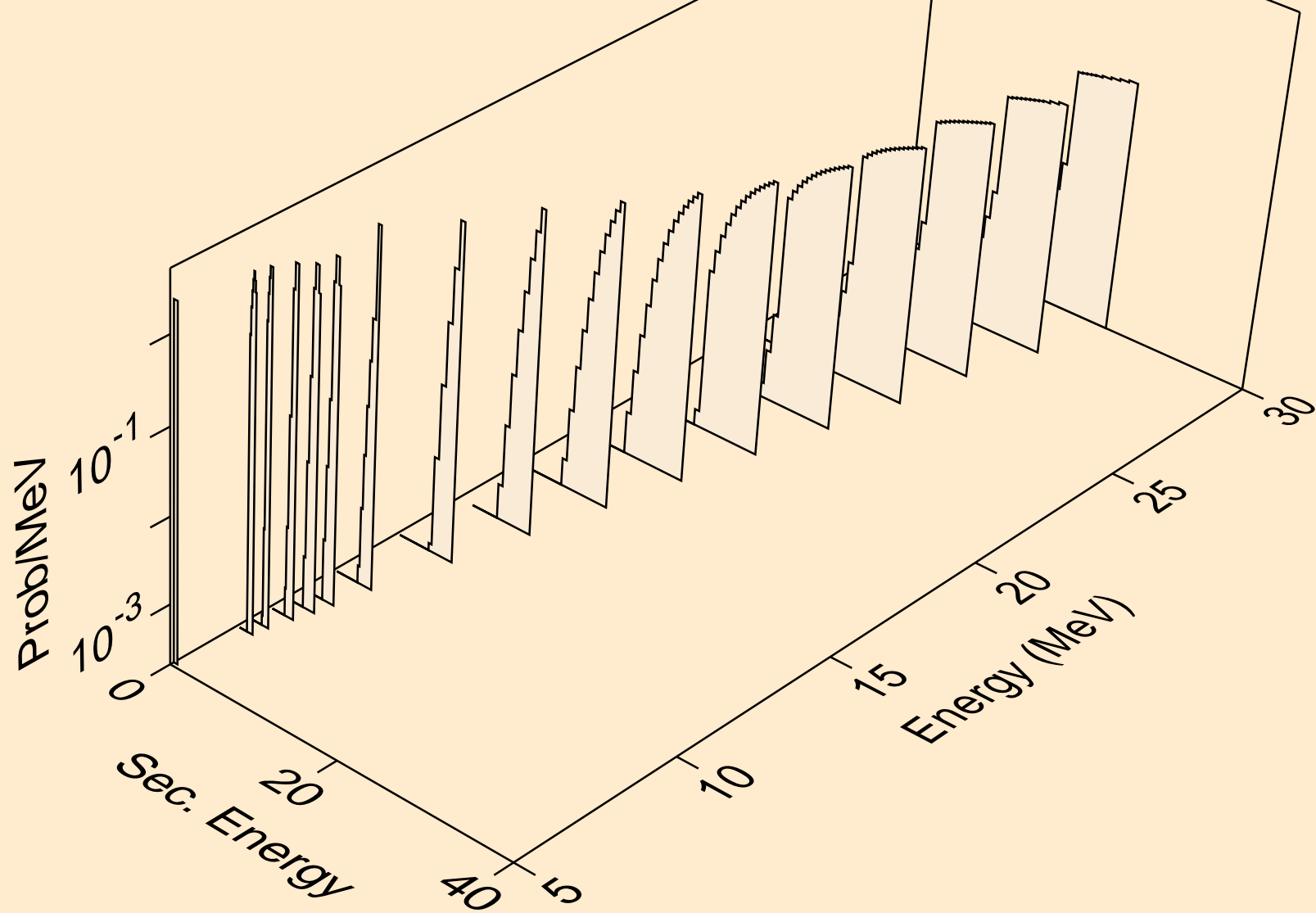

ER167M NEUTRON ACER TENDL-2023 LIBRARY; T=0.K
deuterons from (n,pd)

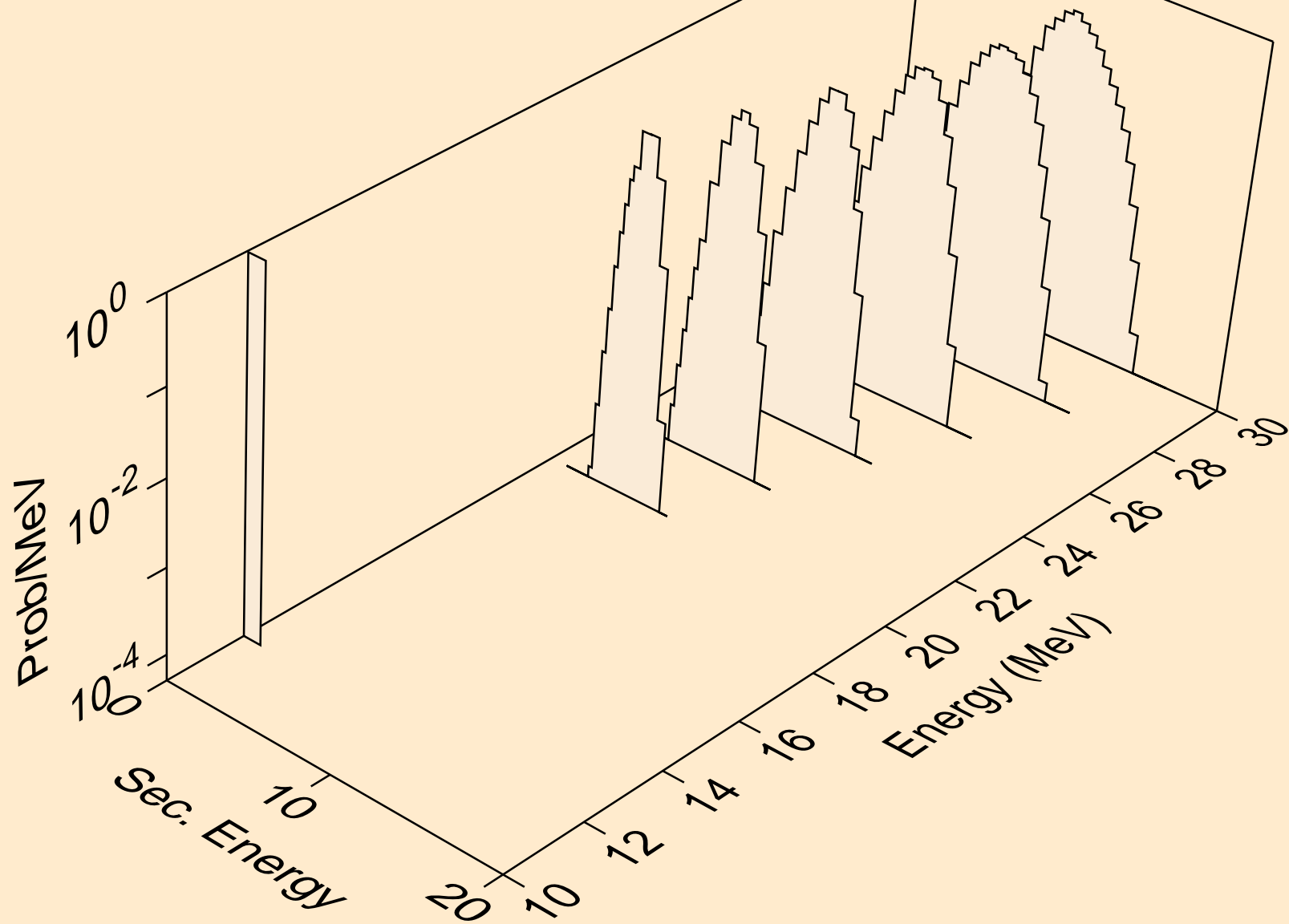

ER167M NEUTRON ACER TENDL-2023 LIBRARY; T=0.K
tritons from (n,x)

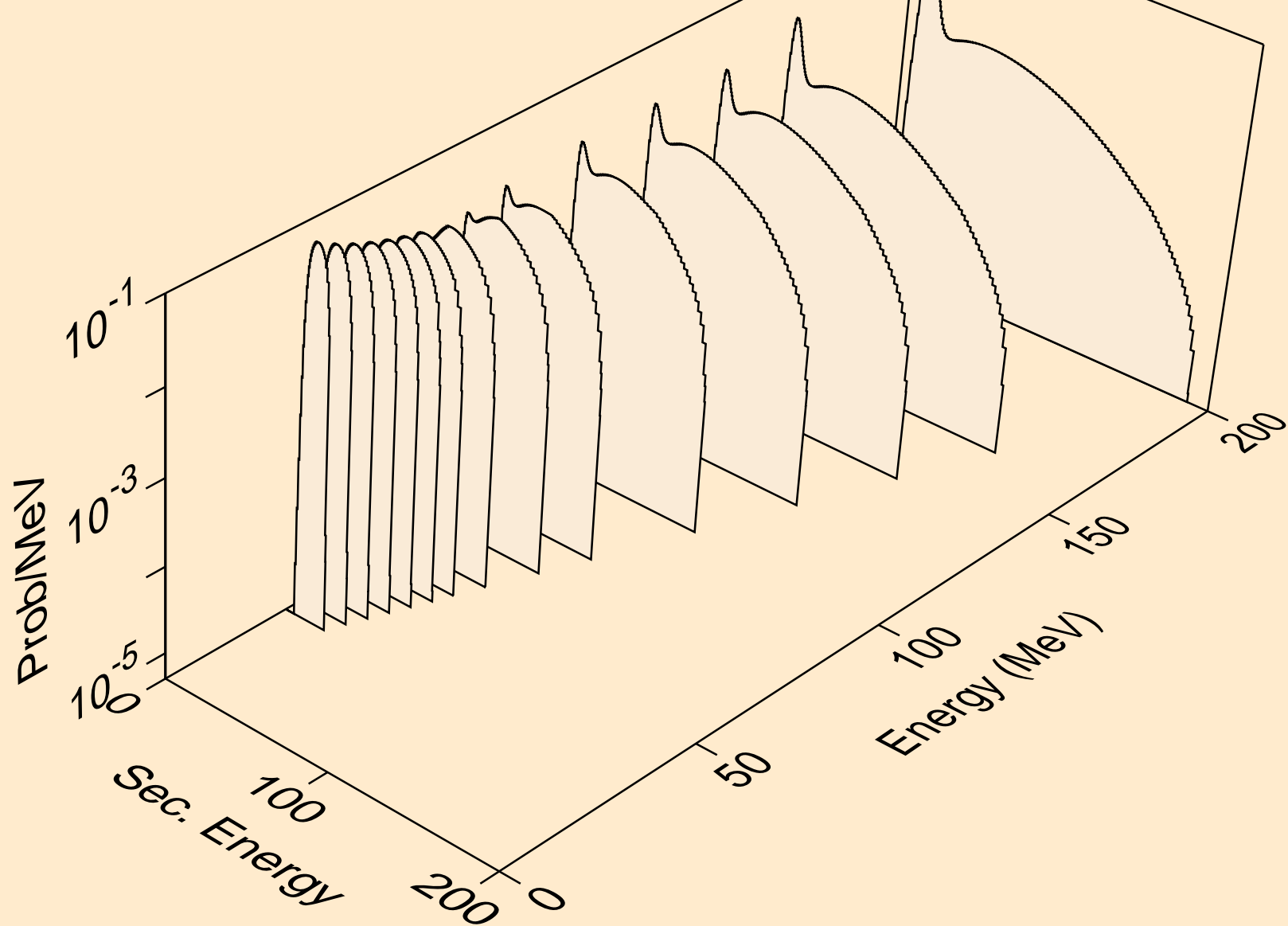

ER167M NEUTRON ACER TENDL-2023 LIBRARY; T=0.K
tritons from (n,n*)t

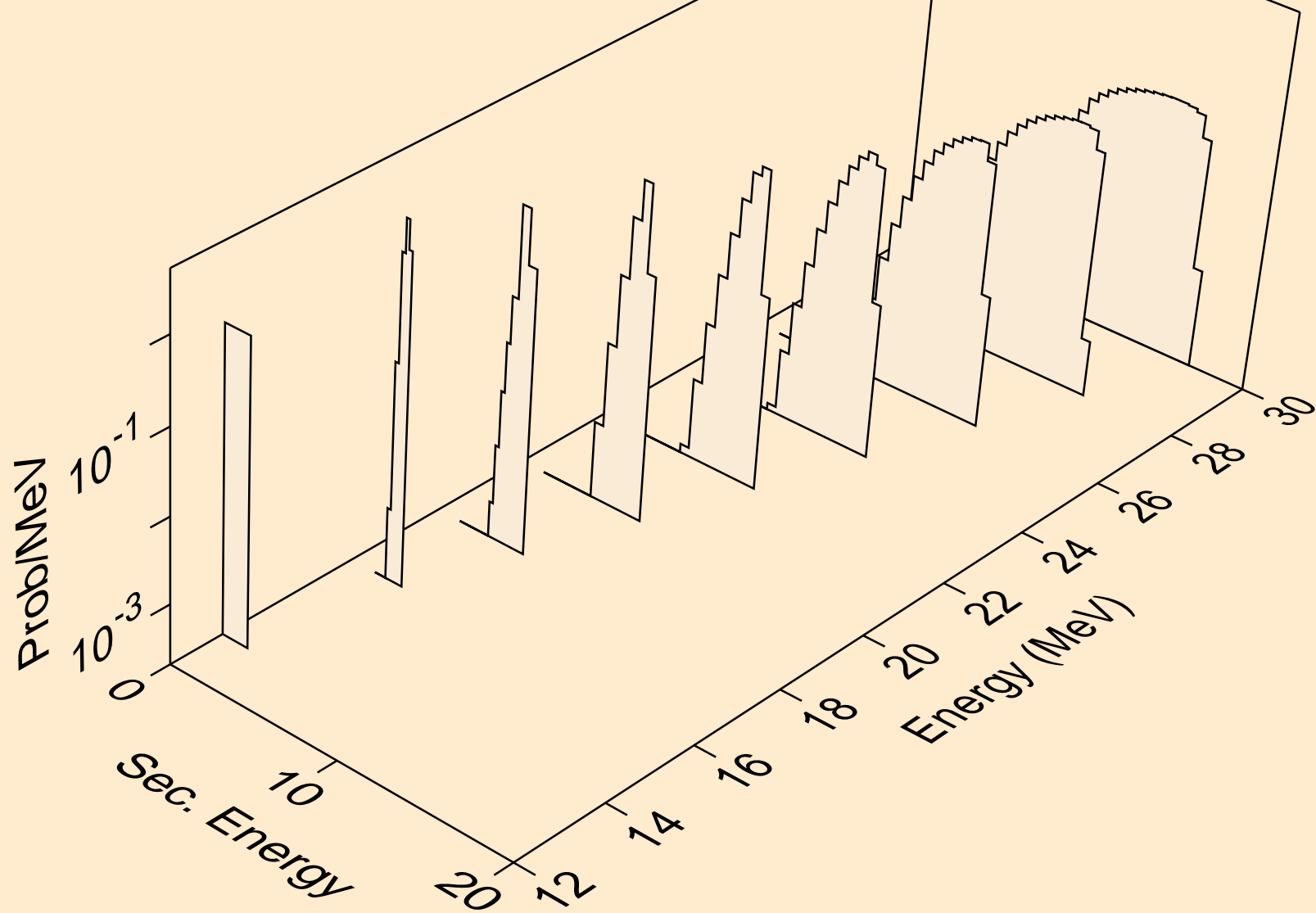

ER167M NEUTRON ACER TENDL-2023 LIBRARY; T=0.K
tritons from (n,t)

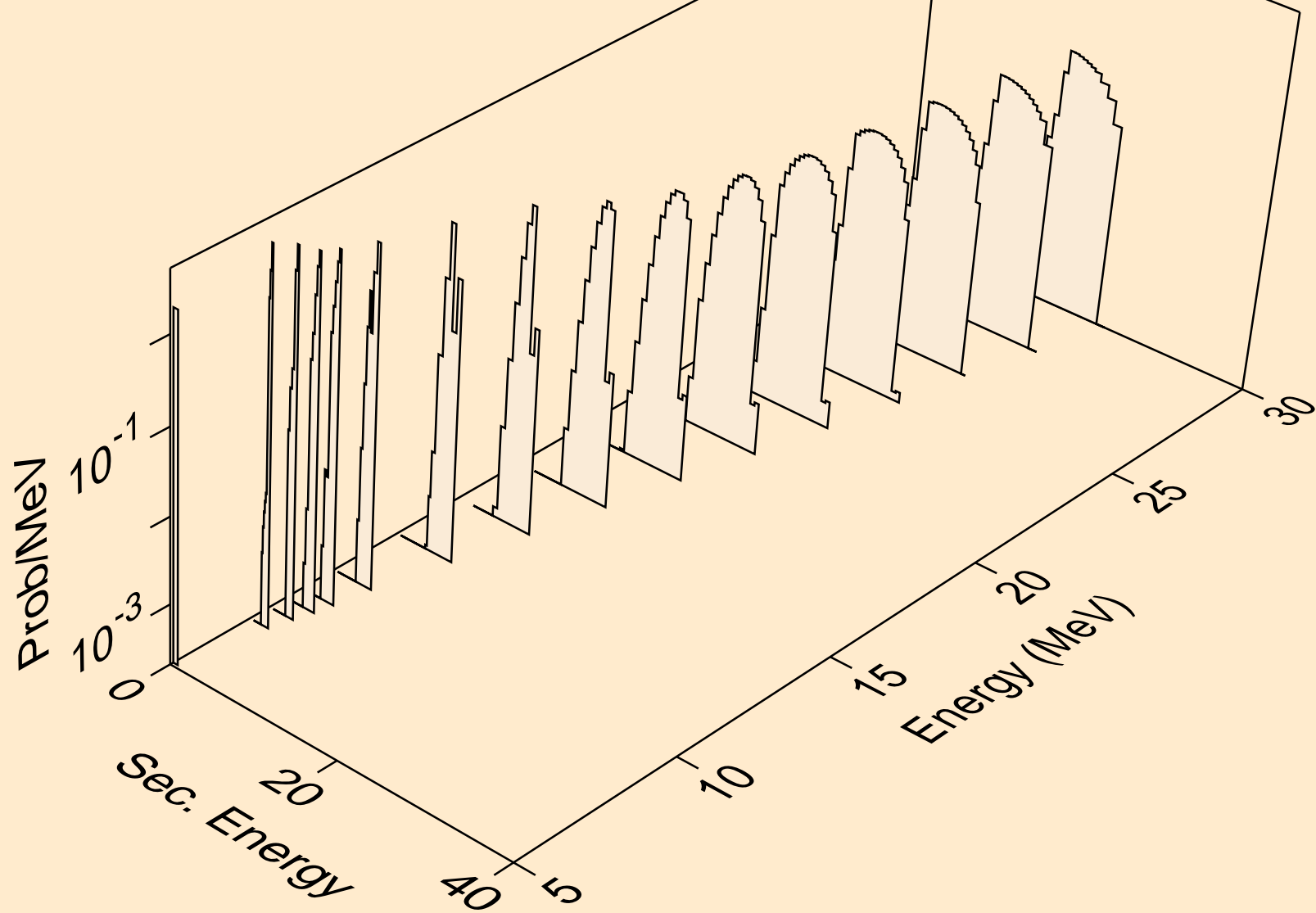

ER167M NEUTRON ACER TENDL-2023 LIBRARY; T=0.K
tritons from (n,pt)

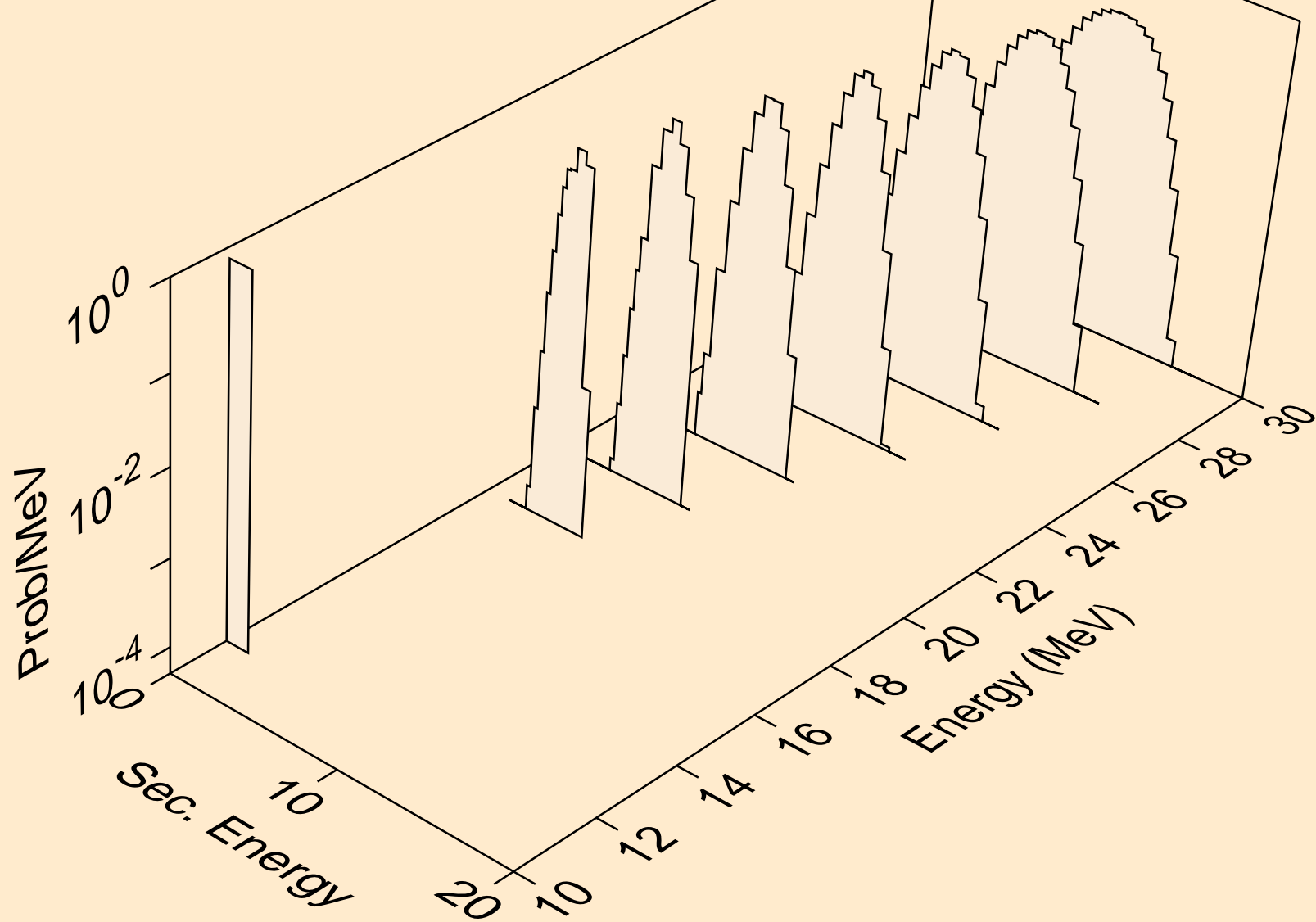

ER167M NEUTRON ACER TENDL-2023 LIBRARY; T=0.K
he3s from (n,x)

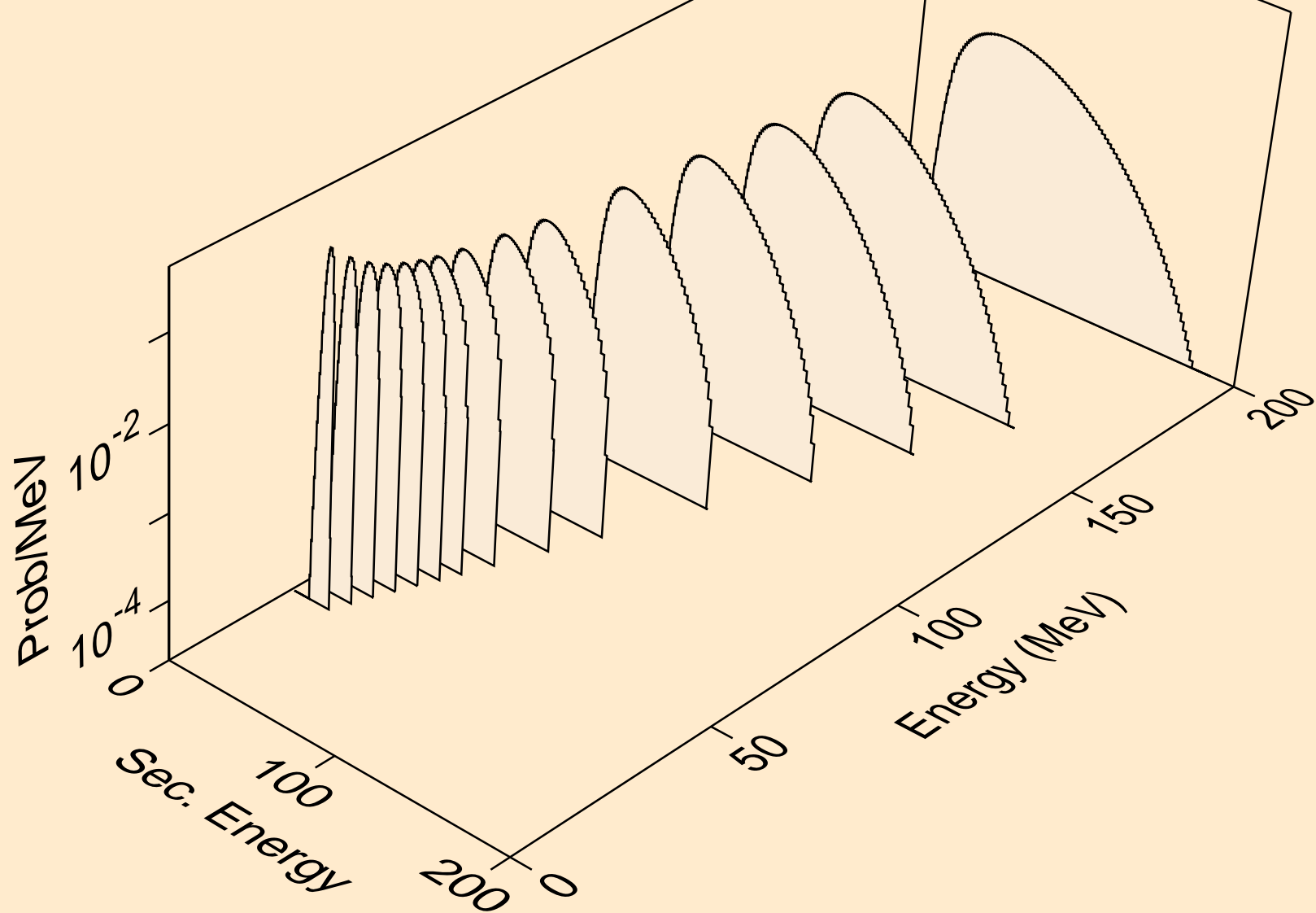

ER167M NEUTRON ACER TENDL-2023 LIBRARY; T=0.K
he3s from (n,n*)he3

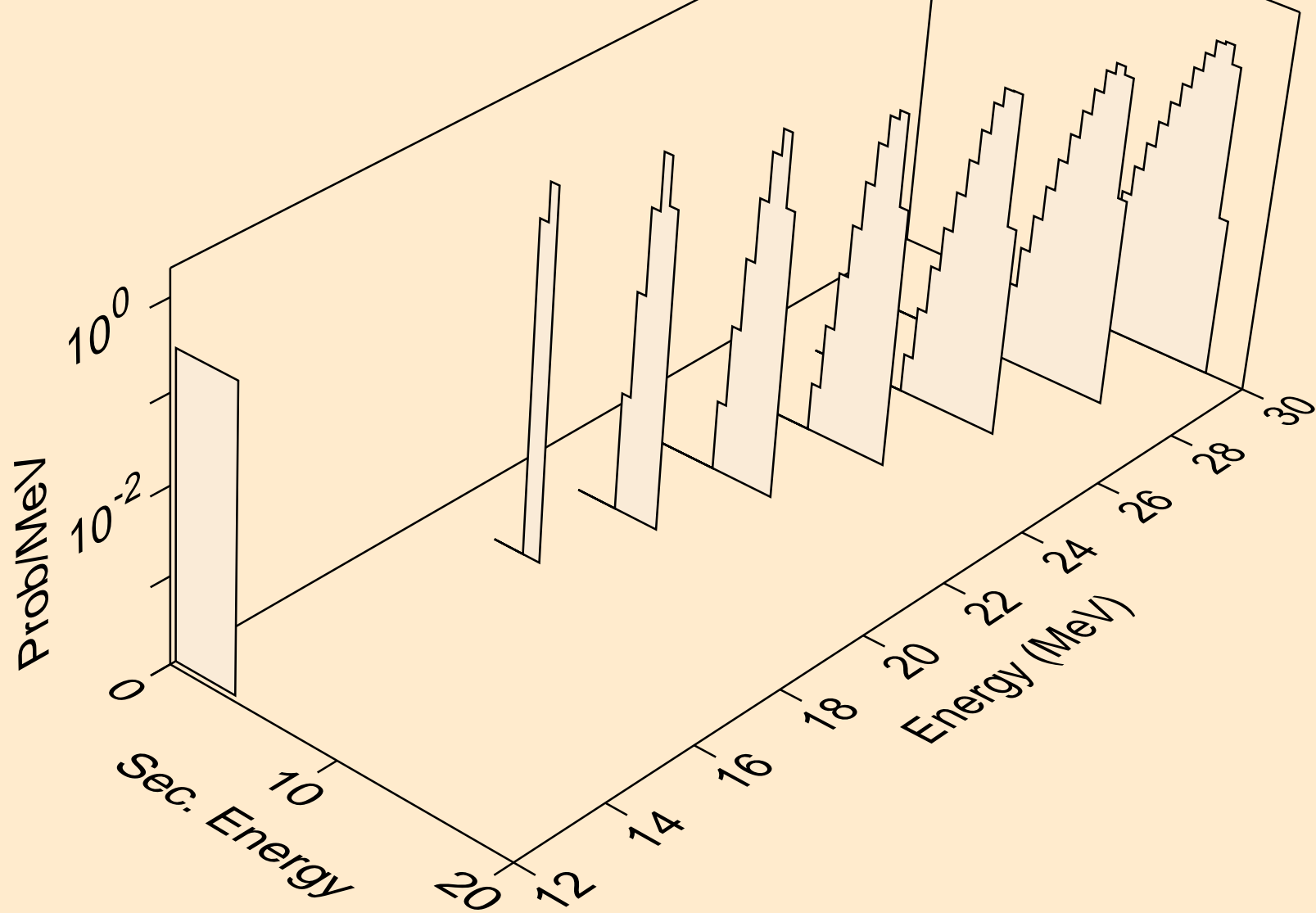

ER167M NEUTRON ACER TENDL-2023 LIBRARY; T=0.K
he3s from (n,he3)

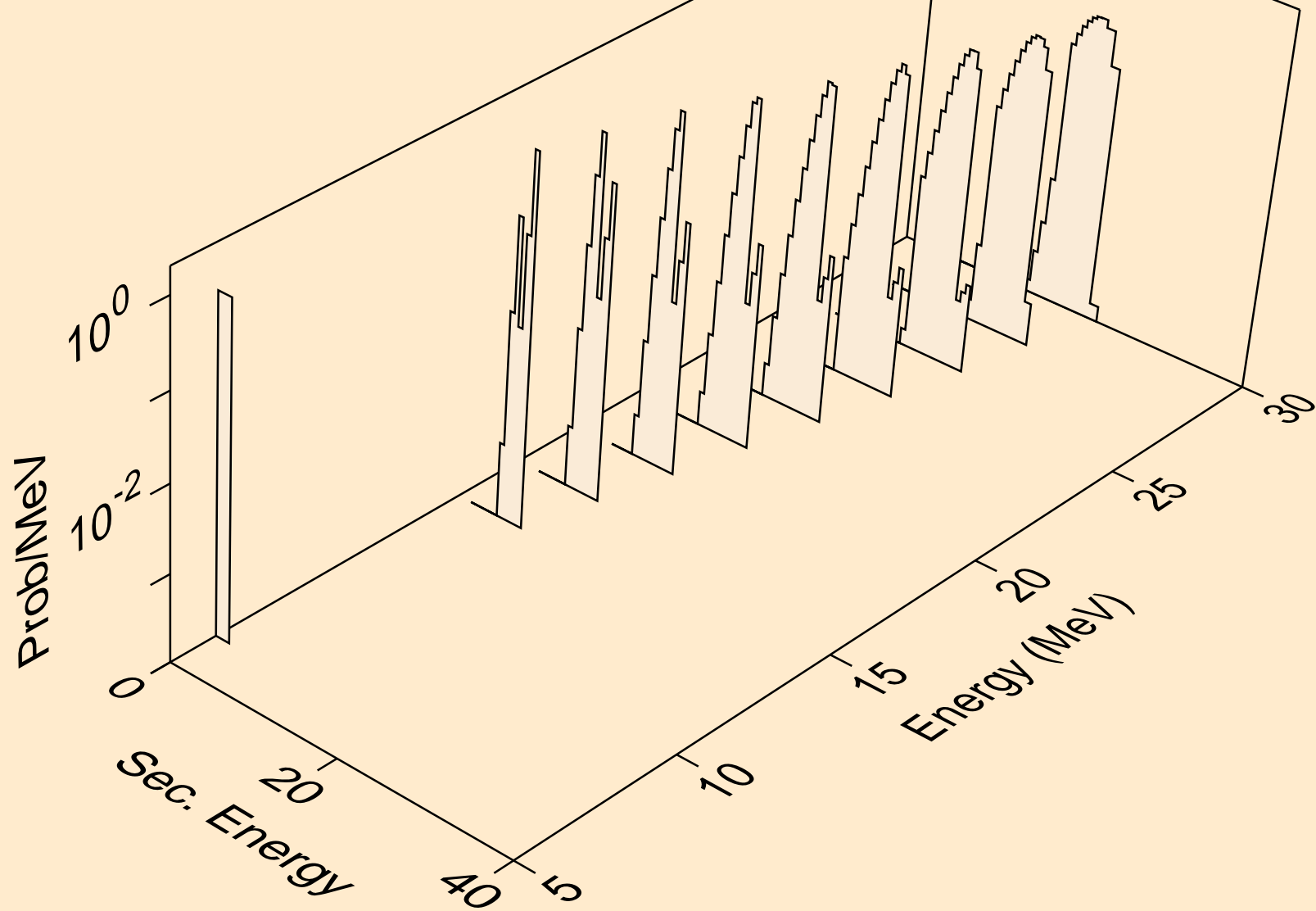

ER167M NEUTRON ACER TENDL-2023 LIBRARY; T=0.K
alphas from (n,x)

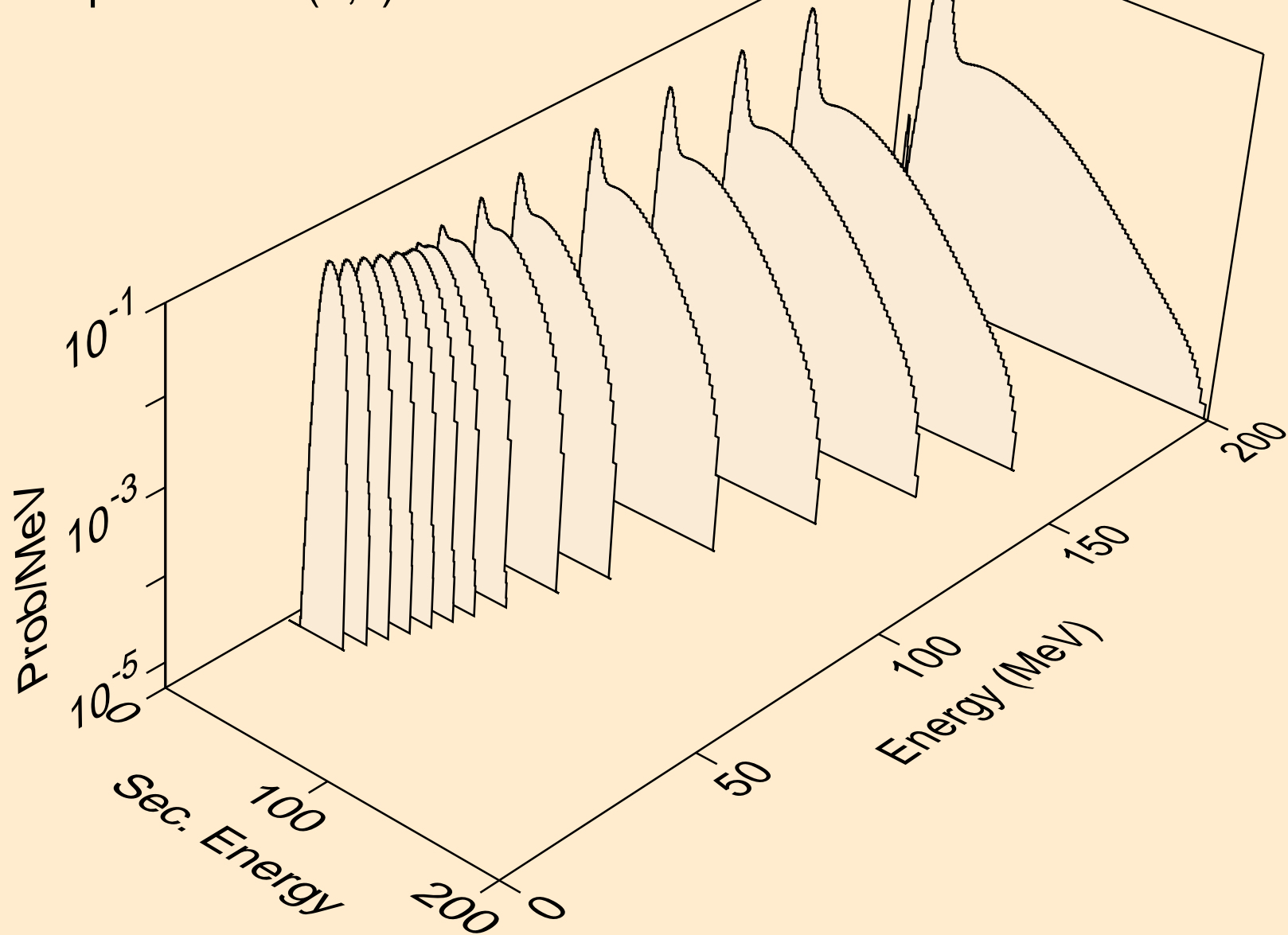

ER167M NEUTRON ACER TENDL-2023 LIBRARY; T=0.K
alphas from (n,n*)a

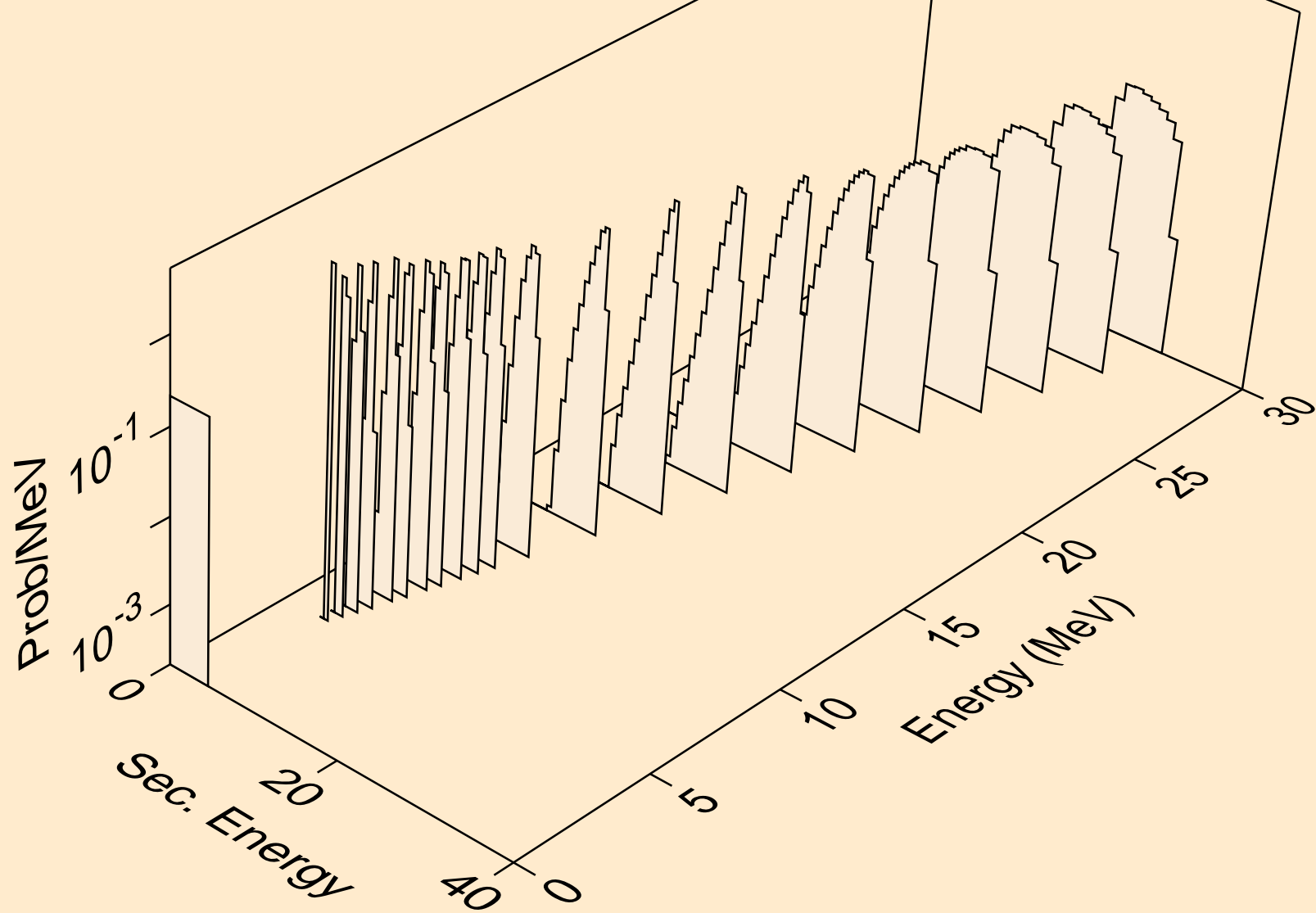

ER167M NEUTRON ACER TENDL-2023 LIBRARY; T=0.K
alphas from (n,2n)a

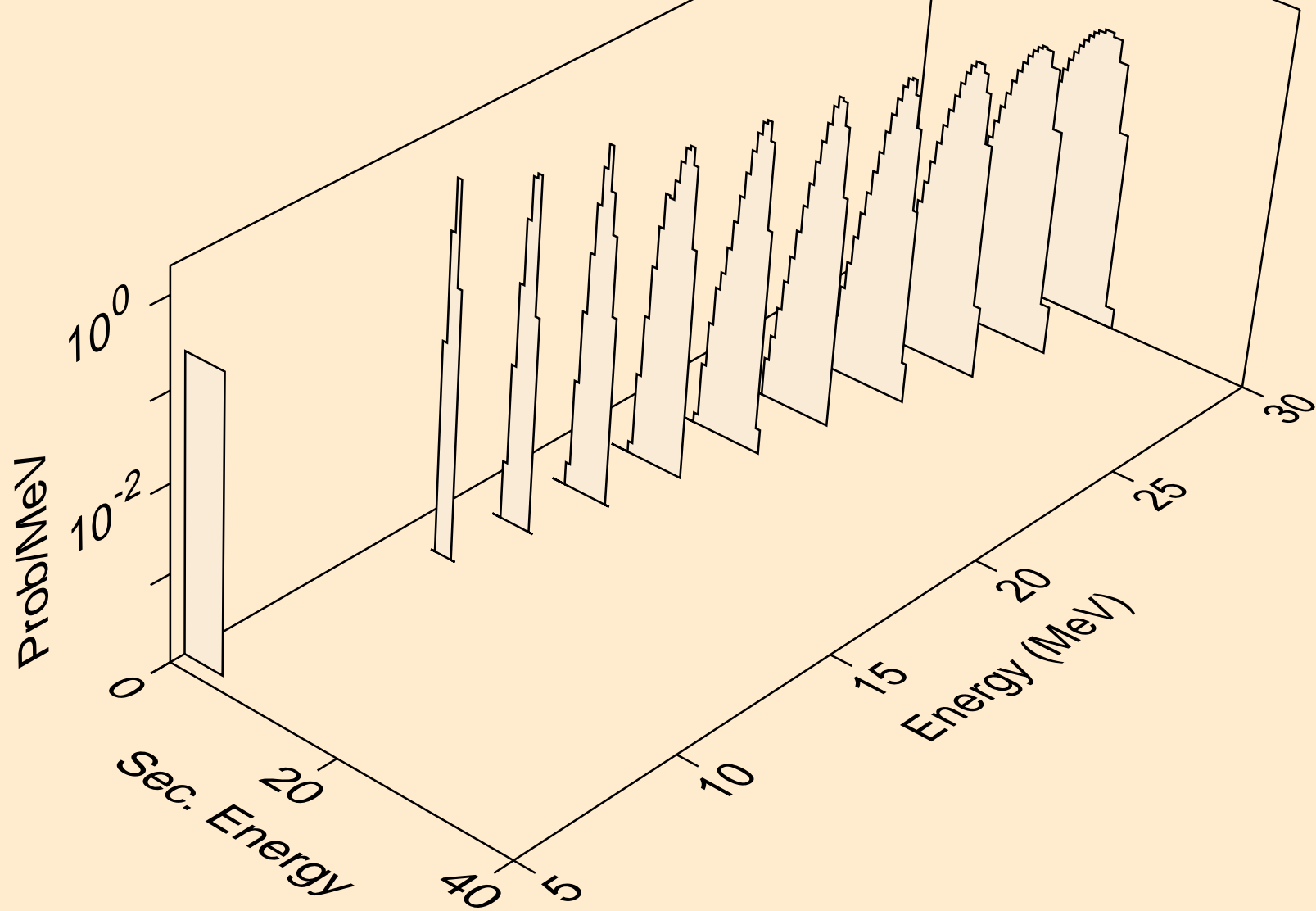

ER167M NEUTRON ACER TENDL-2023 LIBRARY; T=0.K
alphas from (n,3n)a

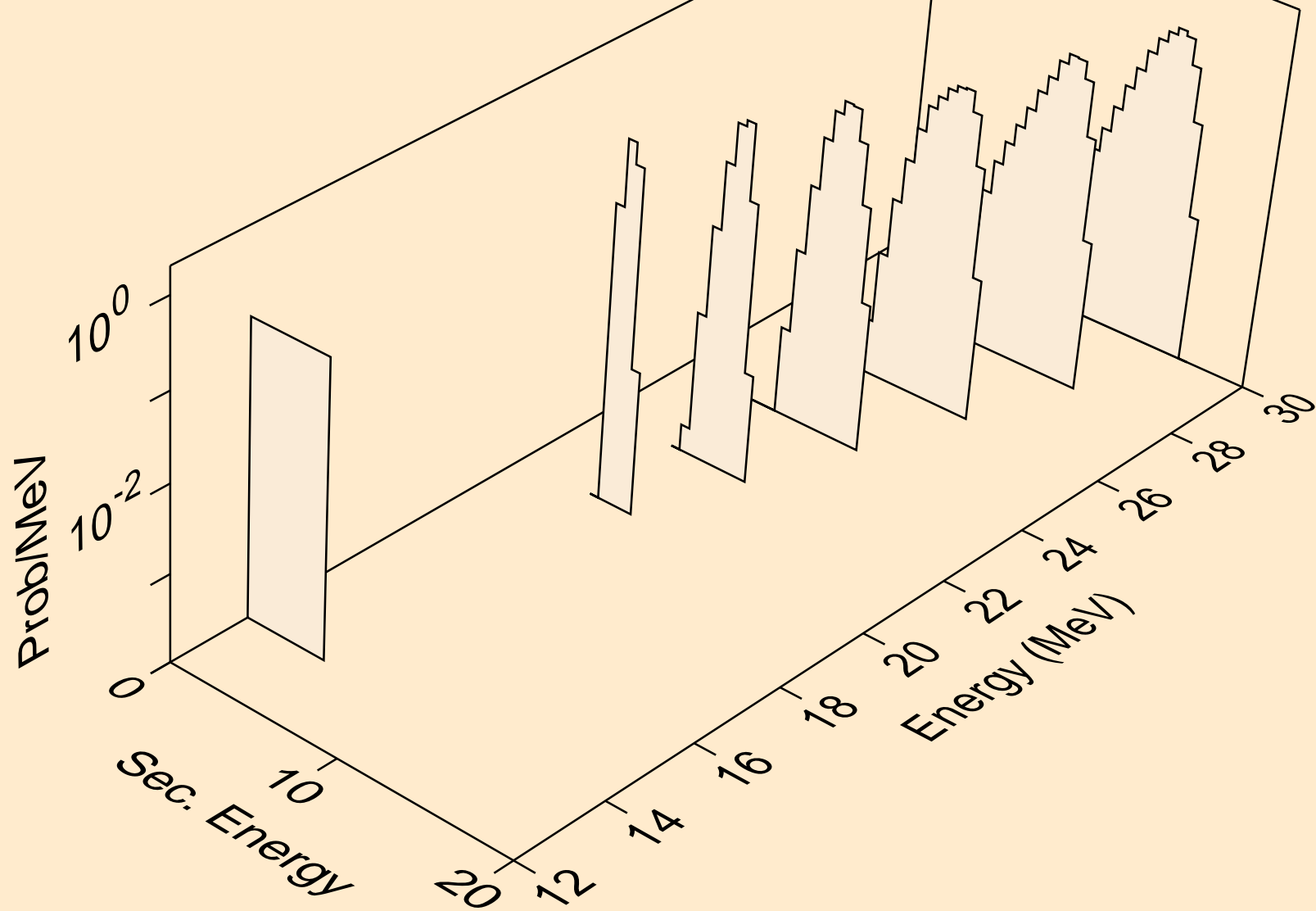

ER167M NEUTRON ACER TENDL-2023 LIBRARY; T=0.K
alphas from (n,n*)2a

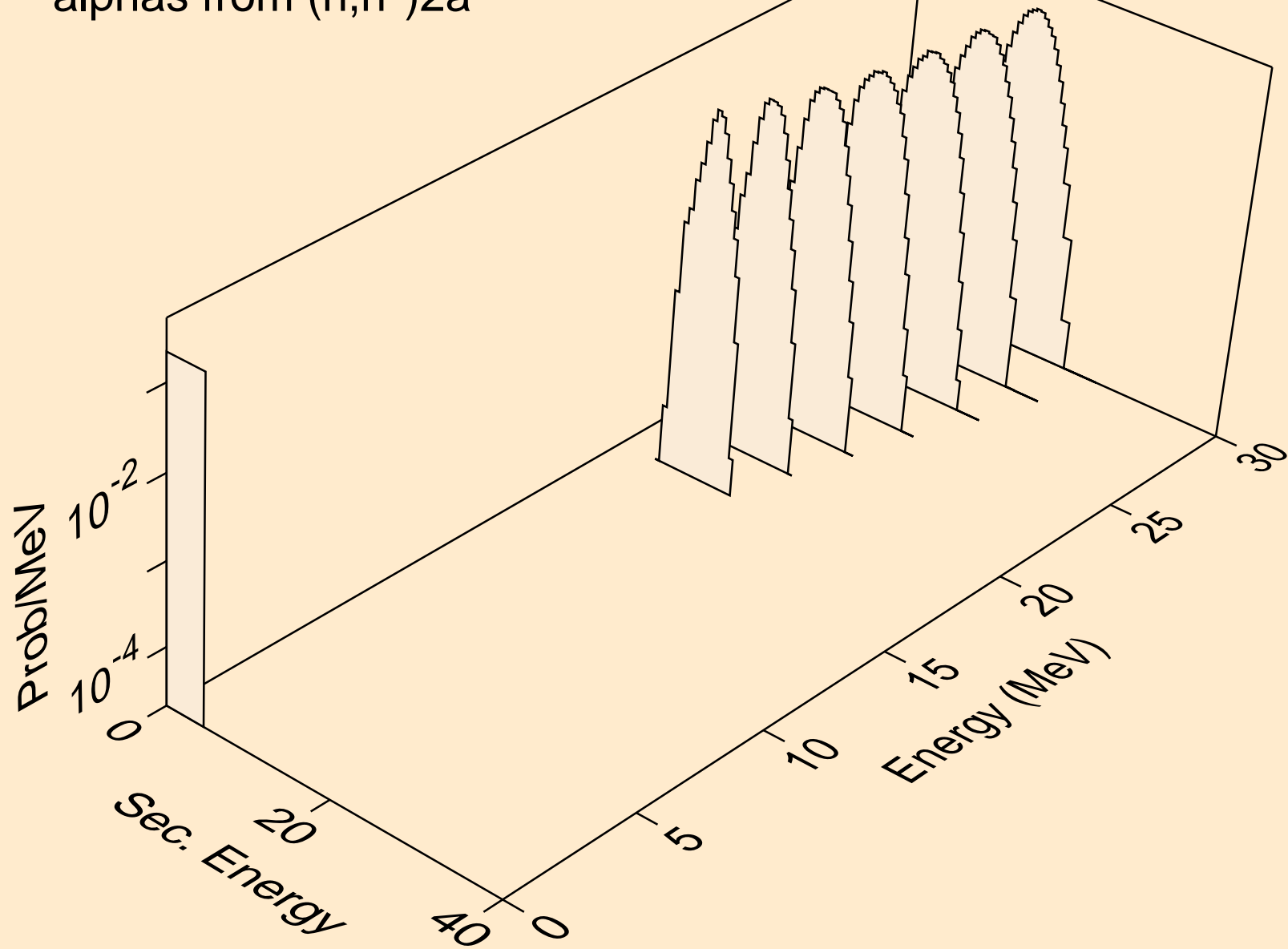

ER167M NEUTRON ACER TENDL-2023 LIBRARY; T=0.K
alphas from (n,npa)

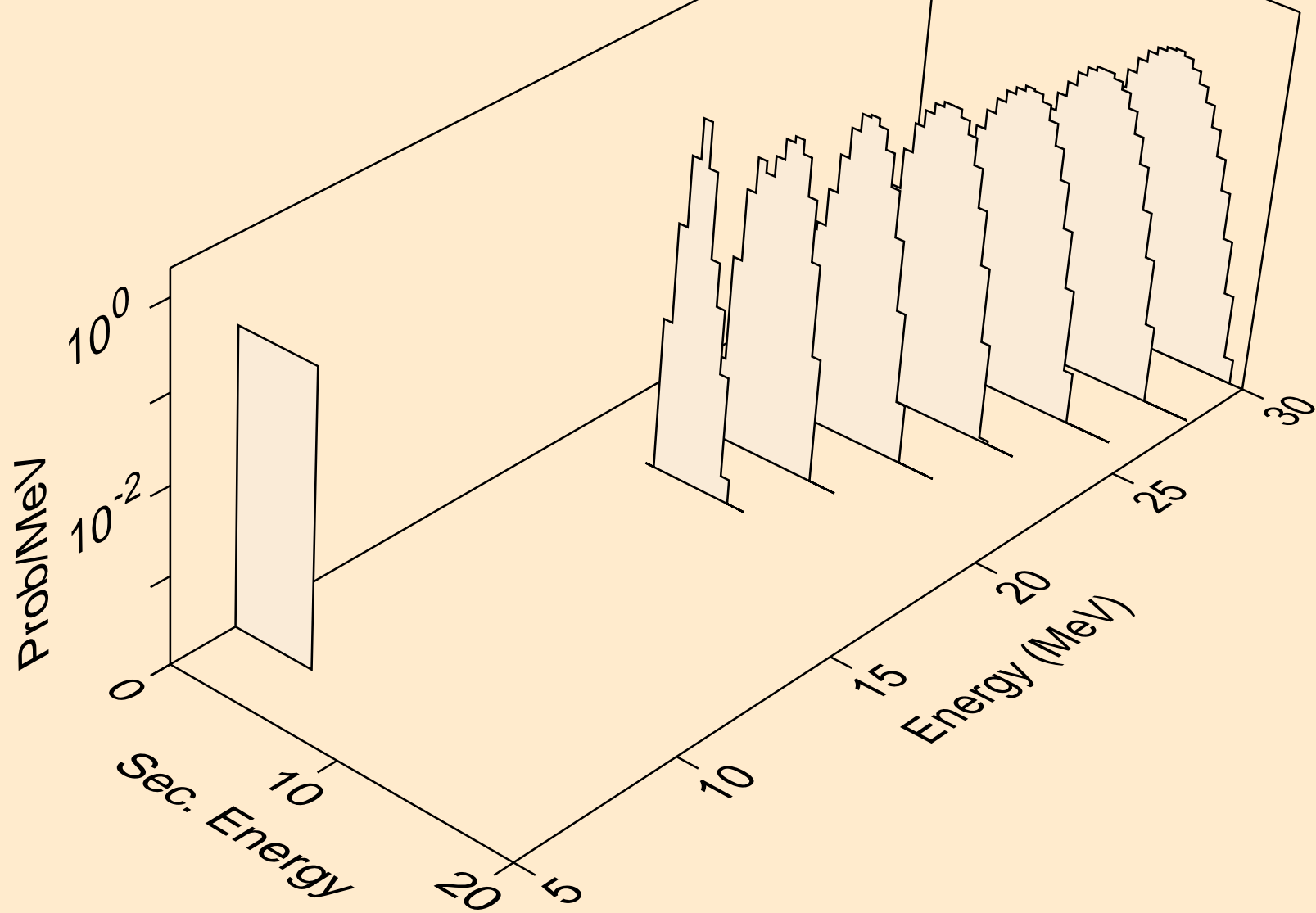

ER167M NEUTRON ACER TENDL-2023 LIBRARY; T=0.K
alphas from (n,a)

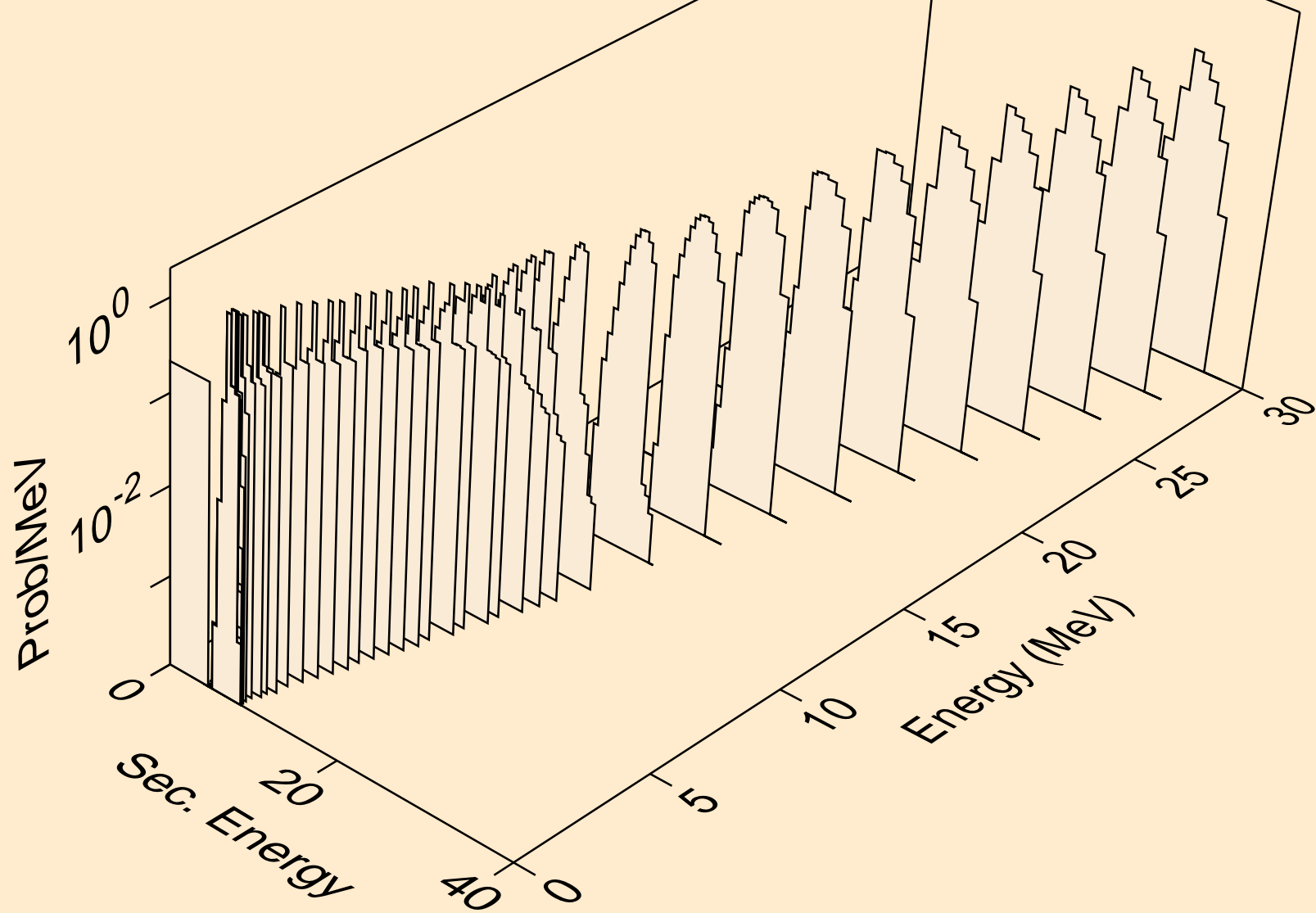

ER167M NEUTRON ACER TENDL-2023 LIBRARY; T=0.K
alphas from (n,2a)

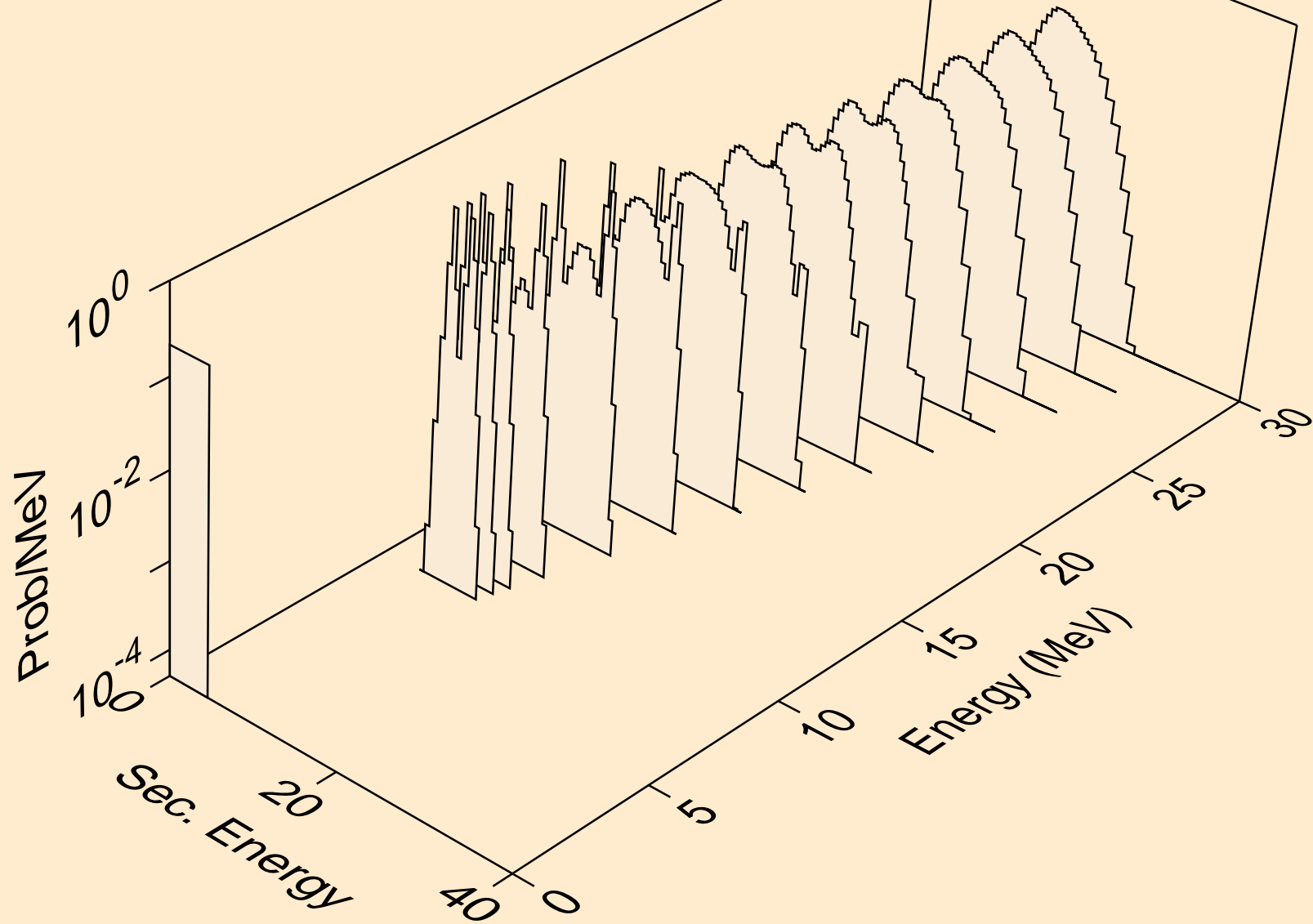

ER167M NEUTRON ACER TENDL-2023 LIBRARY; T=0.K
alphas from (n,pa)

