

ES241 NEUTRON ACER TENDL-2023 LIBRARY; T=0.K

Principal cross sections

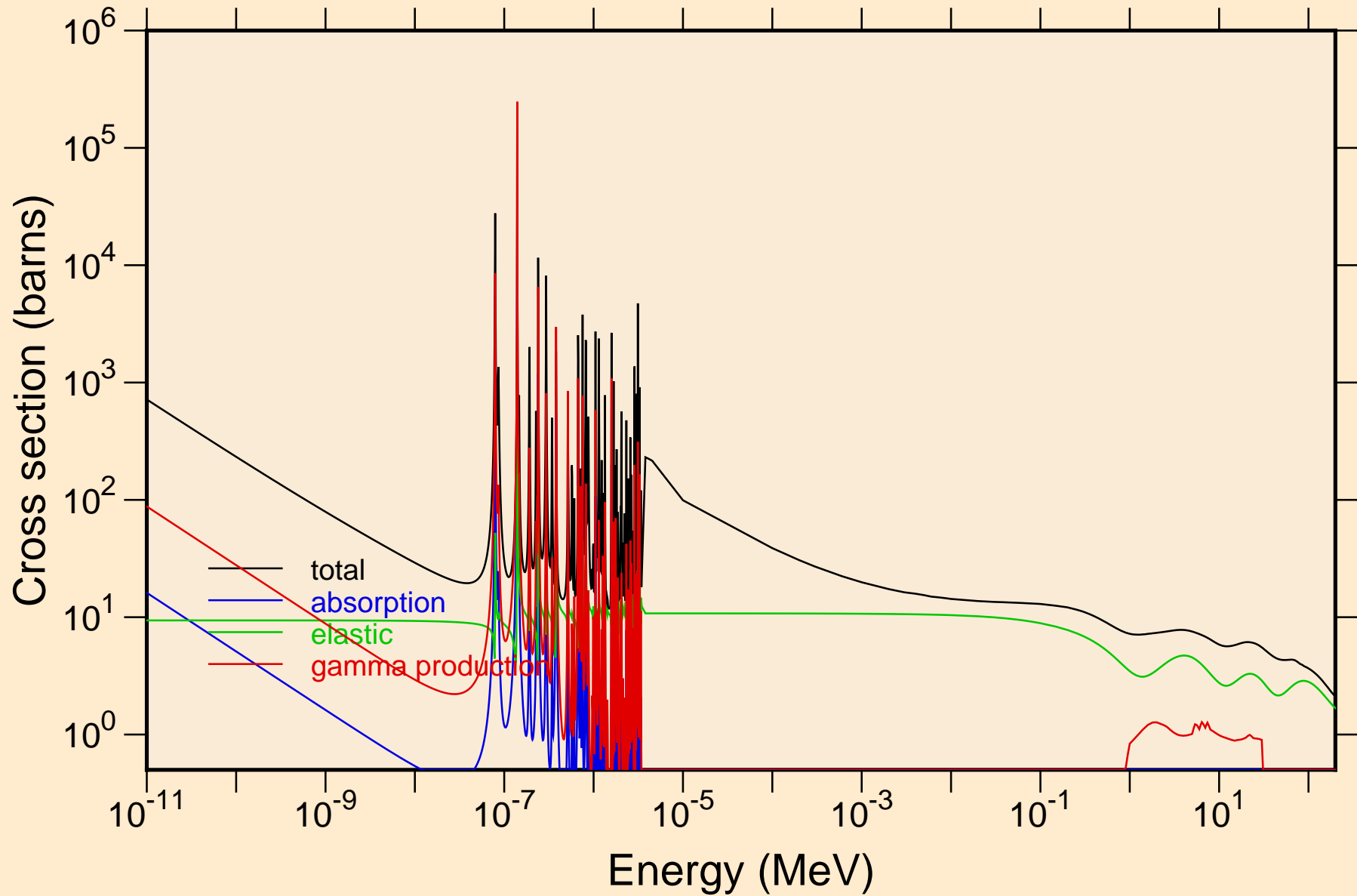

ES241 NEUTRON ACER TENDL-2023 LIBRARY; T=0.K
resonance total cross section

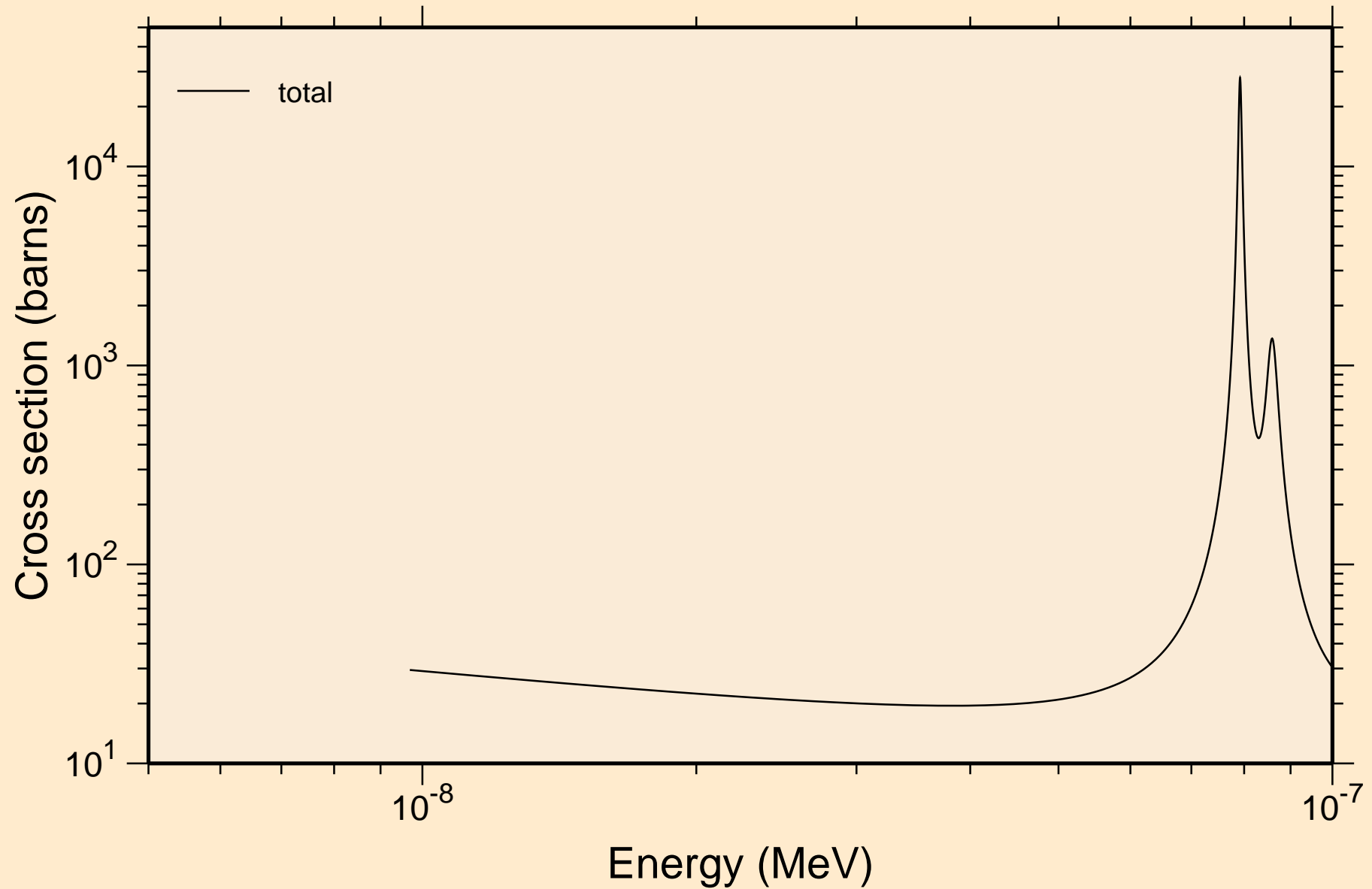

ES241 NEUTRON ACER TENDL-2023 LIBRARY; T=0.K
resonance total cross section

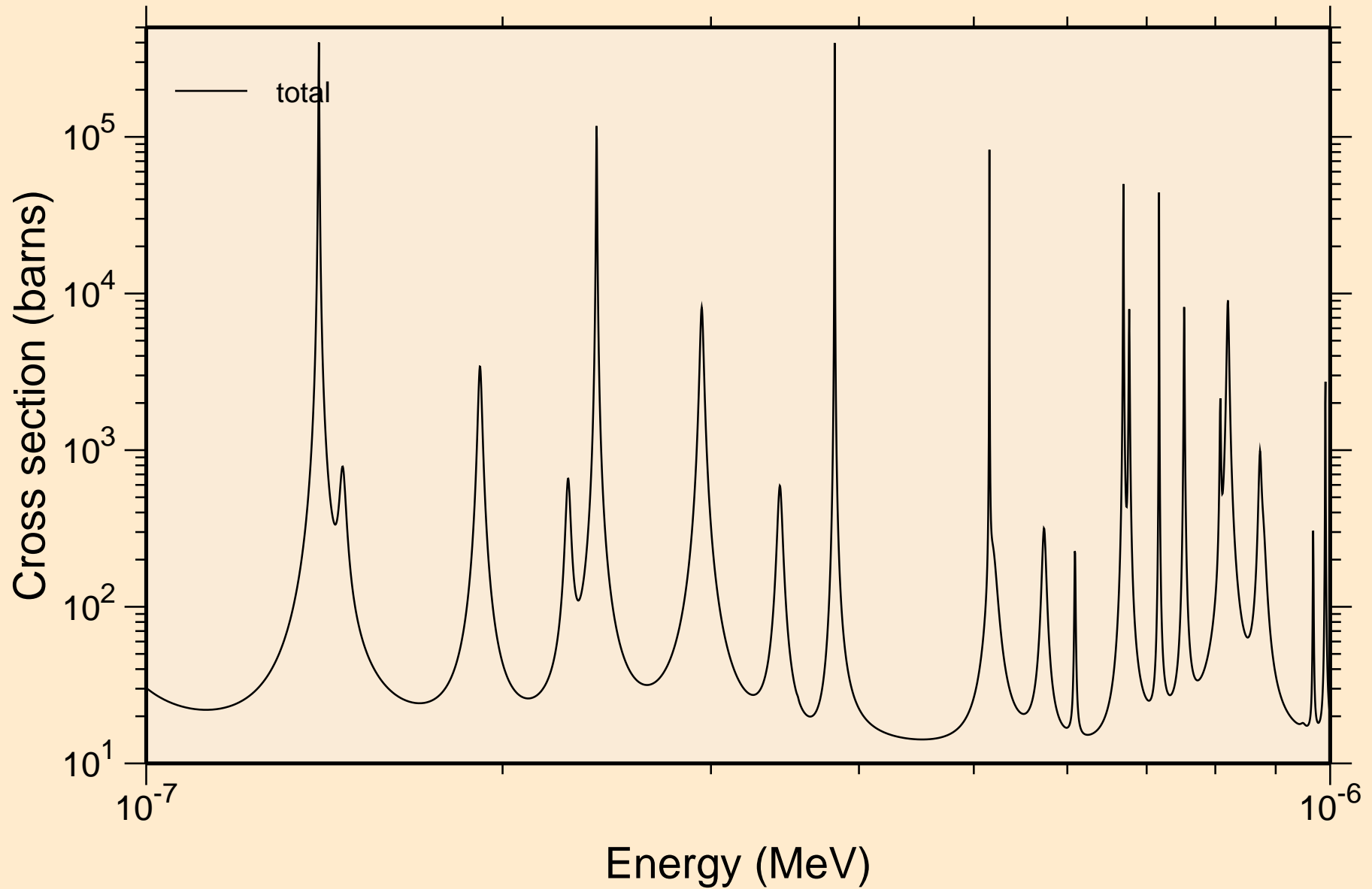

ES241 NEUTRON ACER TENDL-2023 LIBRARY; T=0.K
resonance total cross section

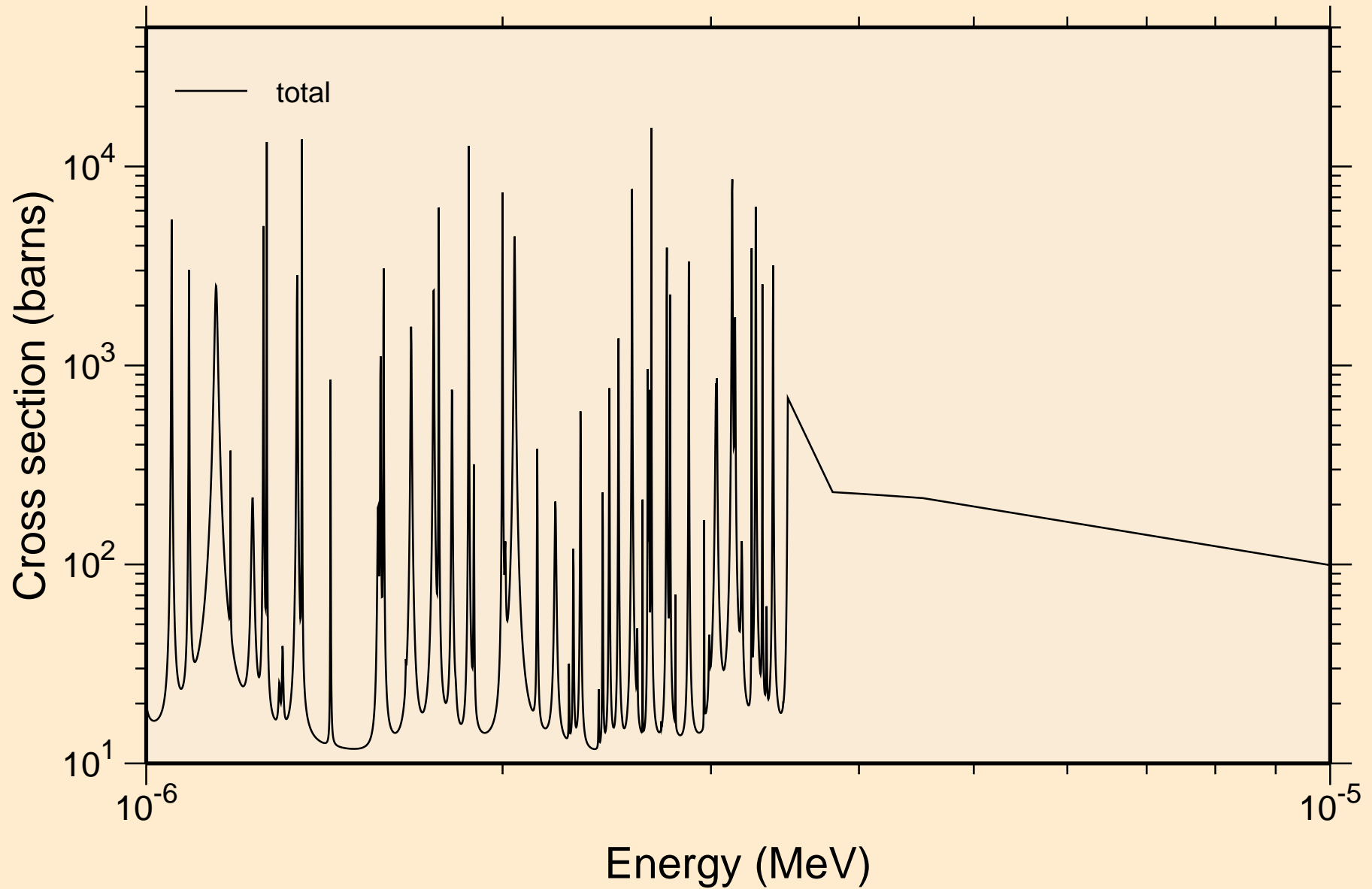

ES241 NEUTRON ACER TENDL-2023 LIBRARY; T=0.K
resonance total cross section

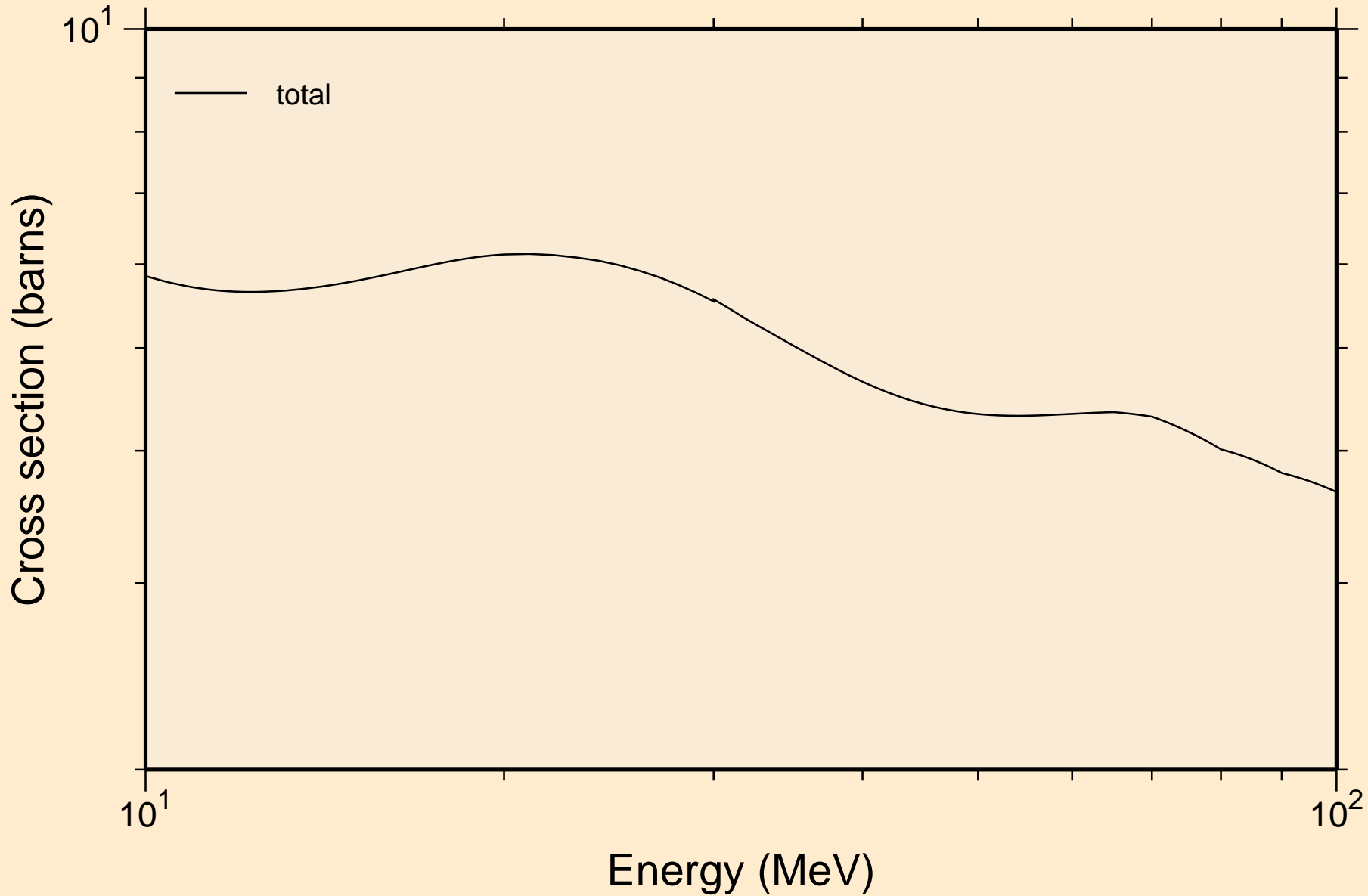

ES241 NEUTRON ACER TENDL-2023 LIBRARY; T=0.K
resonance absorption cross sections

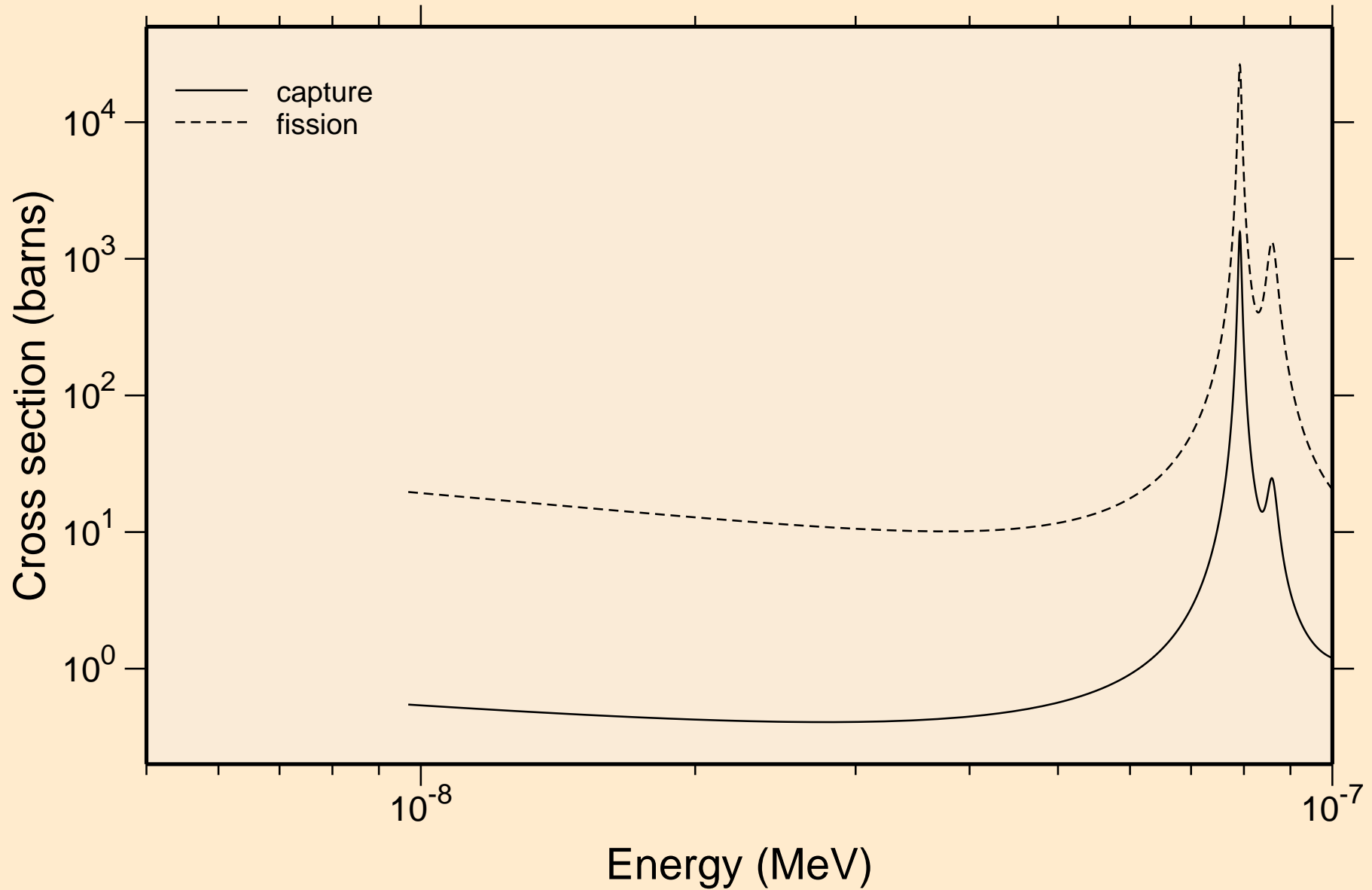

ES241 NEUTRON ACER TENDL-2023 LIBRARY; T=0.K
resonance absorption cross sections

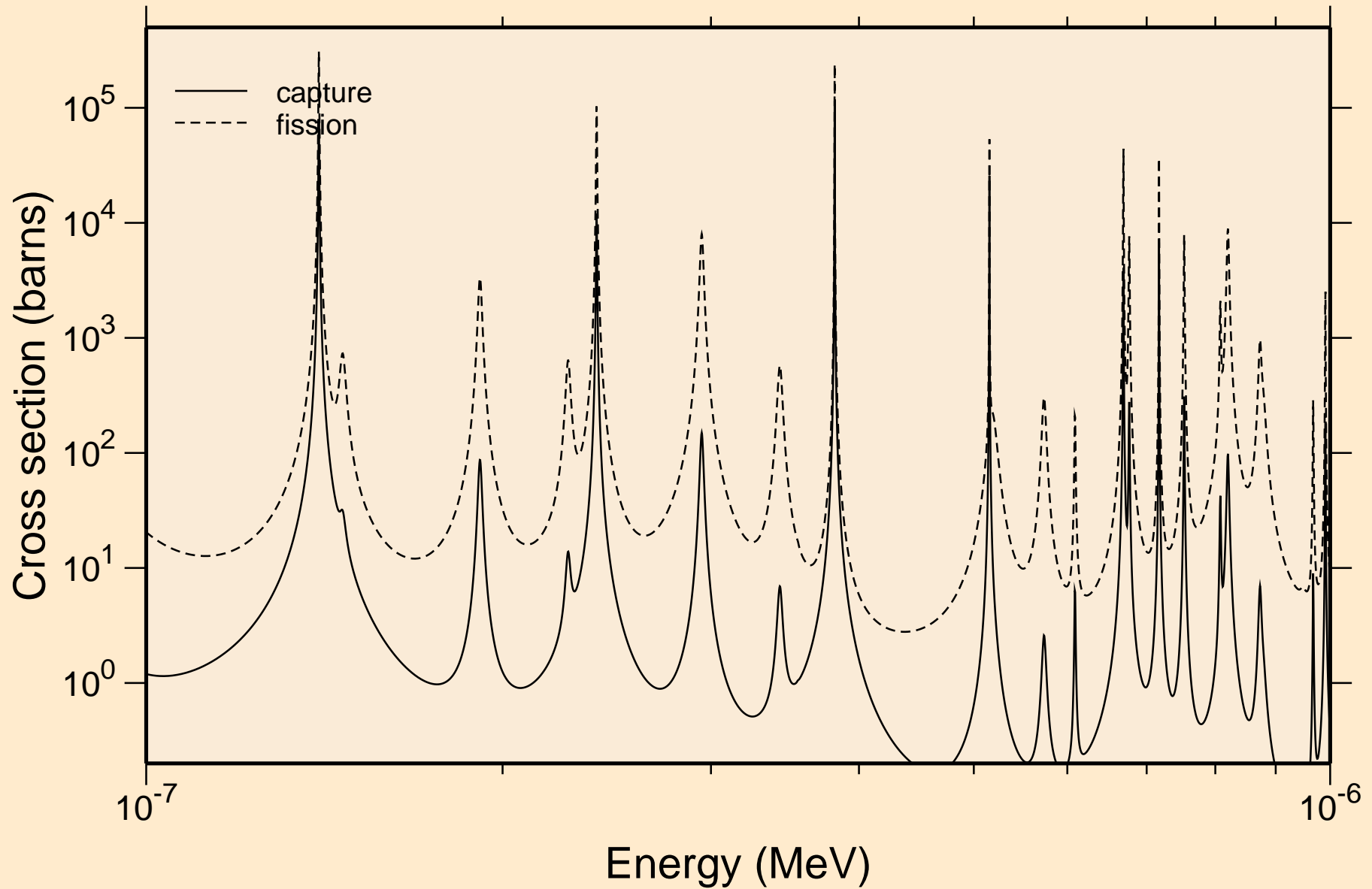

ES241 NEUTRON ACER TENDL-2023 LIBRARY; T=0.K
resonance absorption cross sections

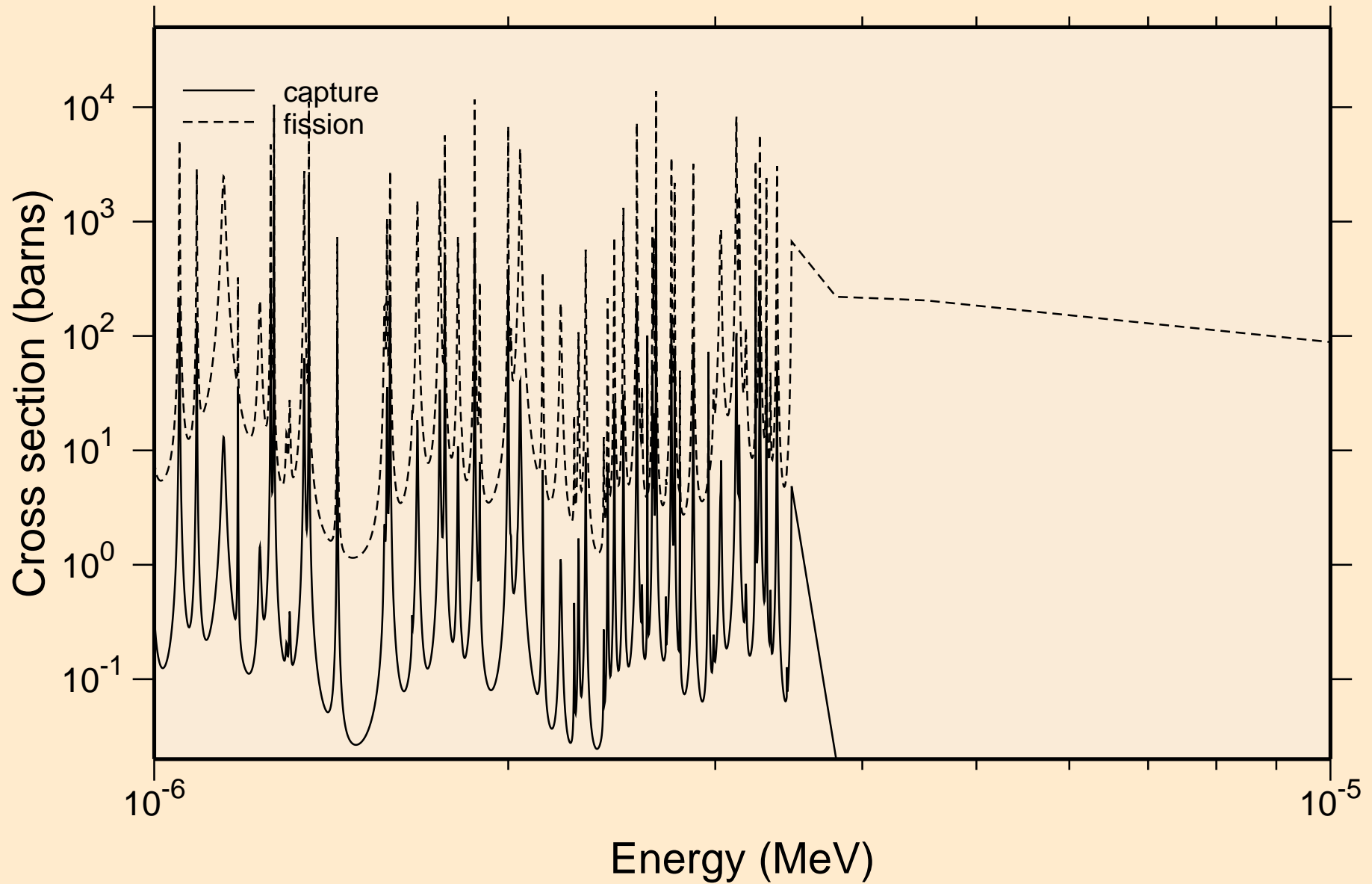

ES241 NEUTRON ACER TENDL-2023 LIBRARY; T=0.K
resonance absorption cross sections

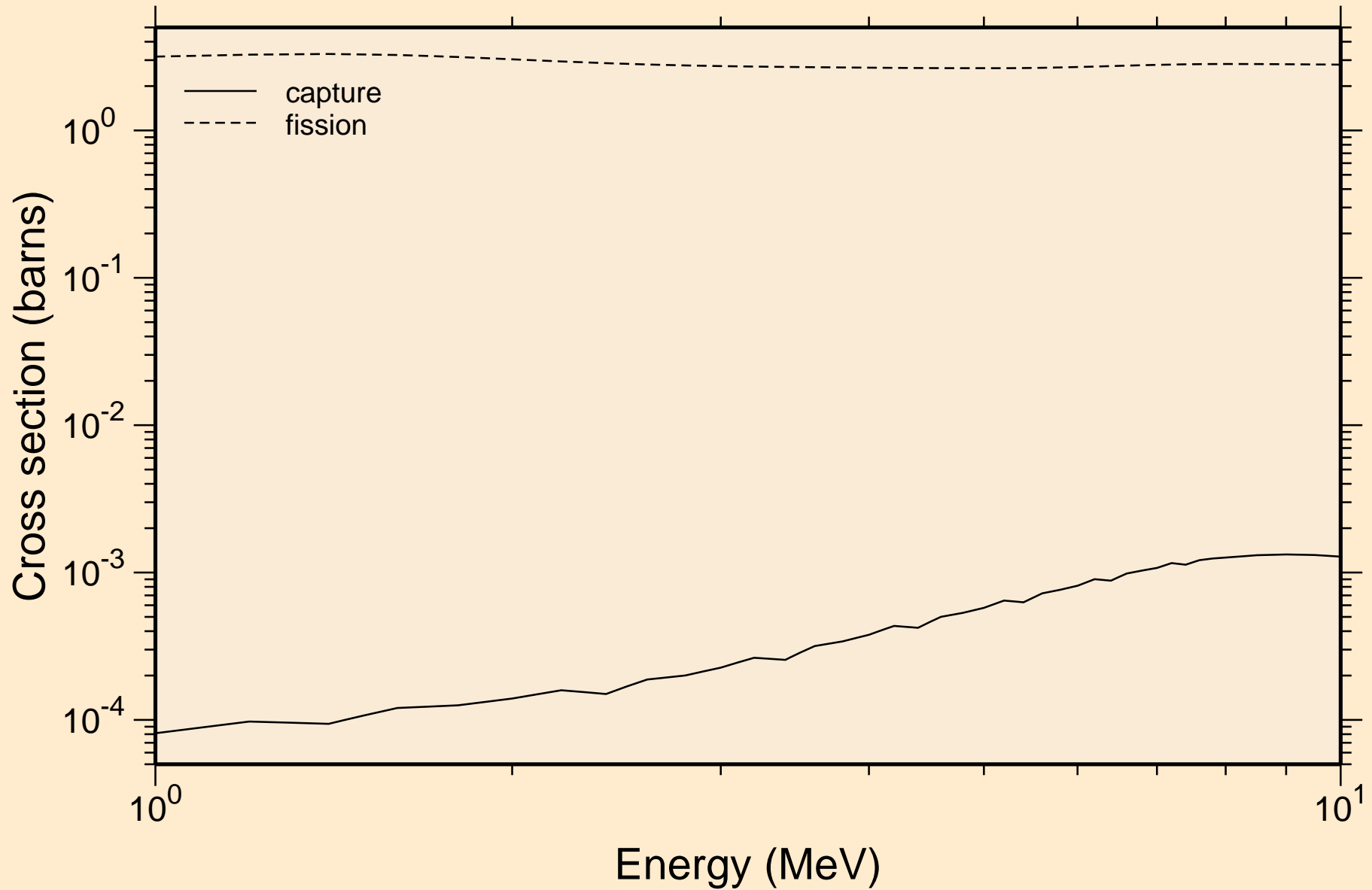

ES241 NEUTRON ACER TENDL-2023 LIBRARY; T=0.K

Heating

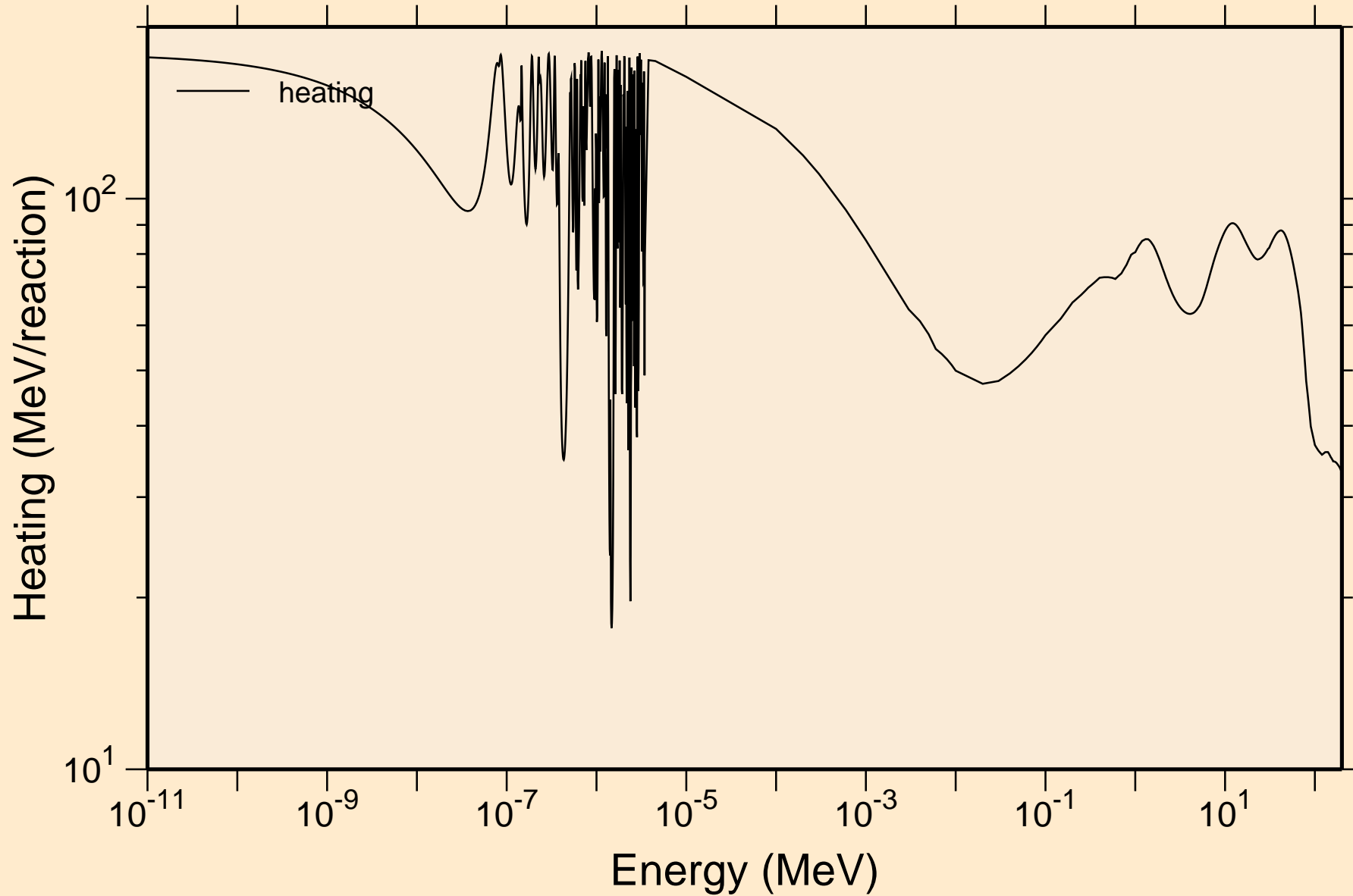

ES241 NEUTRON ACER TENDL-2023 LIBRARY; T=0.K

Damage

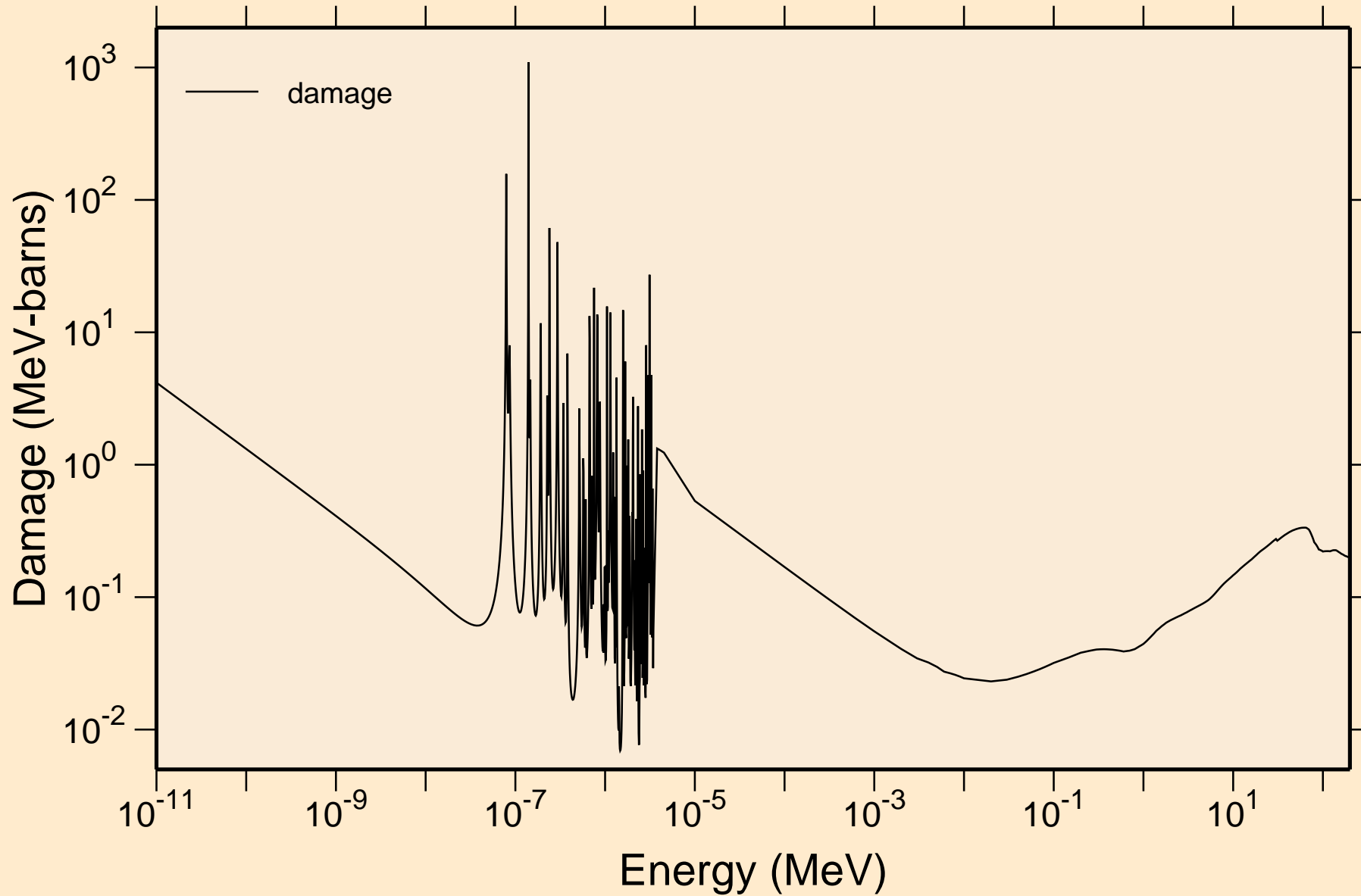

ES241 NEUTRON ACER TENDL-2023 LIBRARY; T=0.K

Non-threshold reactions

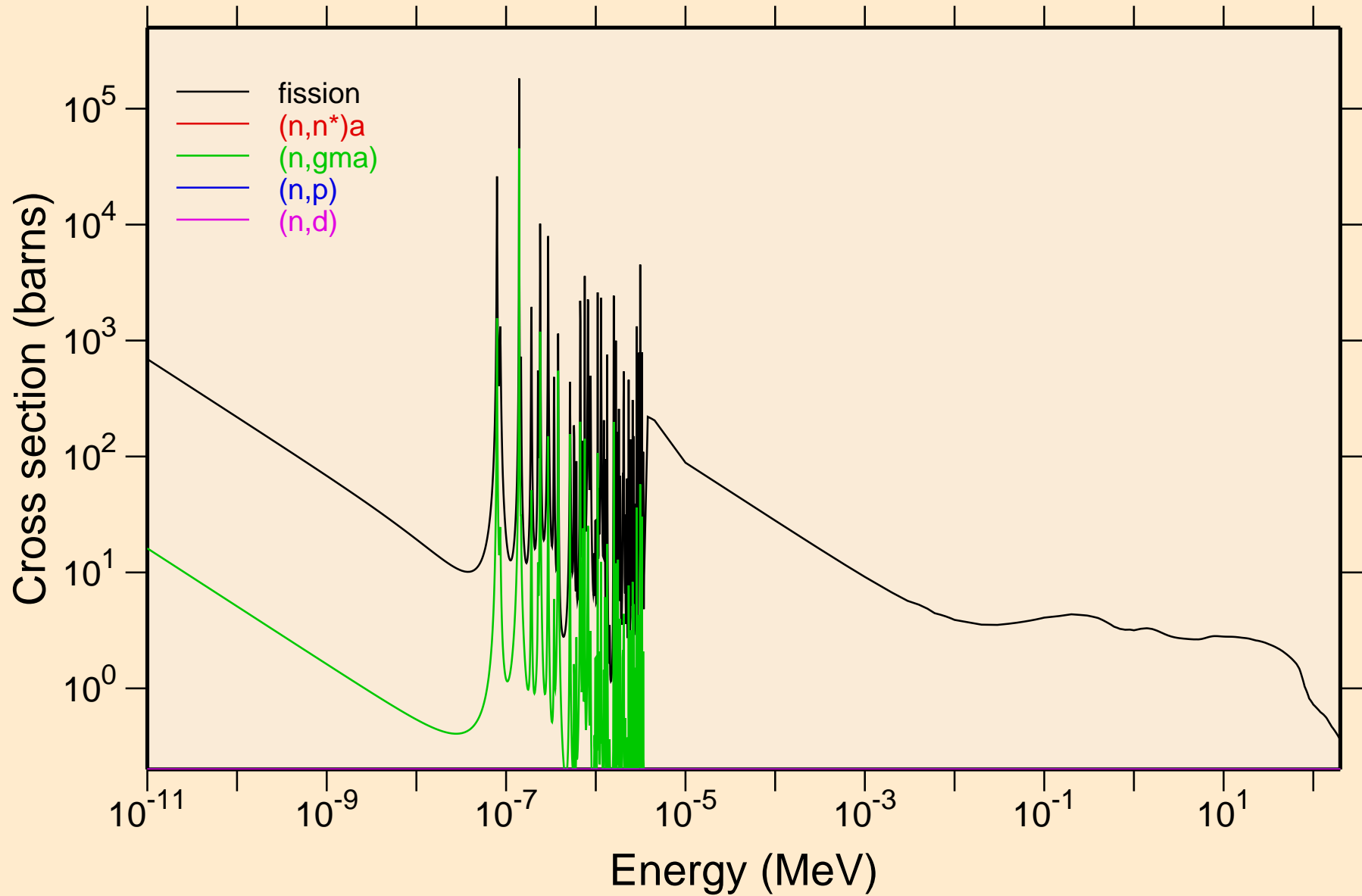

ES241 NEUTRON ACER TENDL-2023 LIBRARY; T=0.K
Non-threshold reactions

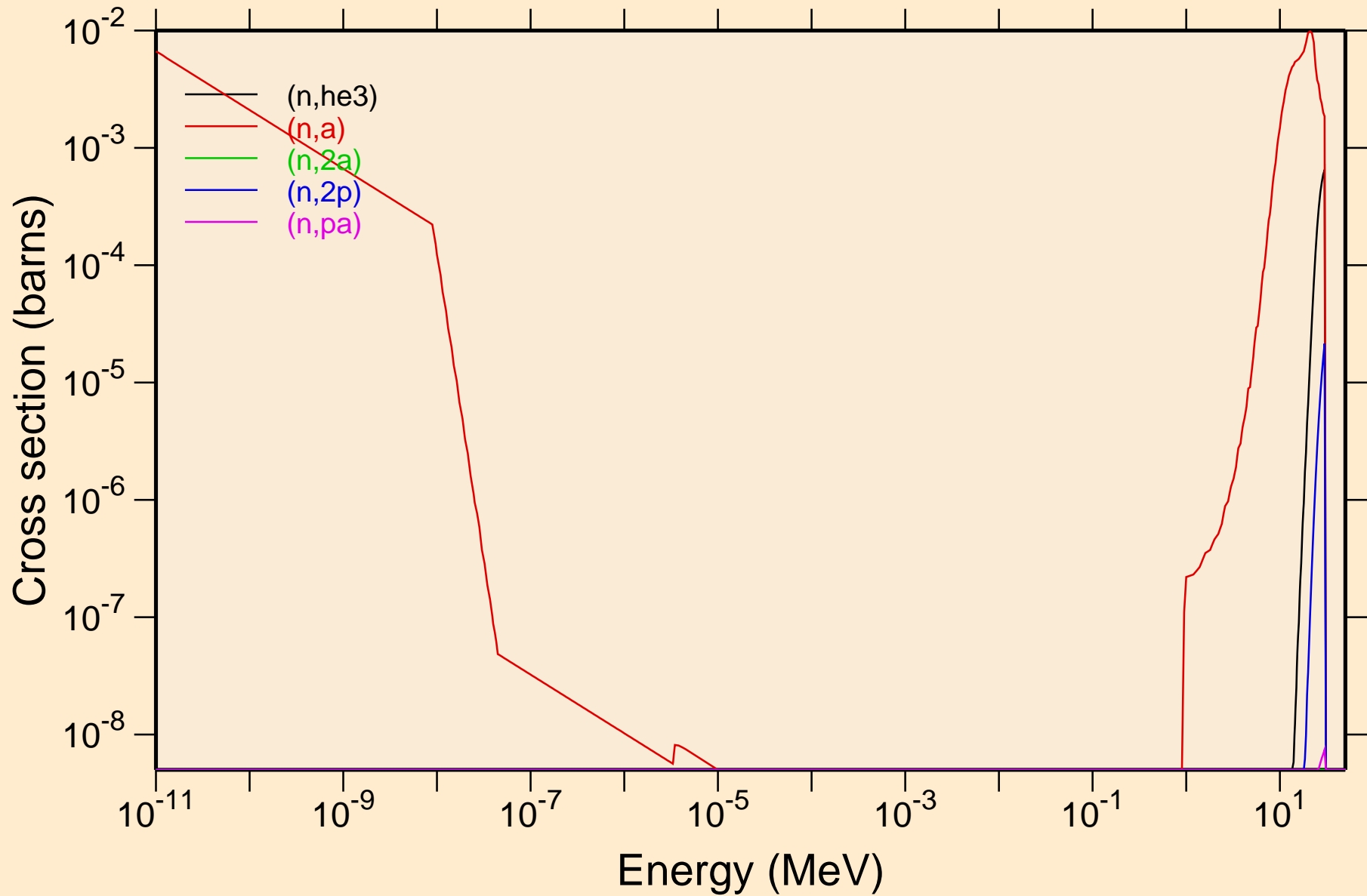

ES241 NEUTRON ACER TENDL-2023 LIBRARY; T=0.K

Non-threshold reactions

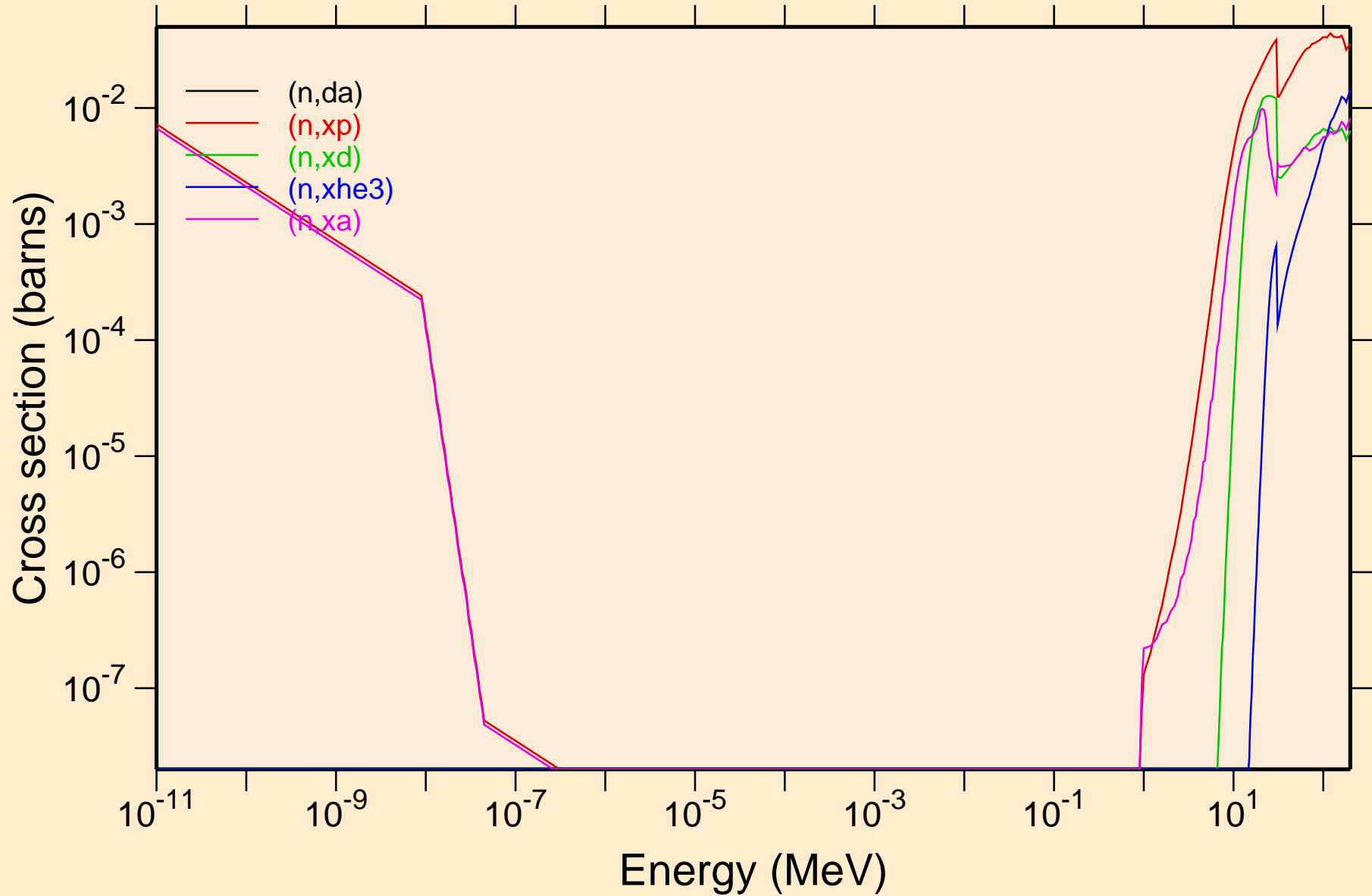

ES241 NEUTRON ACER TENDL-2023 LIBRARY; T=0.K

Principal cross sections

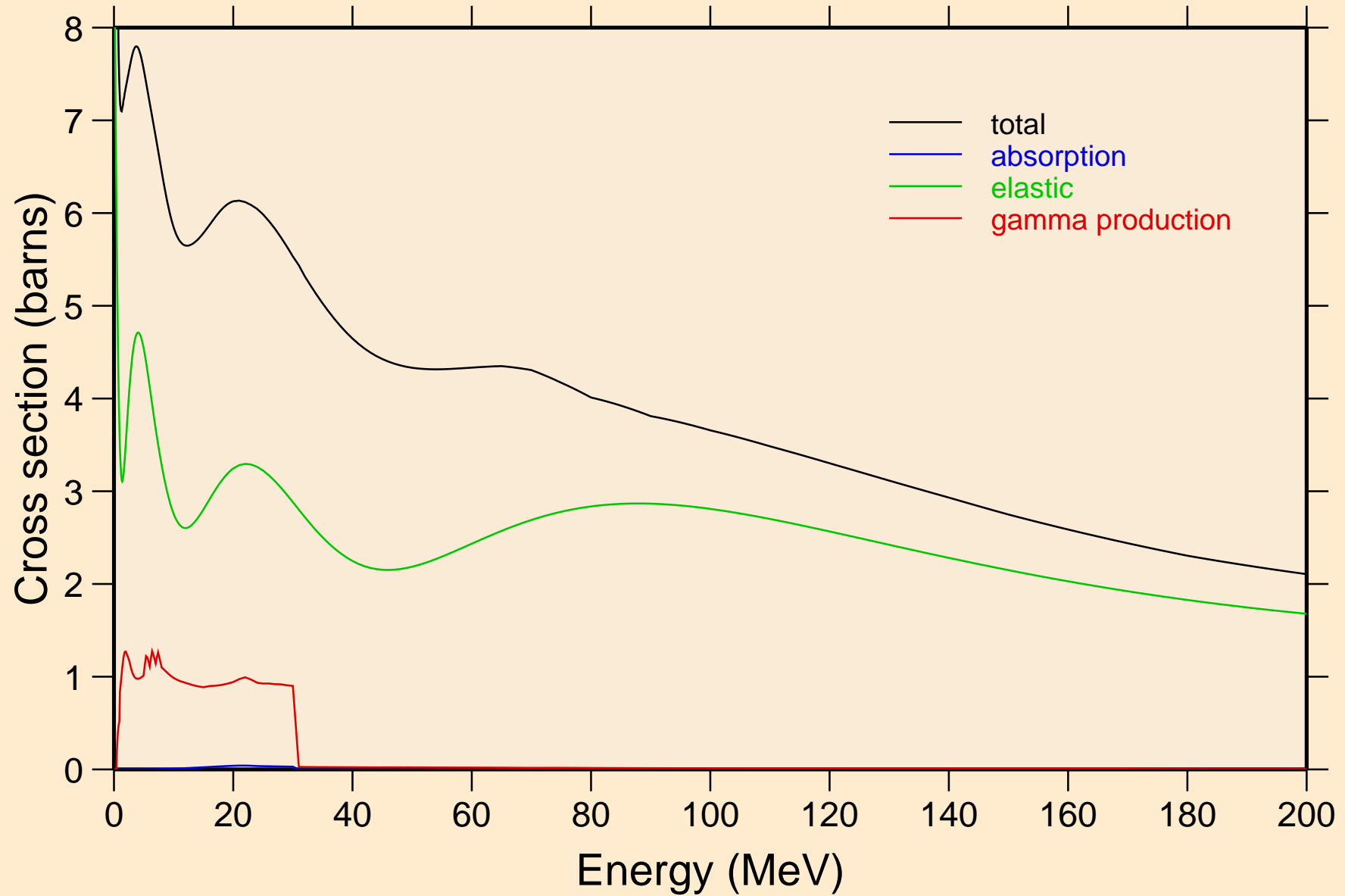

ES241 NEUTRON ACER TENDL-2023 LIBRARY; T=0.K

Heating

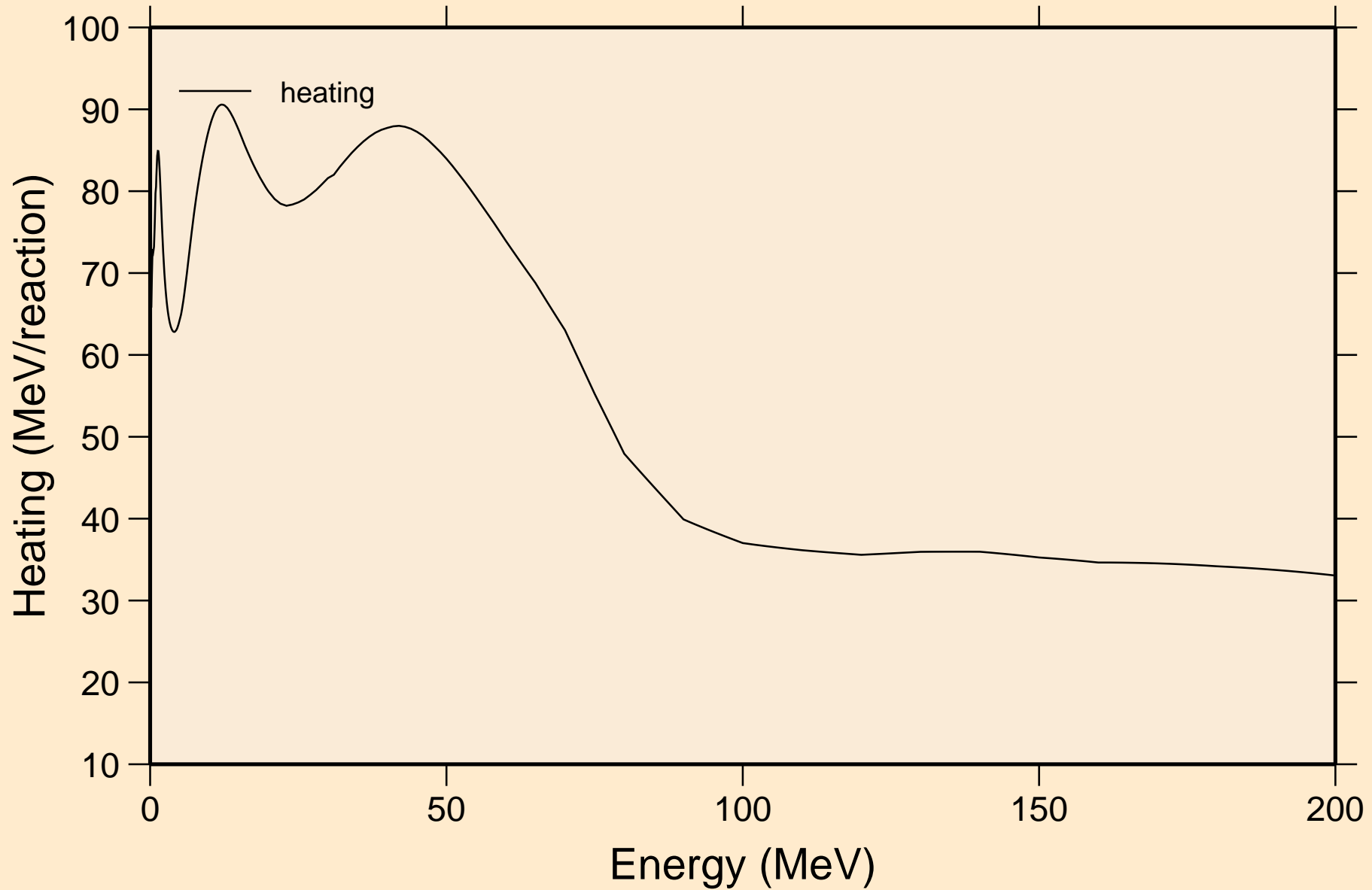

ES241 NEUTRON ACER TENDL-2023 LIBRARY; T=0.K
Damage

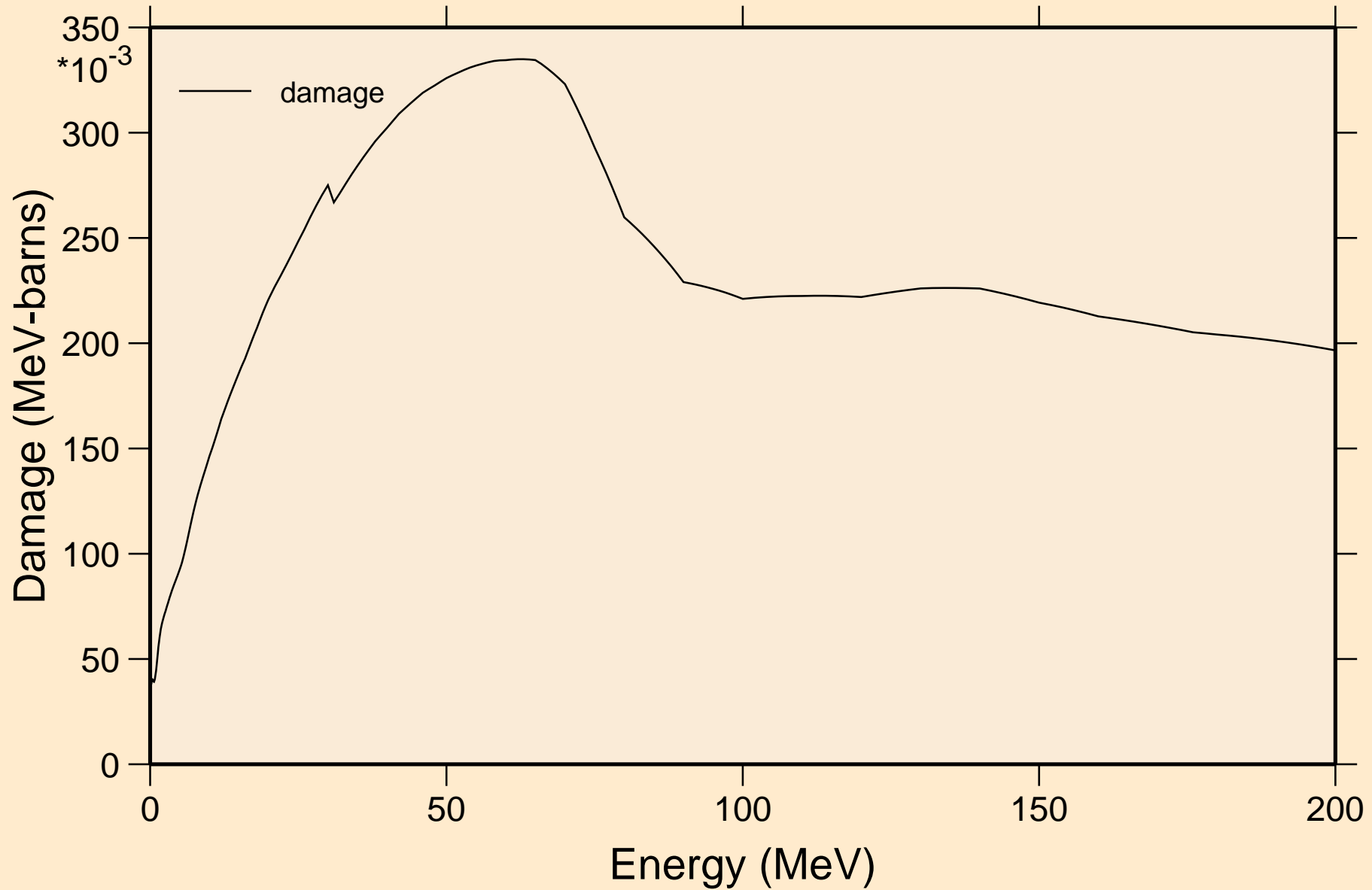

ES241 NEUTRON ACER TENDL-2023 LIBRARY; T=0.K

Non-threshold reactions

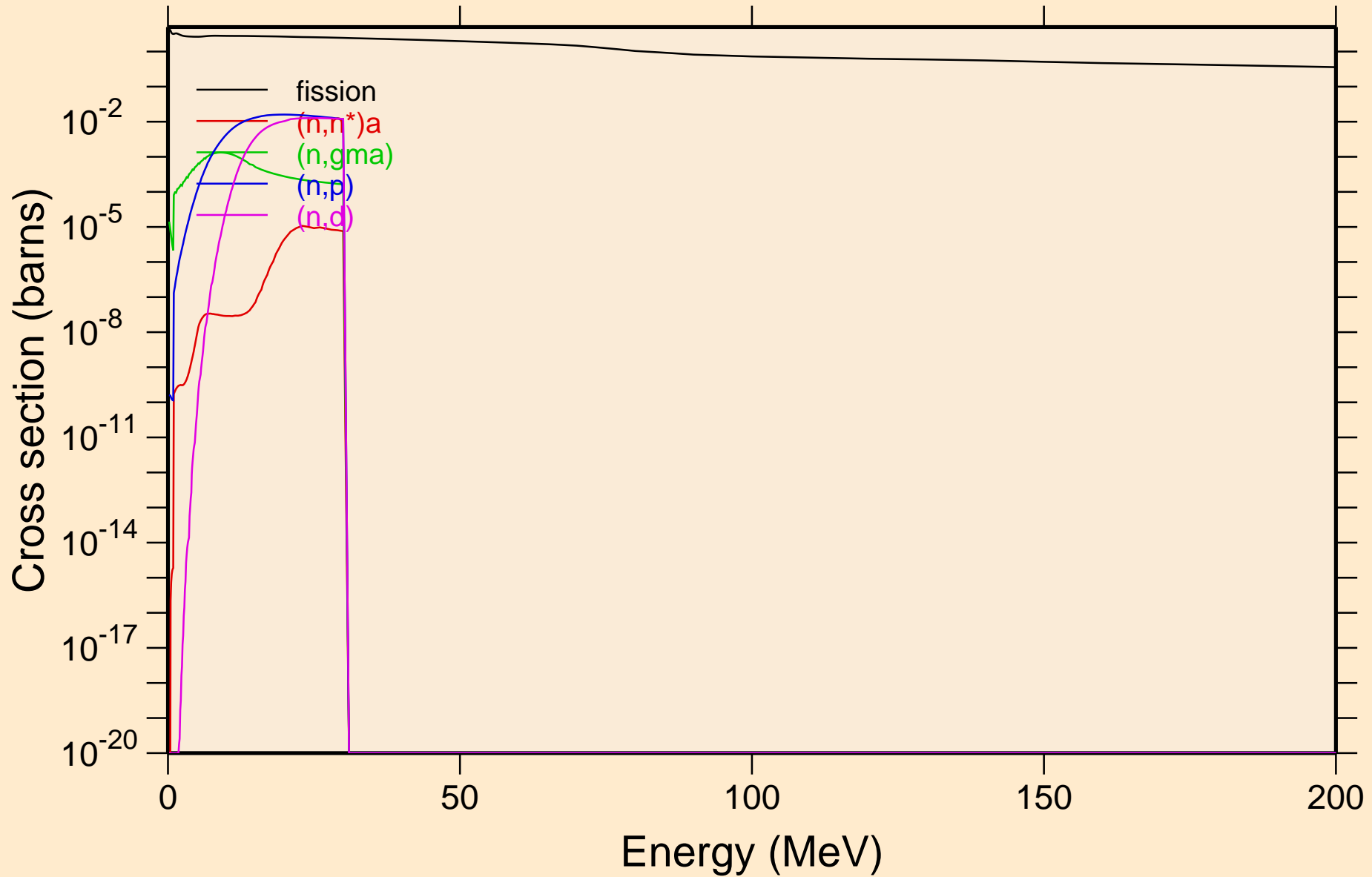

ES241 NEUTRON ACER TENDL-2023 LIBRARY; T=0.K

Non-threshold reactions

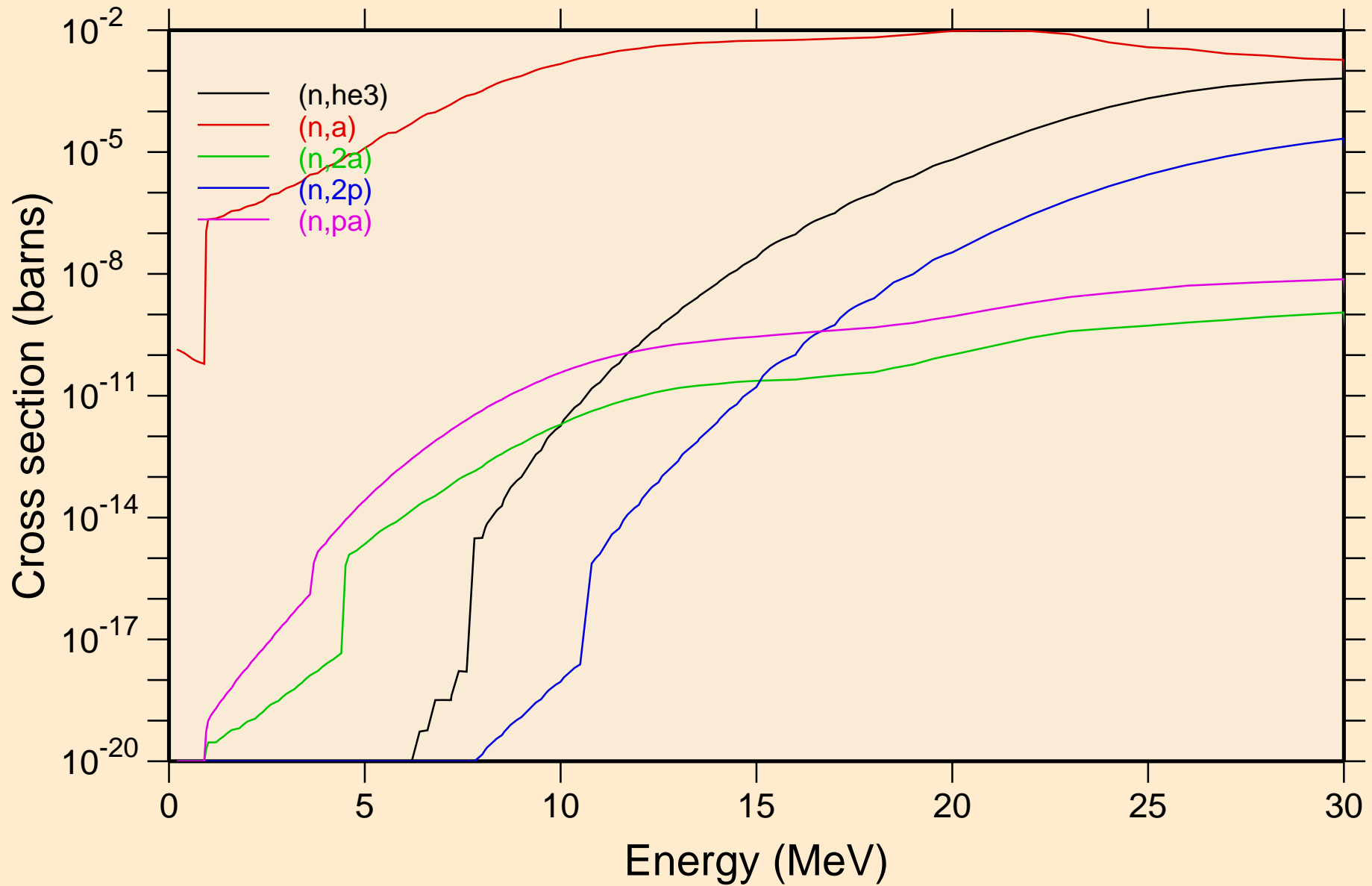

ES241 NEUTRON ACER TENDL-2023 LIBRARY; T=0.K

Non-threshold reactions

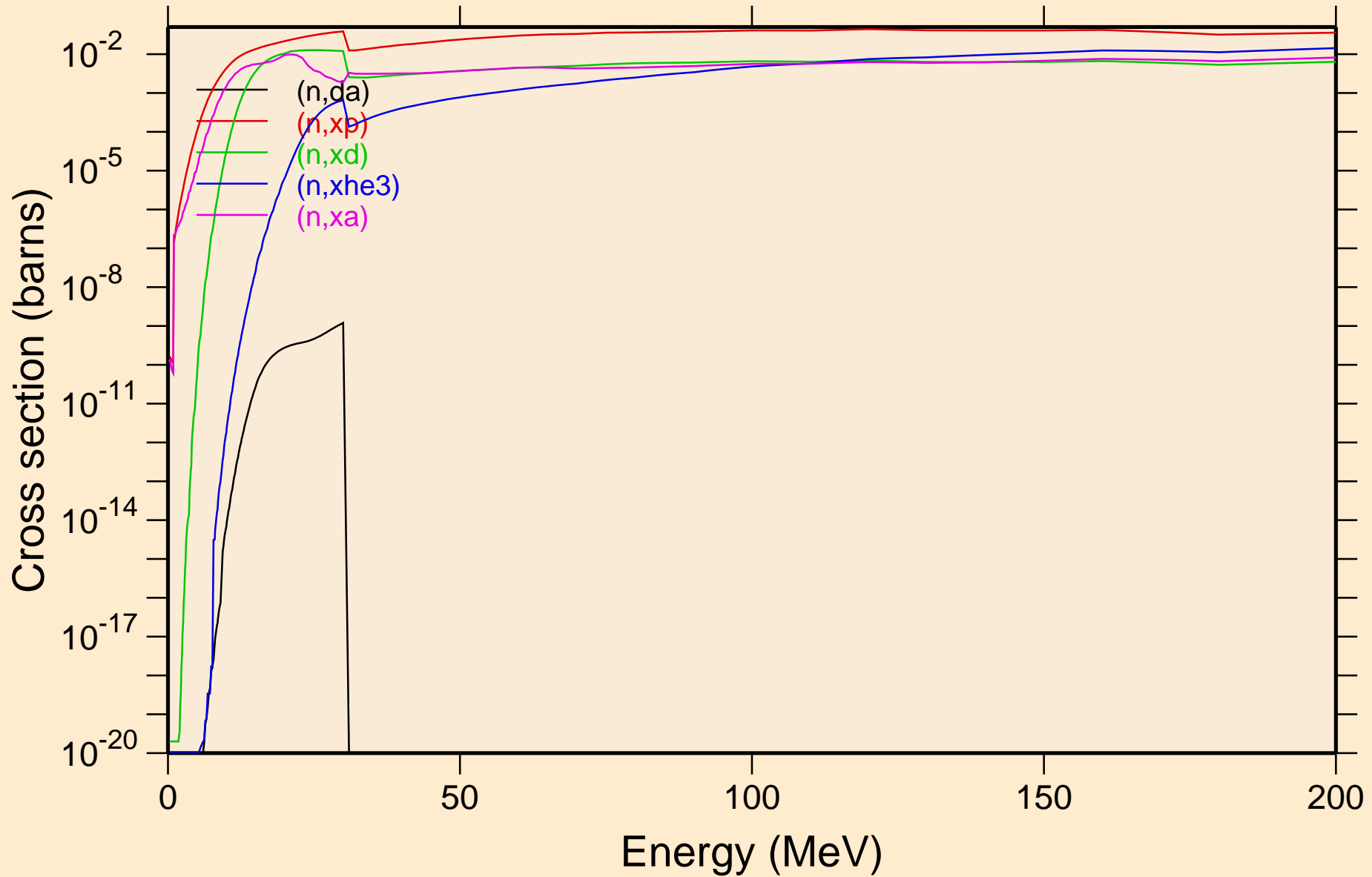

ES241 NEUTRON ACER TENDL-2023 LIBRARY; T=0.K
Inelastic levels

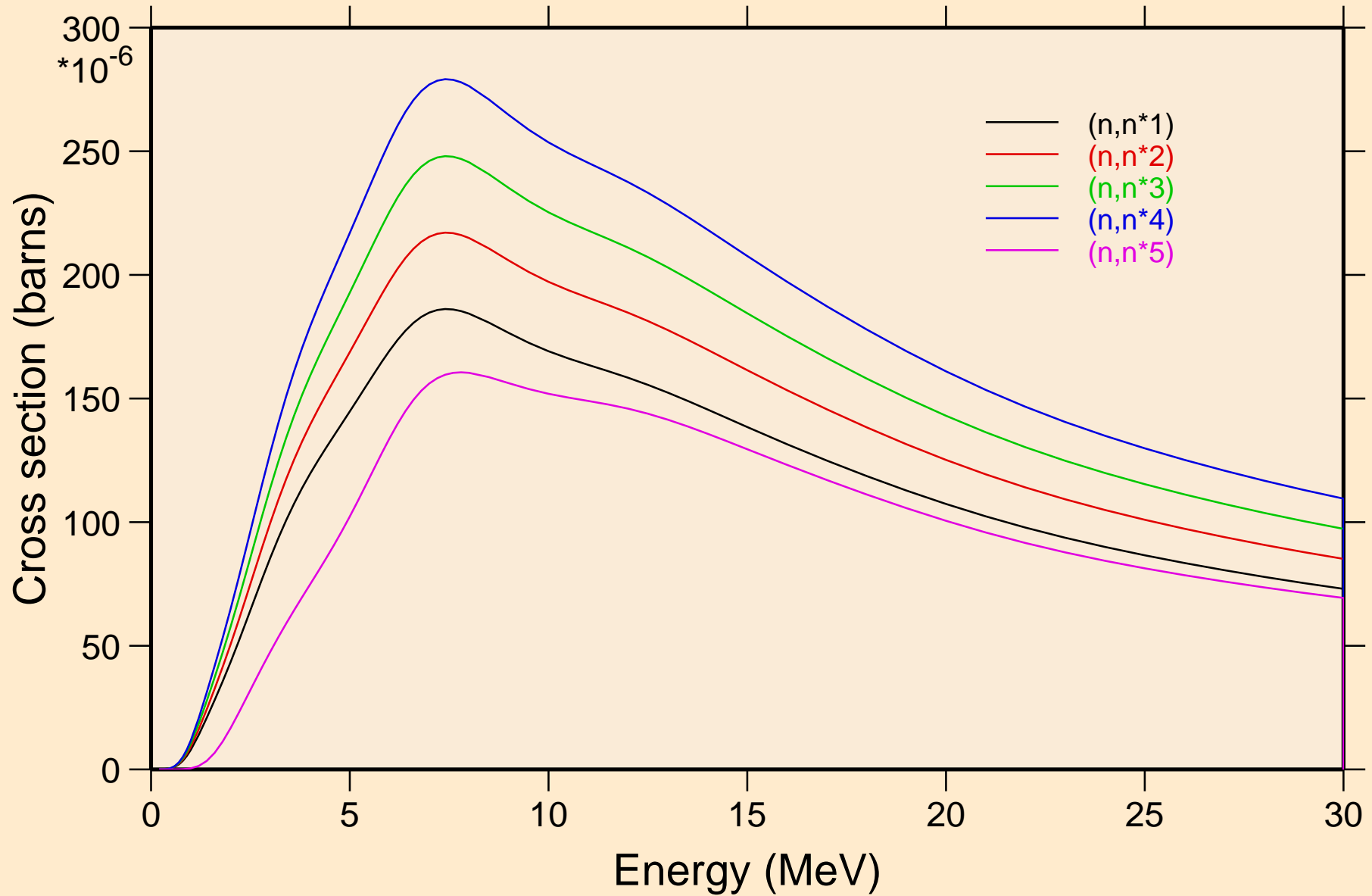

ES241 NEUTRON ACER TENDL-2023 LIBRARY; T=0.K
Inelastic levels

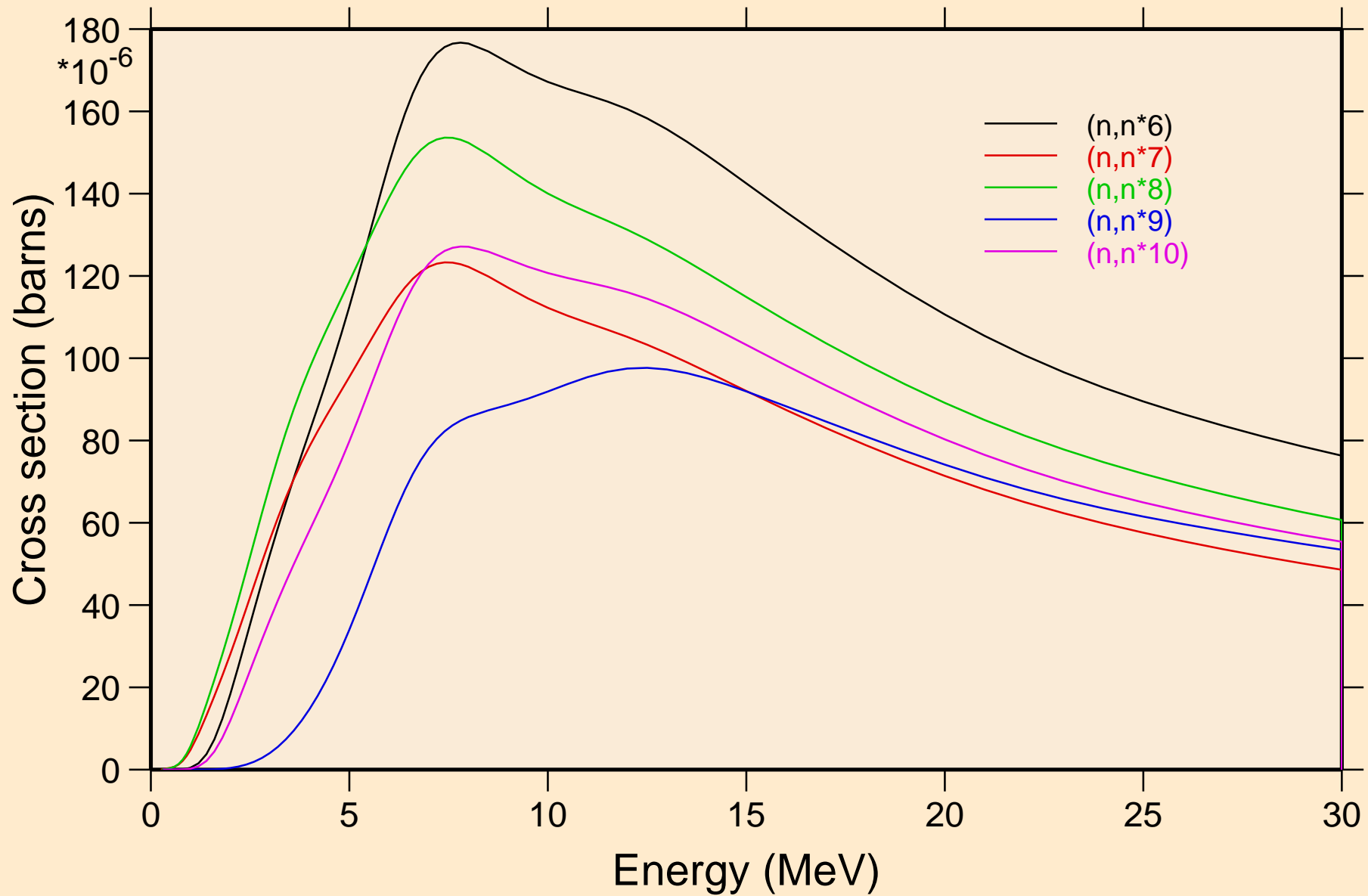

ES241 NEUTRON ACER TENDL-2023 LIBRARY; T=0.K
Inelastic levels

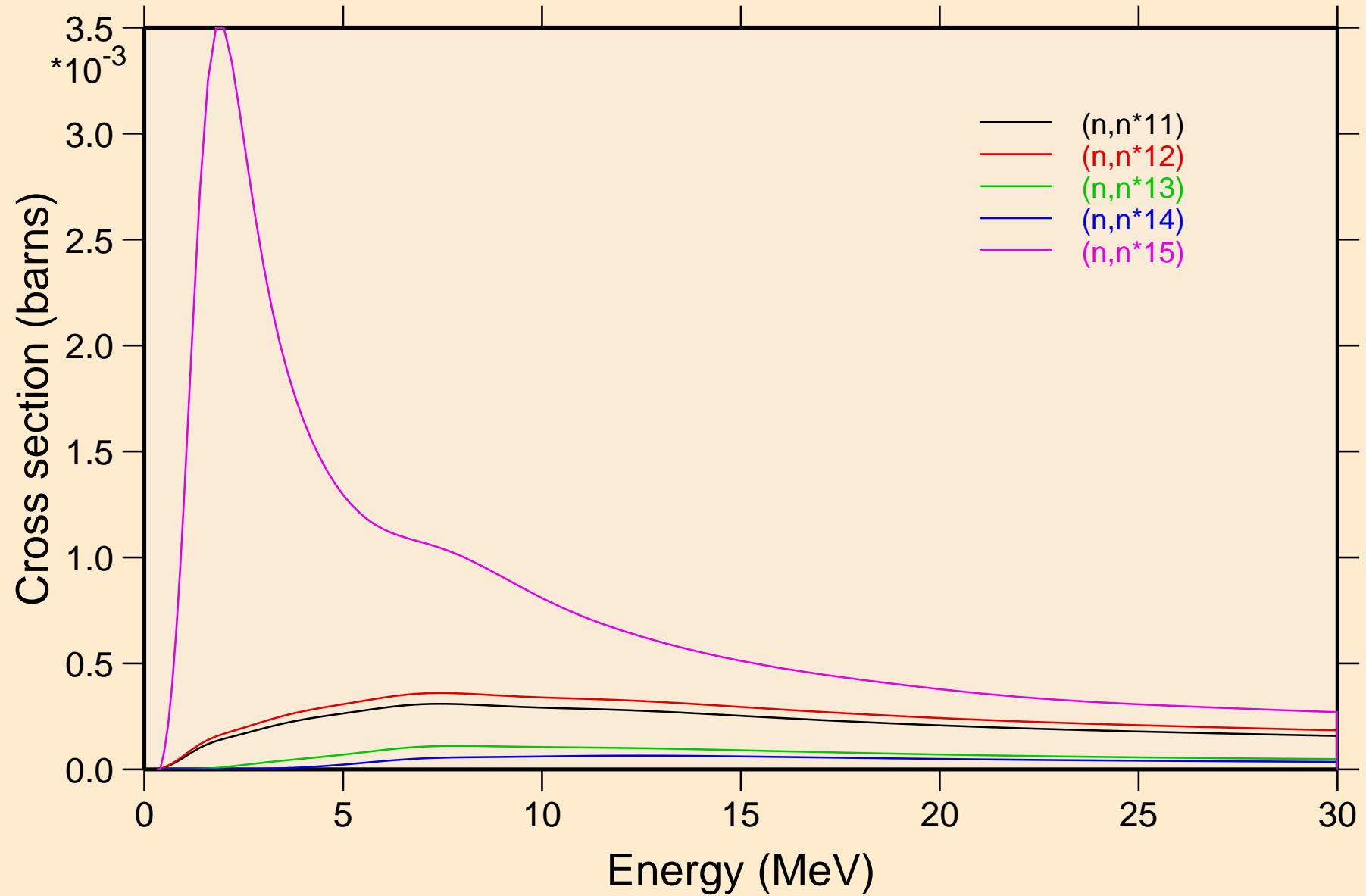

ES241 NEUTRON ACER TENDL-2023 LIBRARY; T=0.K

Inelastic levels

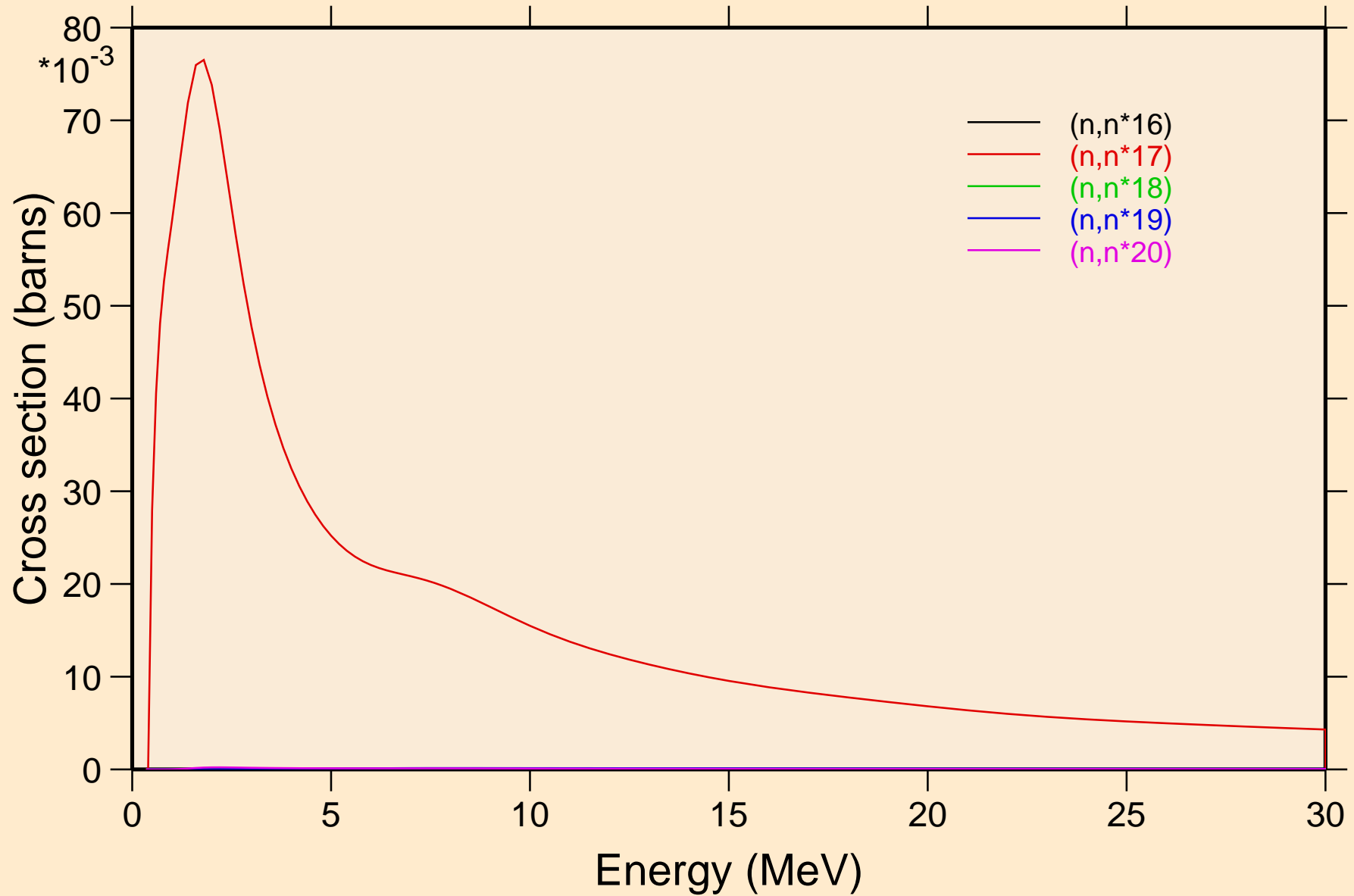

ES241 NEUTRON ACER TENDL-2023 LIBRARY; T=0.K

Inelastic levels

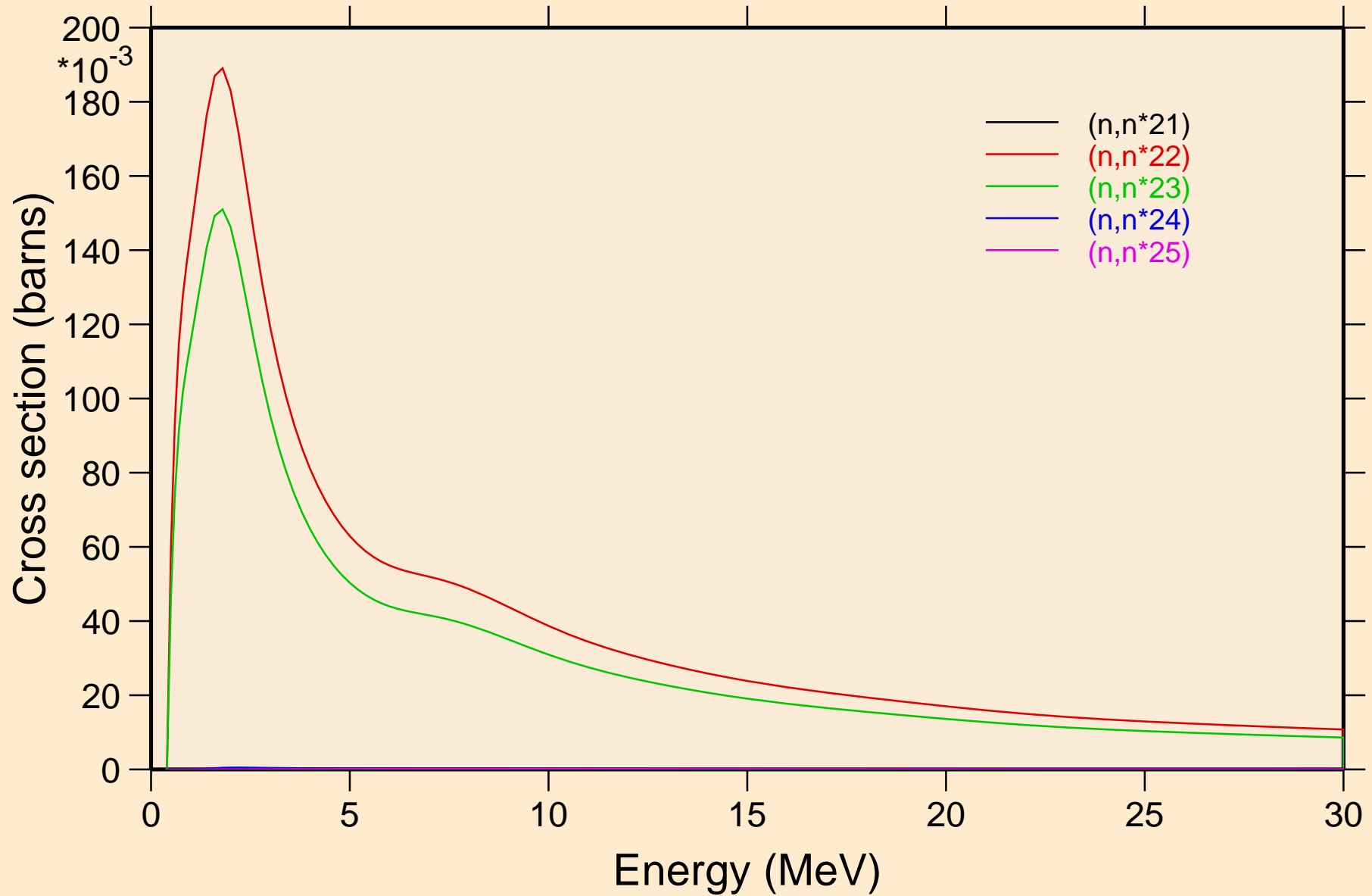

ES241 NEUTRON ACER TENDL-2023 LIBRARY; T=0.K

Inelastic levels

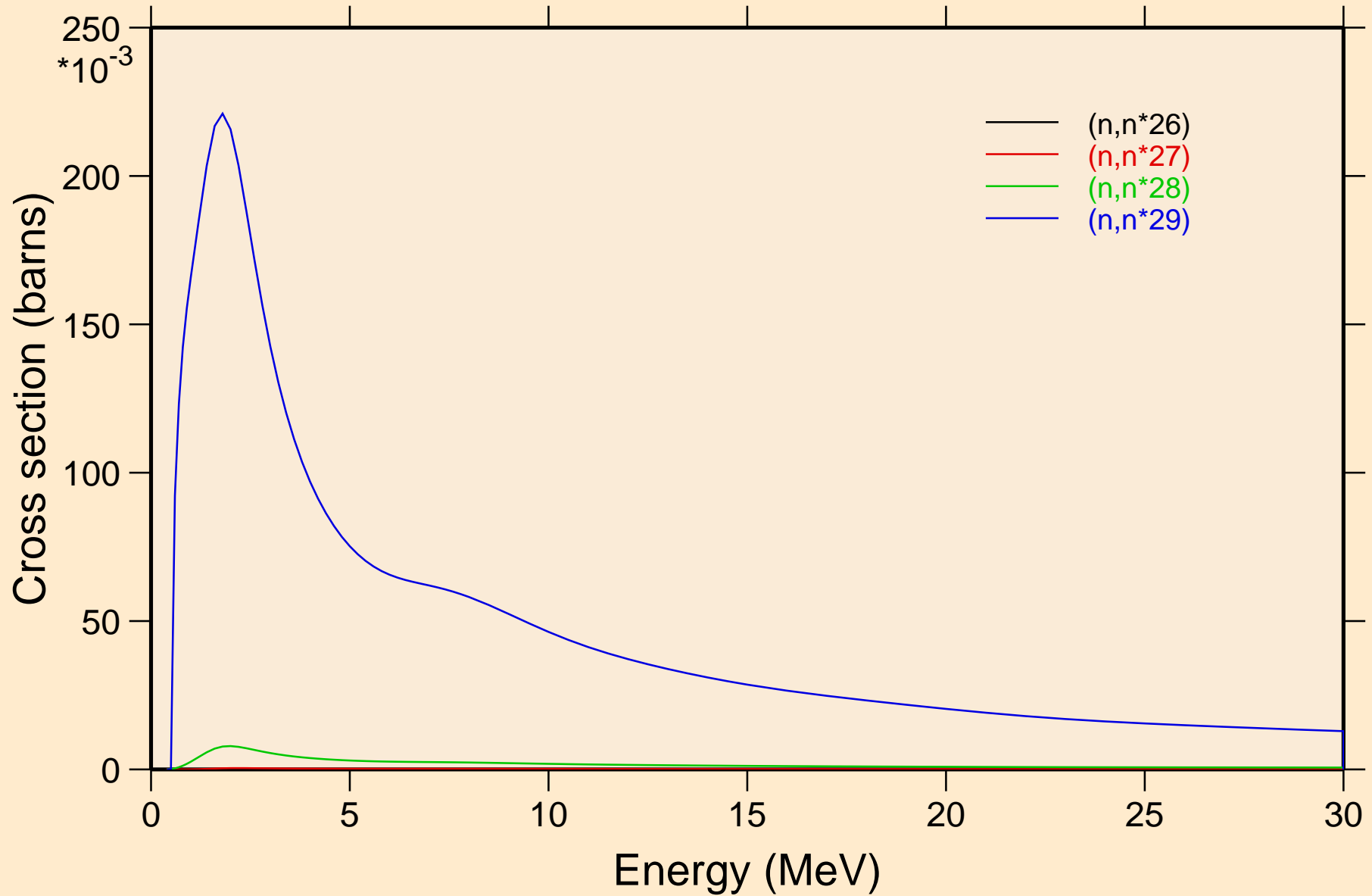

ES241 NEUTRON ACER TENDL-2023 LIBRARY; T=0.K

Threshold reactions

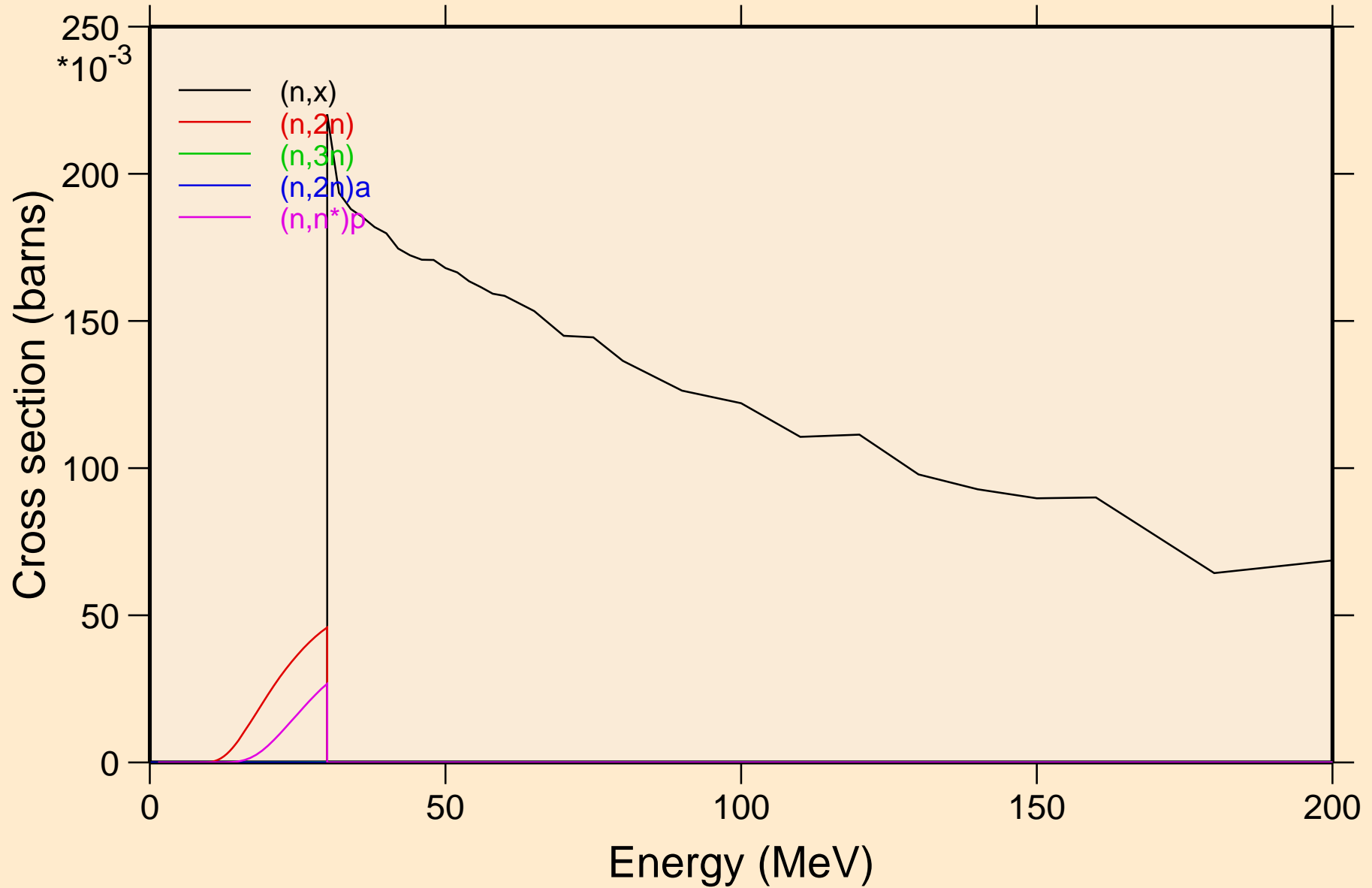

ES241 NEUTRON ACER TENDL-2023 LIBRARY; T=0.K

Threshold reactions

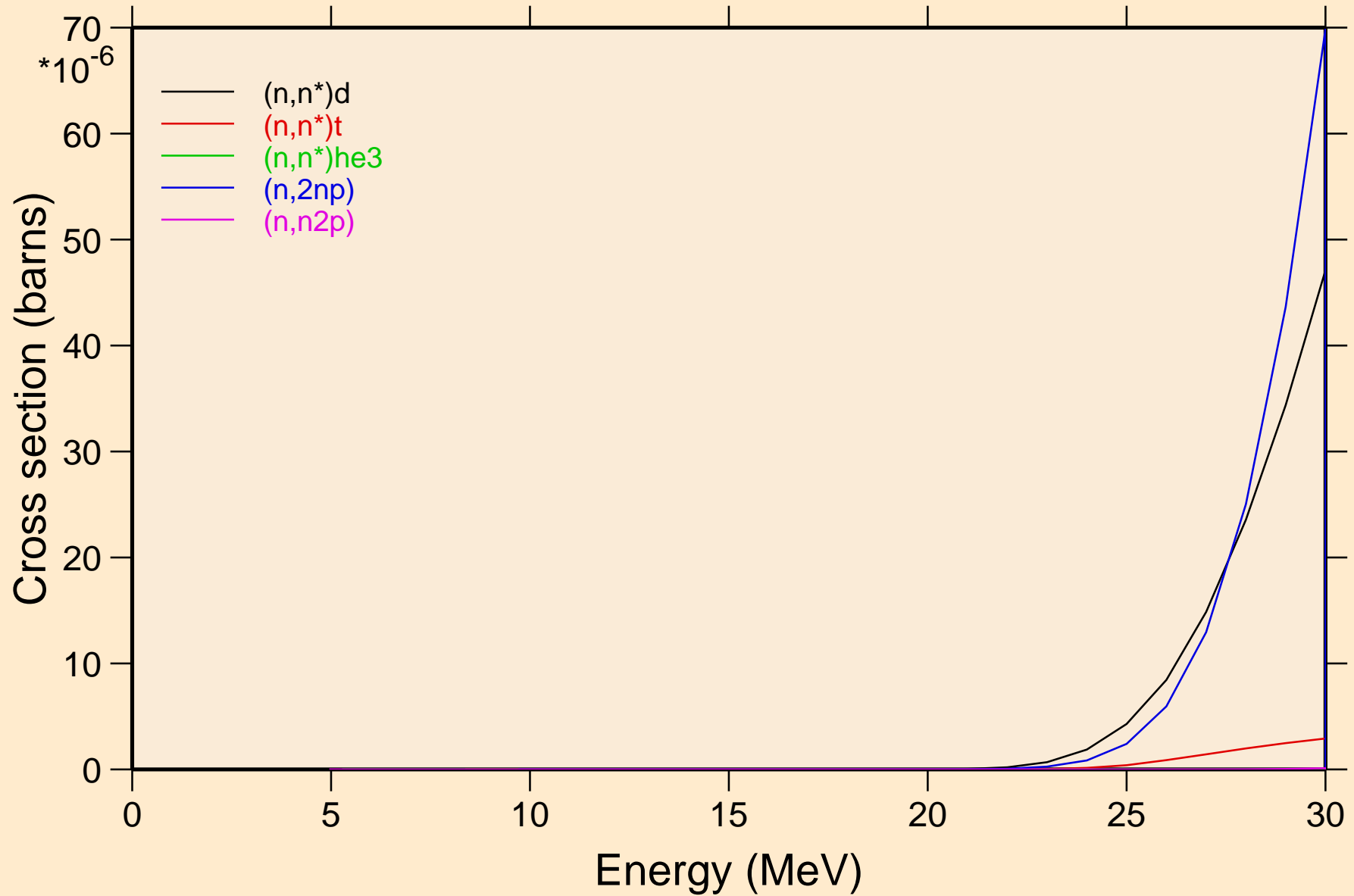

ES241 NEUTRON ACER TENDL-2023 LIBRARY; T=0.K

Threshold reactions

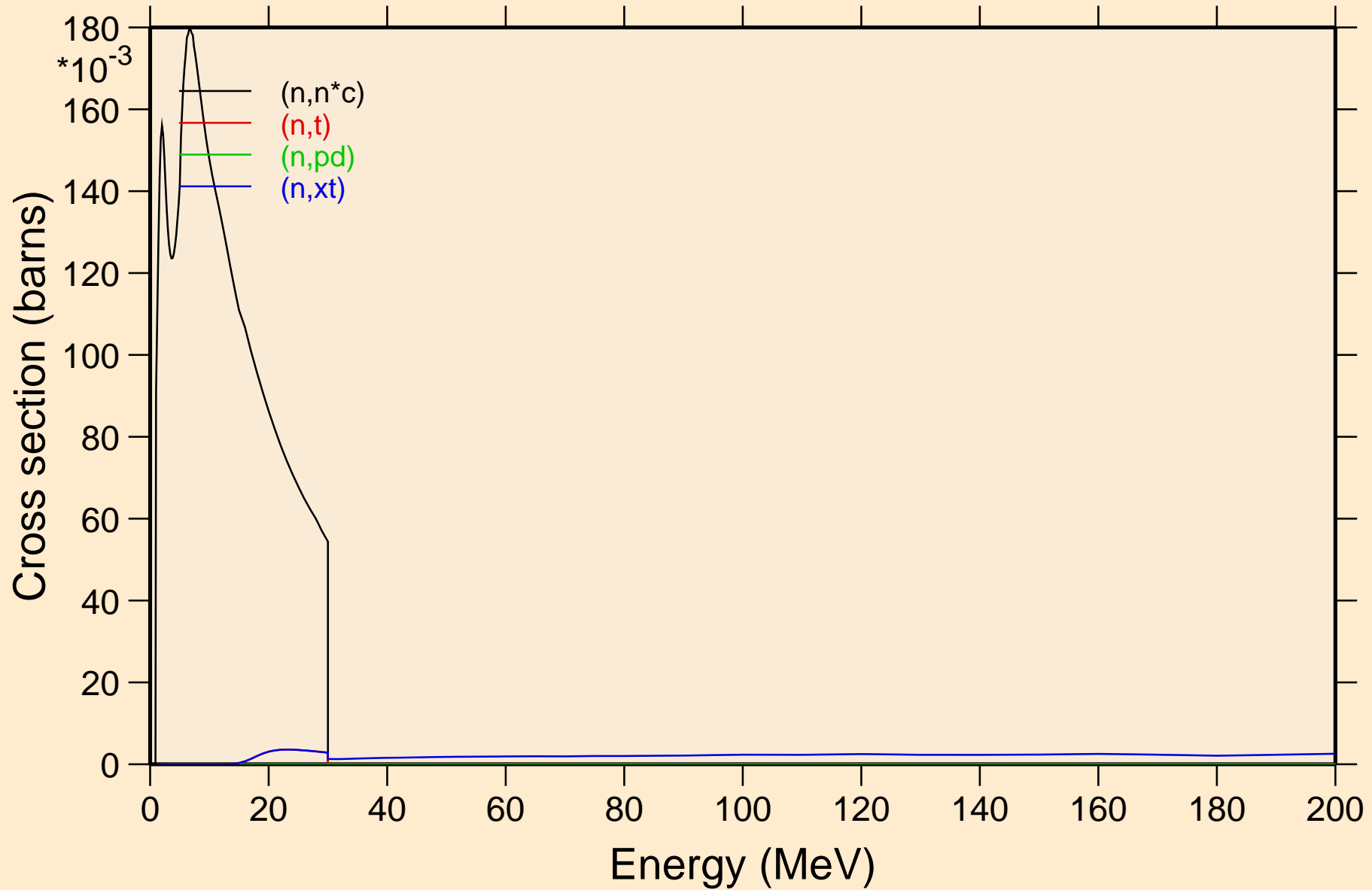

ES241 NEUTRON ACER TENDL-2023 LIBRARY; T=0.K
angular distribution for elastic

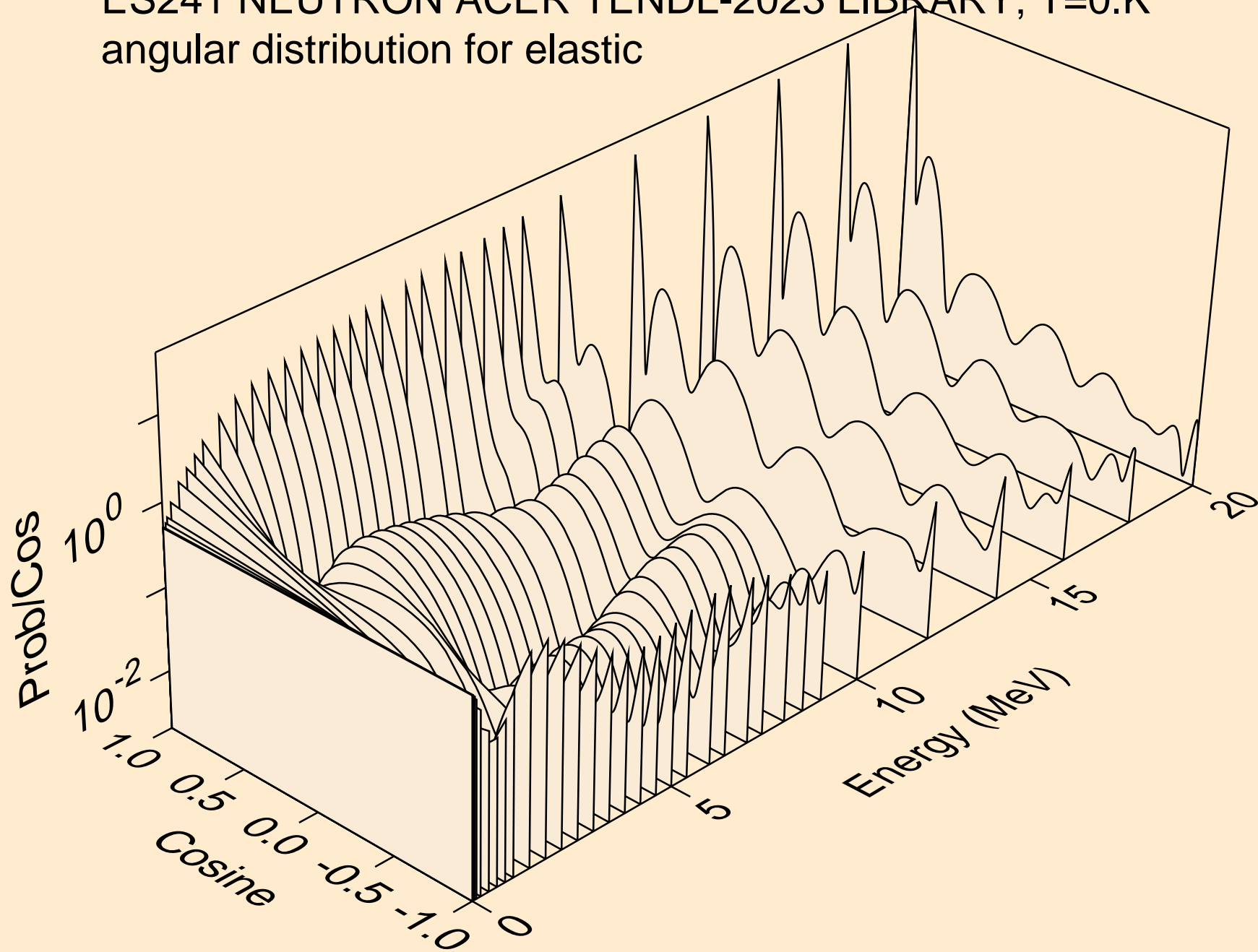

ES241 NEUTRON ACER TENDL-2023 LIBRARY; T=0.K
angular distribution for elastic

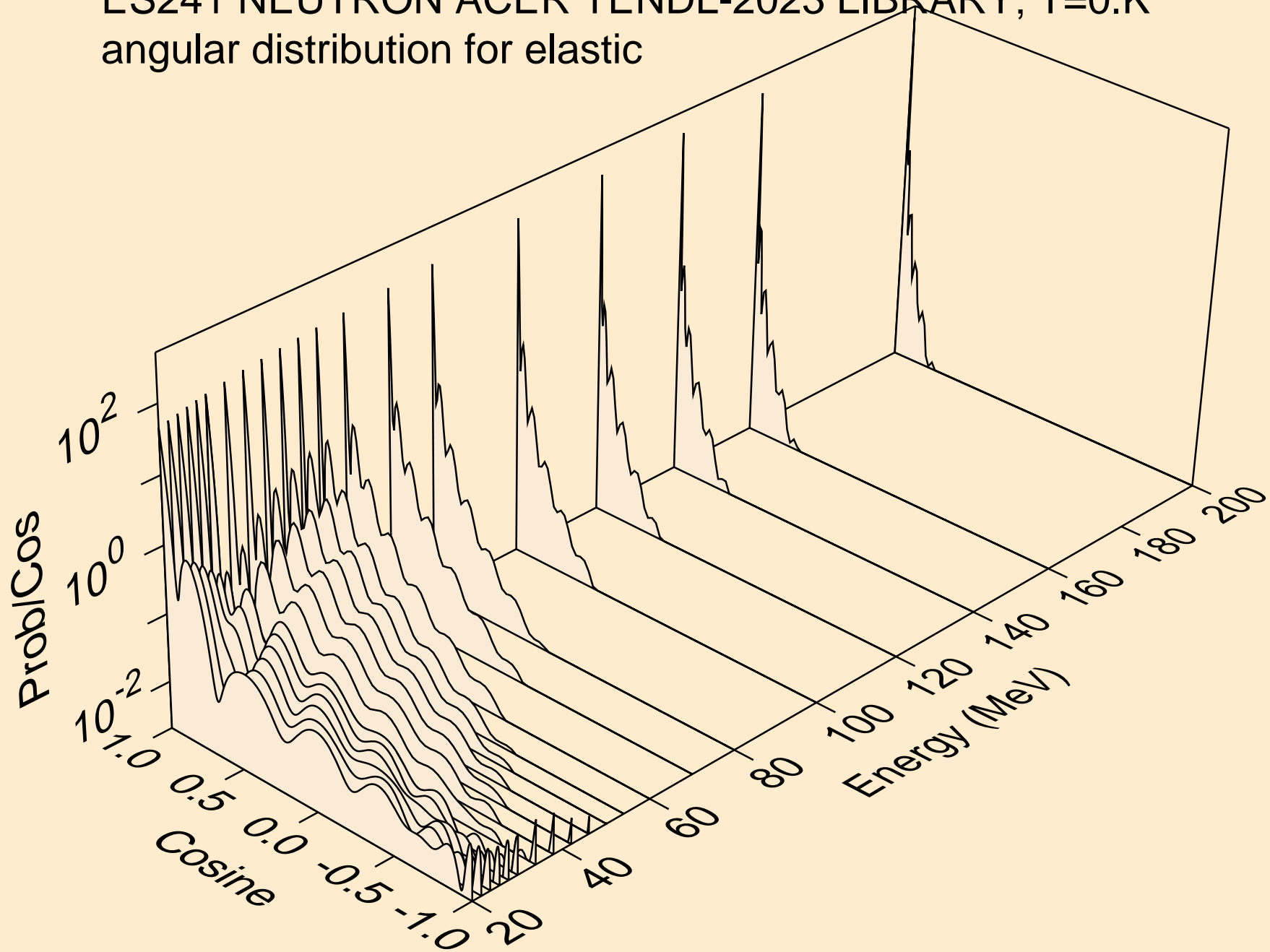

ES241 NEUTRON ACER TENDL-2023 LIBRARY; T=0.K
angular distribution for (n,n*1)

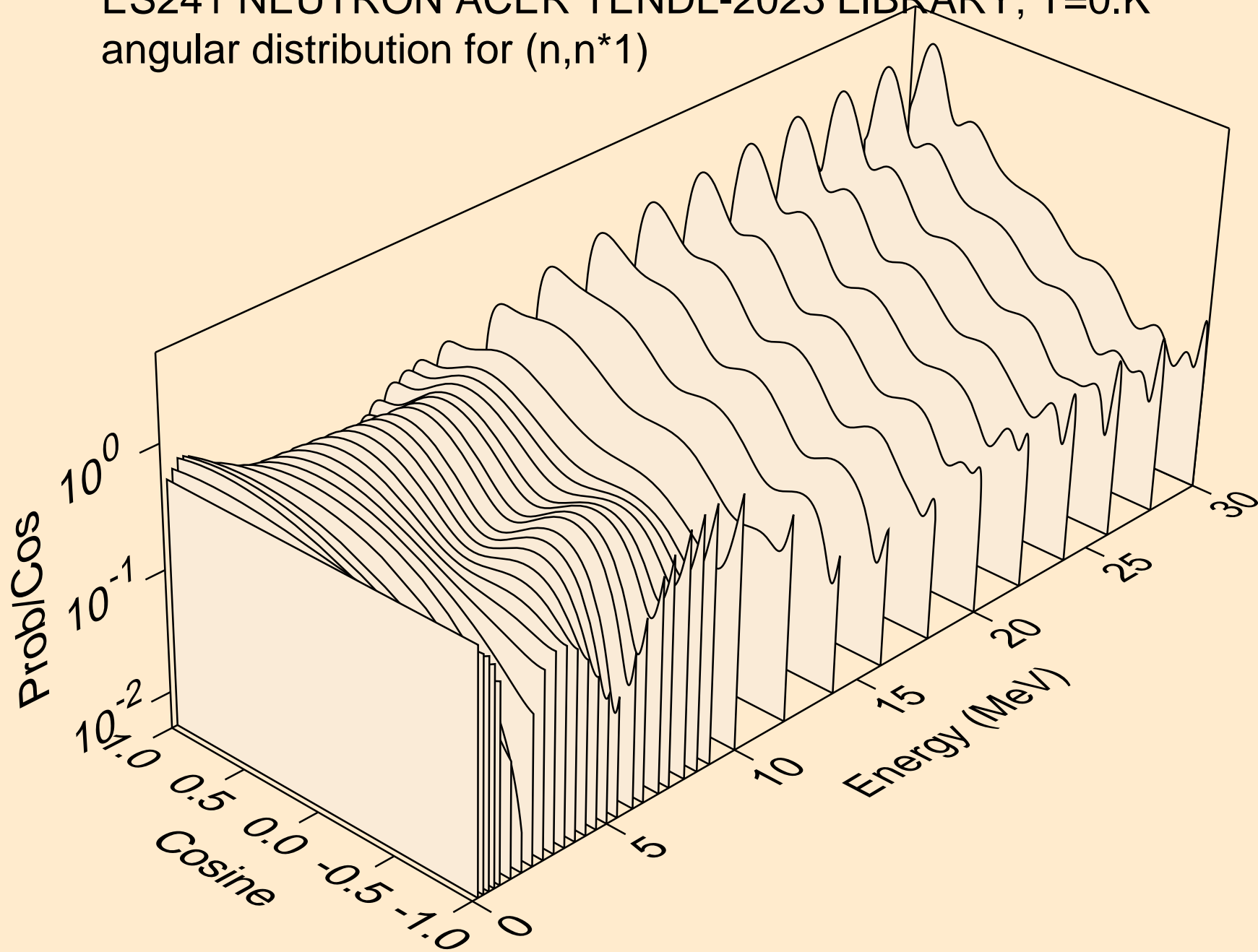

ES241 NEUTRON ACER TENDL-2023 LIBRARY; T=0.K
angular distribution for (n,n*2)

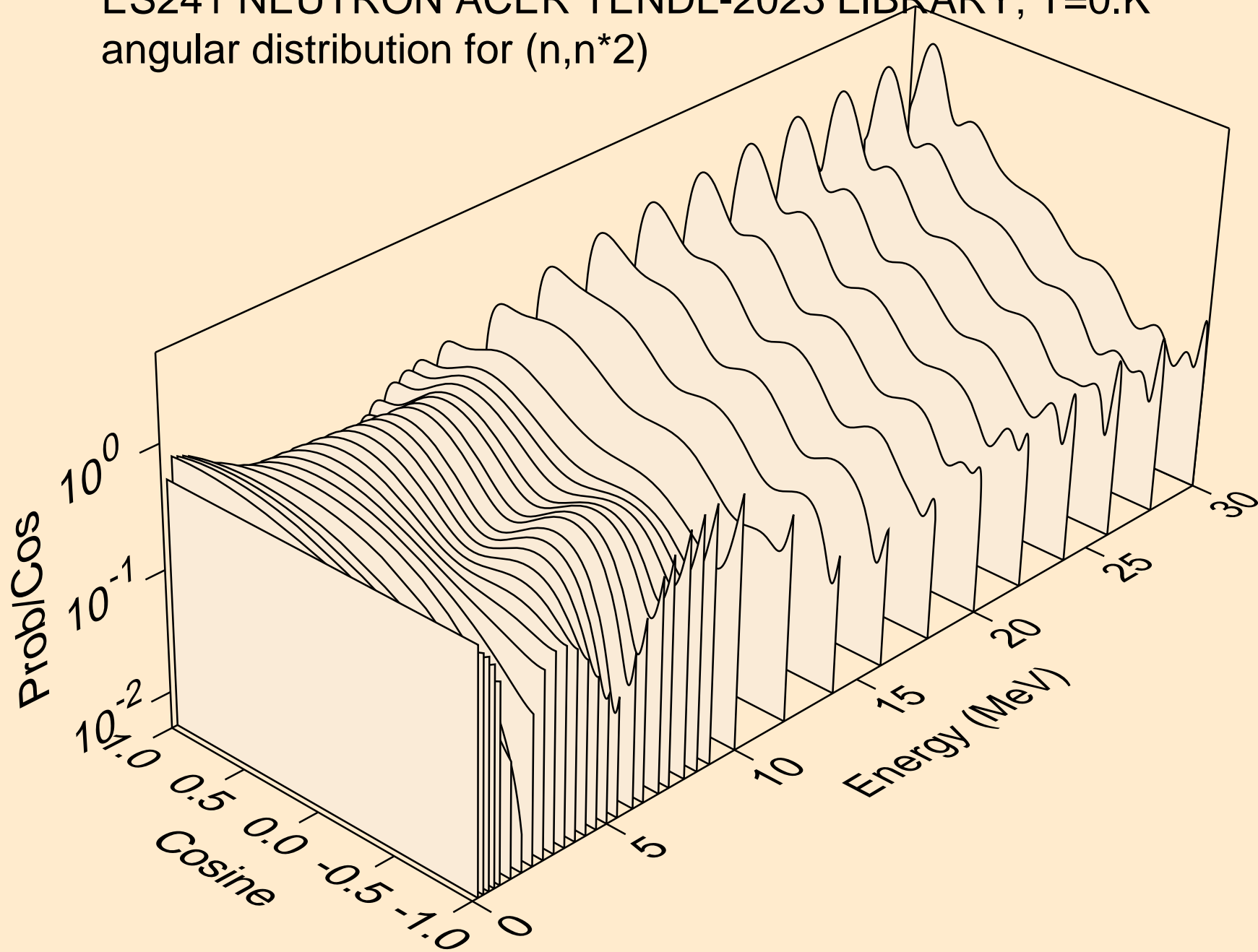

ES241 NEUTRON ACER TENDL-2023 LIBRARY; T=0.K
angular distribution for (n,n*3)

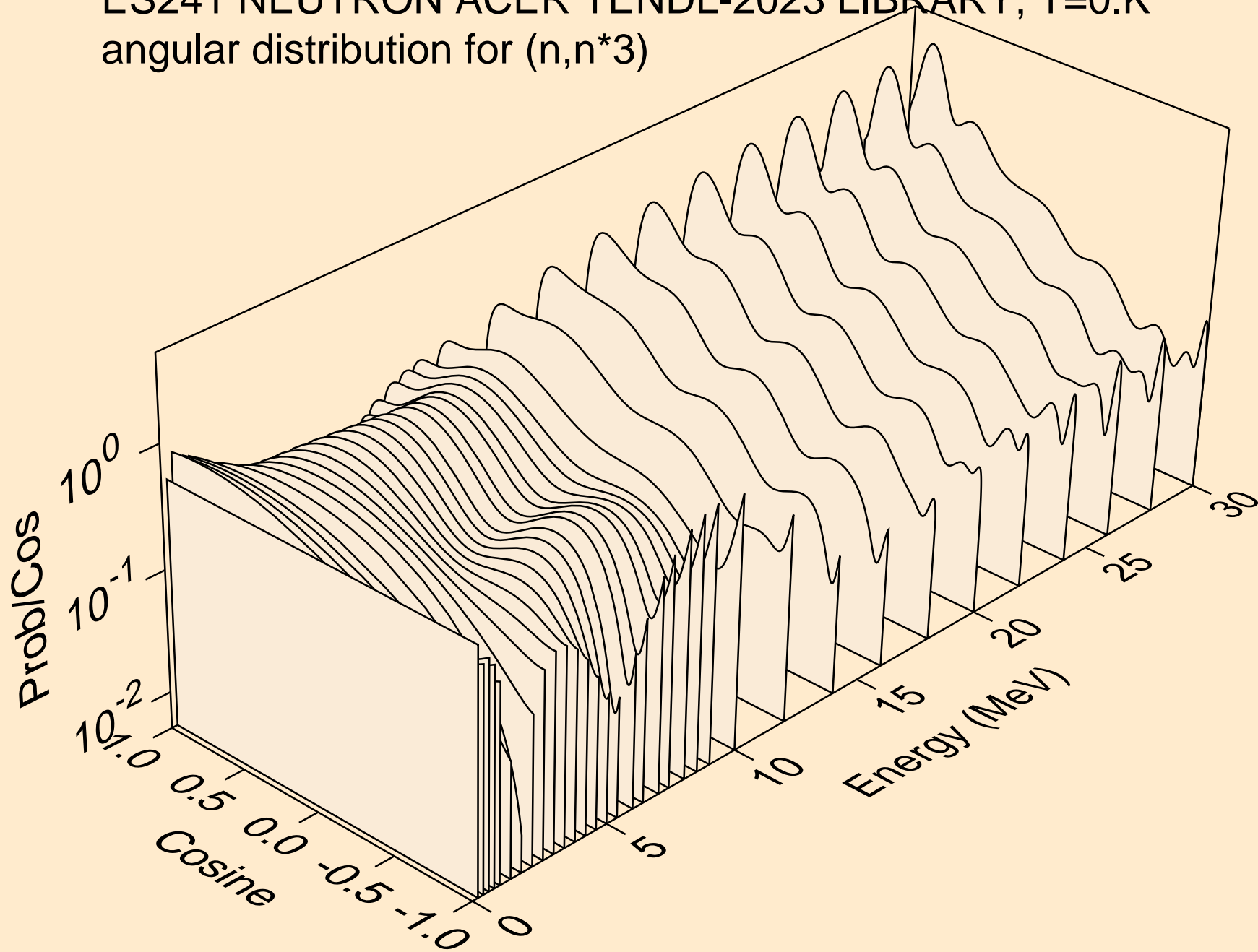

ES241 NEUTRON ACER TENDL-2023 LIBRARY; T=0.K
angular distribution for (n,n*4)

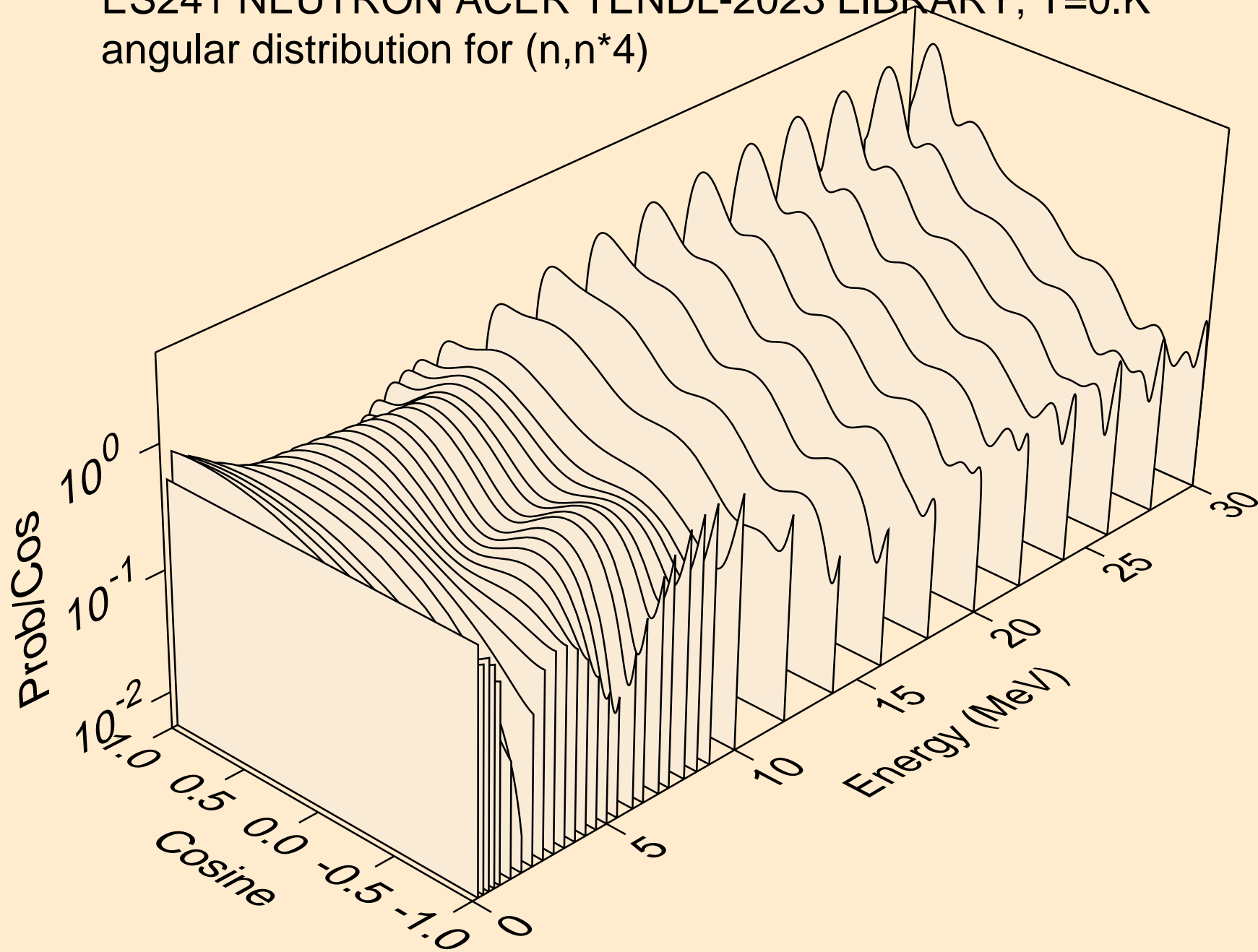

ES241 NEUTRON ACER TENDL-2023 LIBRARY; T=0.K
angular distribution for (n,n*5)

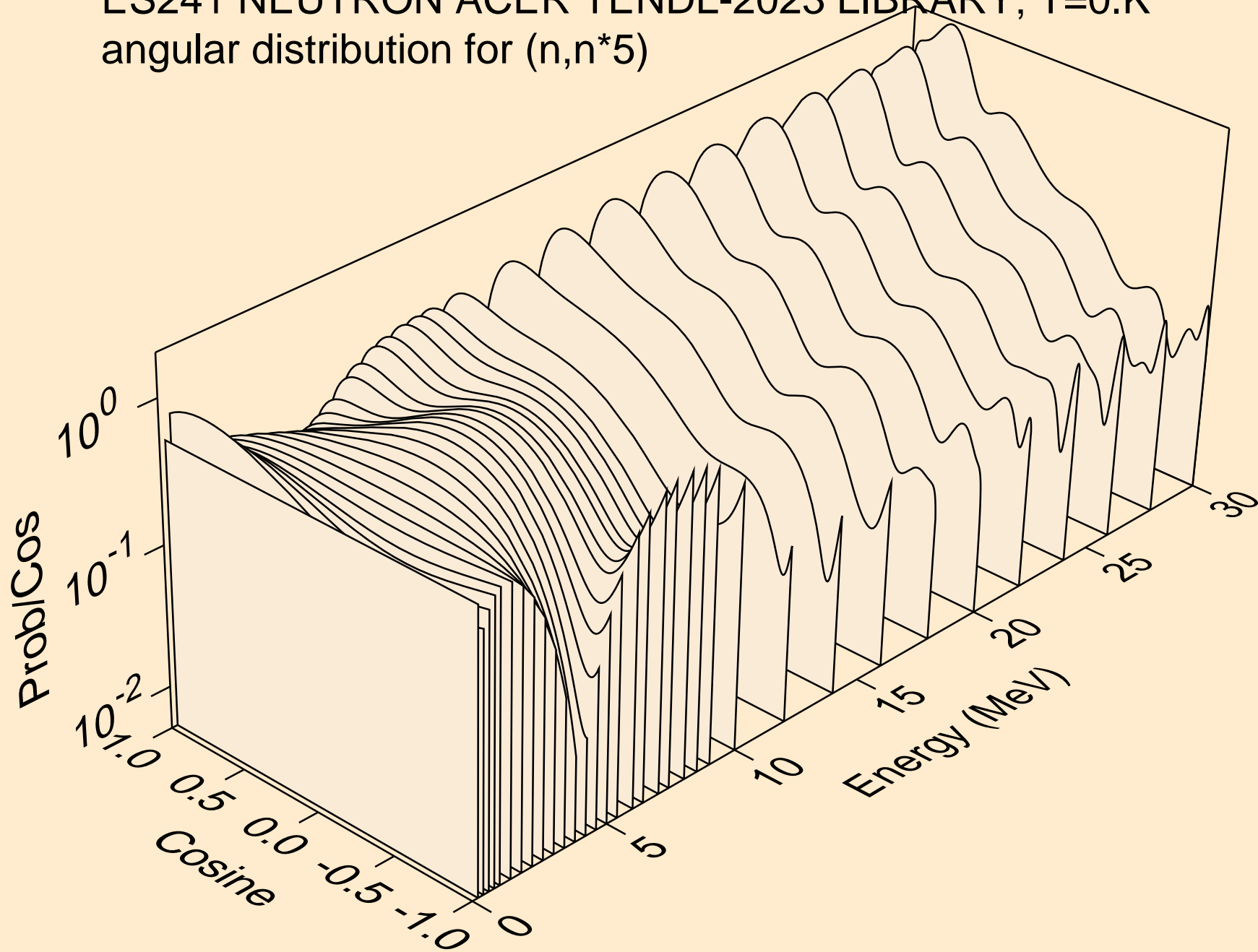

ES241 NEUTRON ACER TENDL-2023 LIBRARY; T=0.K
angular distribution for (n,n*6)

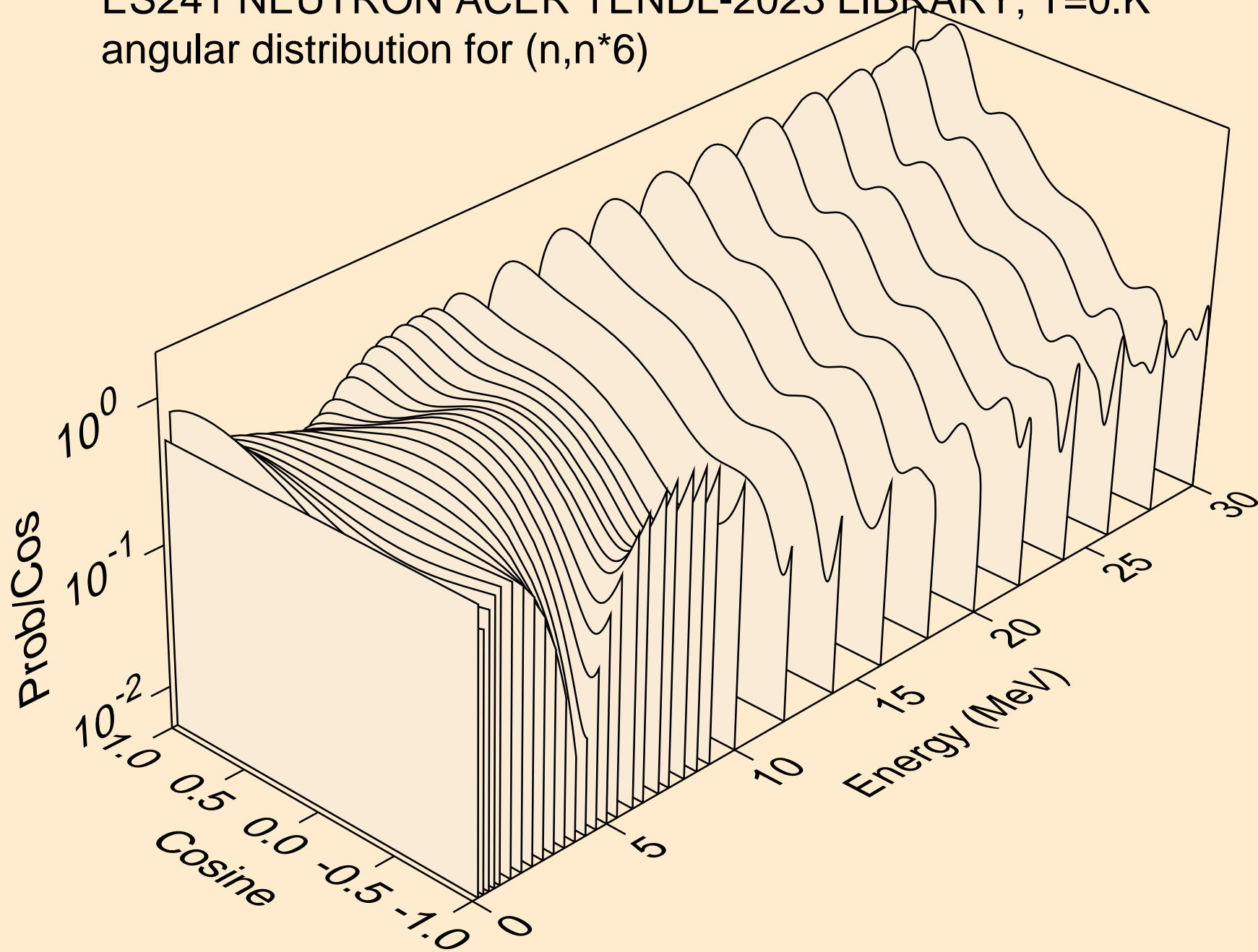

ES241 NEUTRON ACER TENDL-2023 LIBRARY; T=0.K
angular distribution for (n,n*7)

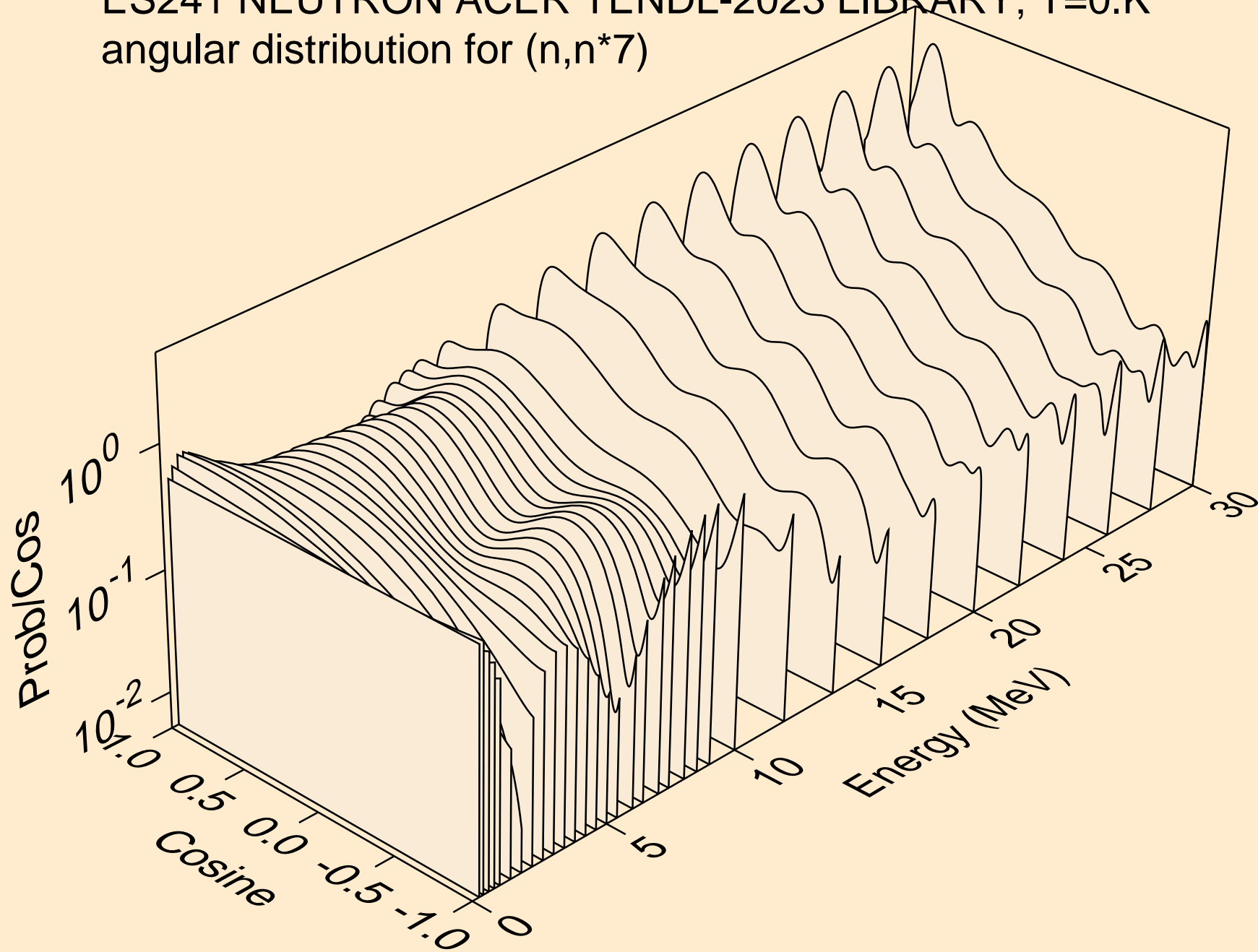

ES241 NEUTRON ACER TENDL-2023 LIBRARY; T=0.K
angular distribution for (n,n*8)

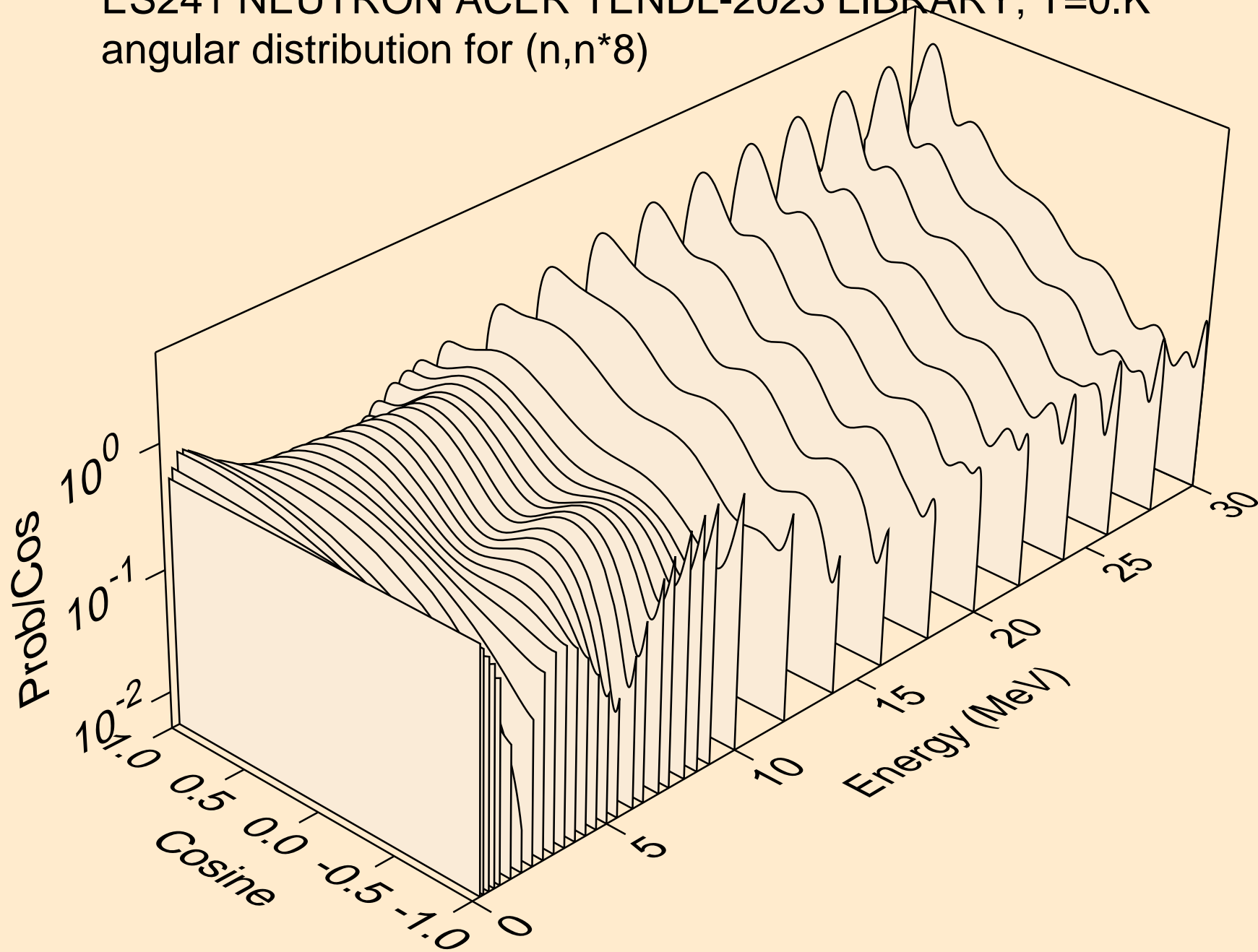

ES241 NEUTRON ACER TENDL-2023 LIBRARY; T=0.K
angular distribution for (n,n*9)

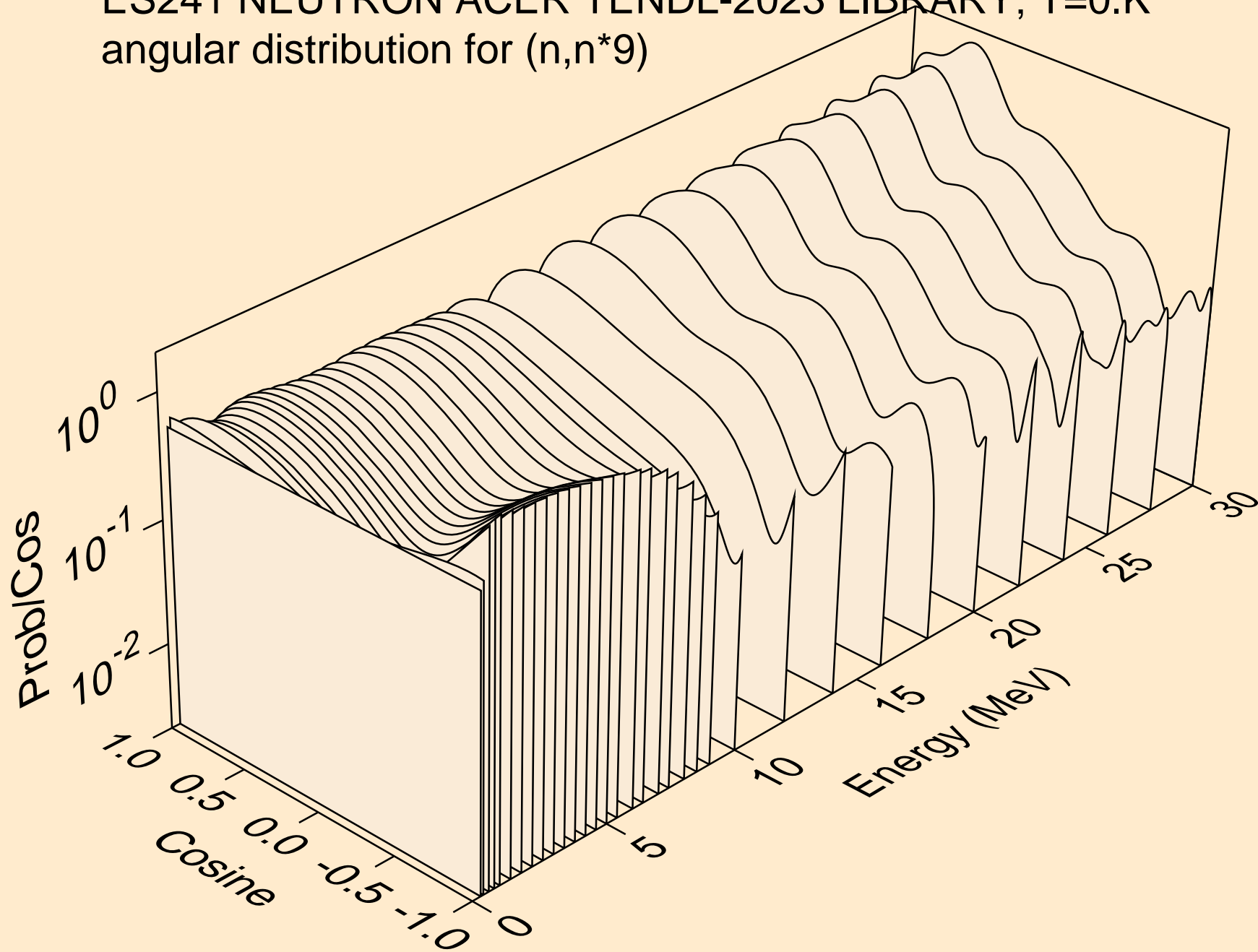

ES241 NEUTRON ACER TENDL-2023 LIBRARY; T=0.K
angular distribution for (n,n*10)

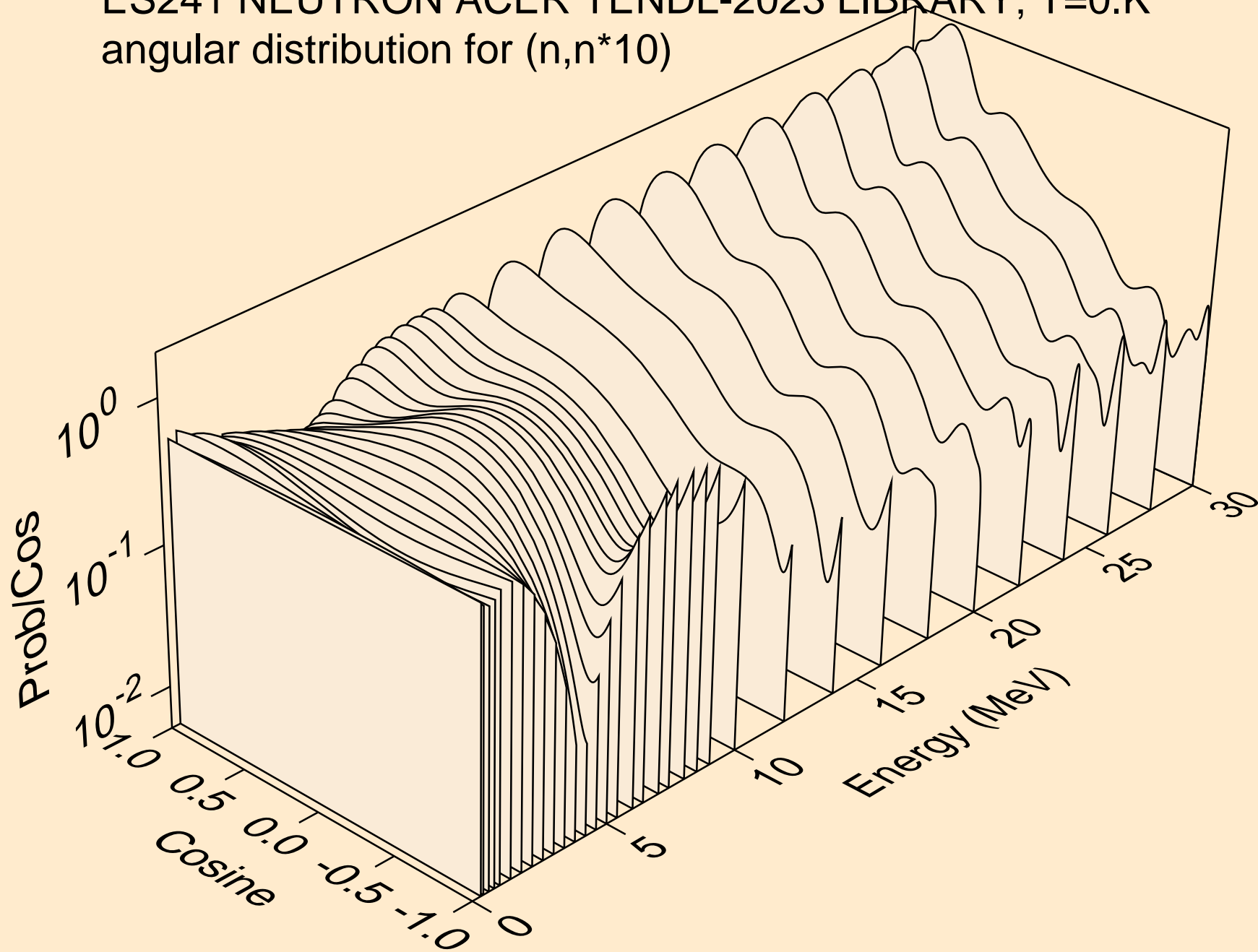

ES241 NEUTRON ACER TENDL-2023 LIBRARY; T=0.K
angular distribution for (n,n*11)

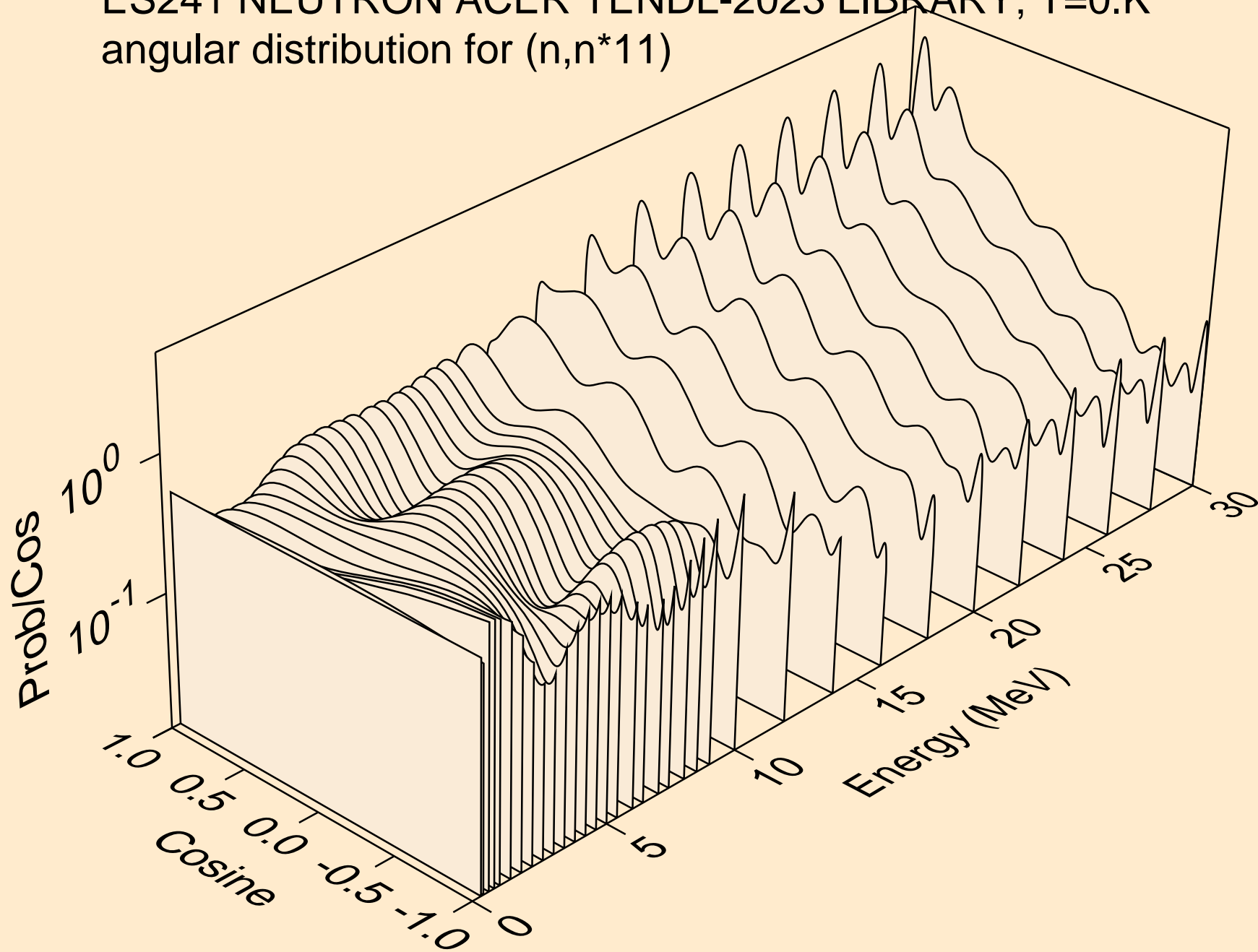

ES241 NEUTRON ACER TENDL-2023 LIBRARY; T=0.K
angular distribution for (n,n*12)

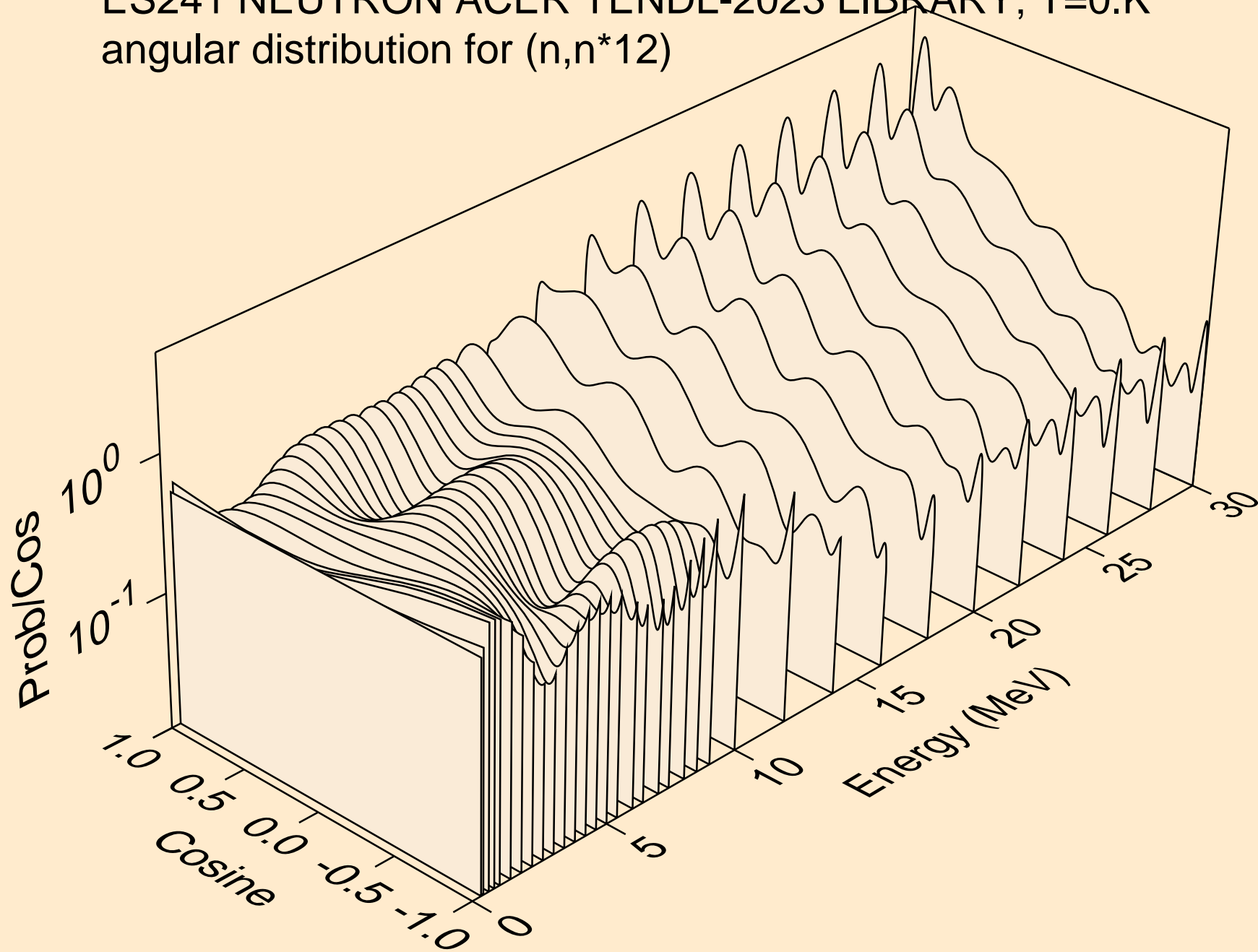

ES241 NEUTRON ACER TENDL-2023 LIBRARY; T=0.K
angular distribution for (n,n*13)

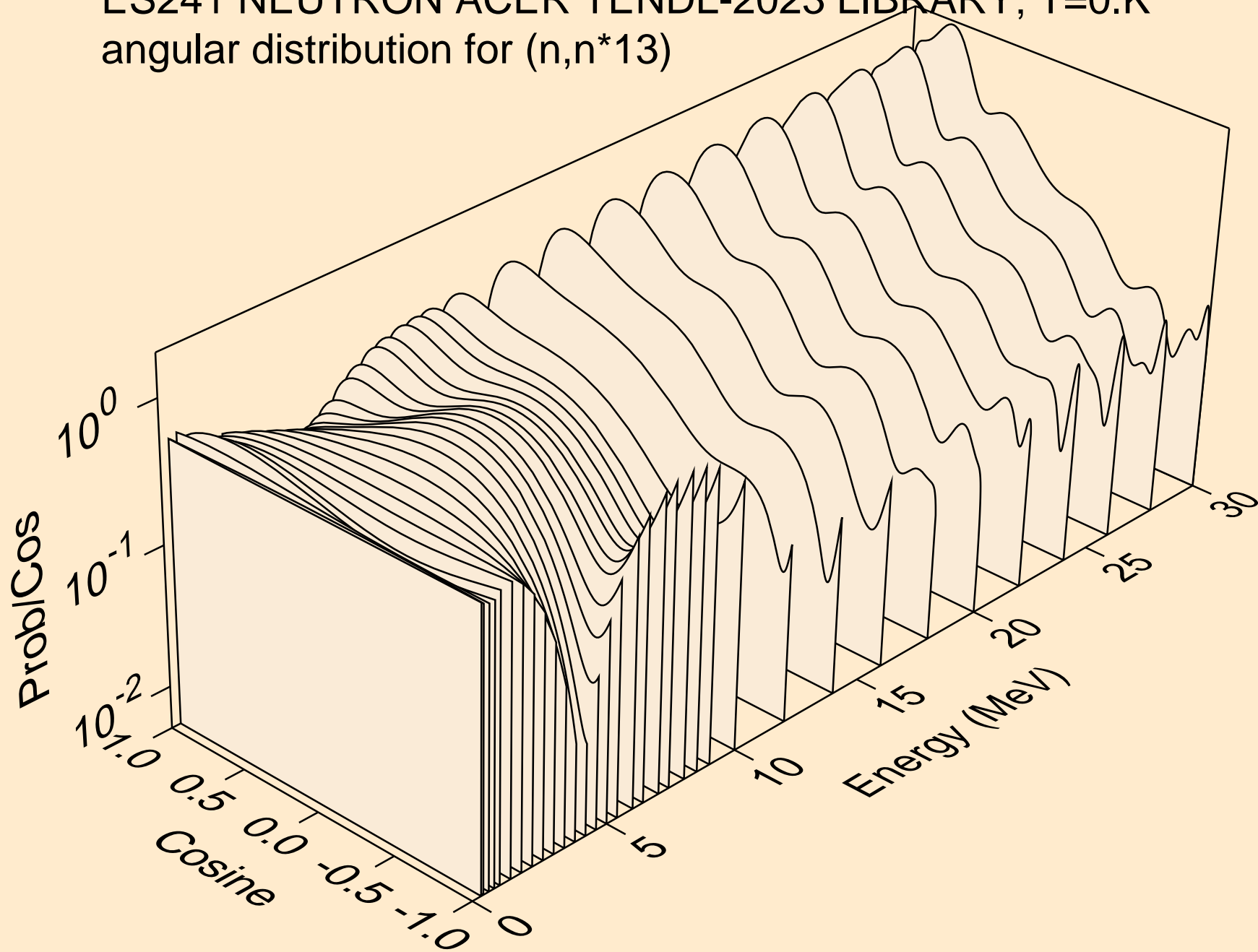

ES241 NEUTRON ACER TENDL-2023 LIBRARY; T=0.K
angular distribution for (n,n*14)

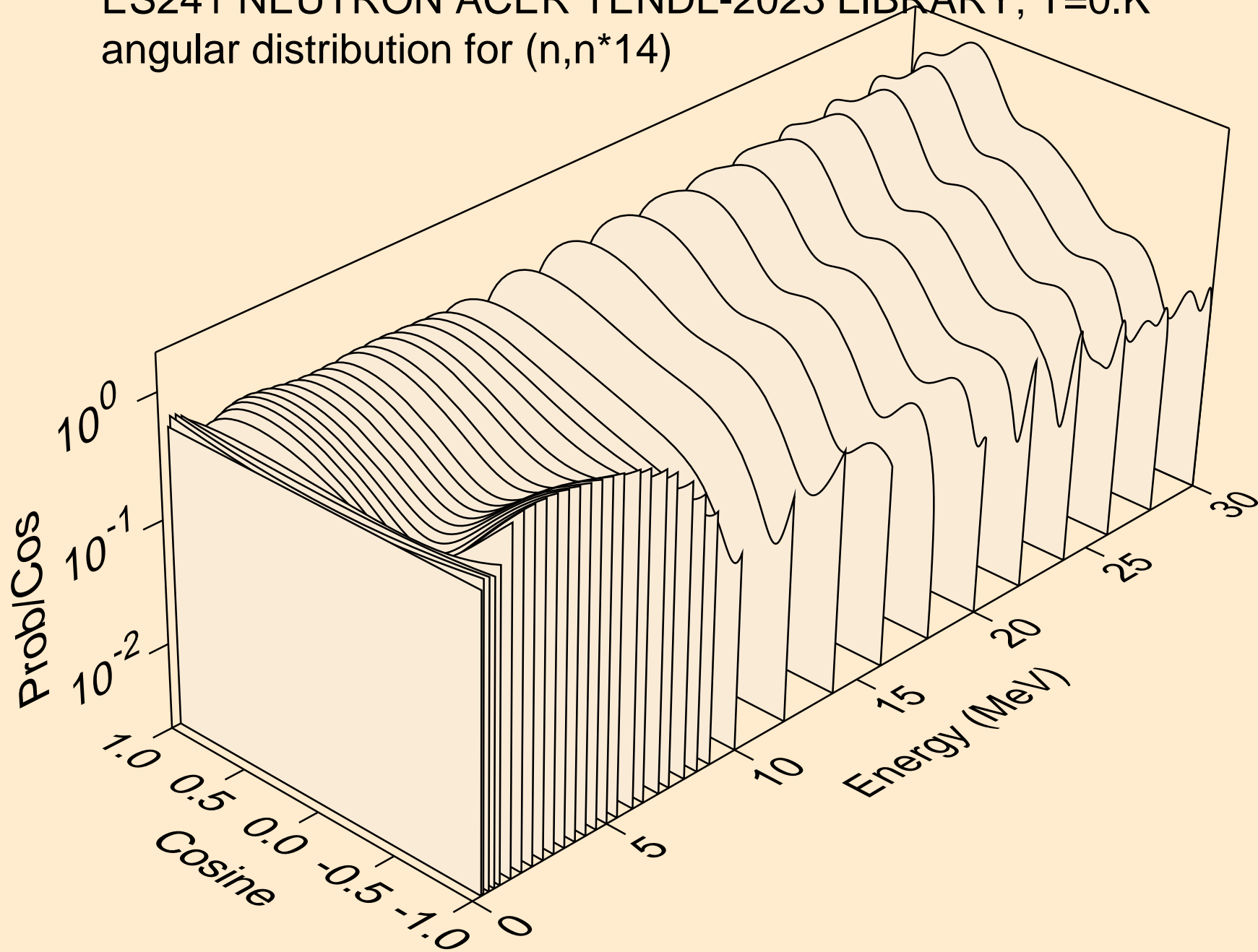

ES241 NEUTRON ACER TENDL-2023 LIBRARY; T=0.K
angular distribution for (n,n*15)

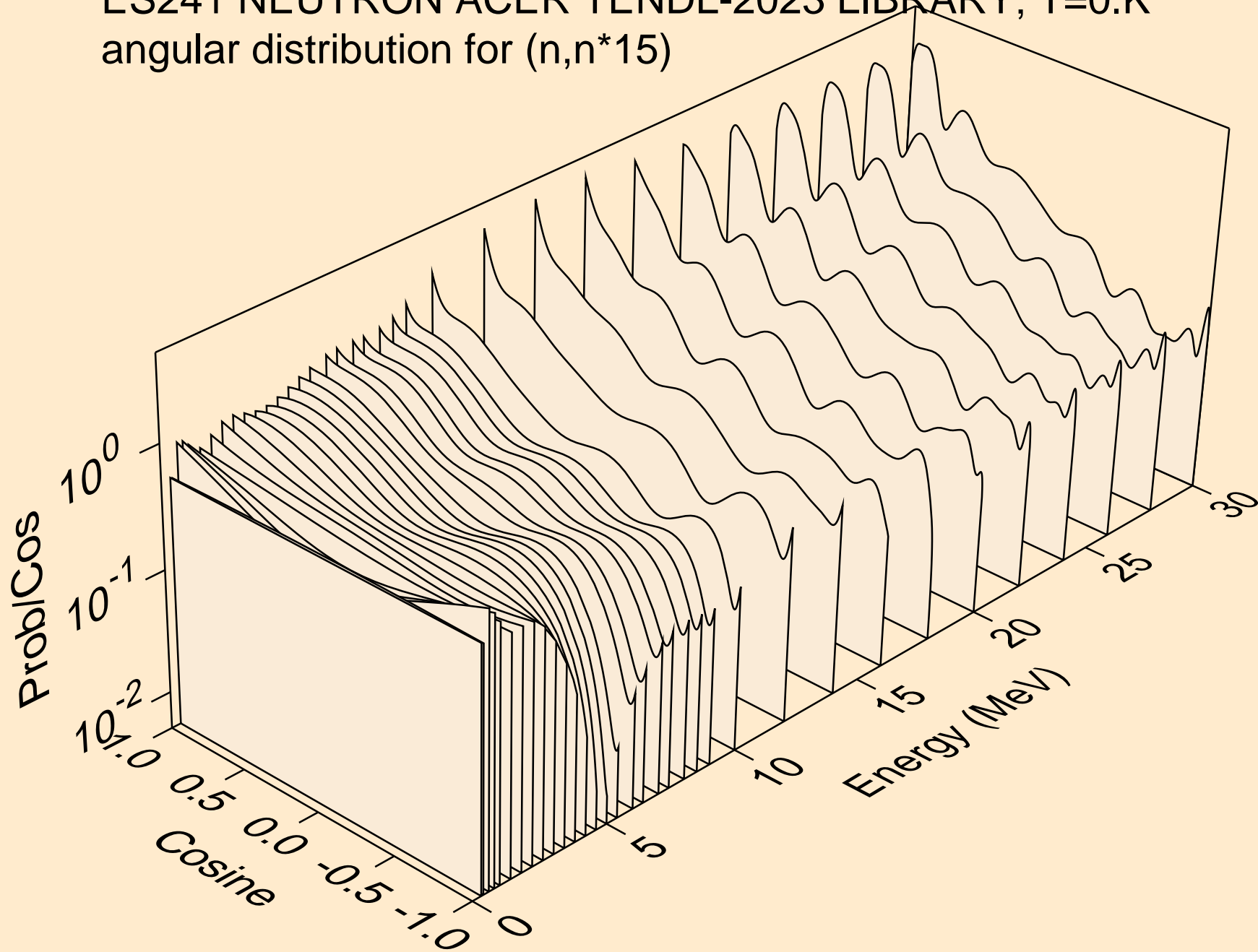

ES241 NEUTRON ACER TENDL-2023 LIBRARY; T=0.K
angular distribution for (n,n*16)

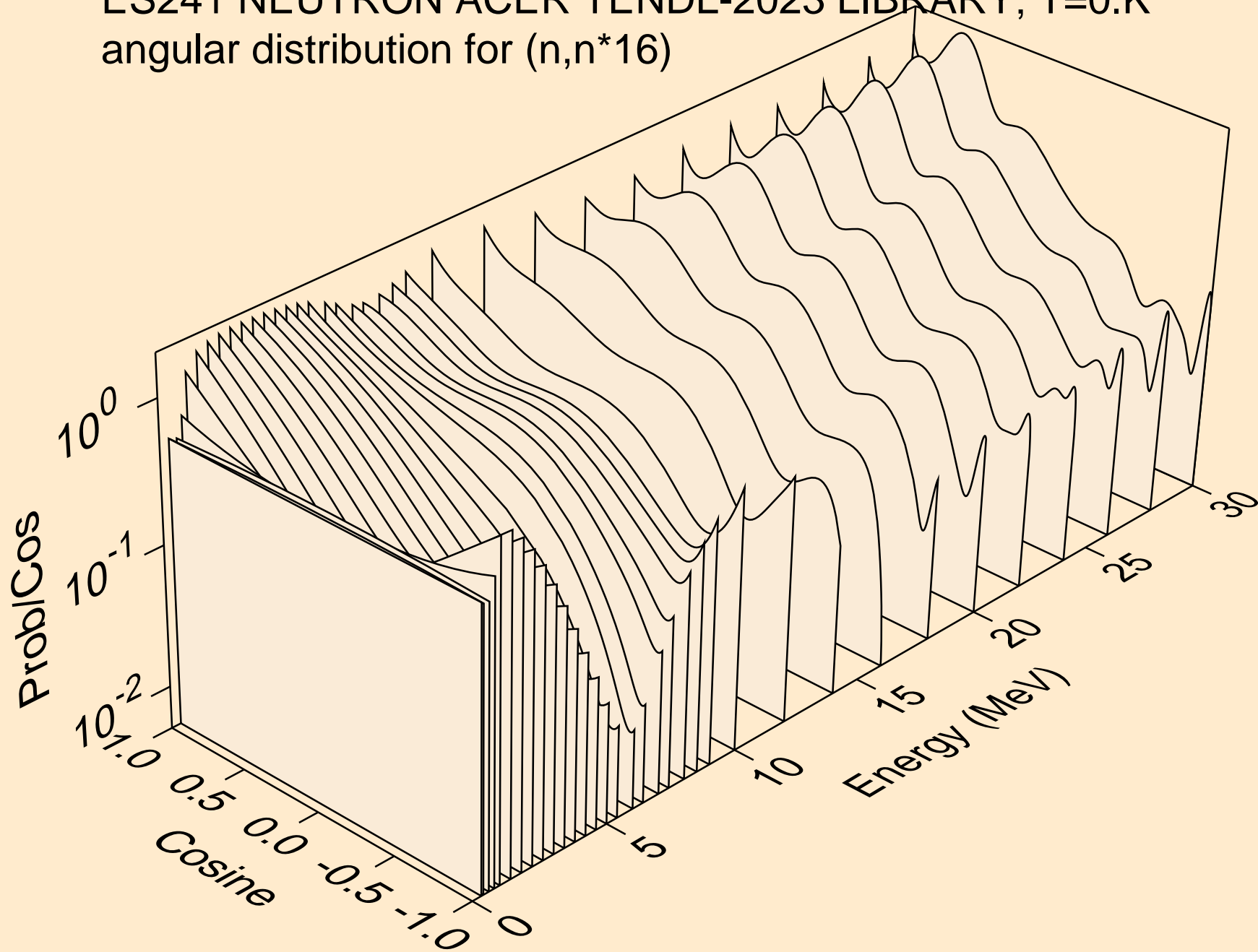

ES241 NEUTRON ACER TENDL-2023 LIBRARY; T=0.K
angular distribution for (n,n*17)

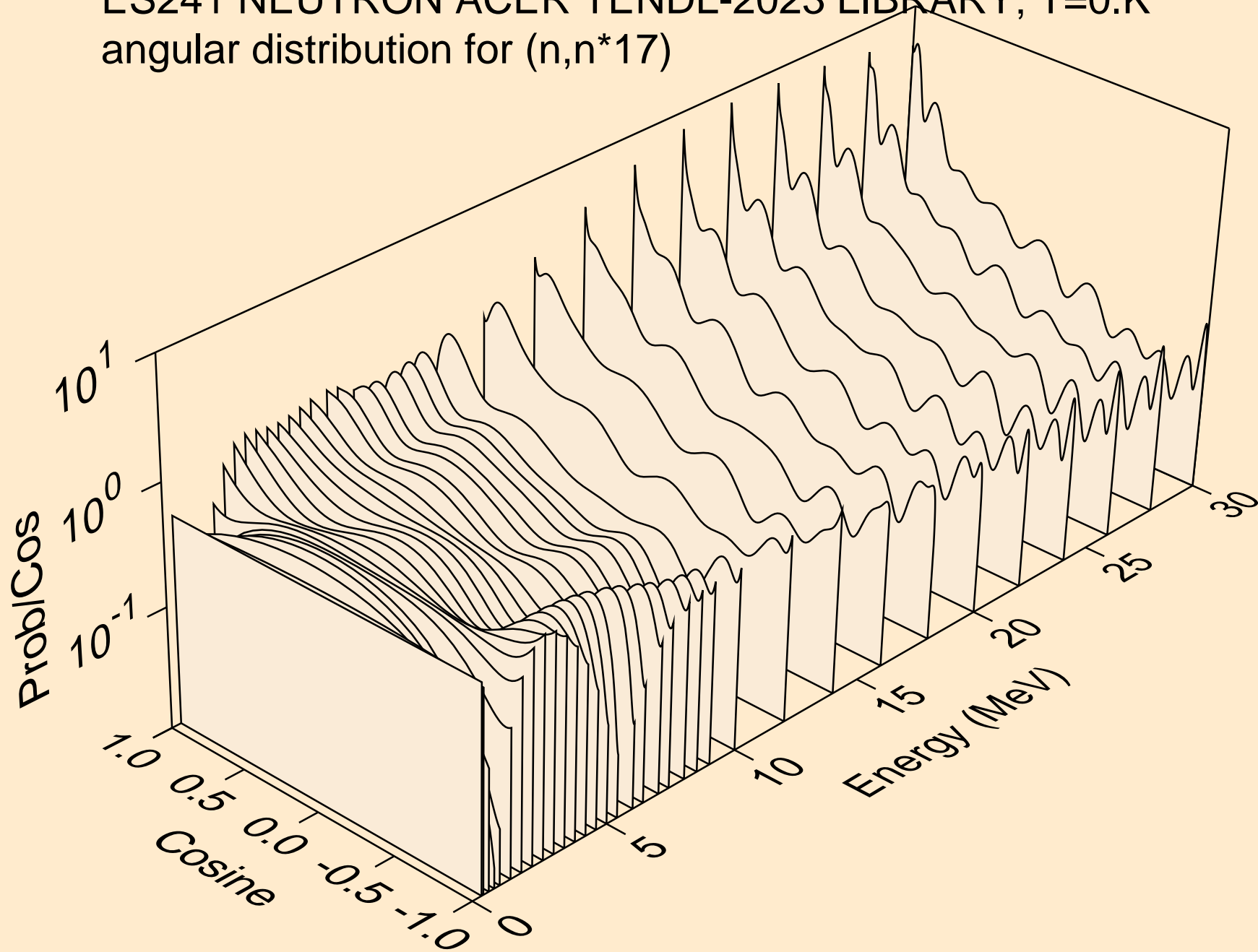

ES241 NEUTRON ACER TENDL-2023 LIBRARY; T=0.K
angular distribution for (n,n*18)

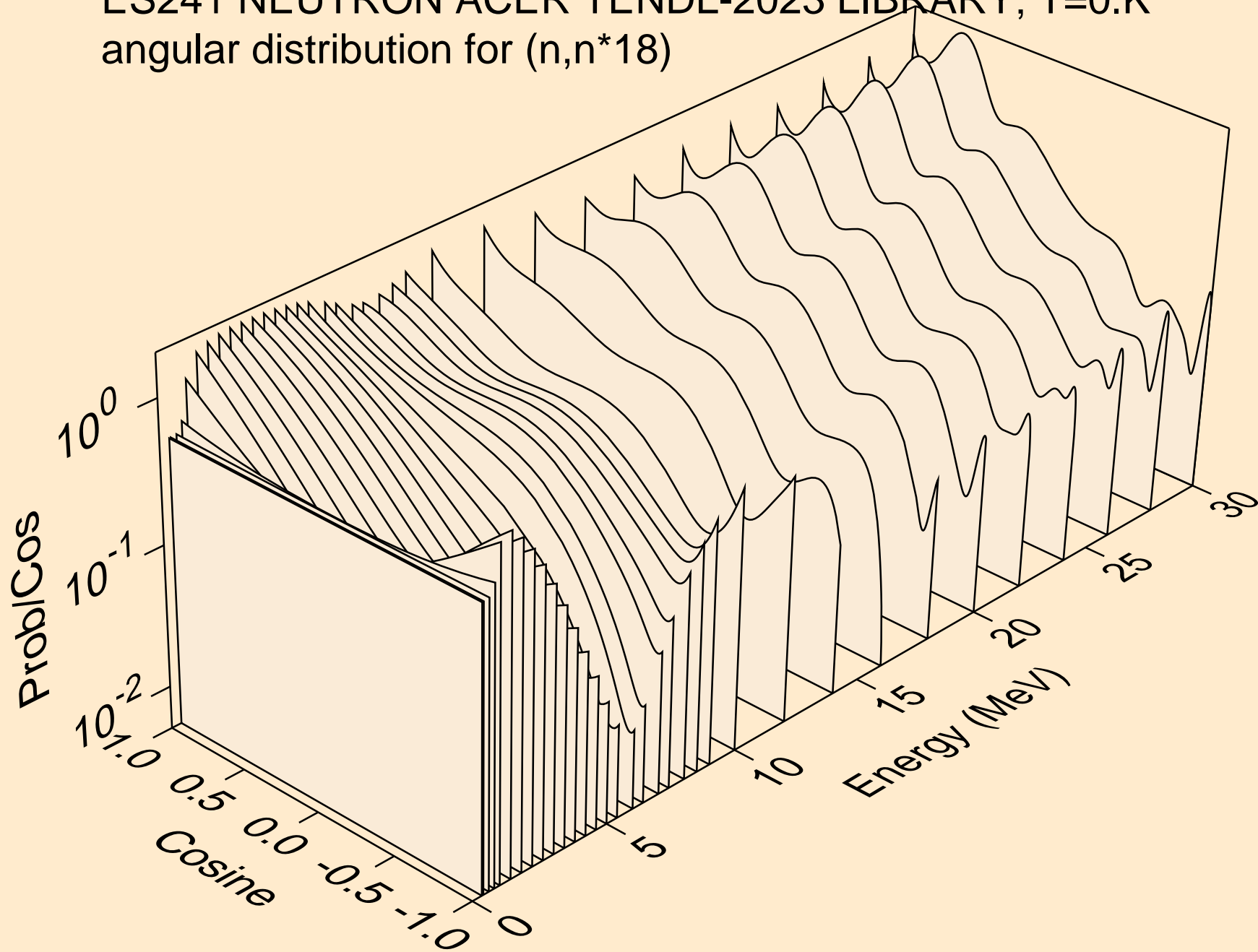

ES241 NEUTRON ACER TENDL-2023 LIBRARY; T=0.K
angular distribution for (n,n*19)

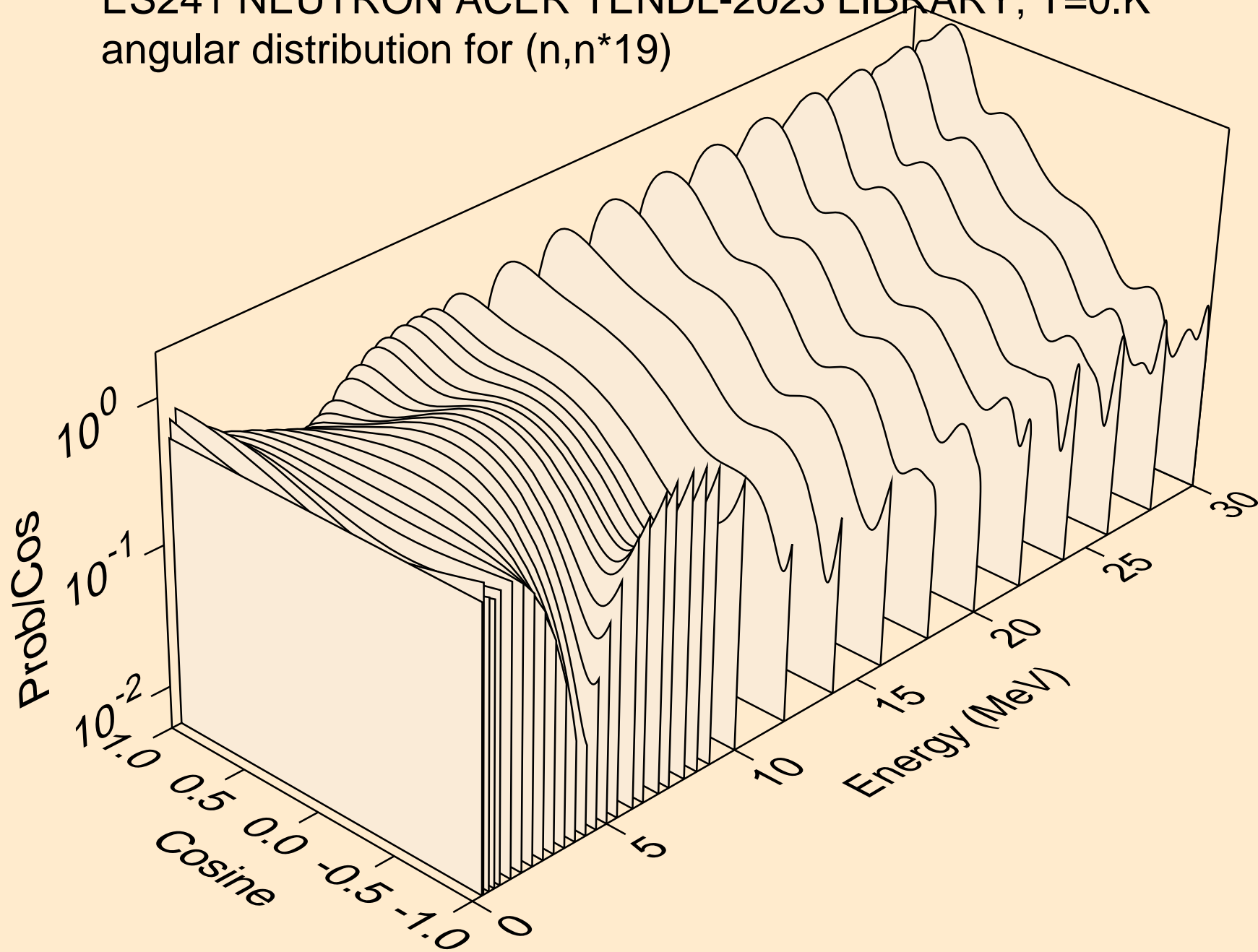

ES241 NEUTRON ACER TENDL-2023 LIBRARY; T=0.K
angular distribution for (n,n*20)

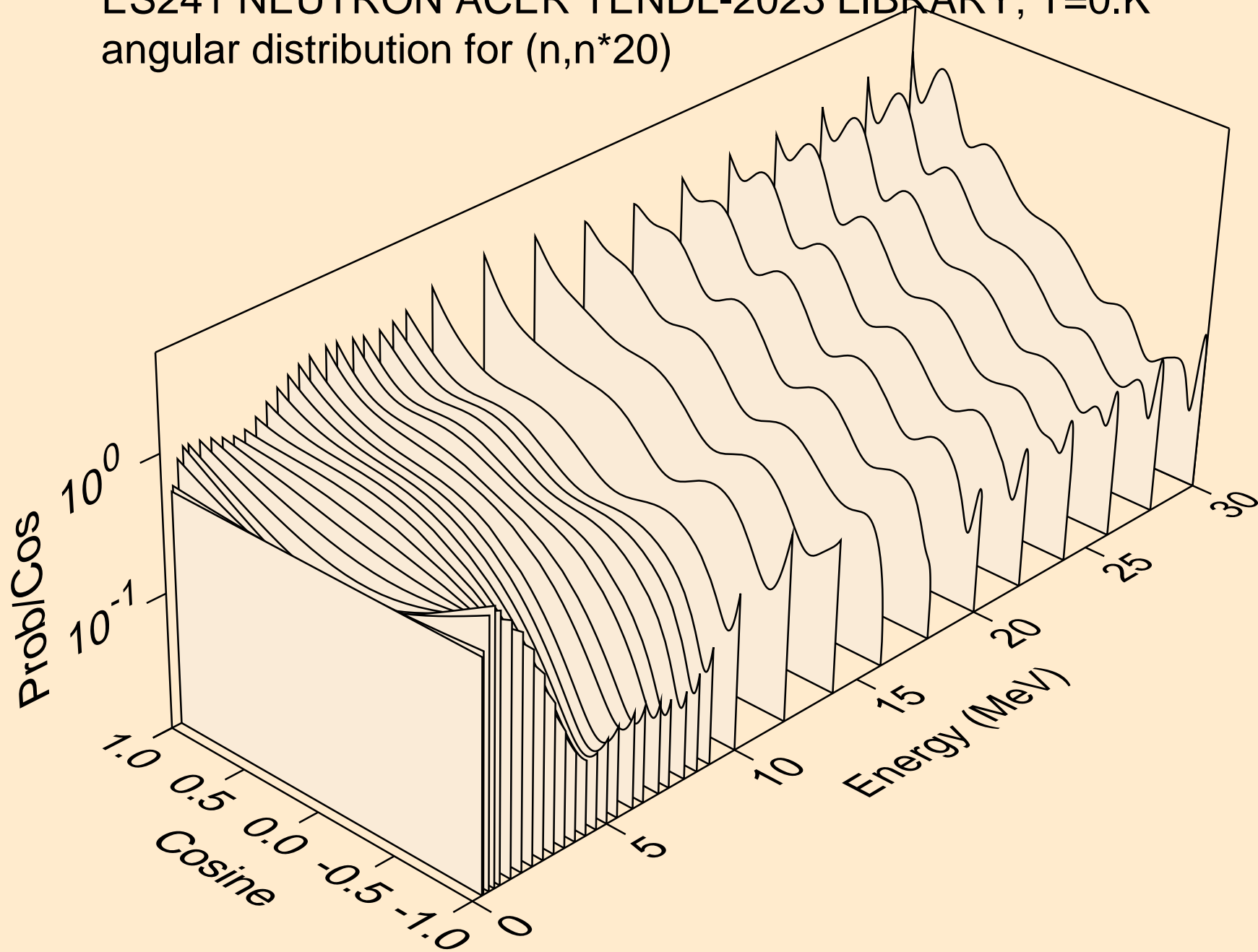

ES241 NEUTRON ACER TENDL-2023 LIBRARY; T=0.K
angular distribution for (n,n*21)

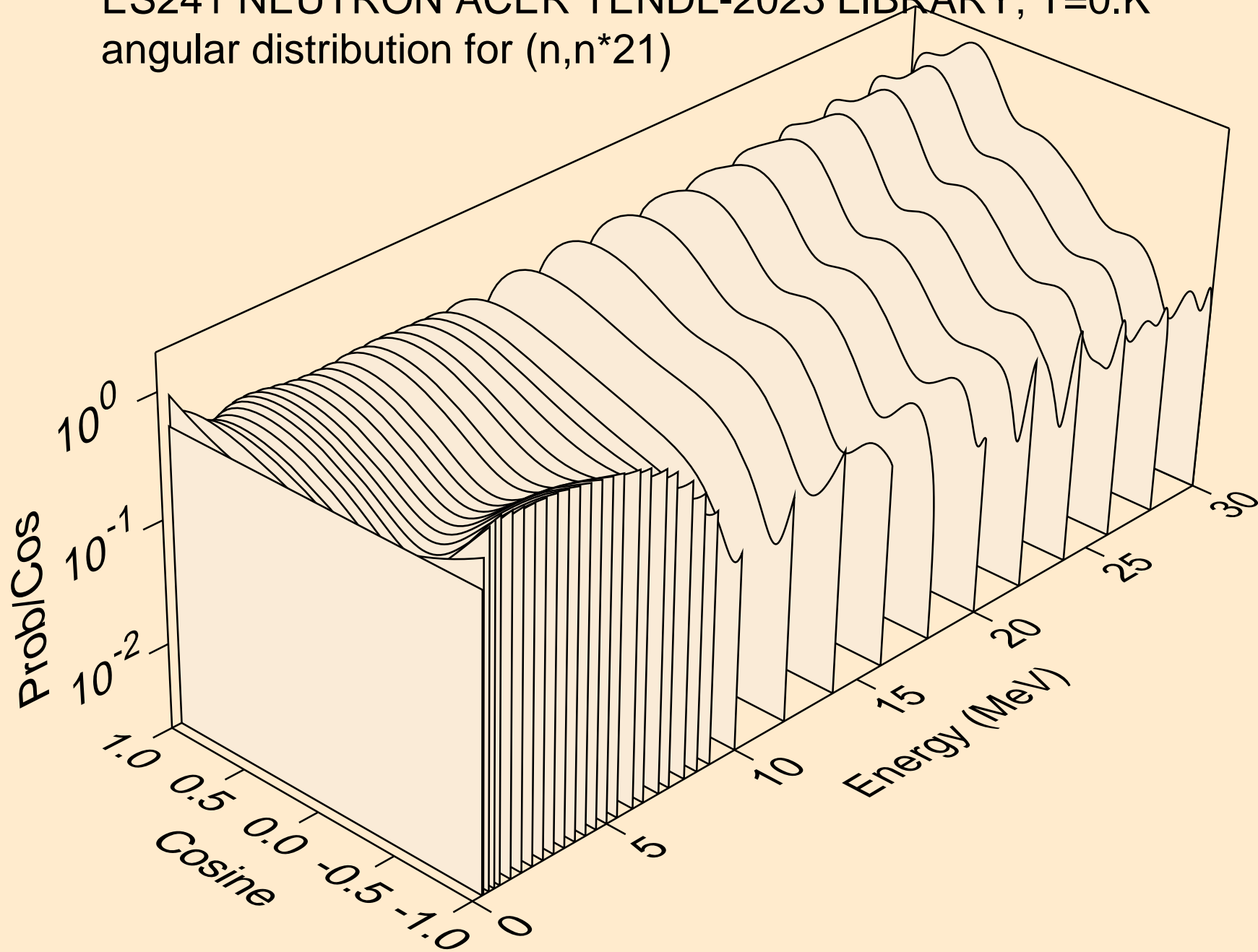

ES241 NEUTRON ACER TENDL-2023 LIBRARY; T=0.K
angular distribution for (n,n*22)

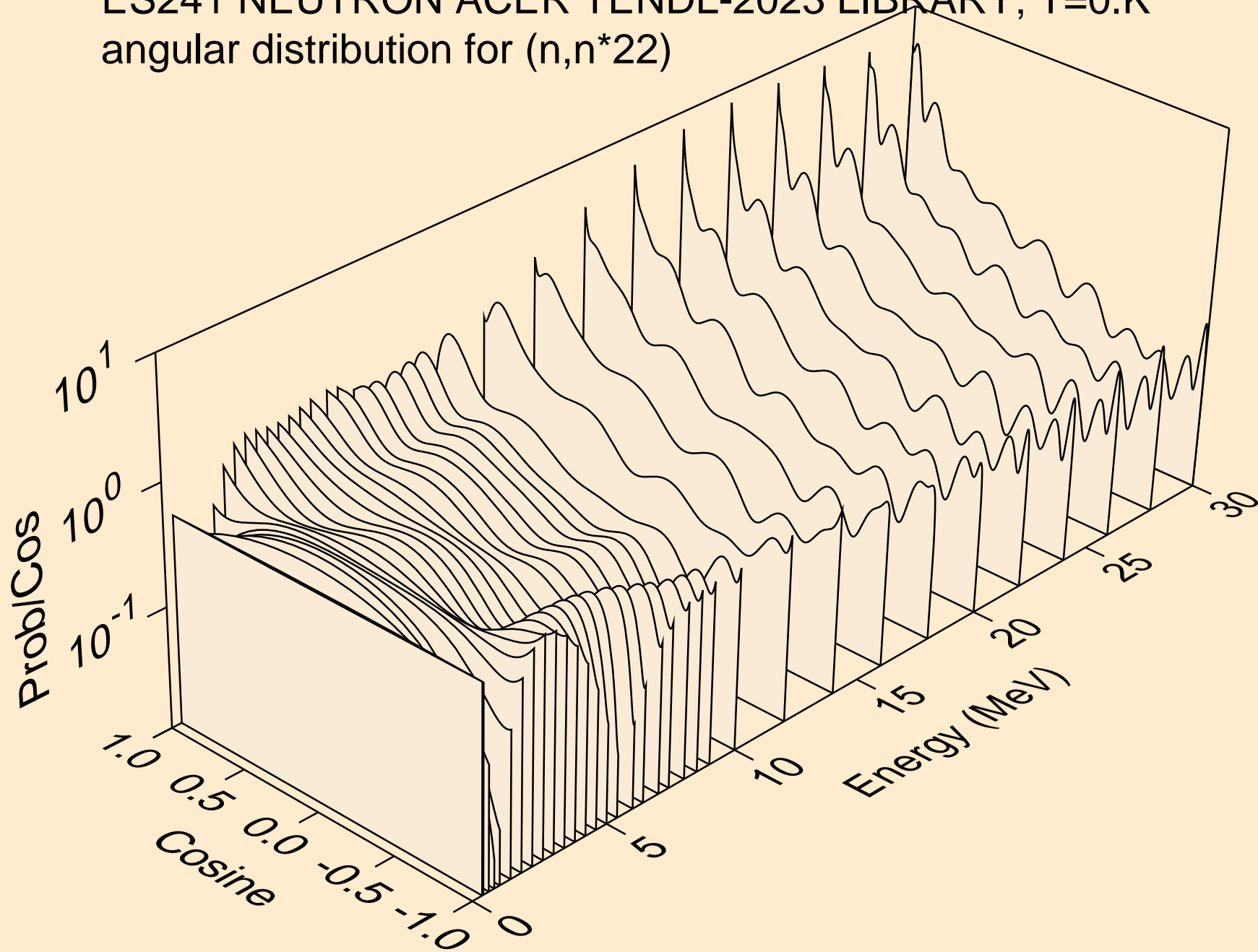

ES241 NEUTRON ACER TENDL-2023 LIBRARY; T=0.K
angular distribution for (n,n*23)

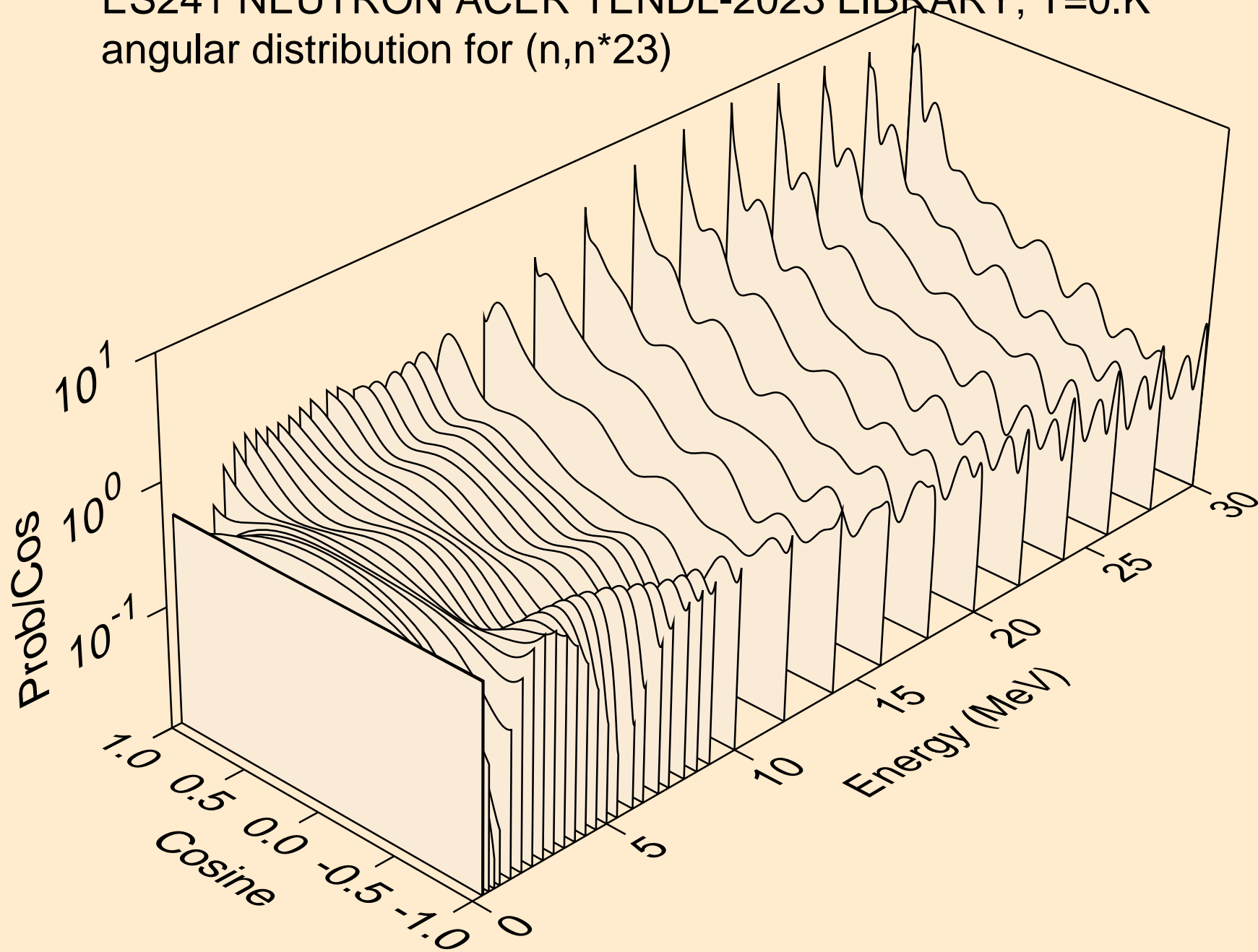

ES241 NEUTRON ACER TENDL-2023 LIBRARY; T=0.K
angular distribution for (n,n*24)

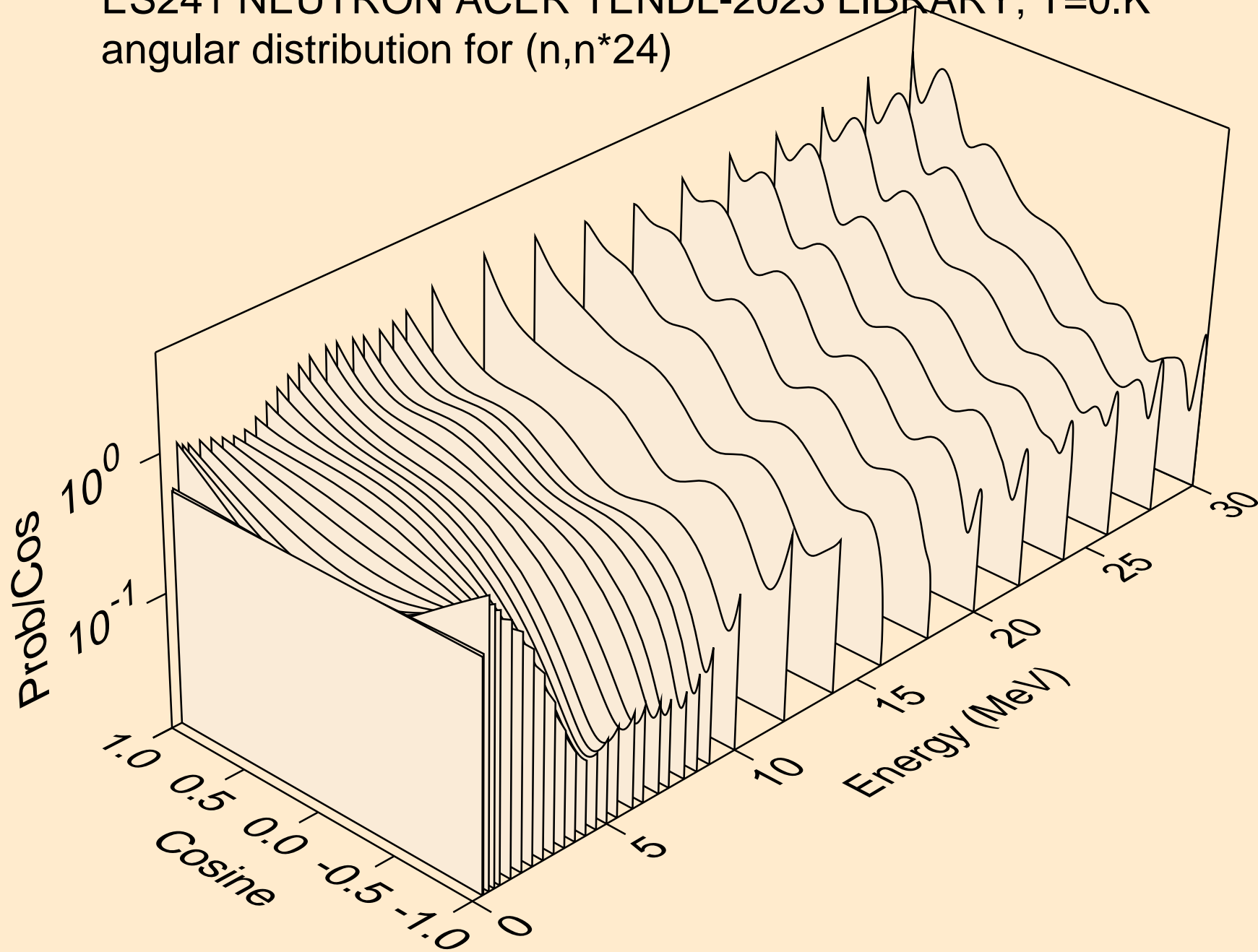

ES241 NEUTRON ACER TENDL-2023 LIBRARY; T=0.K
angular distribution for (n,n*25)

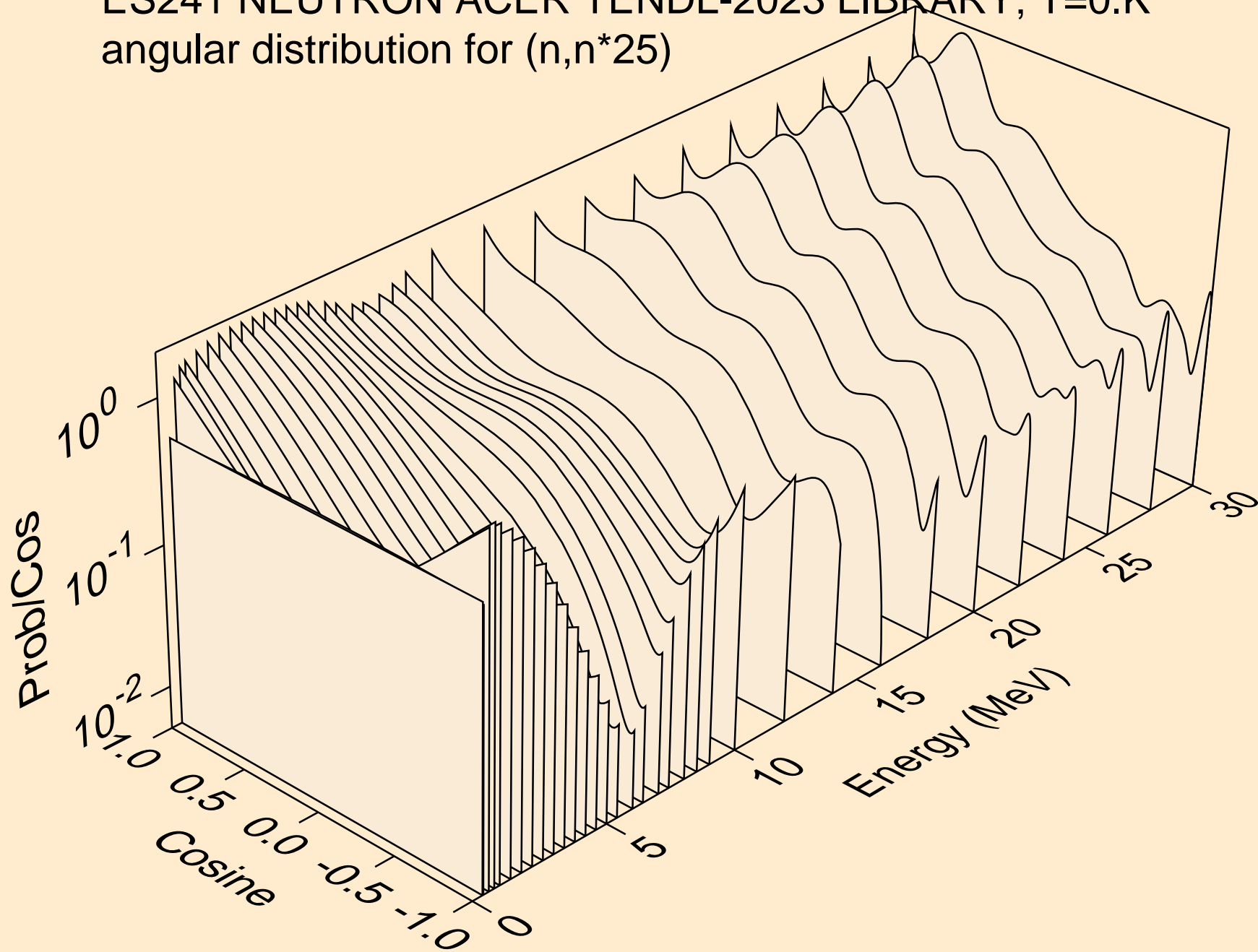

ES241 NEUTRON ACER TENDL-2023 LIBRARY; T=0.K
angular distribution for (n,n*26)

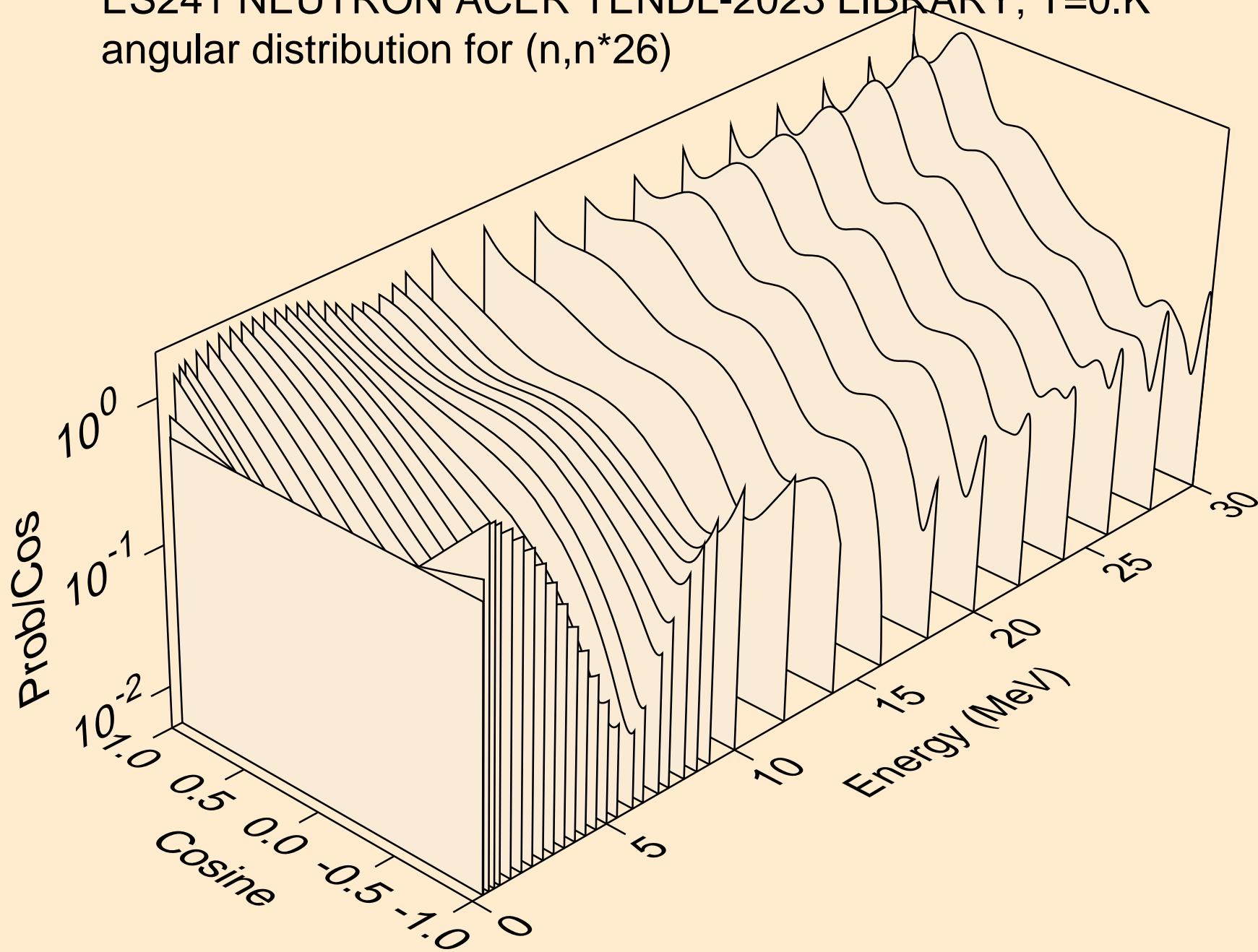

ES241 NEUTRON ACER TENDL-2023 LIBRARY; T=0.K
angular distribution for (n,n*27)

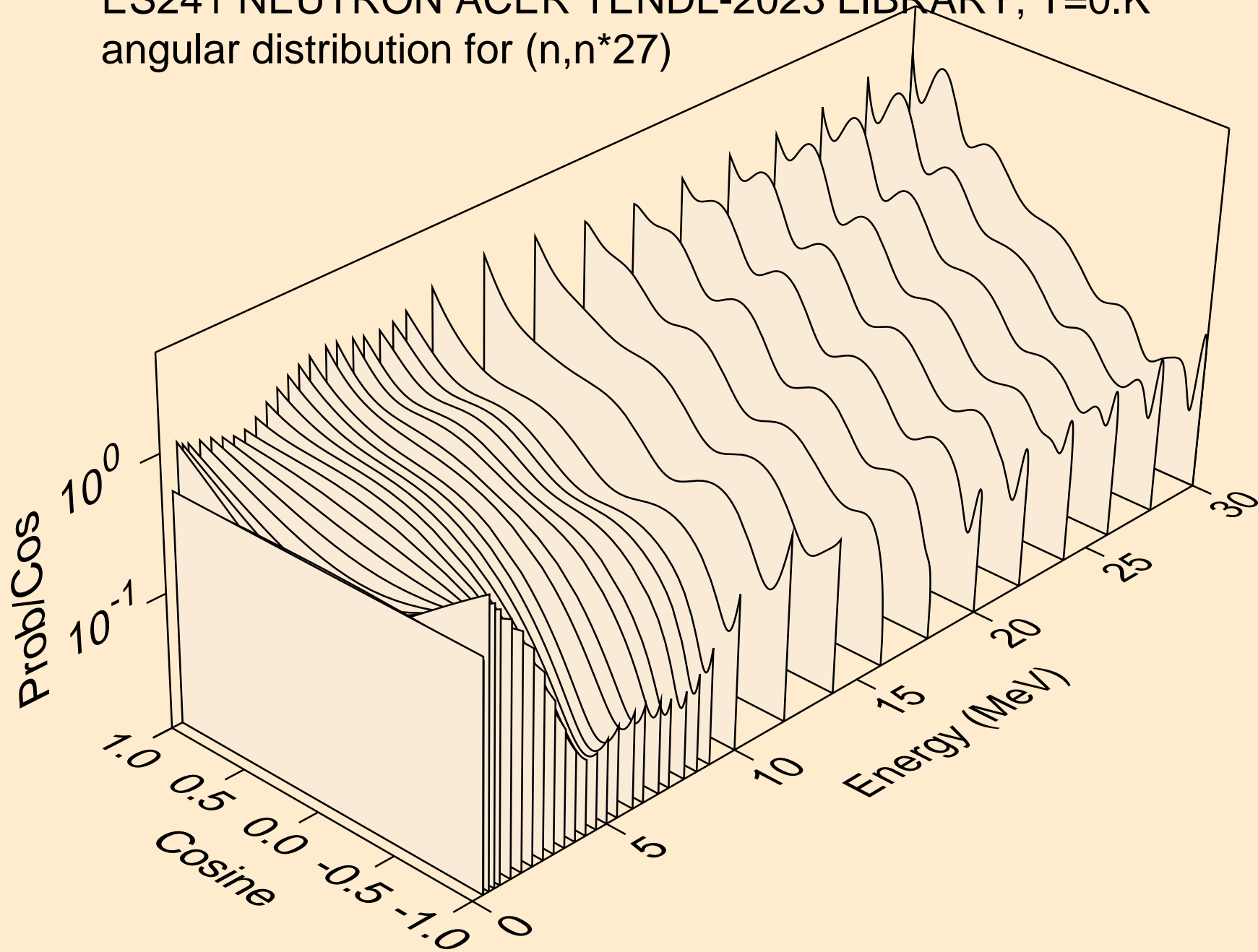

ES241 NEUTRON ACER TENDL-2023 LIBRARY; T=0.K
angular distribution for (n,n*28)

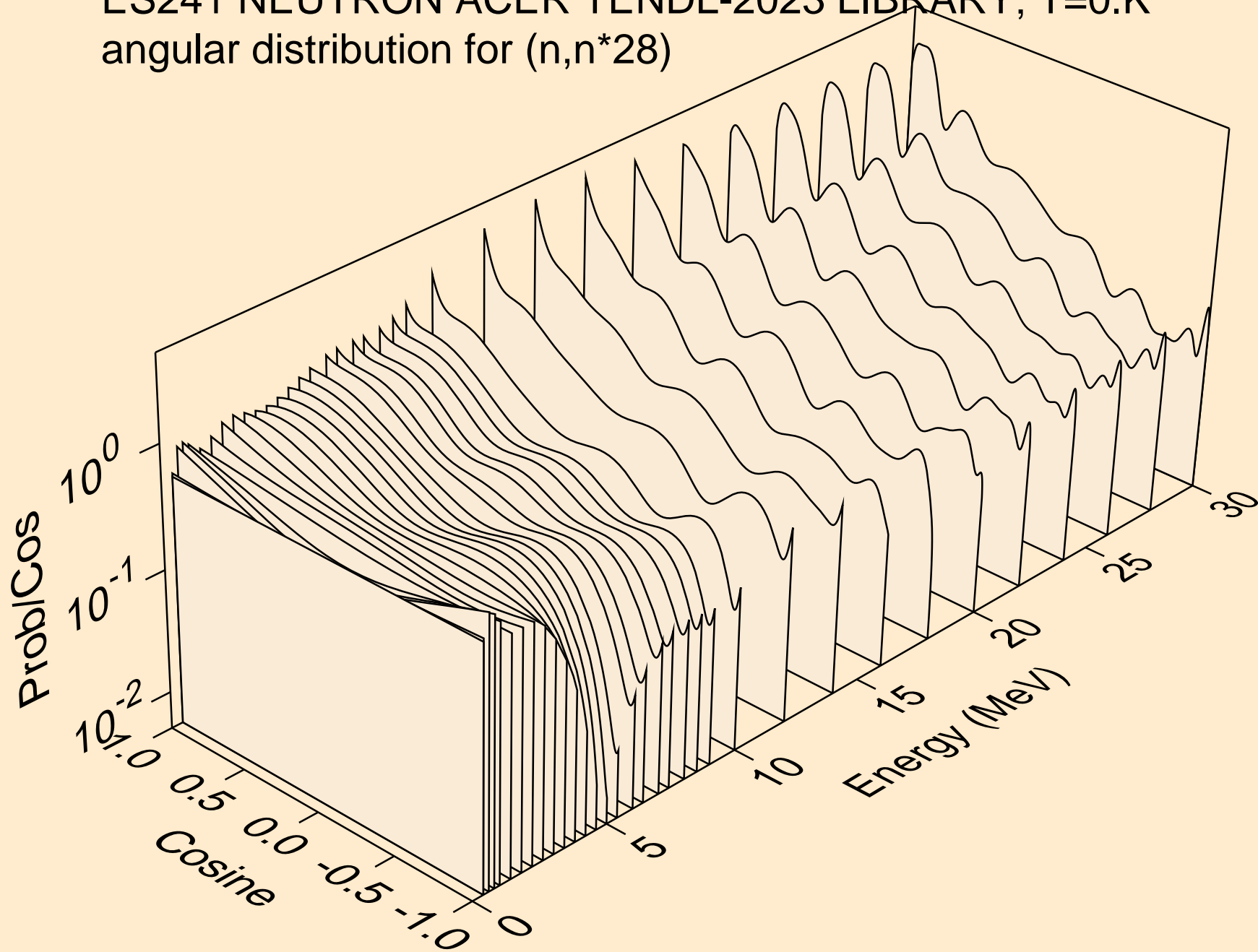

ES241 NEUTRON ACER TENDL-2023 LIBRARY; T=0.K
angular distribution for (n,n*29)

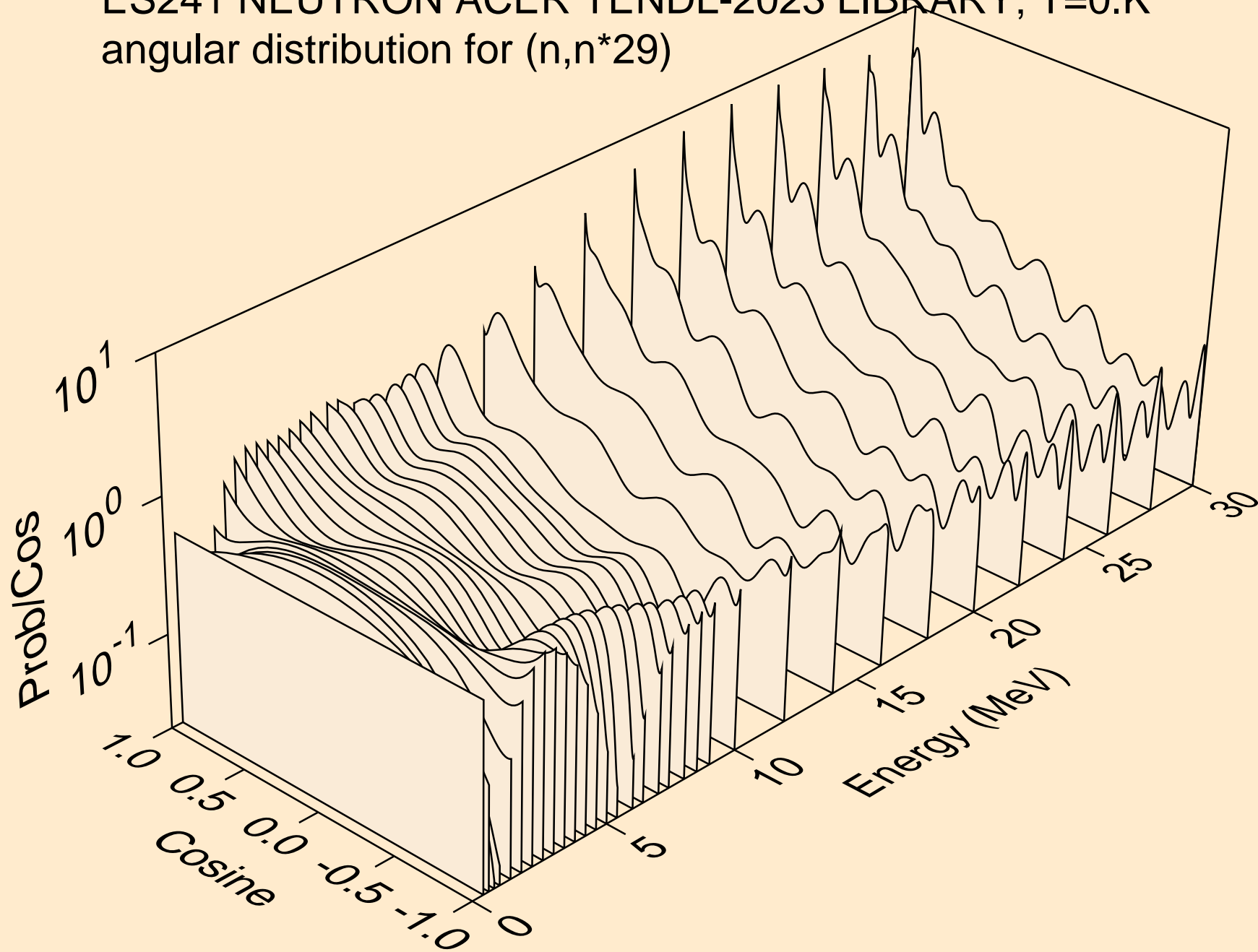

ES241 NEUTRON ACER TENDL-2023 LIBRARY; T=0.K

Total fission nubar

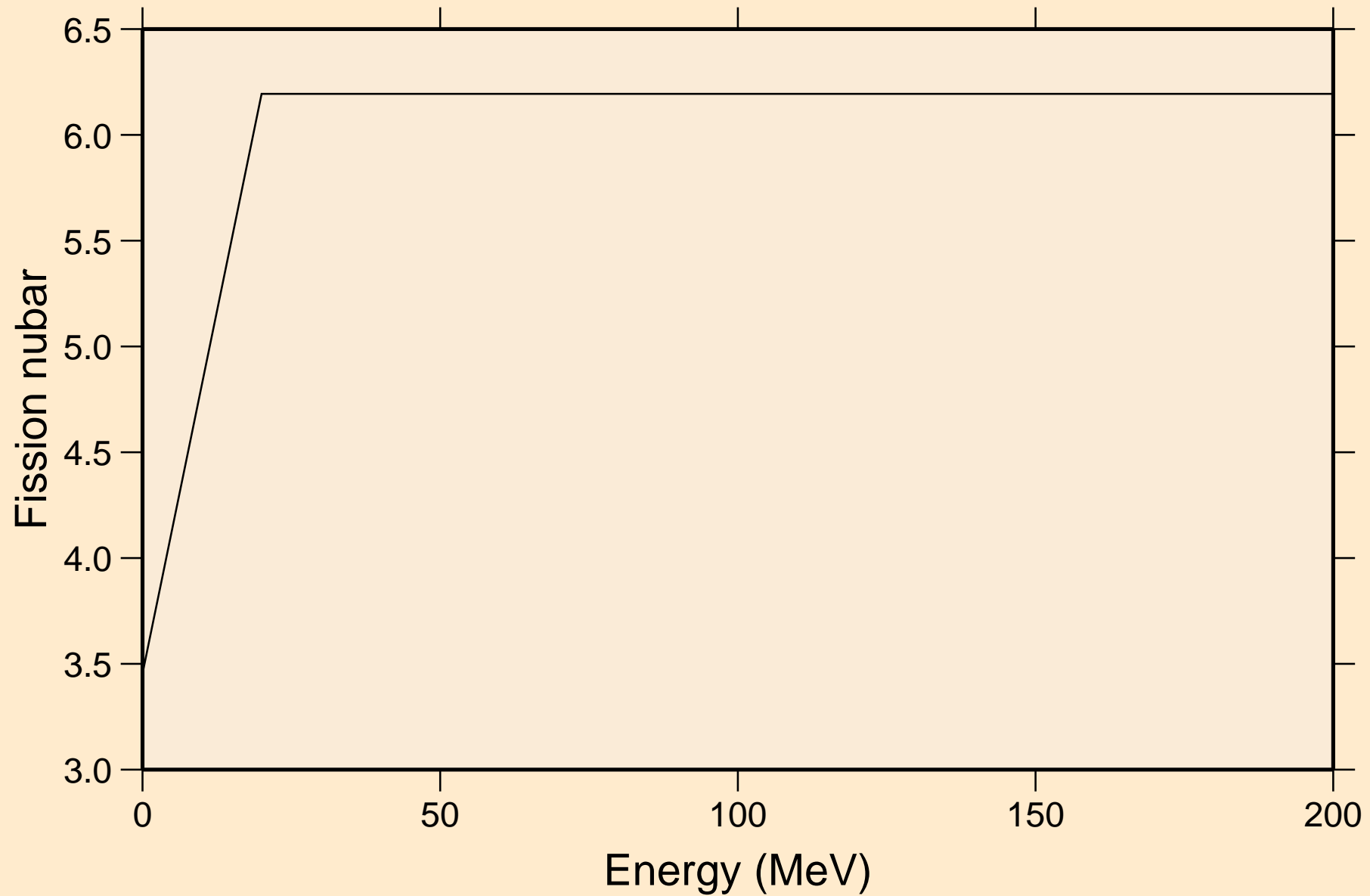

ES241 NEUTRON ACER TENDL-2023 LIBRARY; T=0.K
Neutron emission for (n,x)

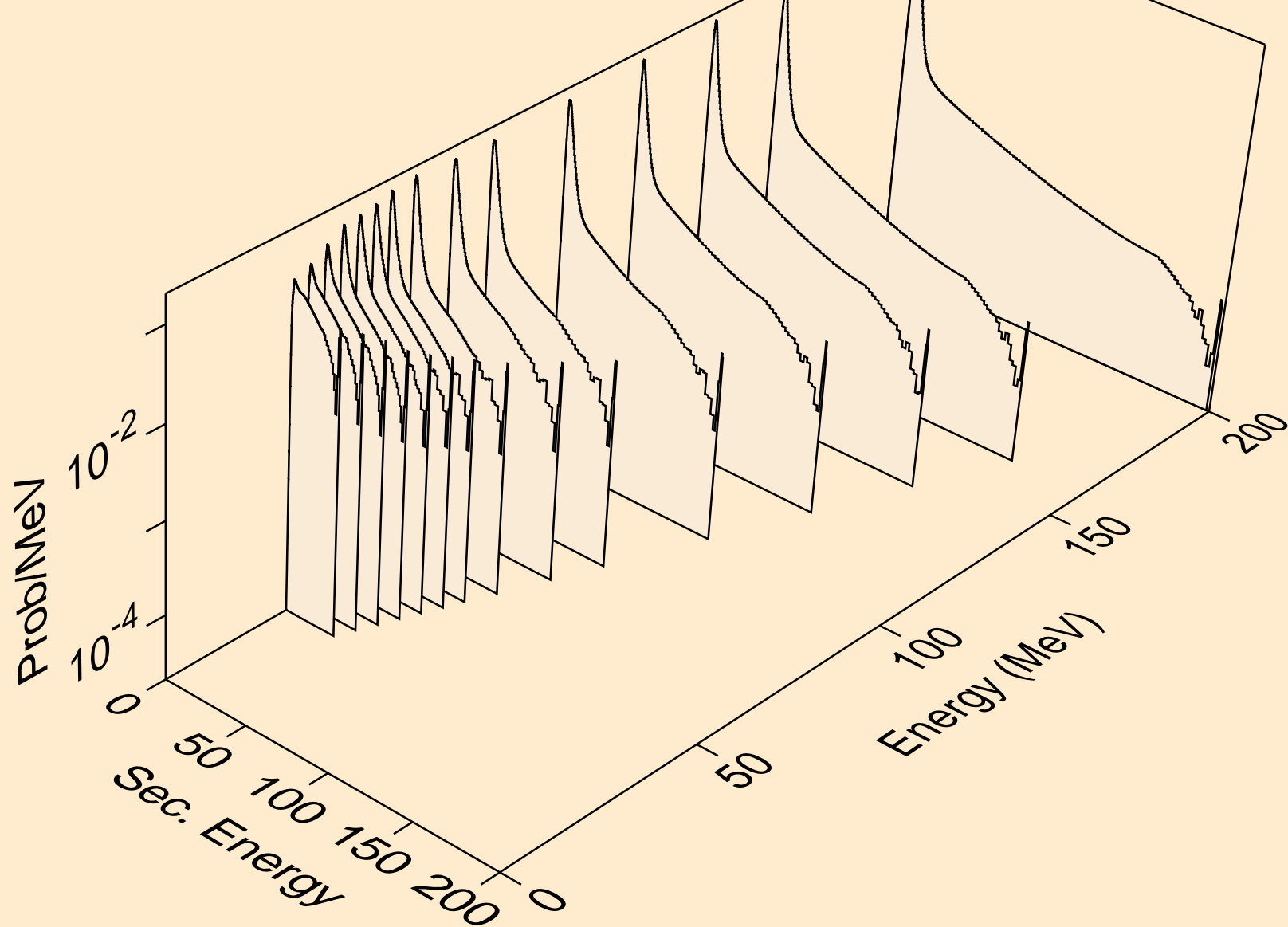

ES241 NEUTRON ACER TENDL-2023 LIBRARY; T=0.K
Neutron emission for (n,2n)

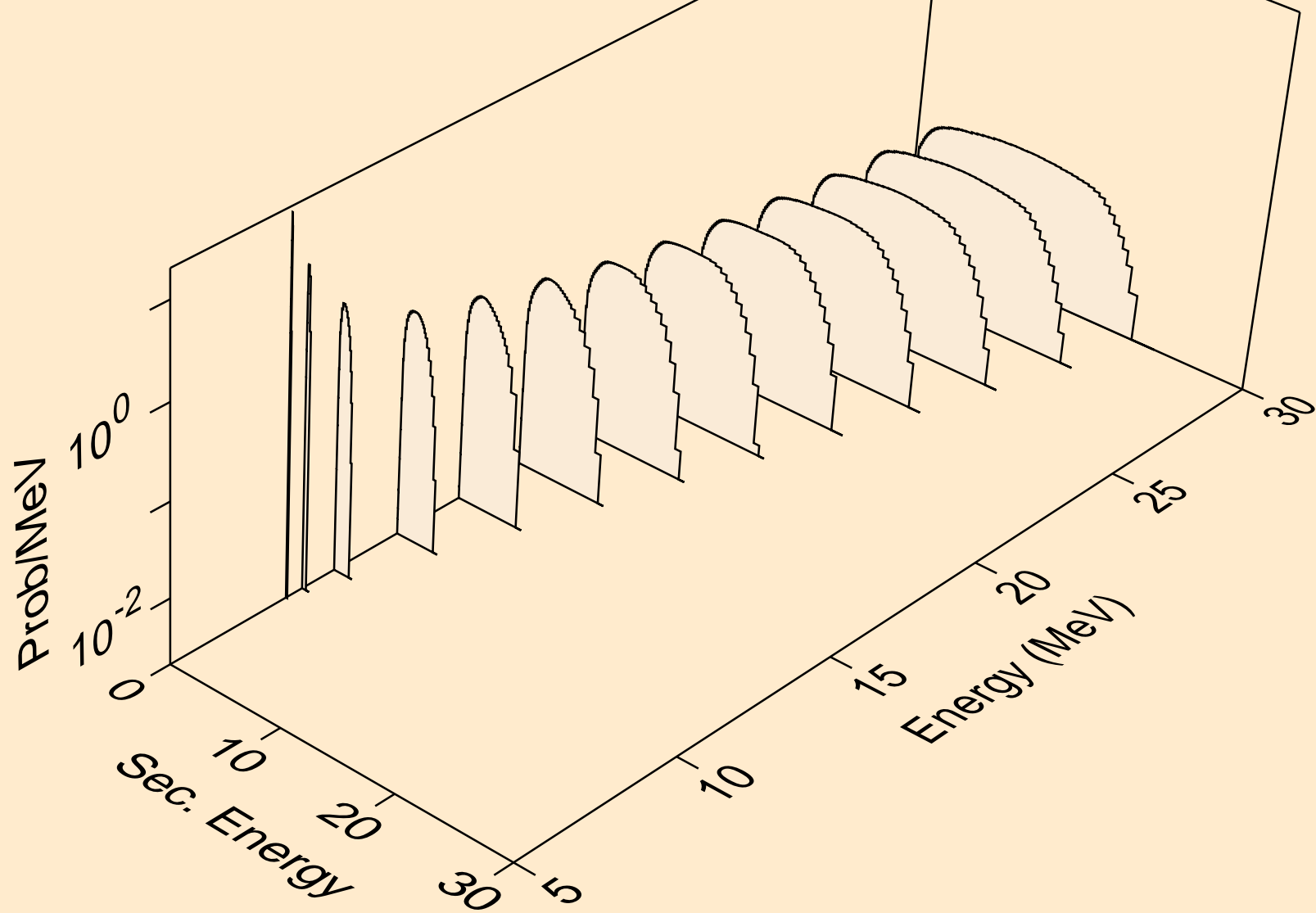

ES241 NEUTRON ACER TENDL-2023 LIBRARY; T=0.K
Neutron emission for (n,3n)

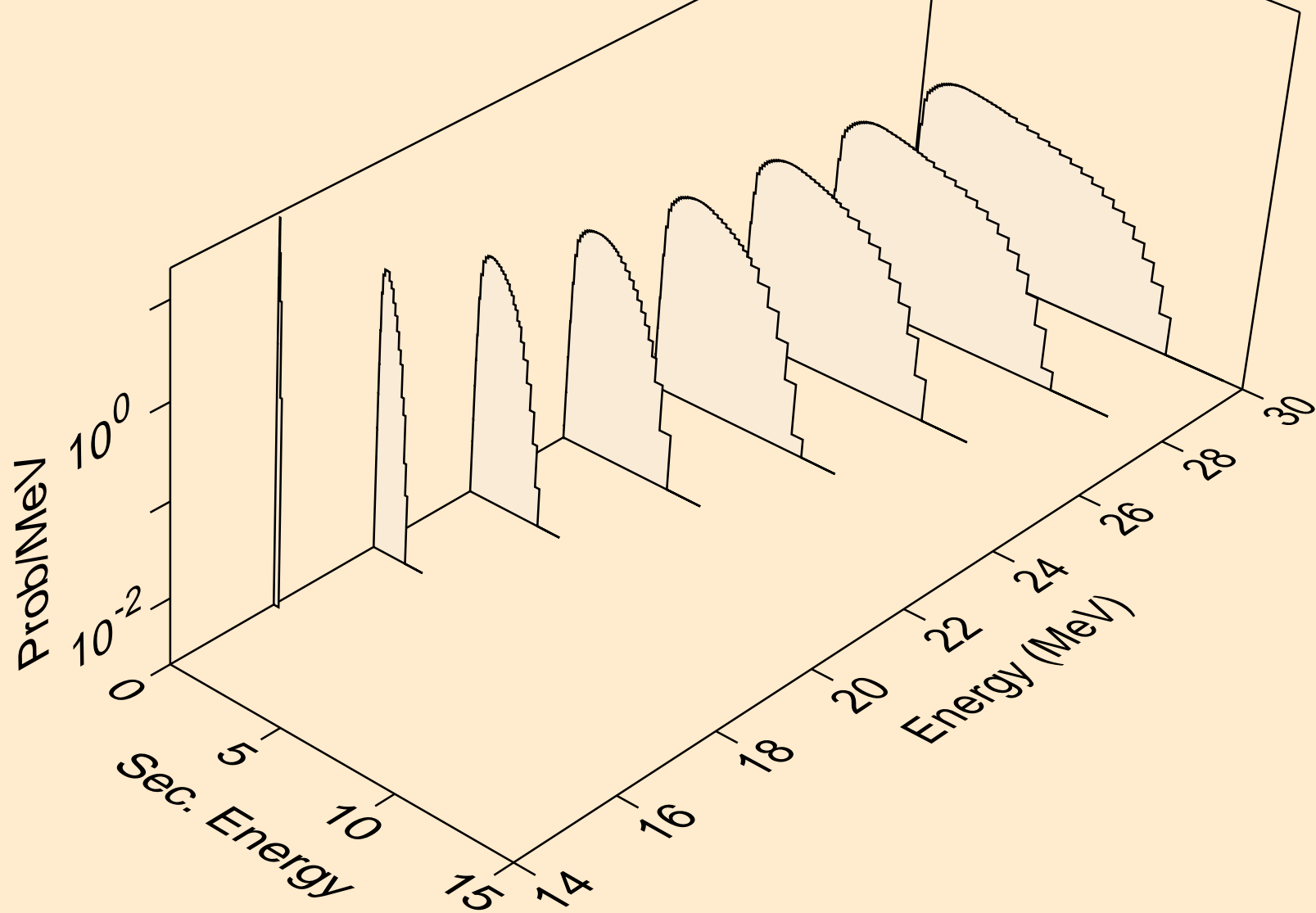

ES241 NEUTRON ACER TENDL-2023 LIBRARY; T=0.K
Neutron emission for fission

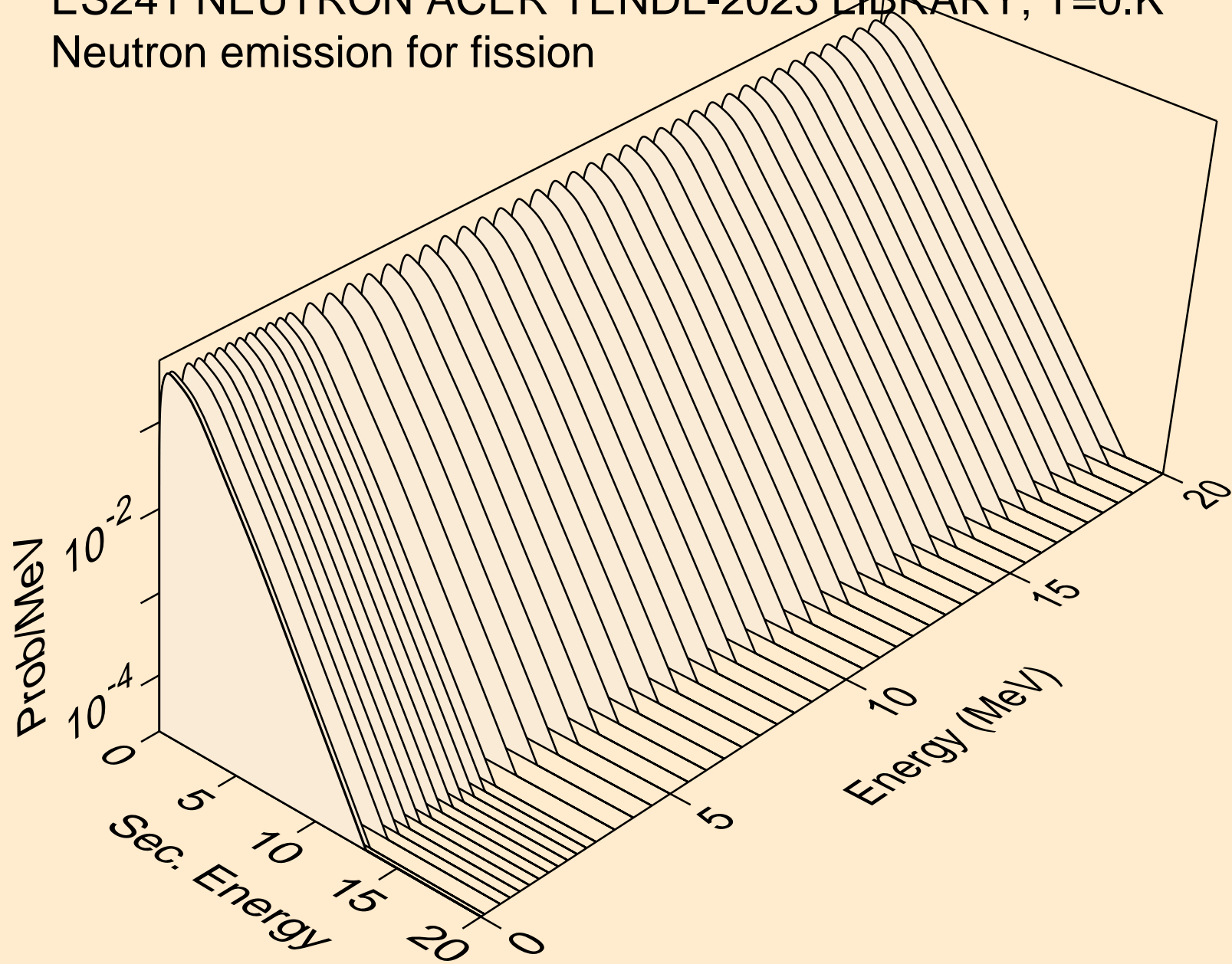

ES241 NEUTRON ACER TENDL-2023 LIBRARY; T=0.K
Neutron emission for (n,n*)a

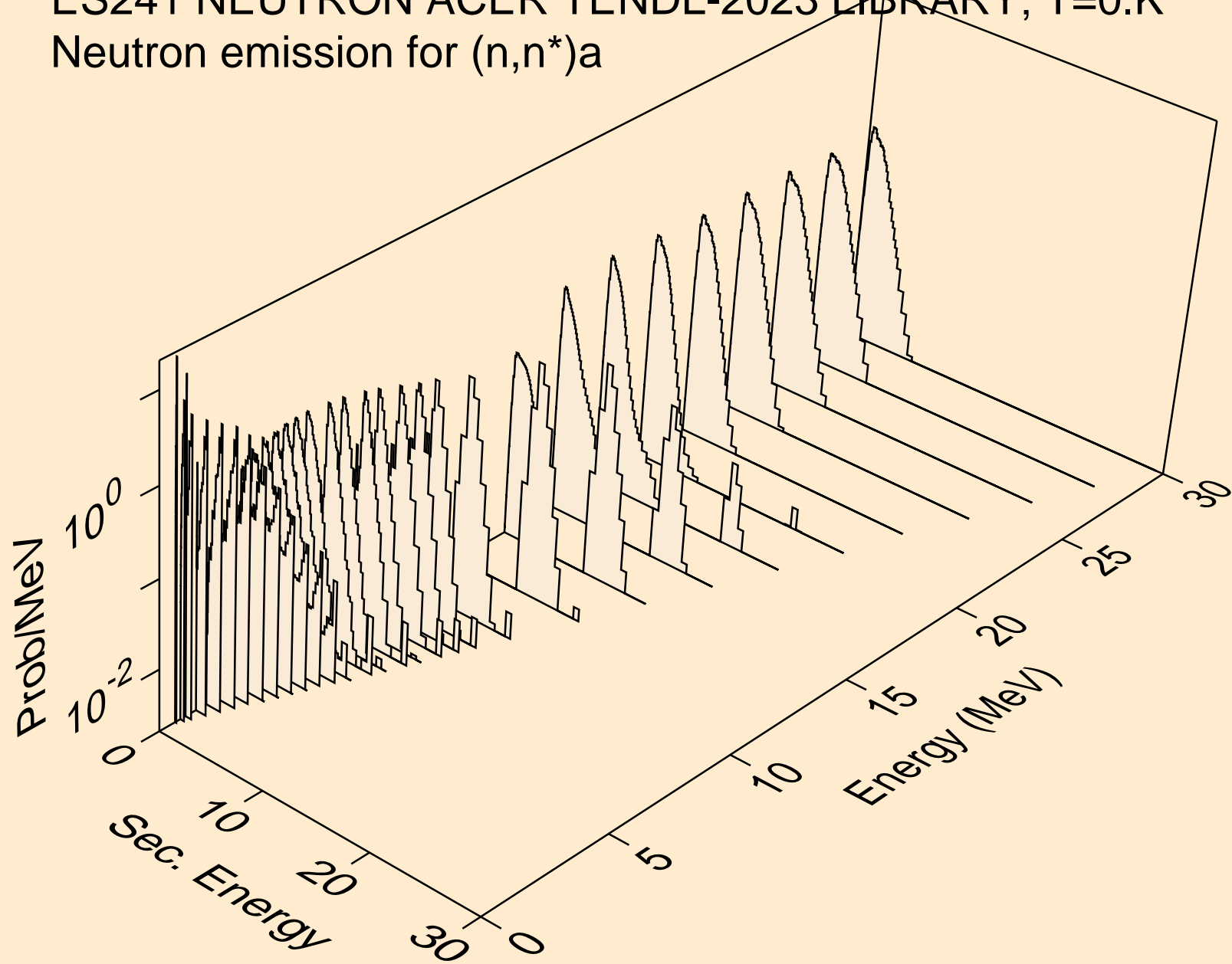

ES241 NEUTRON ACER TENDL-2023 LIBRARY; T=0.K
Neutron emission for (n,2n)a

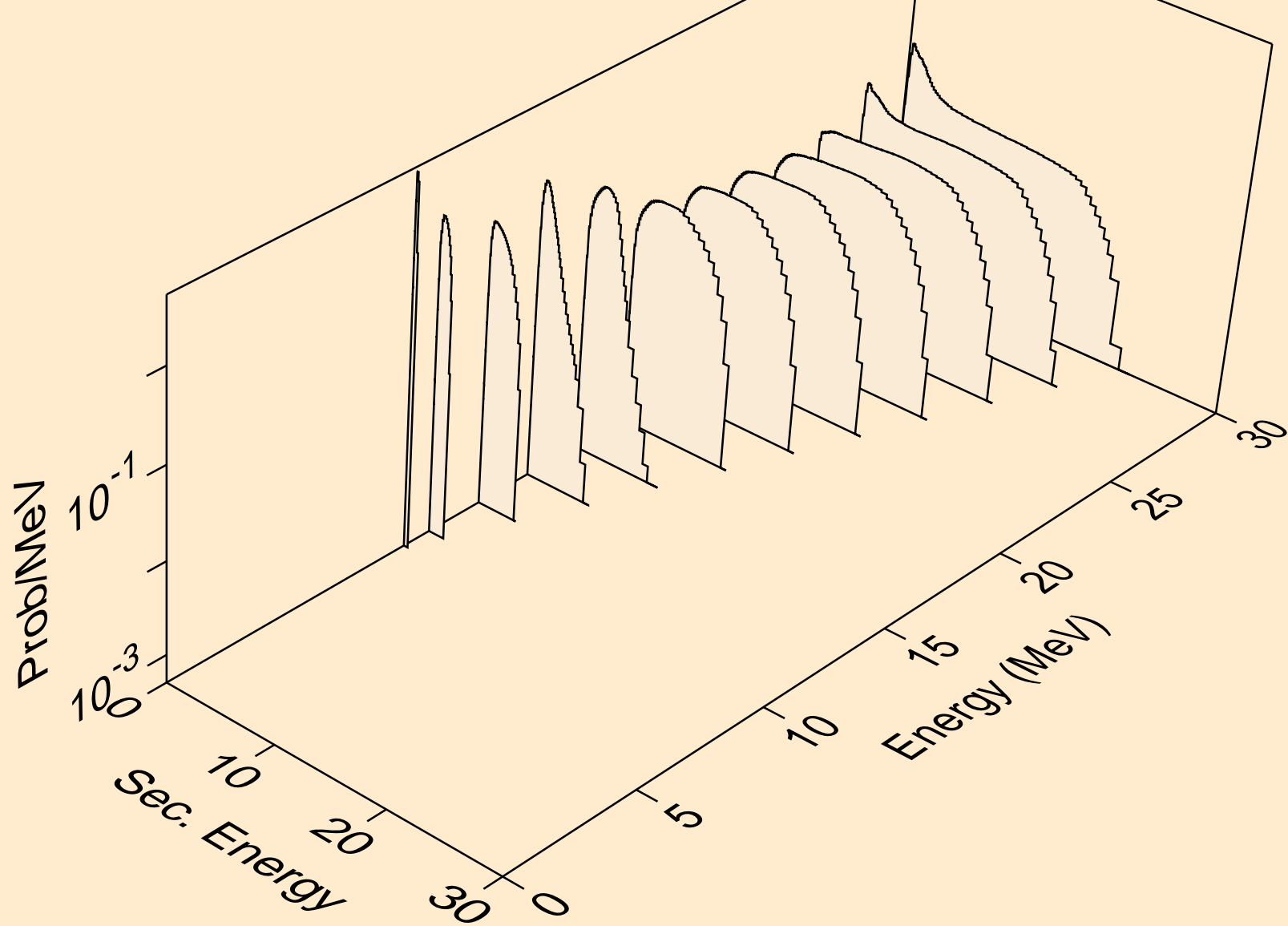

ES241 NEUTRON ACER TENDL-2023 LIBRARY; T=0.K
Neutron emission for (n,n*)p

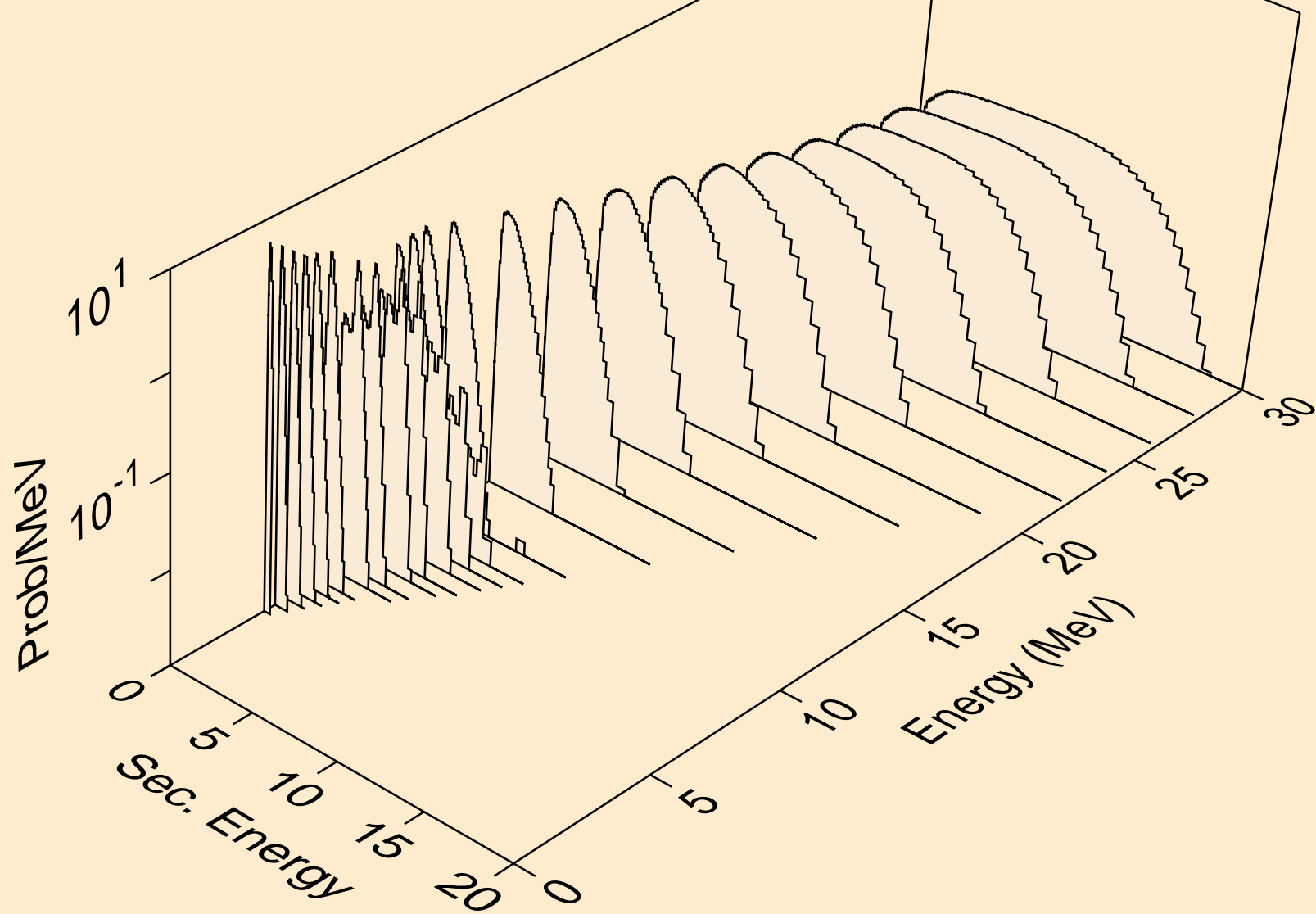

ES241 NEUTRON ACER TENDL-2023 LIBRARY; T=0.K
Neutron emission for (n,n*)d

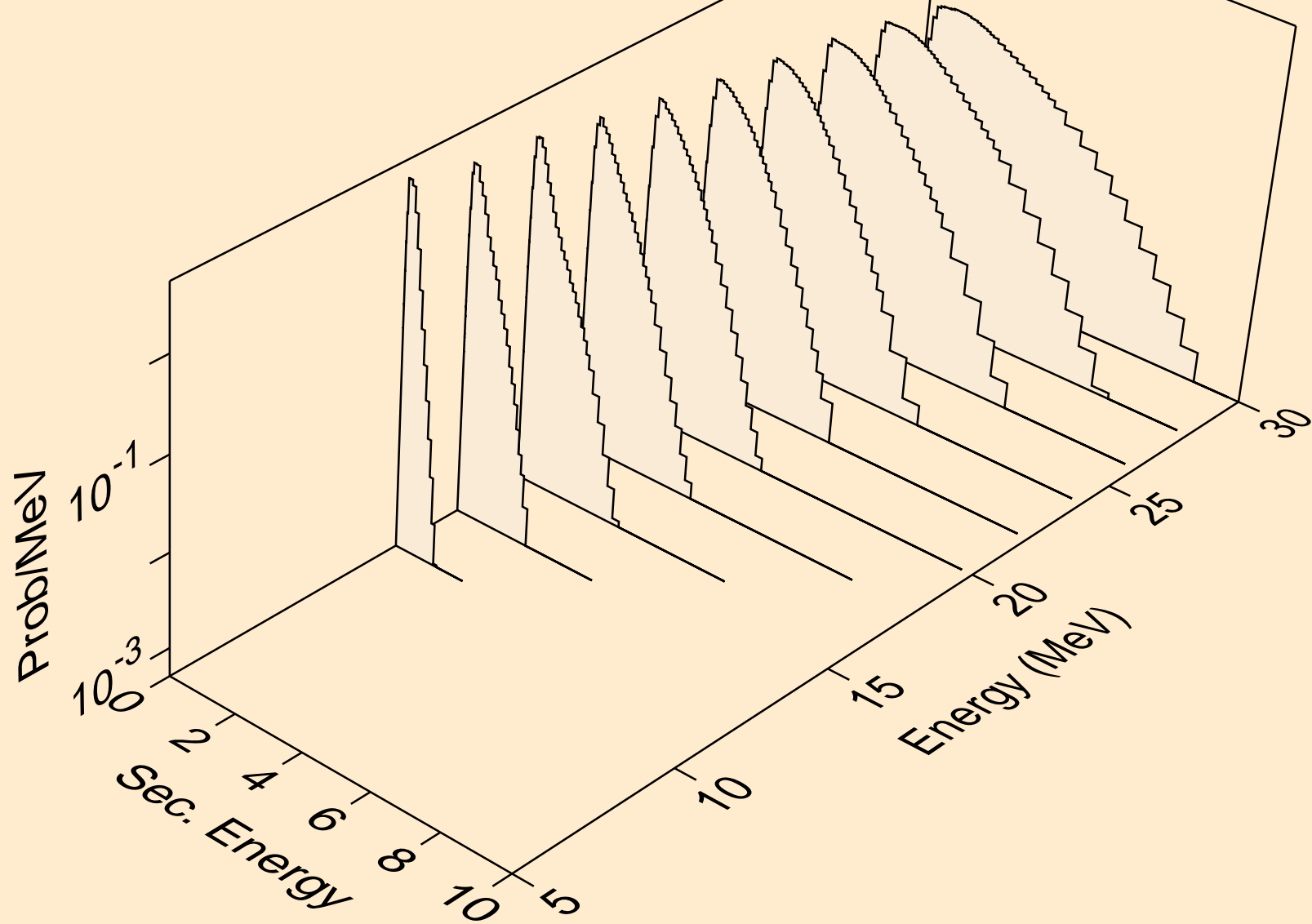

ES241 NEUTRON ACER TENDL-2023 LIBRARY; T=0.K
Neutron emission for (n,n*)t

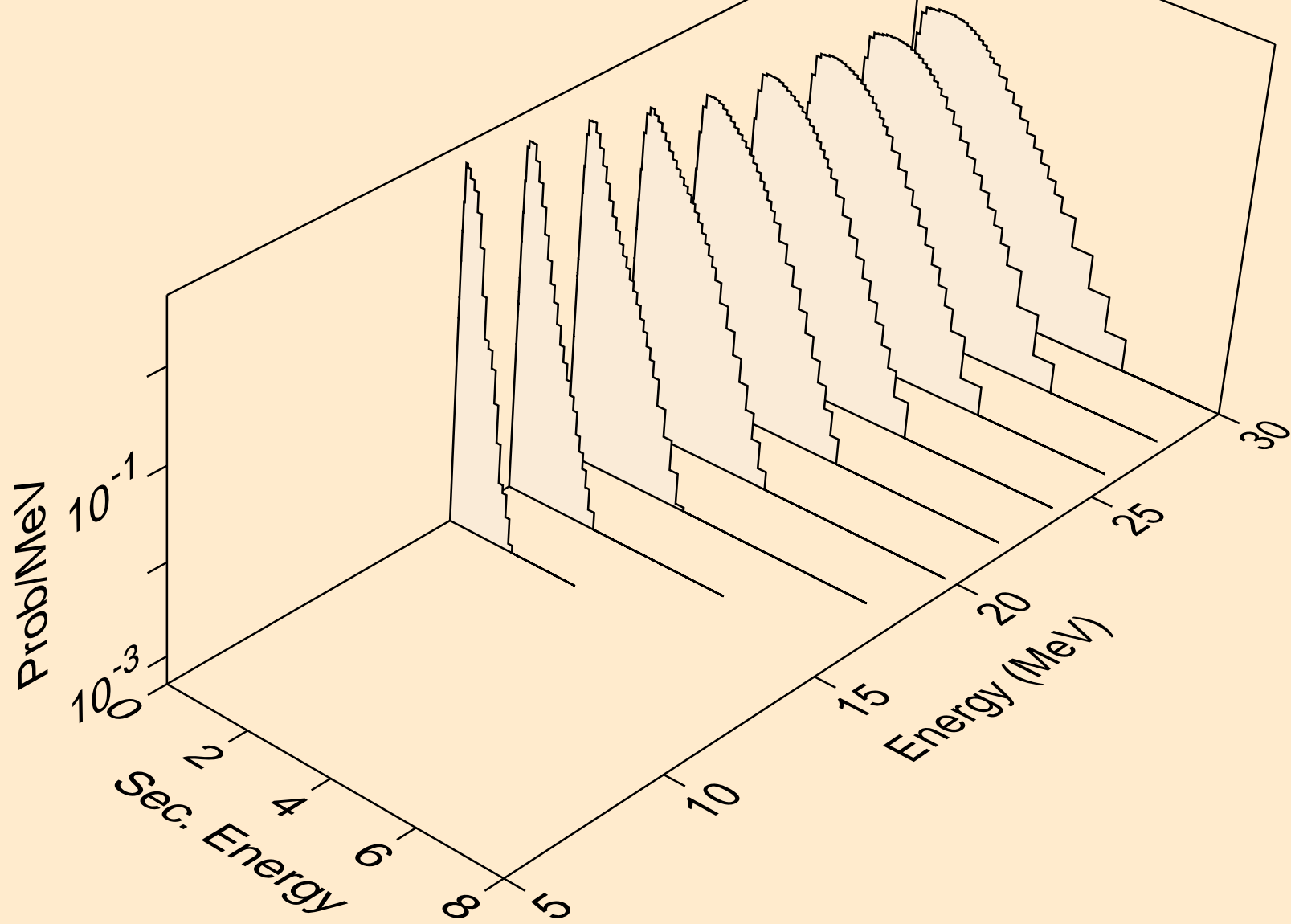

ES241 NEUTRON ACER TENDL-2023 LIBRARY; T=0.K
Neutron emission for (n,n*)he3

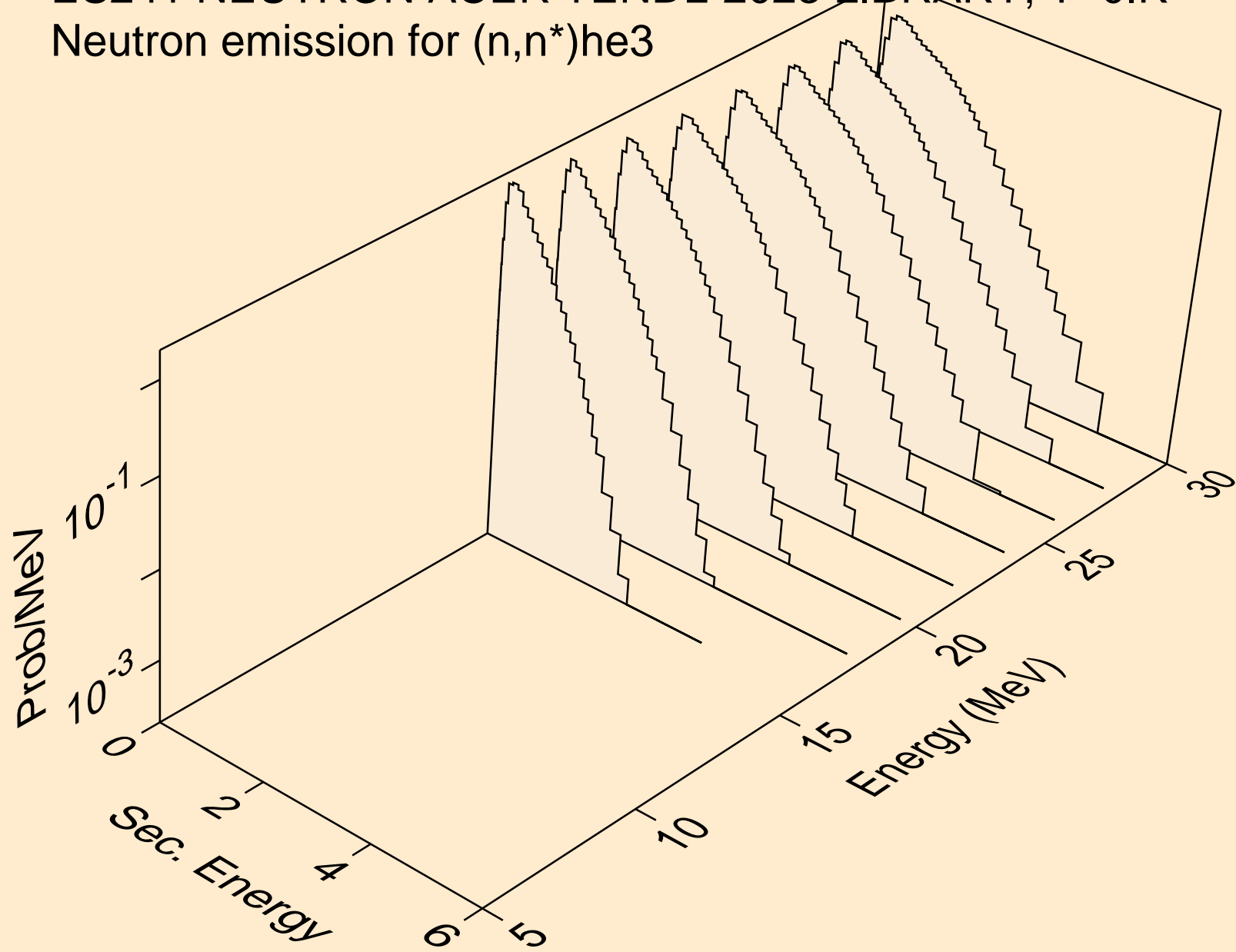

ES241 NEUTRON ACER TENDL-2023 LIBRARY; T=0.K
Neutron emission for (n,2np)

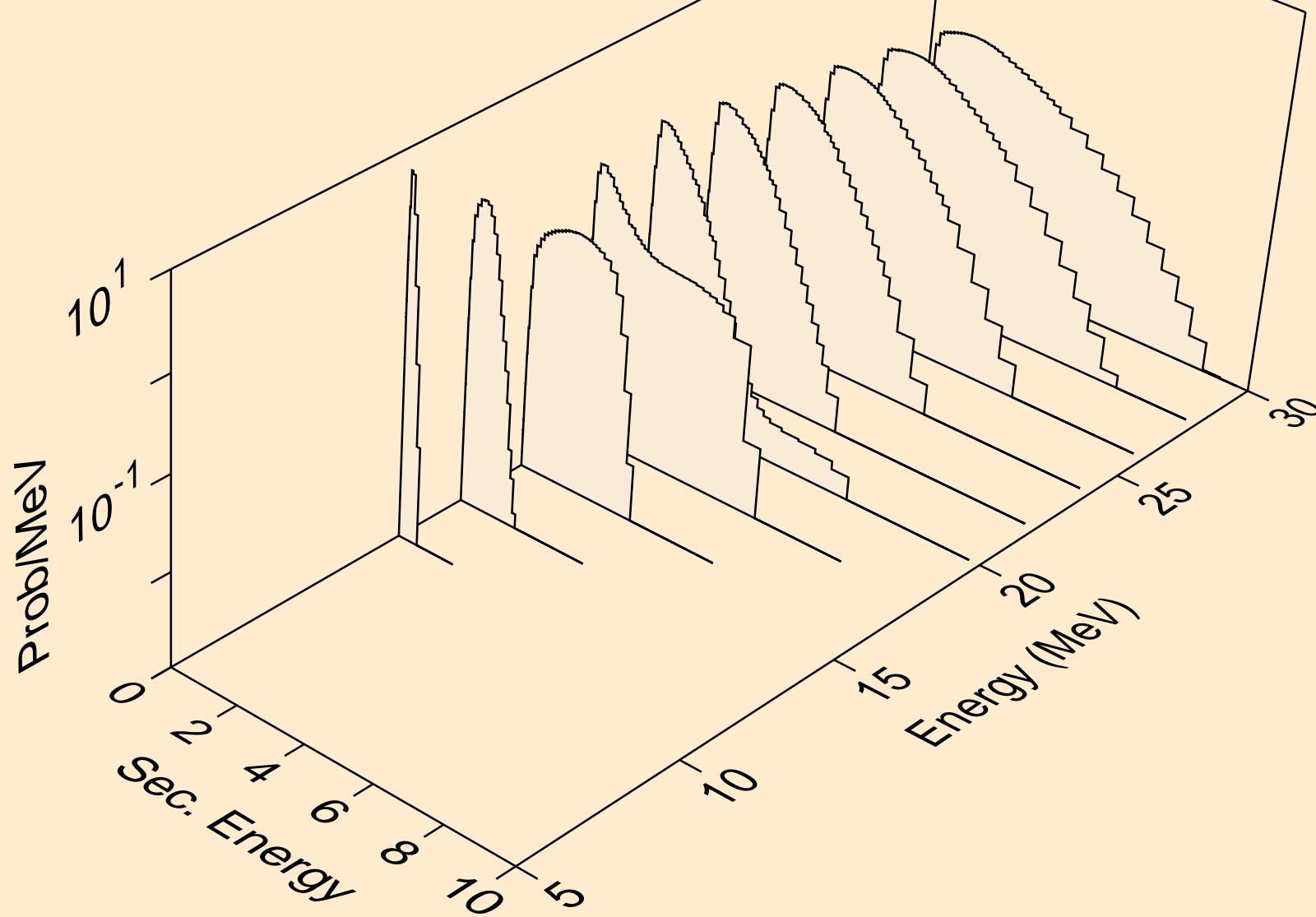

ES241 NEUTRON ACER TENDL-2023 LIBRARY; T=0.K
Neutron emission for (n,n2p)

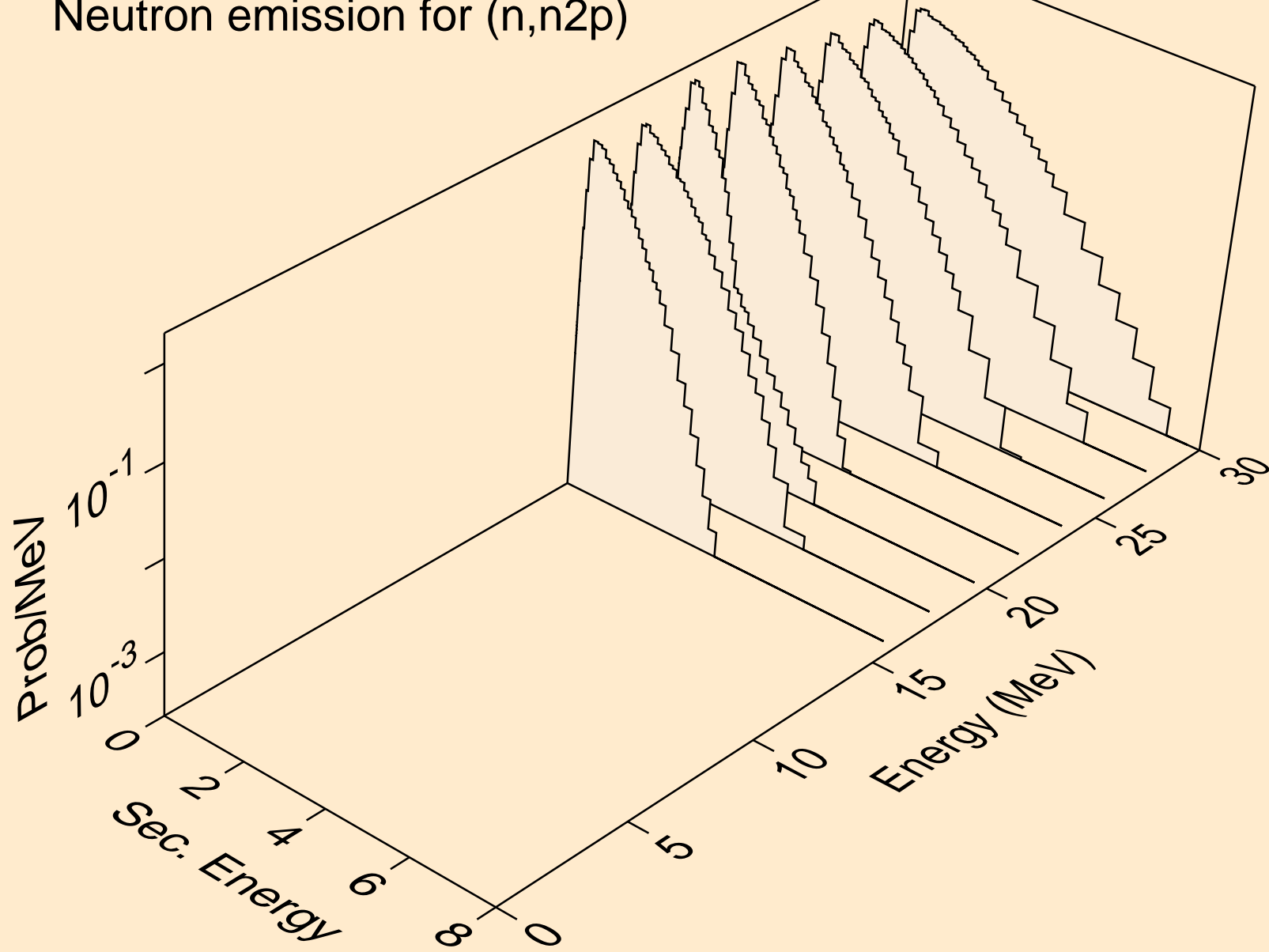

ES241 NEUTRON ACER TENDL-2023 LIBRARY; T=0.K
Neutron emission for (n,n*c)

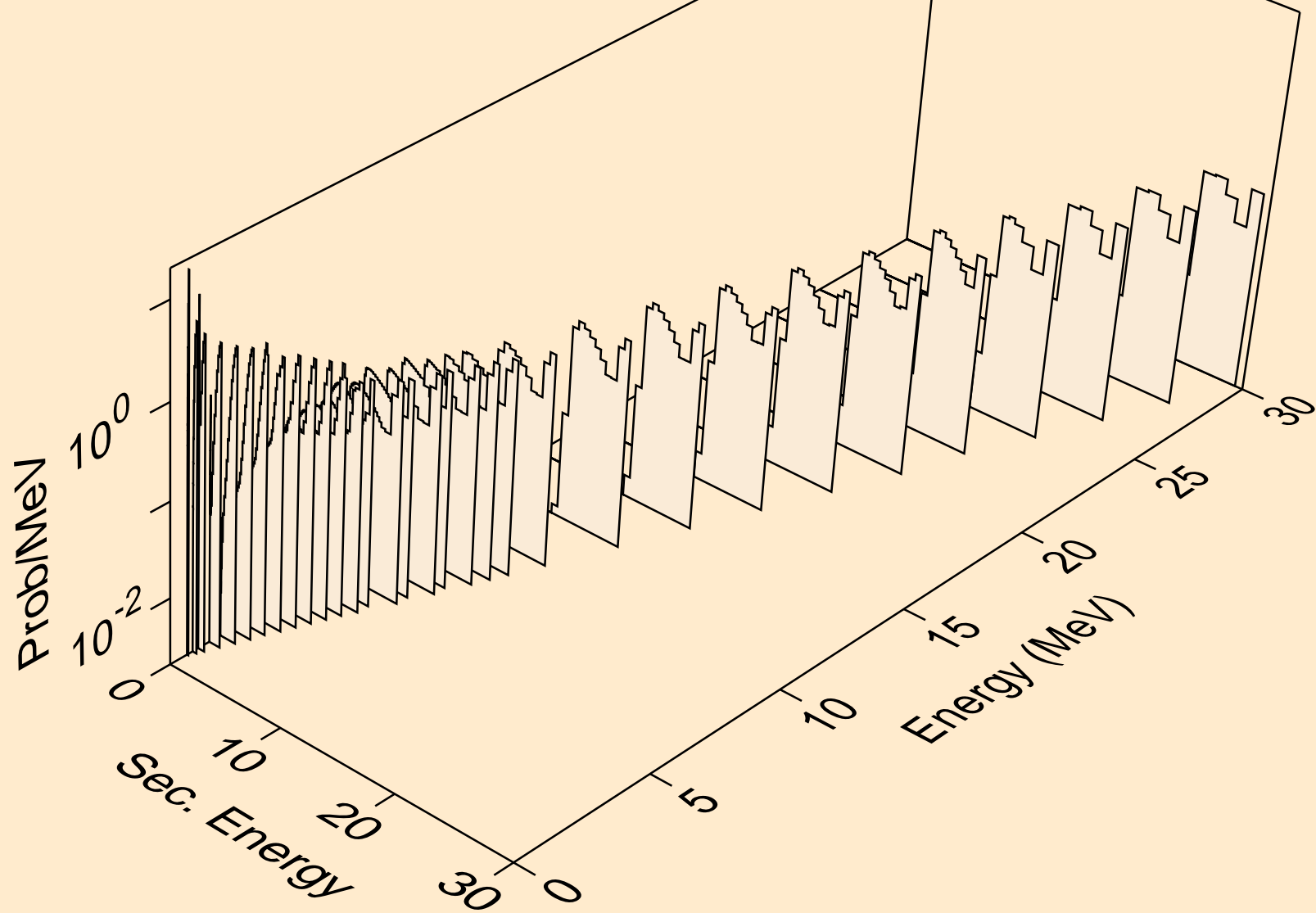

ES241 NEUTRON ACER TENDL-2023 LIBRARY; T=0.K

Delayed nubar

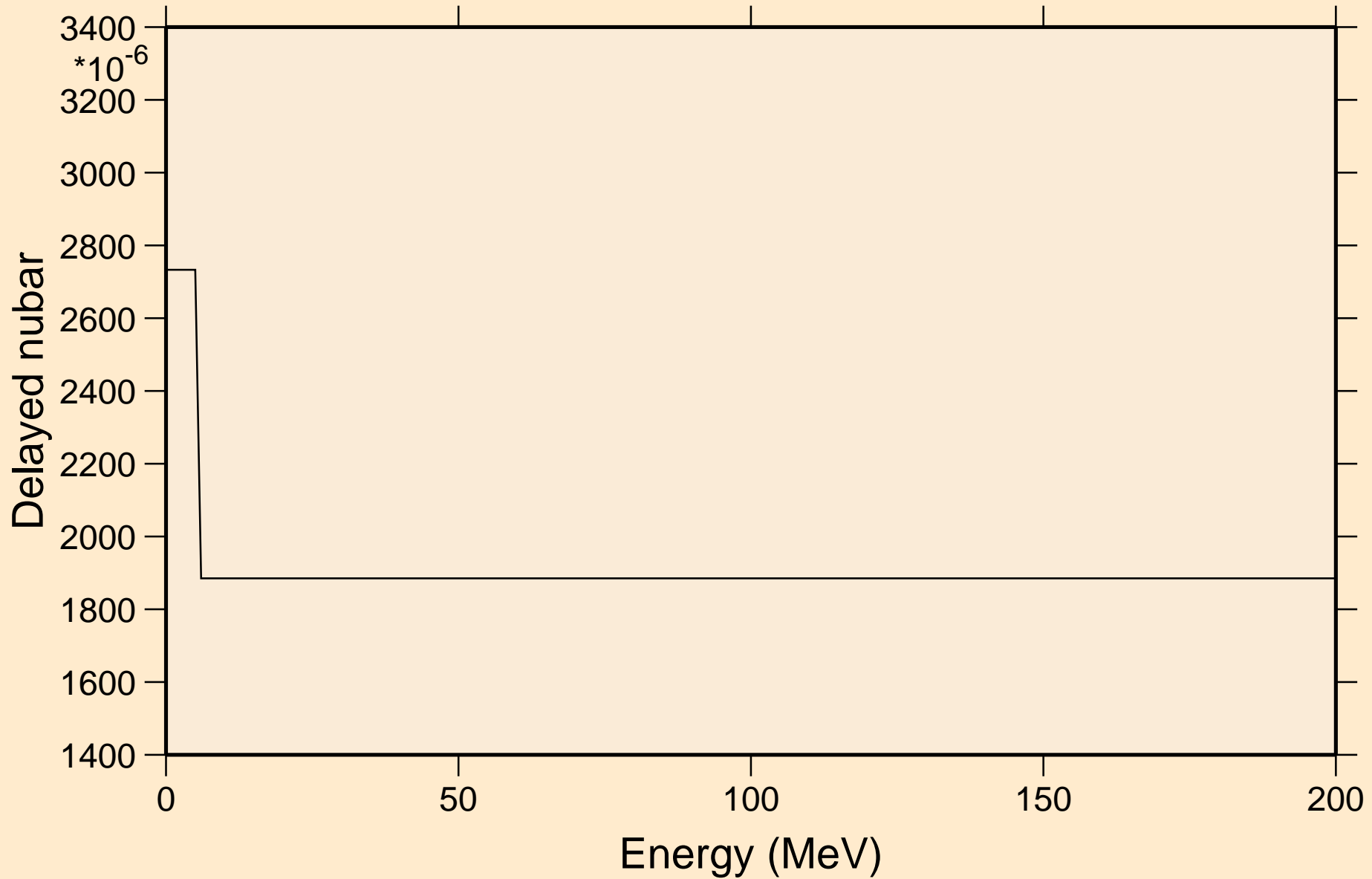

ES241 NEUTRON ACER TENDL-2023 LIBRARY; T=0.K

Delayed neutron spectra

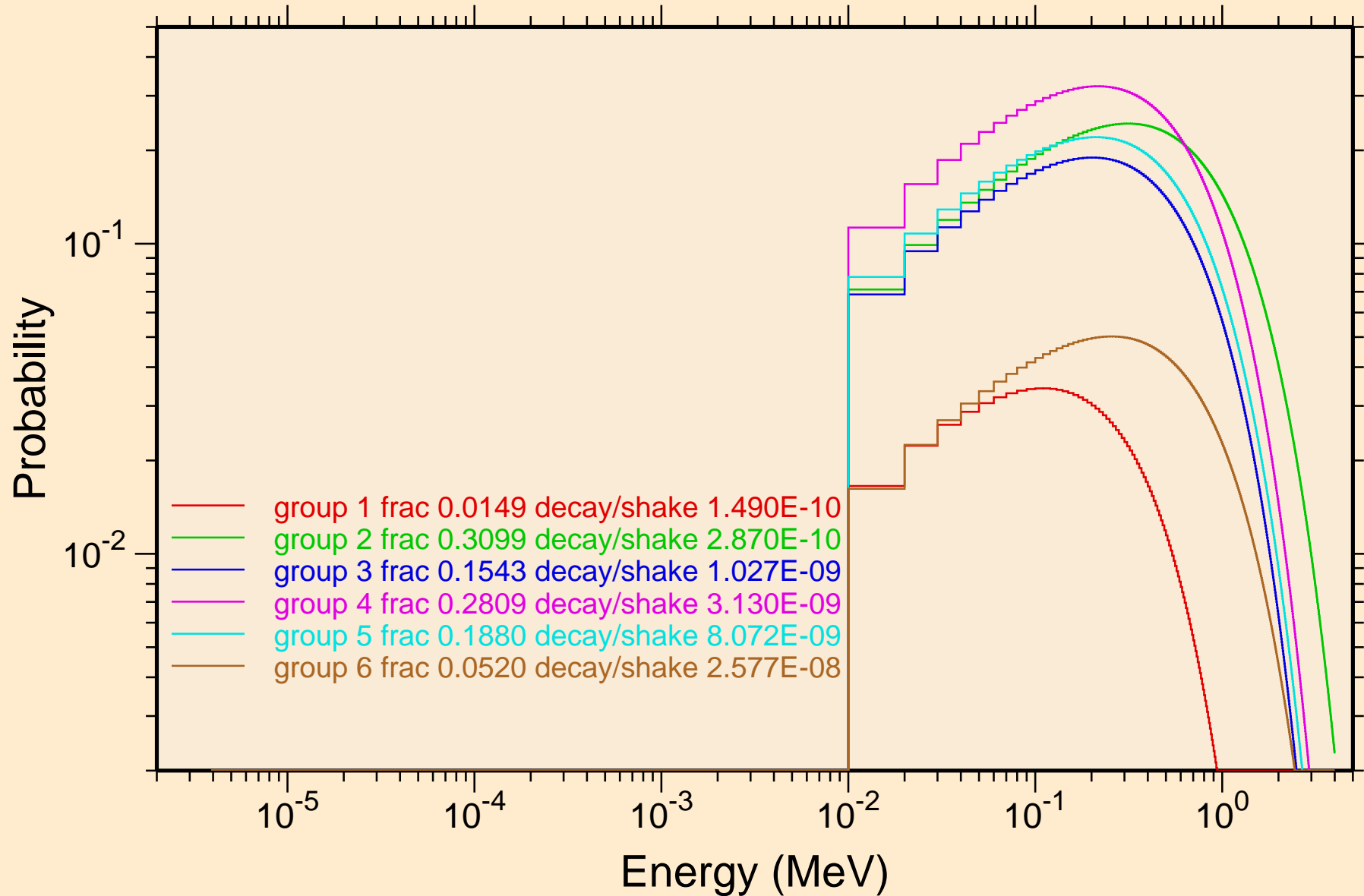

ES241 NEUTRON ACER TENDL-2023 LIBRARY; T=0.K
Photon emission for (n,x)

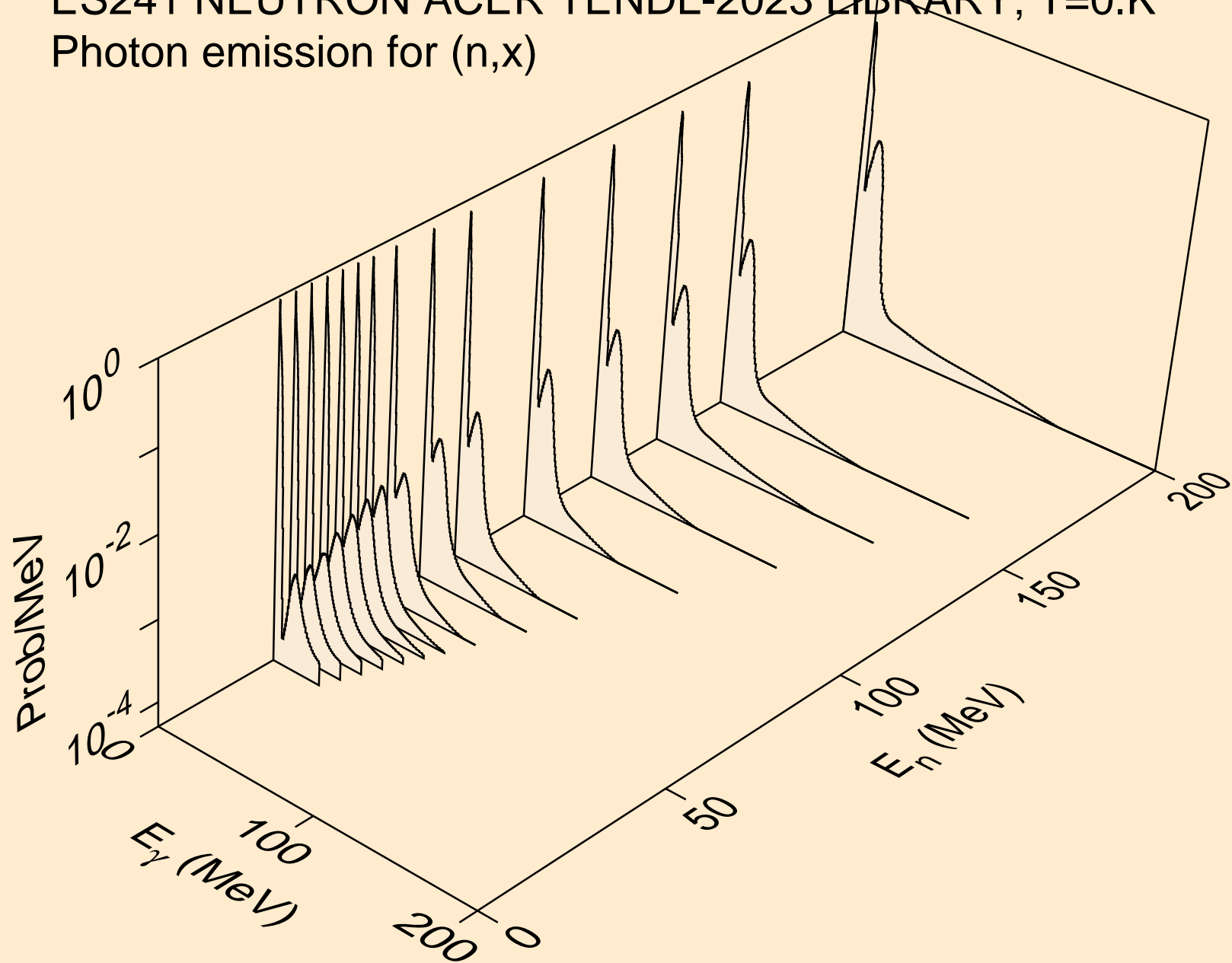

ES241 NEUTRON ACER TENDL-2023 LIBRARY; T=0.K
Photon emission for (n,2n)

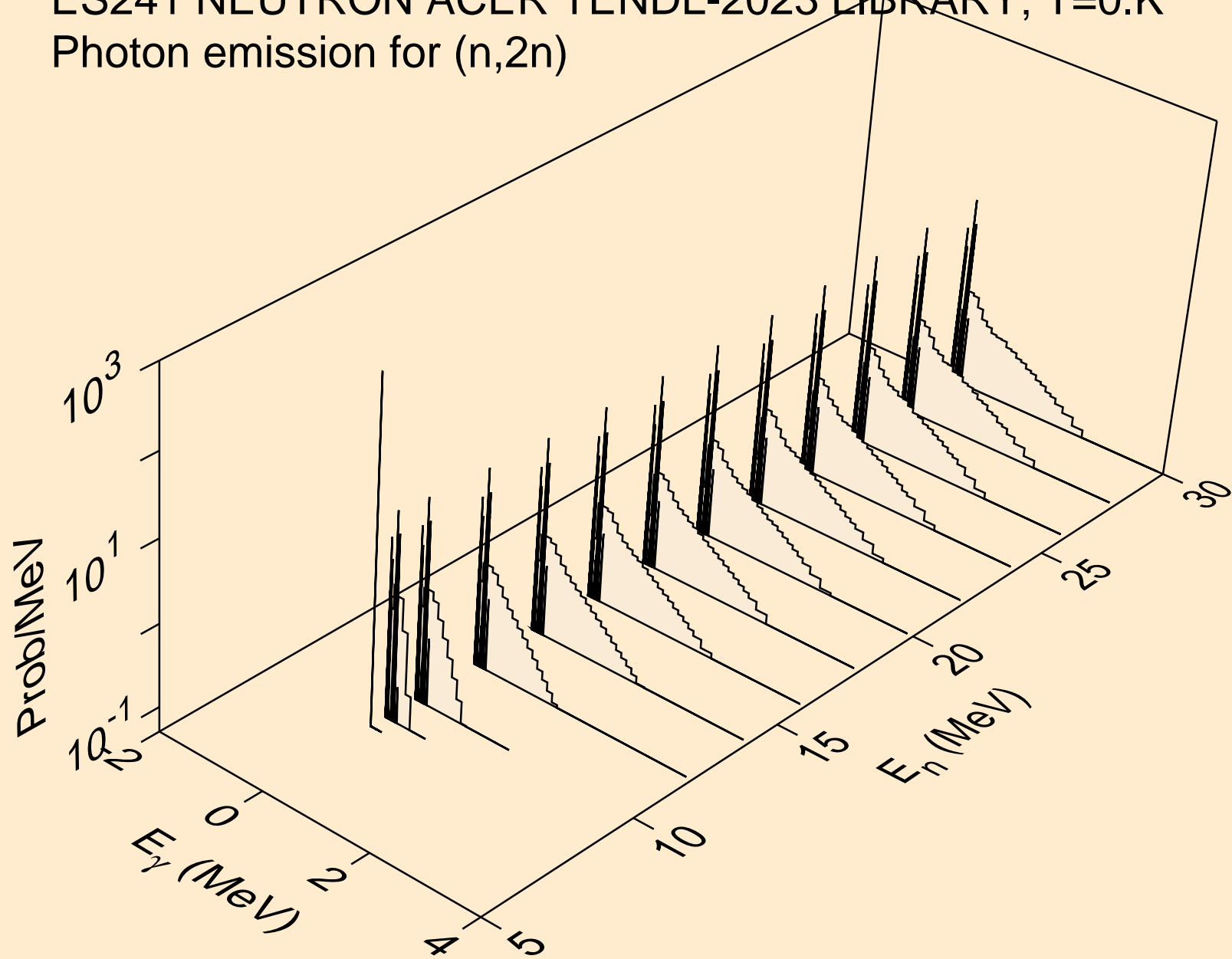

ES241 NEUTRON ACER TENDL-2023 LIBRARY; T=0.K
Photon emission for (n,3n)

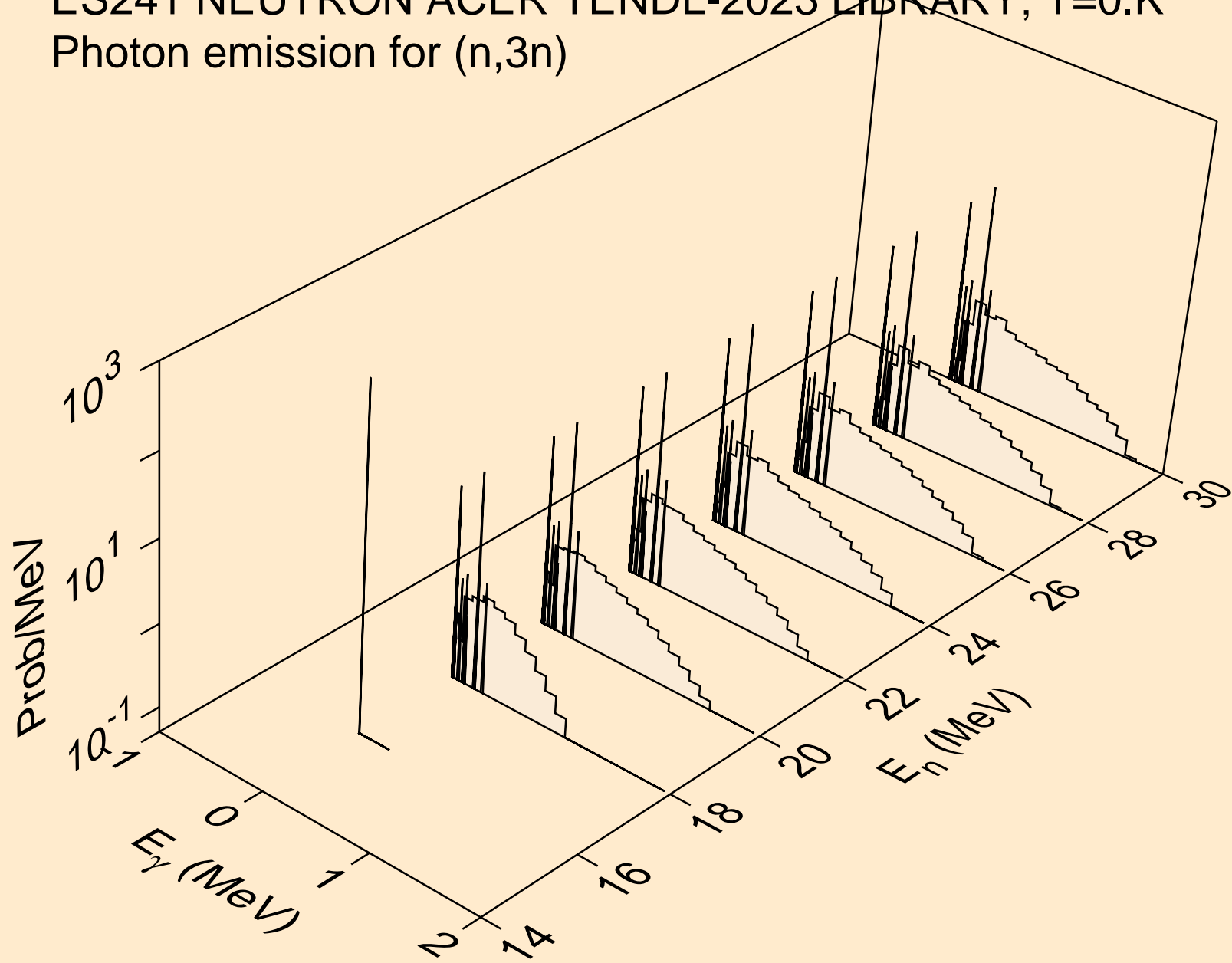

ES241 NEUTRON ACER TENDL-2023 LIBRARY; T=0.K
Photon emission for (n,n*)a

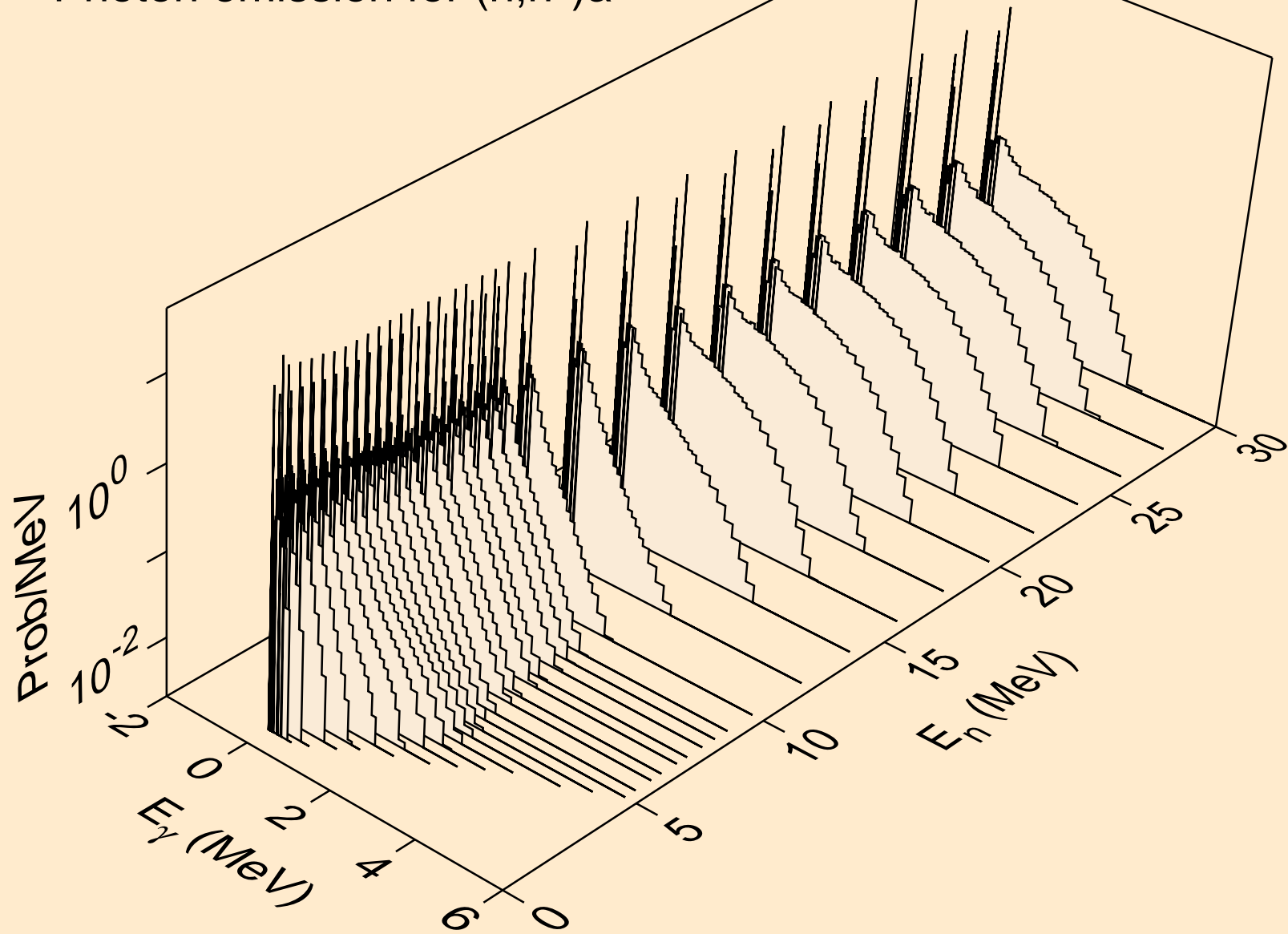

ES241 NEUTRON ACER TENDL-2023 LIBRARY; T=0.K
Photon emission for (n,2n)a

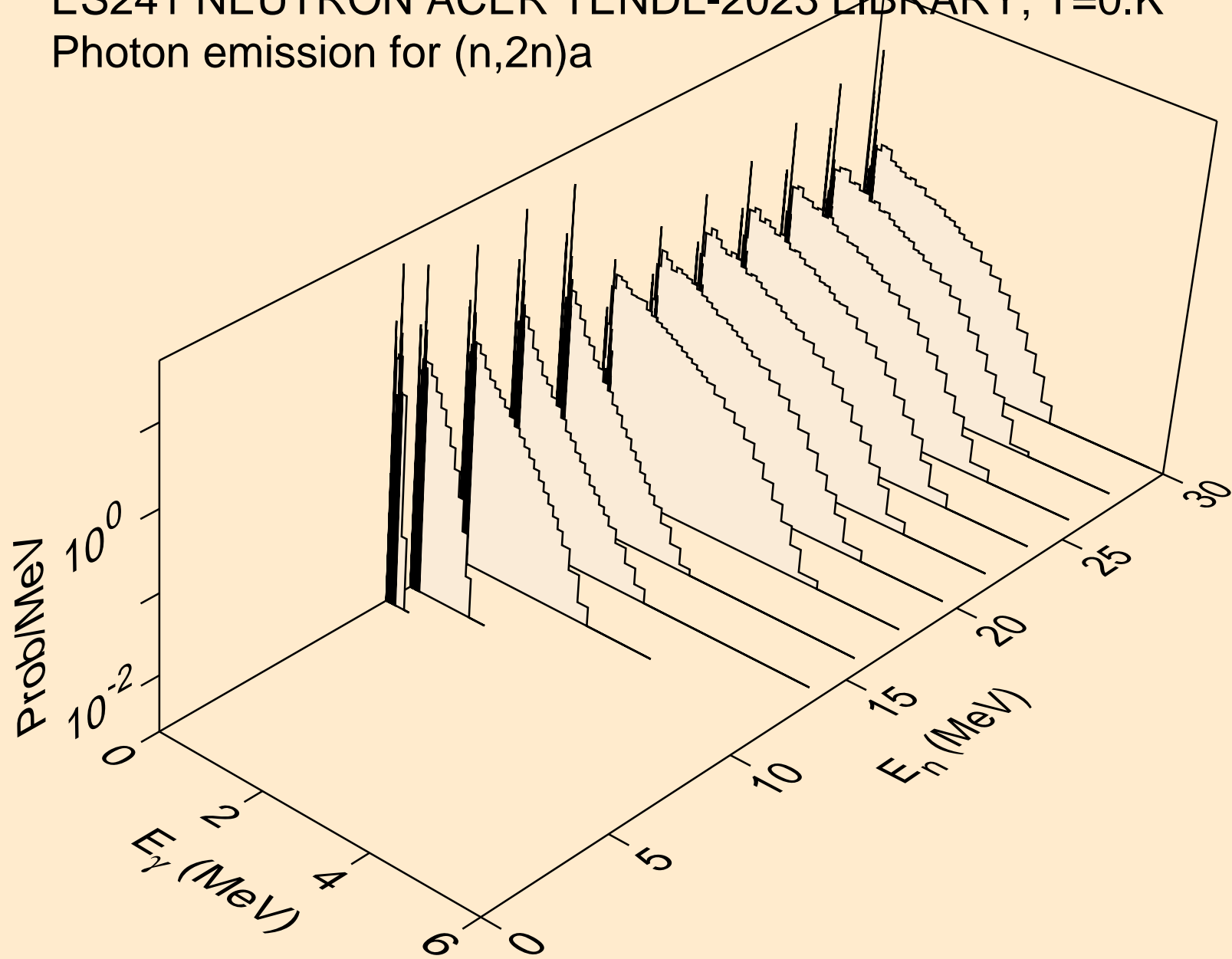

ES241 NEUTRON ACER TENDL-2023 LIBRARY; T=0.K
Photon emission for (n,n*)p

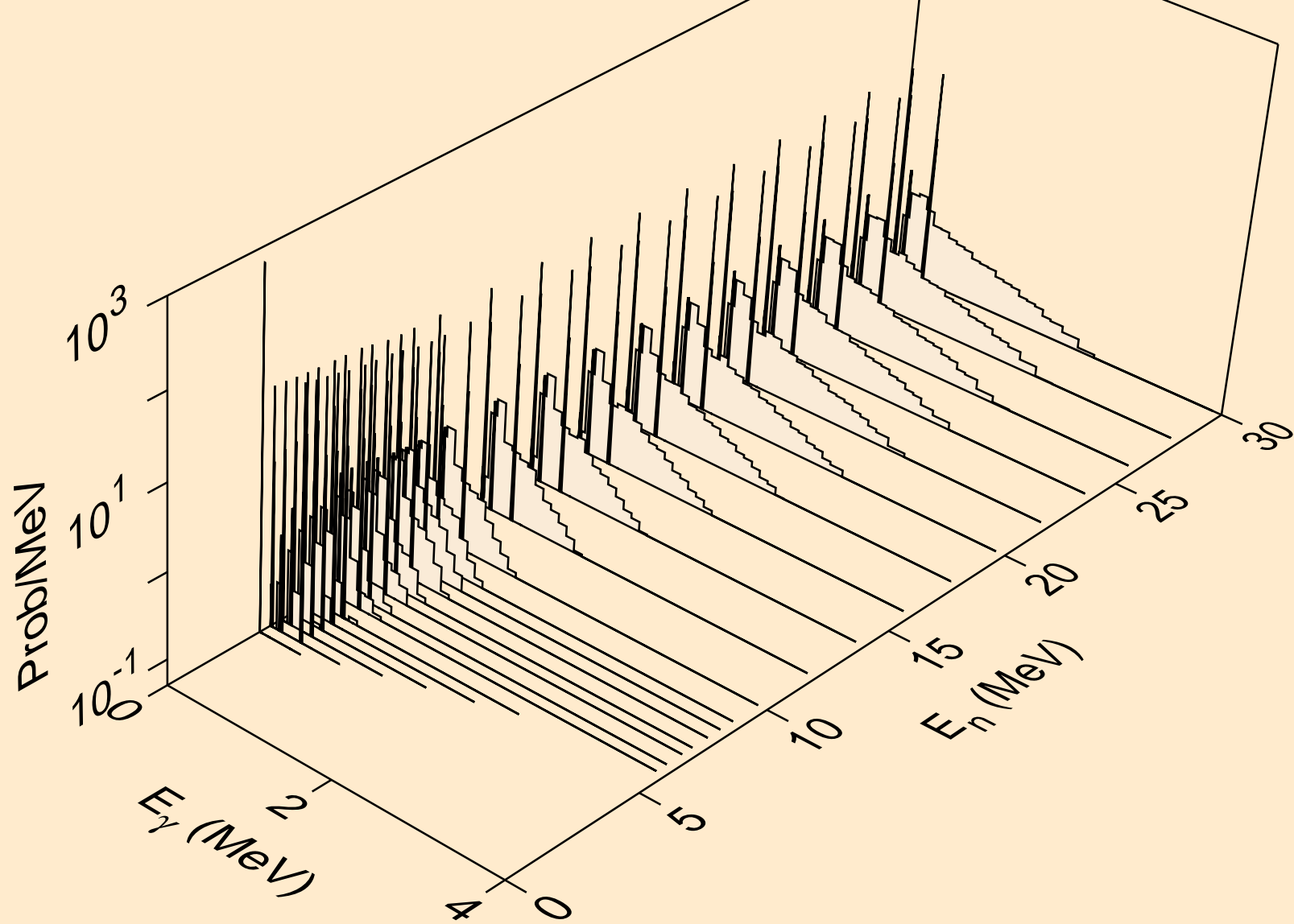

ES241 NEUTRON ACER TENDL-2023 LIBRARY; T=0.K
Photon emission for (n,n*)d

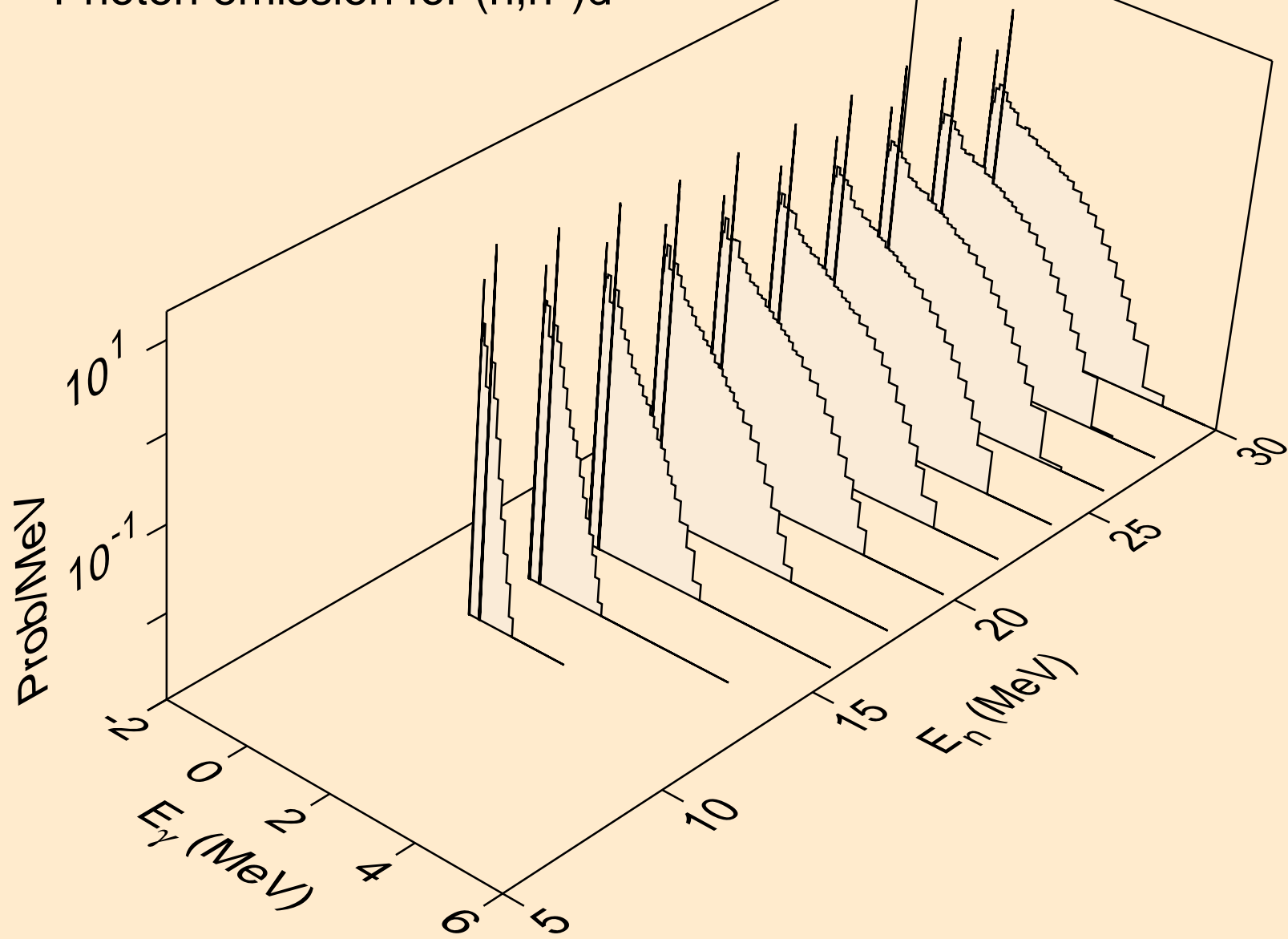

ES241 NEUTRON ACER TENDL-2023 LIBRARY; T=0.K
Photon emission for (n,n*)t

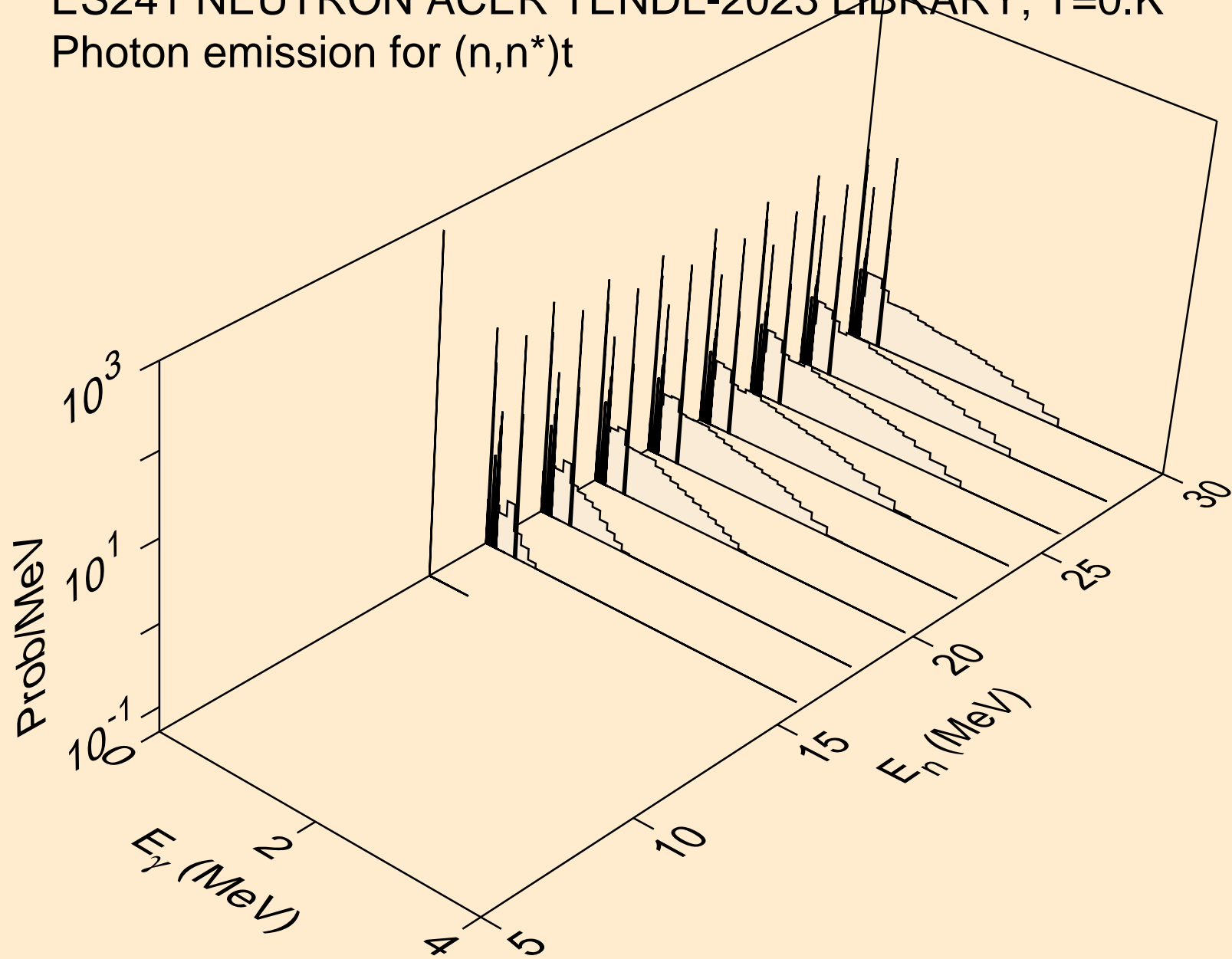

ES241 NEUTRON ACER TENDL-2023 LIBRARY; T=0.K
Photon emission for (n,n*)he3

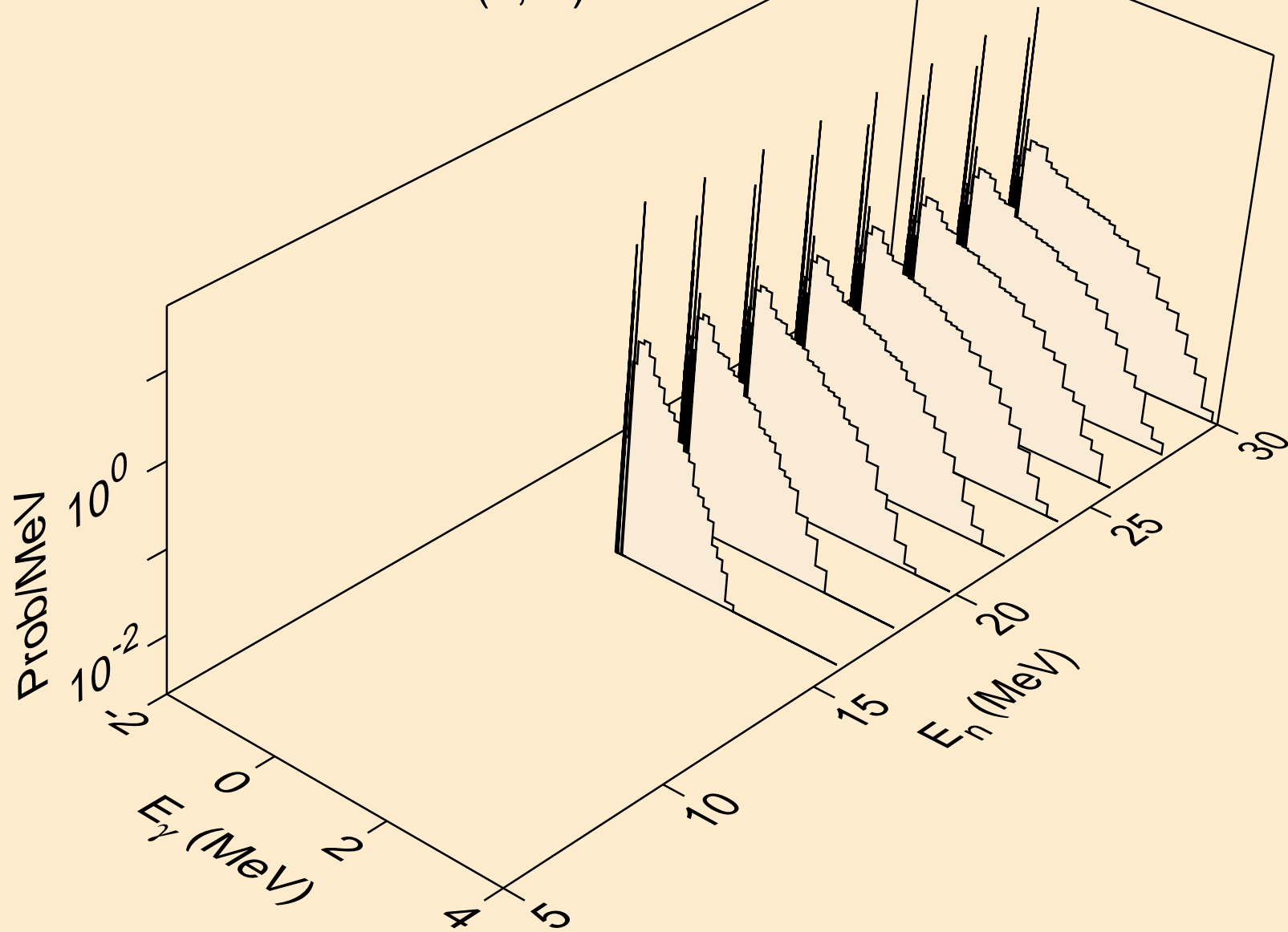

ES241 NEUTRON ACER TENDL-2023 LIBRARY; T=0.K
Photon emission for (n,2np)

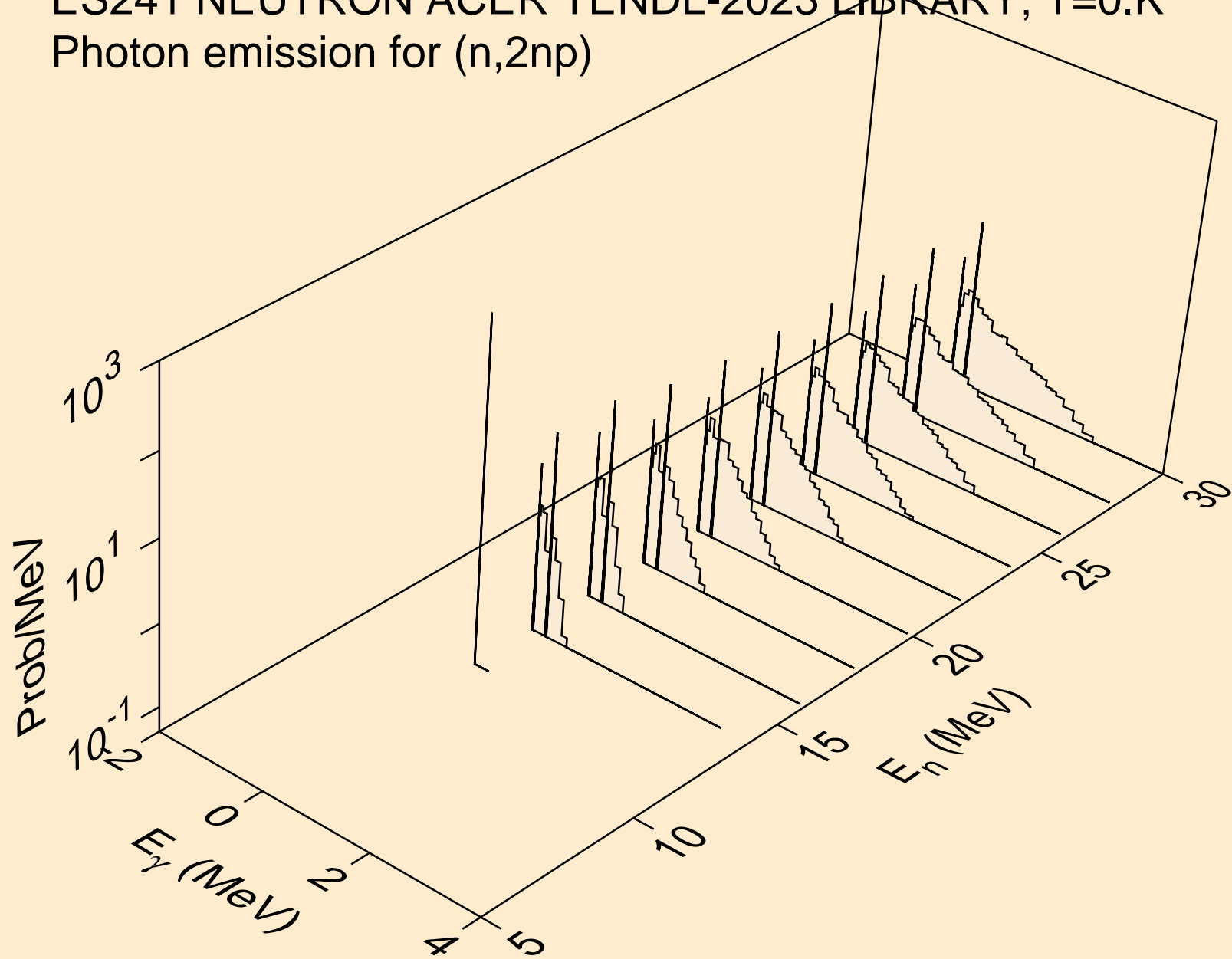

ES241 NEUTRON ACER TENDL-2023 LIBRARY; T=0.K
Photon emission for (n,n2p)

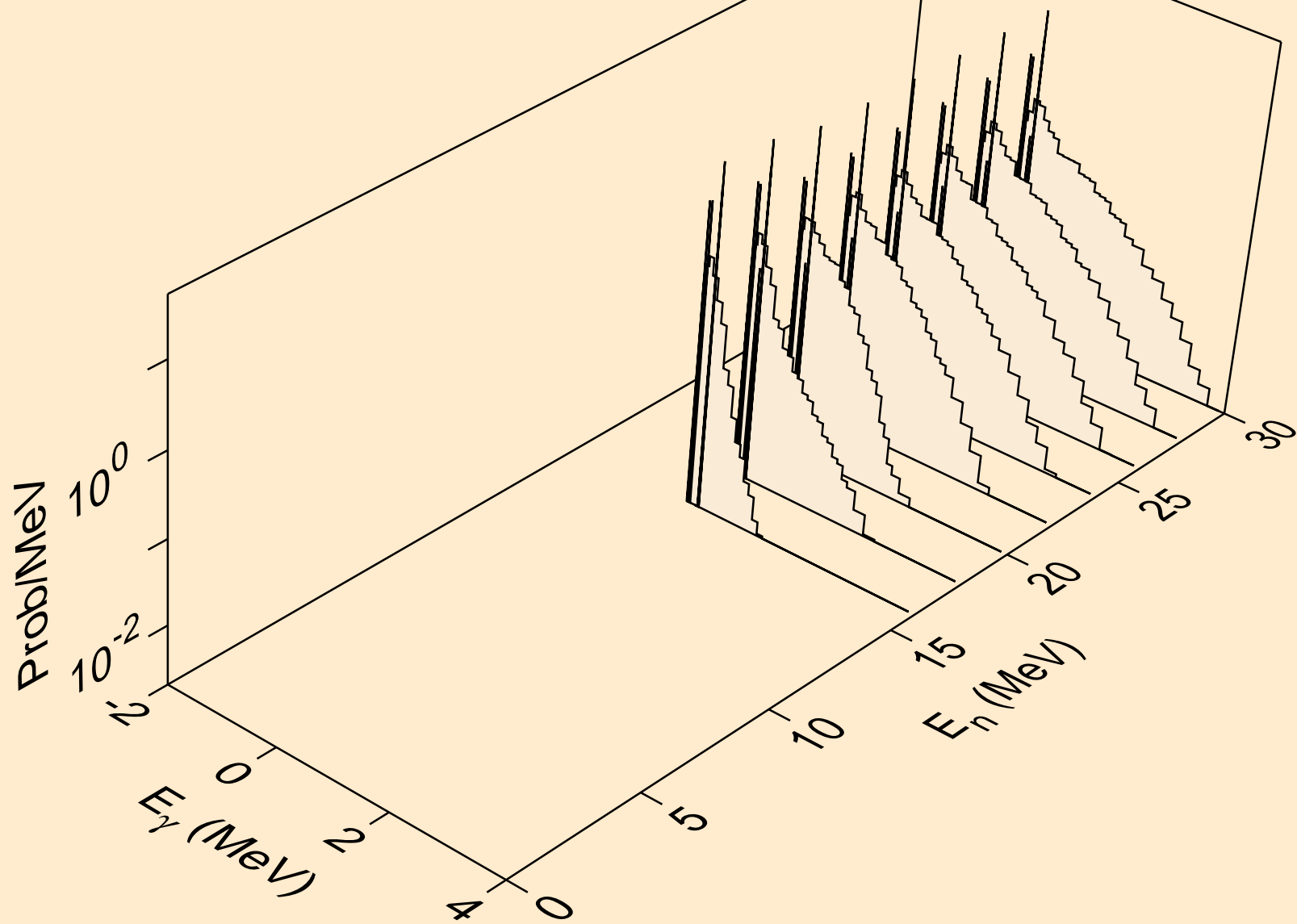

ES241 NEUTRON ACER TENDL-2023 LIBRARY; T=0.K
Photon emission for (n,n*c)

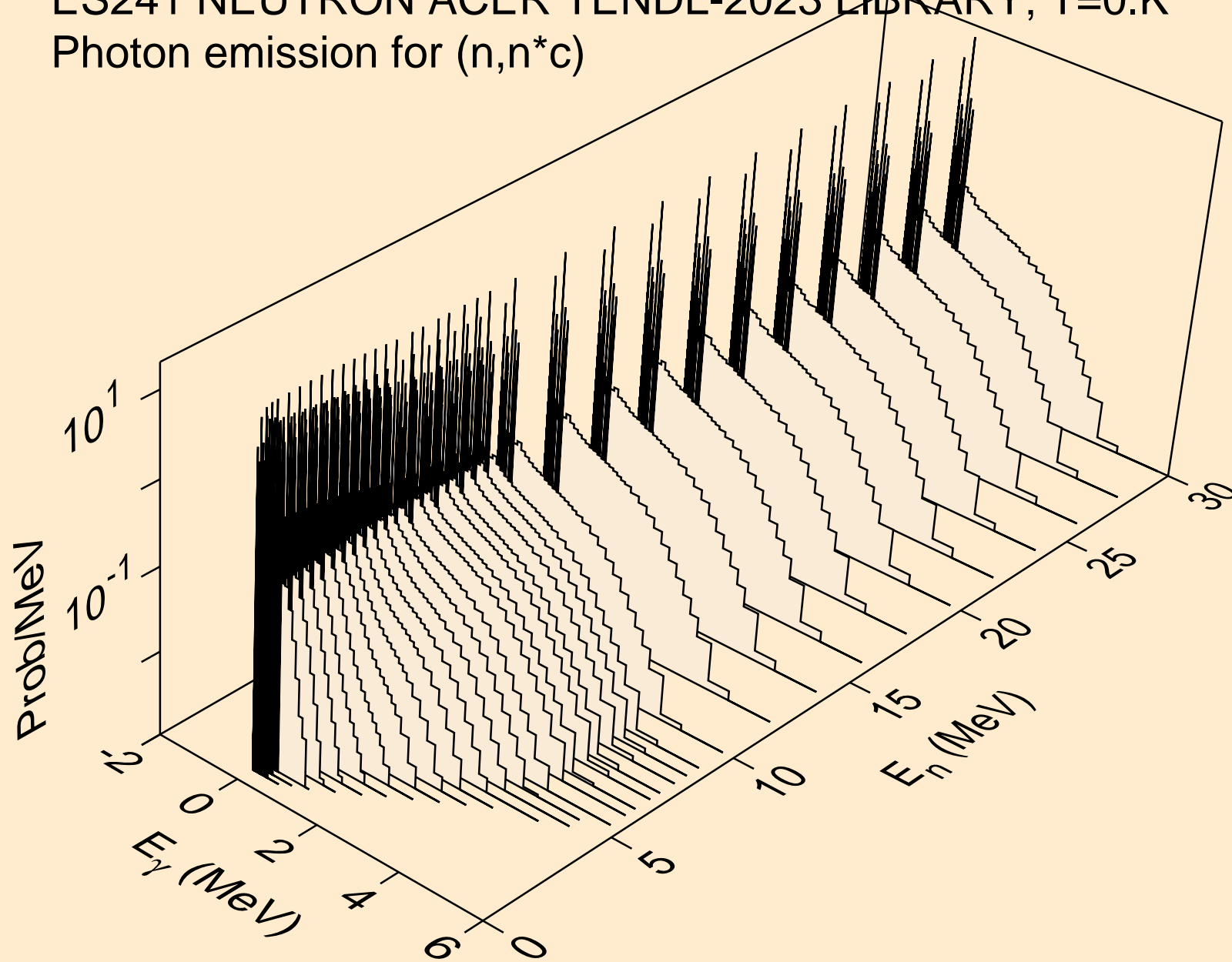

ES241 NEUTRON ACER TENDL-2023 LIBRARY; T=0.K
Photon emission for (n,gma)

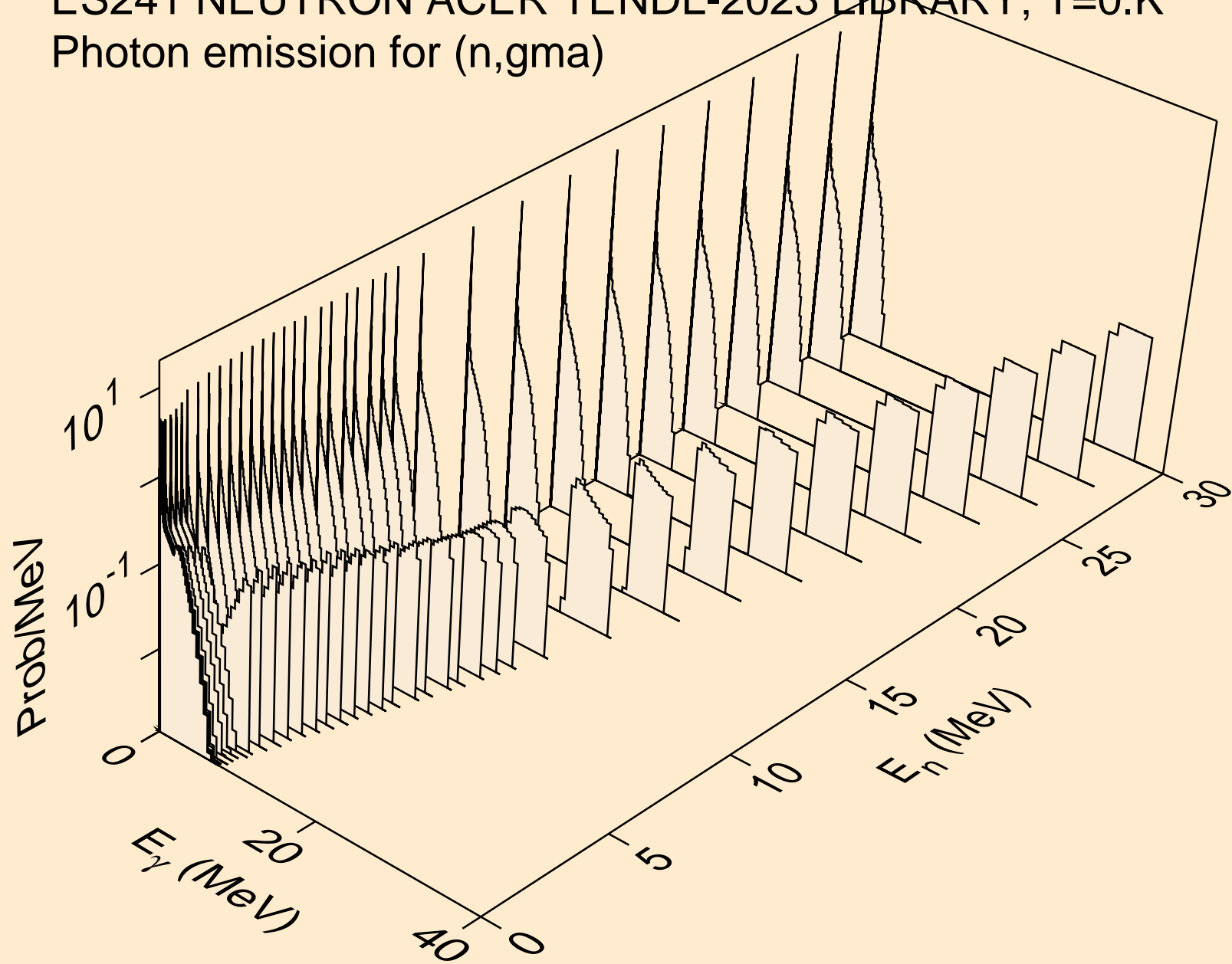

ES241 NEUTRON ACER TENDL-2023 LIBRARY; T=0.K
Photon emission for (n,p)

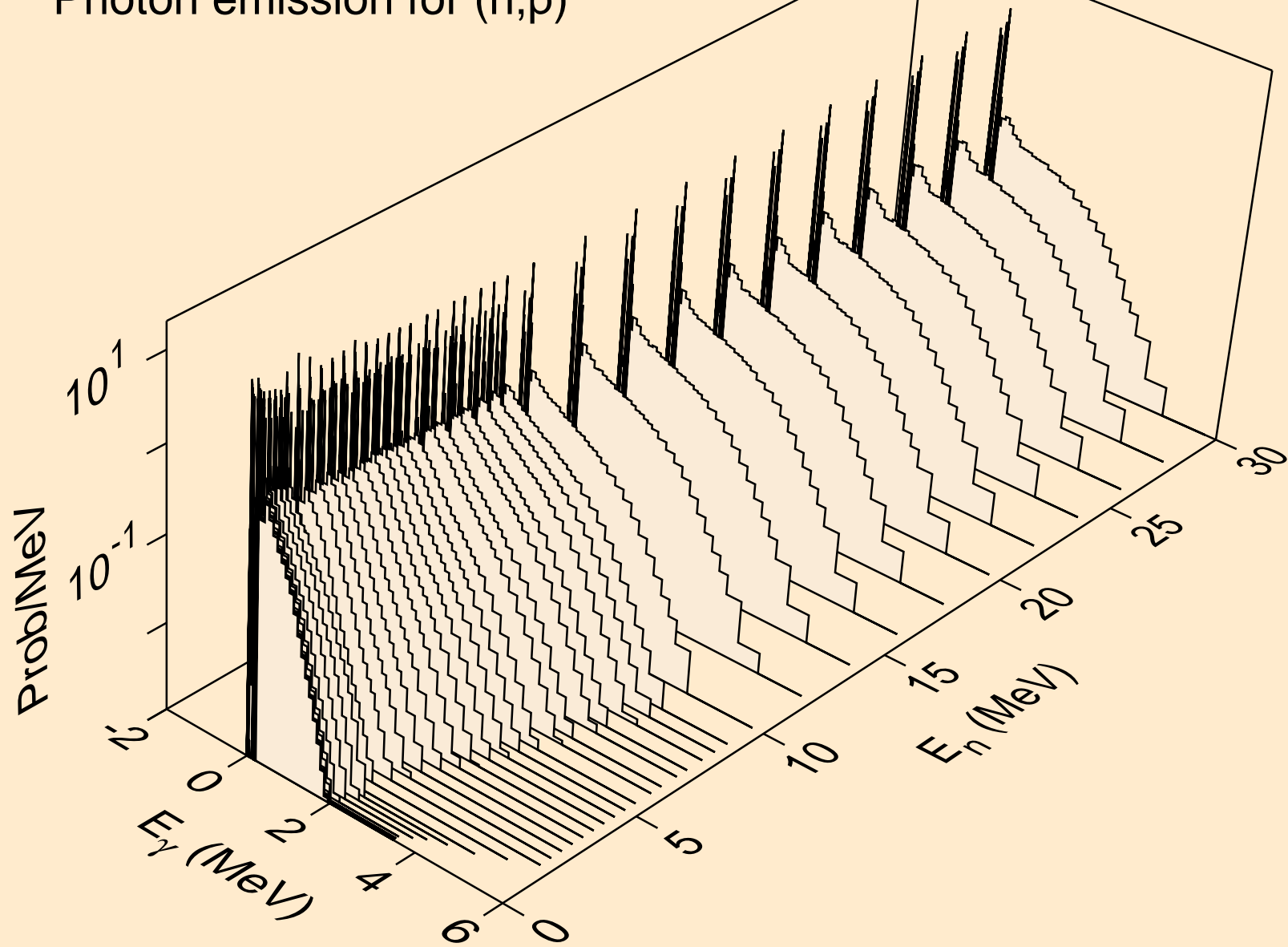

ES241 NEUTRON ACER TENDL-2023 LIBRARY; T=0.K
Photon emission for (n,d)

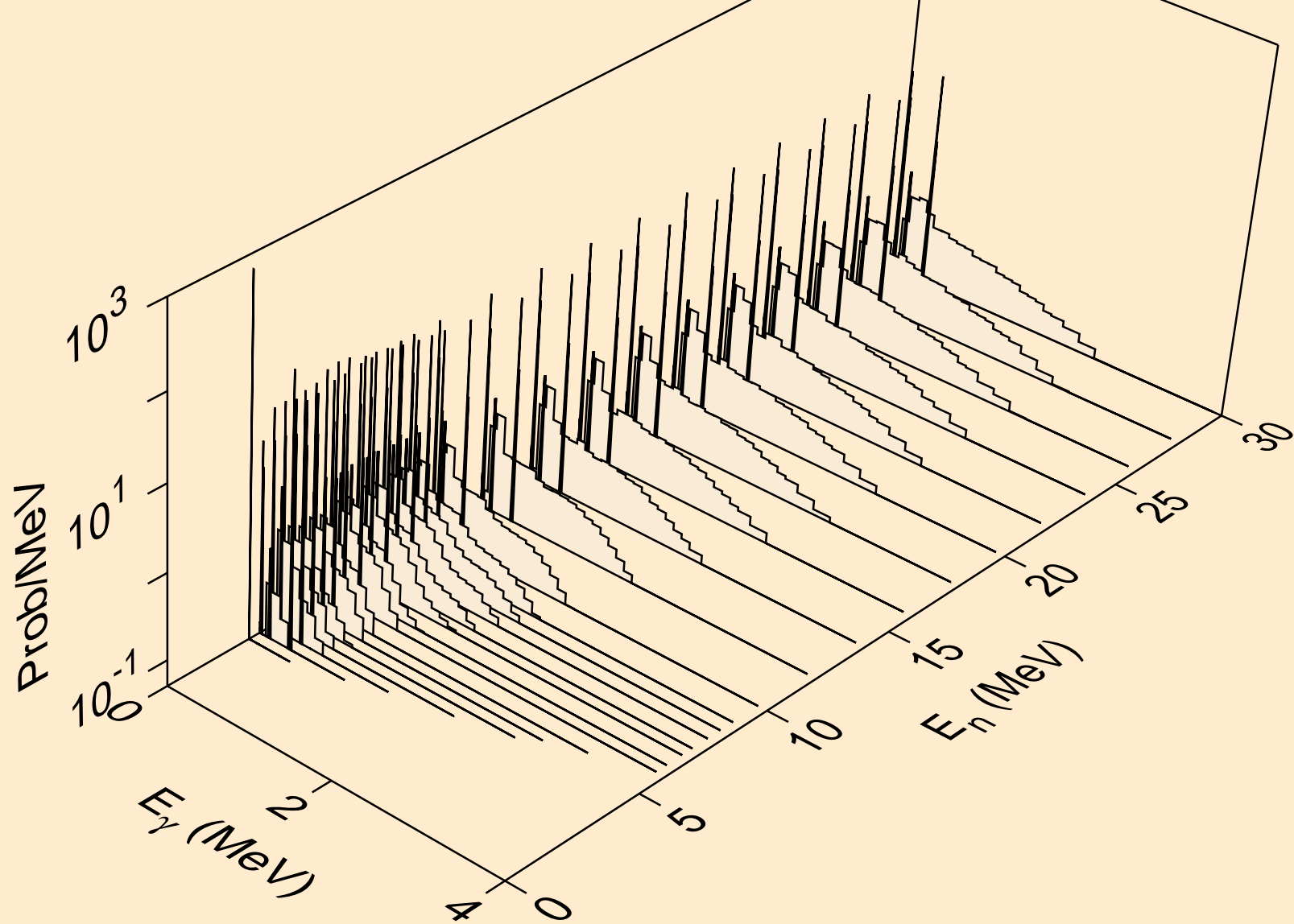

ES241 NEUTRON ACER TENDL-2023 LIBRARY; T=0.K
Photon emission for (n,t)

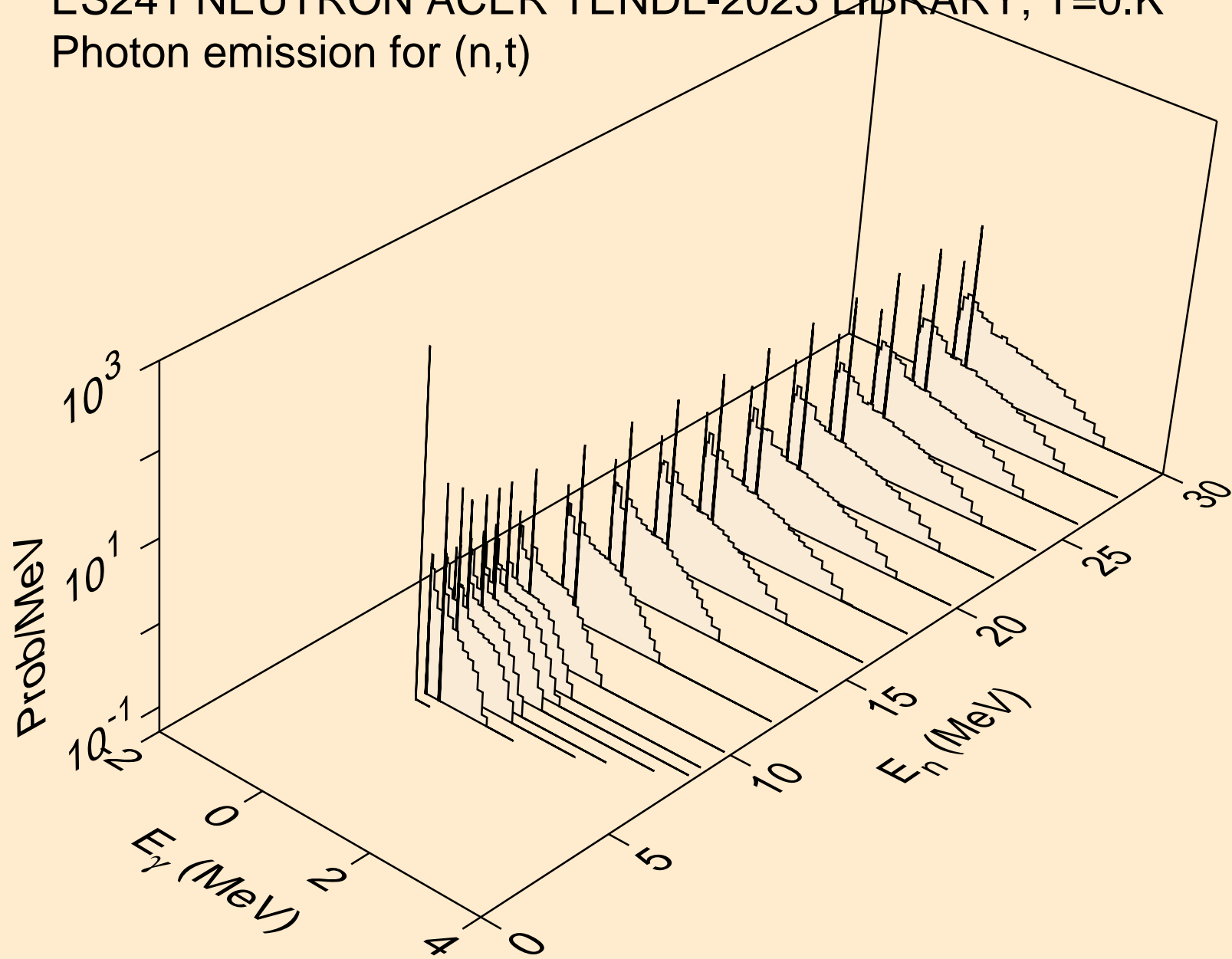

ES241 NEUTRON ACER TENDL-2023 LIBRARY; T=0.K
Photon emission for (n,he3)

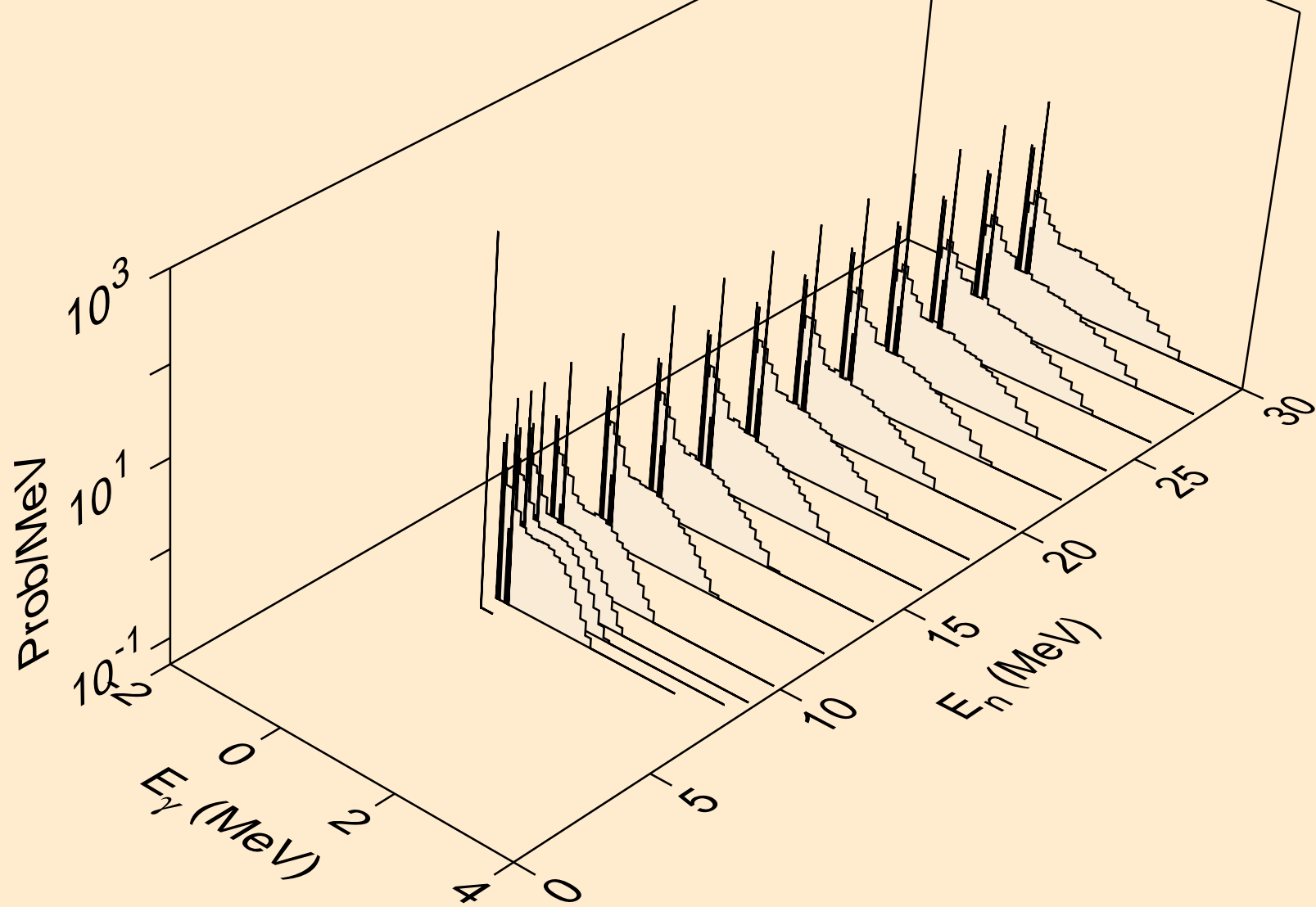

ES241 NEUTRON ACER TENDL-2023 LIBRARY; T=0.K
Photon emission for (n,a)

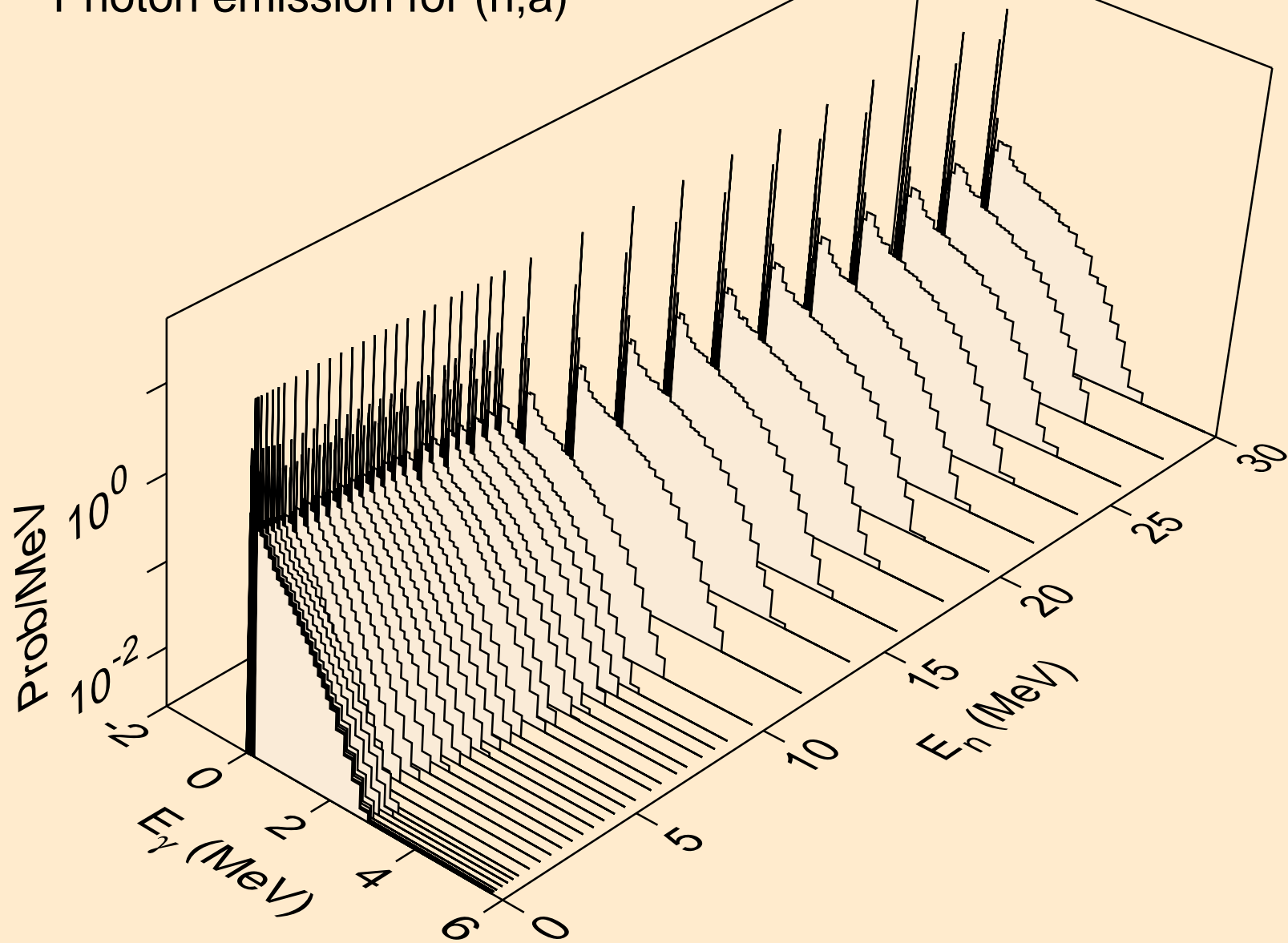

ES241 NEUTRON ACER TENDL-2023 LIBRARY; T=0.K
Photon emission for (n,2a)

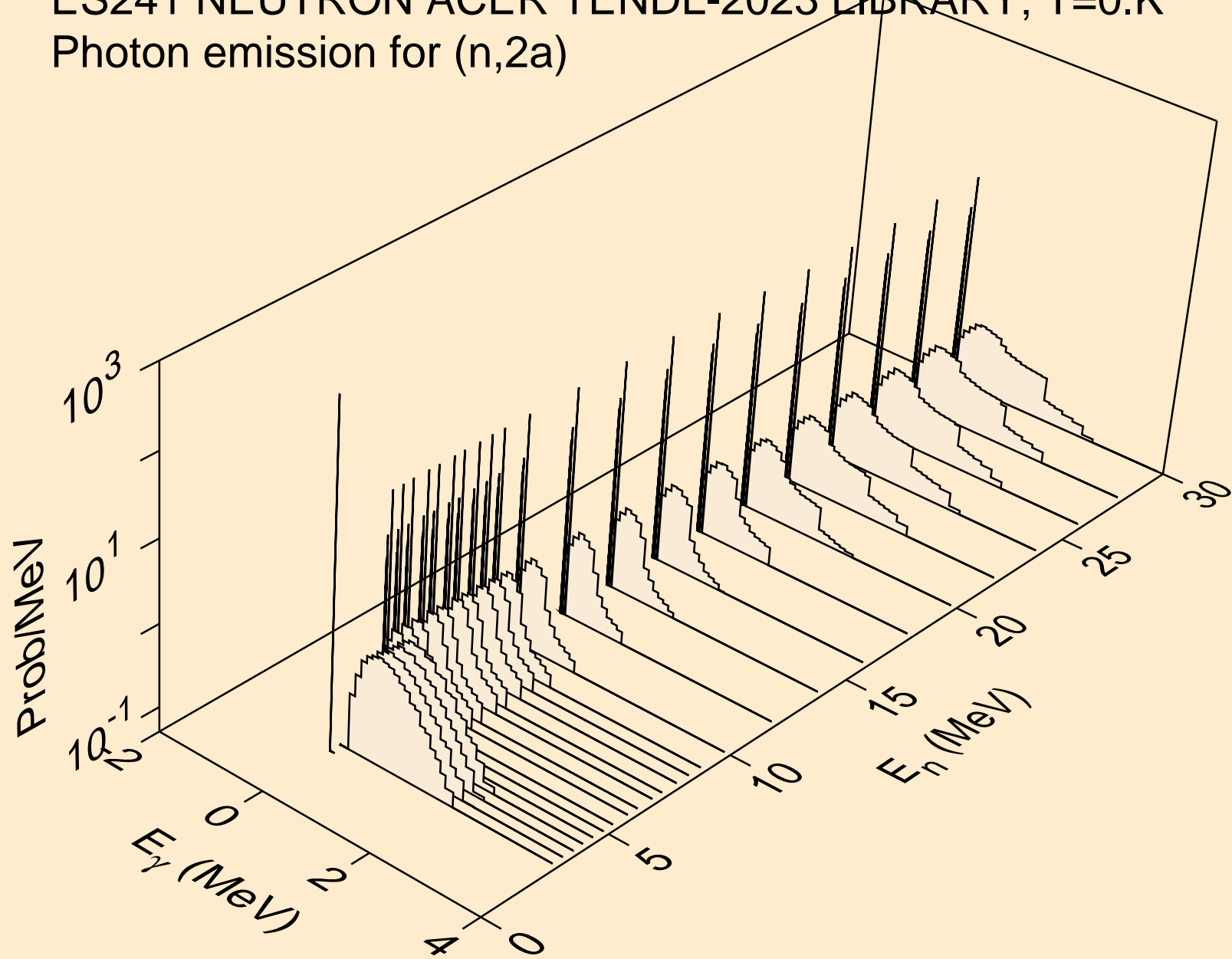

ES241 NEUTRON ACER TENDL-2023 LIBRARY; T=0.K
Photon emission for (n,2p)

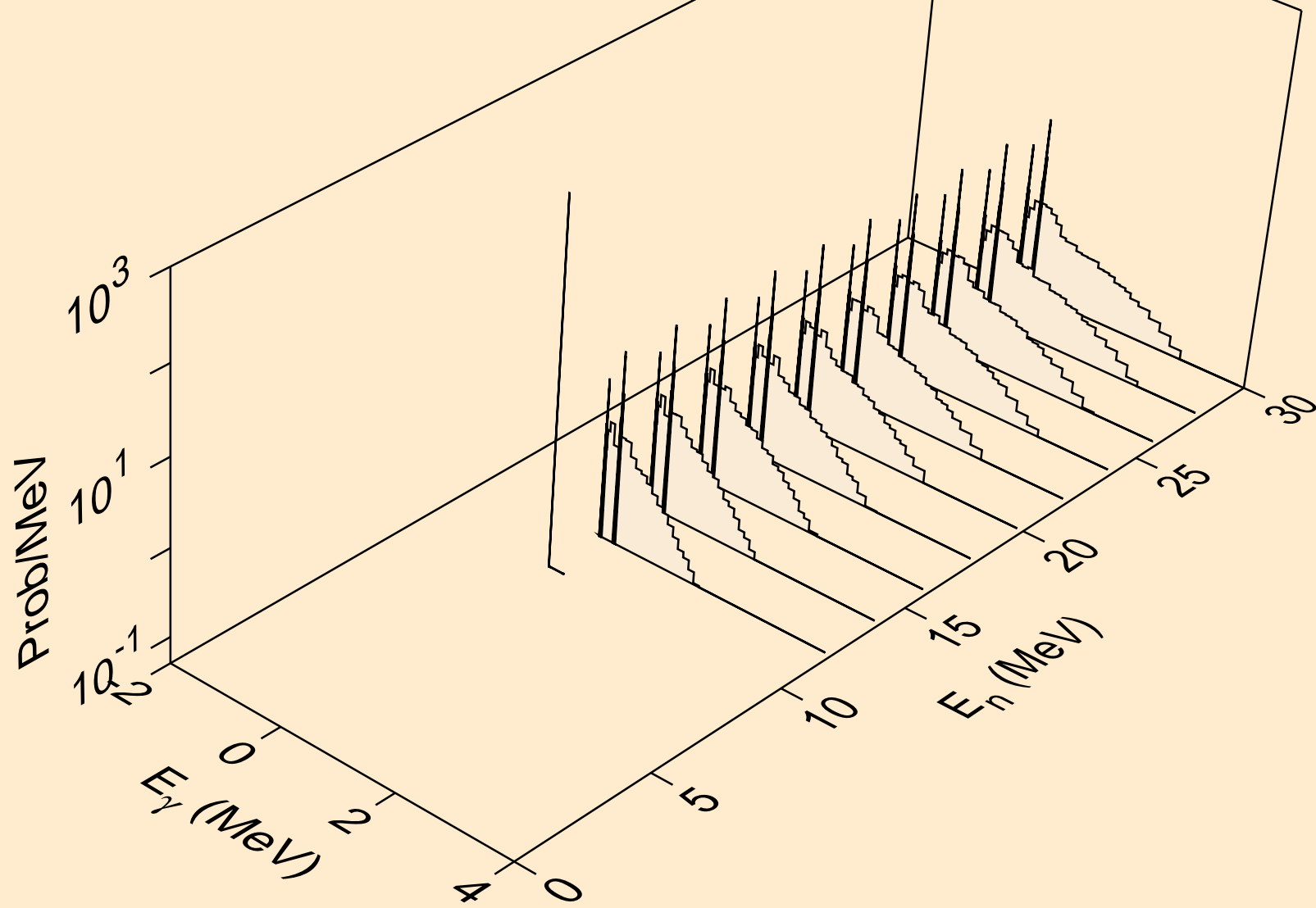

ES241 NEUTRON ACER TENDL-2023 LIBRARY; T=0.K
Photon emission for (n,p α)

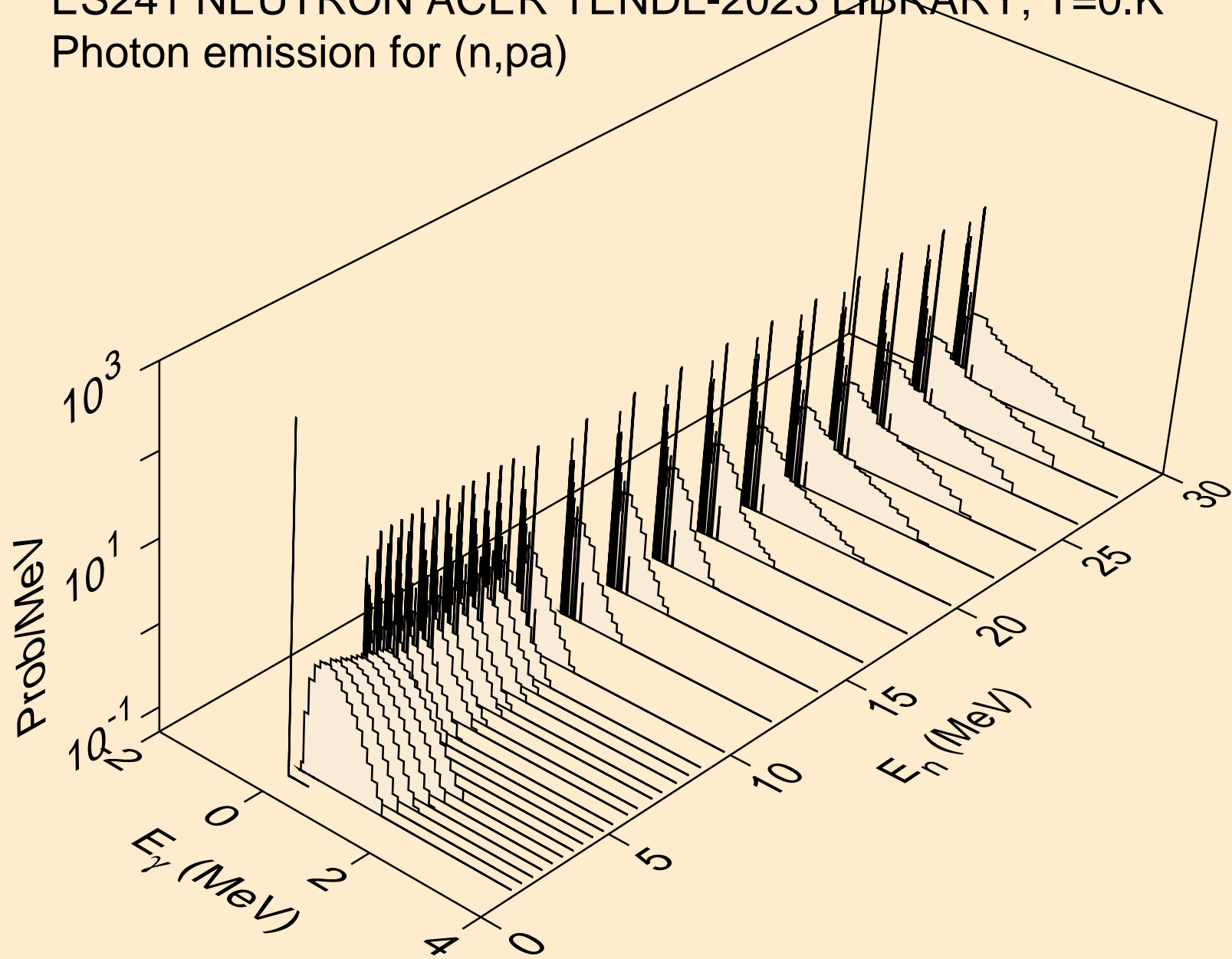

ES241 NEUTRON ACER TENDL-2023 LIBRARY; T=0.K
Photon emission for (n,pd)

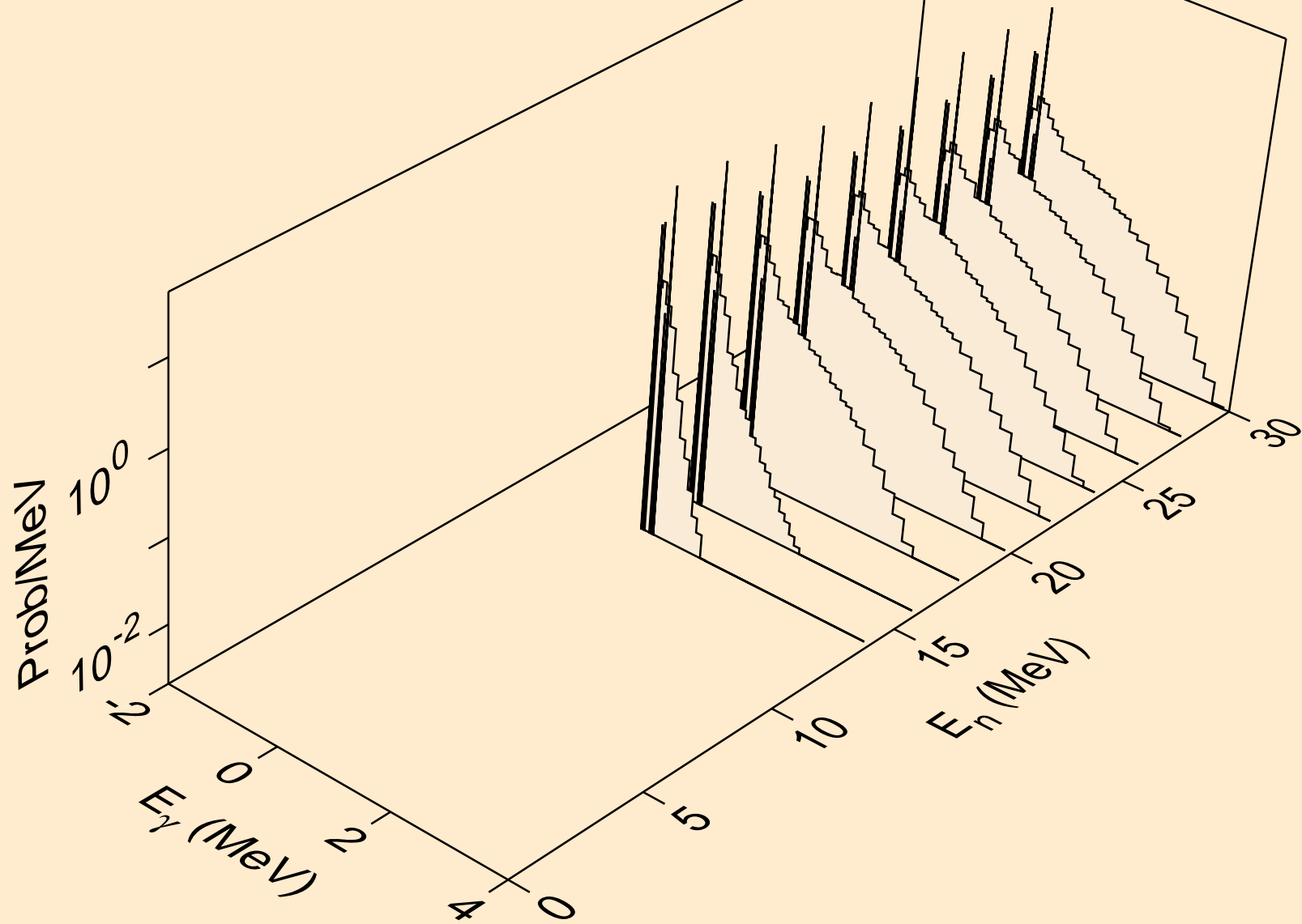

ES241 NEUTRON ACER TENDL-2023 LIBRARY; T=0.K
Photon emission for (n,da)

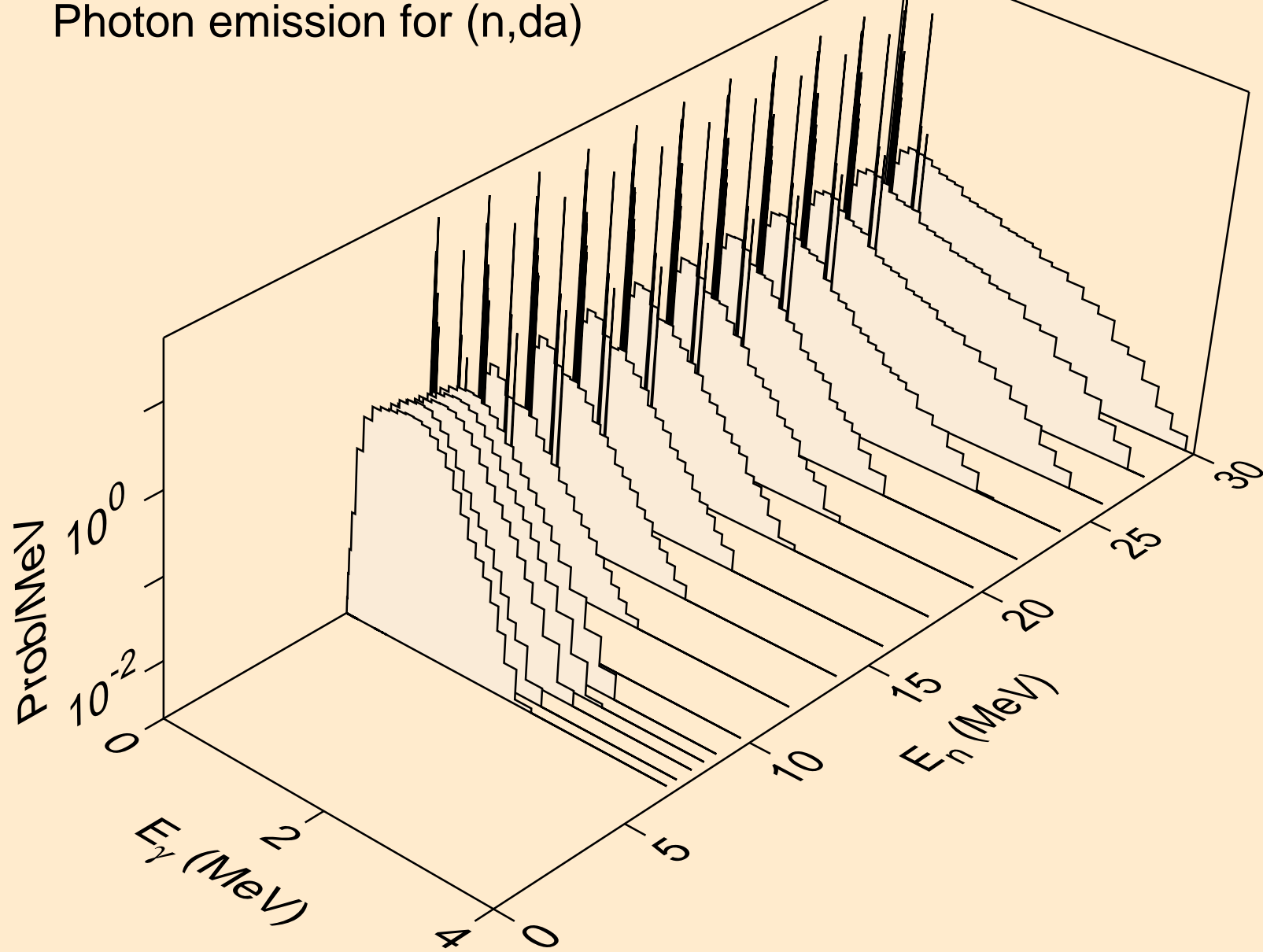

ES241 NEUTRON ACER TENDL-2023 LIBRARY; T=0.K
thermal capture photon spectrum

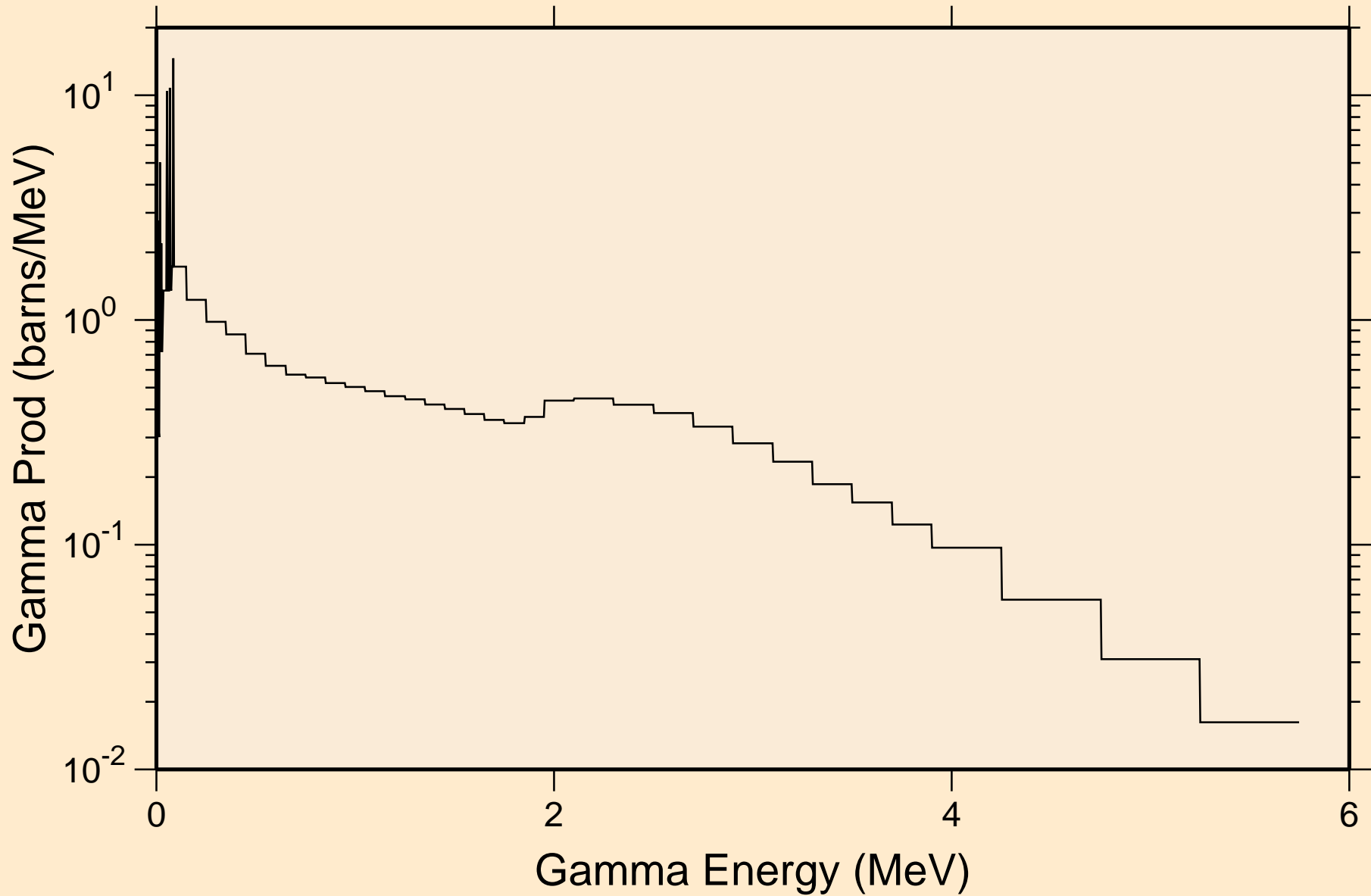

ES241 NEUTRON ACER TENDL-2023 LIBRARY; T=0.K
14 MeV photon spectrum

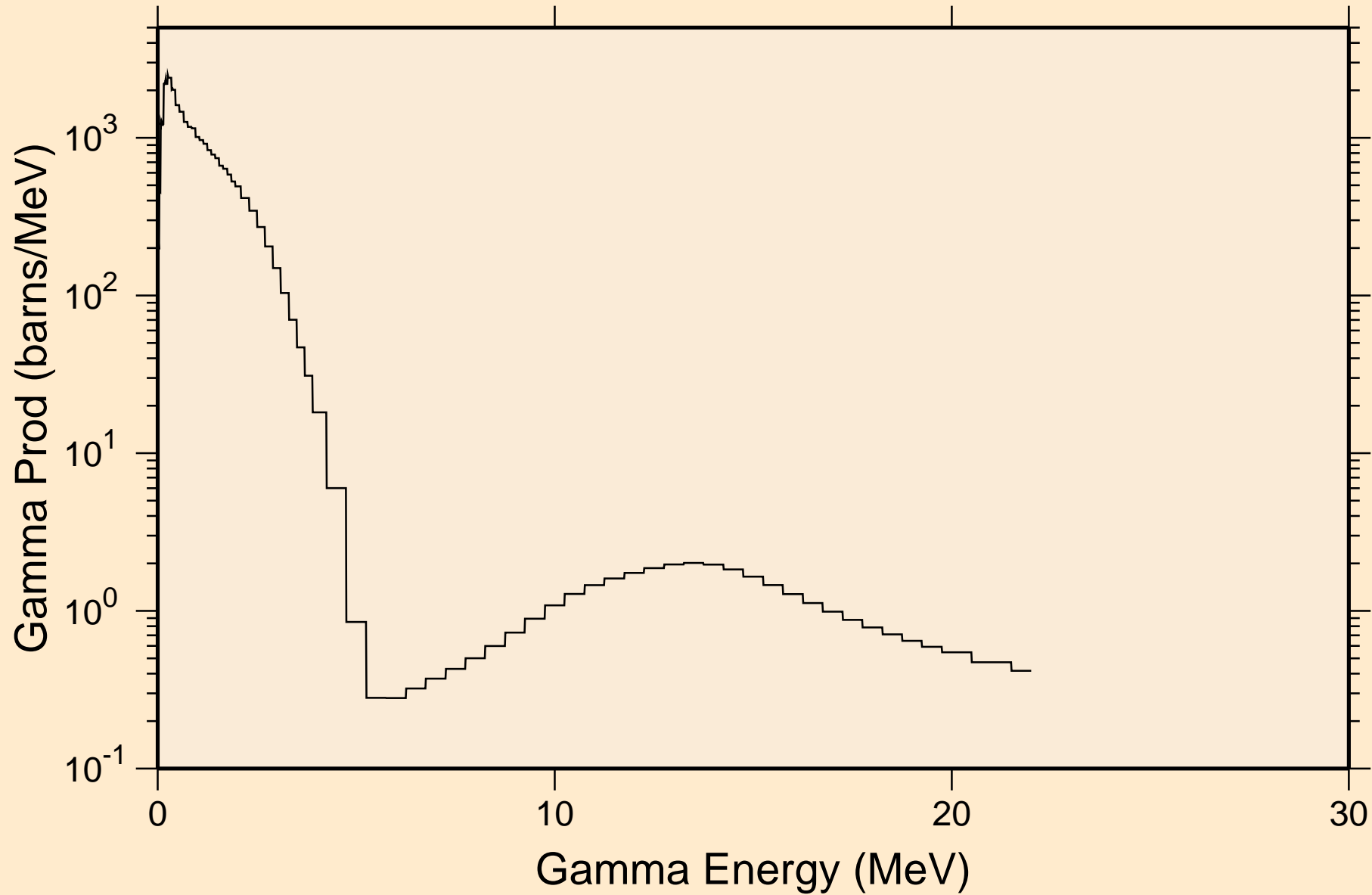

ES241 NEUTRON ACER TENDL-2023 LIBRARY; T=0.K

Particle heating contributions

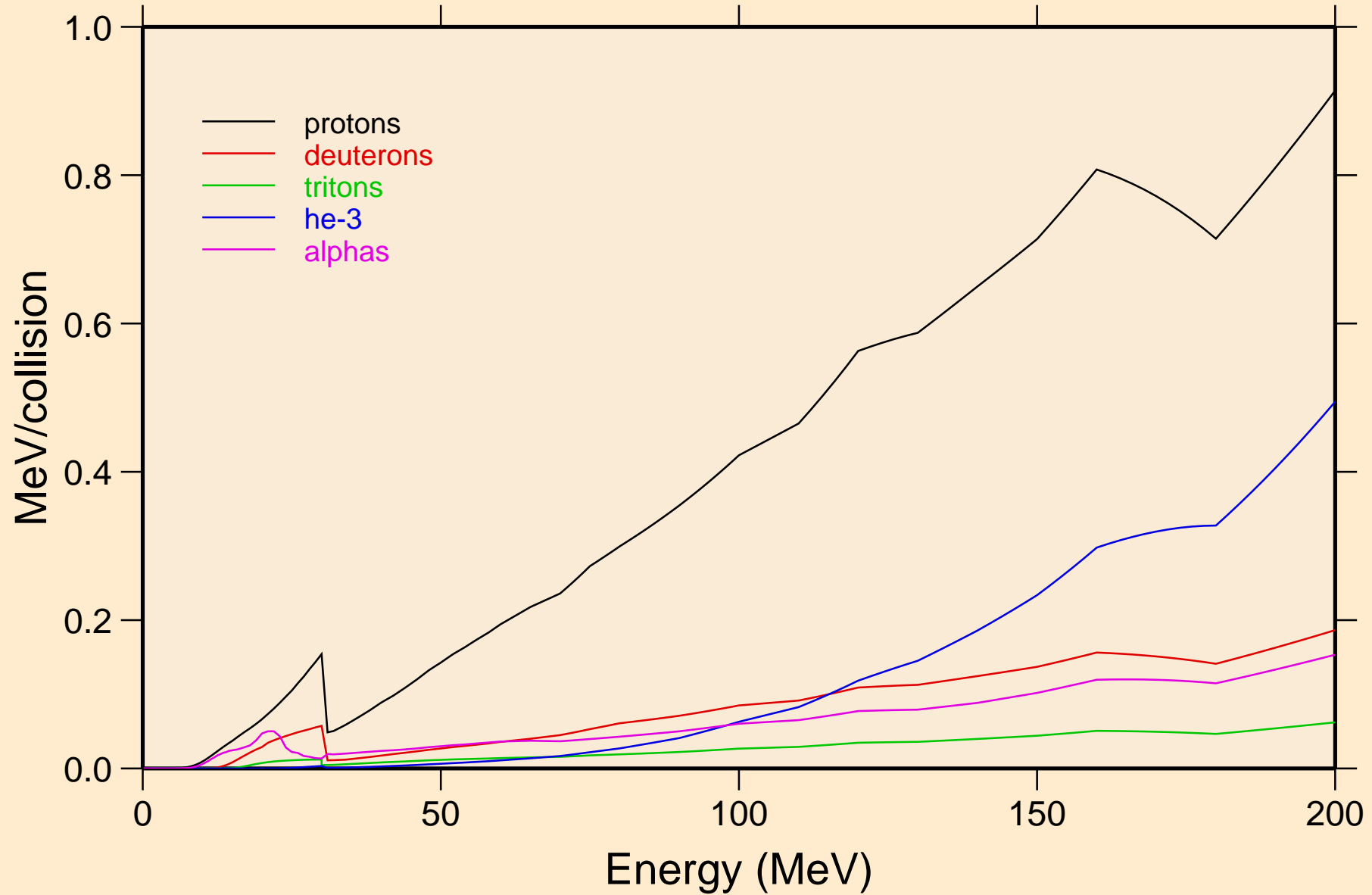

ES241 NEUTRON ACER TENDL-2023 LIBRARY; T=0.K

Recoil Heating

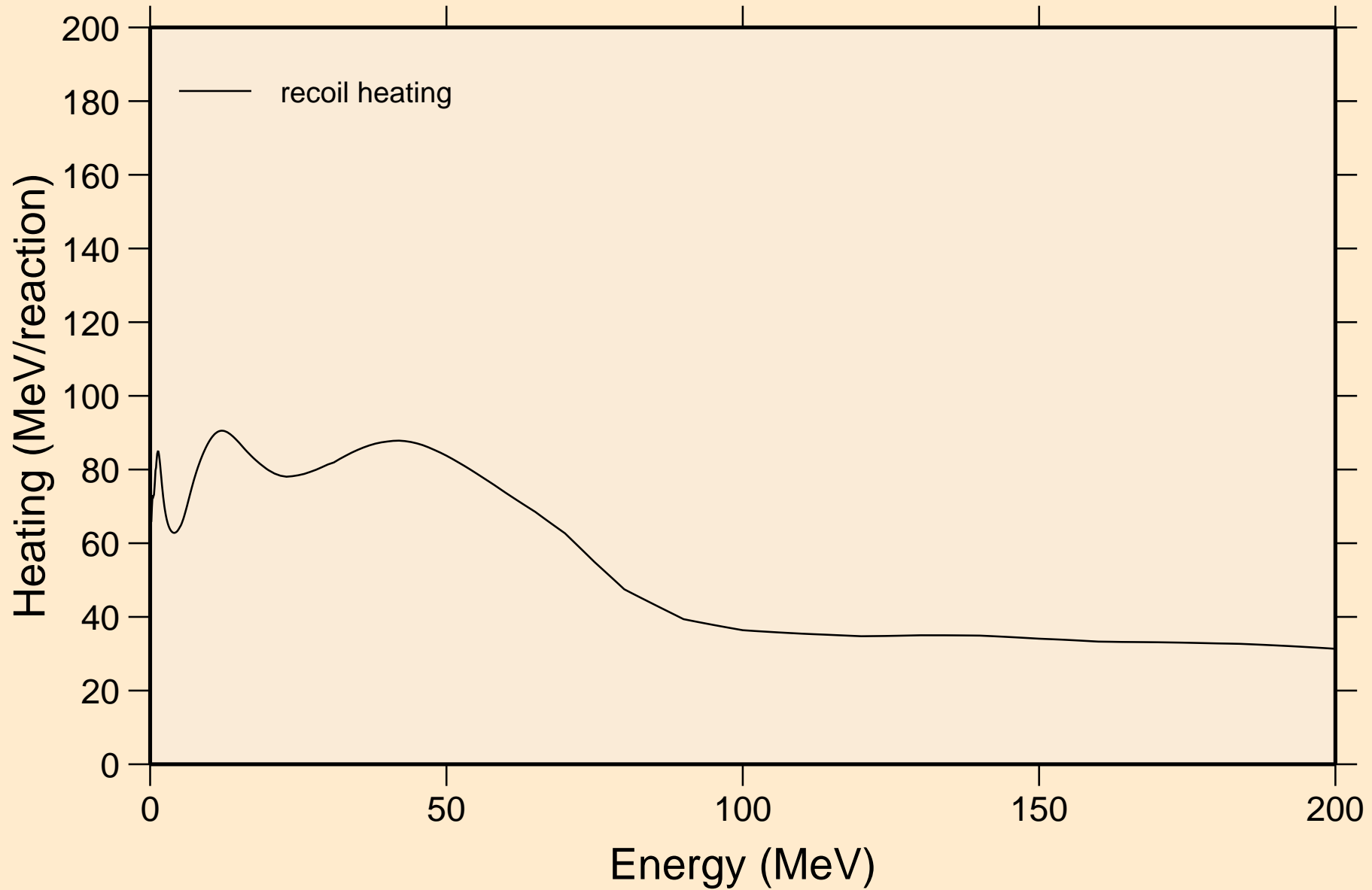

ES241 NEUTRON ACER TENDL-2023 LIBRARY; T=0.K

Particle production cross sections

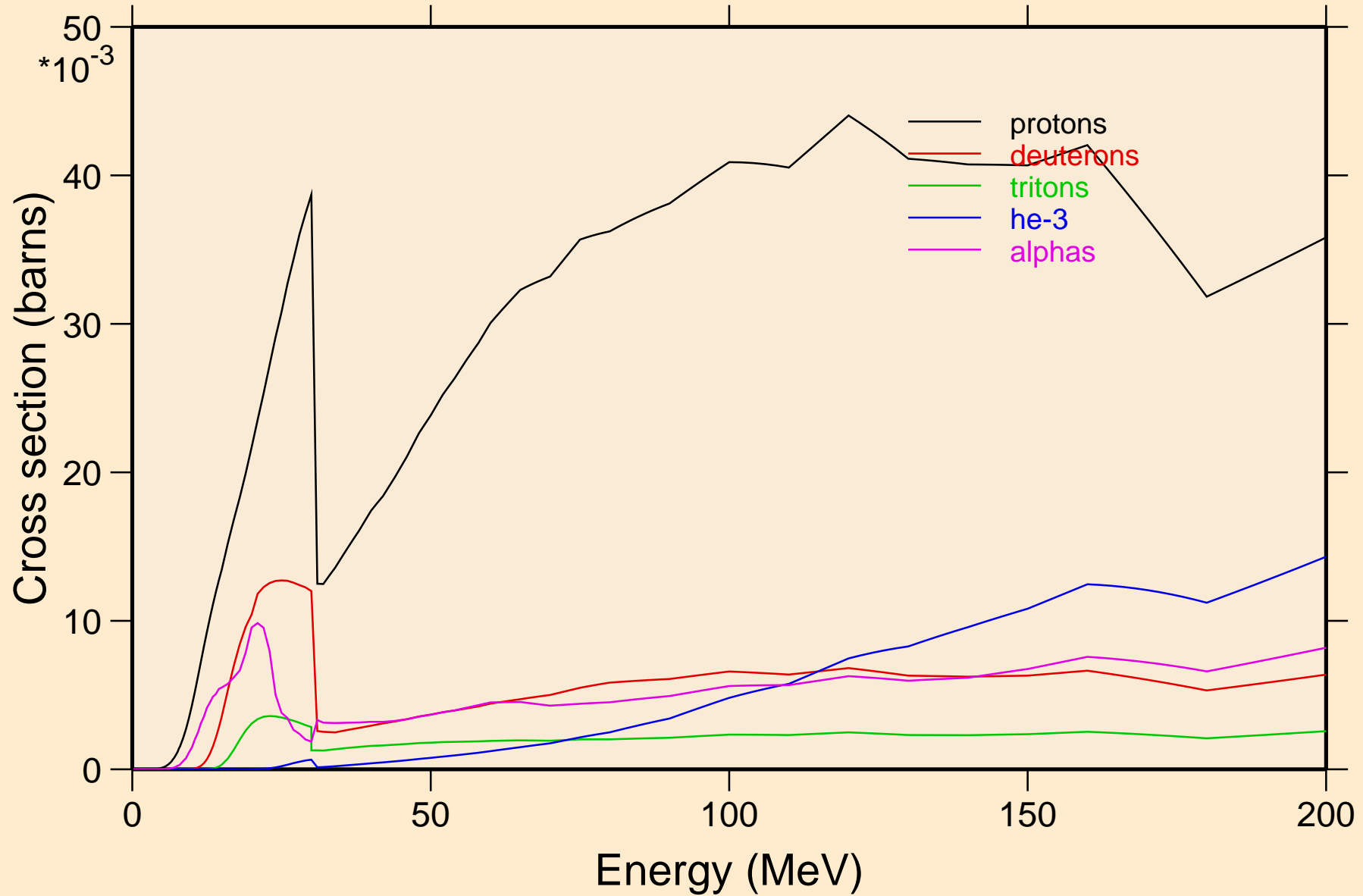

ES241 NEUTRON ACER TENDL-2023 LIBRARY; T=0.K
protons from (n,x)

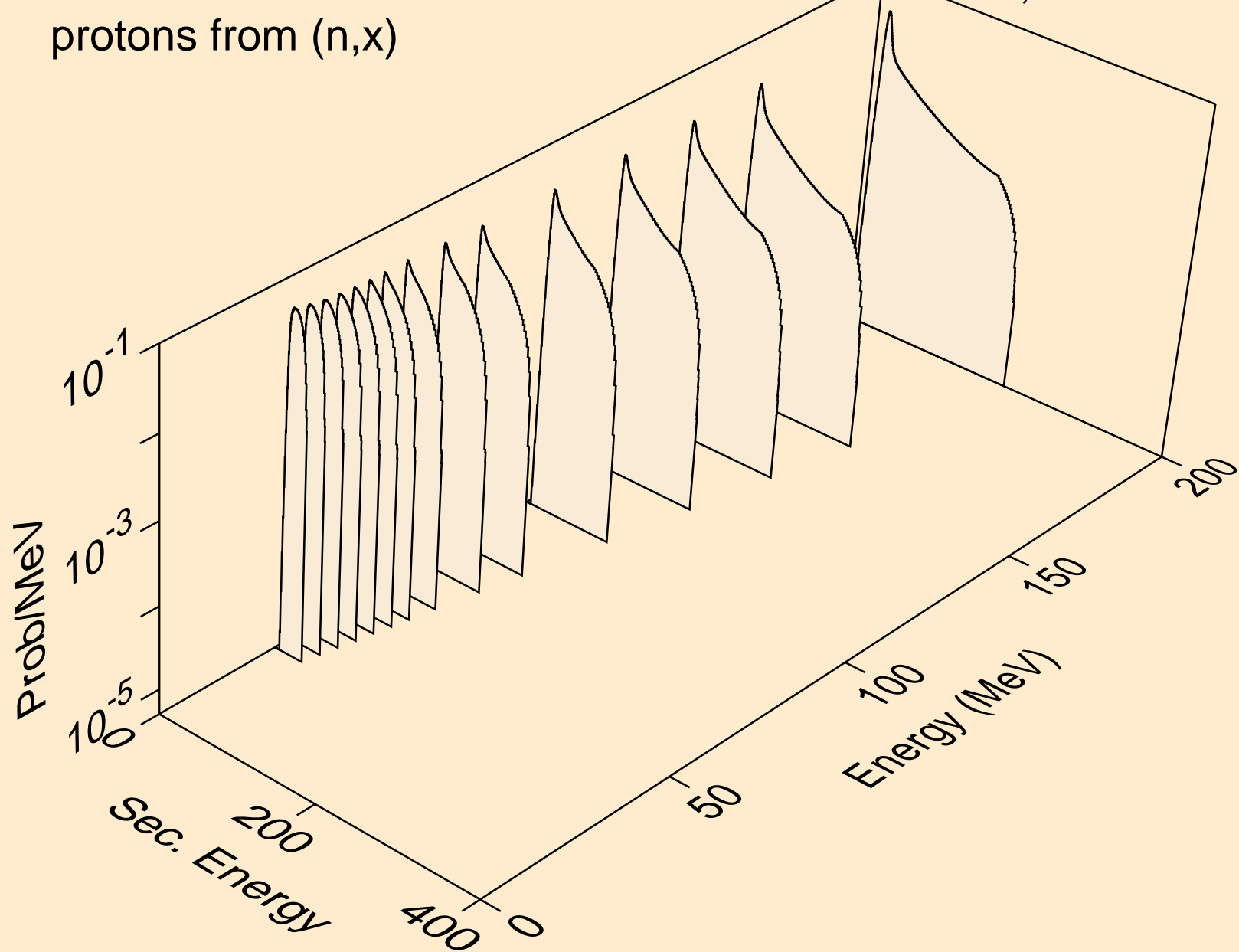

ES241 NEUTRON ACER TENDL-2023 LIBRARY; T=0.K
protons from (n,n*)p

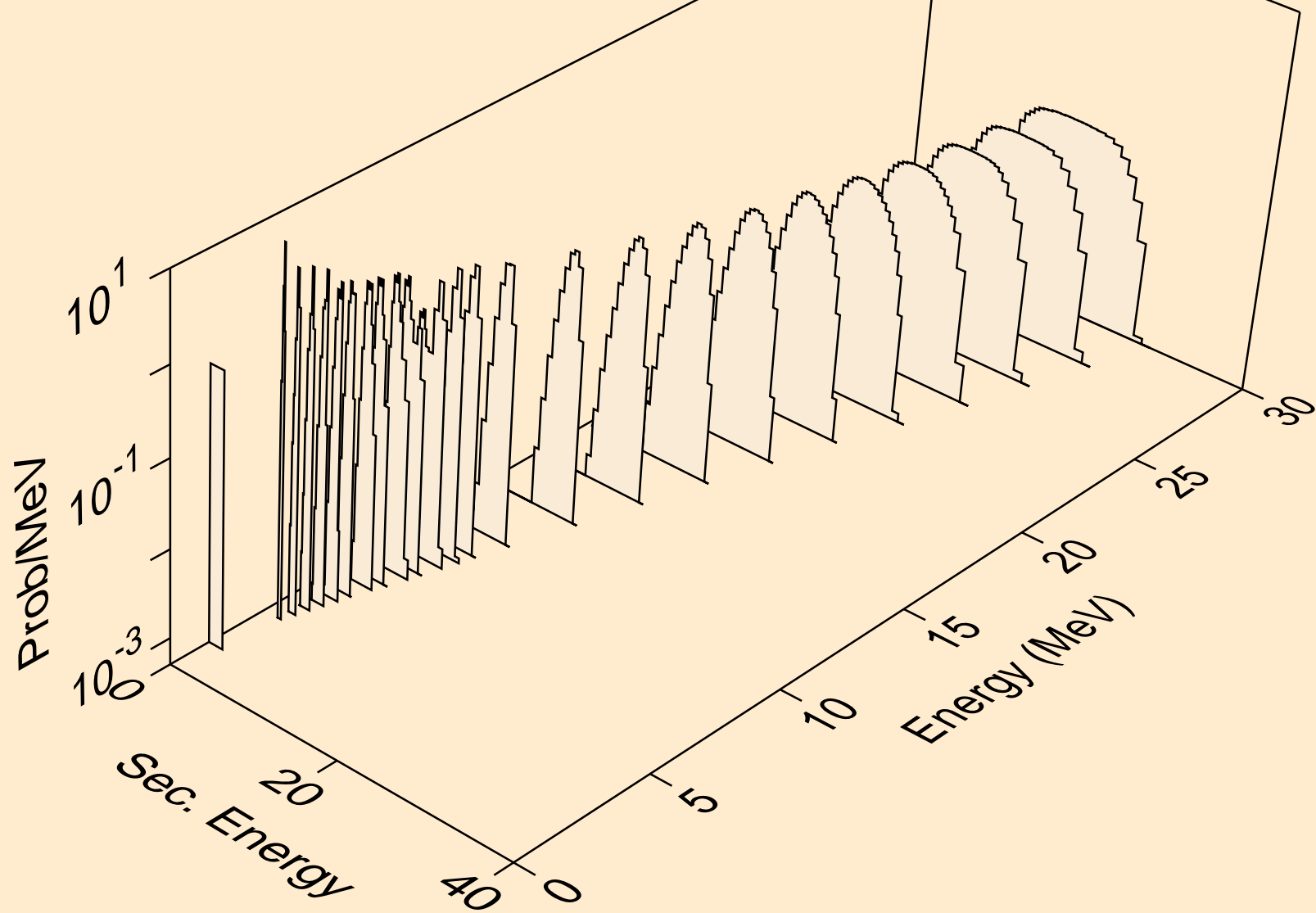

ES241 NEUTRON ACER TENDL-2023 LIBRARY; T=0.K
protons from (n,2np)

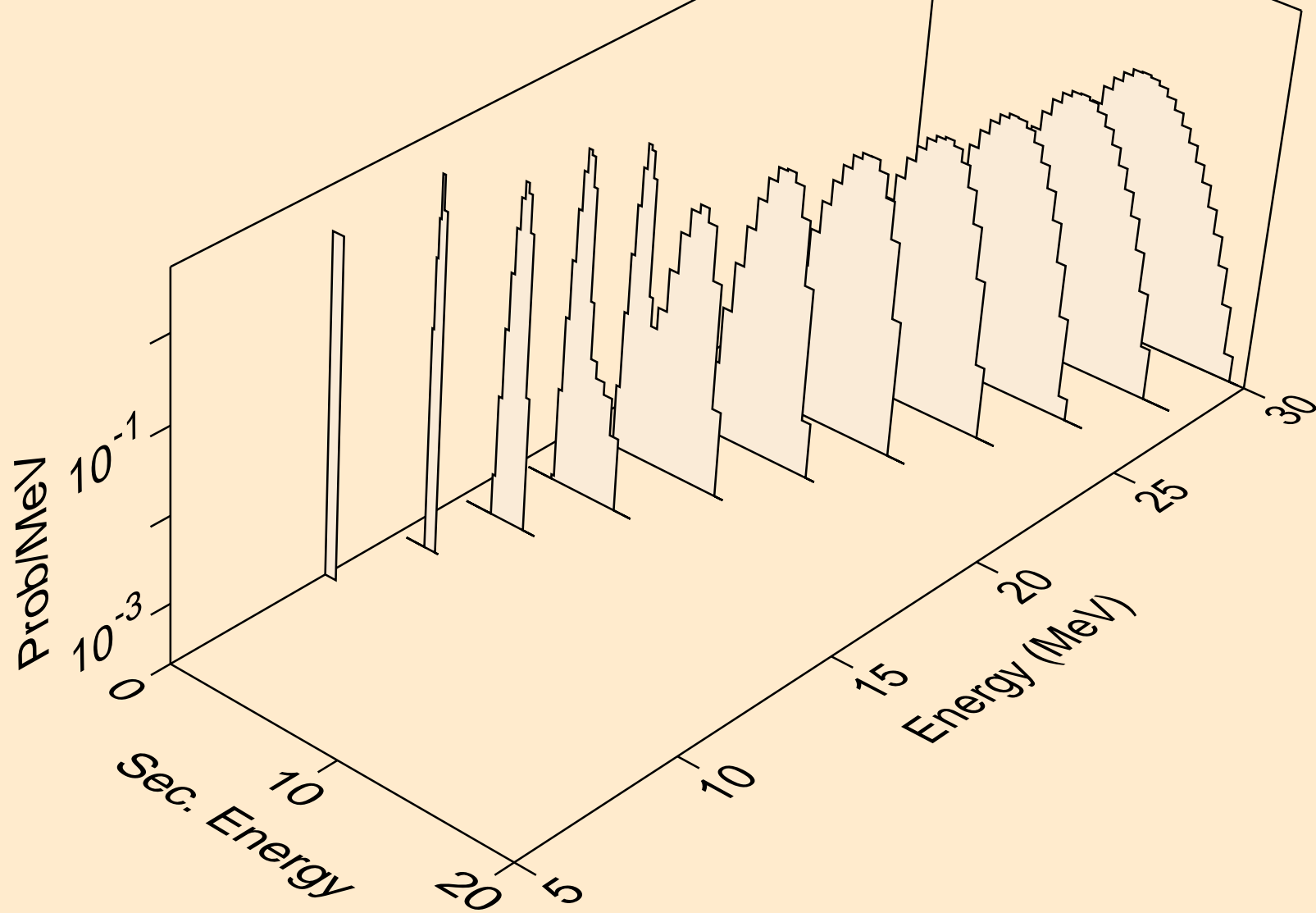

ES241 NEUTRON ACER TENDL-2023 LIBRARY; T=0.K
protons from (n,n2p)

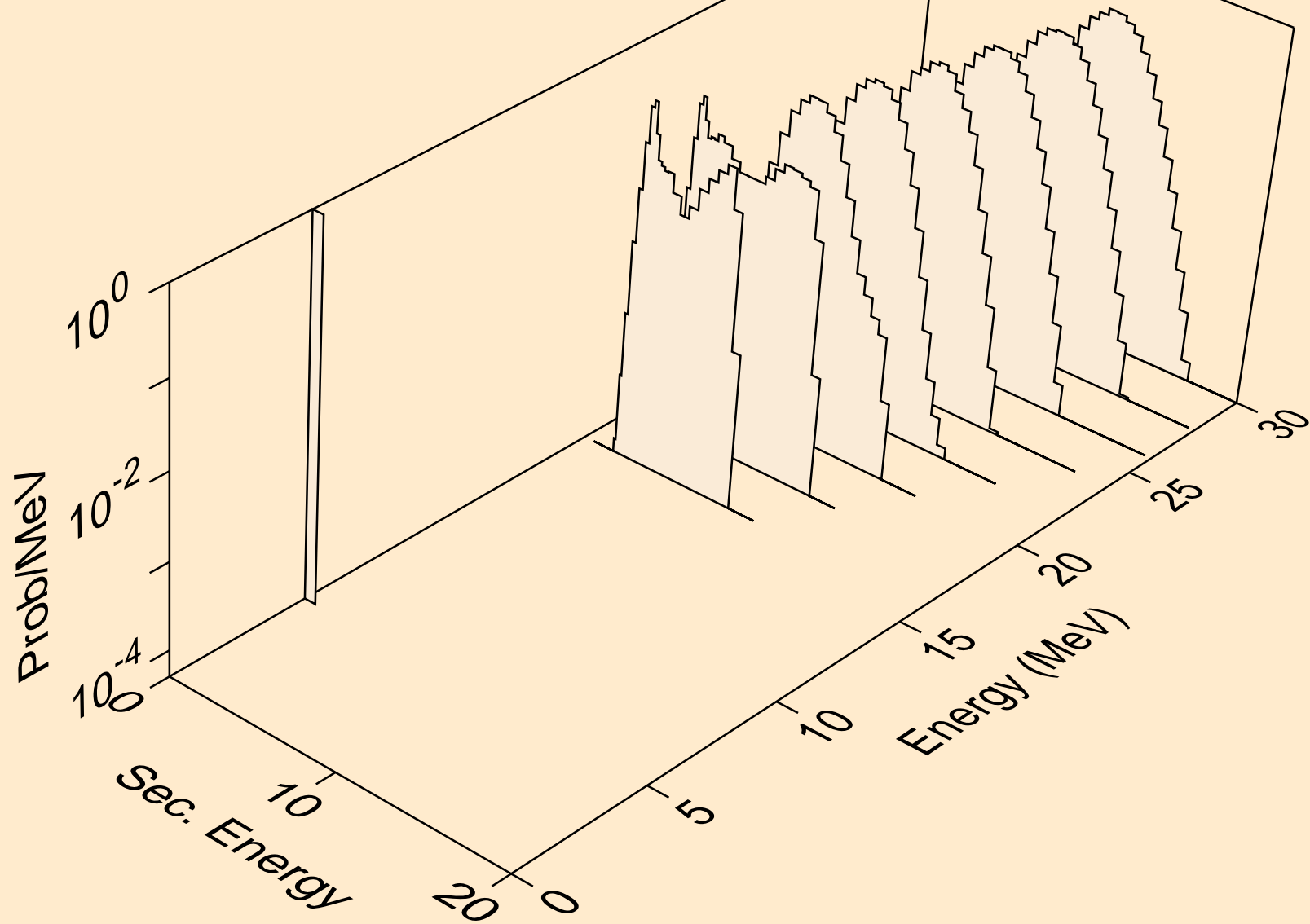

ES241 NEUTRON ACER TENDL-2023 LIBRARY; T=0.K
protons from (n,p)

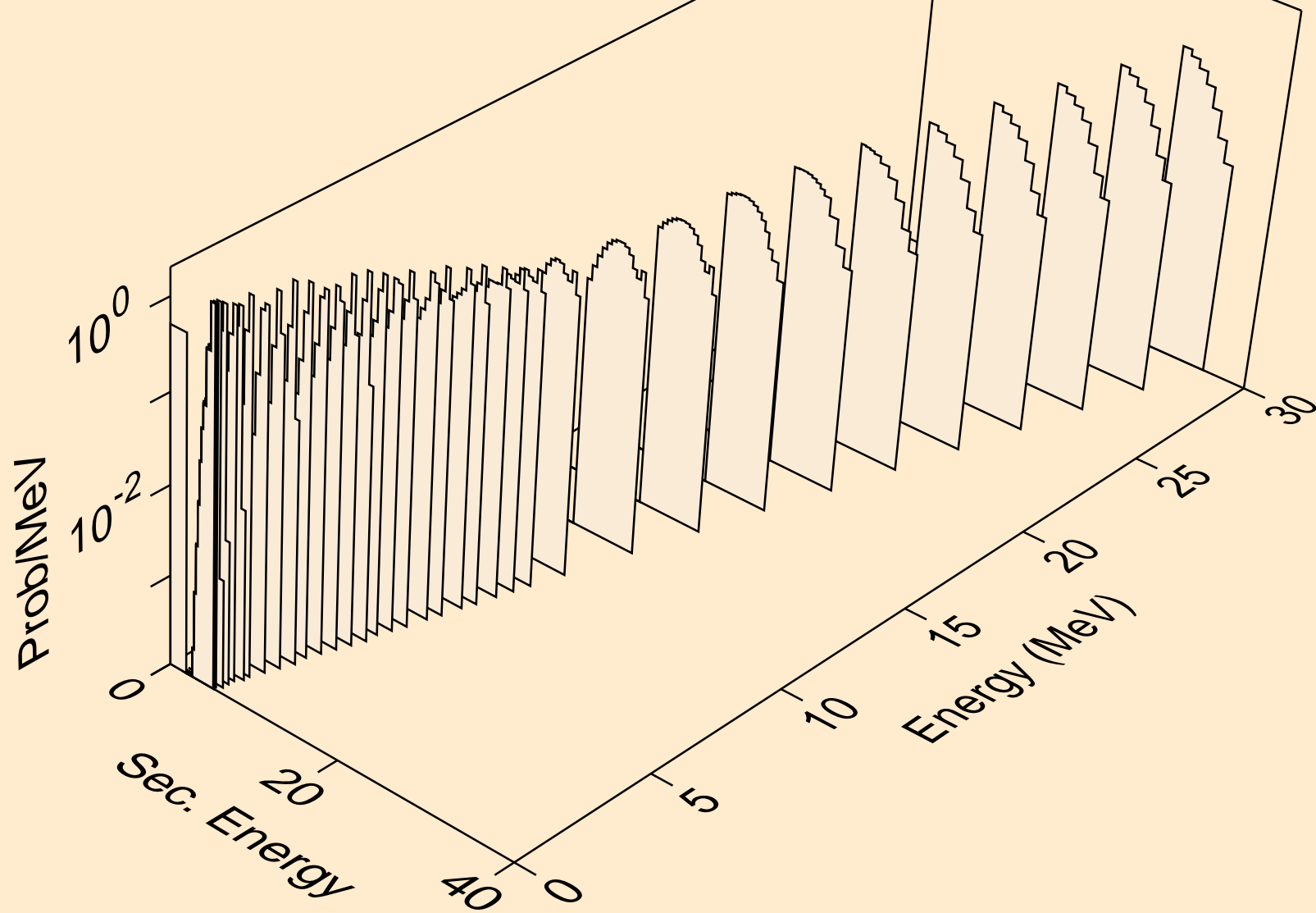

ES241 NEUTRON ACER TENDL-2023 LIBRARY; T=0.K
protons from (n,2p)

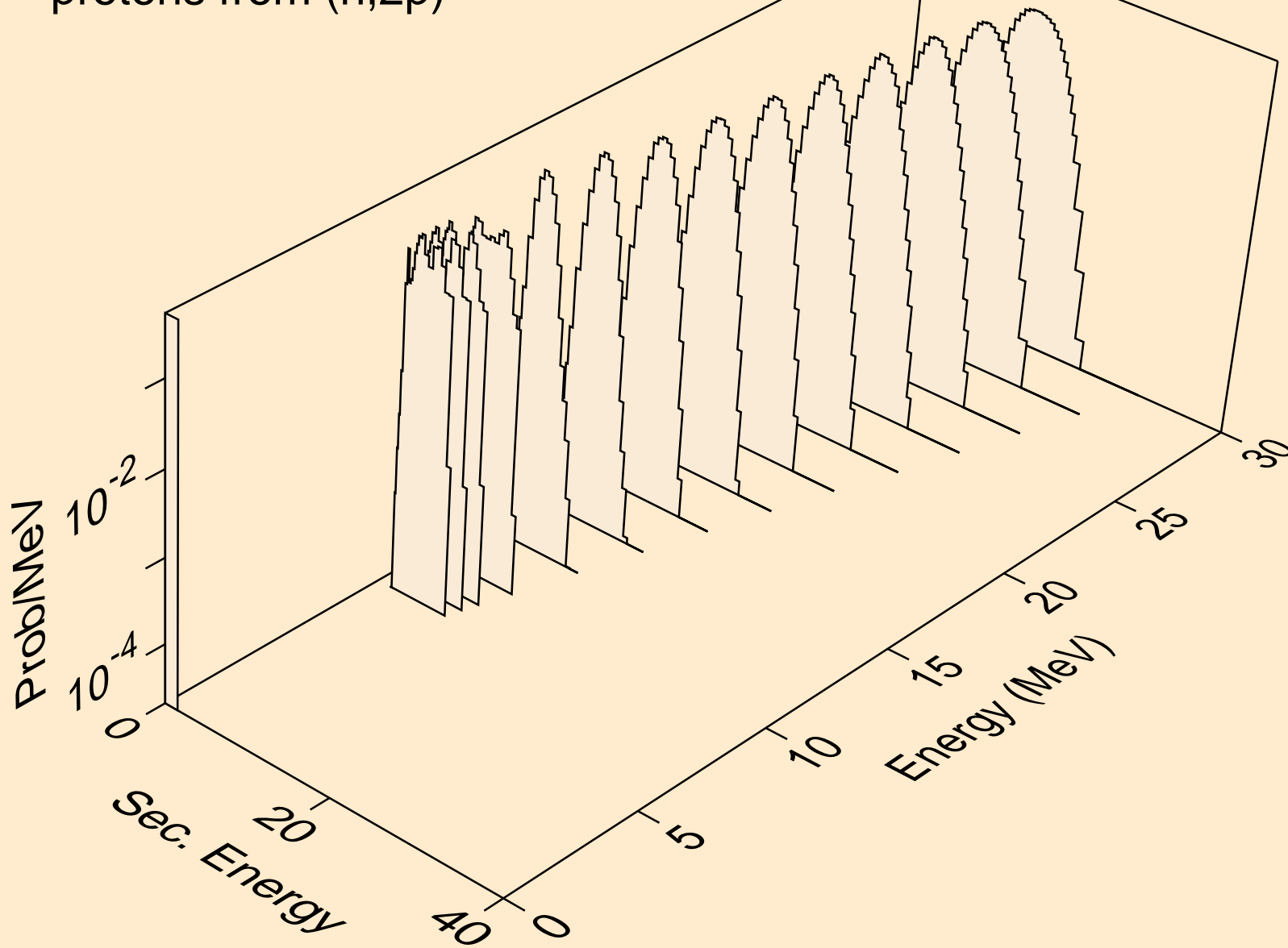

ES241 NEUTRON ACER TENDL-2023 LIBRARY; T=0.K
protons from (n,p)

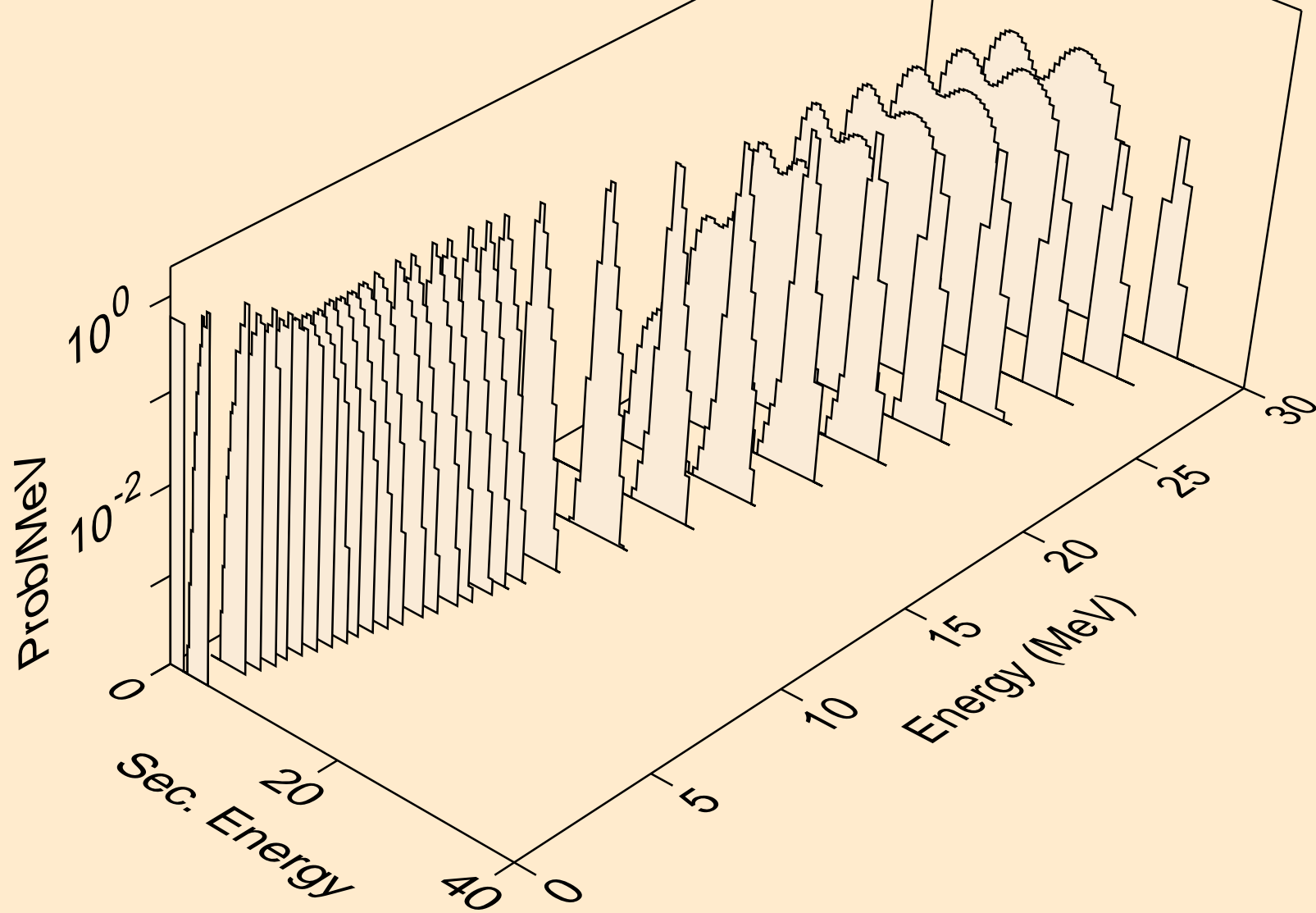

ES241 NEUTRON ACER TENDL-2023 LIBRARY; T=0.K
protons from (n,pd)

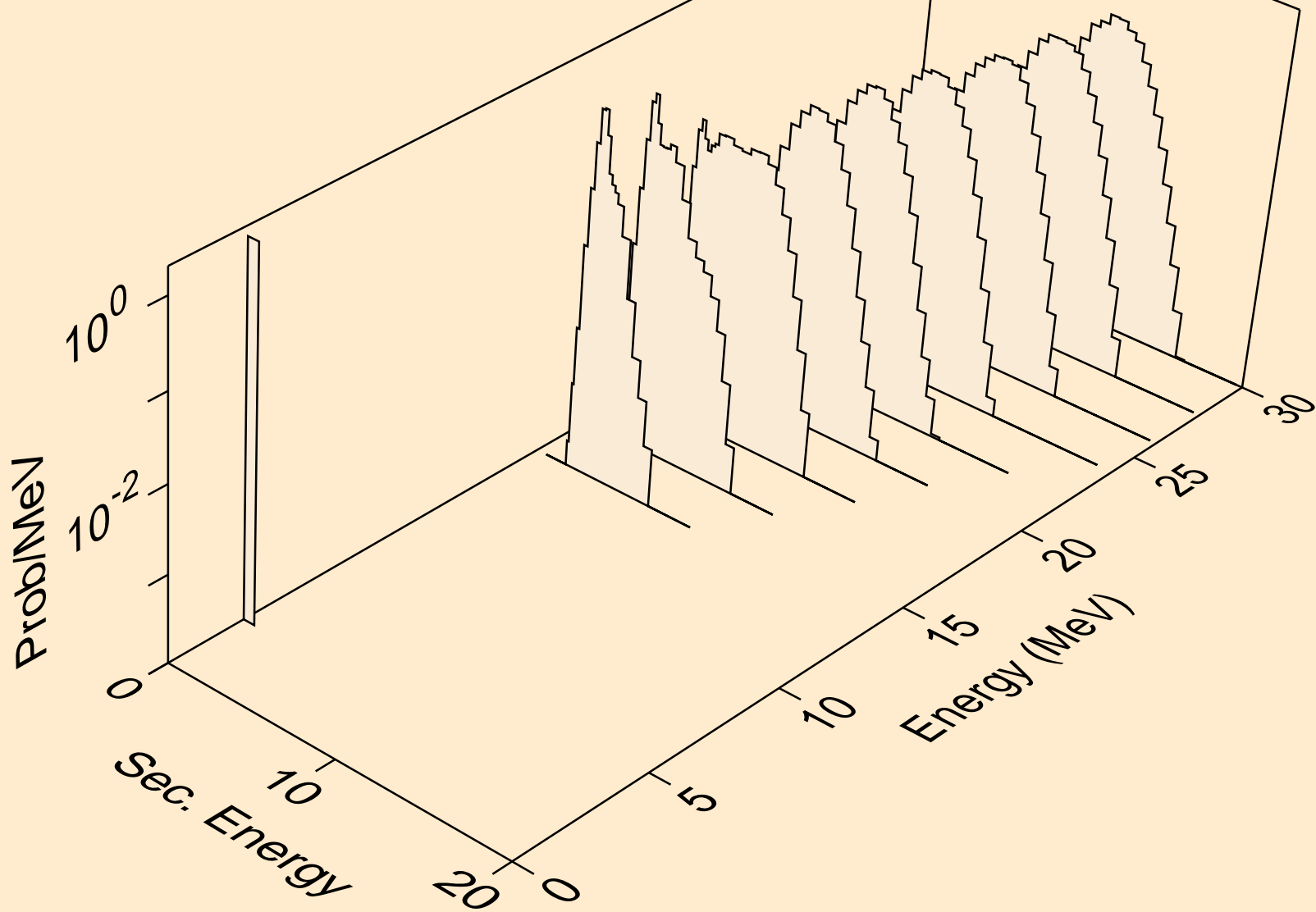

ES241 NEUTRON ACER TENDL-2023 LIBRARY; T=0.K
deuterons from (n,x)

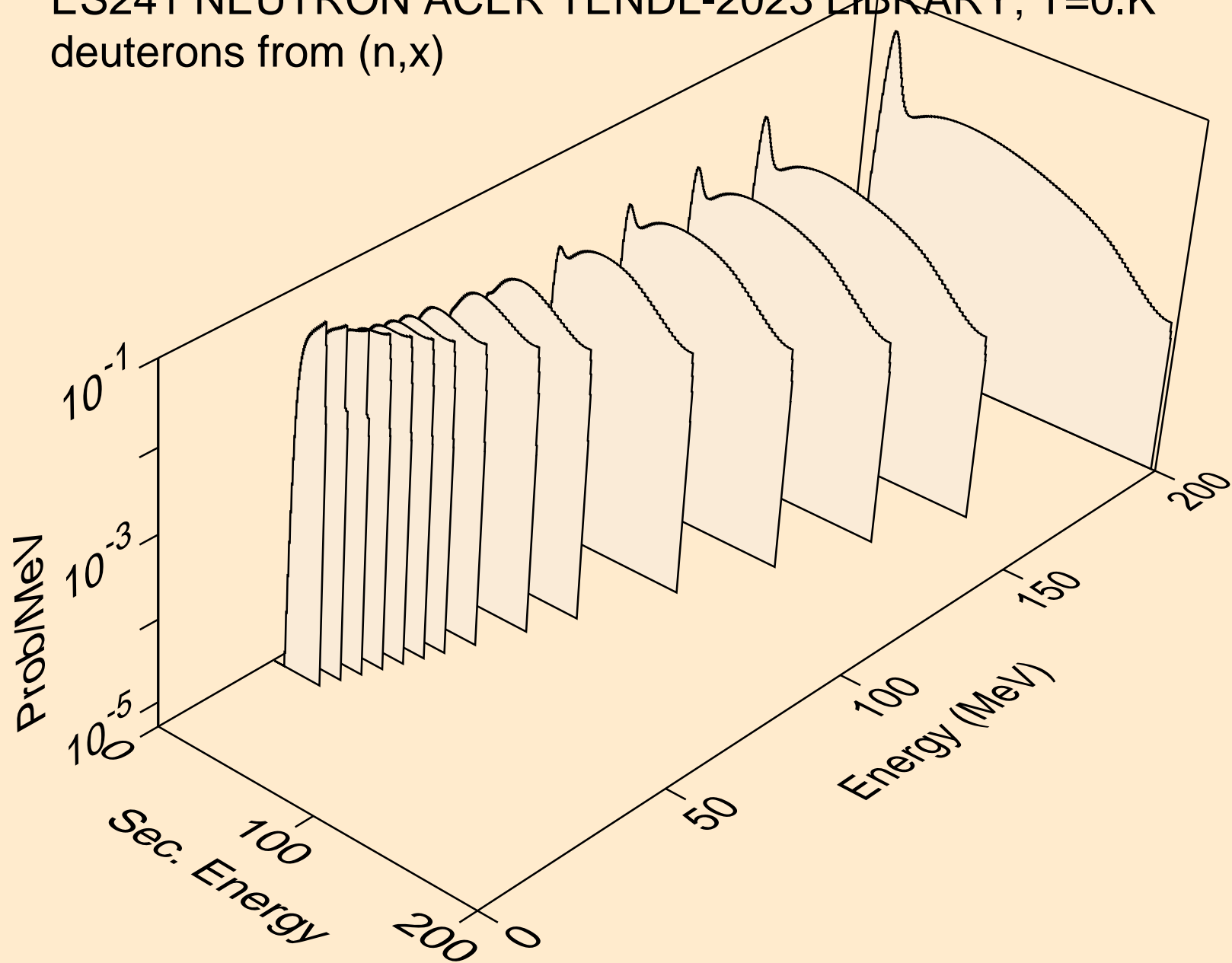

ES241 NEUTRON ACER TENDL-2023 LIBRARY; T=0.K
deuterons from (n,n*)d

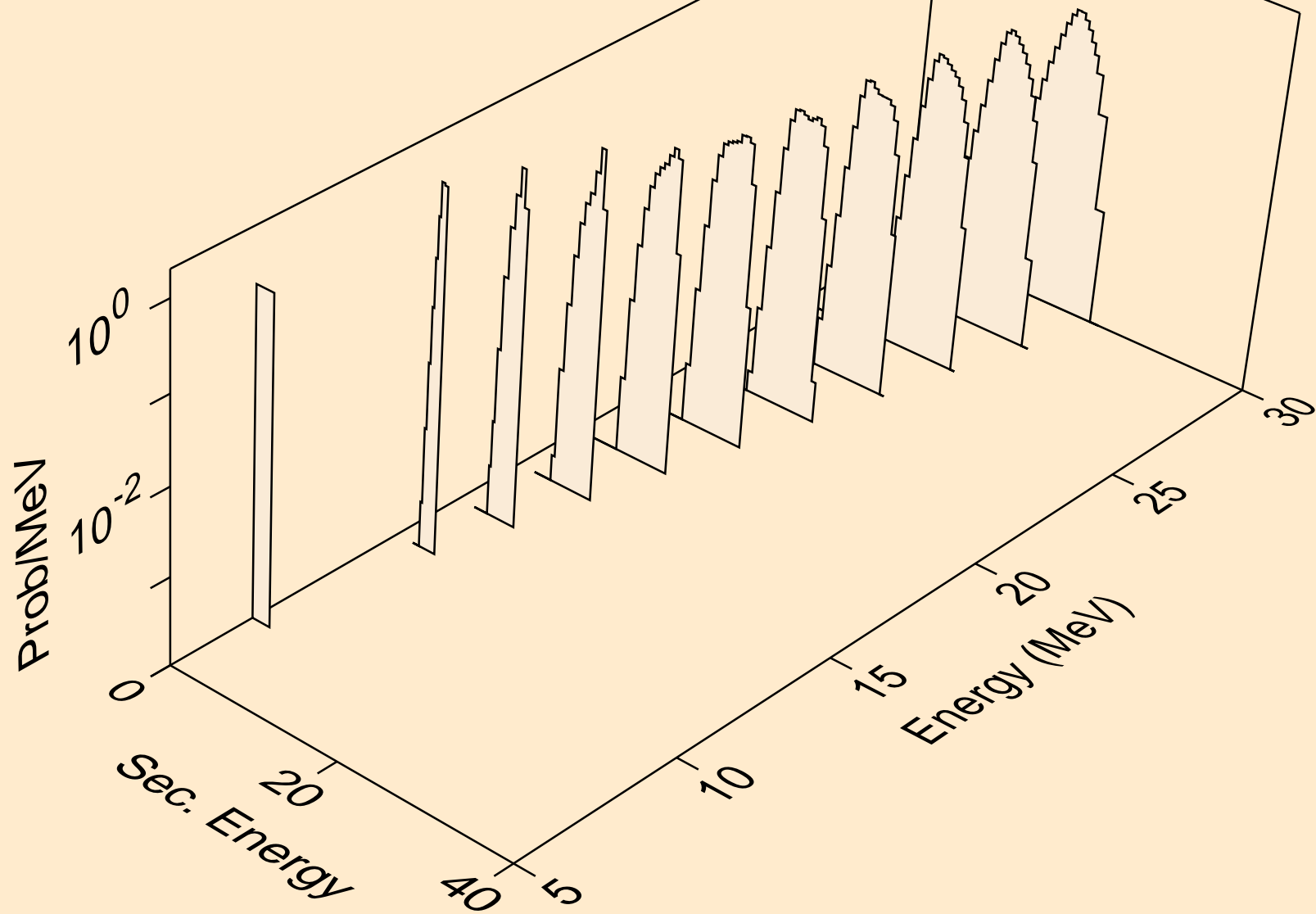

ES241 NEUTRON ACER TENDL-2023 LIBRARY; T=0.K
deuterons from (n,d)

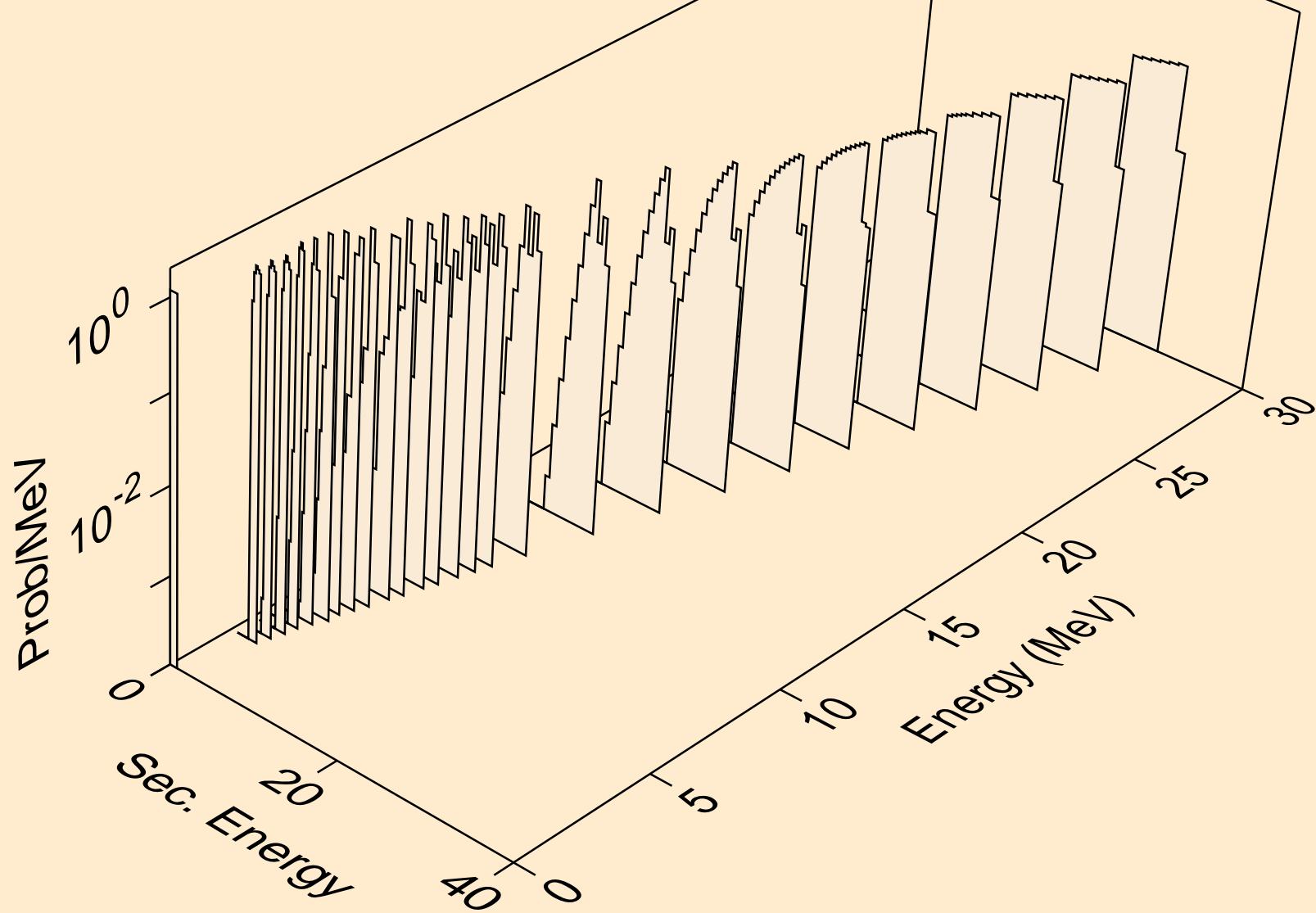

ES241 NEUTRON ACER TENDL-2023 LIBRARY; T=0.K
deuterons from (n,pd)

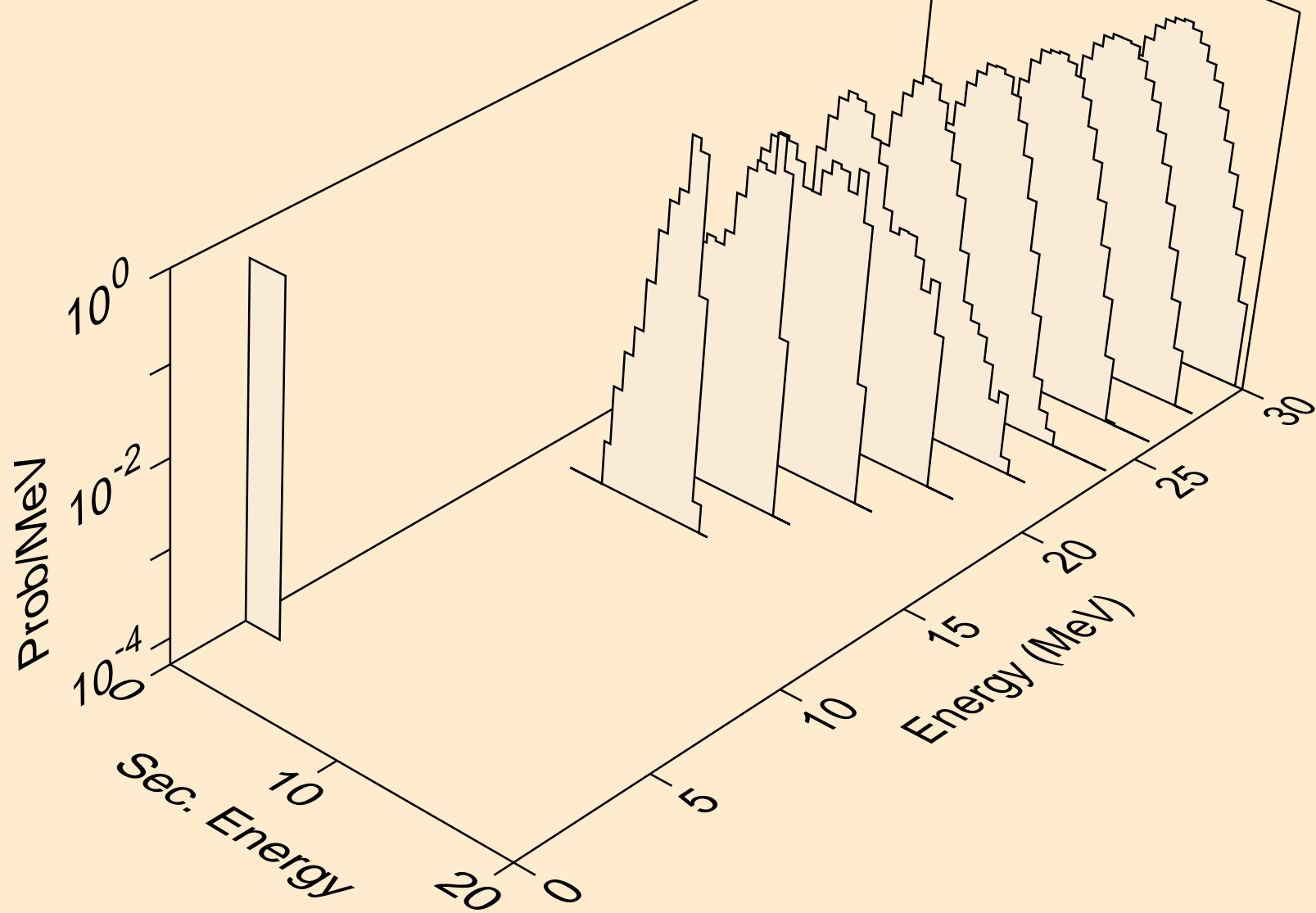

ES241 NEUTRON ACER TENDL-2023 LIBRARY; T=0.K
deuterons from (n,da)

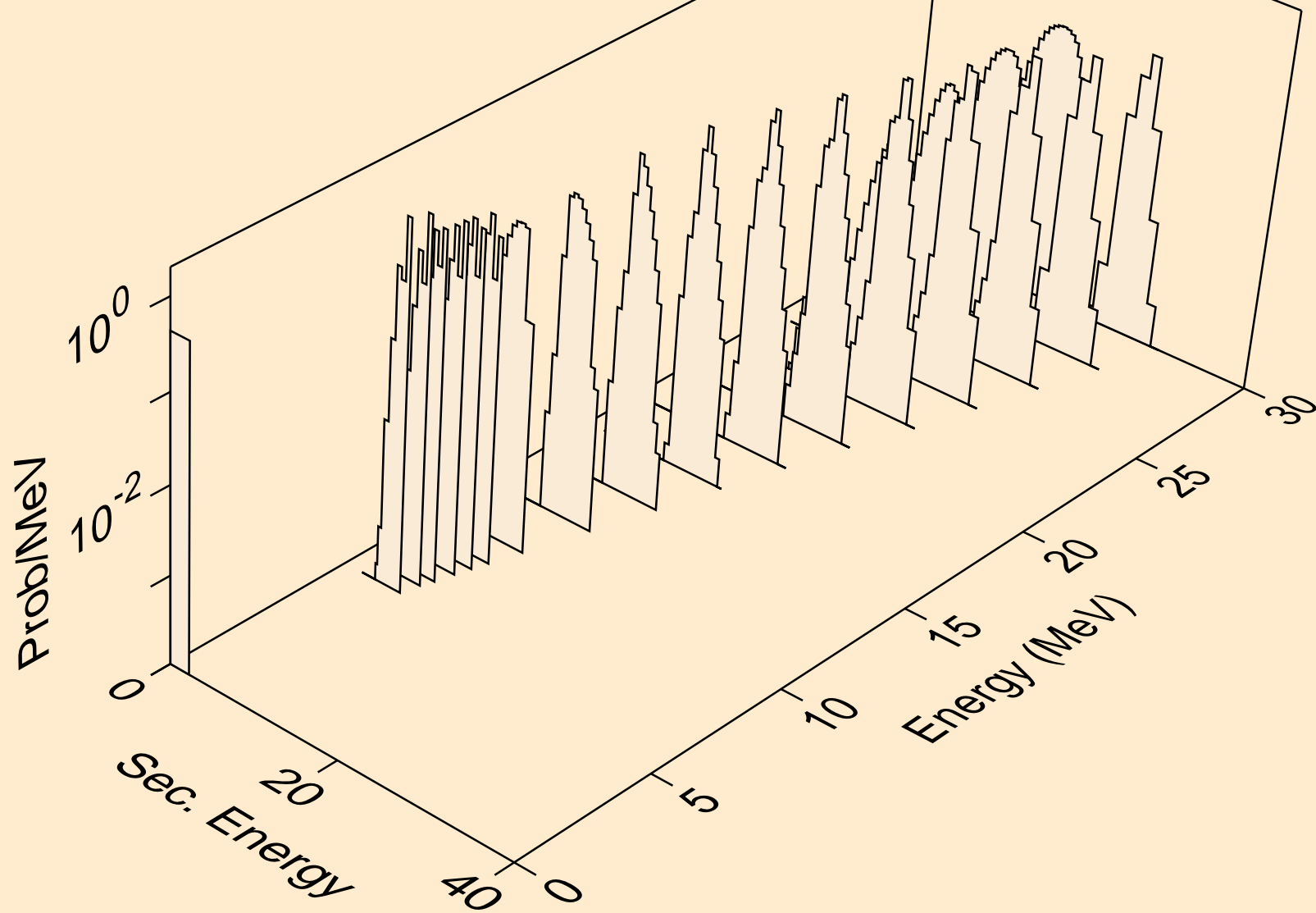

ES241 NEUTRON ACER TENDL-2023 LIBRARY; T=0.K
tritons from (n,x)

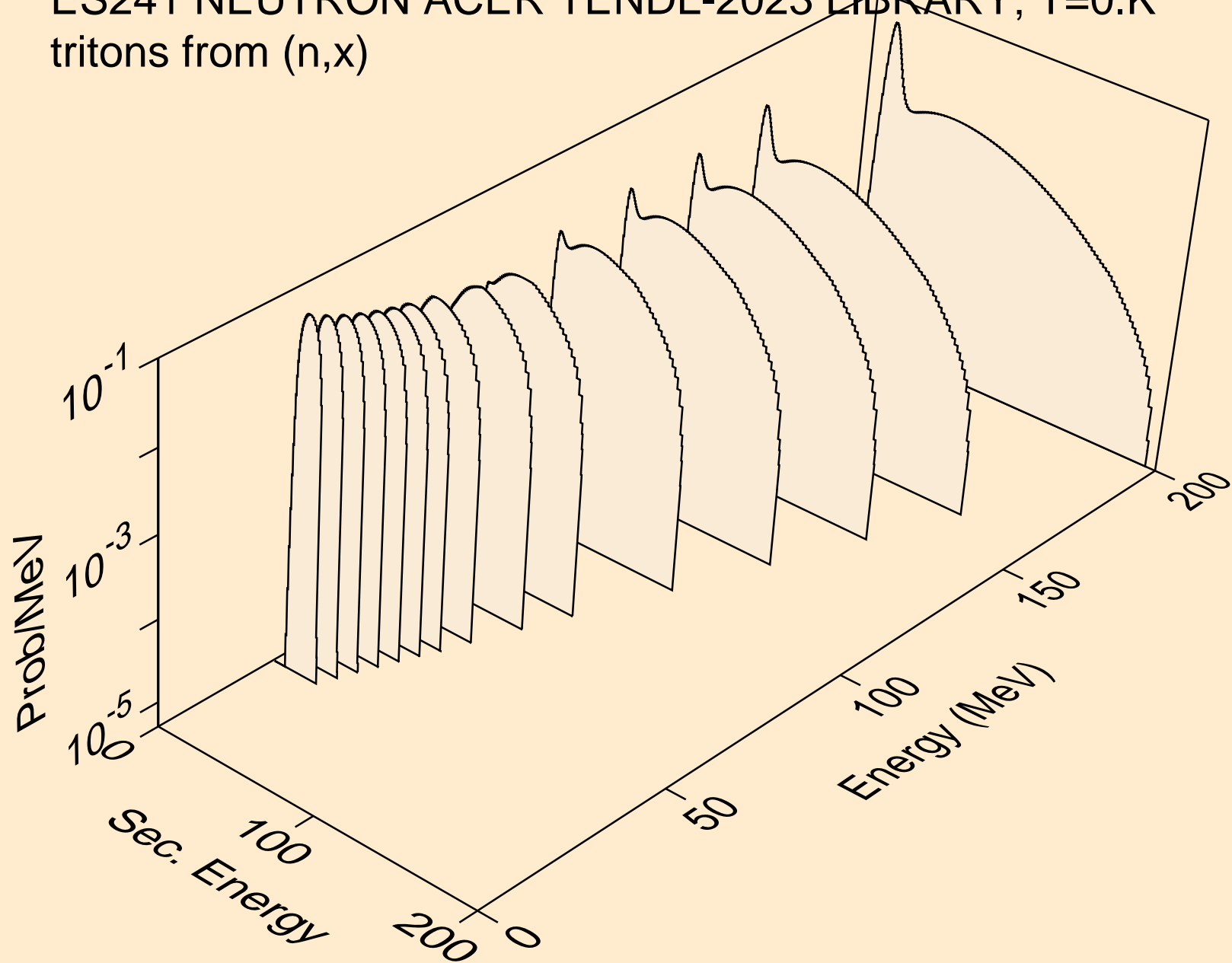

ES241 NEUTRON ACER TENDL-2023 LIBRARY; T=0.K
tritons from (n,n*)t

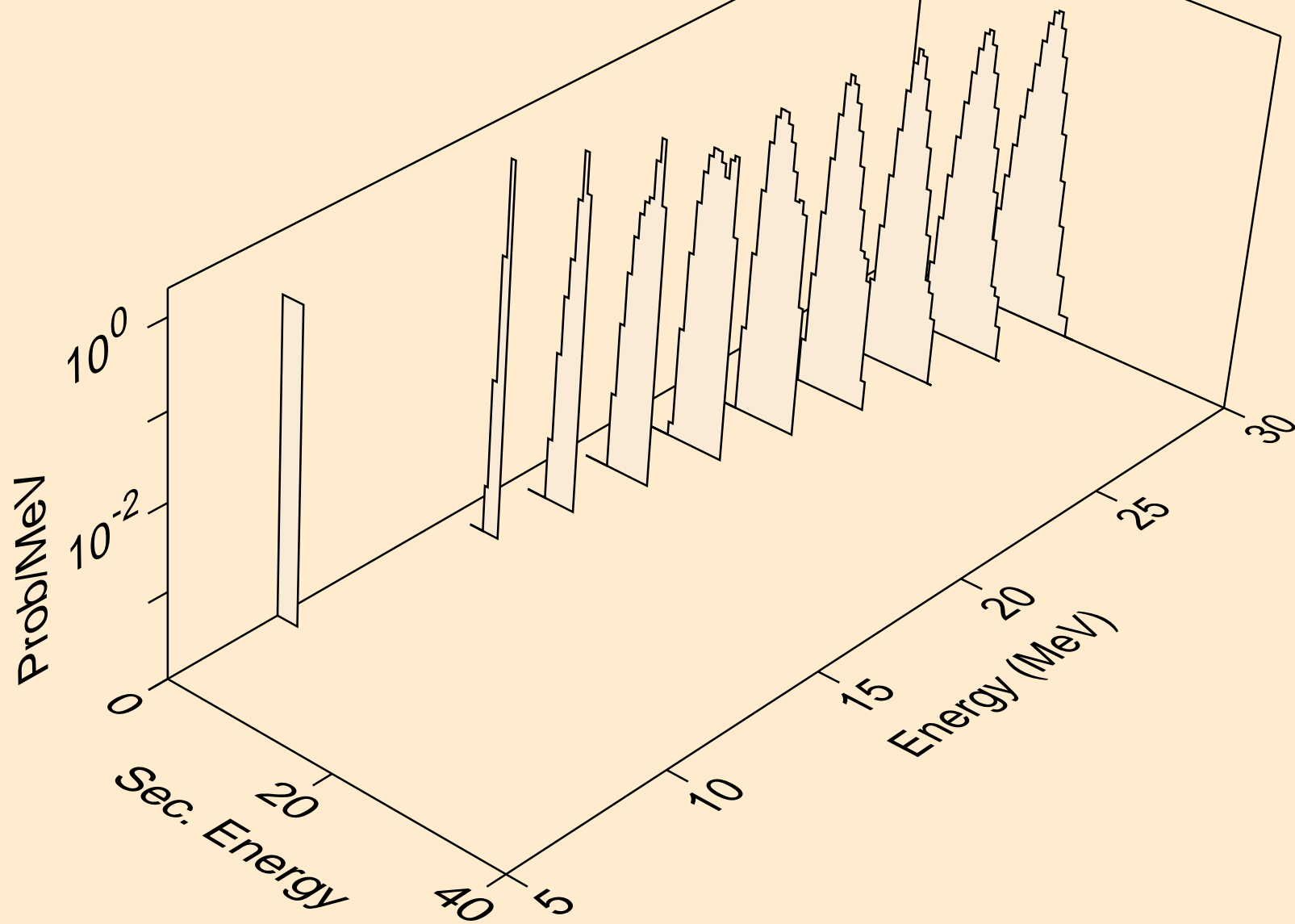

ES241 NEUTRON ACER TENDL-2023 LIBRARY; T=0.K
tritons from (n,t)

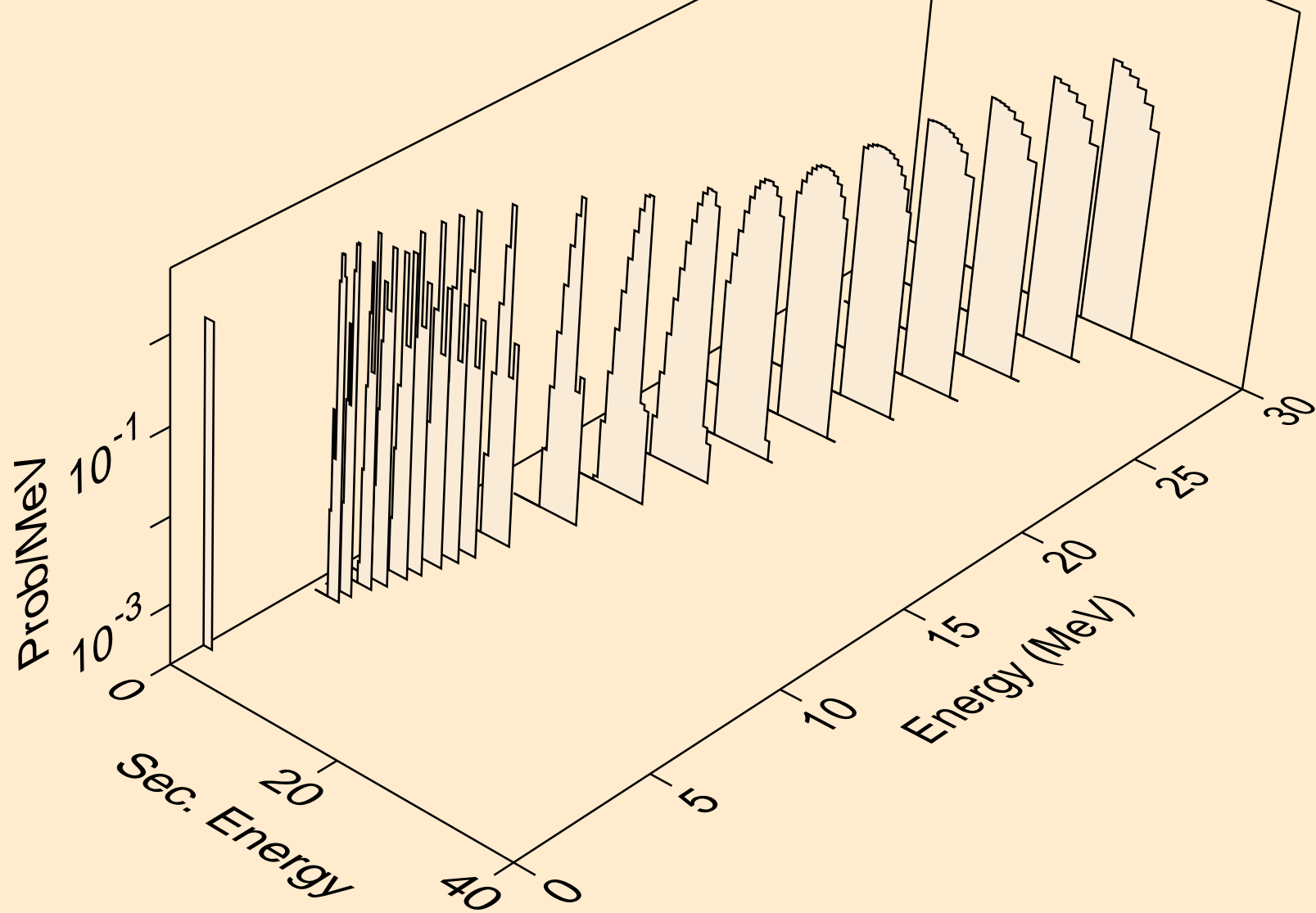

ES241 NEUTRON ACER TENDL-2023 LIBRARY; T=0.K
he3s from (n,x)

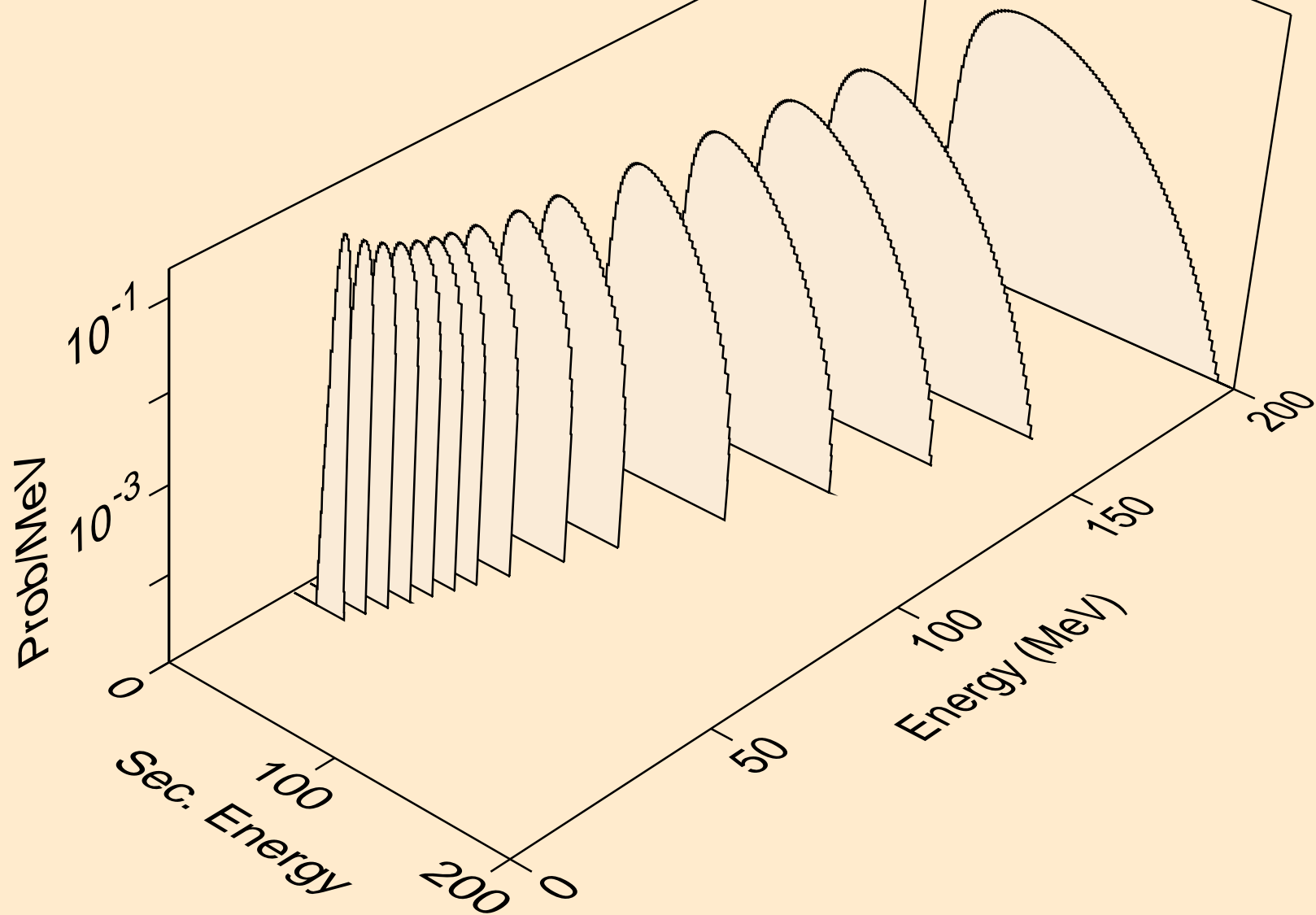

ES241 NEUTRON ACER TENDL-2023 LIBRARY; T=0.K
he3s from (n,n*)he3

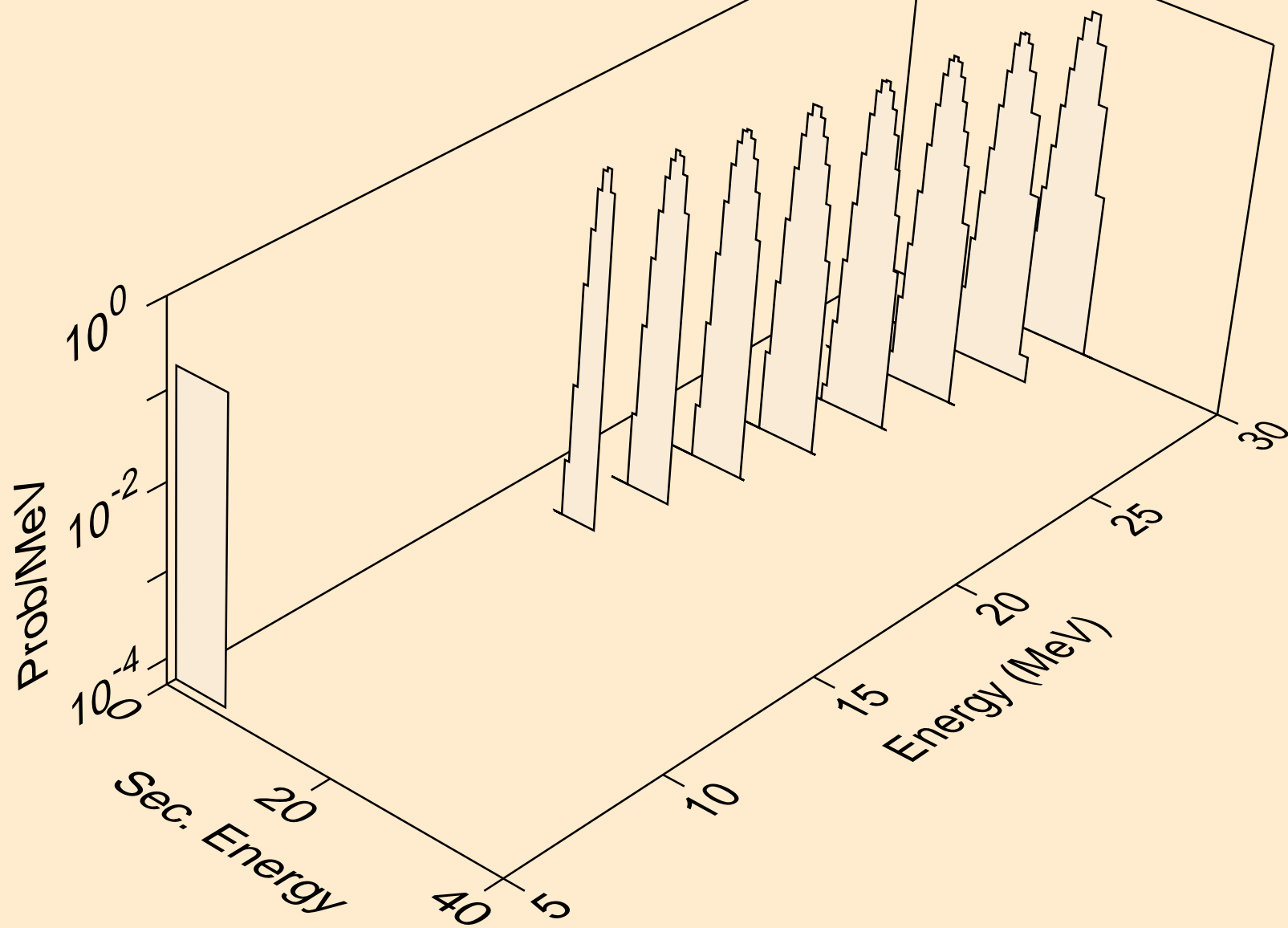

ES241 NEUTRON ACER TENDL-2023 LIBRARY; T=0.K
he3s from (n,he3)

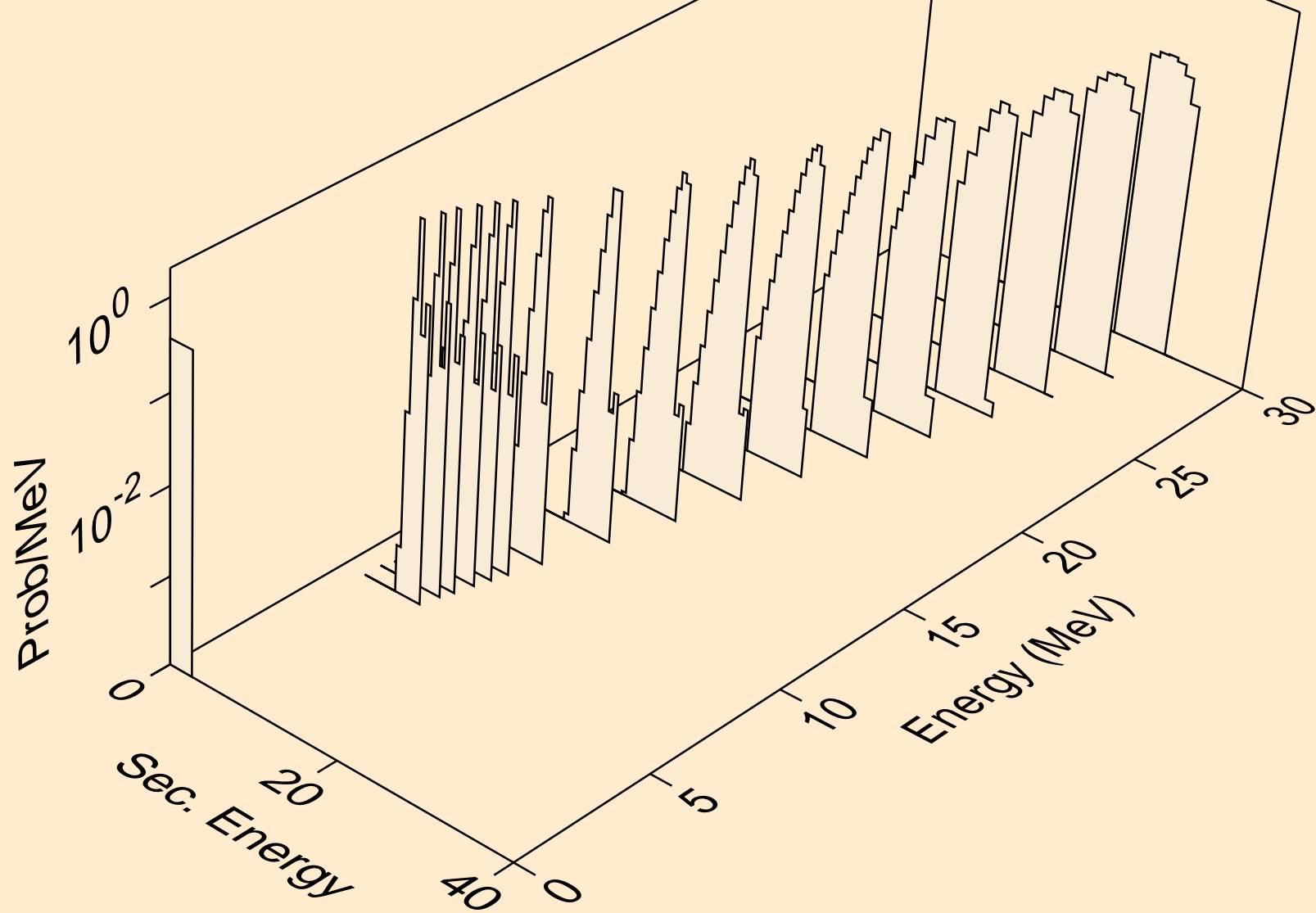

ES241 NEUTRON ACER TENDL-2023 LIBRARY; T=0.K
alphas from (n,x)

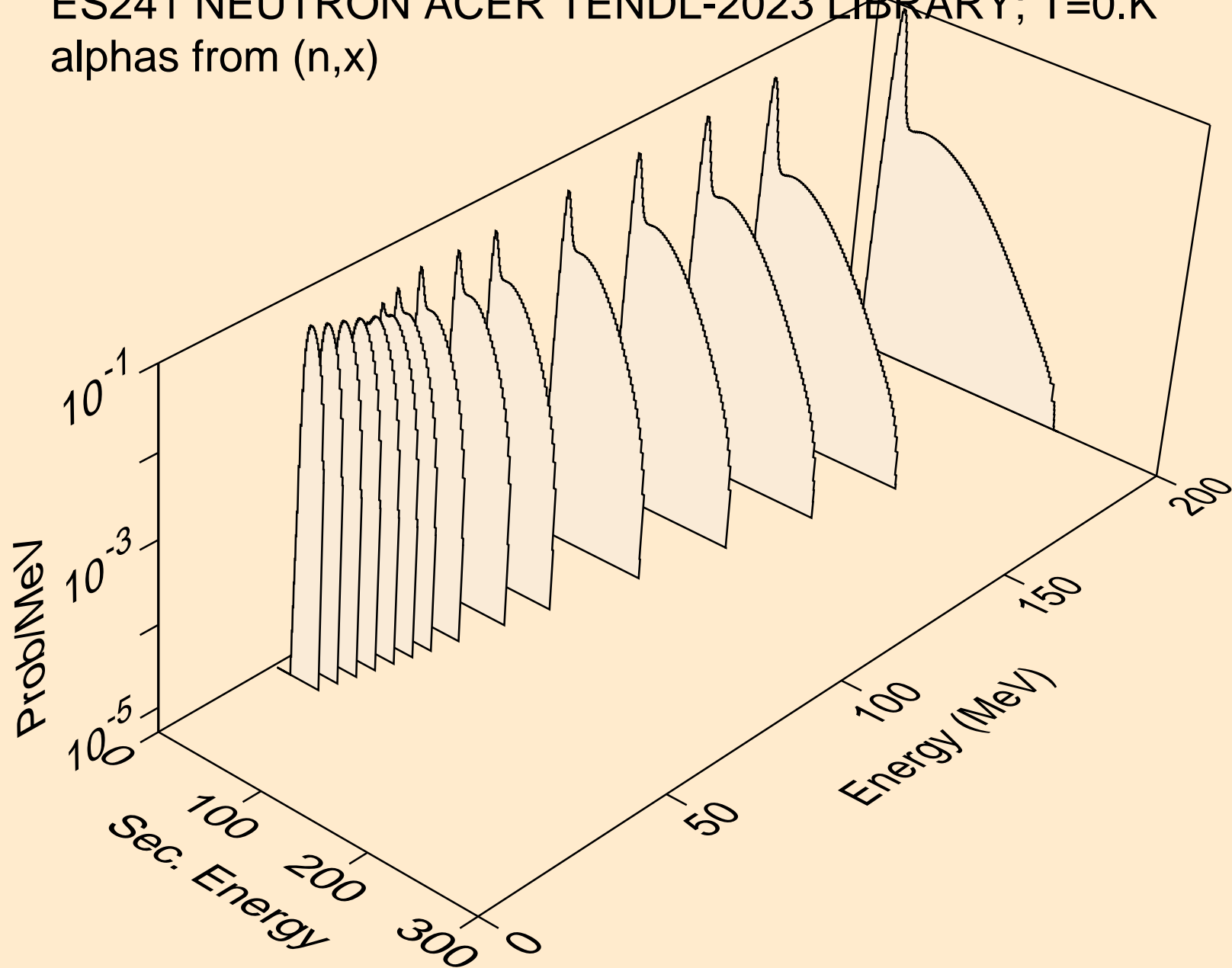

ES241 NEUTRON ACER TENDL-2023 LIBRARY; T=0.K
alphas from (n,n*)a

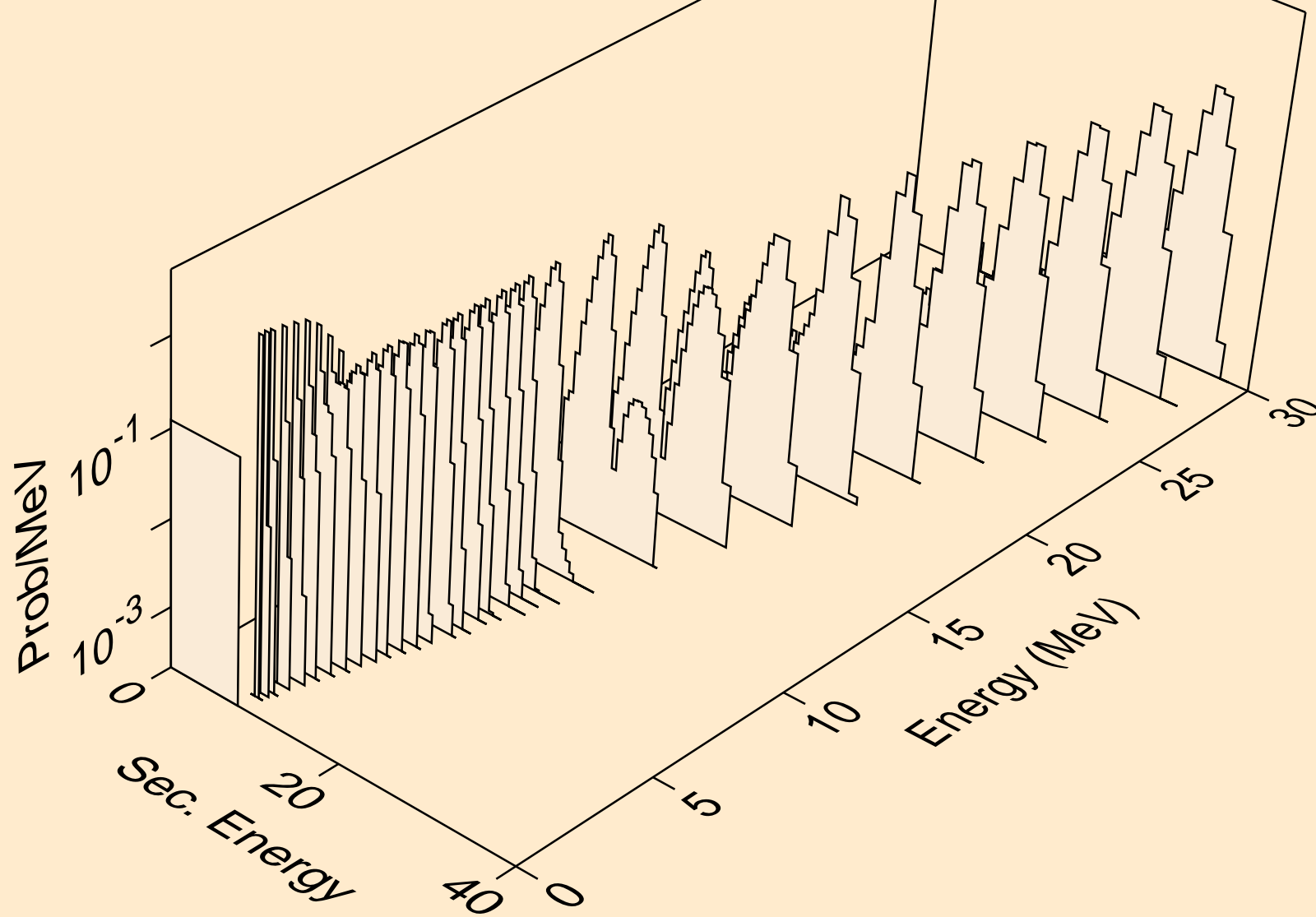

ES241 NEUTRON ACER TENDL-2023 LIBRARY; T=0.K
alphas from (n,2n)a

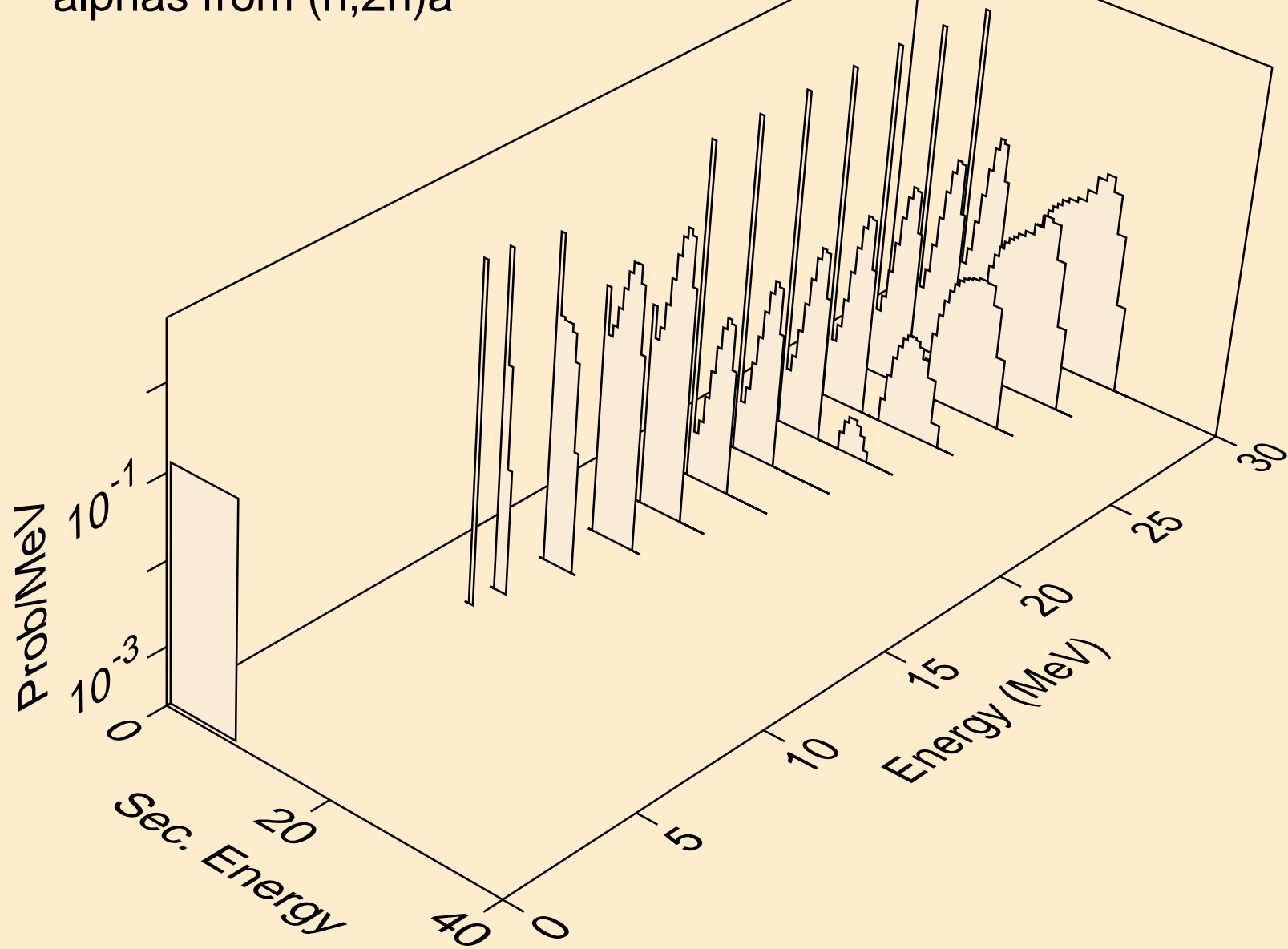

ES241 NEUTRON ACER TENDL-2023 LIBRARY; T=0.K
alphas from (n,a)

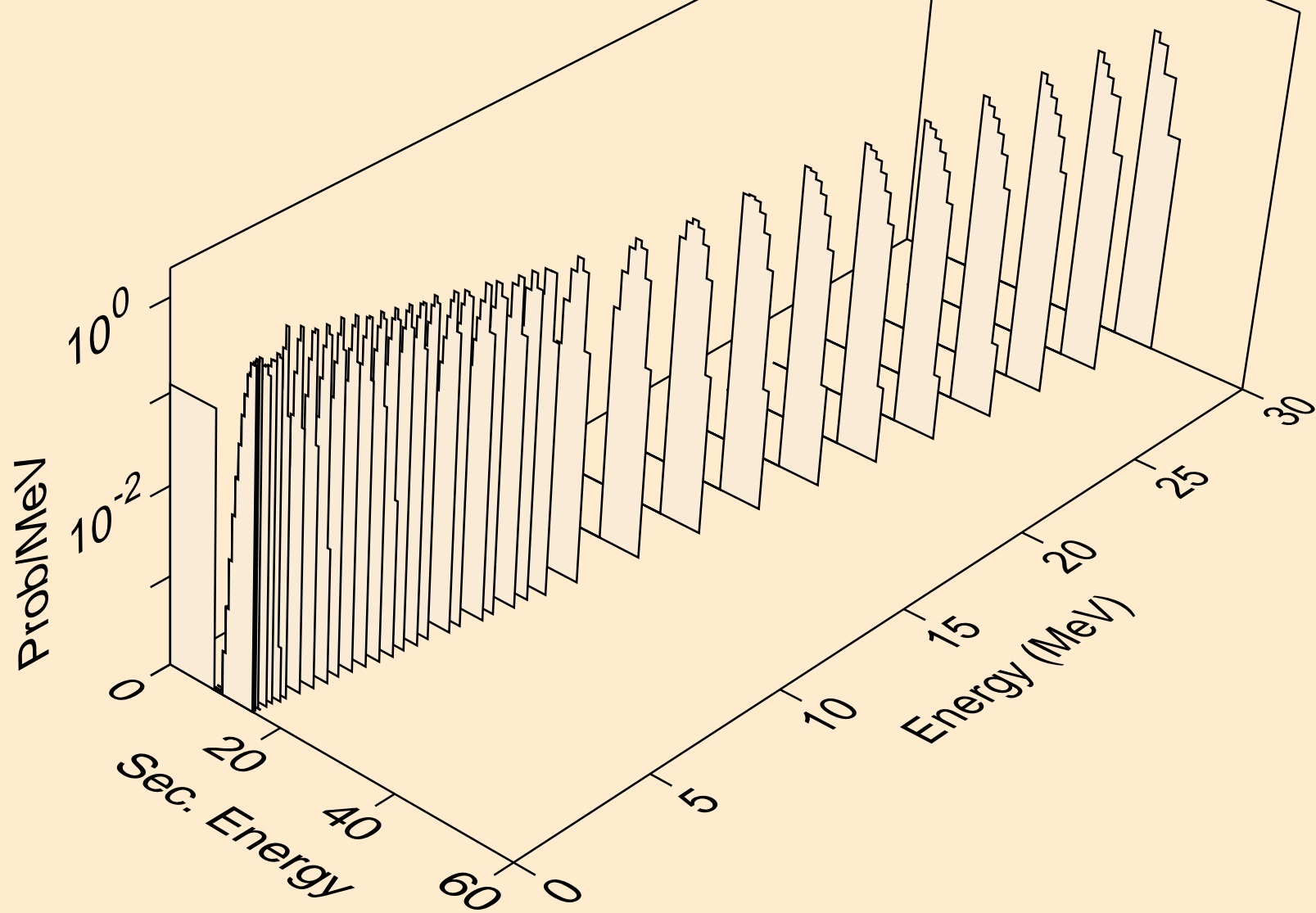

ES241 NEUTRON ACER TENDL-2023 LIBRARY; T=0.K
alphas from (n,2a)

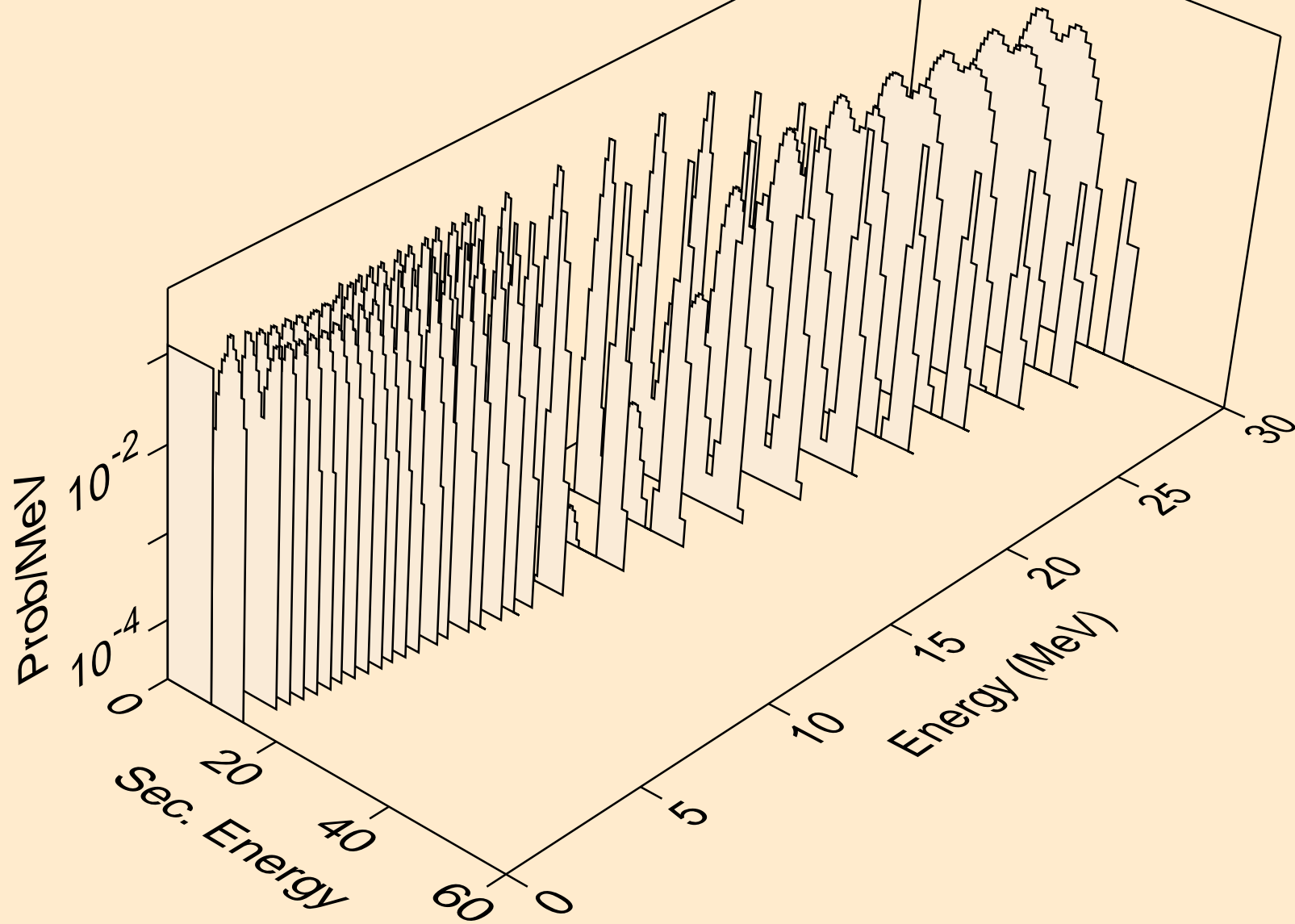

ES241 NEUTRON ACER TENDL-2023 LIBRARY; T=0.K
alphas from (n,pa)

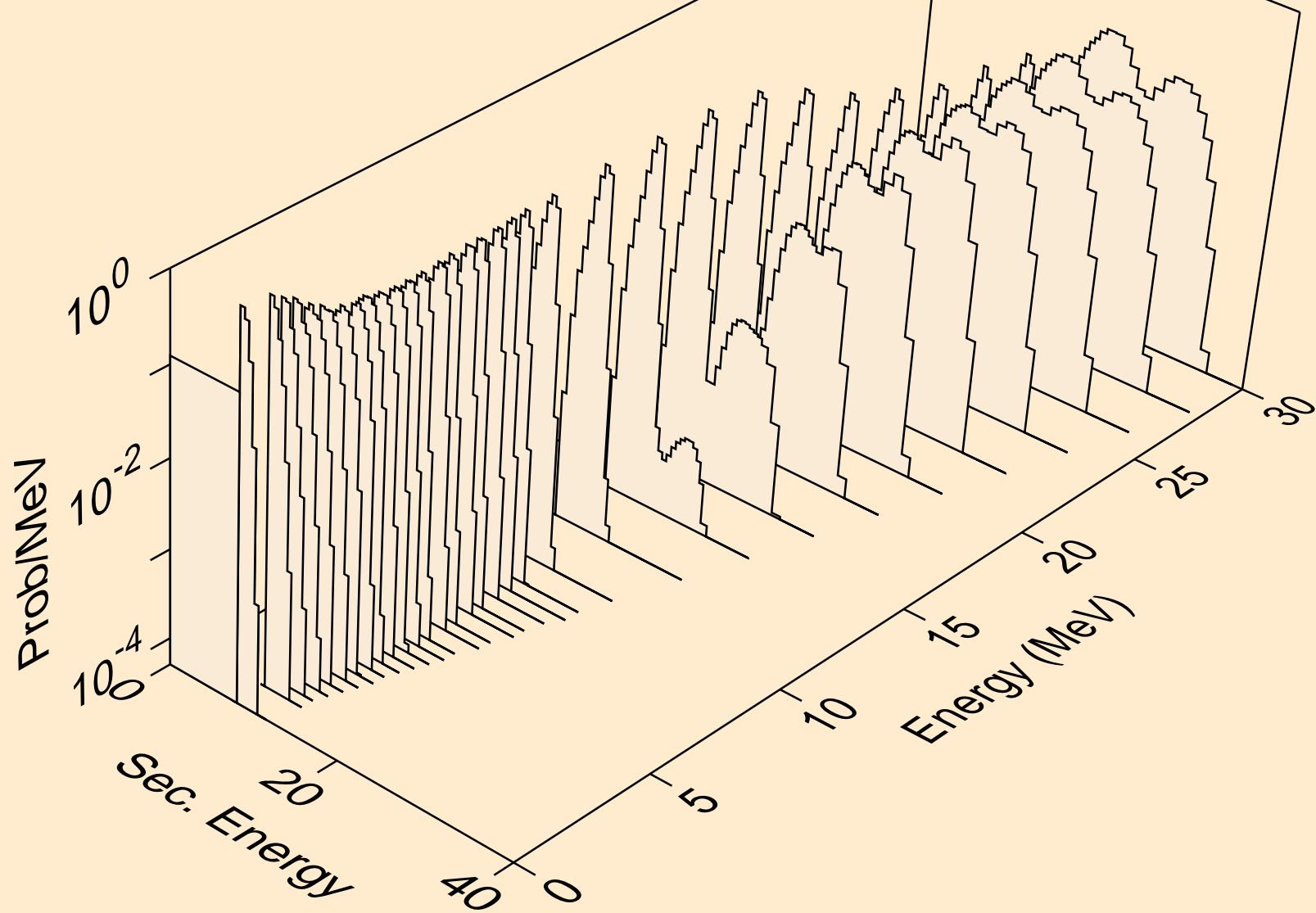

ES241 NEUTRON ACER TENDL-2023 LIBRARY; T=0.K
alphas from (n,da)

