

# EU166 NEUTRON ACER TENDL-2023 LIBRARY; T=0.K

## Principal cross sections

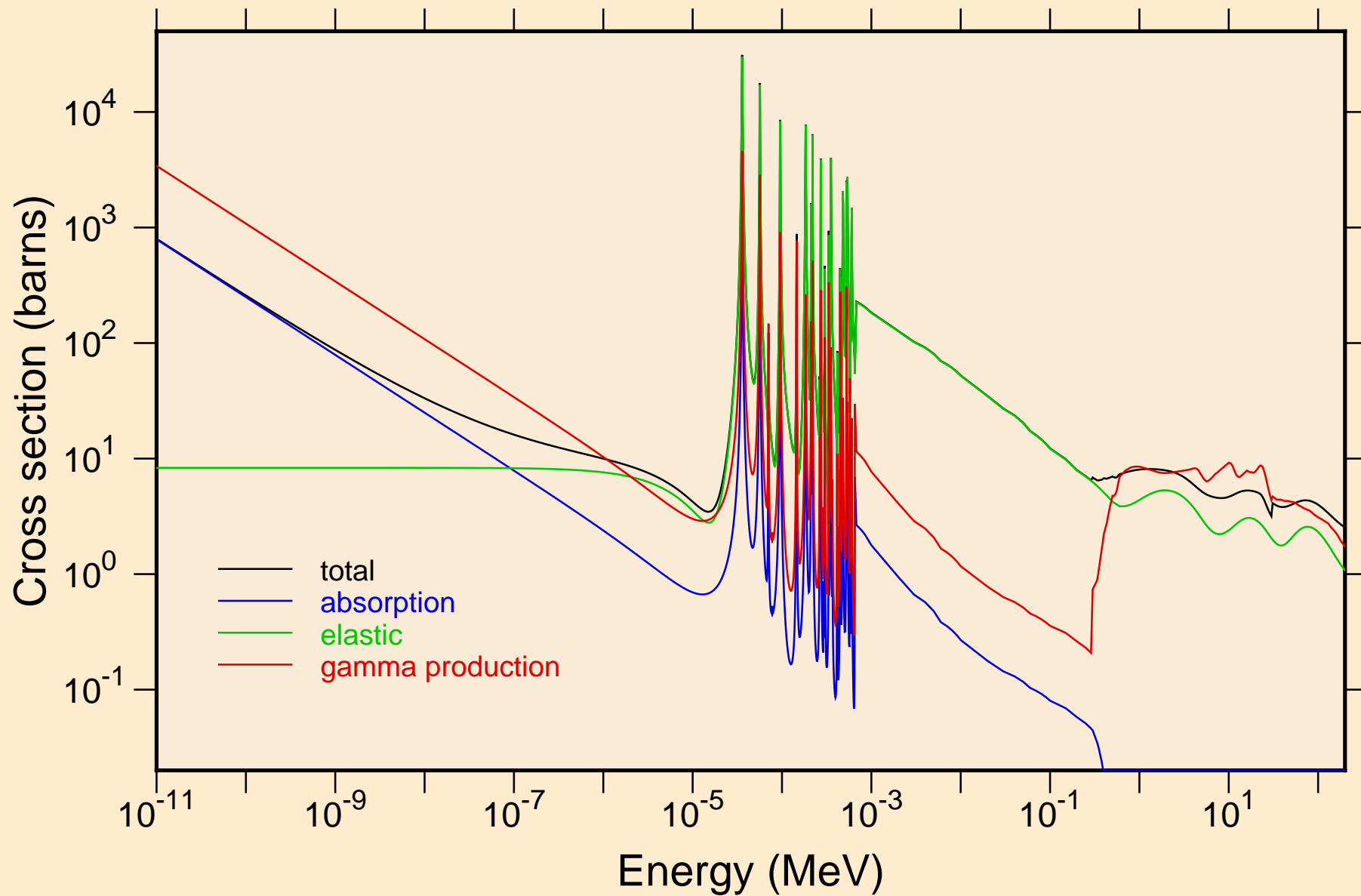

EU166 NEUTRON ACER TENDL-2023 LIBRARY; T=0.K  
resonance total cross section

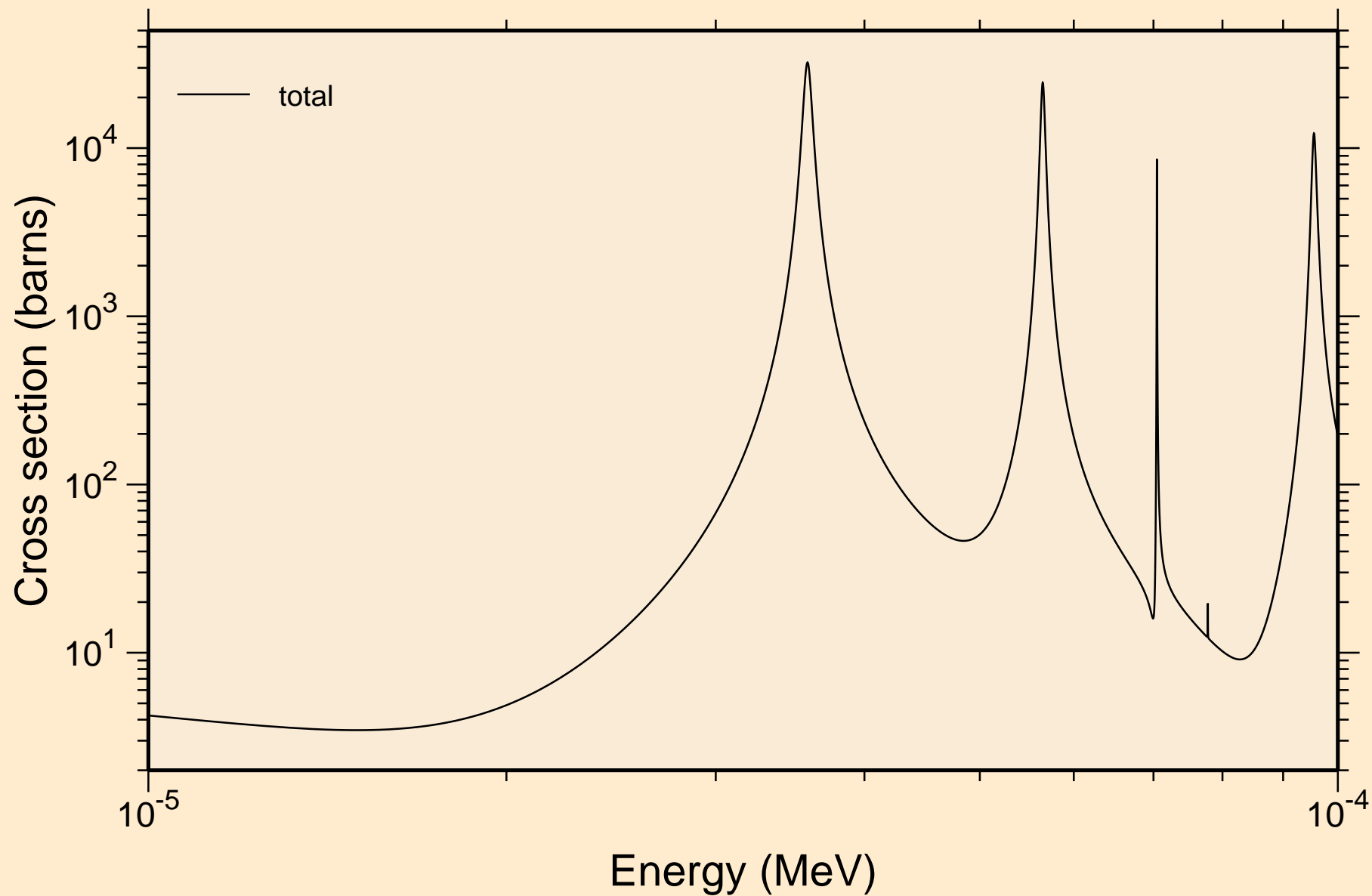

EU166 NEUTRON ACER TENDL-2023 LIBRARY; T=0.K  
resonance total cross section

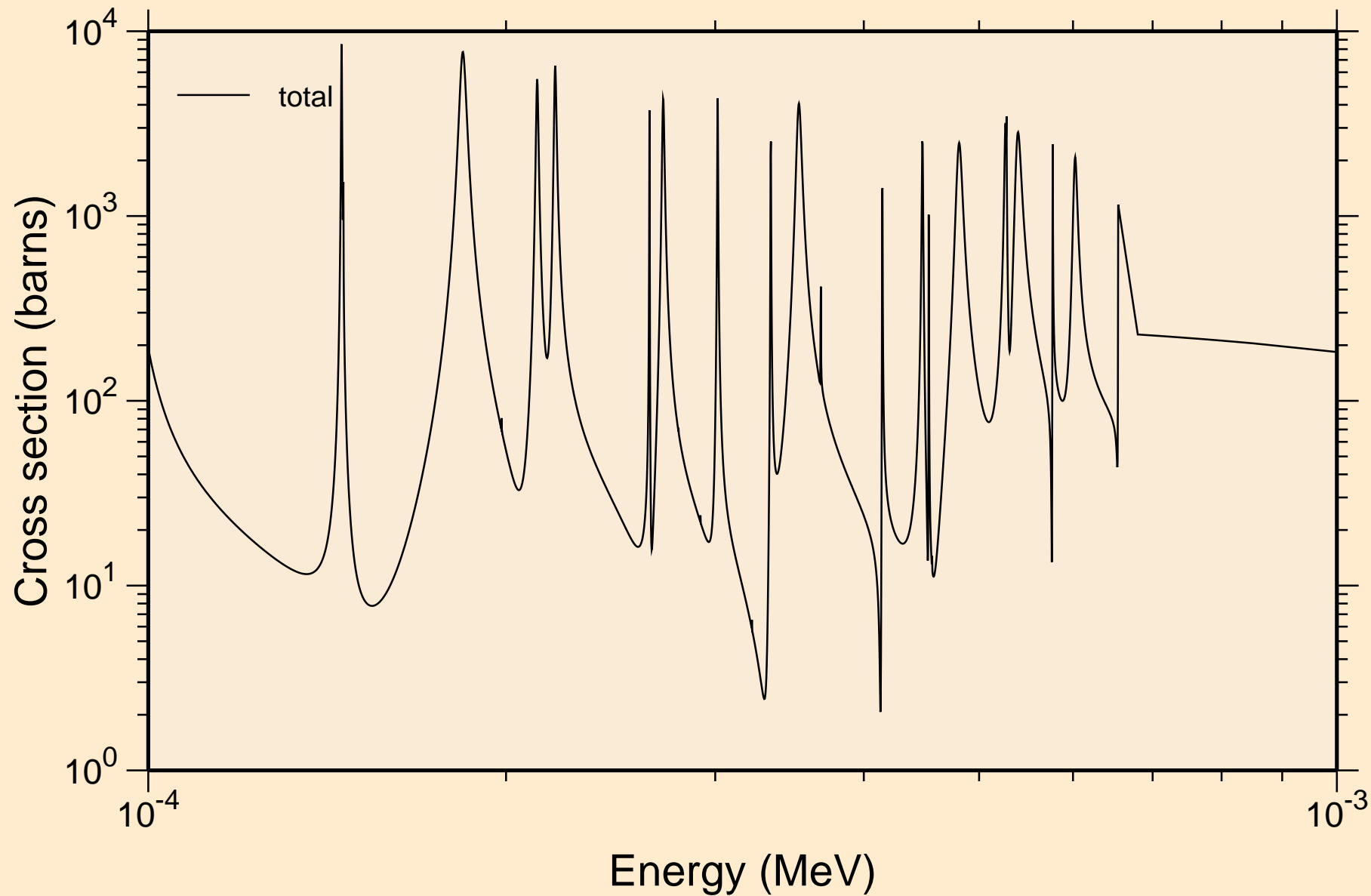

EU166 NEUTRON ACER TENDL-2023 LIBRARY; T=0.K  
resonance total cross section

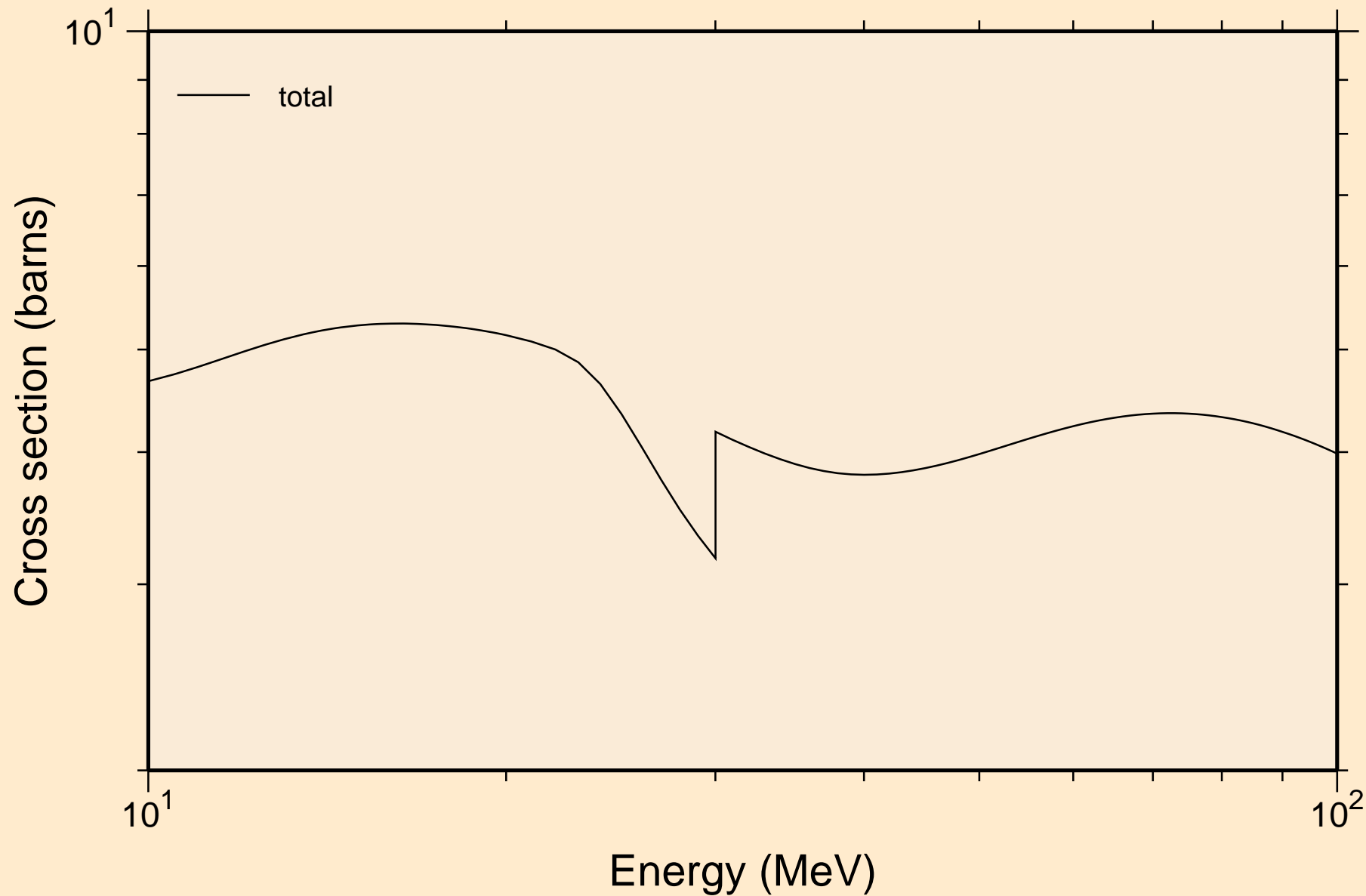

EU166 NEUTRON ACER TENDL-2023 LIBRARY; T=0.K  
resonance absorption cross sections

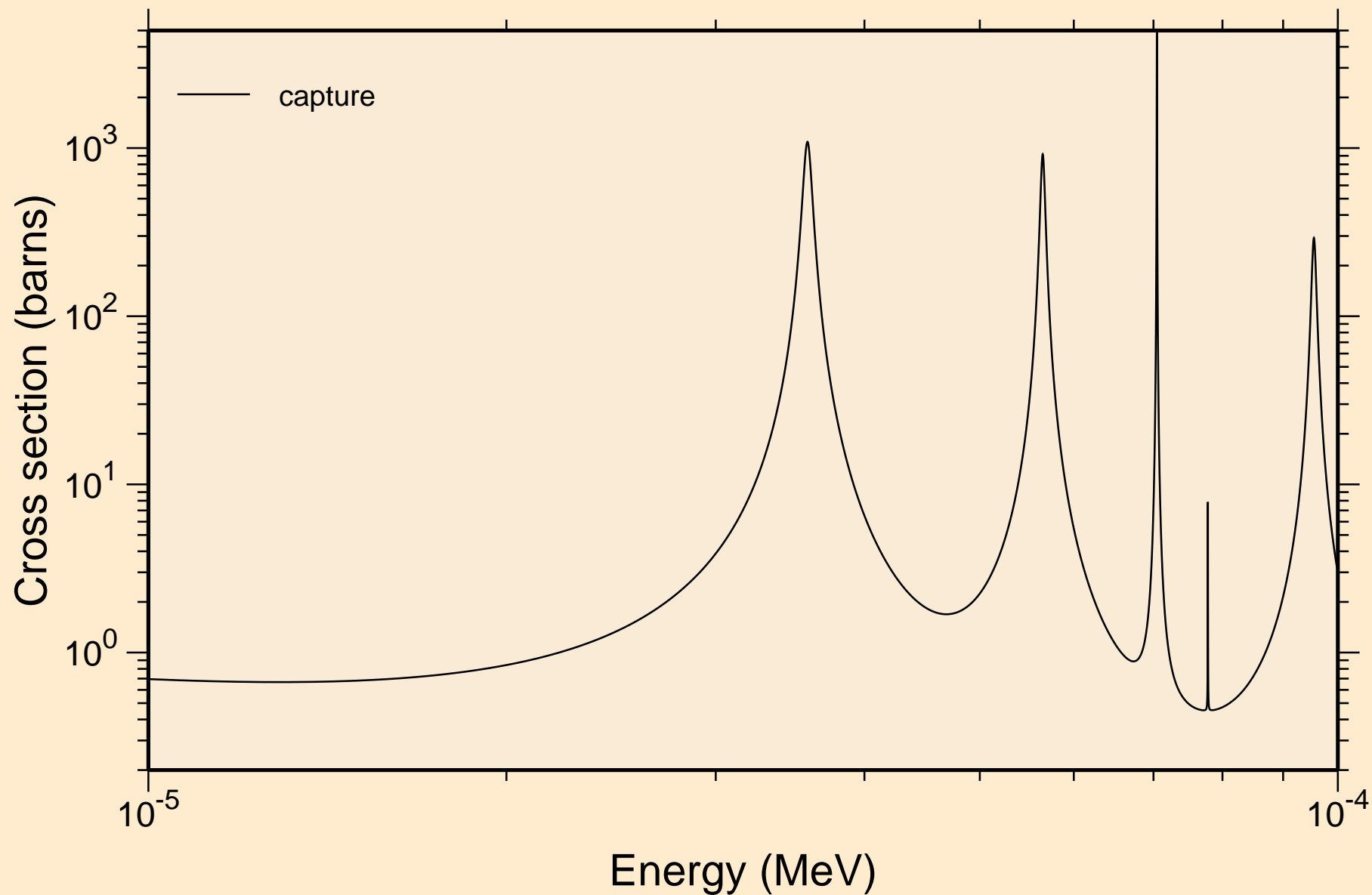

EU166 NEUTRON ACER TENDL-2023 LIBRARY; T=0.K  
resonance absorption cross sections

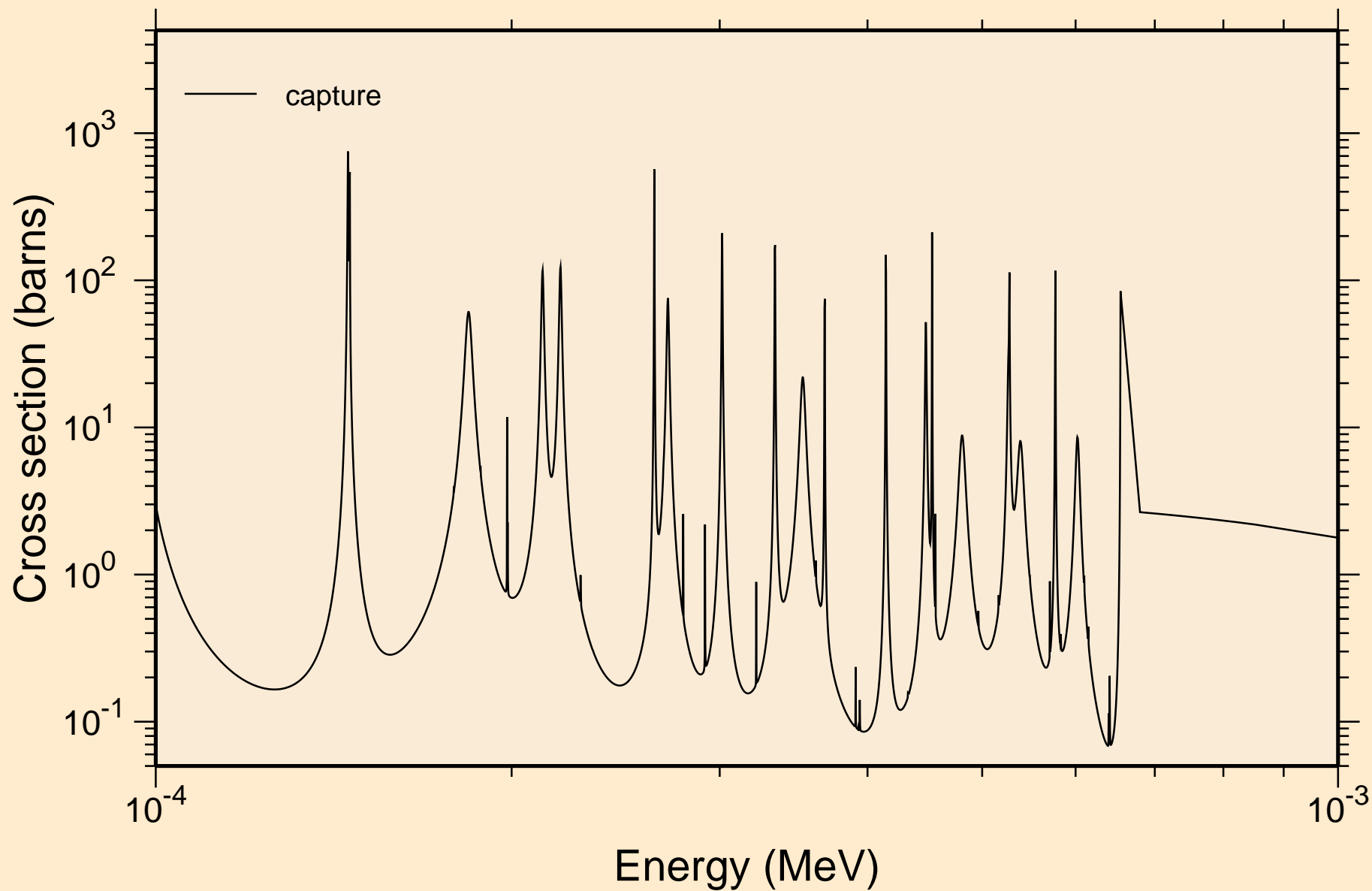

EU166 NEUTRON ACER TENDL-2023 LIBRARY; T=0.K  
resonance absorption cross sections

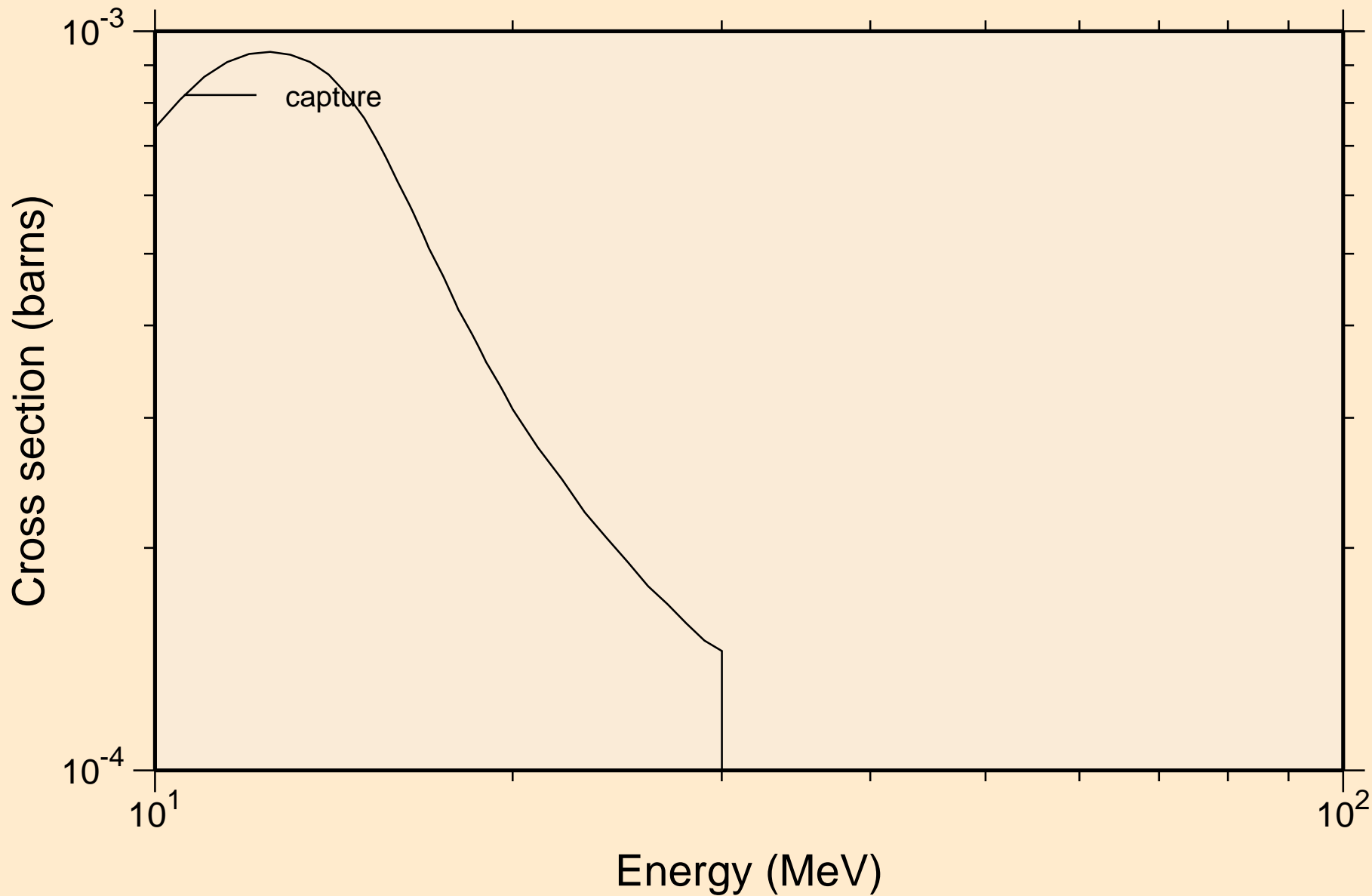

EU166 NEUTRON ACER TENDL-2023 LIBRARY; T=0.K  
Heating

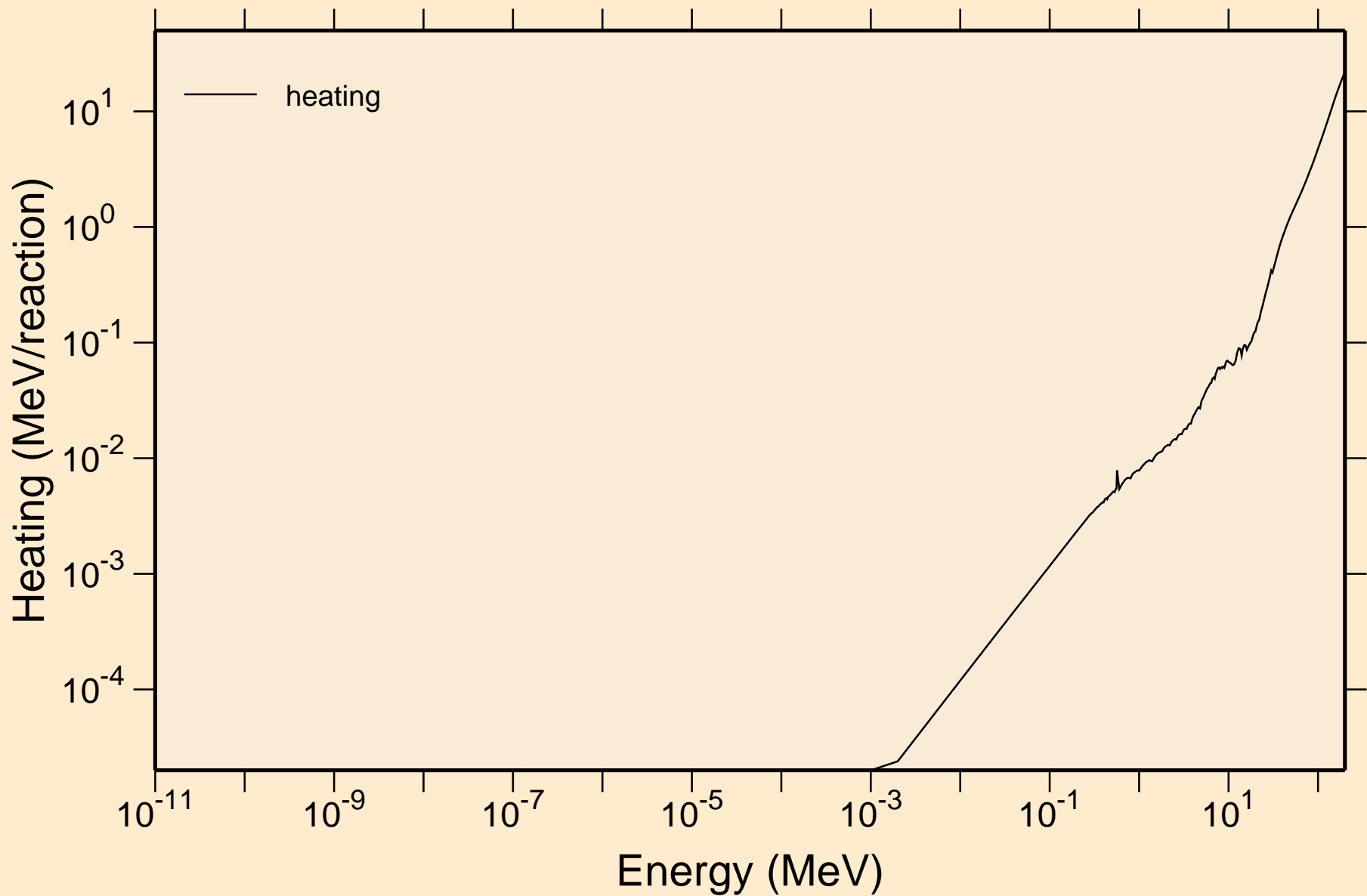



# EU166 NEUTRON ACER TENDL-2023 LIBRARY; T=0.K

## Damage

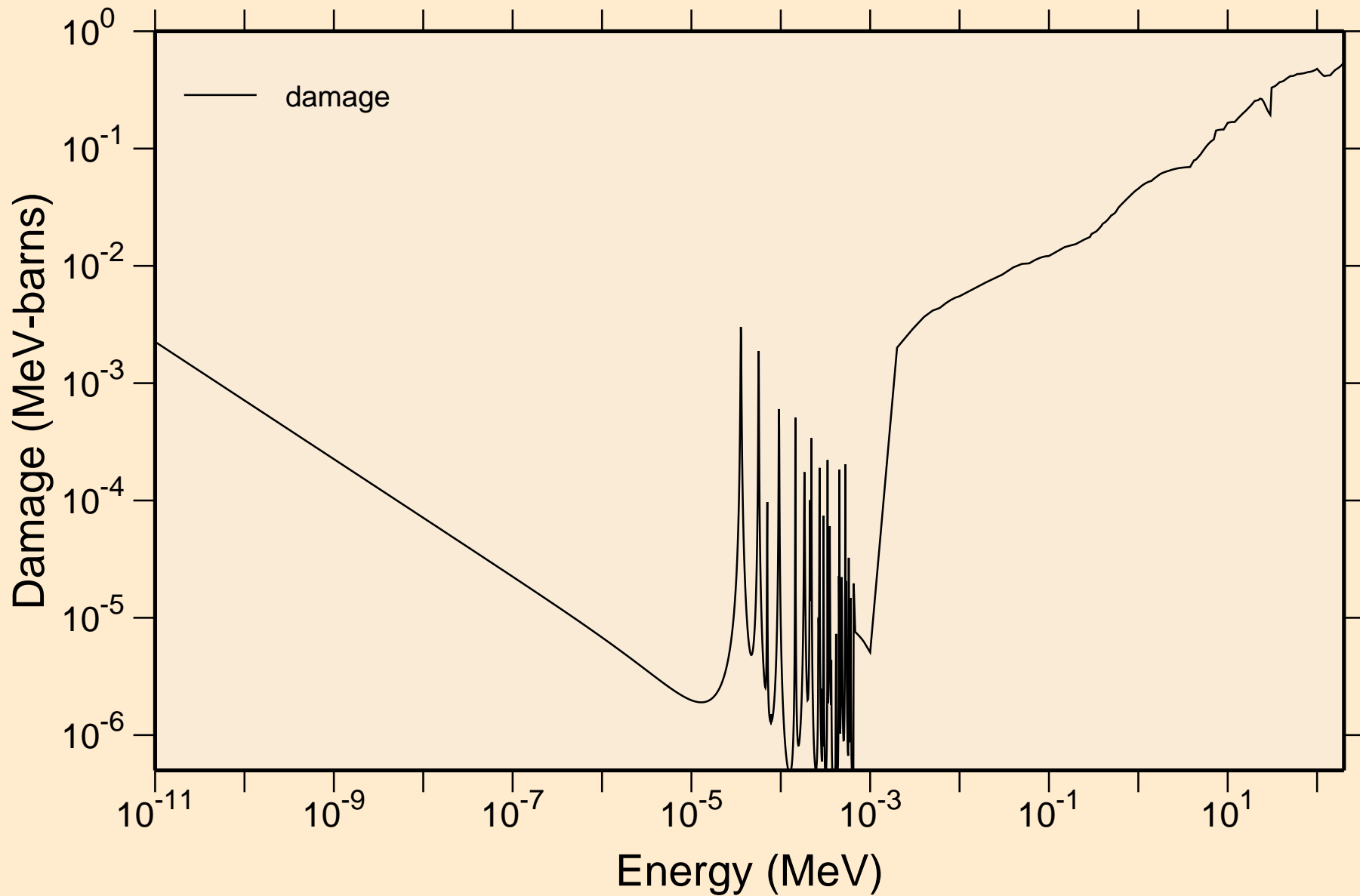

EU166 NEUTRON ACER TENDL-2023 LIBRARY; T=0.K  
Non-threshold reactions

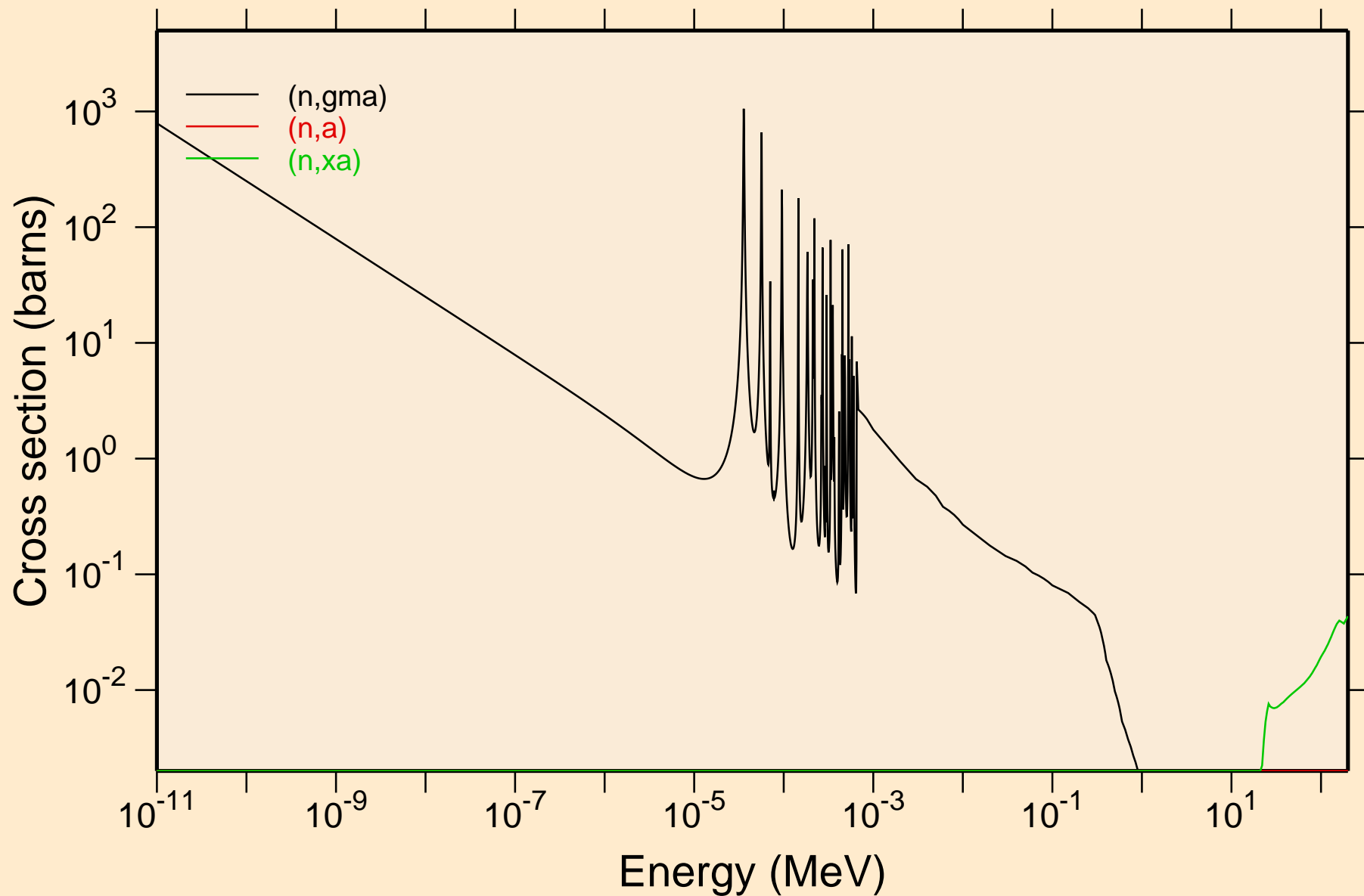

# EU166 NEUTRON ACER TENDL-2023 LIBRARY; T=0.K

## Principal cross sections

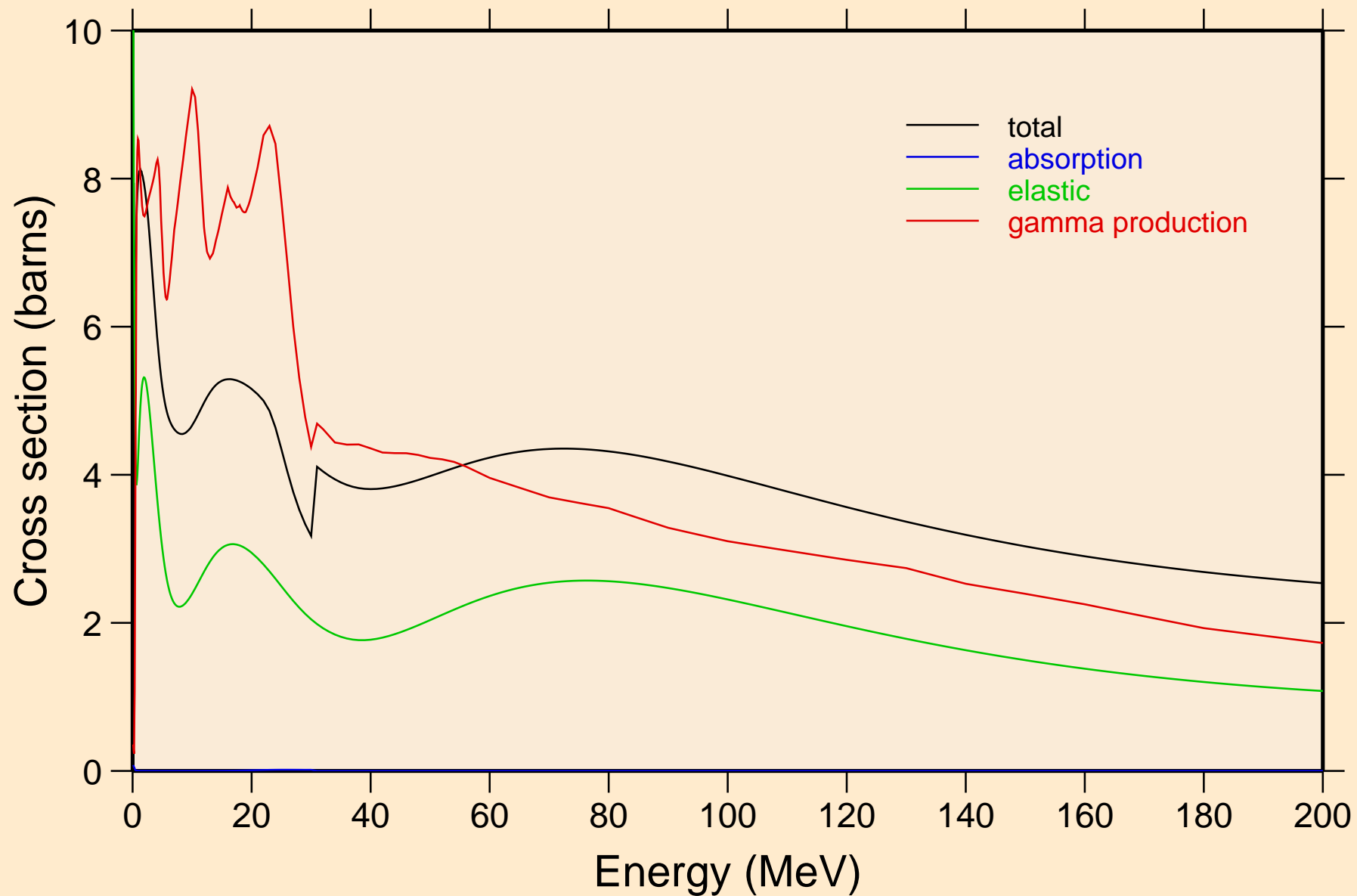

EU166 NEUTRON ACER TENDL-2023 LIBRARY; T=0.K  
Heating

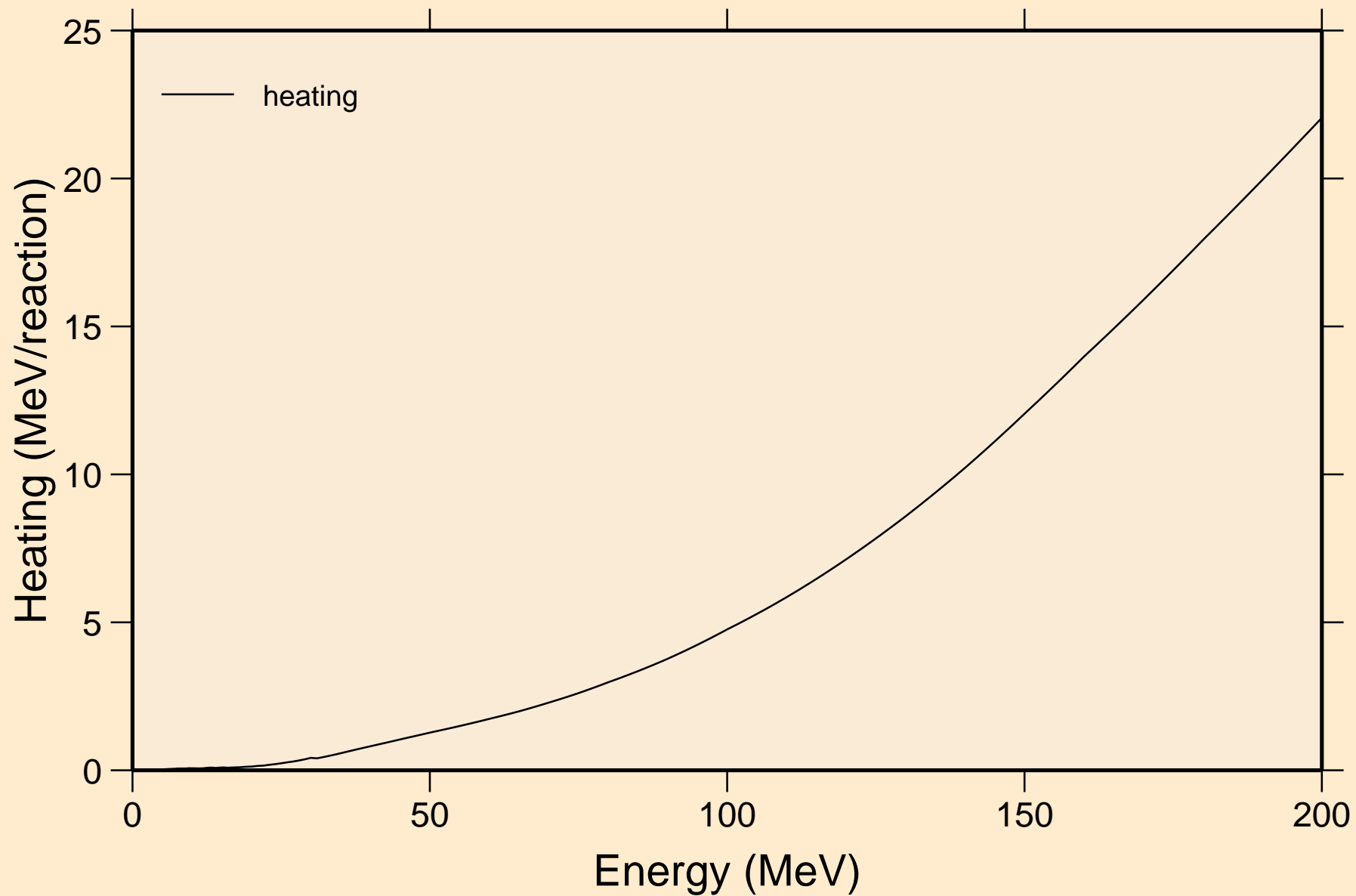

EU166 NEUTRON ACER TENDL-2023 LIBRARY; T=0.K  
Damage

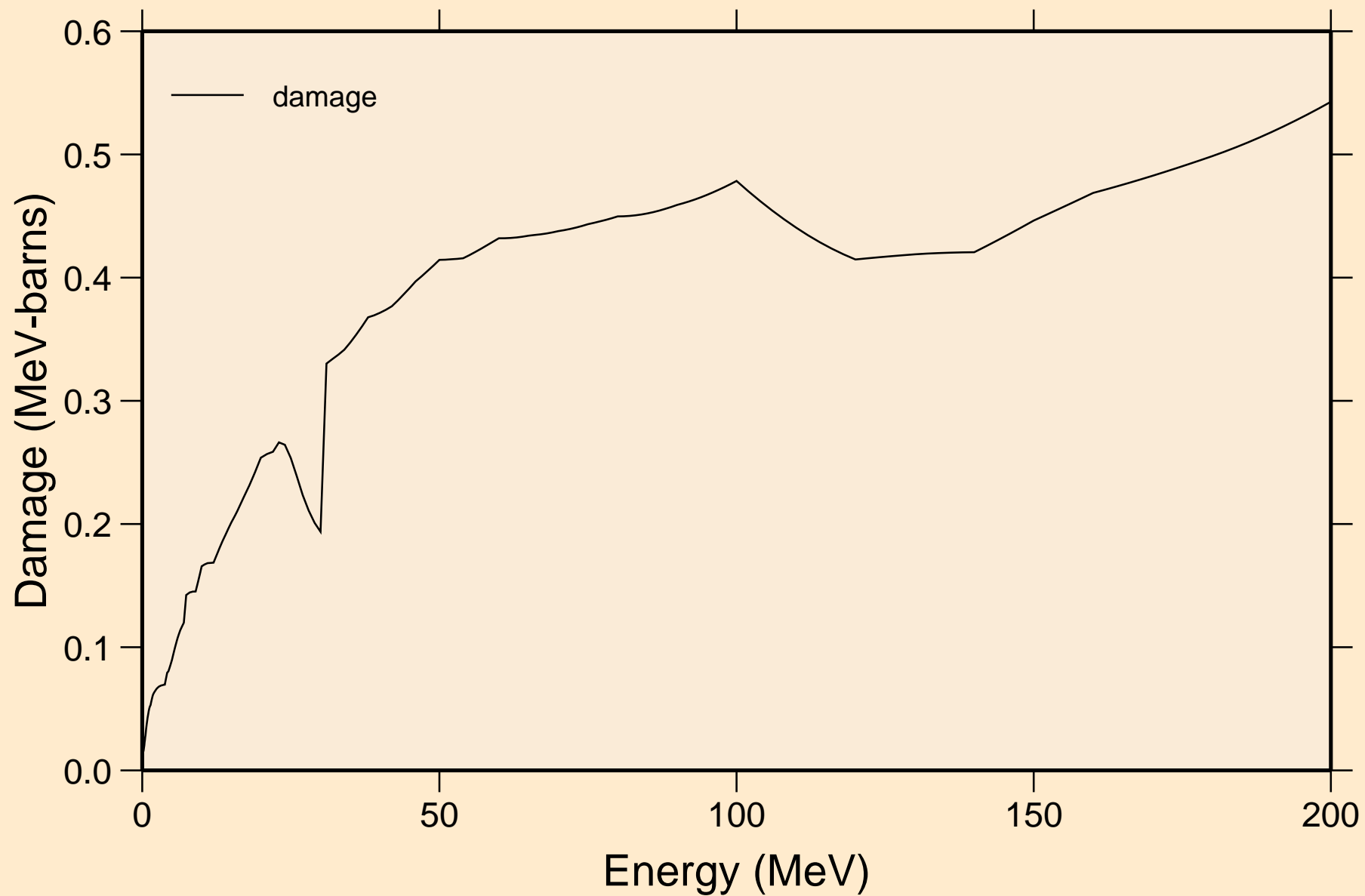

# EU166 NEUTRON ACER TENDL-2023 LIBRARY; T=0.K

## Non-threshold reactions

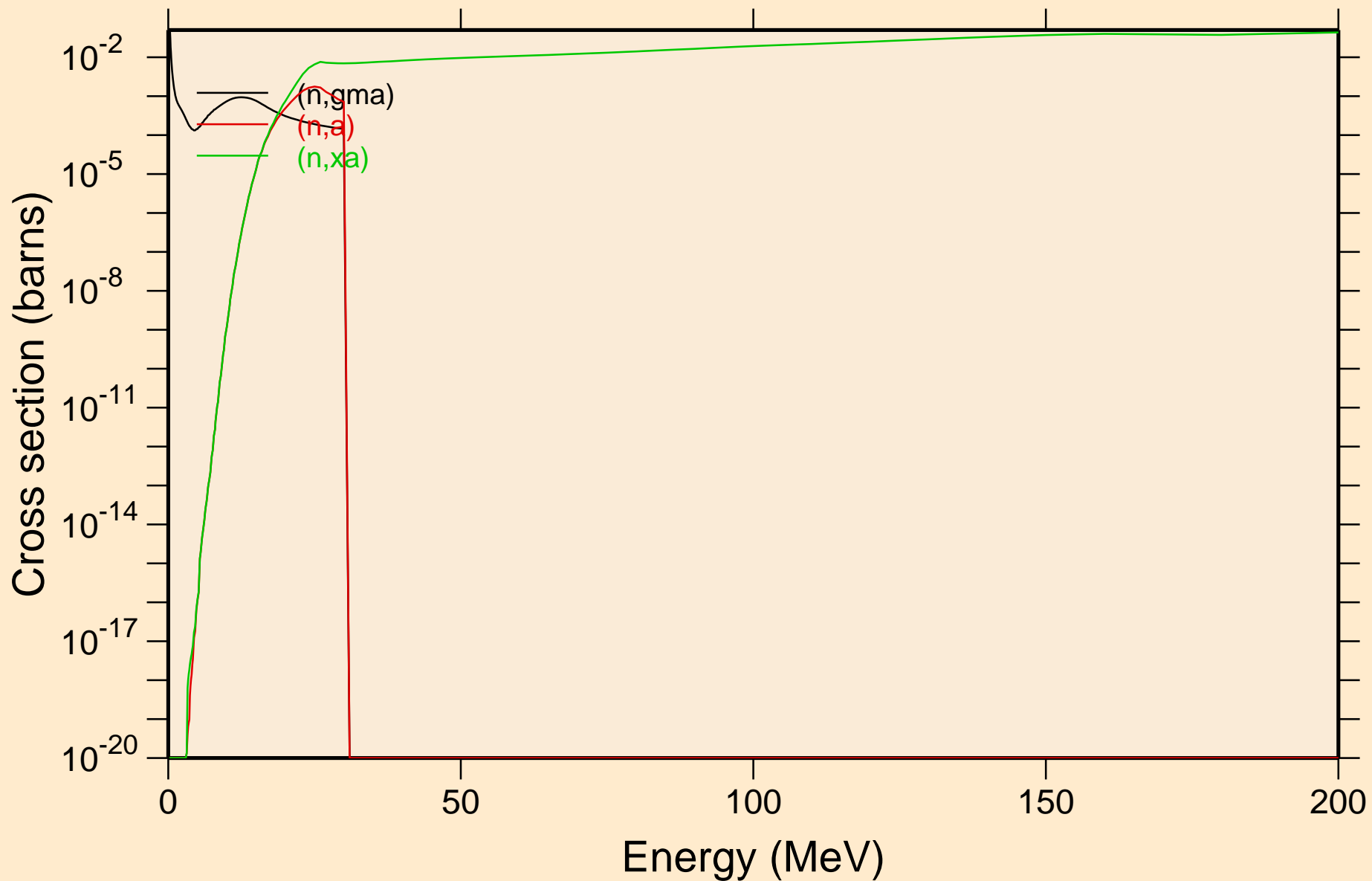

EU166 NEUTRON ACER TENDL-2023 LIBRARY; T=0.K  
Inelastic levels

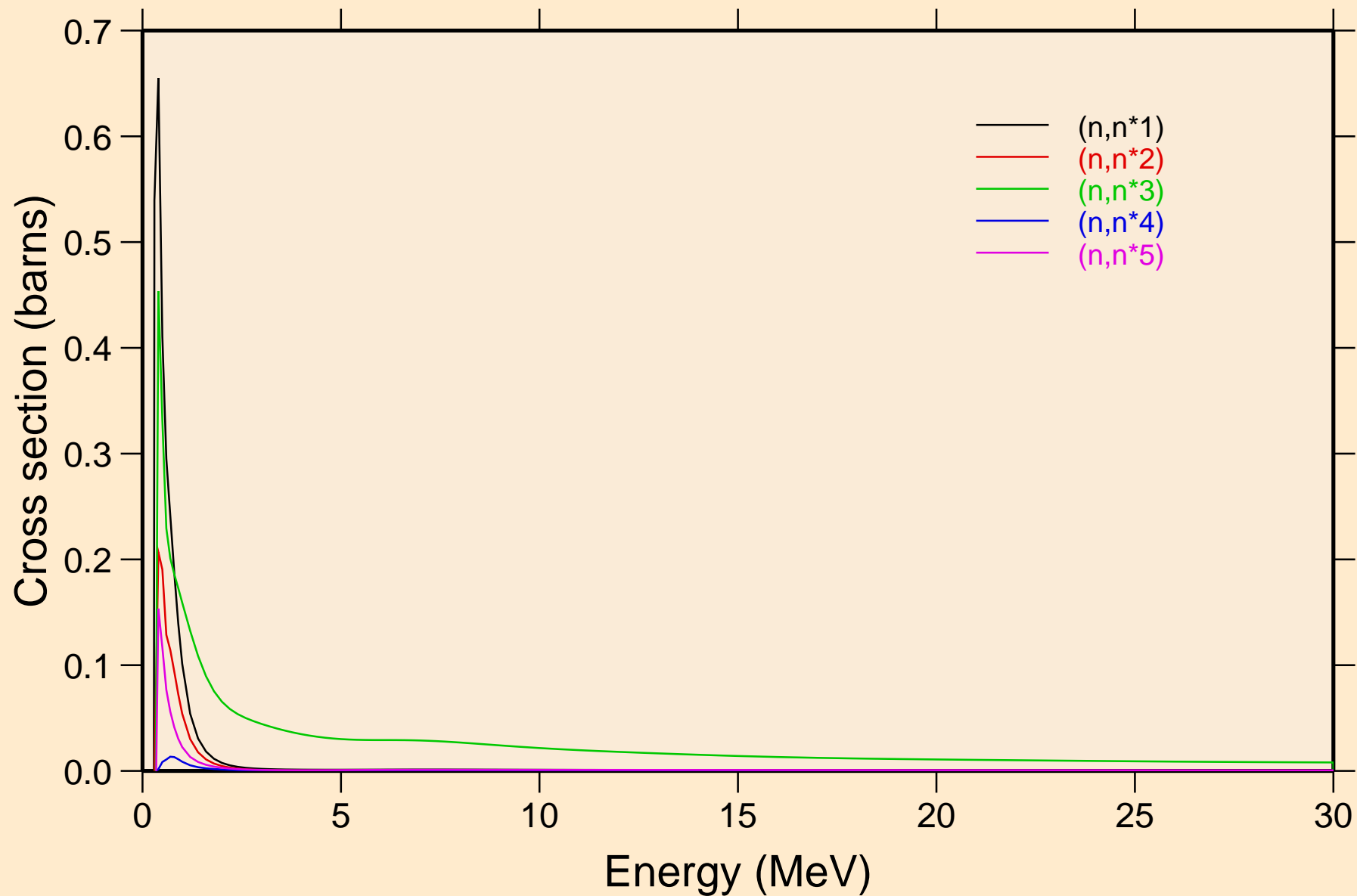

EU166 NEUTRON ACER TENDL-2023 LIBRARY; T=0.K  
Inelastic levels

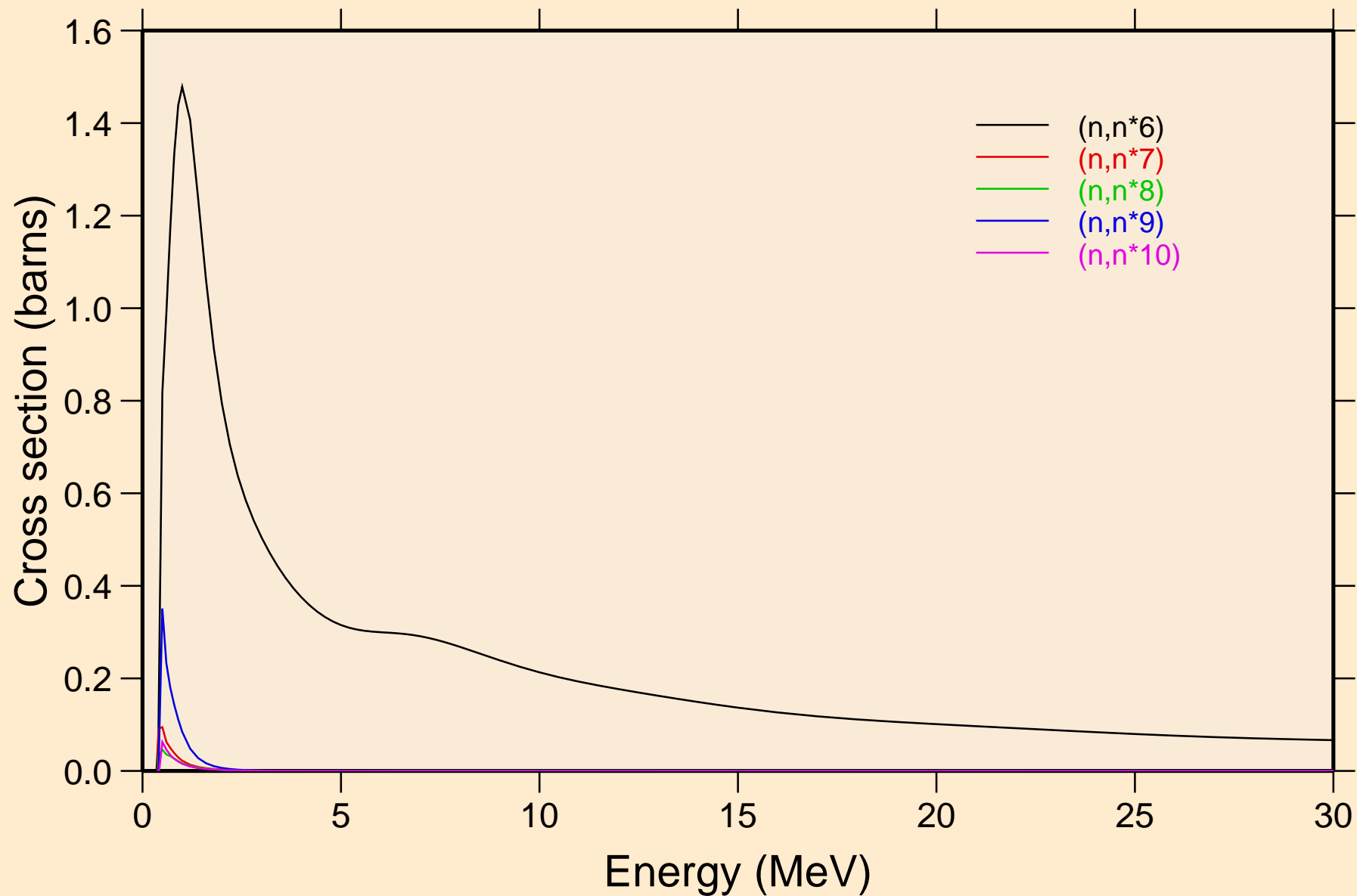



# EU166 NEUTRON ACER TENDL-2023 LIBRARY; T=0.K

## Inelastic levels

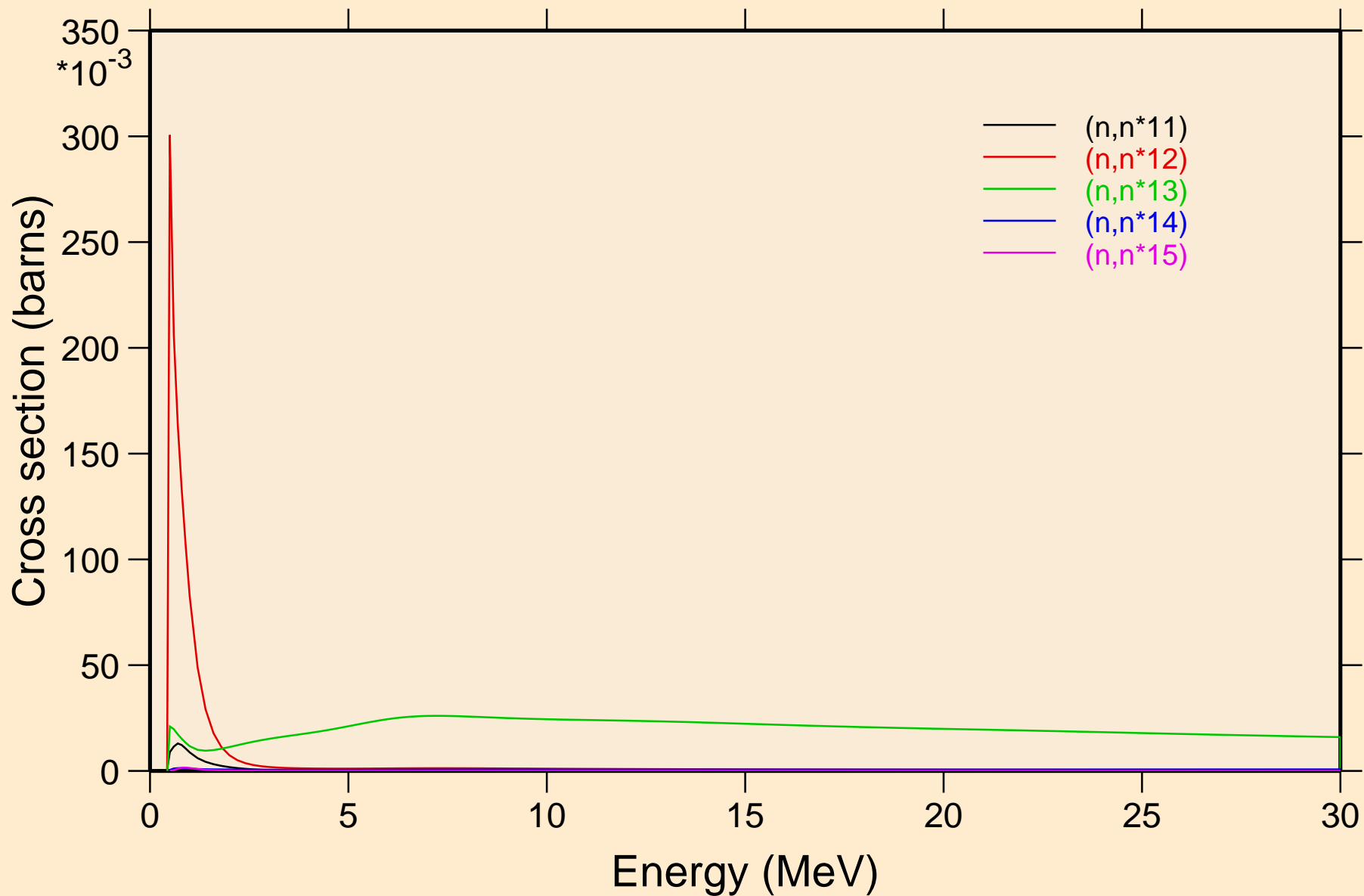

EU166 NEUTRON ACER TENDL-2023 LIBRARY; T=0.K  
Inelastic levels

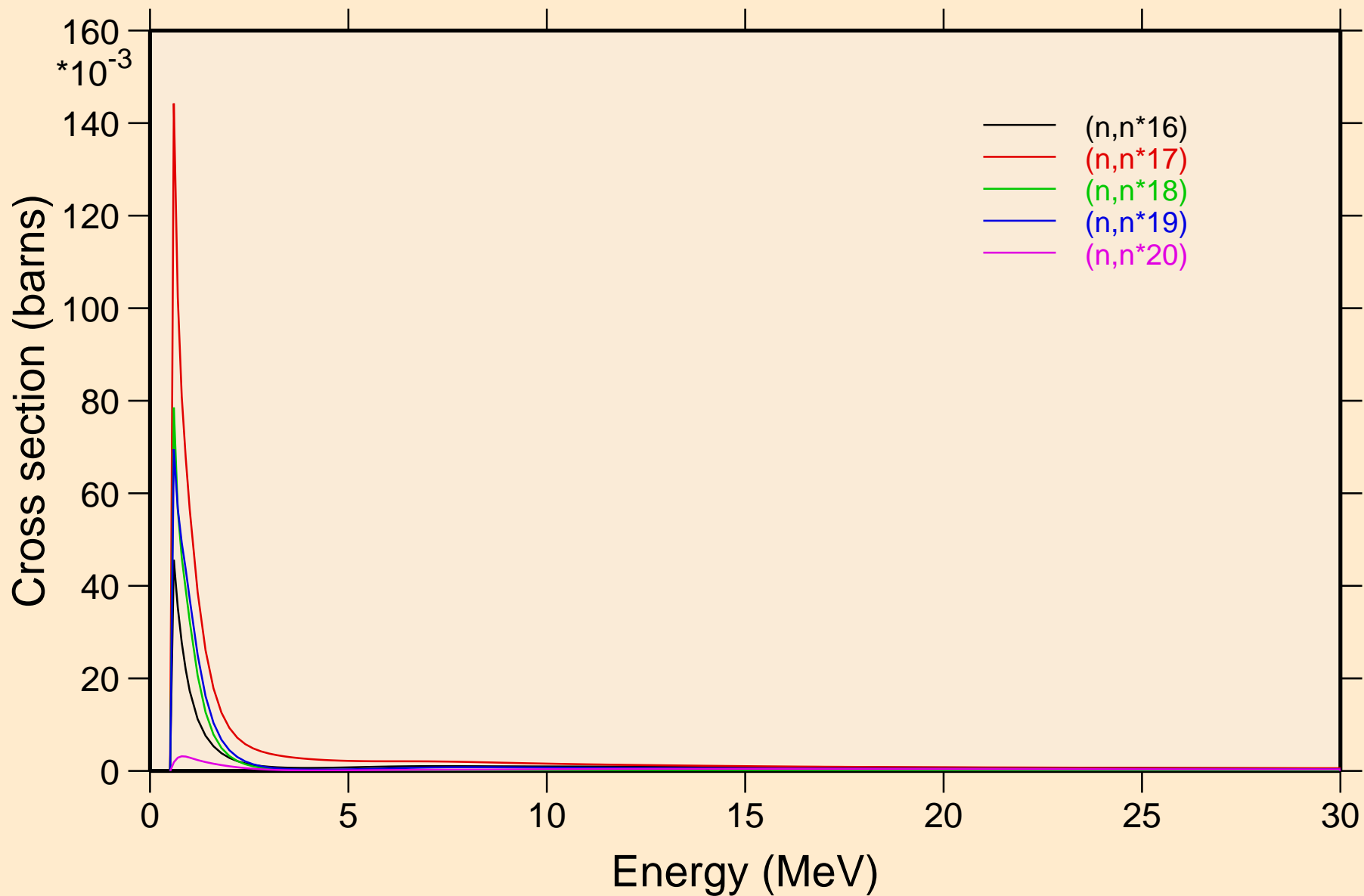

EU166 NEUTRON ACER TENDL-2023 LIBRARY; T=0.K  
Inelastic levels

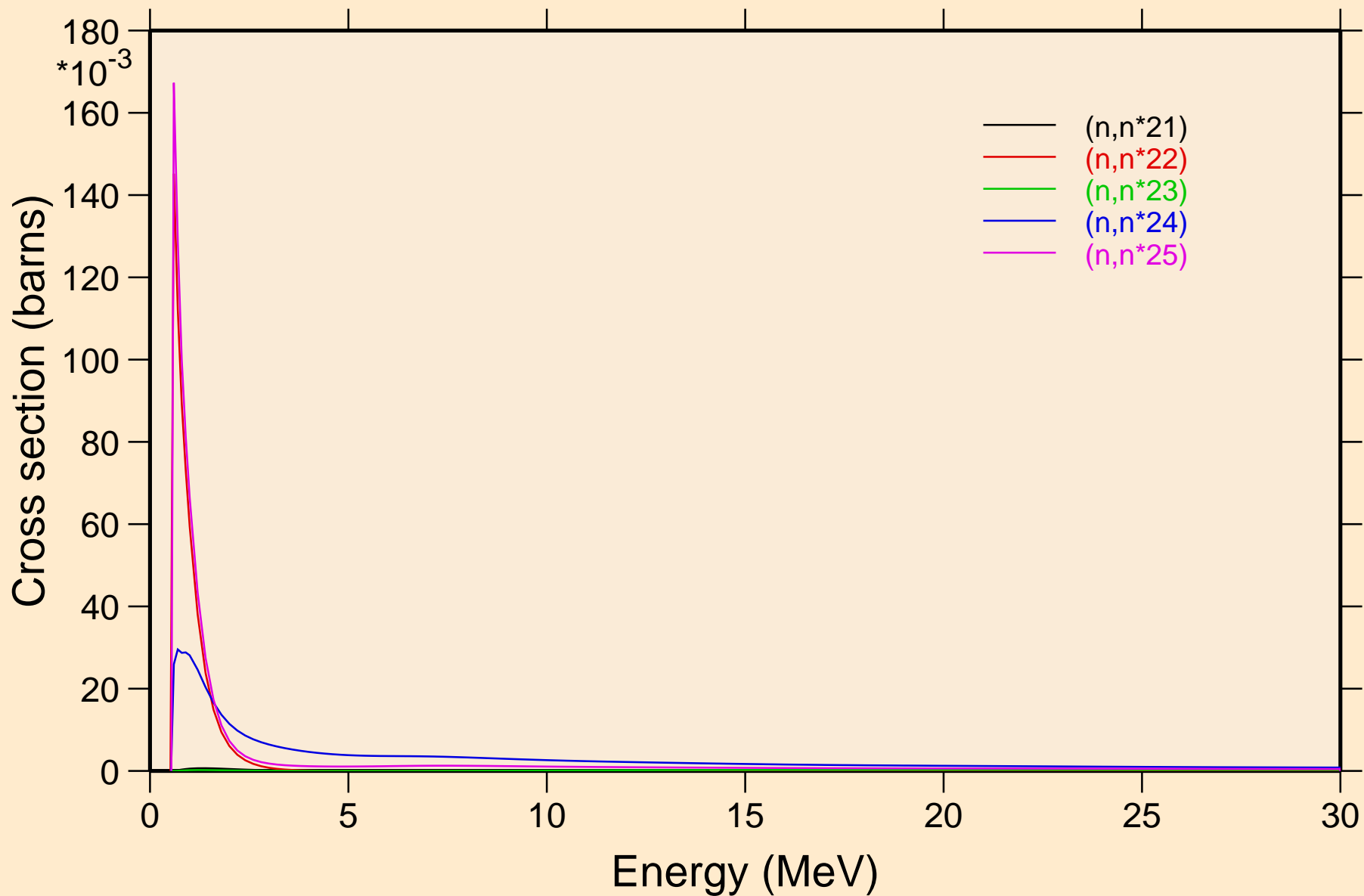

EU166 NEUTRON ACER TENDL-2023 LIBRARY; T=0.K  
Inelastic levels

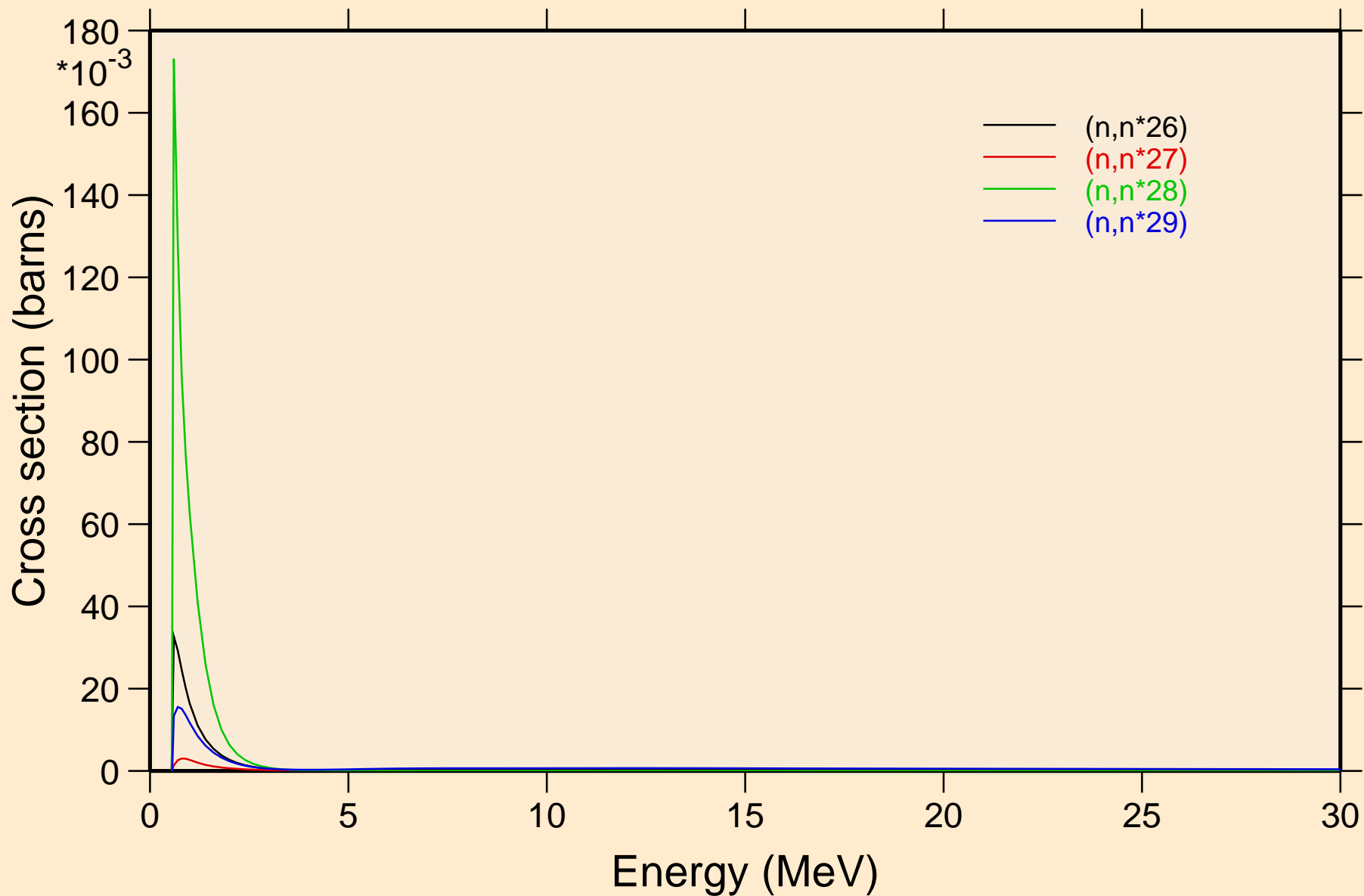

# EU166 NEUTRON ACER TENDL-2023 LIBRARY; T=0.K

## Threshold reactions

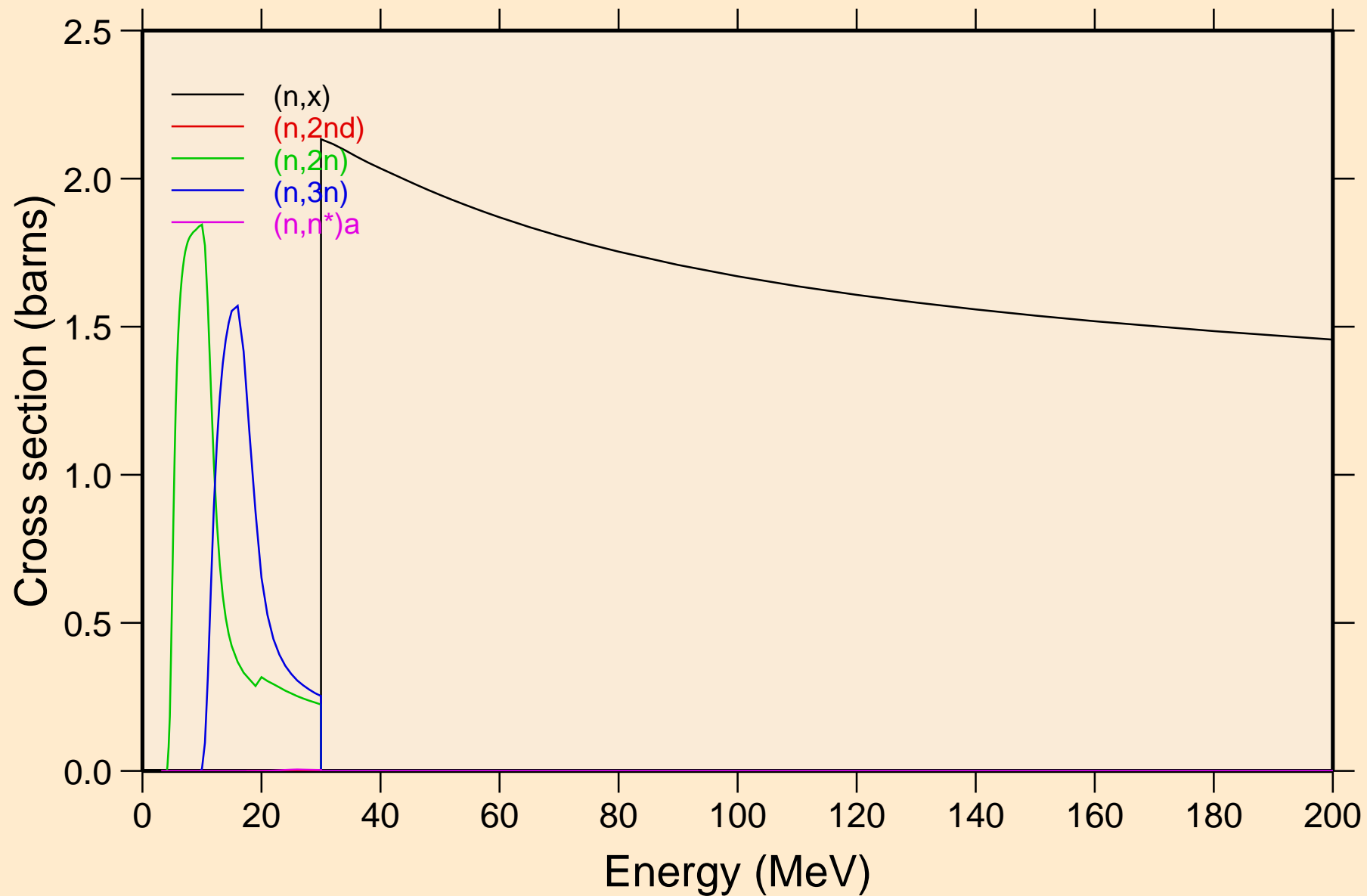

# EU166 NEUTRON ACER TENDL-2023 LIBRARY; T=0.K

## Threshold reactions

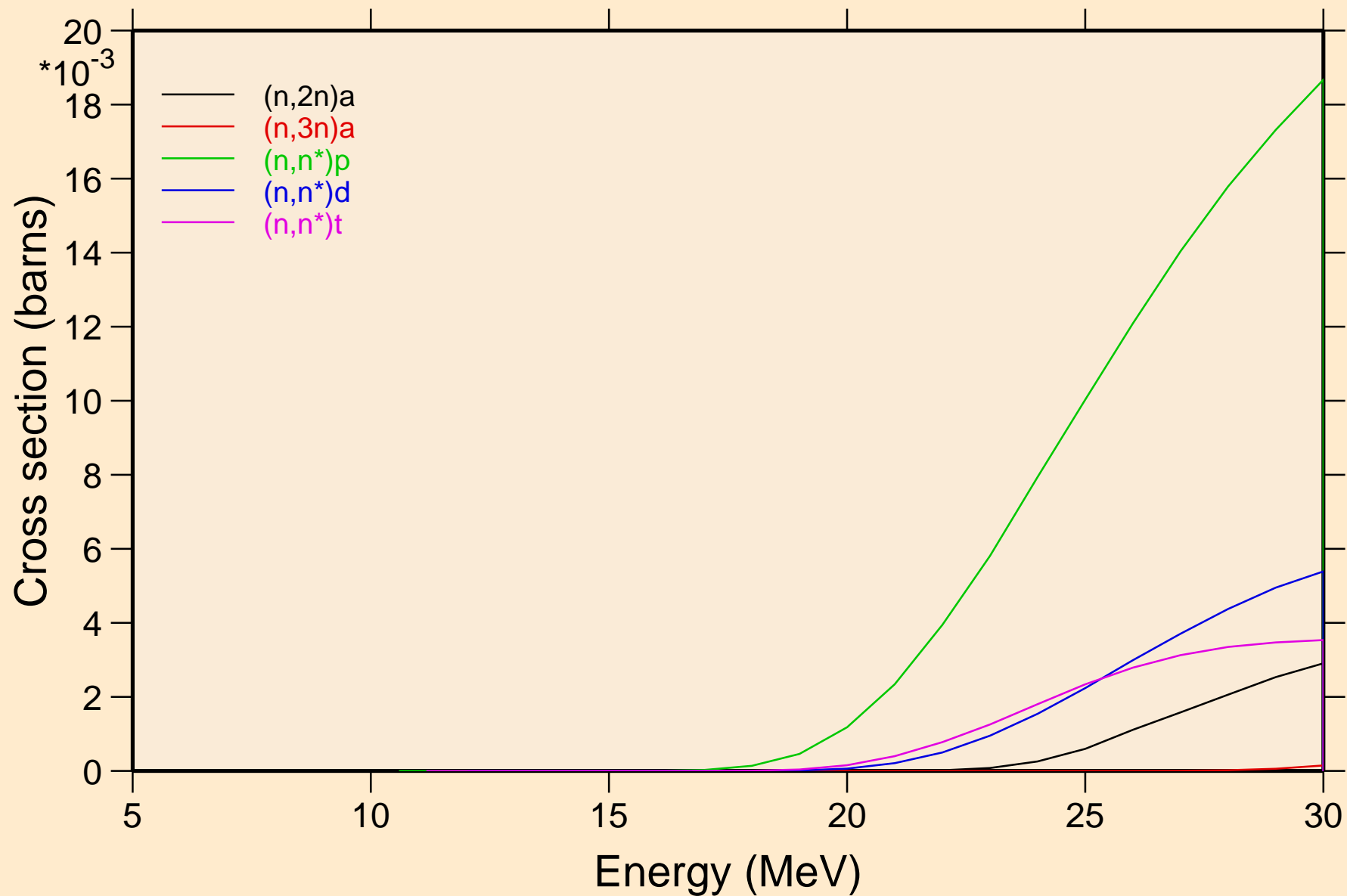

EU166 NEUTRON ACER TENDL-2023 LIBRARY; T=0.K  
Threshold reactions

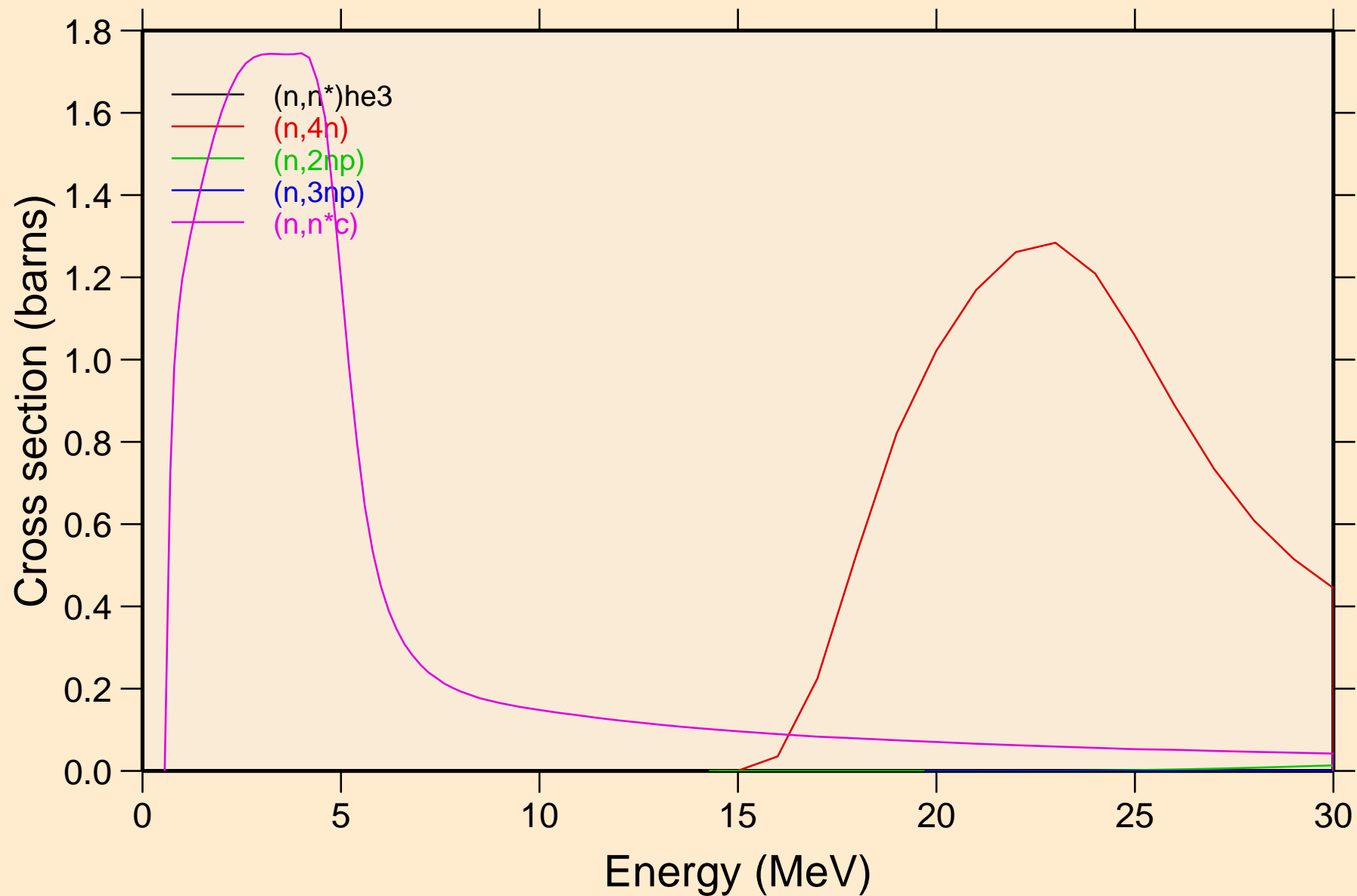

EU166 NEUTRON ACER TENDL-2023 LIBRARY; T=0.K  
Threshold reactions

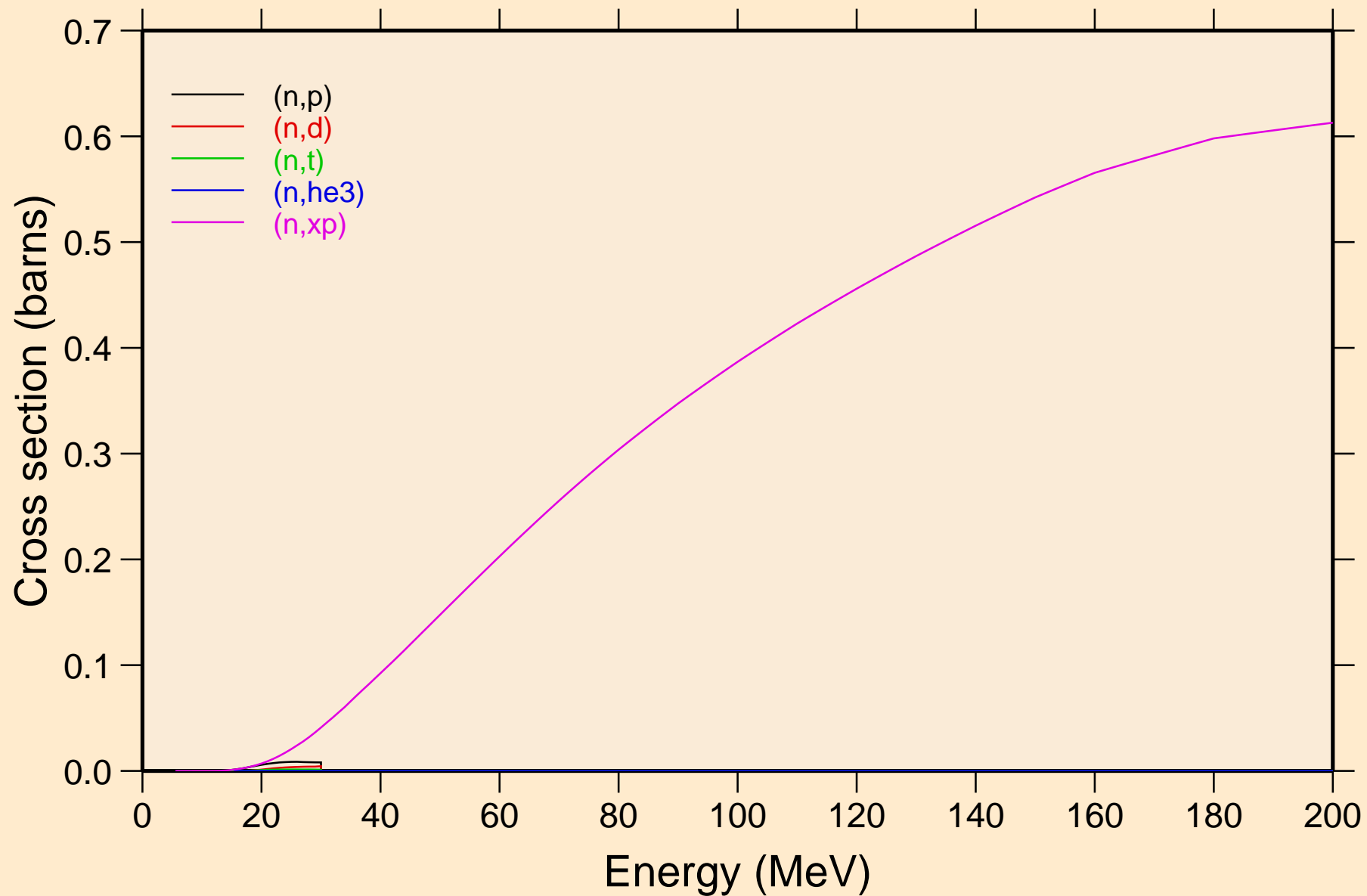



# EU166 NEUTRON ACER TENDL-2023 LIBRARY; T=0.K

## Threshold reactions

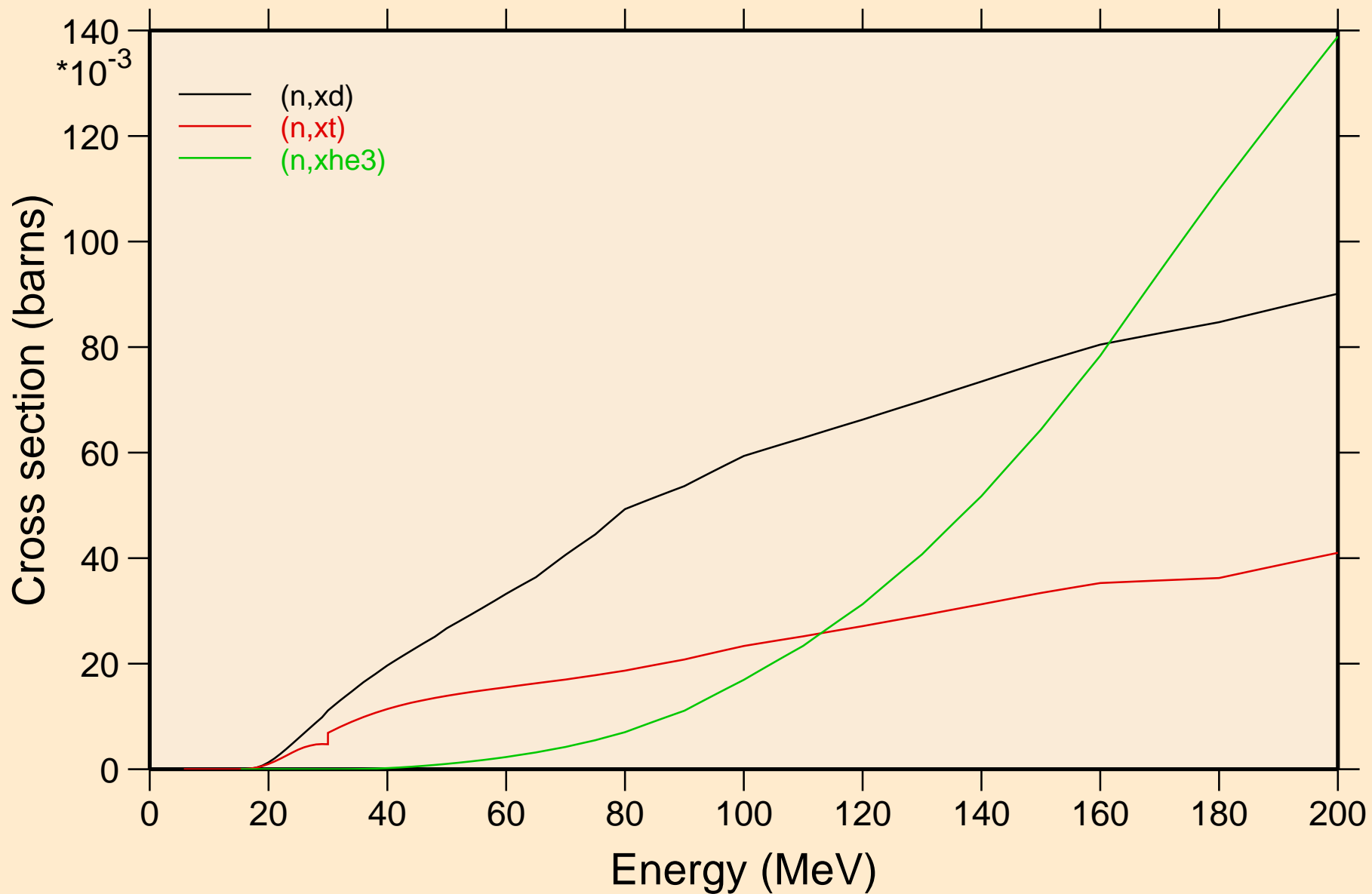

EU166 NEUTRON ACER TENDL-2023 LIBRARY; T=0.K  
angular distribution for elastic

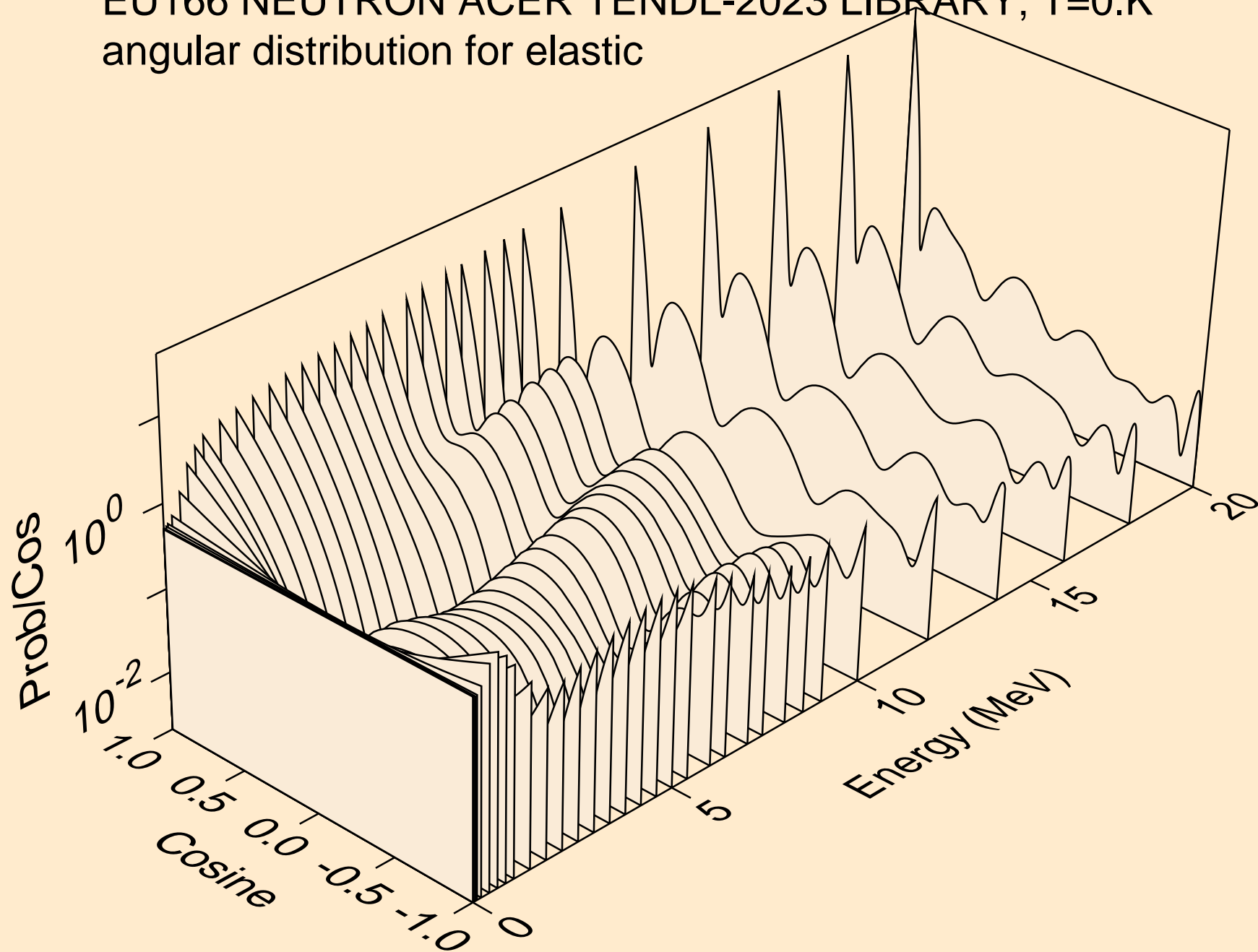

EU166 NEUTRON ACER TENDL-2023 LIBRARY; T=0.K  
angular distribution for elastic

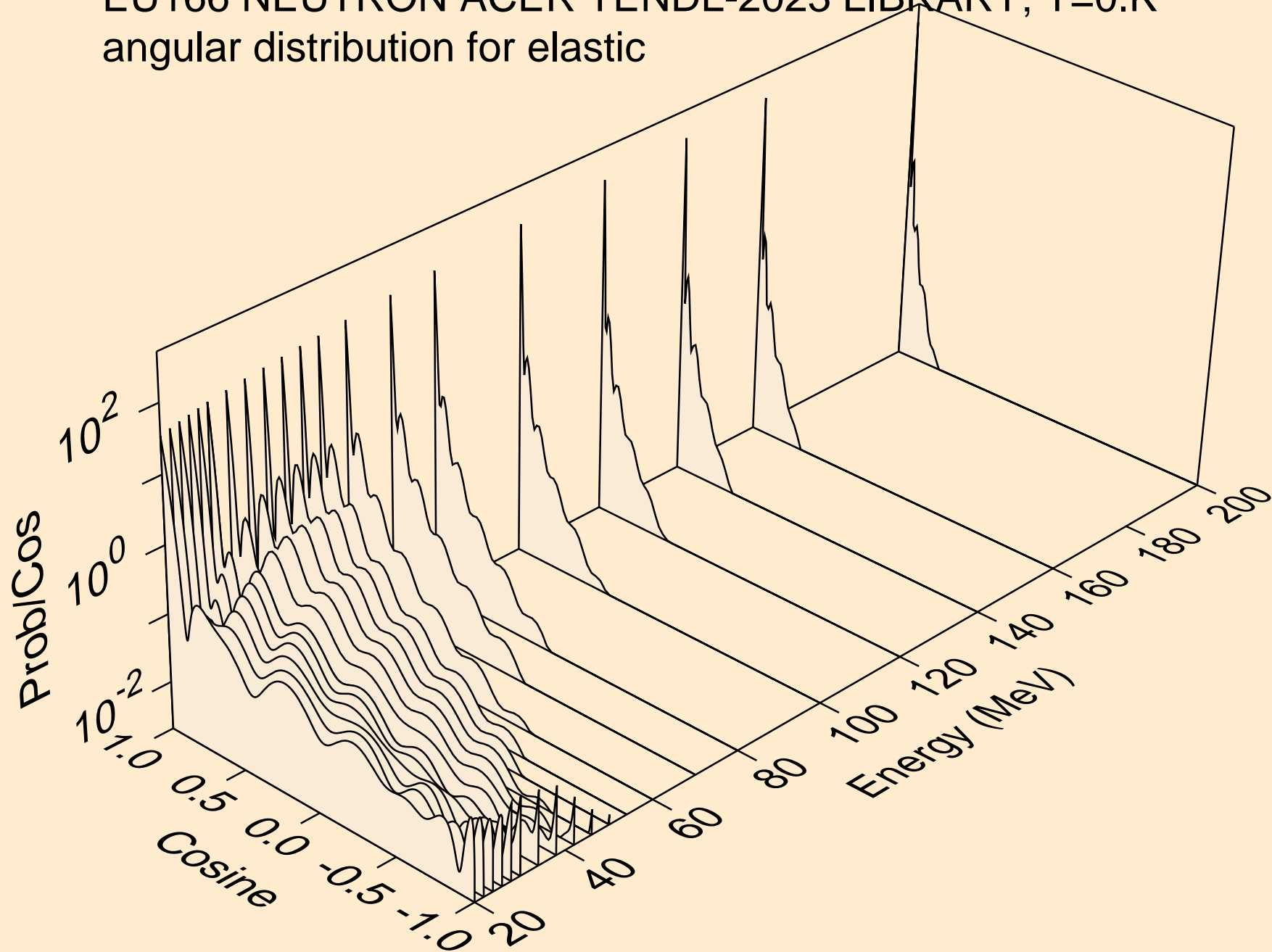

EU166 NEUTRON ACER TENDL-2023 LIBRARY; T=0.K  
angular distribution for (n,n\*1)

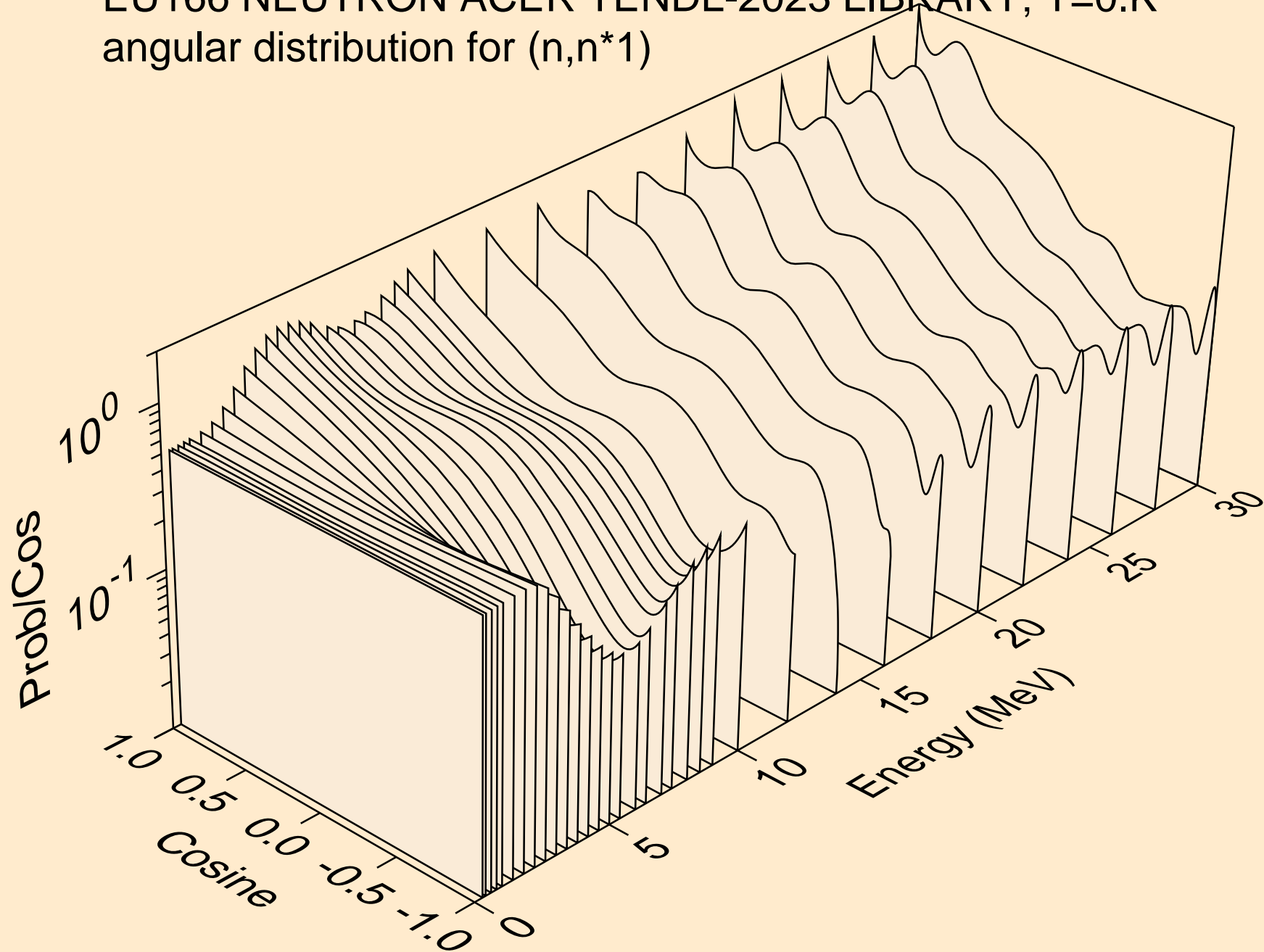

EU166 NEUTRON ACER TENDL-2023 LIBRARY; T=0.K  
angular distribution for (n,n\*2)

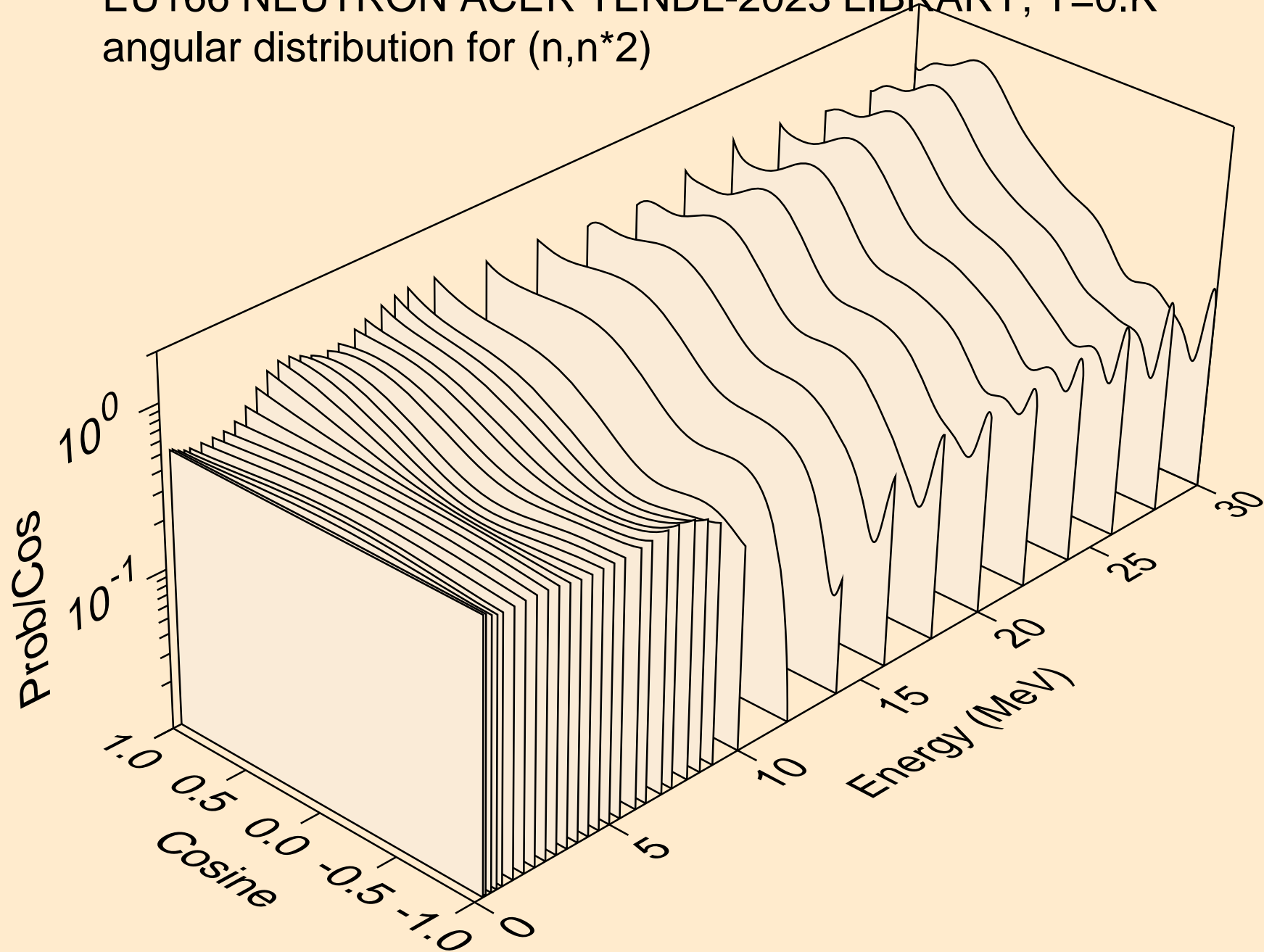

EU166 NEUTRON ACER TENDL-2023 LIBRARY; T=0.K  
angular distribution for (n,n\*3)

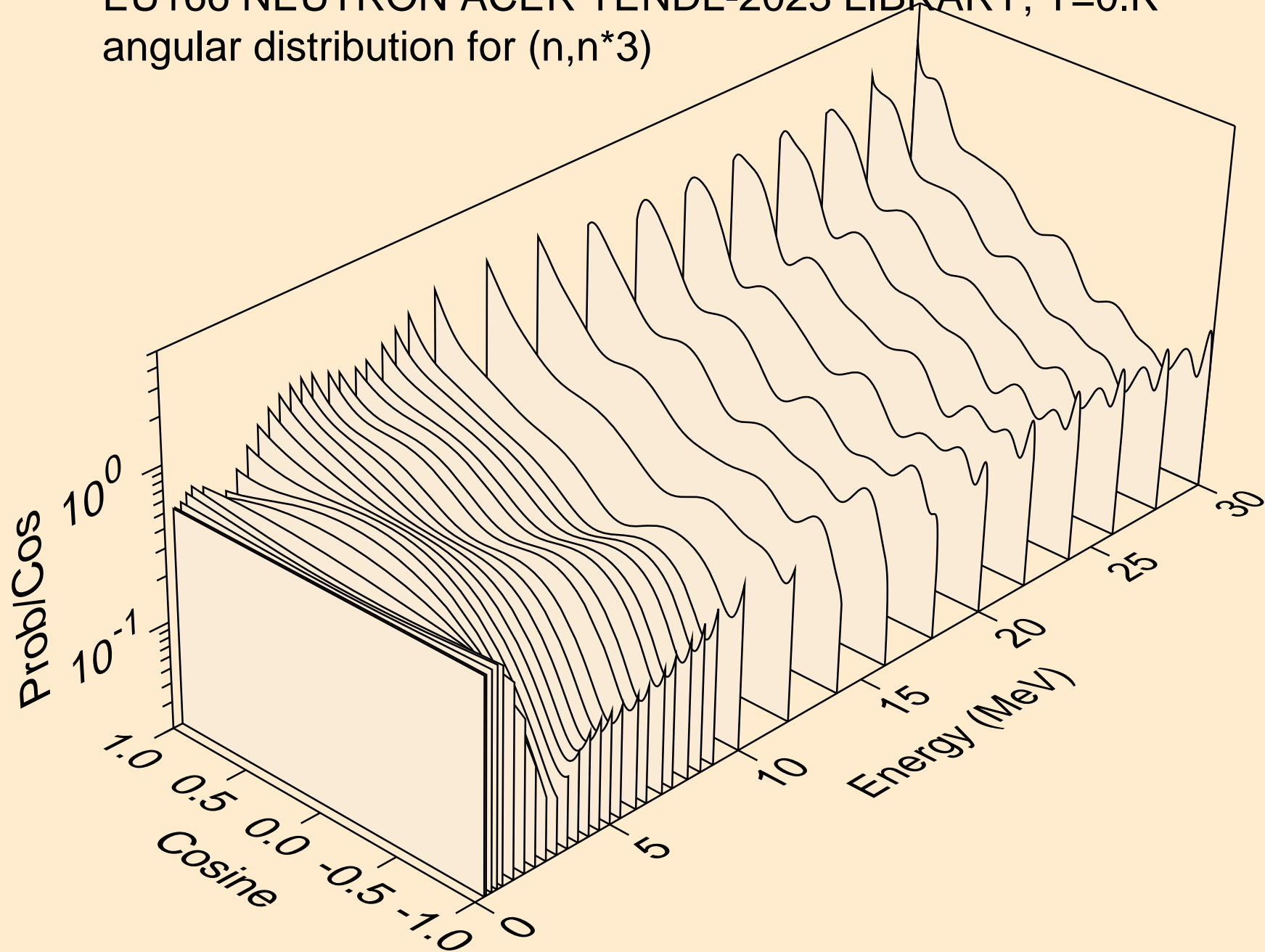

EU166 NEUTRON ACER TENDL-2023 LIBRARY; T=0.K  
angular distribution for (n,n\*4)

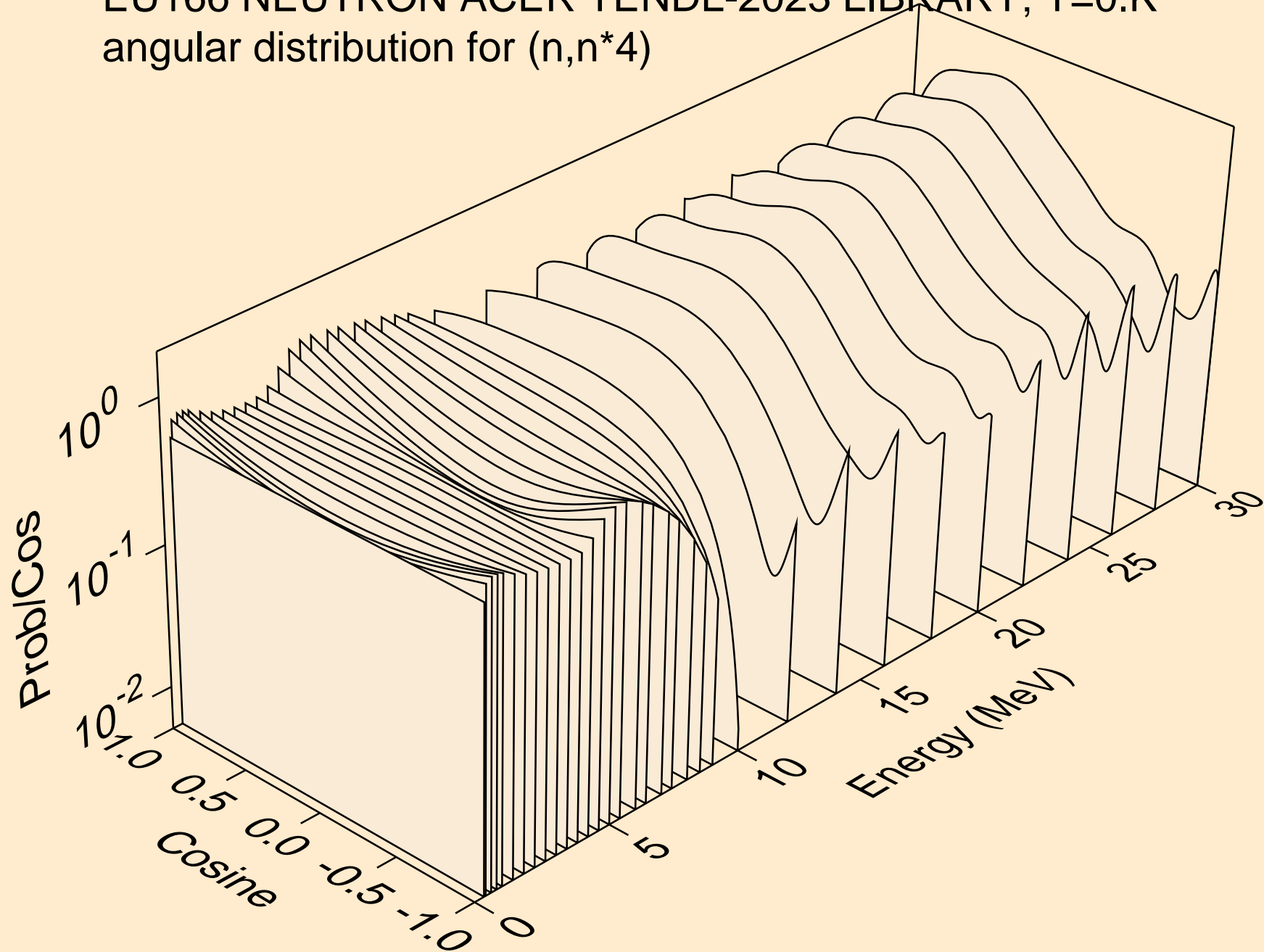

EU166 NEUTRON ACER TENDL-2023 LIBRARY; T=0.K  
angular distribution for (n,n\*5)

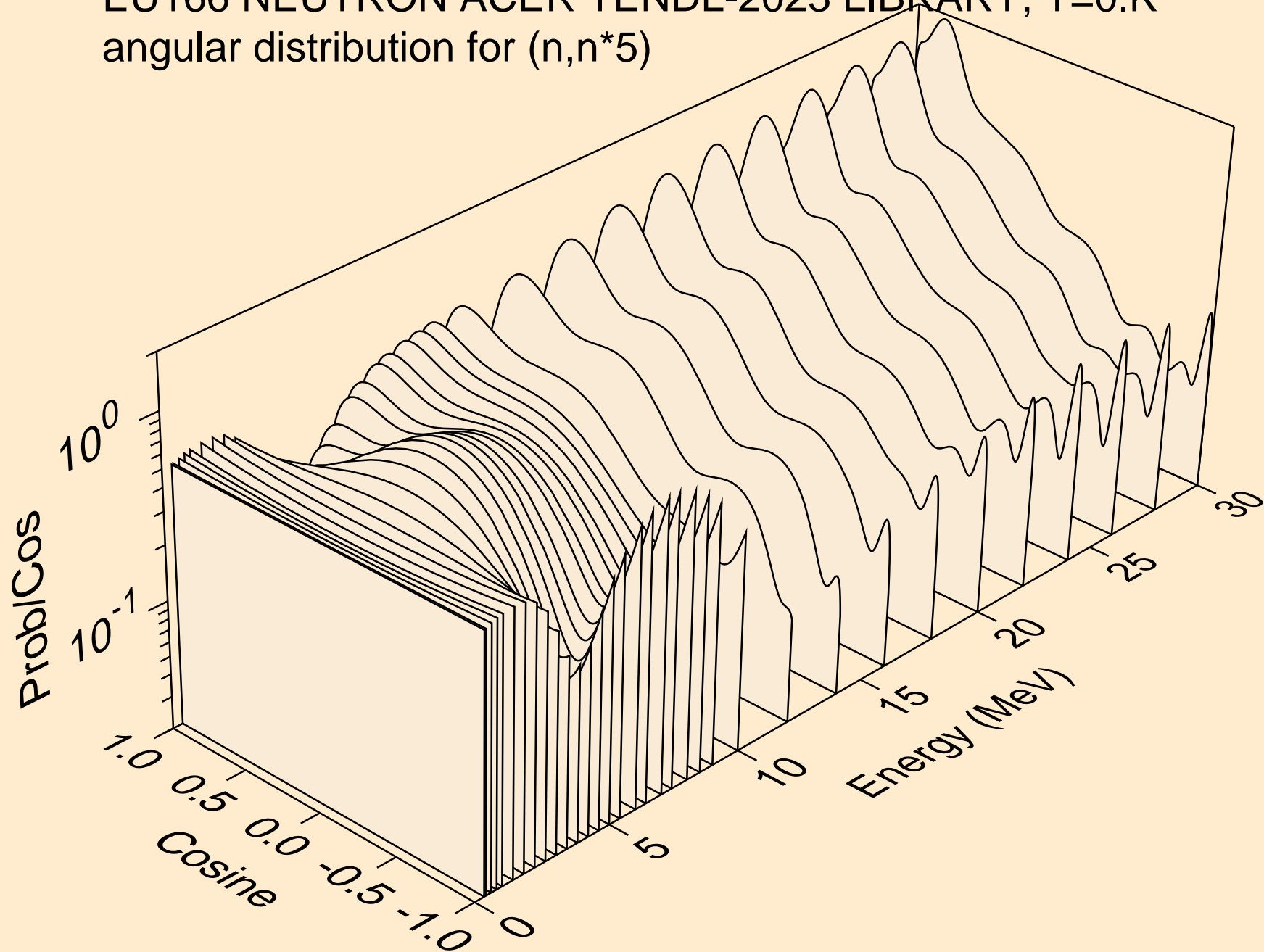



EU166 NEUTRON ACER TENDL-2023 LIBRARY; T=0.K  
angular distribution for (n,n\*6)

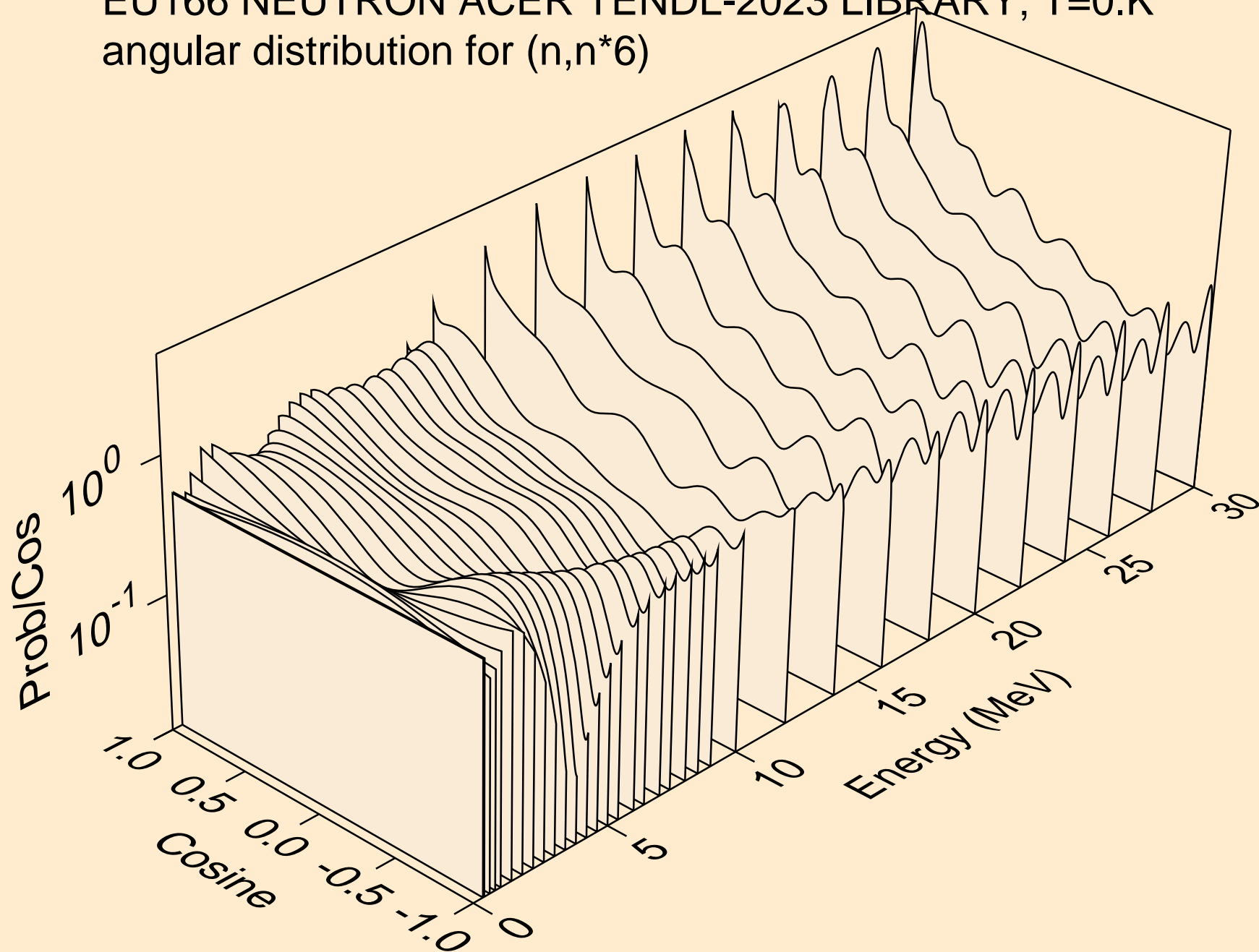

EU166 NEUTRON ACER TENDL-2023 LIBRARY; T=0.K  
angular distribution for (n,n\*7)

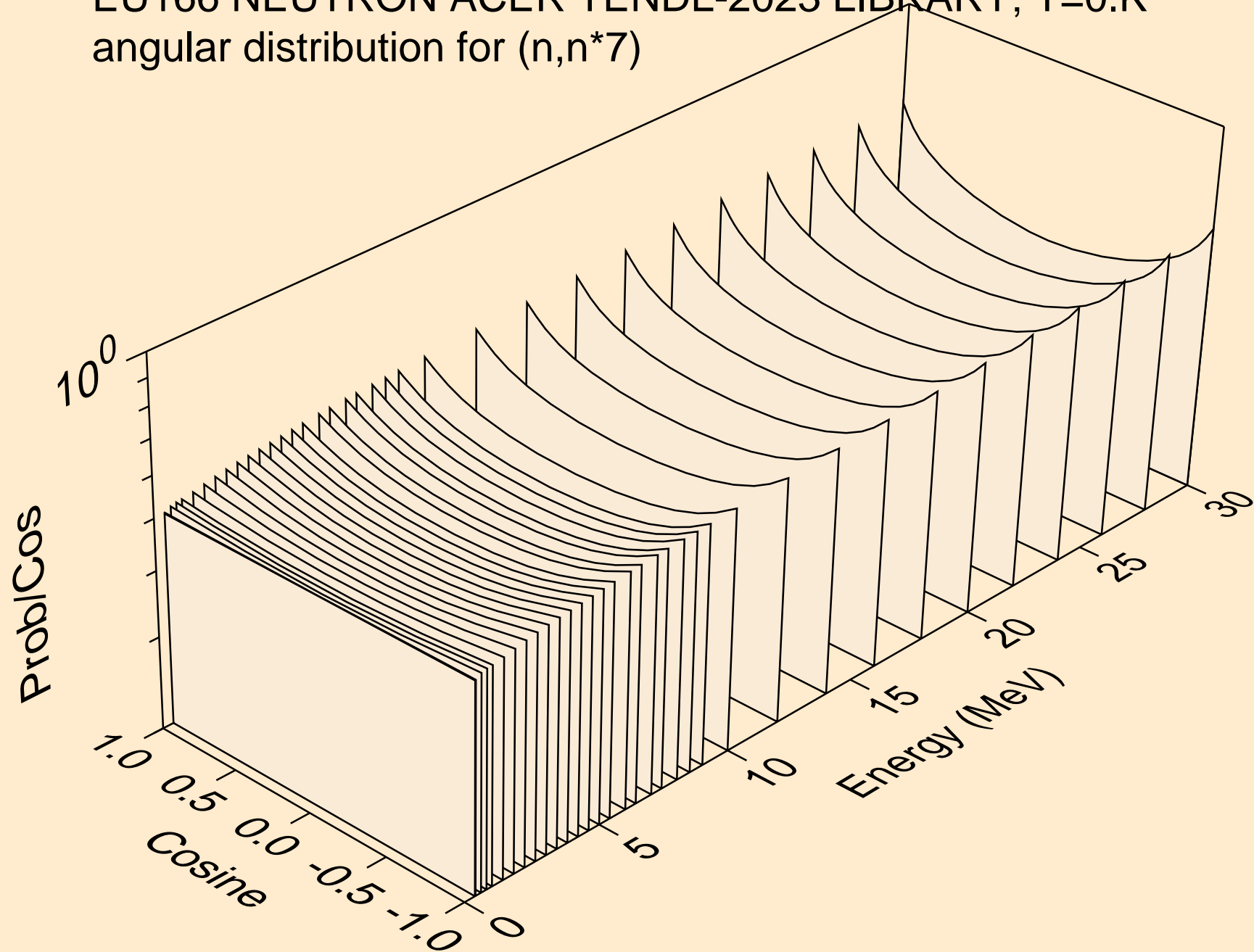

EU166 NEUTRON ACER TENDL-2023 LIBRARY; T=0.K  
angular distribution for (n,n\*8)

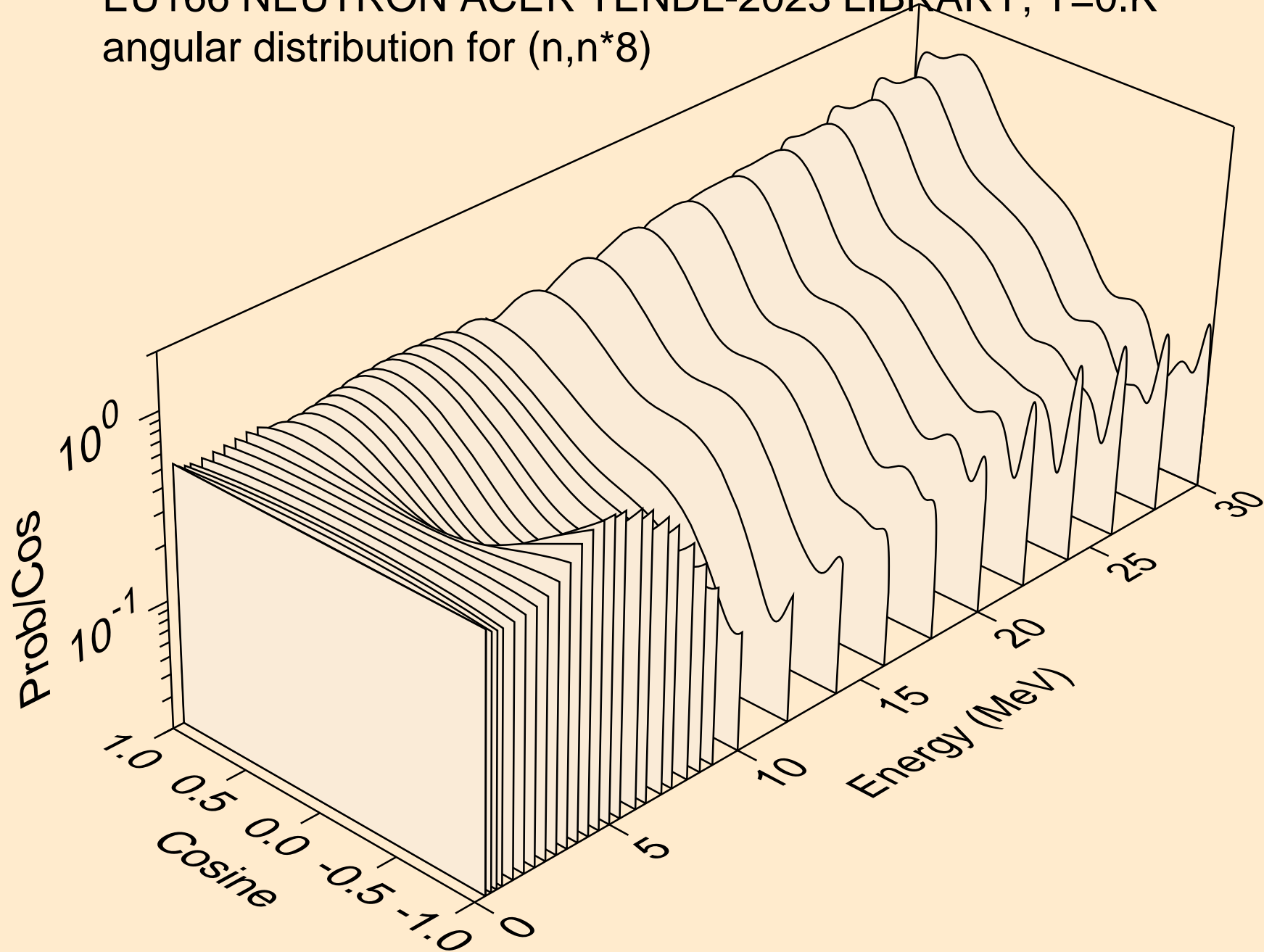

EU166 NEUTRON ACER TENDL-2023 LIBRARY; T=0.K  
angular distribution for (n,n\*9)

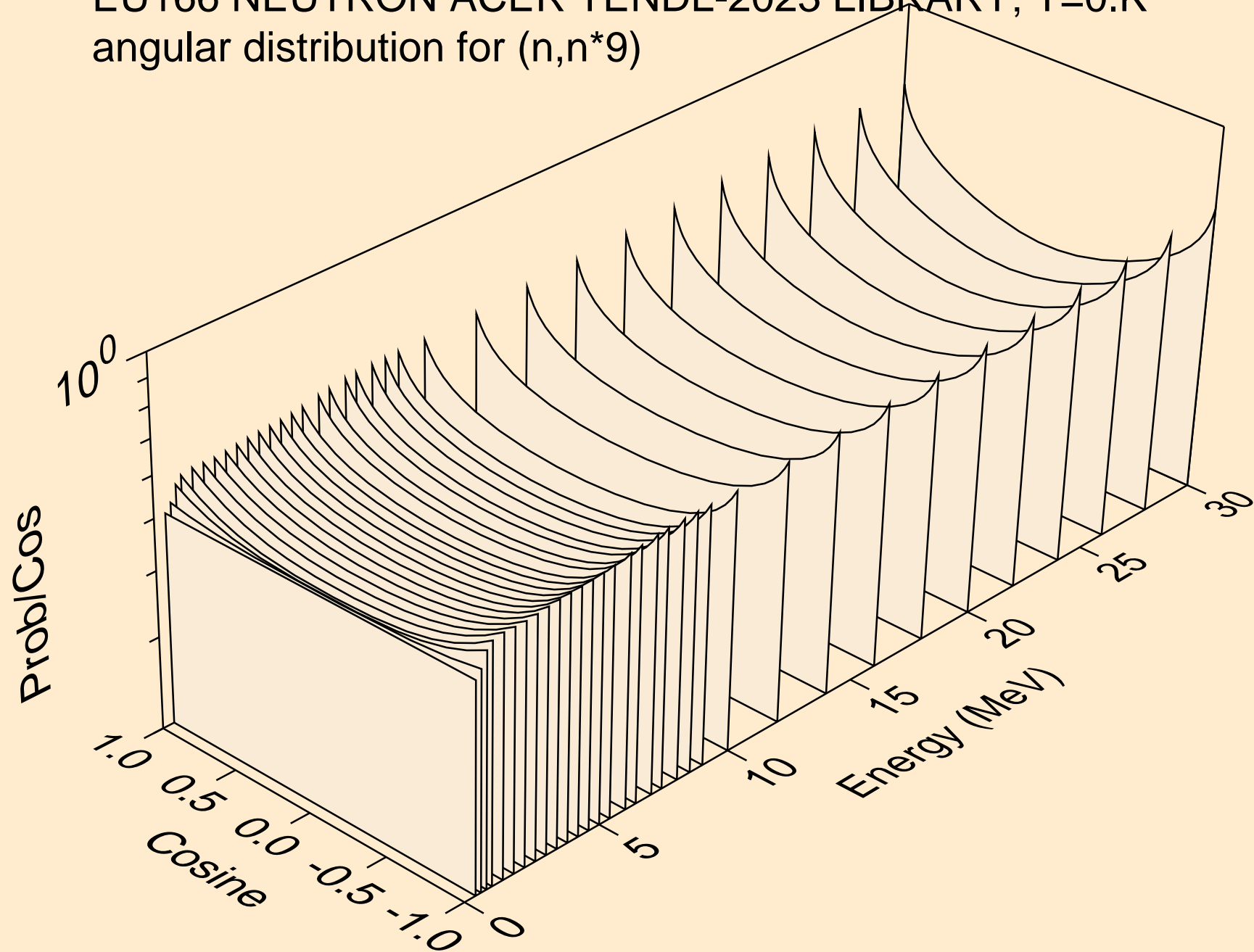

EU166 NEUTRON ACER TENDL-2023 LIBRARY; T=0.K  
angular distribution for (n,n\*10)

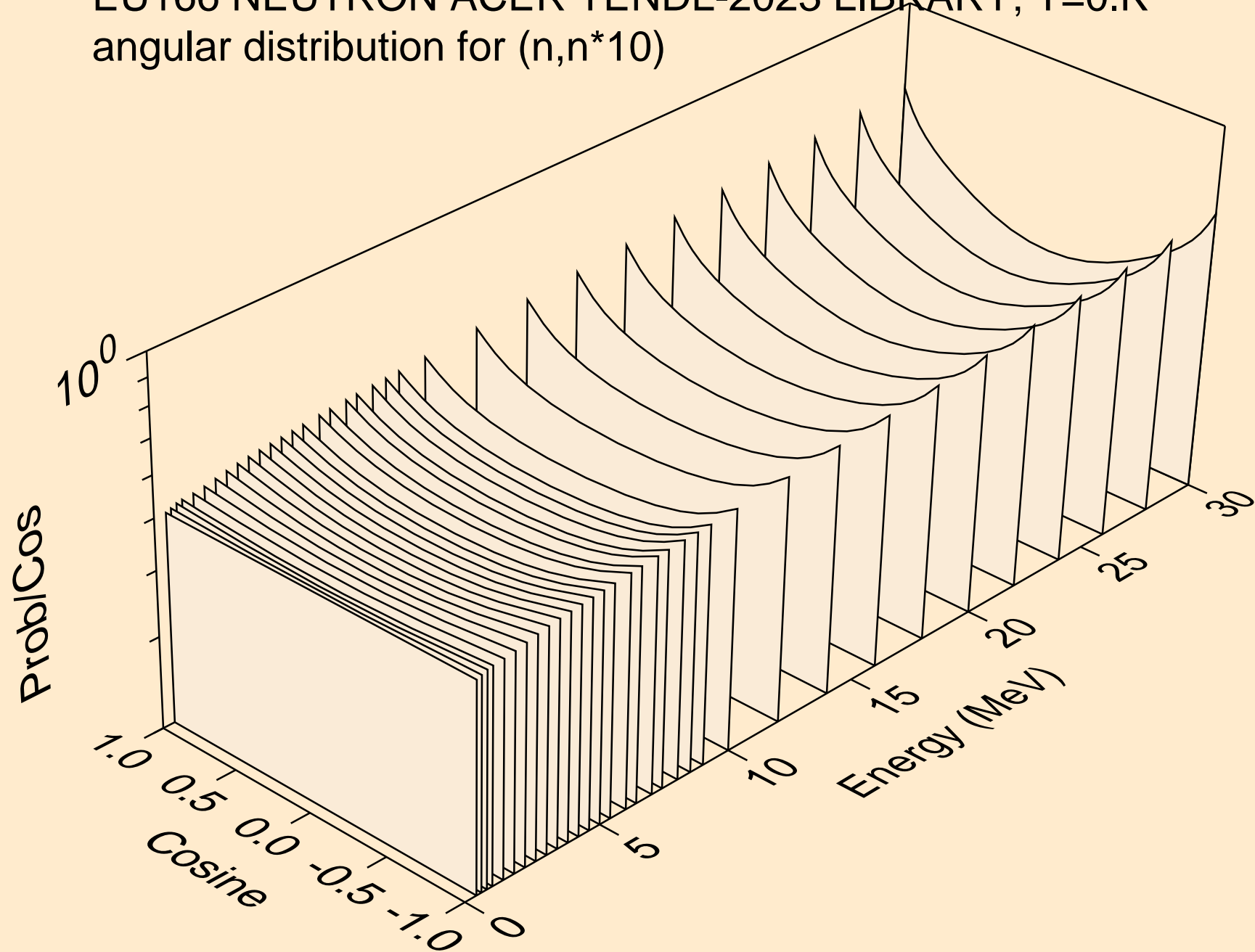

EU166 NEUTRON ACER TENDL-2023 LIBRARY; T=0.K  
angular distribution for (n,n\*11)

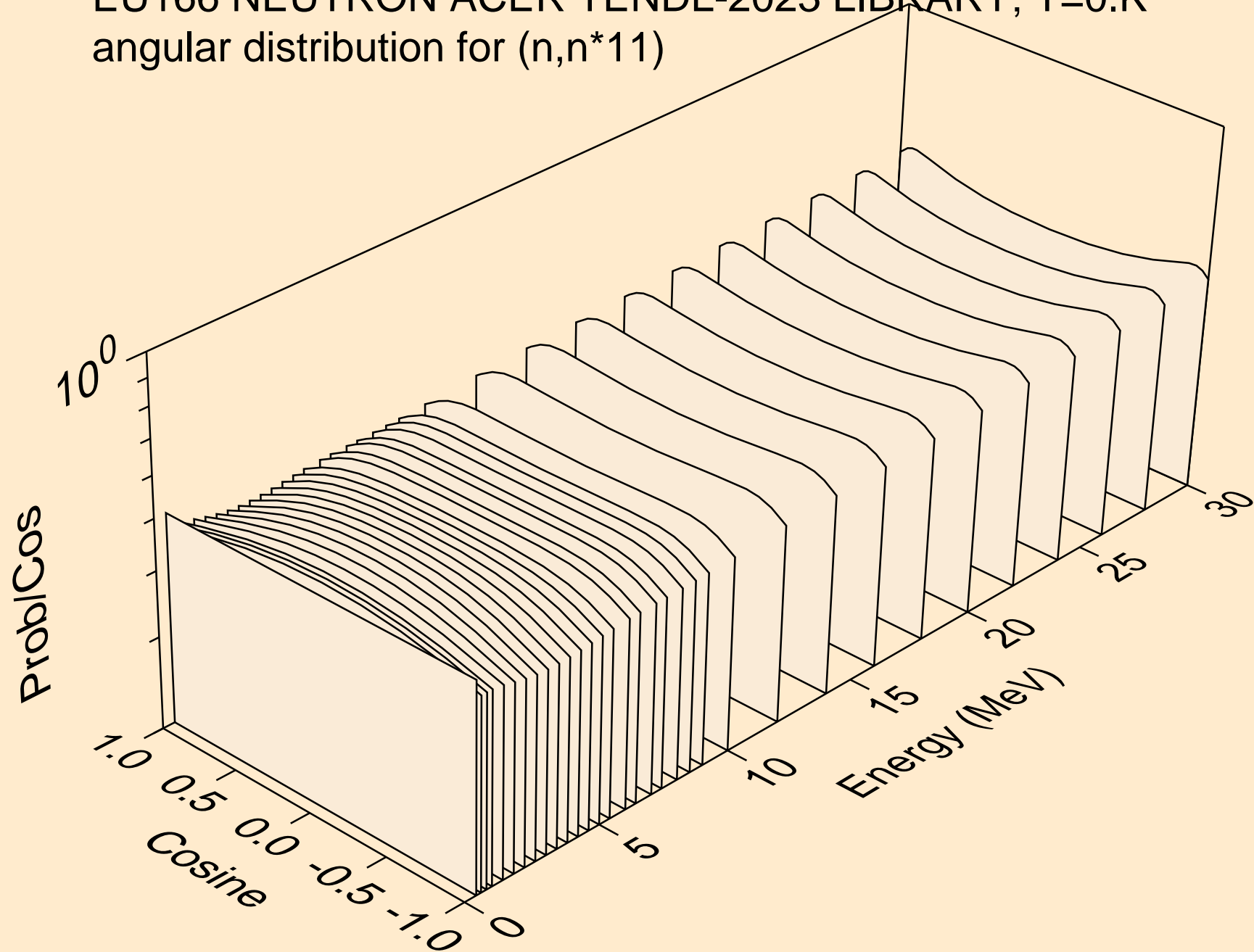

EU166 NEUTRON ACER TENDL-2023 LIBRARY; T=0.K  
angular distribution for (n,n\*12)

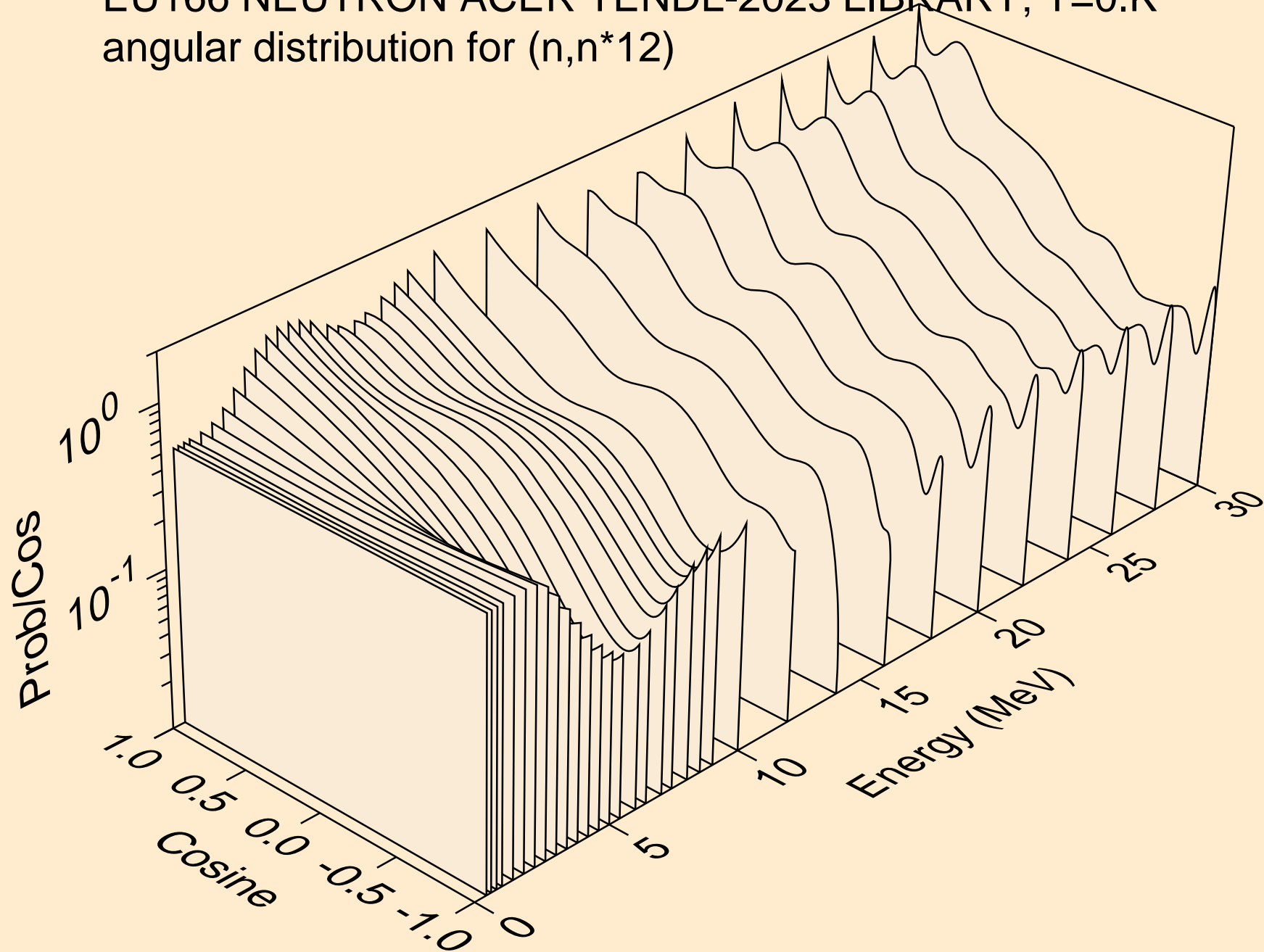

EU166 NEUTRON ACER TENDL-2023 LIBRARY; T=0.K  
angular distribution for (n,n\*13)

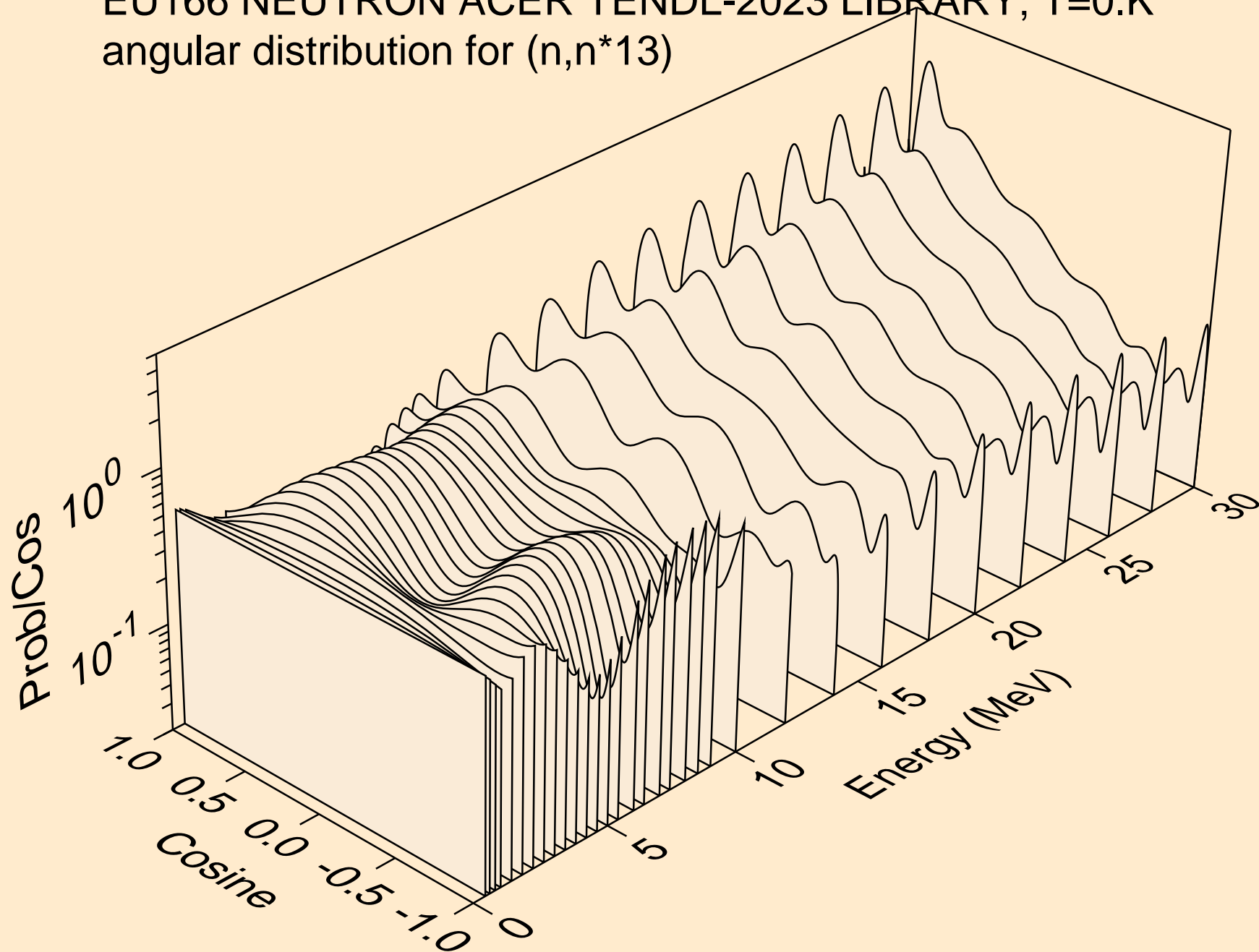



EU166 NEUTRON ACER TENDL-2023 LIBRARY; T=0.K  
angular distribution for (n,n\*14)

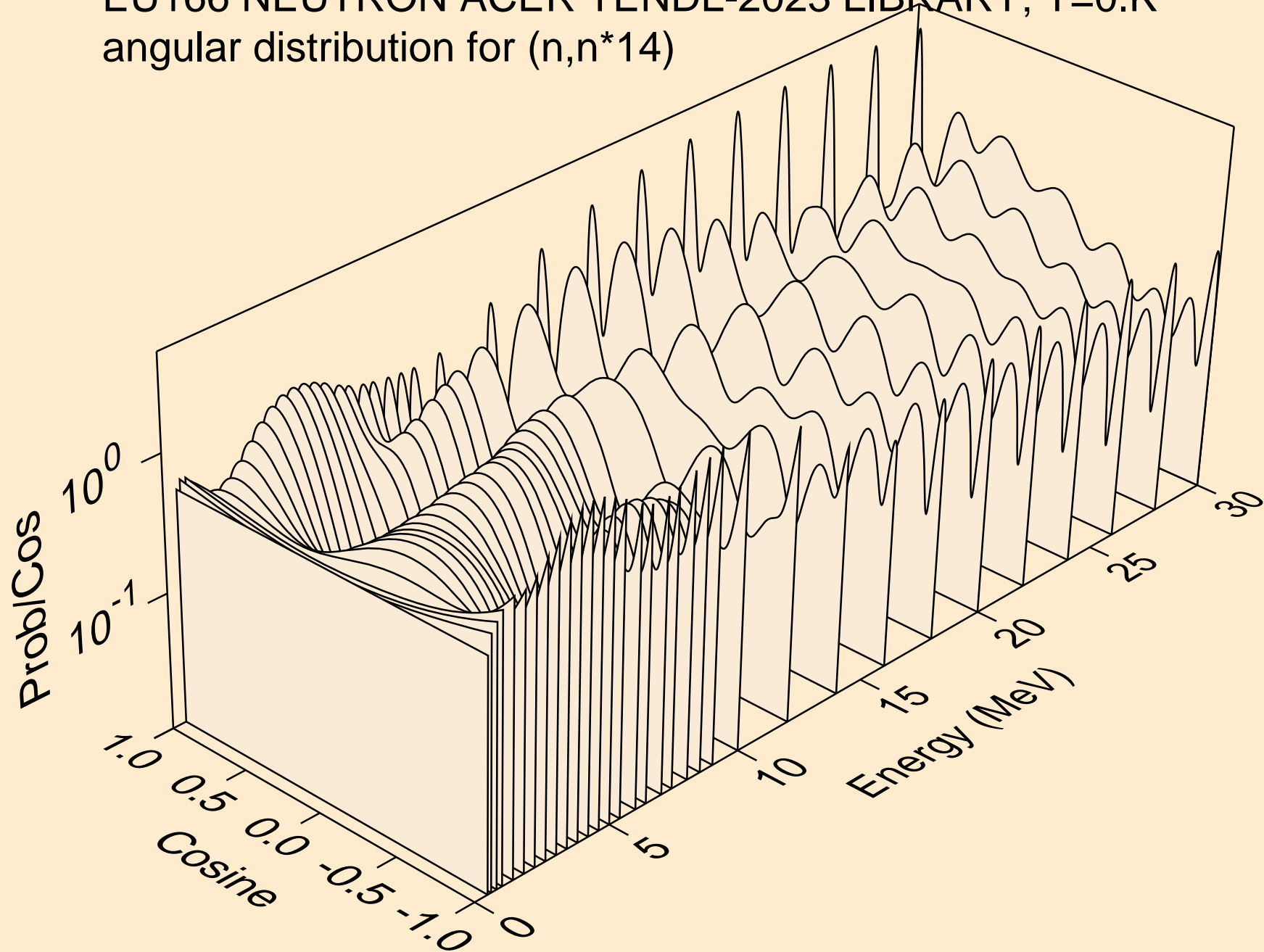

EU166 NEUTRON ACER TENDL-2023 LIBRARY; T=0.K  
angular distribution for (n,n\*15)

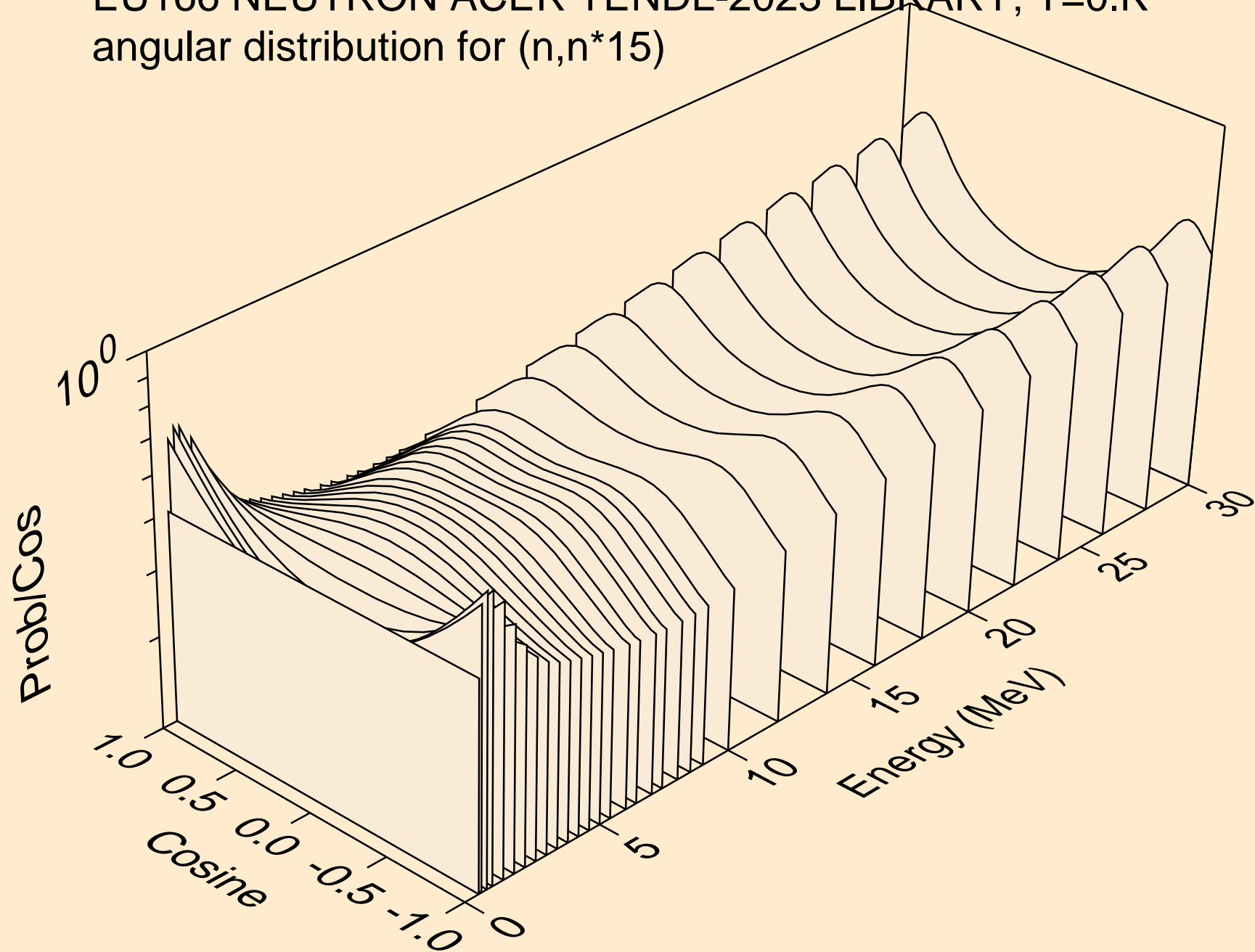

EU166 NEUTRON ACER TENDL-2023 LIBRARY; T=0.K  
angular distribution for (n,n\*16)

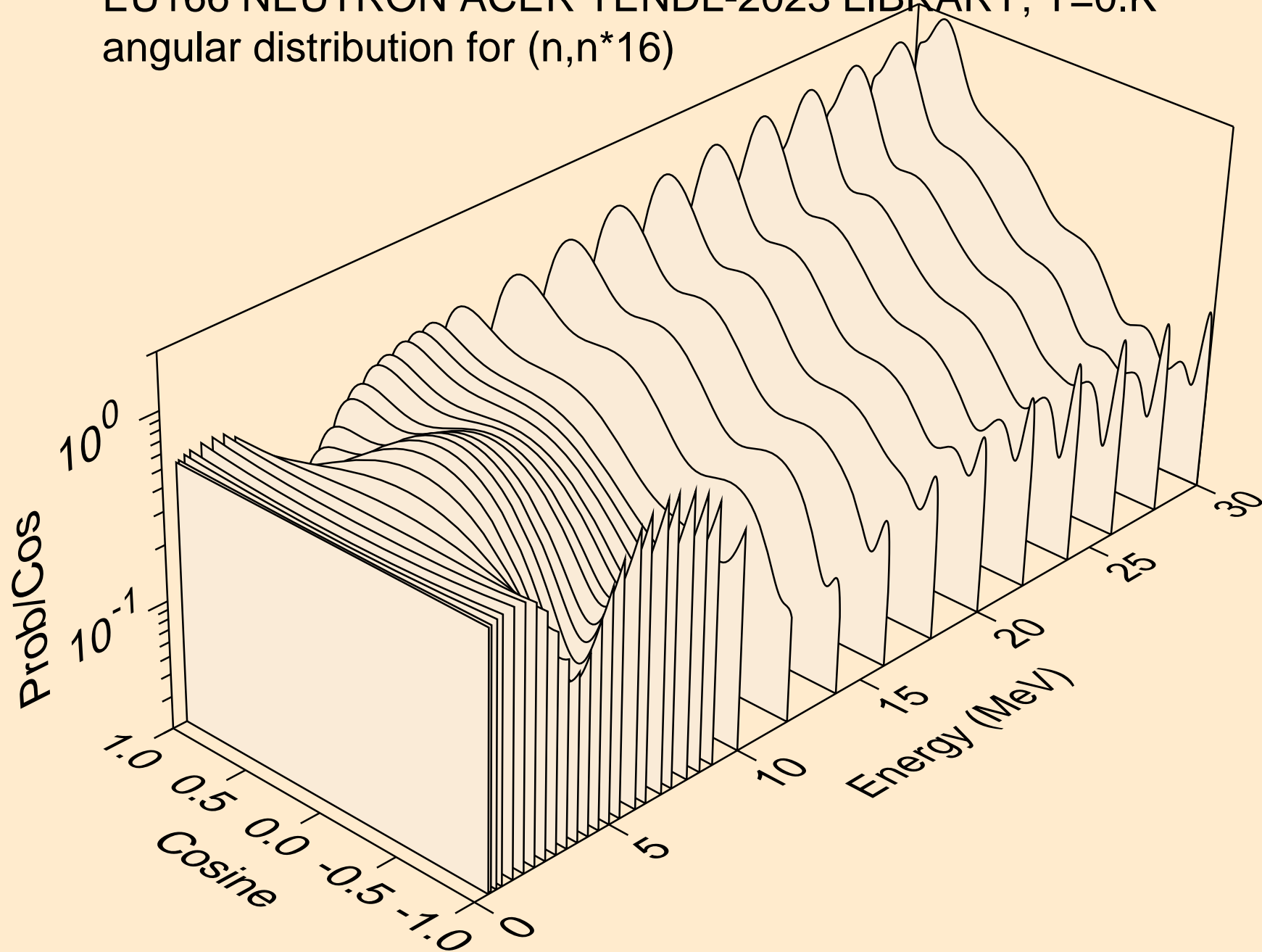

EU166 NEUTRON ACER TENDL-2023 LIBRARY; T=0.K  
angular distribution for (n,n\*17)

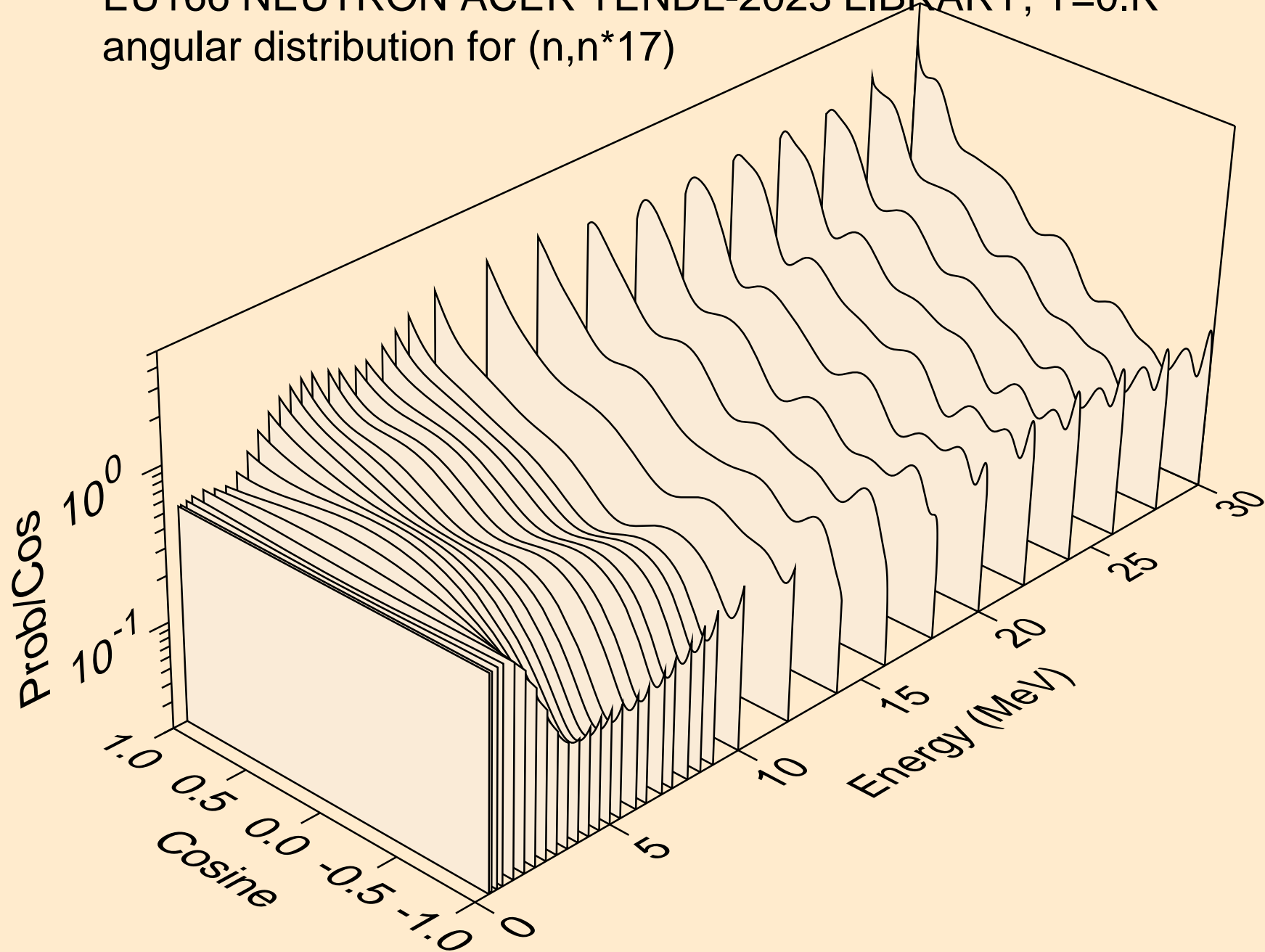

EU166 NEUTRON ACER TENDL-2023 LIBRARY; T=0.K  
angular distribution for (n,n\*18)

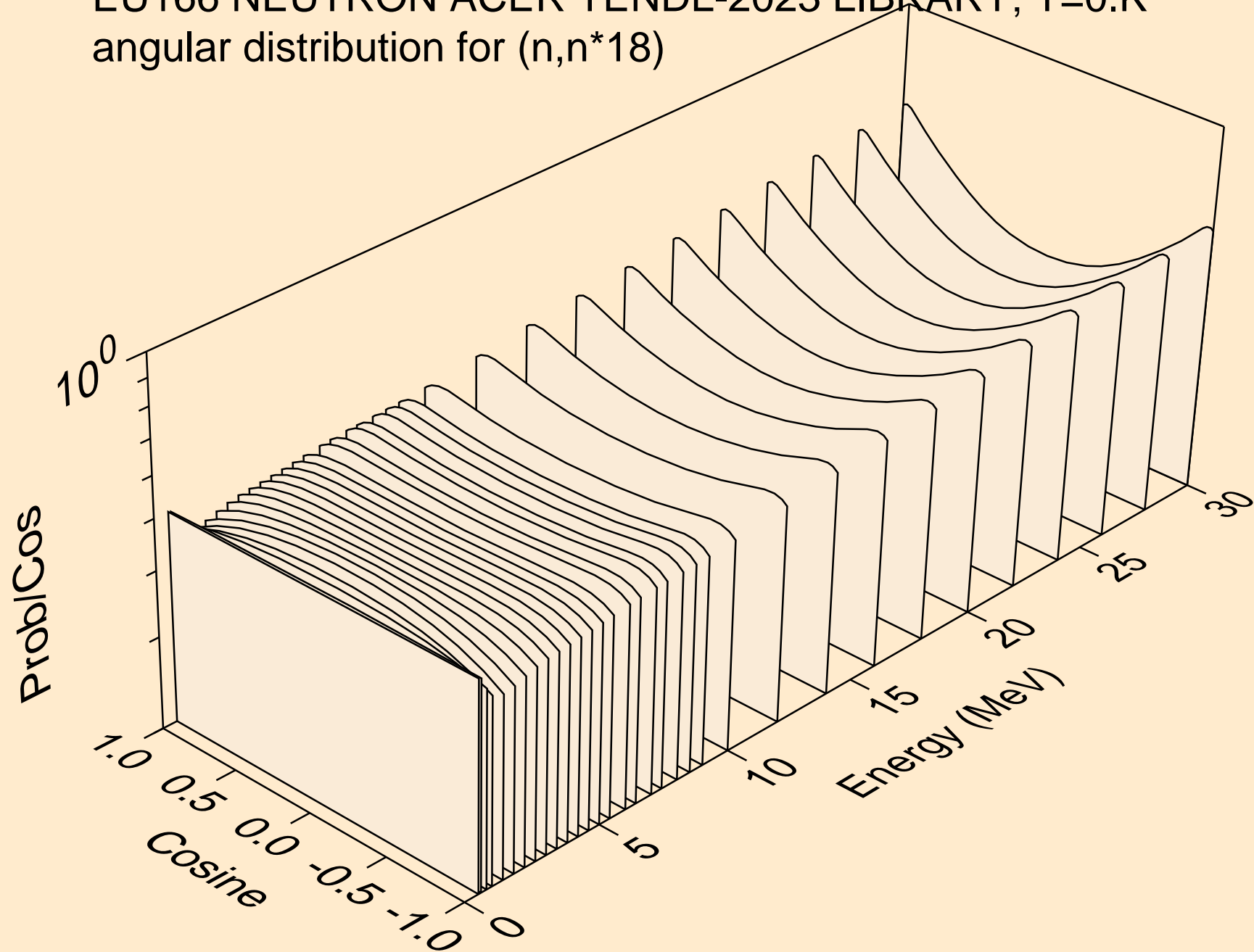

EU166 NEUTRON ACER TENDL-2023 LIBRARY; T=0.K  
angular distribution for (n,n\*19)

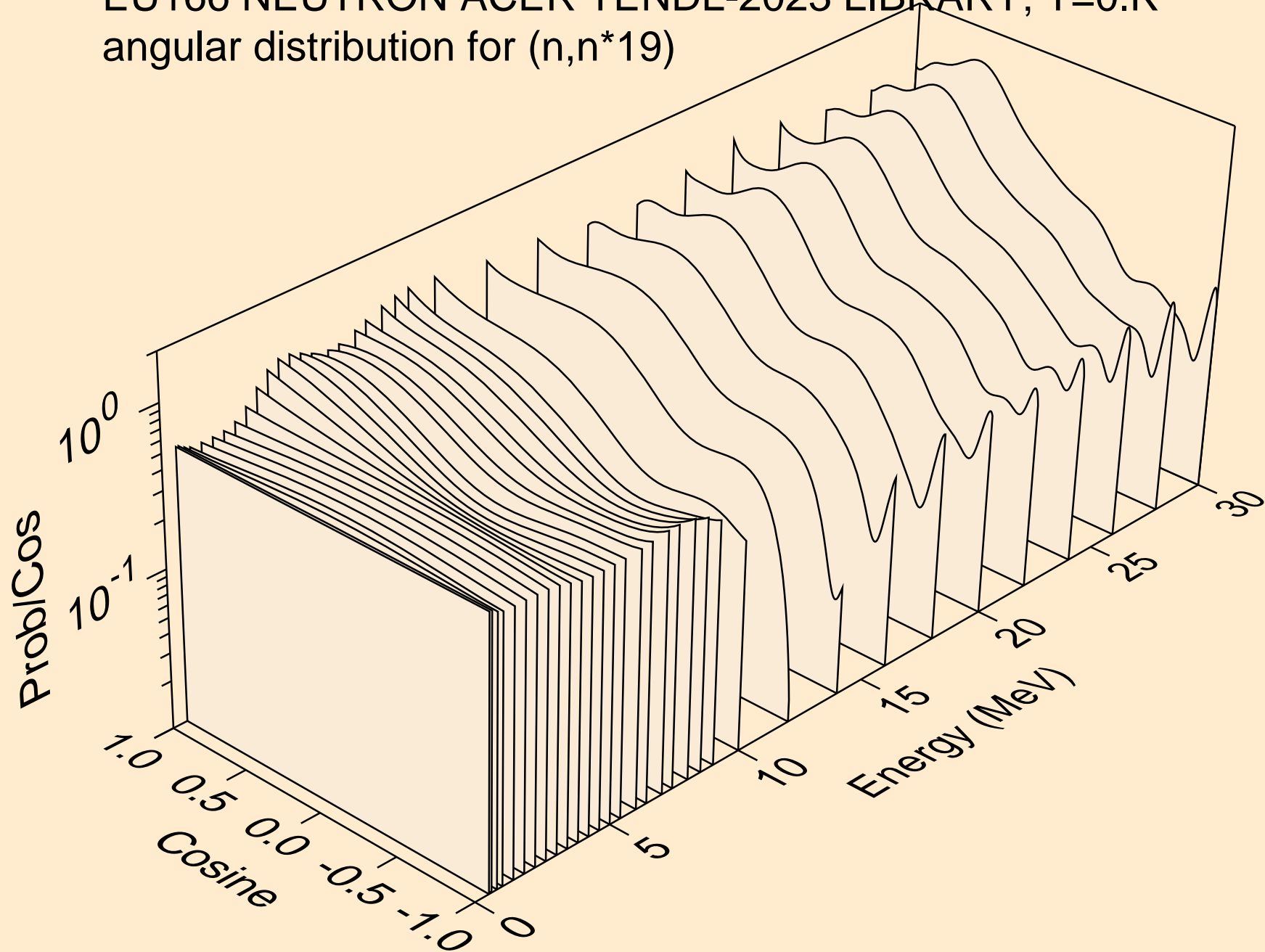

EU166 NEUTRON ACER TENDL-2023 LIBRARY; T=0.K  
angular distribution for (n,n\*20)

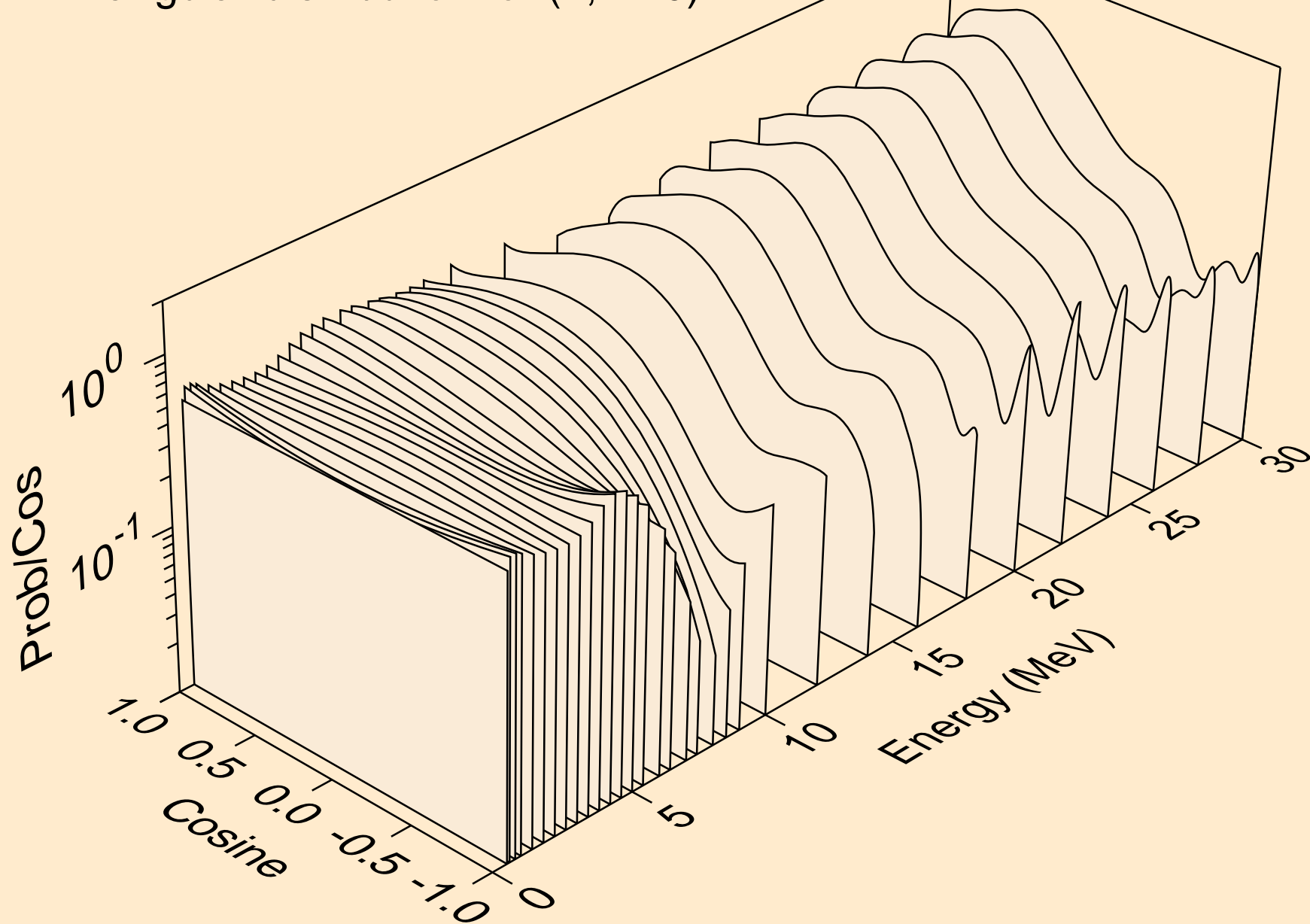

EU166 NEUTRON ACER TENDL-2023 LIBRARY; T=0.K  
angular distribution for (n,n\*21)

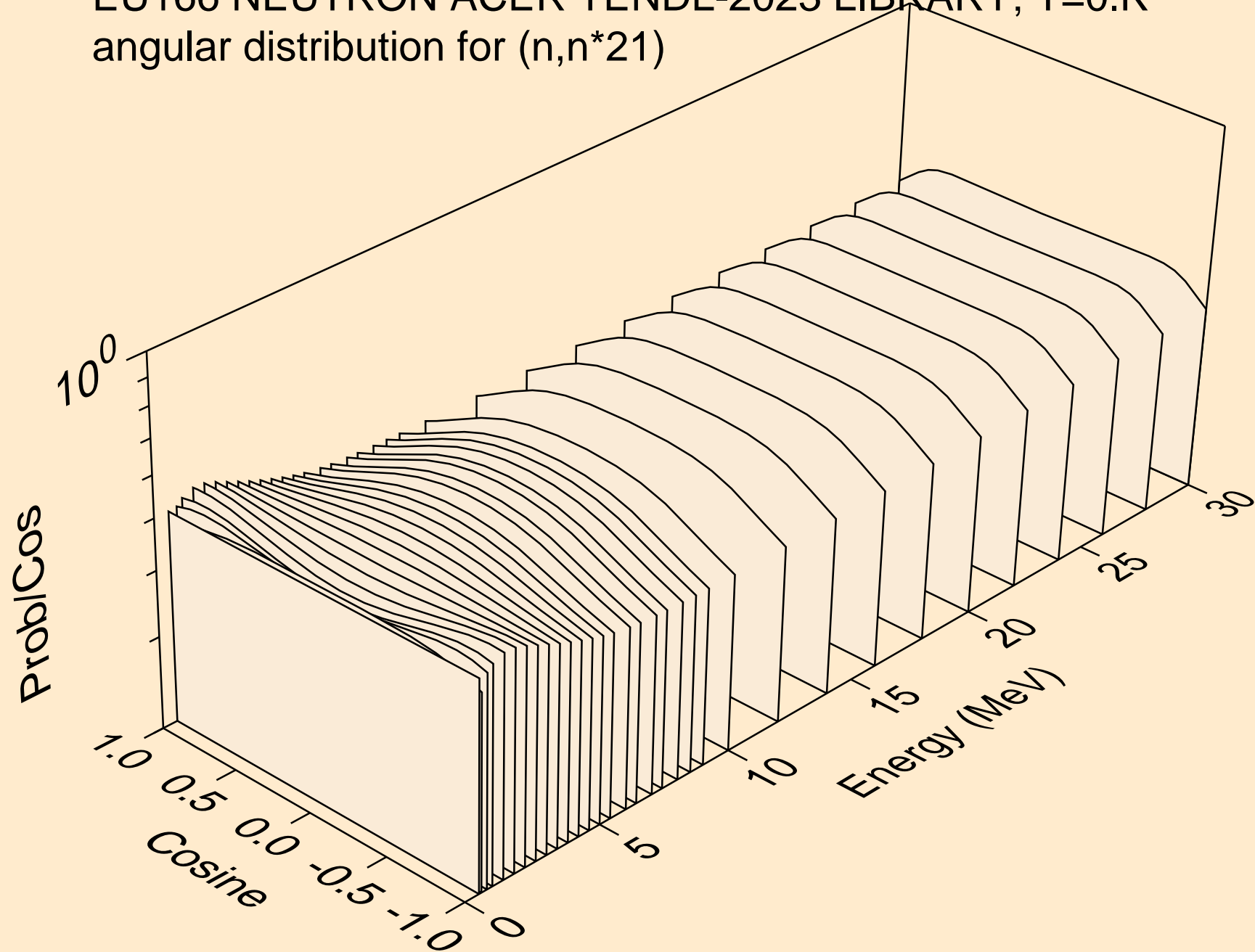



EU166 NEUTRON ACER TENDL-2023 LIBRARY; T=0.K  
angular distribution for (n,n\*22)

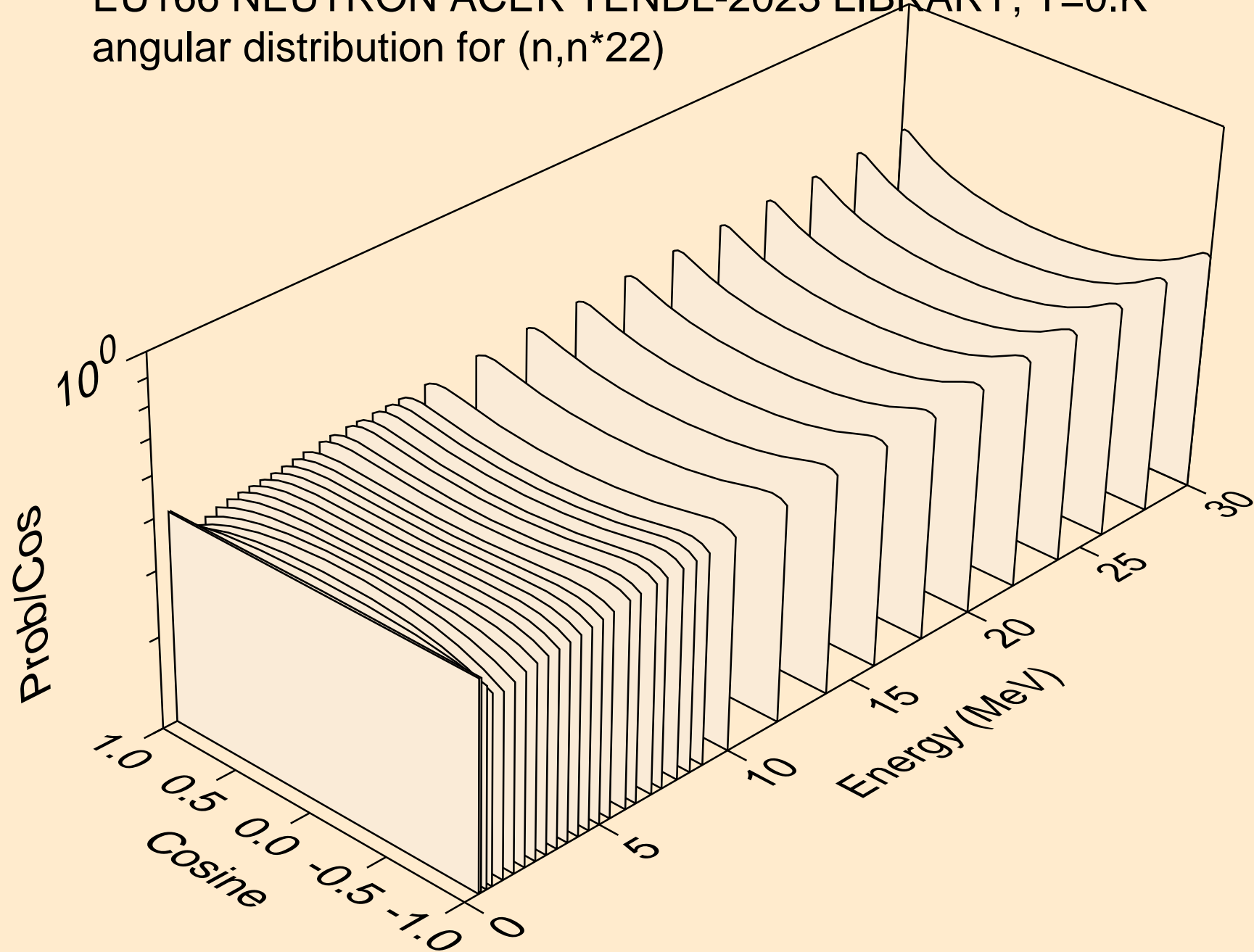

EU166 NEUTRON ACER TENDL-2023 LIBRARY; T=0.K  
angular distribution for (n,n\*23)

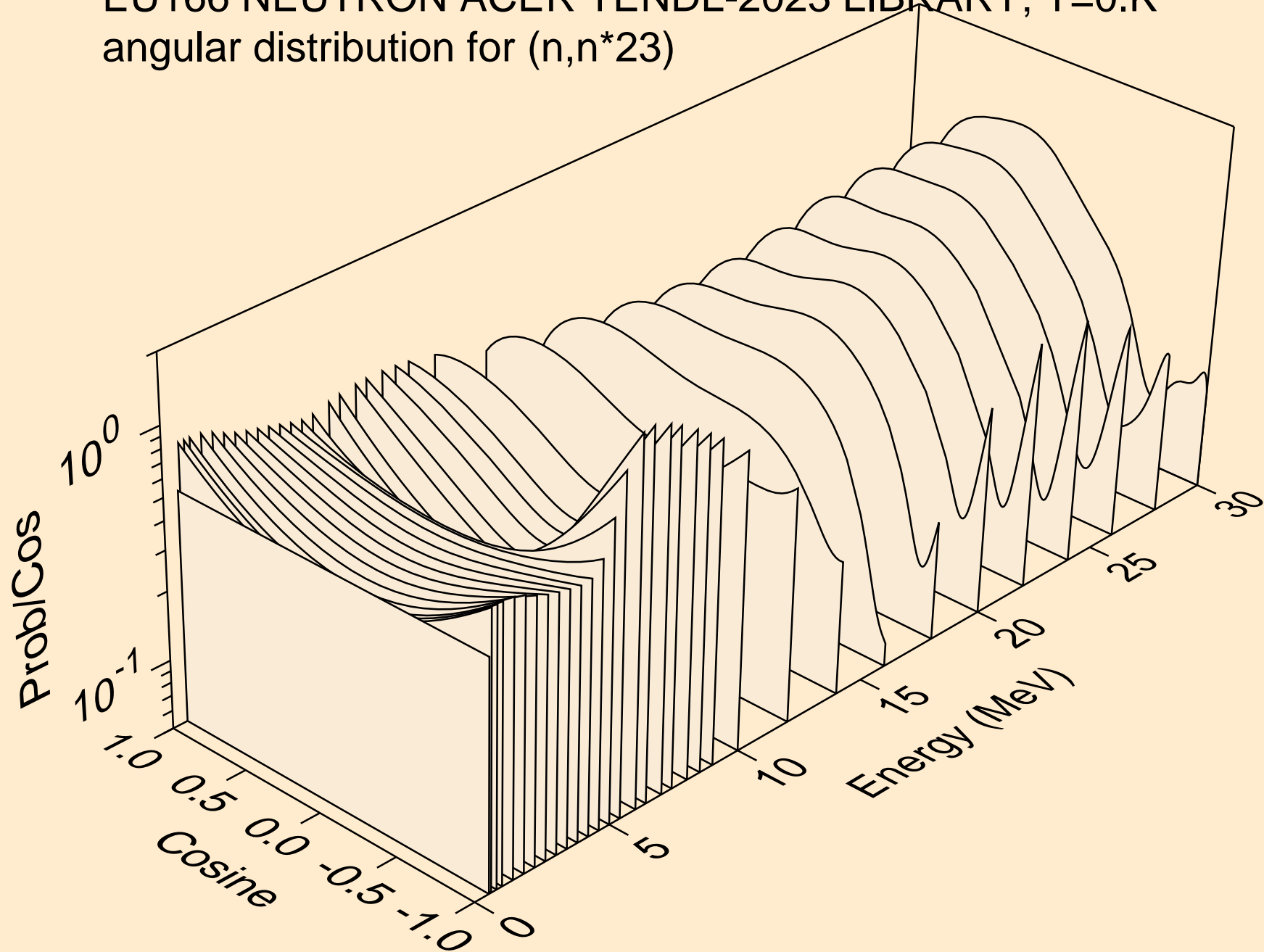

EU166 NEUTRON ACER TENDL-2023 LIBRARY; T=0.K  
angular distribution for (n,n\*24)

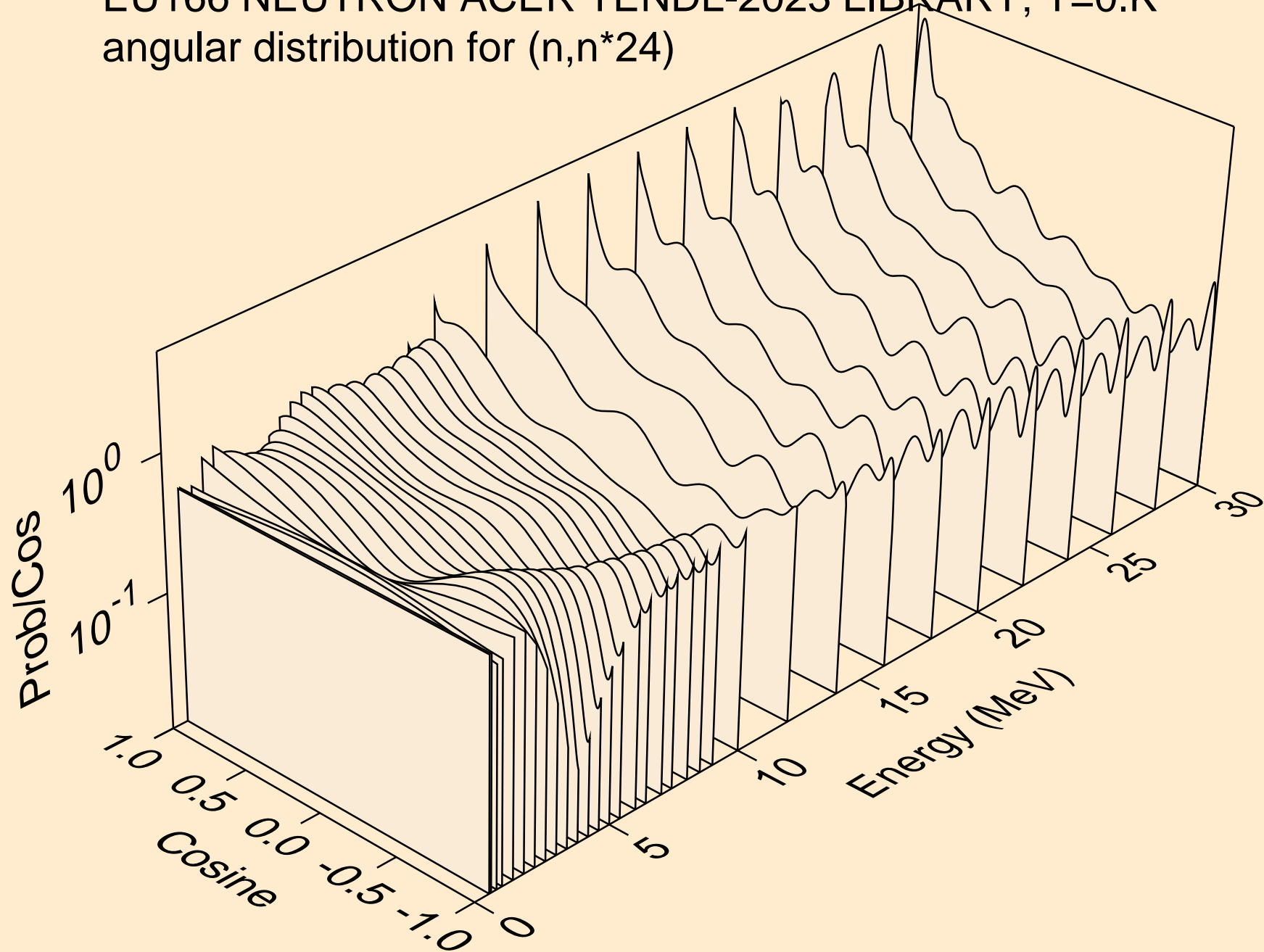

EU166 NEUTRON ACER TENDL-2023 LIBRARY; T=0.K  
angular distribution for (n,n\*25)

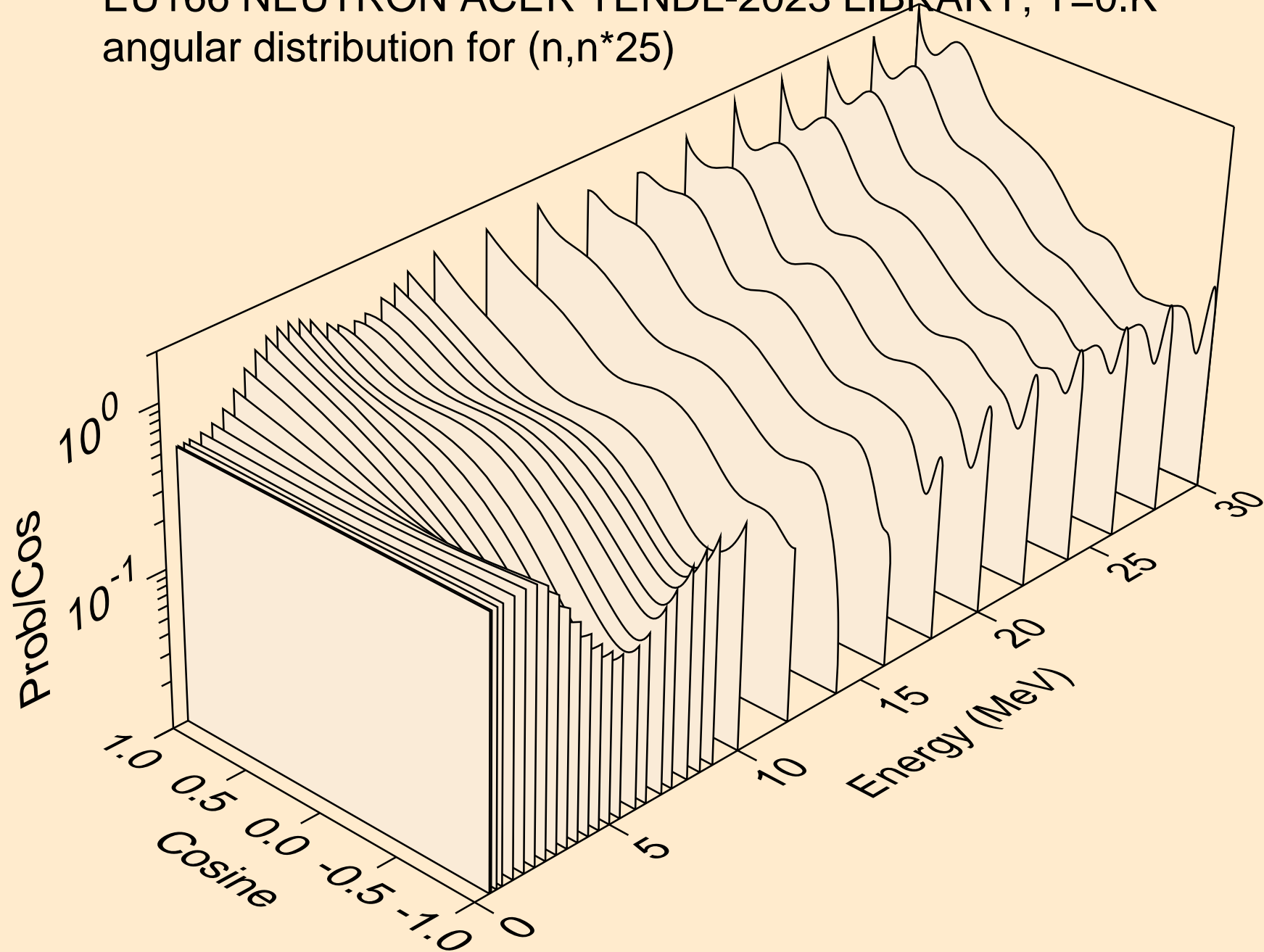

EU166 NEUTRON ACER TENDL-2023 LIBRARY; T=0.K  
angular distribution for (n,n\*26)

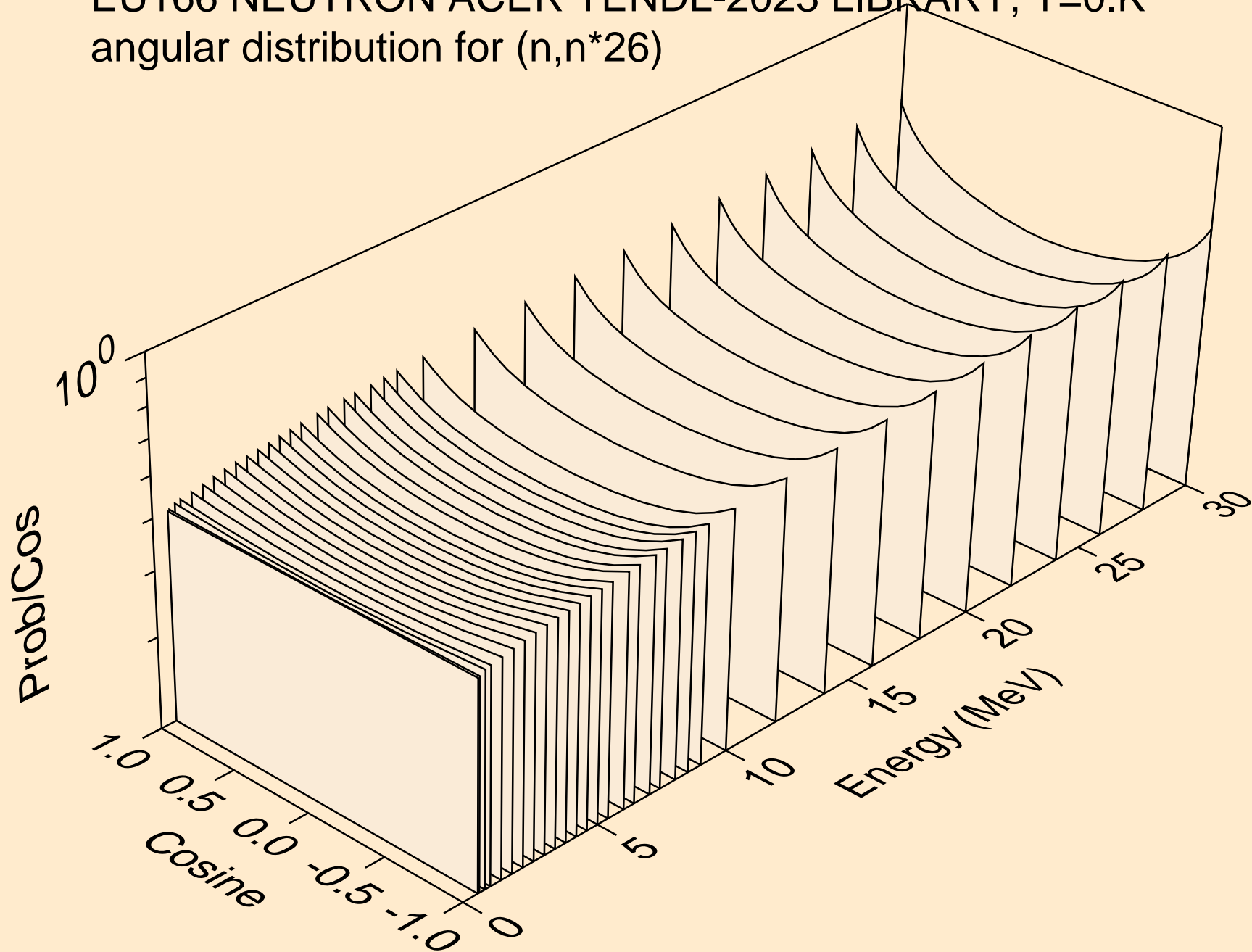

EU166 NEUTRON ACER TENDL-2023 LIBRARY; T=0.K  
angular distribution for (n,n\*27)

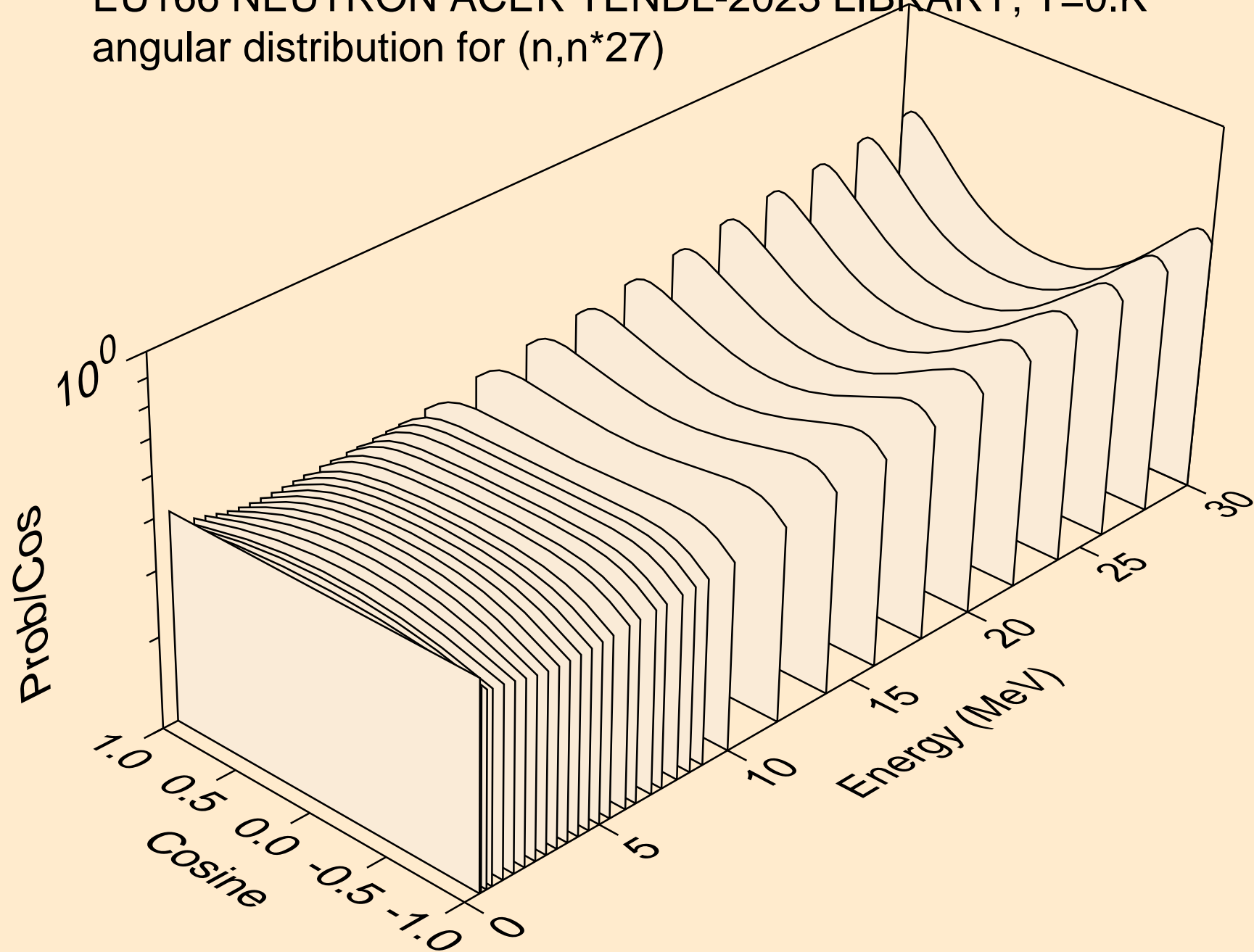

EU166 NEUTRON ACER TENDL-2023 LIBRARY; T=0.K  
angular distribution for (n,n\*28)

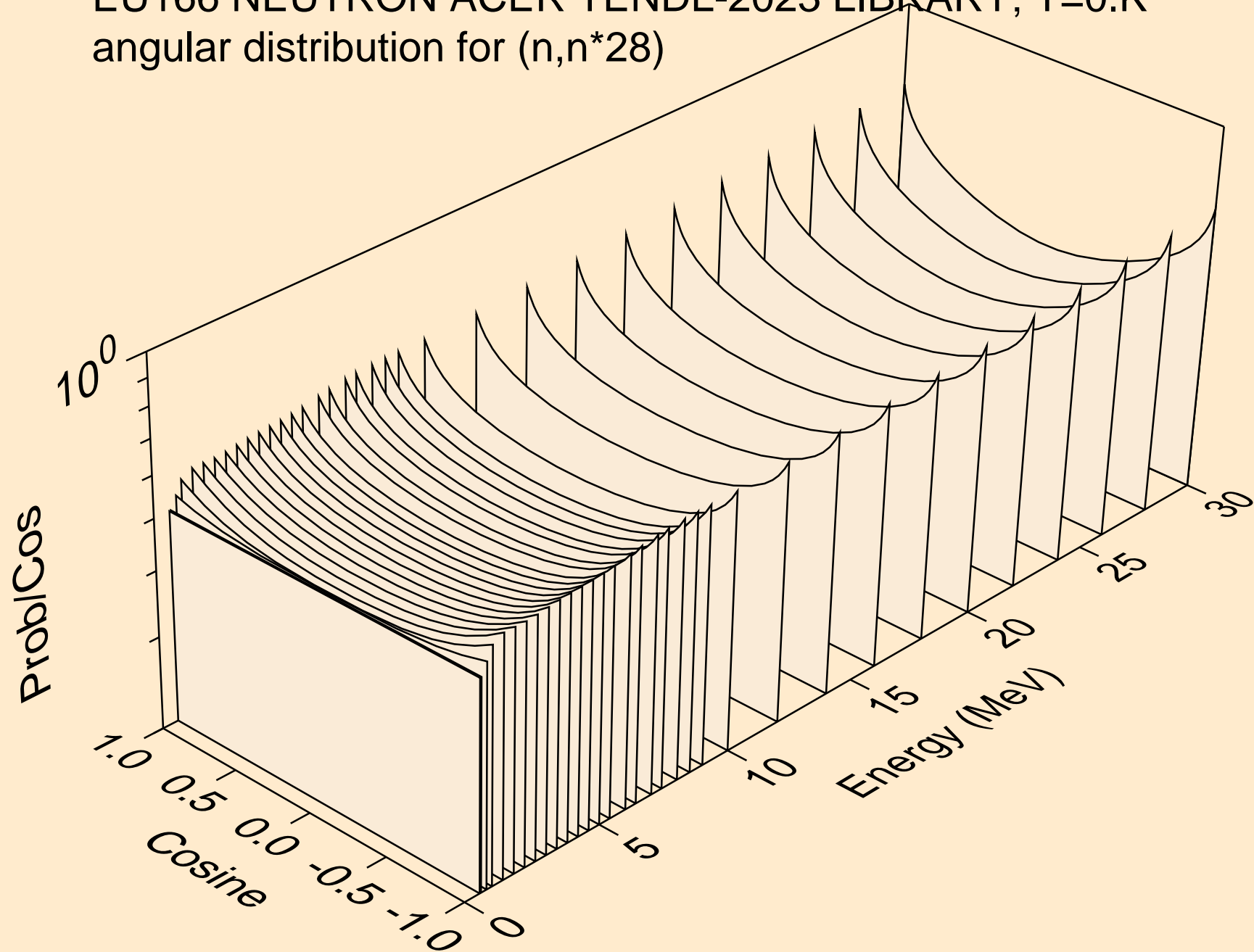

EU166 NEUTRON ACER TENDL-2023 LIBRARY; T=0.K  
angular distribution for (n,n\*29)

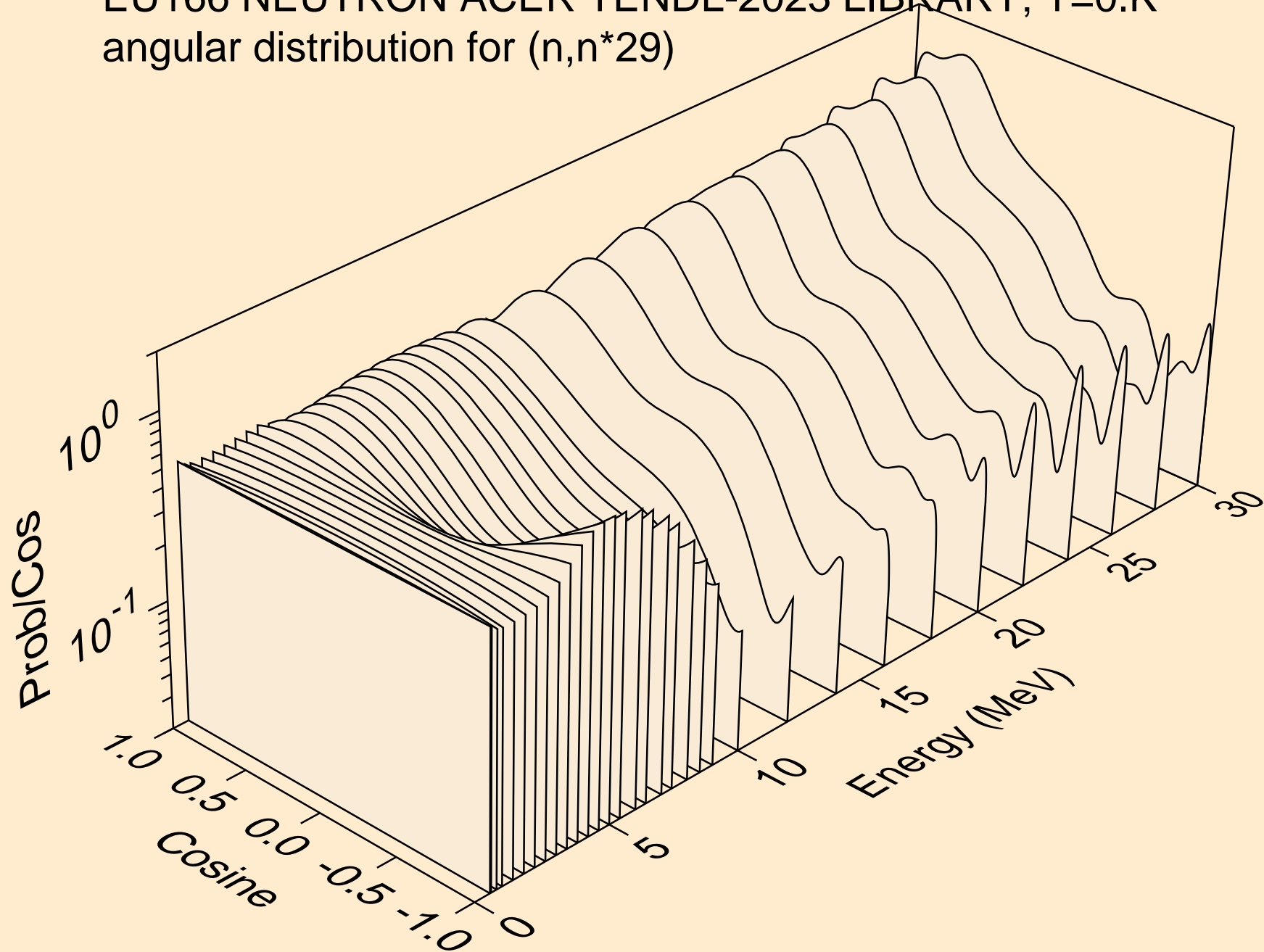



EU166 NEUTRON ACER TENDL-2023 LIBRARY; T=0.K  
Neutron emission for (n,x)

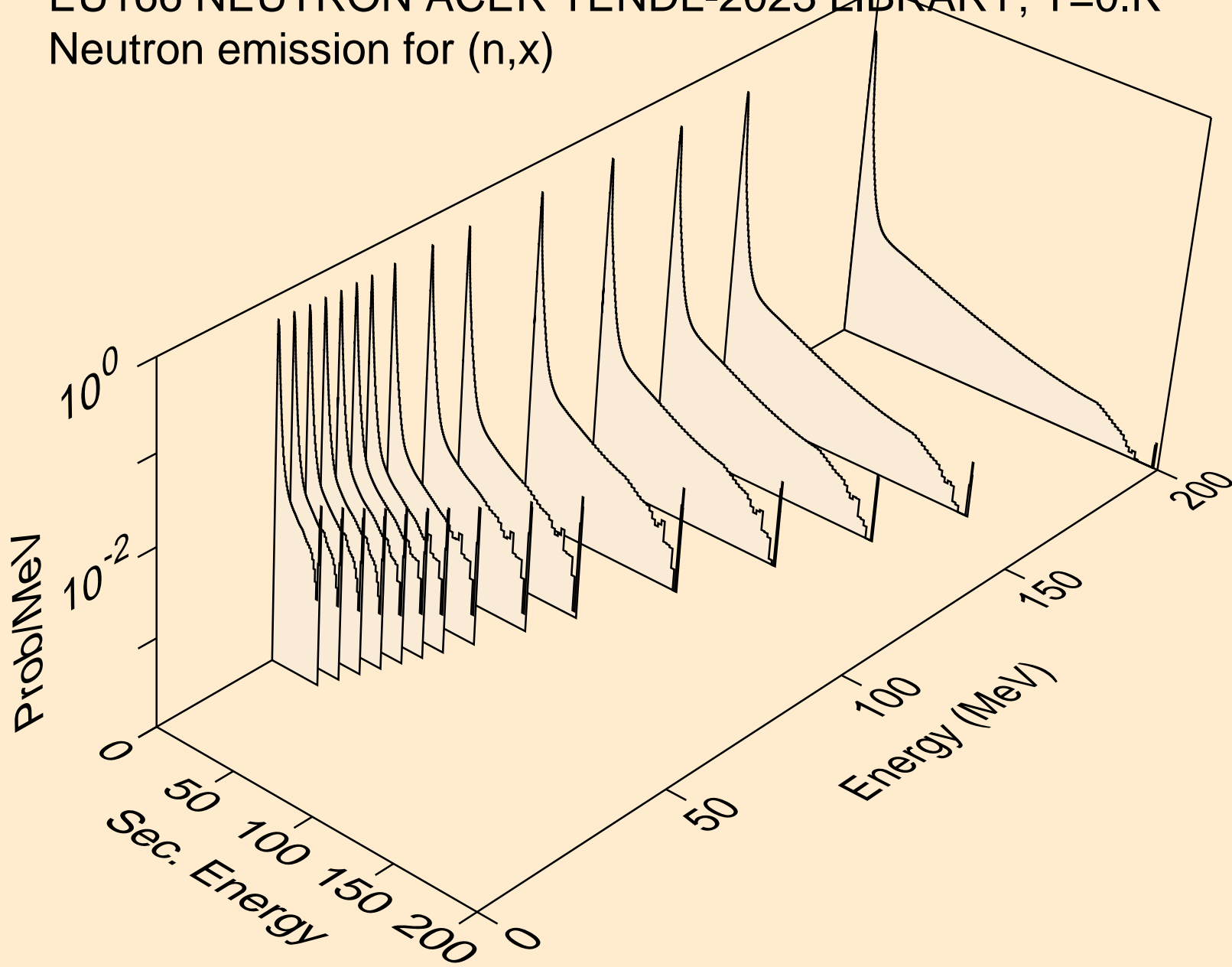

EU166 NEUTRON ACER TENDL-2023 LIBRARY; T=0.K  
Neutron emission for (n,2nd)

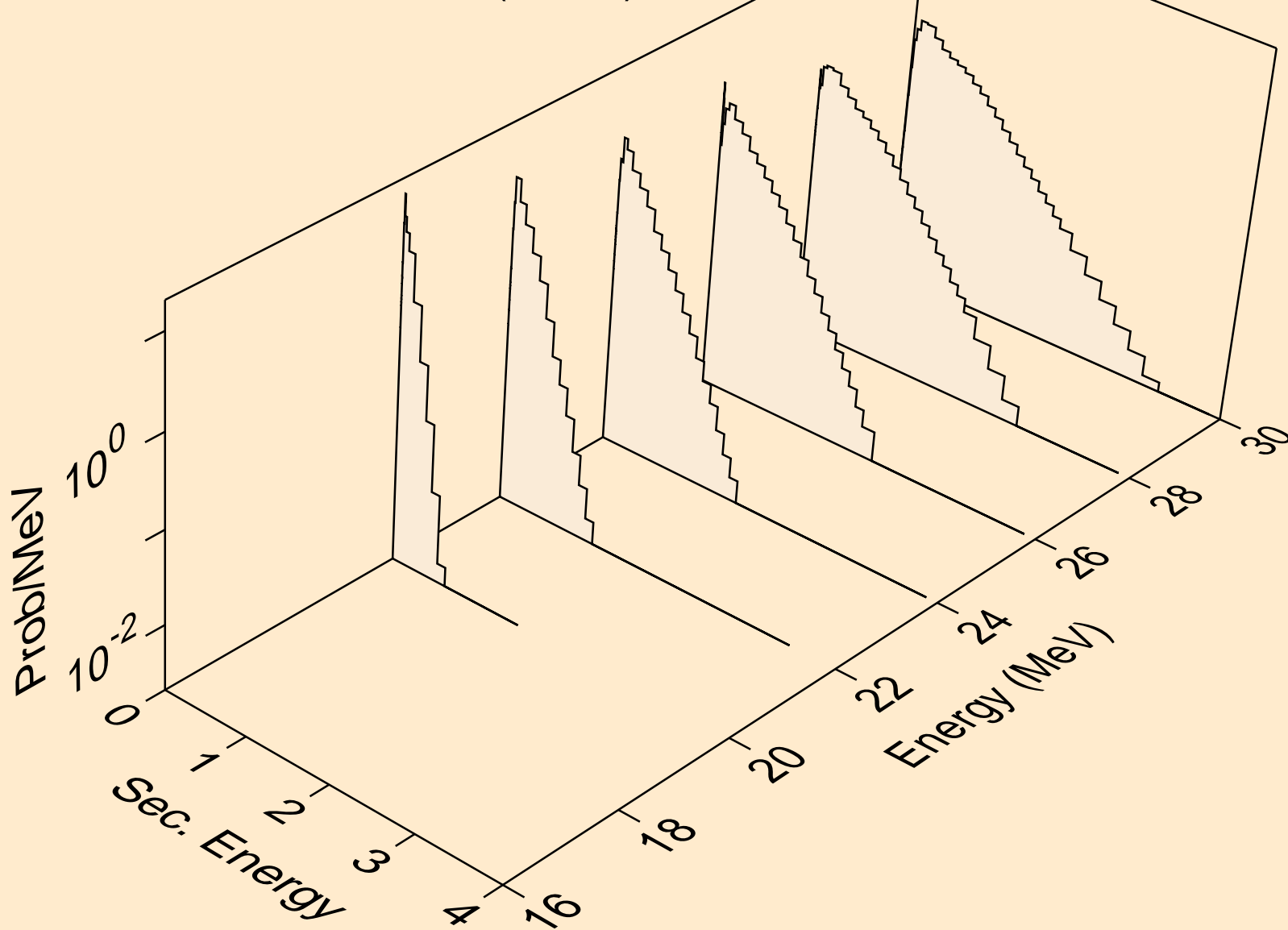

EU166 NEUTRON ACER TENDL-2023 LIBRARY; T=0.K  
Neutron emission for (n,2n)

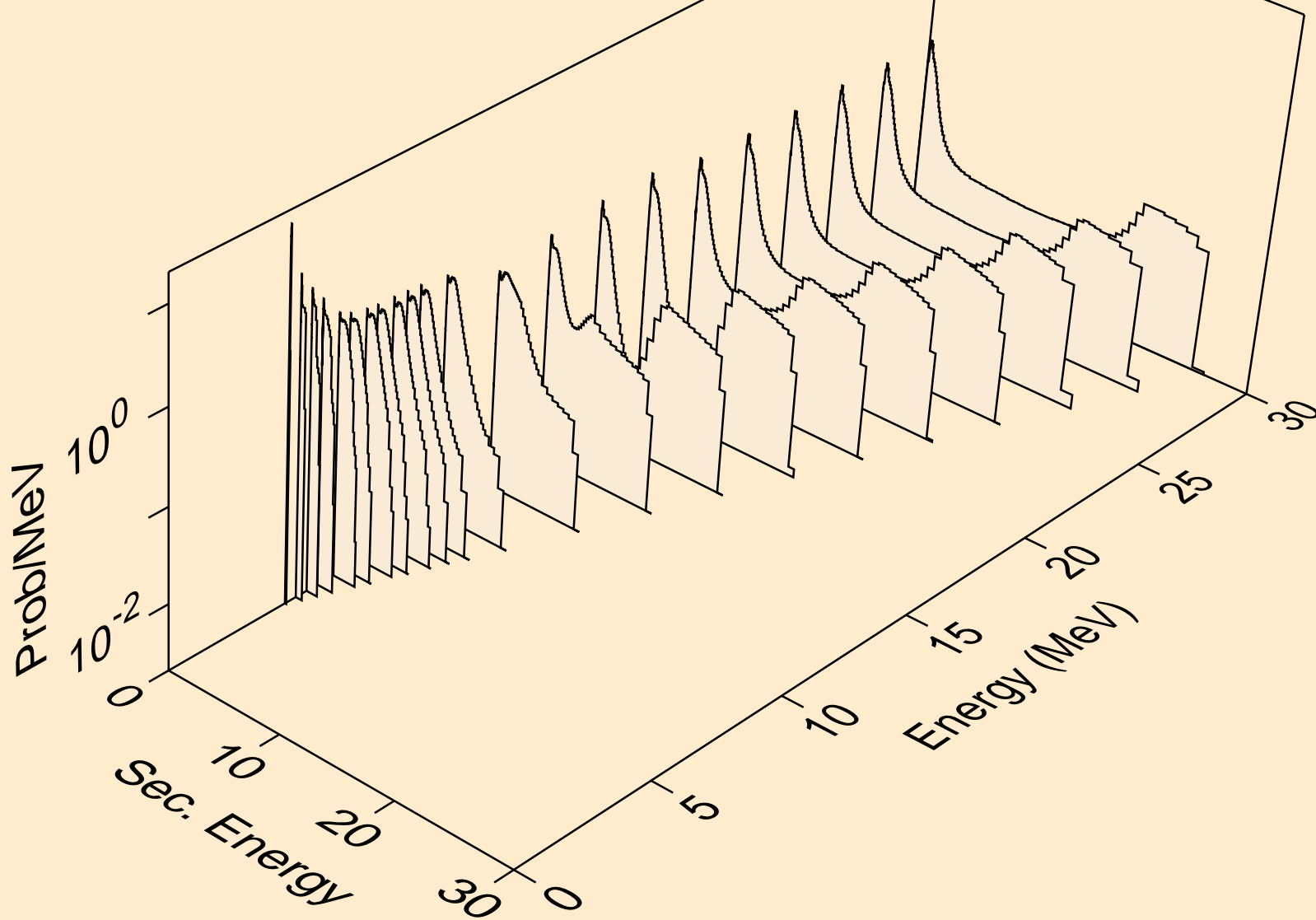

EU166 NEUTRON ACER TENDL-2023 LIBRARY; T=0.K  
Neutron emission for (n,3n)

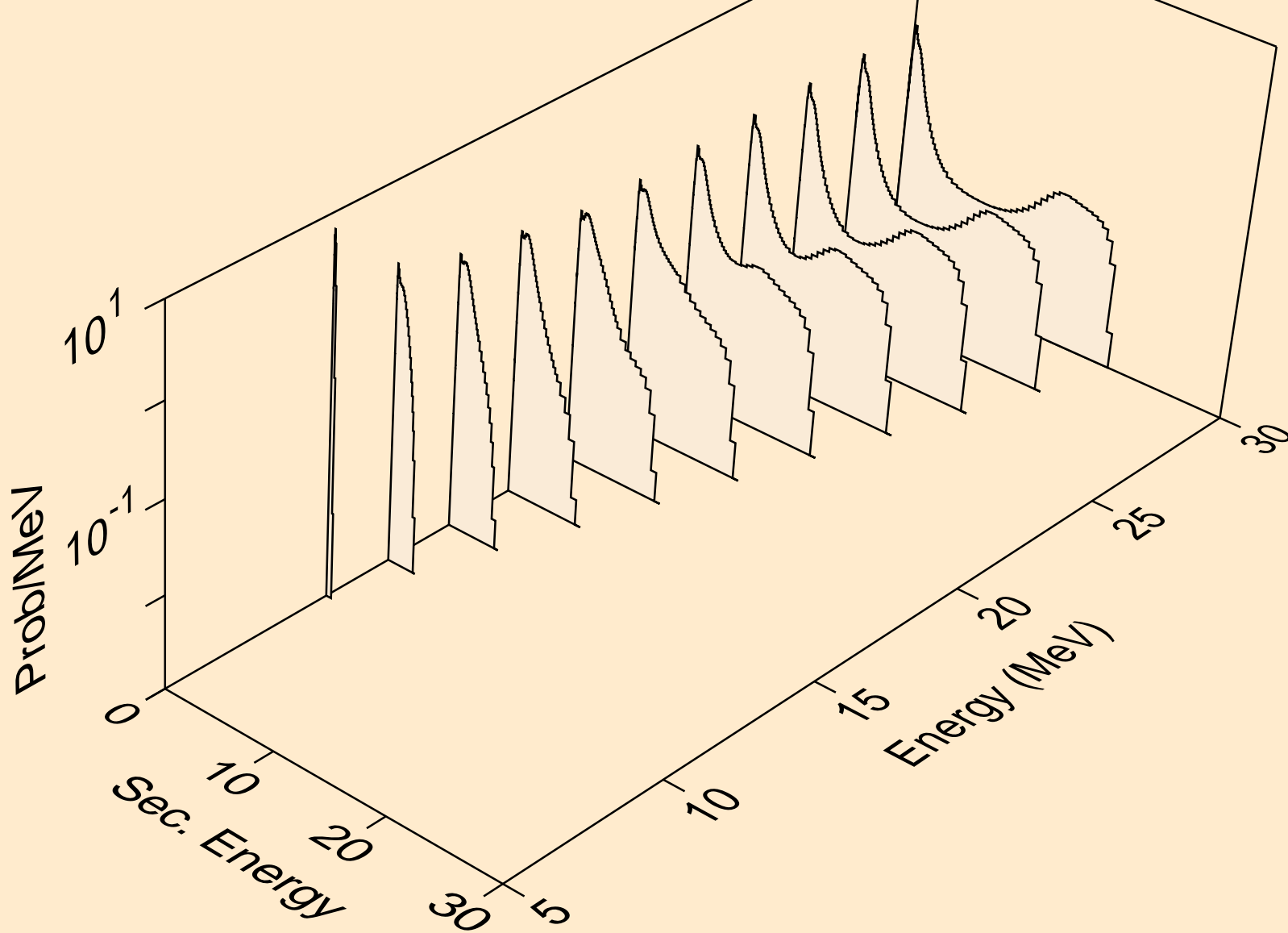

EU166 NEUTRON ACER TENDL-2023 LIBRARY; T=0.K  
Neutron emission for (n,n\*)a

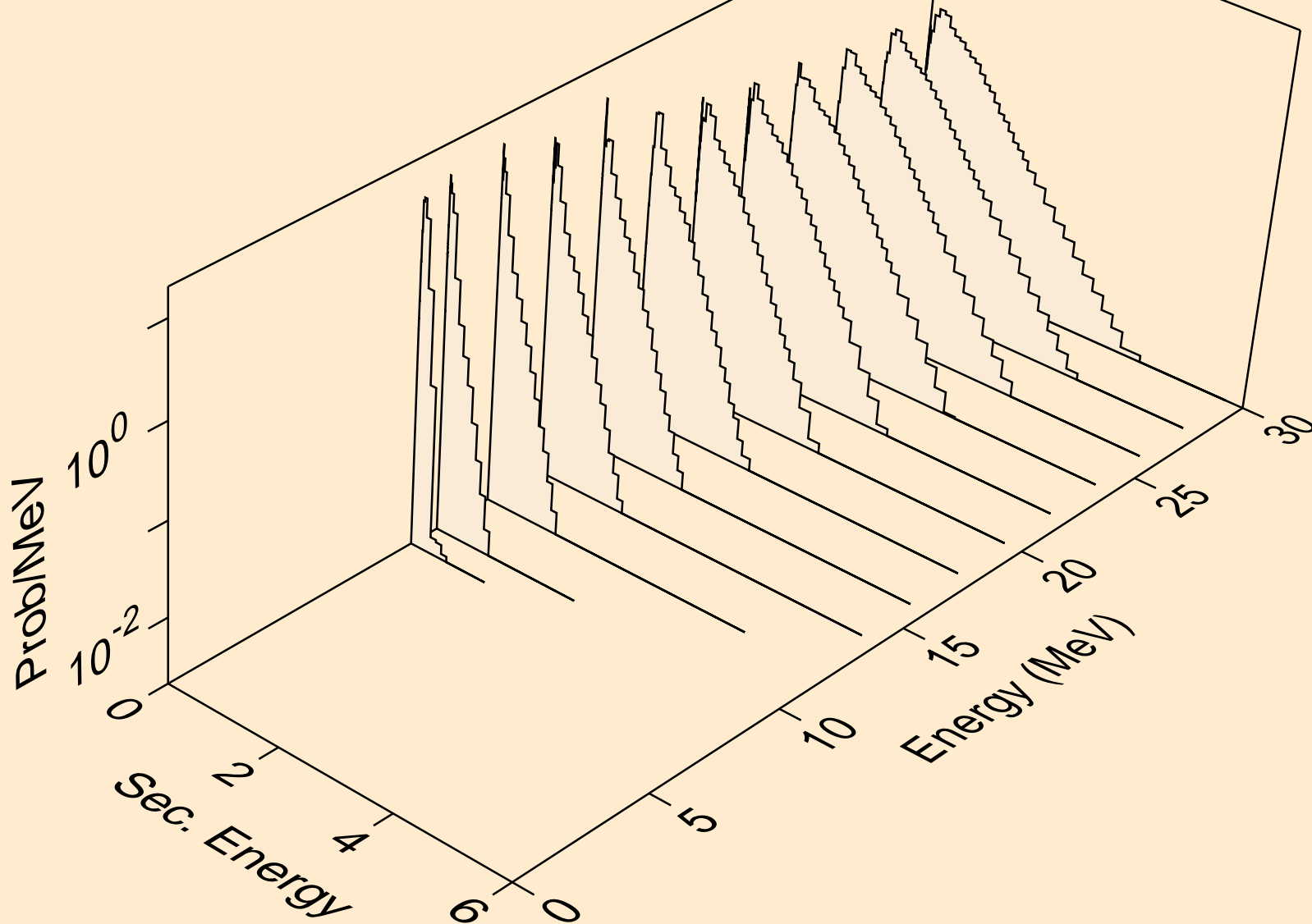

EU166 NEUTRON ACER TENDL-2023 LIBRARY; T=0.K  
Neutron emission for (n,2n)a

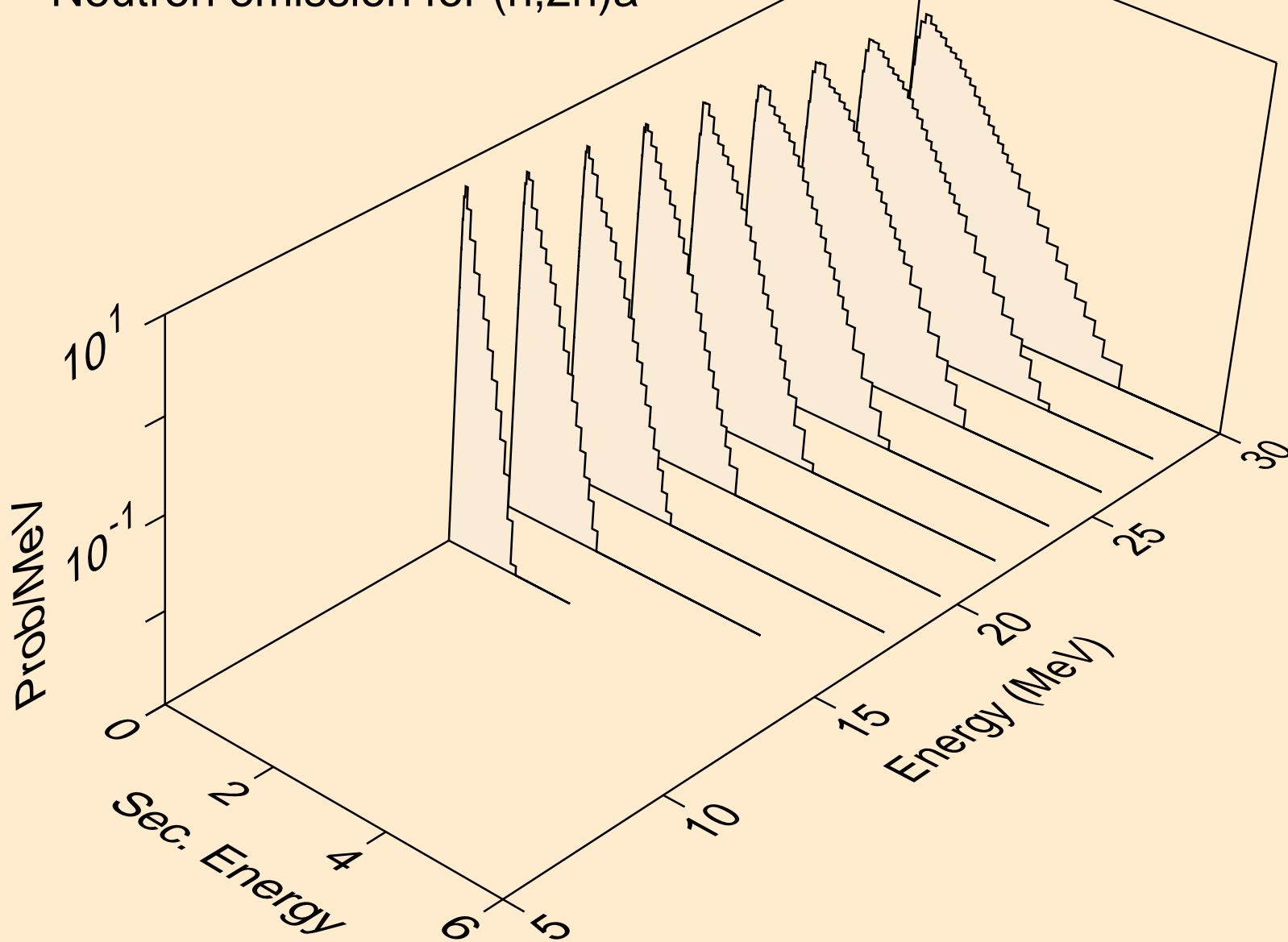

EU166 NEUTRON ACER TENDL-2023 LIBRARY; T=0.K  
Neutron emission for (n,3n)a

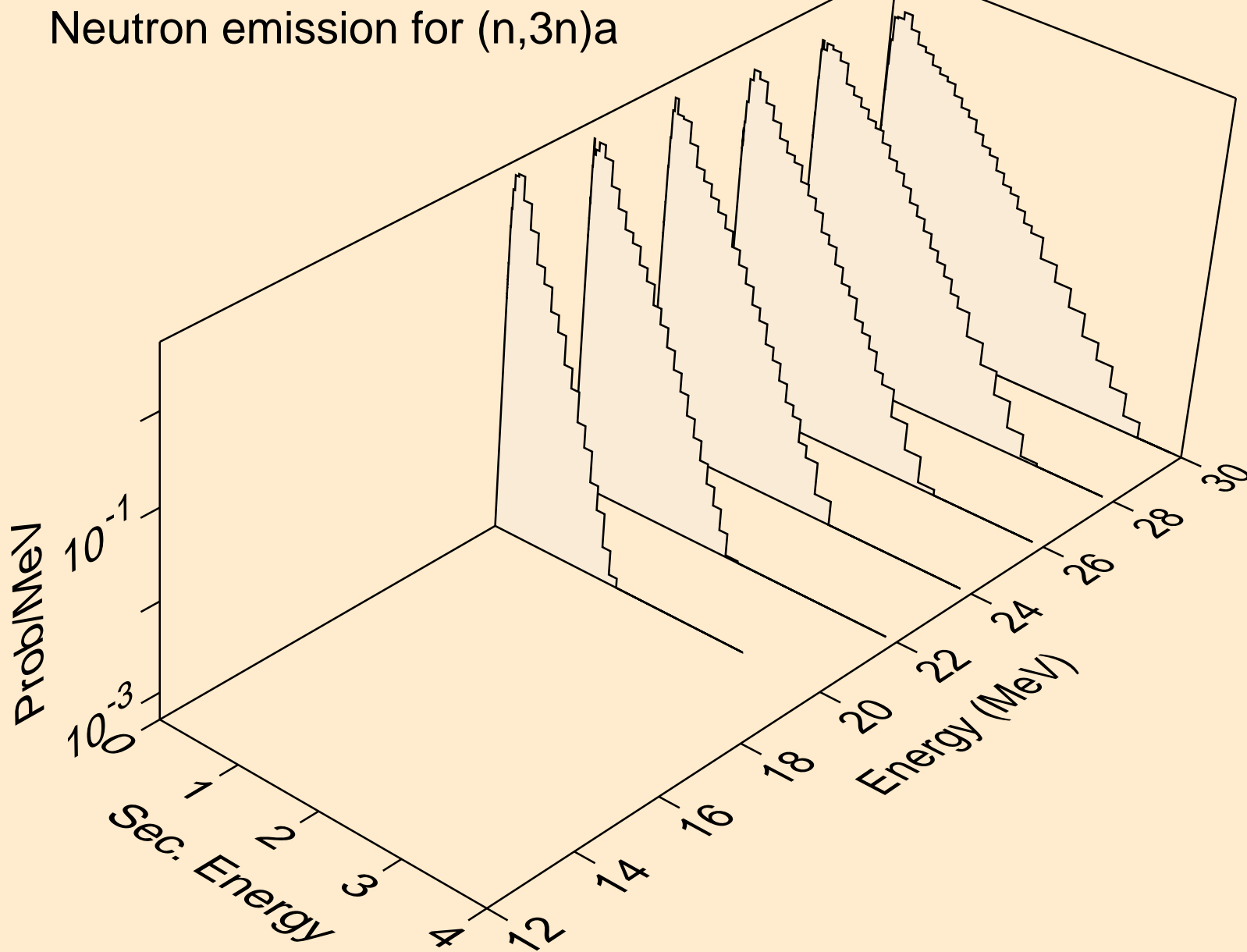

EU166 NEUTRON ACER TENDL-2023 LIBRARY; T=0.K  
Neutron emission for (n,n\*)p

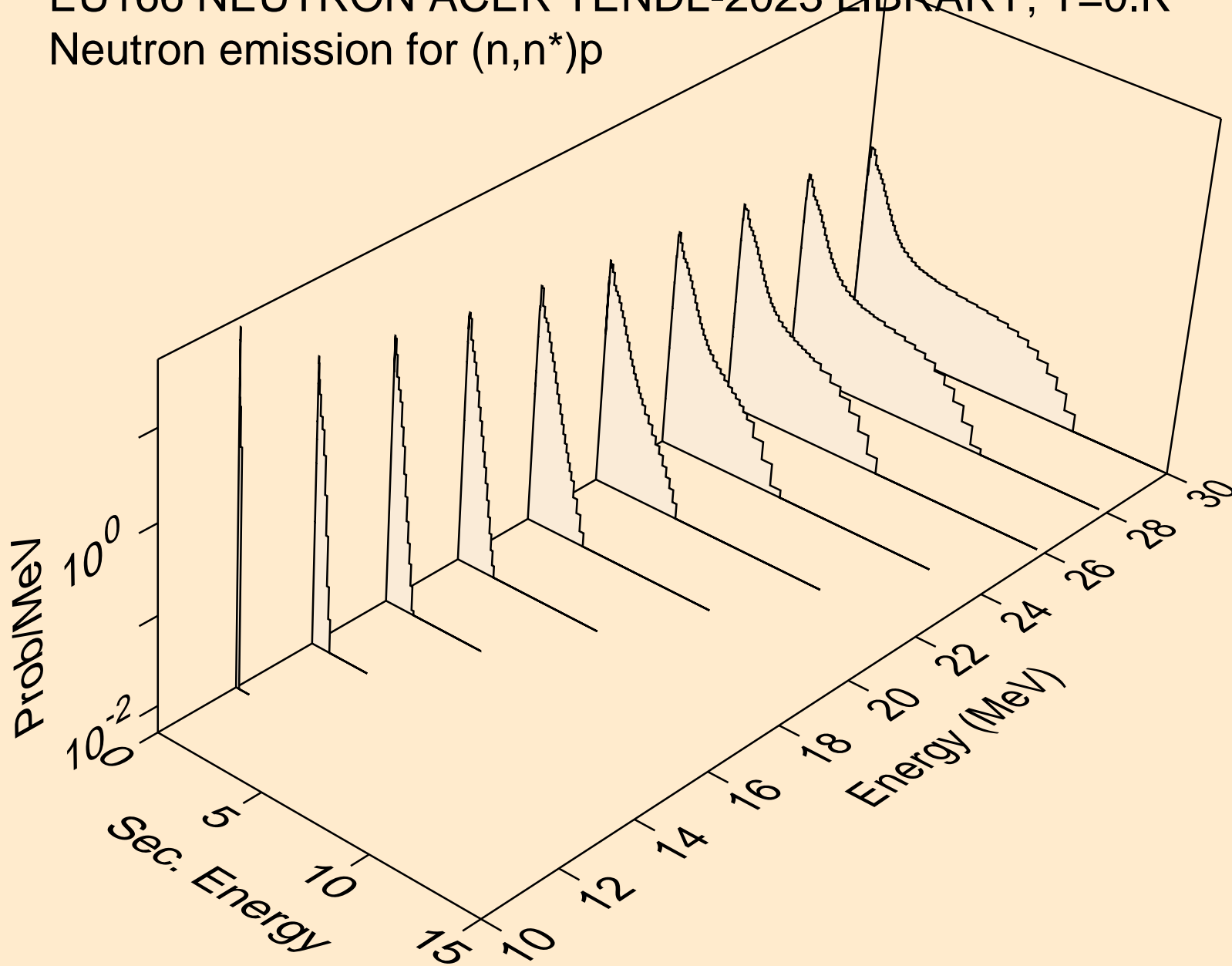



EU166 NEUTRON ACER TENDL-2023 LIBRARY; T=0.K  
Neutron emission for (n,n\*)d

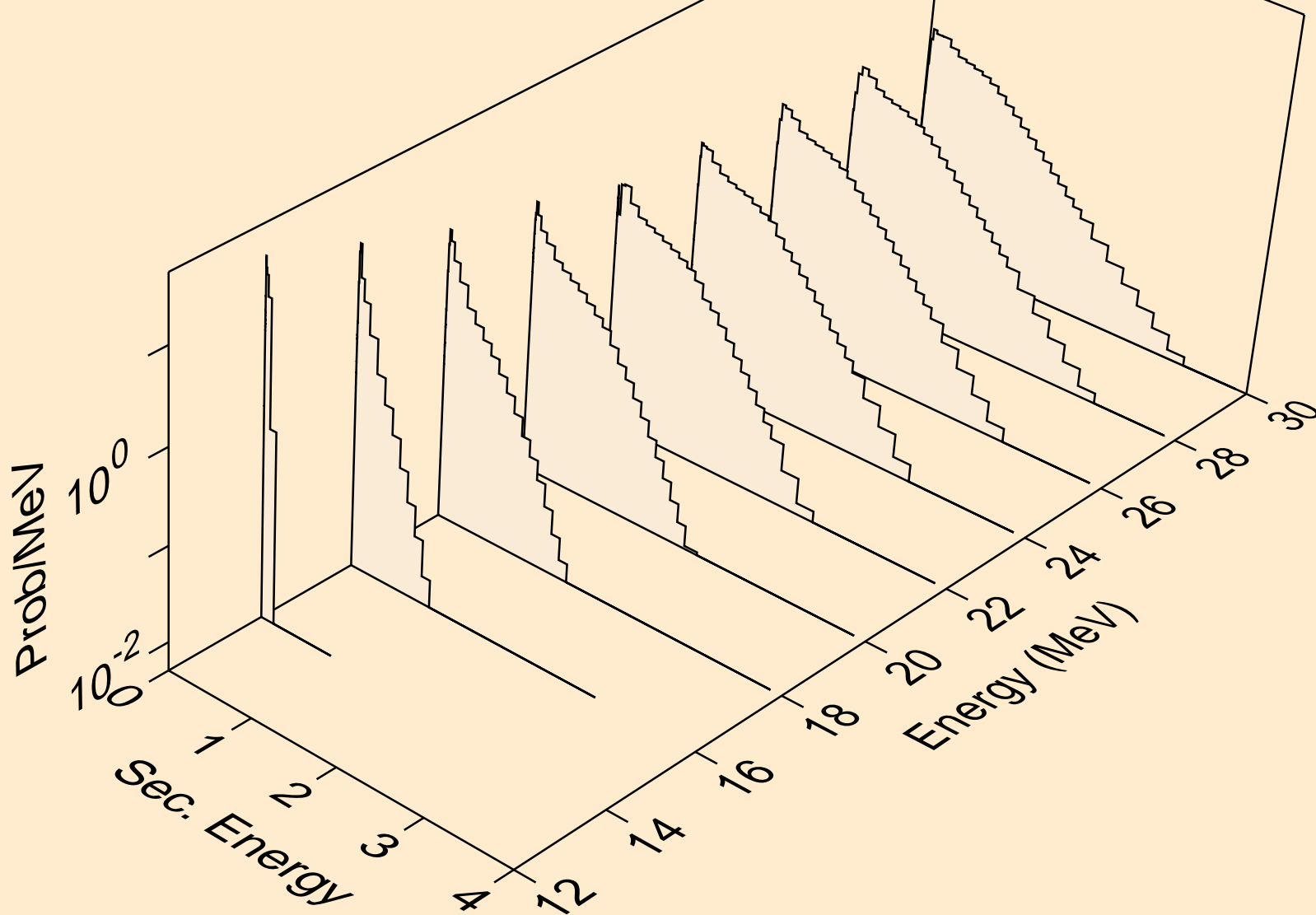

EU166 NEUTRON ACER TENDL-2023 LIBRARY; T=0.K  
Neutron emission for (n,n\*)t

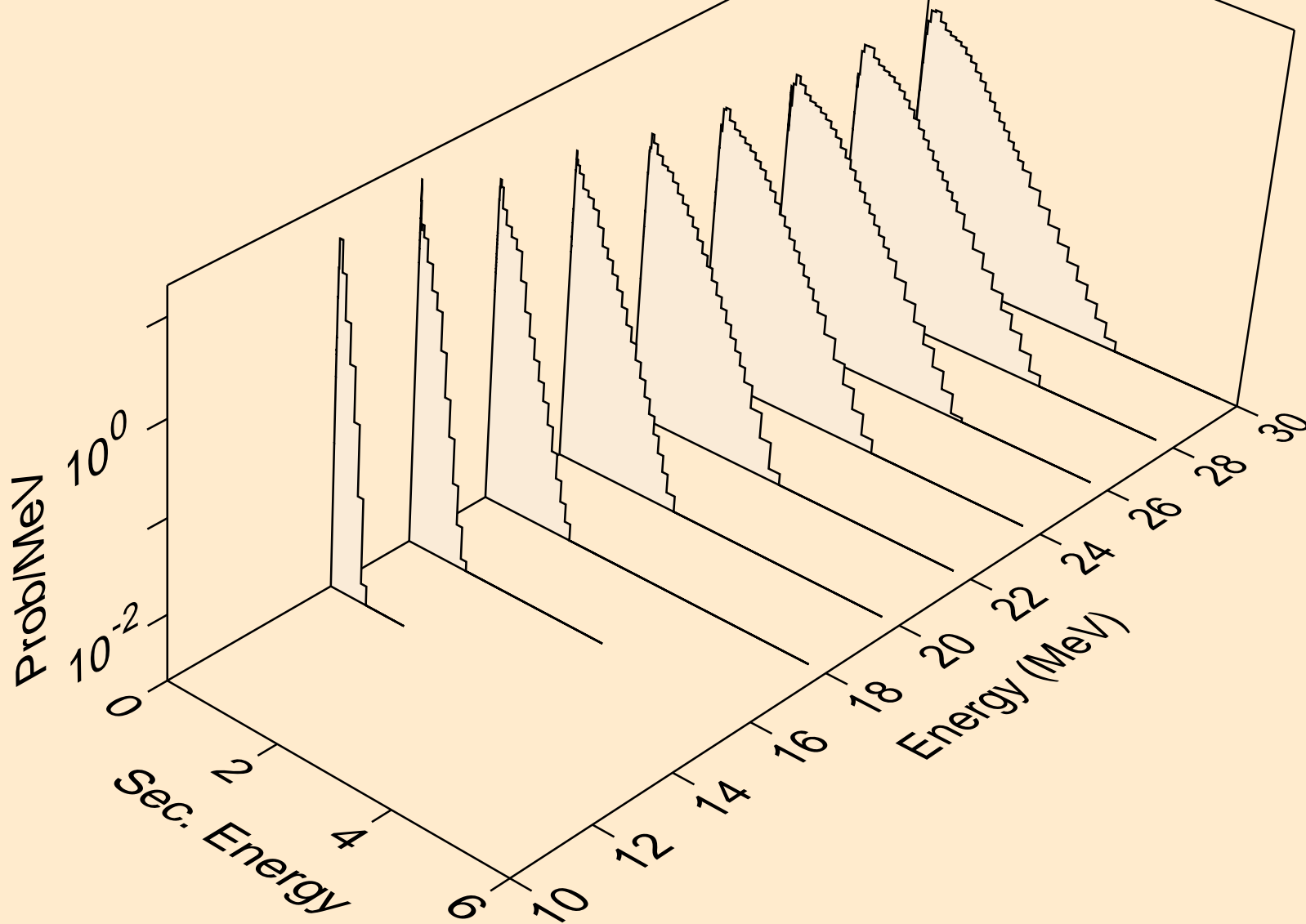

EU166 NEUTRON ACER TENDL-2023 LIBRARY; T=0.K  
Neutron emission for (n,n\*)he3

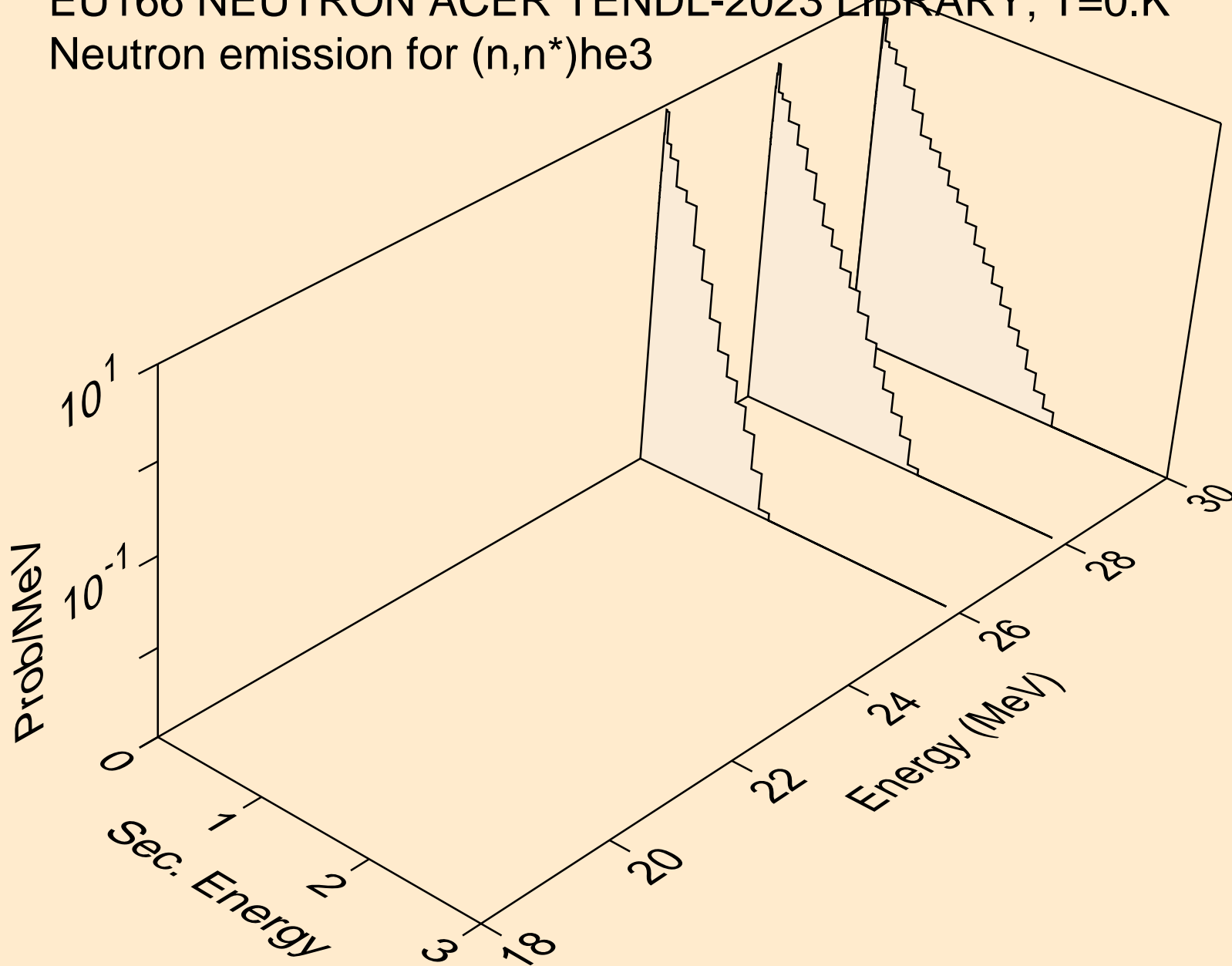

EU166 NEUTRON ACER TENDL-2023 LIBRARY; T=0.K  
Neutron emission for (n,4n)

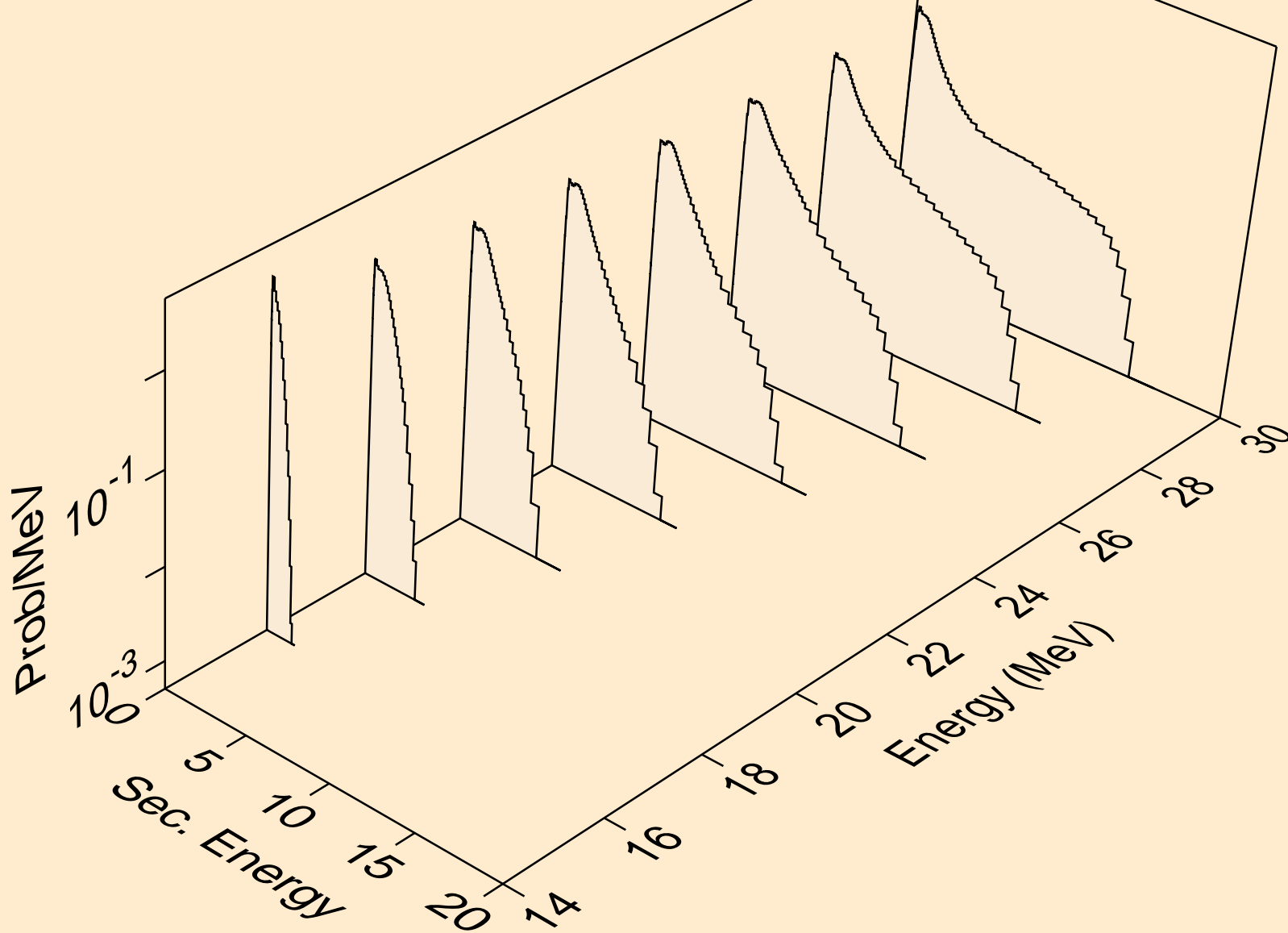

EU166 NEUTRON ACER TENDL-2023 LIBRARY; T=0.K  
Neutron emission for (n,2np)

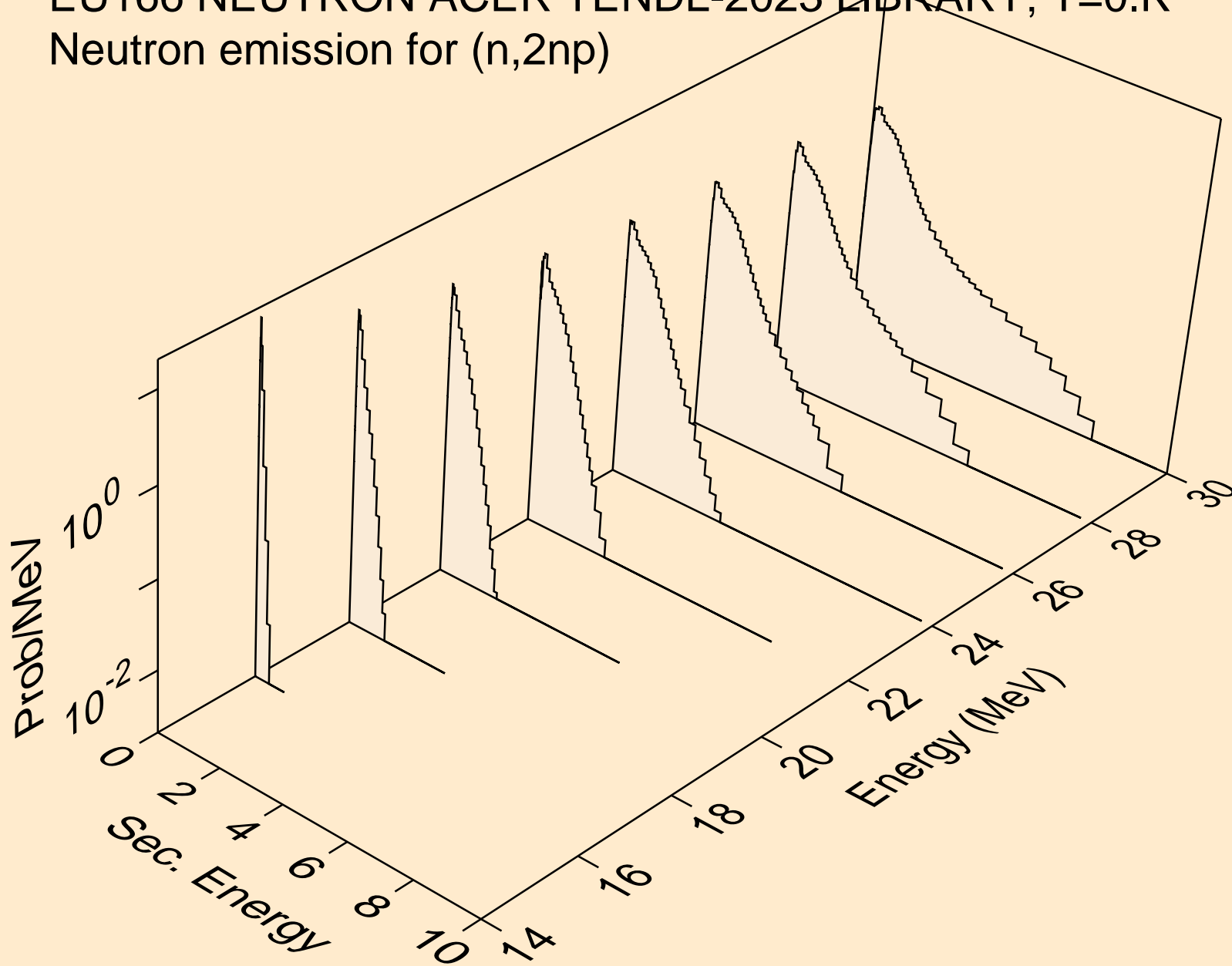

EU166 NEUTRON ACER TENDL-2023 LIBRARY; T=0.K  
Neutron emission for (n,3np)

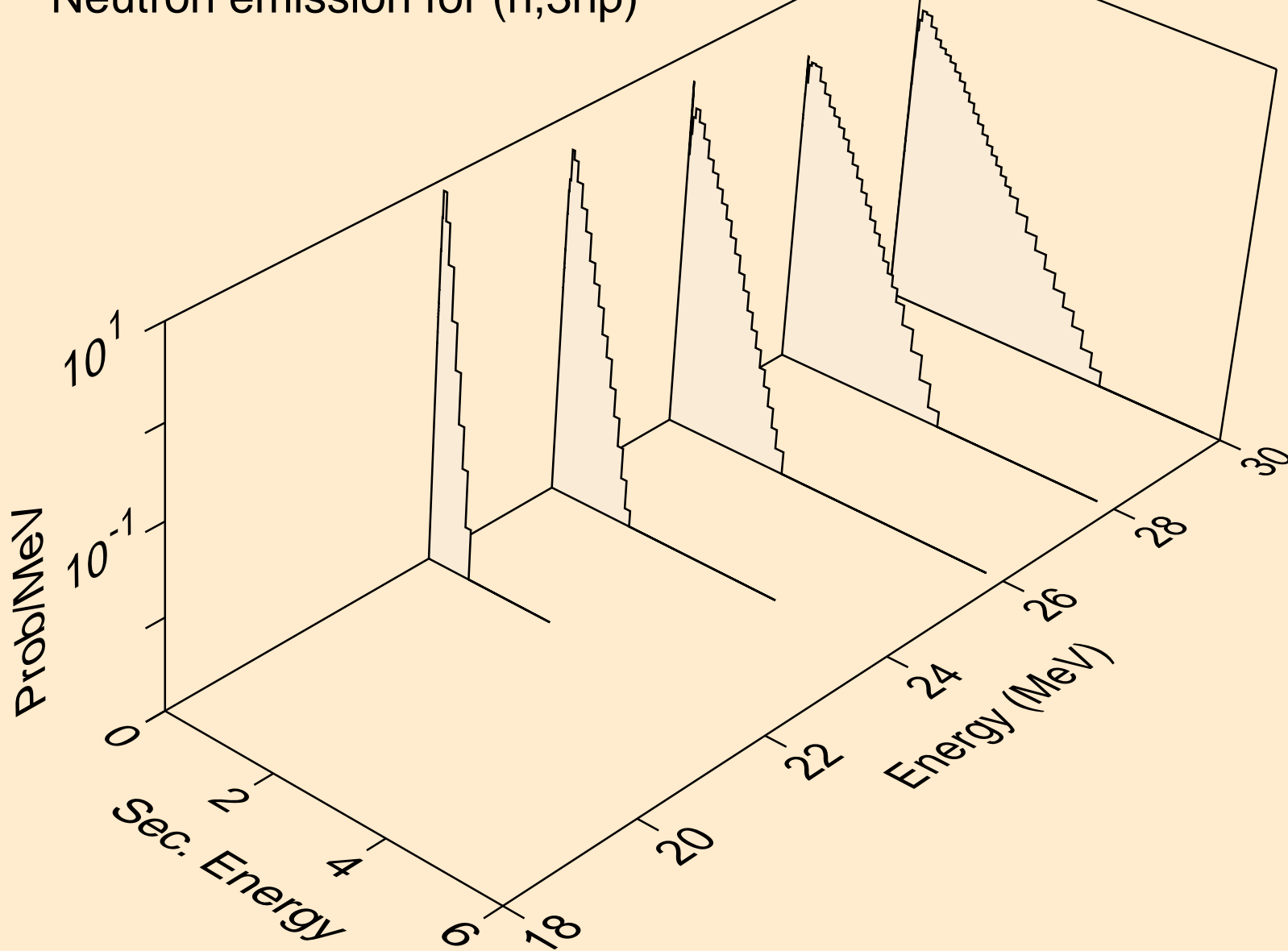

EU166 NEUTRON ACER TENDL-2023 LIBRARY; T=0.K  
Neutron emission for (n,n\*c)

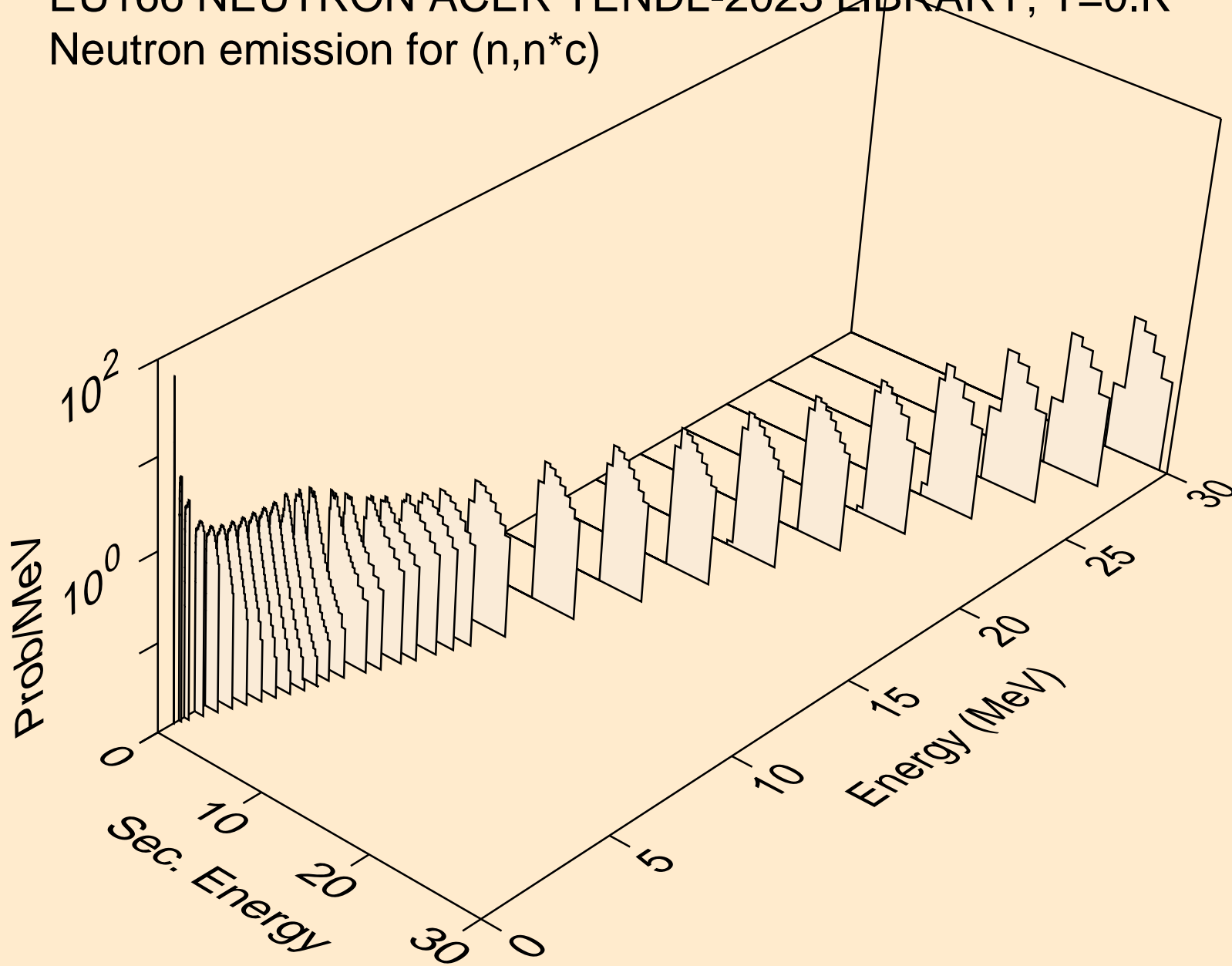

EU166 NEUTRON ACER TENDL-2023 LIBRARY; T=0.K  
Photon emission for (n,x)

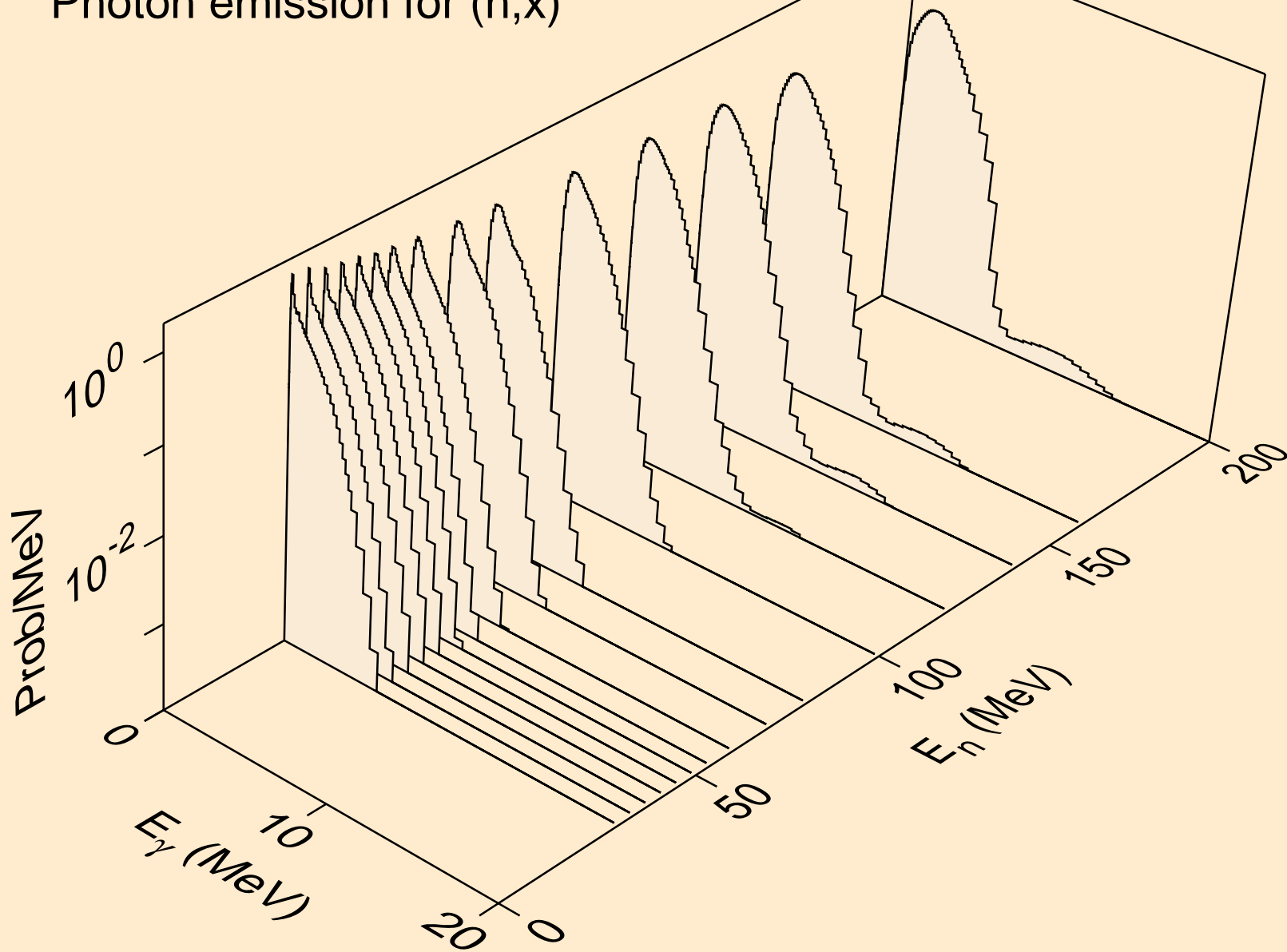



EU166 NEUTRON ACER TENDL-2023 LIBRARY; T=0.K  
Photon emission for (n,2nd)

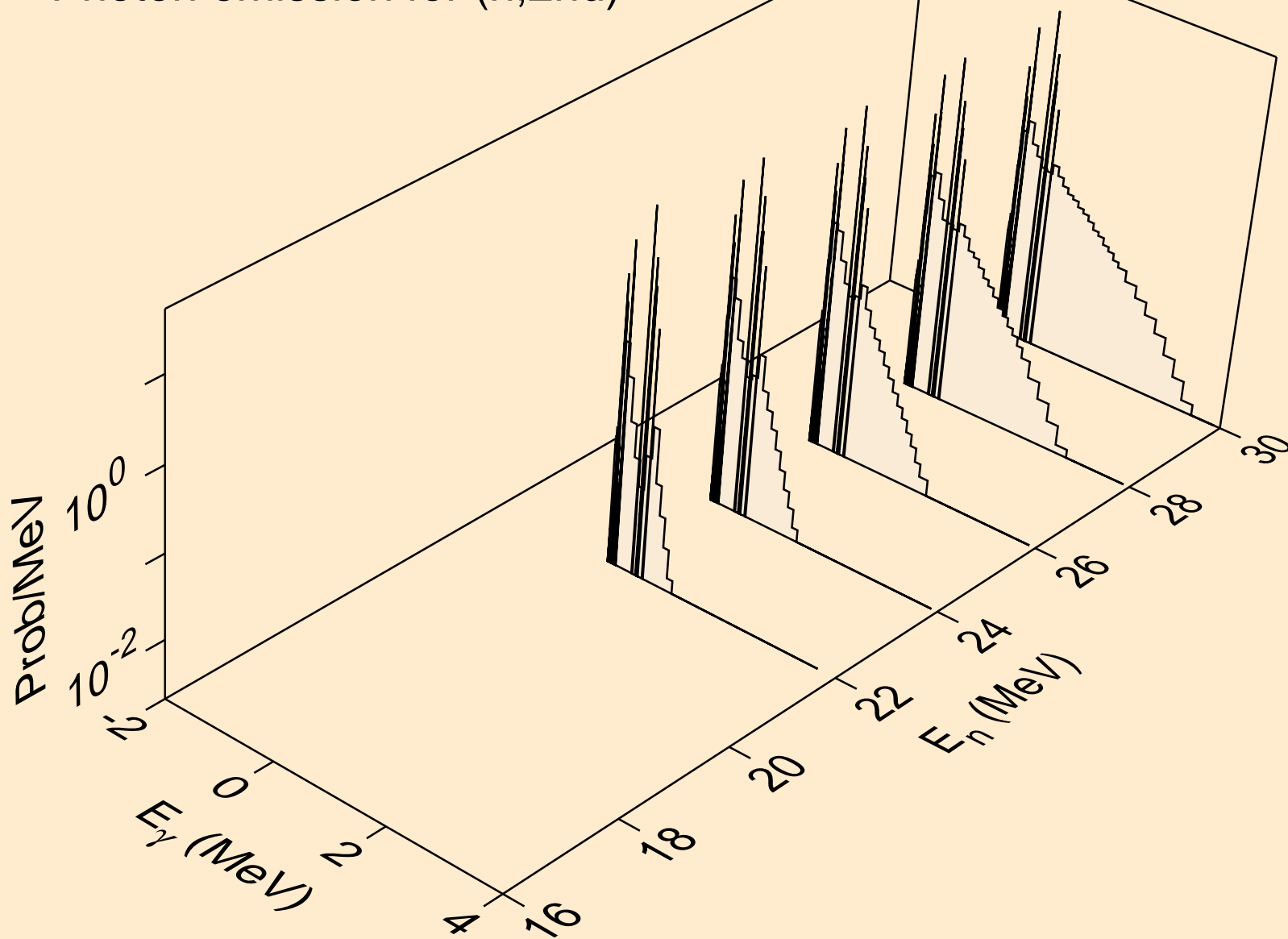

EU166 NEUTRON ACER TENDL-2023 LIBRARY; T=0.K  
Photon emission for (n,2n)

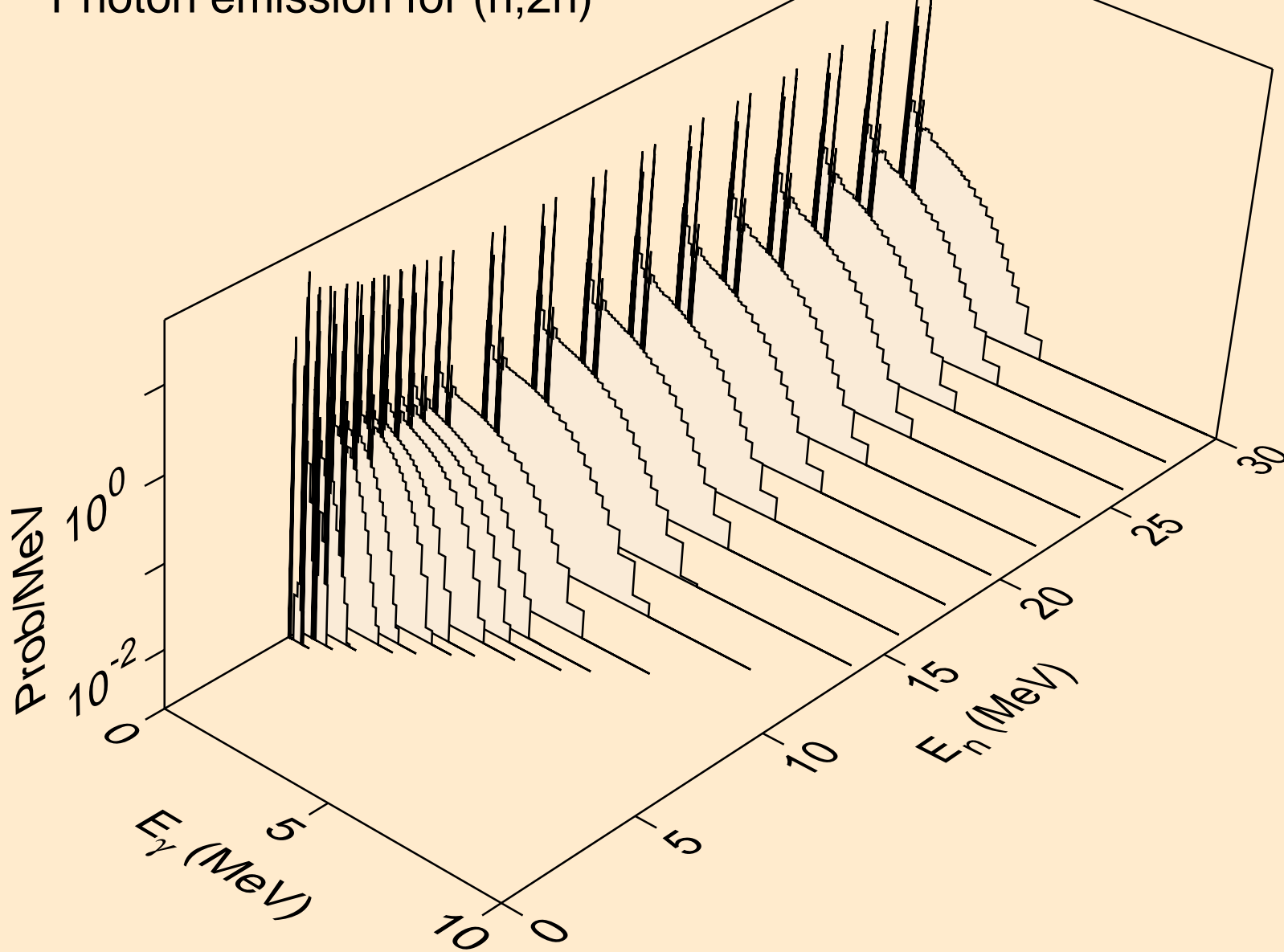

EU166 NEUTRON ACER TENDL-2023 LIBRARY; T=0.K  
Photon emission for (n,3n)

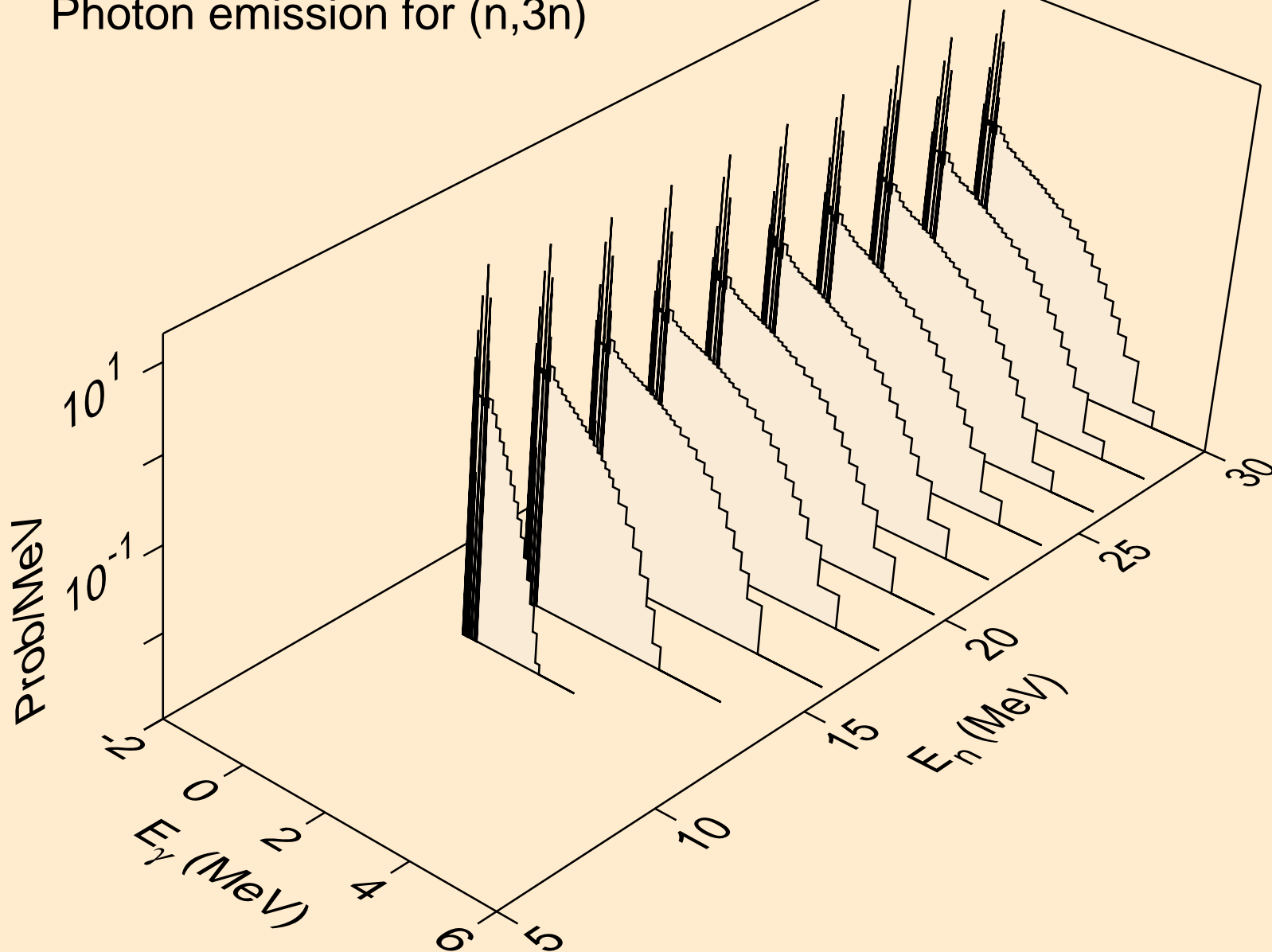

EU166 NEUTRON ACER TENDL-2023 LIBRARY; T=0.K  
Photon emission for (n,n\*)a

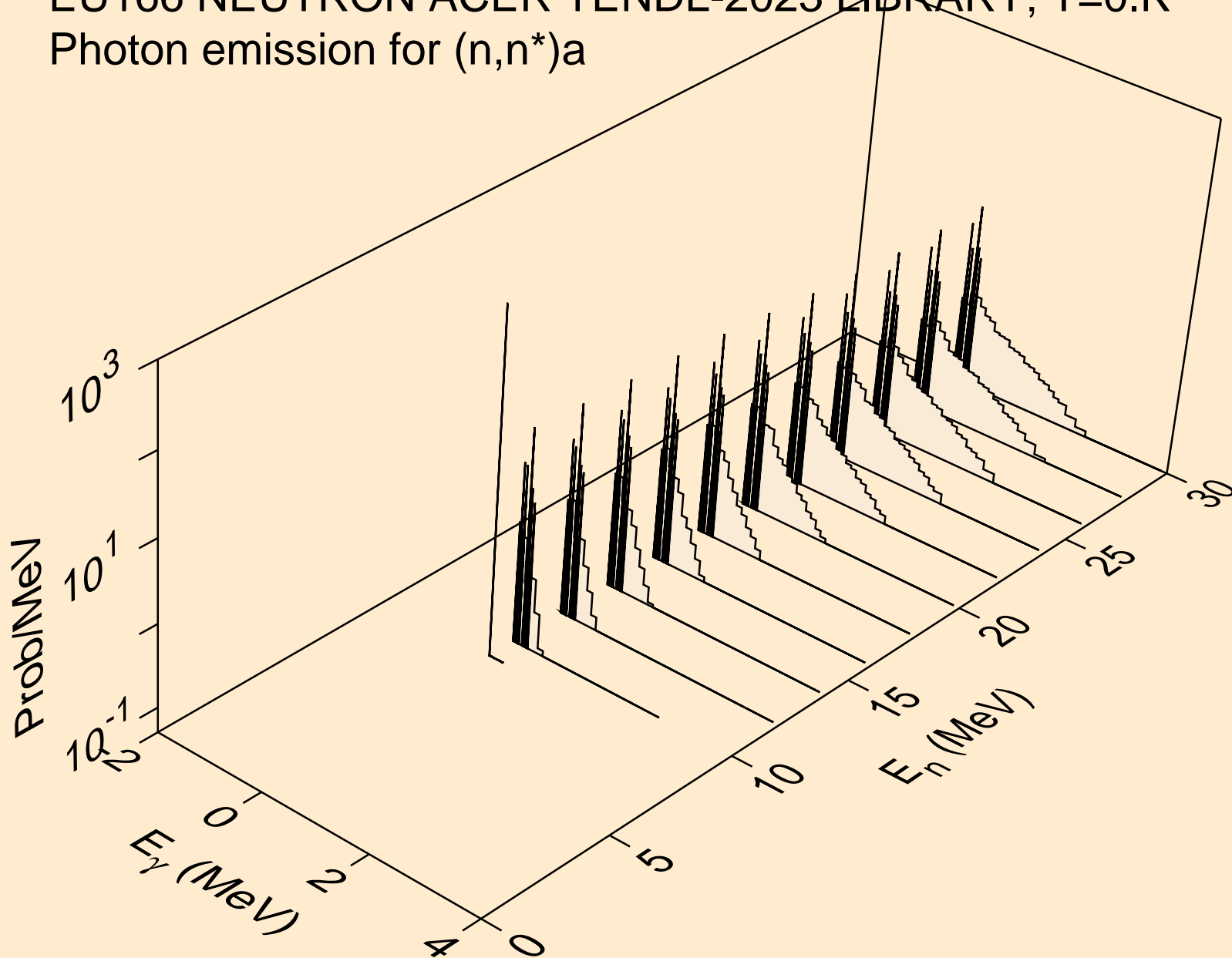

EU166 NEUTRON ACER TENDL-2023 LIBRARY; T=0.K  
Photon emission for (n,2n)a

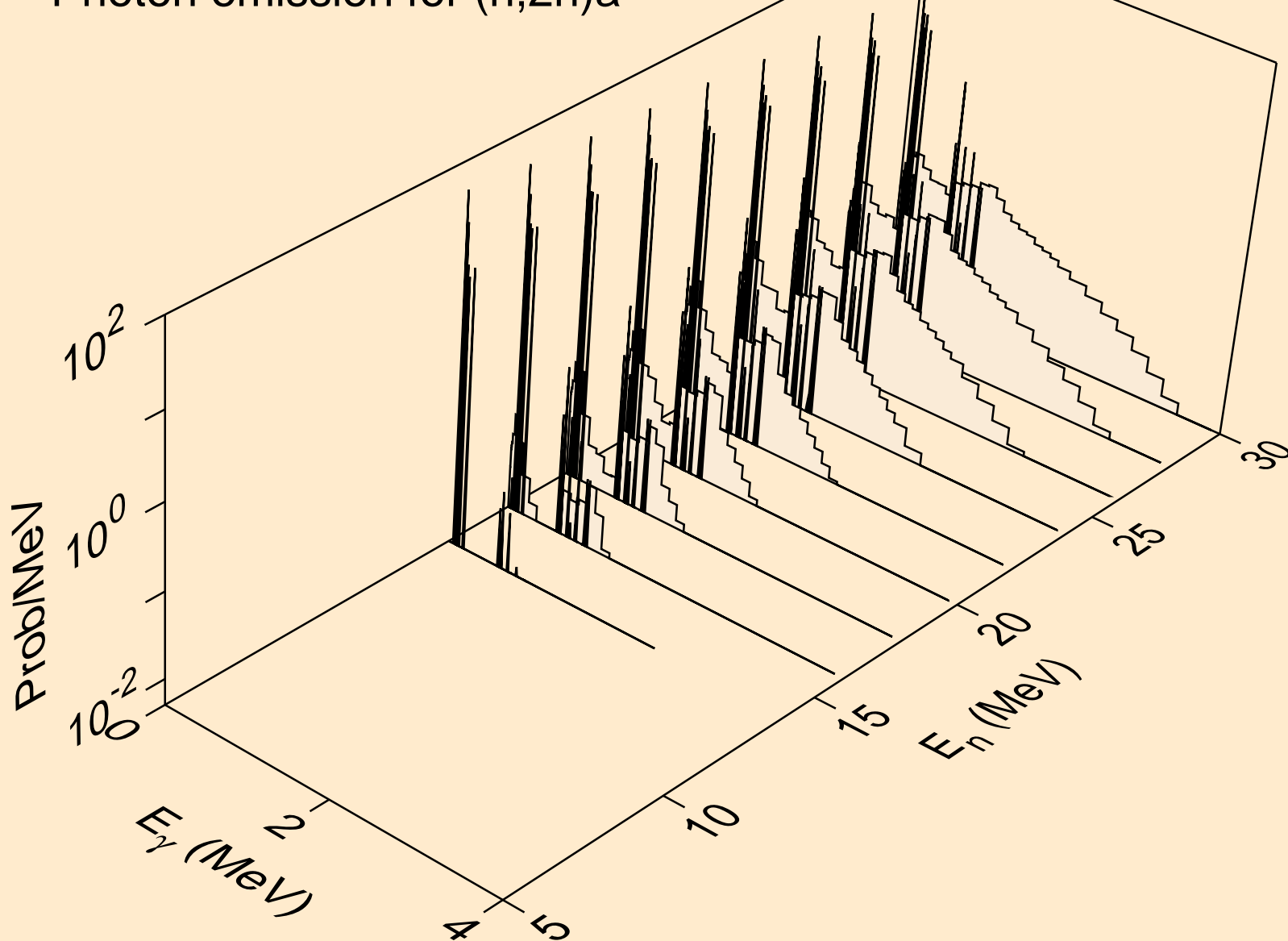

EU166 NEUTRON ACER TENDL-2023 LIBRARY; T=0.K  
Photon emission for (n,3n)a

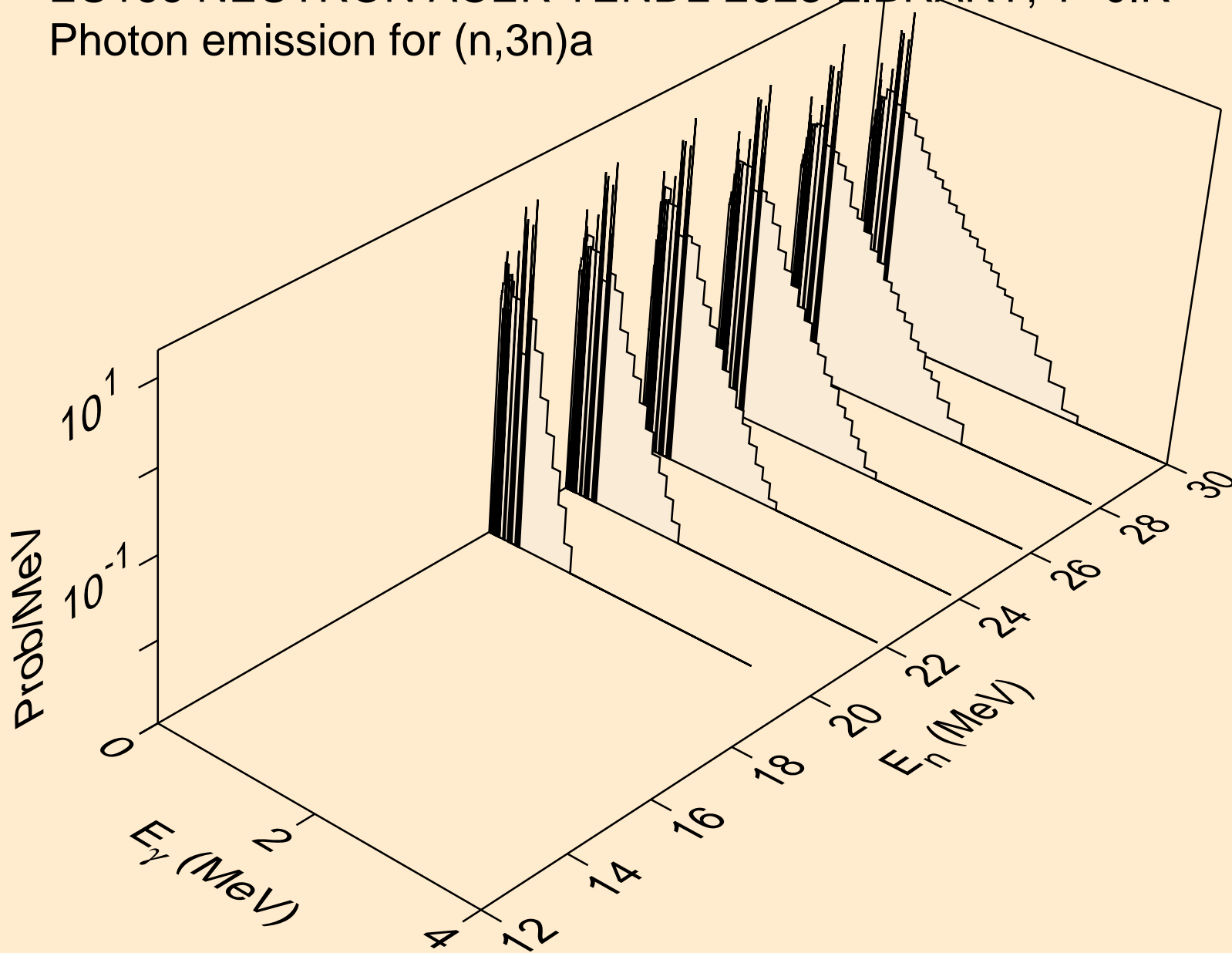

EU166 NEUTRON ACER TENDL-2023 LIBRARY; T=0.K  
Photon emission for (n,n\*)p

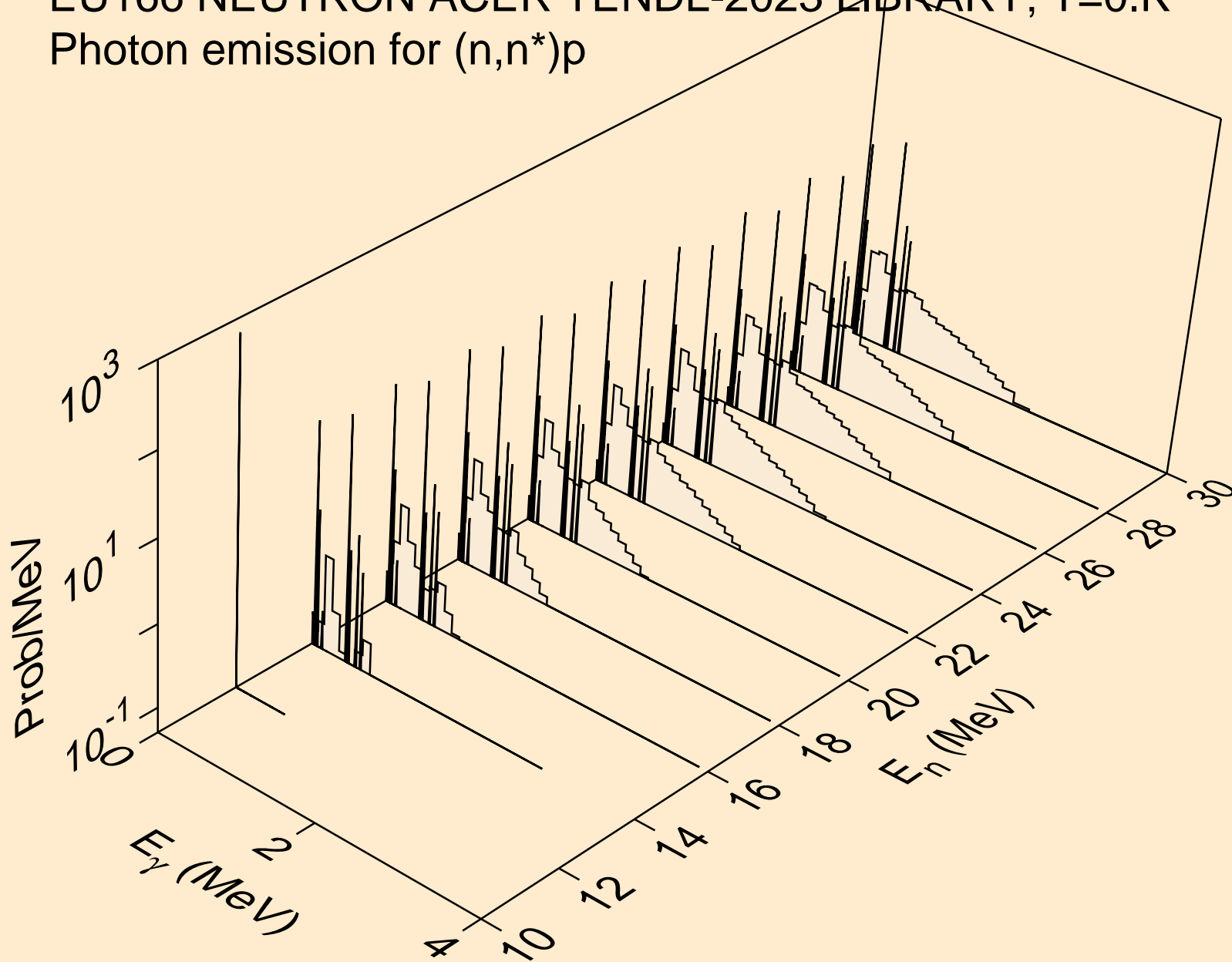

EU166 NEUTRON ACER TENDL-2023 LIBRARY; T=0.K  
Photon emission for (n,n\*)d

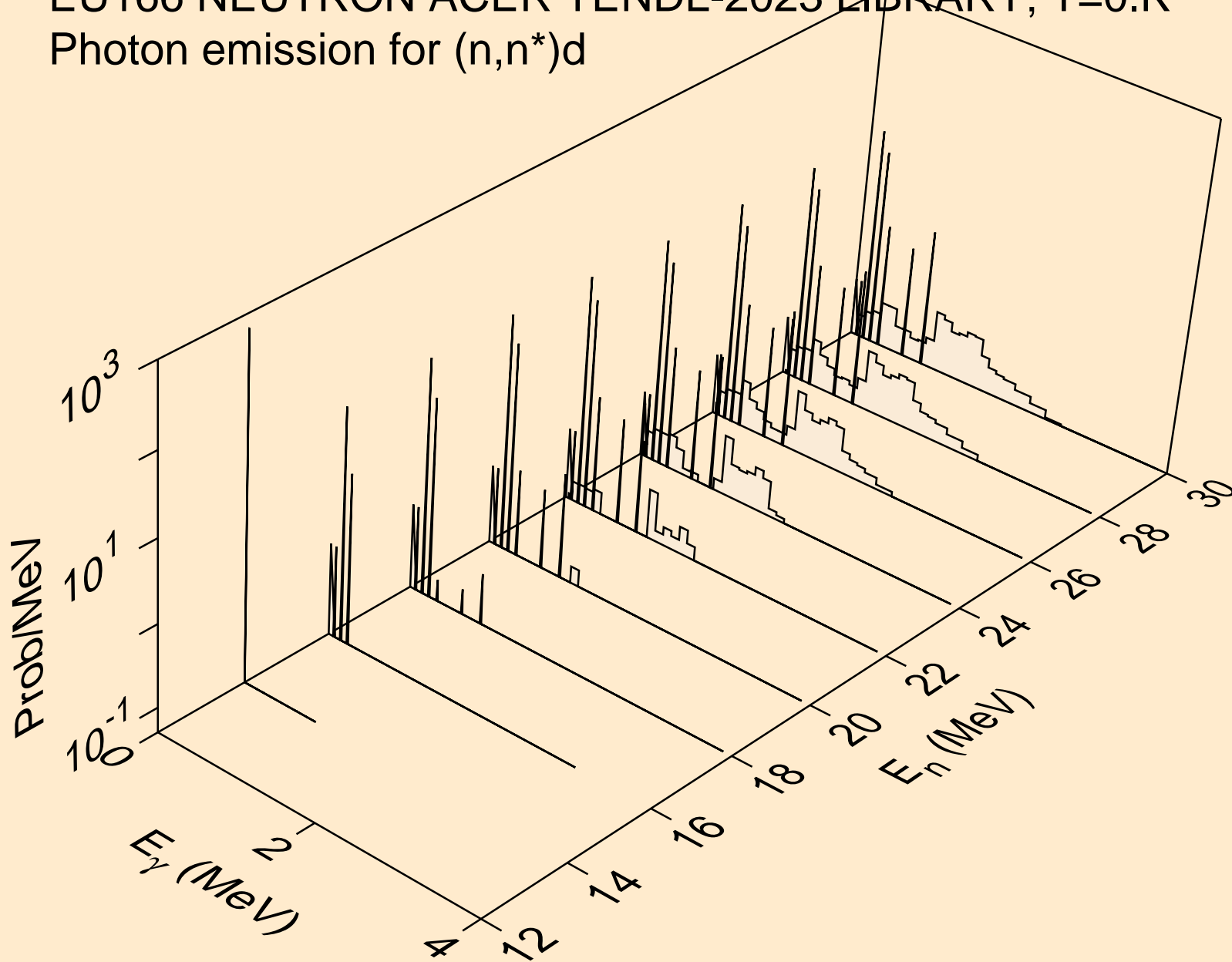



EU166 NEUTRON ACER TENDL-2023 LIBRARY; T=0.K  
Photon emission for (n,n\*)t

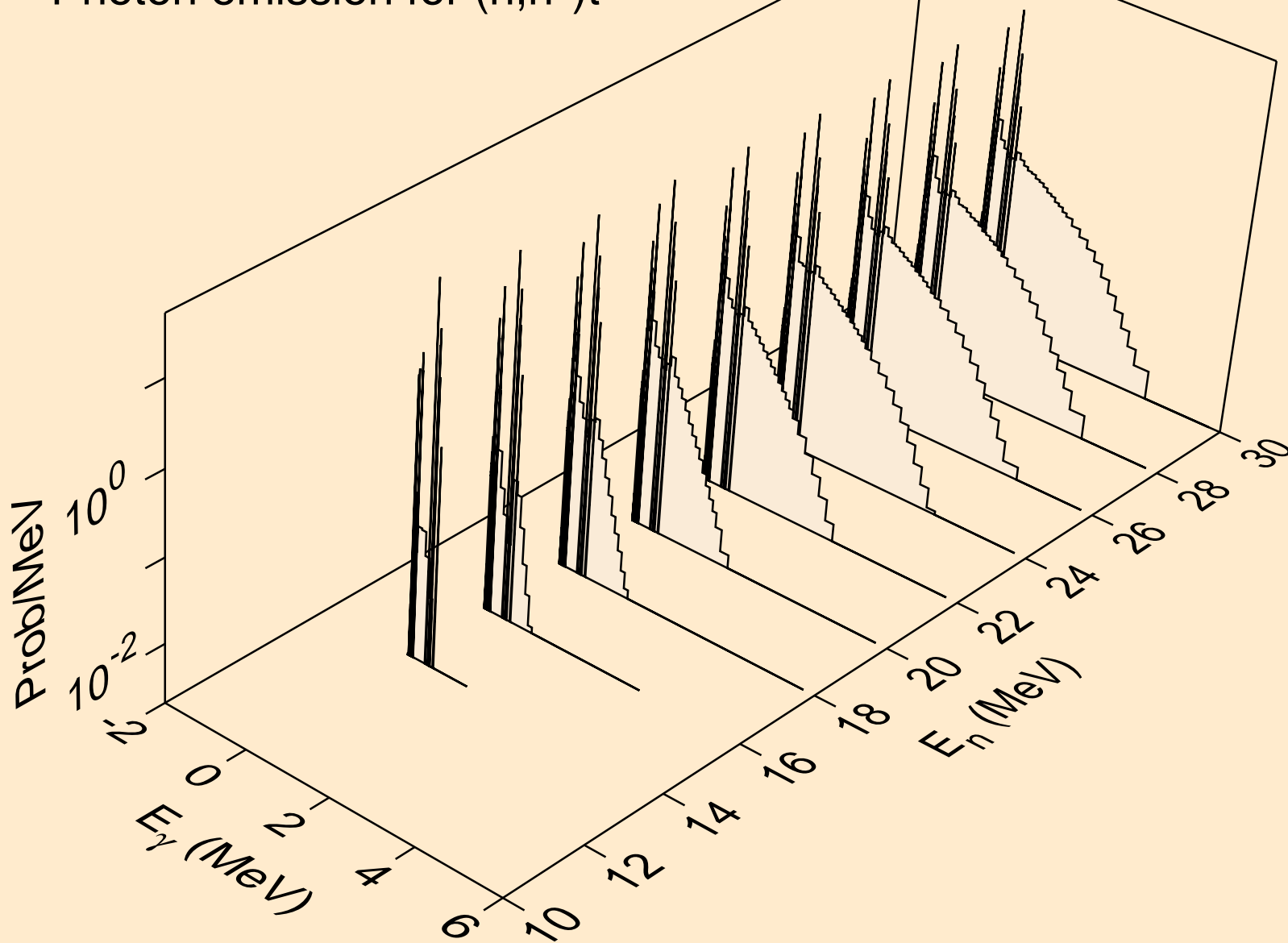

EU166 NEUTRON ACER TENDL-2023 LIBRARY; T=0.K  
Photon emission for (n,n\*)he3

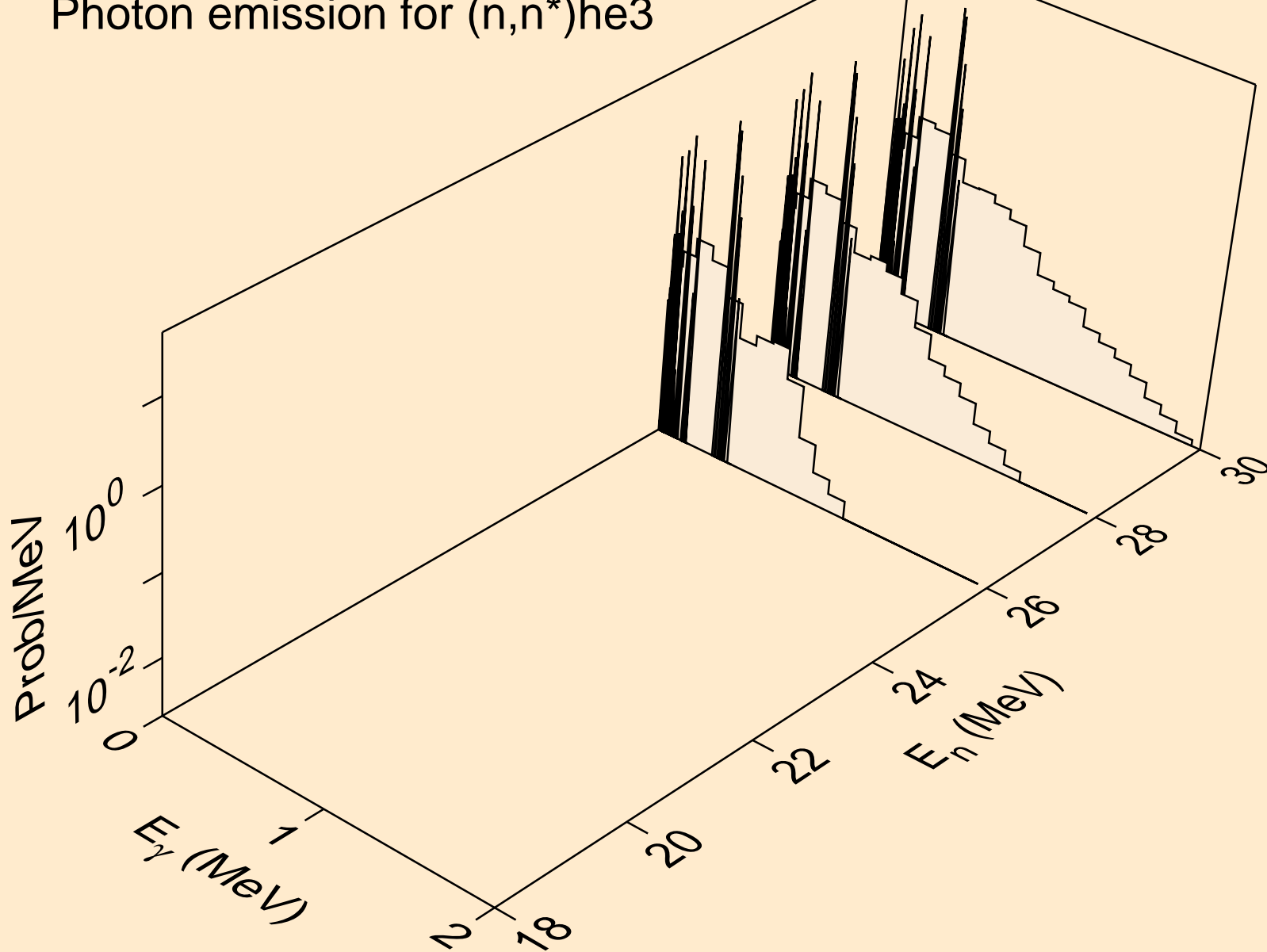

EU166 NEUTRON ACER TENDL-2023 LIBRARY; T=0.K  
Photon emission for (n,4n)

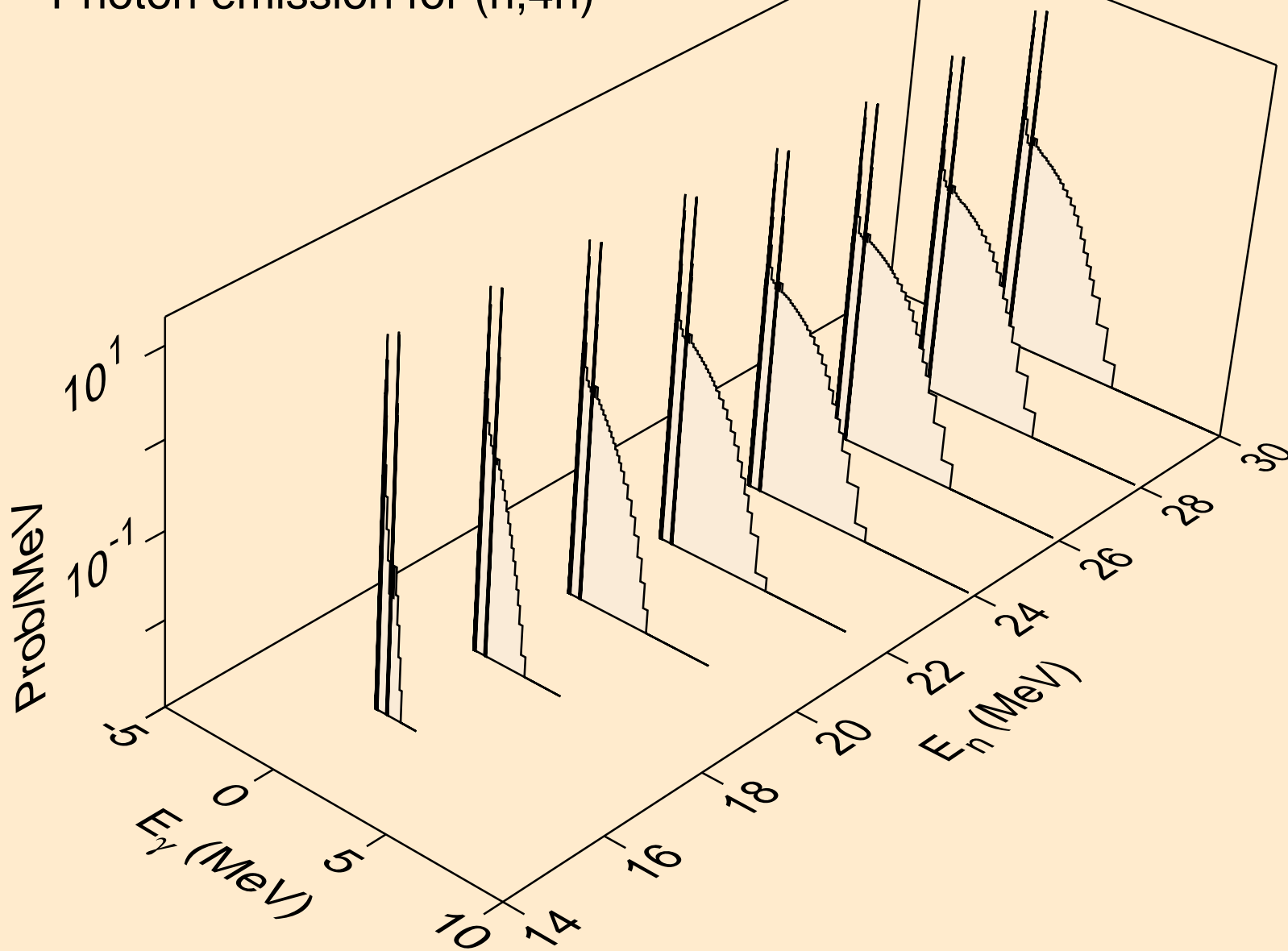

EU166 NEUTRON ACER TENDL-2023 LIBRARY; T=0.K  
Photon emission for (n,2np)

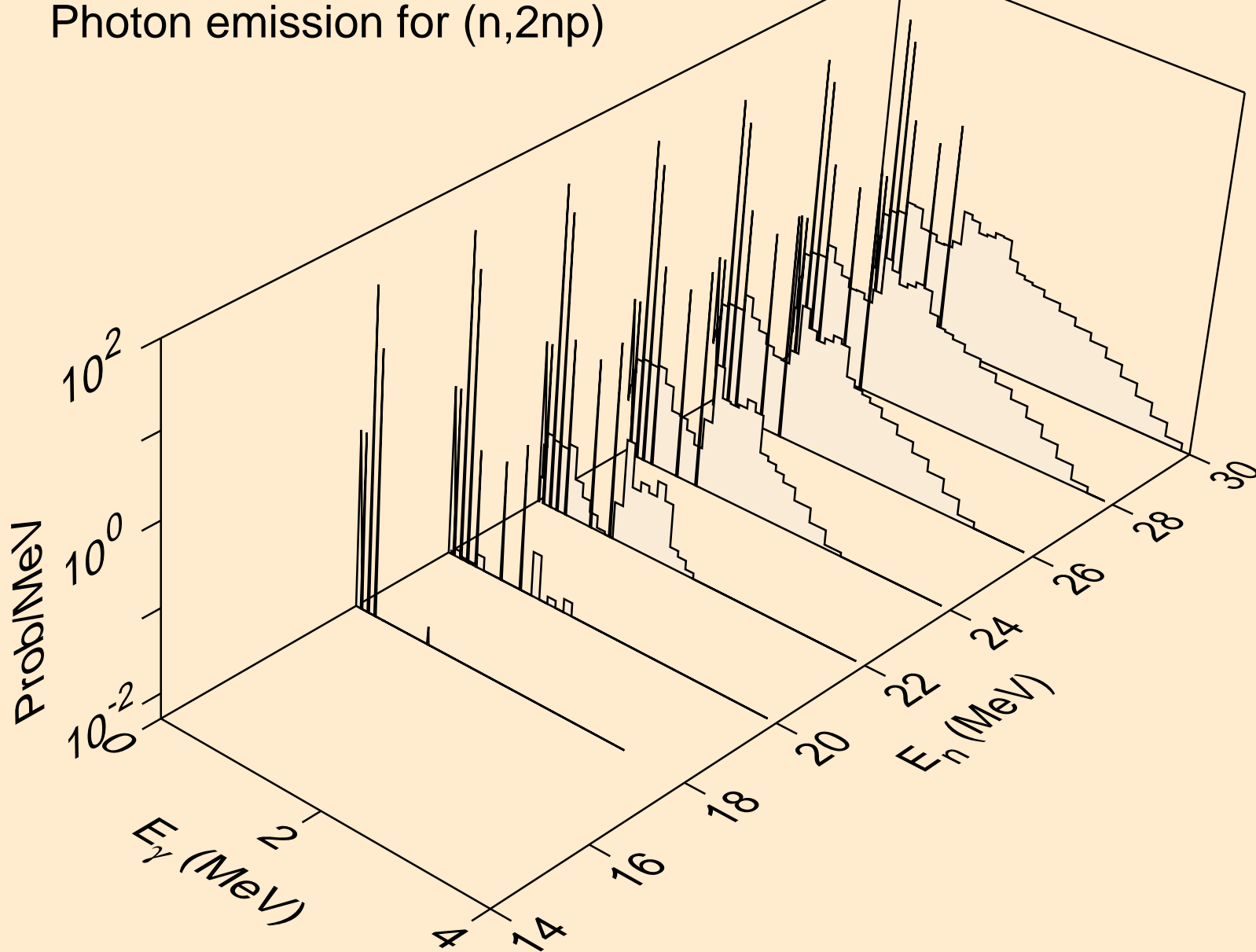

EU166 NEUTRON ACER TENDL-2023 LIBRARY; T=0.K  
Photon emission for (n,3np)

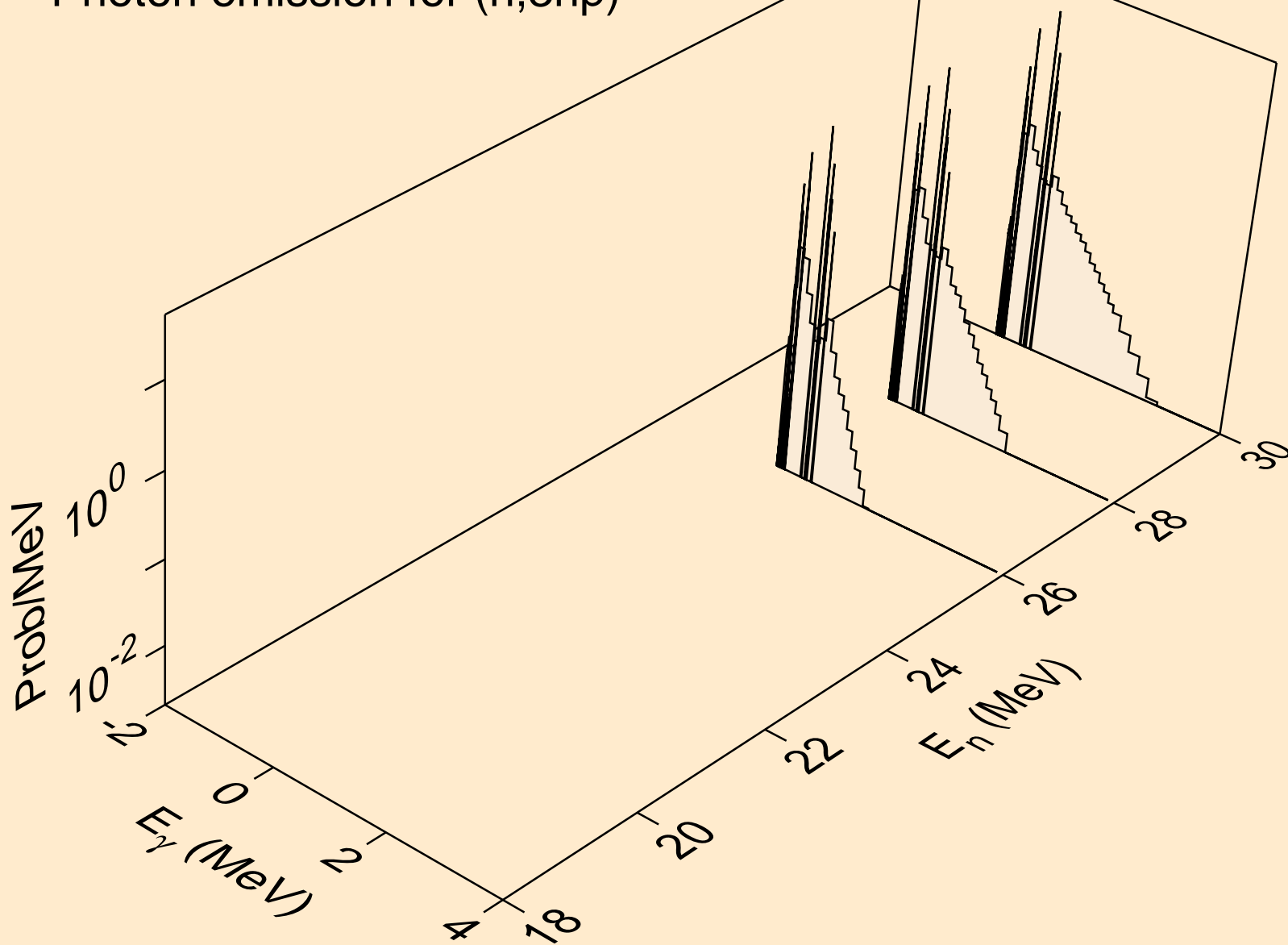

EU166 NEUTRON ACER TENDL-2023 LIBRARY; T=0.K  
Photon emission for (n,n\*c)

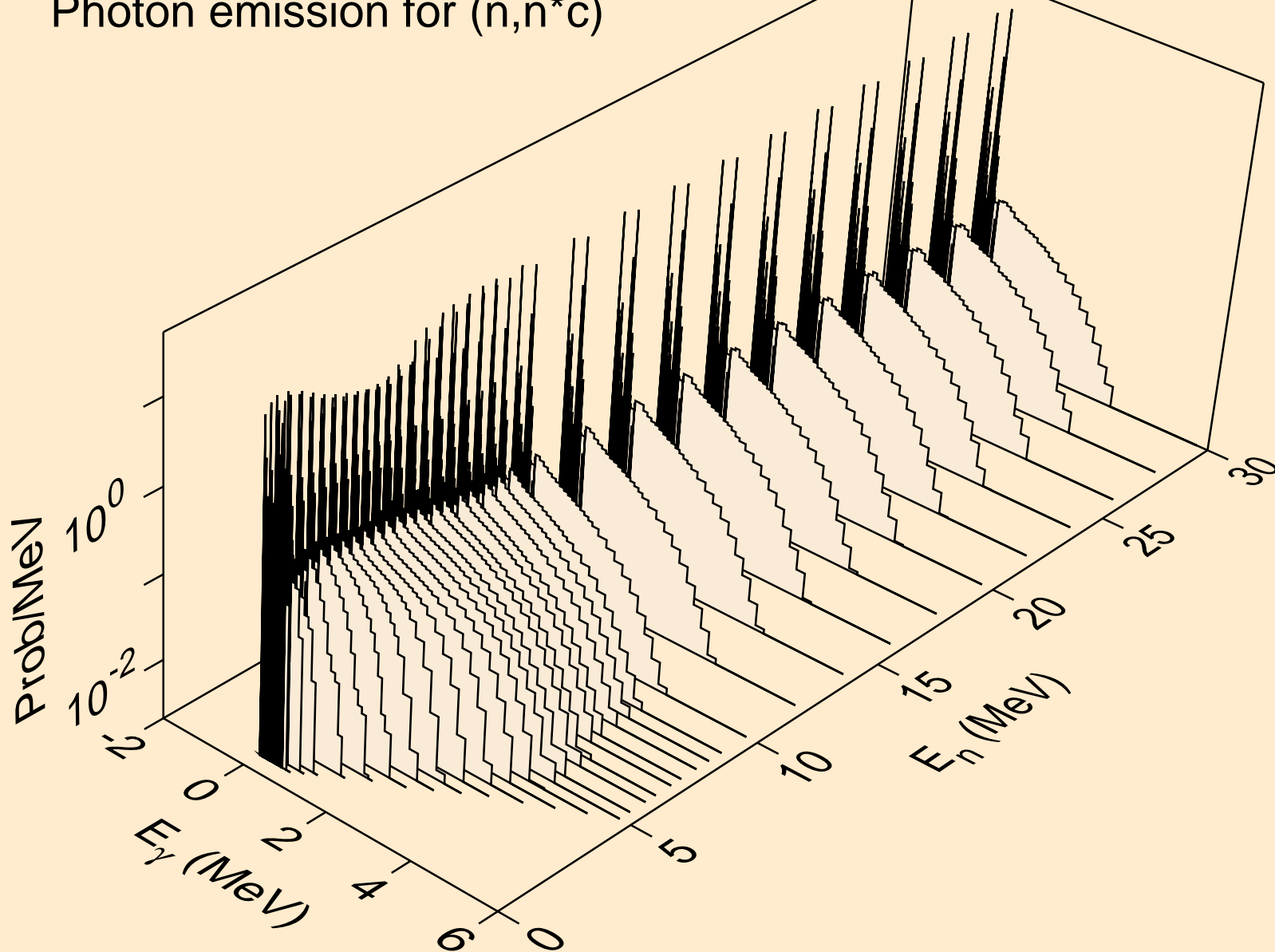

EU166 NEUTRON ACER TENDL-2023 LIBRARY; T=0.K  
Photon emission for (n,gma)

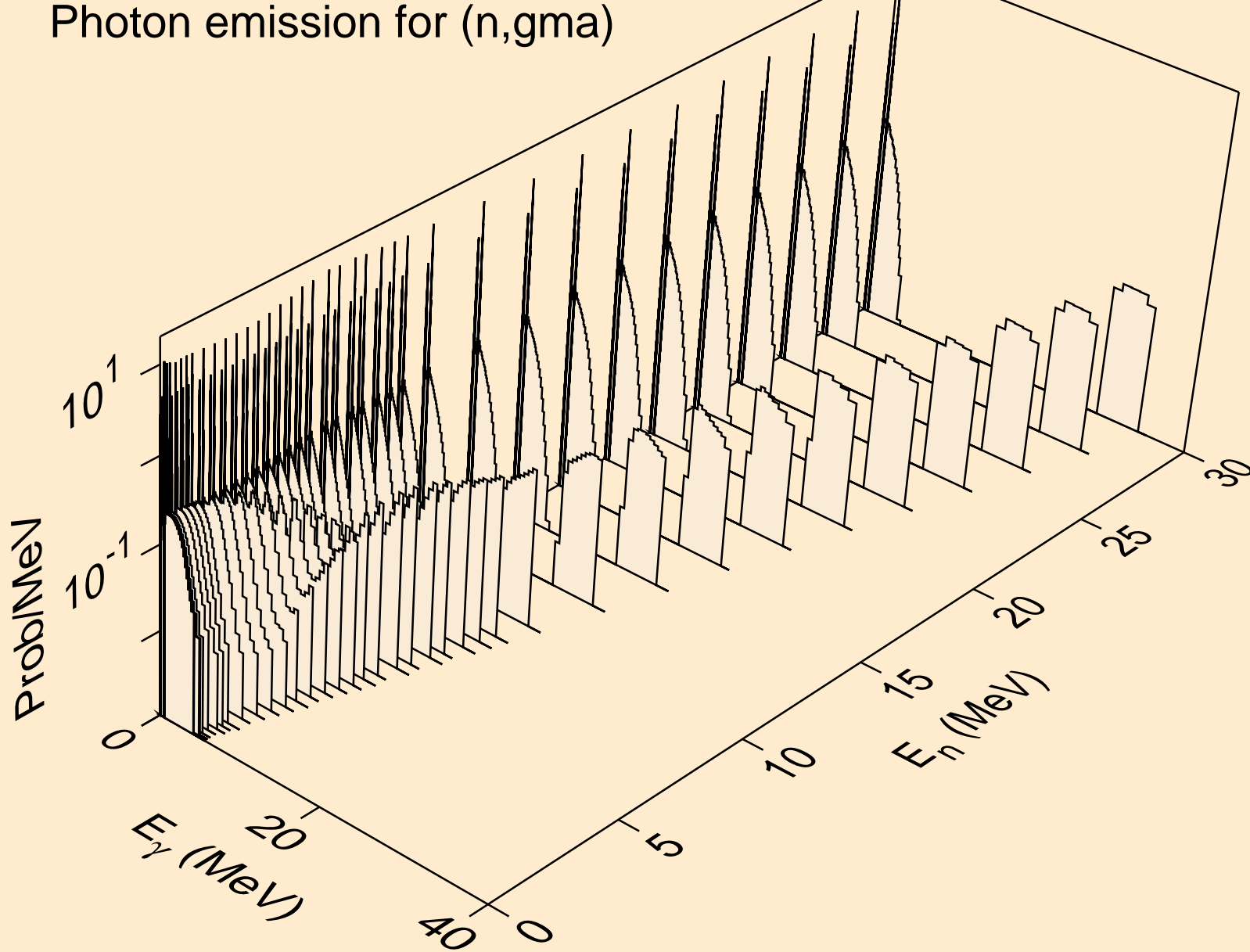

EU166 NEUTRON ACER TENDL-2023 LIBRARY; T=0.K  
Photon emission for (n,p)

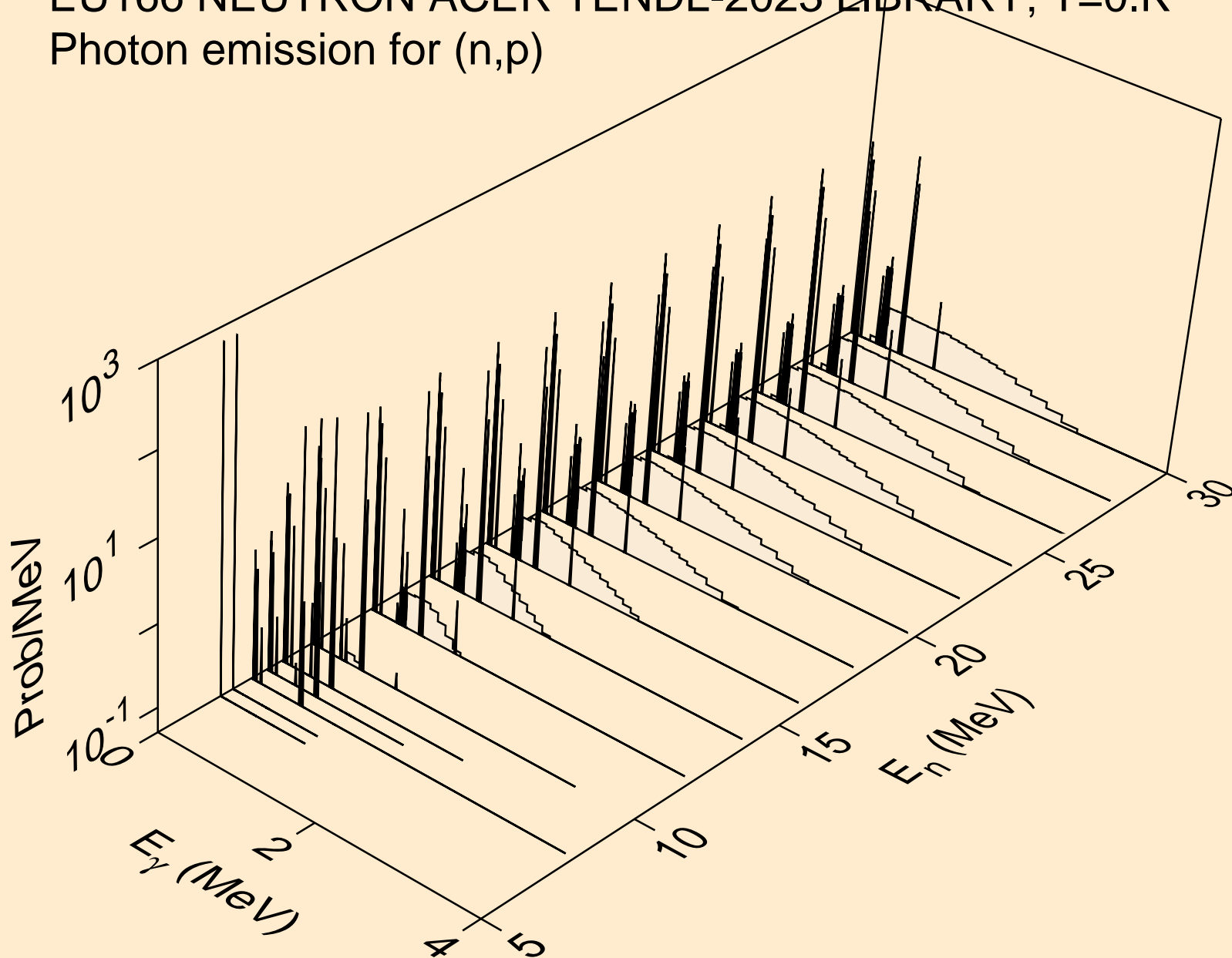



EU166 NEUTRON ACER TENDL-2023 LIBRARY; T=0.K  
Photon emission for (n,d)

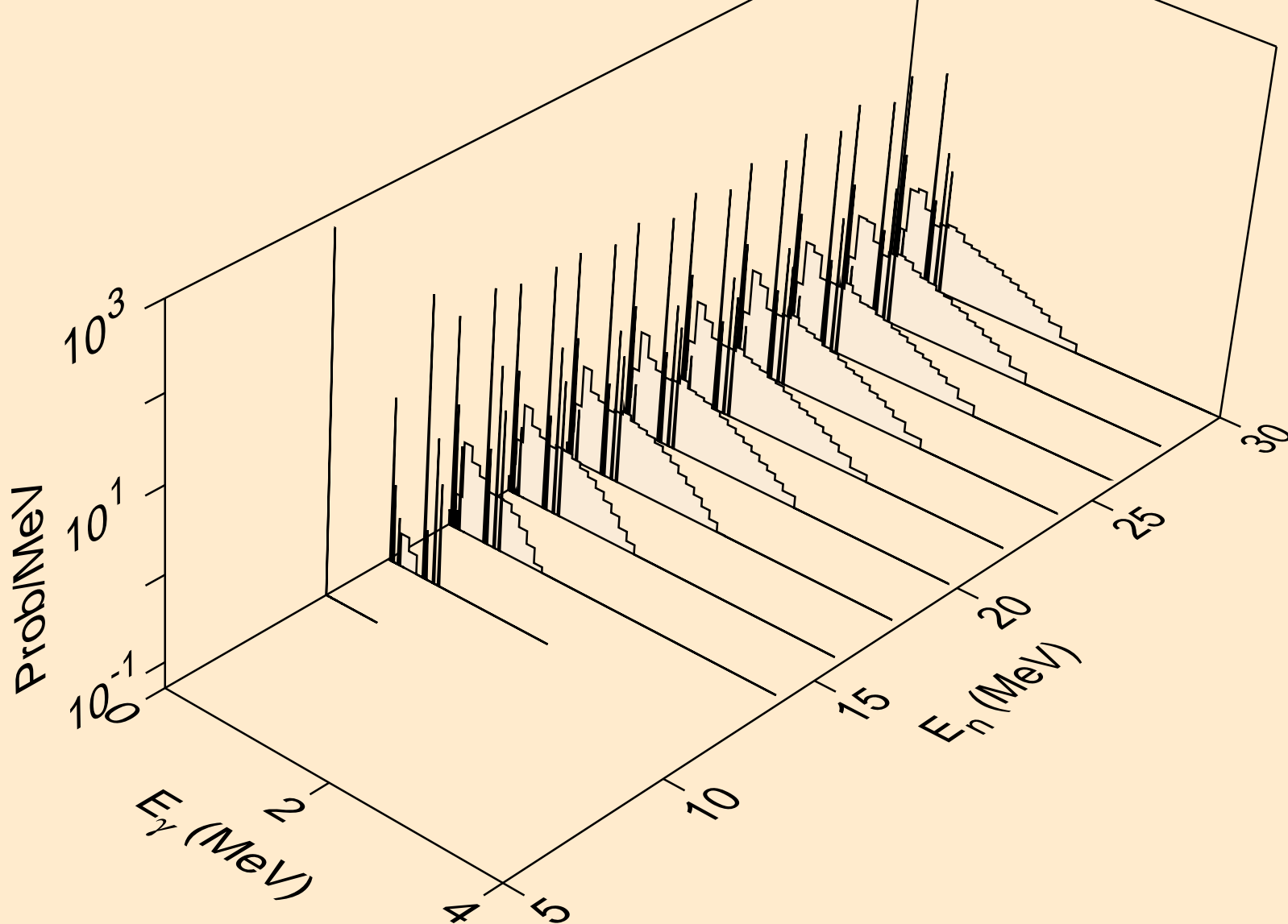

EU166 NEUTRON ACER TENDL-2023 LIBRARY; T=0.K  
Photon emission for (n,t)

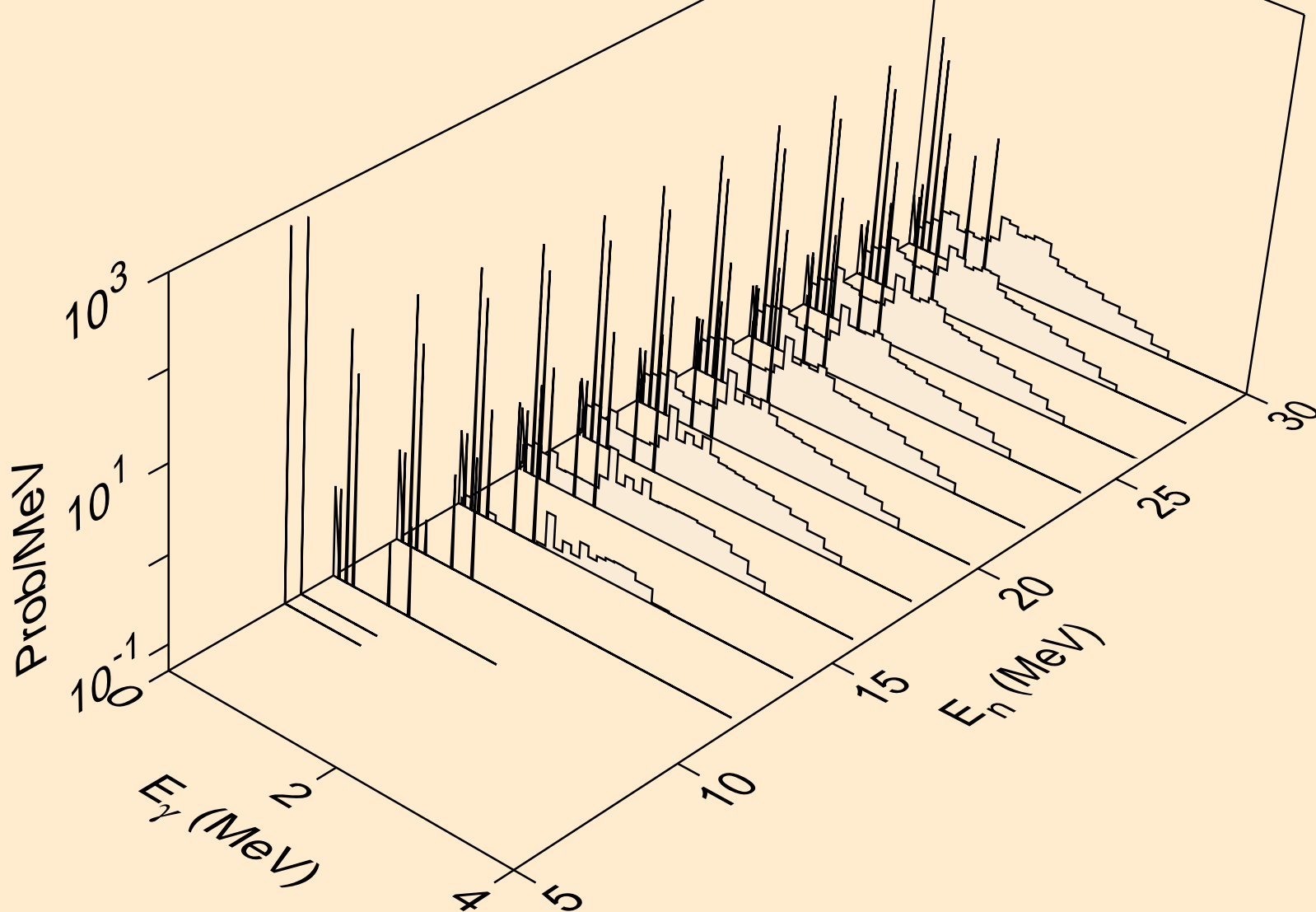

EU166 NEUTRON ACER TENDL-2023 LIBRARY; T=0.K  
Photon emission for (n,he3)

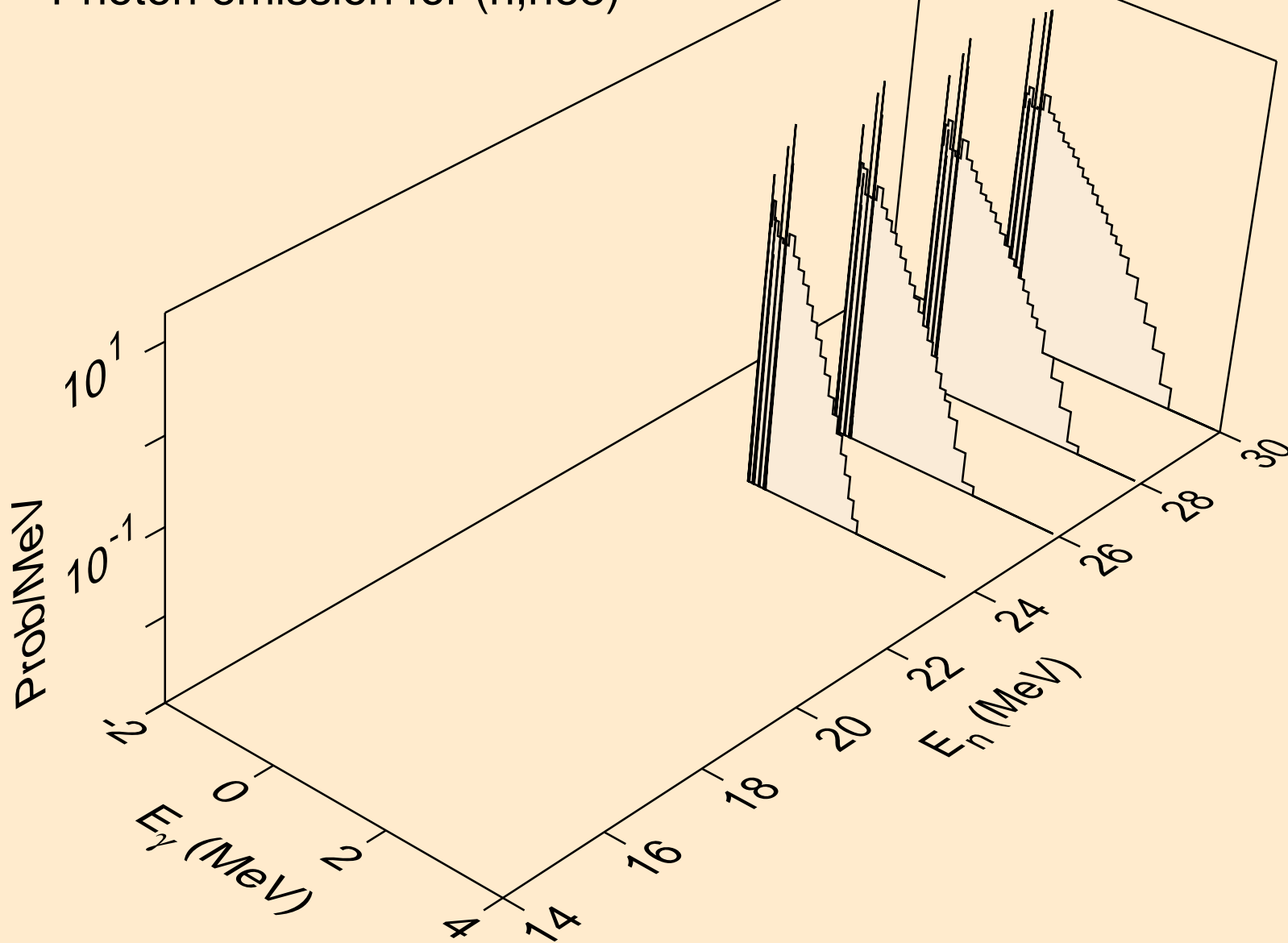

EU166 NEUTRON ACER TENDL-2023 LIBRARY; T=0.K  
Photon emission for (n,a)

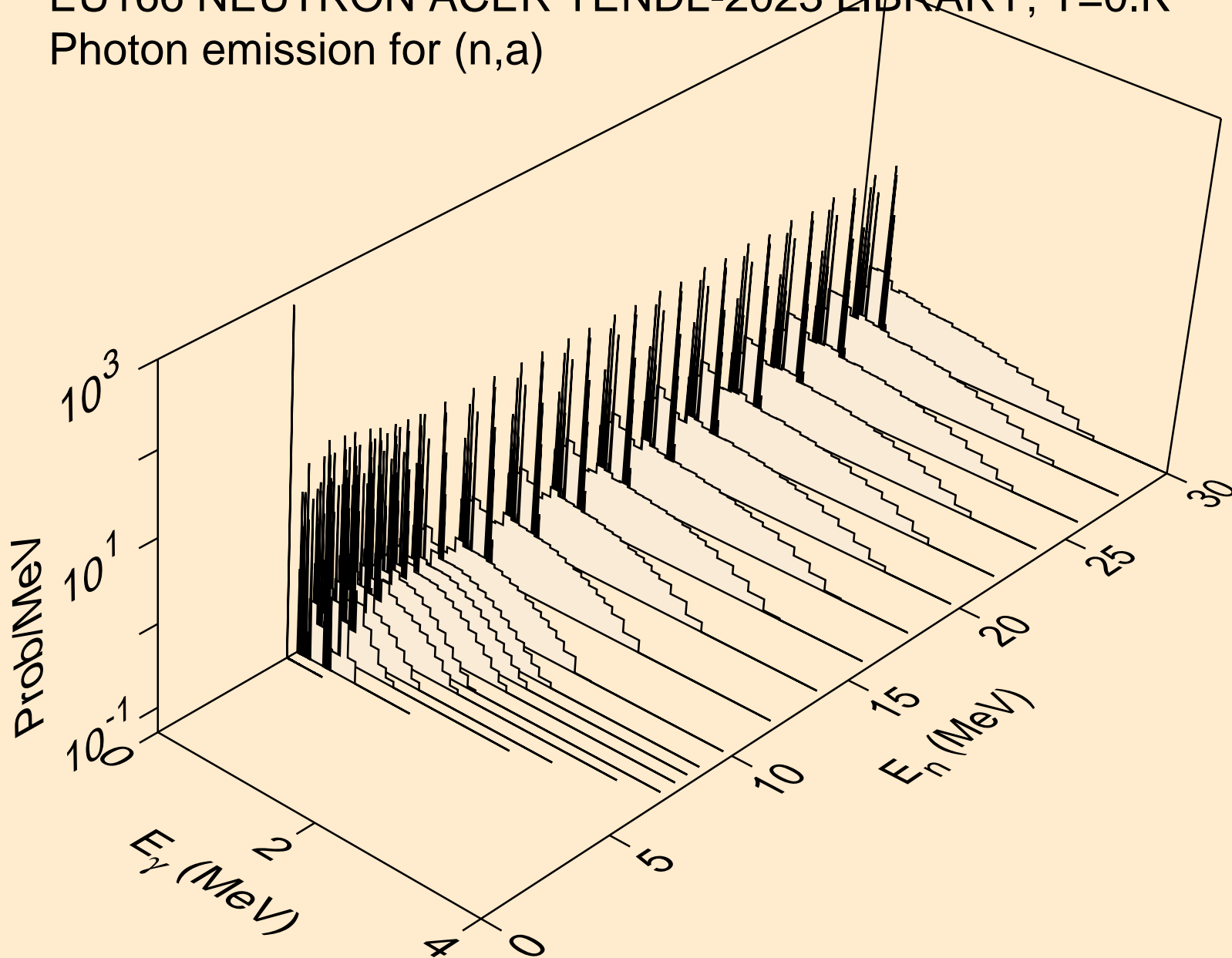

EU166 NEUTRON ACER TENDL-2023 LIBRARY; T=0.K  
thermal capture photon spectrum

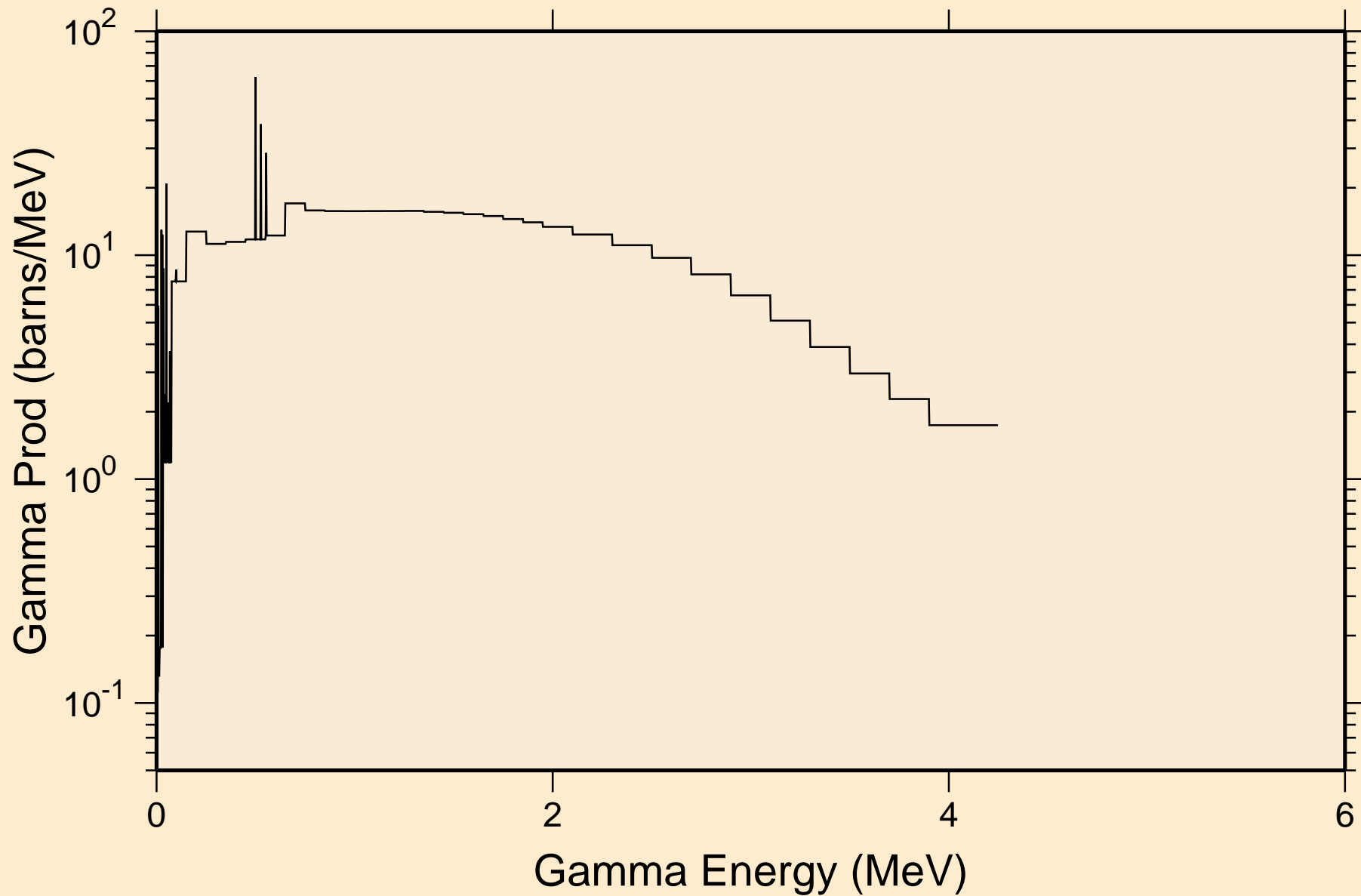

EU166 NEUTRON ACER TENDL-2023 LIBRARY; T=0.K  
14 MeV photon spectrum

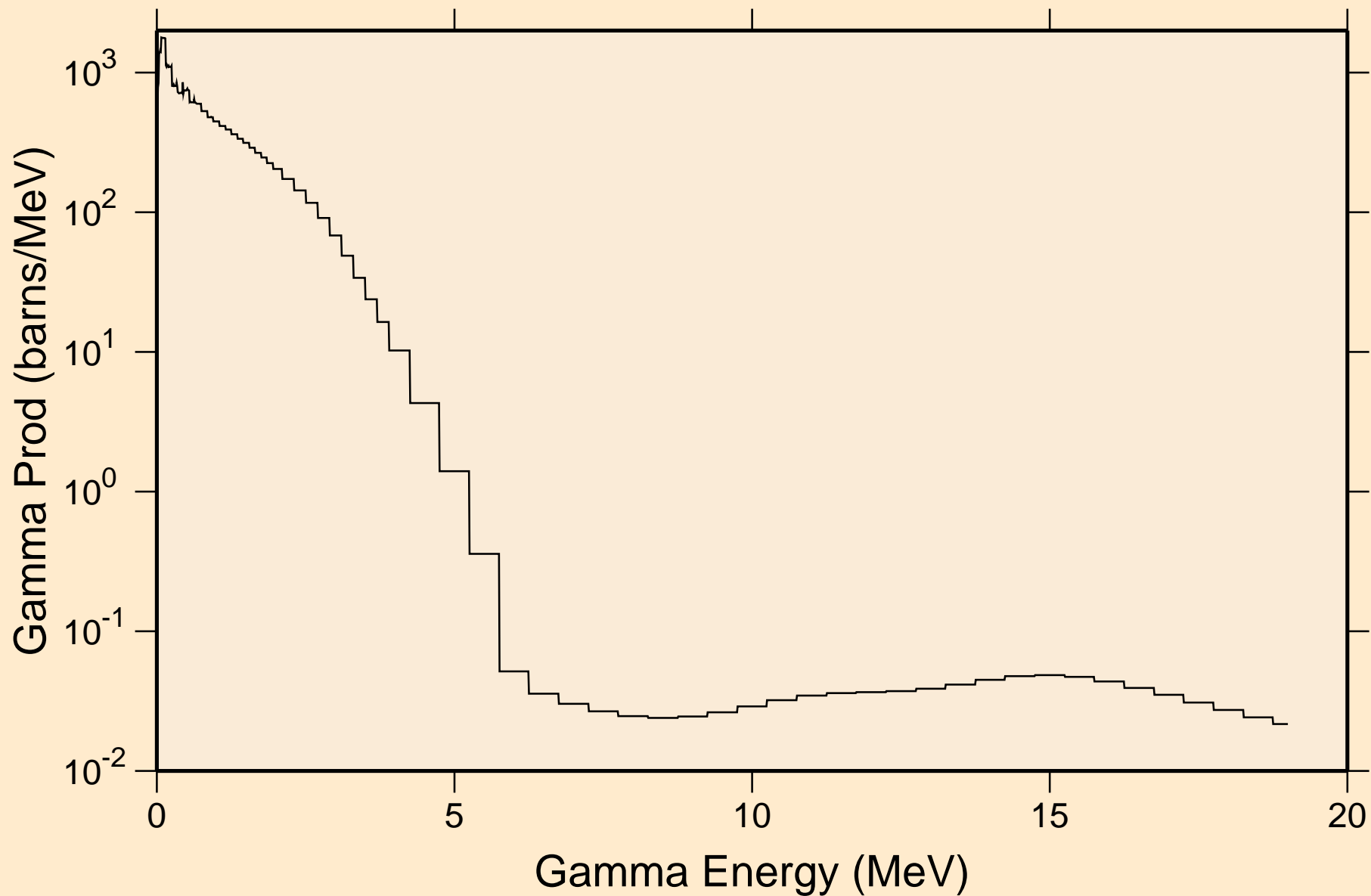

# EU166 NEUTRON ACER TENDL-2023 LIBRARY; T=0.K

## Particle heating contributions

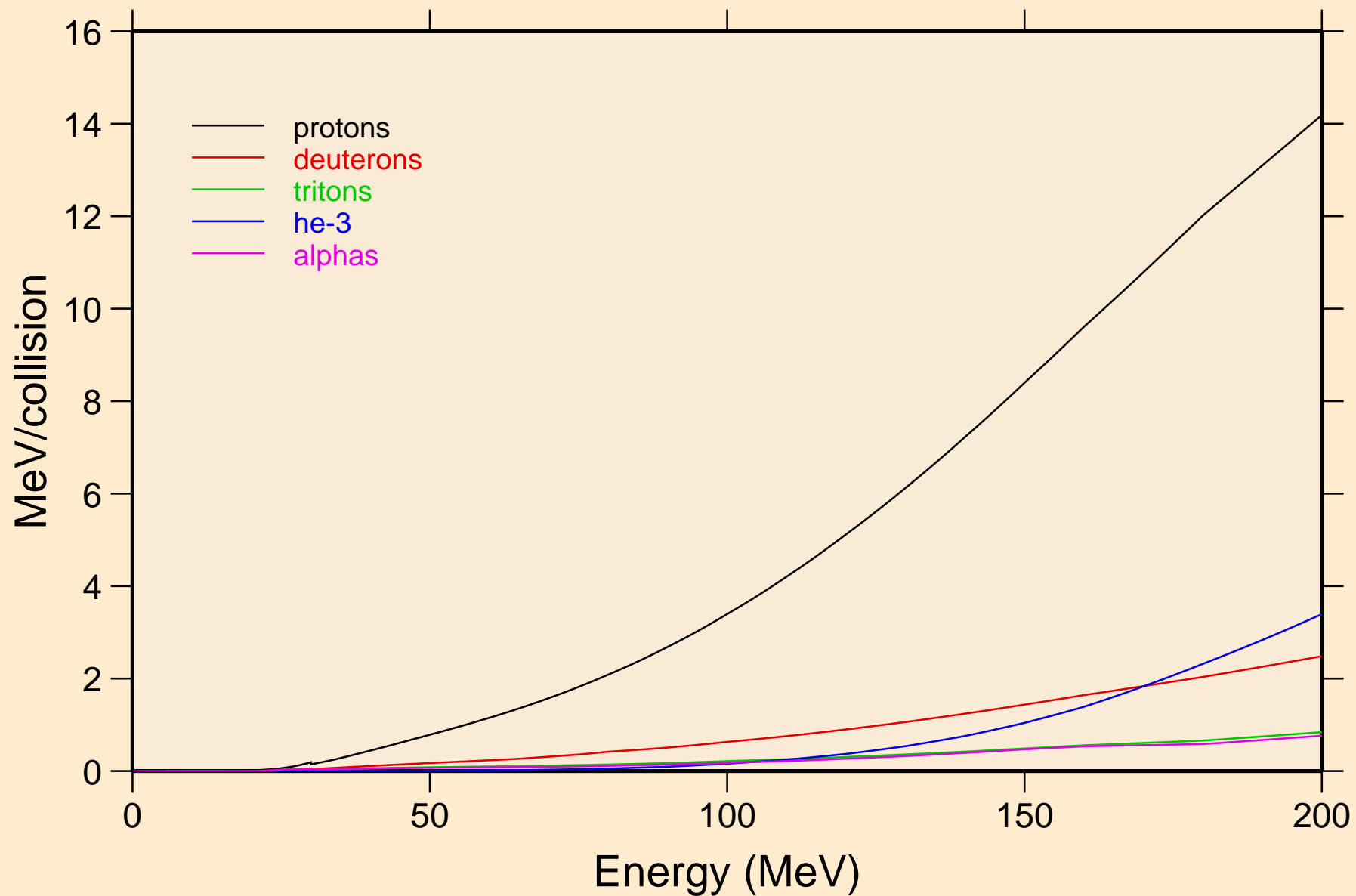

EU166 NEUTRON ACER TENDL-2023 LIBRARY; T=0.K  
Recoil Heating

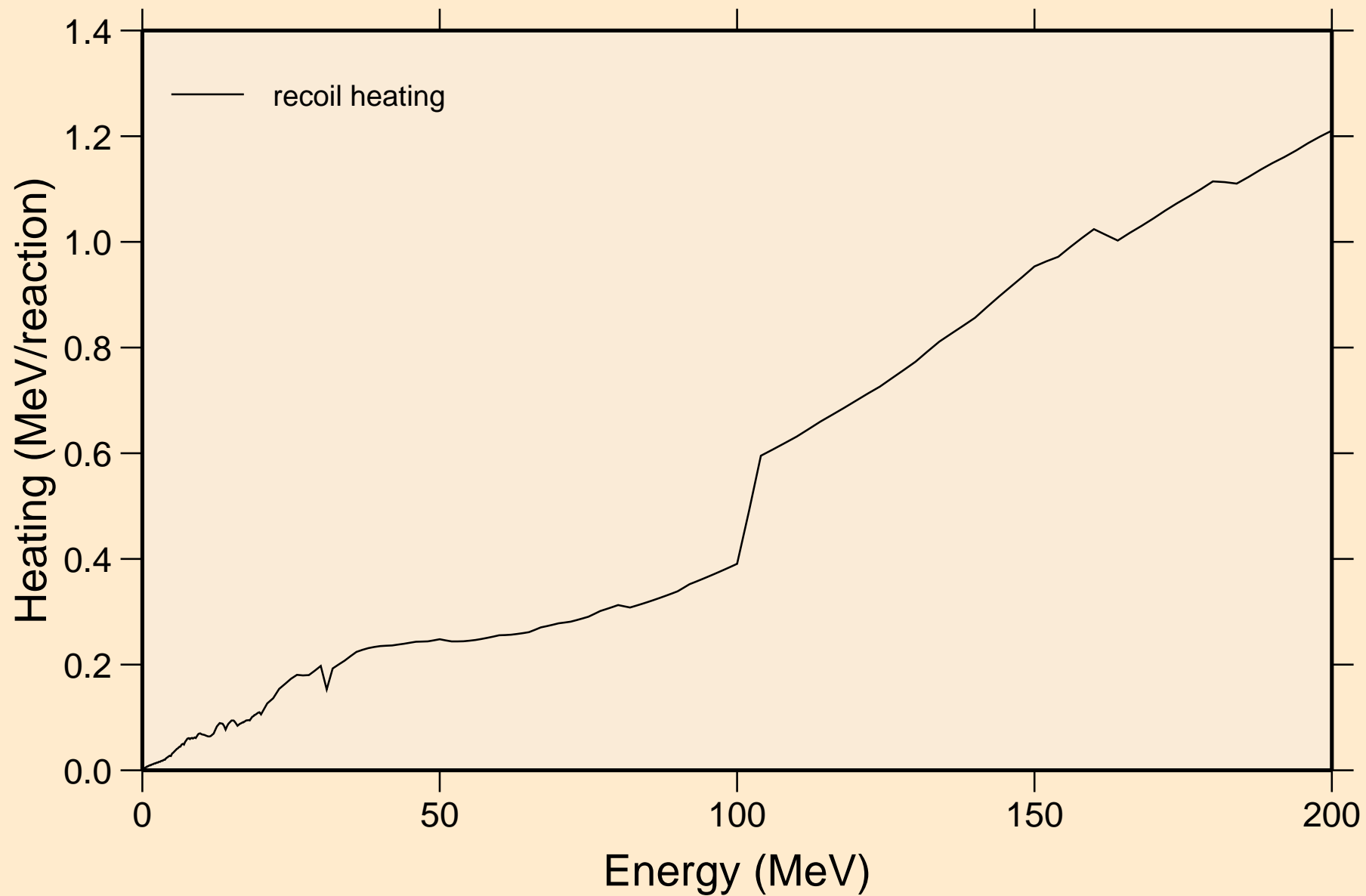



# EU166 NEUTRON ACER TENDL-2023 LIBRARY; T=0.K

## Particle production cross sections

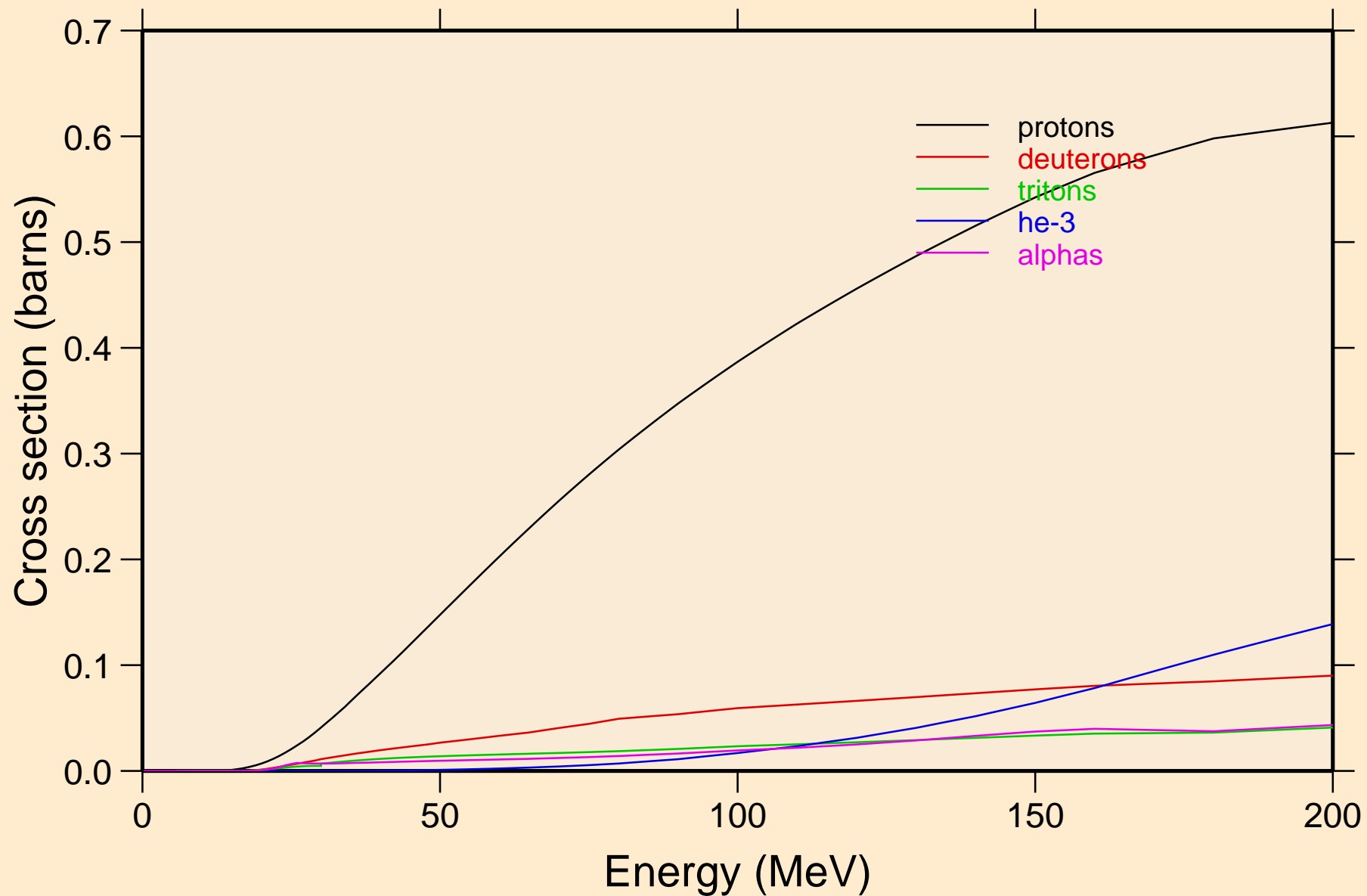

EU166 NEUTRON ACER TENDL-2023 LIBRARY; T=0.K  
protons from (n,x)

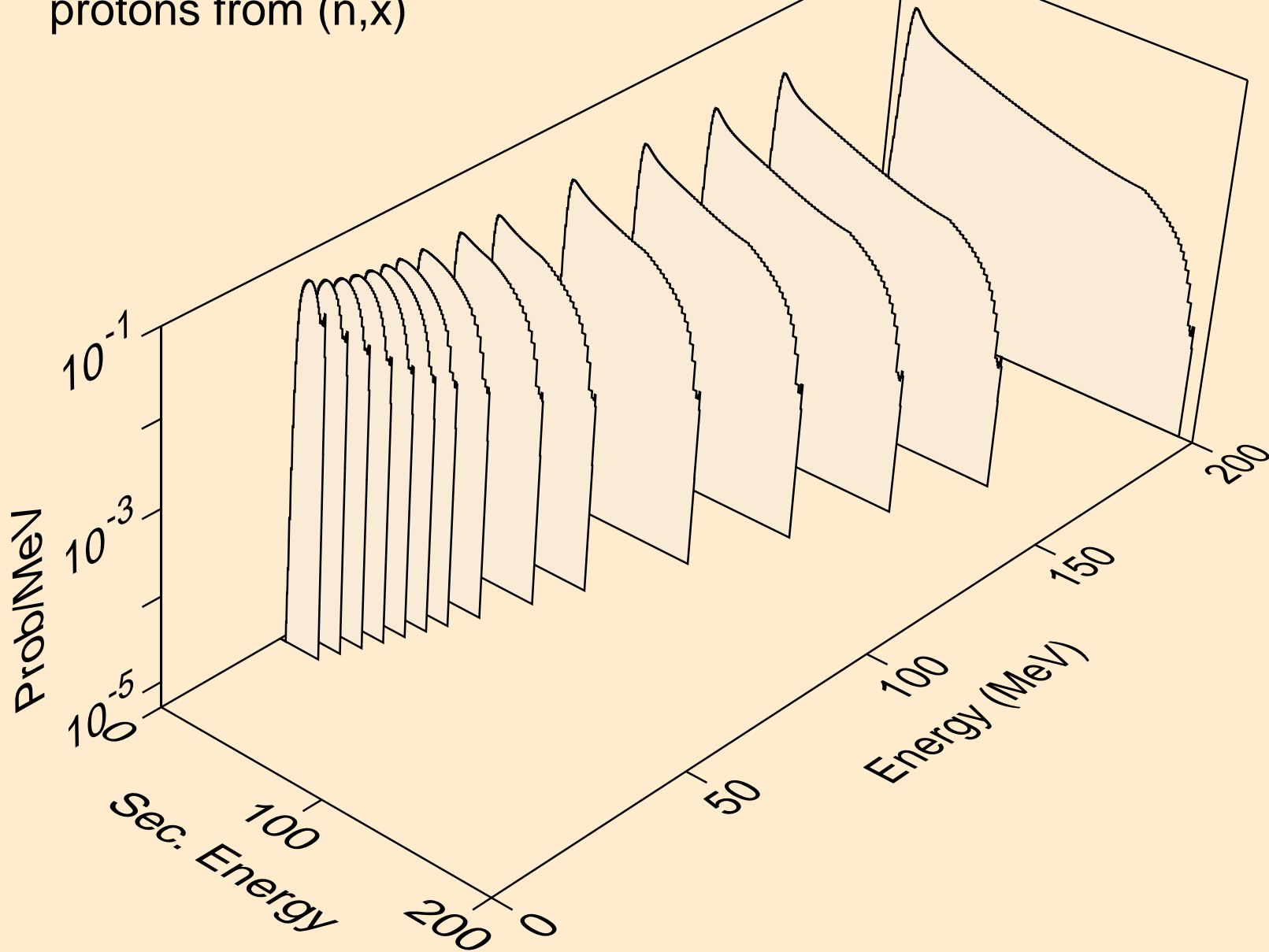

EU166 NEUTRON ACER TENDL-2023 LIBRARY; T=0.K  
protons from (n,n\*)p

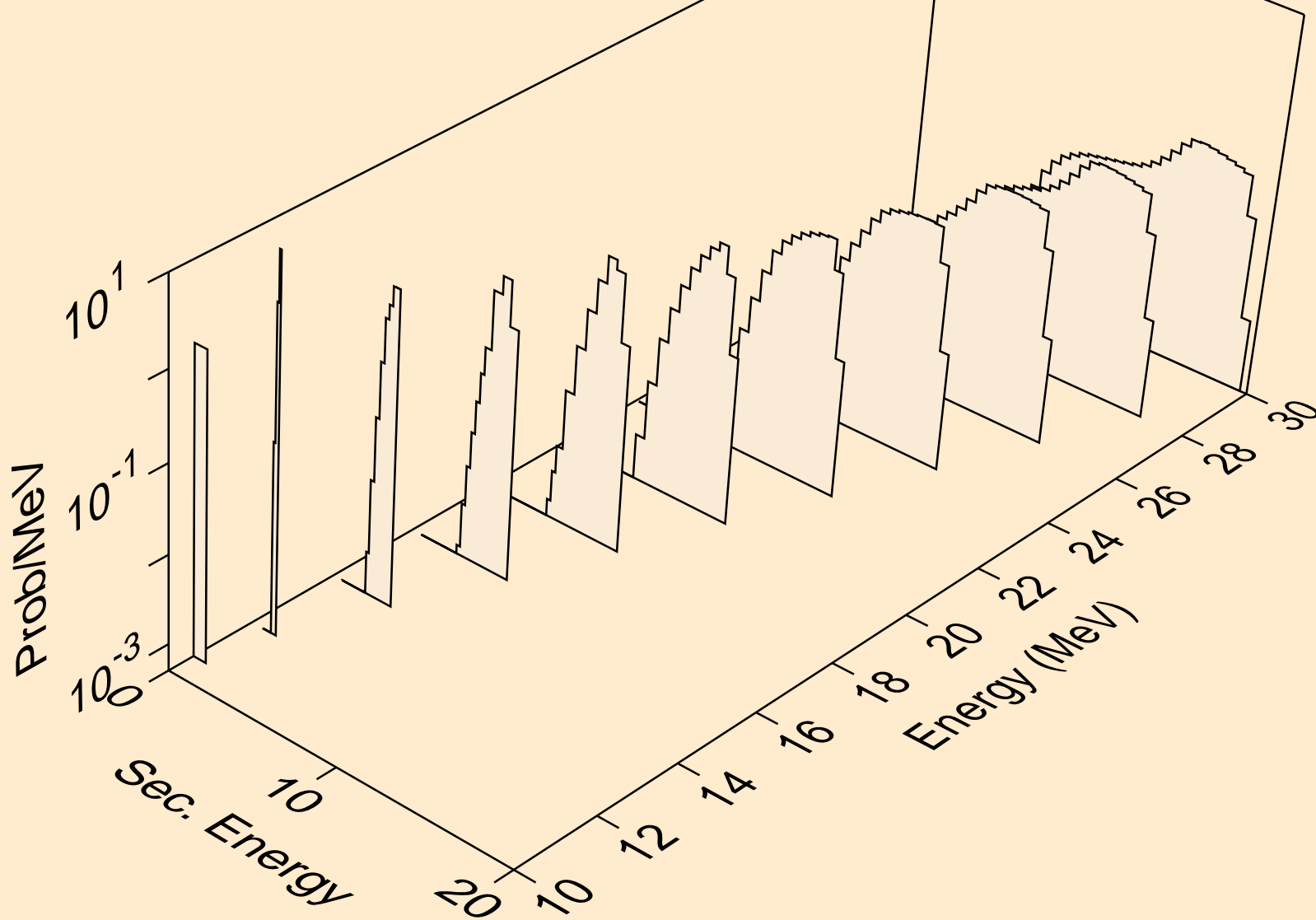

EU166 NEUTRON ACER TENDL-2023 LIBRARY; T=0.K  
protons from (n,2np)

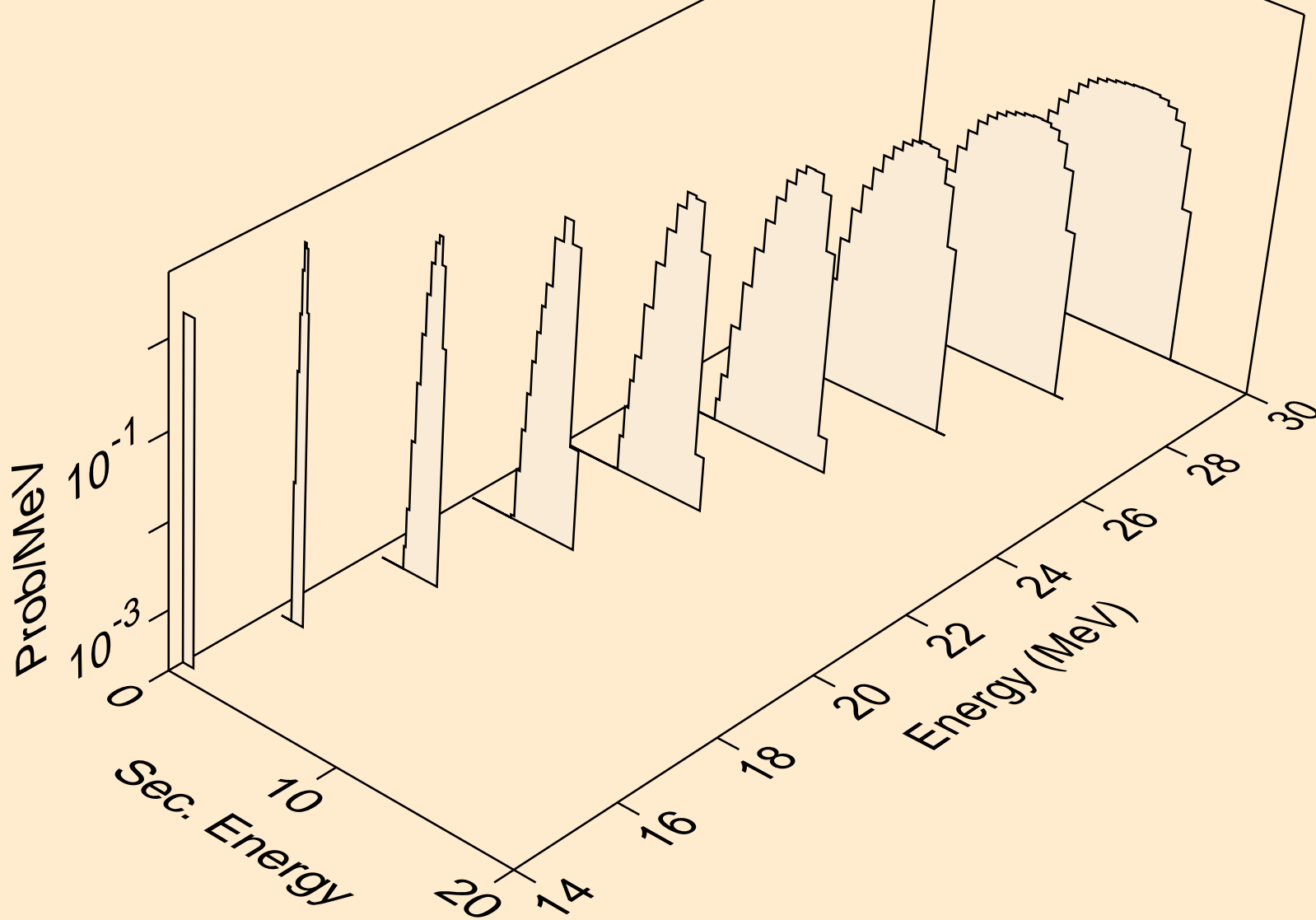

EU166 NEUTRON ACER TENDL-2023 LIBRARY; T=0.K  
protons from (n,3np)

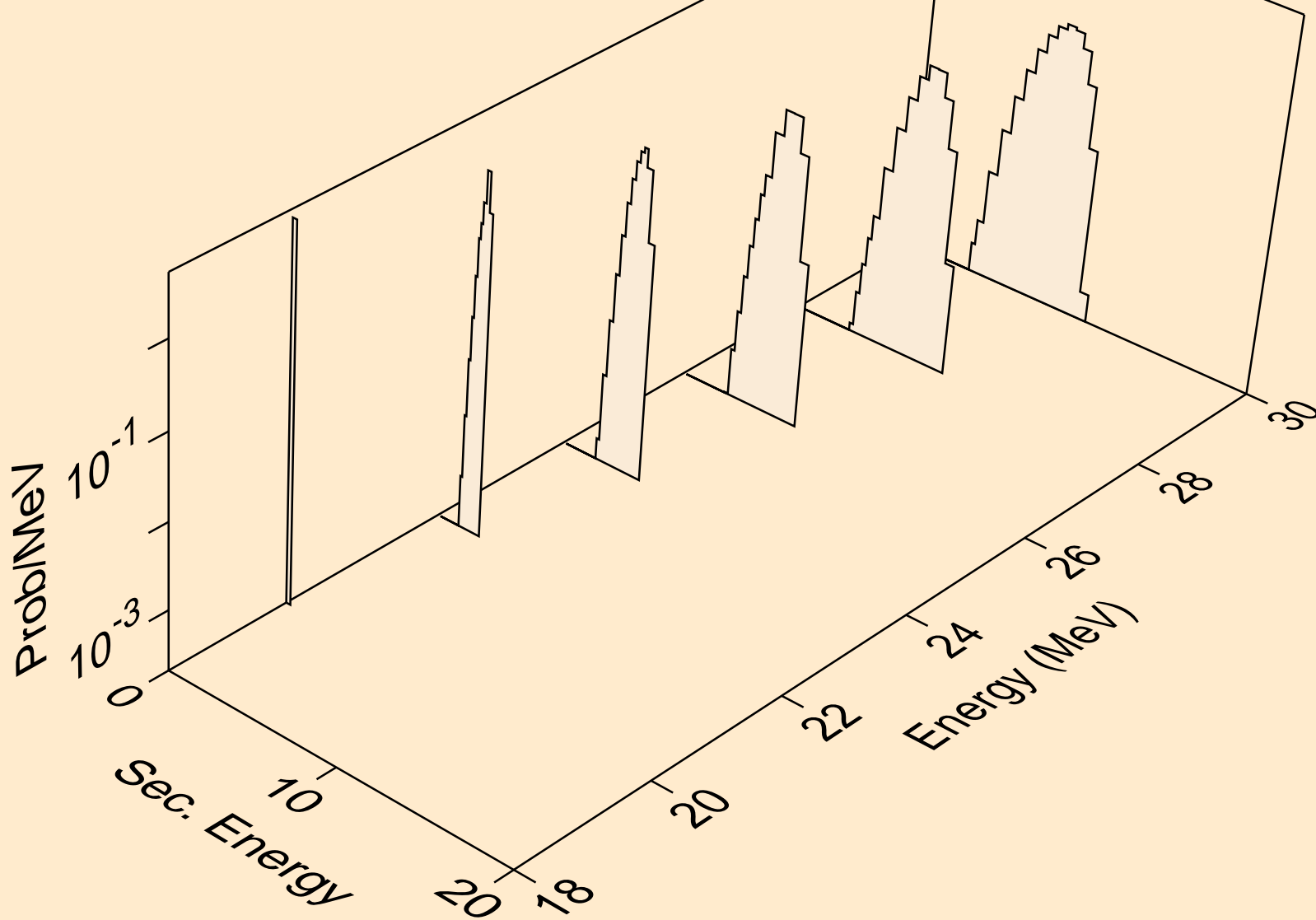

EU166 NEUTRON ACER TENDL-2023 LIBRARY; T=0.K  
protons from (n,p)

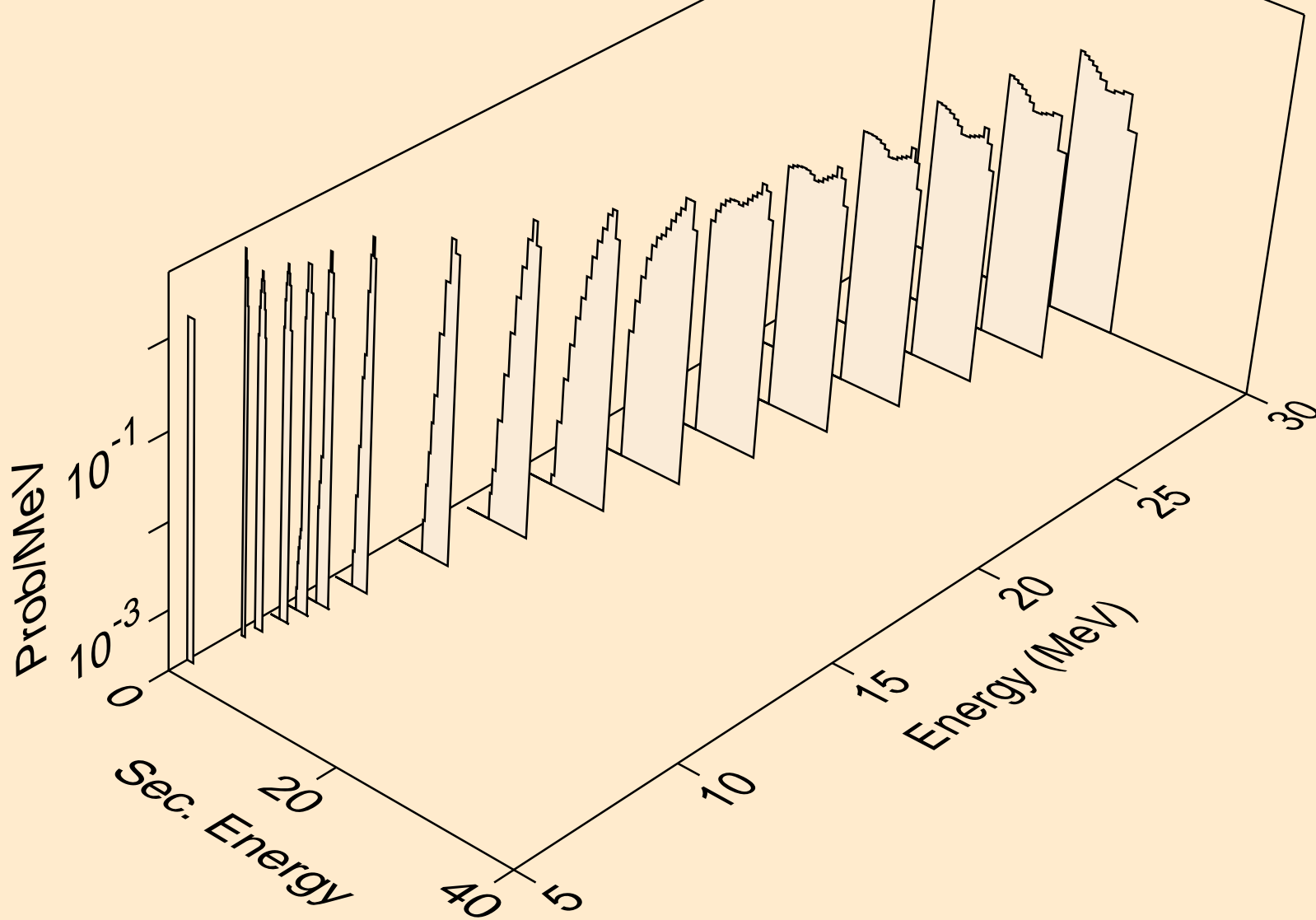

EU166 NEUTRON ACER TENDL-2023 LIBRARY; T=0.K  
deuterons from (n,x)

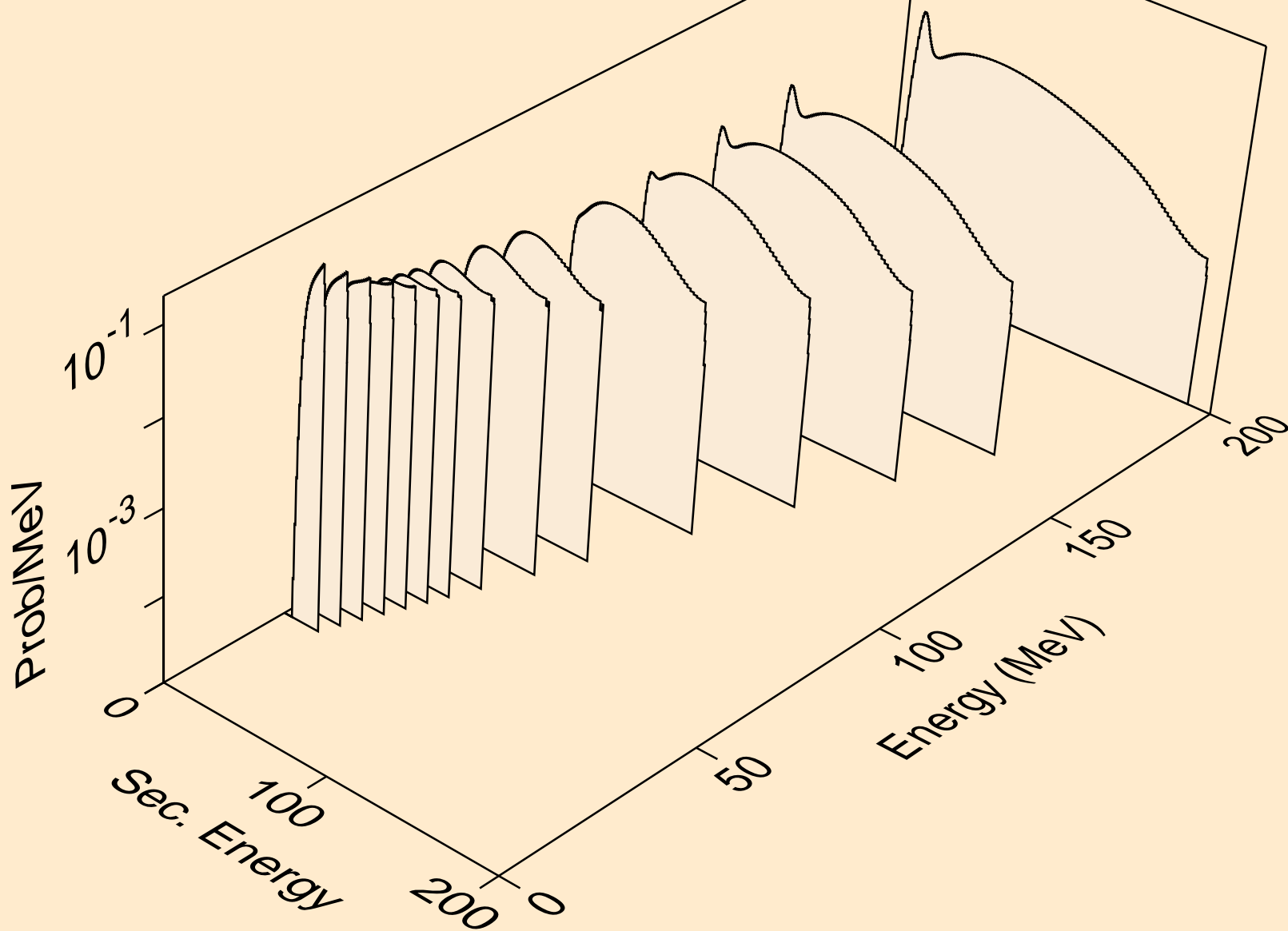

EU166 NEUTRON ACER TENDL-2023 LIBRARY; T=0.K  
deuterons from (n,2nd)

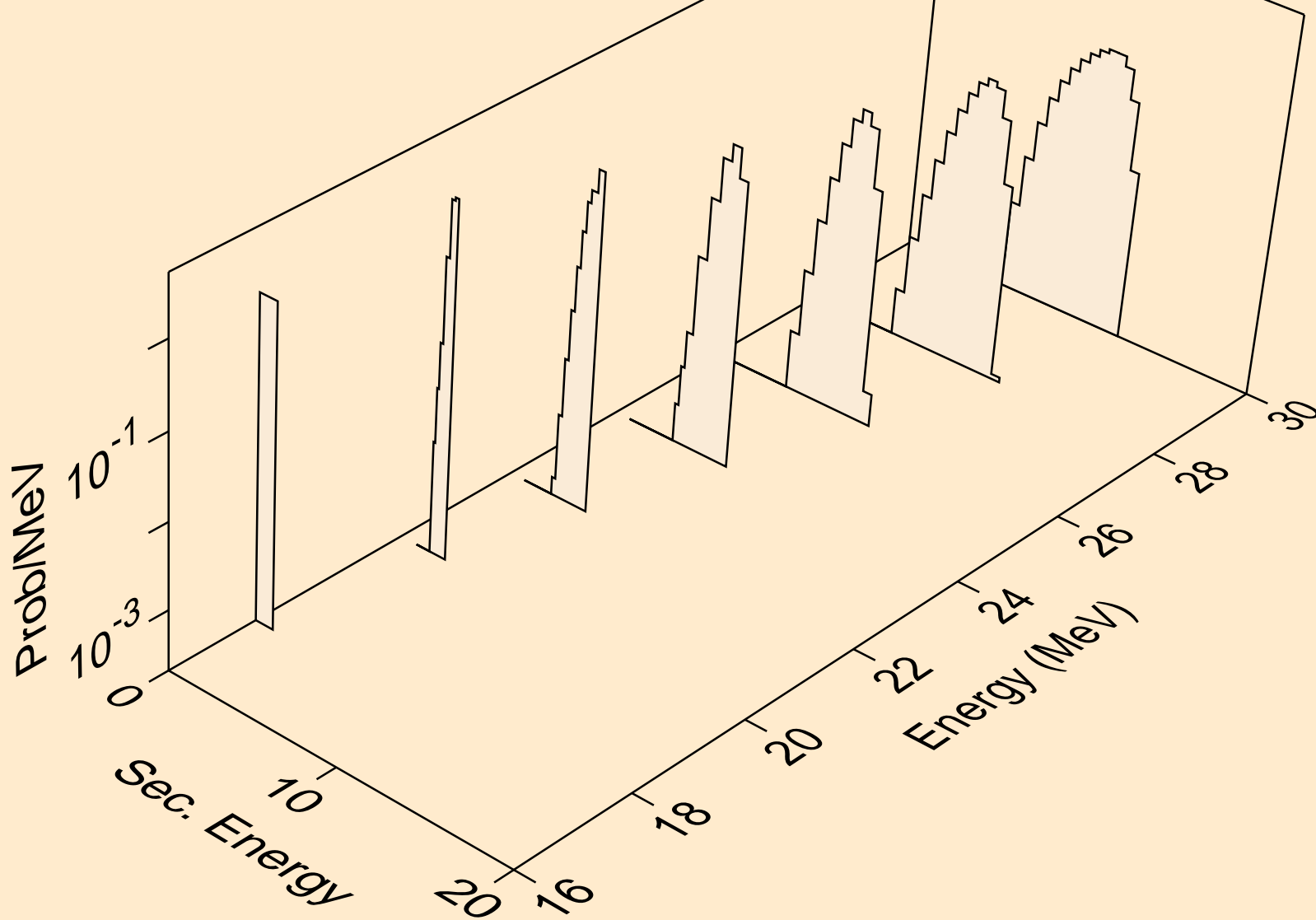



EU166 NEUTRON ACER TENDL-2023 LIBRARY; T=0.K  
deuterons from (n,n\*)d

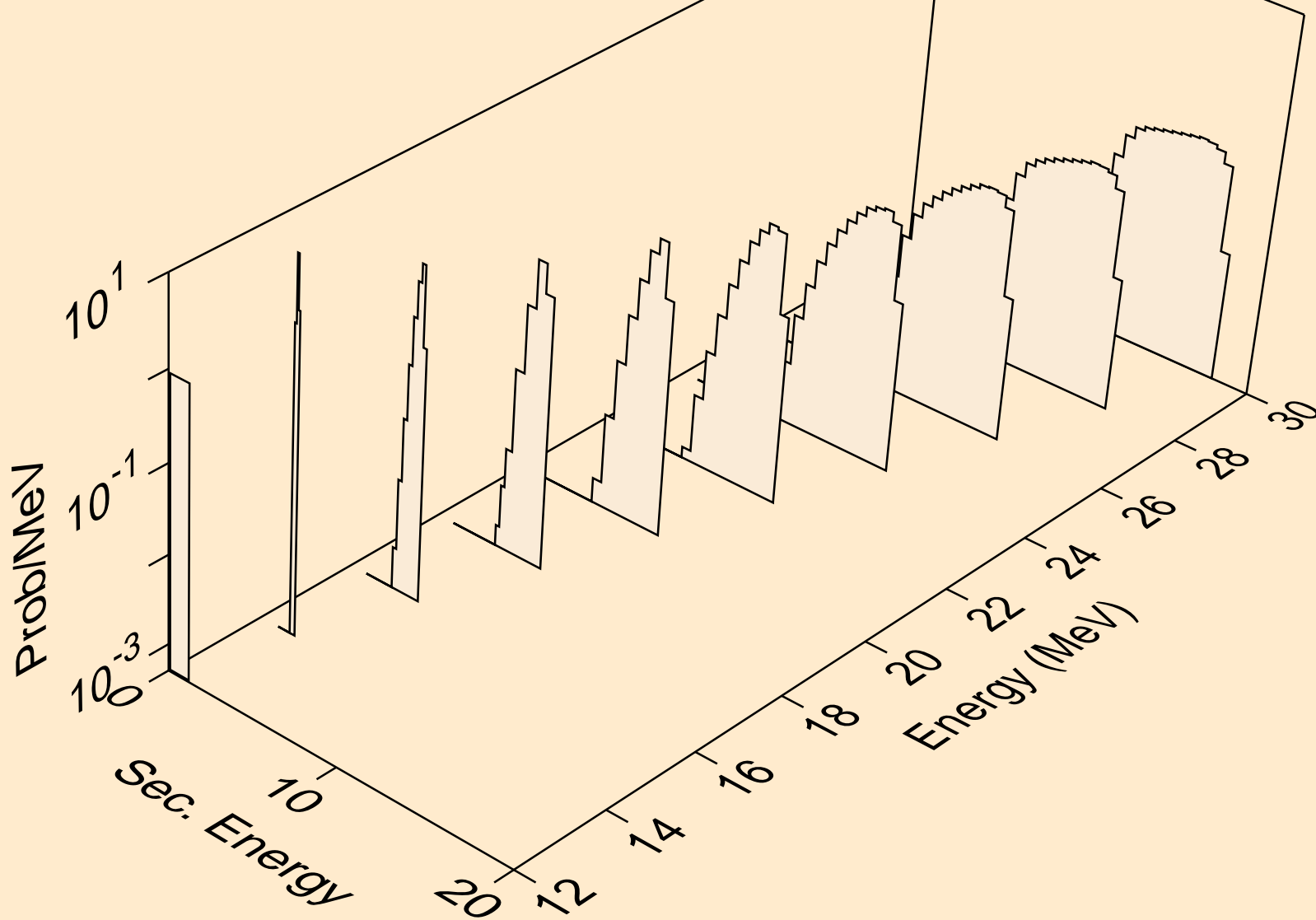

EU166 NEUTRON ACER TENDL-2023 LIBRARY; T=0.K  
deuterons from (n,d)

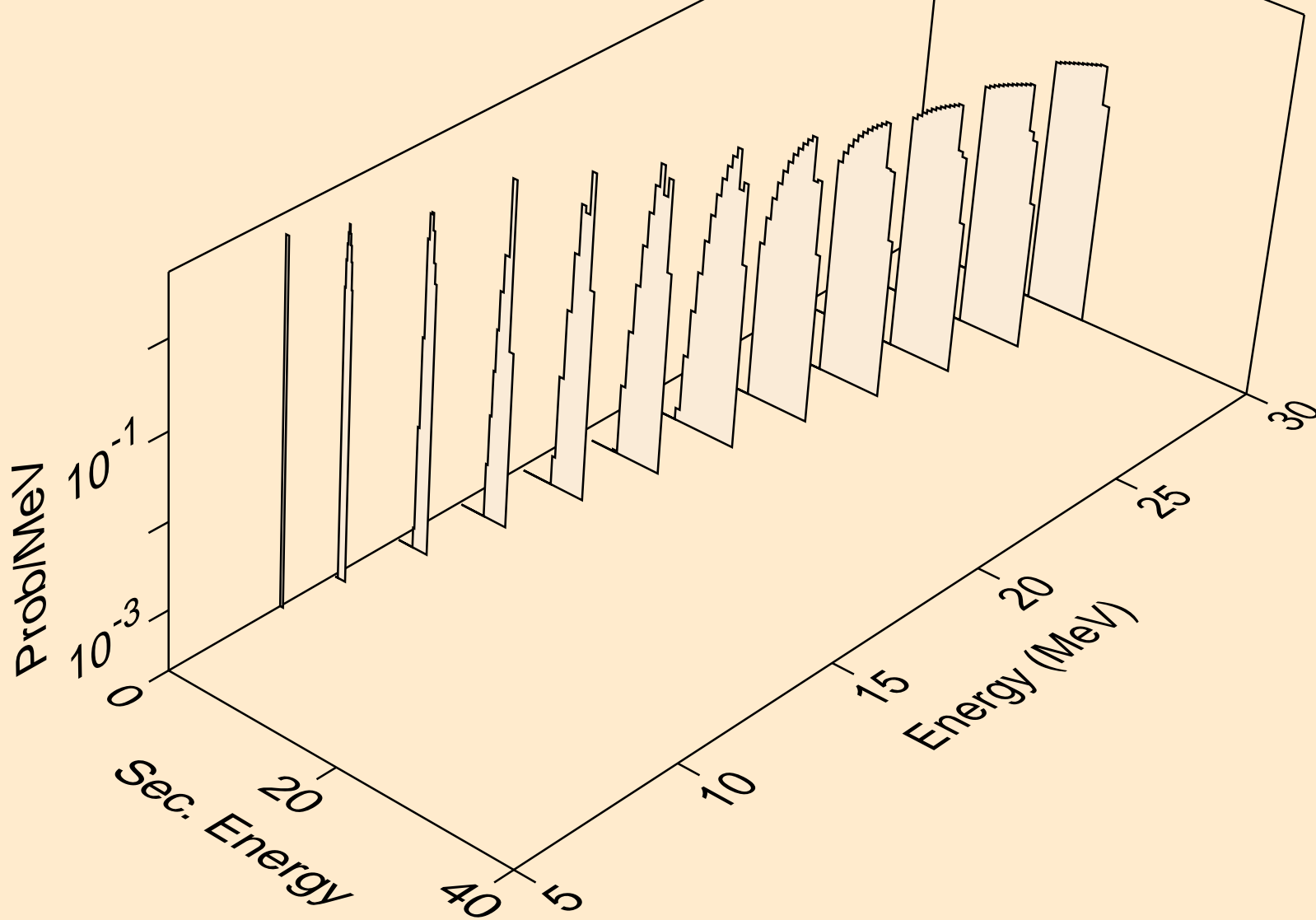

EU166 NEUTRON ACER TENDL-2023 LIBRARY; T=0.K  
tritons from (n,x)

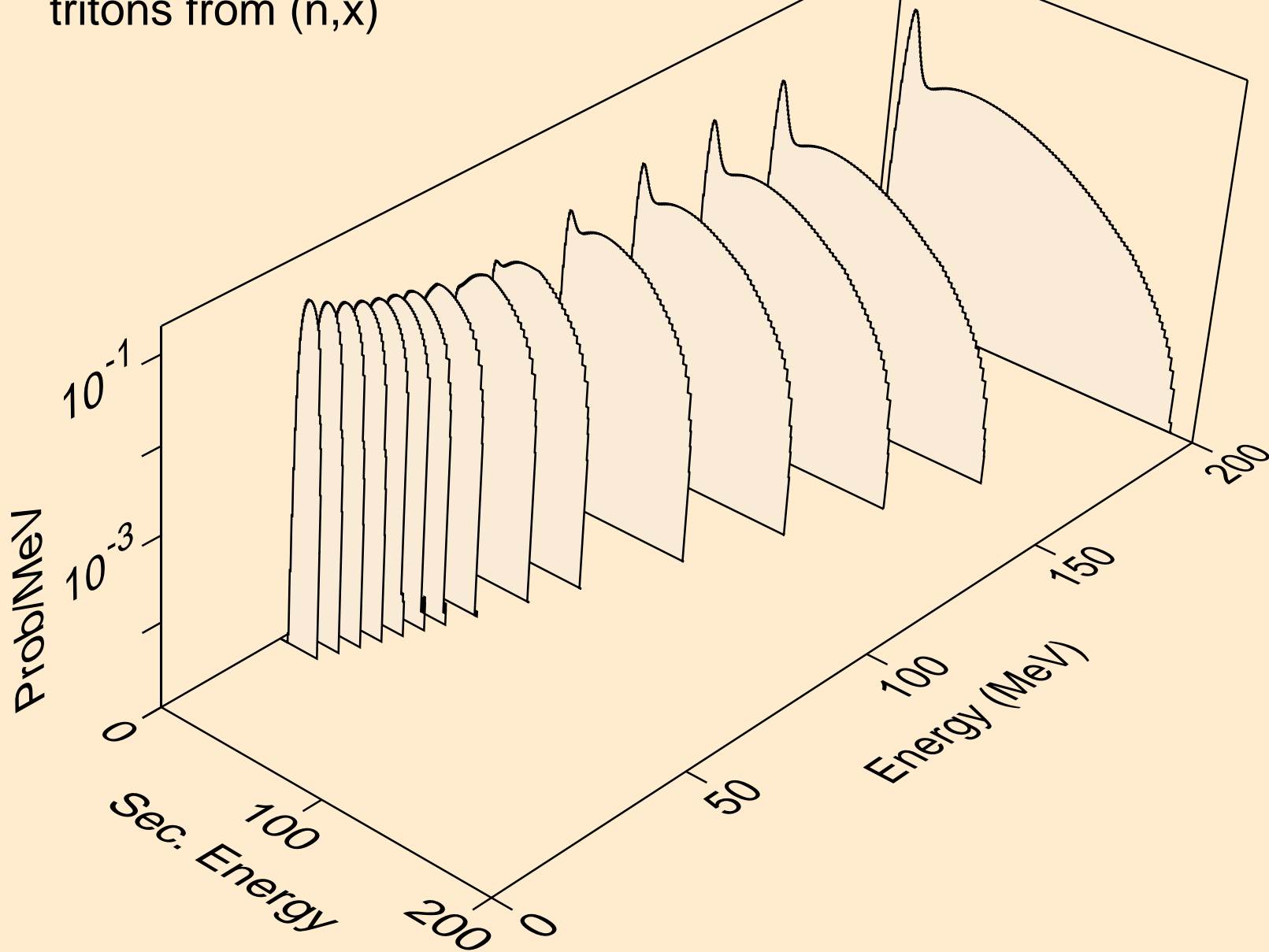

EU166 NEUTRON ACER TENDL-2023 LIBRARY; T=0.K  
tritons from (n,n\*)t

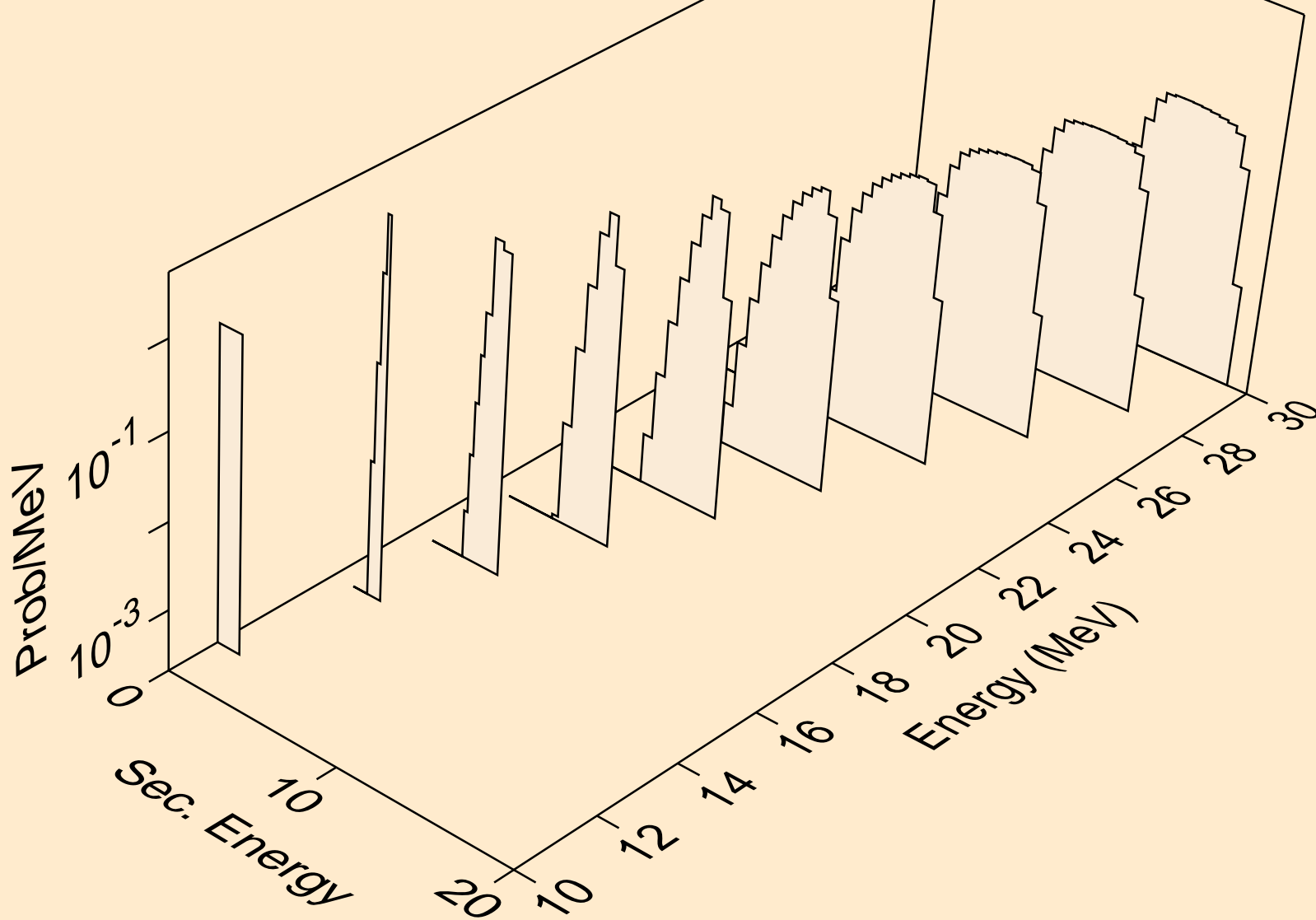

EU166 NEUTRON ACER TENDL-2023 LIBRARY; T=0.K  
tritons from (n,t)

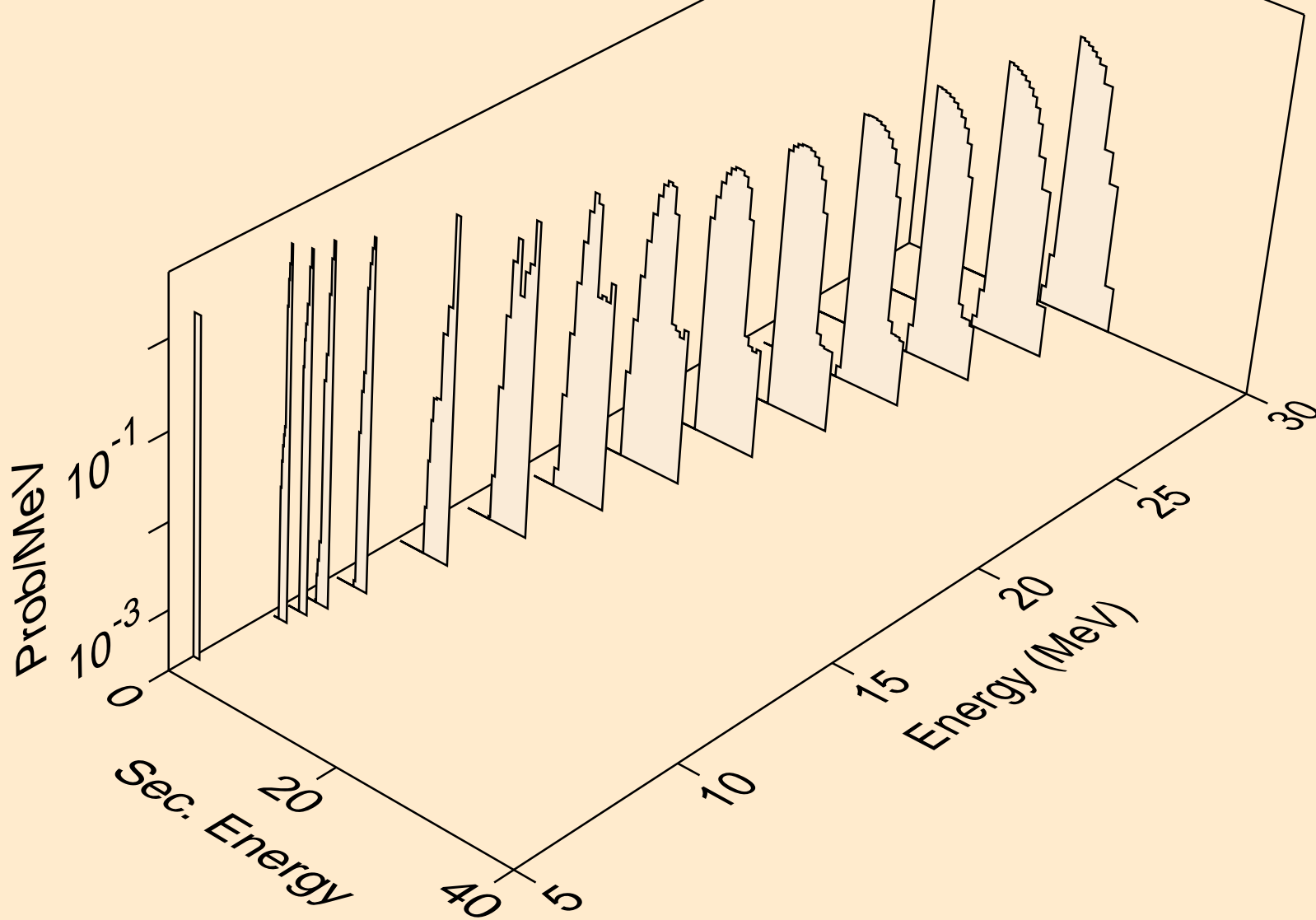

EU166 NEUTRON ACER TENDL-2023 LIBRARY; T=0.K  
he3s from (n,x)

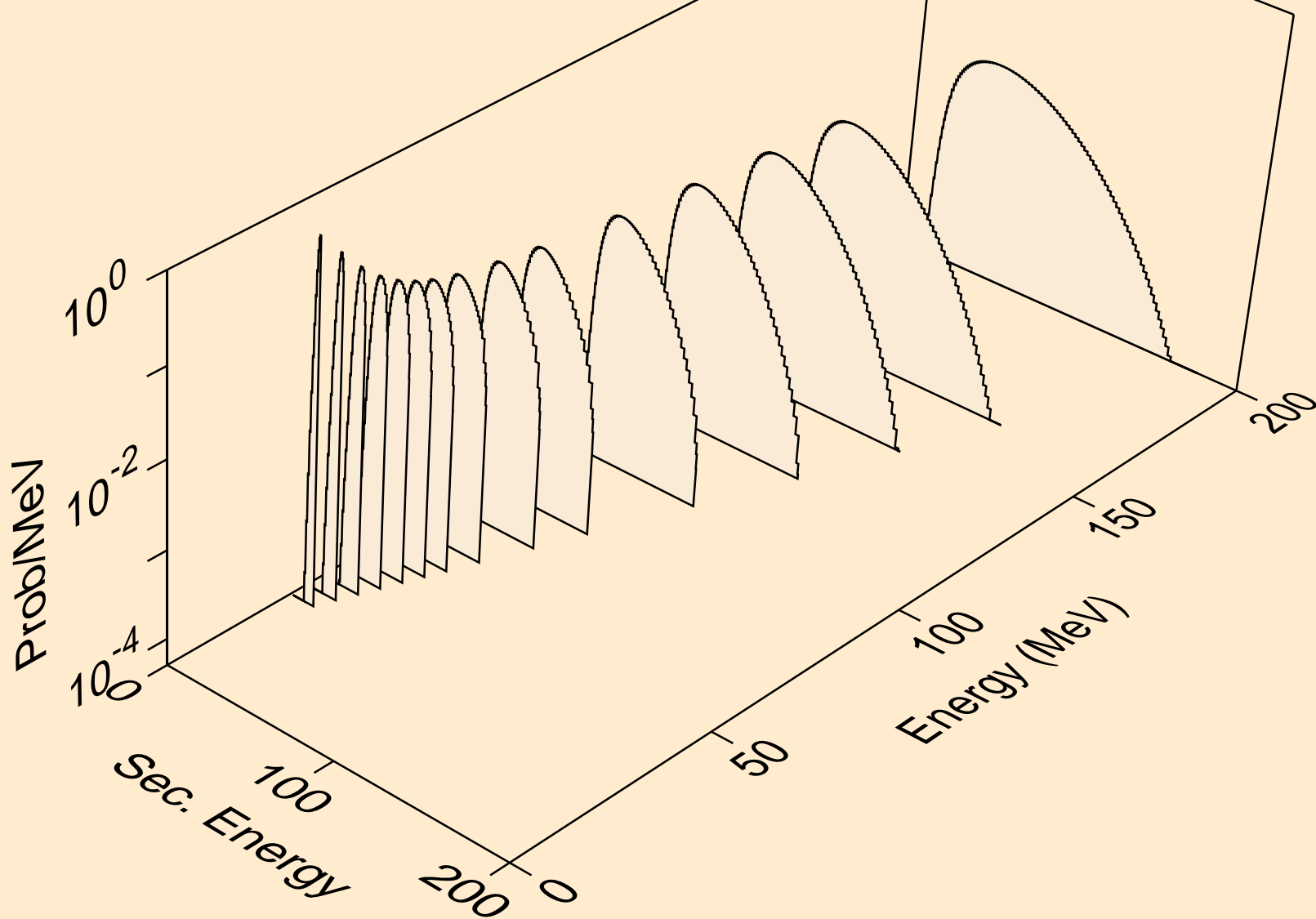

EU166 NEUTRON ACER TENDL-2023 LIBRARY; T=0.K  
he3s from (n,n\*)he3

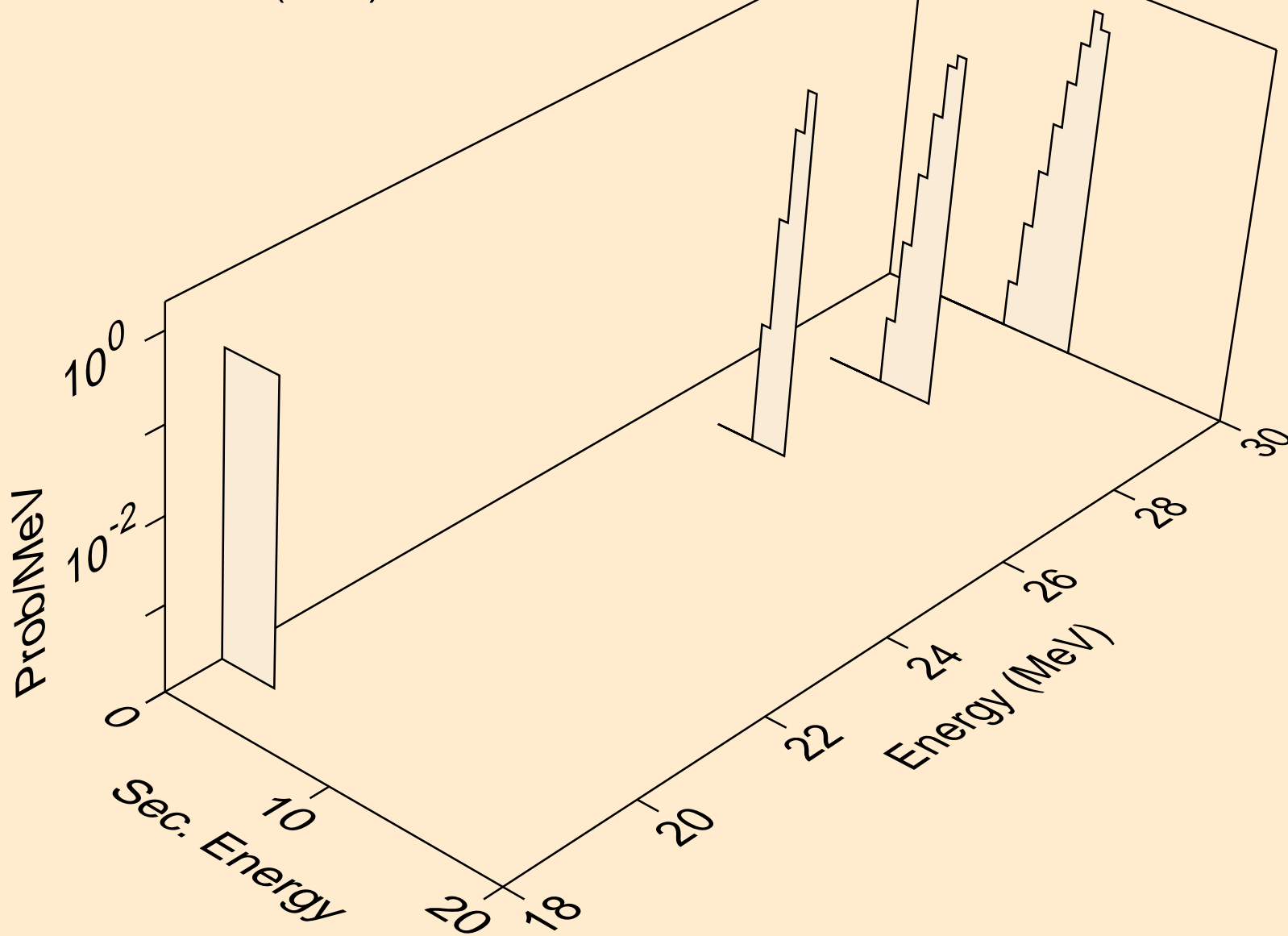

EU166 NEUTRON ACER TENDL-2023 LIBRARY; T=0.K  
he3s from (n,he3)

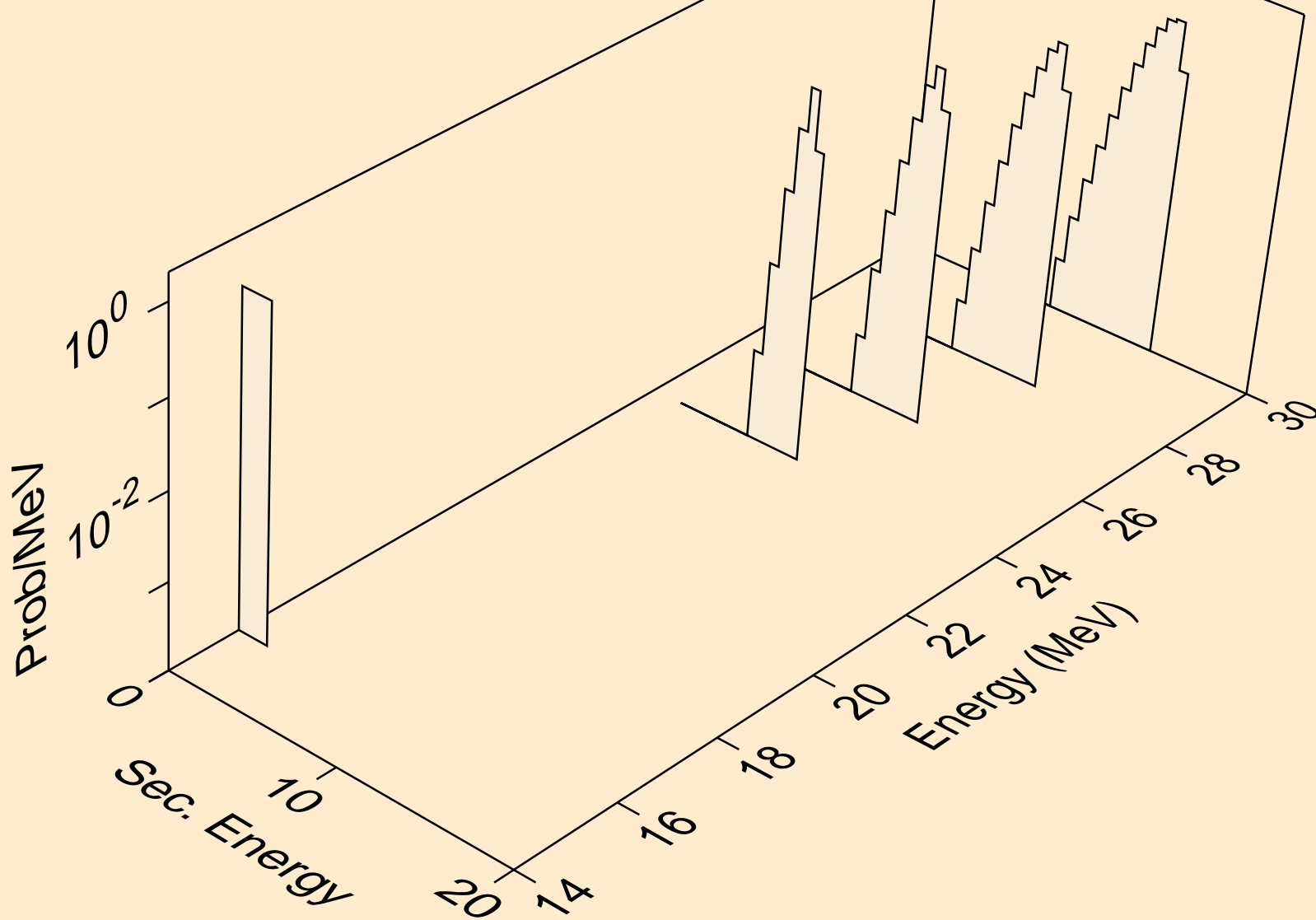



EU166 NEUTRON ACER TENDL-2023 LIBRARY; T=0.K  
alphas from (n,x)

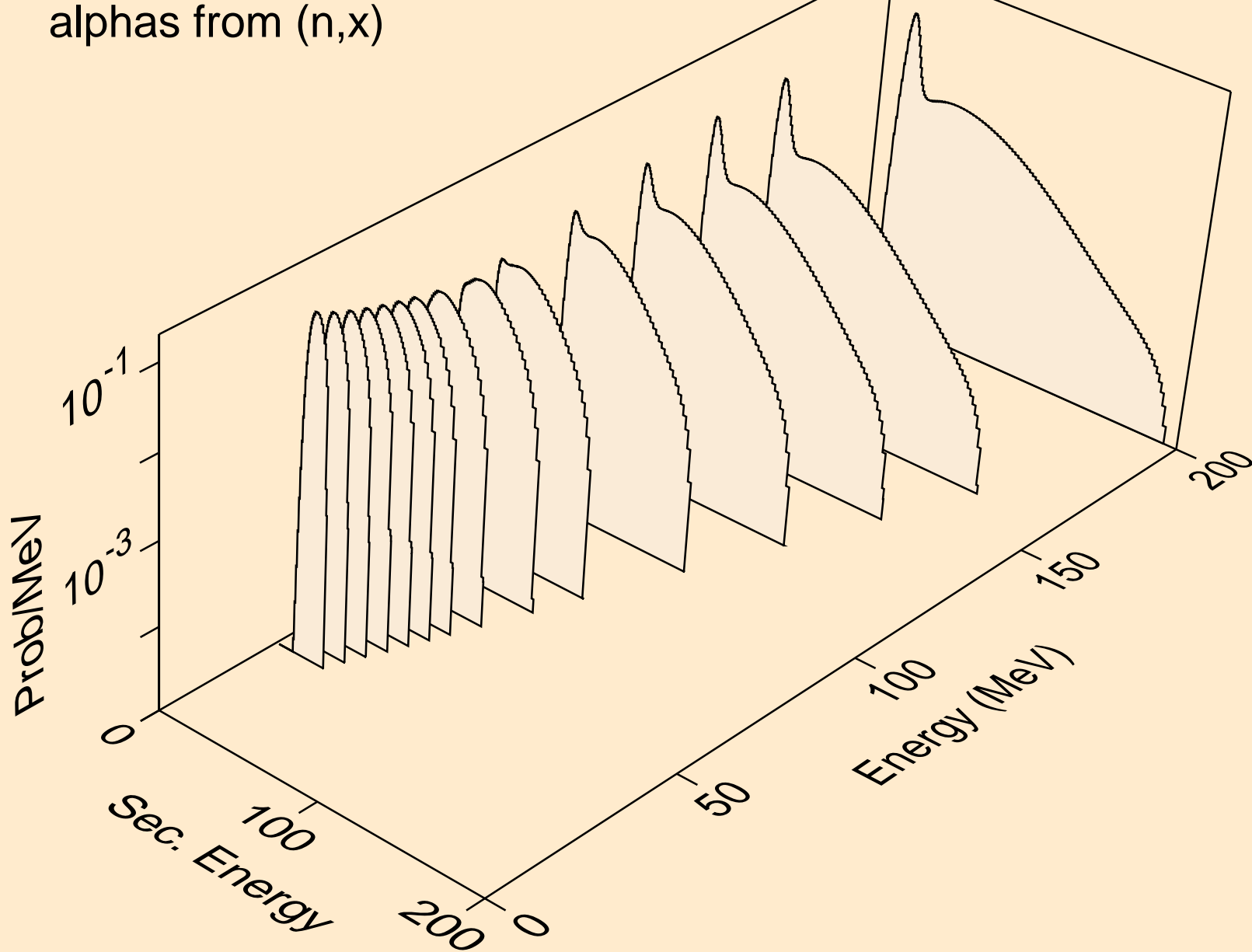

EU166 NEUTRON ACER TENDL-2023 LIBRARY; T=0.K  
alphas from (n,n\*)a

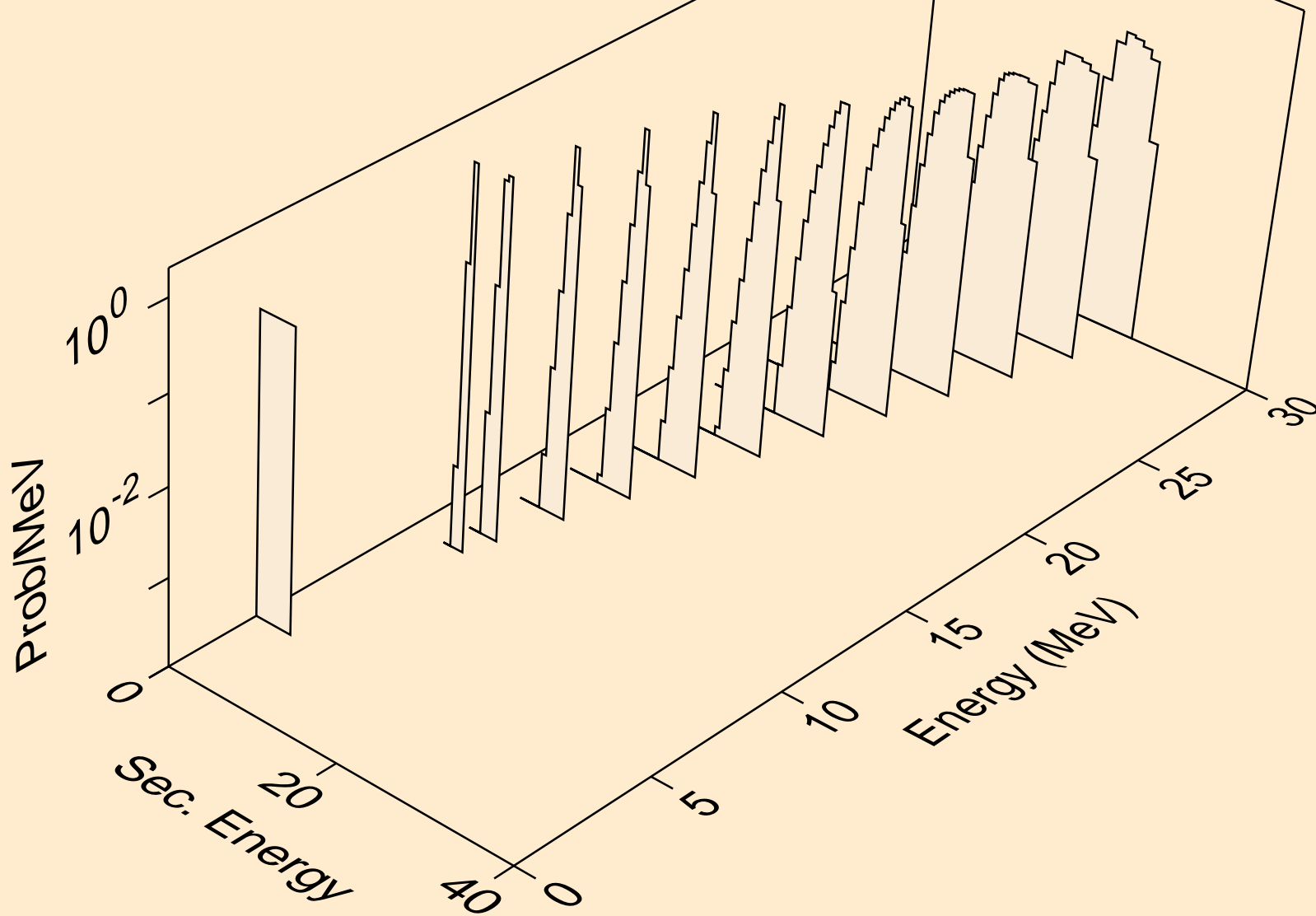

EU166 NEUTRON ACER TENDL-2023 LIBRARY; T=0.K  
alphas from (n,2n)a

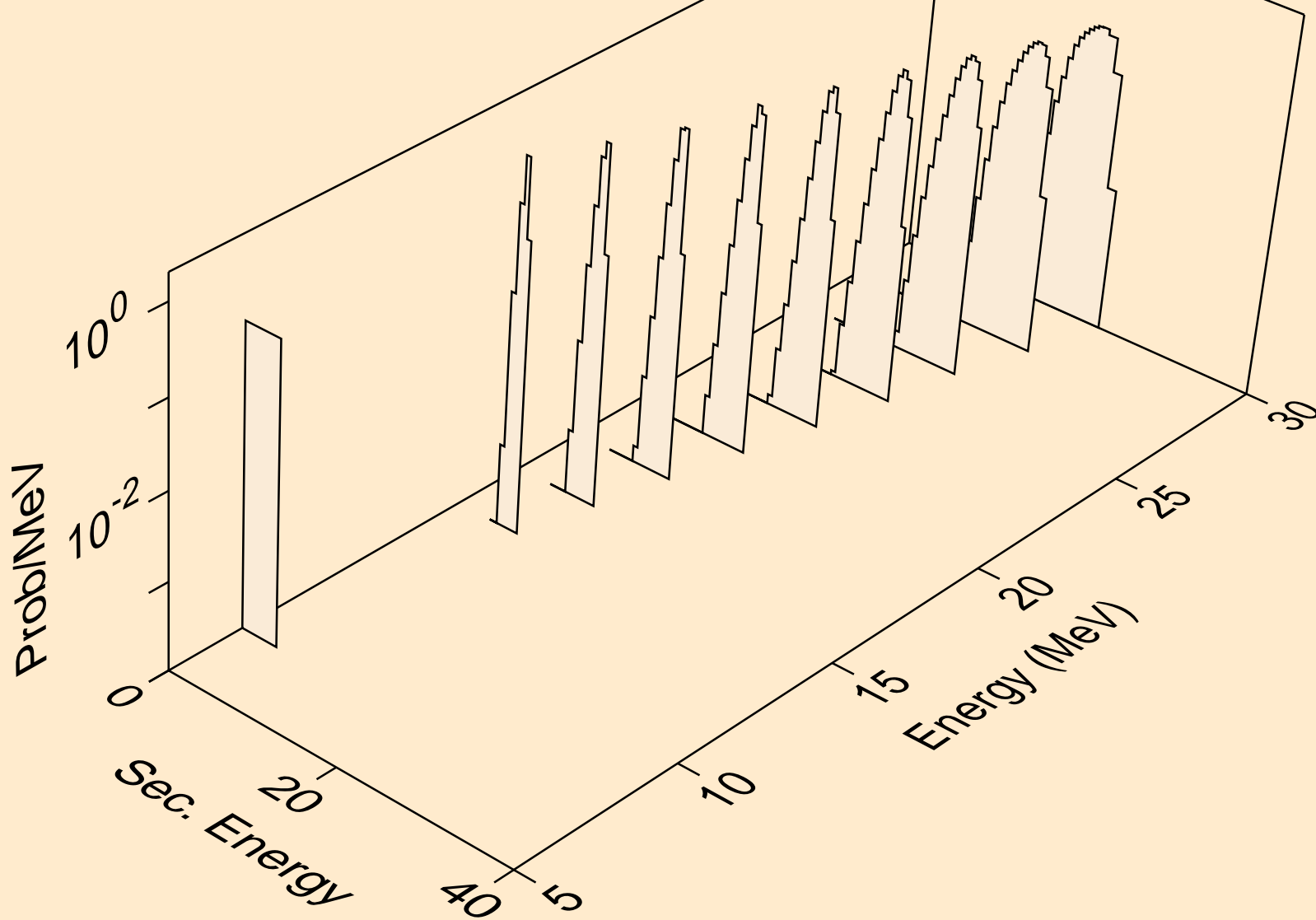

EU166 NEUTRON ACER TENDL-2023 LIBRARY; T=0.K  
alphas from (n,3n)a

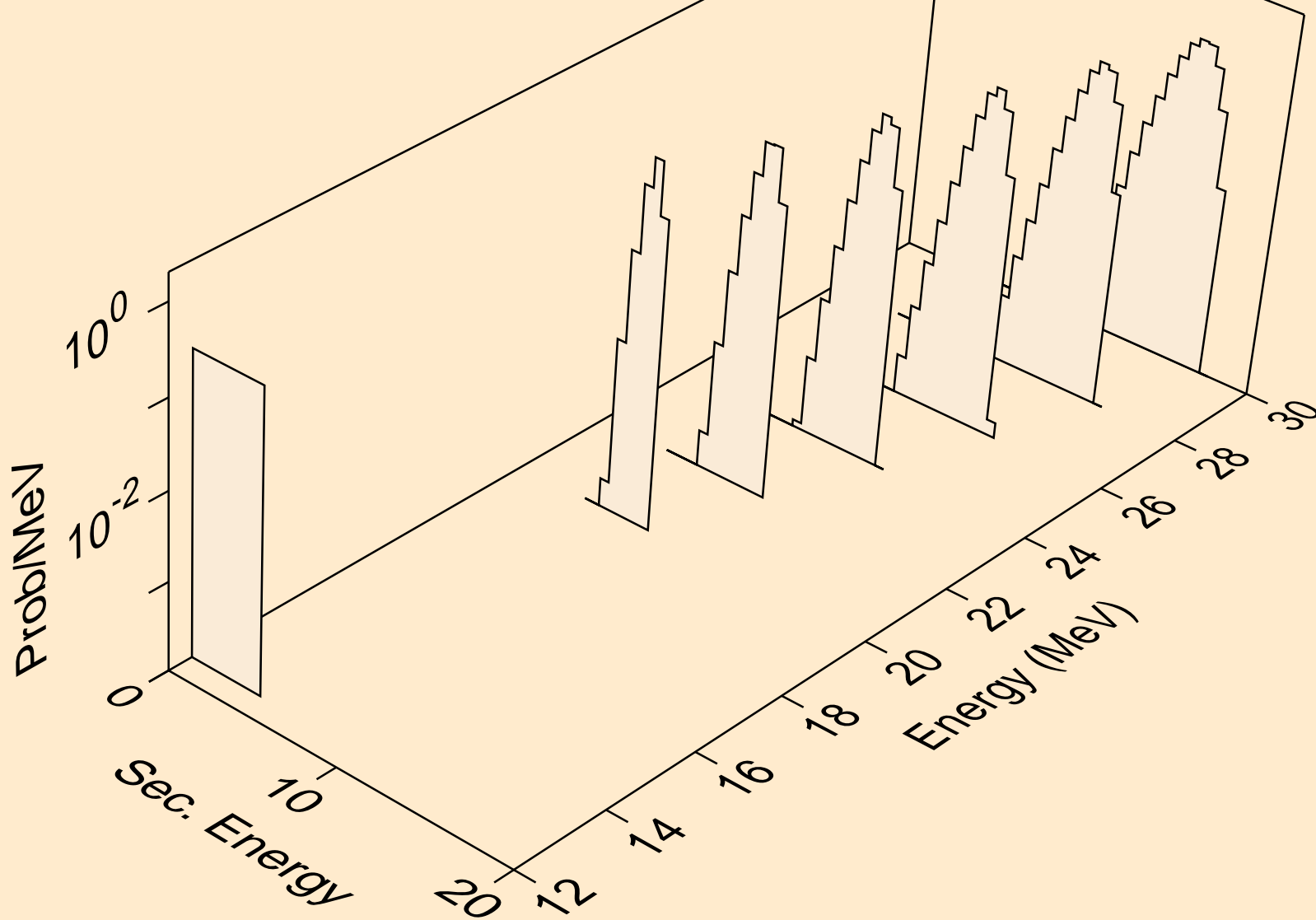

EU166 NEUTRON ACER TENDL-2023 LIBRARY; T=0.K  
alphas from (n,a)

