

F022 NEUTRON ACER TENDL-2023 LIBRARY; T=0.K

Principal cross sections

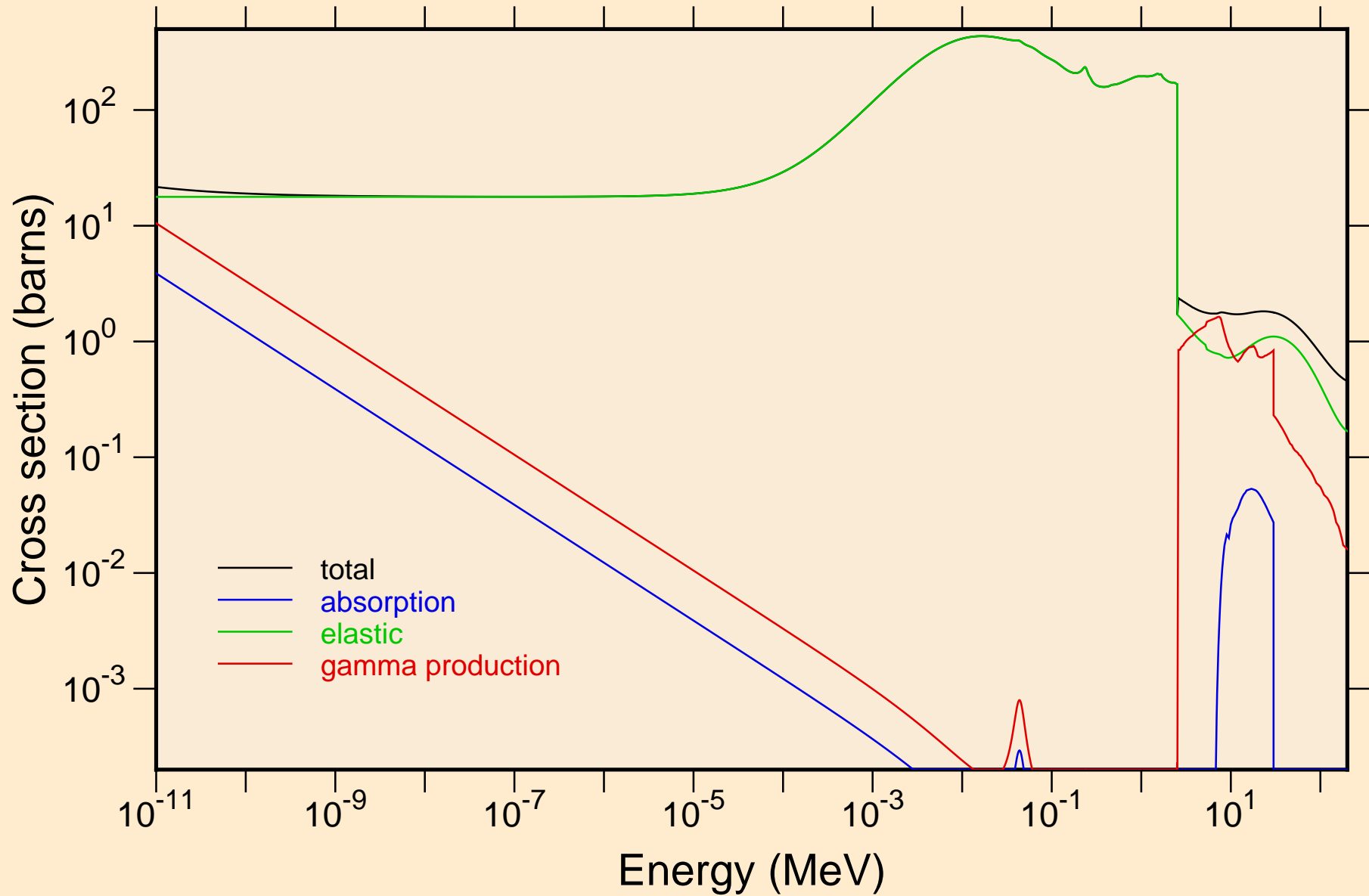

F022 NEUTRON ACER TENDL-2023 LIBRARY; T=0.K

Heating

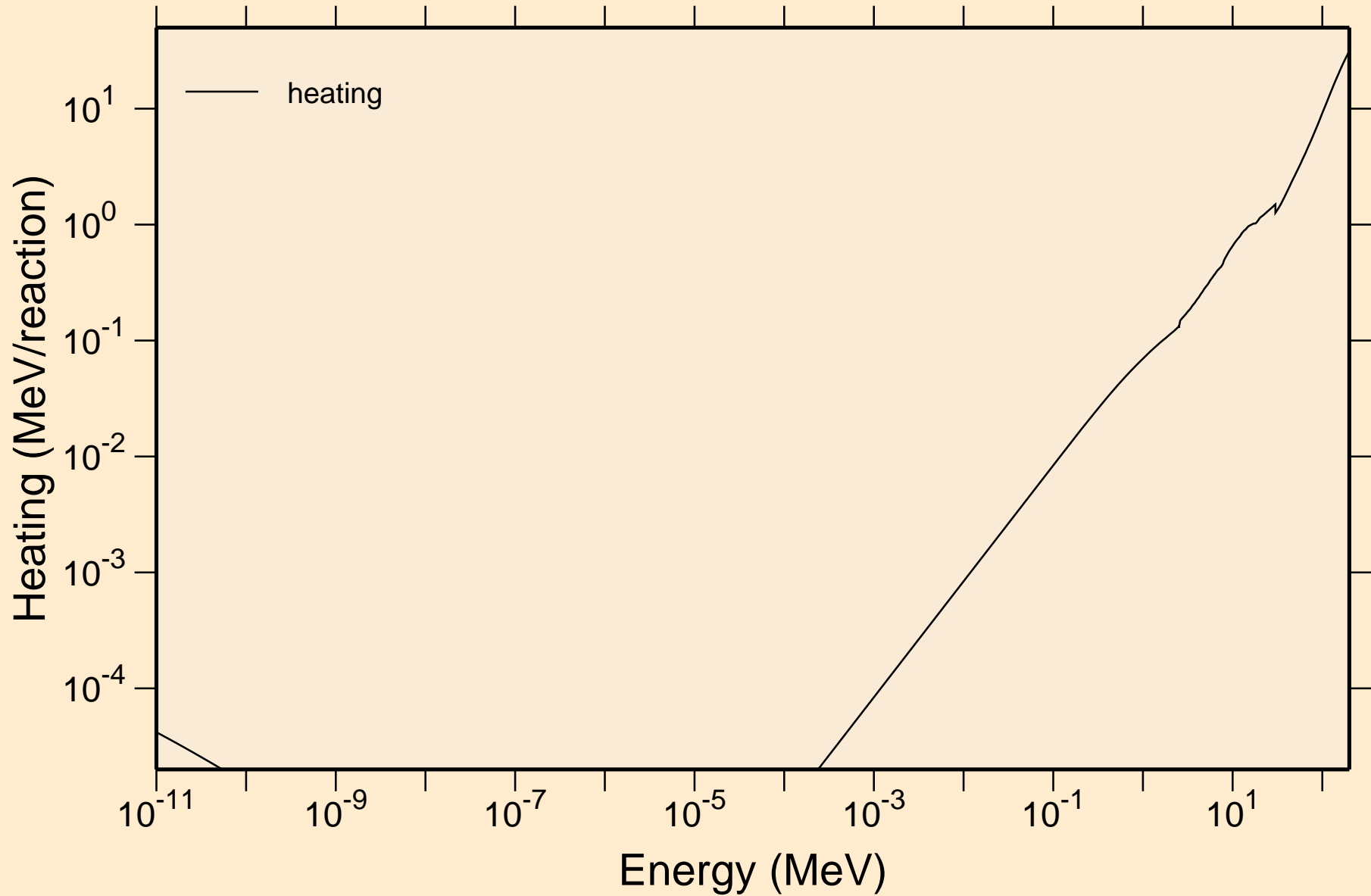

F022 NEUTRON ACER TENDL-2023 LIBRARY; T=0.K
Damage

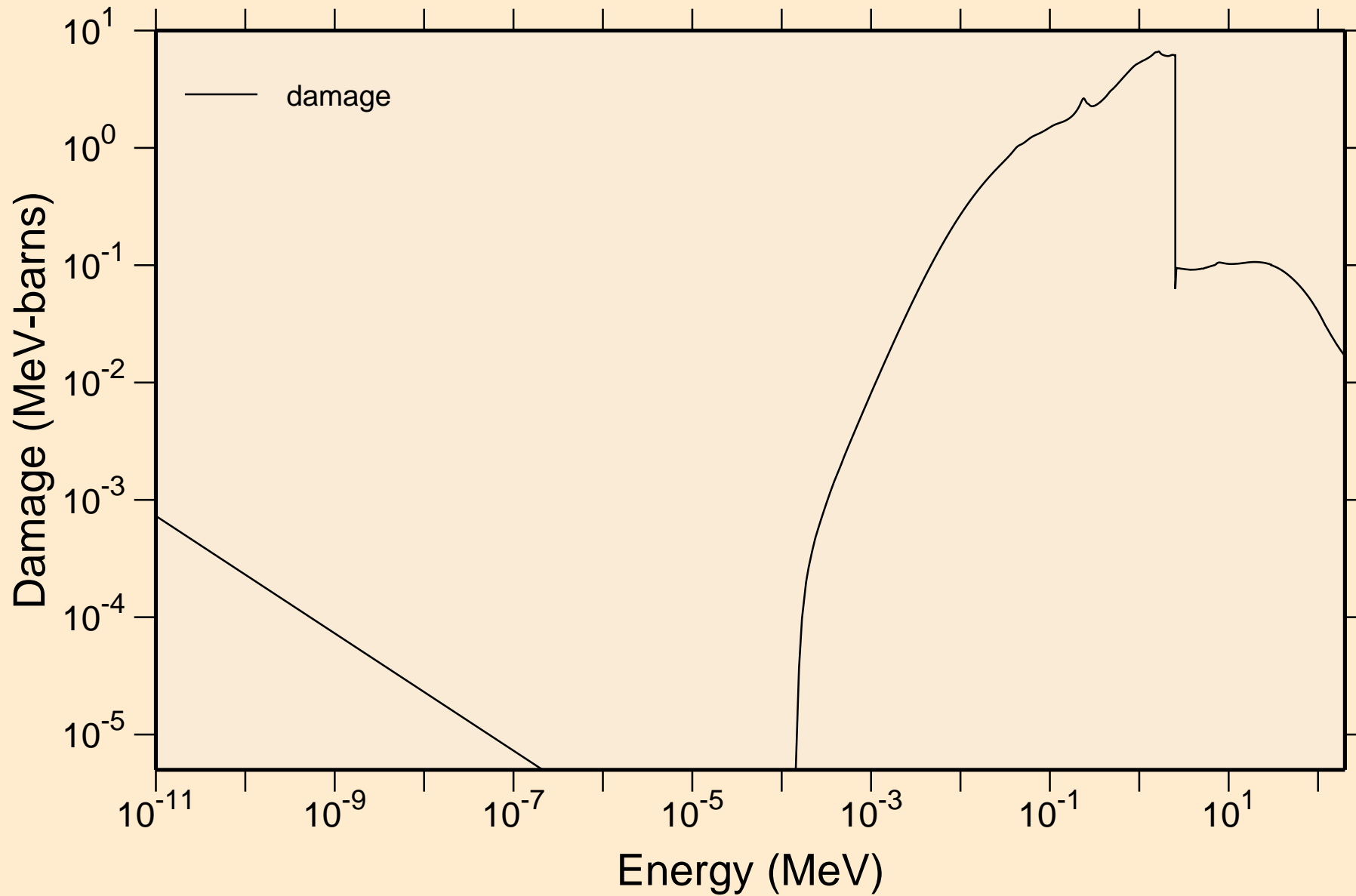

F022 NEUTRON ACER TENDL-2023 LIBRARY; T=0.K
Non-threshold reactions

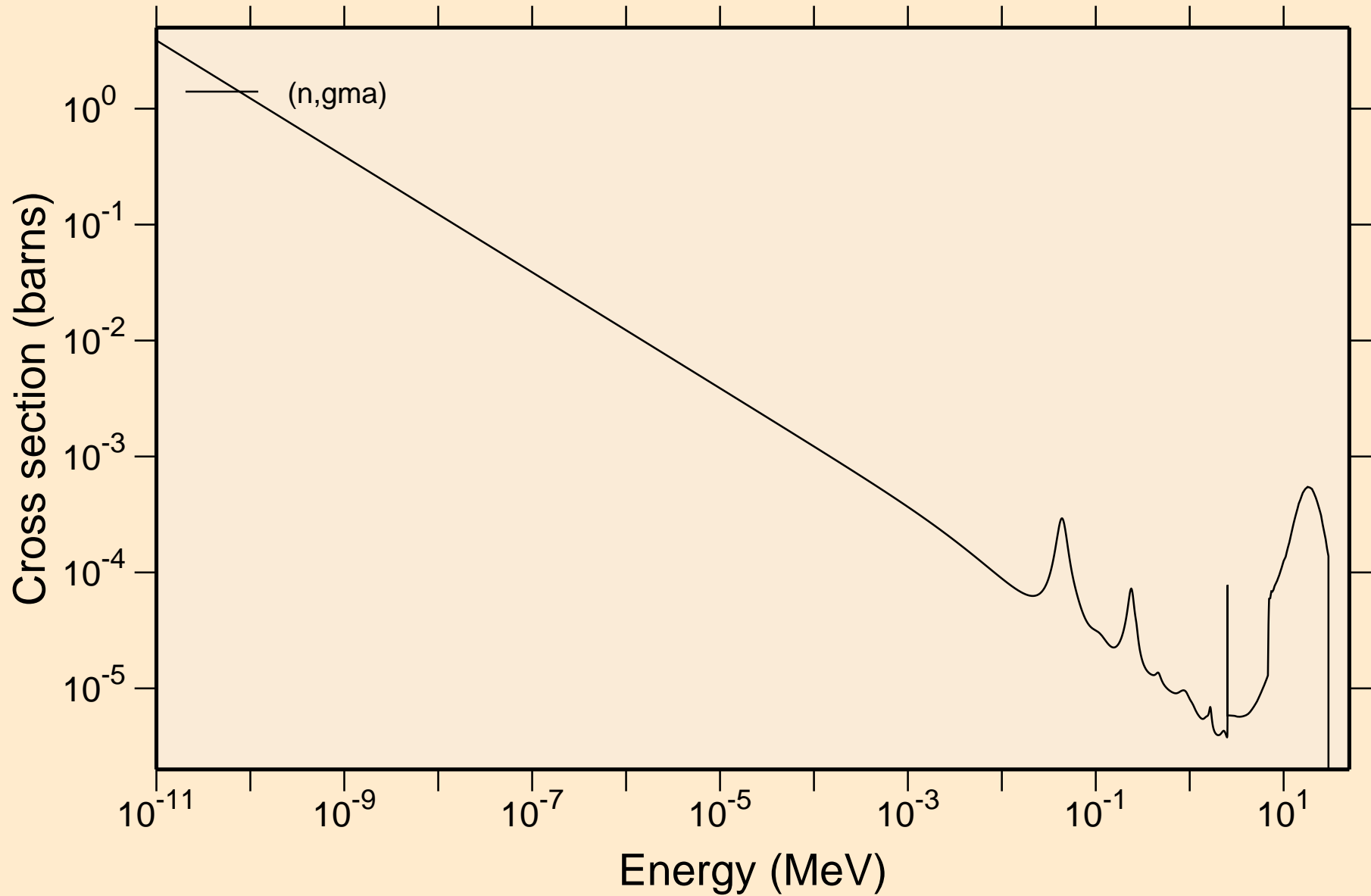

F022 NEUTRON ACER TENDL-2023 LIBRARY; T=0.K

Principal cross sections

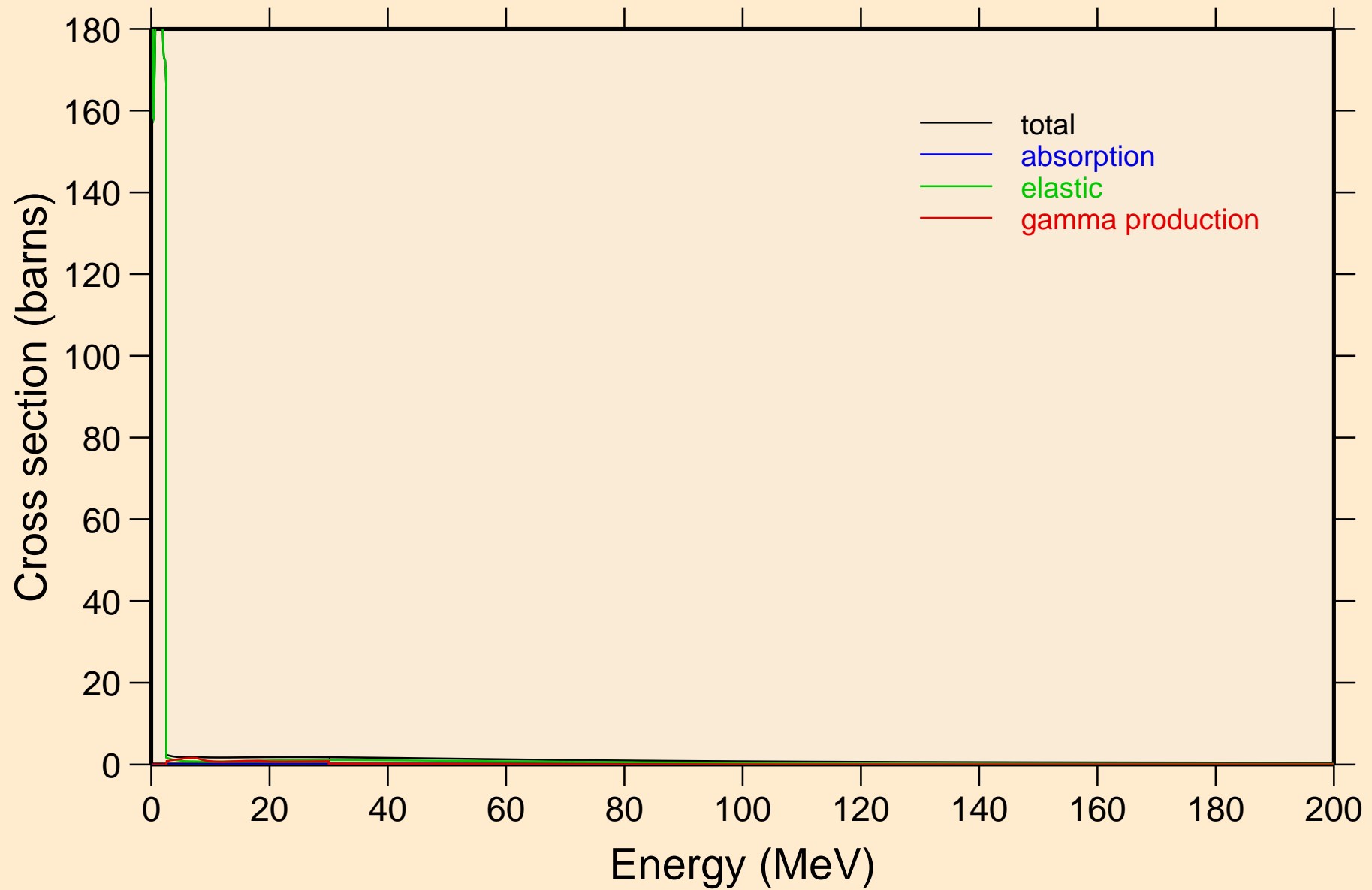

F022 NEUTRON ACER TENDL-2023 LIBRARY; T=0.K

Heating

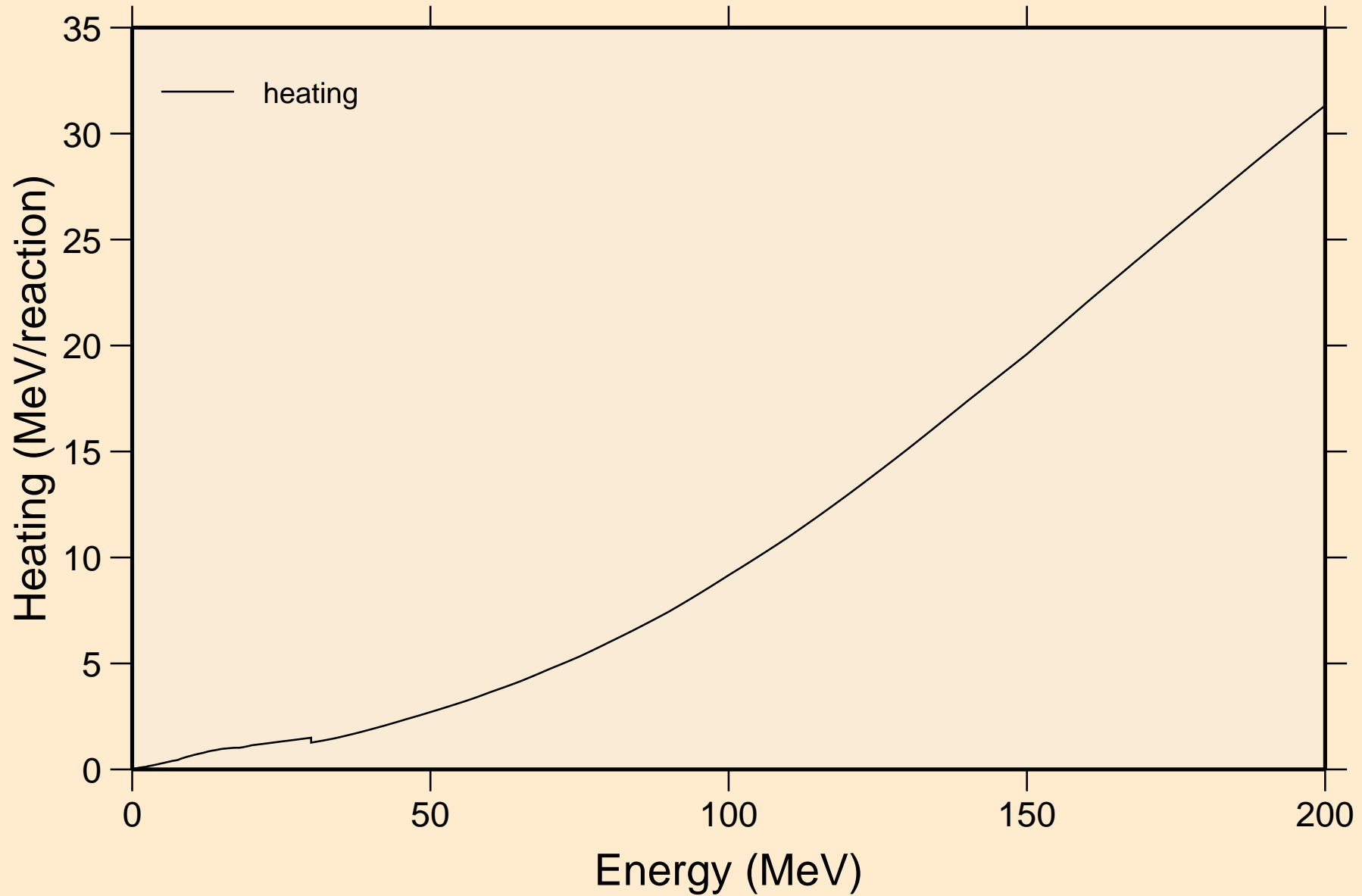

F022 NEUTRON ACER TENDL-2023 LIBRARY; T=0.K

Damage

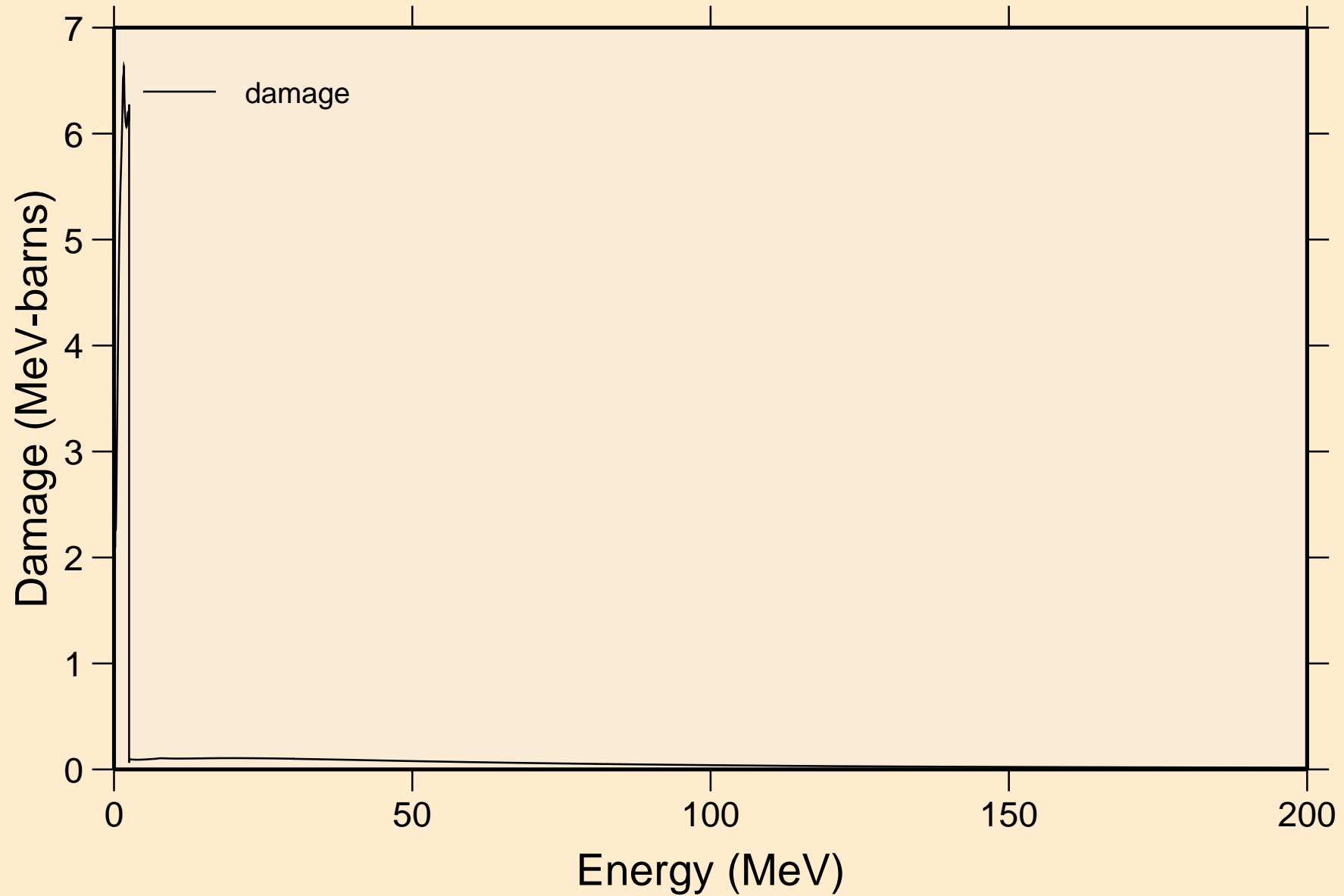

F022 NEUTRON ACER TENDL-2023 LIBRARY; T=0.K
Non-threshold reactions

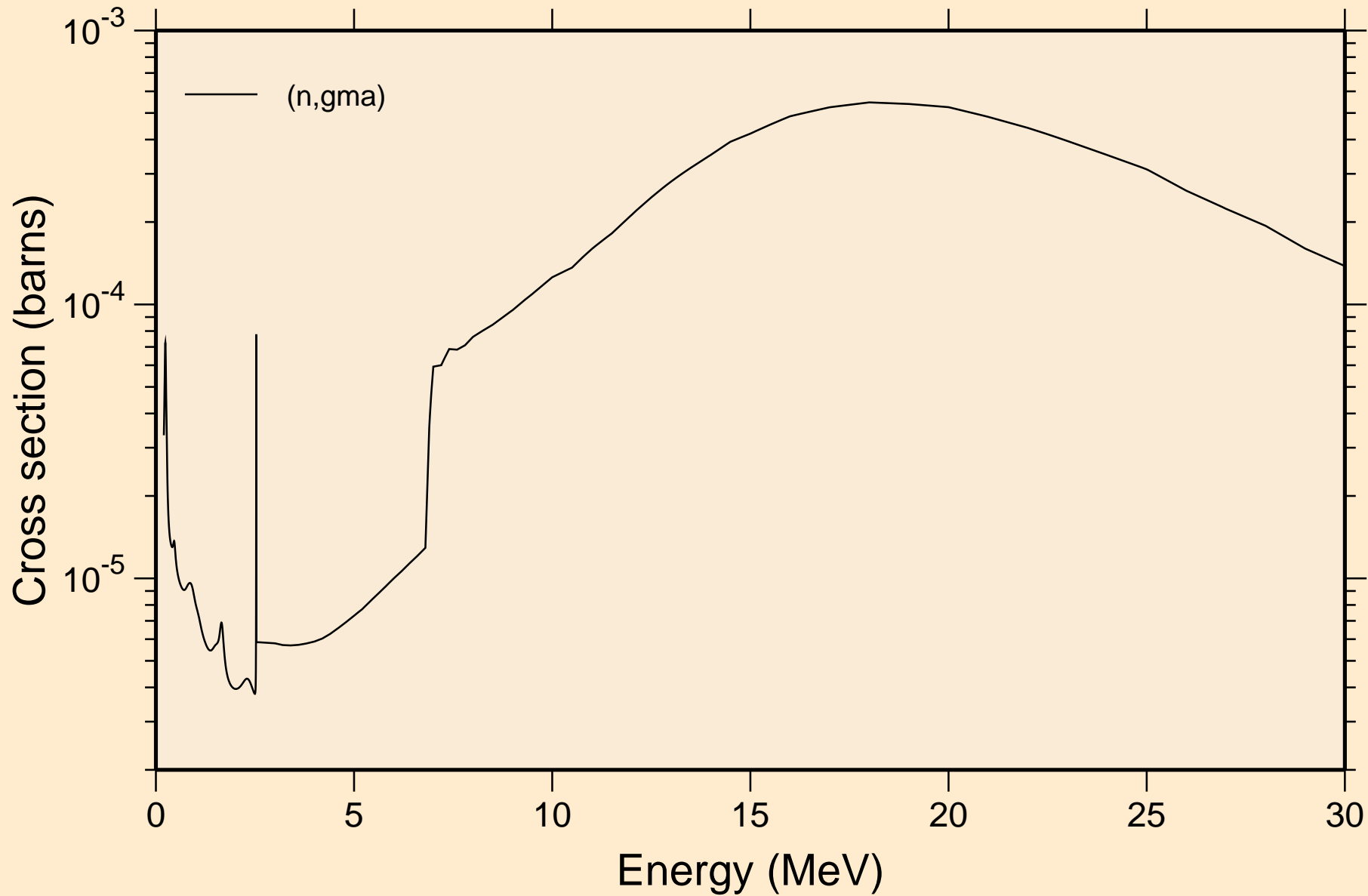

F022 NEUTRON ACER TENDL-2023 LIBRARY; T=0.K

Inelastic levels

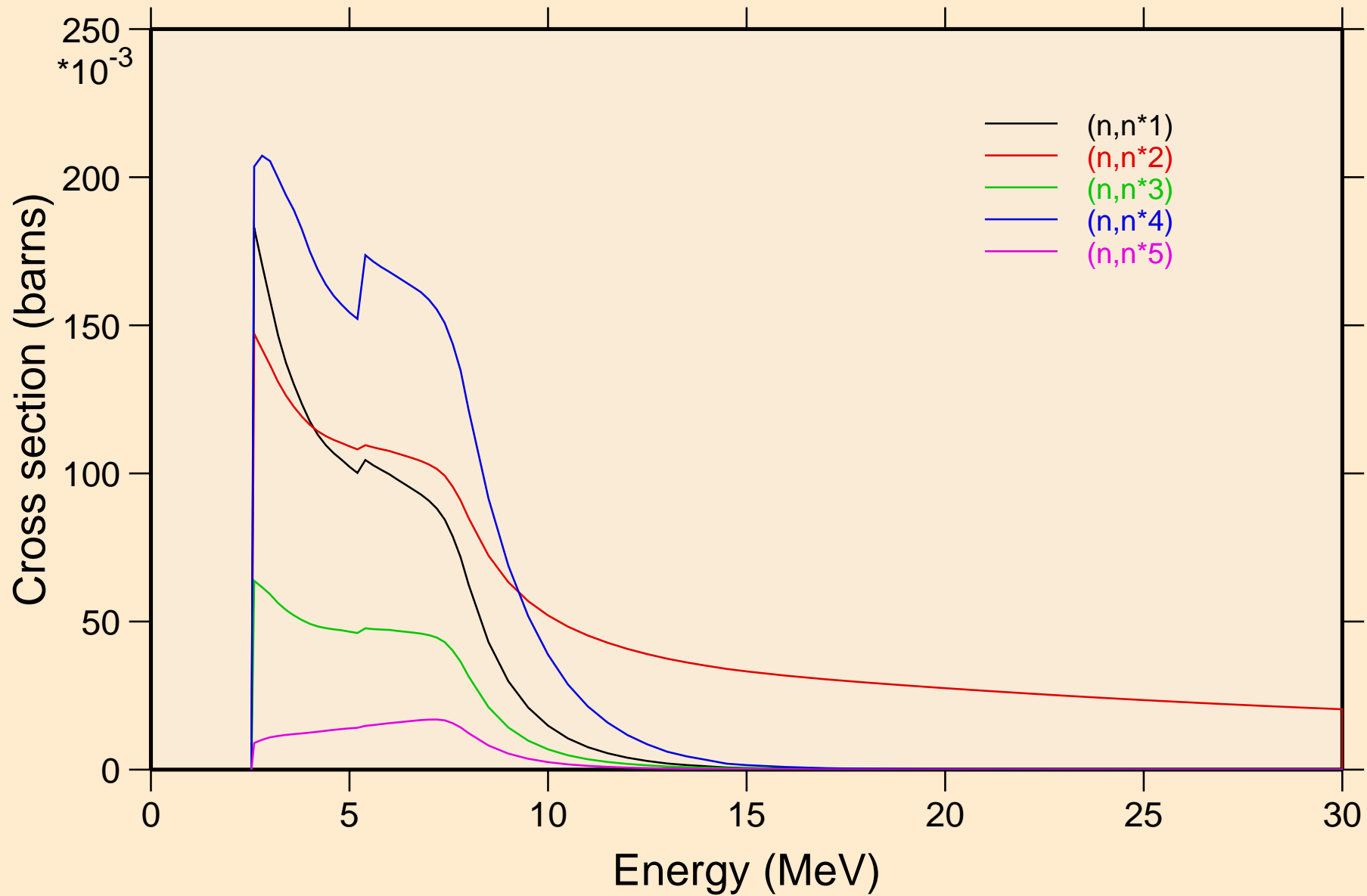

F022 NEUTRON ACER TENDL-2023 LIBRARY; T=0.K
Inelastic levels

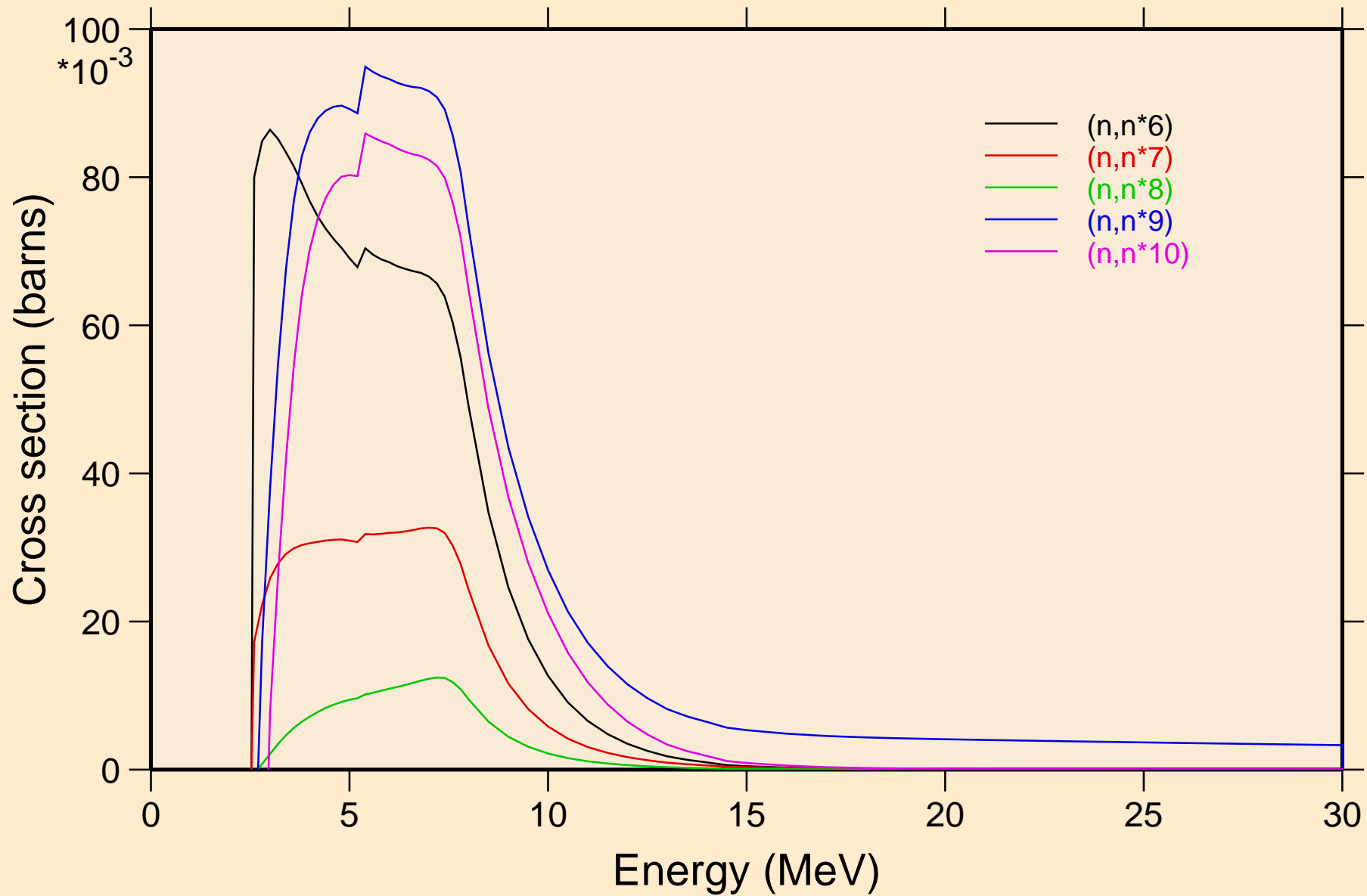

F022 NEUTRON ACER TENDL-2023 LIBRARY; T=0.K
Inelastic levels

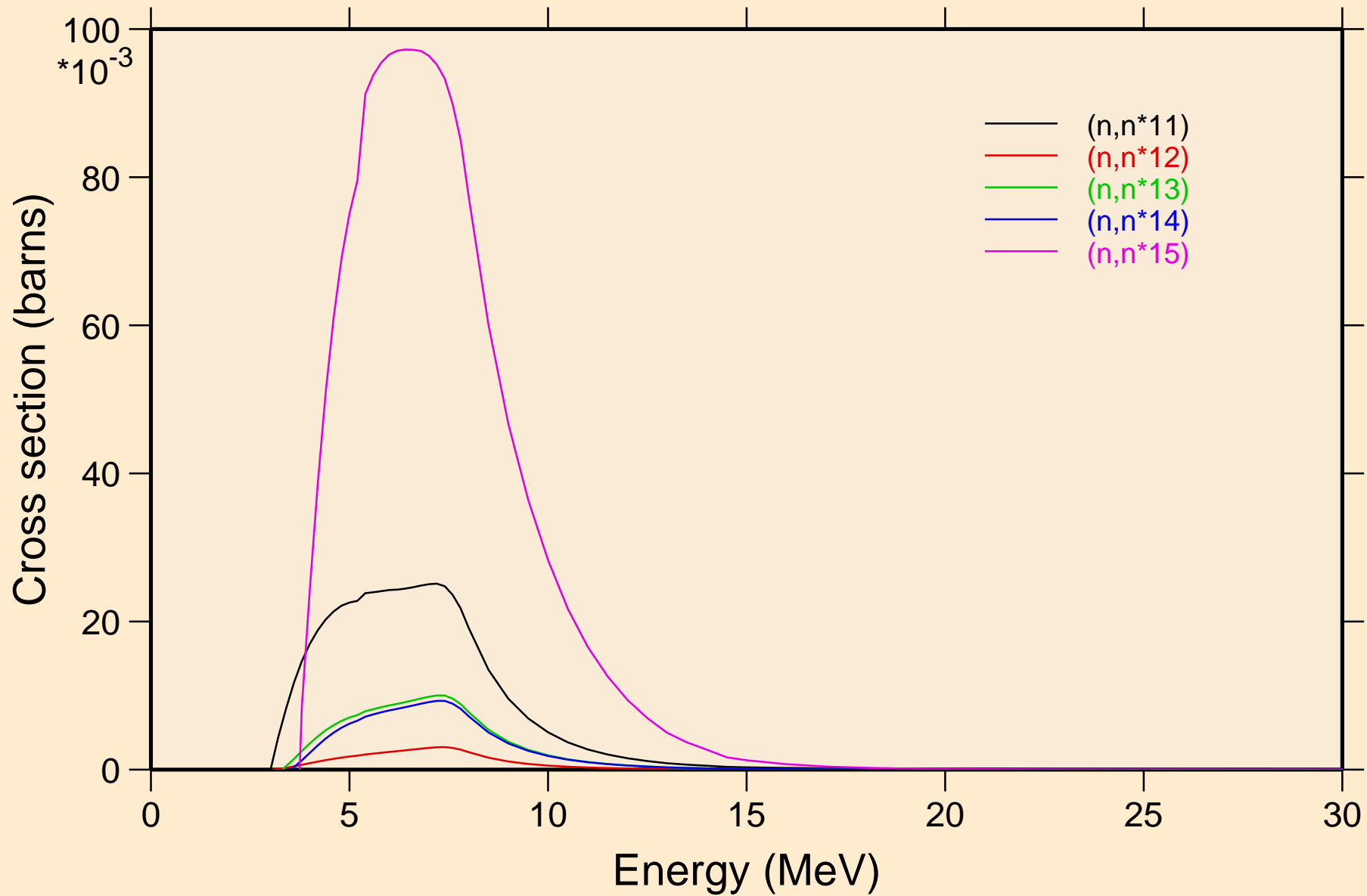

F022 NEUTRON ACER TENDL-2023 LIBRARY; T=0.K
Inelastic levels

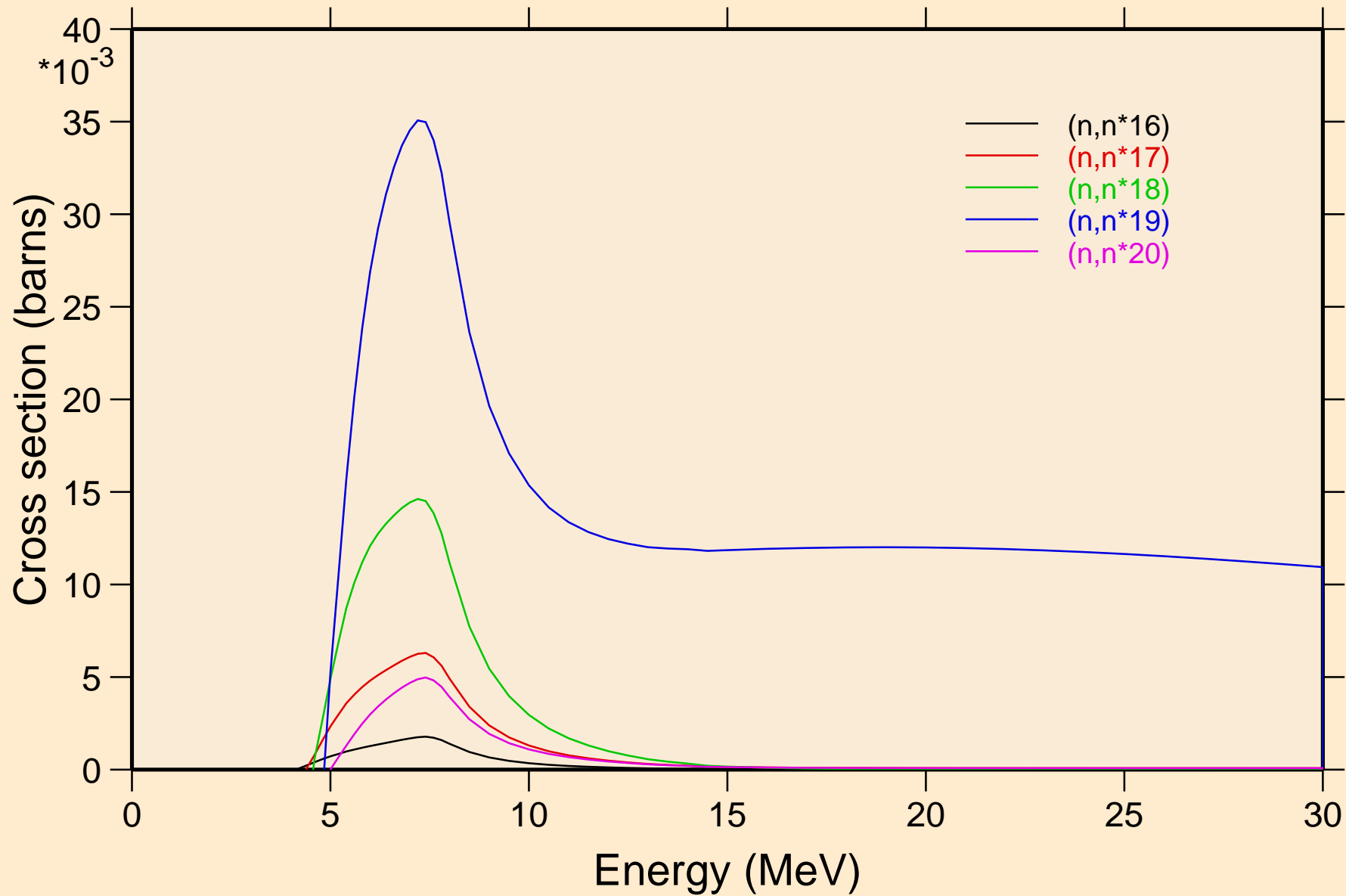

F022 NEUTRON ACER TENDL-2023 LIBRARY; T=0.K
Inelastic levels

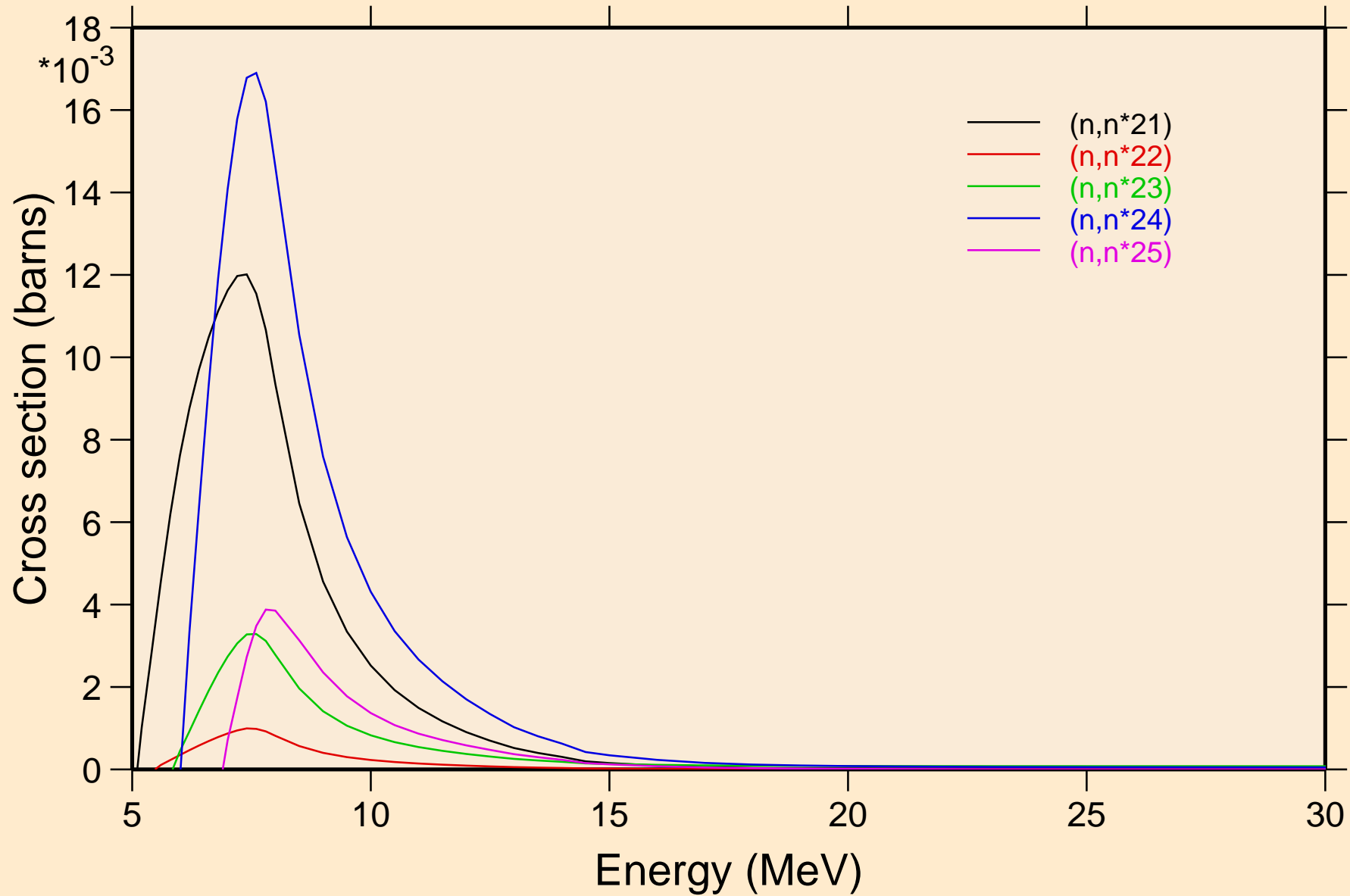

F022 NEUTRON ACER TENDL-2023 LIBRARY; T=0.K
Inelastic levels

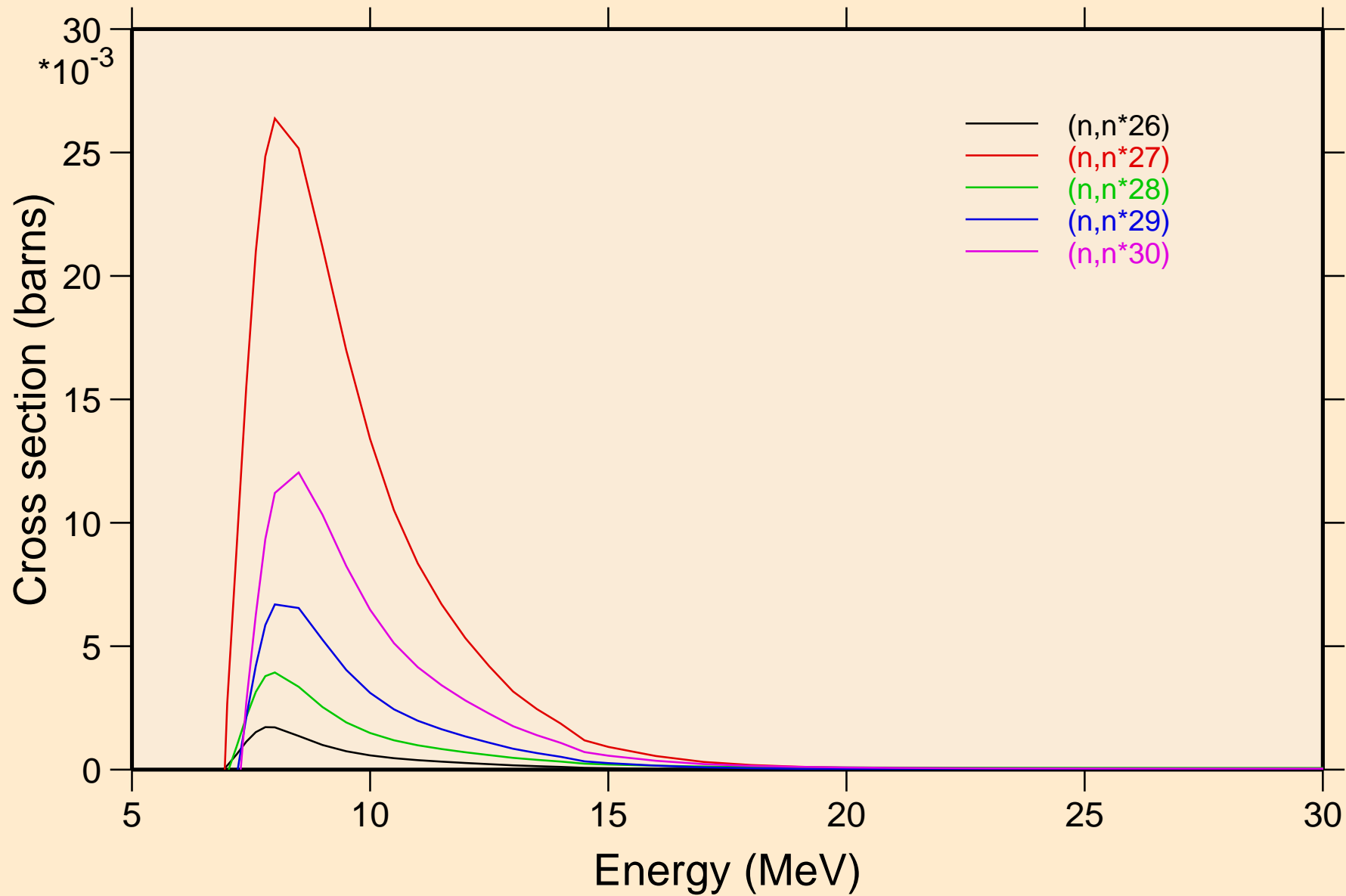

F022 NEUTRON ACER TENDL-2023 LIBRARY; T=0.K

Threshold reactions

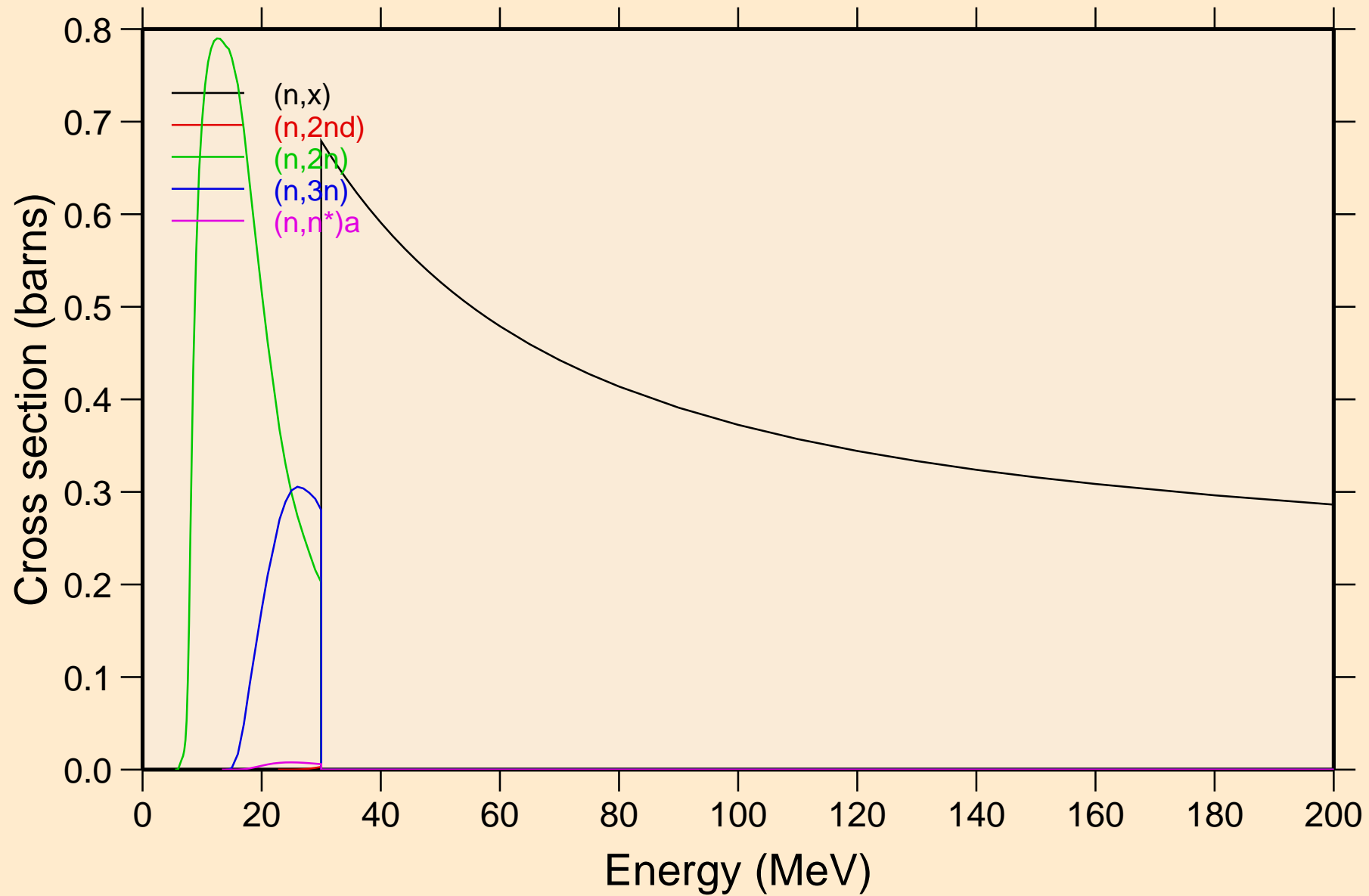

F022 NEUTRON ACER TENDL-2023 LIBRARY; T=0.K

Threshold reactions

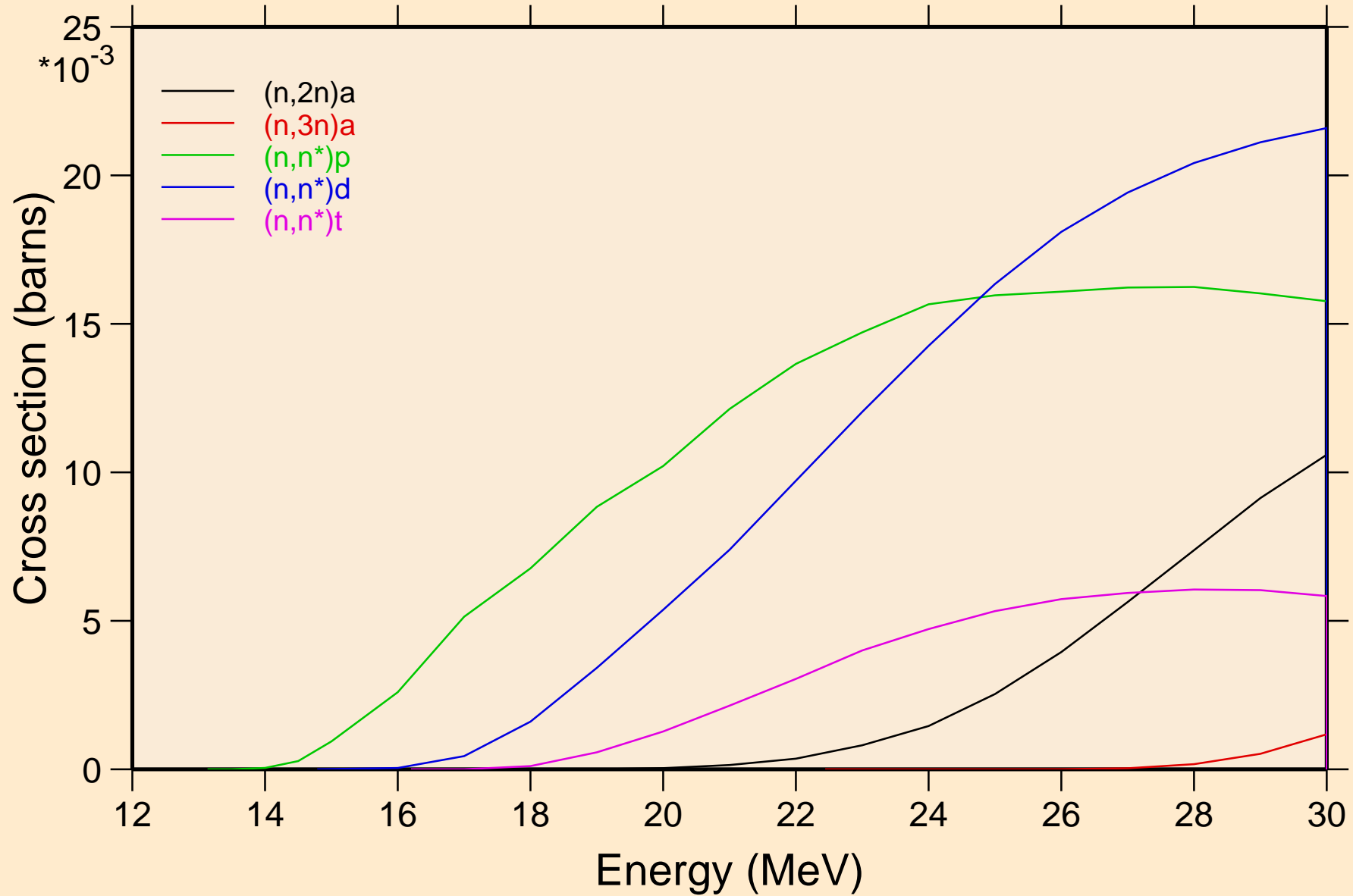

F022 NEUTRON ACER TENDL-2023 LIBRARY; T=0.K

Threshold reactions

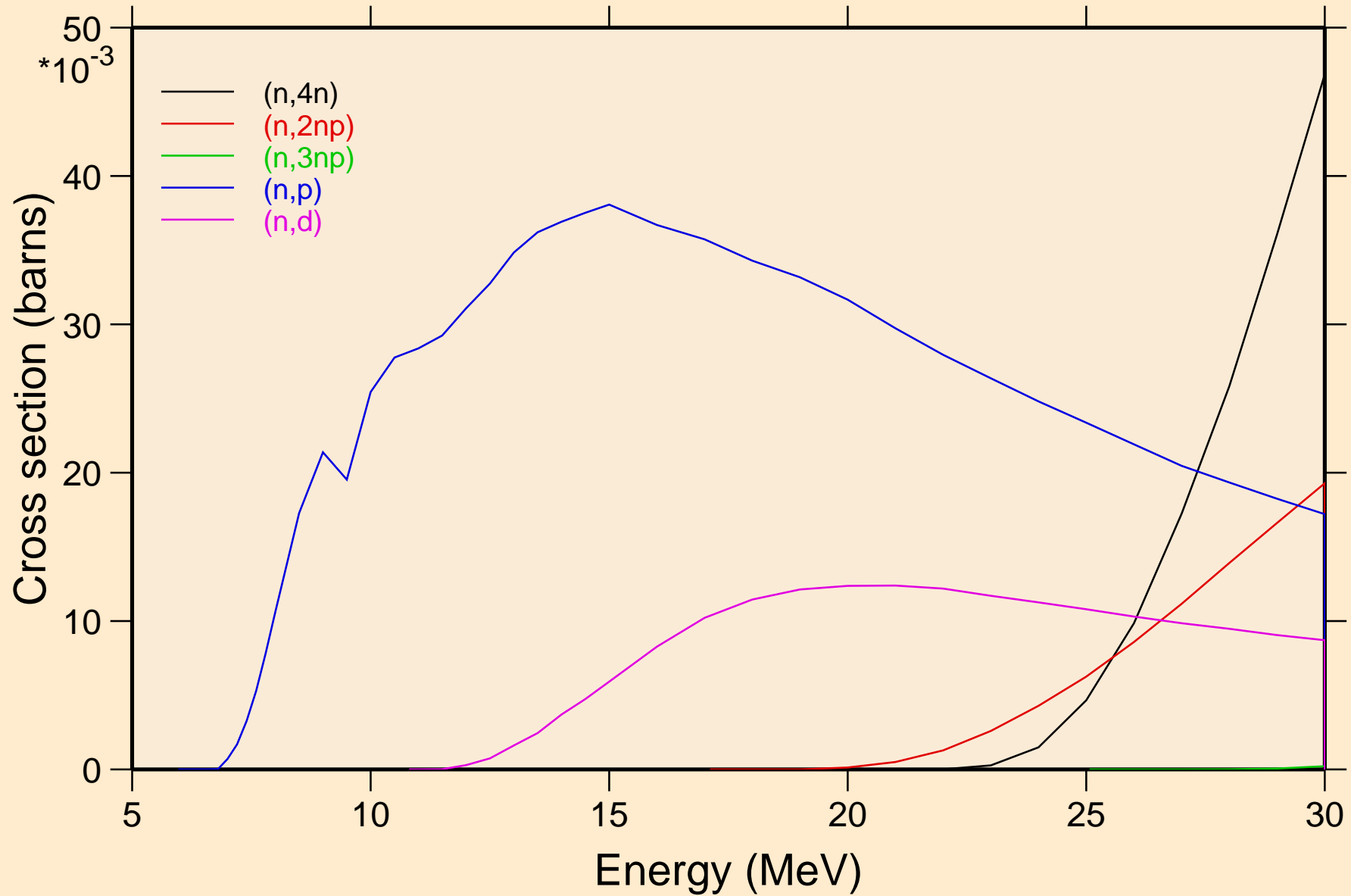

F022 NEUTRON ACER TENDL-2023 LIBRARY; T=0.K
Threshold reactions

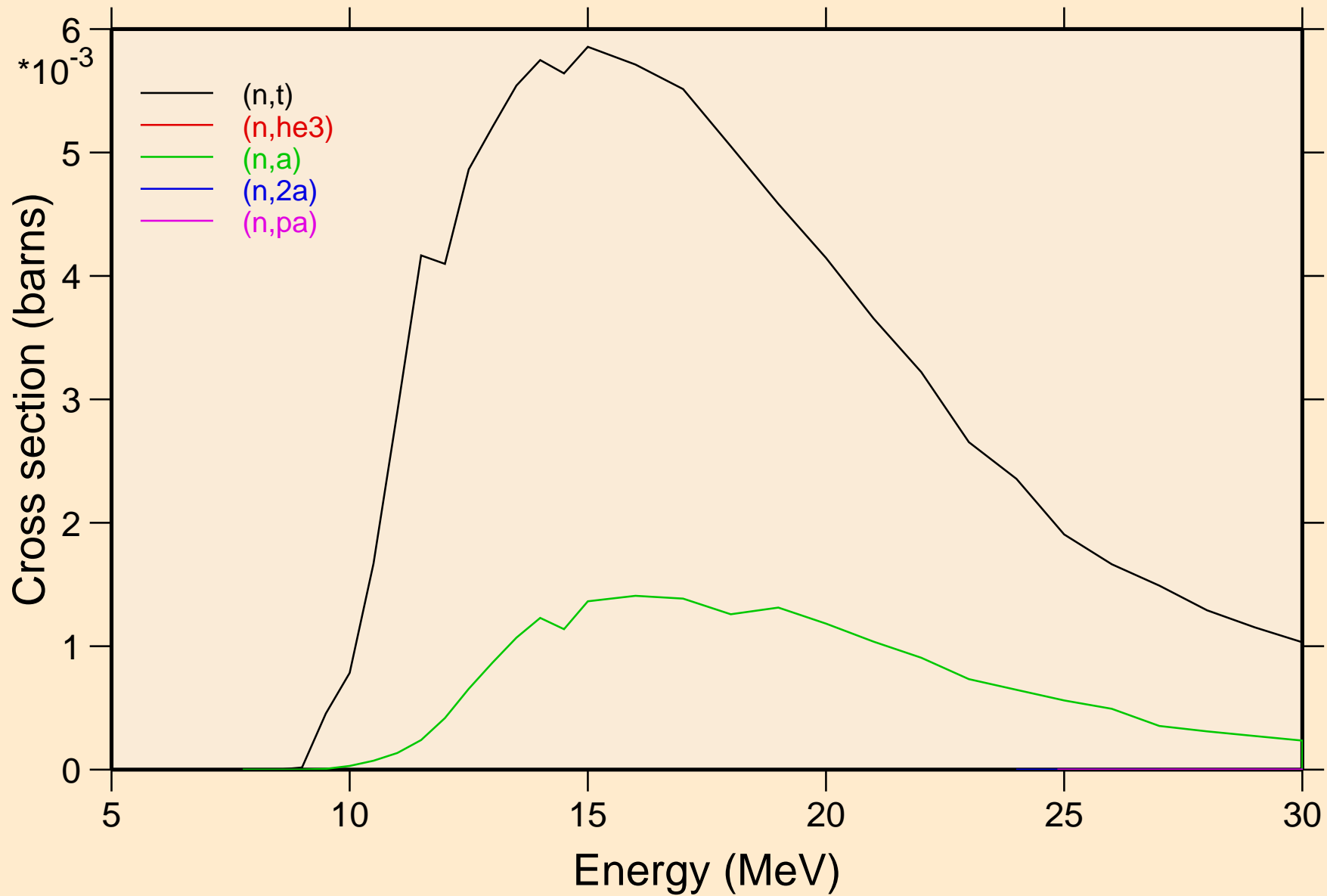

F022 NEUTRON ACER TENDL-2023 LIBRARY; T=0.K
Threshold reactions

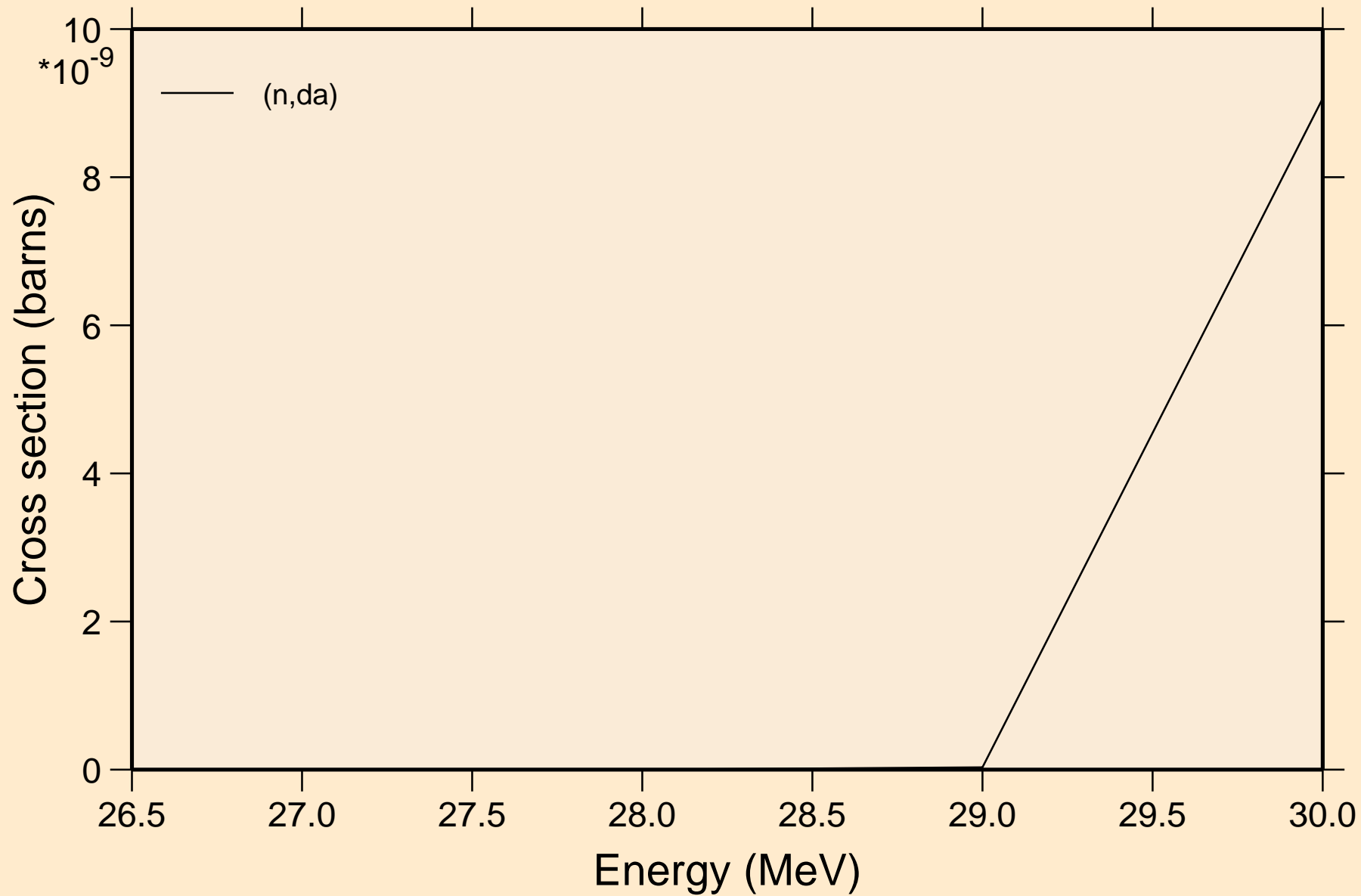

F022 NEUTRON ACER TENDL-2023 LIBRARY; T=0.K

Threshold reactions

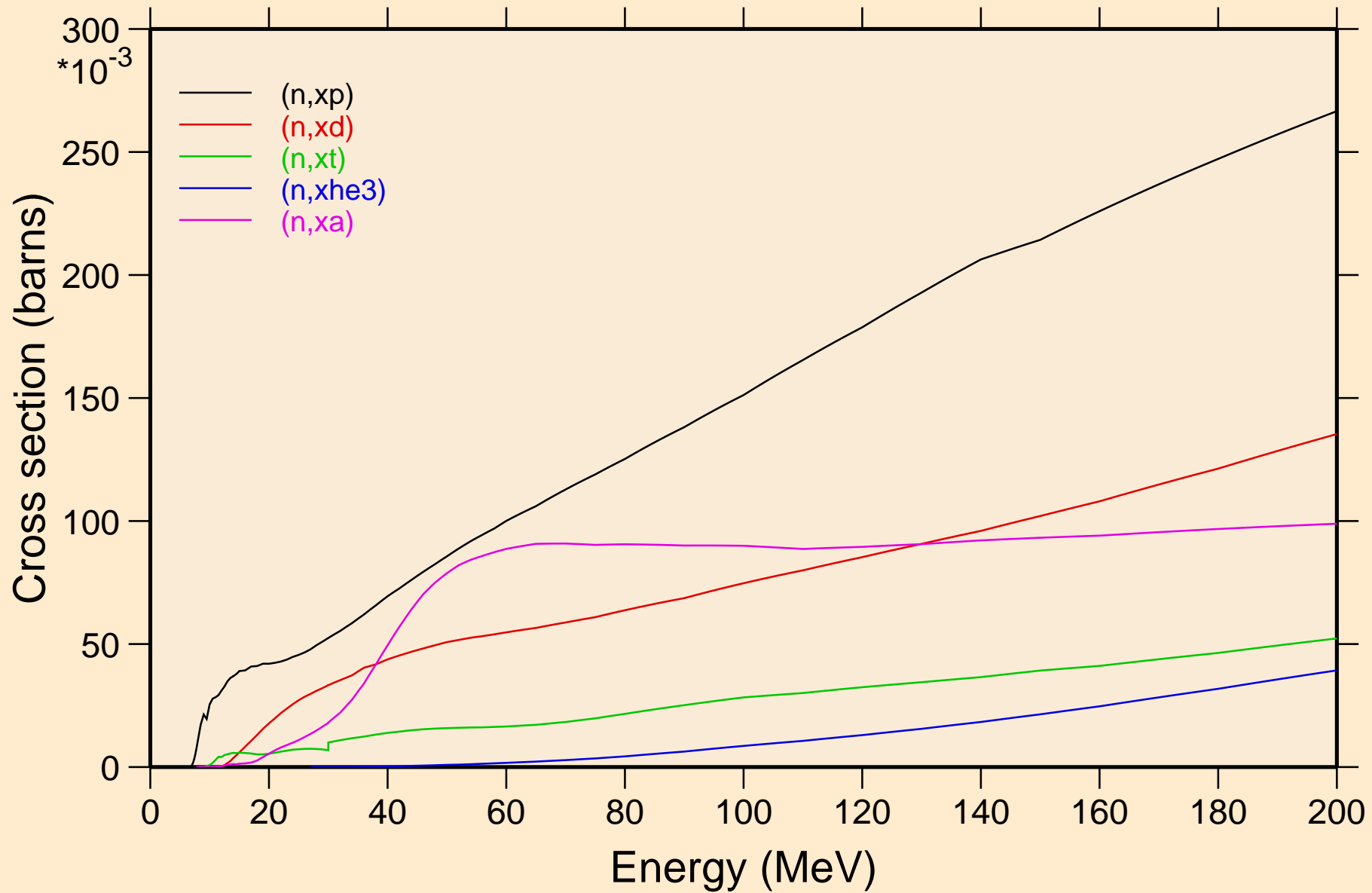

F022 NEUTRON ACER TENDL-2023 LIBRARY; T=0.K
angular distribution for elastic

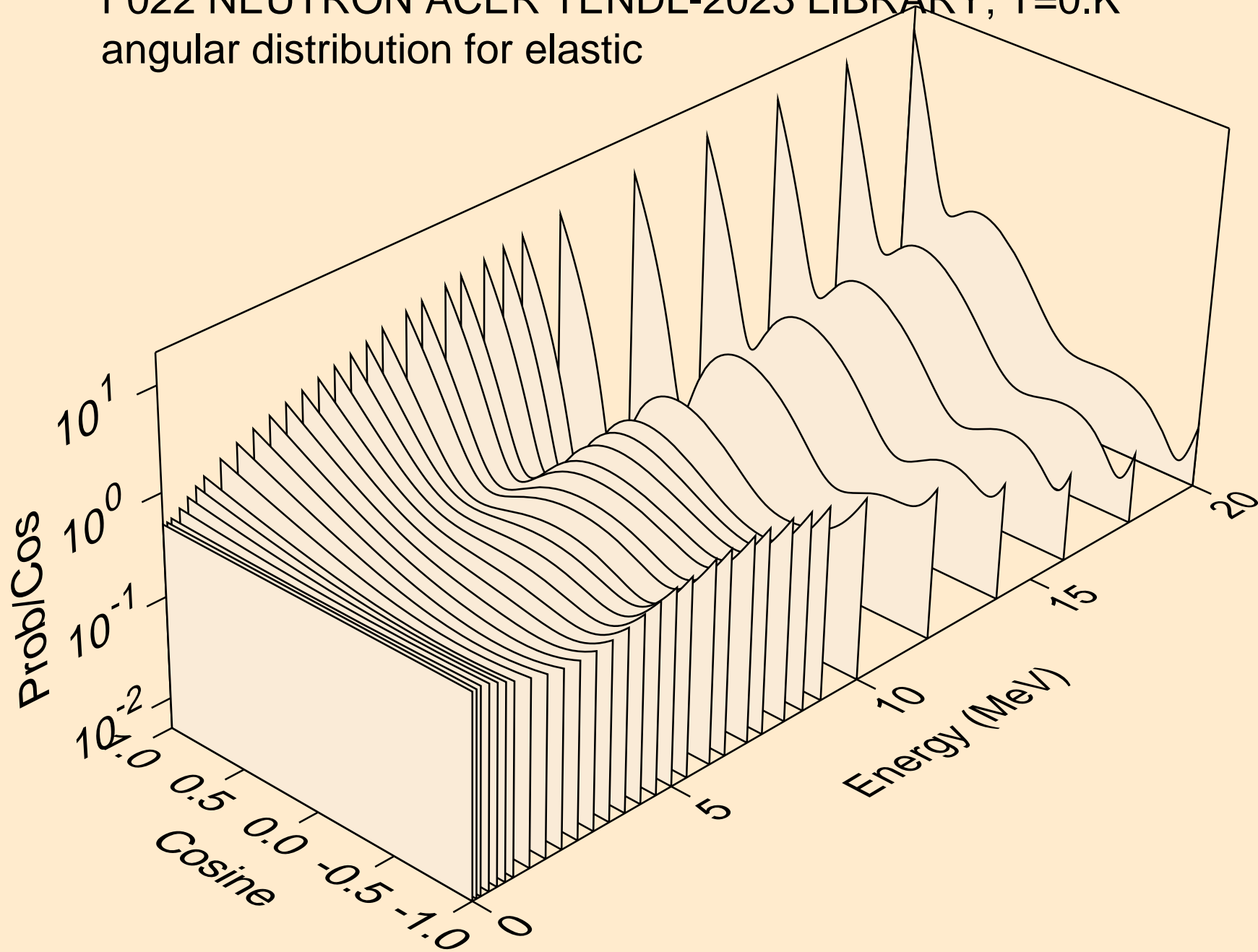

F022 NEUTRON ACER TENDL-2023 LIBRARY; T=0.K
angular distribution for elastic

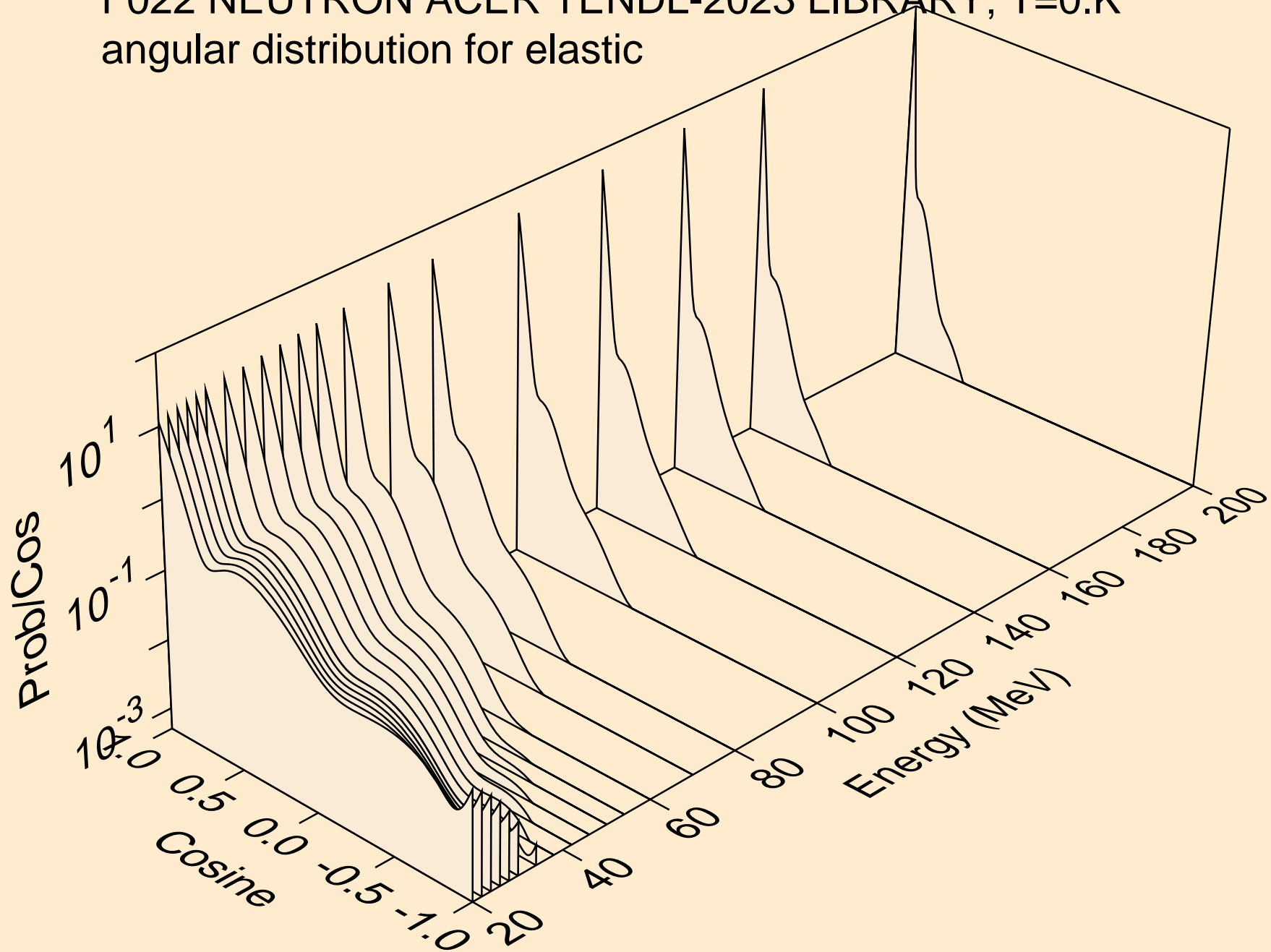

F022 NEUTRON ACER TENDL-2023 LIBRARY; T=0.K
angular distribution for (n,n*1)

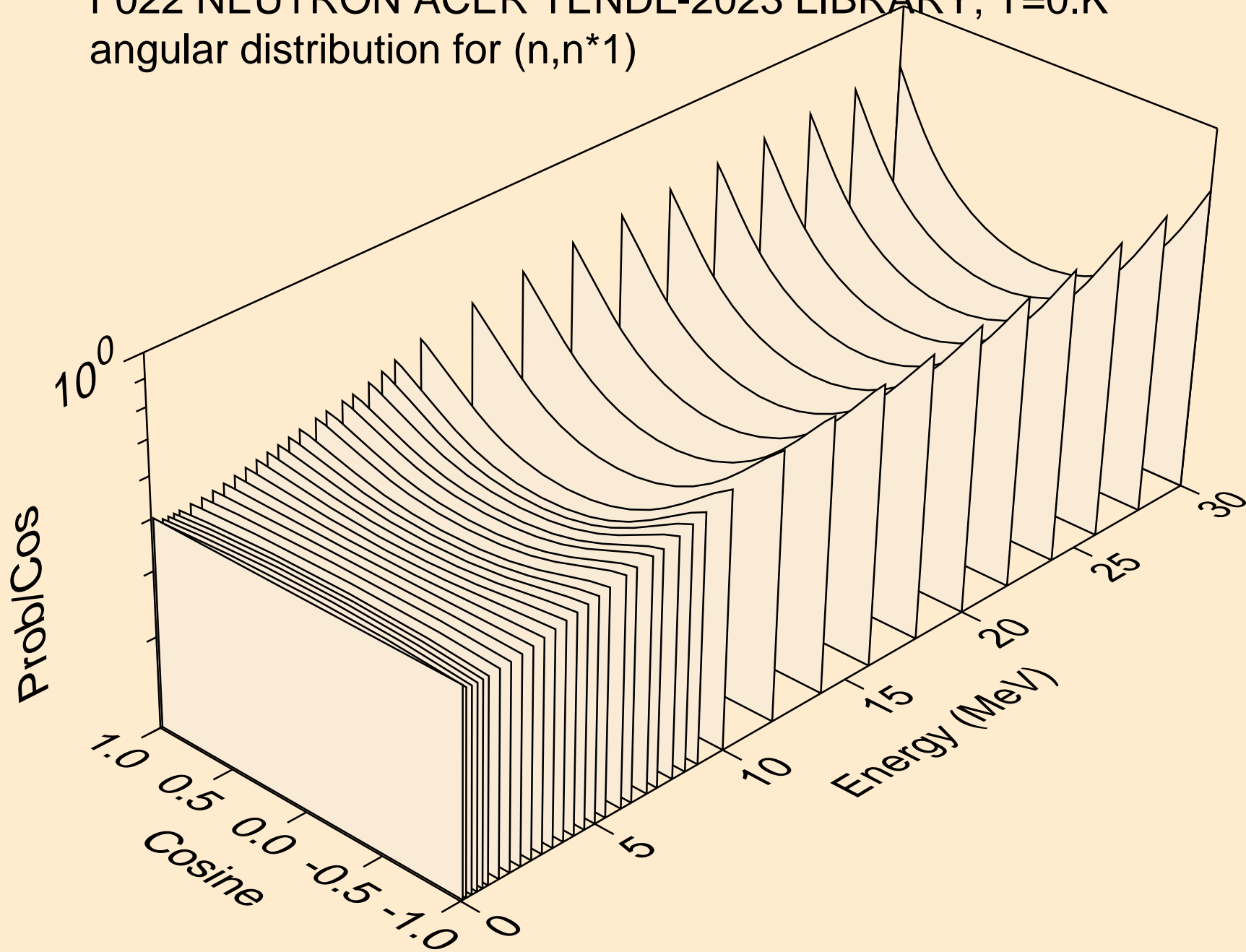

F022 NEUTRON ACER TENDL-2023 LIBRARY; T=0.K
angular distribution for (n,n*2)

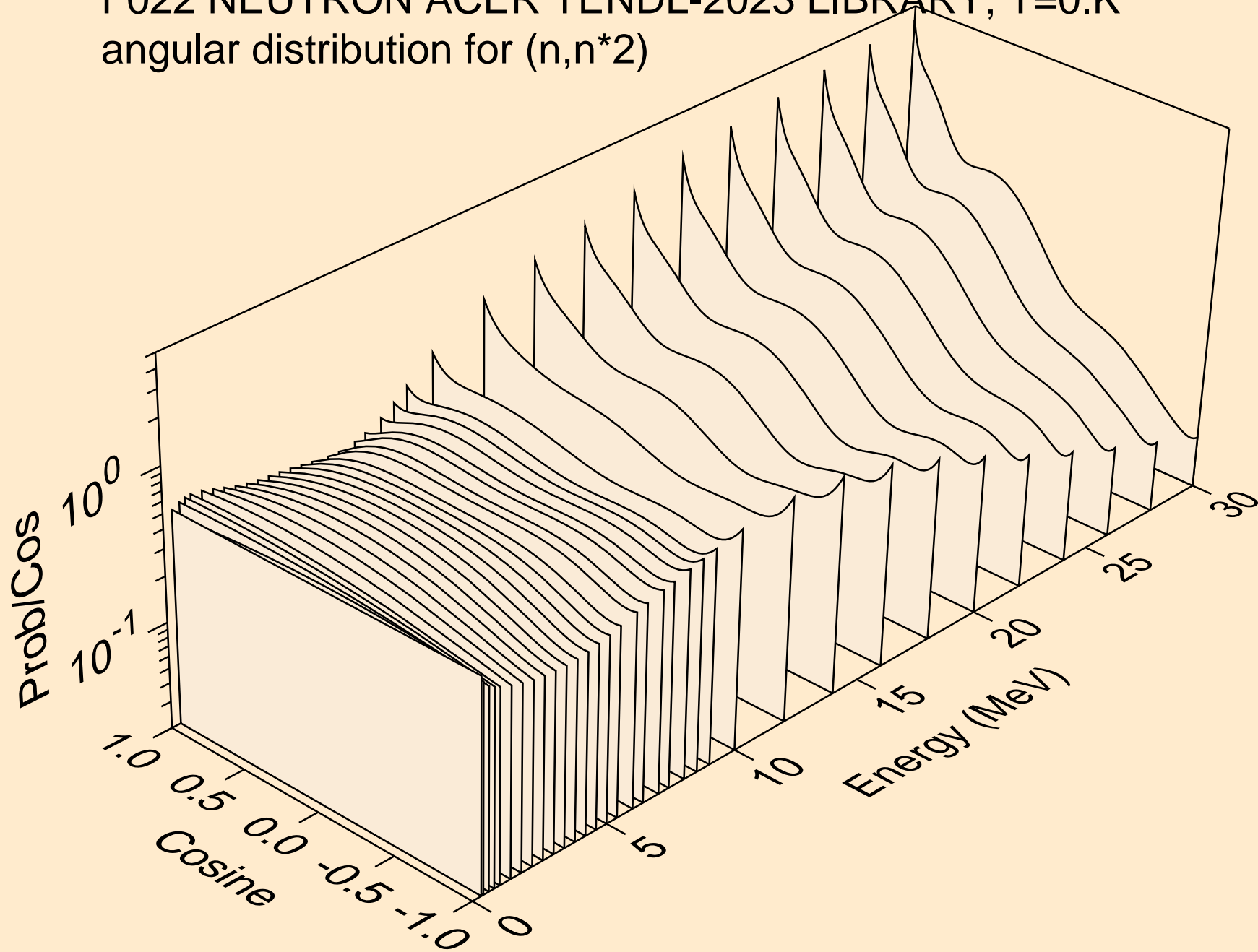

F022 NEUTRON ACER TENDL-2023 LIBRARY; T=0.K
angular distribution for (n,n*3)

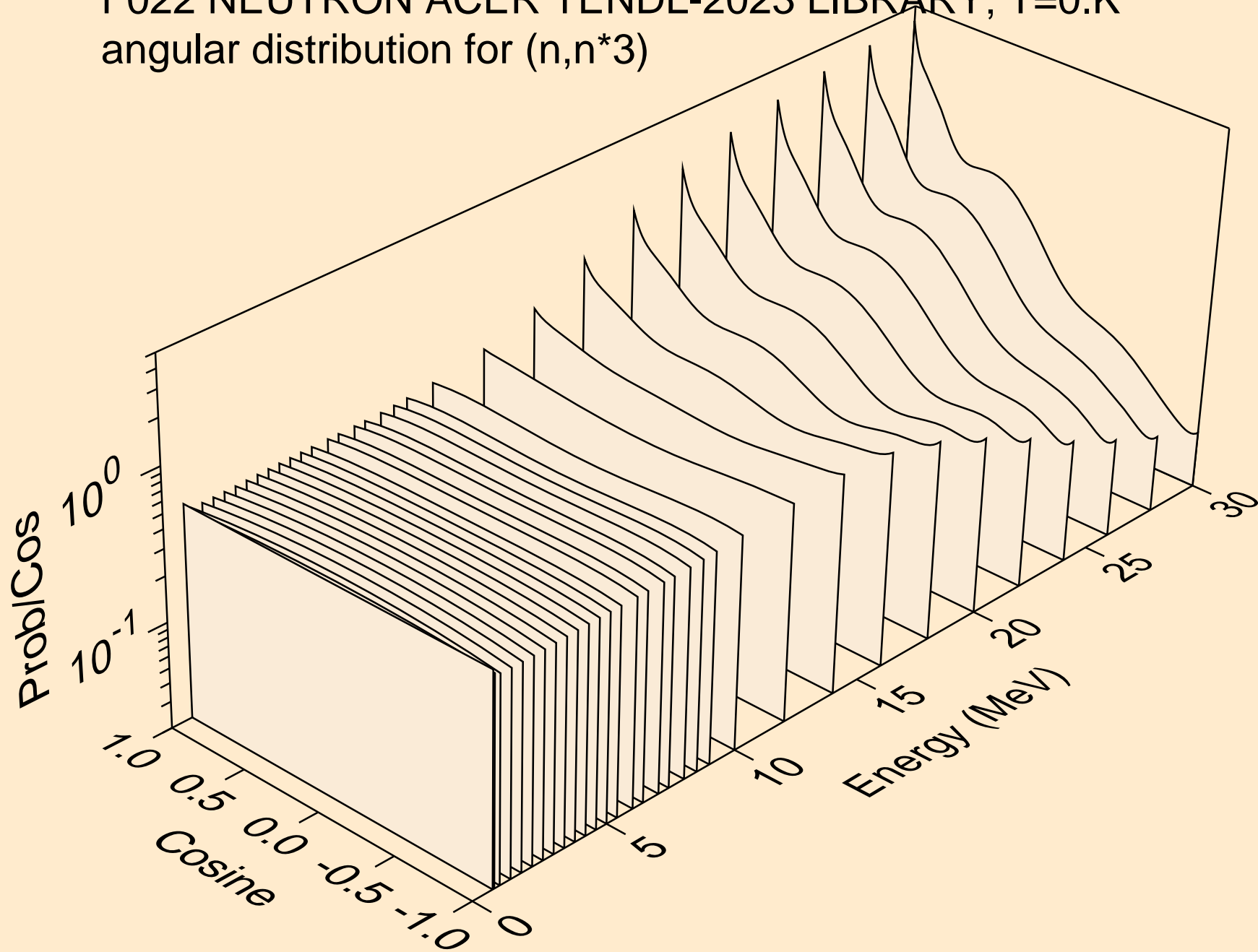

F022 NEUTRON ACER TENDL-2023 LIBRARY; T=0.K
angular distribution for (n,n*4)

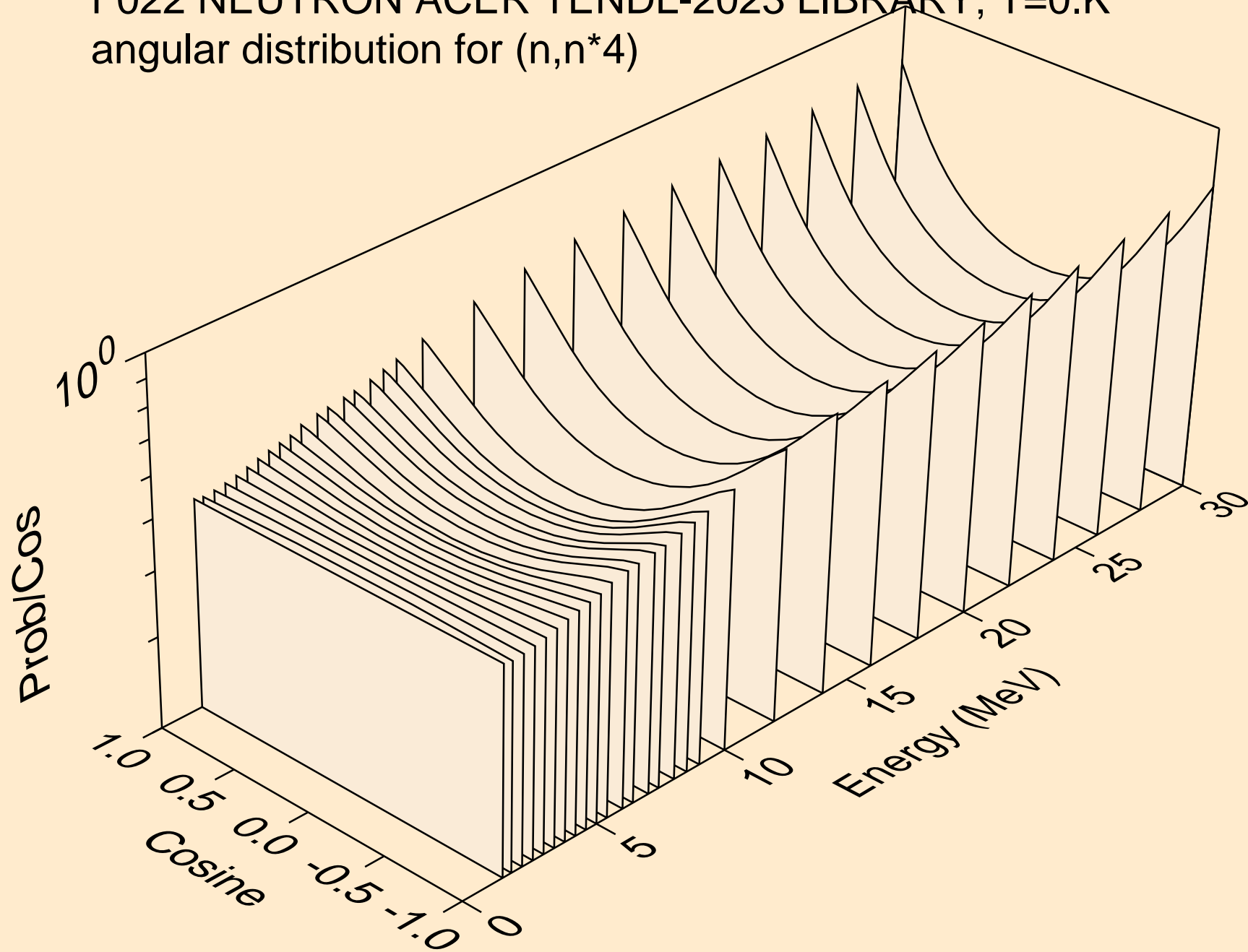

F022 NEUTRON ACER TENDL-2023 LIBRARY; T=0.K
angular distribution for (n,n*5)

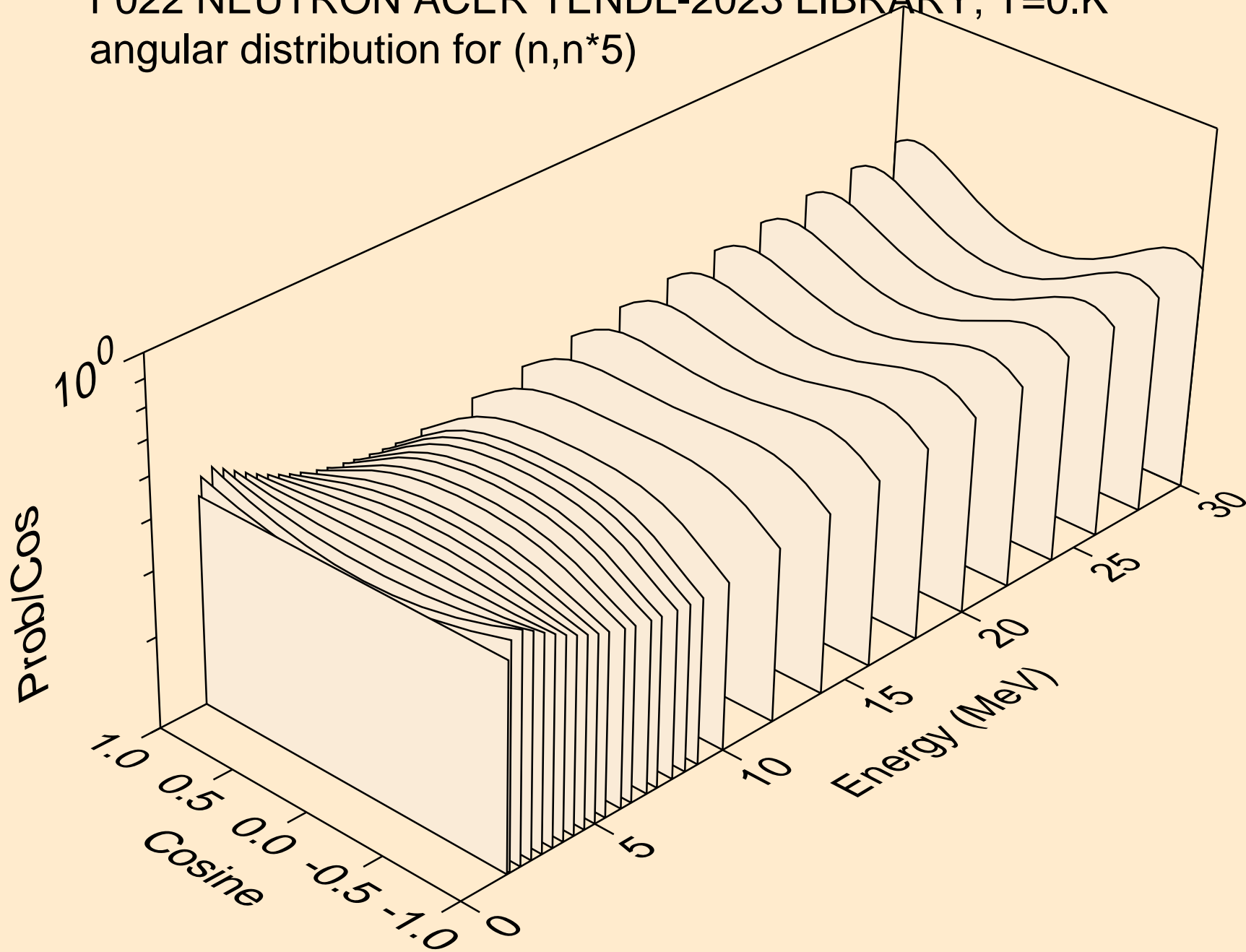

F022 NEUTRON ACER TENDL-2023 LIBRARY; T=0.K
angular distribution for (n,n*6)

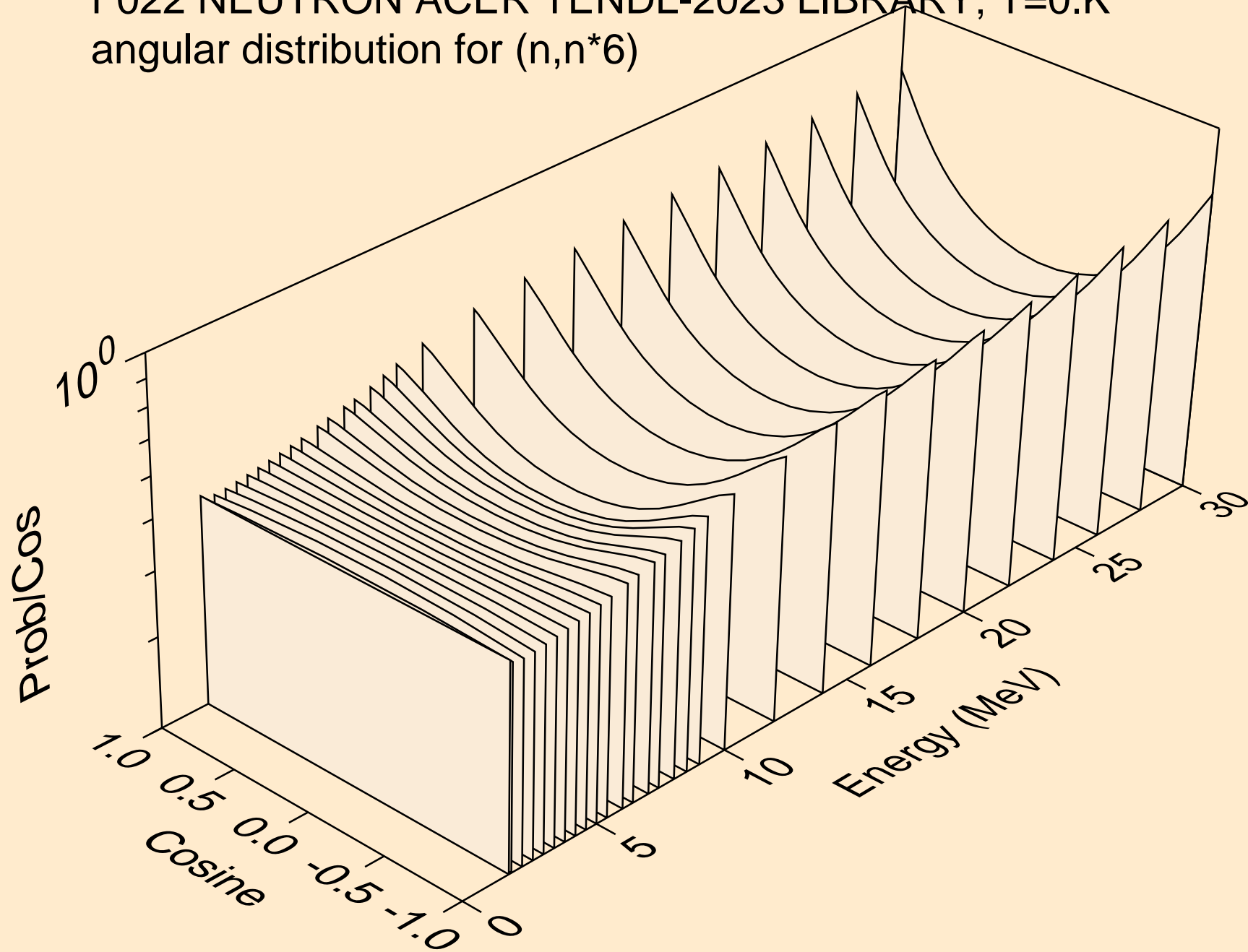

F022 NEUTRON ACER TENDL-2023 LIBRARY; T=0.K
angular distribution for (n,n*7)

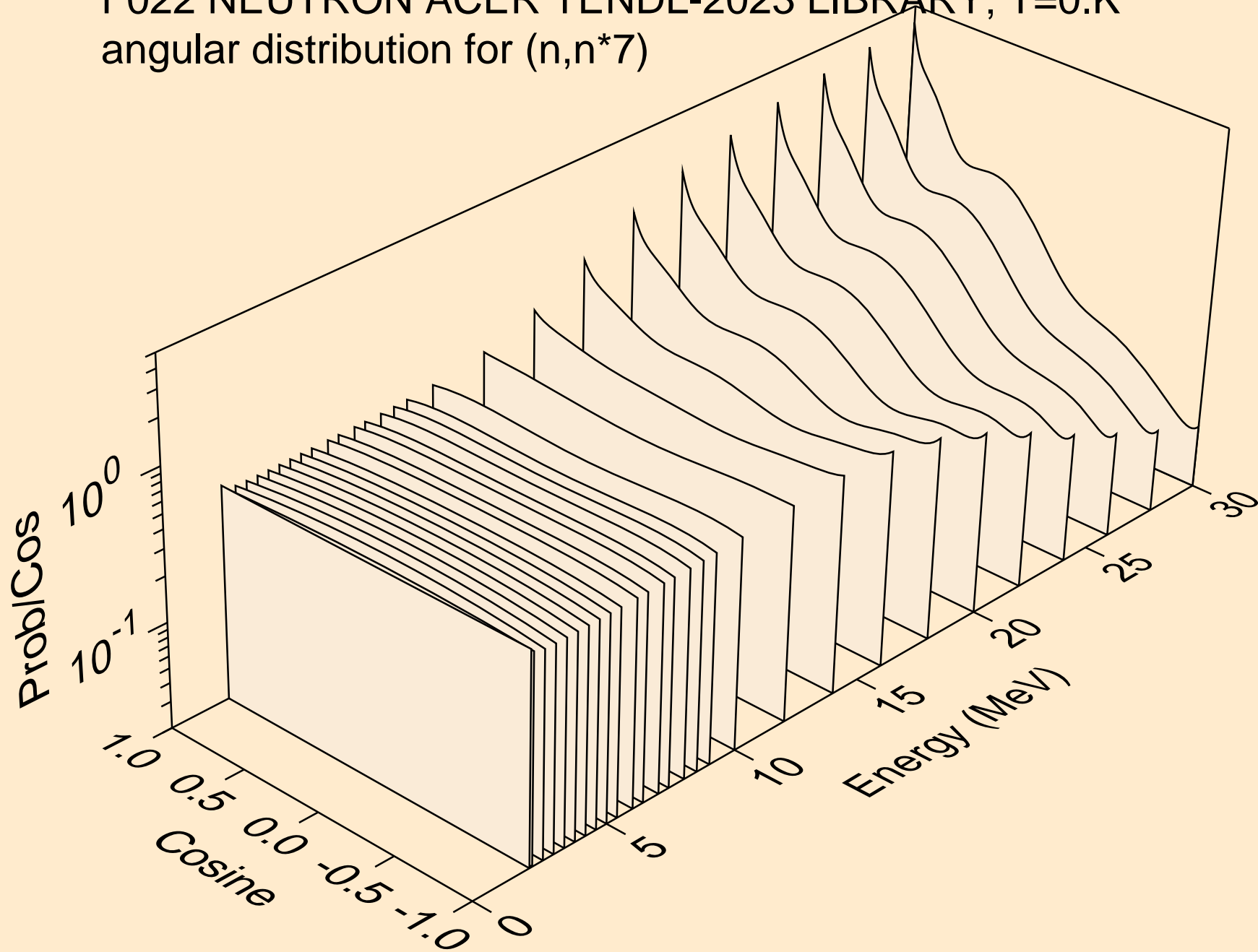

F022 NEUTRON ACER TENDL-2023 LIBRARY; T=0.K
angular distribution for (n,n*8)

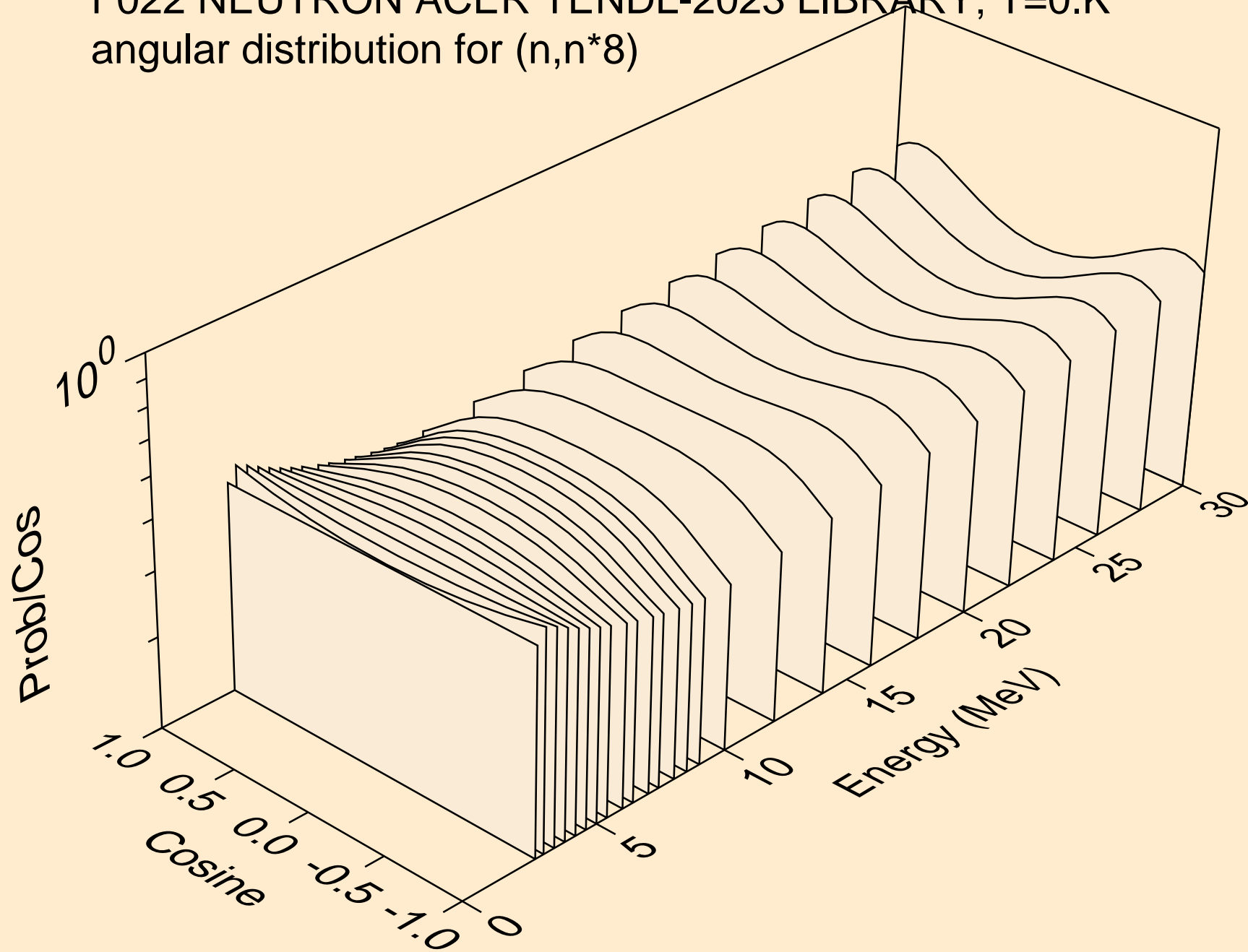

F022 NEUTRON ACER TENDL-2023 LIBRARY; T=0.K
angular distribution for (n,n*9)

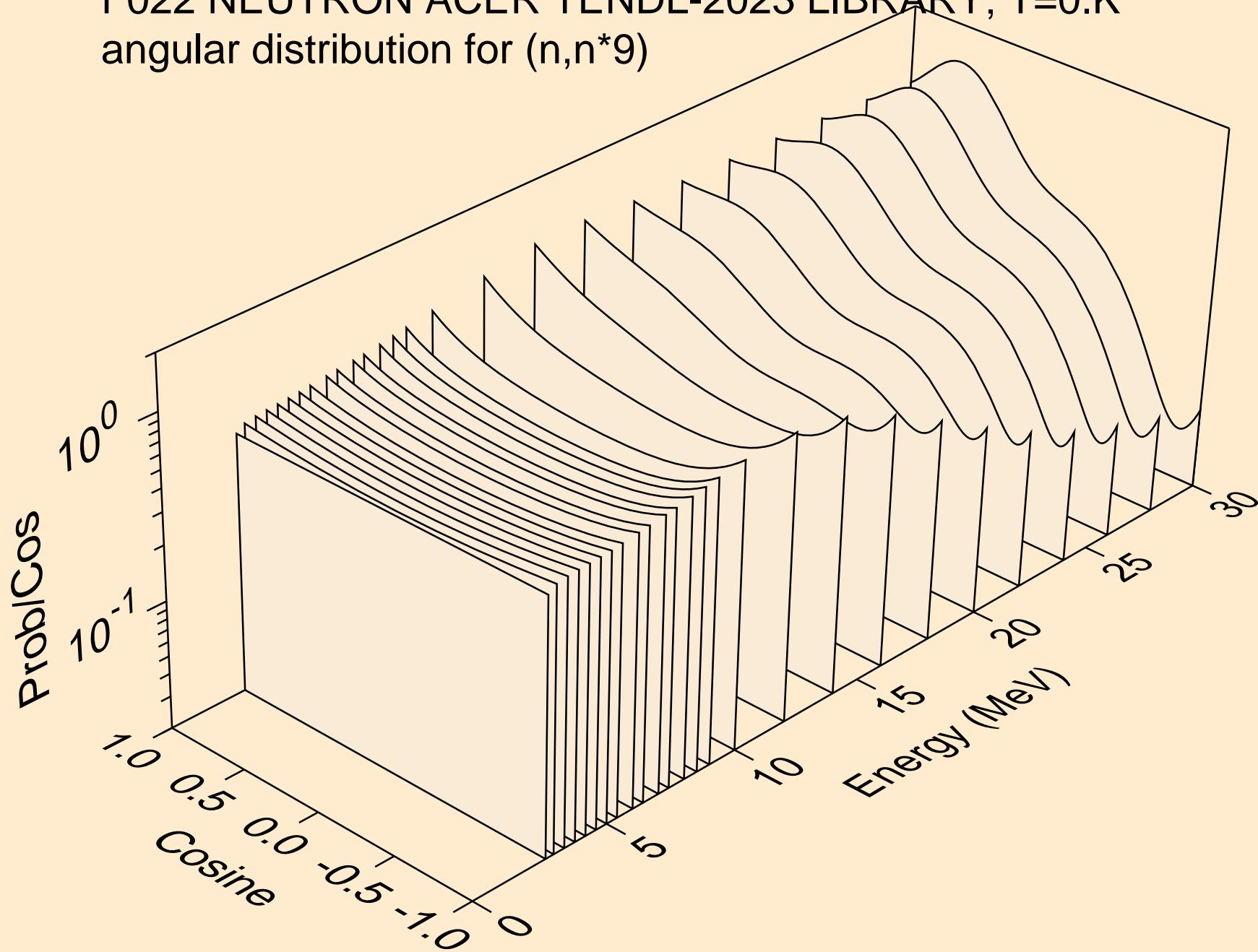

F022 NEUTRON ACER TENDL-2023 LIBRARY; T=0.K
angular distribution for (n,n*10)

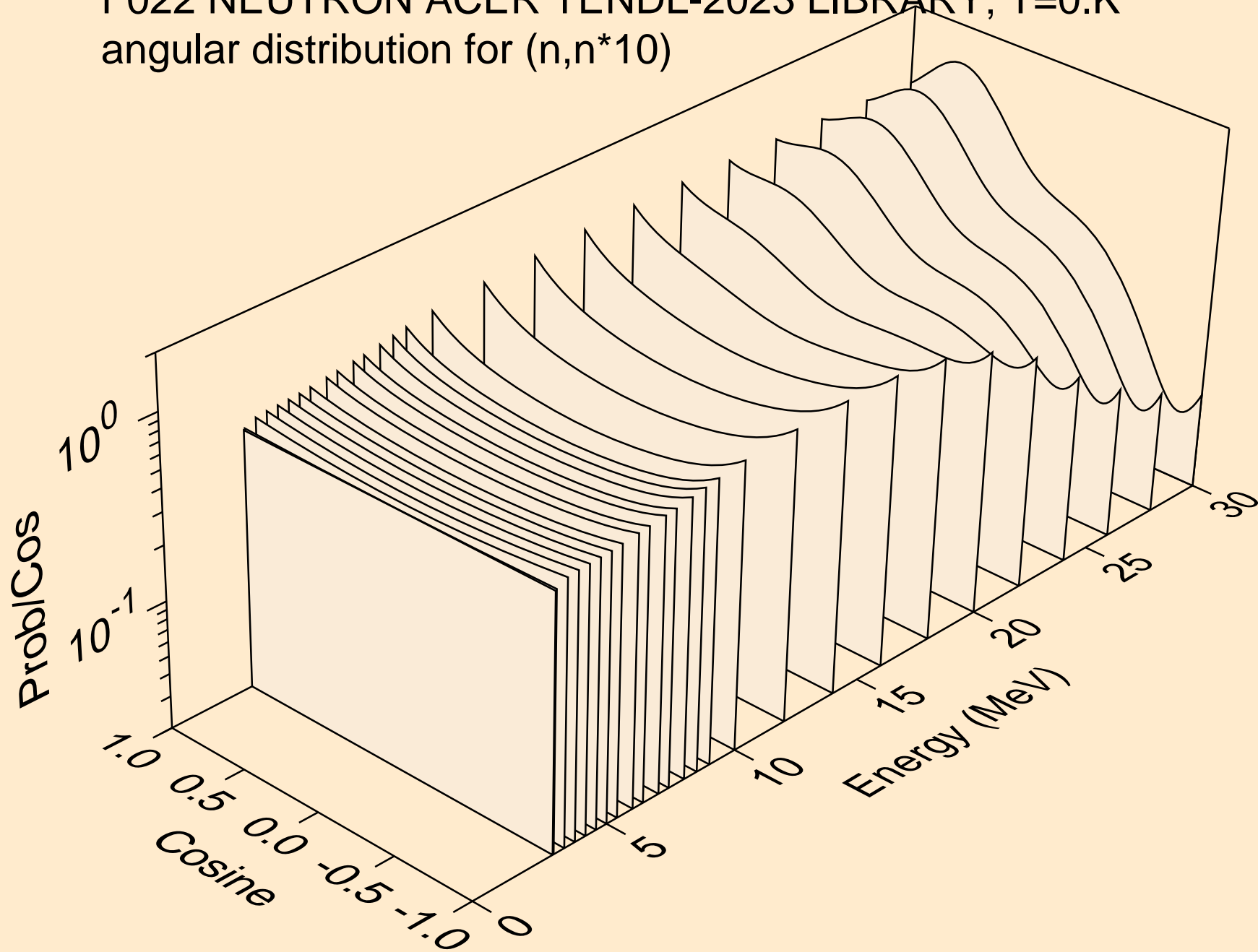

F022 NEUTRON ACER TENDL-2023 LIBRARY; T=0.K
angular distribution for (n,n*11)

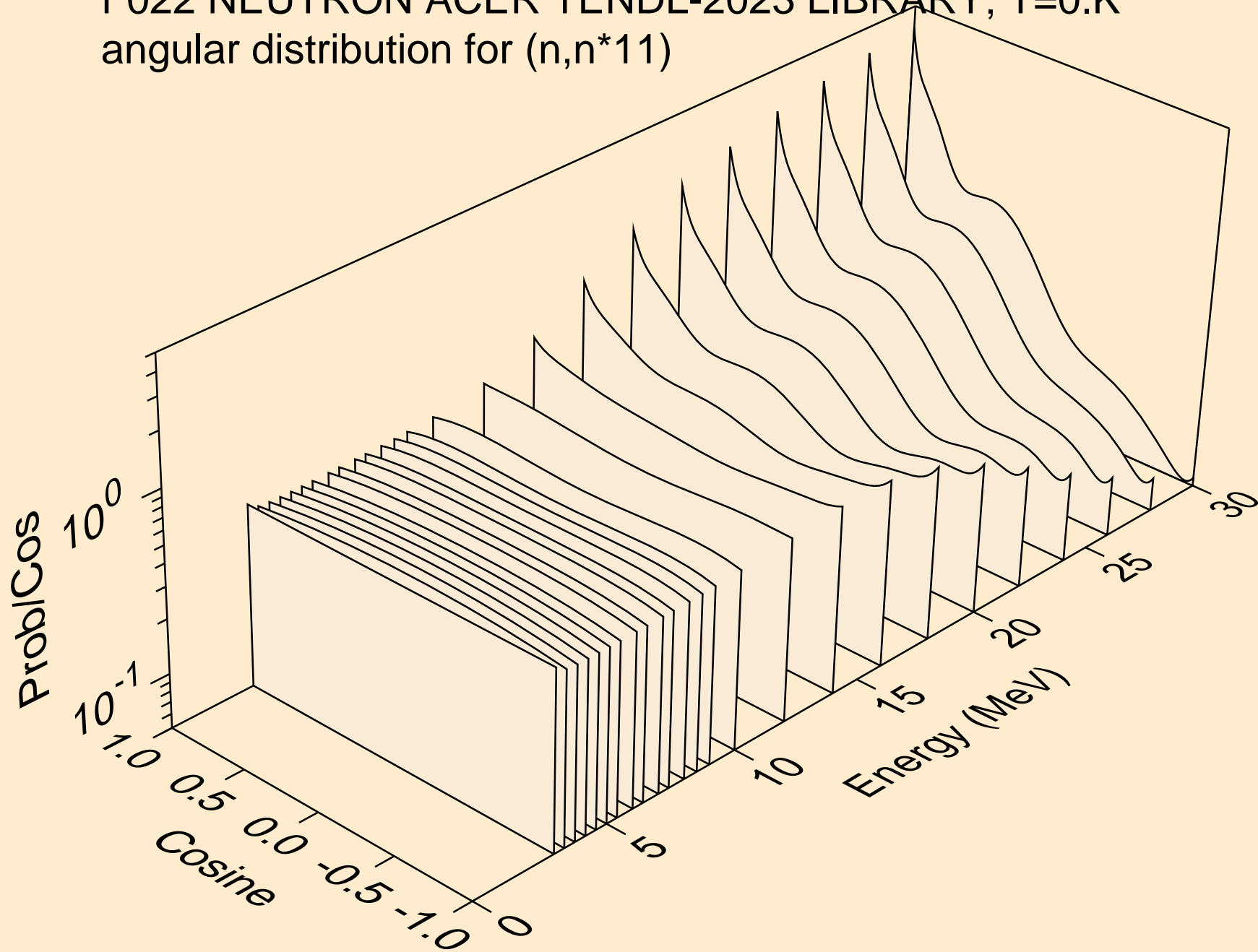

F022 NEUTRON ACER TENDL-2023 LIBRARY; T=0.K
angular distribution for (n,n*12)

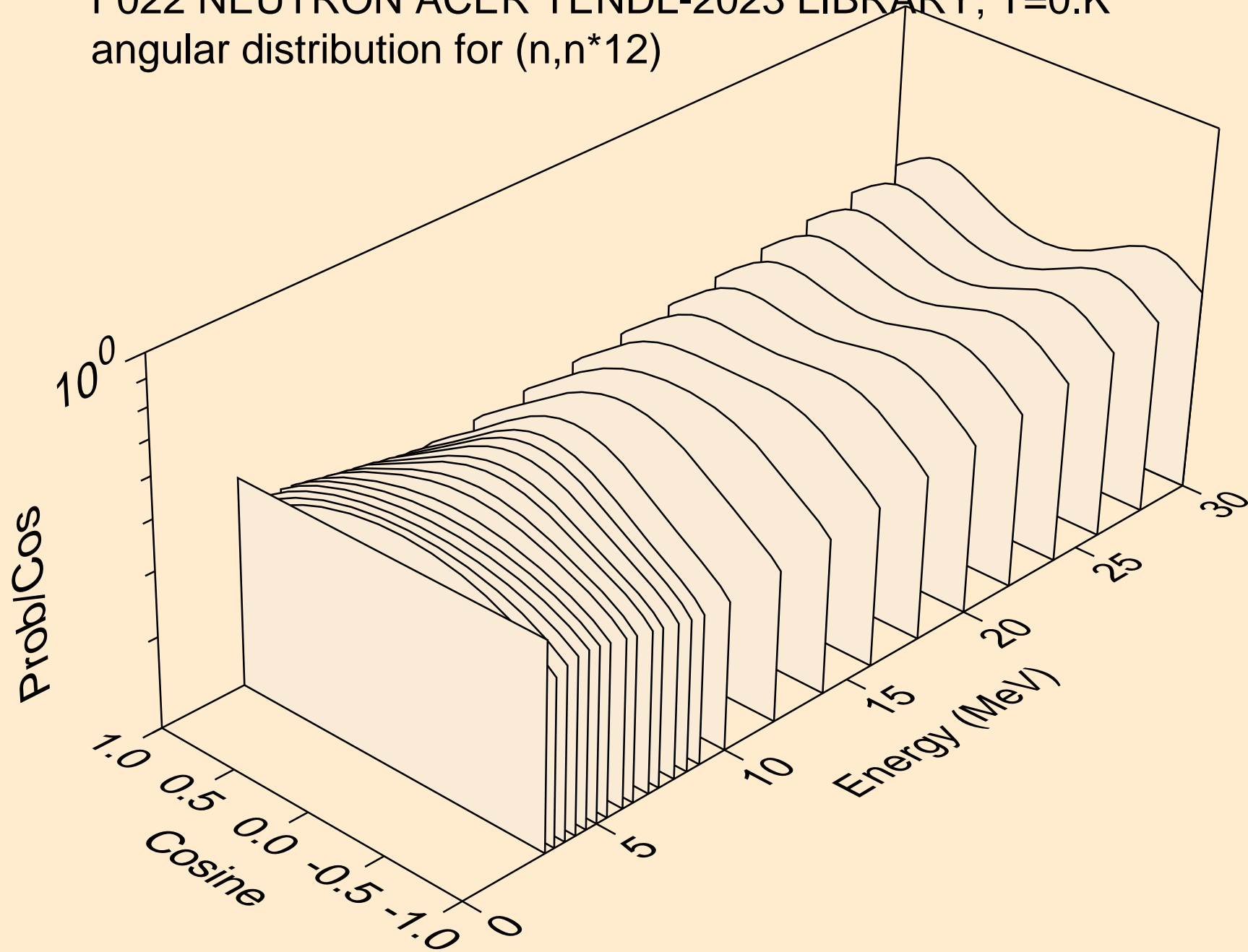

F022 NEUTRON ACER TENDL-2023 LIBRARY; T=0.K
angular distribution for (n,n*13)

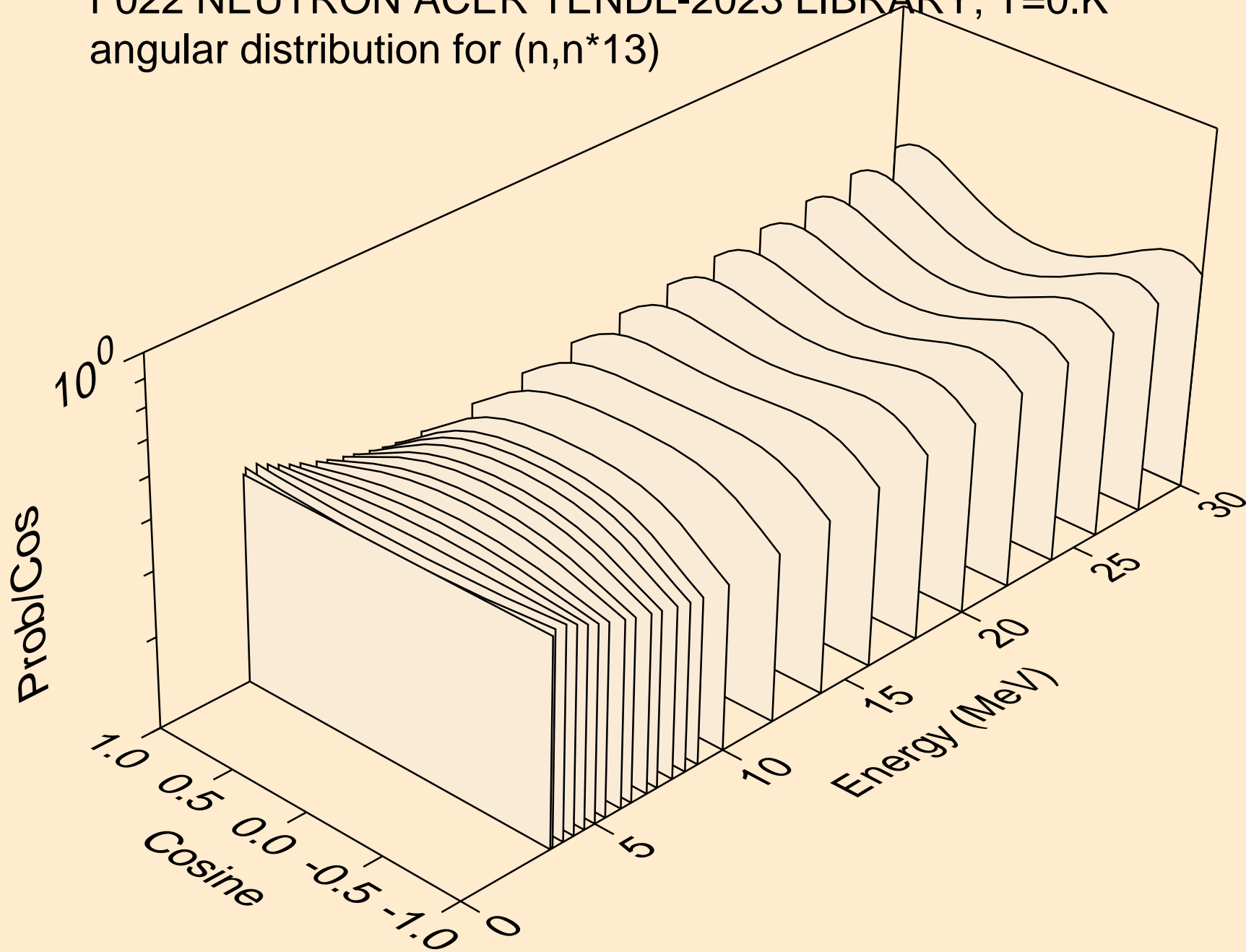

F022 NEUTRON ACER TENDL-2023 LIBRARY; T=0.K
angular distribution for (n,n*14)

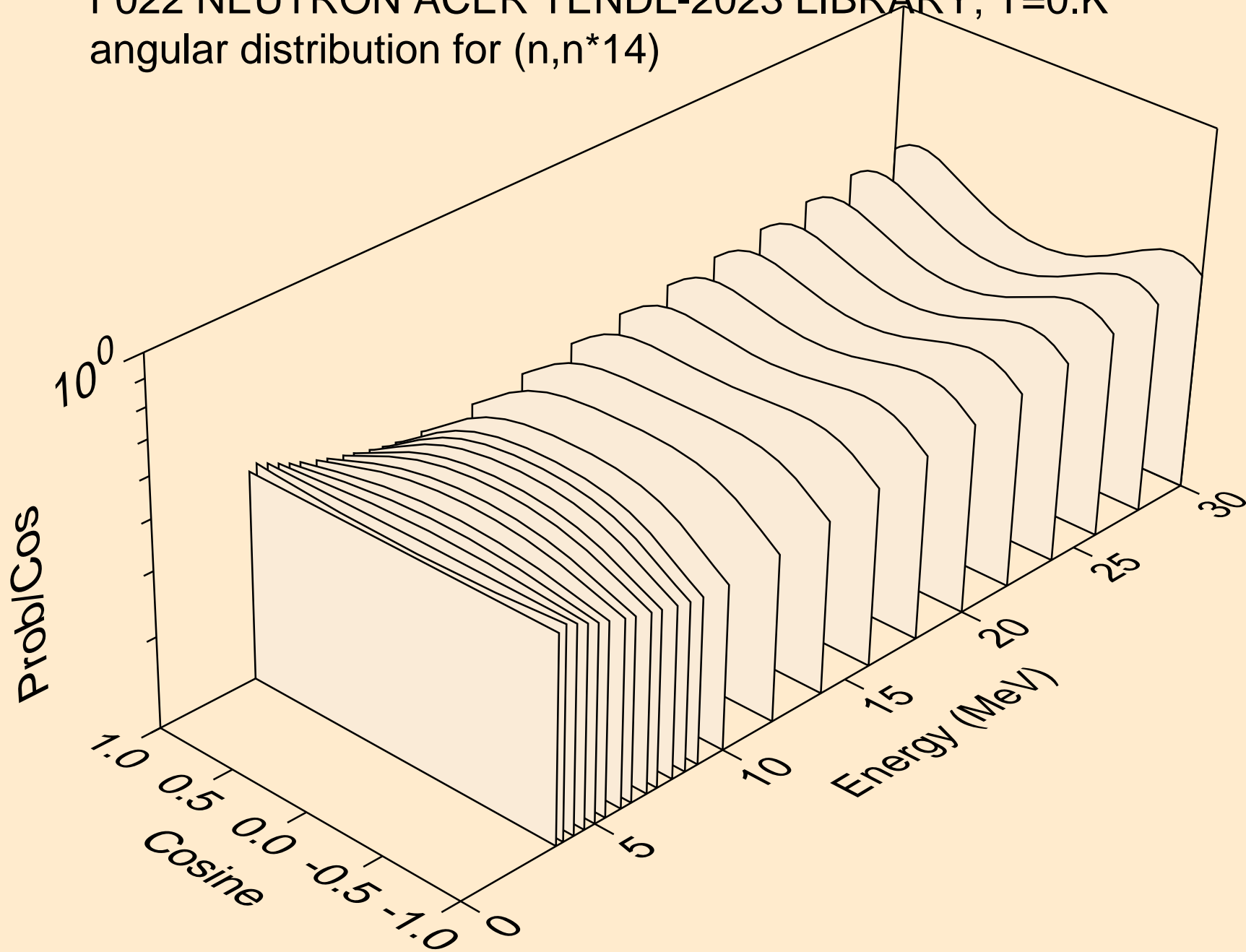

F022 NEUTRON ACER TENDL-2023 LIBRARY; T=0.K
angular distribution for (n,n*15)

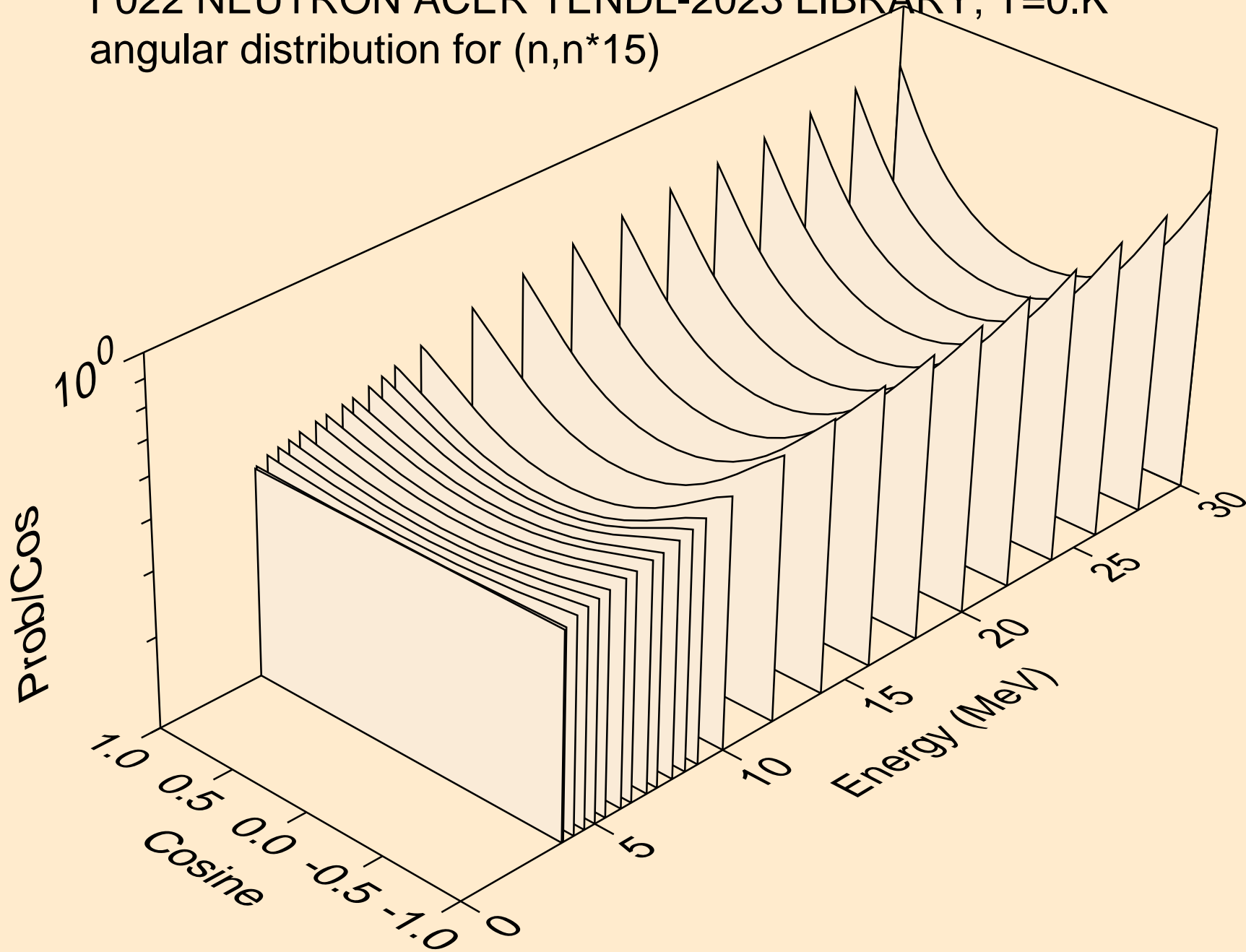

F022 NEUTRON ACER TENDL-2023 LIBRARY; T=0.K
angular distribution for (n,n*16)

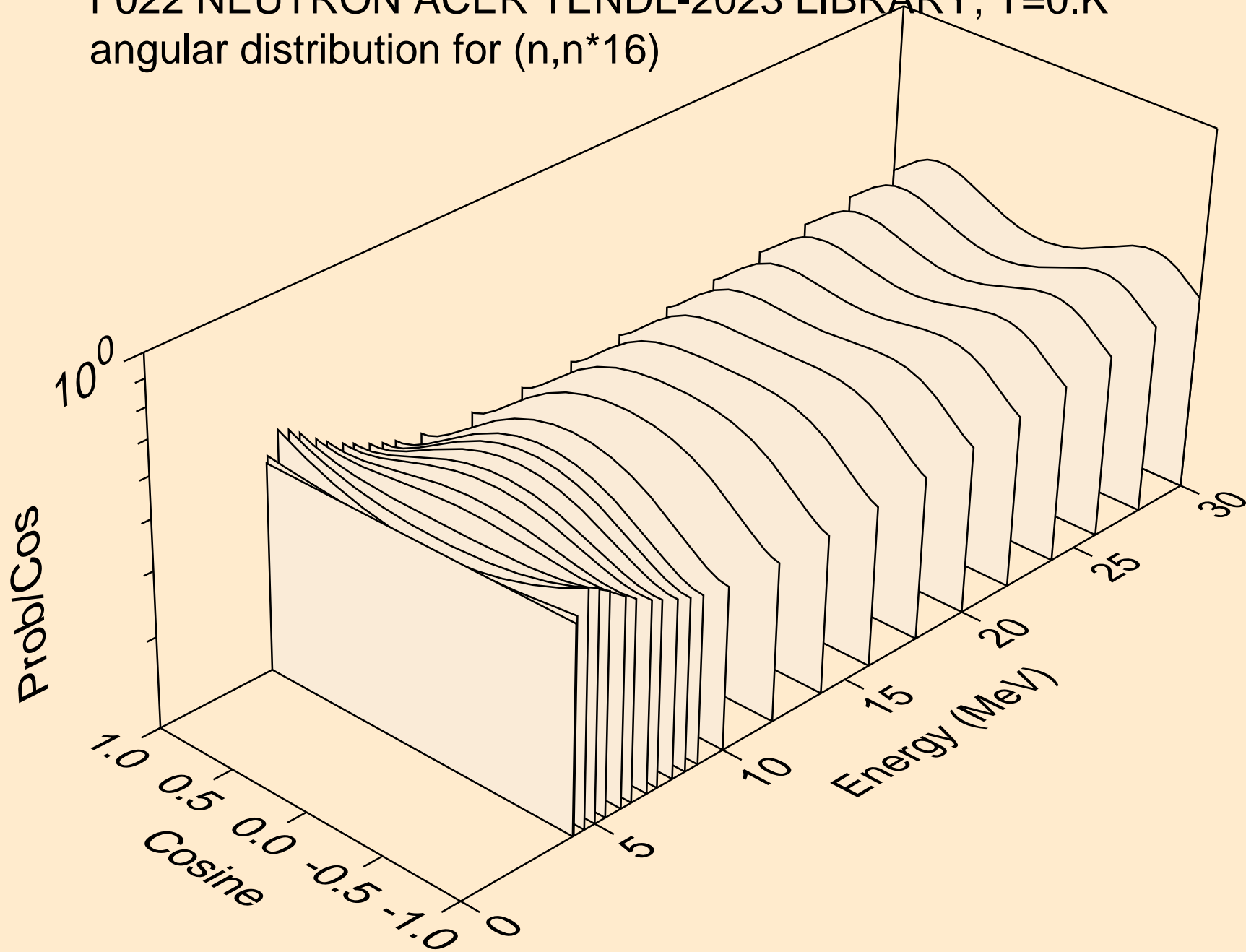

F022 NEUTRON ACER TENDL-2023 LIBRARY; T=0.K
angular distribution for (n,n*17)

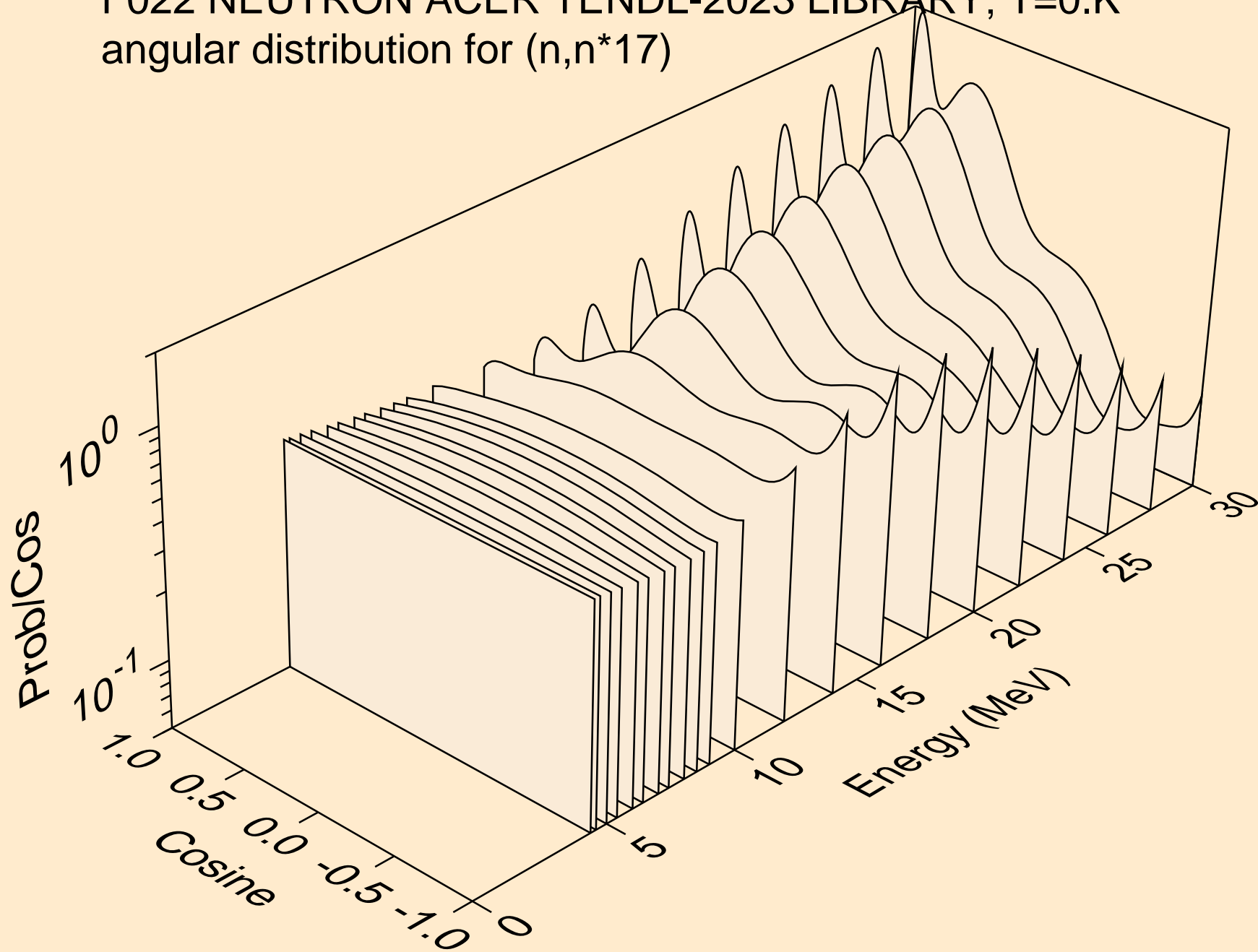

F022 NEUTRON ACER TENDL-2023 LIBRARY; T=0.K
angular distribution for (n,n*18)

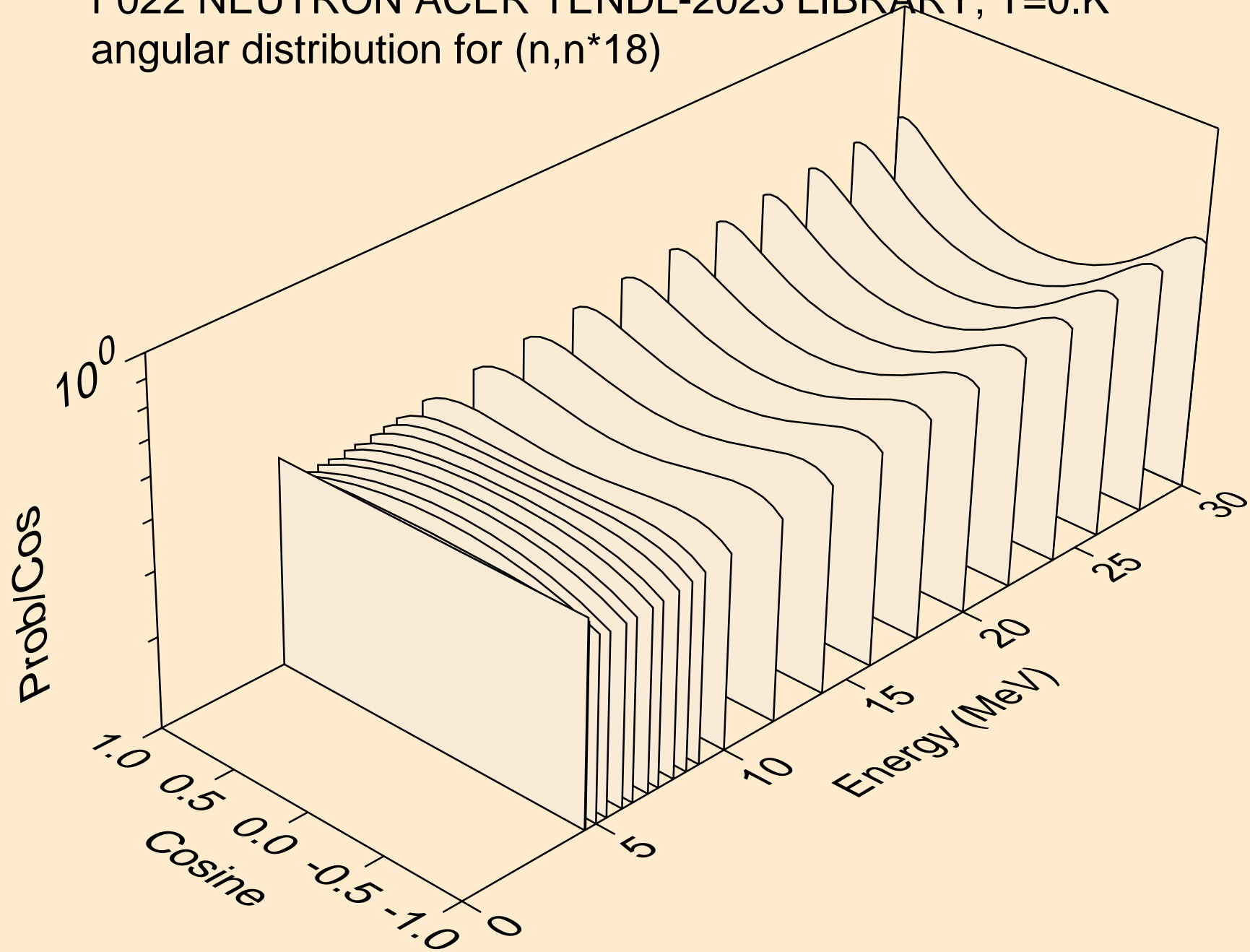

F022 NEUTRON ACER TENDL-2023 LIBRARY; T=0.K
angular distribution for (n,n*19)

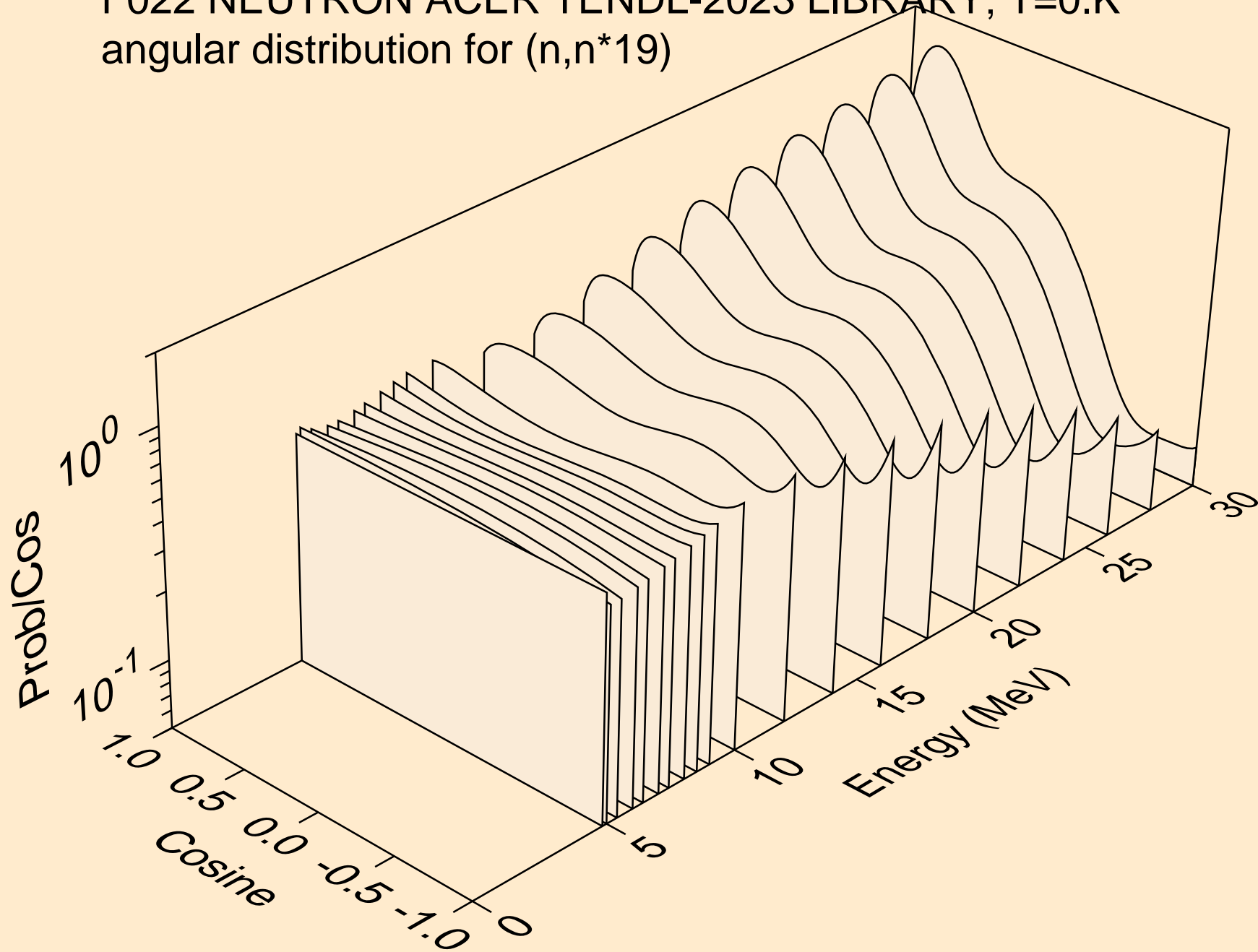

F022 NEUTRON ACER TENDL-2023 LIBRARY; T=0.K
angular distribution for (n,n*20)

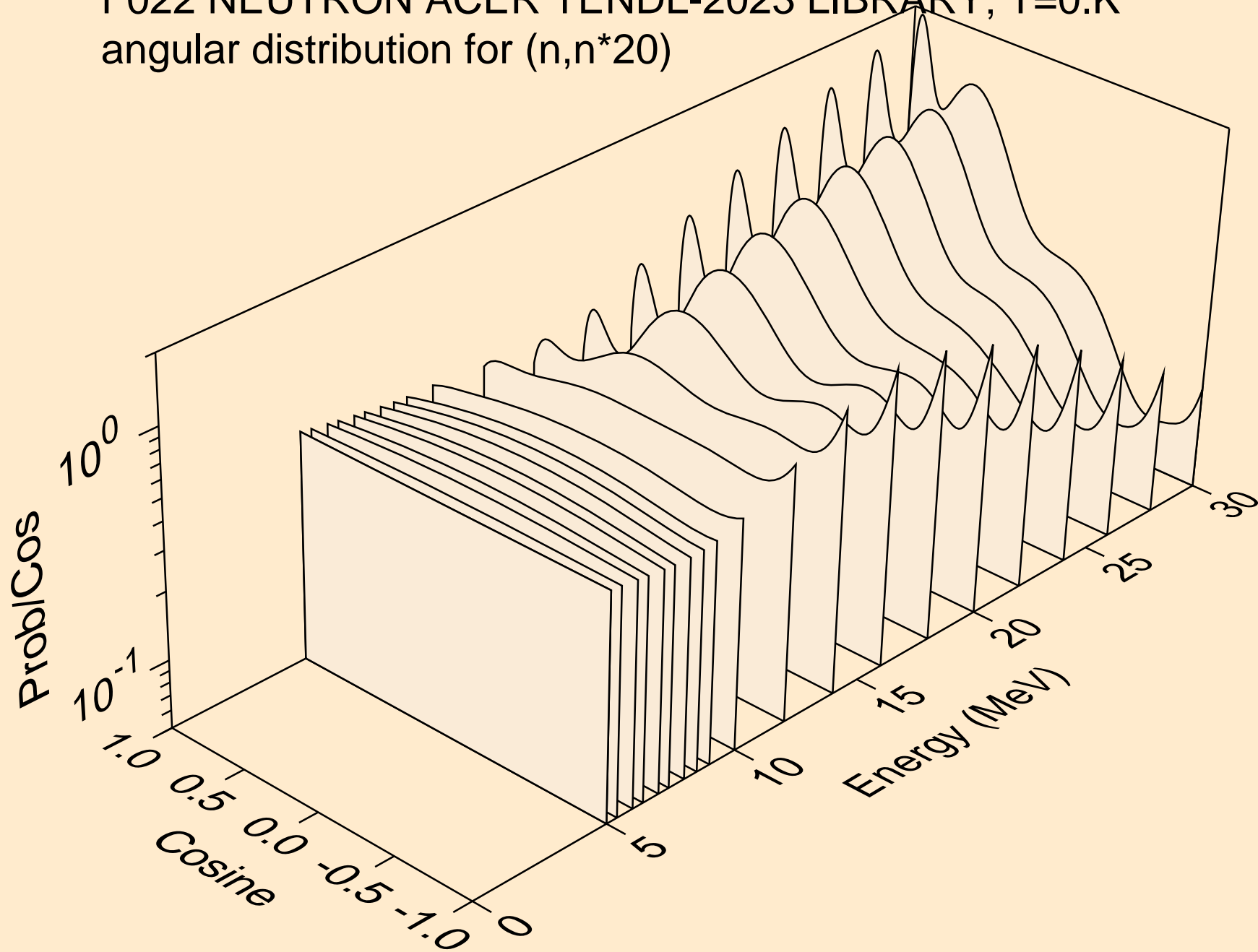

F022 NEUTRON ACER TENDL-2023 LIBRARY; T=0.K
angular distribution for (n,n*21)

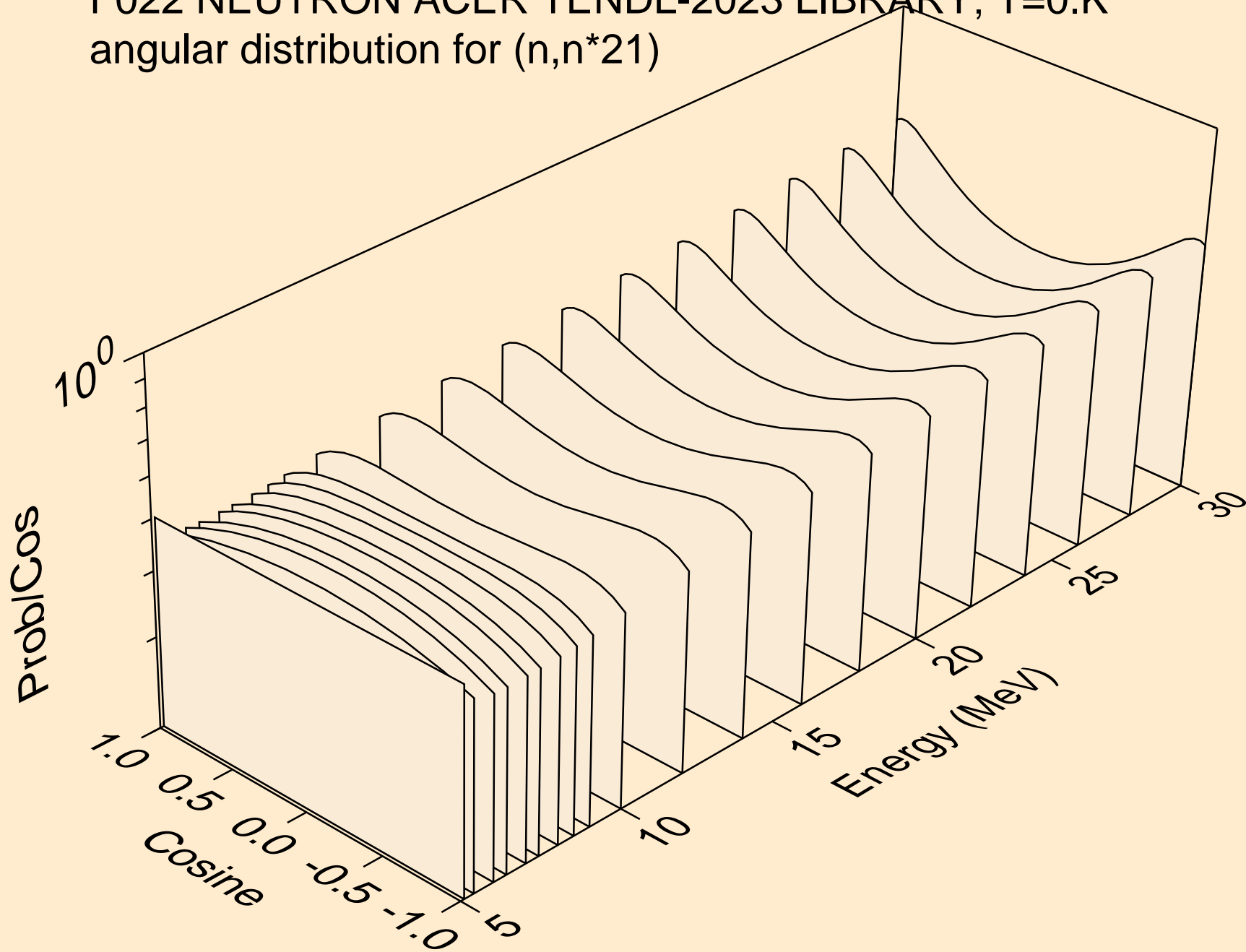

F022 NEUTRON ACER TENDL-2023 LIBRARY; T=0.K
angular distribution for (n,n*22)

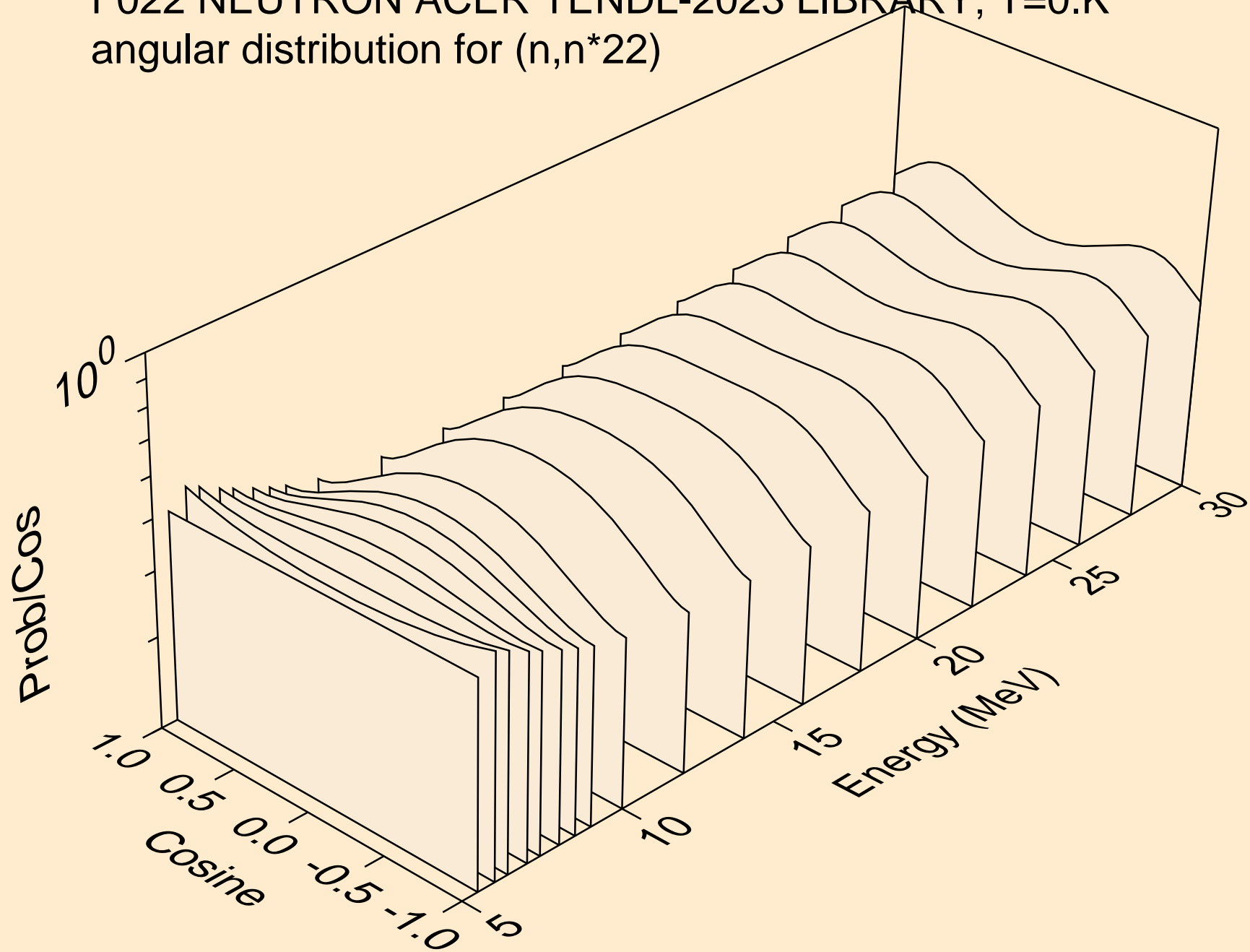

F022 NEUTRON ACER TENDL-2023 LIBRARY; T=0.K
angular distribution for (n,n*23)

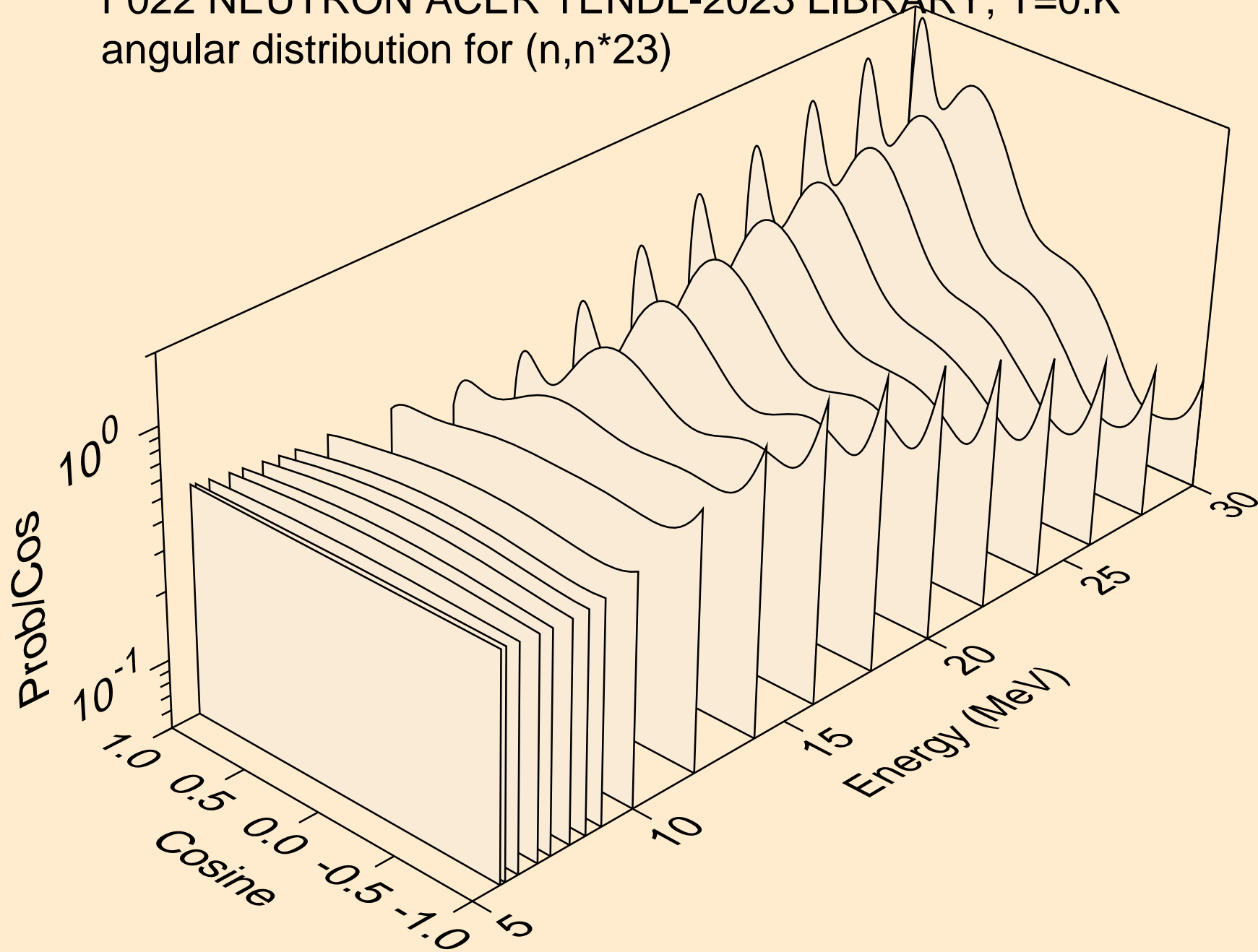

F022 NEUTRON ACER TENDL-2023 LIBRARY; T=0.K
angular distribution for (n,n*24)

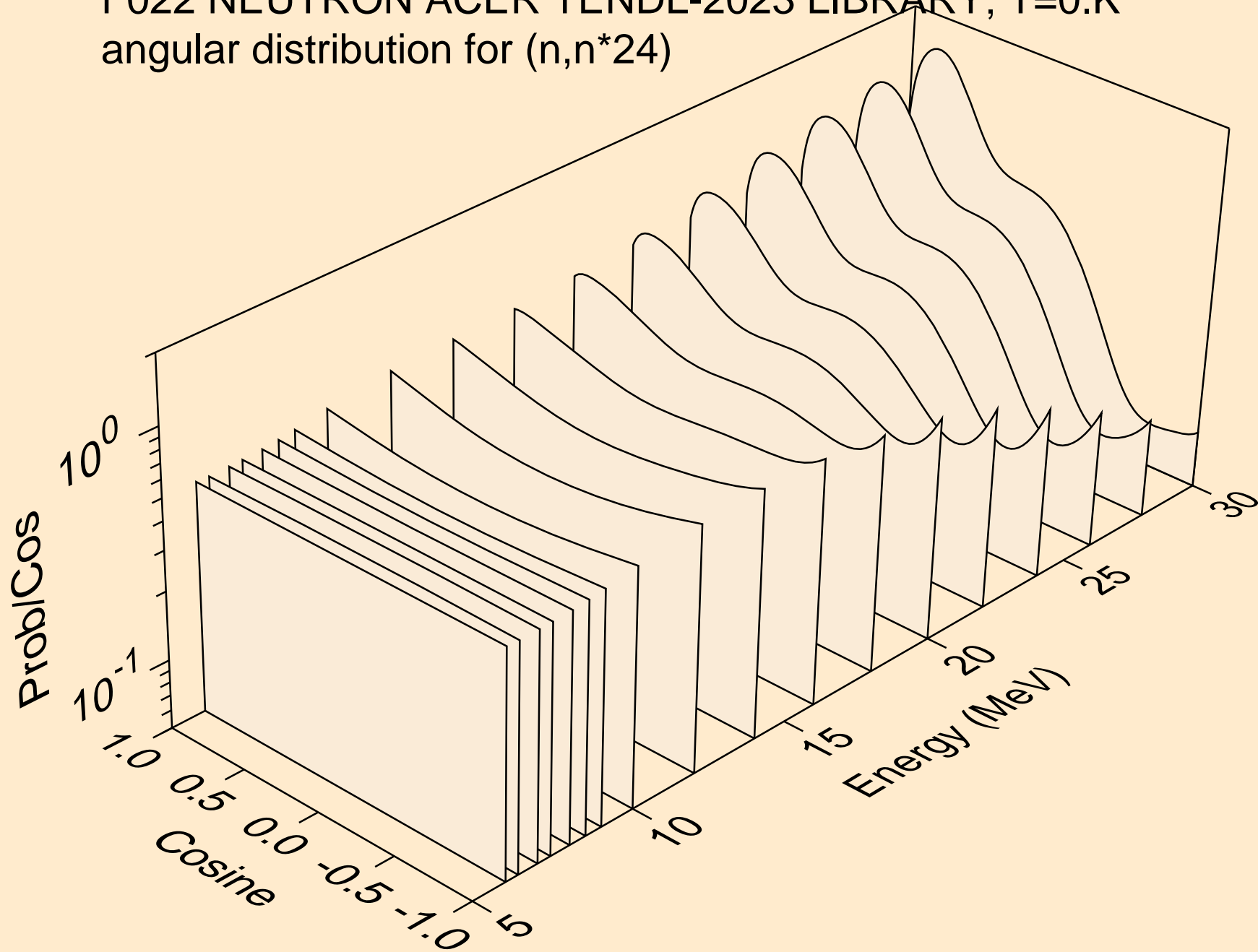

F022 NEUTRON ACER TENDL-2023 LIBRARY; T=0.K
angular distribution for (n,n*25)

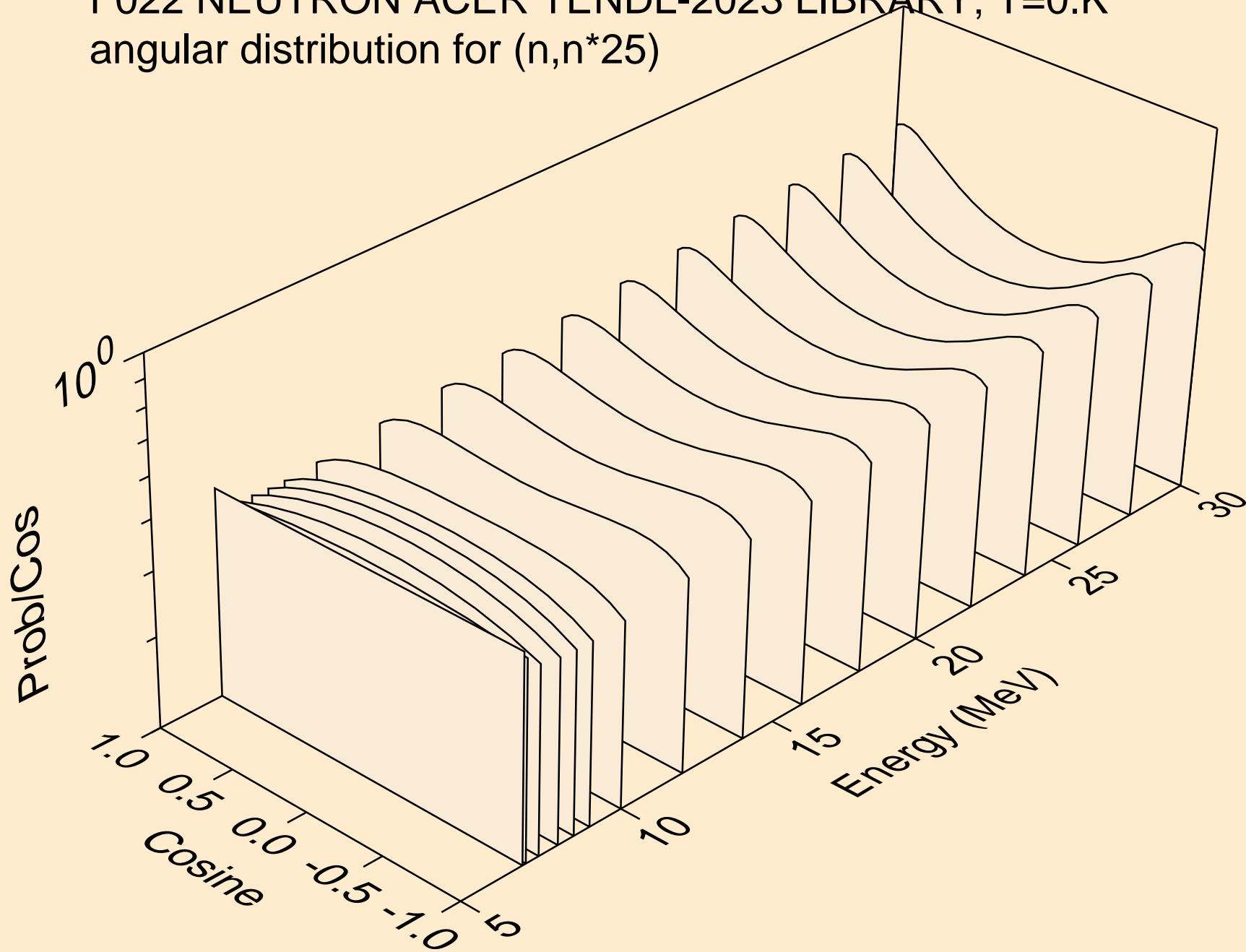

F022 NEUTRON ACER TENDL-2023 LIBRARY; T=0.K
angular distribution for (n,n*26)

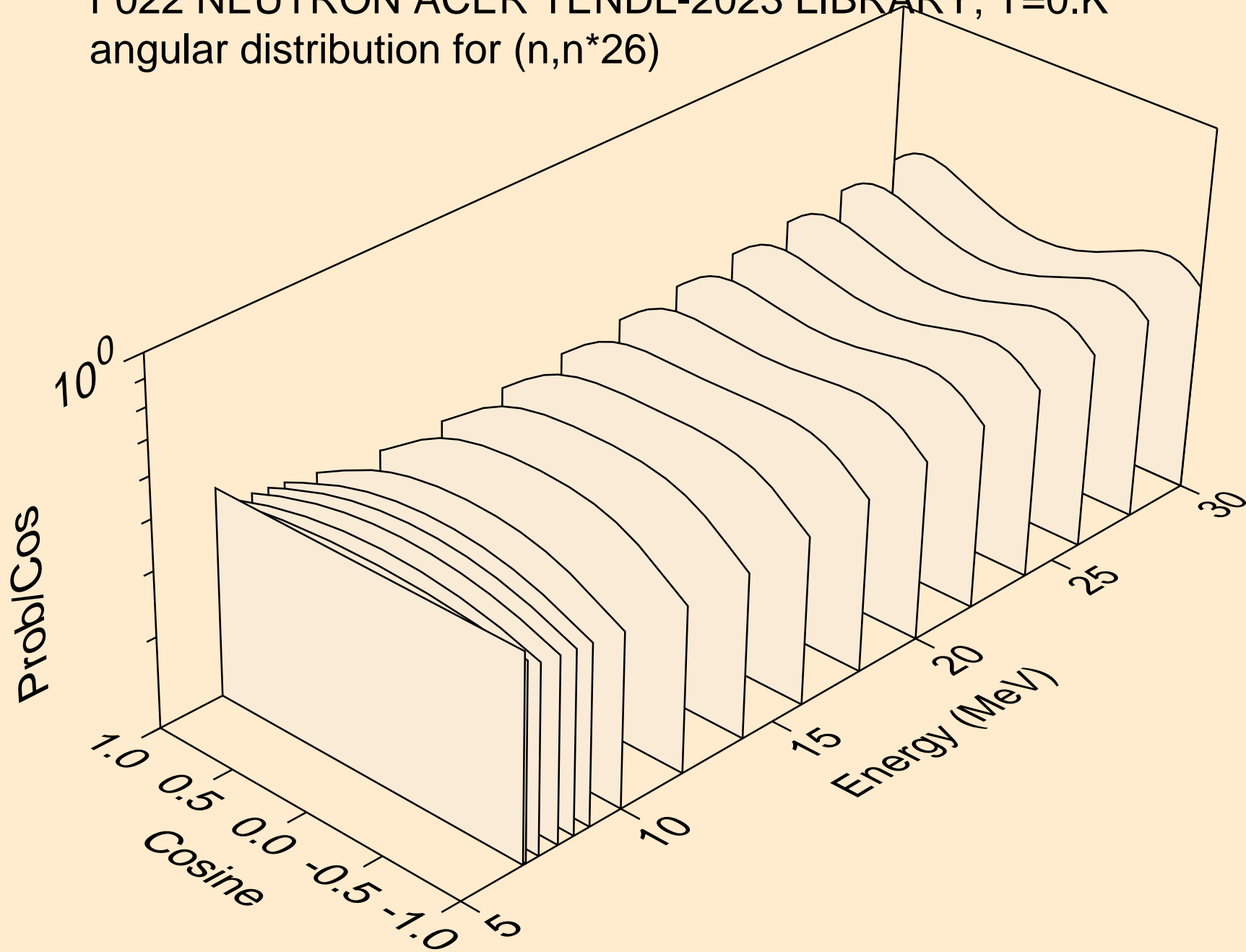

F022 NEUTRON ACER TENDL-2023 LIBRARY; T=0.K
angular distribution for (n,n*27)

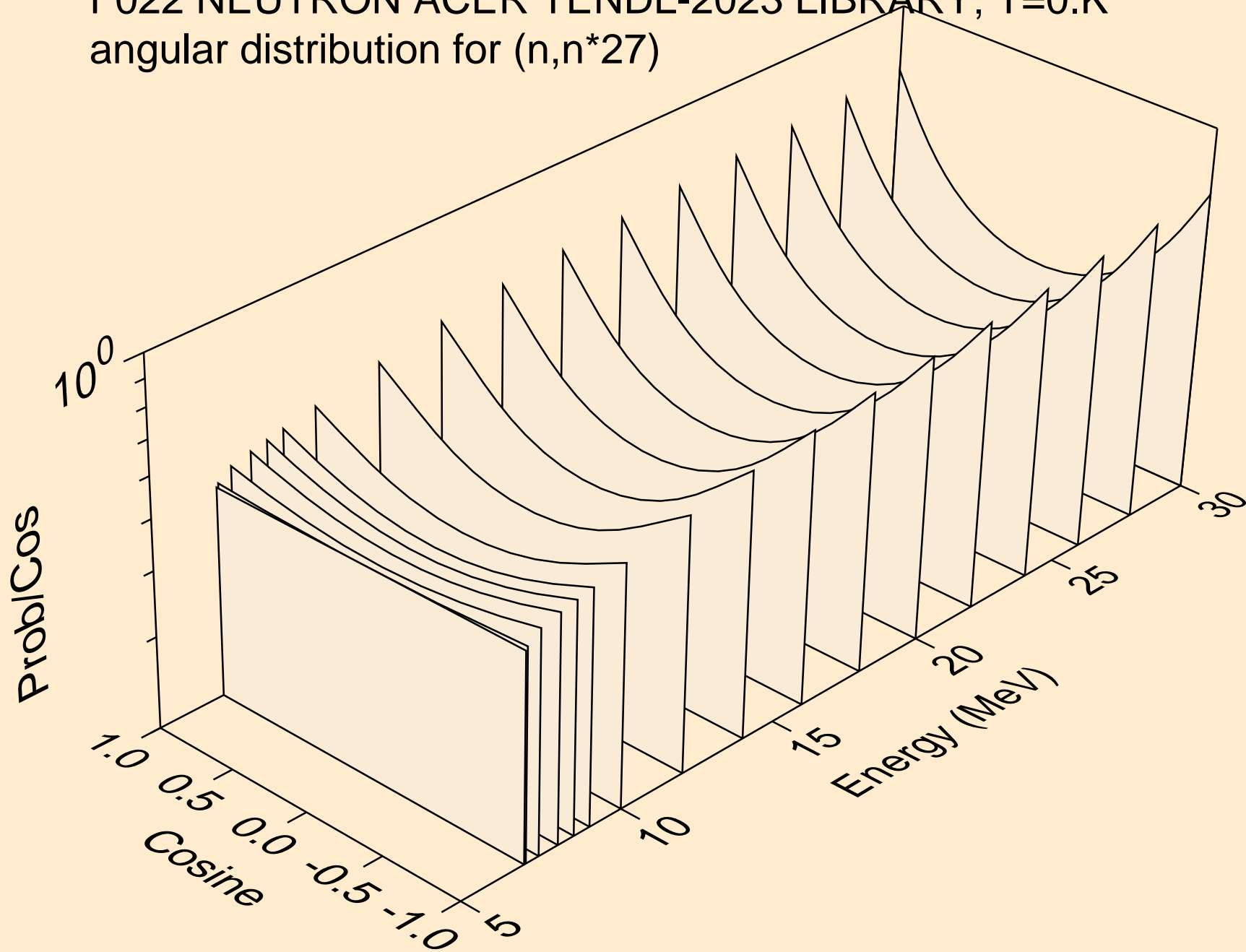

F022 NEUTRON ACER TENDL-2023 LIBRARY; T=0.K
angular distribution for (n,n*28)

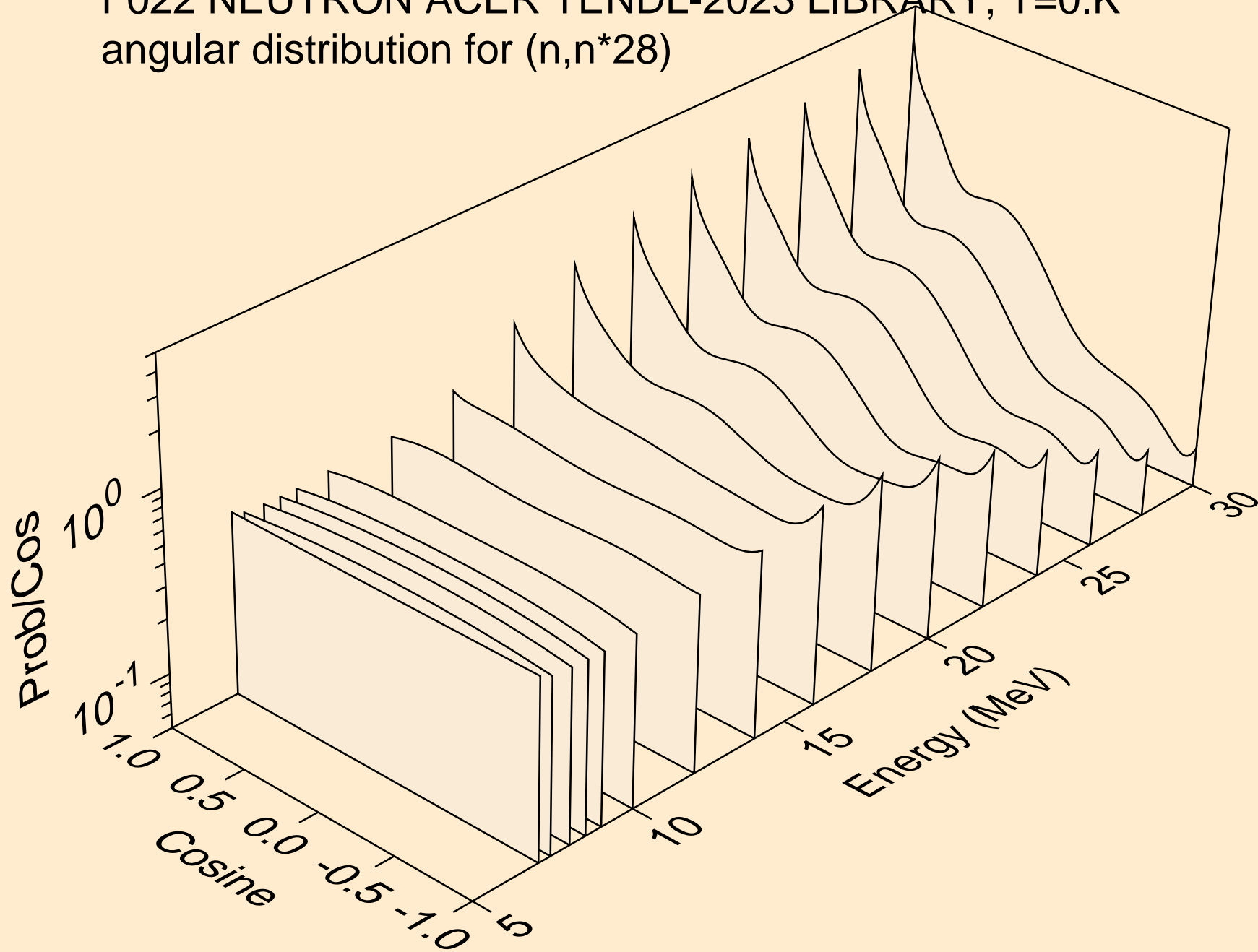

F022 NEUTRON ACER TENDL-2023 LIBRARY; T=0.K
angular distribution for (n,n*29)

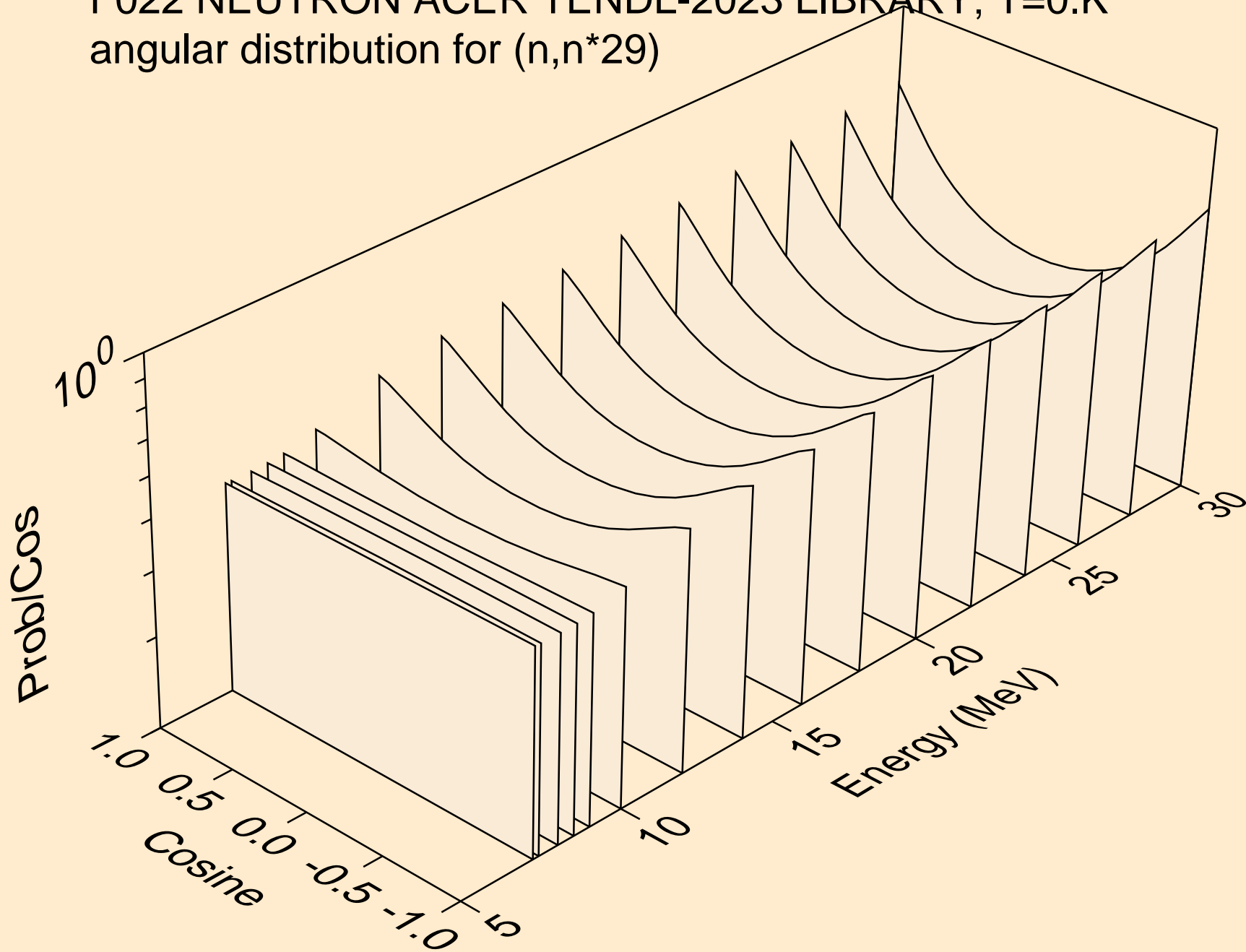

F022 NEUTRON ACER TENDL-2023 LIBRARY; T=0.K
angular distribution for (n,n*30)

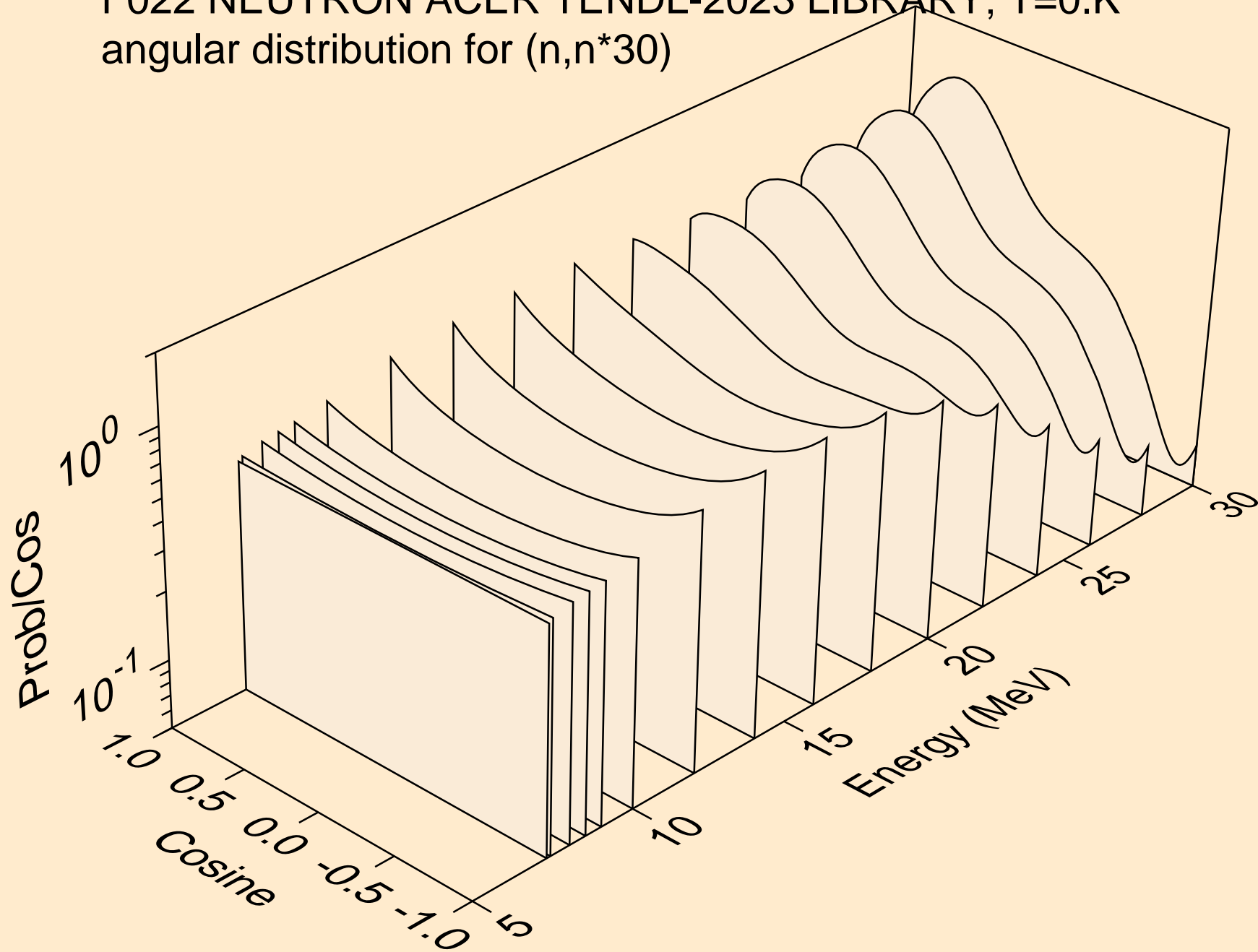

F022 NEUTRON ACER TENDL-2023 LIBRARY; T=0.K
Neutron emission for (n,x)

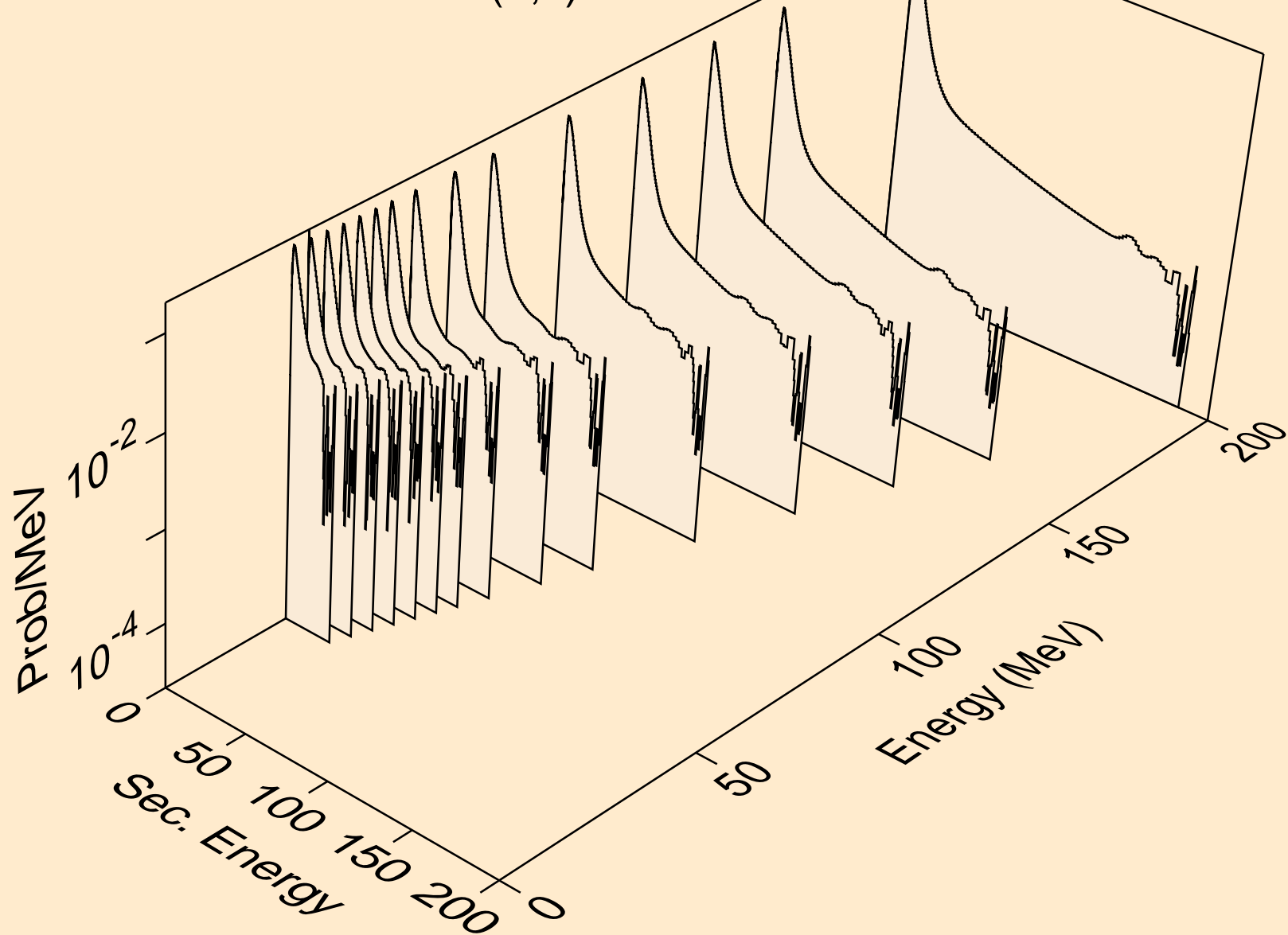

F022 NEUTRON ACER TENDL-2023 LIBRARY; T=0.K
Neutron emission for (n,2nd)

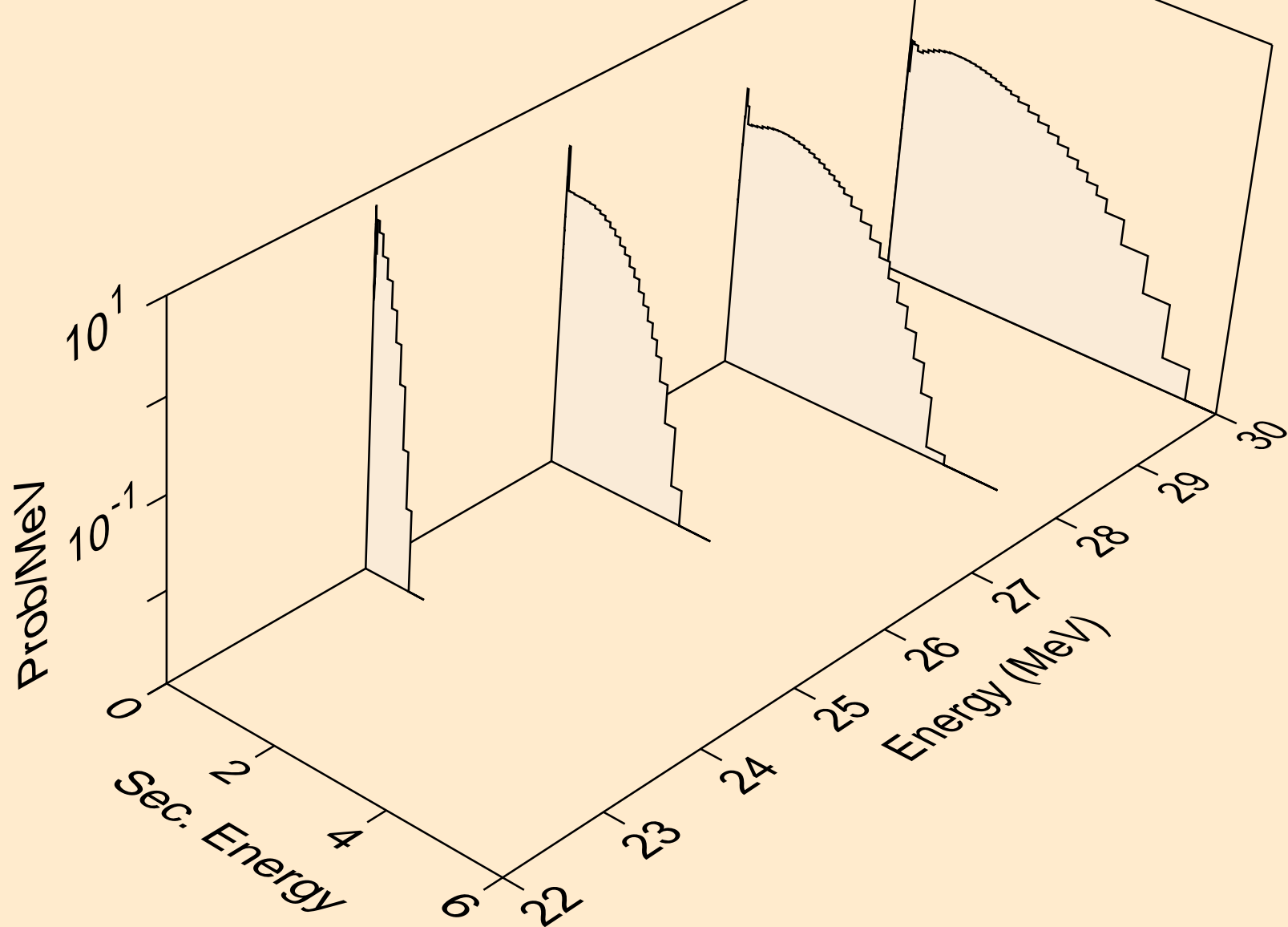

F022 NEUTRON ACER TENDL-2023 LIBRARY; T=0.K
Neutron emission for (n,2n)

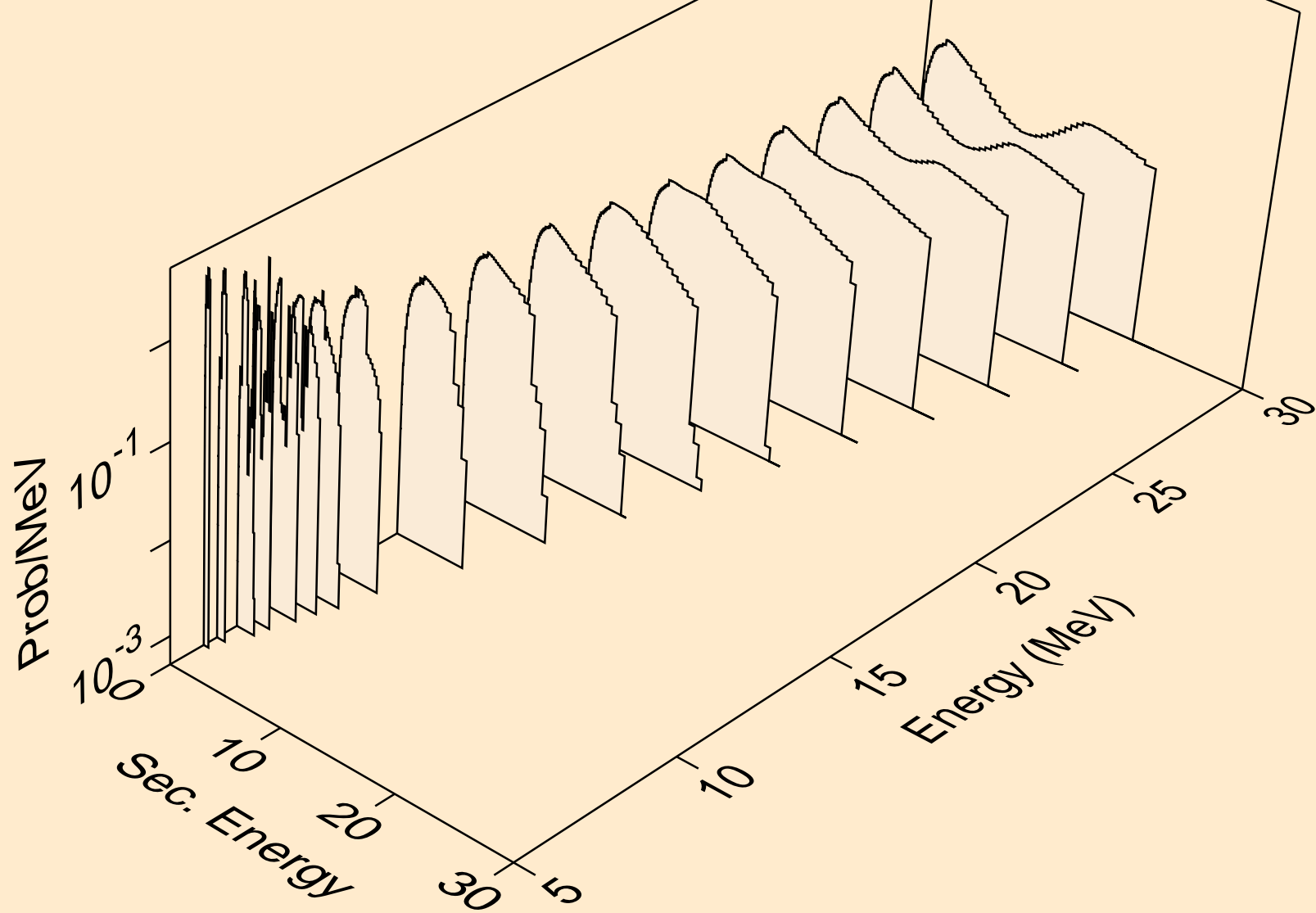

F022 NEUTRON ACER TENDL-2023 LIBRARY; T=0.K
Neutron emission for (n,3n)

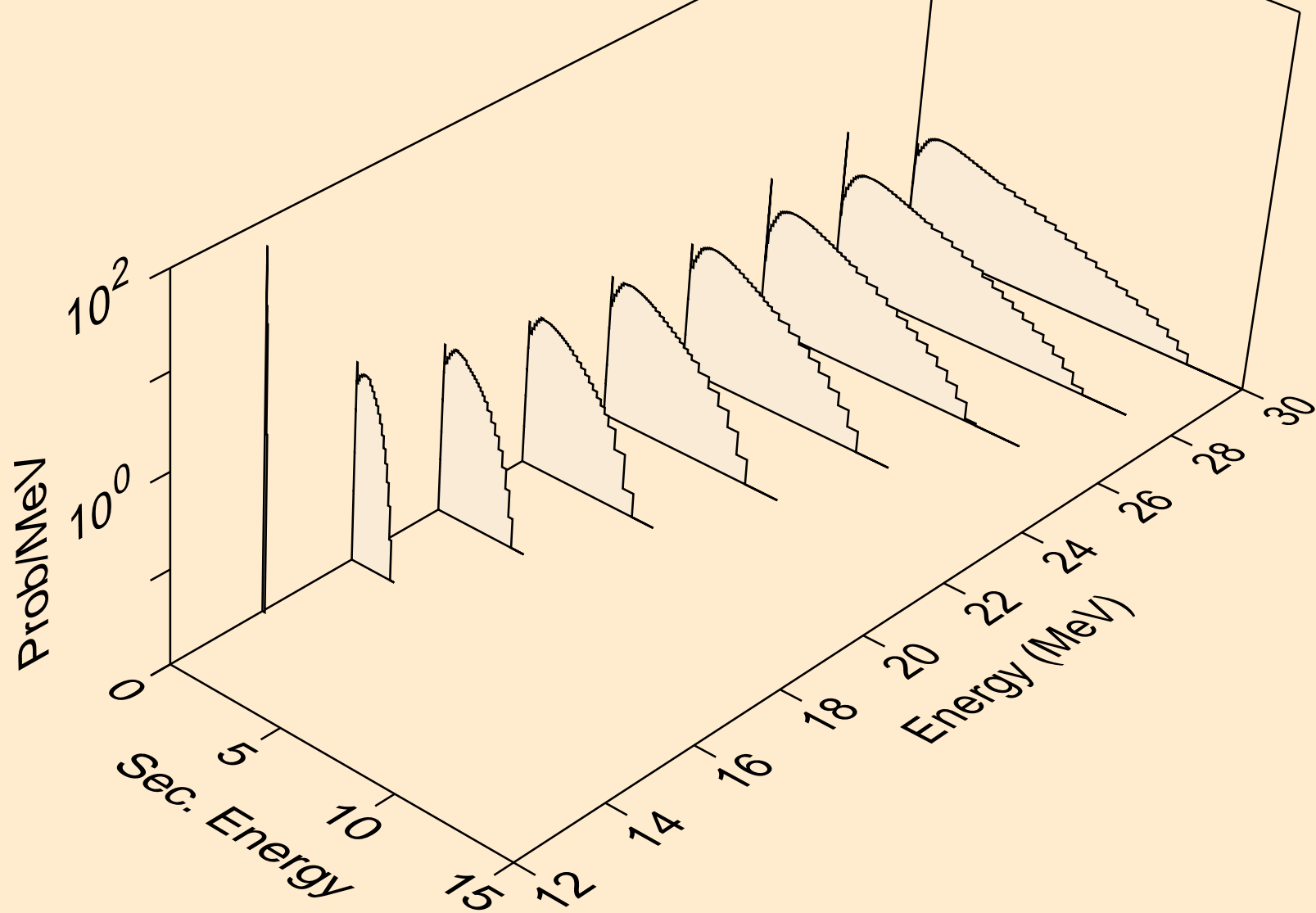

F022 NEUTRON ACER TENDL-2023 LIBRARY; T=0.K
Neutron emission for (n,n*)a

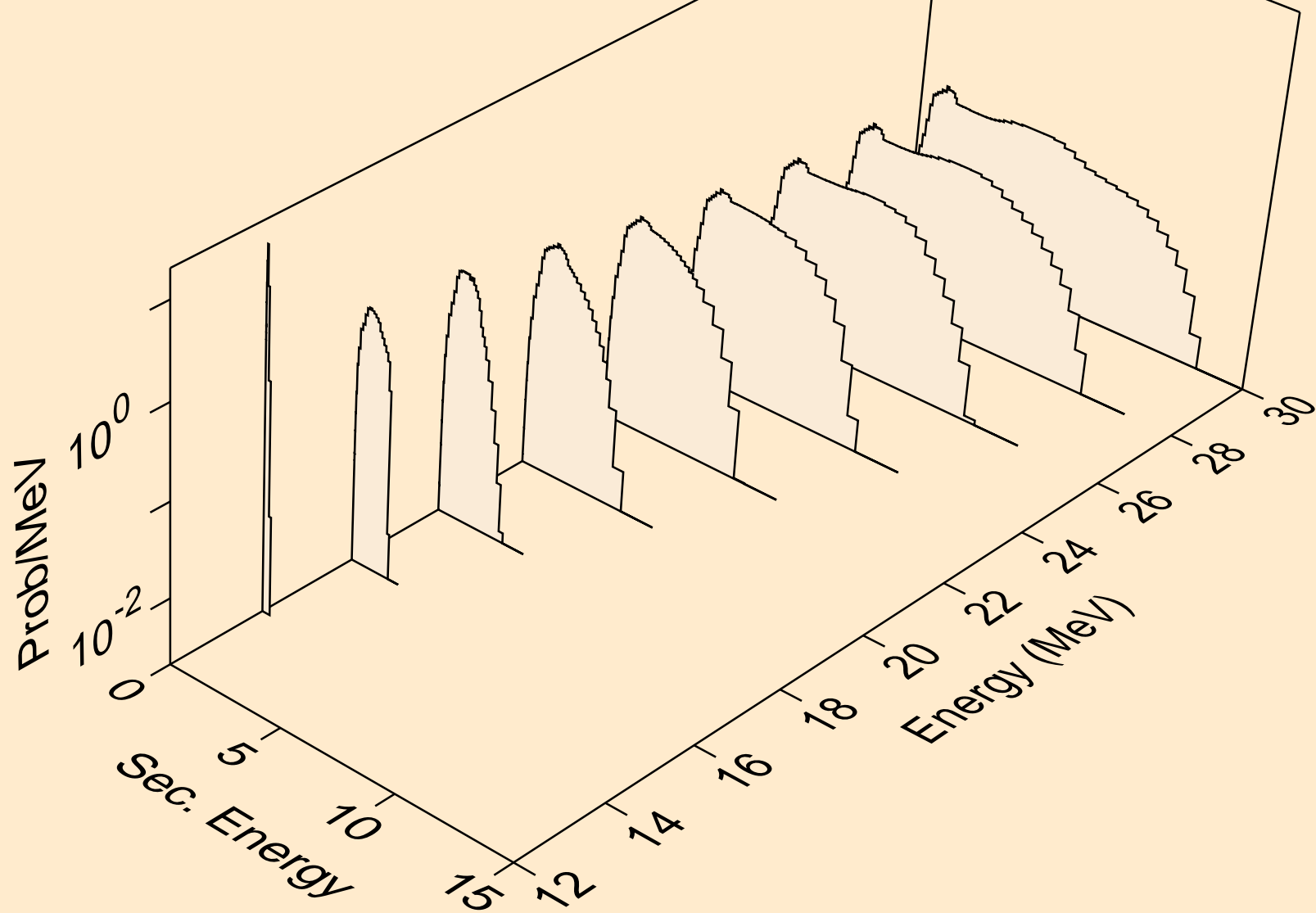

F022 NEUTRON ACER TENDL-2023 LIBRARY; T=0.K
Neutron emission for (n,2n)a

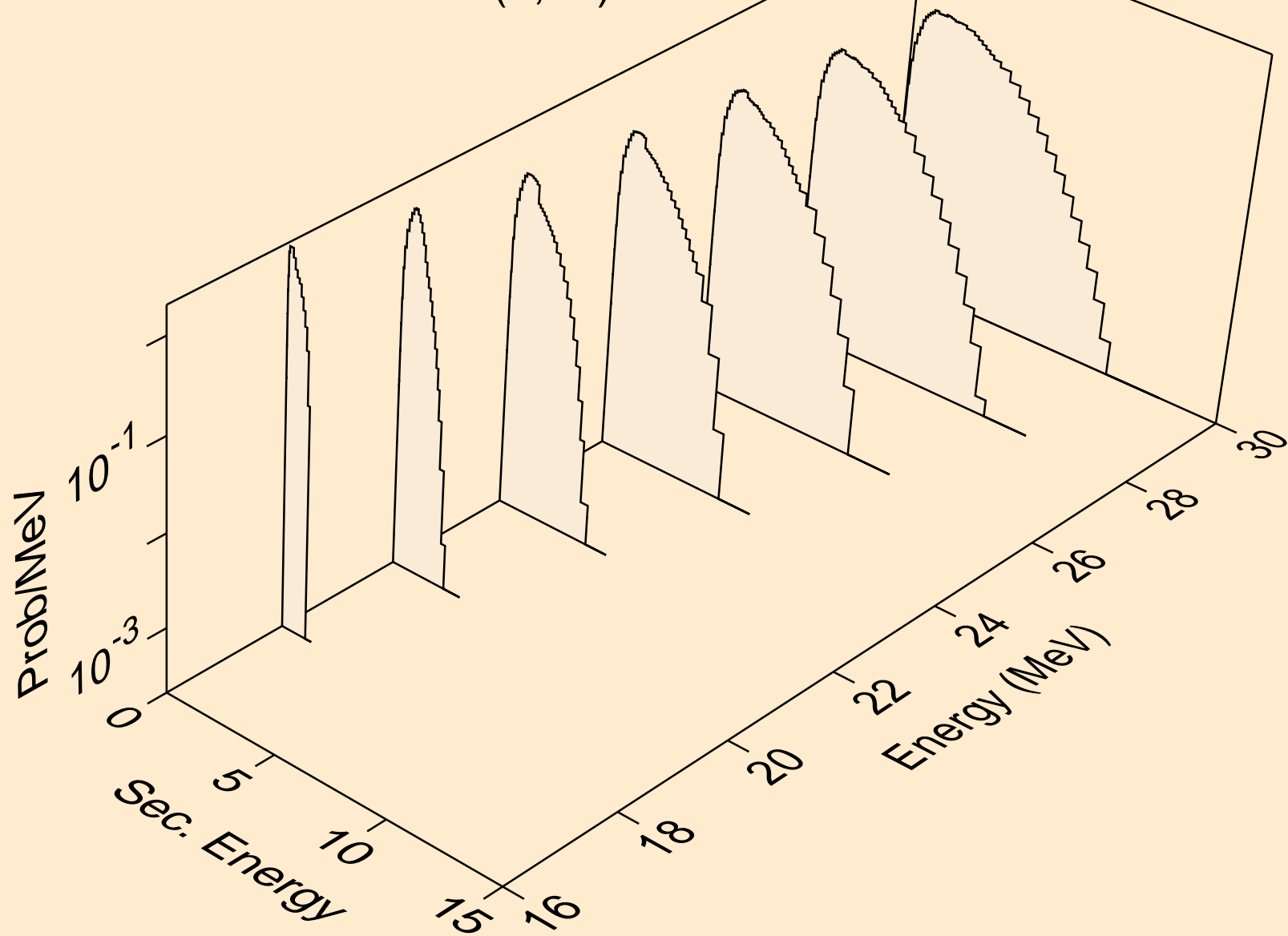

F022 NEUTRON ACER TENDL-2023 LIBRARY; T=0.K
Neutron emission for (n,3n)a

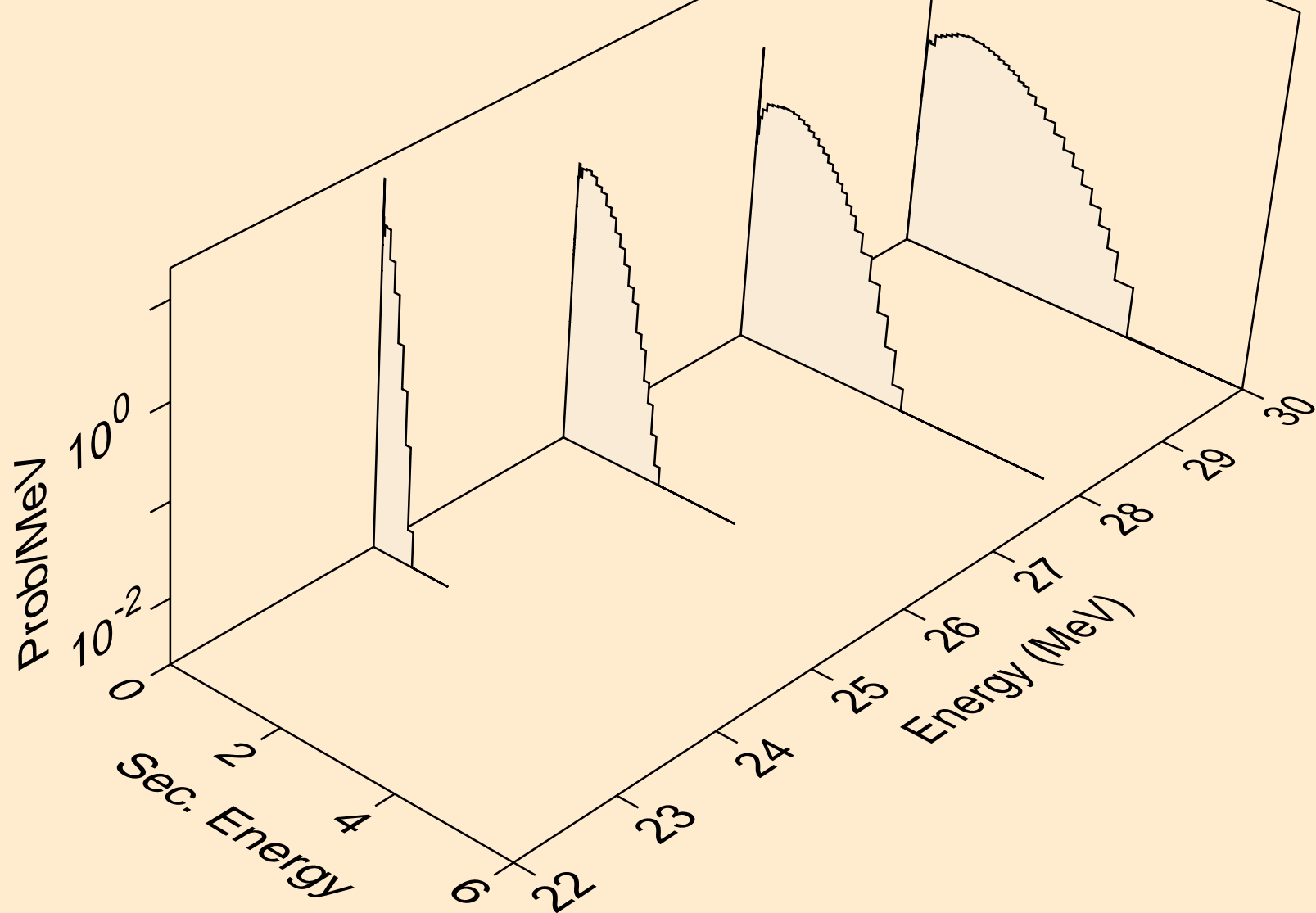

F022 NEUTRON ACER TENDL-2023 LIBRARY; T=0.K
Neutron emission for (n,n*)p

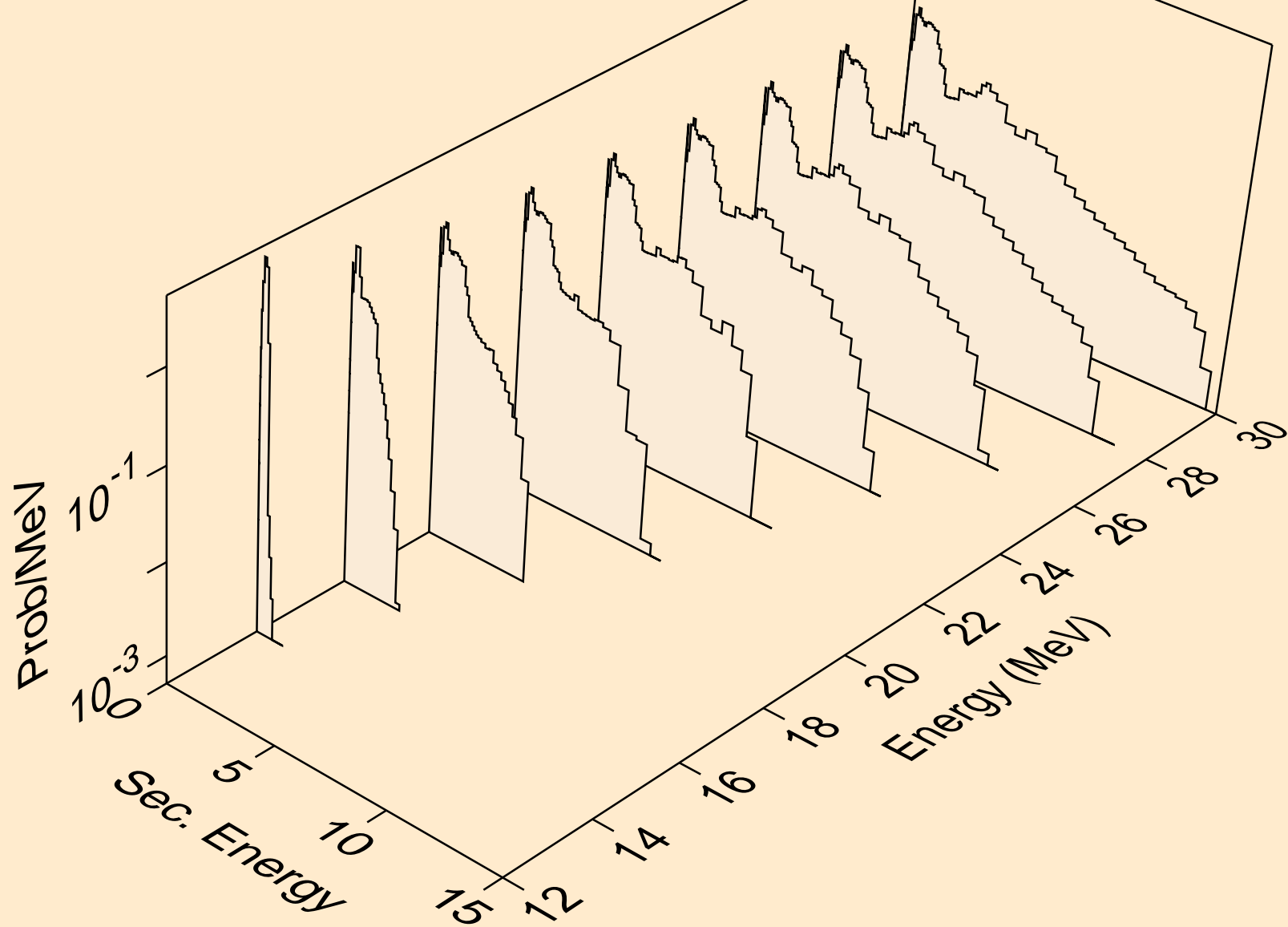

F022 NEUTRON ACER TENDL-2023 LIBRARY; T=0.K
Neutron emission for (n,n*)d

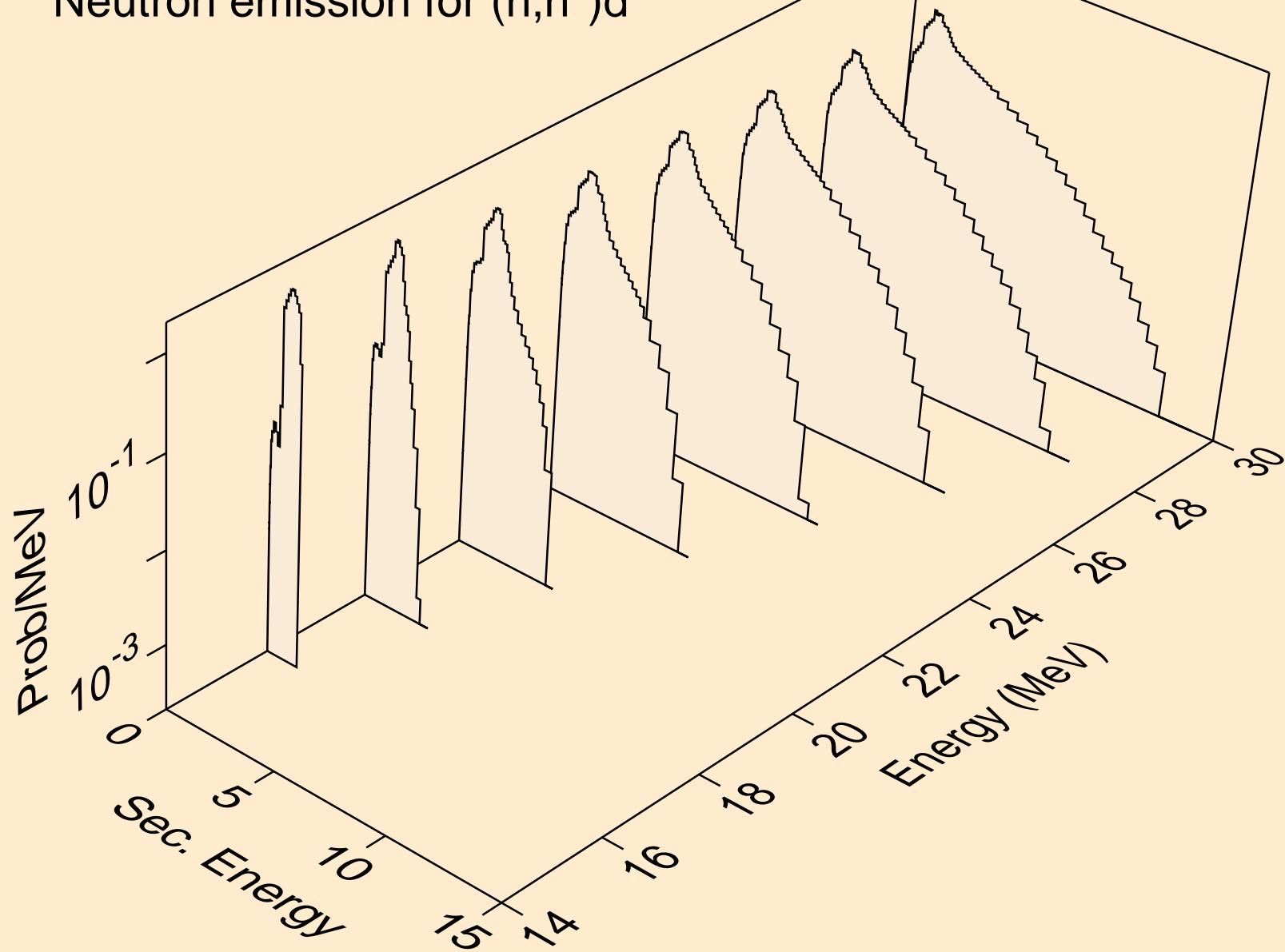

F022 NEUTRON ACER TENDL-2023 LIBRARY; T=0.K
Neutron emission for (n,n*)t

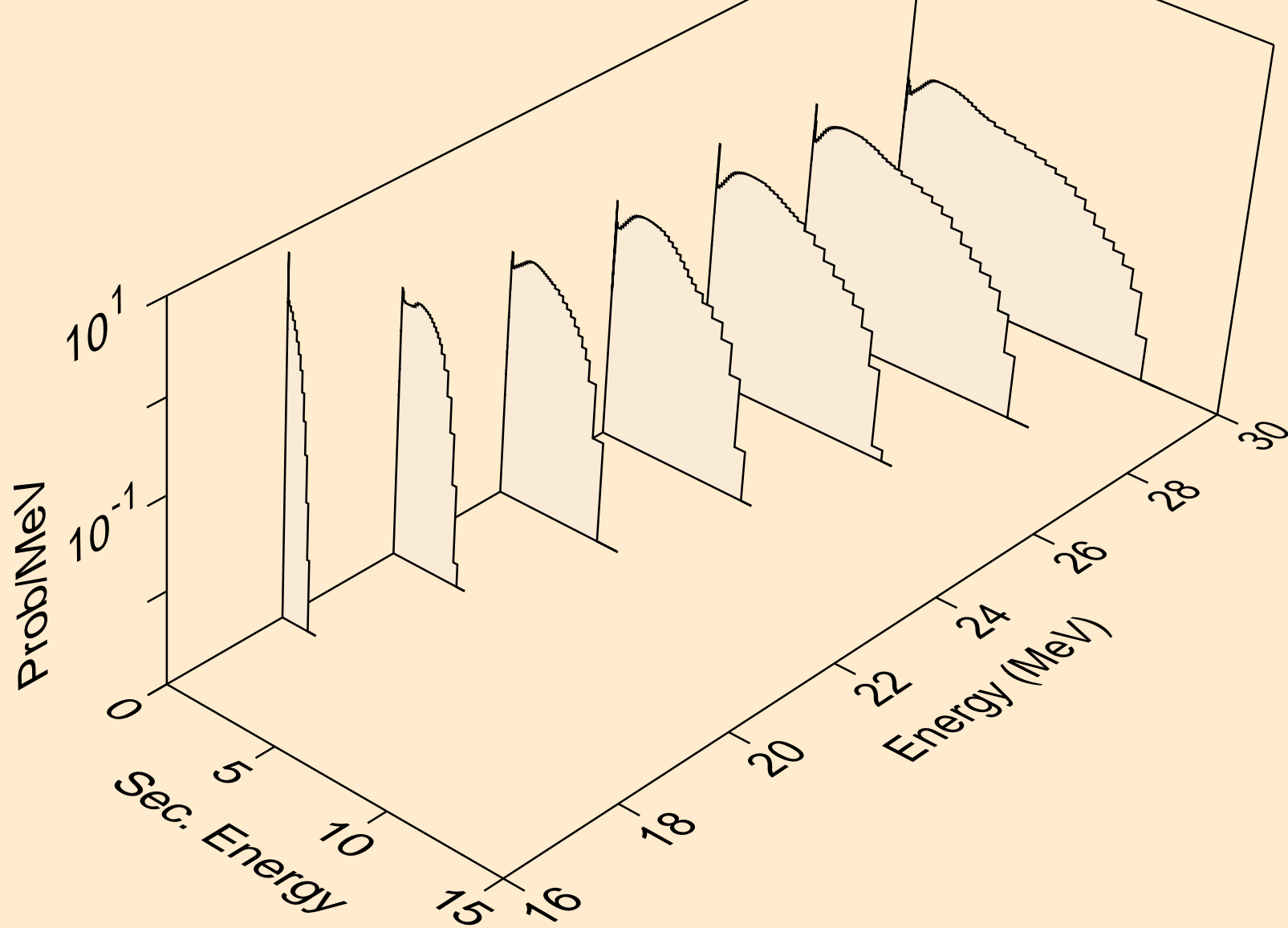

F022 NEUTRON ACER TENDL-2023 LIBRARY; T=0.K
Neutron emission for (n,4n)

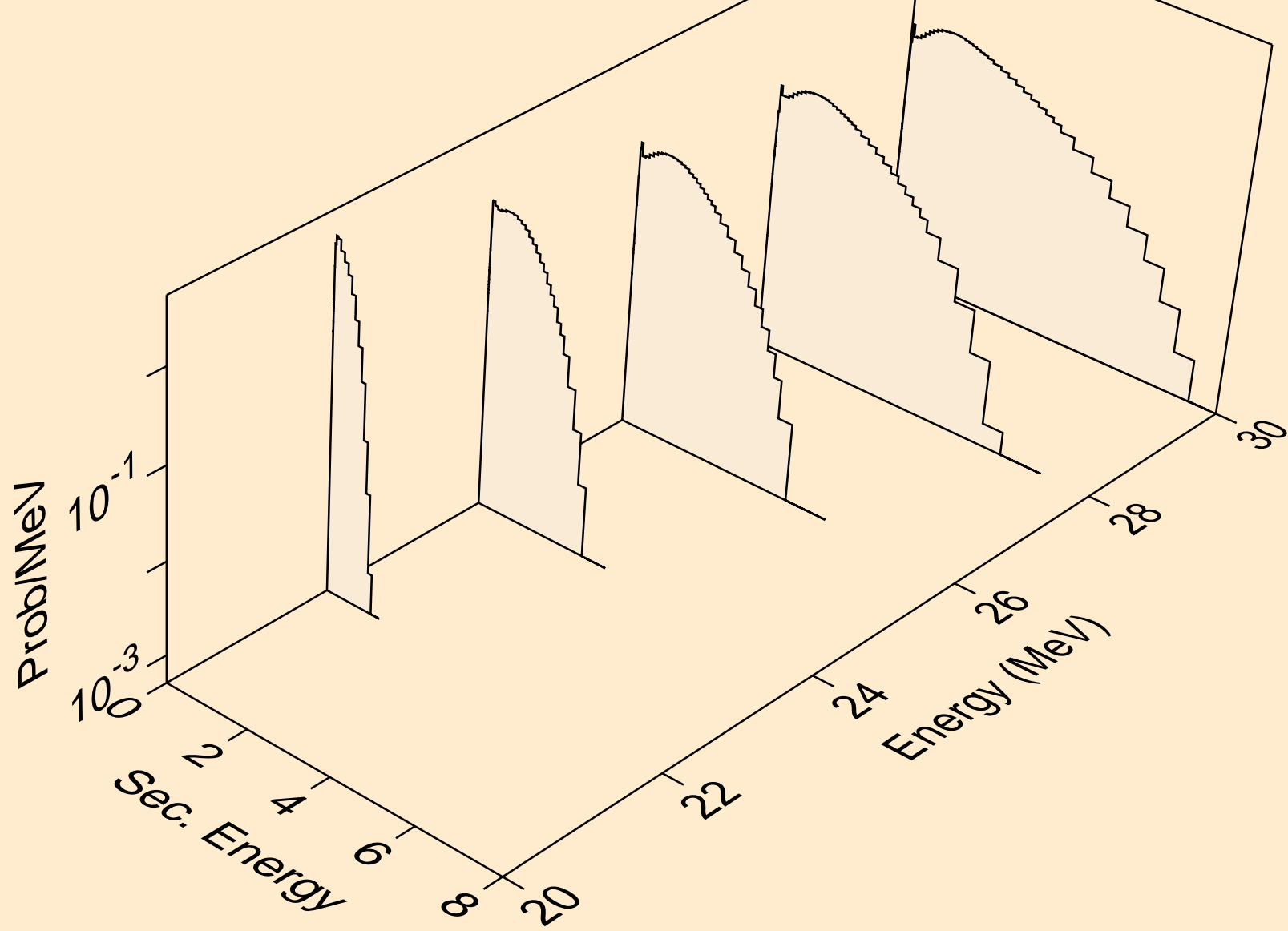

F022 NEUTRON ACER TENDL-2023 LIBRARY; T=0.K
Neutron emission for (n,2np)

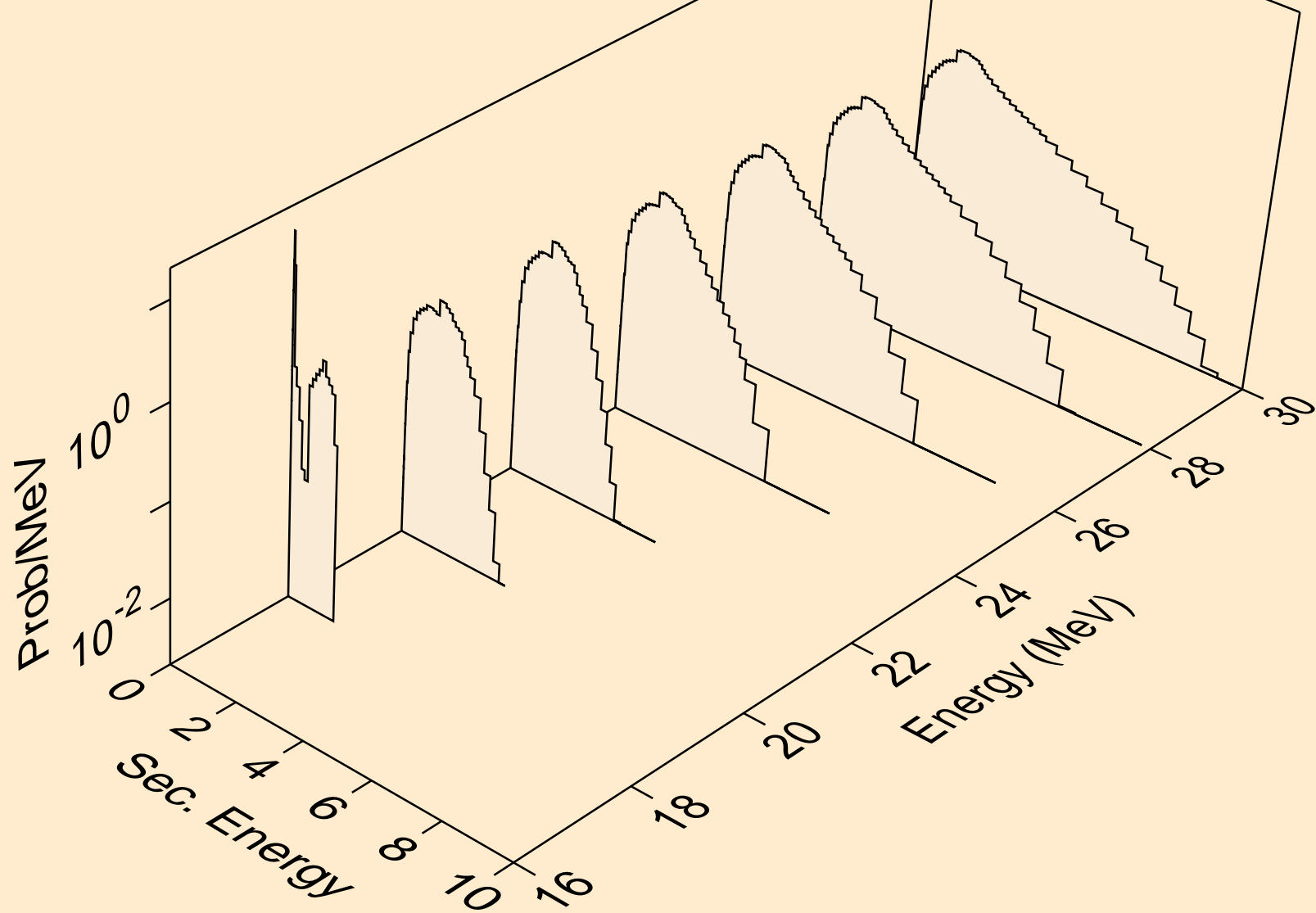

F022 NEUTRON ACER TENDL-2023 LIBRARY; T=0.K
Neutron emission for (n,3np)

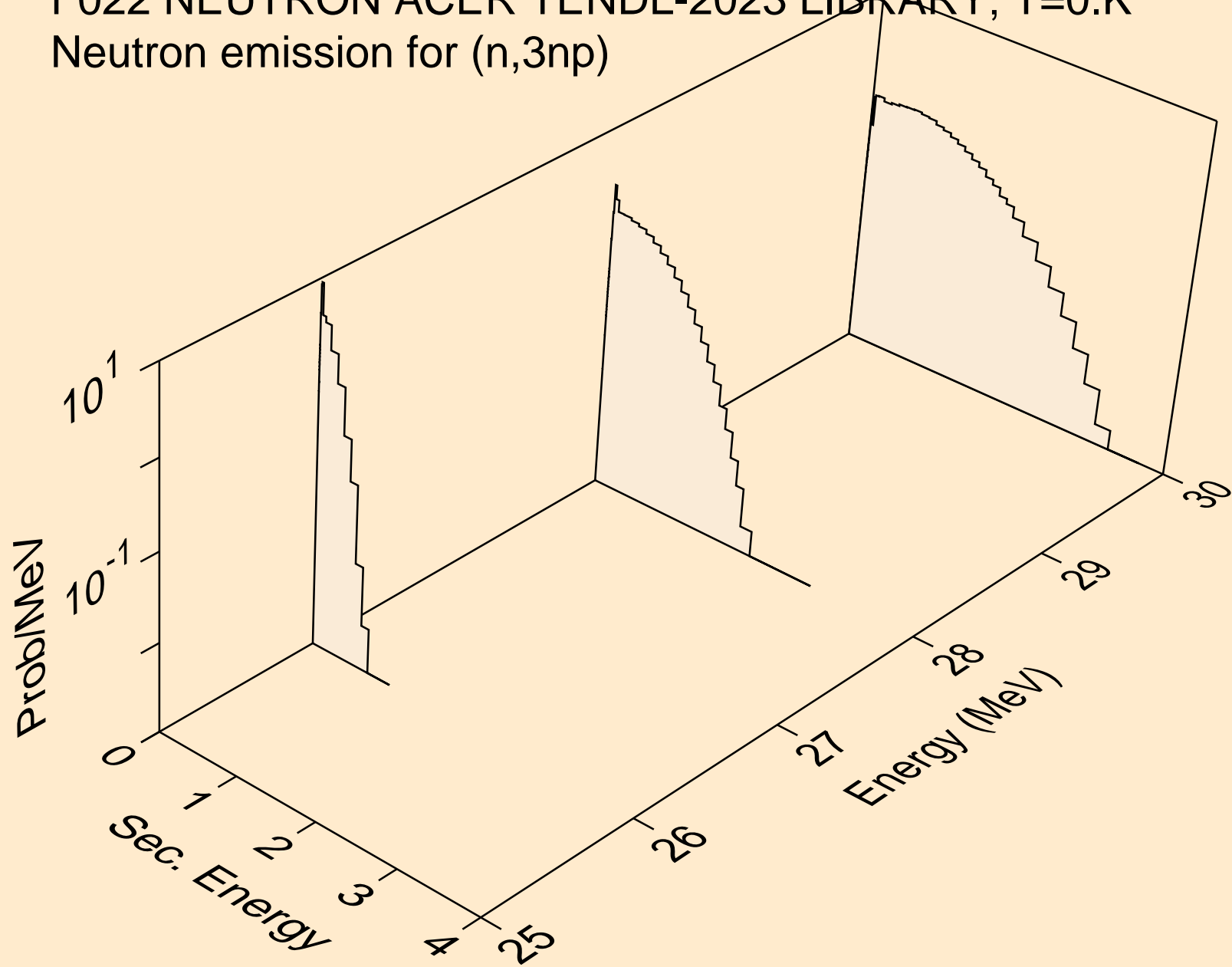

F022 NEUTRON ACER TENDL-2023 LIBRARY; T=0.K
Photon emission for (n,x)

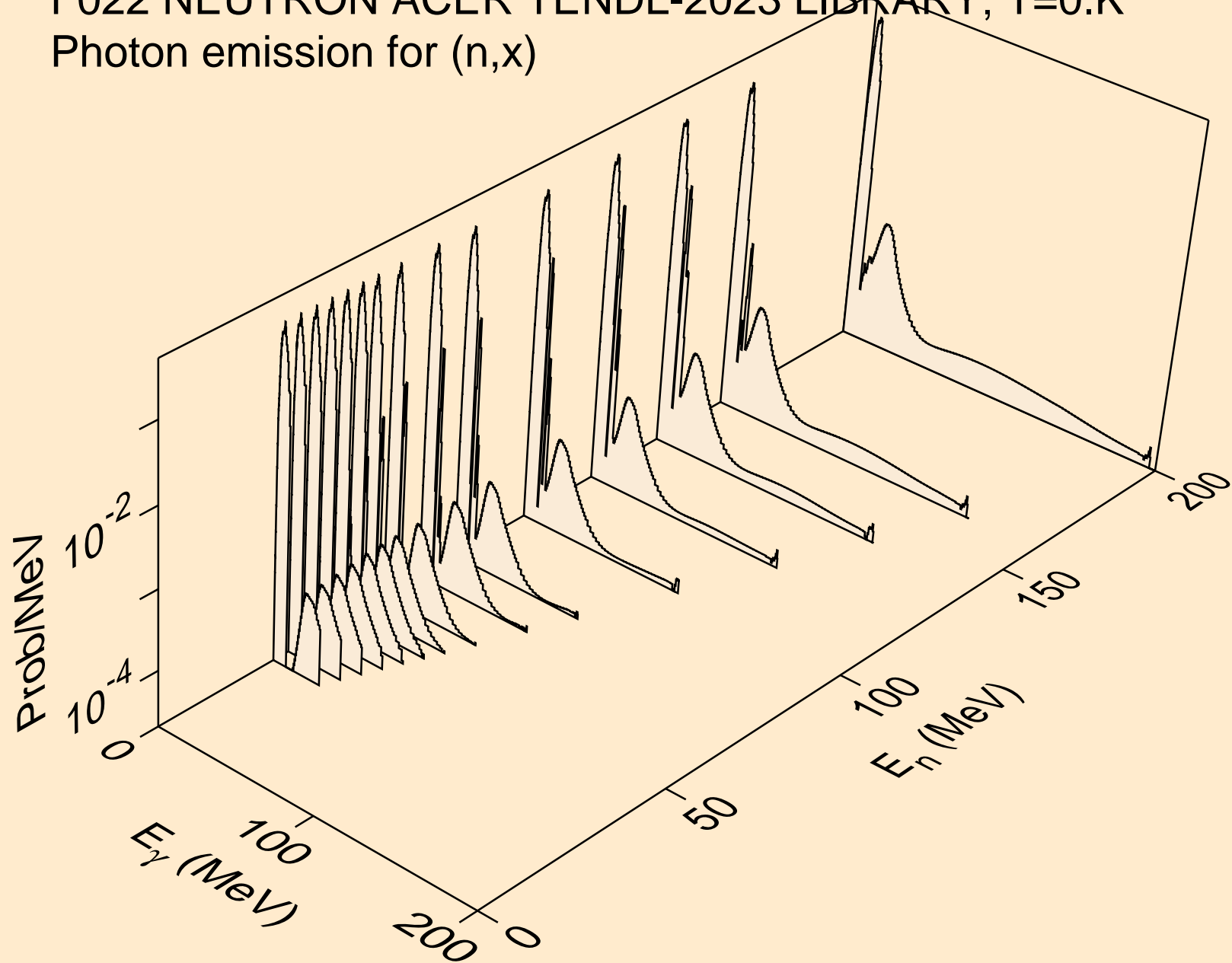

F022 NEUTRON ACER TENDL-2023 LIBRARY; T=0.K
Photon emission for (n,2nd)

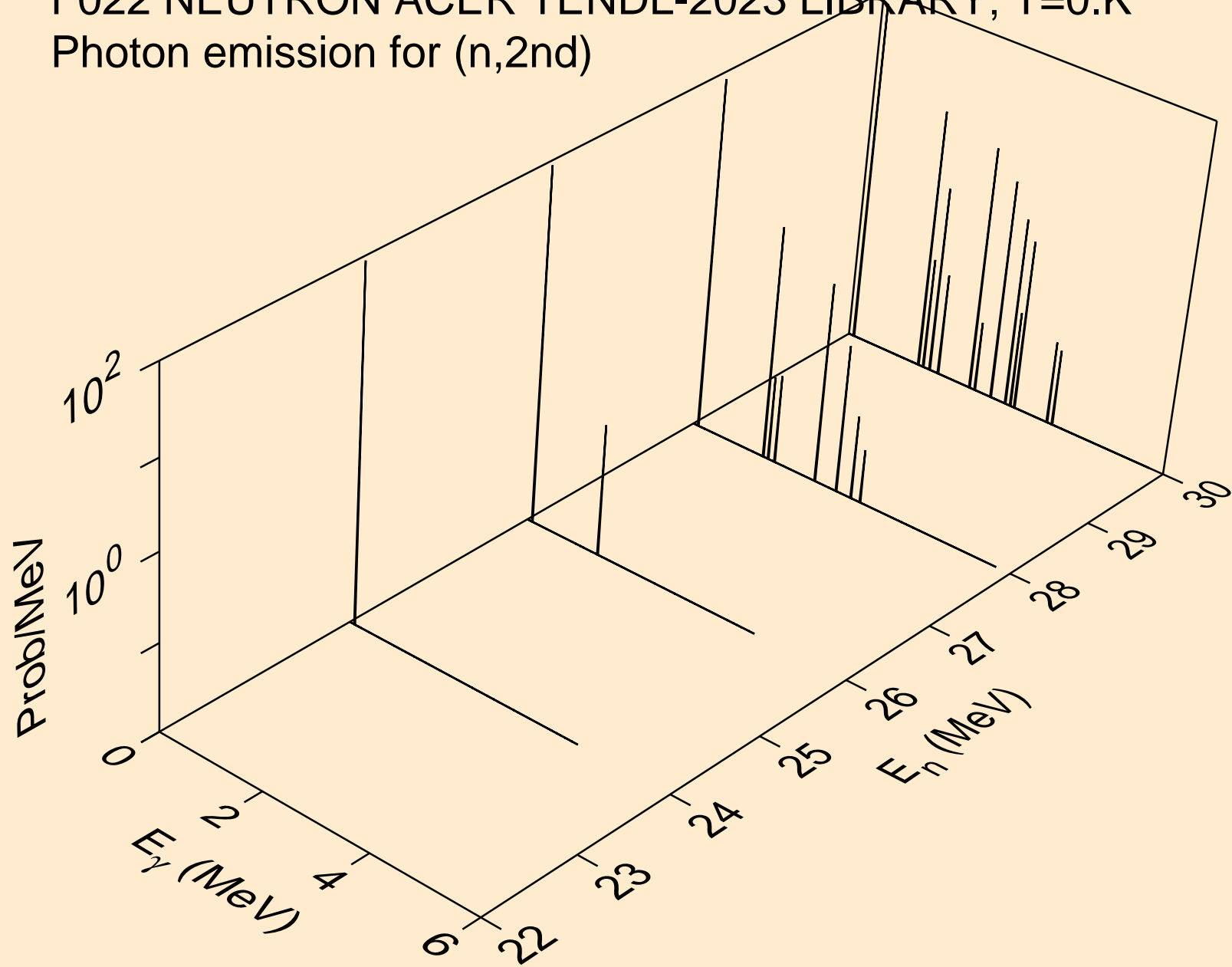

F022 NEUTRON ACER TENDL-2023 LIBRARY; T=0.K
Photon emission for (n,2n)

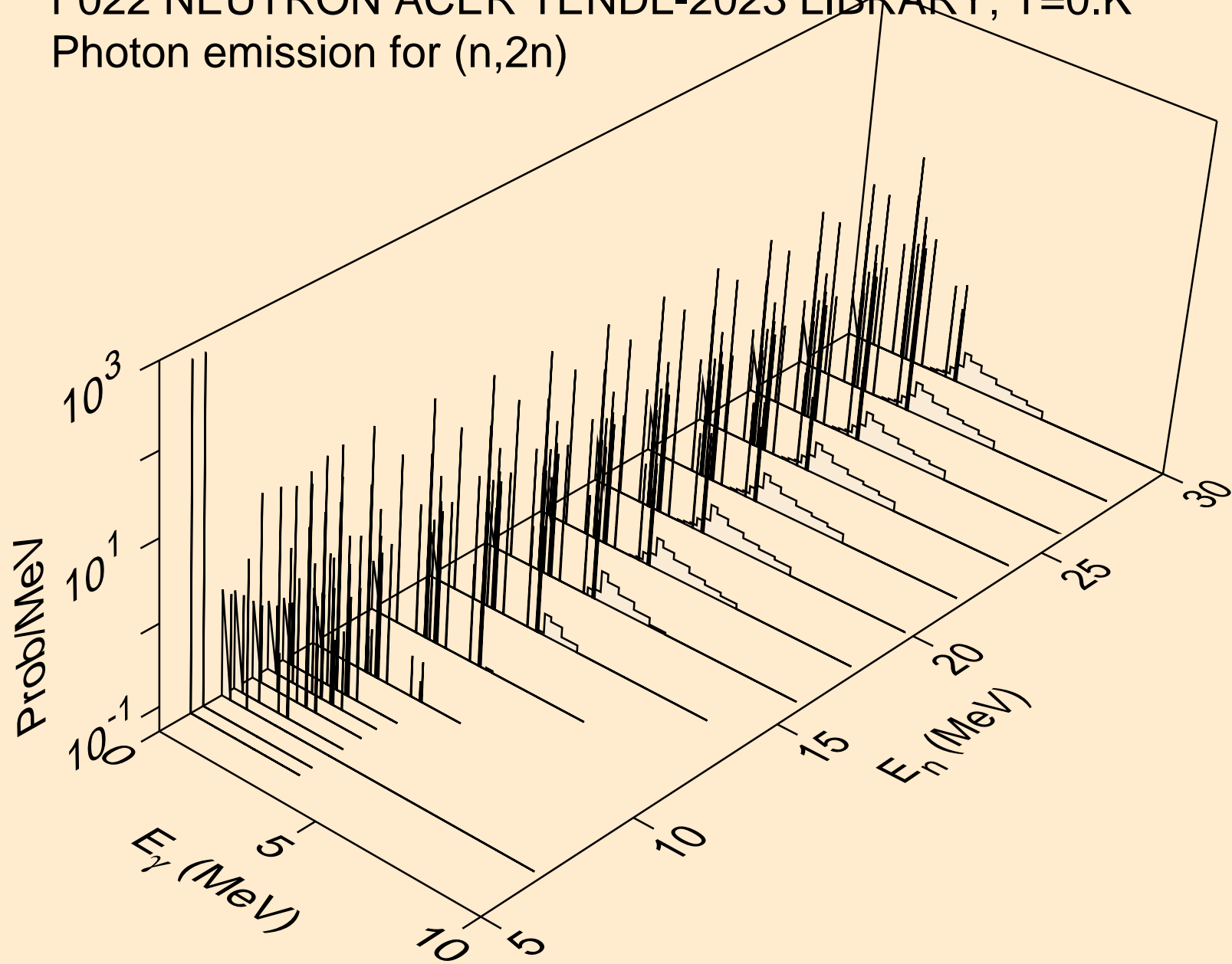

F022 NEUTRON ACER TENDL-2023 LIBRARY; T=0.K
Photon emission for (n,3n)

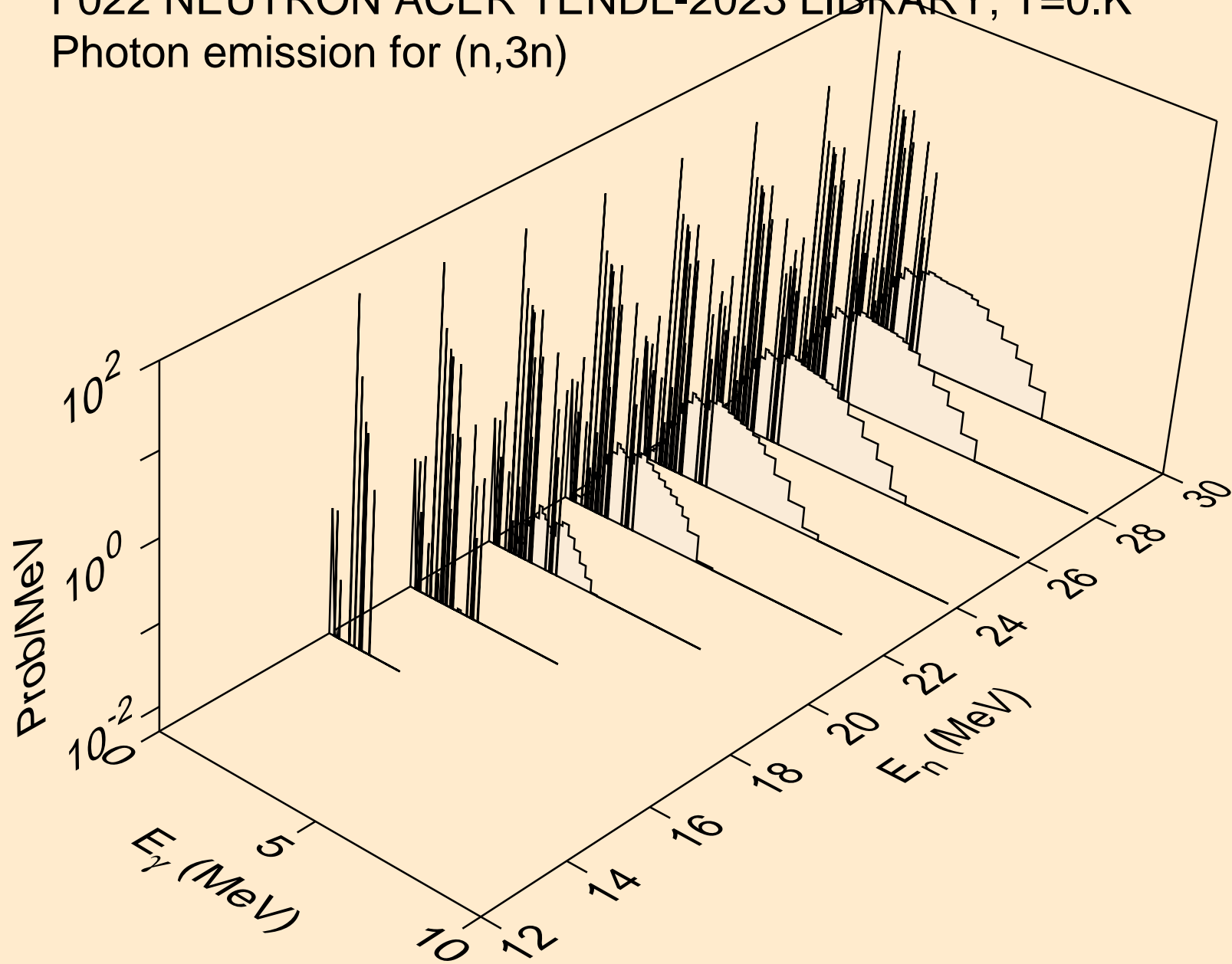

F022 NEUTRON ACER TENDL-2023 LIBRARY; T=0.K
Photon emission for (n,n*)a

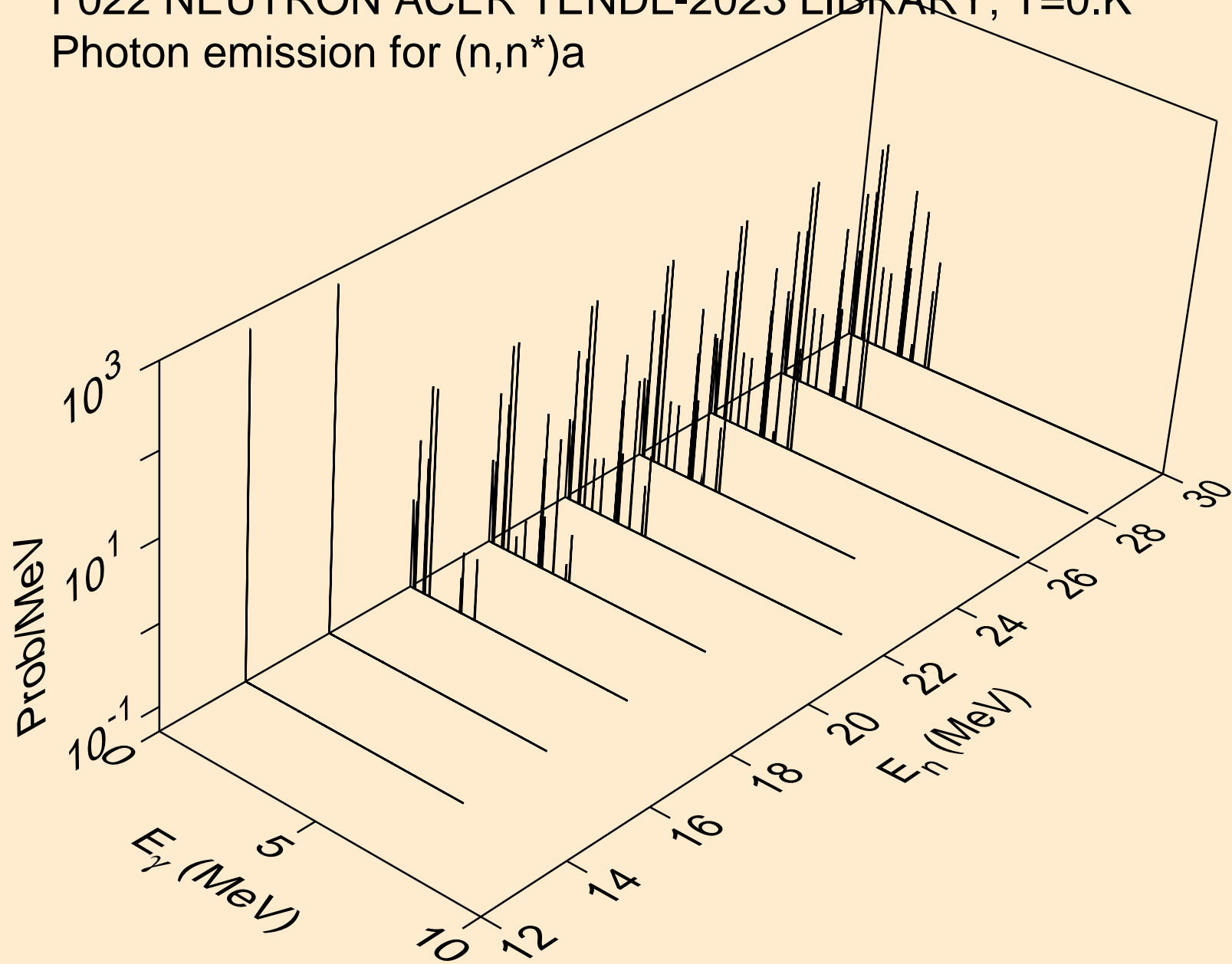

F022 NEUTRON ACER TENDL-2023 LIBRARY; T=0.K
Photon emission for (n,2n)a

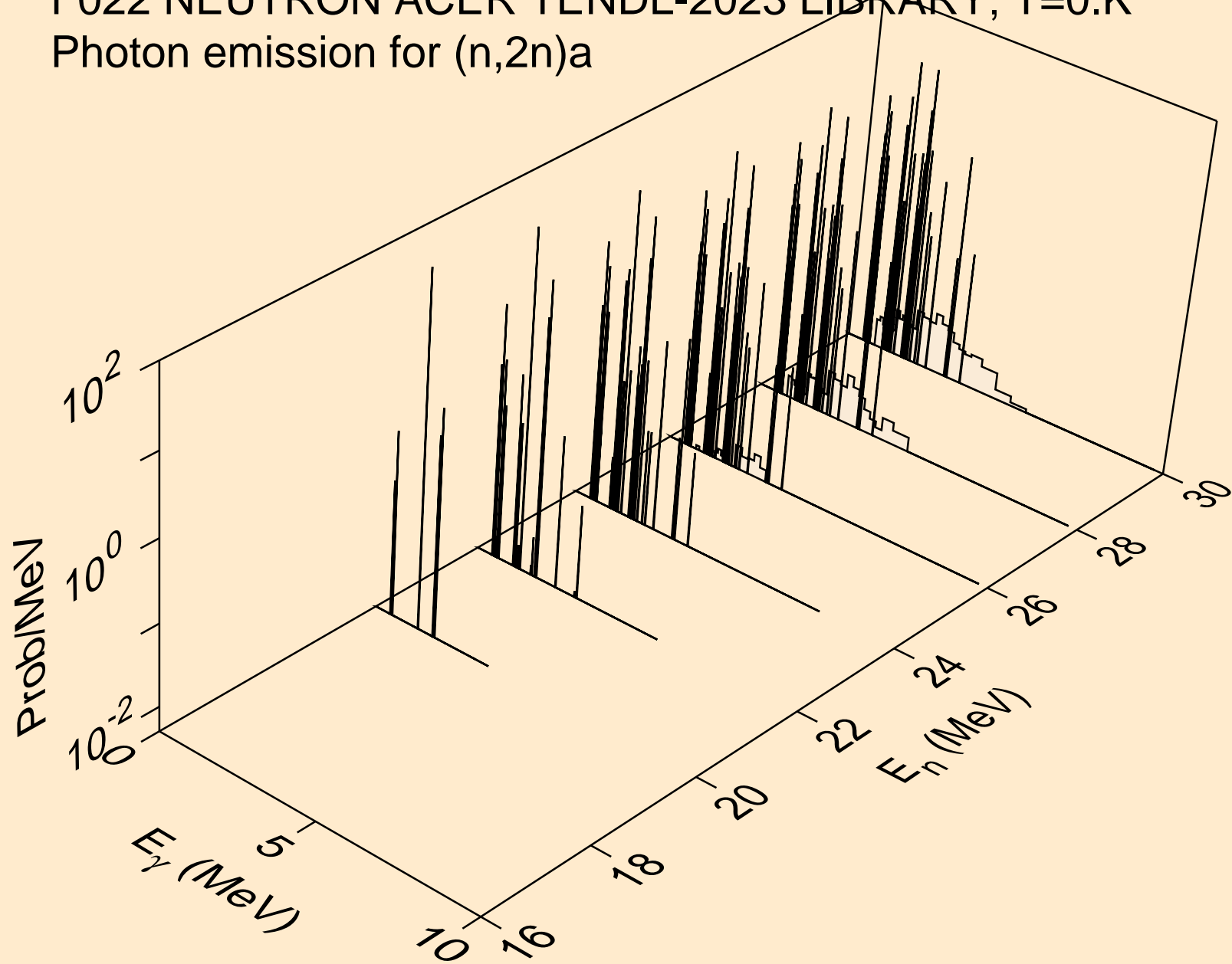

F022 NEUTRON ACER TENDL-2023 LIBRARY; T=0.K
Photon emission for (n,3n)a

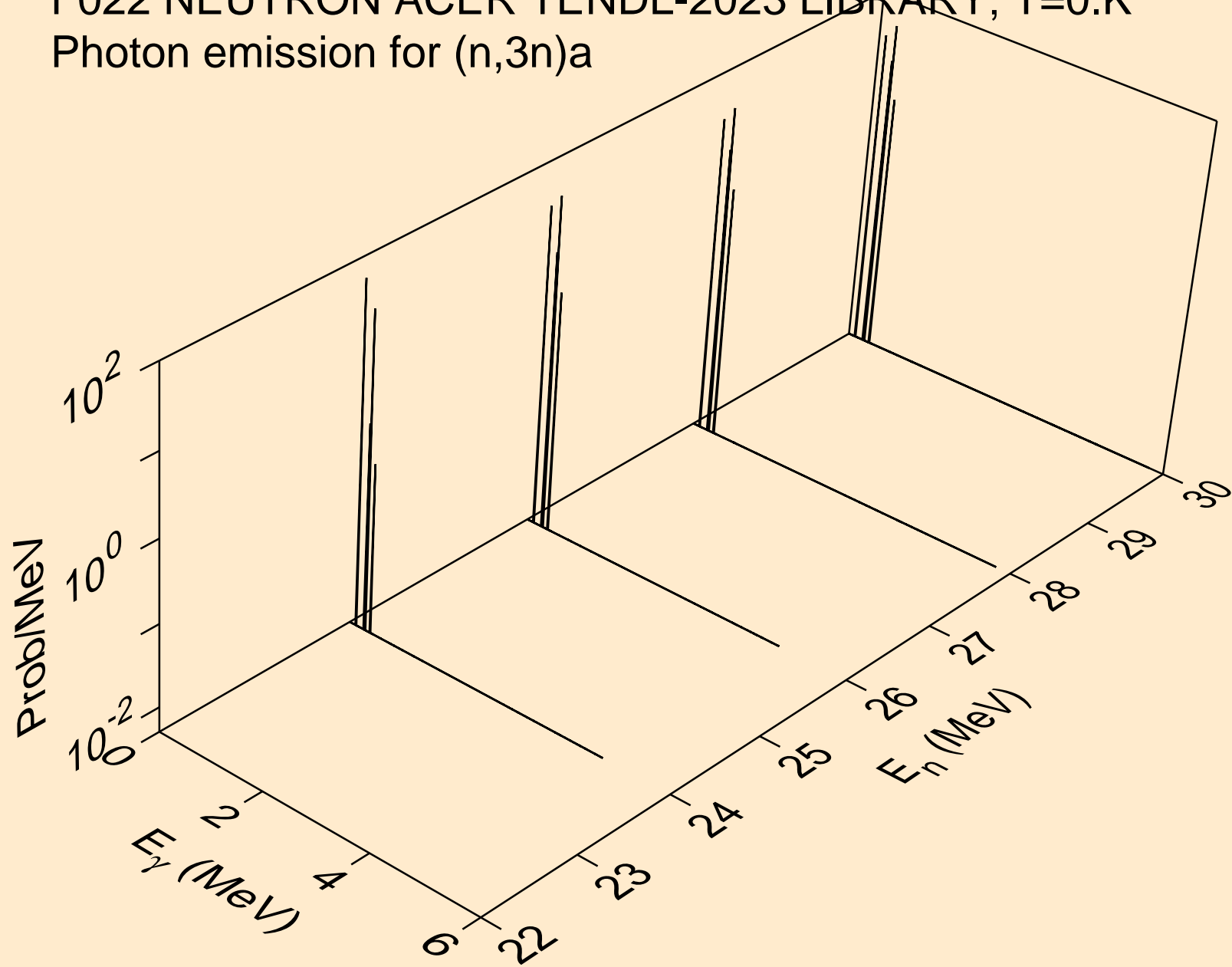

F022 NEUTRON ACER TENDL-2023 LIBRARY; T=0.K
Photon emission for (n,n*)p

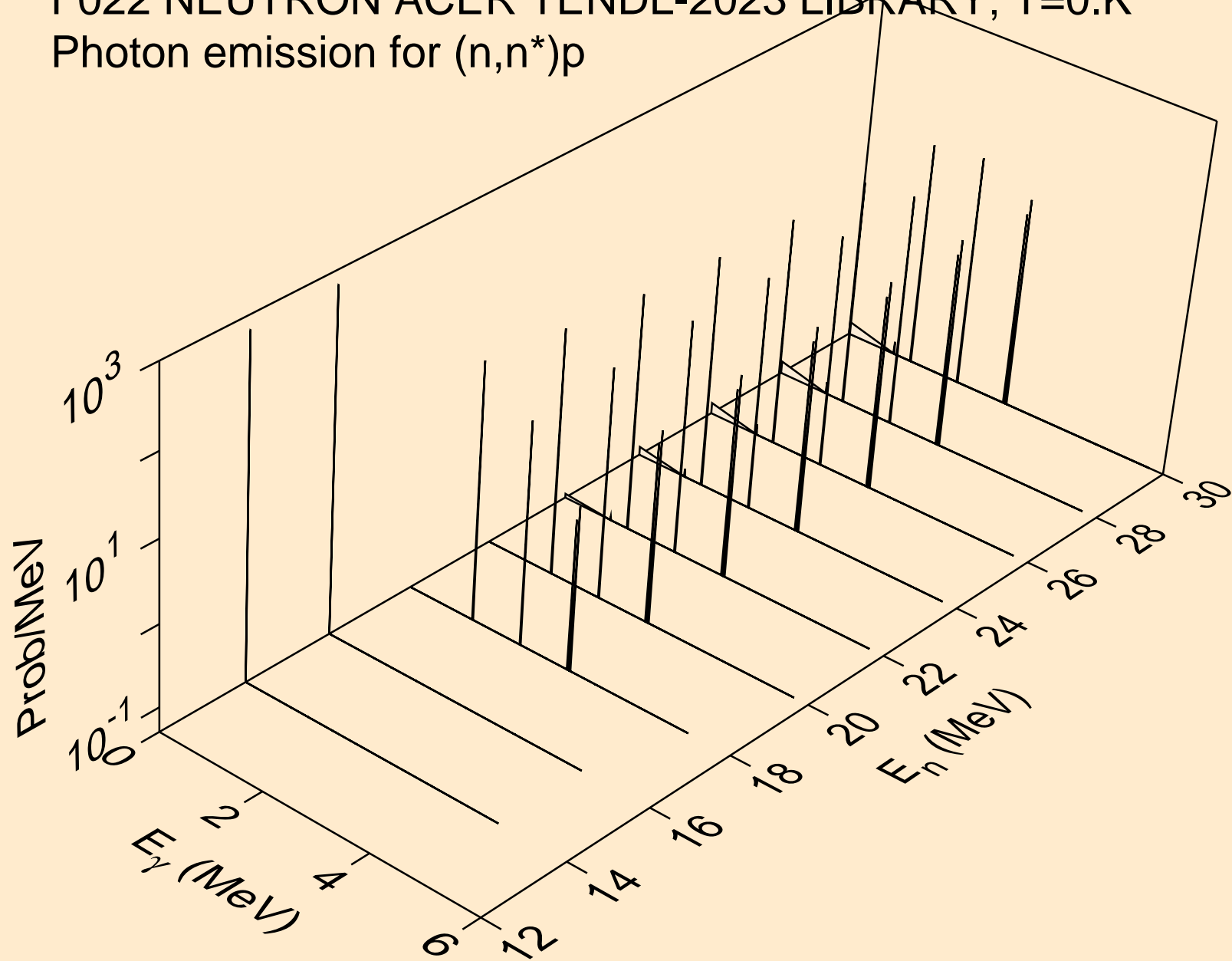

F022 NEUTRON ACER TENDL-2023 LIBRARY; T=0.K
Photon emission for (n,n*)d

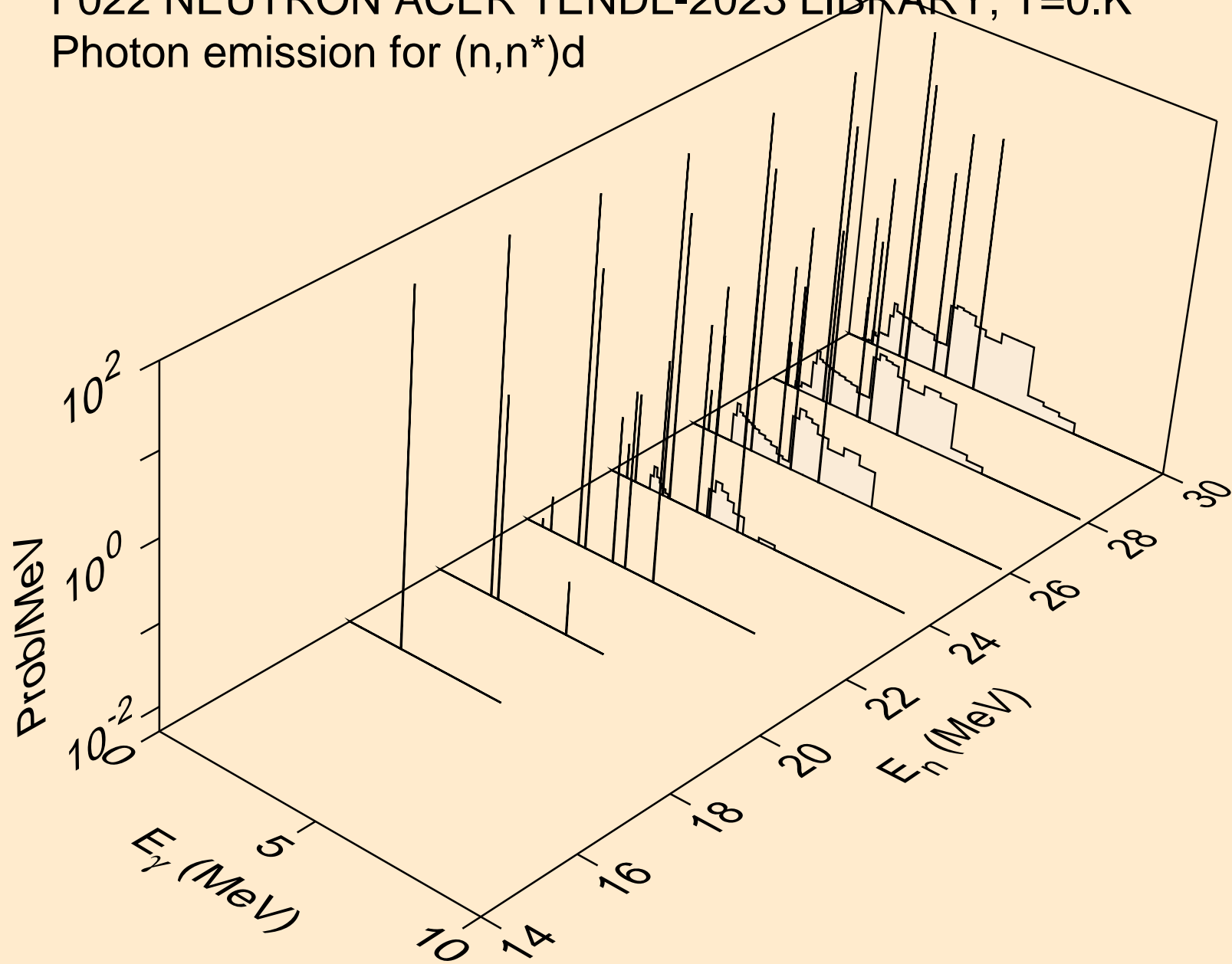

F022 NEUTRON ACER TENDL-2023 LIBRARY; T=0.K
Photon emission for (n,n*)t

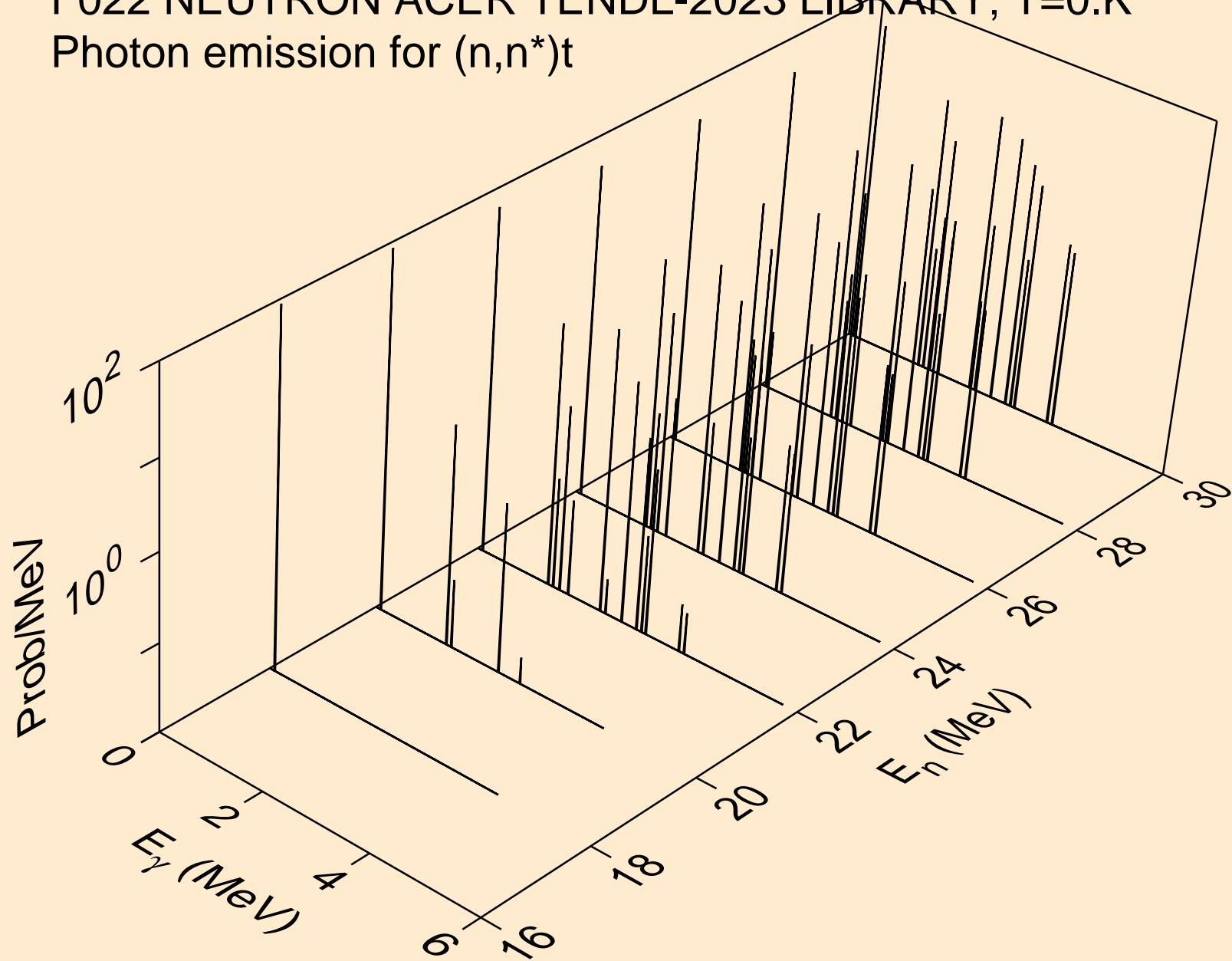

F022 NEUTRON ACER TENDL-2023 LIBRARY; T=0.K
Photon emission for (n,4n)

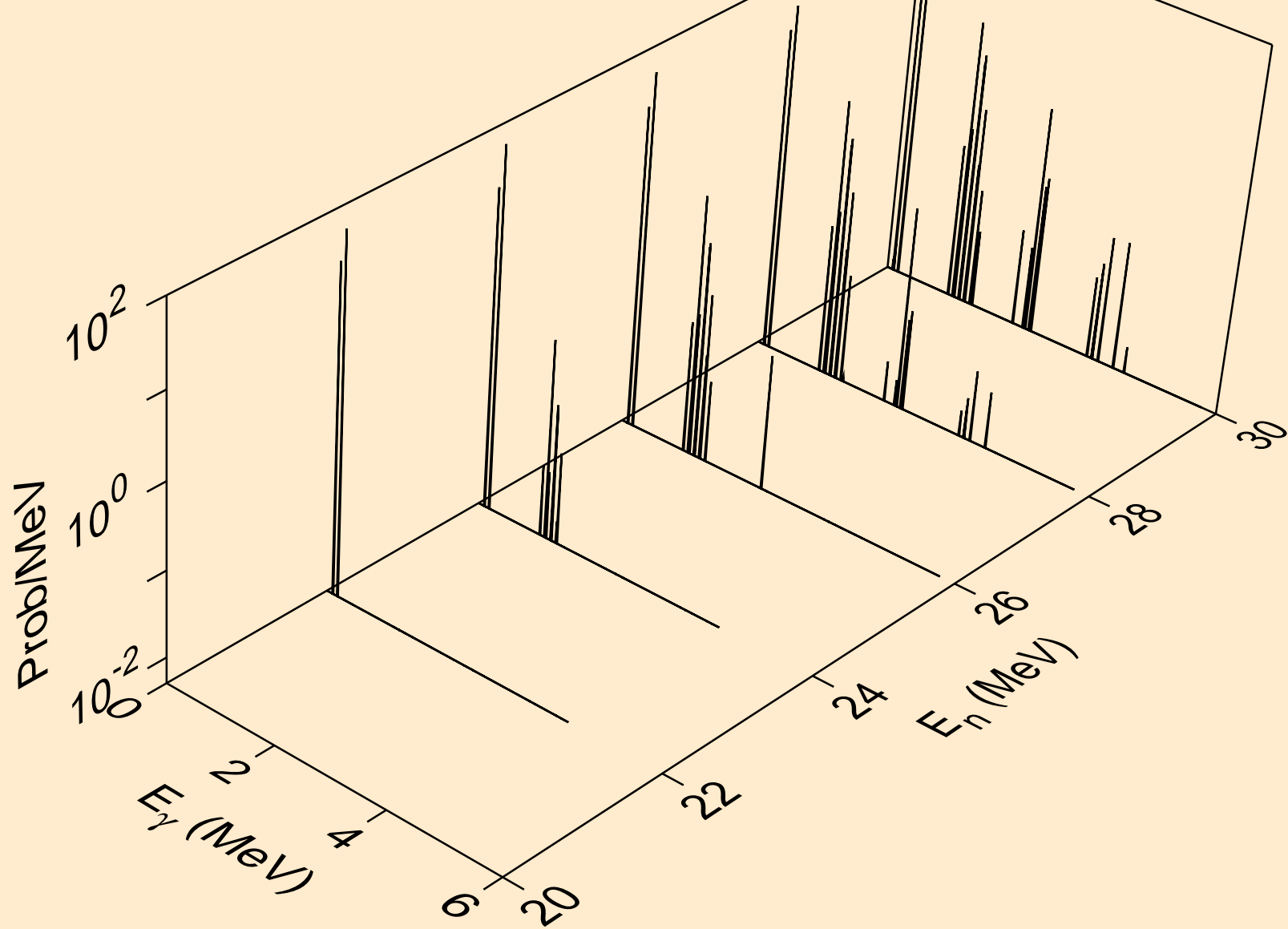

F022 NEUTRON ACER TENDL-2023 LIBRARY; T=0.K
Photon emission for (n,2np)

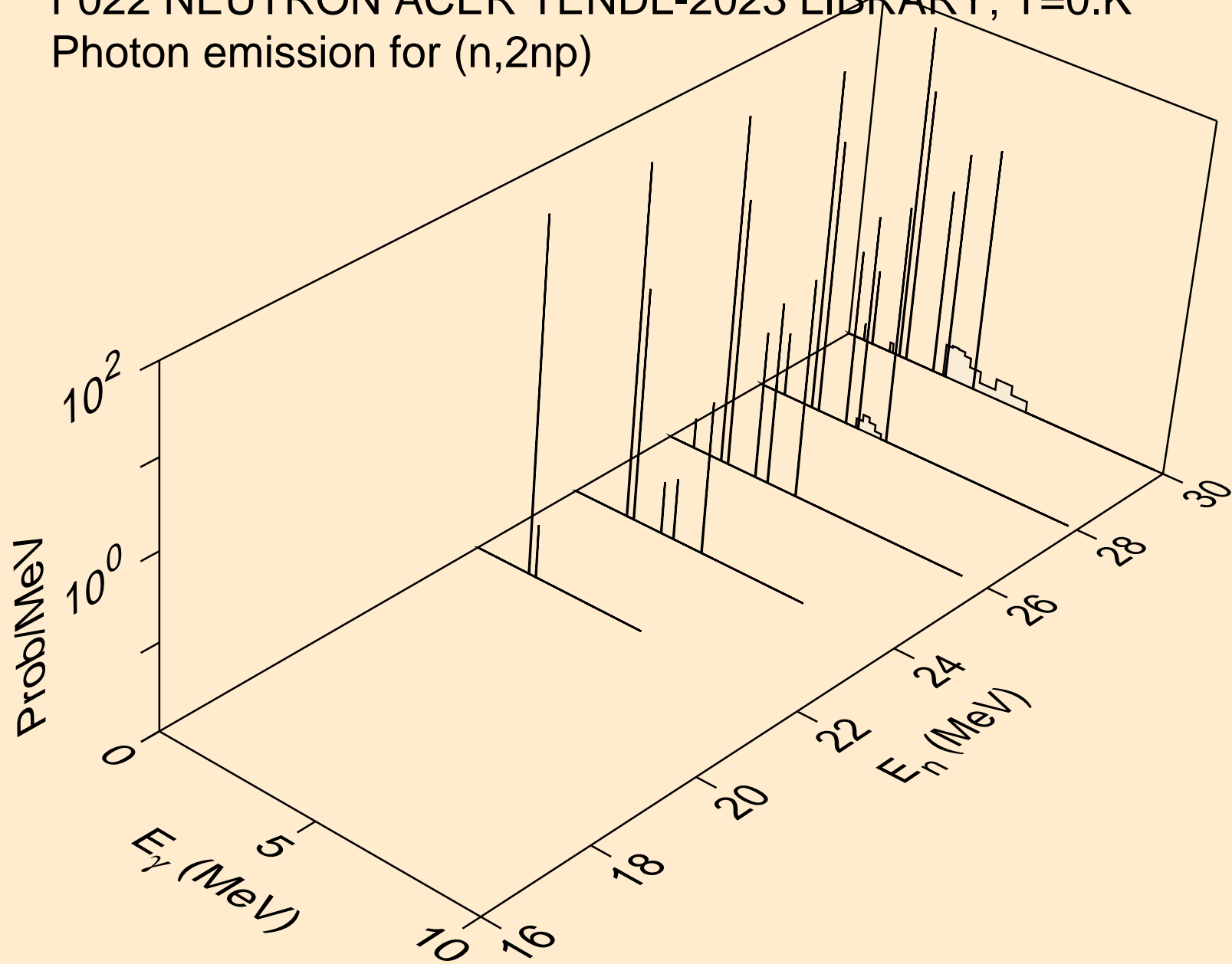

F022 NEUTRON ACER TENDL-2023 LIBRARY; T=0.K
Photon emission for (n,3np)

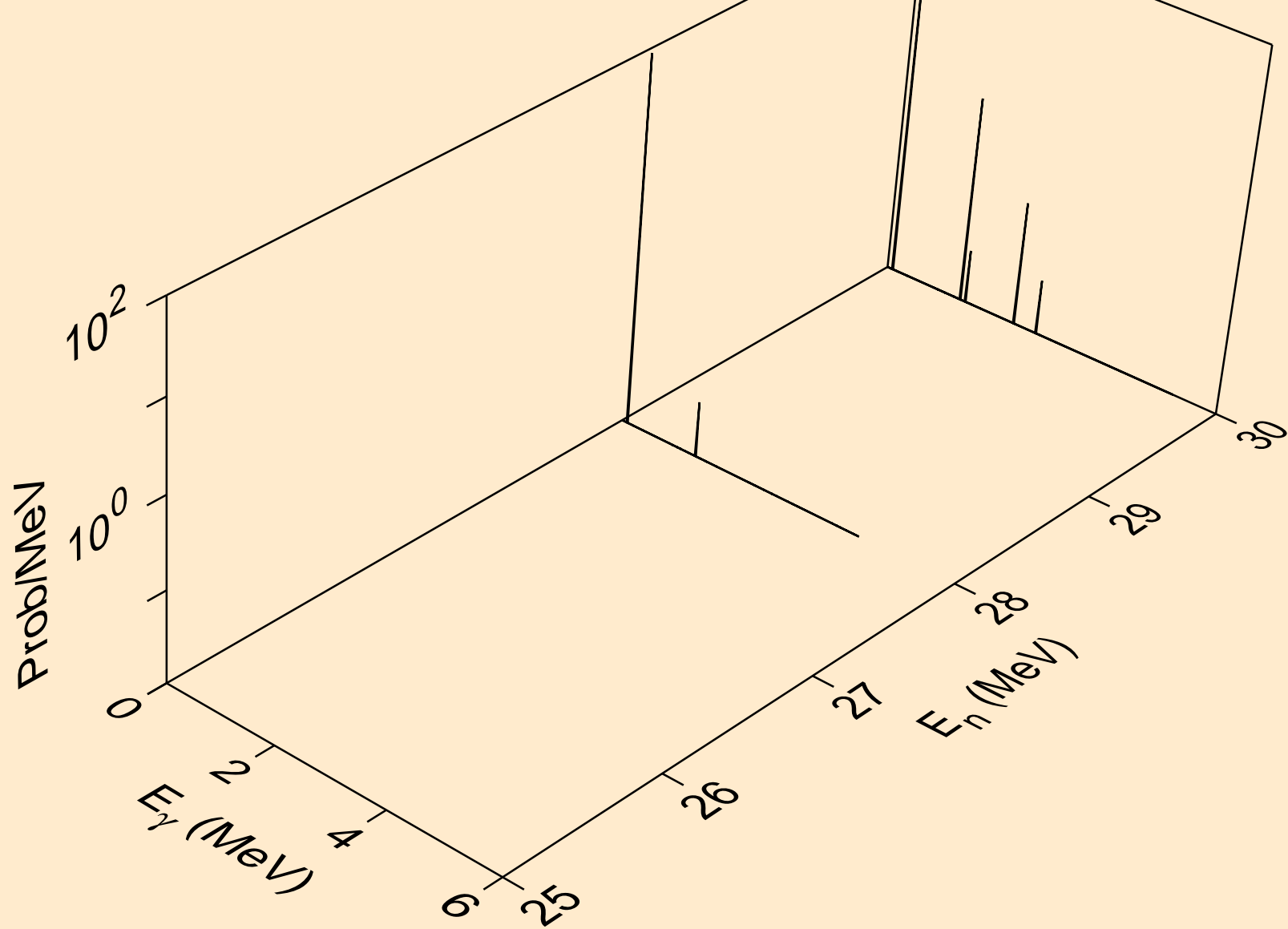

F022 NEUTRON ACER TENDL-2023 LIBRARY; T=0.K
Photon emission for (n,gma)

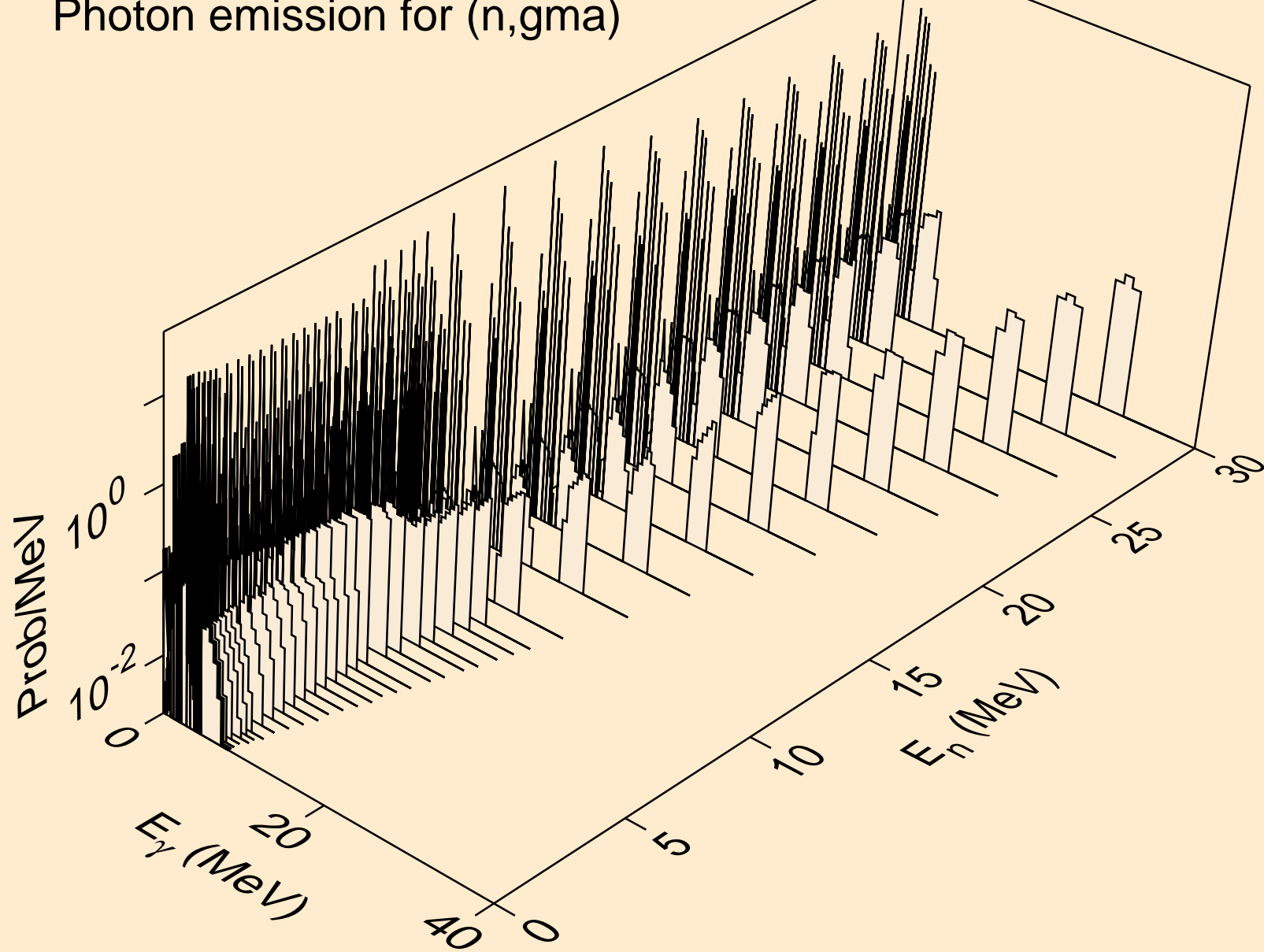

F022 NEUTRON ACER TENDL-2023 LIBRARY; T=0.K
Photon emission for (n,p)

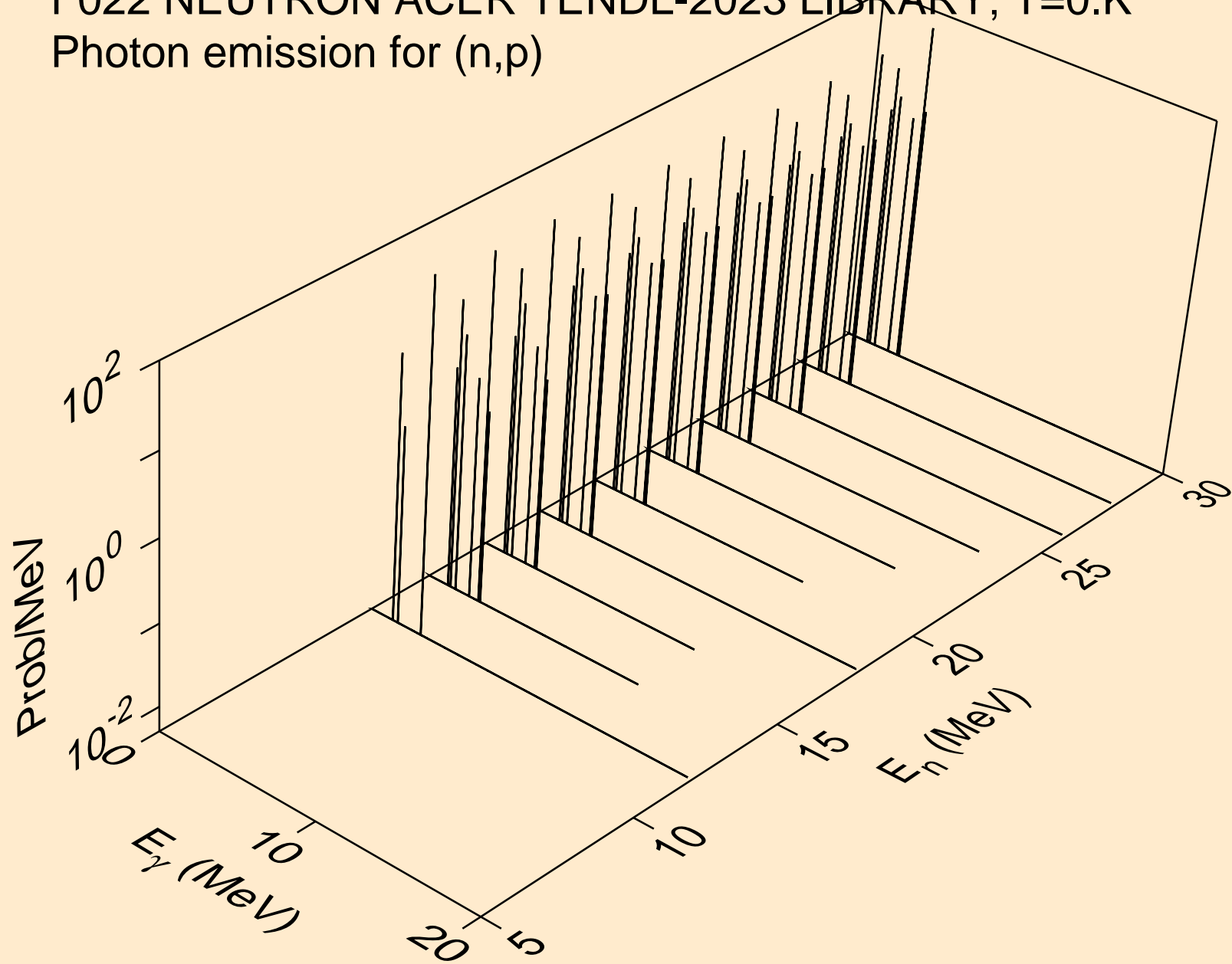

F022 NEUTRON ACER TENDL-2023 LIBRARY; T=0.K
Photon emission for (n,d)

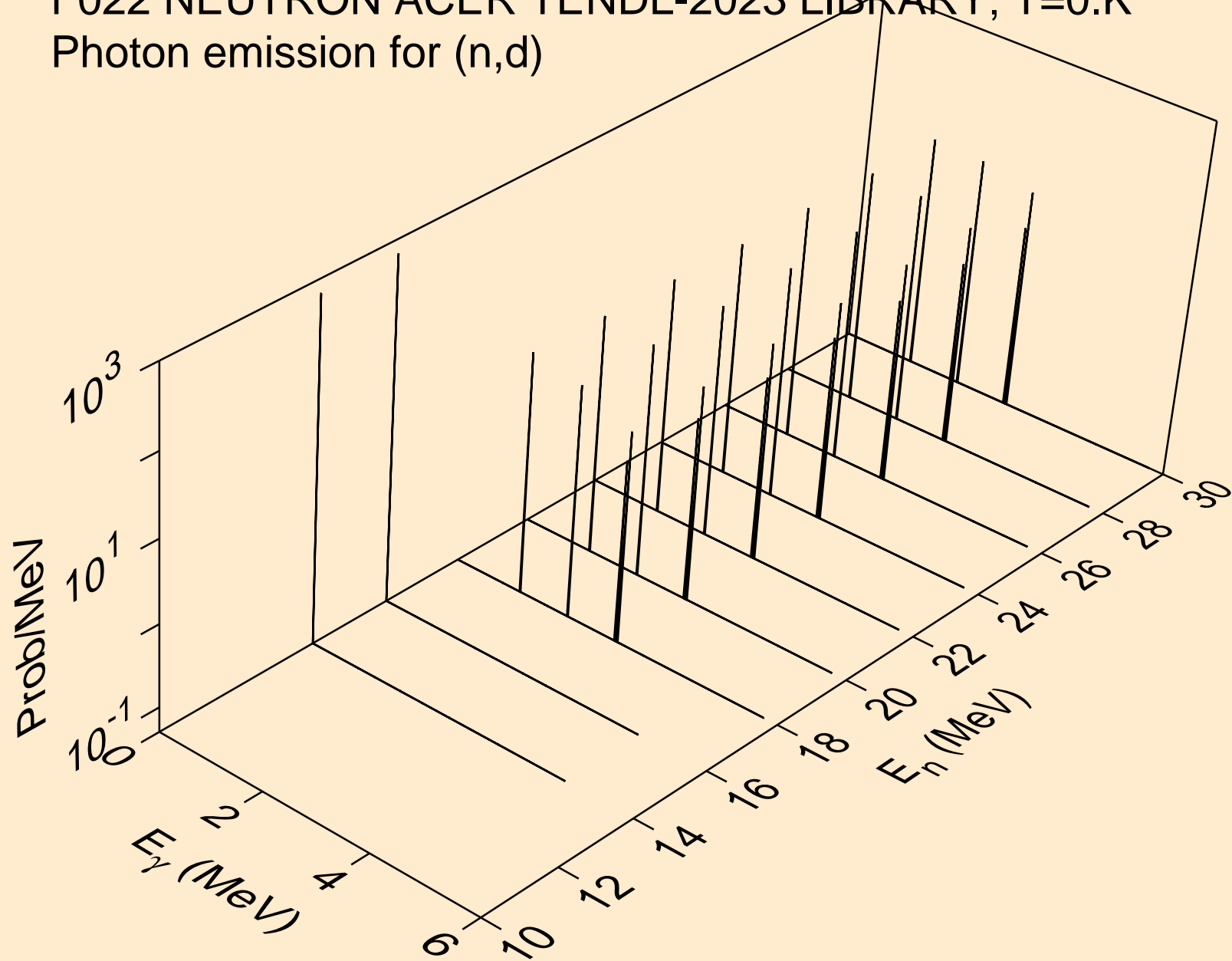

F022 NEUTRON ACER TENDL-2023 LIBRARY; T=0.K
Photon emission for (n,t)

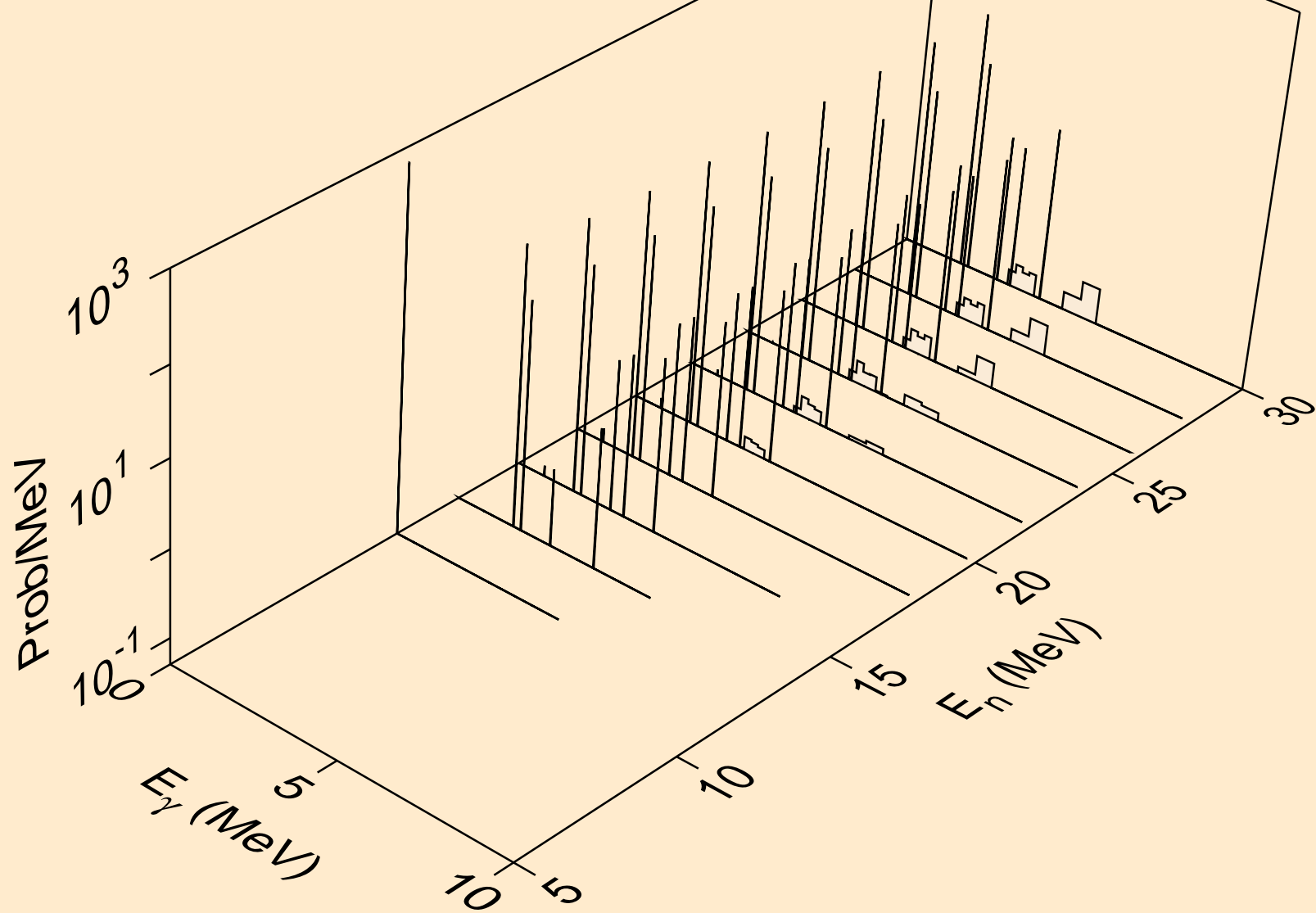

F022 NEUTRON ACER TENDL-2023 LIBRARY; T=0.K
Photon emission for (n,he3)

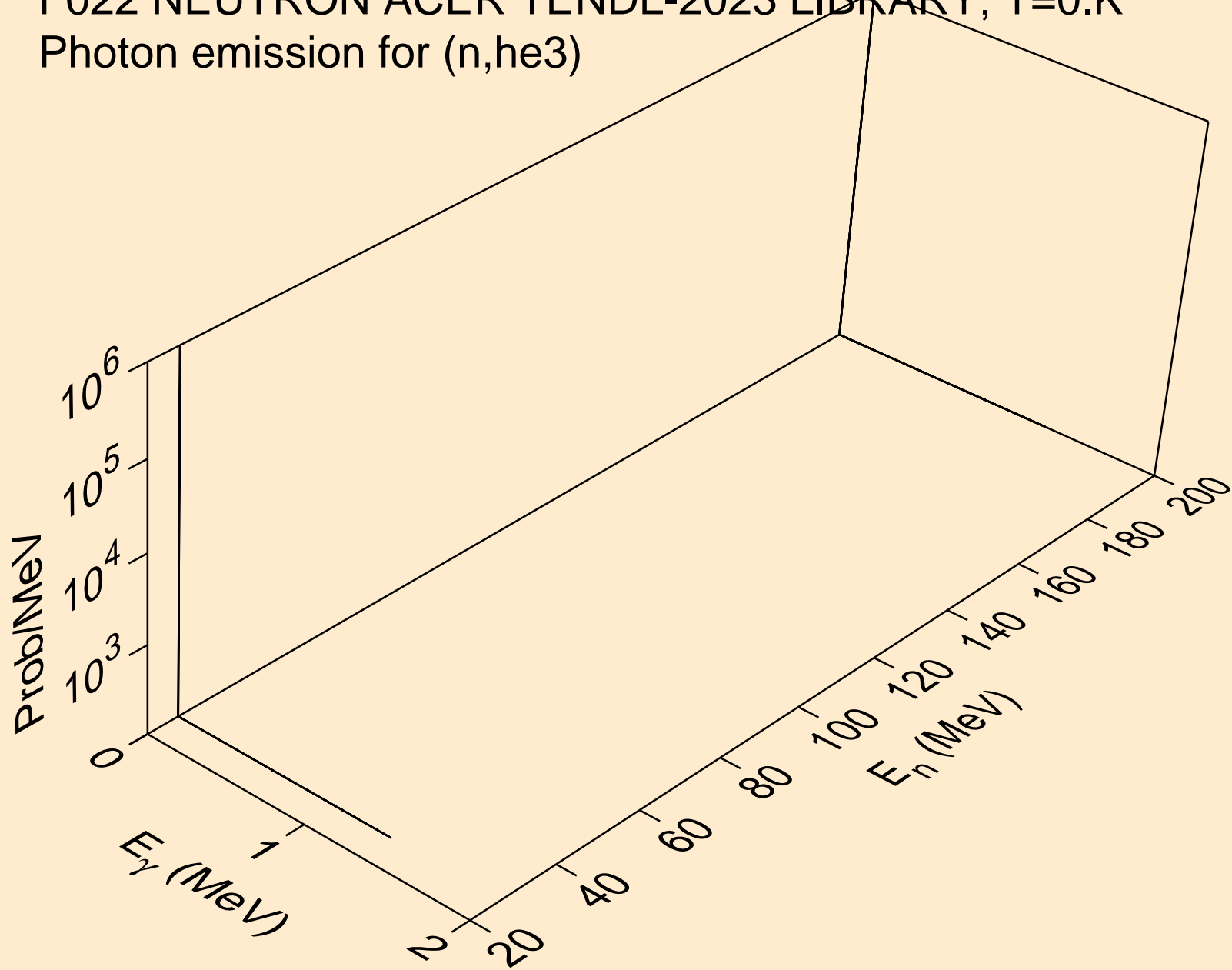

F022 NEUTRON ACER TENDL-2023 LIBRARY; T=0.K
Photon emission for (n,a)

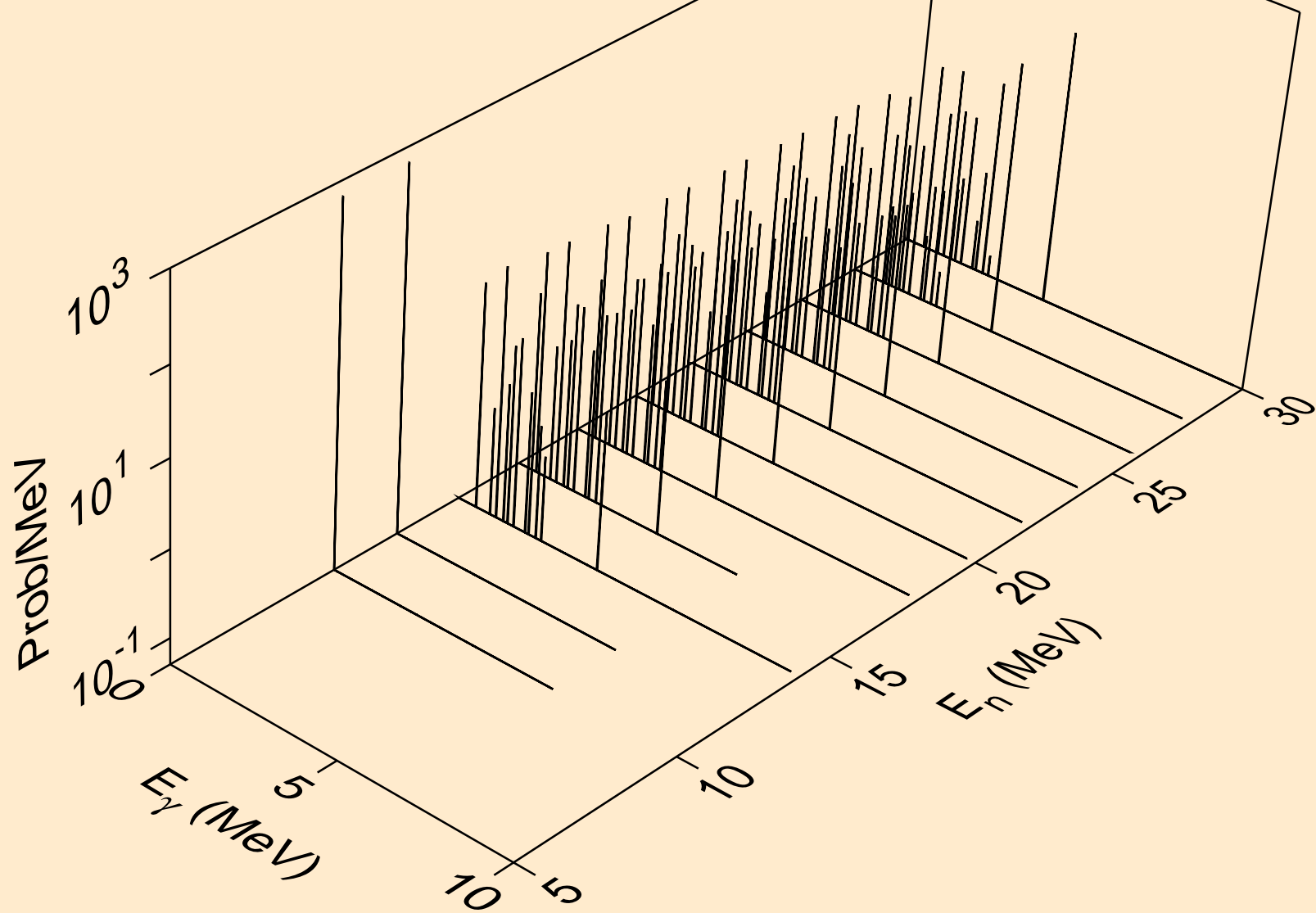

F022 NEUTRON ACER TENDL-2023 LIBRARY; T=0.K
Photon emission for (n,2a)

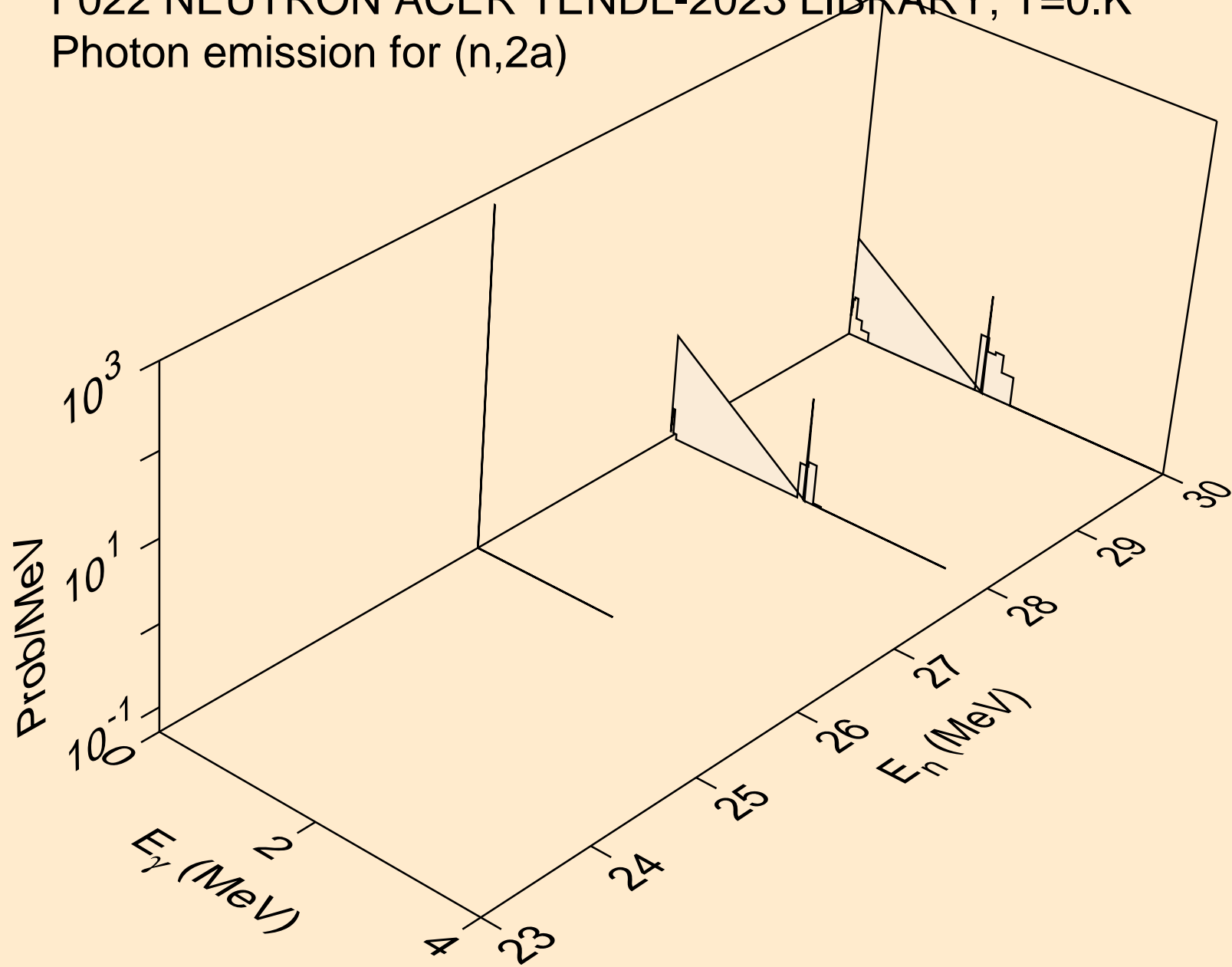

F022 NEUTRON ACER TENDL-2023 LIBRARY; T=0.K
Photon emission for (n,p)

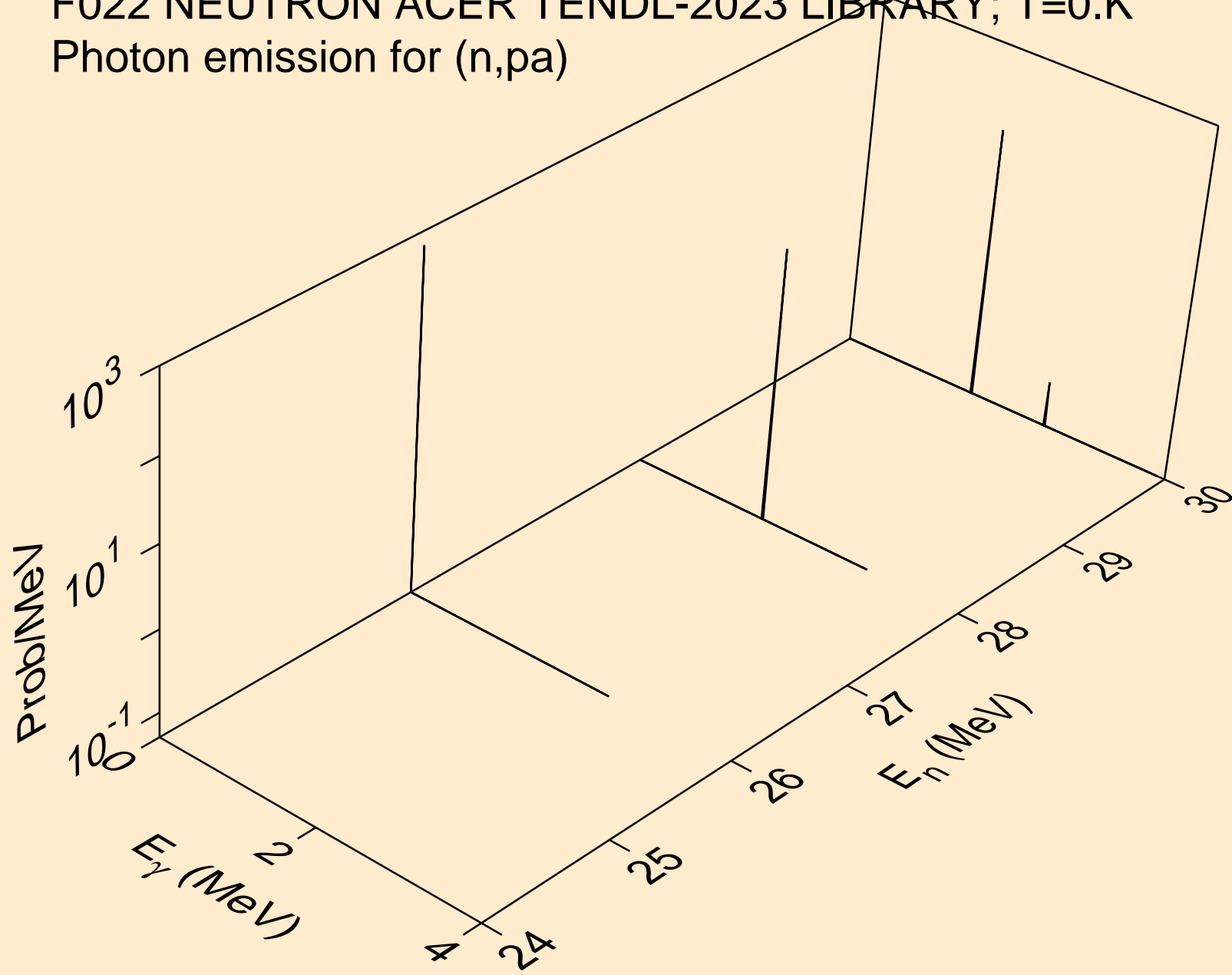

F022 NEUTRON ACER TENDL-2023 LIBRARY; T=0.K
Photon emission for (n,da)

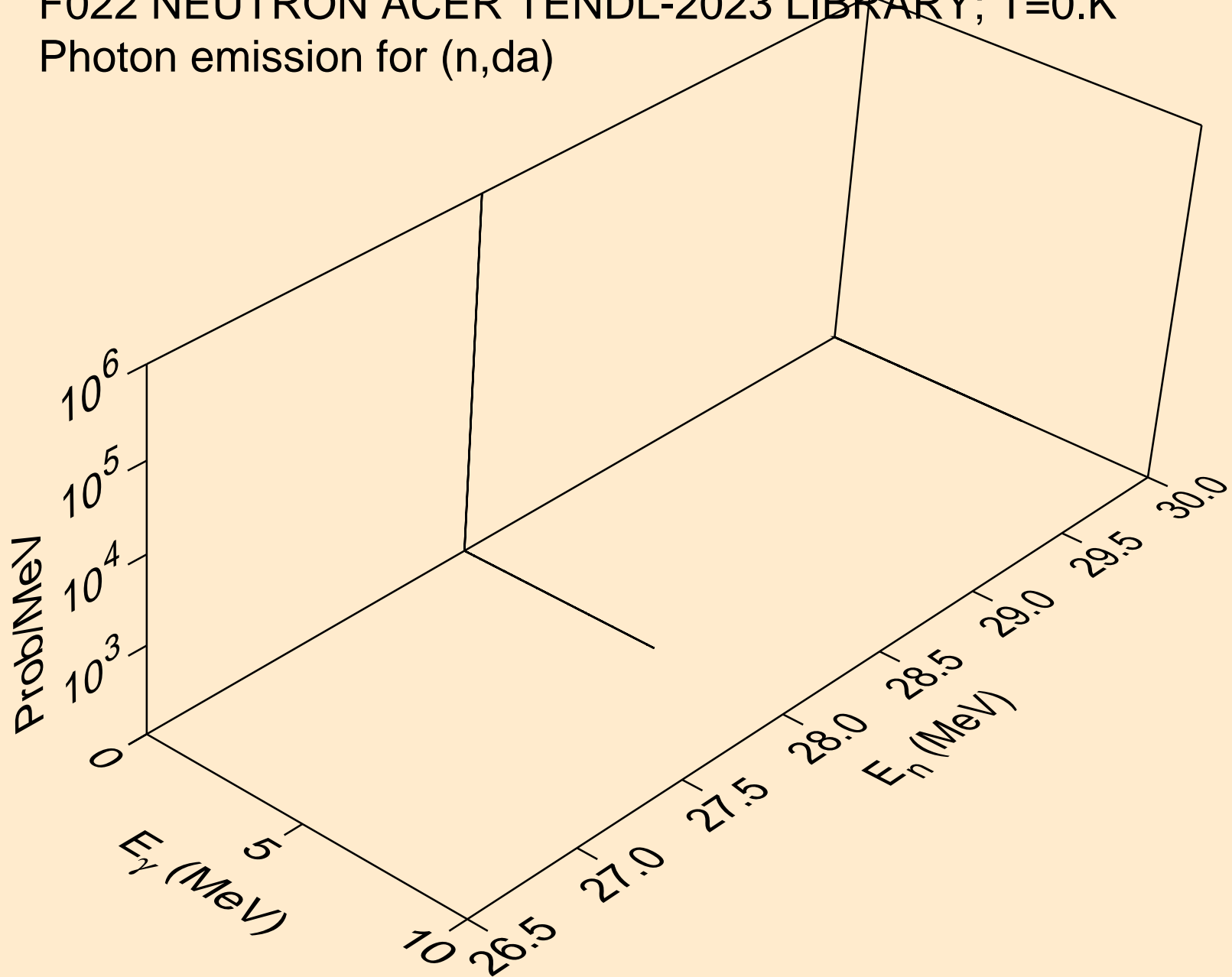

F022 NEUTRON ACER TENDL-2023 LIBRARY; T=0.K
thermal capture photon spectrum

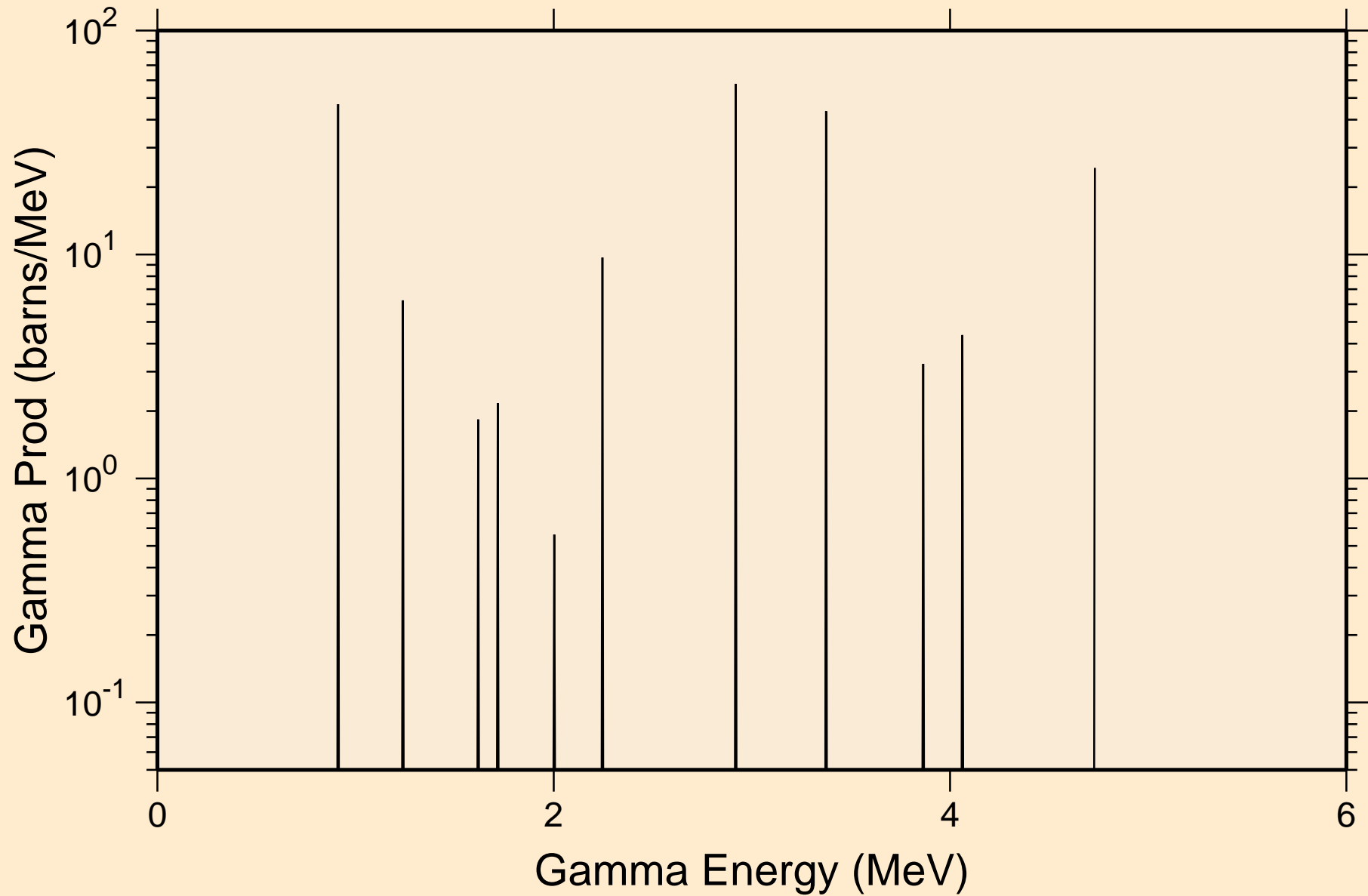

F022 NEUTRON ACER TENDL-2023 LIBRARY; T=0.K
14 MeV photon spectrum

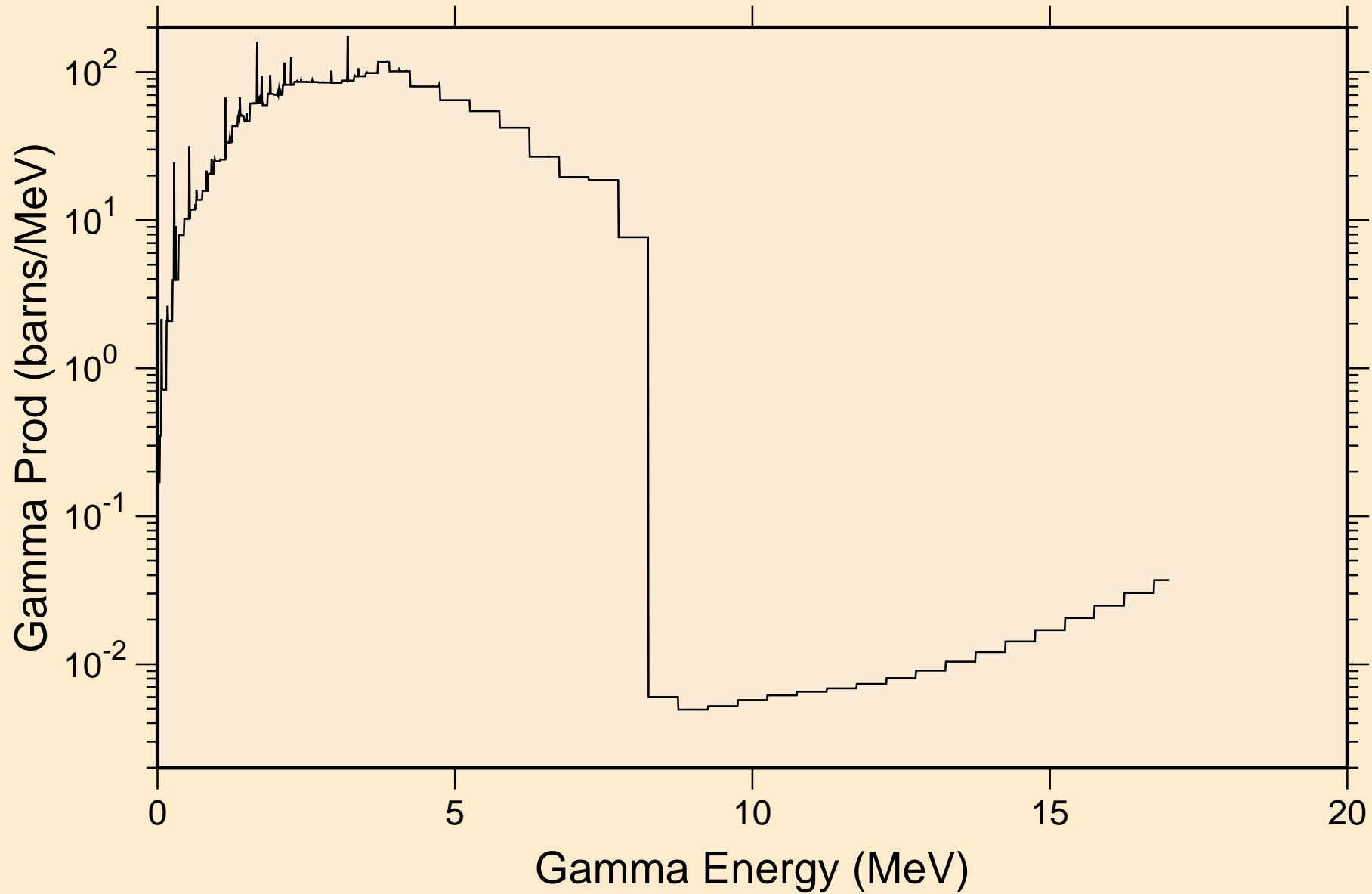

F022 NEUTRON ACER TENDL-2023 LIBRARY; T=0.K

Particle heating contributions

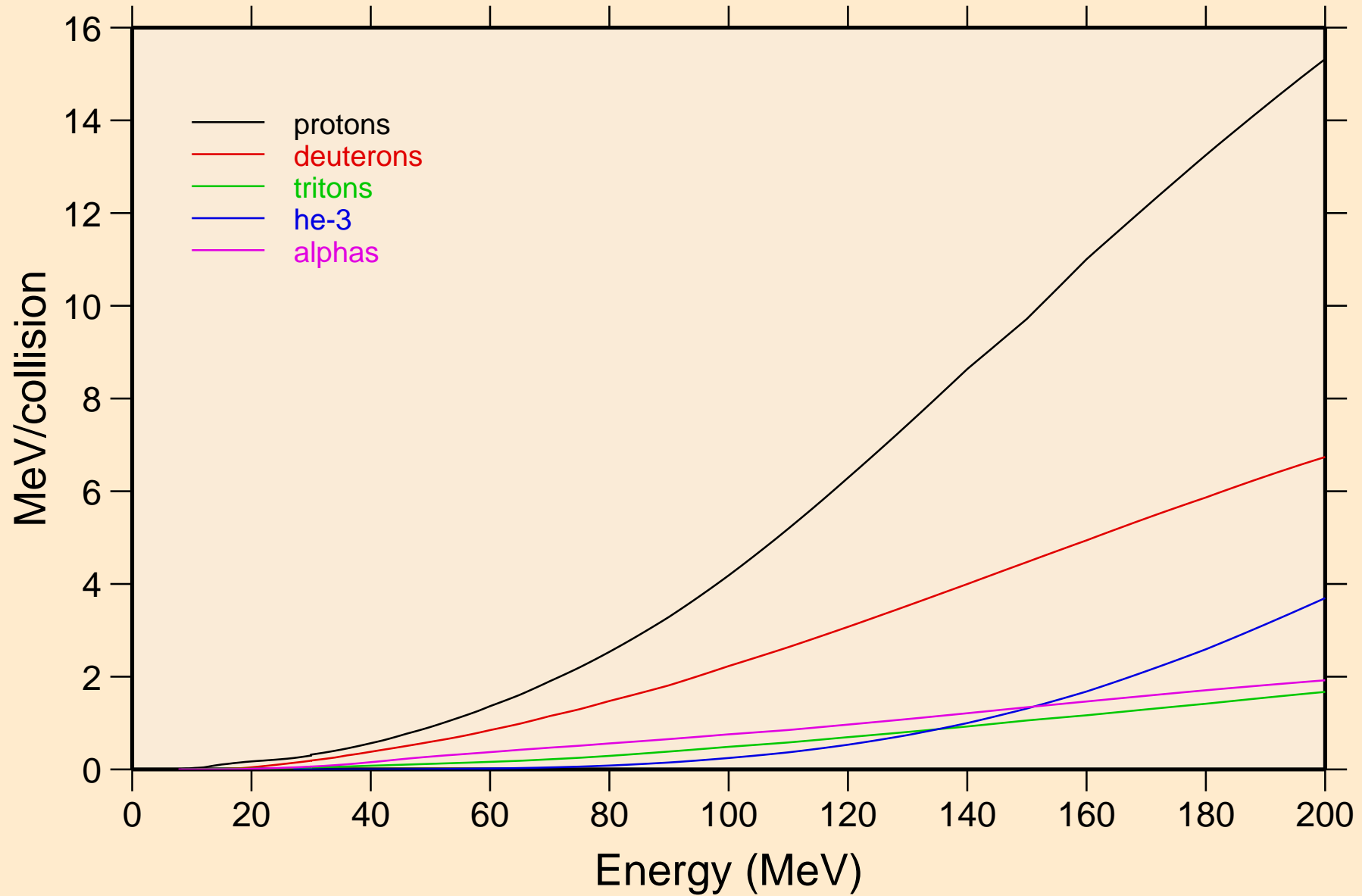

F022 NEUTRON ACER TENDL-2023 LIBRARY; T=0.K
Recoil Heating

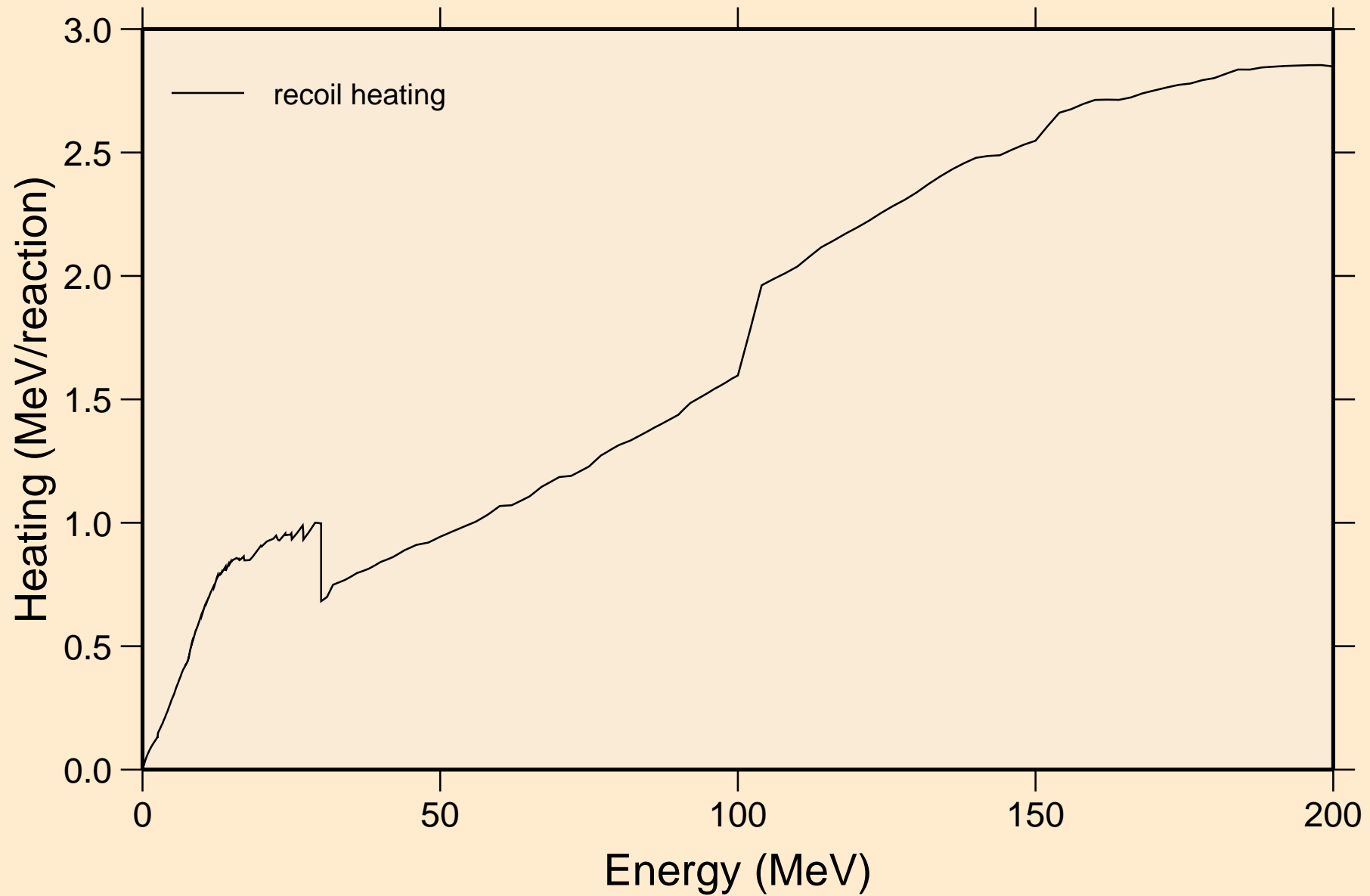

F022 NEUTRON ACER TENDL-2023 LIBRARY; T=0.K

Particle production cross sections

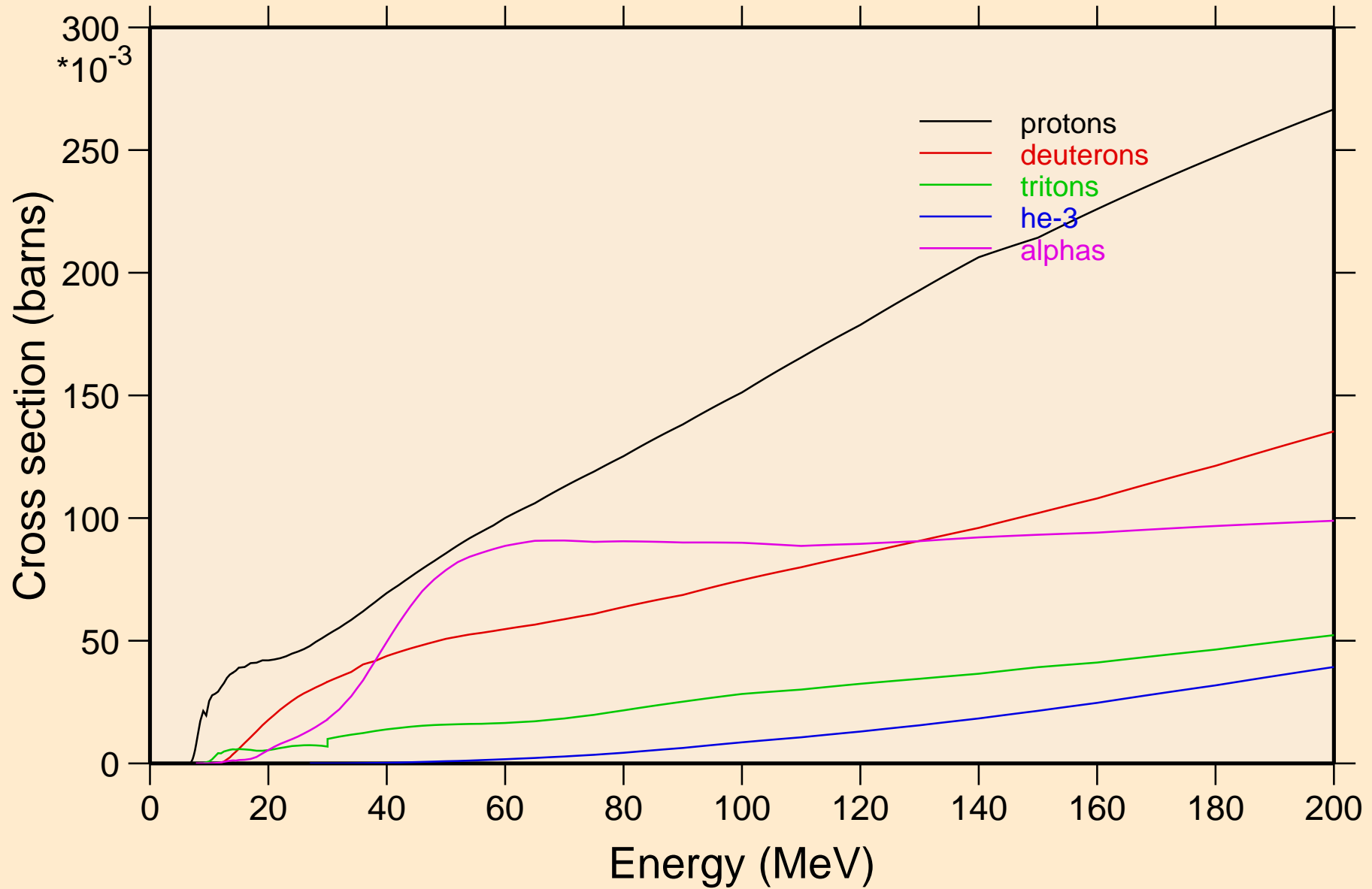

F022 NEUTRON ACER TENDL-2023 LIBRARY; T=0.K
protons from (n,x)

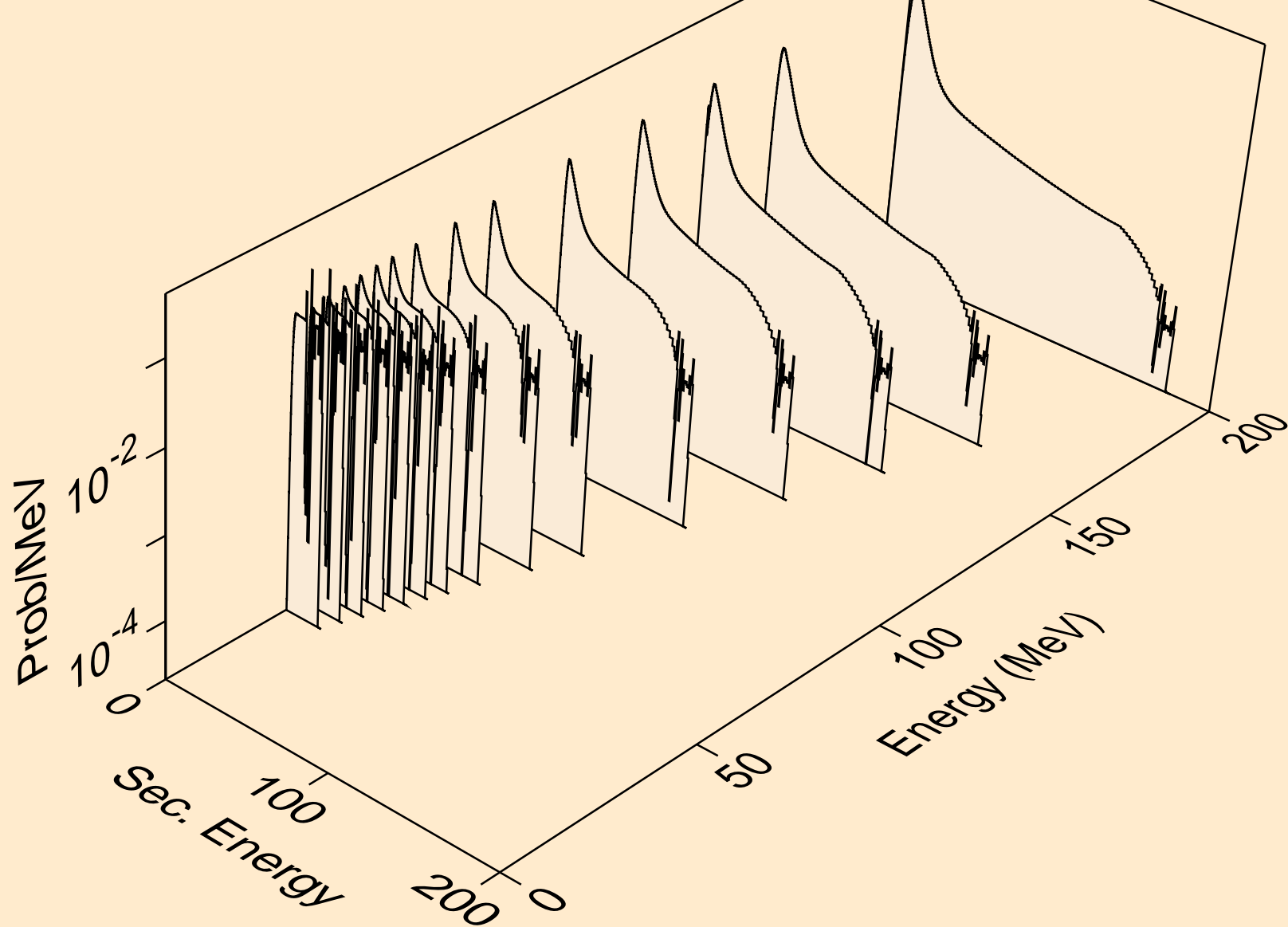

F022 NEUTRON ACER TENDL-2023 LIBRARY; T=0.K
protons from (n,n*)p

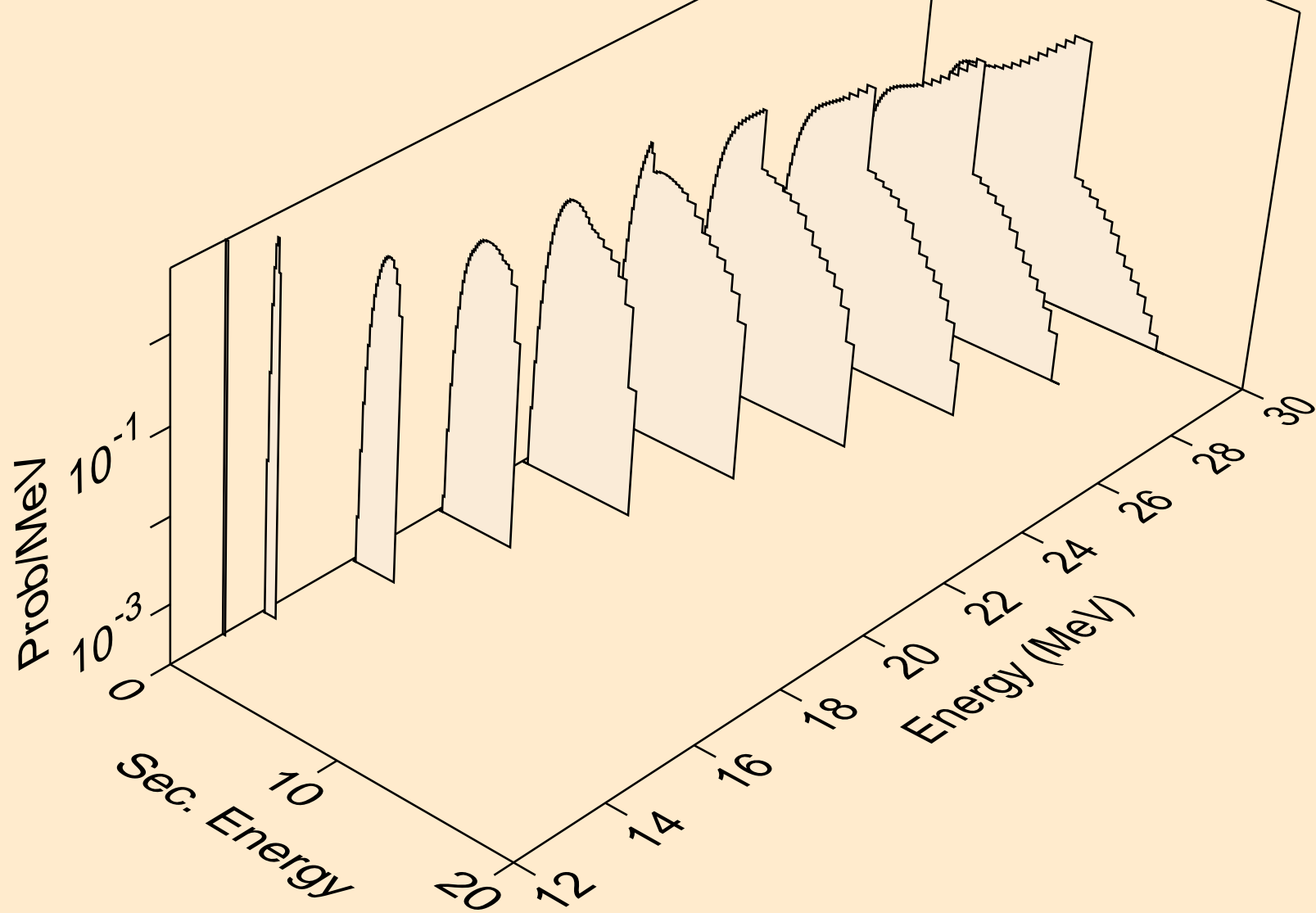

F022 NEUTRON ACER TENDL-2023 LIBRARY; T=0.K
protons from (n,2np)

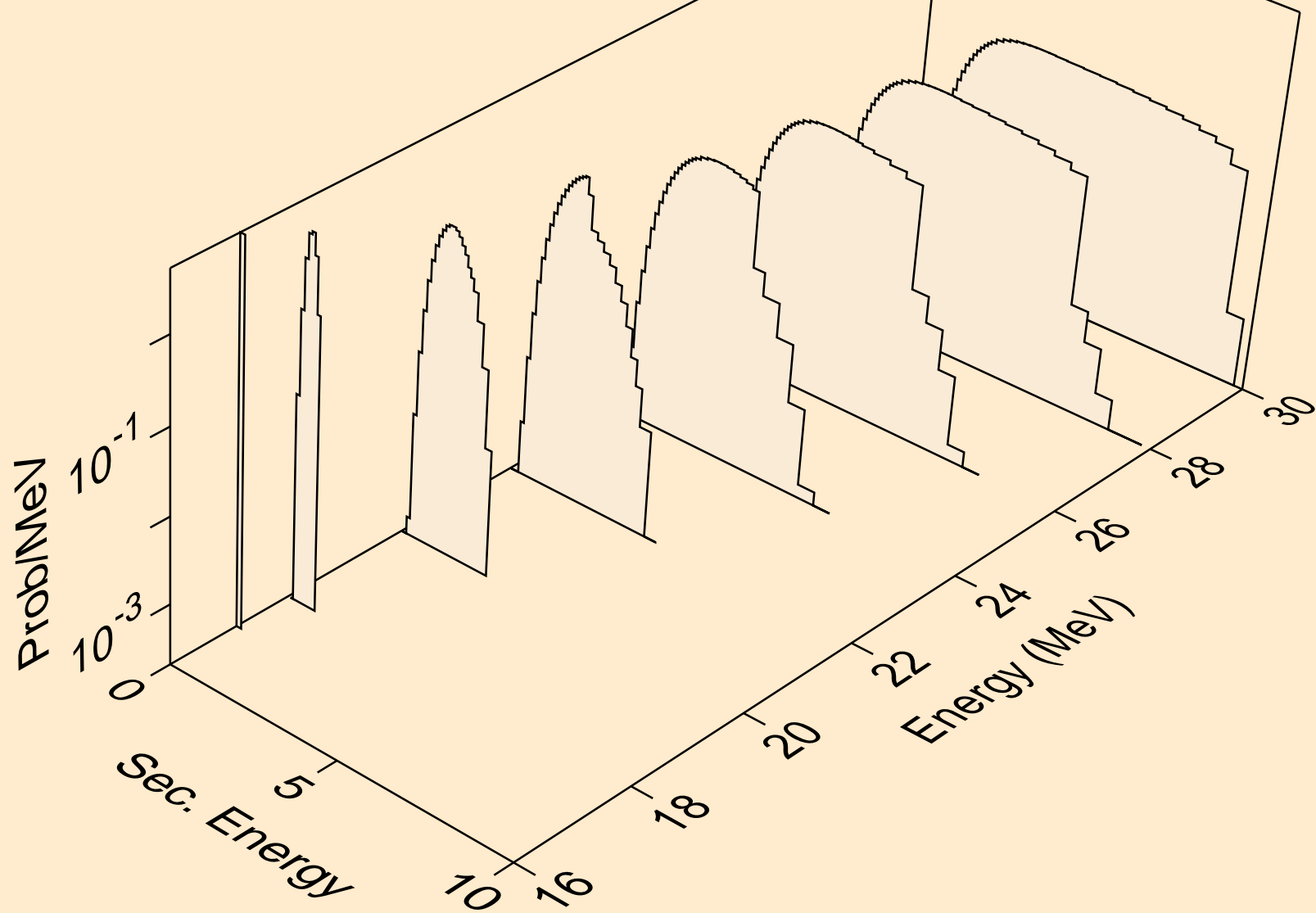

F022 NEUTRON ACER TENDL-2023 LIBRARY; T=0.K
protons from (n,3np)

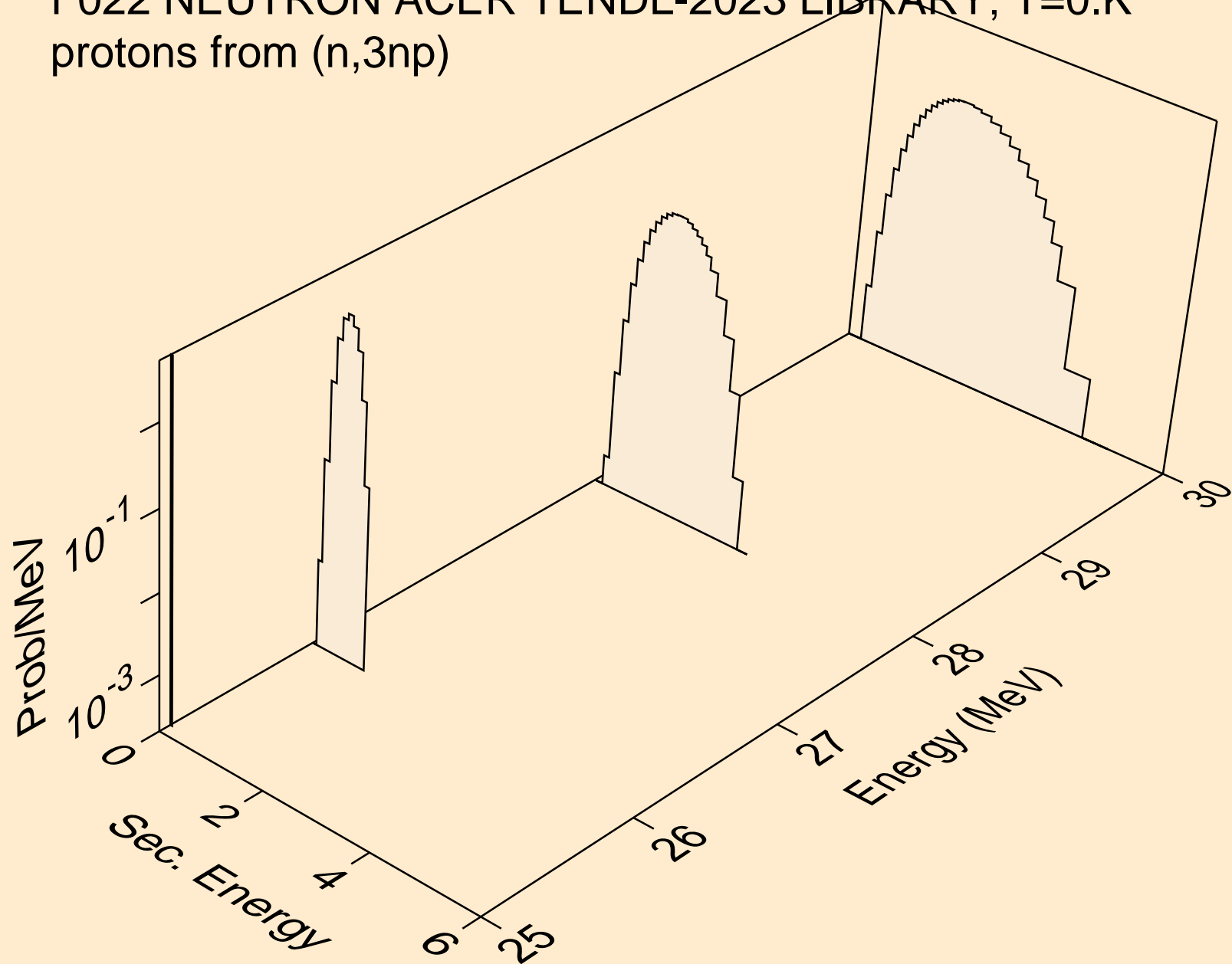

F022 NEUTRON ACER TENDL-2023 LIBRARY; T=0.K
protons from (n,p)

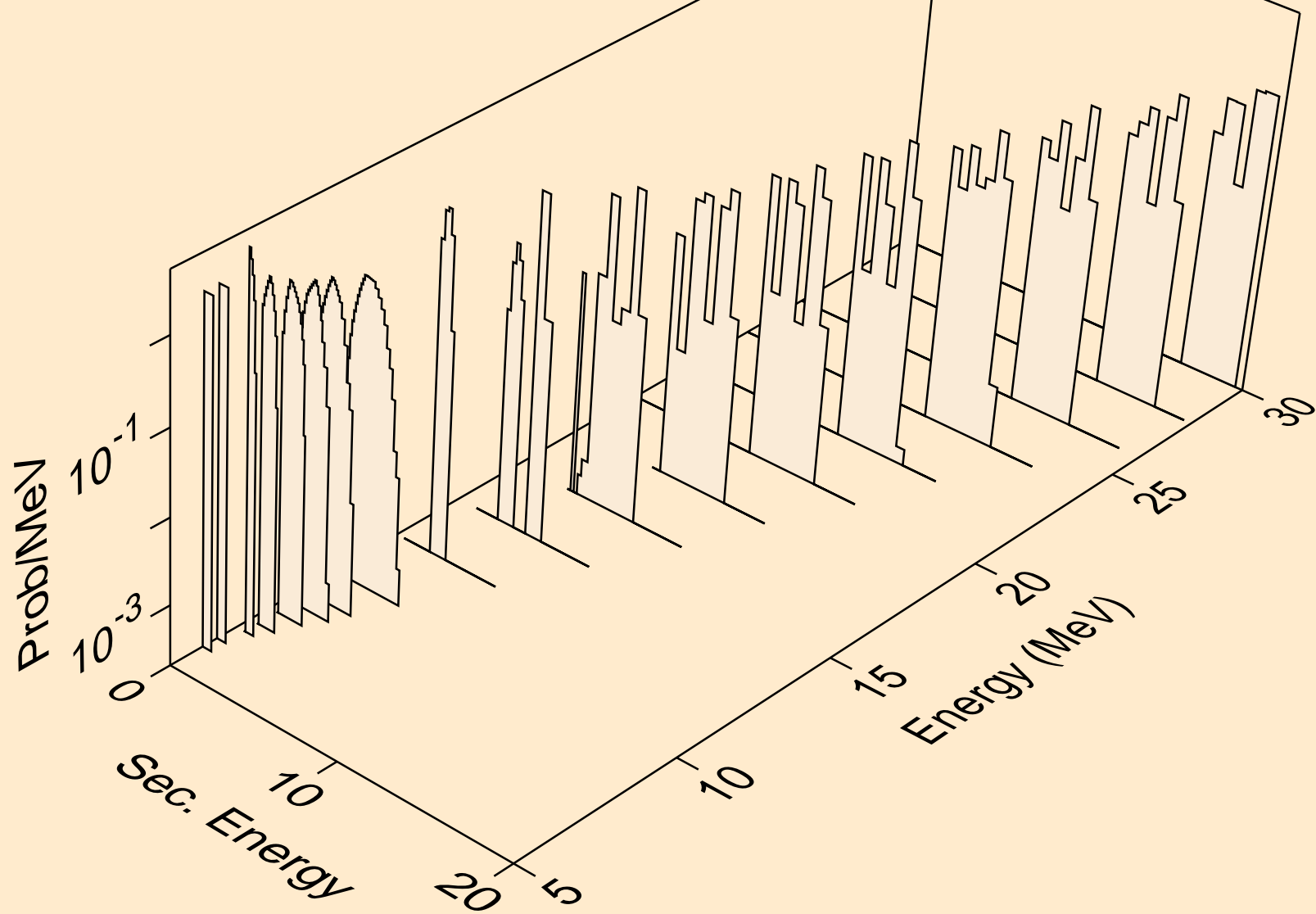

F022 NEUTRON ACER TENDL-2023 LIBRARY; T=0.K
protons from (n,pa)

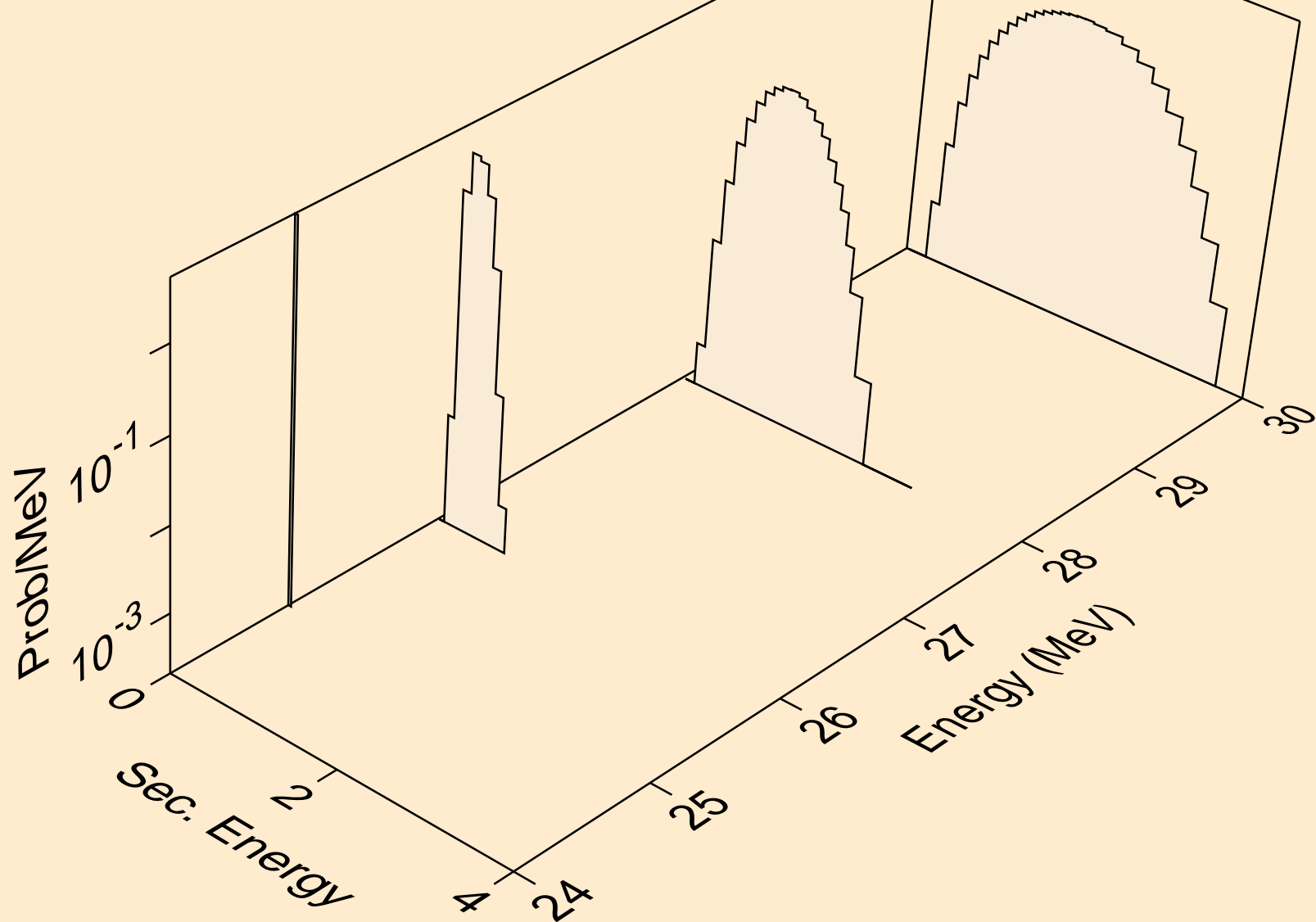

F022 NEUTRON ACER TENDL-2023 LIBRARY; T=0.K
deuterons from (n,x)

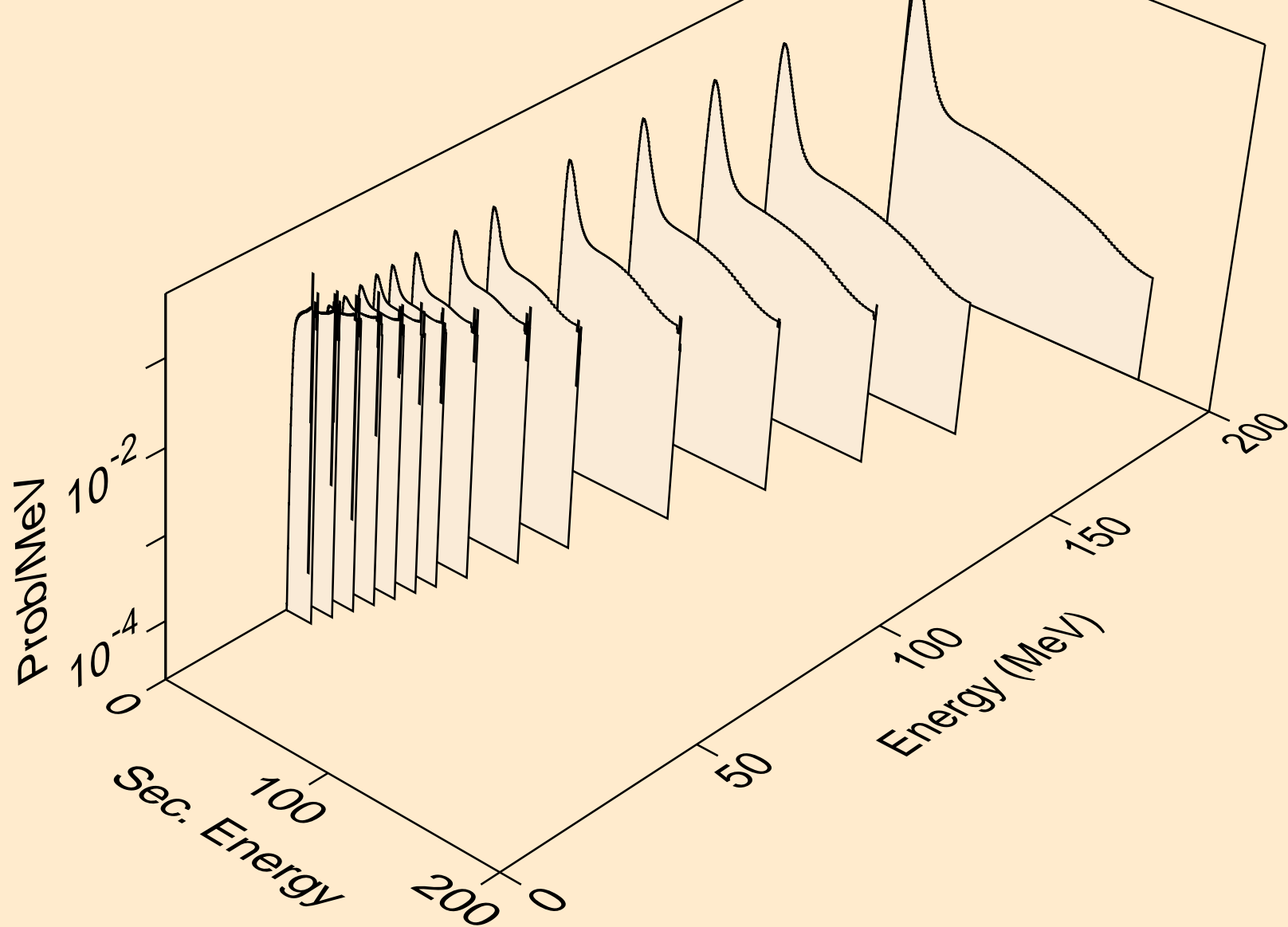

F022 NEUTRON ACER TENDL-2023 LIBRARY; T=0.K
deuterons from (n,2nd)

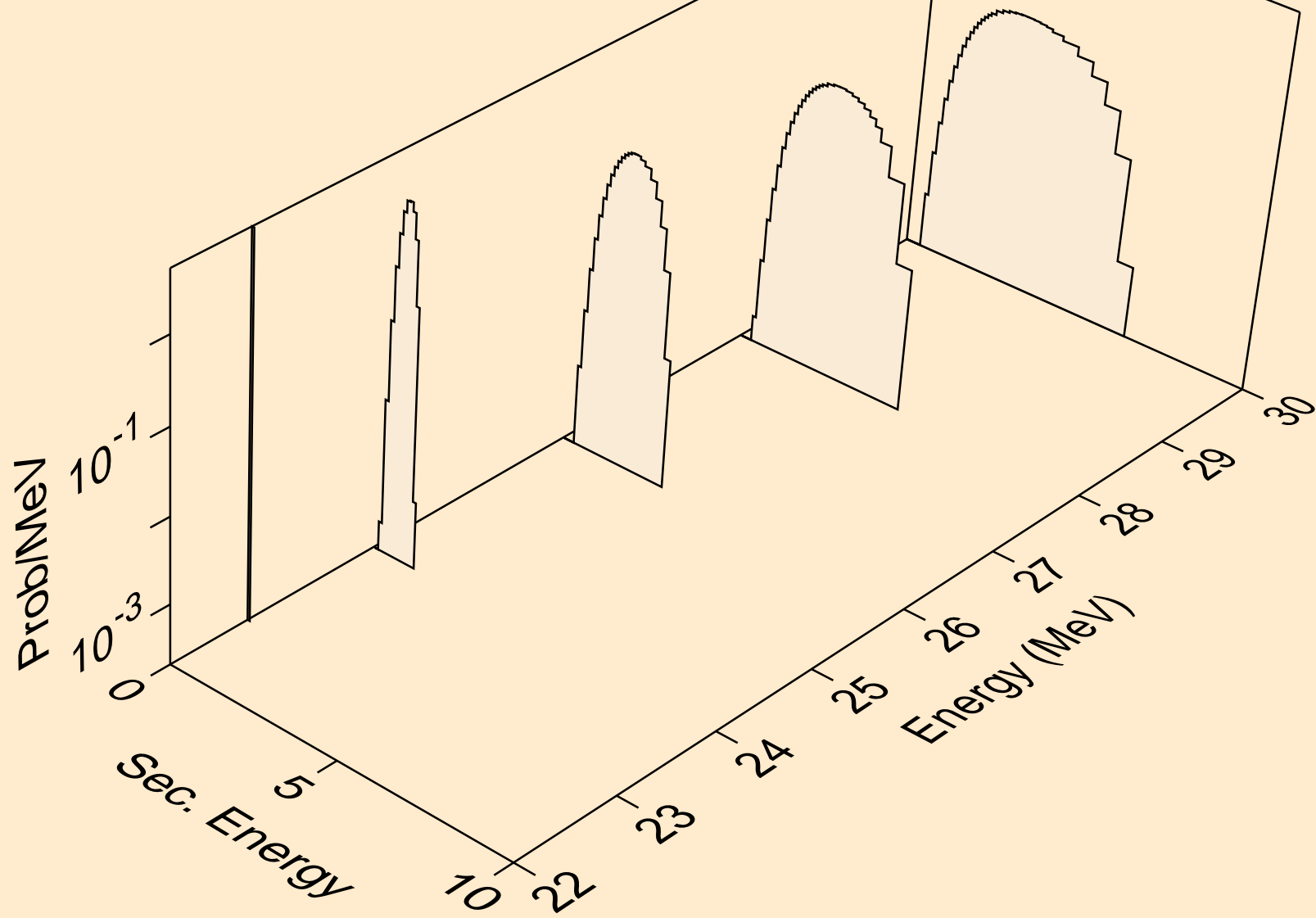

F022 NEUTRON ACER TENDL-2023 LIBRARY; T=0.K
deuterons from (n,n*)d

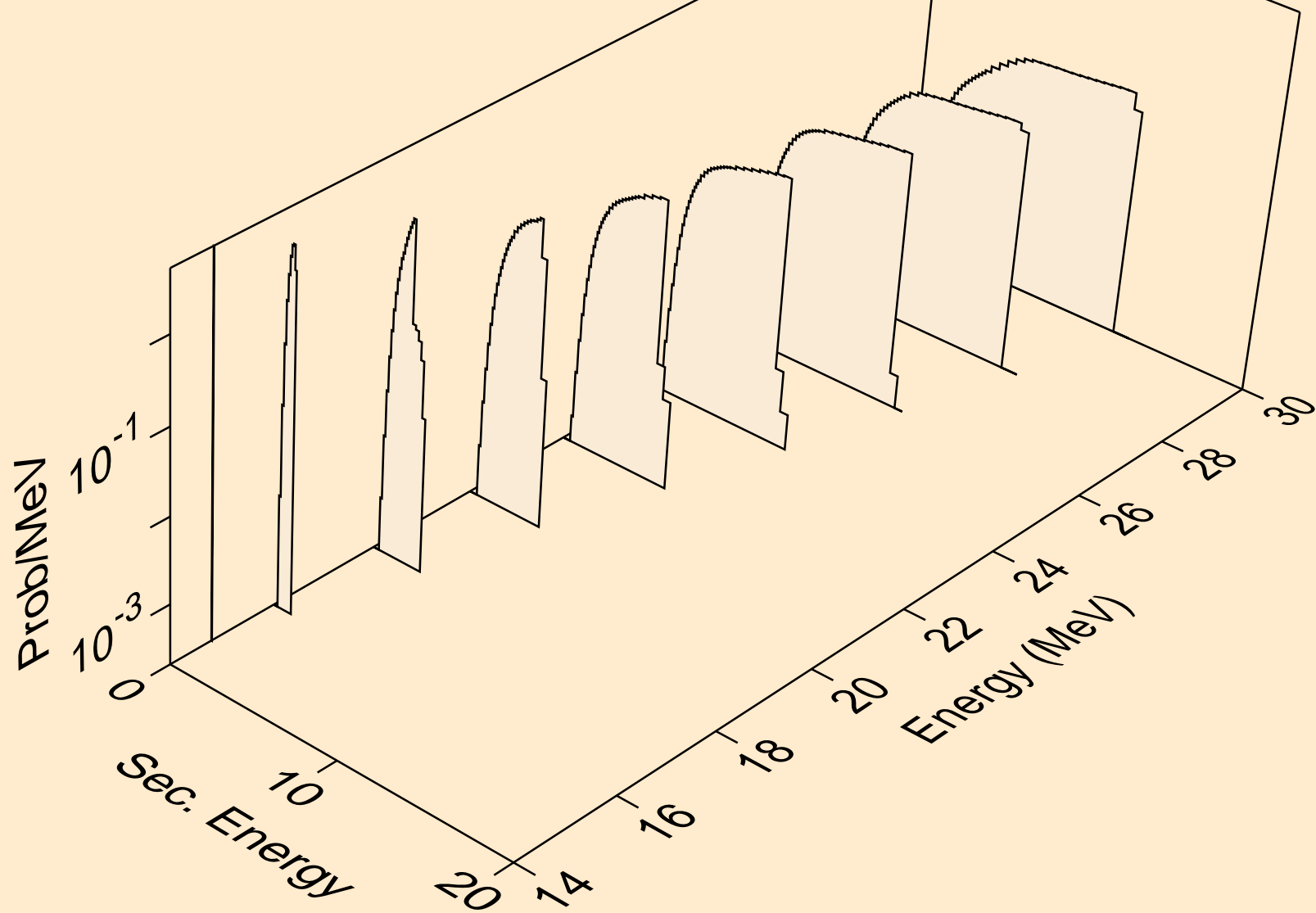

F022 NEUTRON ACER TENDL-2023 LIBRARY; T=0.K
deuterons from (n,d)

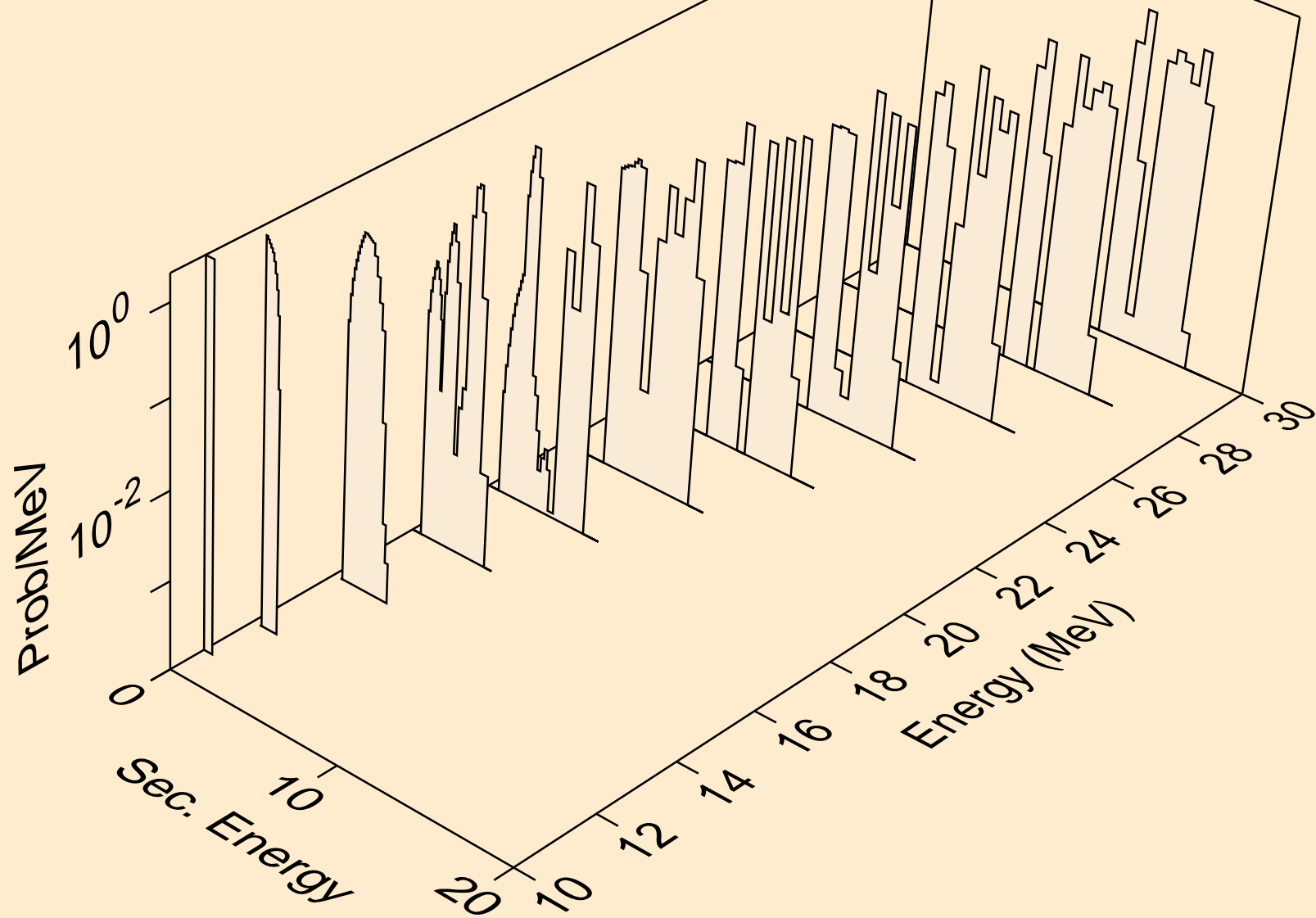

F022 NEUTRON ACER TENDL-2023 LIBRARY; T=0.K
deuterons from (n,da)

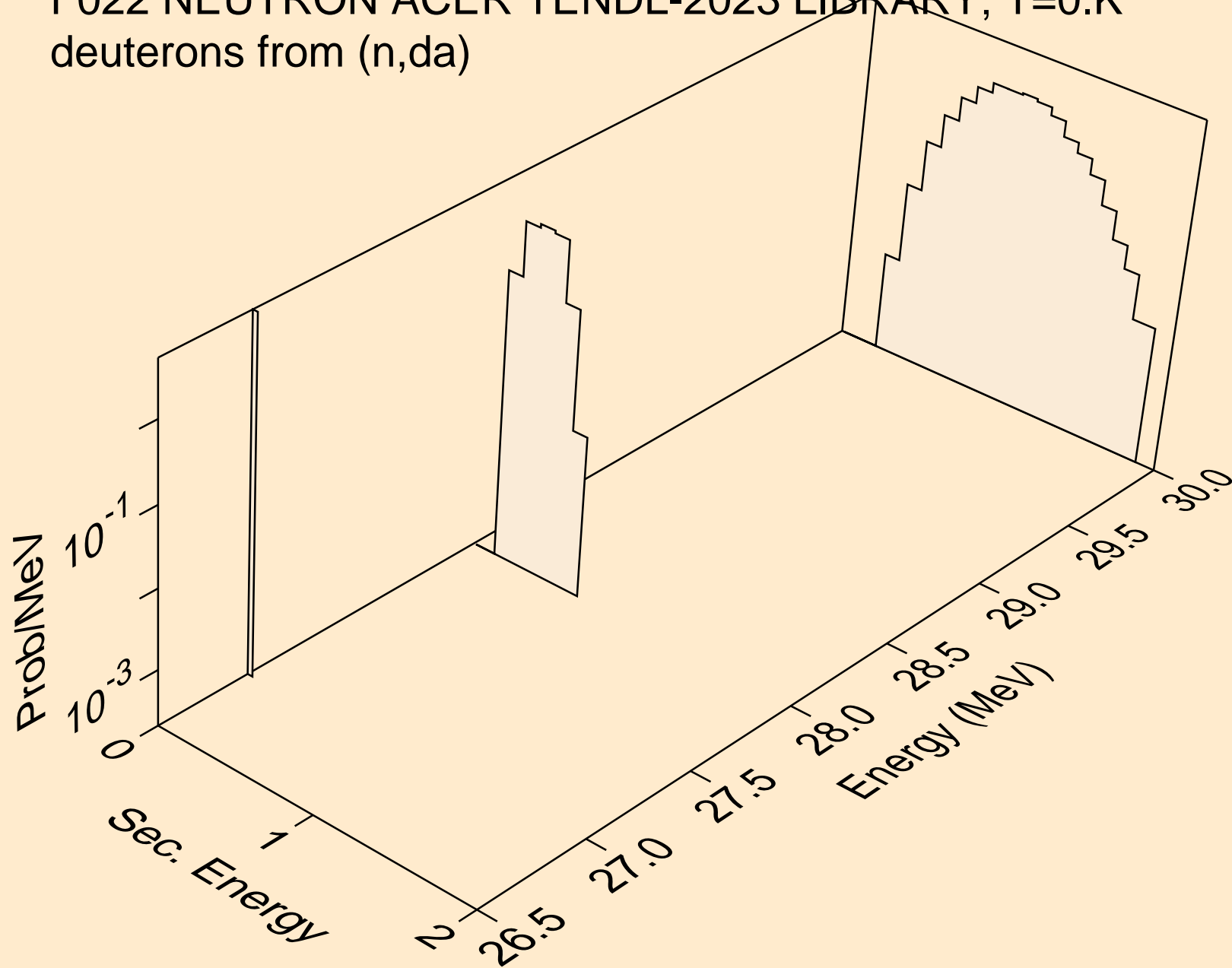

F022 NEUTRON ACER TENDL-2023 LIBRARY; T=0.K
tritons from (n,x)

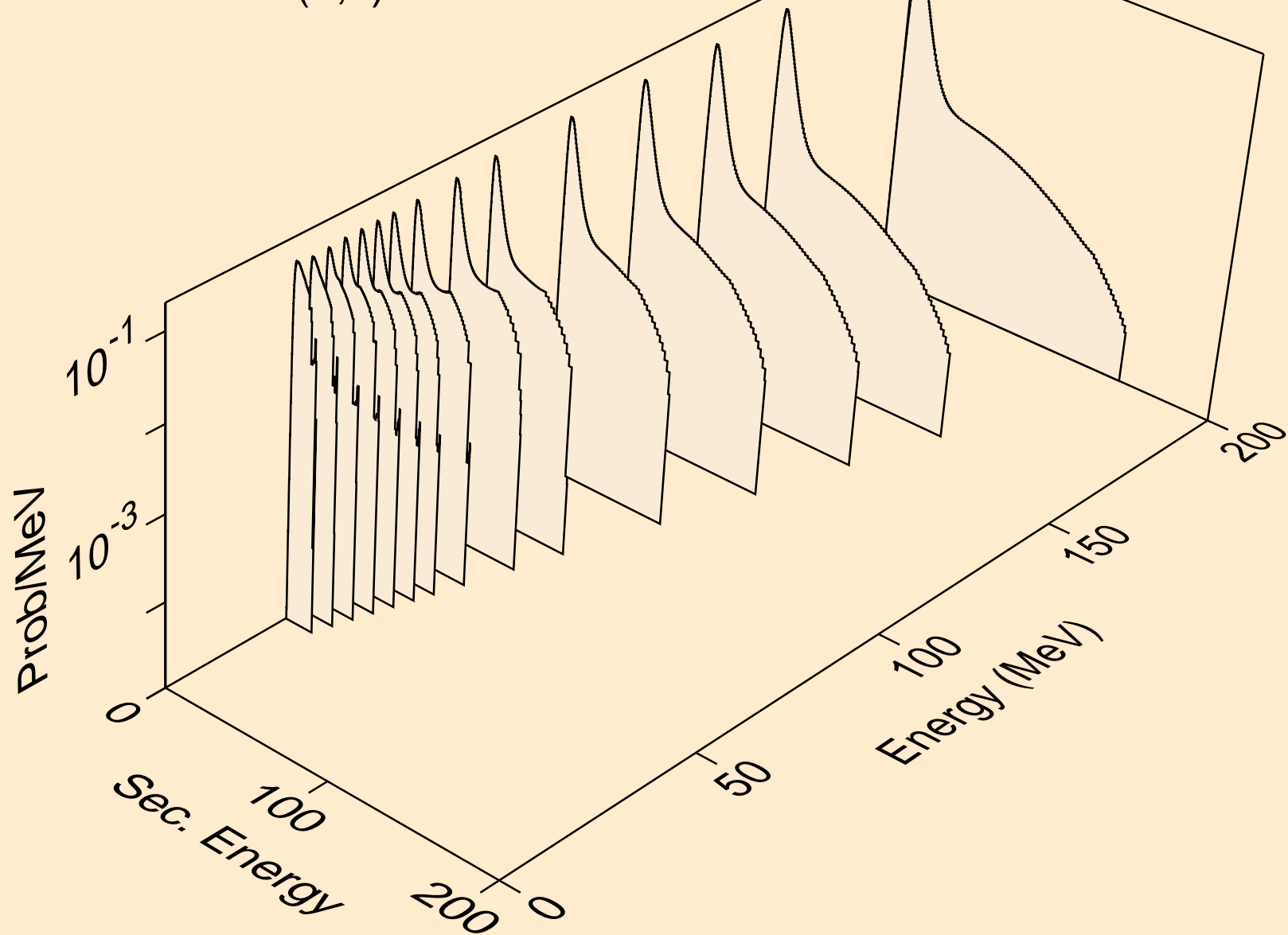

F022 NEUTRON ACER TENDL-2023 LIBRARY; T=0.K
tritons from (n,n*)t

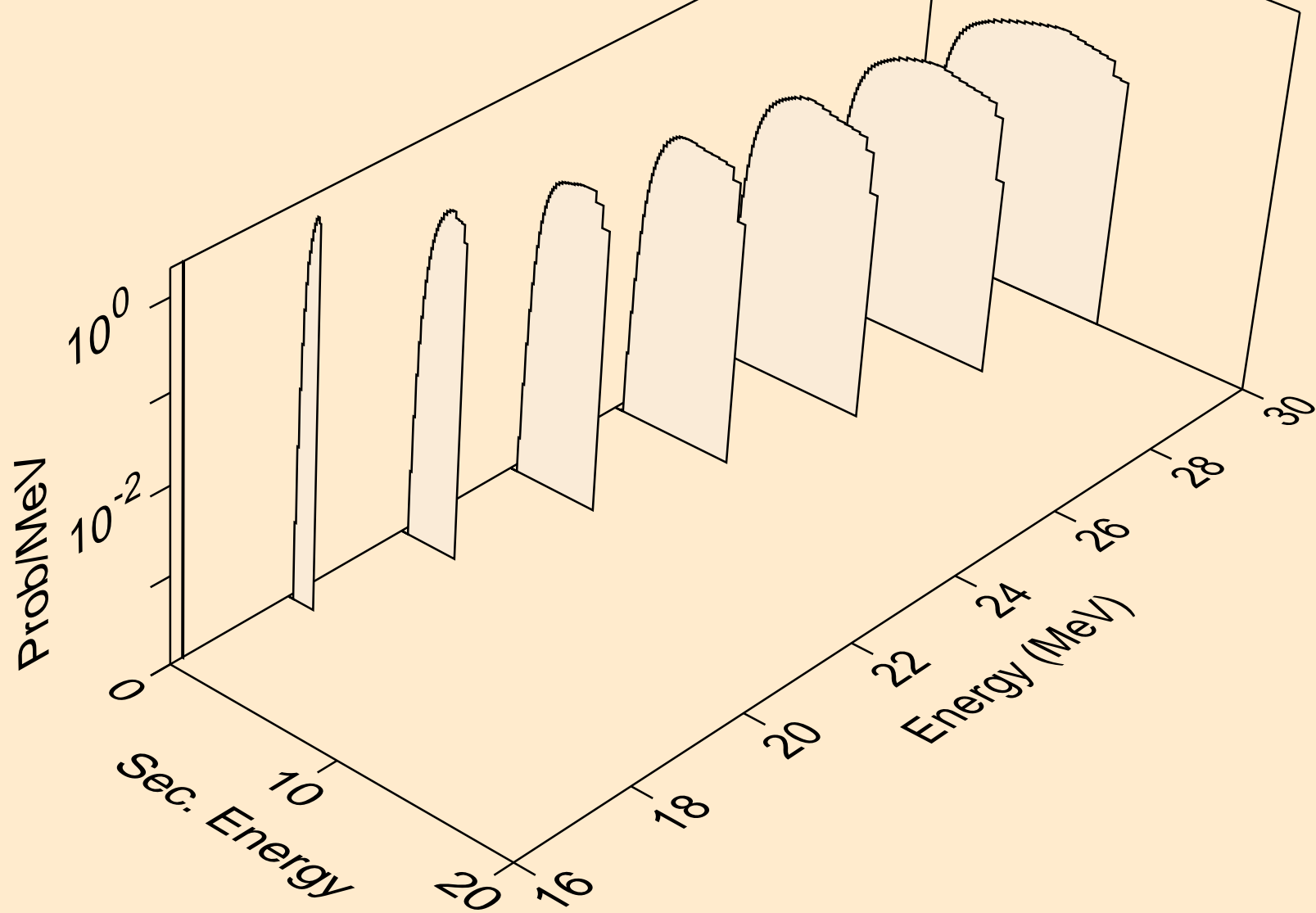

F022 NEUTRON ACER TENDL-2023 LIBRARY; T=0.K
tritons from (n,t)

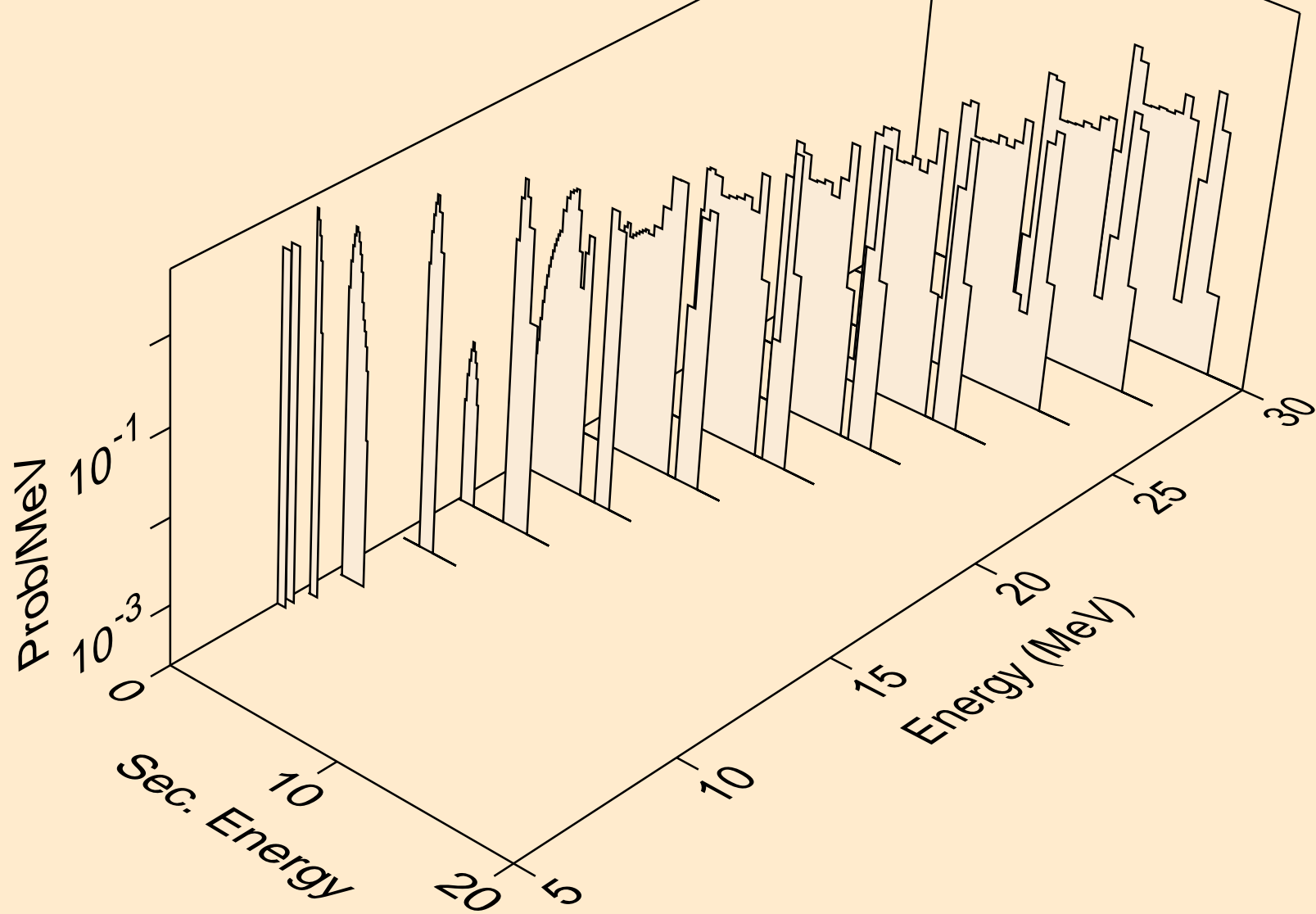

F022 NEUTRON ACER TENDL-2023 LIBRARY; T=0.K
he3s from (n,x)

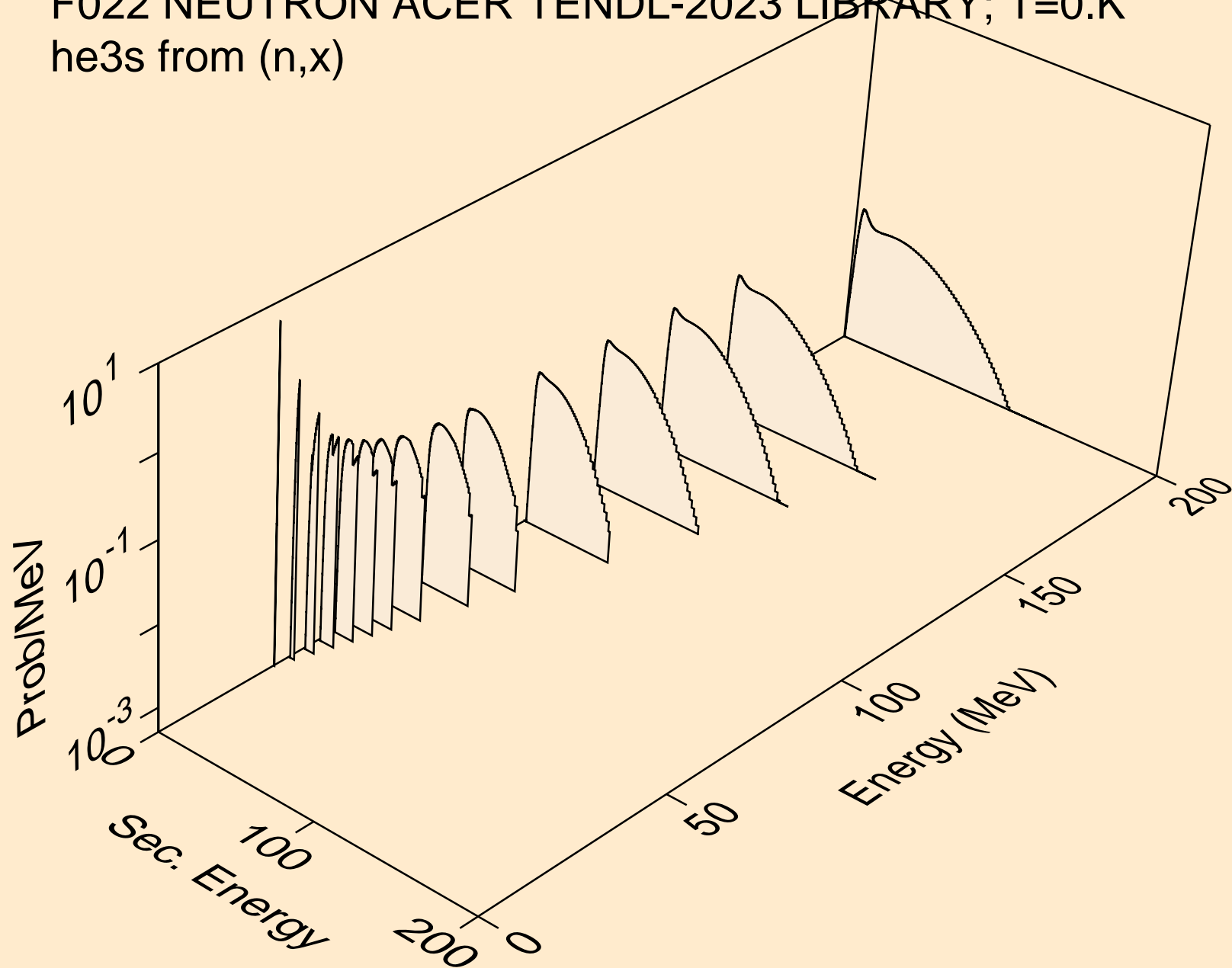

F022 NEUTRON ACER TENDL-2023 LIBRARY; T=0.K
he3s from (n,he3)

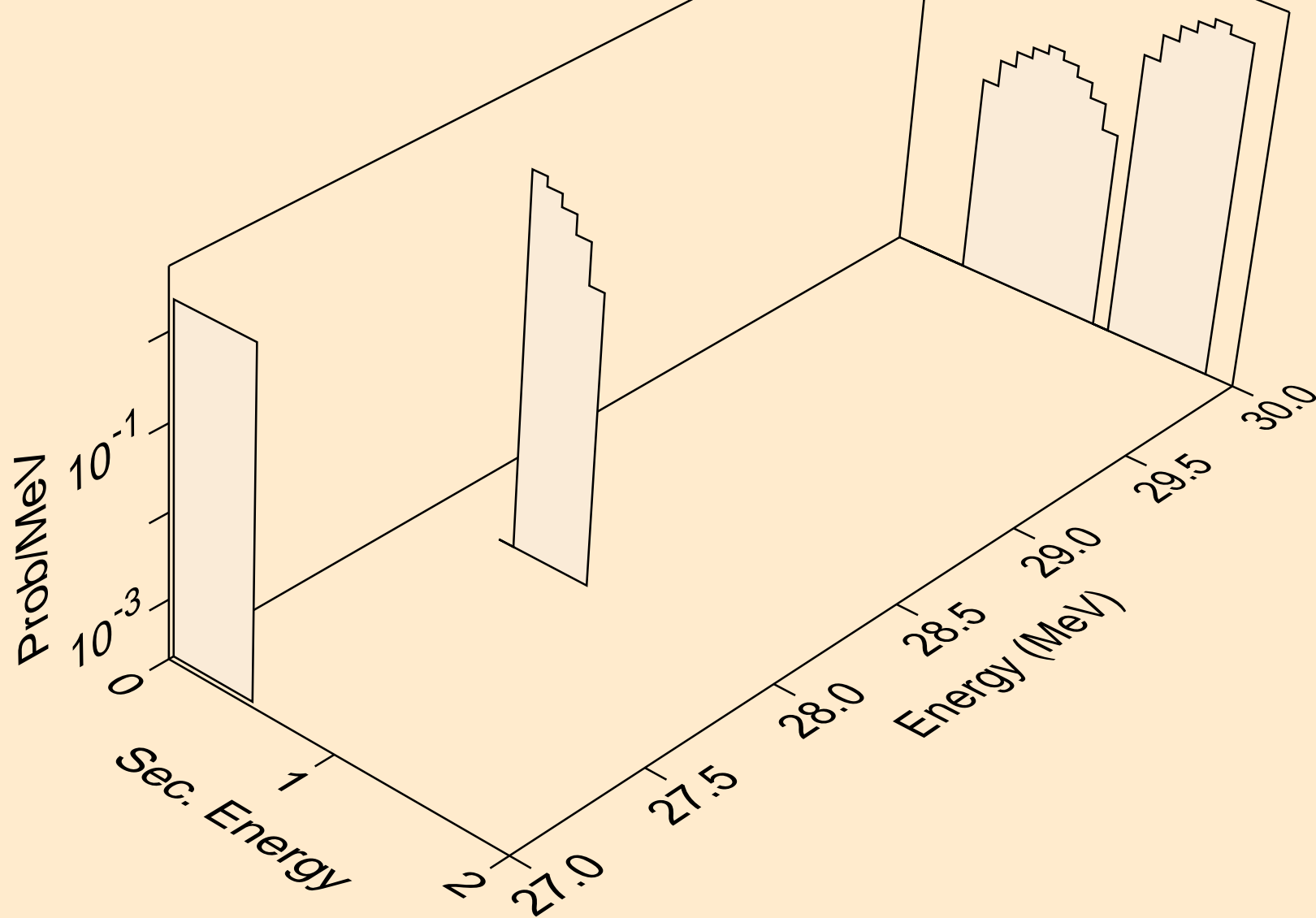

F022 NEUTRON ACER TENDL-2023 LIBRARY; T=0.K
alphas from (n,x)

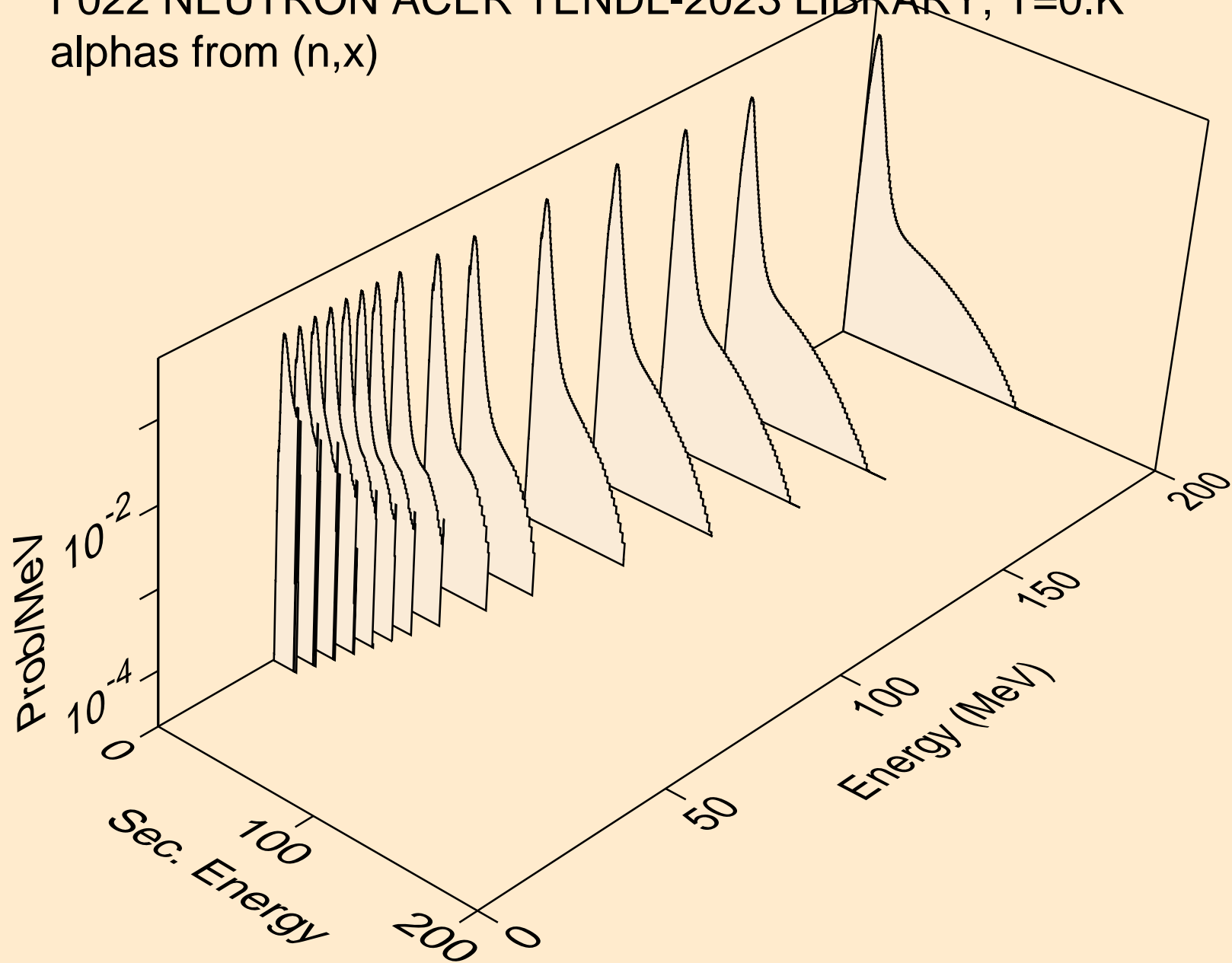

F022 NEUTRON ACER TENDL-2023 LIBRARY; T=0.K
alphas from (n,n*)a

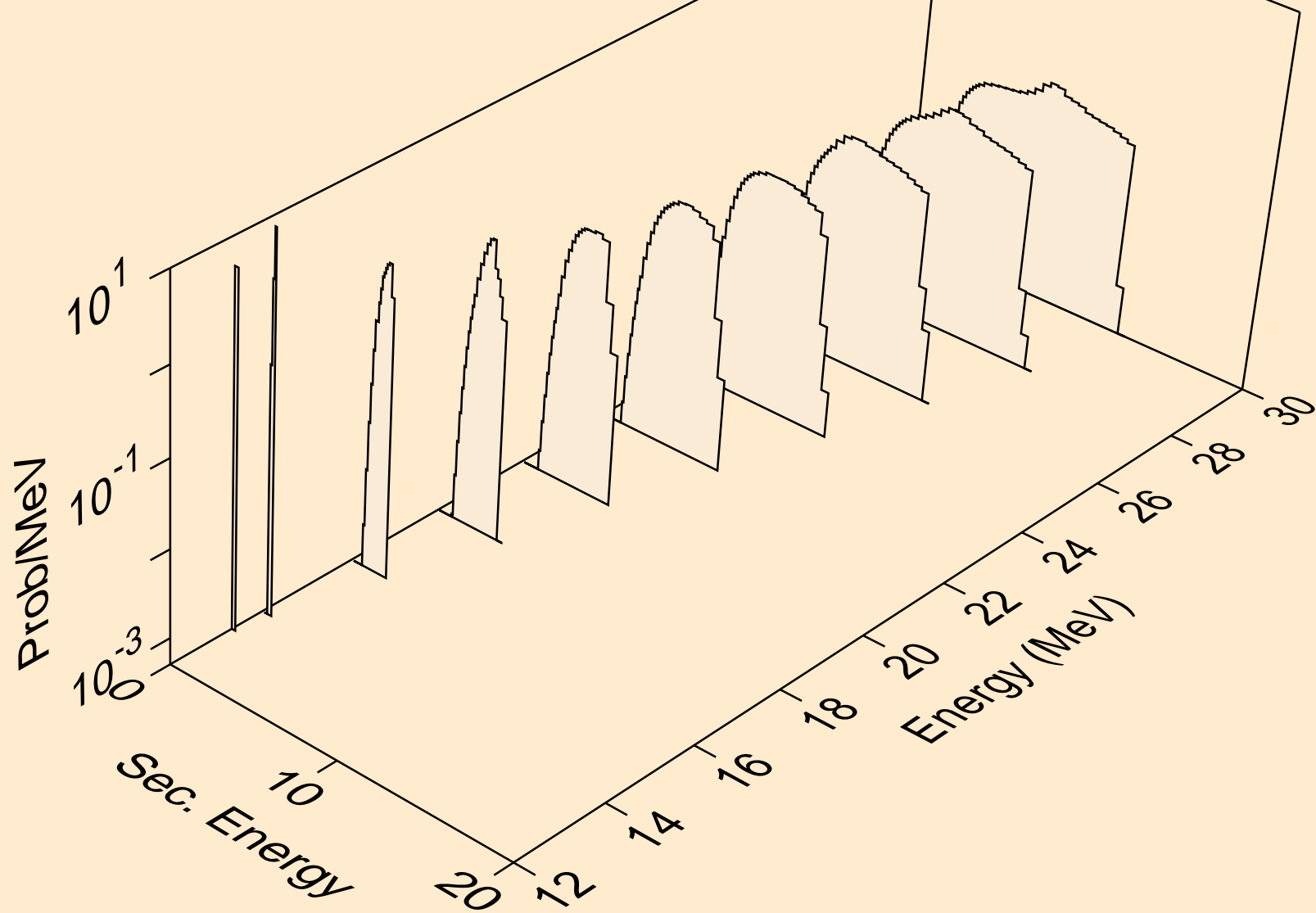

F022 NEUTRON ACER TENDL-2023 LIBRARY; T=0.K
alphas from (n,2n)a

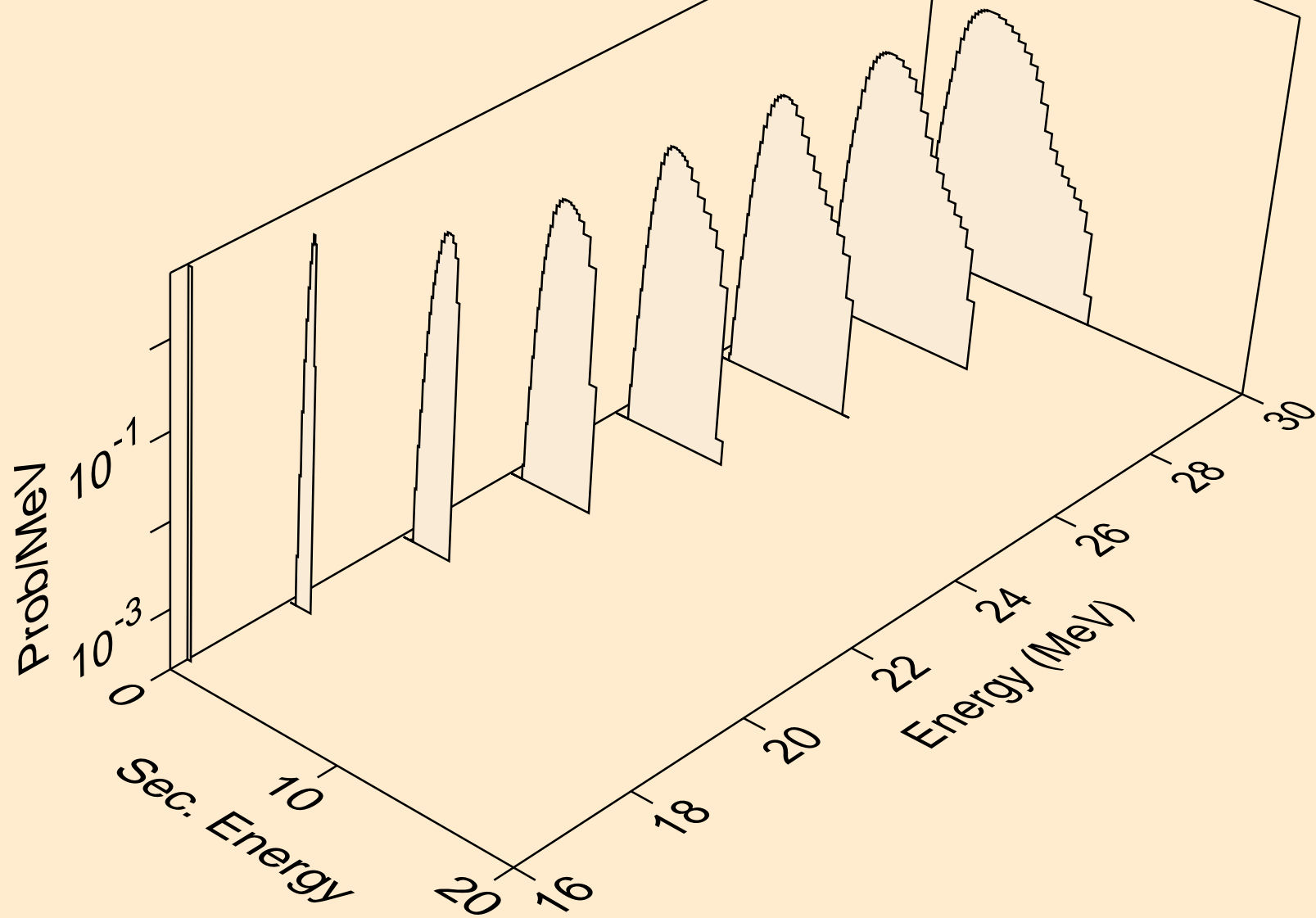

F022 NEUTRON ACER TENDL-2023 LIBRARY; T=0.K
alphas from (n,3n)a

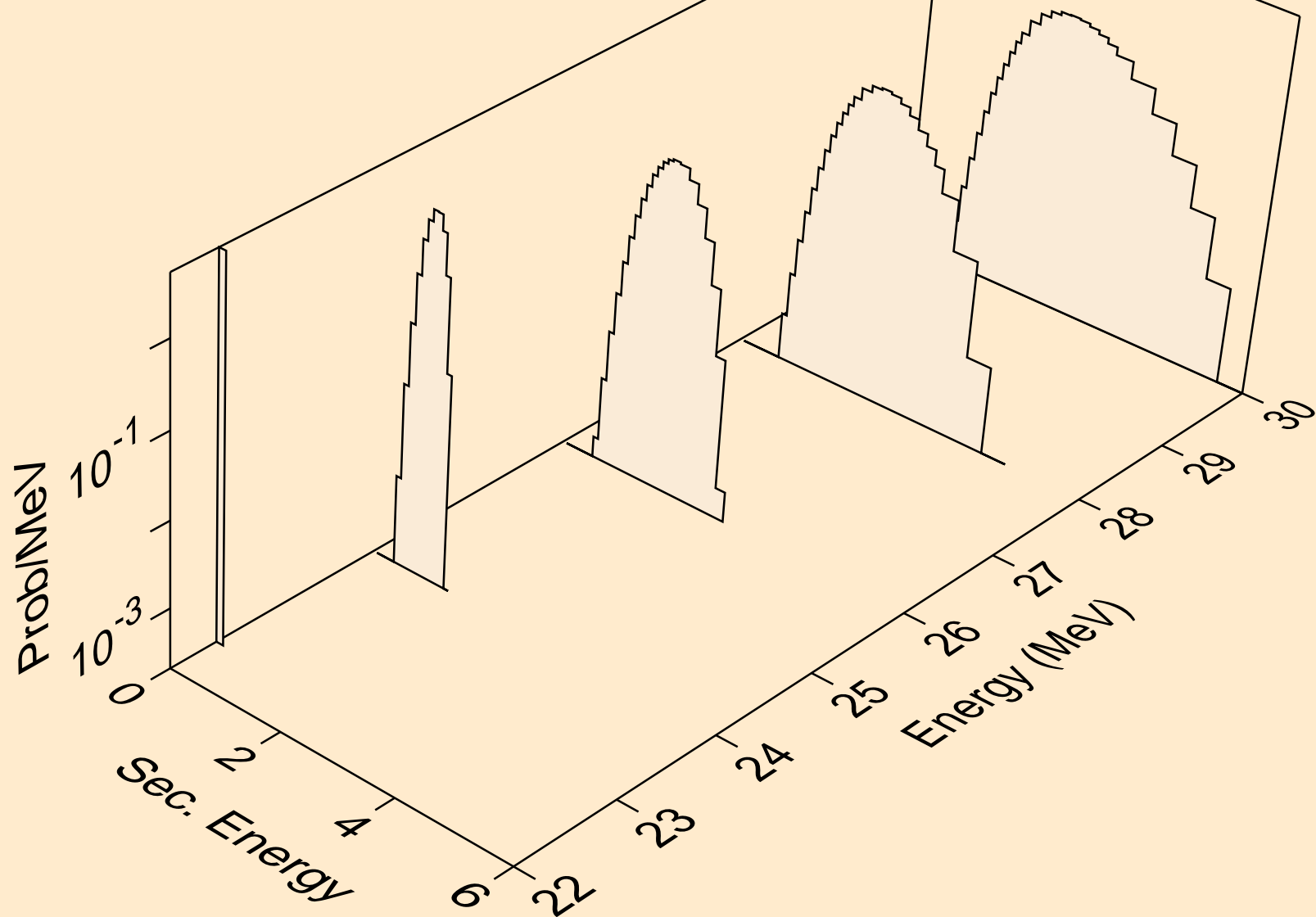

F022 NEUTRON ACER TENDL-2023 LIBRARY; T=0.K
alphas from (n,a)

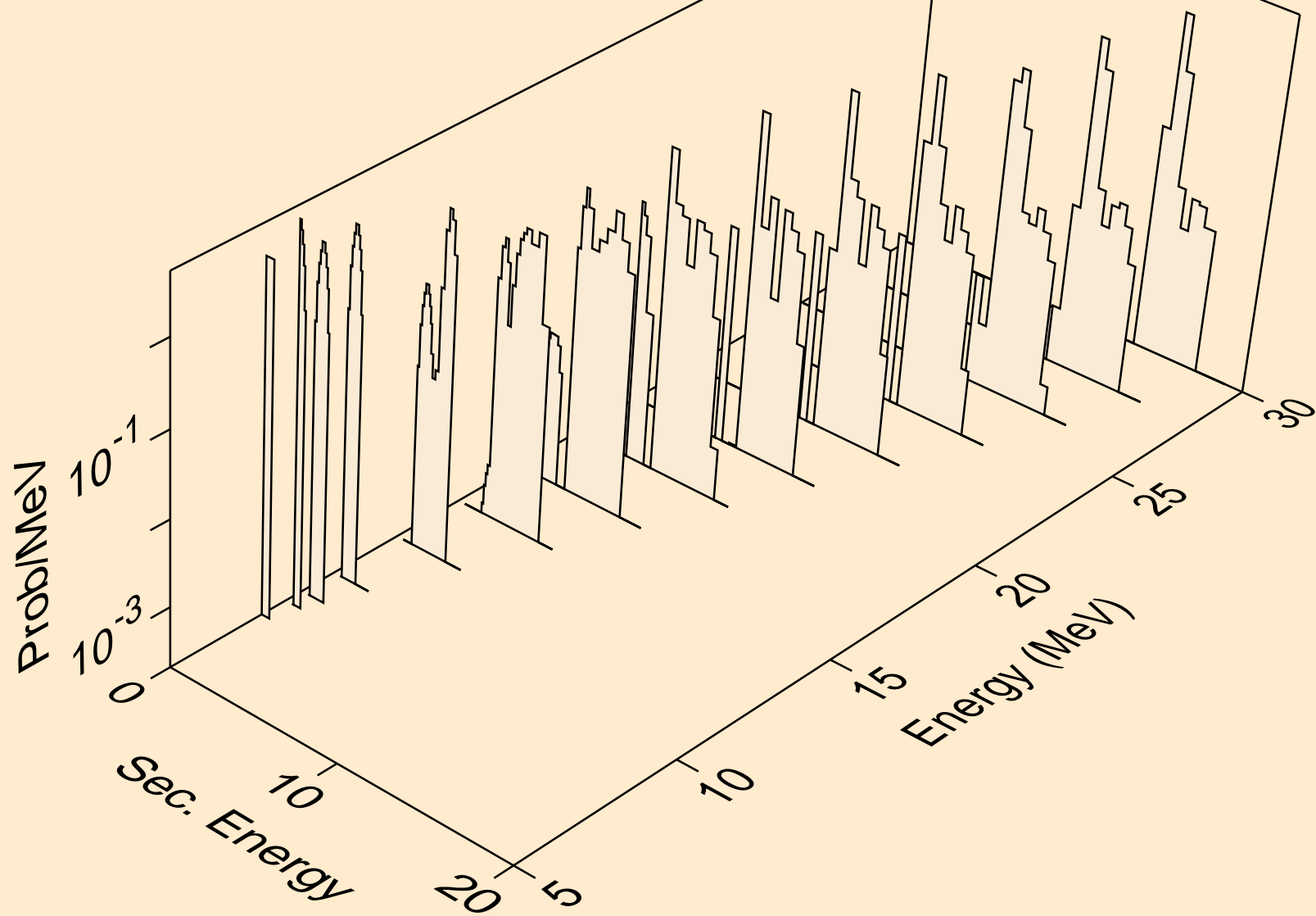

F022 NEUTRON ACER TENDL-2023 LIBRARY; T=0.K
alphas from (n,2a)

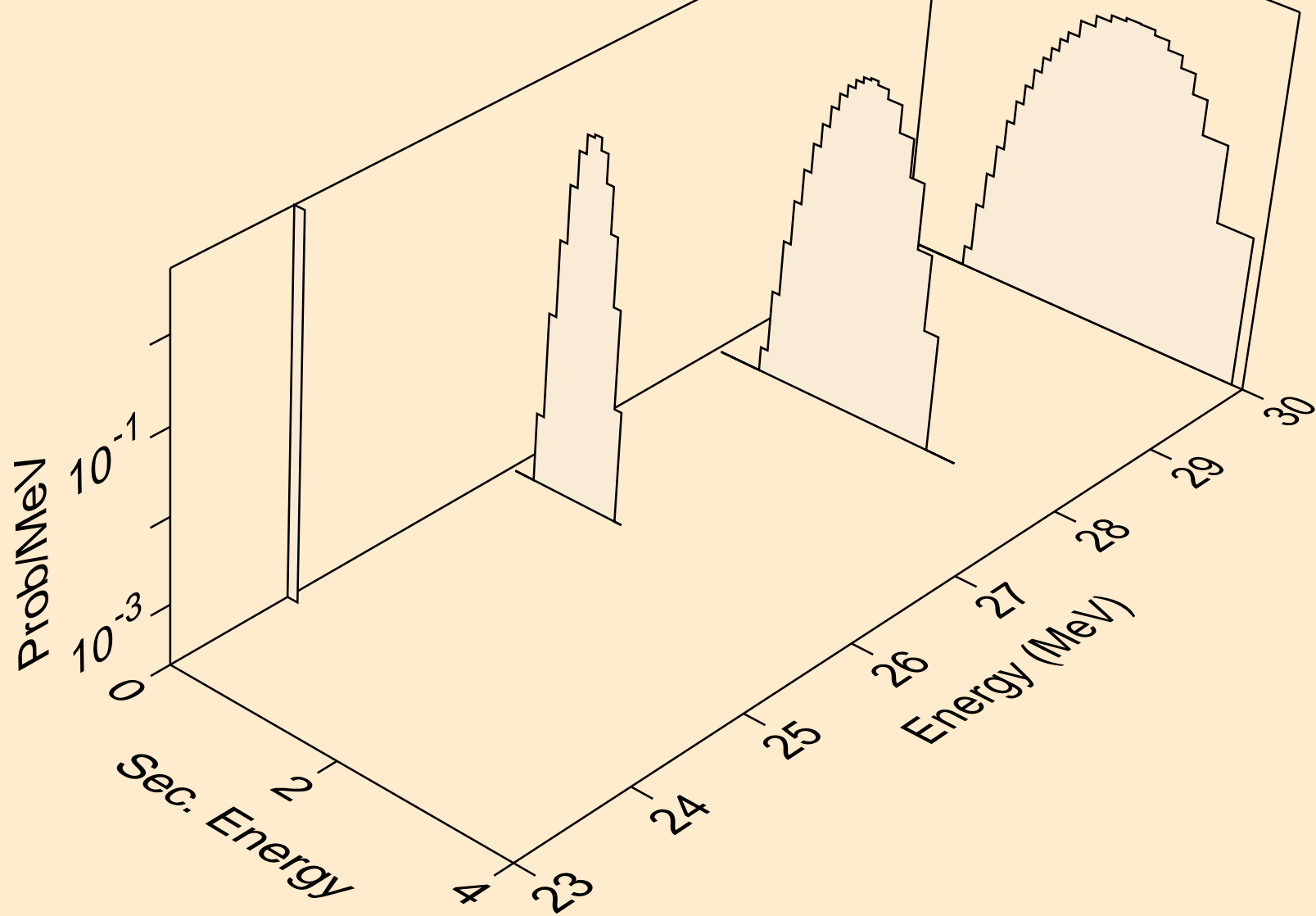

F022 NEUTRON ACER TENDL-2023 LIBRARY; T=0.K
alphas from (n,pa)

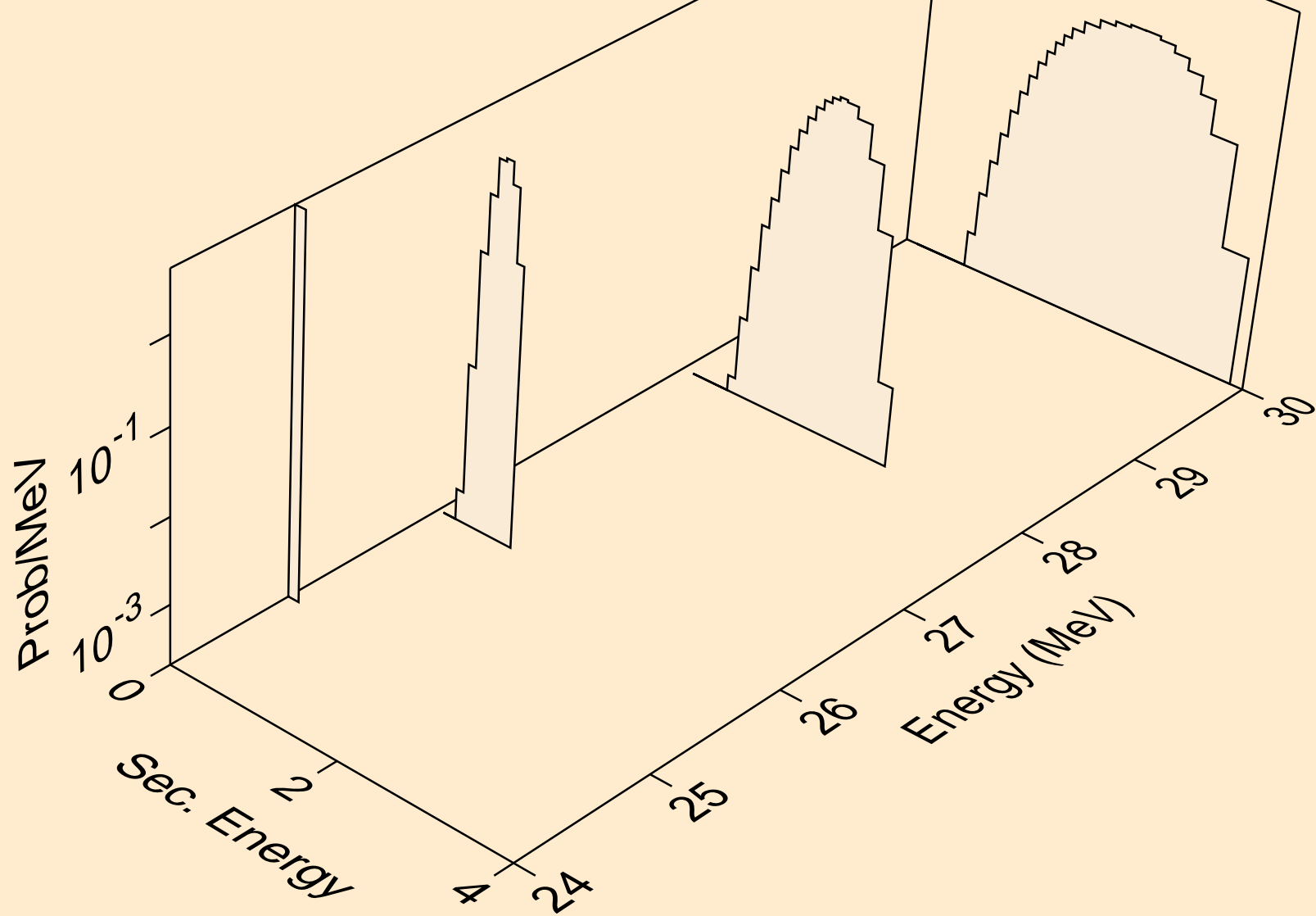

F022 NEUTRON ACER TENDL-2023 LIBRARY; T=0.K
alphas from (n,da)

