

# FE059 NEUTRON ACER TENDL-2023 LIBRARY; T=0.K

## Principal cross sections

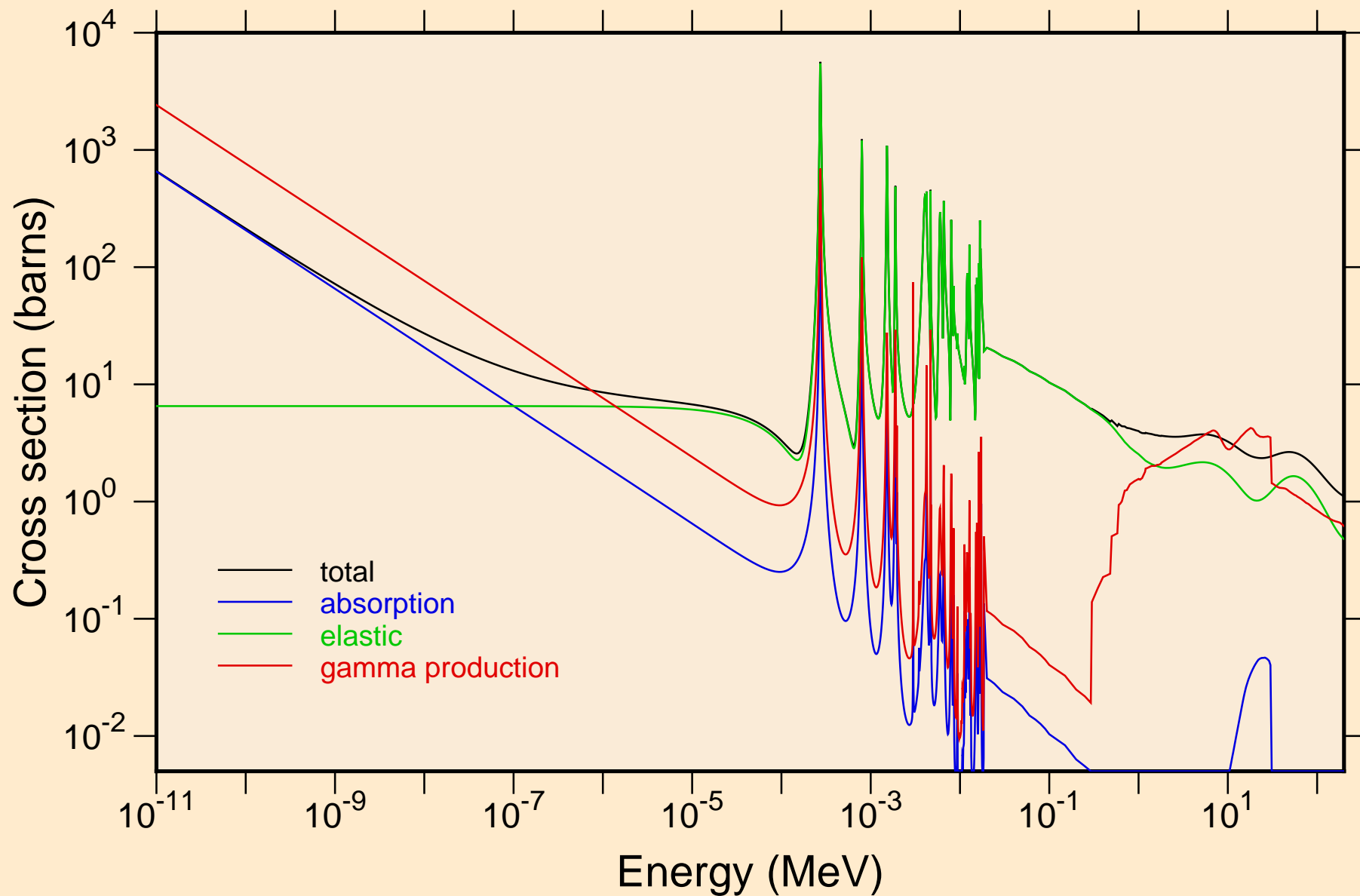

FE059 NEUTRON ACER TENDL-2023 LIBRARY; T=0.K  
resonance total cross section

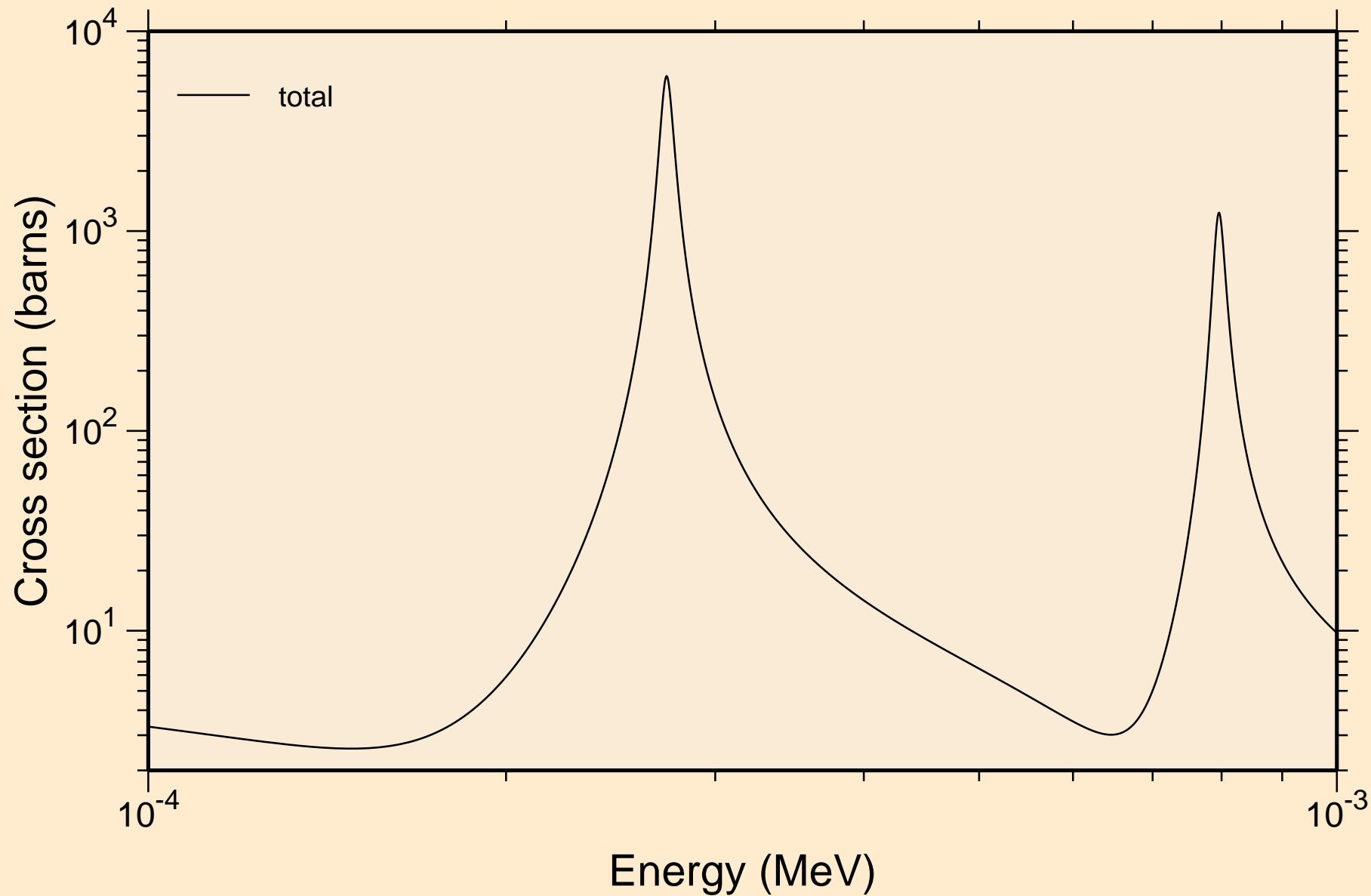

FE059 NEUTRON ACER TENDL-2023 LIBRARY; T=0.K  
resonance total cross section

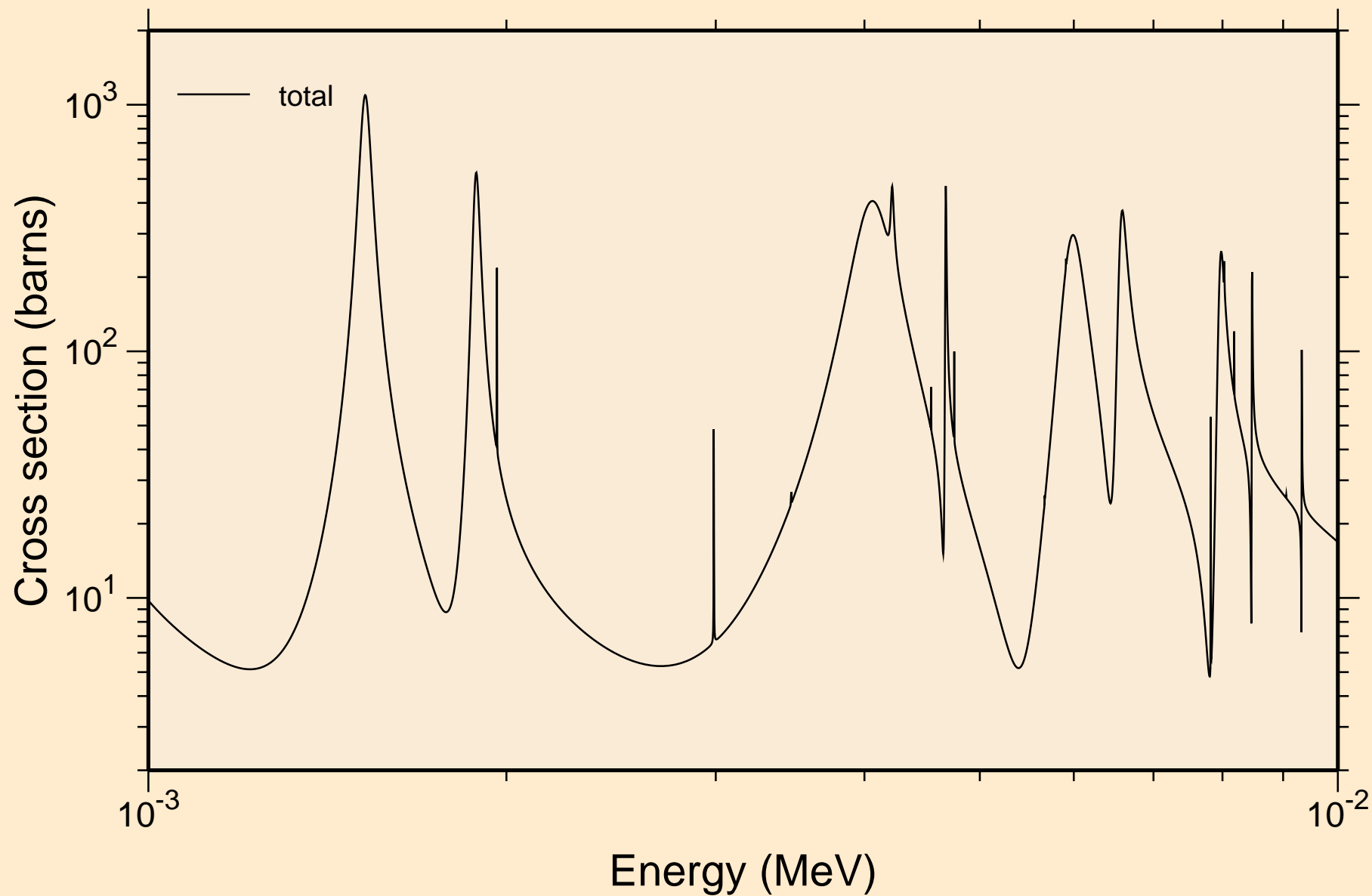

FE059 NEUTRON ACER TENDL-2023 LIBRARY; T=0.K  
resonance total cross section

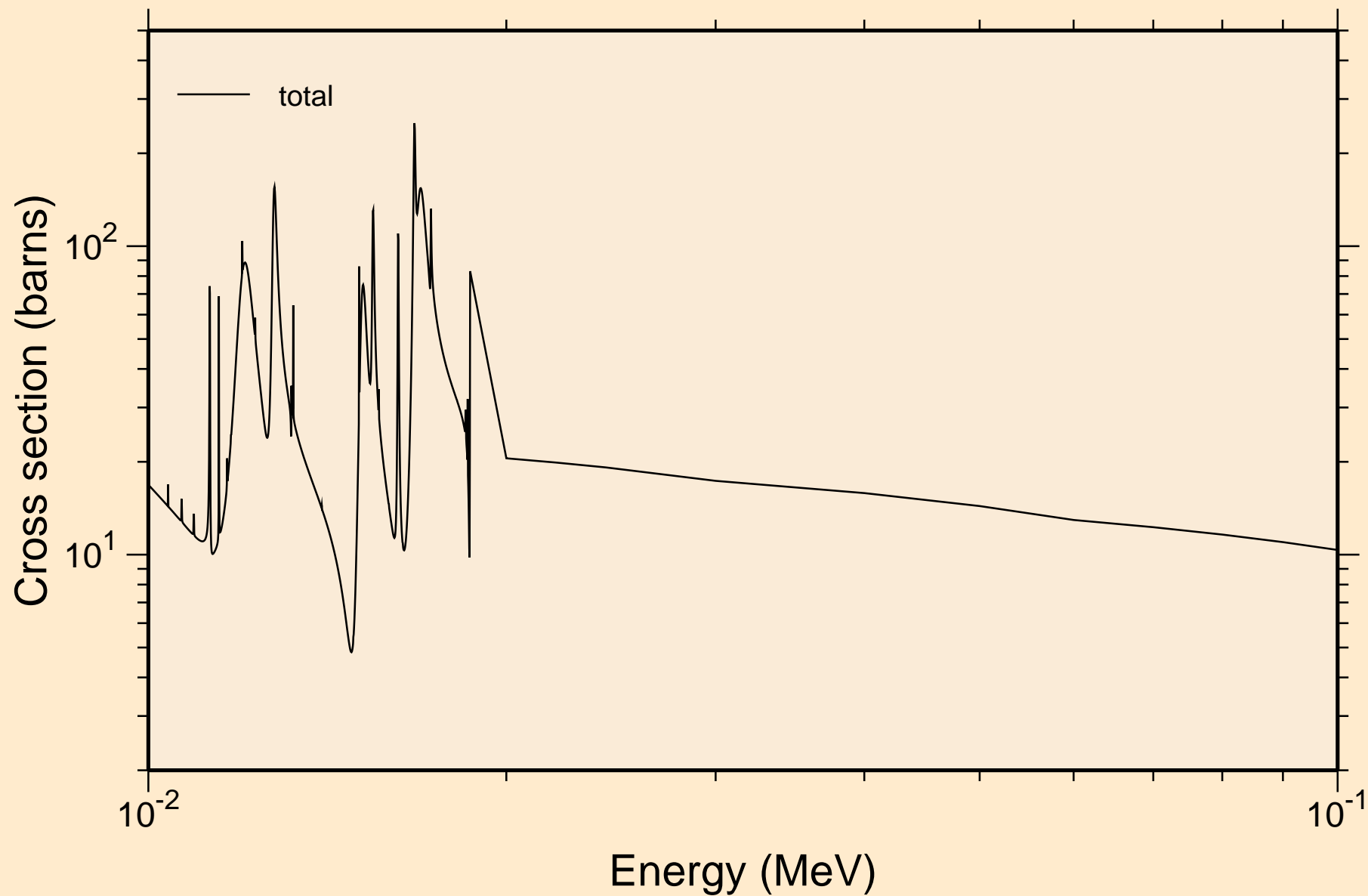

FE059 NEUTRON ACER TENDL-2023 LIBRARY; T=0.K  
resonance total cross section

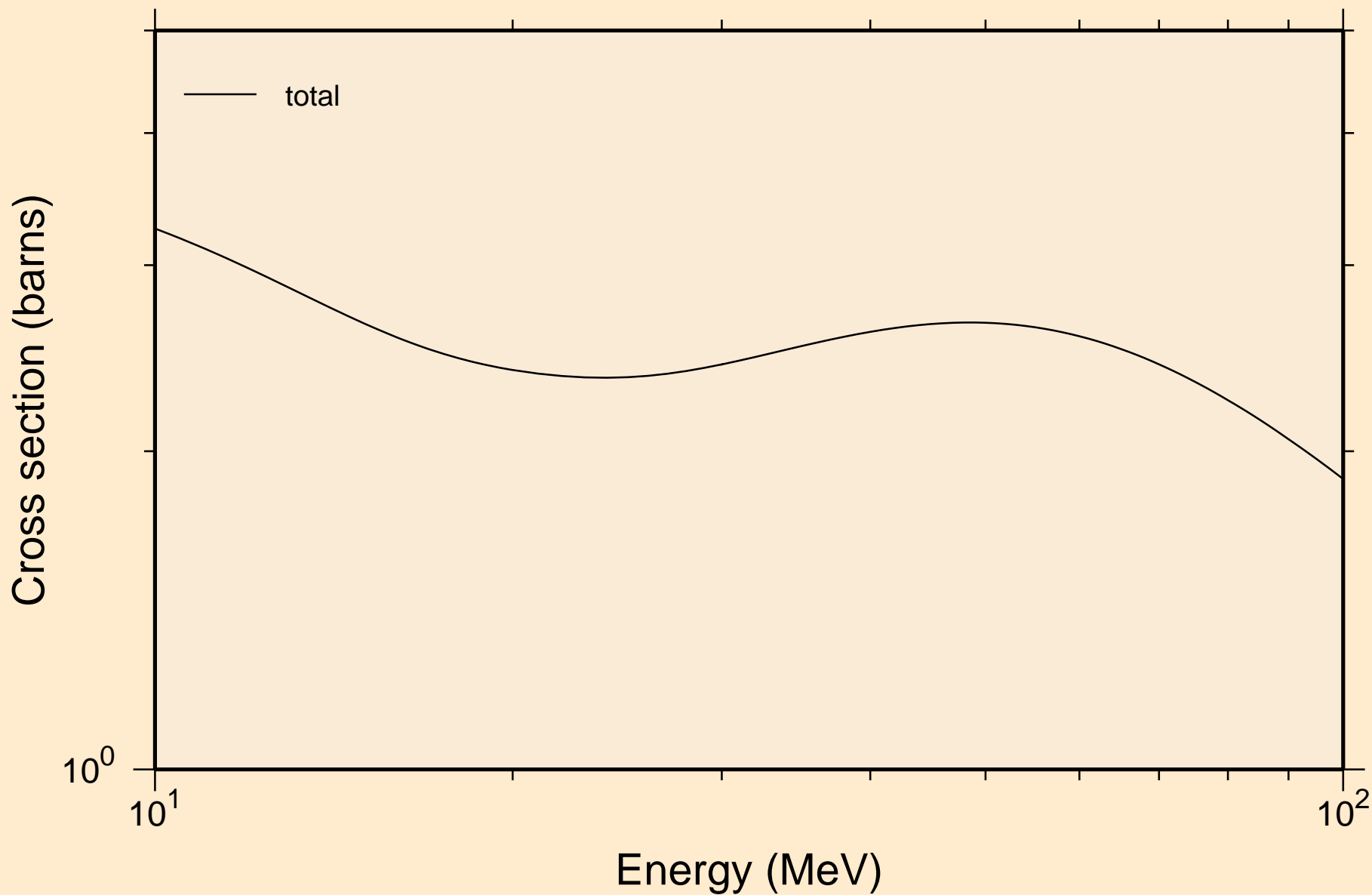

FE059 NEUTRON ACER TENDL-2023 LIBRARY; T=0.K  
resonance absorption cross sections

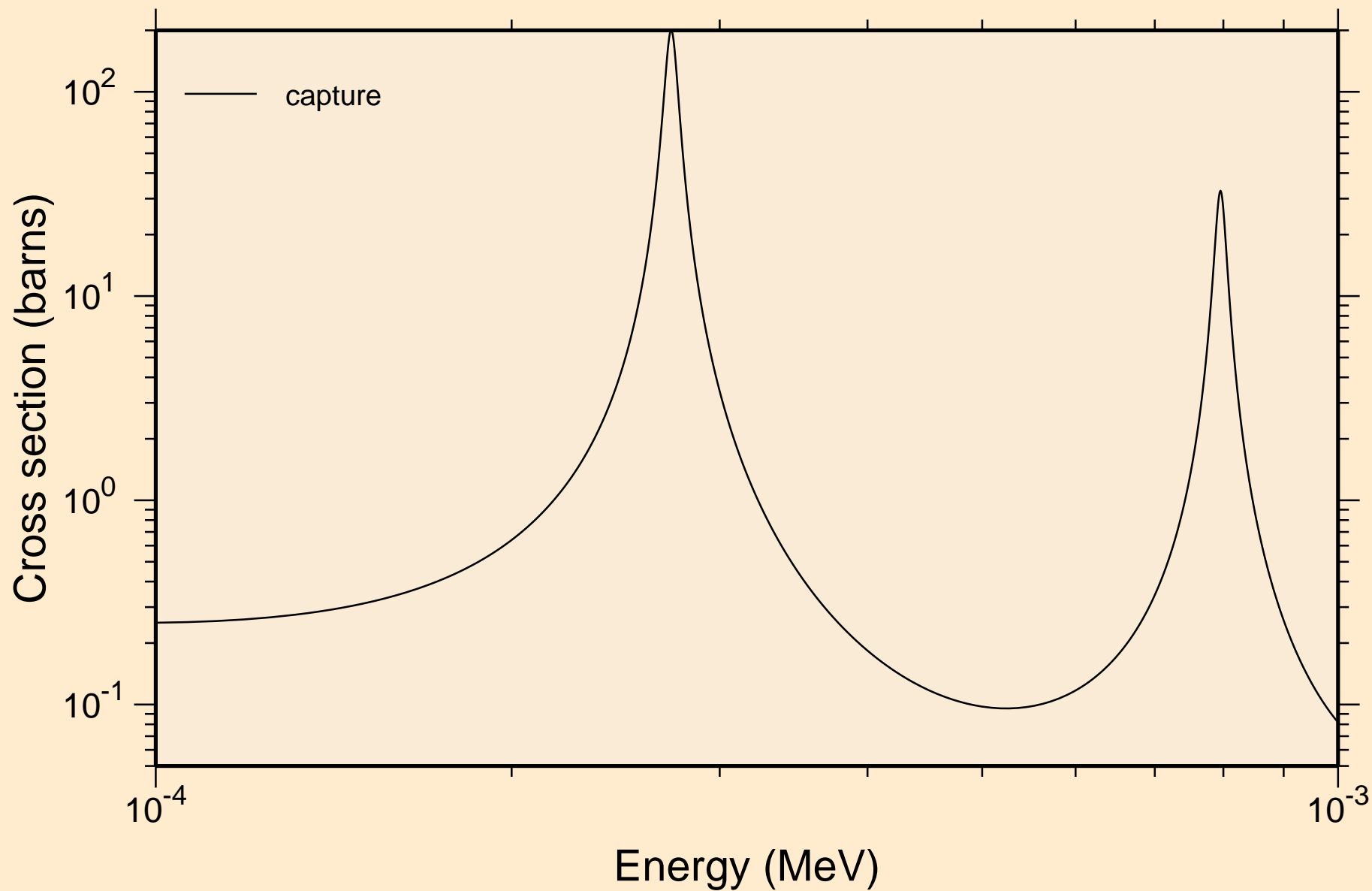

FE059 NEUTRON ACER TENDL-2023 LIBRARY; T=0.K  
resonance absorption cross sections

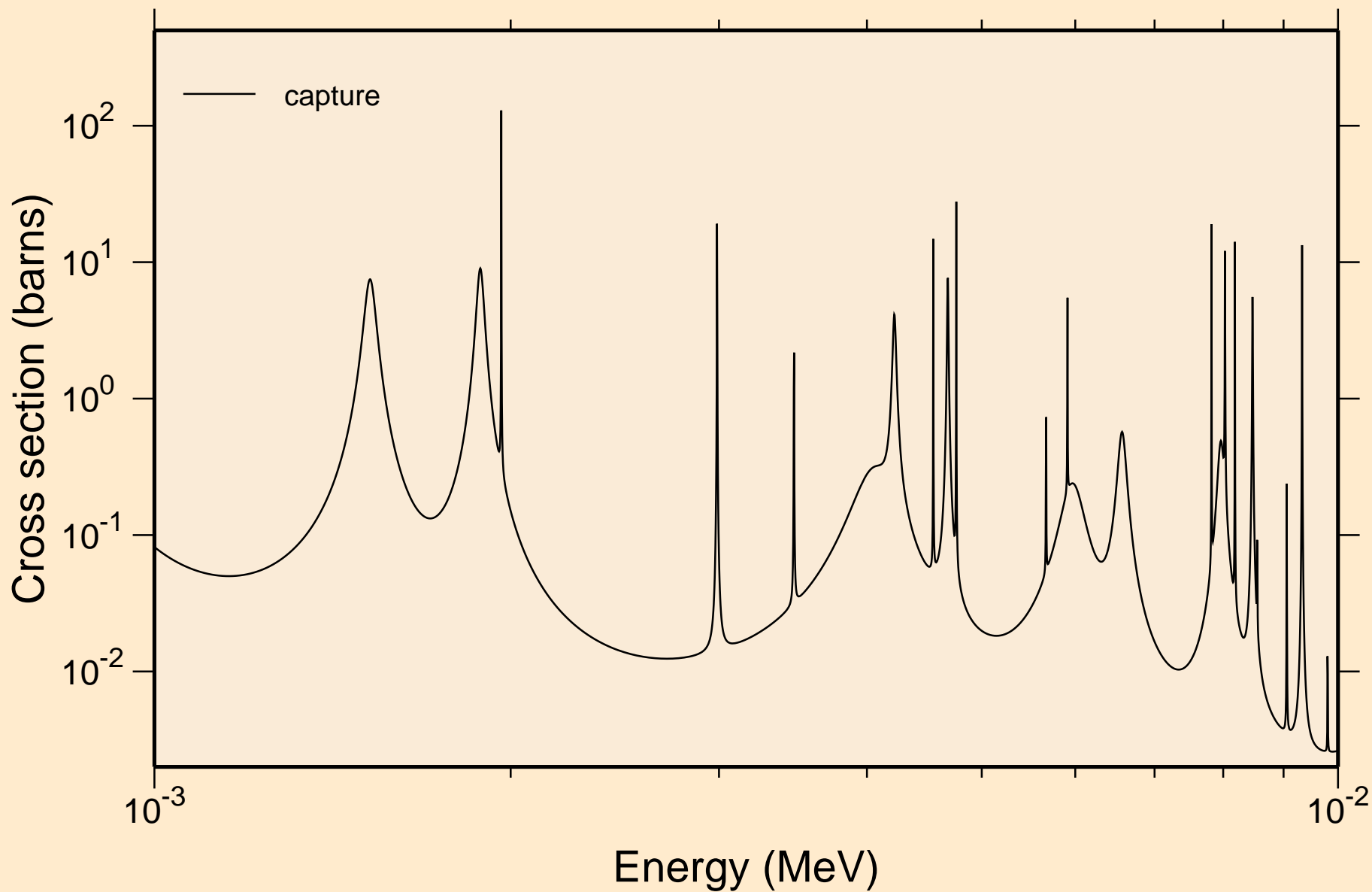

FE059 NEUTRON ACER TENDL-2023 LIBRARY; T=0.K  
resonance absorption cross sections

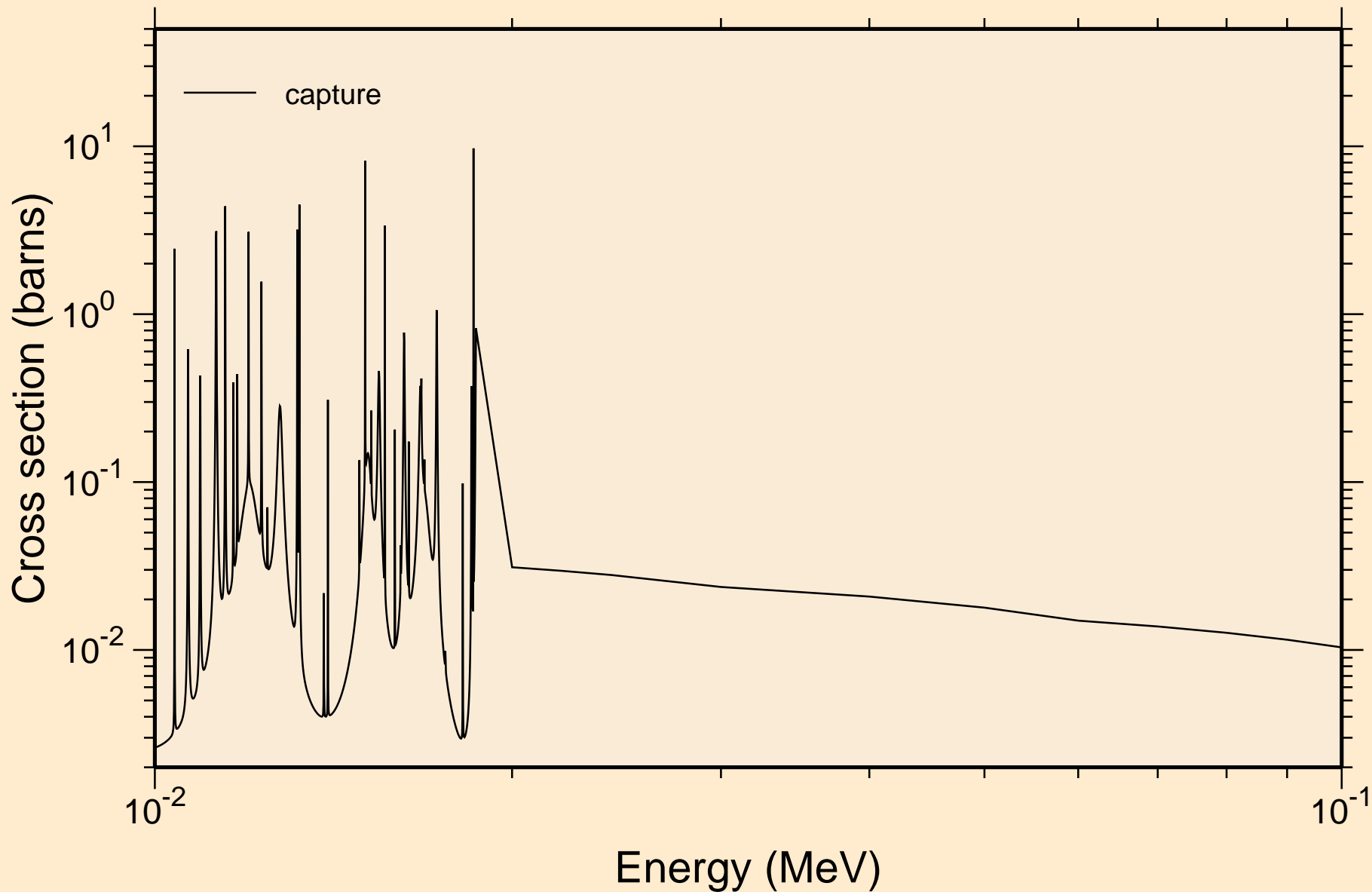



FE059 NEUTRON ACER TENDL-2023 LIBRARY; T=0.K  
resonance absorption cross sections

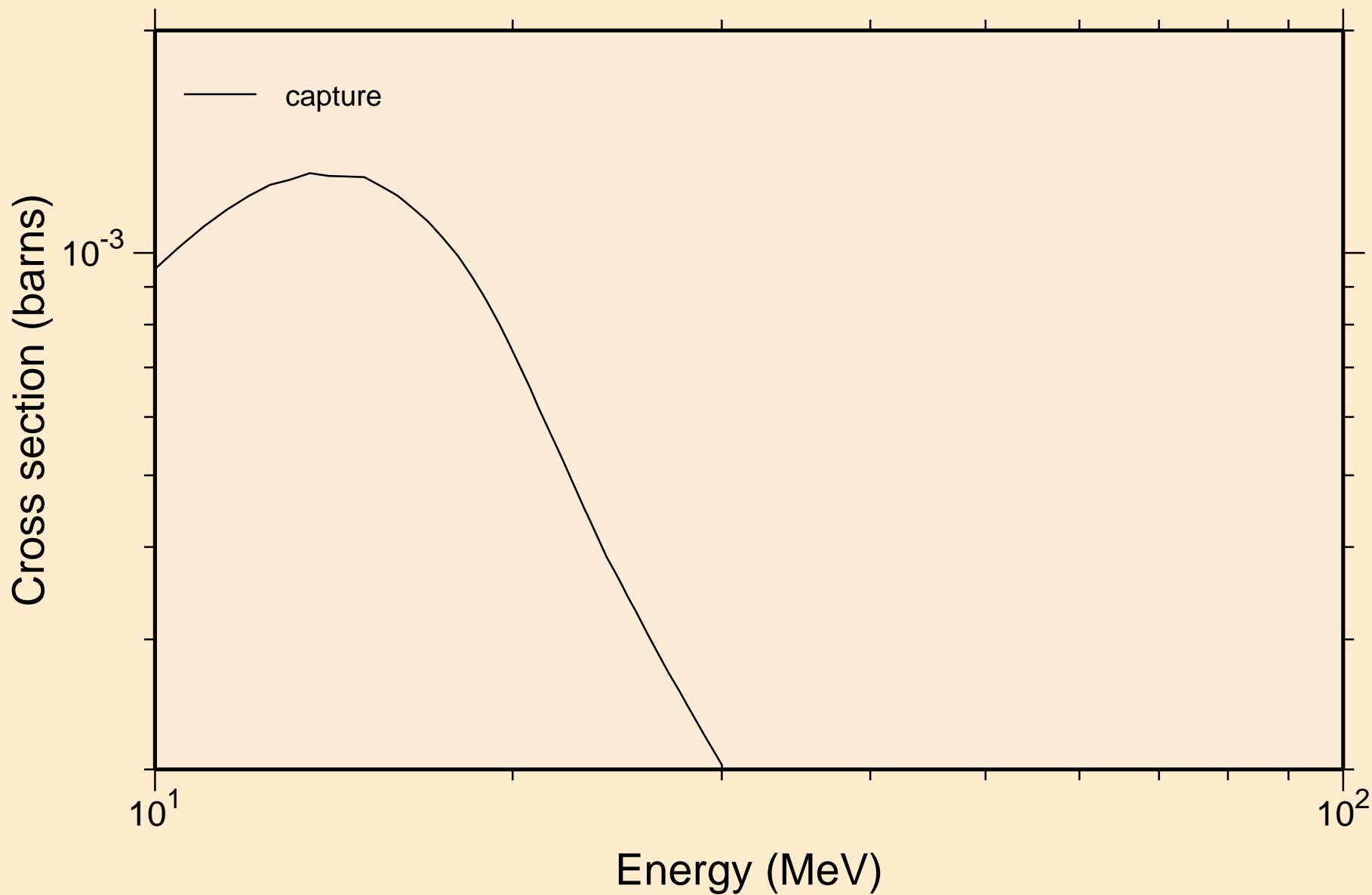

FE059 NEUTRON ACER TENDL-2023 LIBRARY; T=0.K  
Heating

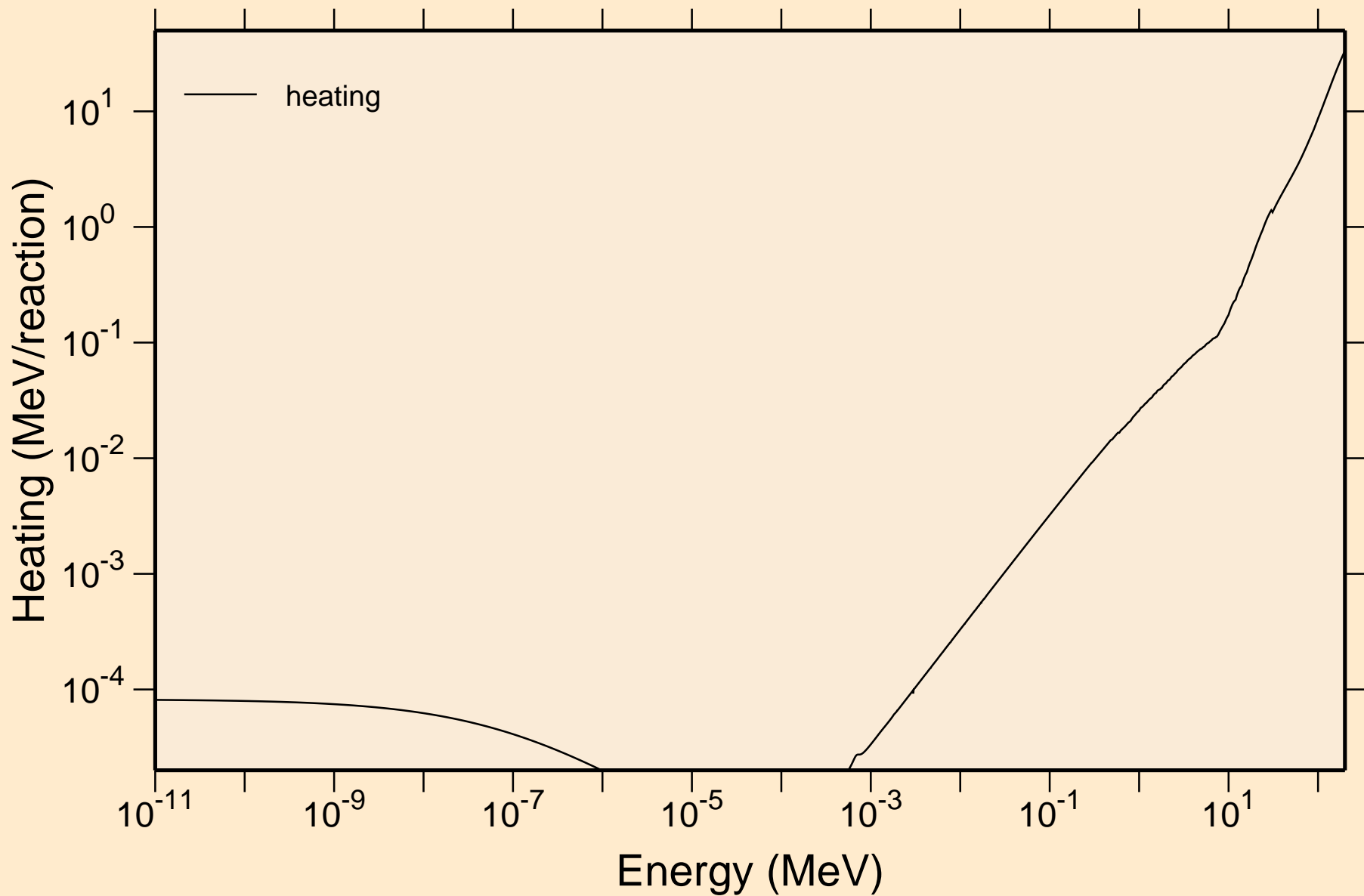

FE059 NEUTRON ACER TENDL-2023 LIBRARY; T=0.K  
Damage

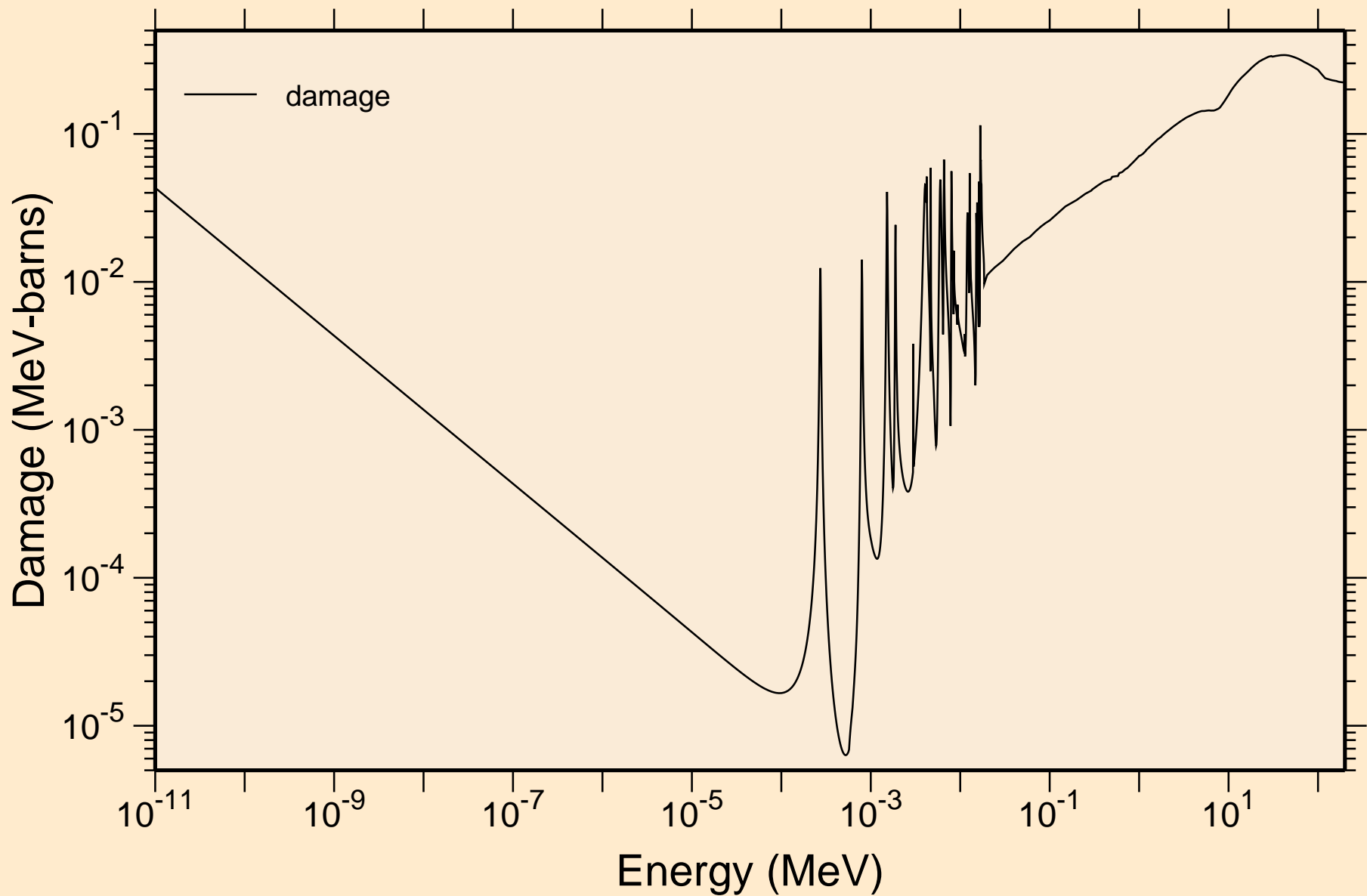

FE059 NEUTRON ACER TENDL-2023 LIBRARY; T=0.K  
Non-threshold reactions

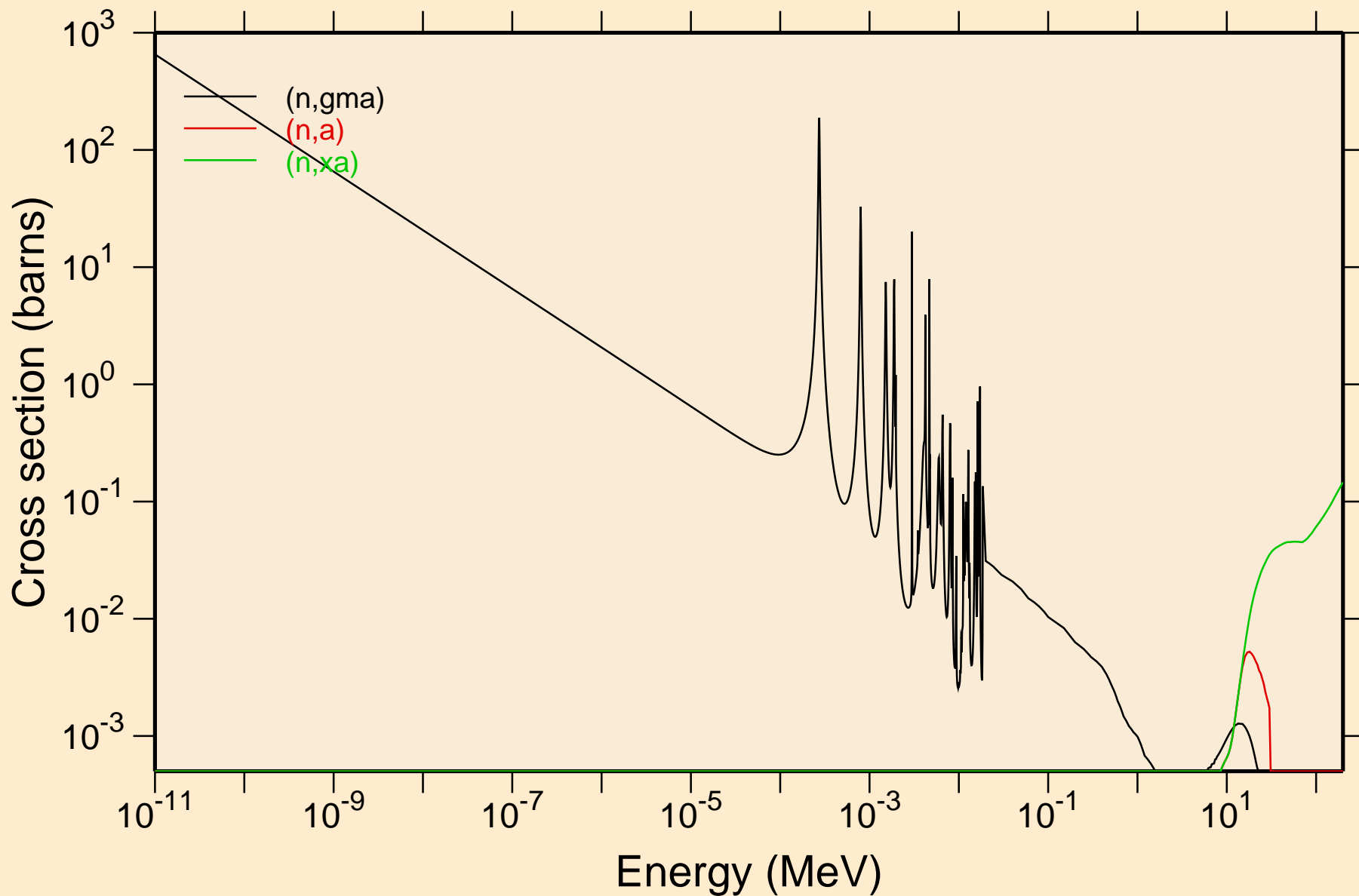

# FE059 NEUTRON ACER TENDL-2023 LIBRARY; T=0.K

## Principal cross sections

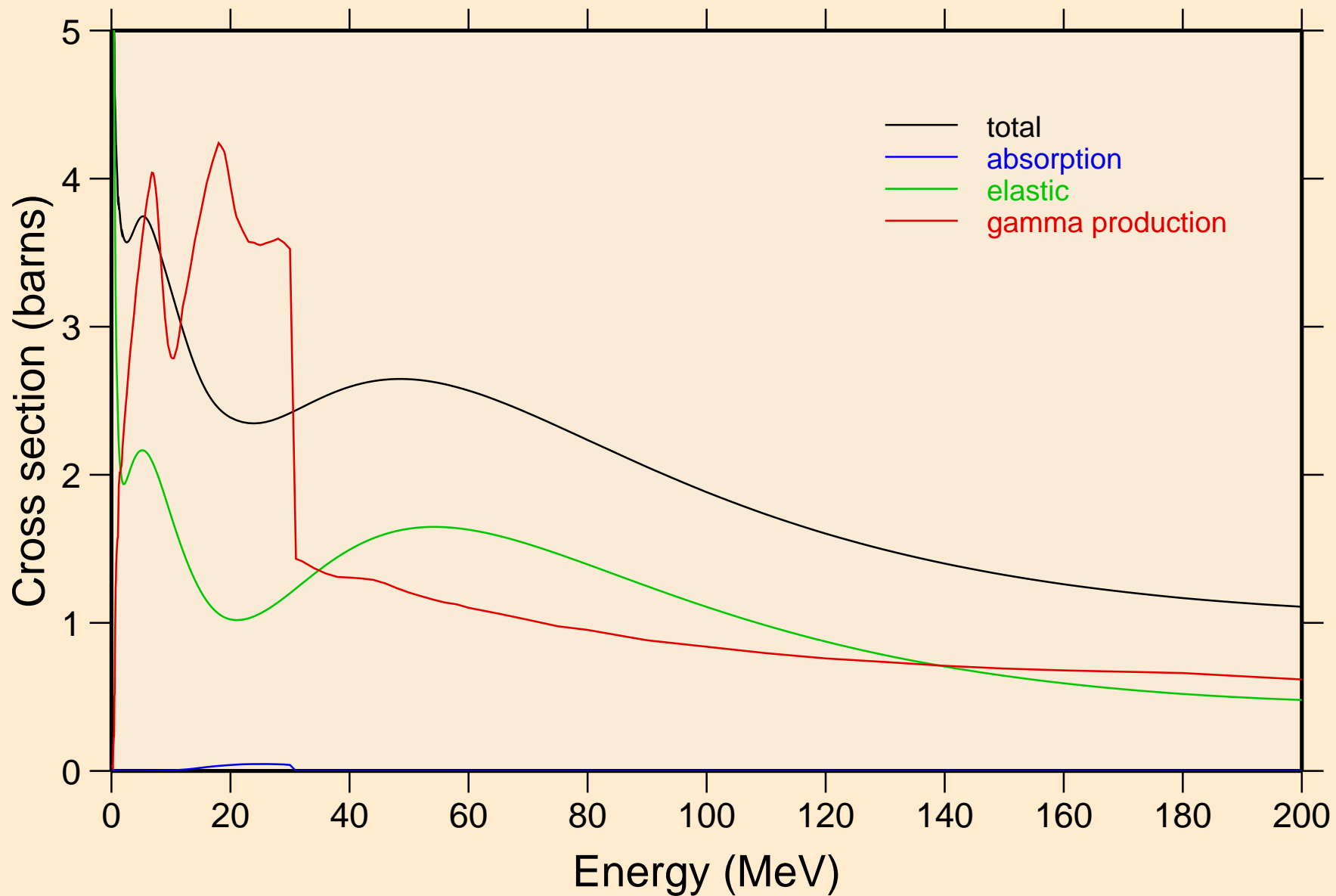

FE059 NEUTRON ACER TENDL-2023 LIBRARY; T=0.K  
Heating

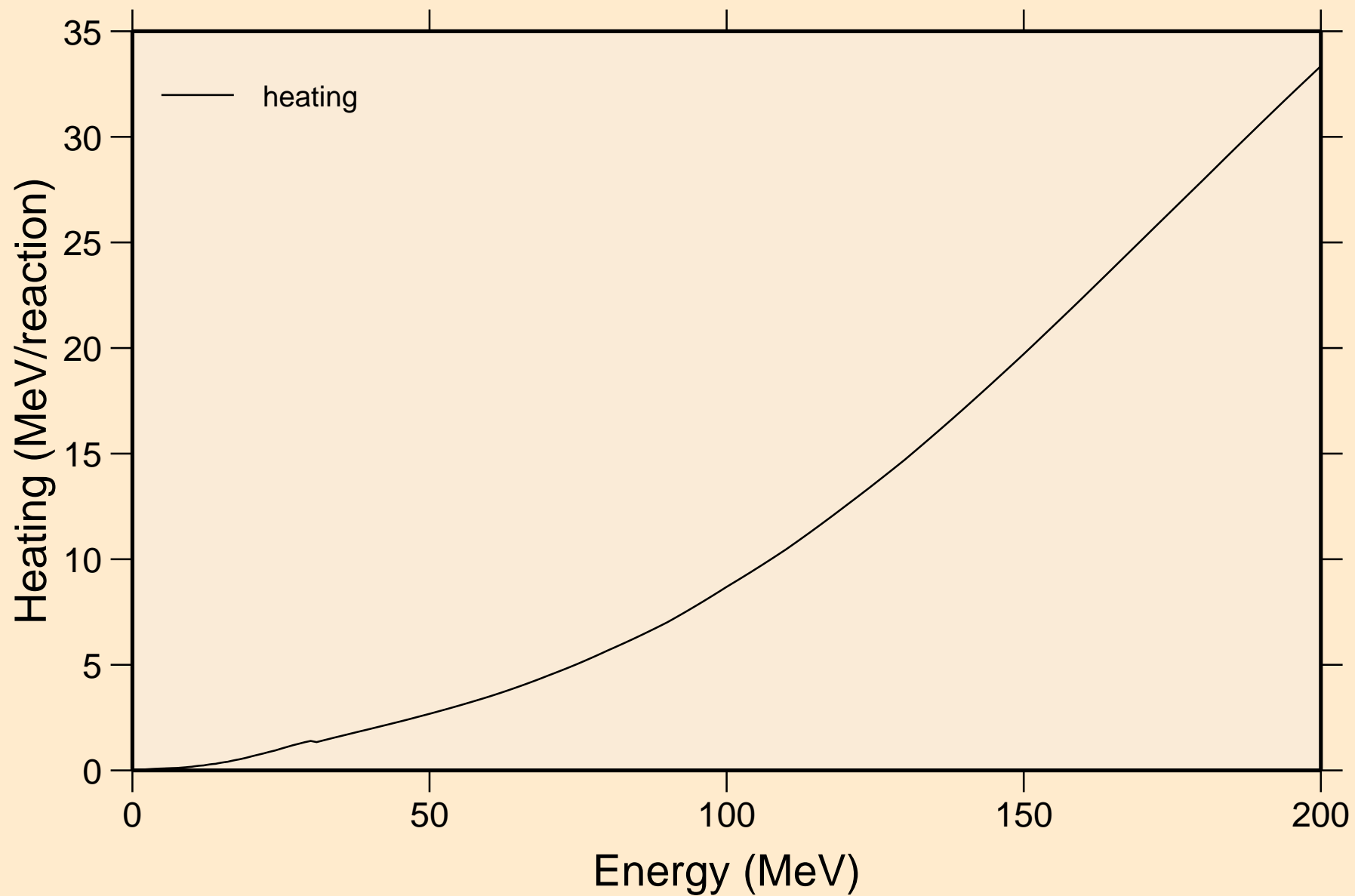

FE059 NEUTRON ACER TENDL-2023 LIBRARY; T=0.K  
Damage

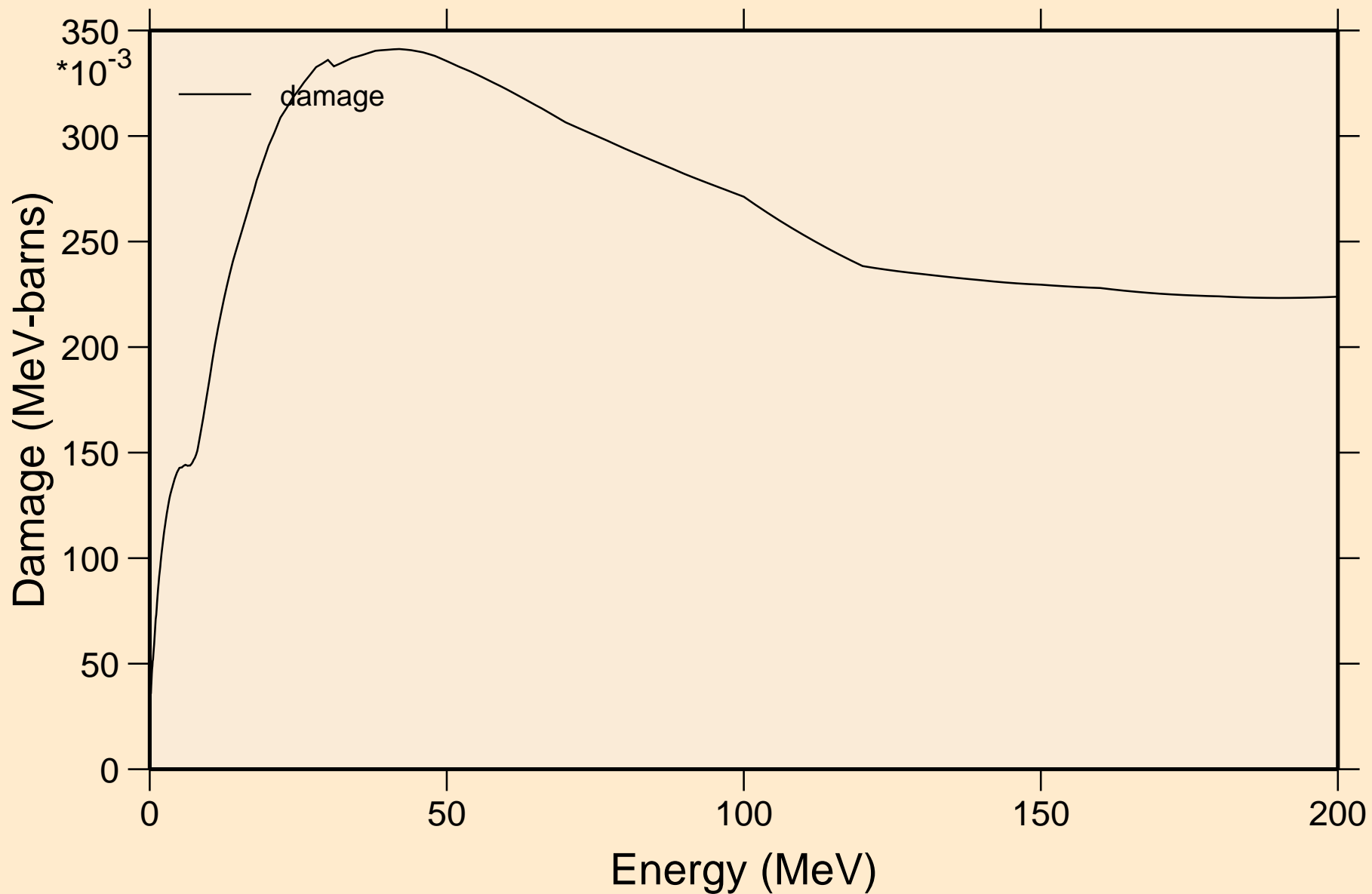

FE059 NEUTRON ACER TENDL-2023 LIBRARY; T=0.K  
Non-threshold reactions

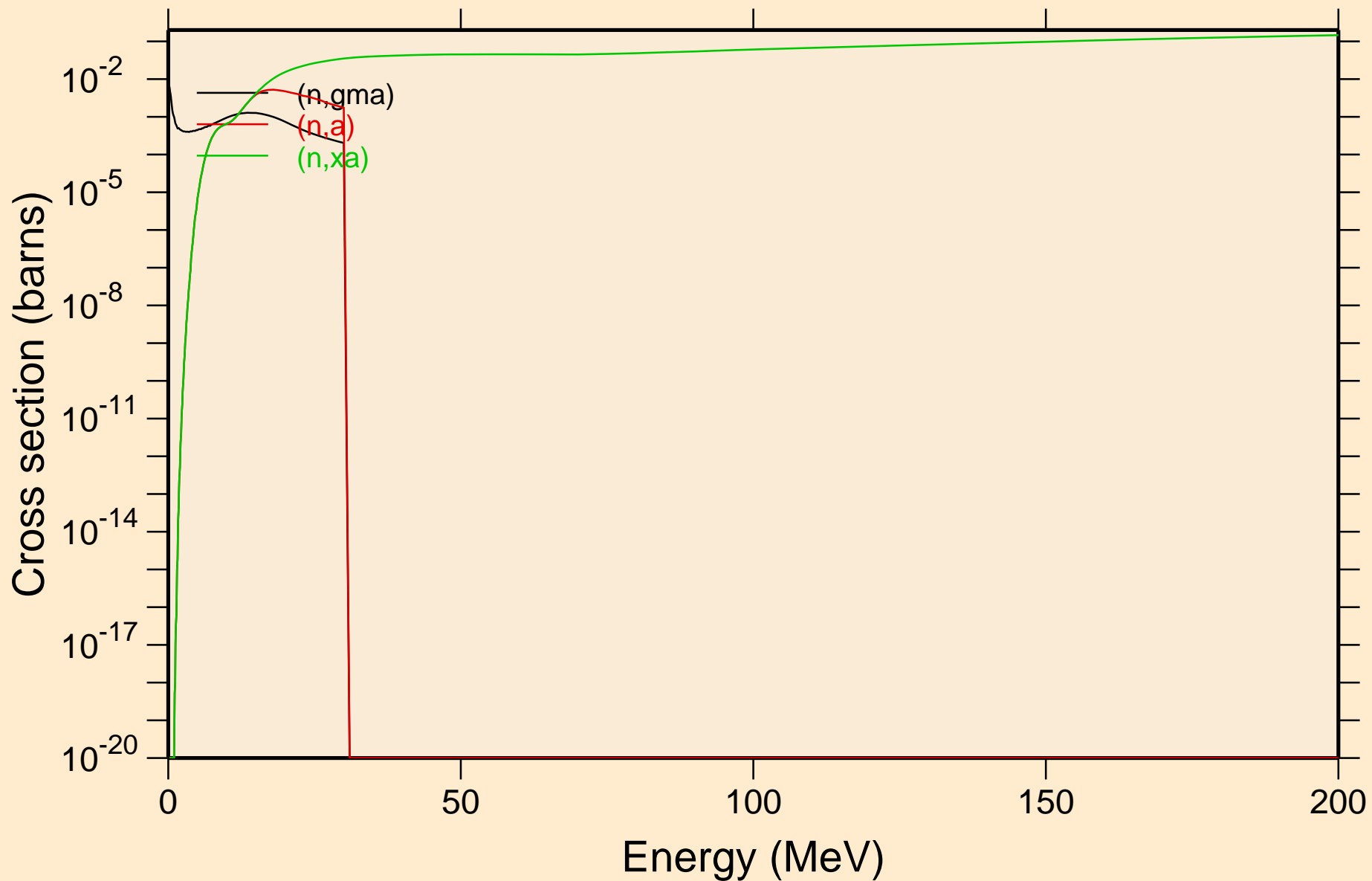



FE059 NEUTRON ACER TENDL-2023 LIBRARY; T=0.K  
Inelastic levels

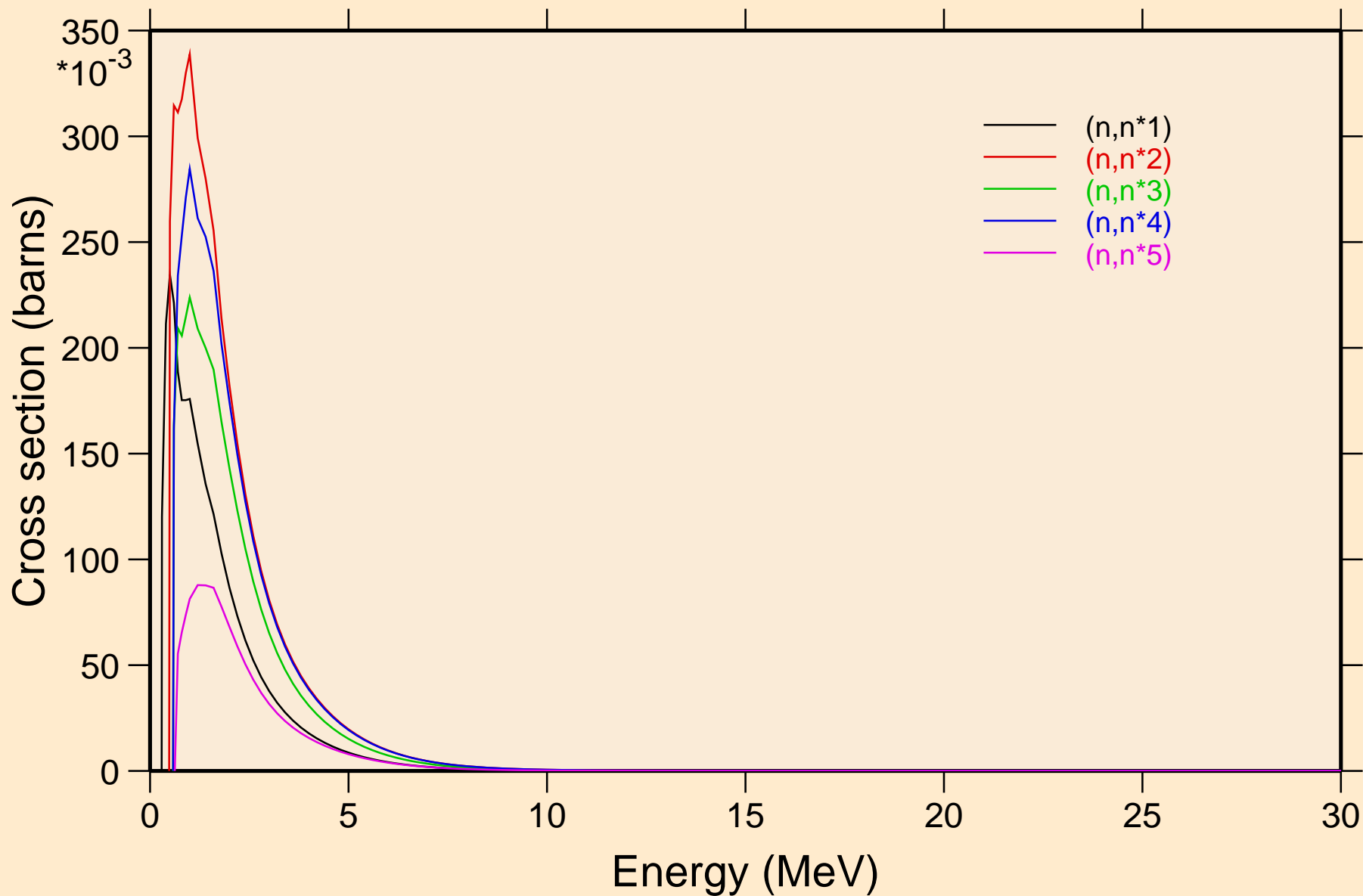

FE059 NEUTRON ACER TENDL-2023 LIBRARY; T=0.K  
Inelastic levels

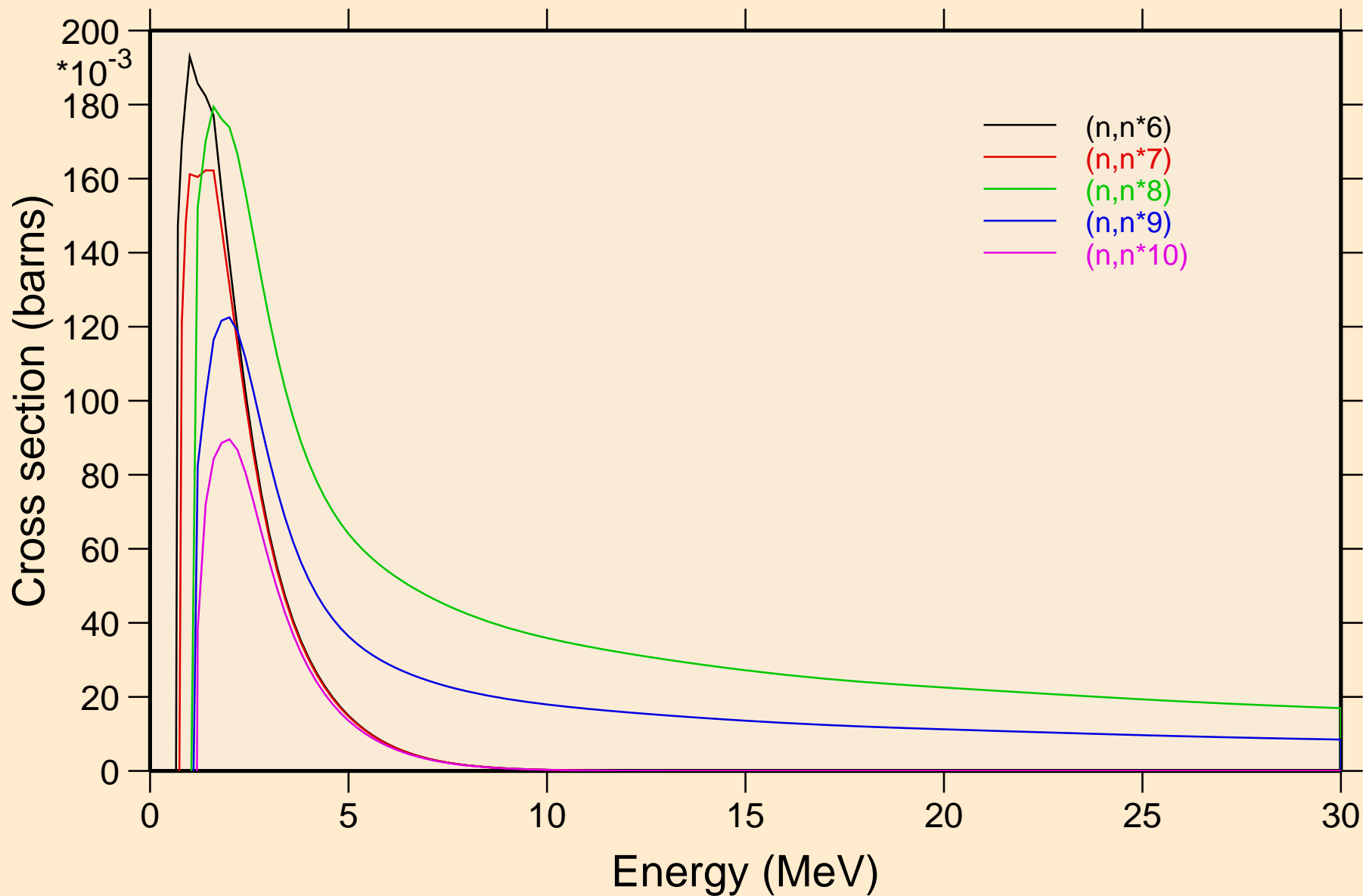

FE059 NEUTRON ACER TENDL-2023 LIBRARY; T=0.K  
Inelastic levels

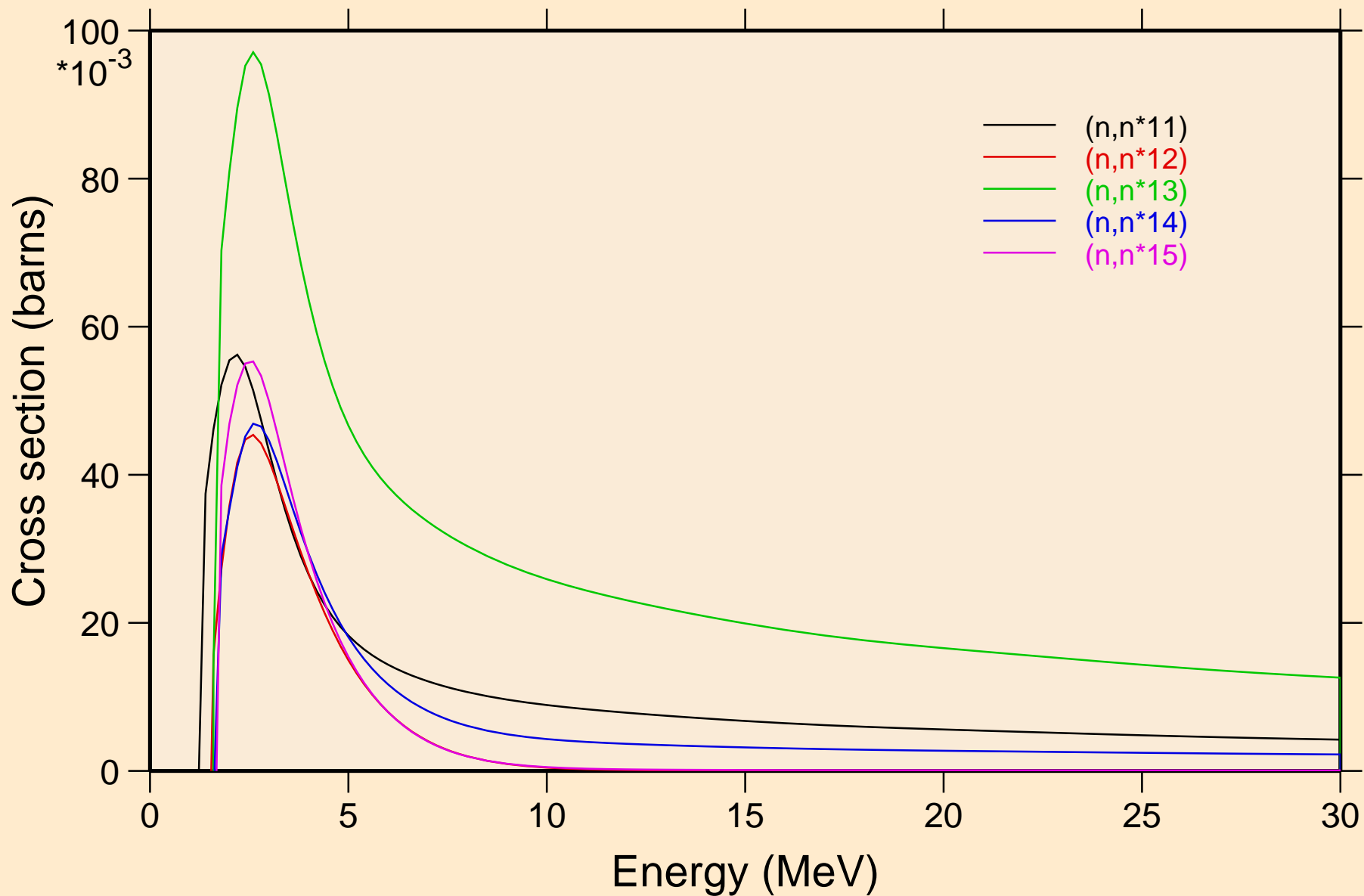

FE059 NEUTRON ACER TENDL-2023 LIBRARY; T=0.K  
Inelastic levels

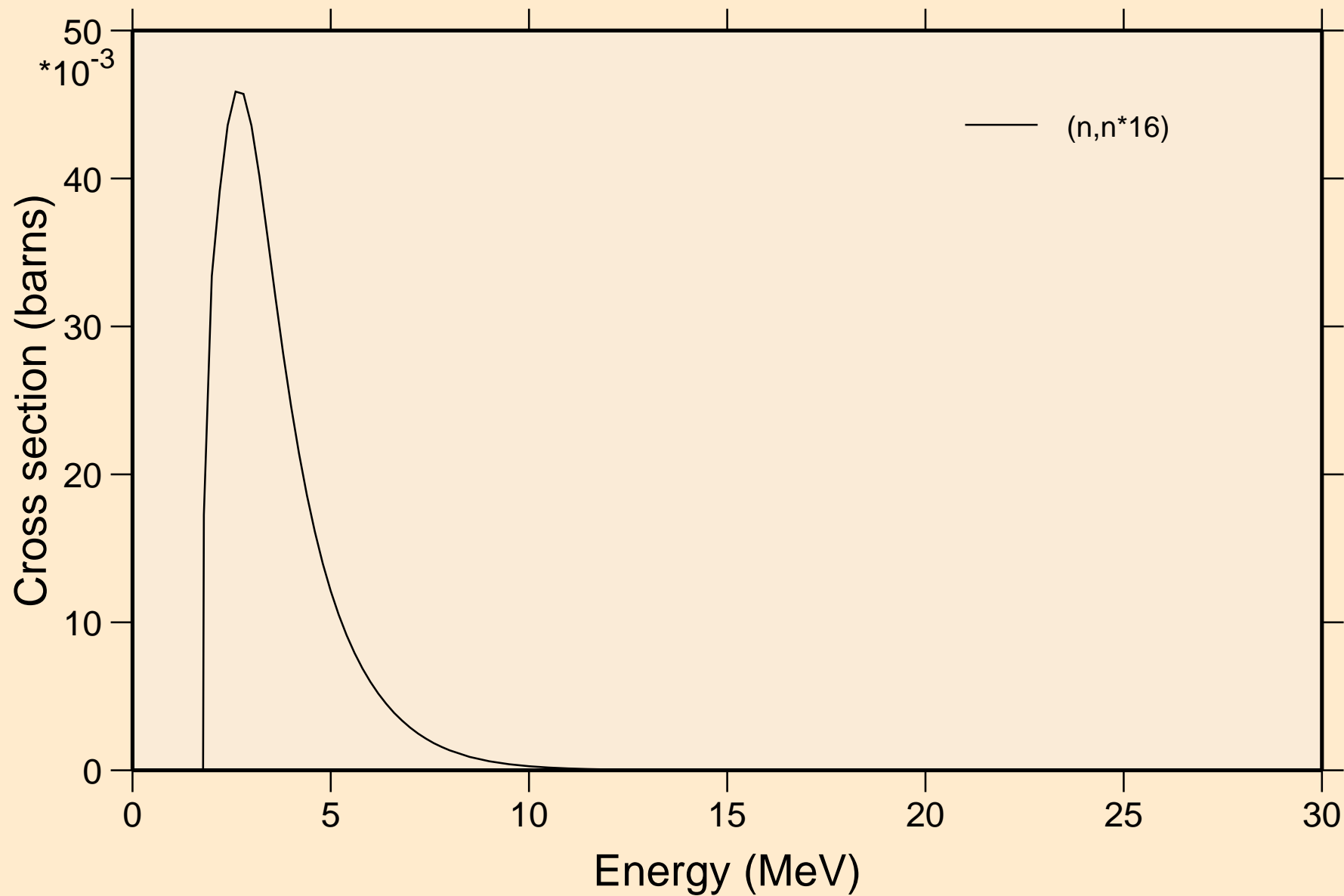

# FE059 NEUTRON ACER TENDL-2023 LIBRARY; T=0.K

## Threshold reactions

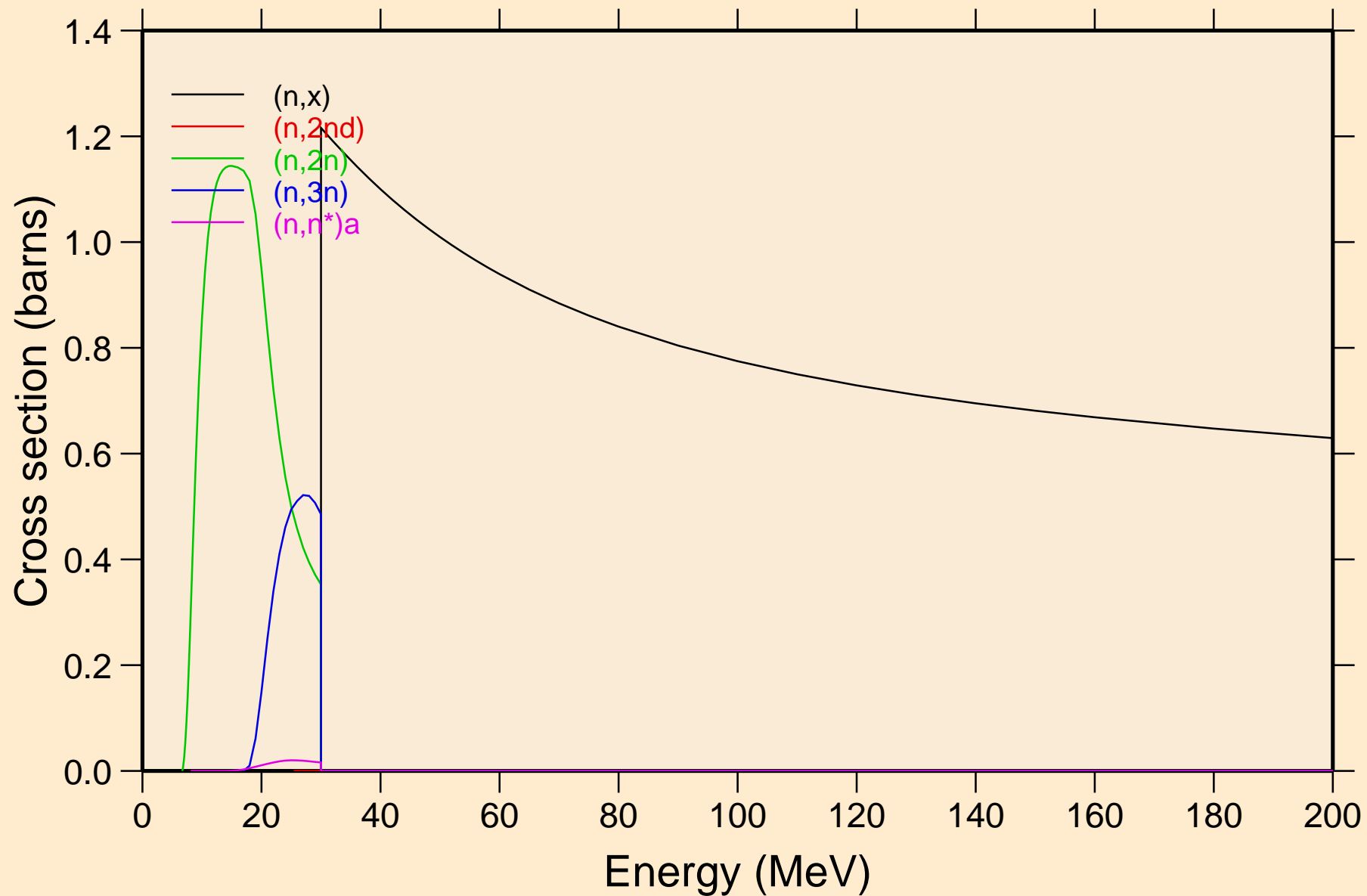

# FE059 NEUTRON ACER TENDL-2023 LIBRARY; T=0.K

## Threshold reactions

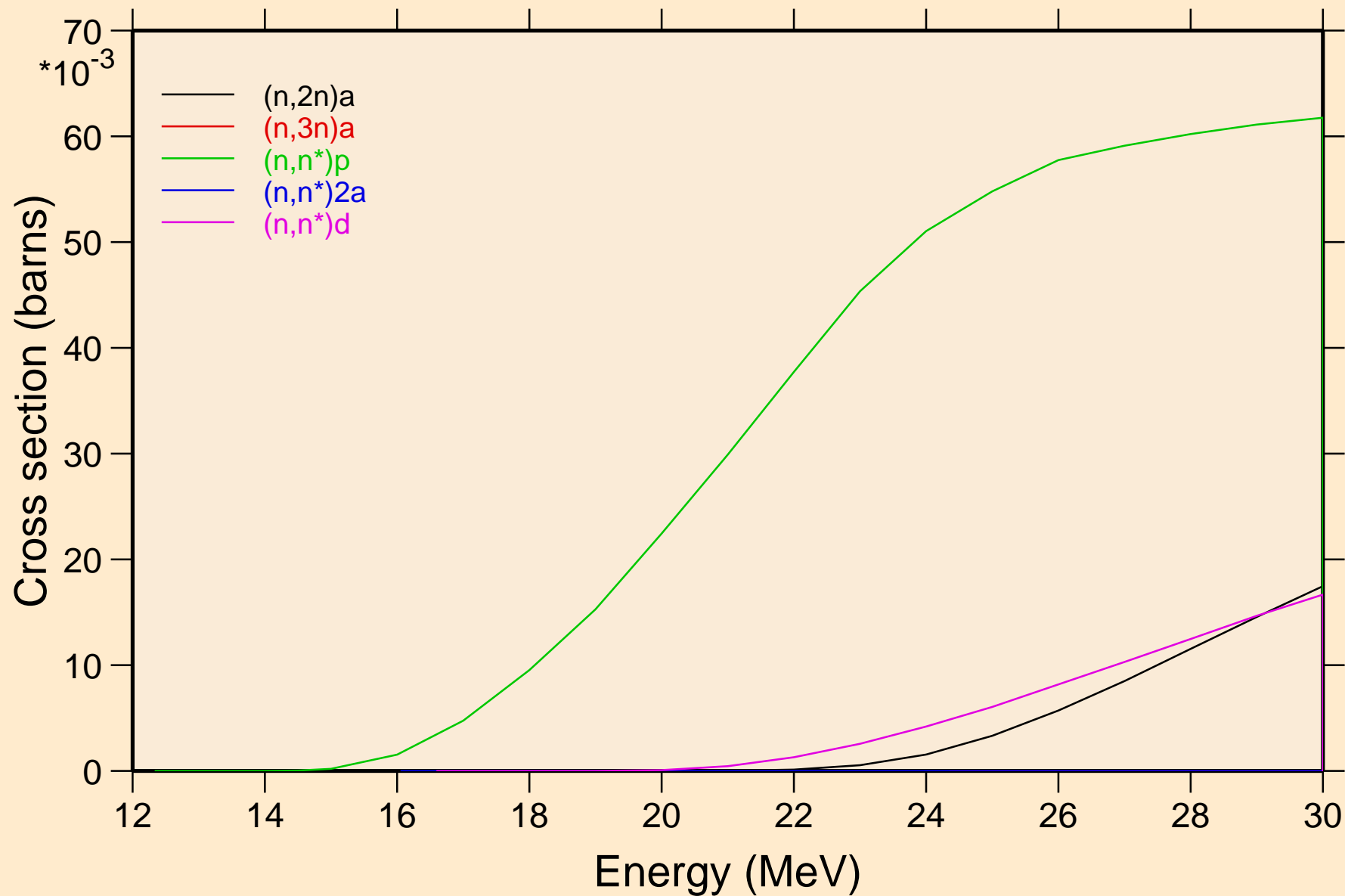

FE059 NEUTRON ACER TENDL-2023 LIBRARY; T=0.K  
Threshold reactions

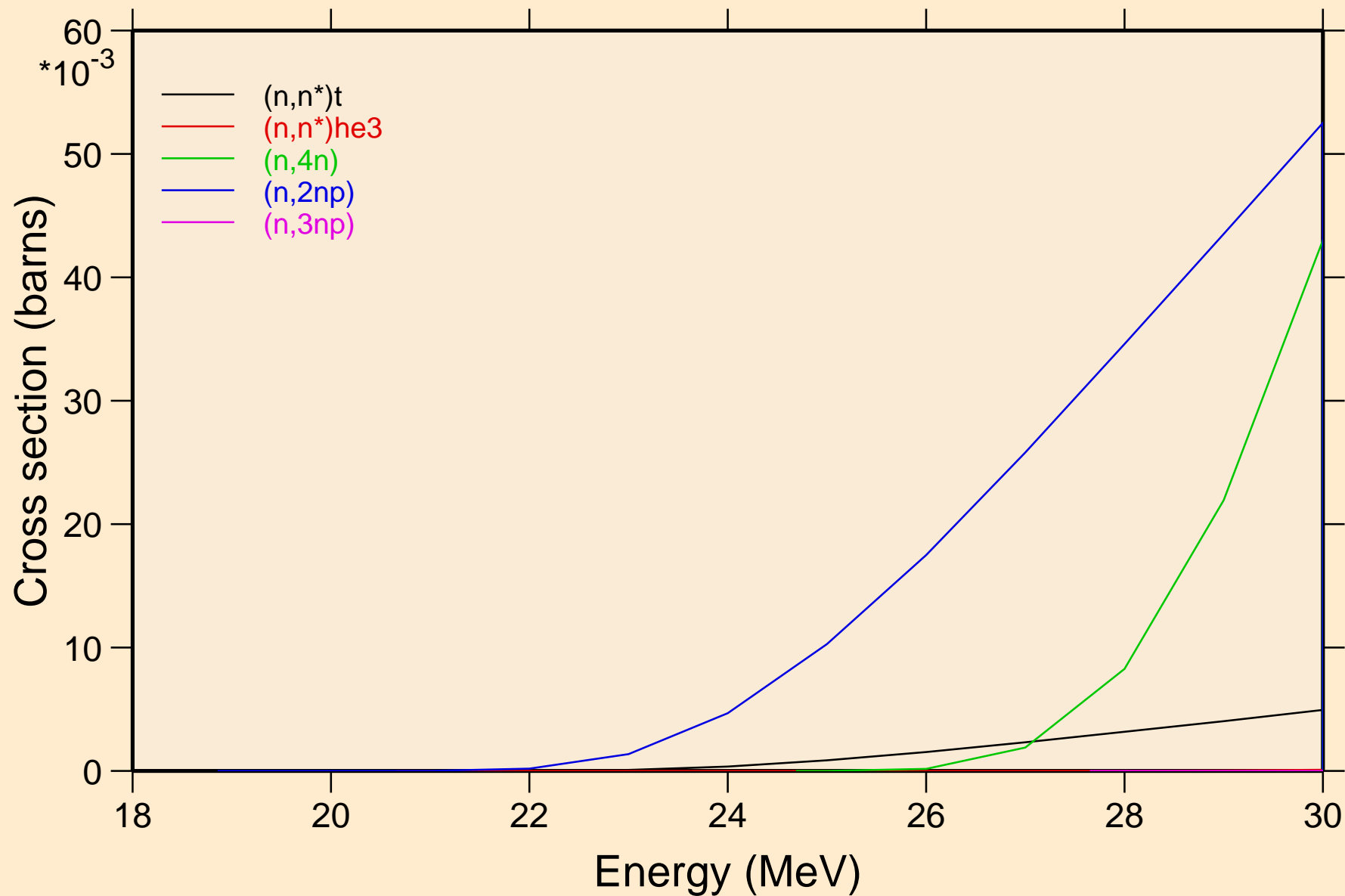

# FE059 NEUTRON ACER TENDL-2023 LIBRARY; T=0.K

## Threshold reactions

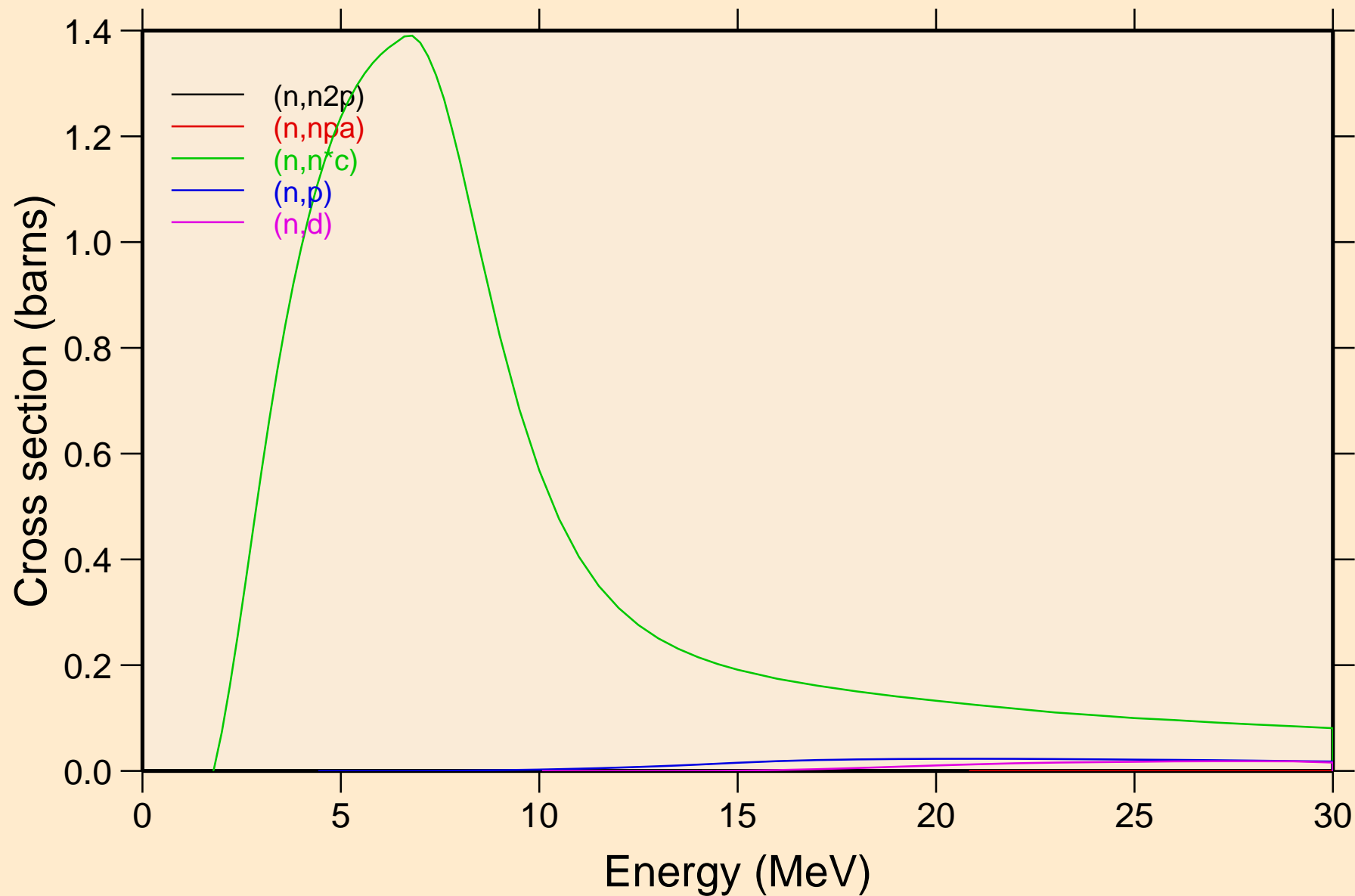



FE059 NEUTRON ACER TENDL-2023 LIBRARY; T=0.K  
Threshold reactions

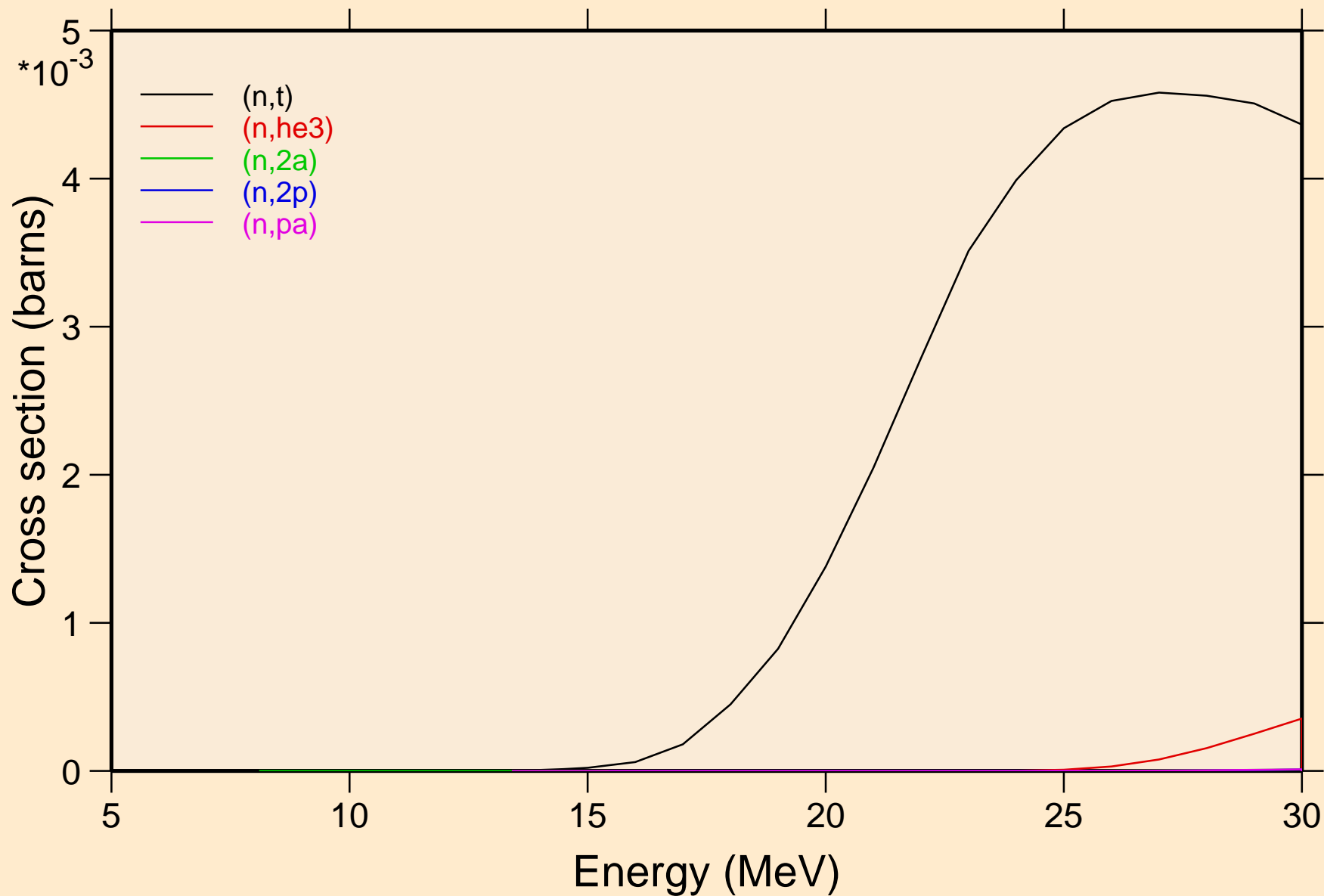

# FE059 NEUTRON ACER TENDL-2023 LIBRARY; T=0.K

## Threshold reactions

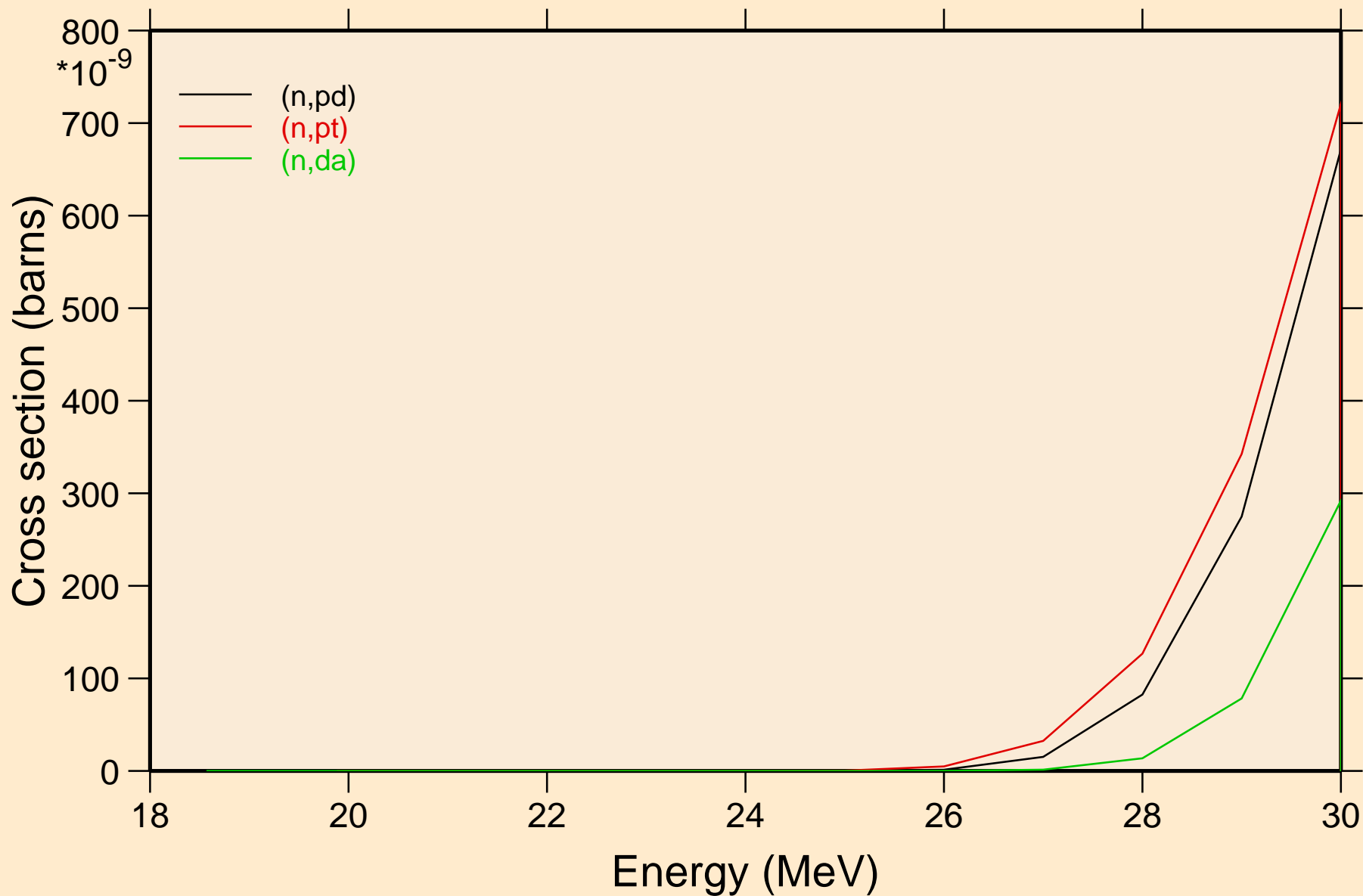

FE059 NEUTRON ACER TENDL-2023 LIBRARY; T=0.K  
Threshold reactions

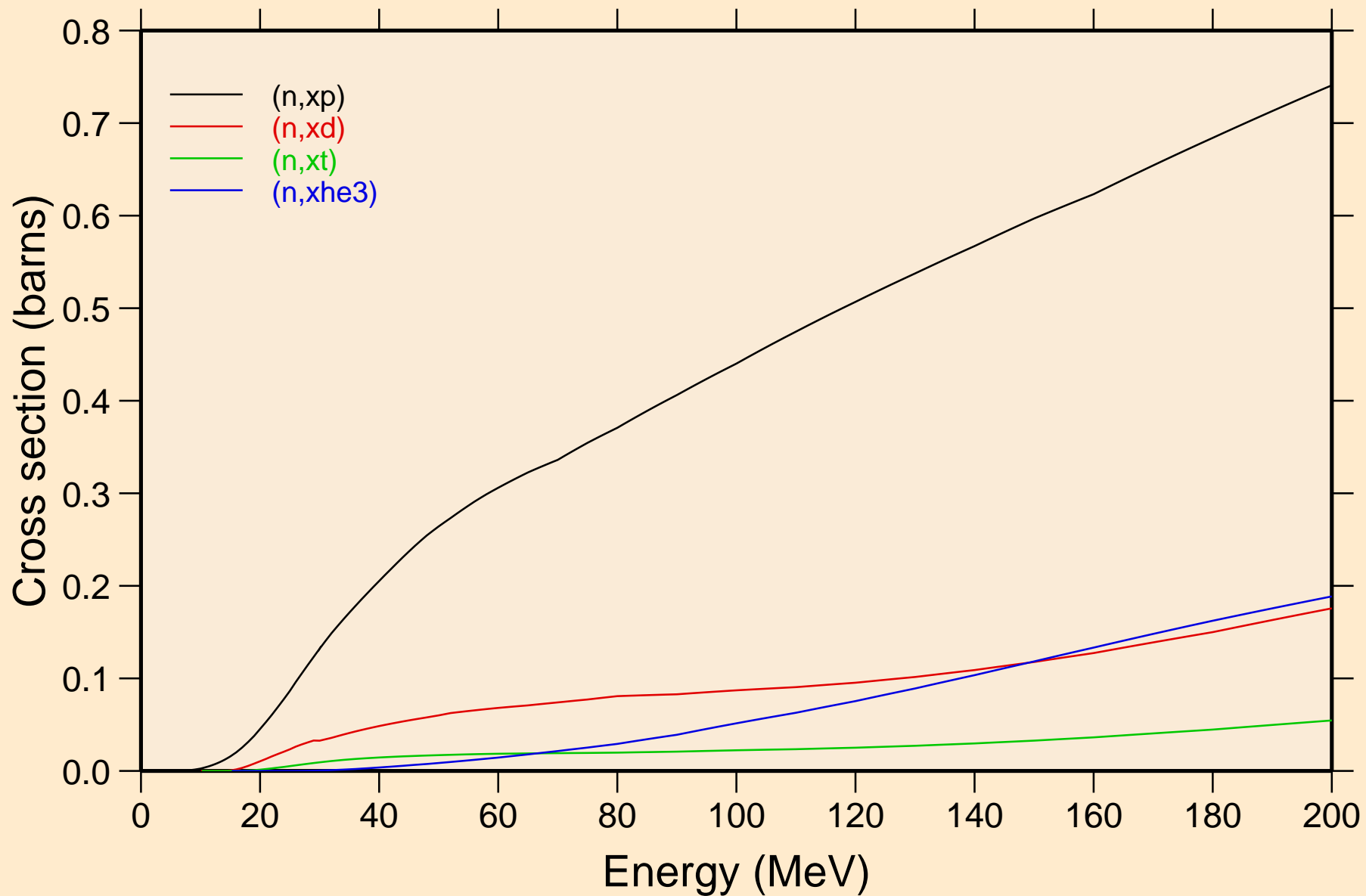

FE059 NEUTRON ACER TENDL-2023 LIBRARY; T=0.K  
angular distribution for elastic

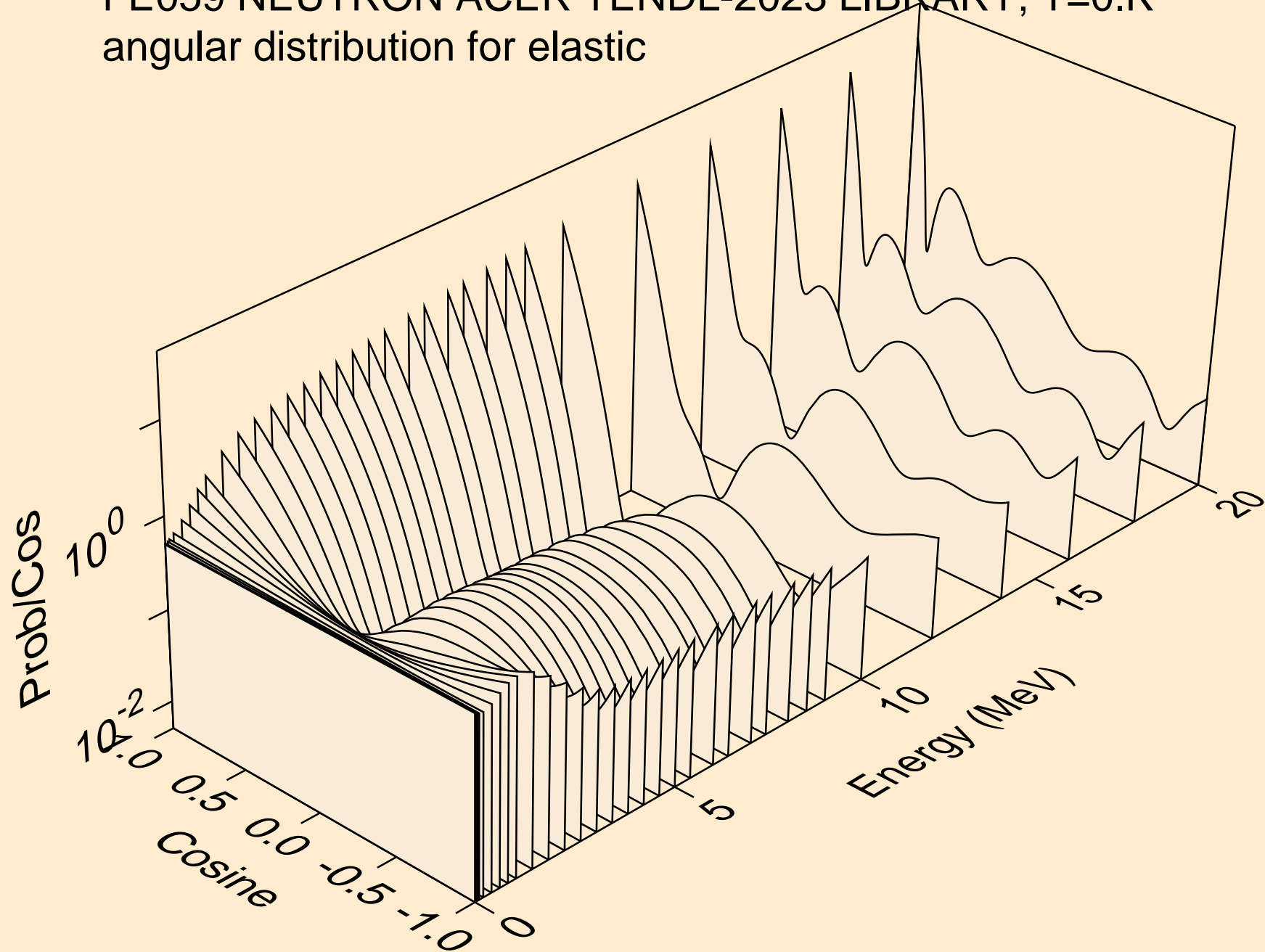

FE059 NEUTRON ACER TENDL-2023 LIBRARY; T=0.K  
angular distribution for elastic

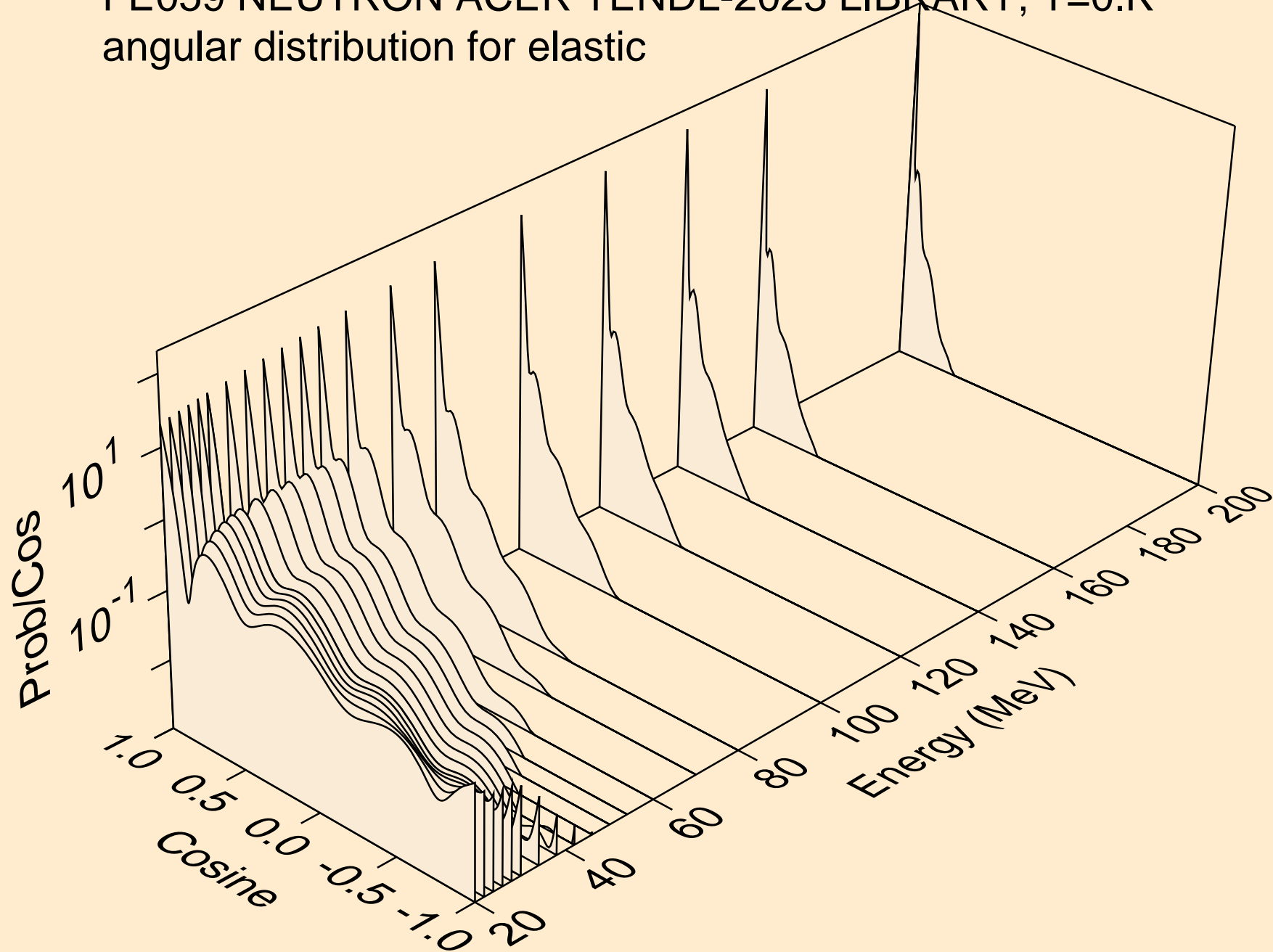

FE059 NEUTRON ACER TENDL-2023 LIBRARY; T=0.K  
angular distribution for (n,n\*1)

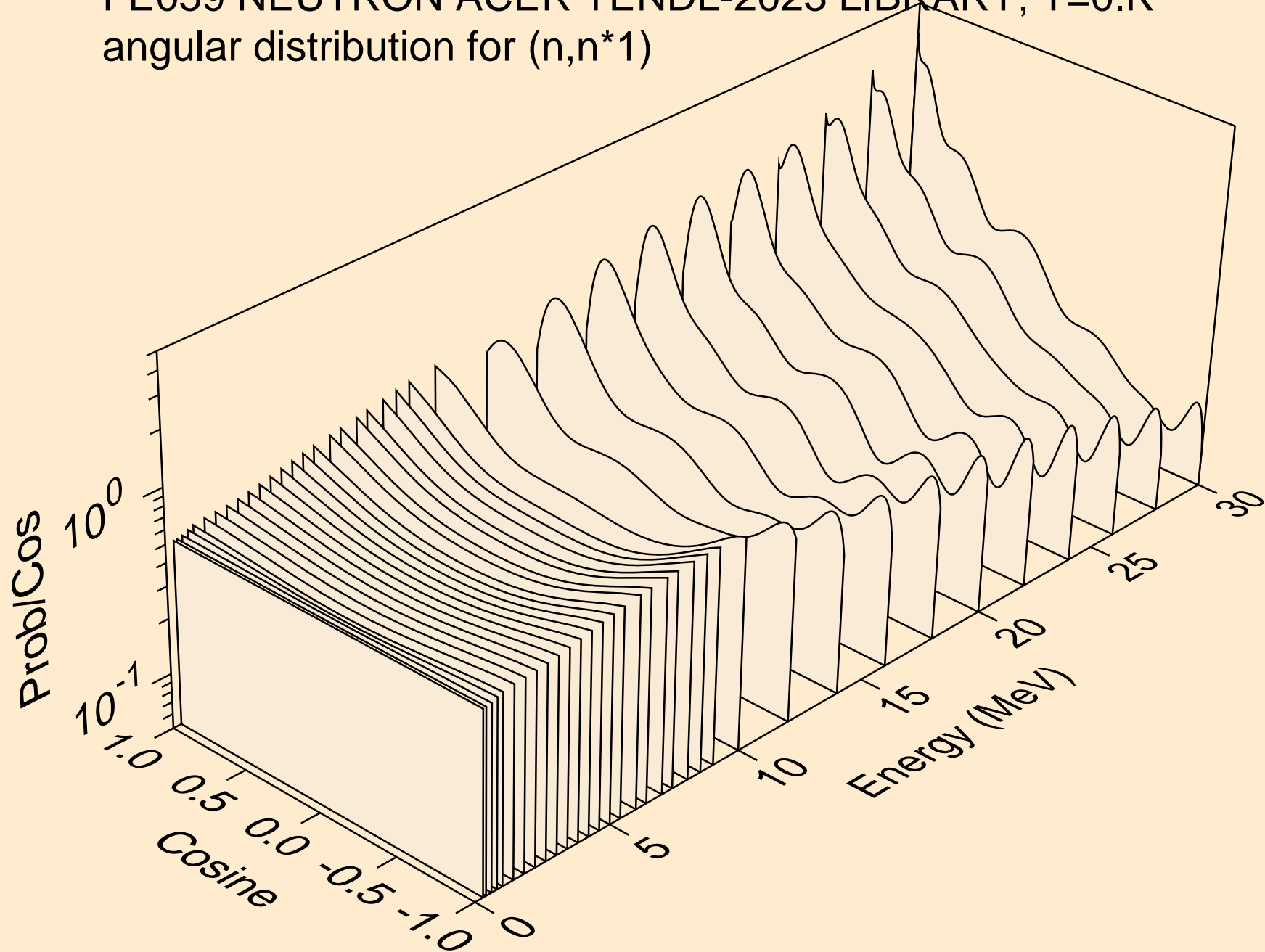

FE059 NEUTRON ACER TENDL-2023 LIBRARY; T=0.K  
angular distribution for (n,n\*2)

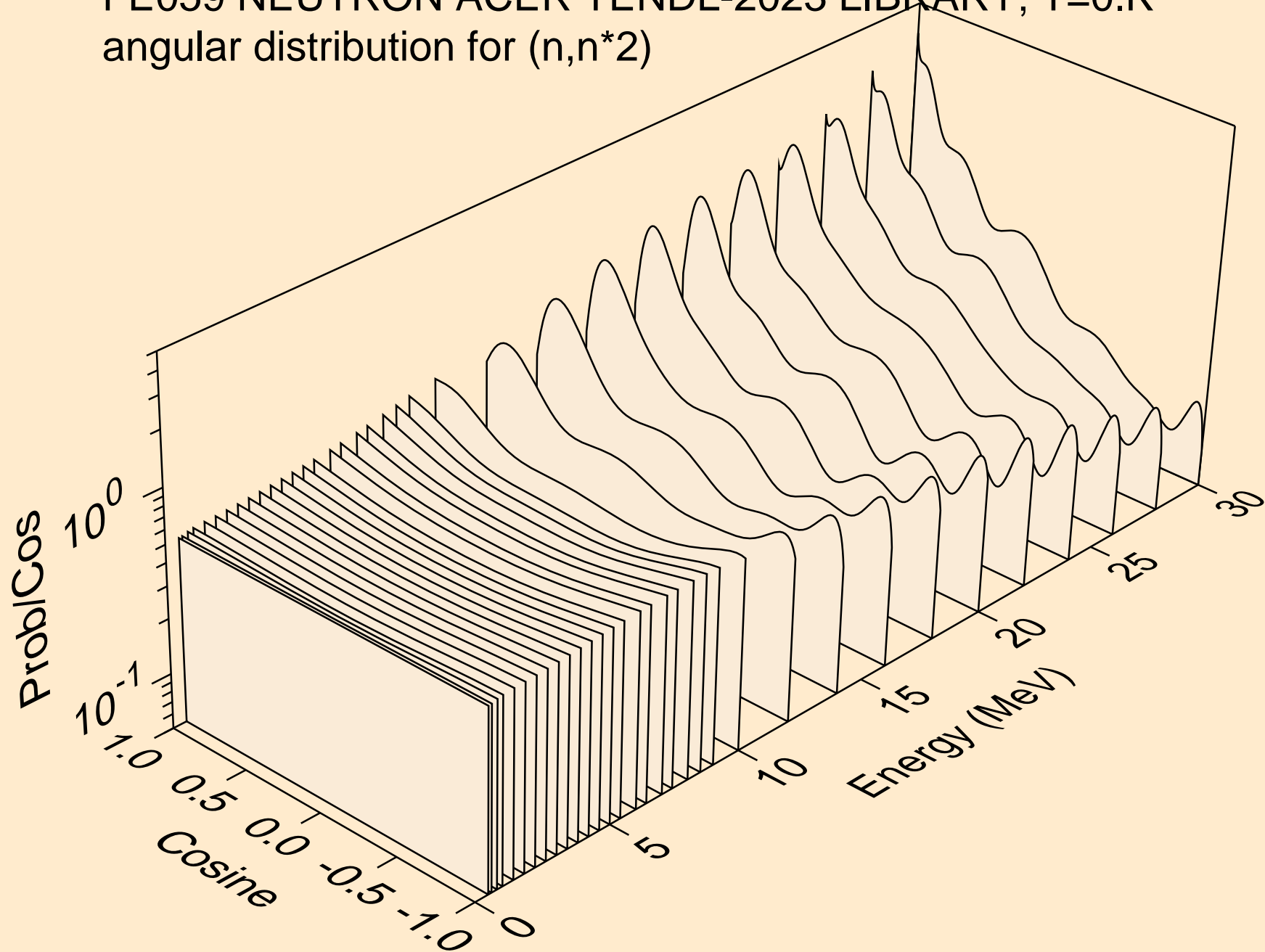

FE059 NEUTRON ACER TENDL-2023 LIBRARY; T=0.K  
angular distribution for (n,n\*3)

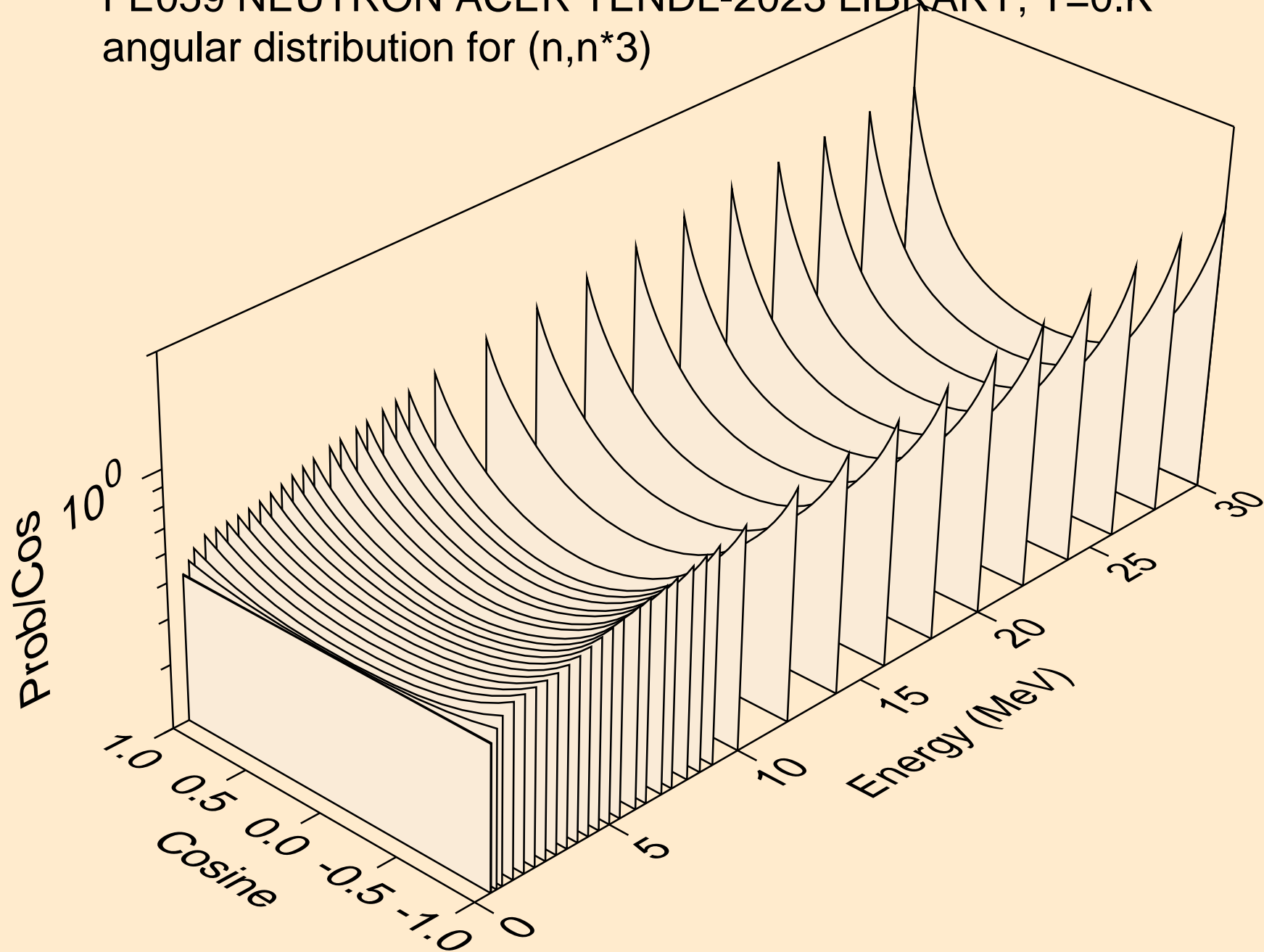



FE059 NEUTRON ACER TENDL-2023 LIBRARY; T=0.K  
angular distribution for (n,n\*4)

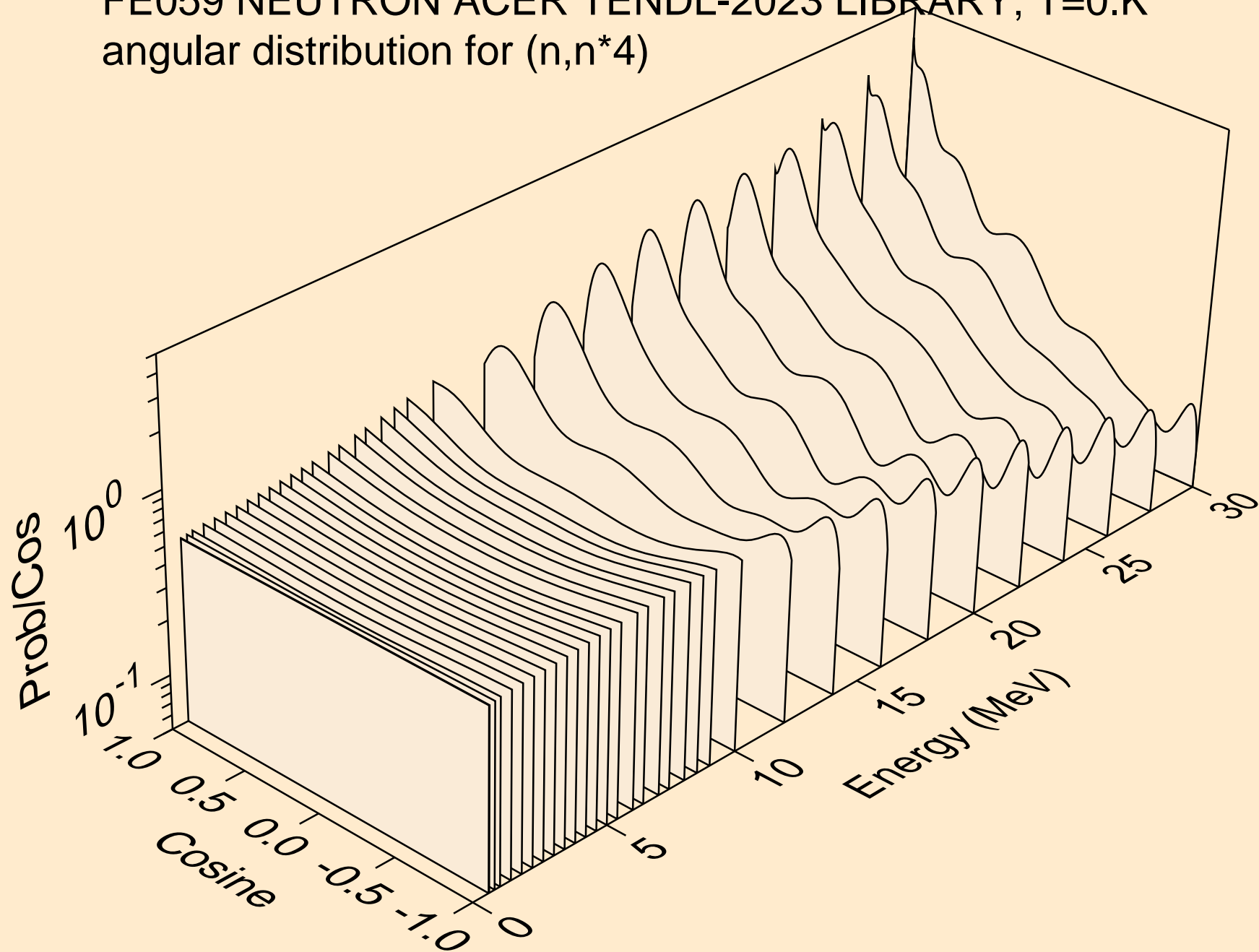

FE059 NEUTRON ACER TENDL-2023 LIBRARY; T=0.K  
angular distribution for (n,n\*5)

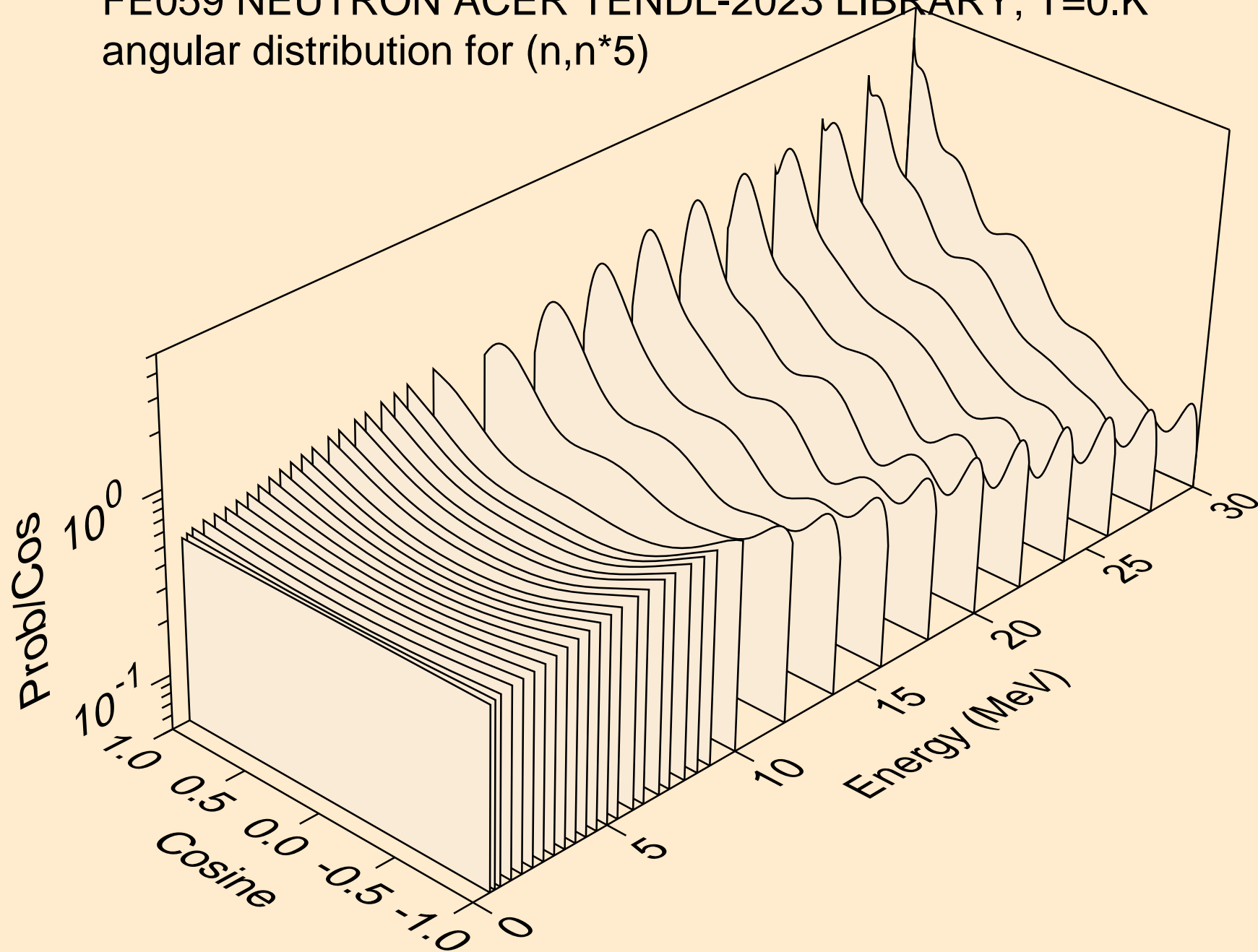

FE059 NEUTRON ACER TENDL-2023 LIBRARY; T=0.K  
angular distribution for (n,n\*6)

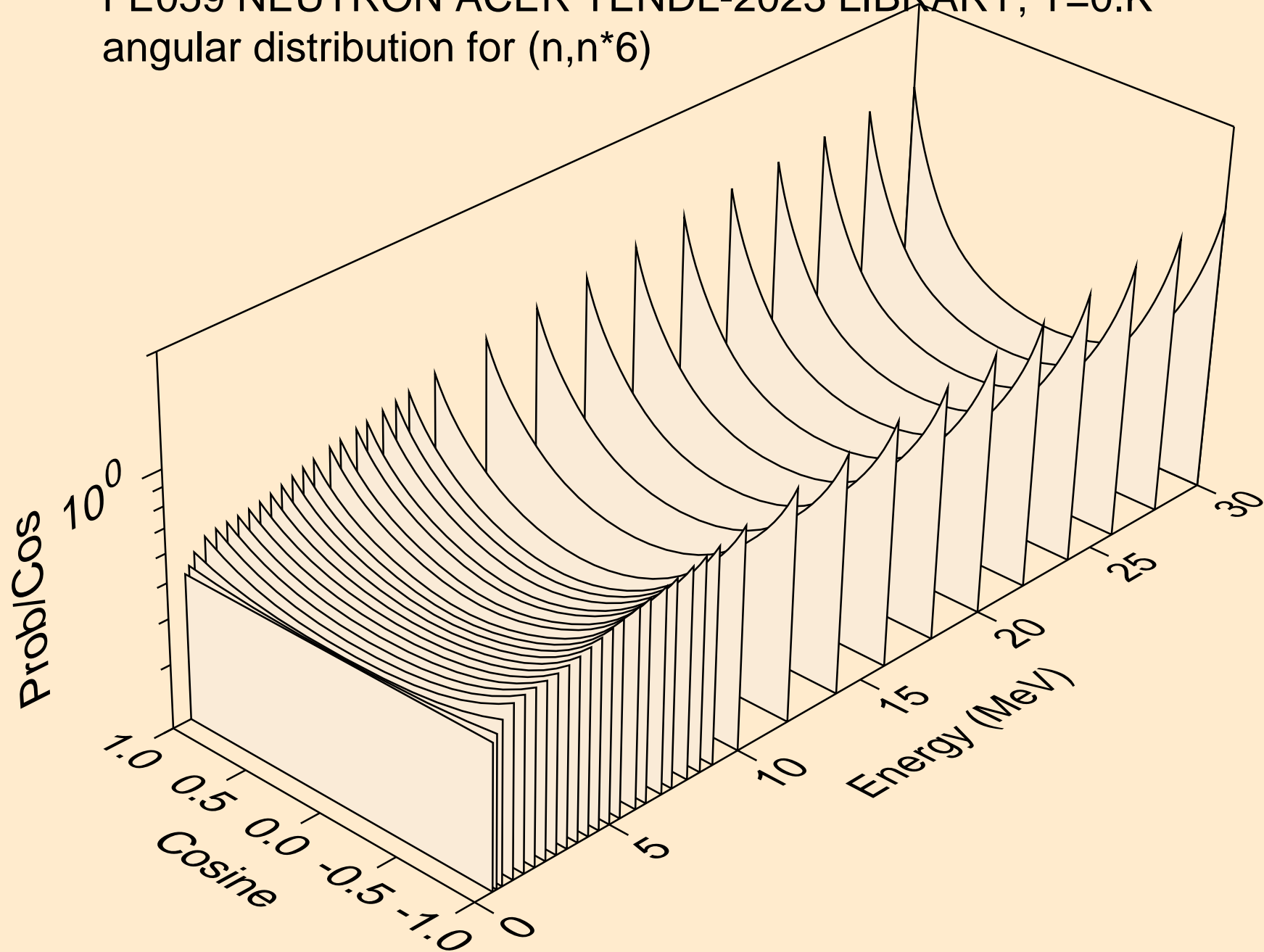

FE059 NEUTRON ACER TENDL-2023 LIBRARY; T=0.K  
angular distribution for (n,n\*7)

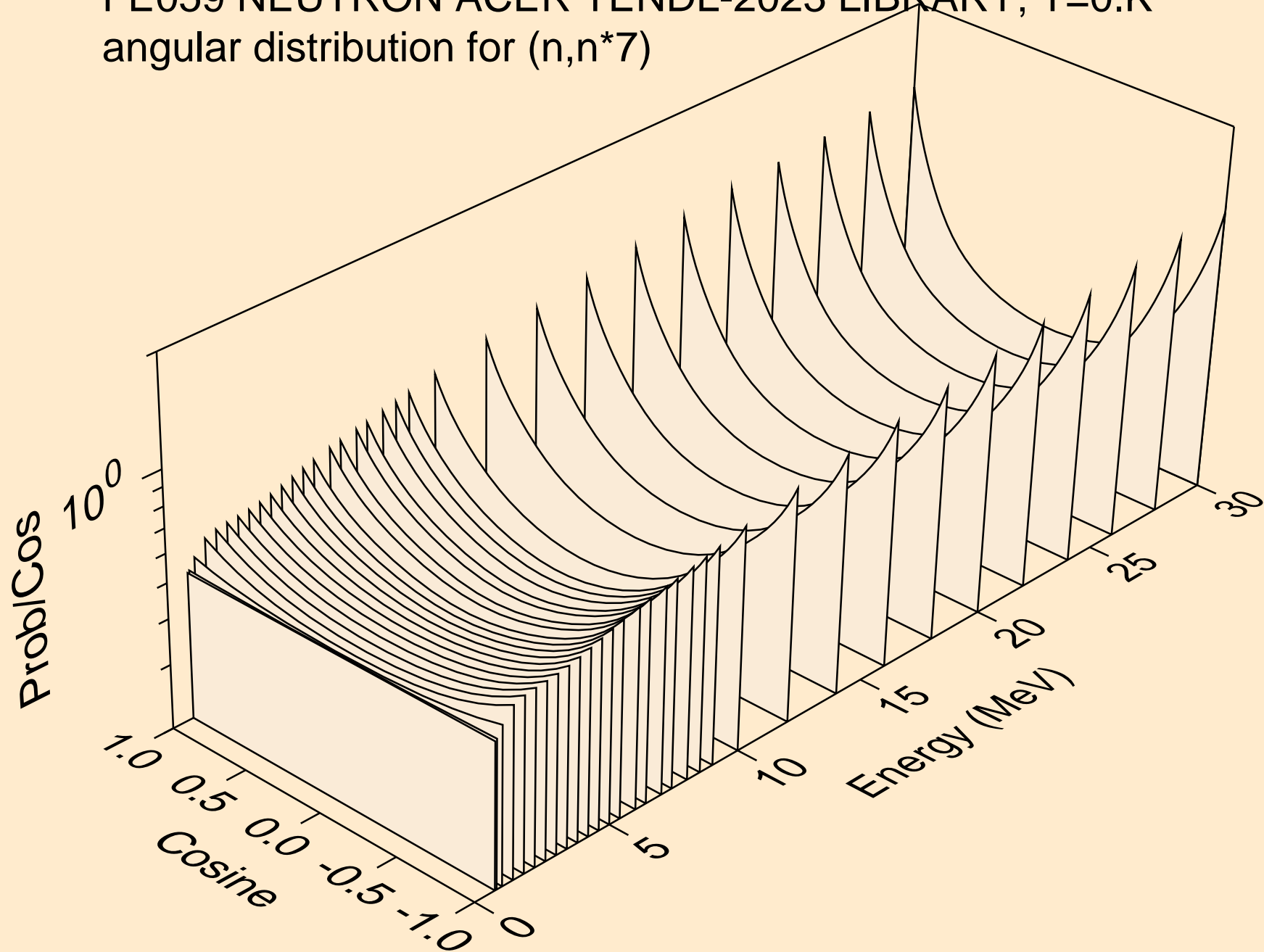

FE059 NEUTRON ACER TENDL-2023 LIBRARY; T=0.K  
angular distribution for (n,n\*8)

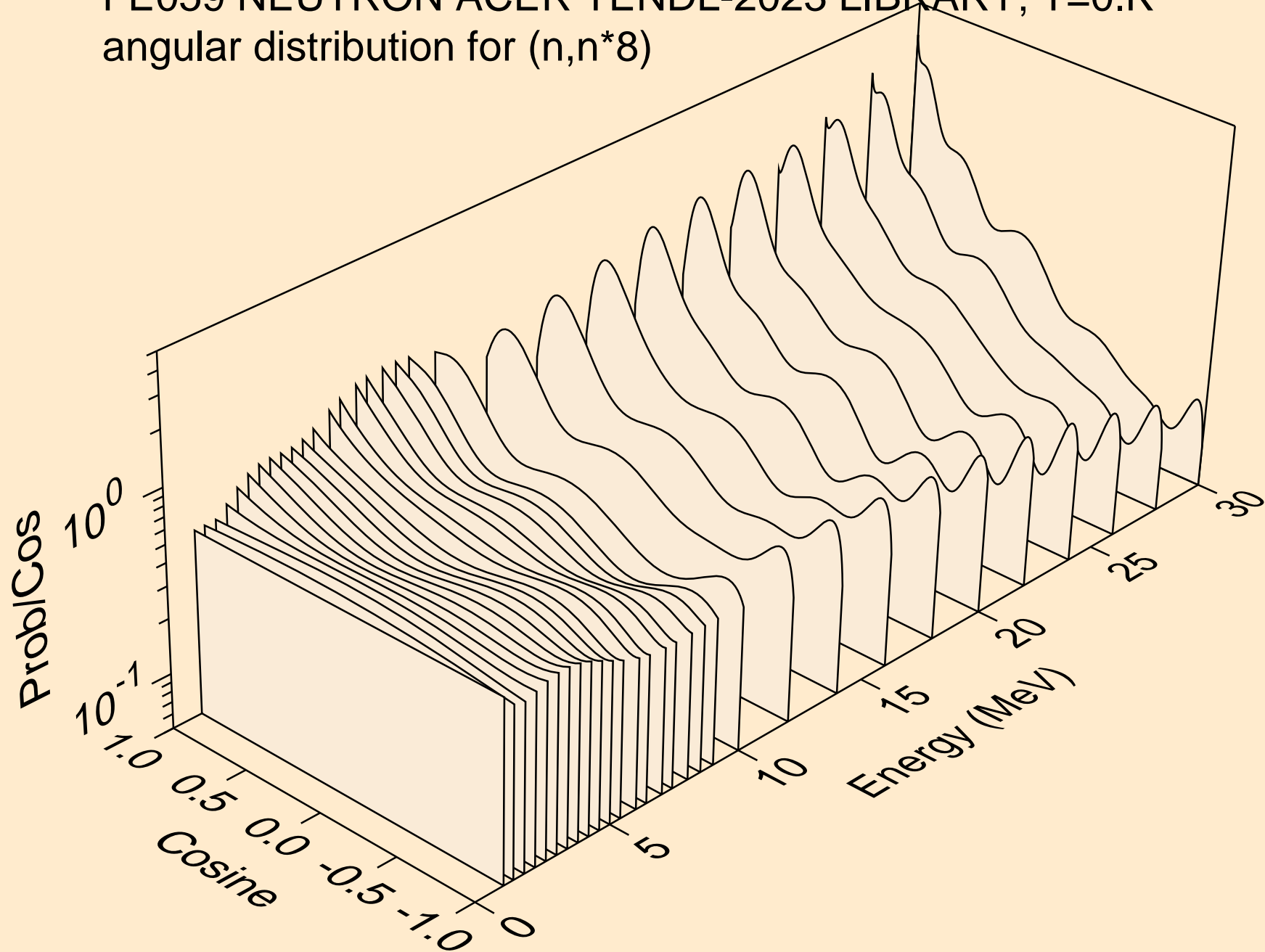

FE059 NEUTRON ACER TENDL-2023 LIBRARY; T=0.K  
angular distribution for (n,n\*9)

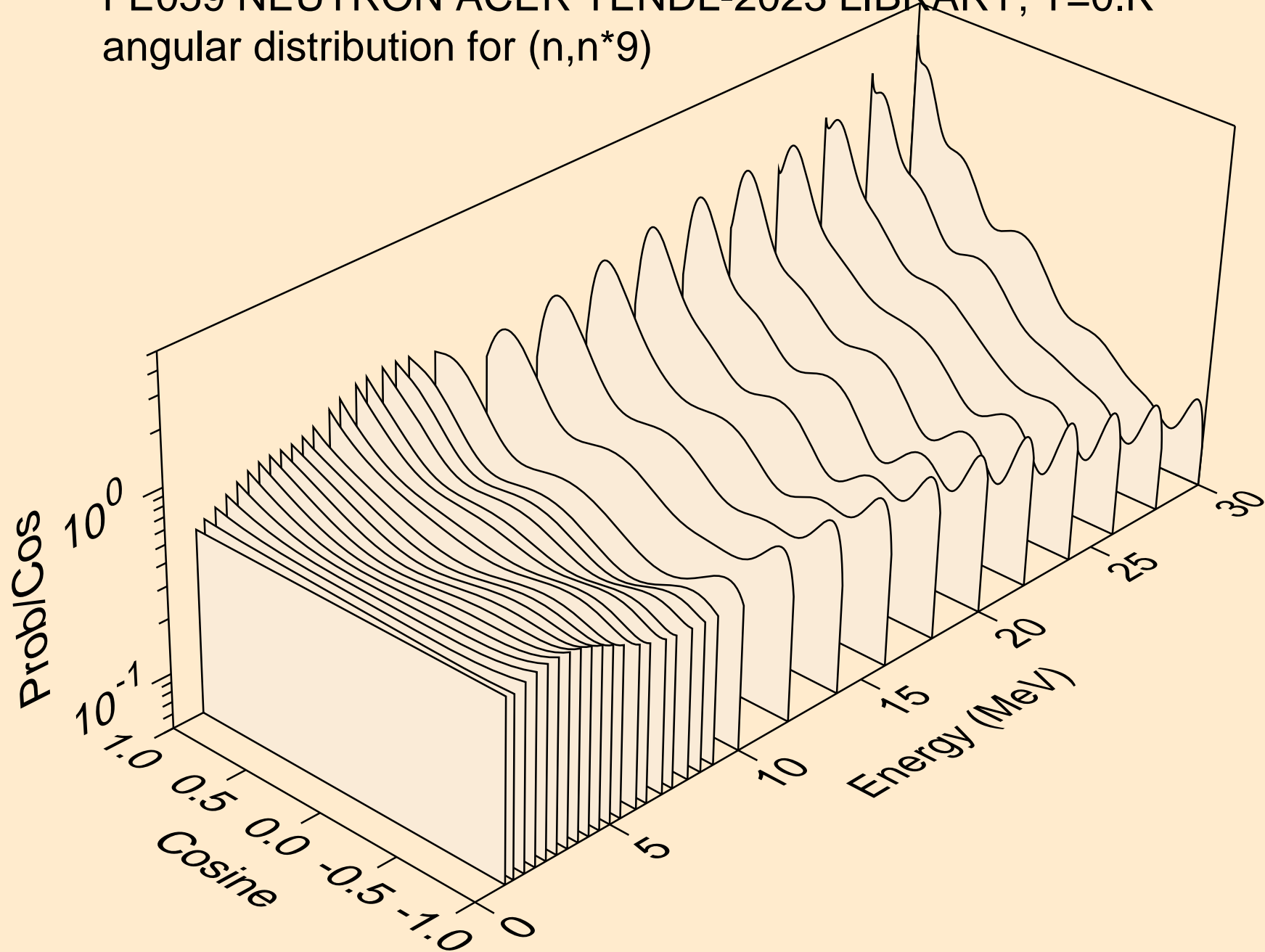

FE059 NEUTRON ACER TENDL-2023 LIBRARY; T=0.K  
angular distribution for (n,n\*10)

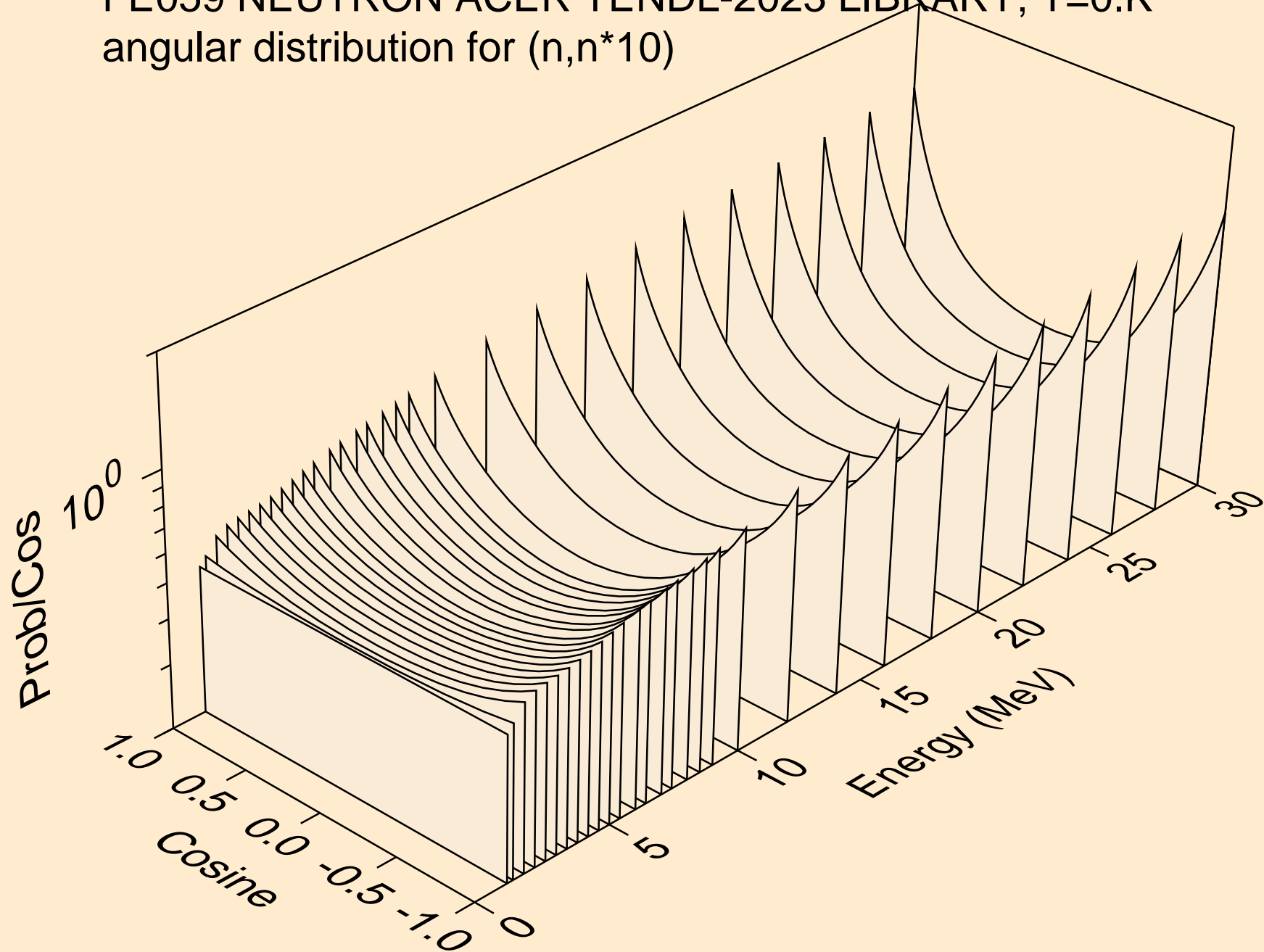

FE059 NEUTRON ACER TENDL-2023 LIBRARY; T=0.K  
angular distribution for (n,n\*11)

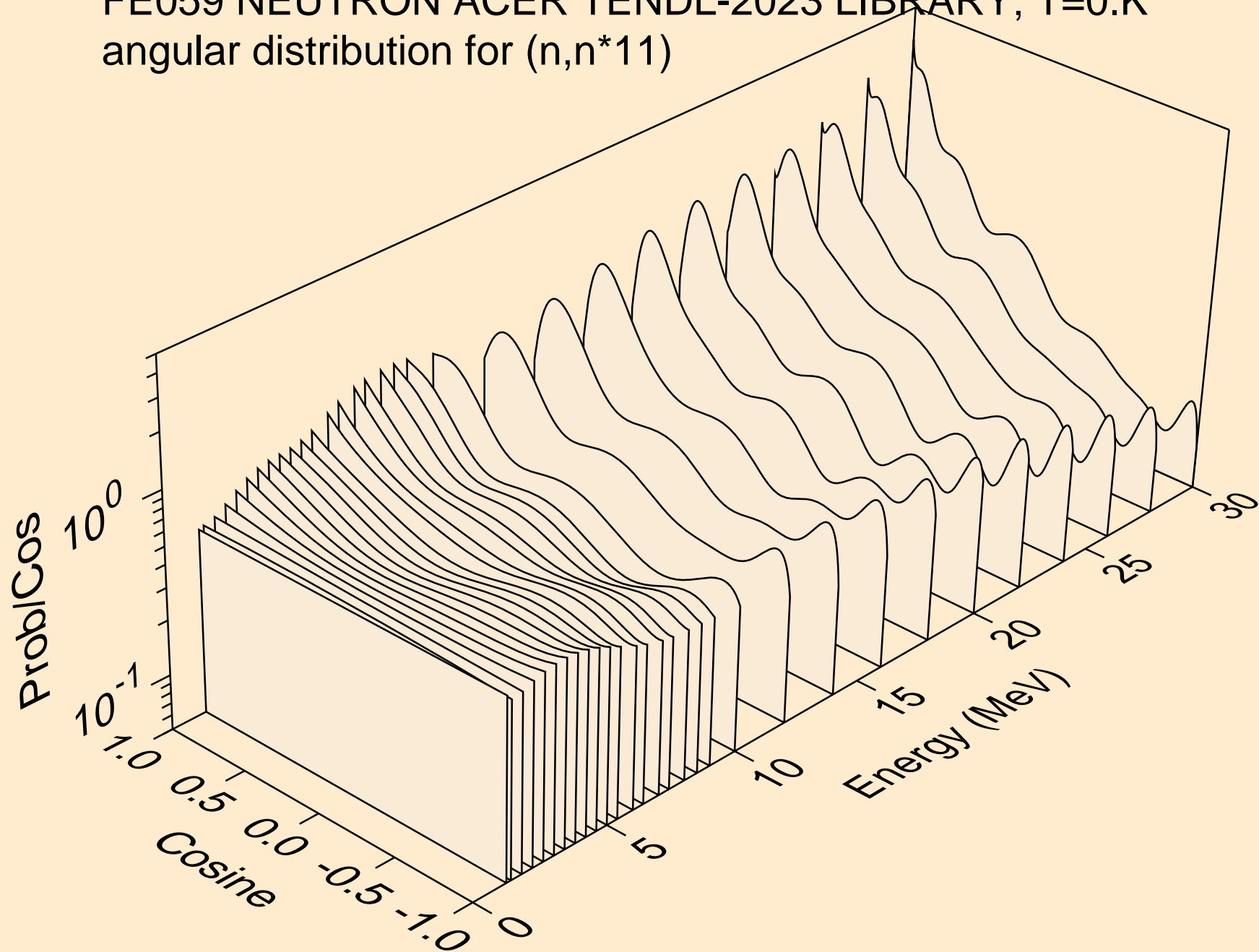



FE059 NEUTRON ACER TENDL-2023 LIBRARY; T=0.K  
angular distribution for (n,n\*12)

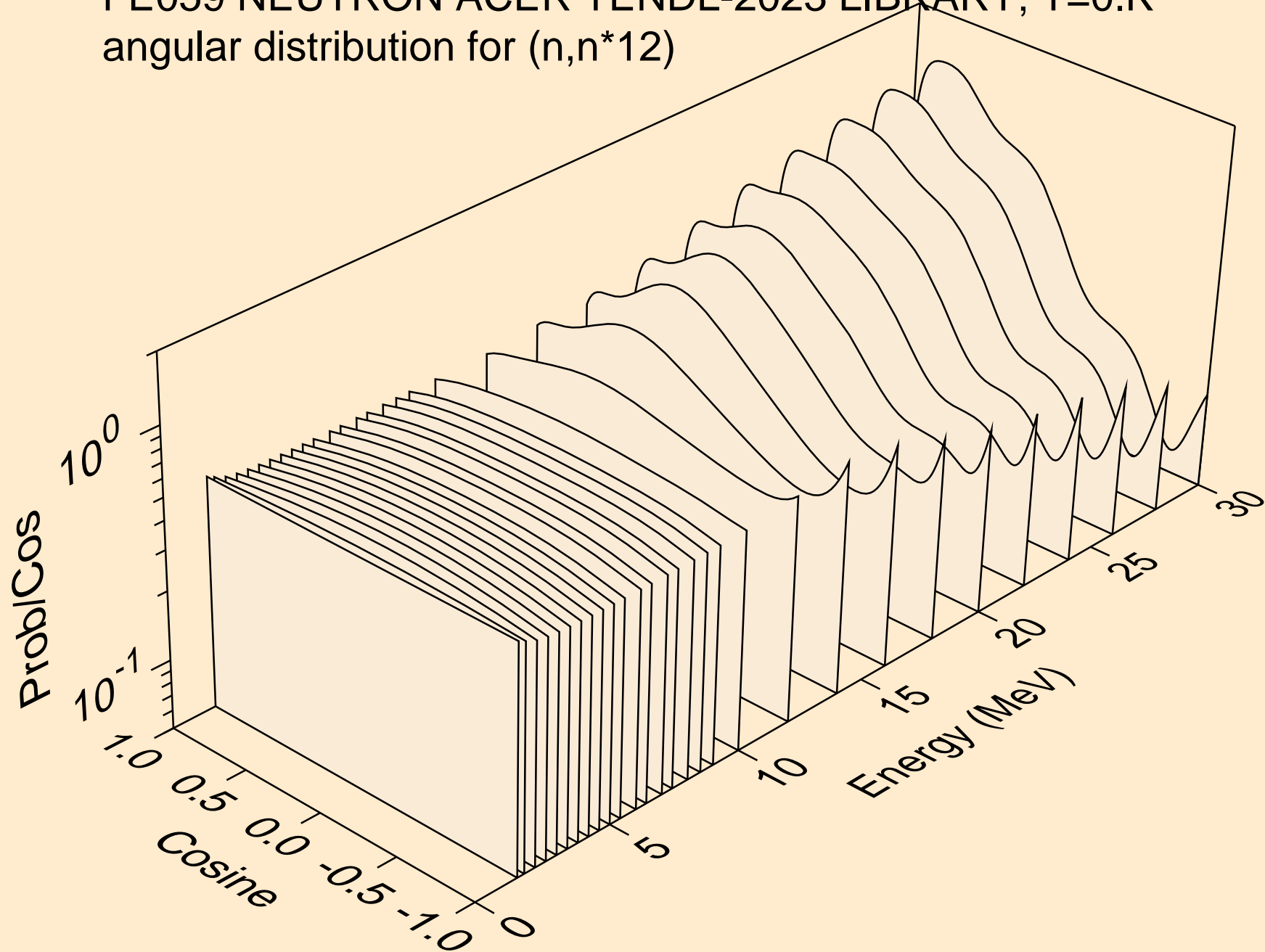

FE059 NEUTRON ACER TENDL-2023 LIBRARY; T=0.K  
angular distribution for (n,n\*13)

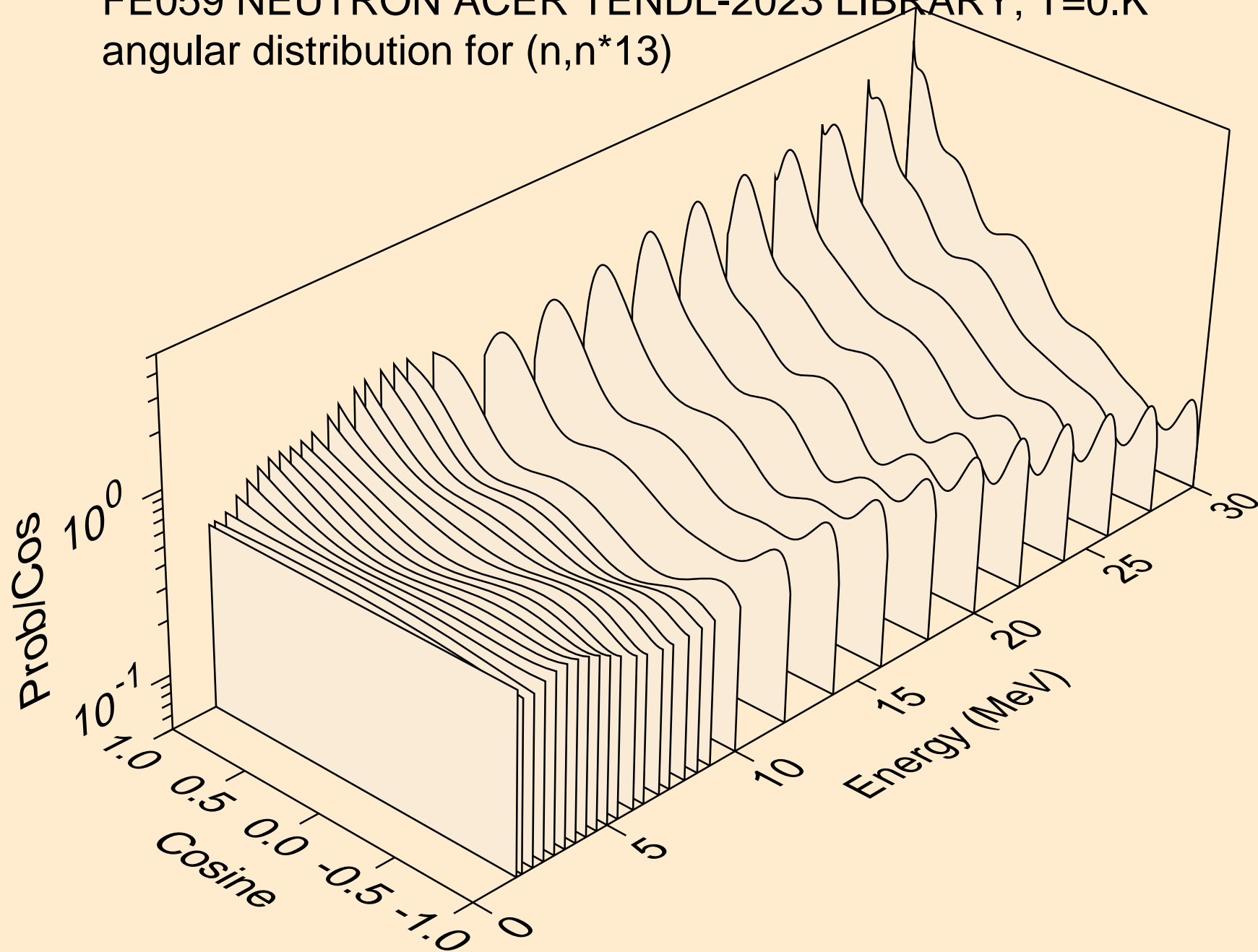

FE059 NEUTRON ACER TENDL-2023 LIBRARY; T=0.K  
angular distribution for (n,n\*14)

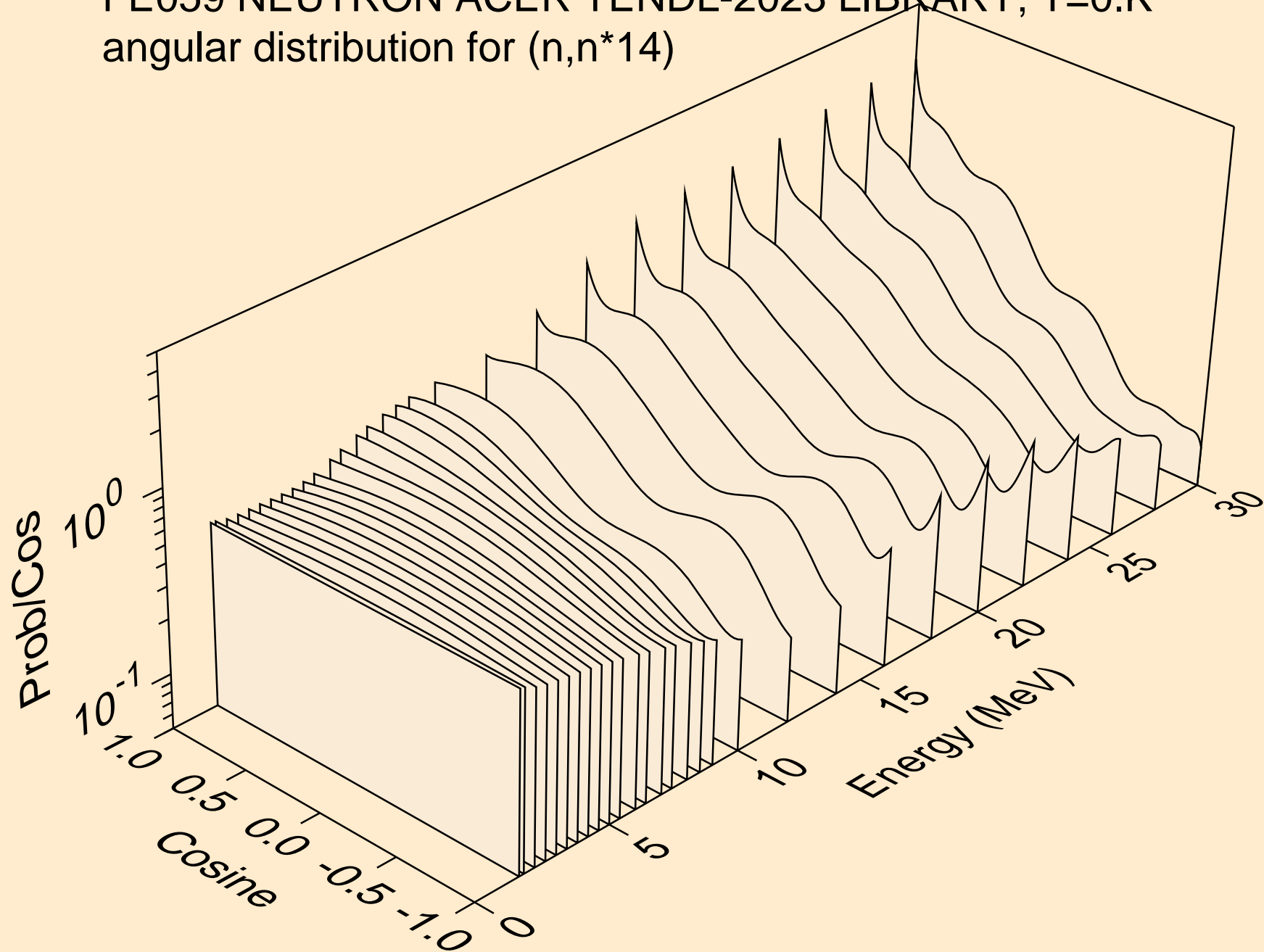

FE059 NEUTRON ACER TENDL-2023 LIBRARY; T=0.K  
angular distribution for (n,n\*15)

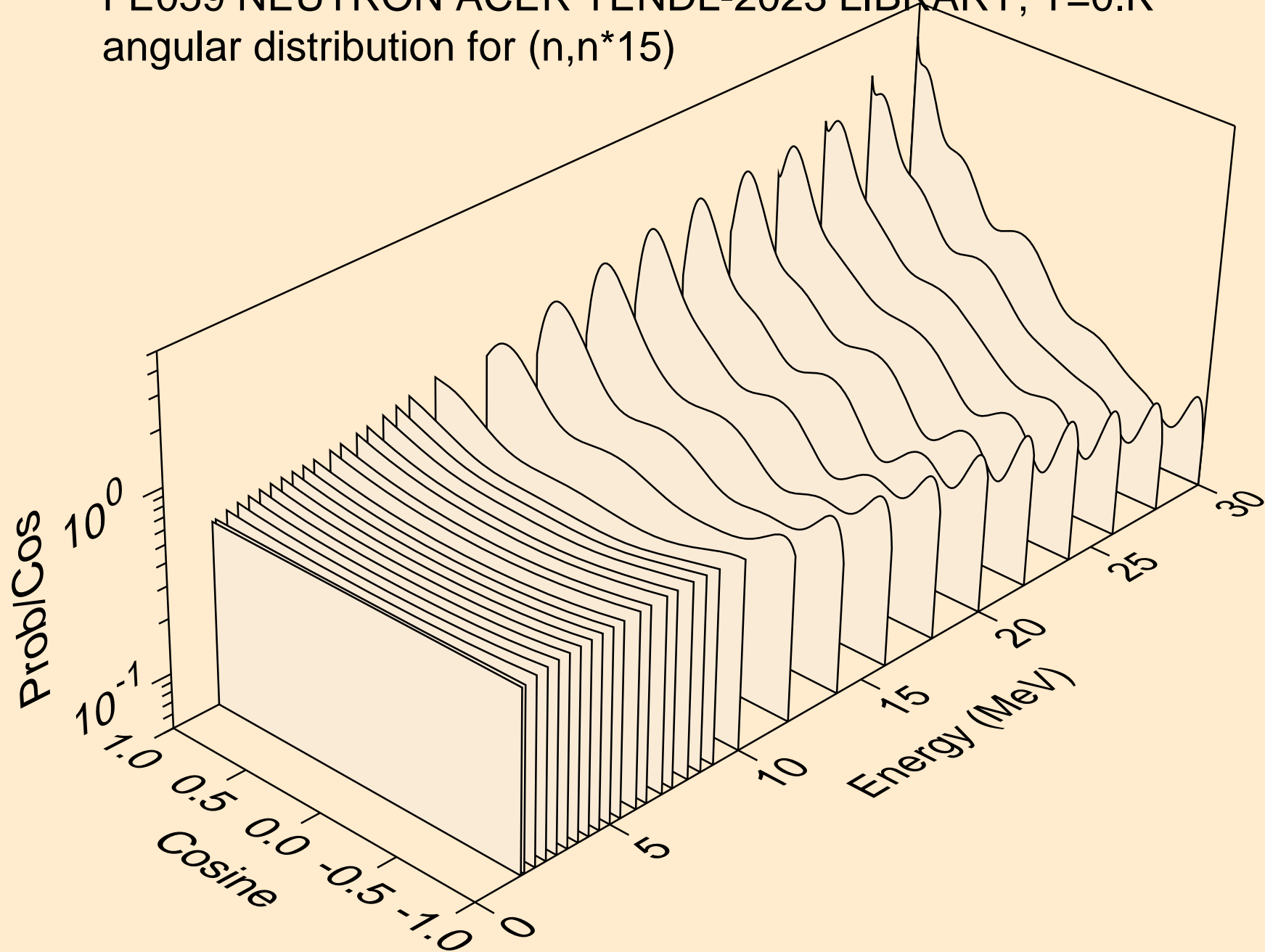

FE059 NEUTRON ACER TENDL-2023 LIBRARY; T=0.K  
angular distribution for (n,n\*16)

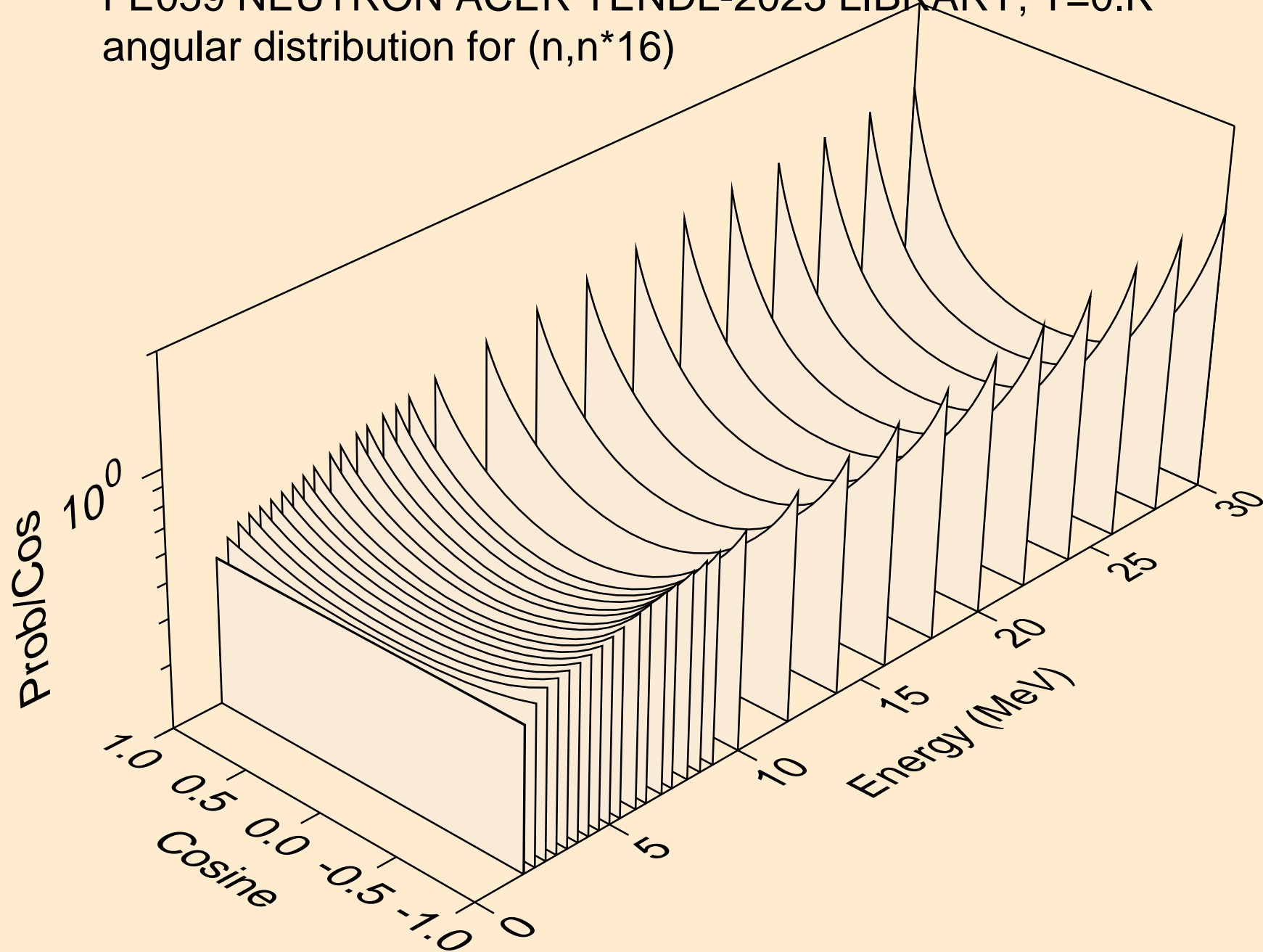

FE059 NEUTRON ACER TENDL-2023 LIBRARY; T=0.K  
Neutron emission for (n,x)

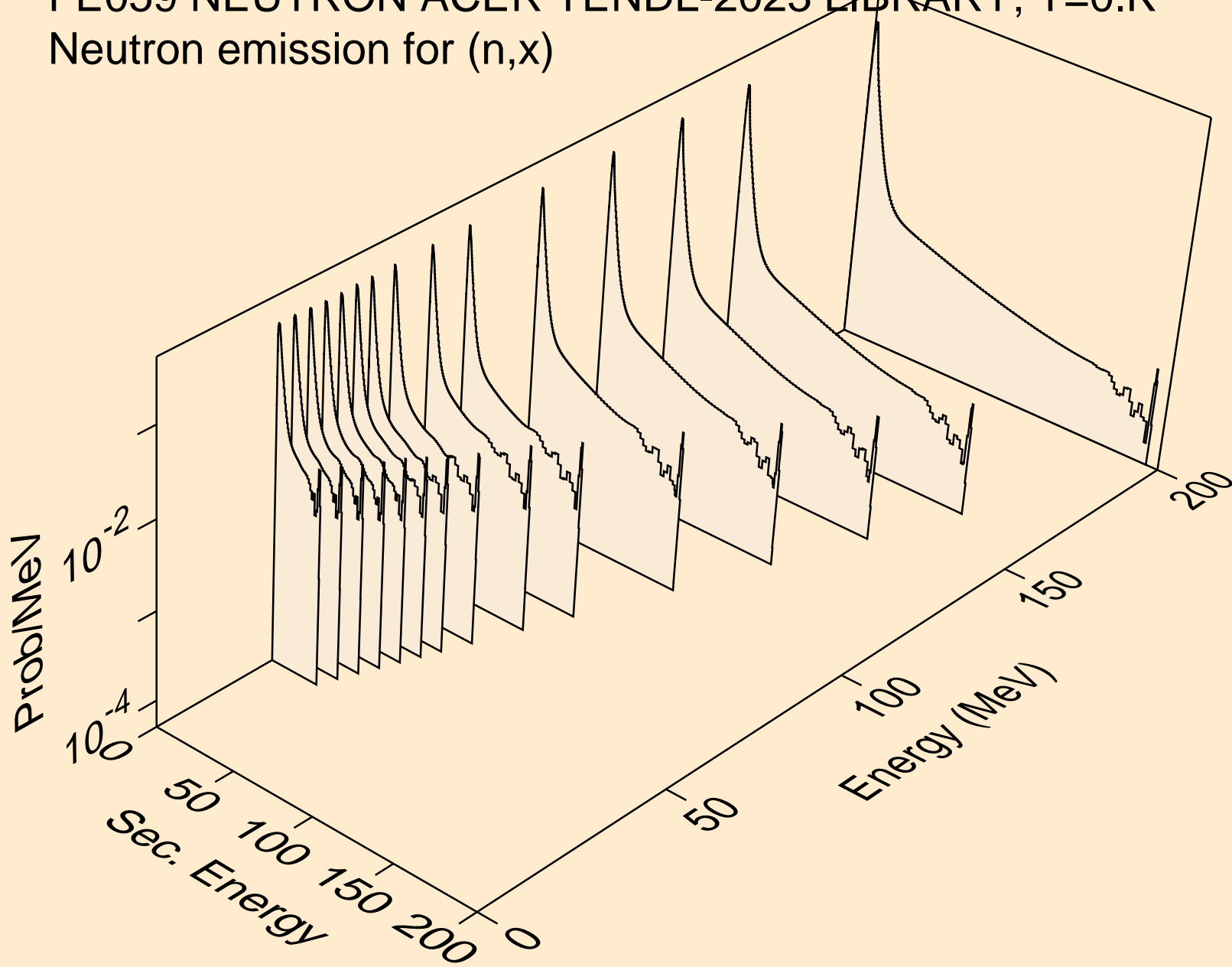

FE059 NEUTRON ACER TENDL-2023 LIBRARY; T=0.K  
Neutron emission for (n,2nd)

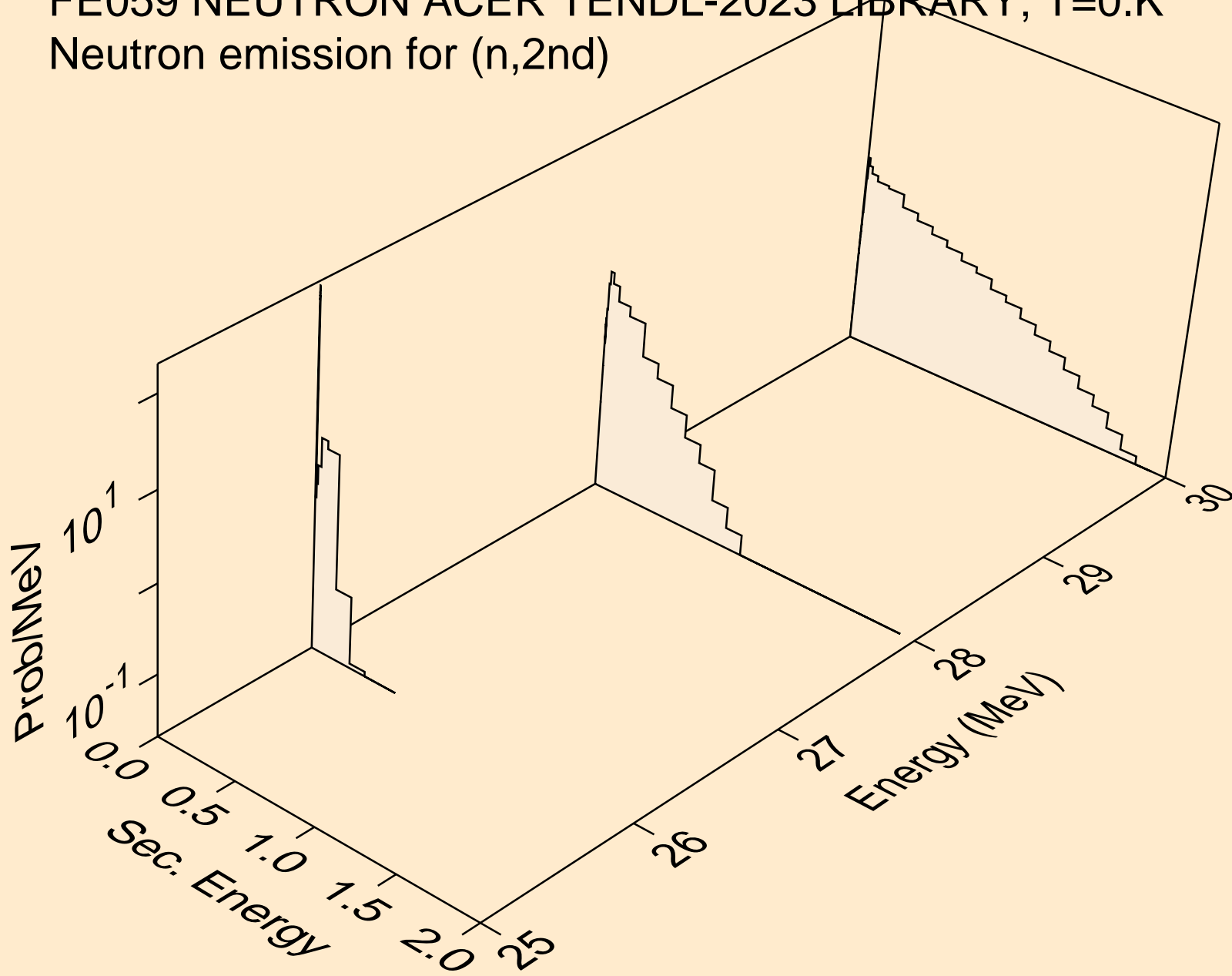

FE059 NEUTRON ACER TENDL-2023 LIBRARY; T=0.K  
Neutron emission for (n,2n)

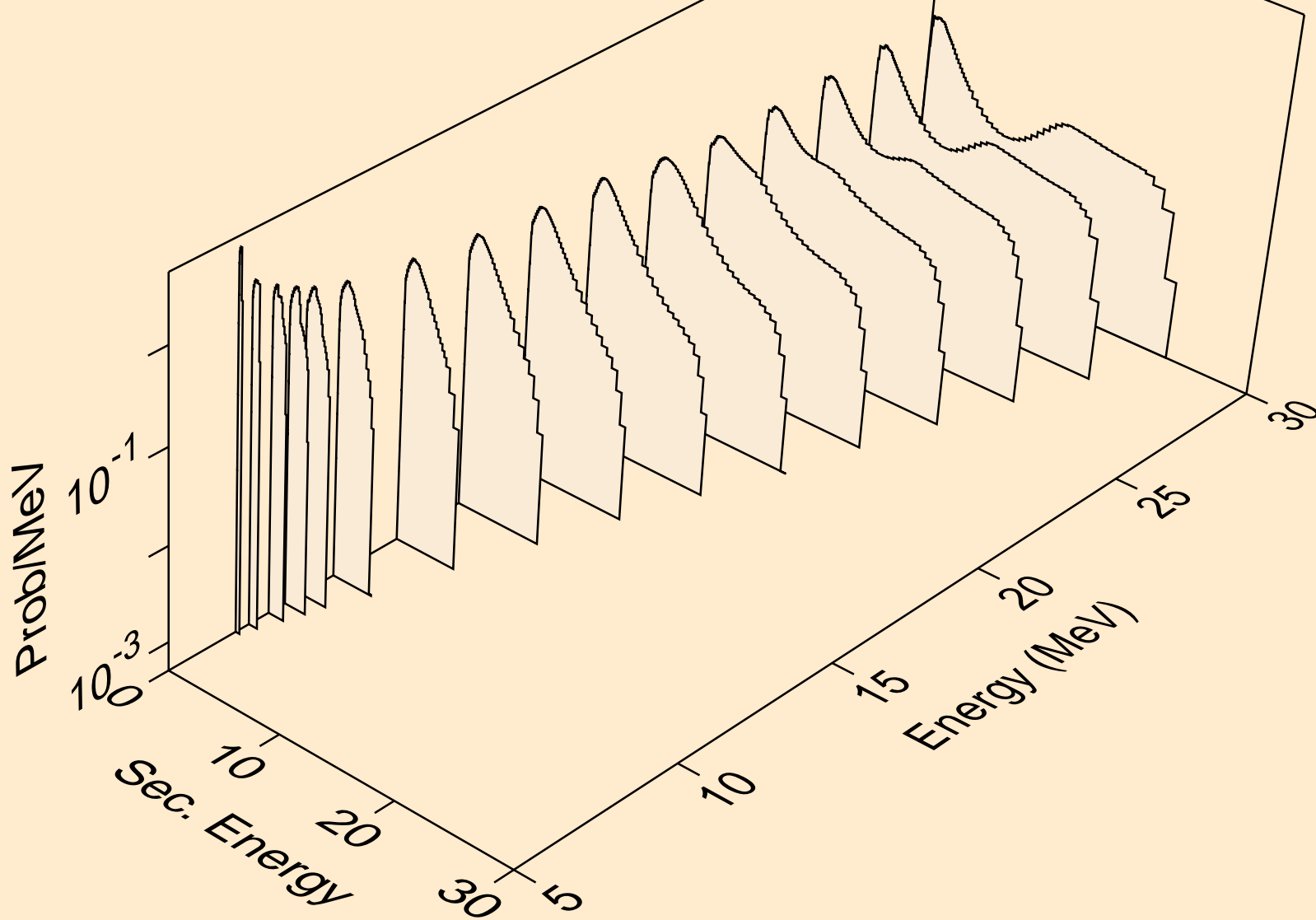



FE059 NEUTRON ACER TENDL-2023 LIBRARY; T=0.K  
Neutron emission for (n,3n)

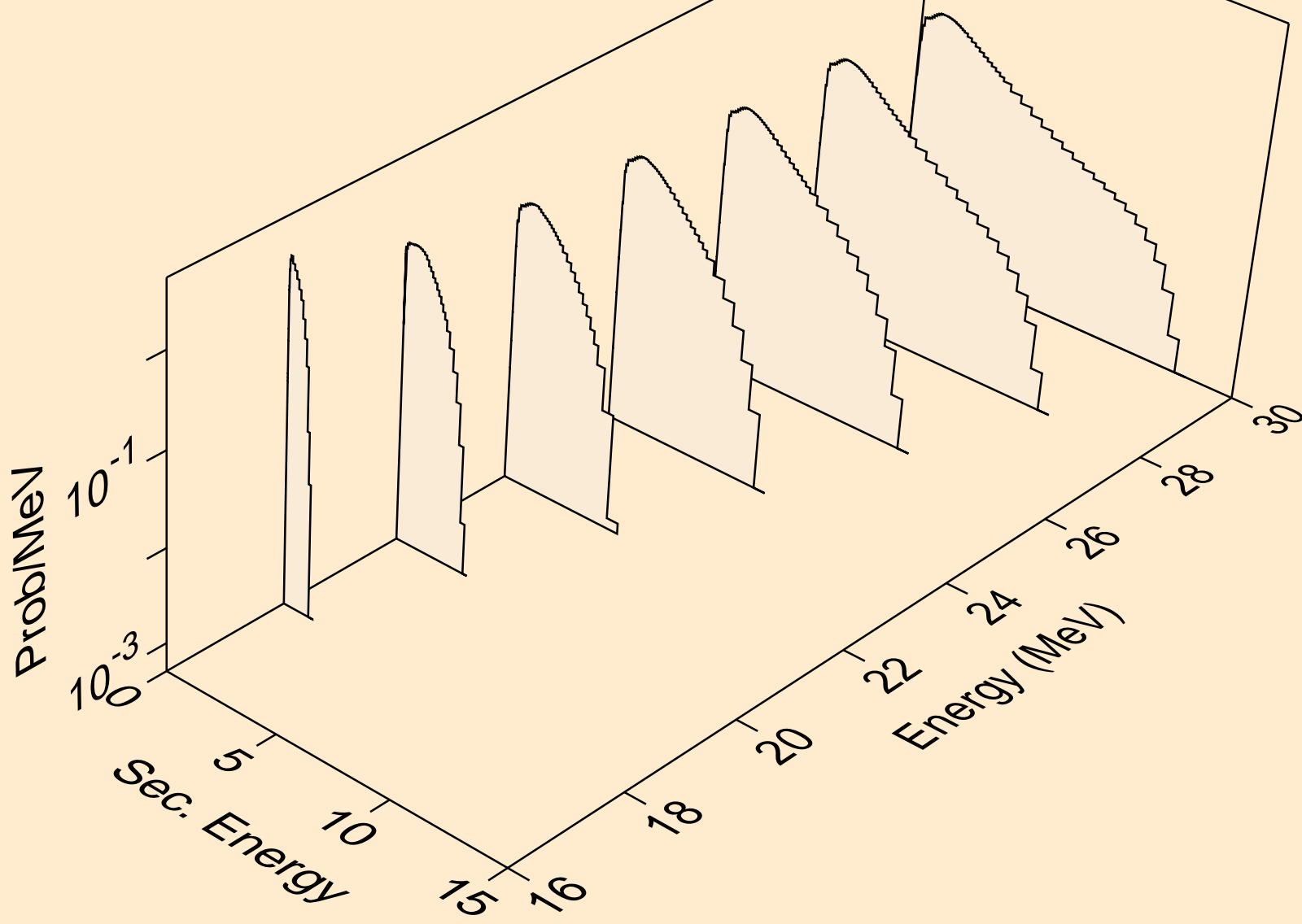

FE059 NEUTRON ACER TENDL-2023 LIBRARY; T=0.K  
Neutron emission for (n,n\*)a

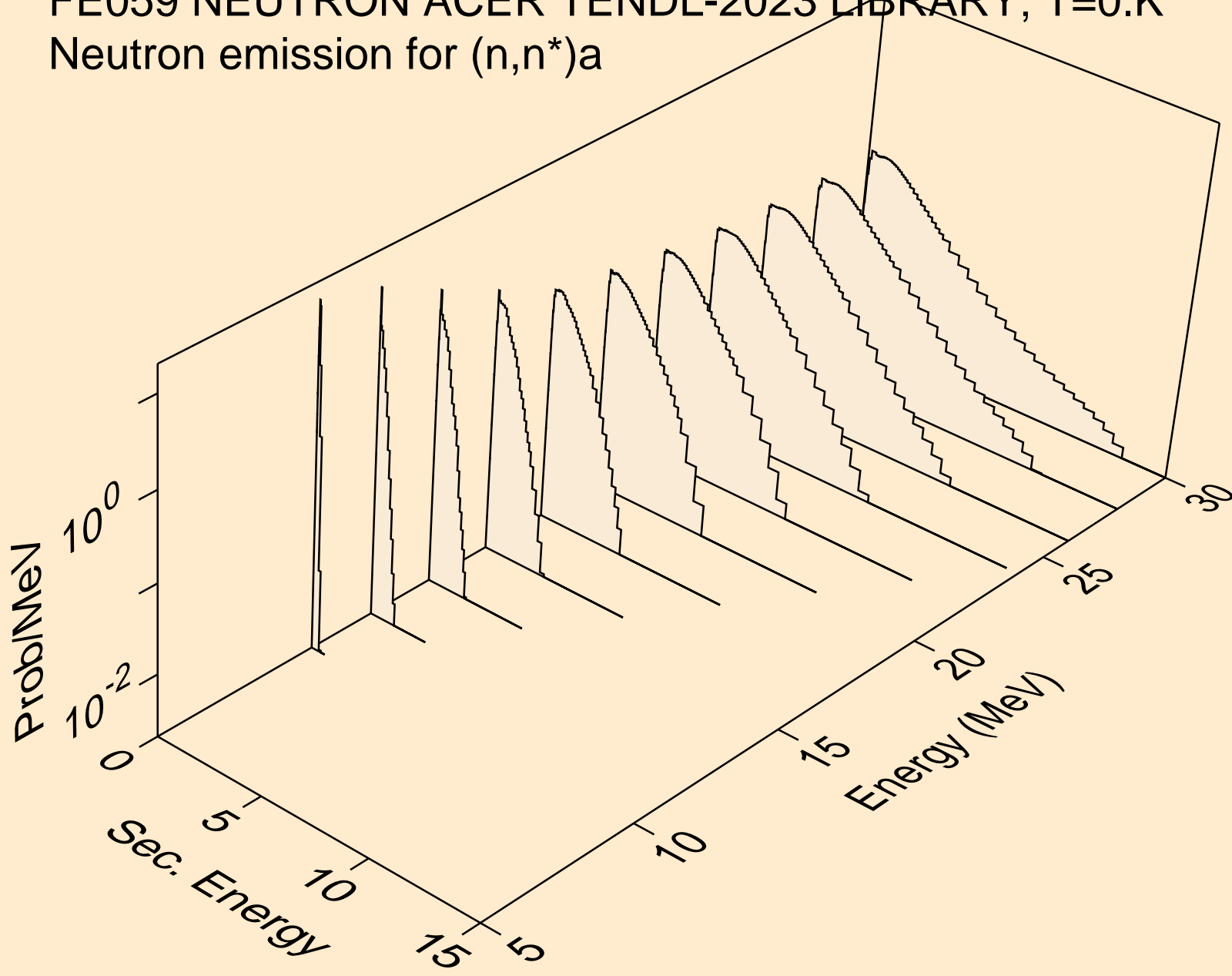

FE059 NEUTRON ACER TENDL-2023 LIBRARY; T=0.K  
Neutron emission for (n,2n)a

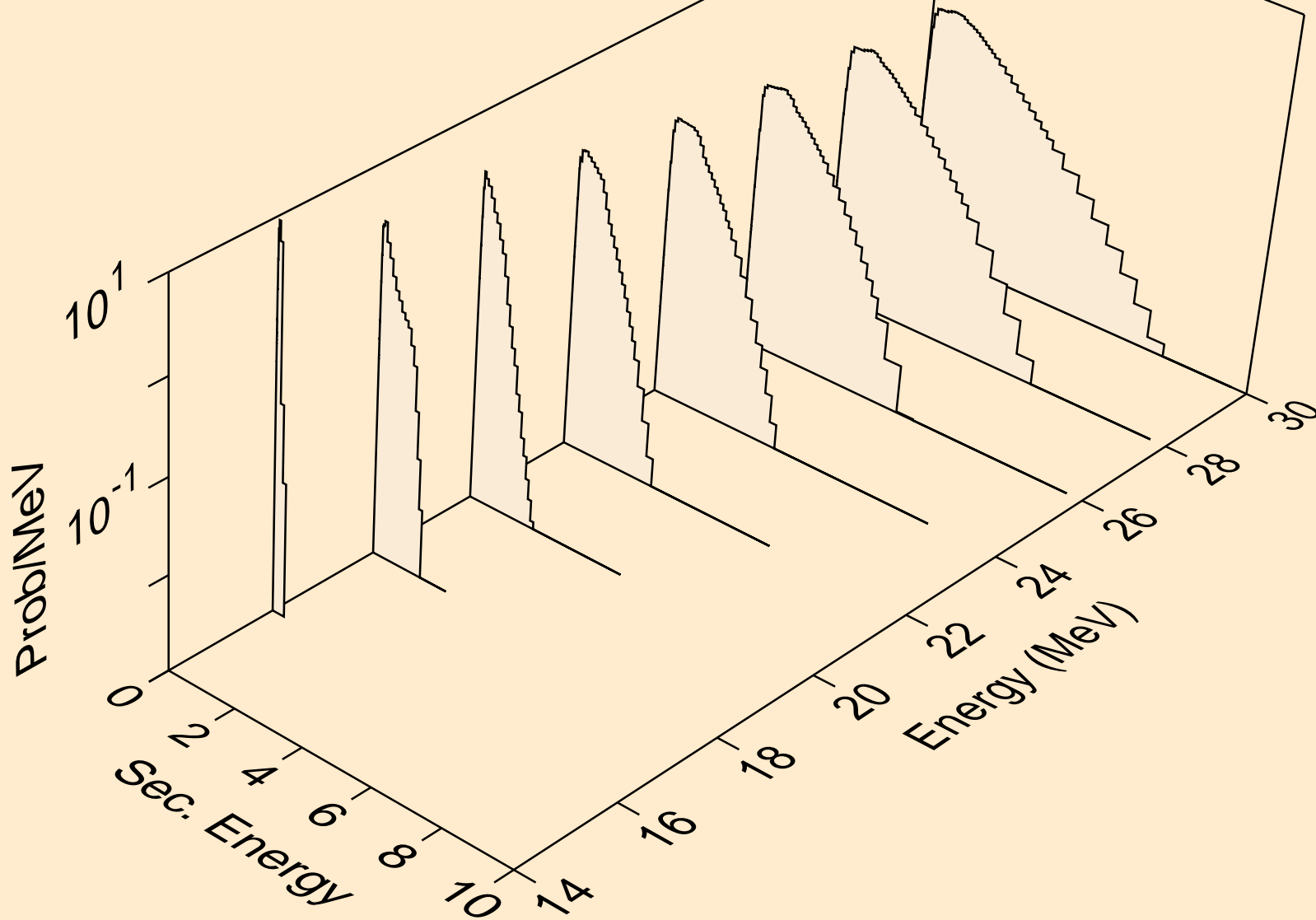

FE059 NEUTRON ACER TENDL-2023 LIBRARY; T=0.K  
Neutron emission for (n,3n)a

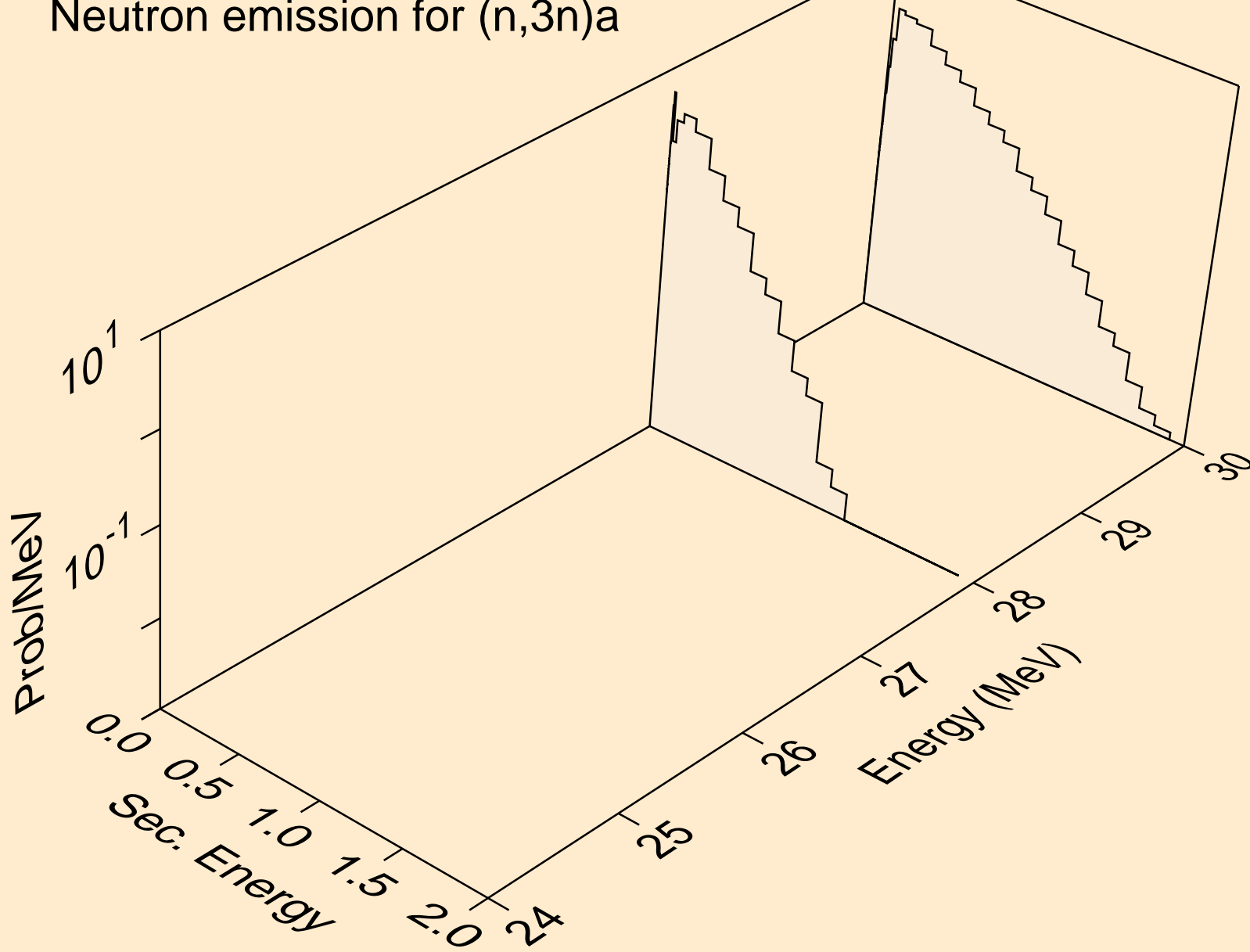

FE059 NEUTRON ACER TENDL-2023 LIBRARY; T=0.K  
Neutron emission for (n,n\*)p

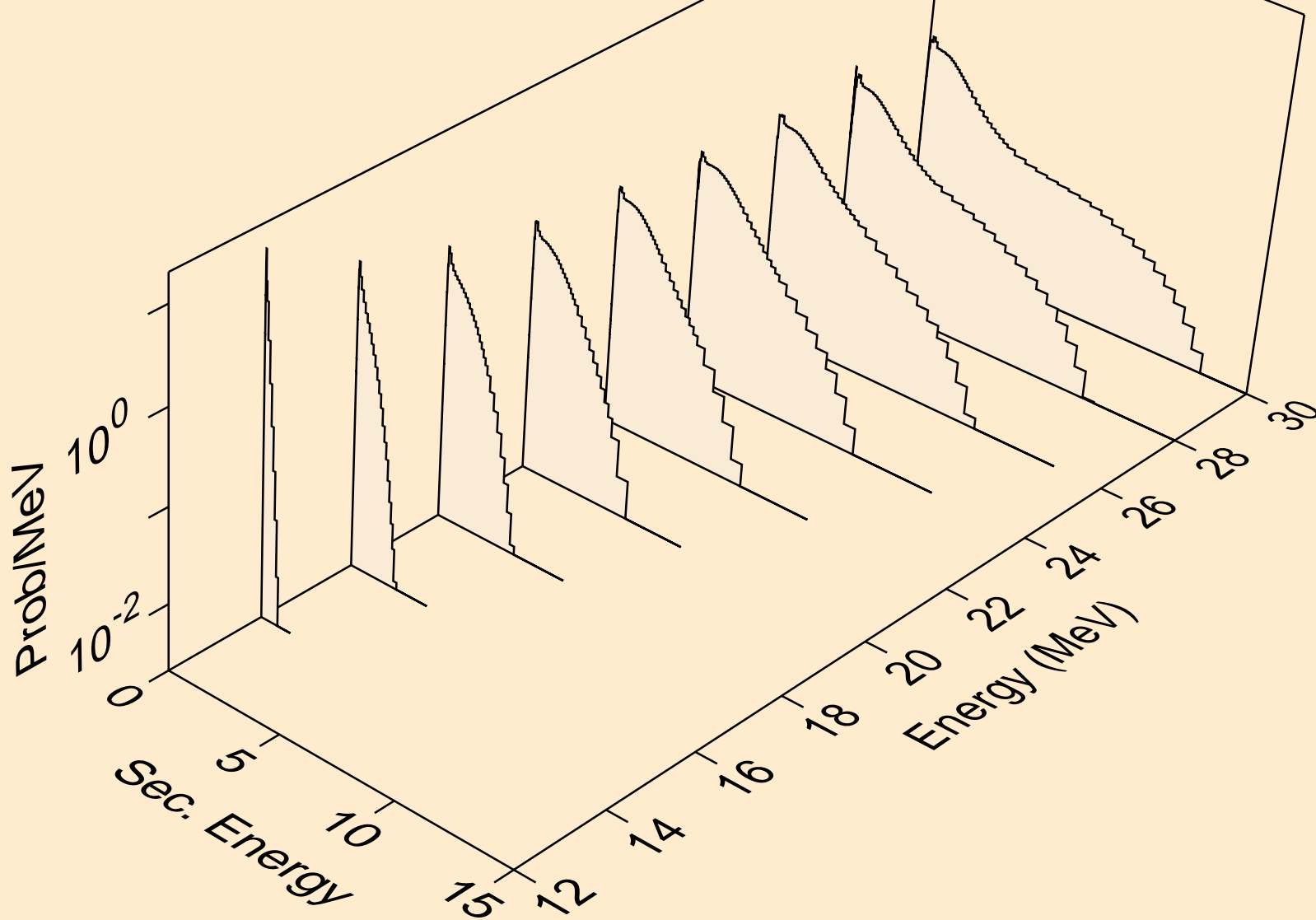

FE059 NEUTRON ACER TENDL-2023 LIBRARY; T=0.K  
Neutron emission for (n,n\*)2a

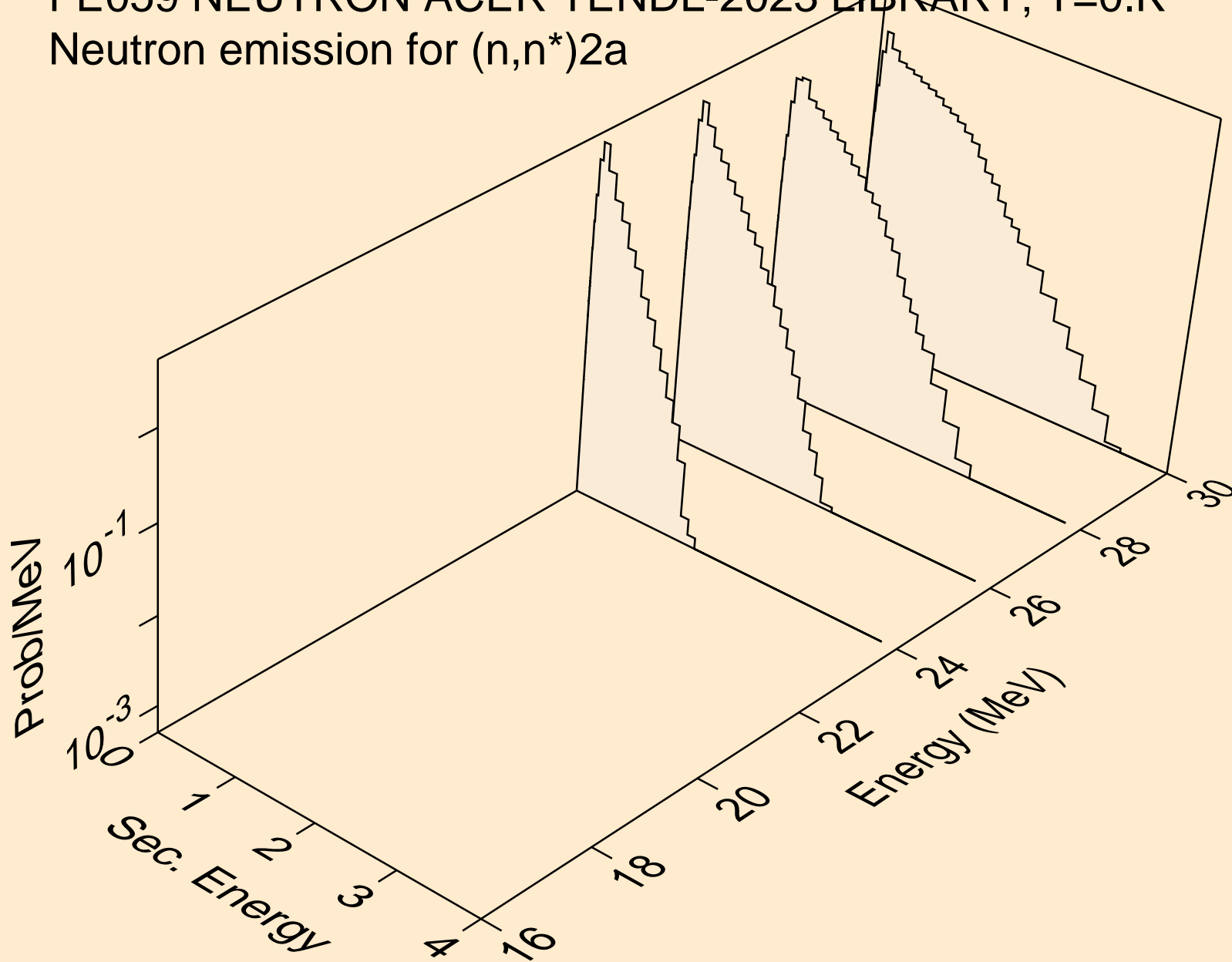

FE059 NEUTRON ACER TENDL-2023 LIBRARY; T=0.K  
Neutron emission for (n,n\*)d

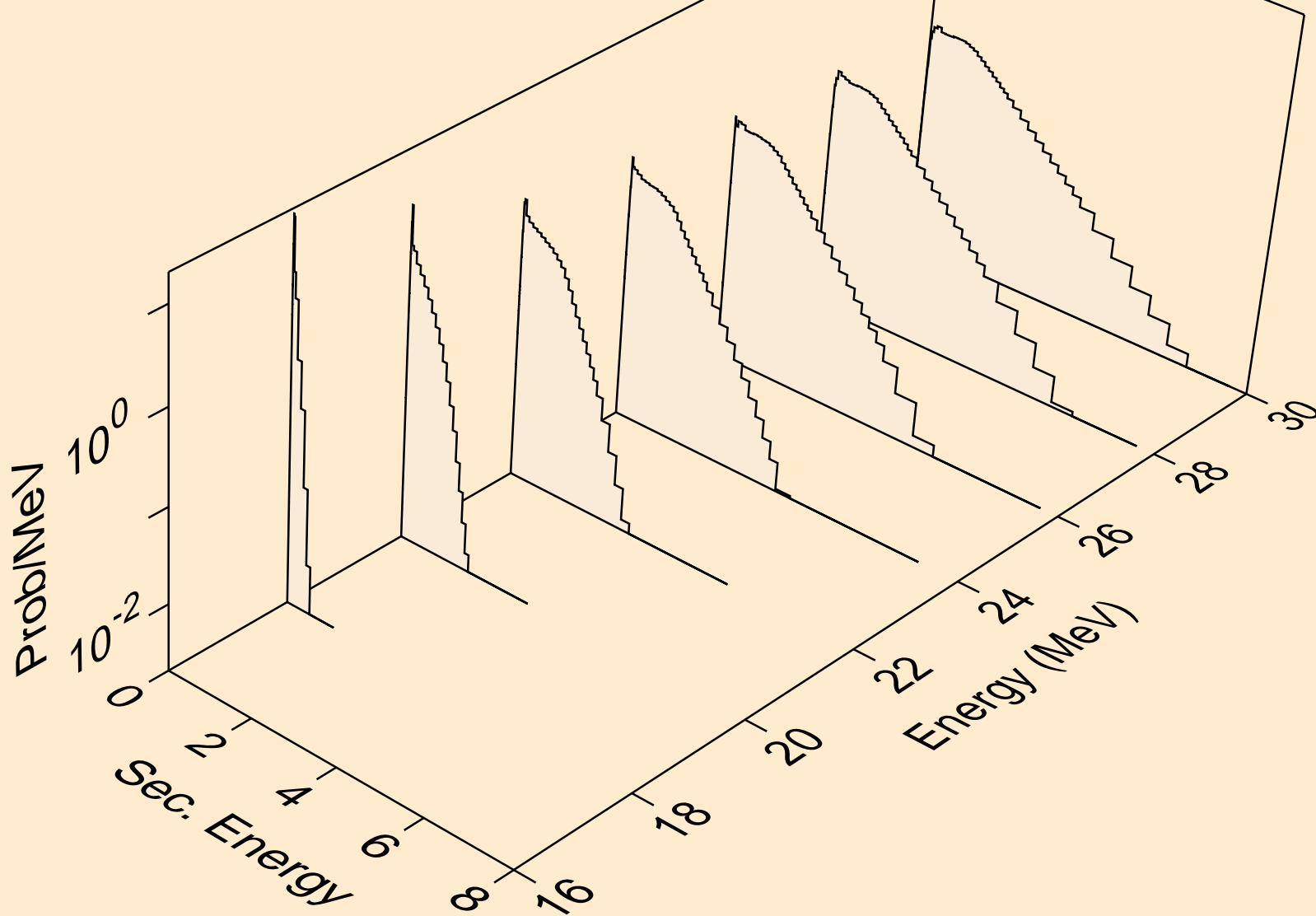

FE059 NEUTRON ACER TENDL-2023 LIBRARY; T=0.K  
Neutron emission for (n,n\*)t

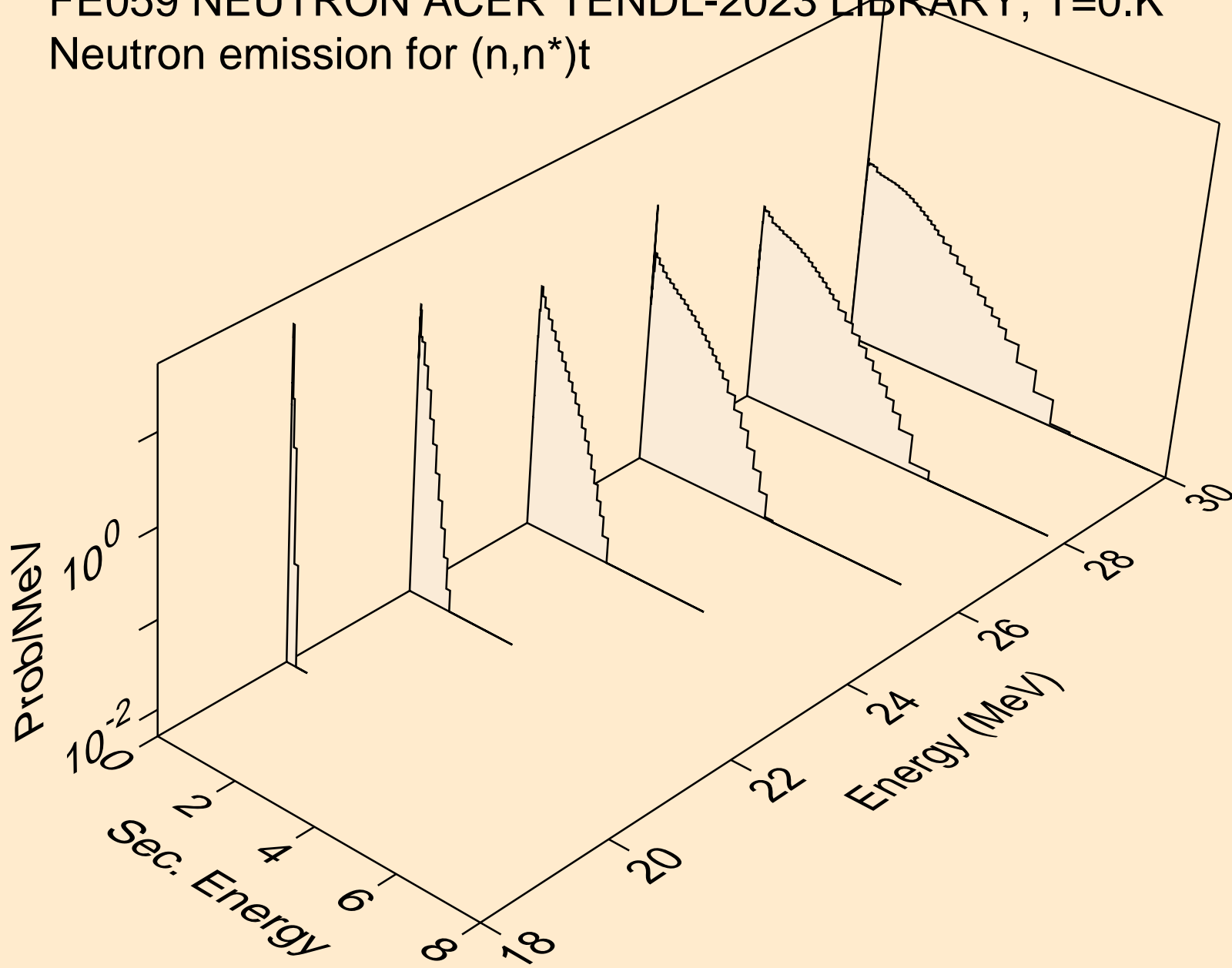



FE059 NEUTRON ACER TENDL-2023 LIBRARY; T=0.K  
Neutron emission for (n,n\*)he3

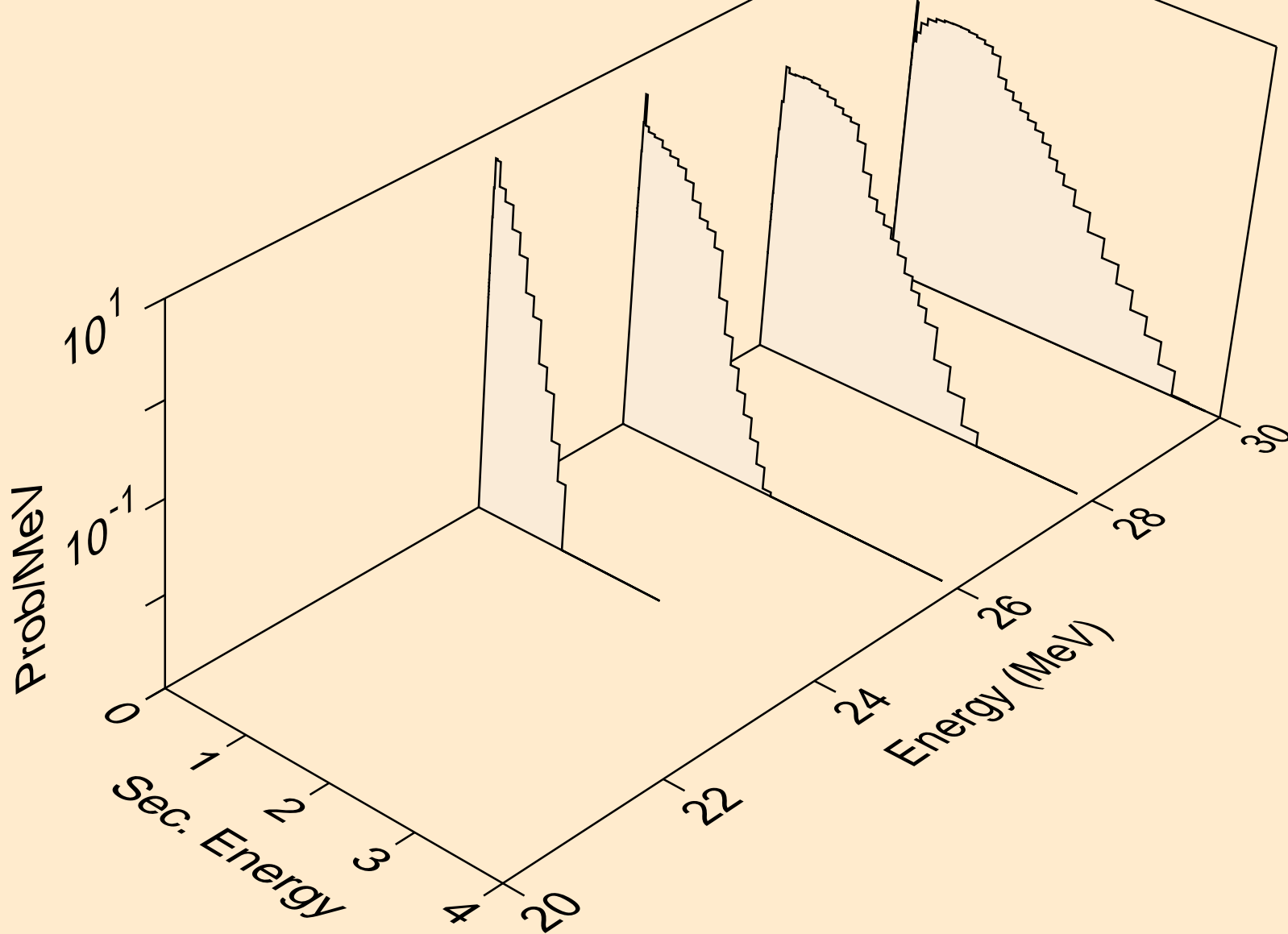

FE059 NEUTRON ACER TENDL-2023 LIBRARY; T=0.K  
Neutron emission for (n,4n)

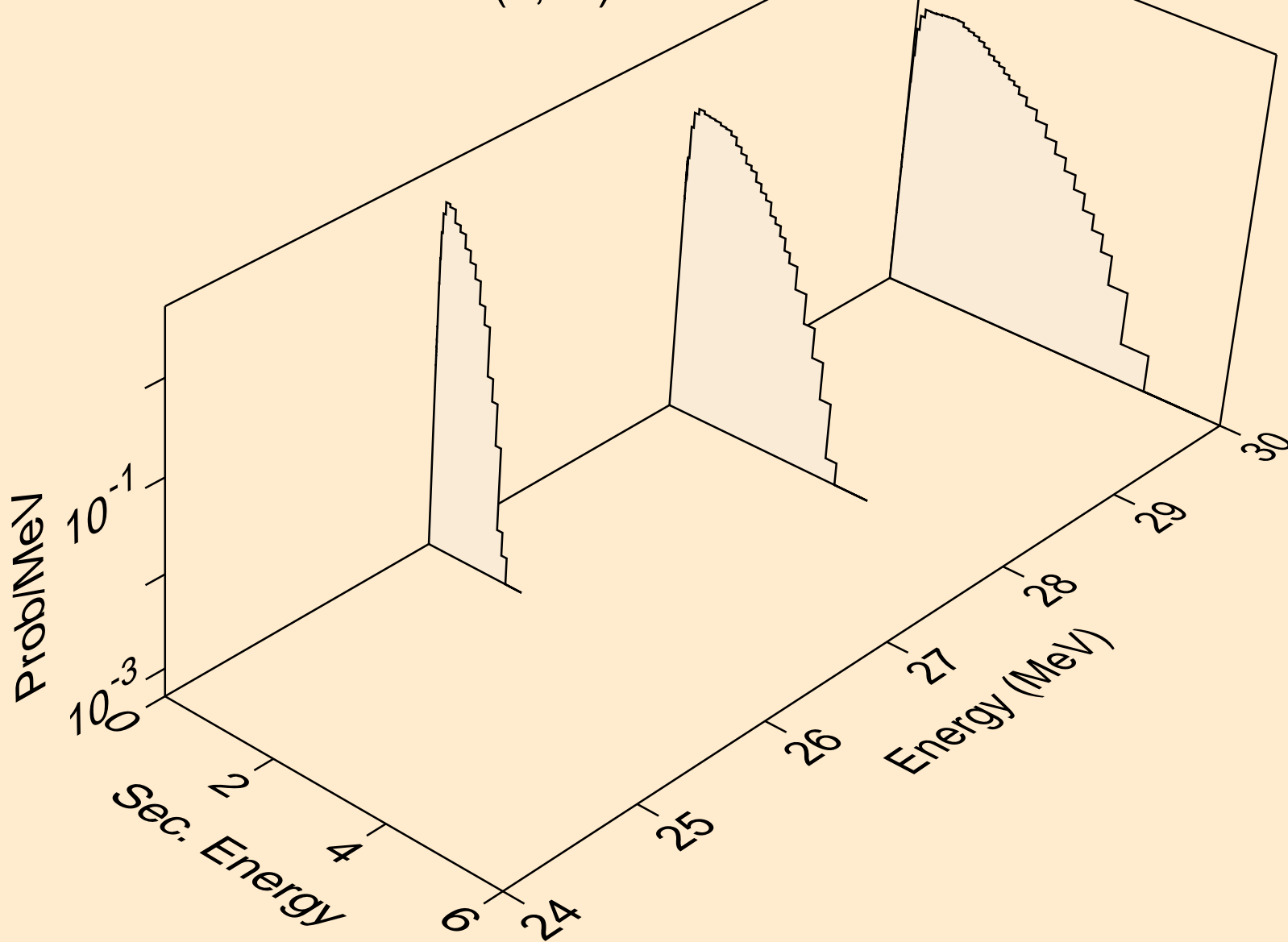

FE059 NEUTRON ACER TENDL-2023 LIBRARY; T=0.K  
Neutron emission for (n,2np)

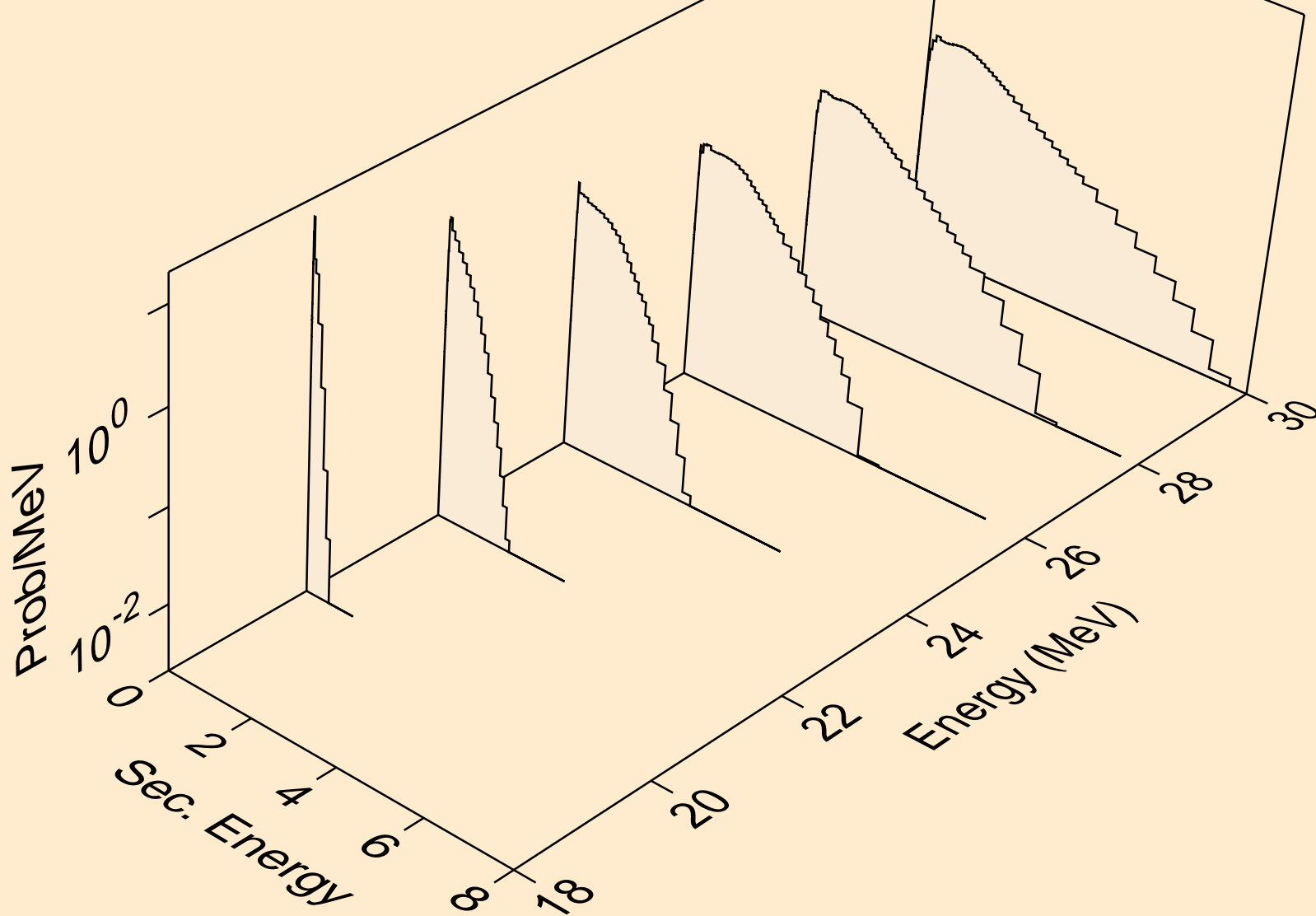

FE059 NEUTRON ACER TENDL-2023 LIBRARY; T=0.K  
Neutron emission for (n,3np)

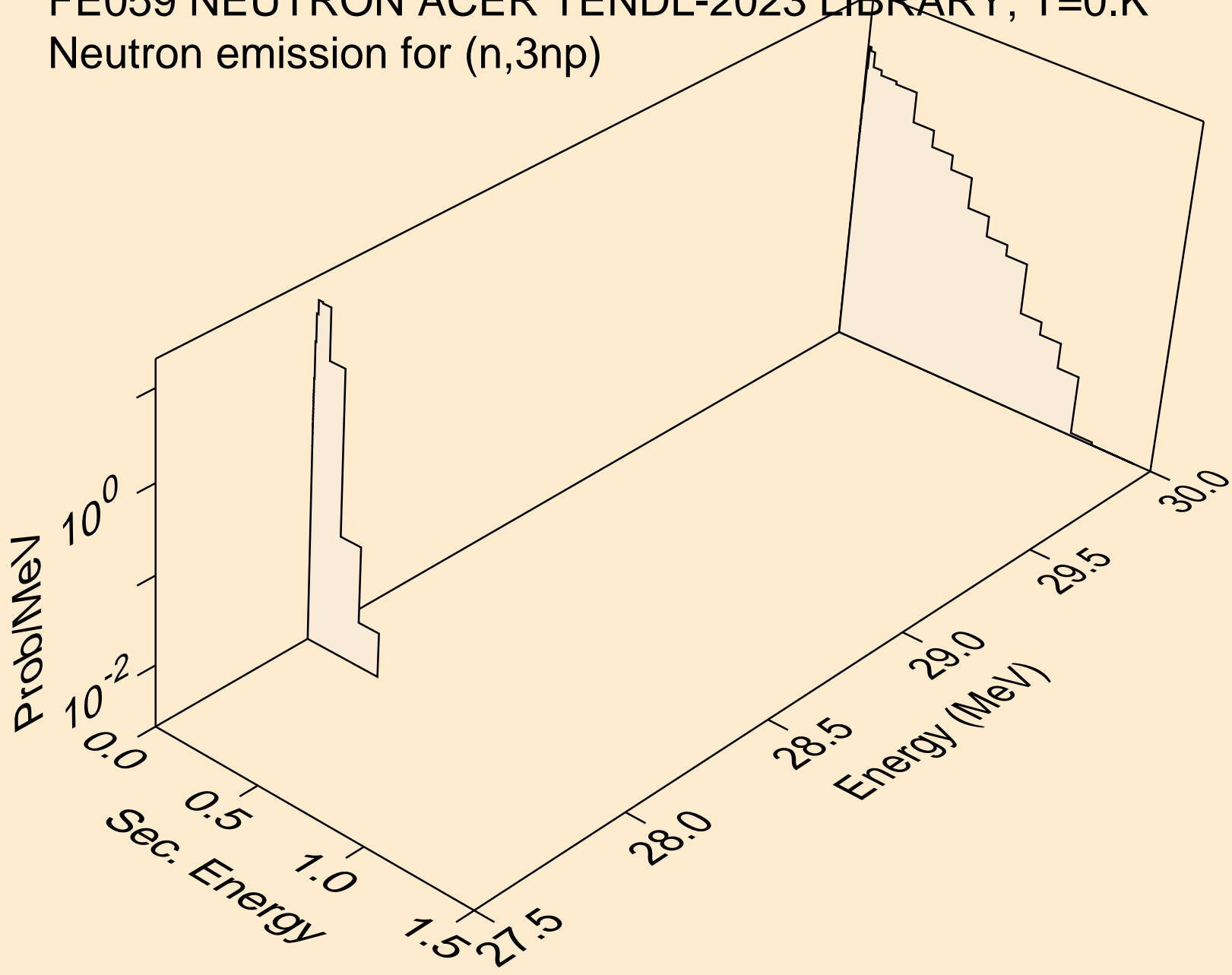

FE059 NEUTRON ACER TENDL-2023 LIBRARY; T=0.K  
Neutron emission for (n,n2p)

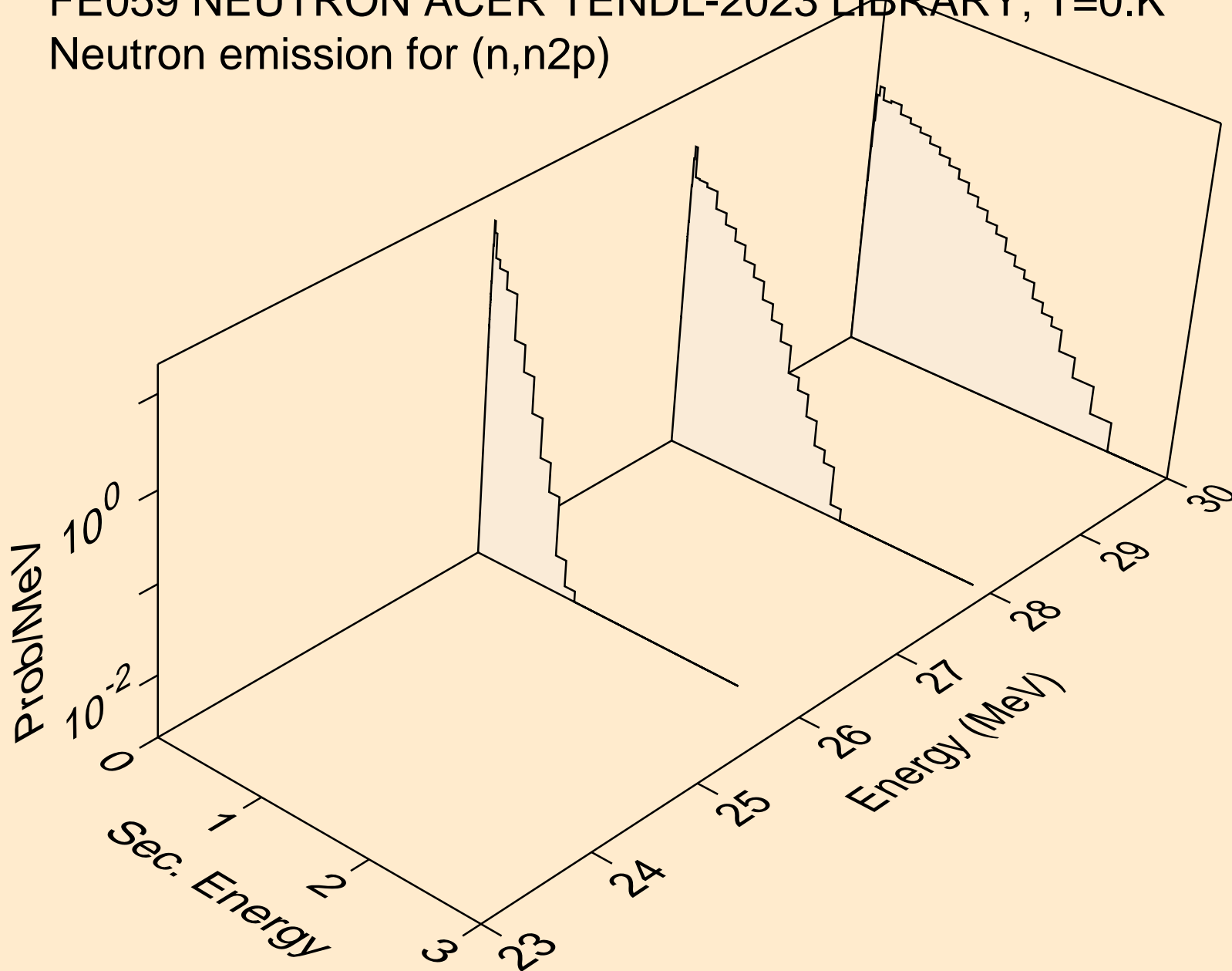

FE059 NEUTRON ACER TENDL-2023 LIBRARY; T=0.K  
Neutron emission for (n,npa)

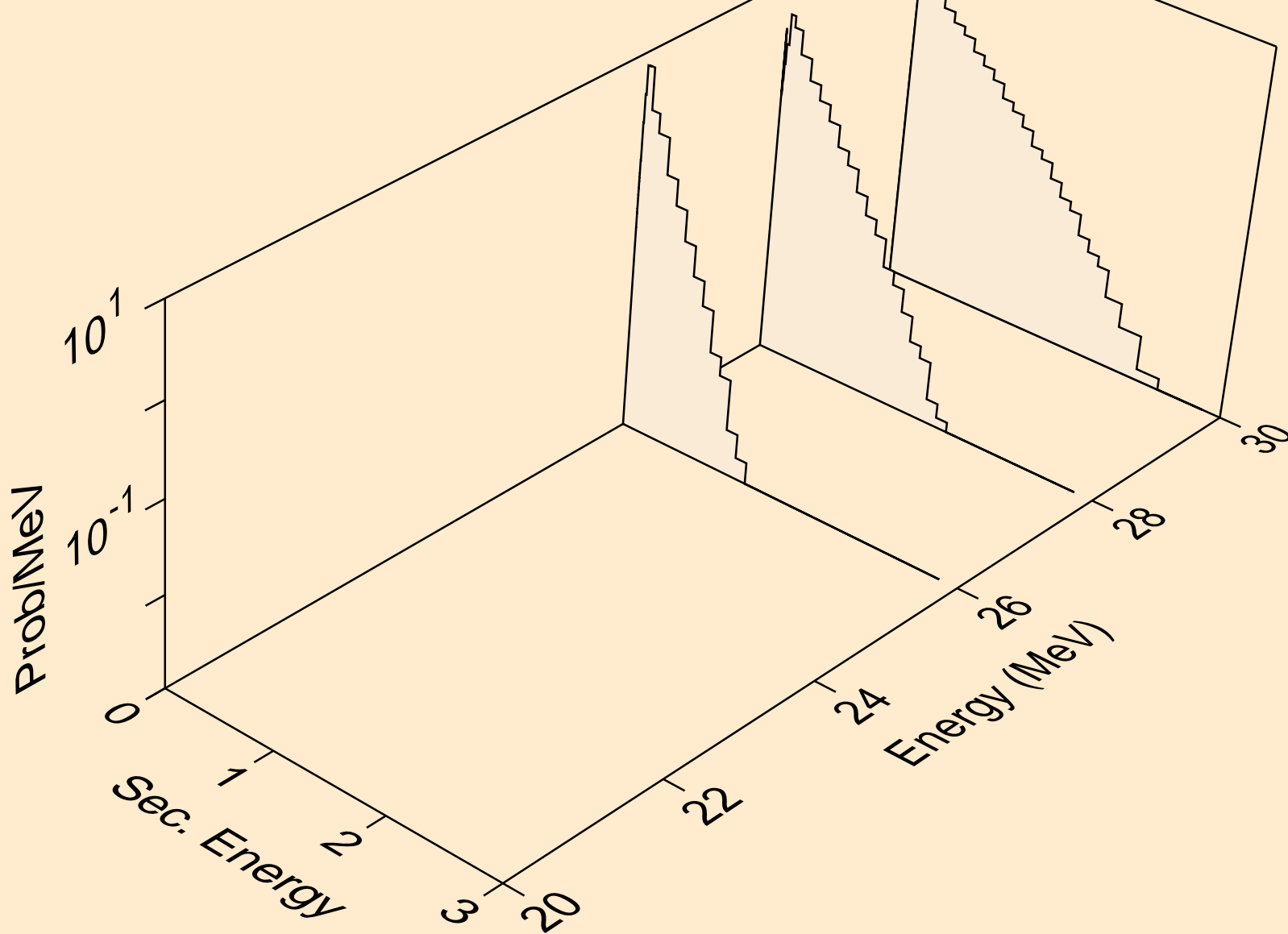

FE059 NEUTRON ACER TENDL-2023 LIBRARY; T=0.K  
Neutron emission for (n,n\*c)

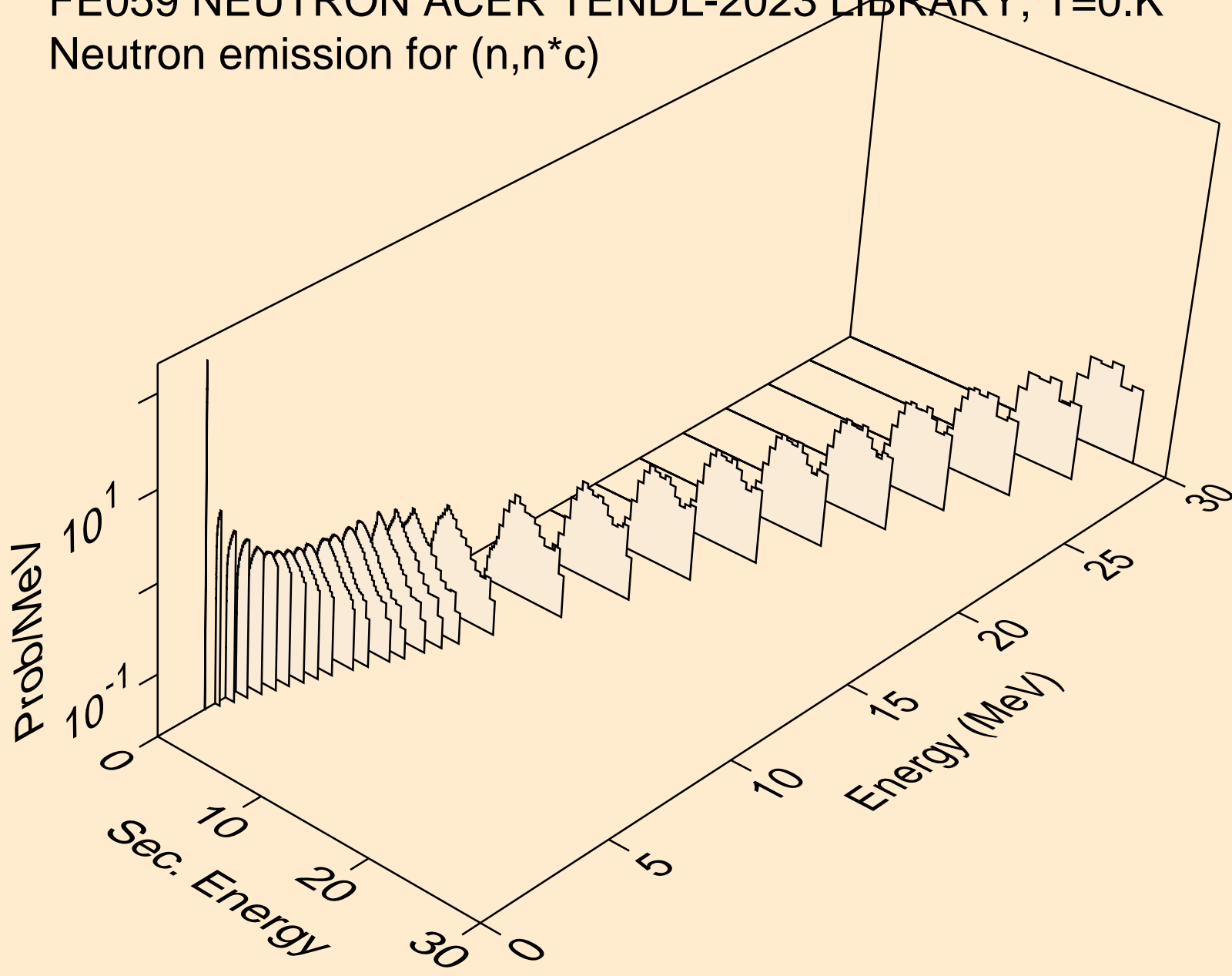

FE059 NEUTRON ACER TENDL-2023 LIBRARY; T=0.K  
Photon emission for (n,x)

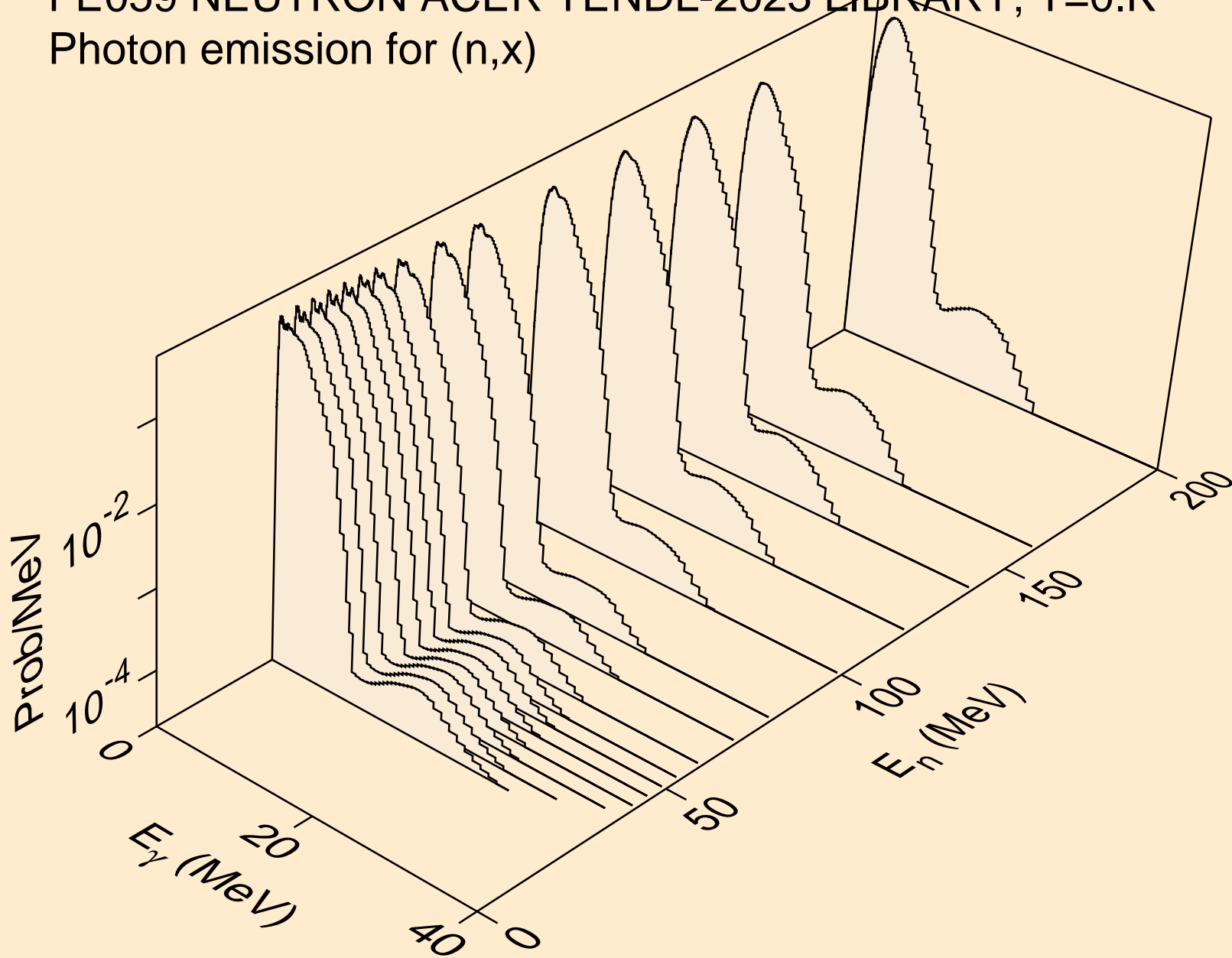



FE059 NEUTRON ACER TENDL-2023 LIBRARY; T=0.K  
Photon emission for (n,2nd)

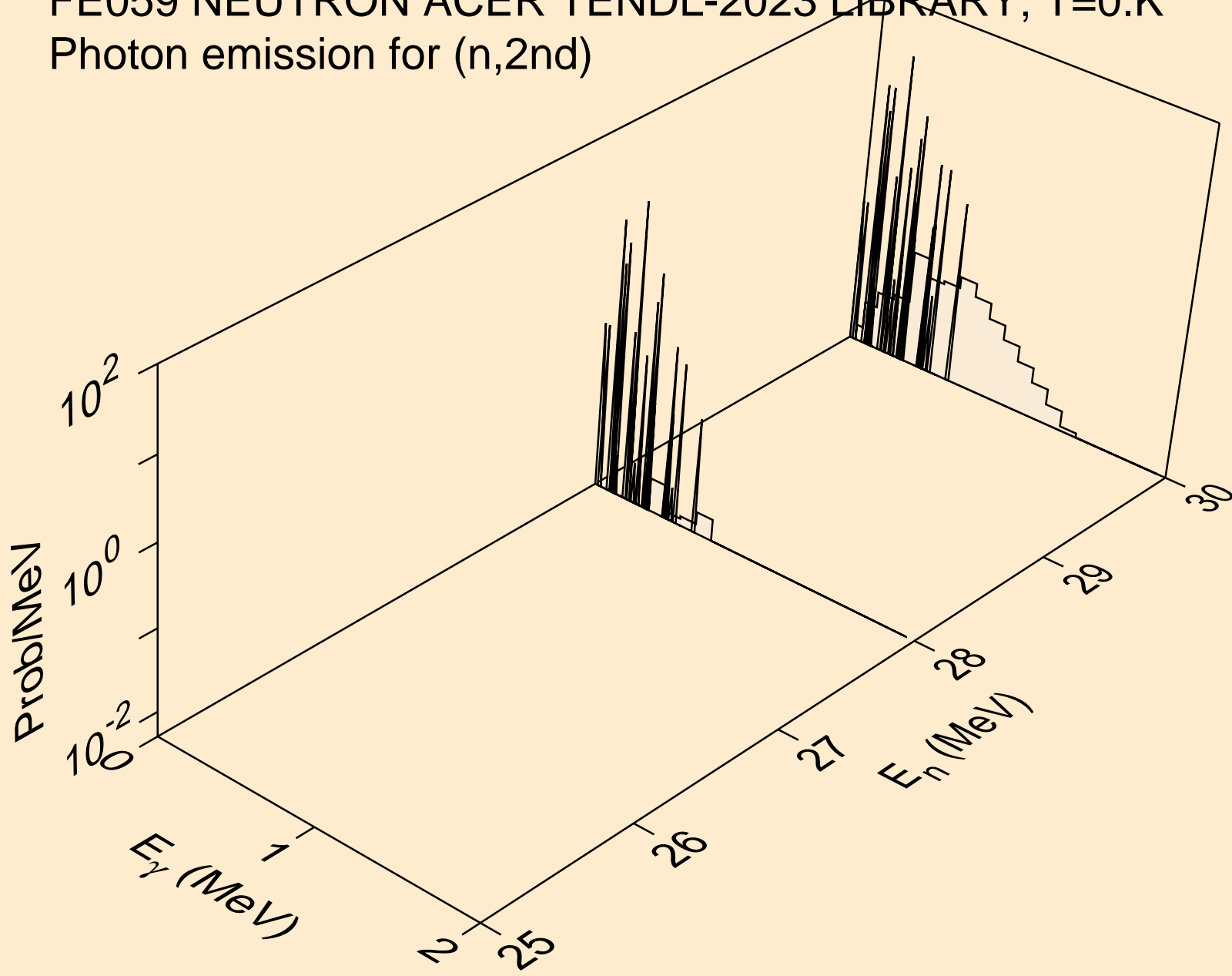

FE059 NEUTRON ACER TENDL-2023 LIBRARY; T=0.K  
Photon emission for (n,2n)

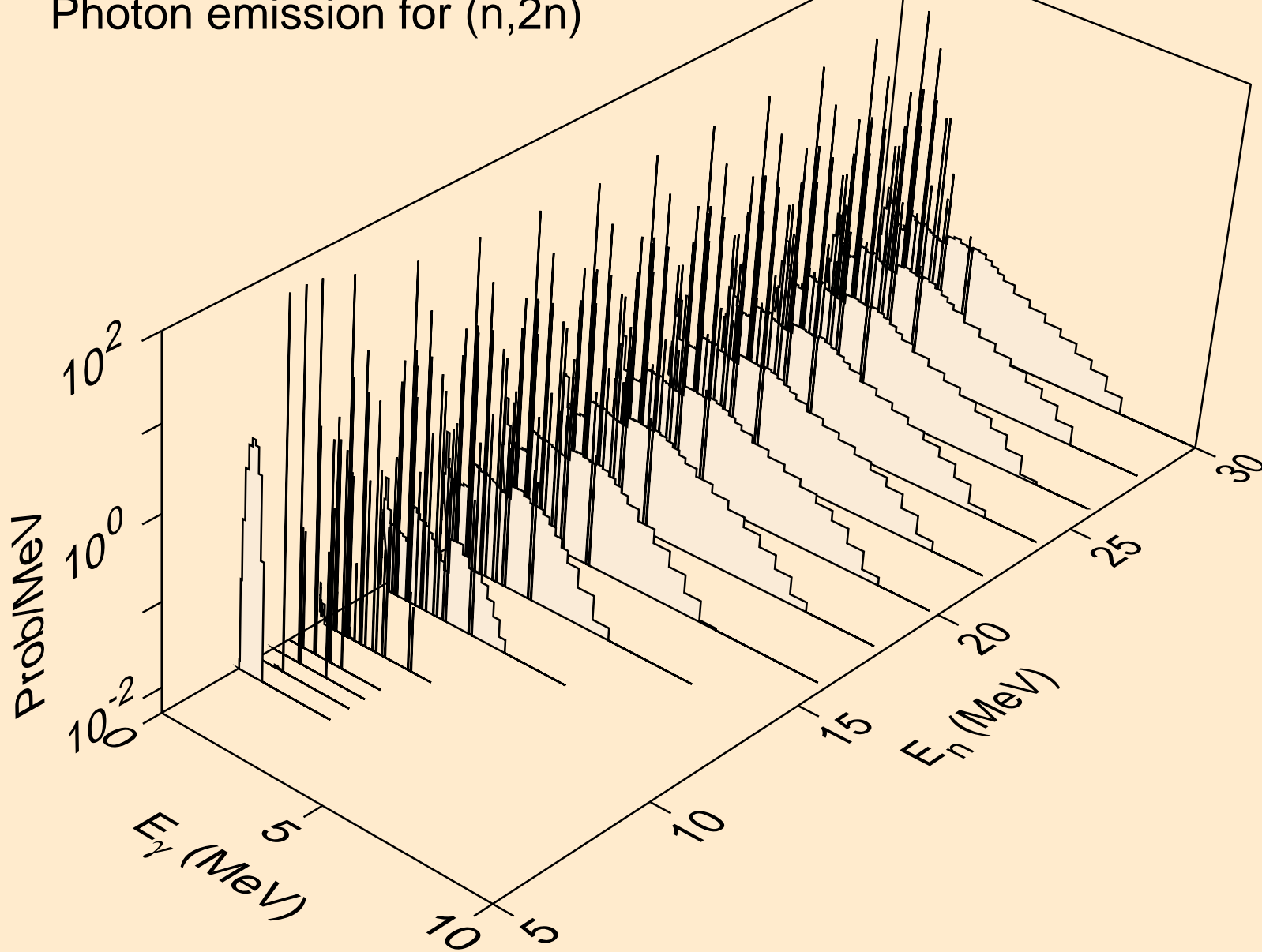

FE059 NEUTRON ACER TENDL-2023 LIBRARY; T=0.K  
Photon emission for (n,3n)

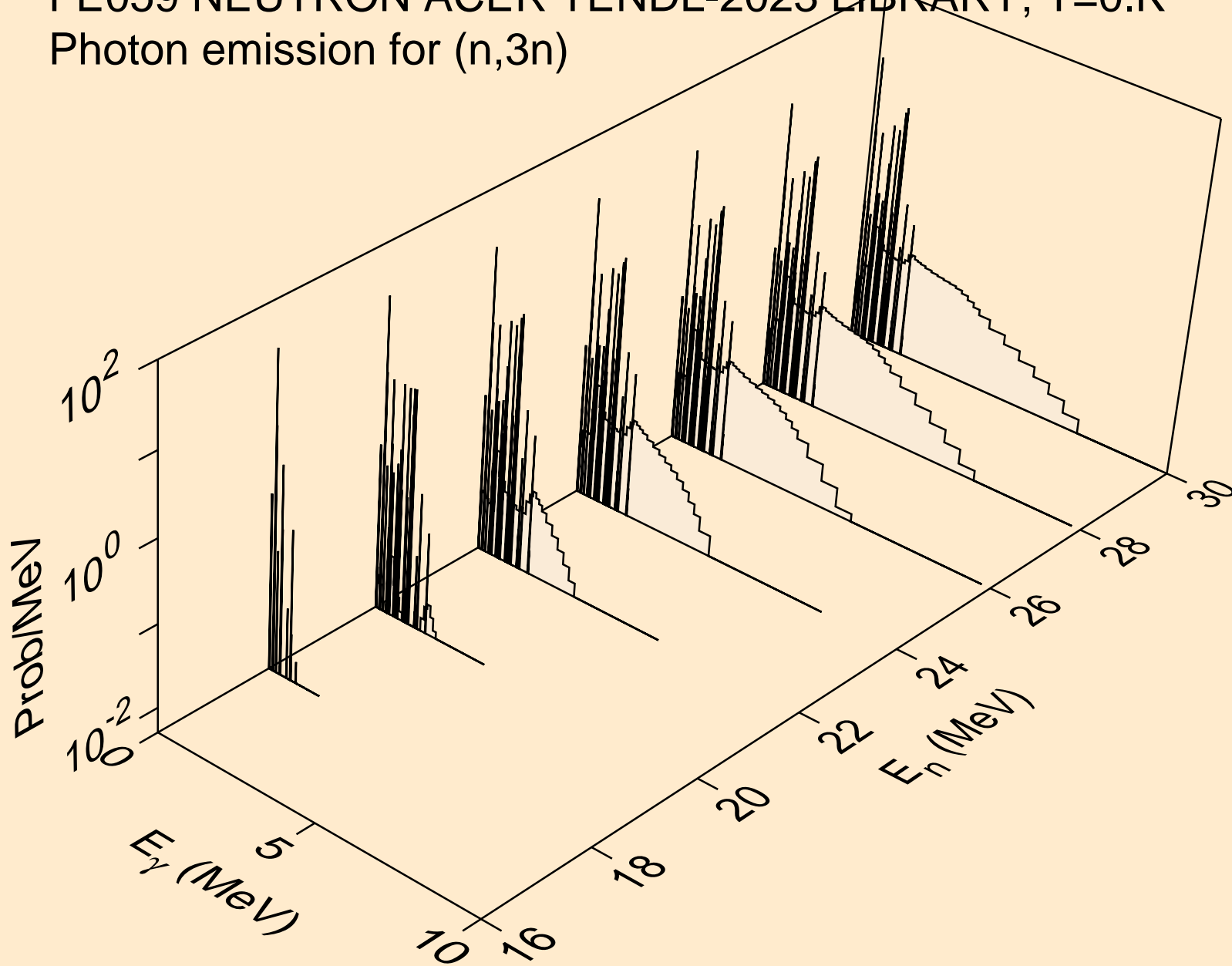

FE059 NEUTRON ACER TENDL-2023 LIBRARY; T=0.K  
Photon emission for (n,n\*)a

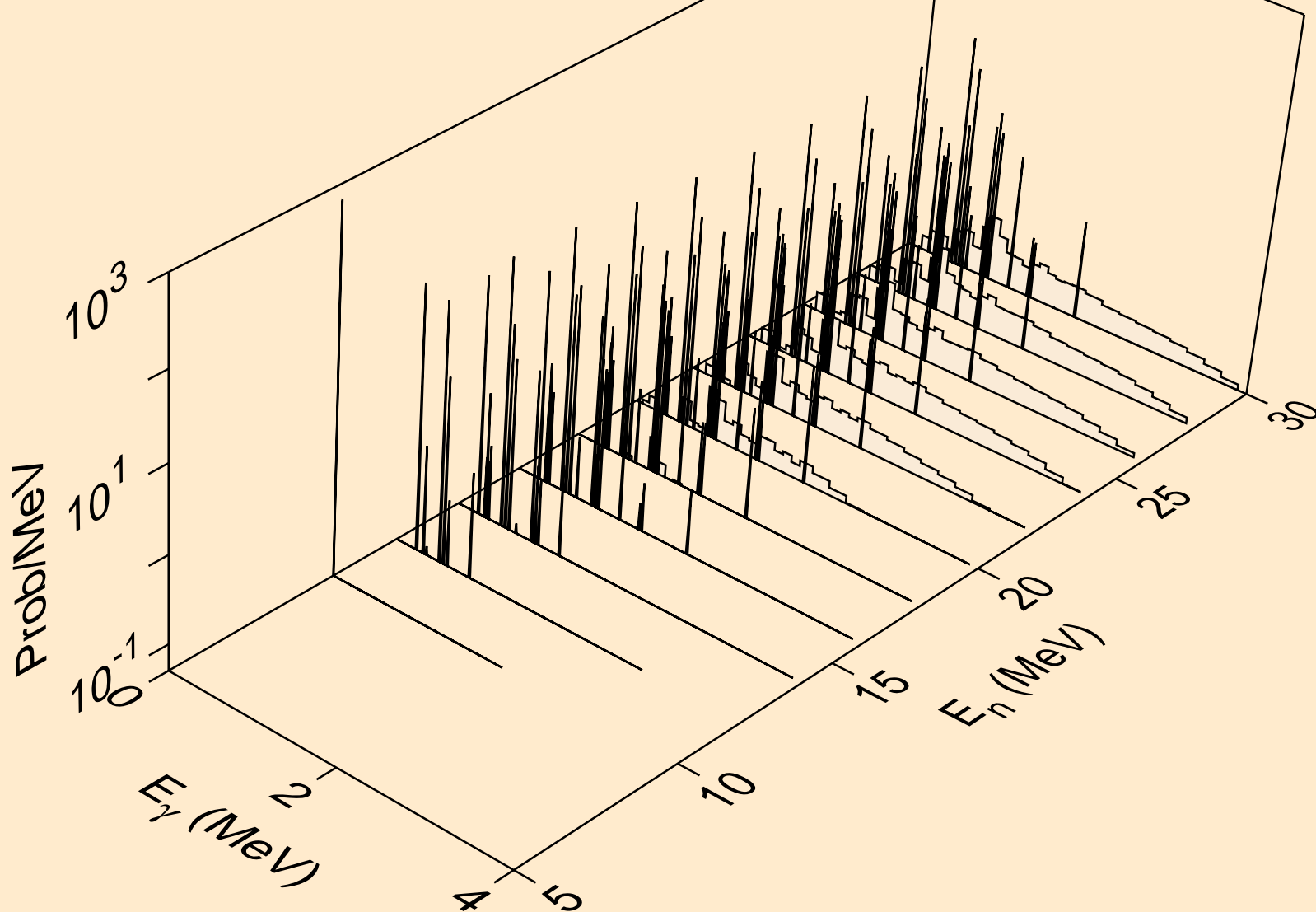

FE059 NEUTRON ACER TENDL-2023 LIBRARY; T=0.K  
Photon emission for (n,2n)a

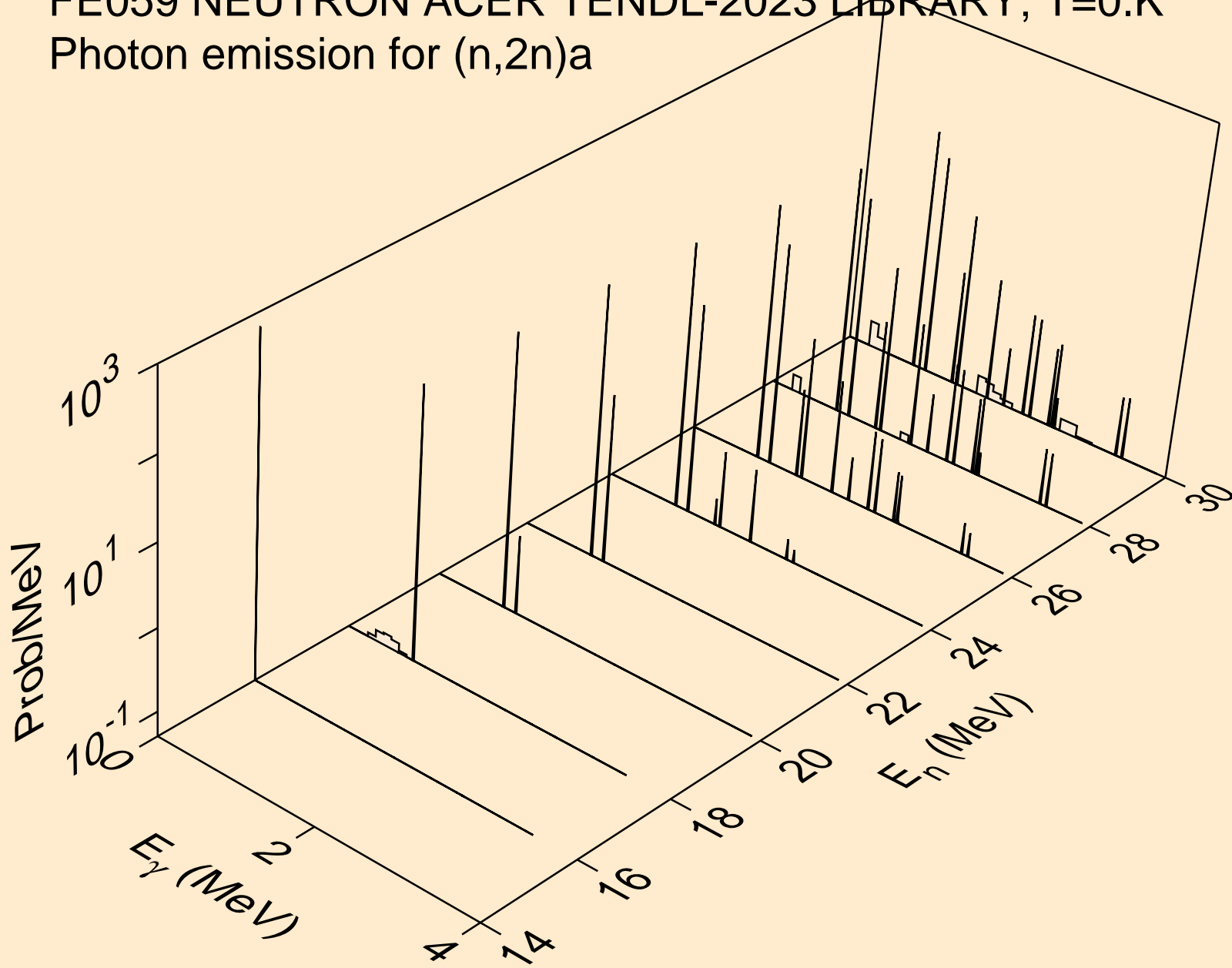

FE059 NEUTRON ACER TENDL-2023 LIBRARY; T=0.K  
Photon emission for (n,3n)a

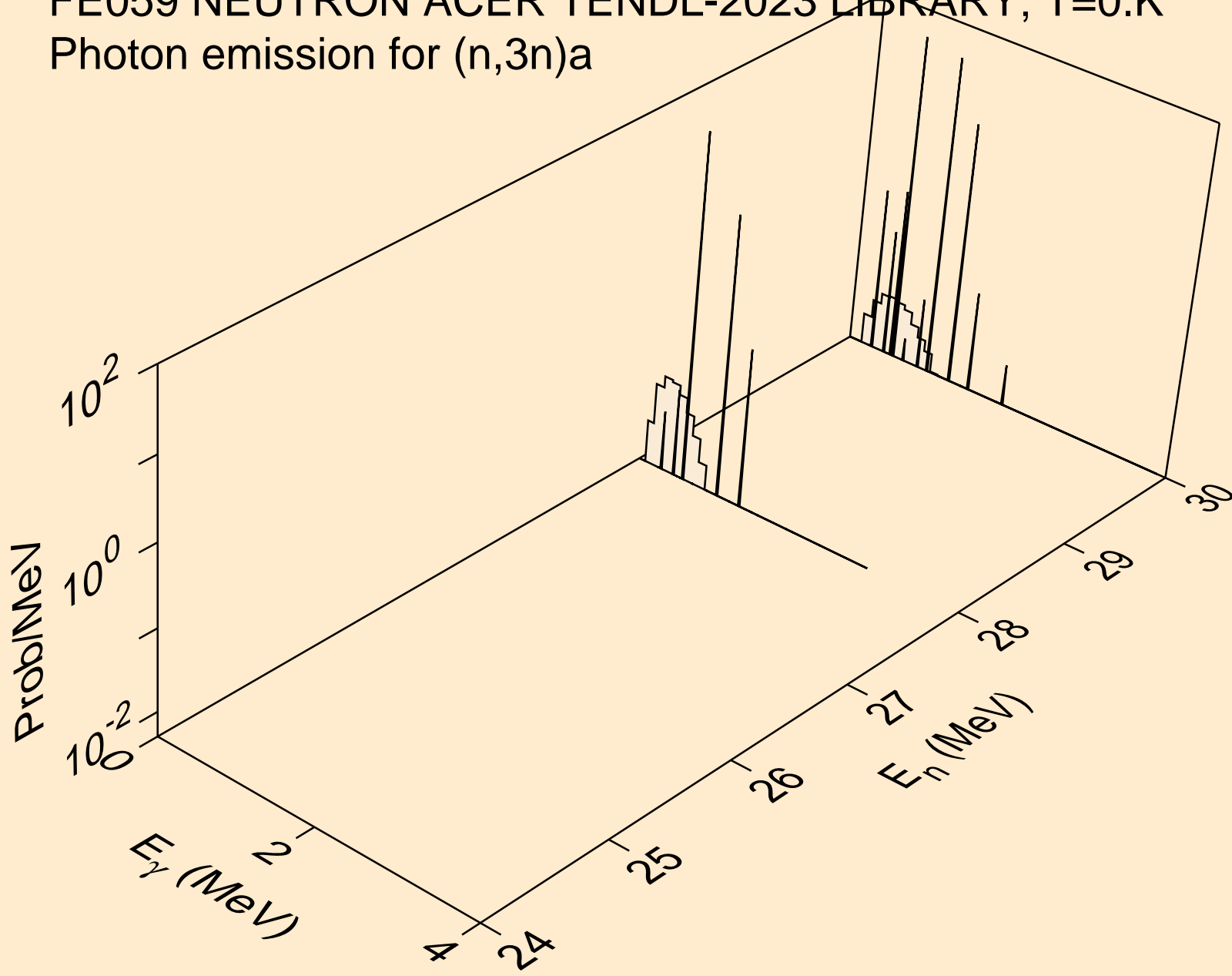

FE059 NEUTRON ACER TENDL-2023 LIBRARY; T=0.K  
Photon emission for (n,n\*)p

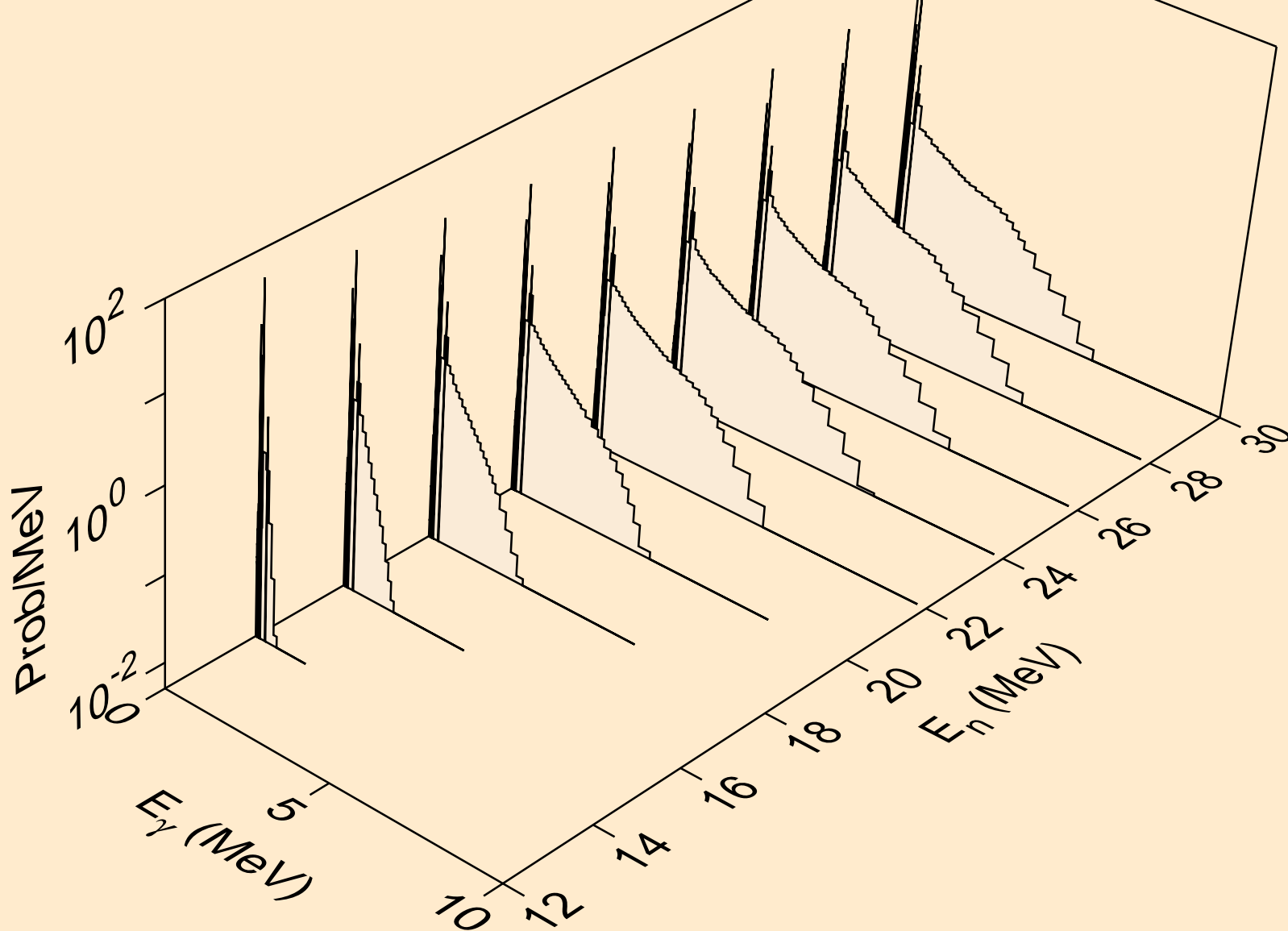

FE059 NEUTRON ACER TENDL-2023 LIBRARY; T=0.K  
Photon emission for (n,n\*)2a

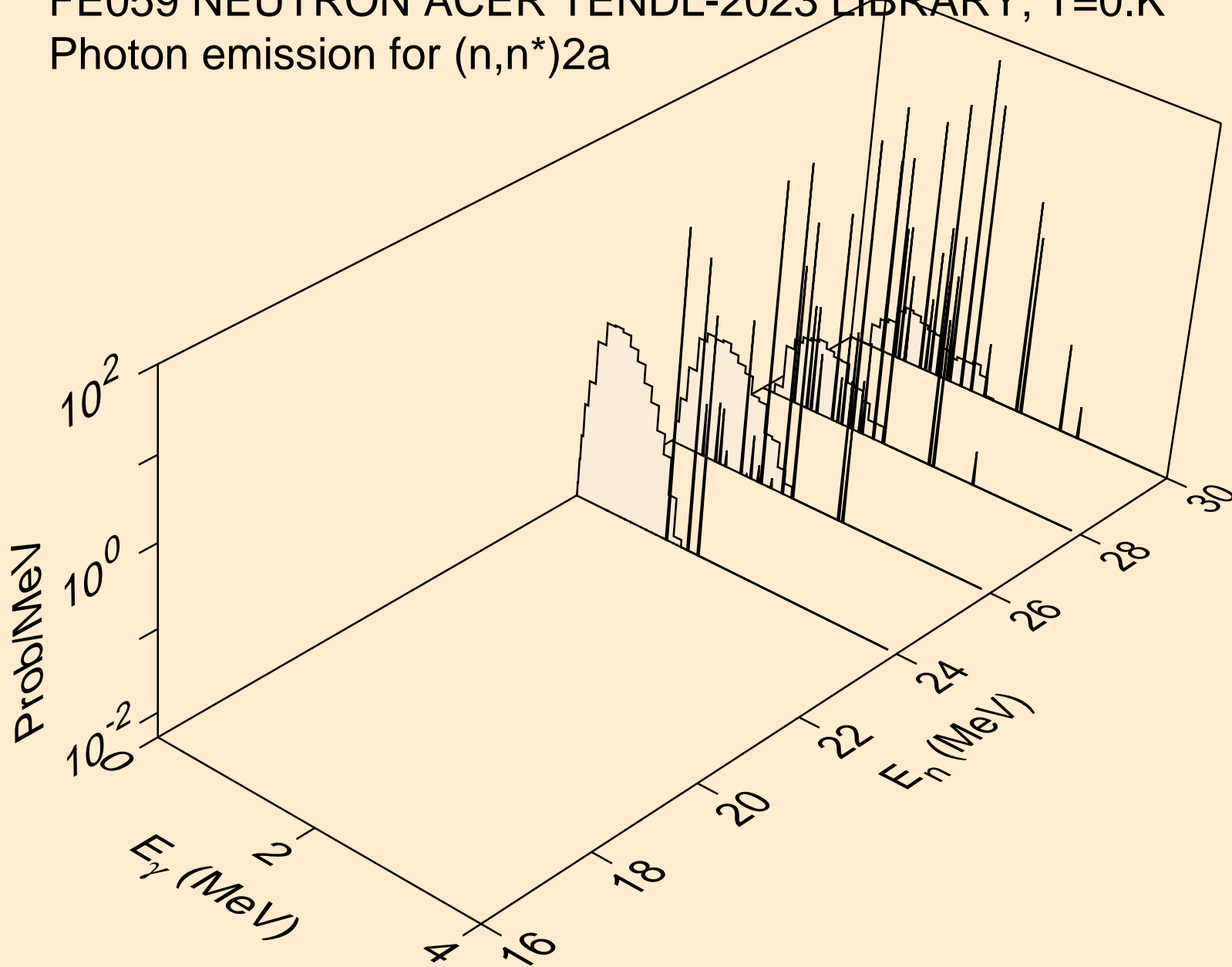



FE059 NEUTRON ACER TENDL-2023 LIBRARY; T=0.K  
Photon emission for (n,n\*)d

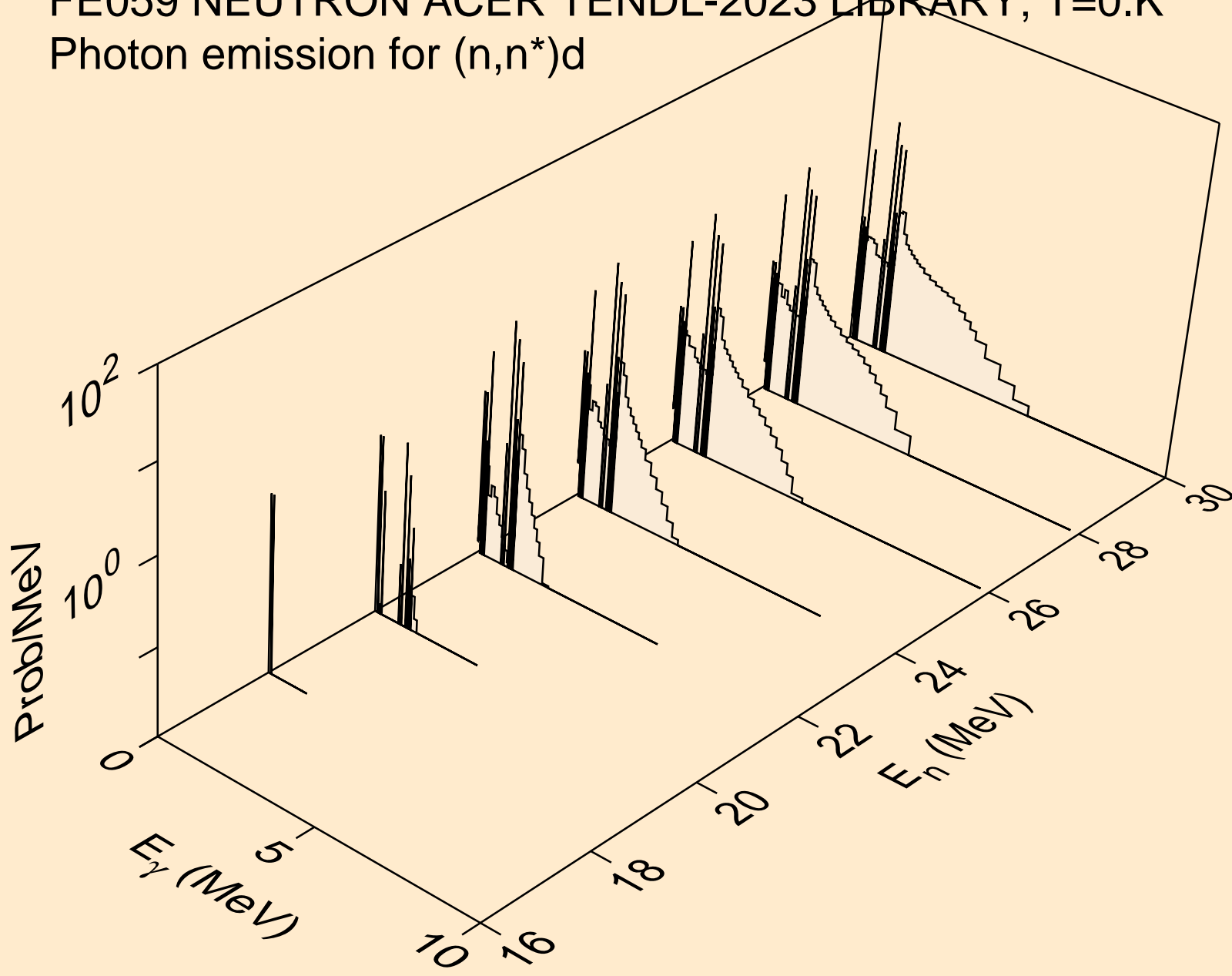

FE059 NEUTRON ACER TENDL-2023 LIBRARY; T=0.K  
Photon emission for (n,n\*)t

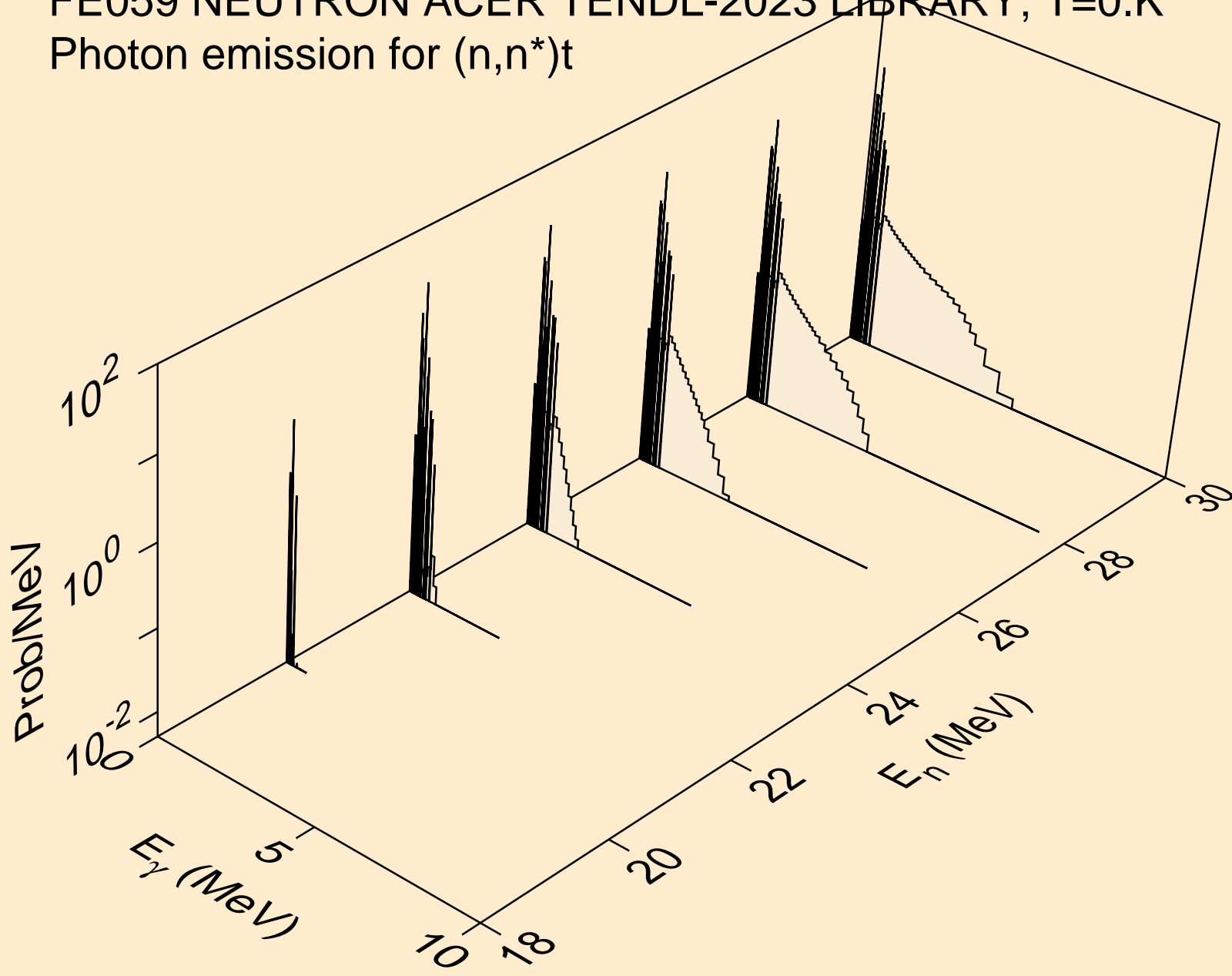

FE059 NEUTRON ACER TENDL-2023 LIBRARY; T=0.K  
Photon emission for (n,n\*)he3

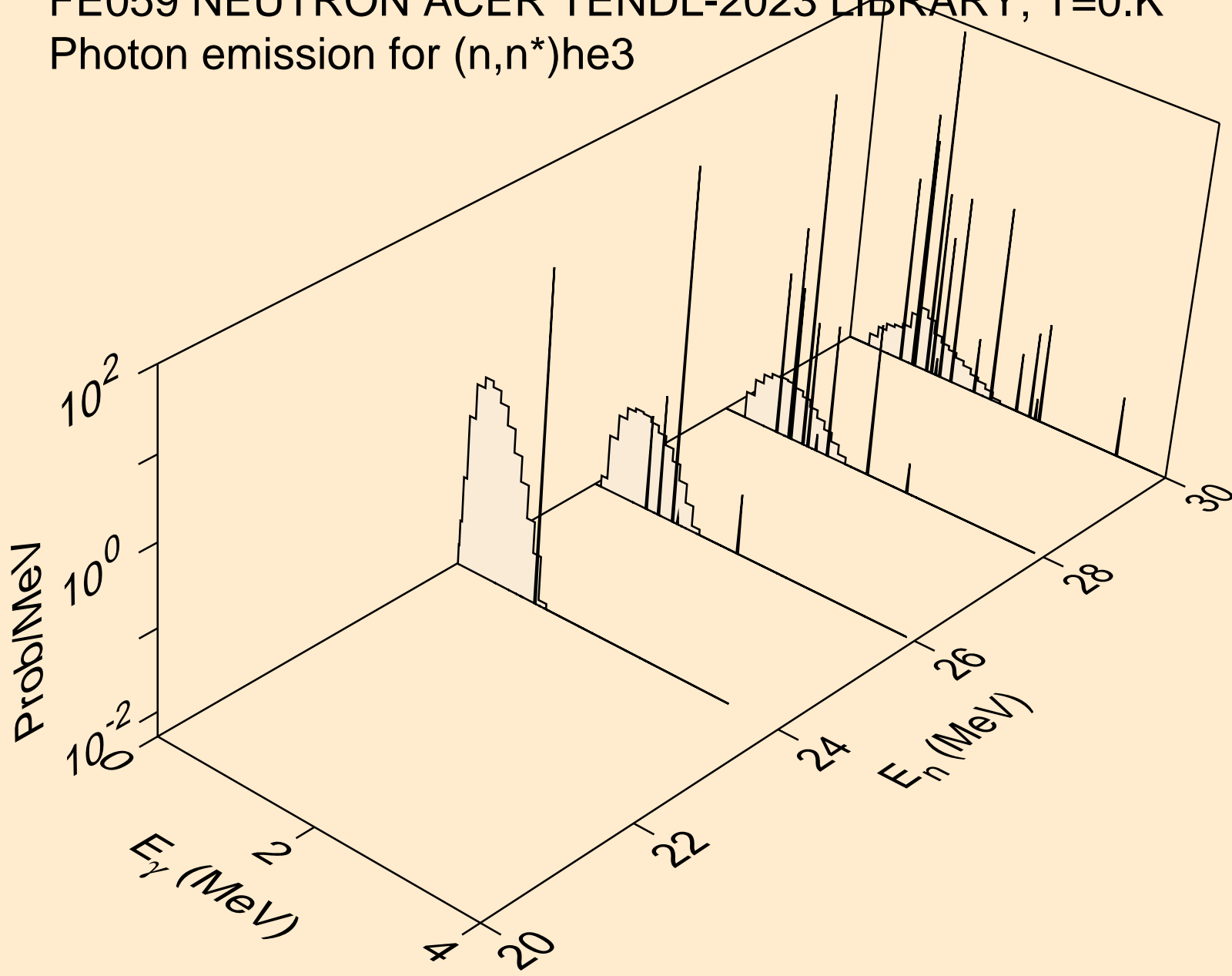

FE059 NEUTRON ACER TENDL-2023 LIBRARY; T=0.K  
Photon emission for (n,4n)

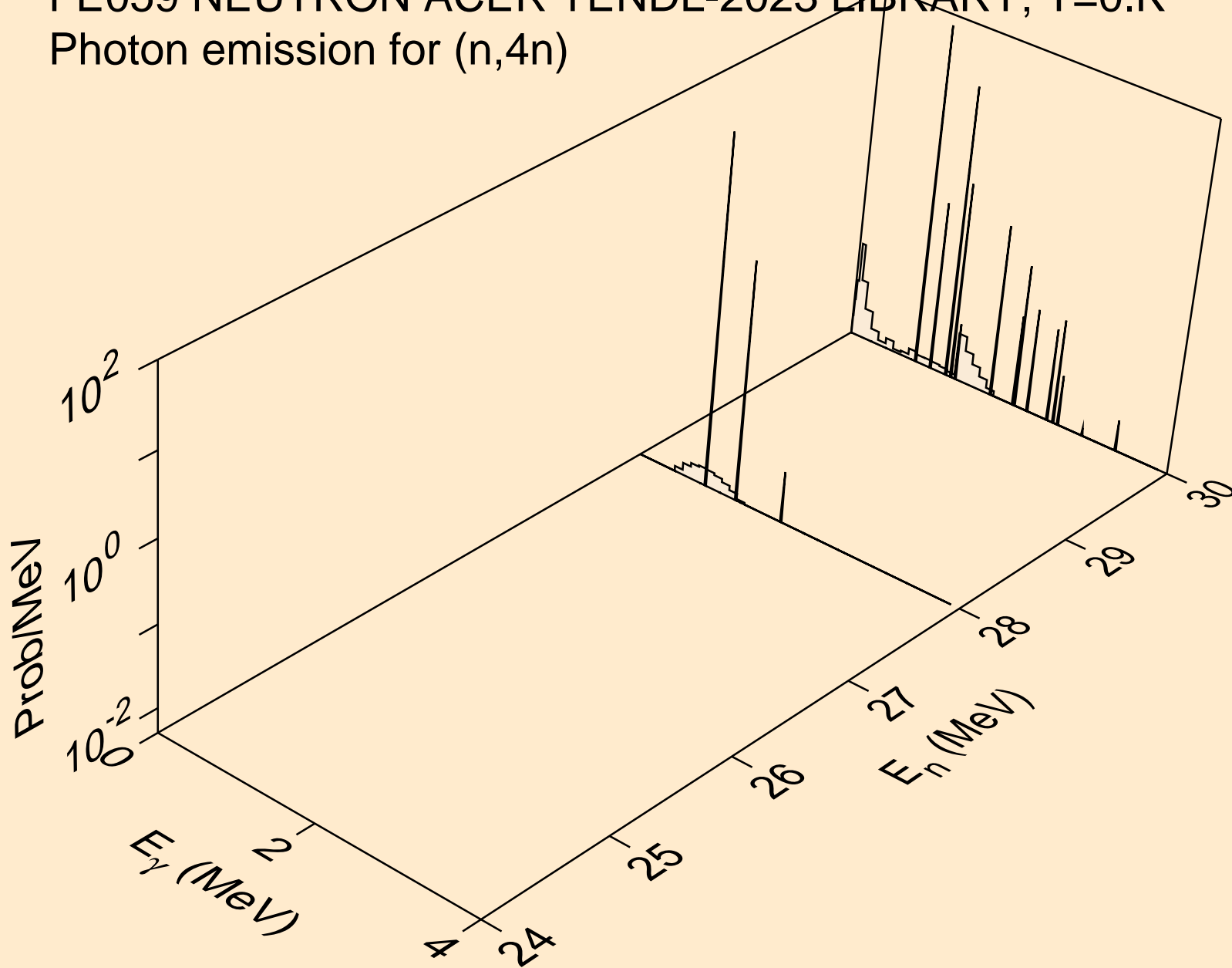

FE059 NEUTRON ACER TENDL-2023 LIBRARY; T=0.K  
Photon emission for (n,2np)

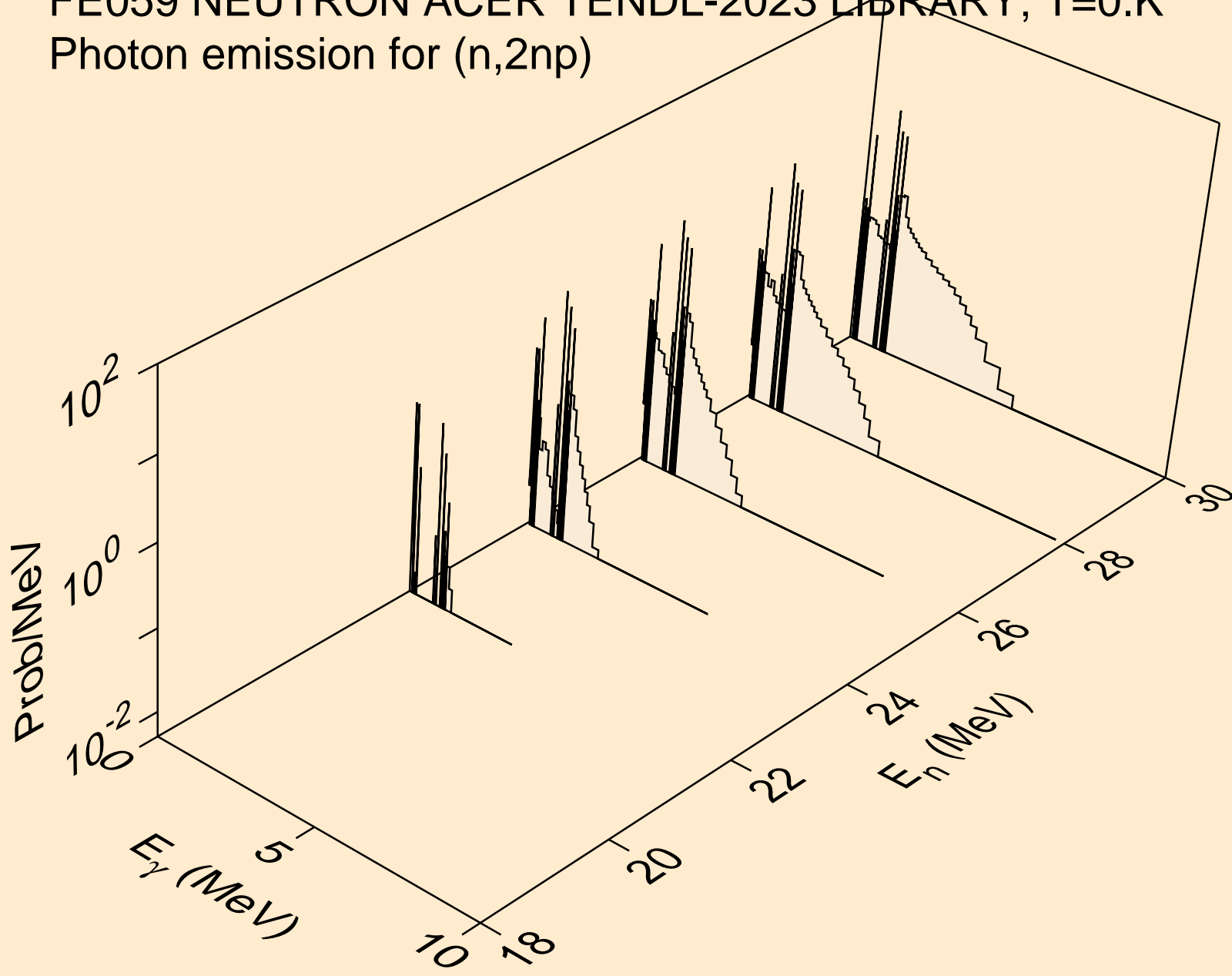

FE059 NEUTRON ACER TENDL-2023 LIBRARY; T=0.K  
Photon emission for (n,3np)

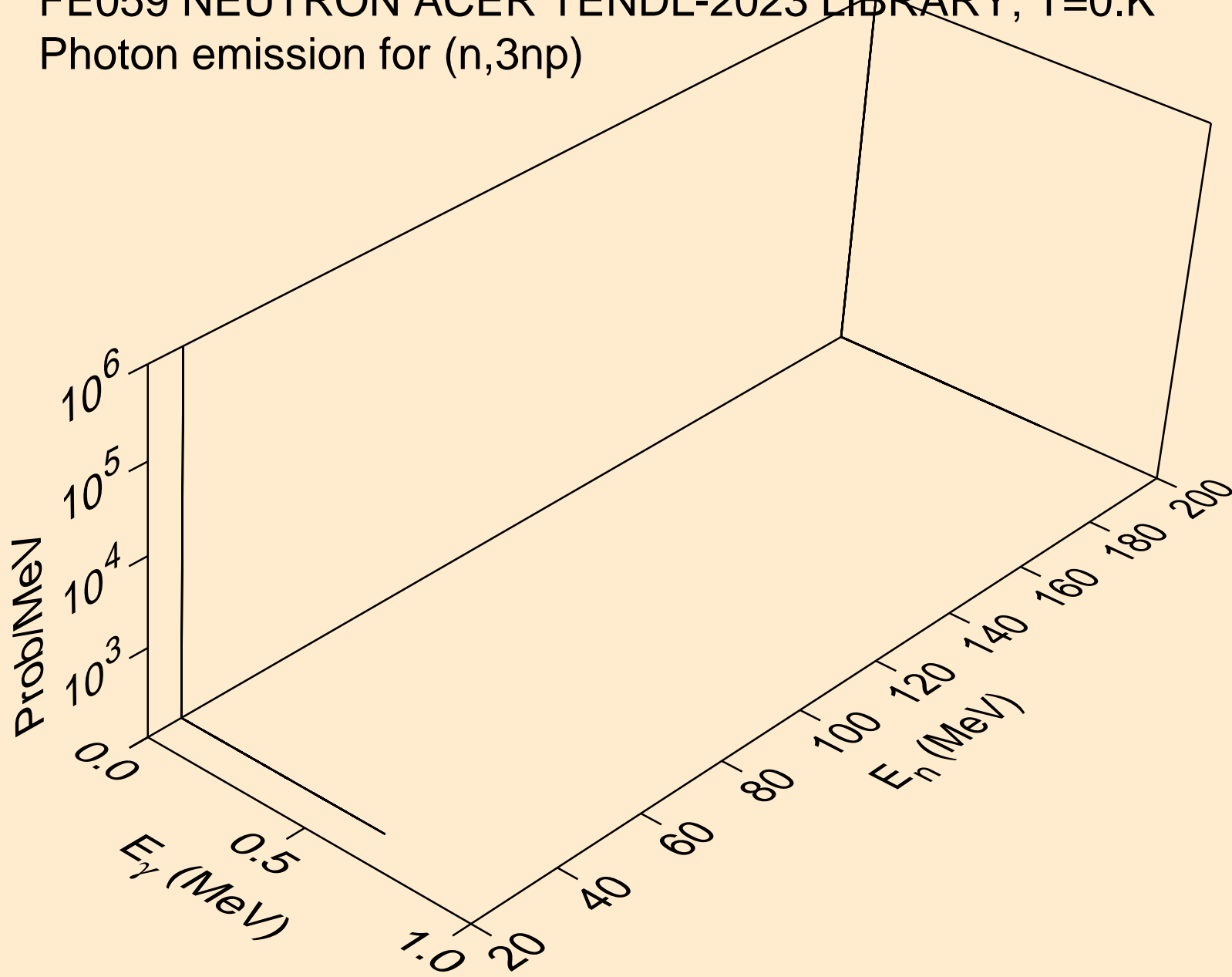

FE059 NEUTRON ACER TENDL-2023 LIBRARY; T=0.K  
Photon emission for (n,n2p)

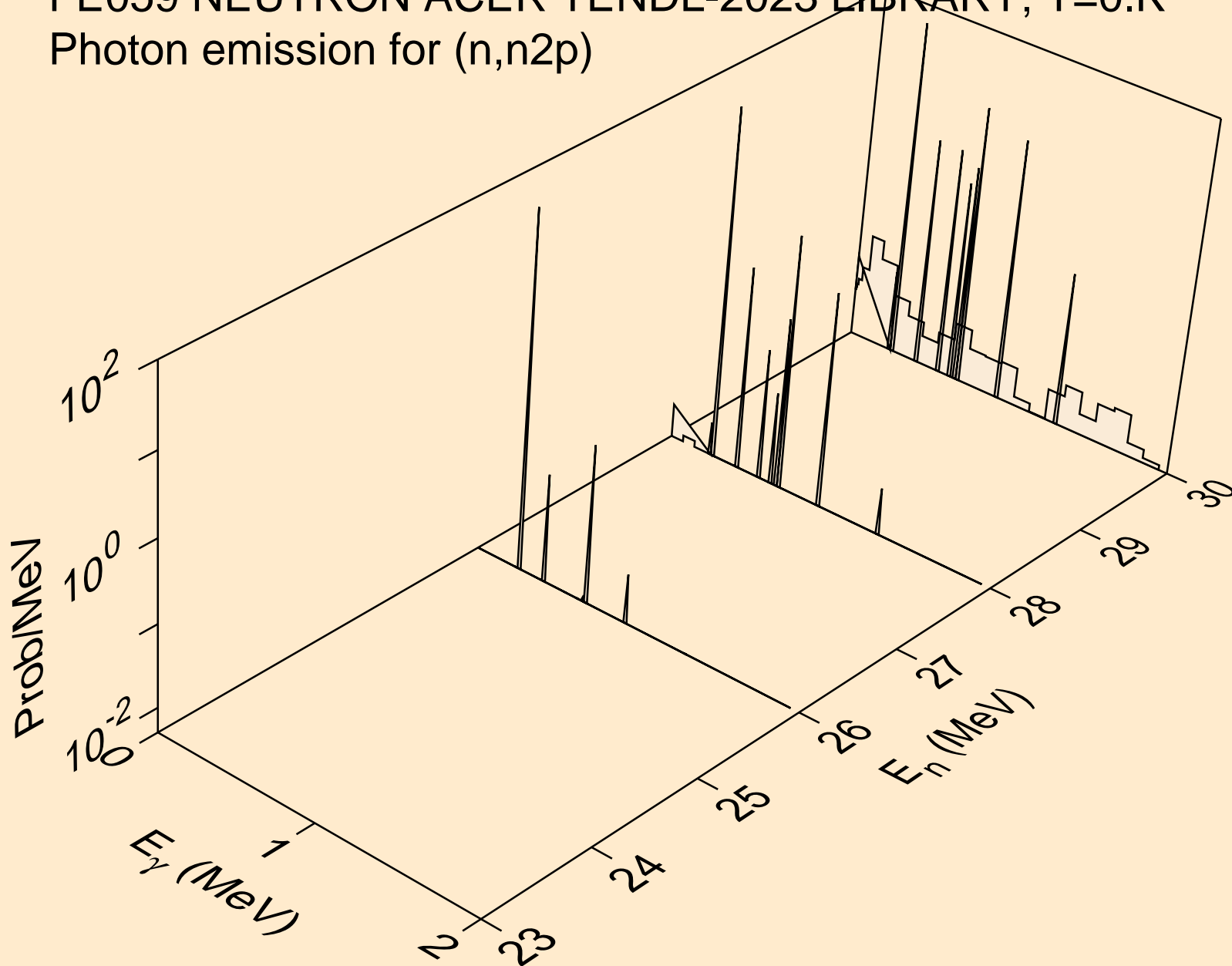

FE059 NEUTRON ACER TENDL-2023 LIBRARY; T=0.K  
Photon emission for (n,npa)

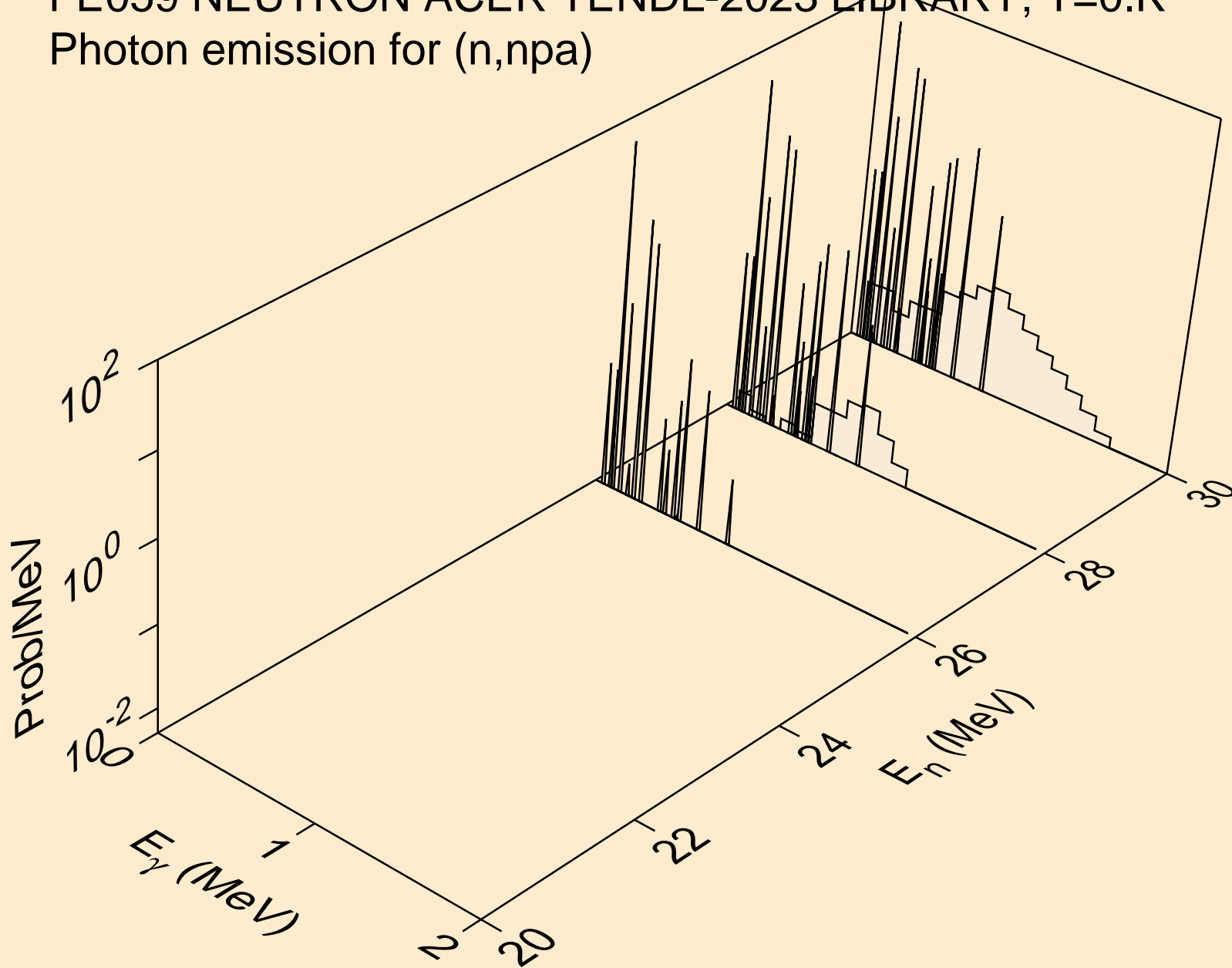



FE059 NEUTRON ACER TENDL-2023 LIBRARY; T=0.K  
Photon emission for (n,n\*c)

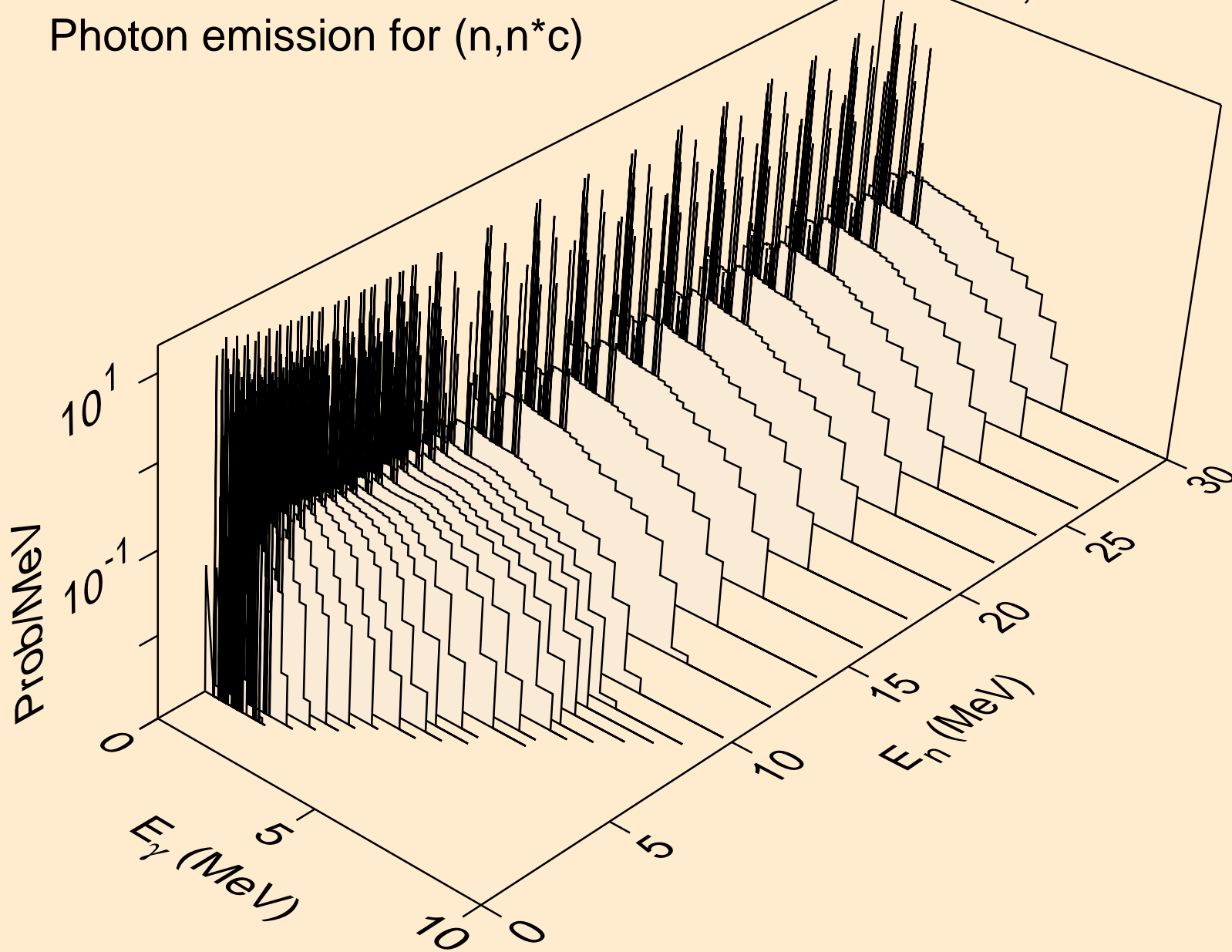

FE059 NEUTRON ACER TENDL-2023 LIBRARY; T=0.K  
Photon emission for (n,gma)

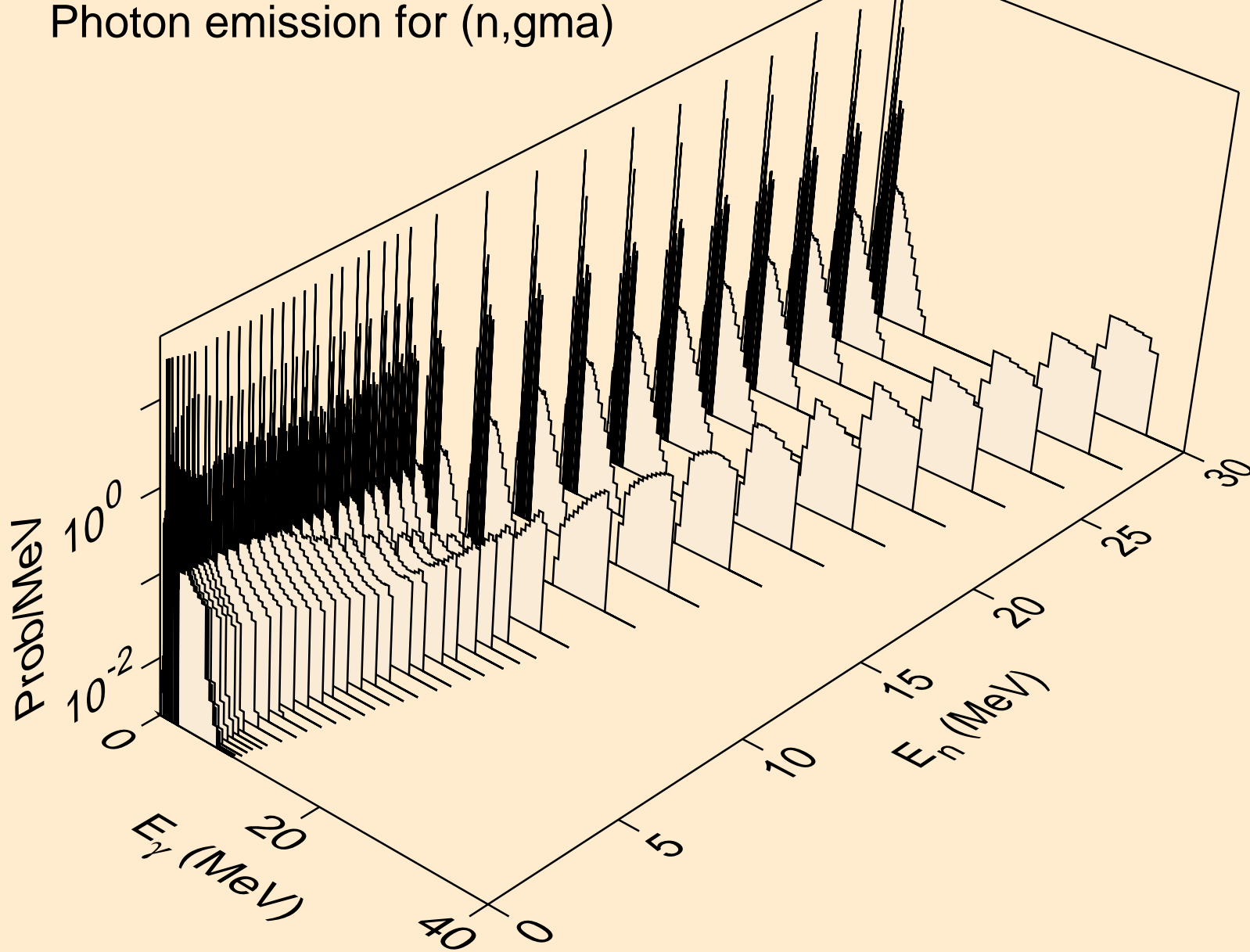

FE059 NEUTRON ACER TENDL-2023 LIBRARY; T=0.K  
Photon emission for (n,p)

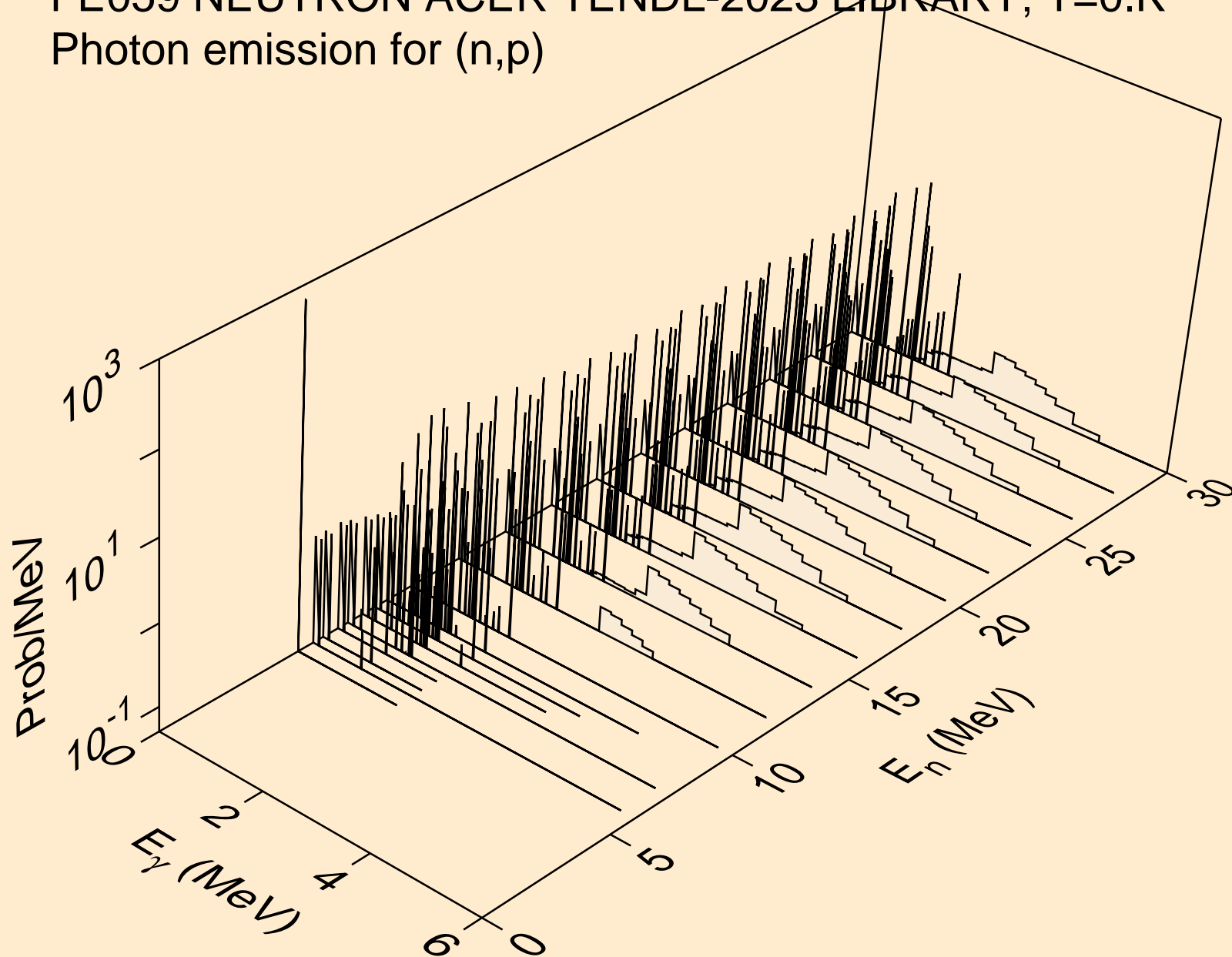

FE059 NEUTRON ACER TENDL-2023 LIBRARY; T=0.K  
Photon emission for (n,d)

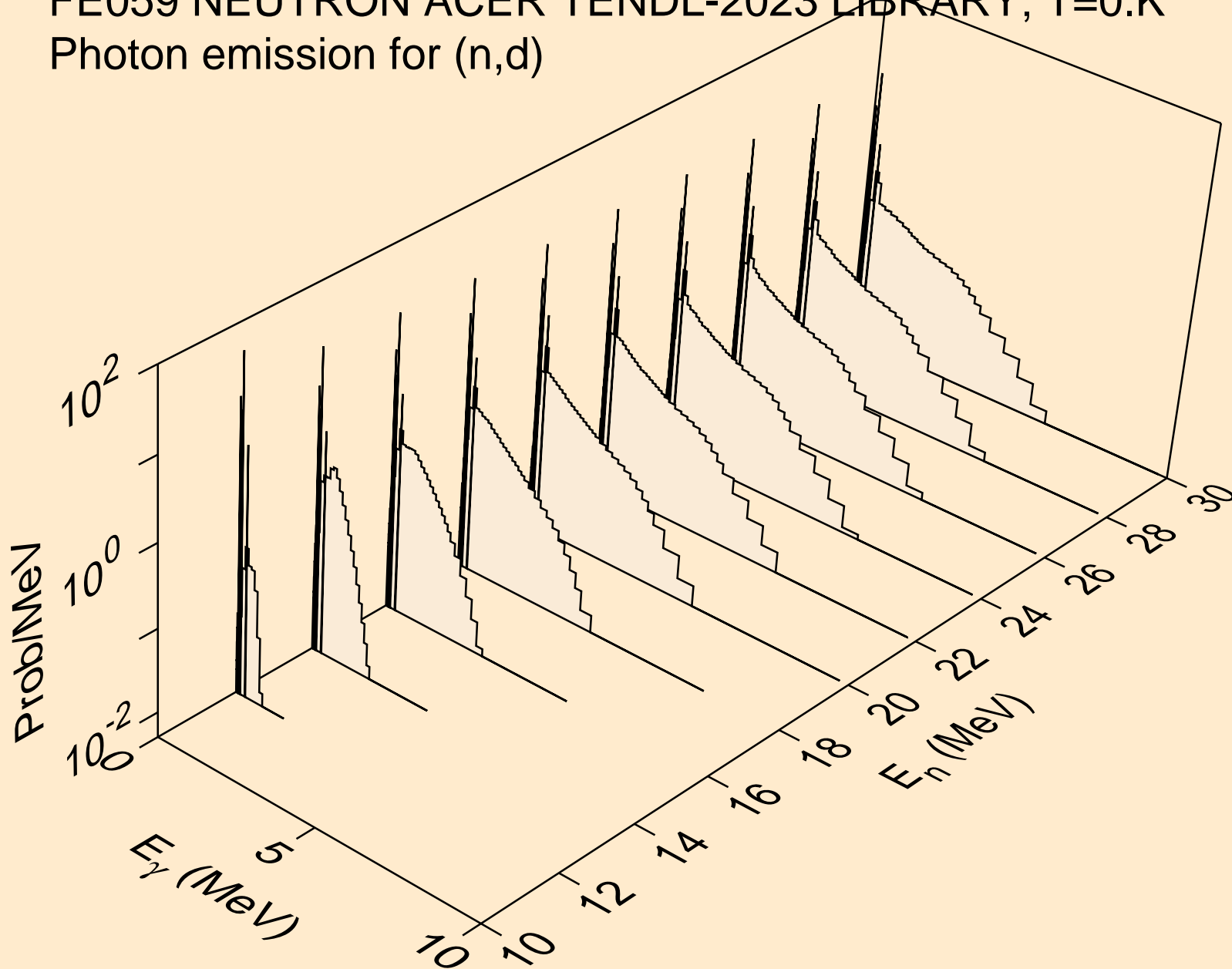

FE059 NEUTRON ACER TENDL-2023 LIBRARY; T=0.K  
Photon emission for (n,t)

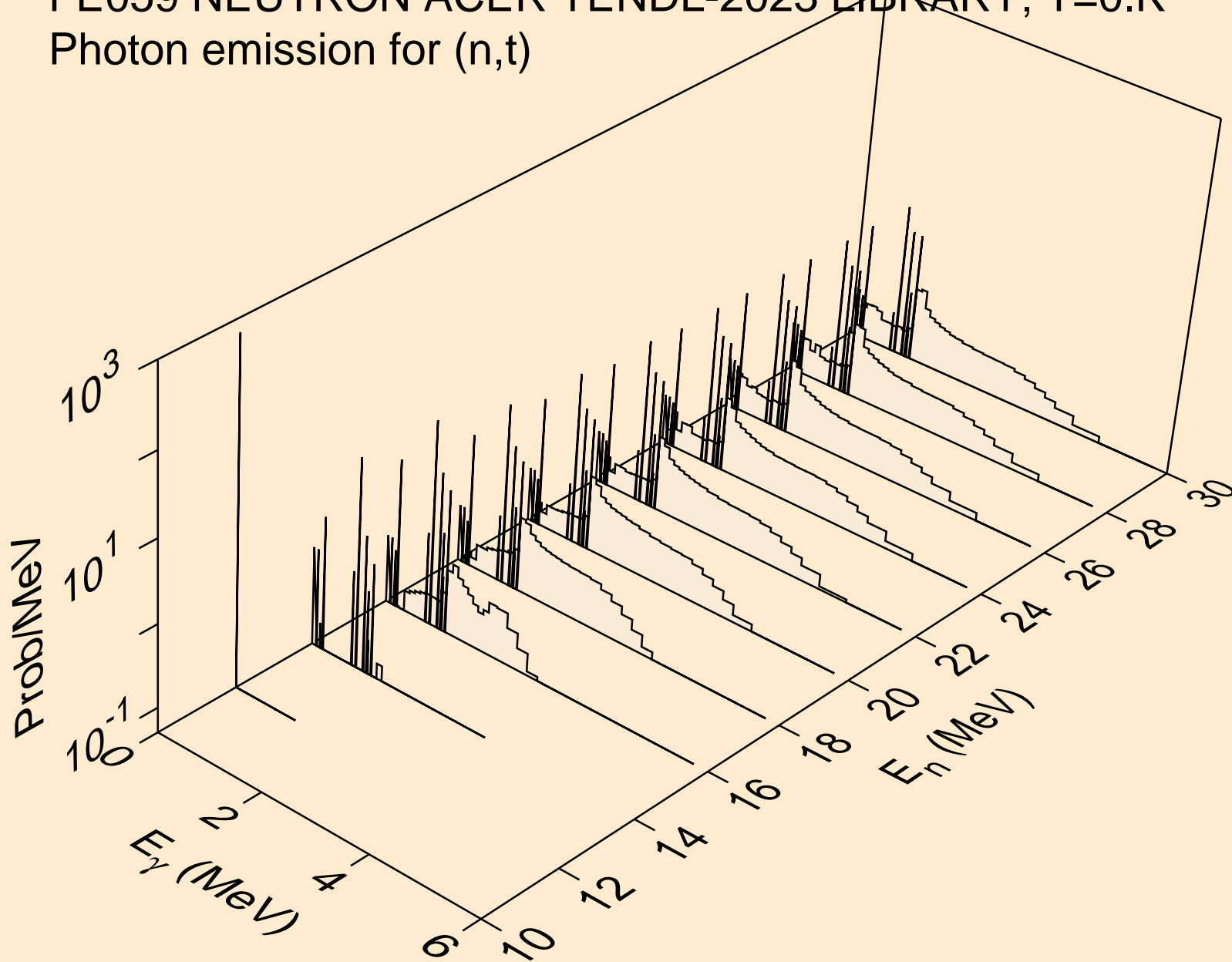

FE059 NEUTRON ACER TENDL-2023 LIBRARY; T=0.K  
Photon emission for (n,he3)

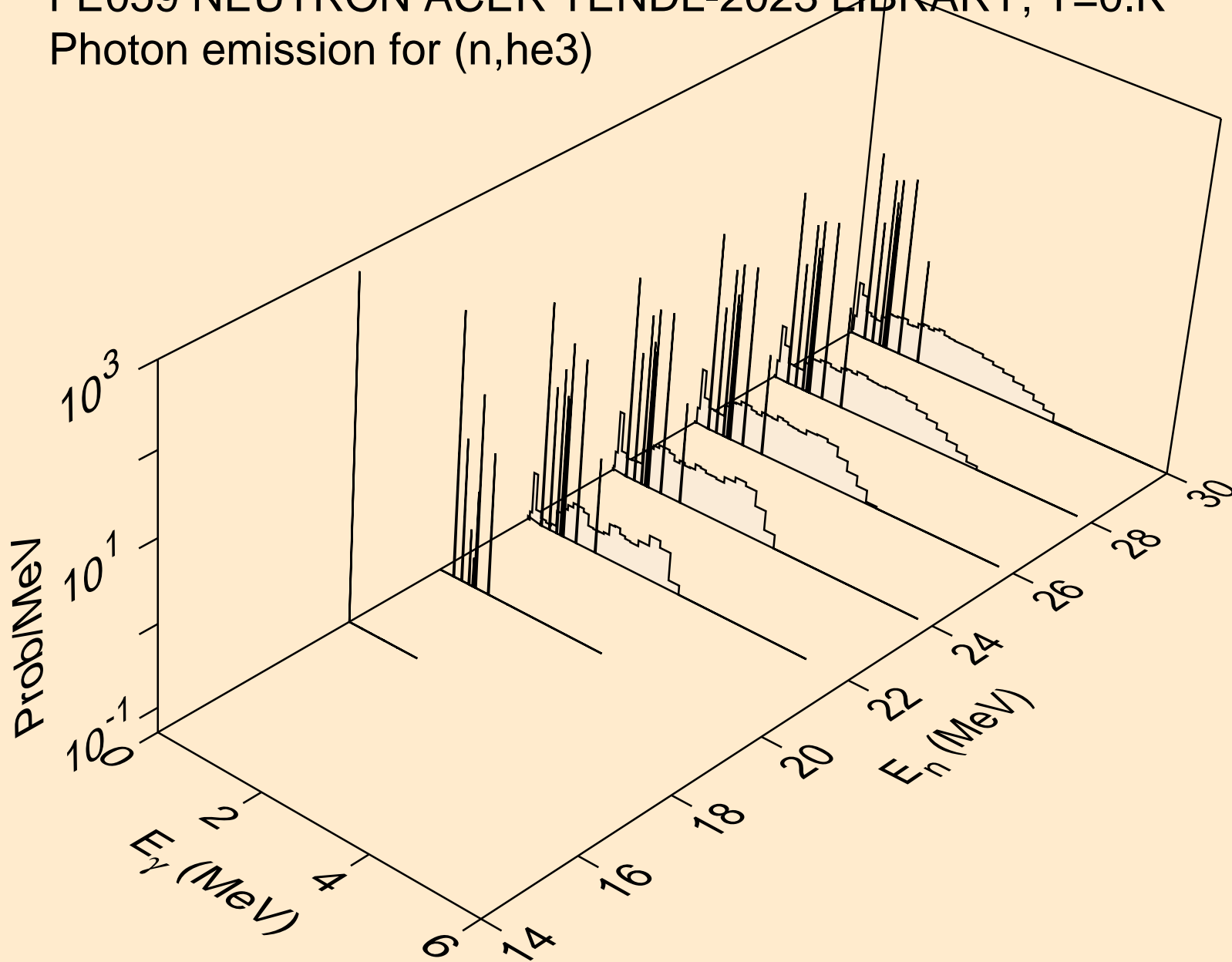

FE059 NEUTRON ACER TENDL-2023 LIBRARY; T=0.K  
Photon emission for (n,a)

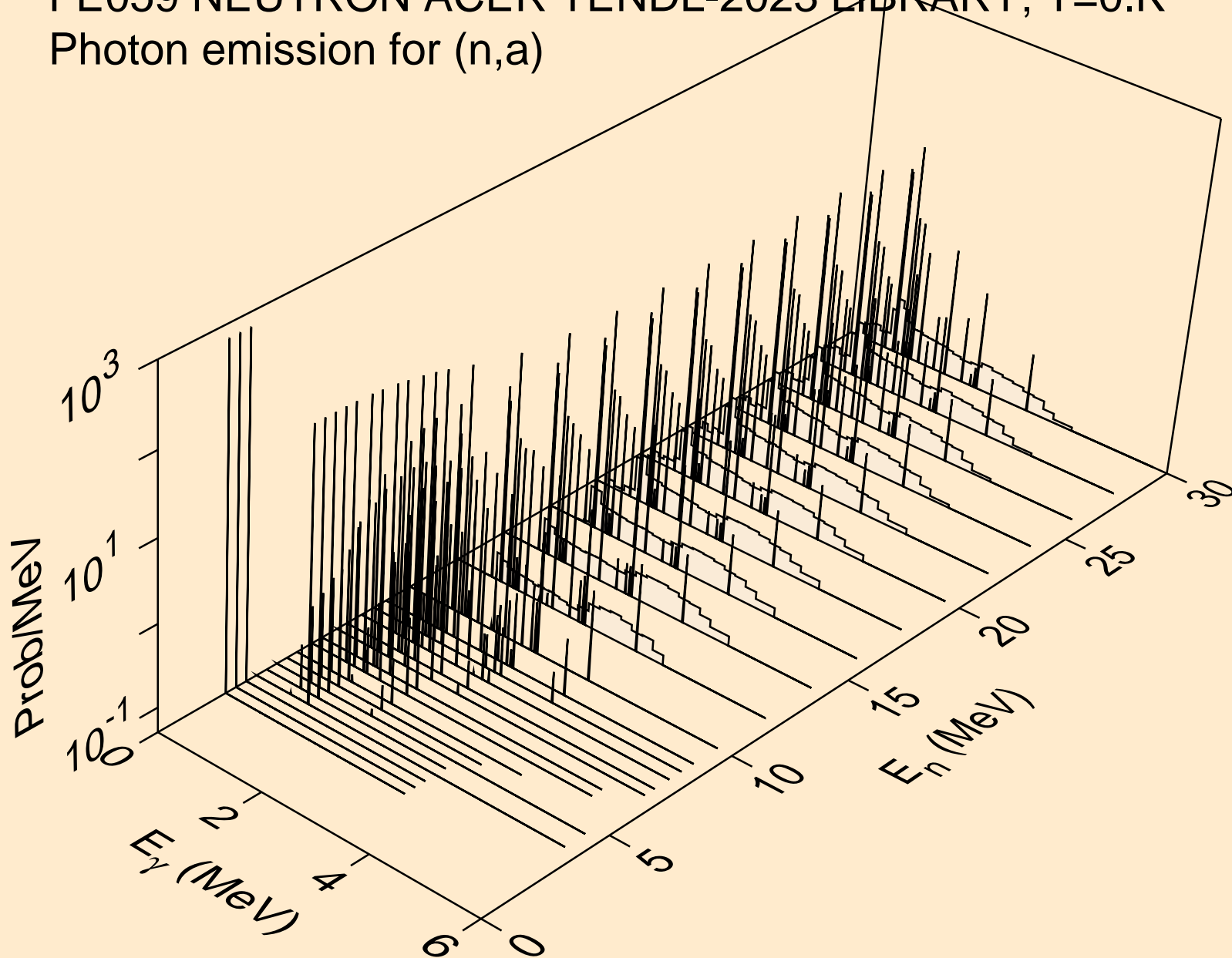

FE059 NEUTRON ACER TENDL-2023 LIBRARY; T=0.K  
Photon emission for (n,2a)

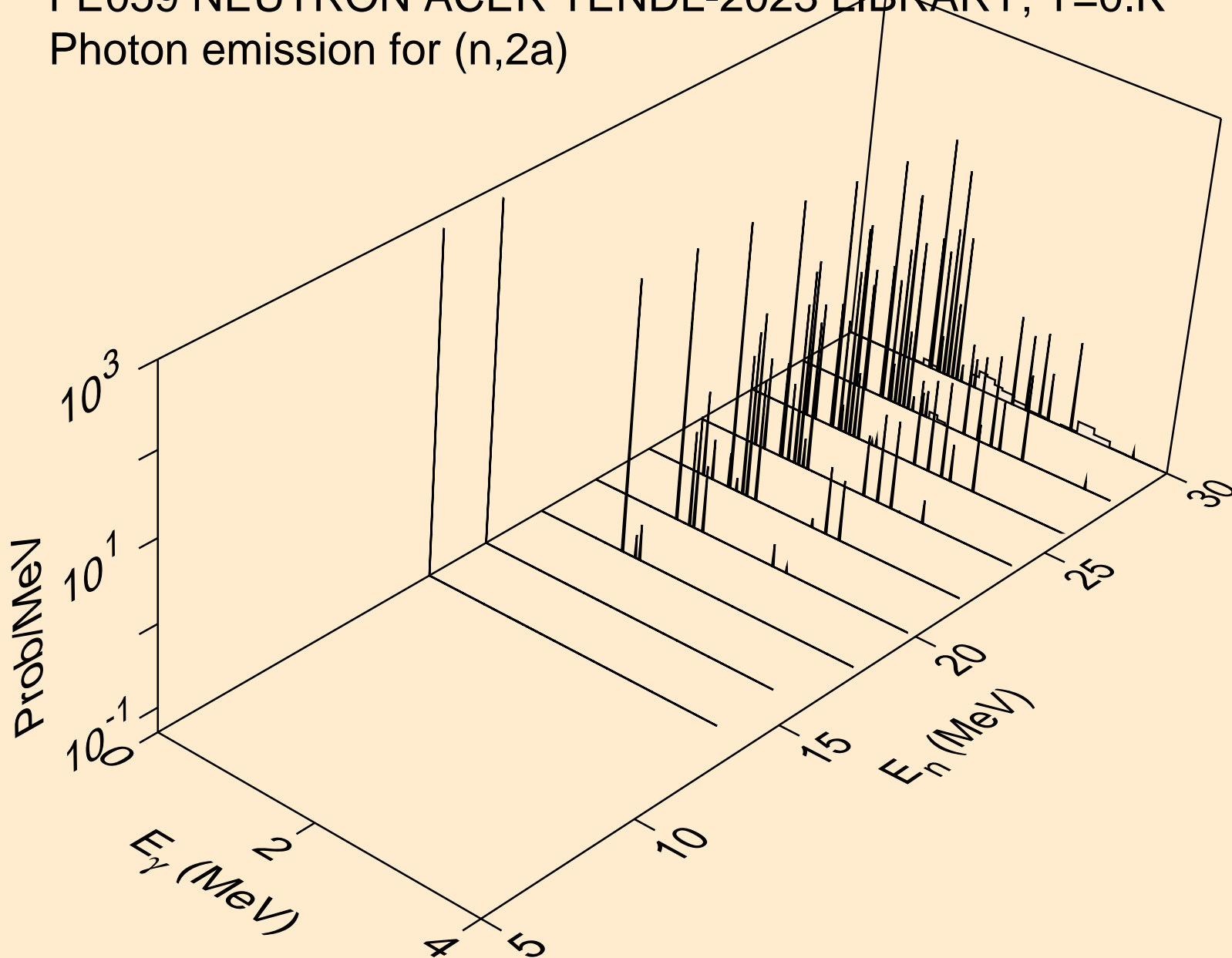



FE059 NEUTRON ACER TENDL-2023 LIBRARY; T=0.K  
Photon emission for (n,2p)

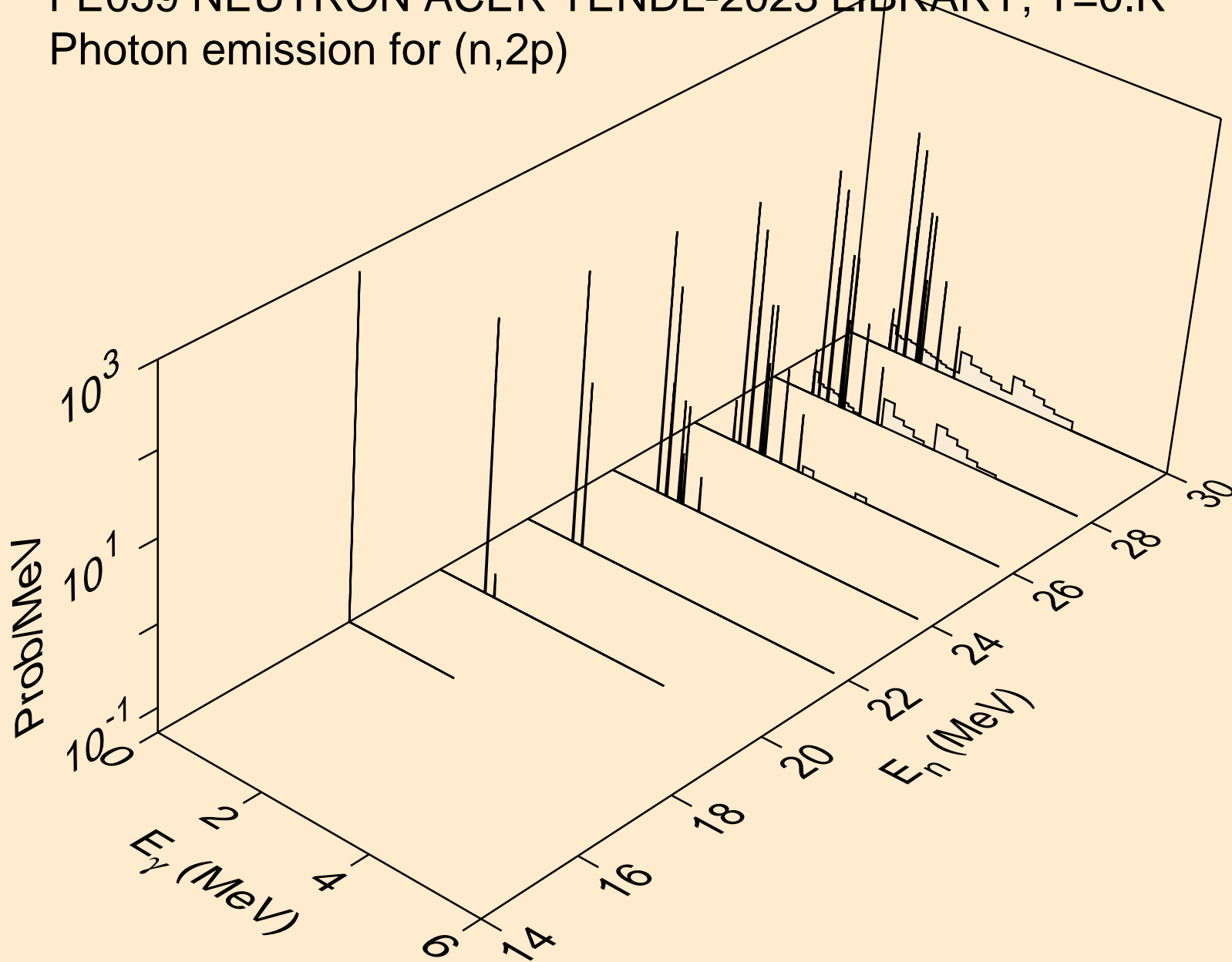

FE059 NEUTRON ACER TENDL-2023 LIBRARY; T=0.K  
Photon emission for (n,pa)

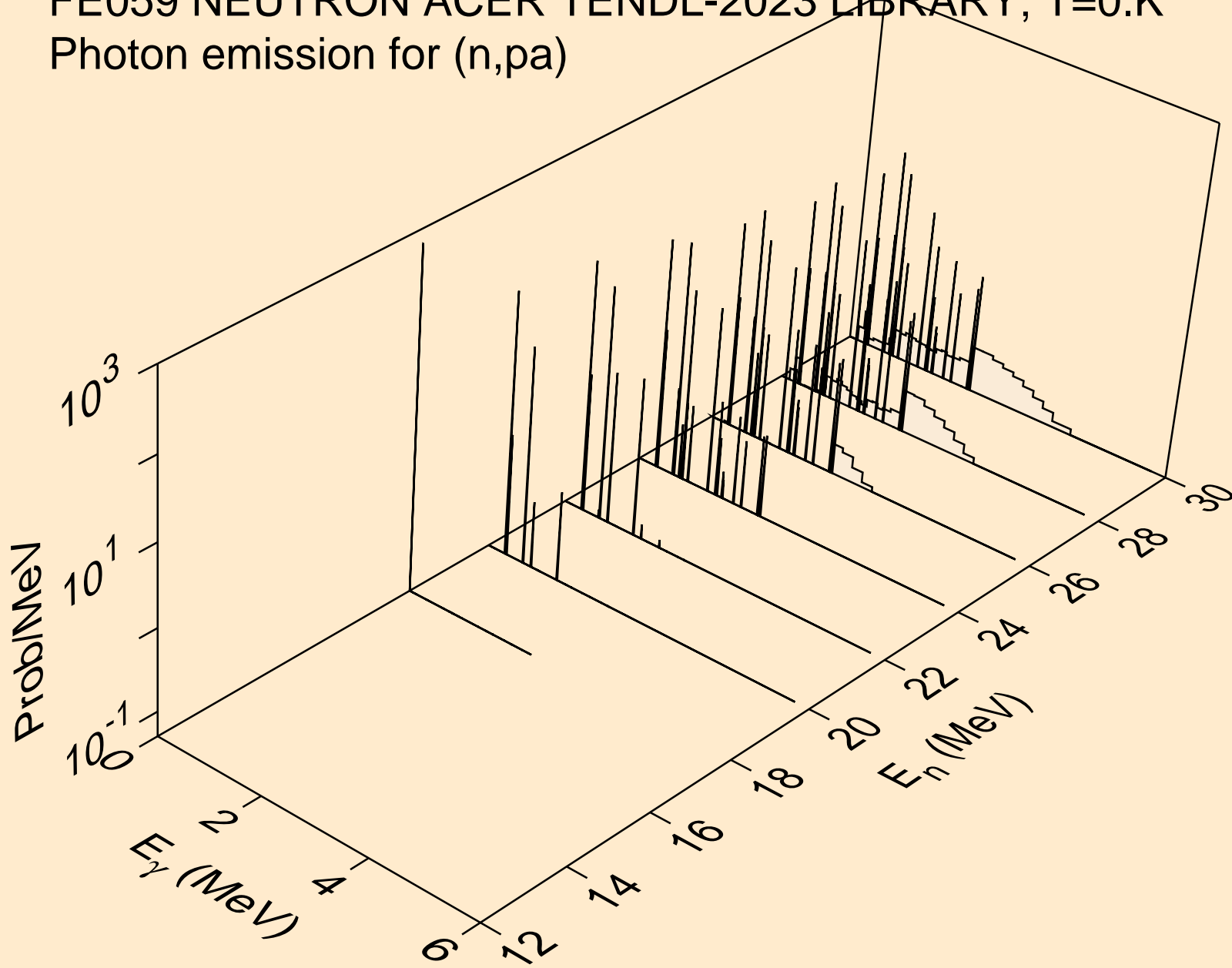

FE059 NEUTRON ACER TENDL-2023 LIBRARY; T=0.K  
Photon emission for (n,pd)

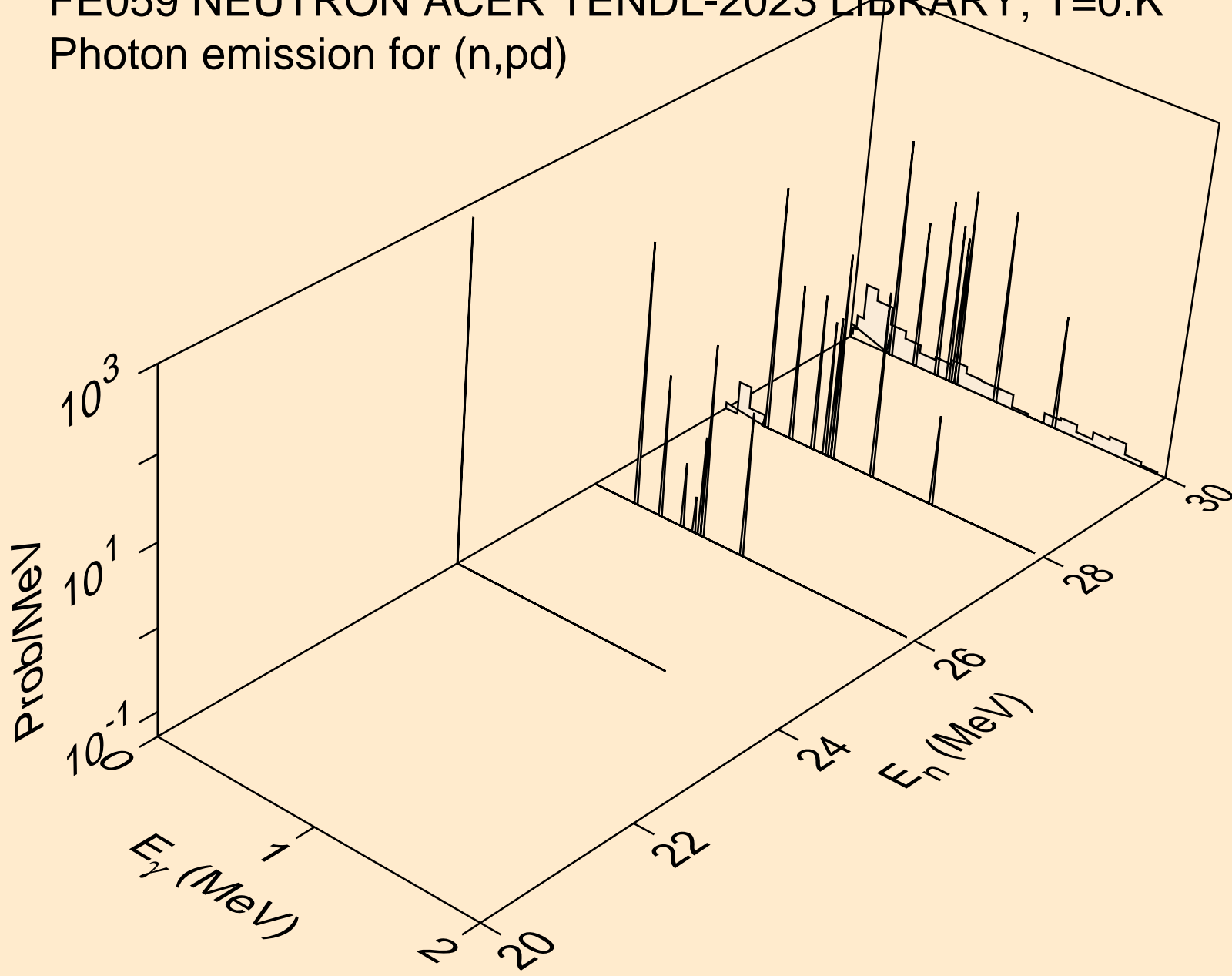

FE059 NEUTRON ACER TENDL-2023 LIBRARY; T=0.K  
Photon emission for (n,pt)

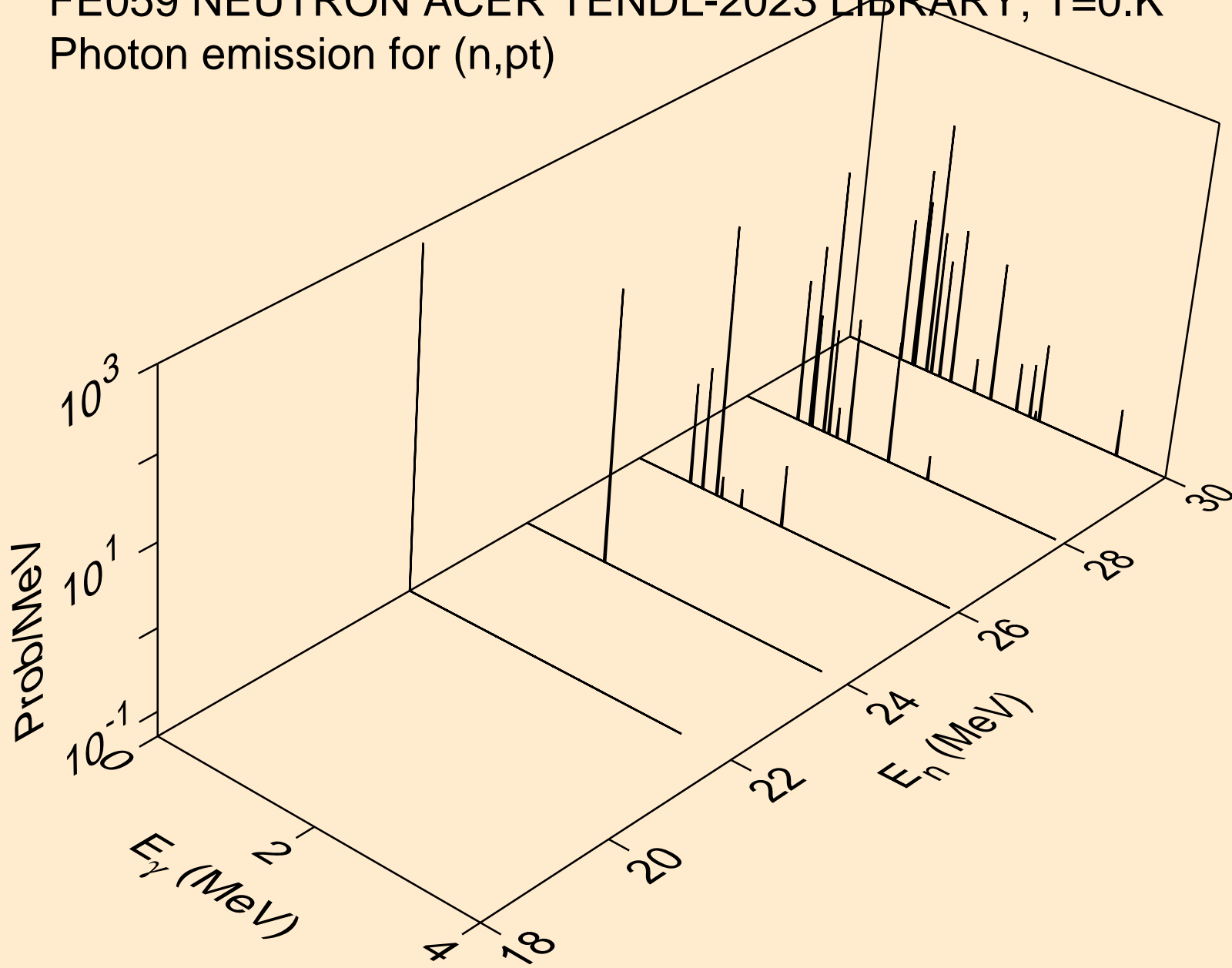

FE059 NEUTRON ACER TENDL-2023 LIBRARY; T=0.K  
Photon emission for (n,da)

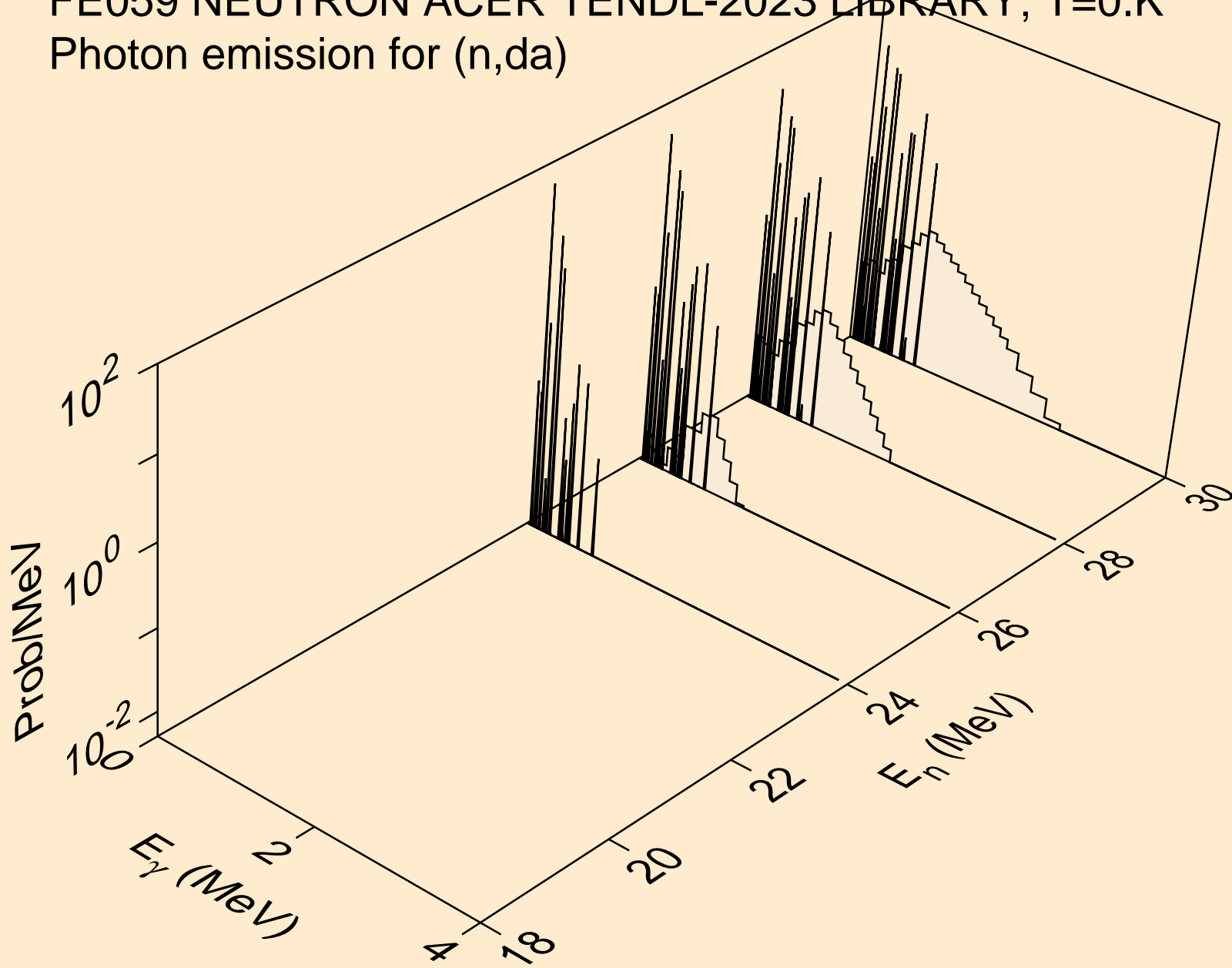

FE059 NEUTRON ACER TENDL-2023 LIBRARY; T=0.K  
thermal capture photon spectrum

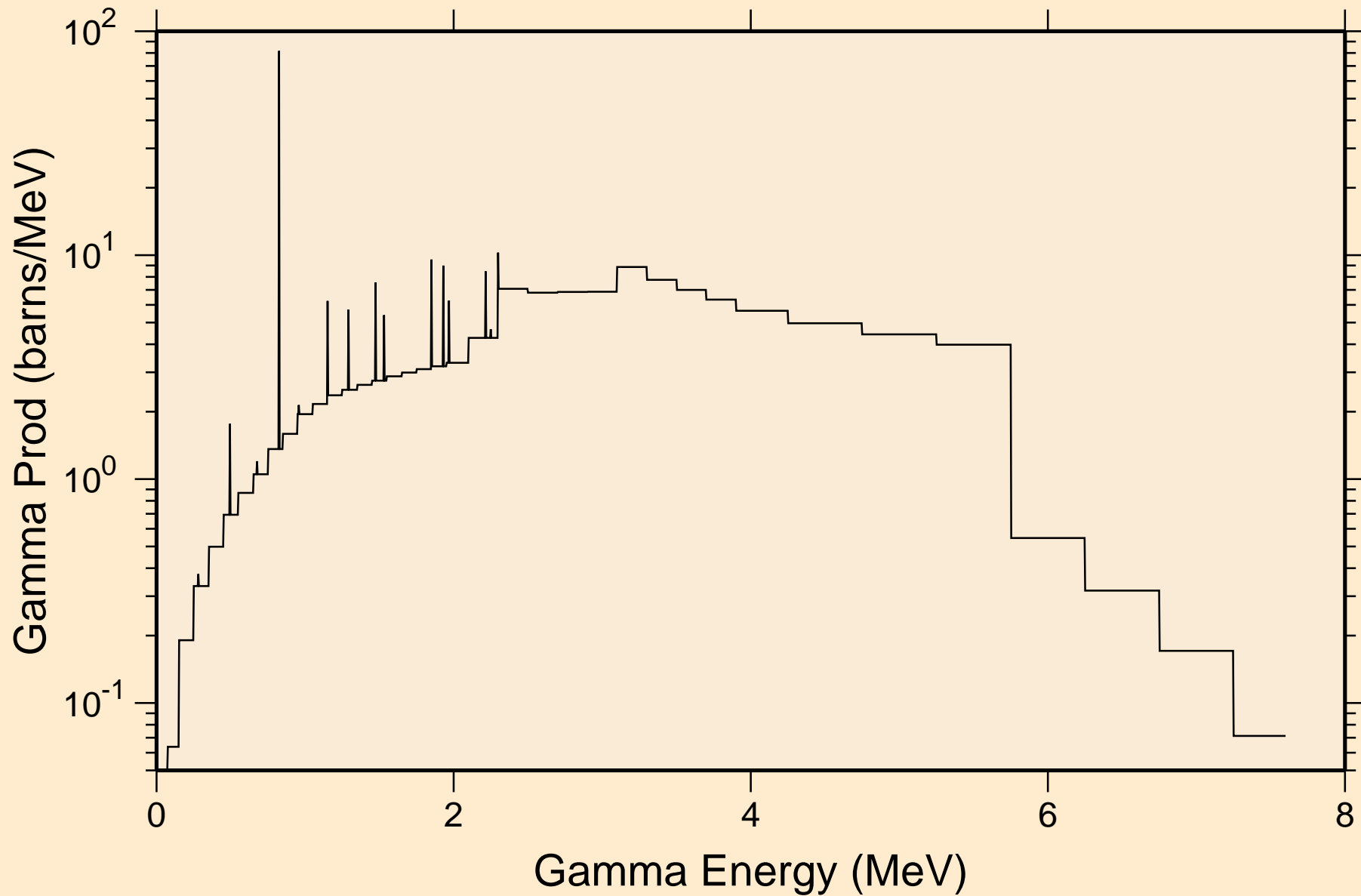

FE059 NEUTRON ACER TENDL-2023 LIBRARY; T=0.K  
14 MeV photon spectrum

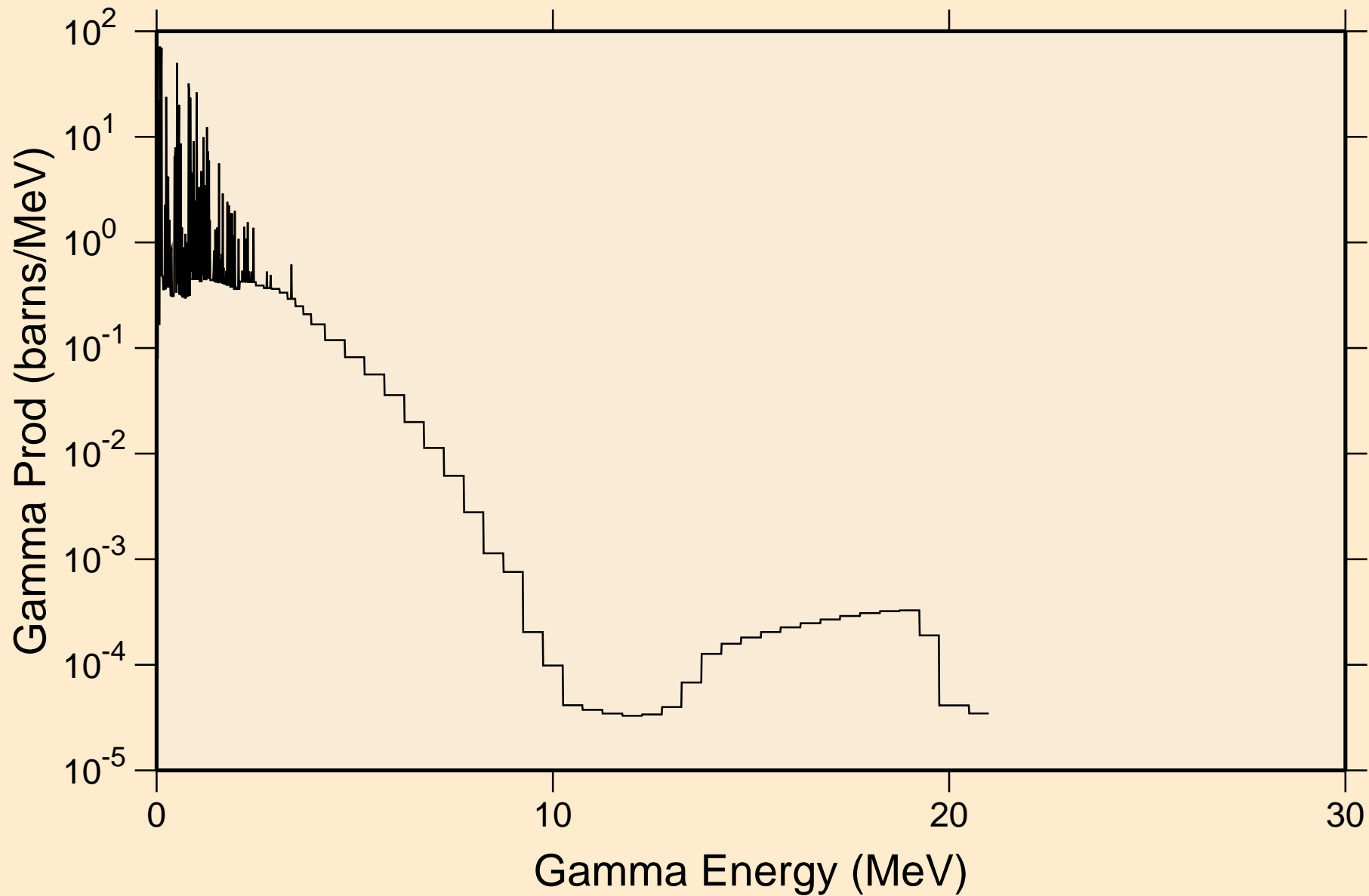

# FE059 NEUTRON ACER TENDL-2023 LIBRARY; T=0.K

## Particle heating contributions

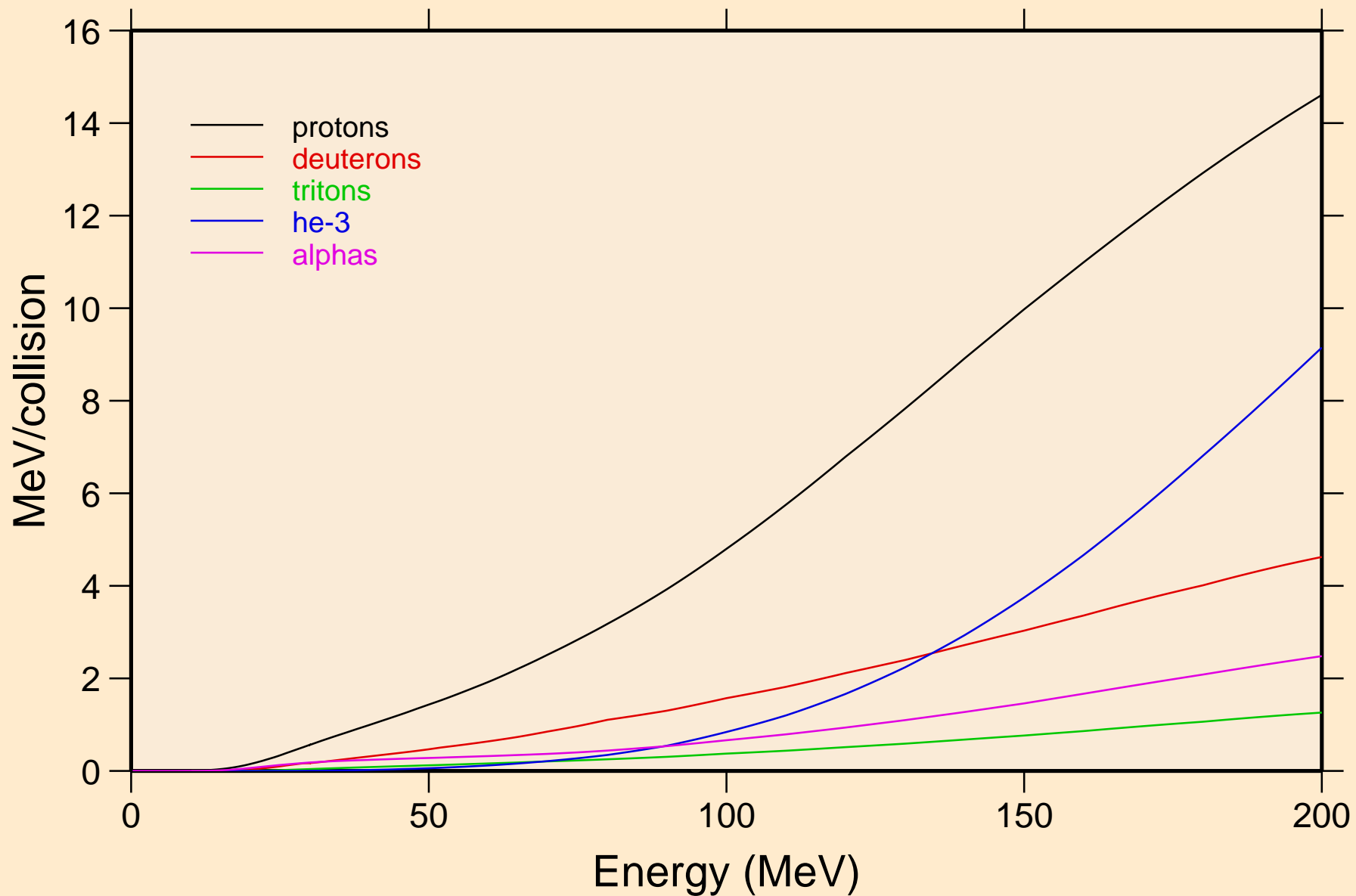



# FE059 NEUTRON ACER TENDL-2023 LIBRARY; T=0.K

## Recoil Heating

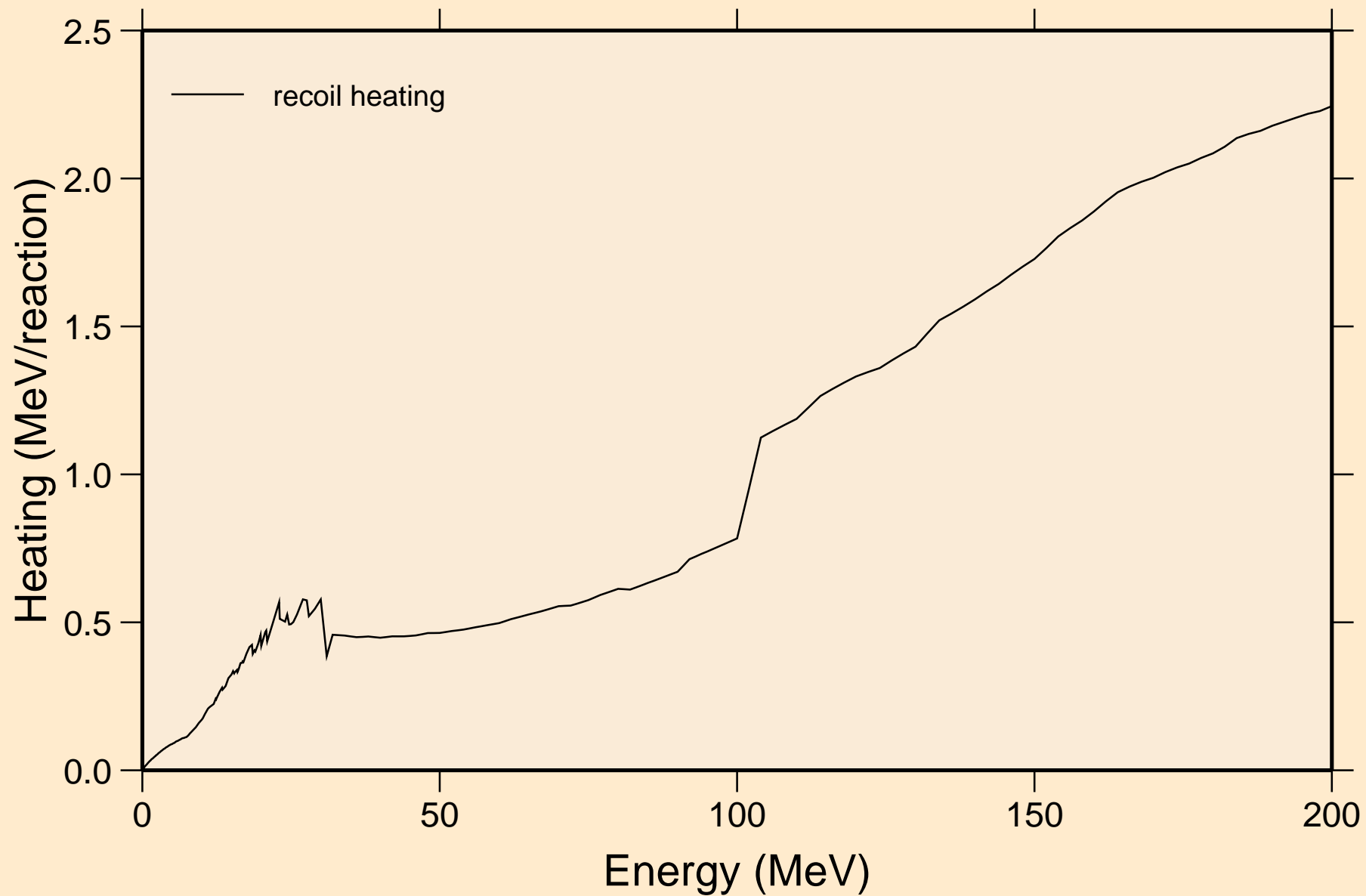

# FE059 NEUTRON ACER TENDL-2023 LIBRARY; T=0.K

## Particle production cross sections

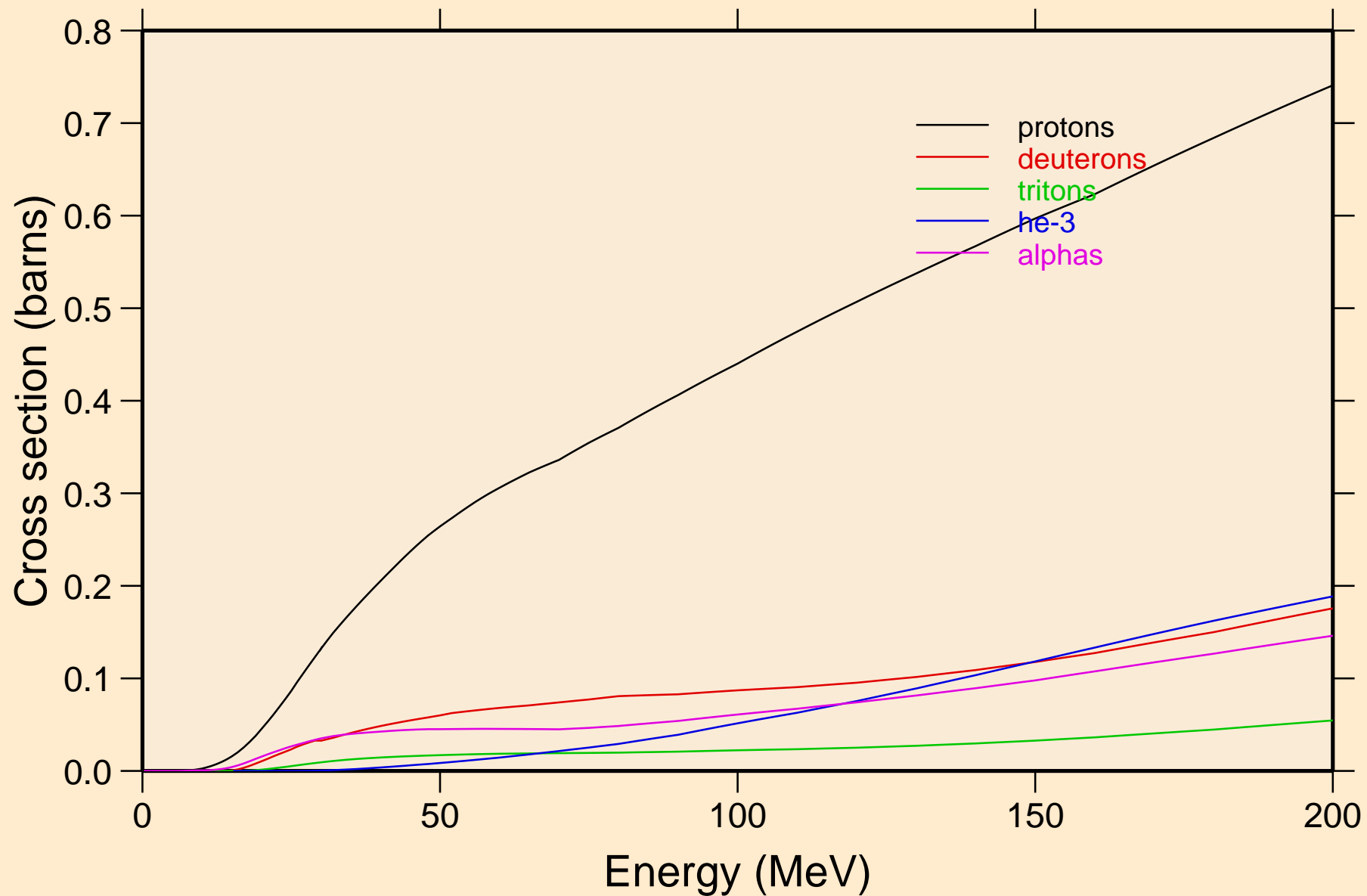

FE059 NEUTRON ACER TENDL-2023 LIBRARY; T=0.K  
protons from (n,x)

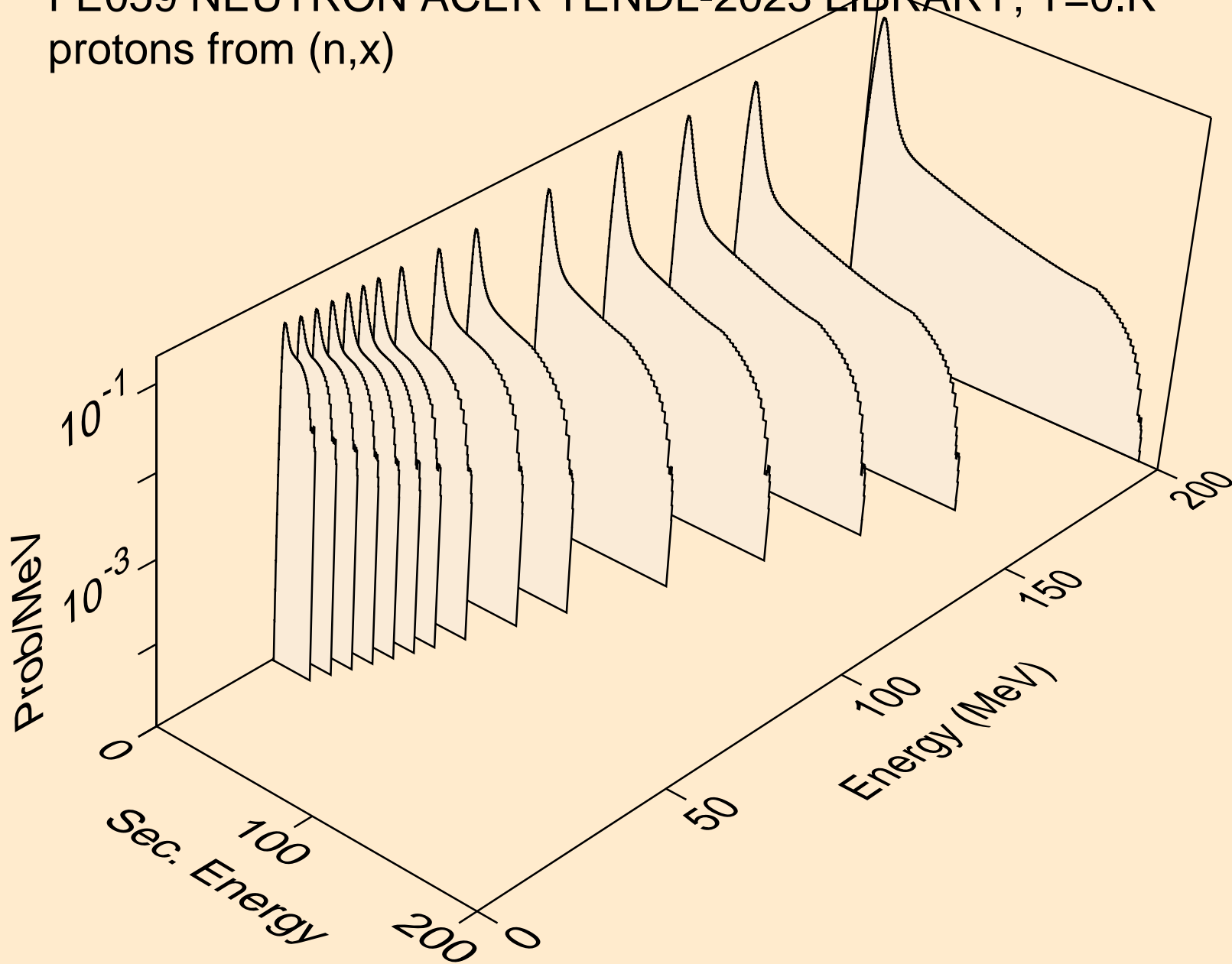

FE059 NEUTRON ACER TENDL-2023 LIBRARY; T=0.K  
protons from (n,n\*)p

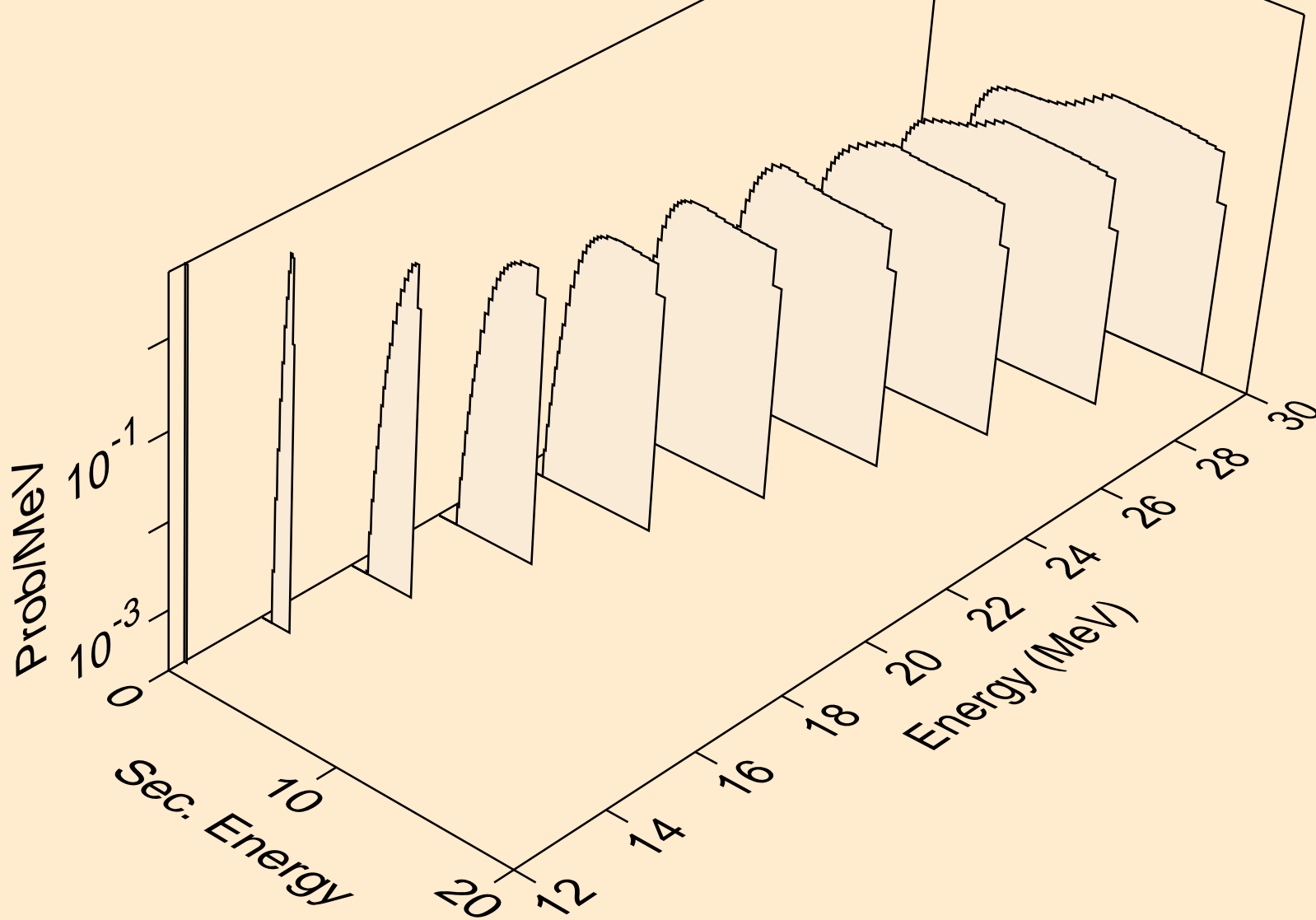

FE059 NEUTRON ACER TENDL-2023 LIBRARY; T=0.K  
protons from (n,2np)

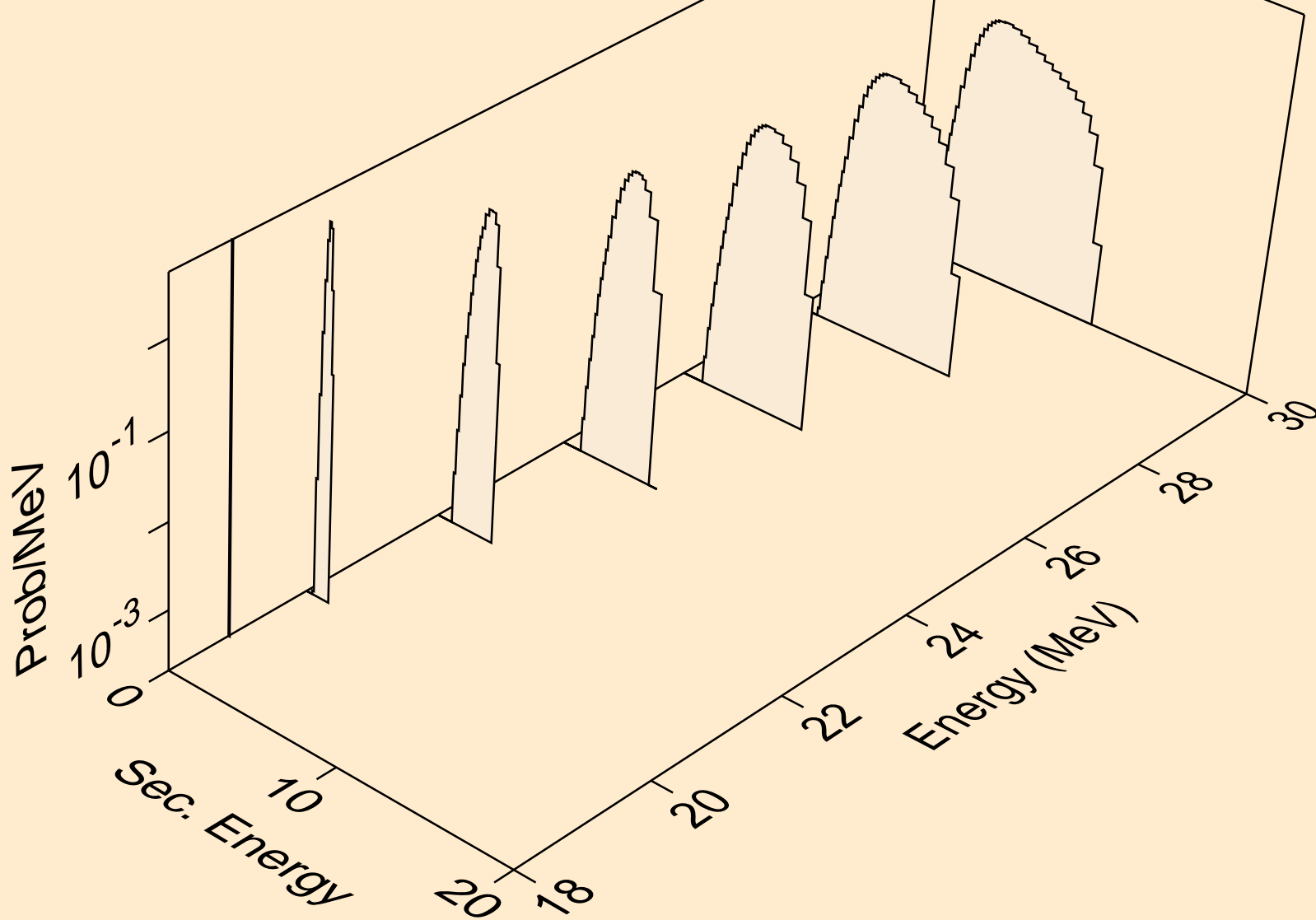

FE059 NEUTRON ACER TENDL-2023 LIBRARY; T=0.K  
protons from (n,3np)

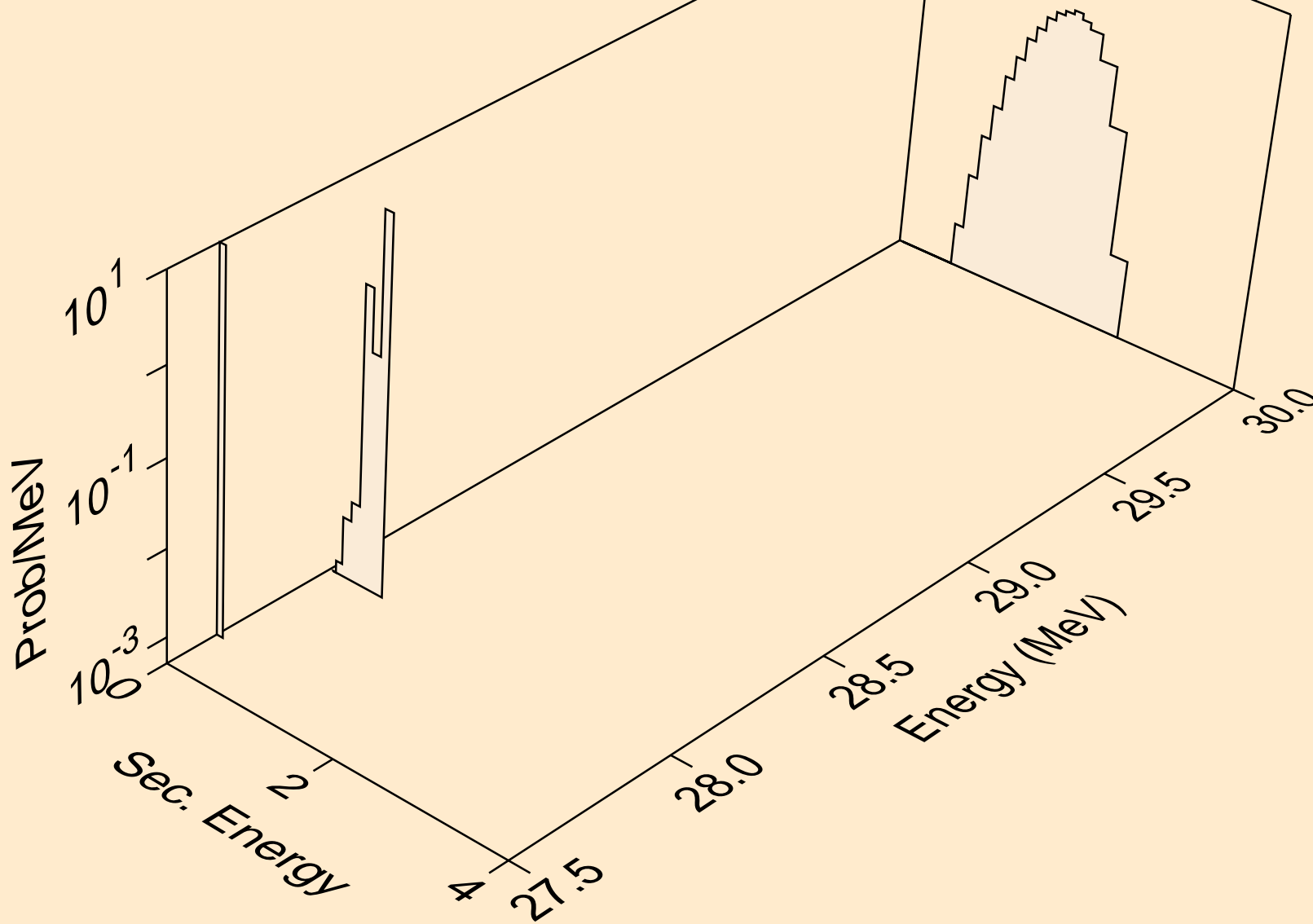

FE059 NEUTRON ACER TENDL-2023 LIBRARY; T=0.K  
protons from (n,n2p)

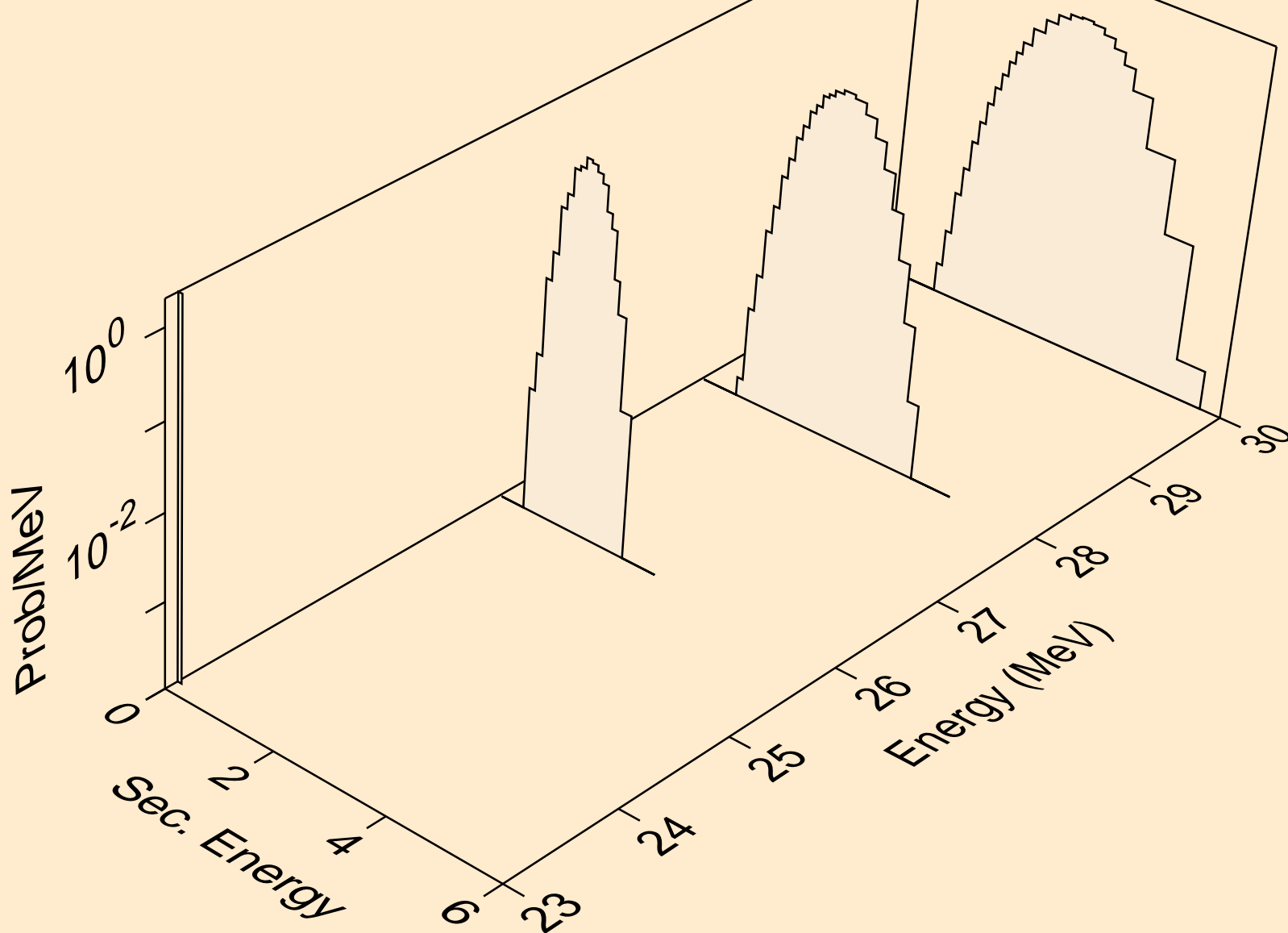

FE059 NEUTRON ACER TENDL-2023 LIBRARY; T=0.K  
protons from (n,npa)

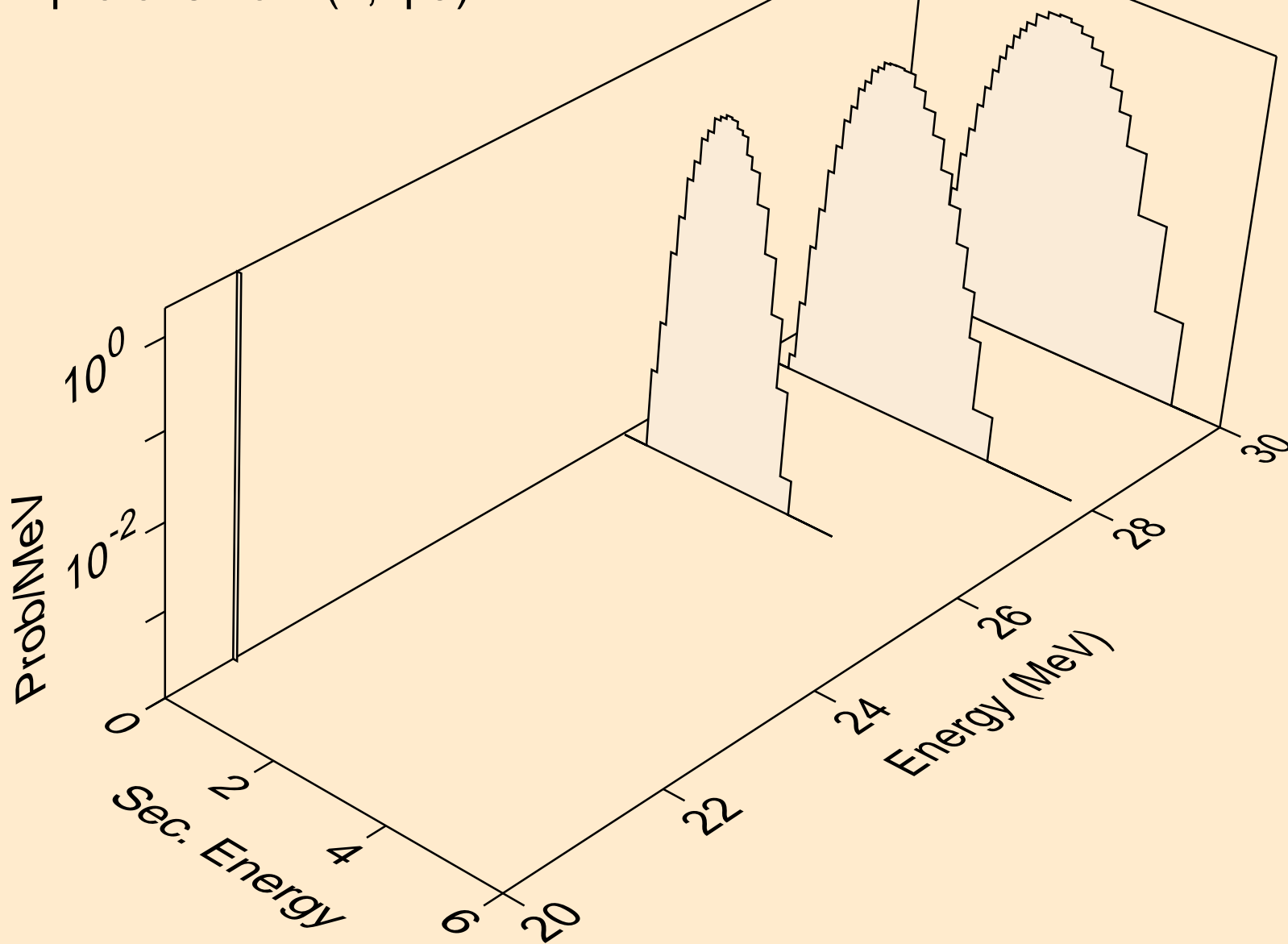



FE059 NEUTRON ACER TENDL-2023 LIBRARY; T=0.K  
protons from (n,p)

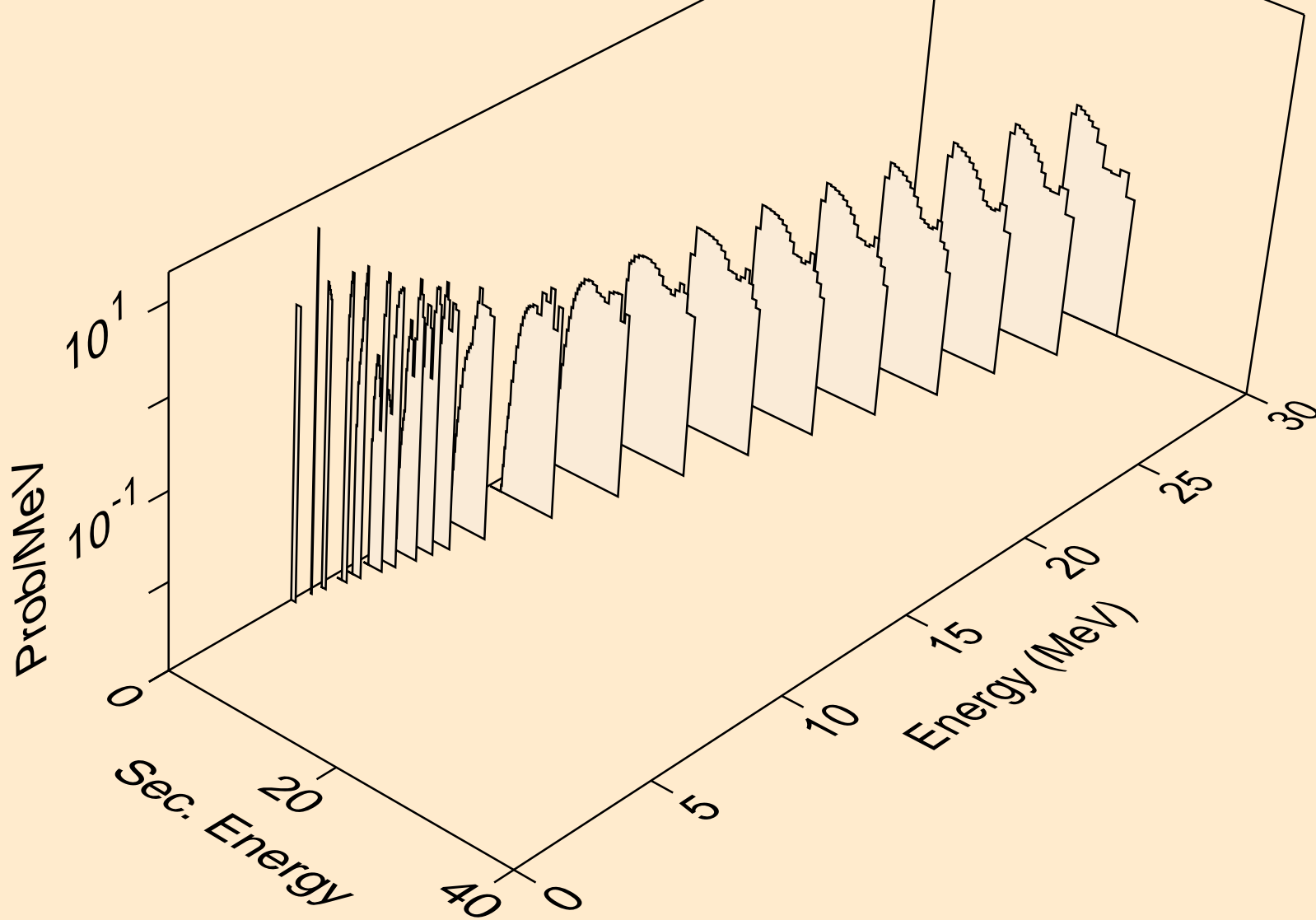

FE059 NEUTRON ACER TENDL-2023 LIBRARY; T=0.K  
protons from (n,2p)

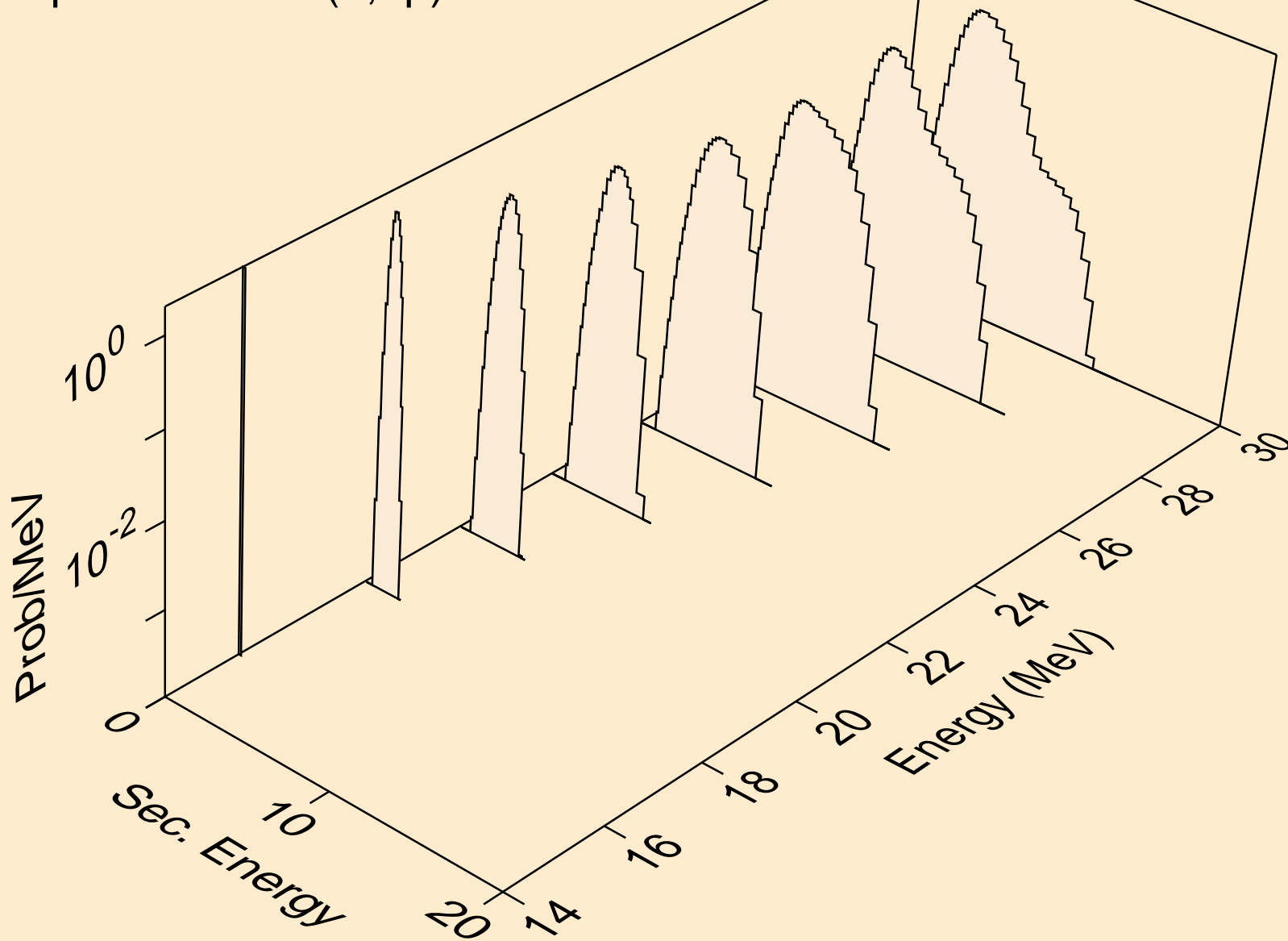

FE059 NEUTRON ACER TENDL-2023 LIBRARY; T=0.K  
protons from (n,pa)

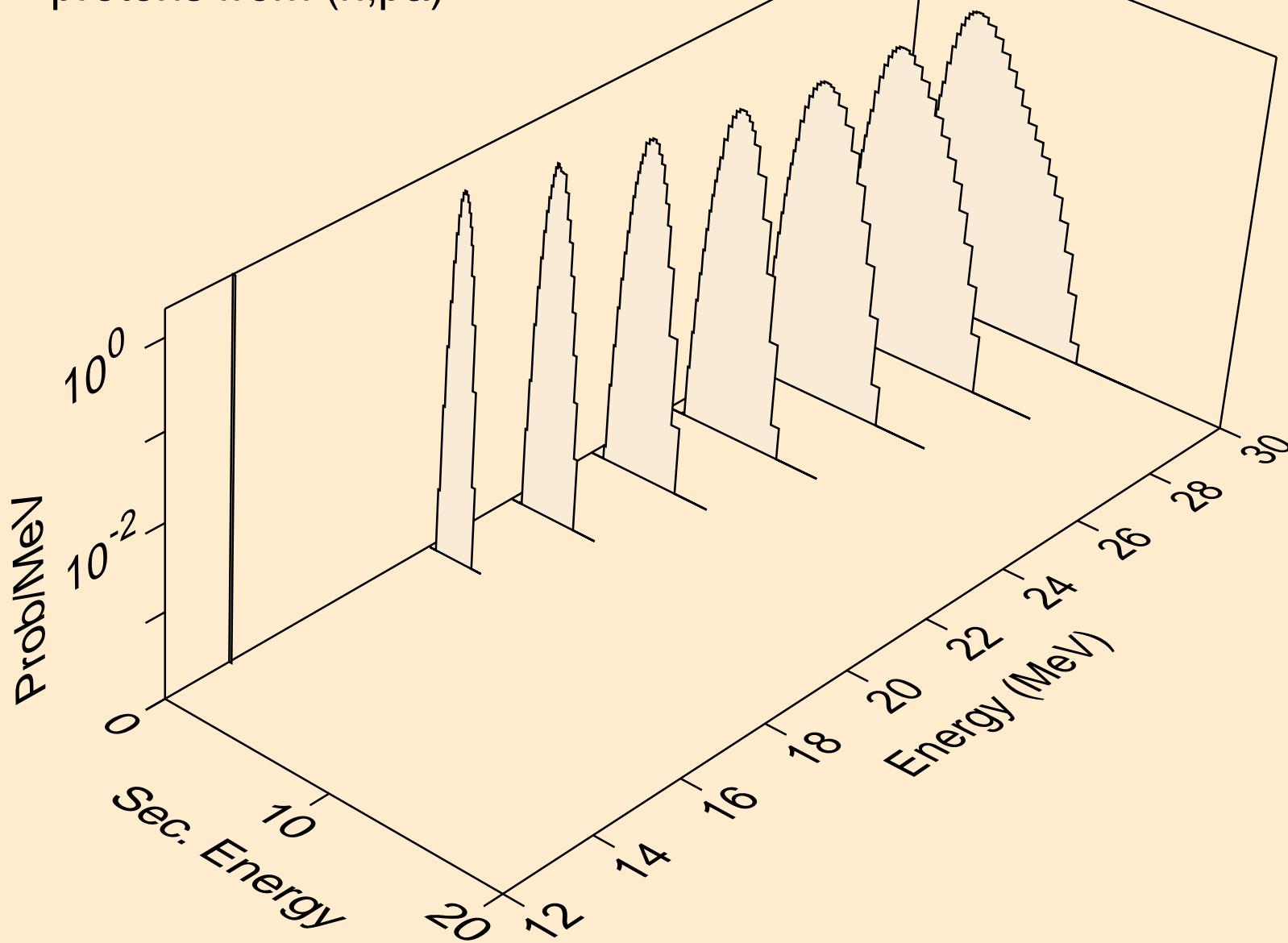

FE059 NEUTRON ACER TENDL-2023 LIBRARY; T=0.K  
protons from (n,pd)

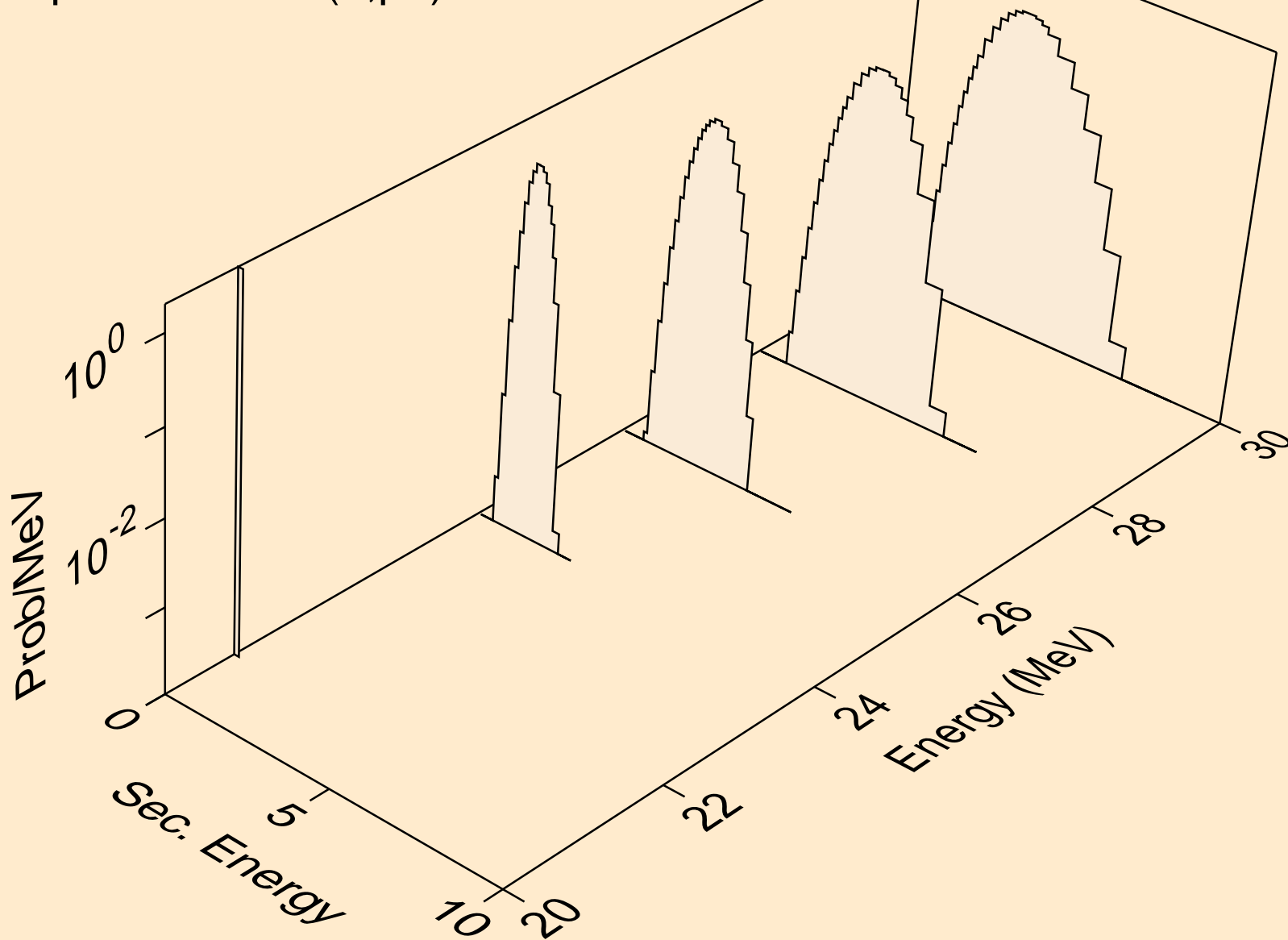

FE059 NEUTRON ACER TENDL-2023 LIBRARY; T=0.K  
protons from (n,pt)

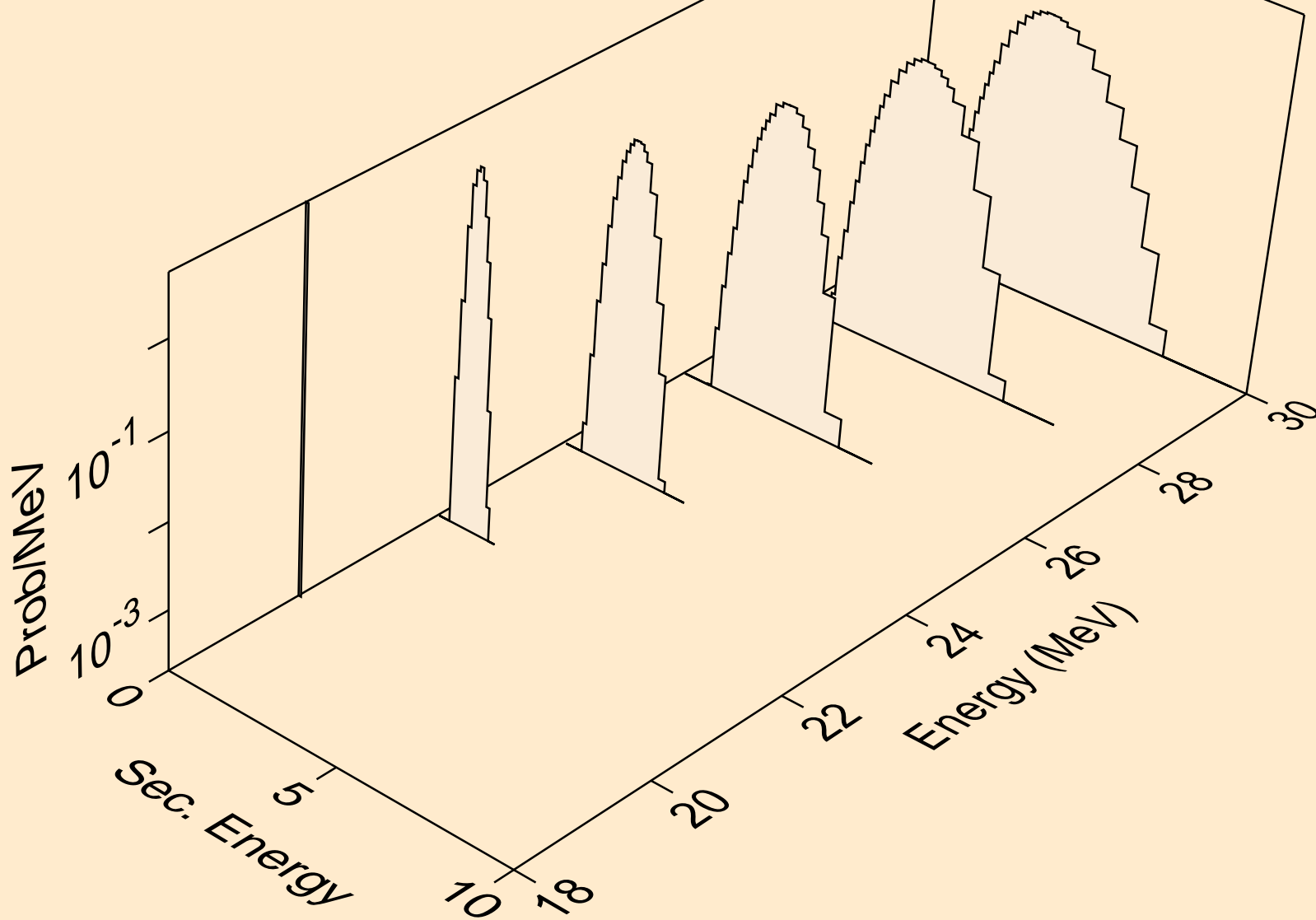

FE059 NEUTRON ACER TENDL-2023 LIBRARY; T=0.K  
deuterons from (n,x)

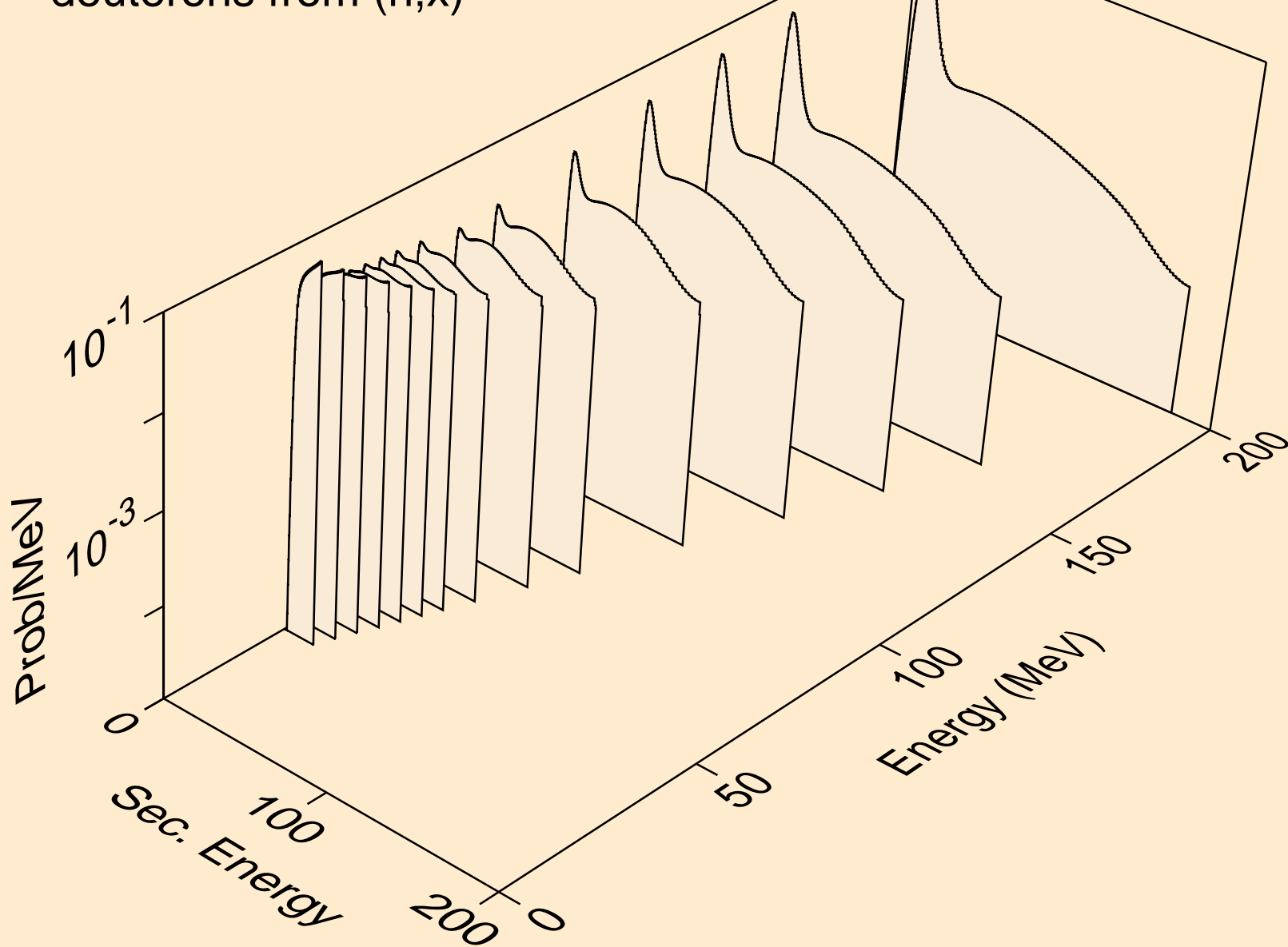

FE059 NEUTRON ACER TENDL-2023 LIBRARY; T=0.K  
deuterons from (n,2nd)

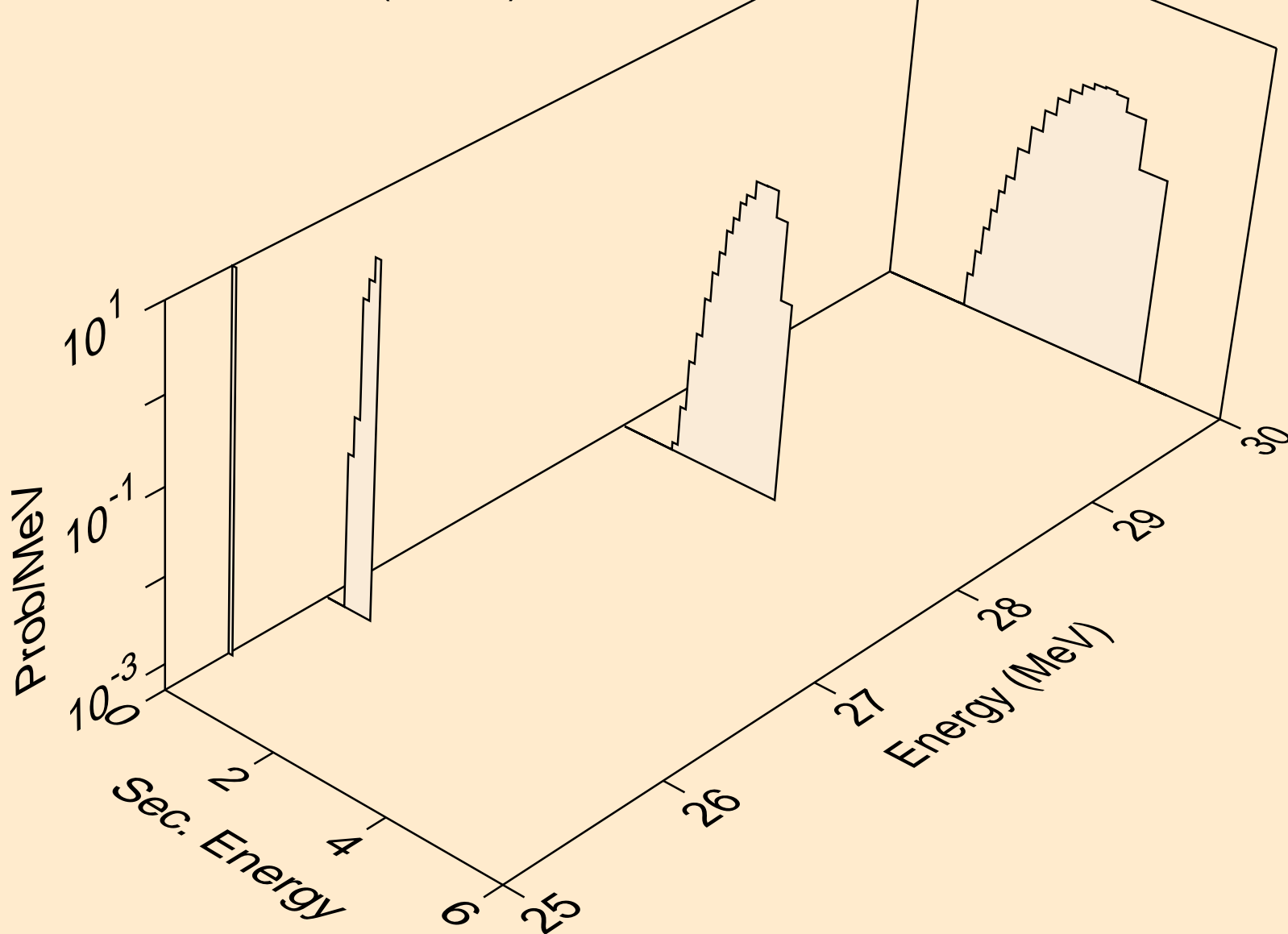

FE059 NEUTRON ACER TENDL-2023 LIBRARY; T=0.K  
deuterons from (n,n\*)d

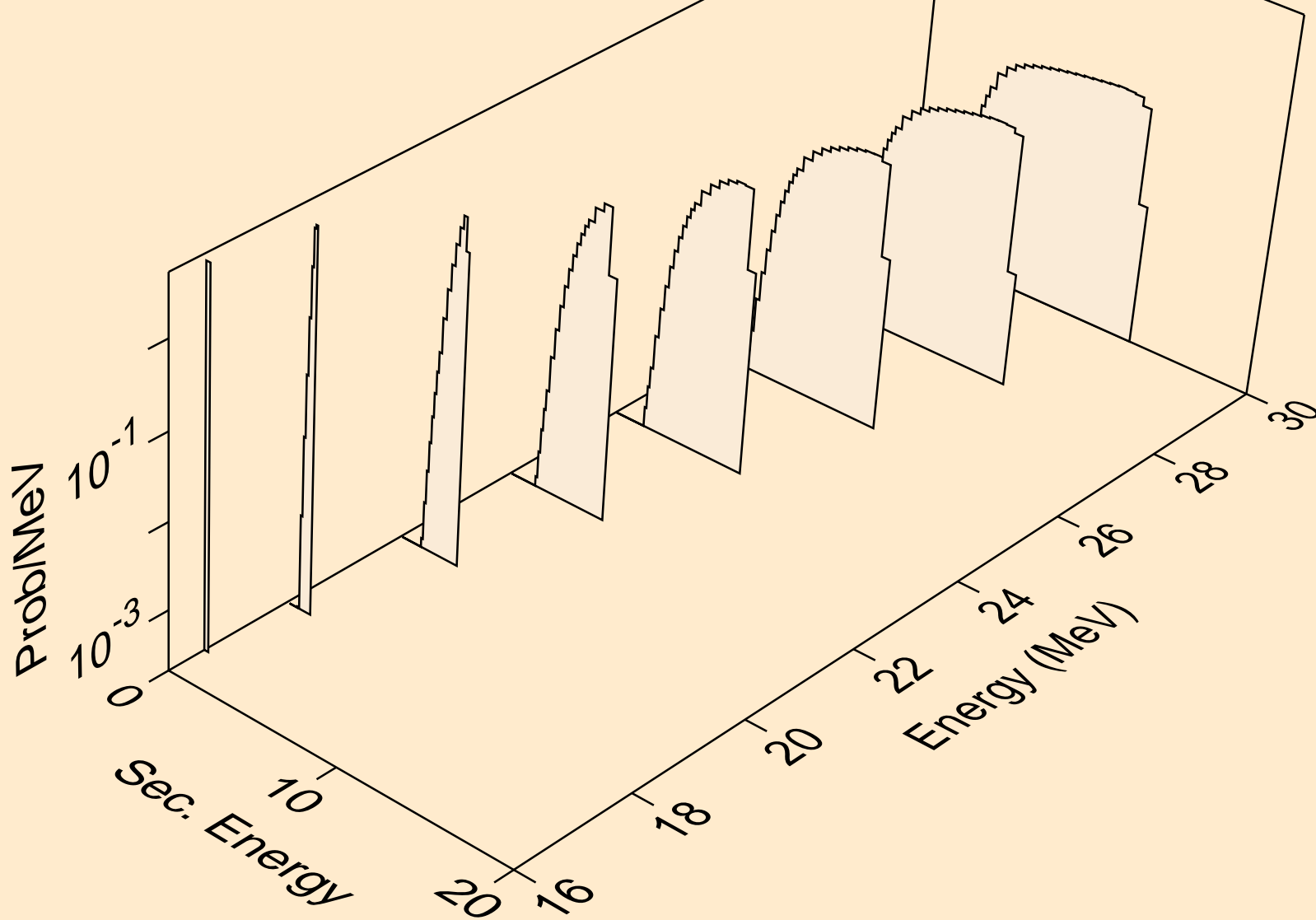



FE059 NEUTRON ACER TENDL-2023 LIBRARY; T=0.K  
deuterons from (n,d)

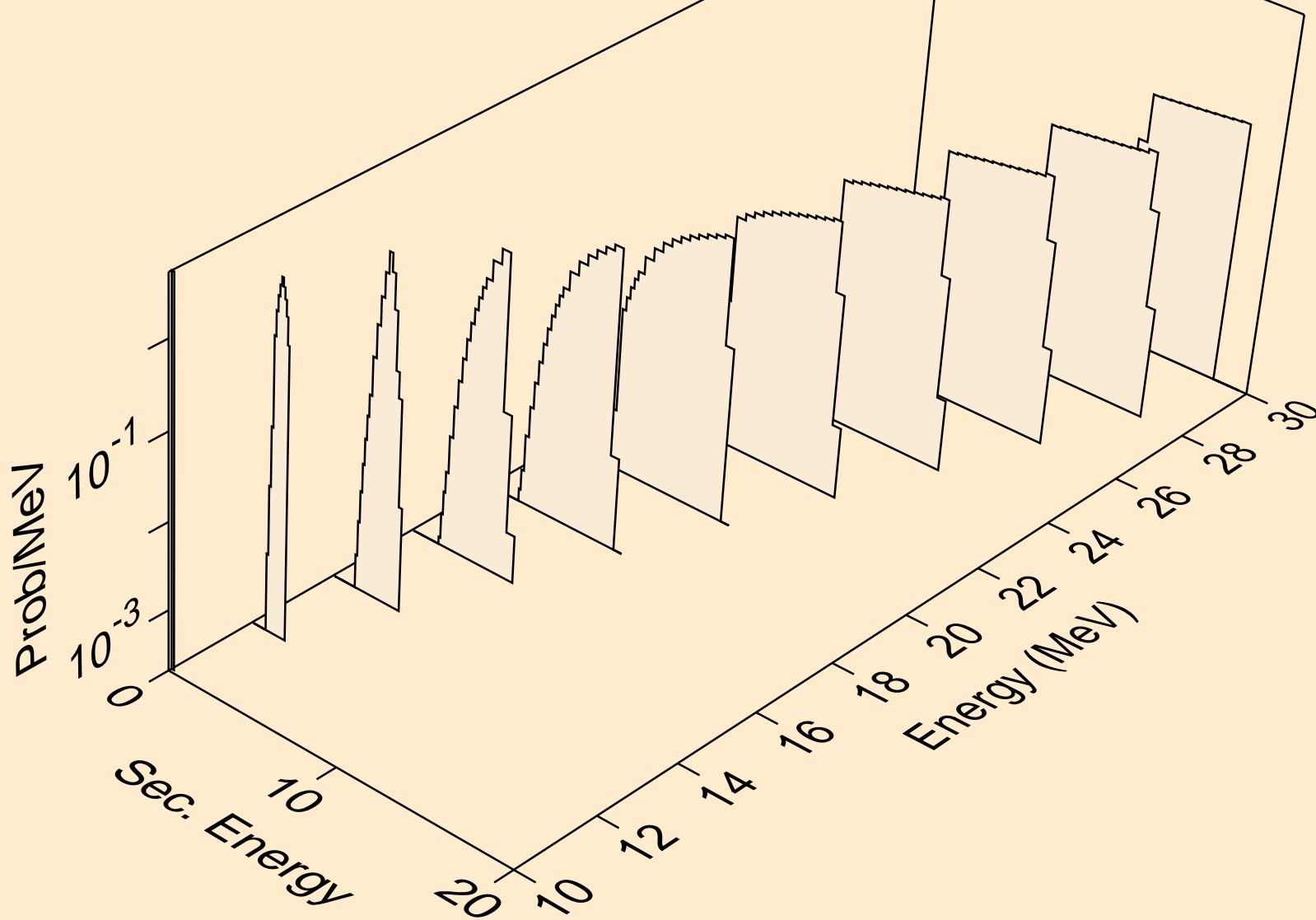

FE059 NEUTRON ACER TENDL-2023 LIBRARY; T=0.K  
deuterons from (n,pd)

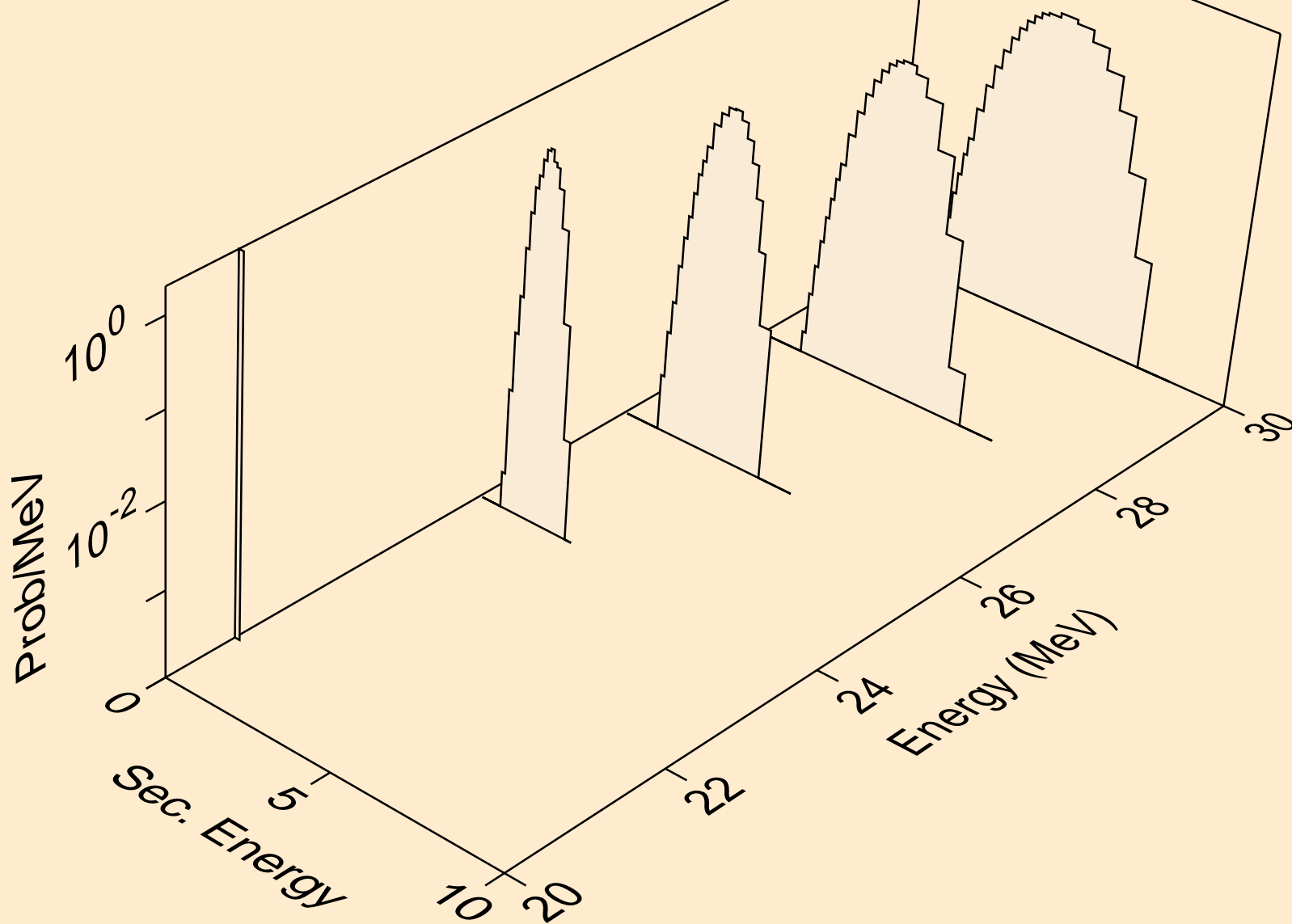

FE059 NEUTRON ACER TENDL-2023 LIBRARY; T=0.K  
deuterons from (n,da)

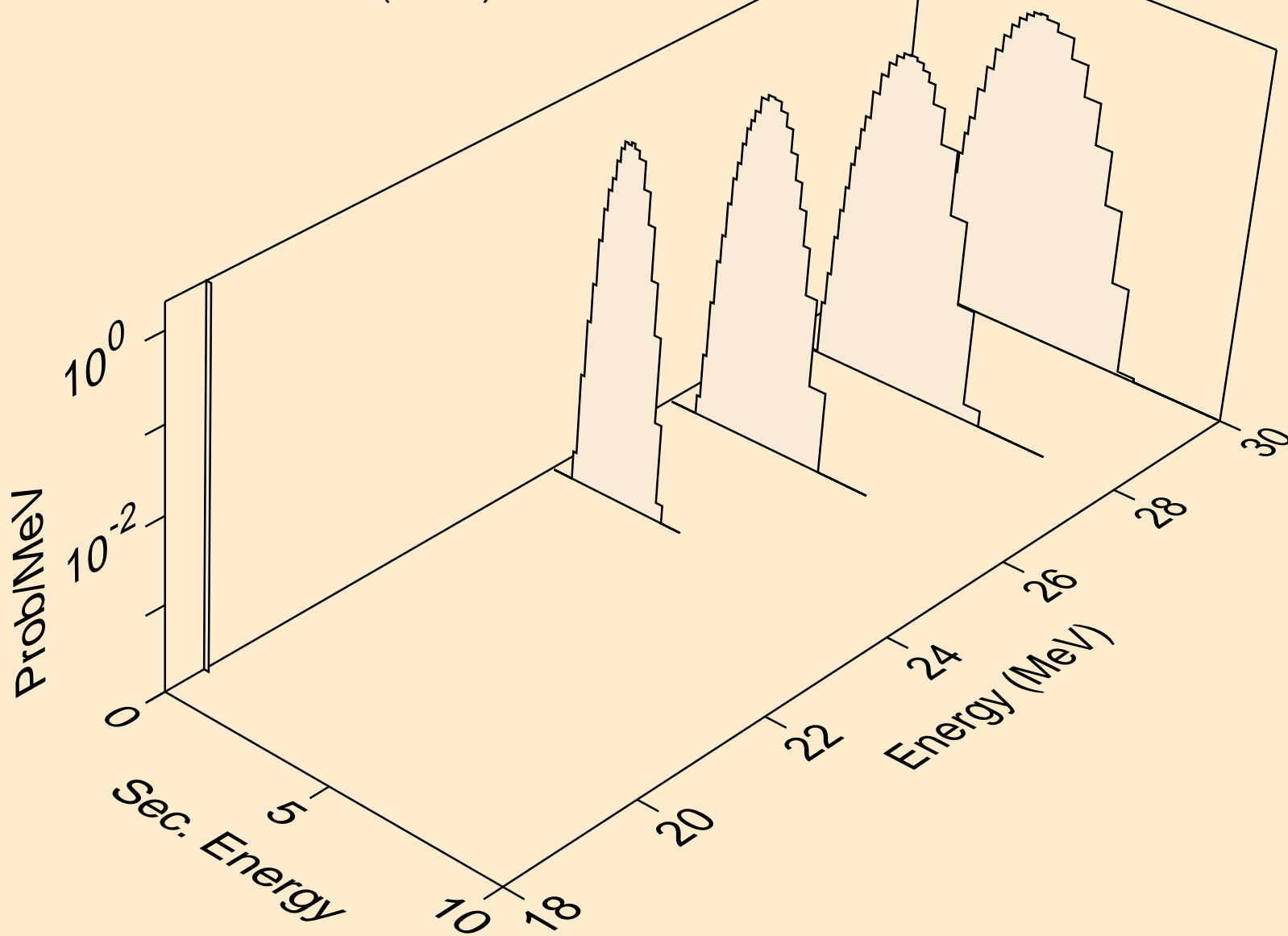

FE059 NEUTRON ACER TENDL-2023 LIBRARY; T=0.K  
tritons from (n,x)

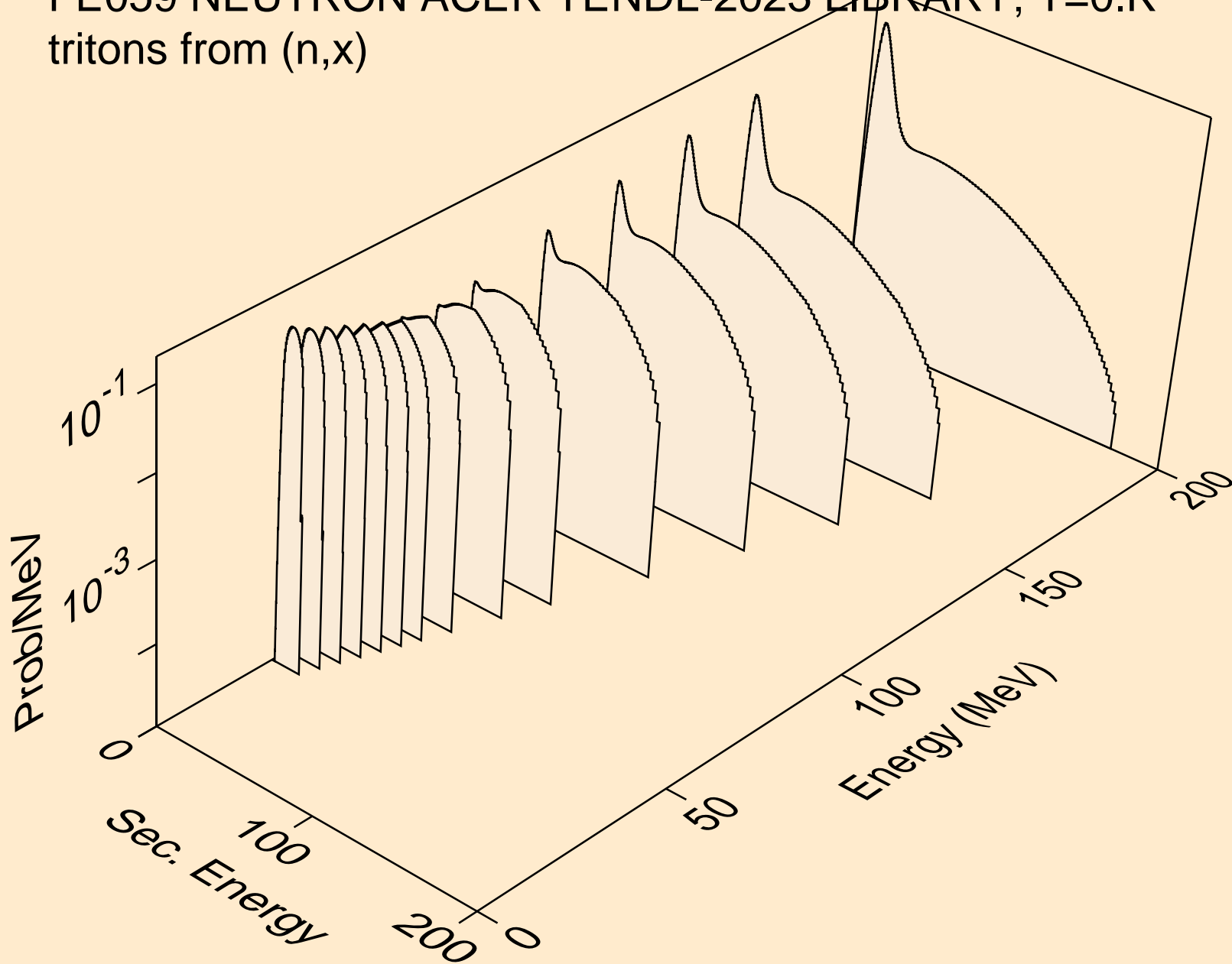

FE059 NEUTRON ACER TENDL-2023 LIBRARY; T=0.K  
tritons from (n,n\*)t

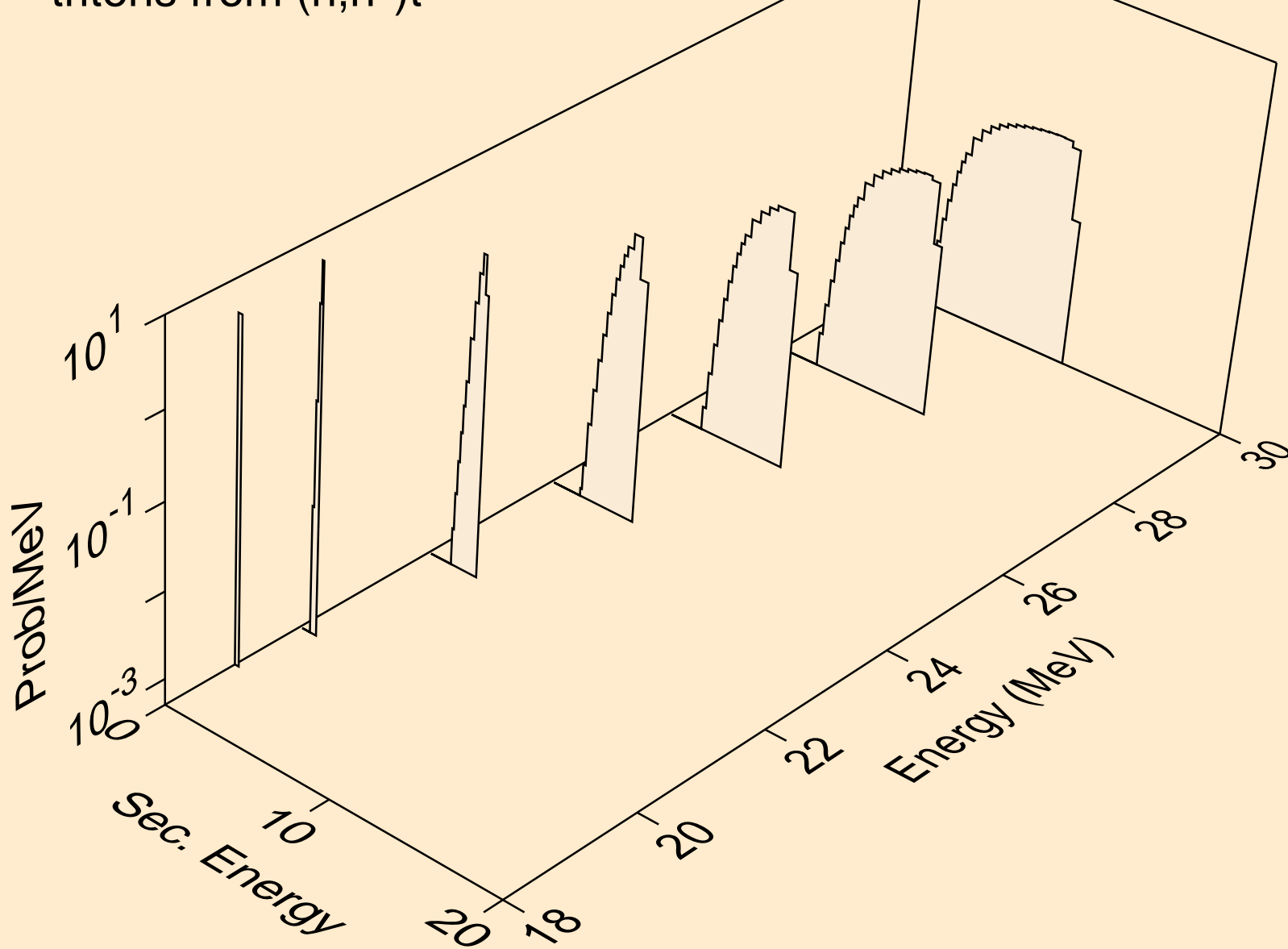

FE059 NEUTRON ACER TENDL-2023 LIBRARY; T=0.K  
tritons from (n,t)

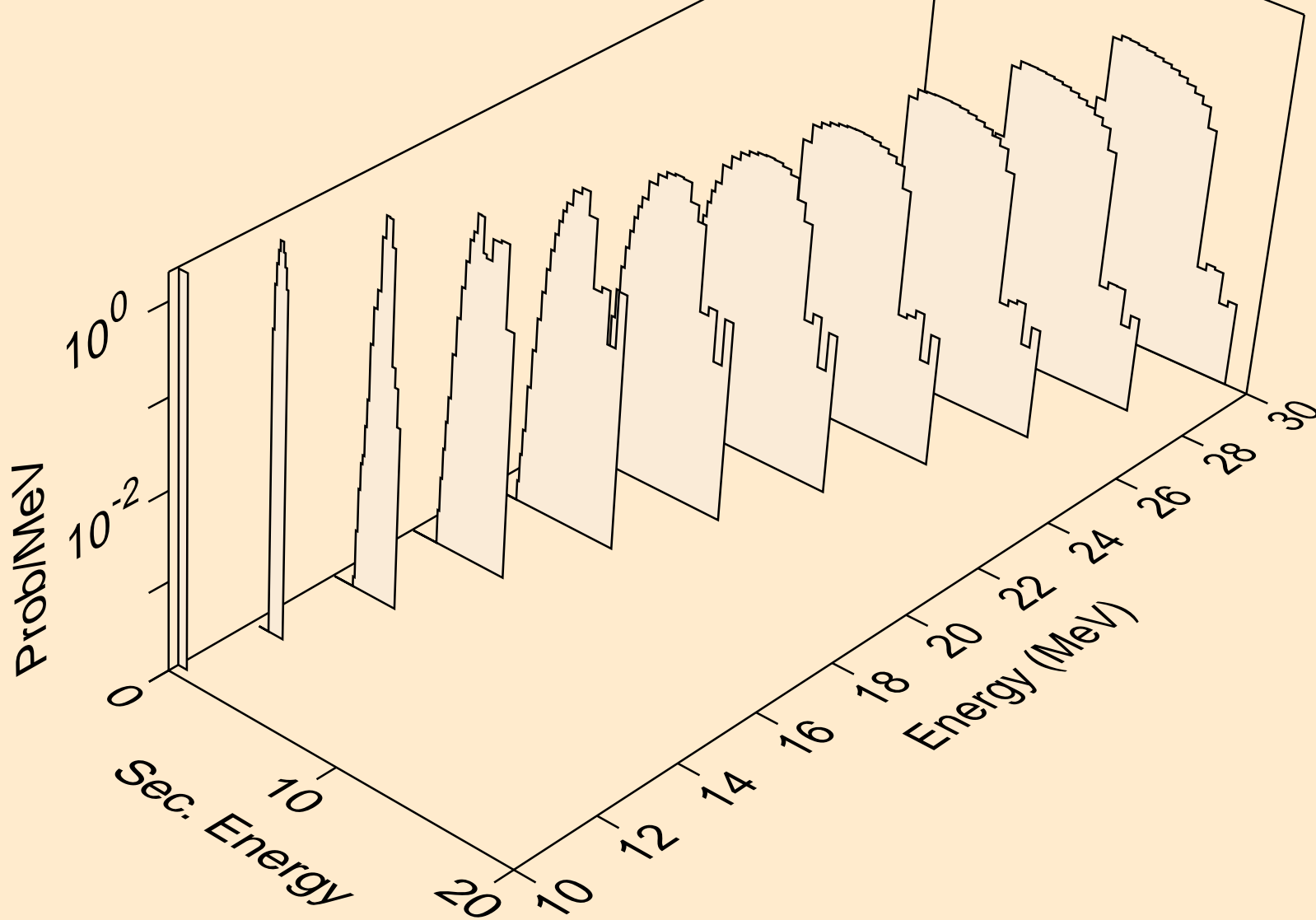

FE059 NEUTRON ACER TENDL-2023 LIBRARY; T=0.K  
tritons from (n,pt)

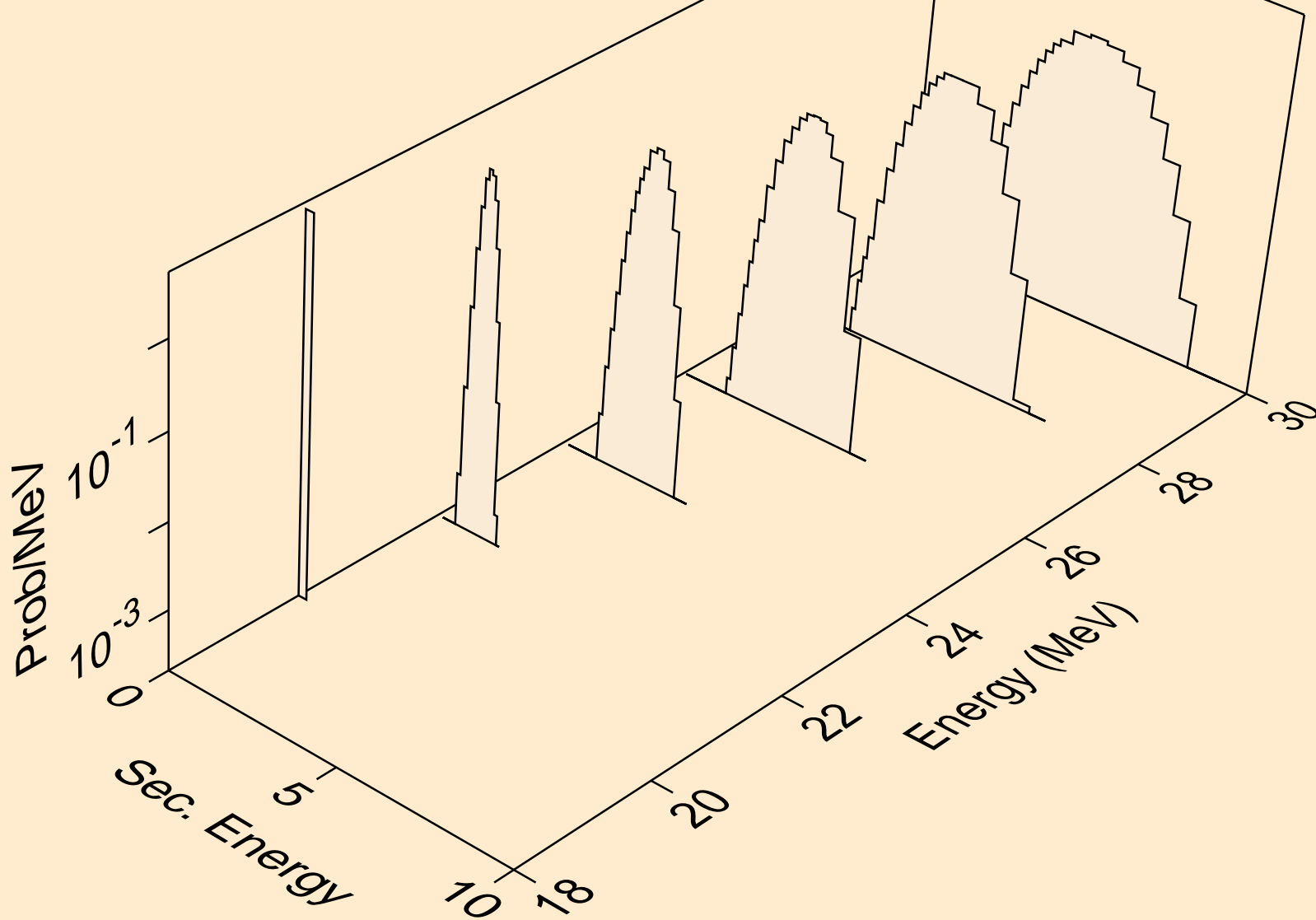

FE059 NEUTRON ACER TENDL-2023 LIBRARY; T=0.K  
he3s from (n,x)

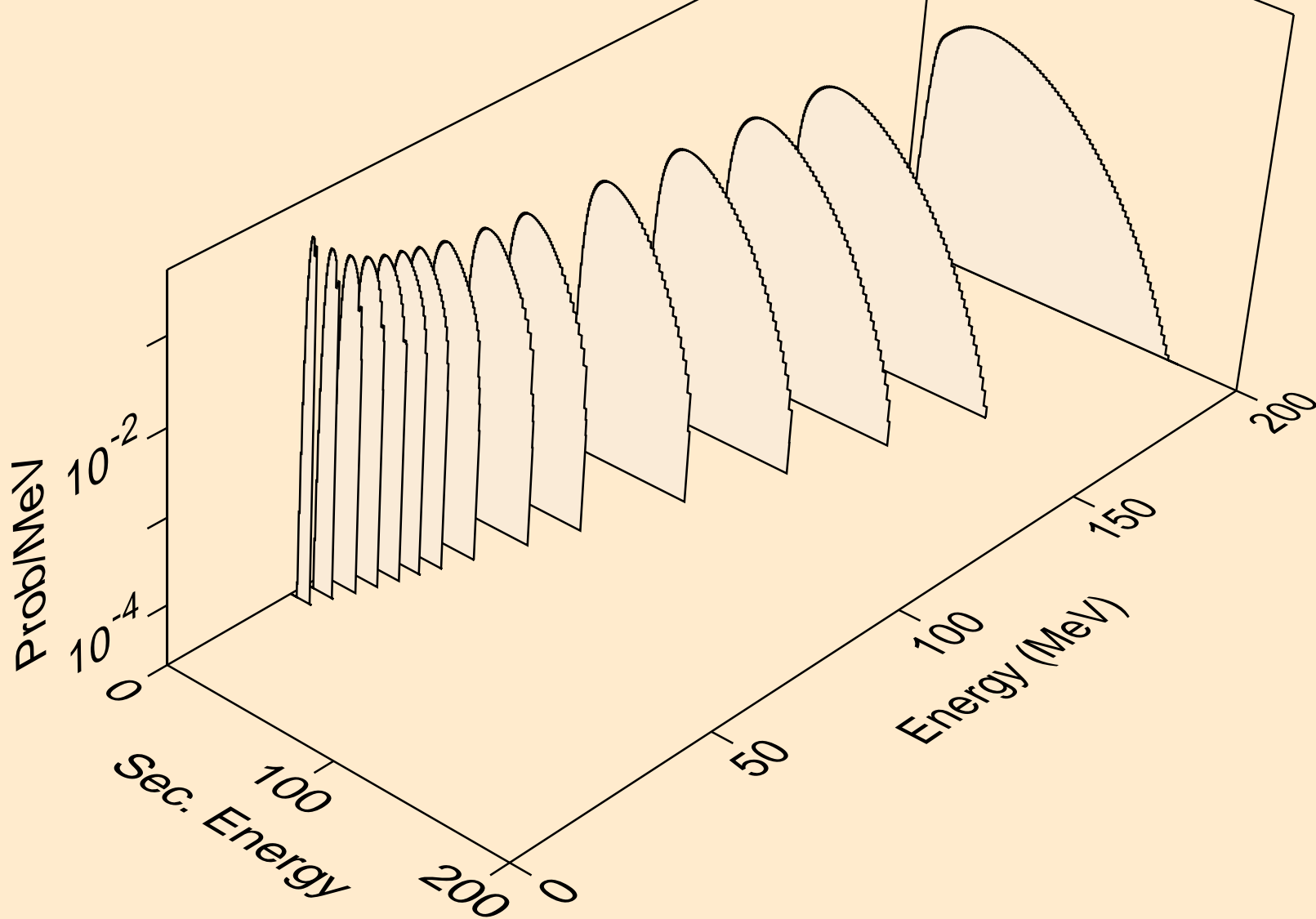



FE059 NEUTRON ACER TENDL-2023 LIBRARY; T=0.K  
he3s from (n,n\*)he3

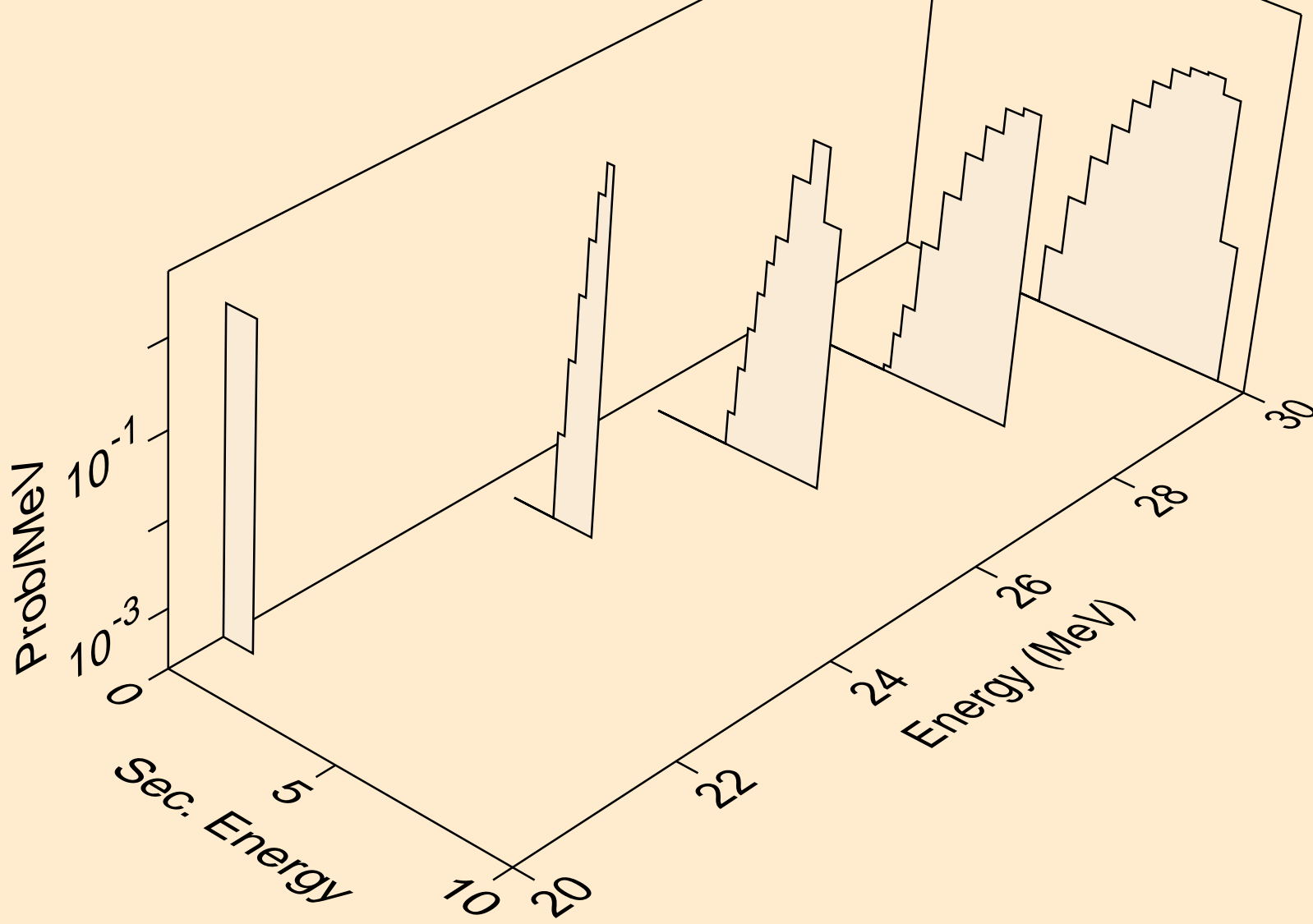

FE059 NEUTRON ACER TENDL-2023 LIBRARY; T=0.K  
he3s from (n,he3)

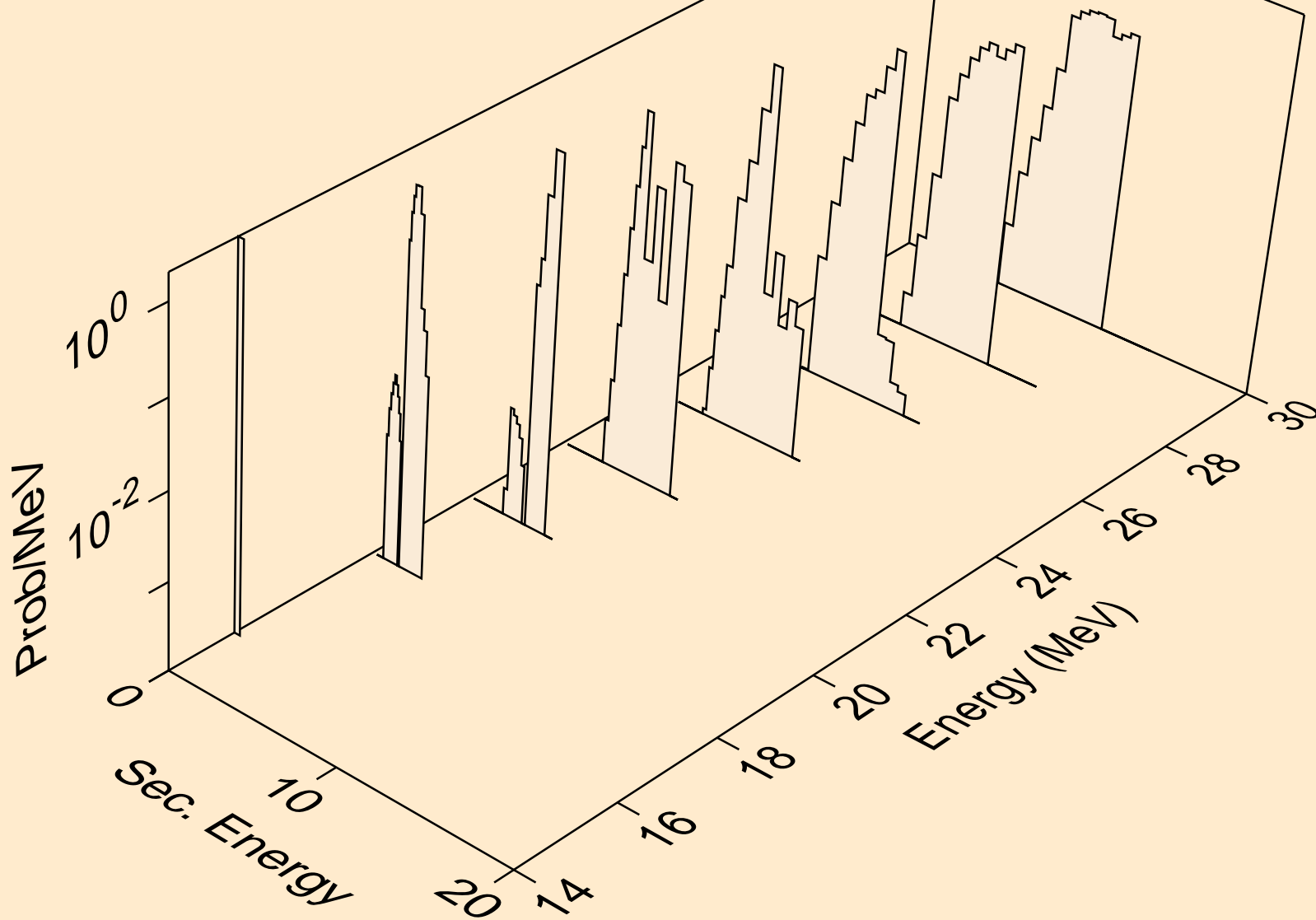

FE059 NEUTRON ACER TENDL-2023 LIBRARY; T=0.K  
alphas from (n,x)

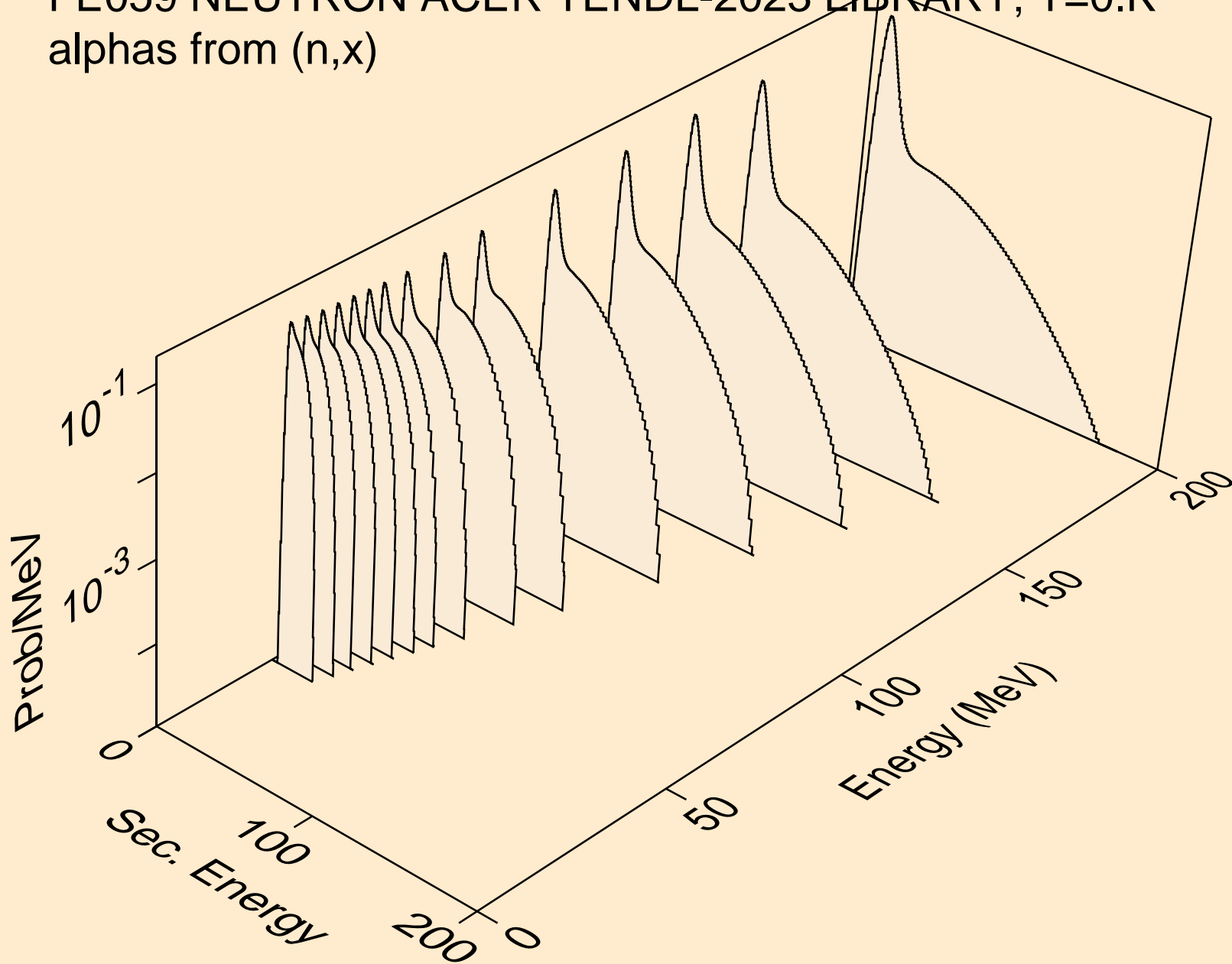

FE059 NEUTRON ACER TENDL-2023 LIBRARY; T=0.K  
alphas from (n,n\*)a

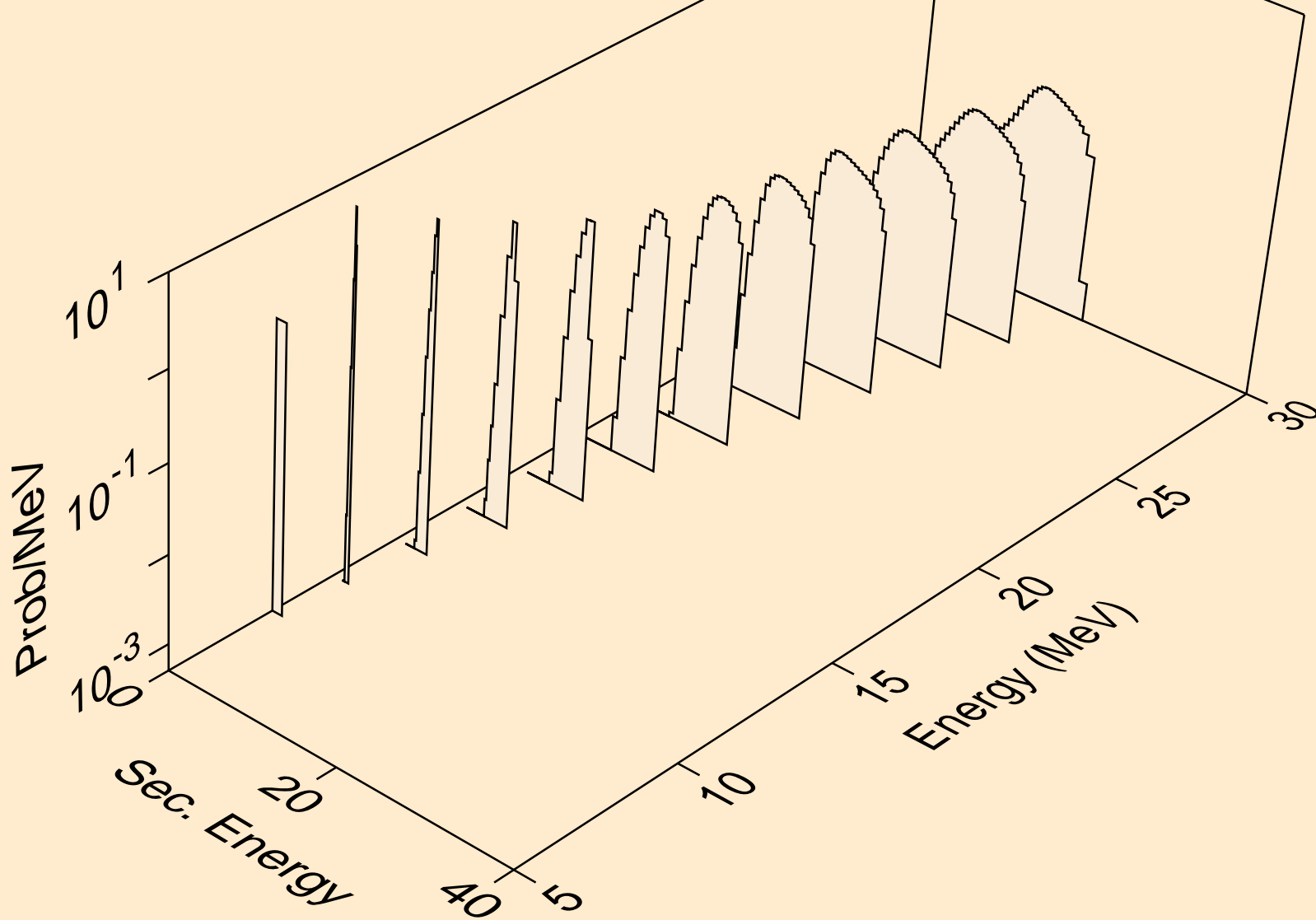

FE059 NEUTRON ACER TENDL-2023 LIBRARY; T=0.K  
alphas from (n,2n)a

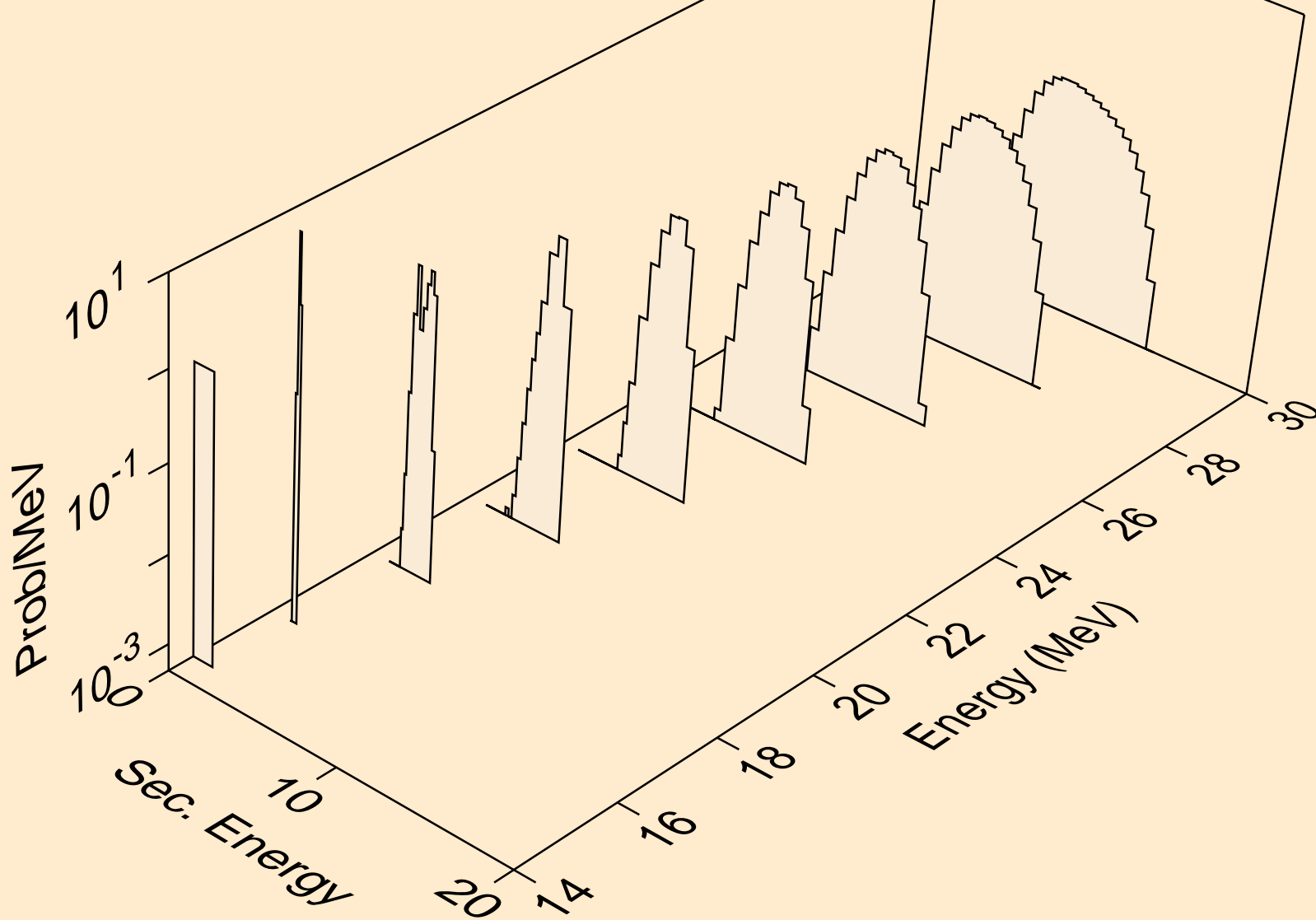

FE059 NEUTRON ACER TENDL-2023 LIBRARY; T=0.K  
alphas from (n,3n)a

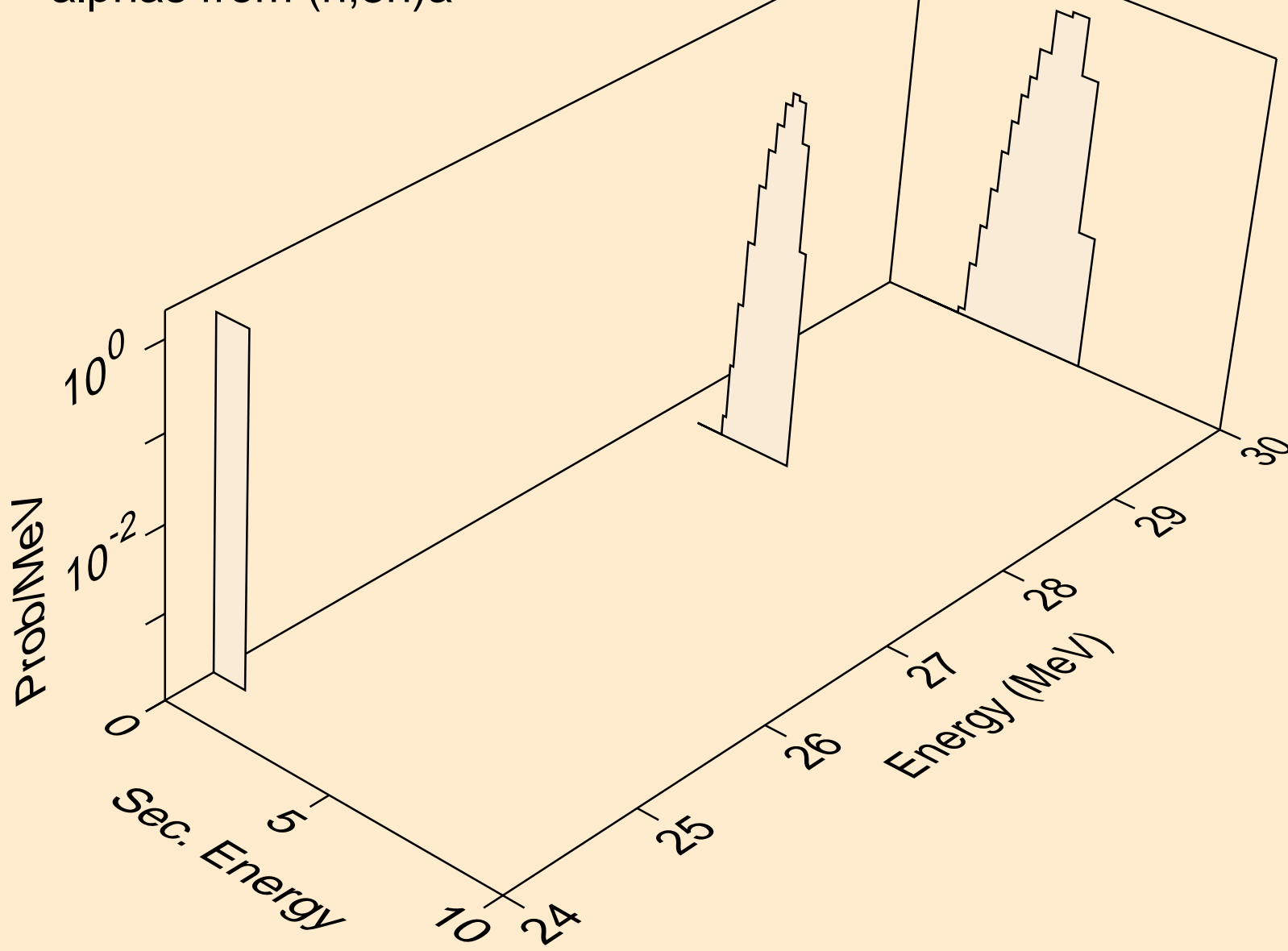

FE059 NEUTRON ACER TENDL-2023 LIBRARY; T=0.K  
alphas from (n,n\*)2a

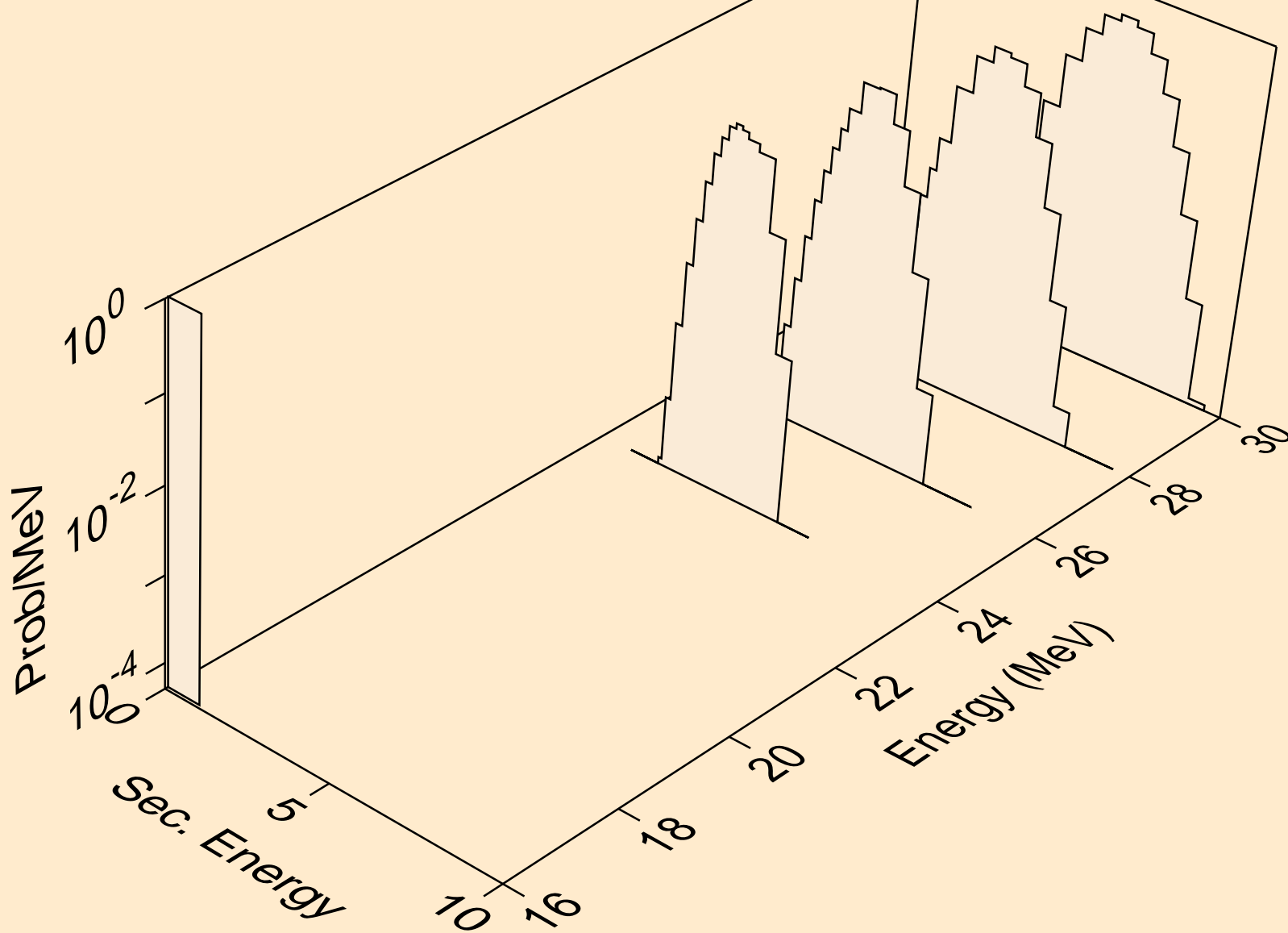

FE059 NEUTRON ACER TENDL-2023 LIBRARY; T=0.K  
alphas from (n,npa)

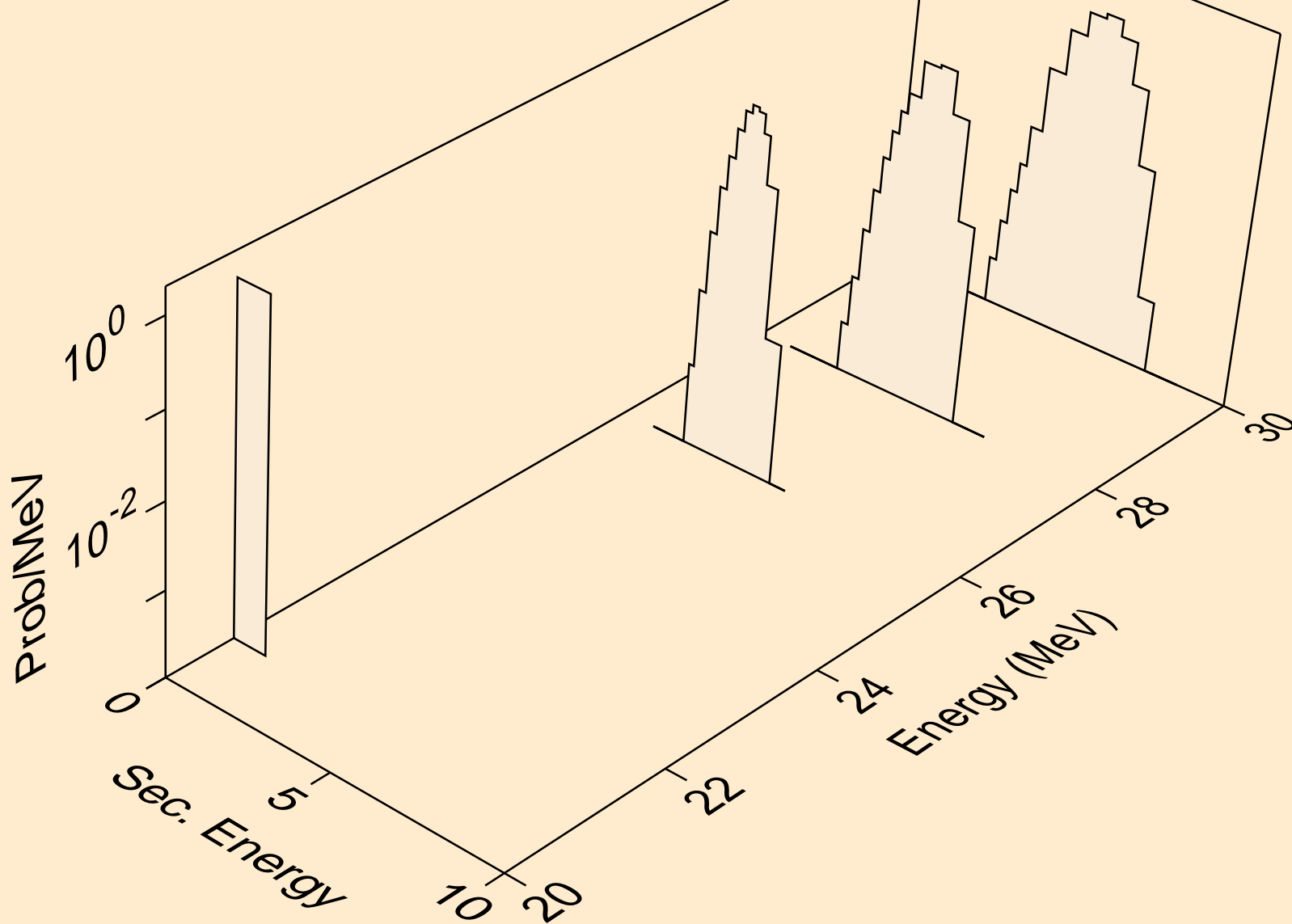



FE059 NEUTRON ACER TENDL-2023 LIBRARY; T=0.K  
alphas from (n,a)

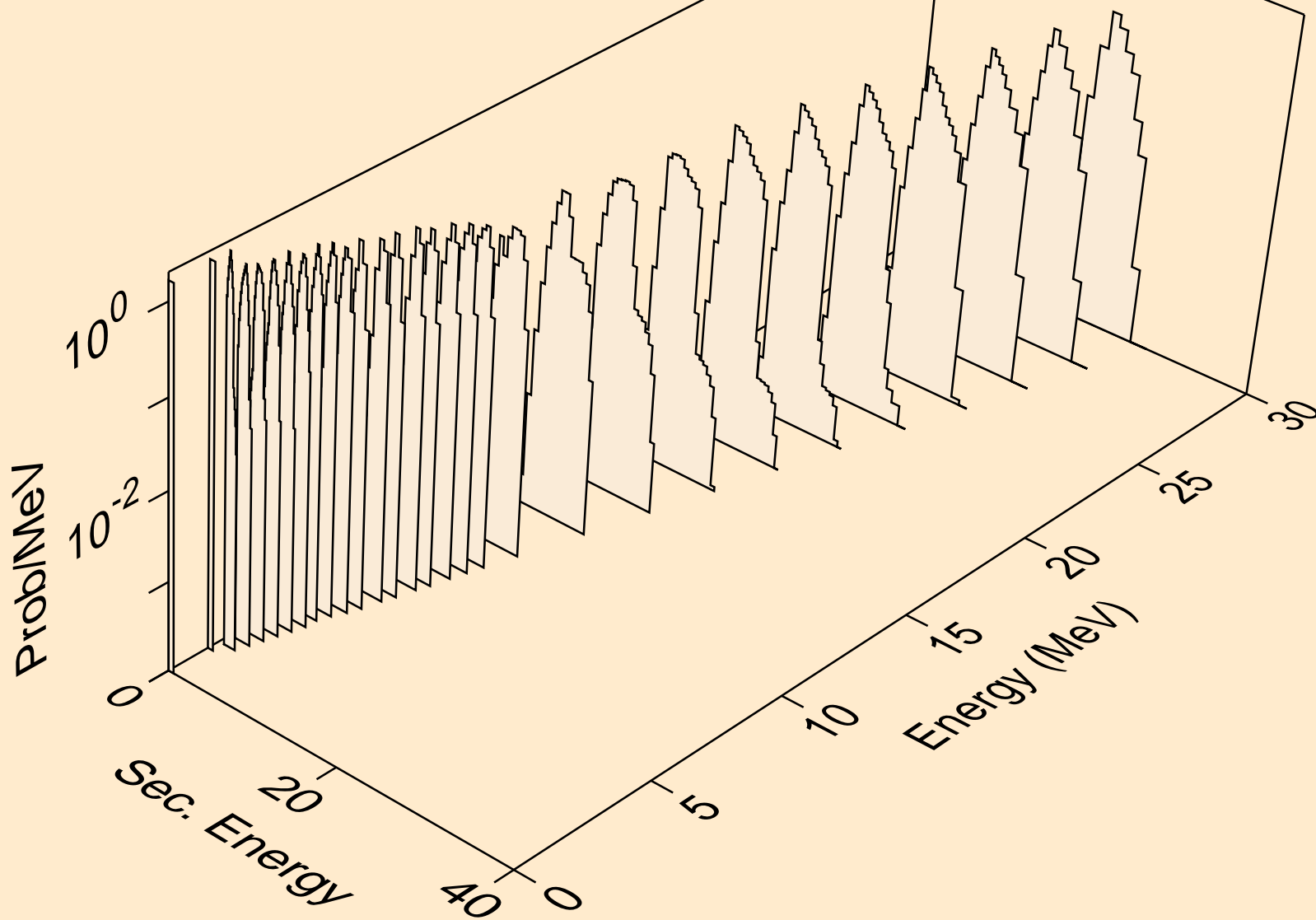

FE059 NEUTRON ACER TENDL-2023 LIBRARY; T=0.K  
alphas from (n,2a)

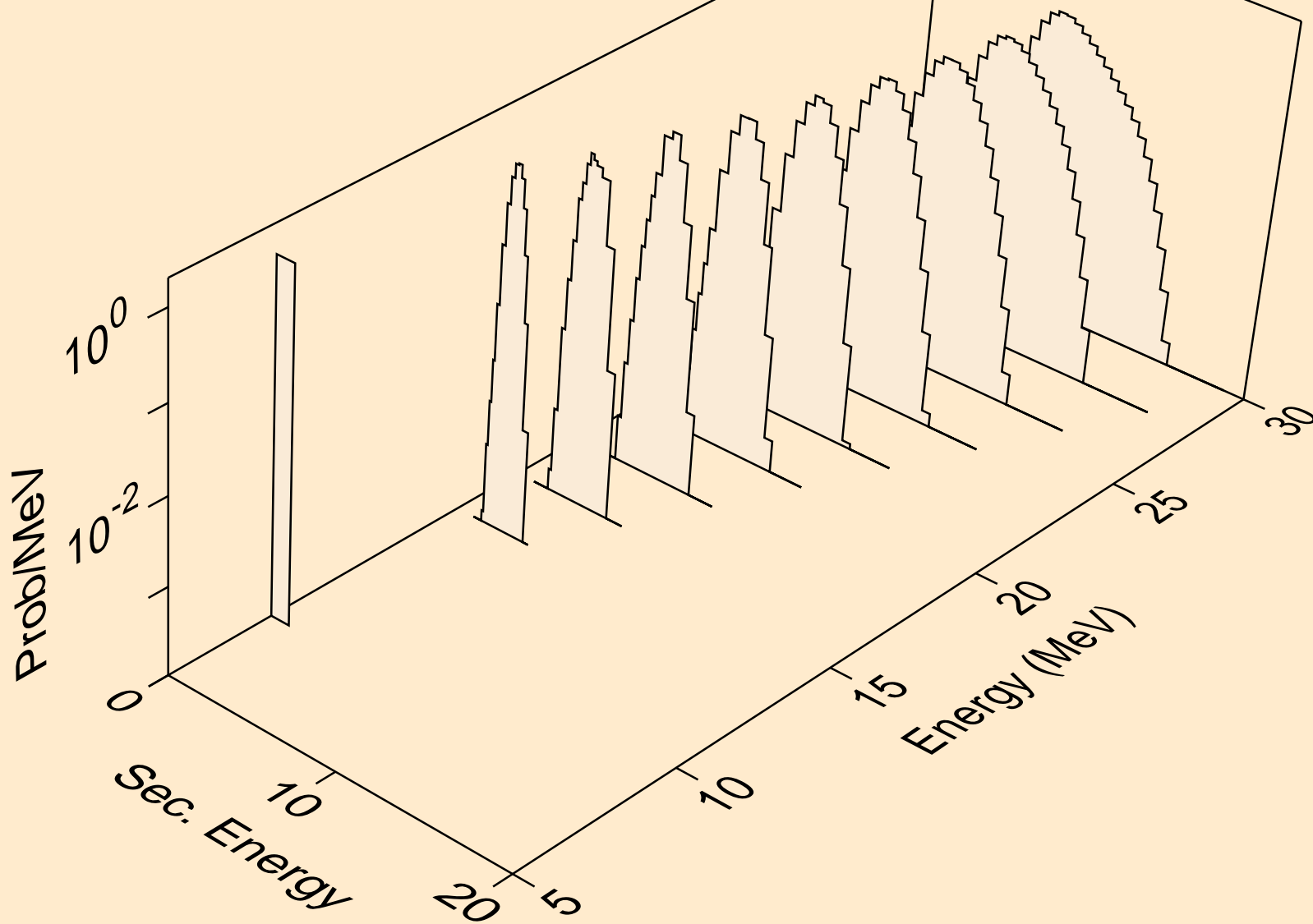

FE059 NEUTRON ACER TENDL-2023 LIBRARY; T=0.K  
alphas from (n,pa)

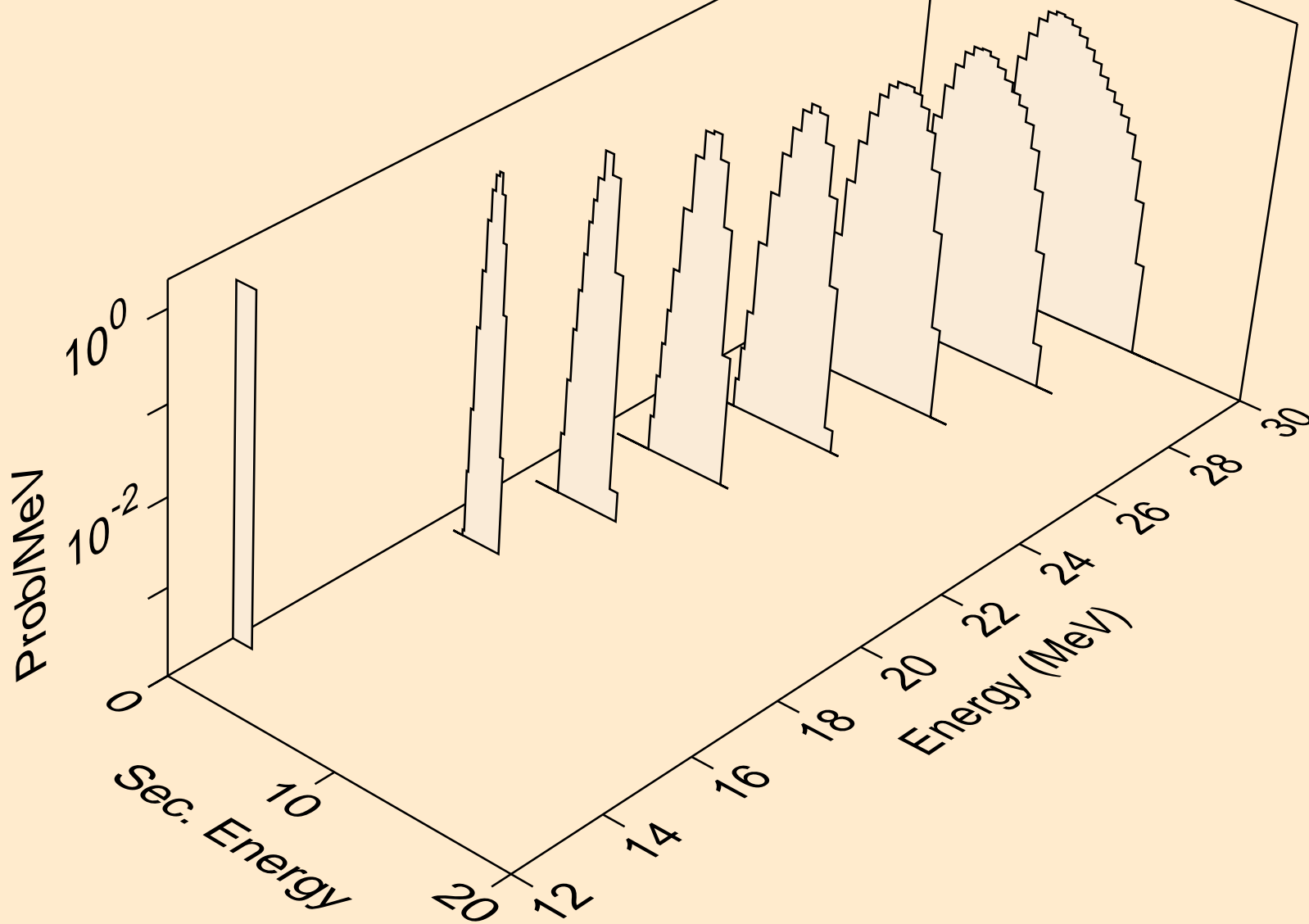

FE059 NEUTRON ACER TENDL-2023 LIBRARY; T=0.K  
alphas from (n,da)

