

FE062 NEUTRON ACER TENDL-2023 LIBRARY; T=0.K

Principal cross sections

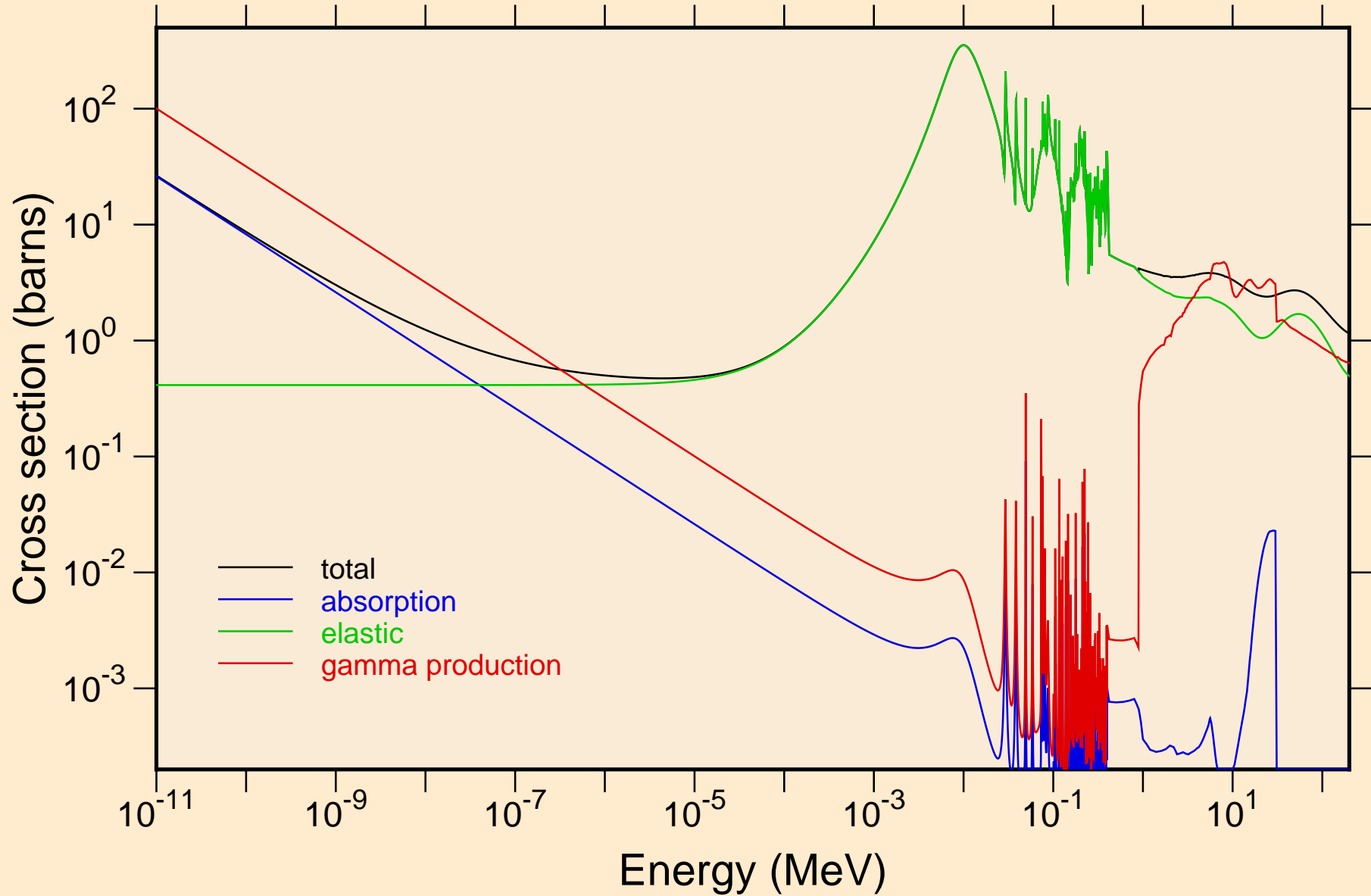

FE062 NEUTRON ACER TENDL-2023 LIBRARY; T=0.K
resonance total cross section

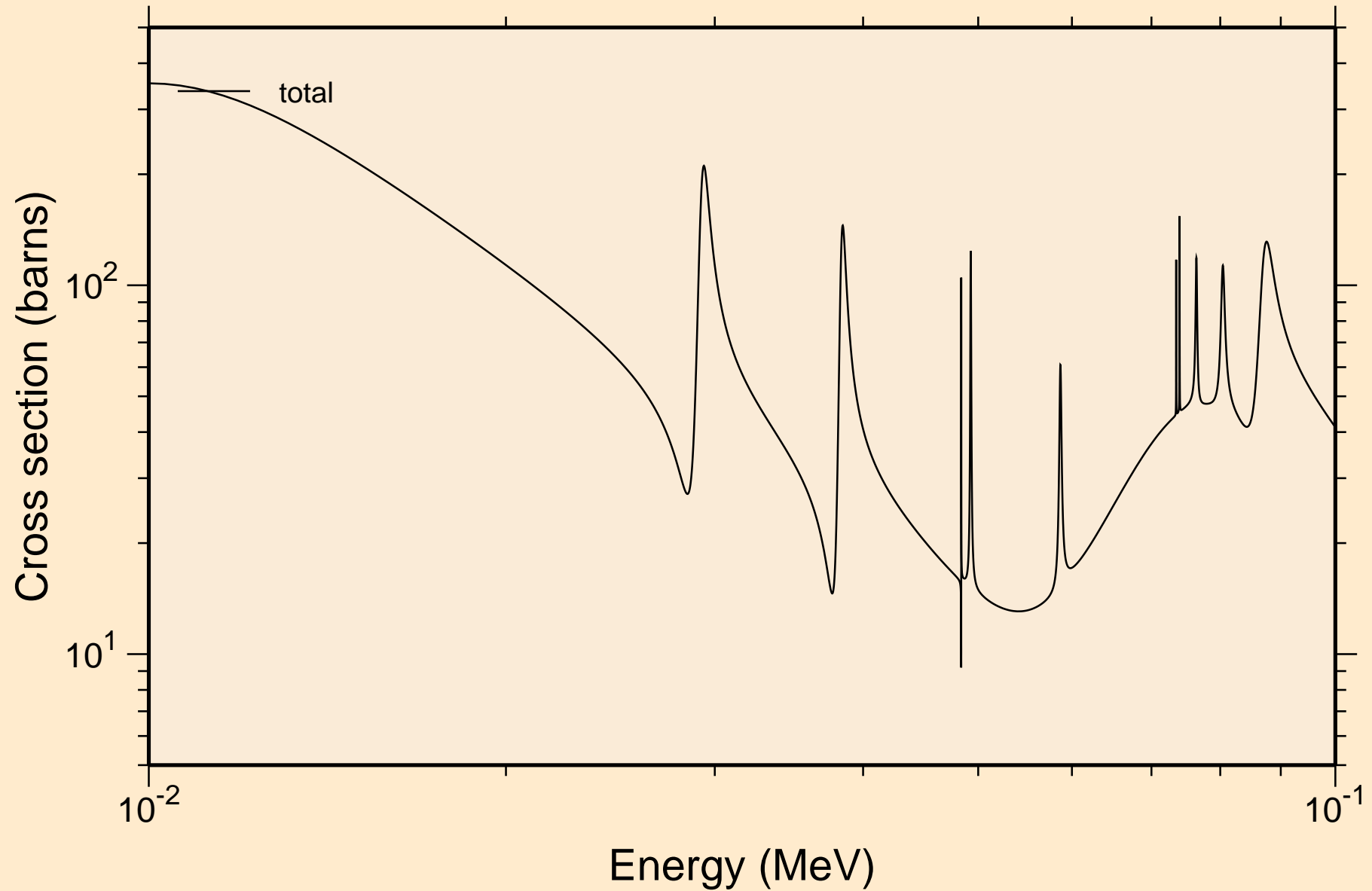

FE062 NEUTRON ACER TENDL-2023 LIBRARY; T=0.K
resonance total cross section

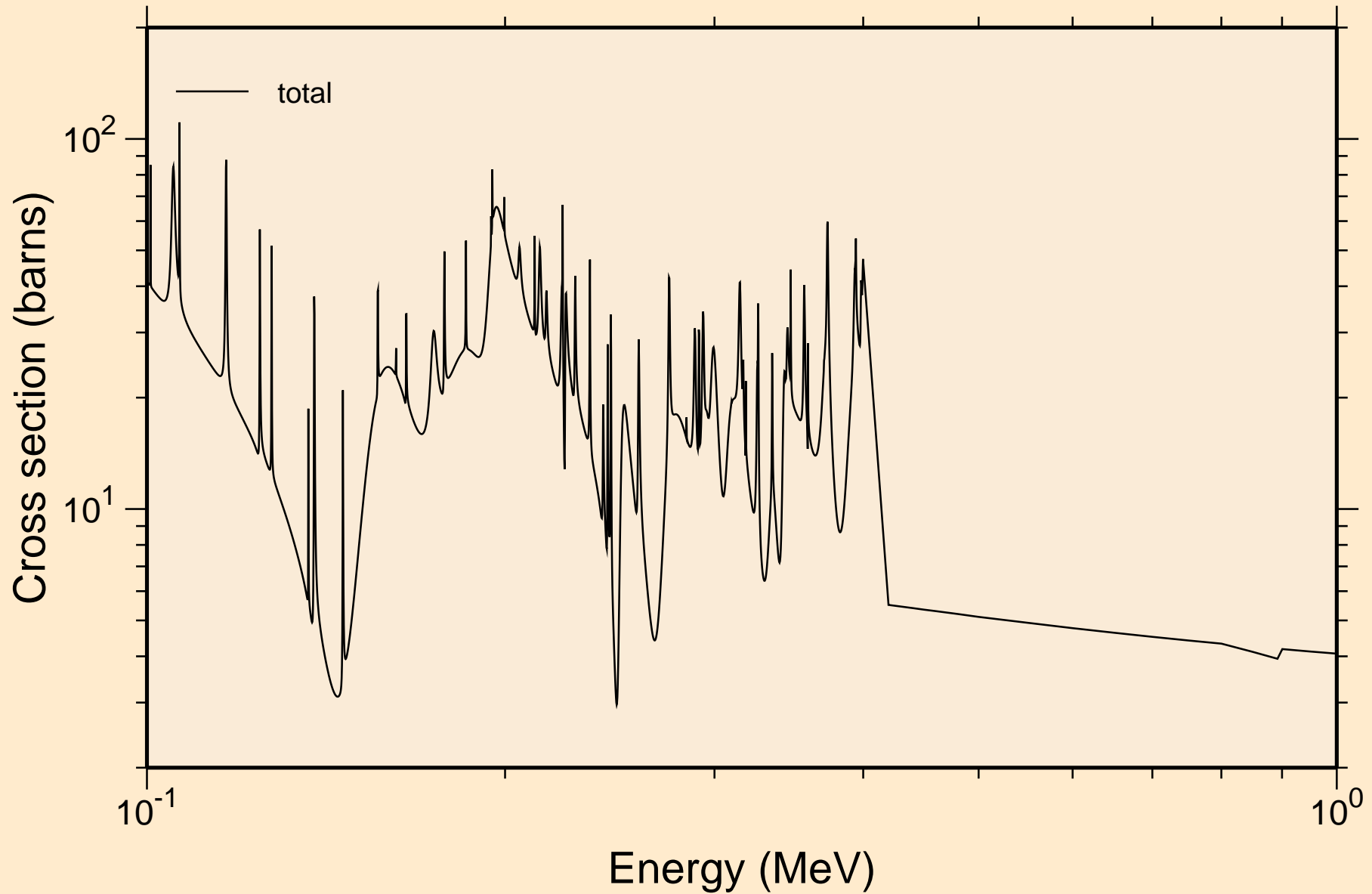

F⁵⁴Fe062 NEUTRON ACER TENDL-2023 LIBRARY; T=0.K
resonance total cross section

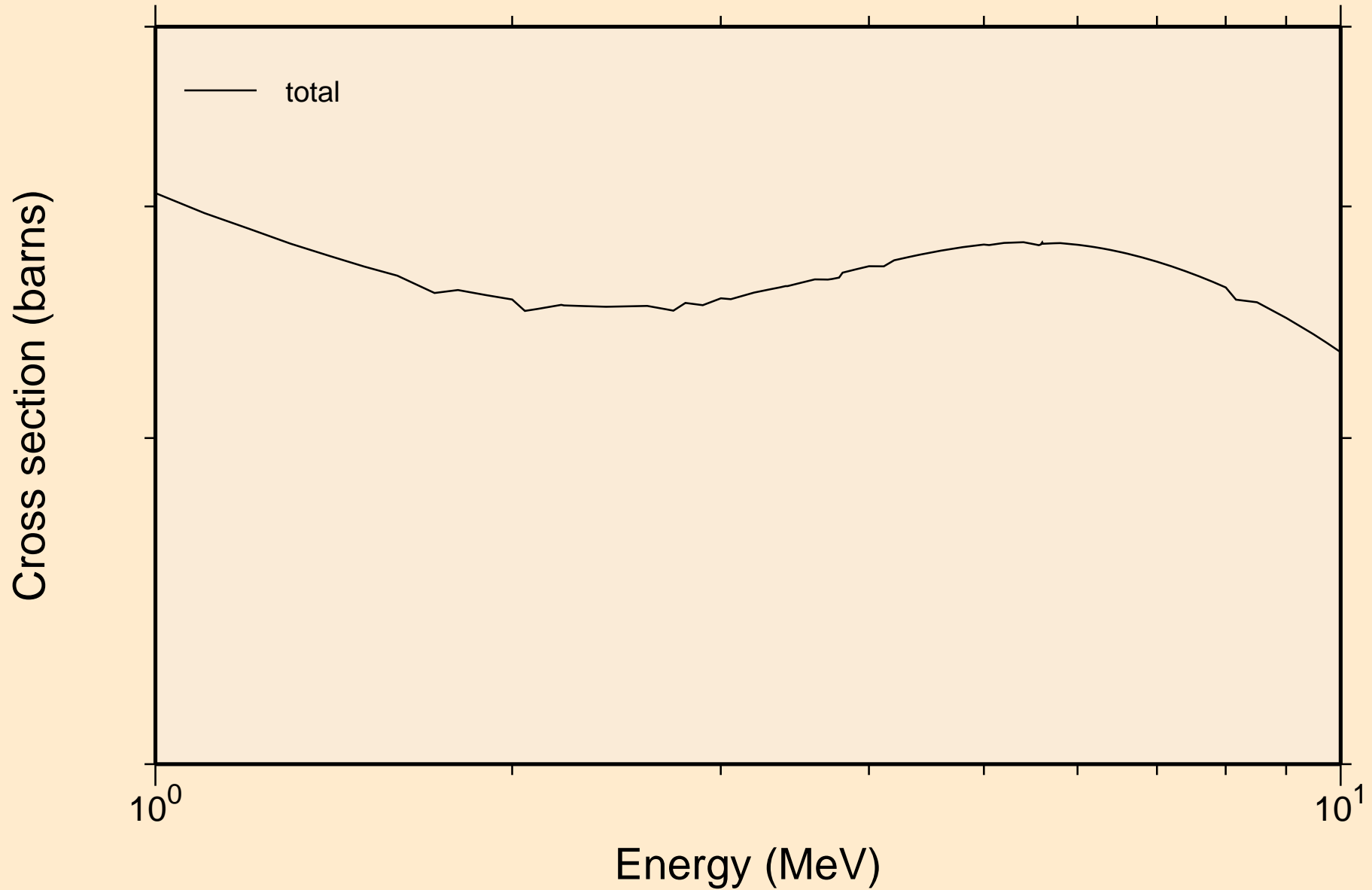

FE062 NEUTRON ACER TENDL-2023 LIBRARY; T=0.K
resonance absorption cross sections

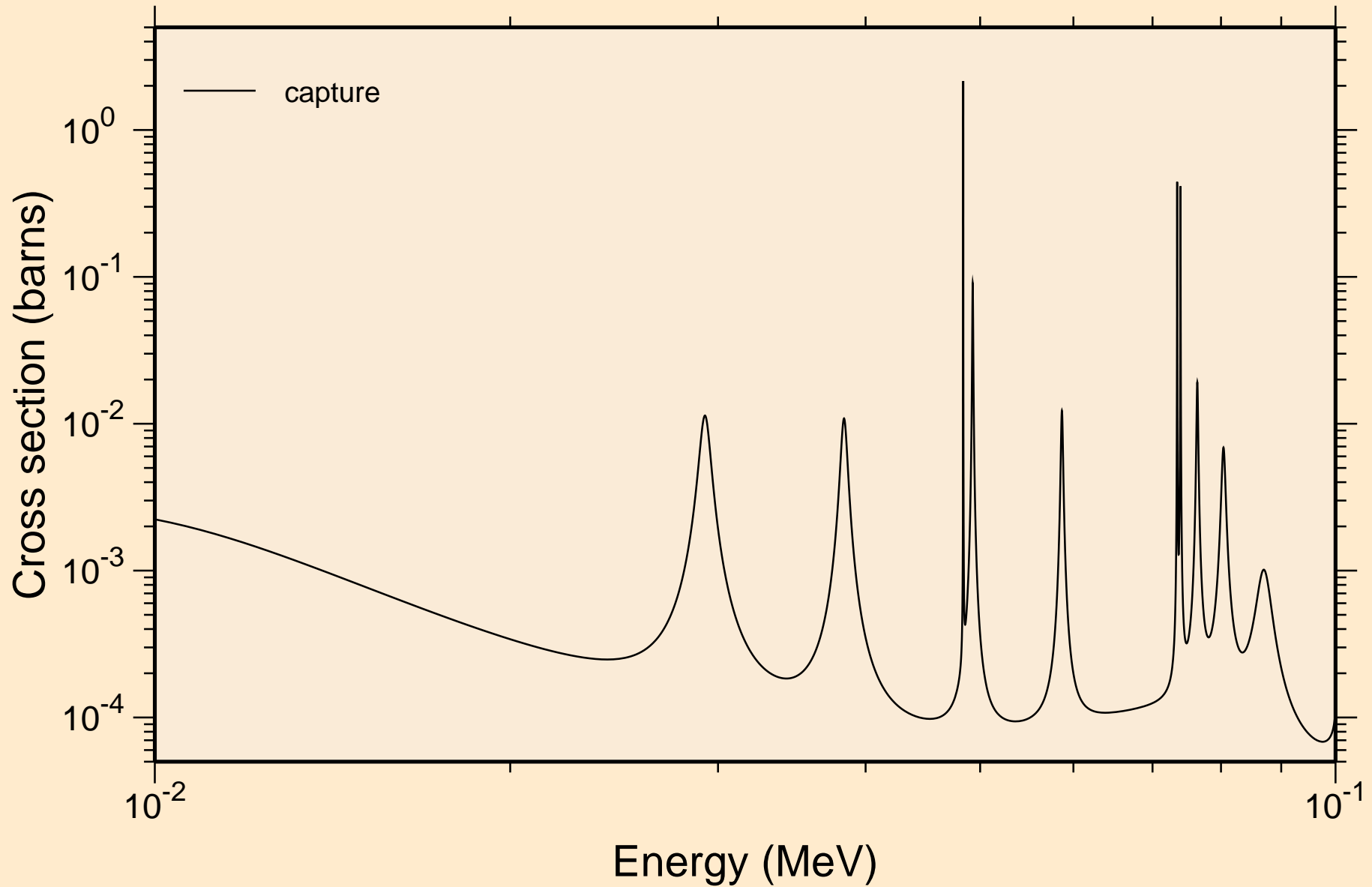

FE062 NEUTRON ACER TENDL-2023 LIBRARY; T=0.K
resonance absorption cross sections

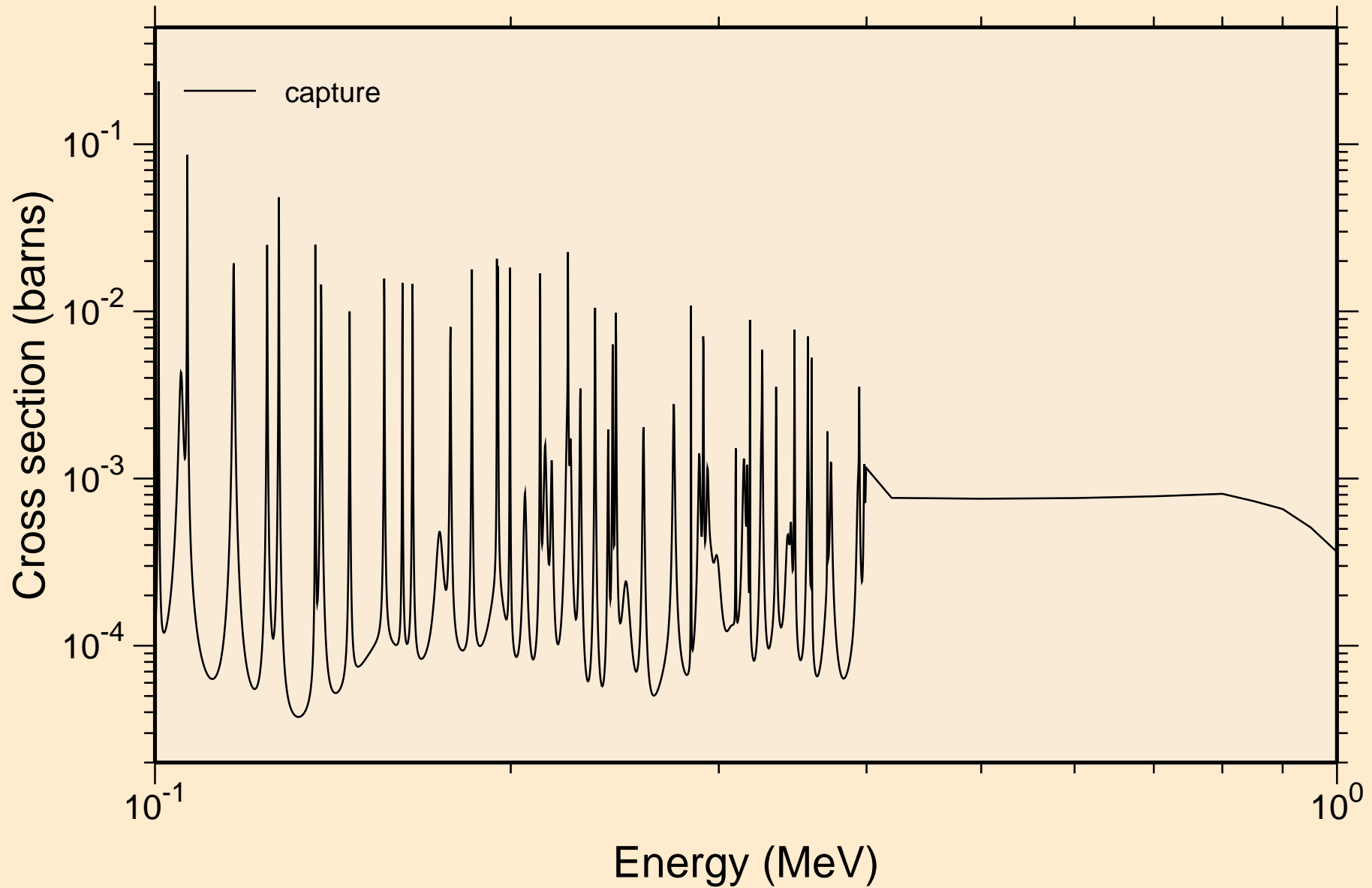

FE062 NEUTRON ACER TENDL-2023 LIBRARY; T=0.K
resonance absorption cross sections

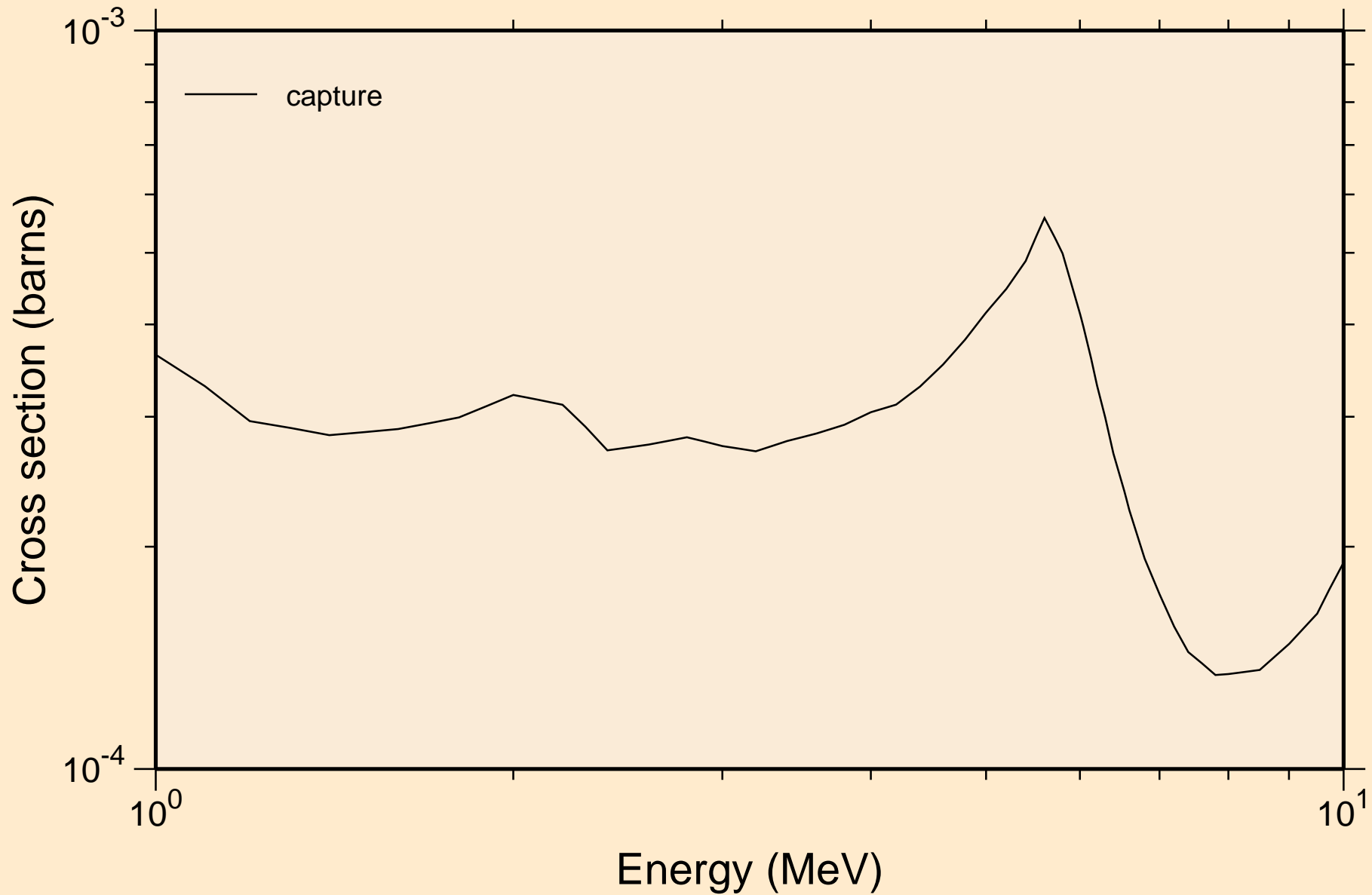

FE062 NEUTRON ACER TENDL-2023 LIBRARY; T=0.K
Heating

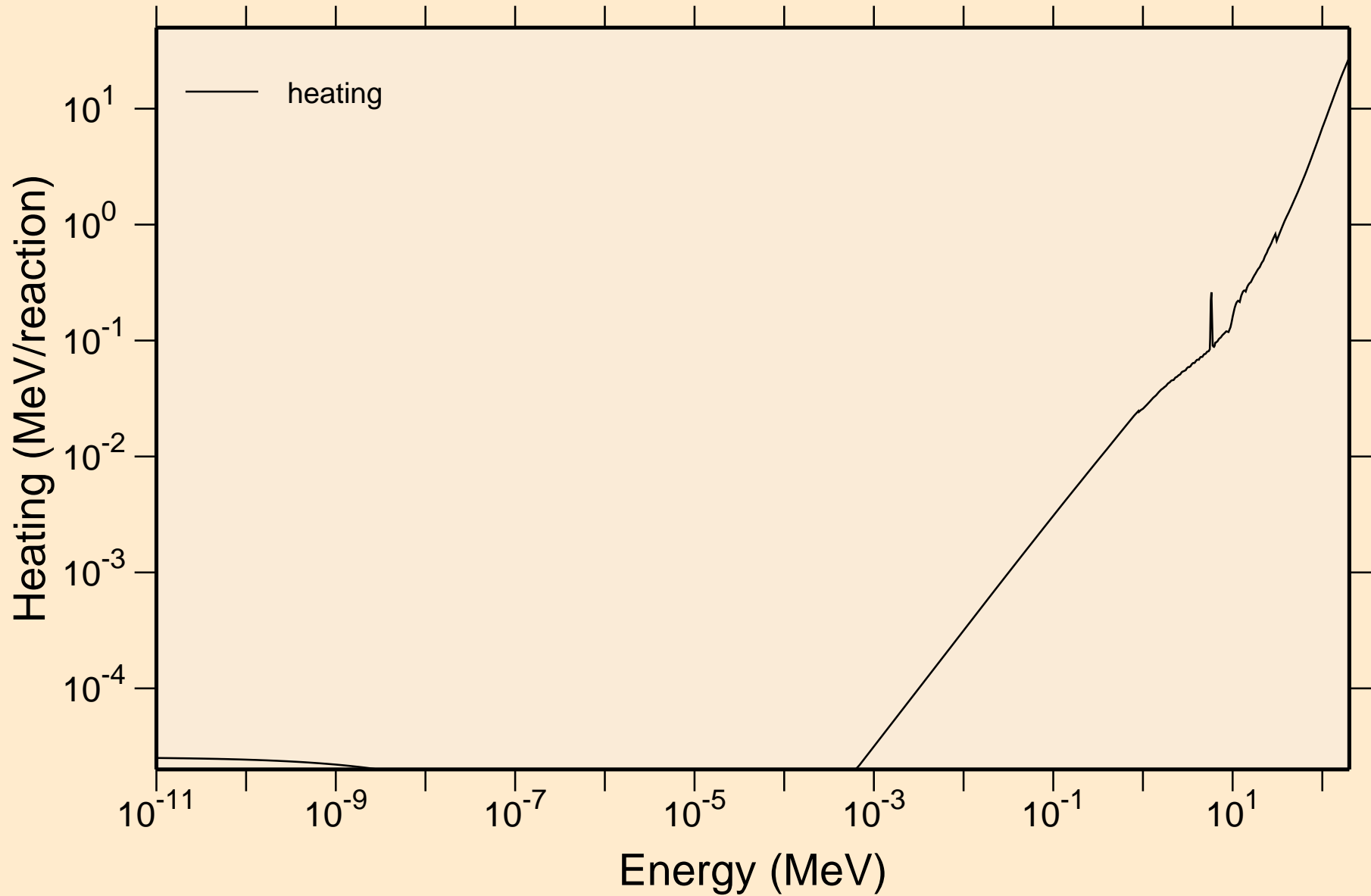

FE062 NEUTRON ACER TENDL-2023 LIBRARY; T=0.K
Damage

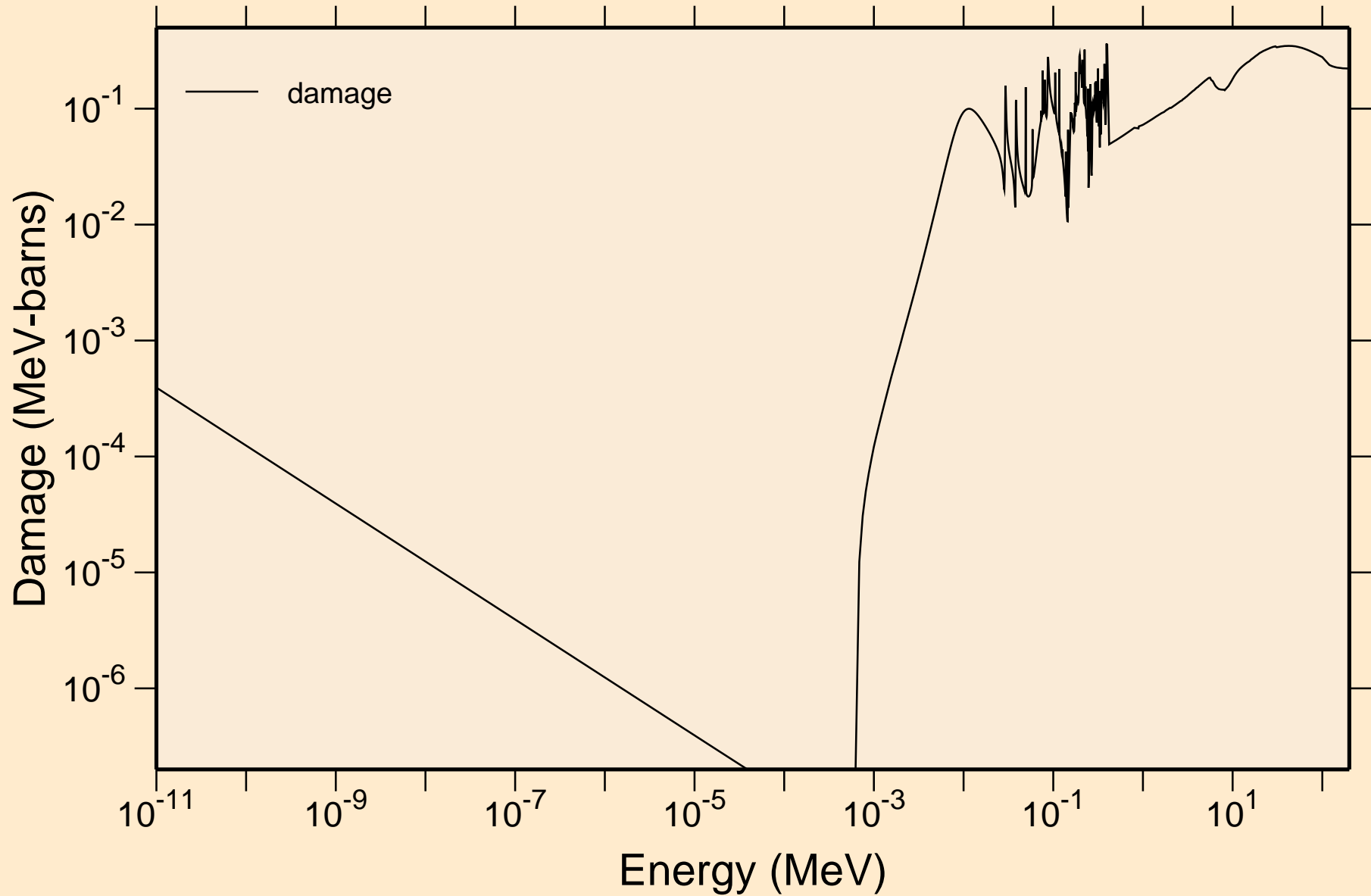

FE062 NEUTRON ACER TENDL-2023 LIBRARY; T=0.K
Non-threshold reactions

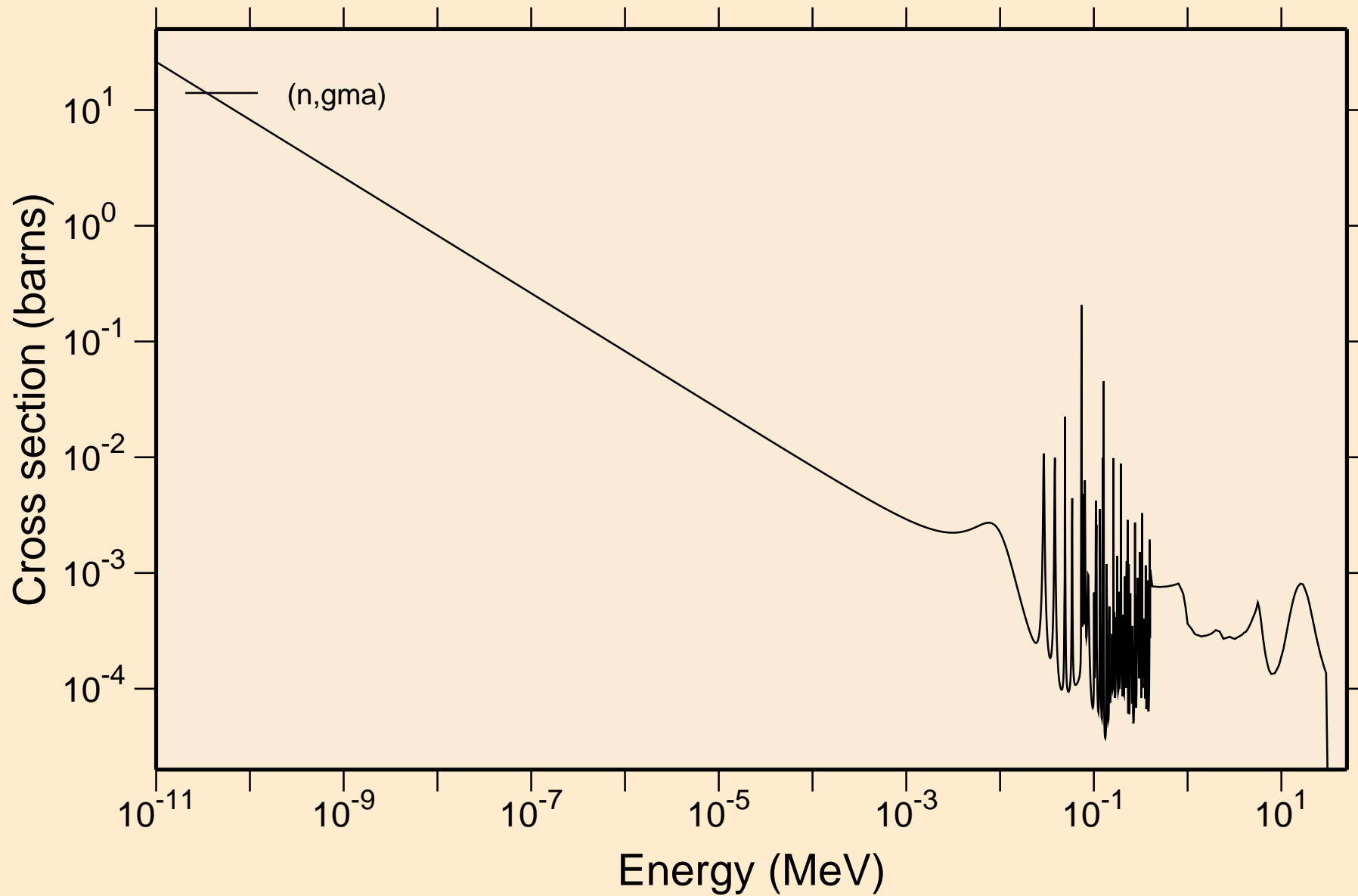

FE062 NEUTRON ACER TENDL-2023 LIBRARY; T=0.K

Principal cross sections

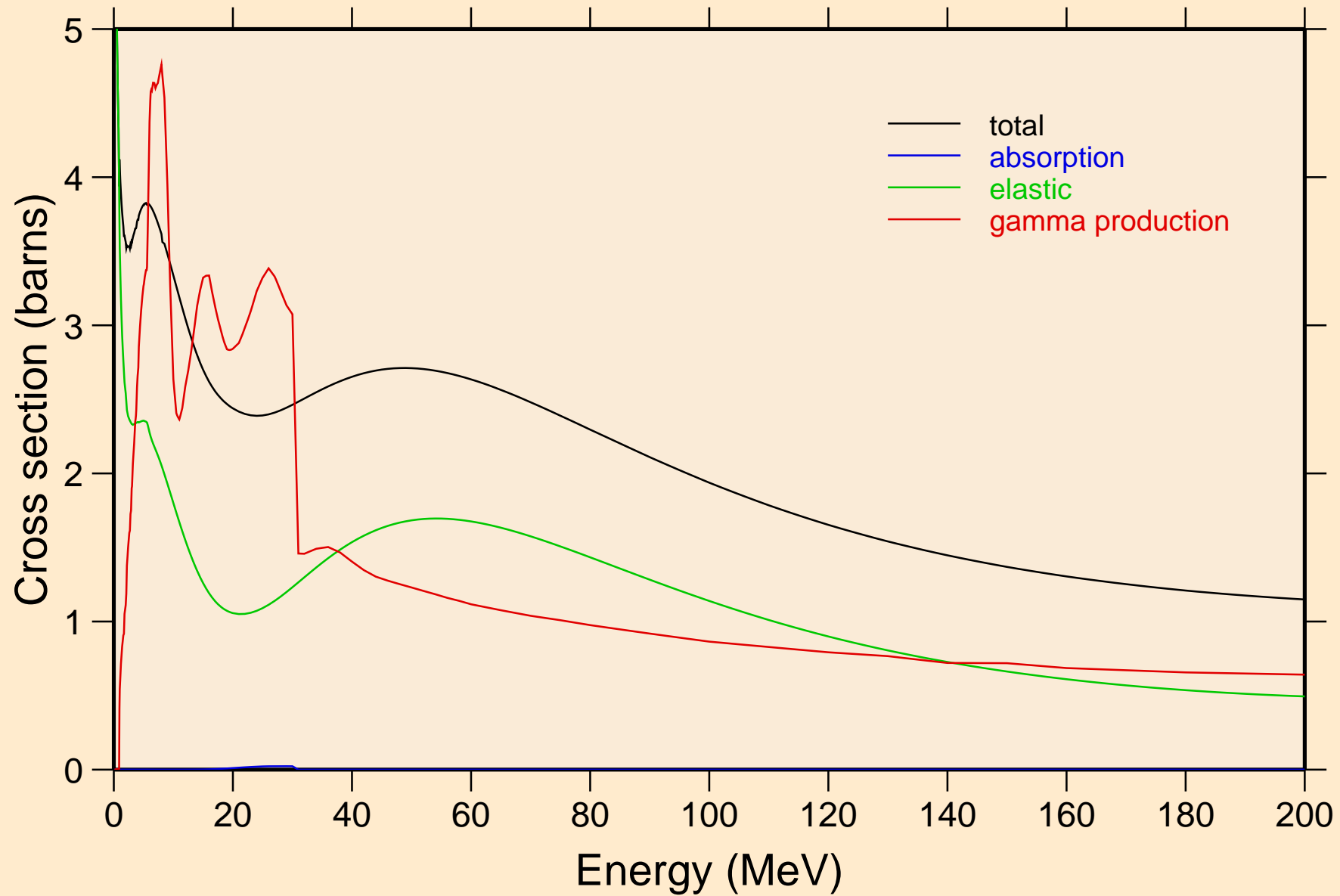

FE062 NEUTRON ACER TENDL-2023 LIBRARY; T=0.K

Heating

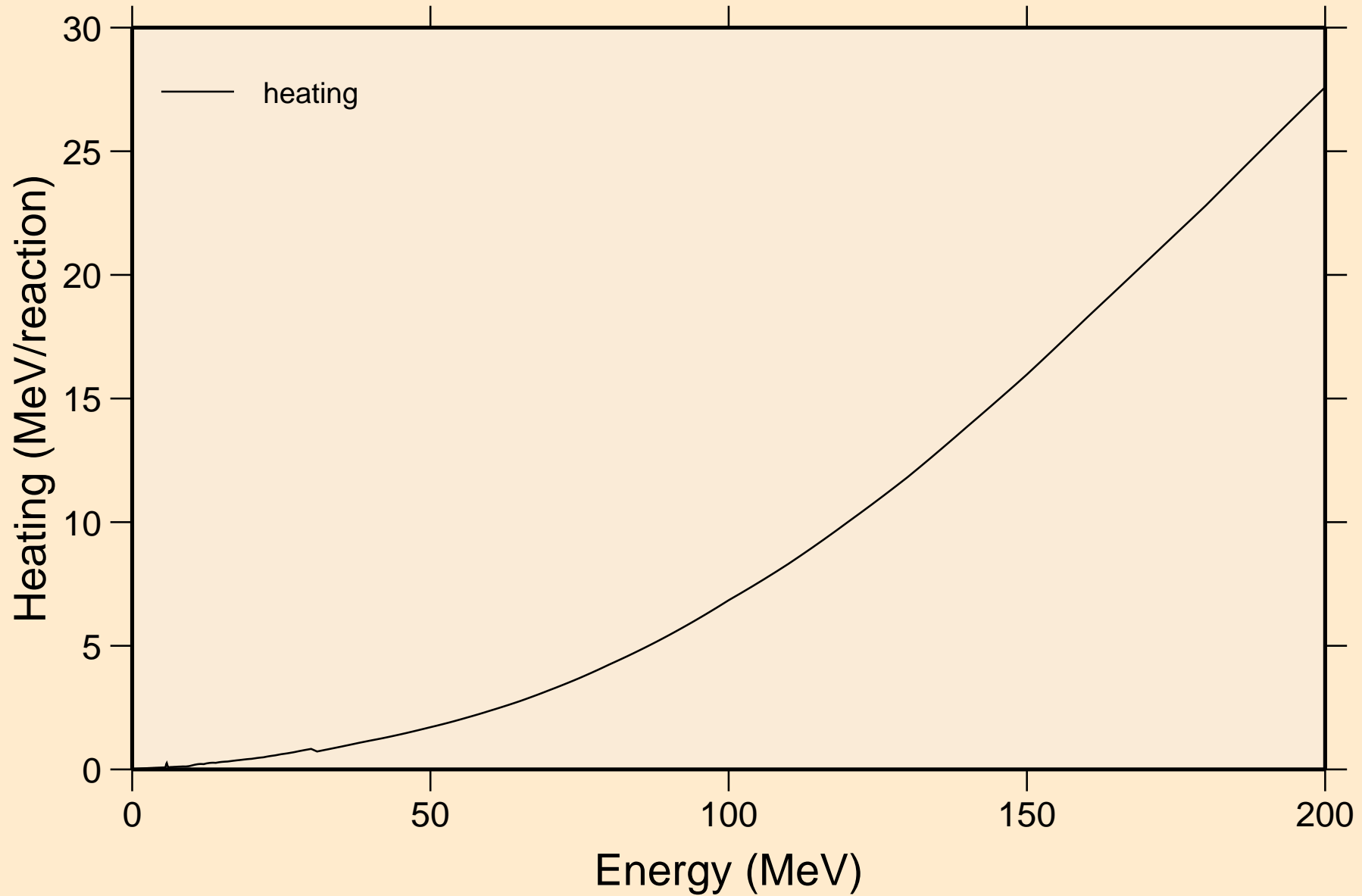

FE062 NEUTRON ACER TENDL-2023 LIBRARY; T=0.K
Damage

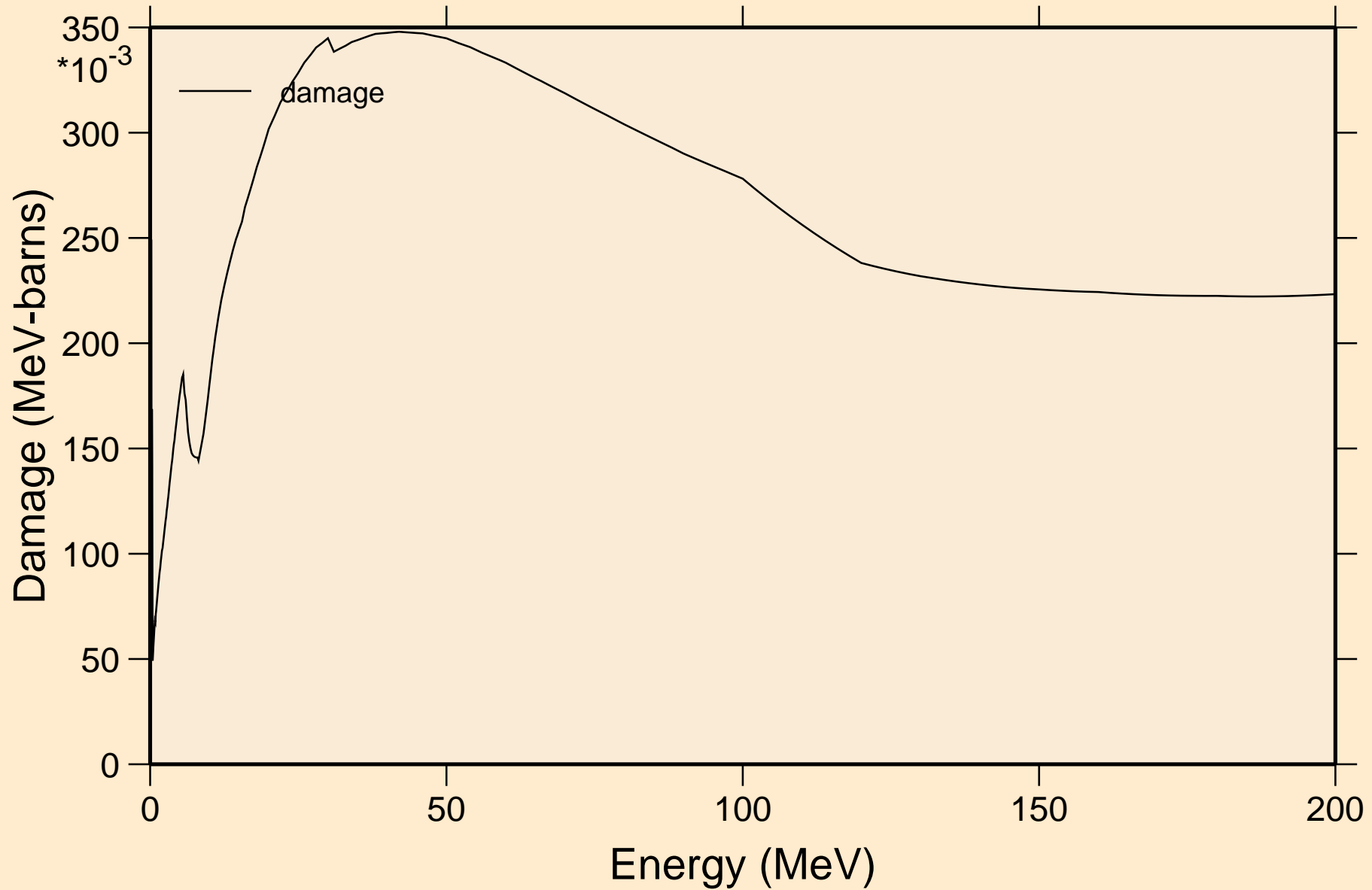

FE062 NEUTRON ACER TENDL-2023 LIBRARY; T=0.K
Non-threshold reactions

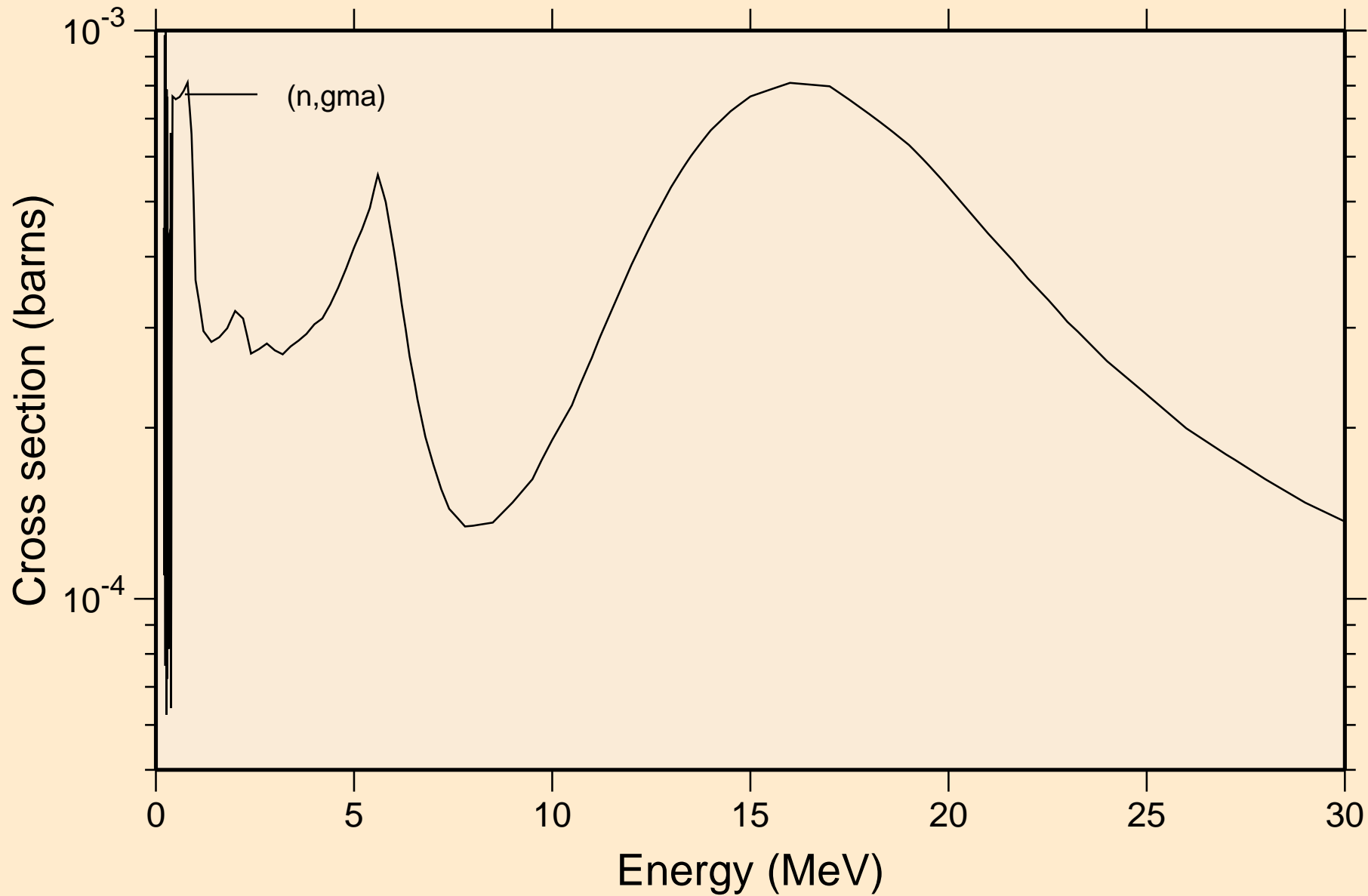

FE062 NEUTRON ACER TENDL-2023 LIBRARY; T=0.K
Inelastic levels

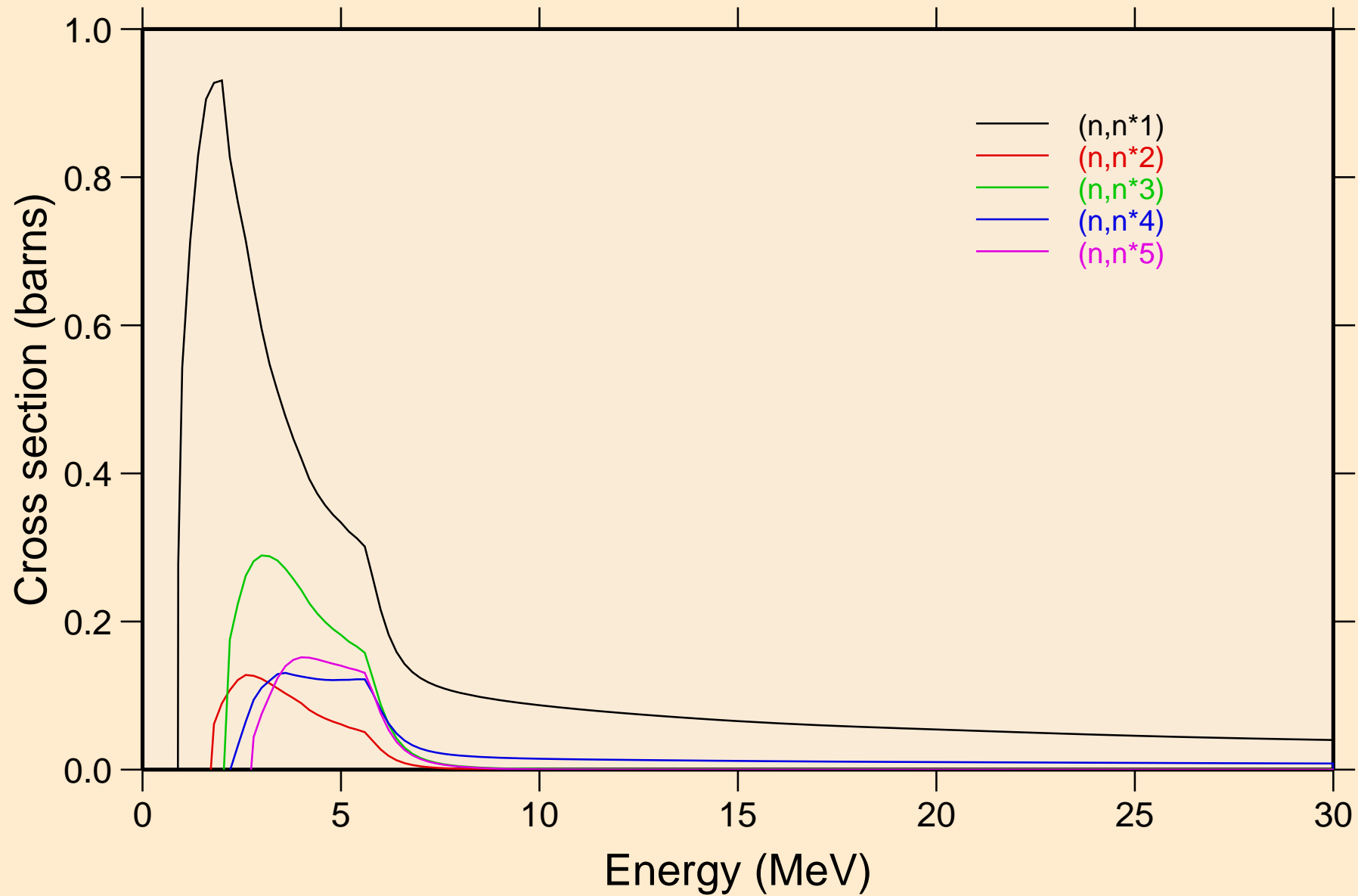

FE062 NEUTRON ACER TENDL-2023 LIBRARY; T=0.K
Inelastic levels

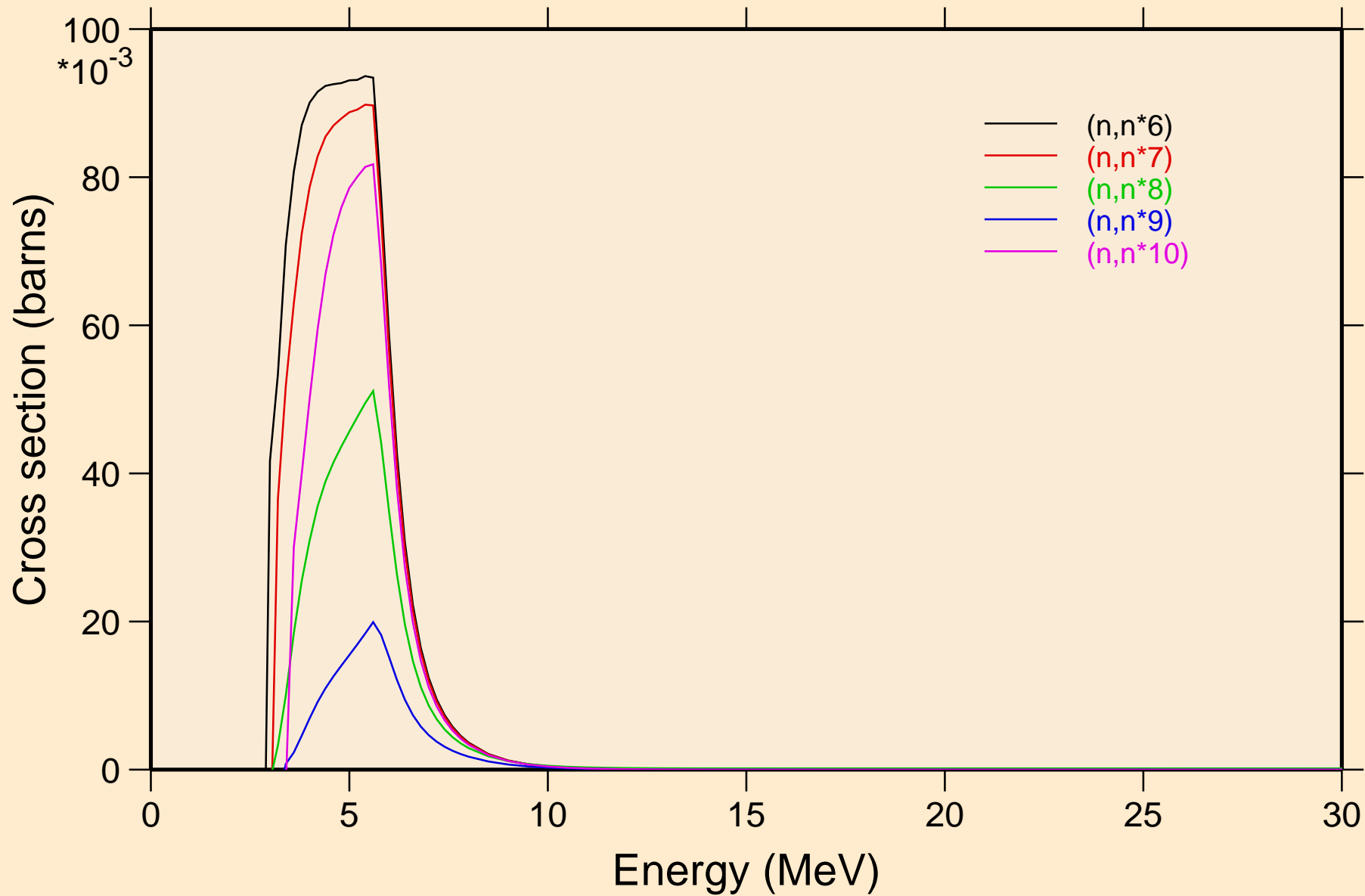

FE062 NEUTRON ACER TENDL-2023 LIBRARY; T=0.K
Inelastic levels

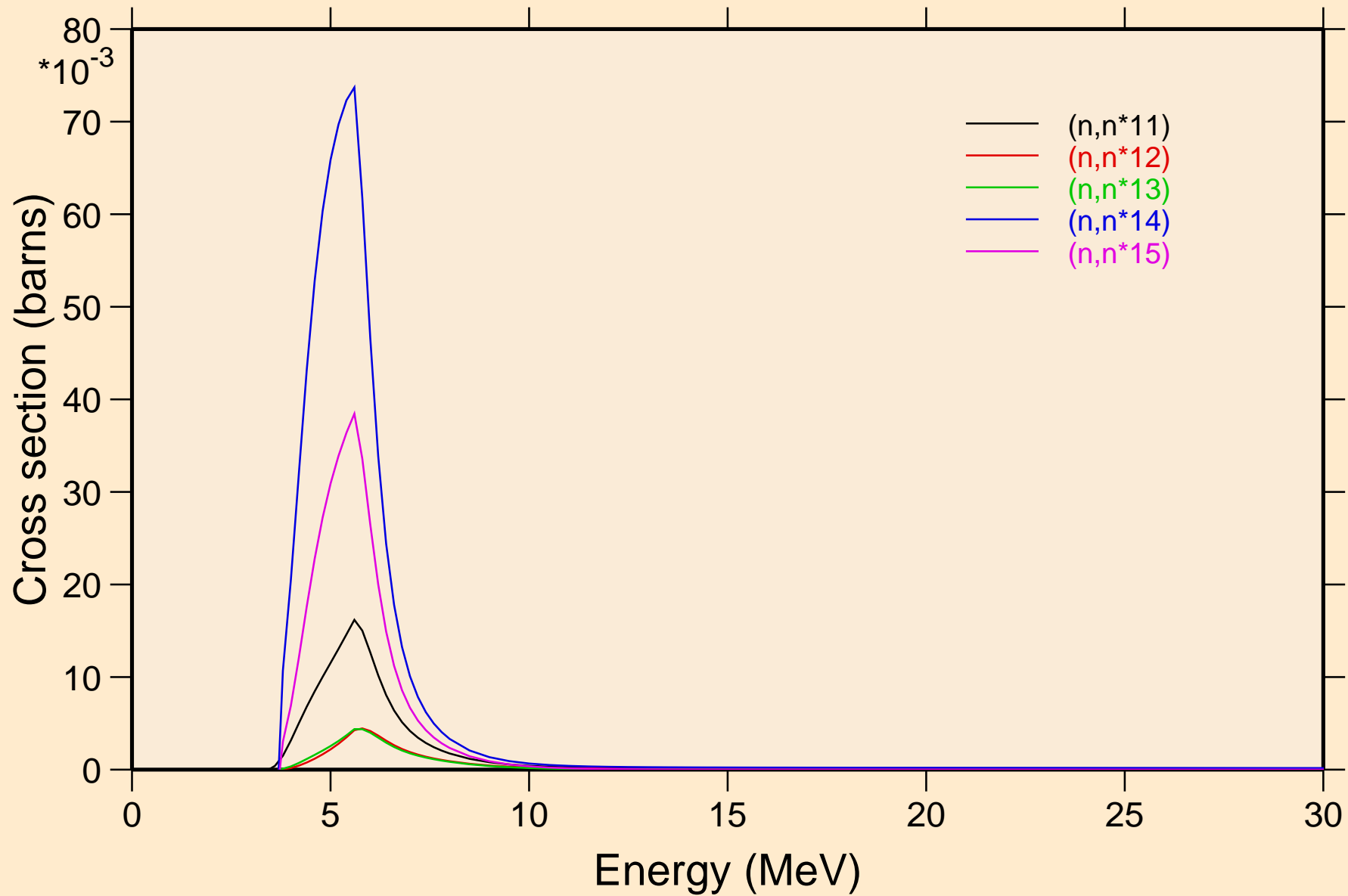

FE062 NEUTRON ACER TENDL-2023 LIBRARY; T=0.K
Inelastic levels

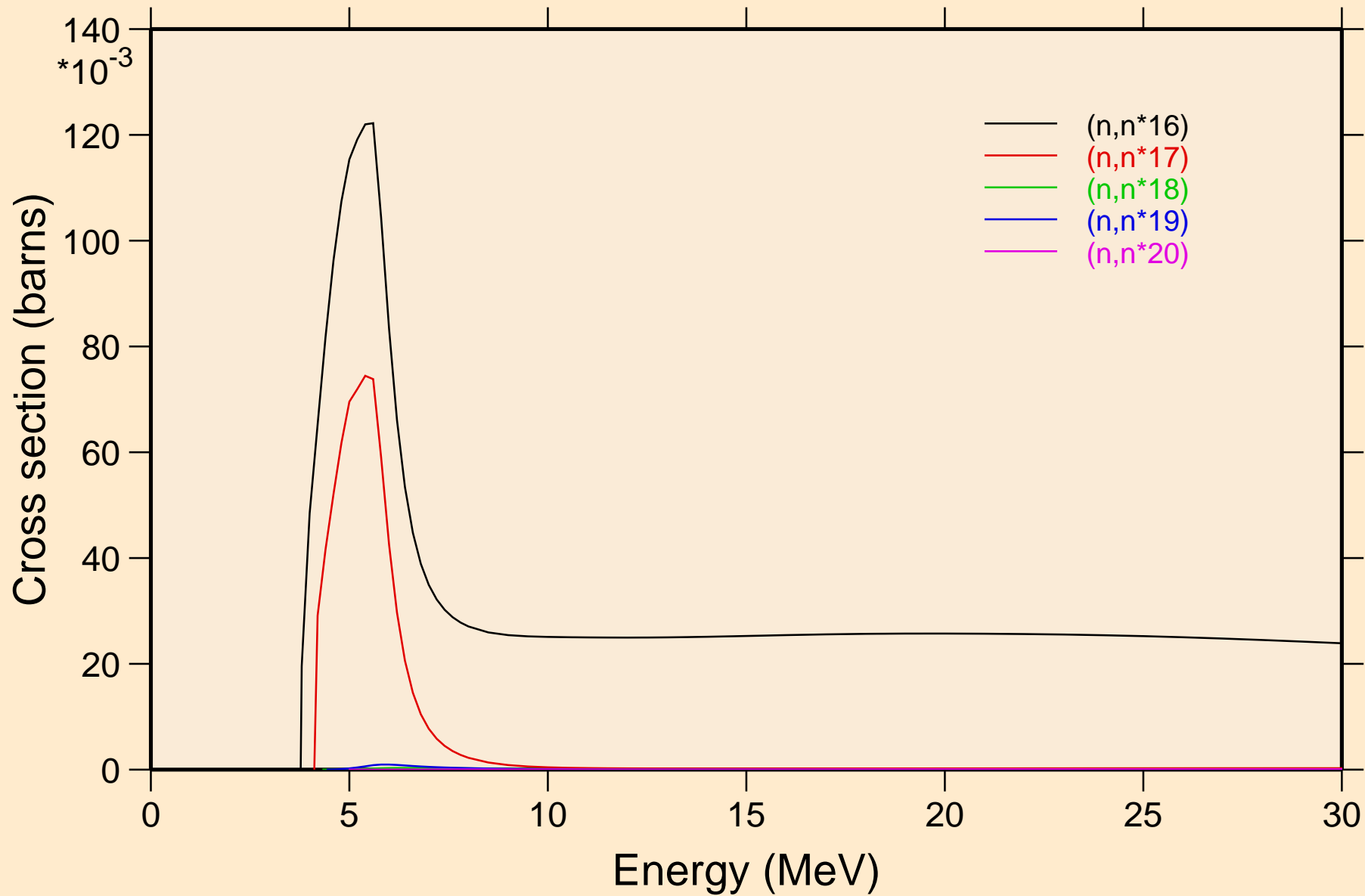

FE062 NEUTRON ACER TENDL-2023 LIBRARY; T=0.K
Inelastic levels

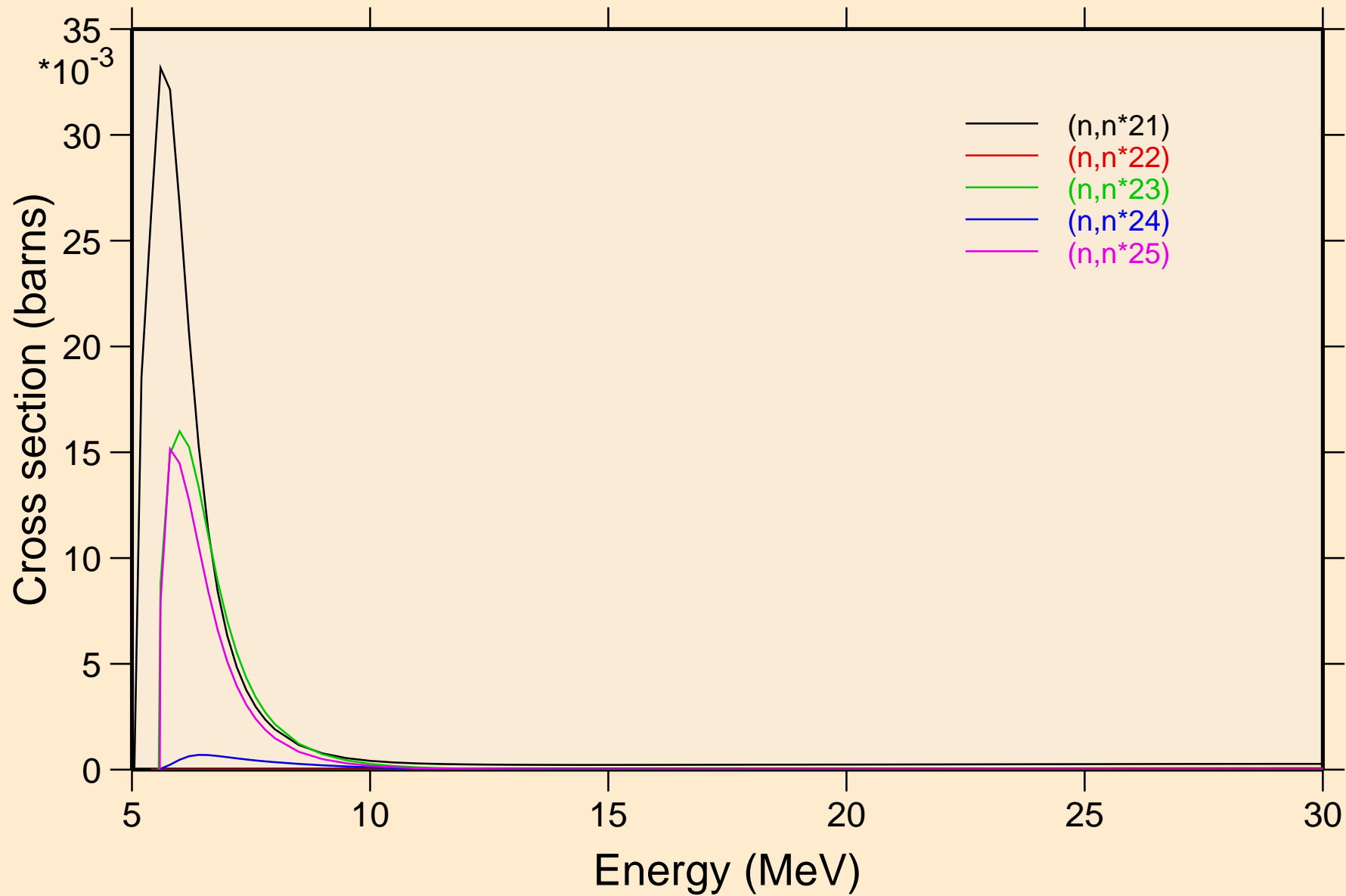

FE062 NEUTRON ACER TENDL-2023 LIBRARY; T=0.K
Inelastic levels

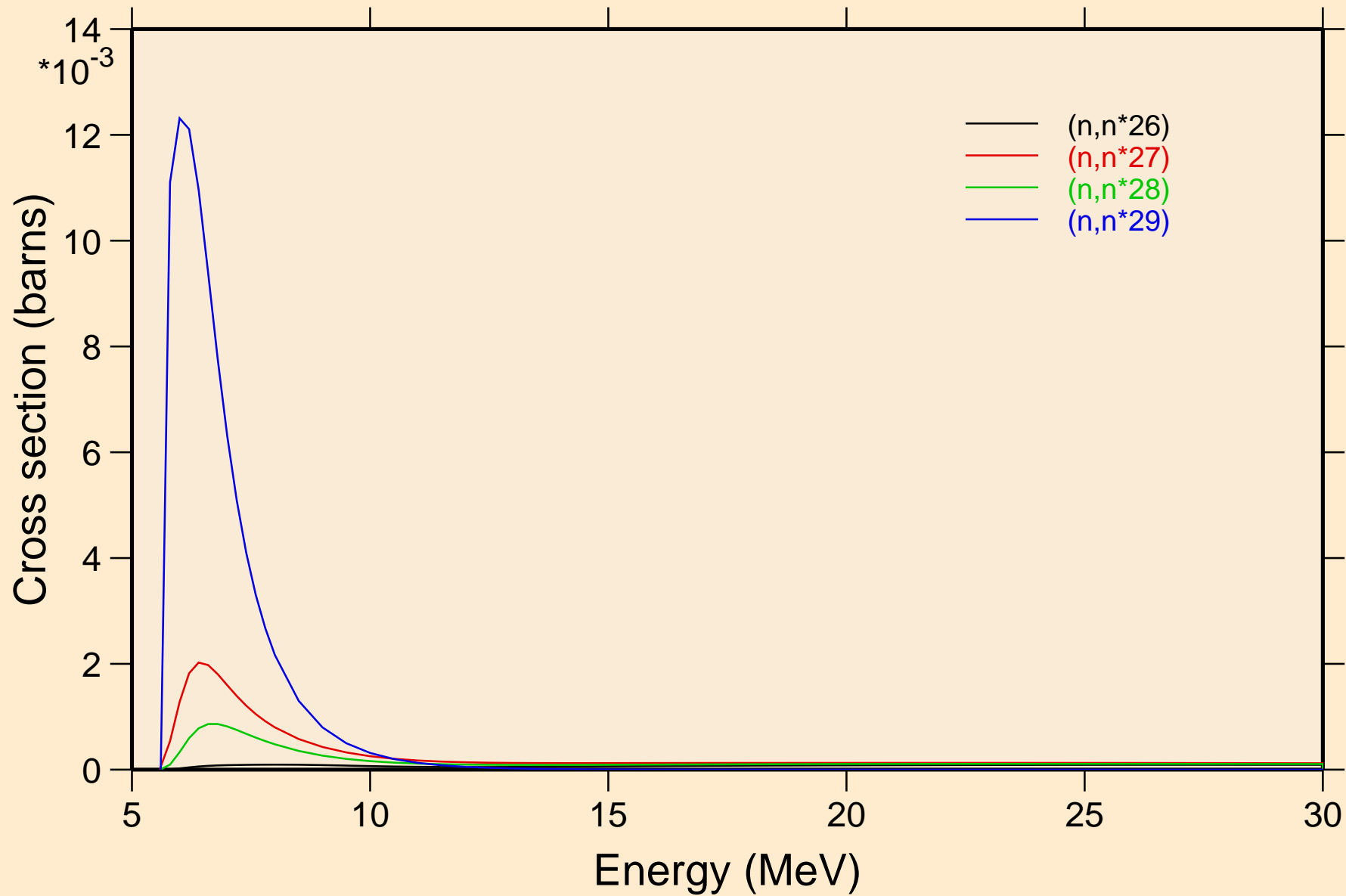

FE062 NEUTRON ACER TENDL-2023 LIBRARY; T=0.K
Threshold reactions

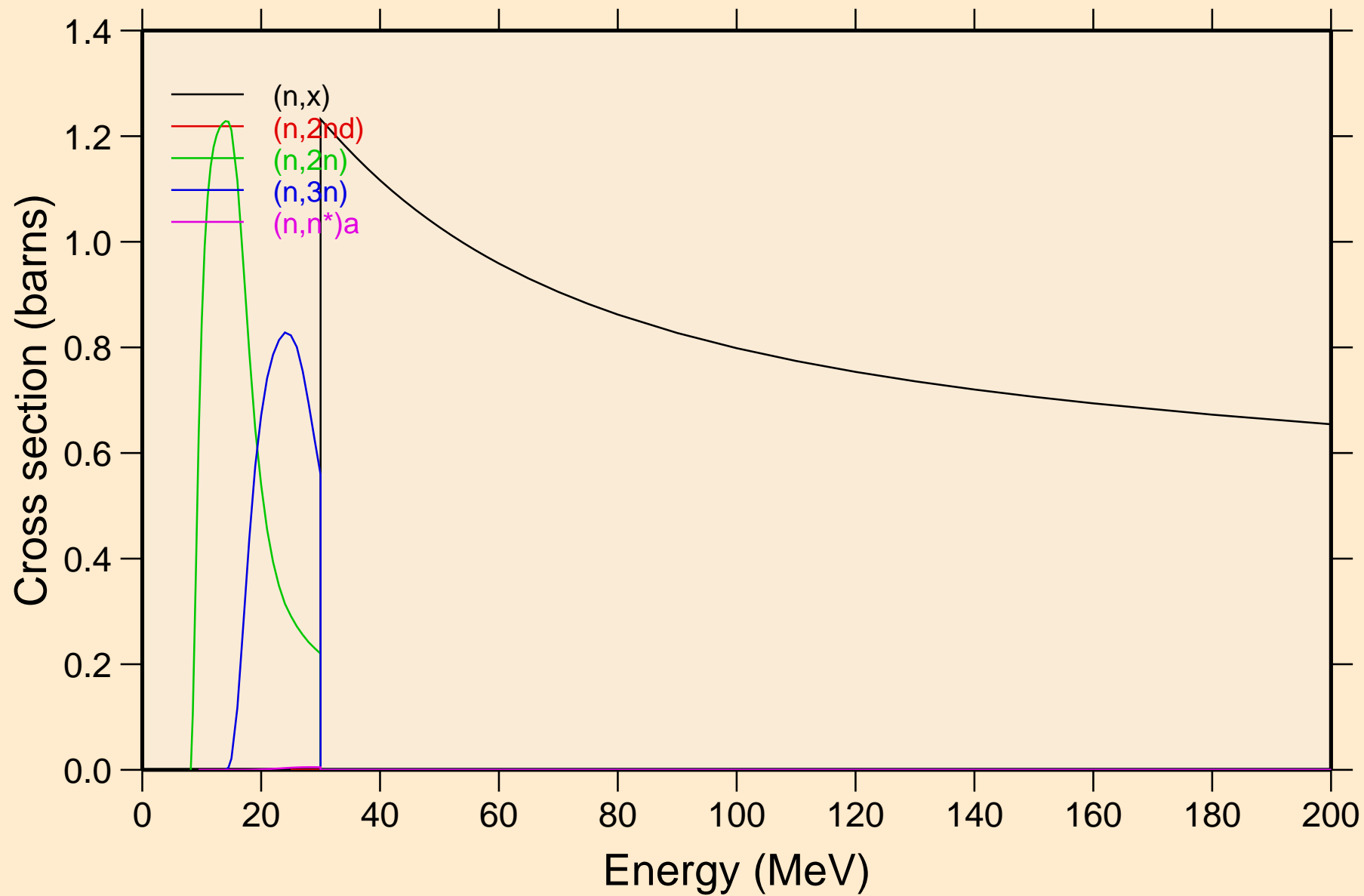

FE062 NEUTRON ACER TENDL-2023 LIBRARY; T=0.K
Threshold reactions

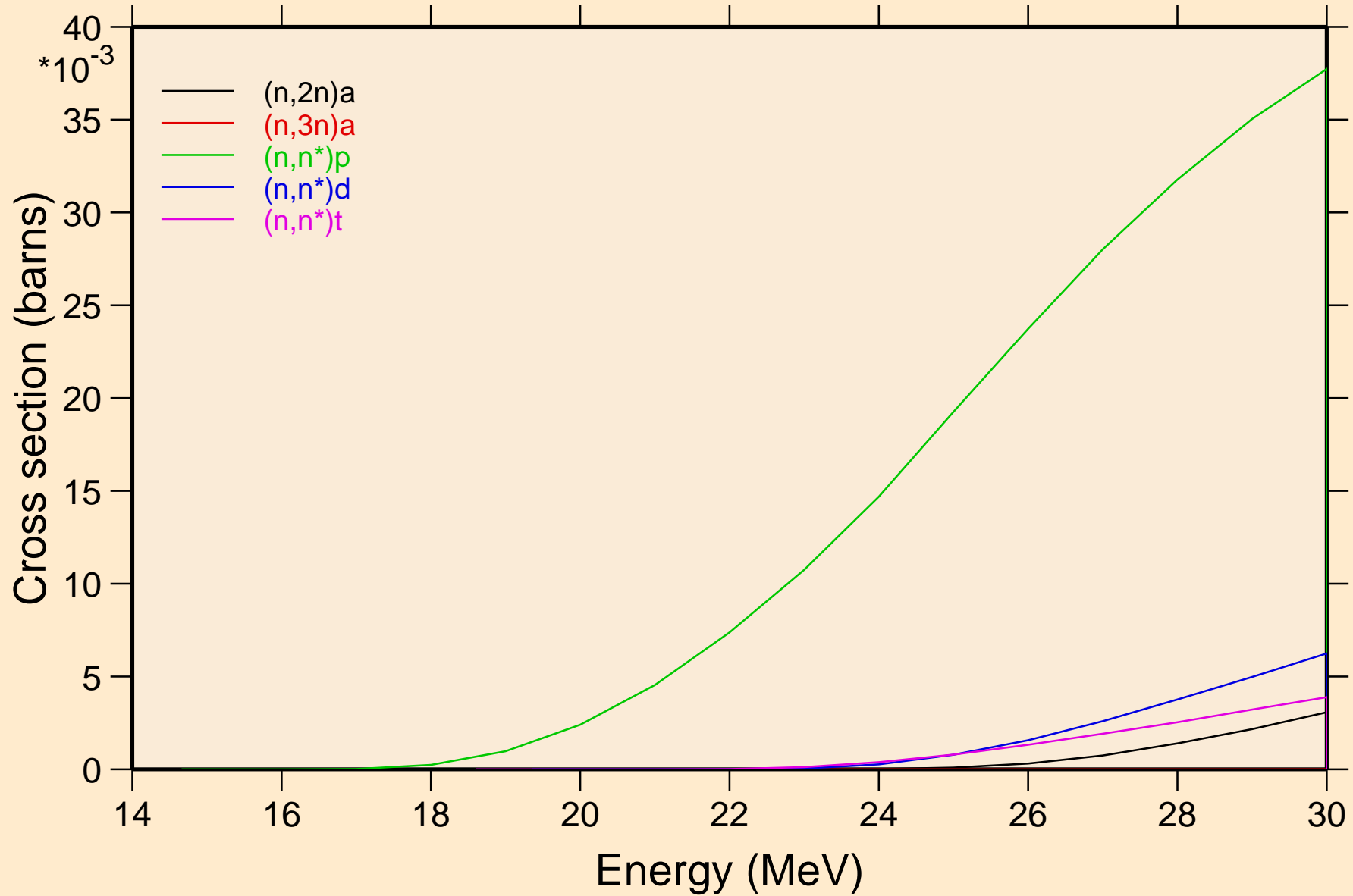

FE062 NEUTRON ACER TENDL-2023 LIBRARY; T=0.K
Threshold reactions

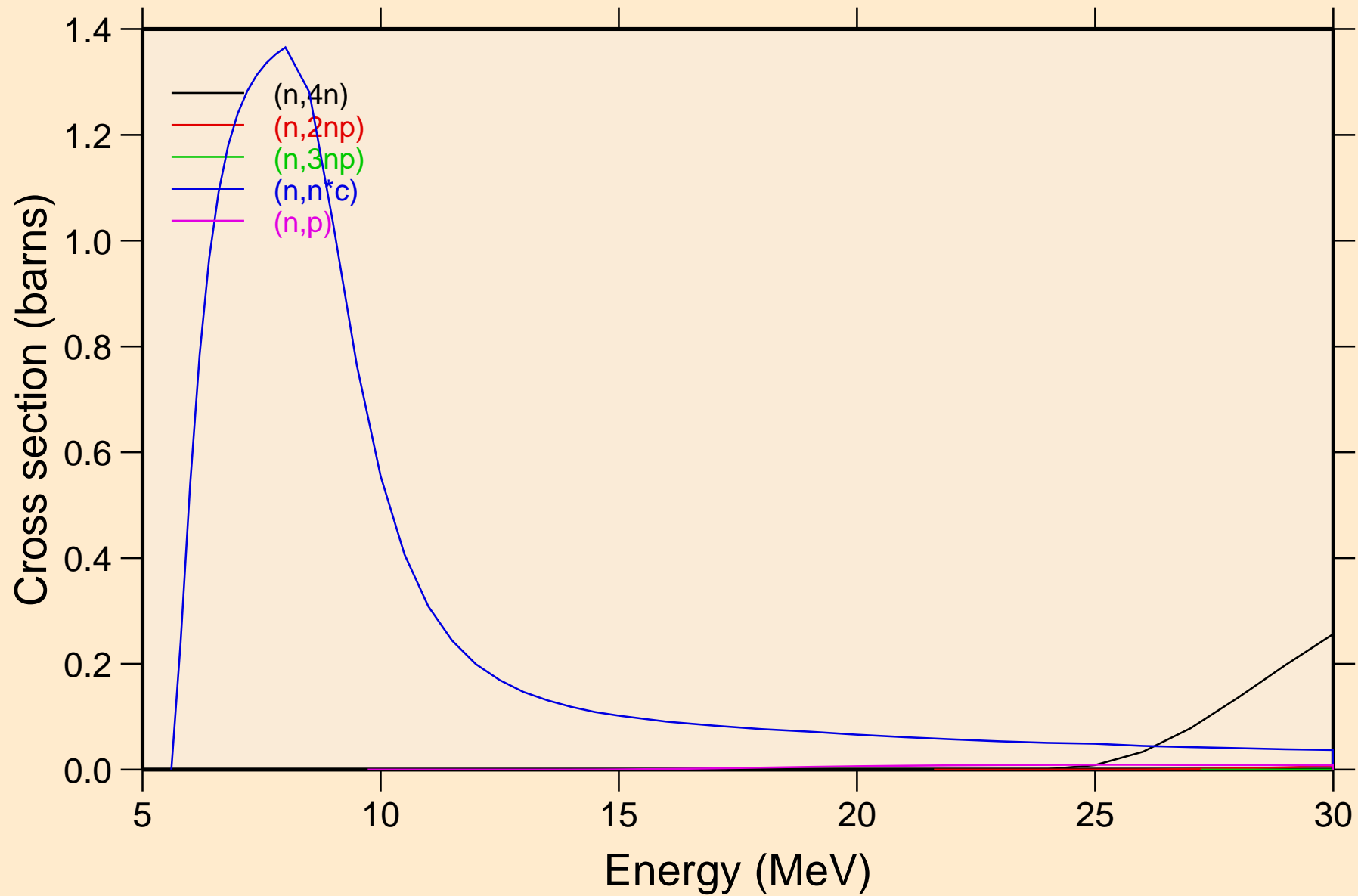

FE062 NEUTRON ACER TENDL-2023 LIBRARY; T=0.K
Threshold reactions

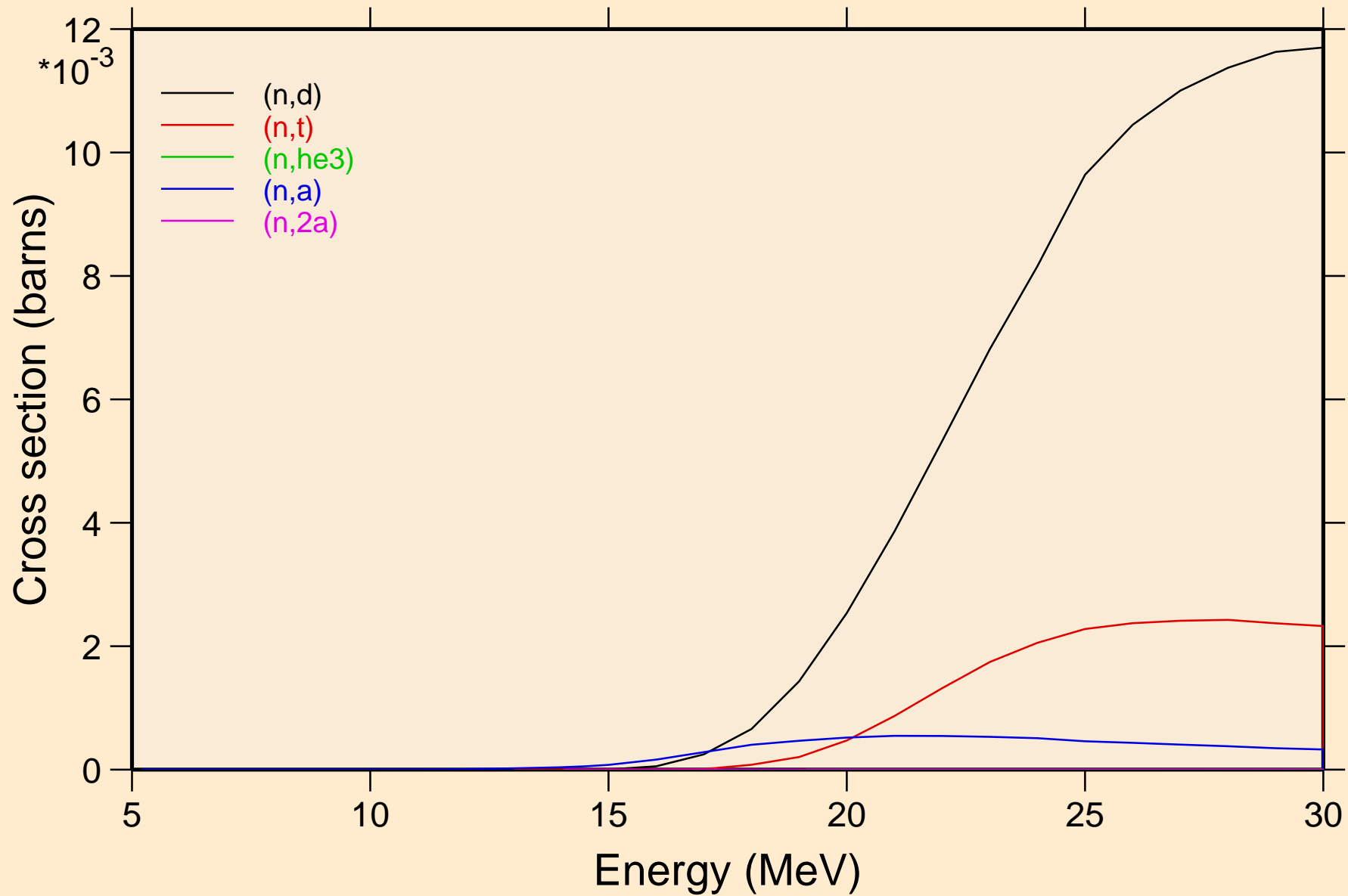

FE062 NEUTRON ACER TENDL-2023 LIBRARY; T=0.K
Threshold reactions

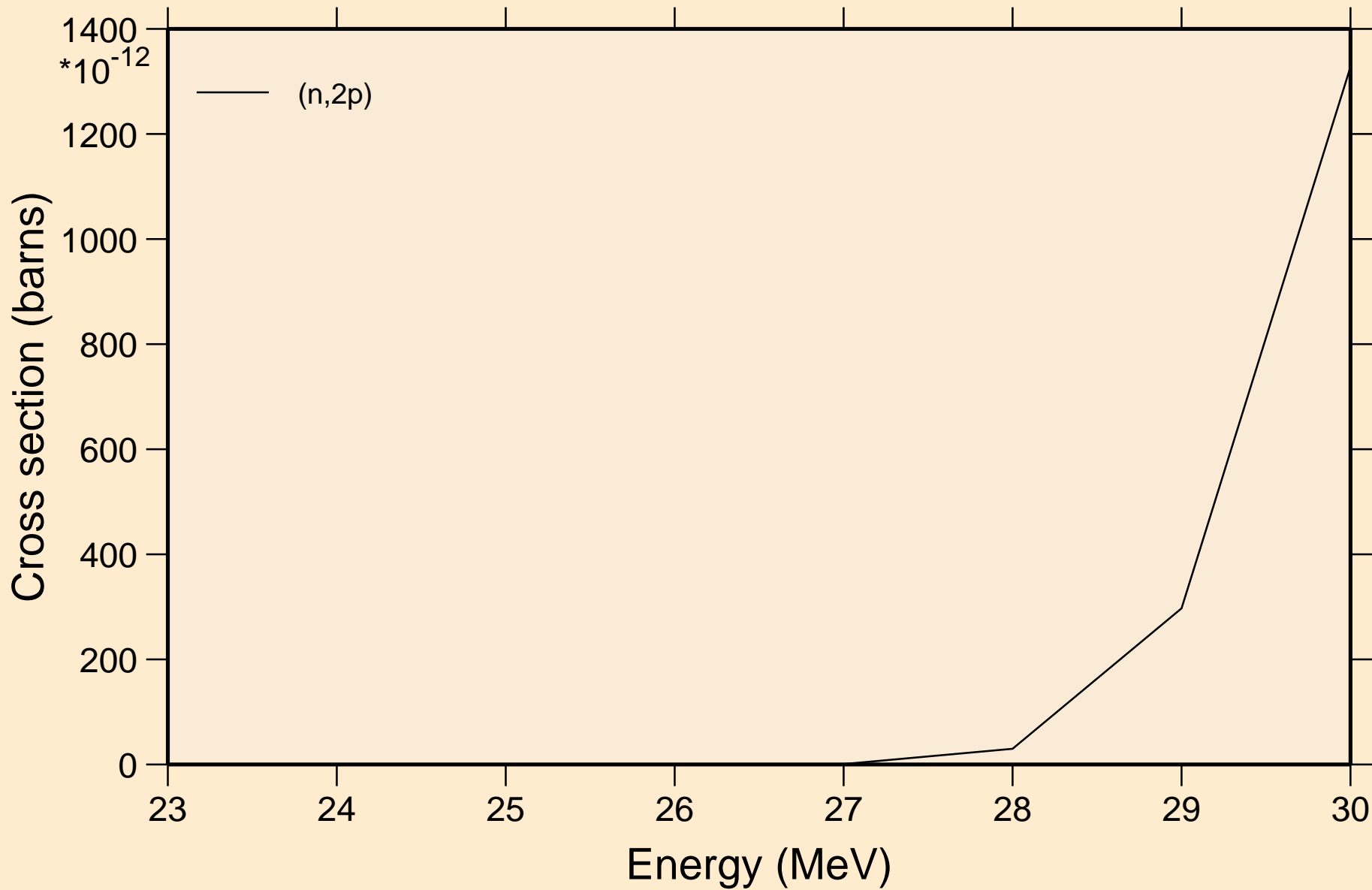

FE062 NEUTRON ACER TENDL-2023 LIBRARY; T=0.K
Threshold reactions

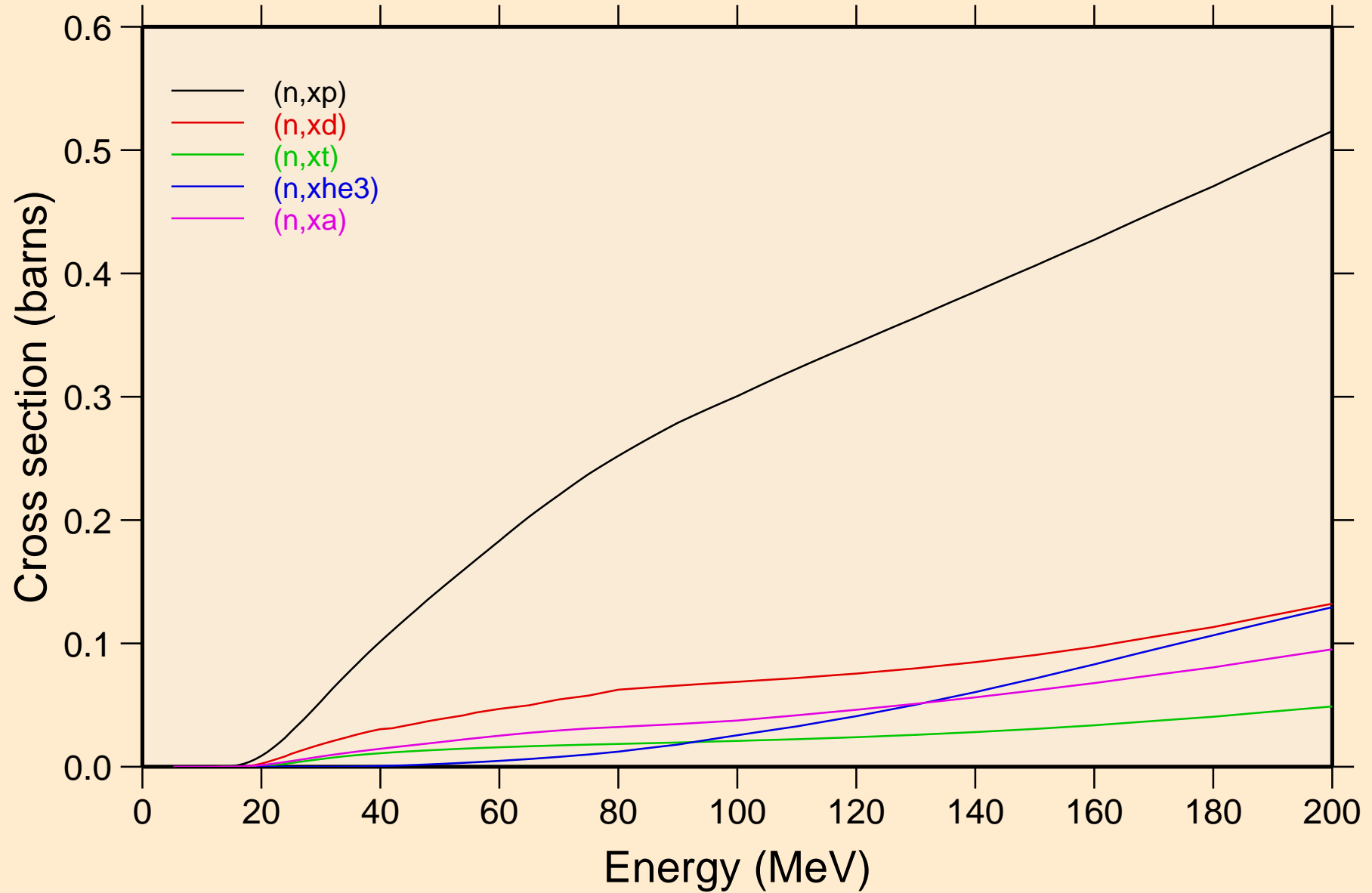

FE062 NEUTRON ACER TENDL-2023 LIBRARY; T=0.K
angular distribution for elastic

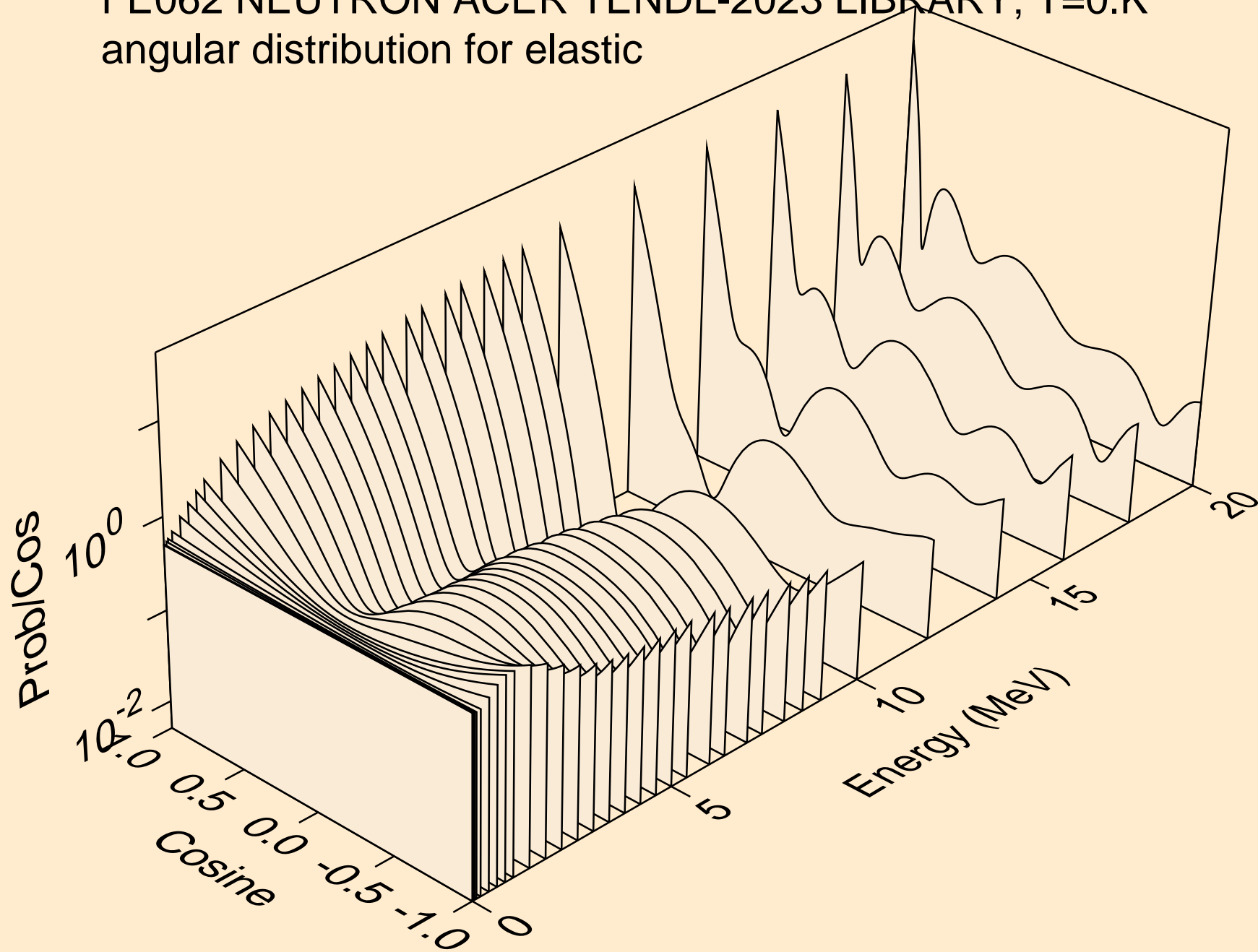

FE062 NEUTRON ACER TENDL-2023 LIBRARY; T=0.K
angular distribution for elastic

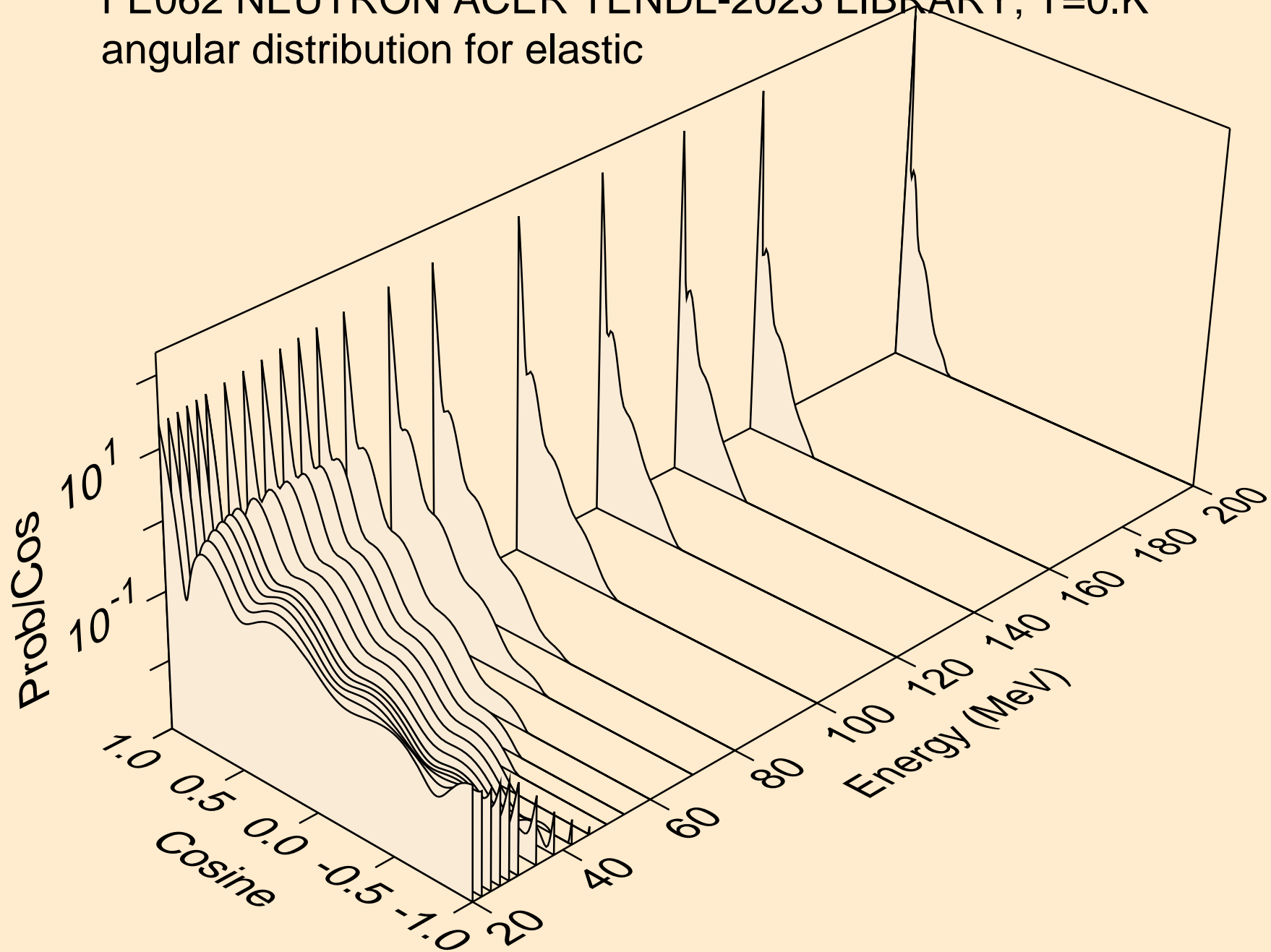

FE062 NEUTRON ACER TENDL-2023 LIBRARY; T=0.K
angular distribution for (n,n*1)

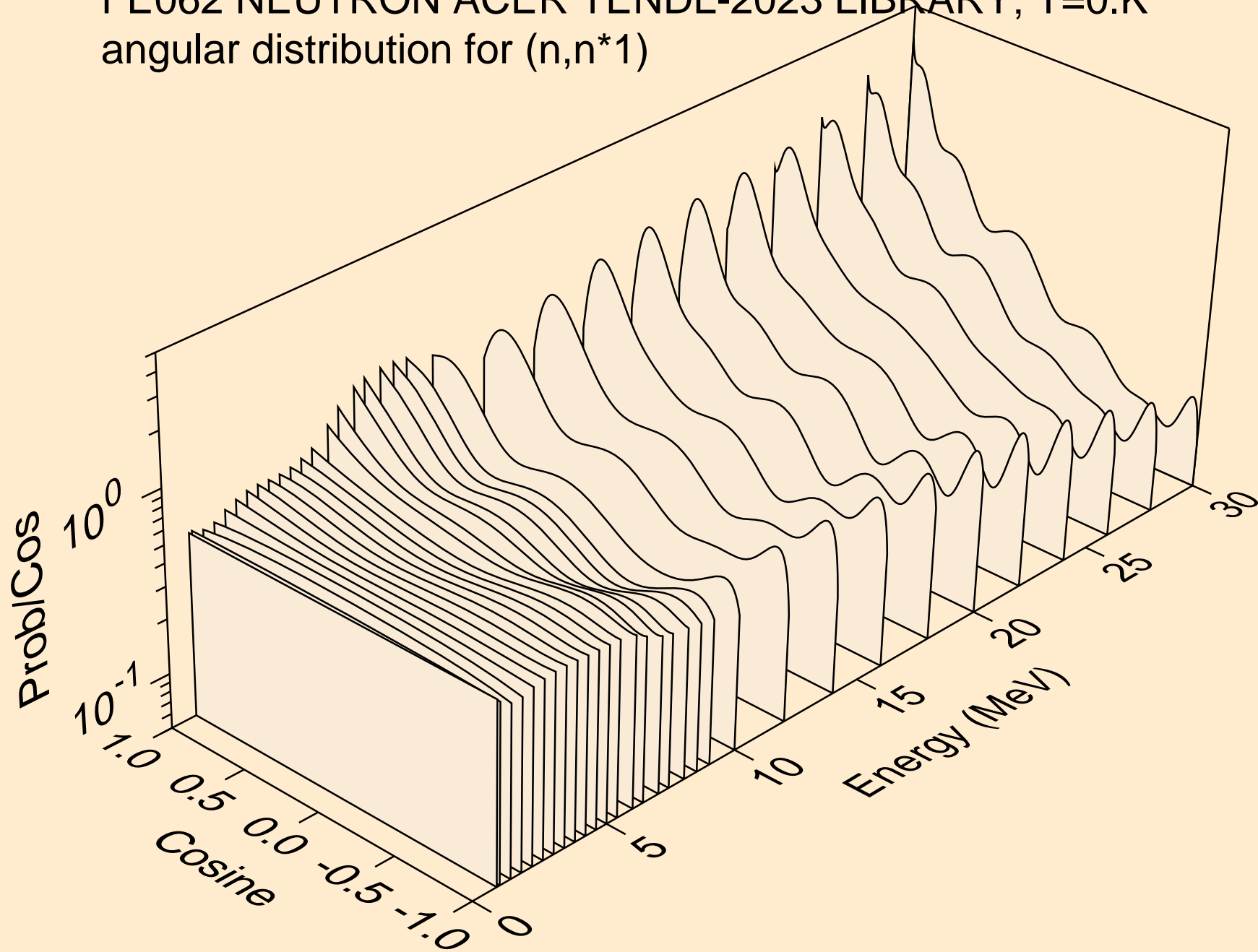

FE062 NEUTRON ACER TENDL-2023 LIBRARY; T=0.K
angular distribution for (n,n*2)

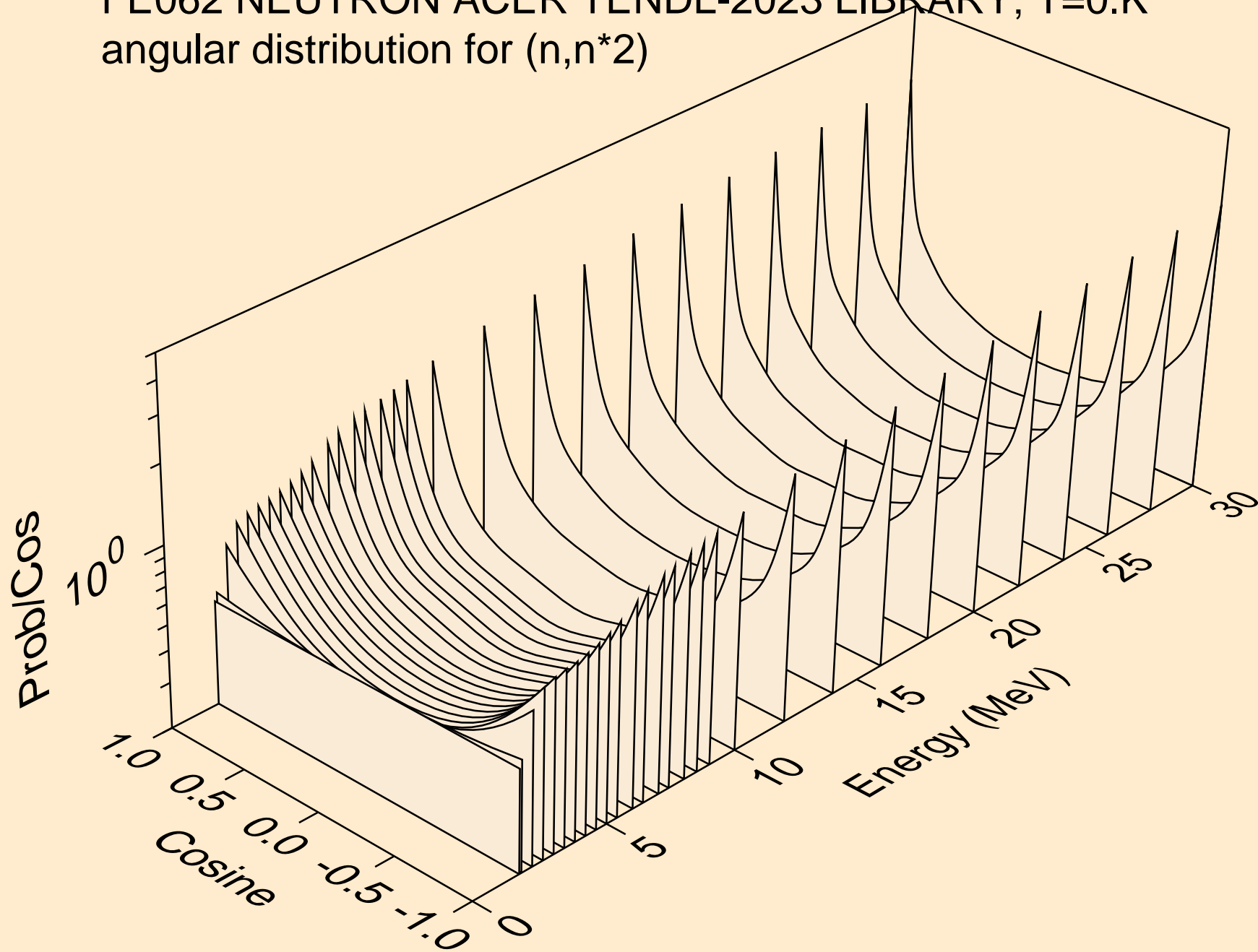

FE062 NEUTRON ACER TENDL-2023 LIBRARY; T=0.K
angular distribution for (n,n*3)

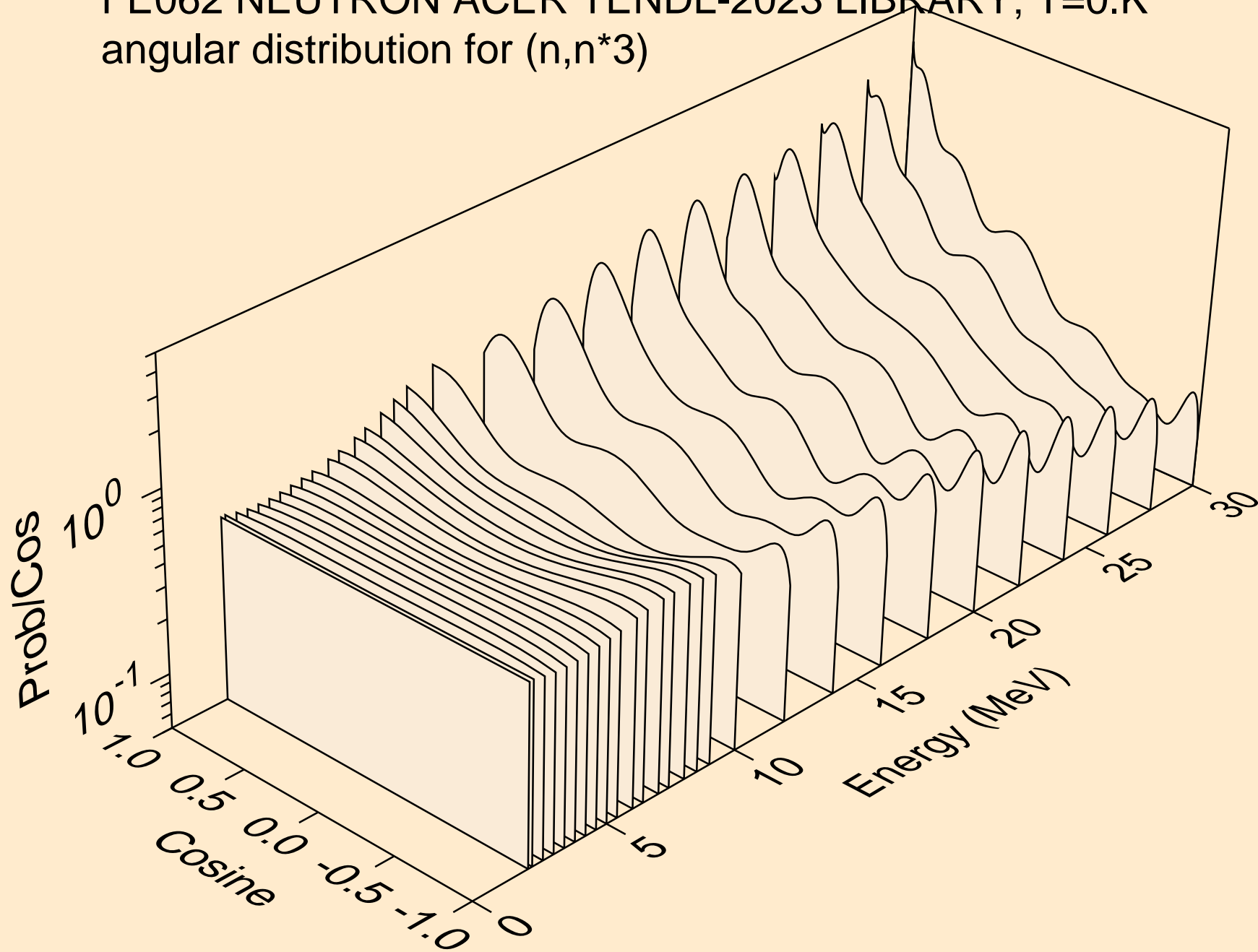

FE062 NEUTRON ACER TENDL-2023 LIBRARY; T=0.K
angular distribution for (n,n*4)

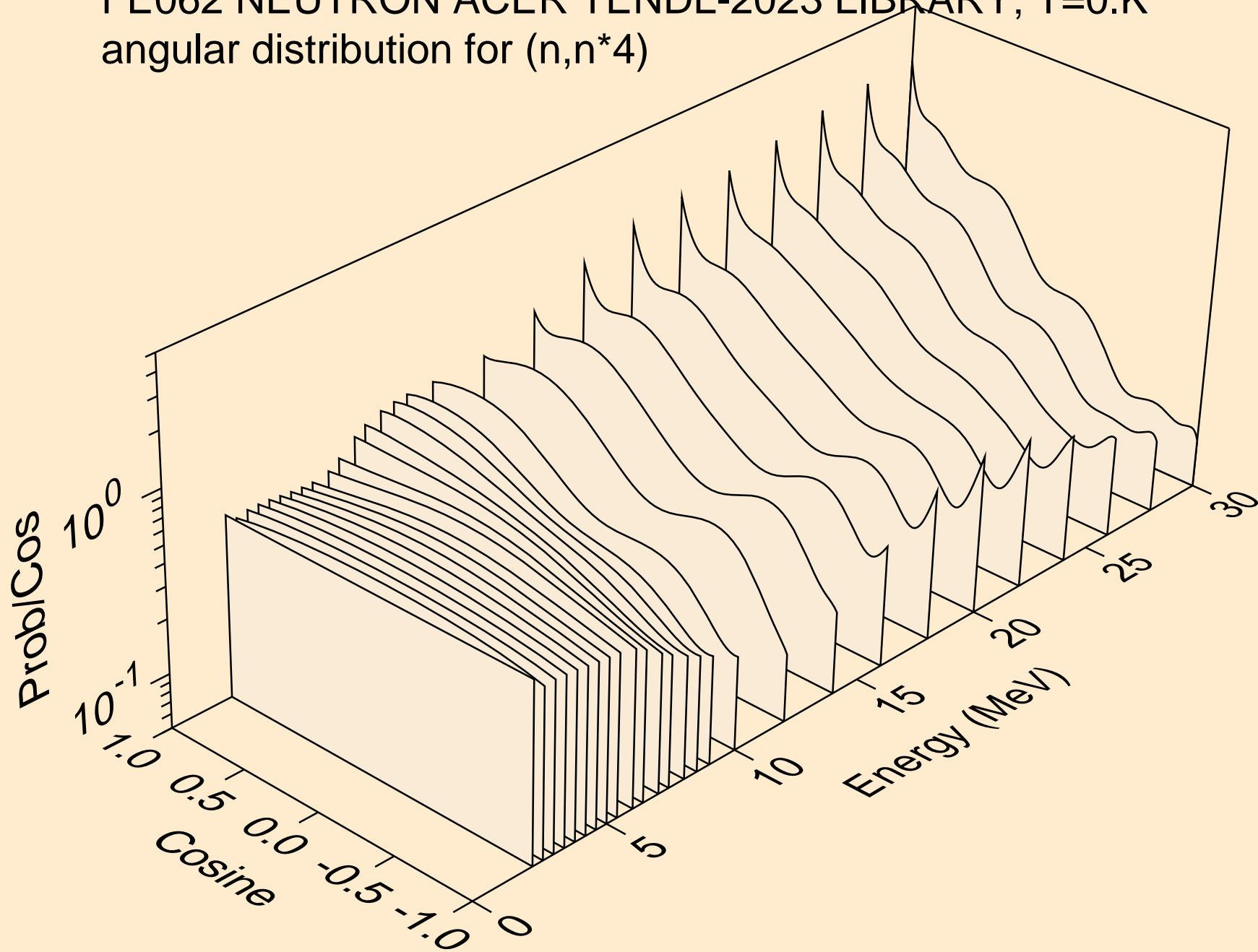

FE062 NEUTRON ACER TENDL-2023 LIBRARY; T=0.K
angular distribution for (n,n*5)

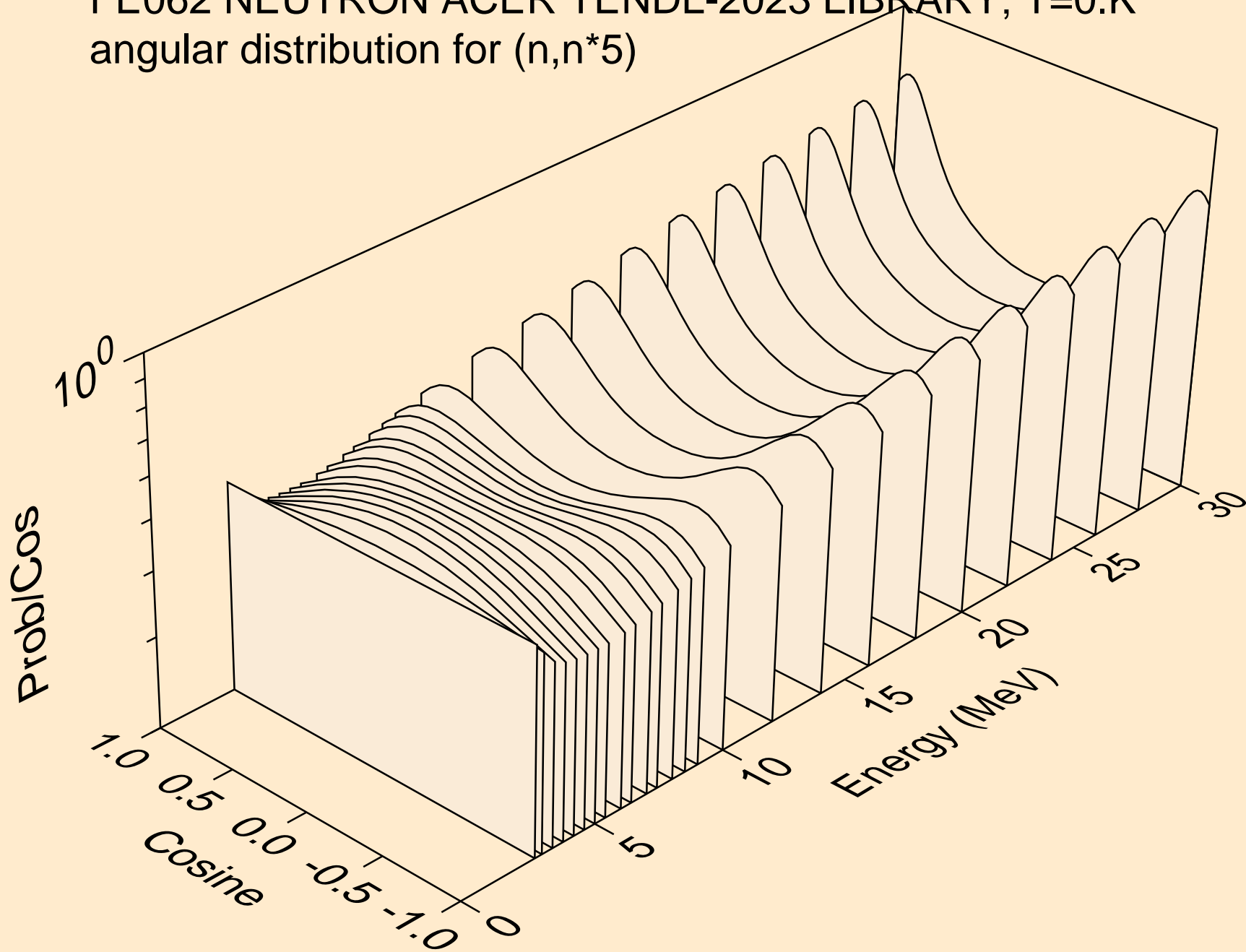

FE062 NEUTRON ACER TENDL-2023 LIBRARY; T=0.K
angular distribution for (n,n*6)

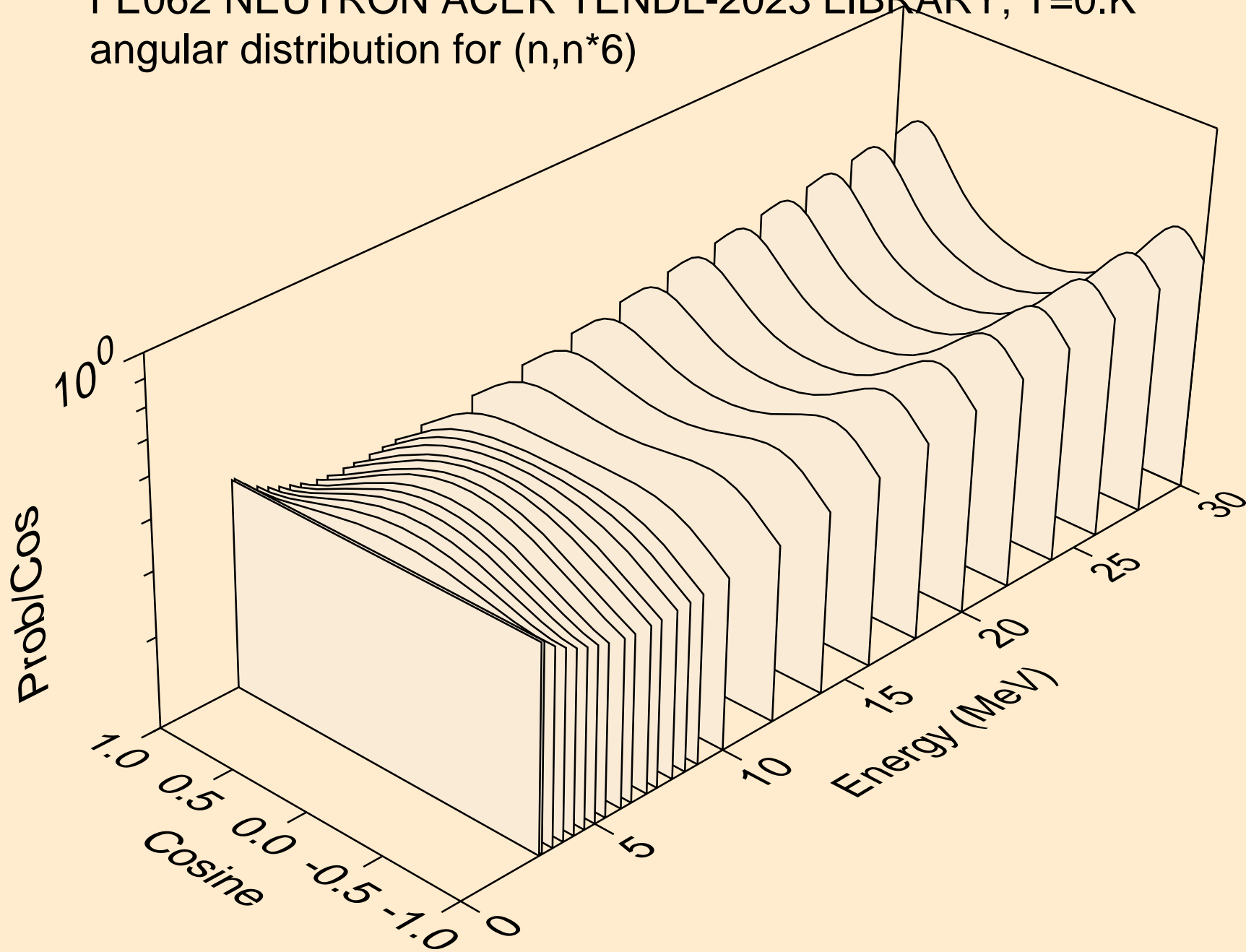

FE062 NEUTRON ACER TENDL-2023 LIBRARY; T=0.K
angular distribution for (n,n*7)

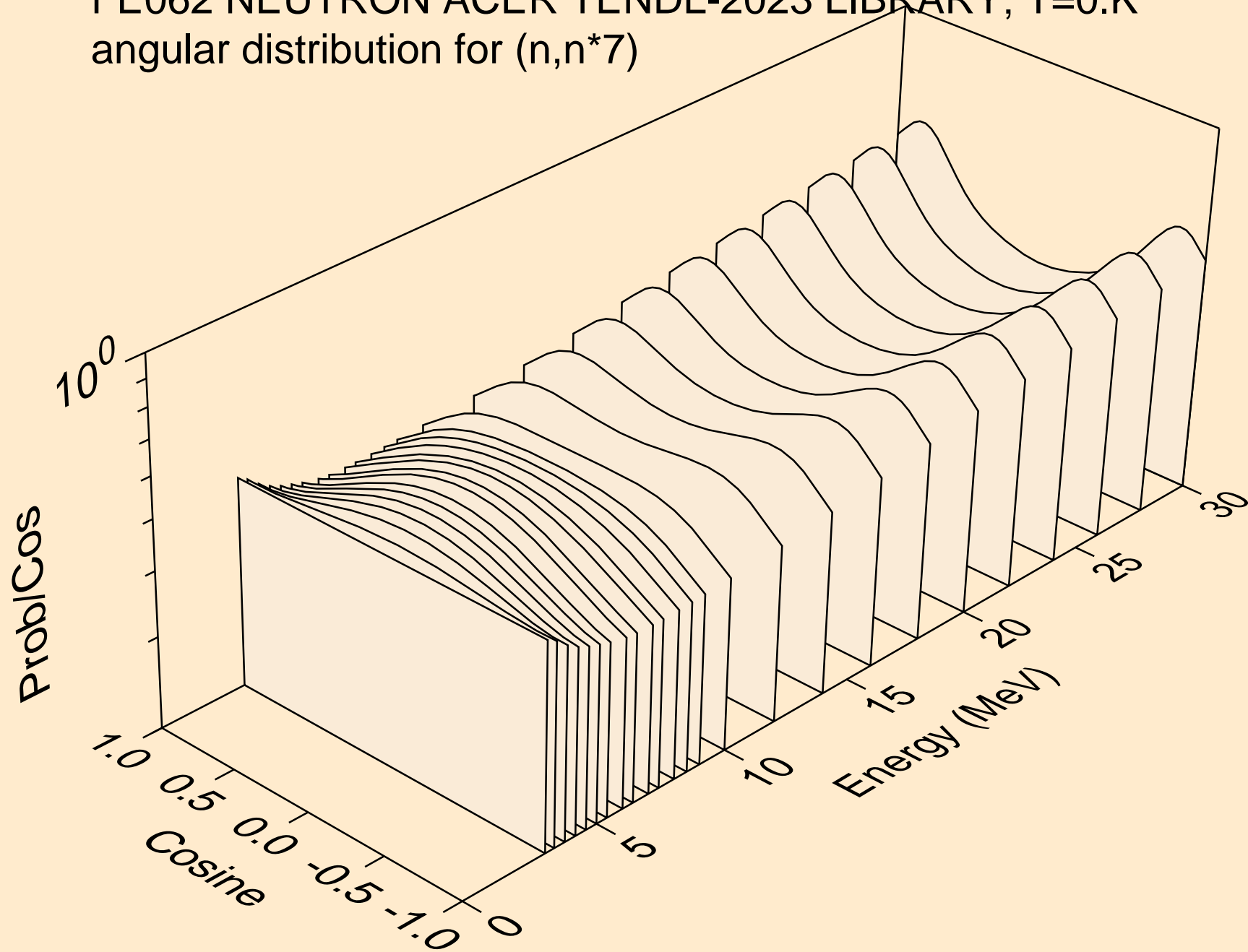

FE062 NEUTRON ACER TENDL-2023 LIBRARY; T=0.K
angular distribution for (n,n*8)

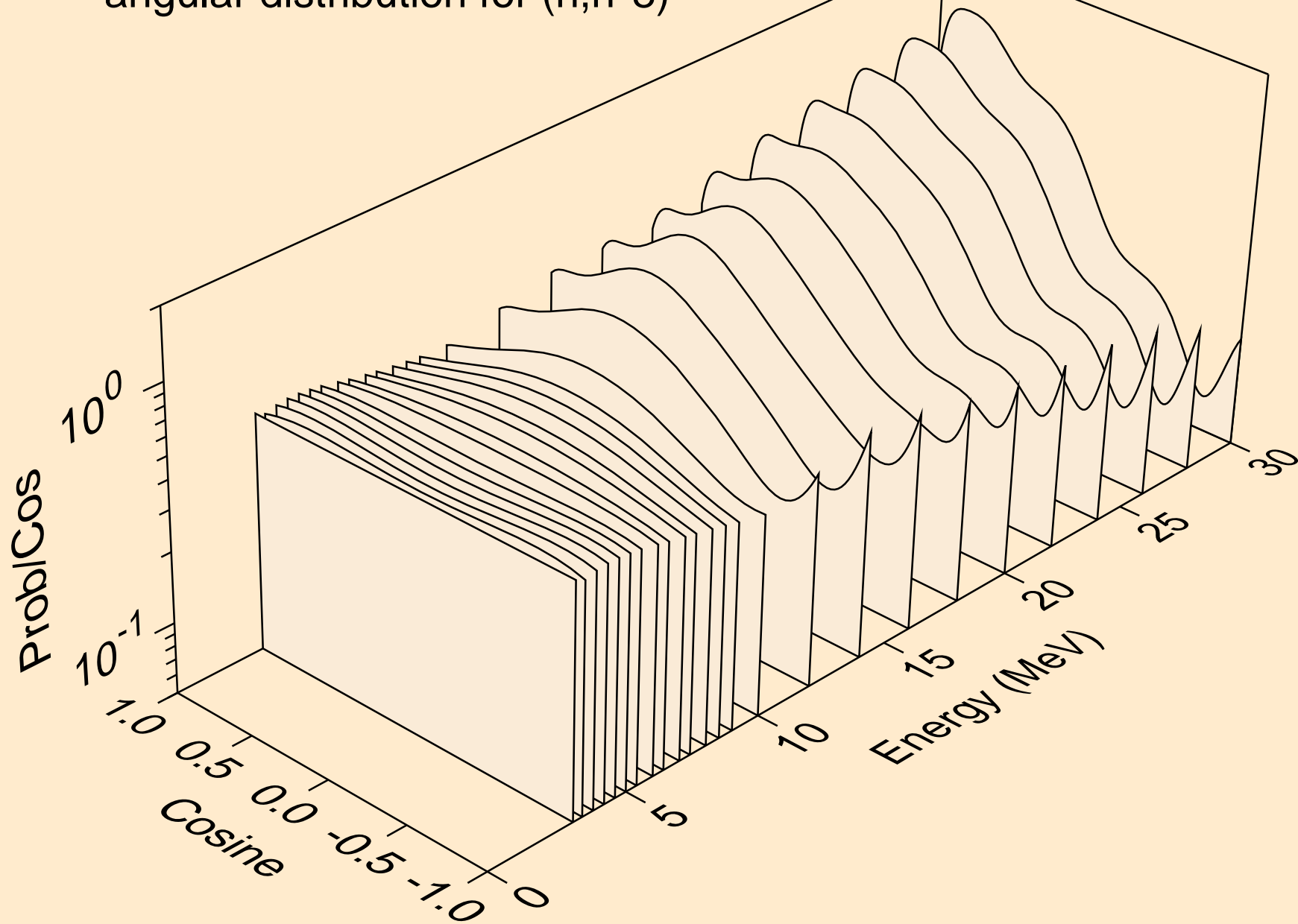

FE062 NEUTRON ACER TENDL-2023 LIBRARY; T=0.K
angular distribution for (n,n*9)

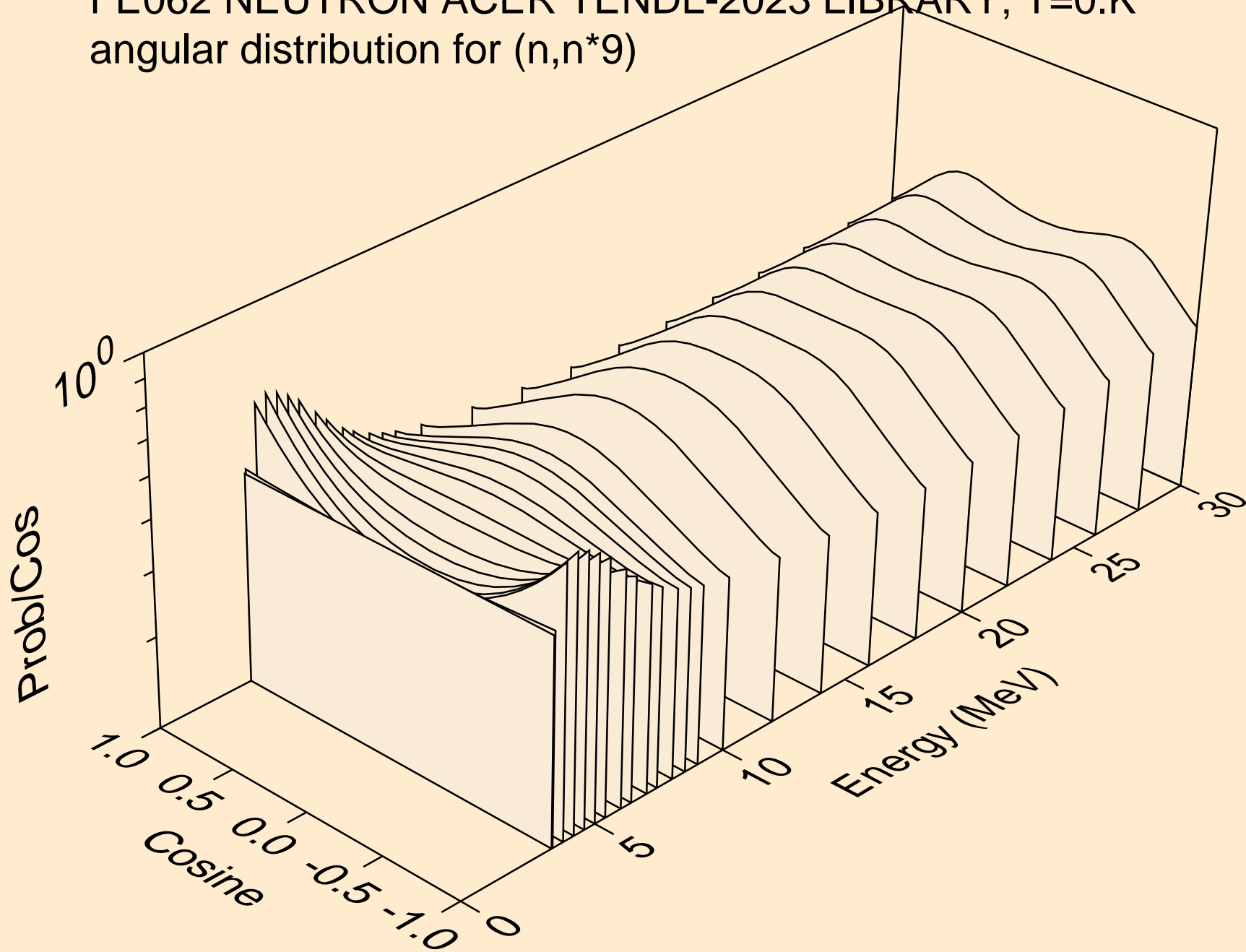

FE062 NEUTRON ACER TENDL-2023 LIBRARY; T=0.K
angular distribution for (n,n*10)

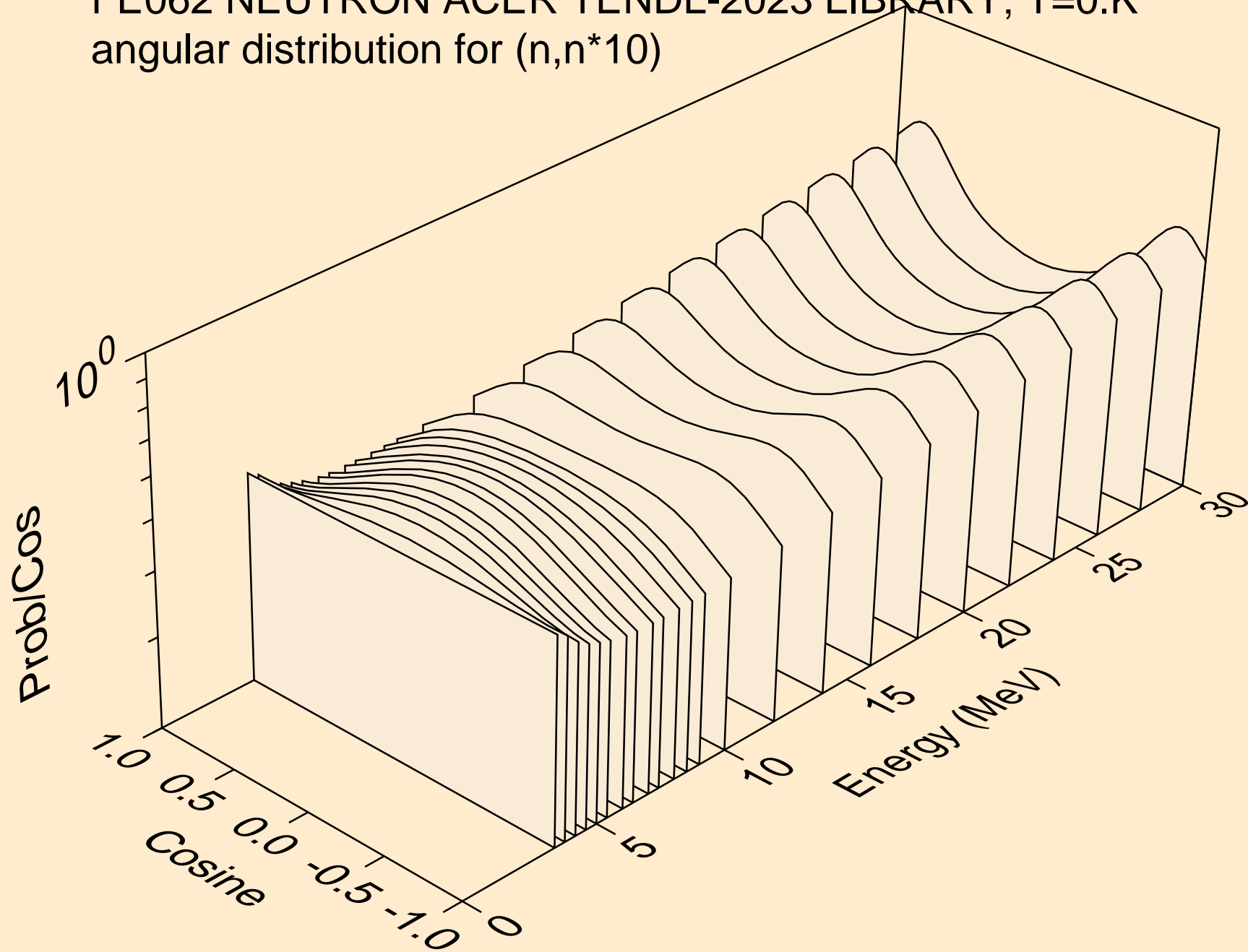

FE062 NEUTRON ACER TENDL-2023 LIBRARY; T=0.K
angular distribution for (n,n*11)

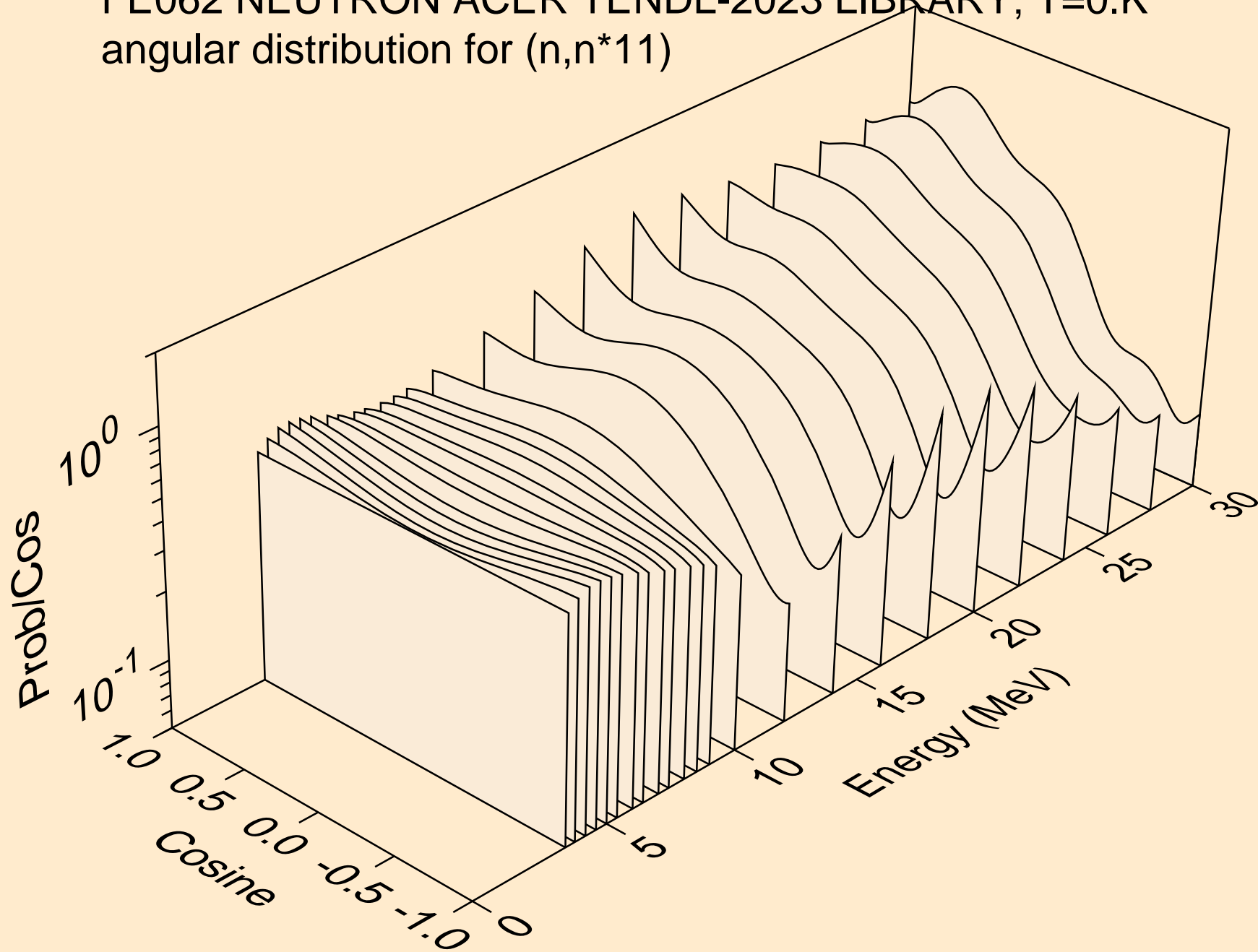

FE062 NEUTRON ACER TENDL-2023 LIBRARY; T=0.K
angular distribution for (n,n*12)

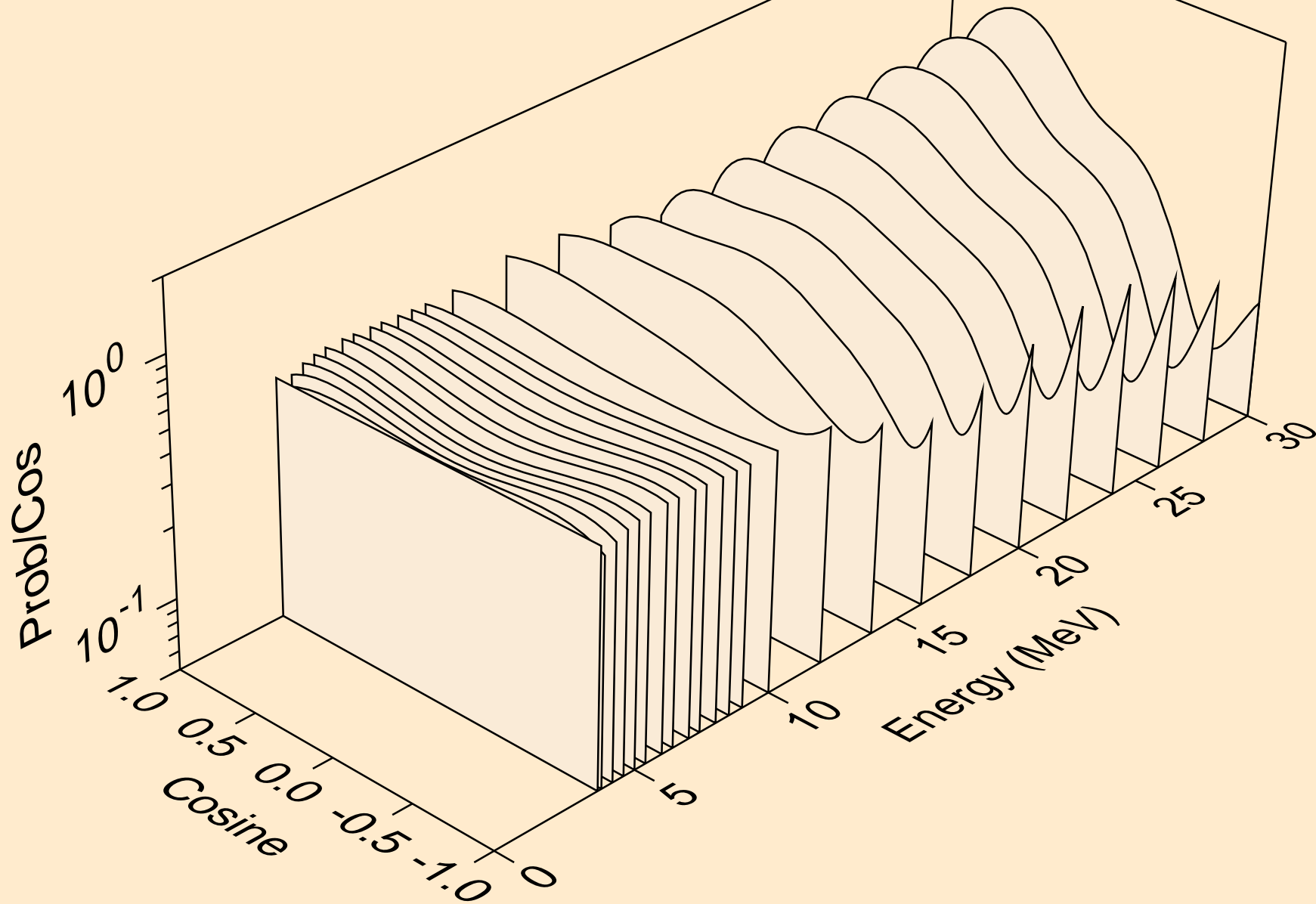

FE062 NEUTRON ACER TENDL-2023 LIBRARY; T=0.K
angular distribution for (n,n*13)

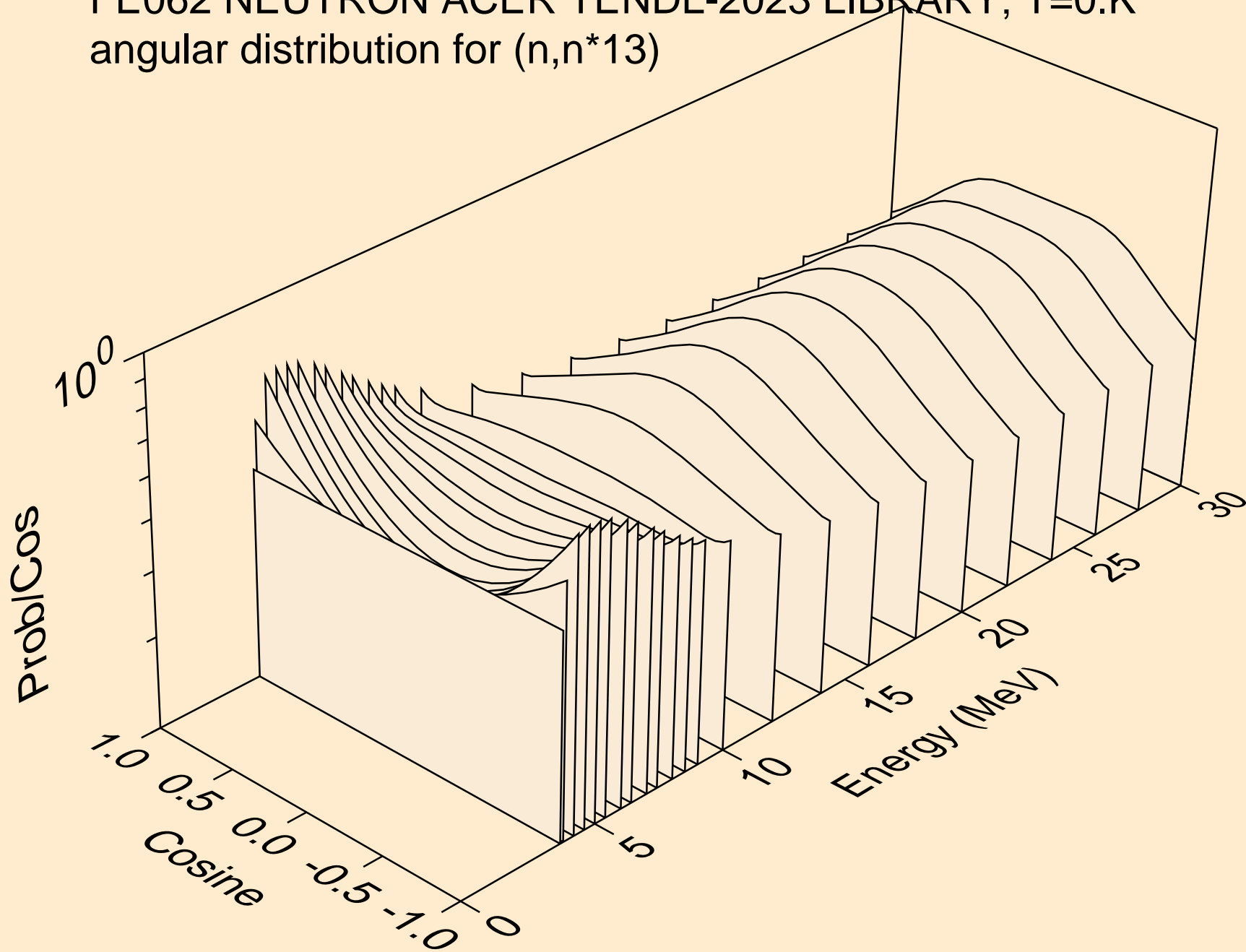

FE062 NEUTRON ACER TENDL-2023 LIBRARY; T=0.K
angular distribution for (n,n*14)

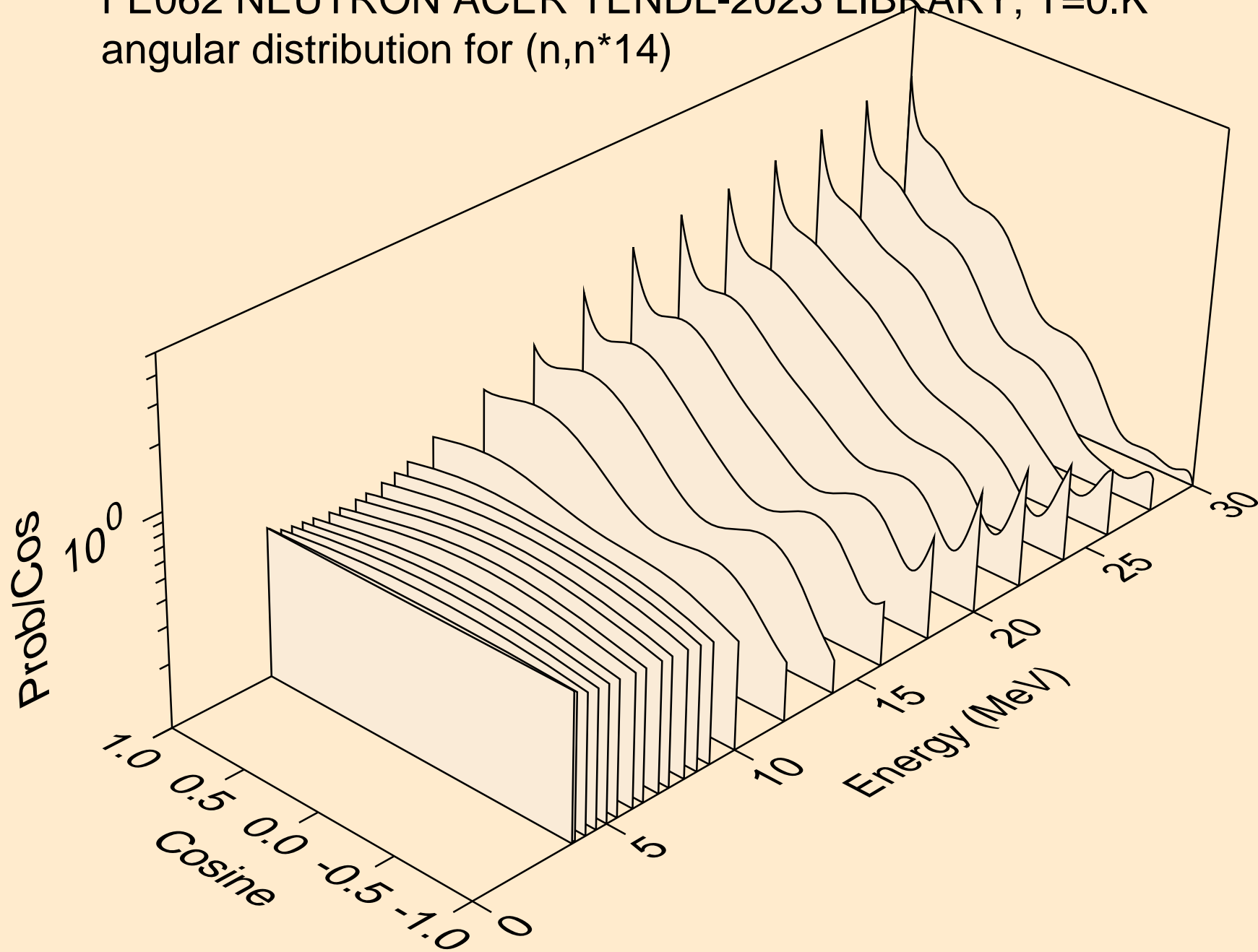

FE062 NEUTRON ACER TENDL-2023 LIBRARY; T=0.K
angular distribution for (n,n*15)

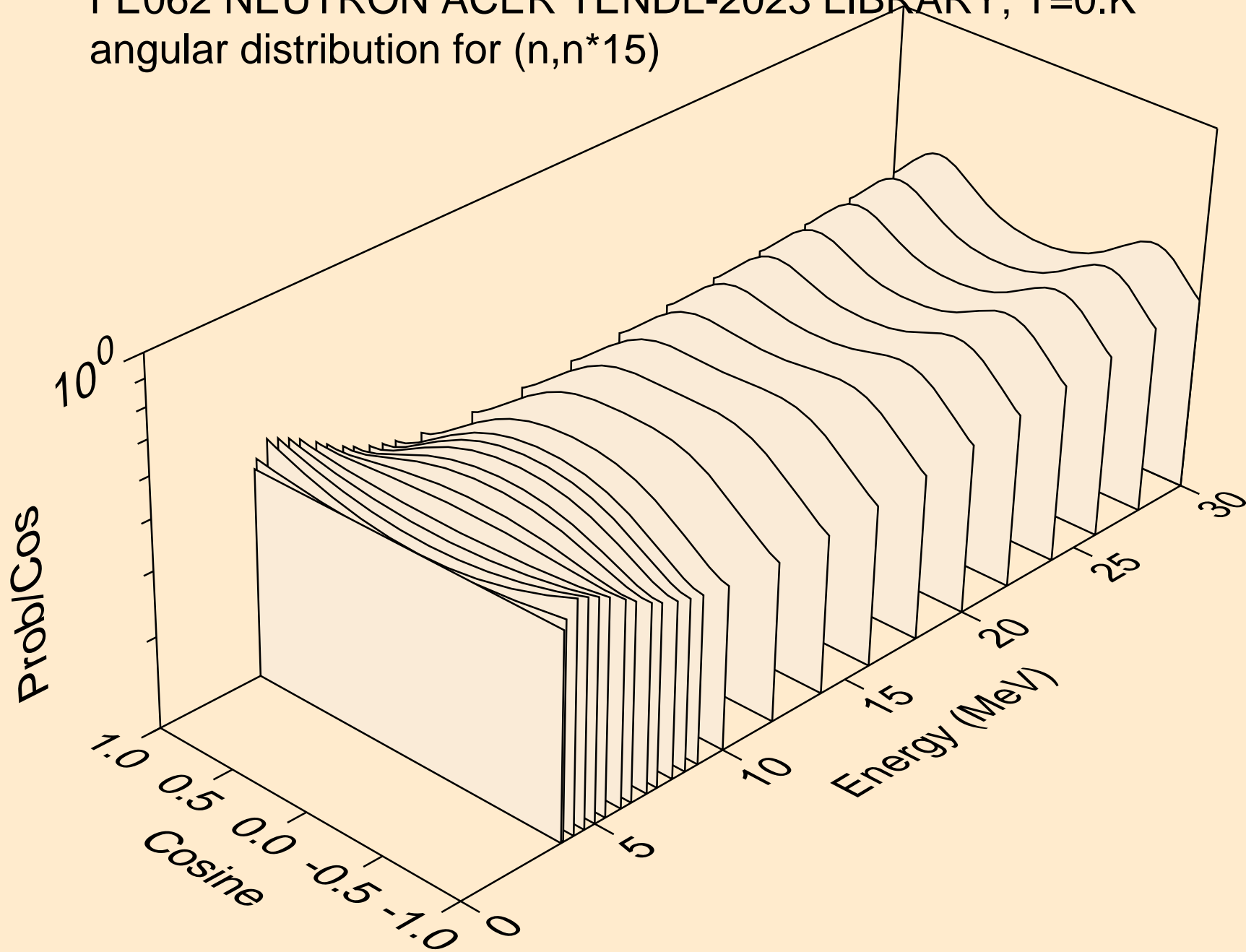

FE062 NEUTRON ACER TENDL-2023 LIBRARY; T=0.K
angular distribution for (n,n*16)

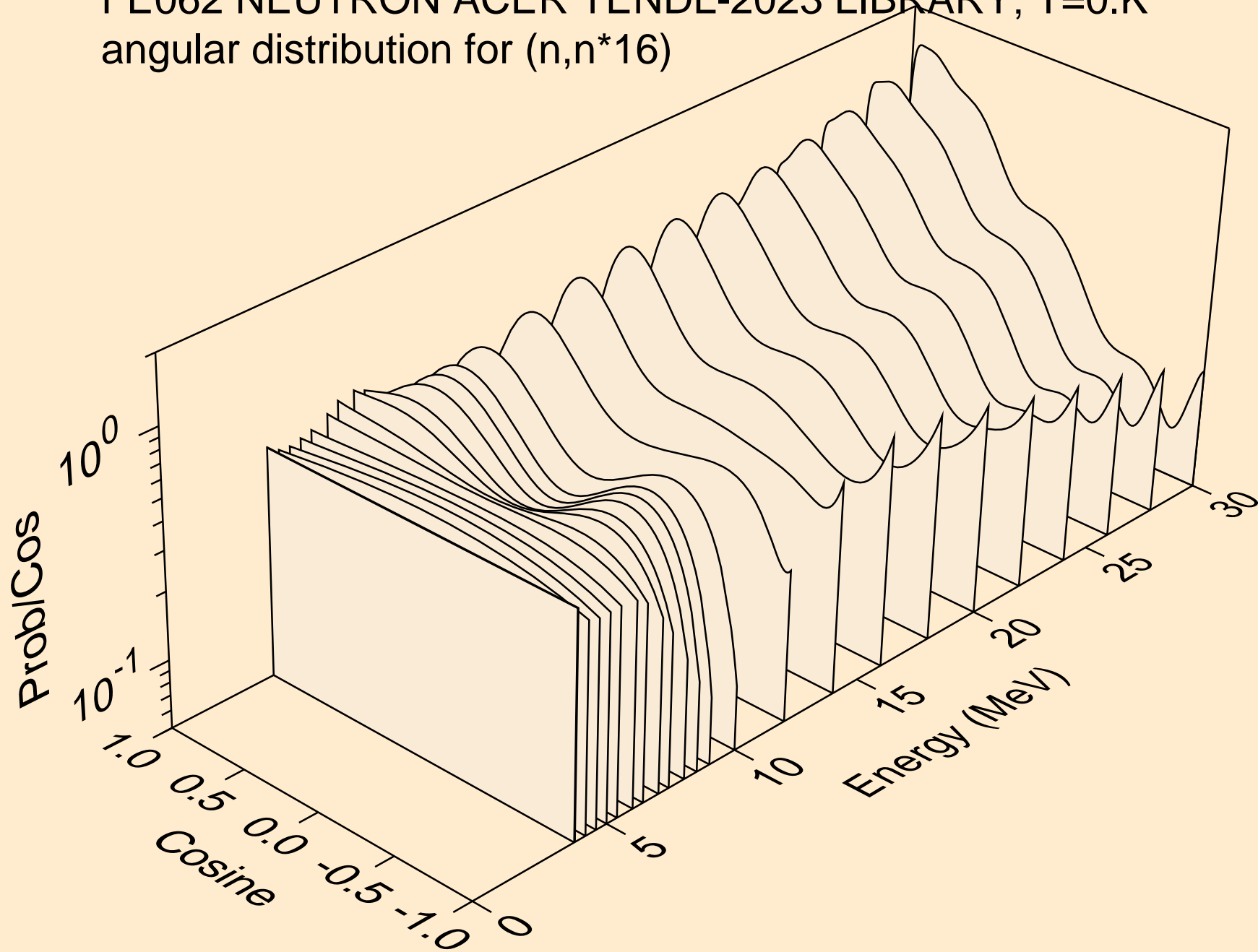

FE062 NEUTRON ACER TENDL-2023 LIBRARY; T=0.K
angular distribution for (n,n*17)

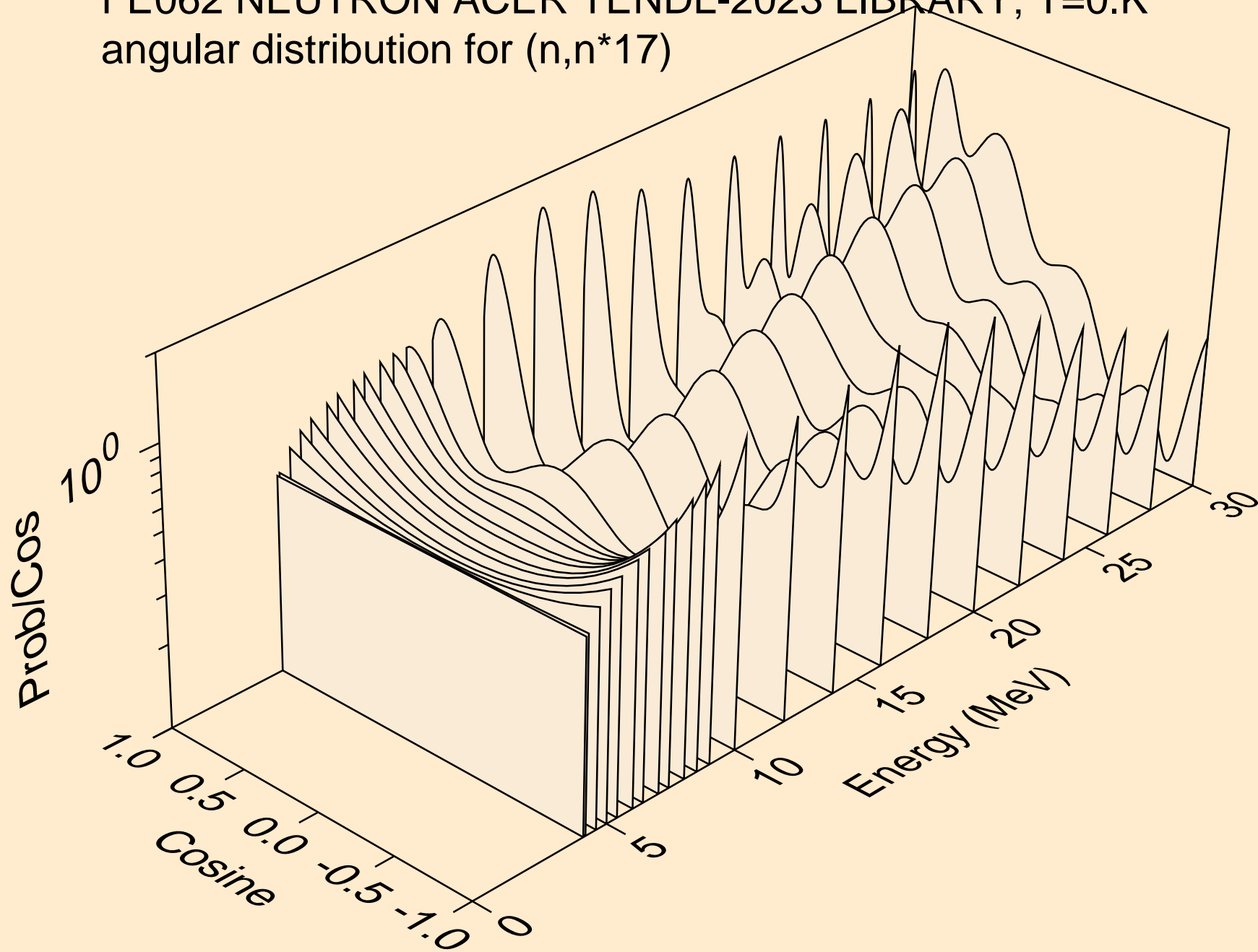

FE062 NEUTRON ACER TENDL-2023 LIBRARY; T=0.K
angular distribution for (n,n*18)

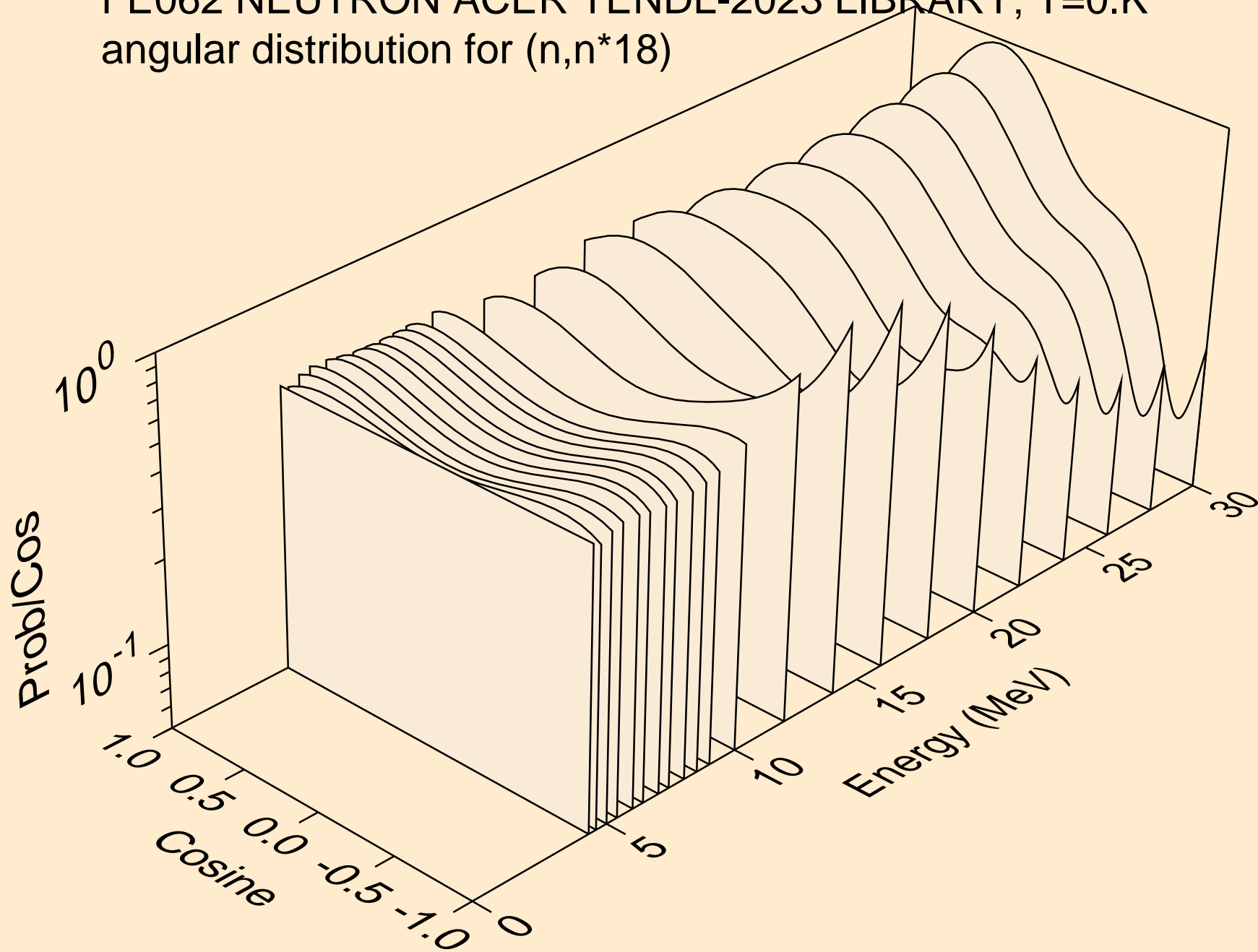

FE062 NEUTRON ACER TENDL-2023 LIBRARY; T=0.K
angular distribution for (n,n*19)

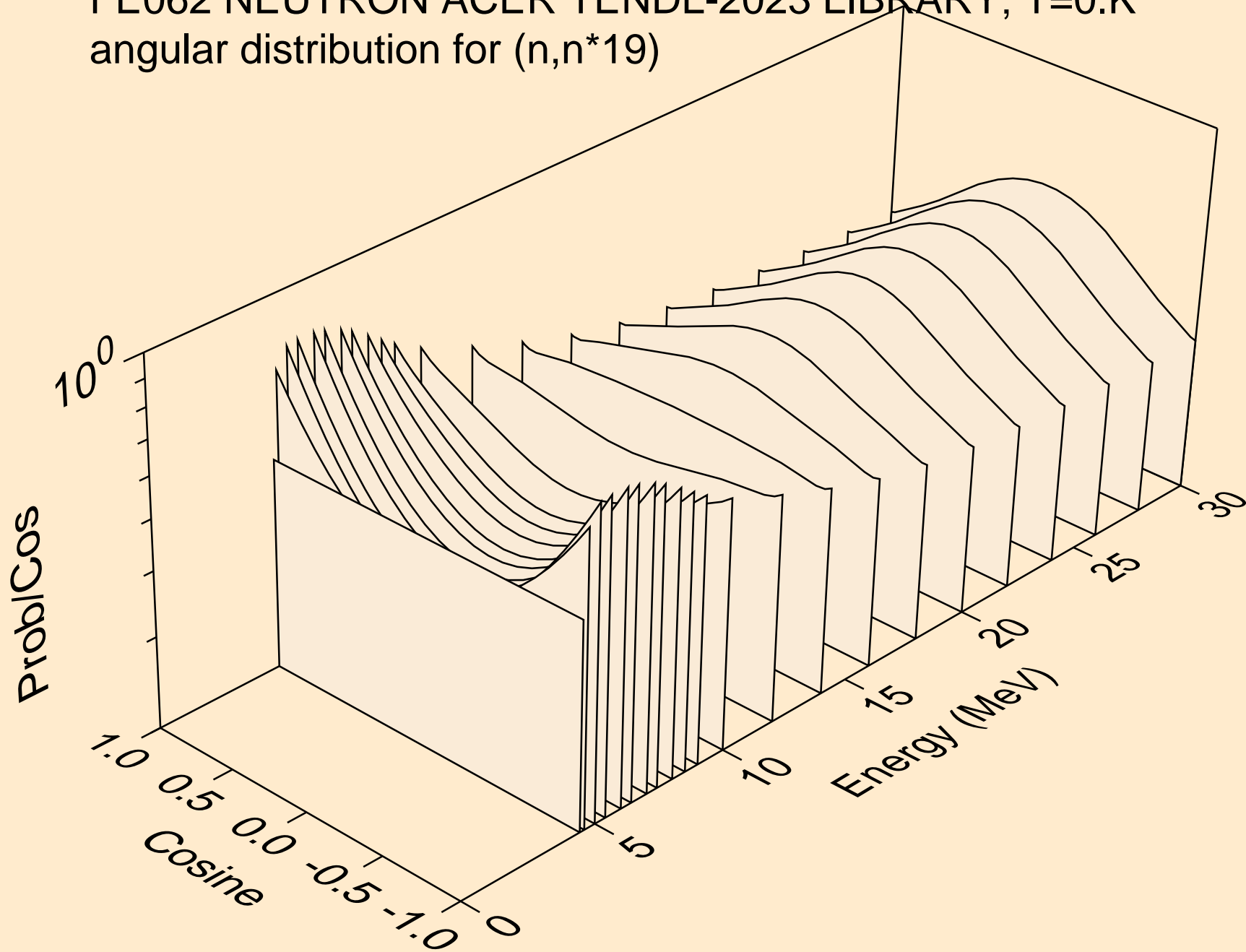

FE062 NEUTRON ACER TENDL-2023 LIBRARY; T=0.K
angular distribution for (n,n*20)

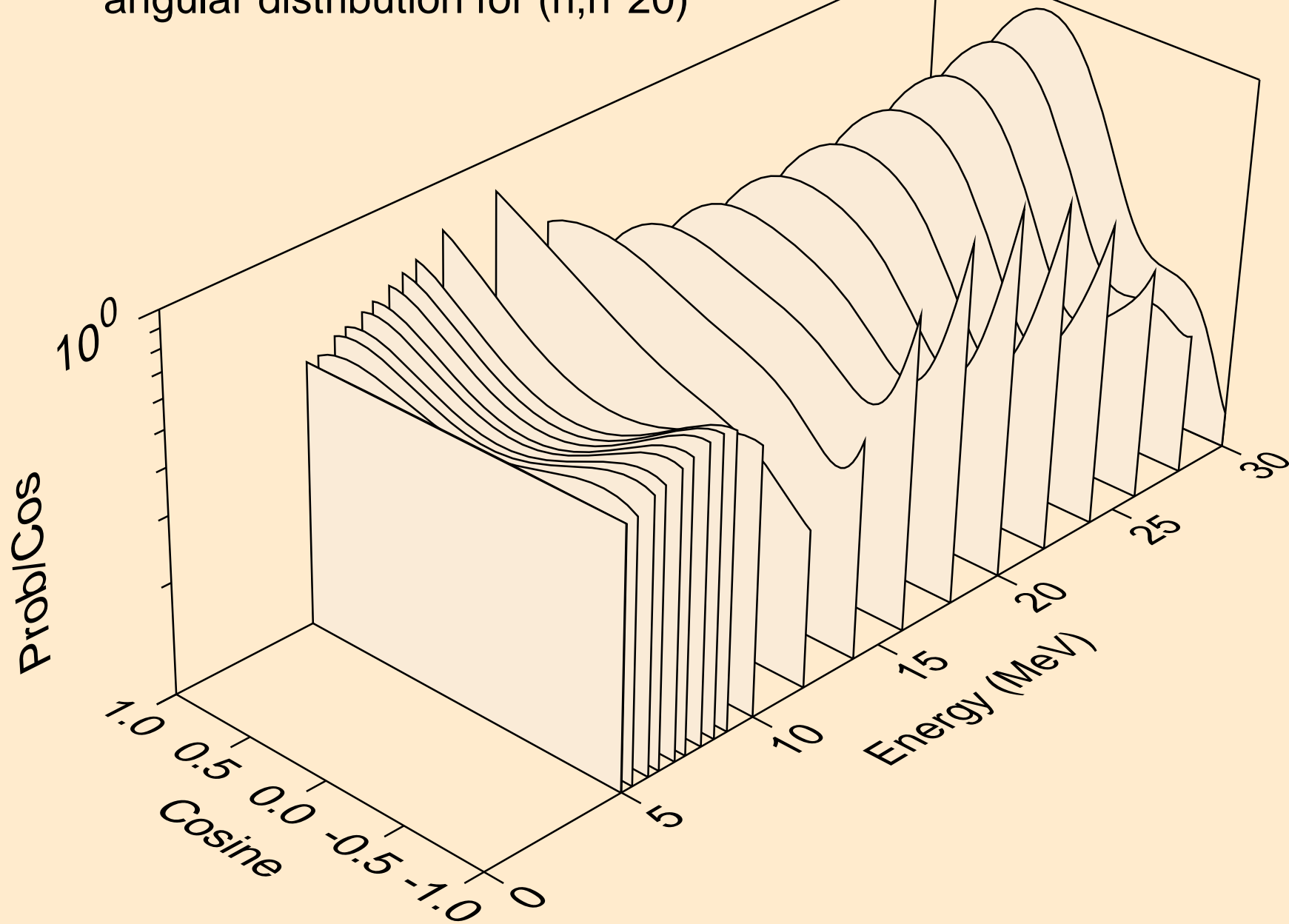

FE062 NEUTRON ACER TENDL-2023 LIBRARY; T=0.K
angular distribution for (n,n*21)

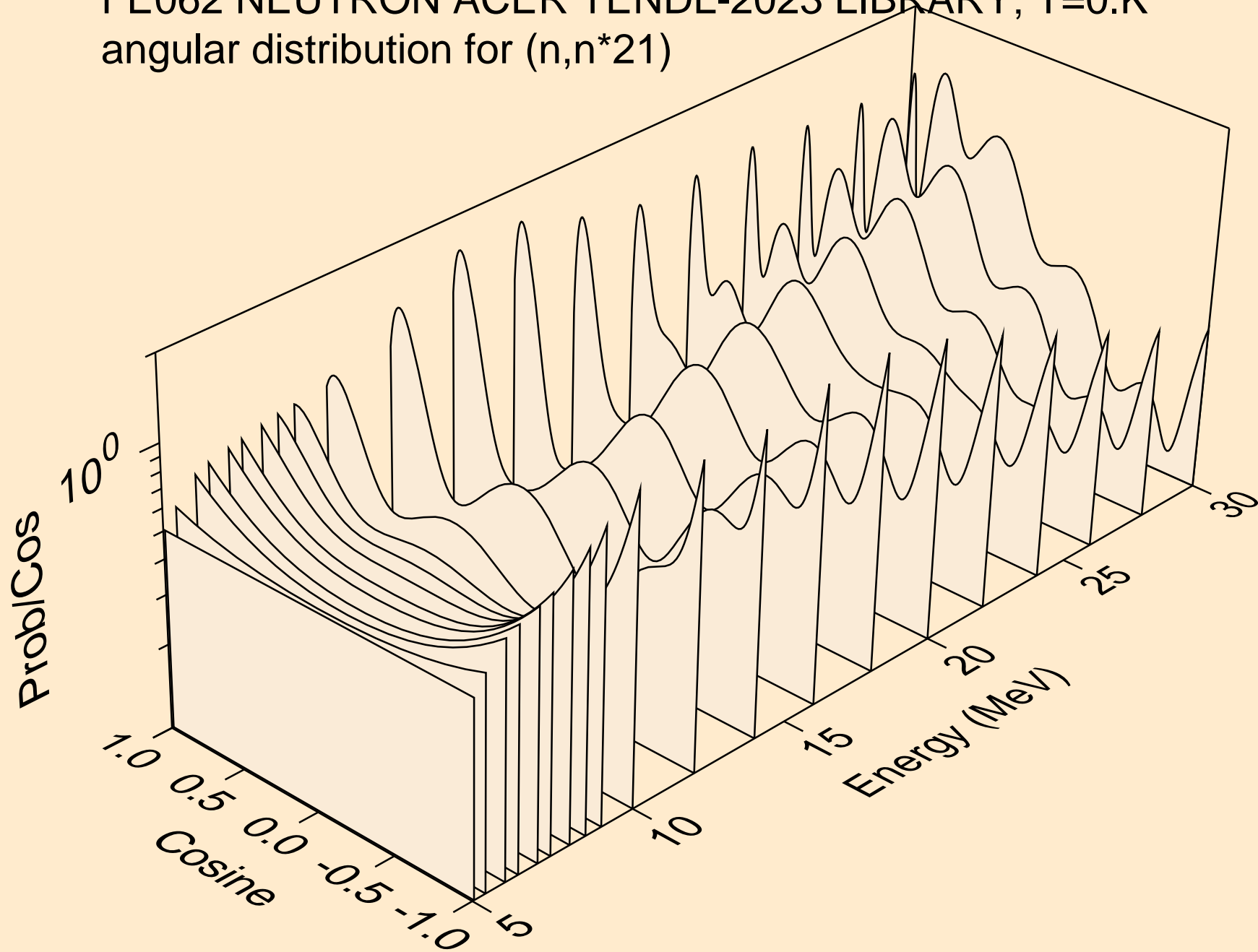

FE062 NEUTRON ACER TENDL-2023 LIBRARY; T=0.K
angular distribution for (n,n*22)

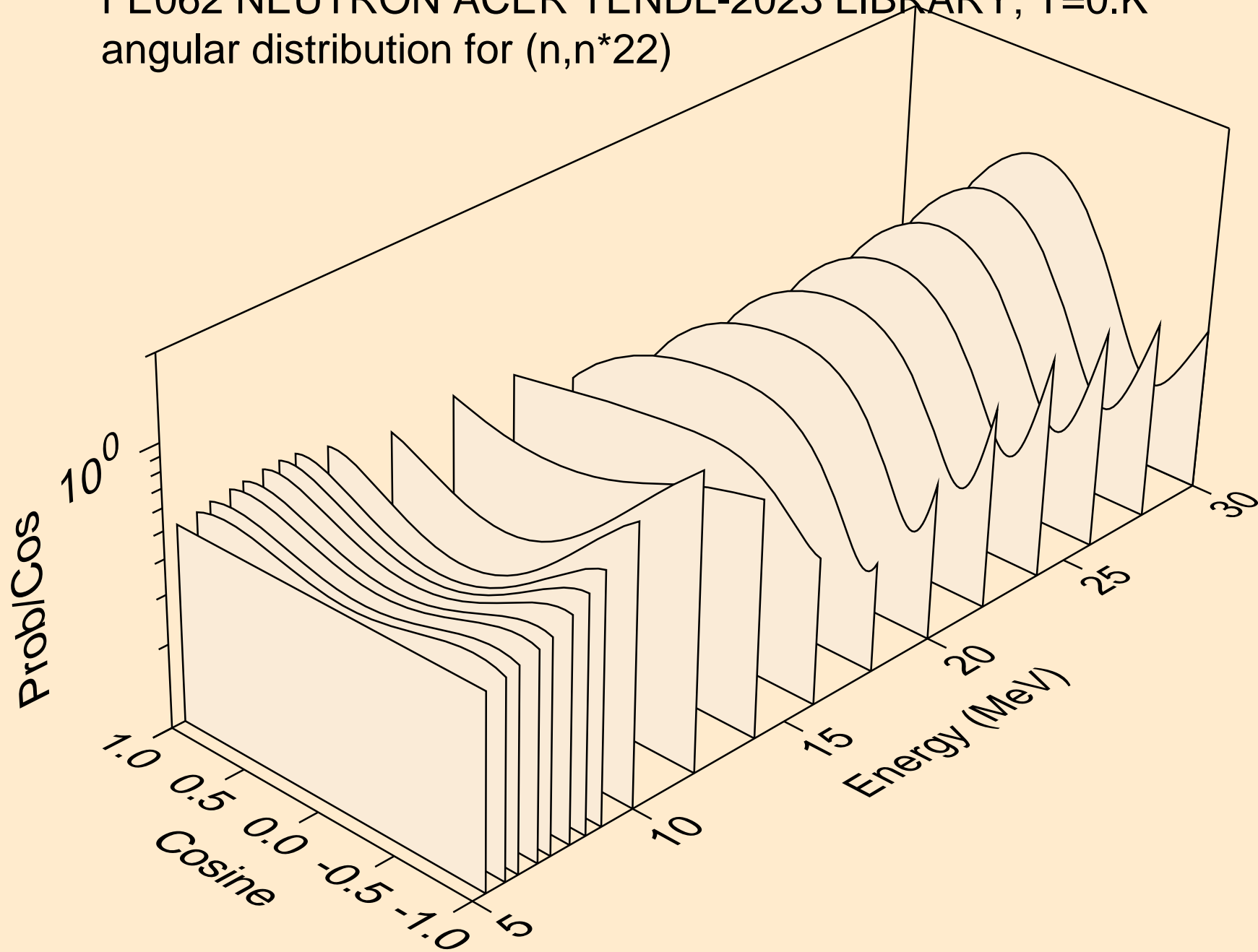

FE062 NEUTRON ACER TENDL-2023 LIBRARY; T=0.K
angular distribution for (n,n*23)

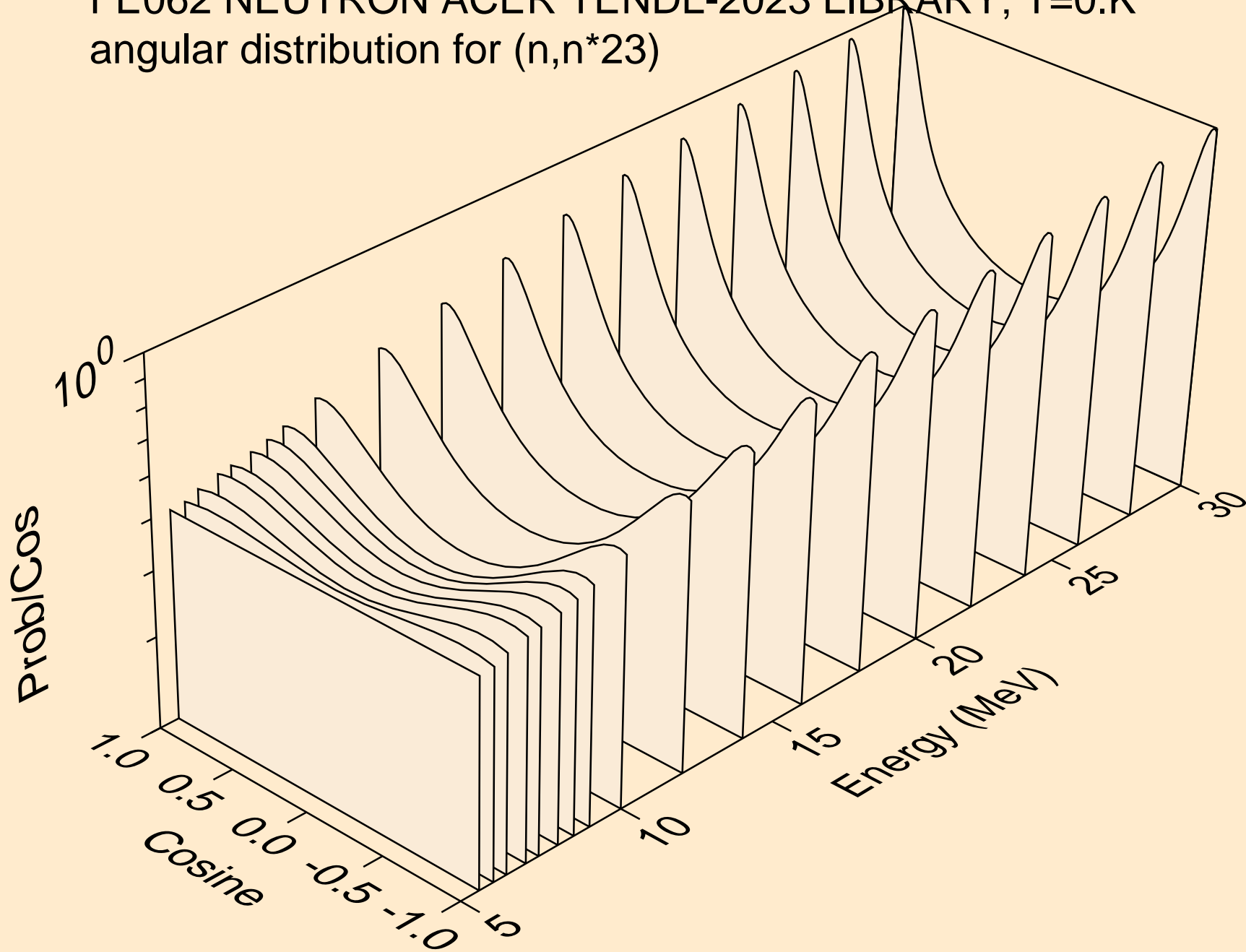

FE062 NEUTRON ACER TENDL-2023 LIBRARY; T=0.K
angular distribution for (n,n*24)

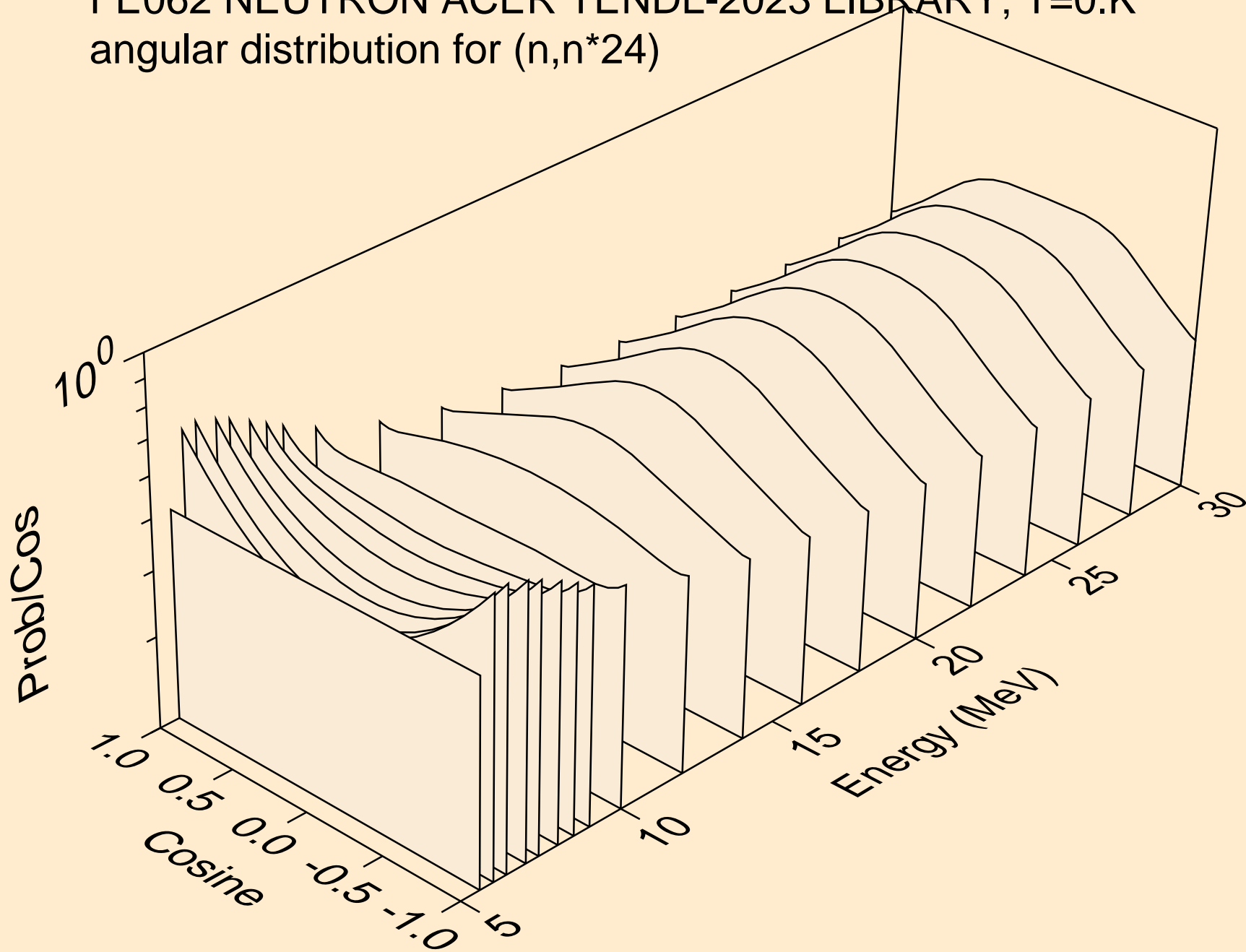

FE062 NEUTRON ACER TENDL-2023 LIBRARY; T=0.K
angular distribution for (n,n*25)

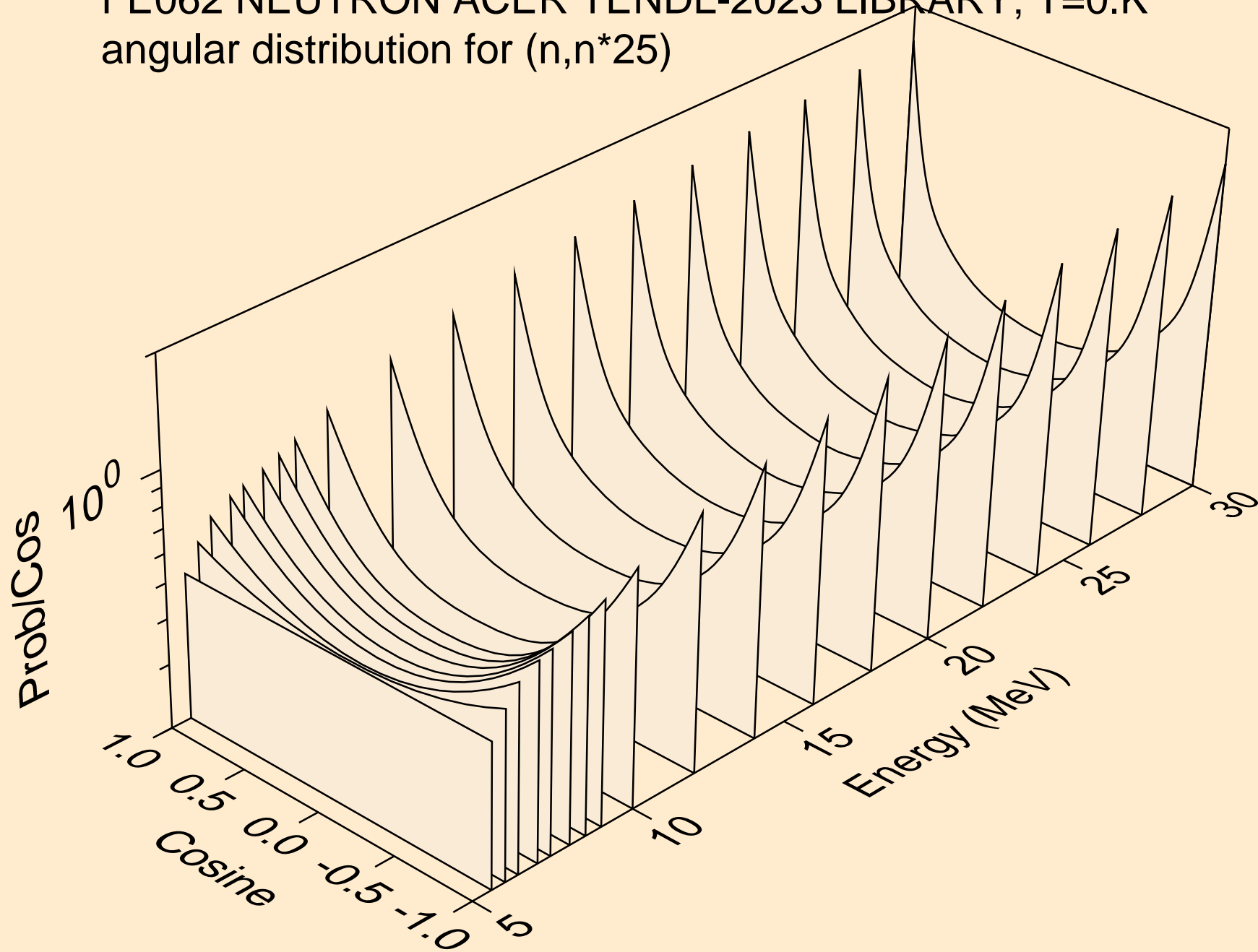

FE062 NEUTRON ACER TENDL-2023 LIBRARY; T=0.K
angular distribution for (n,n*26)

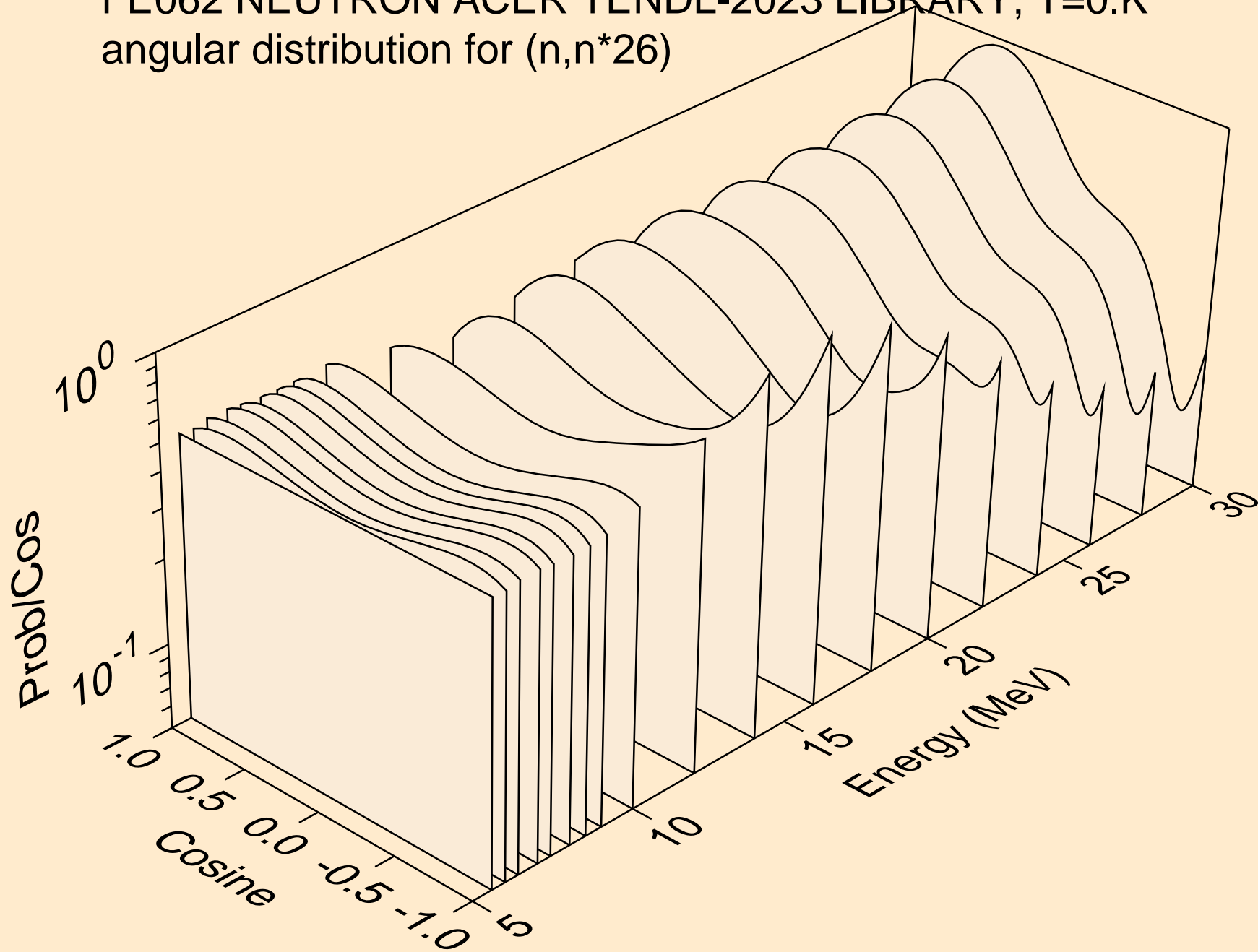

FE062 NEUTRON ACER TENDL-2023 LIBRARY; T=0.K
angular distribution for (n,n*27)

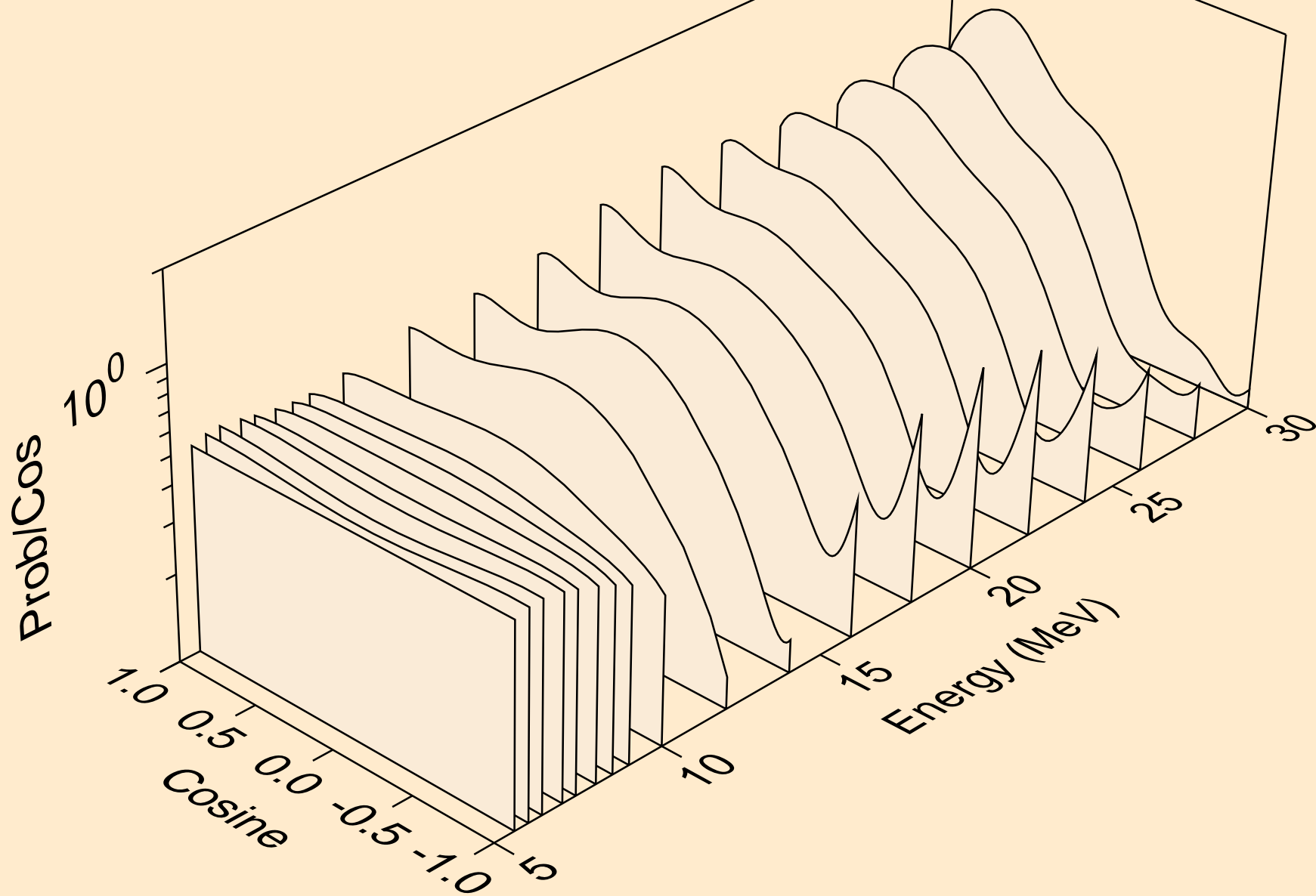

FE062 NEUTRON ACER TENDL-2023 LIBRARY; T=0.K
angular distribution for (n,n*28)

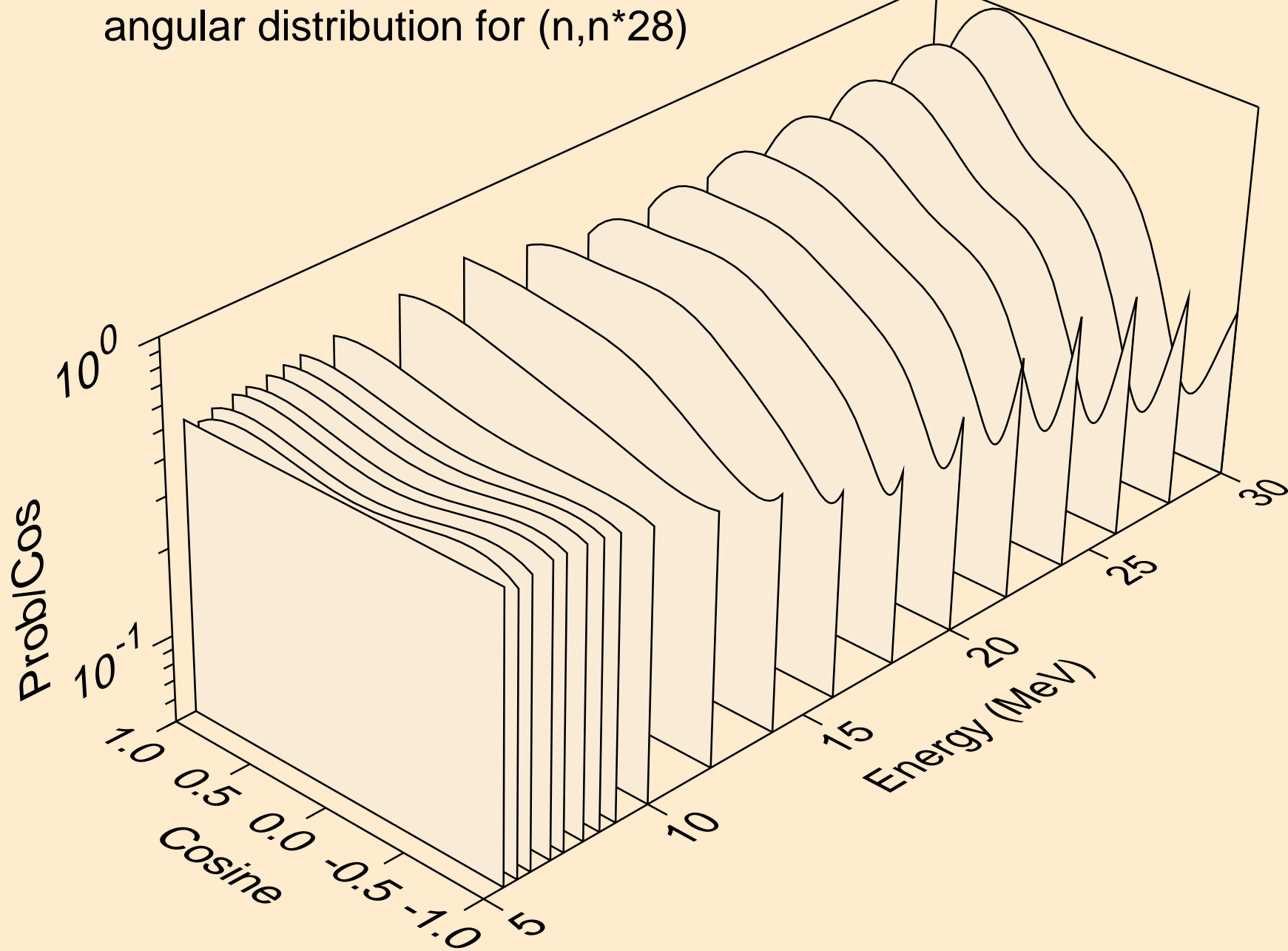

FE062 NEUTRON ACER TENDL-2023 LIBRARY; T=0.K
angular distribution for (n,n*29)

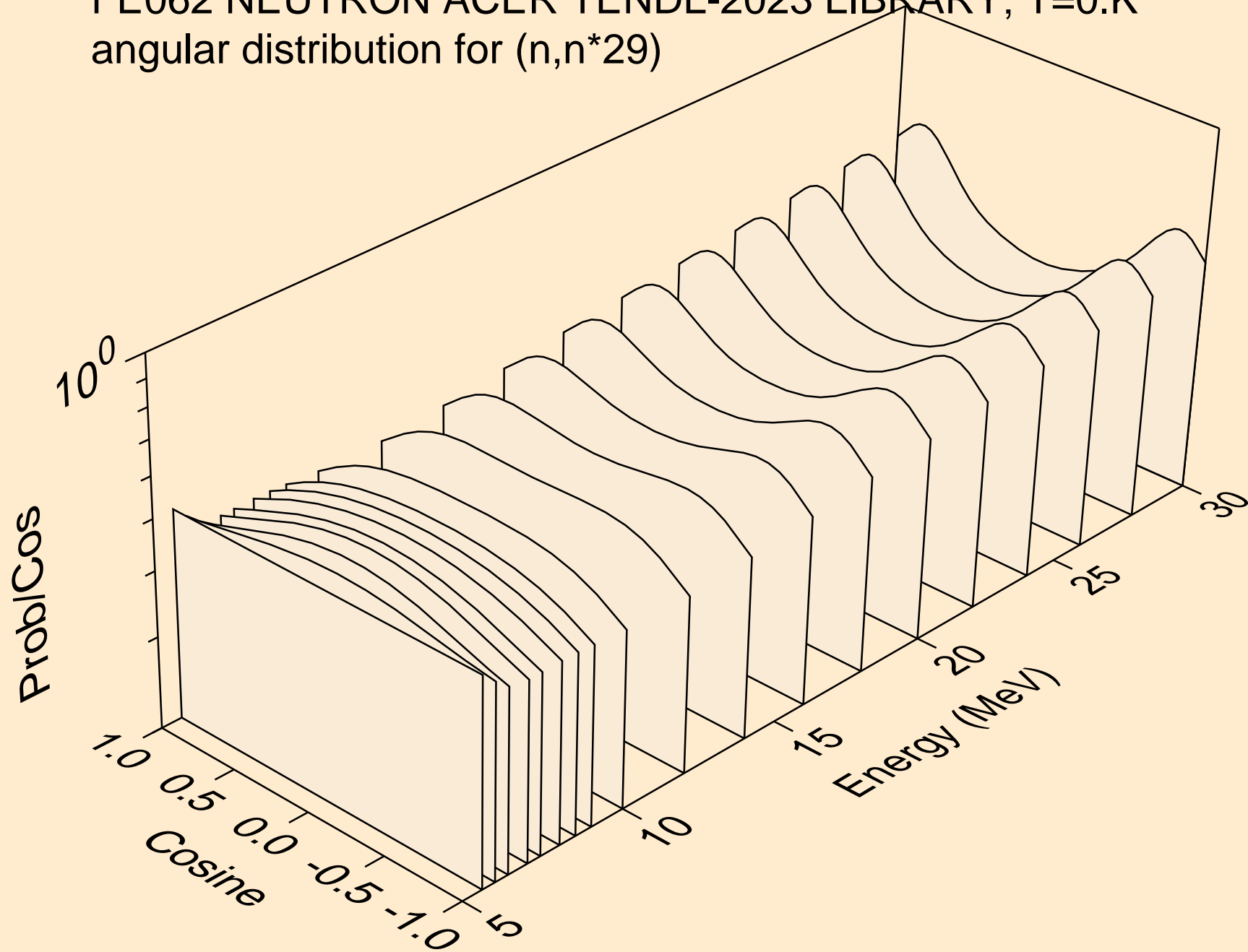

FE062 NEUTRON ACER TENDL-2023 LIBRARY; T=0.K
Neutron emission for (n,x)

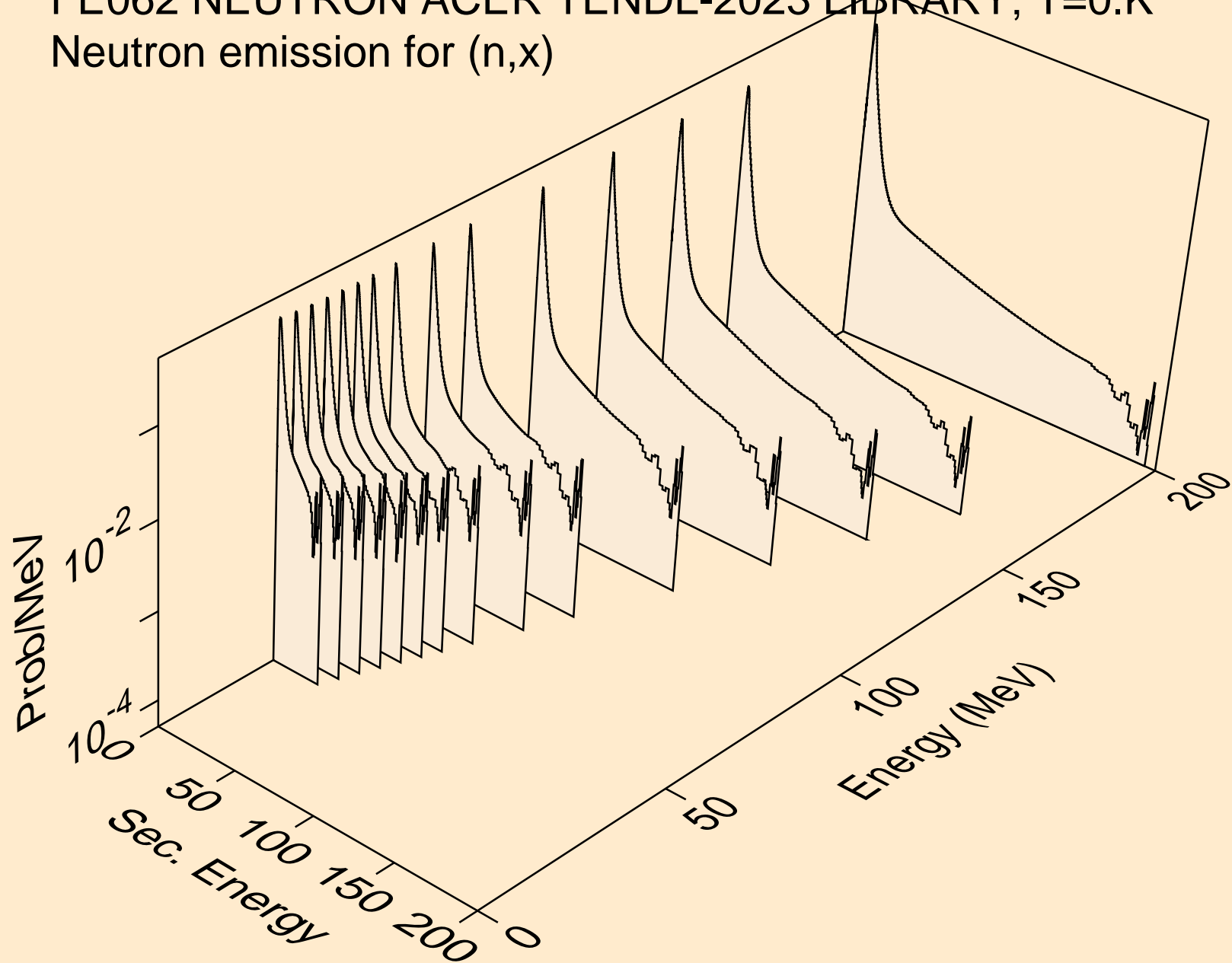

FE062 NEUTRON ACER TENDL-2023 LIBRARY; T=0.K
Neutron emission for (n,2nd)

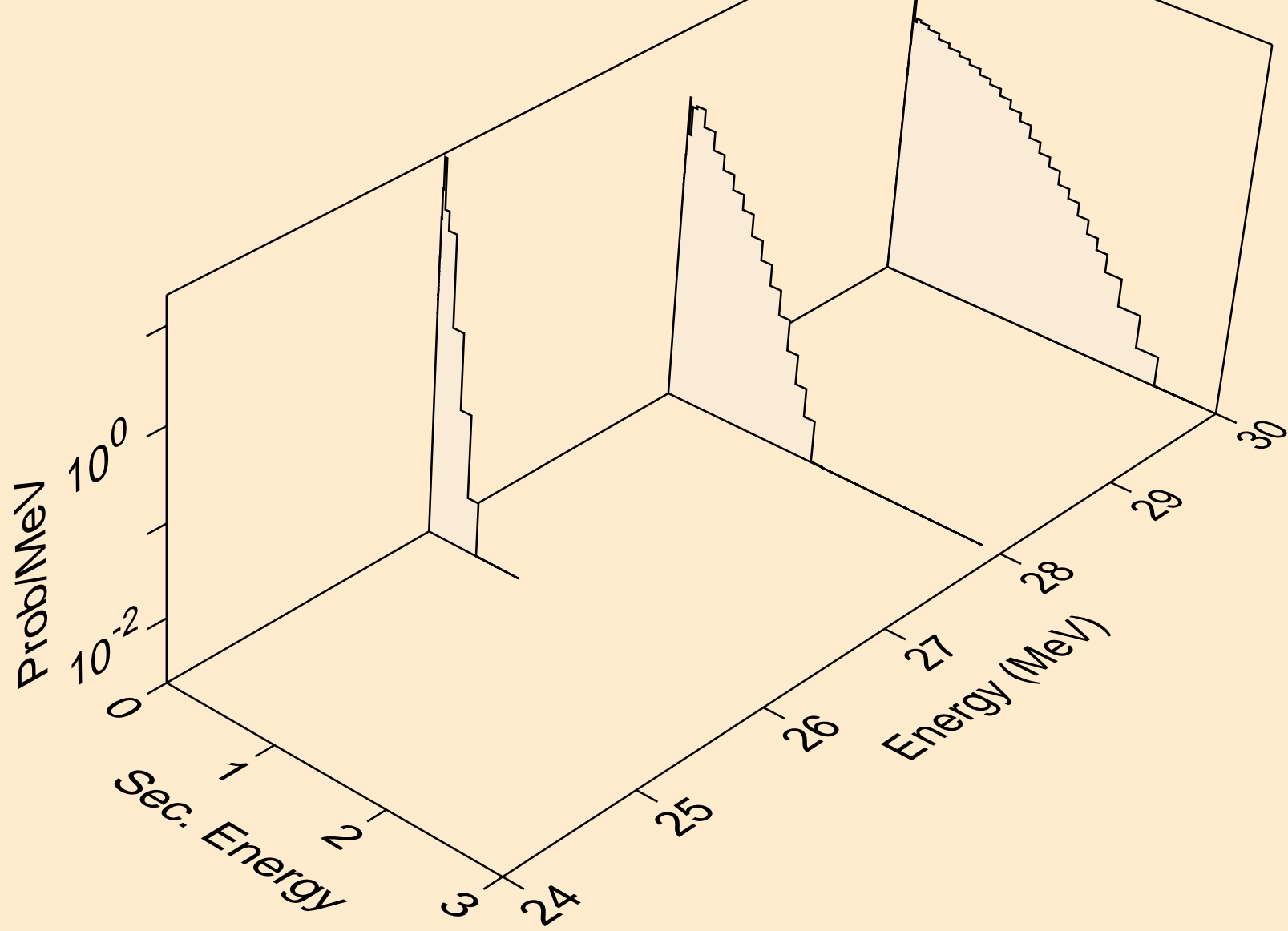

FE062 NEUTRON ACER TENDL-2023 LIBRARY; T=0.K
Neutron emission for (n,2n)

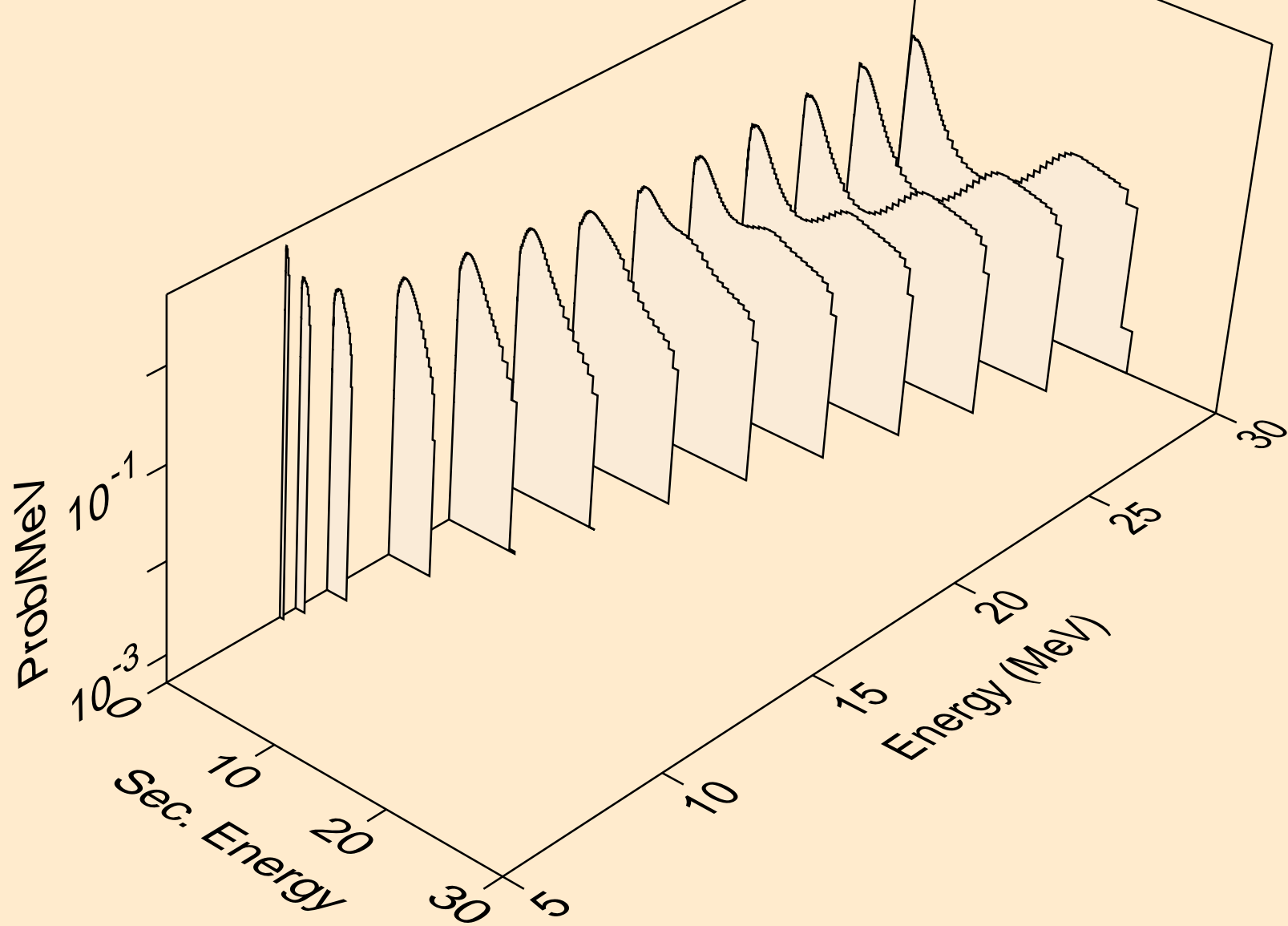

FE062 NEUTRON ACER TENDL-2023 LIBRARY; T=0.K
Neutron emission for (n,3n)

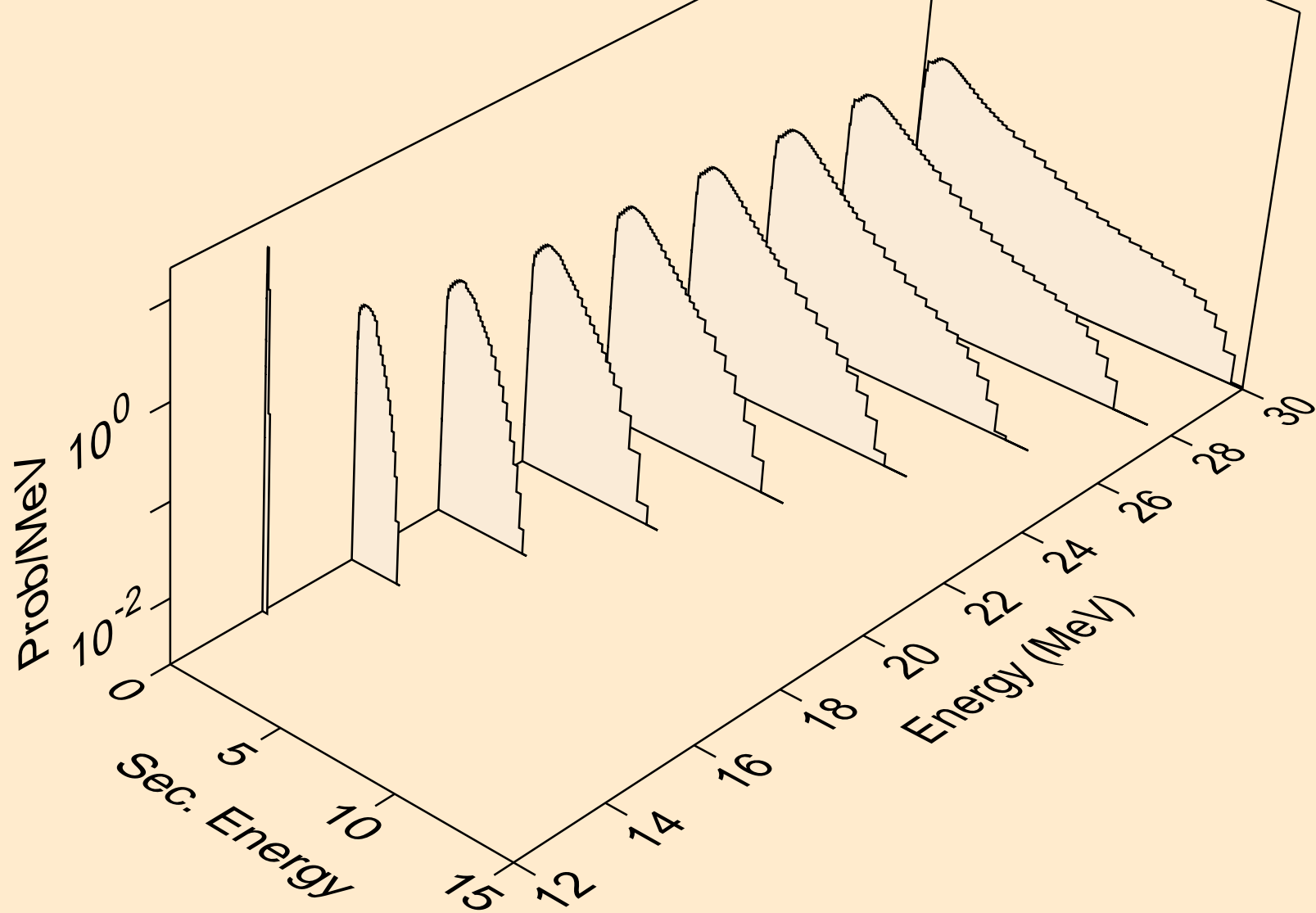

FE062 NEUTRON ACER TENDL-2023 LIBRARY; T=0.K
Neutron emission for (n,n*)a

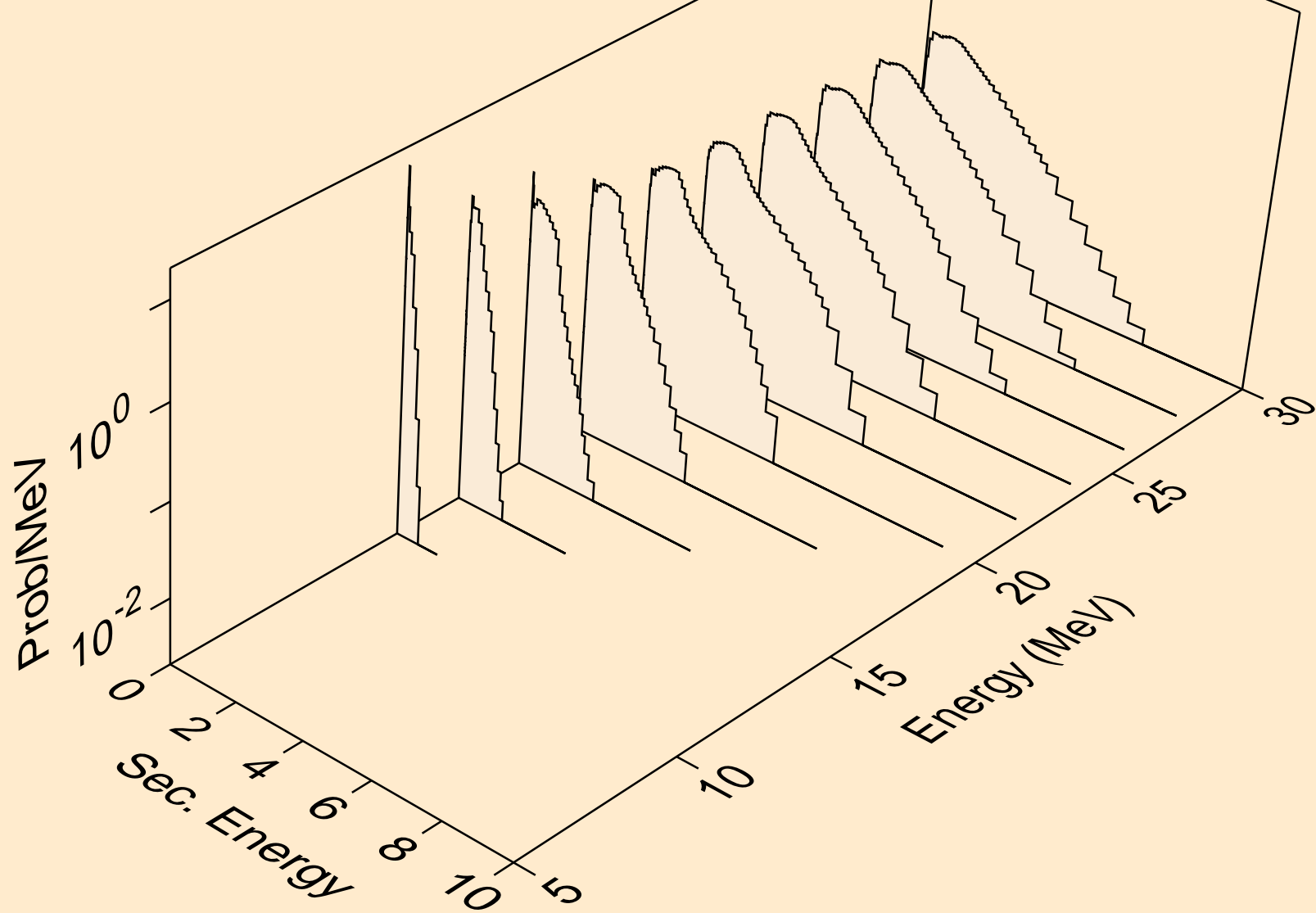

FE062 NEUTRON ACER TENDL-2023 LIBRARY; T=0.K
Neutron emission for (n,2n)a

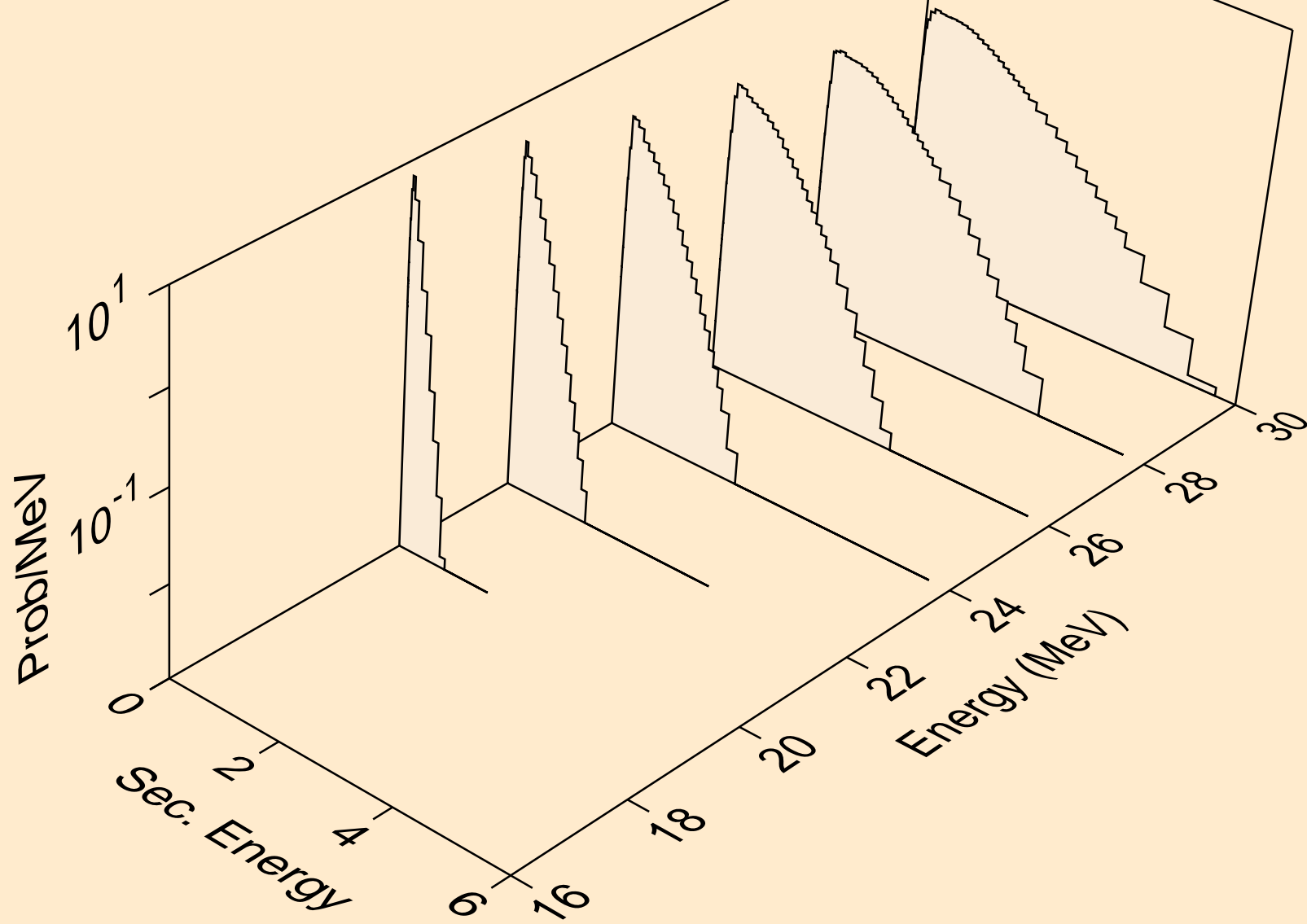

FE062 NEUTRON ACER TENDL-2023 LIBRARY; T=0.K
Neutron emission for (n,3n)a

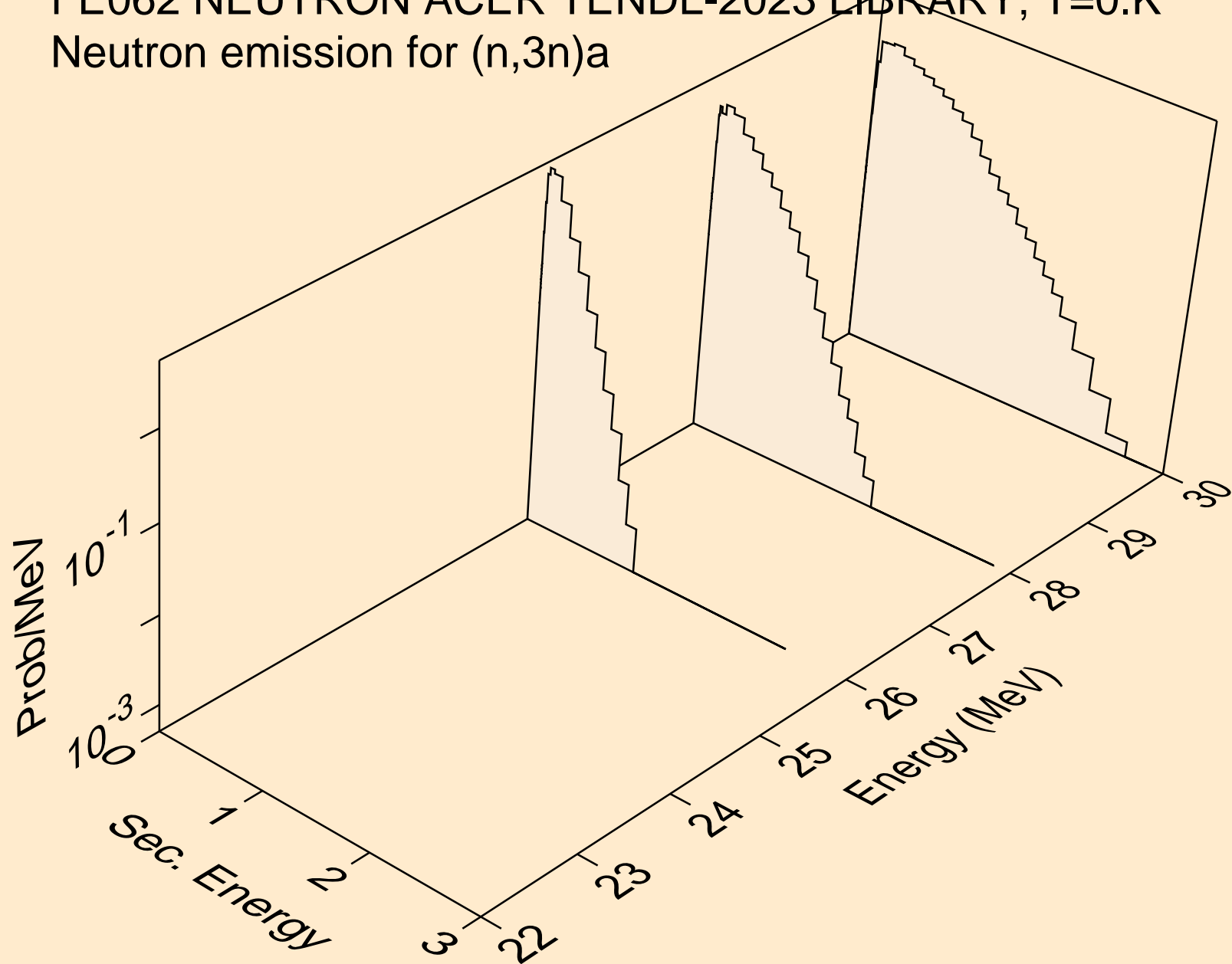

FE062 NEUTRON ACER TENDL-2023 LIBRARY; T=0.K
Neutron emission for (n,n*)p

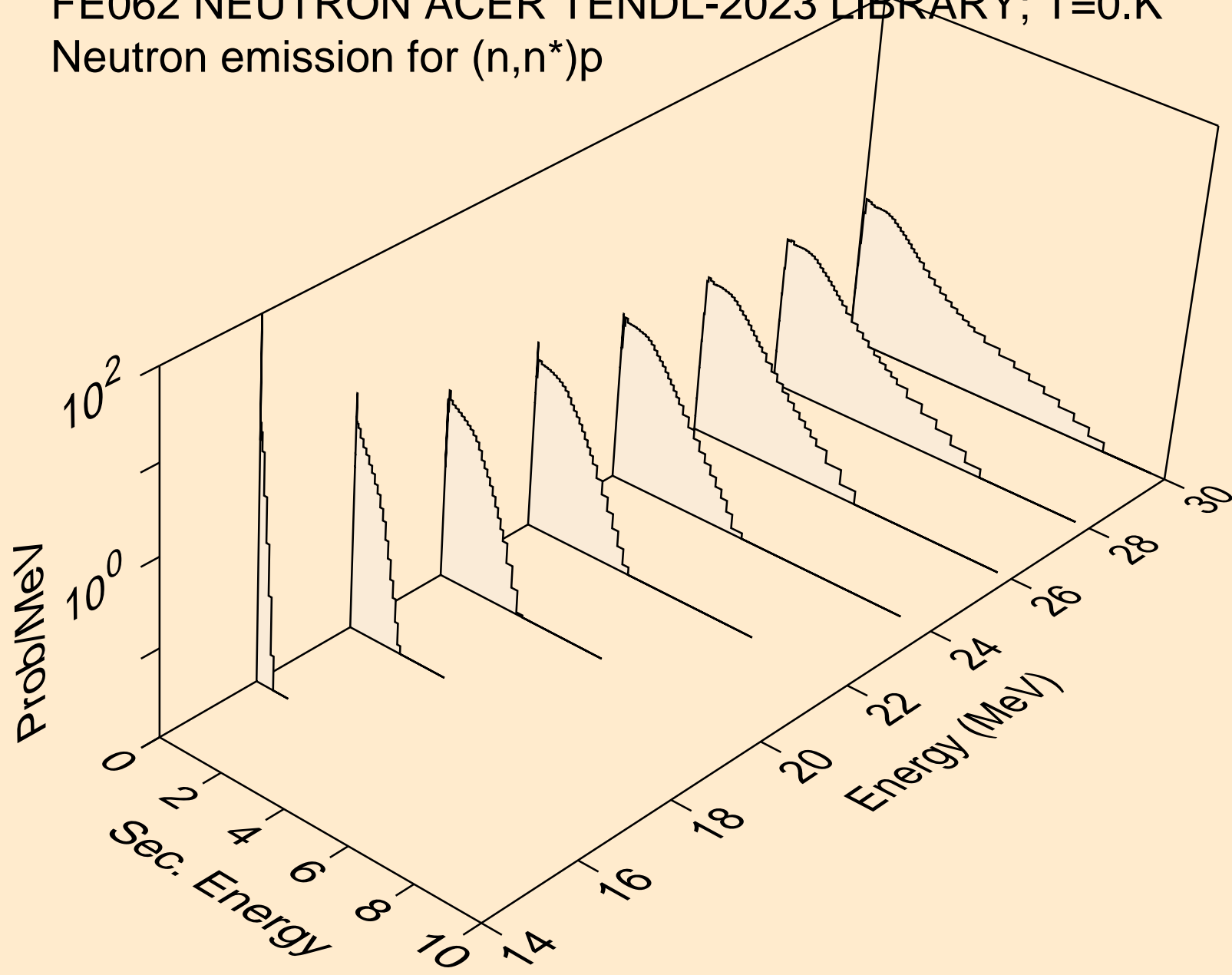

FE062 NEUTRON ACER TENDL-2023 LIBRARY; T=0.K
Neutron emission for (n,n*)d

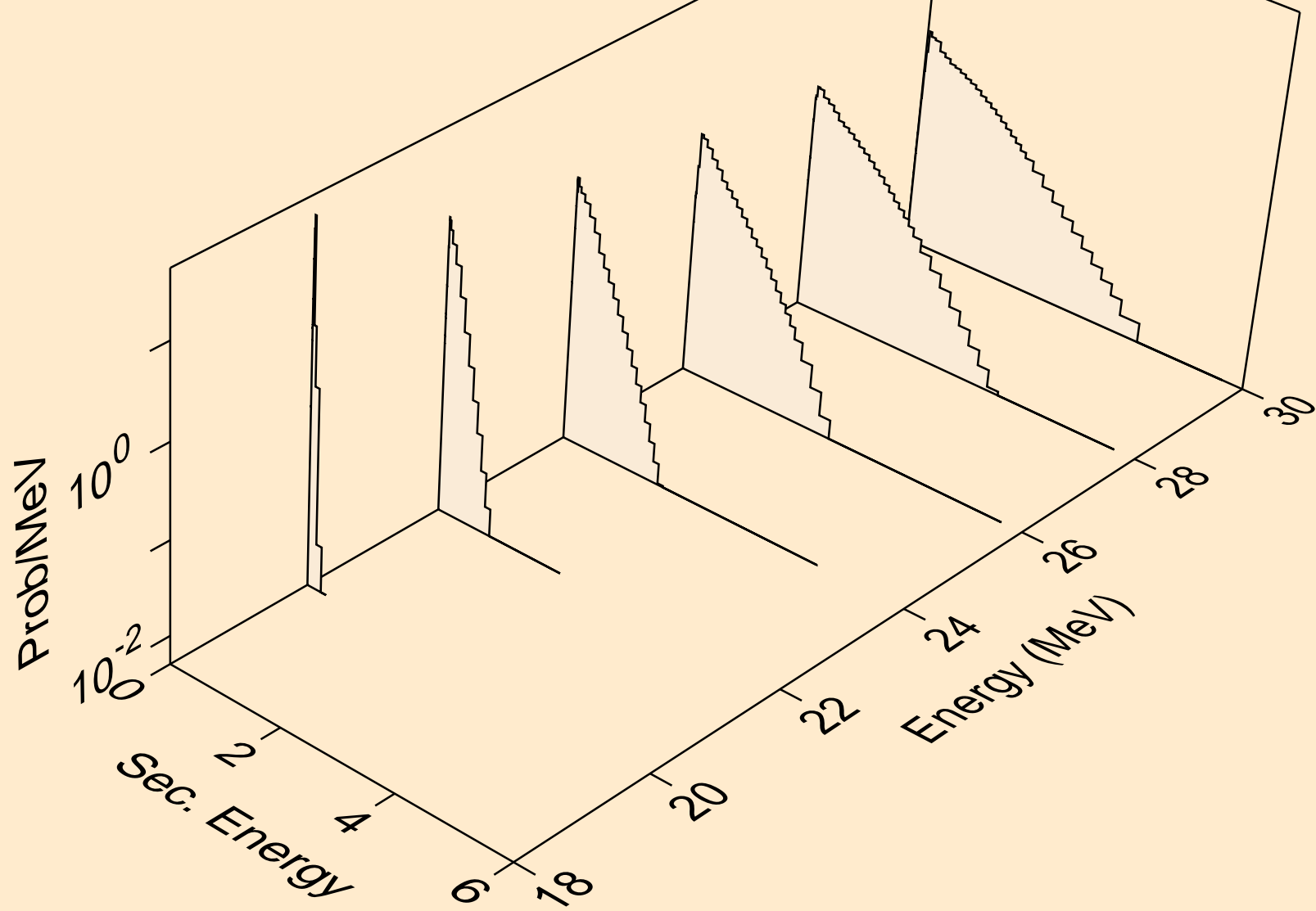

FE062 NEUTRON ACER TENDL-2023 LIBRARY; T=0.K
Neutron emission for (n,n*)t

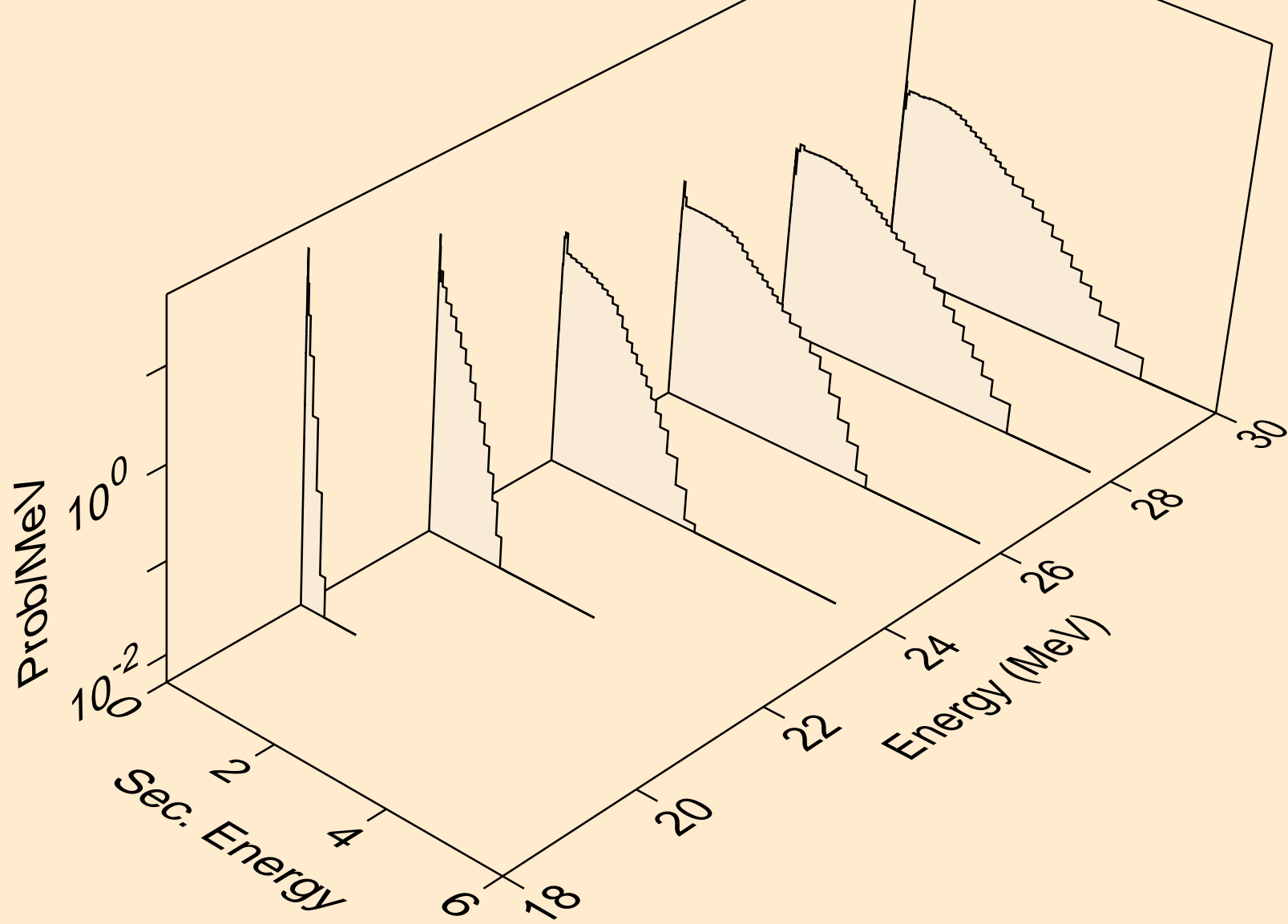

FE062 NEUTRON ACER TENDL-2023 LIBRARY; T=0.K
Neutron emission for (n,4n)

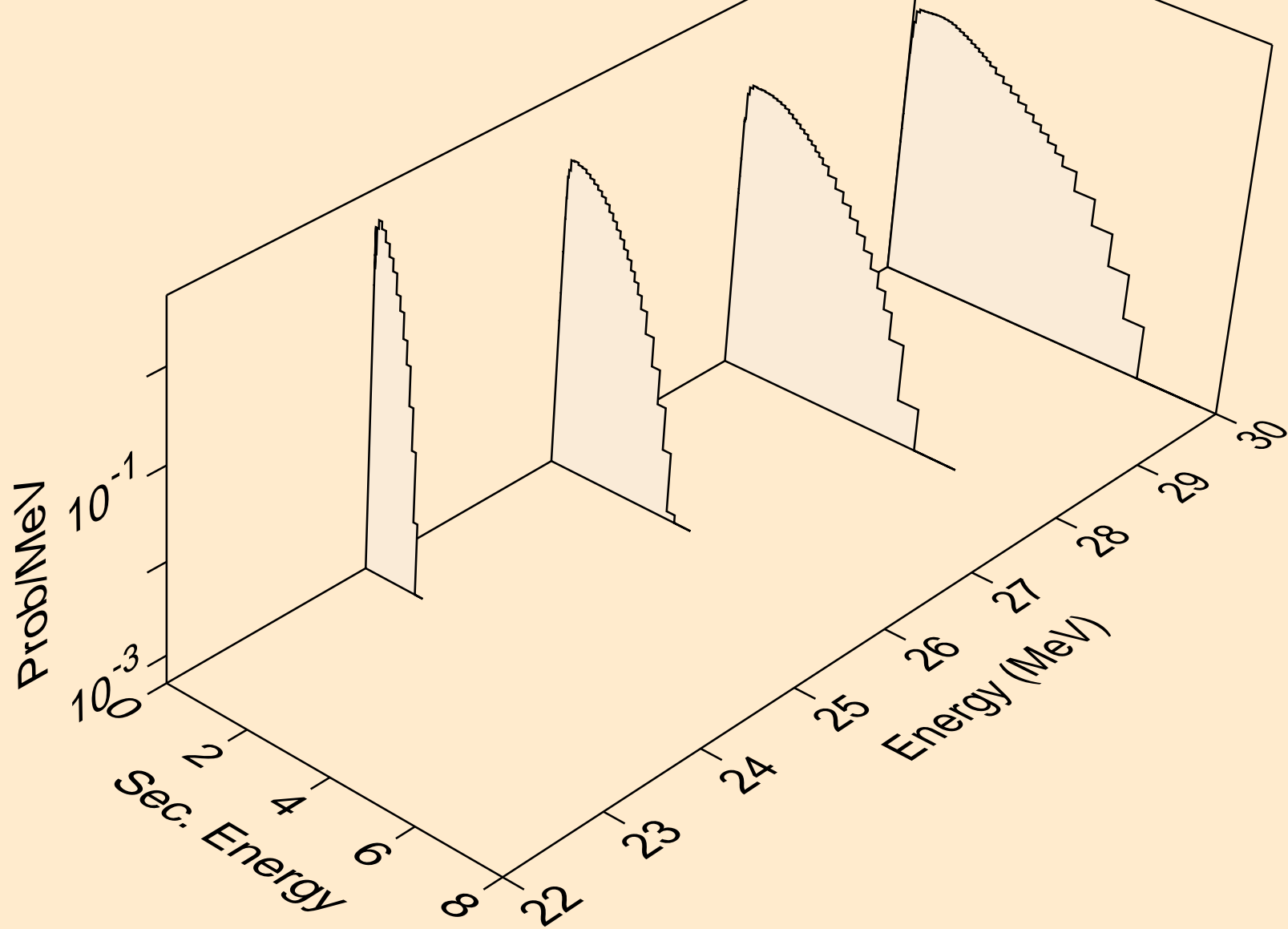

FE062 NEUTRON ACER TENDL-2023 LIBRARY; T=0.K
Neutron emission for (n,2np)

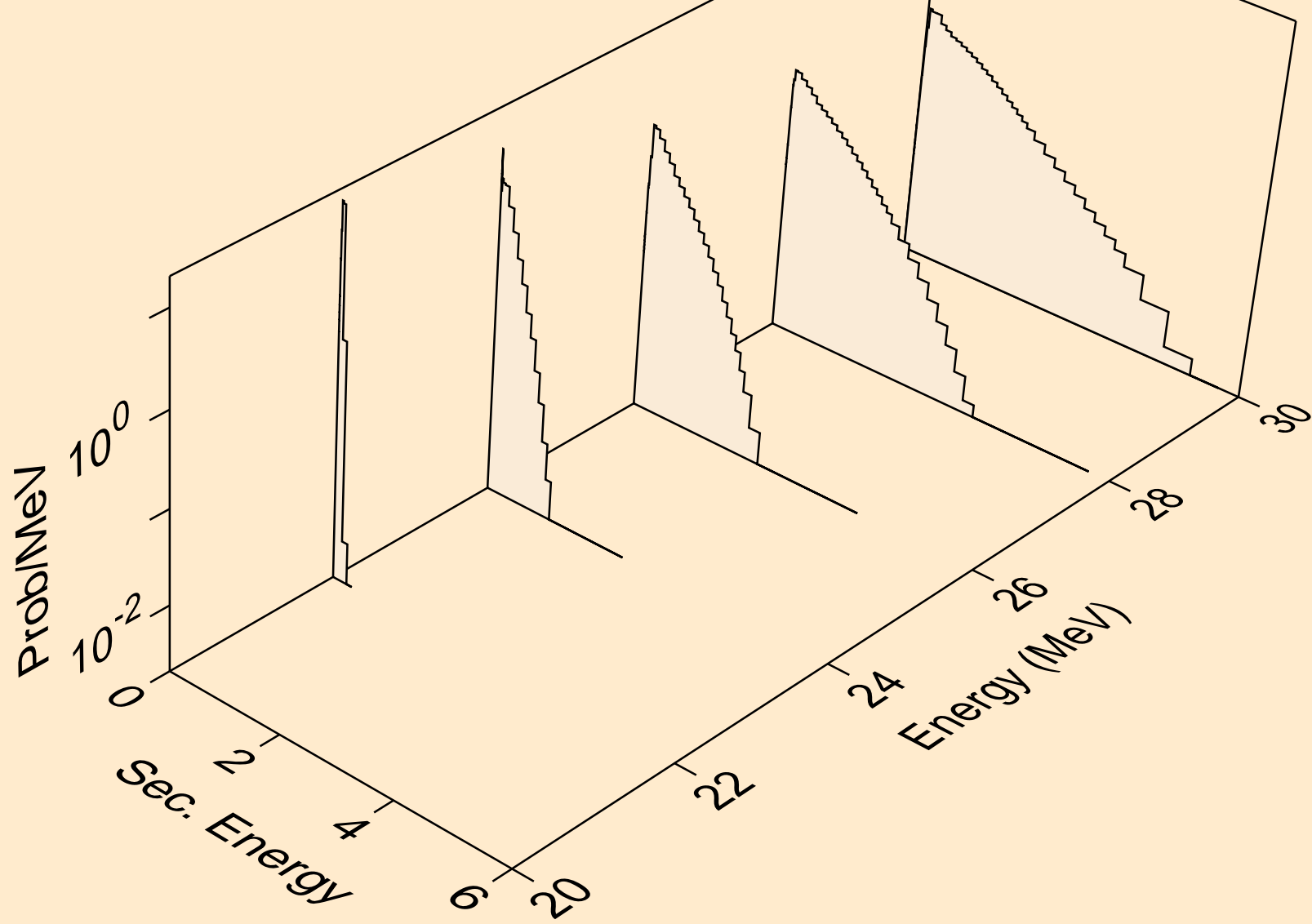

FE062 NEUTRON ACER TENDL-2023 LIBRARY; T=0.K
Neutron emission for (n,3np)

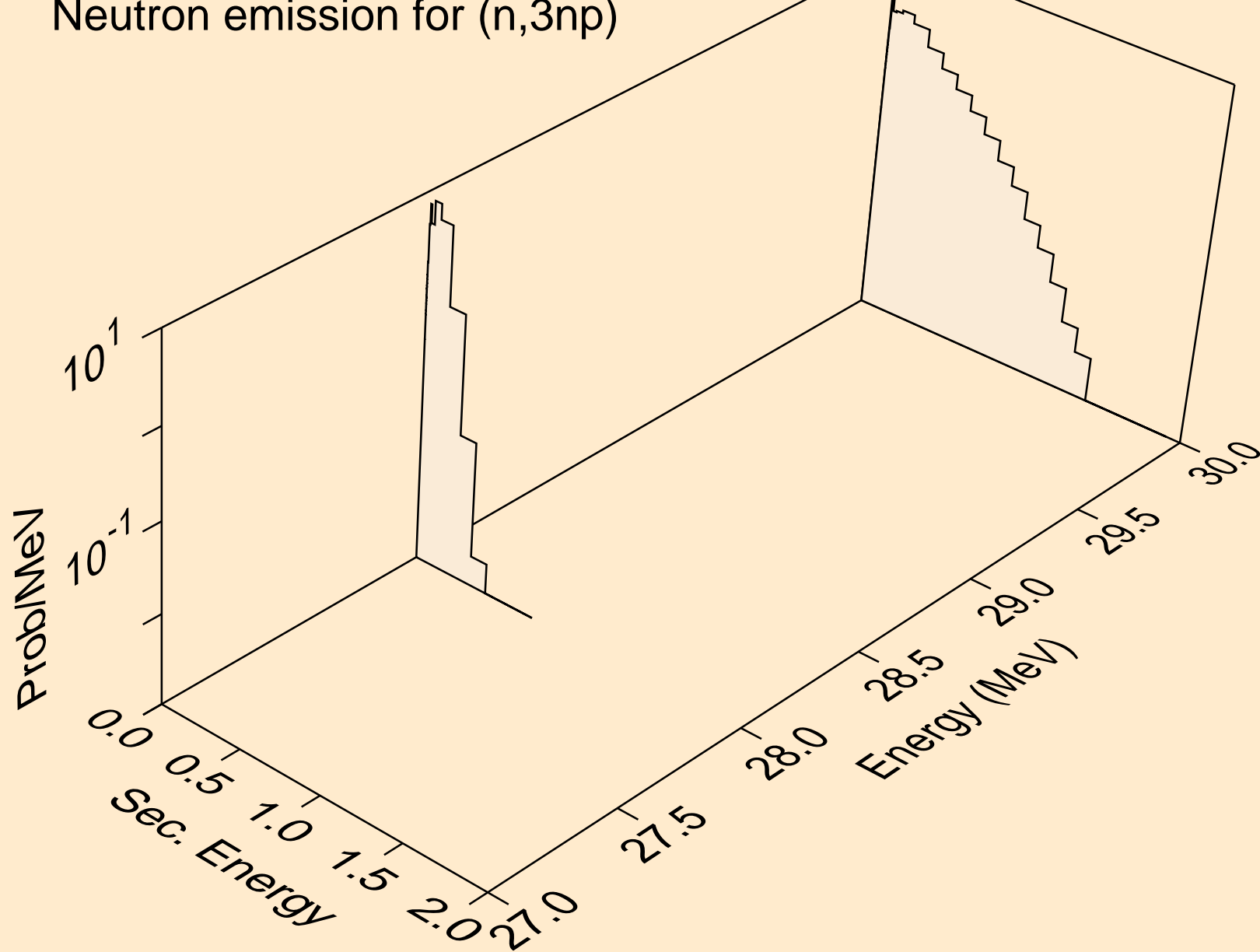

FE062 NEUTRON ACER TENDL-2023 LIBRARY; T=0.K
Neutron emission for (n,n*c)

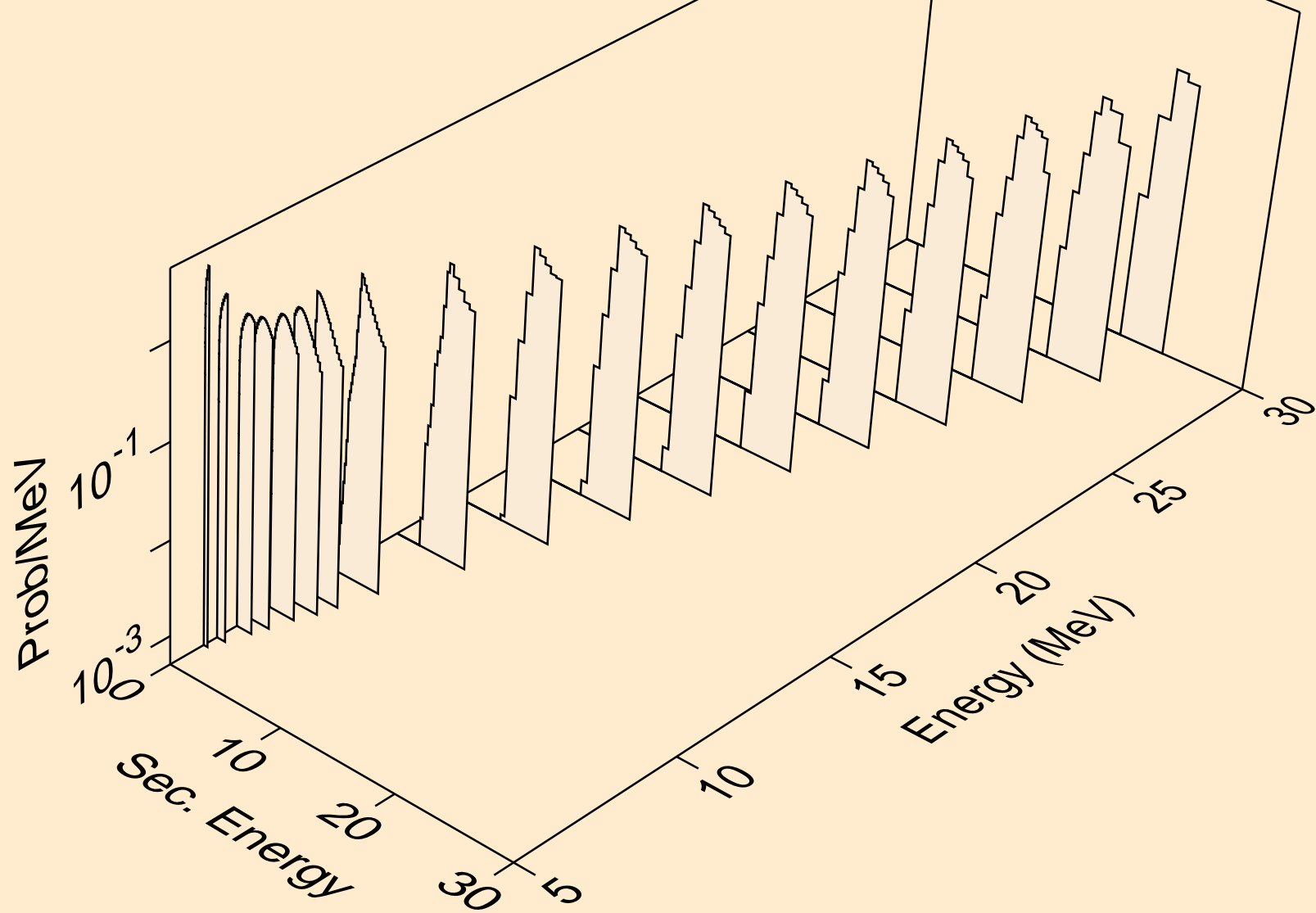

FE062 NEUTRON ACER TENDL-2023 LIBRARY; T=0.K
Photon emission for (n,x)

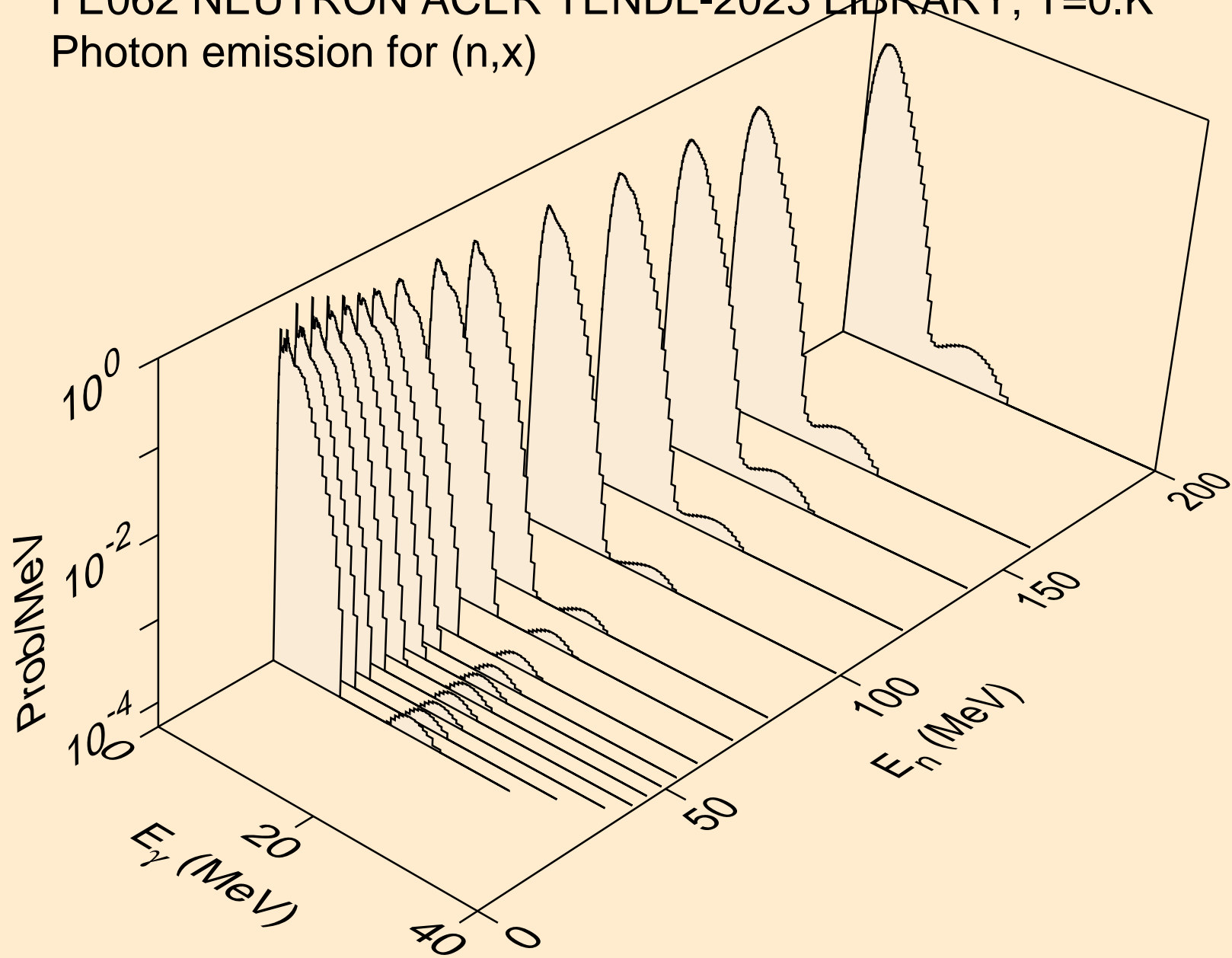

FE062 NEUTRON ACER TENDL-2023 LIBRARY; T=0.K
Photon emission for (n,2nd)

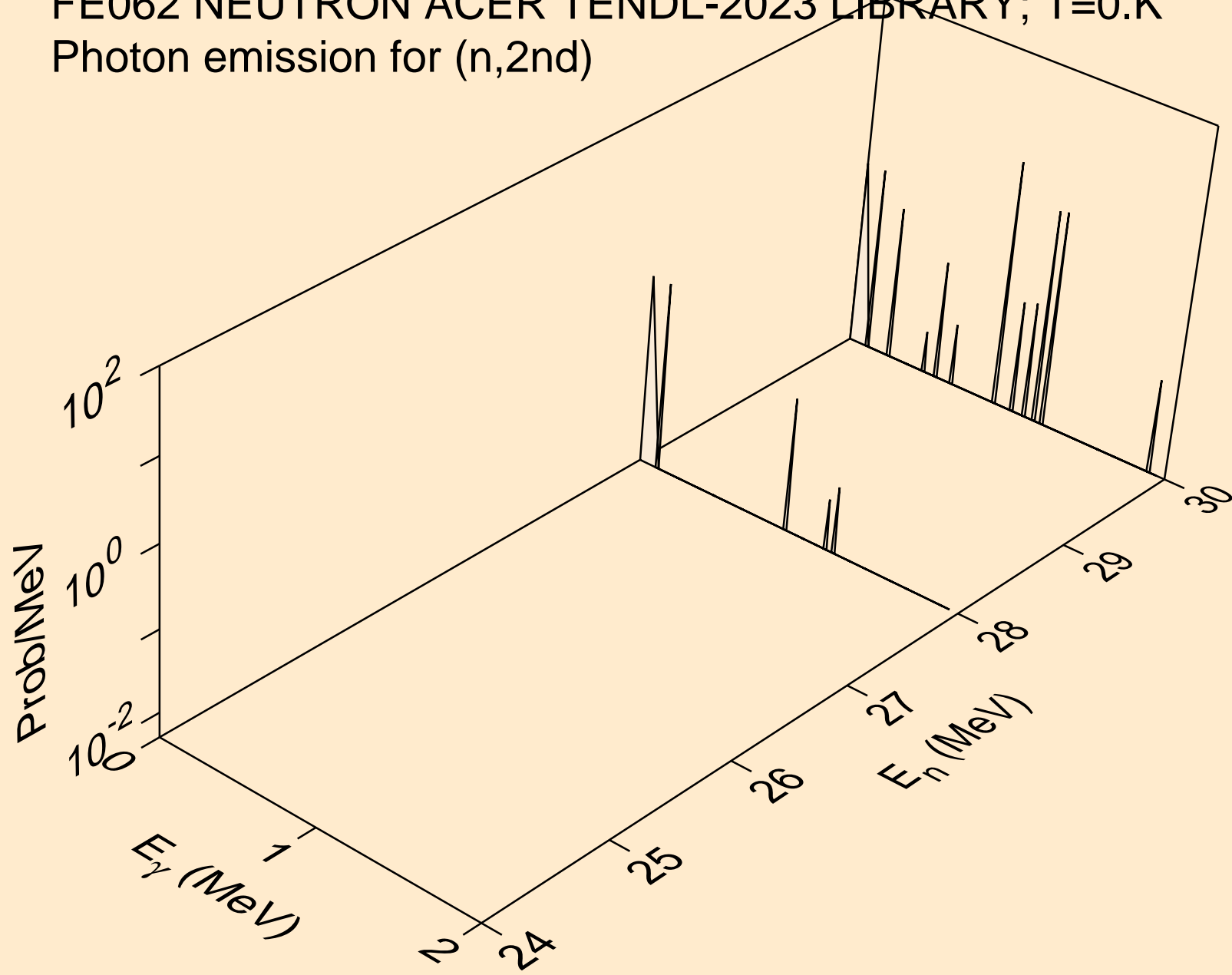

FE062 NEUTRON ACER TENDL-2023 LIBRARY; T=0.K
Photon emission for (n,2n)

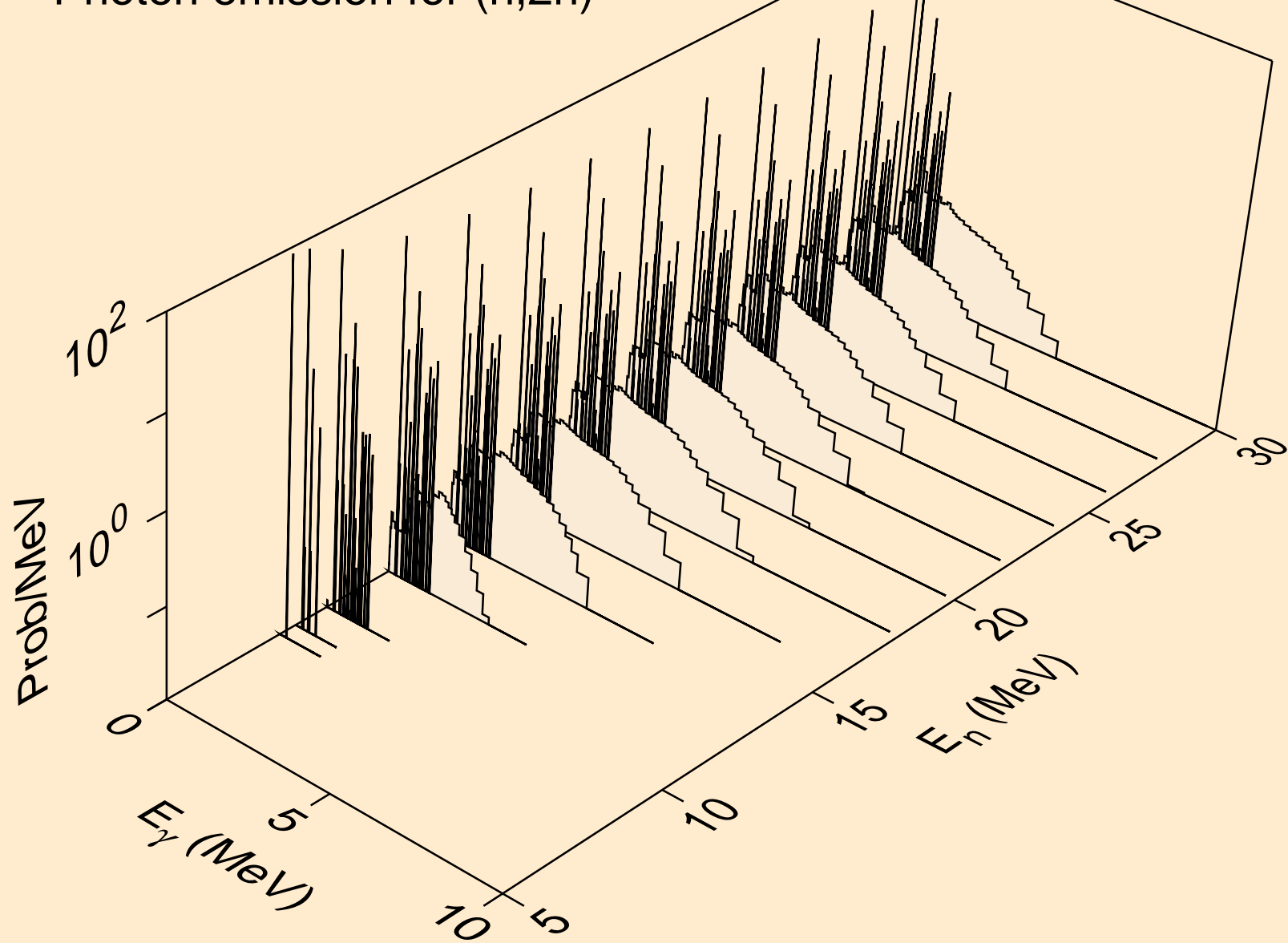

FE062 NEUTRON ACER TENDL-2023 LIBRARY; T=0.K
Photon emission for (n,3n)

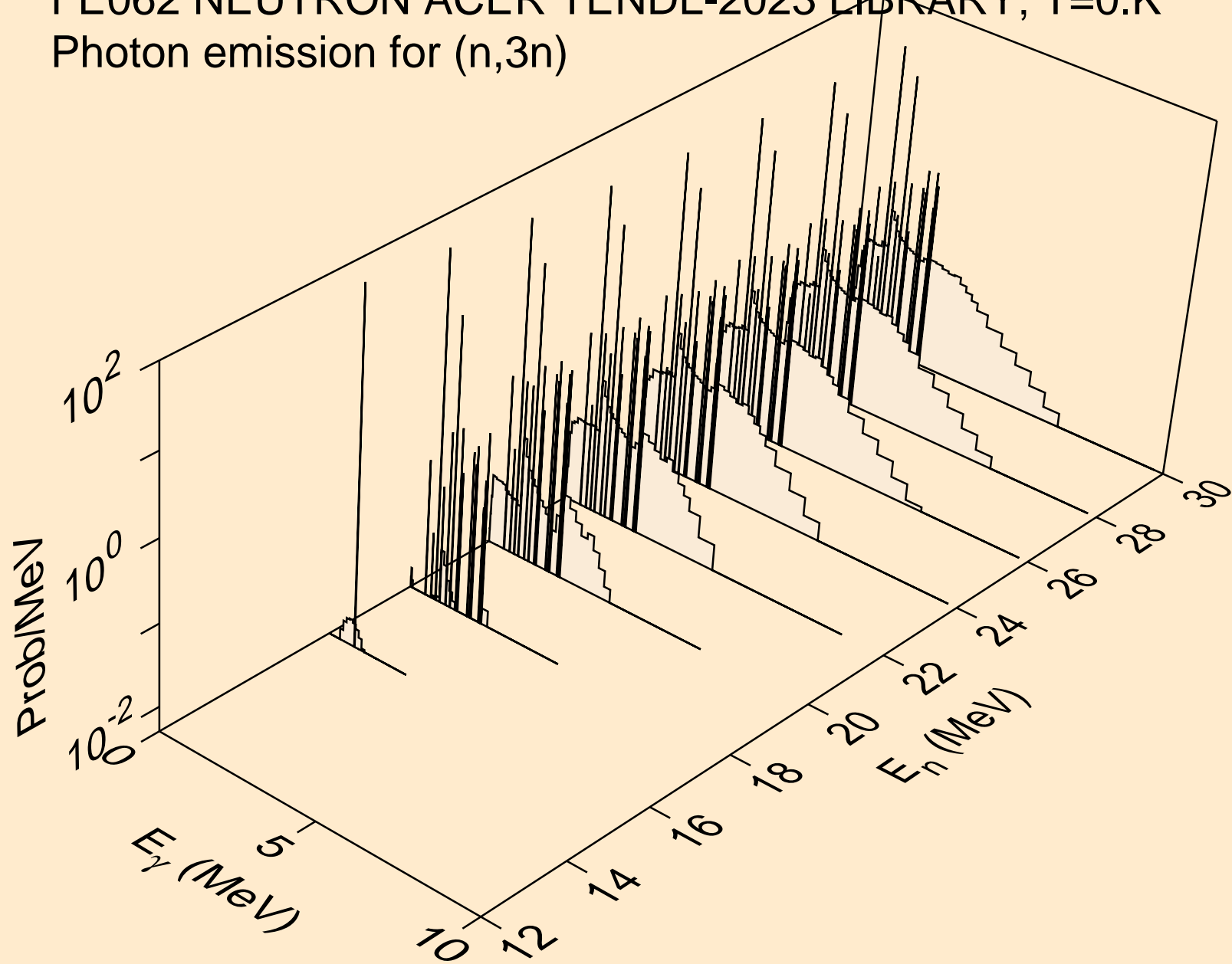

FE062 NEUTRON ACER TENDL-2023 LIBRARY; T=0.K
Photon emission for (n,n*)a

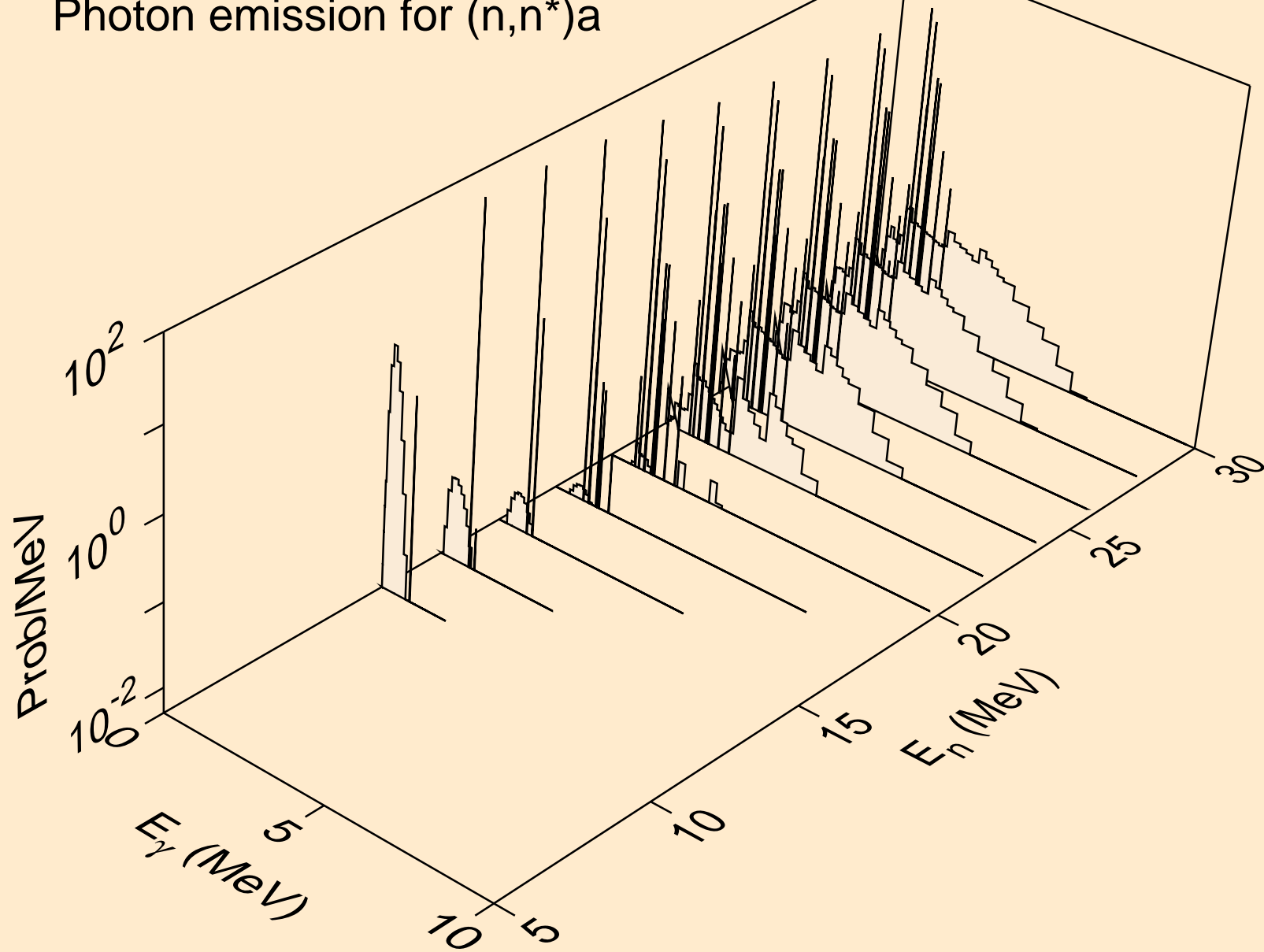

FE062 NEUTRON ACER TENDL-2023 LIBRARY; T=0.K
Photon emission for (n,2n)a

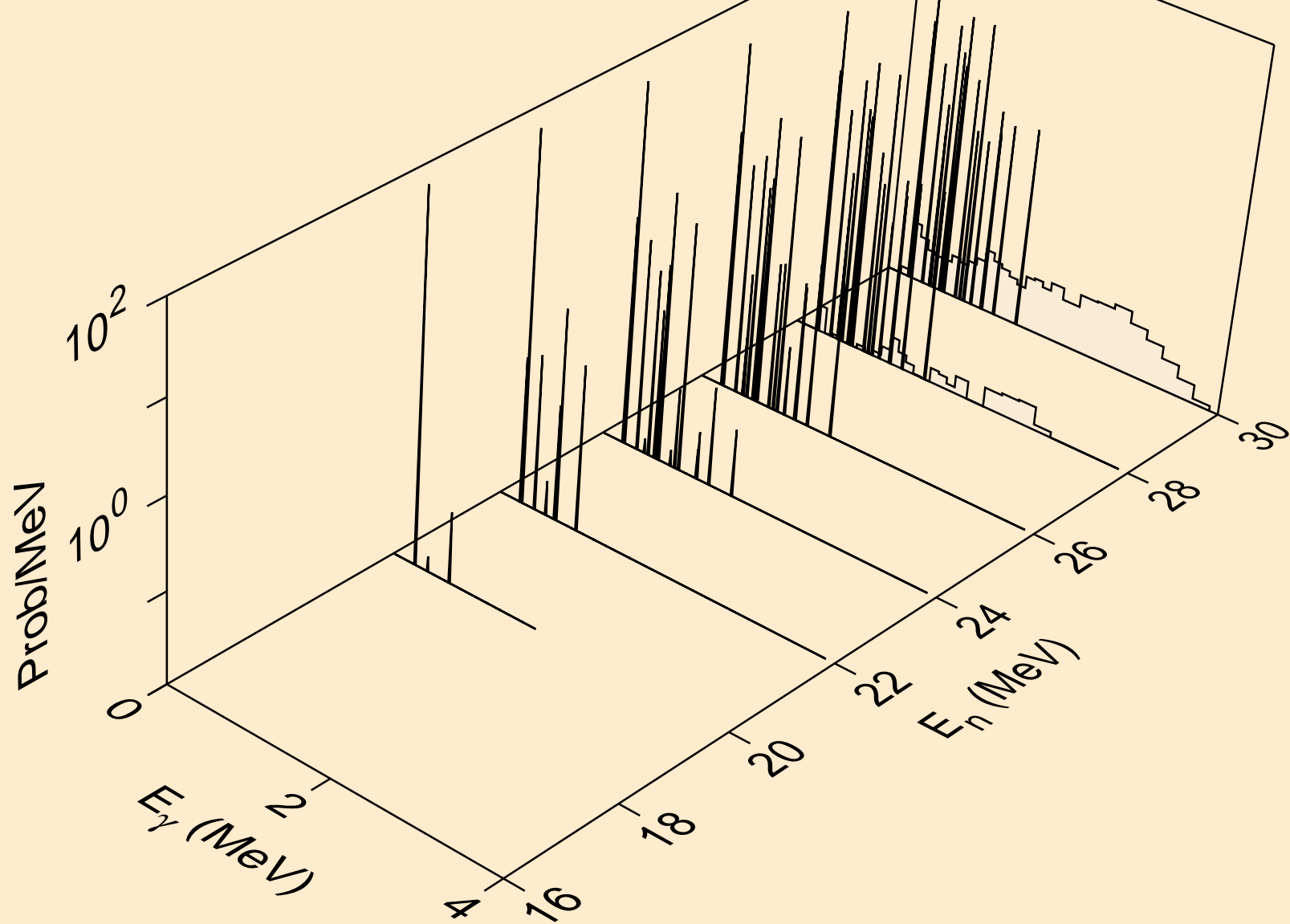

FE062 NEUTRON ACER TENDL-2023 LIBRARY; T=0.K
Photon emission for (n,3n)a

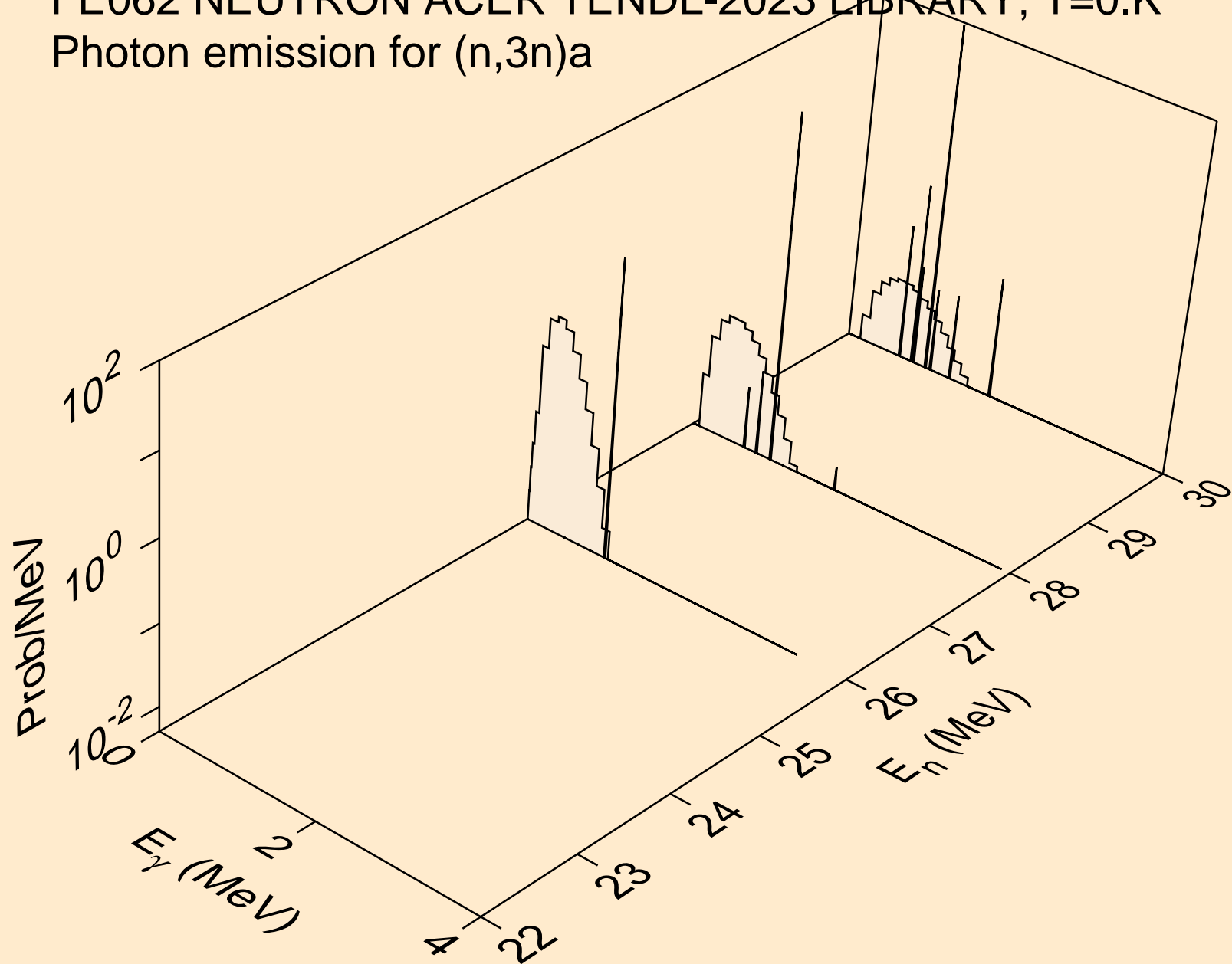

FE062 NEUTRON ACER TENDL-2023 LIBRARY; T=0.K
Photon emission for (n,n*)p

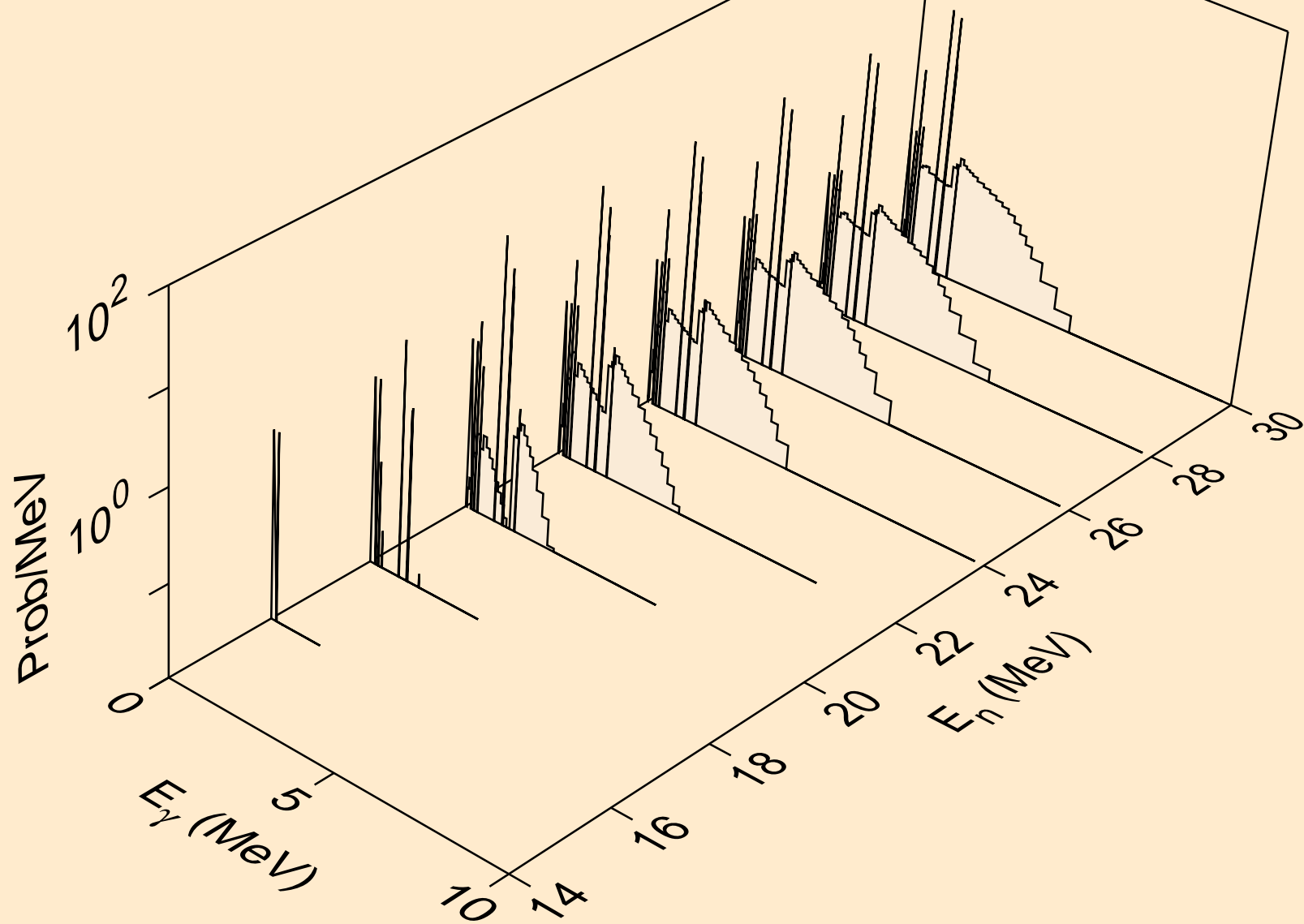

FE062 NEUTRON ACER TENDL-2023 LIBRARY; T=0.K
Photon emission for (n,n*)d

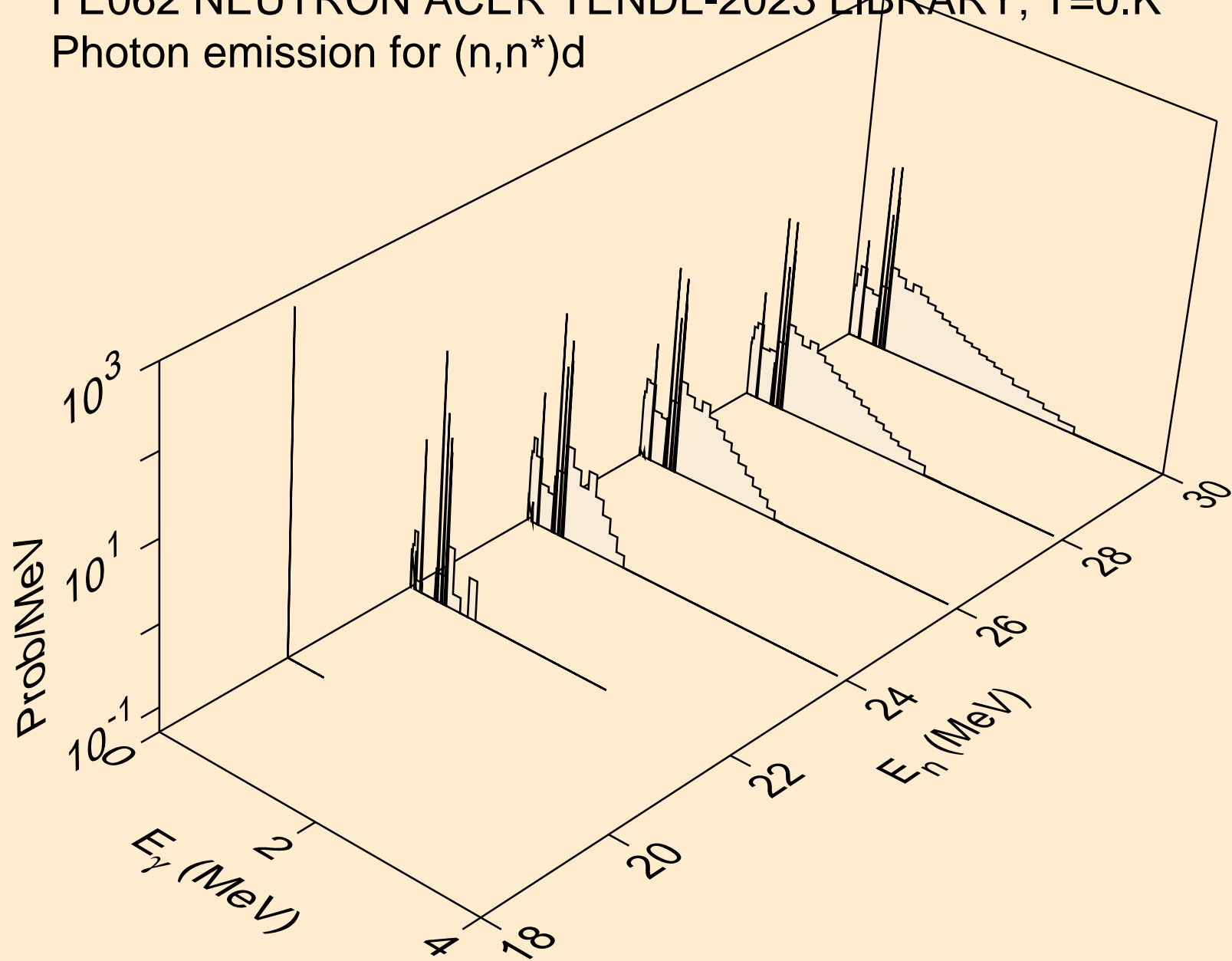

FE062 NEUTRON ACER TENDL-2023 LIBRARY; T=0.K
Photon emission for (n,n*)t

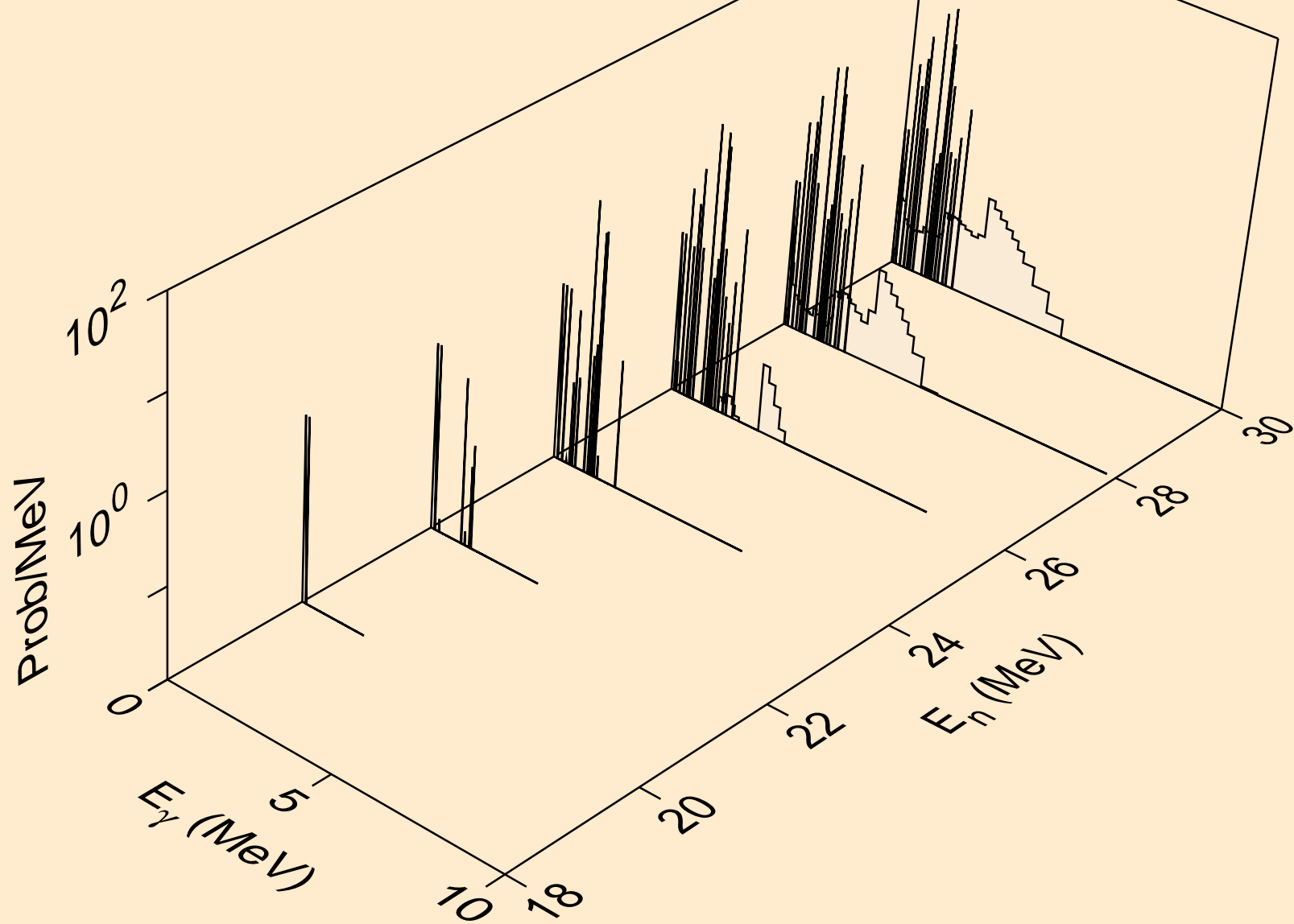

FE062 NEUTRON ACER TENDL-2023 LIBRARY; T=0.K
Photon emission for (n,4n)

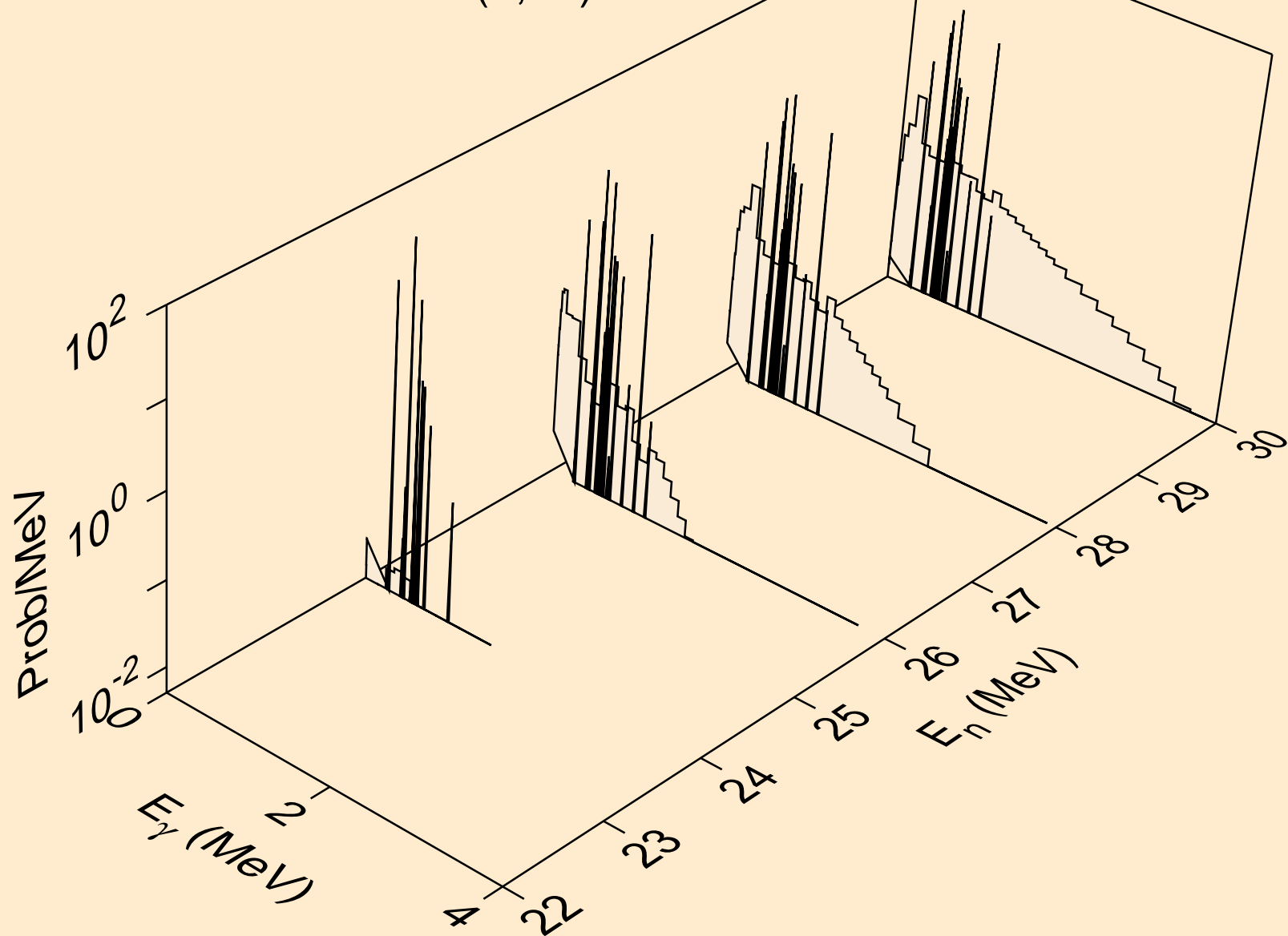

FE062 NEUTRON ACER TENDL-2023 LIBRARY; T=0.K
Photon emission for (n,2np)

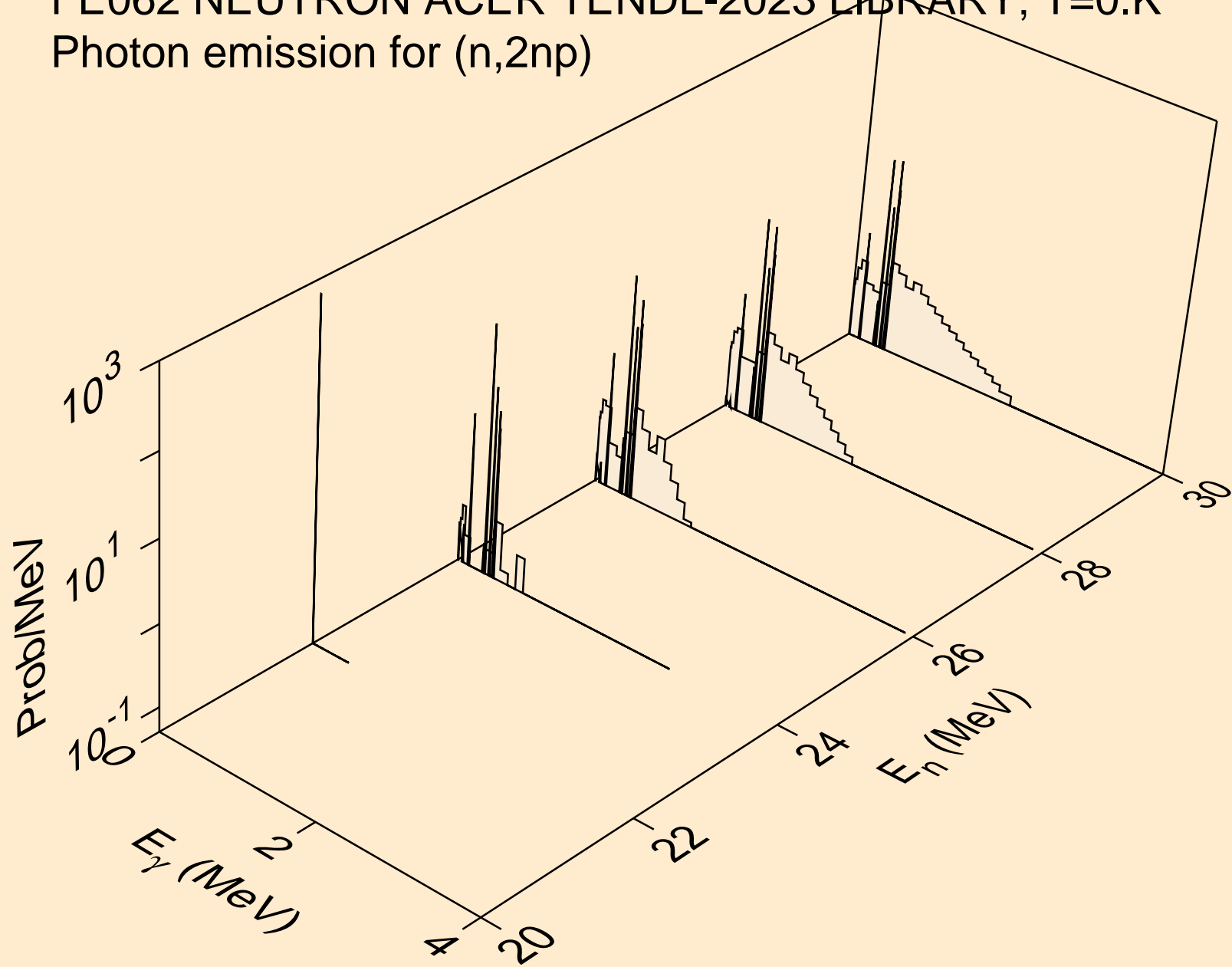

FE062 NEUTRON ACER TENDL-2023 LIBRARY; T=0.K
Photon emission for (n,3np)

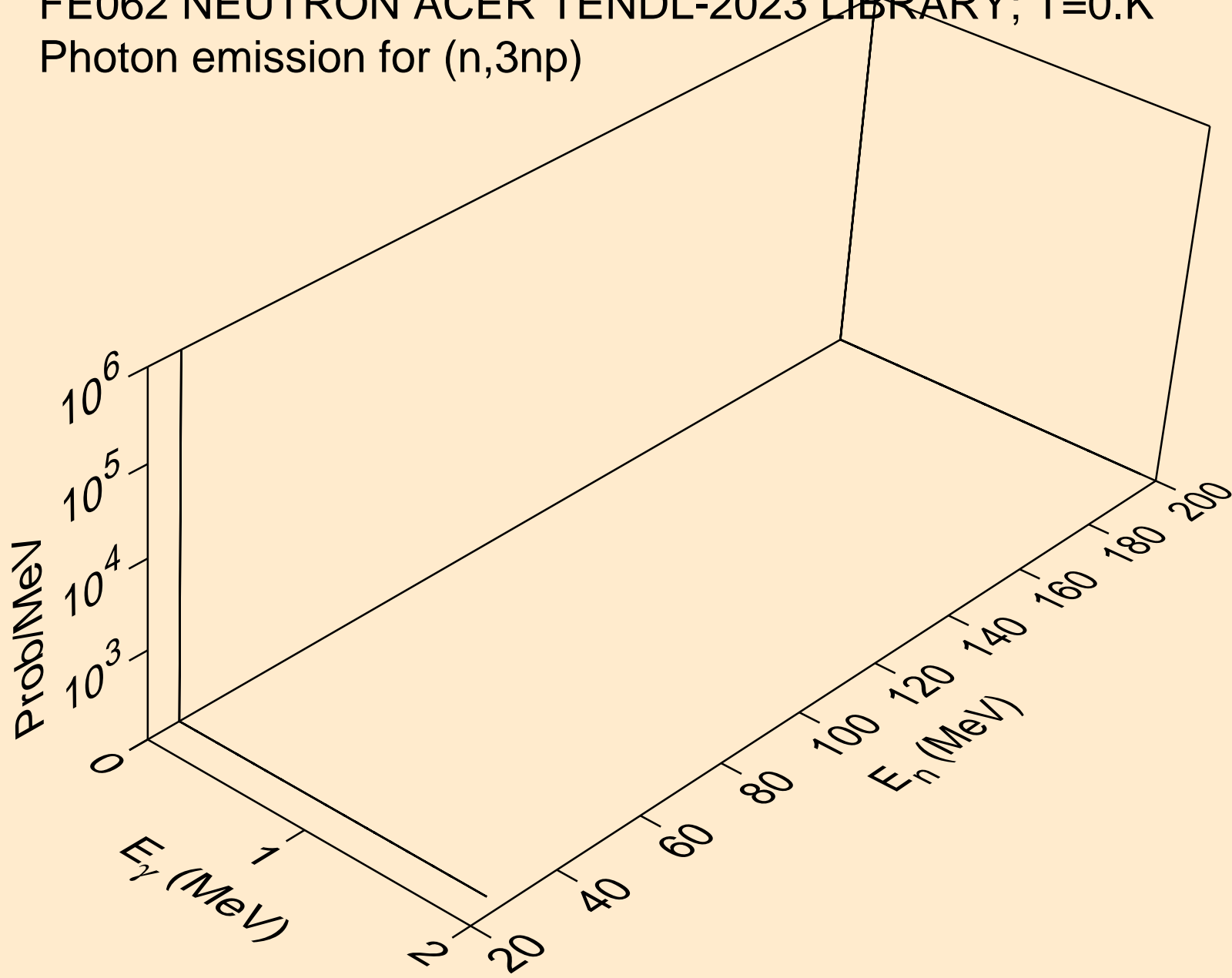

FE062 NEUTRON ACER TENDL-2023 LIBRARY; T=0.K
Photon emission for (n,n*c)

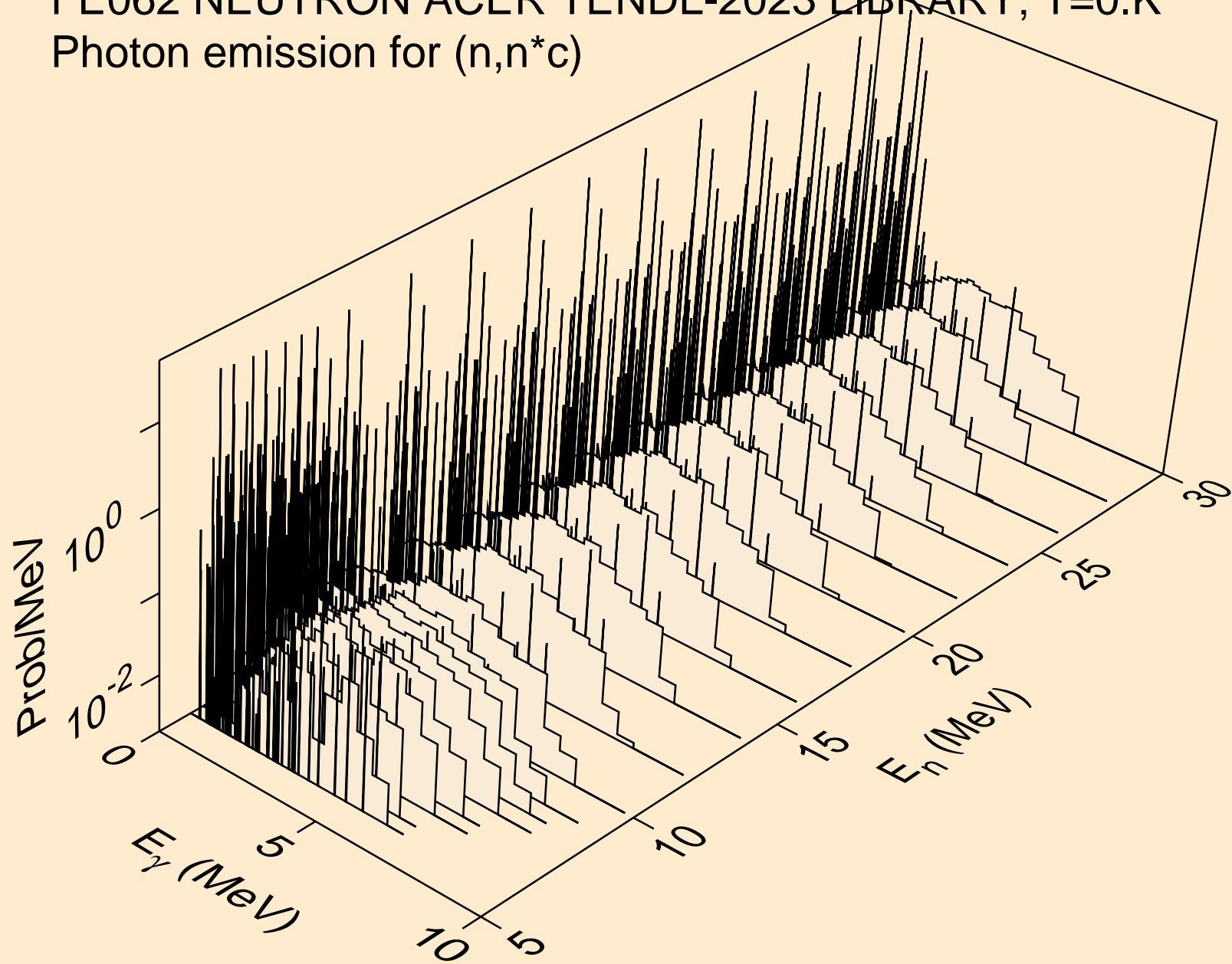

FE062 NEUTRON ACER TENDL-2023 LIBRARY; T=0.K
Photon emission for (n,gma)

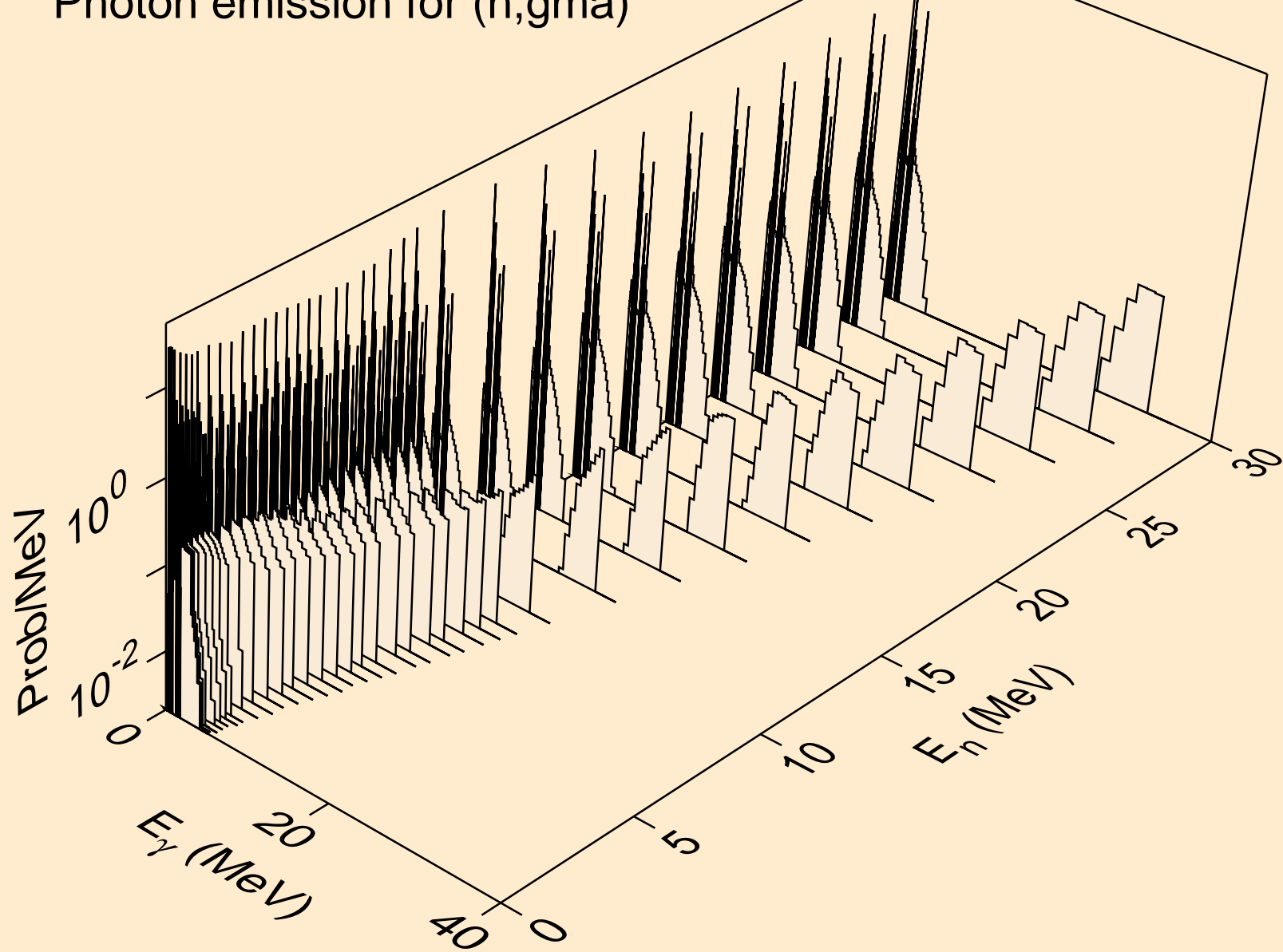

FE062 NEUTRON ACER TENDL-2023 LIBRARY; T=0.K
Photon emission for (n,p)

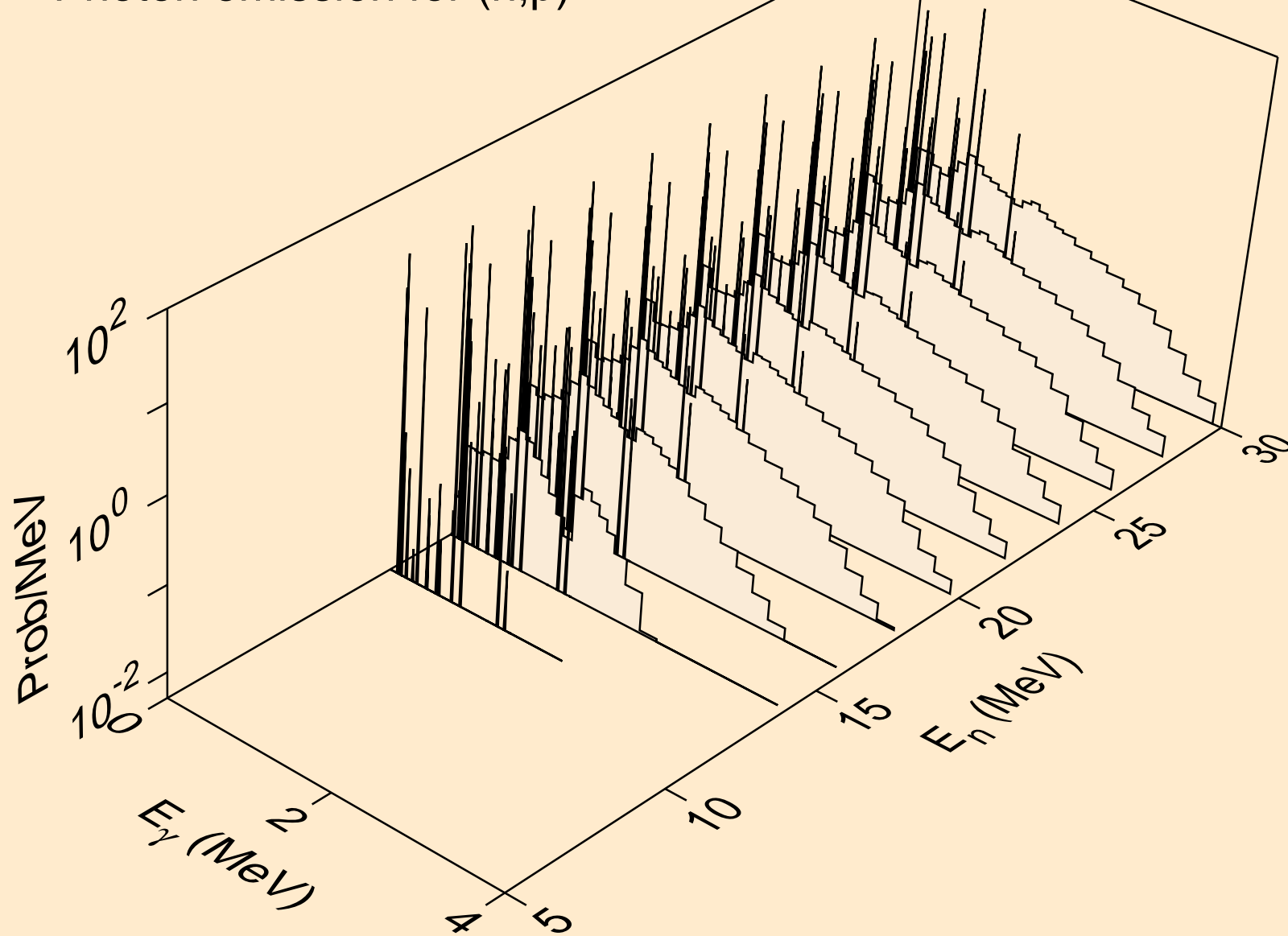

FE062 NEUTRON ACER TENDL-2023 LIBRARY; T=0.K
Photon emission for (n,d)

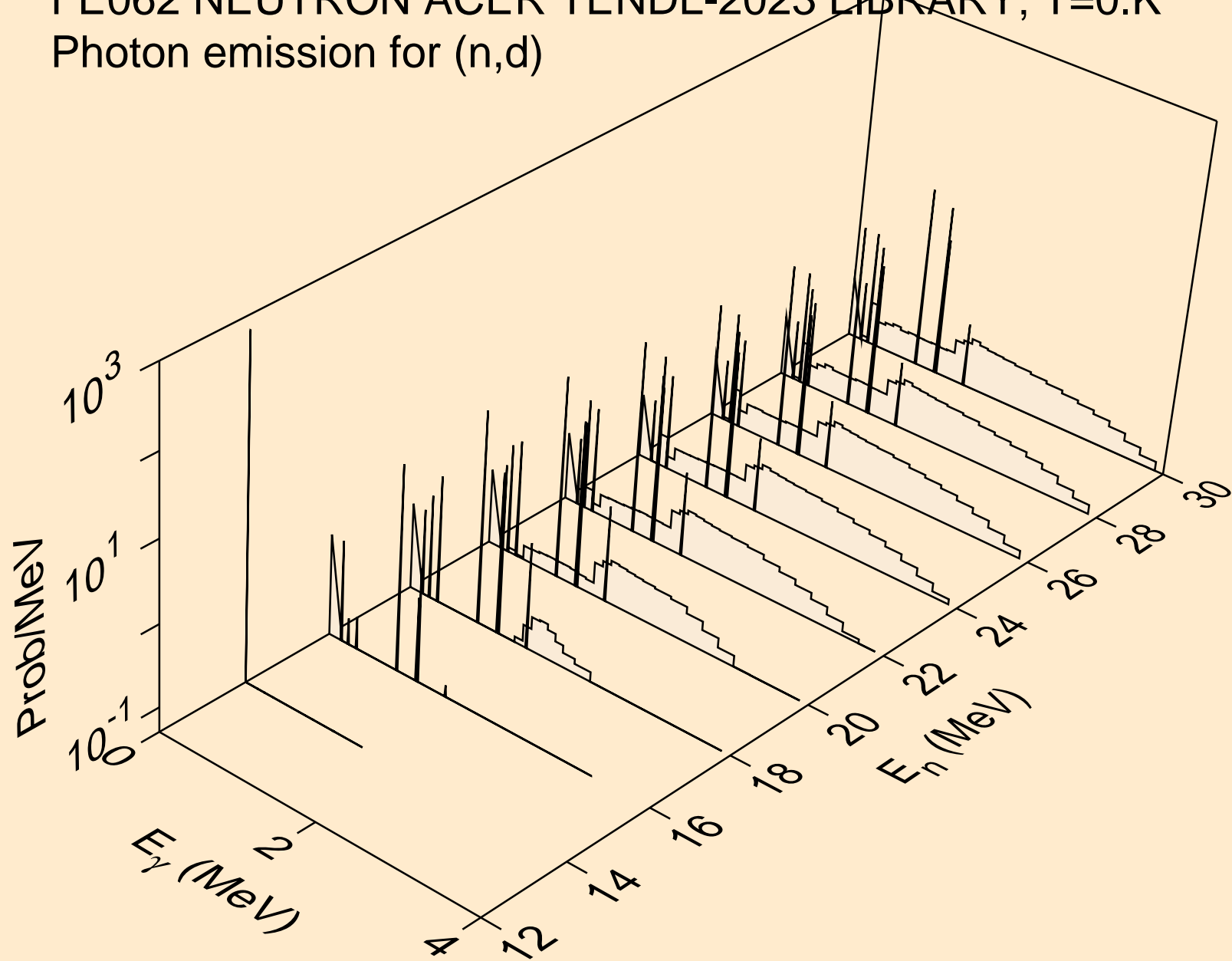

FE062 NEUTRON ACER TENDL-2023 LIBRARY; T=0.K
Photon emission for (n,t)

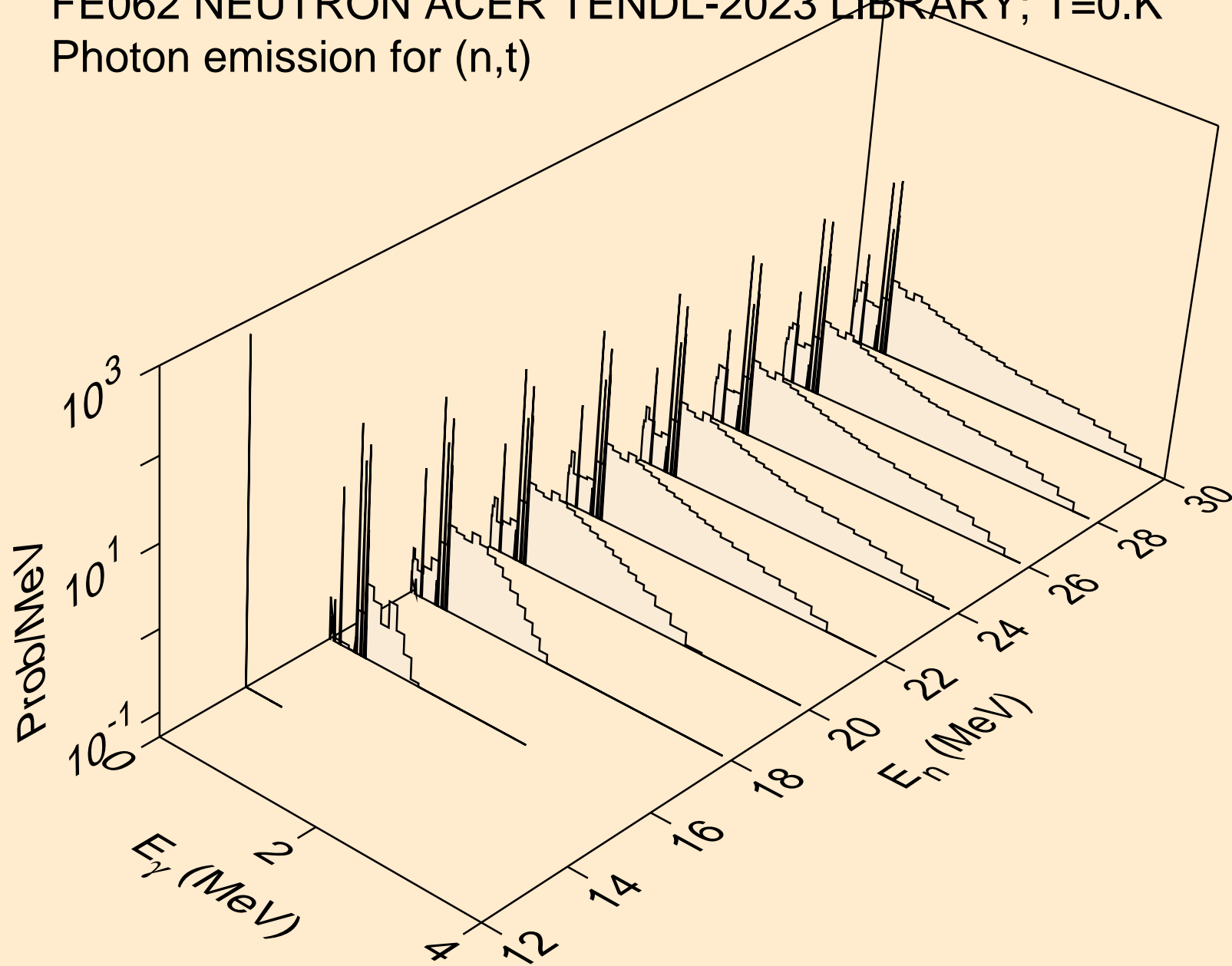

FE062 NEUTRON ACER TENDL-2023 LIBRARY; T=0.K
Photon emission for (n,he3)

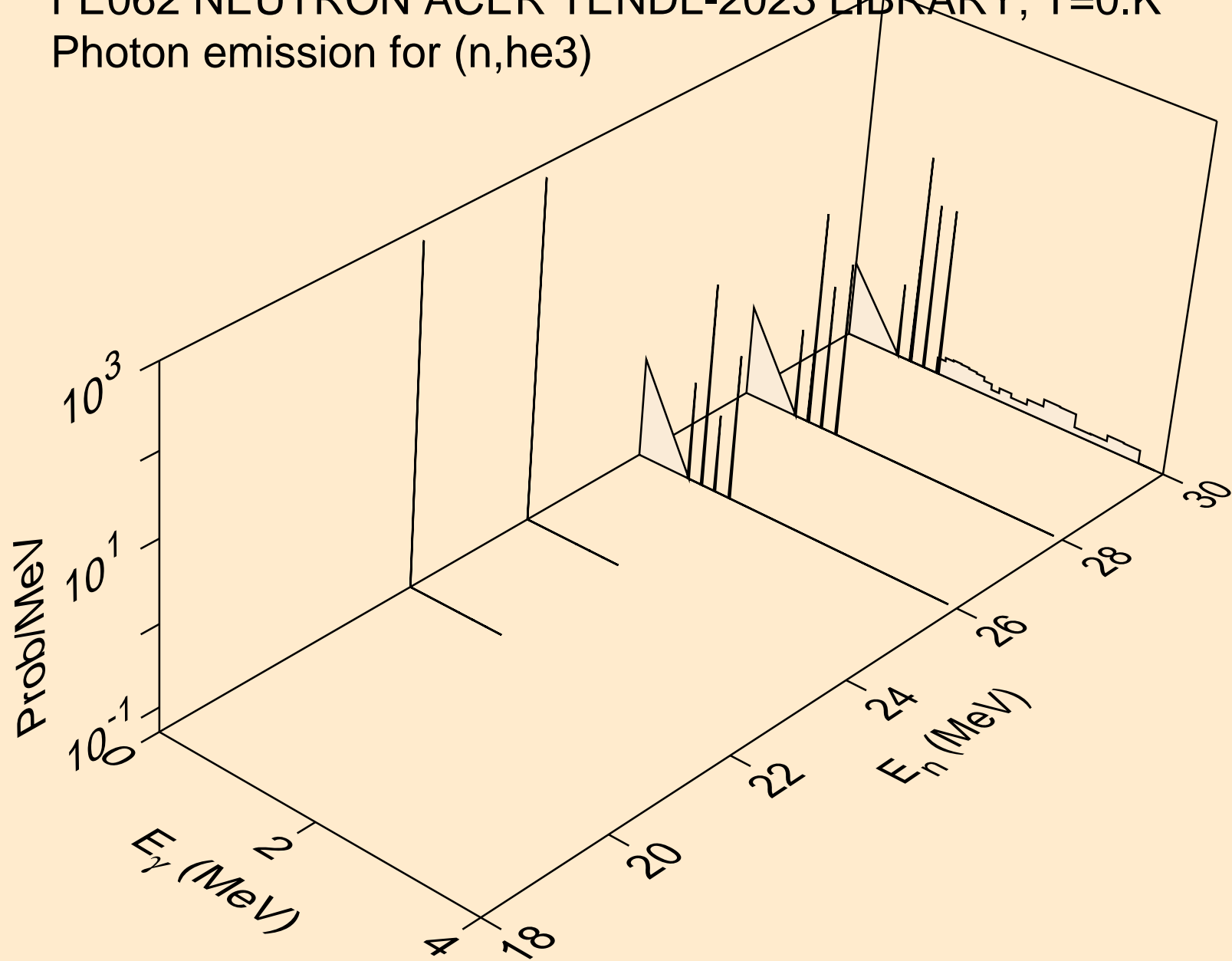

FE062 NEUTRON ACER TENDL-2023 LIBRARY; T=0.K
Photon emission for (n,a)

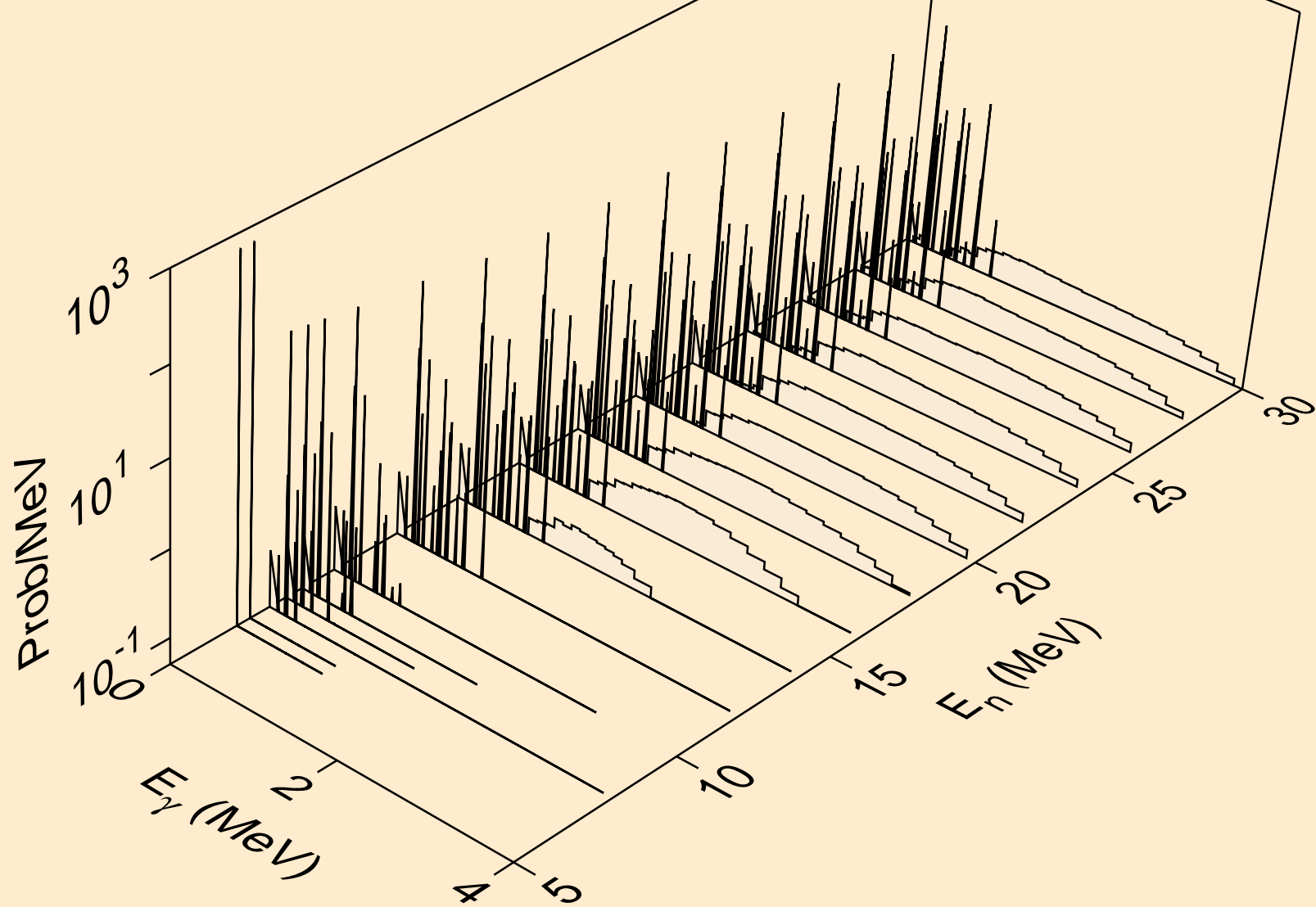

FE062 NEUTRON ACER TENDL-2023 LIBRARY; T=0.K
Photon emission for (n,2a)

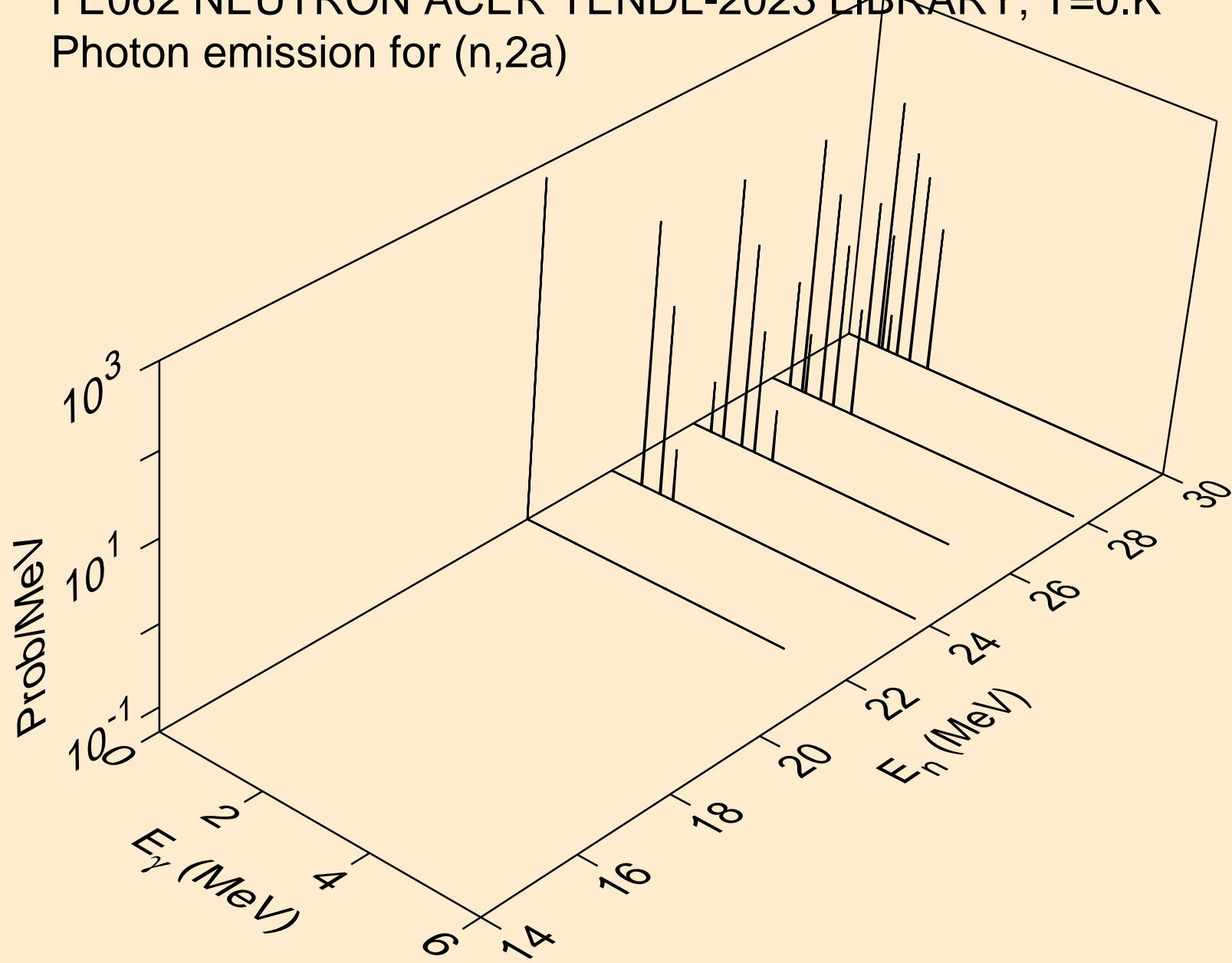

FE062 NEUTRON ACER TENDL-2023 LIBRARY; T=0.K
Photon emission for (n,2p)

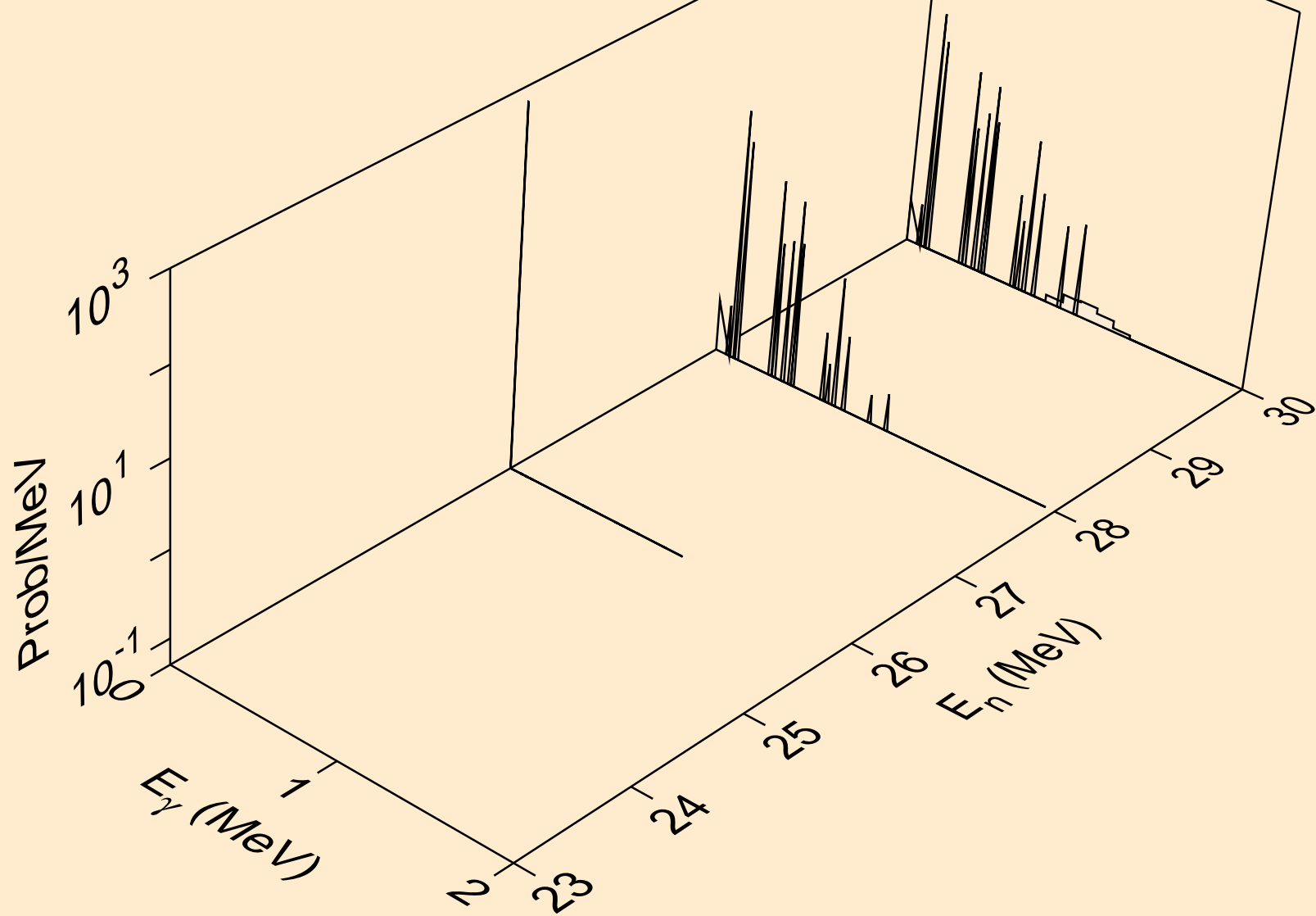

FE062 NEUTRON ACER TENDL-2023 LIBRARY; T=0.K
thermal capture photon spectrum

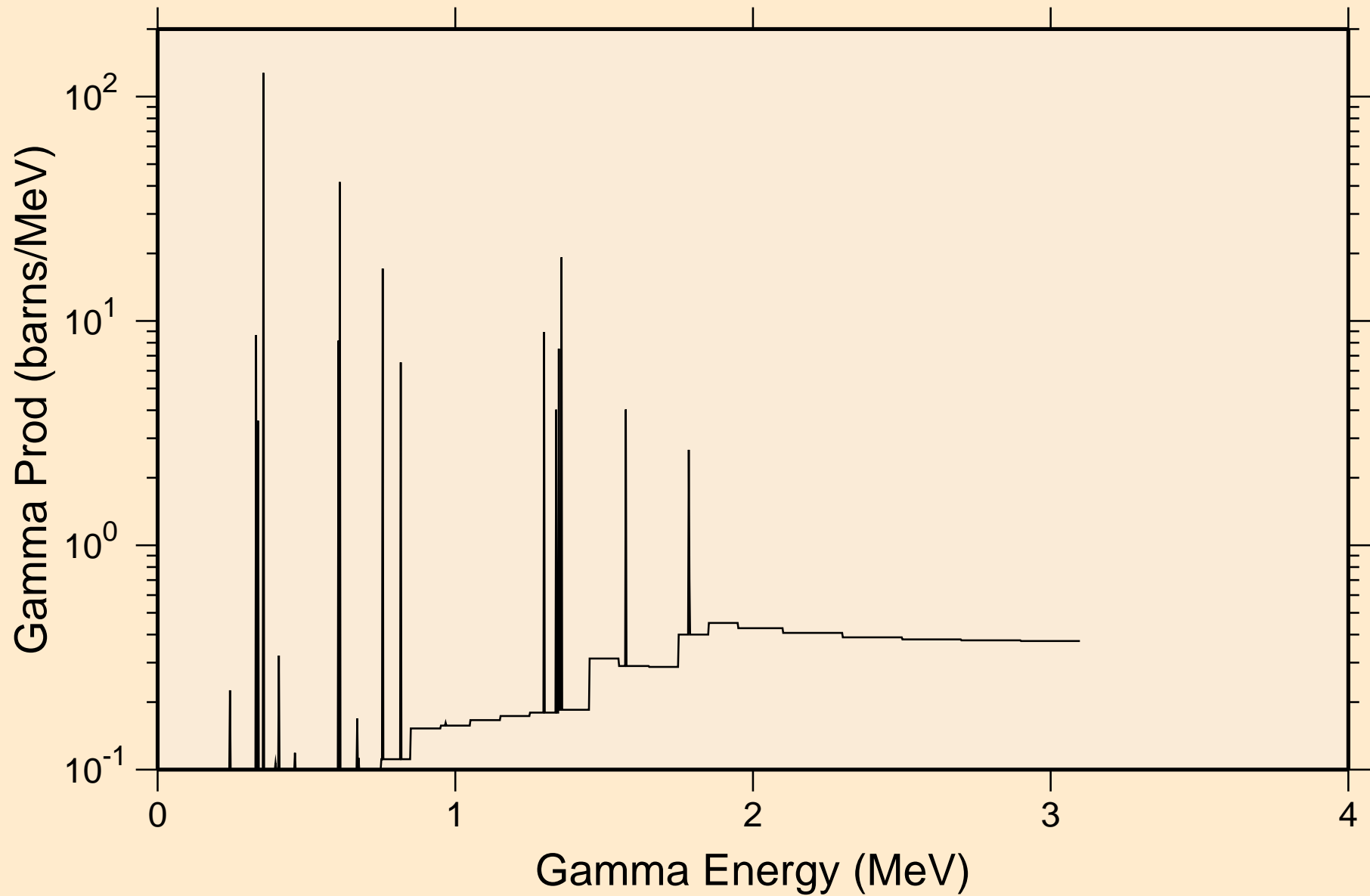

FE062 NEUTRON ACER TENDL-2023 LIBRARY; T=0.K
14 MeV photon spectrum

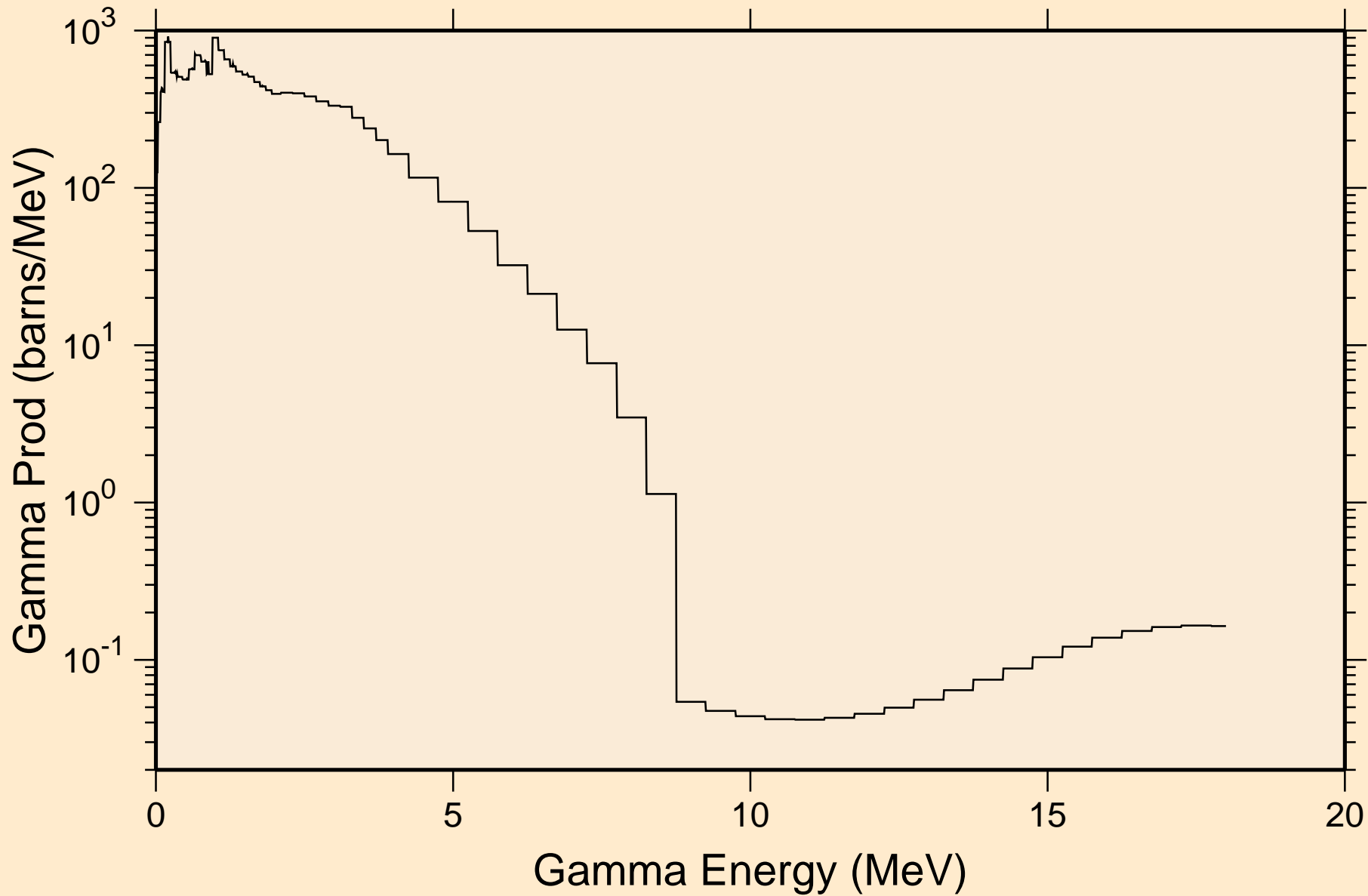

FE062 NEUTRON ACER TENDL-2023 LIBRARY; T=0.K

Particle heating contributions

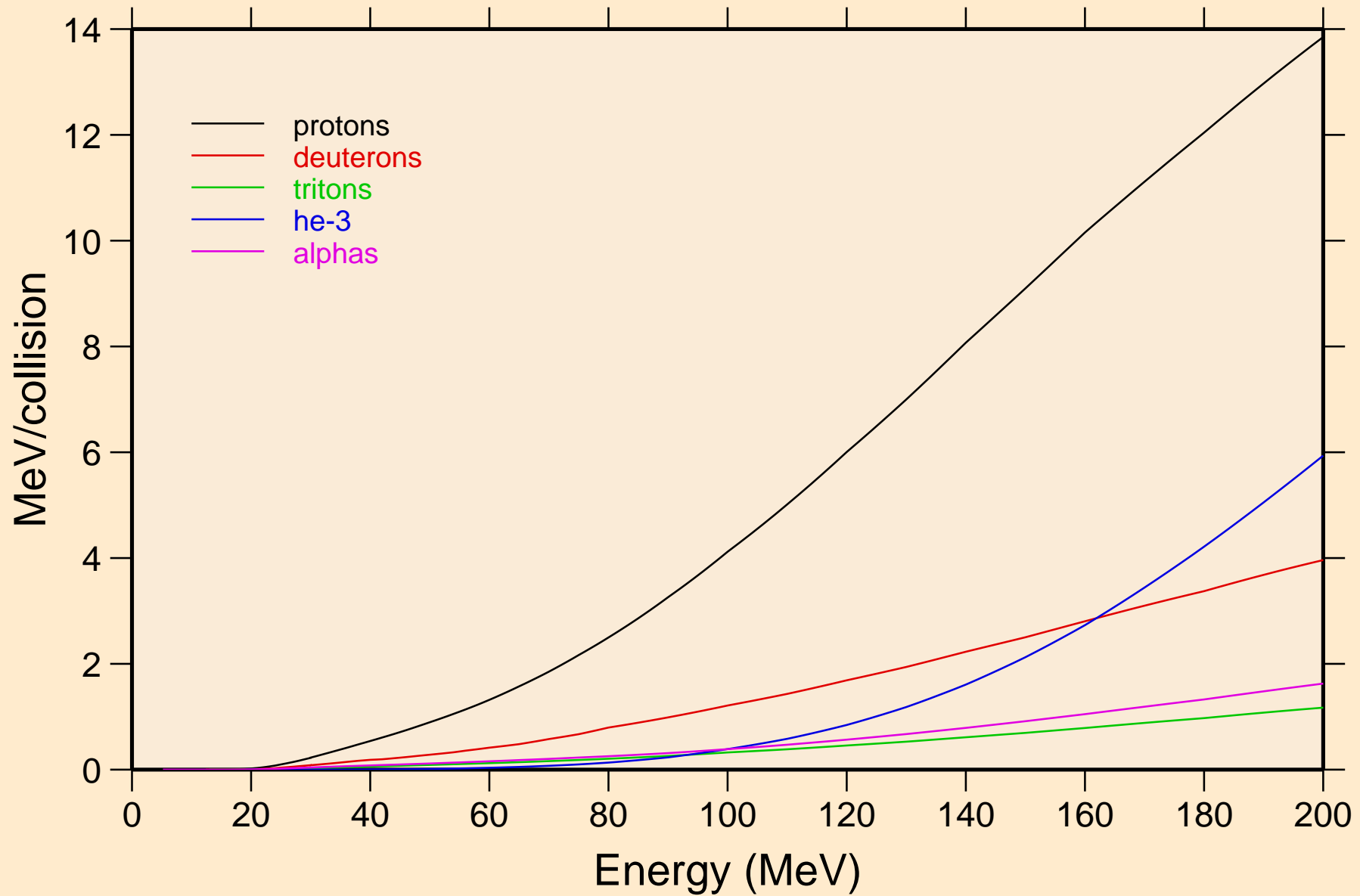

FE062 NEUTRON ACER TENDL-2023 LIBRARY; T=0.K
Recoil Heating

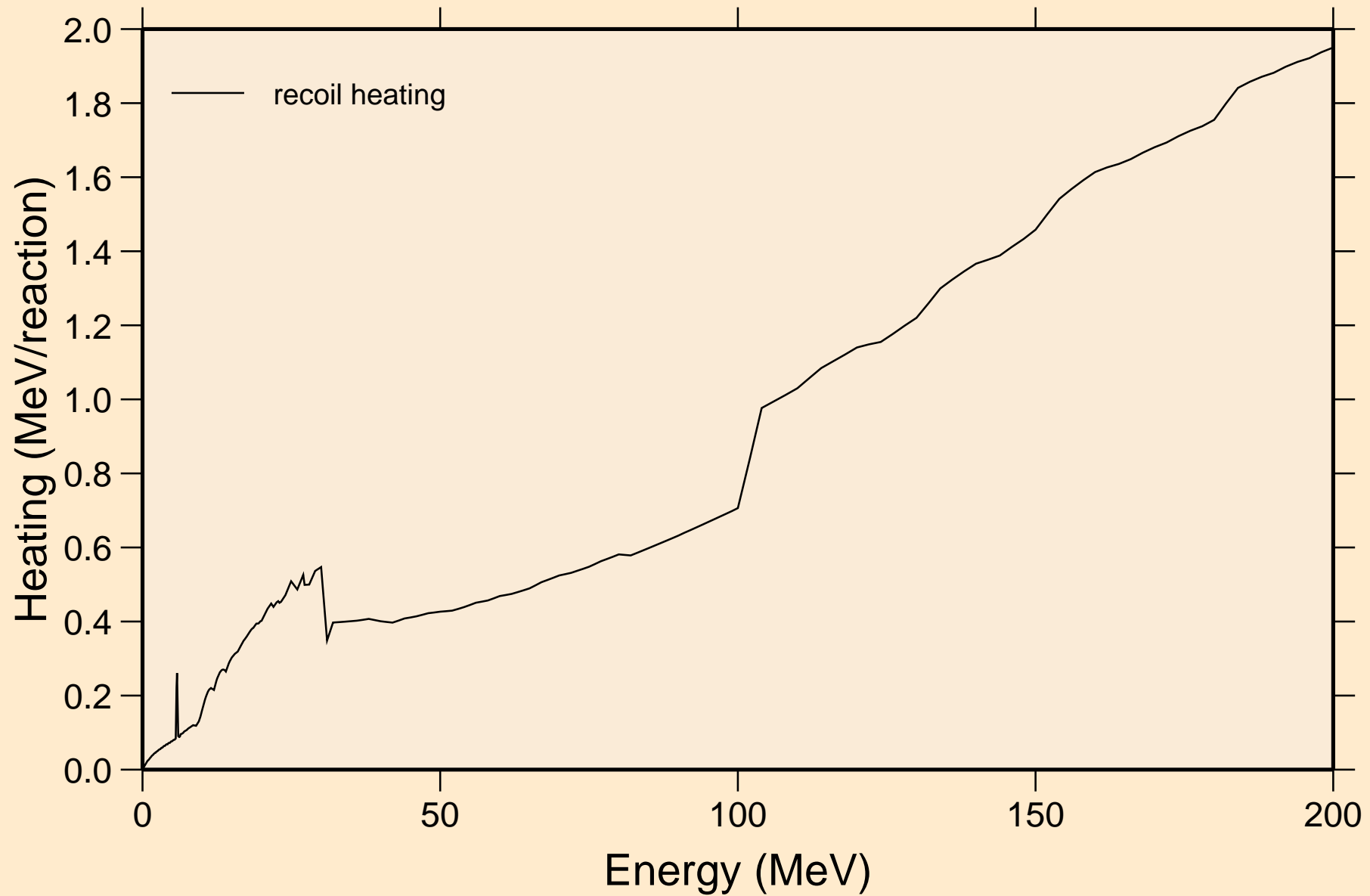

FE062 NEUTRON ACER TENDL-2023 LIBRARY; T=0.K

Particle production cross sections

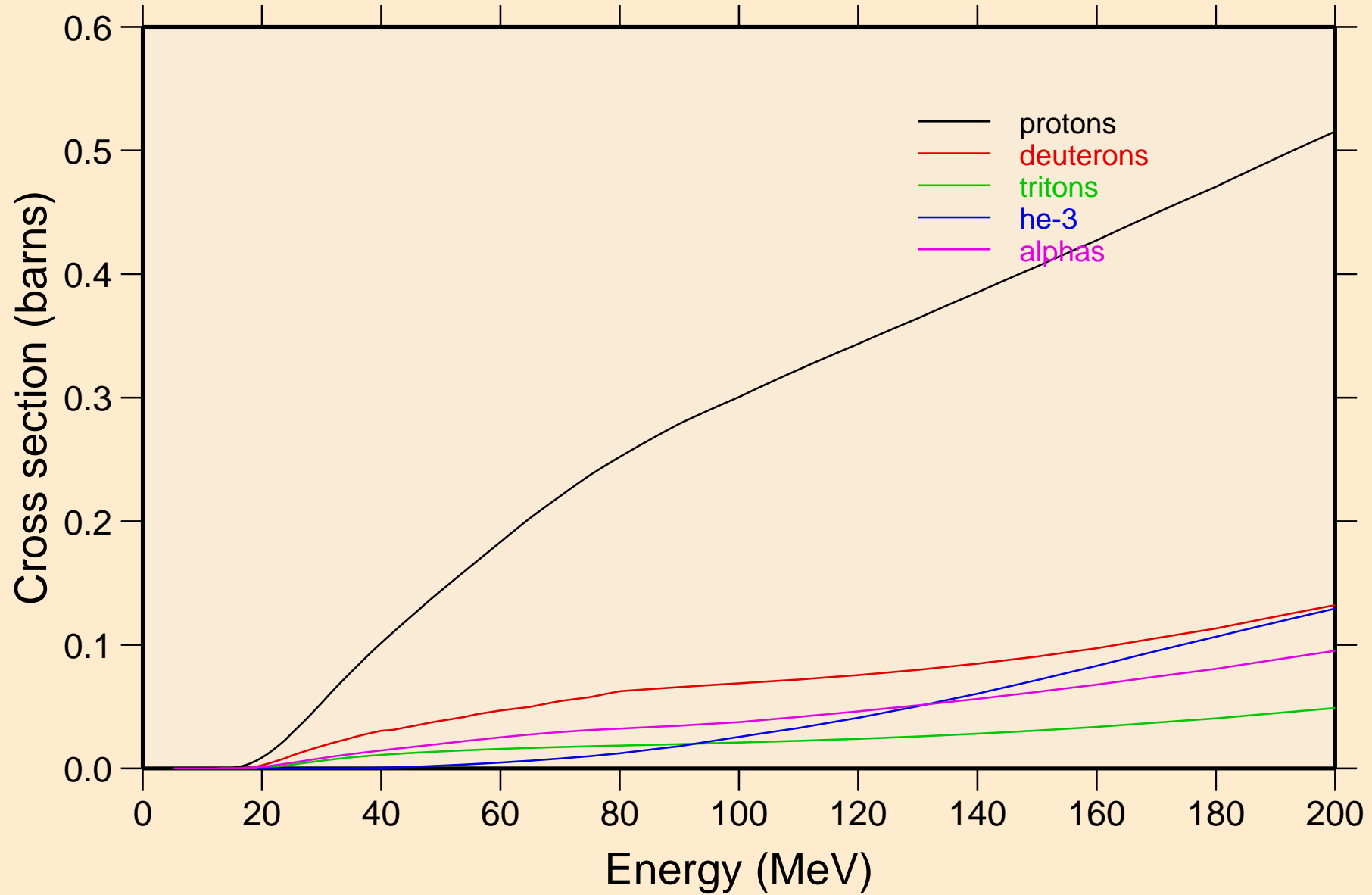

FE062 NEUTRON ACER TENDL-2023 LIBRARY; T=0.K
protons from (n,x)

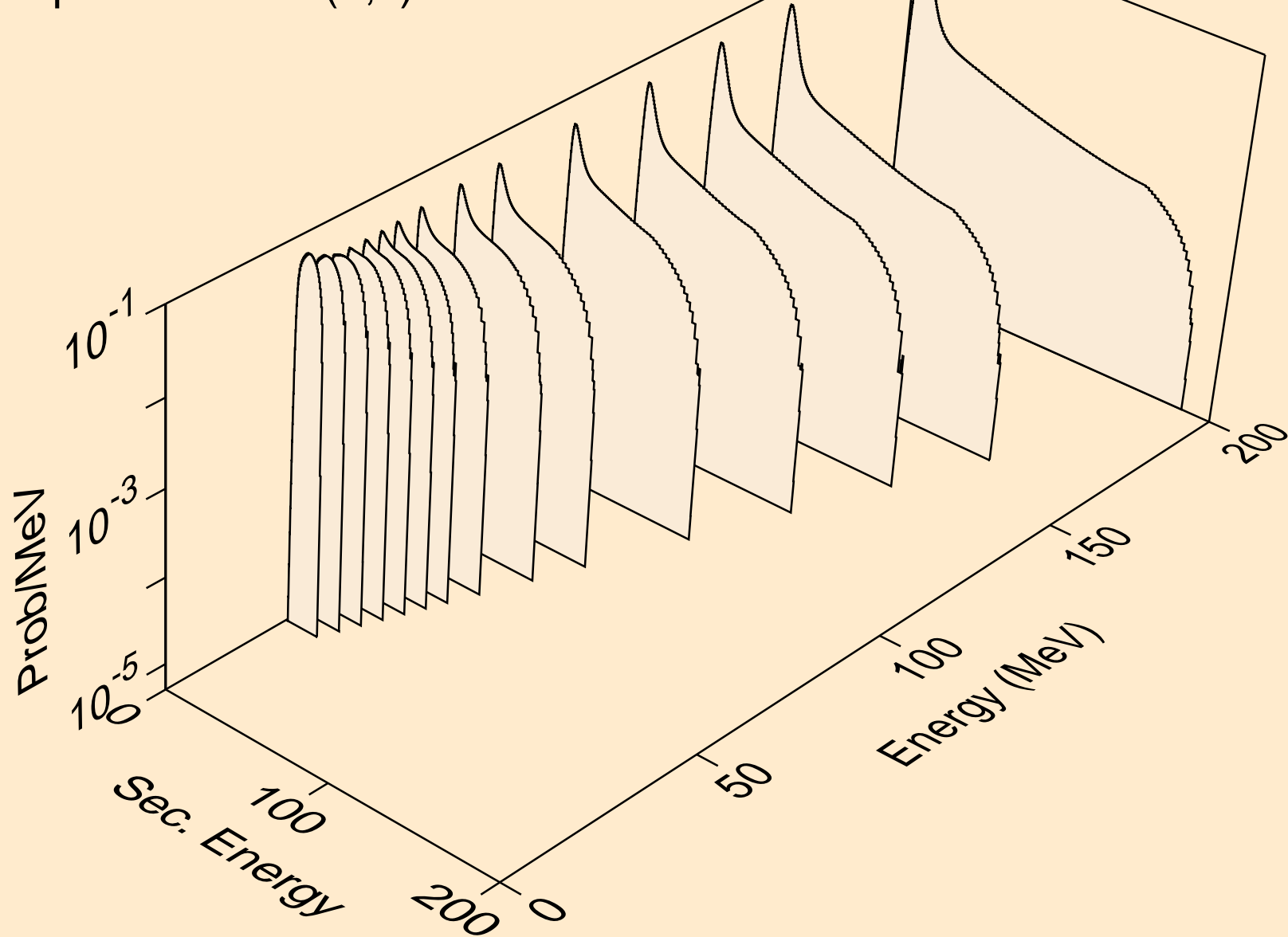

FE062 NEUTRON ACER TENDL-2023 LIBRARY; T=0.K
protons from (n,n*)p

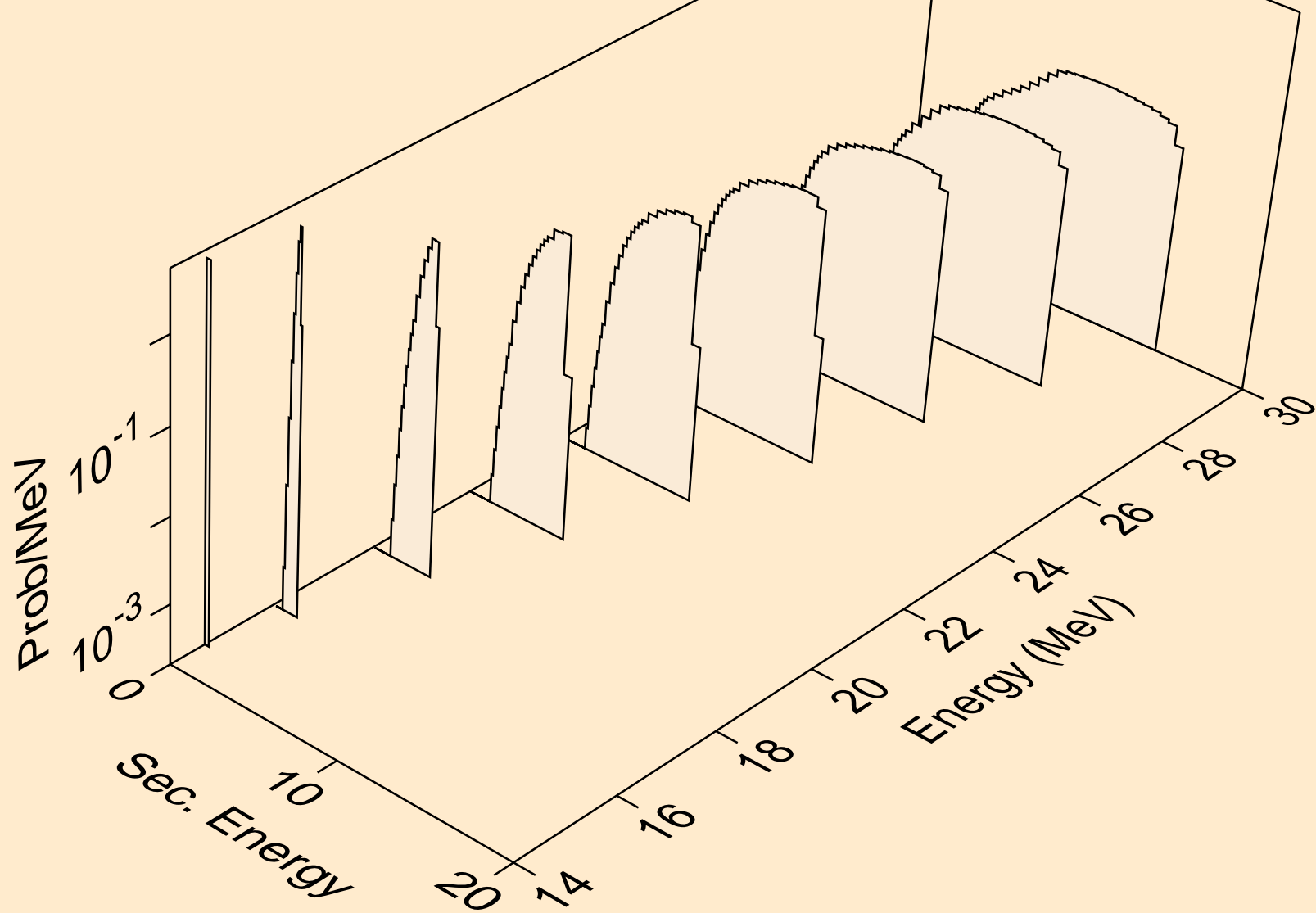

FE062 NEUTRON ACER TENDL-2023 LIBRARY; T=0.K
protons from (n,2np)

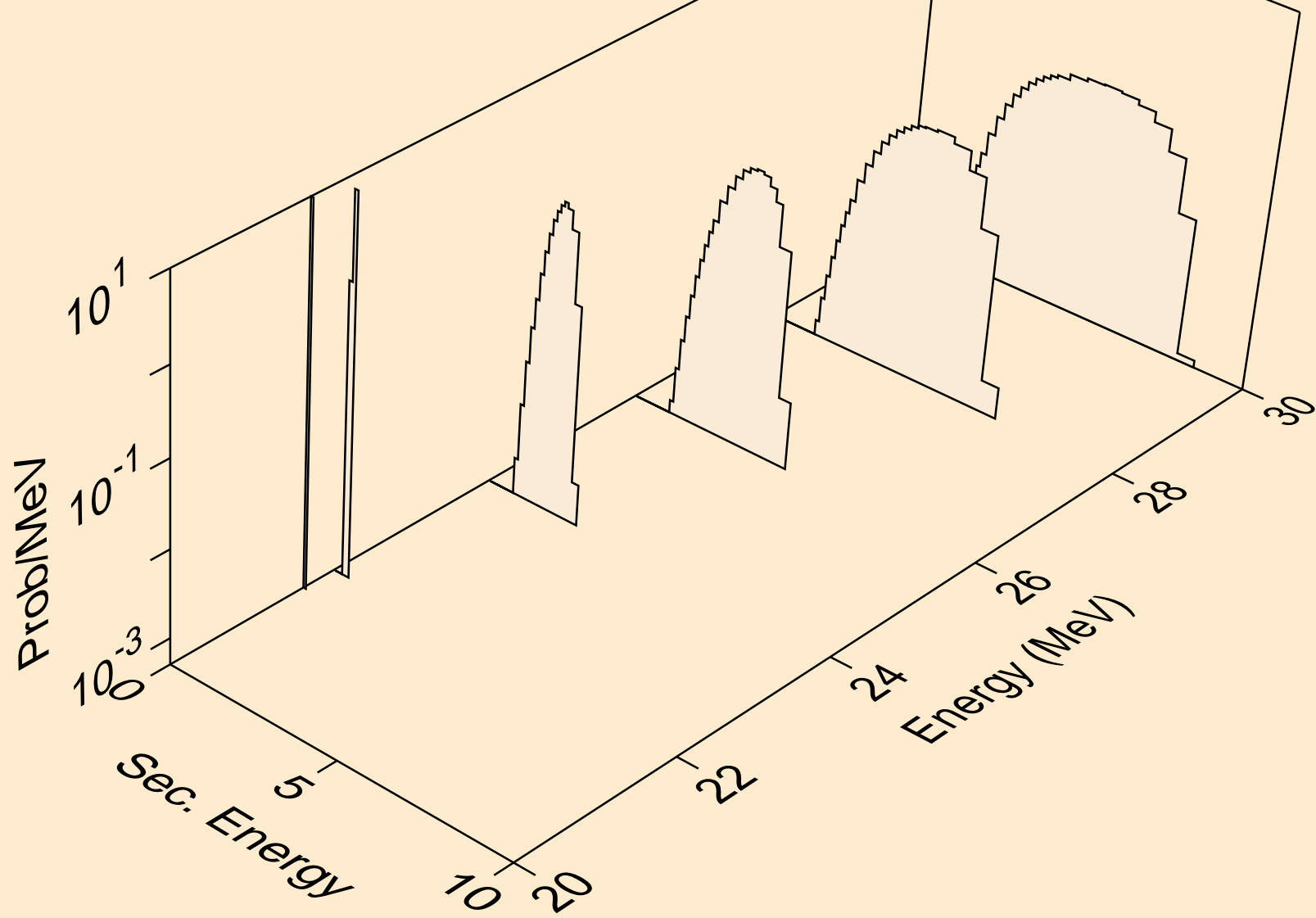

FE062 NEUTRON ACER TENDL-2023 LIBRARY; T=0.K
protons from (n,3np)

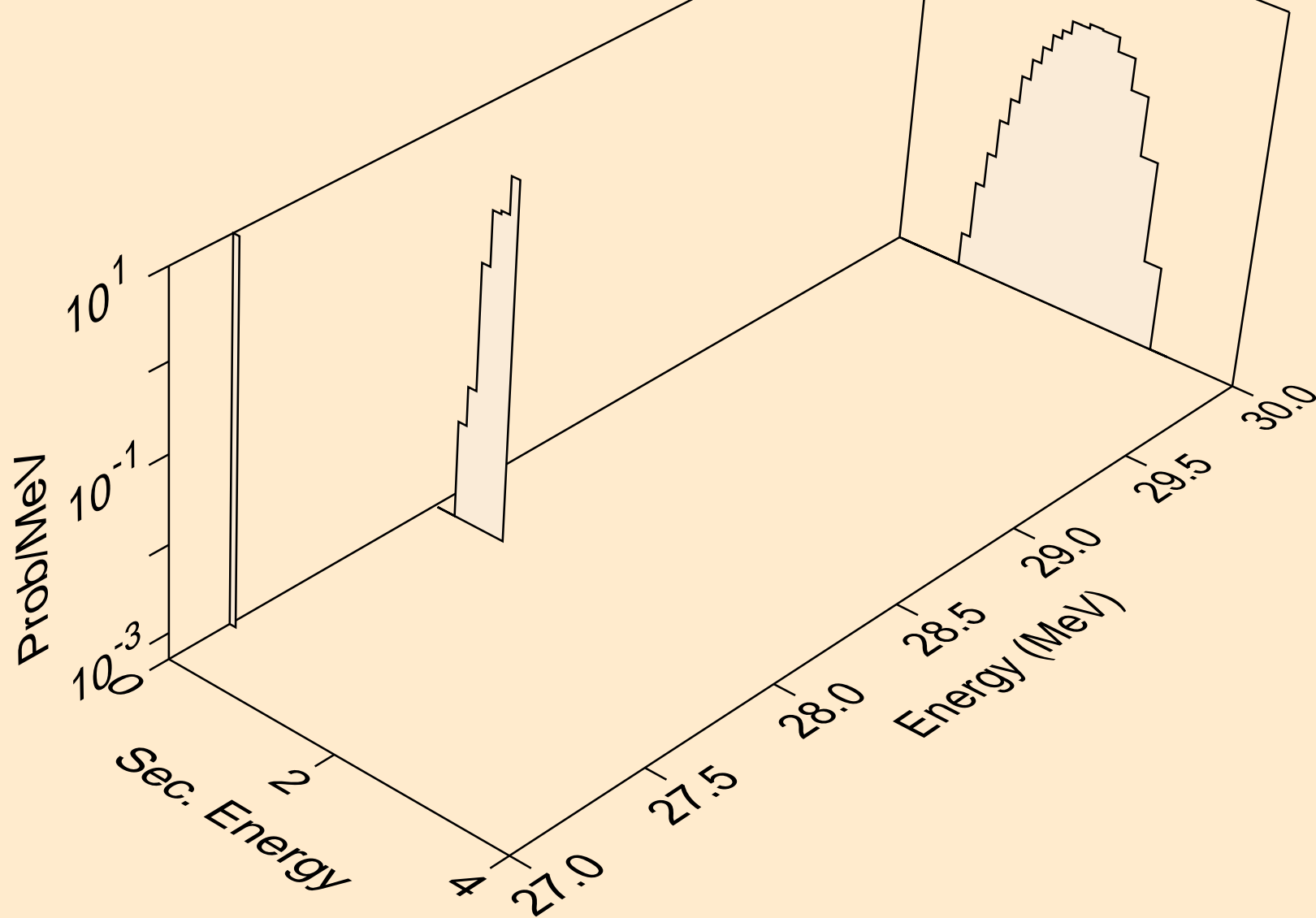

FE062 NEUTRON ACER TENDL-2023 LIBRARY; T=0.K
protons from (n,p)

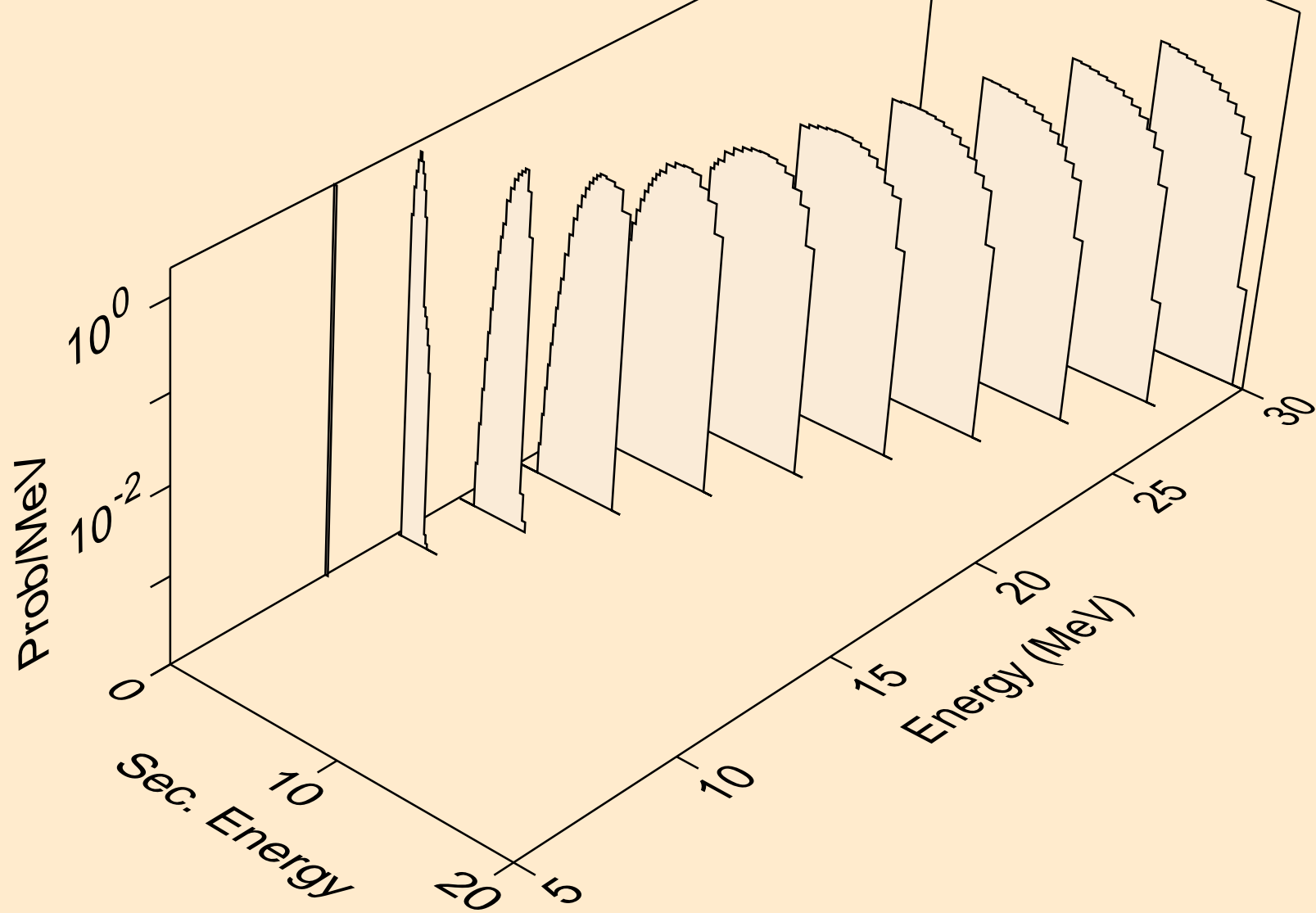

FE062 NEUTRON ACER TENDL-2023 LIBRARY; T=0.K
protons from (n,2p)

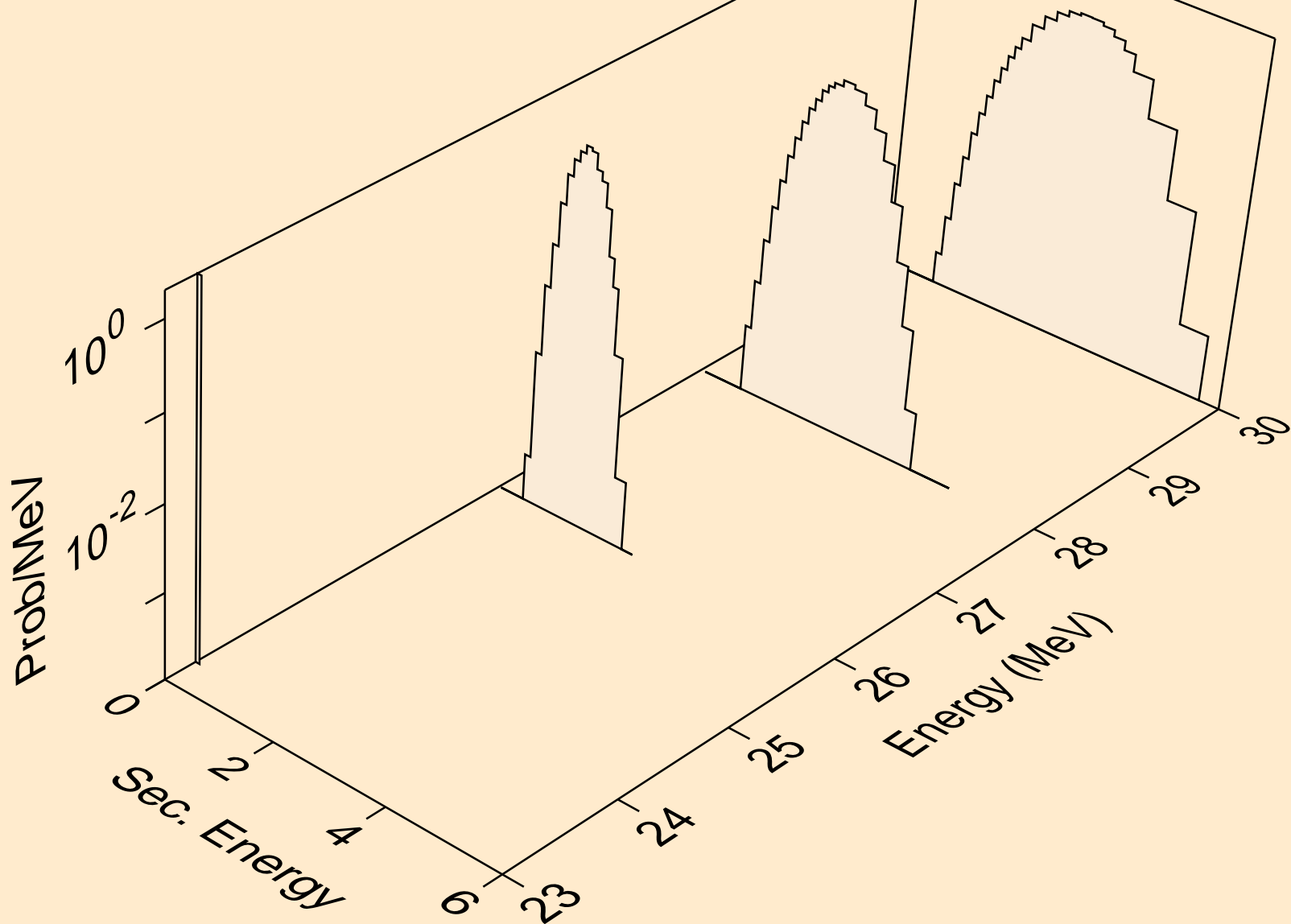

FE062 NEUTRON ACER TENDL-2023 LIBRARY; T=0.K
deuterons from (n,x)

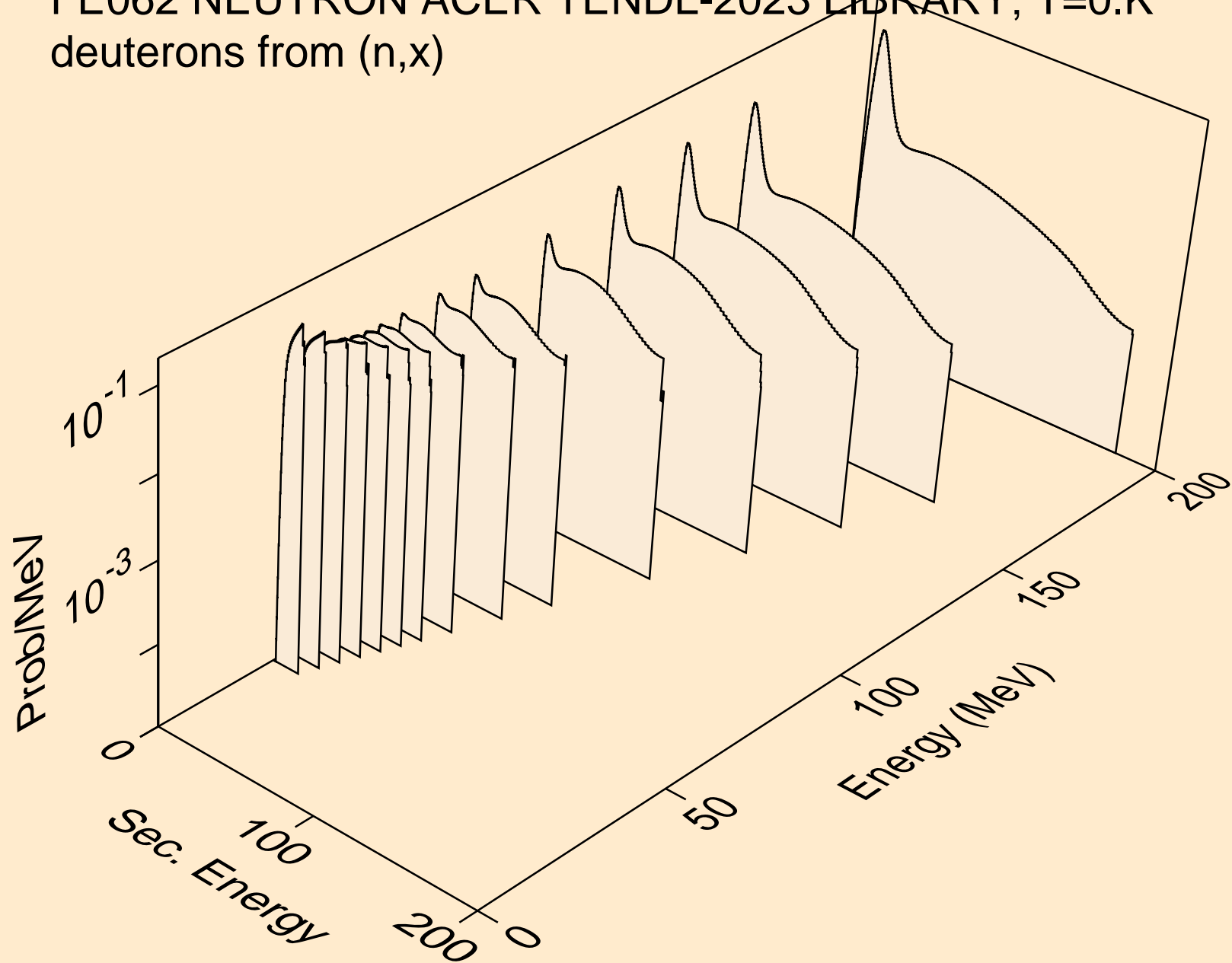

FE062 NEUTRON ACER TENDL-2023 LIBRARY; T=0.K
deuterons from (n,2nd)

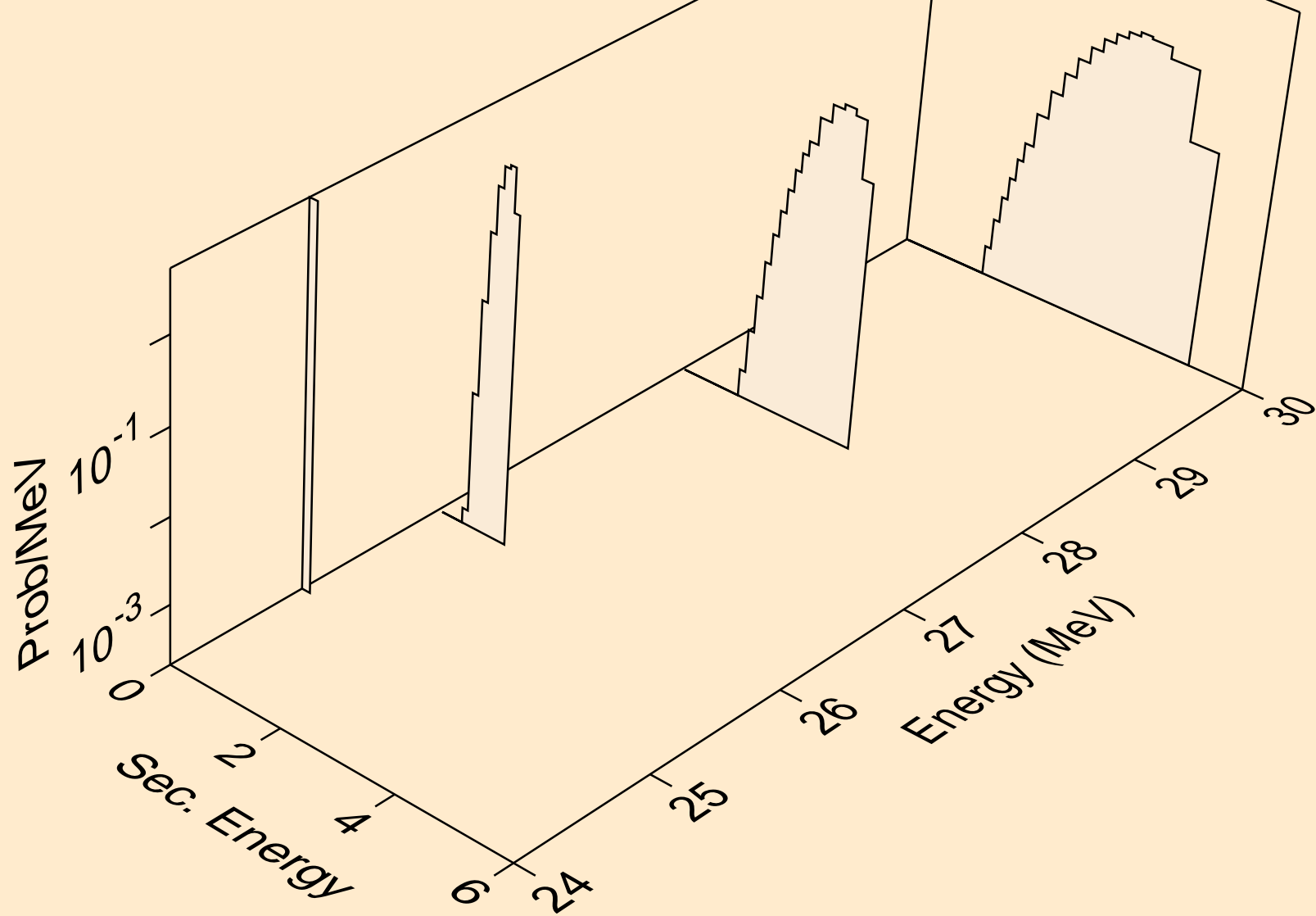

FE062 NEUTRON ACER TENDL-2023 LIBRARY; T=0.K
deuterons from (n,n*)d

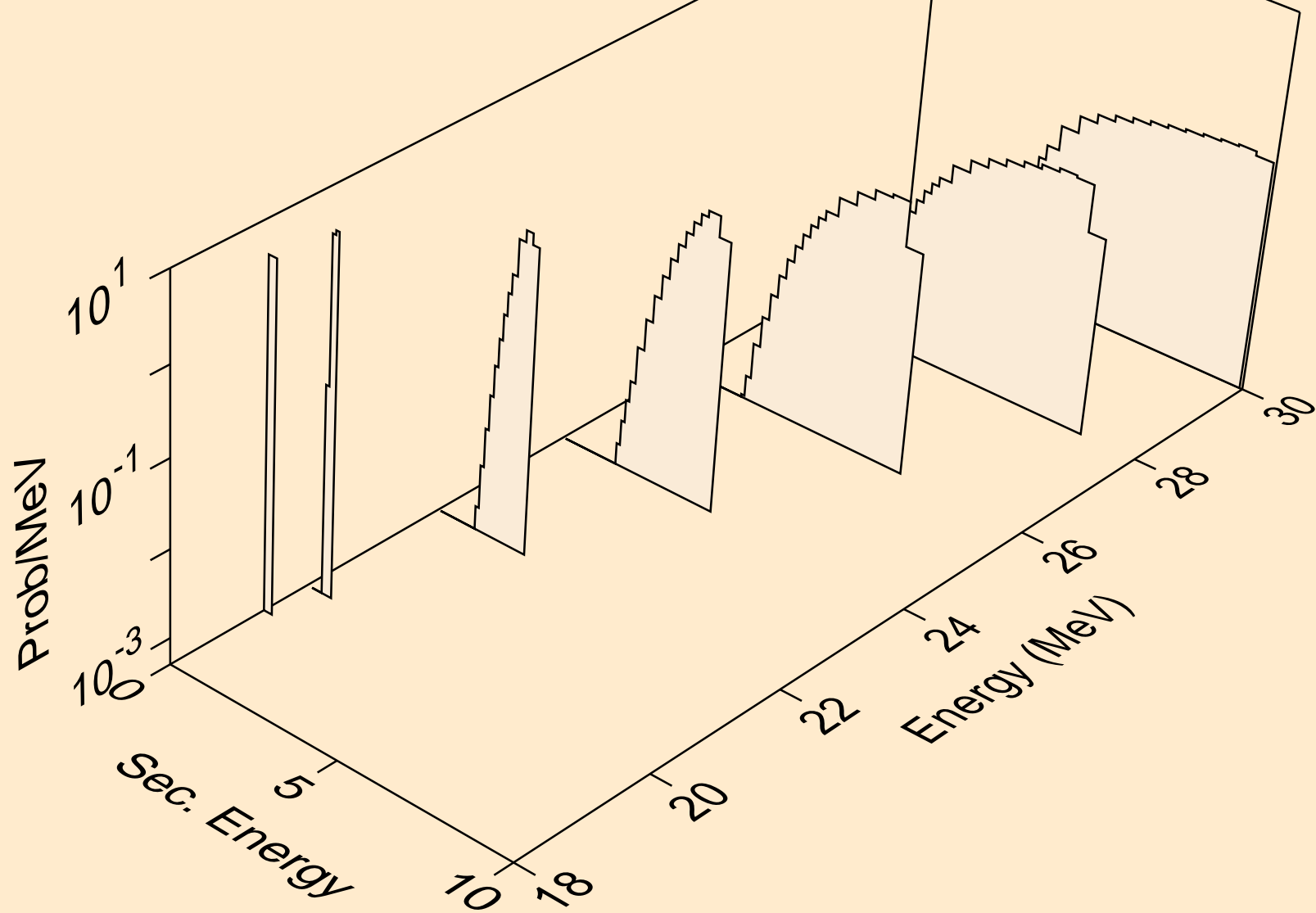

FE062 NEUTRON ACER TENDL-2023 LIBRARY; T=0.K
deuterons from (n,d)

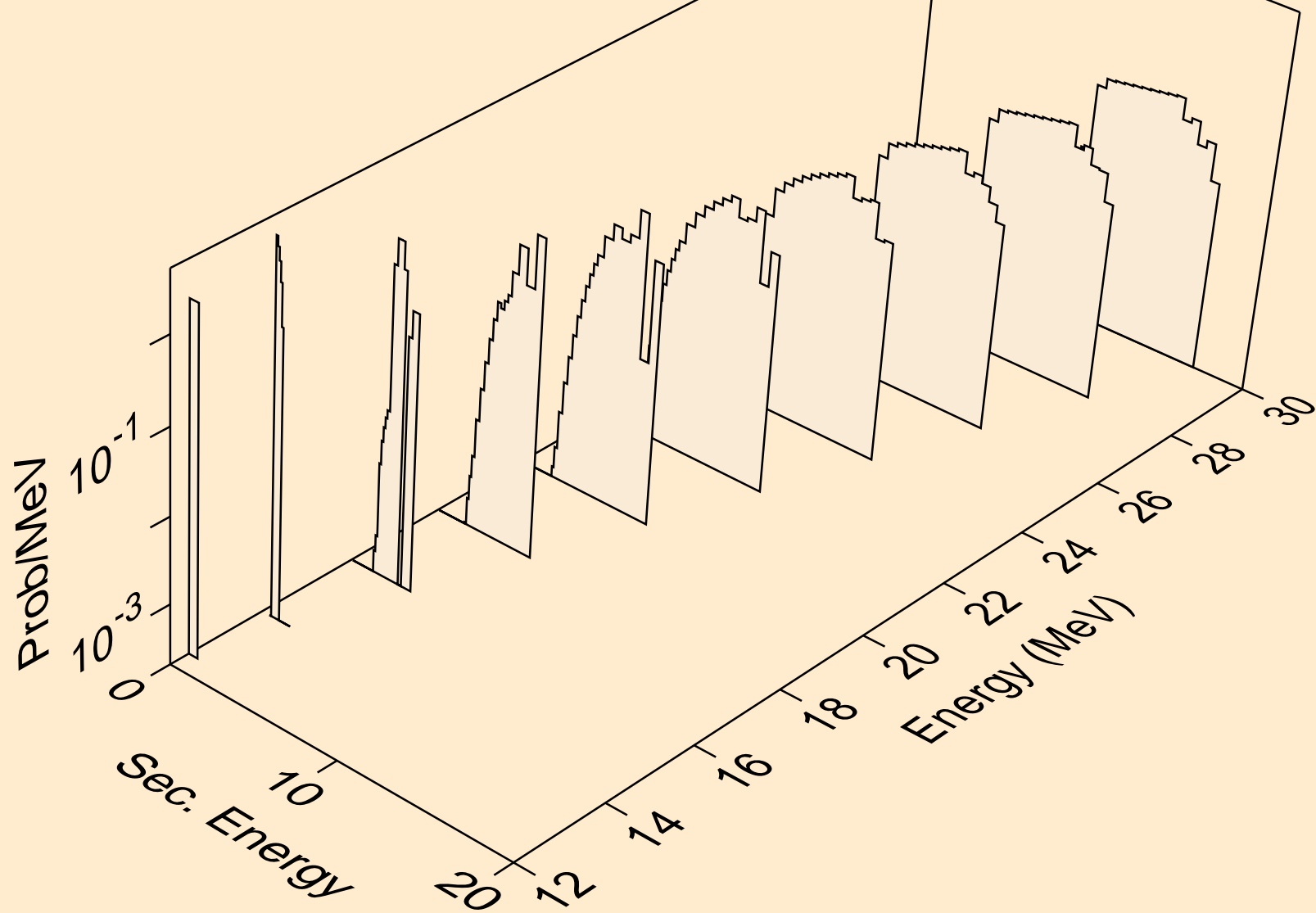

FE062 NEUTRON ACER TENDL-2023 LIBRARY; T=0.K
tritons from (n,x)

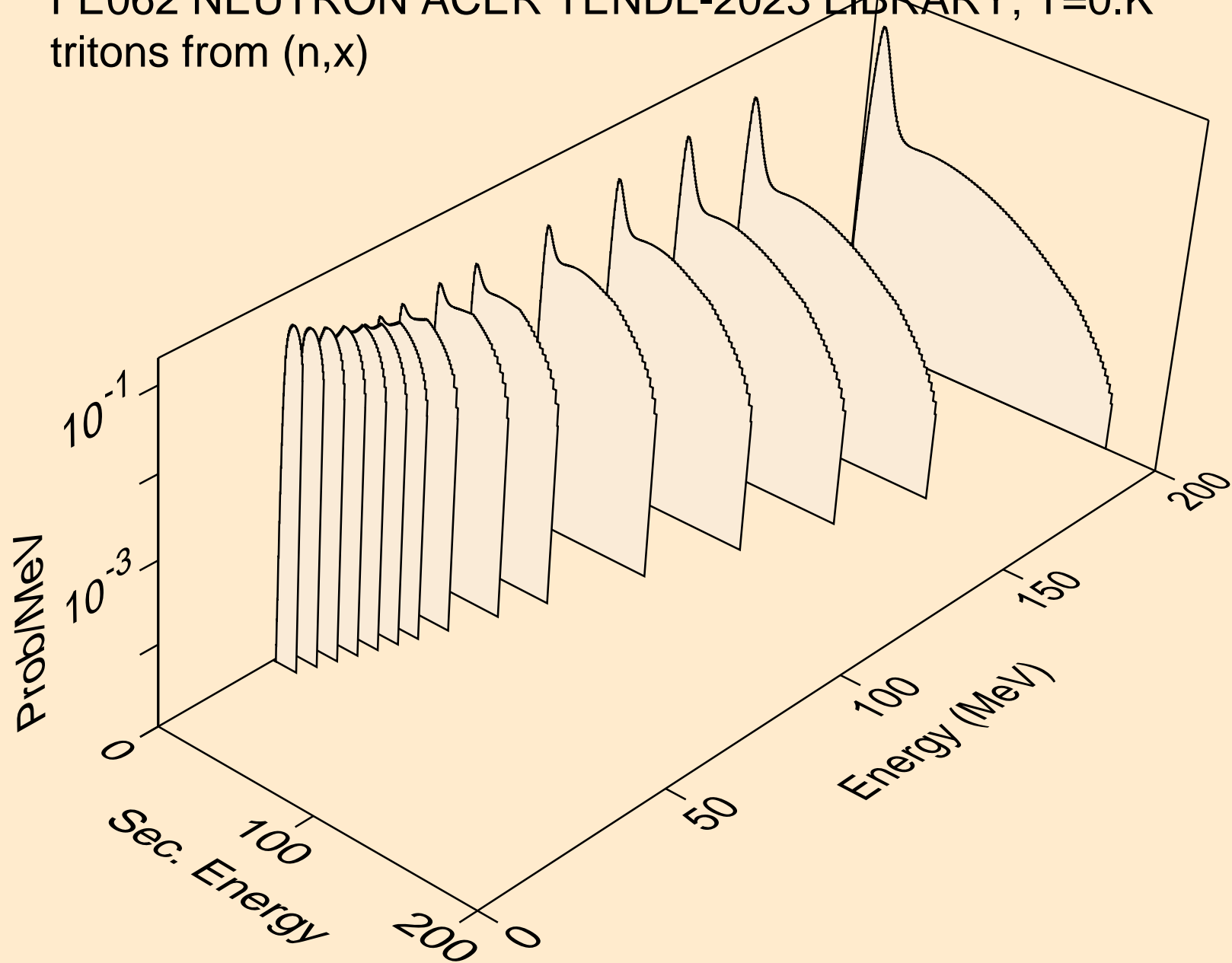

FE062 NEUTRON ACER TENDL-2023 LIBRARY; T=0.K
tritons from (n,n*)t

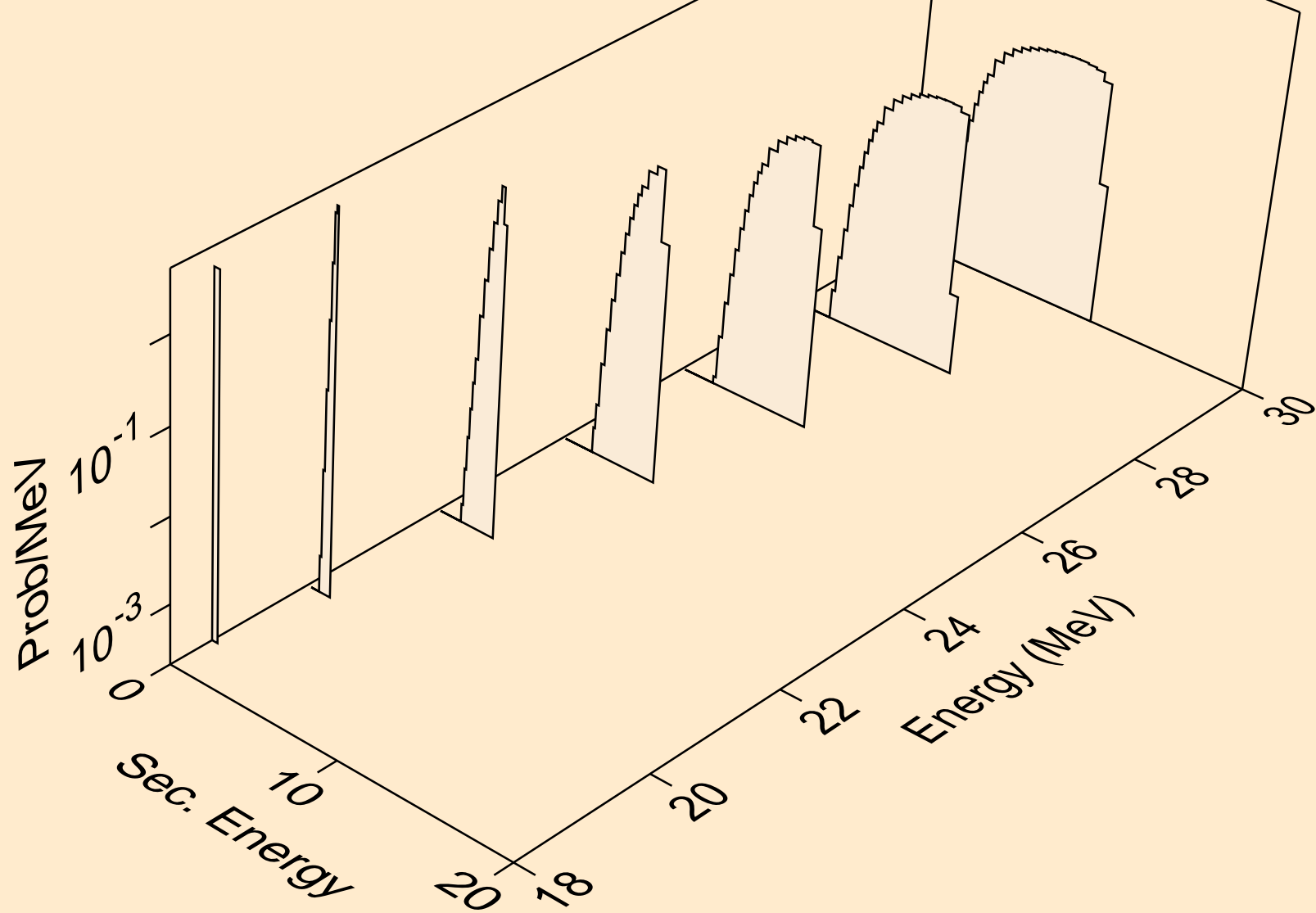

FE062 NEUTRON ACER TENDL-2023 LIBRARY; T=0.K
tritons from (n,t)

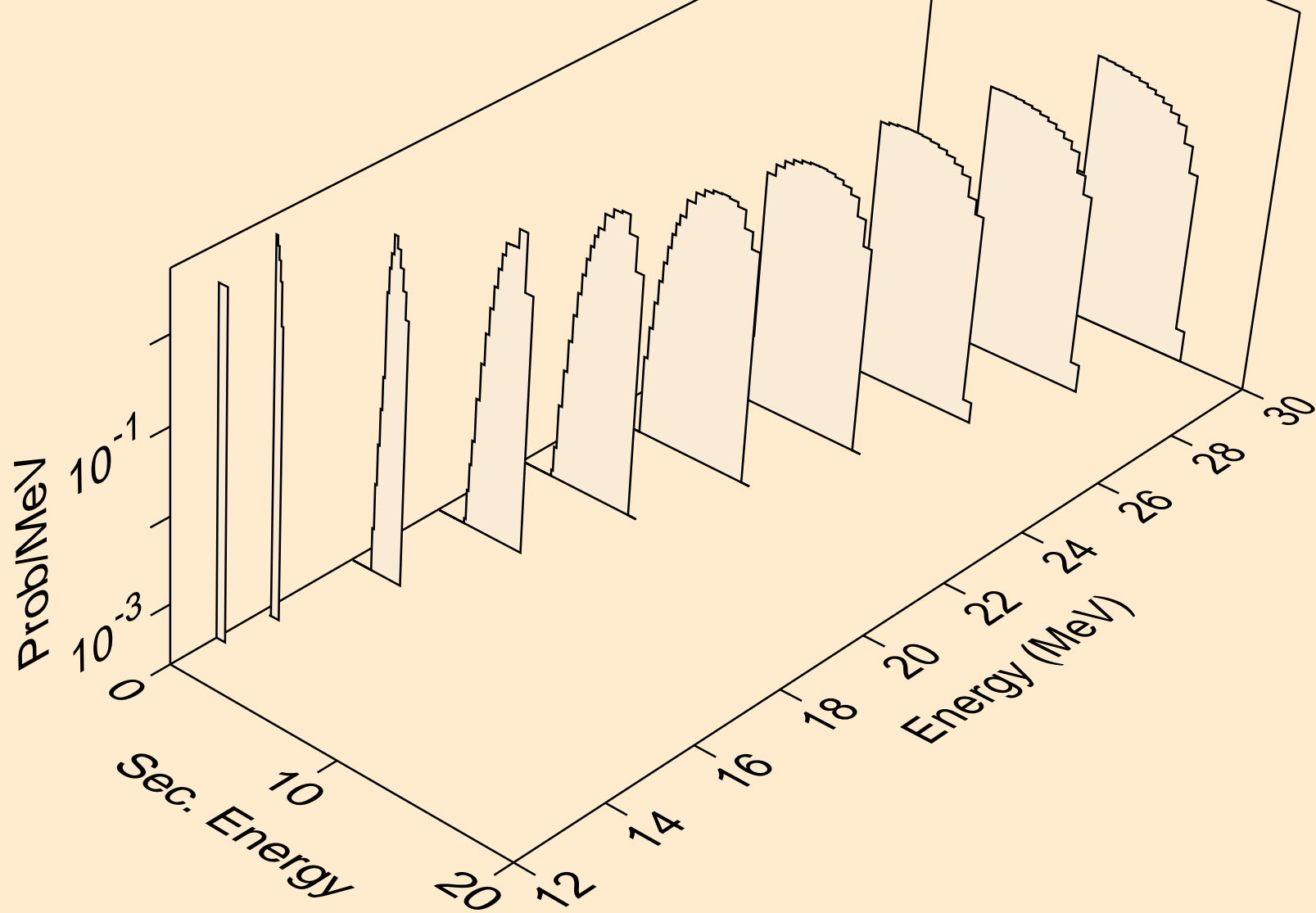

FE062 NEUTRON ACER TENDL-2023 LIBRARY; T=0.K
he3s from (n,x)

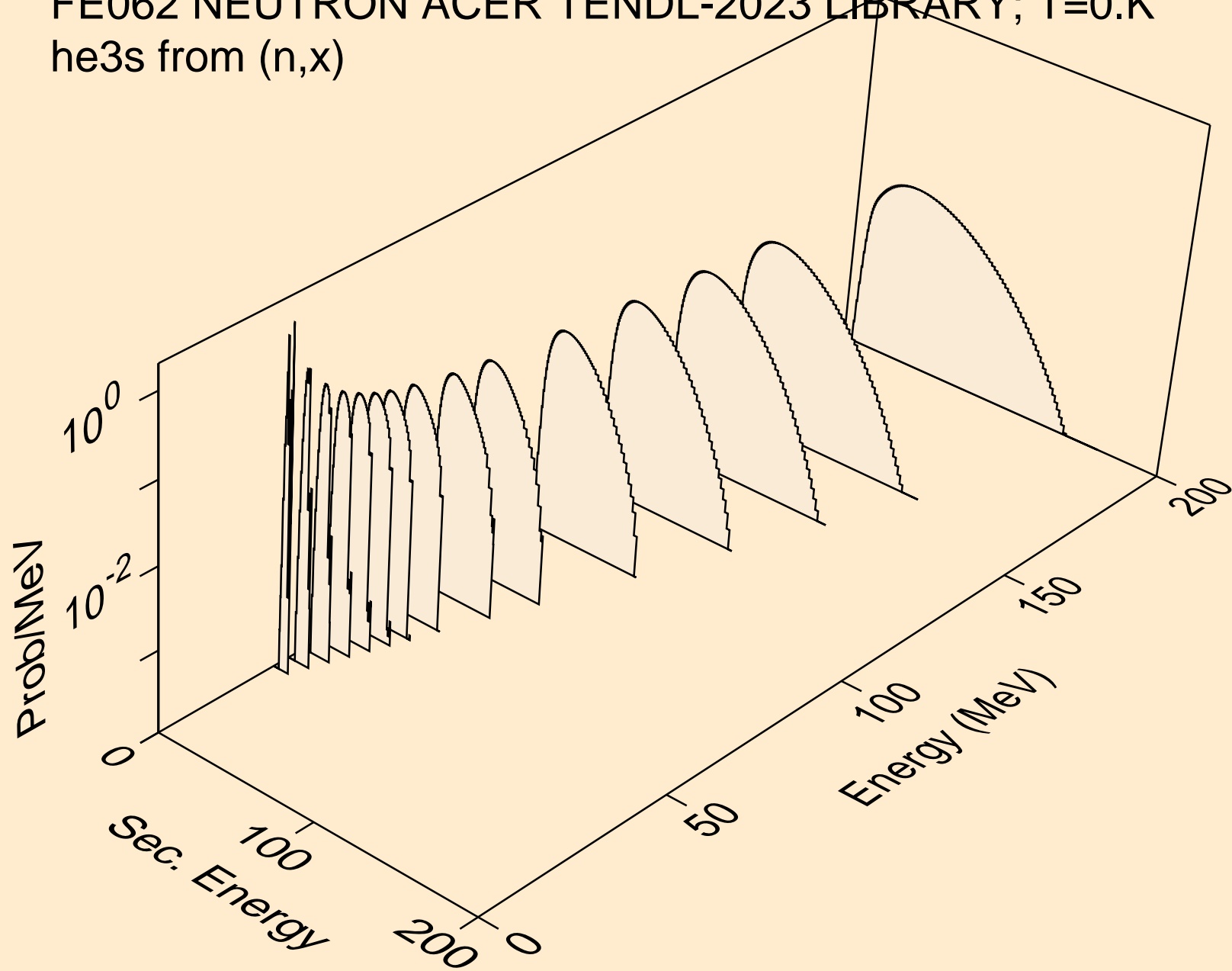

FE062 NEUTRON ACER TENDL-2023 LIBRARY; T=0.K
he3s from (n,he3)

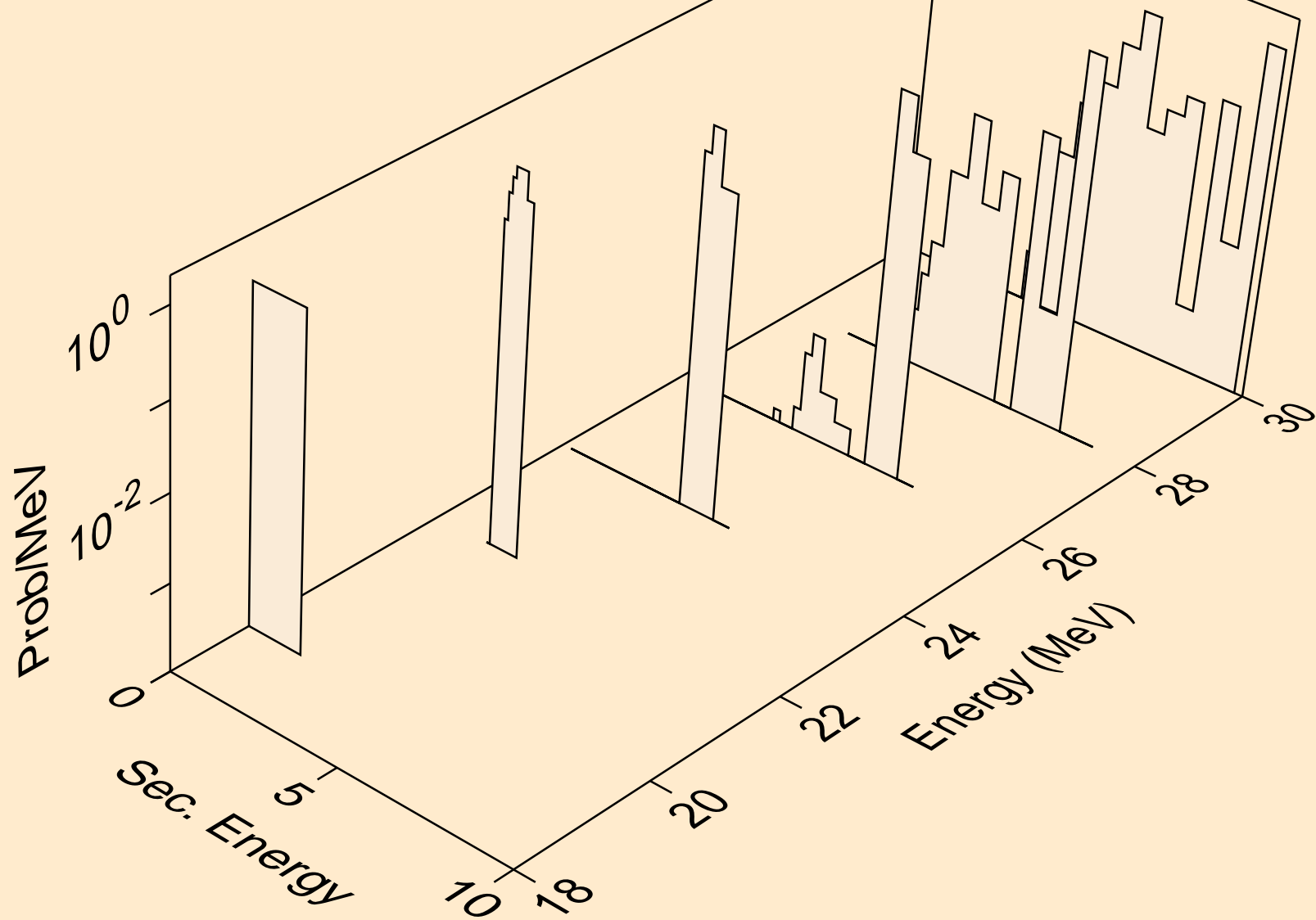

FE062 NEUTRON ACER TENDL-2023 LIBRARY; T=0.K
alphas from (n,x)

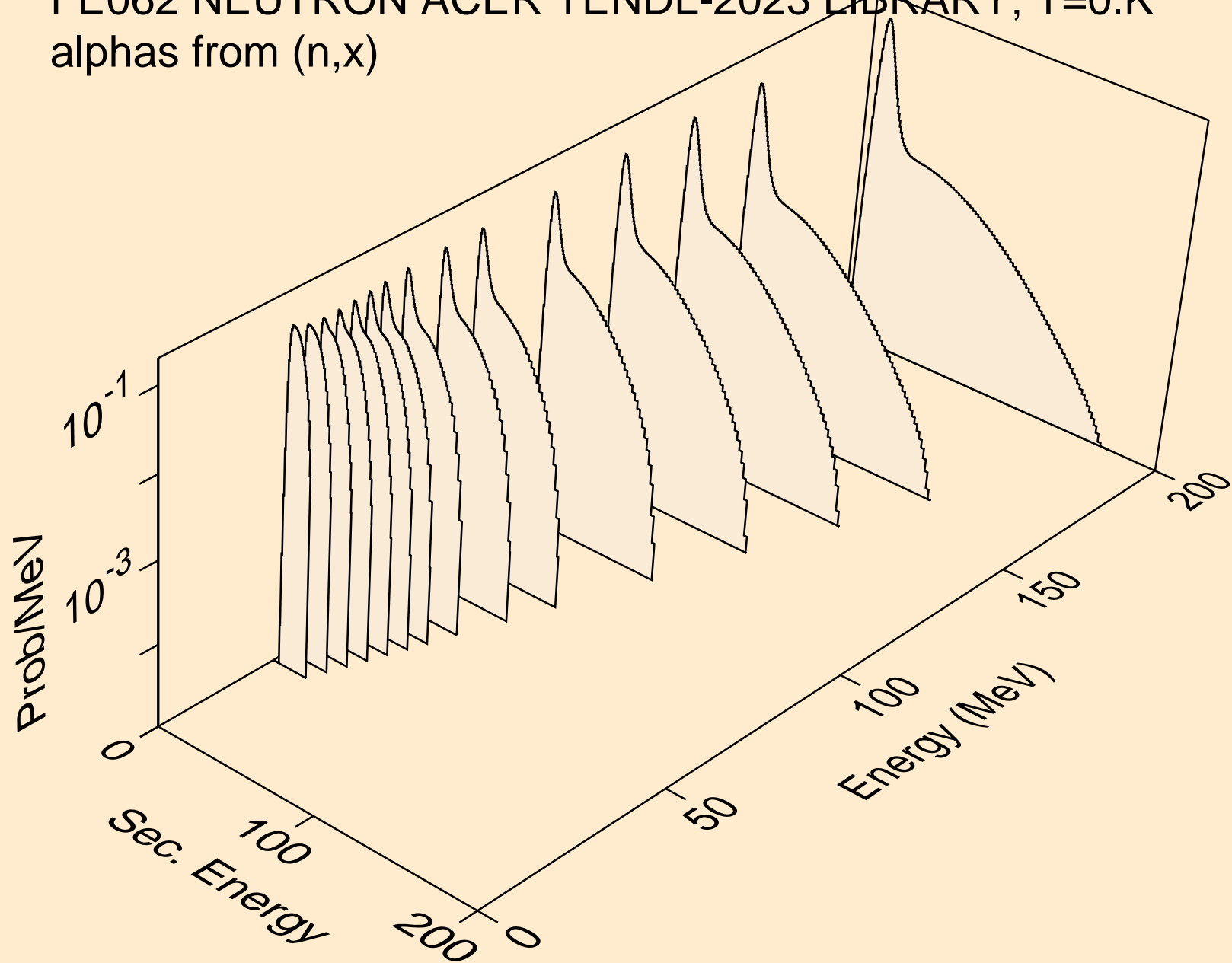

FE062 NEUTRON ACER TENDL-2023 LIBRARY; T=0.K
alphas from (n,n*)a

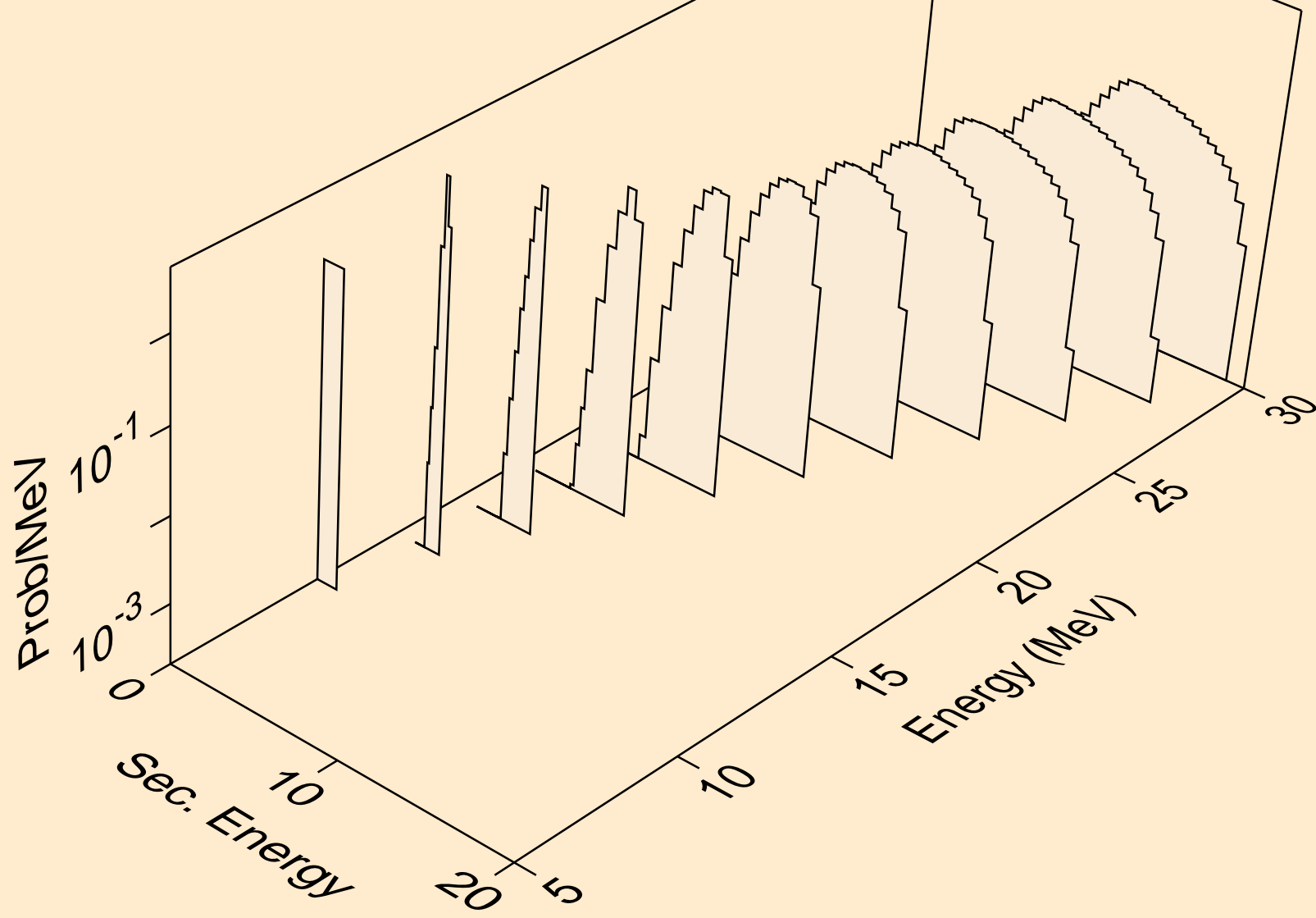

FE062 NEUTRON ACER TENDL-2023 LIBRARY; T=0.K
alphas from (n,2n)a

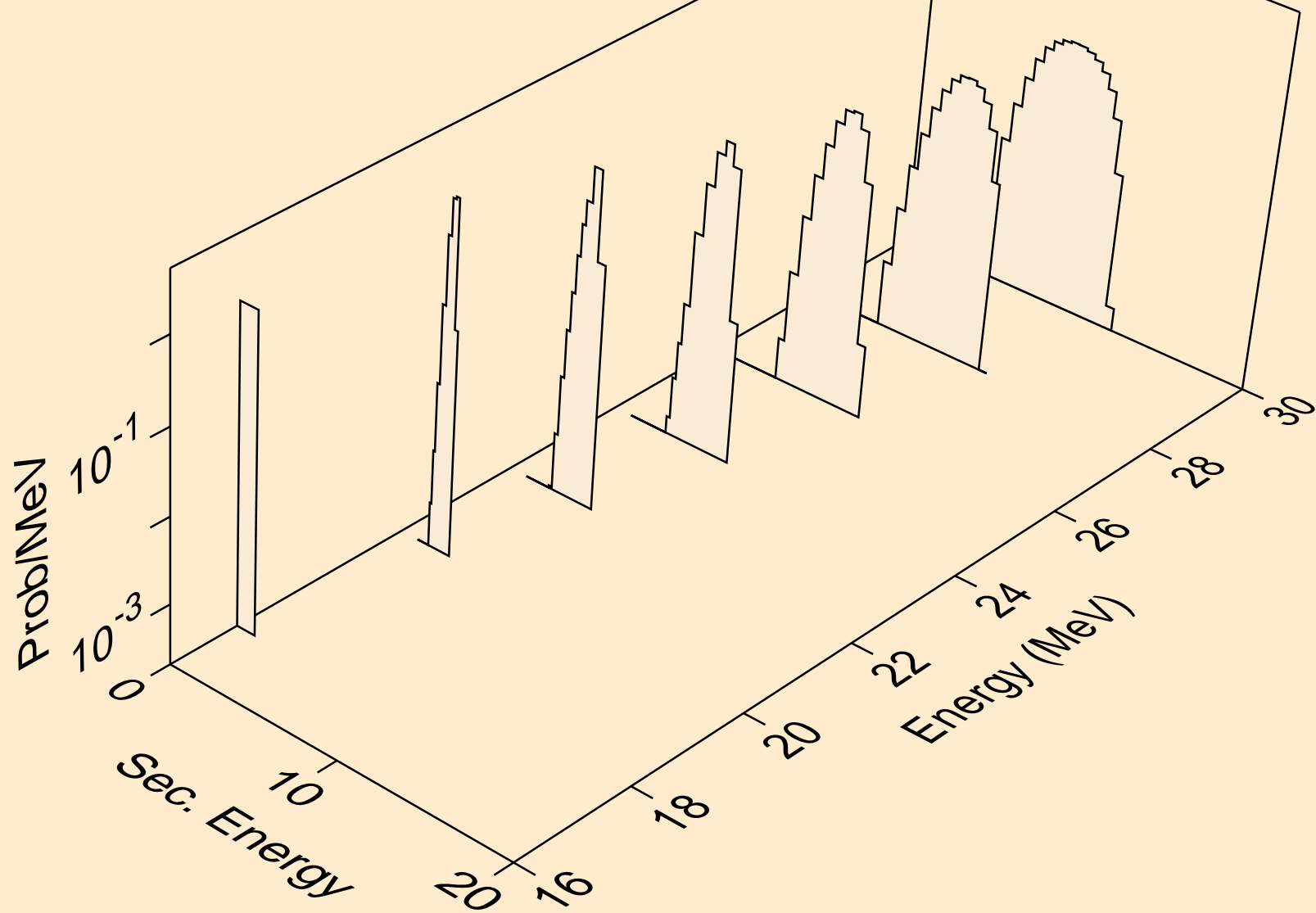

FE062 NEUTRON ACER TENDL-2023 LIBRARY; T=0.K
alphas from (n,3n)a

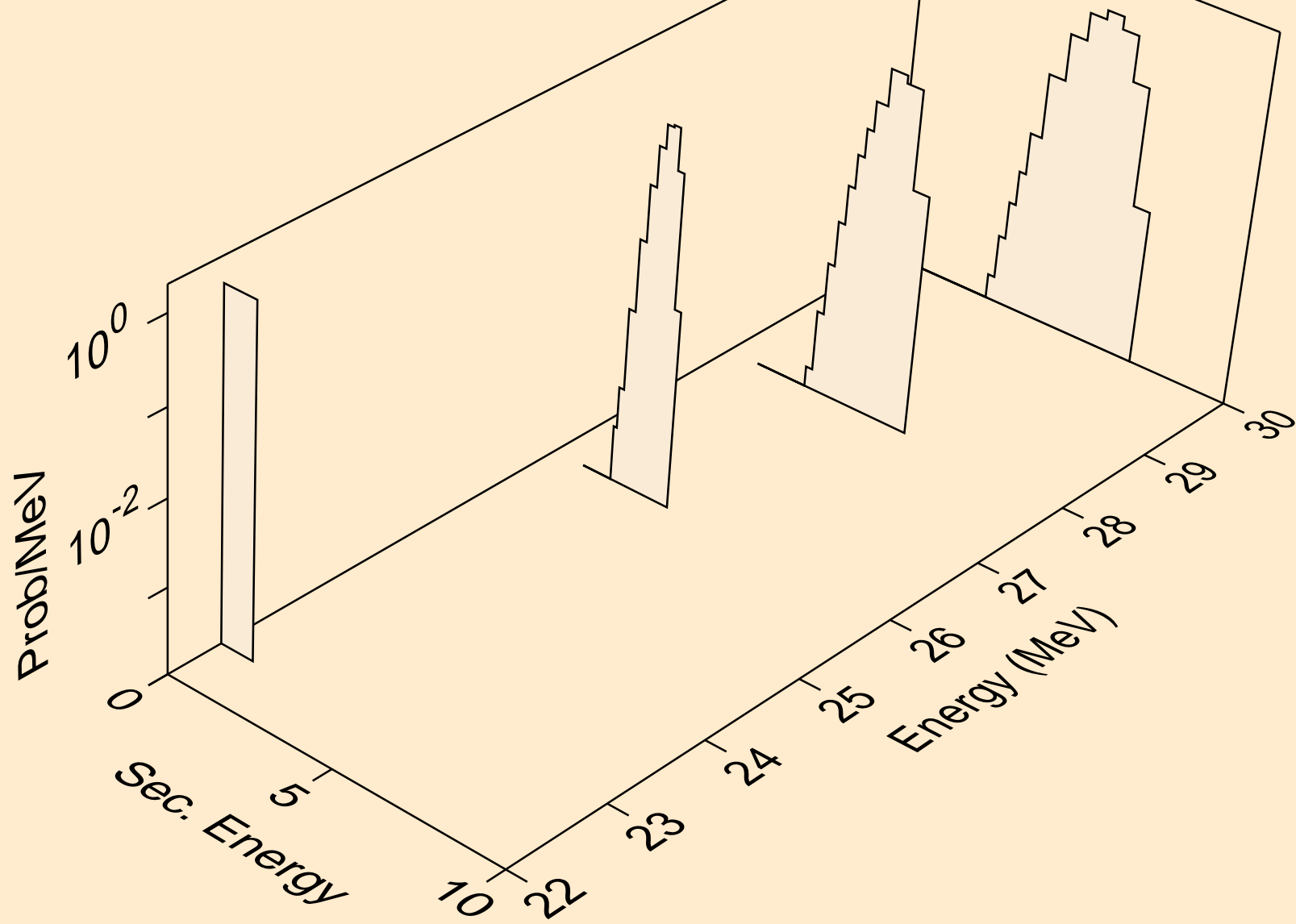

FE062 NEUTRON ACER TENDL-2023 LIBRARY; T=0.K
alphas from (n,a)

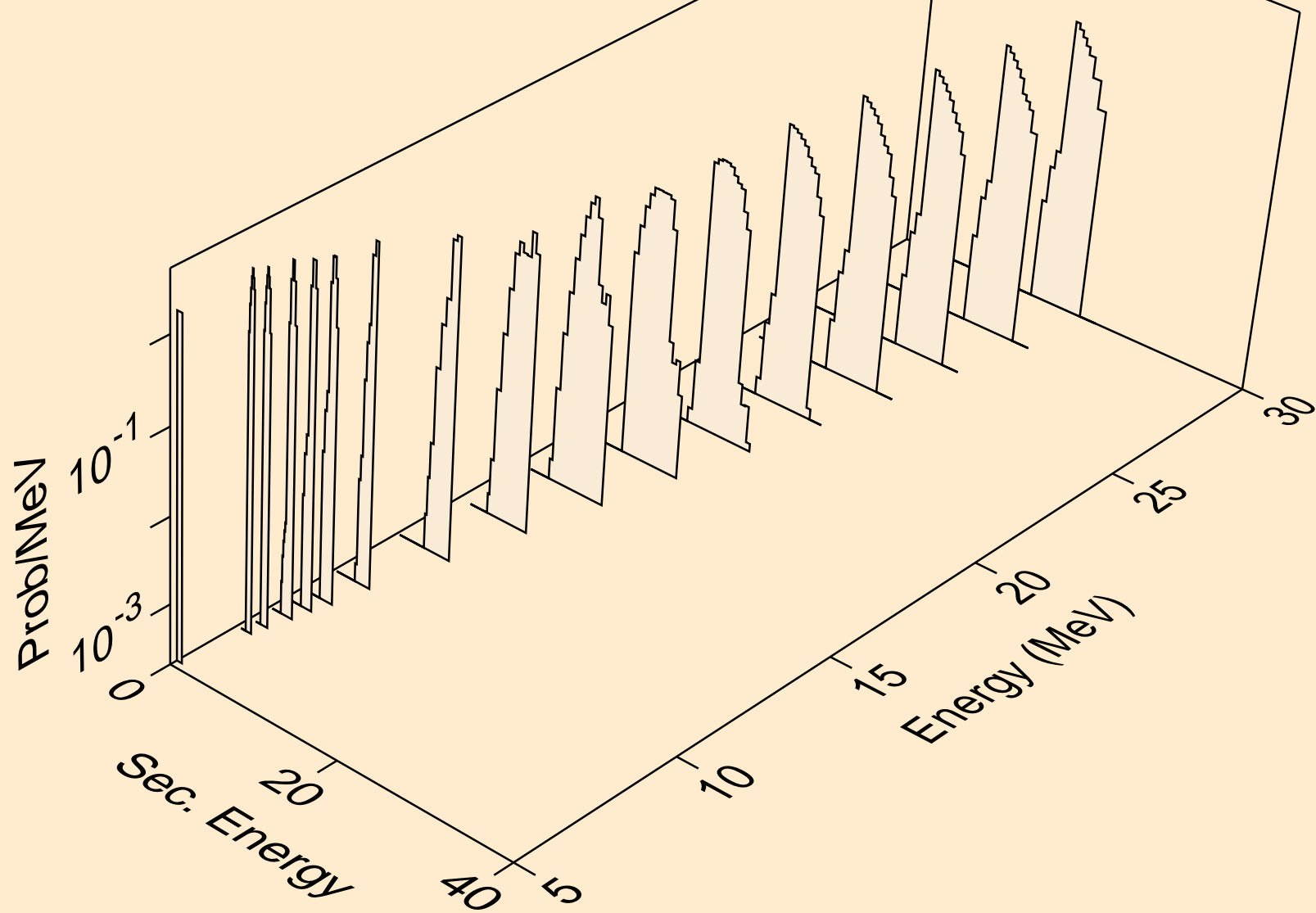

FE062 NEUTRON ACER TENDL-2023 LIBRARY; T=0.K
alphas from (n,2a)

