

FM257 NEUTRON ACER TENDL-2023 LIBRARY; T=0.K

Principal cross sections

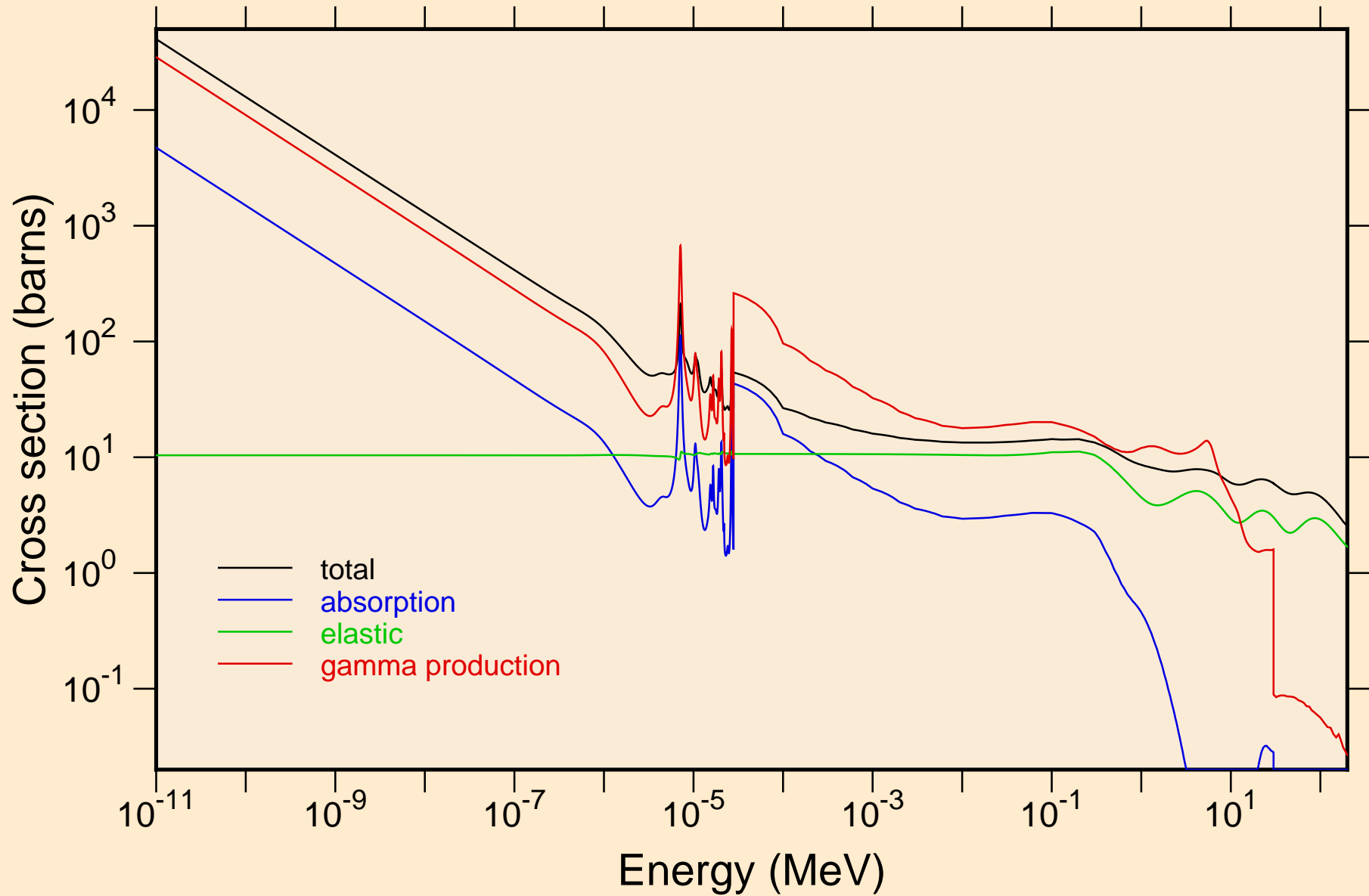

FM257 NEUTRON ACER TENDL-2023 LIBRARY; T=0.K
Heating

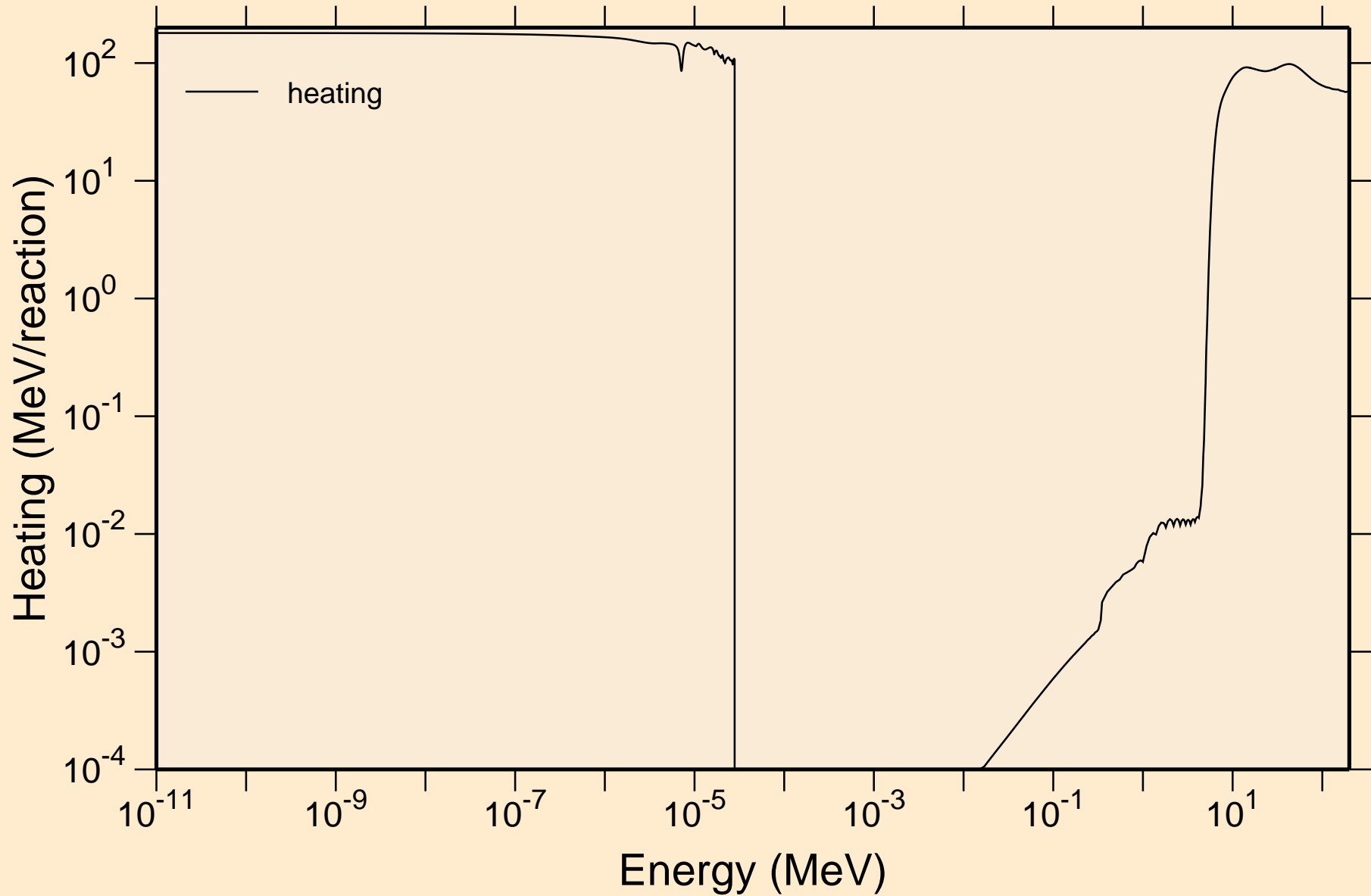

FM257 NEUTRON ACER TENDL-2023 LIBRARY; T=0.K
Damage

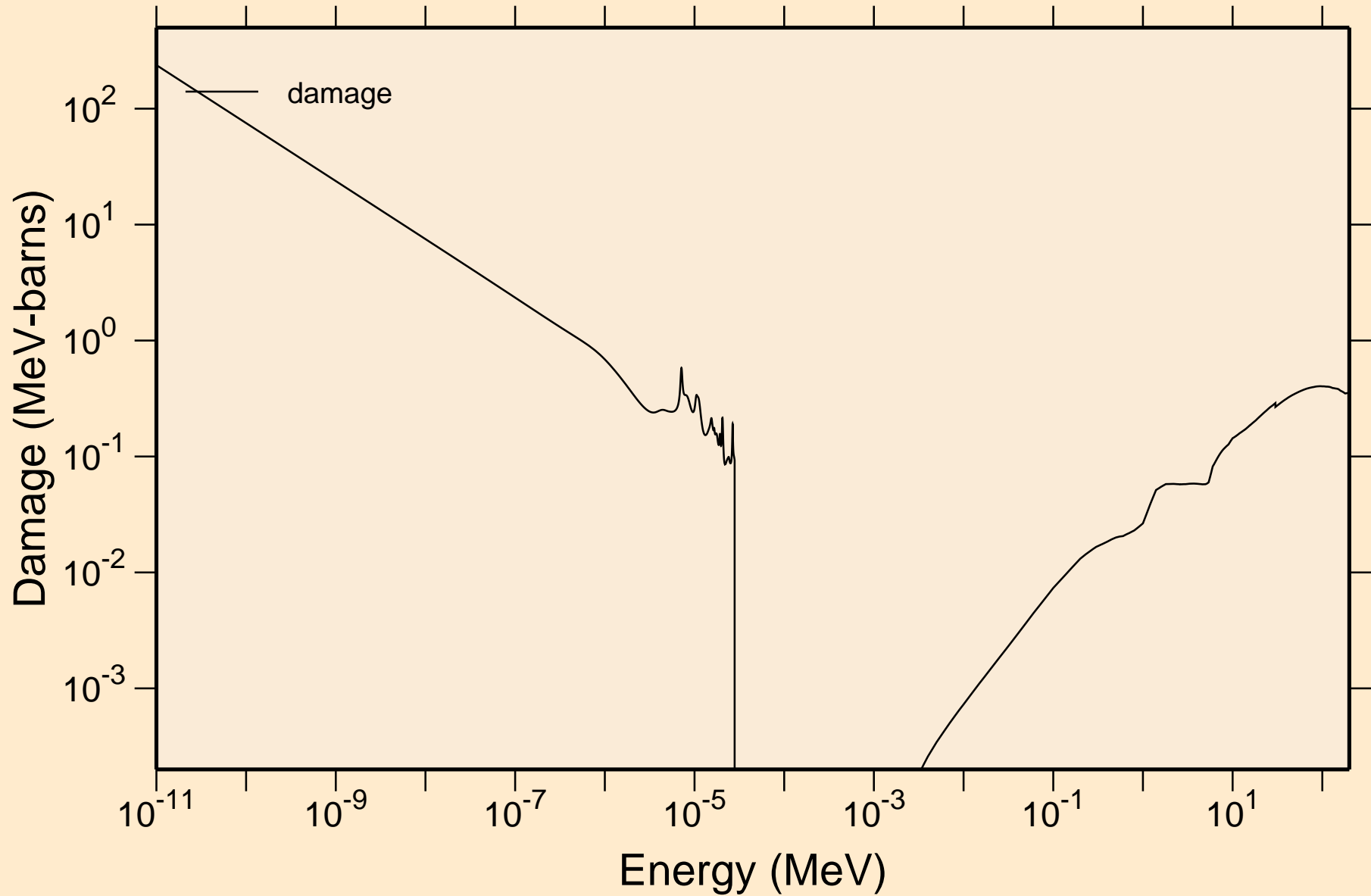

FM257 NEUTRON ACER TENDL-2023 LIBRARY; T=0.K
Non-threshold reactions

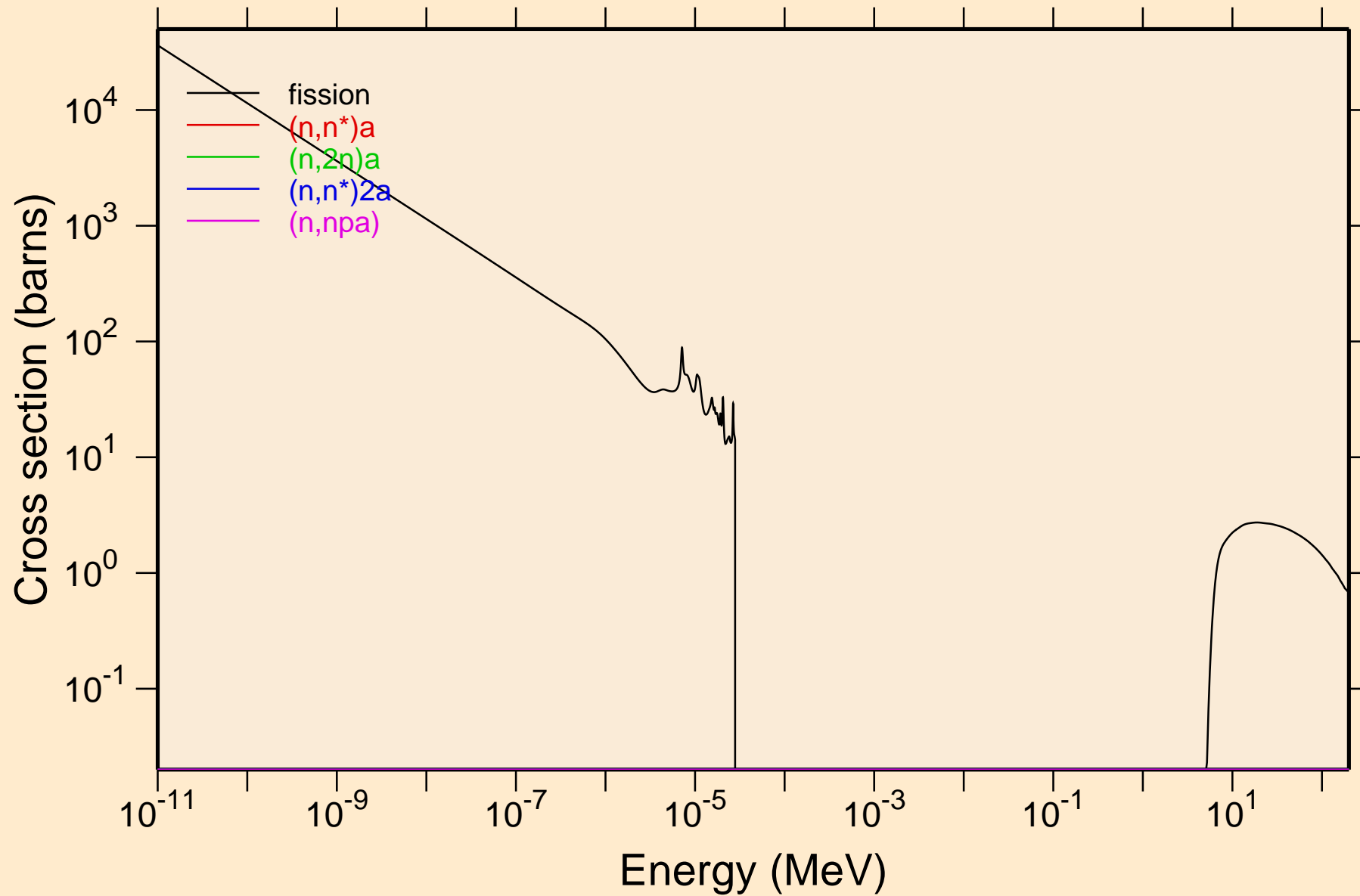

FM257 NEUTRON ACER TENDL-2023 LIBRARY; T=0.K

Non-threshold reactions

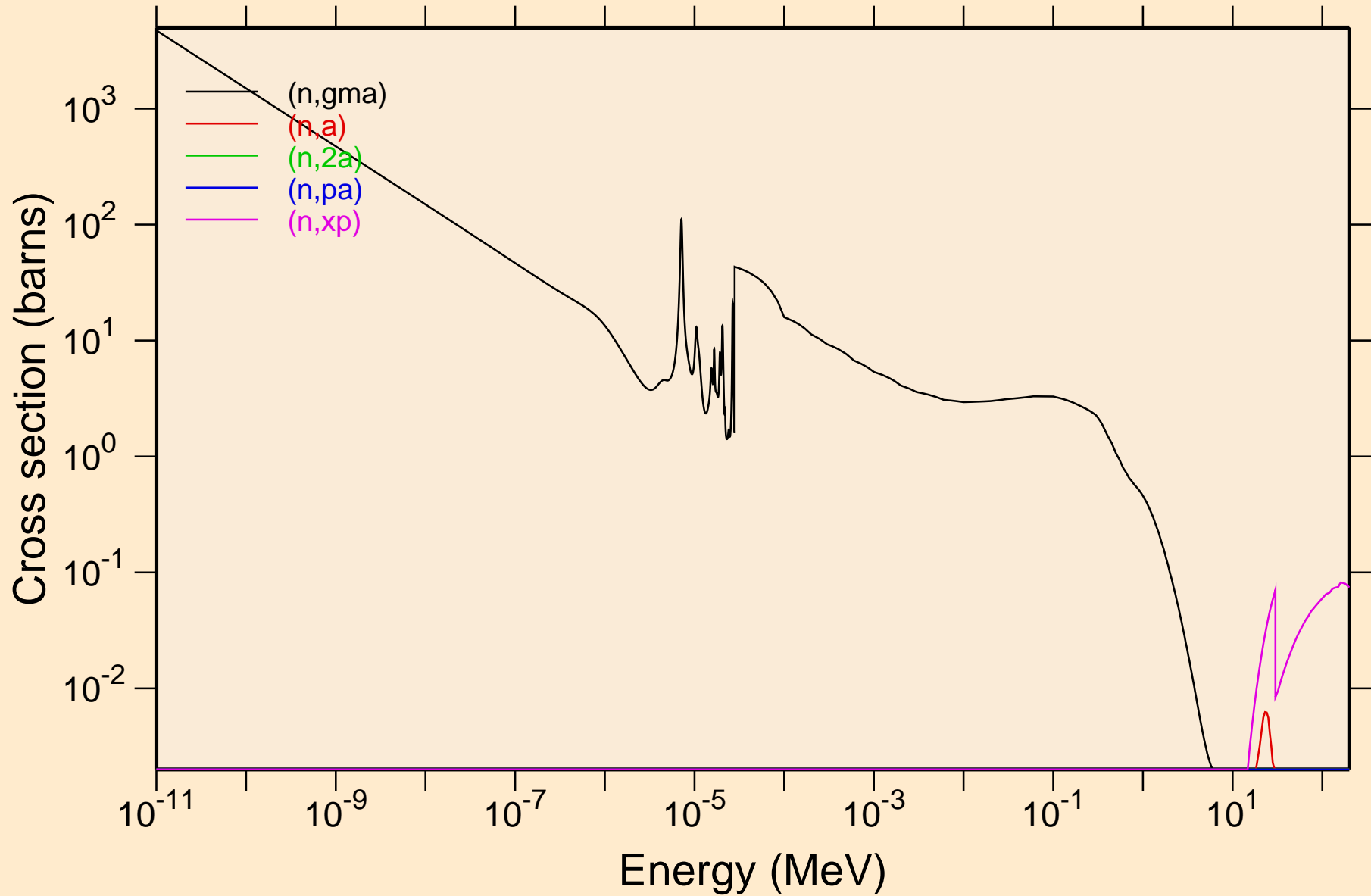

FM257 NEUTRON ACER TENDL-2023 LIBRARY; T=0.K
Non-threshold reactions

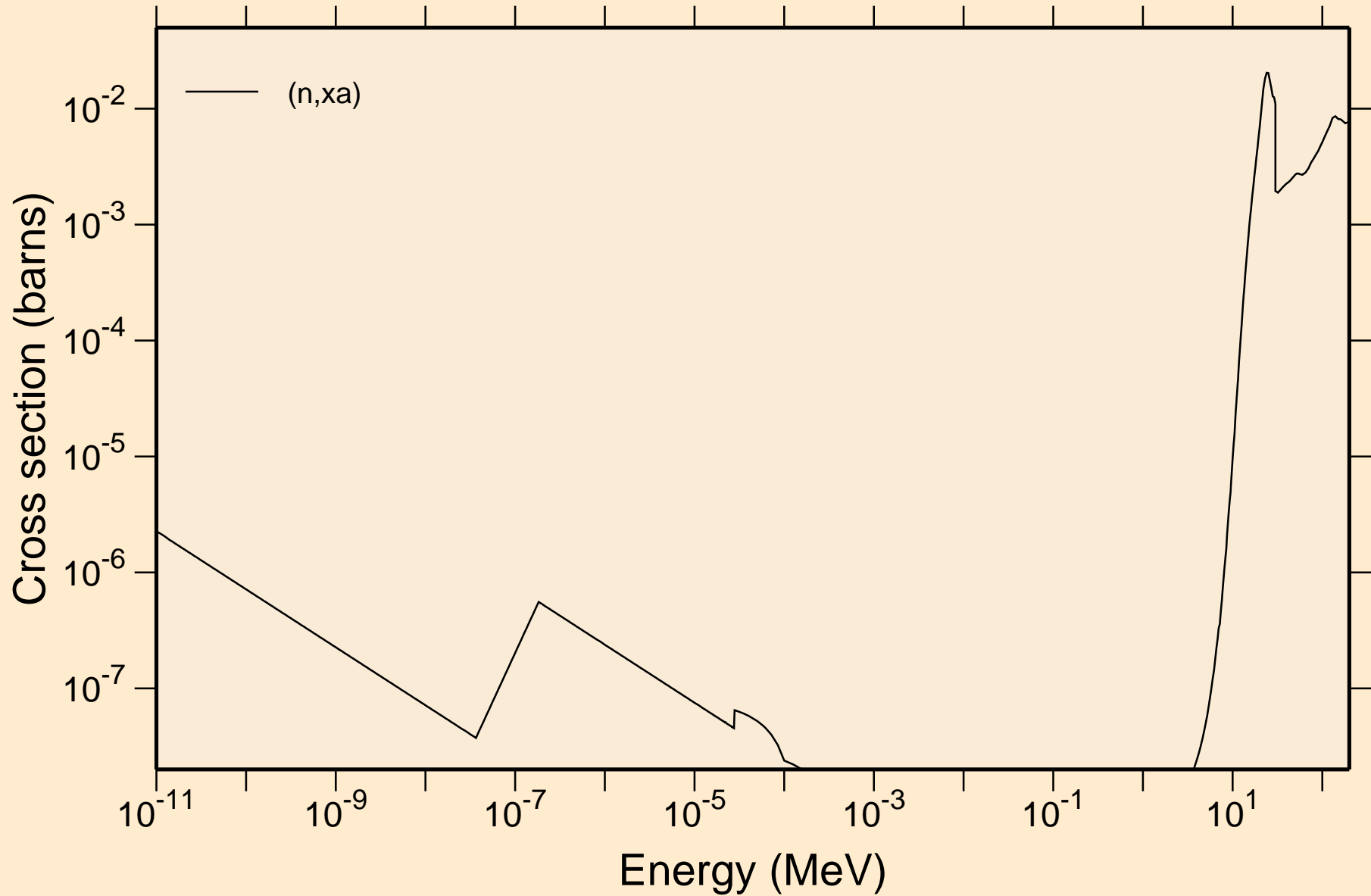

FM257 NEUTRON ACER TENDL-2023 LIBRARY; T=0.K

Principal cross sections

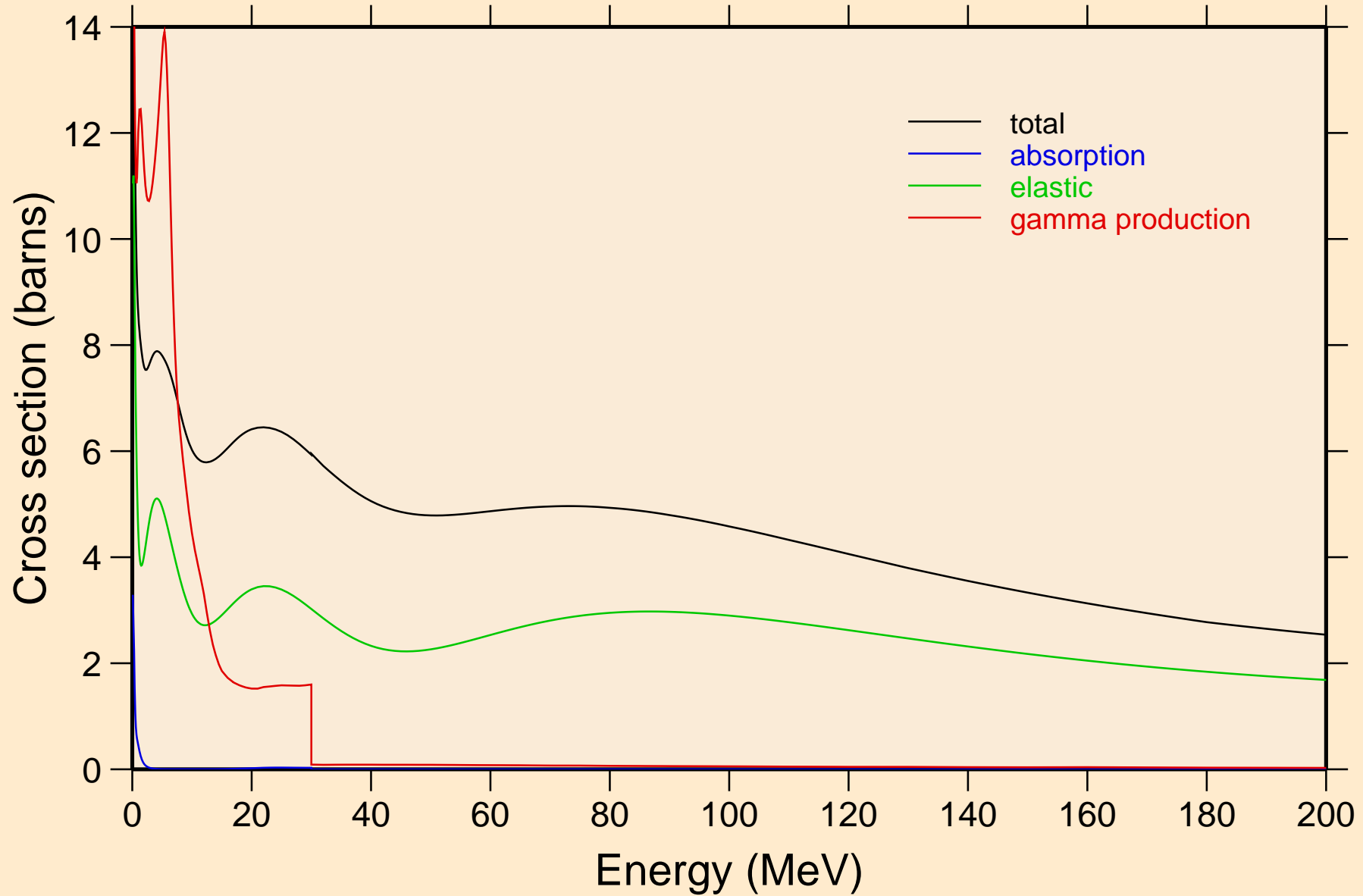

FM257 NEUTRON ACER TENDL-2023 LIBRARY; T=0.K

Heating

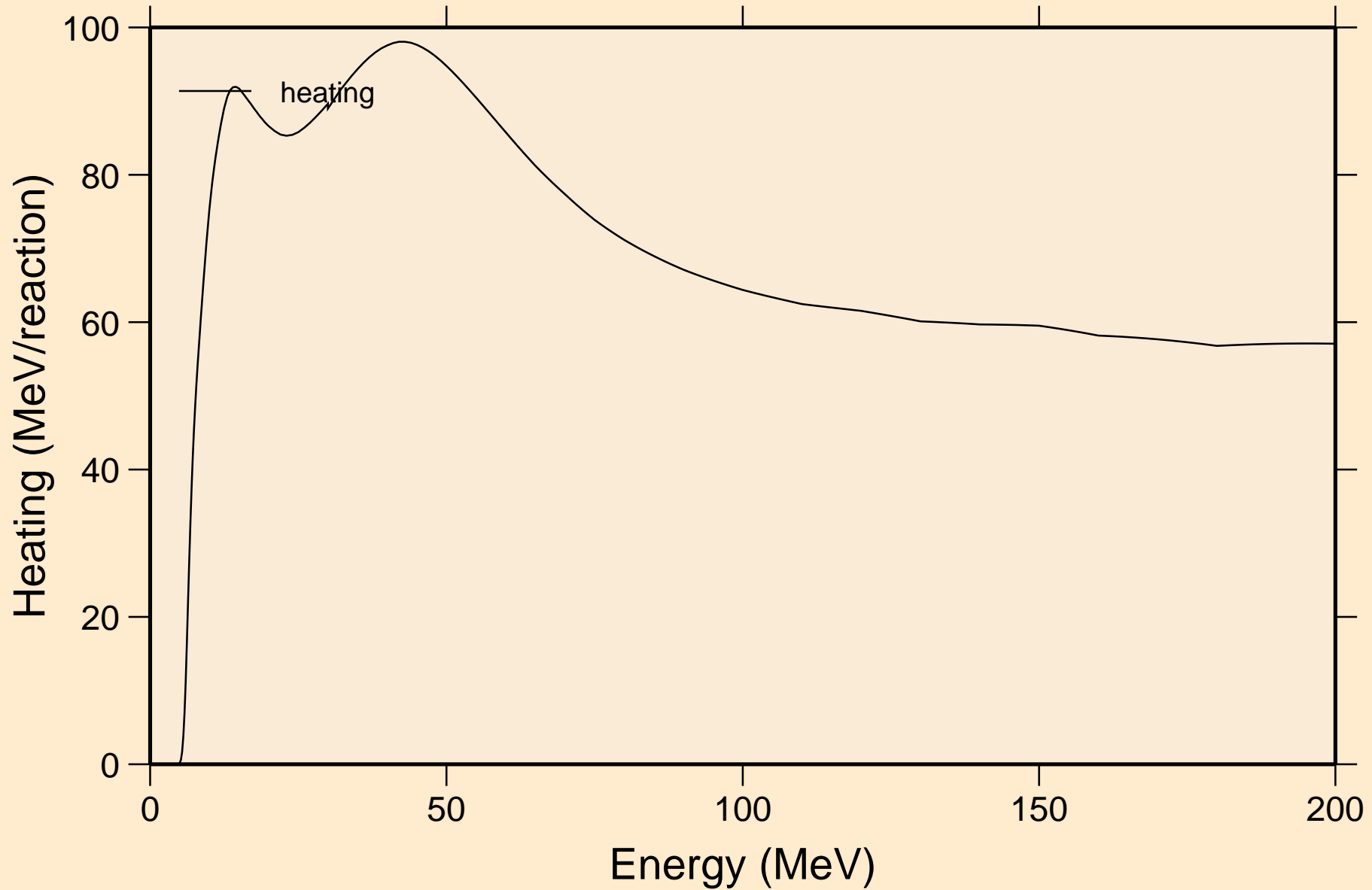

FM257 NEUTRON ACER TENDL-2023 LIBRARY; T=0.K

Damage

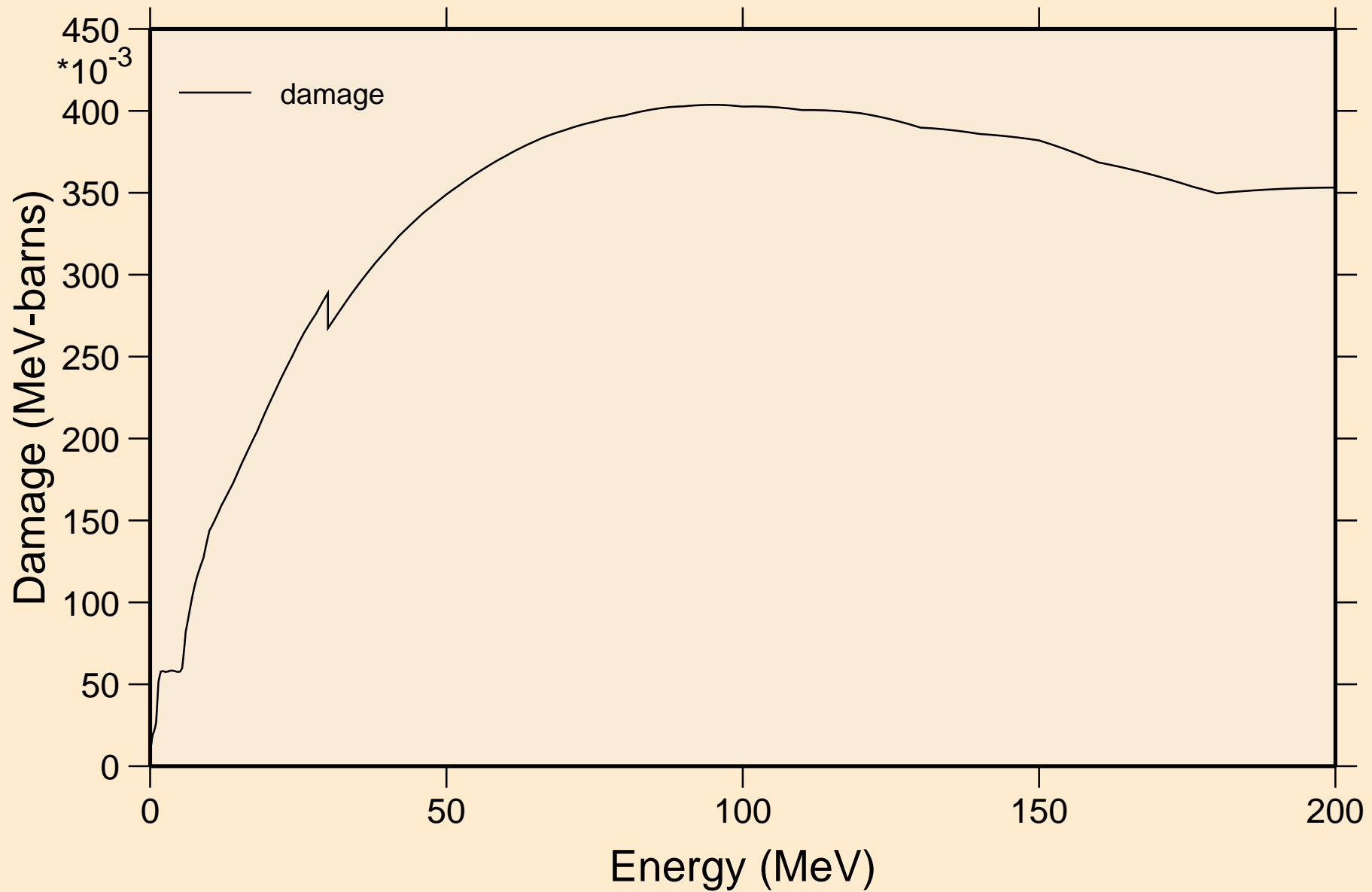

FM257 NEUTRON ACER TENDL-2023 LIBRARY; T=0.K

Non-threshold reactions

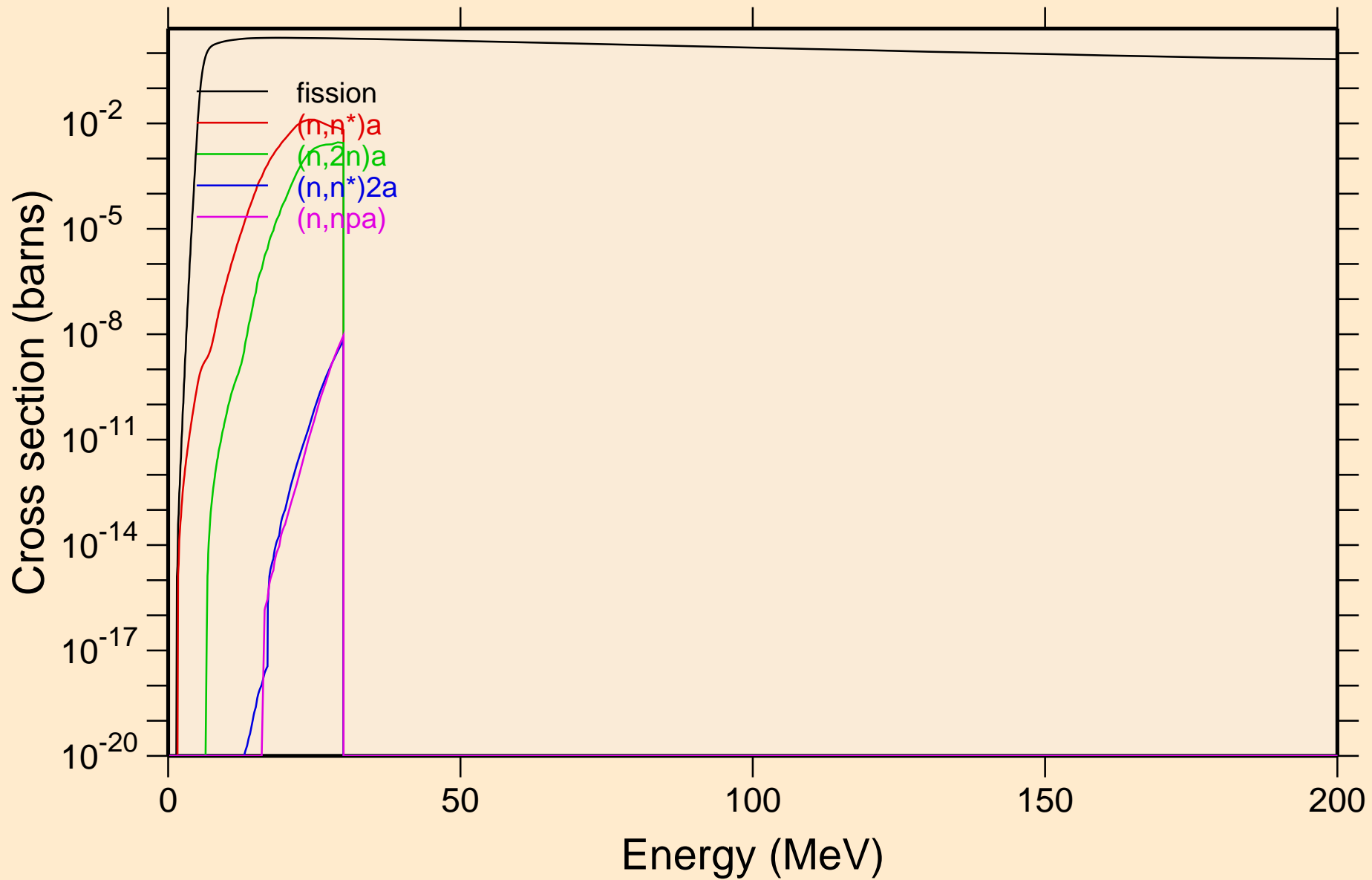

FM257 NEUTRON ACER TENDL-2023 LIBRARY; T=0.K
Non-threshold reactions

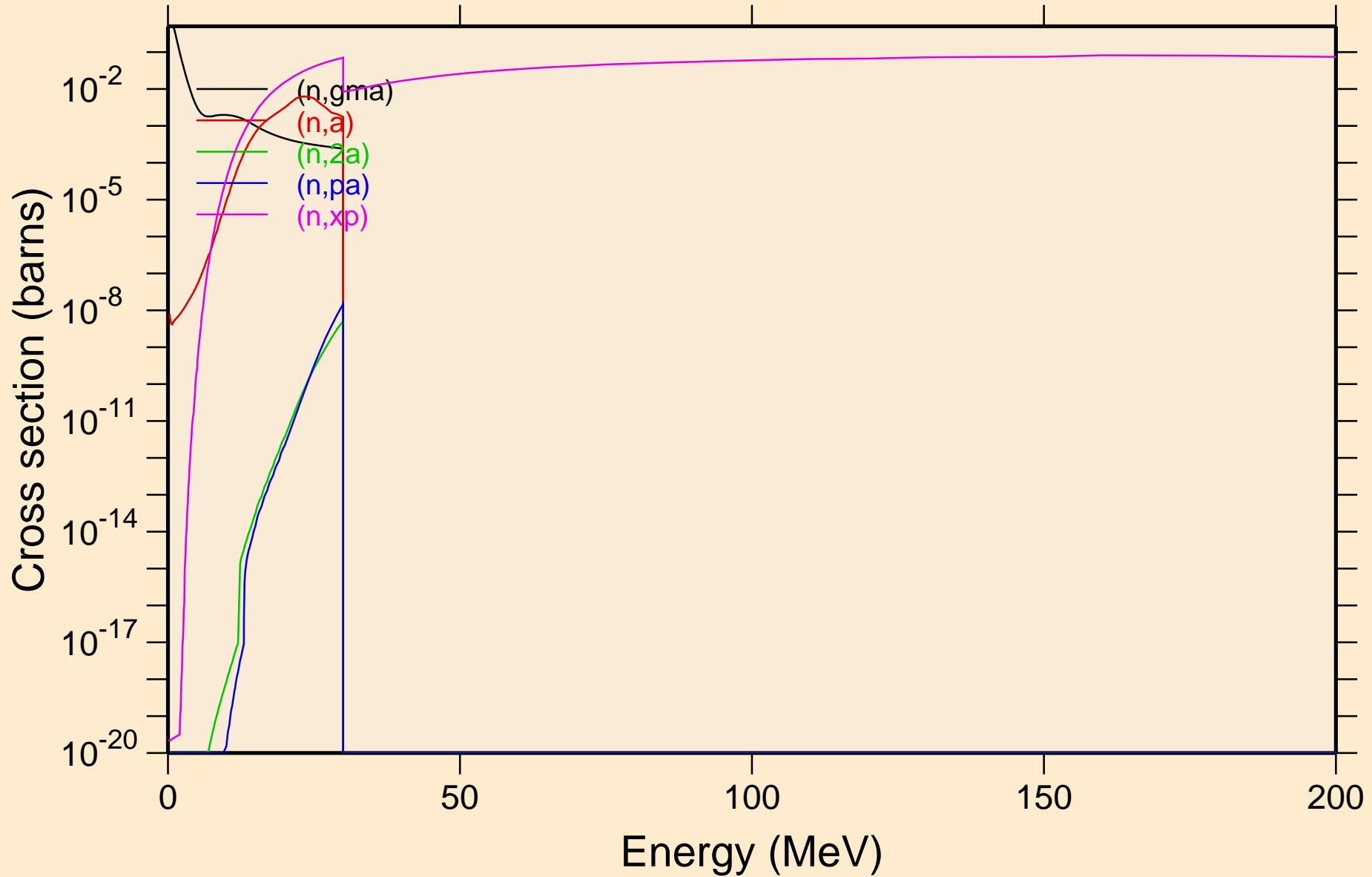

FM257 NEUTRON ACER TENDL-2023 LIBRARY; T=0.K
Non-threshold reactions

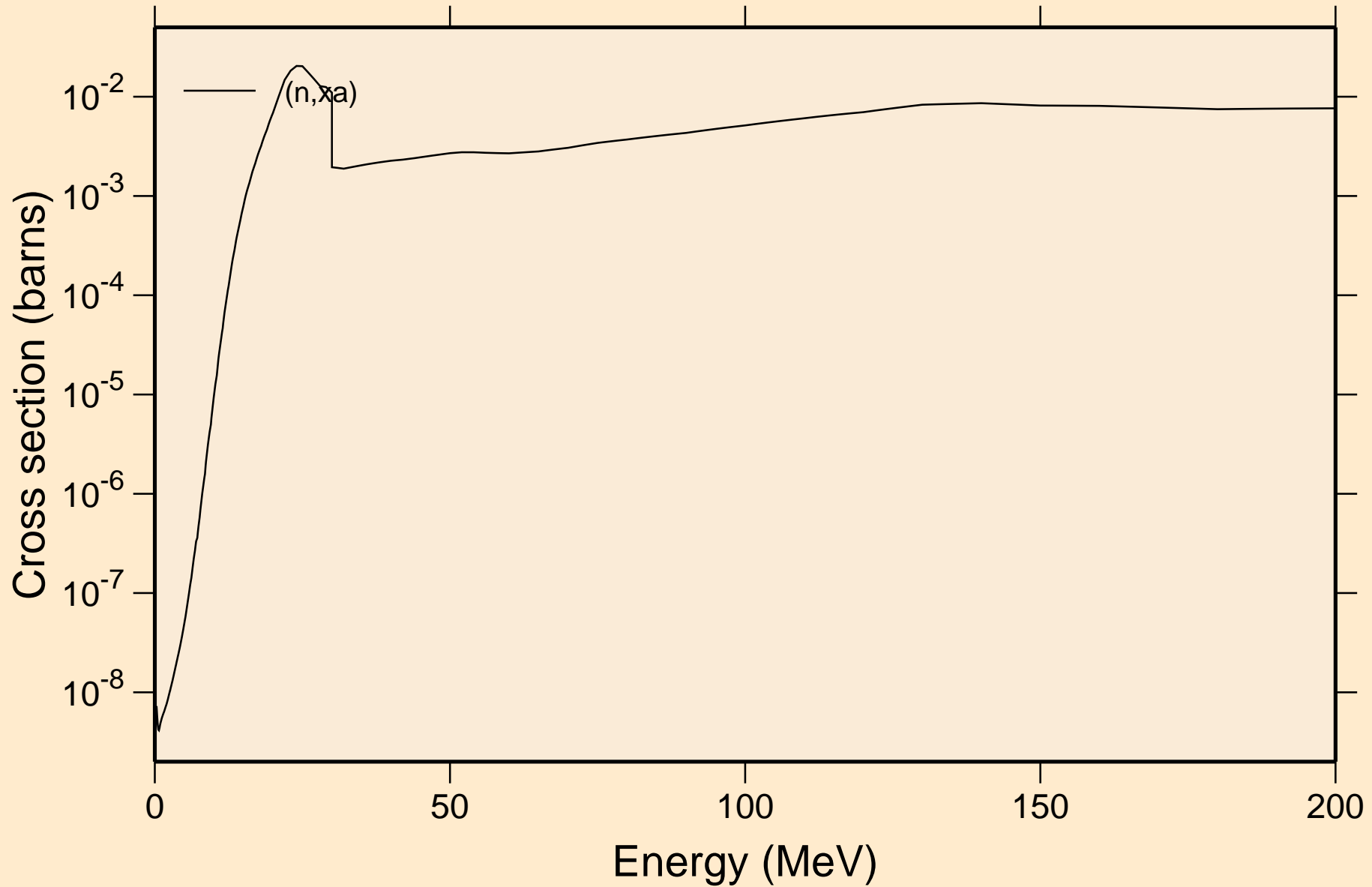

FM257 NEUTRON ACER TENDL-2023 LIBRARY; T=0.K
Inelastic levels

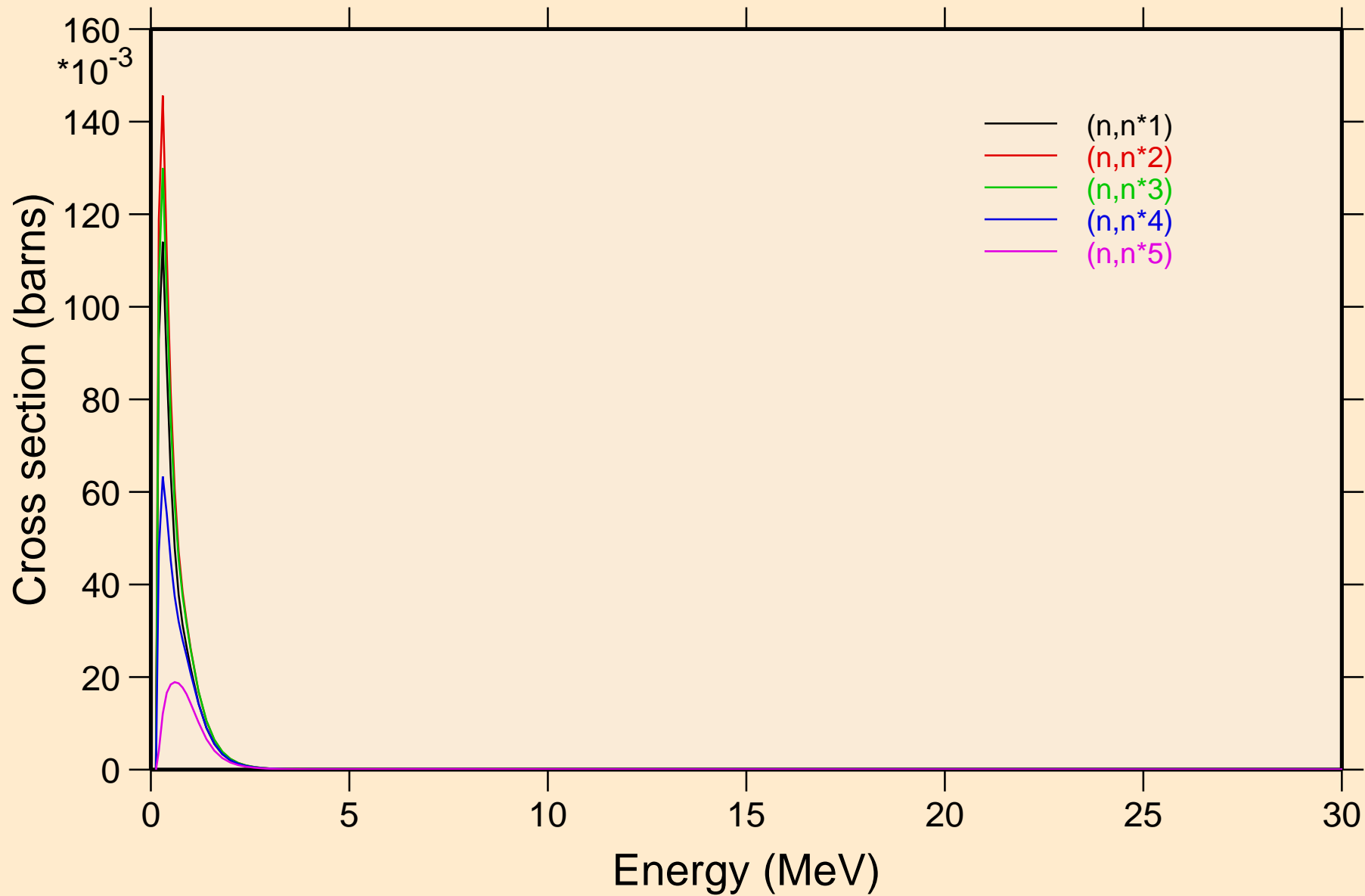

FM257 NEUTRON ACER TENDL-2023 LIBRARY; T=0.K

Inelastic levels

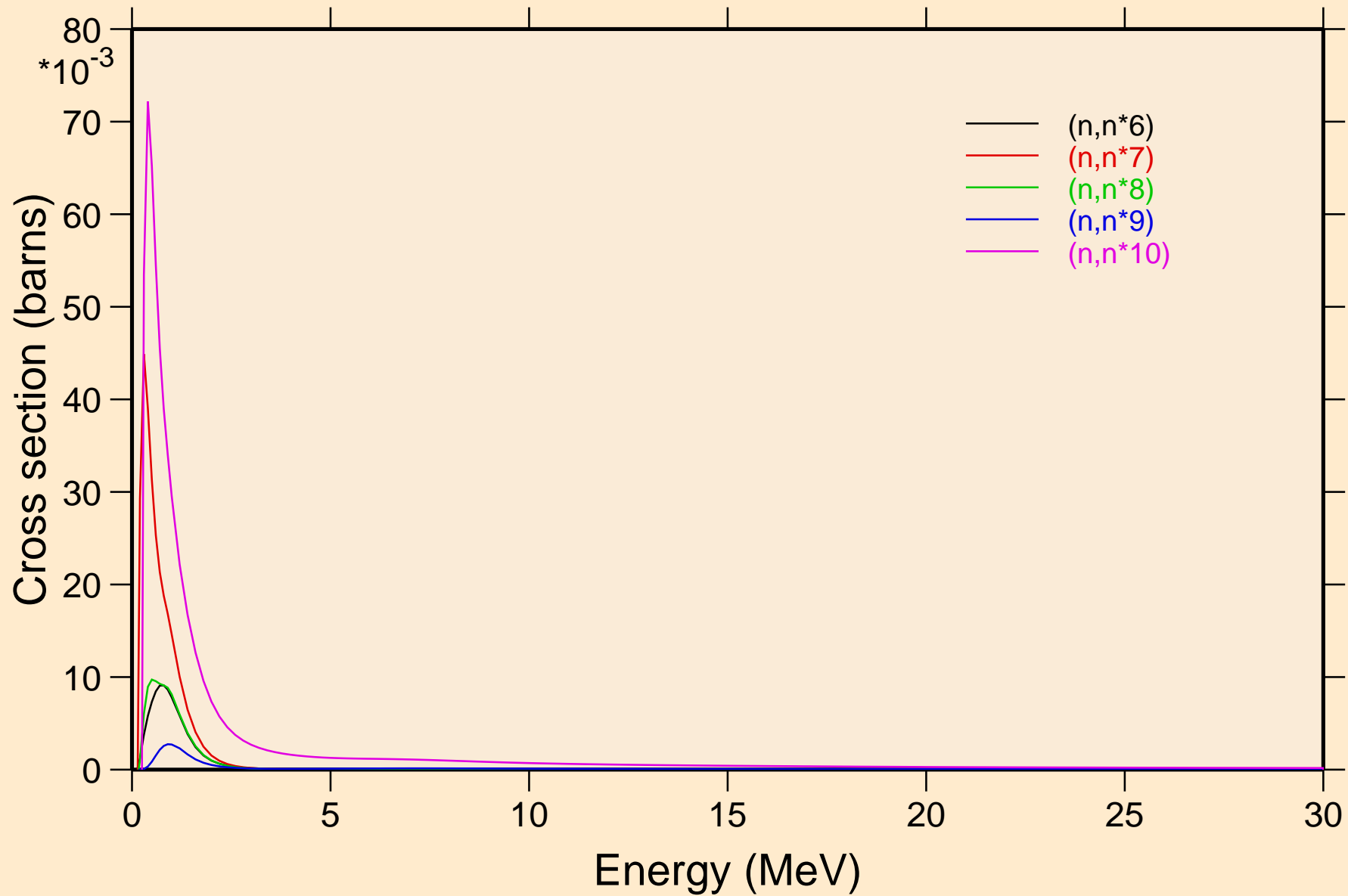

FM257 NEUTRON ACER TENDL-2023 LIBRARY; T=0.K
Inelastic levels

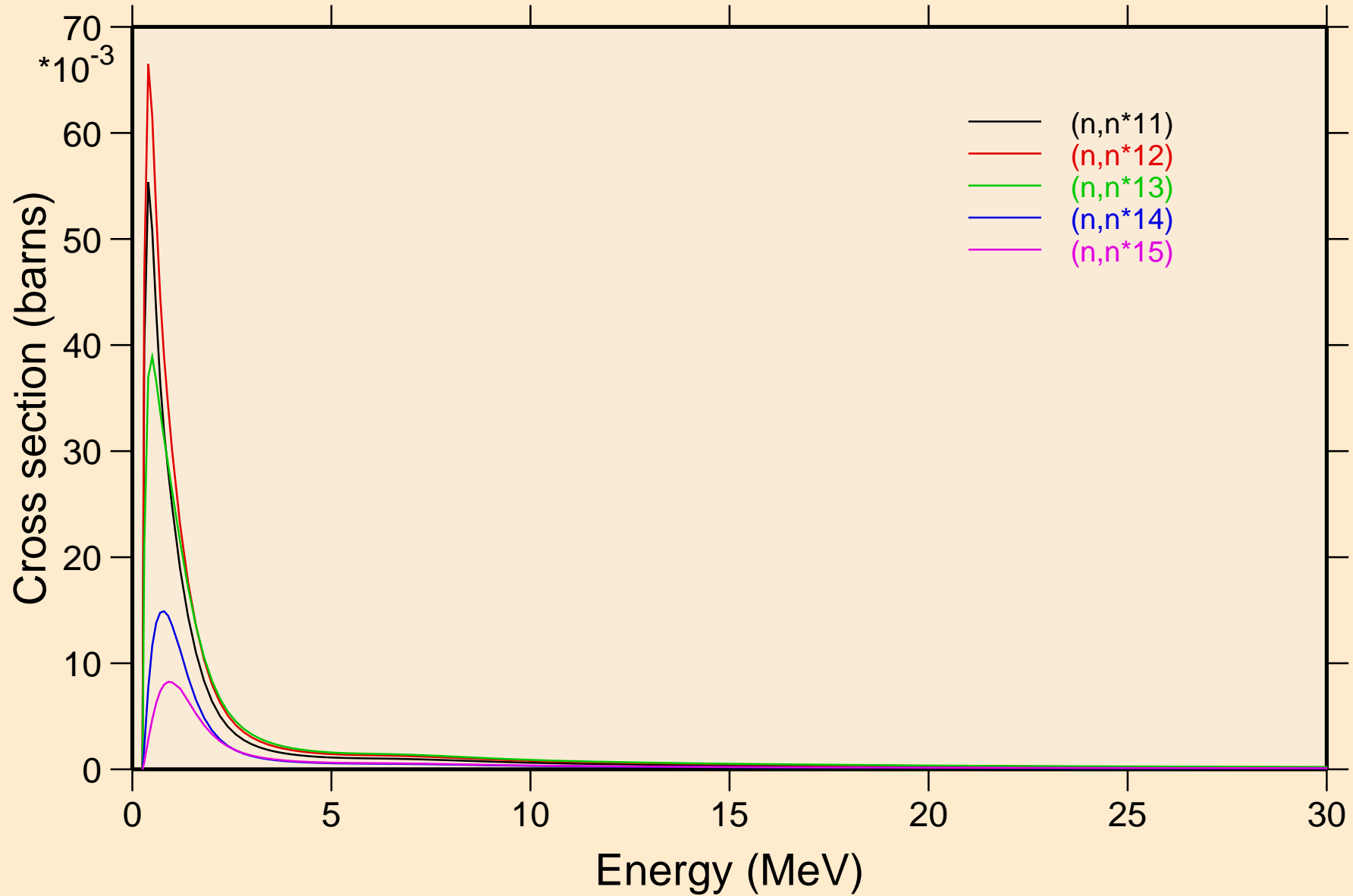

FM257 NEUTRON ACER TENDL-2023 LIBRARY; T=0.K

Inelastic levels

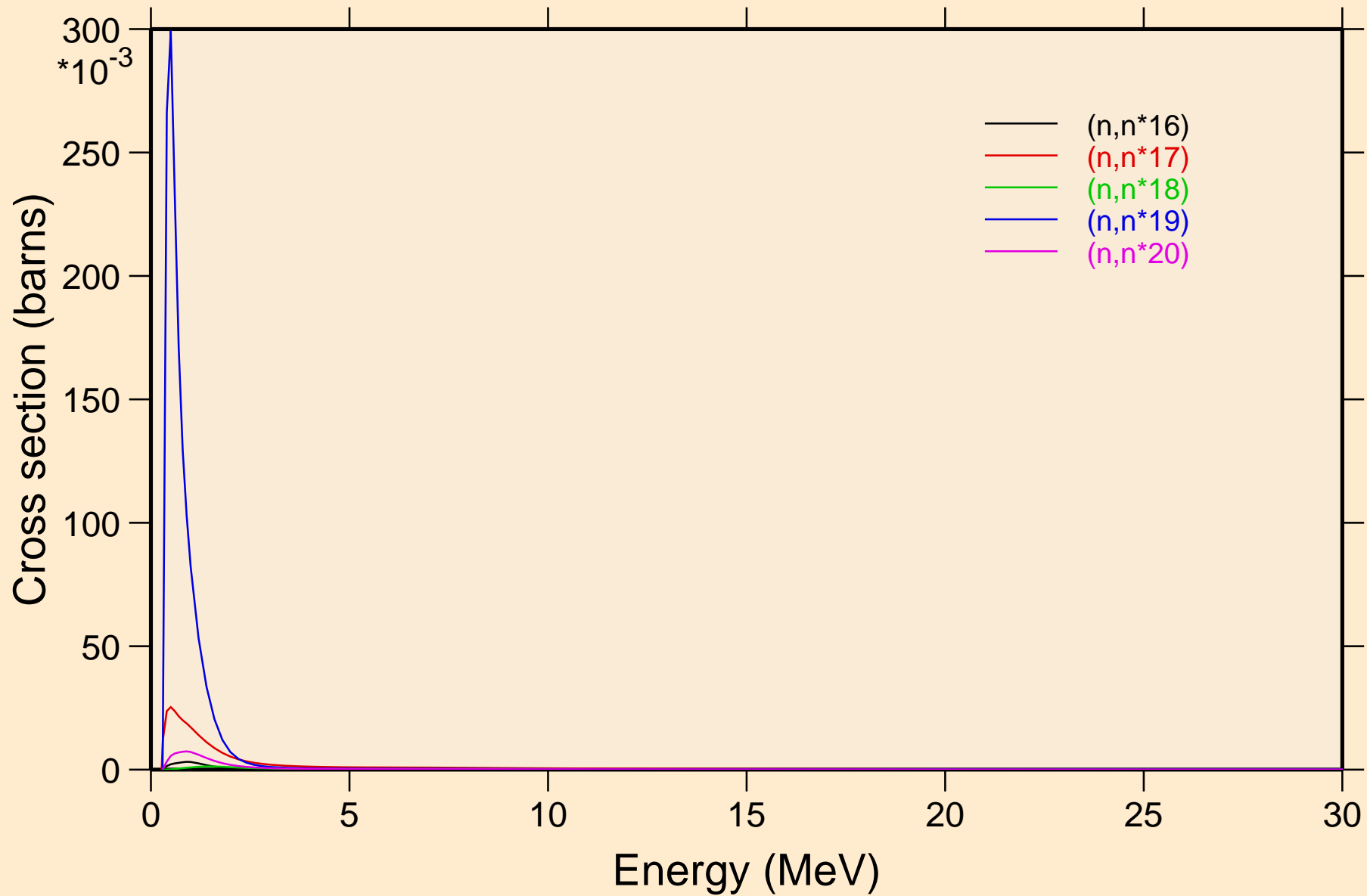

FM257 NEUTRON ACER TENDL-2023 LIBRARY; T=0.K
Inelastic levels

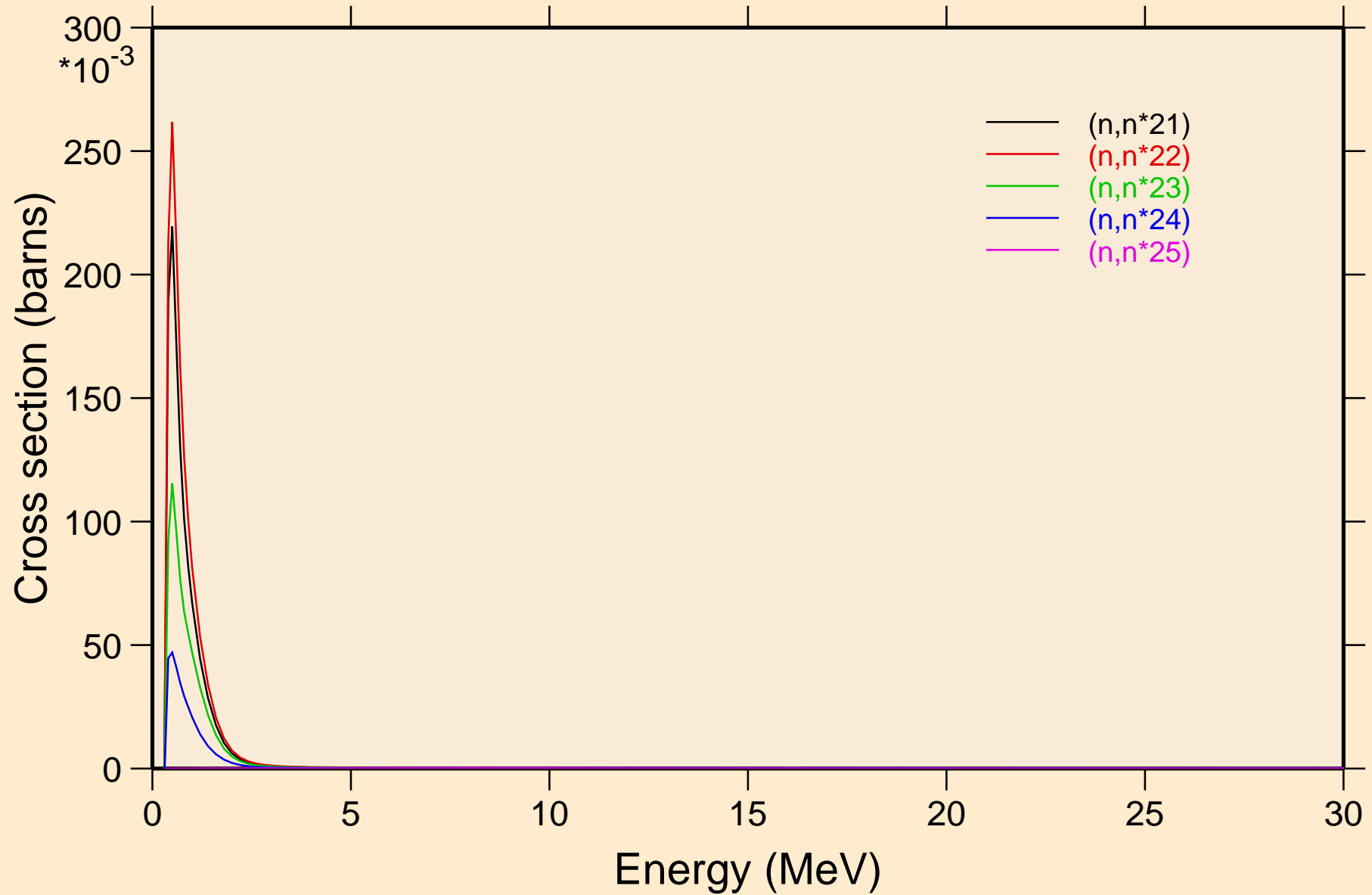

FM257 NEUTRON ACER TENDL-2023 LIBRARY; T=0.K
Inelastic levels

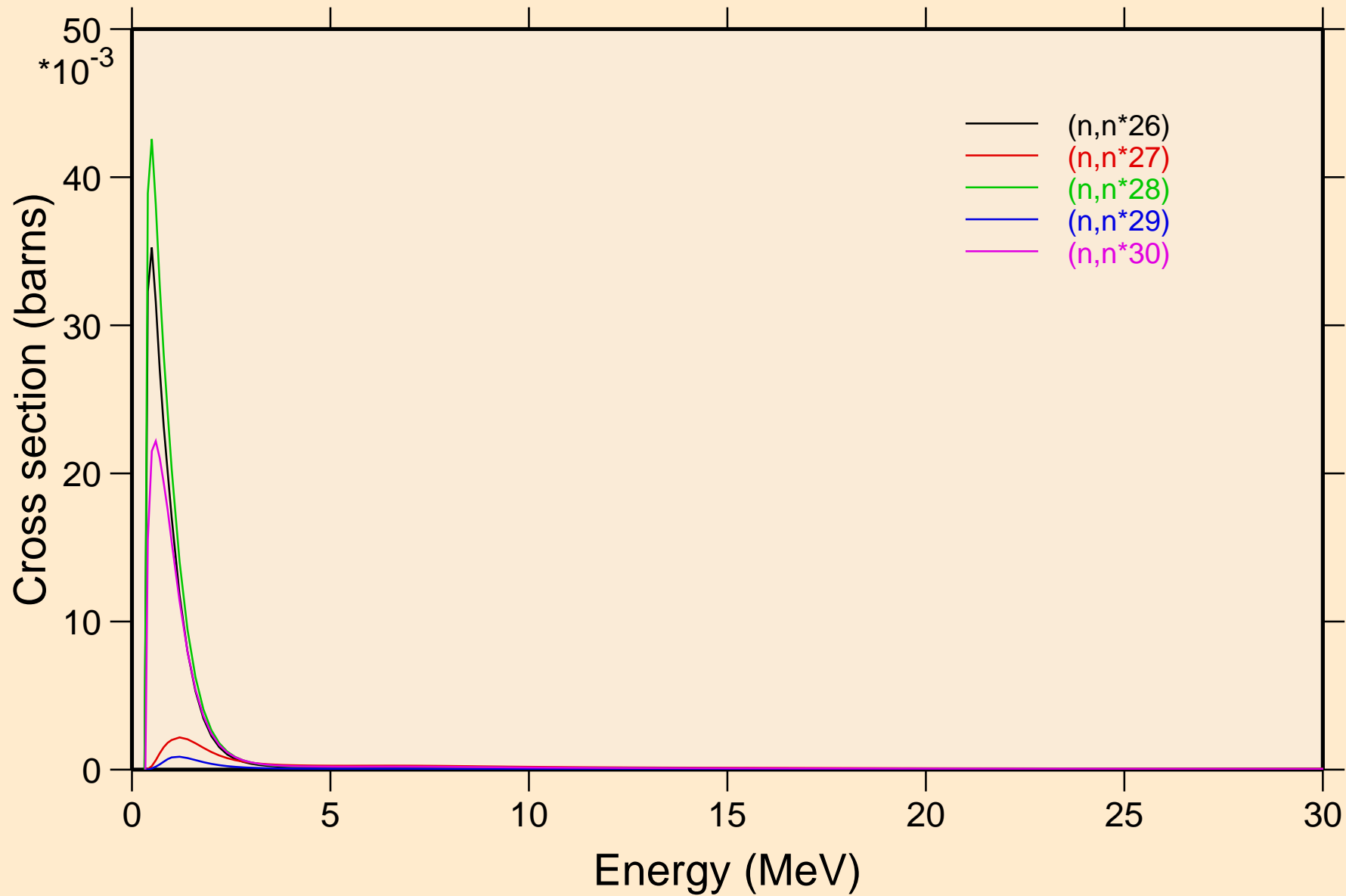

FM257 NEUTRON ACER TENDL-2023 LIBRARY; T=0.K

Threshold reactions

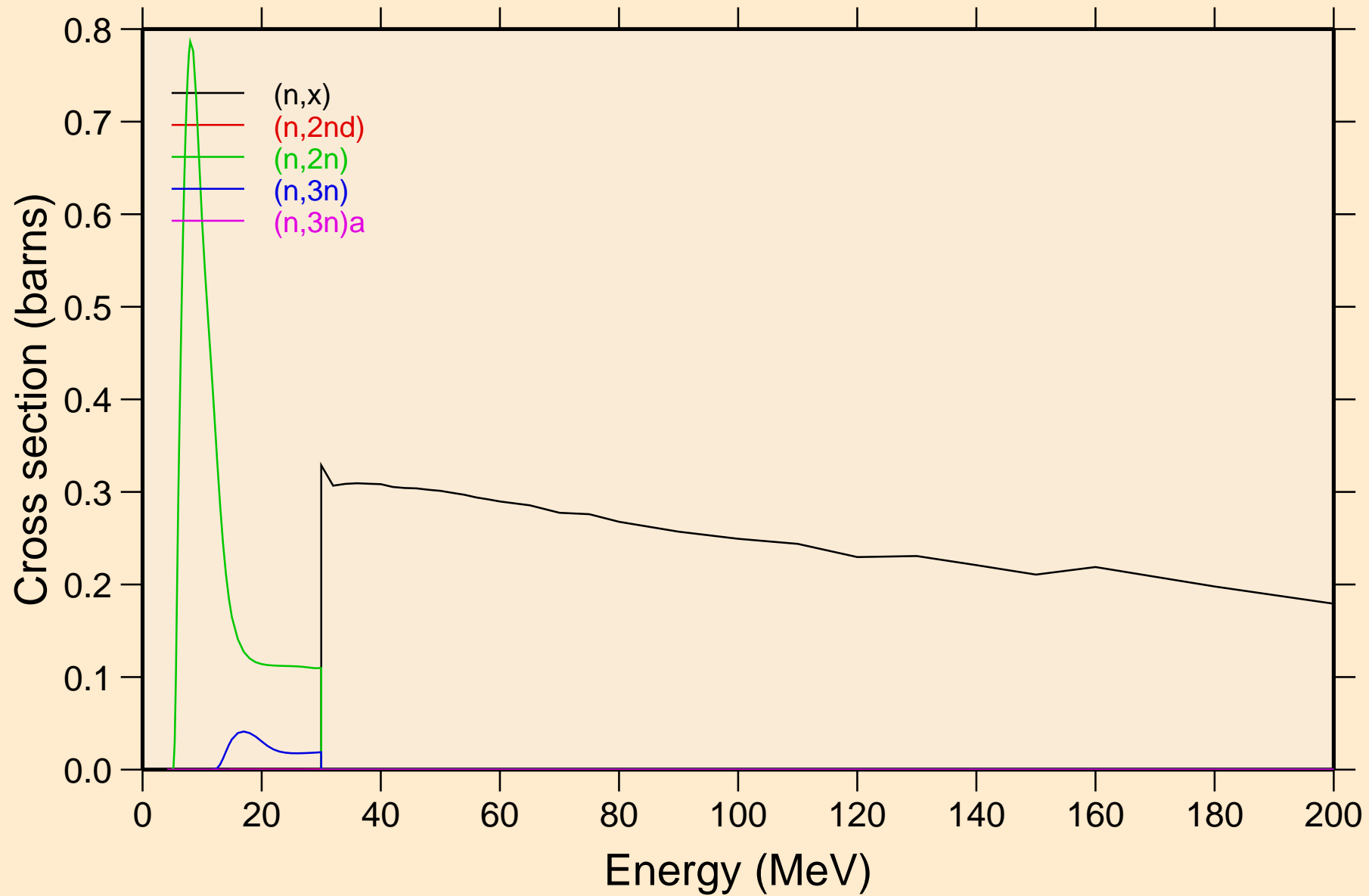

FM257 NEUTRON ACER TENDL-2023 LIBRARY; T=0.K

Threshold reactions

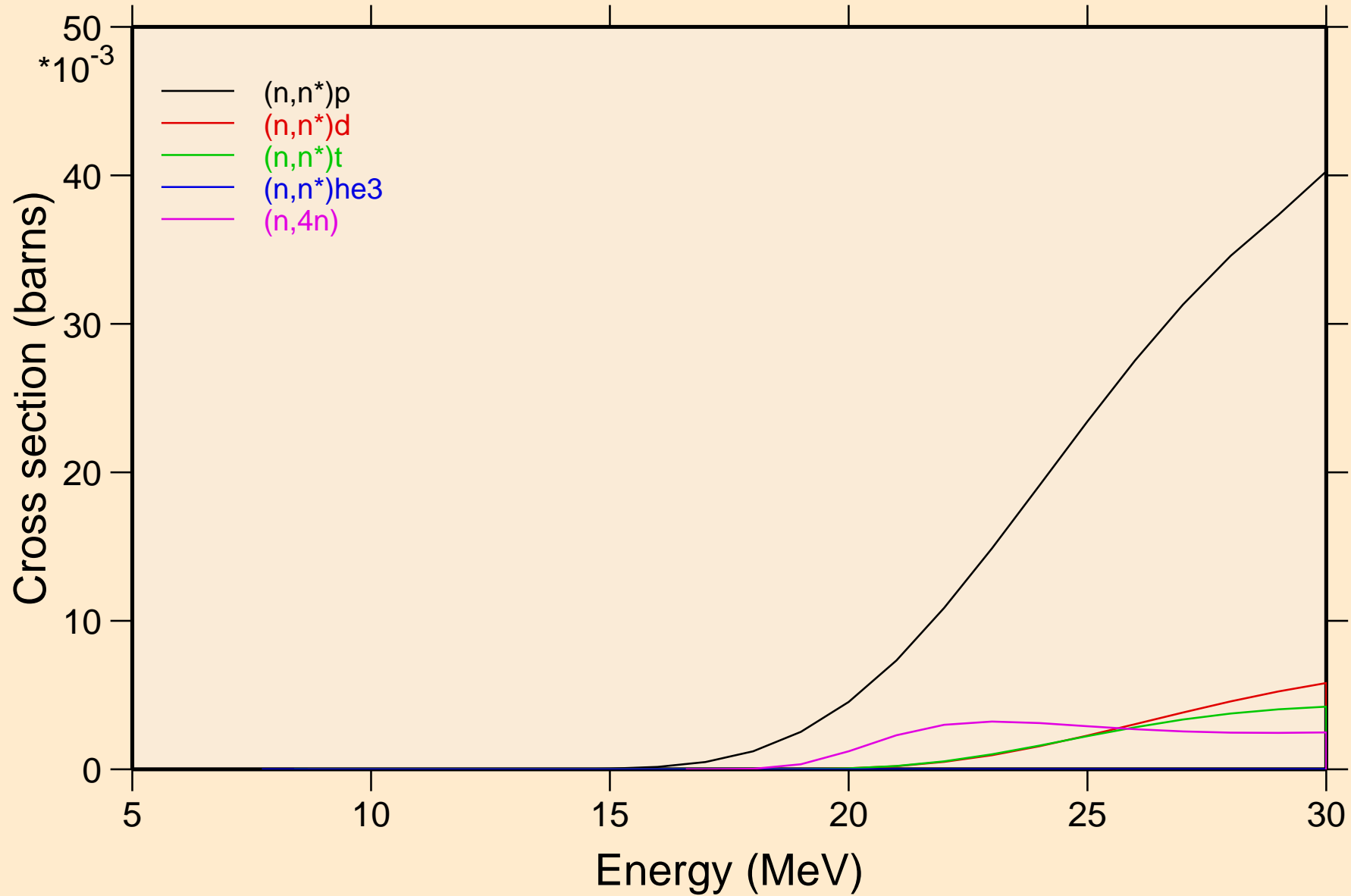

FM257 NEUTRON ACER TENDL-2023 LIBRARY; T=0.K
Threshold reactions

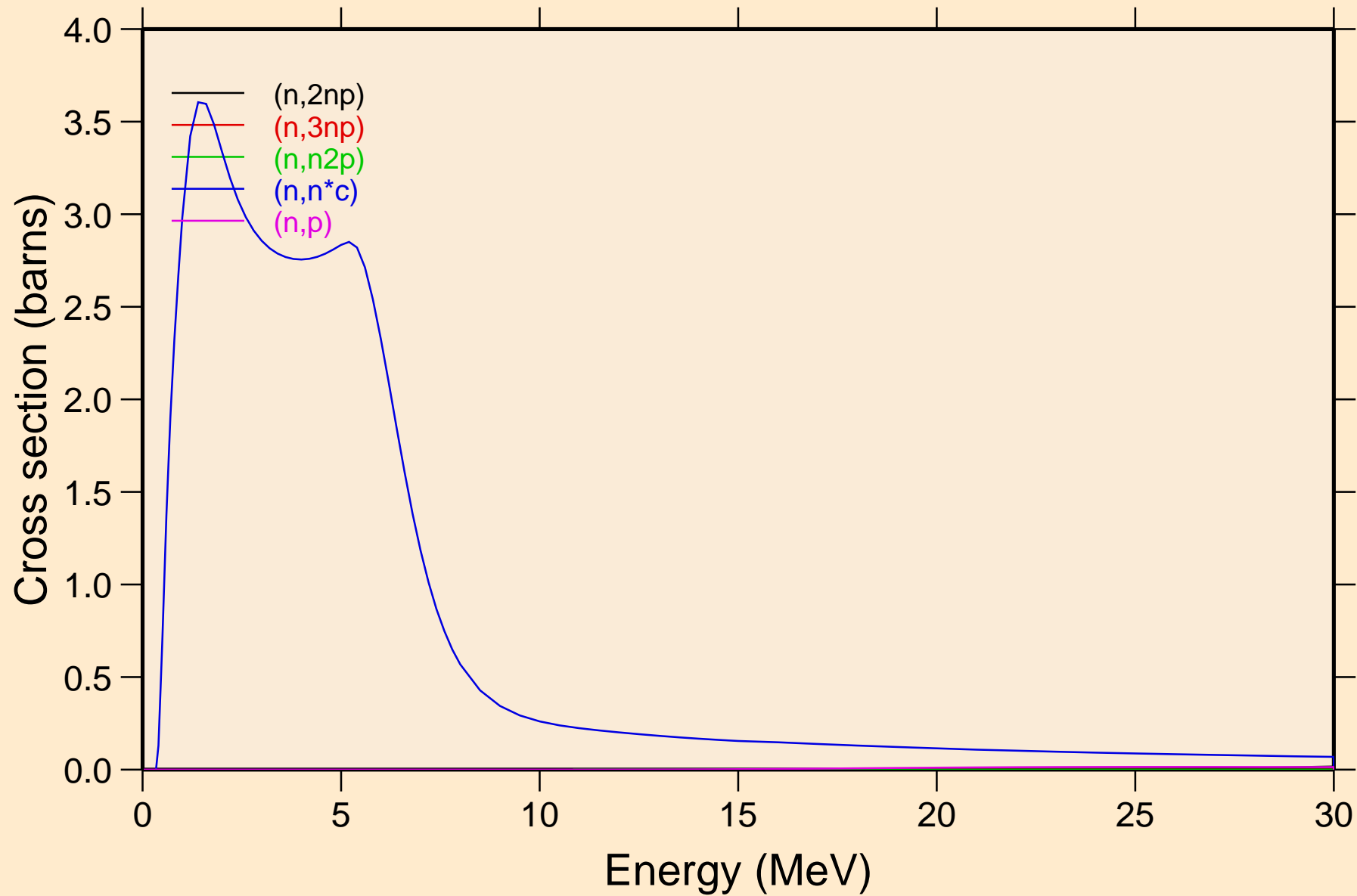

FM257 NEUTRON ACER TENDL-2023 LIBRARY; T=0.K

Threshold reactions

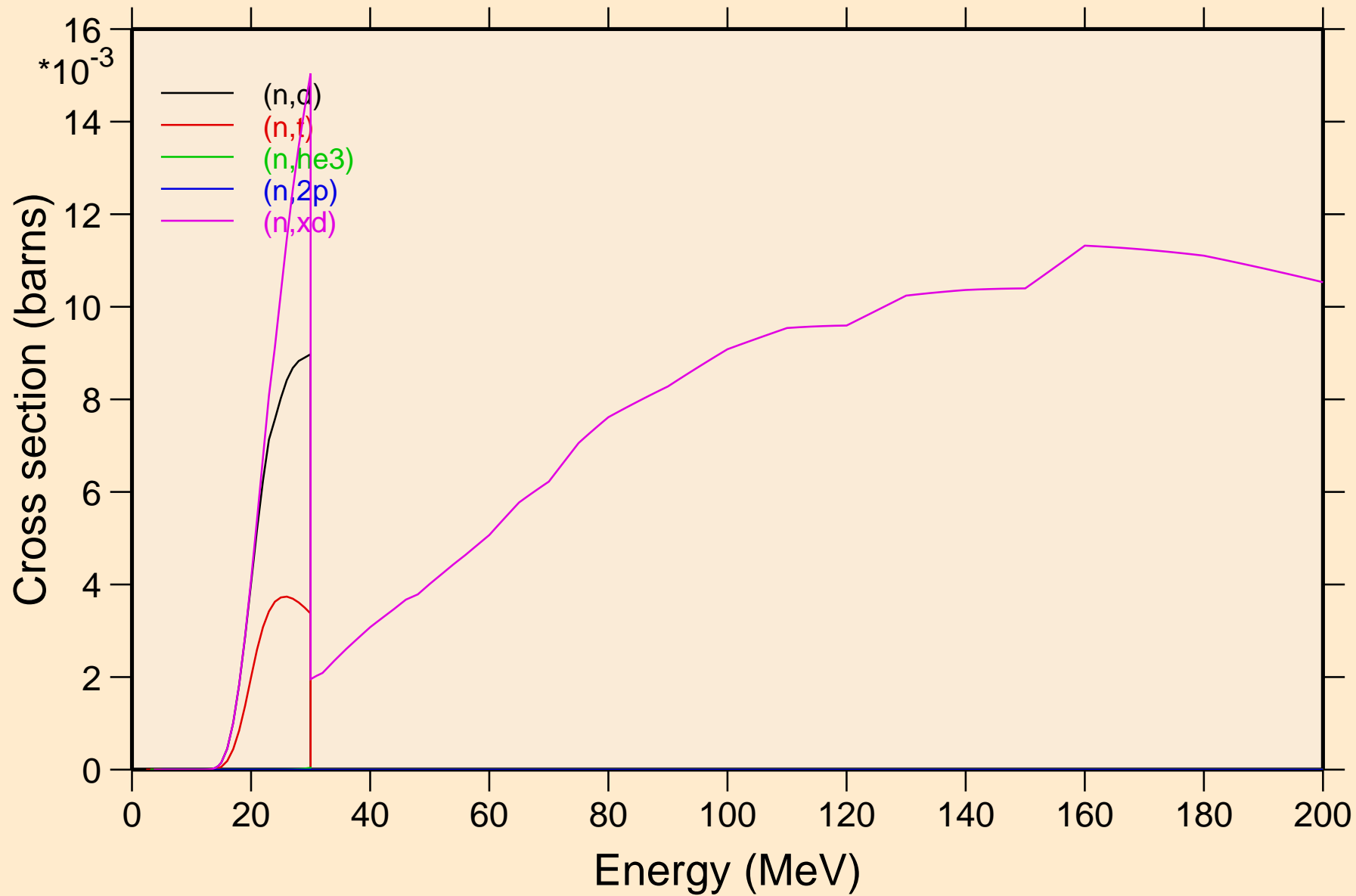

FM257 NEUTRON ACER TENDL-2023 LIBRARY; T=0.K
Threshold reactions

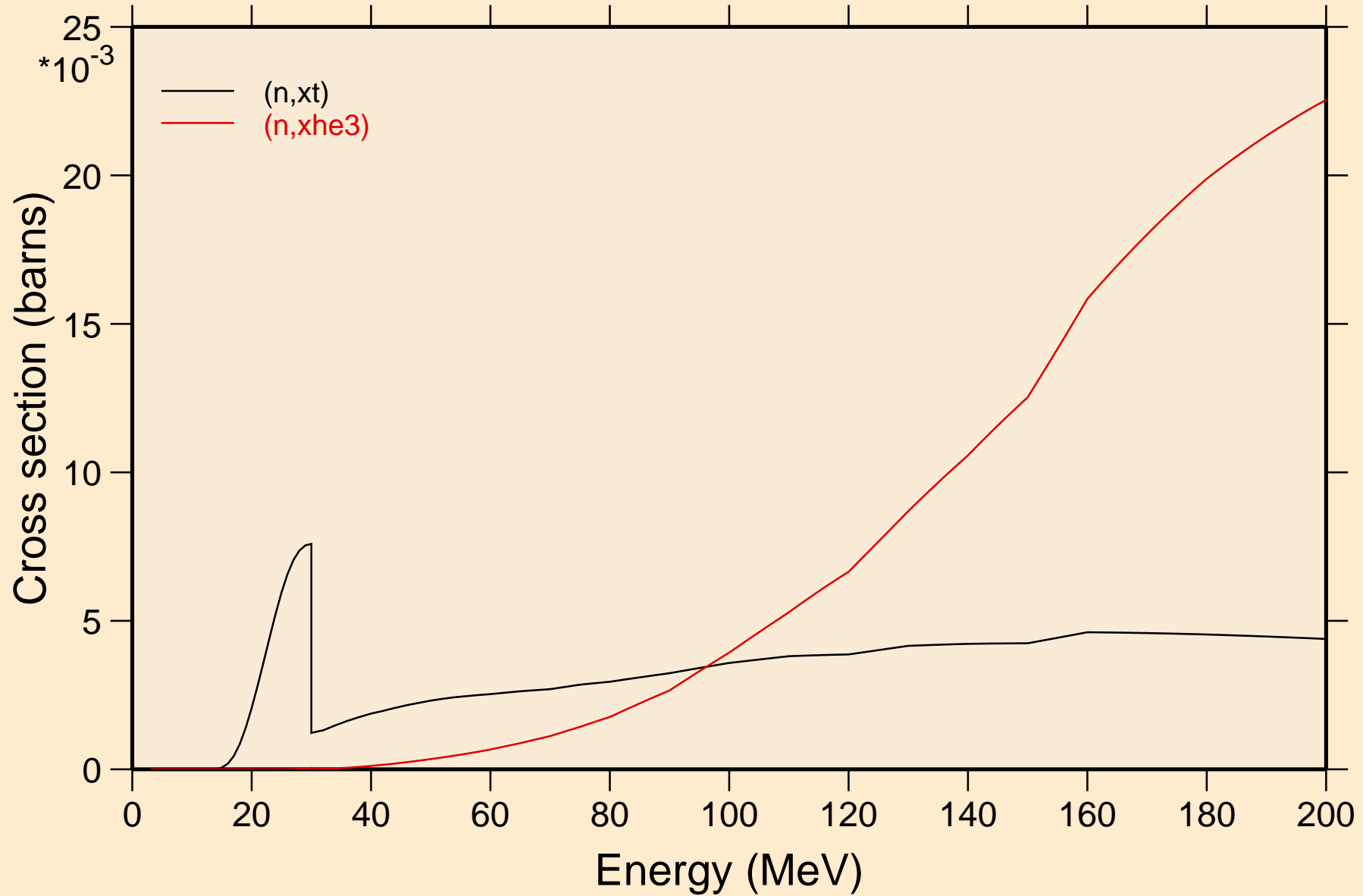

FM257 NEUTRON ACER TENDL-2023 LIBRARY; T=0.K
angular distribution for elastic

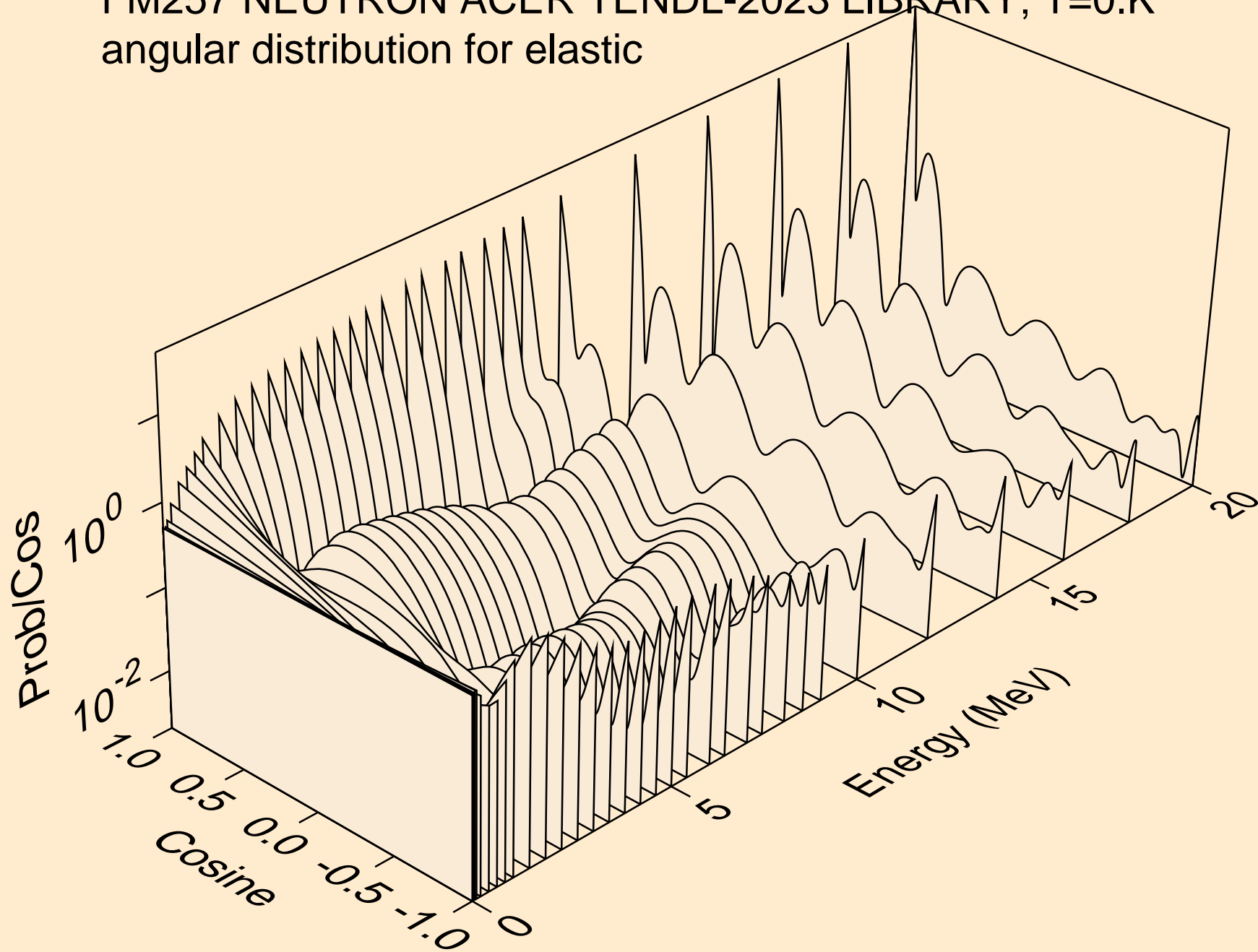

FM257 NEUTRON ACER TENDL-2023 LIBRARY; T=0.K
angular distribution for elastic

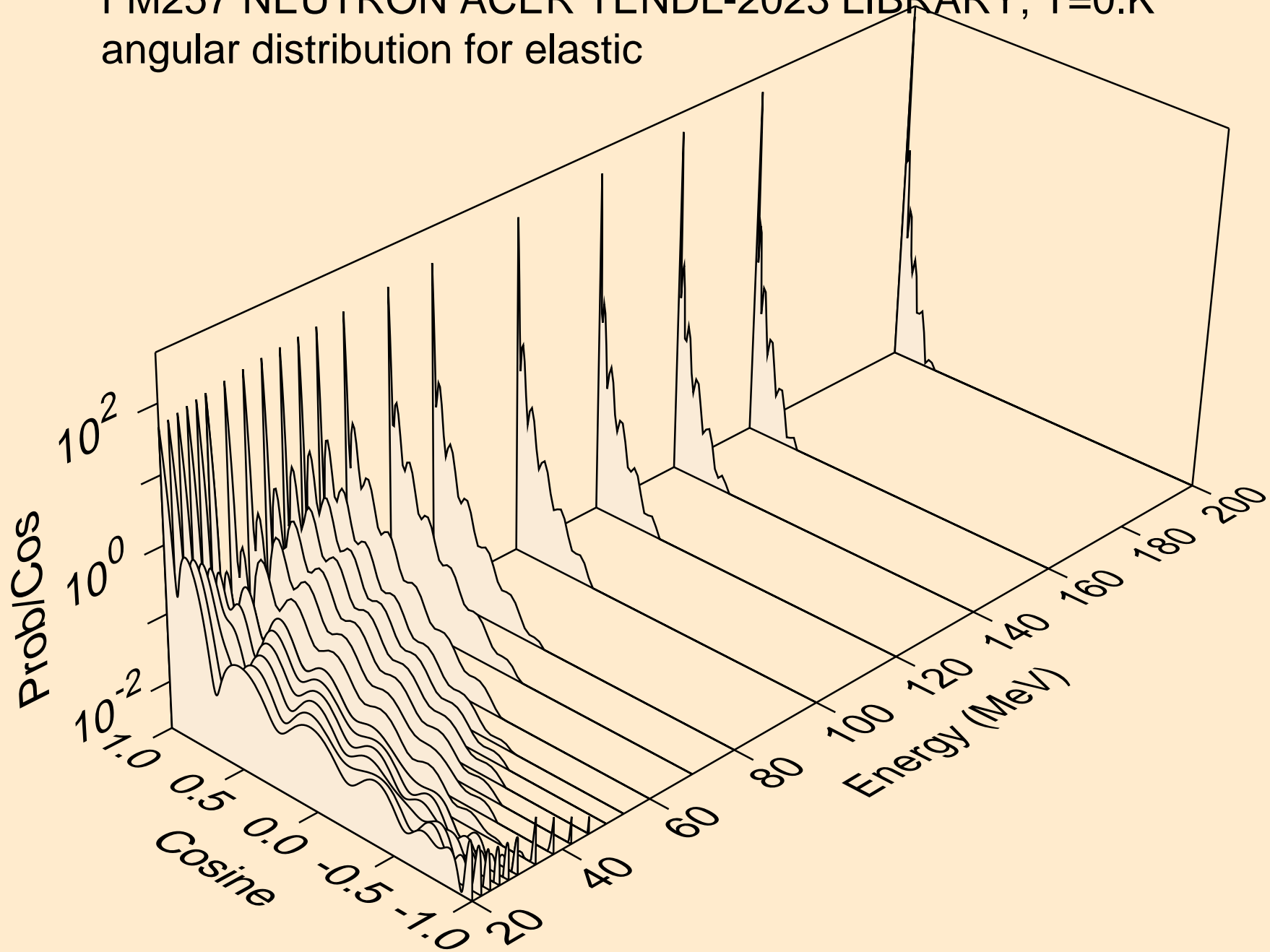

FM257 NEUTRON ACER TENDL-2023 LIBRARY; T=0.K
angular distribution for (n,n*1)

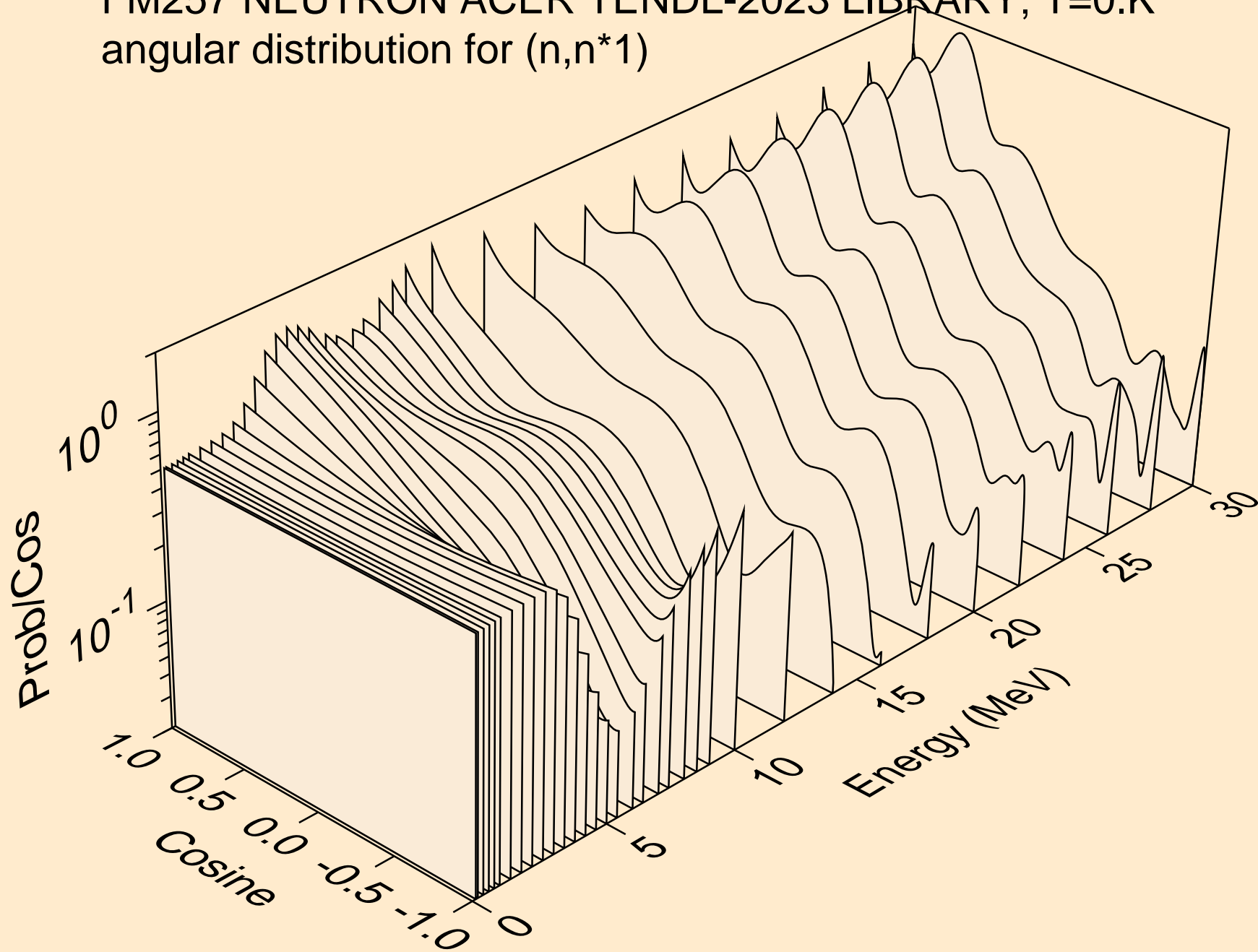

FM257 NEUTRON ACER TENDL-2023 LIBRARY; T=0.K
angular distribution for (n,n*2)

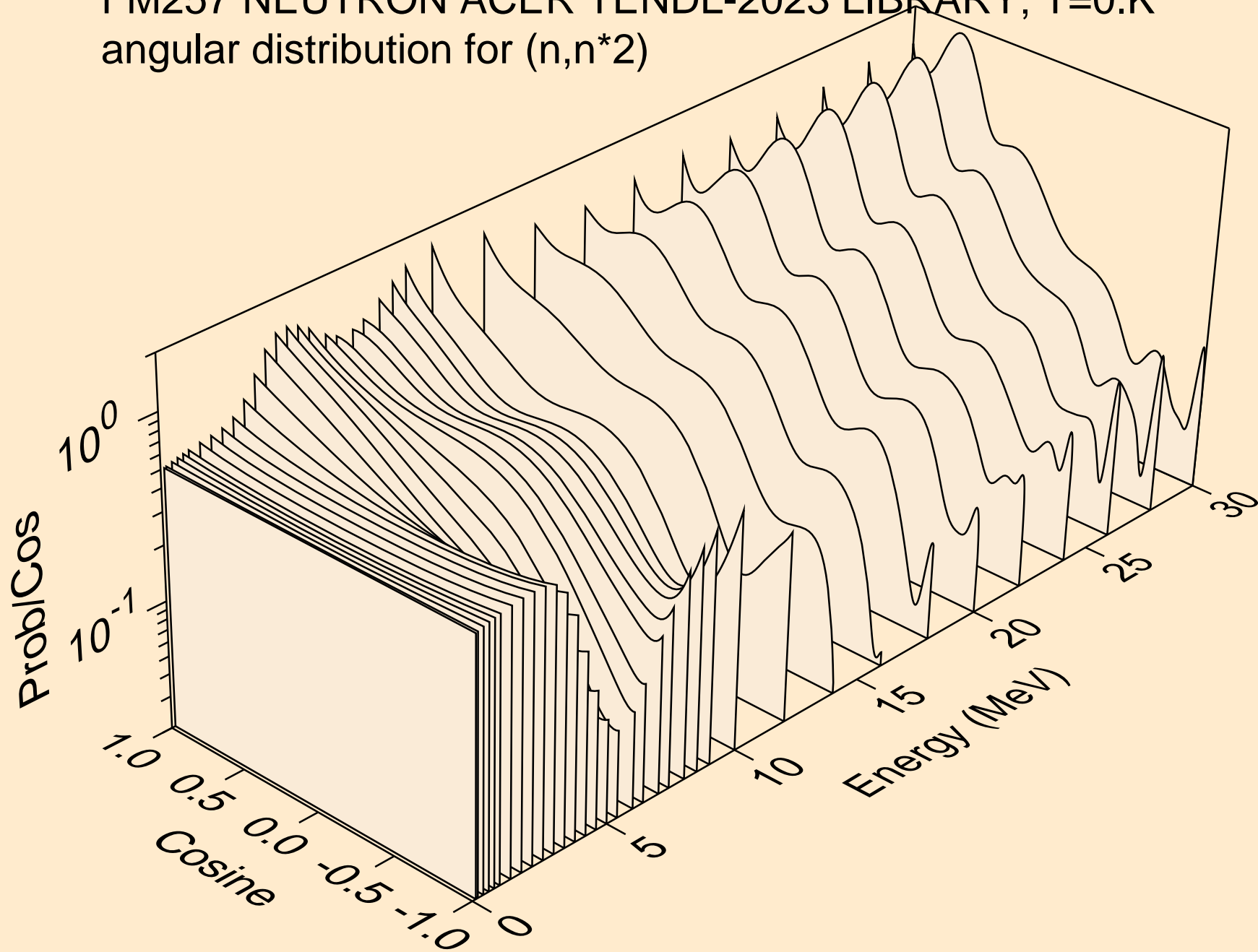

FM257 NEUTRON ACER TENDL-2023 LIBRARY; T=0.K
angular distribution for (n,n*3)

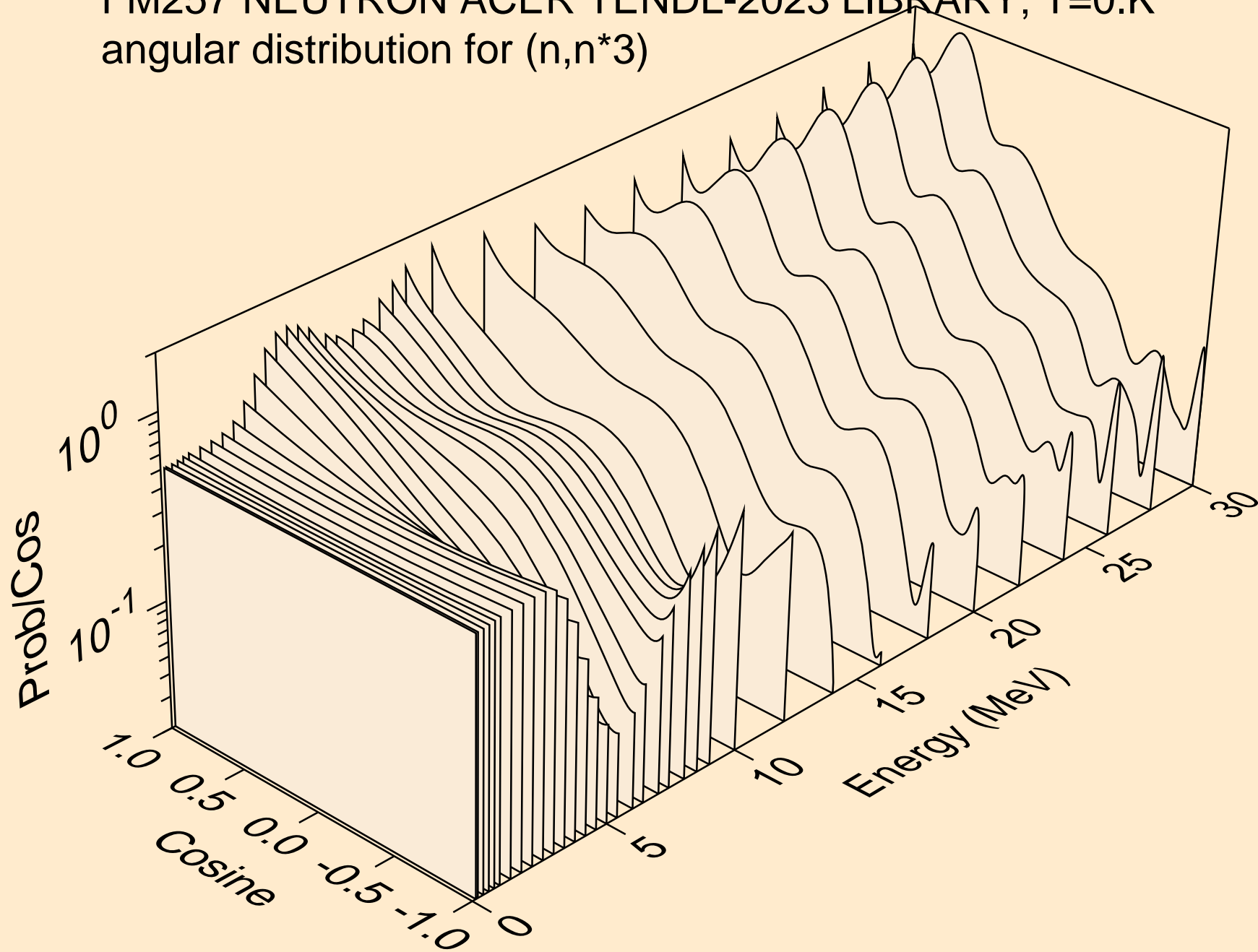

FM257 NEUTRON ACER TENDL-2023 LIBRARY; T=0.K
angular distribution for (n,n*4)

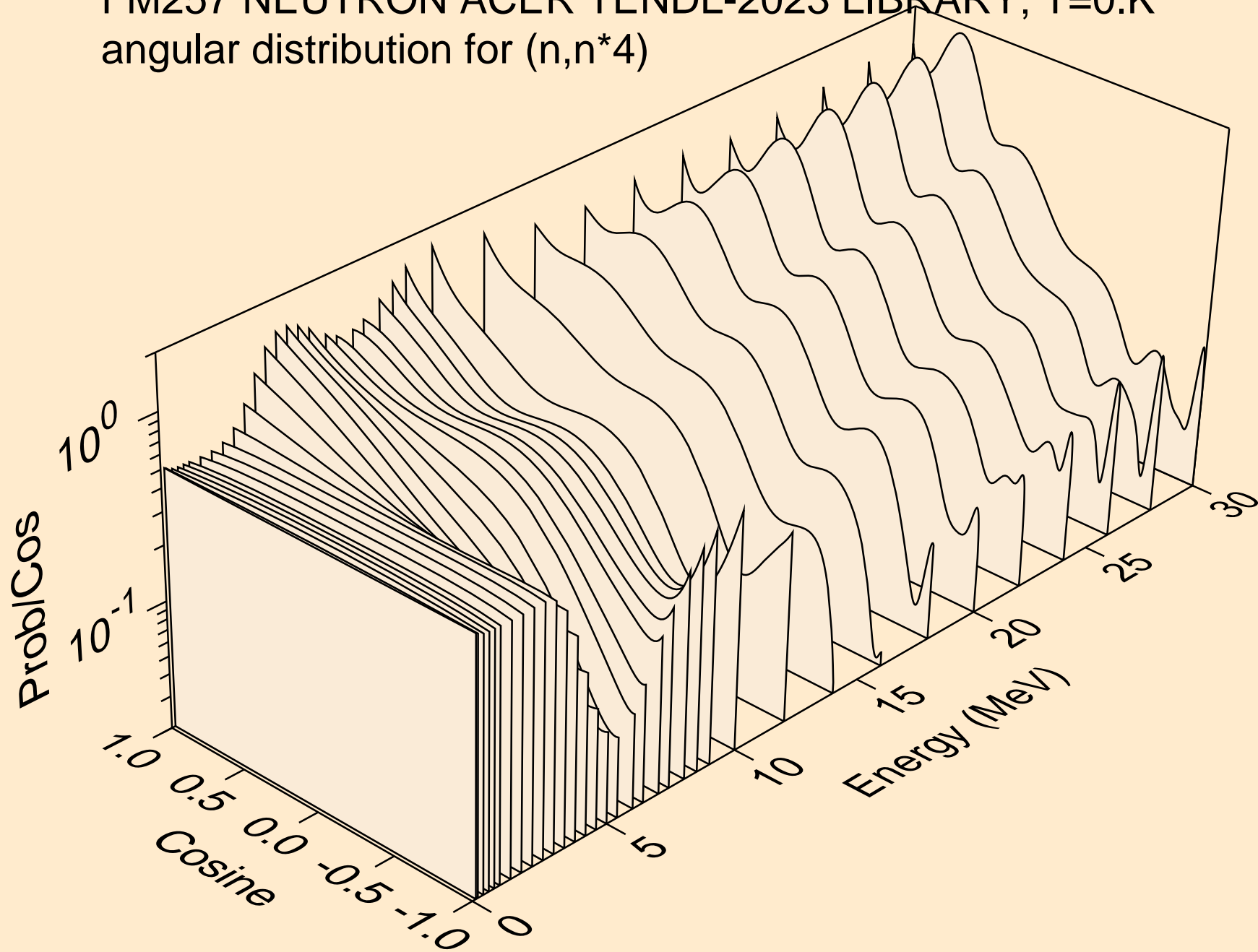

FM257 NEUTRON ACER TENDL-2023 LIBRARY; T=0.K
angular distribution for (n,n*5)

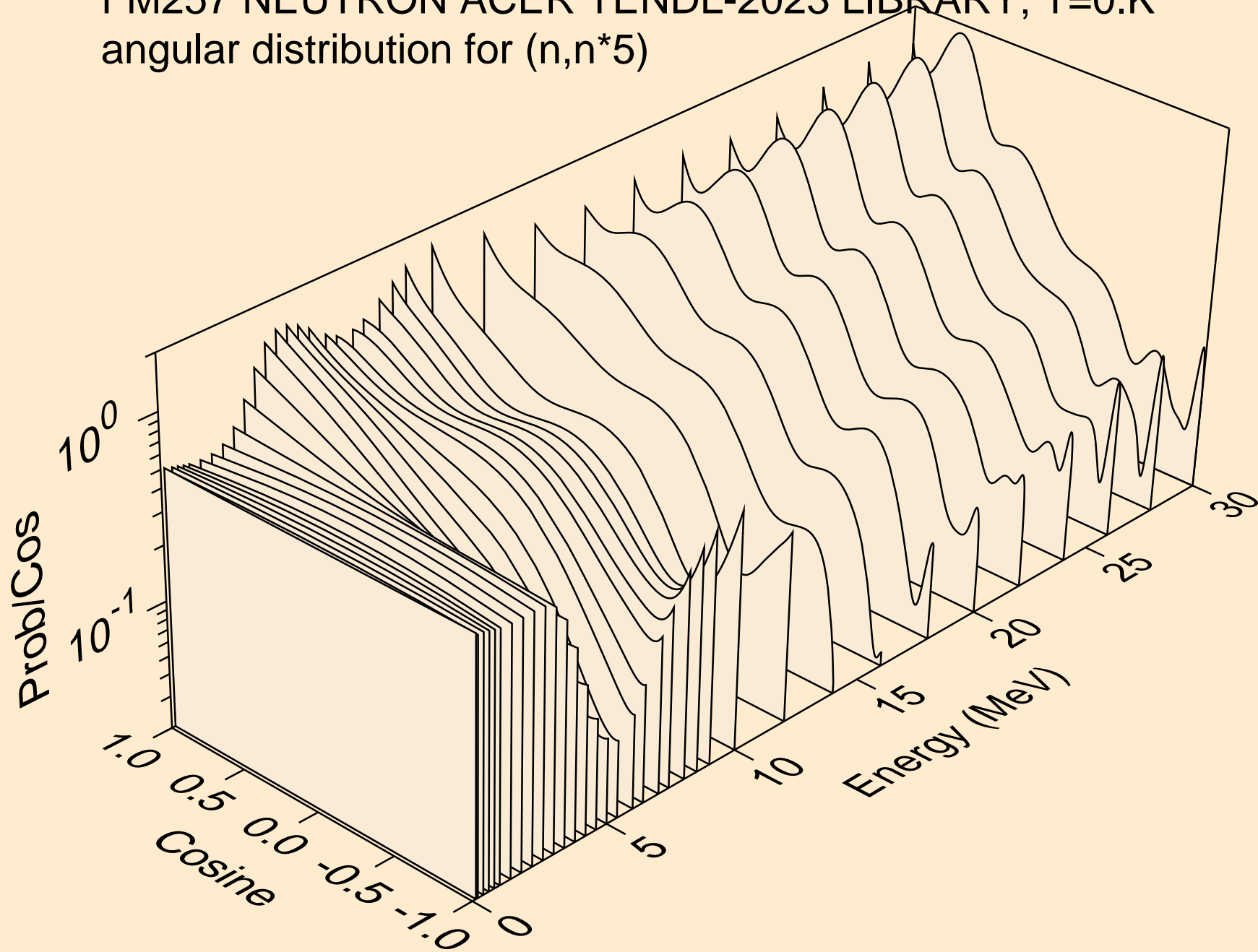

FM257 NEUTRON ACER TENDL-2023 LIBRARY; T=0.K
angular distribution for (n,n*6)

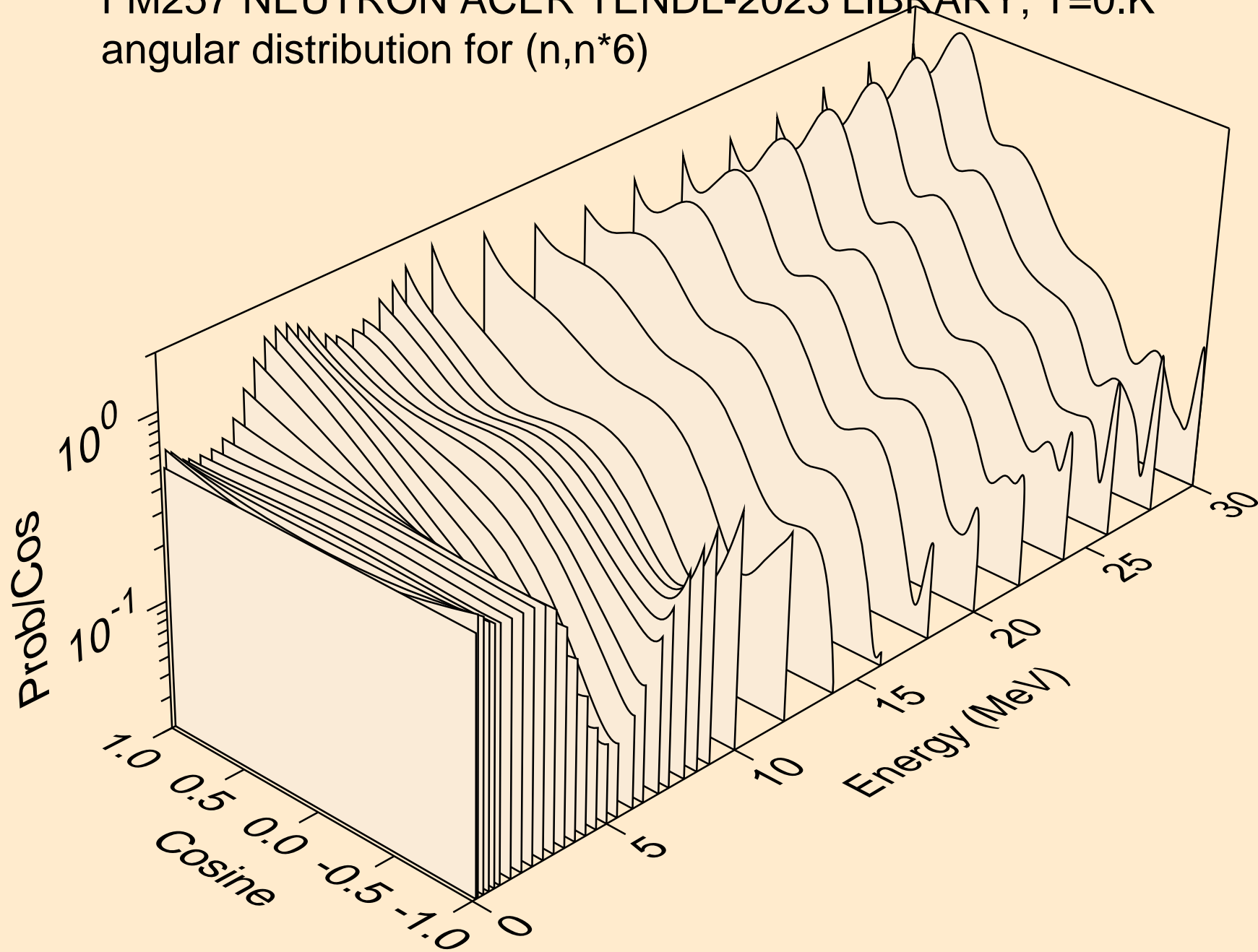

FM257 NEUTRON ACER TENDL-2023 LIBRARY; T=0.K
angular distribution for (n,n*7)

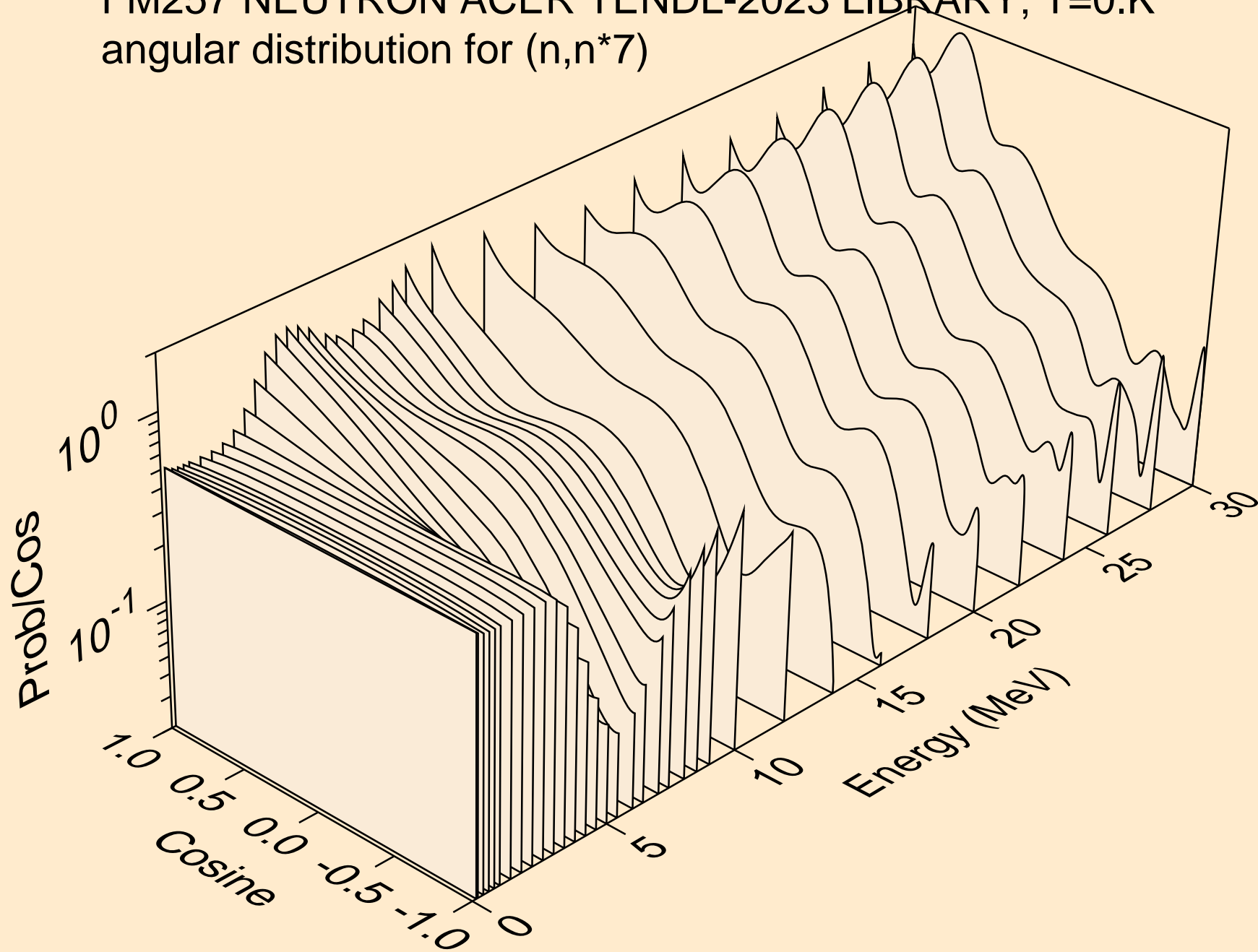

FM257 NEUTRON ACER TENDL-2023 LIBRARY; T=0.K
angular distribution for (n,n*8)

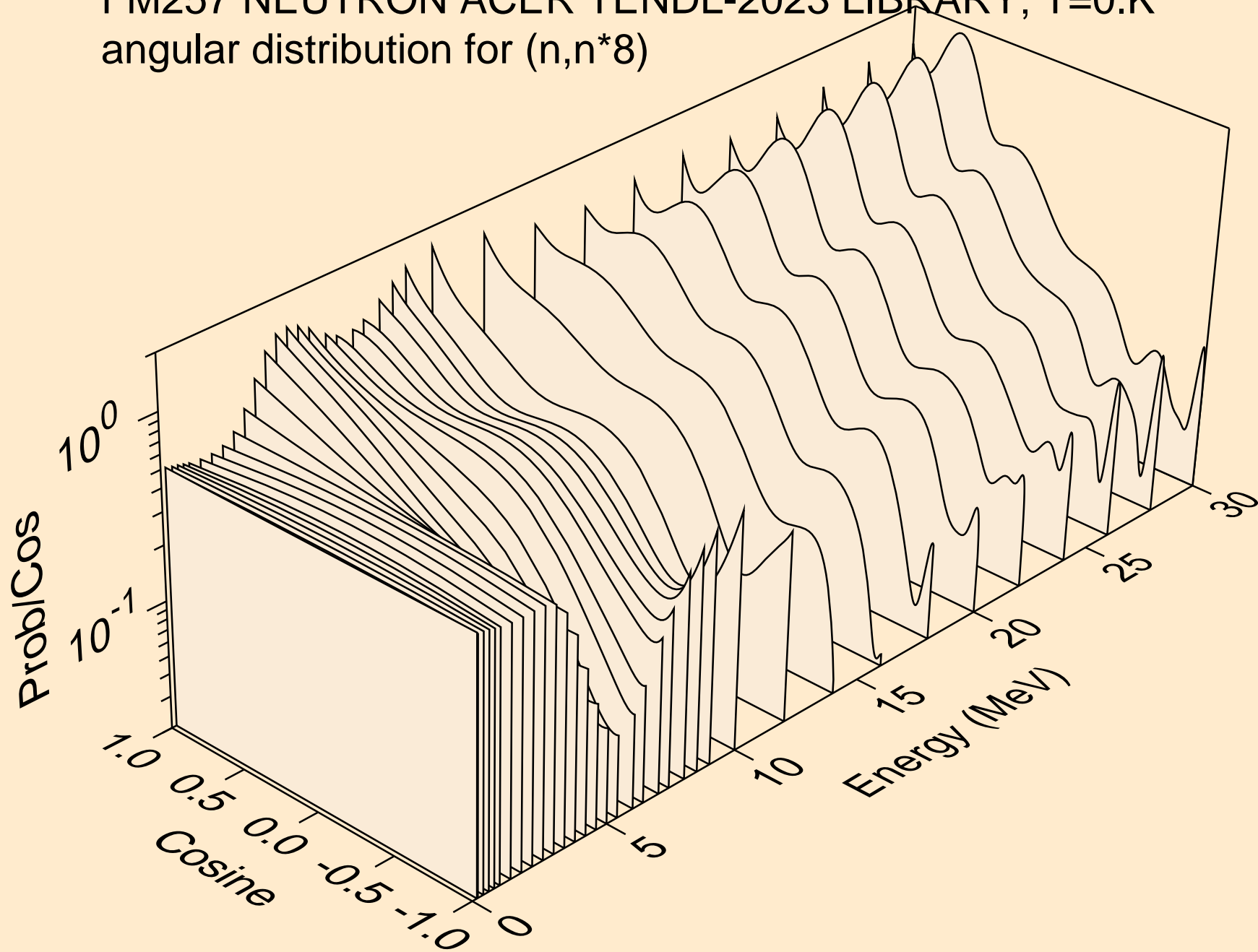

FM257 NEUTRON ACER TENDL-2023 LIBRARY; T=0.K
angular distribution for (n,n*9)

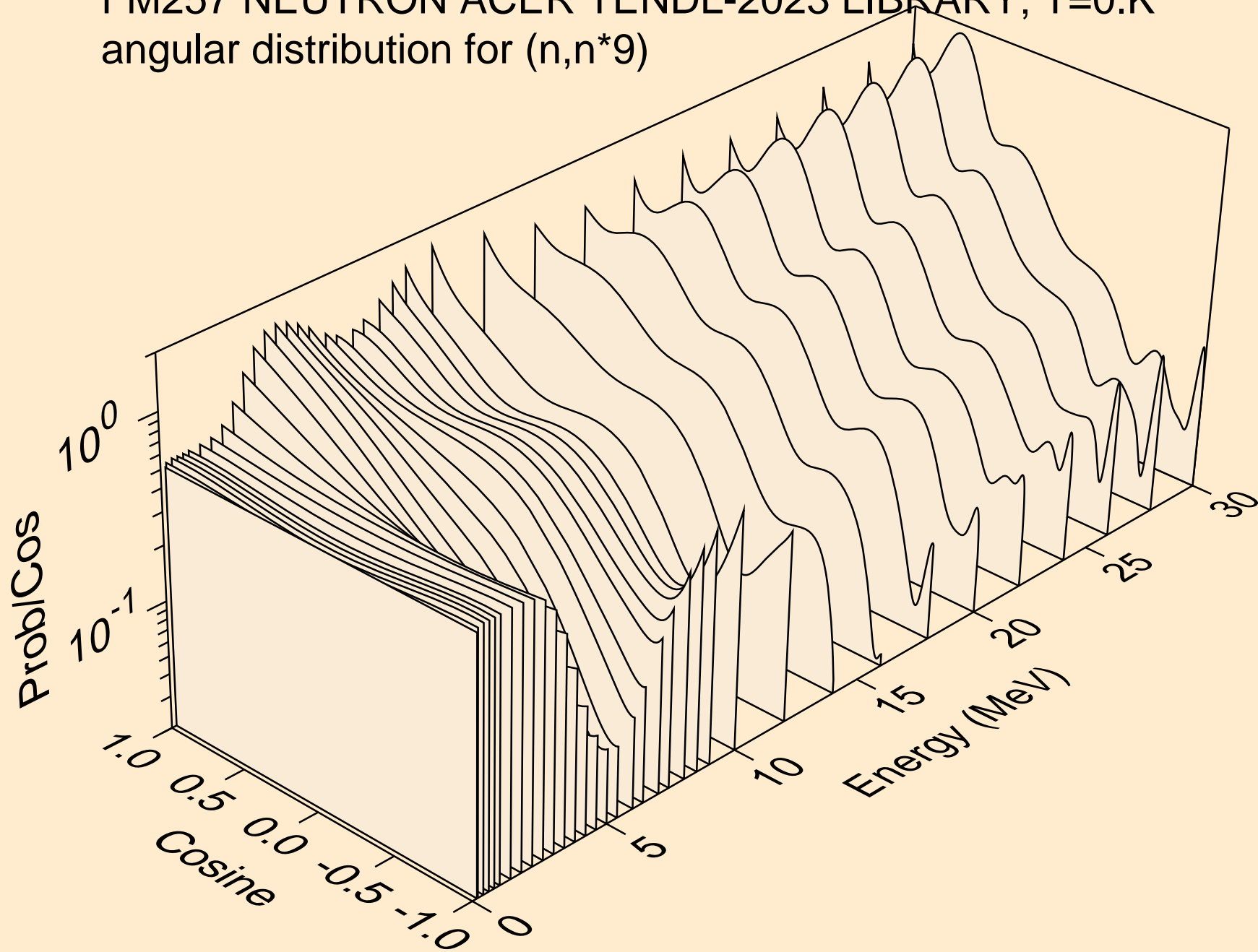

FM257 NEUTRON ACER TENDL-2023 LIBRARY; T=0.K
angular distribution for (n,n*10)

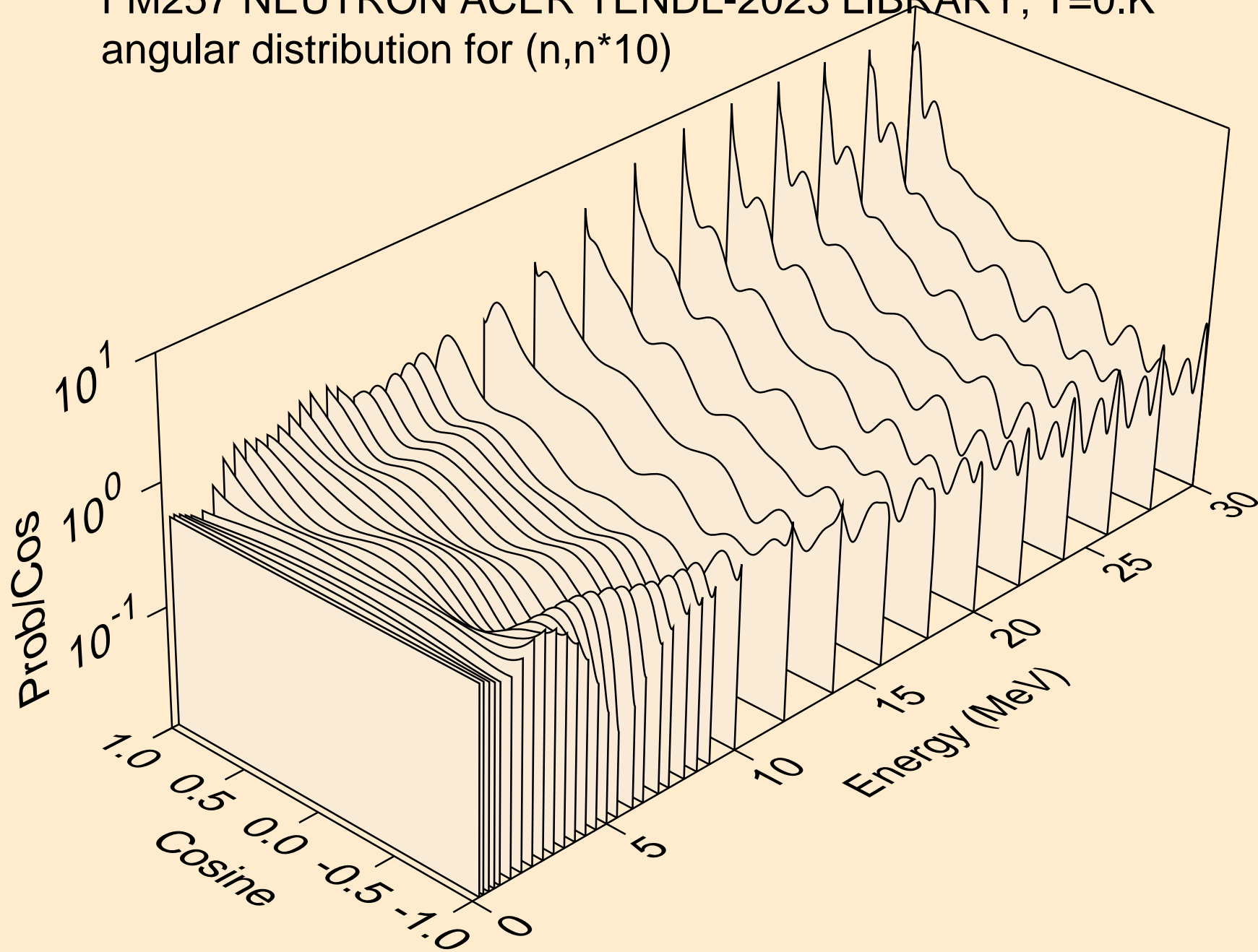

FM257 NEUTRON ACER TENDL-2023 LIBRARY; T=0.K
angular distribution for (n,n*11)

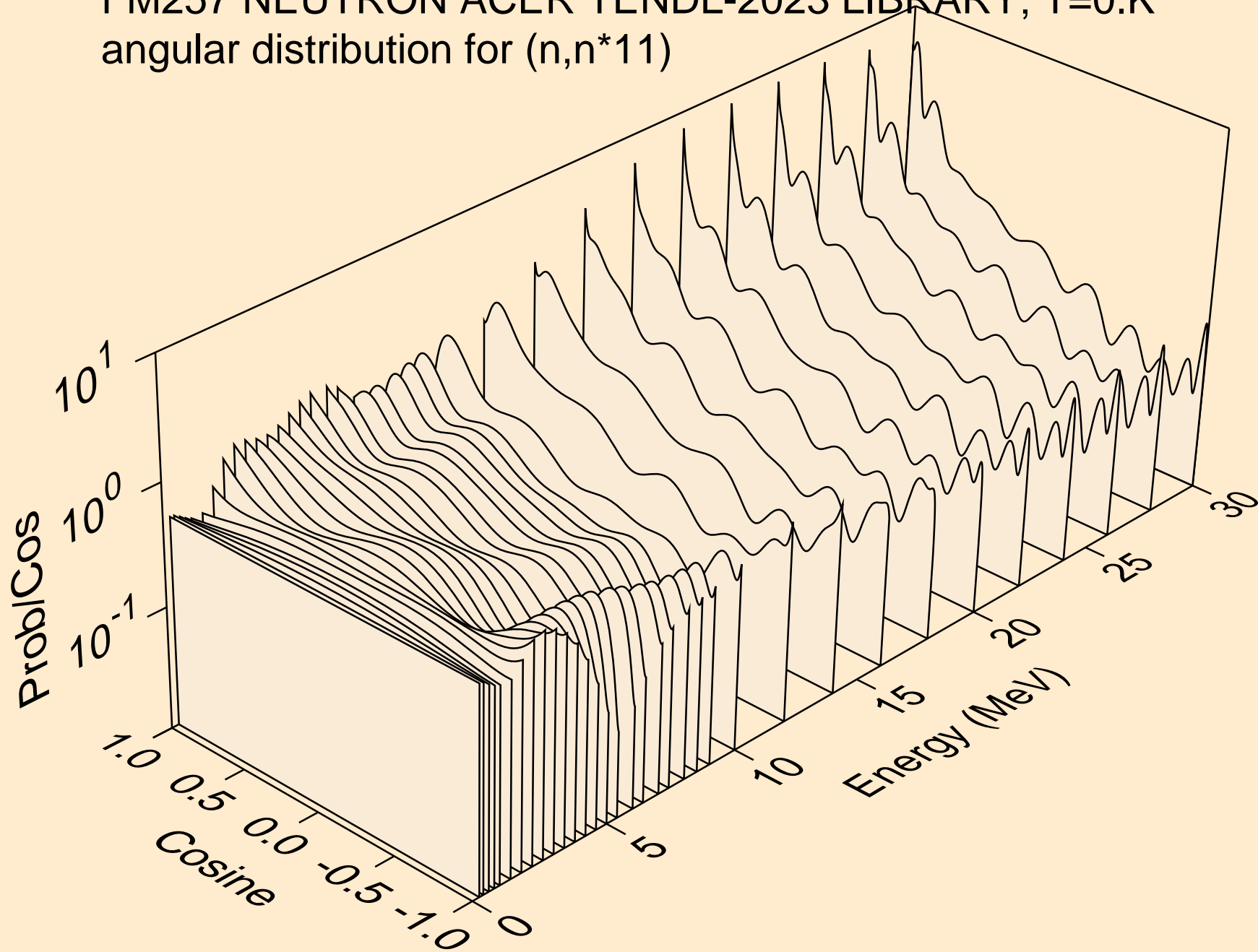

FM257 NEUTRON ACER TENDL-2023 LIBRARY; T=0.K
angular distribution for (n,n*12)

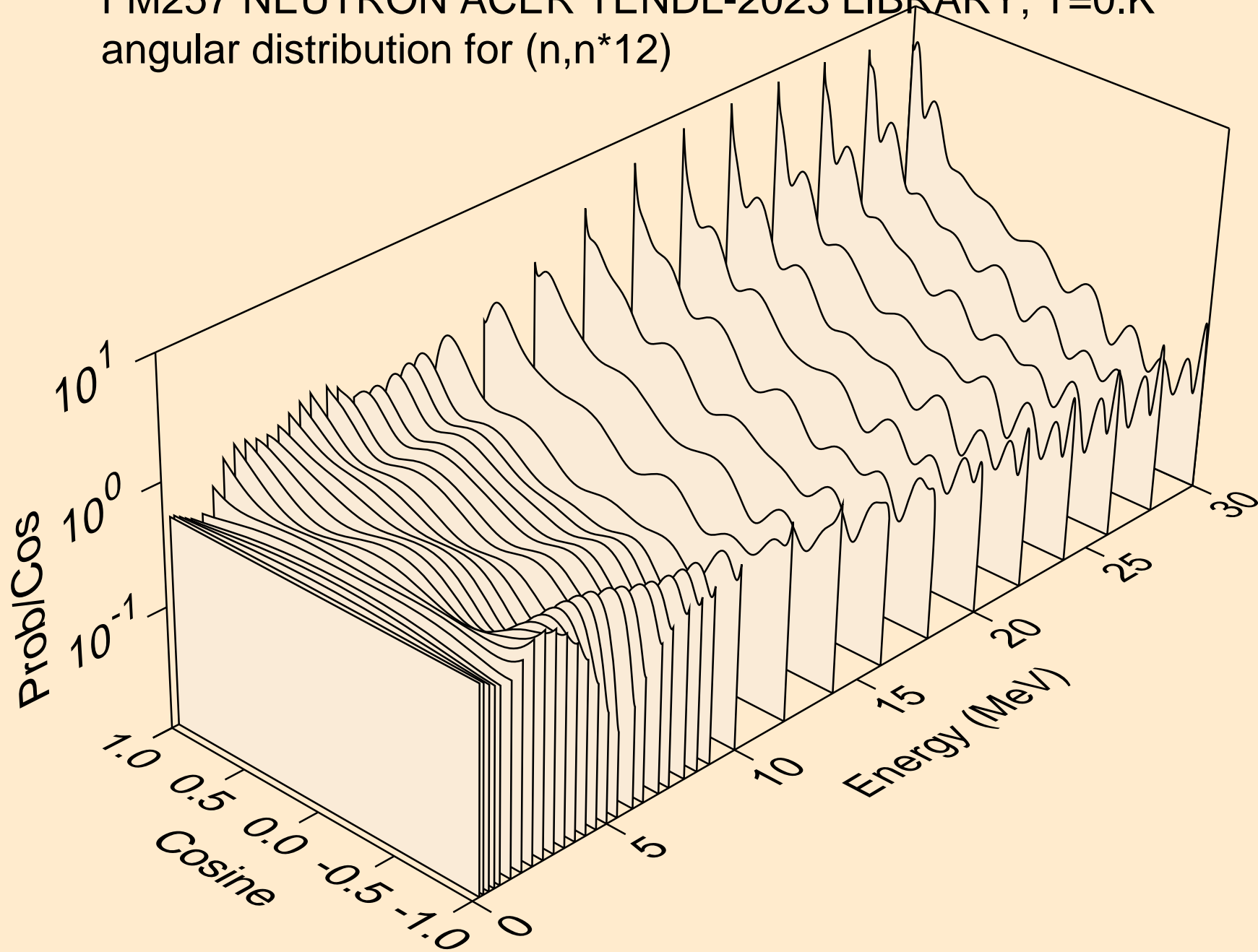

FM257 NEUTRON ACER TENDL-2023 LIBRARY; T=0.K
angular distribution for (n,n*13)

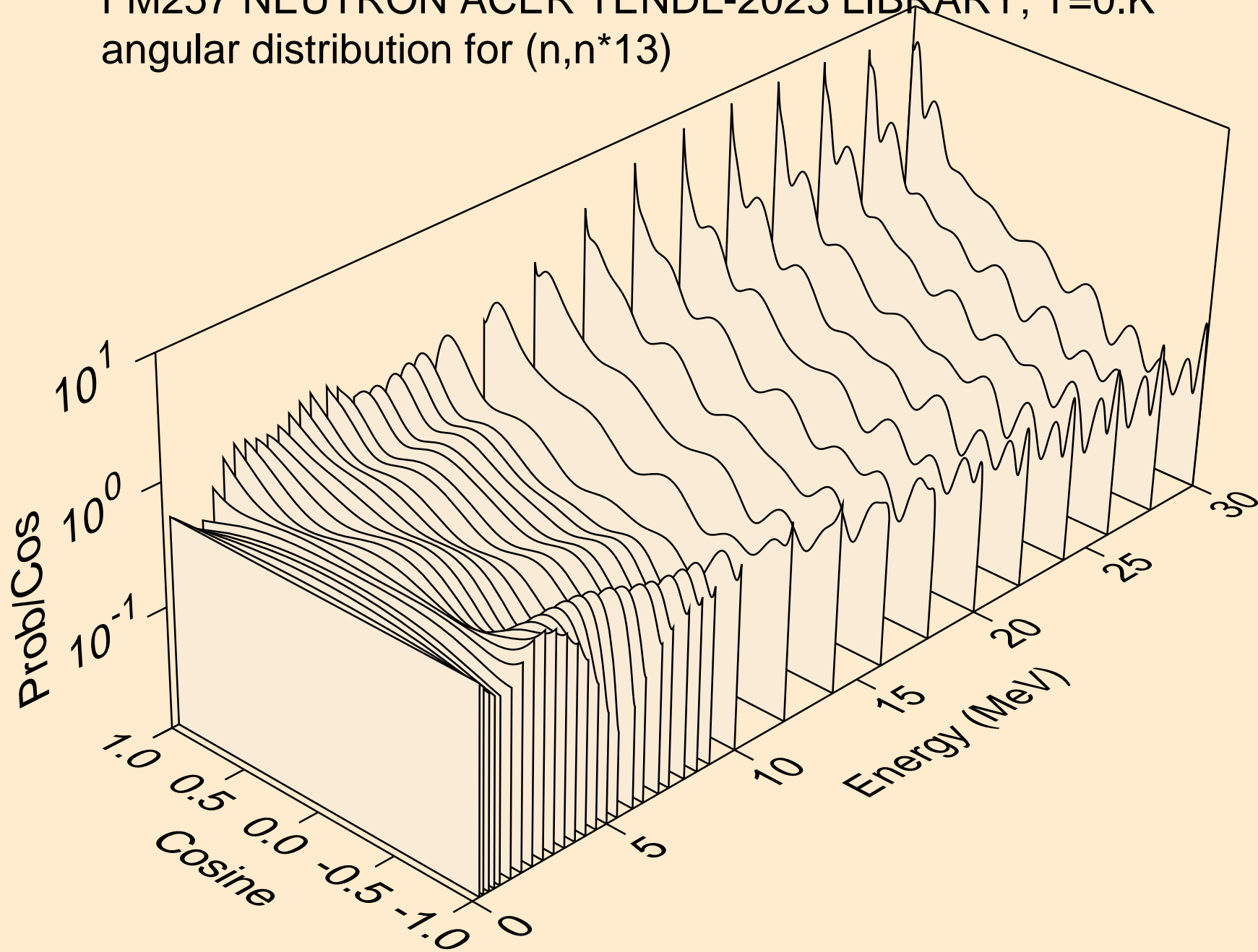

FM257 NEUTRON ACER TENDL-2023 LIBRARY; T=0.K
angular distribution for (n,n*14)

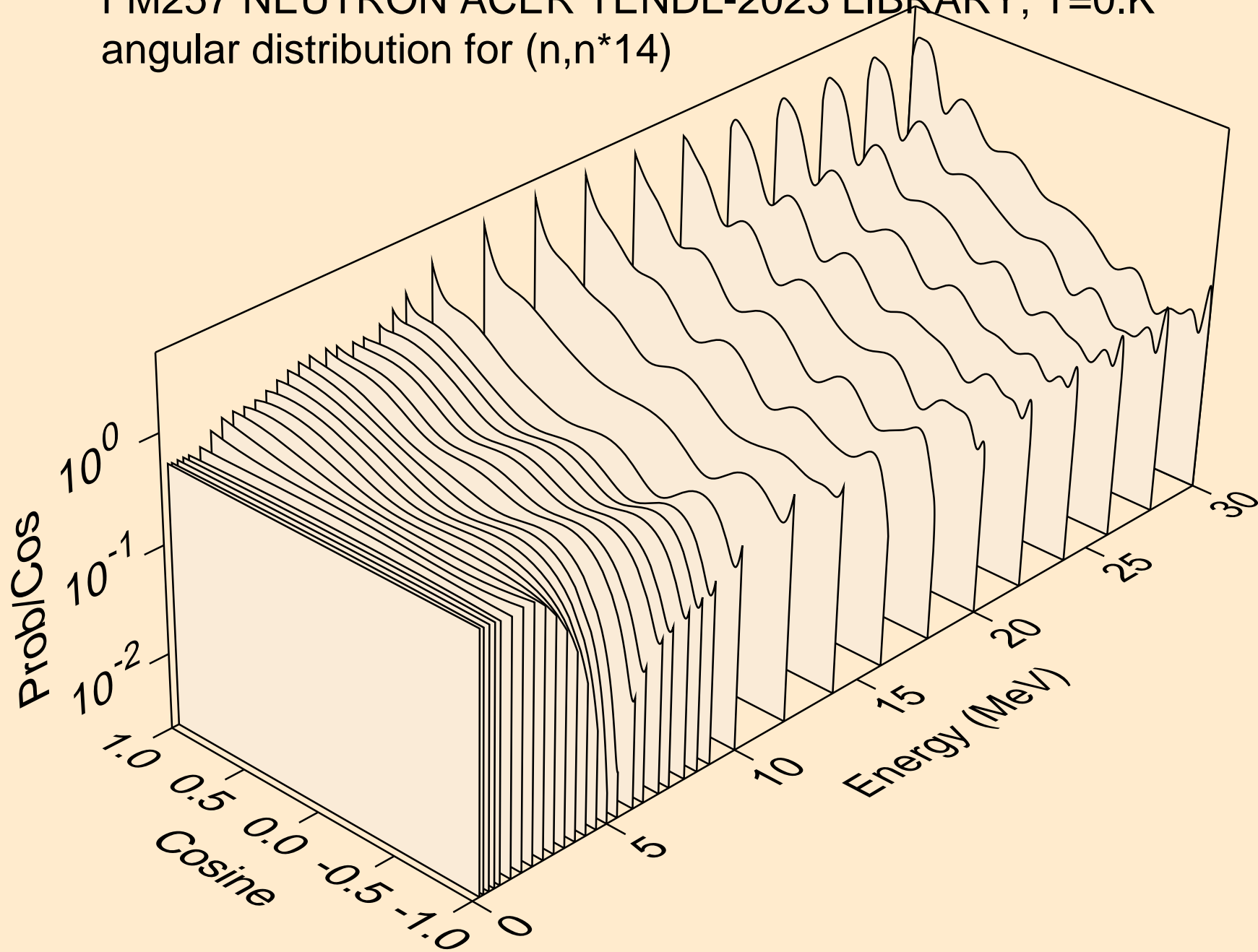

FM257 NEUTRON ACER TENDL-2023 LIBRARY; T=0.K
angular distribution for (n,n*15)

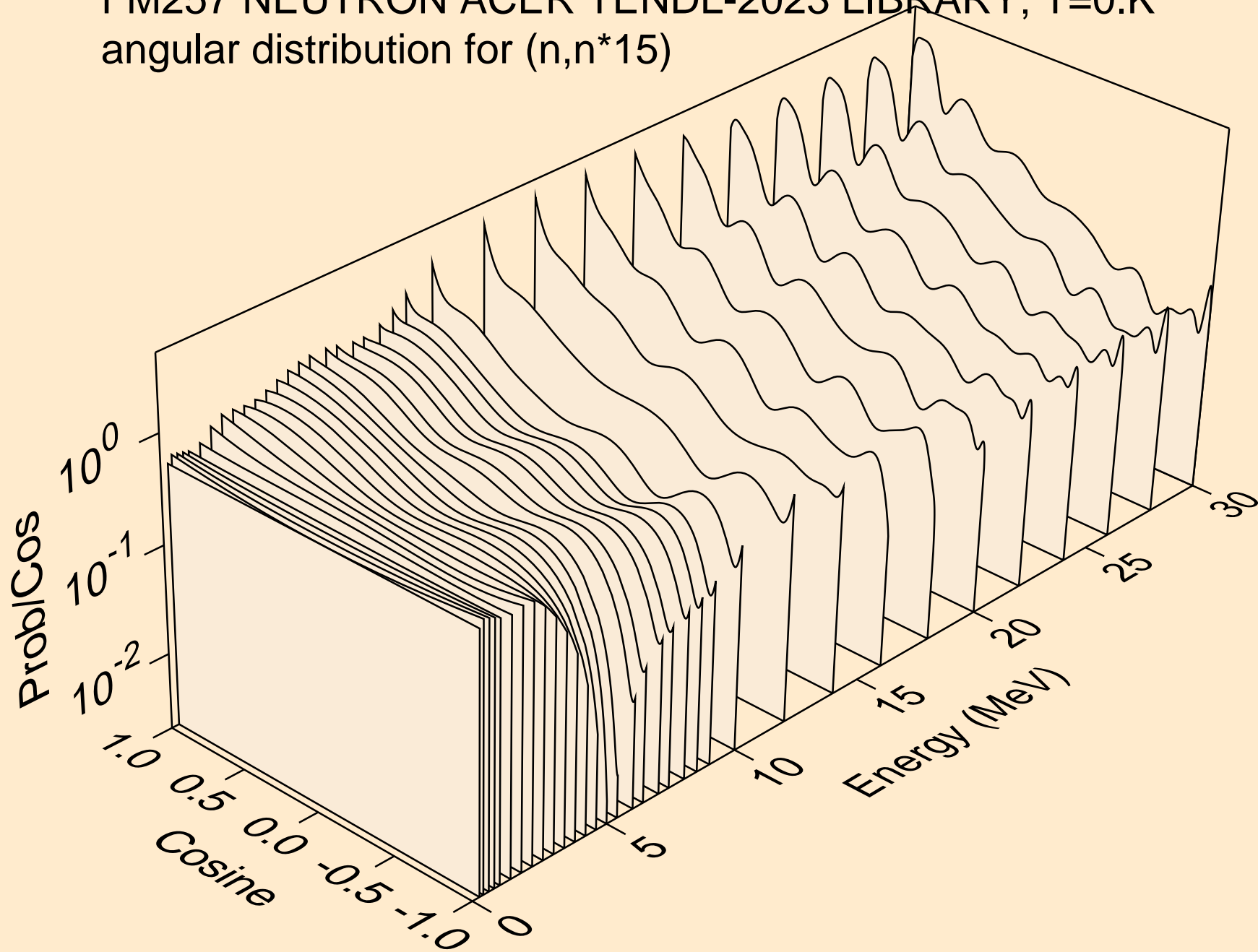

FM257 NEUTRON ACER TENDL-2023 LIBRARY; T=0.K
angular distribution for (n,n*16)

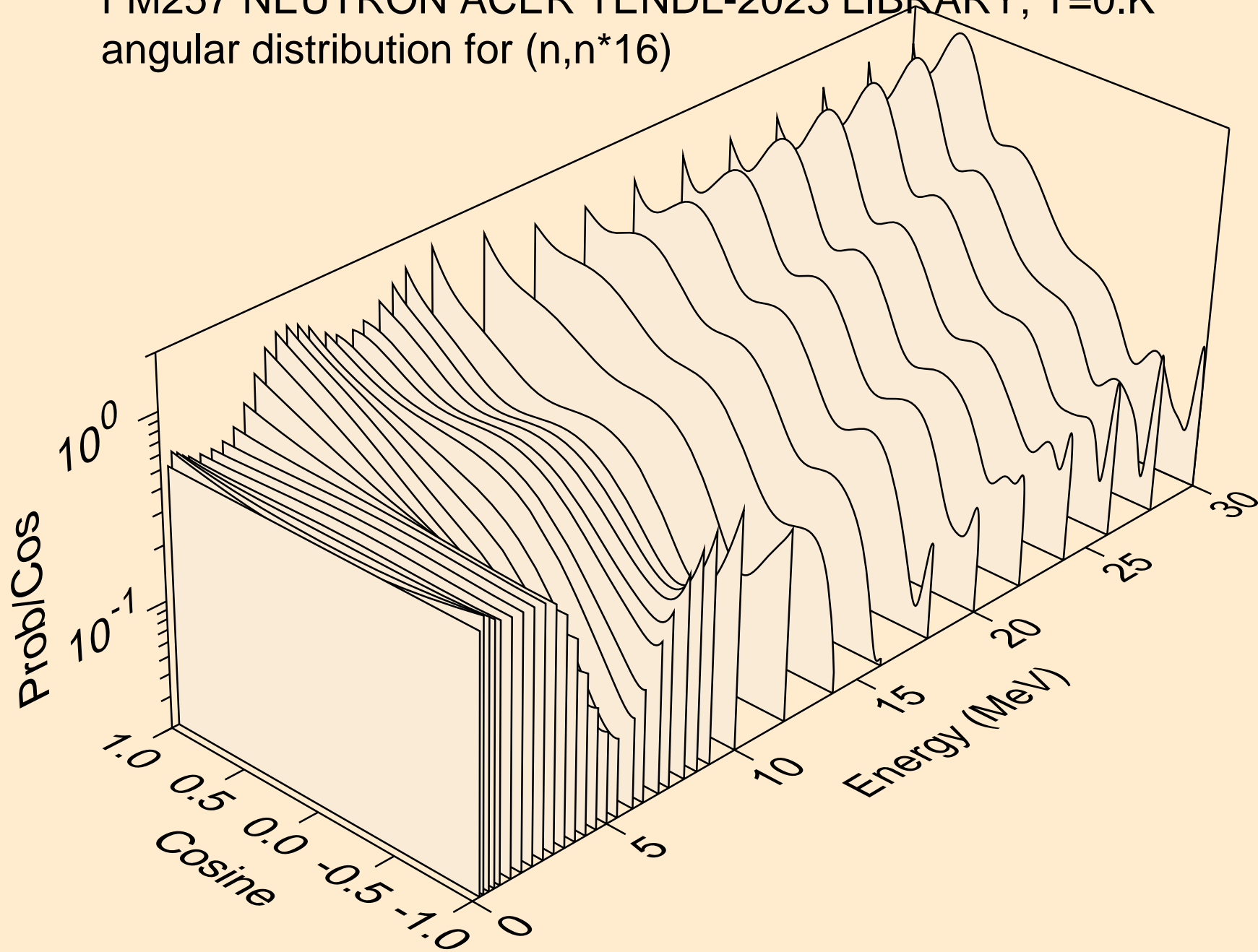

FM257 NEUTRON ACER TENDL-2023 LIBRARY; T=0.K
angular distribution for (n,n*17)

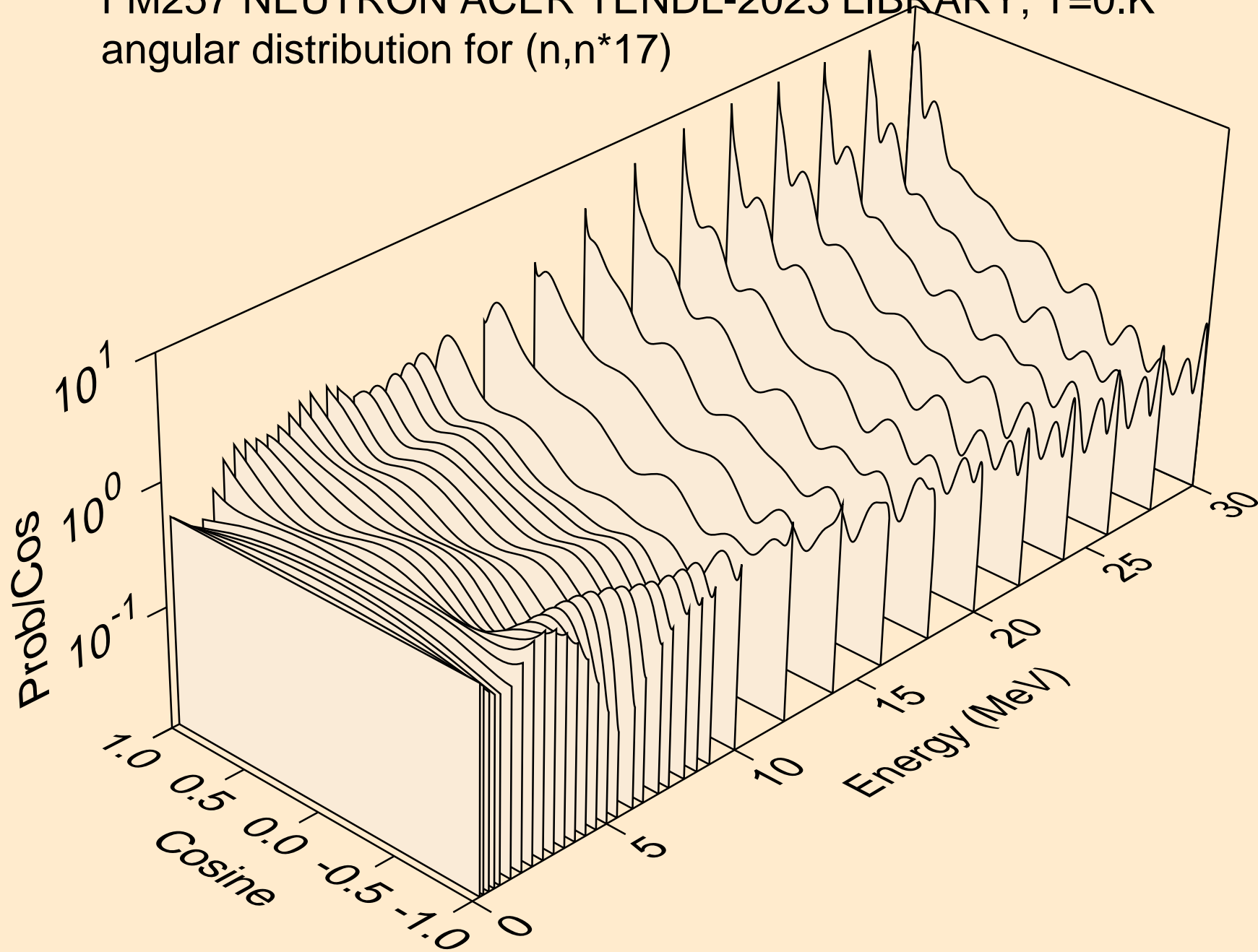

FM257 NEUTRON ACER TENDL-2023 LIBRARY; T=0.K
angular distribution for (n,n*18)

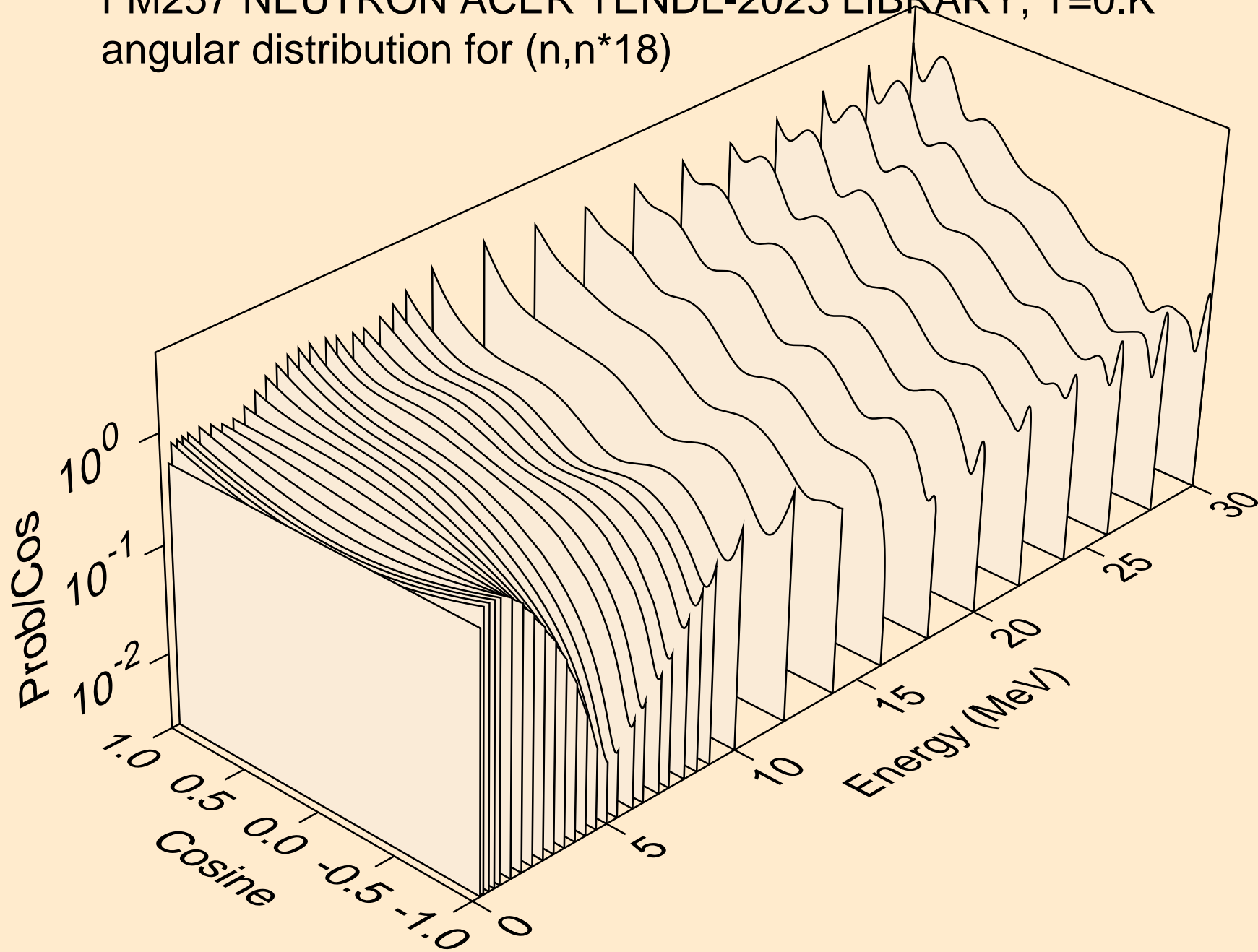

FM257 NEUTRON ACER TENDL-2023 LIBRARY; T=0.K
angular distribution for (n,n*19)

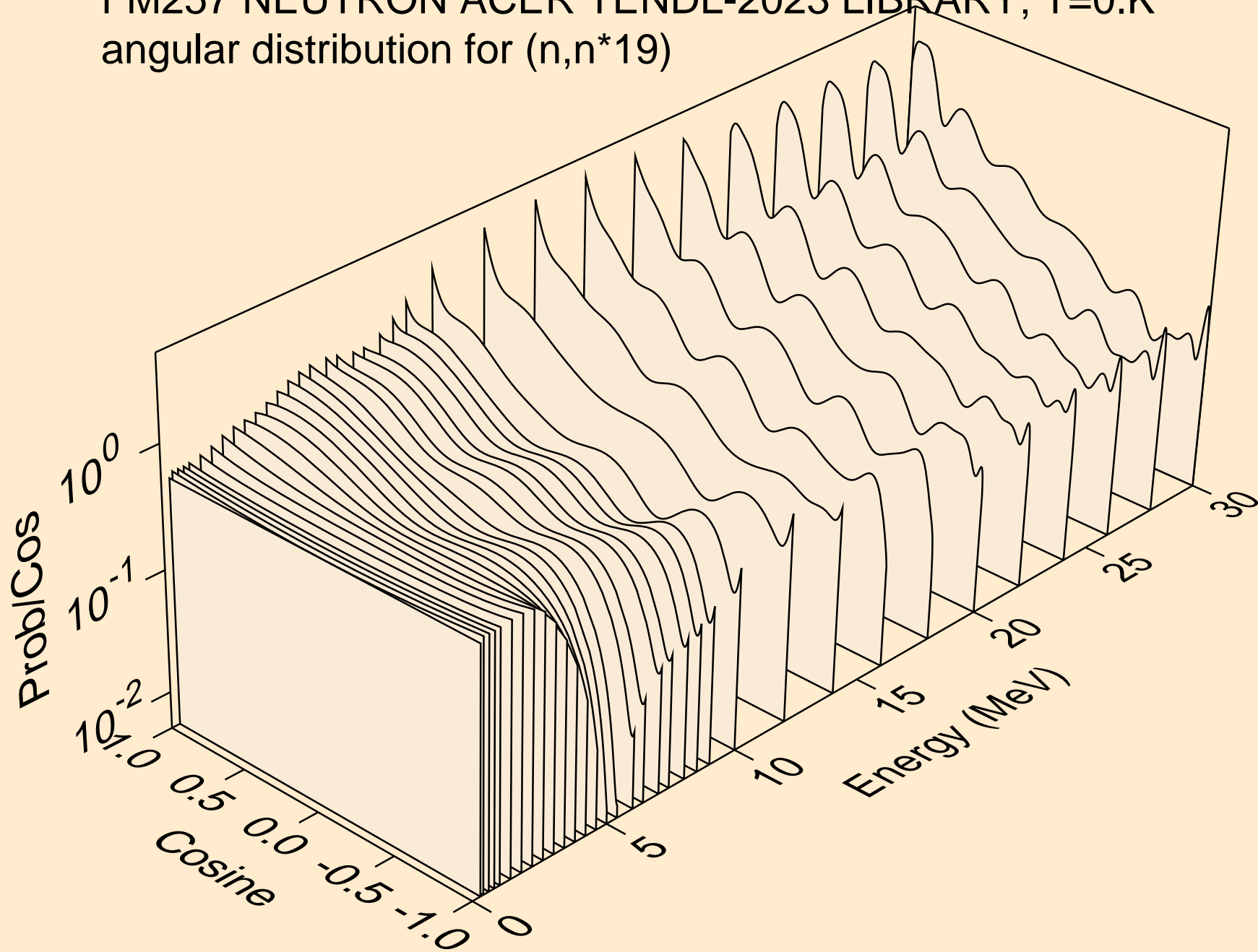

FM257 NEUTRON ACER TENDL-2023 LIBRARY; T=0.K
angular distribution for (n,n*20)

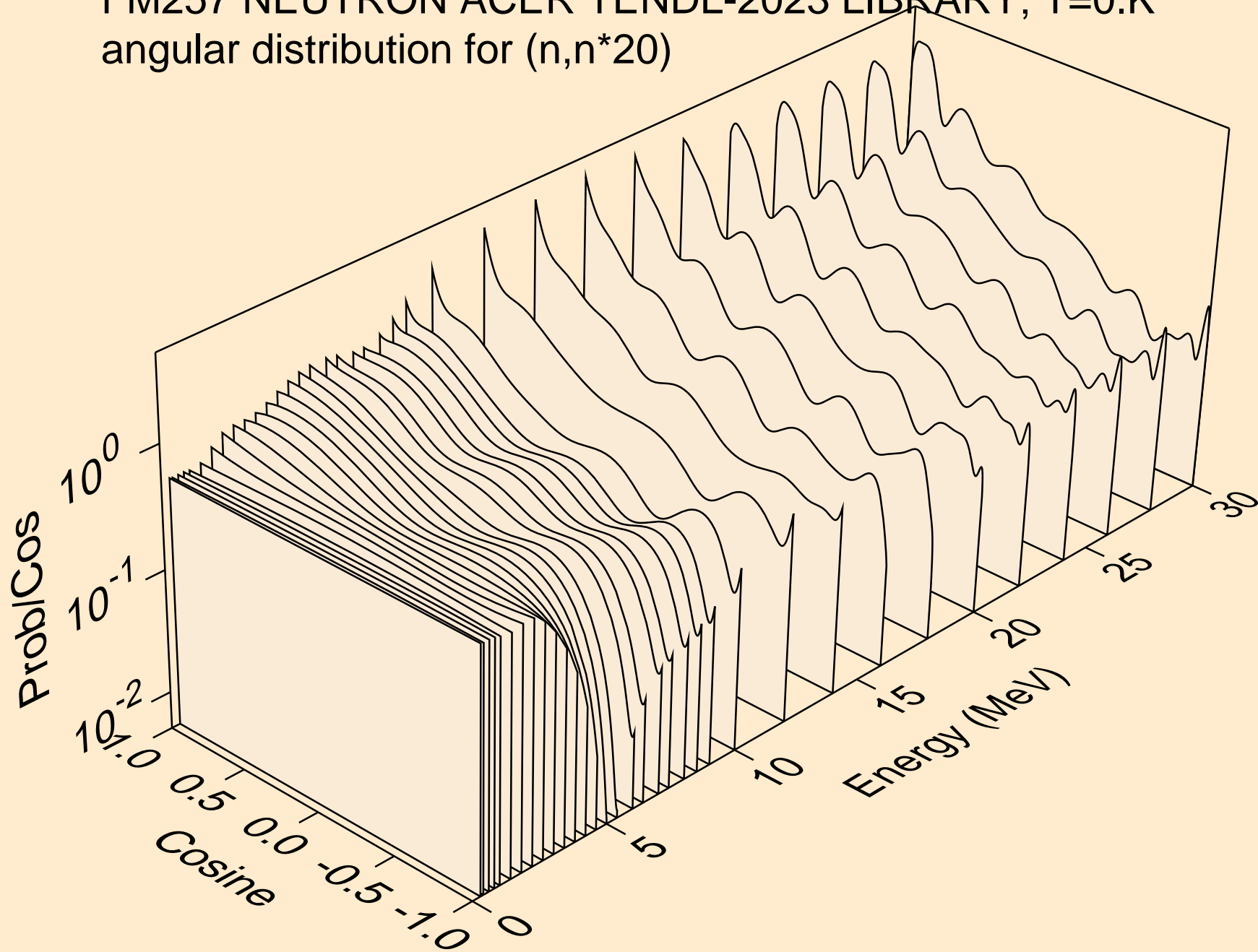

FM257 NEUTRON ACER TENDL-2023 LIBRARY; T=0.K
angular distribution for (n,n*21)

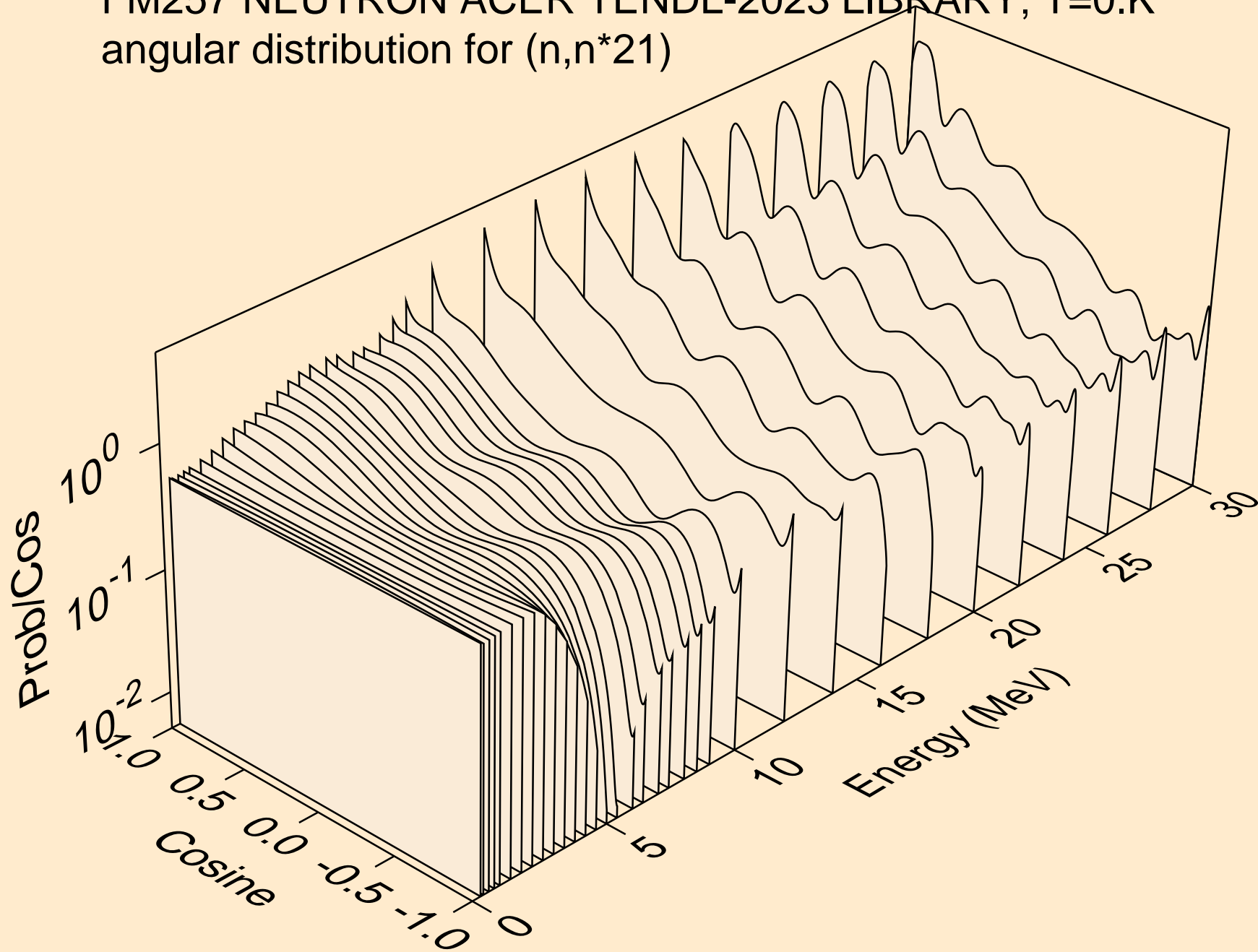

FM257 NEUTRON ACER TENDL-2023 LIBRARY; T=0.K
angular distribution for (n,n*22)

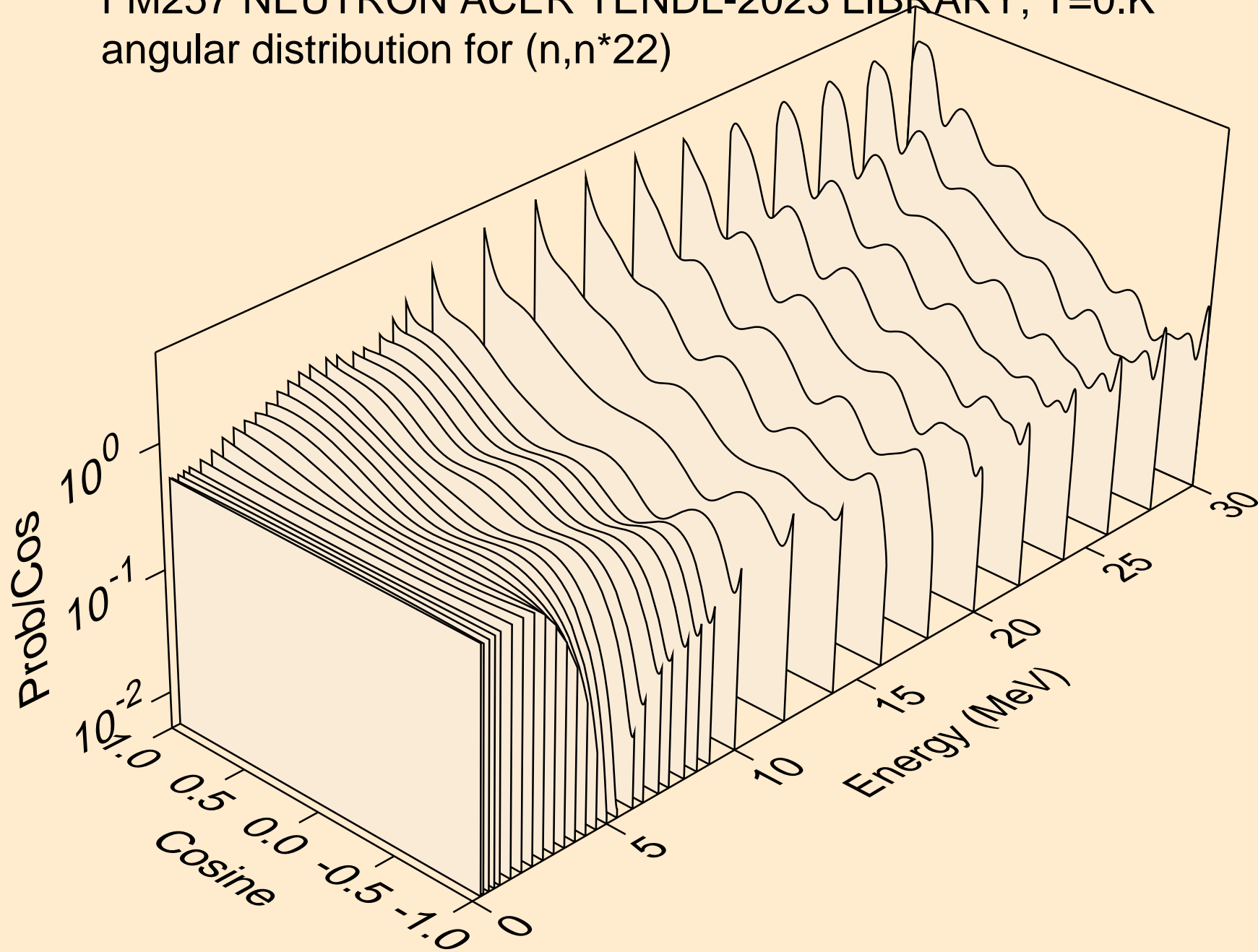

FM257 NEUTRON ACER TENDL-2023 LIBRARY; T=0.K
angular distribution for (n,n*23)

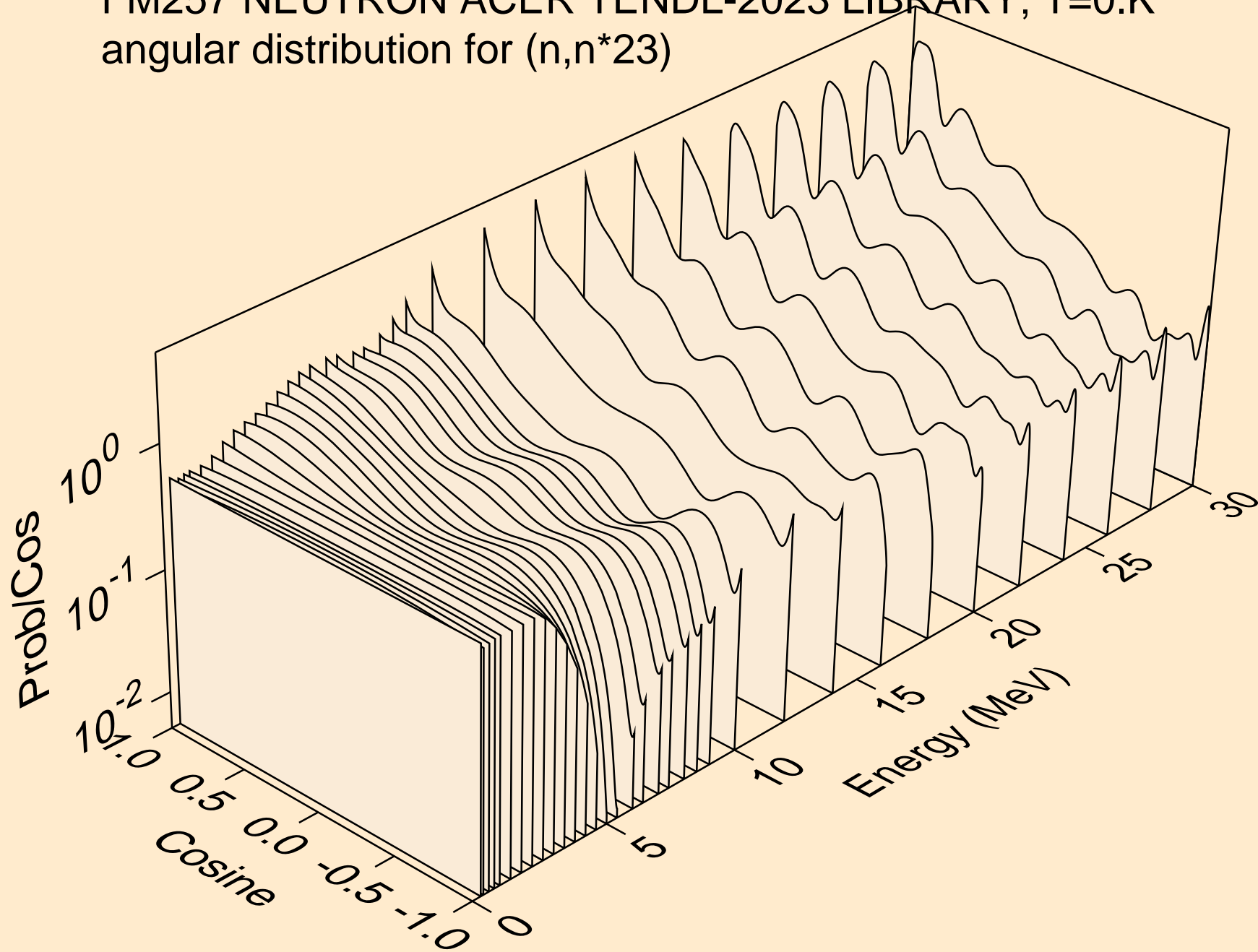

FM257 NEUTRON ACER TENDL-2023 LIBRARY; T=0.K
angular distribution for (n,n*24)

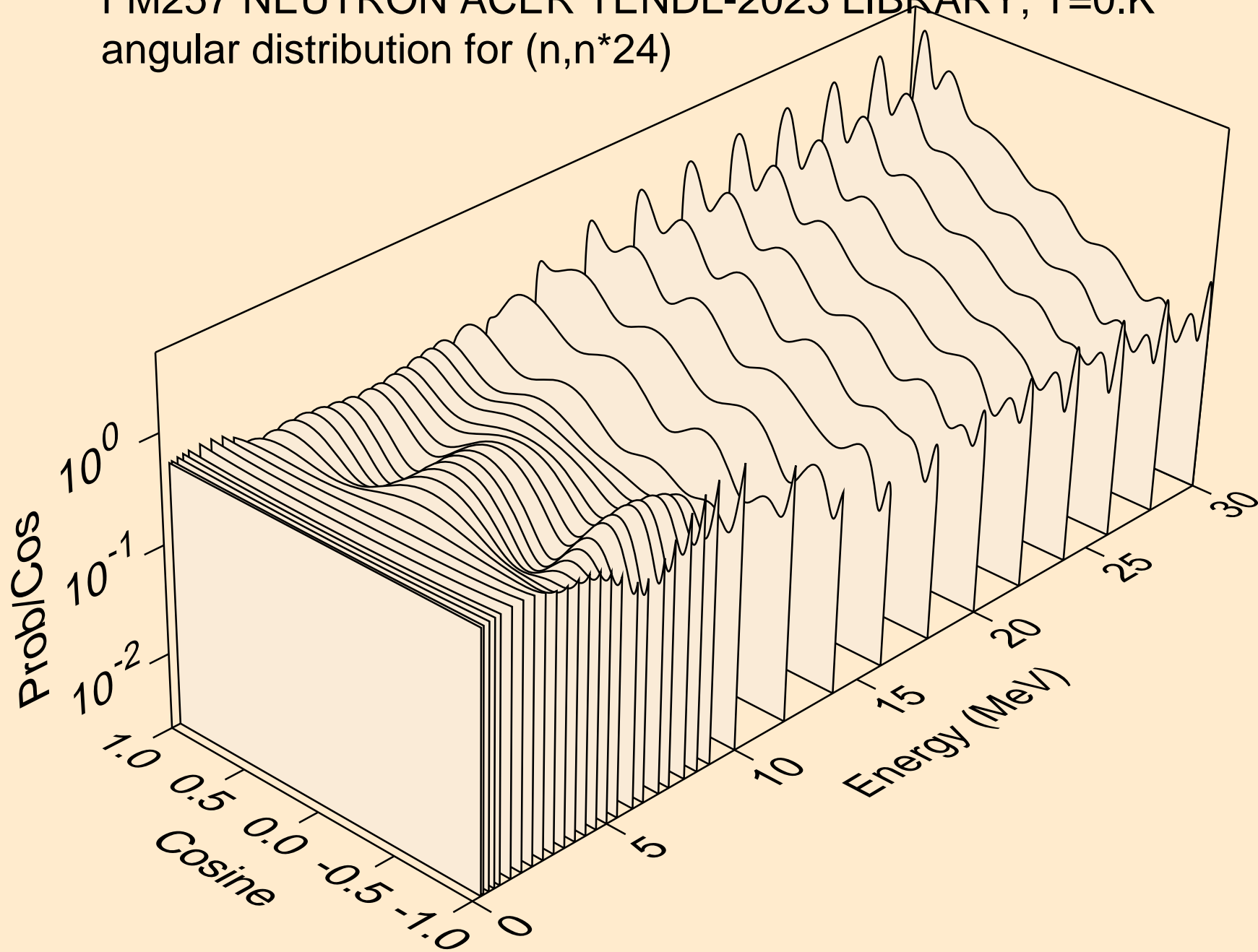

FM257 NEUTRON ACER TENDL-2023 LIBRARY; T=0.K
angular distribution for (n,n*25)

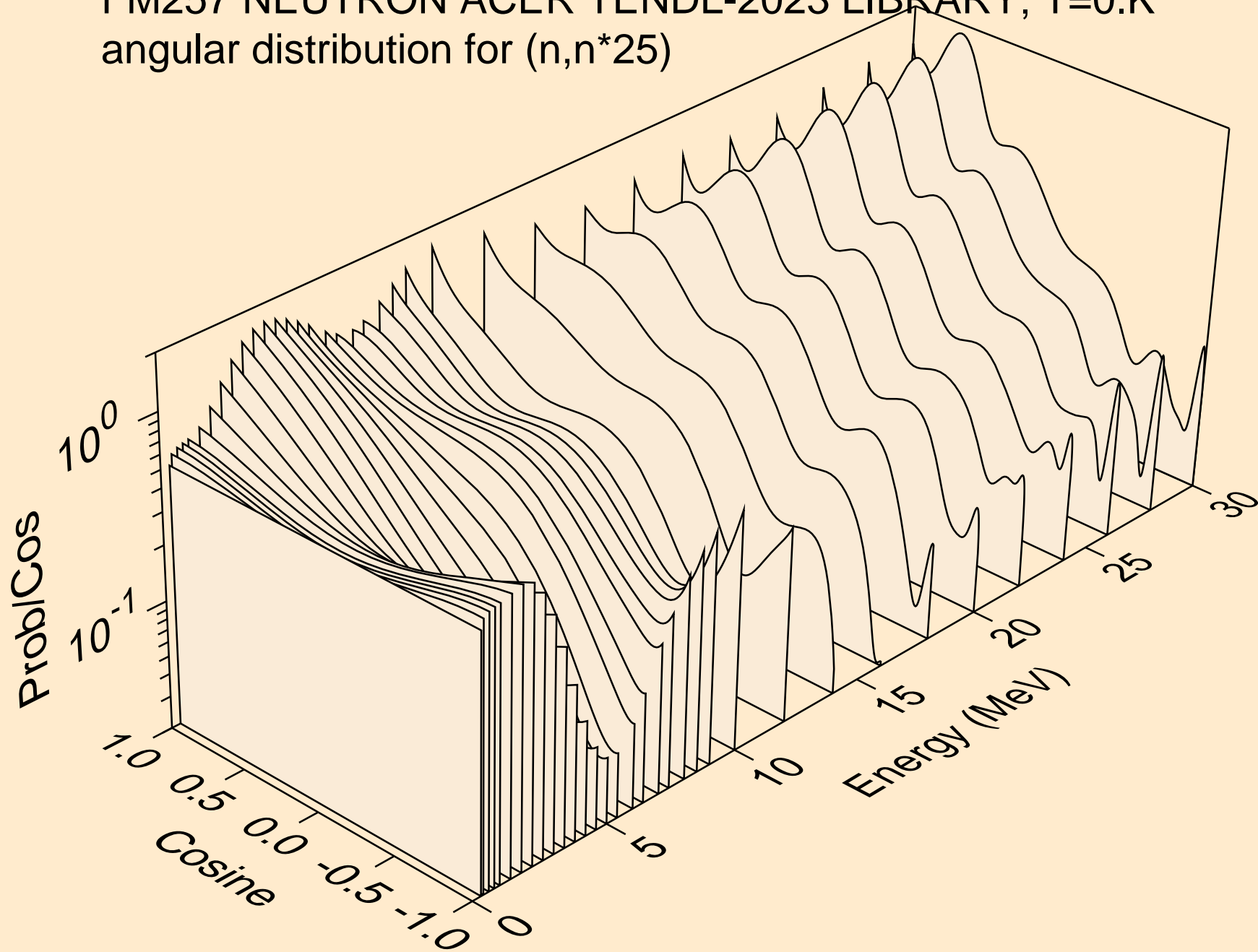

FM257 NEUTRON ACER TENDL-2023 LIBRARY; T=0.K
angular distribution for (n,n*26)

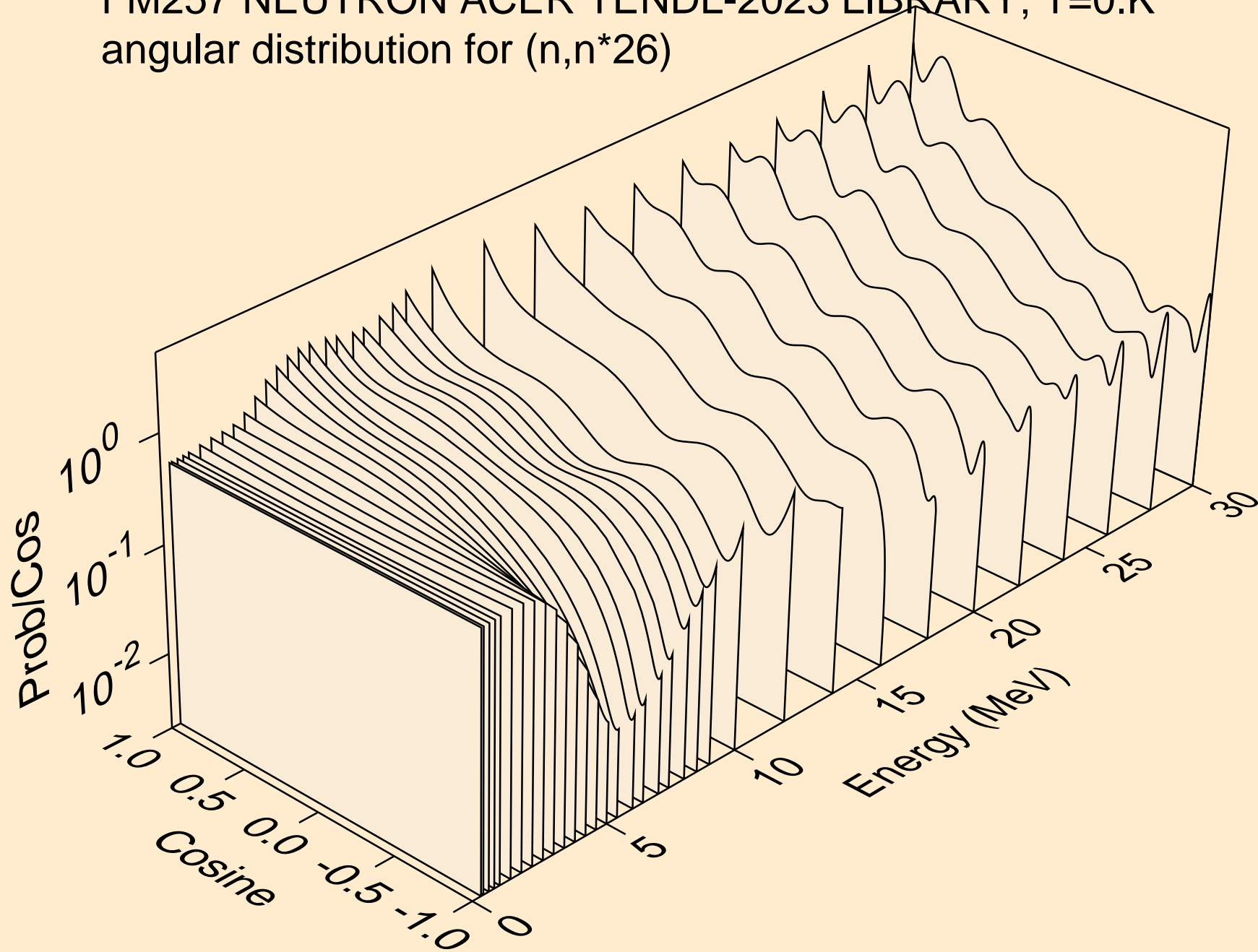

FM257 NEUTRON ACER TENDL-2023 LIBRARY; T=0.K
angular distribution for (n,n*27)

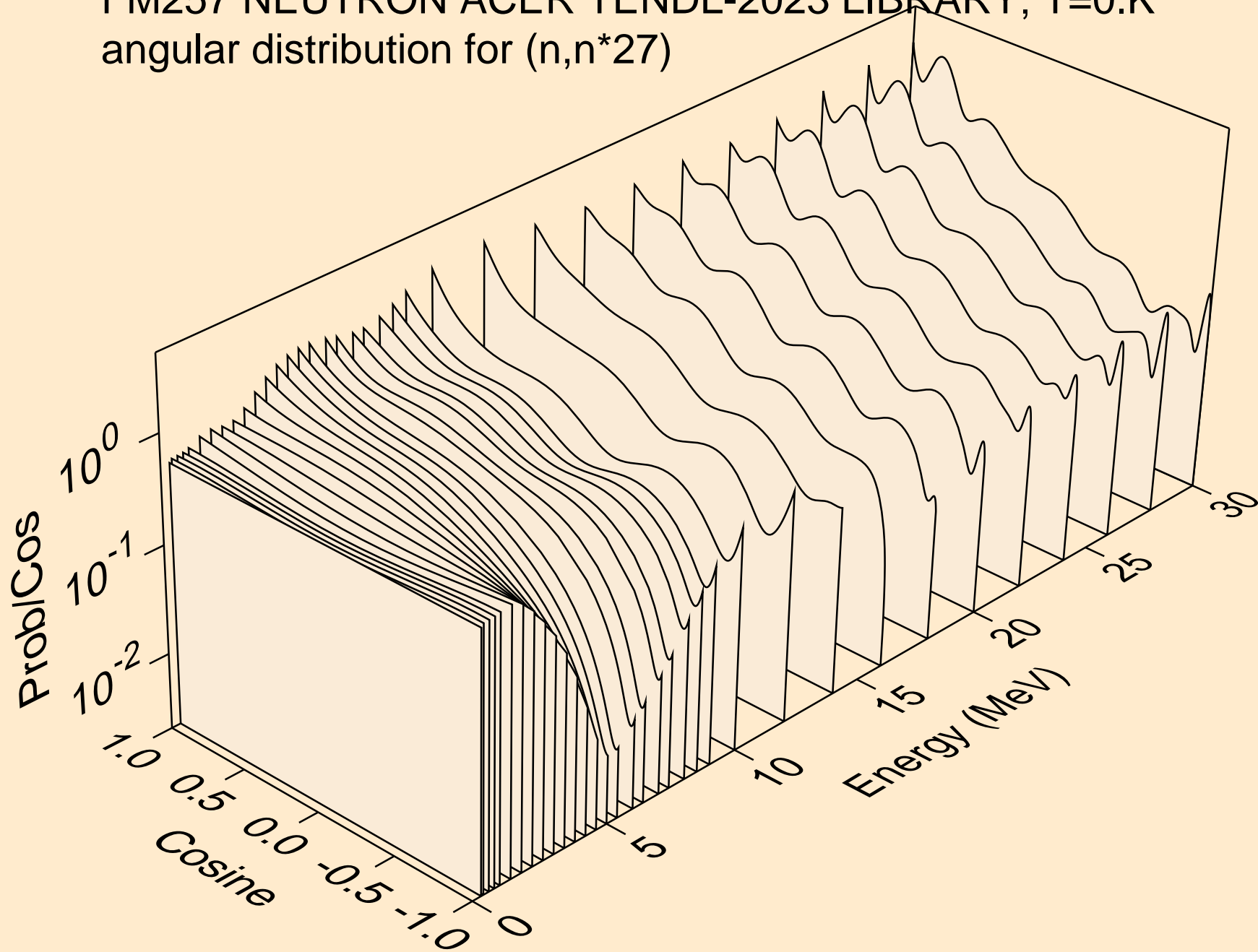

FM257 NEUTRON ACER TENDL-2023 LIBRARY; T=0.K
angular distribution for (n,n*28)

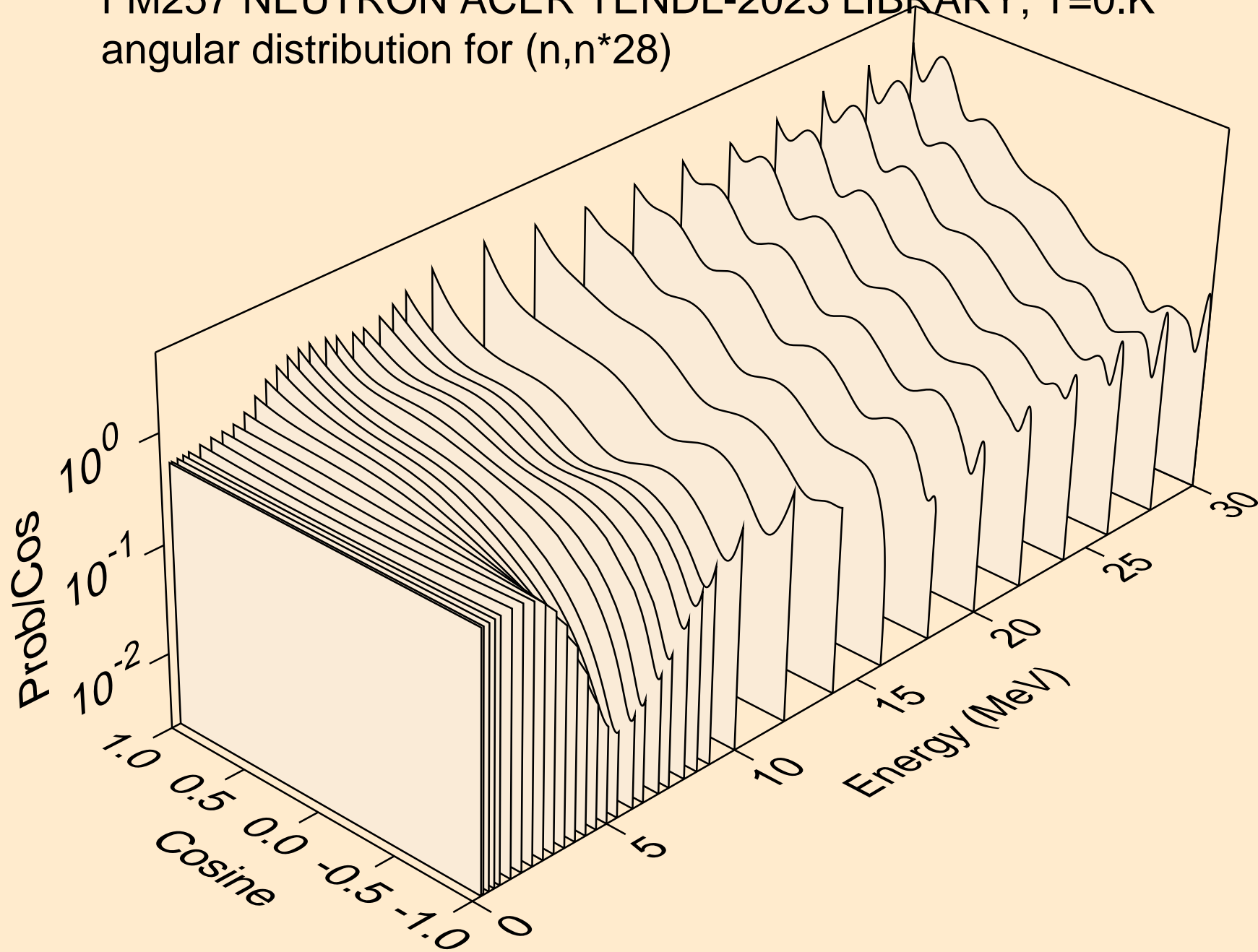

FM257 NEUTRON ACER TENDL-2023 LIBRARY; T=0.K
angular distribution for (n,n*29)

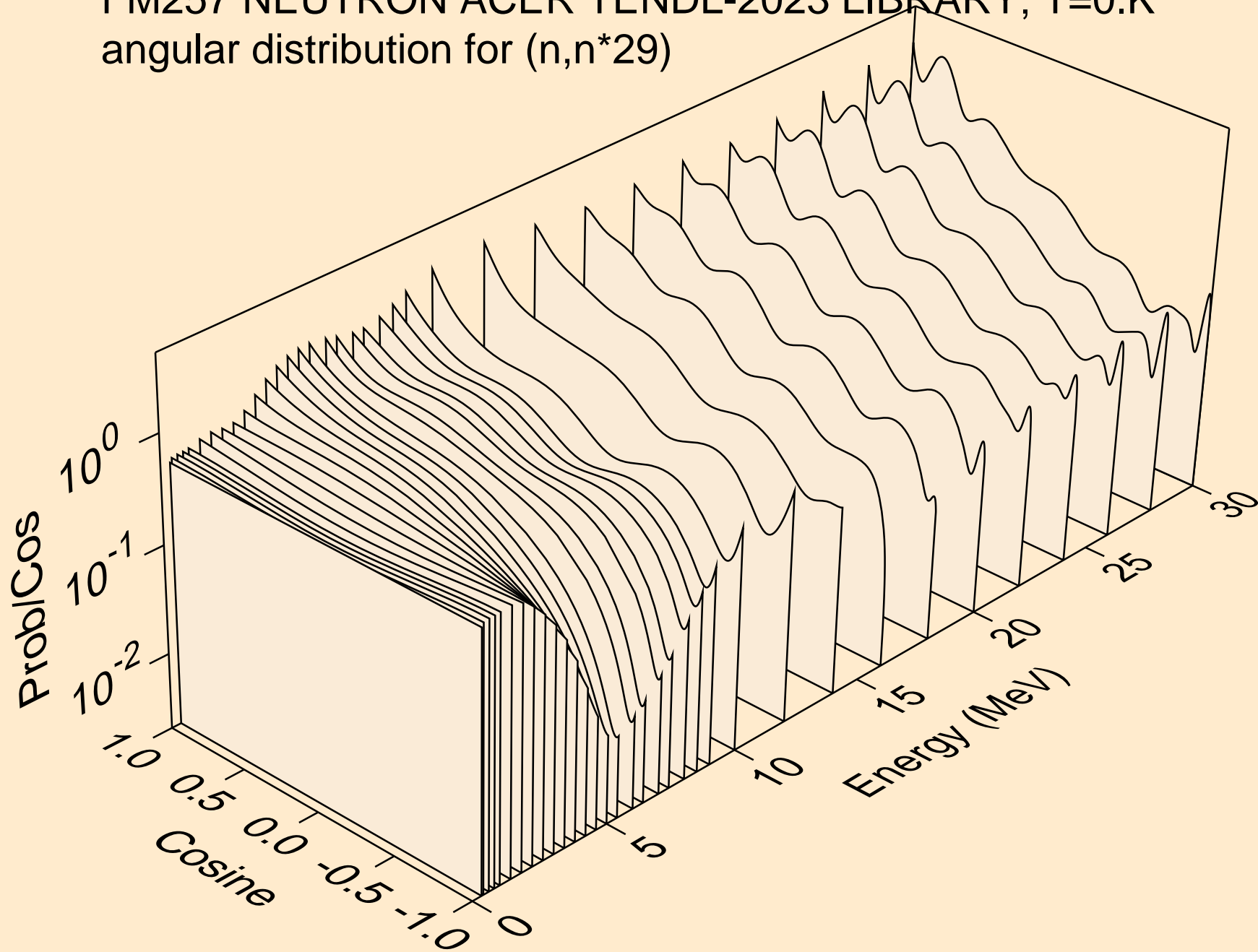

FM257 NEUTRON ACER TENDL-2023 LIBRARY; T=0.K
angular distribution for (n,n*30)

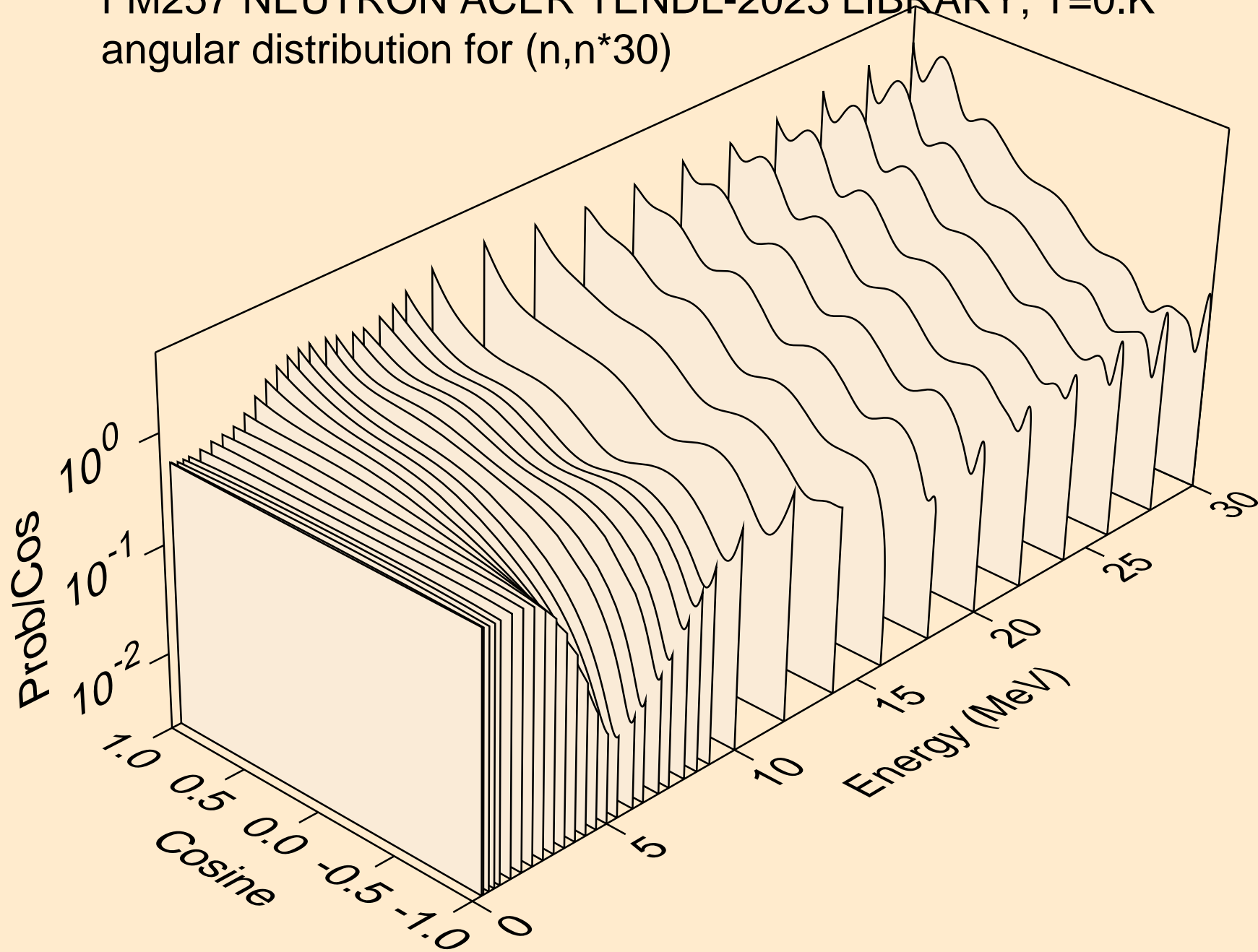

FM257 NEUTRON ACER TENDL-2023 LIBRARY; T=0.K
Total fission nubar

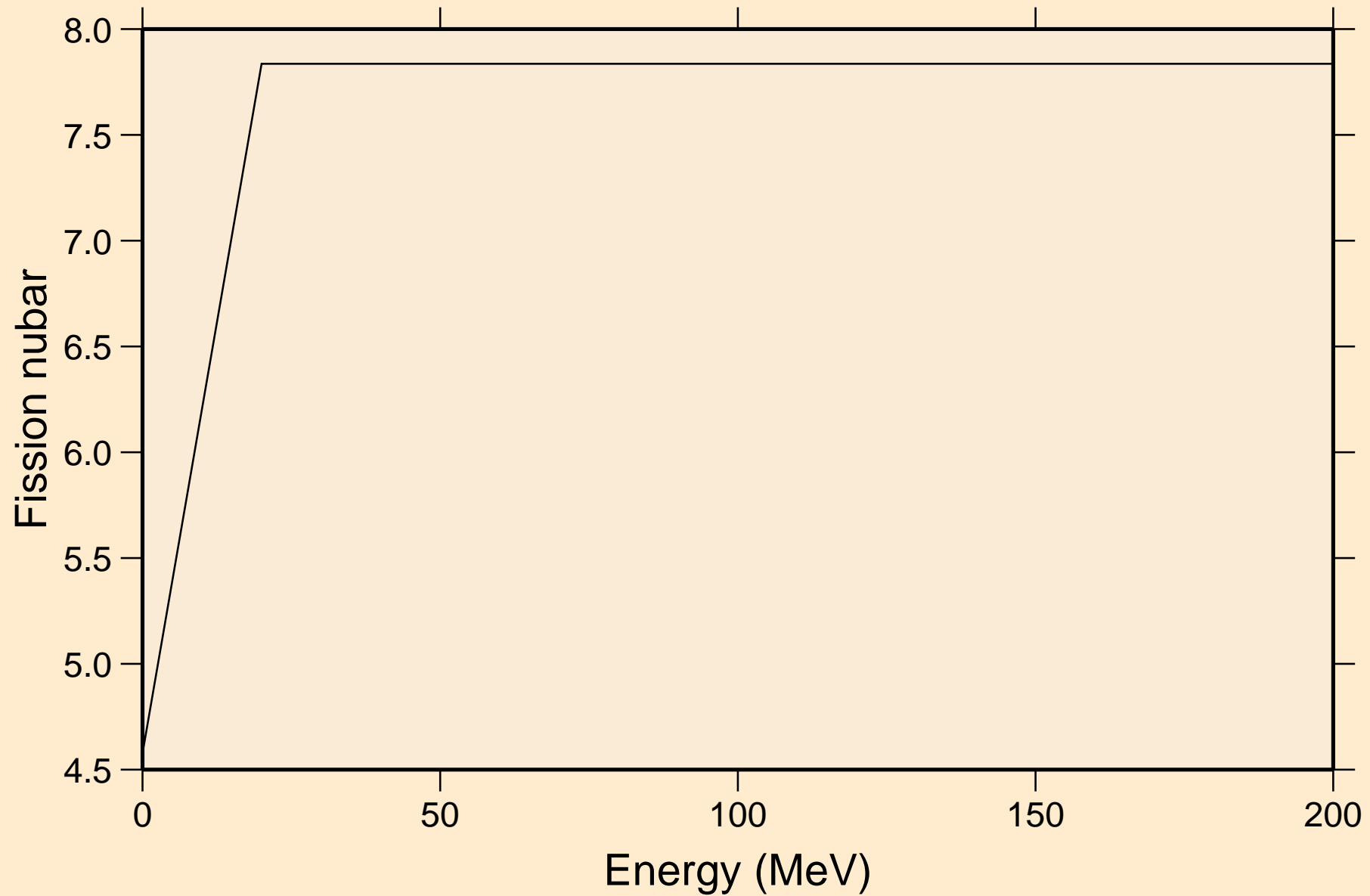

FM257 NEUTRON ACER TENDL-2023 LIBRARY; T=0.K
Neutron emission for (n,x)

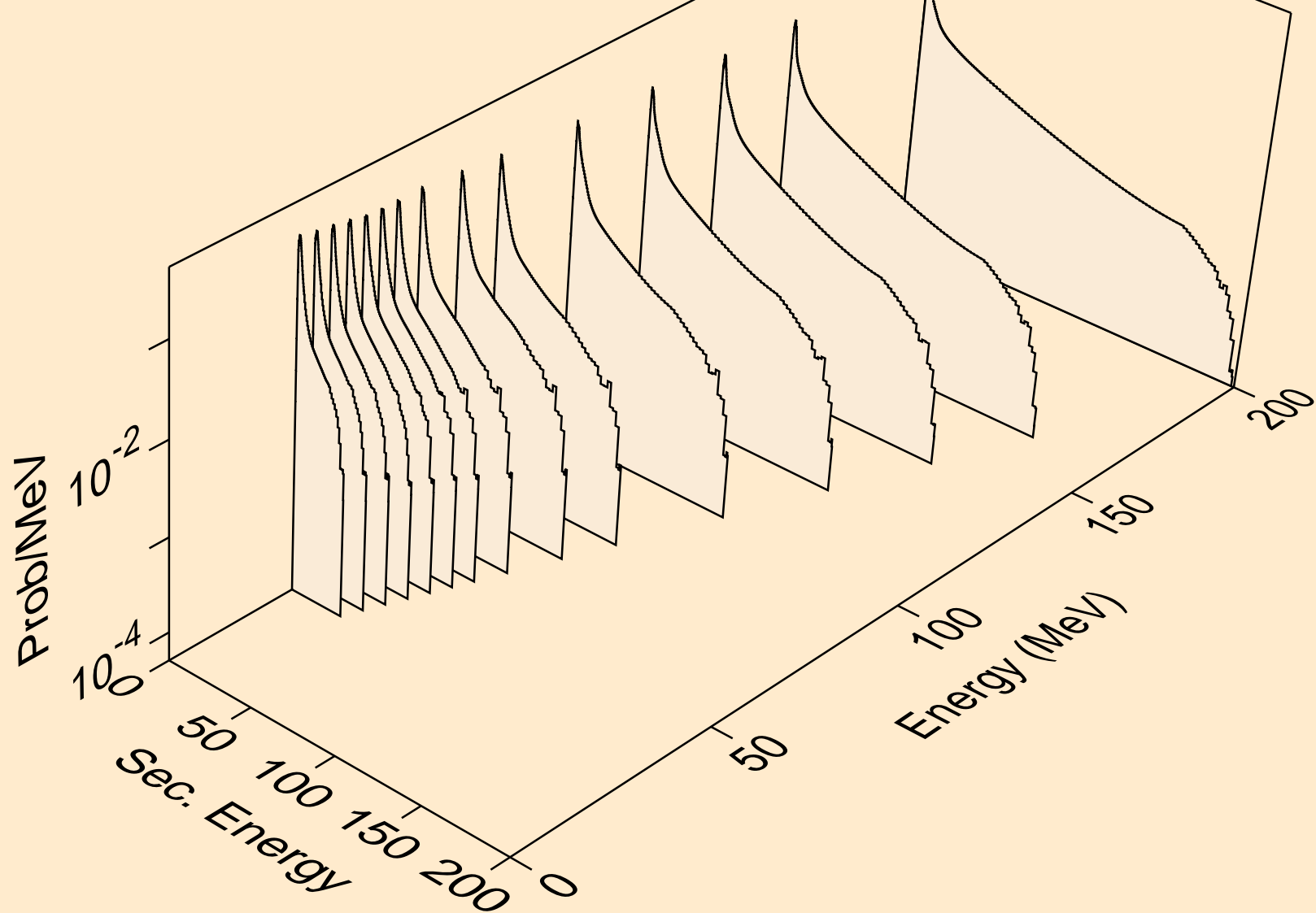

FM257 NEUTRON ACER TENDL-2023 LIBRARY; T=0.K
Neutron emission for (n,2nd)

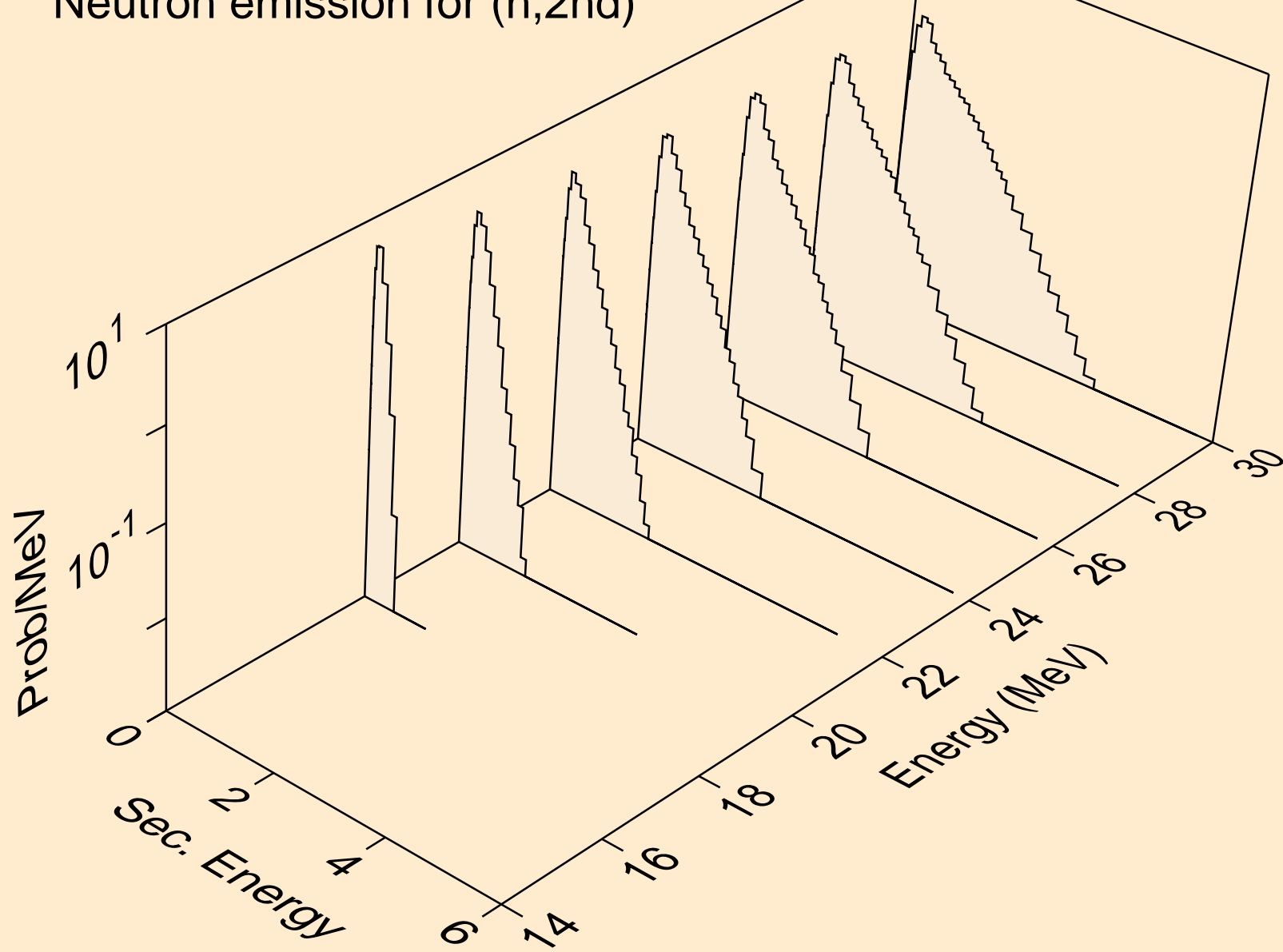

FM257 NEUTRON ACER TENDL-2023 LIBRARY; T=0.K
Neutron emission for (n,2n)

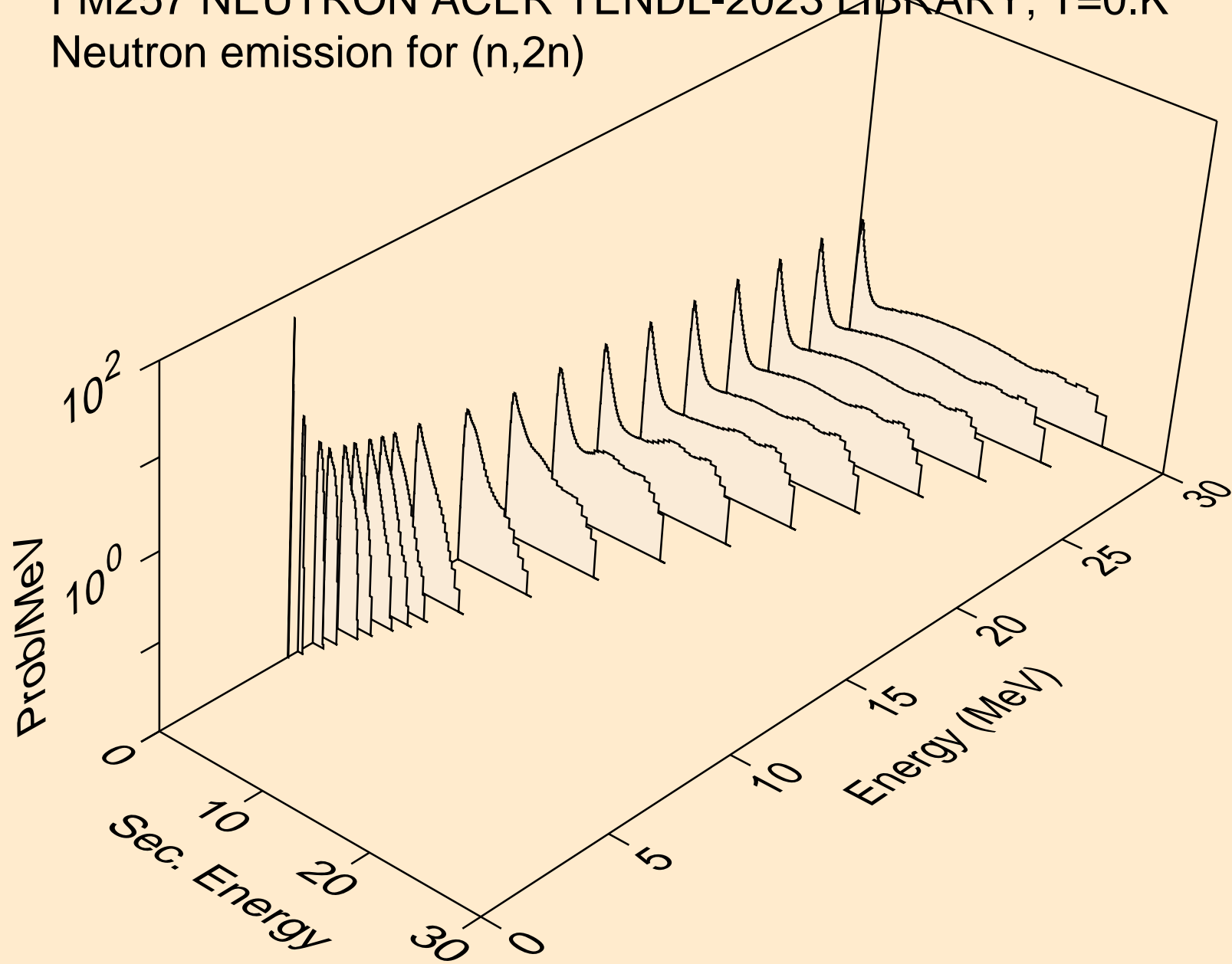

FM257 NEUTRON ACER TENDL-2023 LIBRARY; T=0.K
Neutron emission for (n,3n)

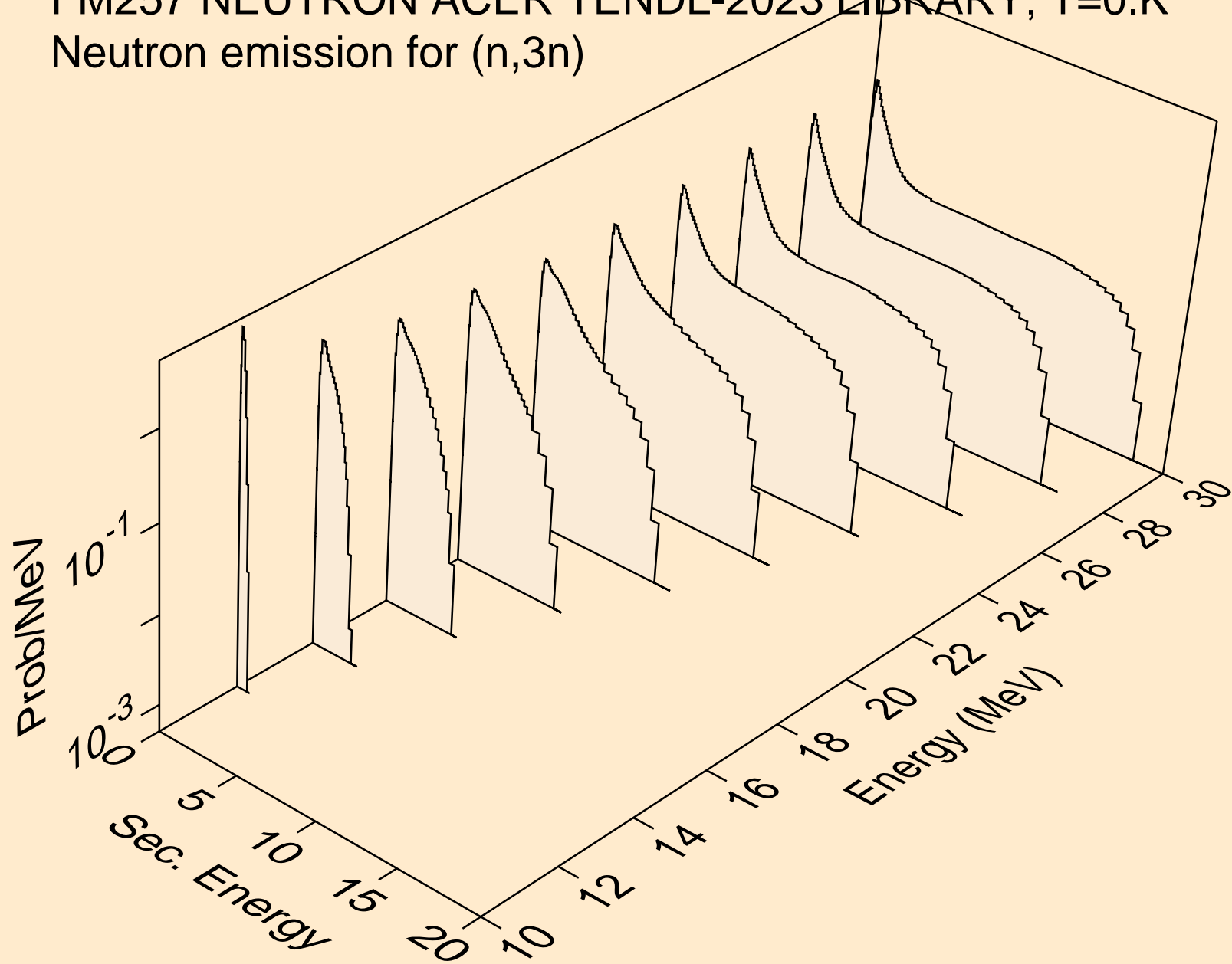

FM257 NEUTRON ACER TENDL-2023 LIBRARY; T=0.K
Neutron emission for fission

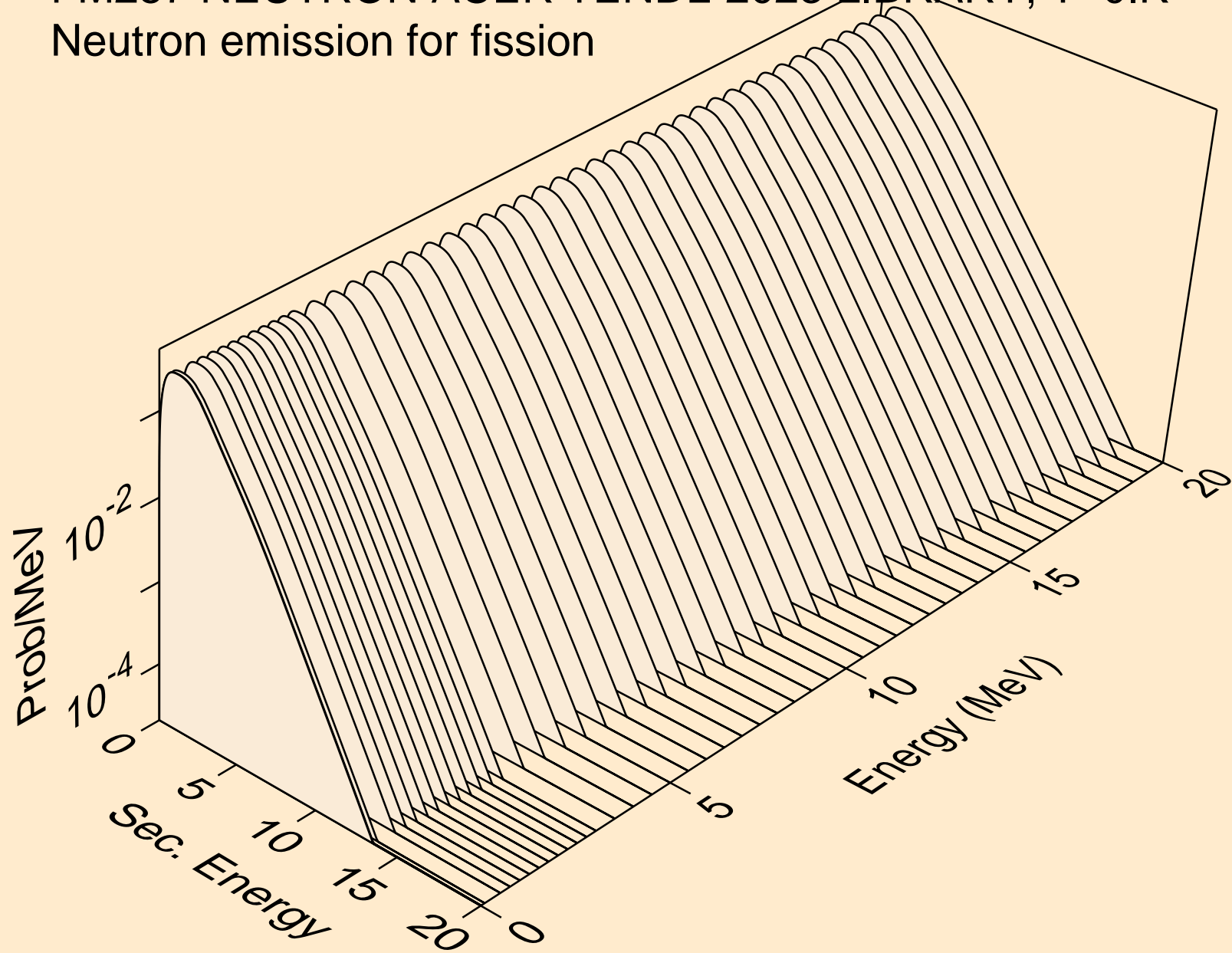

FM257 NEUTRON ACER TENDL-2023 LIBRARY; T=0.K
Neutron emission for (n,n*)a

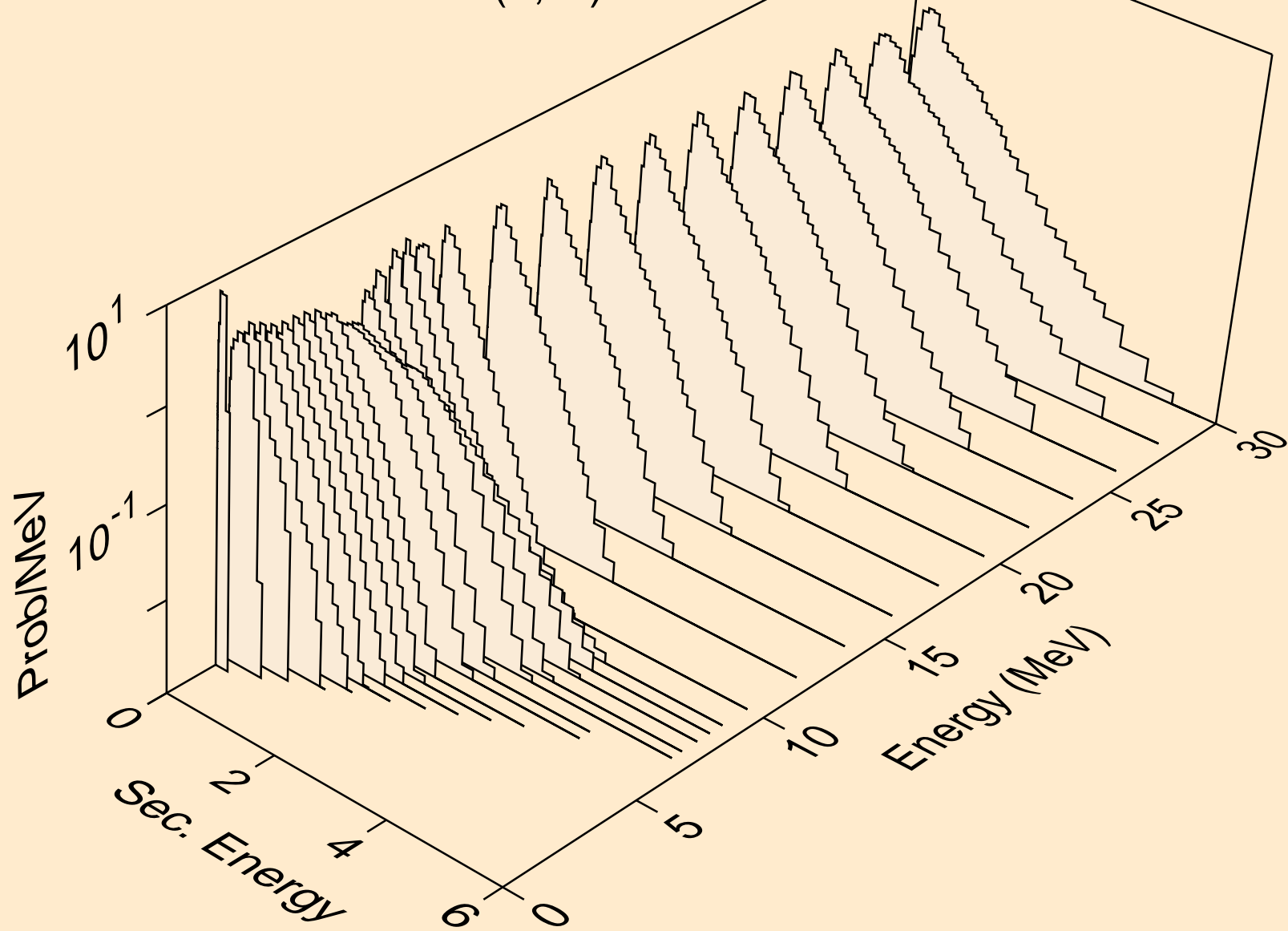

FM257 NEUTRON ACER TENDL-2023 LIBRARY; T=0.K
Neutron emission for (n,2n)a

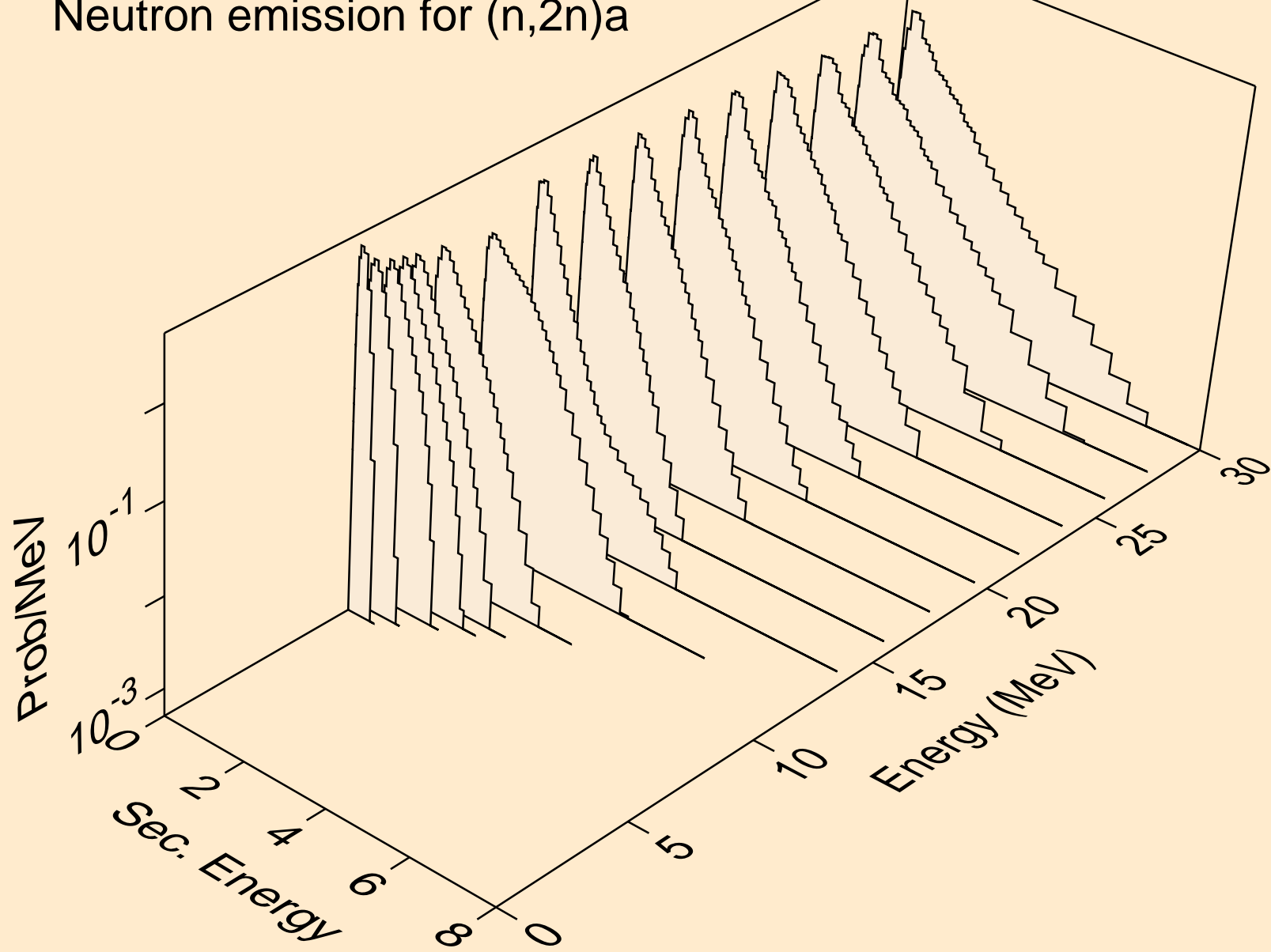

FM257 NEUTRON ACER TENDL-2023 LIBRARY; T=0.K
Neutron emission for (n,3n)a

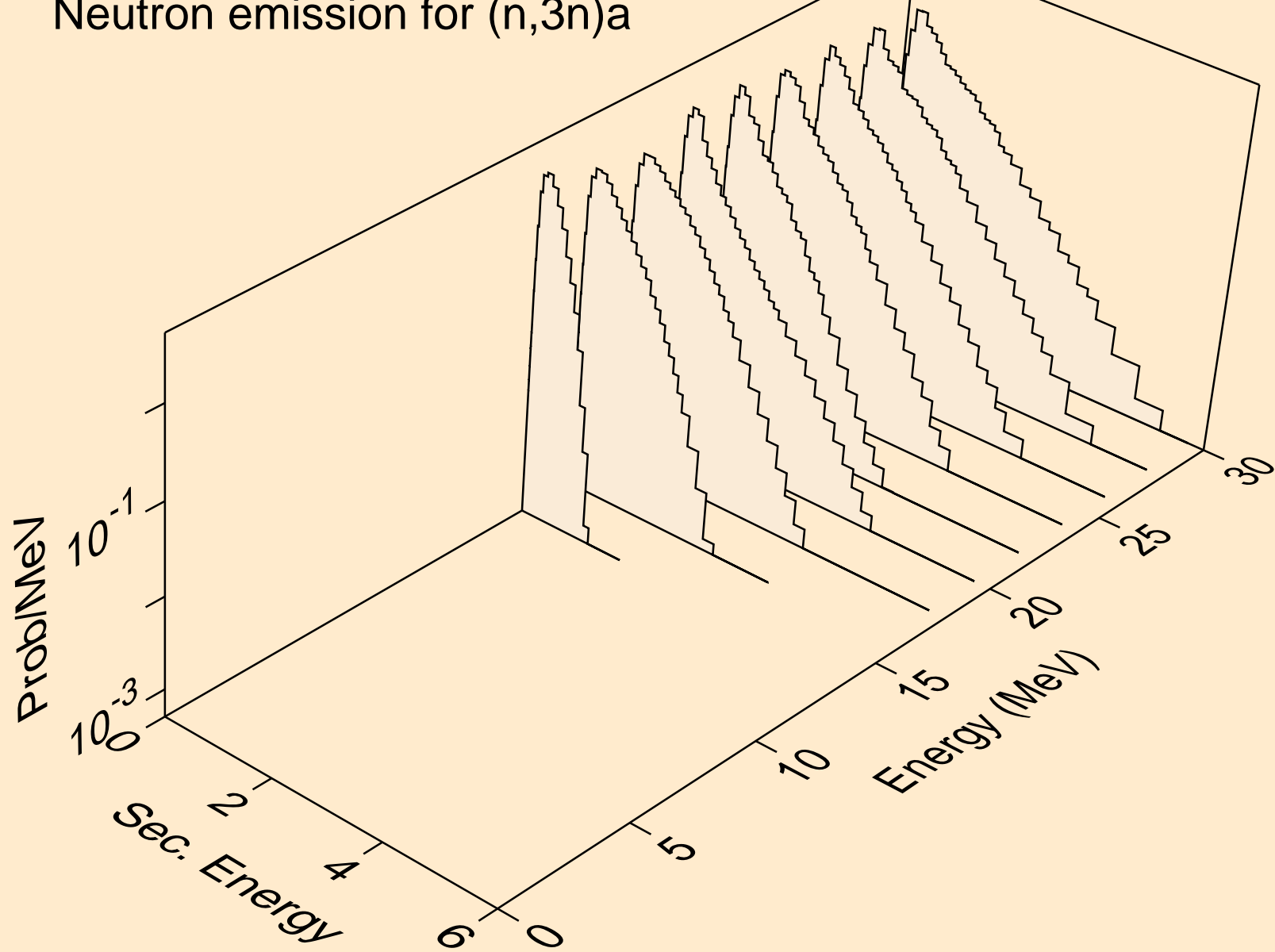

FM257 NEUTRON ACER TENDL-2023 LIBRARY; T=0.K
Neutron emission for (n,n*)p

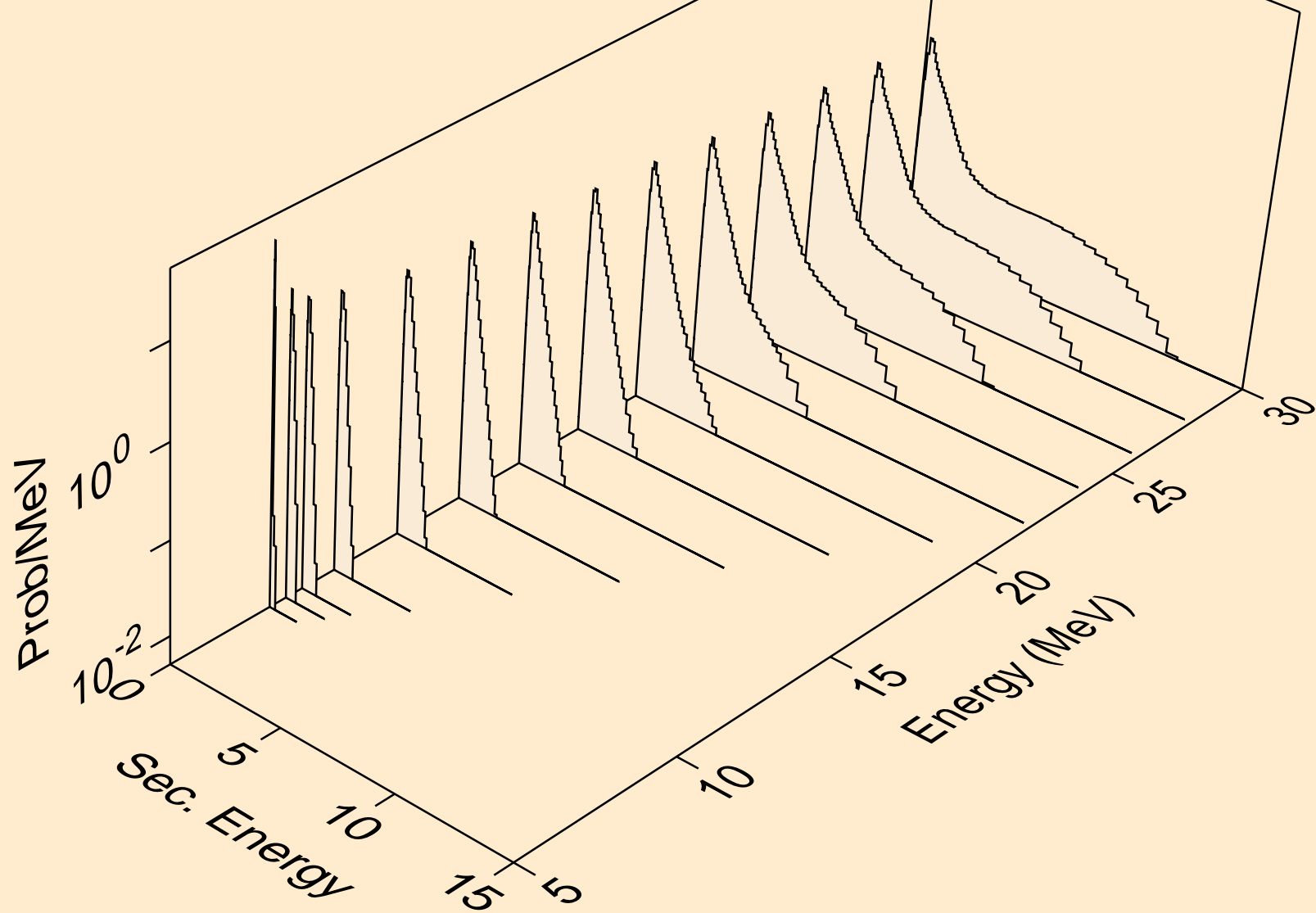

FM257 NEUTRON ACER TENDL-2023 LIBRARY; T=0.K
Neutron emission for (n,n*)2a

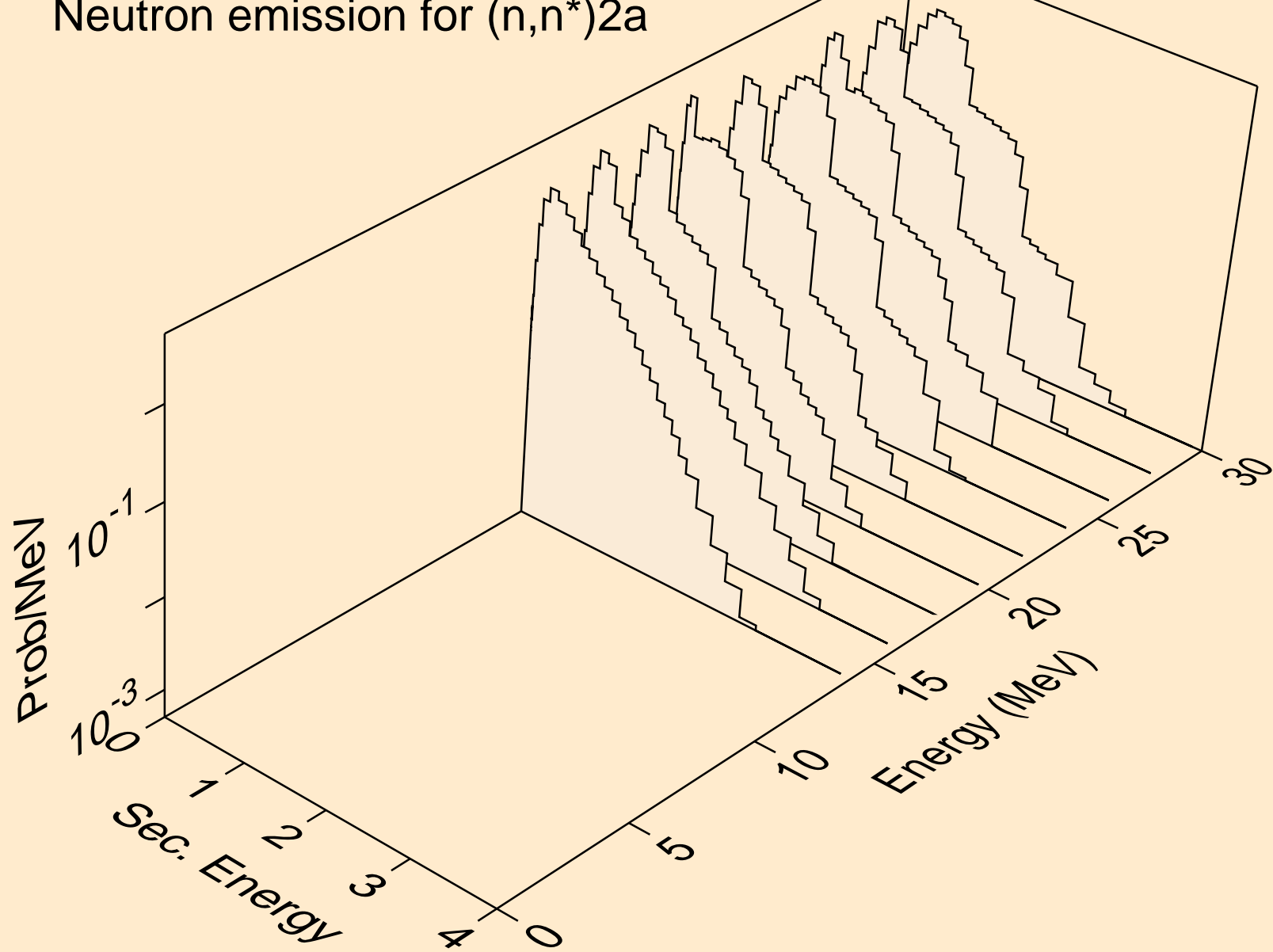

FM257 NEUTRON ACER TENDL-2023 LIBRARY; T=0.K
Neutron emission for (n,n*)d

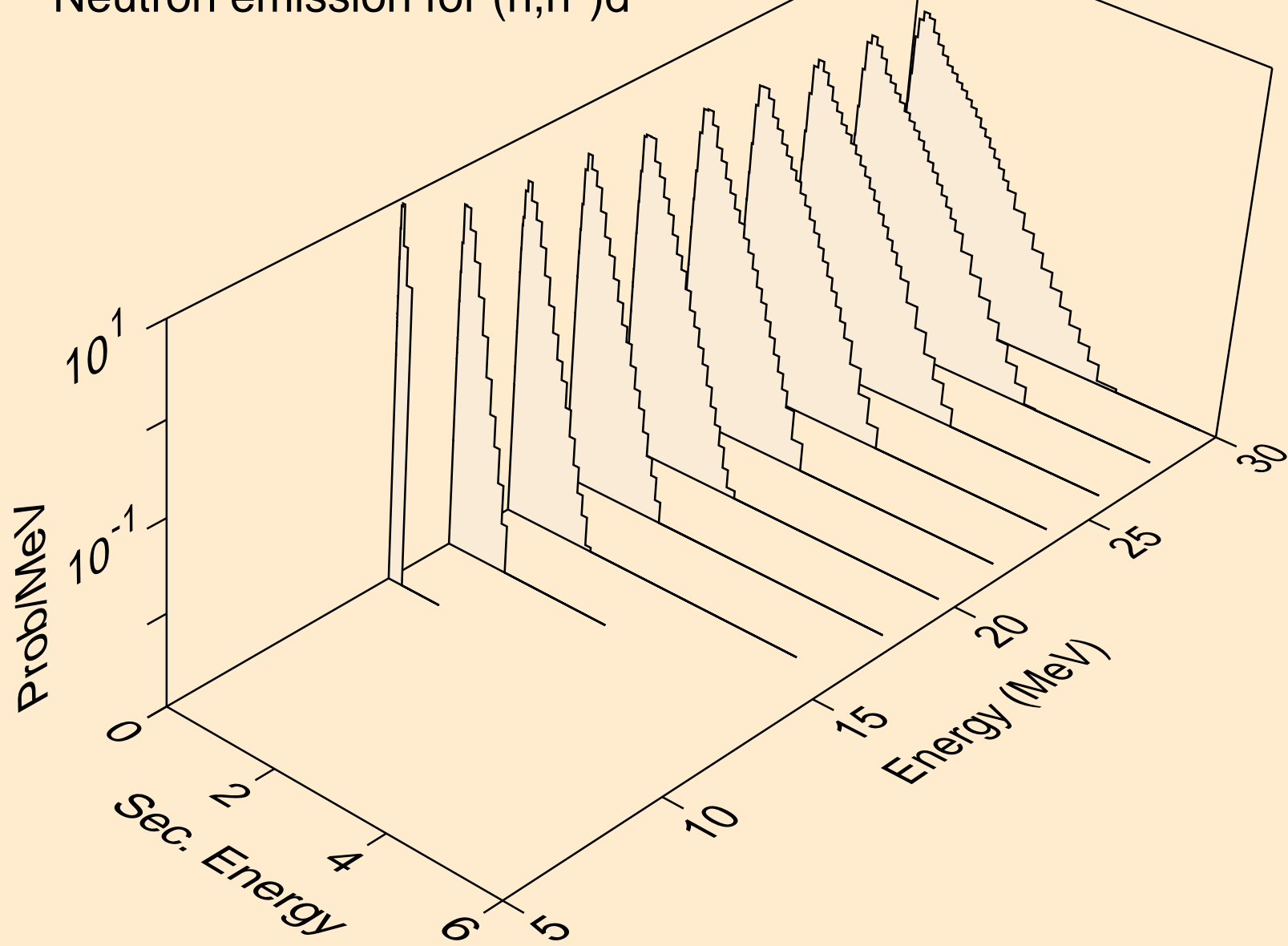

FM257 NEUTRON ACER TENDL-2023 LIBRARY; T=0.K
Neutron emission for (n,n*)t

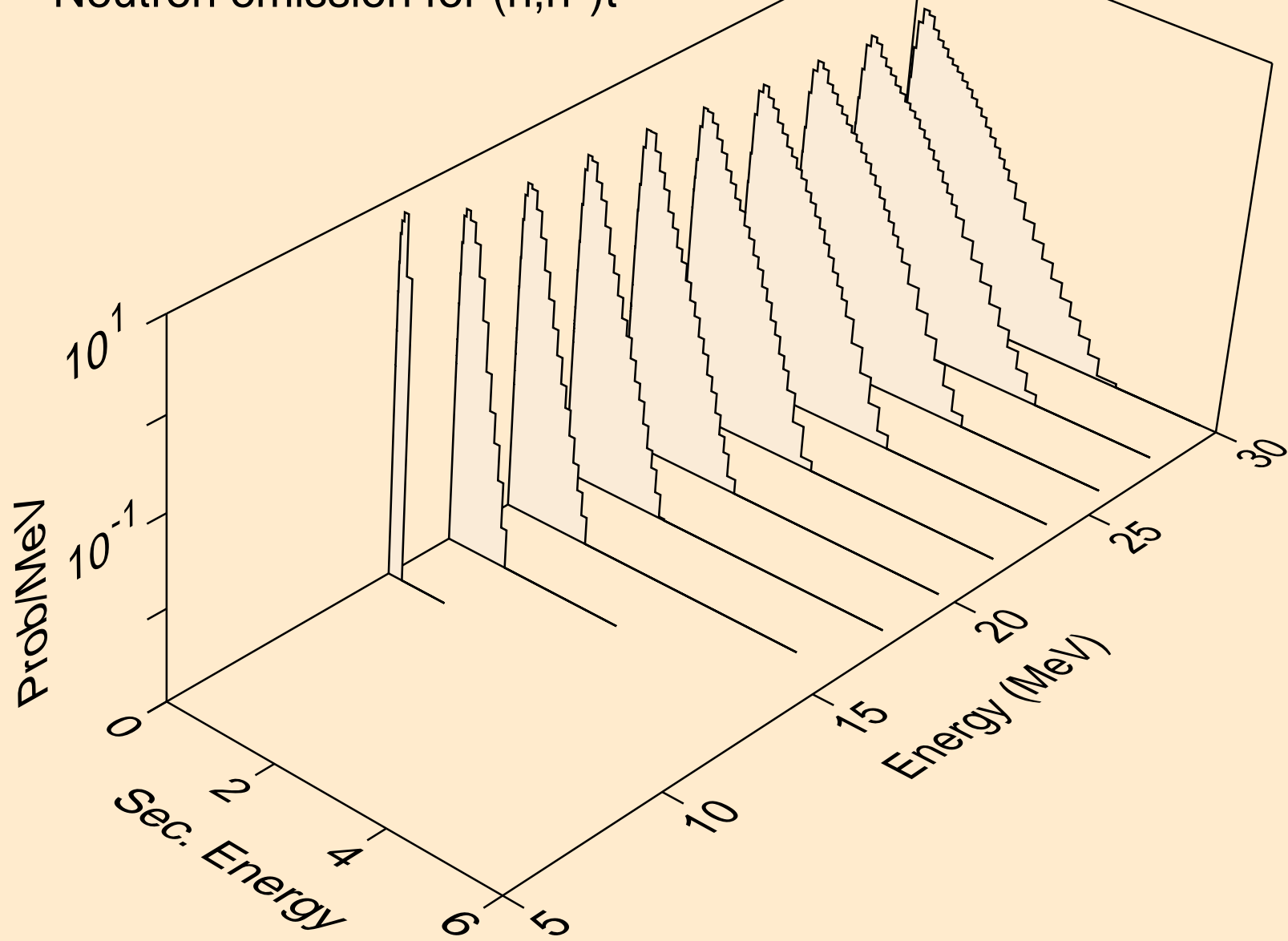

FM257 NEUTRON ACER TENDL-2023 LIBRARY; T=0.K
Neutron emission for (n,n*)he3

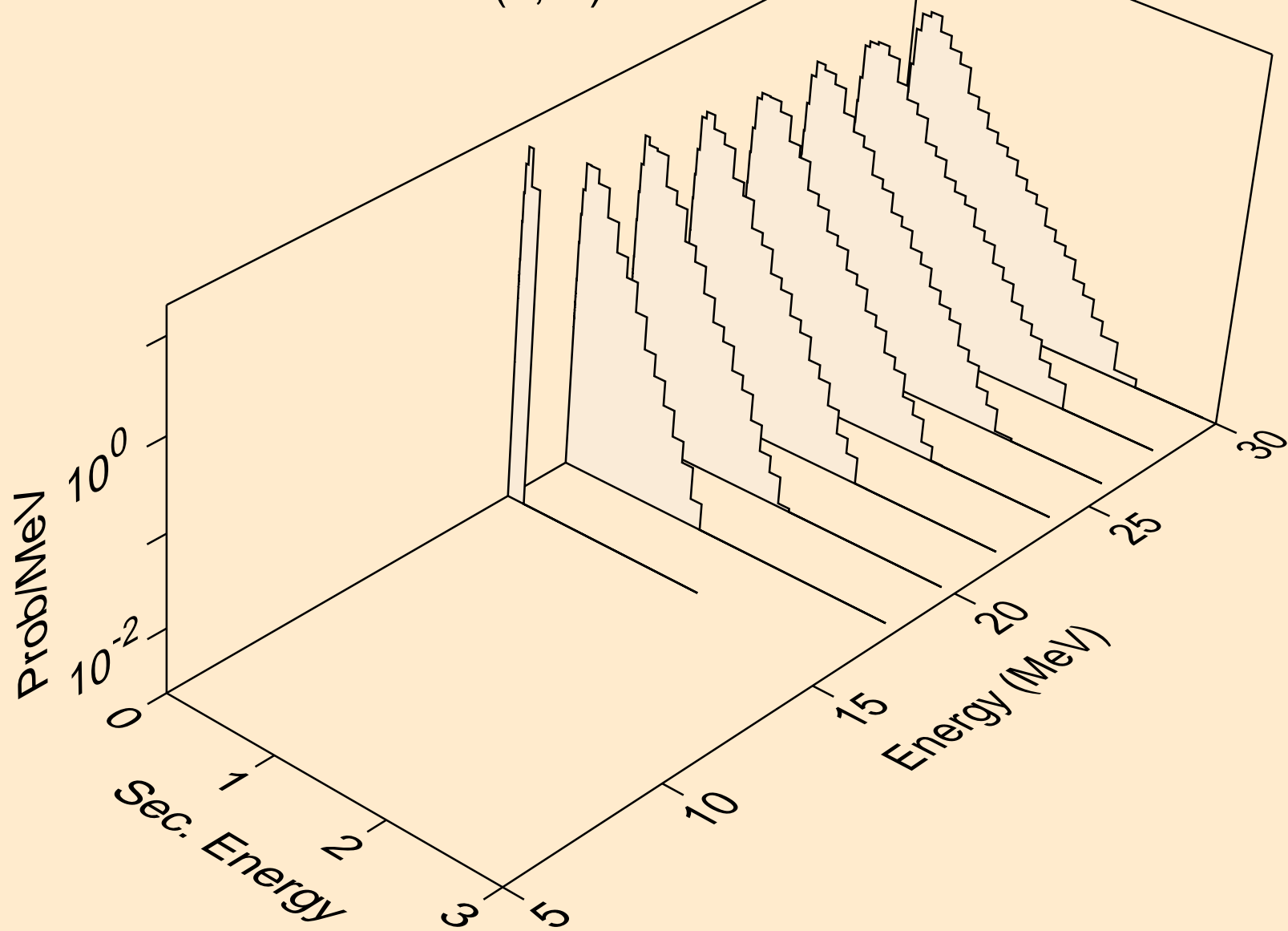

FM257 NEUTRON ACER TENDL-2023 LIBRARY; T=0.K
Neutron emission for (n,4n)

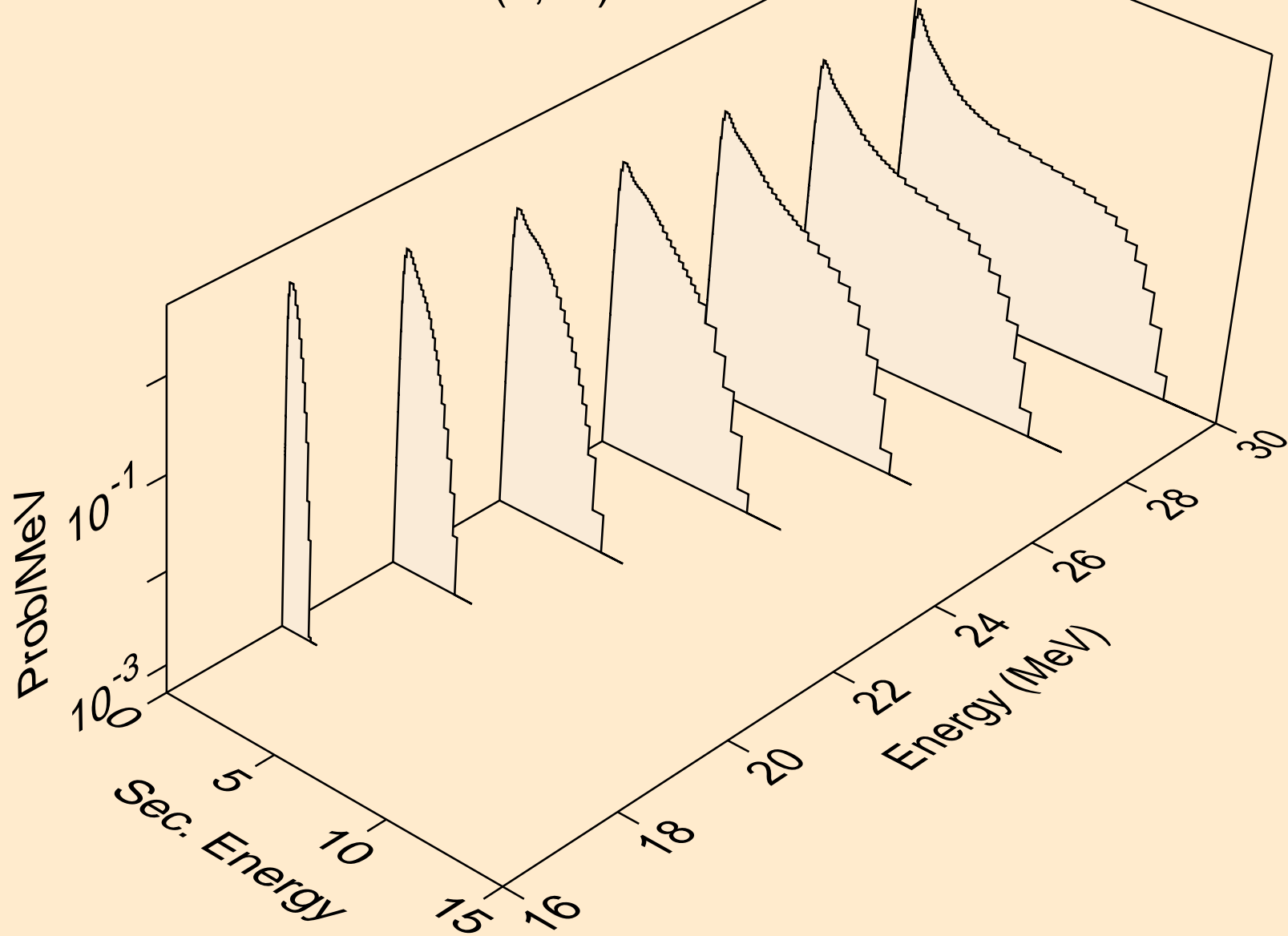

FM257 NEUTRON ACER TENDL-2023 LIBRARY; T=0.K
Neutron emission for (n,2np)

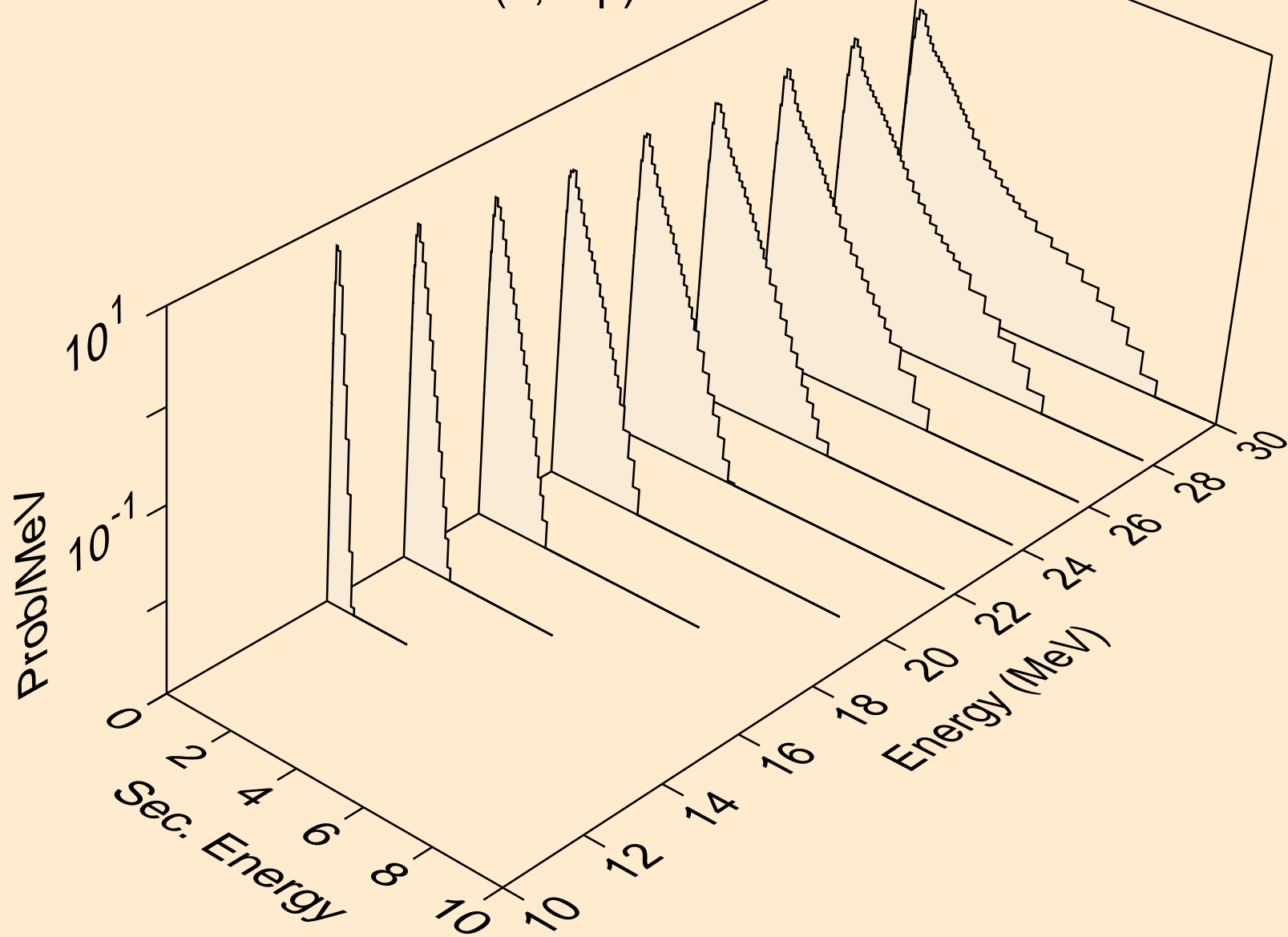

FM257 NEUTRON ACER TENDL-2023 LIBRARY; T=0.K
Neutron emission for (n,3np)

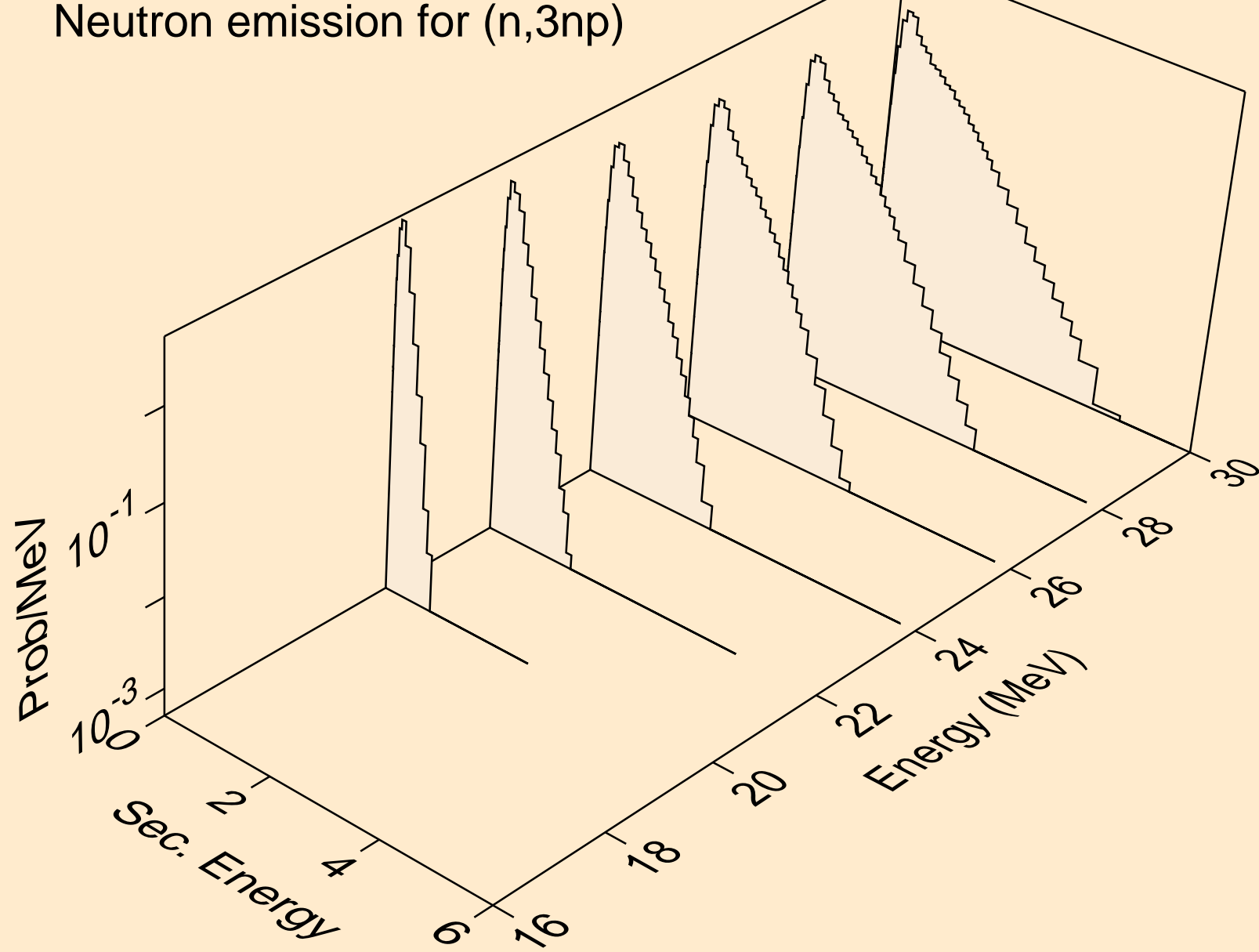

FM257 NEUTRON ACER TENDL-2023 LIBRARY; T=0.K
Neutron emission for (n,n2p)

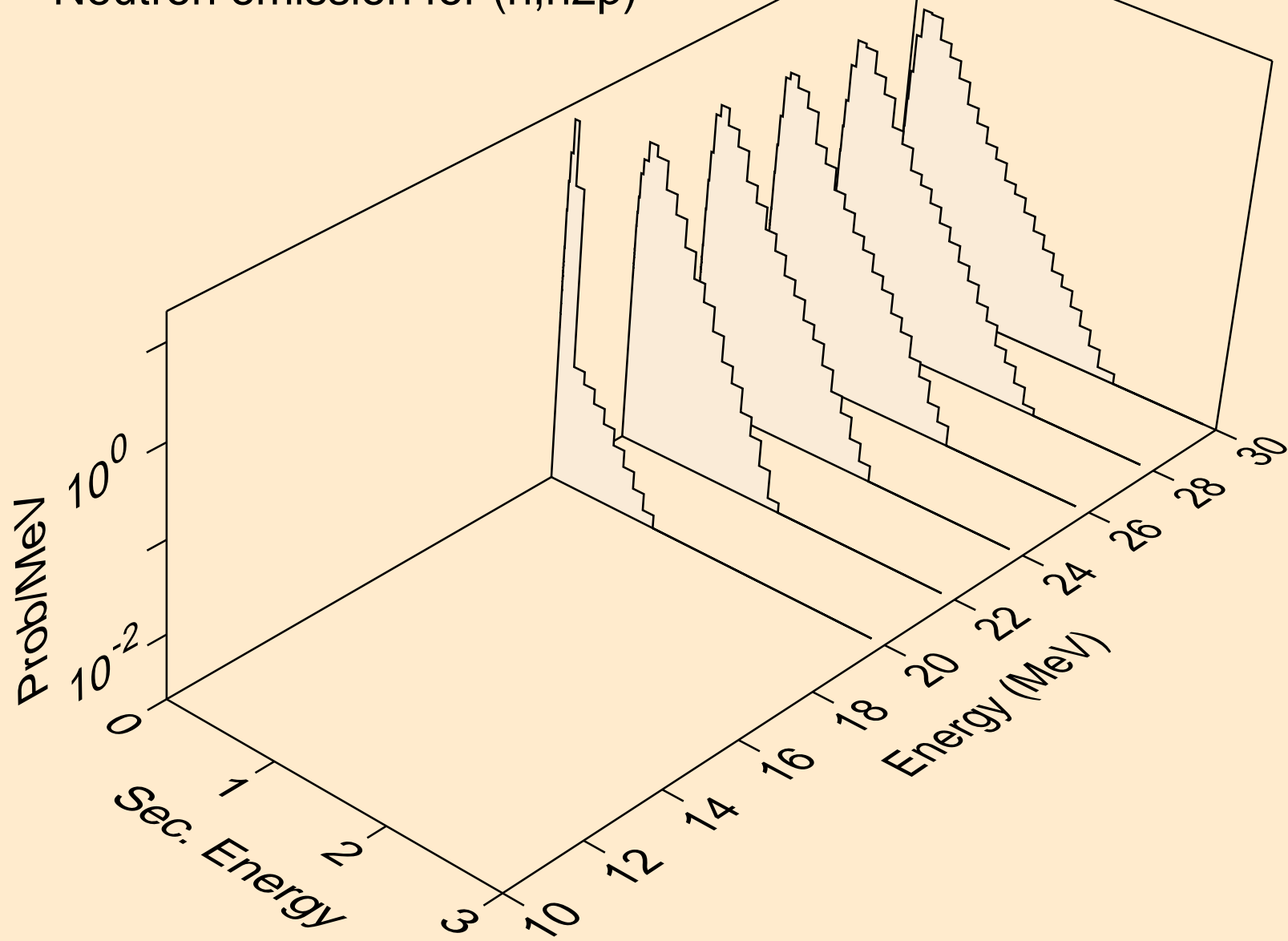

FM257 NEUTRON ACER TENDL-2023 LIBRARY; T=0.K
Neutron emission for (n,npa)

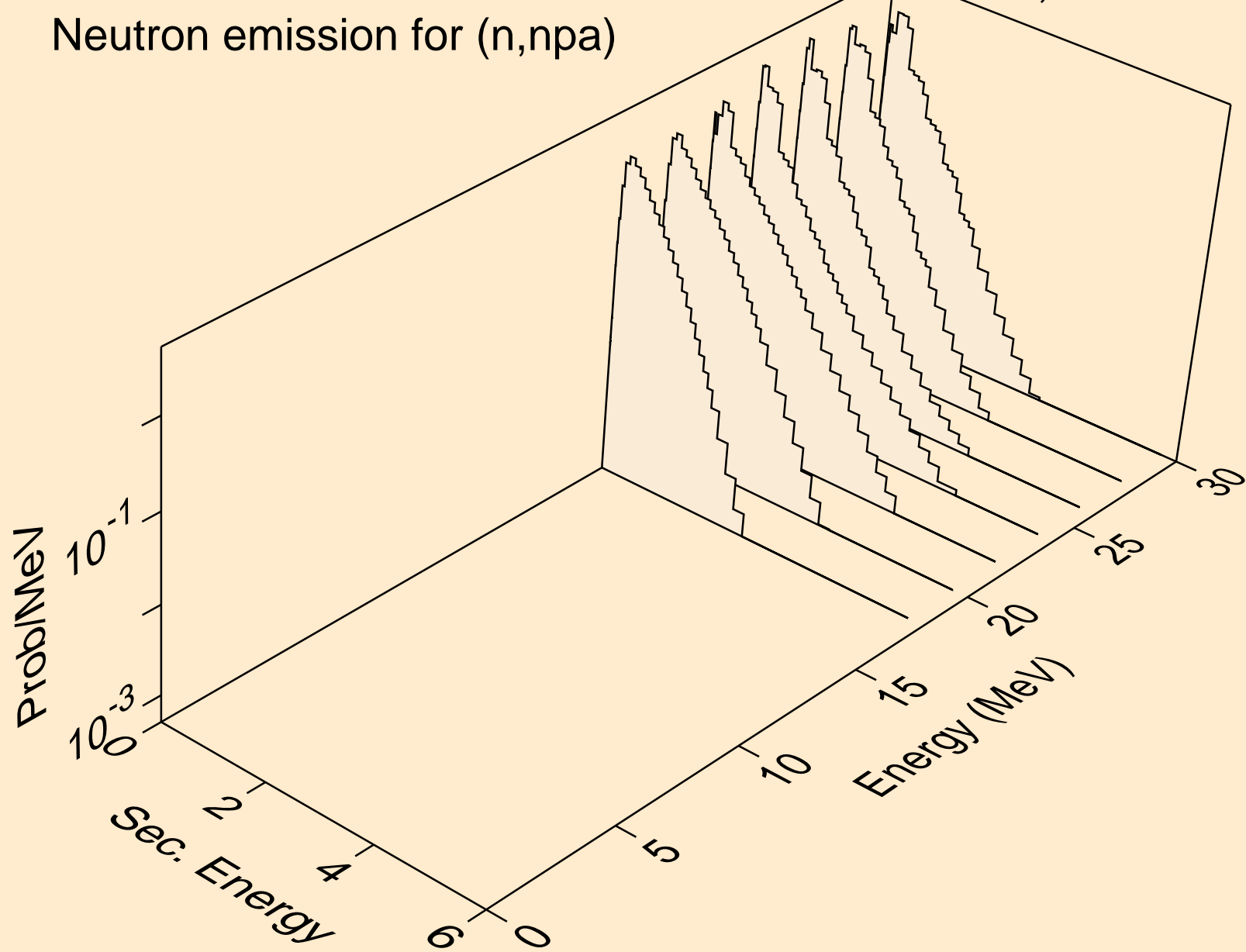

FM257 NEUTRON ACER TENDL-2023 LIBRARY; T=0.K
Neutron emission for (n,n*c)

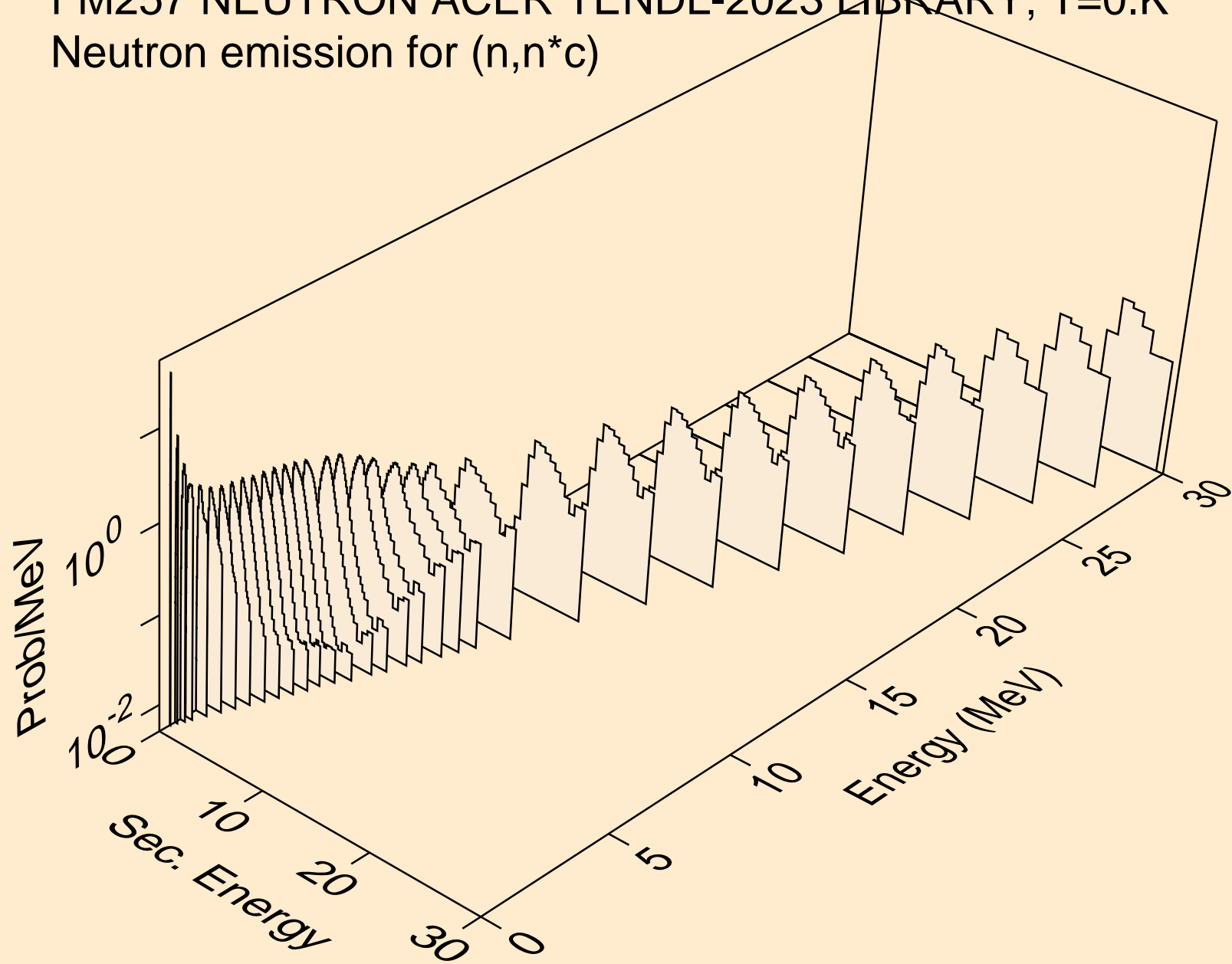

FM257 NEUTRON ACER TENDL-2023 LIBRARY; T=0.K

Delayed nubar

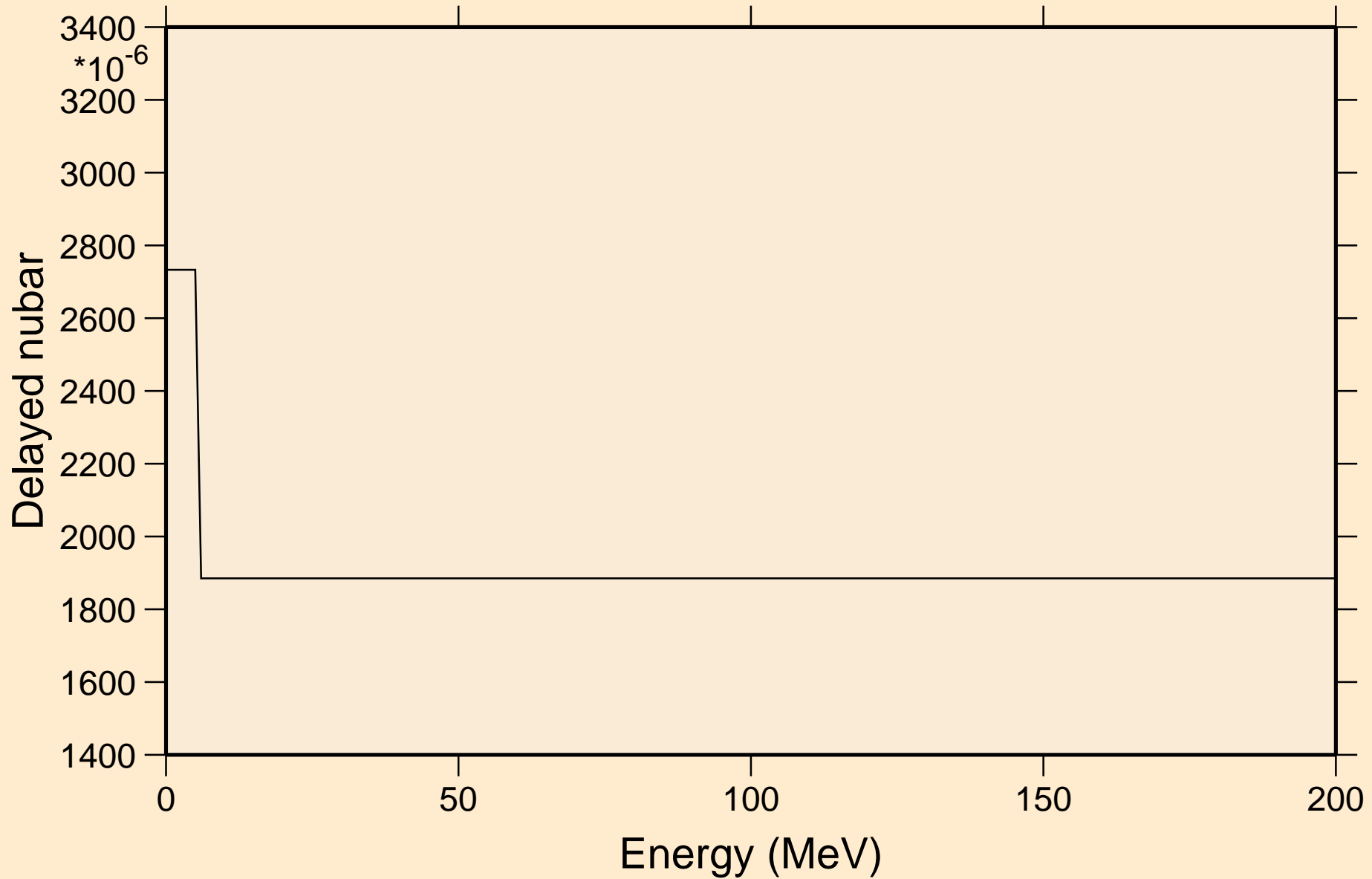

FM257 NEUTRON ACER TENDL-2023 LIBRARY; T=0.K

Delayed neutron spectra

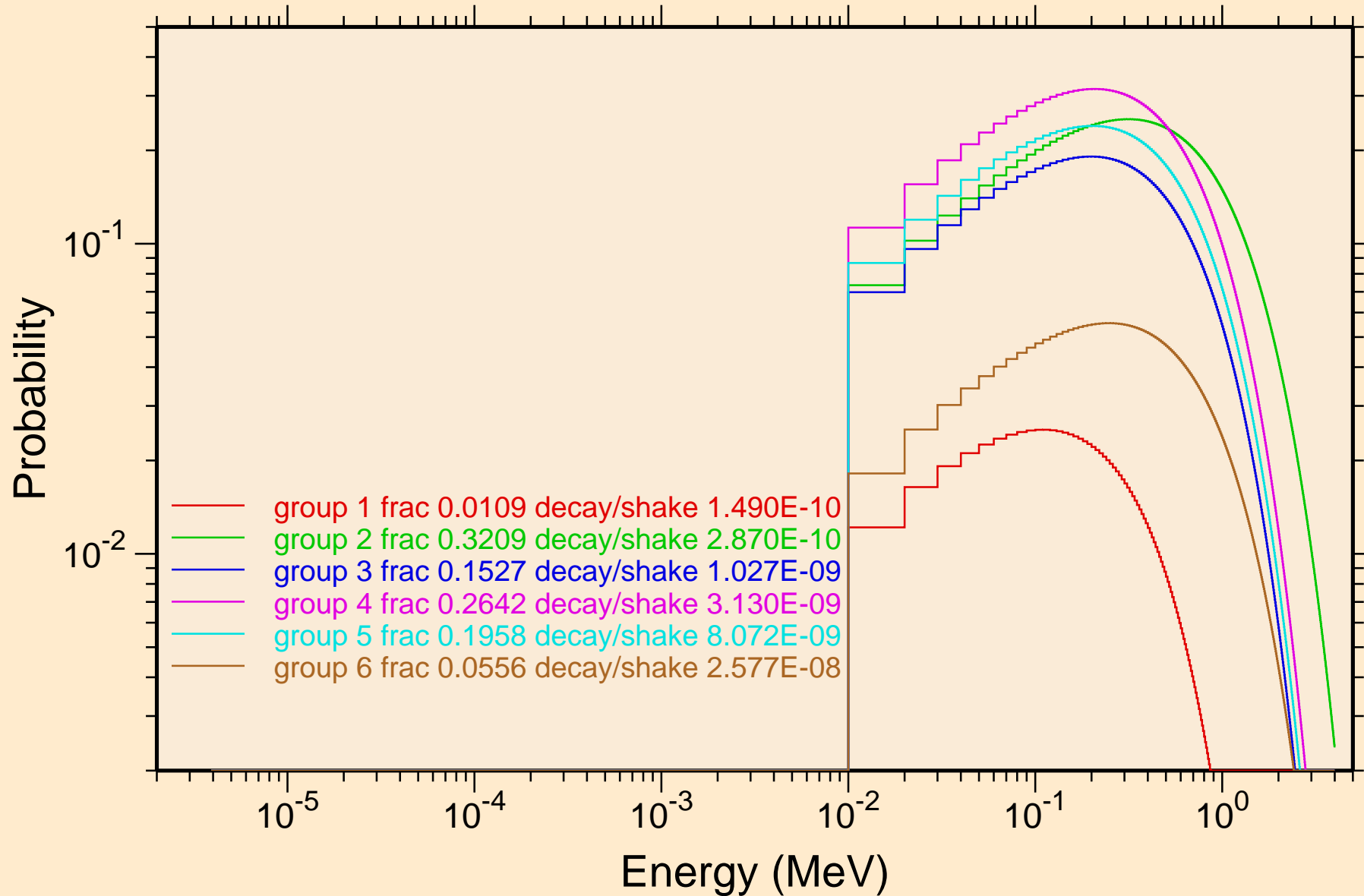

FM257 NEUTRON ACER TENDL-2023 LIBRARY; T=0.K
Photon emission for (n,x)

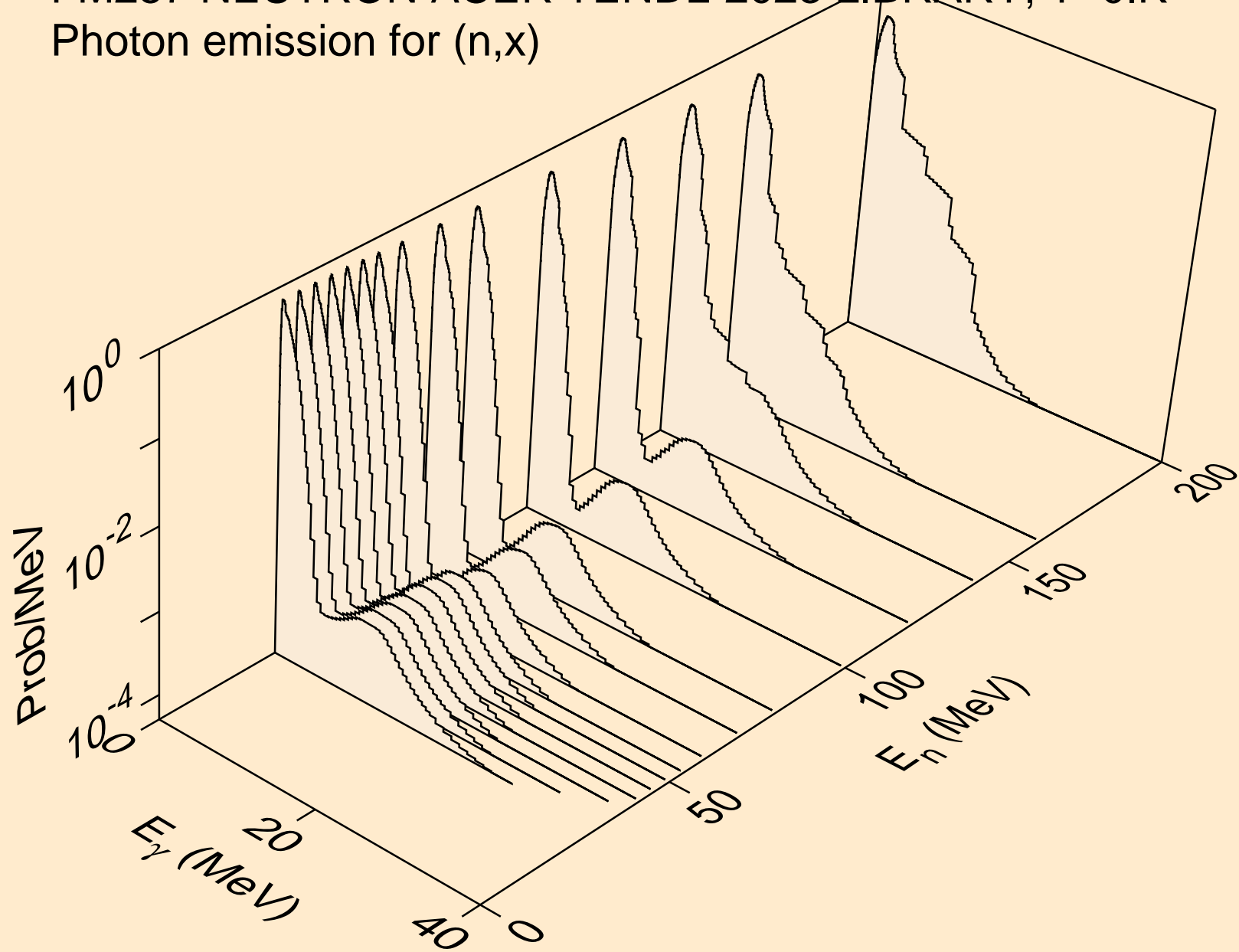

FM257 NEUTRON ACER TENDL-2023 LIBRARY; T=0.K
Photon emission for (n,2nd)

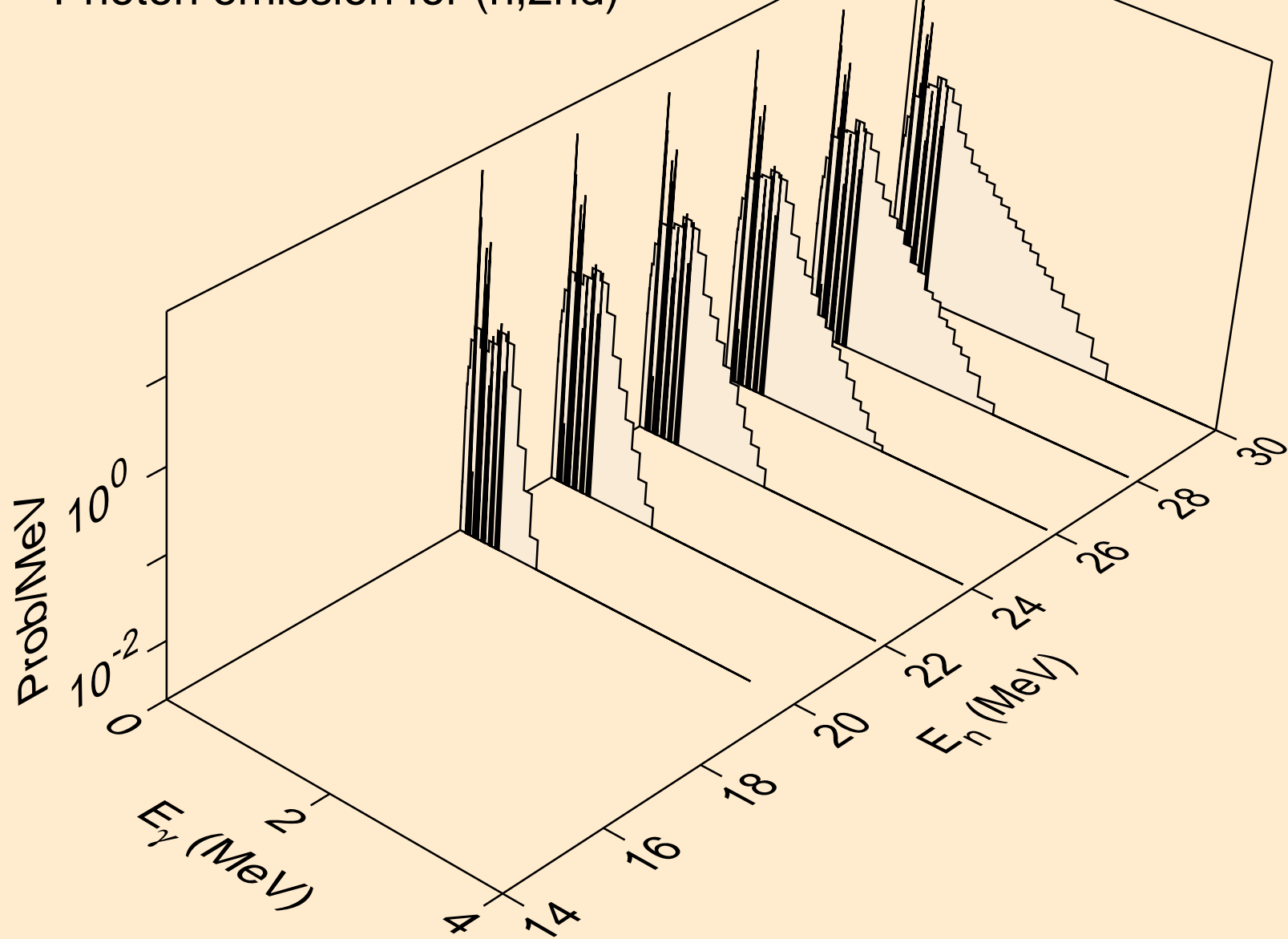

FM257 NEUTRON ACER TENDL-2023 LIBRARY; T=0.K
Photon emission for (n,2n)

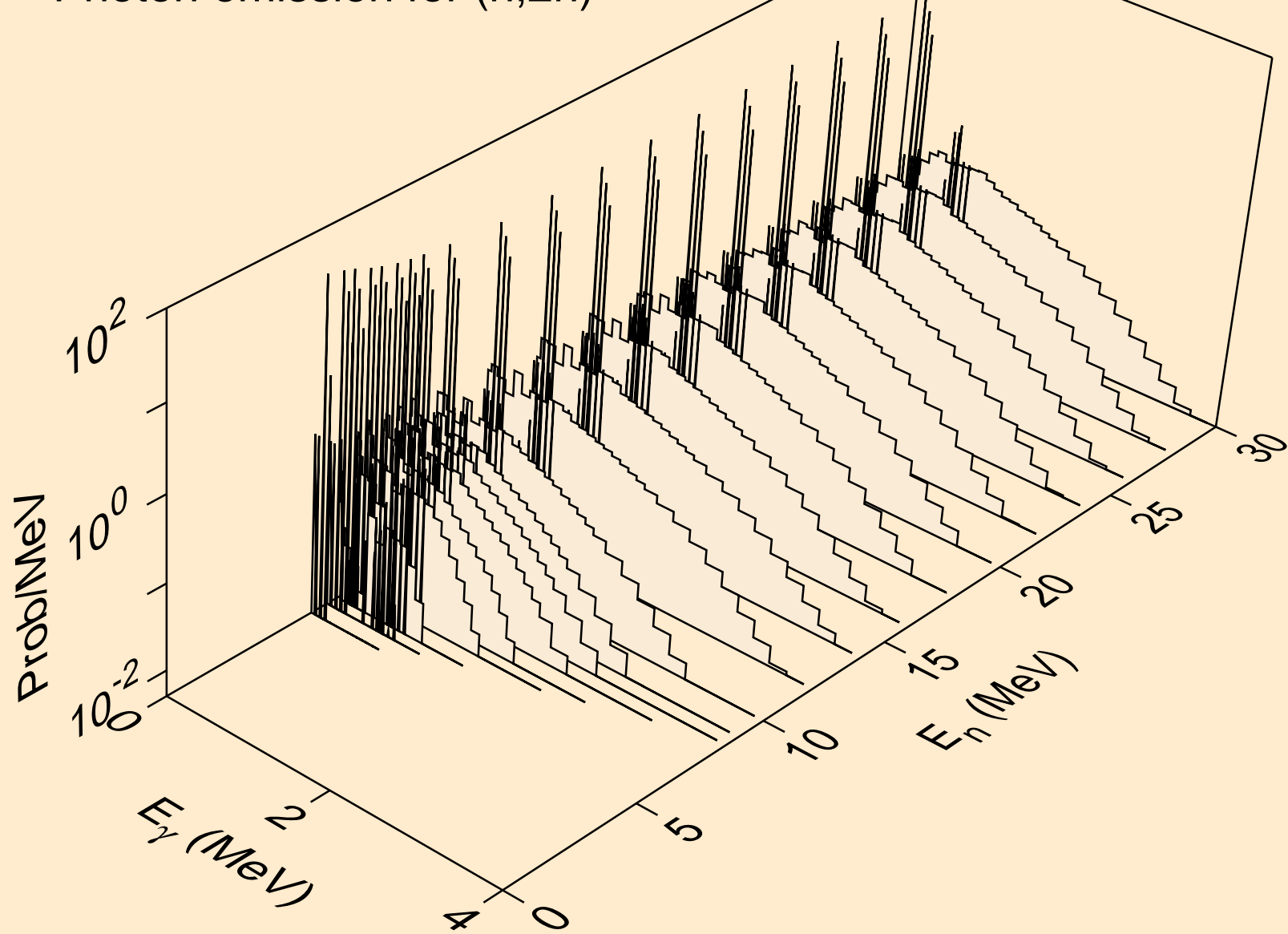

FM257 NEUTRON ACER TENDL-2023 LIBRARY; T=0.K
Photon emission for (n,3n)

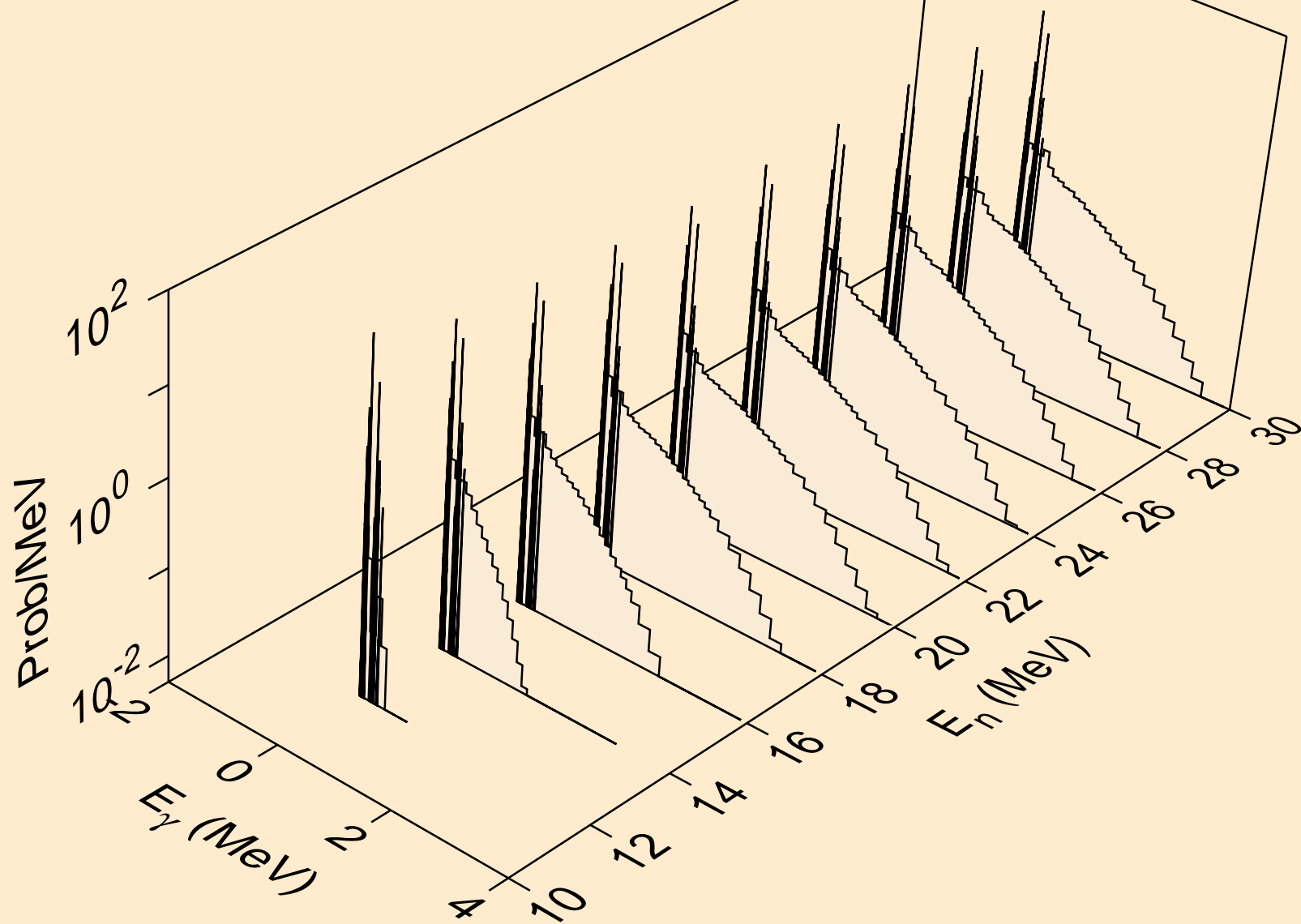

FM257 NEUTRON ACER TENDL-2023 LIBRARY; T=0.K
Photon emission for (n,n*)a

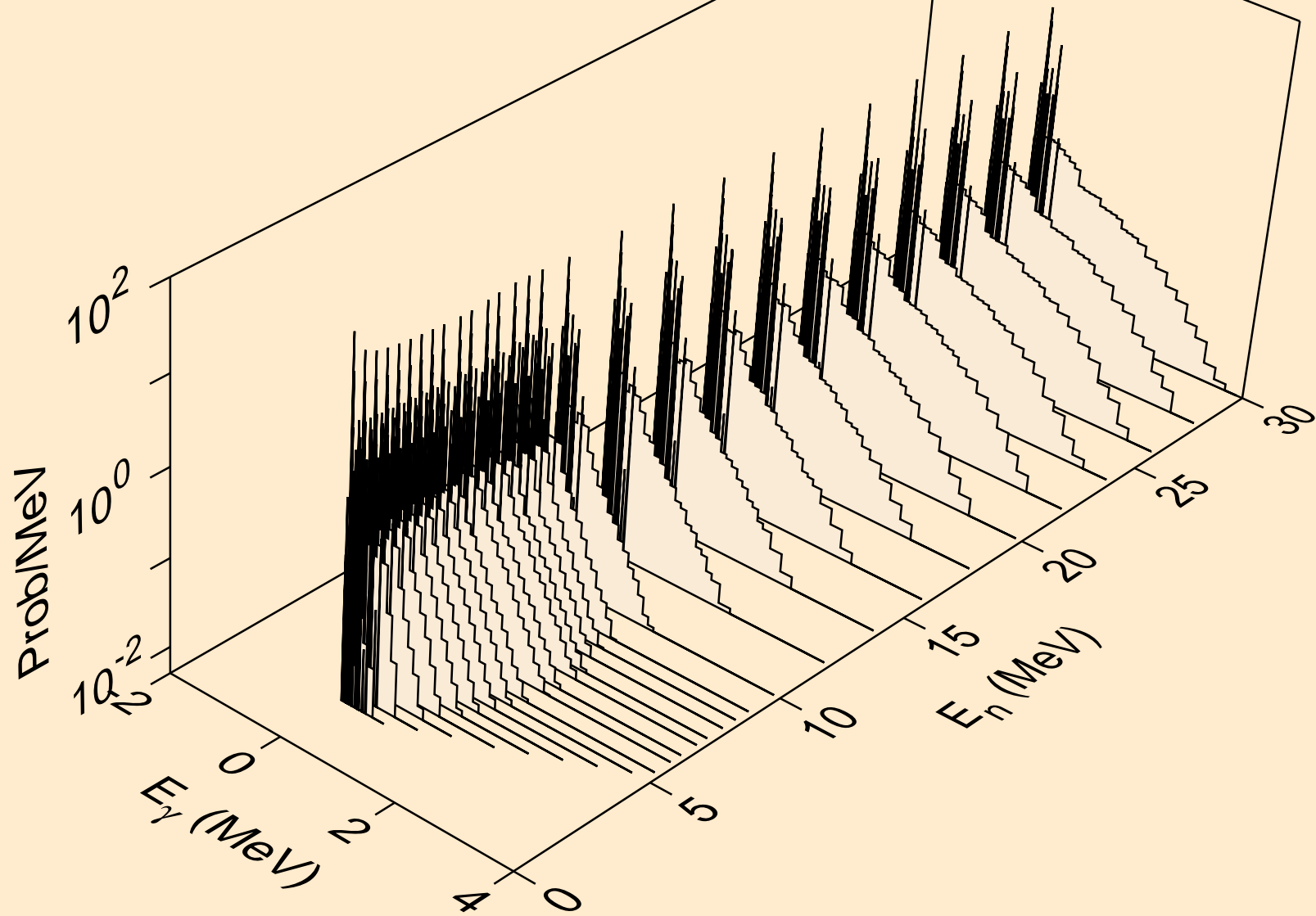

FM257 NEUTRON ACER TENDL-2023 LIBRARY; T=0.K
Photon emission for (n,2n)a

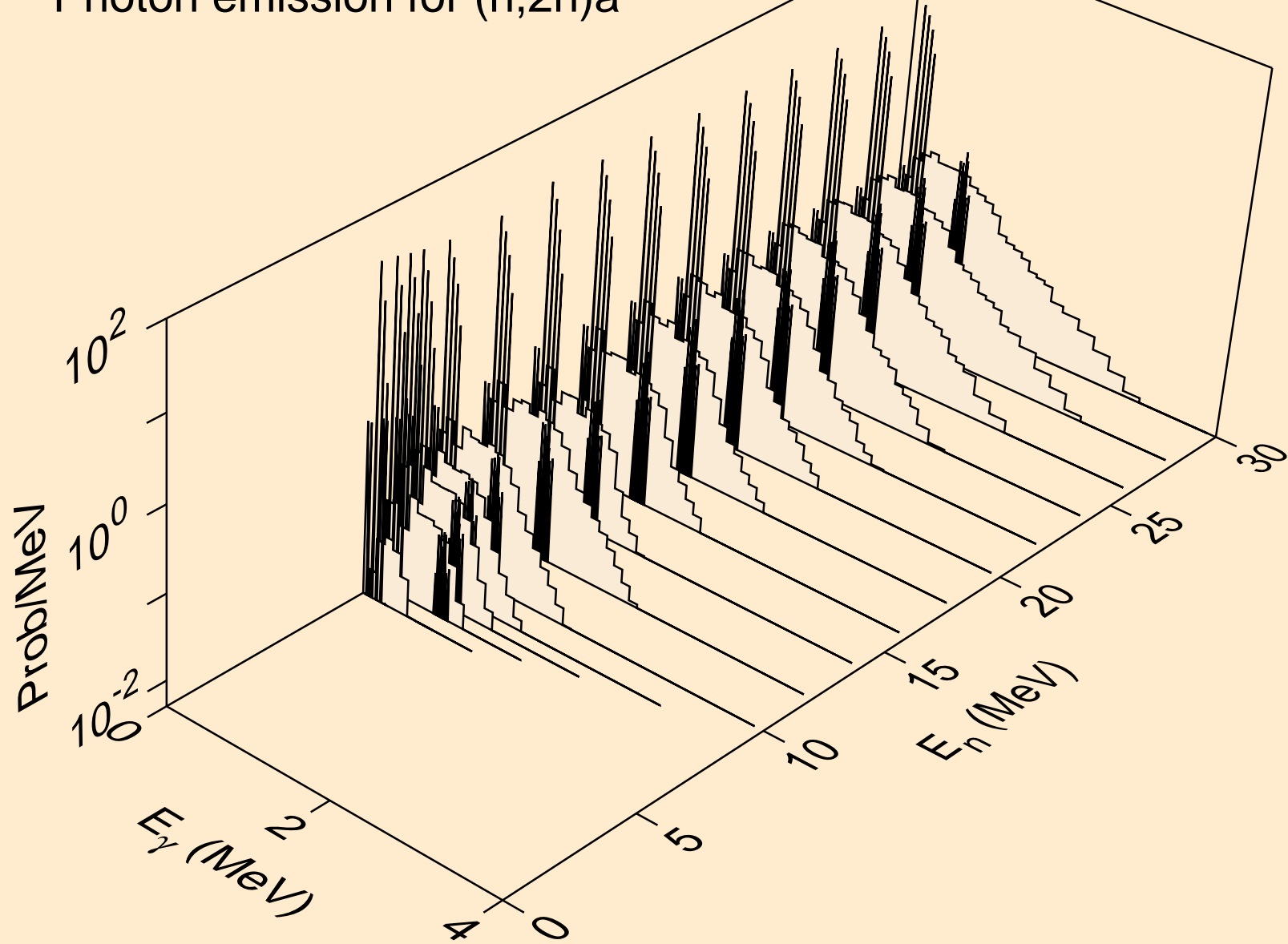

FM257 NEUTRON ACER TENDL-2023 LIBRARY; T=0.K
Photon emission for (n,3n)a

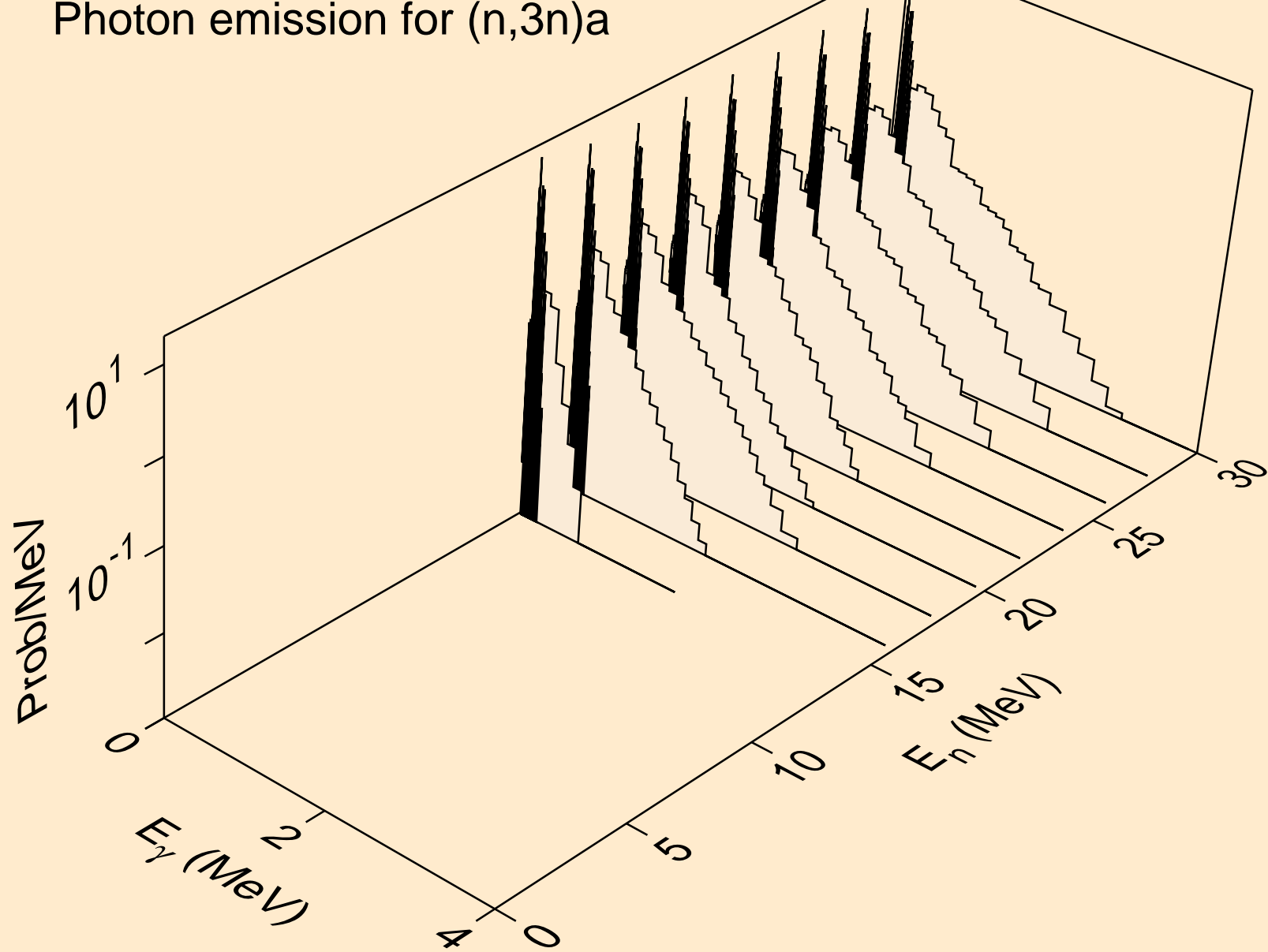

FM257 NEUTRON ACER TENDL-2023 LIBRARY; T=0.K
Photon emission for (n,n*)p

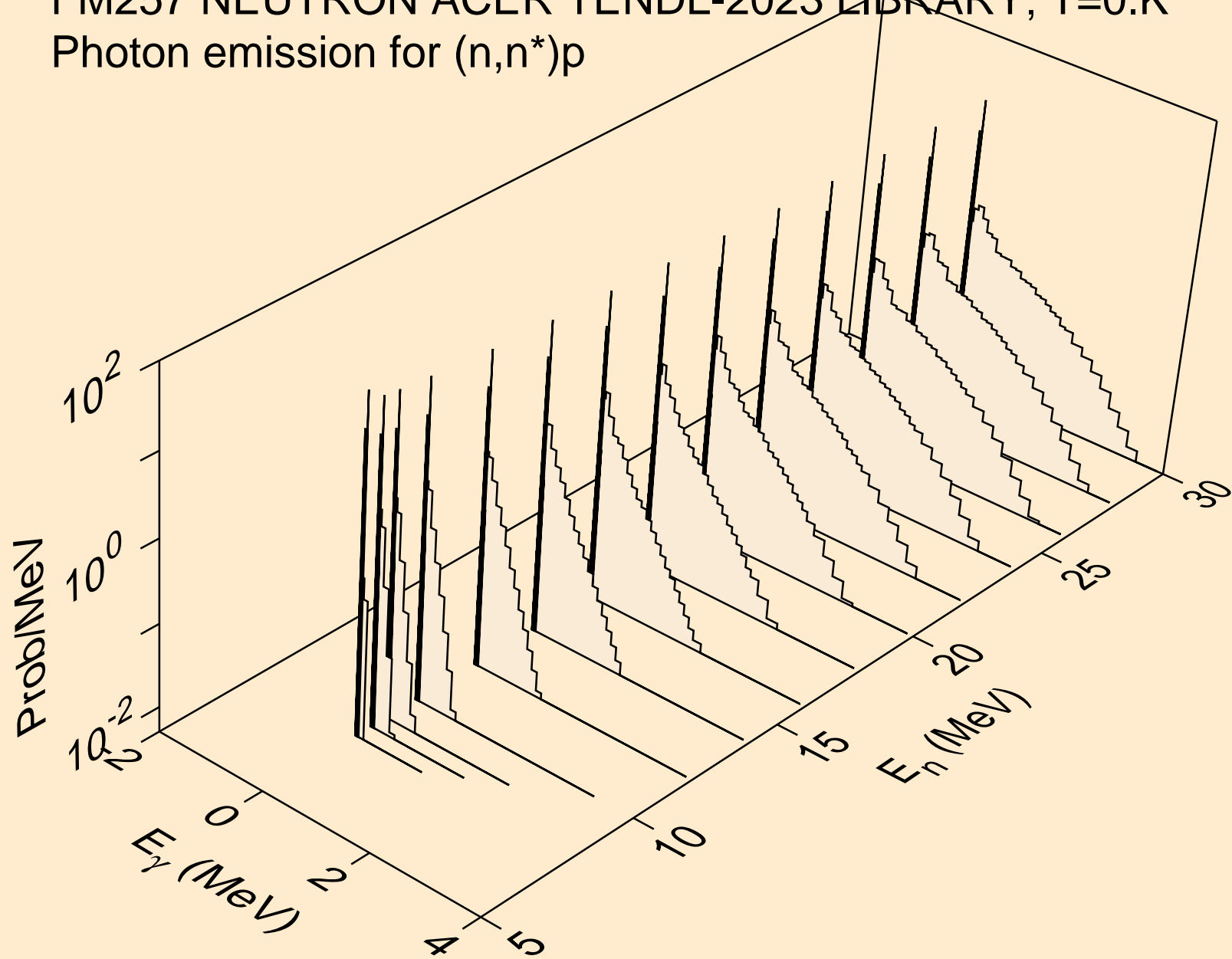

FM257 NEUTRON ACER TENDL-2023 LIBRARY; T=0.K
Photon emission for (n,n*)2a

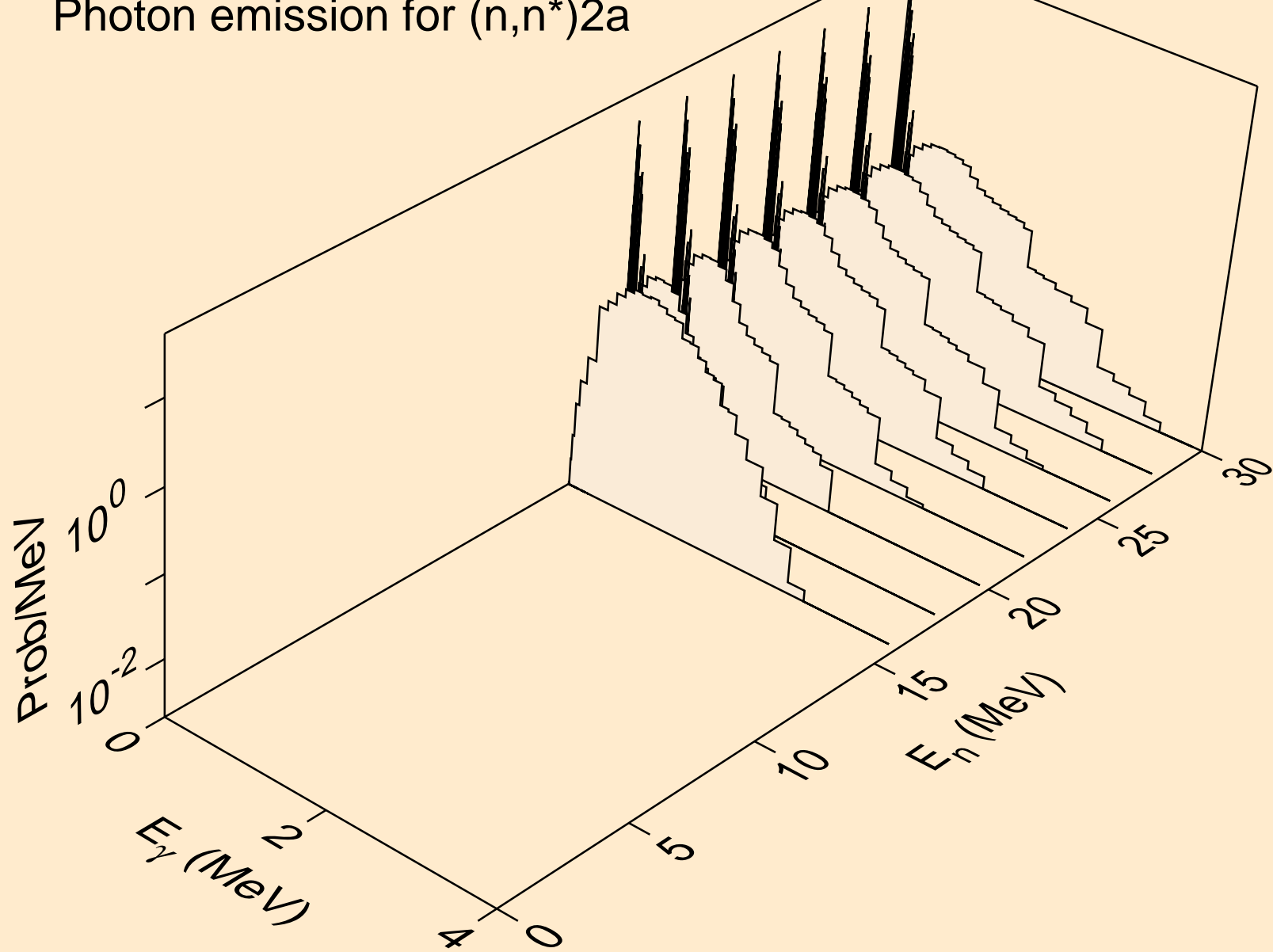

FM257 NEUTRON ACER TENDL-2023 LIBRARY; T=0.K
Photon emission for (n,n*)d

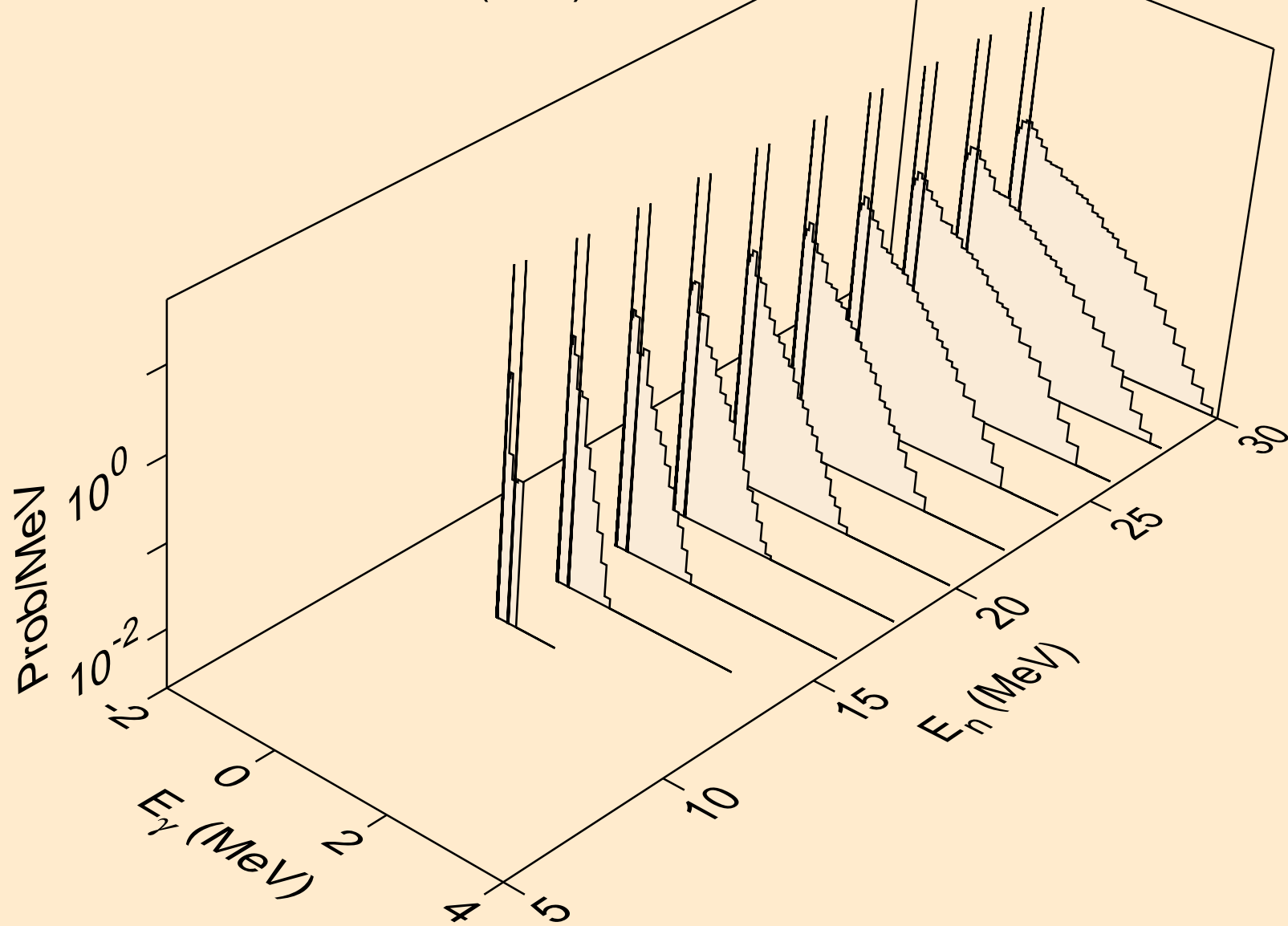

FM257 NEUTRON ACER TENDL-2023 LIBRARY; T=0.K
Photon emission for (n,n*)t

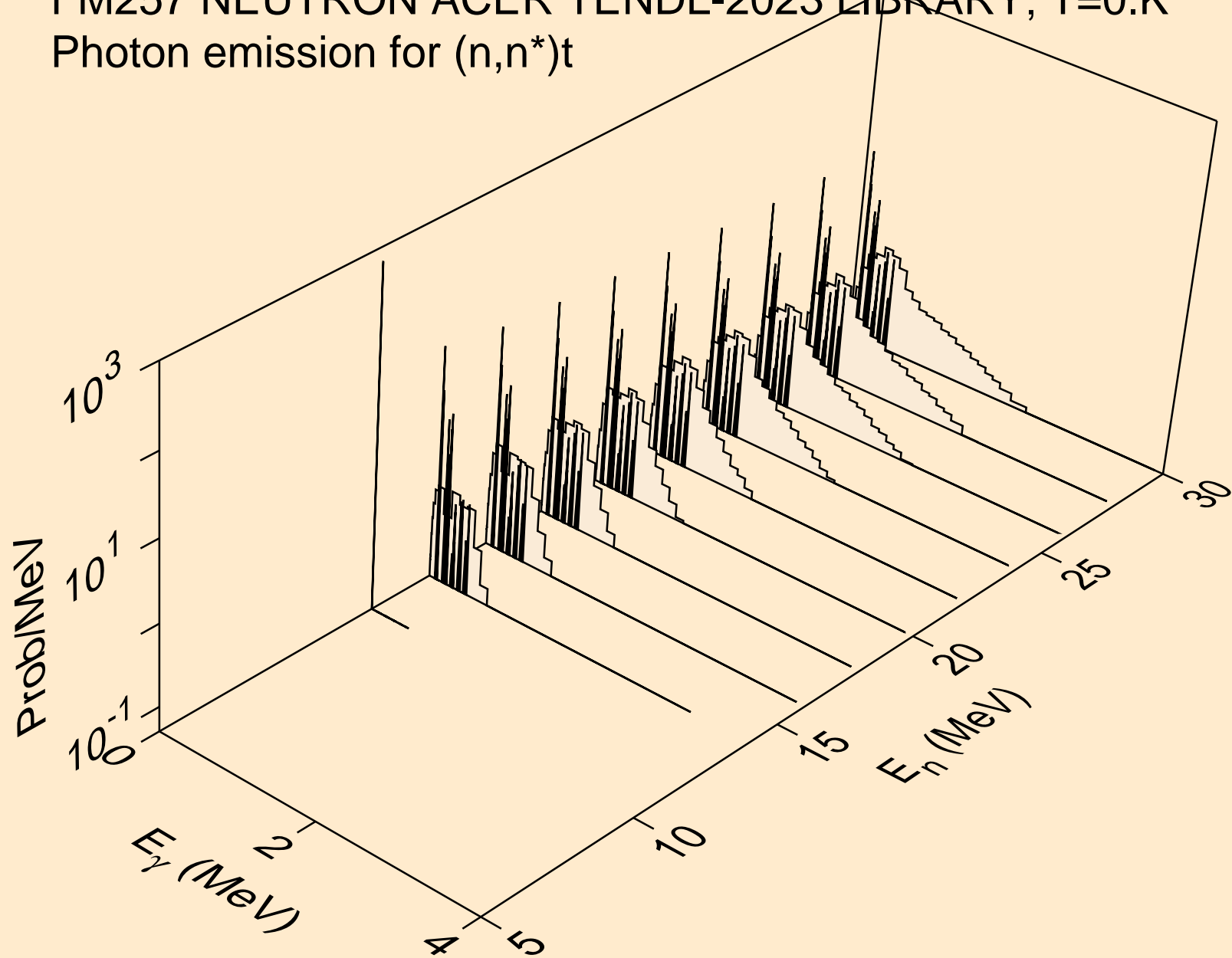

FM257 NEUTRON ACER TENDL-2023 LIBRARY; T=0.K
Photon emission for (n,n*)he3

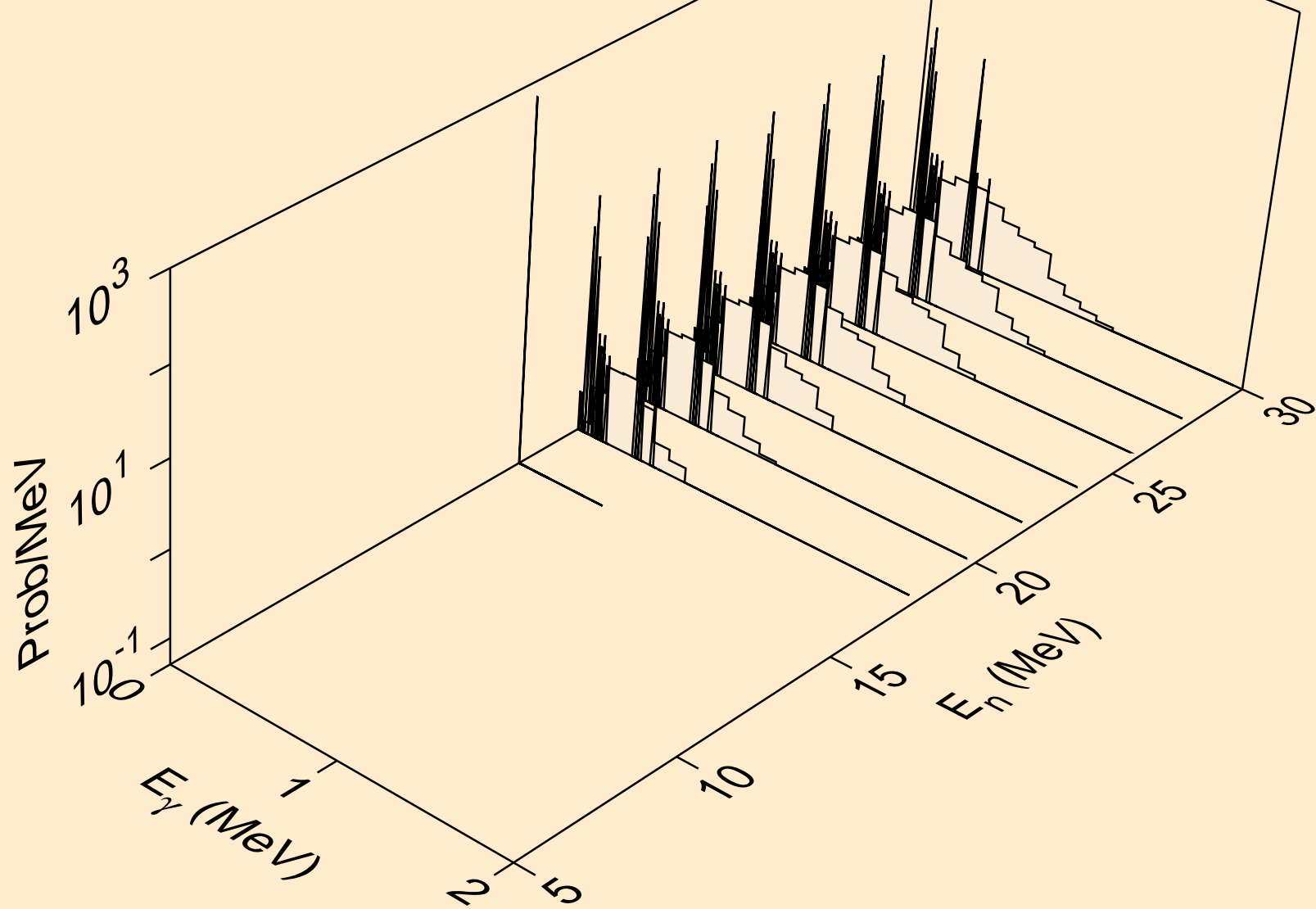

FM257 NEUTRON ACER TENDL-2023 LIBRARY; T=0.K
Photon emission for (n,4n)

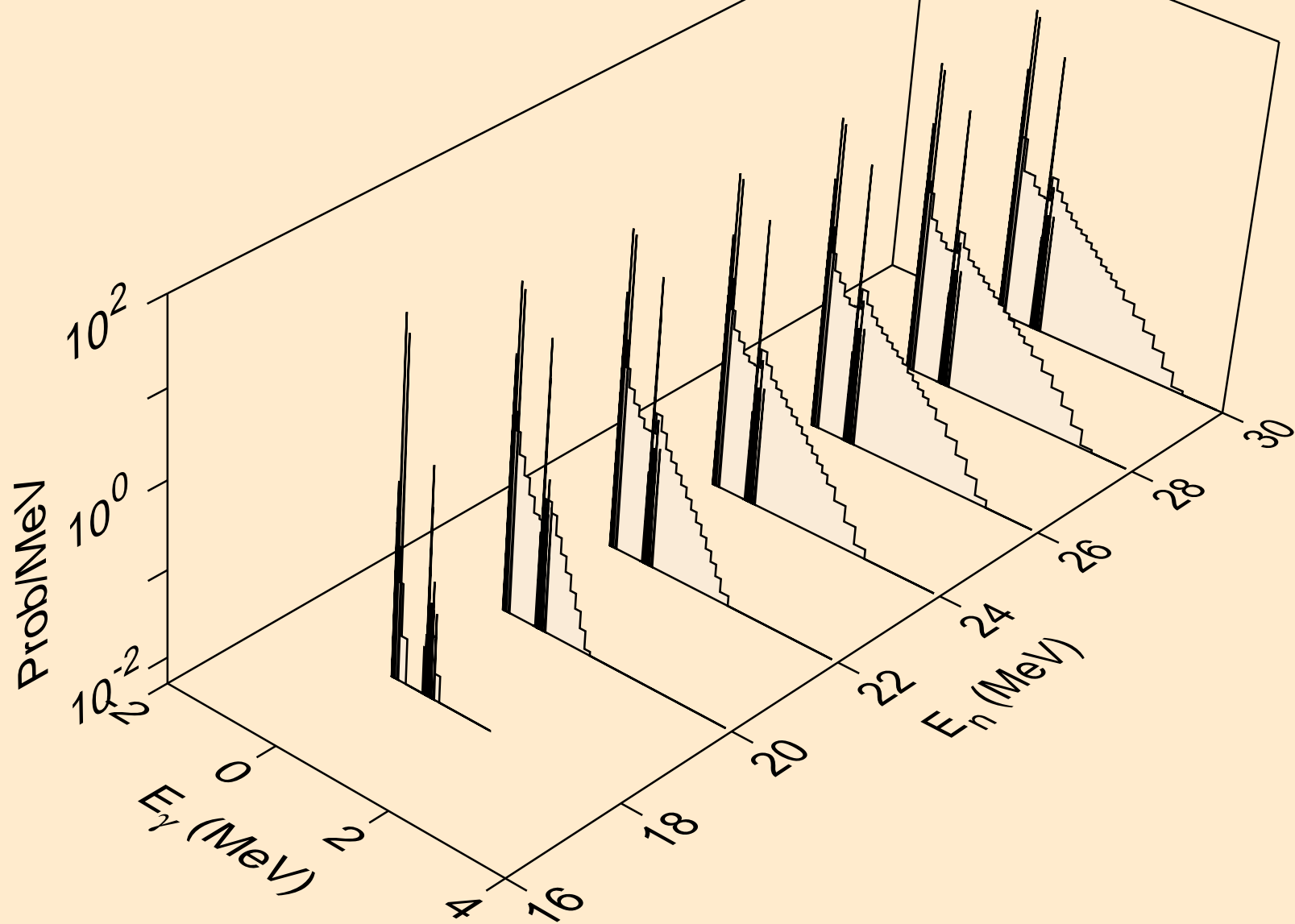

FM257 NEUTRON ACER TENDL-2023 LIBRARY; T=0.K
Photon emission for (n,2np)

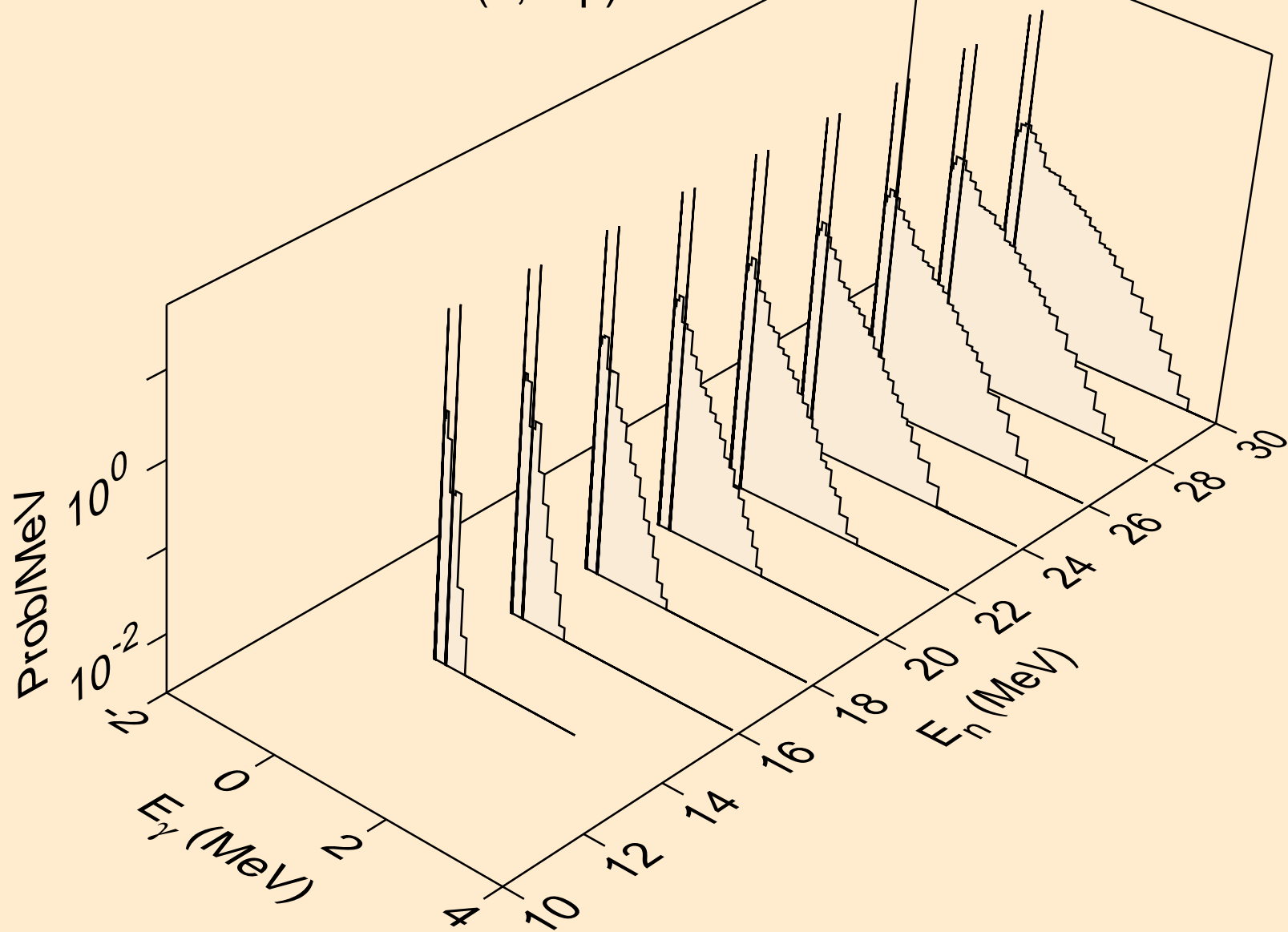

FM257 NEUTRON ACER TENDL-2023 LIBRARY; T=0.K
Photon emission for (n,3np)

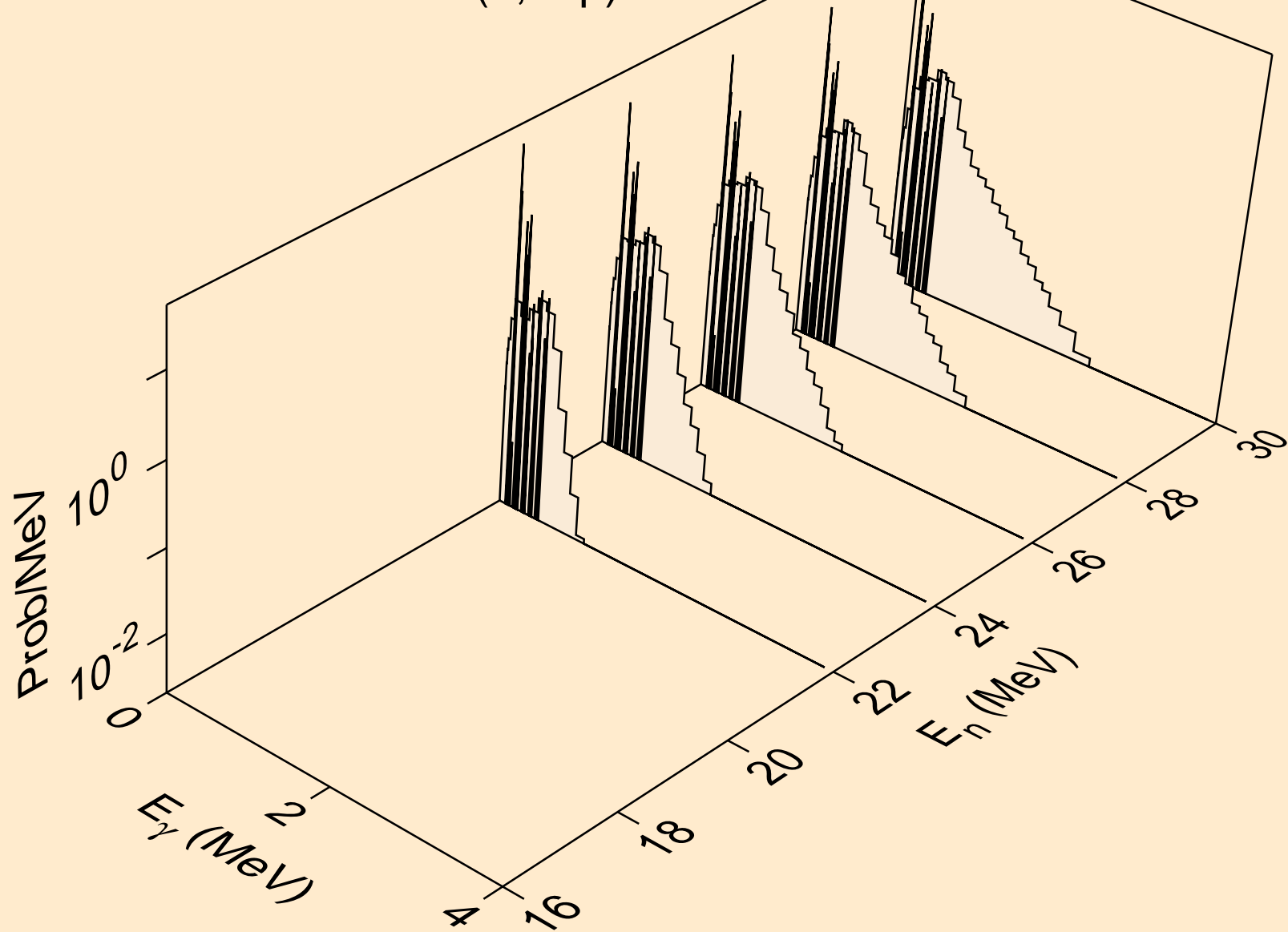

FM257 NEUTRON ACER TENDL-2023 LIBRARY; T=0.K
Photon emission for (n,n2p)

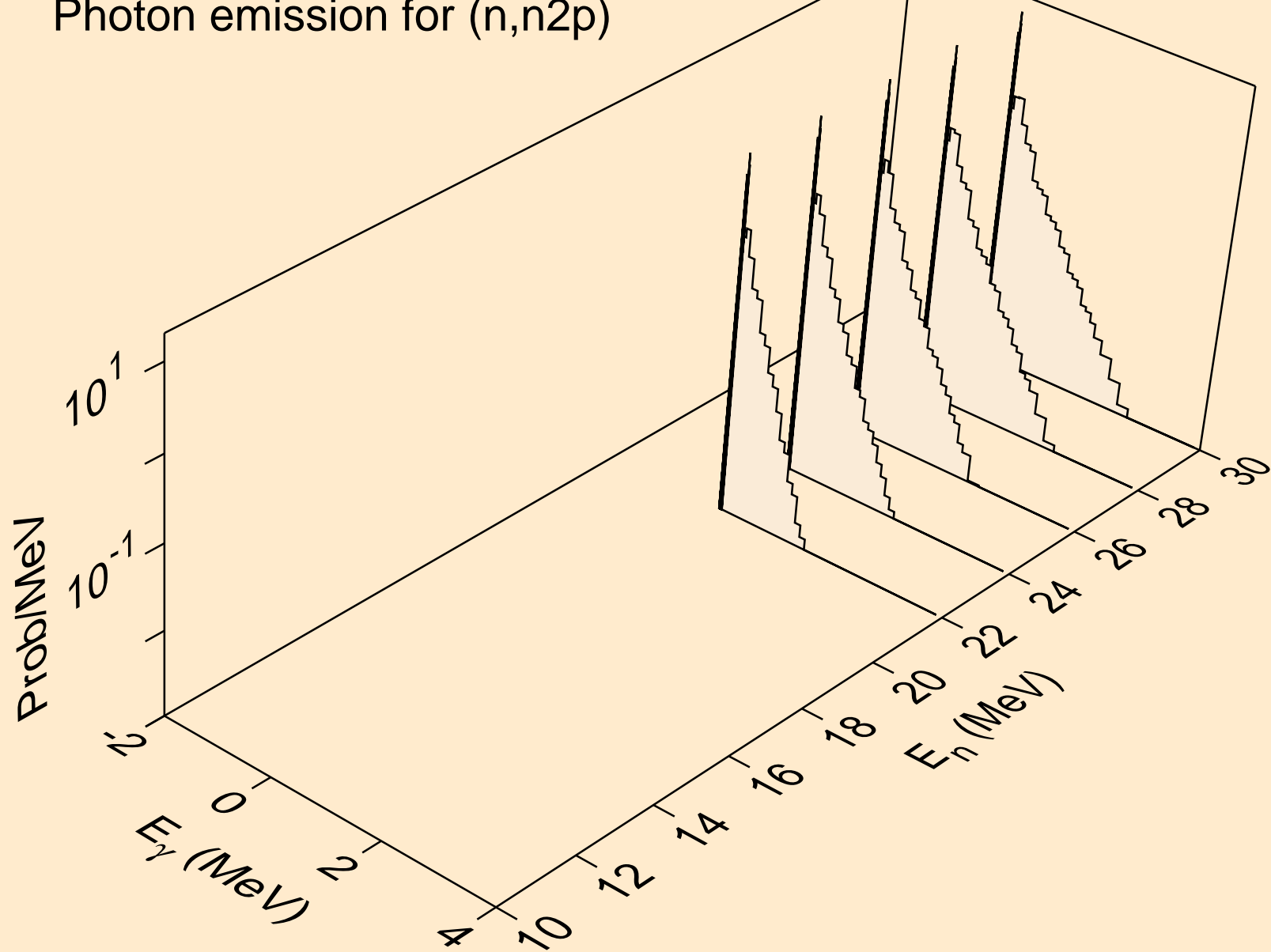

FM257 NEUTRON ACER TENDL-2023 LIBRARY; T=0.K
Photon emission for (n,npa)

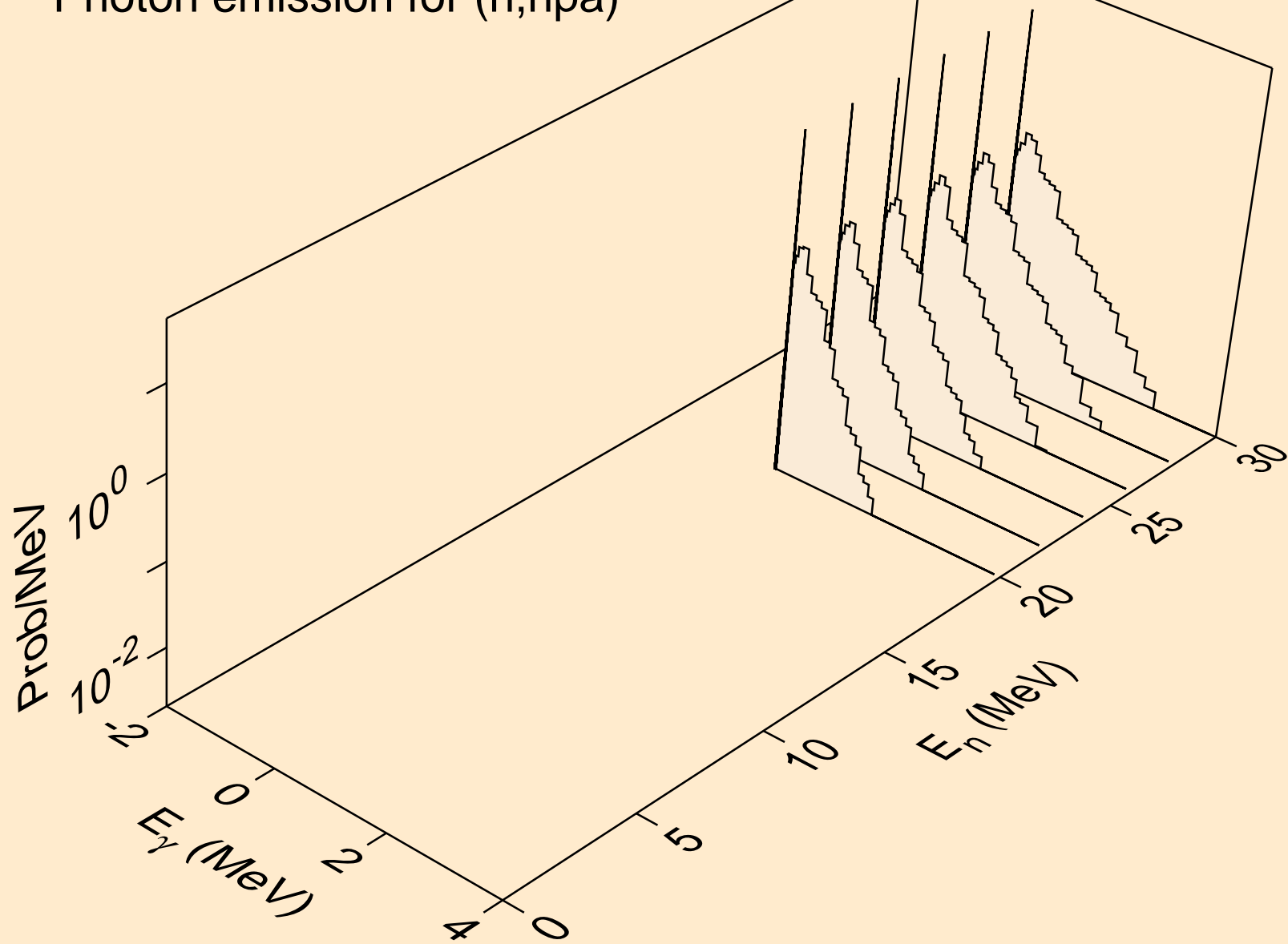

FM257 NEUTRON ACER TENDL-2023 LIBRARY; T=0.K
Photon emission for (n,n*c)

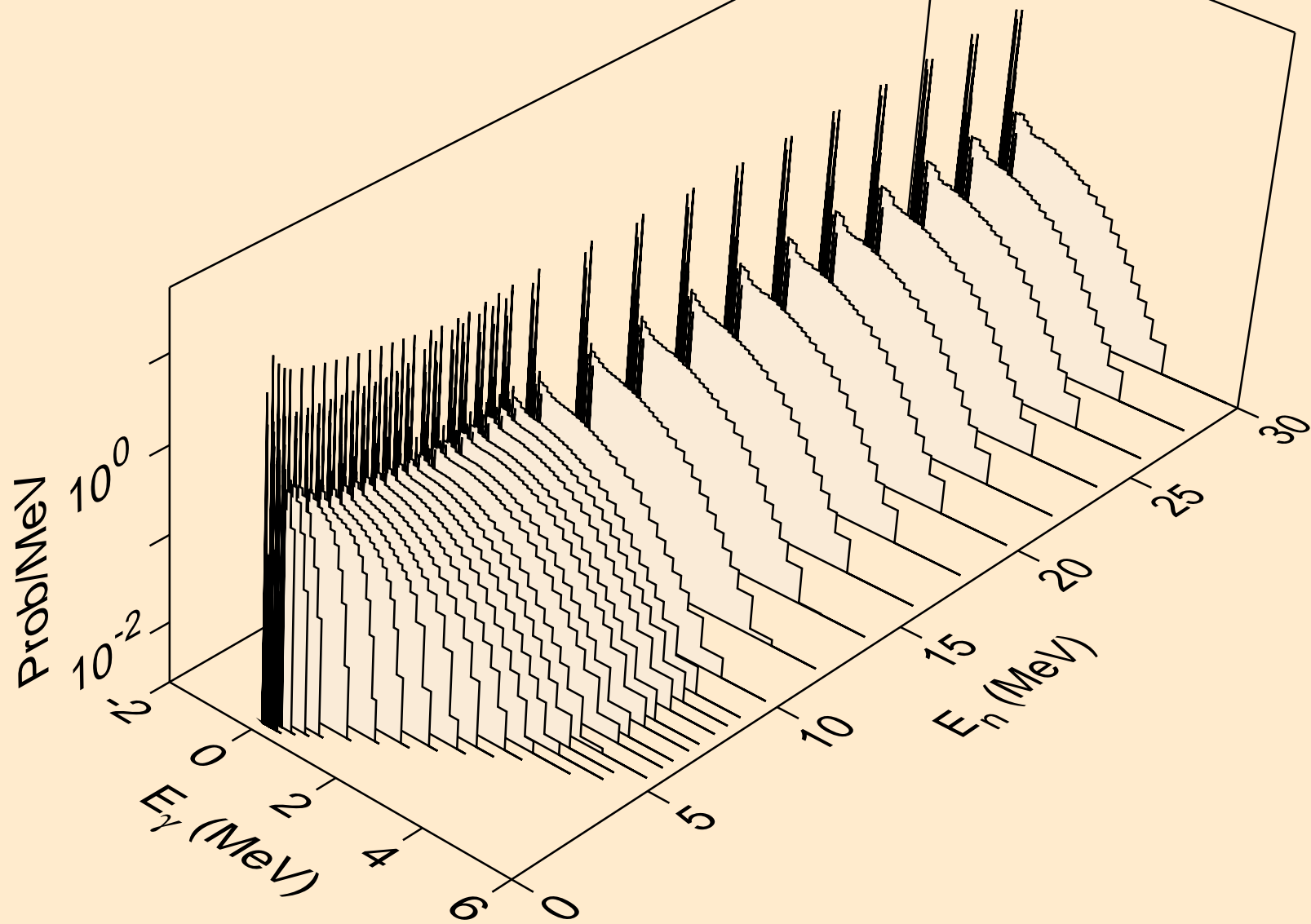

FM257 NEUTRON ACER TENDL-2023 LIBRARY; T=0.K
Photon emission for (n,gma)

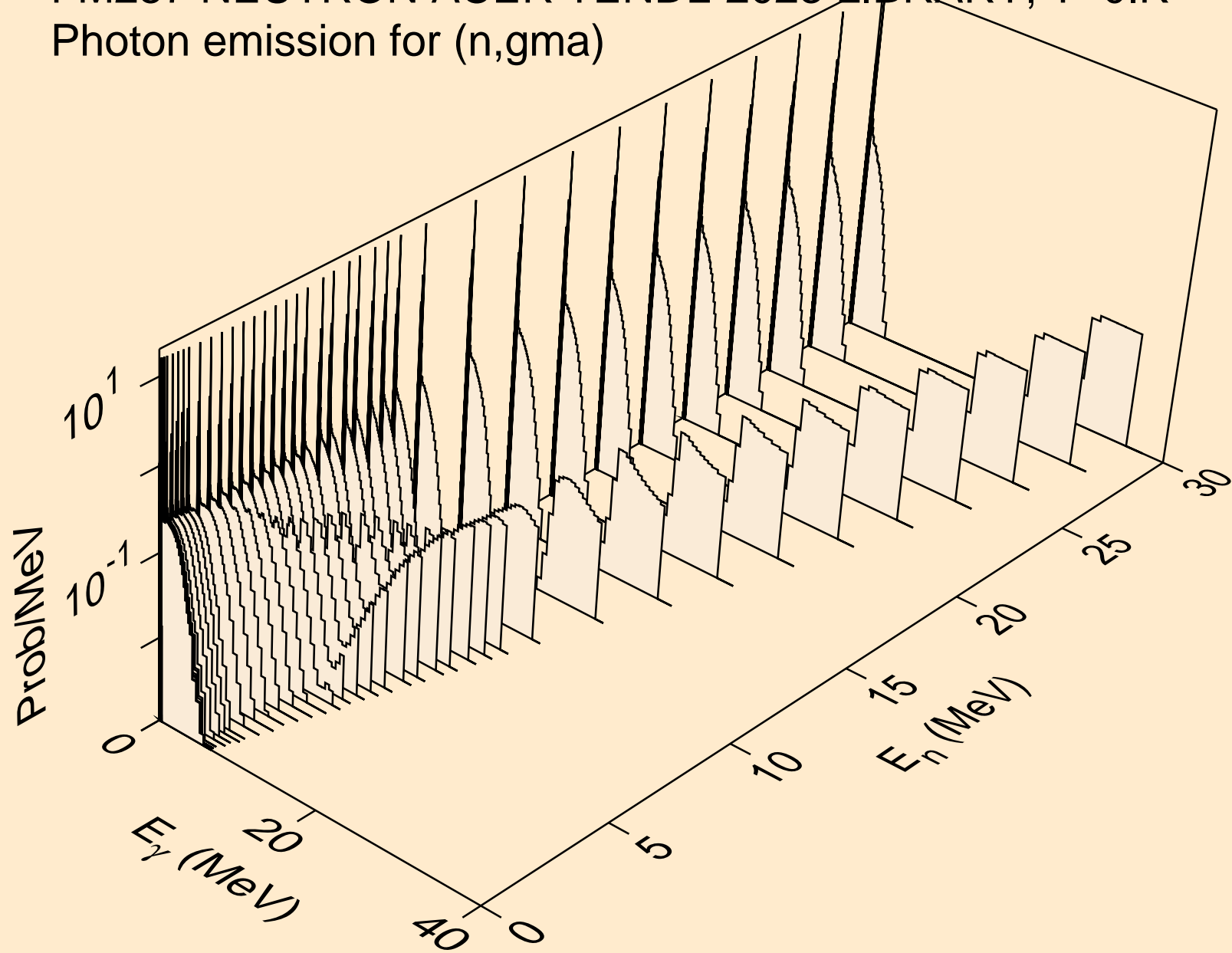

FM257 NEUTRON ACER TENDL-2023 LIBRARY; T=0.K
Photon emission for (n,p)

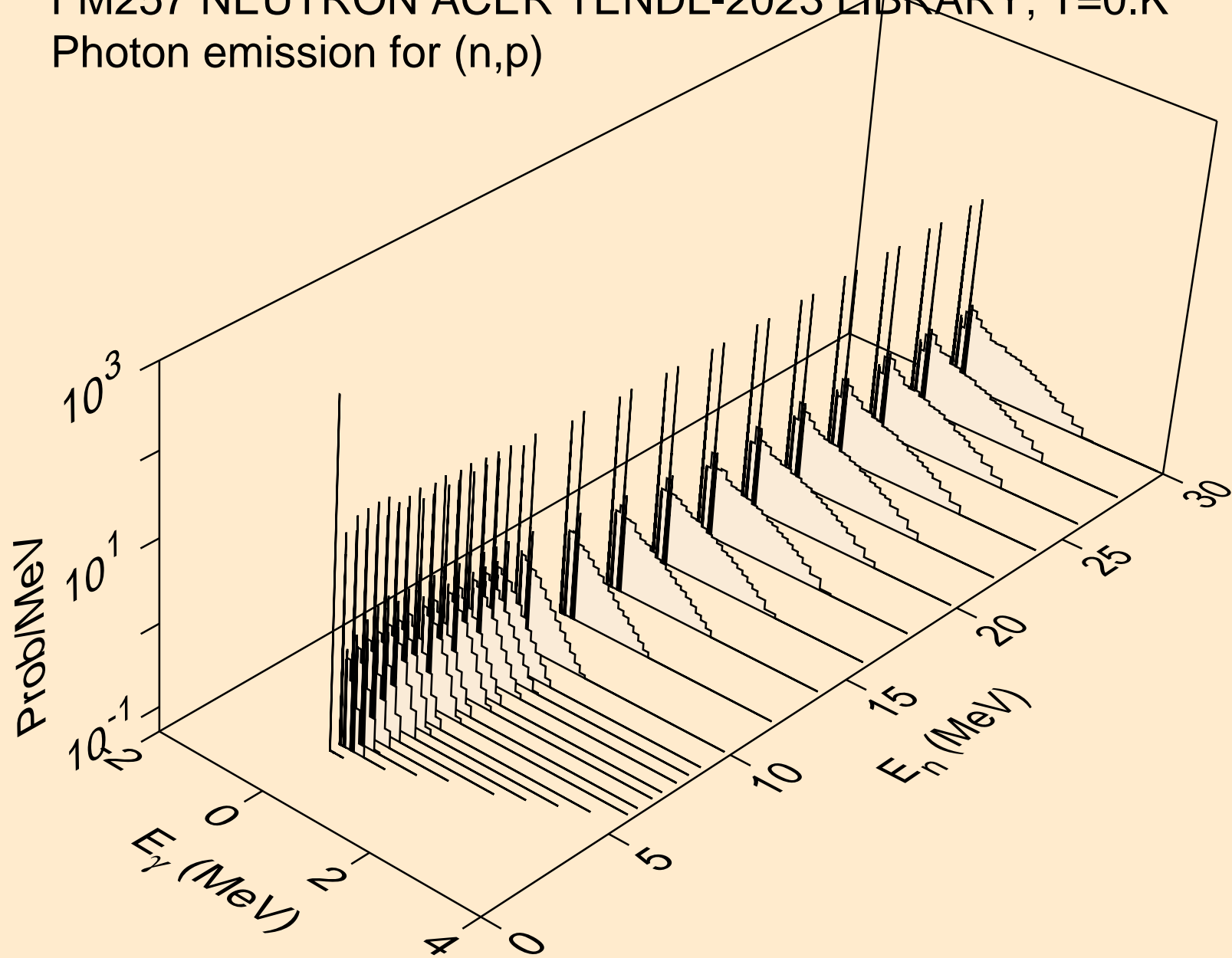

FM257 NEUTRON ACER TENDL-2023 LIBRARY; T=0.K
Photon emission for (n,d)

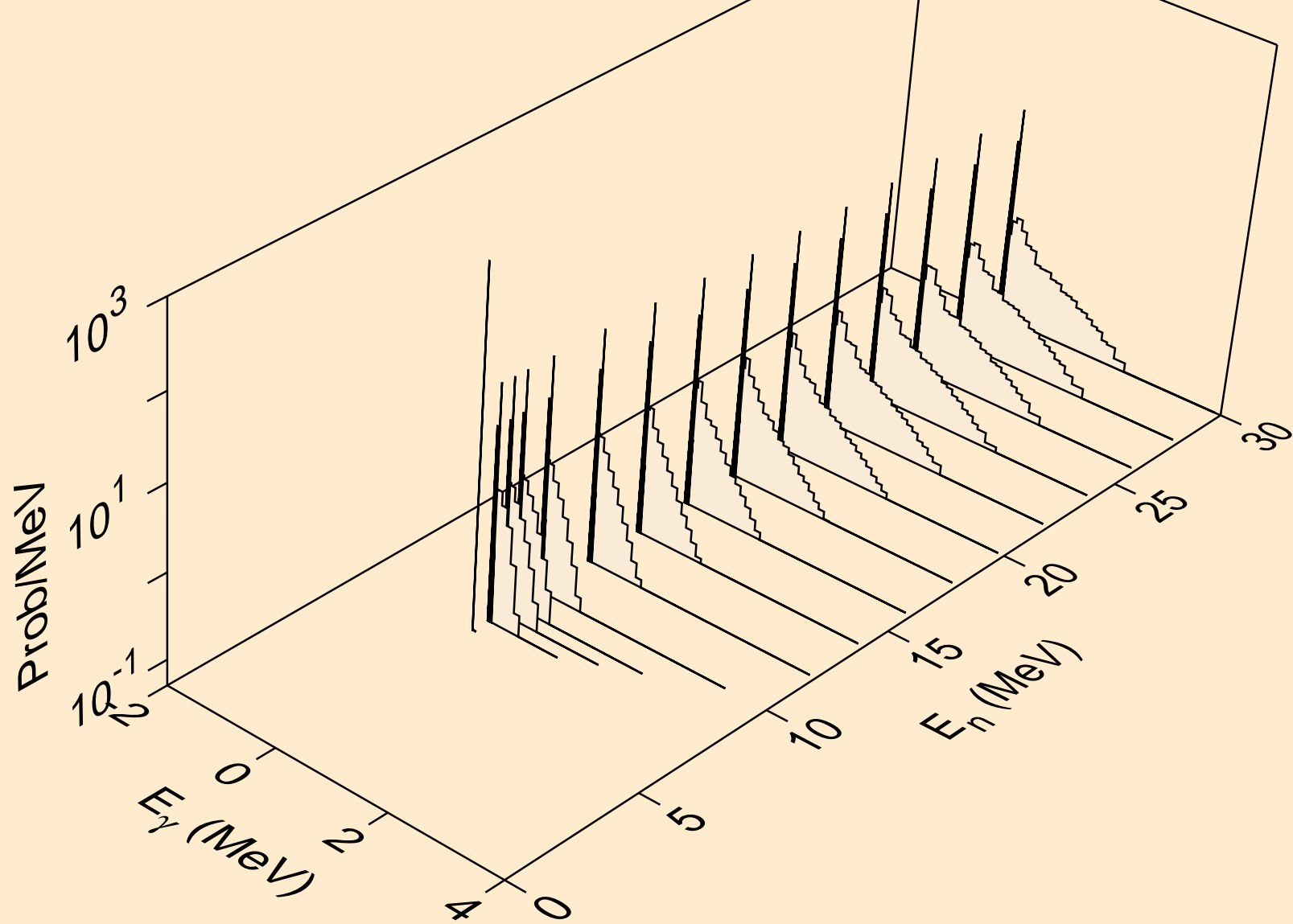

FM257 NEUTRON ACER TENDL-2023 LIBRARY; T=0.K
Photon emission for (n,t)

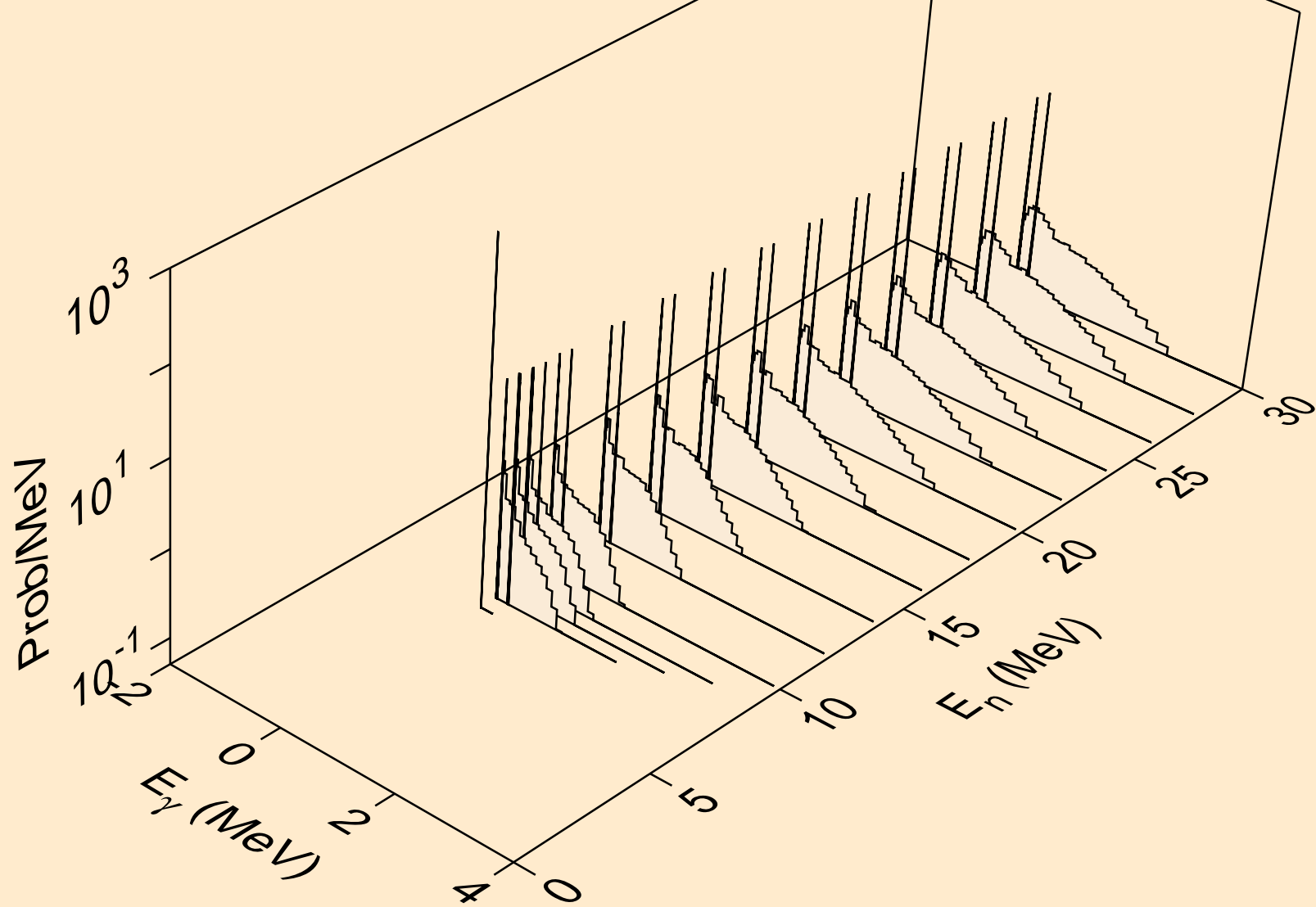

FM257 NEUTRON ACER TENDL-2023 LIBRARY; T=0.K
Photon emission for (n,he3)

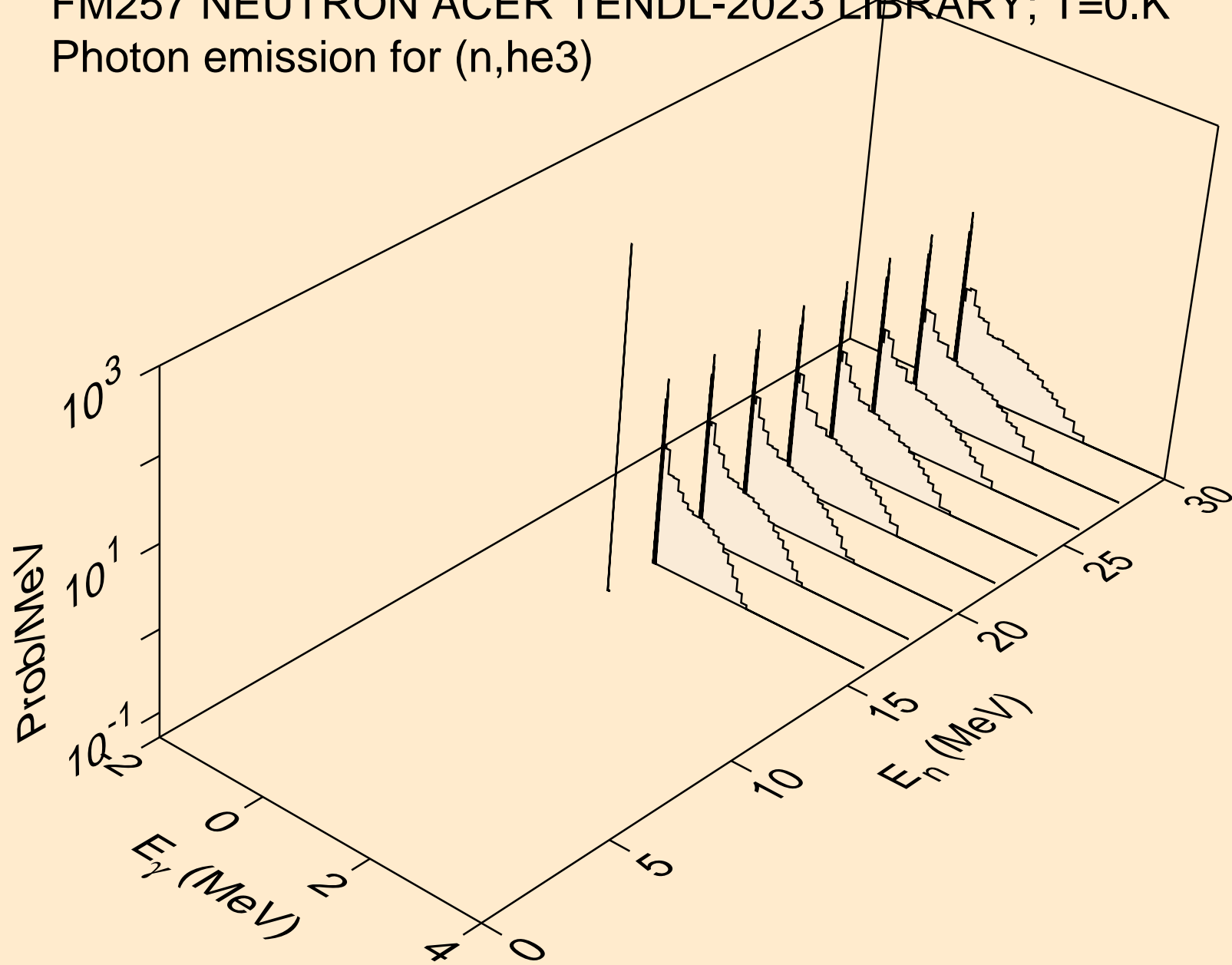

FM257 NEUTRON ACER TENDL-2023 LIBRARY; T=0.K
Photon emission for (n,a)

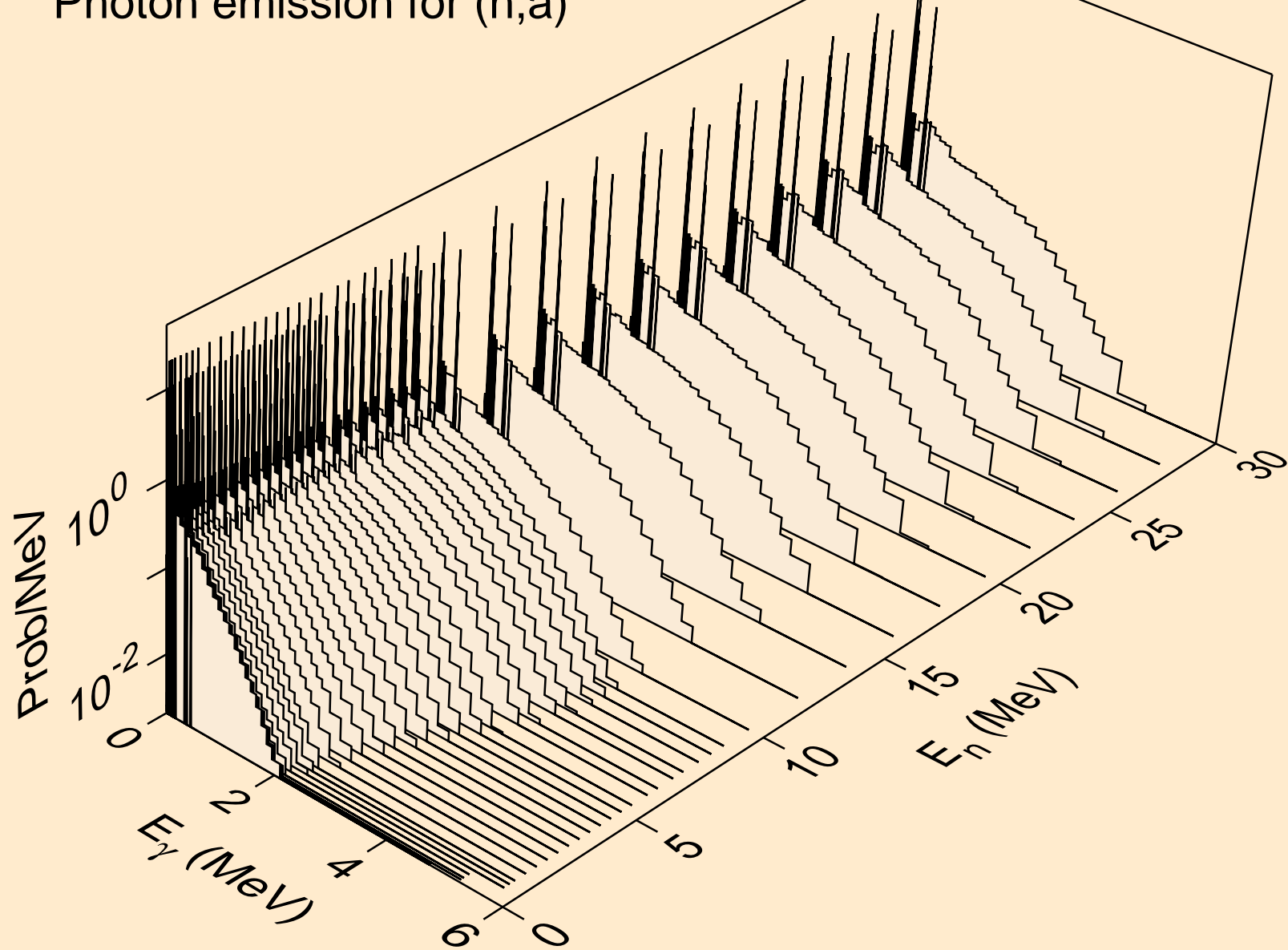

FM257 NEUTRON ACER TENDL-2023 LIBRARY; T=0.K
Photon emission for (n,2a)

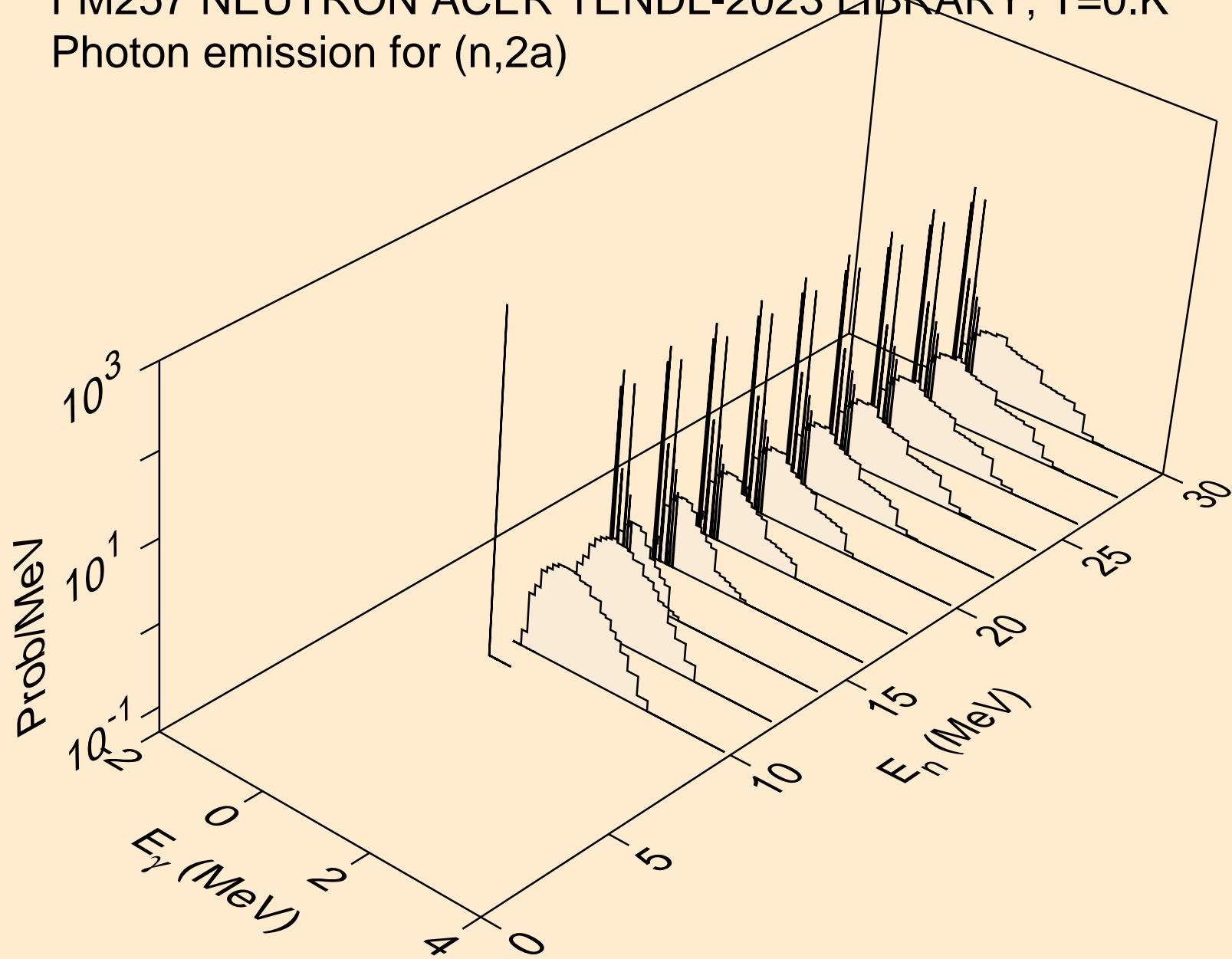

FM257 NEUTRON ACER TENDL-2023 LIBRARY; T=0.K
Photon emission for (n,2p)

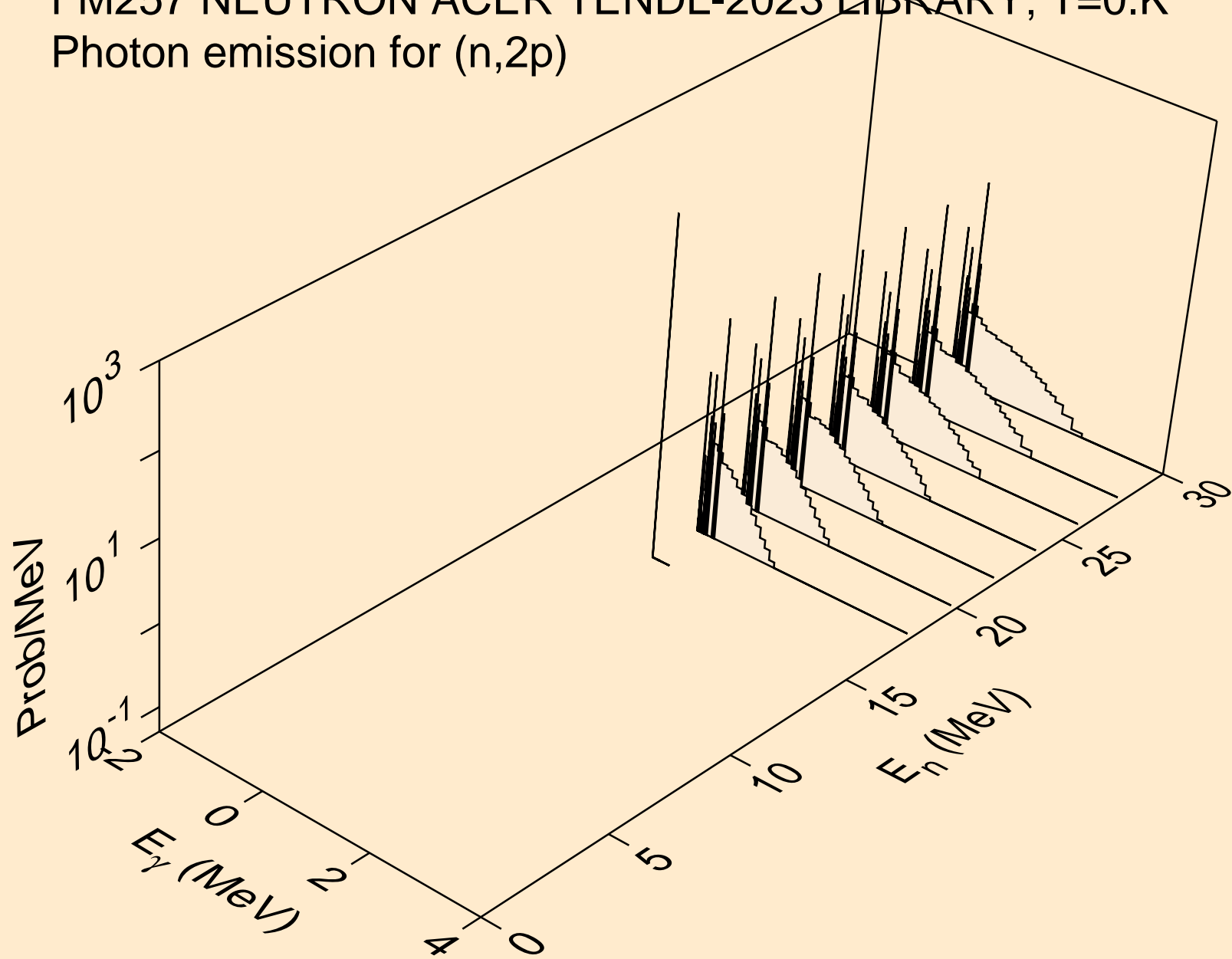

FM257 NEUTRON ACER TENDL-2023 LIBRARY; T=0.K
Photon emission for (n,p)

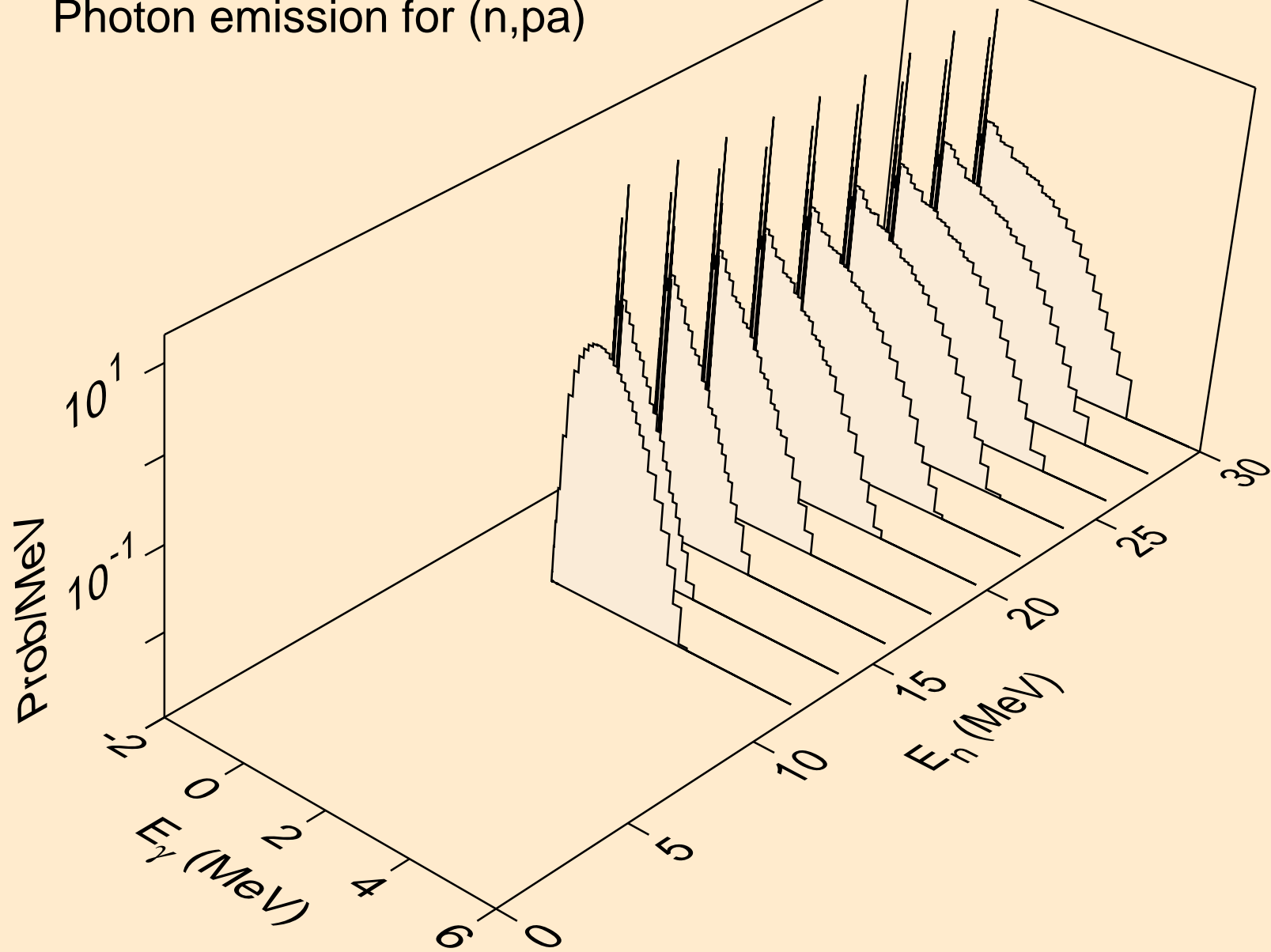

FM257 NEUTRON ACER TENDL-2023 LIBRARY; T=0.K
thermal capture photon spectrum

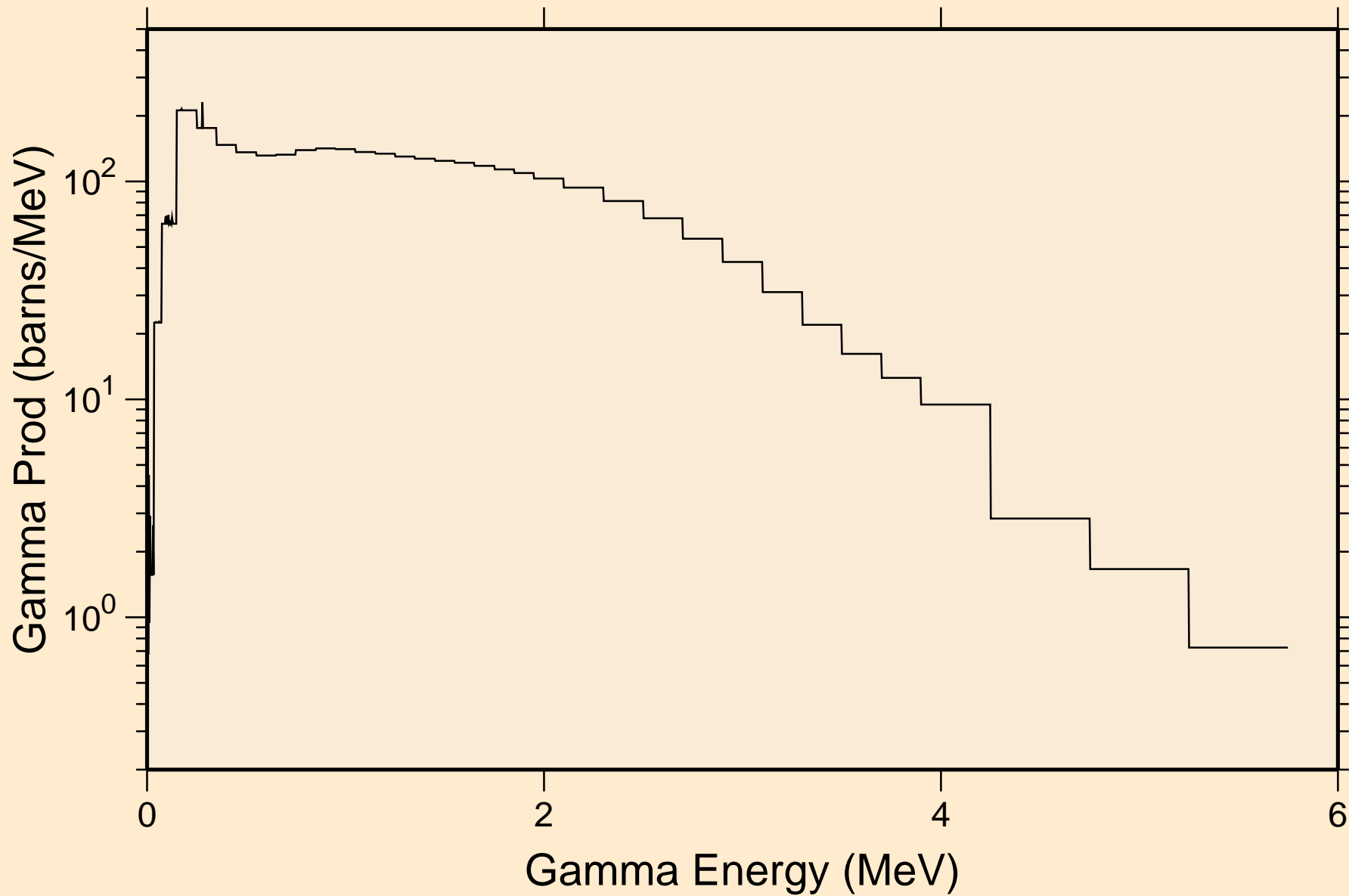

FM257 NEUTRON ACER TENDL-2023 LIBRARY; T=0.K
14 MeV photon spectrum

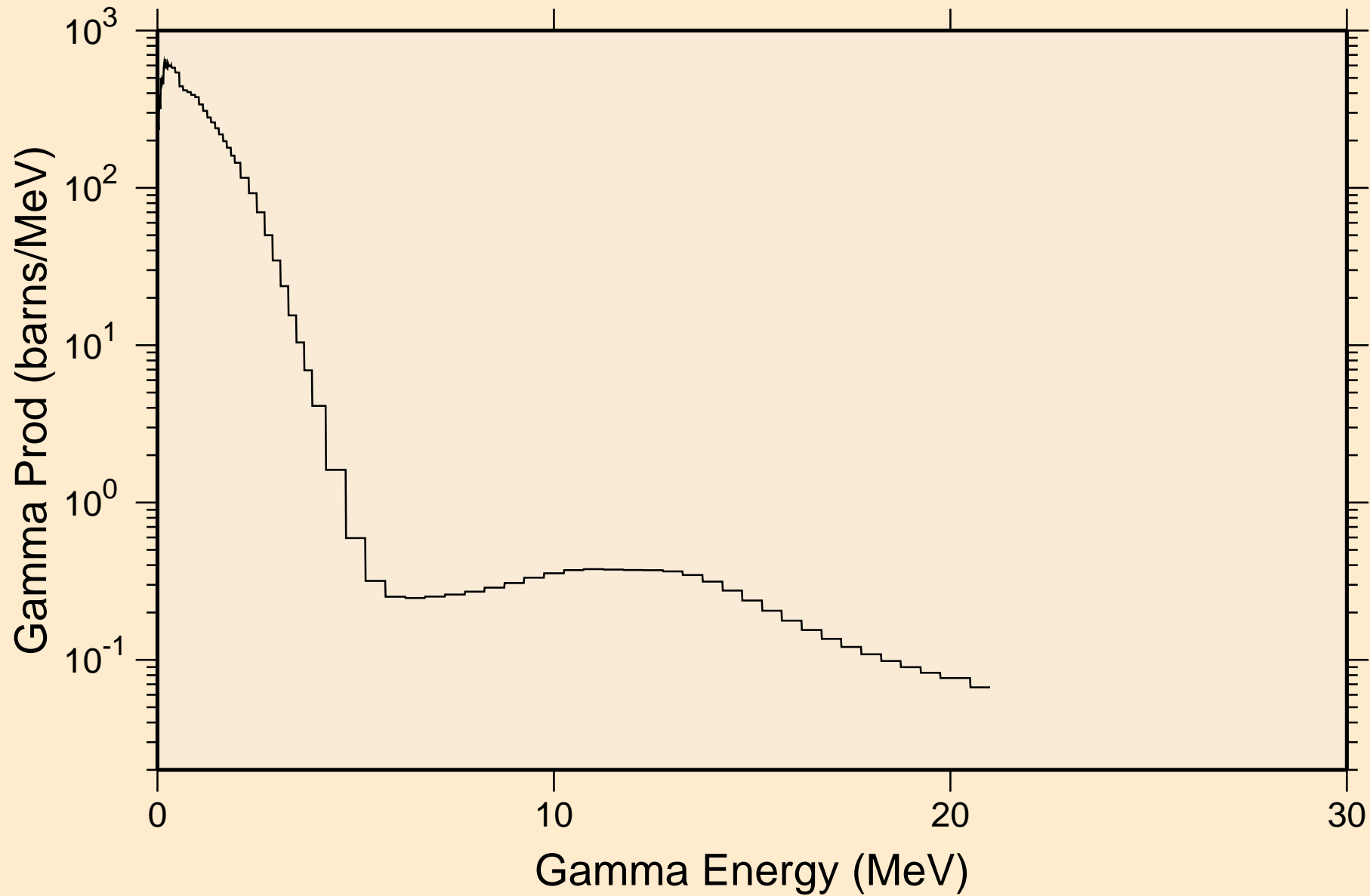

FM257 NEUTRON ACER TENDL-2023 LIBRARY; T=0.K

Particle heating contributions

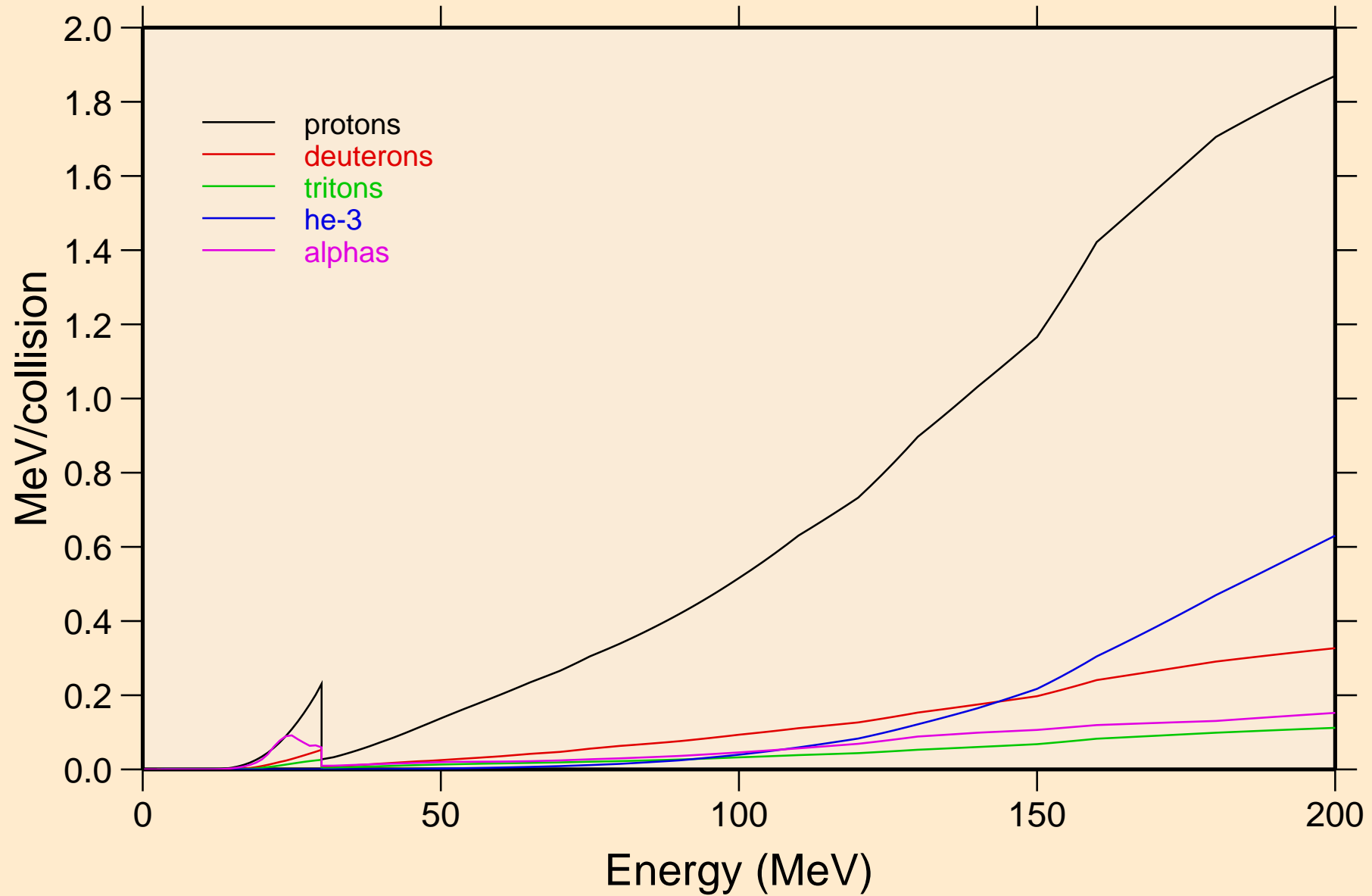

FM257 NEUTRON ACER TENDL-2023 LIBRARY; T=0.K
Recoil Heating

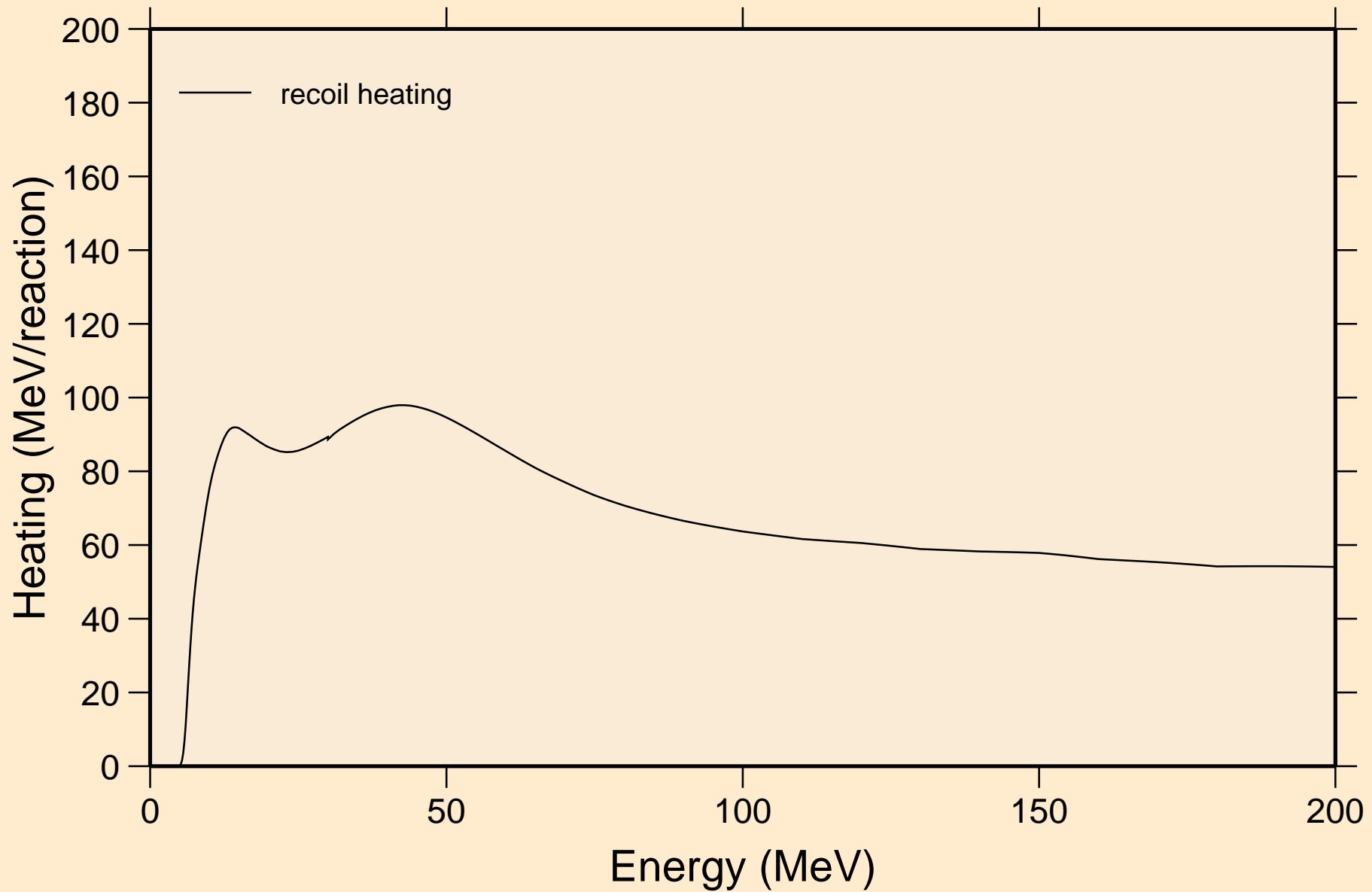

FM257 NEUTRON ACER TENDL-2023 LIBRARY; T=0.K

Particle production cross sections

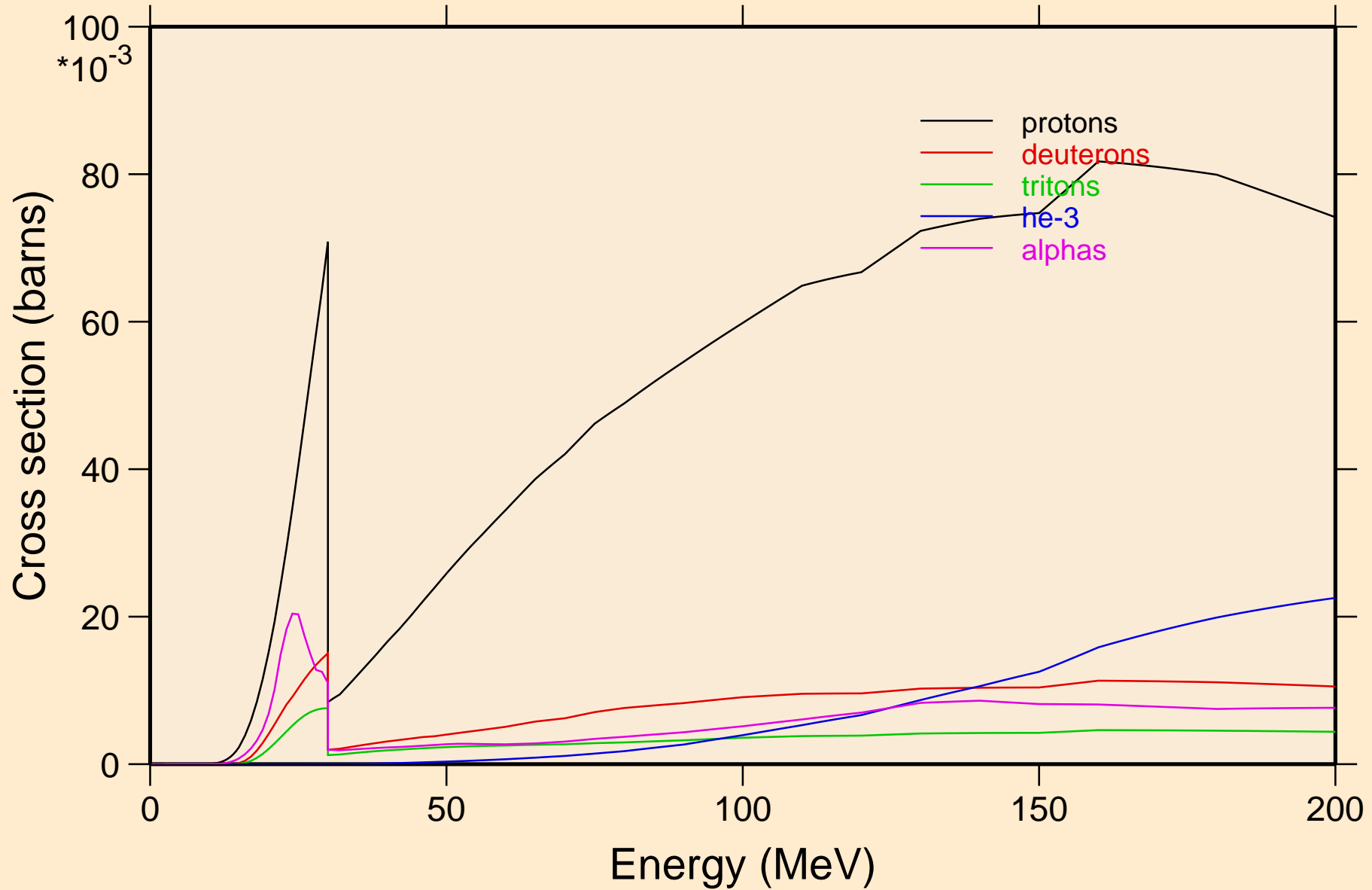

FM257 NEUTRON ACER TENDL-2023 LIBRARY; T=0.K
protons from (n,x)

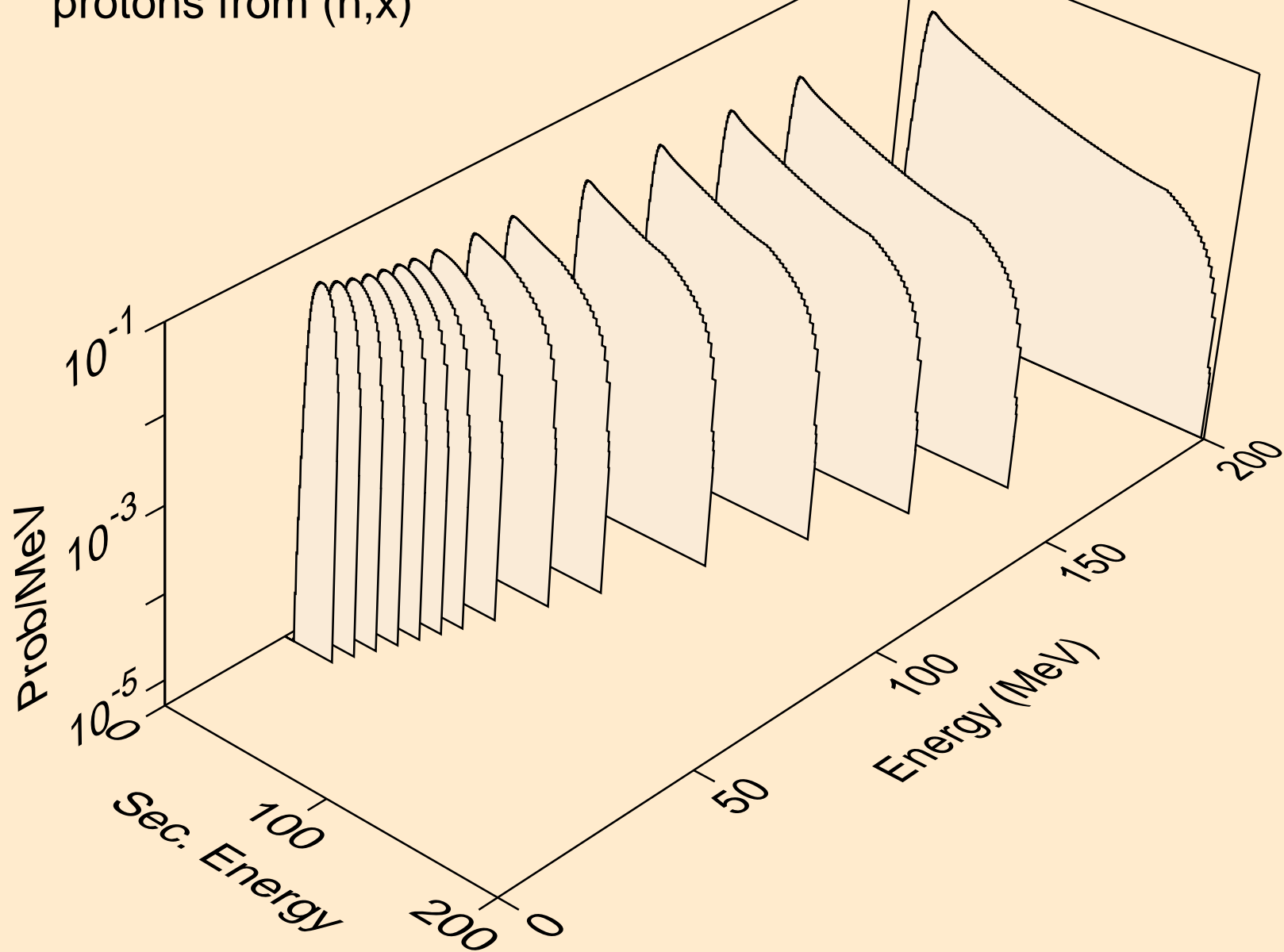

FM257 NEUTRON ACER TENDL-2023 LIBRARY; T=0.K
protons from (n,n*)p

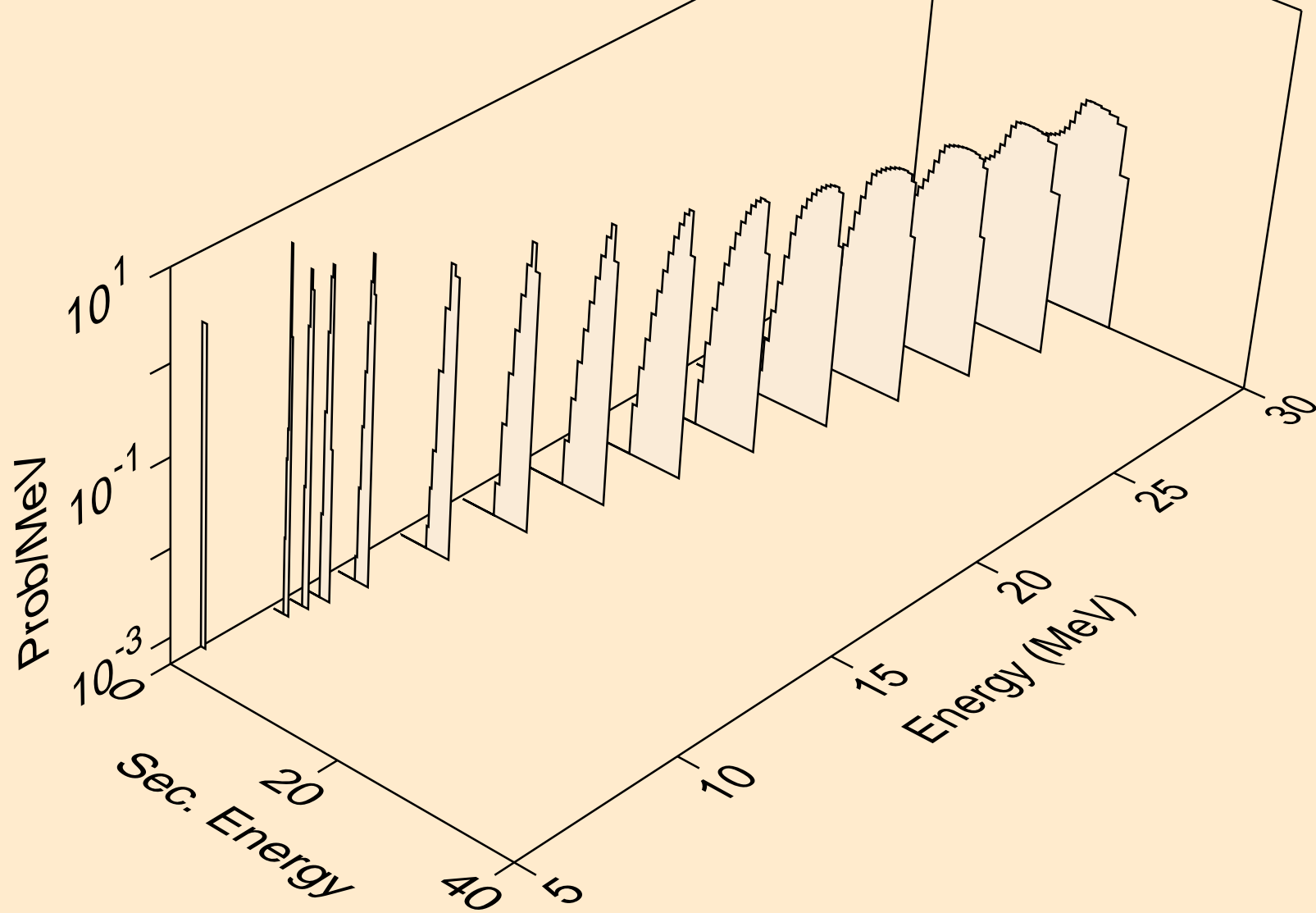

FM257 NEUTRON ACER TENDL-2023 LIBRARY; T=0.K
protons from (n,2np)

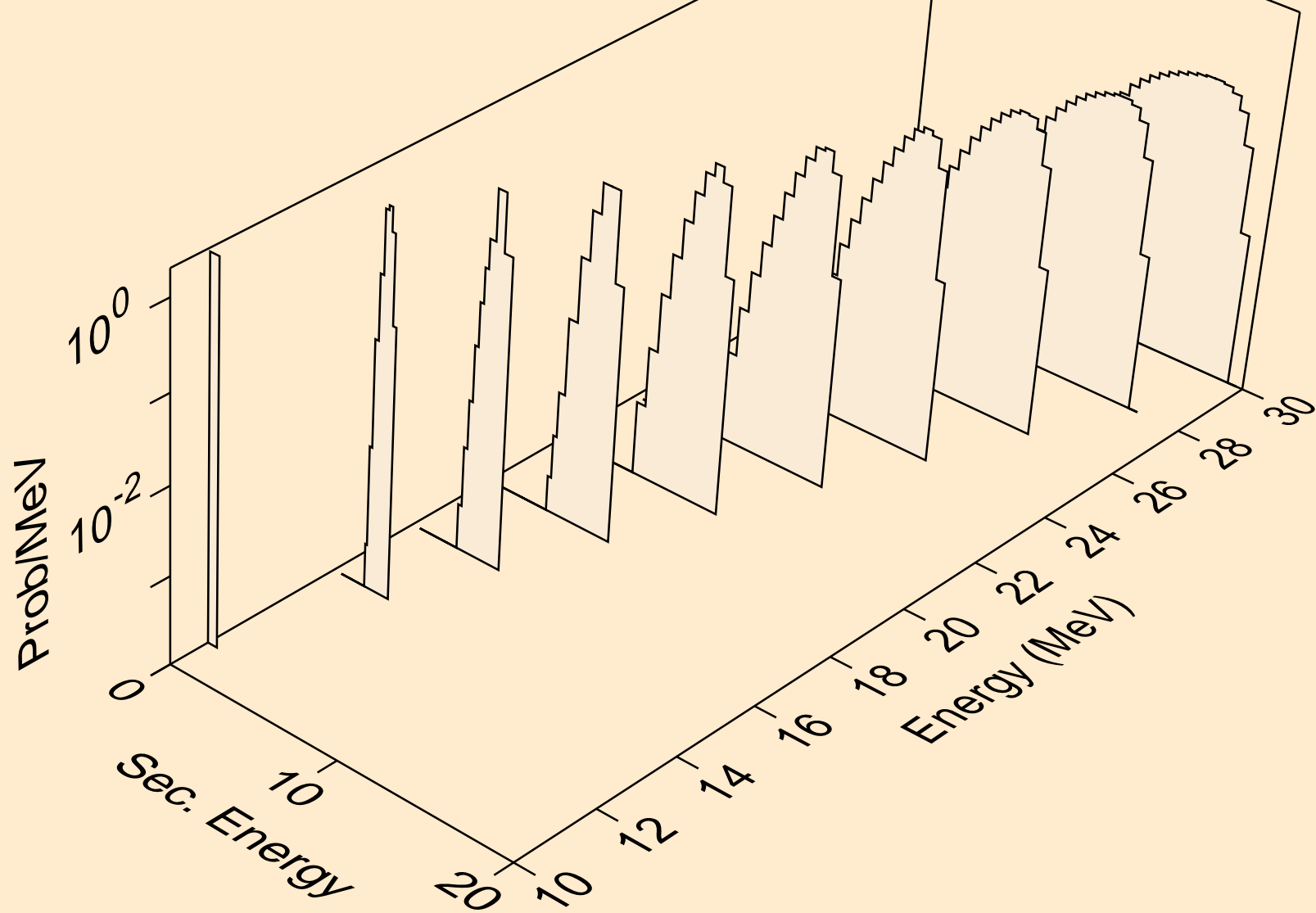

FM257 NEUTRON ACER TENDL-2023 LIBRARY; T=0.K
protons from (n,3np)

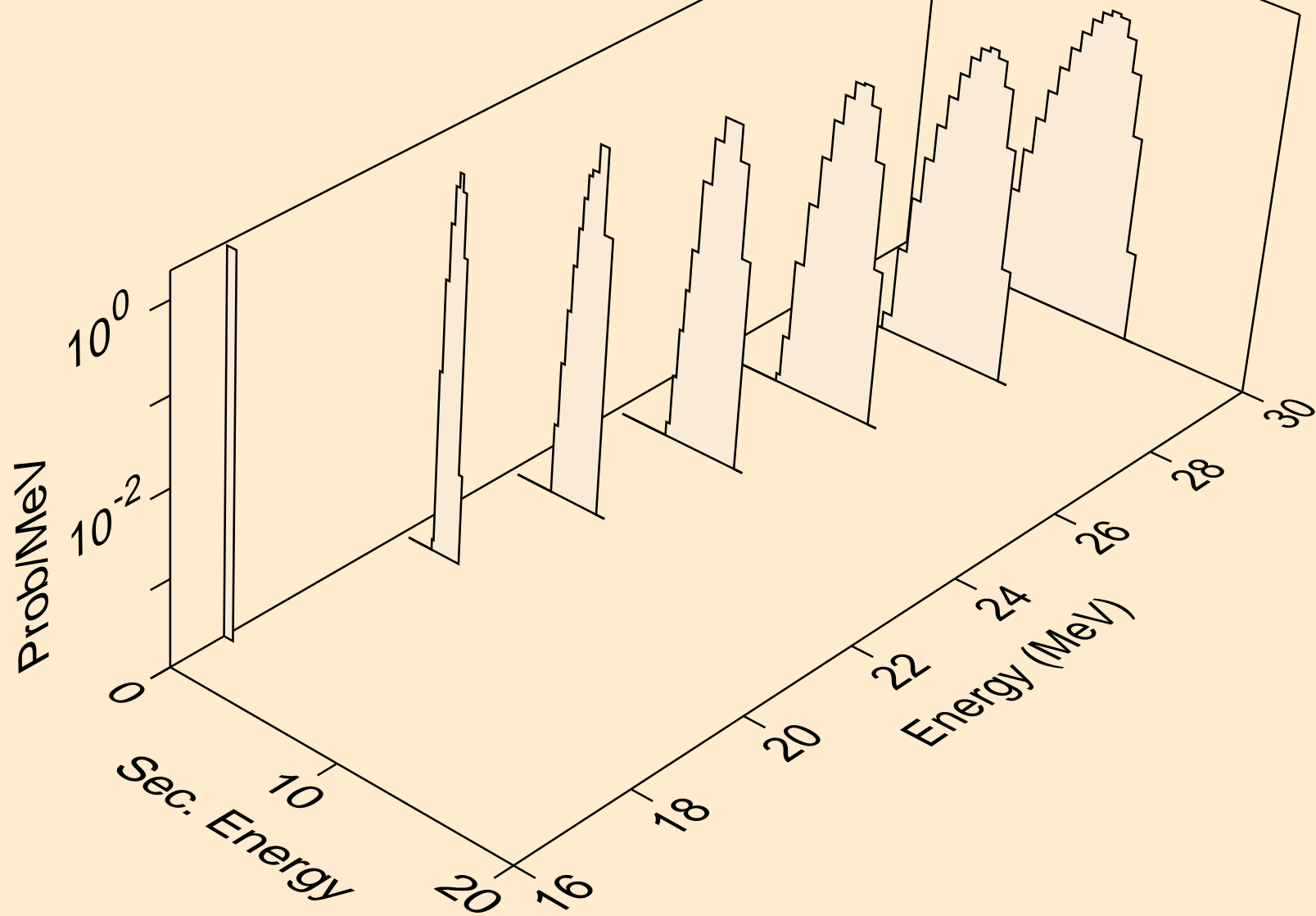

FM257 NEUTRON ACER TENDL-2023 LIBRARY; T=0.K
protons from (n,n2p)

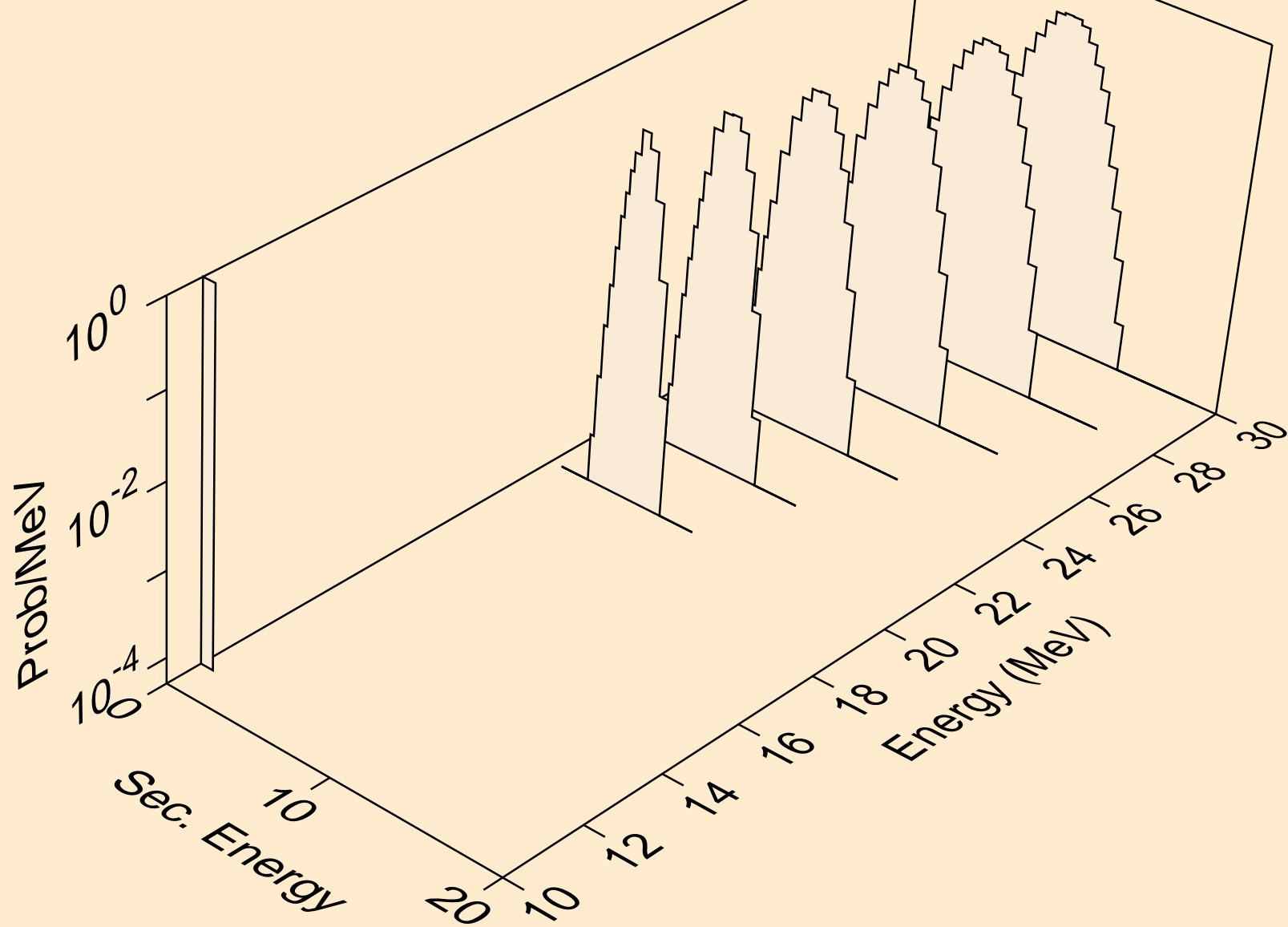

FM257 NEUTRON ACER TENDL-2023 LIBRARY; T=0.K
protons from (n,npa)

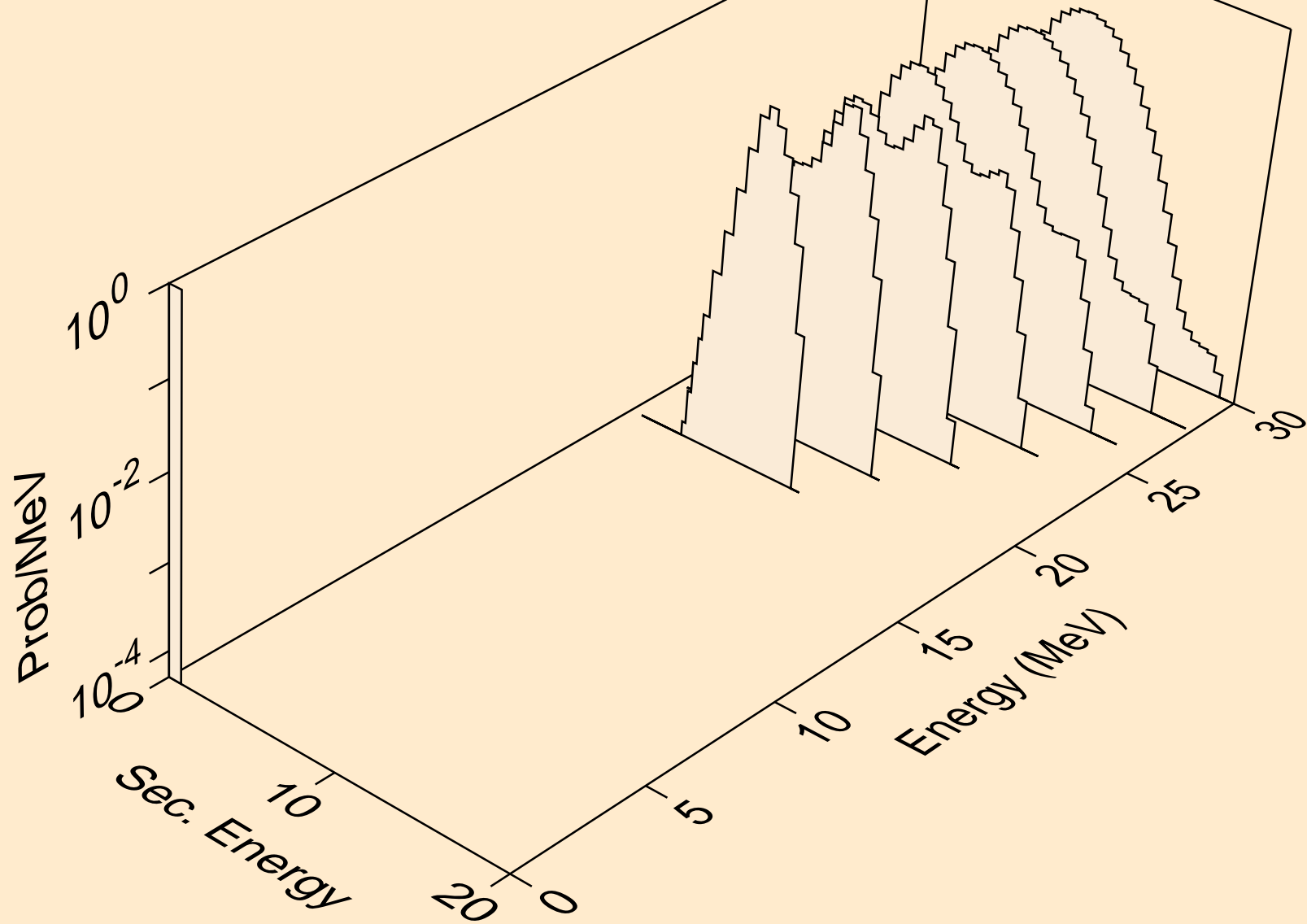

FM257 NEUTRON ACER TENDL-2023 LIBRARY; T=0.K
protons from (n,p)

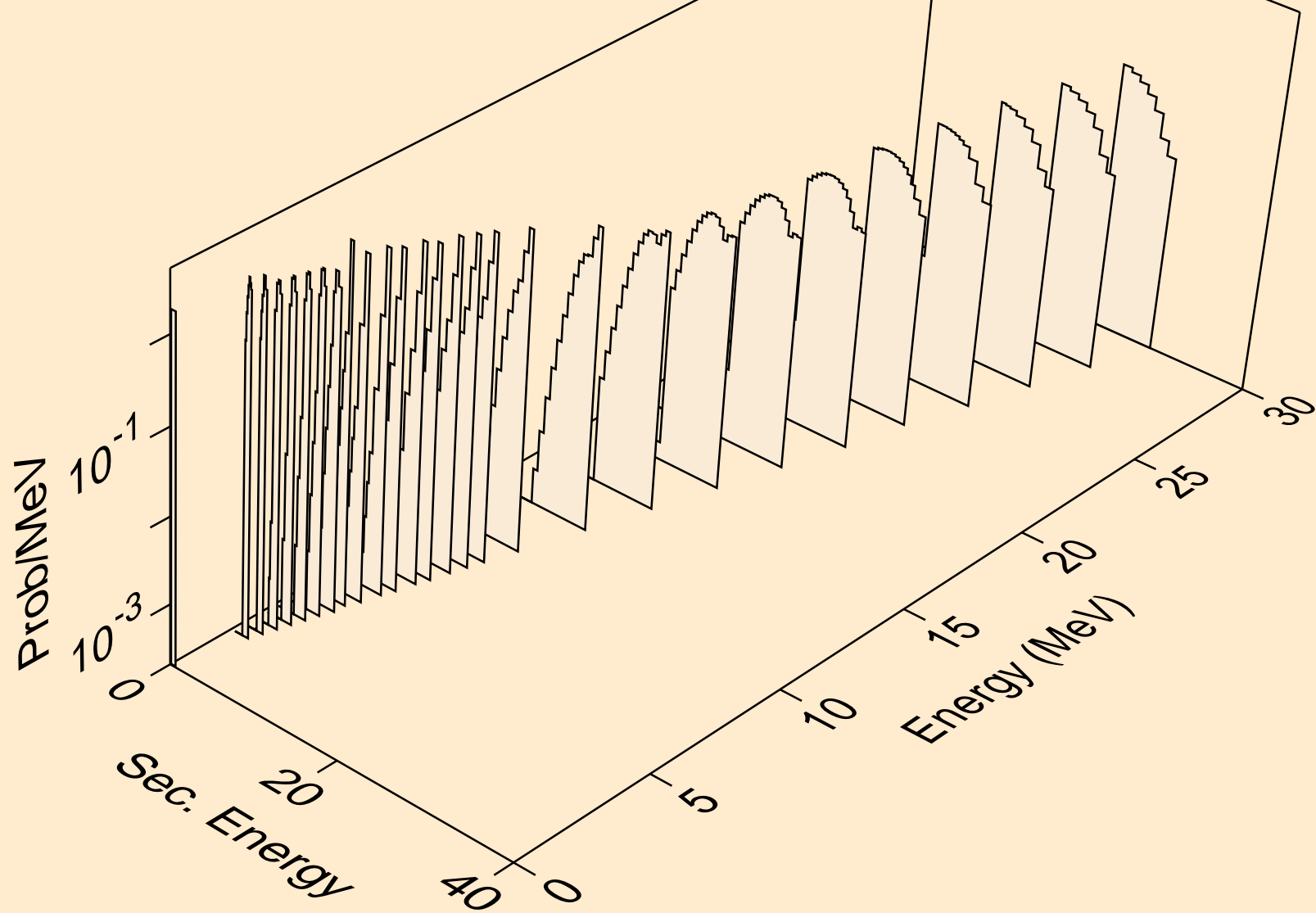

FM257 NEUTRON ACER TENDL-2023 LIBRARY; T=0.K
protons from (n,2p)

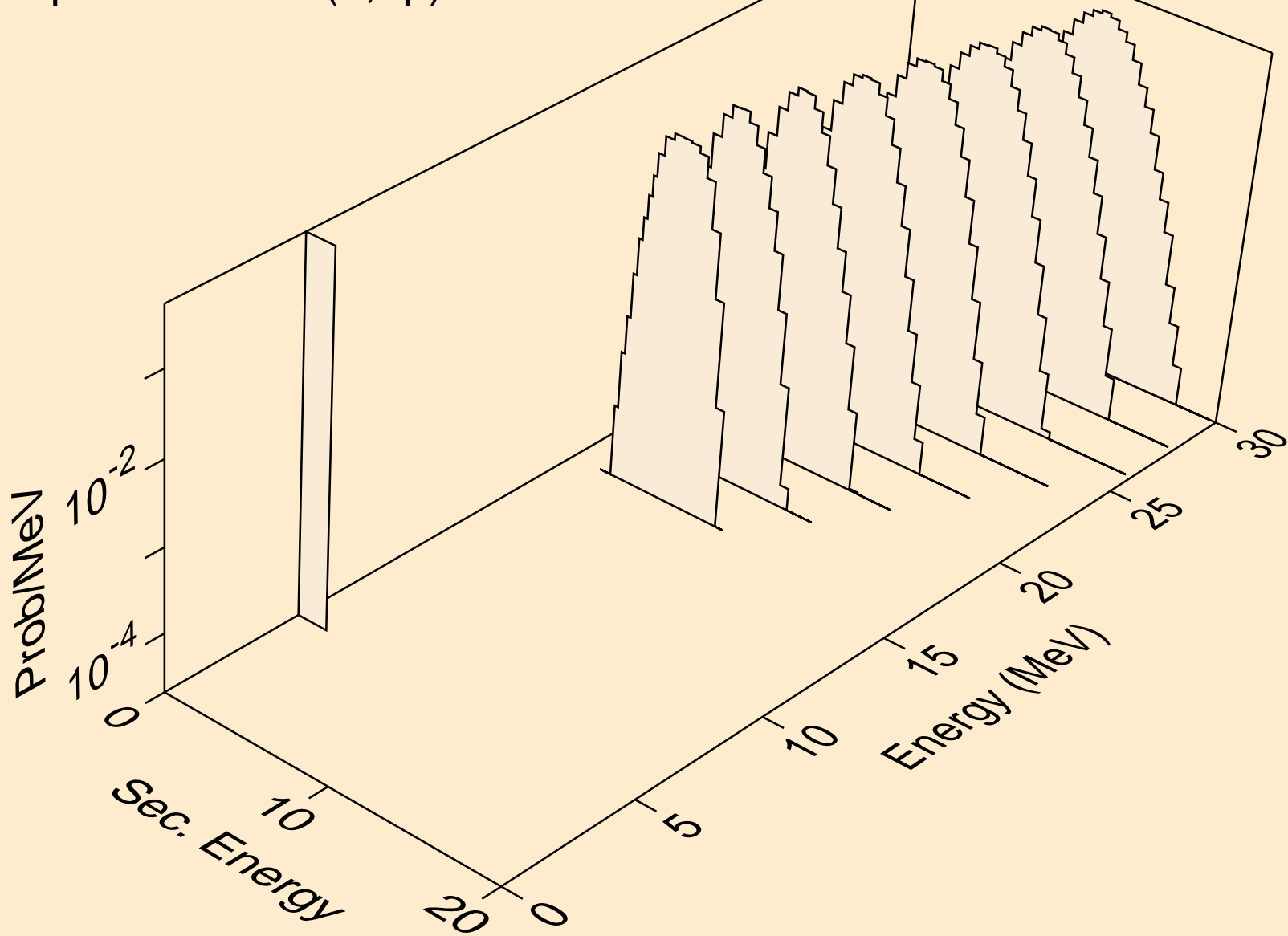

FM257 NEUTRON ACER TENDL-2023 LIBRARY; T=0.K
protons from (n,p)

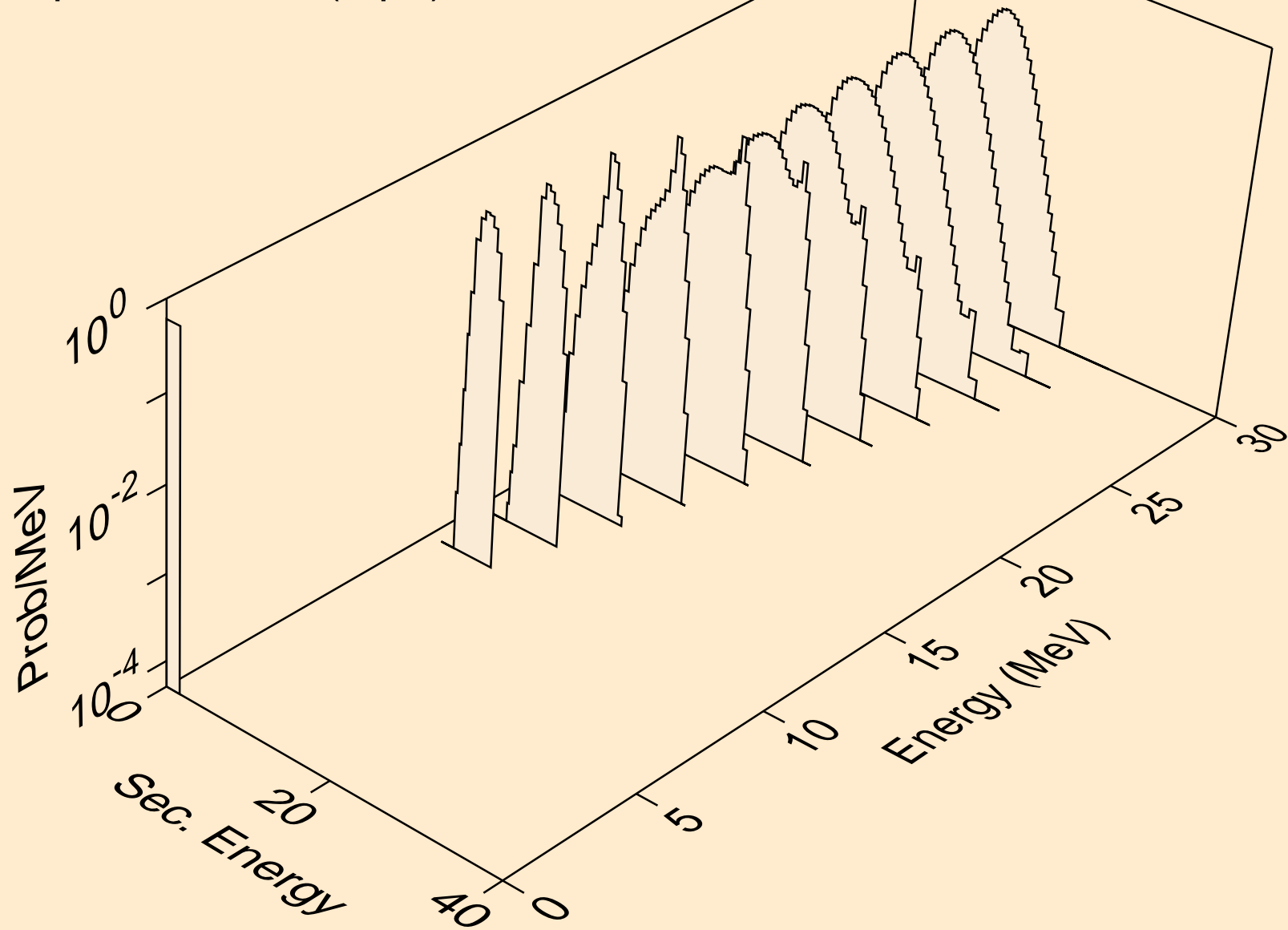

FM257 NEUTRON ACER TENDL-2023 LIBRARY; T=0.K
deuterons from (n,x)

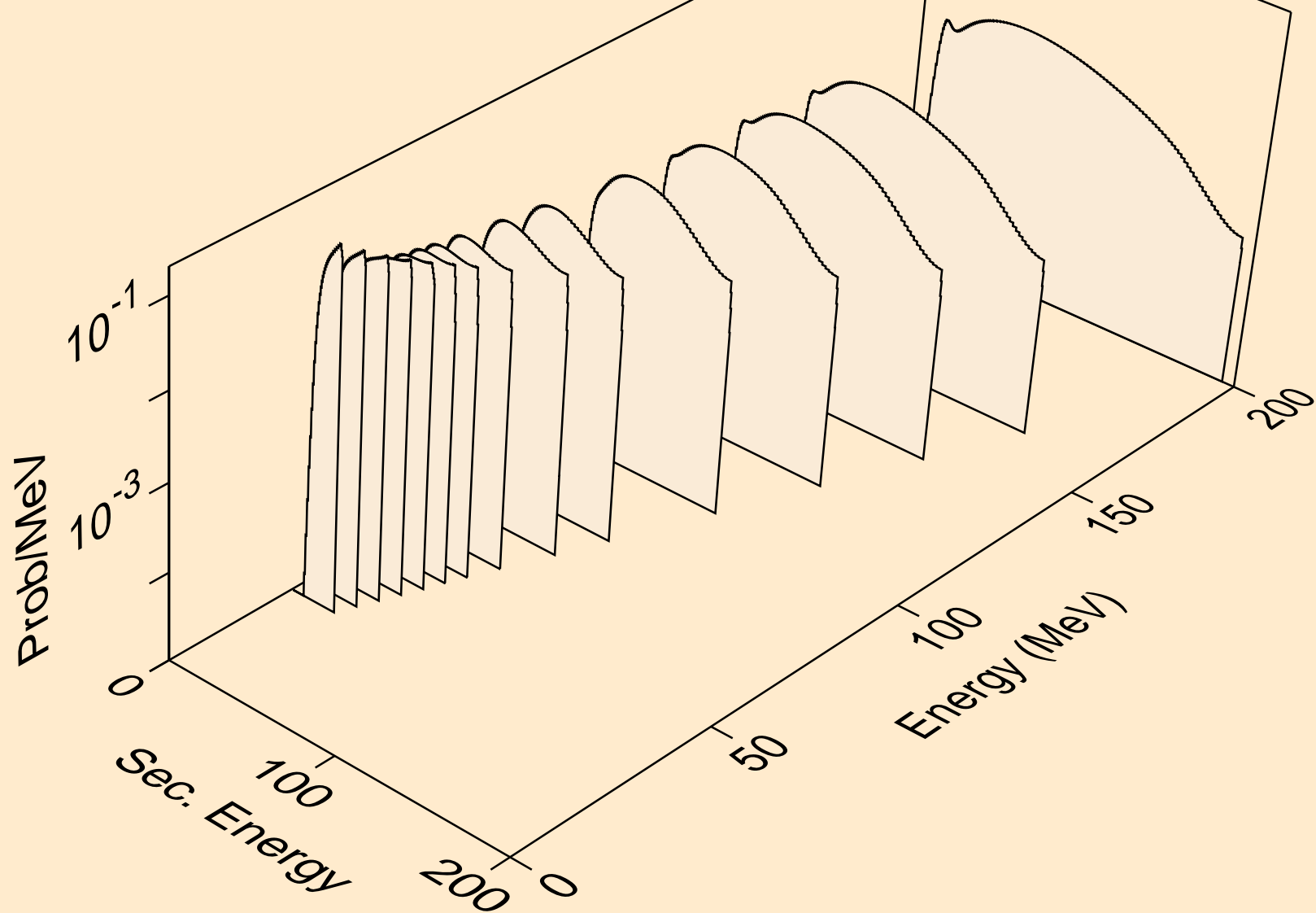

FM257 NEUTRON ACER TENDL-2023 LIBRARY; T=0.K
deuterons from (n,2nd)

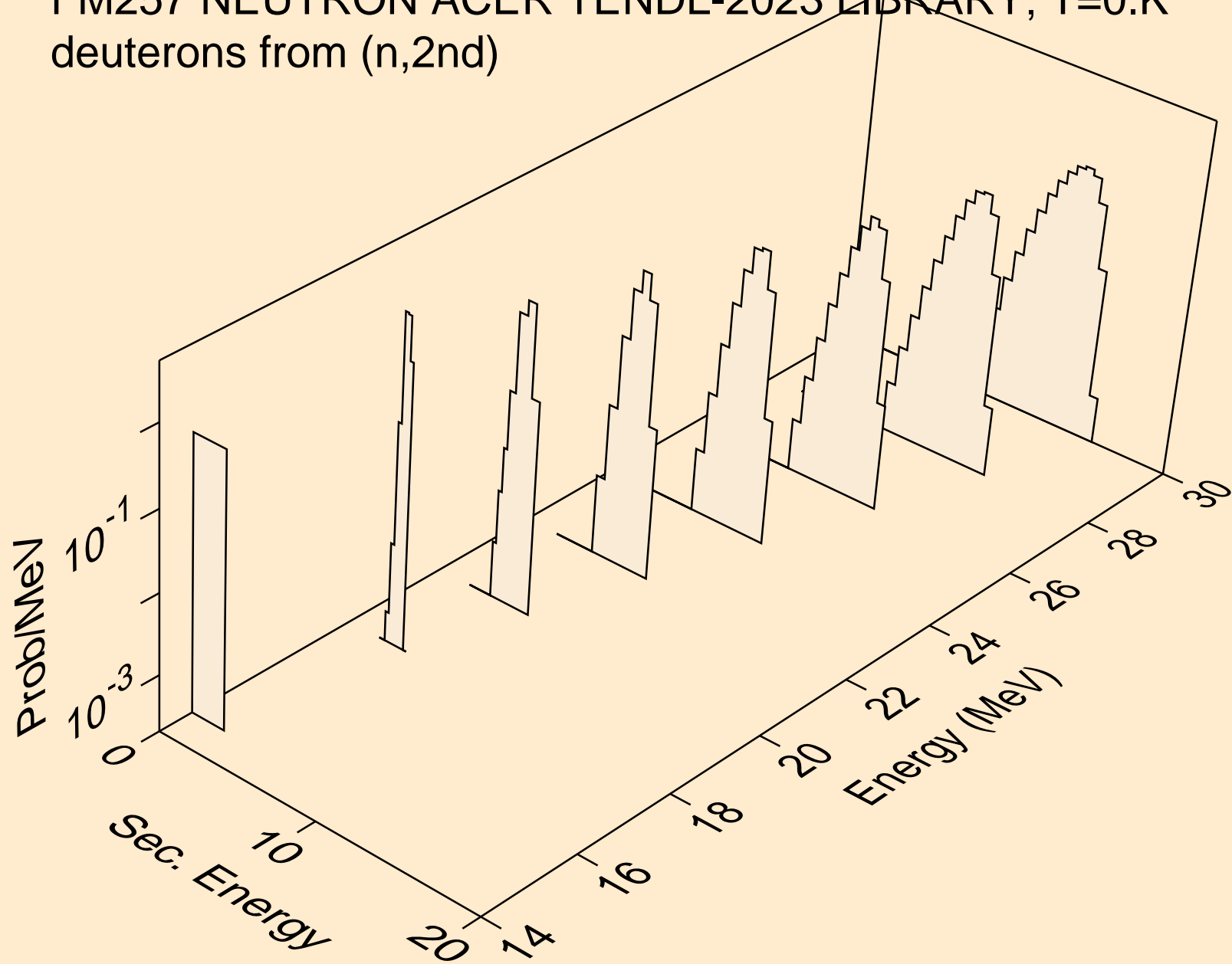

FM257 NEUTRON ACER TENDL-2023 LIBRARY; T=0.K
deuterons from (n,n*)d

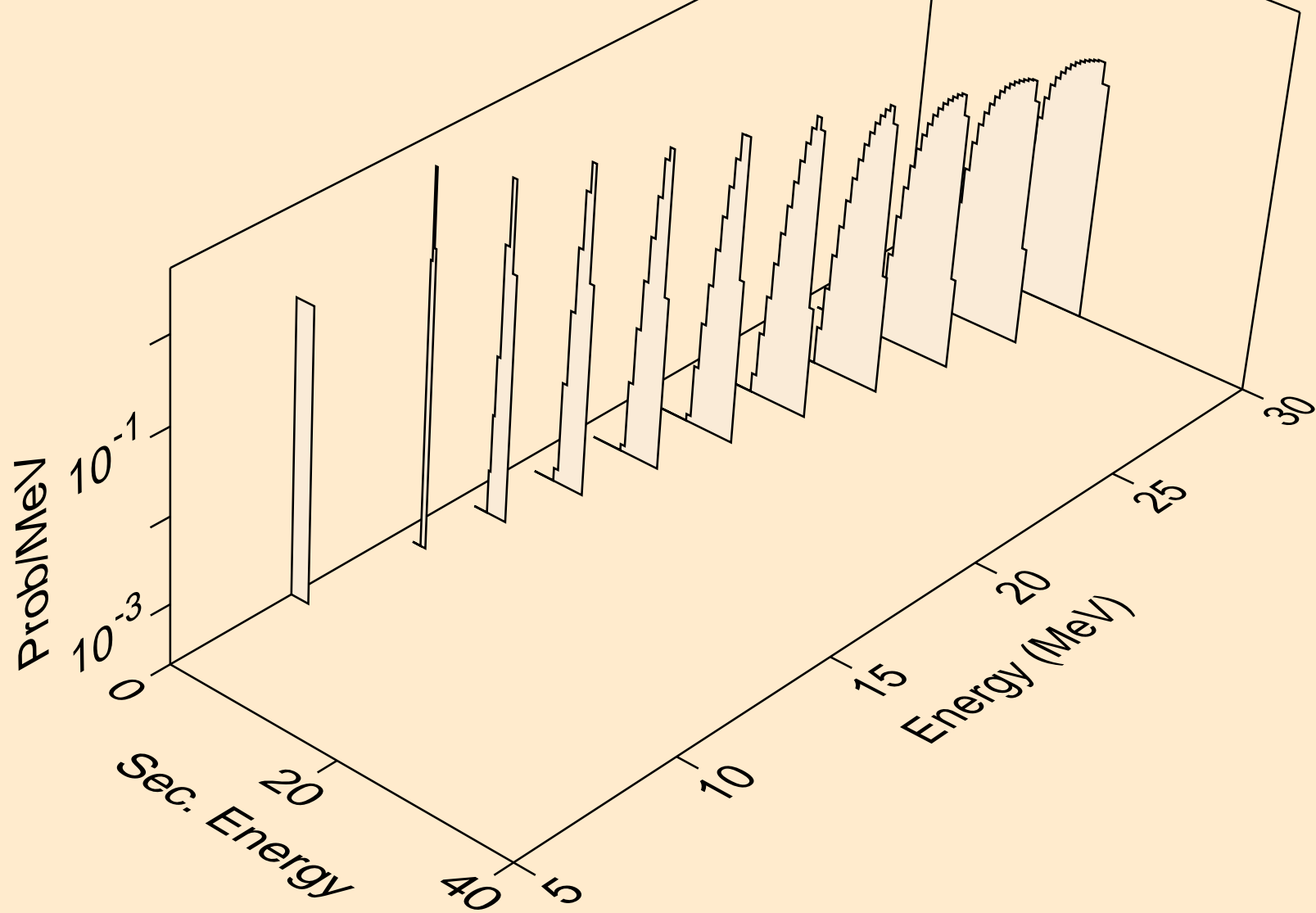

FM257 NEUTRON ACER TENDL-2023 LIBRARY; T=0.K
deuterons from (n,d)

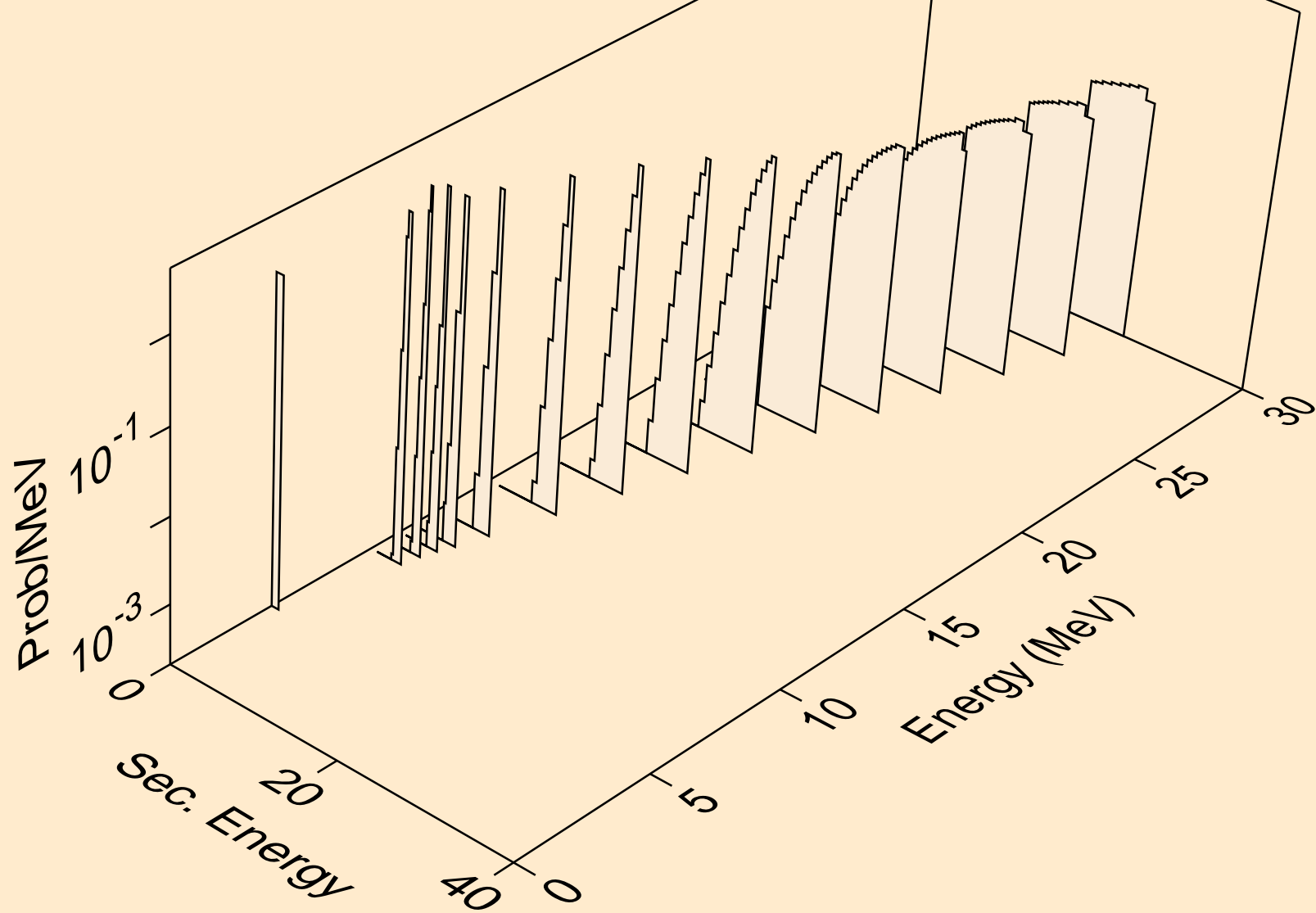

FM257 NEUTRON ACER TENDL-2023 LIBRARY; T=0.K
tritons from (n,x)

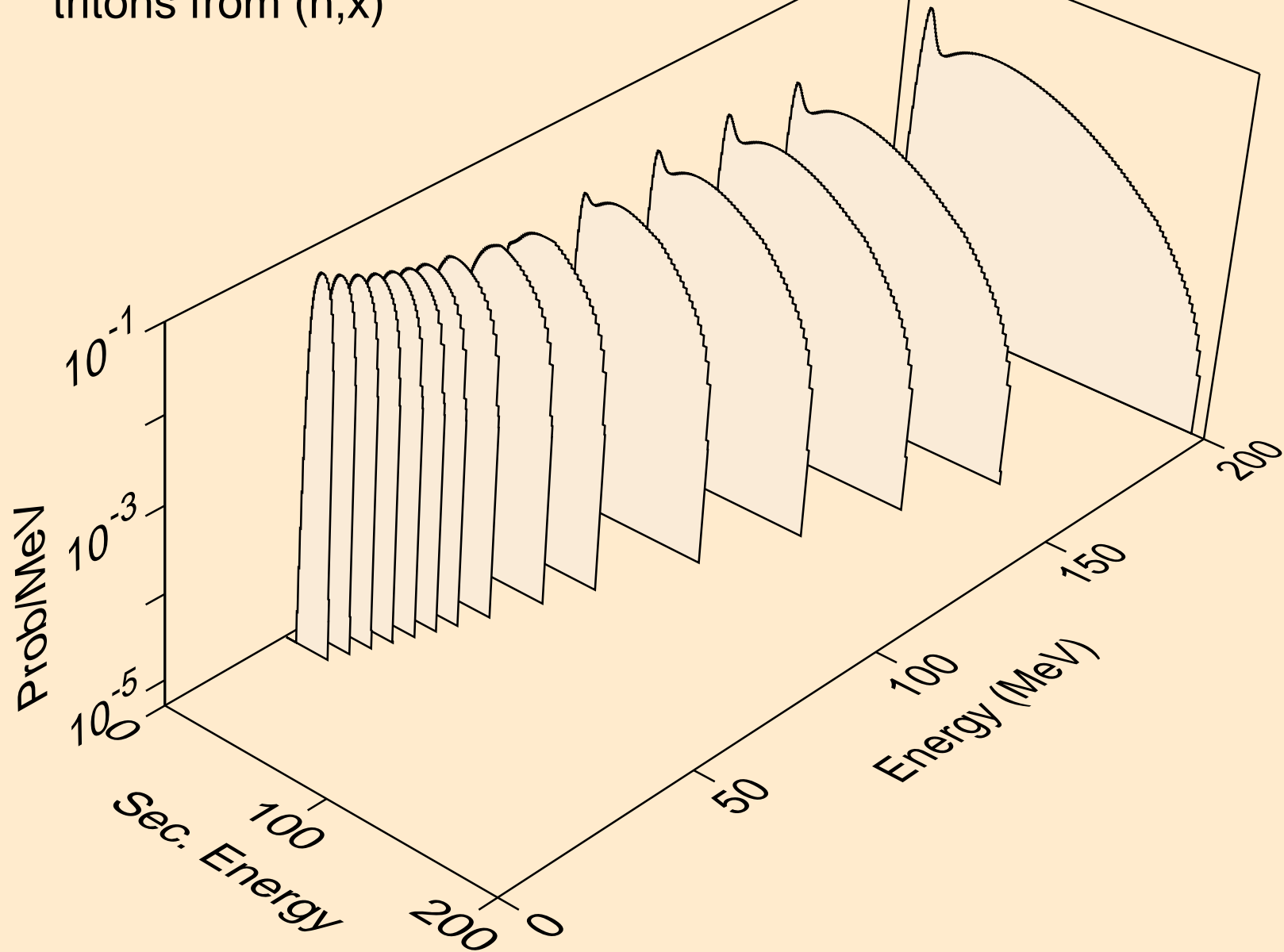

FM257 NEUTRON ACER TENDL-2023 LIBRARY; T=0.K
tritons from (n,n*)t

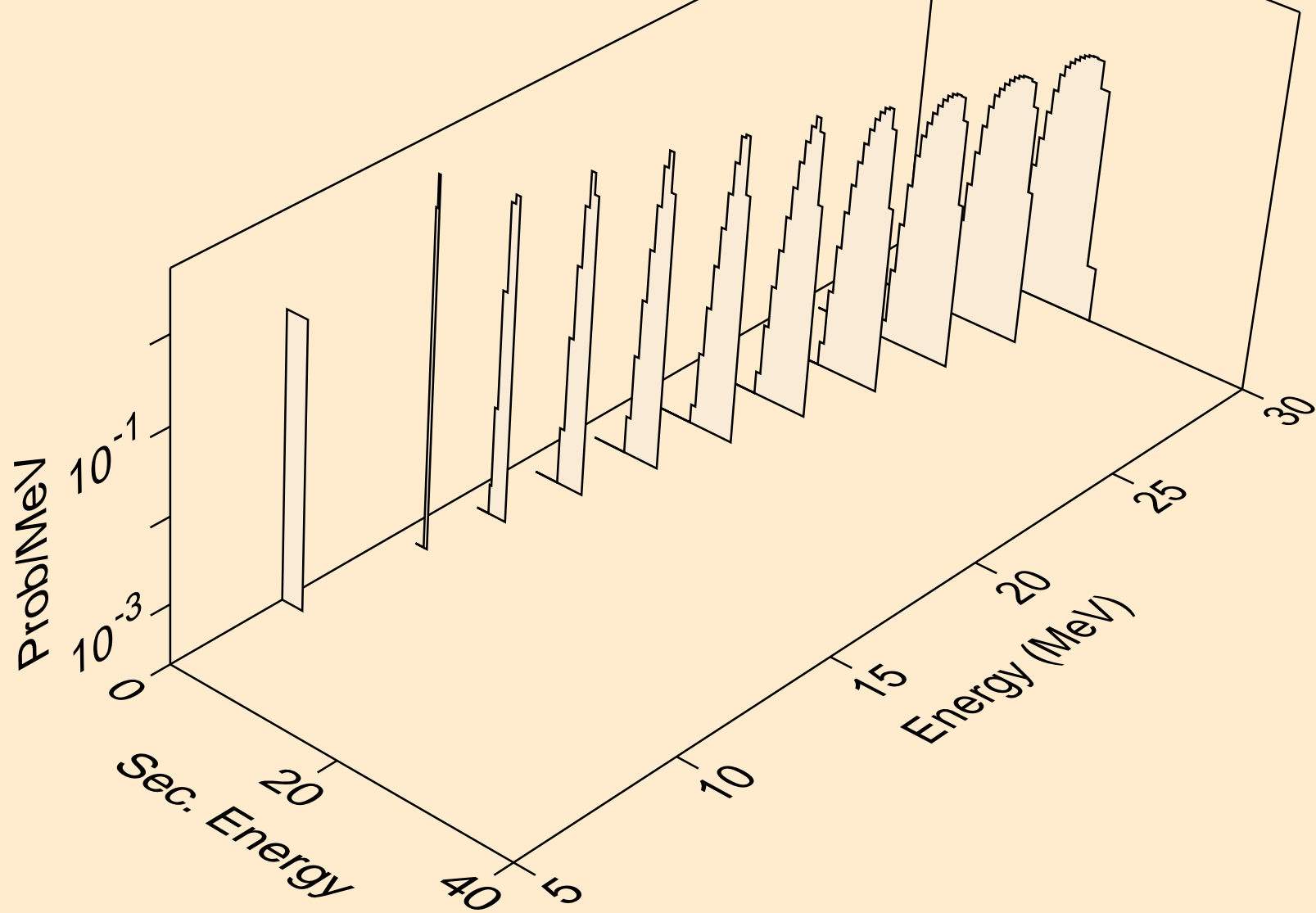

FM257 NEUTRON ACER TENDL-2023 LIBRARY; T=0.K
tritons from (n,t)

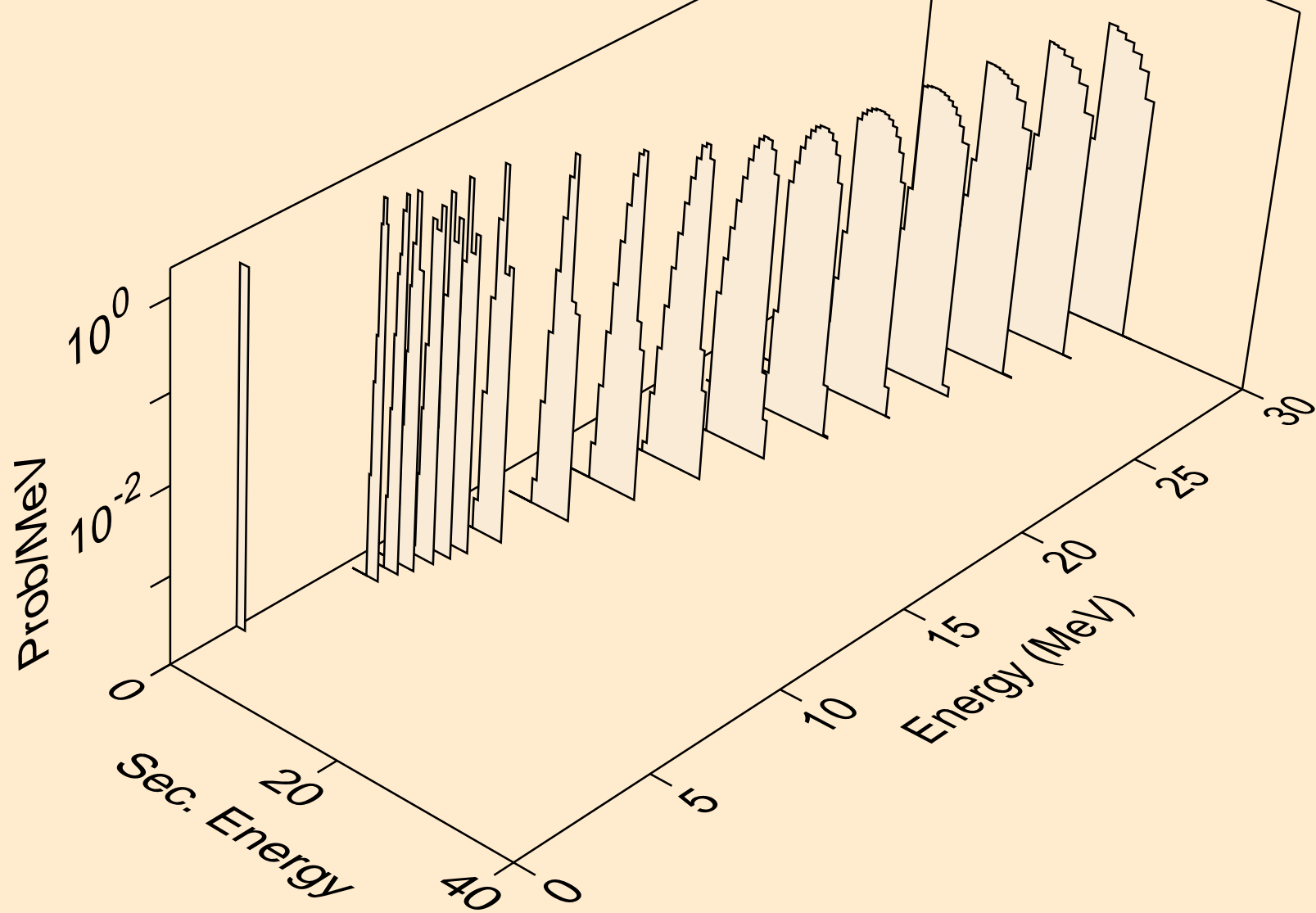

FM257 NEUTRON ACER TENDL-2023 LIBRARY; T=0.K
he3s from (n,x)

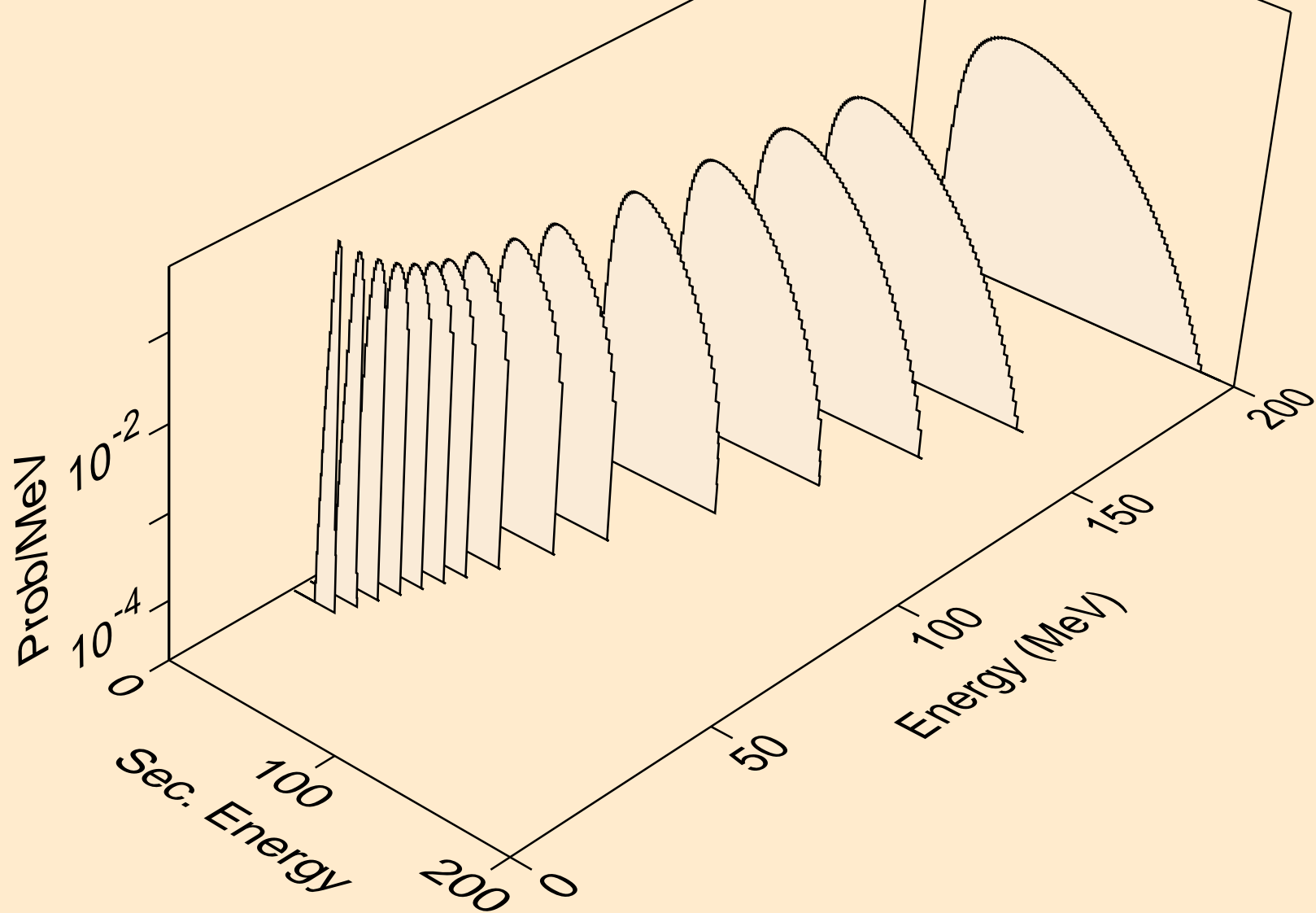

FM257 NEUTRON ACER TENDL-2023 LIBRARY; T=0.K
he3s from (n,n*)he3

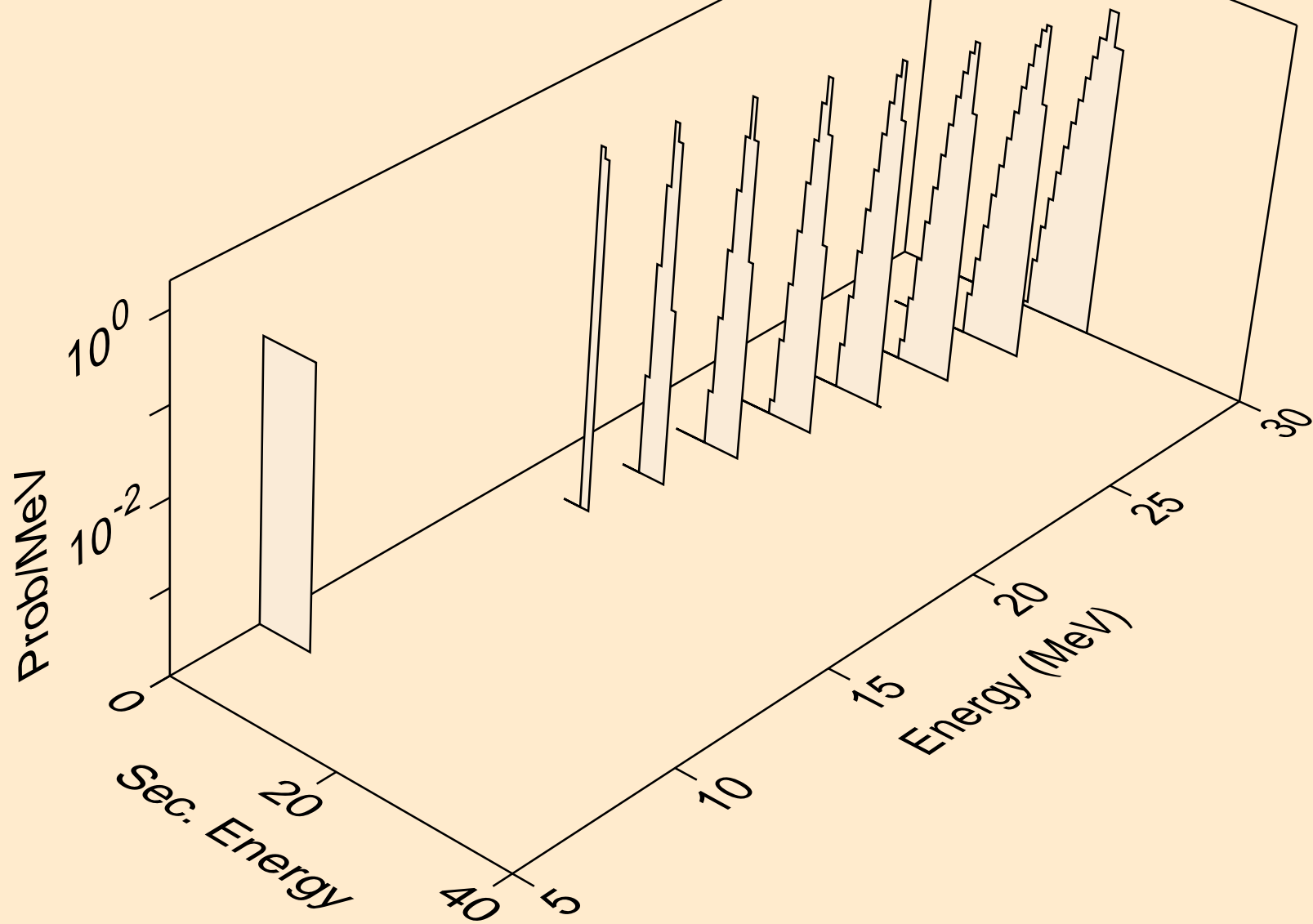

FM257 NEUTRON ACER TENDL-2023 LIBRARY; T=0.K
he3s from (n,he3)

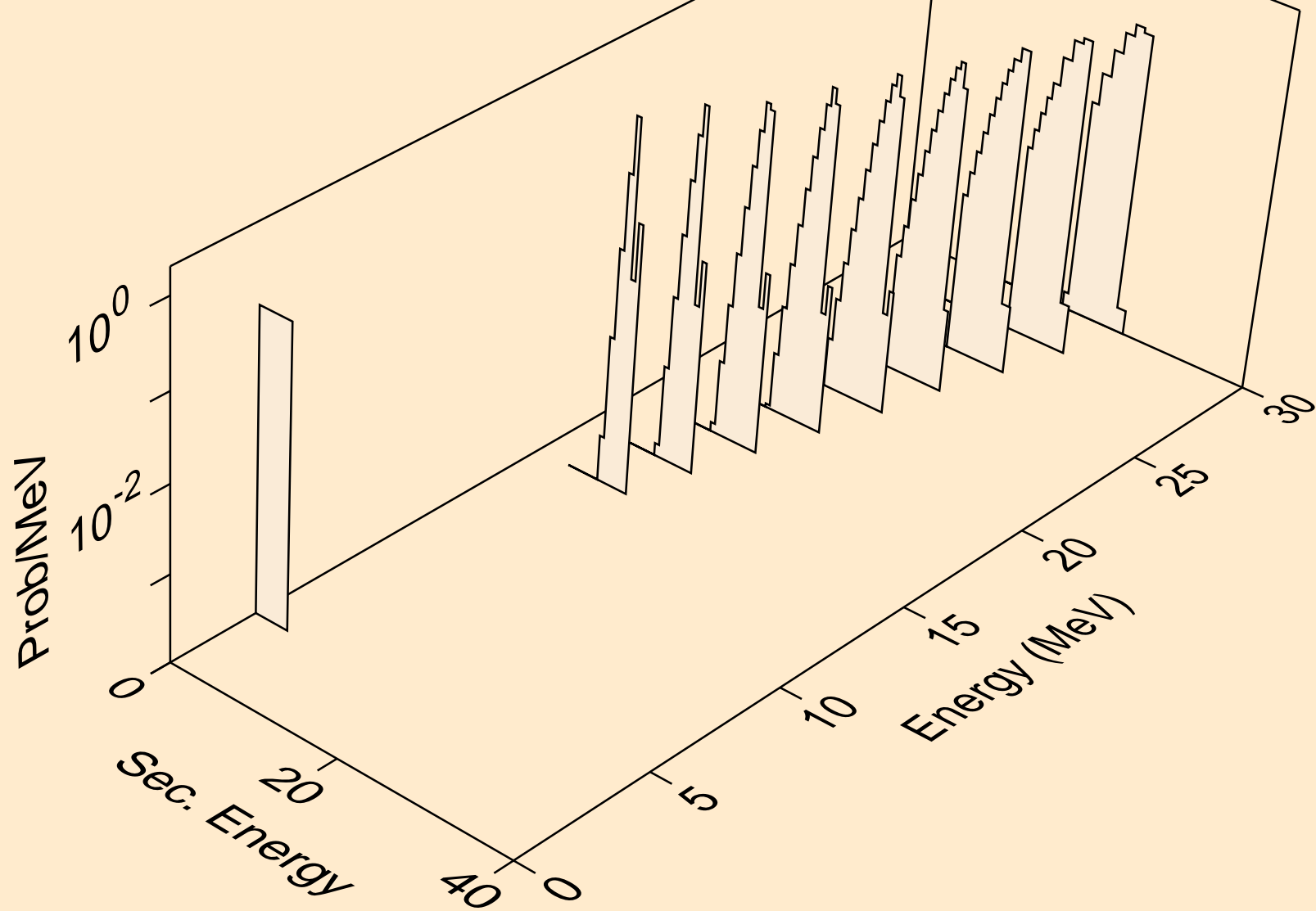

FM257 NEUTRON ACER TENDL-2023 LIBRARY; T=0.K
alphas from (n,x)

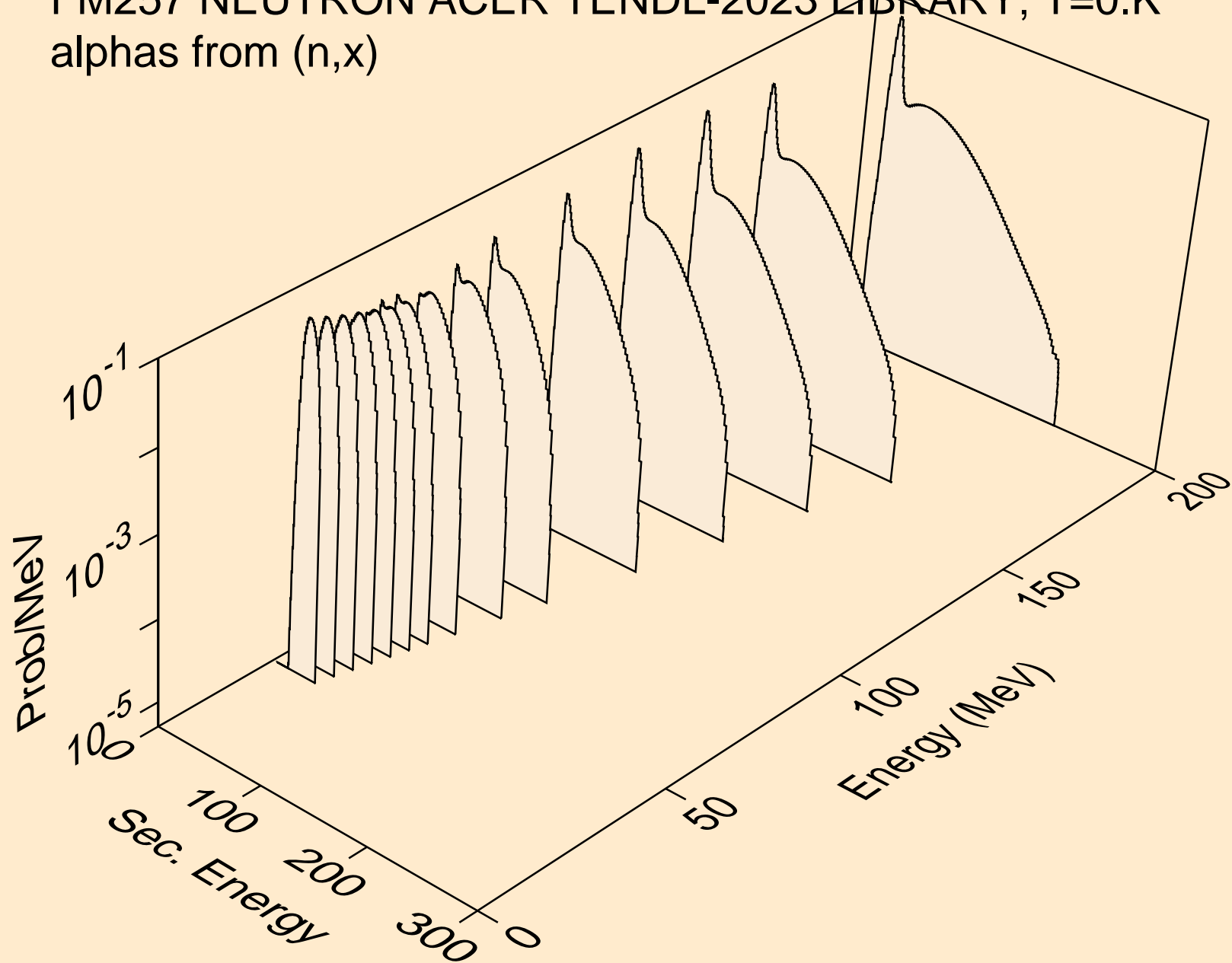

FM257 NEUTRON ACER TENDL-2023 LIBRARY; T=0.K
alphas from (n,n*)a

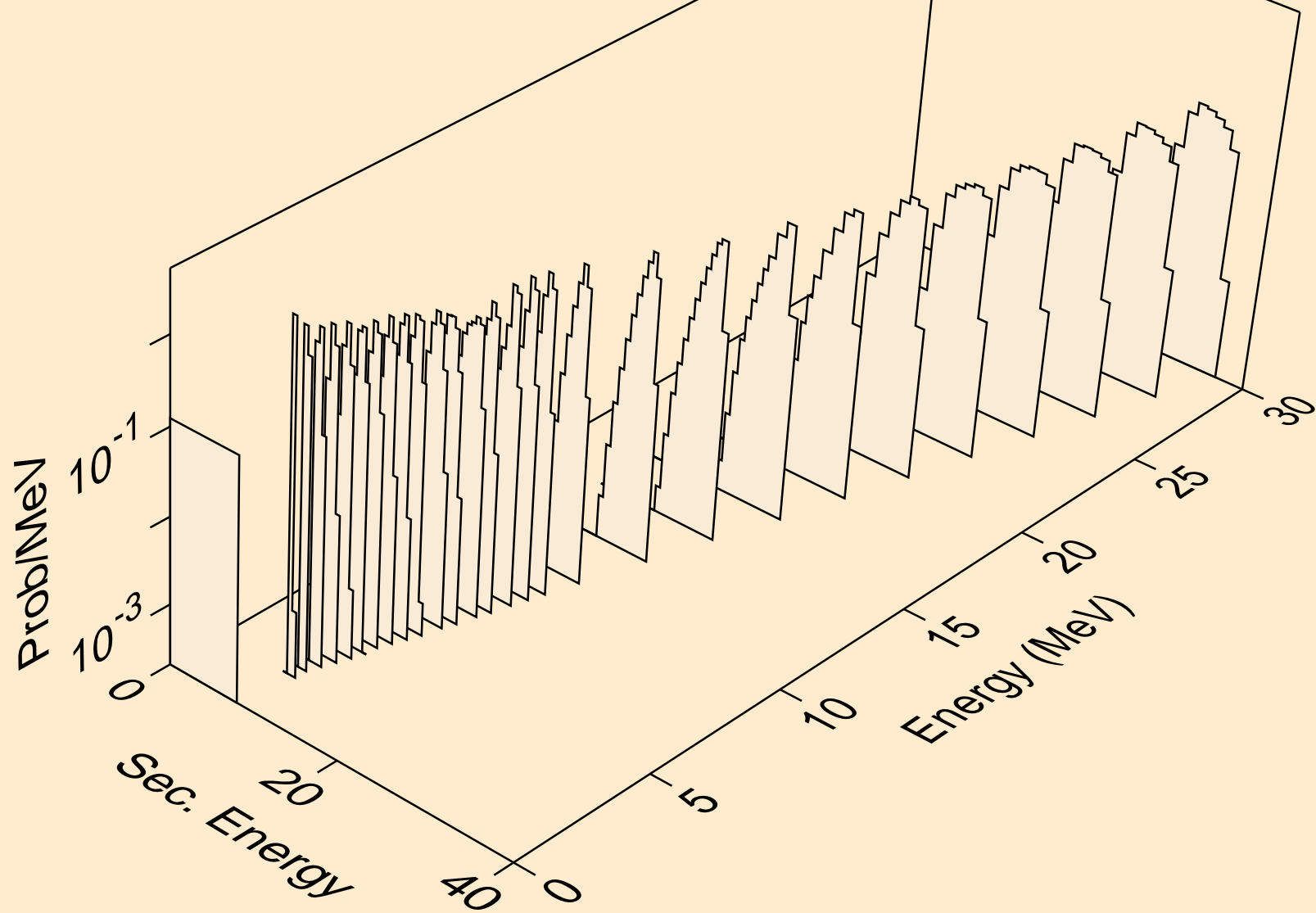

FM257 NEUTRON ACER TENDL-2023 LIBRARY; T=0.K
alphas from (n,2n)a

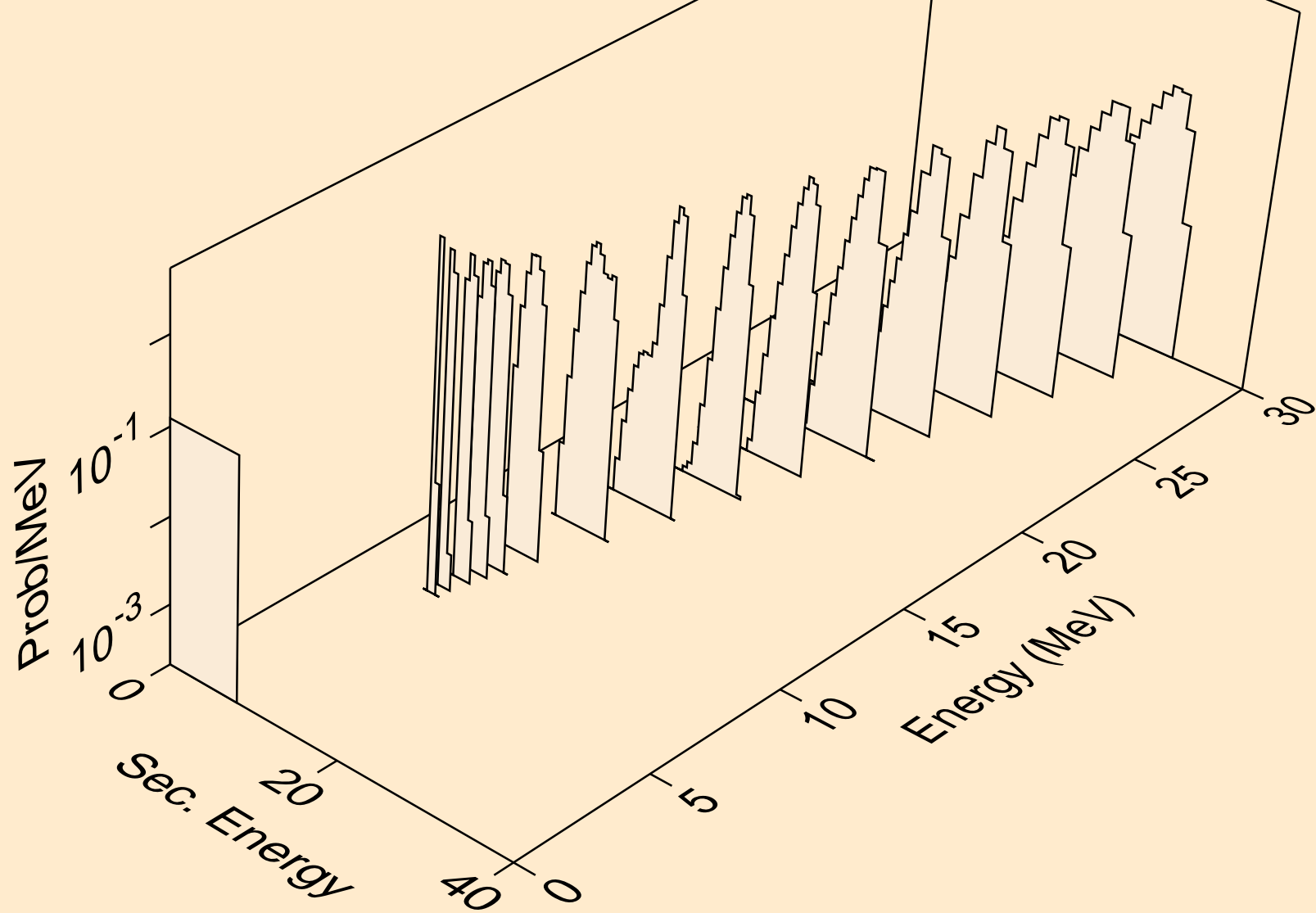

FM257 NEUTRON ACER TENDL-2023 LIBRARY; T=0.K
alphas from (n,3n)a

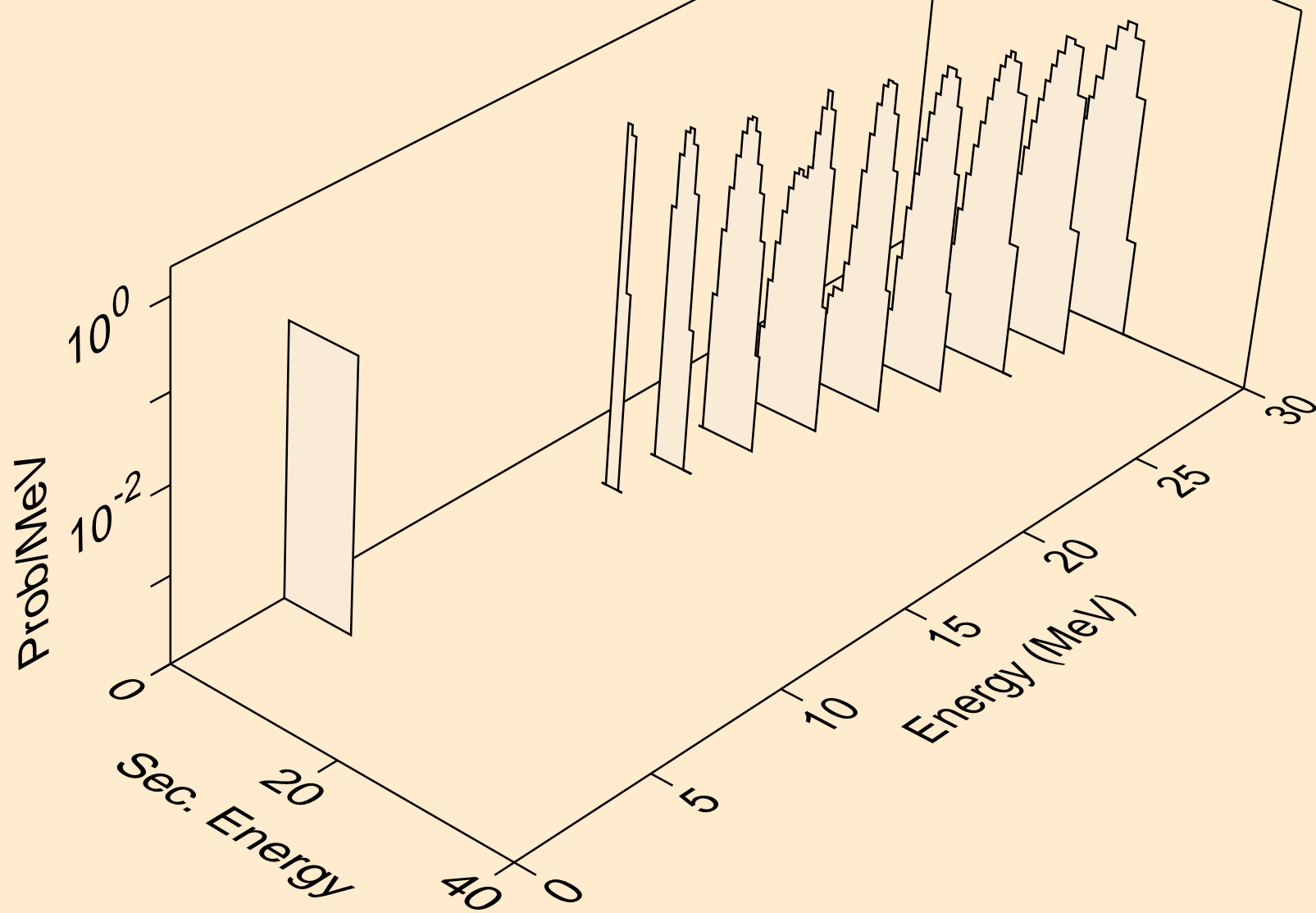

FM257 NEUTRON ACER TENDL-2023 LIBRARY; T=0.K
alphas from (n,n*)2a

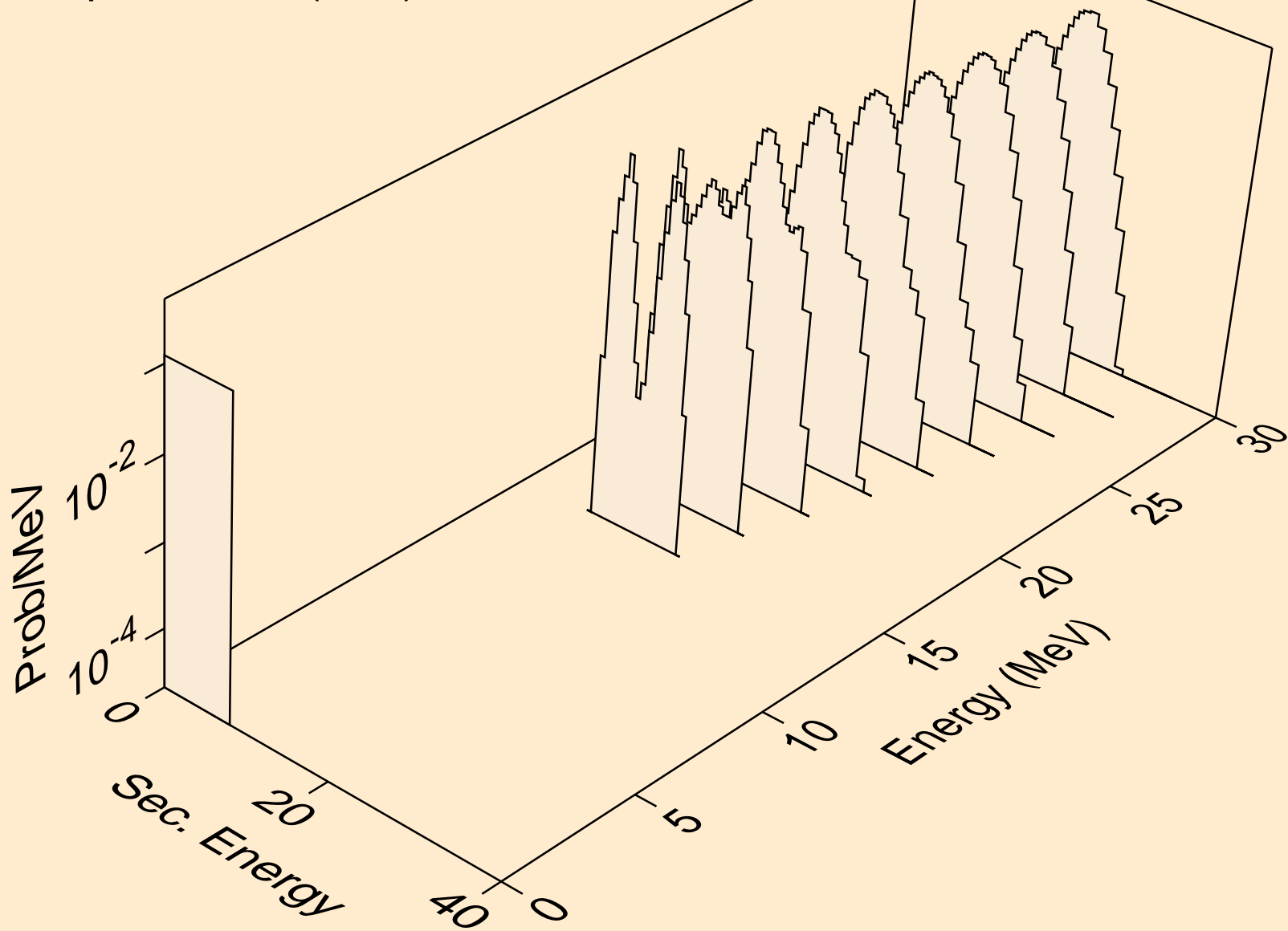

FM257 NEUTRON ACER TENDL-2023 LIBRARY; T=0.K
alphas from (n,npa)

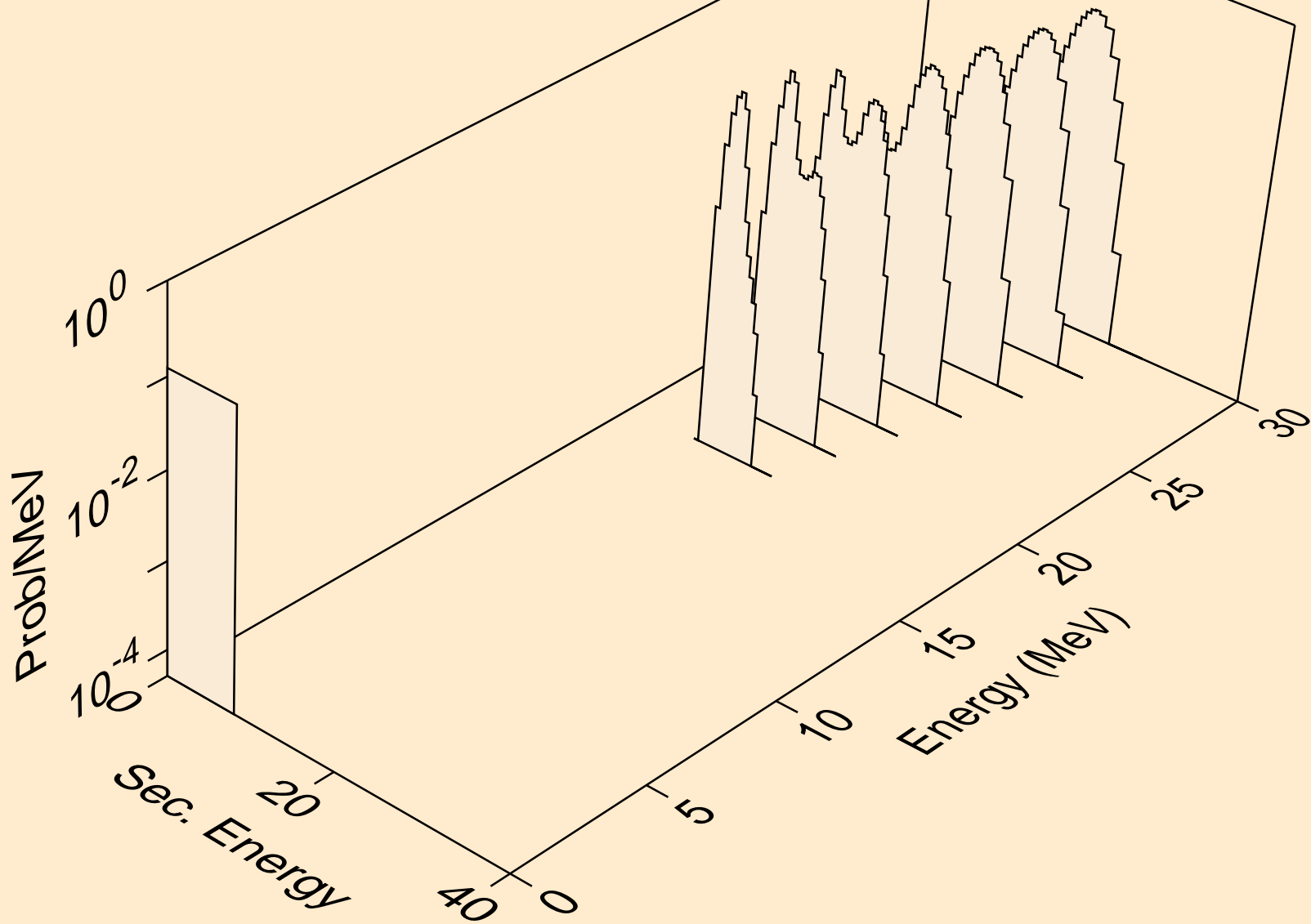

FM257 NEUTRON ACER TENDL-2023 LIBRARY; T=0.K
alphas from (n,a)

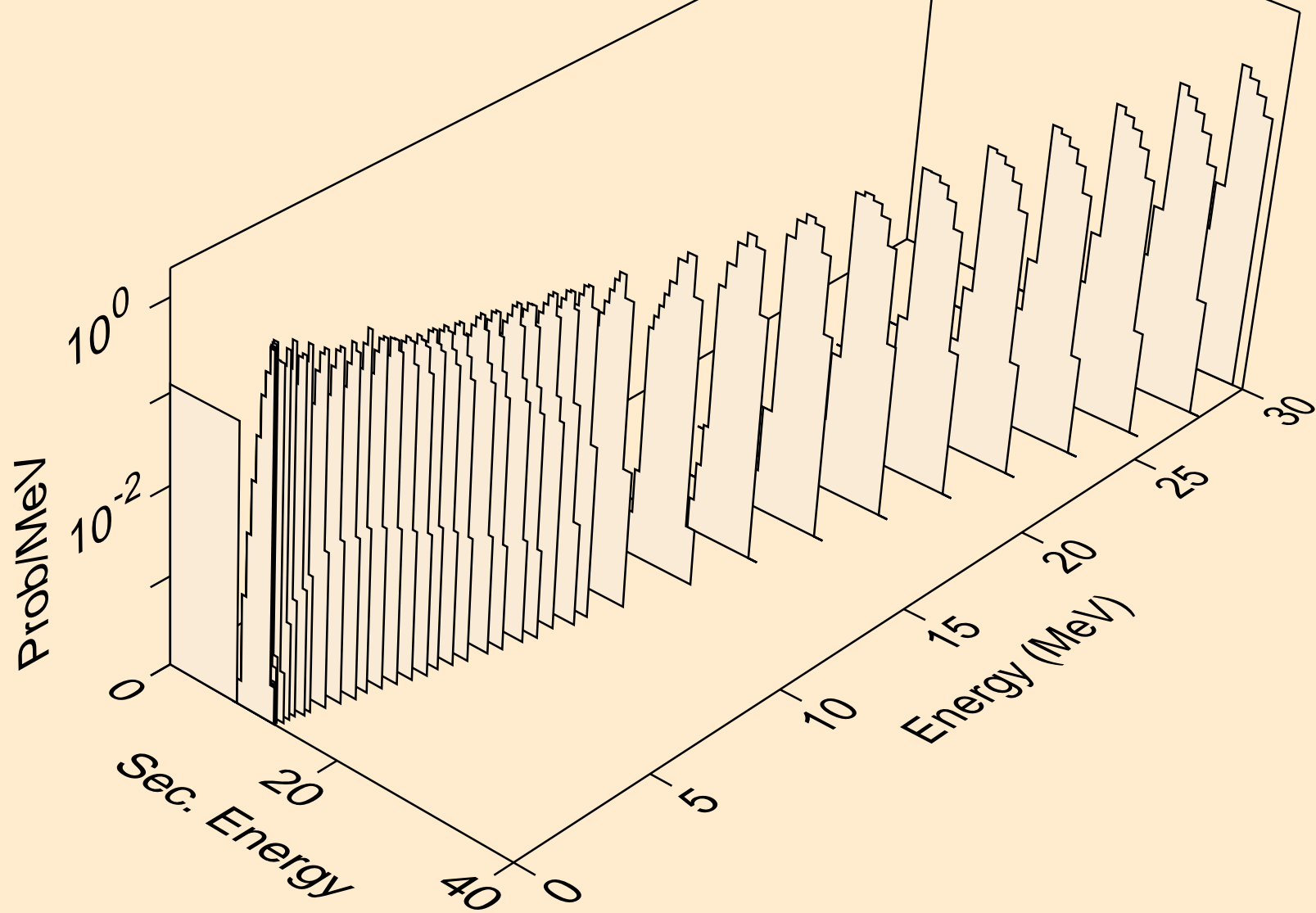

FM257 NEUTRON ACER TENDL-2023 LIBRARY; T=0.K
alphas from (n,2a)

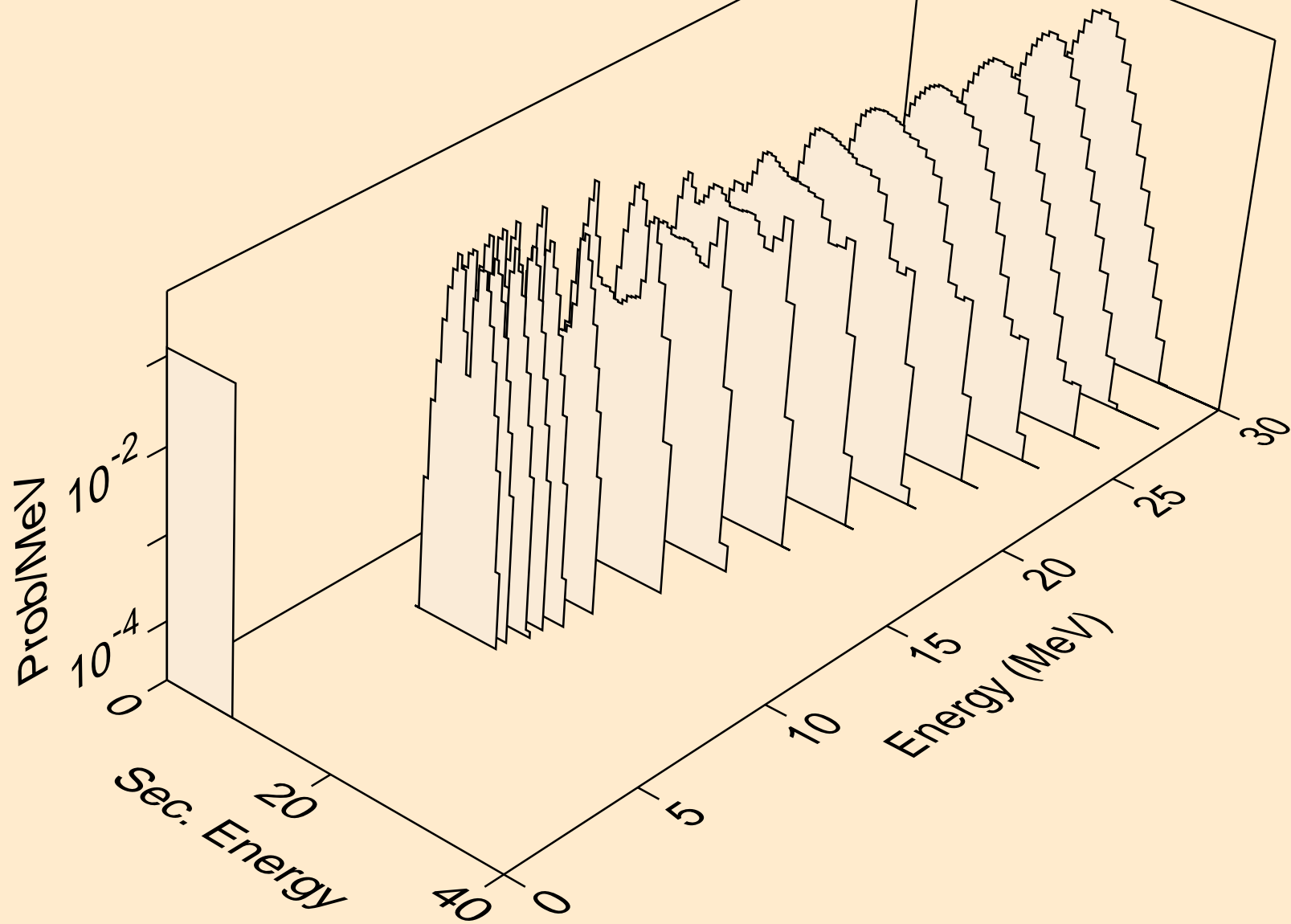

FM257 NEUTRON ACER TENDL-2023 LIBRARY; T=0.K
alphas from (n,pa)

