

# HG189 NEUTRON ACER TENDL-2023 LIBRARY; T=0.K

## Principal cross sections

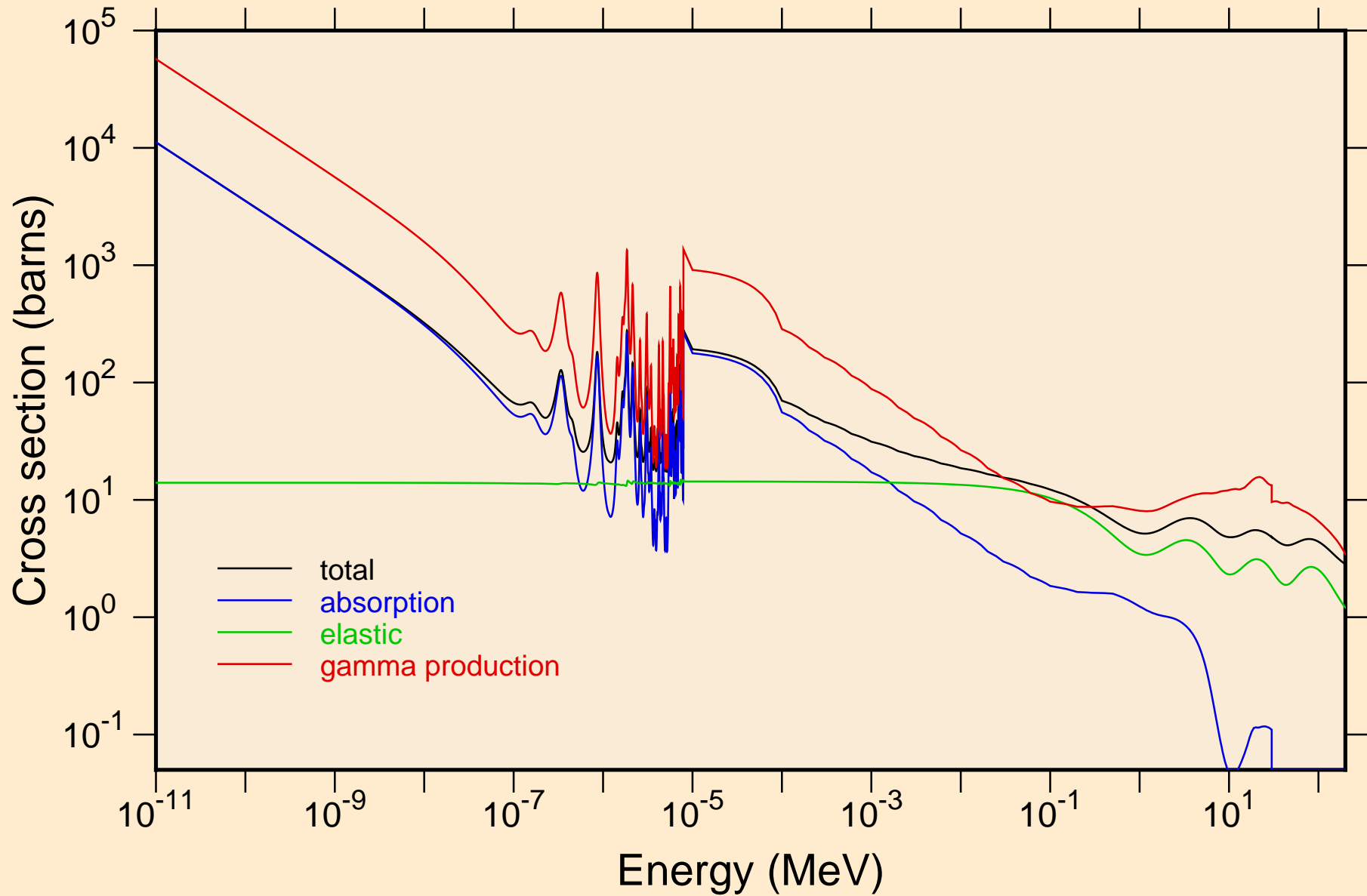

HG189 NEUTRON ACER TENDL-2023 LIBRARY; T=0.K  
resonance total cross section

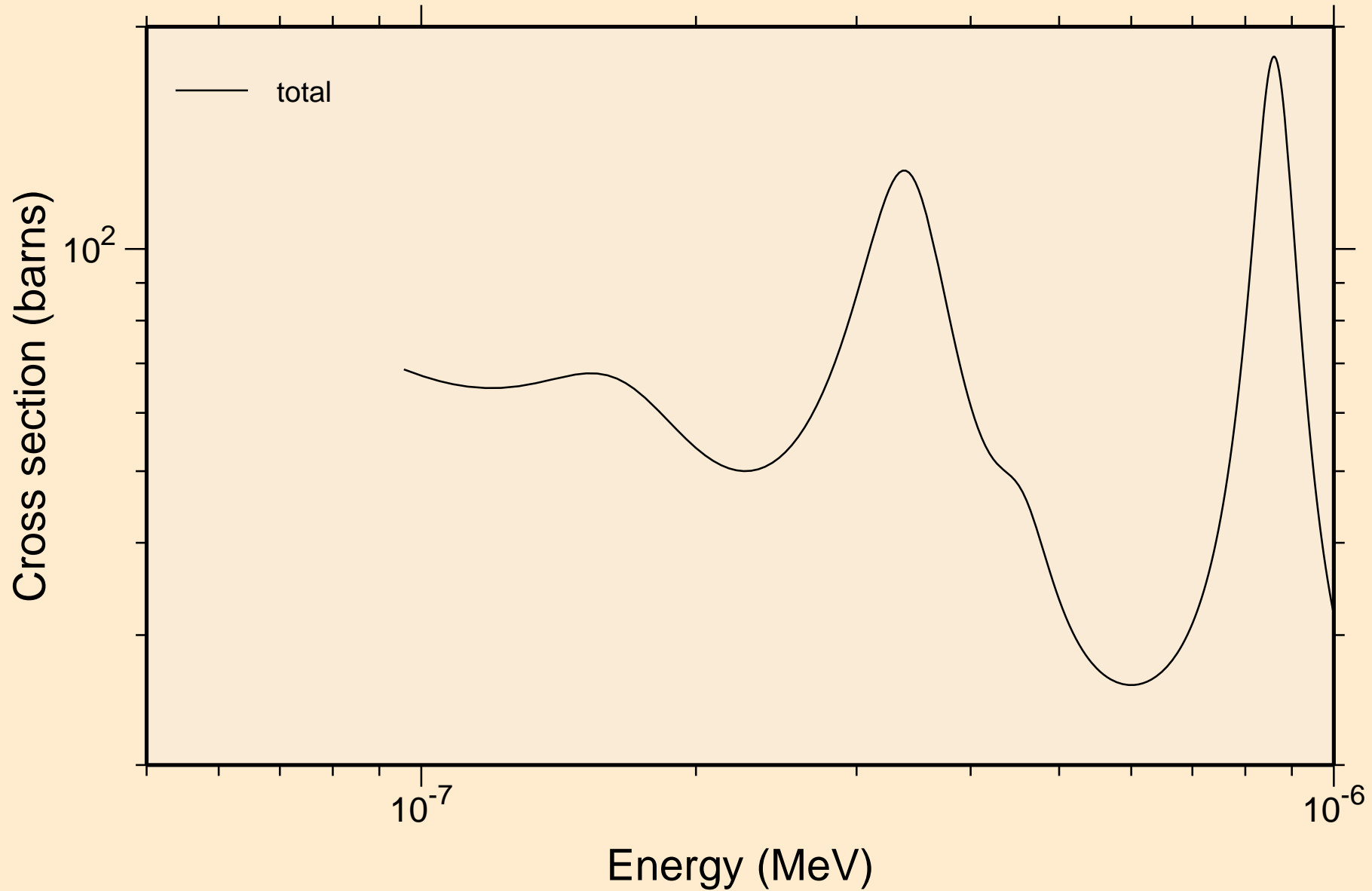

HG189 NEUTRON ACER TENDL-2023 LIBRARY; T=0.K  
resonance total cross section

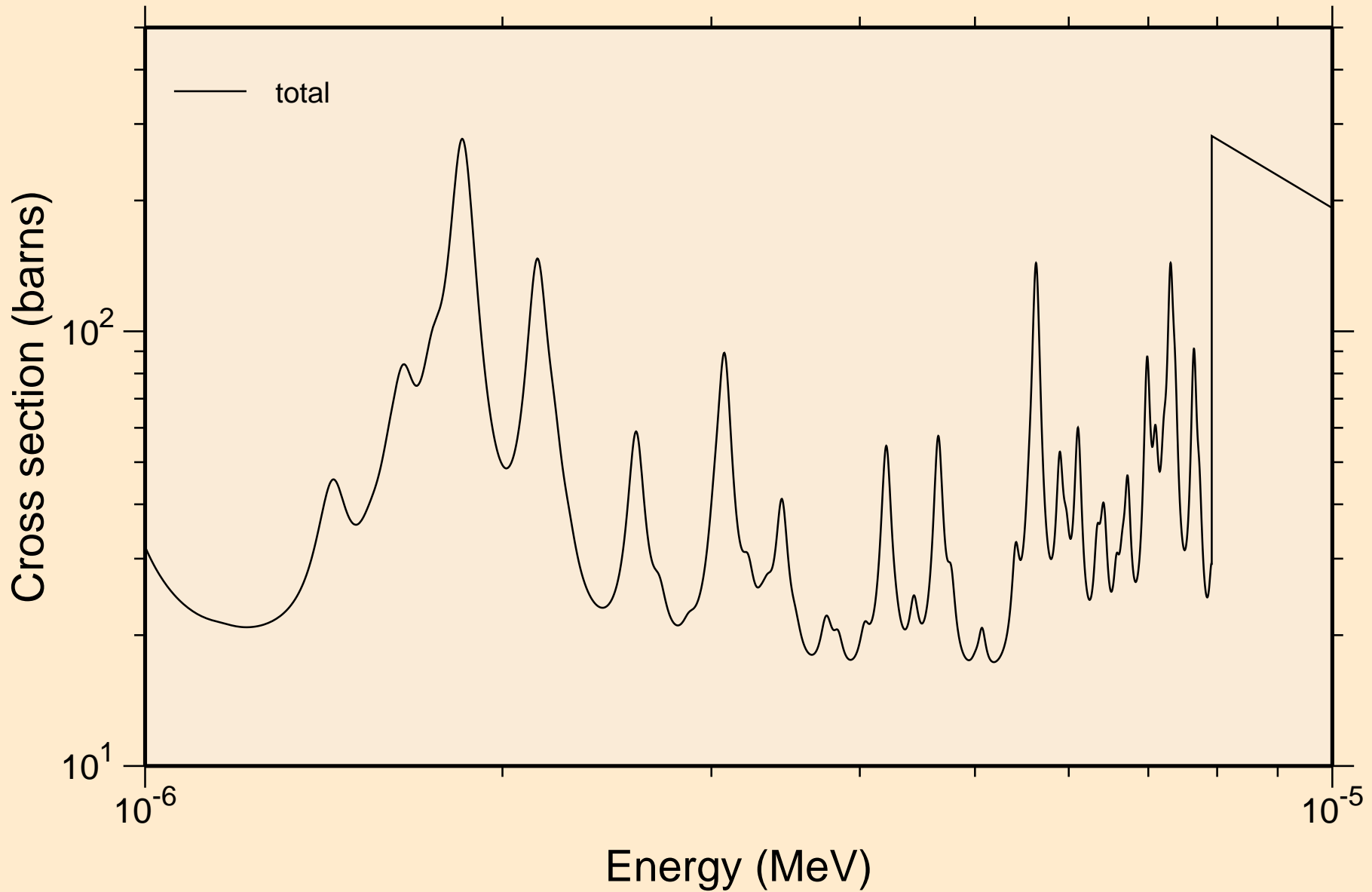

HG189 NEUTRON ACER TENDL-2023 LIBRARY; T=0.K  
resonance total cross section

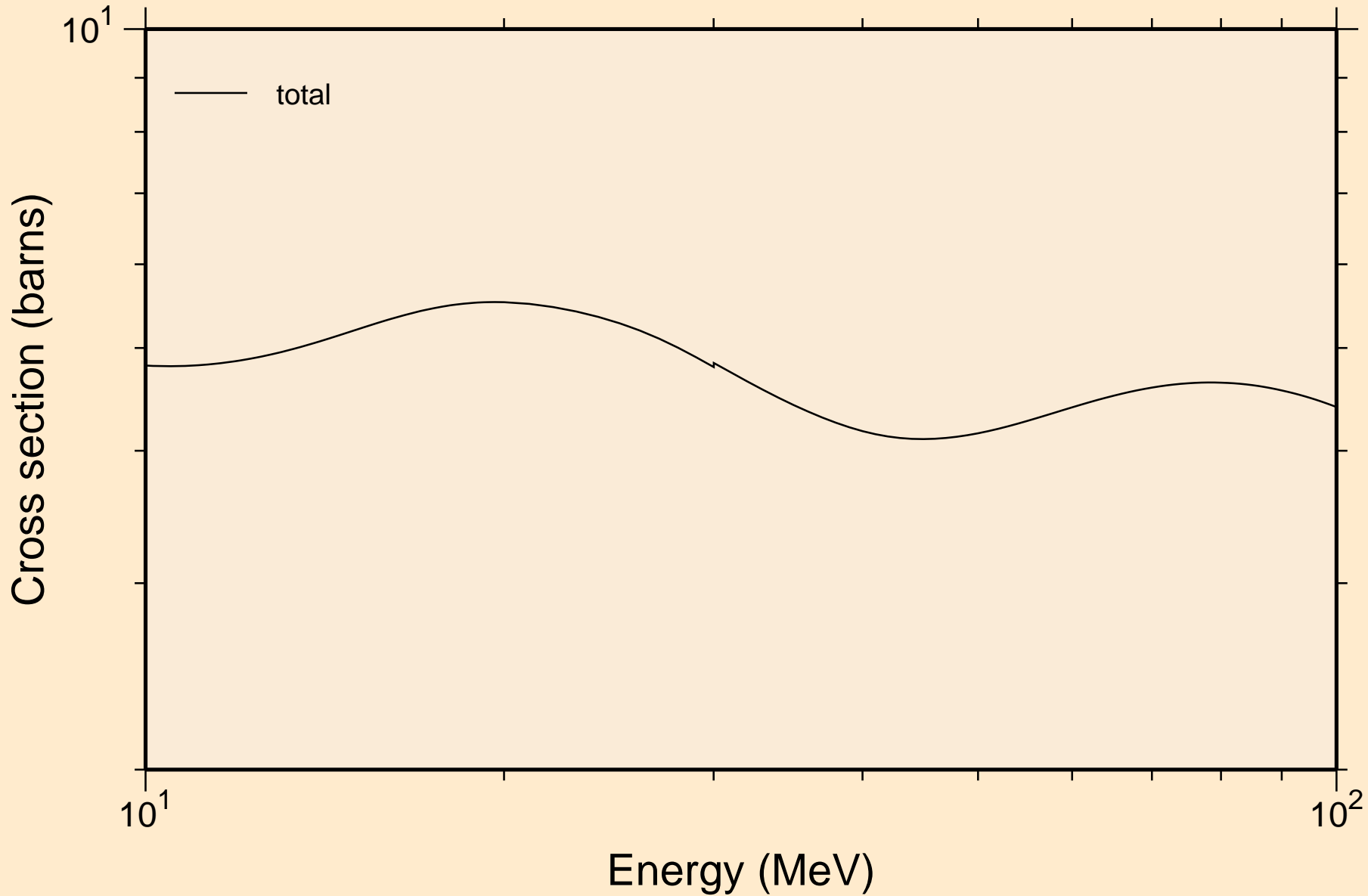

HG189 NEUTRON ACER TENDL-2023 LIBRARY; T=0.K  
resonance absorption cross sections

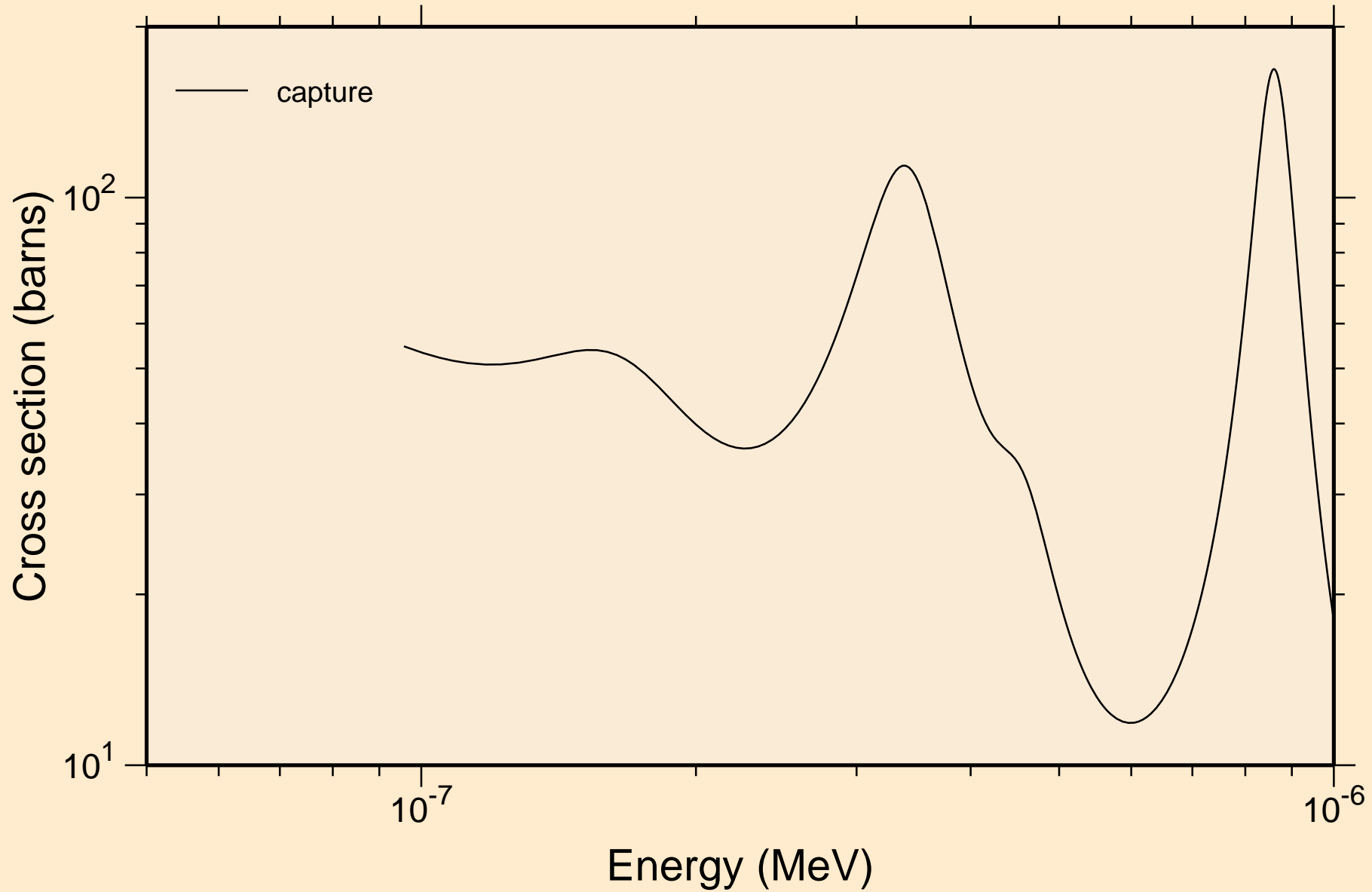

HG189 NEUTRON ACER TENDL-2023 LIBRARY; T=0.K  
resonance absorption cross sections

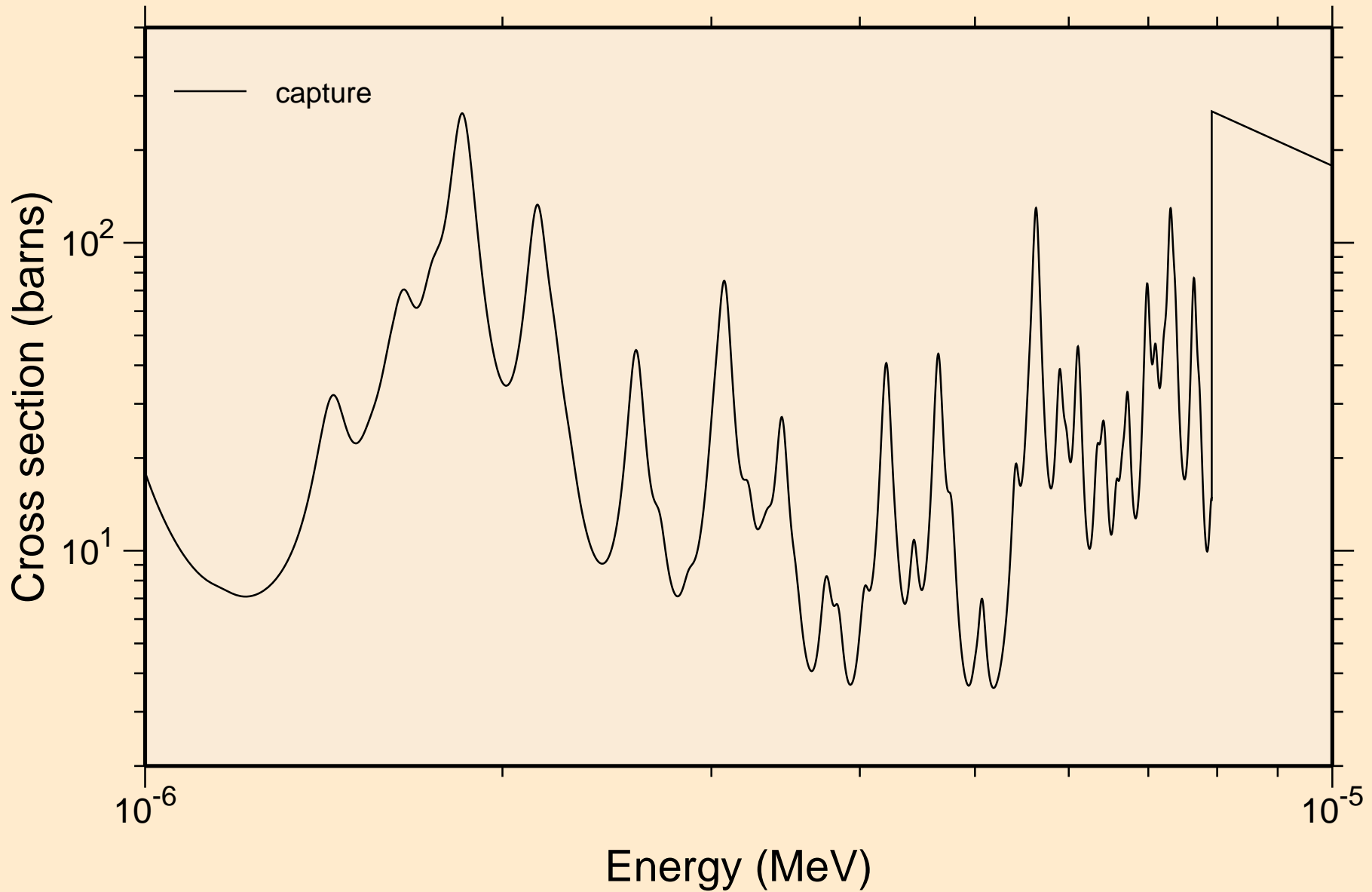

HG189 NEUTRON ACER TENDL-2023 LIBRARY; T=0.K  
resonance absorption cross sections

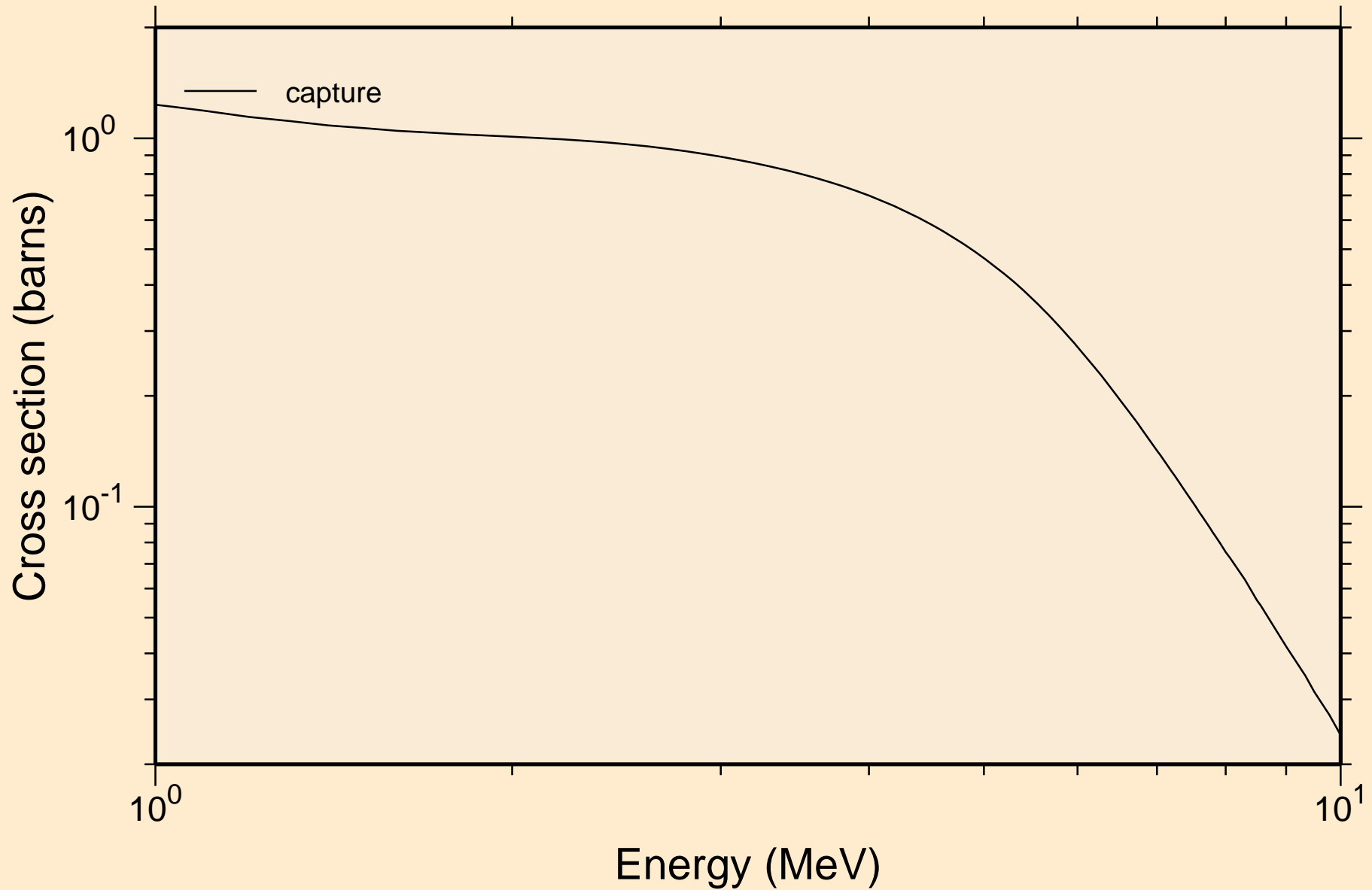

HG189 NEUTRON ACER TENDL-2023 LIBRARY; T=0.K  
Heating

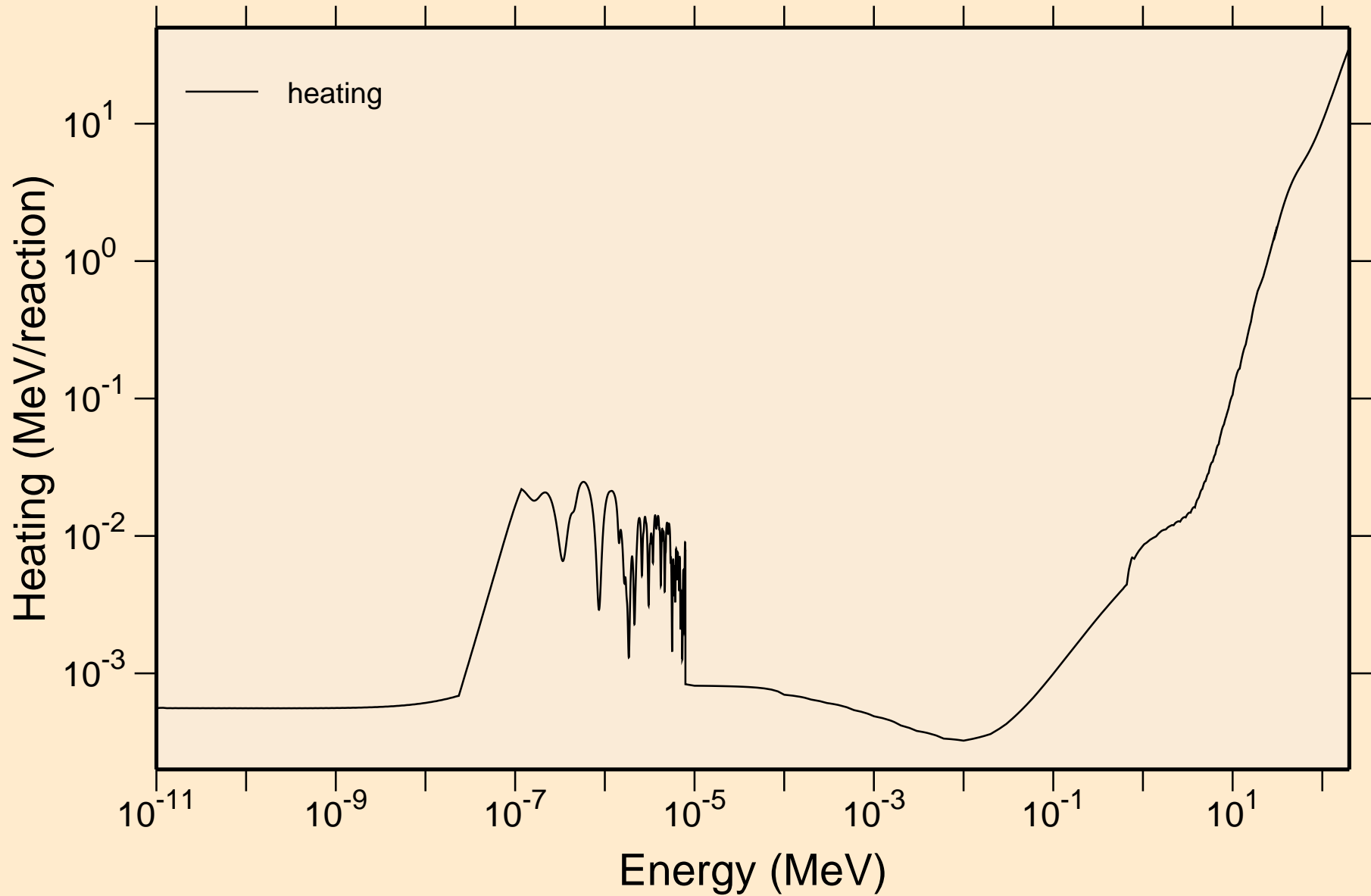



# HG189 NEUTRON ACER TENDL-2023 LIBRARY; T=0.K

## Damage

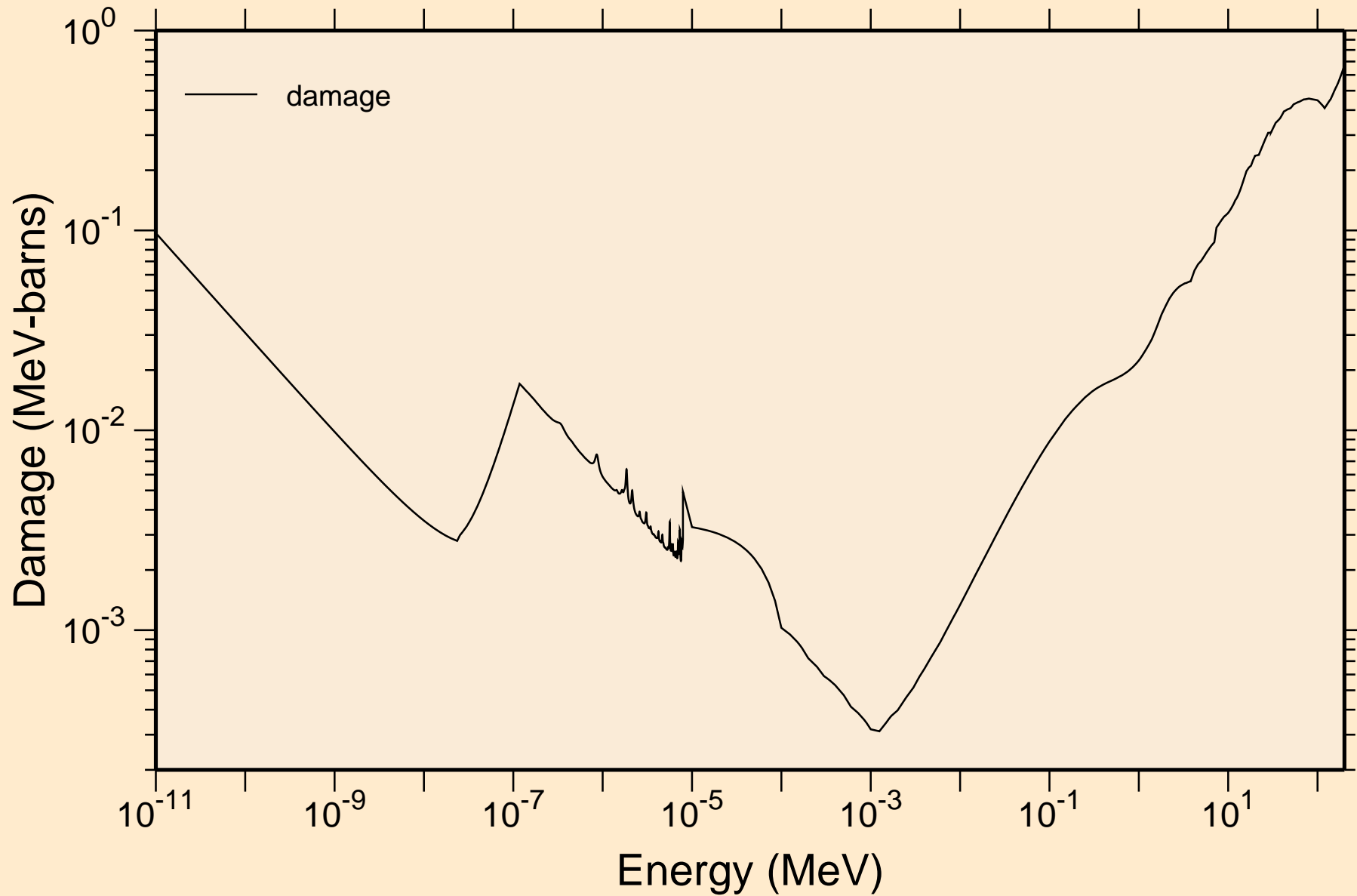

# HG189 NEUTRON ACER TENDL-2023 LIBRARY; T=0.K

## Non-threshold reactions

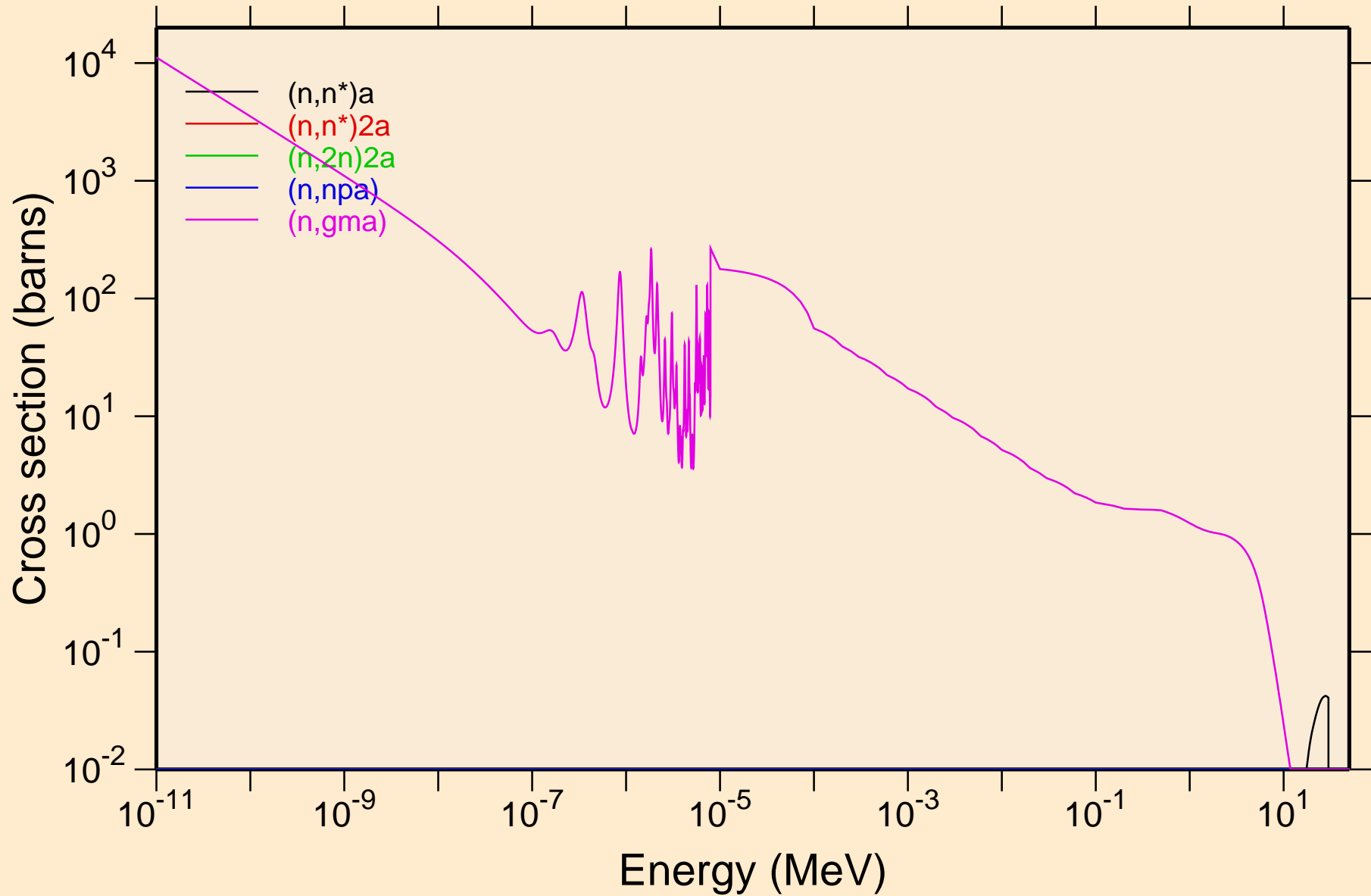

# HG189 NEUTRON ACER TENDL-2023 LIBRARY; T=0.K

## Non-threshold reactions

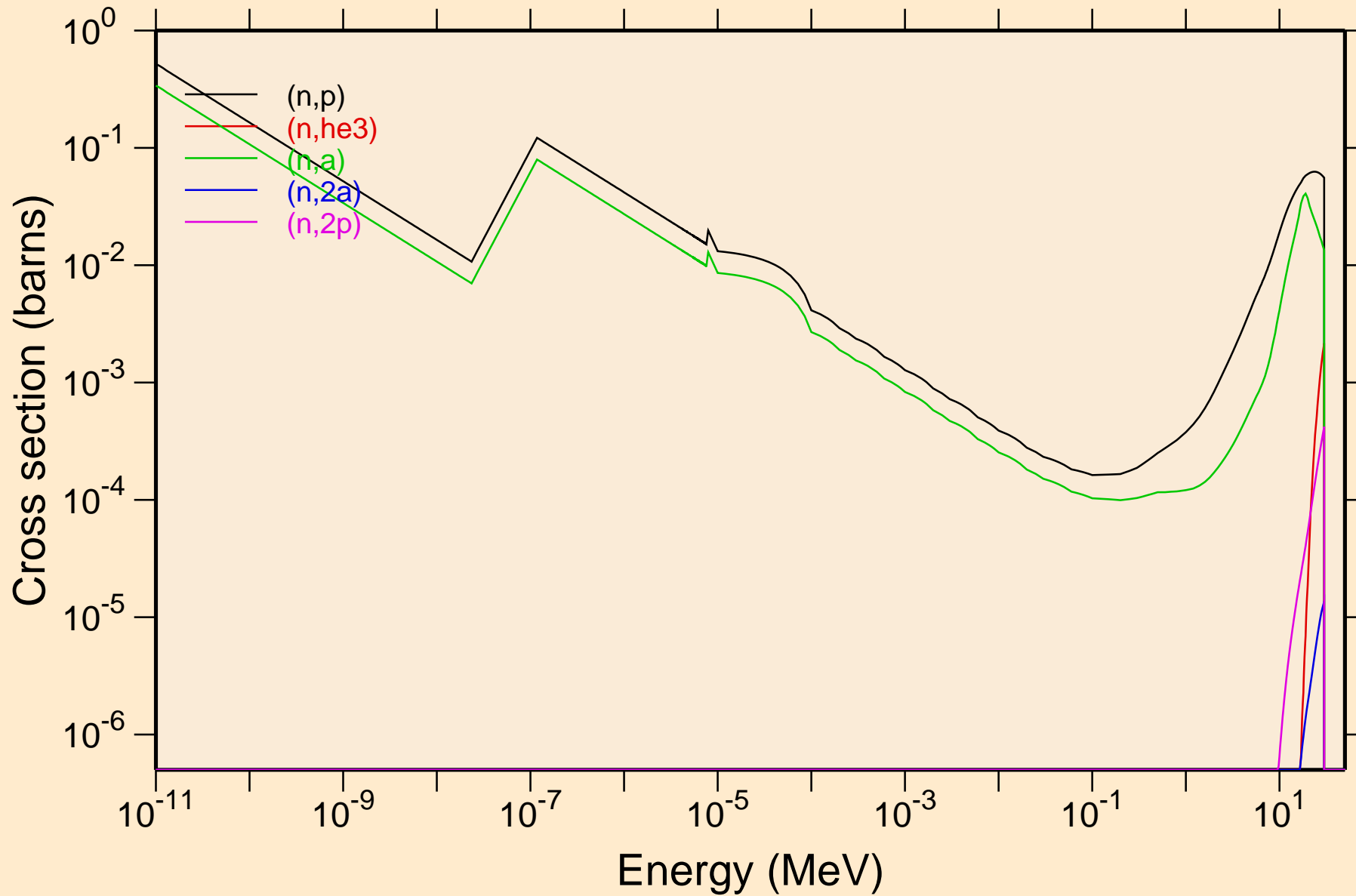

# HG189 NEUTRON ACER TENDL-2023 LIBRARY; T=0.K

## Non-threshold reactions

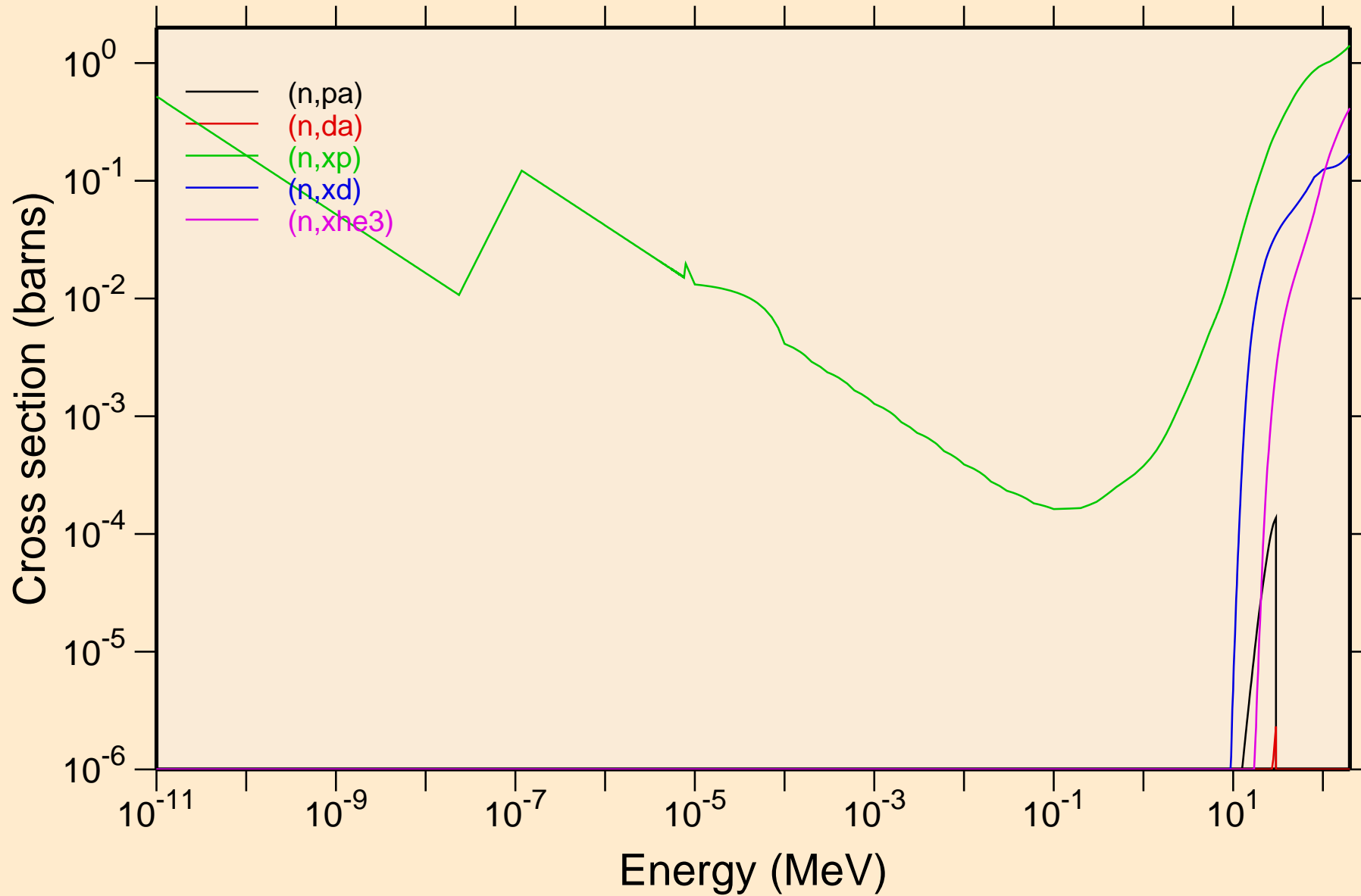

HG189 NEUTRON ACER TENDL-2023 LIBRARY; T=0.K  
Non-threshold reactions

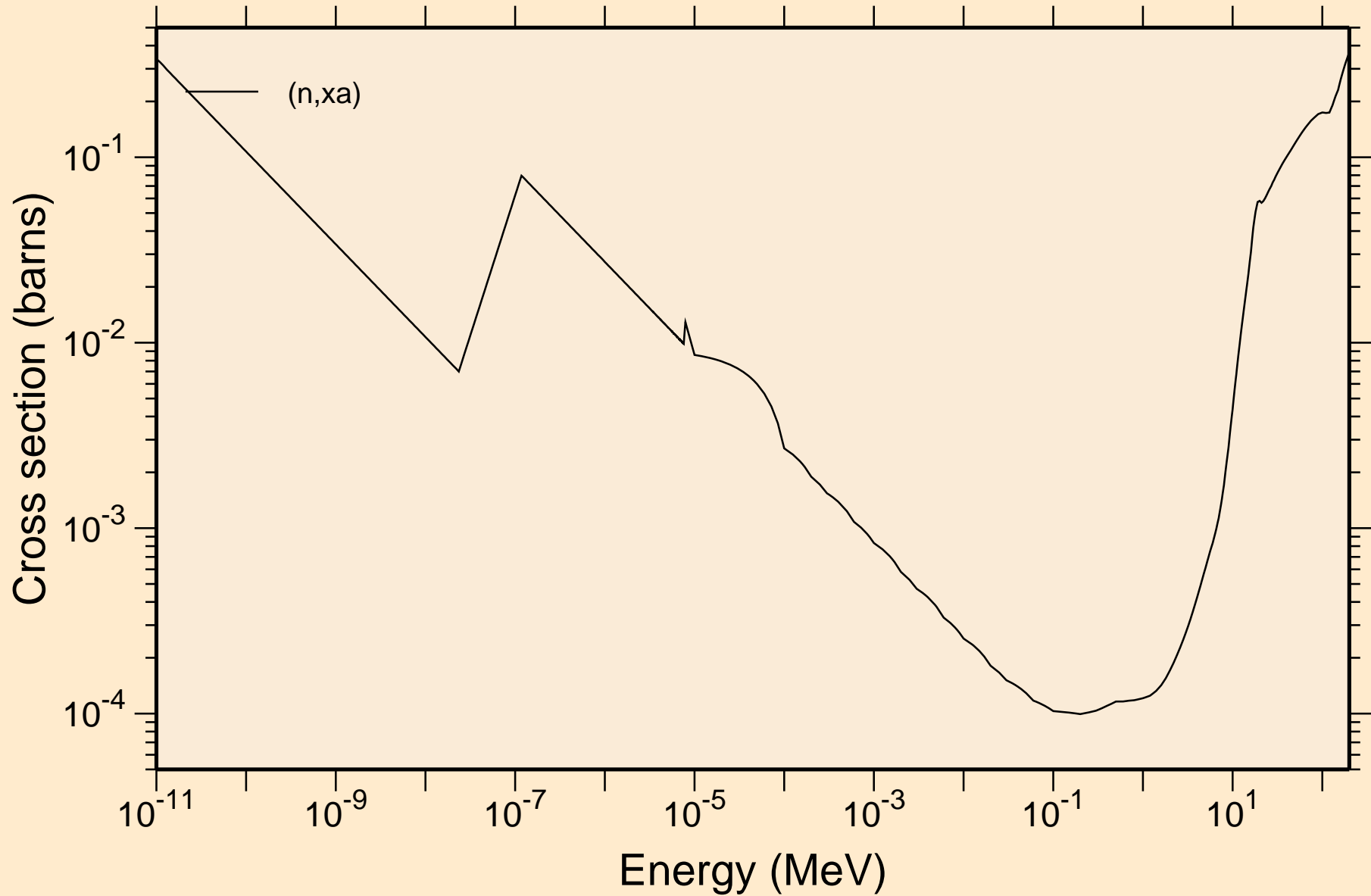

# HG189 NEUTRON ACER TENDL-2023 LIBRARY; T=0.K

## Principal cross sections

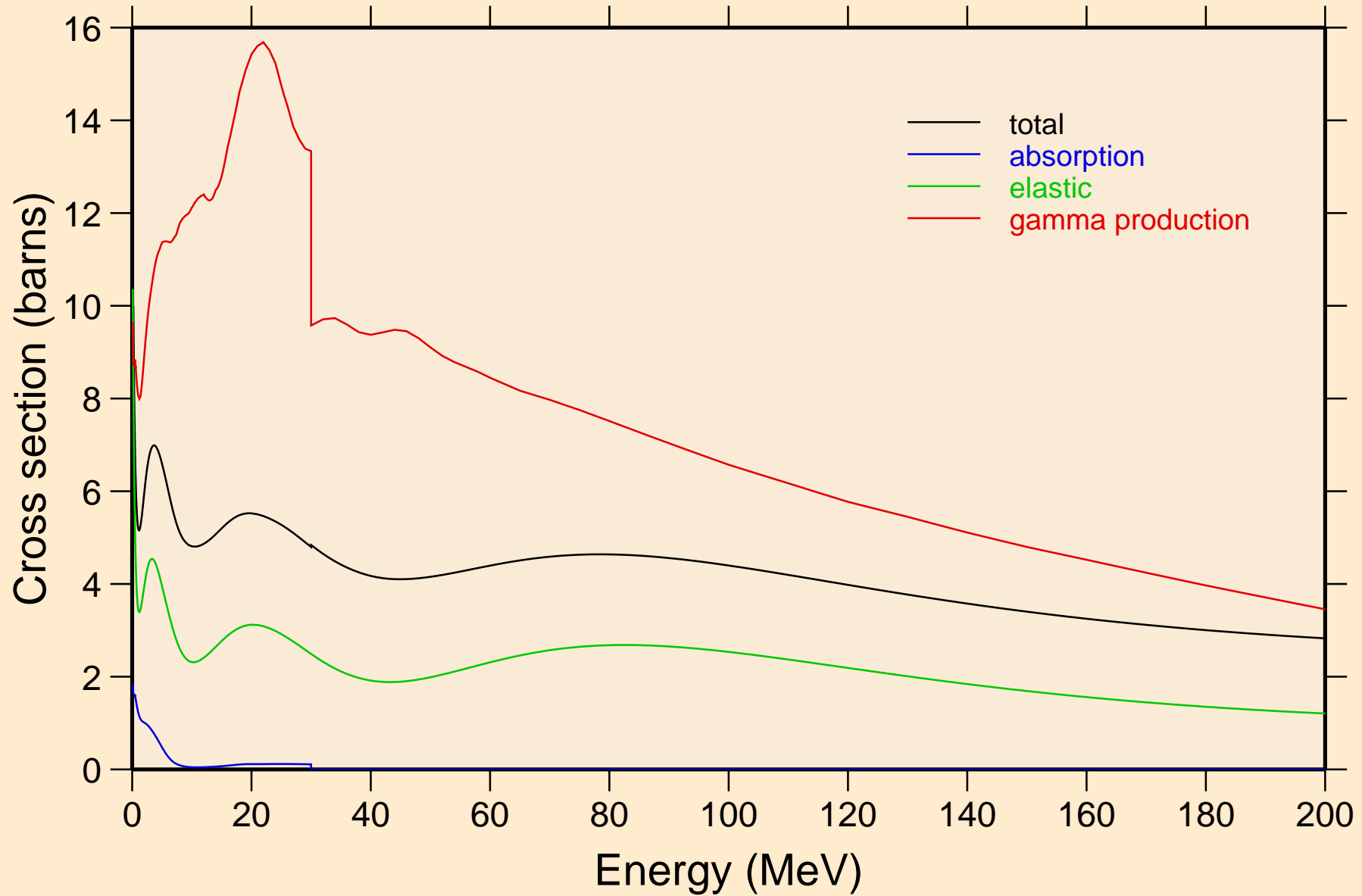

# HG189 NEUTRON ACER TENDL-2023 LIBRARY; T=0.K

## Heating

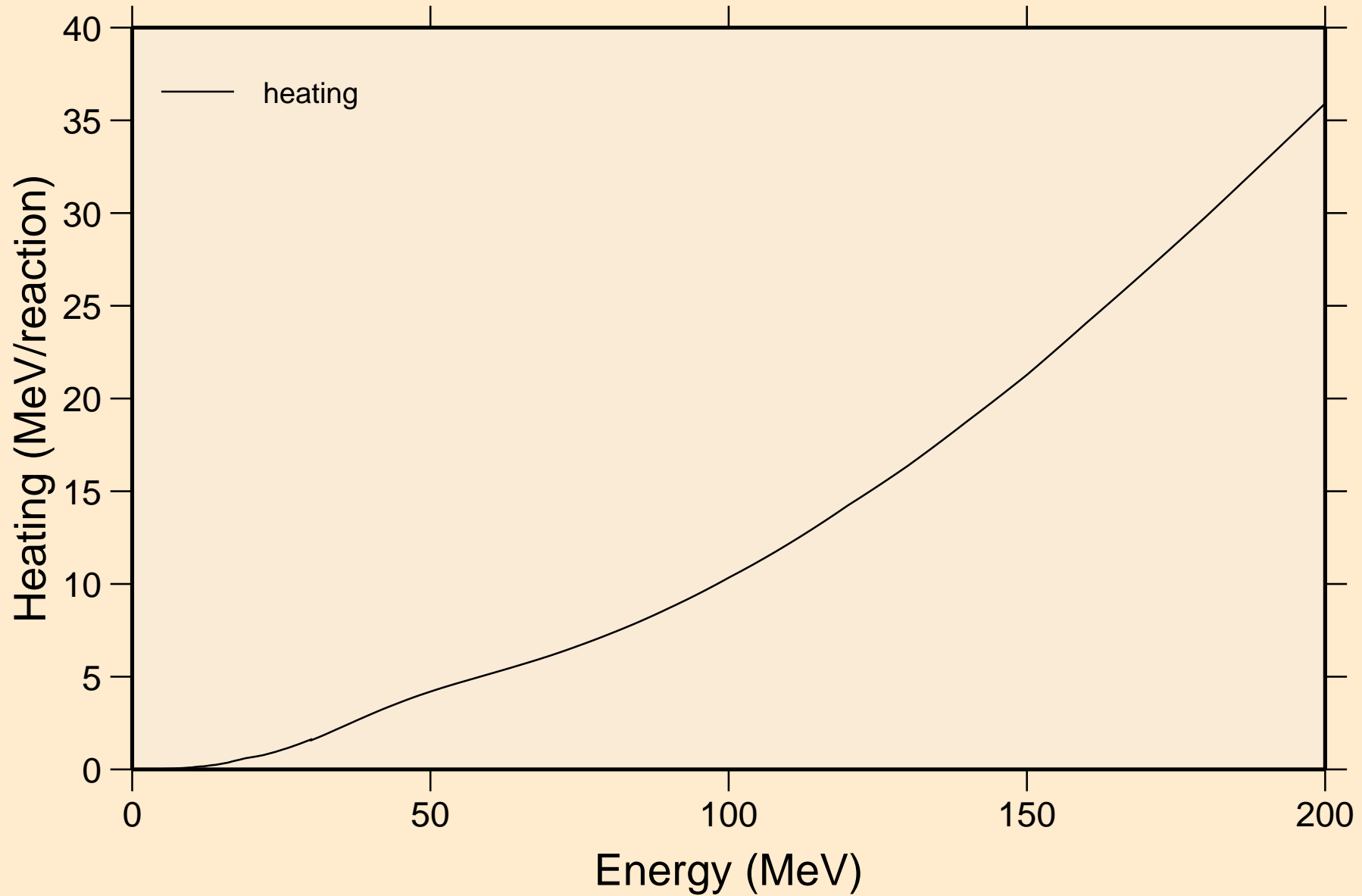

# HG189 NEUTRON ACER TENDL-2023 LIBRARY; T=0.K

## Damage

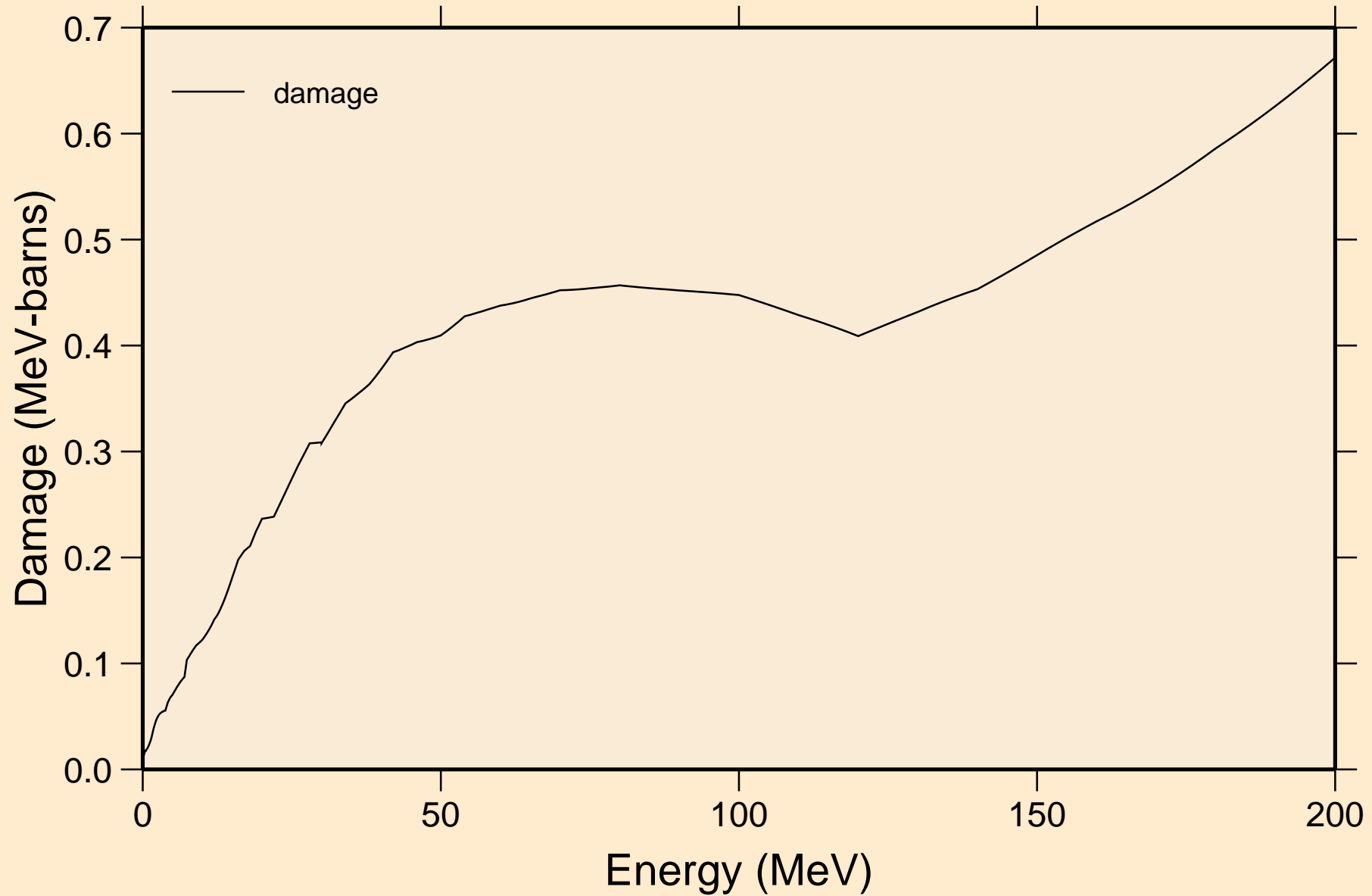



# HG189 NEUTRON ACER TENDL-2023 LIBRARY; T=0.K

## Non-threshold reactions

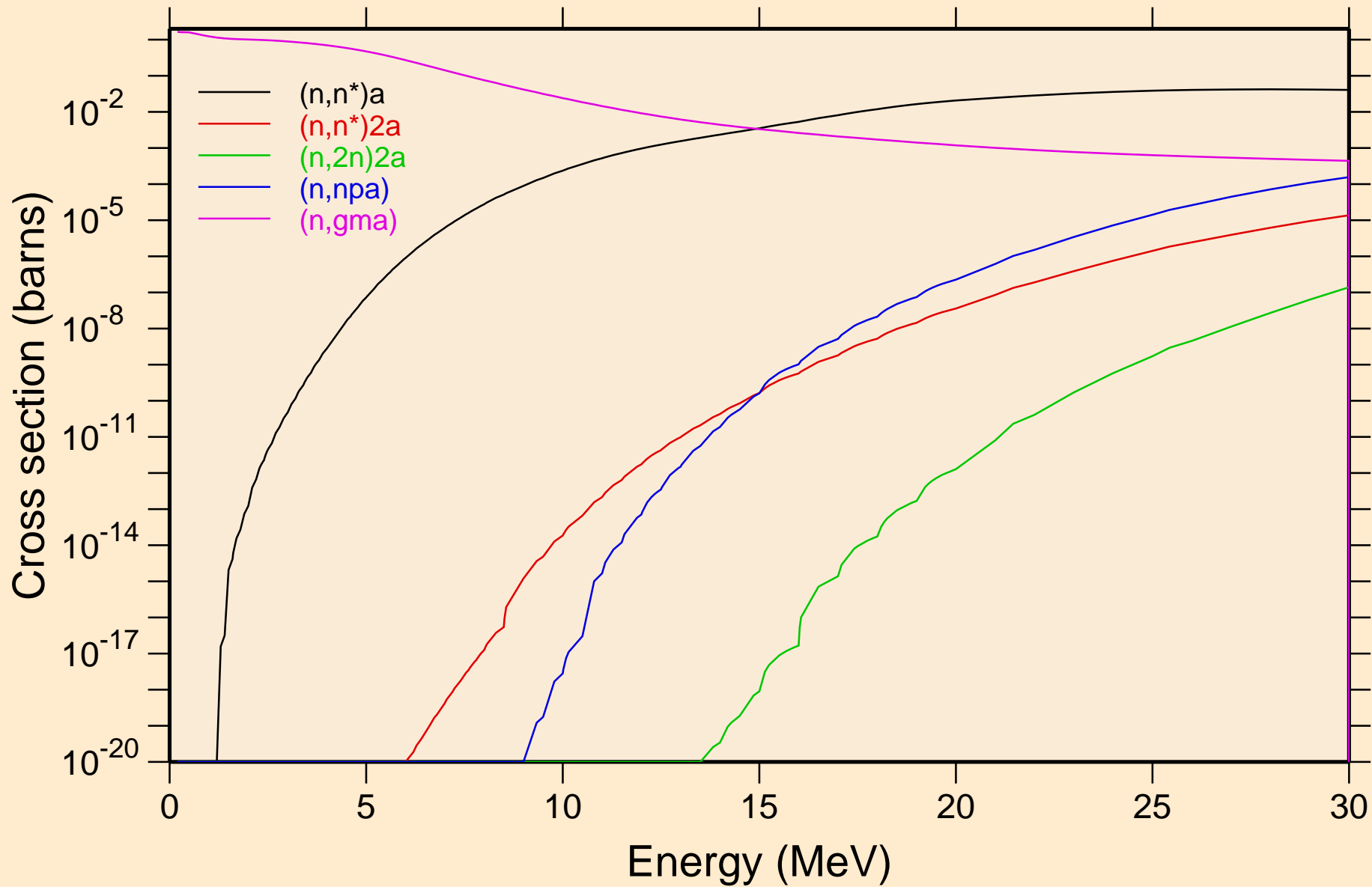

# HG189 NEUTRON ACER TENDL-2023 LIBRARY; T=0.K

## Non-threshold reactions

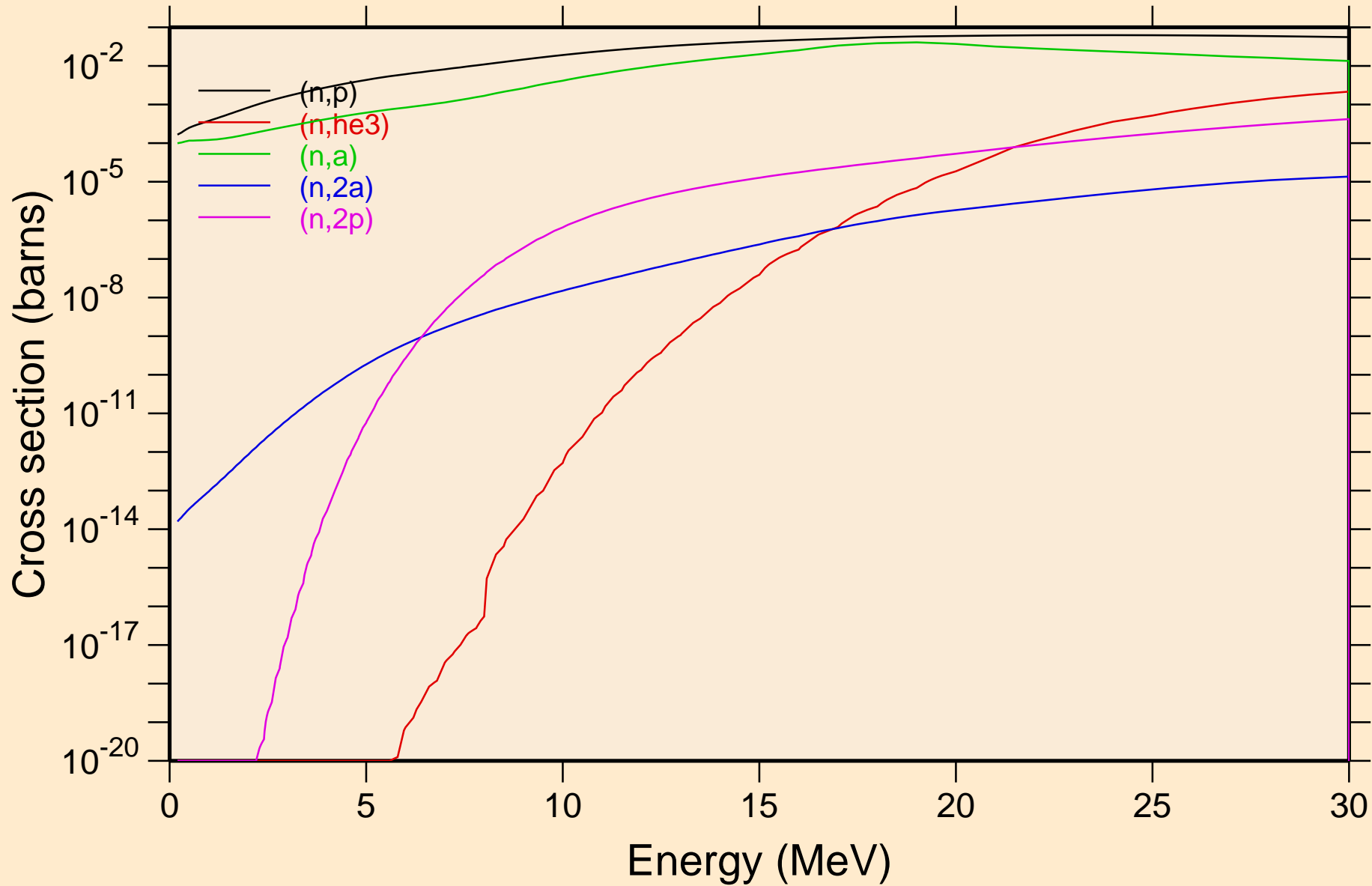

# HG189 NEUTRON ACER TENDL-2023 LIBRARY; T=0.K

## Non-threshold reactions

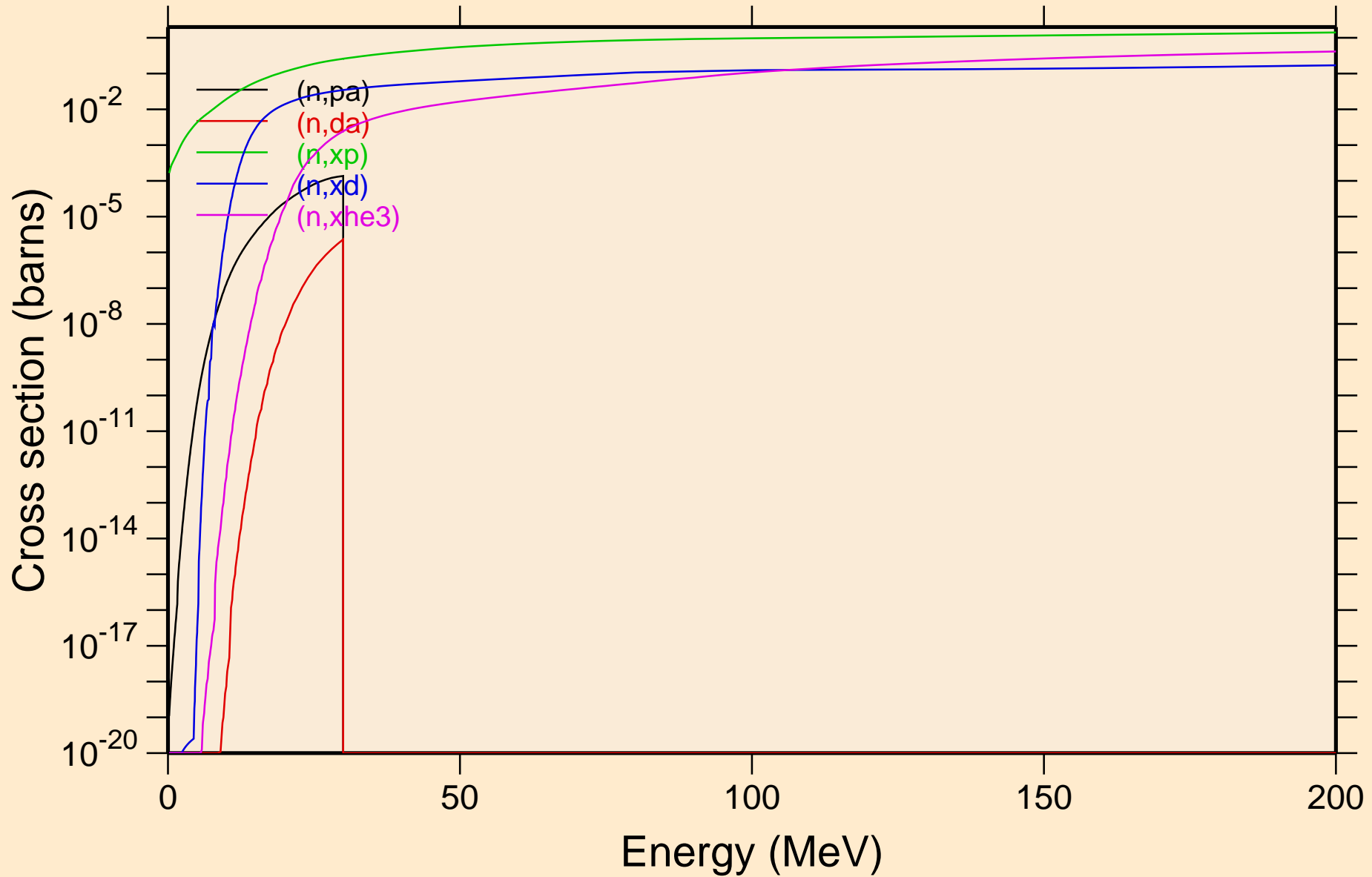

HG189 NEUTRON ACER TENDL-2023 LIBRARY; T=0.K  
Non-threshold reactions

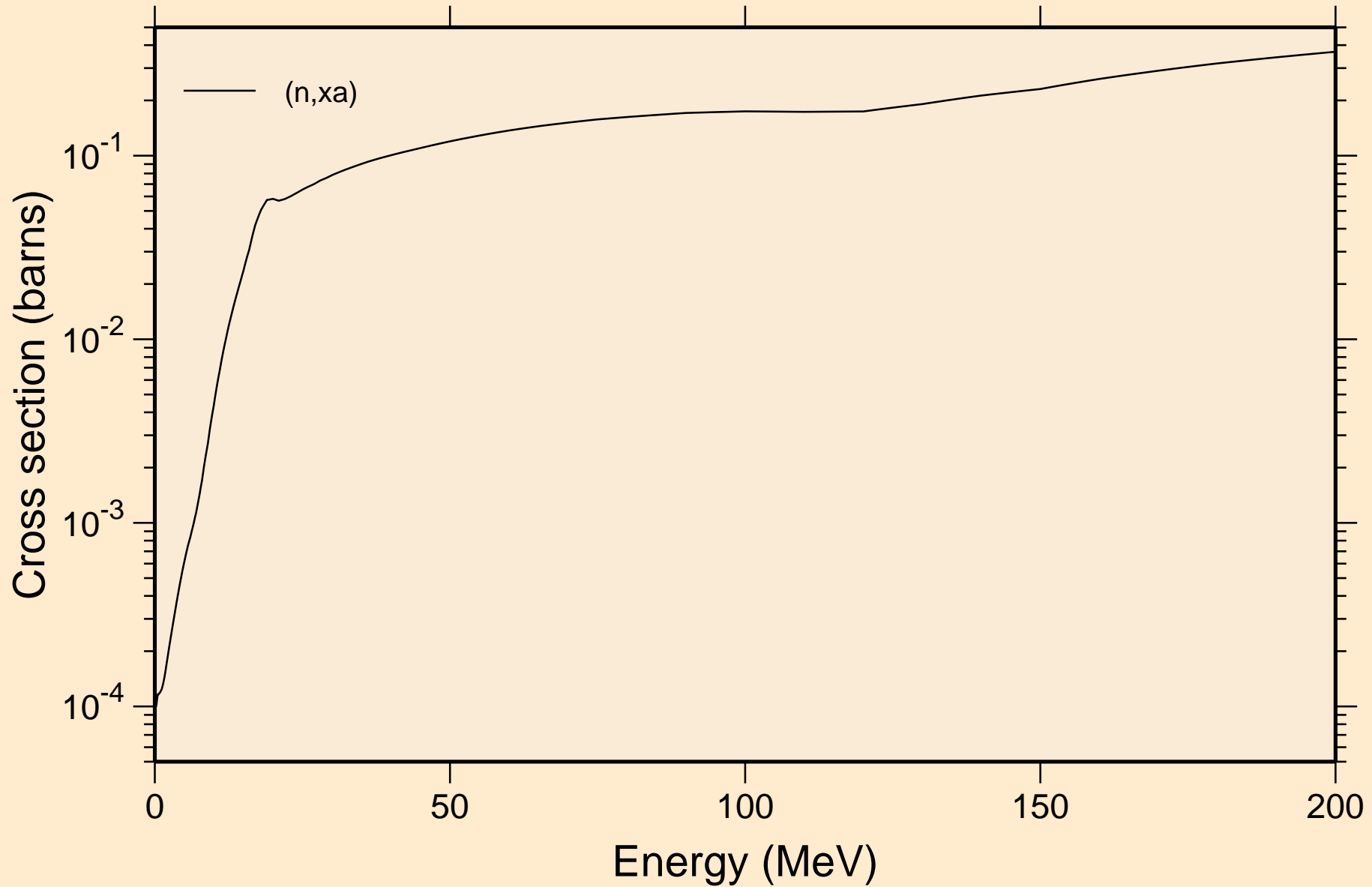

# HG189 NEUTRON ACER TENDL-2023 LIBRARY; T=0.K

## Inelastic levels

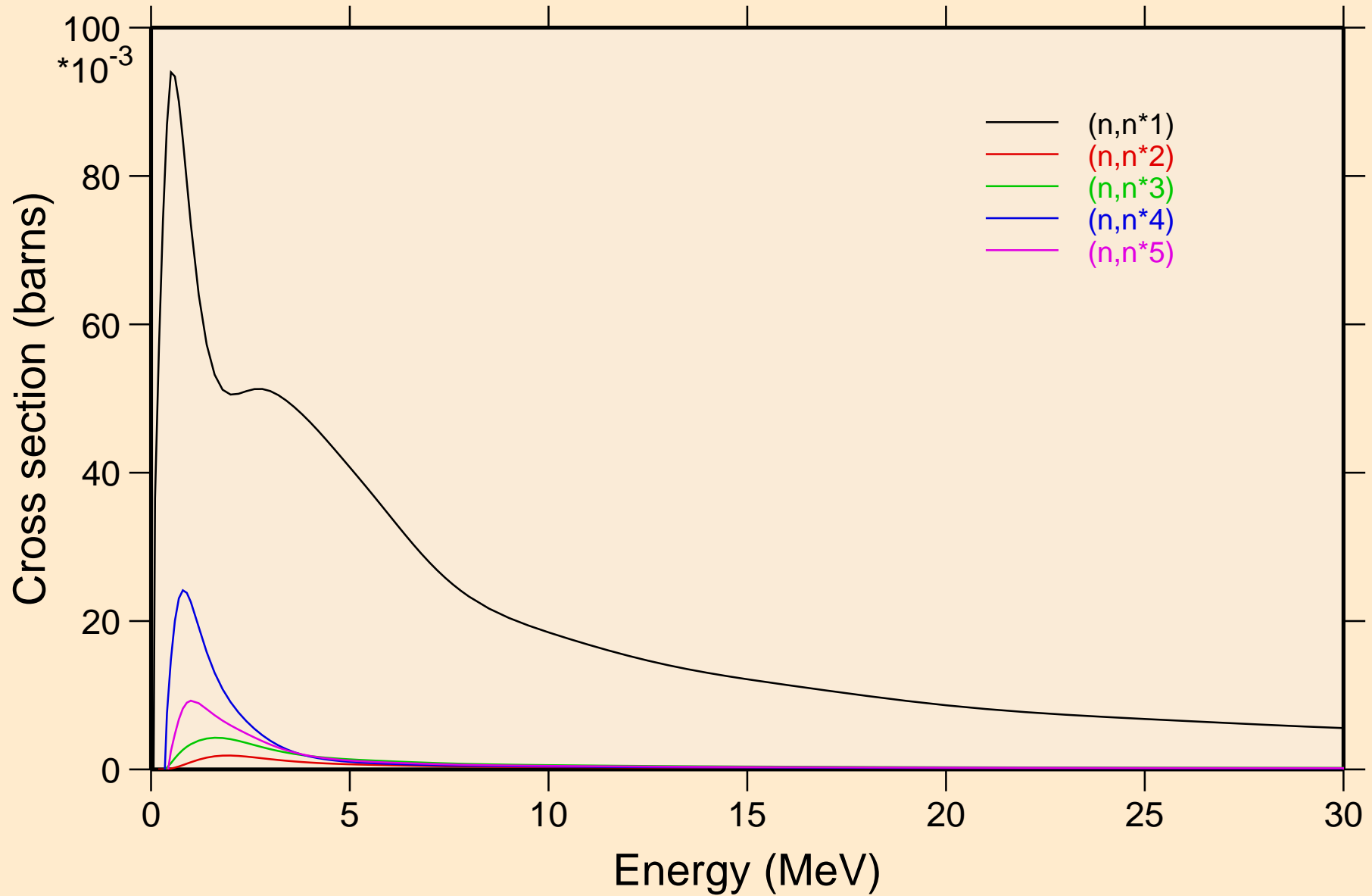

HG189 NEUTRON ACER TENDL-2023 LIBRARY; T=0.K  
Inelastic levels

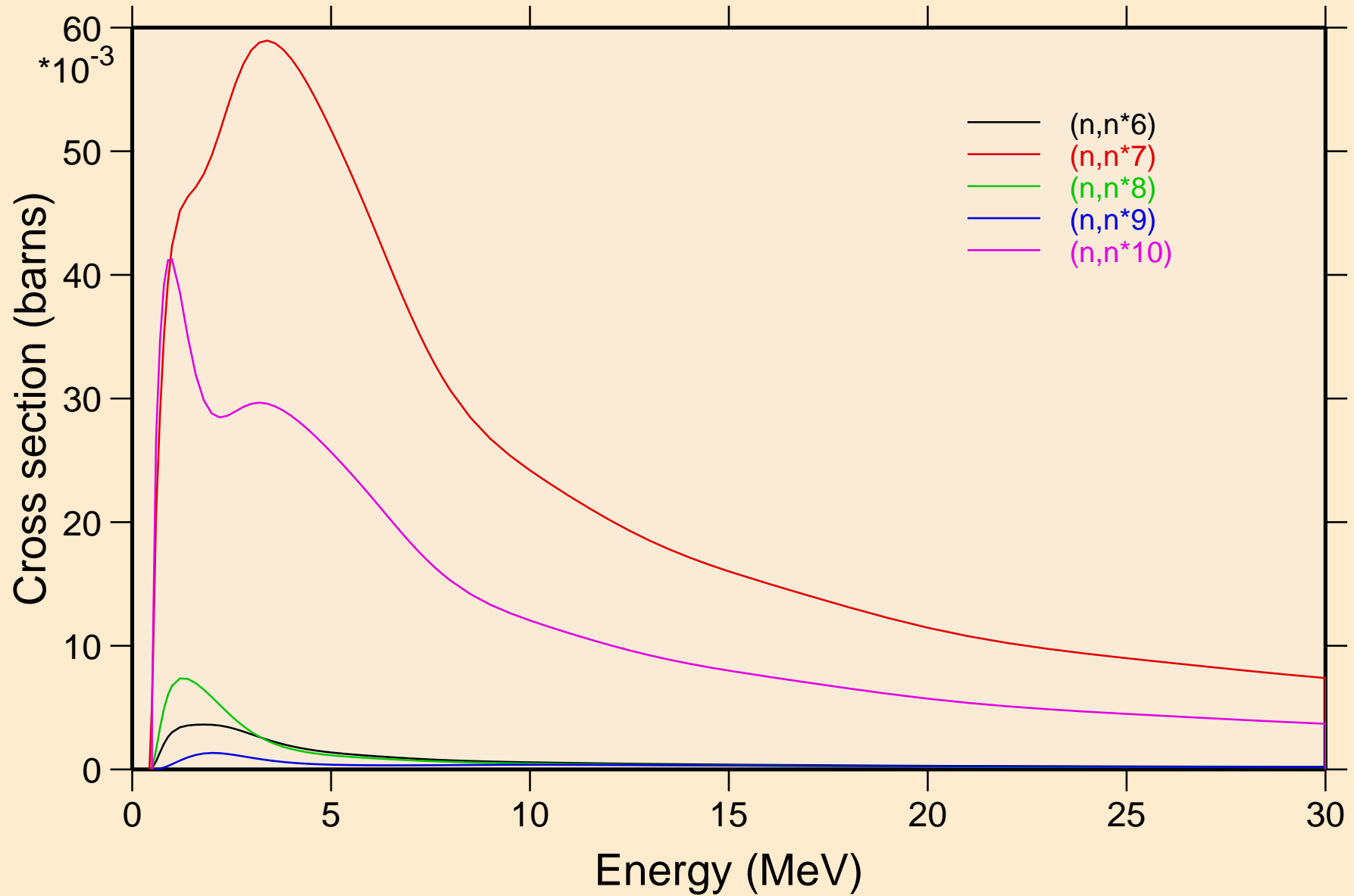

# HG189 NEUTRON ACER TENDL-2023 LIBRARY; T=0.K

## Inelastic levels

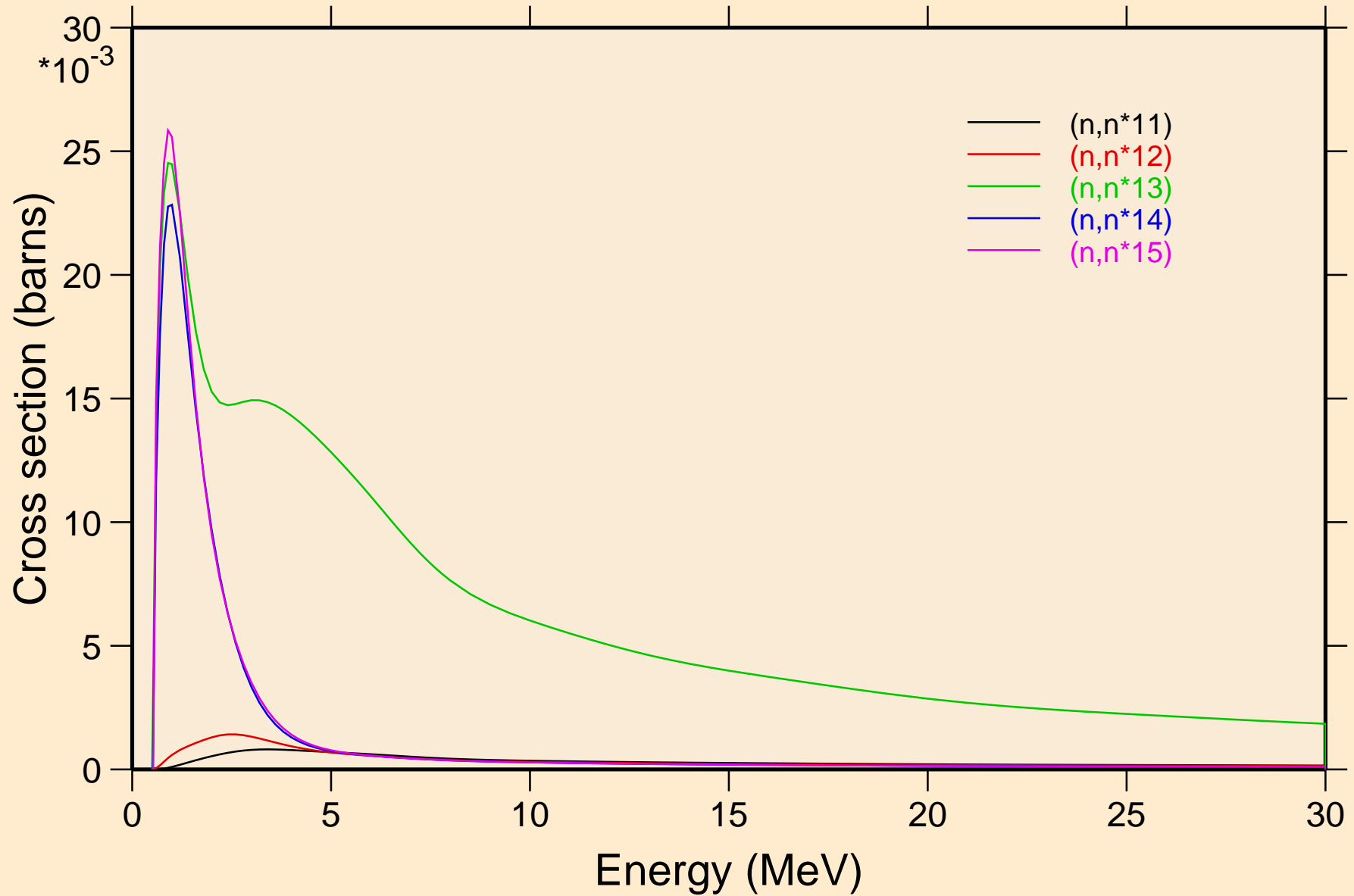

# HG189 NEUTRON ACER TENDL-2023 LIBRARY; T=0.K

## Inelastic levels

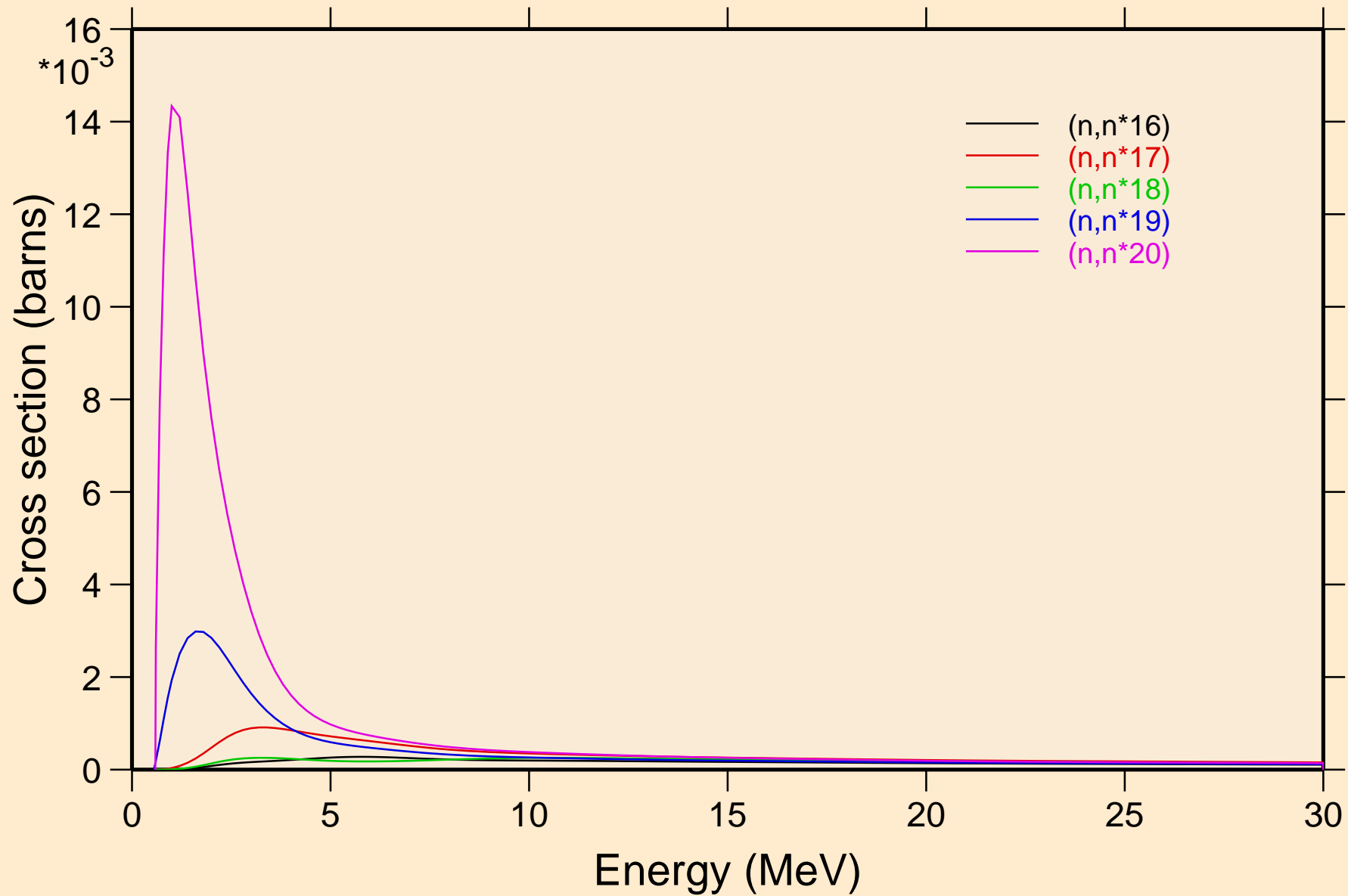



HG189 NEUTRON ACER TENDL-2023 LIBRARY; T=0.K  
Inelastic levels

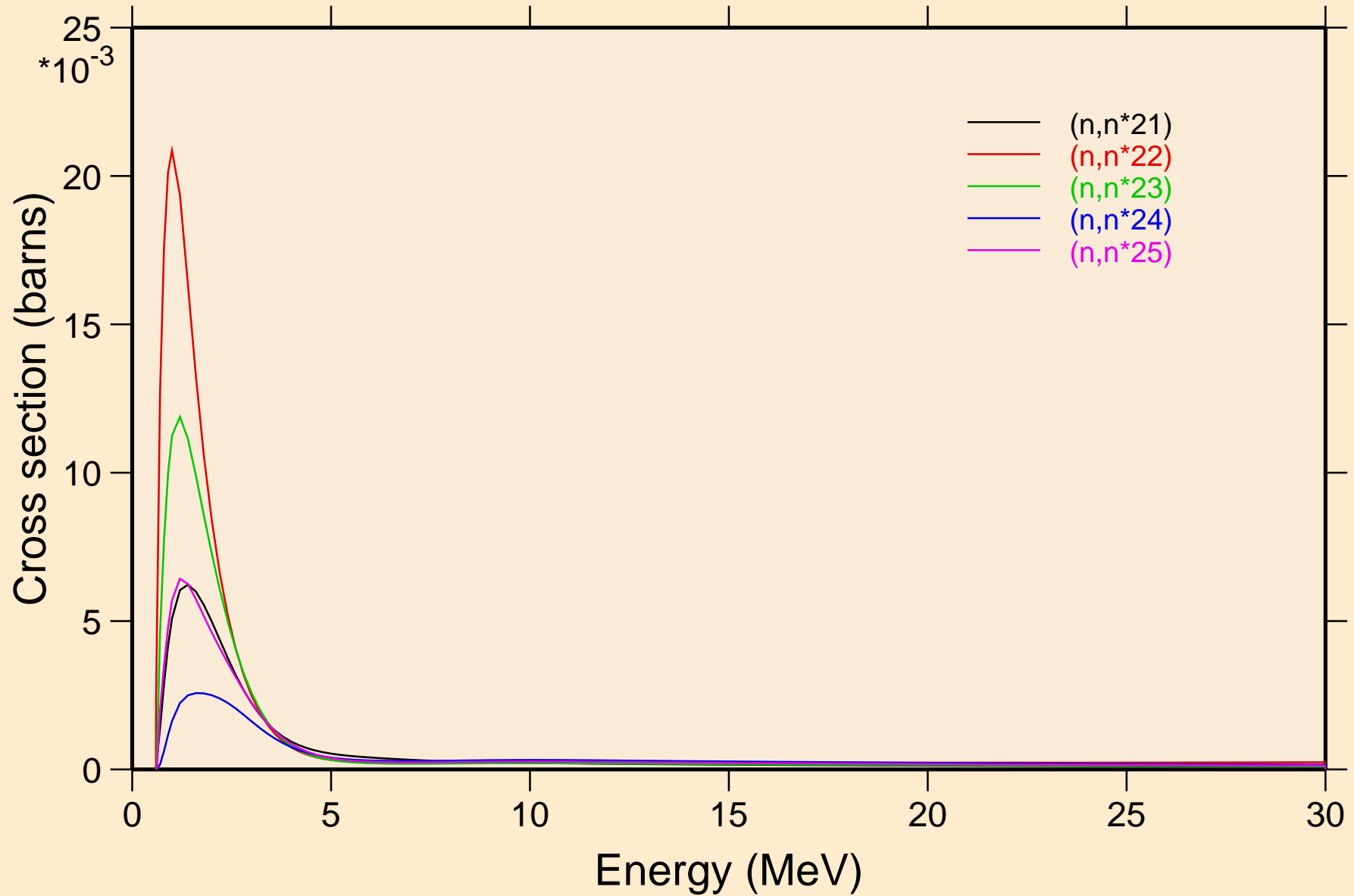

HG189 NEUTRON ACER TENDL-2023 LIBRARY; T=0.K  
Inelastic levels

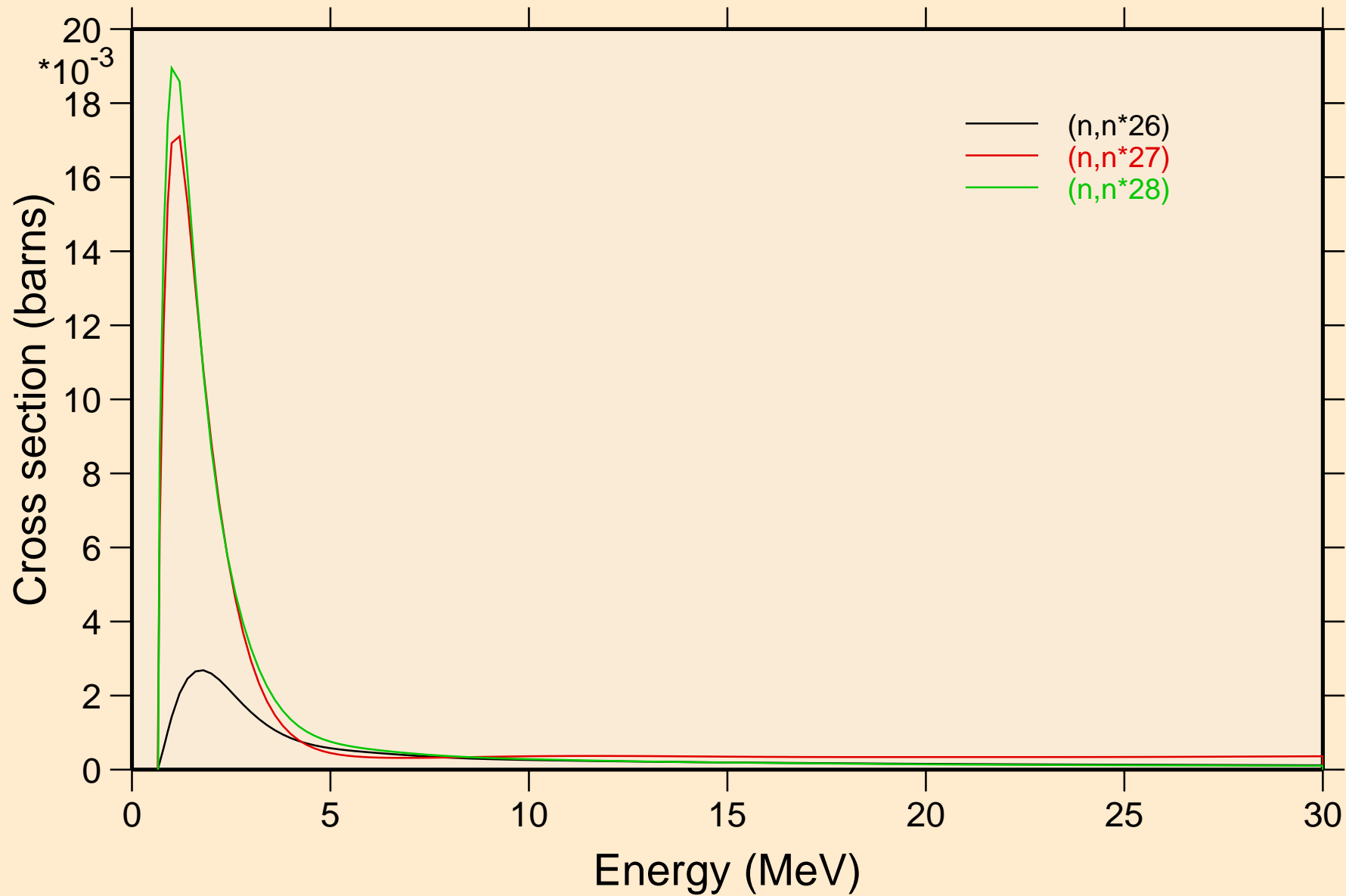

# HG189 NEUTRON ACER TENDL-2023 LIBRARY; T=0.K

## Threshold reactions

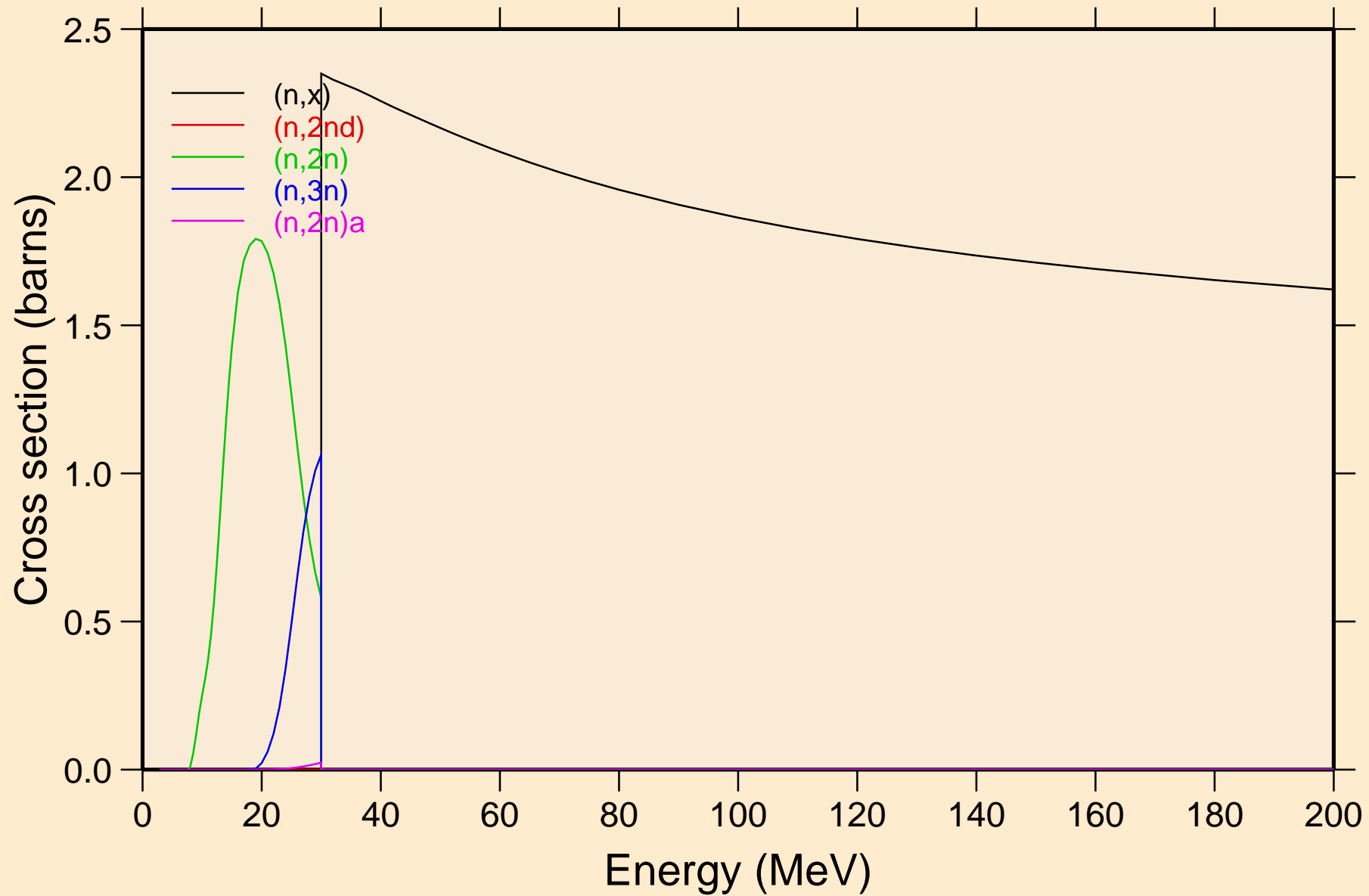

# HG189 NEUTRON ACER TENDL-2023 LIBRARY; T=0.K

## Threshold reactions

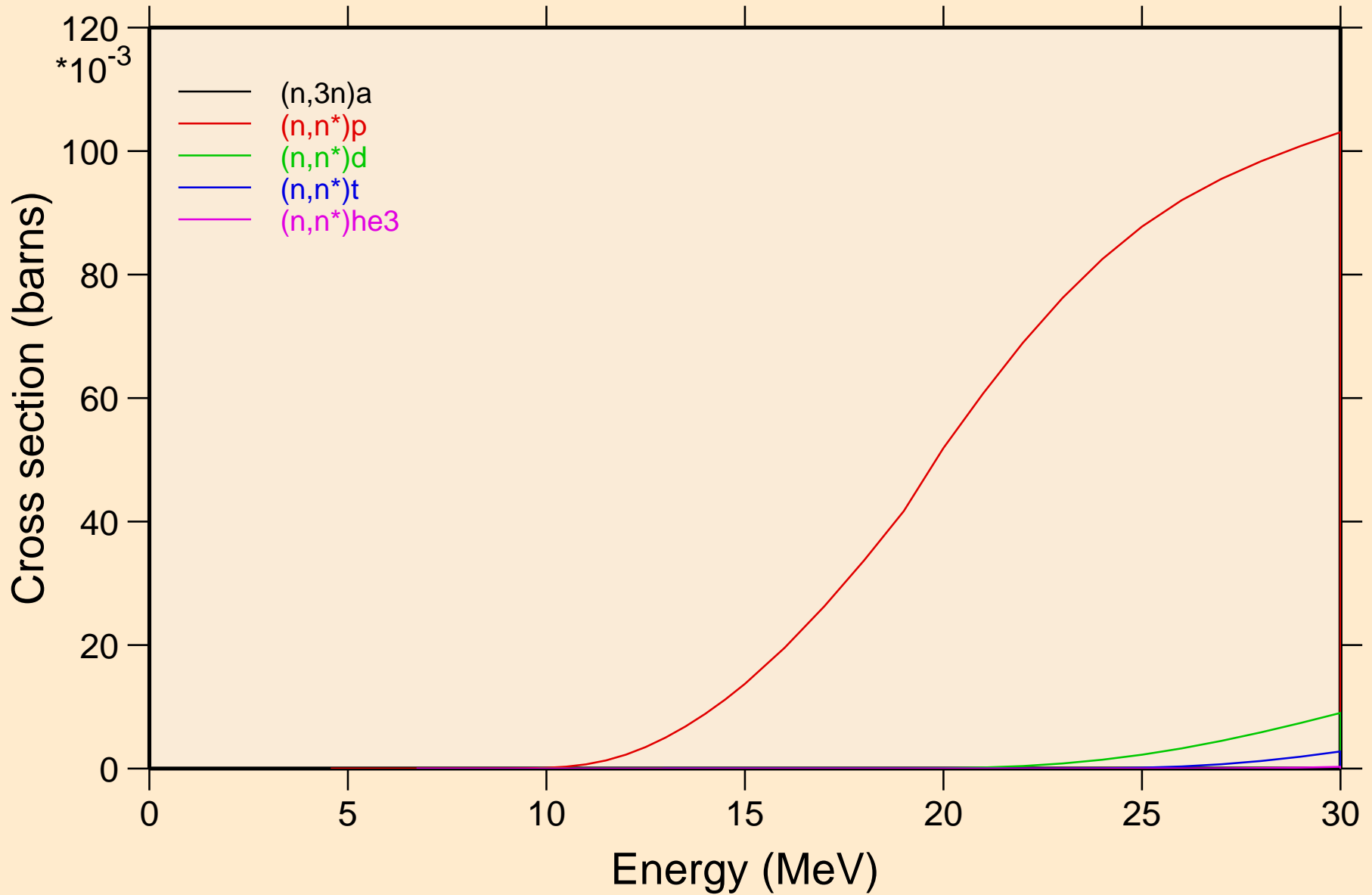

# HG189 NEUTRON ACER TENDL-2023 LIBRARY; T=0.K

## Threshold reactions

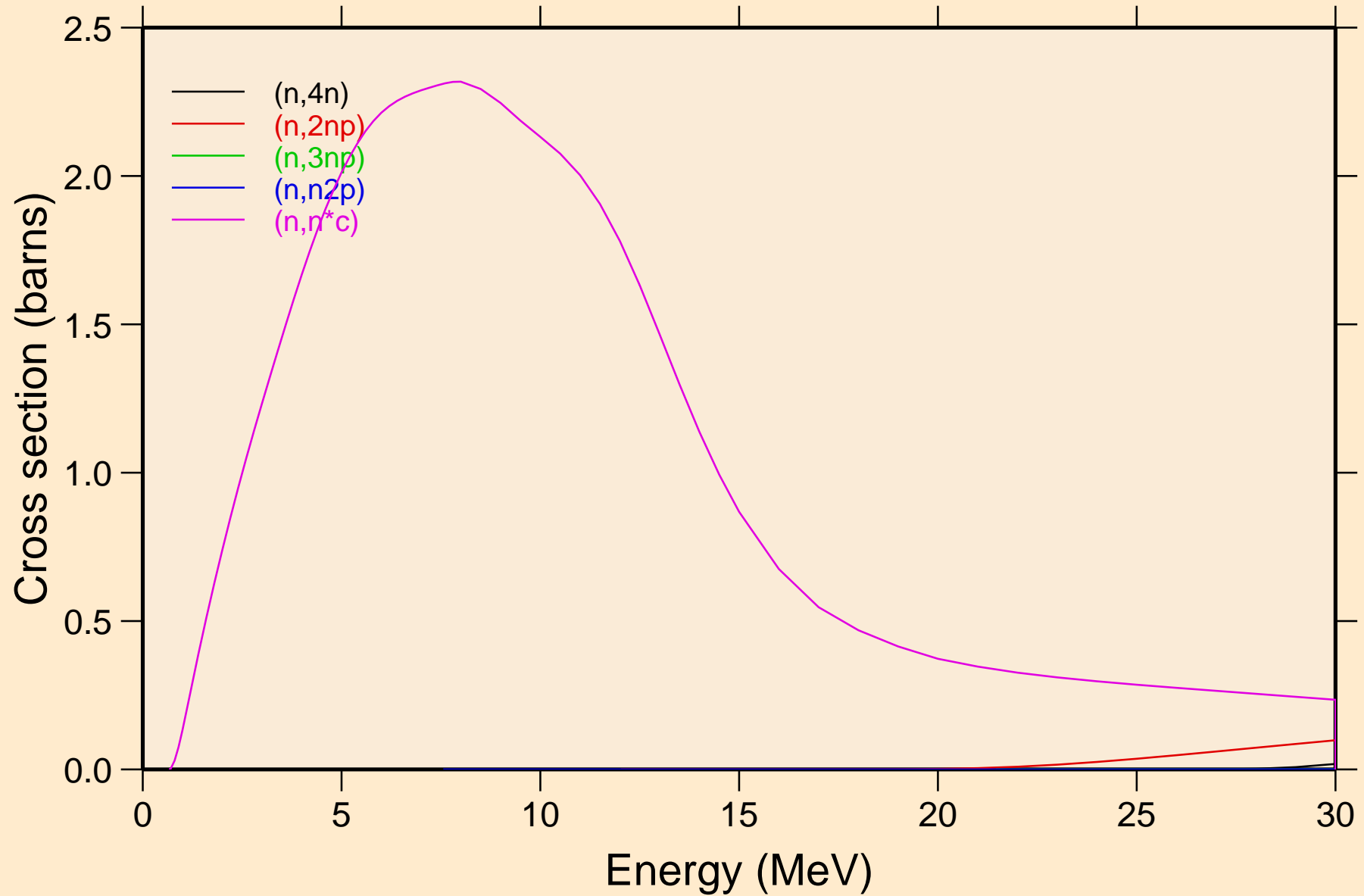

# HG189 NEUTRON ACER TENDL-2023 LIBRARY; T=0.K

## Threshold reactions

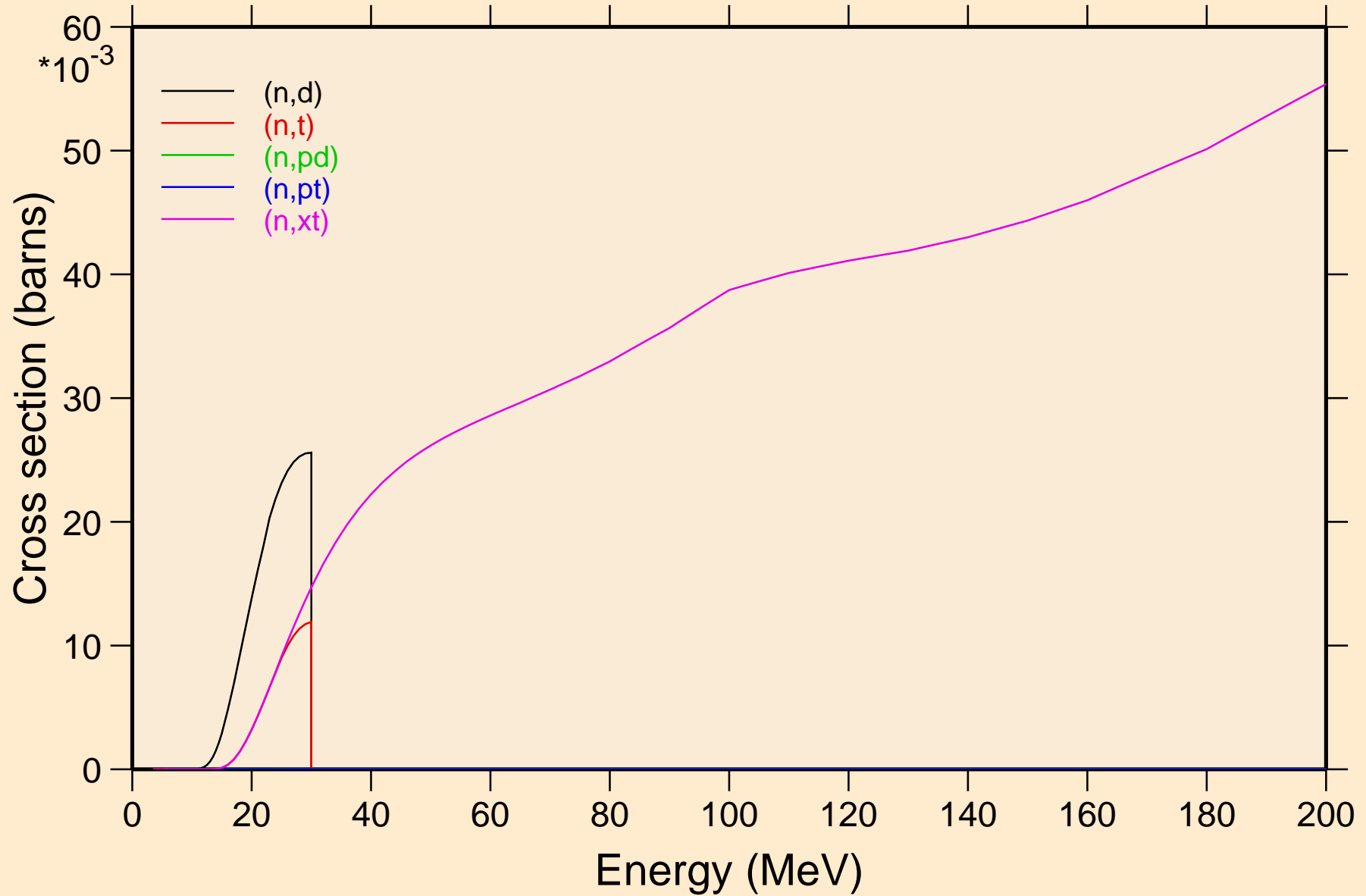

HG189 NEUTRON ACER TENDL-2023 LIBRARY; T=0.K  
angular distribution for elastic

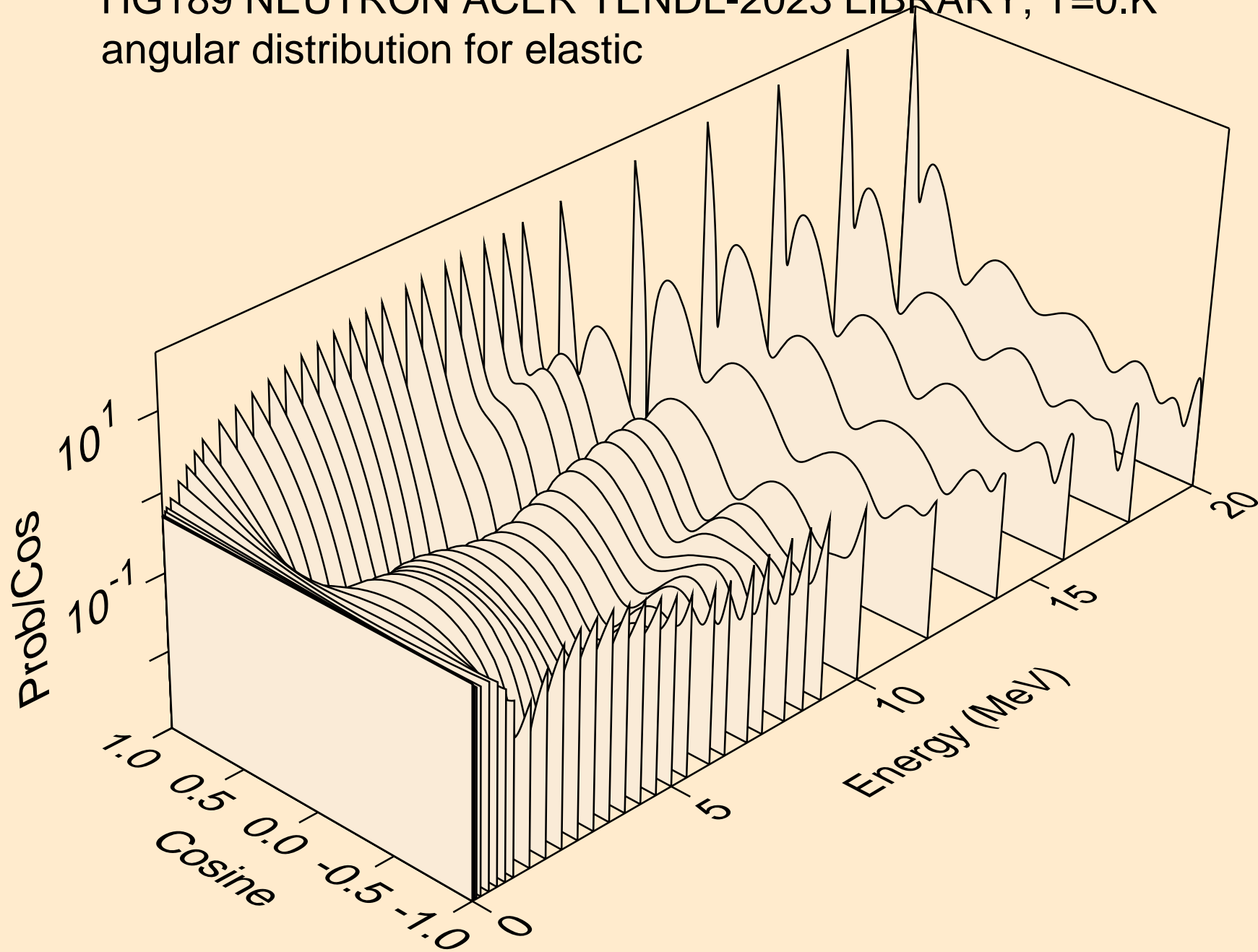

HG189 NEUTRON ACER TENDL-2023 LIBRARY; T=0.K  
angular distribution for elastic

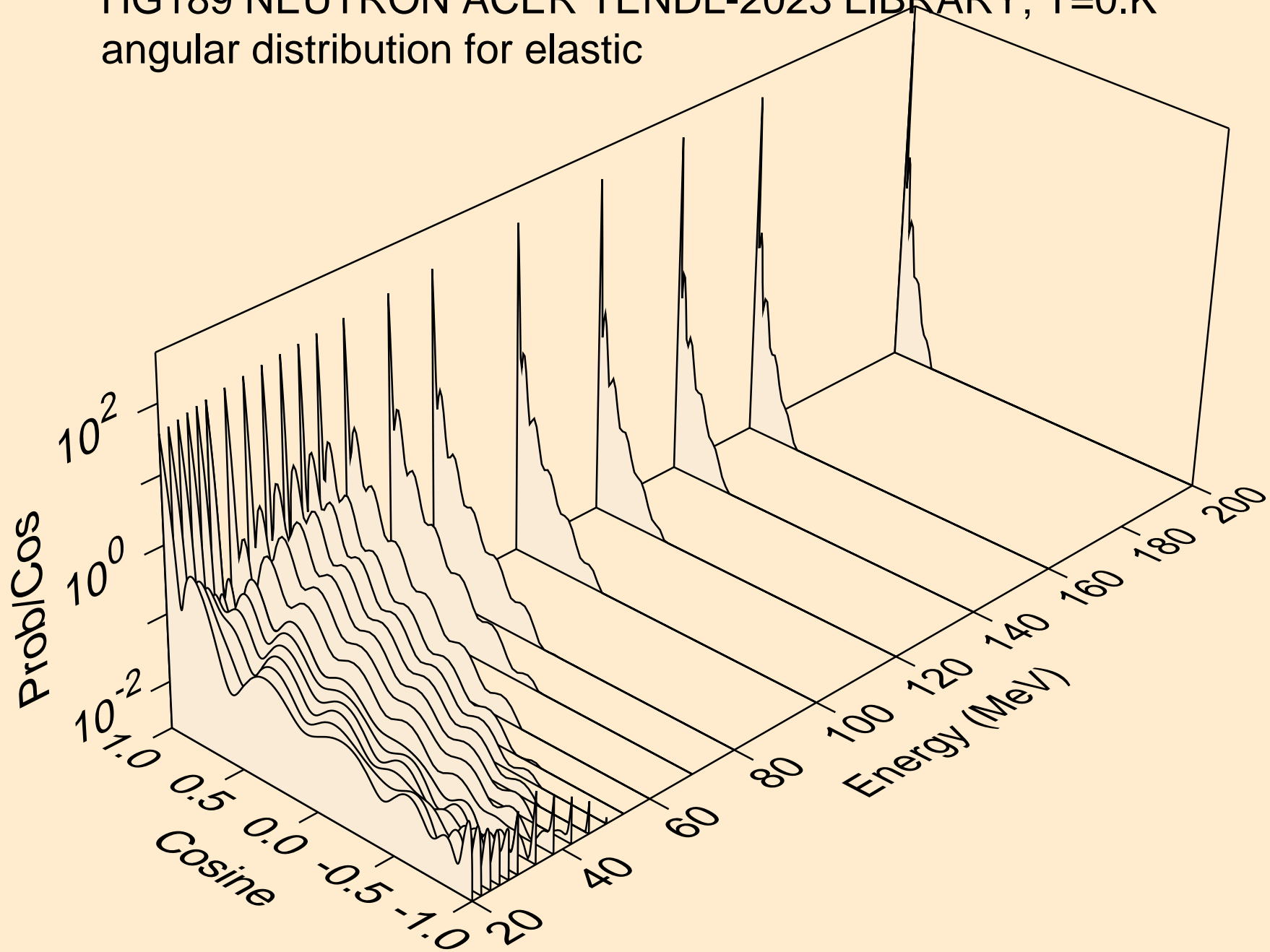



HG189 NEUTRON ACER TENDL-2023 LIBRARY; T=0.K  
angular distribution for (n,n\*1)

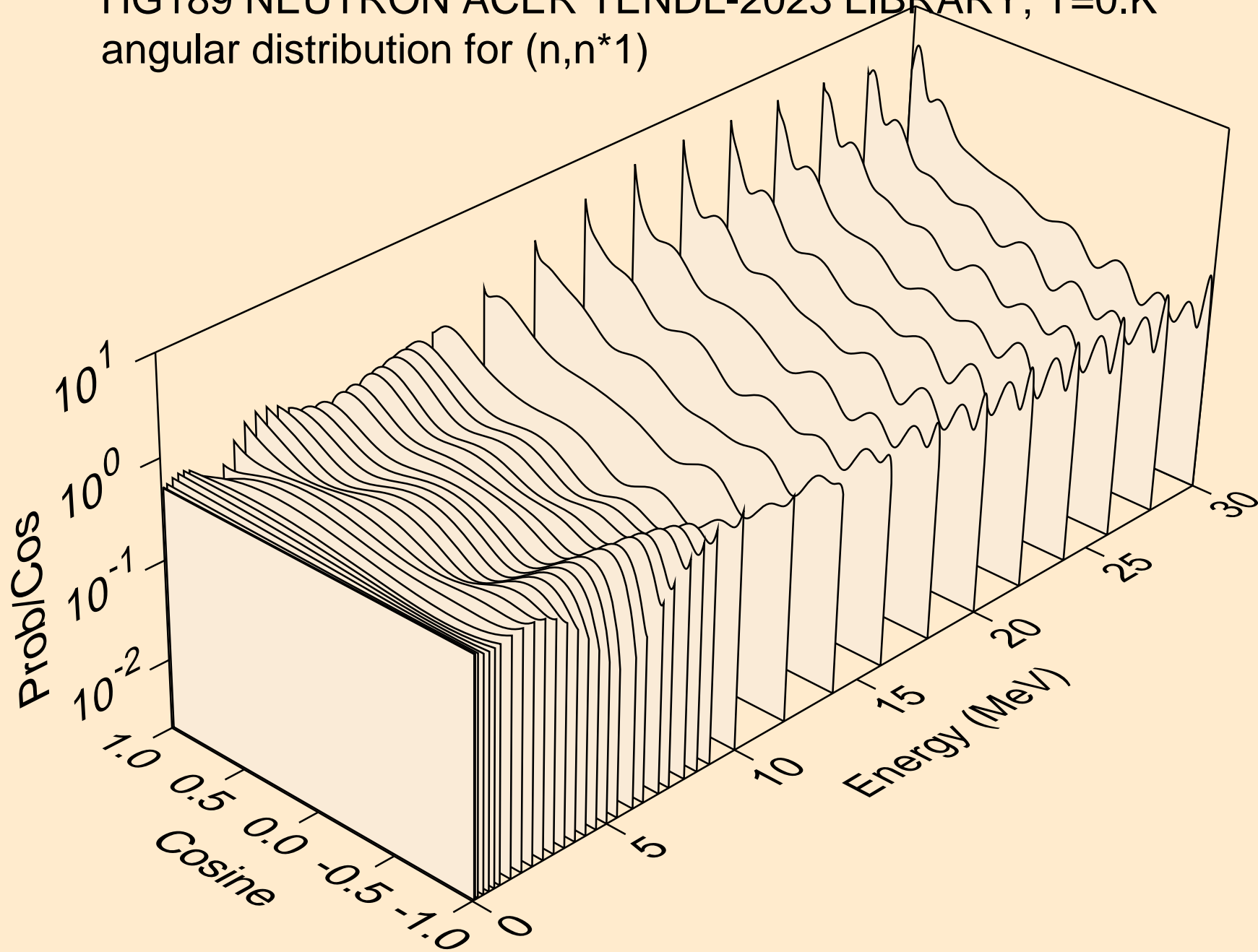

HG189 NEUTRON ACER TENDL-2023 LIBRARY; T=0.K  
angular distribution for (n,n\*2)

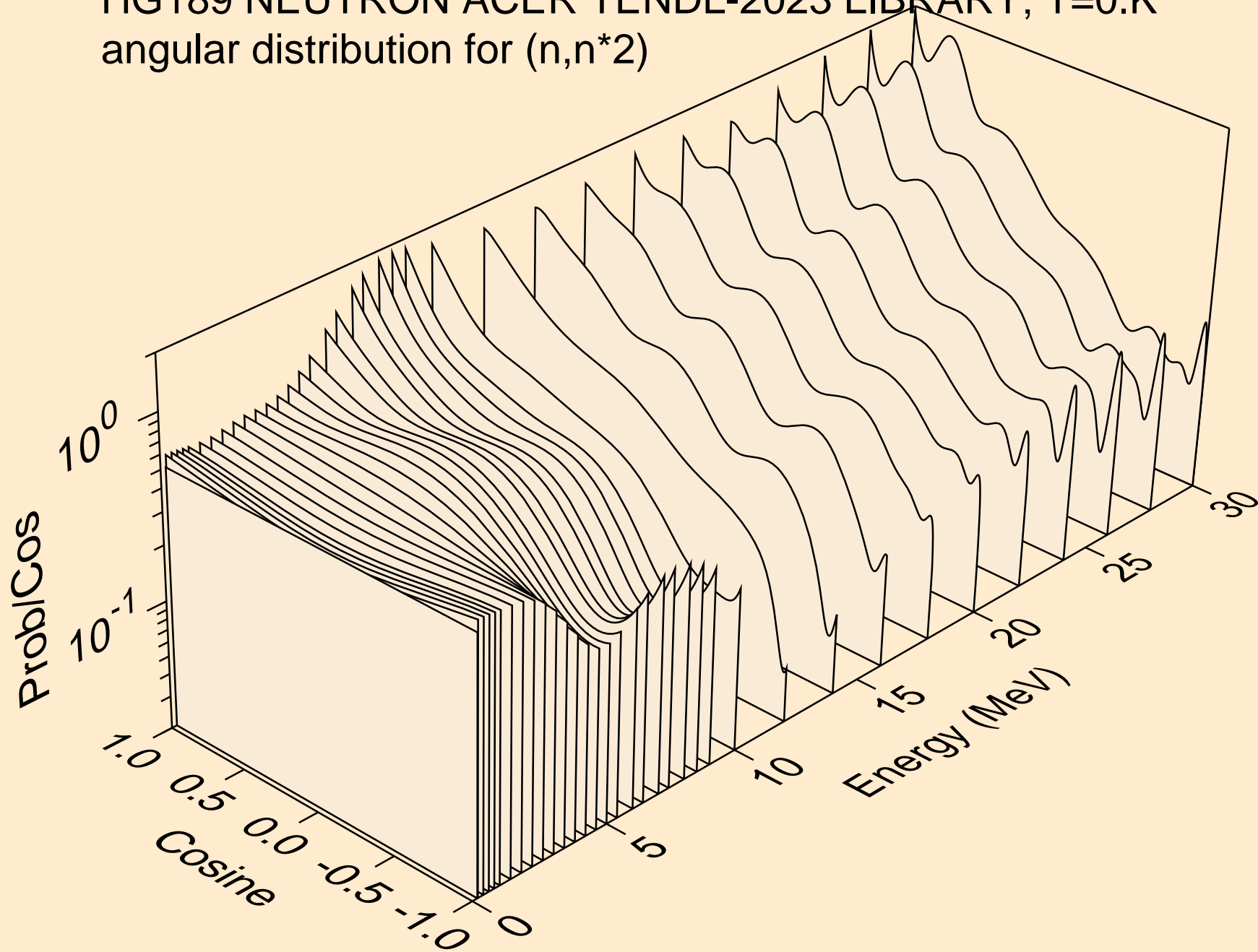

HG189 NEUTRON ACER TENDL-2023 LIBRARY; T=0.K  
angular distribution for (n,n\*3)

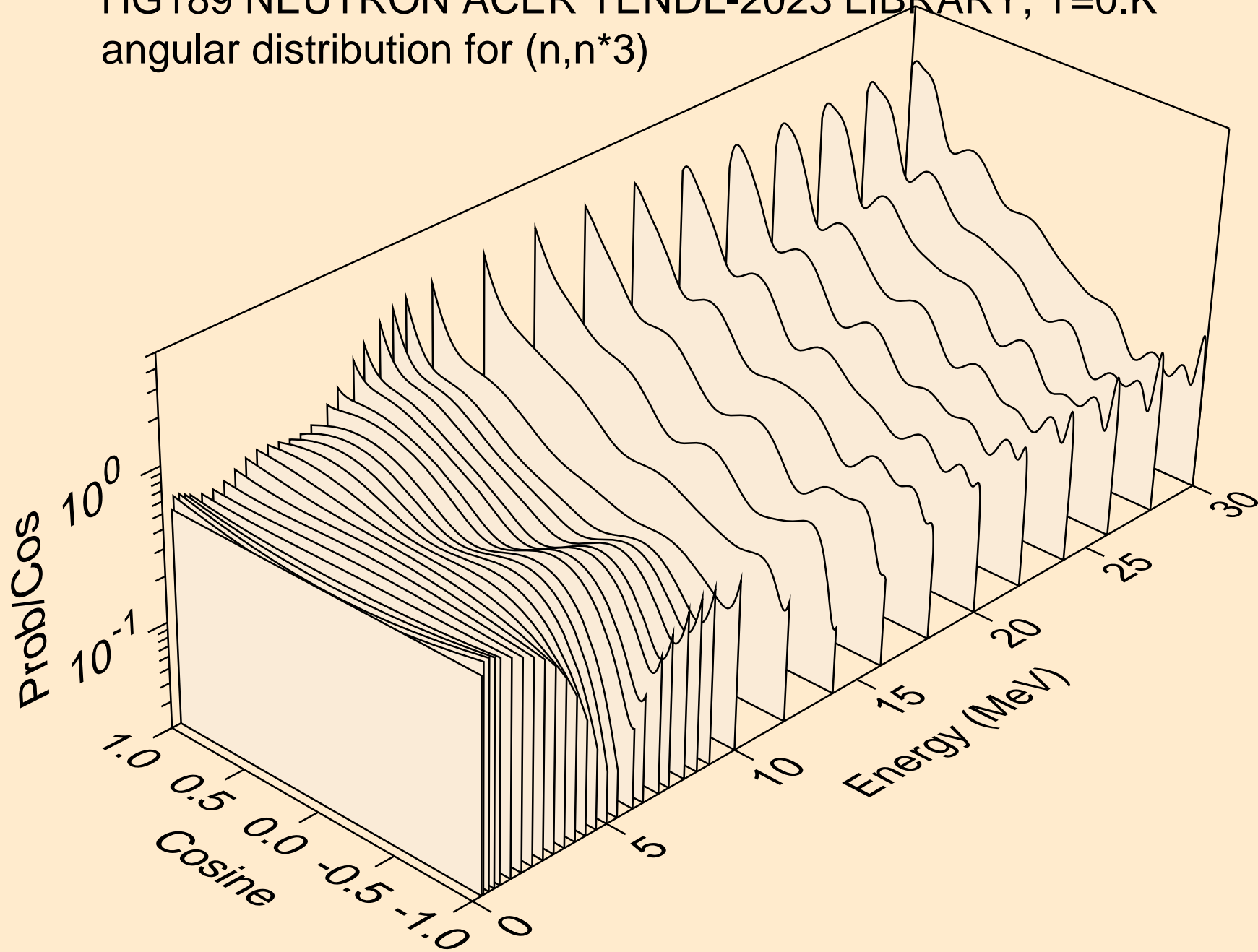

HG189 NEUTRON ACER TENDL-2023 LIBRARY; T=0.K  
angular distribution for (n,n\*4)

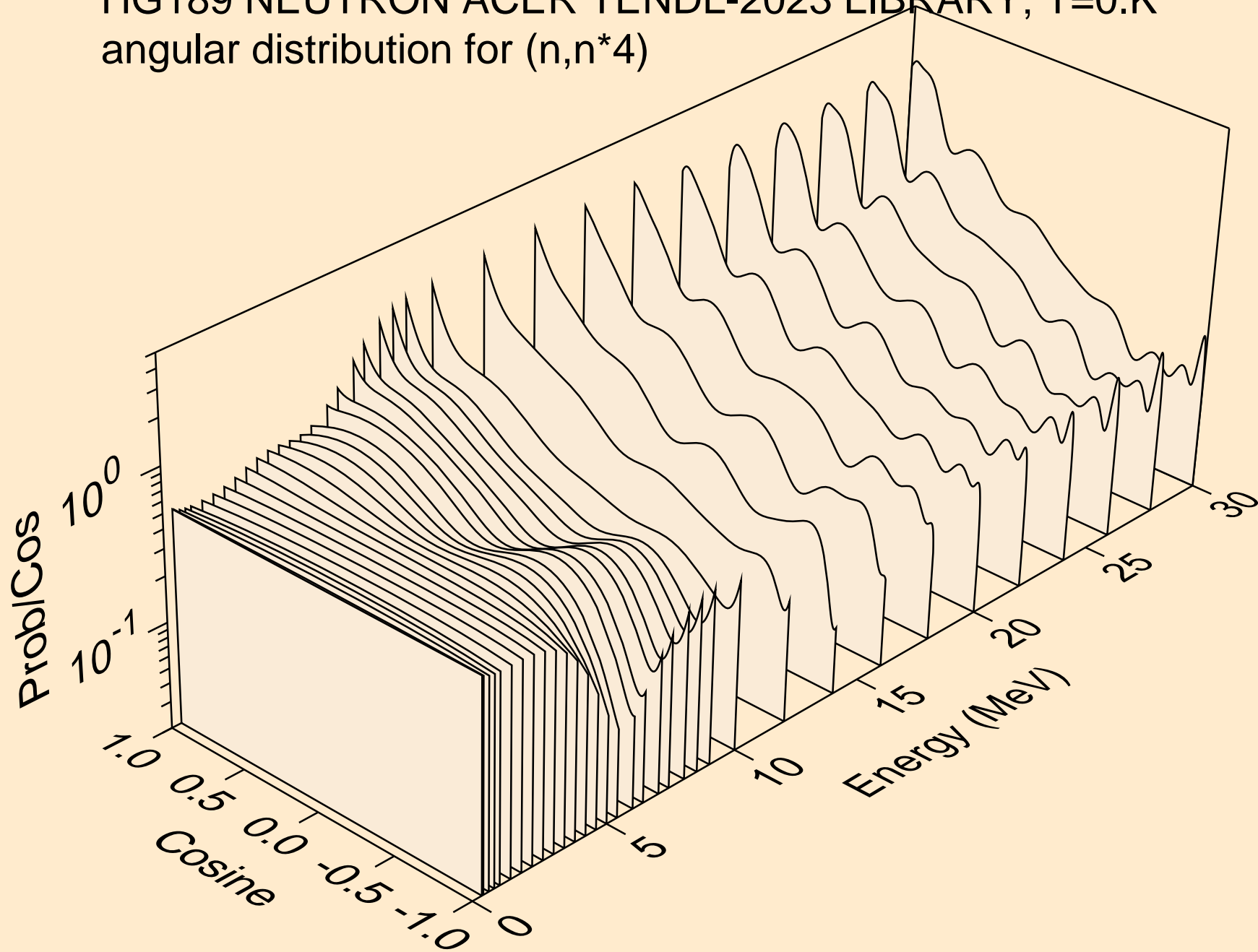

HG189 NEUTRON ACER TENDL-2023 LIBRARY; T=0.K  
angular distribution for (n,n\*5)

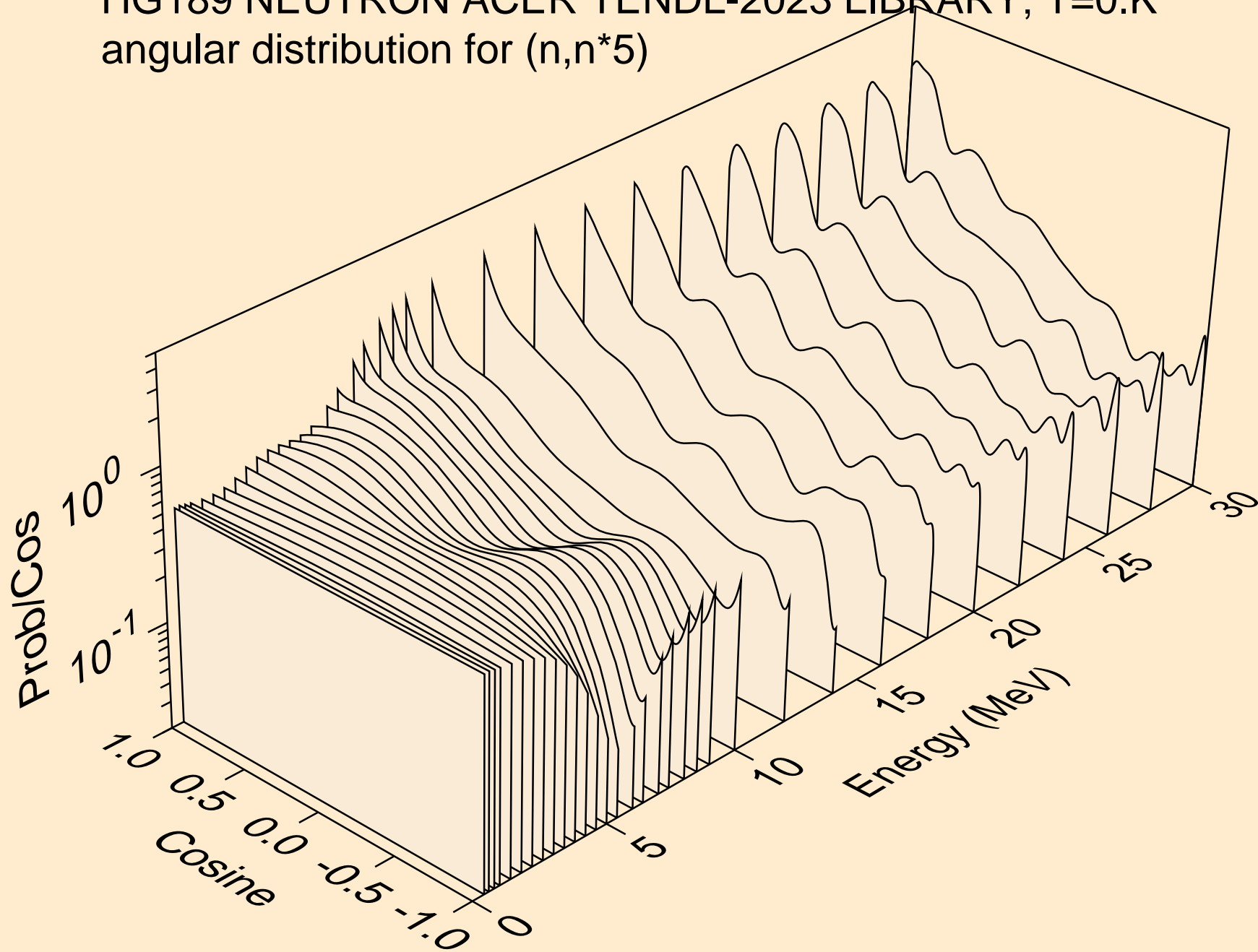

HG189 NEUTRON ACER TENDL-2023 LIBRARY; T=0.K  
angular distribution for (n,n\*6)

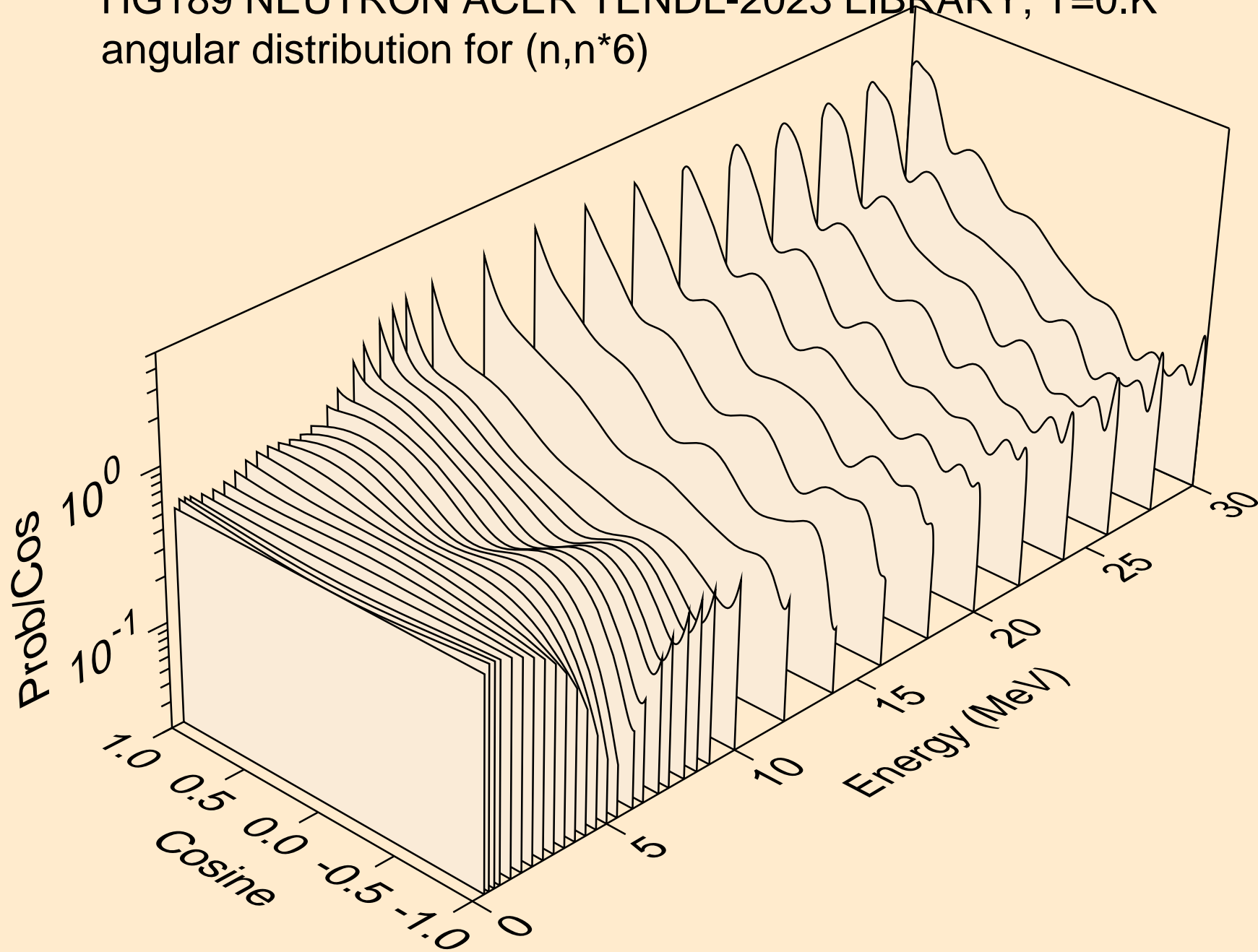

HG189 NEUTRON ACER TENDL-2023 LIBRARY; T=0.K  
angular distribution for (n,n\*7)

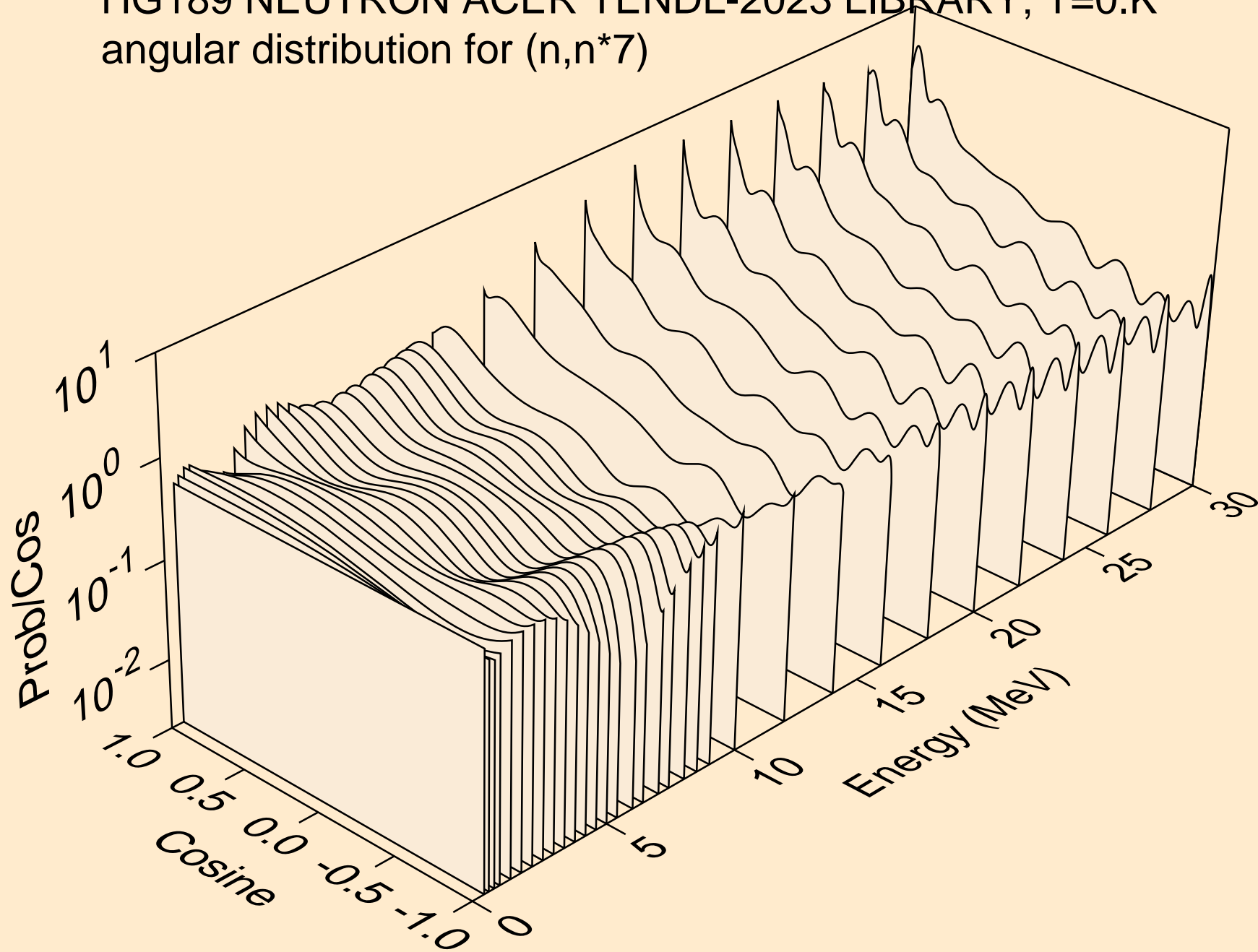



HG189 NEUTRON ACER TENDL-2023 LIBRARY; T=0.K  
angular distribution for (n,n\*8)

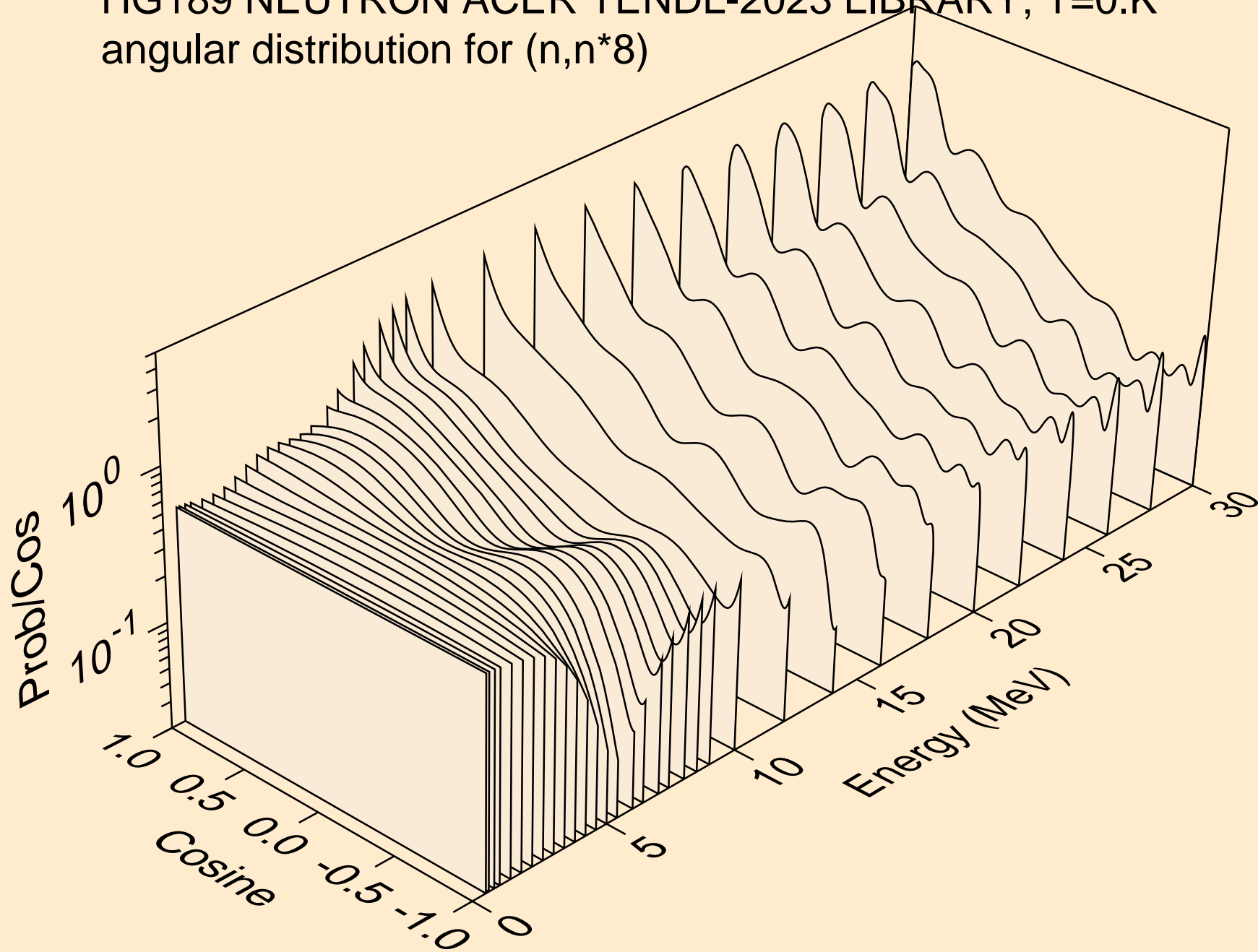



HG189 NEUTRON ACER TENDL-2023 LIBRARY; T=0.K  
angular distribution for (n,n\*9)

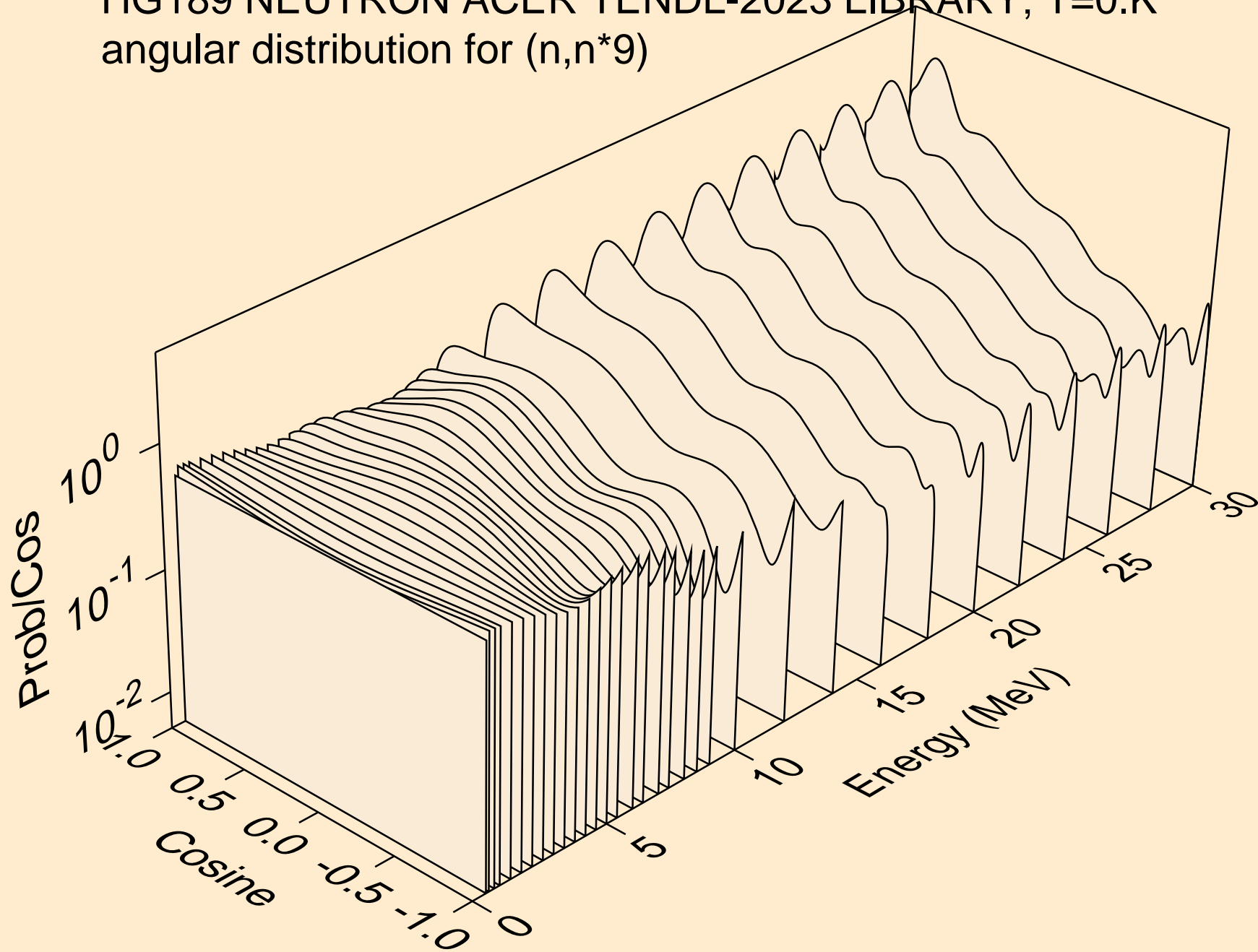

HG189 NEUTRON ACER TENDL-2023 LIBRARY; T=0.K  
angular distribution for (n,n\*10)

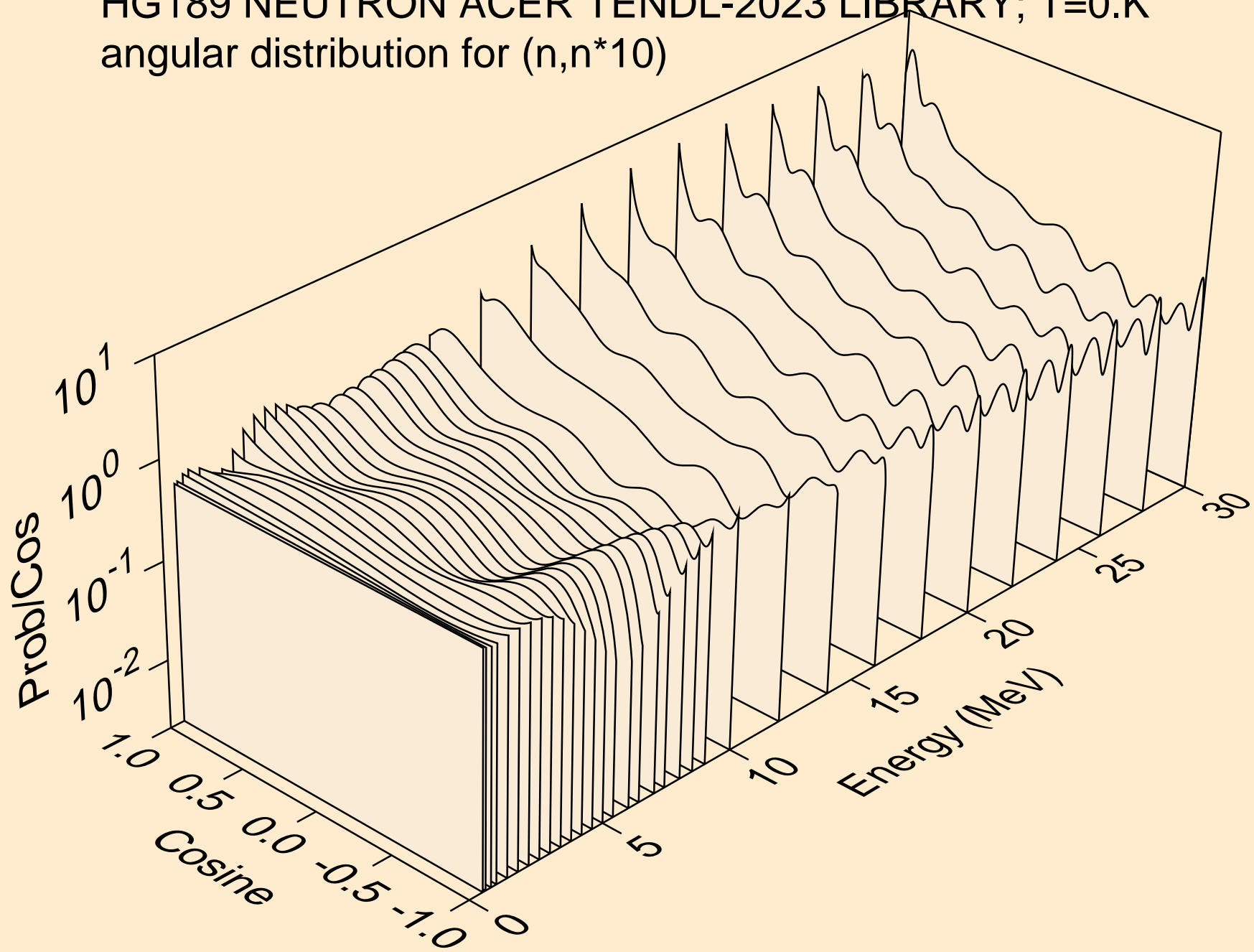

HG189 NEUTRON ACER TENDL-2023 LIBRARY; T=0.K  
angular distribution for (n,n\*11)

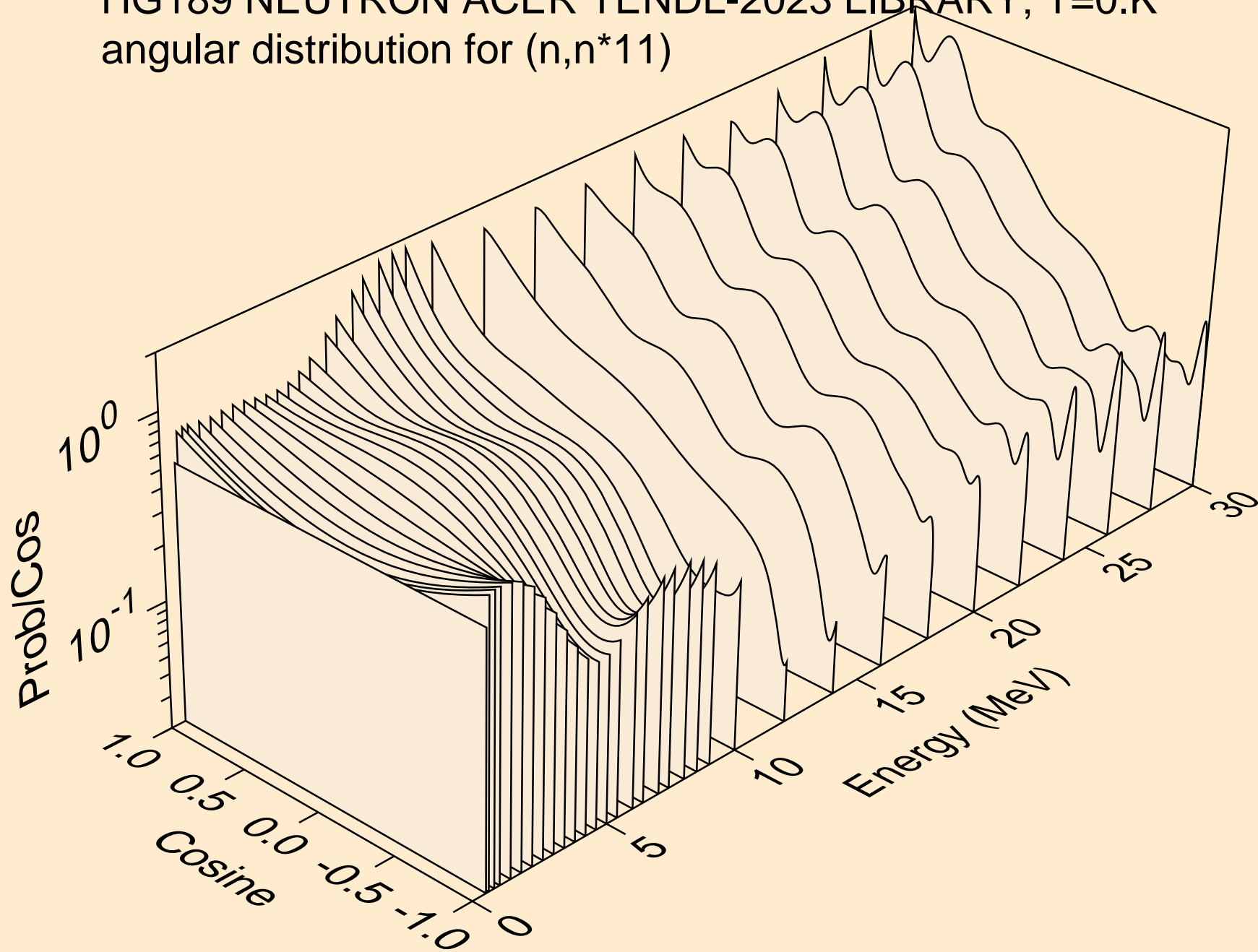

HG189 NEUTRON ACER TENDL-2023 LIBRARY; T=0.K  
angular distribution for (n,n\*12)

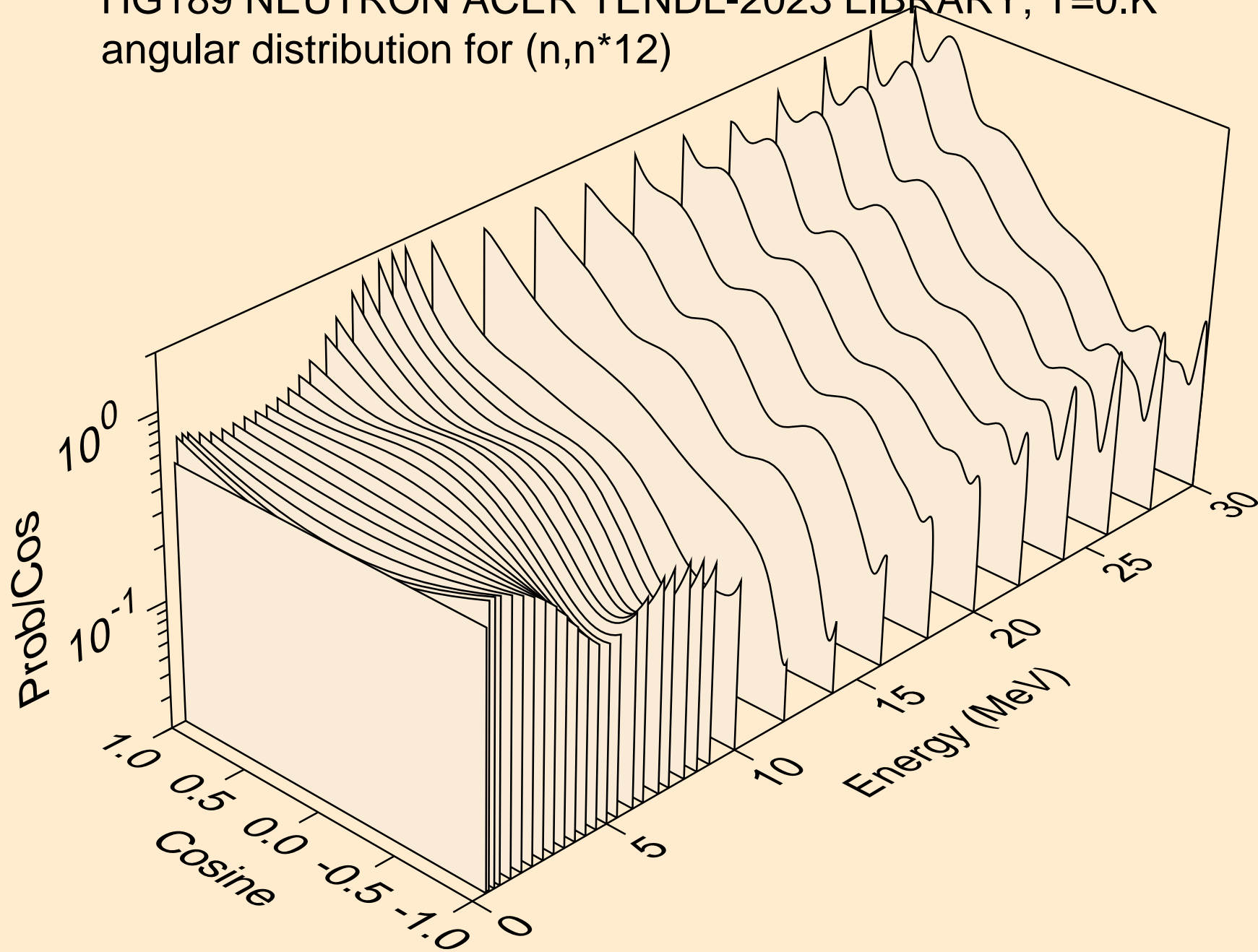

HG189 NEUTRON ACER TENDL-2023 LIBRARY; T=0.K  
angular distribution for (n,n\*13)

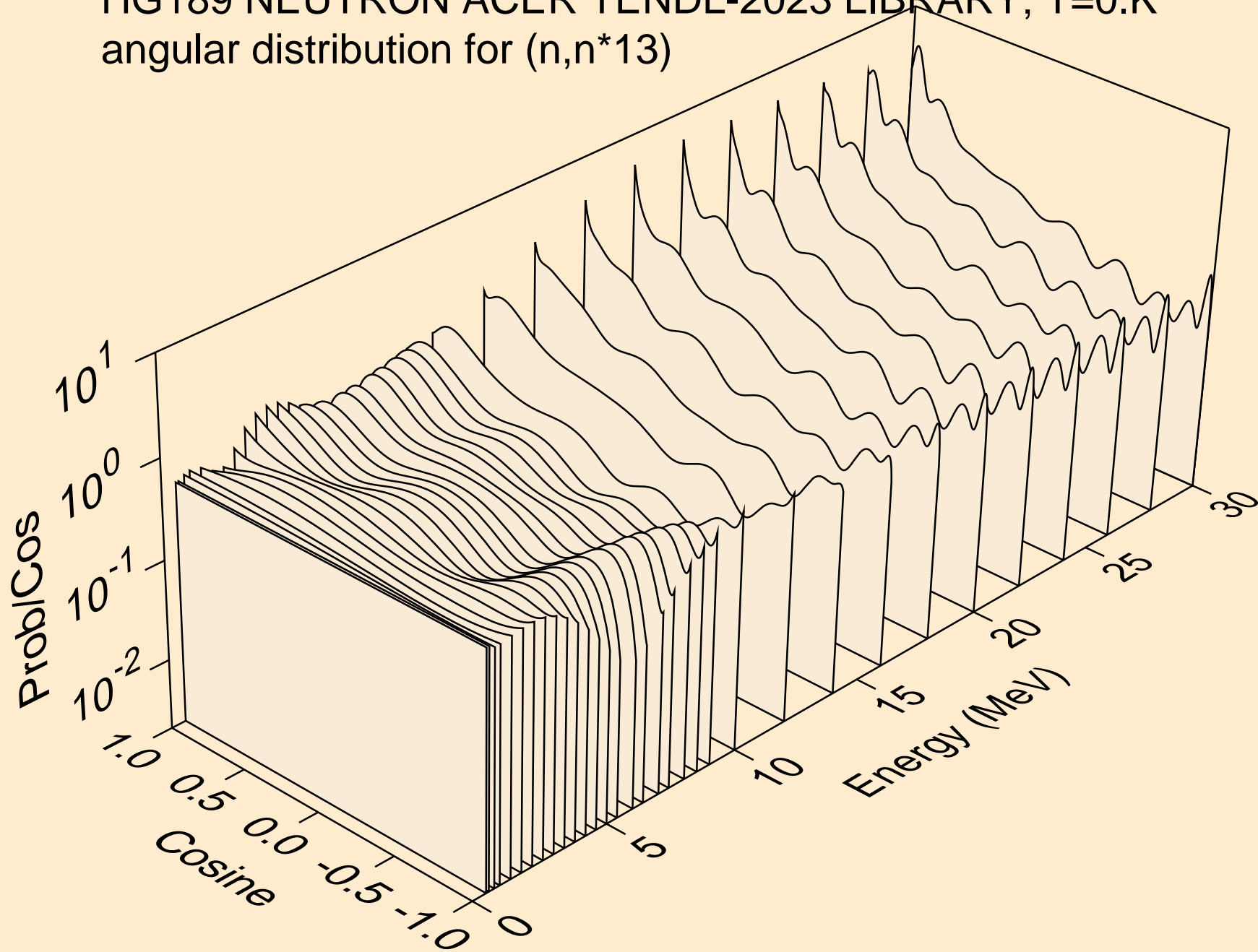

HG189 NEUTRON ACER TENDL-2023 LIBRARY; T=0.K  
angular distribution for (n,n\*14)

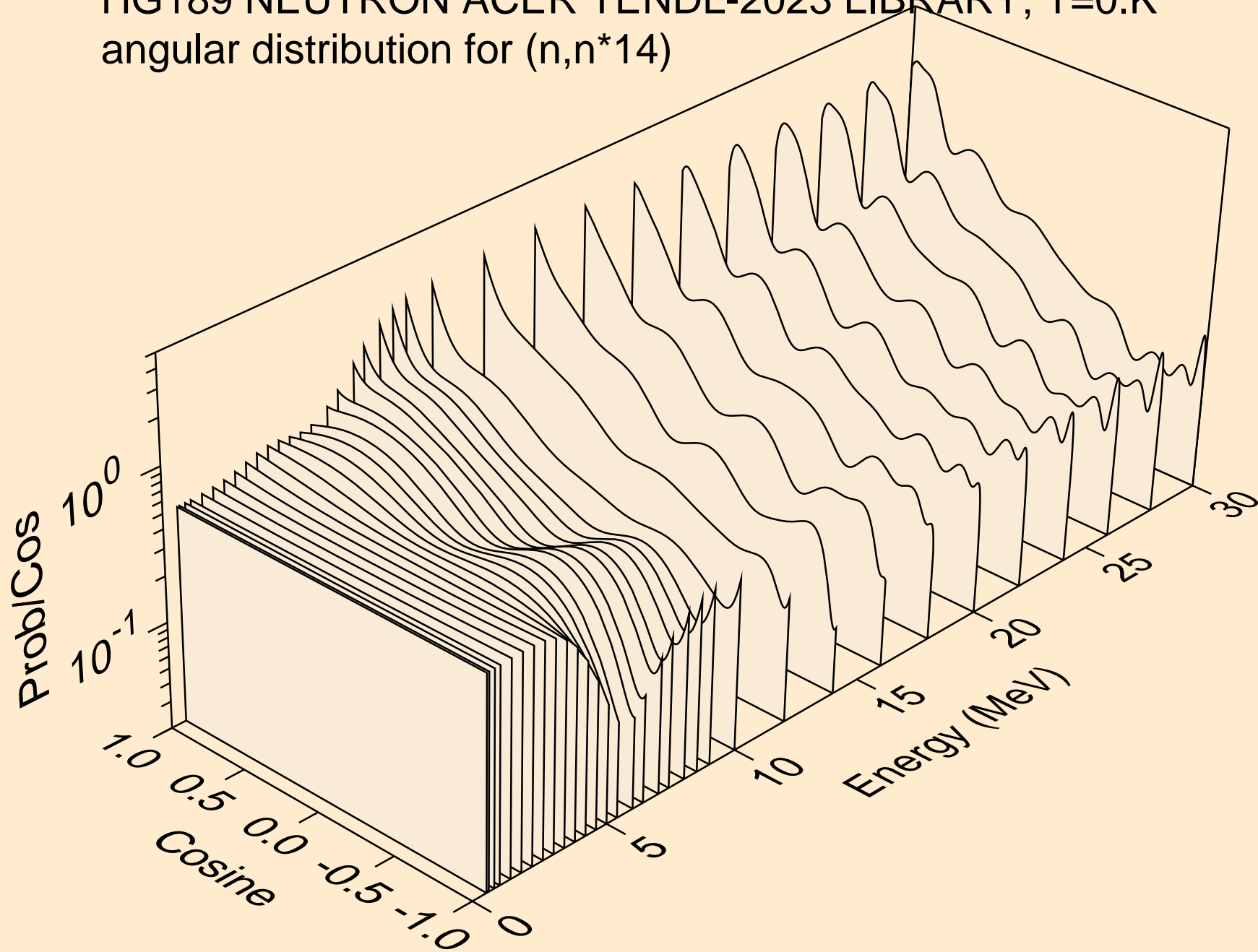

HG189 NEUTRON ACER TENDL-2023 LIBRARY; T=0.K  
angular distribution for (n,n\*15)

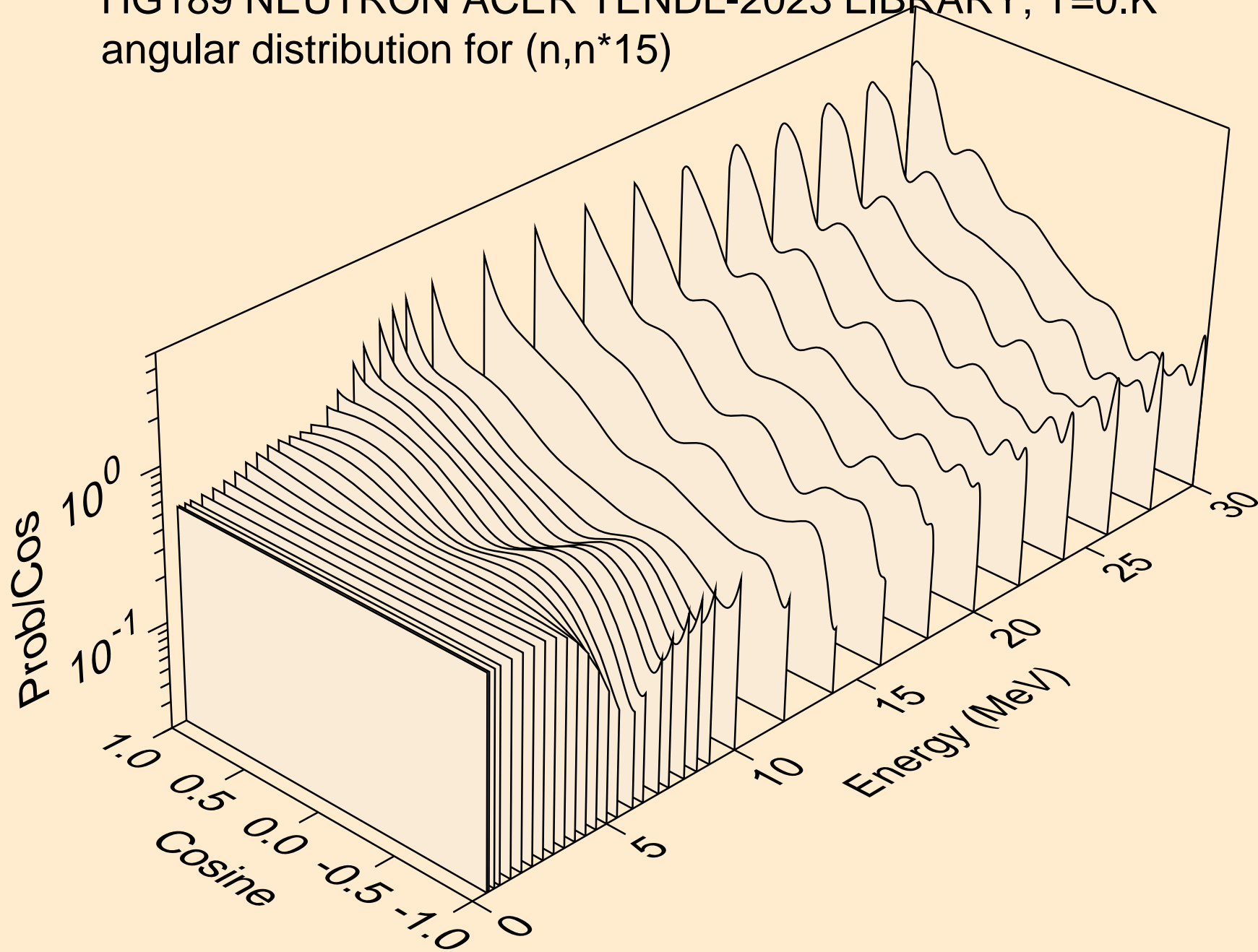



HG189 NEUTRON ACER TENDL-2023 LIBRARY; T=0.K  
angular distribution for (n,n\*16)

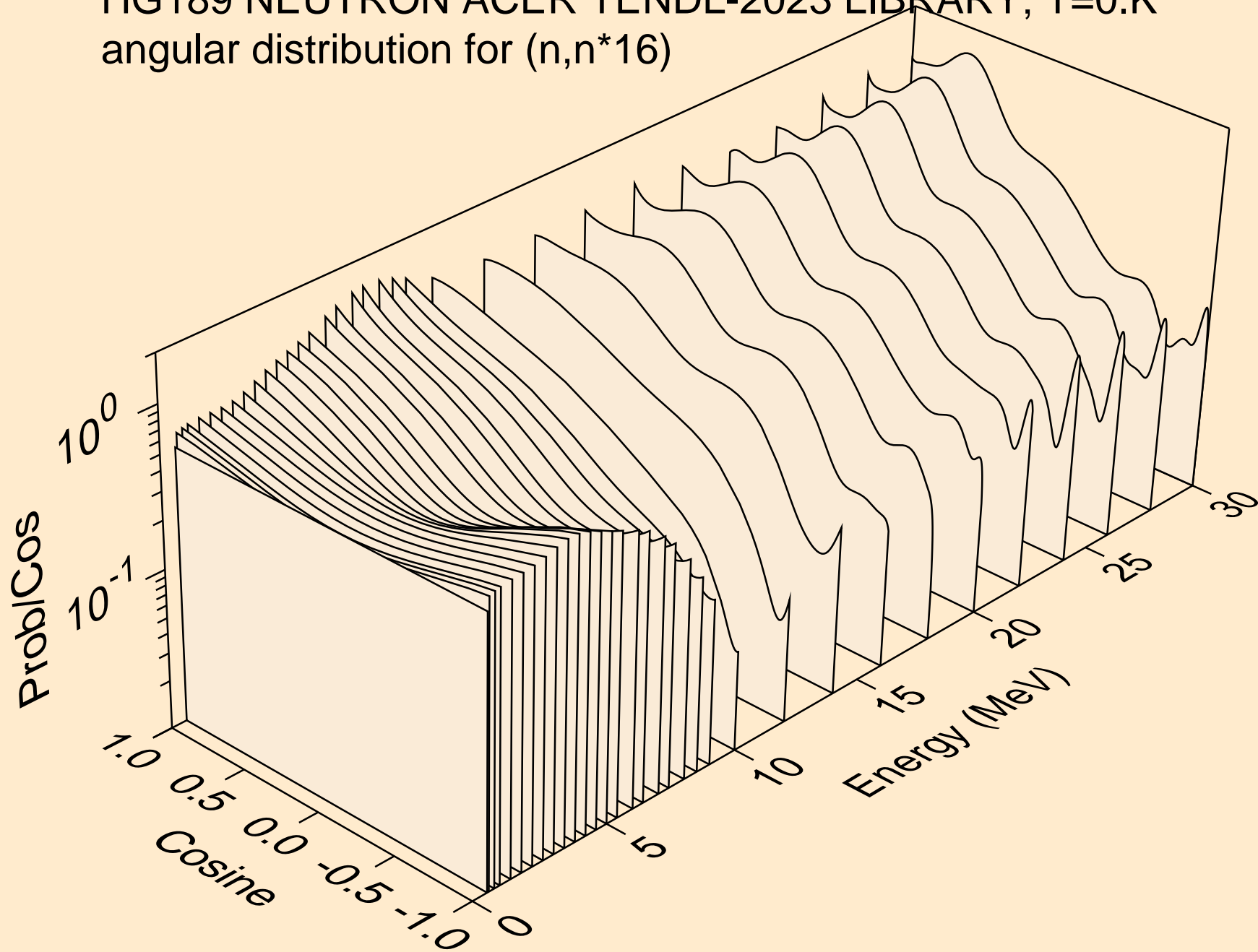



HG189 NEUTRON ACER TENDL-2023 LIBRARY; T=0.K  
angular distribution for (n,n\*17)

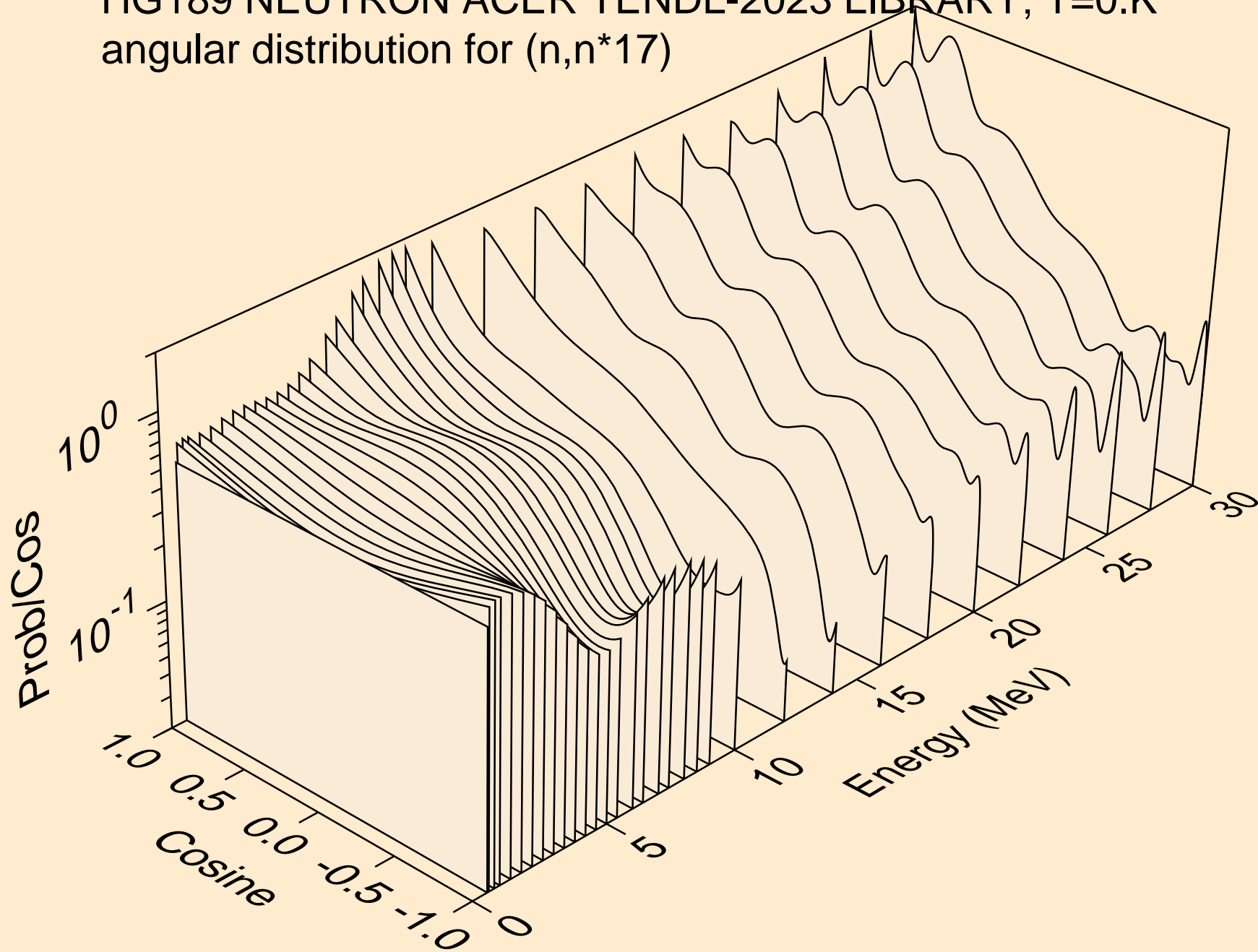

HG189 NEUTRON ACER TENDL-2023 LIBRARY; T=0.K  
angular distribution for (n,n\*18)

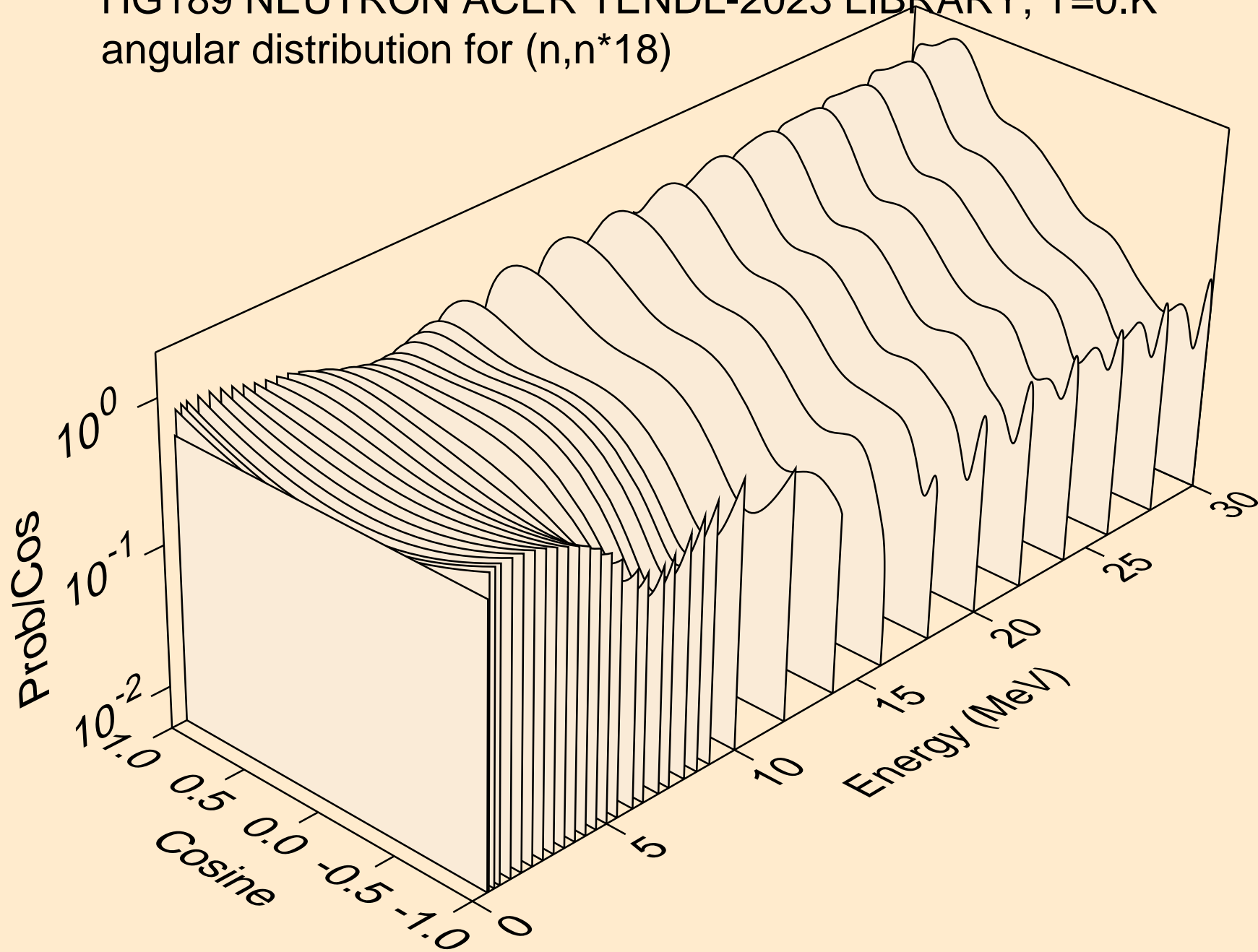

HG189 NEUTRON ACER TENDL-2023 LIBRARY; T=0.K  
angular distribution for (n,n\*19)

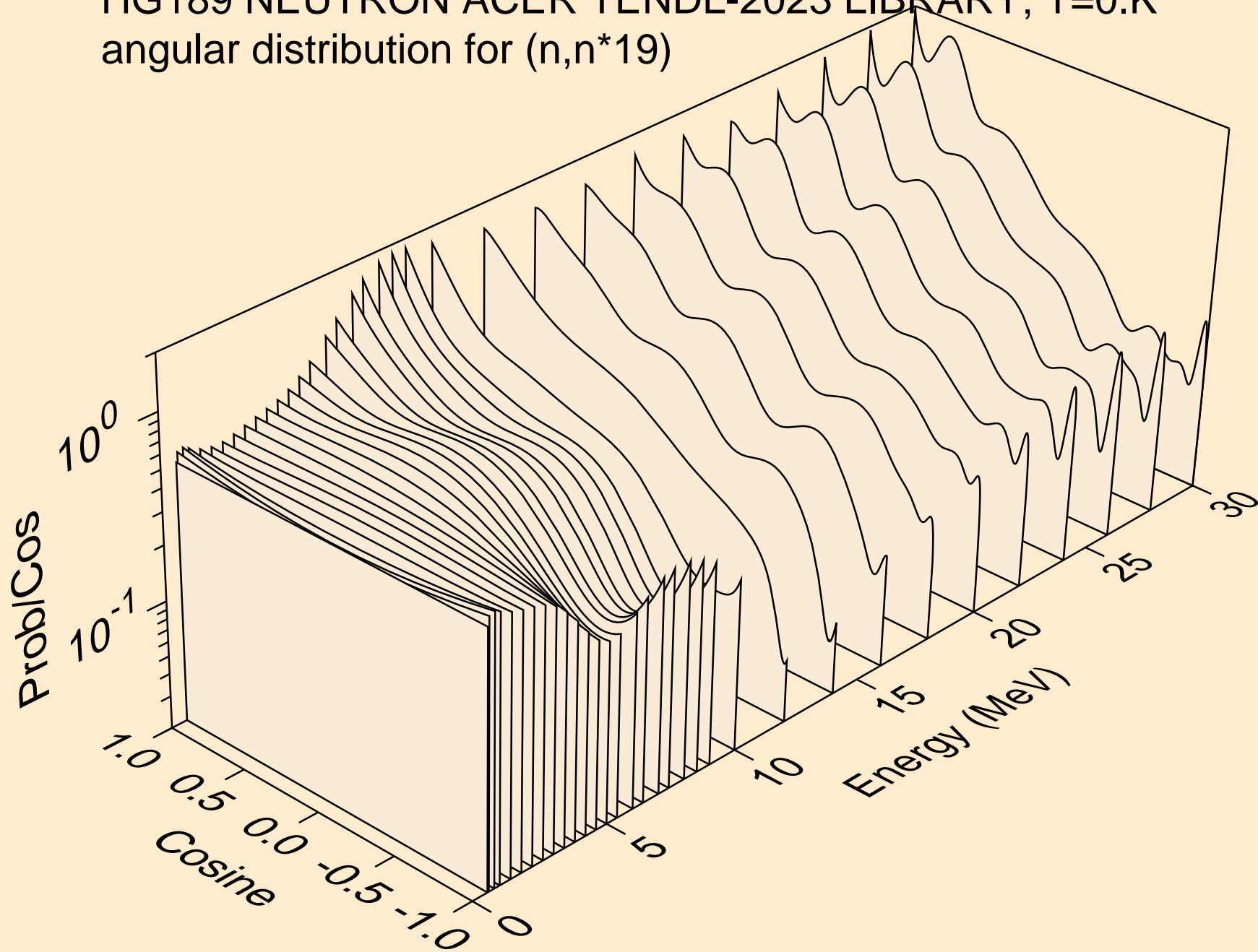

HG189 NEUTRON ACER TENDL-2023 LIBRARY; T=0.K  
angular distribution for (n,n\*20)

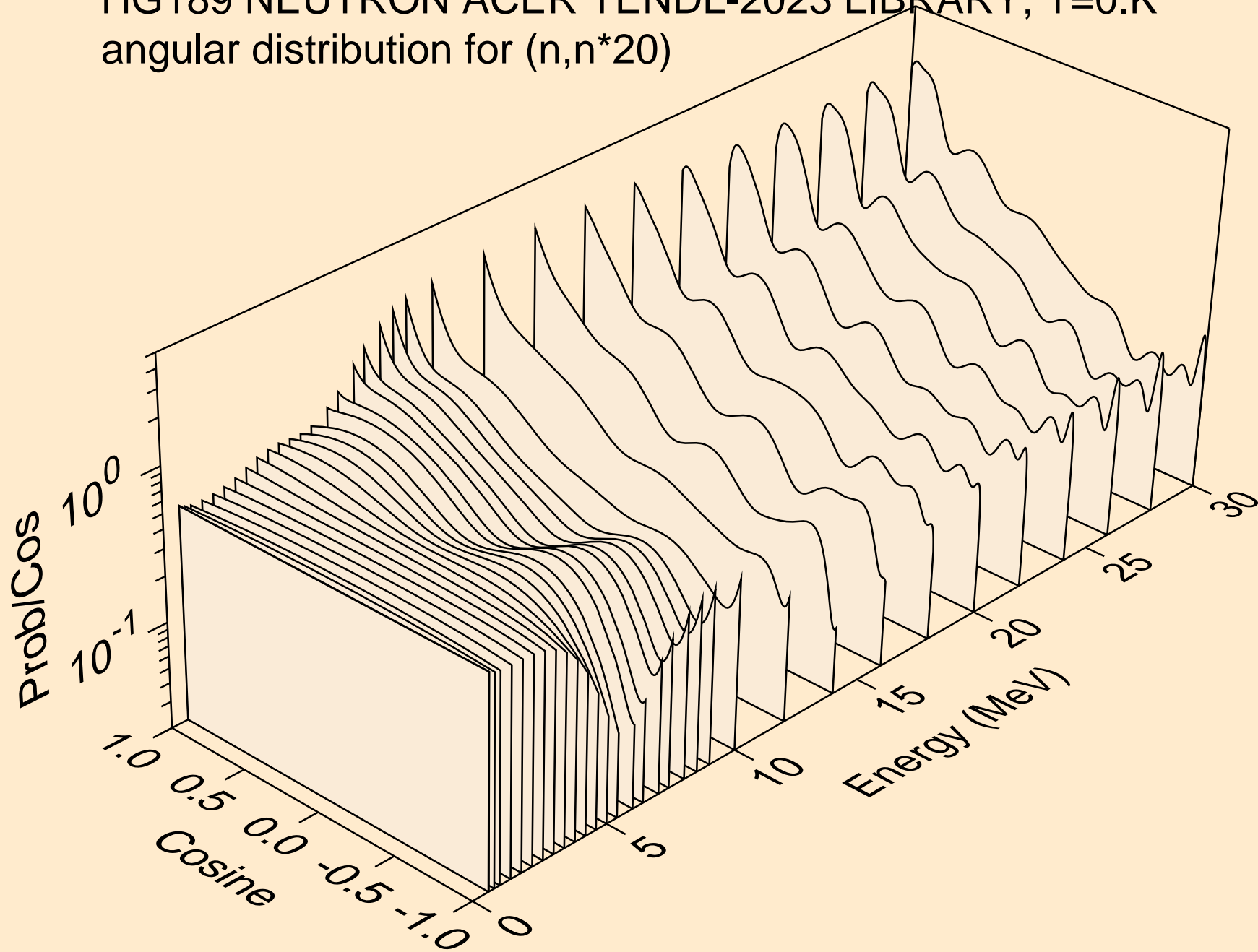

HG189 NEUTRON ACER TENDL-2023 LIBRARY; T=0.K  
angular distribution for (n,n\*21)

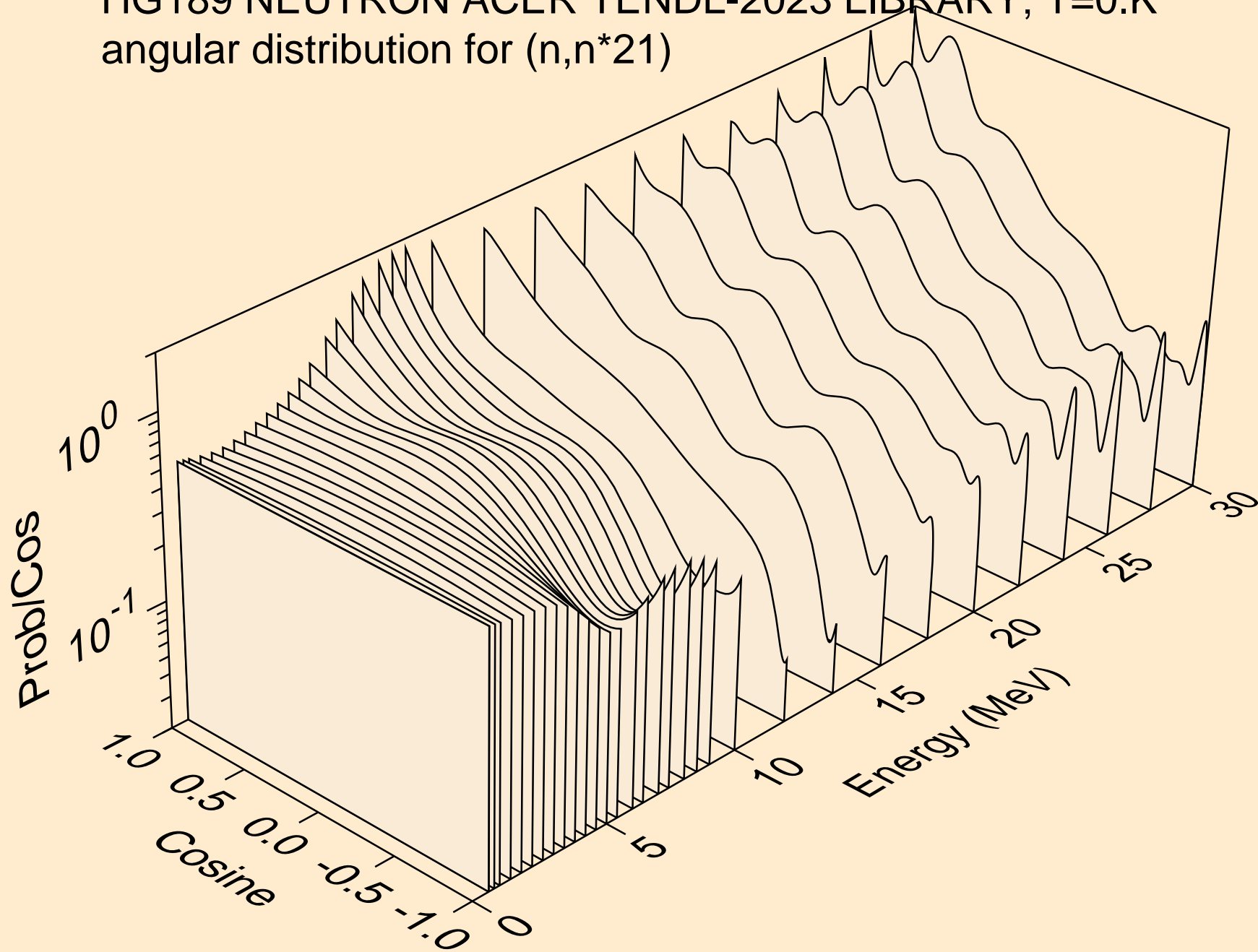

HG189 NEUTRON ACER TENDL-2023 LIBRARY; T=0.K  
angular distribution for (n,n\*22)

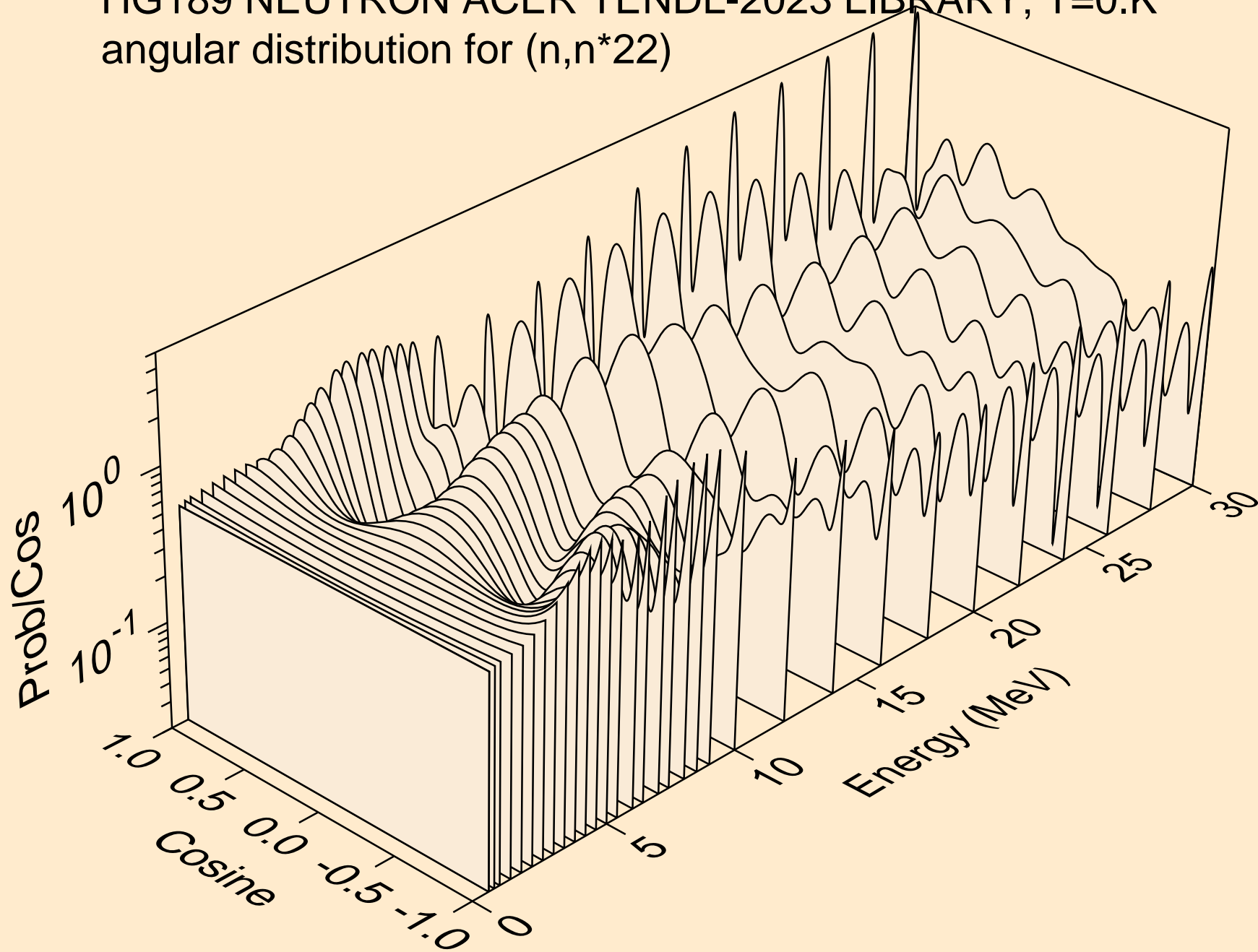

HG189 NEUTRON ACER TENDL-2023 LIBRARY; T=0.K  
angular distribution for (n,n\*23)

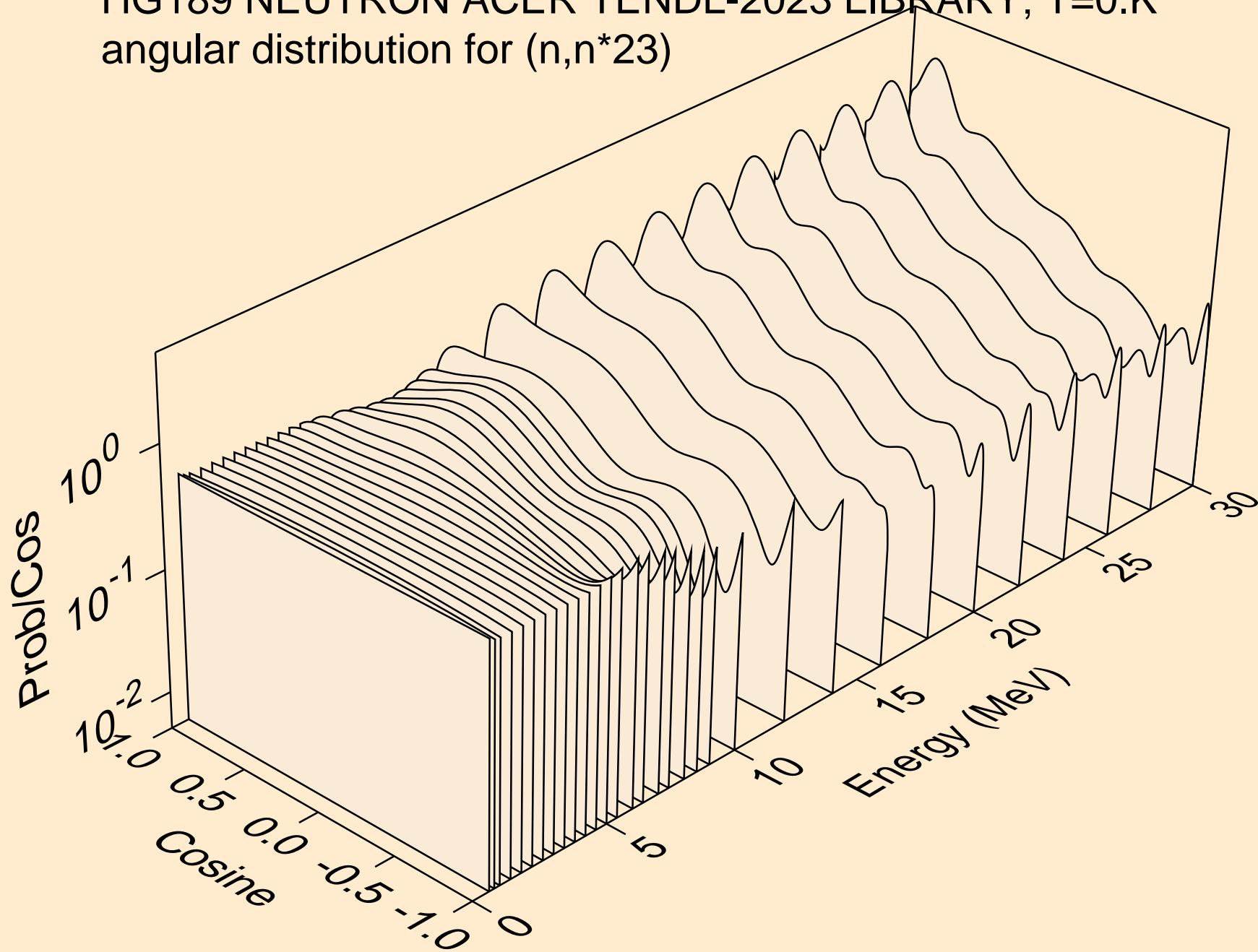



HG189 NEUTRON ACER TENDL-2023 LIBRARY; T=0.K  
angular distribution for (n,n\*24)

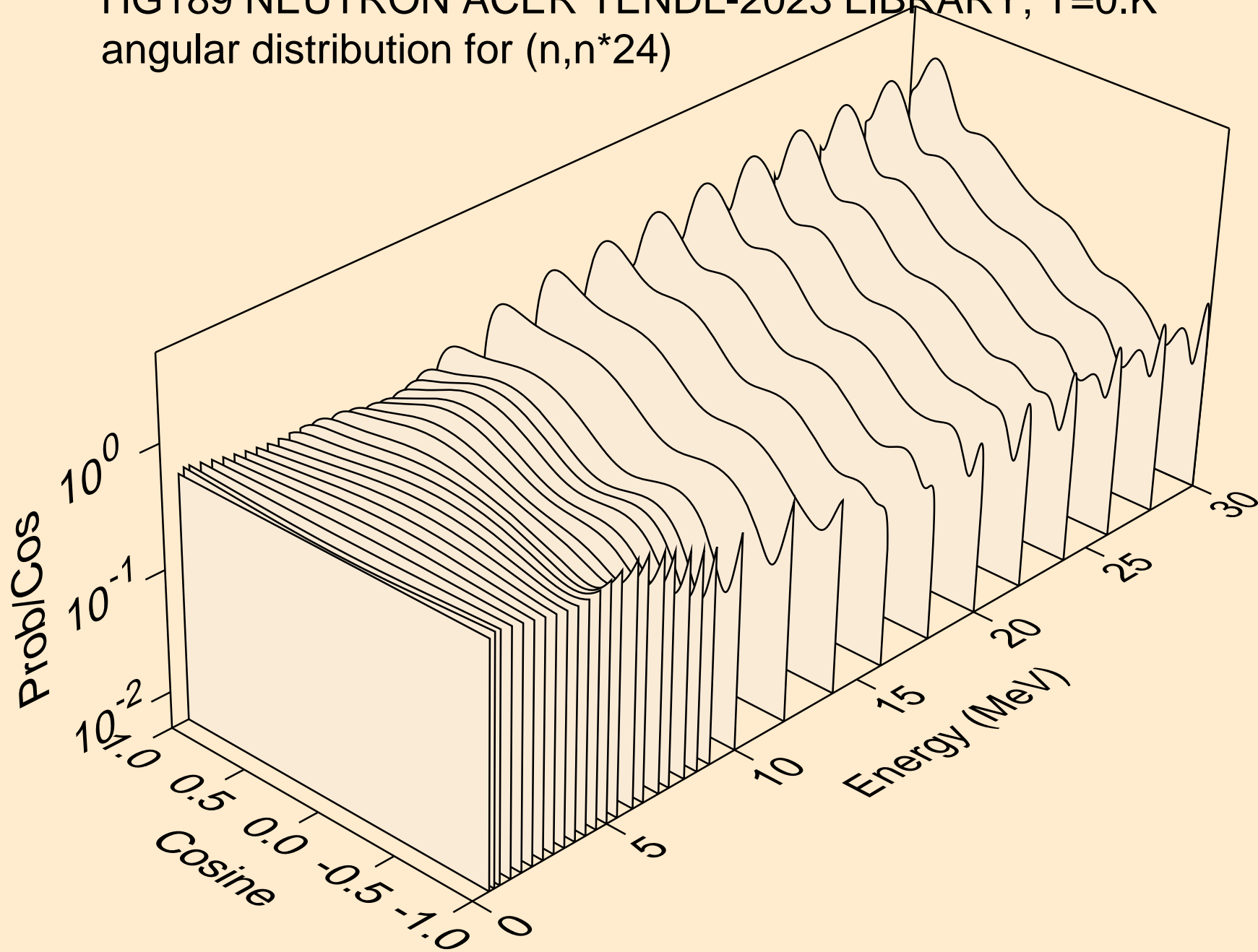



HG189 NEUTRON ACER TENDL-2023 LIBRARY; T=0.K  
angular distribution for (n,n\*25)

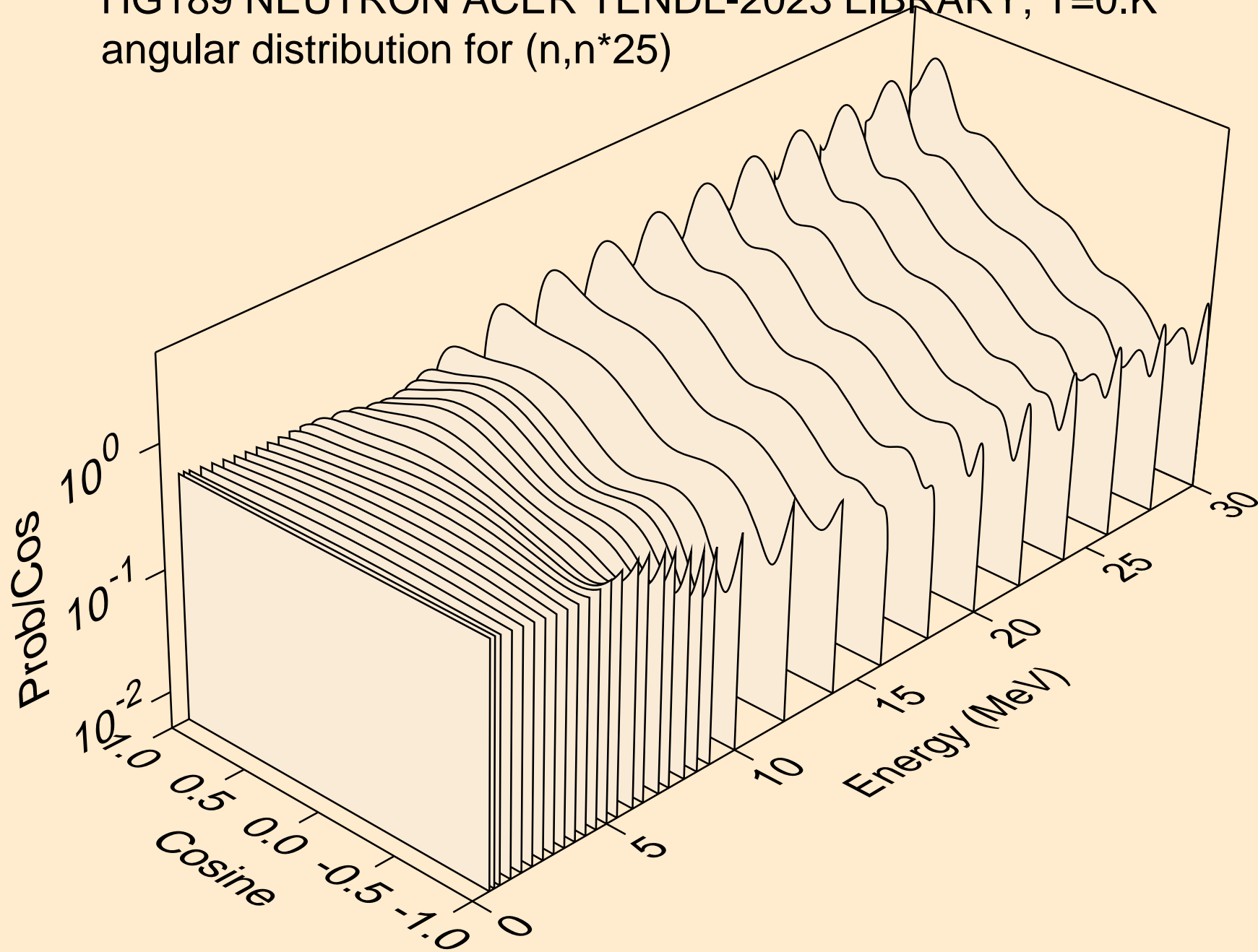

HG189 NEUTRON ACER TENDL-2023 LIBRARY; T=0.K  
angular distribution for (n,n\*26)

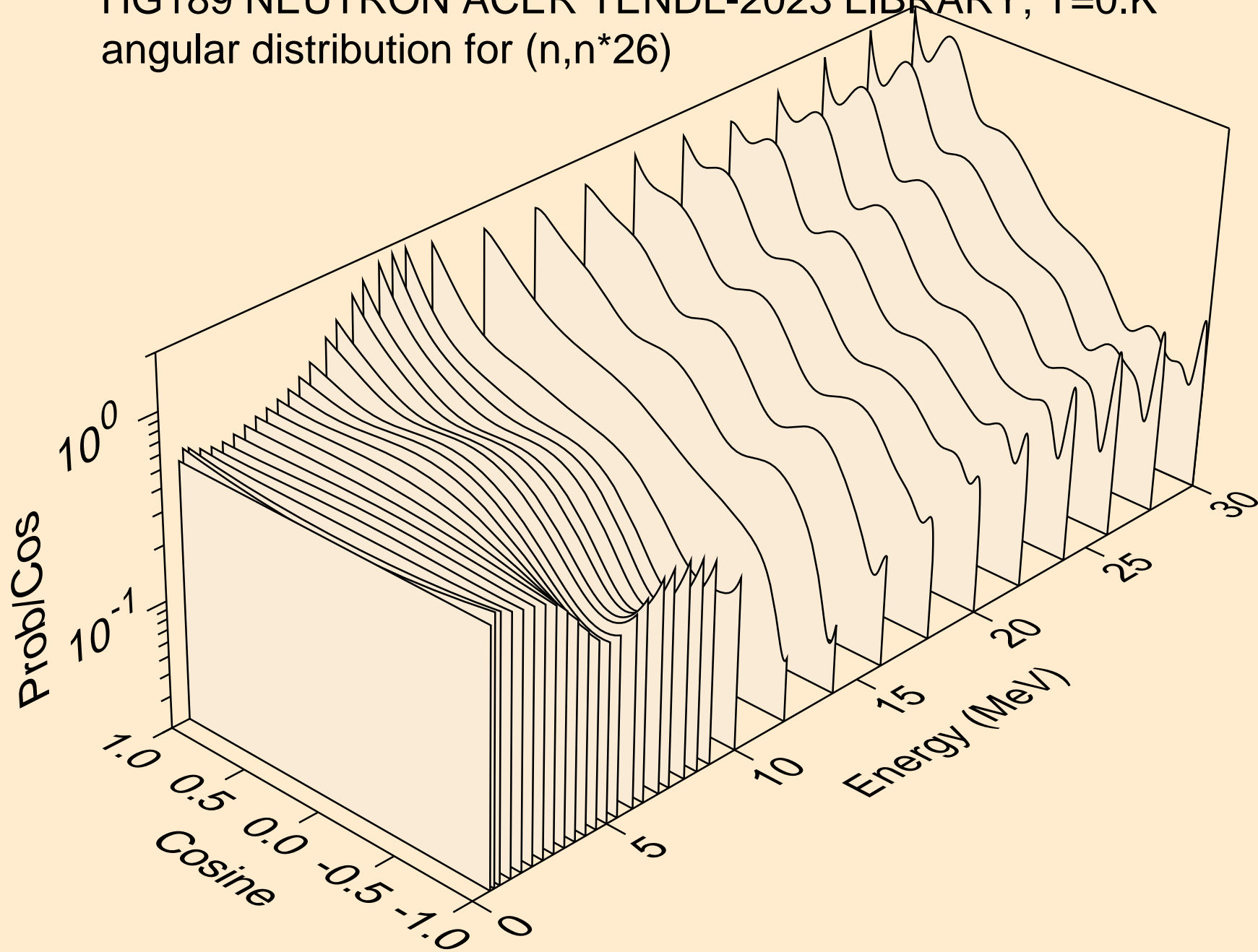

HG189 NEUTRON ACER TENDL-2023 LIBRARY; T=0.K  
angular distribution for (n,n\*27)

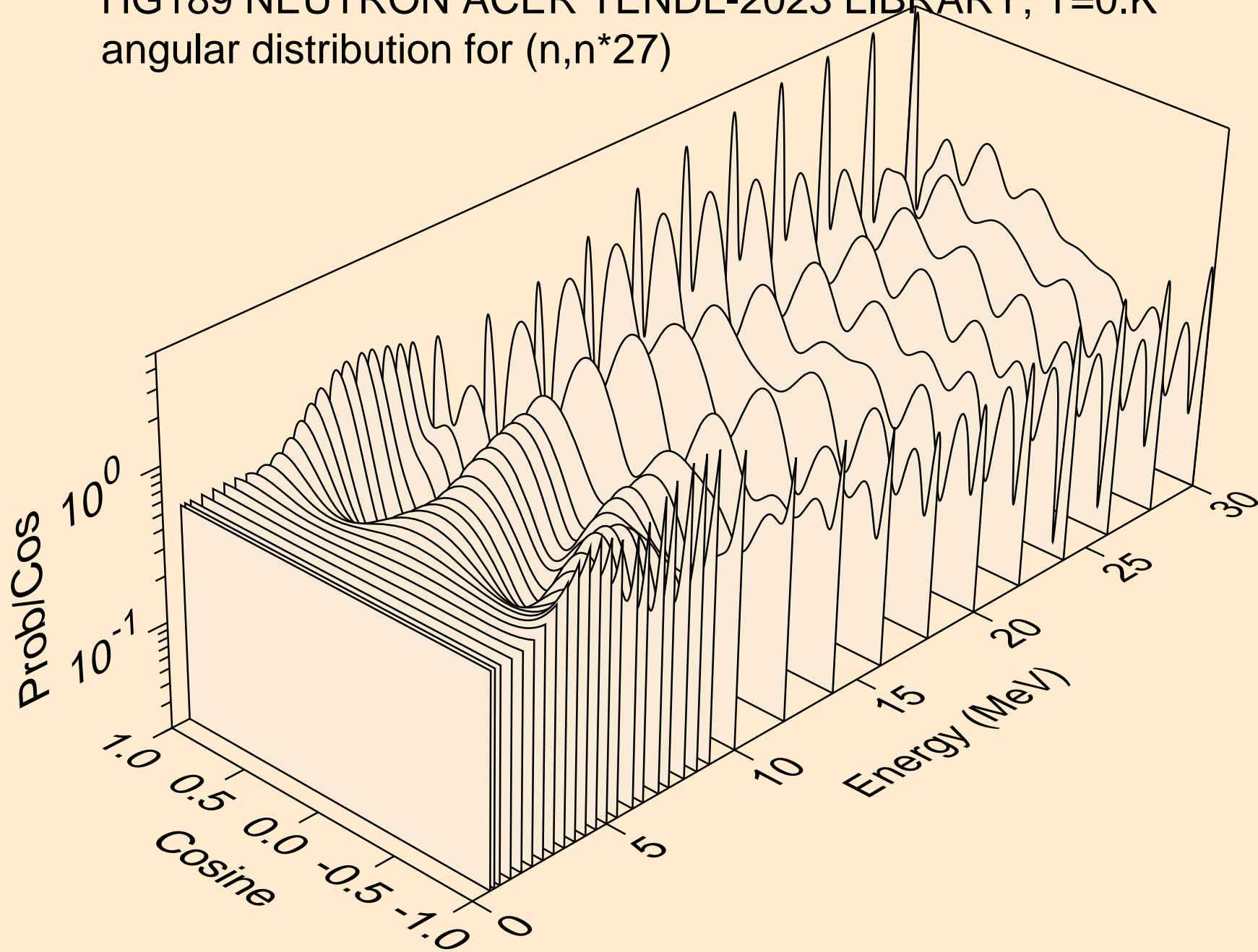

HG189 NEUTRON ACER TENDL-2023 LIBRARY; T=0.K  
angular distribution for (n,n\*28)

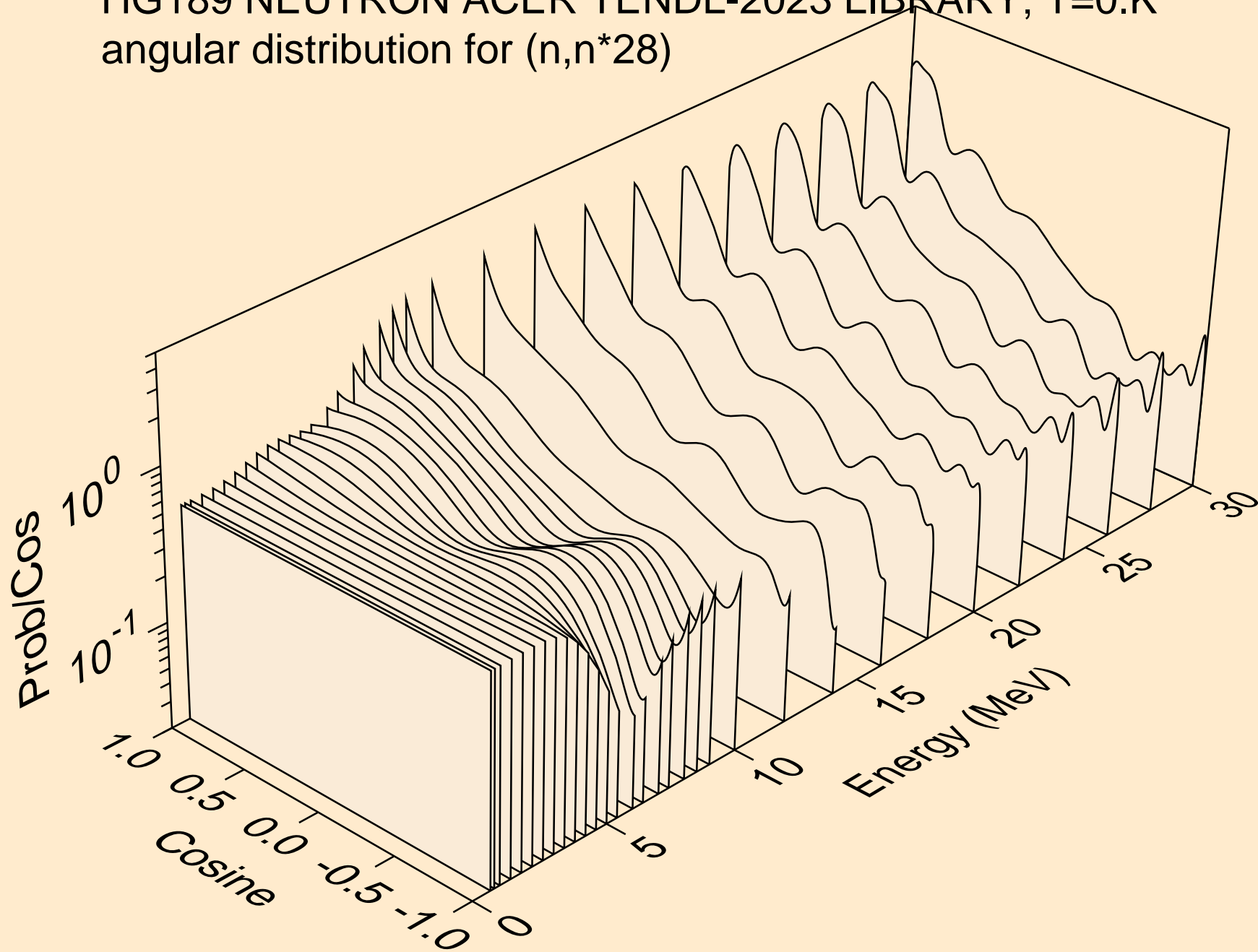

HG189 NEUTRON ACER TENDL-2023 LIBRARY; T=0.K  
Neutron emission for (n,x)

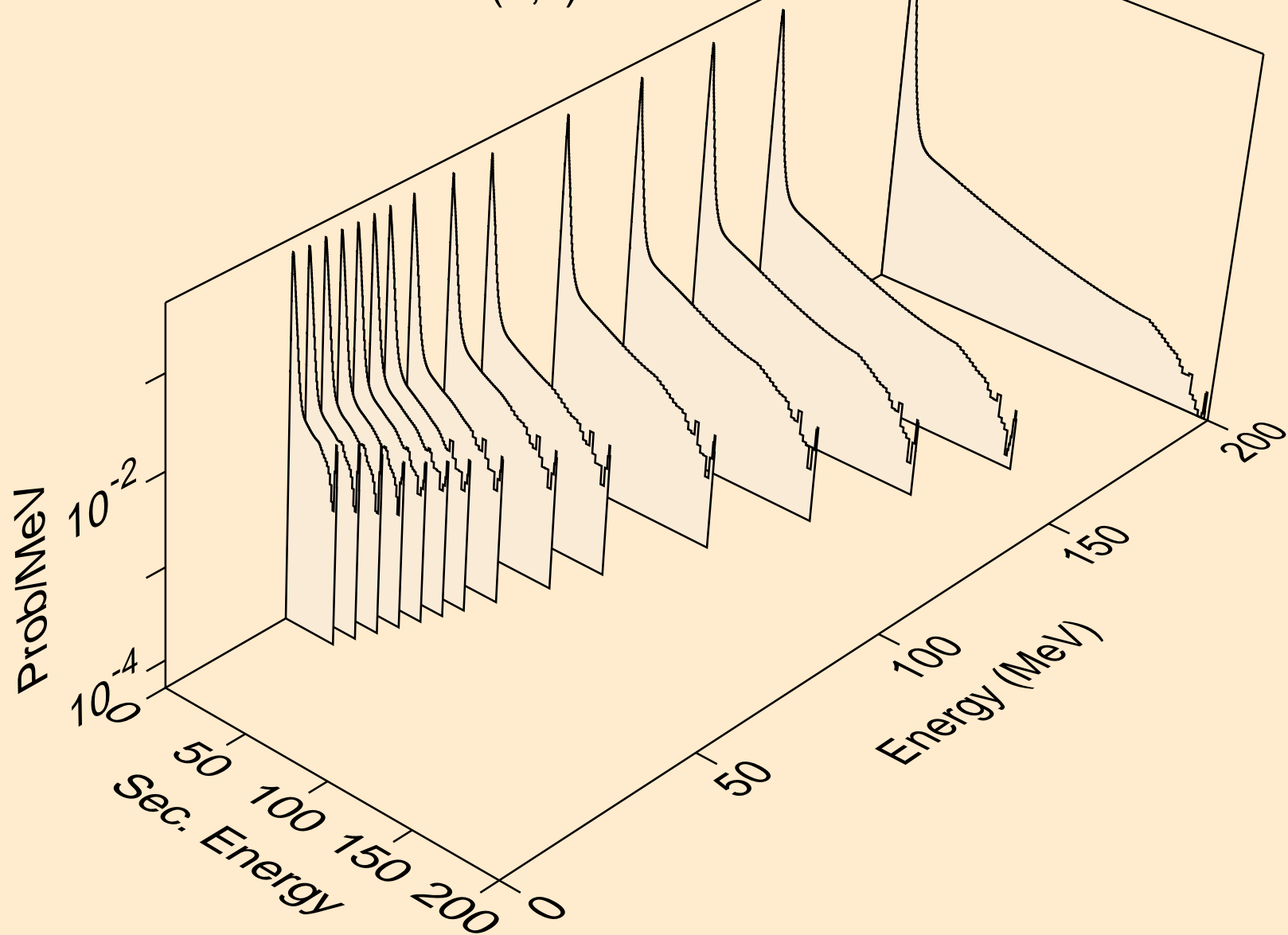

HG189 NEUTRON ACER TENDL-2023 LIBRARY; T=0.K  
Neutron emission for (n,2nd)

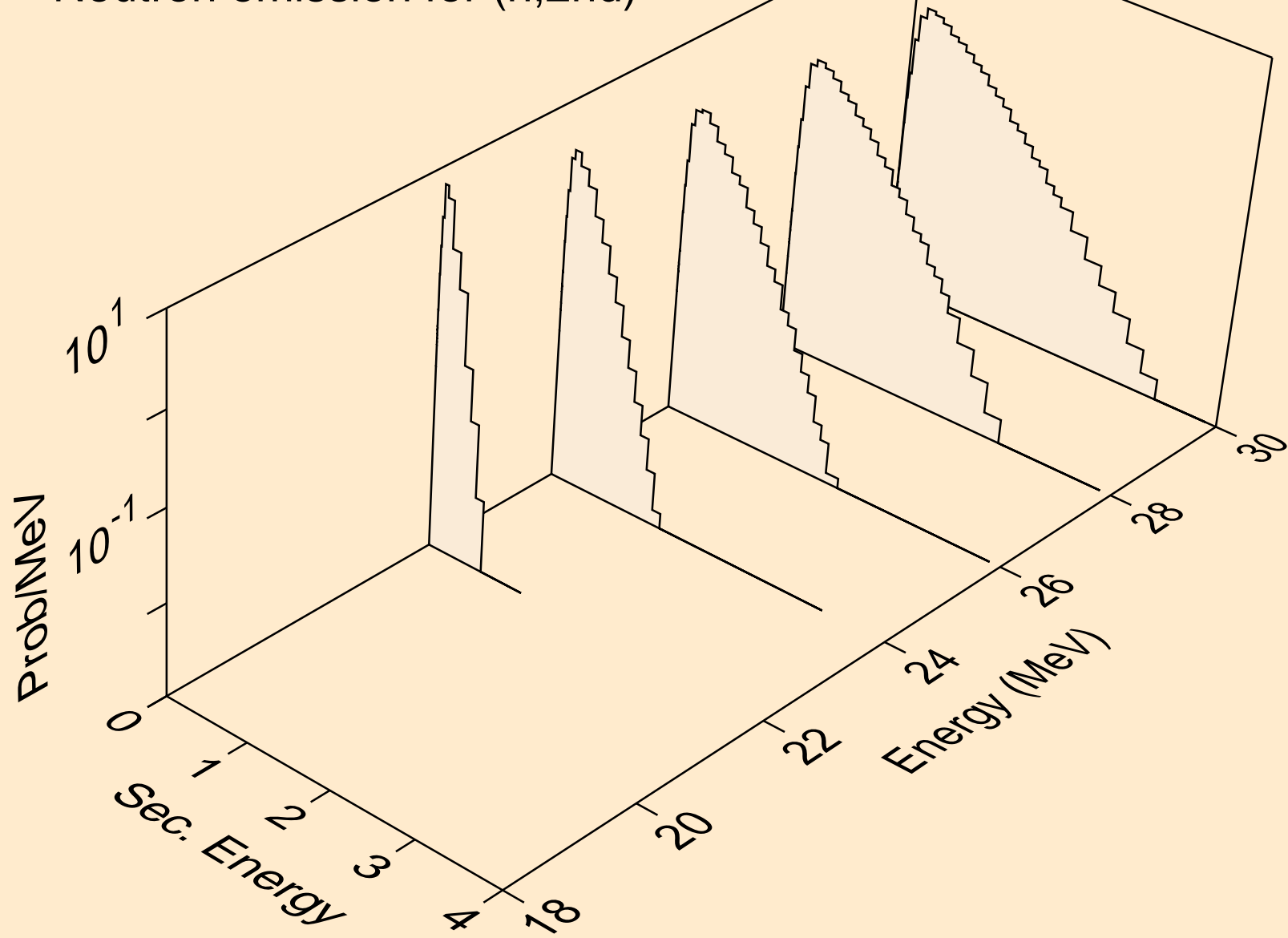

HG189 NEUTRON ACER TENDL-2023 LIBRARY; T=0.K  
Neutron emission for (n,2n)

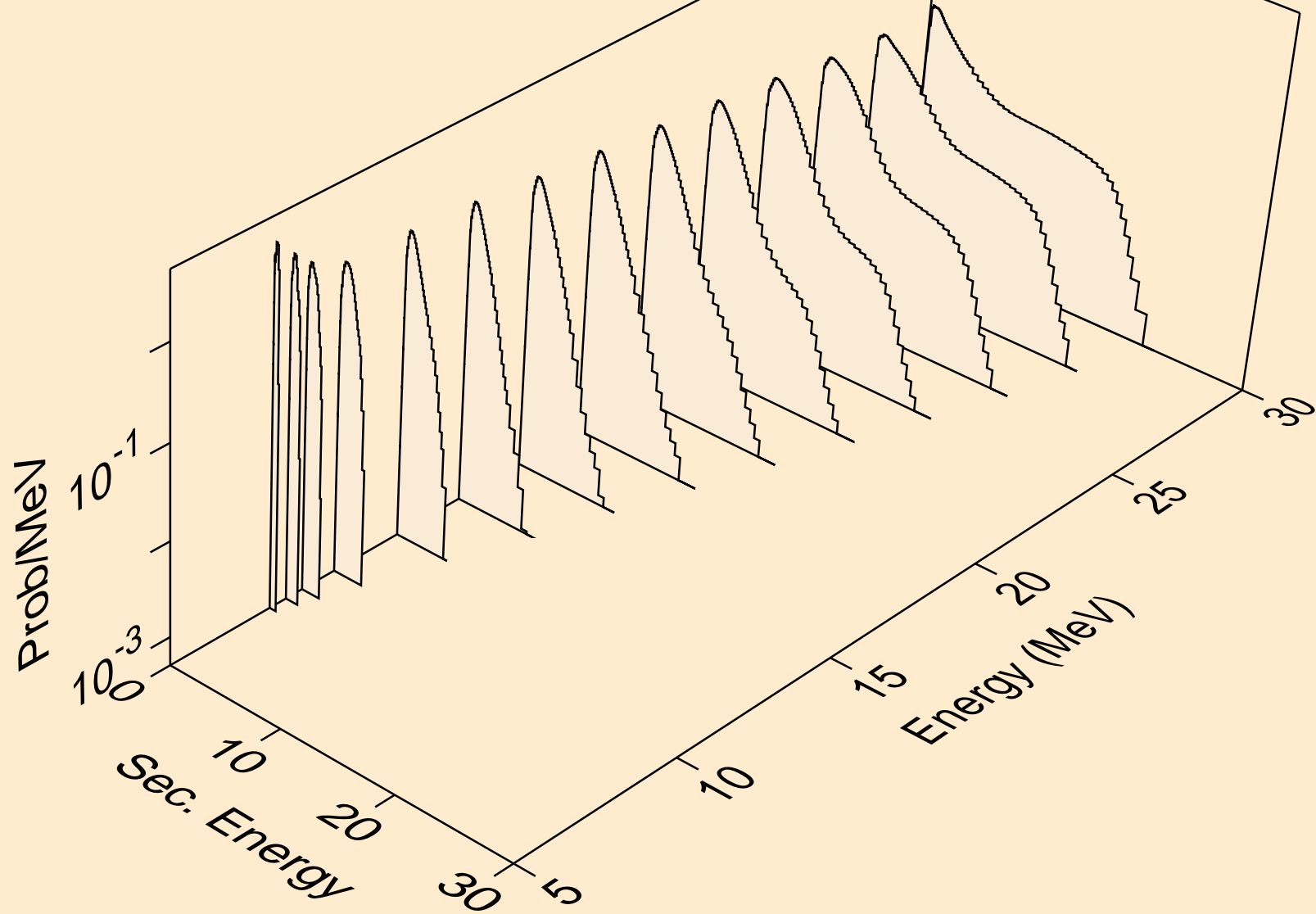

HG189 NEUTRON ACER TENDL-2023 LIBRARY; T=0.K  
Neutron emission for (n,3n)

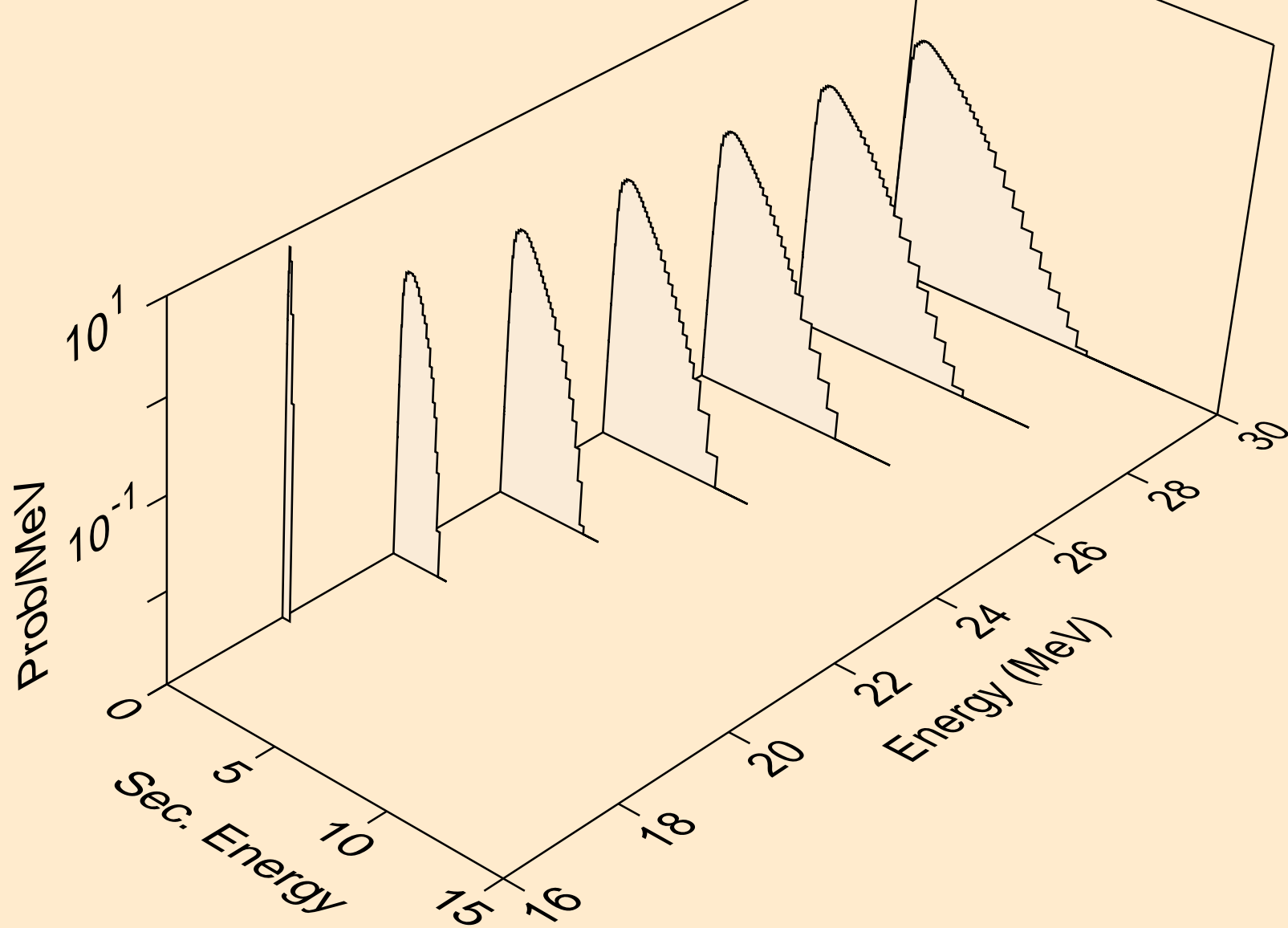



HG189 NEUTRON ACER TENDL-2023 LIBRARY; T=0.K  
Neutron emission for (n,n\*)a

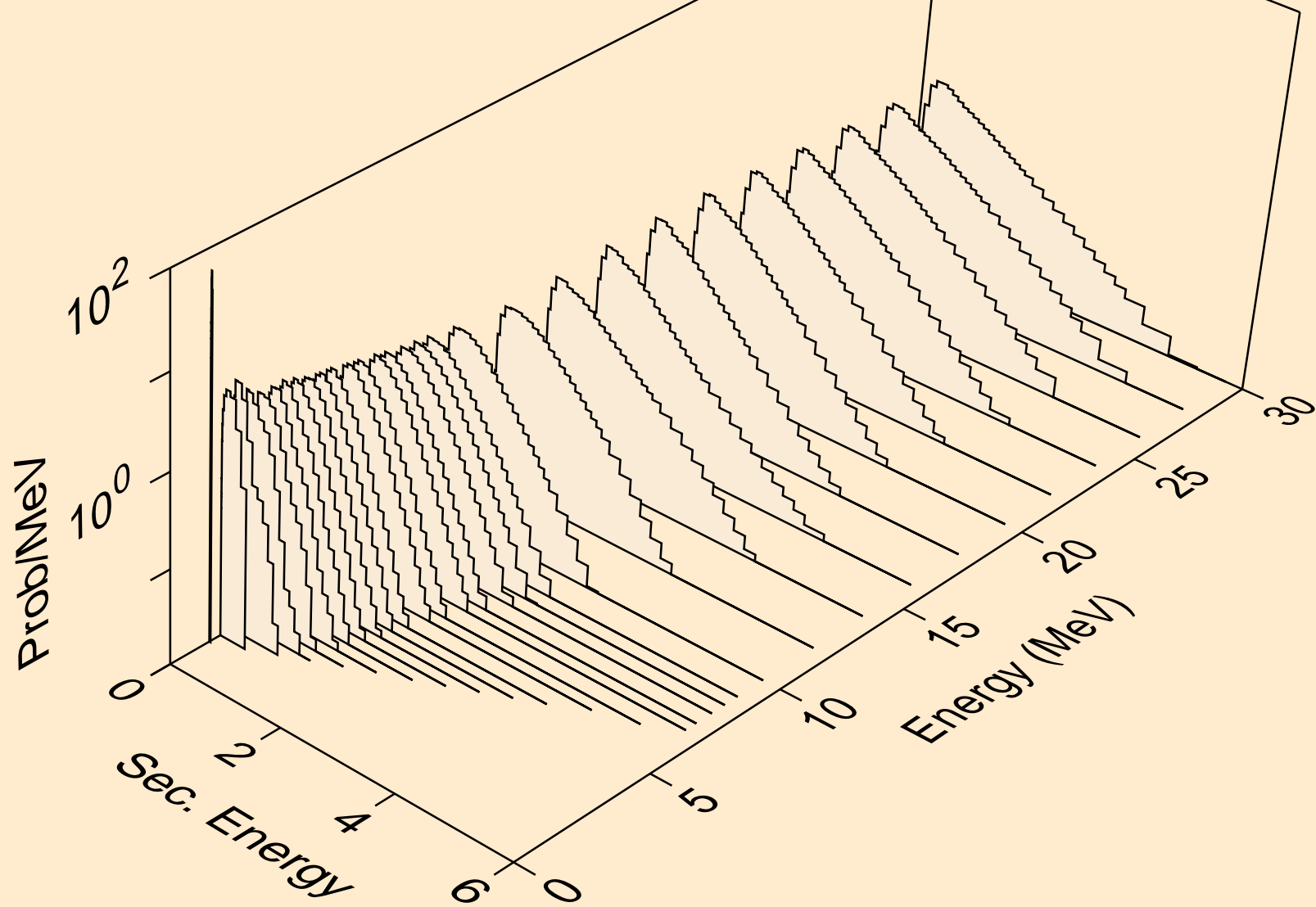

HG189 NEUTRON ACER TENDL-2023 LIBRARY; T=0.K  
Neutron emission for (n,2n)a

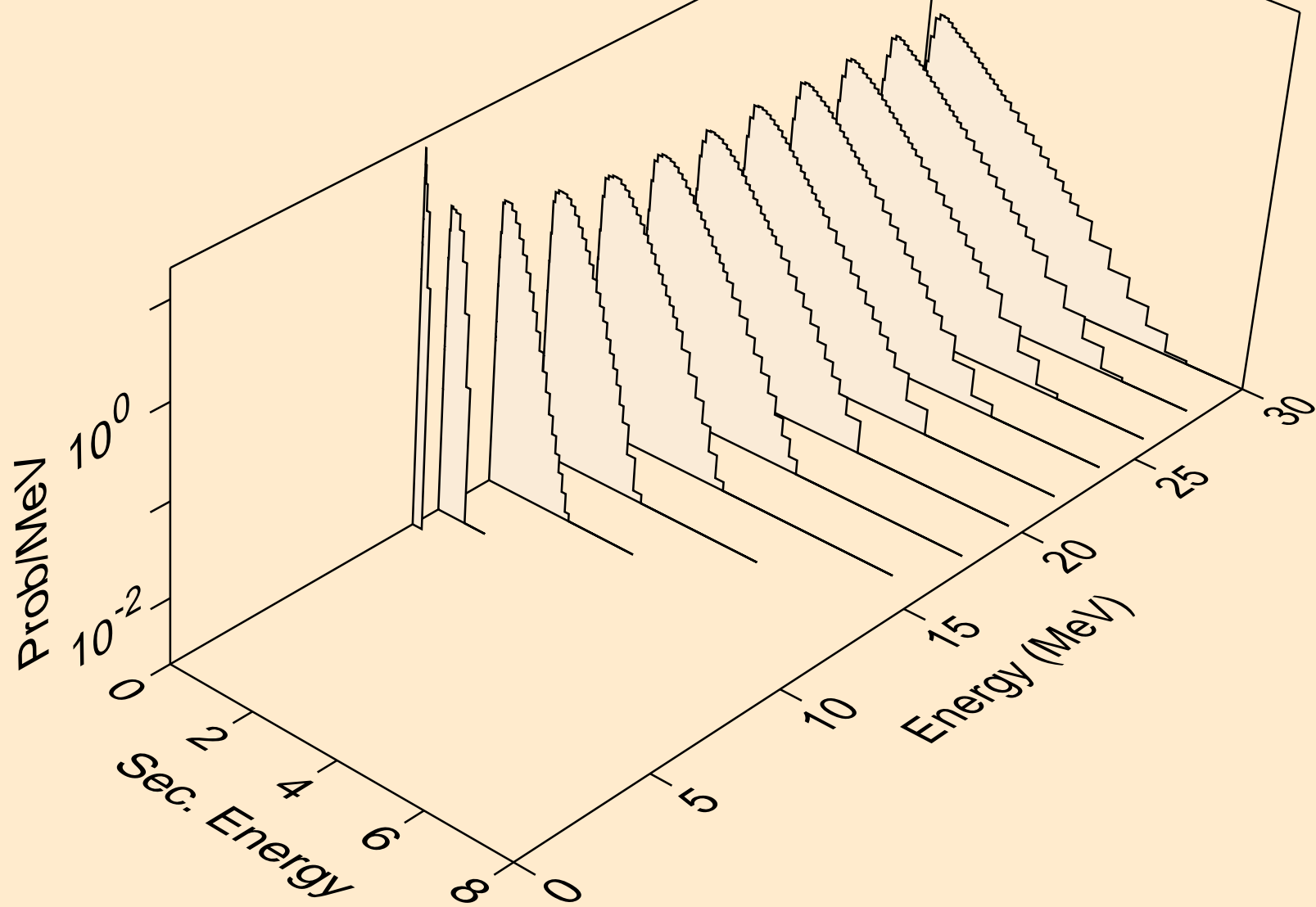

HG189 NEUTRON ACER TENDL-2023 LIBRARY; T=0.K  
Neutron emission for (n,3n)a

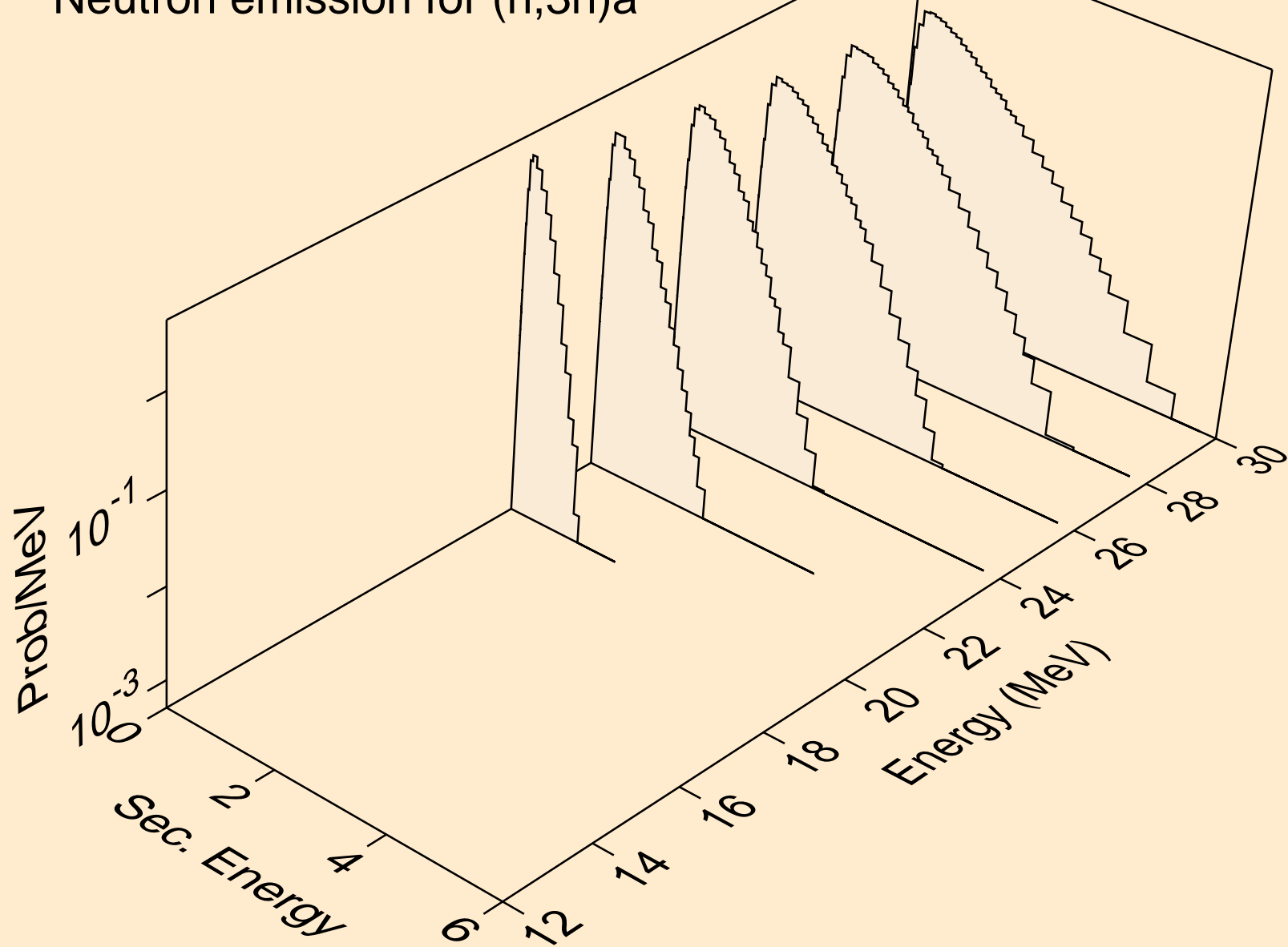

HG189 NEUTRON ACER TENDL-2023 LIBRARY; T=0.K  
Neutron emission for (n,n\*)p

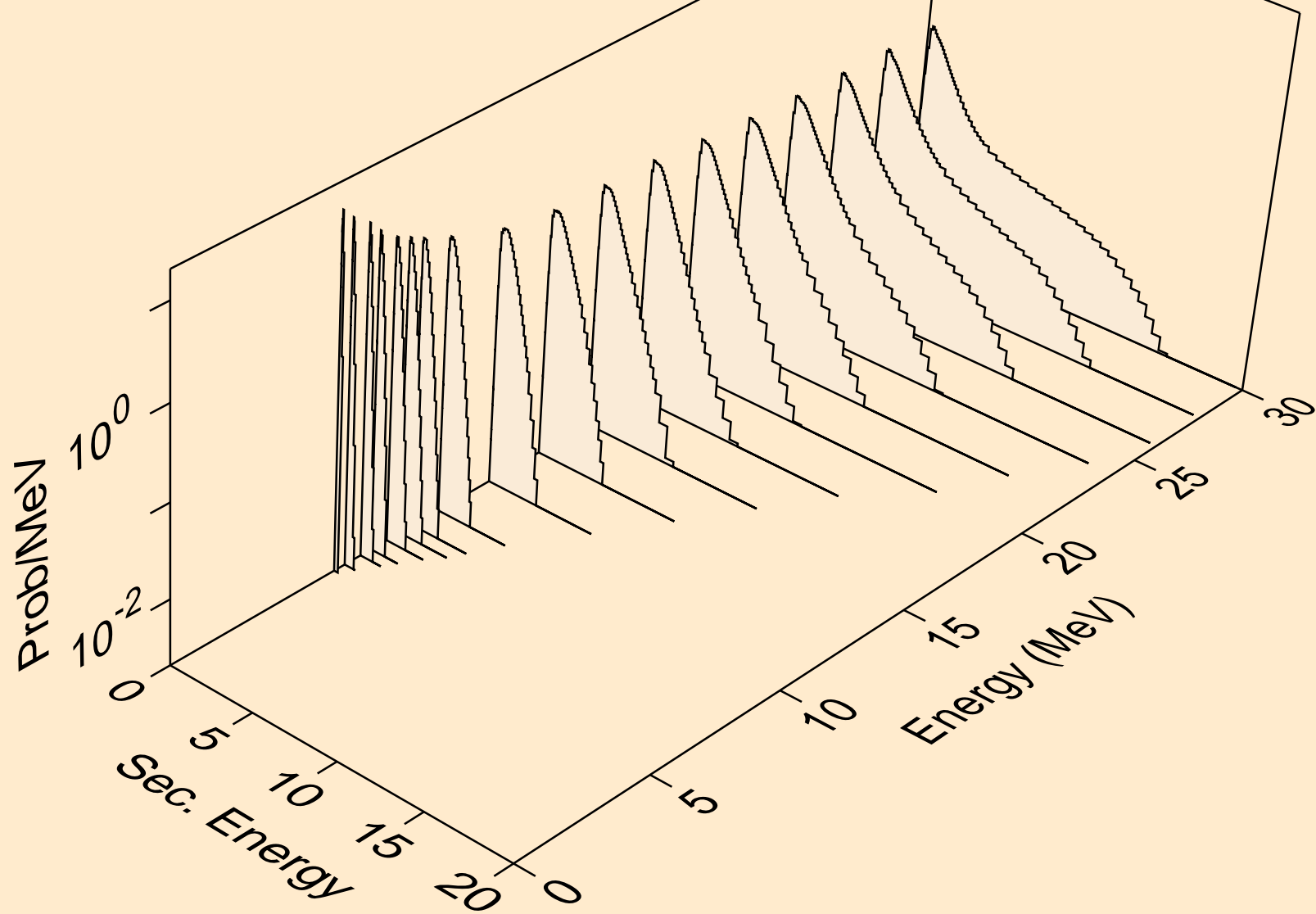

HG189 NEUTRON ACER TENDL-2023 LIBRARY; T=0.K  
Neutron emission for (n,n\*)2a

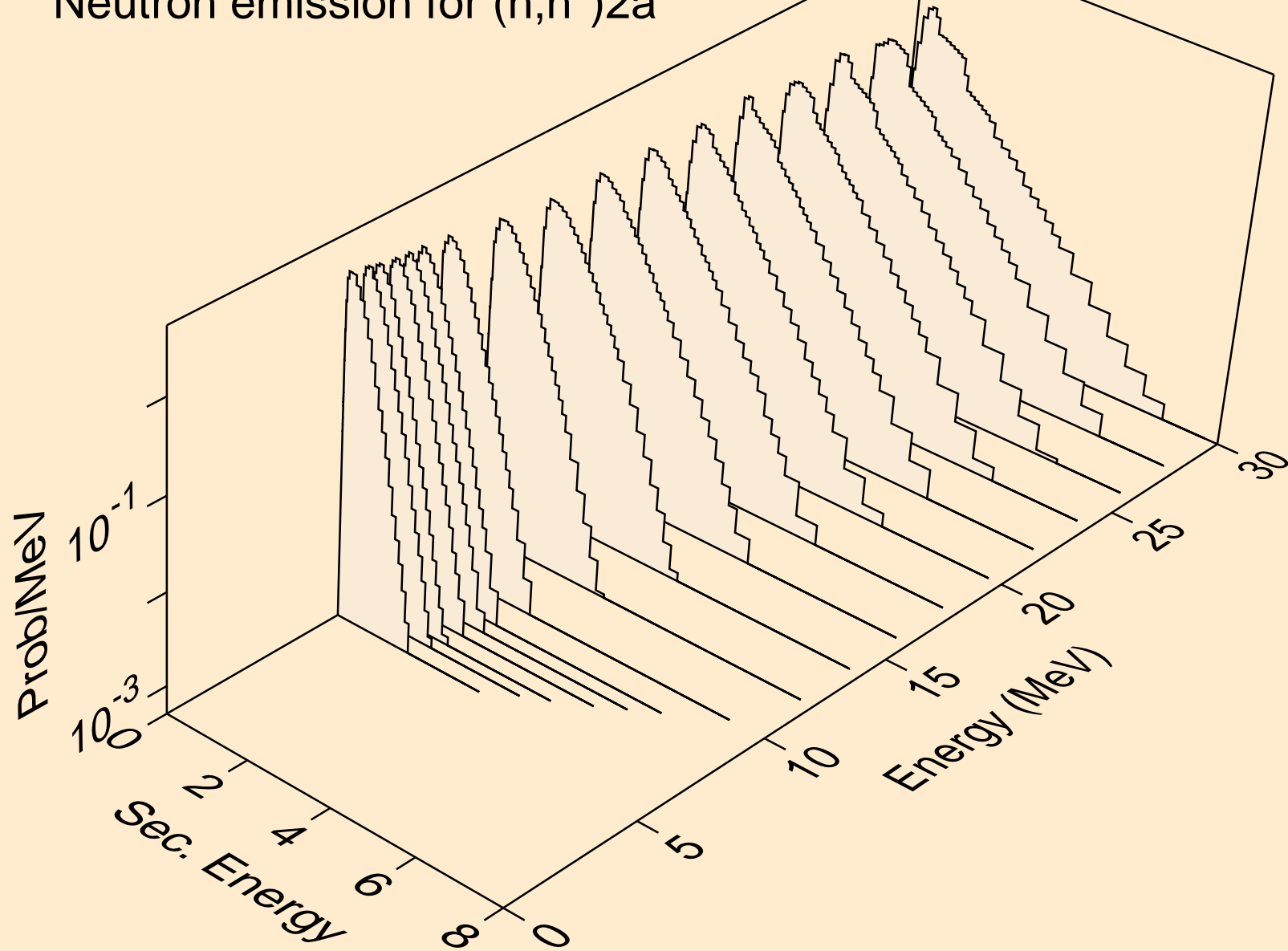

HG189 NEUTRON ACER TENDL-2023 LIBRARY; T=0.K  
Neutron emission for (n,2n)2a

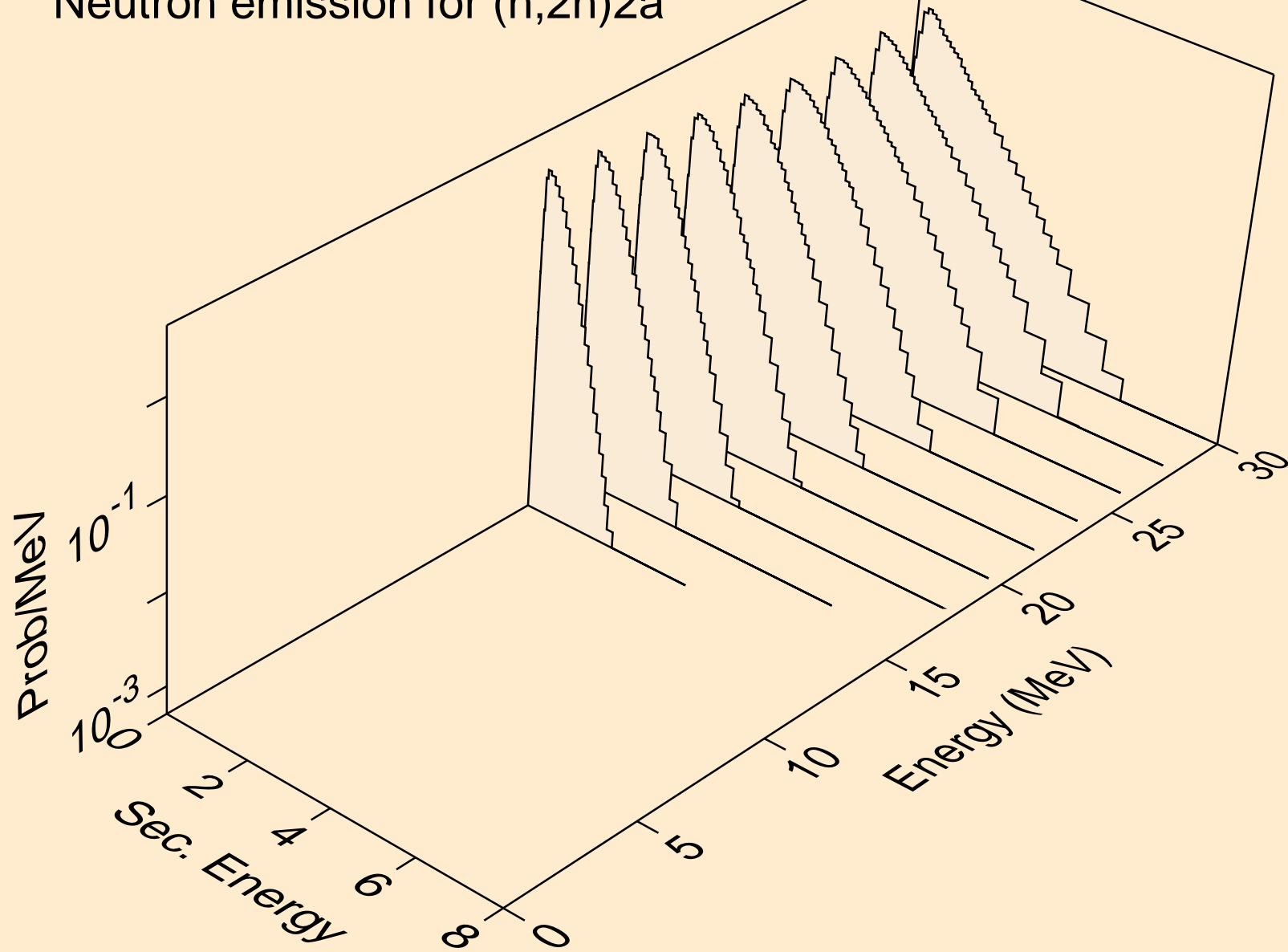

HG189 NEUTRON ACER TENDL-2023 LIBRARY; T=0.K  
Neutron emission for (n,n\*)d

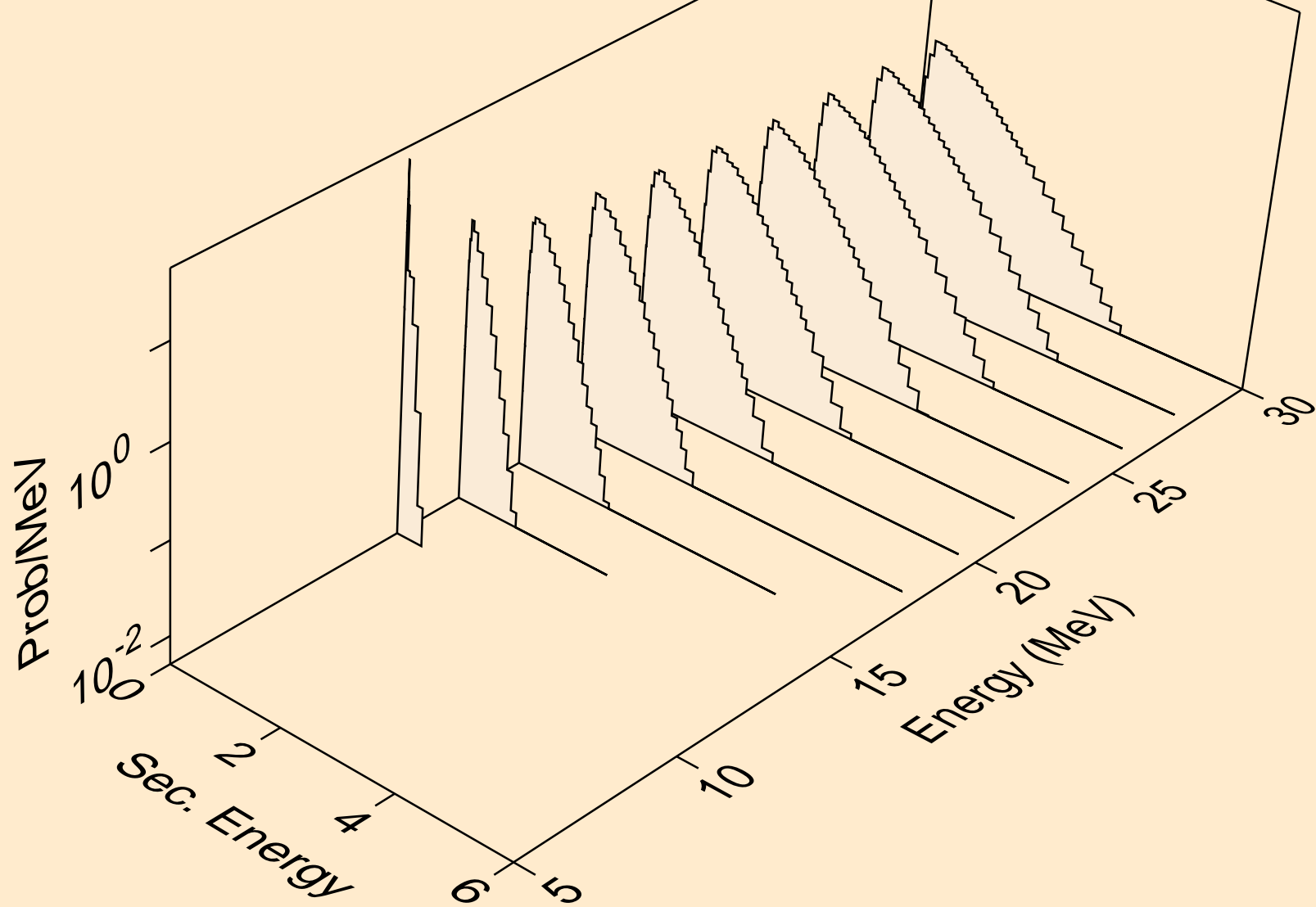

HG189 NEUTRON ACER TENDL-2023 LIBRARY; T=0.K  
Neutron emission for (n,n\*)t

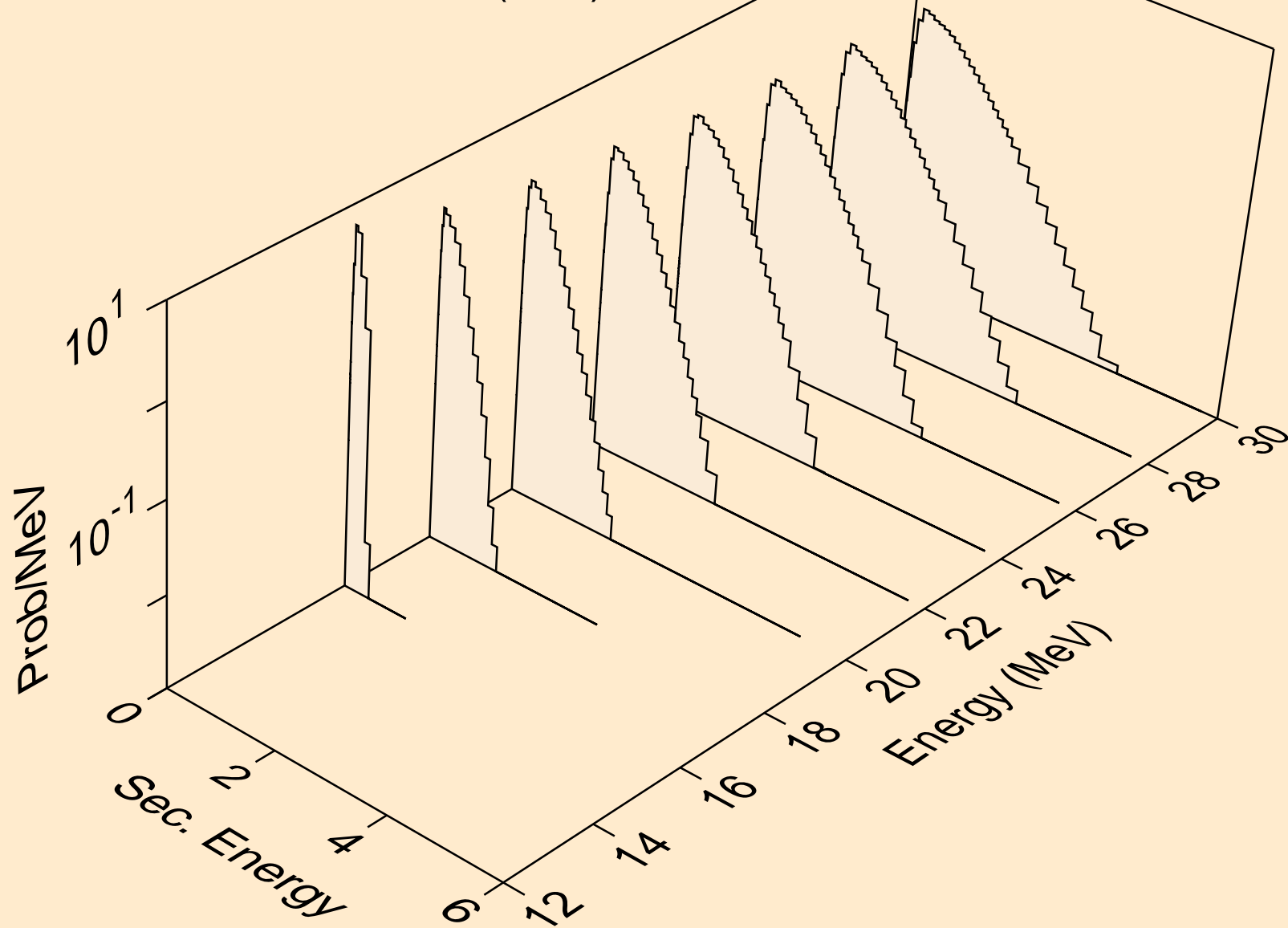



HG189 NEUTRON ACER TENDL-2023 LIBRARY; T=0.K  
Neutron emission for (n,n\*)he3

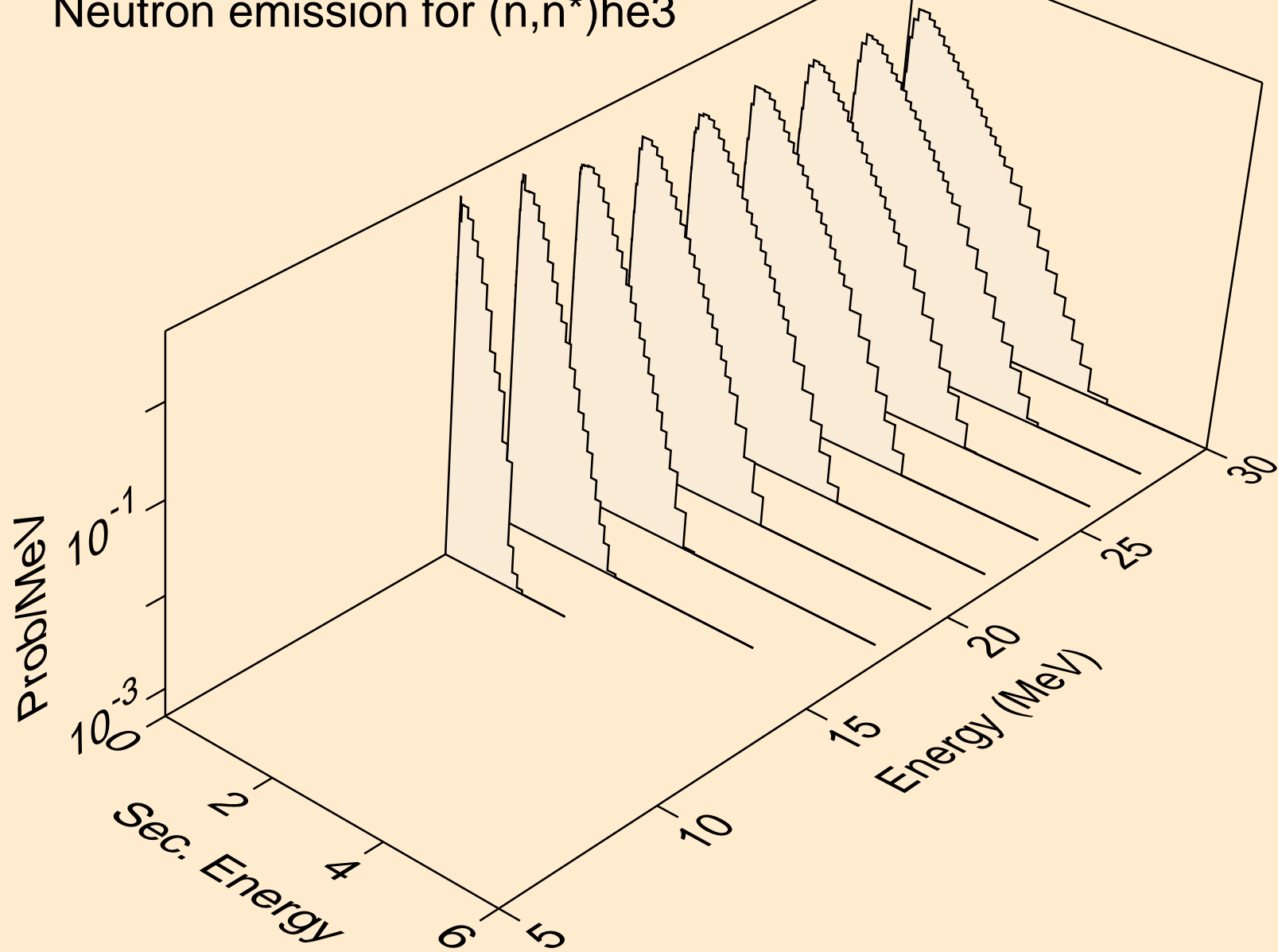

HG189 NEUTRON ACER TENDL-2023 LIBRARY; T=0.K  
Neutron emission for (n,4n)

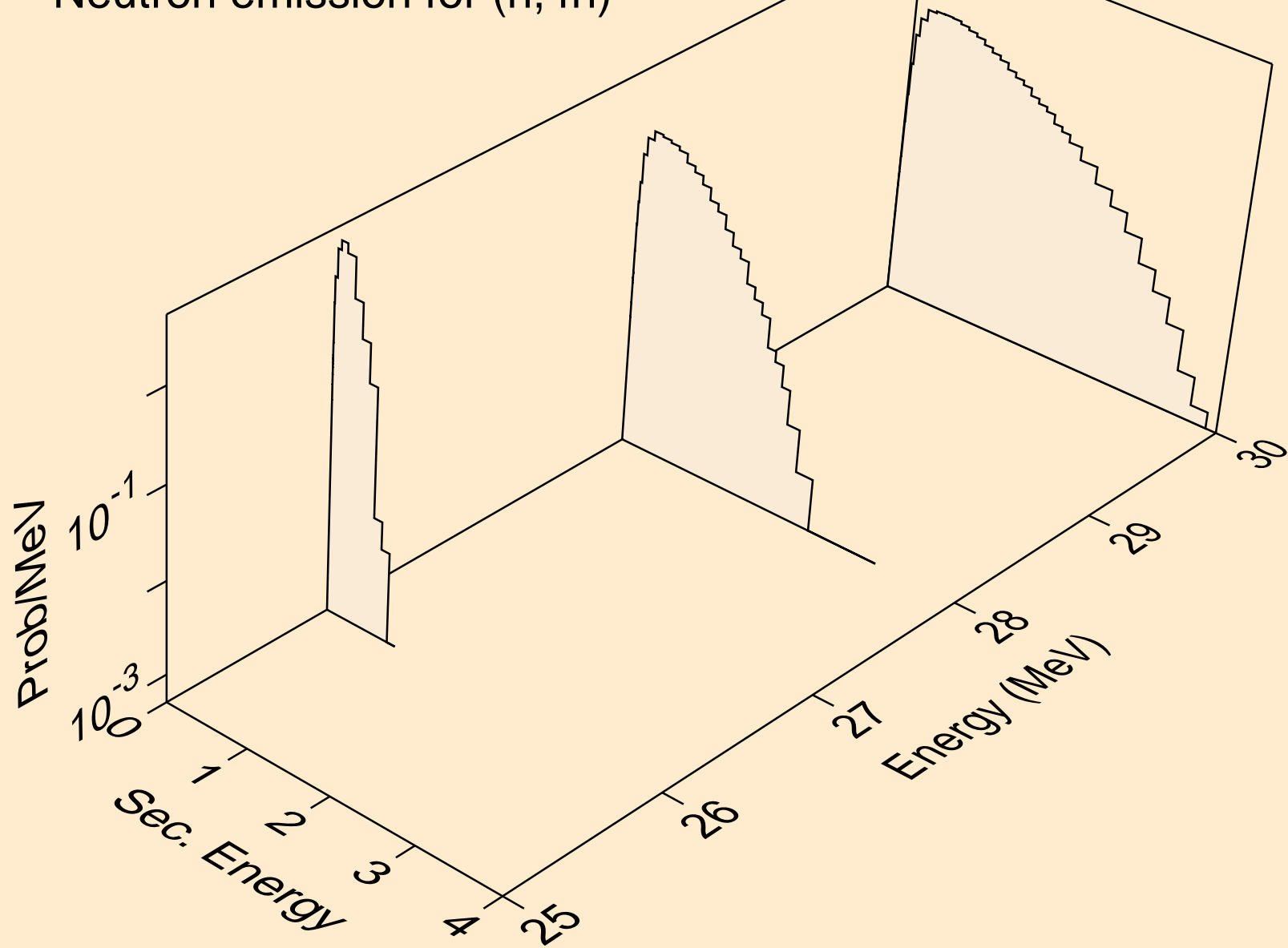

HG189 NEUTRON ACER TENDL-2023 LIBRARY; T=0.K  
Neutron emission for (n,2np)

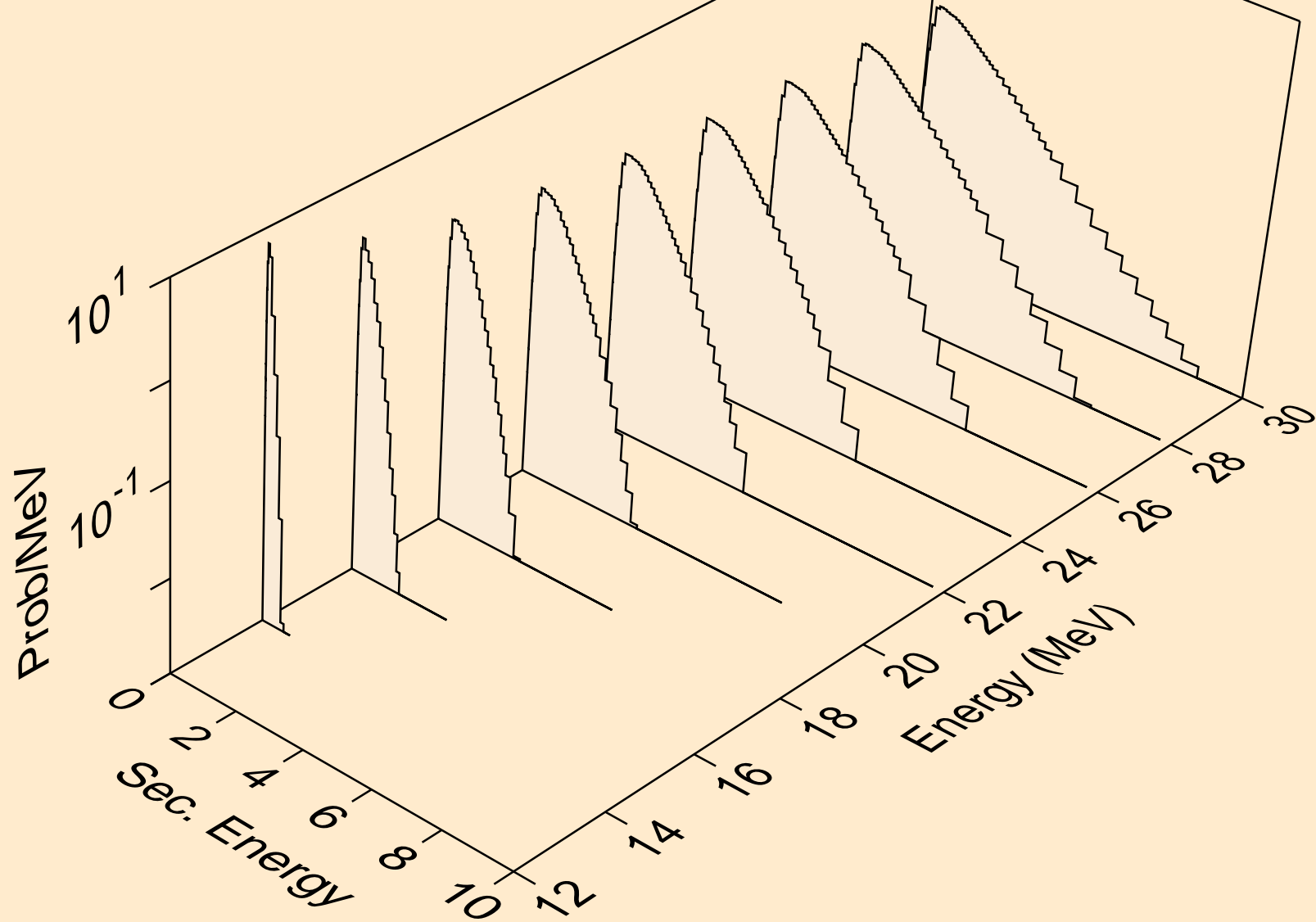

HG189 NEUTRON ACER TENDL-2023 LIBRARY; T=0.K  
Neutron emission for (n,3np)

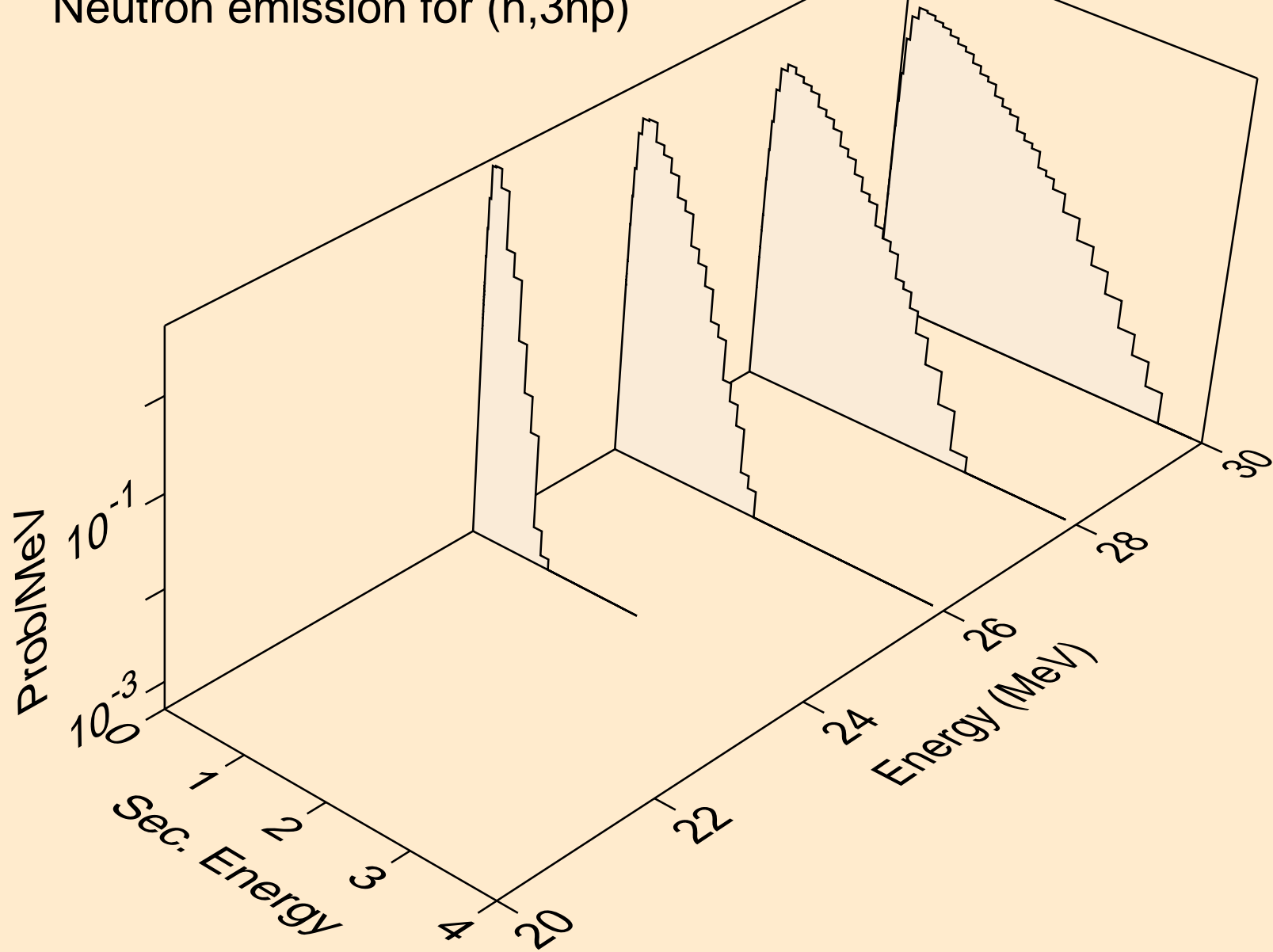

HG189 NEUTRON ACER TENDL-2023 LIBRARY; T=0.K  
Neutron emission for (n,n2p)

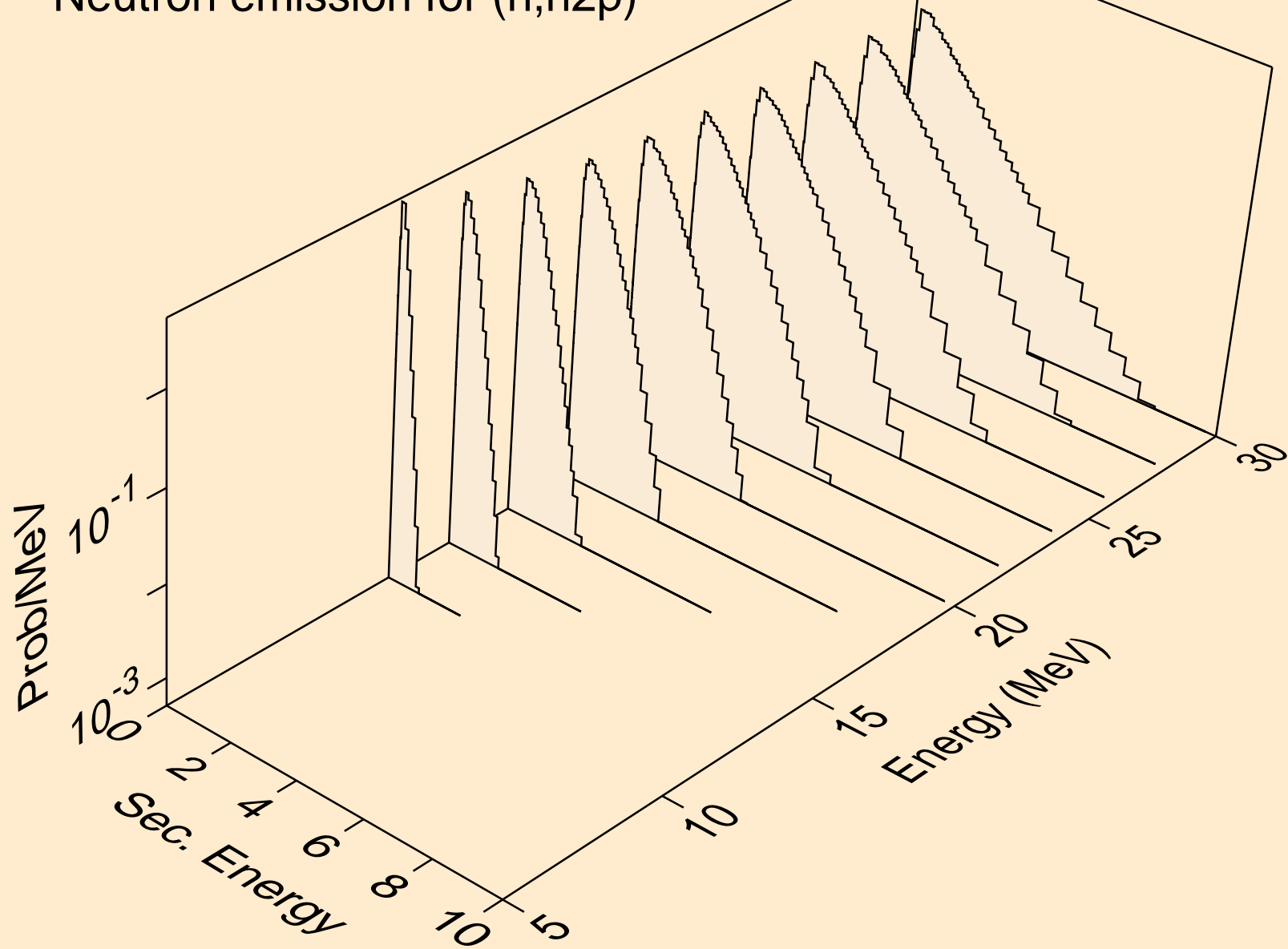

HG189 NEUTRON ACER TENDL-2023 LIBRARY; T=0.K  
Neutron emission for (n,npa)

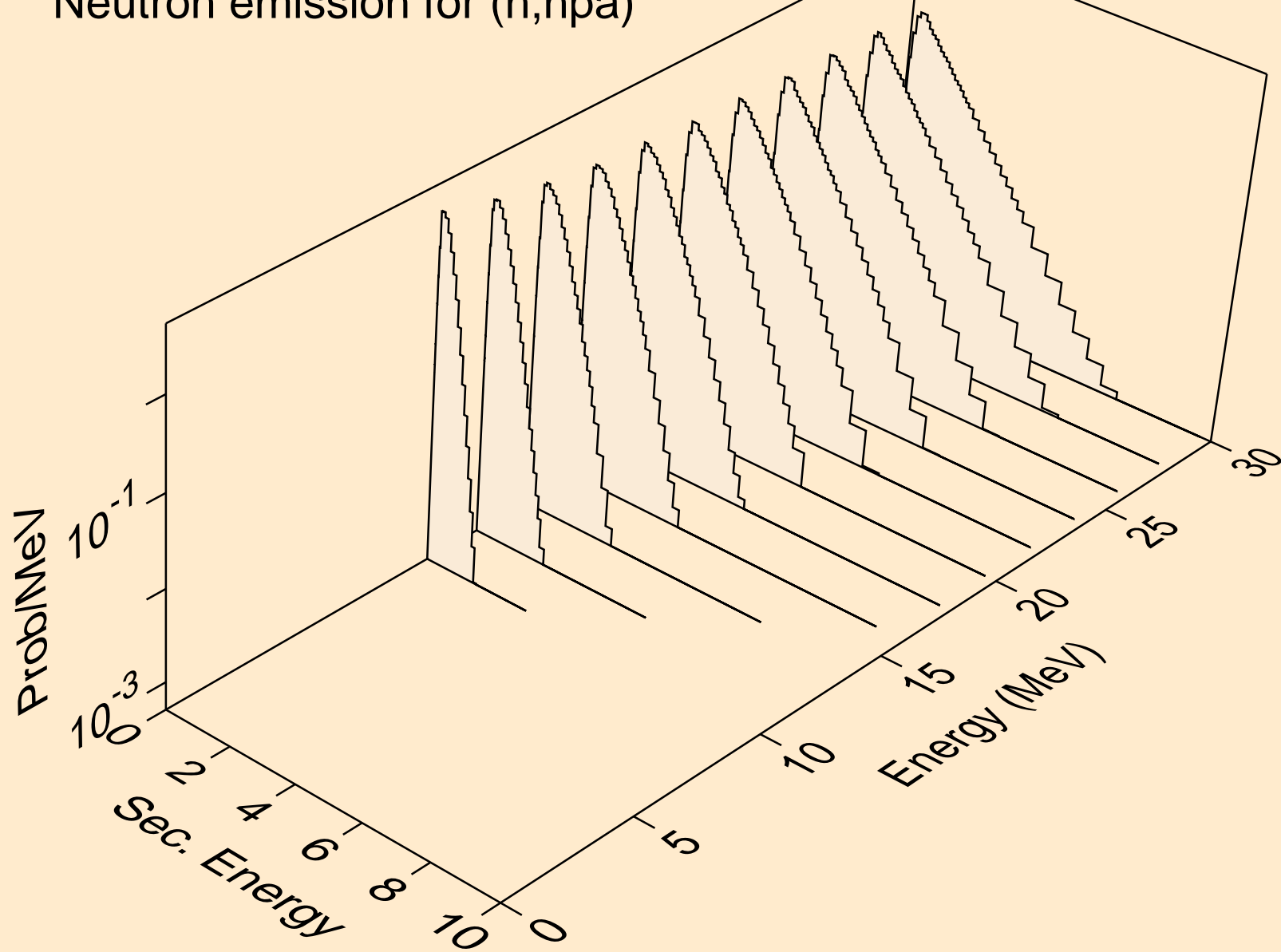

HG189 NEUTRON ACER TENDL-2023 LIBRARY; T=0.K  
Neutron emission for (n,n\*c)

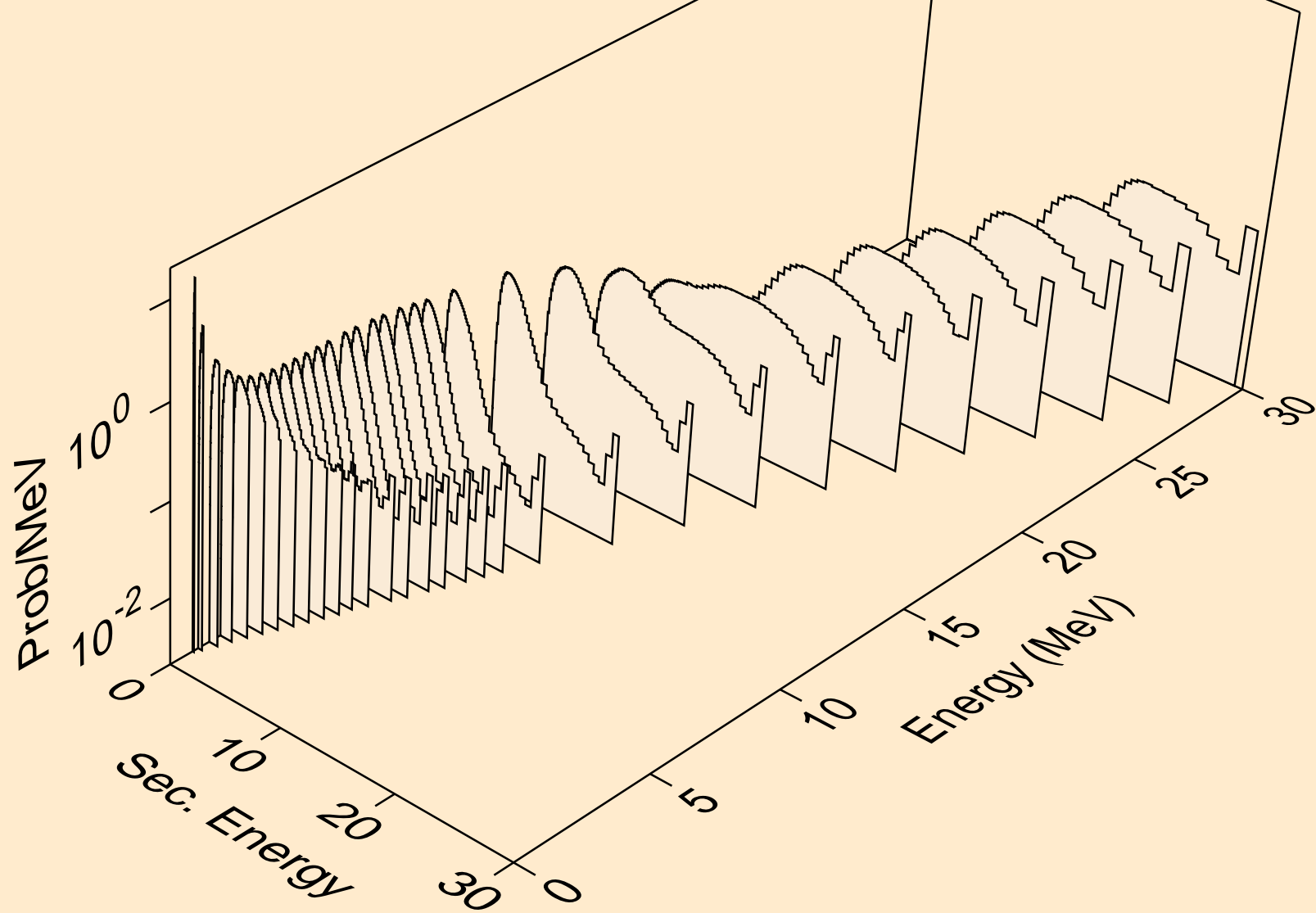

HG189 NEUTRON ACER TENDL-2023 LIBRARY; T=0.K  
Photon emission for (n,x)

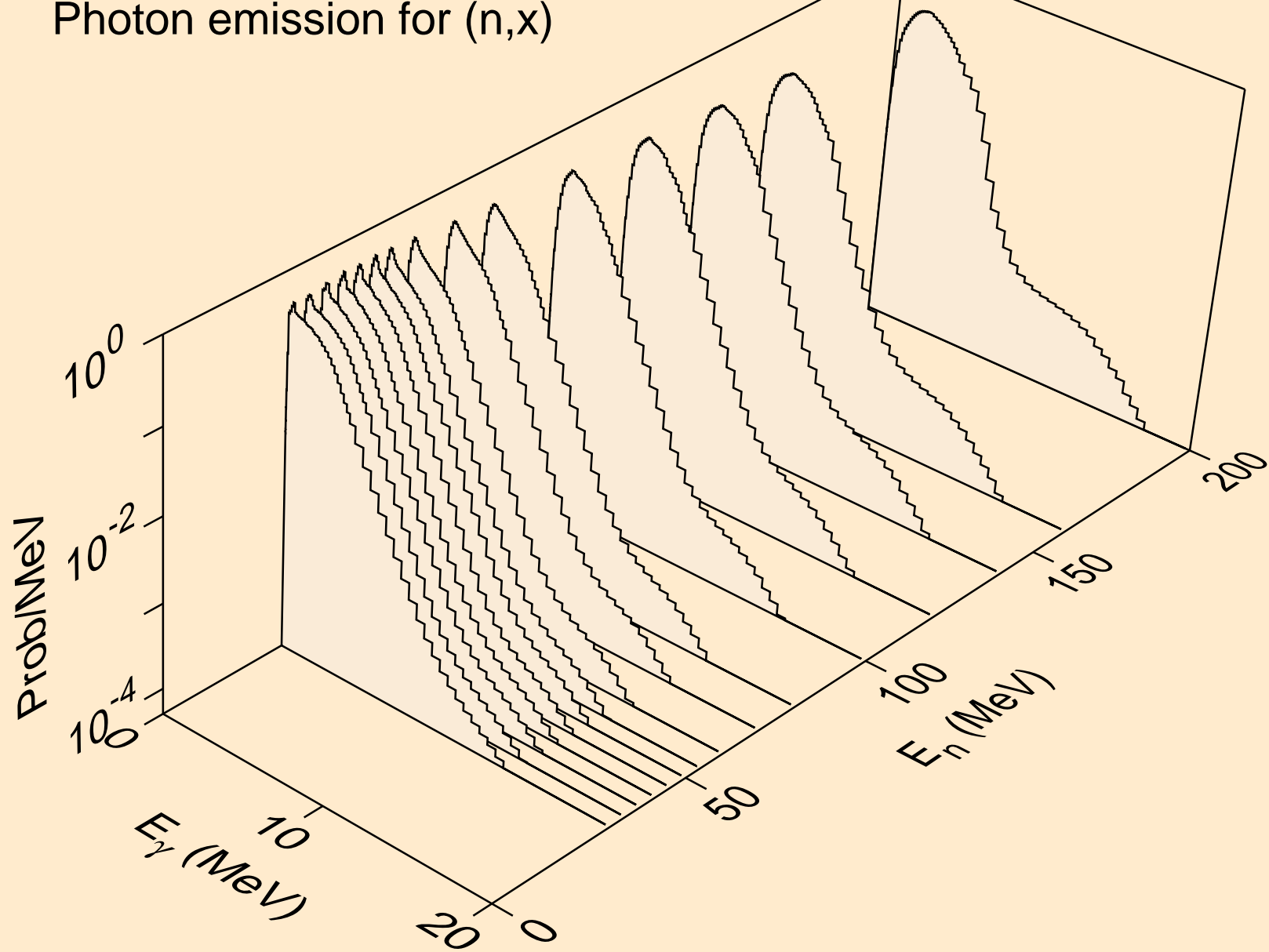



HG189 NEUTRON ACER TENDL-2023 LIBRARY; T=0.K  
Photon emission for (n,2nd)

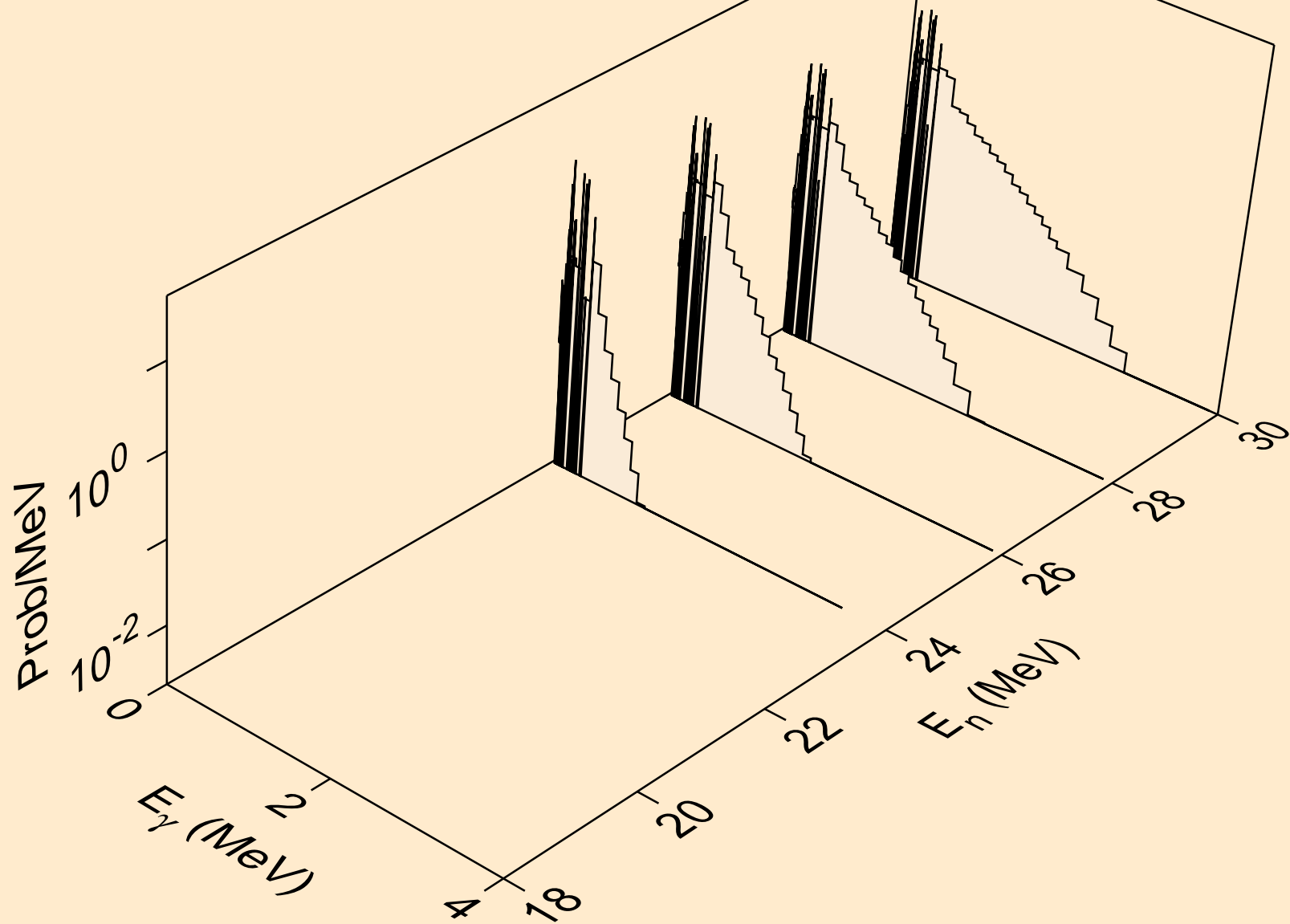

HG189 NEUTRON ACER TENDL-2023 LIBRARY; T=0.K  
Photon emission for (n,2n)

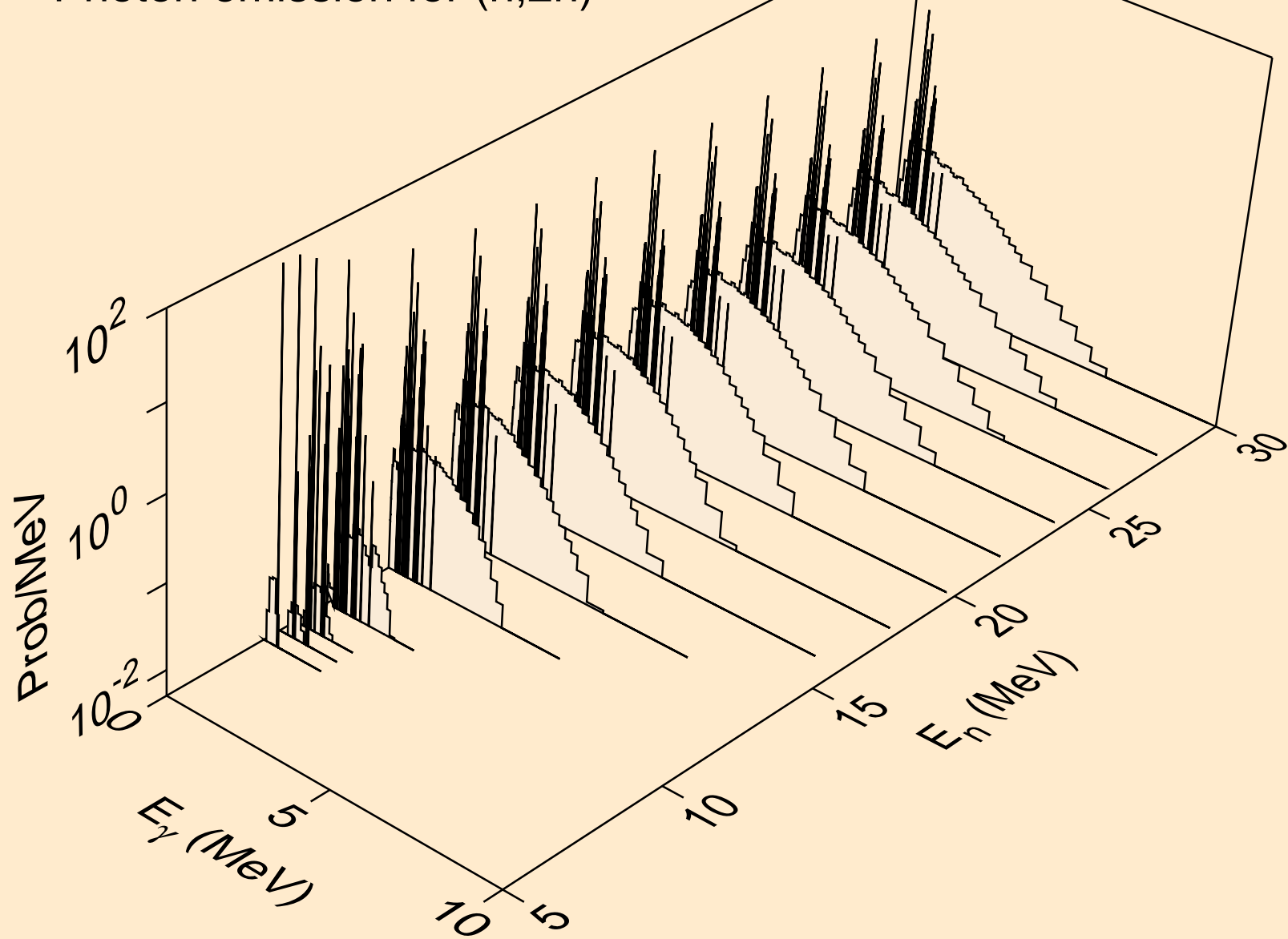

HG189 NEUTRON ACER TENDL-2023 LIBRARY; T=0.K  
Photon emission for (n,3n)

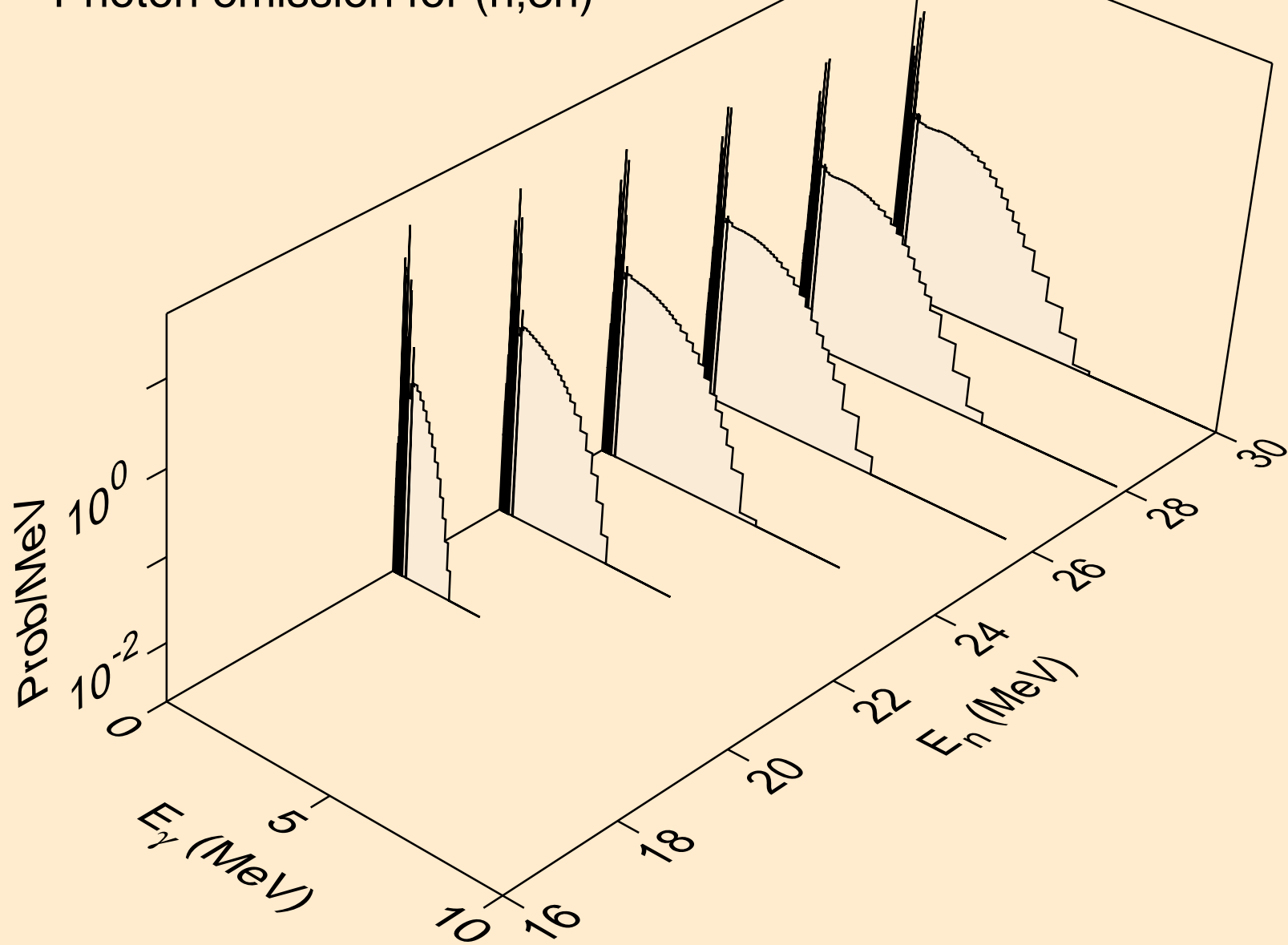

HG189 NEUTRON ACER TENDL-2023 LIBRARY; T=0.K  
Photon emission for (n,n\*)a

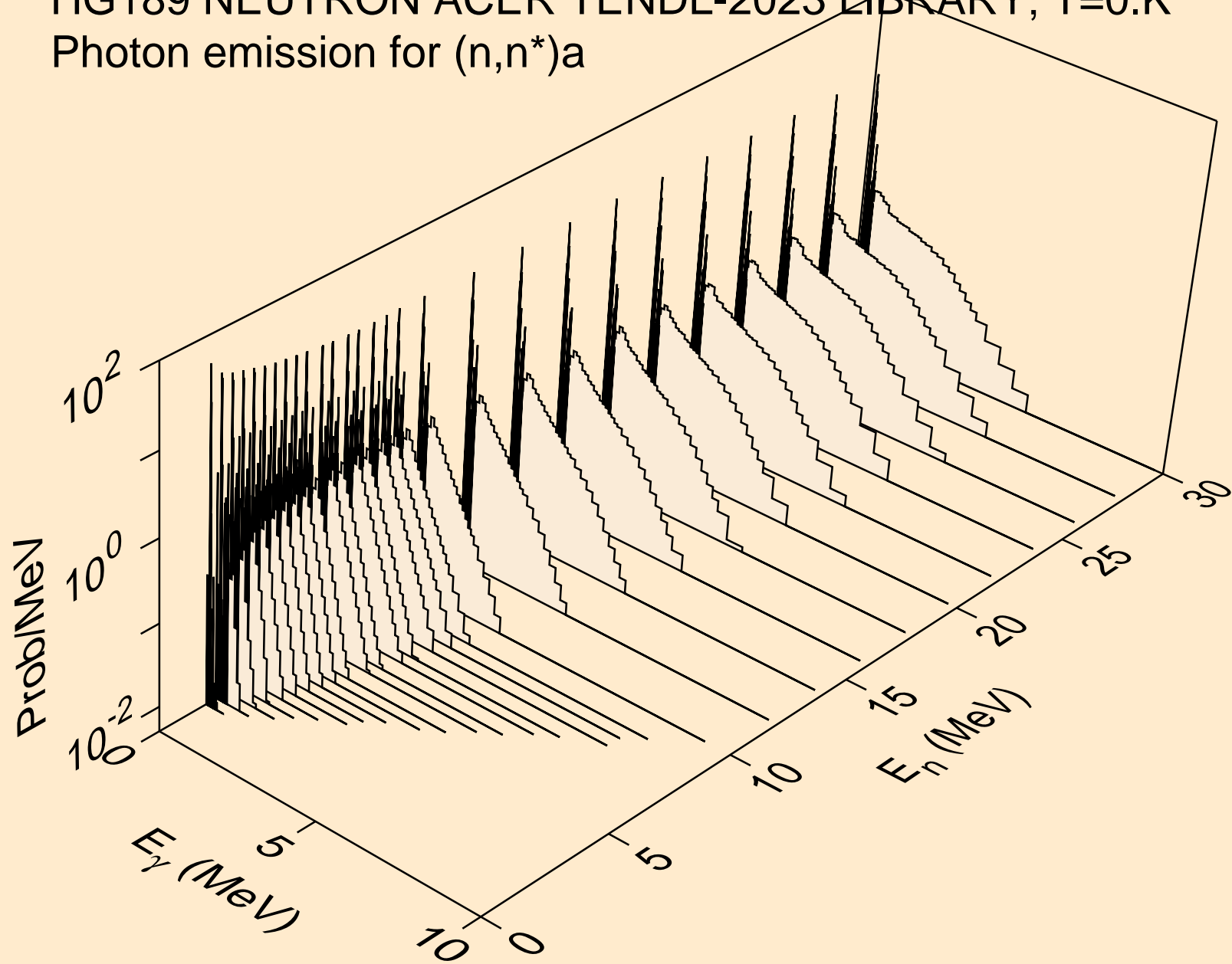

HG189 NEUTRON ACER TENDL-2023 LIBRARY; T=0.K  
Photon emission for (n,2n)a

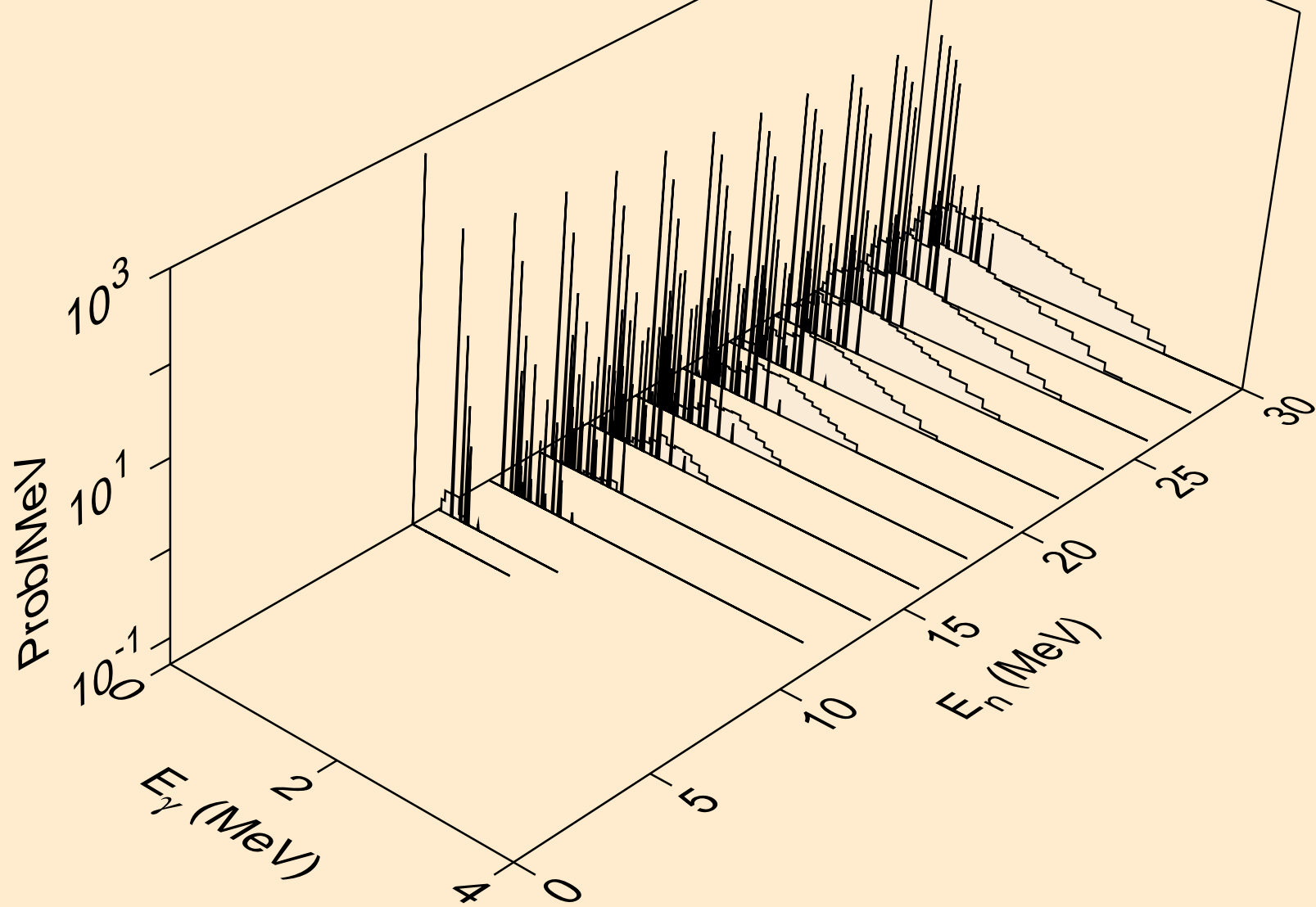

HG189 NEUTRON ACER TENDL-2023 LIBRARY; T=0.K  
Photon emission for (n,3n)a

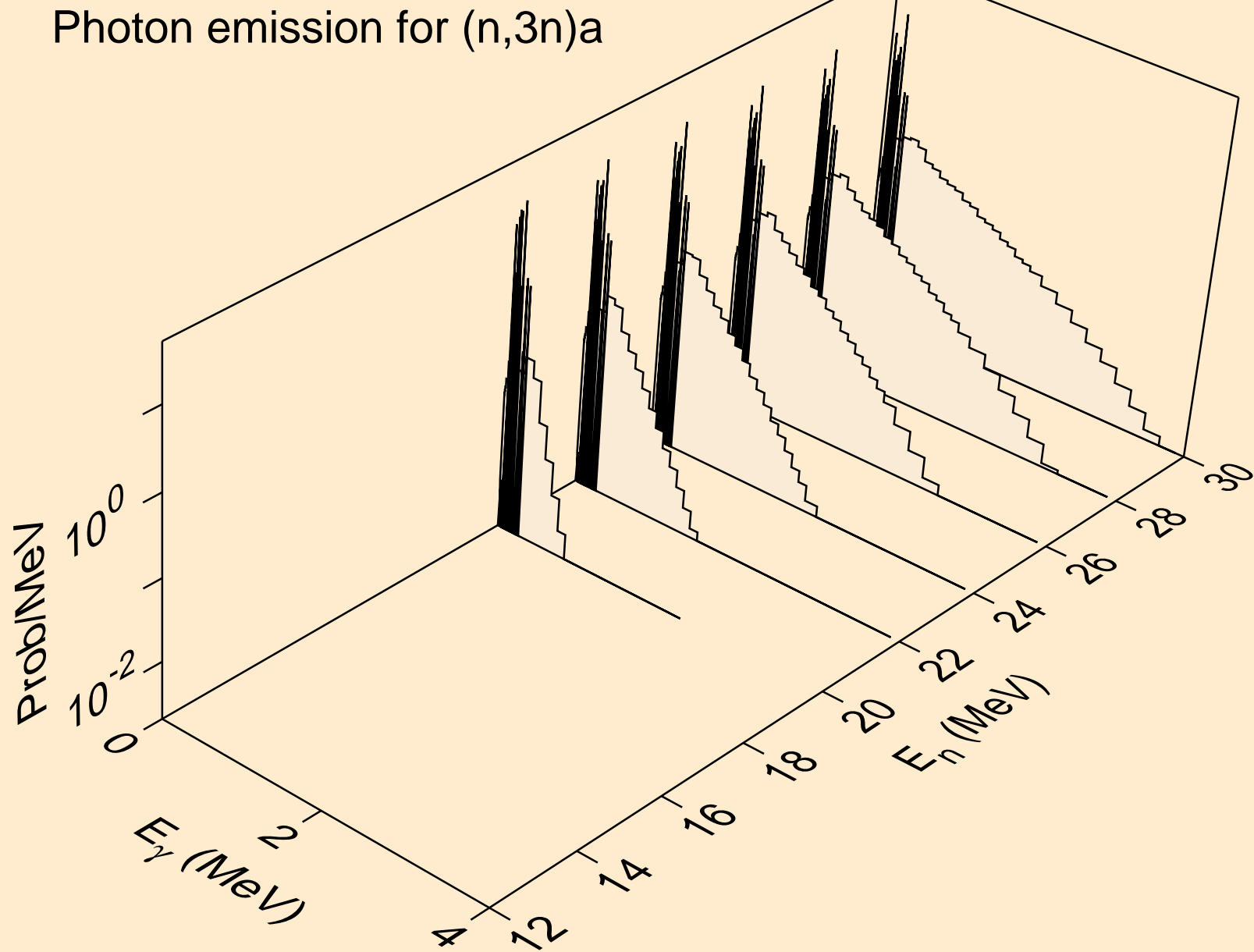

HG189 NEUTRON ACER TENDL-2023 LIBRARY; T=0.K  
Photon emission for (n,n\*)p

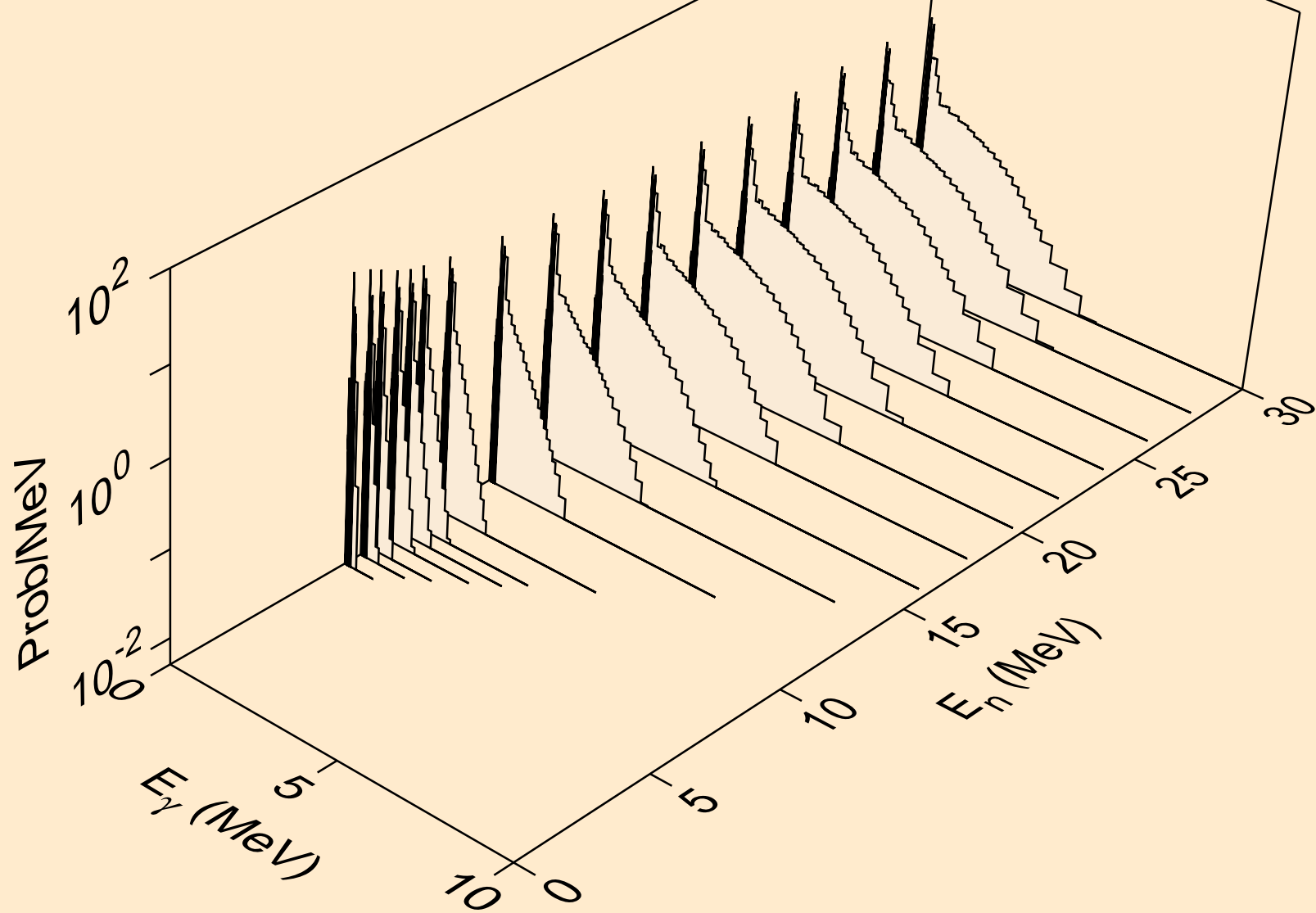

HG189 NEUTRON ACER TENDL-2023 LIBRARY; T=0.K  
Photon emission for (n,n\*)2a

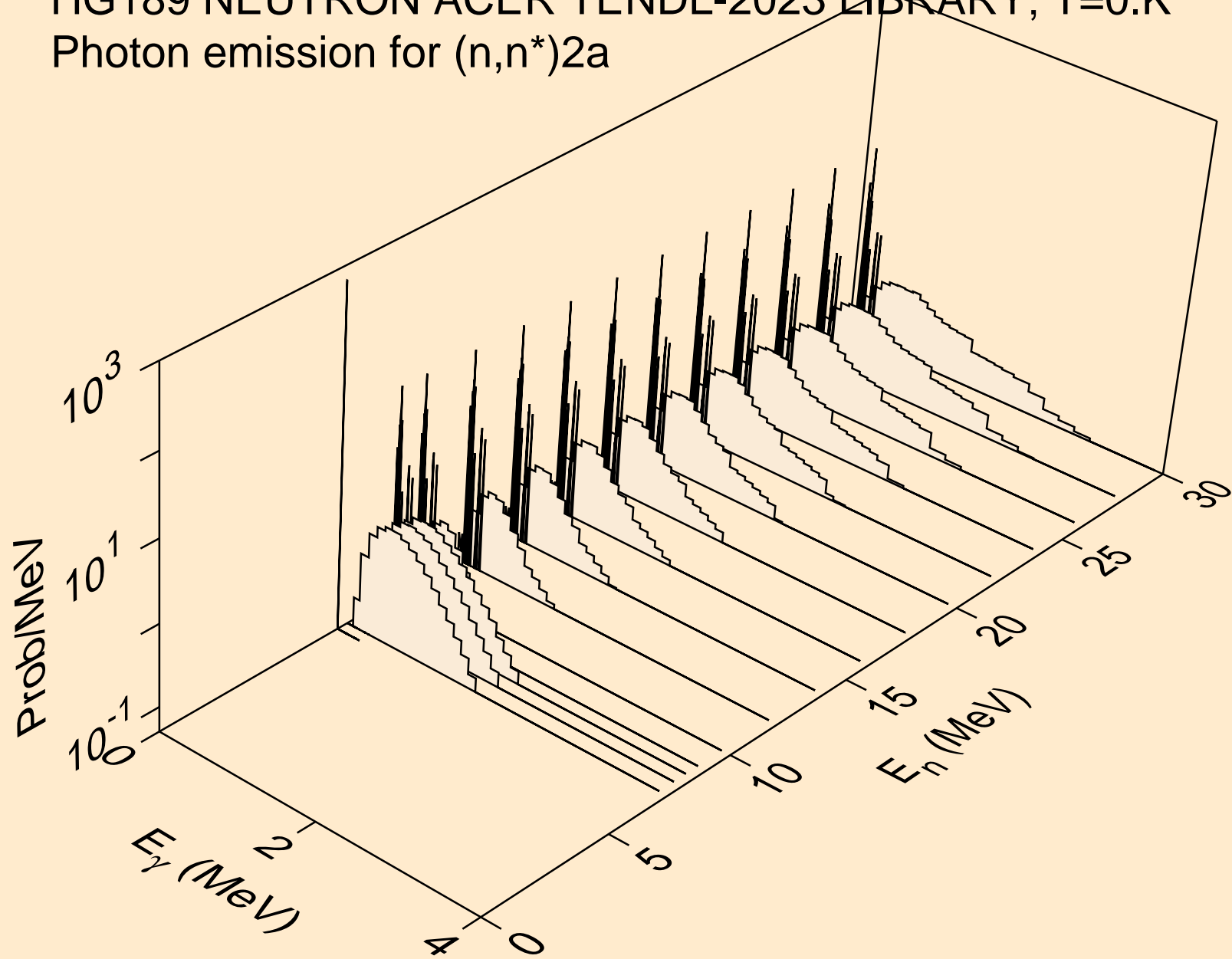



HG189 NEUTRON ACER TENDL-2023 LIBRARY; T=0.K  
Photon emission for (n,2n)2a

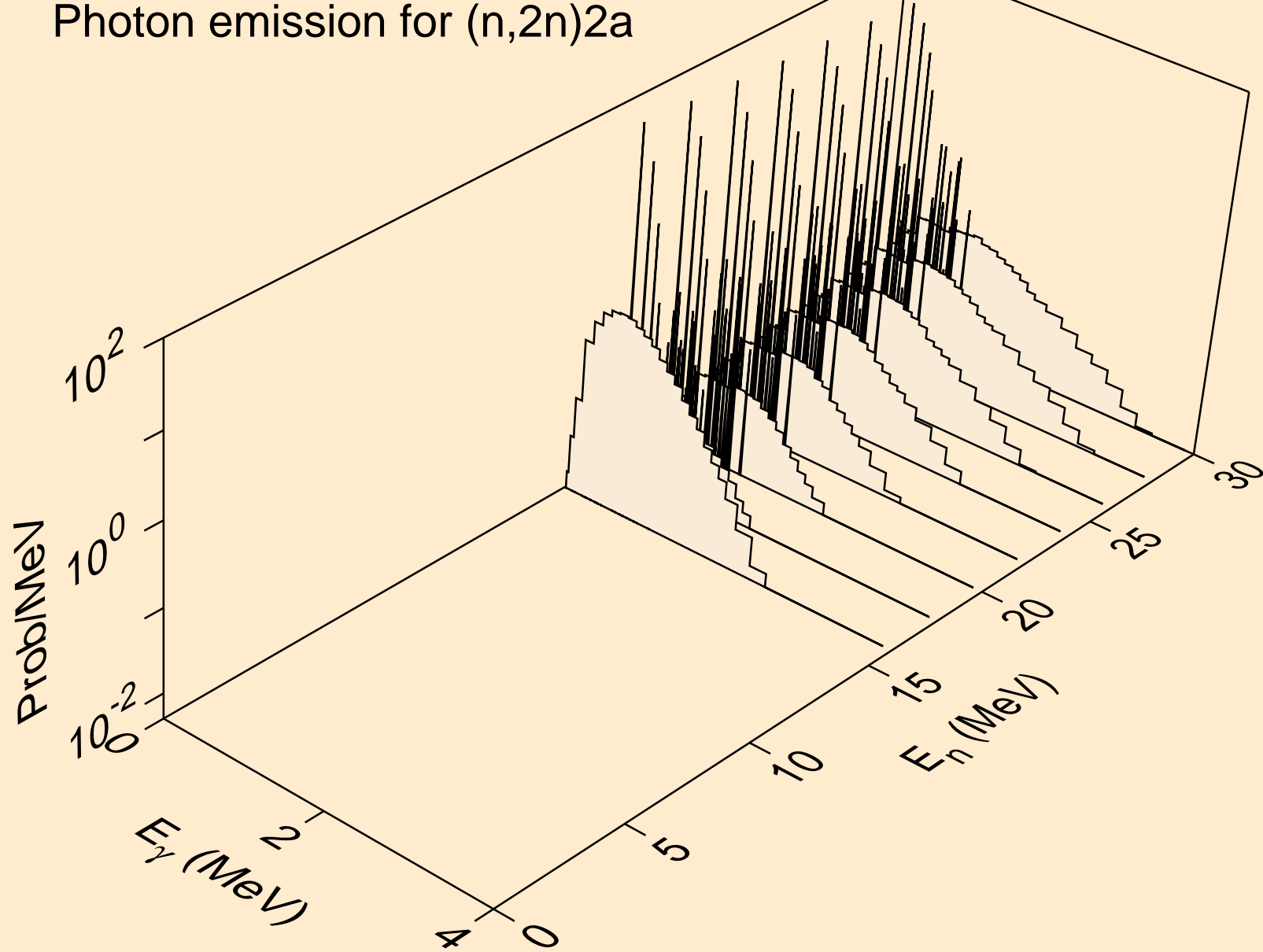

HG189 NEUTRON ACER TENDL-2023 LIBRARY; T=0.K  
Photon emission for (n,n\*)d

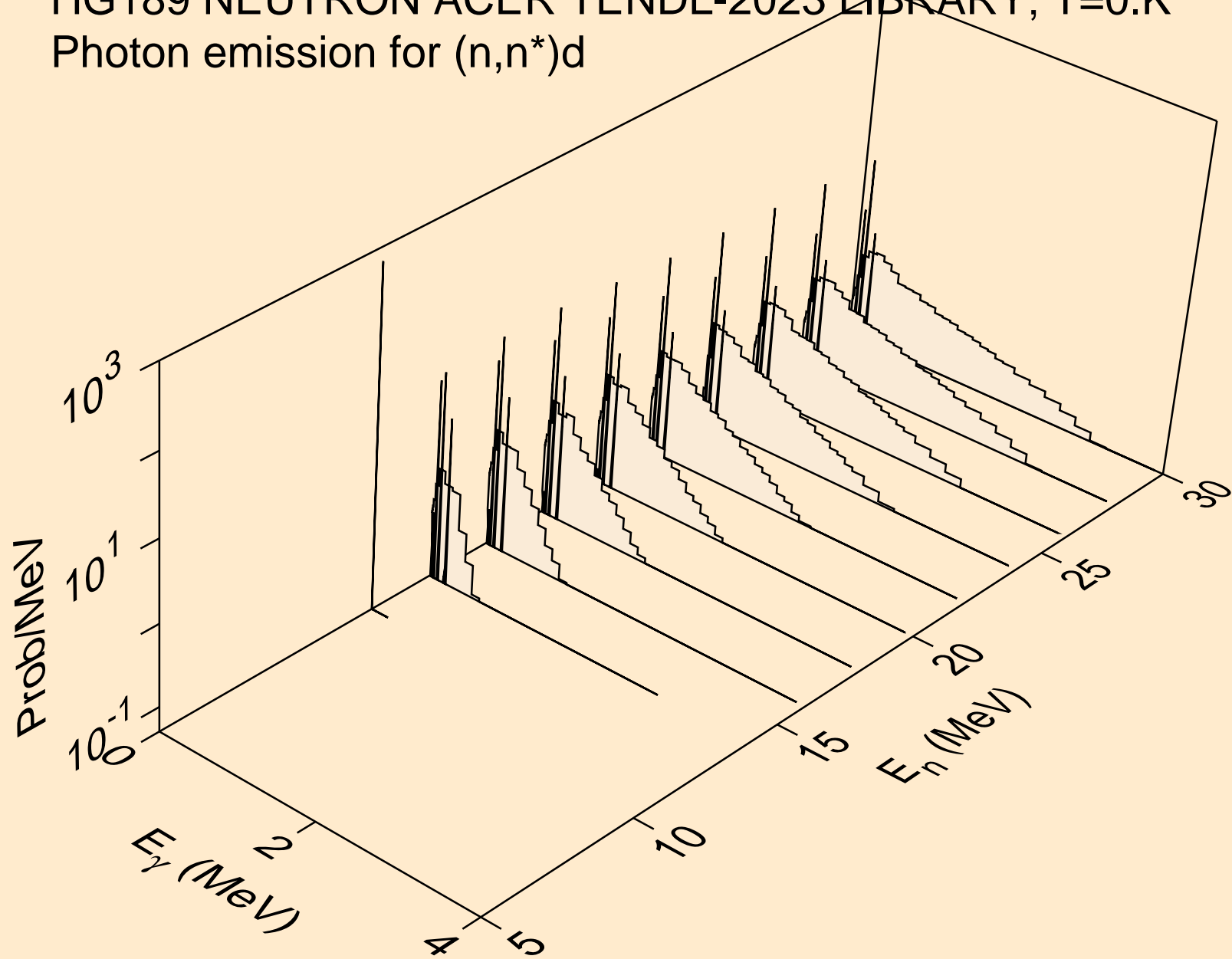

HG189 NEUTRON ACER TENDL-2023 LIBRARY; T=0.K  
Photon emission for (n,n\*)t

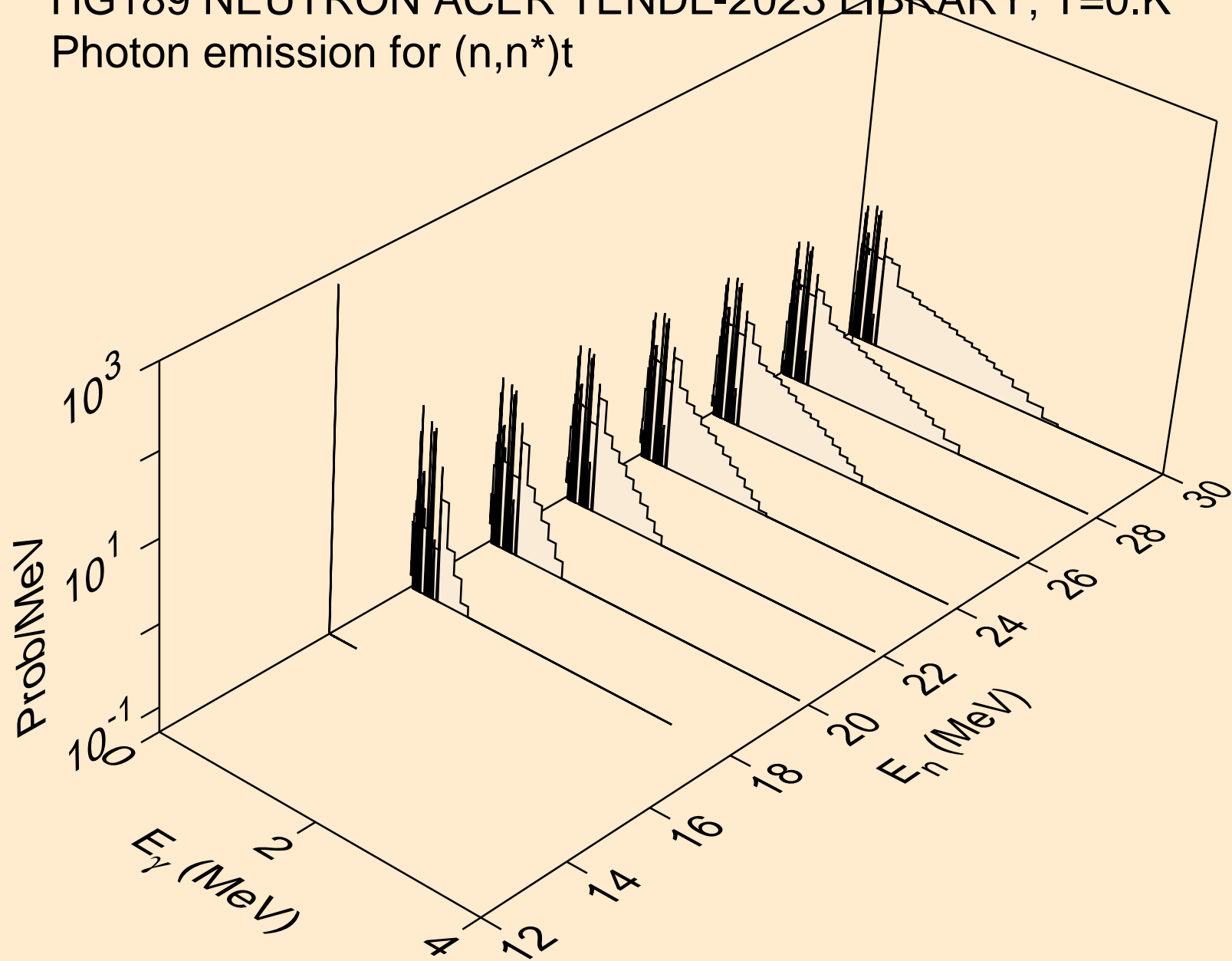

HG189 NEUTRON ACER TENDL-2023 LIBRARY; T=0.K  
Photon emission for (n,n\*)he3

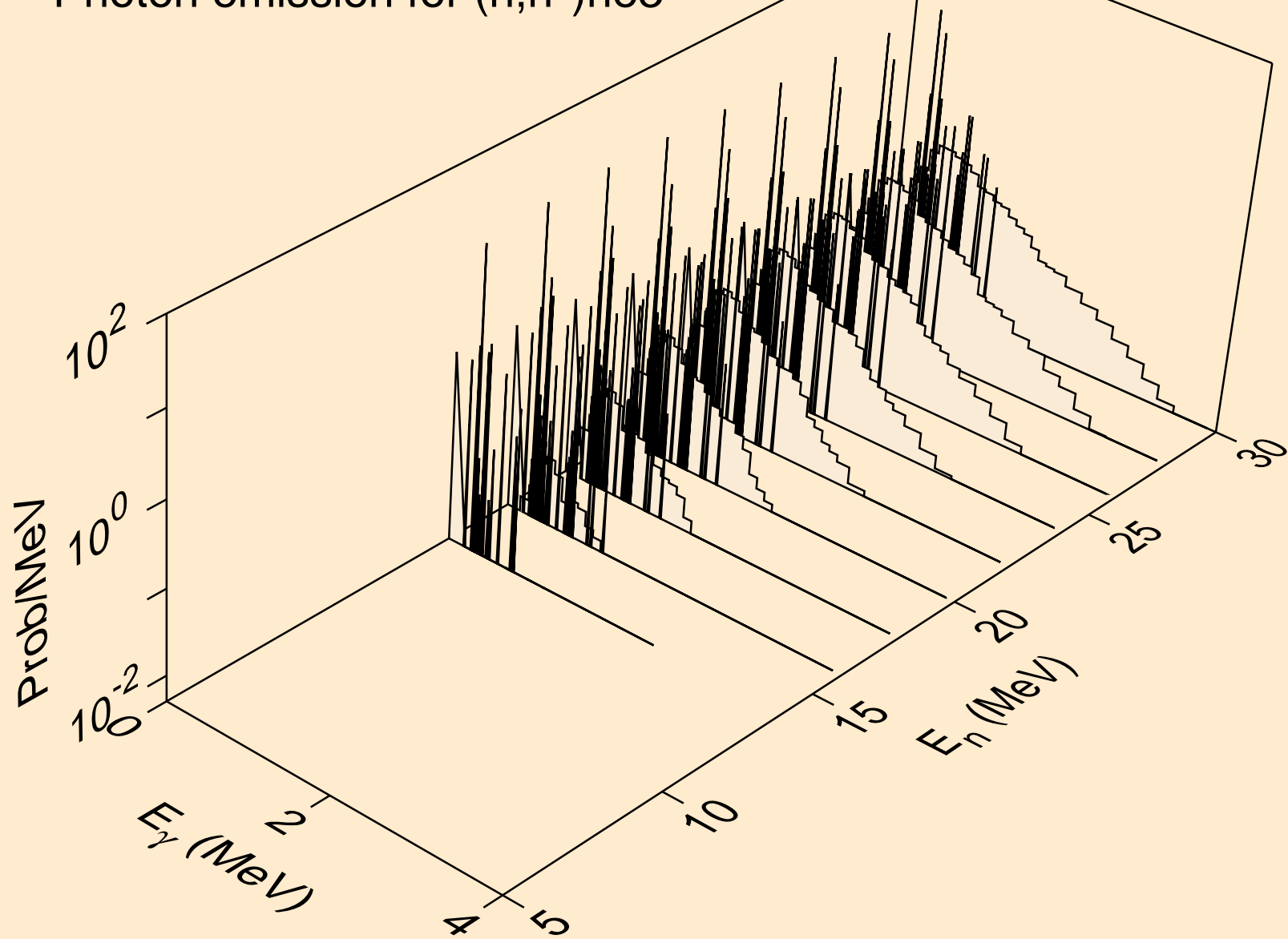

HG189 NEUTRON ACER TENDL-2023 LIBRARY; T=0.K  
Photon emission for (n,4n)

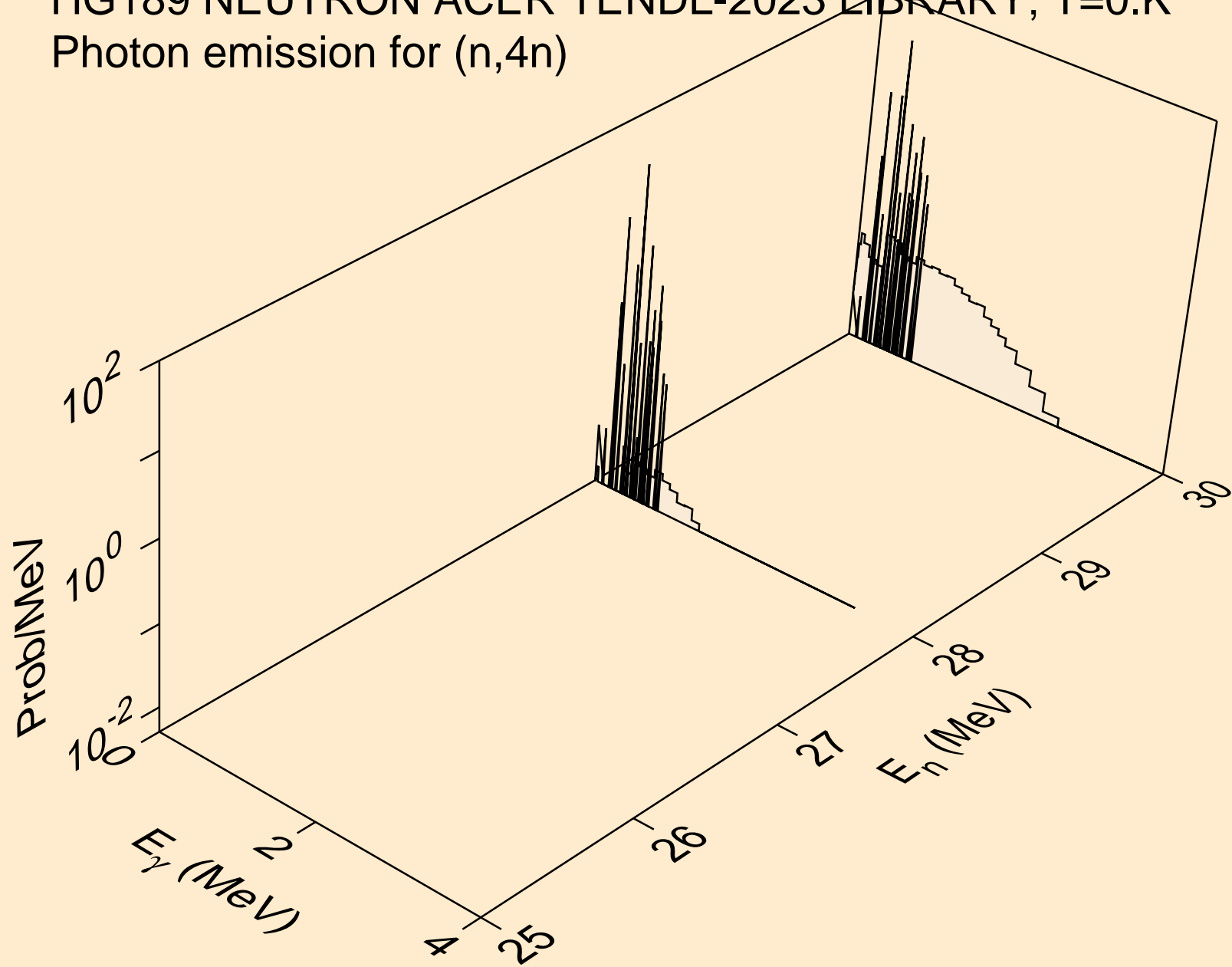

HG189 NEUTRON ACER TENDL-2023 LIBRARY; T=0.K  
Photon emission for (n,2np)

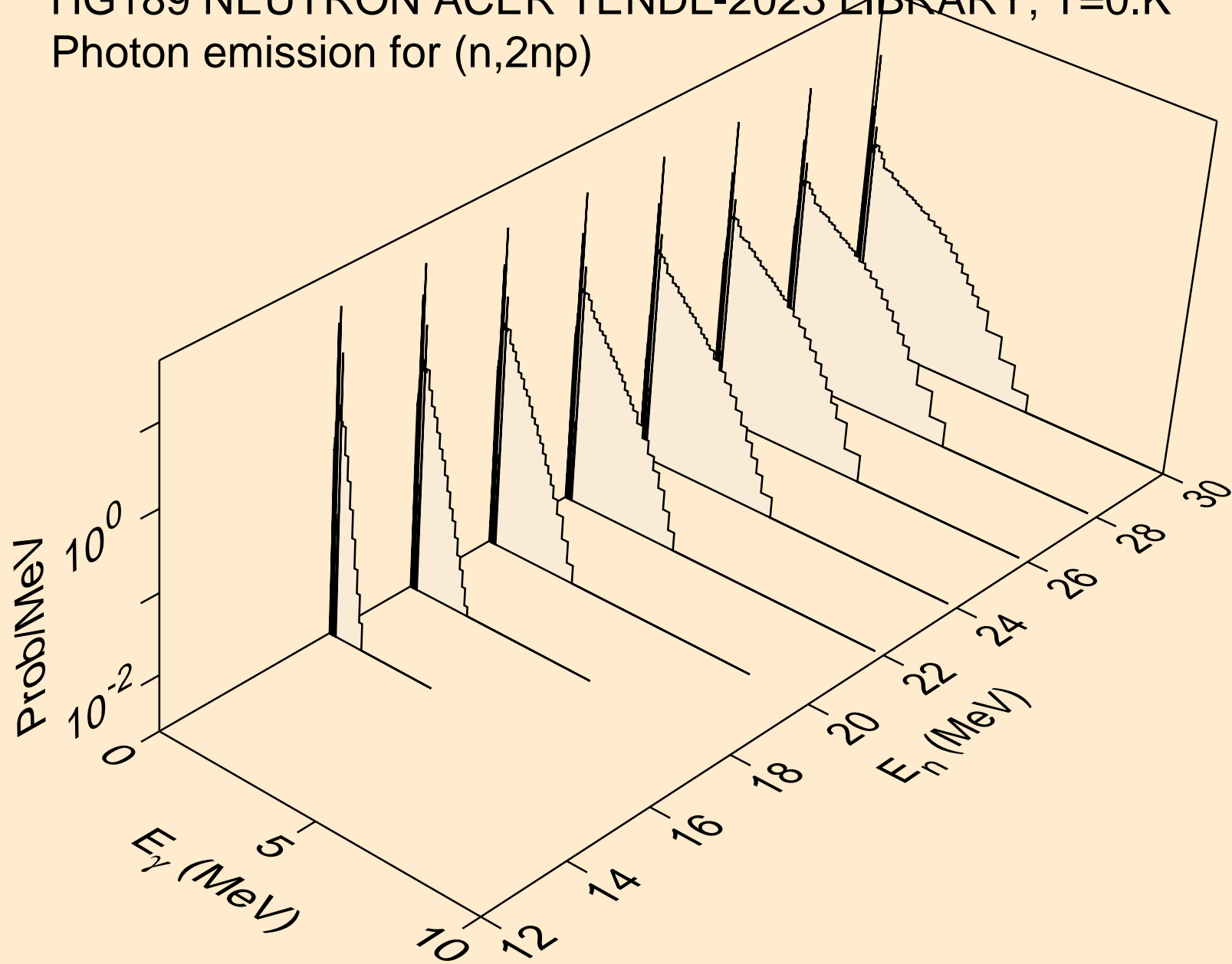

HG189 NEUTRON ACER TENDL-2023 LIBRARY; T=0.K  
Photon emission for (n,3np)

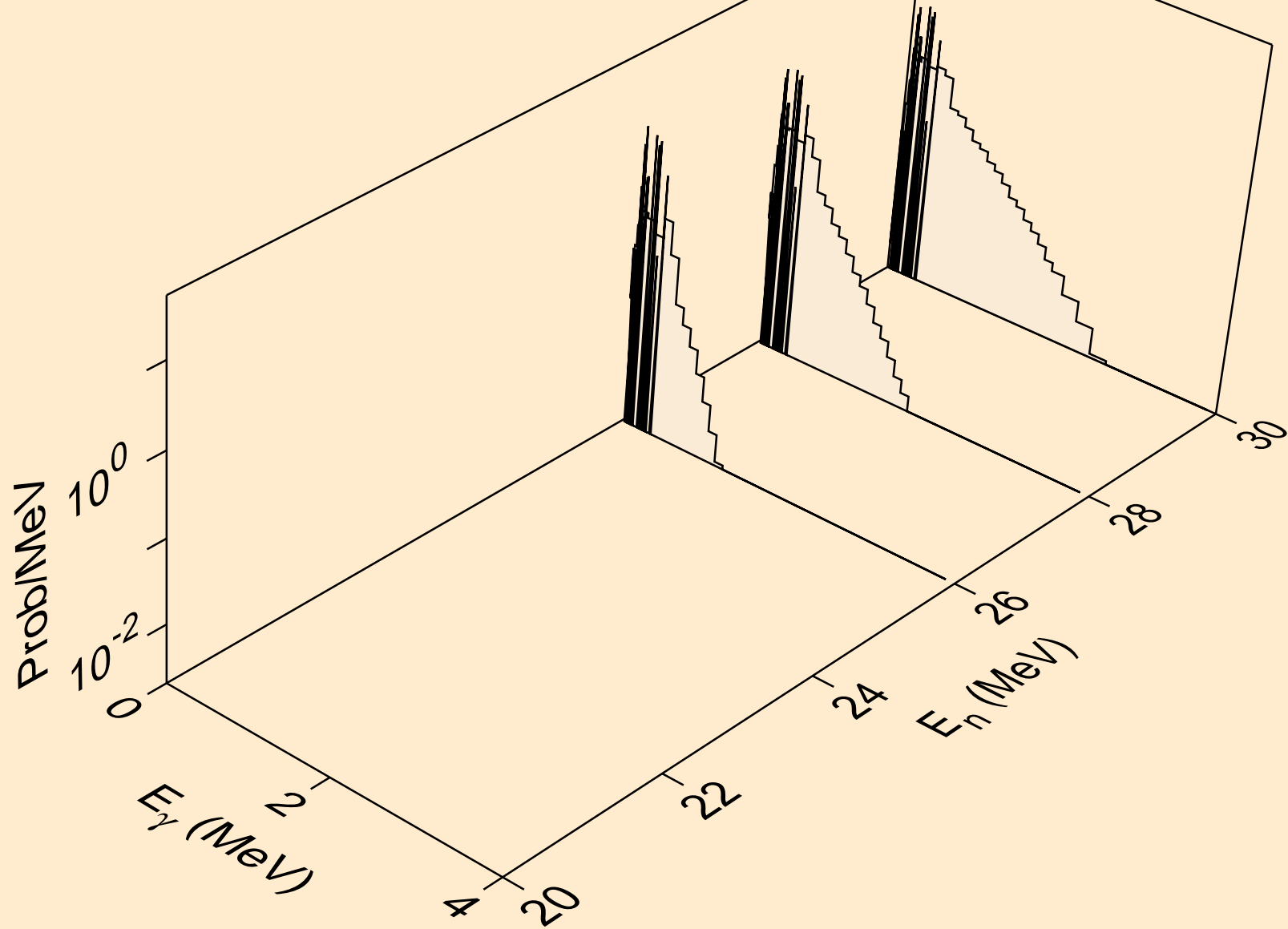

HG189 NEUTRON ACER TENDL-2023 LIBRARY; T=0.K  
Photon emission for (n,n2p)

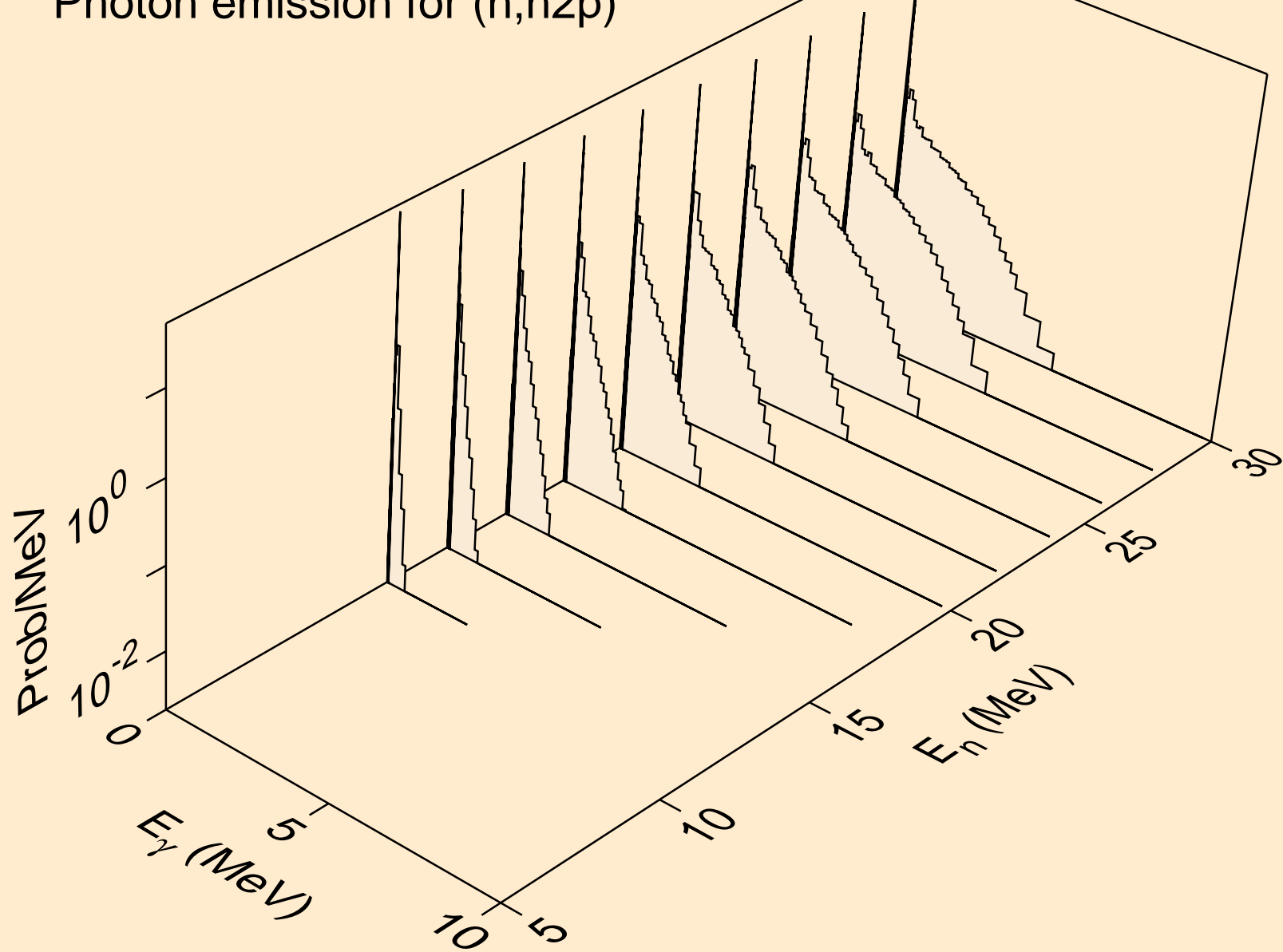



HG189 NEUTRON ACER TENDL-2023 LIBRARY; T=0.K  
Photon emission for (n,npa)

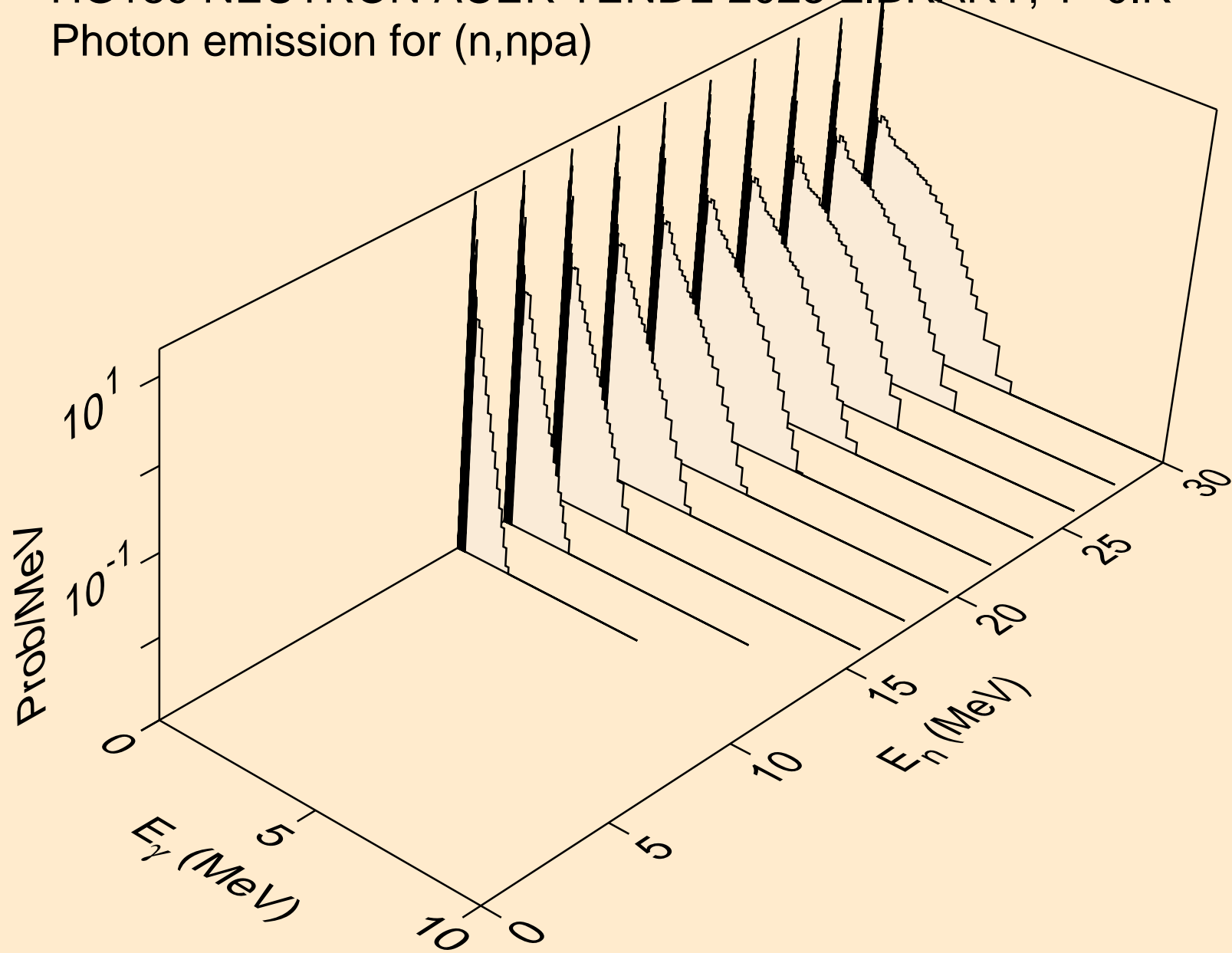

HG189 NEUTRON ACER TENDL-2023 LIBRARY; T=0.K  
Photon emission for (n,n\*c)

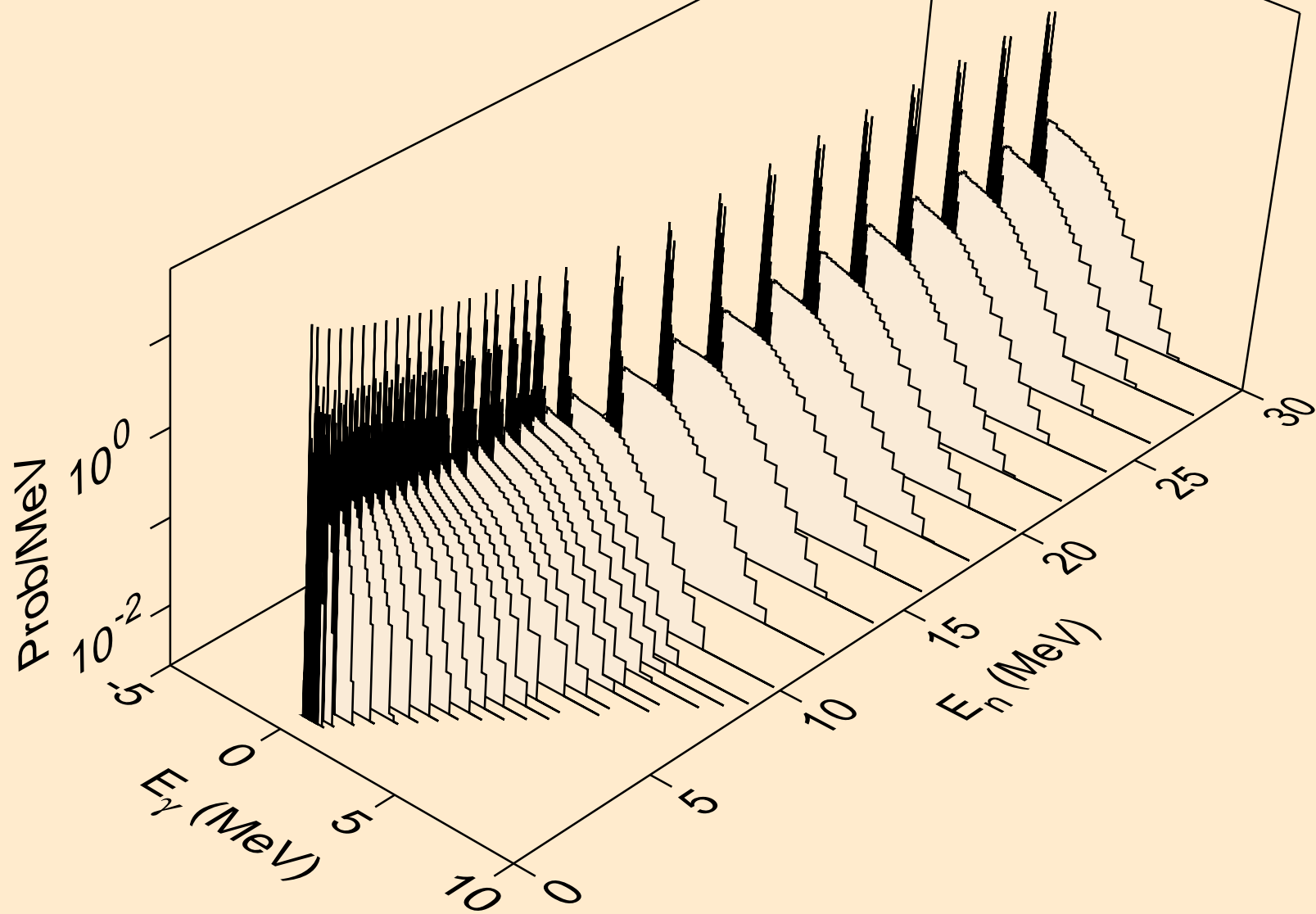

HG189 NEUTRON ACER TENDL-2023 LIBRARY; T=0.K  
Photon emission for (n,gma)

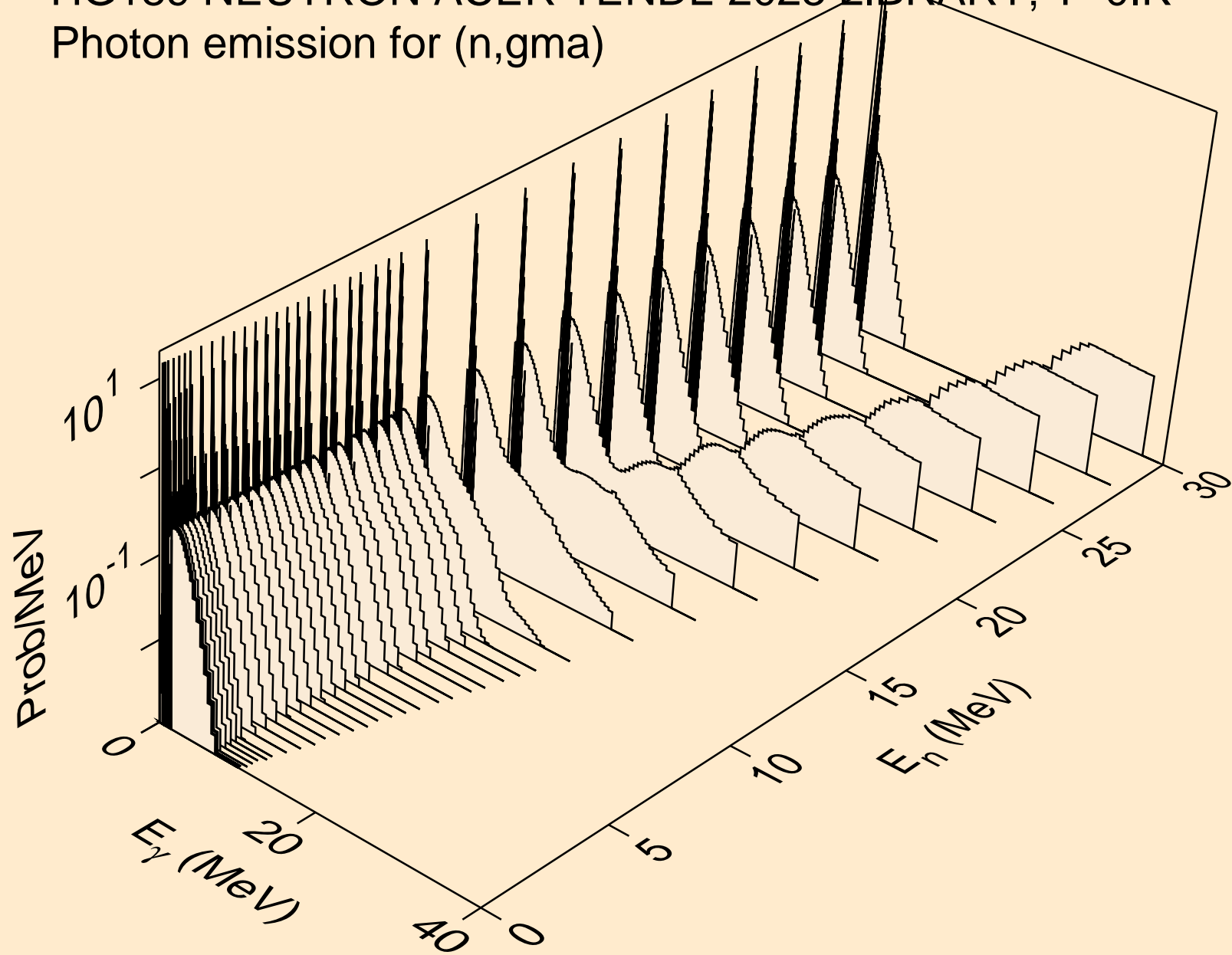

HG189 NEUTRON ACER TENDL-2023 LIBRARY; T=0.K  
Photon emission for (n,p)

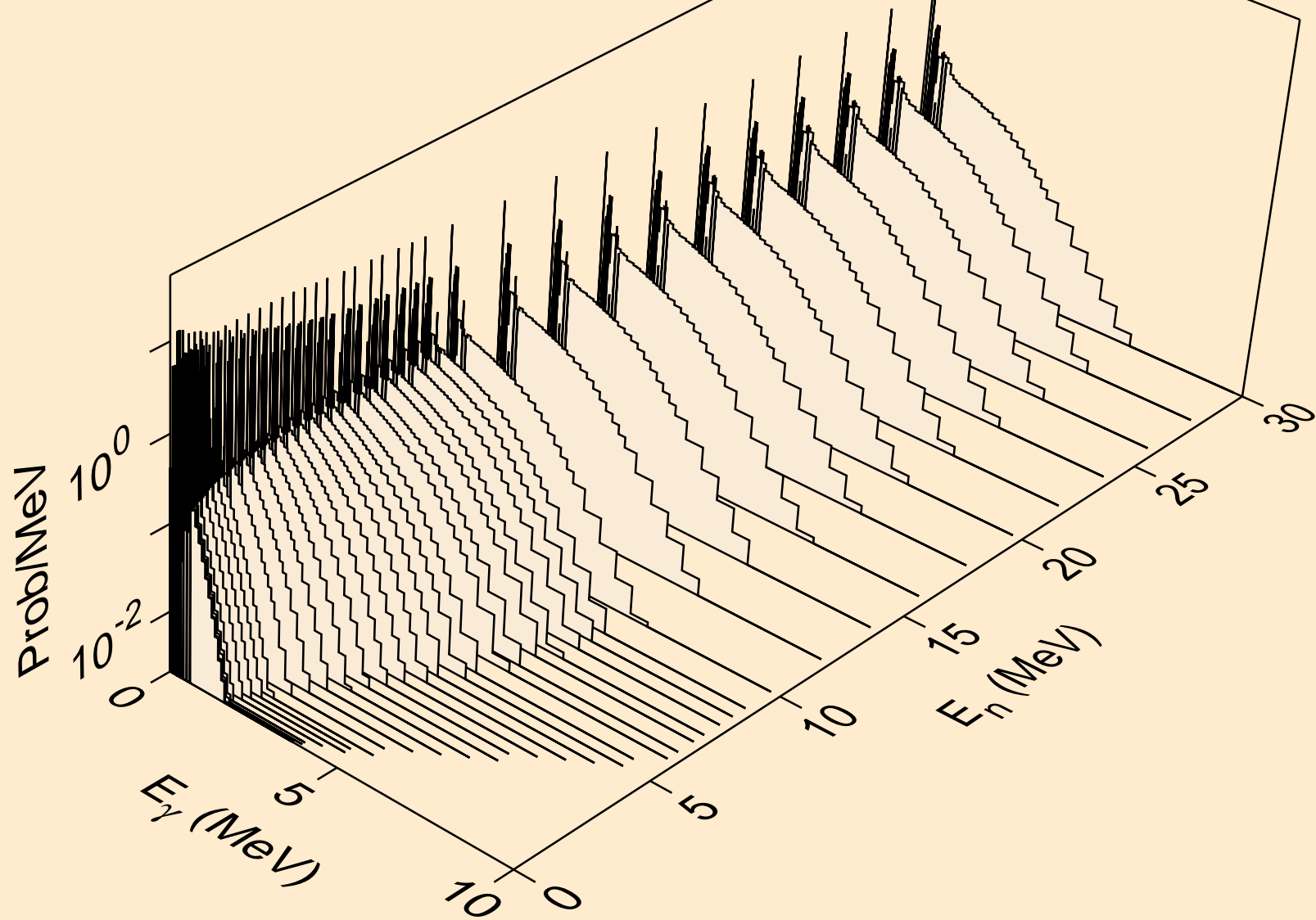

HG189 NEUTRON ACER TENDL-2023 LIBRARY; T=0.K  
Photon emission for (n,d)

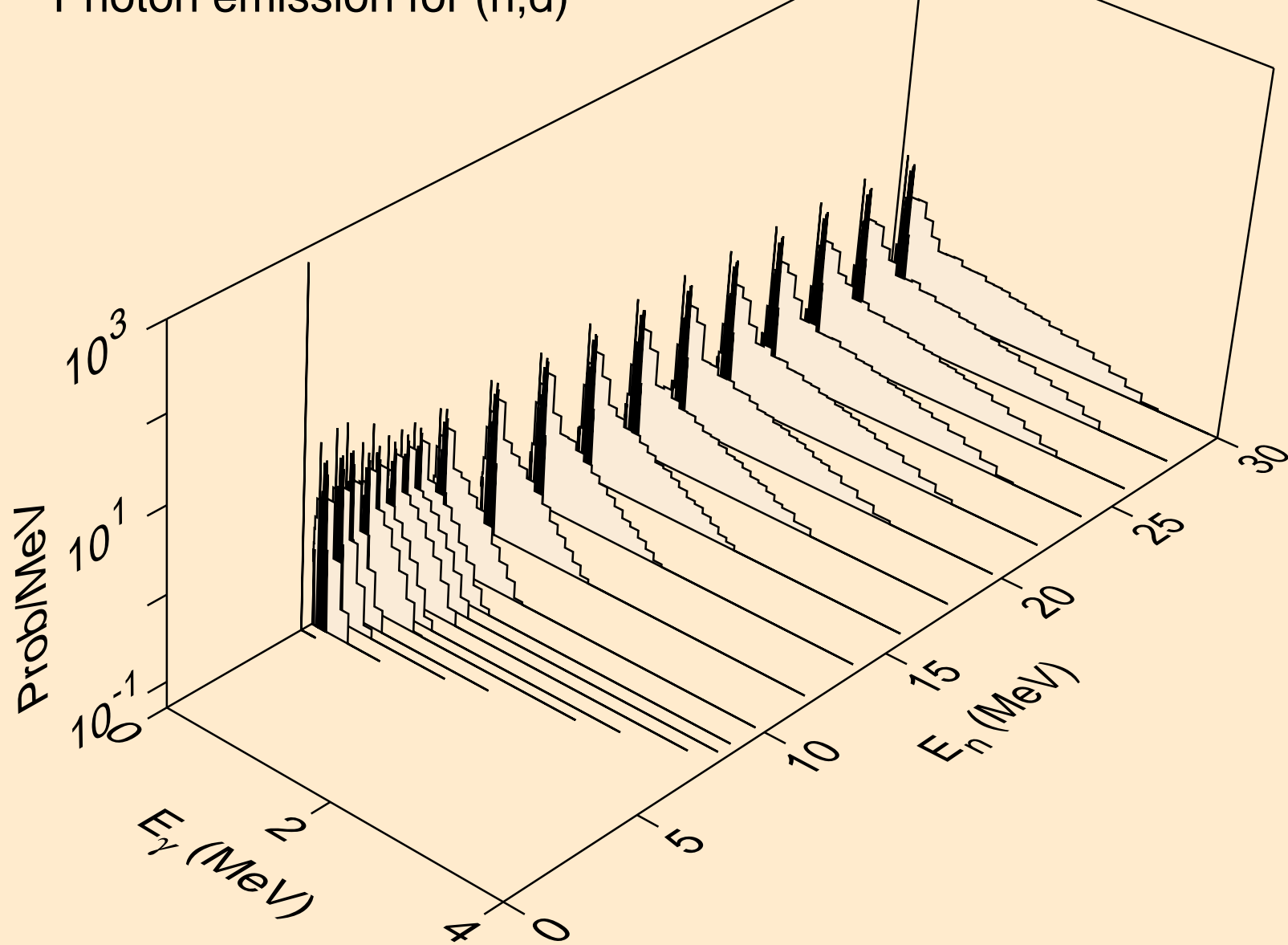

HG189 NEUTRON ACER TENDL-2023 LIBRARY; T=0.K  
Photon emission for (n,t)

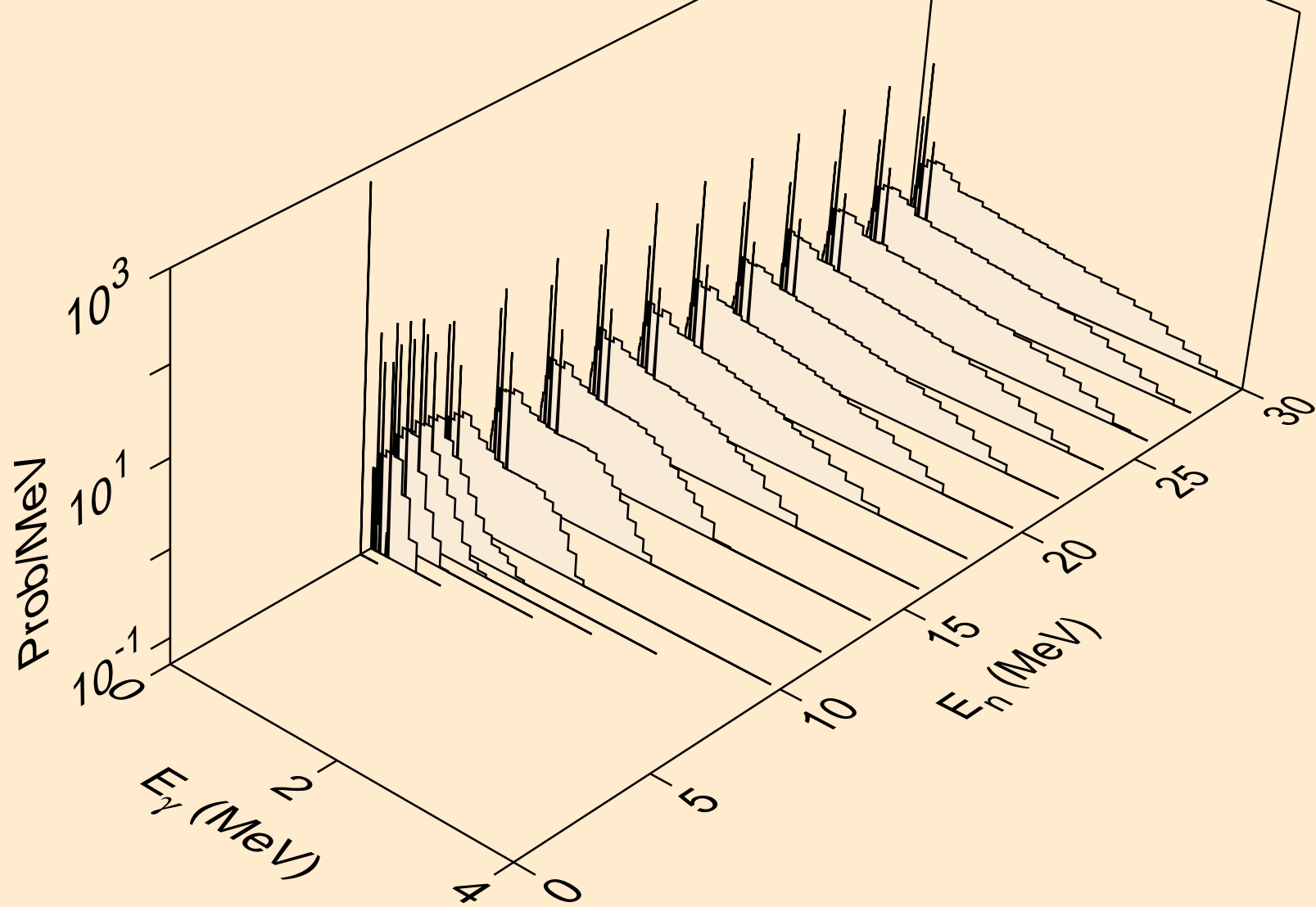

HG189 NEUTRON ACER TENDL-2023 LIBRARY; T=0.K  
Photon emission for (n,he3)

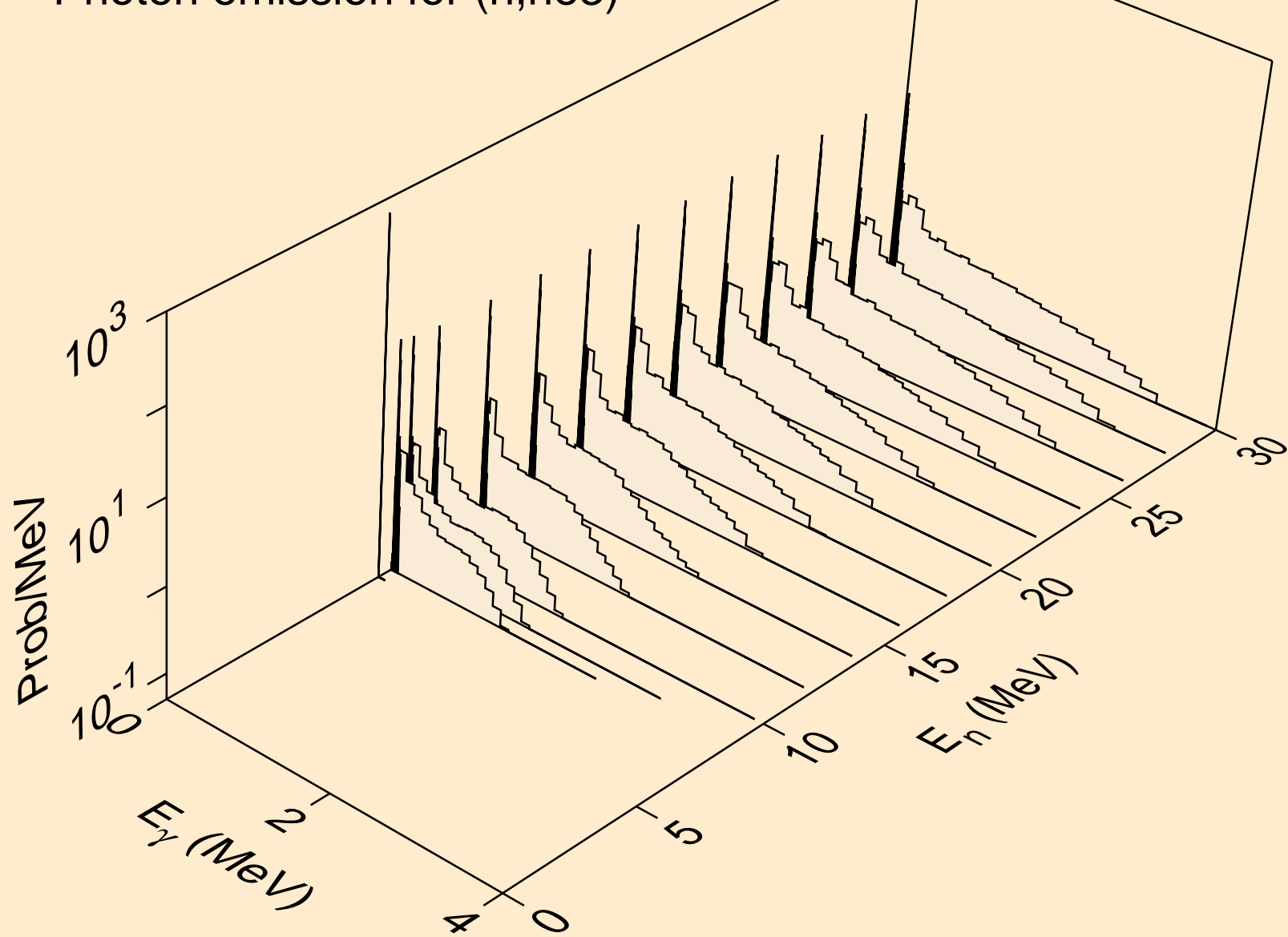

HG189 NEUTRON ACER TENDL-2023 LIBRARY; T=0.K  
Photon emission for (n,a)

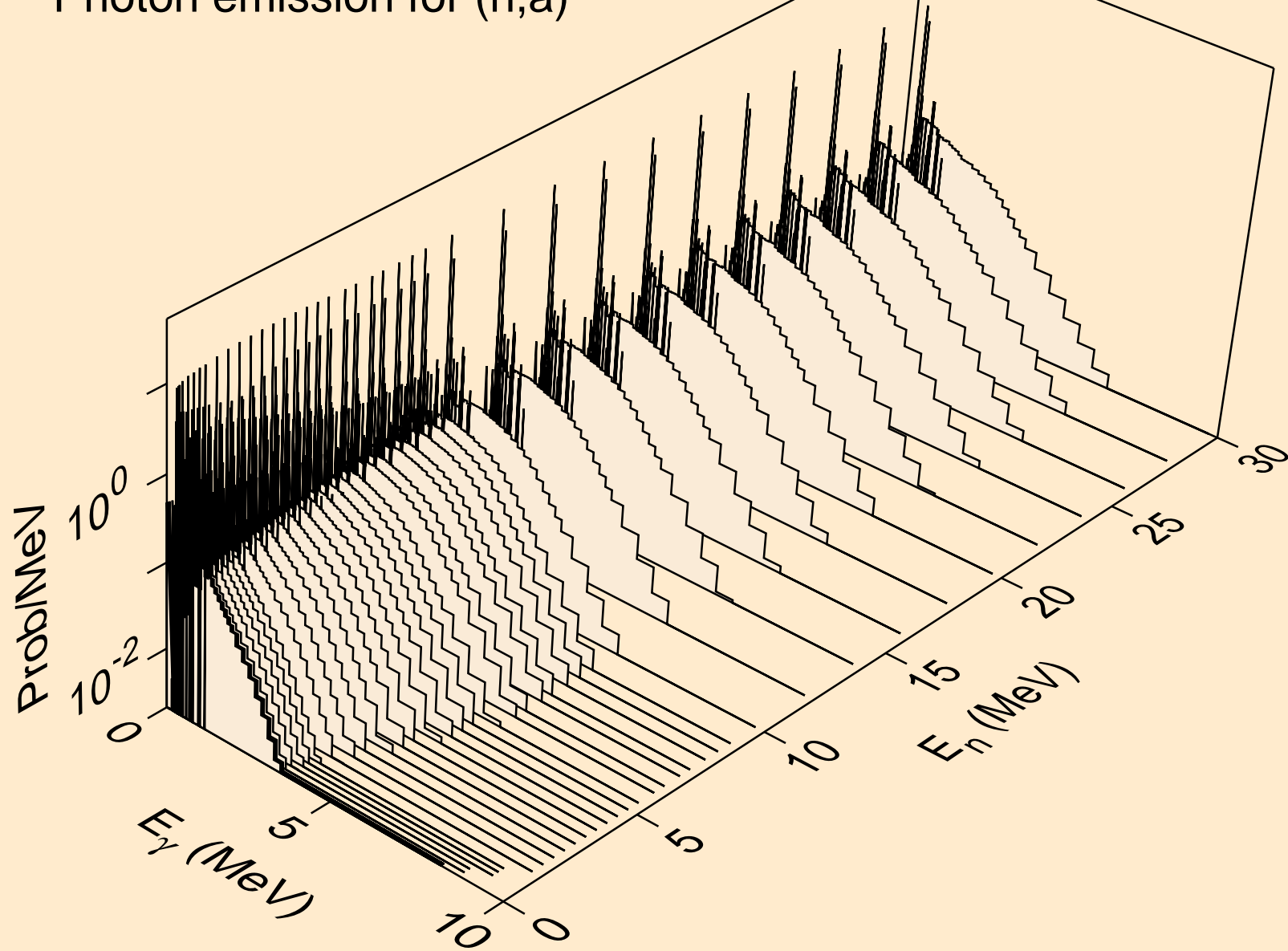



HG189 NEUTRON ACER TENDL-2023 LIBRARY; T=0.K  
Photon emission for (n,2a)

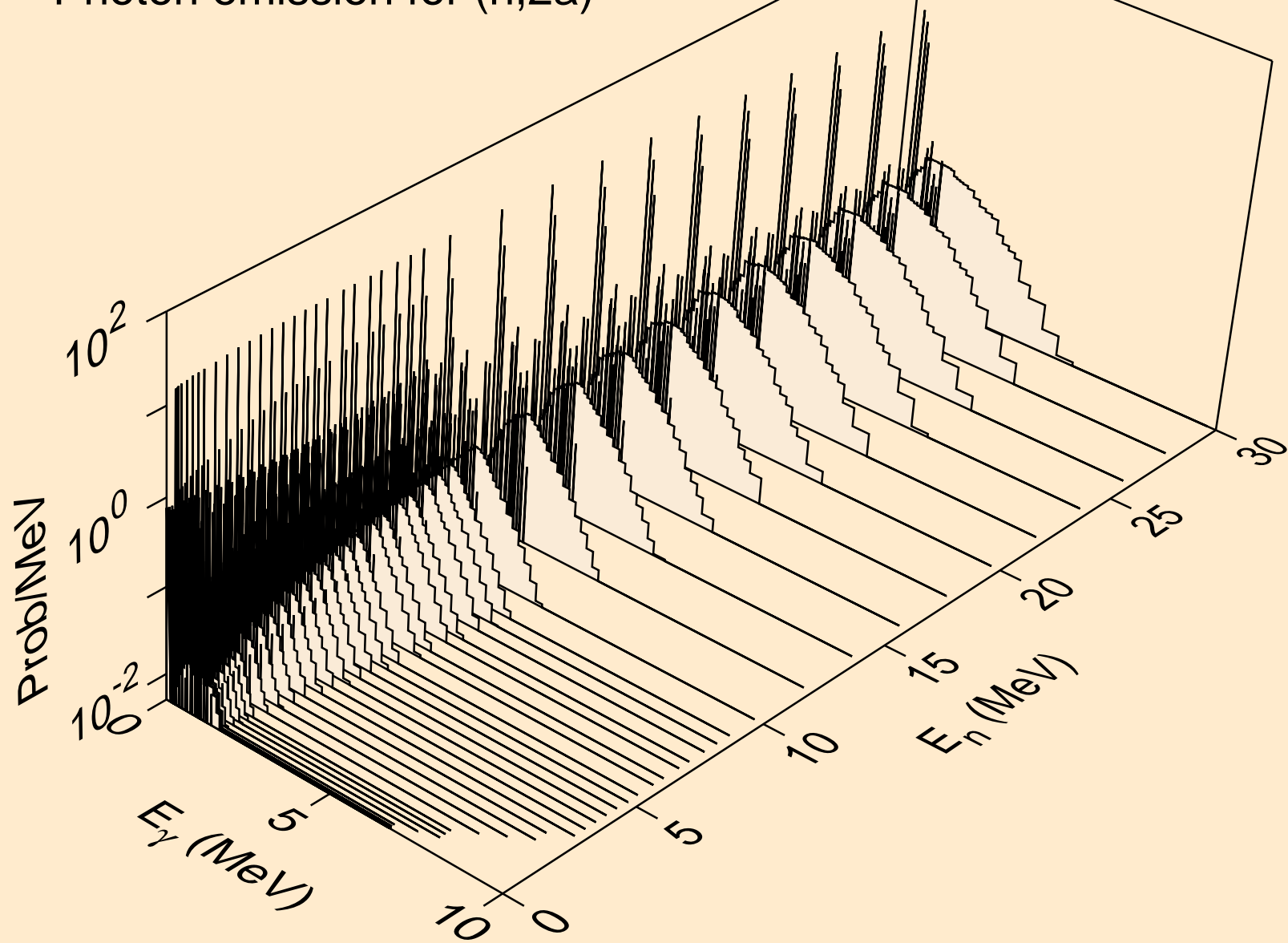

HG189 NEUTRON ACER TENDL-2023 LIBRARY; T=0.K  
Photon emission for (n,2p)

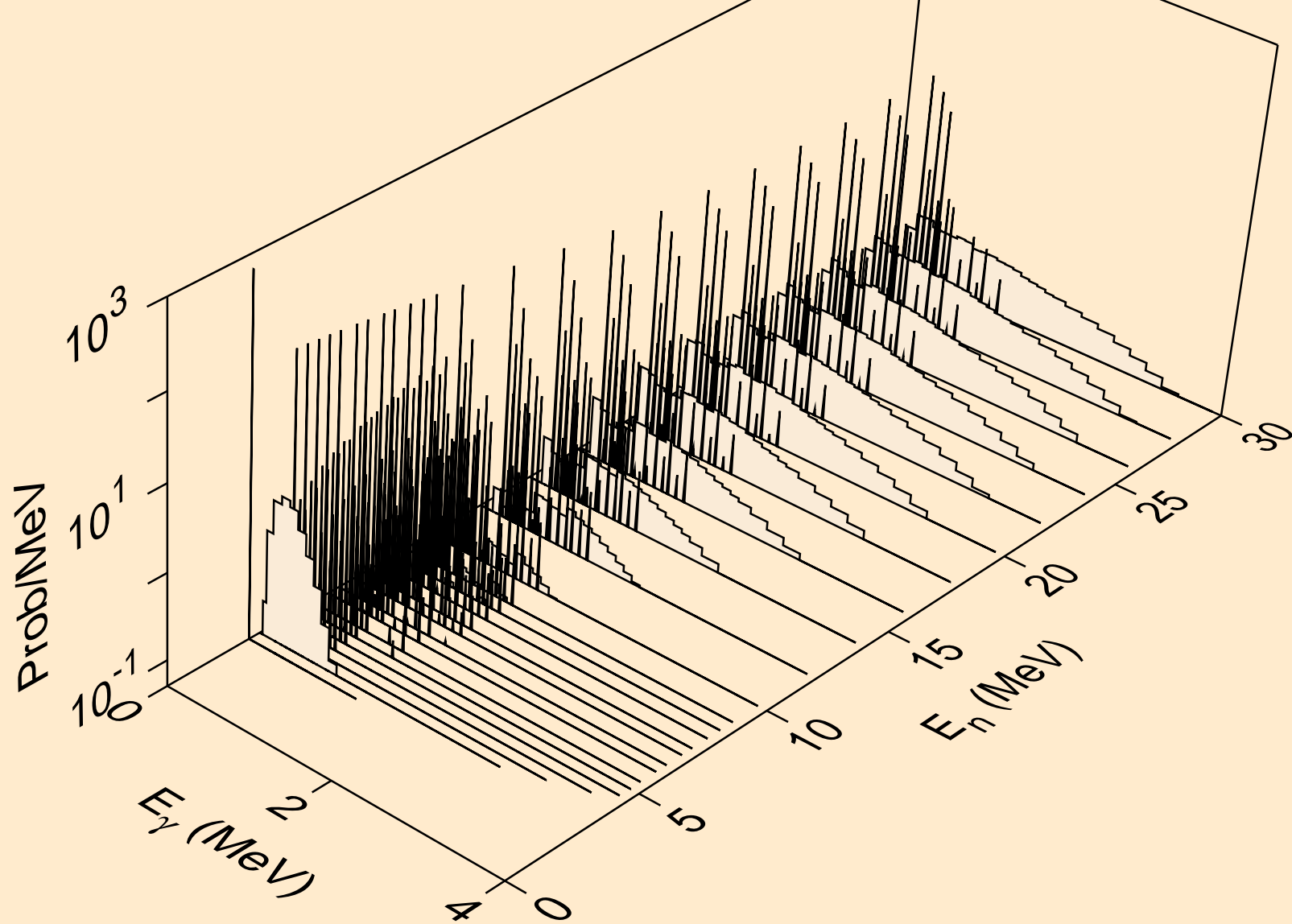

HG189 NEUTRON ACER TENDL-2023 LIBRARY; T=0.K  
Photon emission for (n,p $\alpha$ )

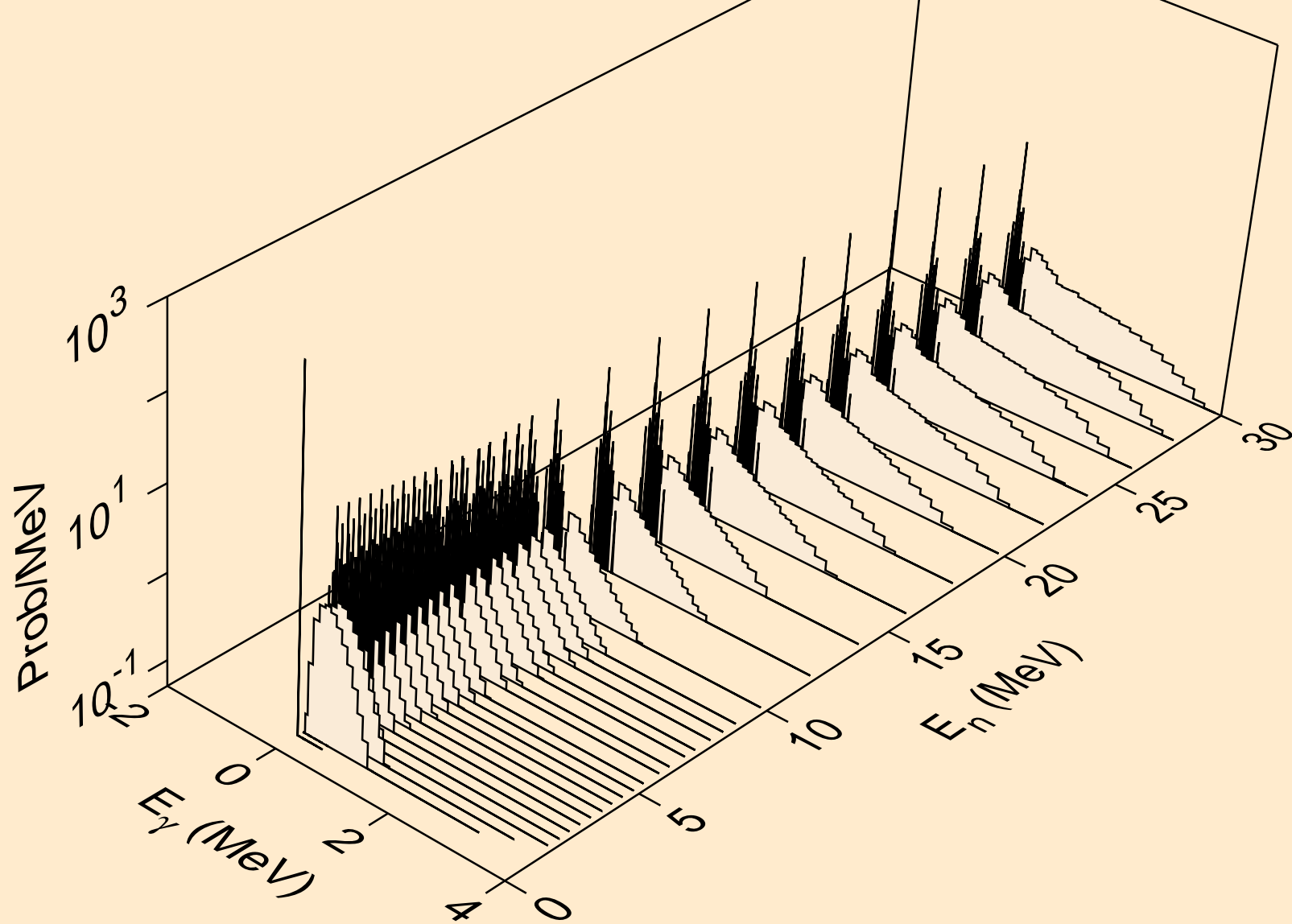

HG189 NEUTRON ACER TENDL-2023 LIBRARY; T=0.K  
Photon emission for (n,pd)

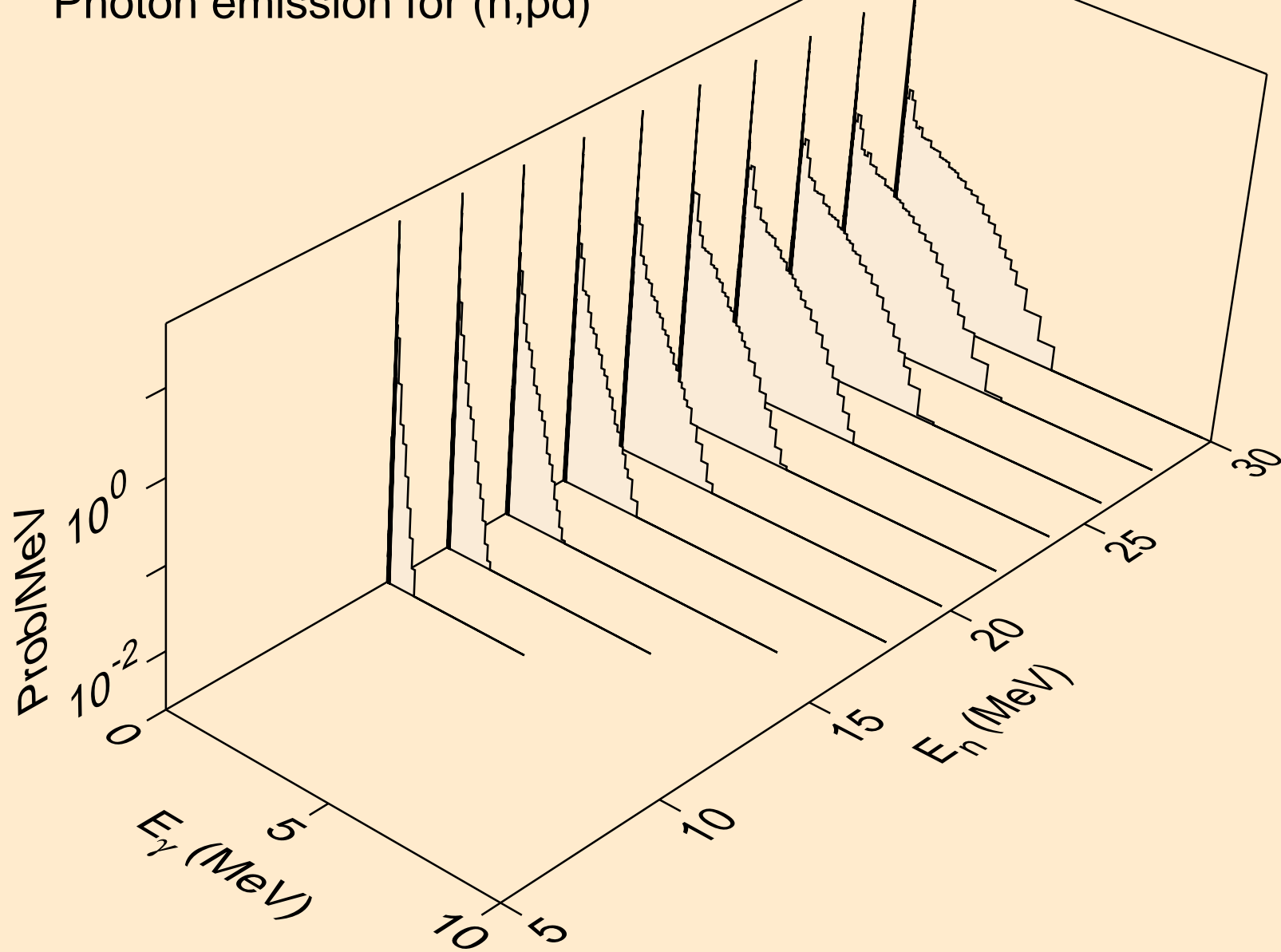

HG189 NEUTRON ACER TENDL-2023 LIBRARY; T=0.K  
Photon emission for (n,pt)

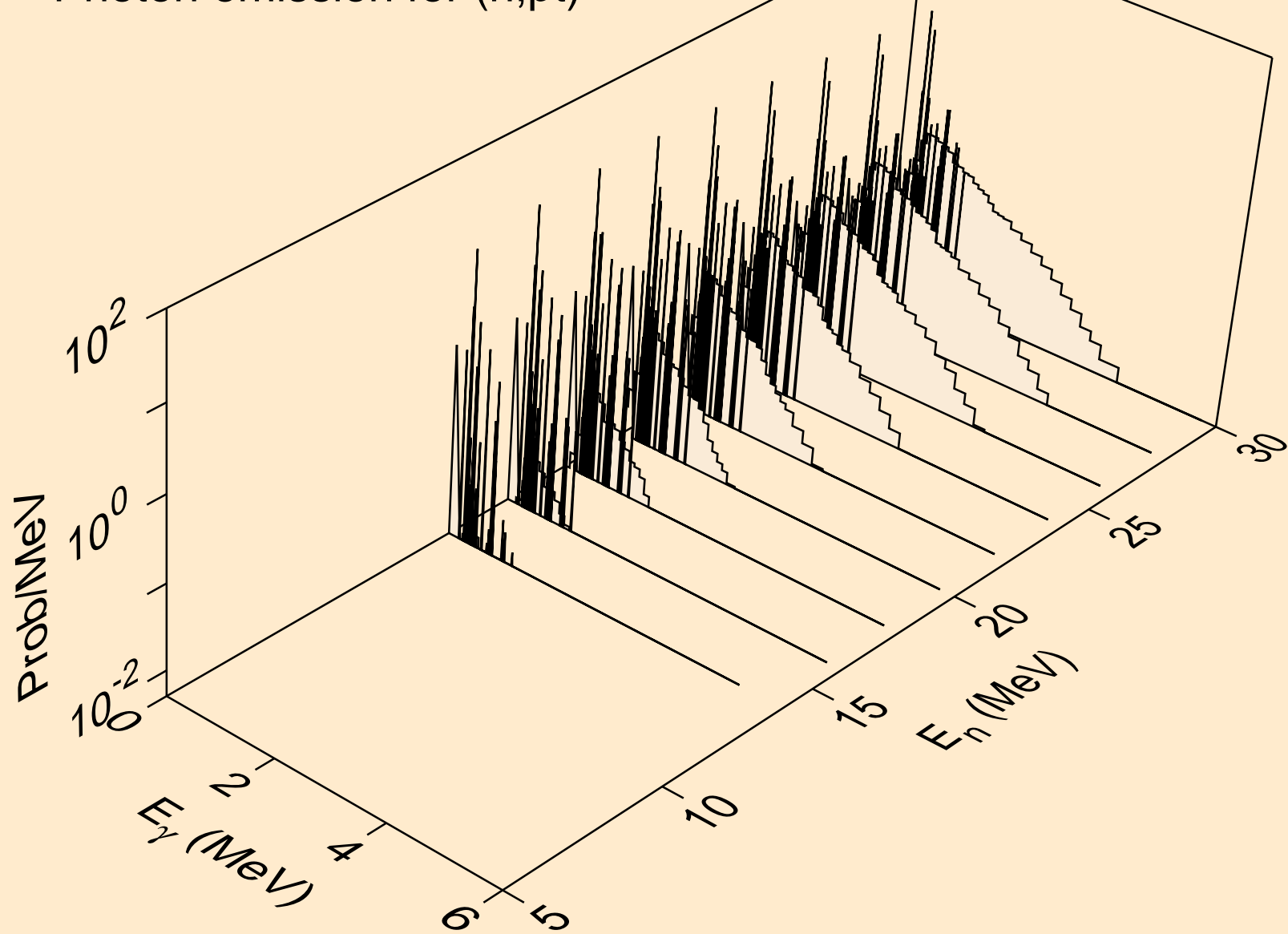

HG189 NEUTRON ACER TENDL-2023 LIBRARY; T=0.K  
Photon emission for (n,da)

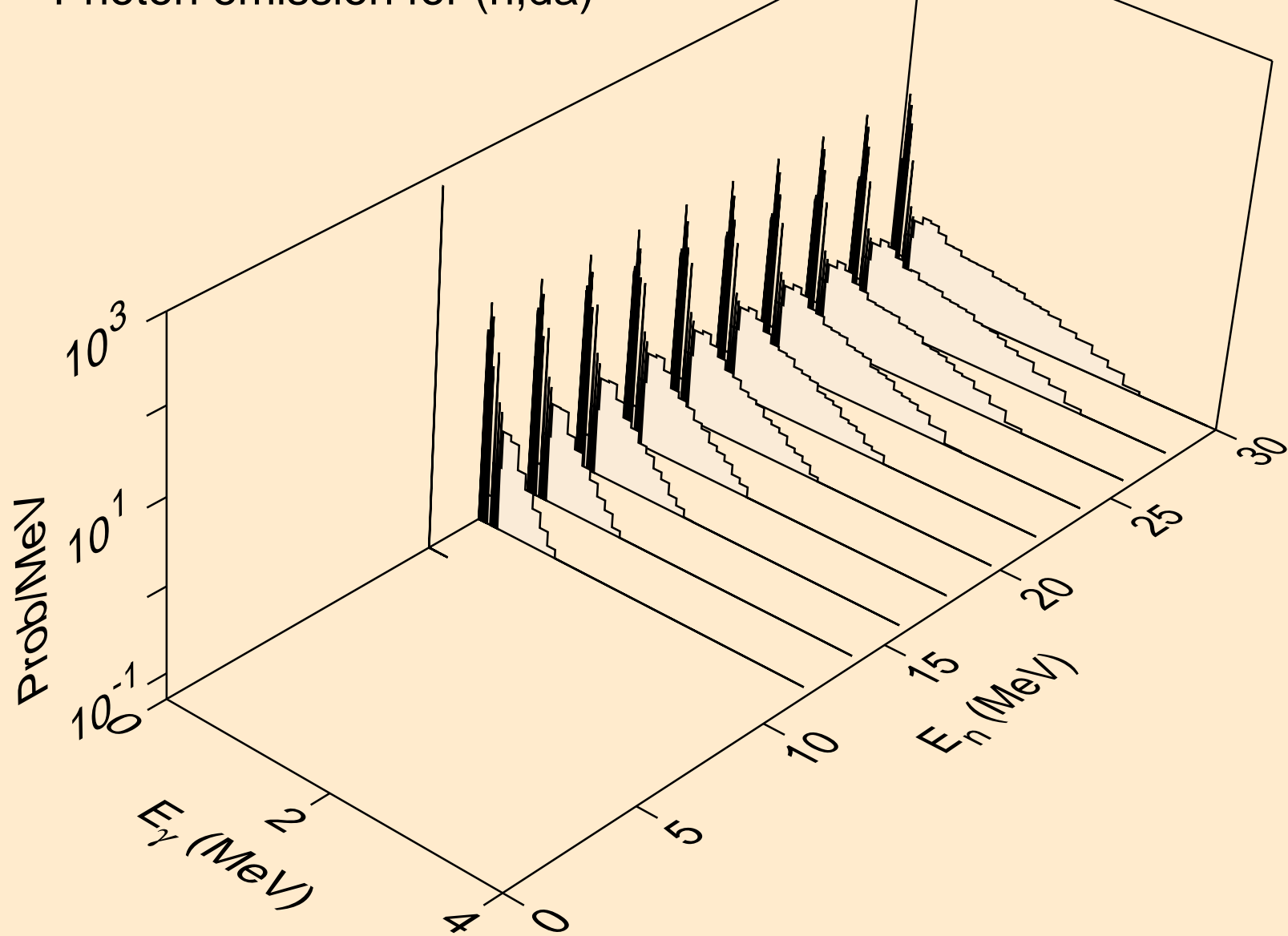

HG189 NEUTRON ACER TENDL-2023 LIBRARY; T=0.K  
thermal capture photon spectrum

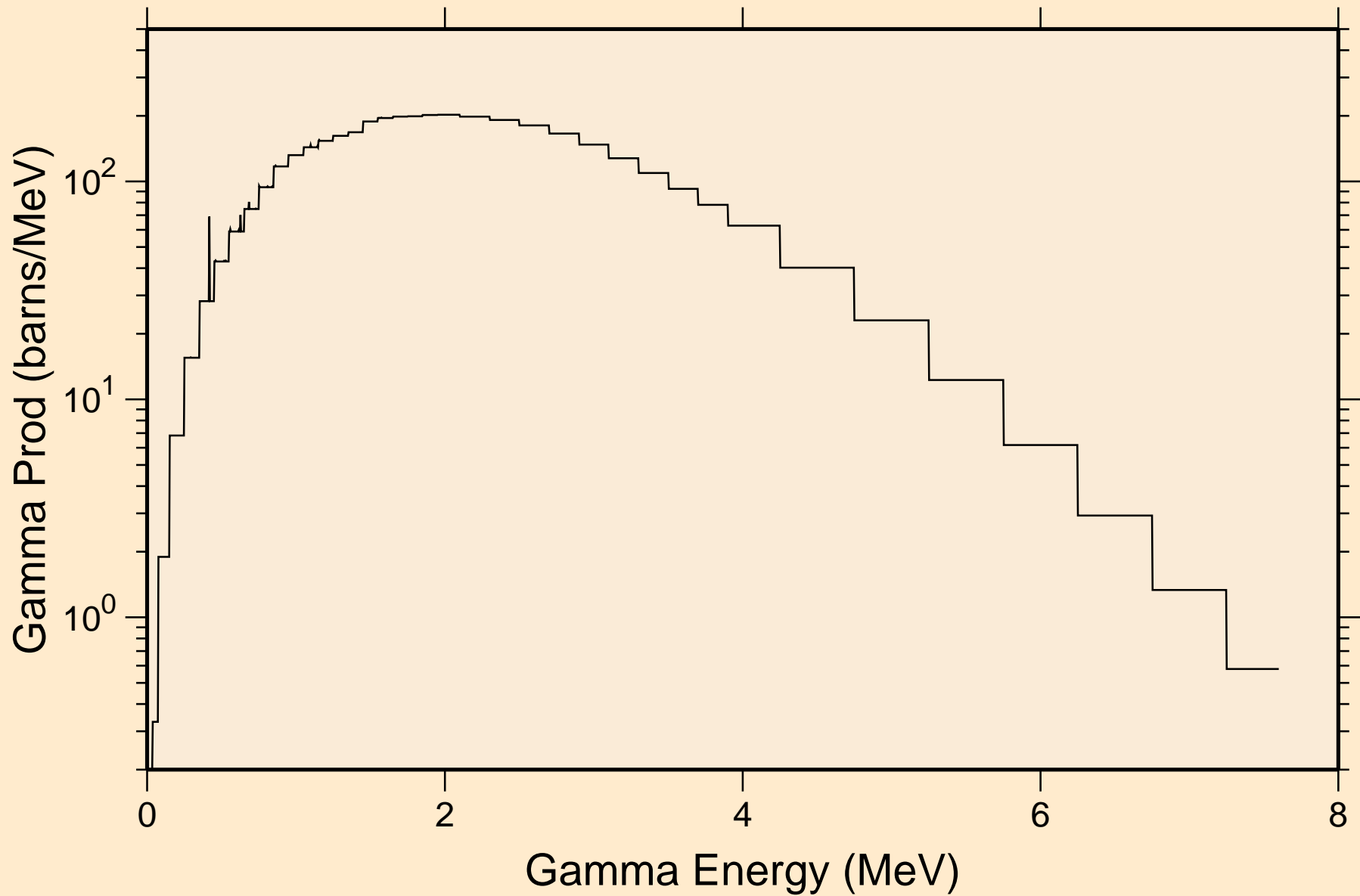

HG189 NEUTRON ACER TENDL-2023 LIBRARY; T=0.K  
14 MeV photon spectrum

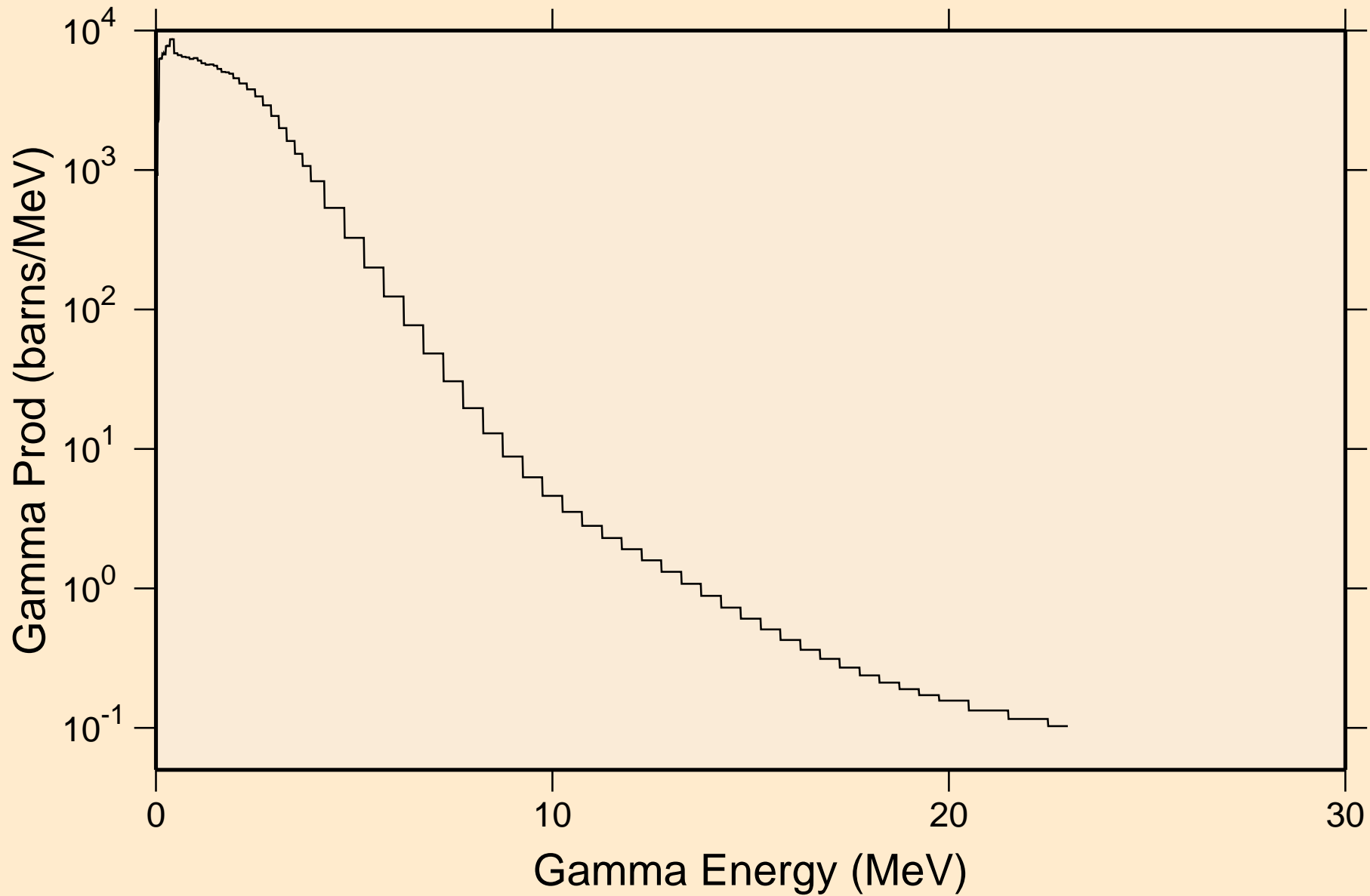



# HG189 NEUTRON ACER TENDL-2023 LIBRARY; T=0.K

## Particle heating contributions

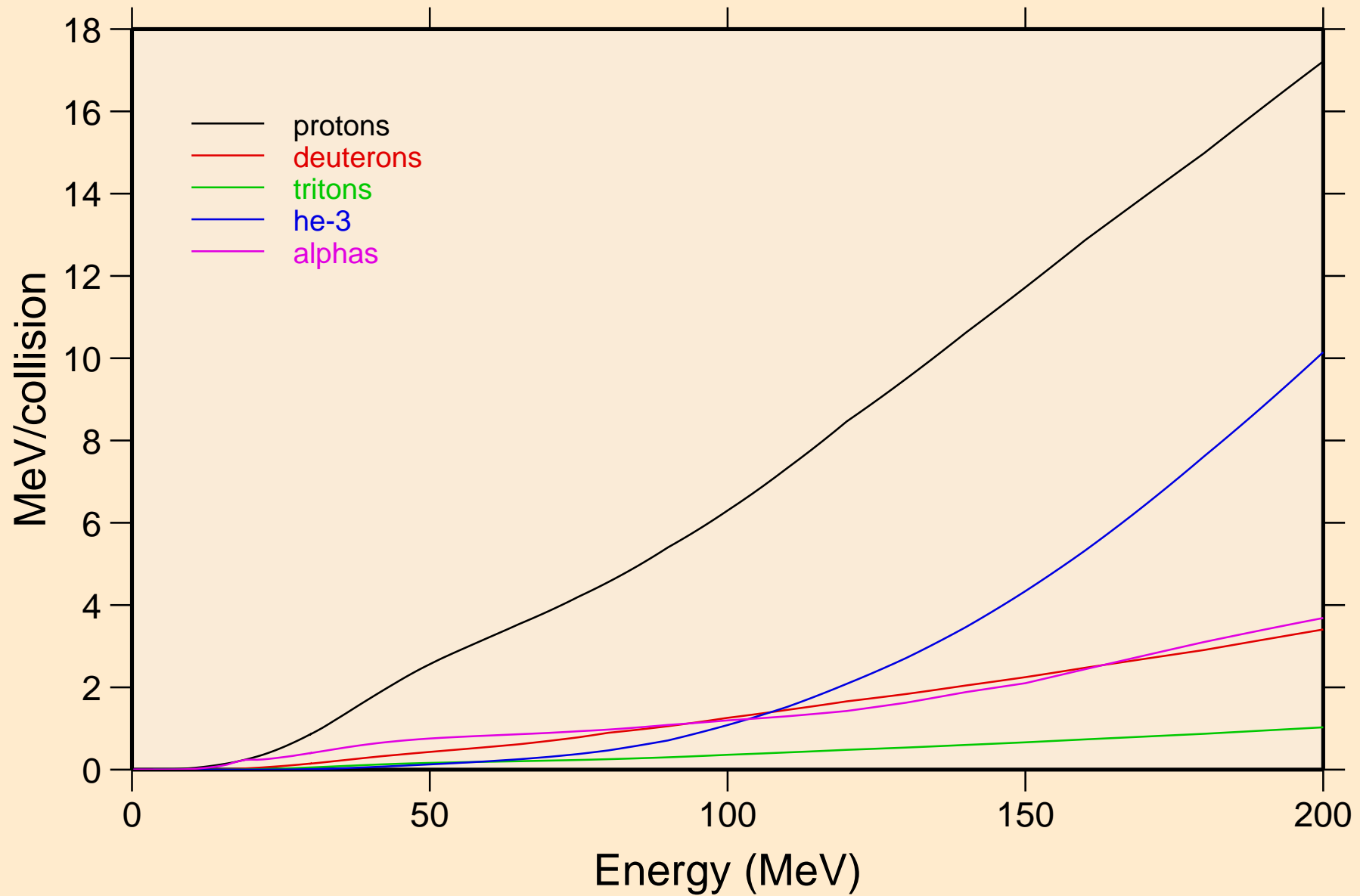

# HG189 NEUTRON ACER TENDL-2023 LIBRARY; T=0.K

## Recoil Heating

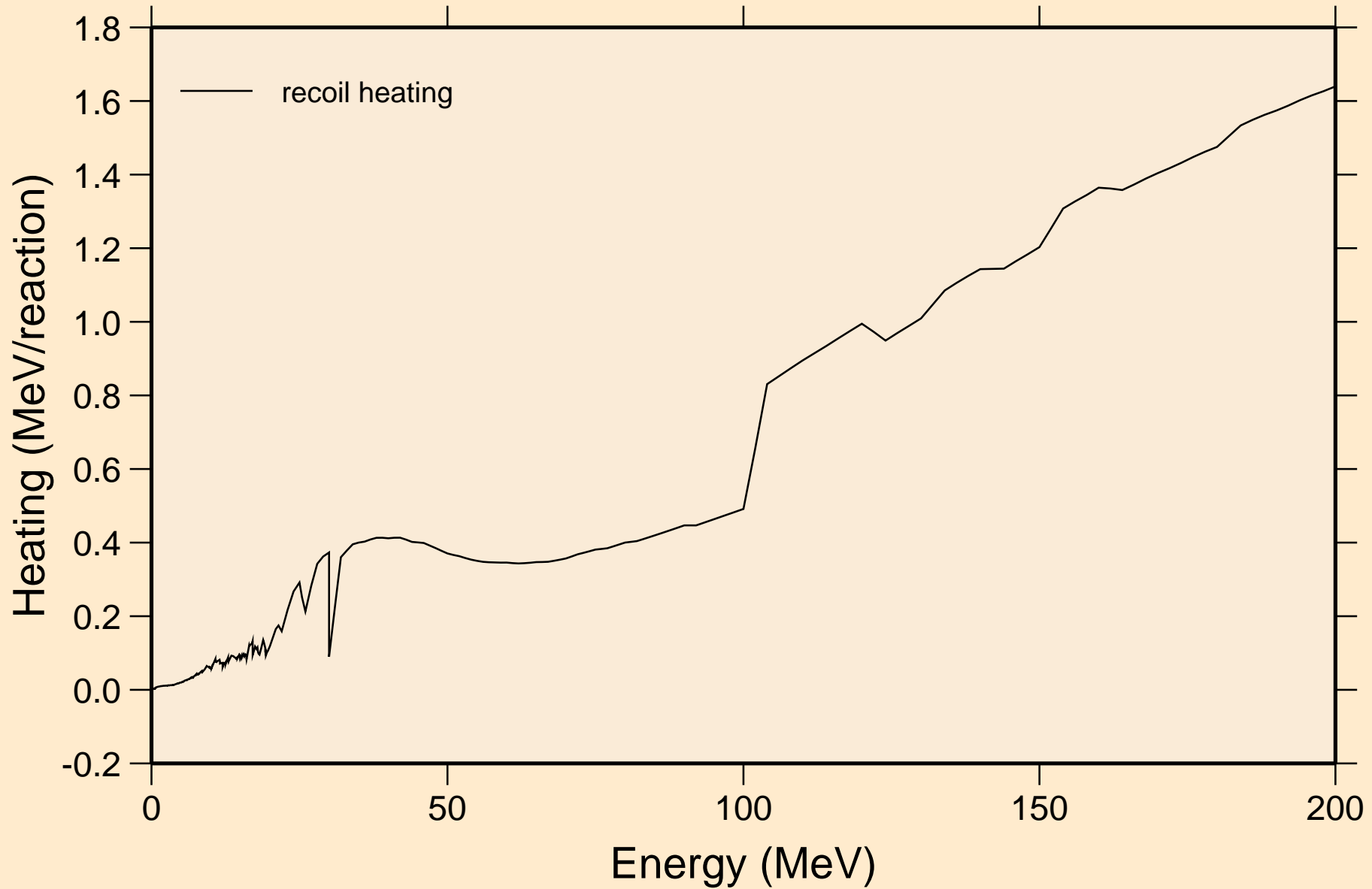

HG189 NEUTRON ACER TENDL-2023 LIBRARY; T=0.K  
Particle production cross sections

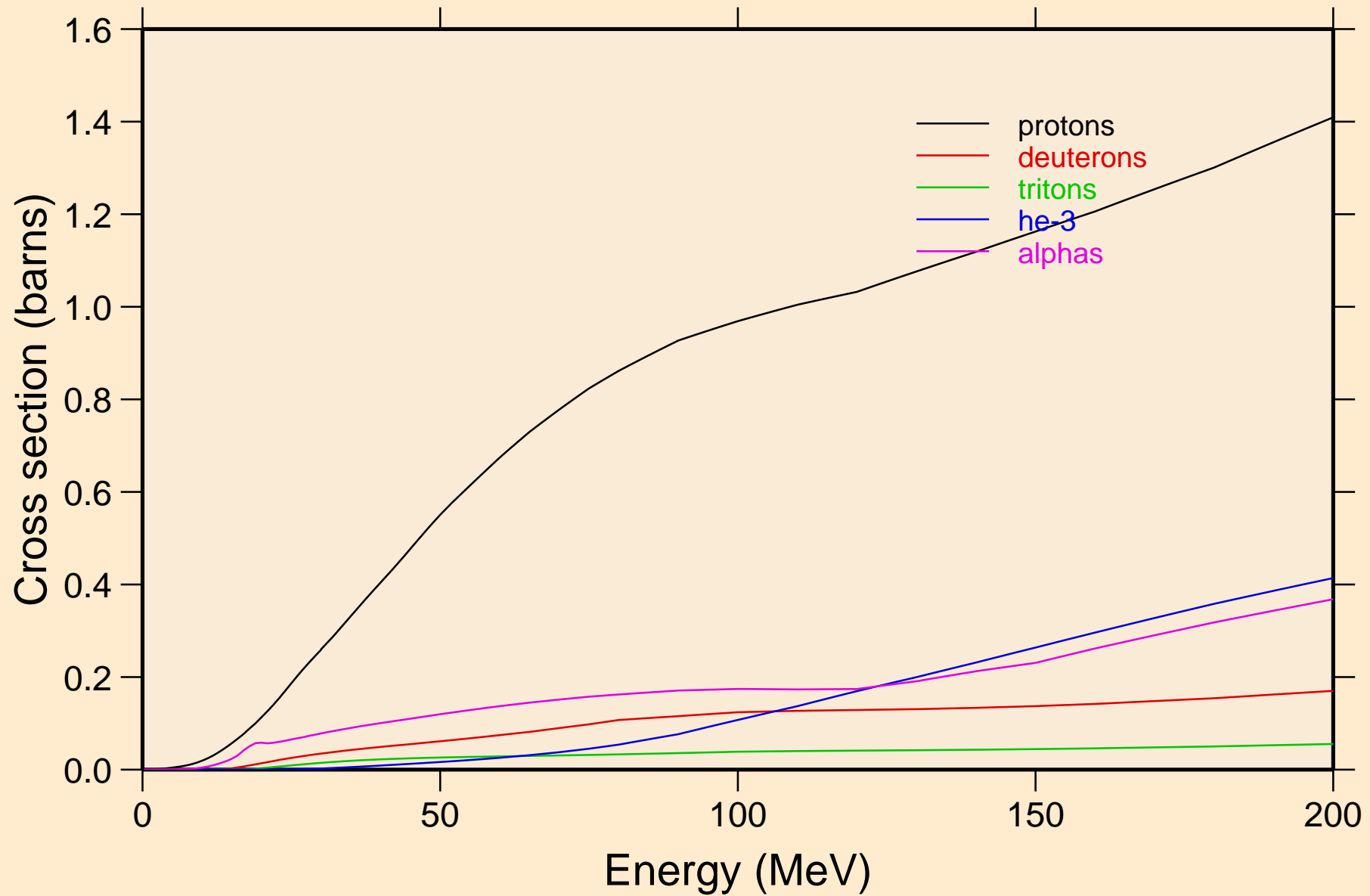

HG189 NEUTRON ACER TENDL-2023 LIBRARY; T=0.K  
protons from (n,x)

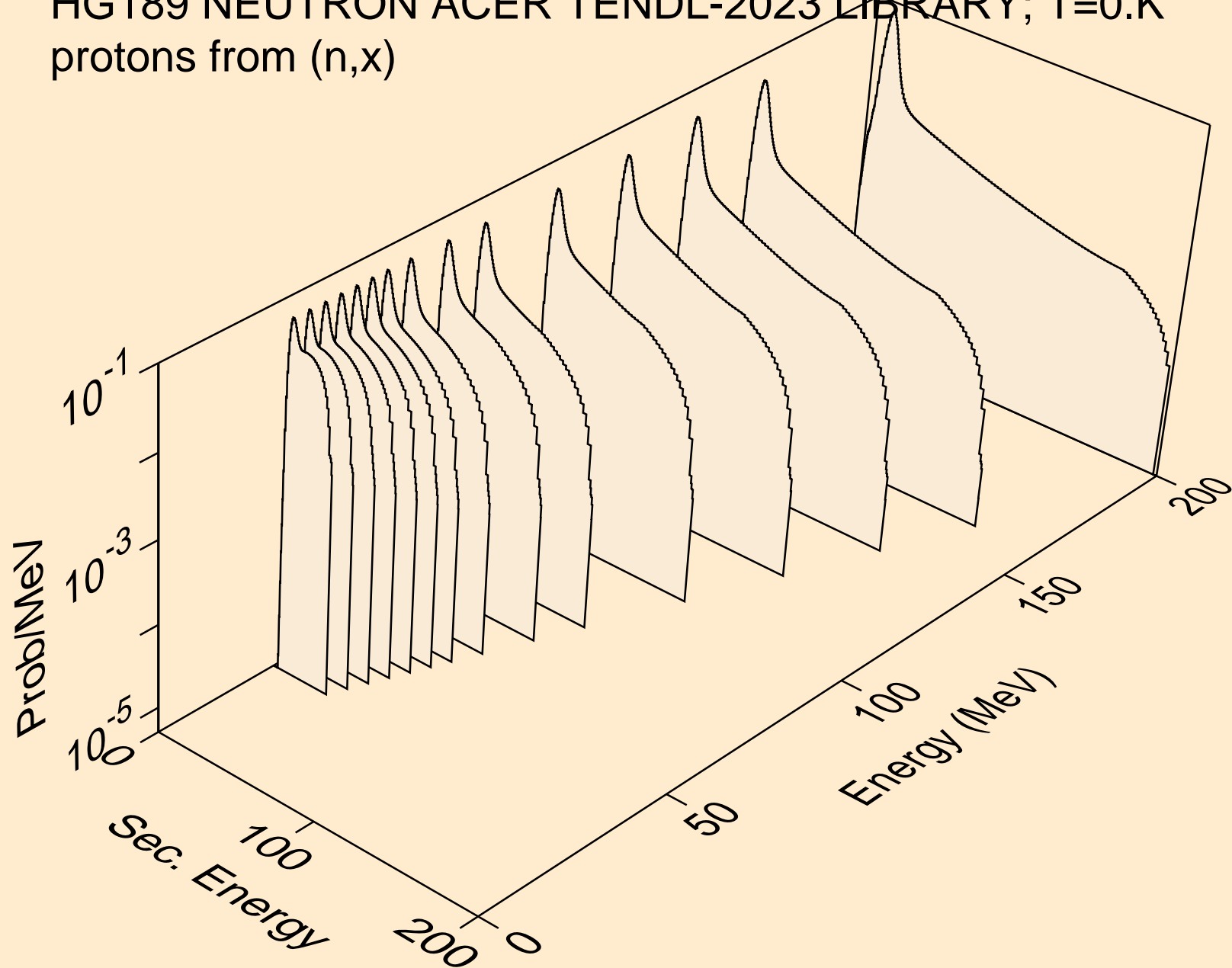

HG189 NEUTRON ACER TENDL-2023 LIBRARY; T=0.K  
protons from (n,n\*)p

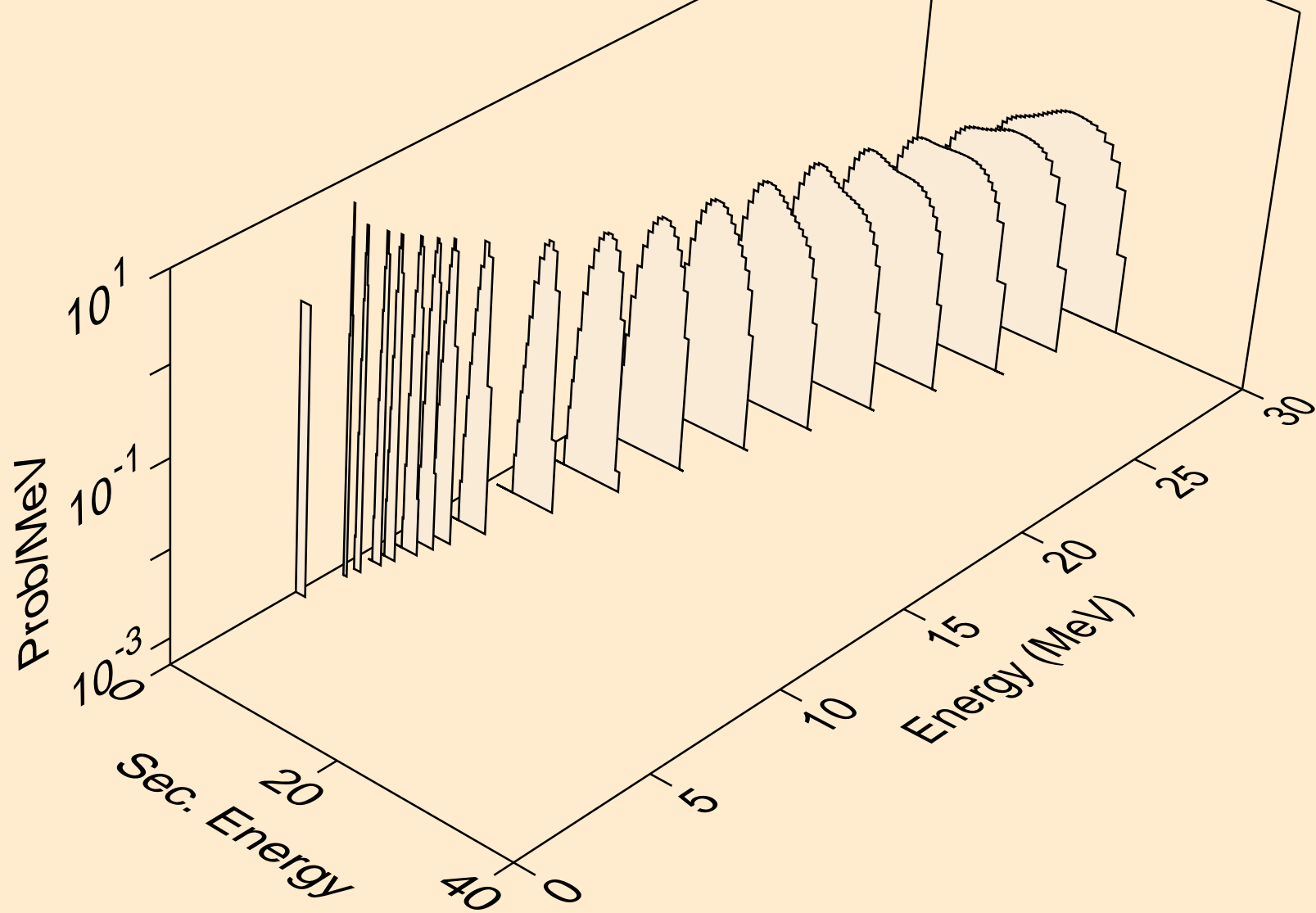

HG189 NEUTRON ACER TENDL-2023 LIBRARY; T=0.K  
protons from (n,2np)

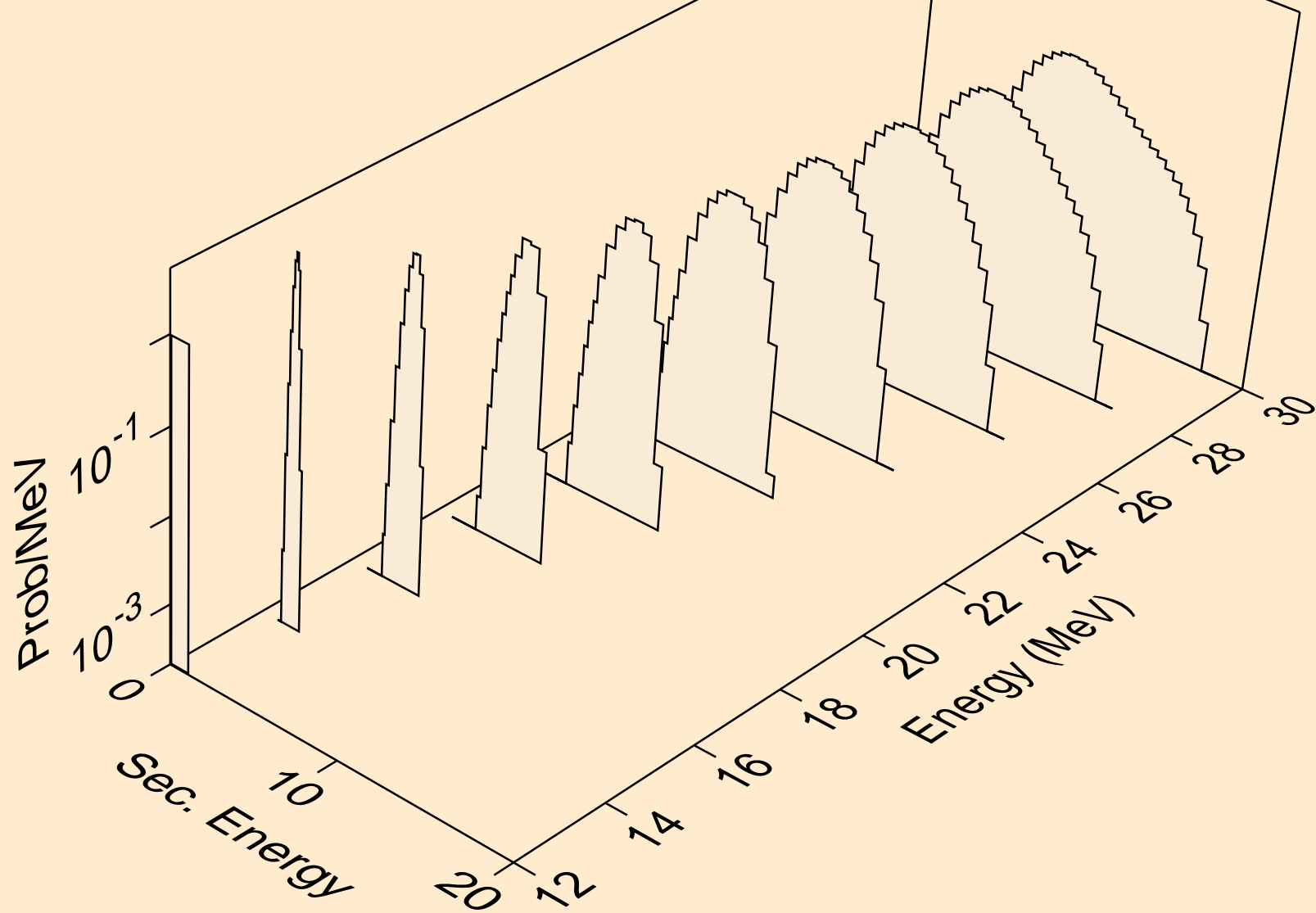

HG189 NEUTRON ACER TENDL-2023 LIBRARY; T=0.K  
protons from (n,3np)

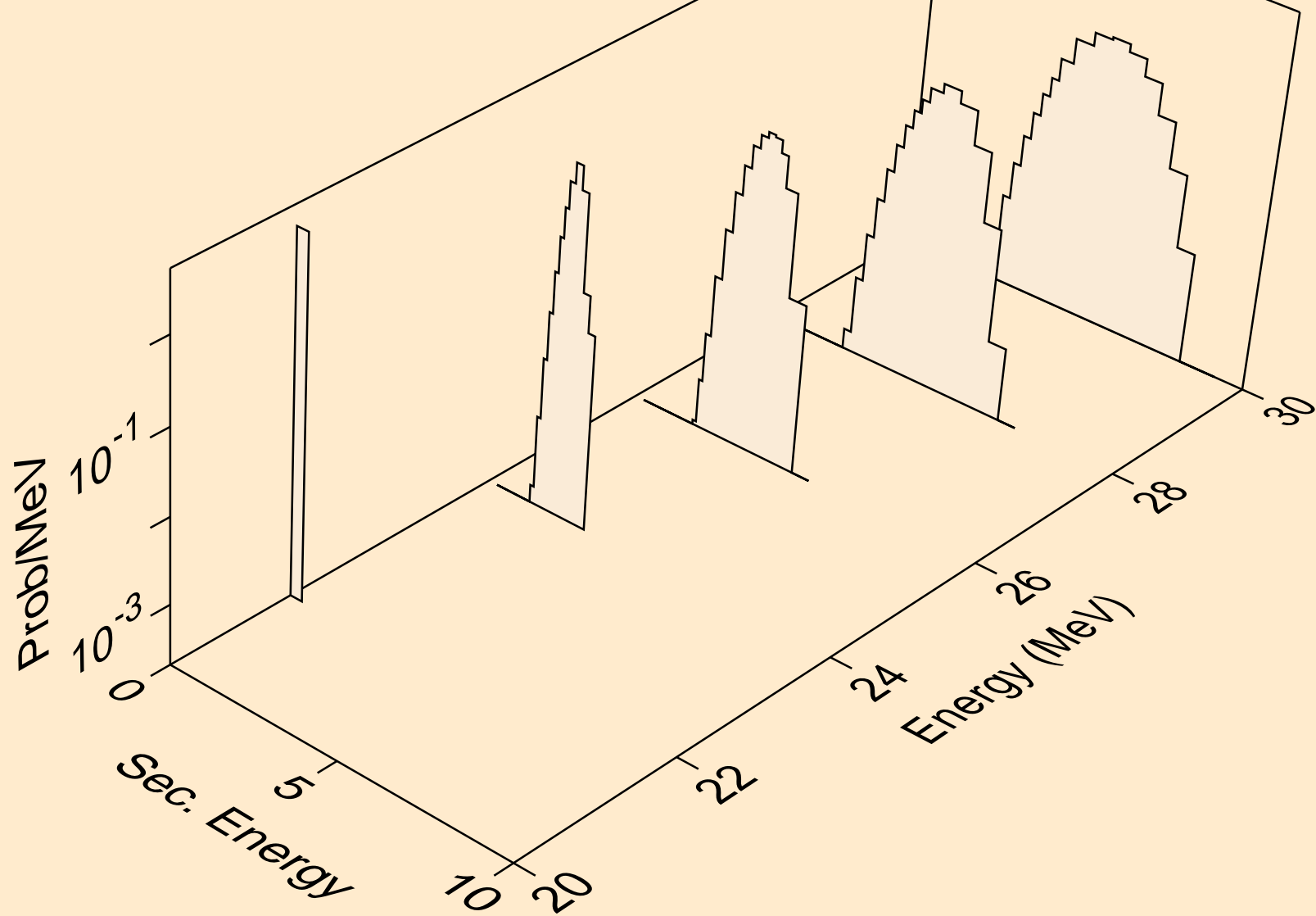

HG189 NEUTRON ACER TENDL-2023 LIBRARY; T=0.K  
protons from (n,n2p)

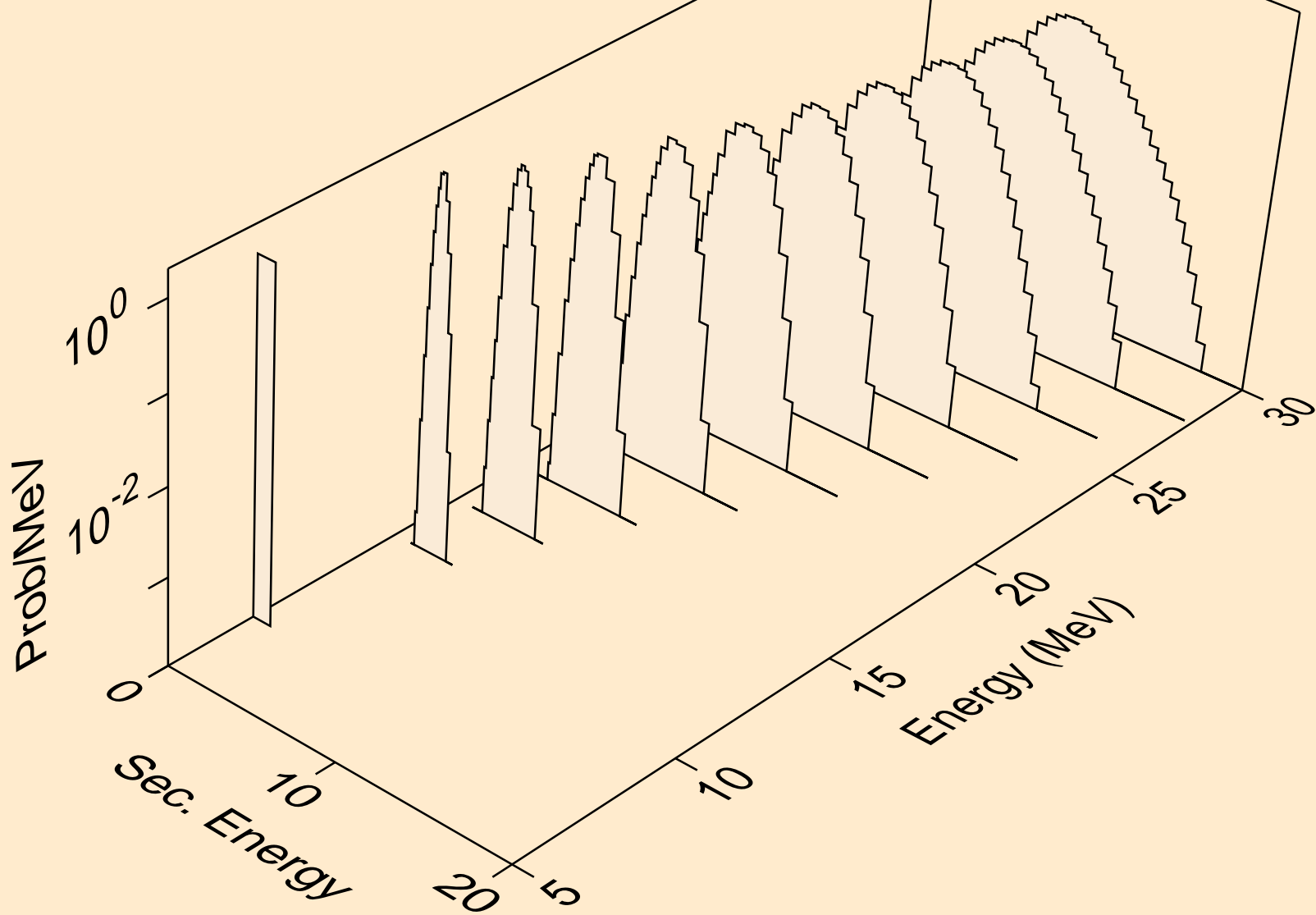



HG189 NEUTRON ACER TENDL-2023 LIBRARY; T=0.K  
protons from (n,npa)

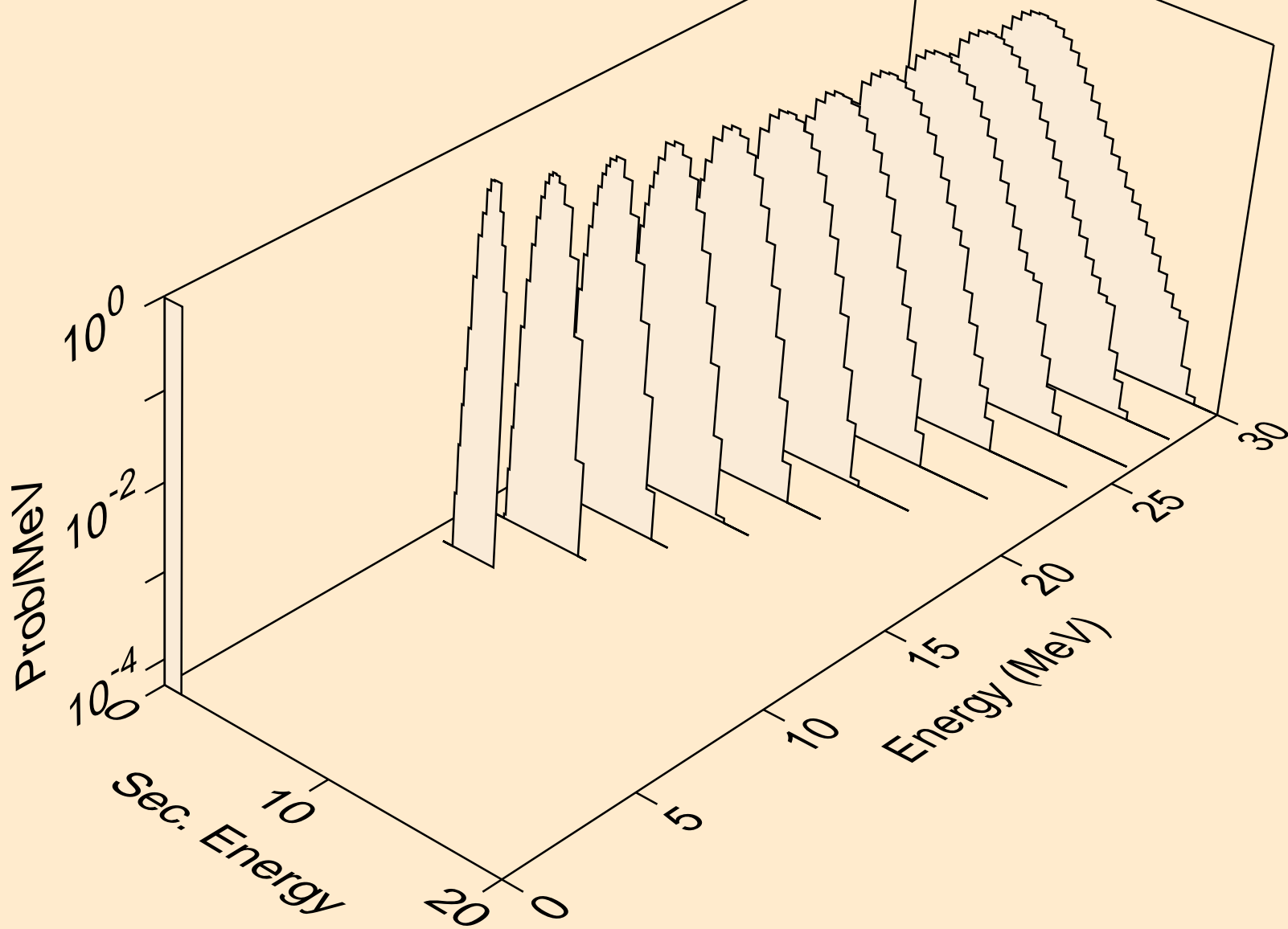

HG189 NEUTRON ACER TENDL-2023 LIBRARY; T=0.K  
protons from (n,p)

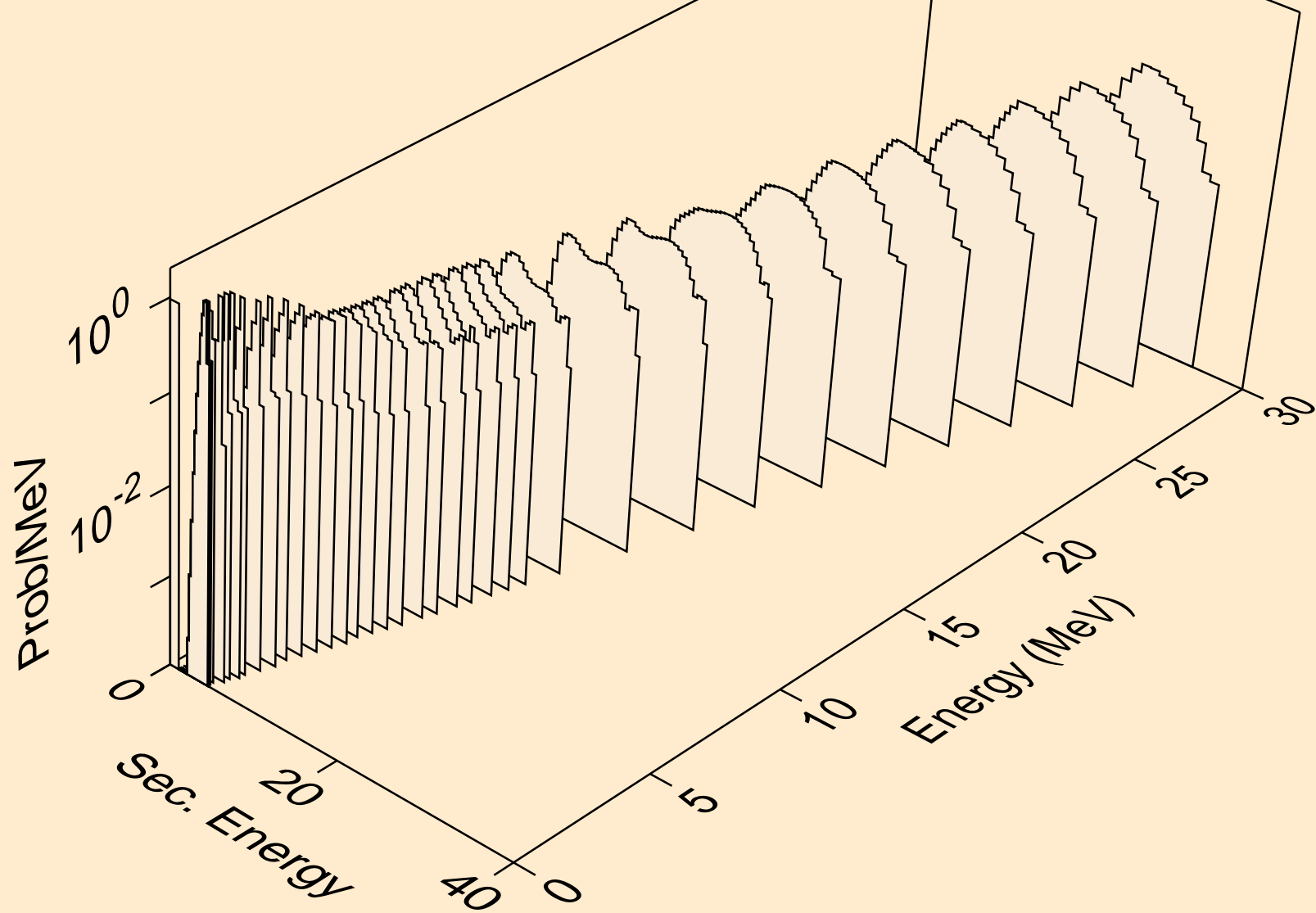

HG189 NEUTRON ACER TENDL-2023 LIBRARY; T=0.K  
protons from (n,2p)

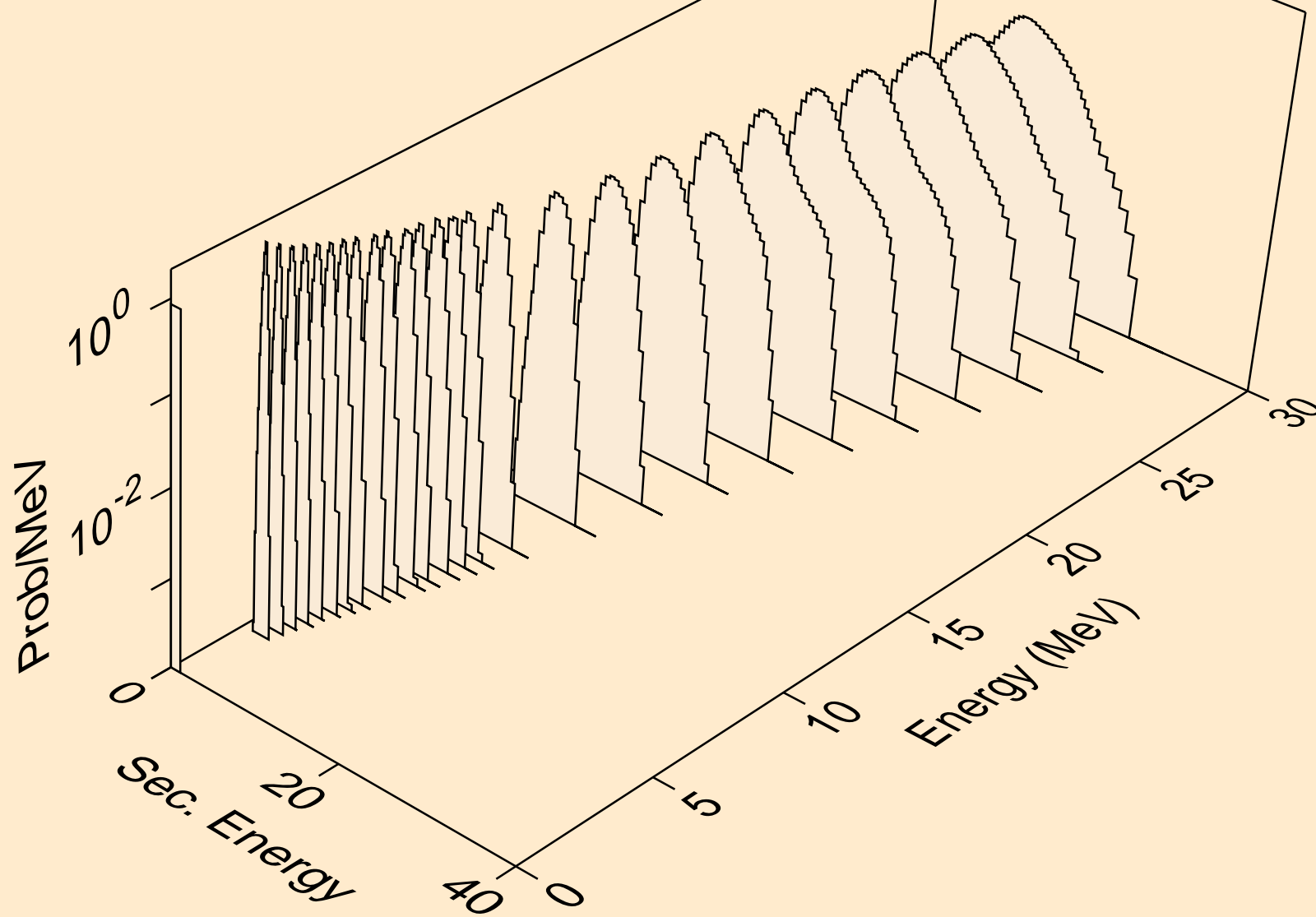

HG189 NEUTRON ACER TENDL-2023 LIBRARY; T=0.K  
protons from (n,p)

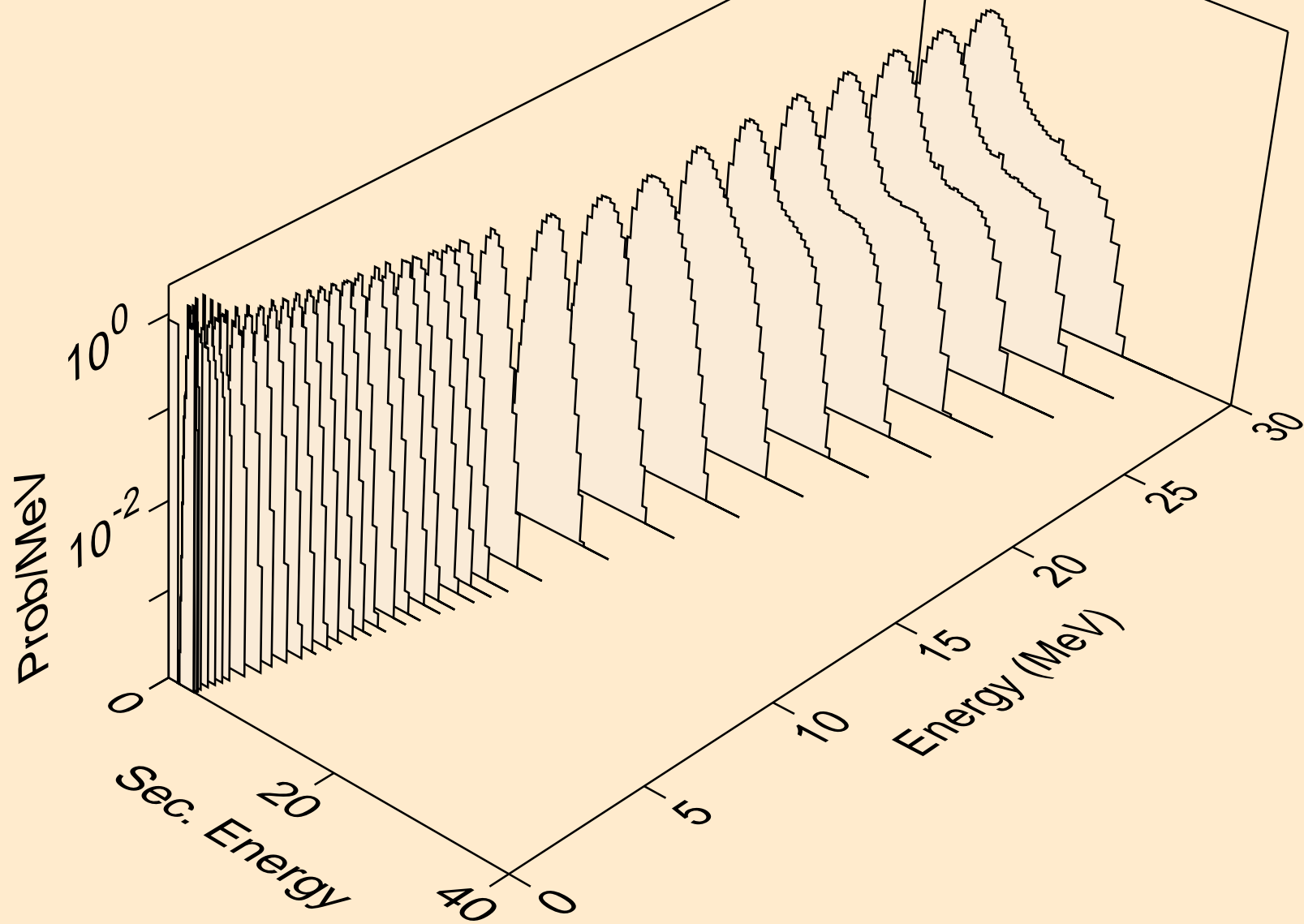

HG189 NEUTRON ACER TENDL-2023 LIBRARY; T=0.K  
protons from (n,pd)

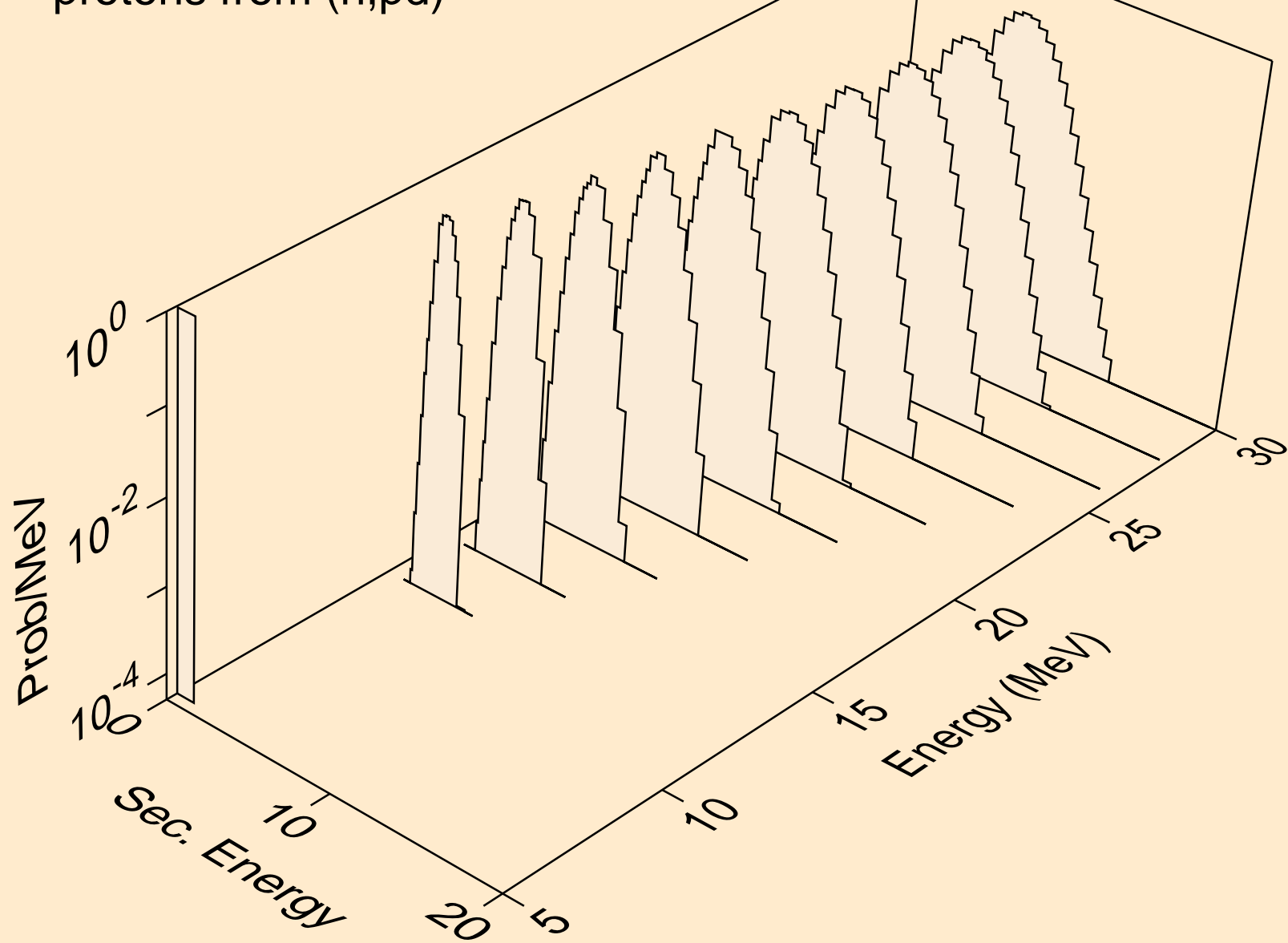

HG189 NEUTRON ACER TENDL-2023 LIBRARY; T=0.K  
protons from (n,pt)

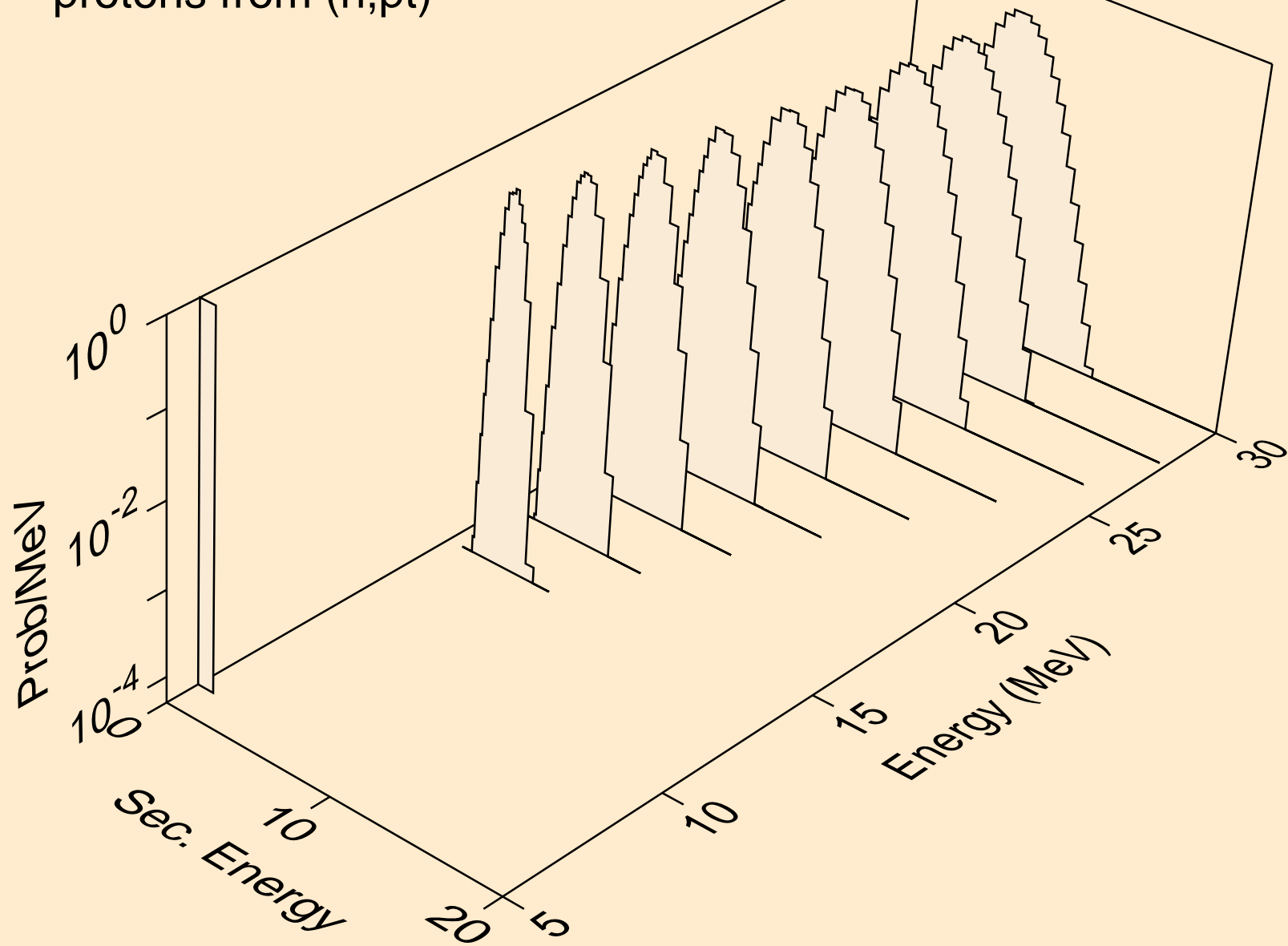

HG189 NEUTRON ACER TENDL-2023 LIBRARY; T=0.K  
deuterons from (n,x)

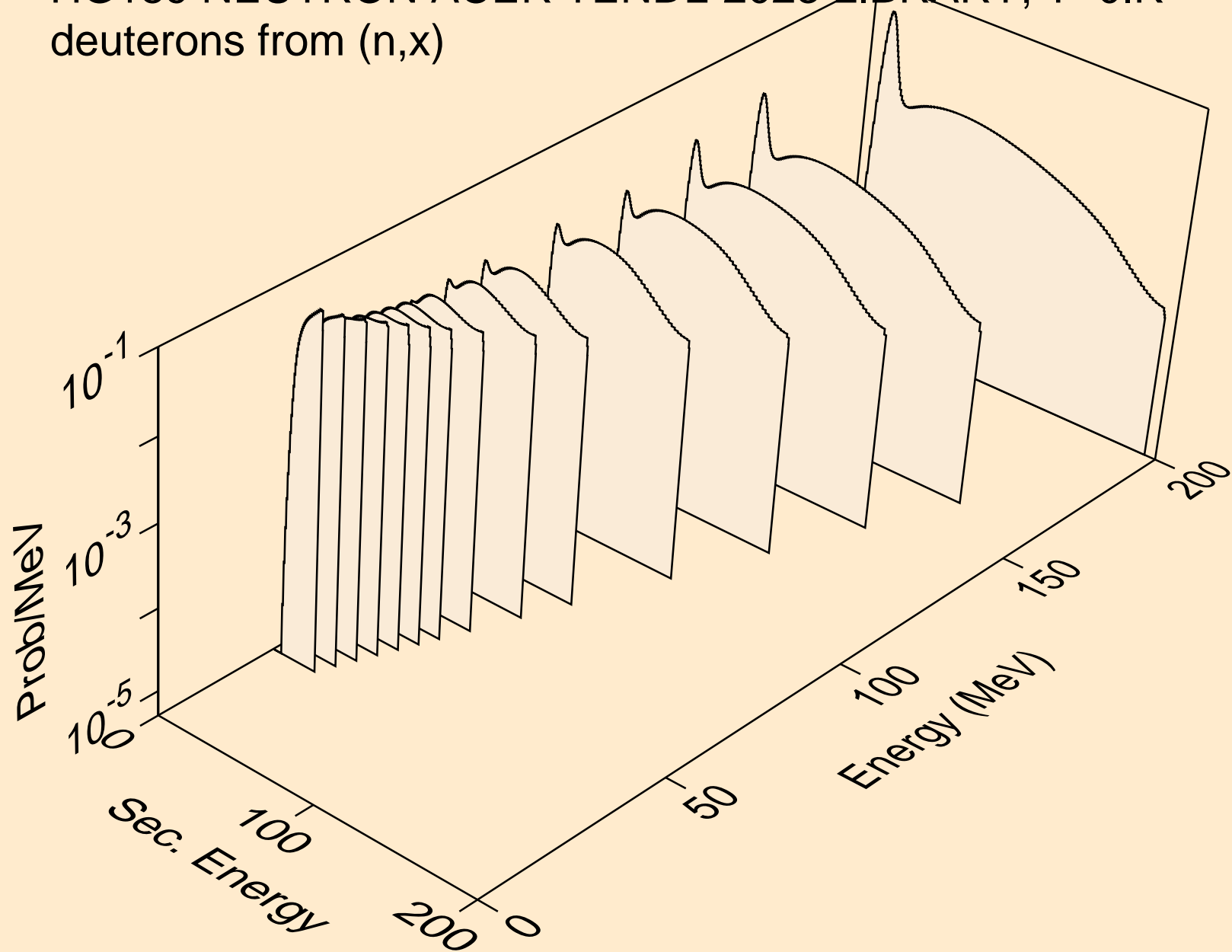

HG189 NEUTRON ACER TENDL-2023 LIBRARY; T=0.K  
deuterons from (n,2nd)

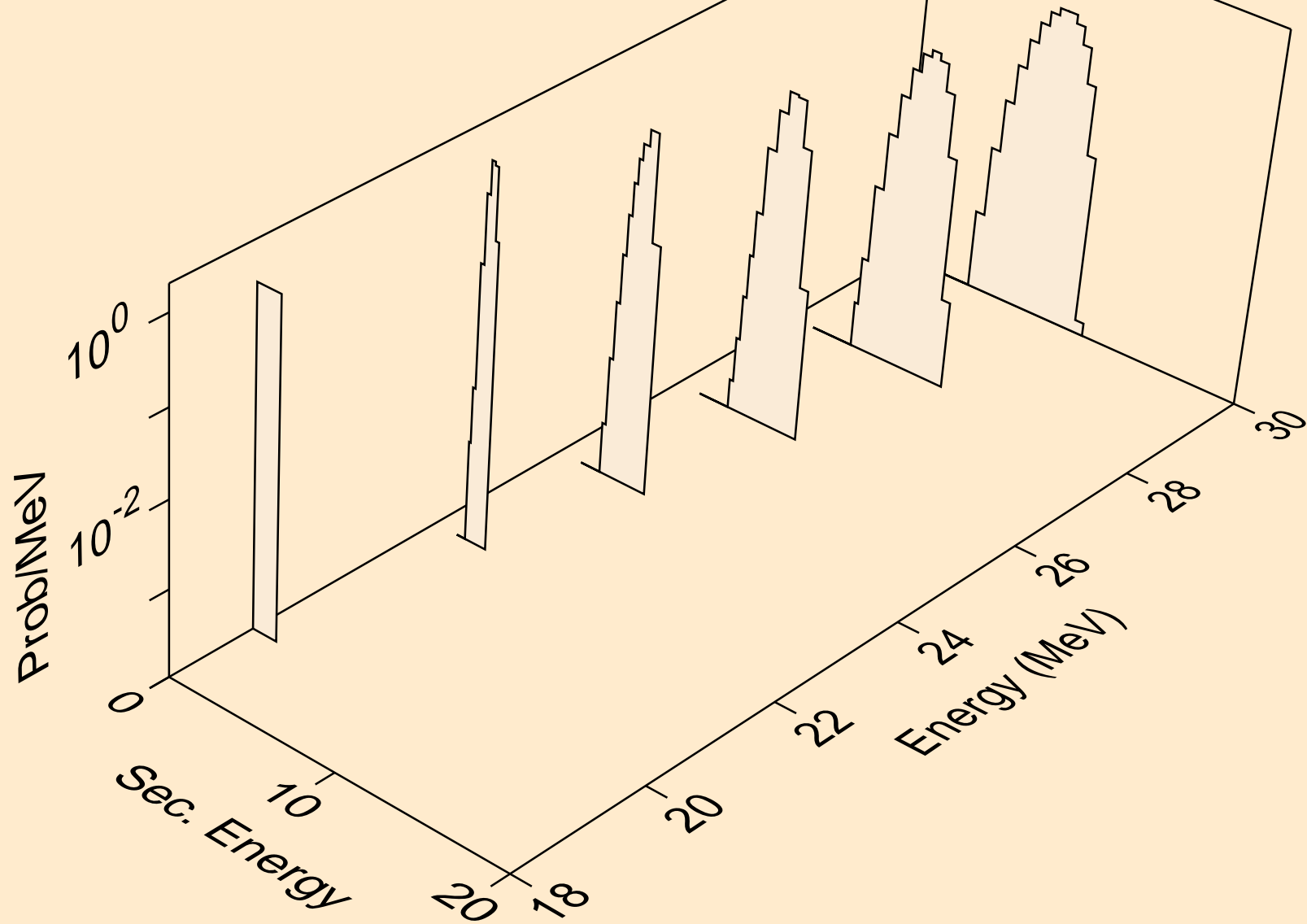



HG189 NEUTRON ACER TENDL-2023 LIBRARY; T=0.K  
deuterons from (n,n\*)d

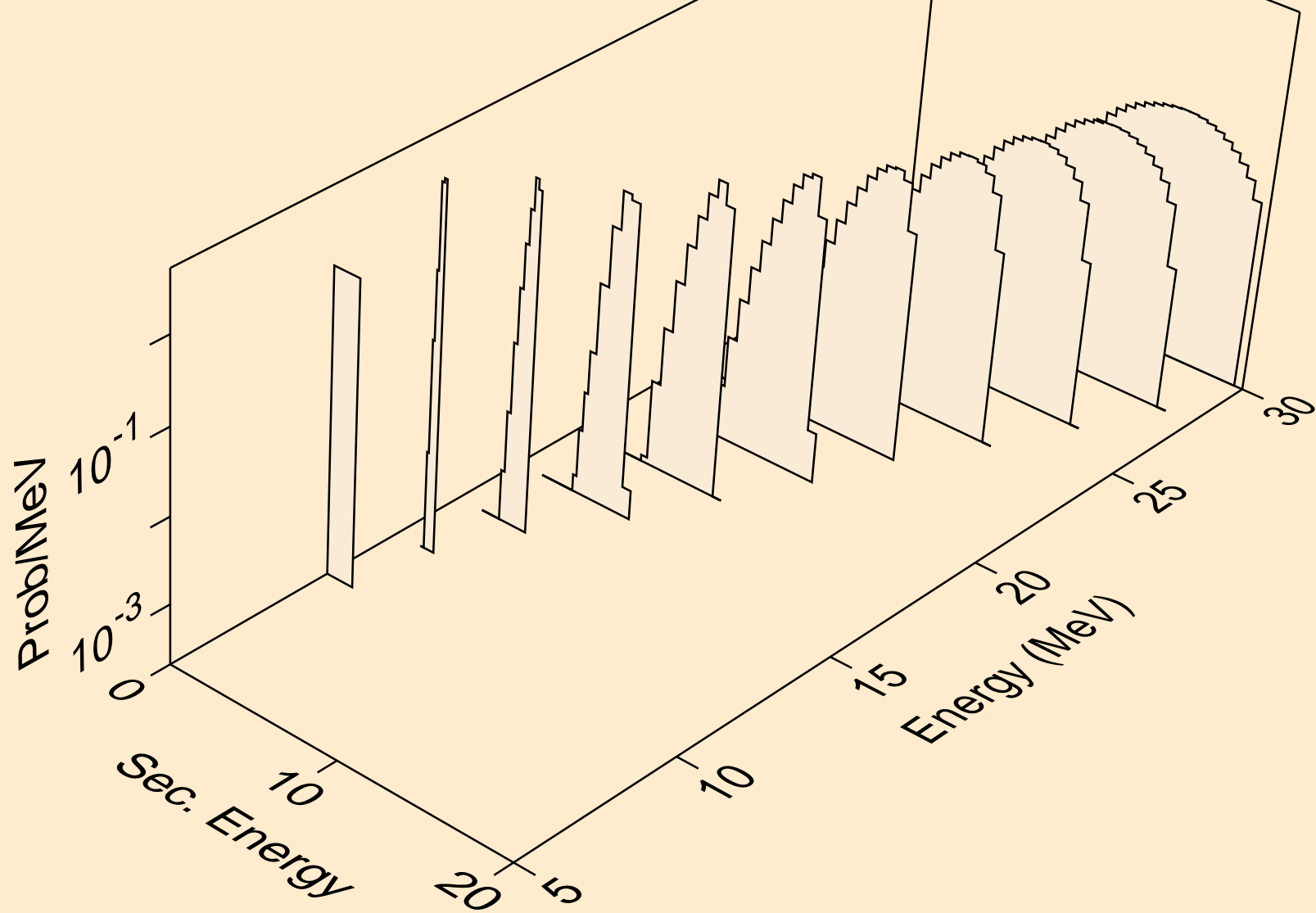

HG189 NEUTRON ACER TENDL-2023 LIBRARY; T=0.K  
deuterons from (n,d)

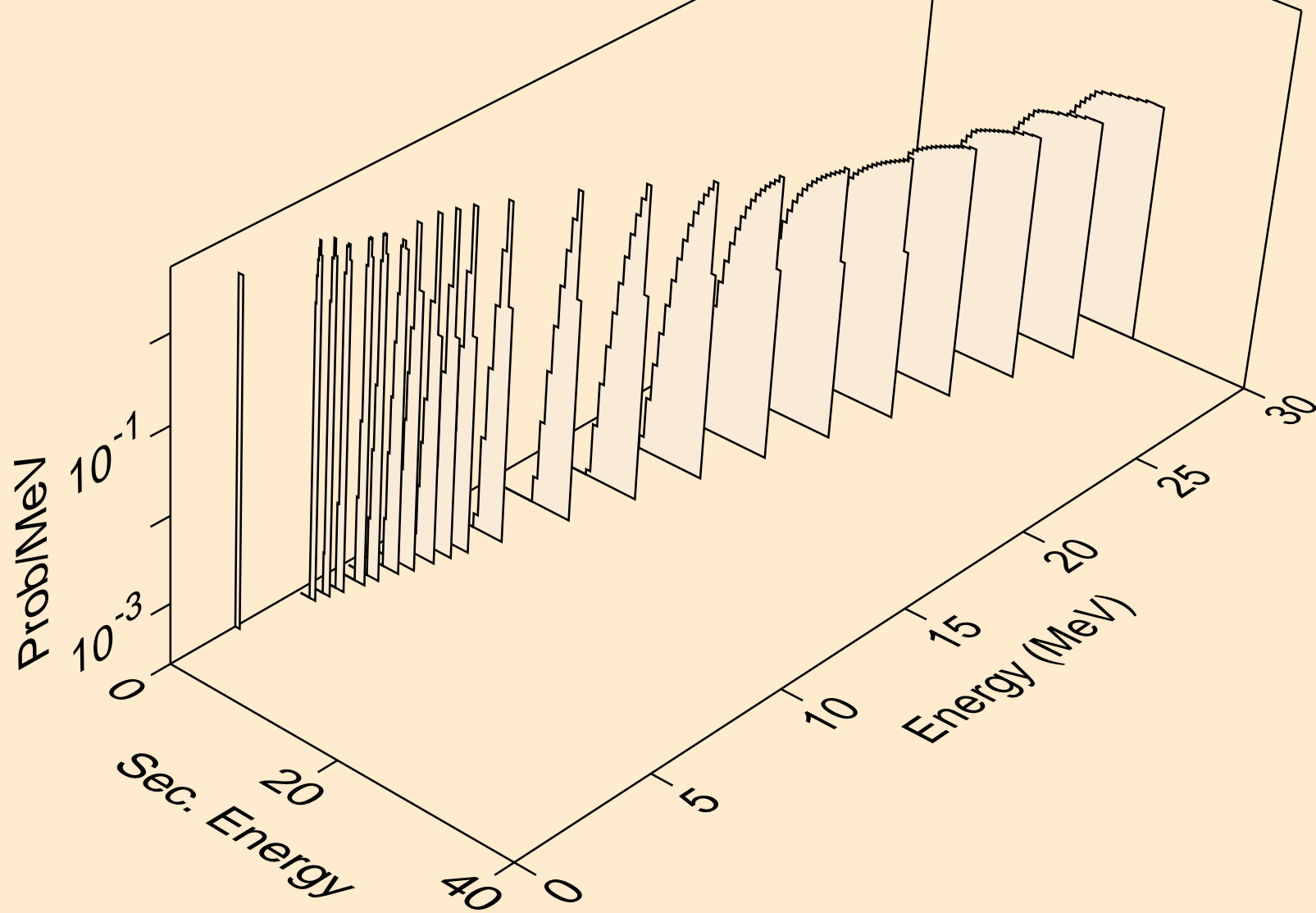

HG189 NEUTRON ACER TENDL-2023 LIBRARY; T=0.K  
deuterons from (n,pd)

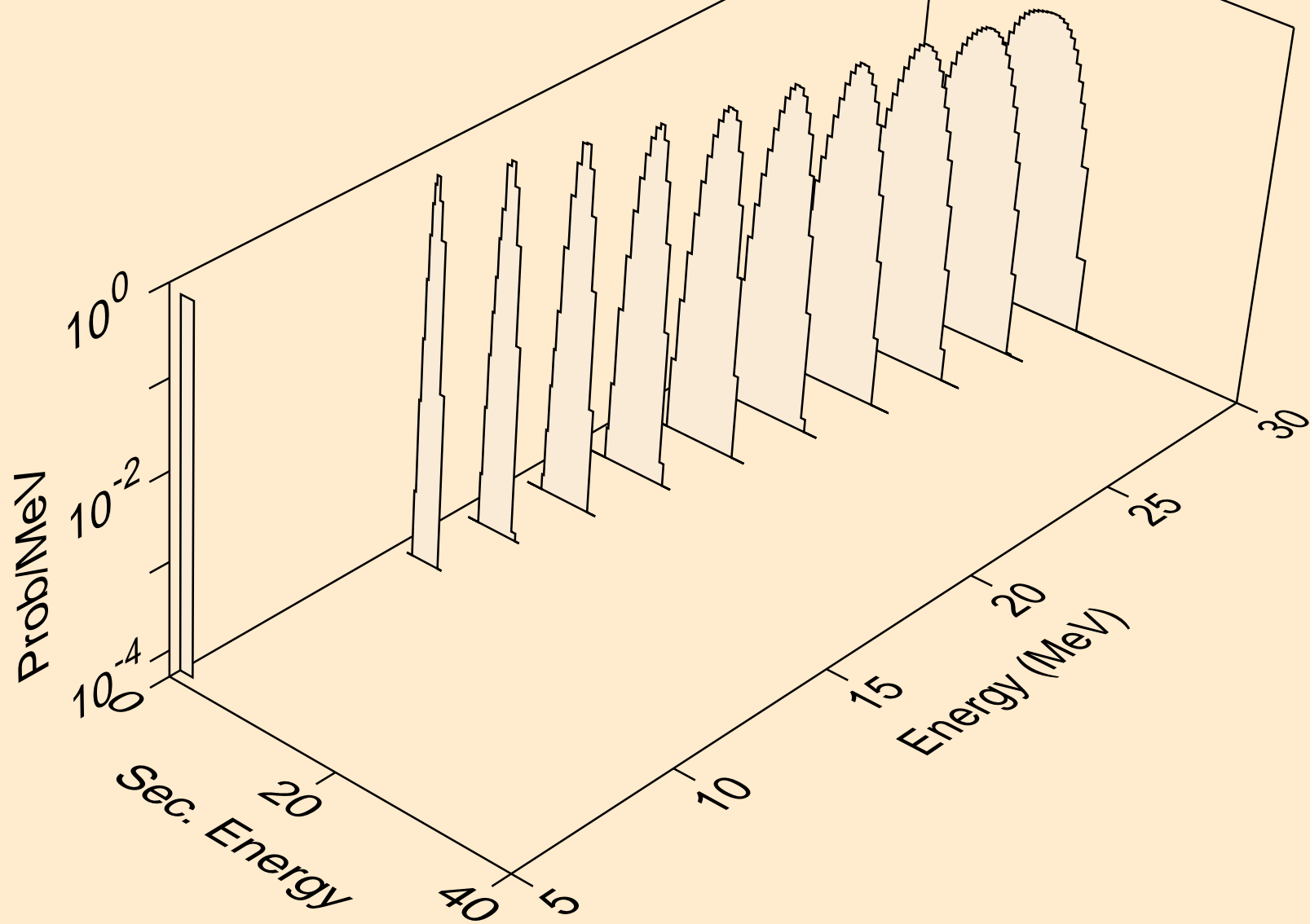

HG189 NEUTRON ACER TENDL-2023 LIBRARY; T=0.K  
deuterons from (n,da)

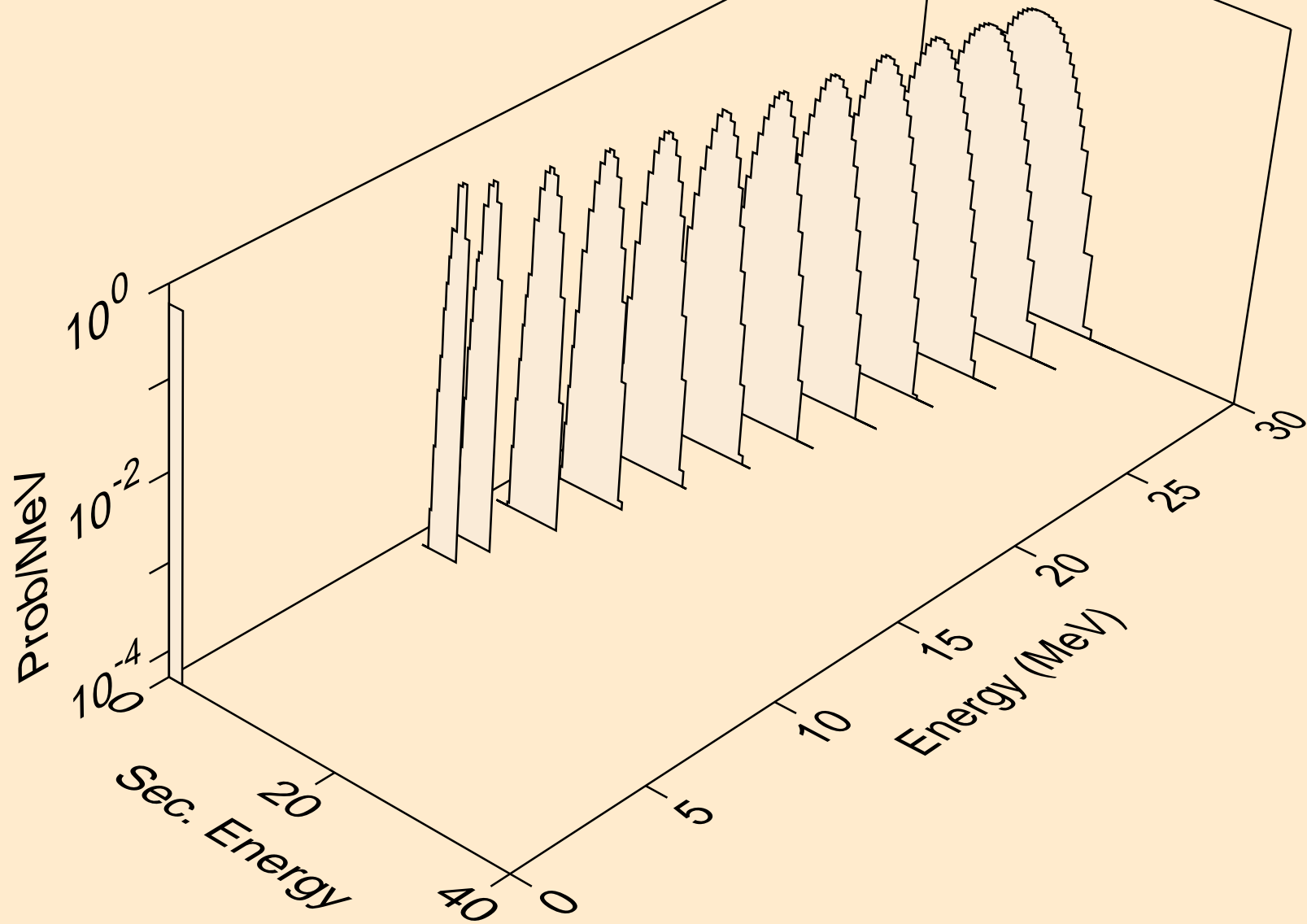

HG189 NEUTRON ACER TENDL-2023 LIBRARY; T=0.K  
tritons from (n,x)

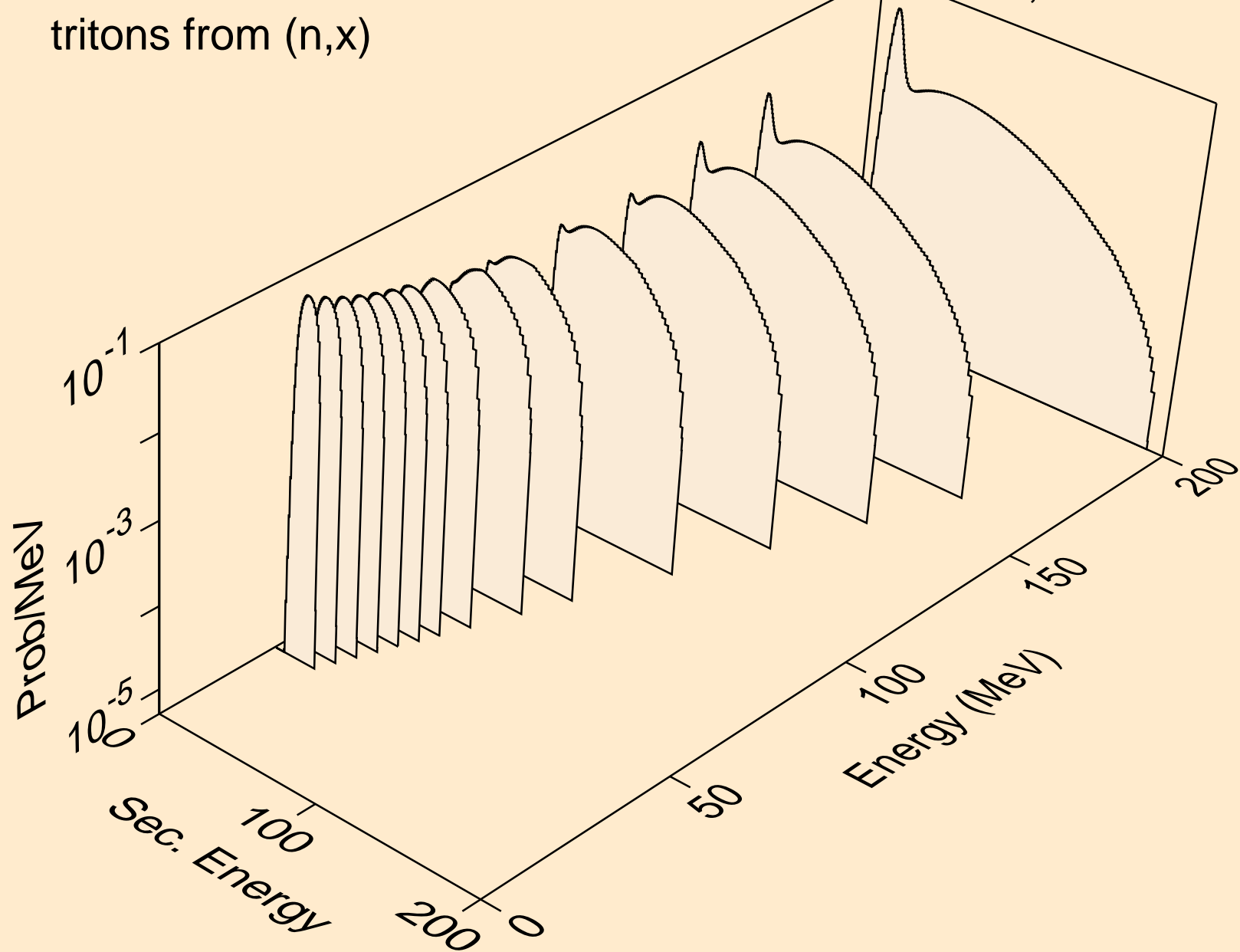

HG189 NEUTRON ACER TENDL-2023 LIBRARY; T=0.K  
tritons from (n,n\*)t

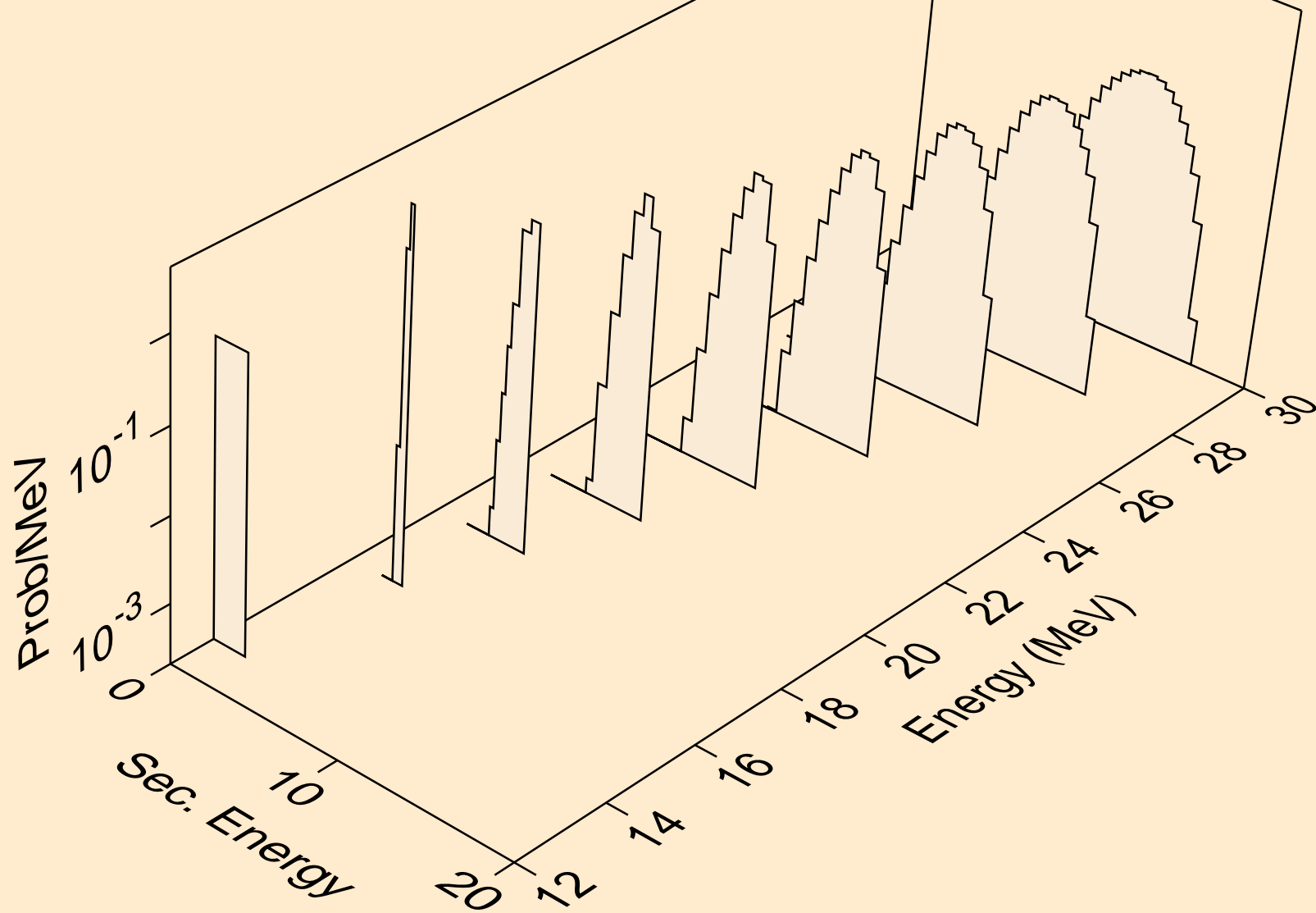

HG189 NEUTRON ACER TENDL-2023 LIBRARY; T=0.K  
tritons from (n,t)

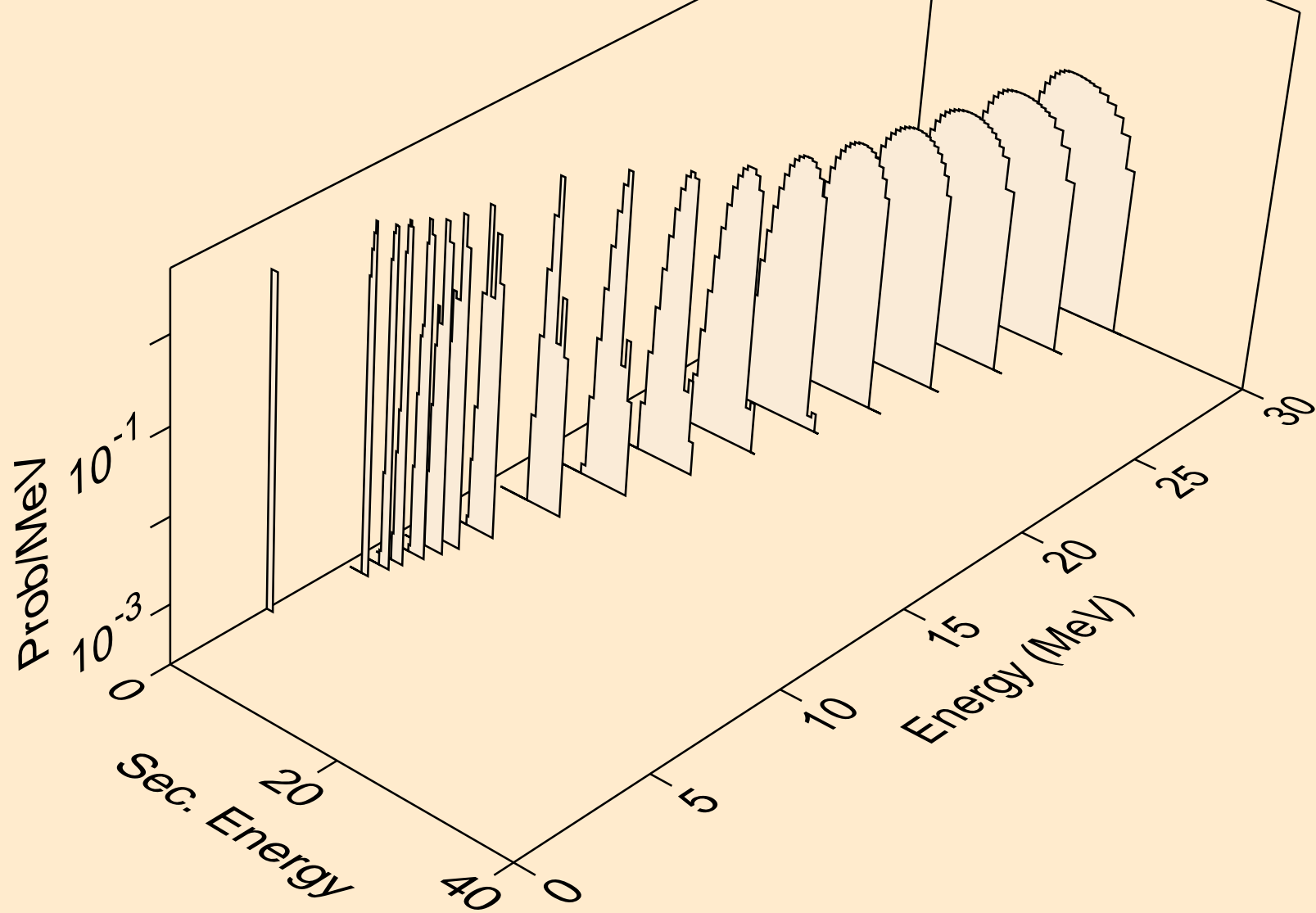

HG189 NEUTRON ACER TENDL-2023 LIBRARY; T=0.K  
tritons from (n,pt)

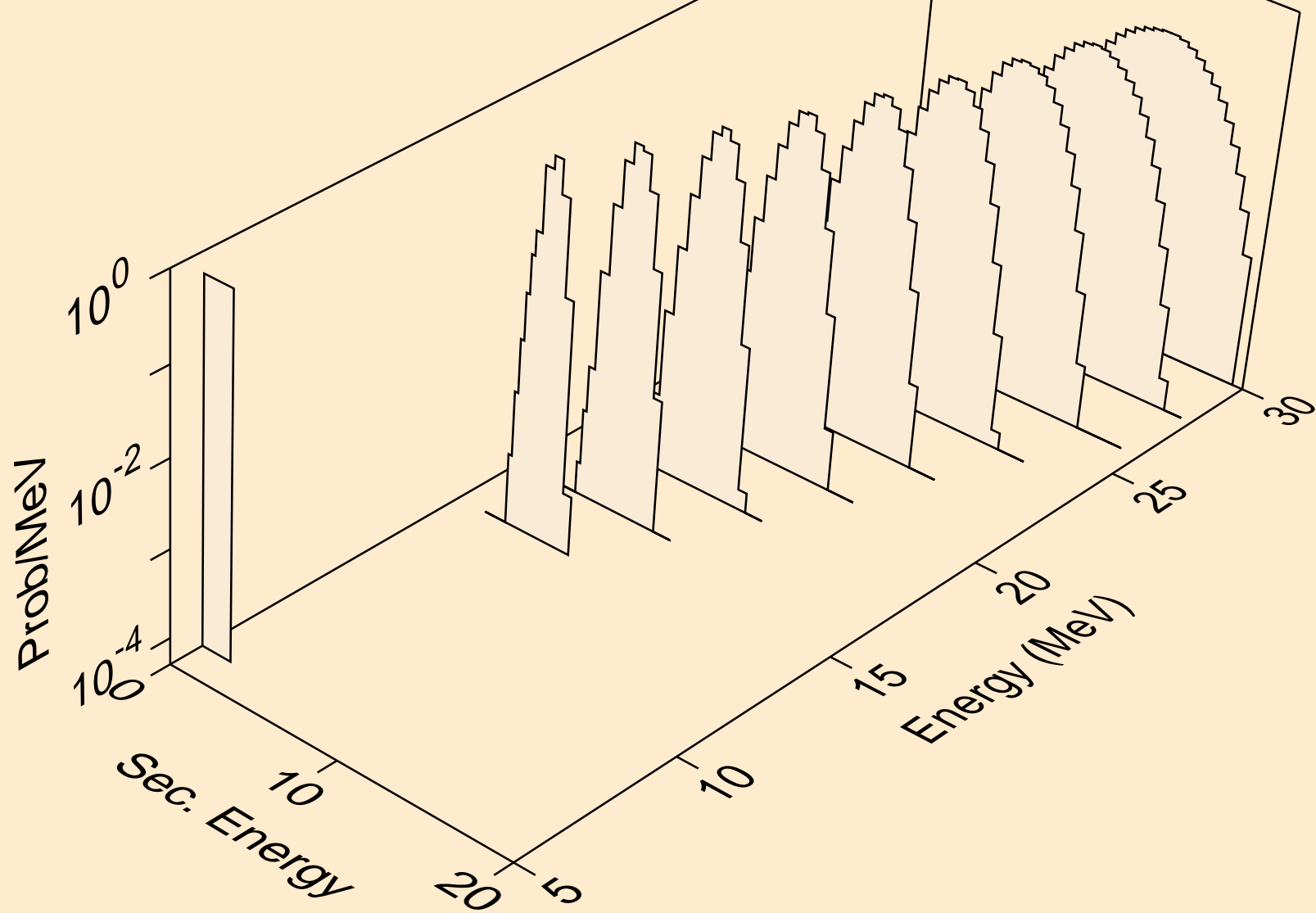



HG189 NEUTRON ACER TENDL-2023 LIBRARY; T=0.K  
he3s from (n,x)

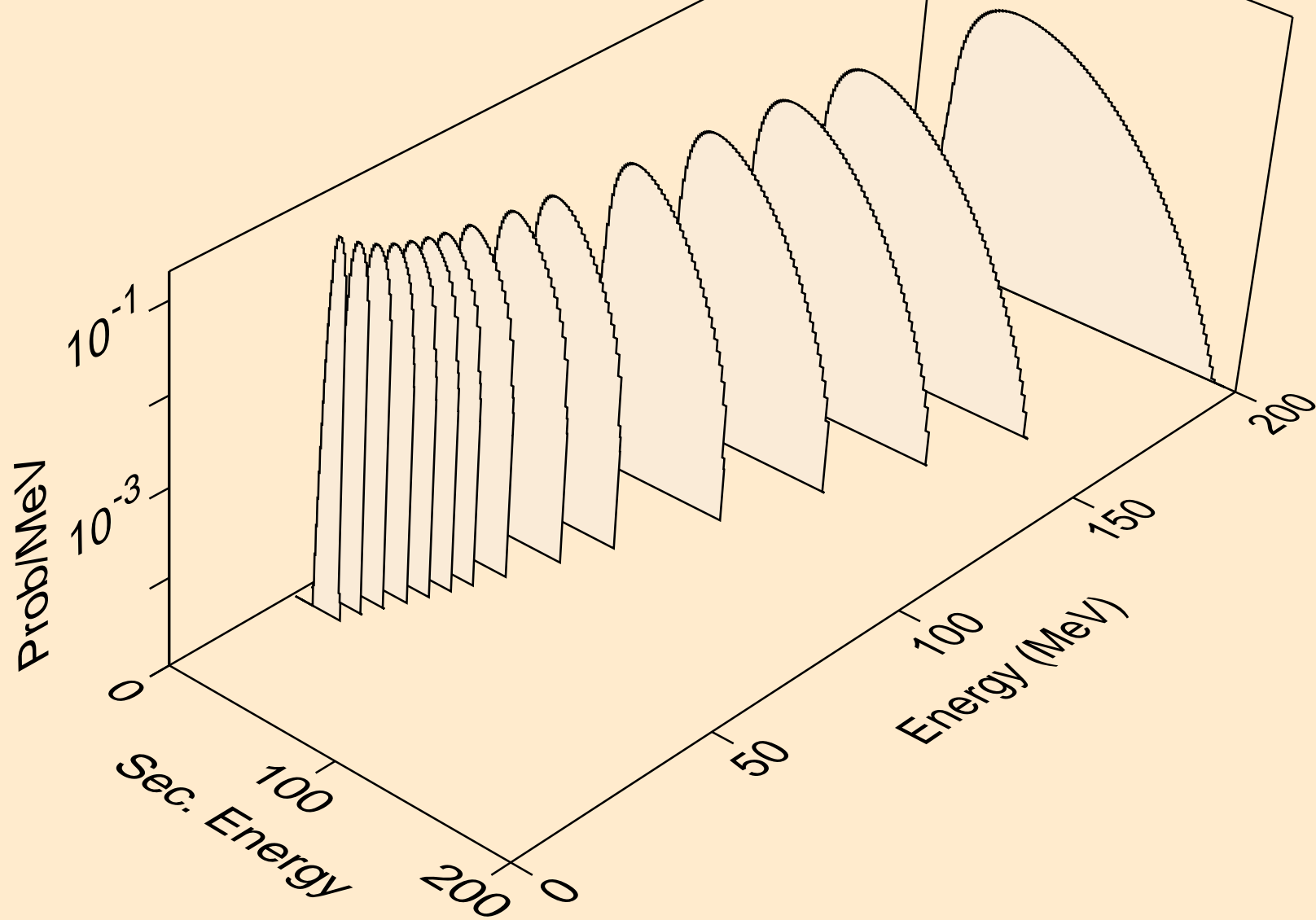

HG189 NEUTRON ACER TENDL-2023 LIBRARY; T=0.K  
he3s from (n,n\*)he3

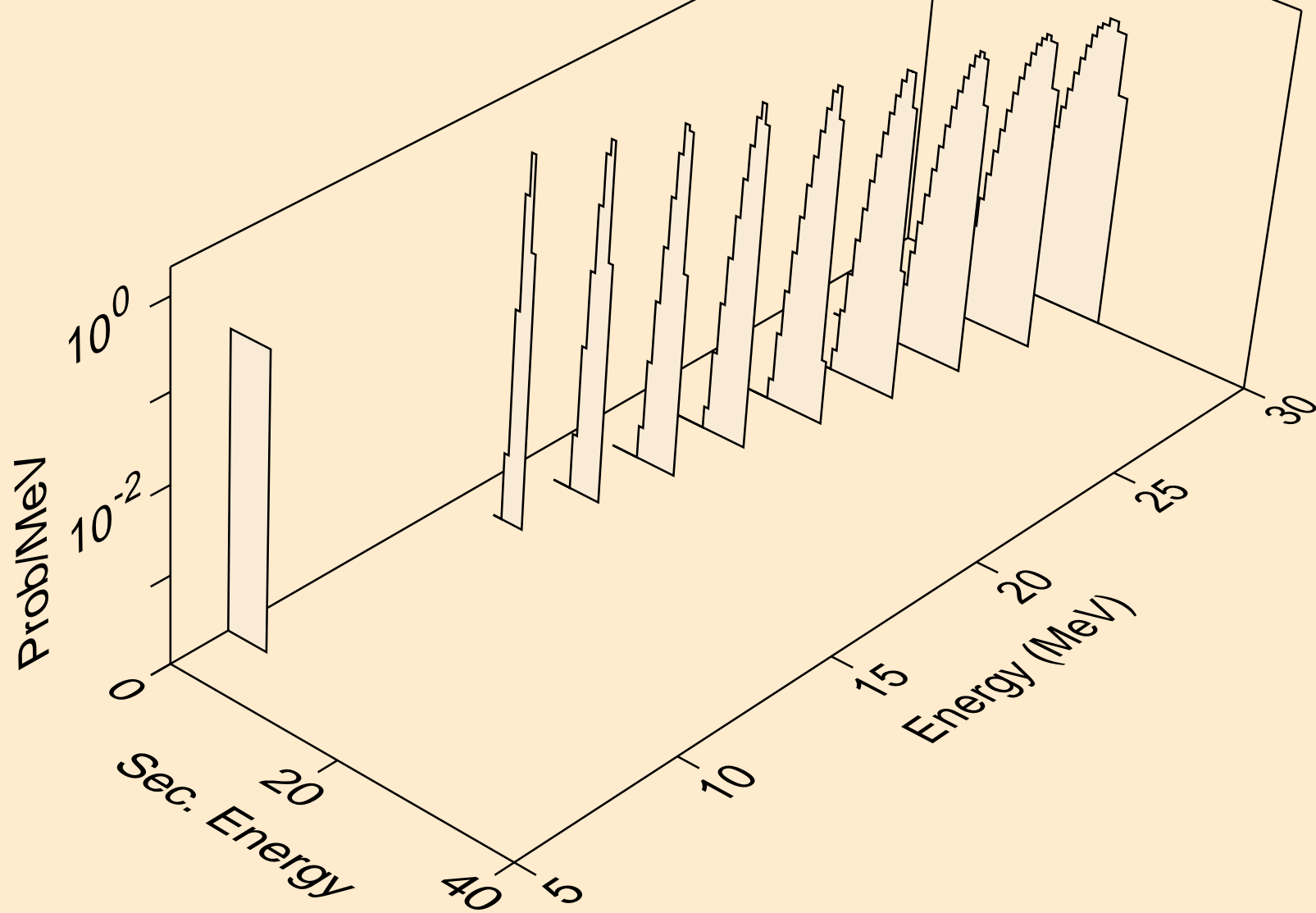

HG189 NEUTRON ACER TENDL-2023 LIBRARY; T=0.K  
he3s from (n,he3)

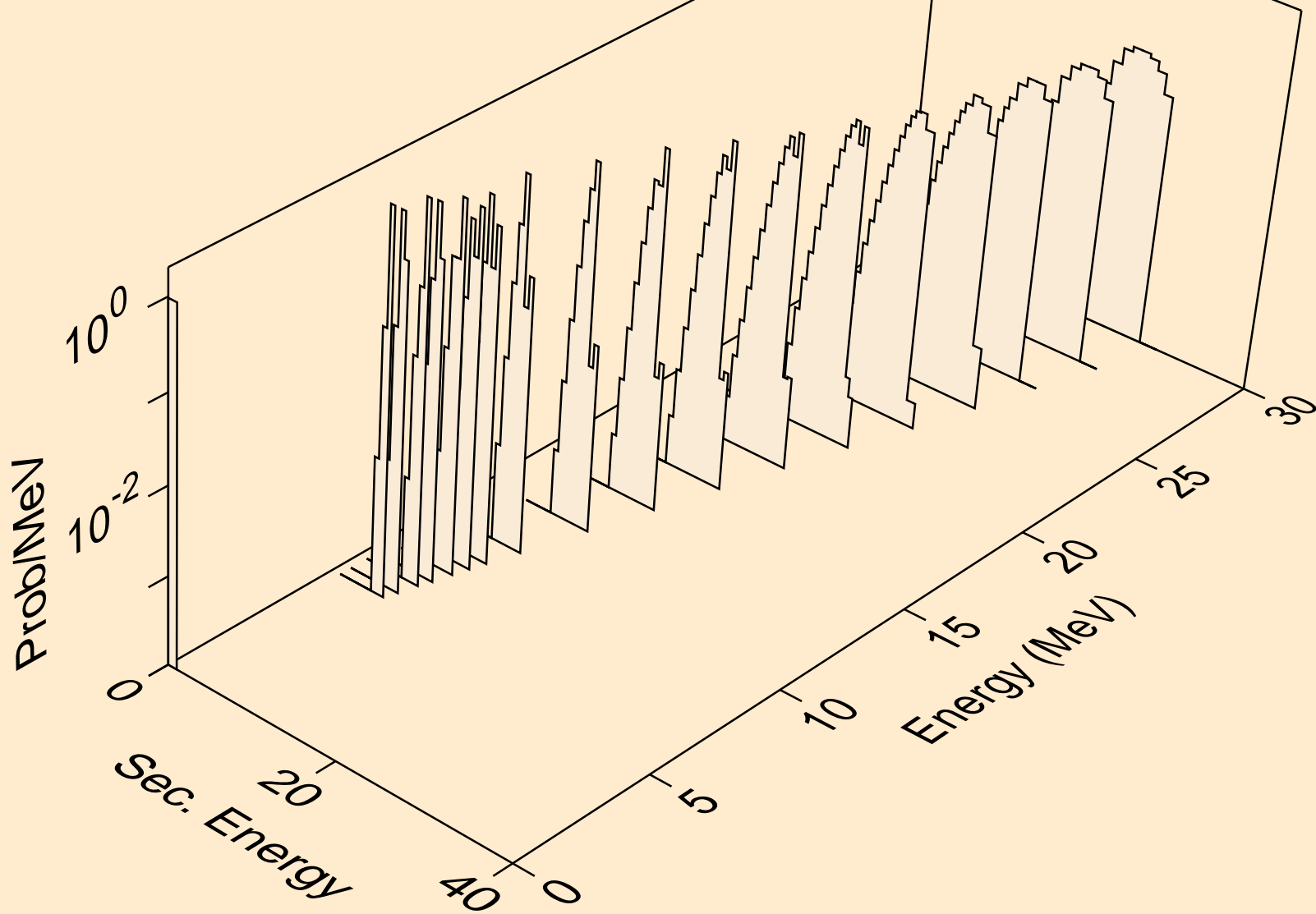

HG189 NEUTRON ACER TENDL-2023 LIBRARY; T=0.K  
alphas from (n,x)

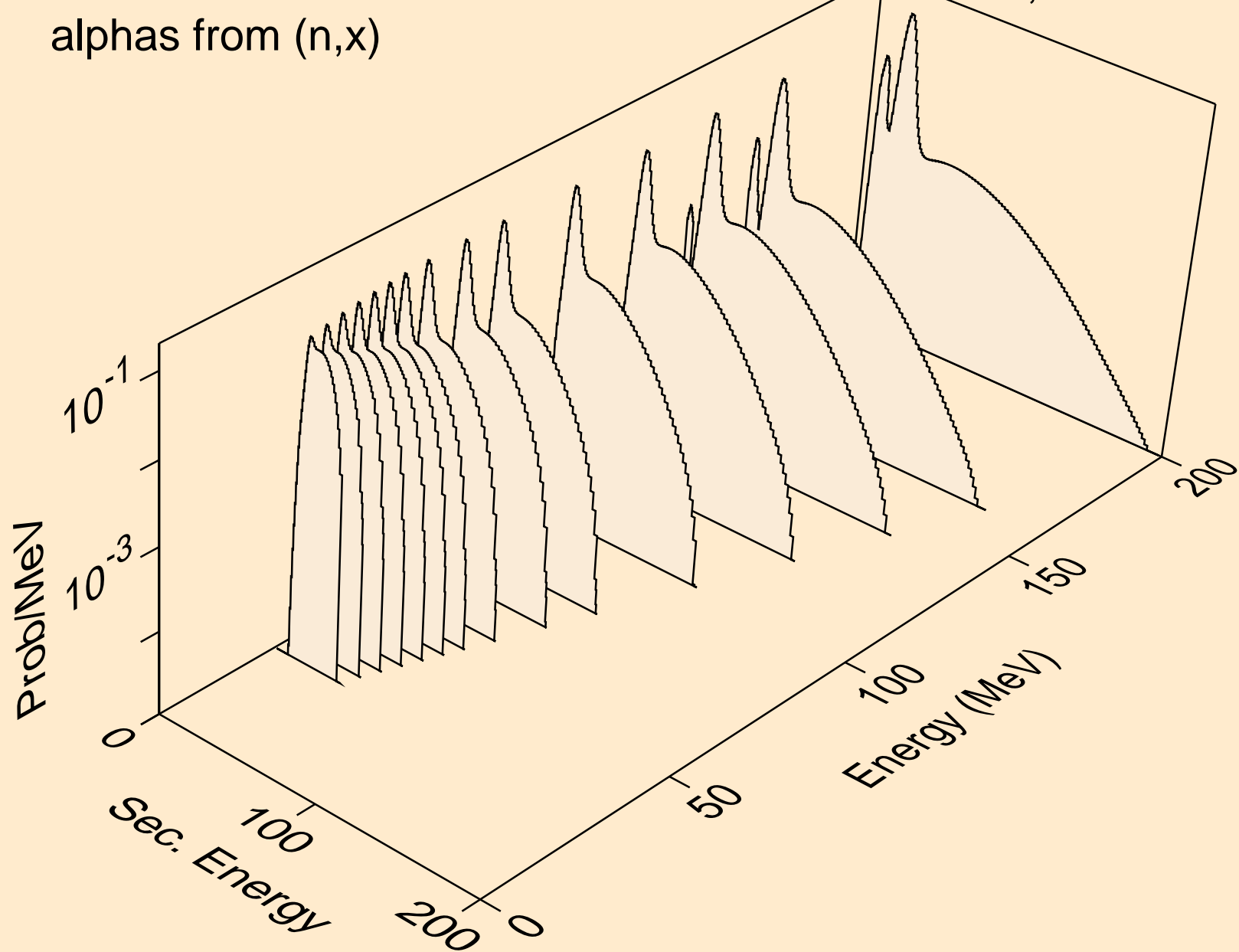

HG189 NEUTRON ACER TENDL-2023 LIBRARY; T=0.K  
alphas from (n,n\*)a

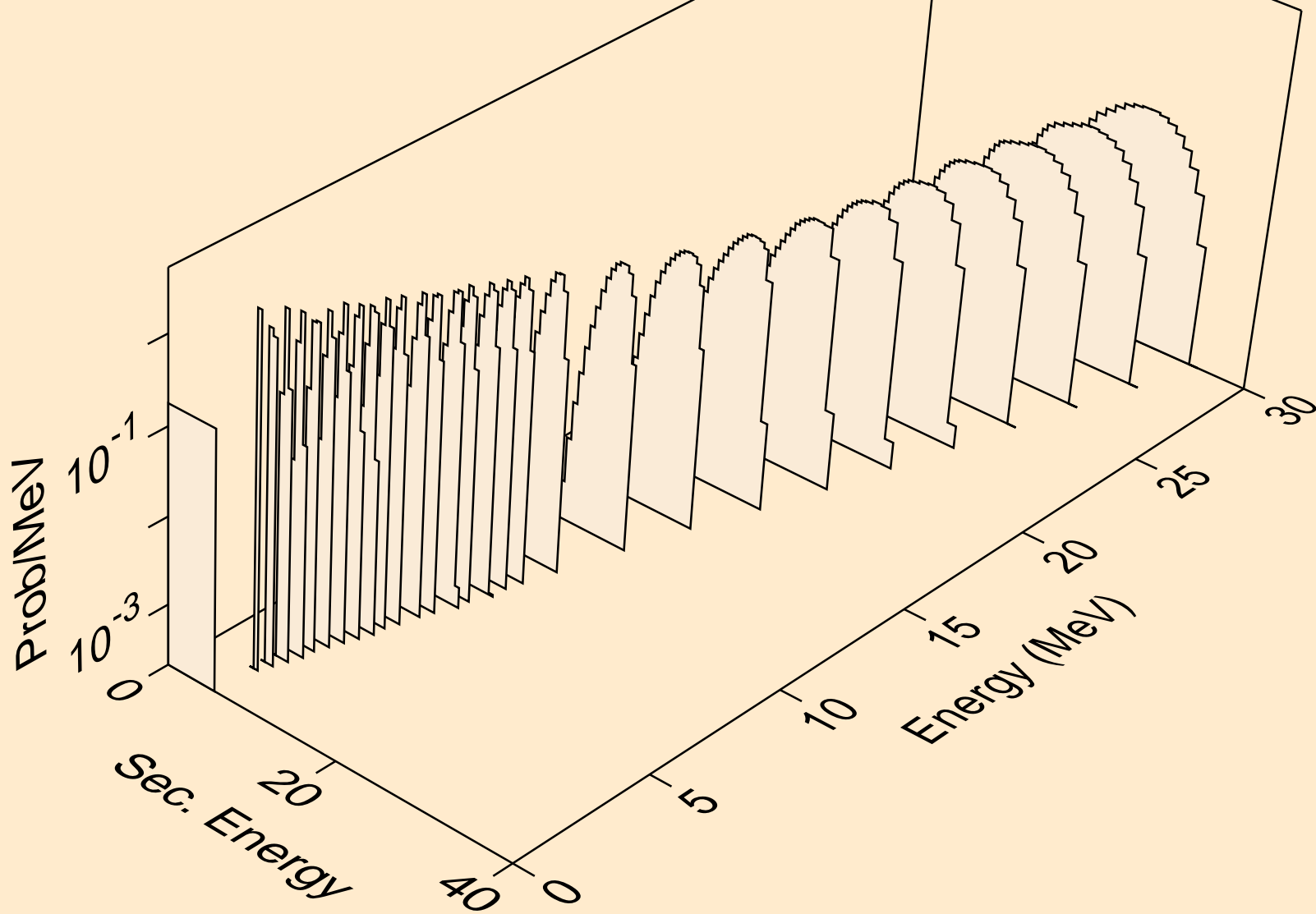

HG189 NEUTRON ACER TENDL-2023 LIBRARY; T=0.K  
alphas from (n,2n)a

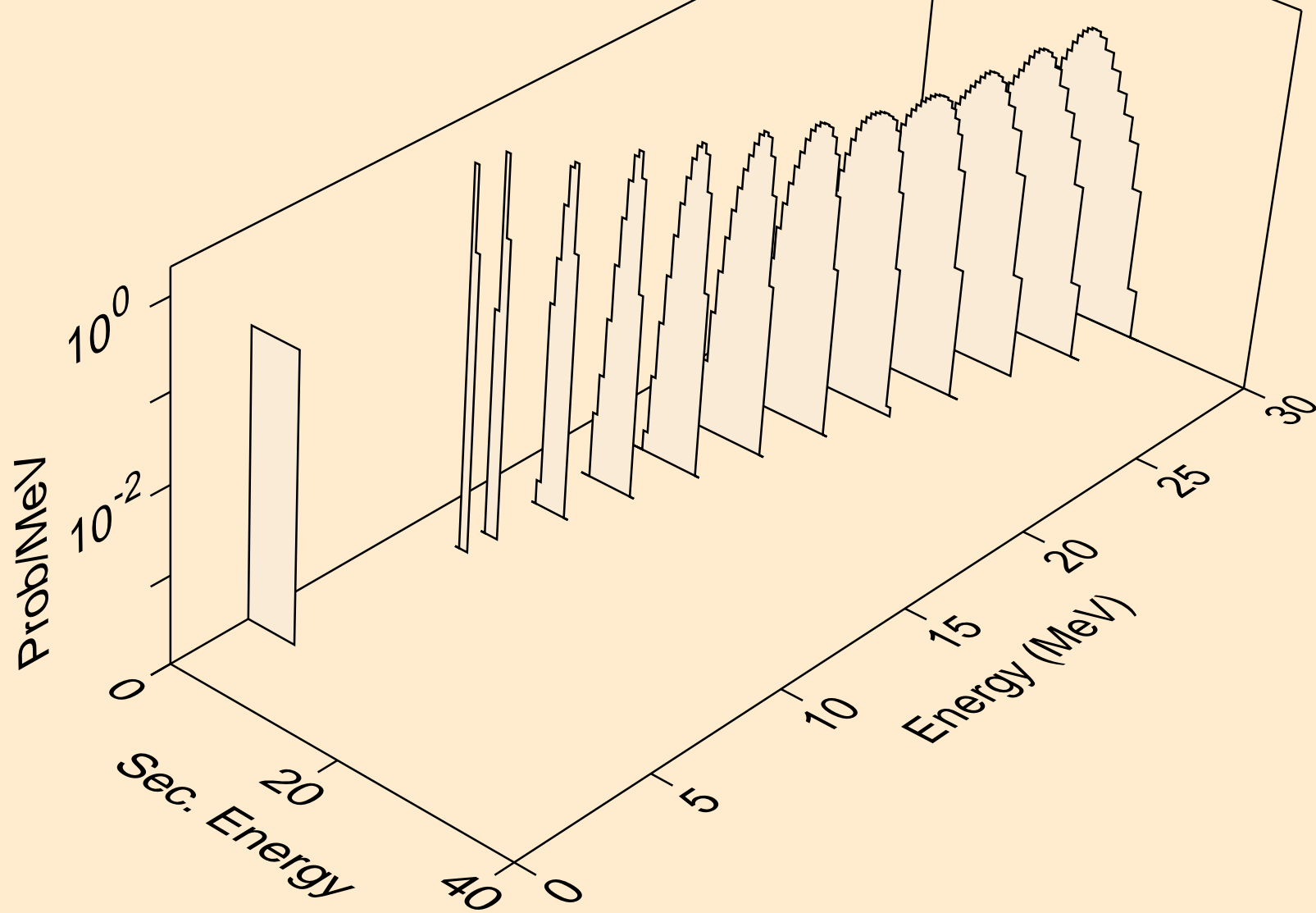

HG189 NEUTRON ACER TENDL-2023 LIBRARY; T=0.K  
alphas from (n,3n)a

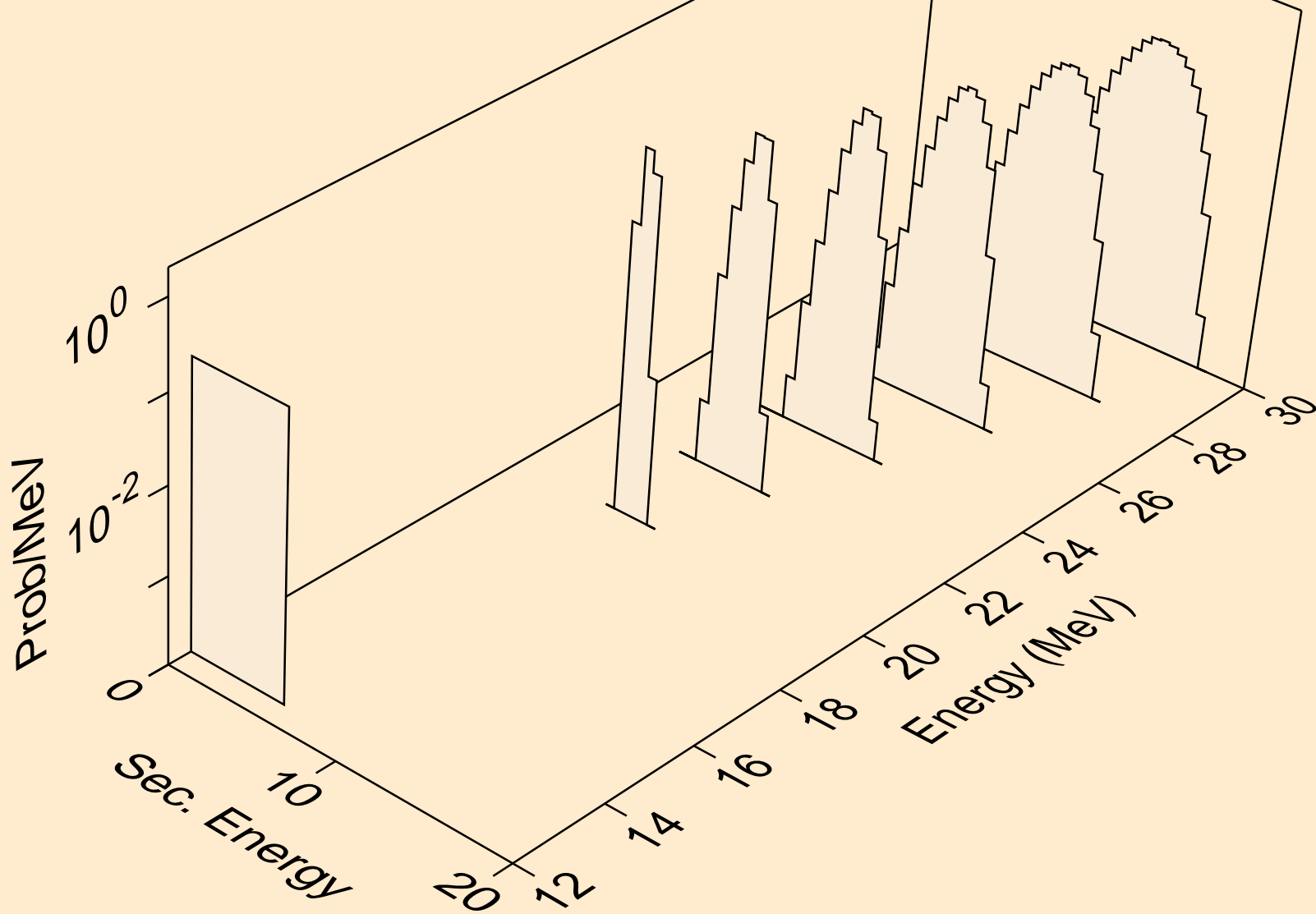

HG189 NEUTRON ACER TENDL-2023 LIBRARY; T=0.K  
alphas from (n,n\*)2a

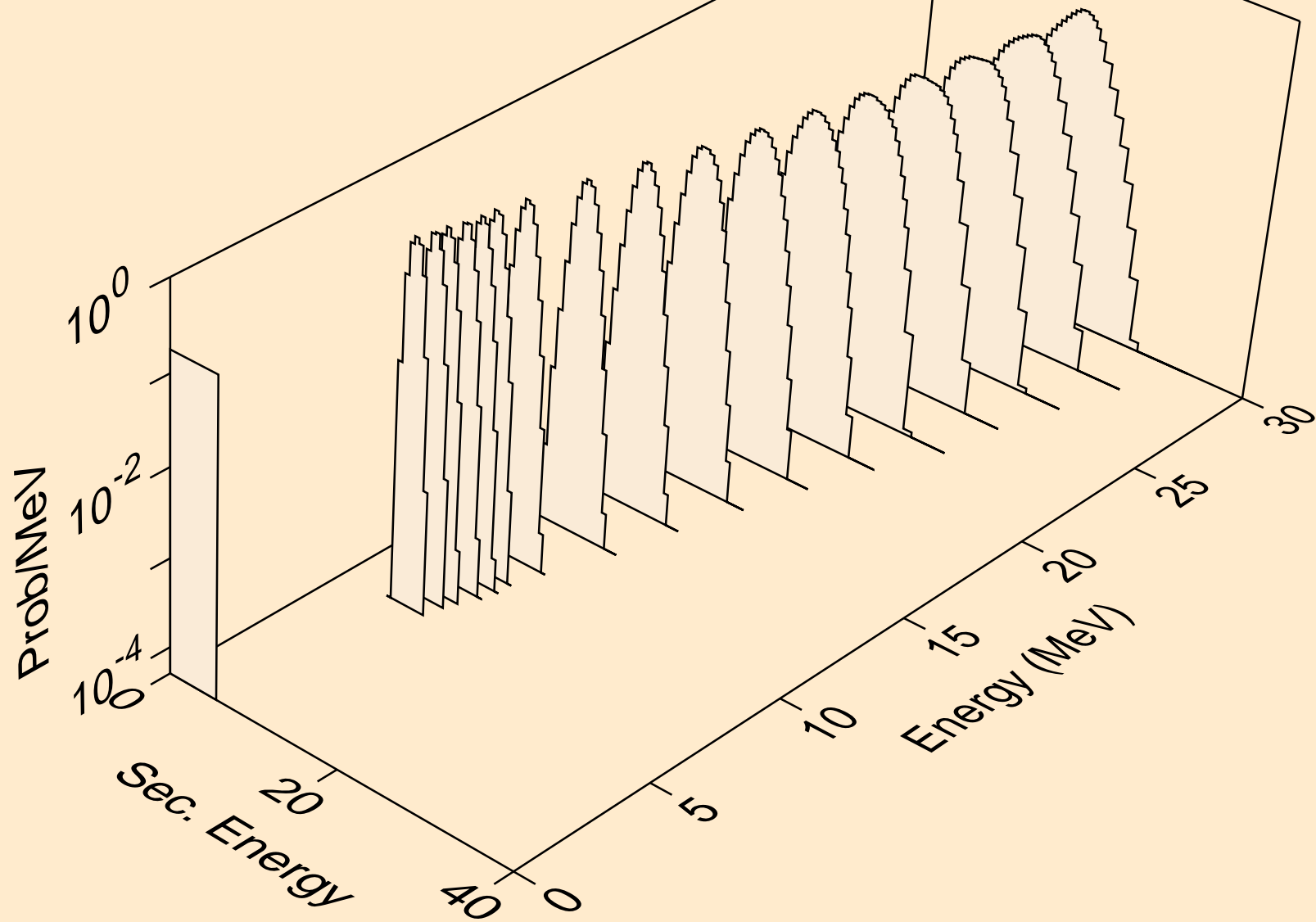



HG189 NEUTRON ACER TENDL-2023 LIBRARY; T=0.K  
alphas from (n,2n)2a

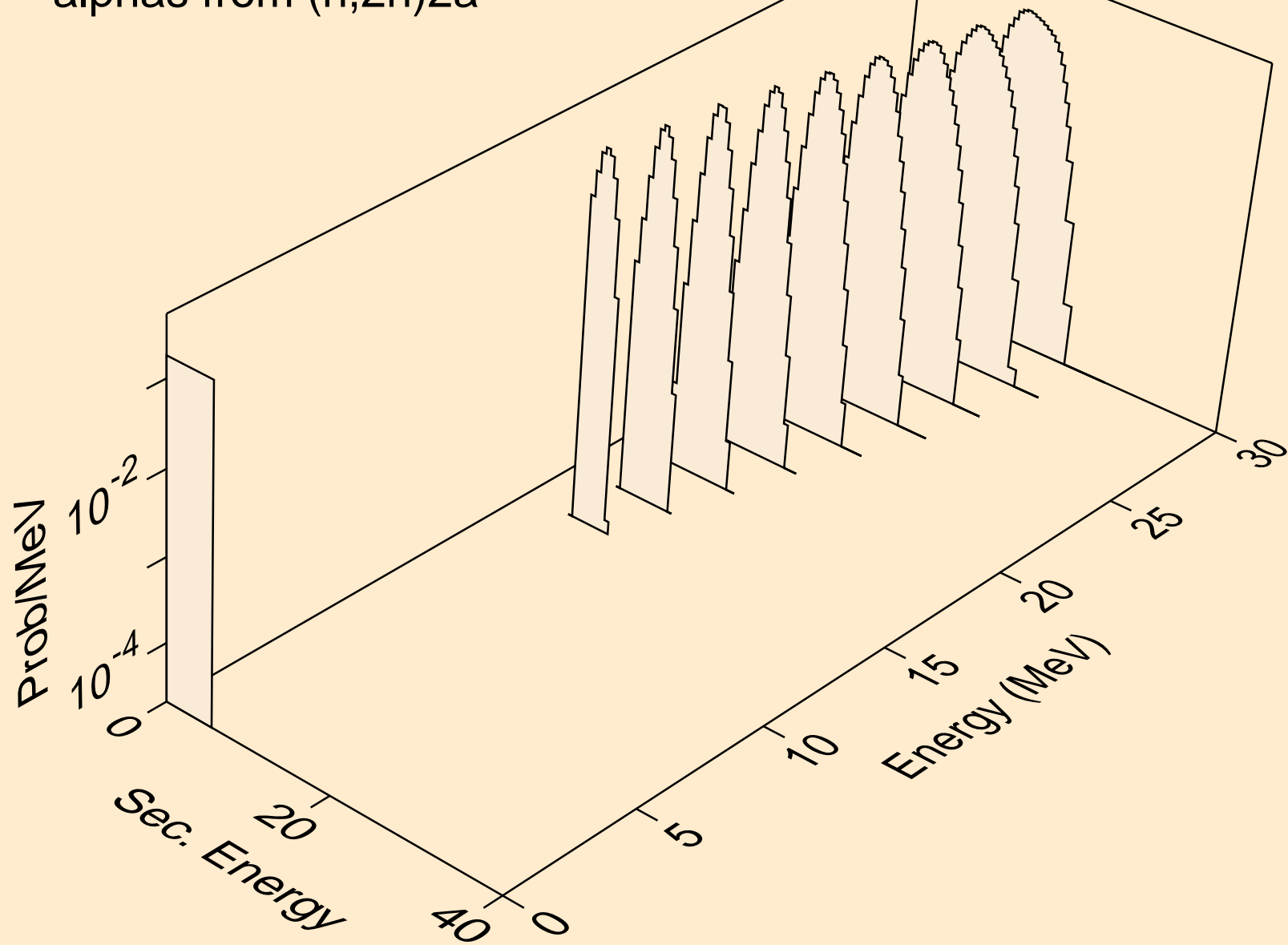

HG189 NEUTRON ACER TENDL-2023 LIBRARY; T=0.K  
alphas from (n,npa)

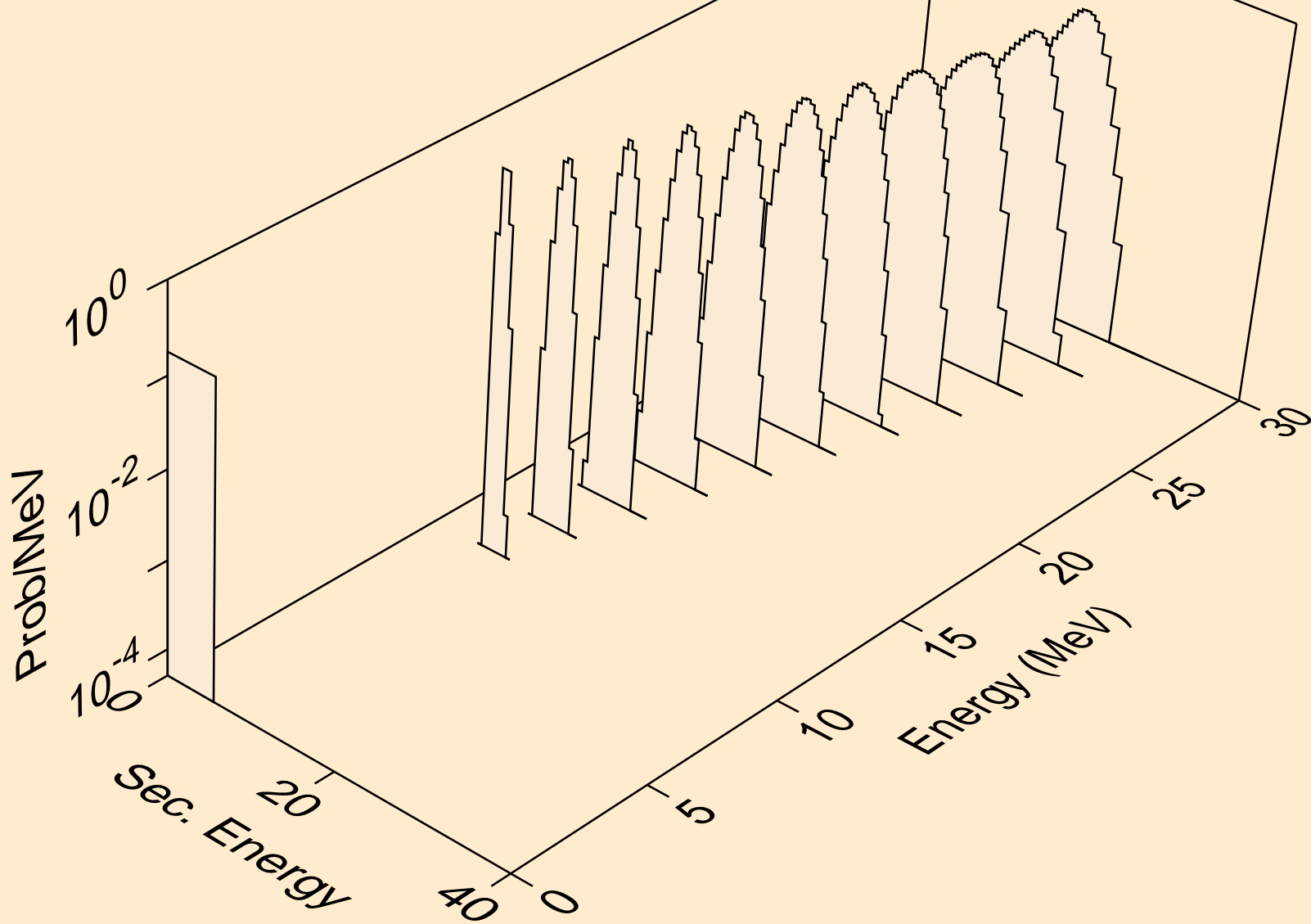

HG189 NEUTRON ACER TENDL-2023 LIBRARY; T=0.K  
alphas from (n,a)

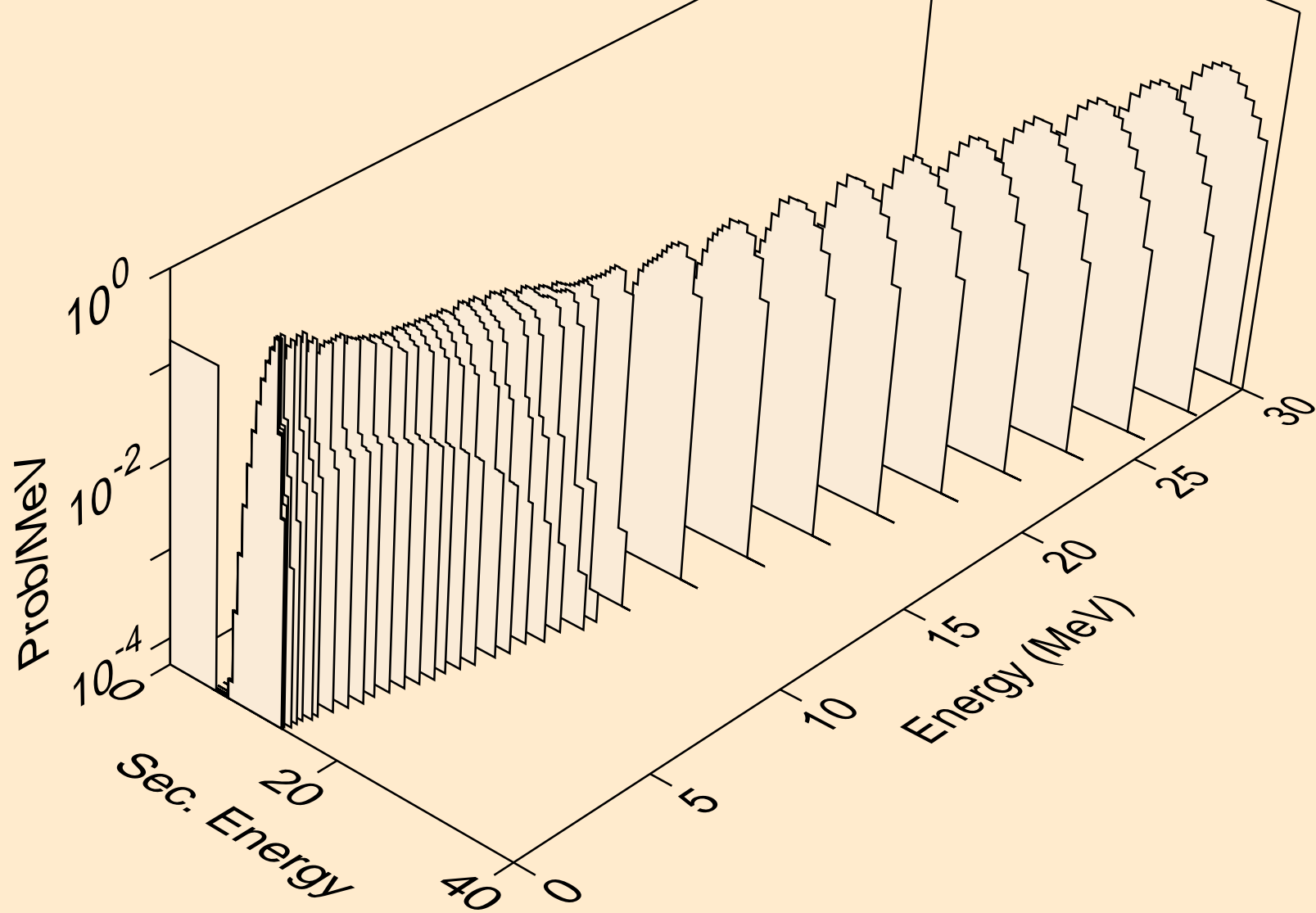

HG189 NEUTRON ACER TENDL-2023 LIBRARY; T=0.K  
alphas from (n,2a)

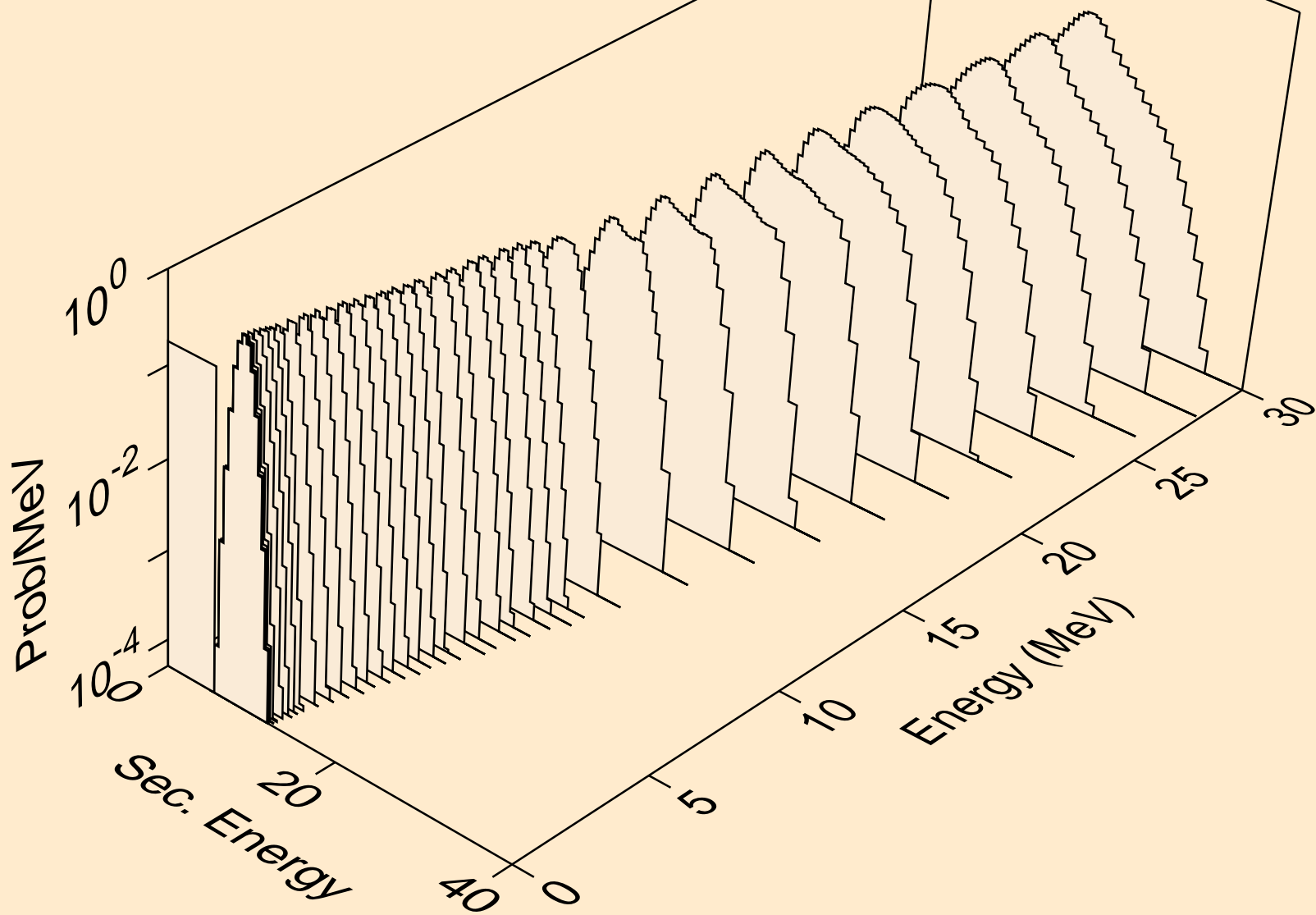

HG189 NEUTRON ACER TENDL-2023 LIBRARY; T=0.K  
alphas from (n,pa)

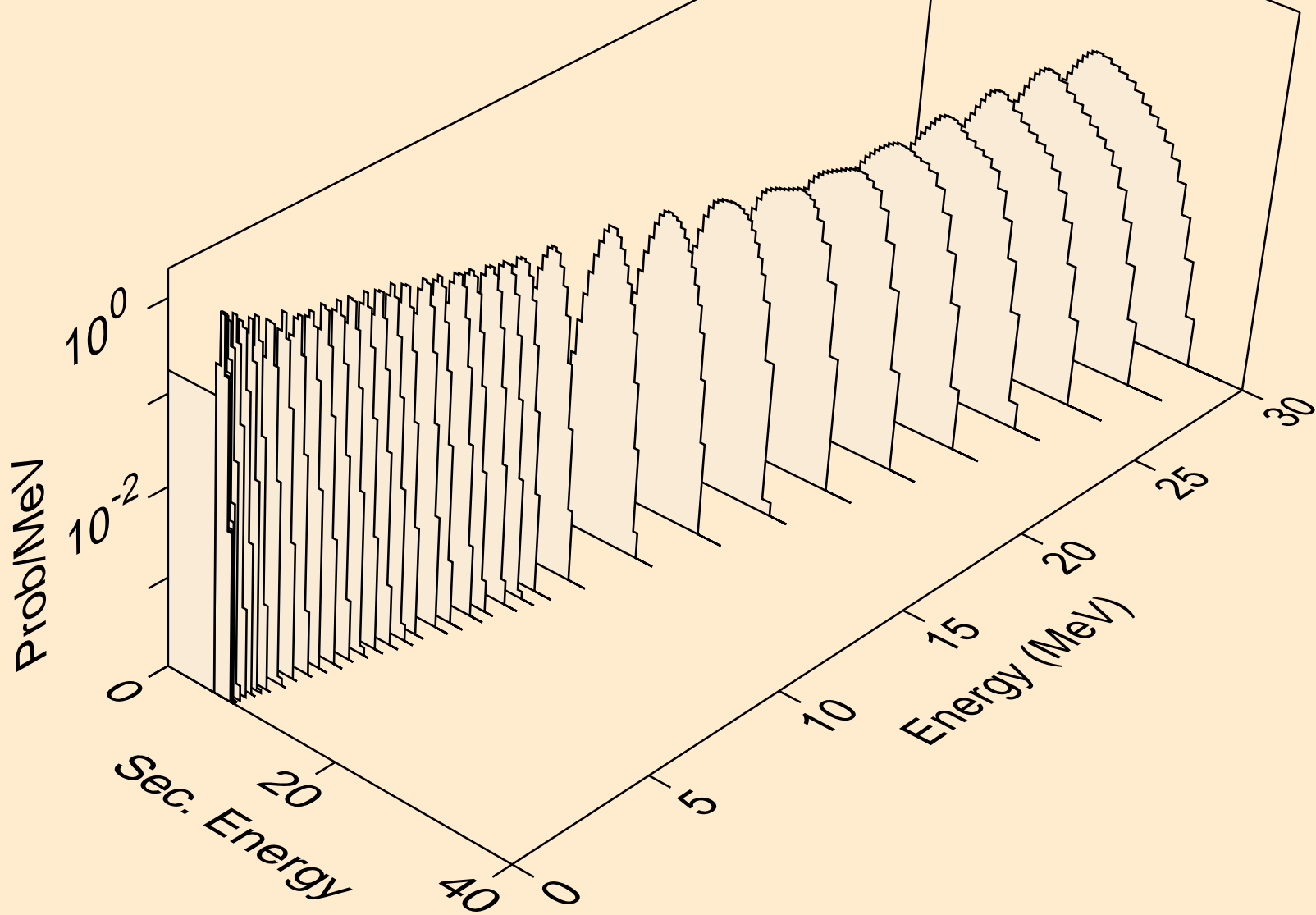

HG189 NEUTRON ACER TENDL-2023 LIBRARY; T=0.K  
alphas from (n,da)

