

HG191 NEUTRON ACER TENDL-2023 LIBRARY; T=0.K

Principal cross sections

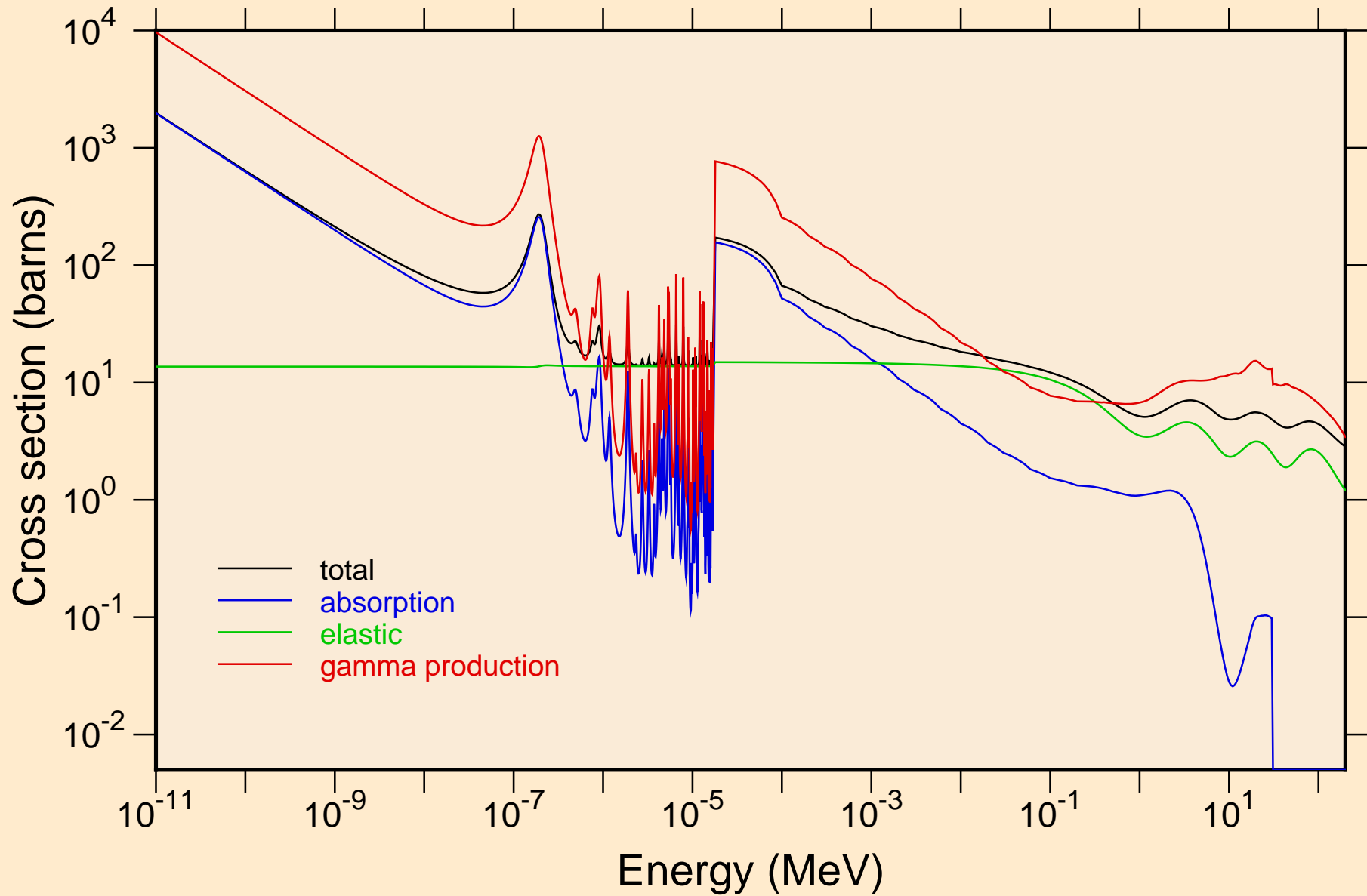

HG191 NEUTRON ACER TENDL-2023 LIBRARY; T=0.K
resonance total cross section

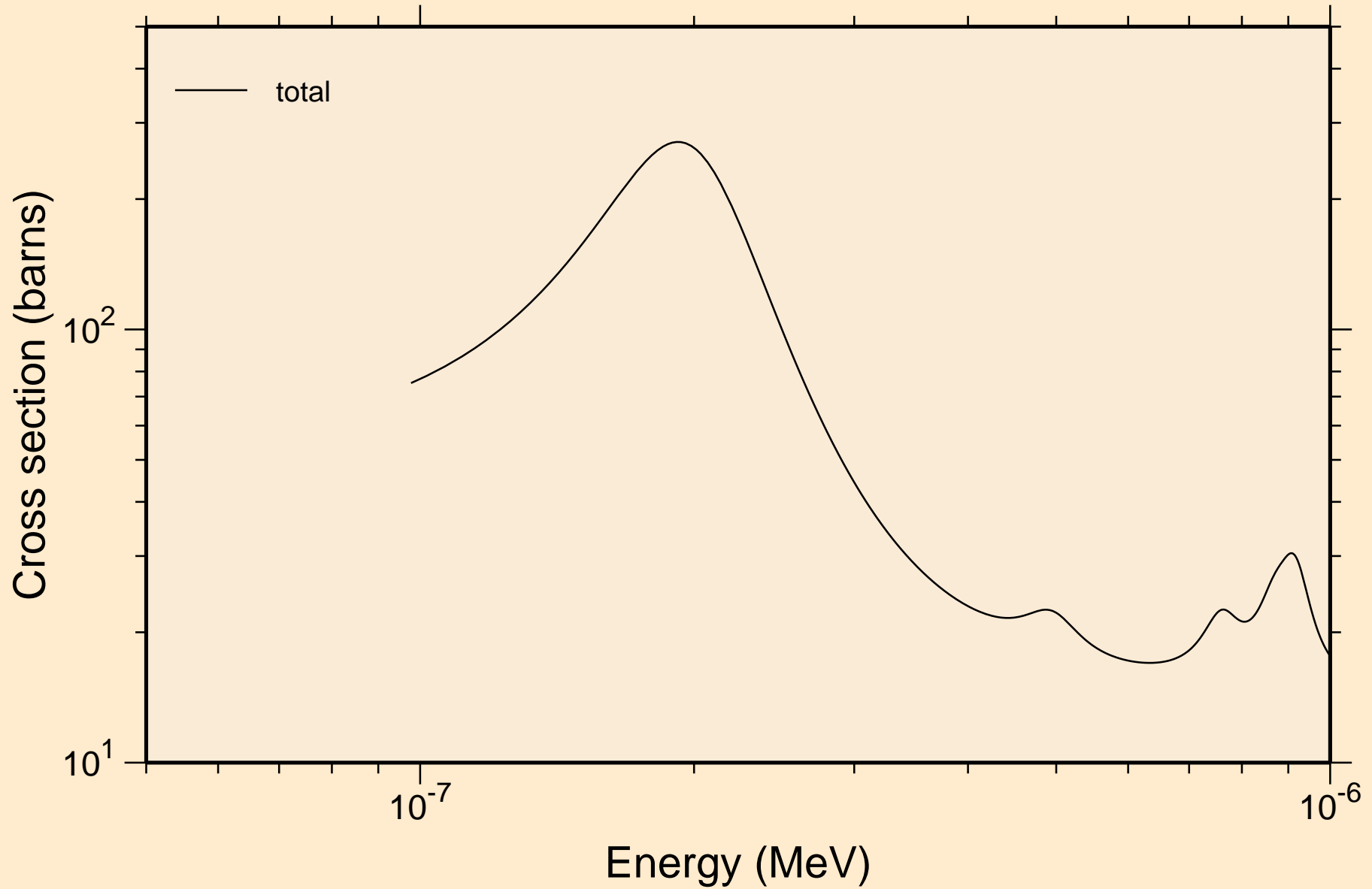

HG191 NEUTRON ACER TENDL-2023 LIBRARY; T=0.K
resonance total cross section

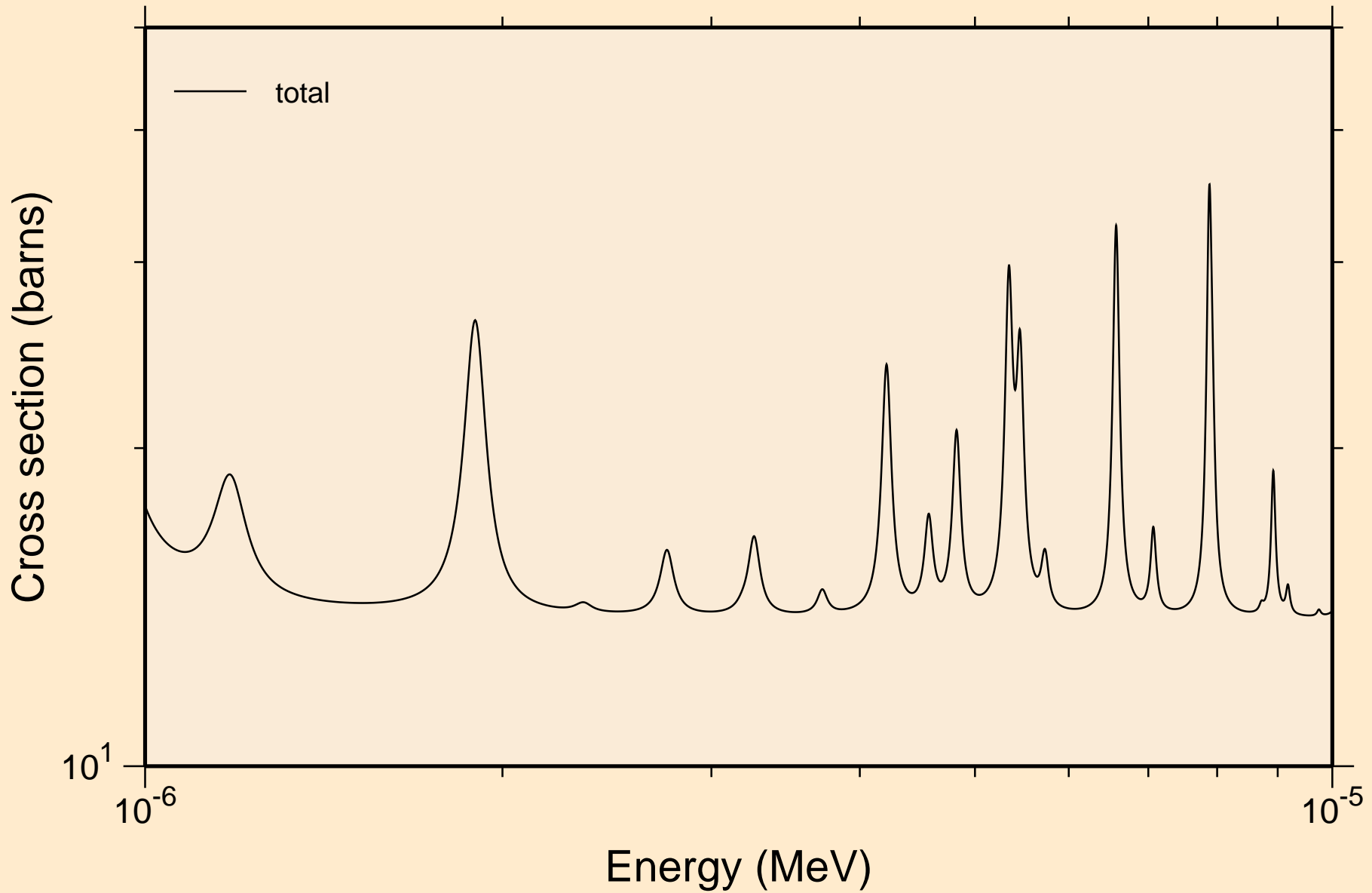

HG191 NEUTRON ACER TENDL-2023 LIBRARY; T=0.K
resonance total cross section

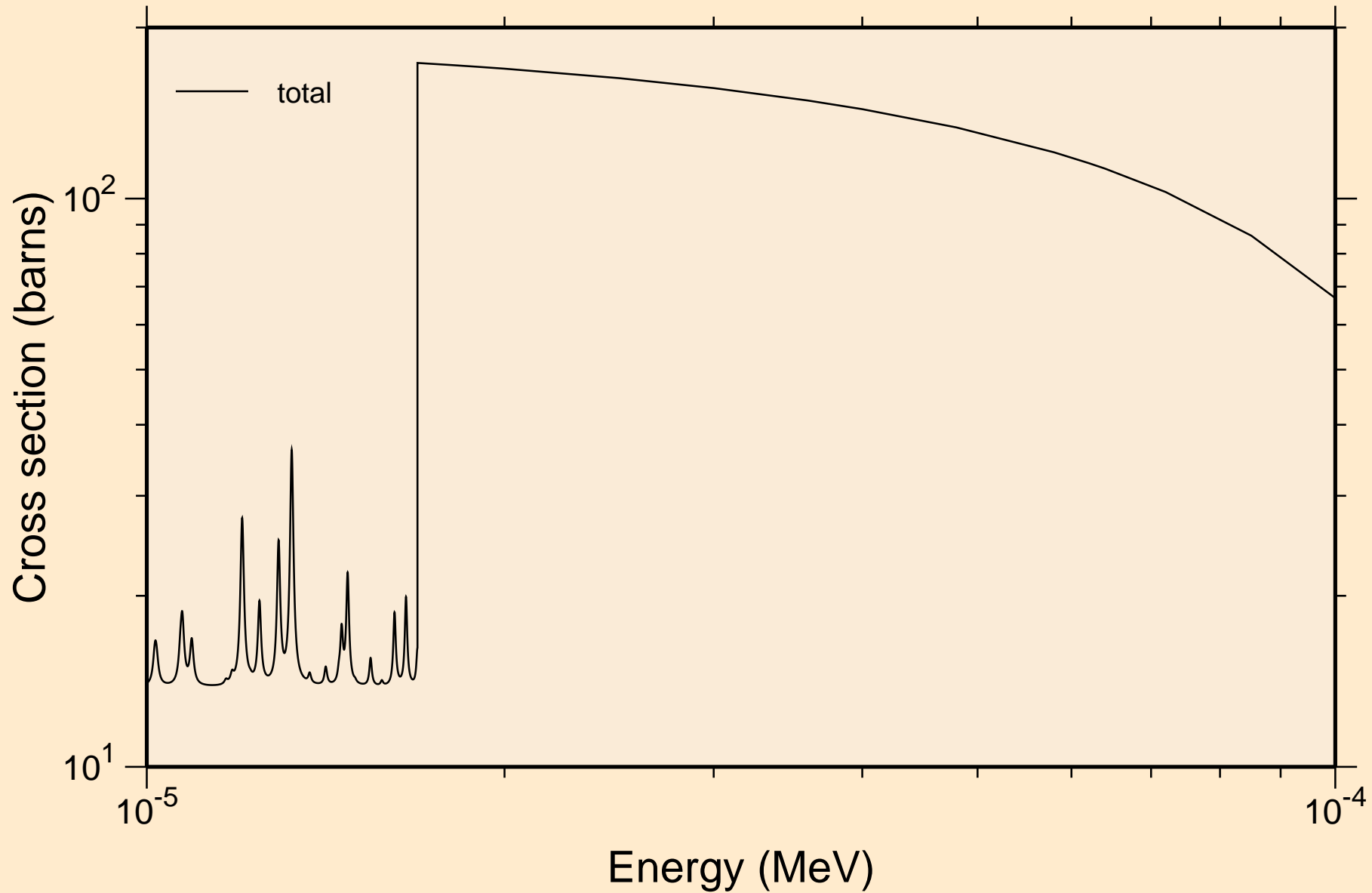

HG191 NEUTRON ACER TENDL-2023 LIBRARY; T=0.K
resonance total cross section

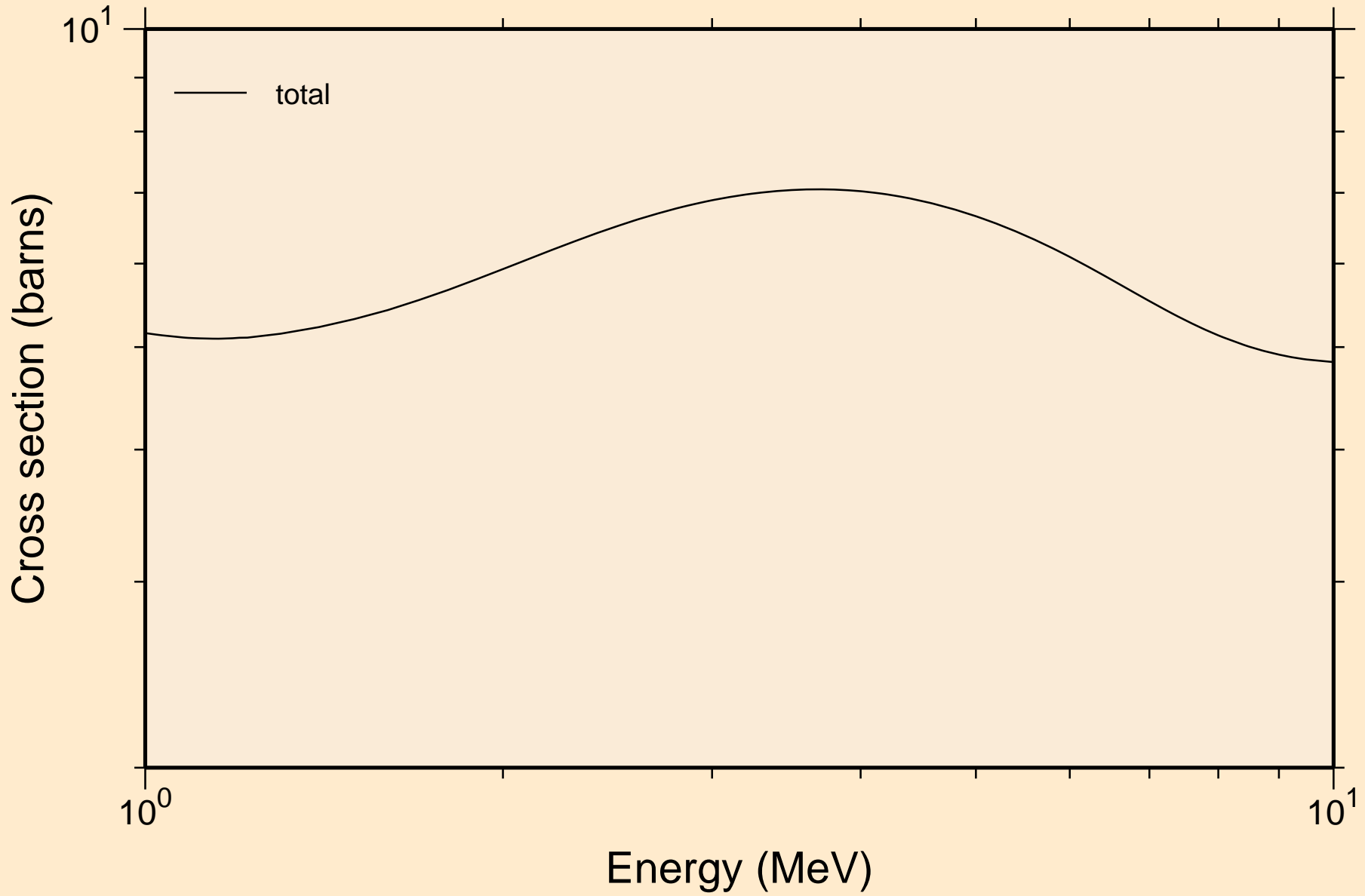

HG191 NEUTRON ACER TENDL-2023 LIBRARY; T=0.K
resonance absorption cross sections

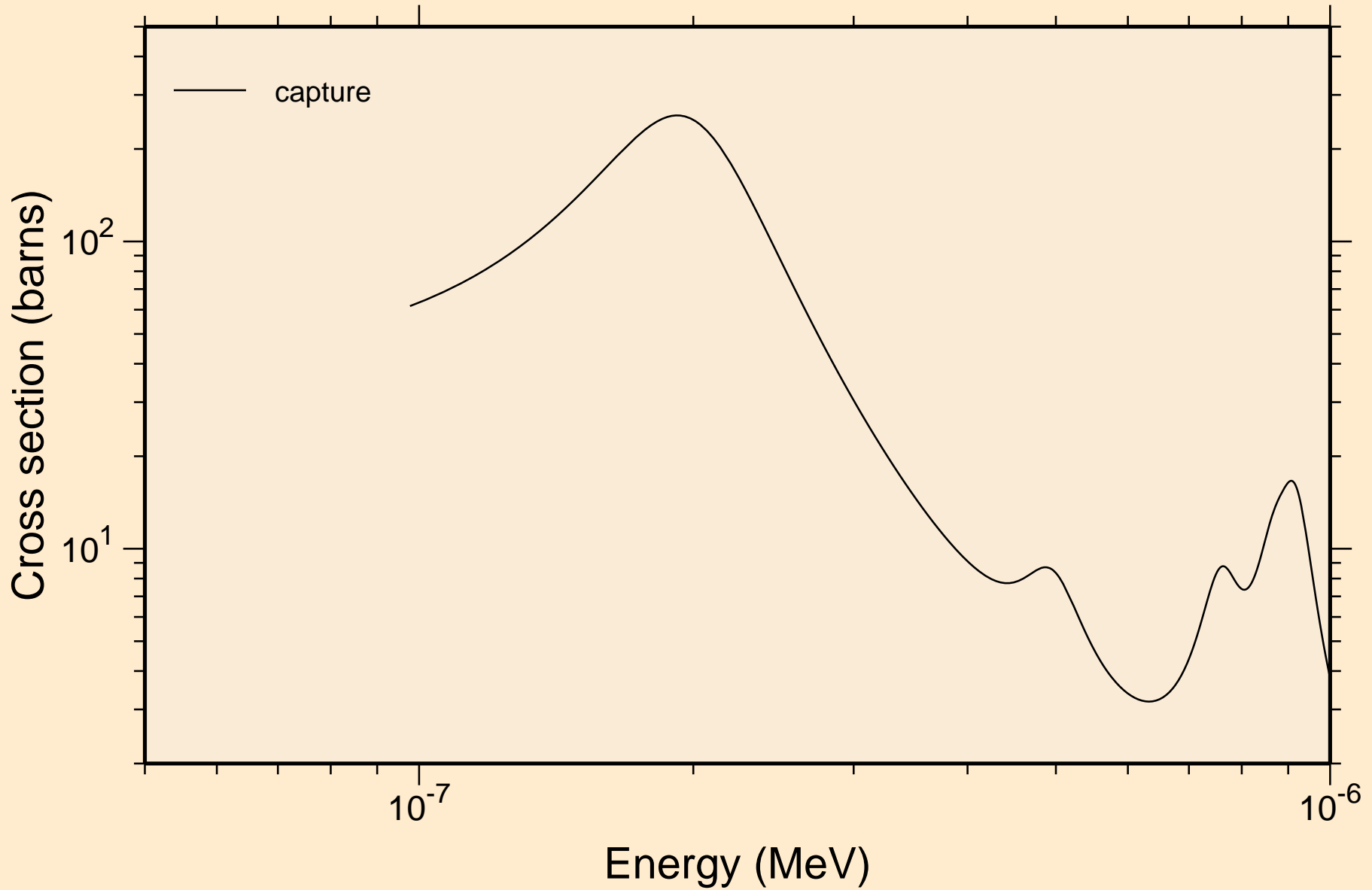

HG191 NEUTRON ACER TENDL-2023 LIBRARY; T=0.K
resonance absorption cross sections

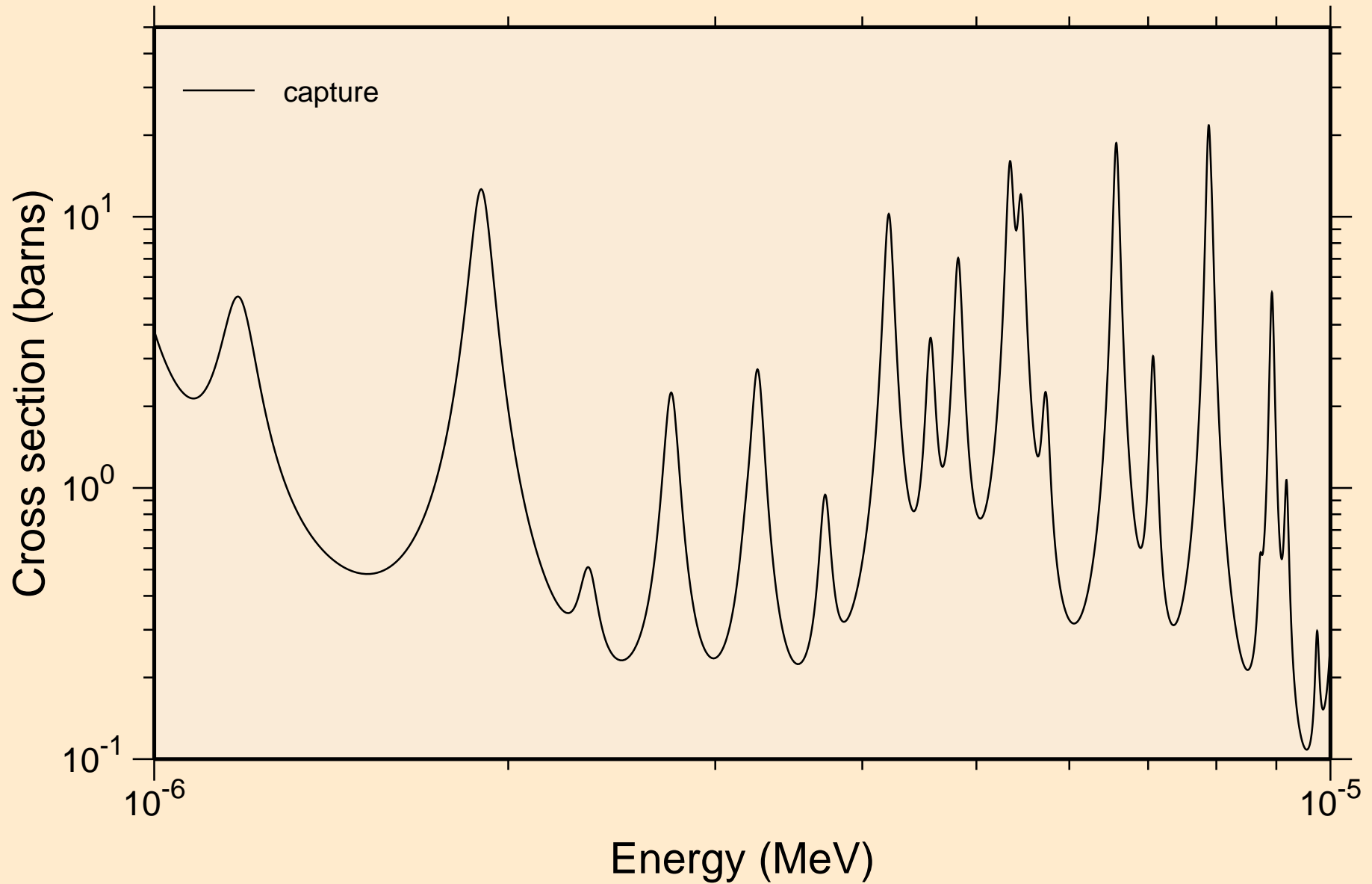

HG191 NEUTRON ACER TENDL-2023 LIBRARY; T=0.K
resonance absorption cross sections

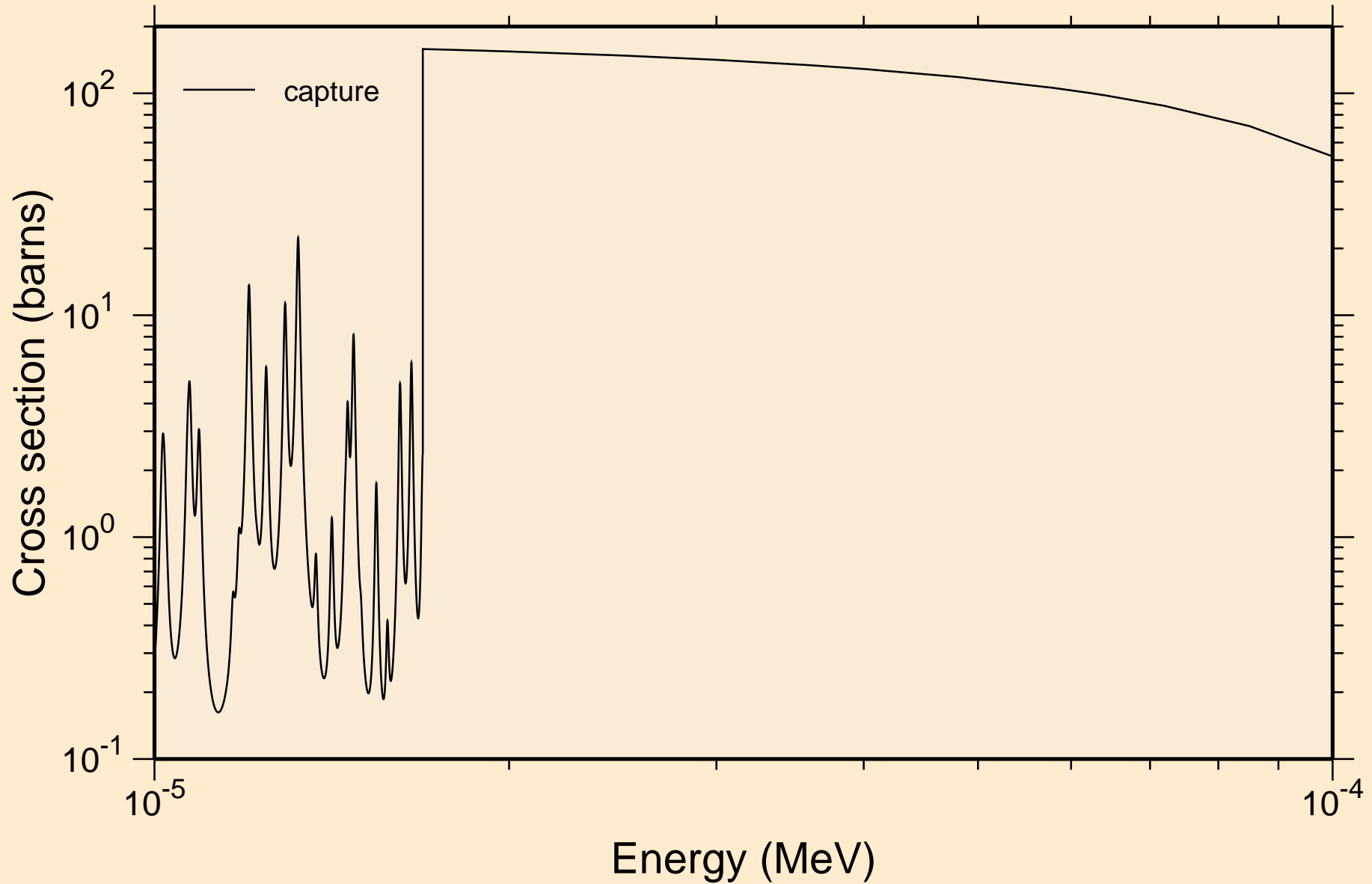

HG191 NEUTRON ACER TENDL-2023 LIBRARY; T=0.K
resonance absorption cross sections

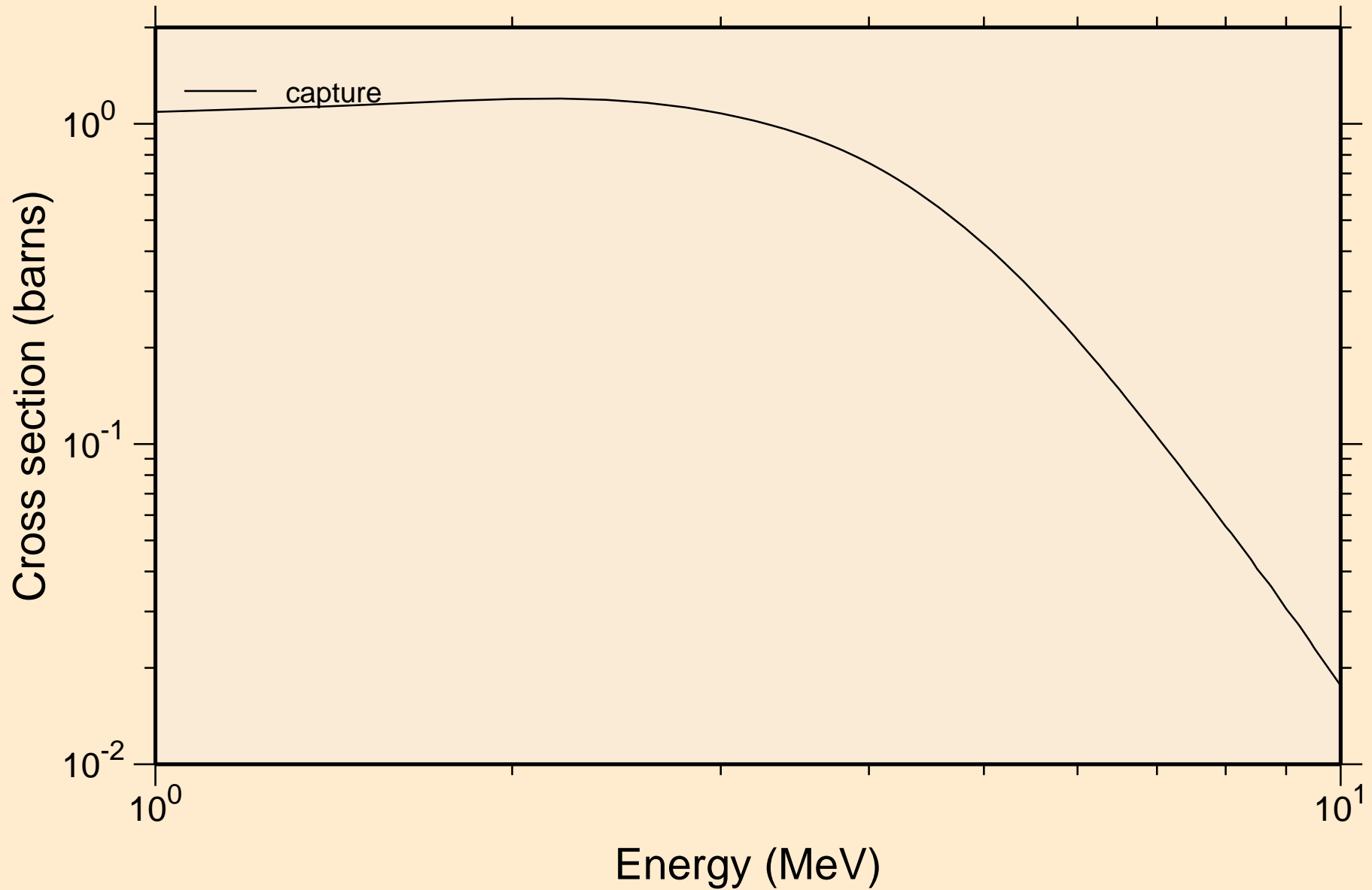

HG191 NEUTRON ACER TENDL-2023 LIBRARY; T=0.K

Heating

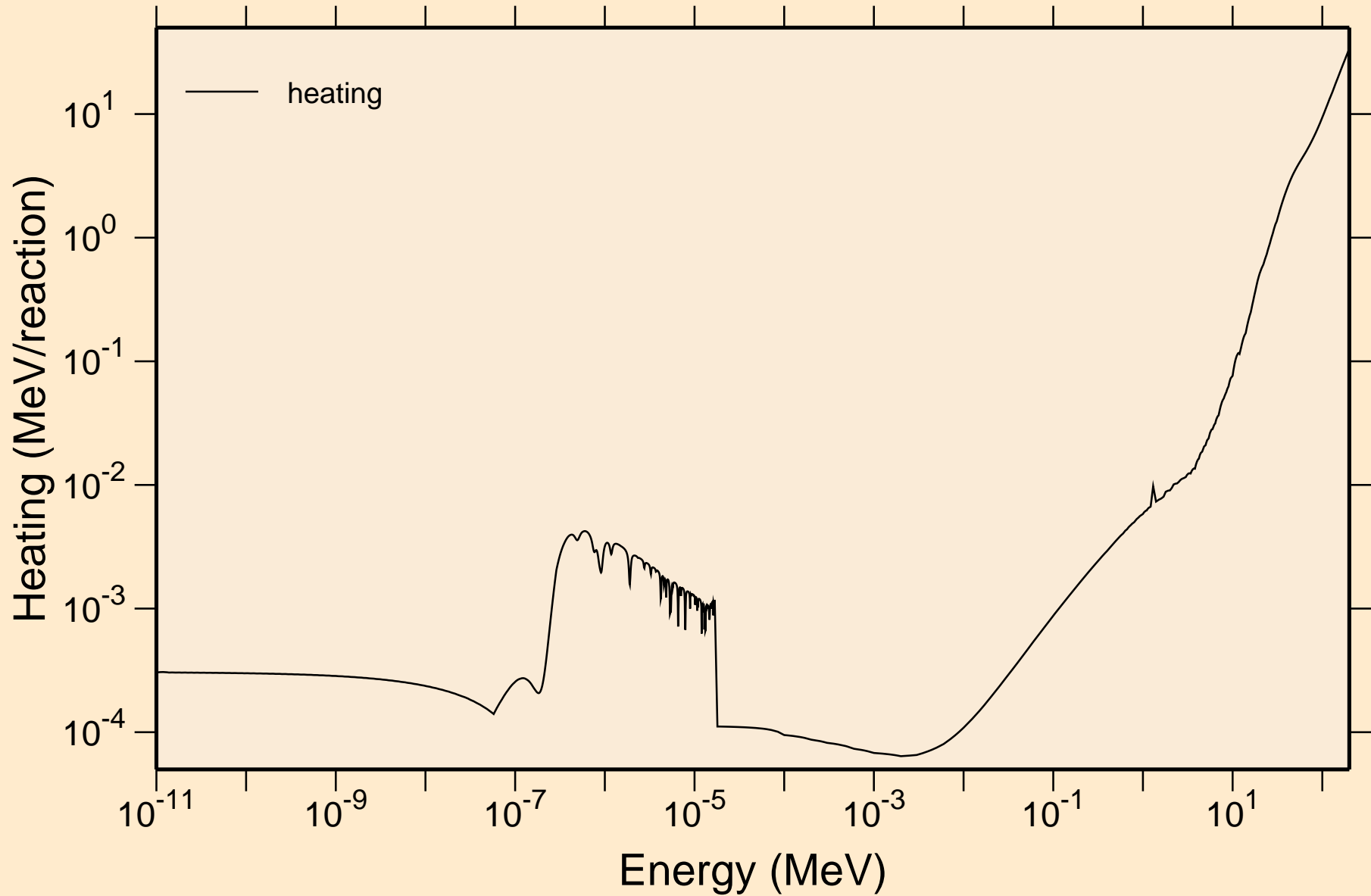

HG191 NEUTRON ACER TENDL-2023 LIBRARY; T=0.K

Damage

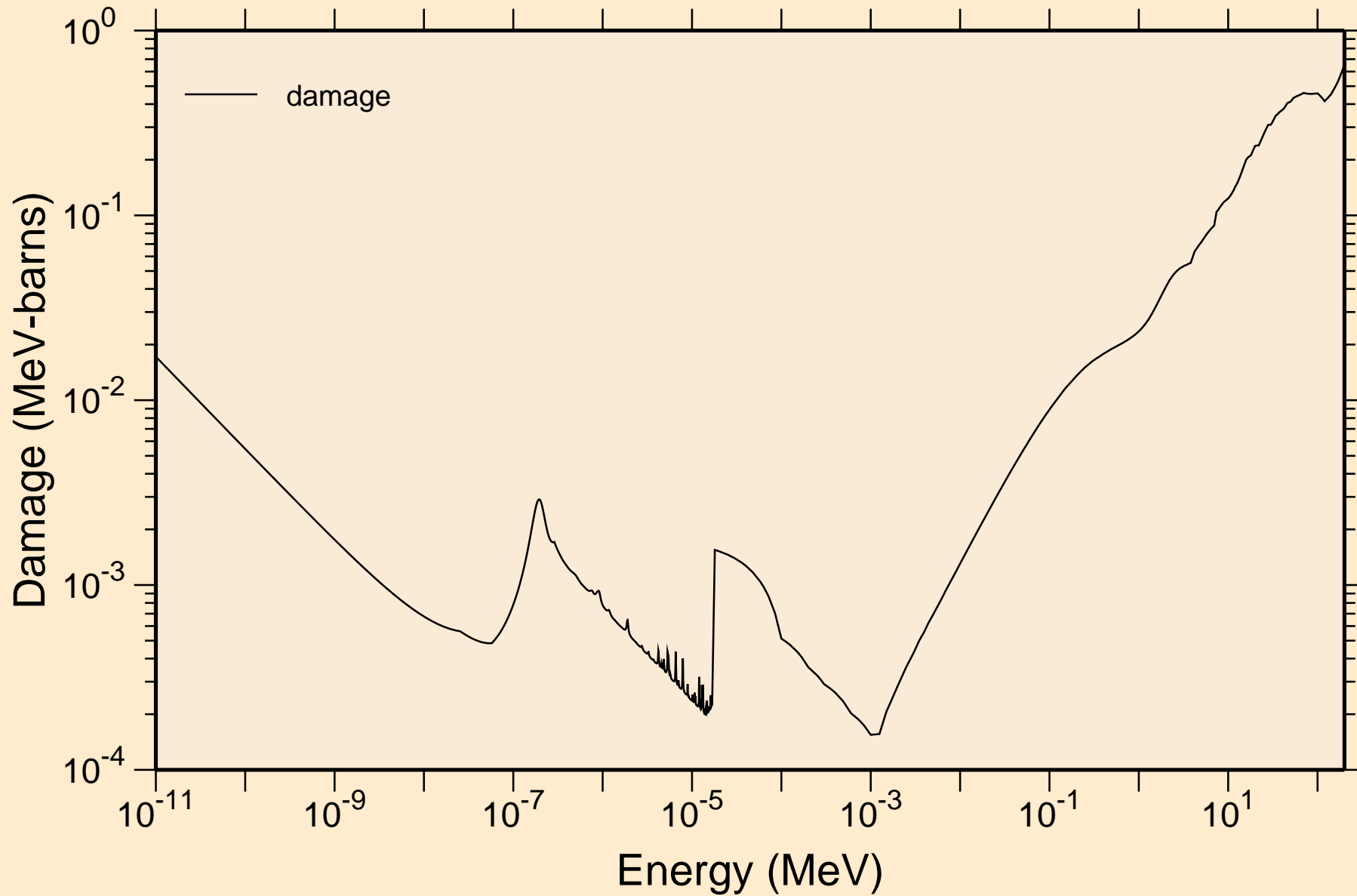

HG191 NEUTRON ACER TENDL-2023 LIBRARY; T=0.K

Non-threshold reactions

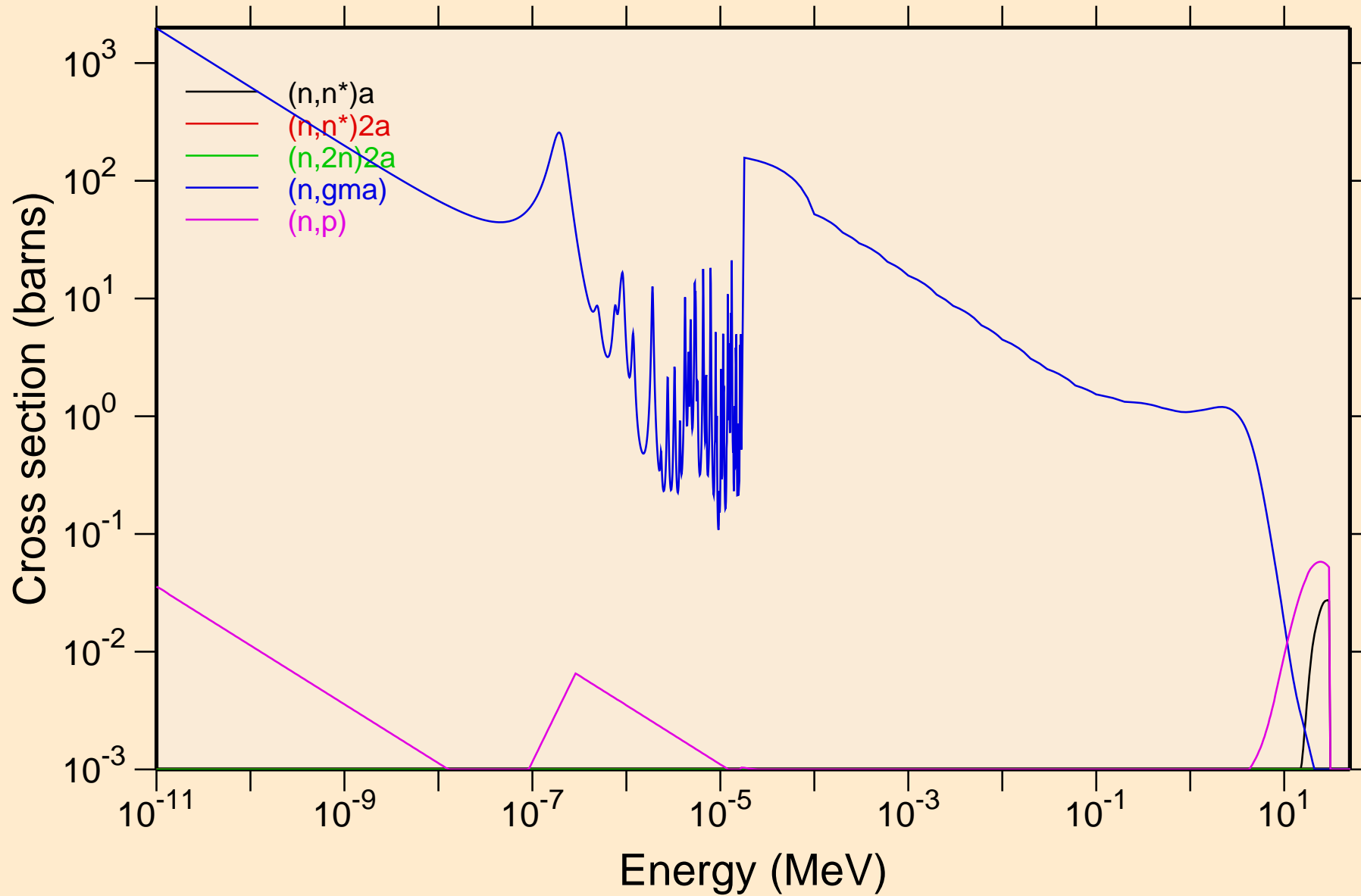

HG191 NEUTRON ACER TENDL-2023 LIBRARY; T=0.K

Non-threshold reactions

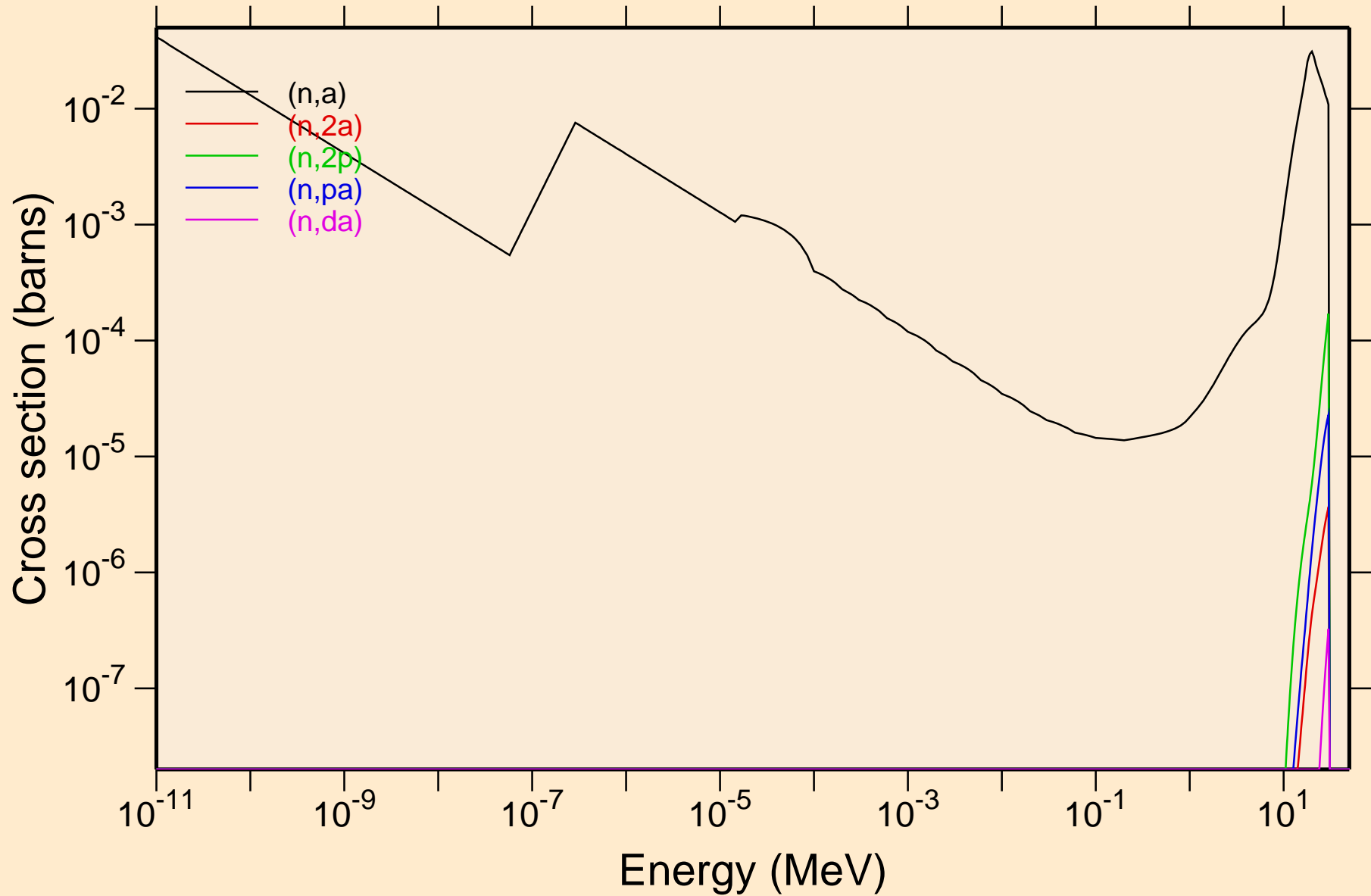

HG191 NEUTRON ACER TENDL-2023 LIBRARY; T=0.K
Non-threshold reactions

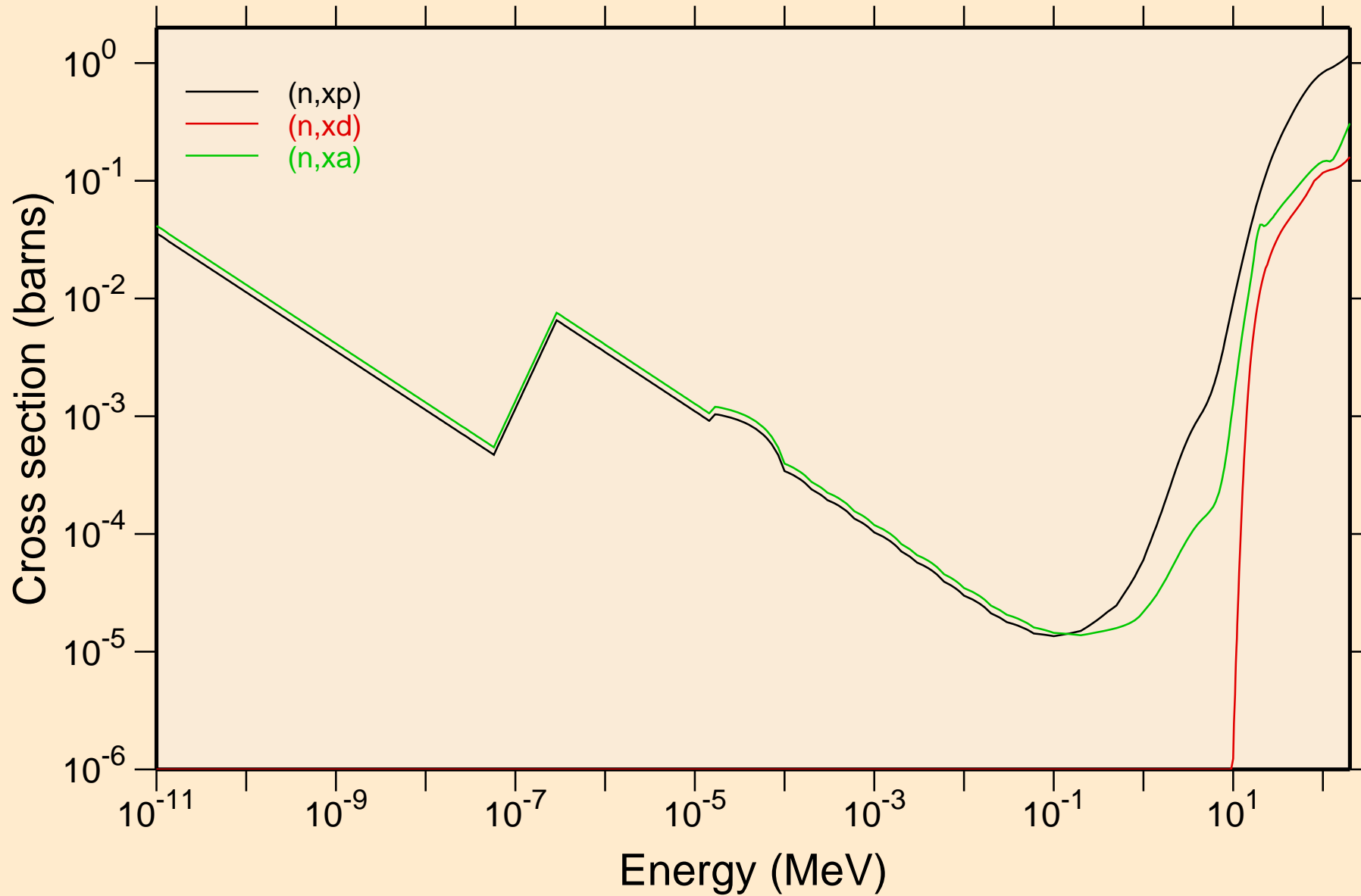

HG191 NEUTRON ACER TENDL-2023 LIBRARY; T=0.K

Principal cross sections

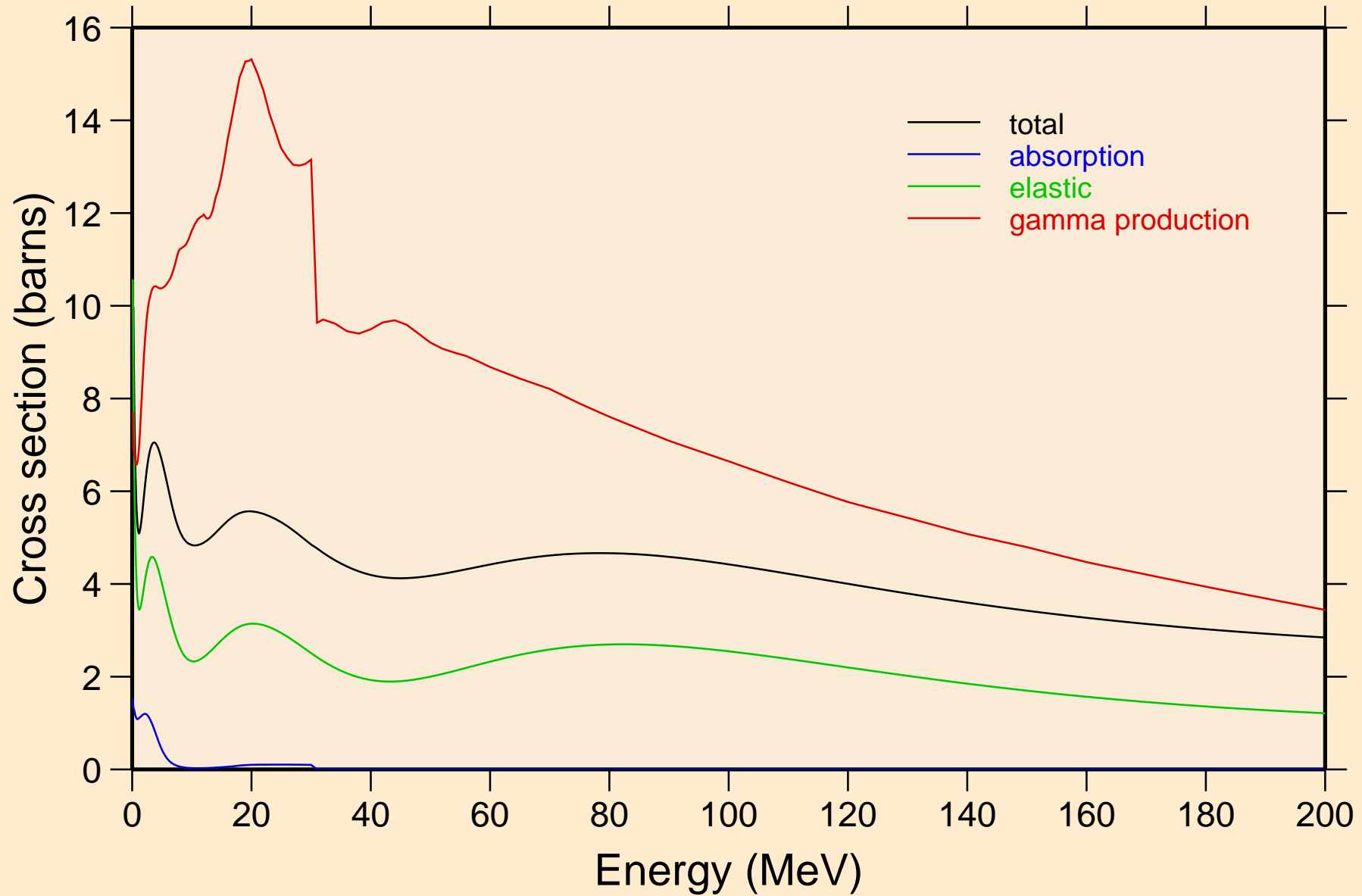

HG191 NEUTRON ACER TENDL-2023 LIBRARY; T=0.K

Heating

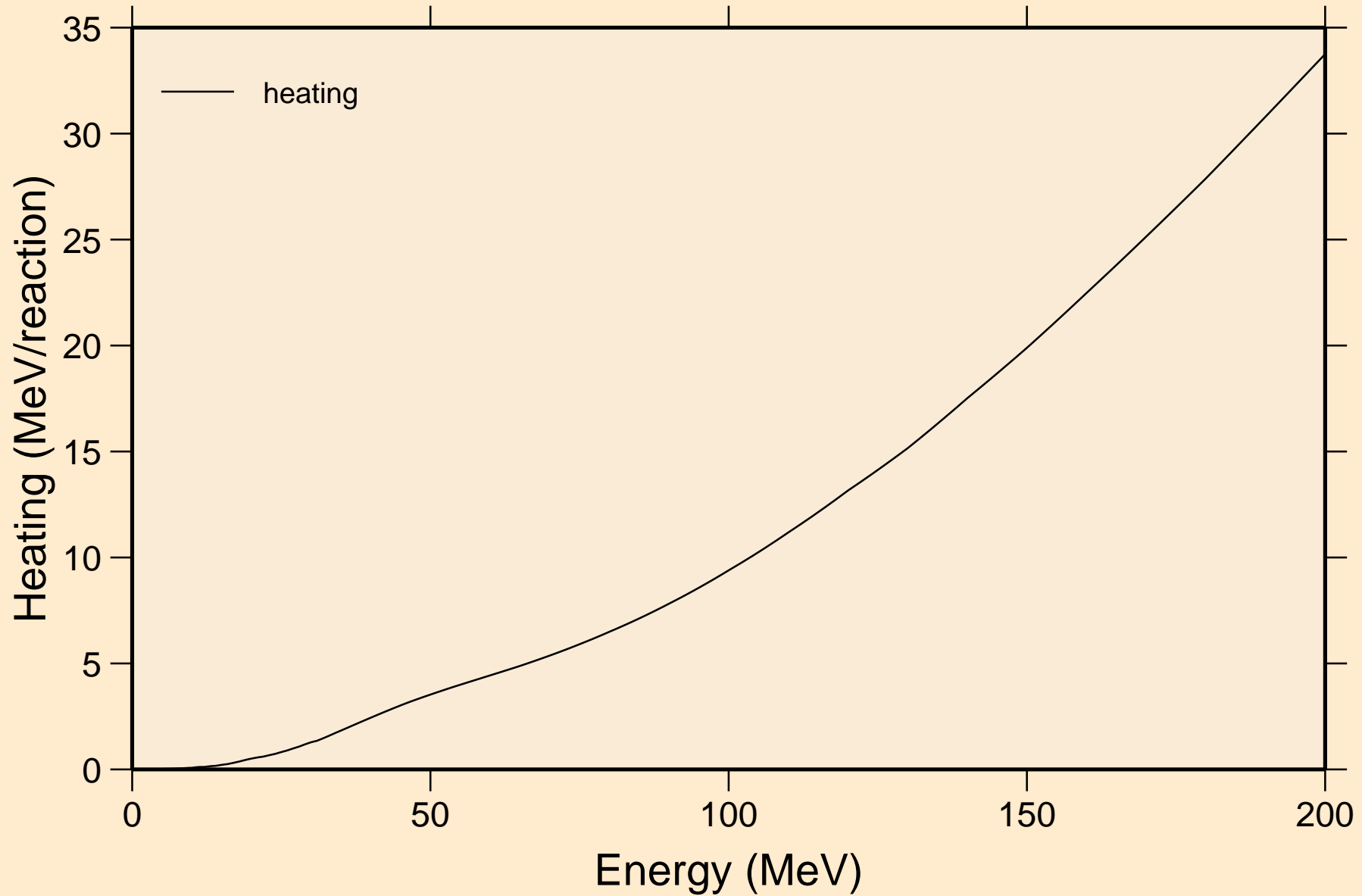

HG191 NEUTRON ACER TENDL-2023 LIBRARY; T=0.K

Damage

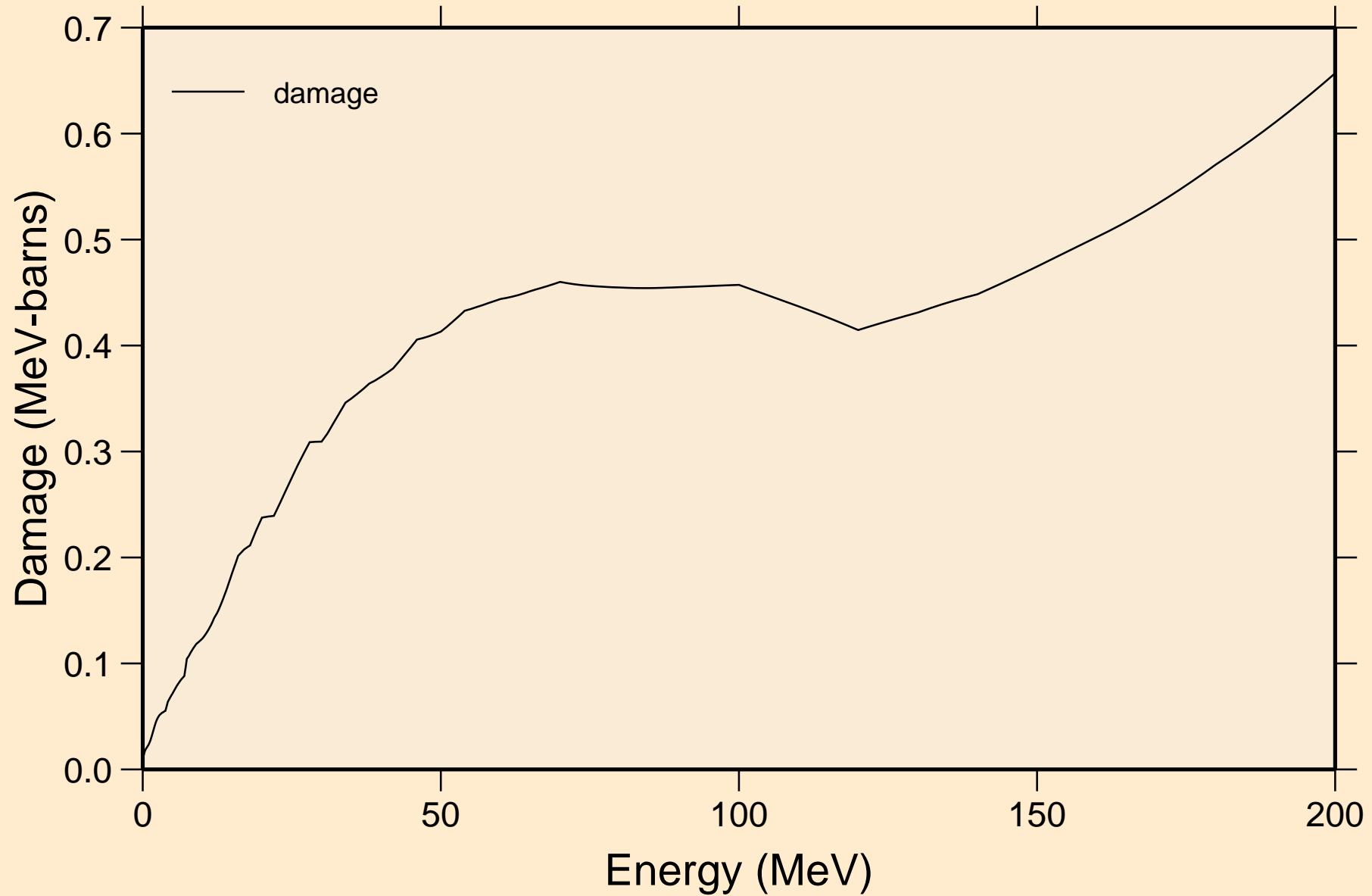

HG191 NEUTRON ACER TENDL-2023 LIBRARY; T=0.K

Non-threshold reactions

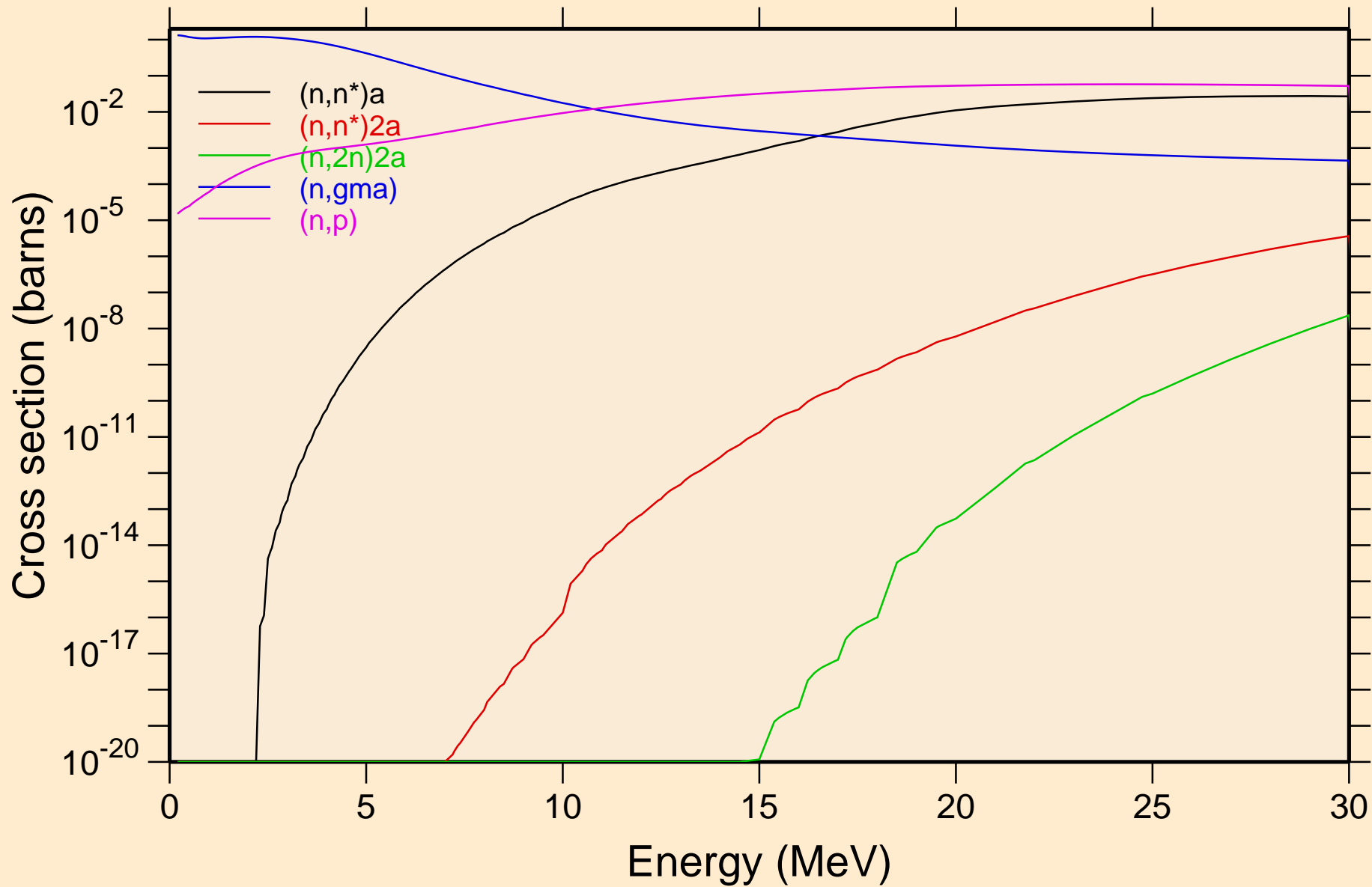

HG191 NEUTRON ACER TENDL-2023 LIBRARY; T=0.K

Non-threshold reactions

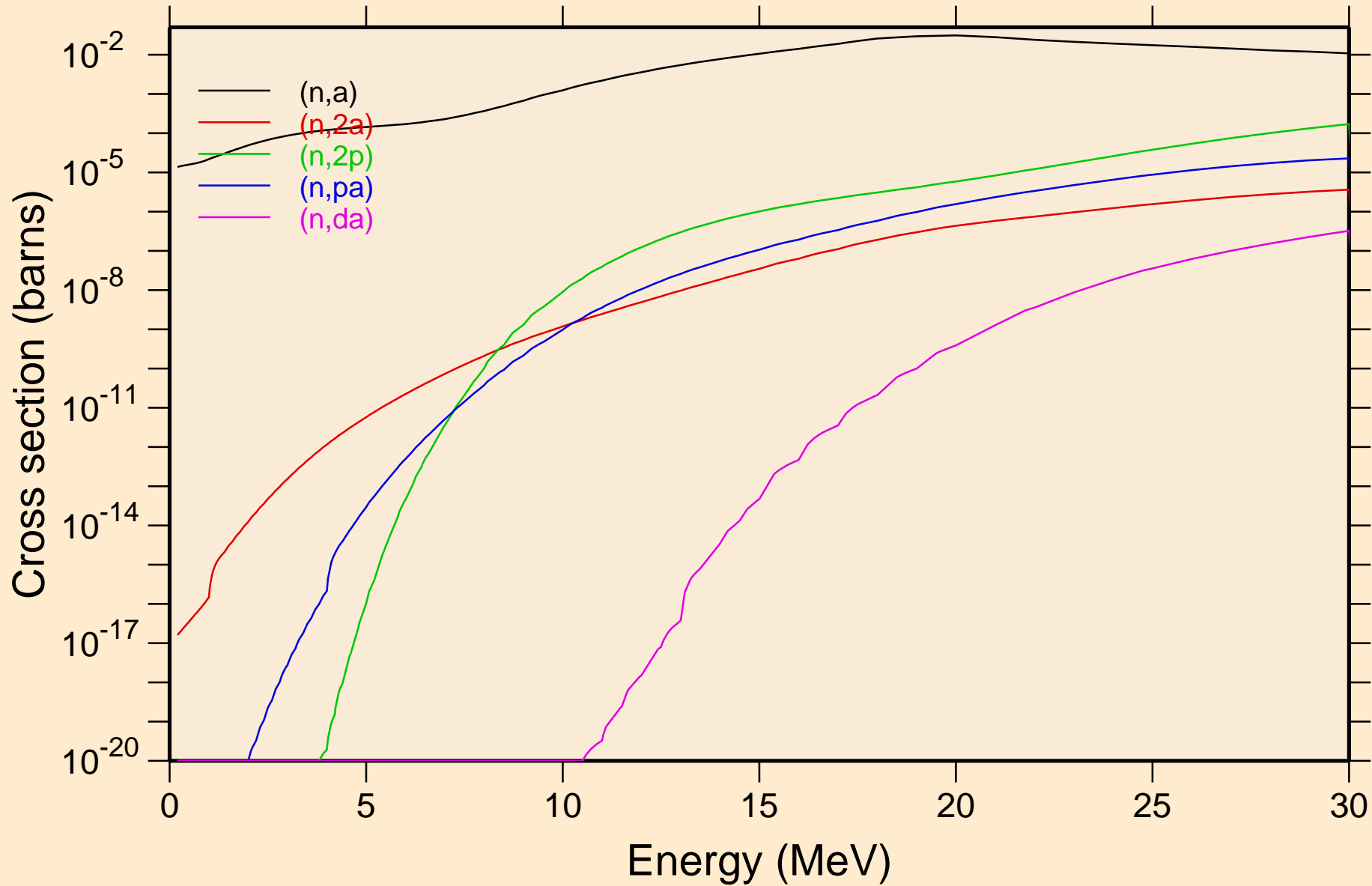

HG191 NEUTRON ACER TENDL-2023 LIBRARY; T=0.K

Non-threshold reactions

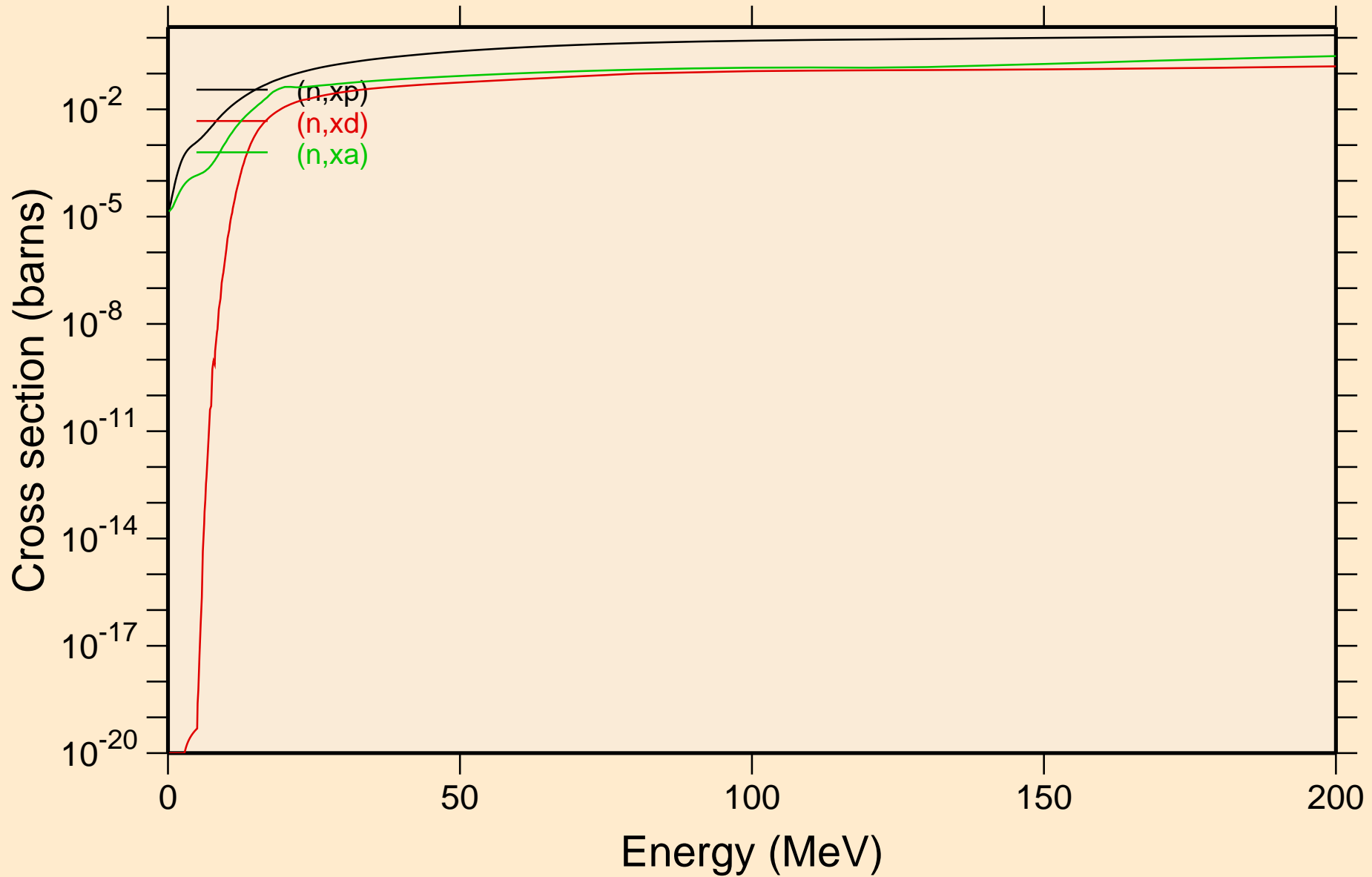

HG191 NEUTRON ACER TENDL-2023 LIBRARY; T=0.K

Inelastic levels

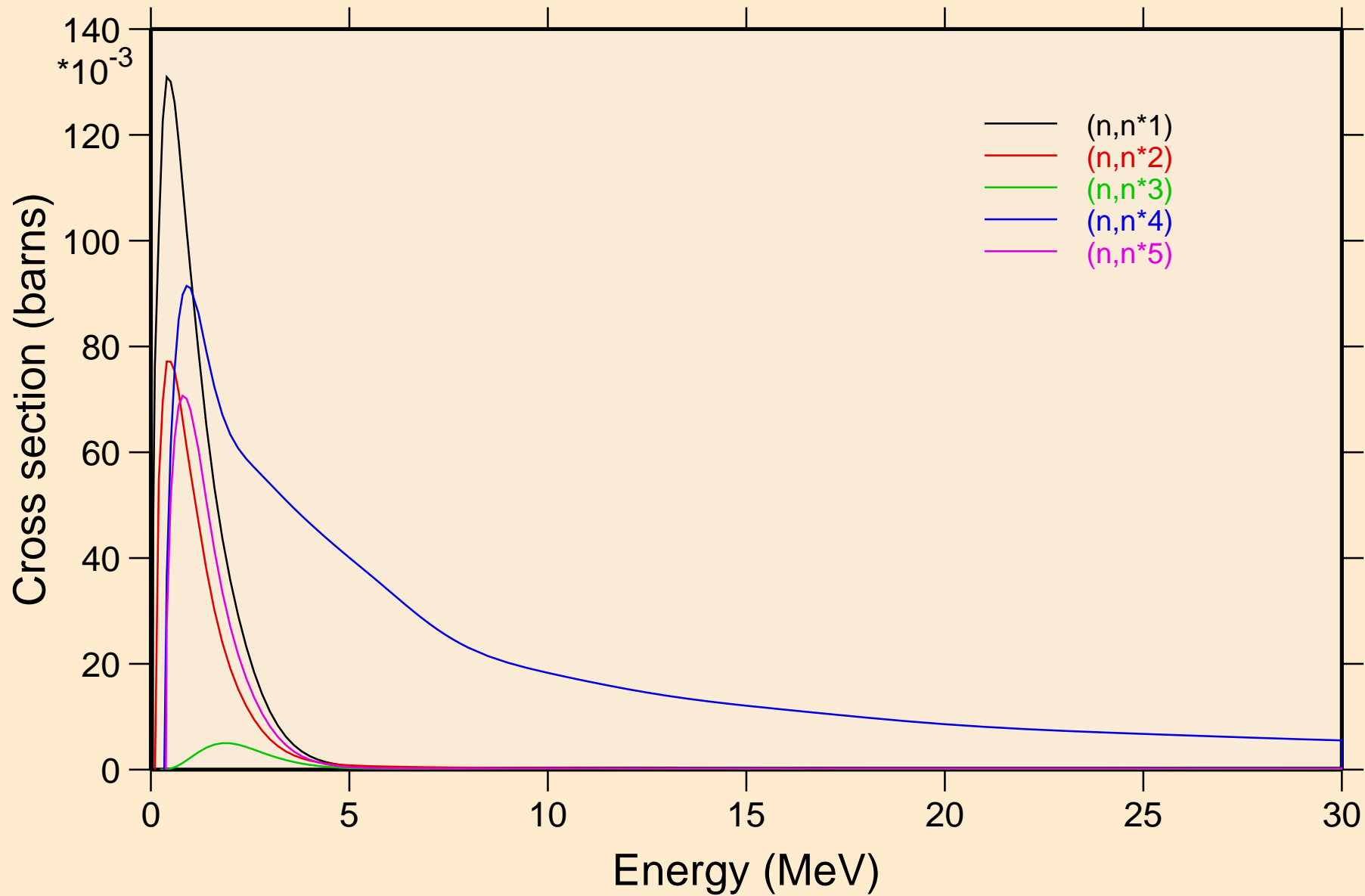

HG191 NEUTRON ACER TENDL-2023 LIBRARY; T=0.K
Inelastic levels

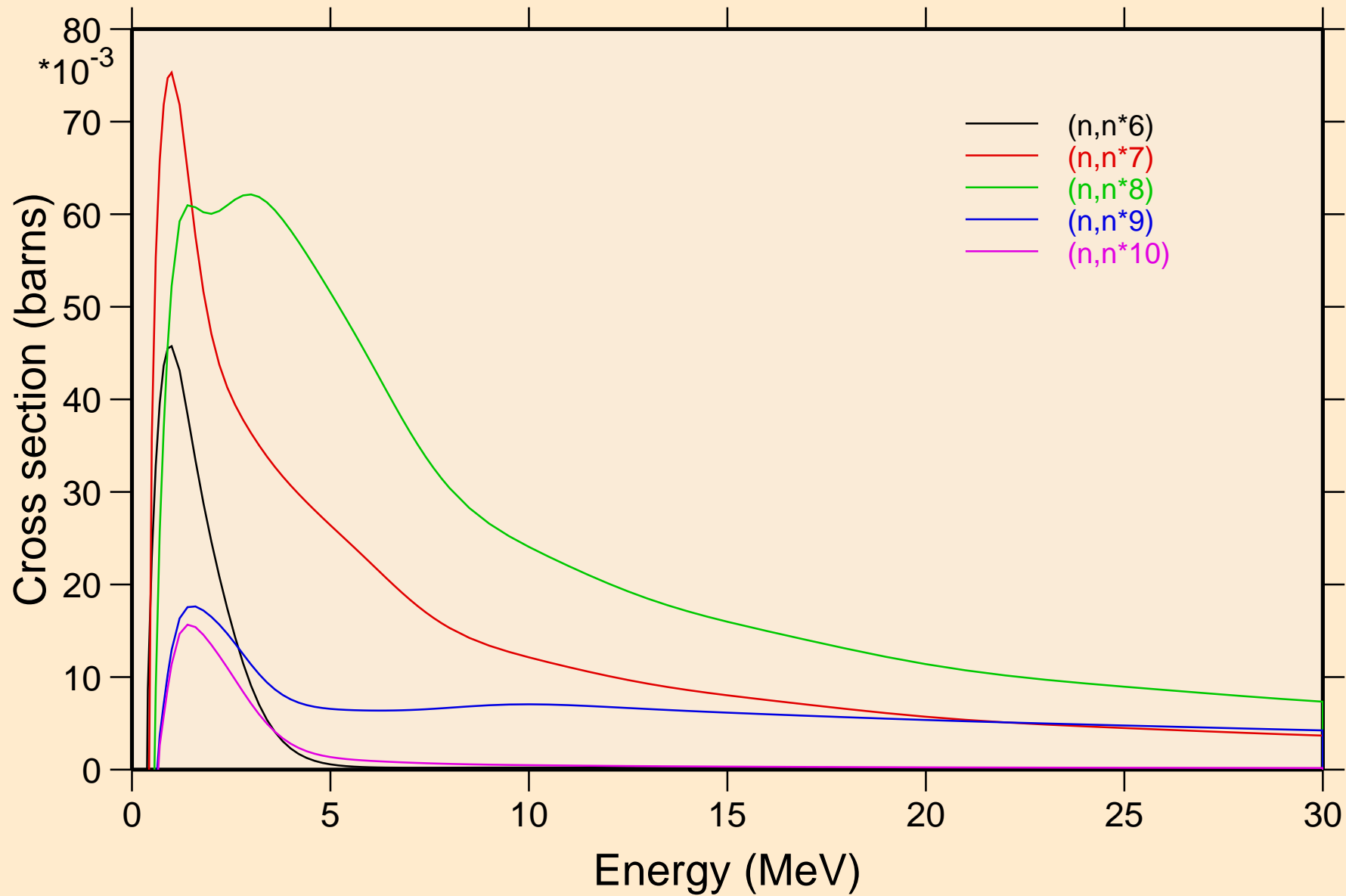

HG191 NEUTRON ACER TENDL-2023 LIBRARY; T=0.K

Inelastic levels

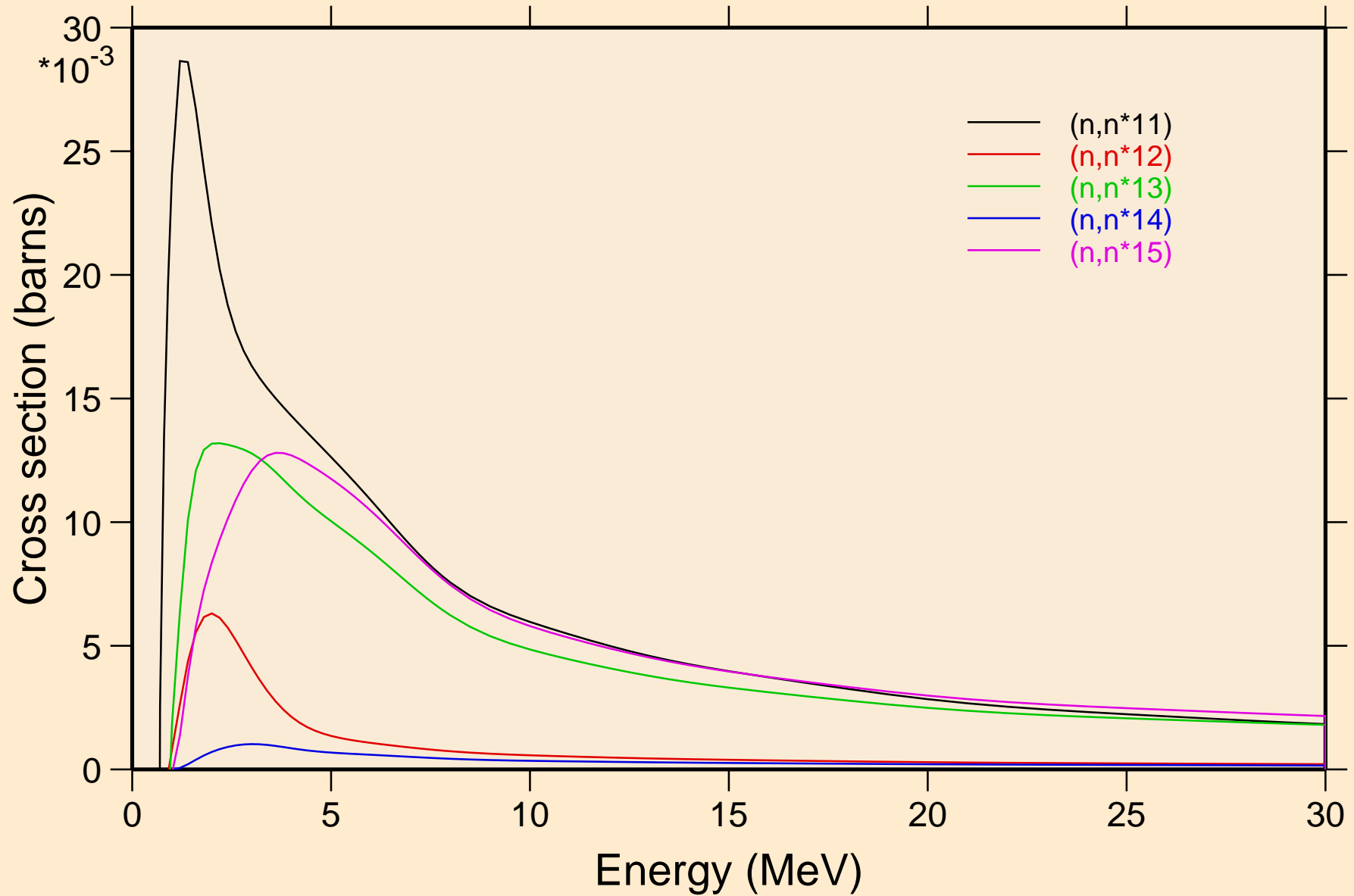

HG191 NEUTRON ACER TENDL-2023 LIBRARY; T=0.K

Inelastic levels

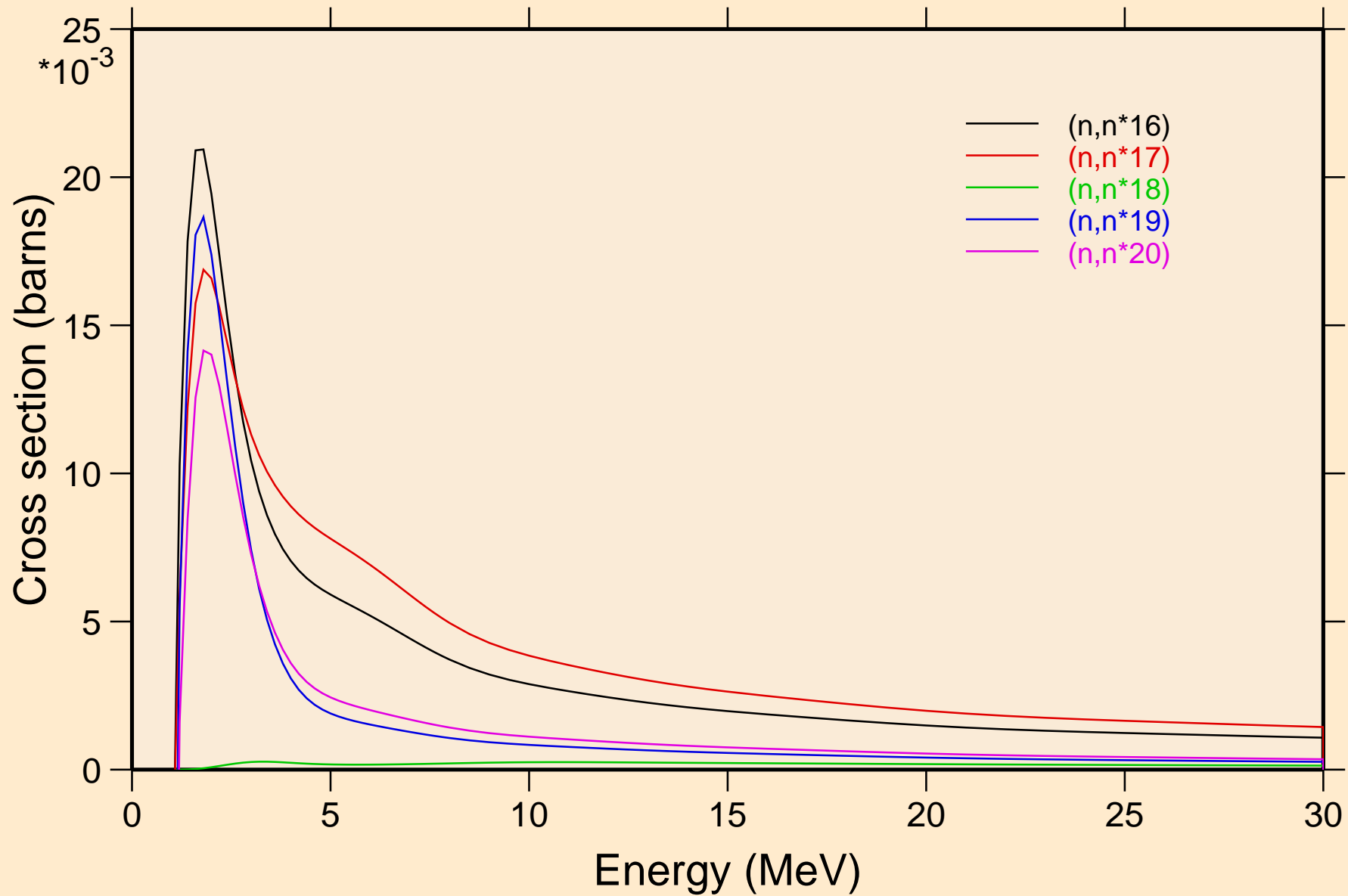

HG191 NEUTRON ACER TENDL-2023 LIBRARY; T=0.K
Inelastic levels

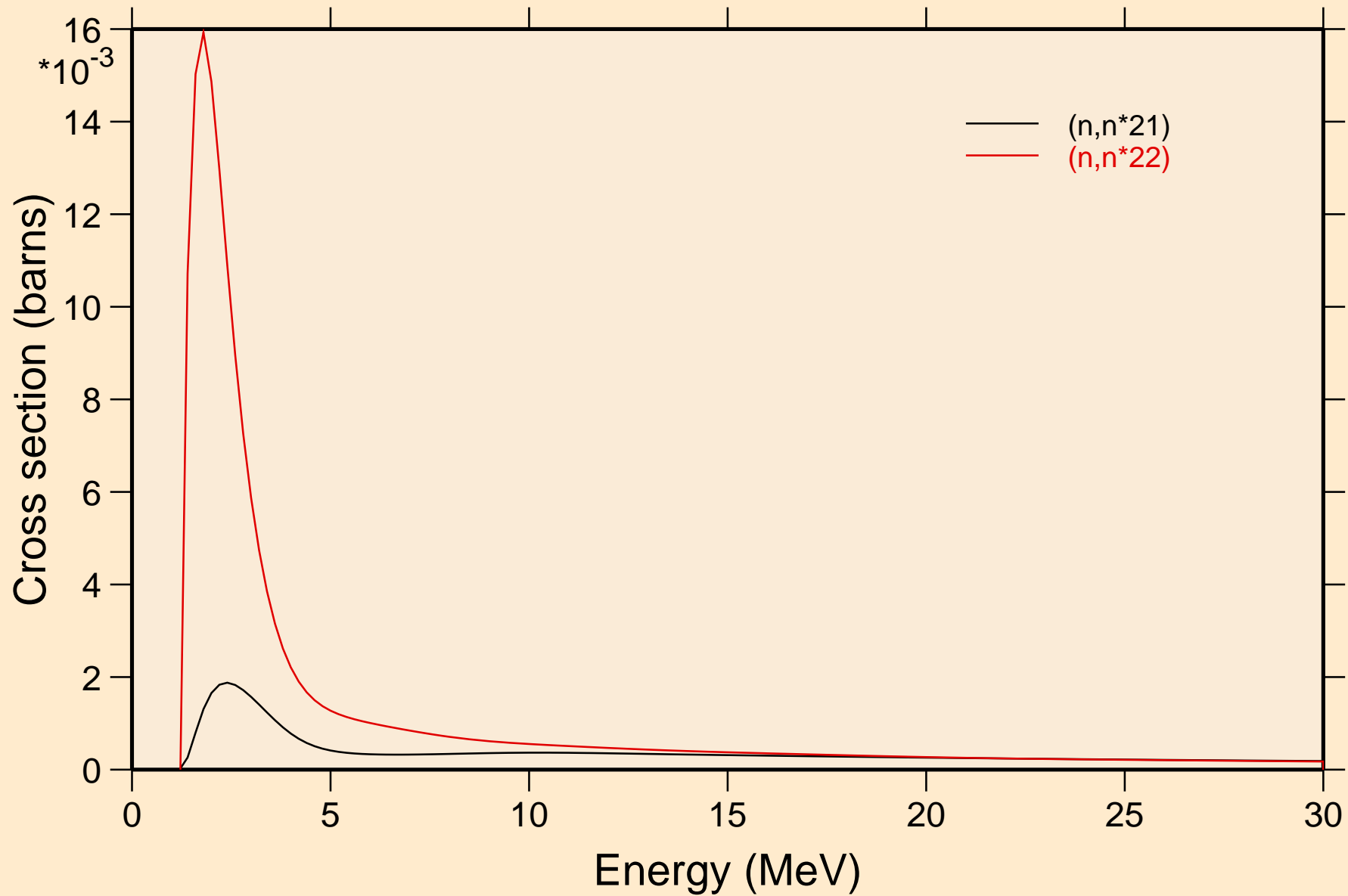

HG191 NEUTRON ACER TENDL-2023 LIBRARY; T=0.K

Threshold reactions

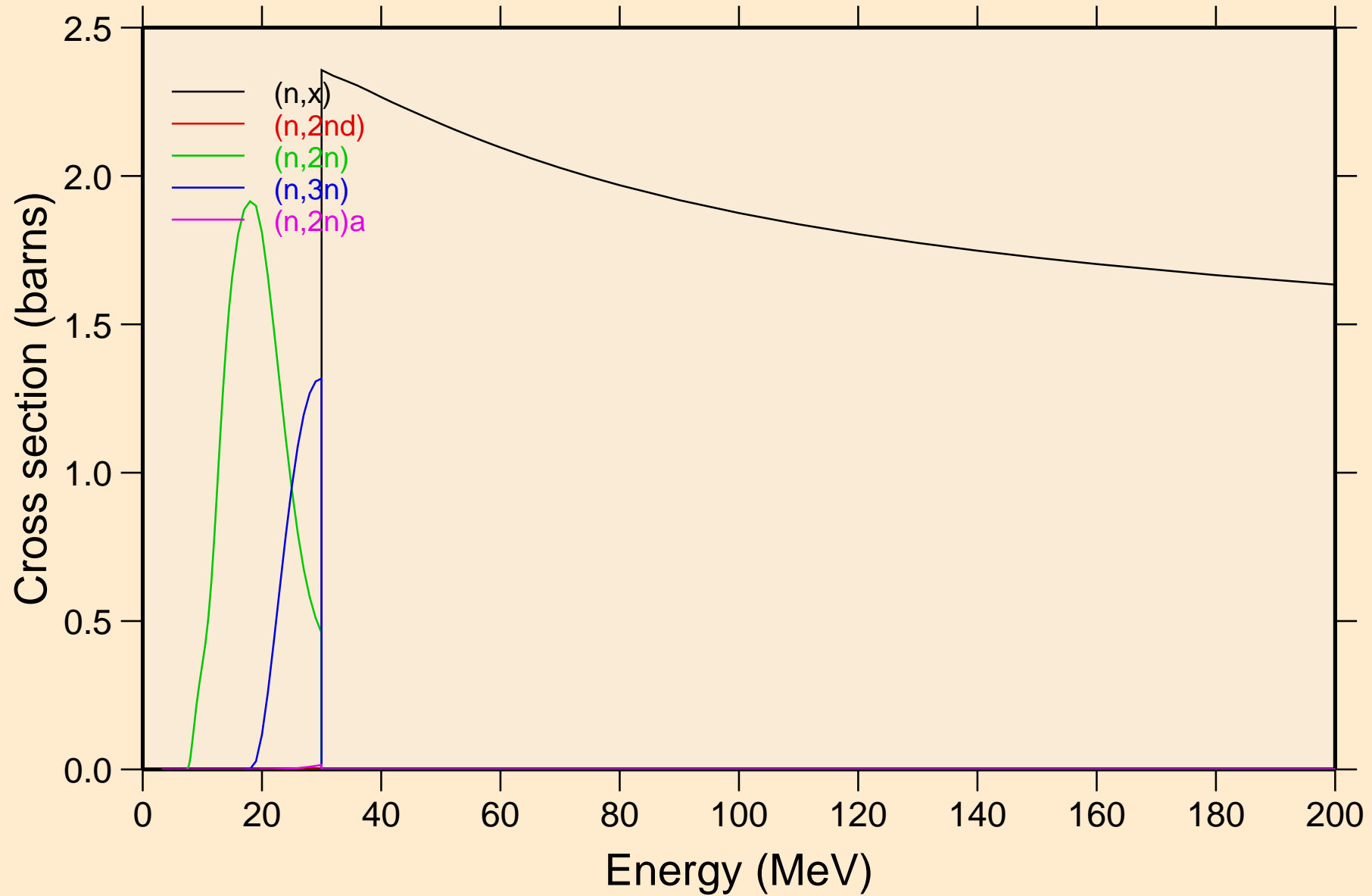

HG191 NEUTRON ACER TENDL-2023 LIBRARY; T=0.K

Threshold reactions

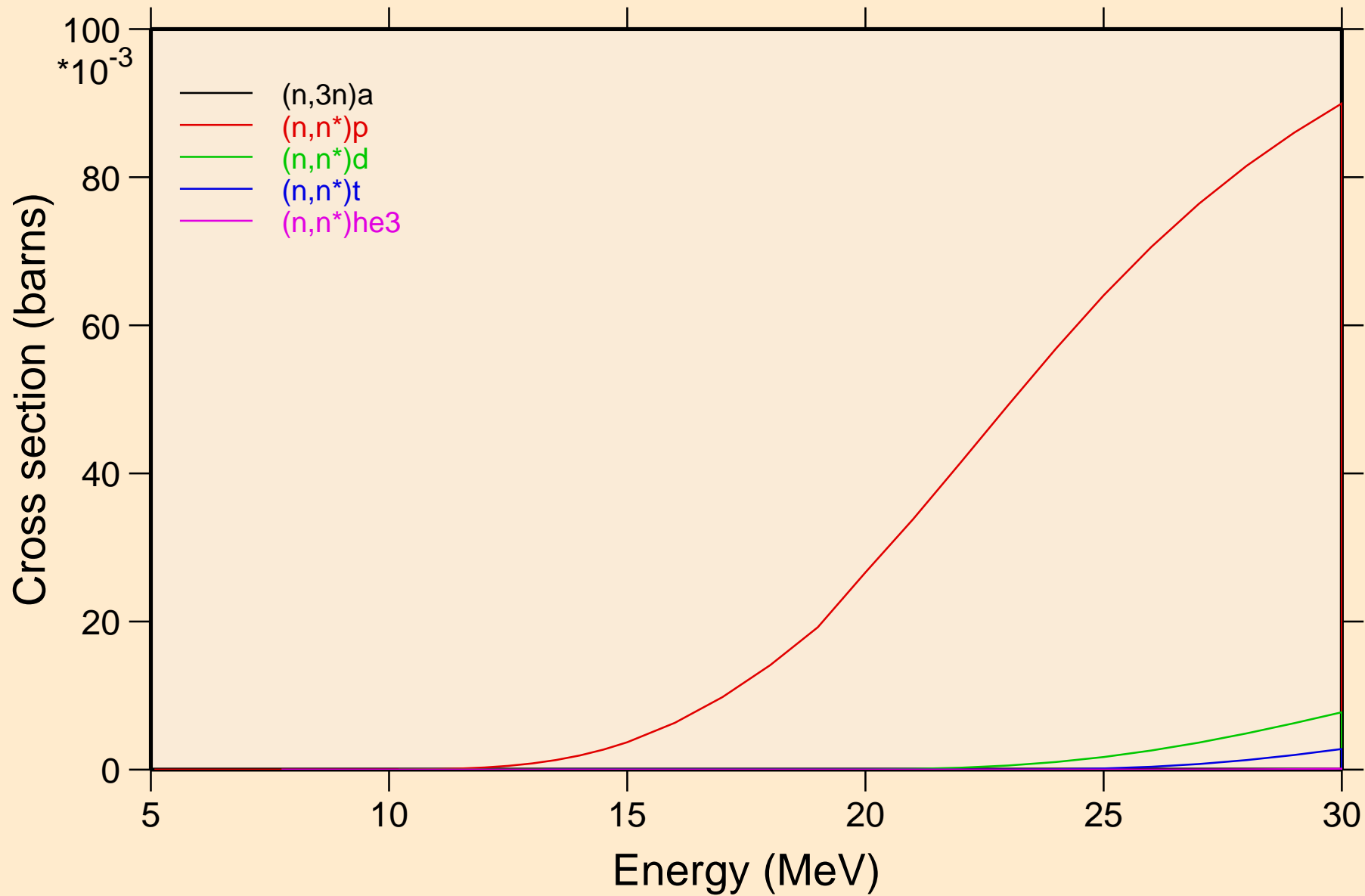

HG191 NEUTRON ACER TENDL-2023 LIBRARY; T=0.K

Threshold reactions

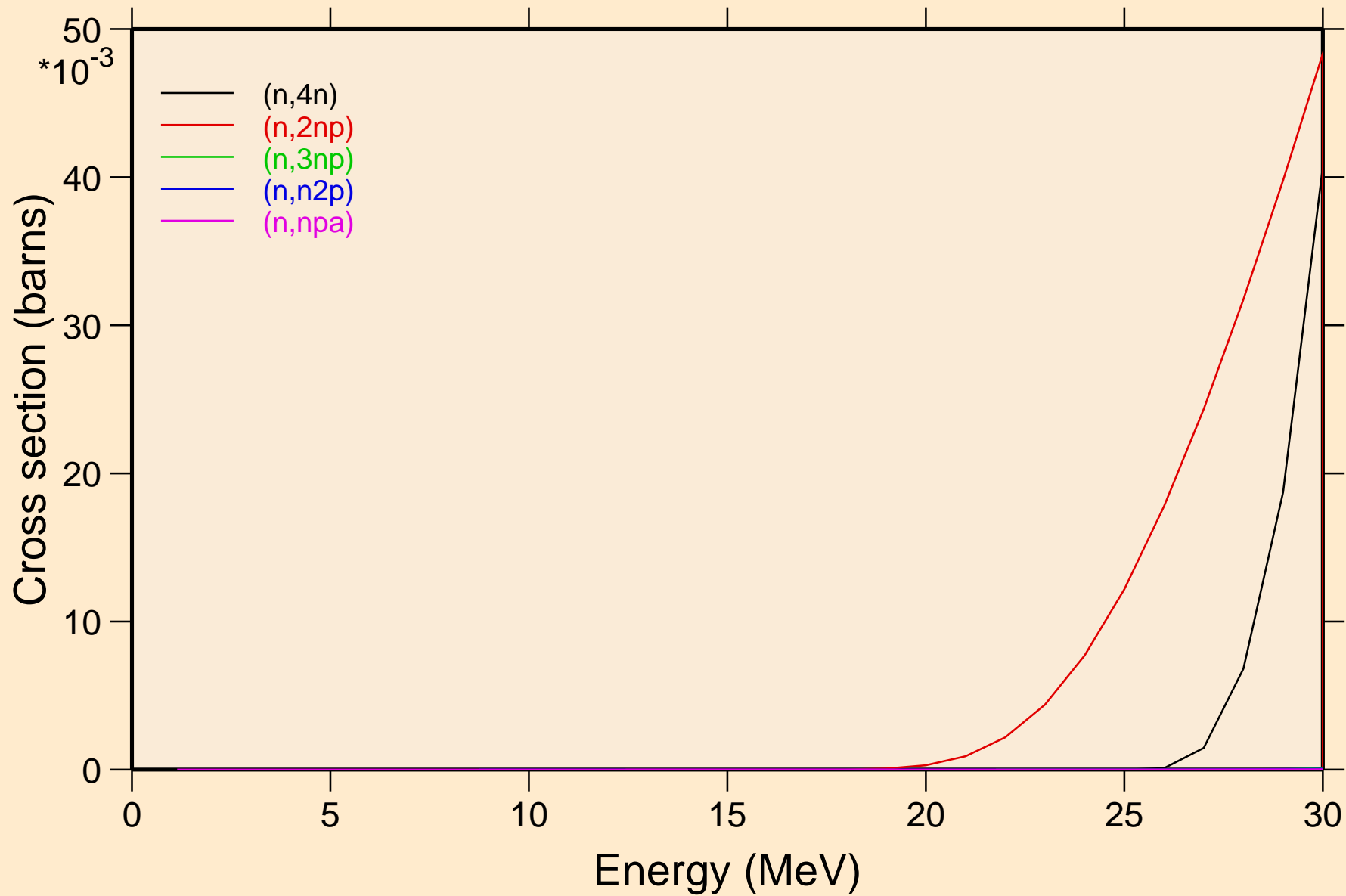

HG191 NEUTRON ACER TENDL-2023 LIBRARY; T=0.K

Threshold reactions

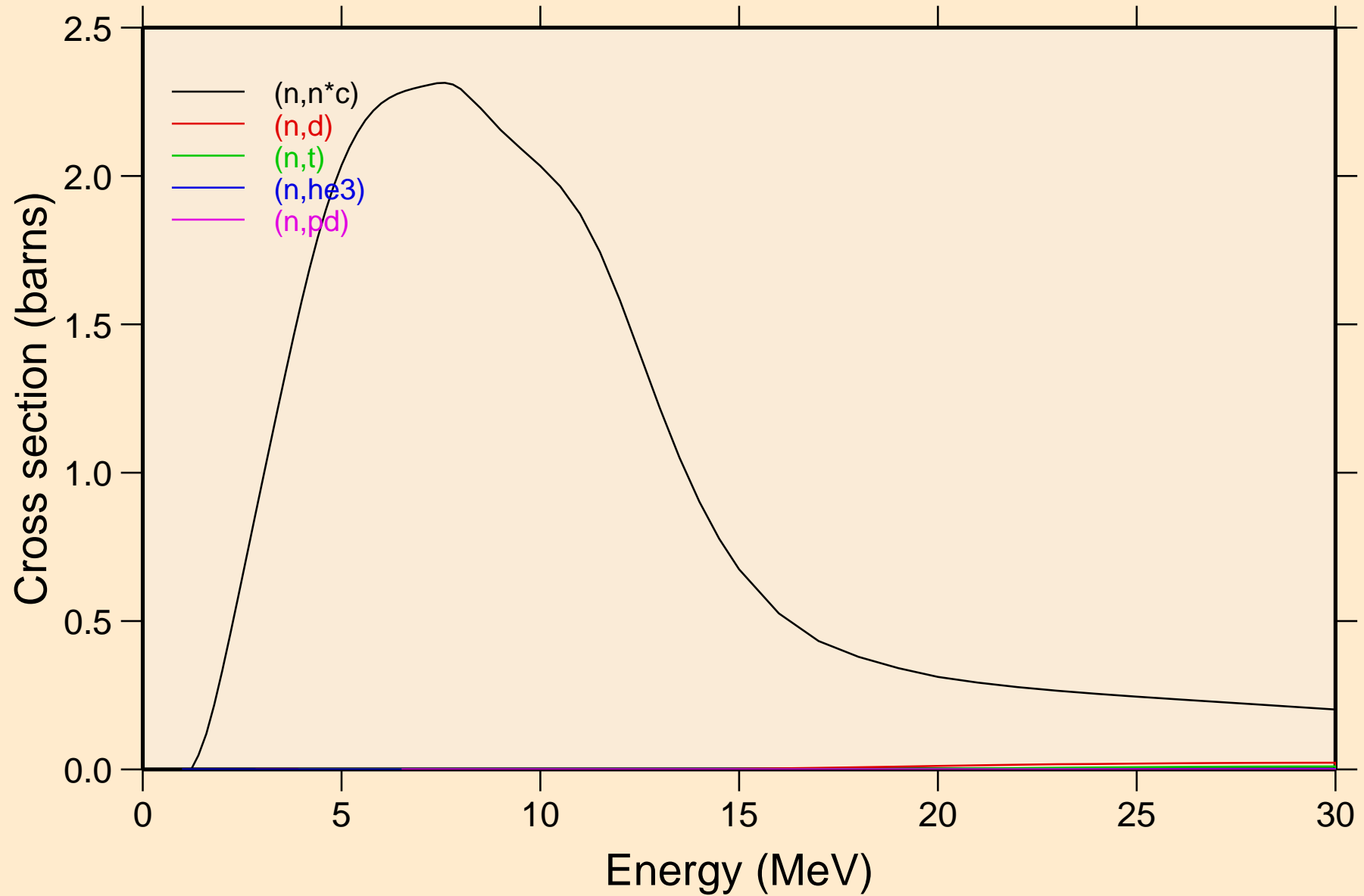

HG191 NEUTRON ACER TENDL-2023 LIBRARY; T=0.K

Threshold reactions

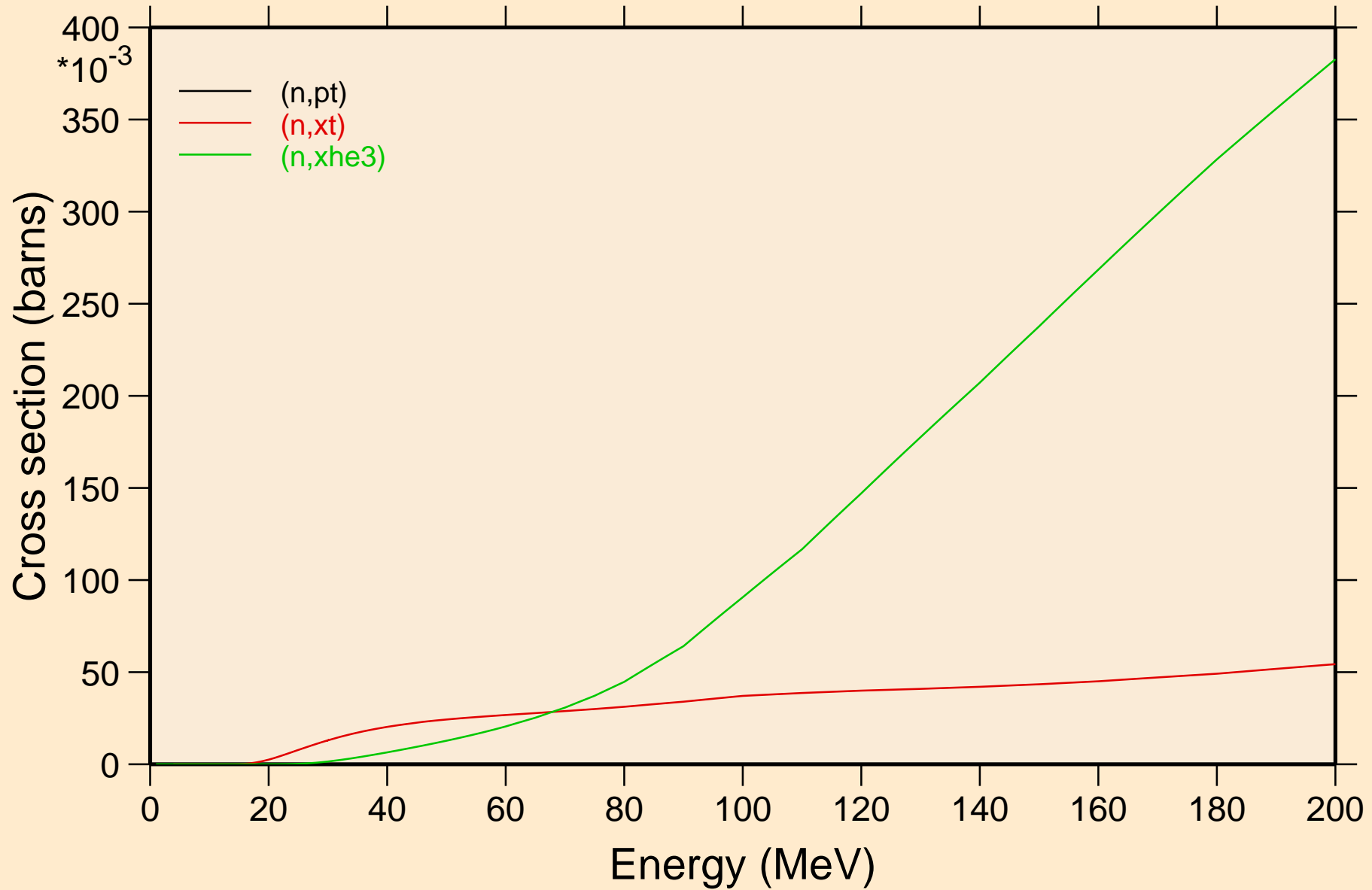

HG191 NEUTRON ACER TENDL-2023 LIBRARY; T=0.K
angular distribution for elastic

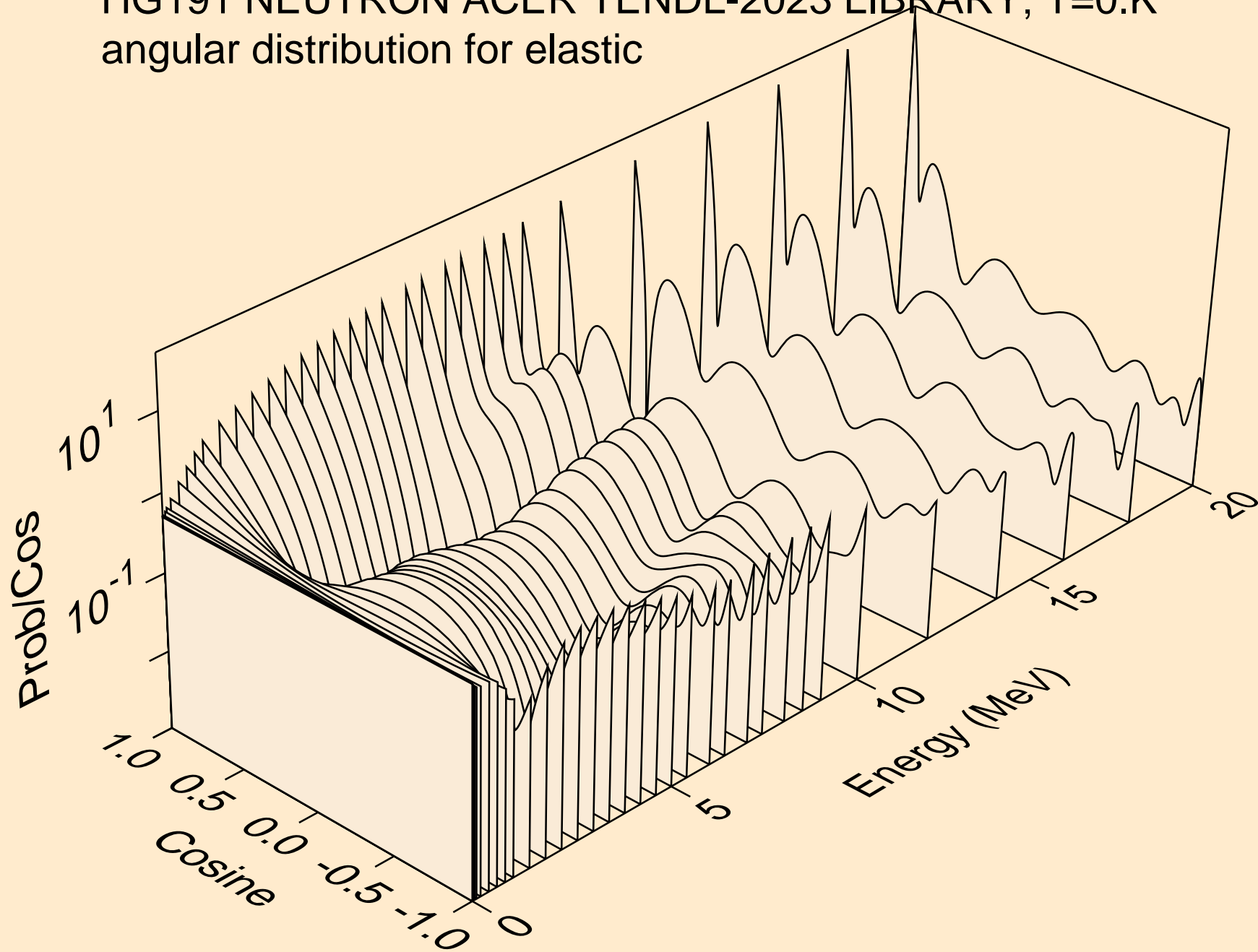

HG191 NEUTRON ACER TENDL-2023 LIBRARY; T=0.K
angular distribution for elastic

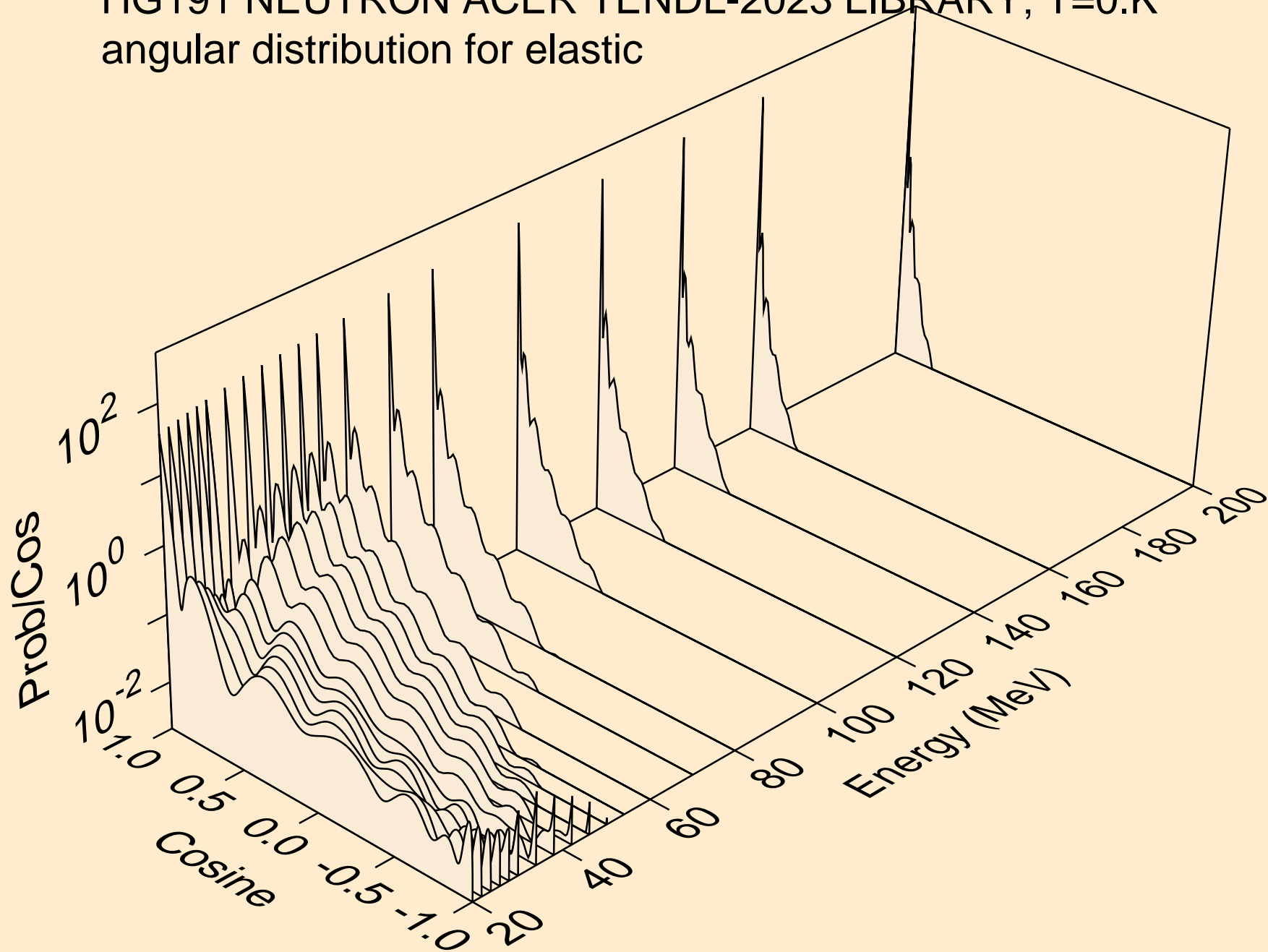

HG191 NEUTRON ACER TENDL-2023 LIBRARY; T=0.K
angular distribution for (n,n*1)

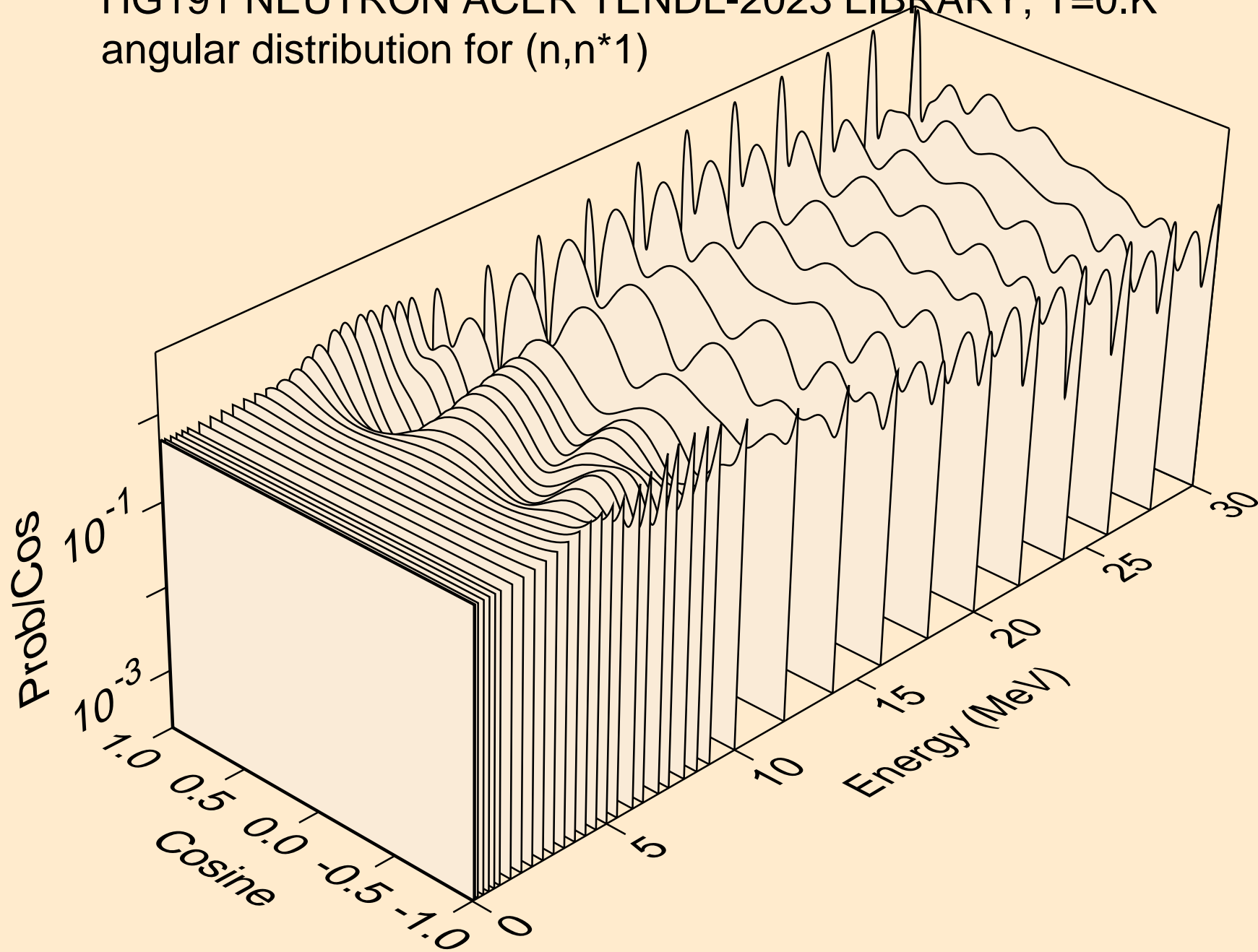

HG191 NEUTRON ACER TENDL-2023 LIBRARY; T=0.K
angular distribution for (n,n*2)

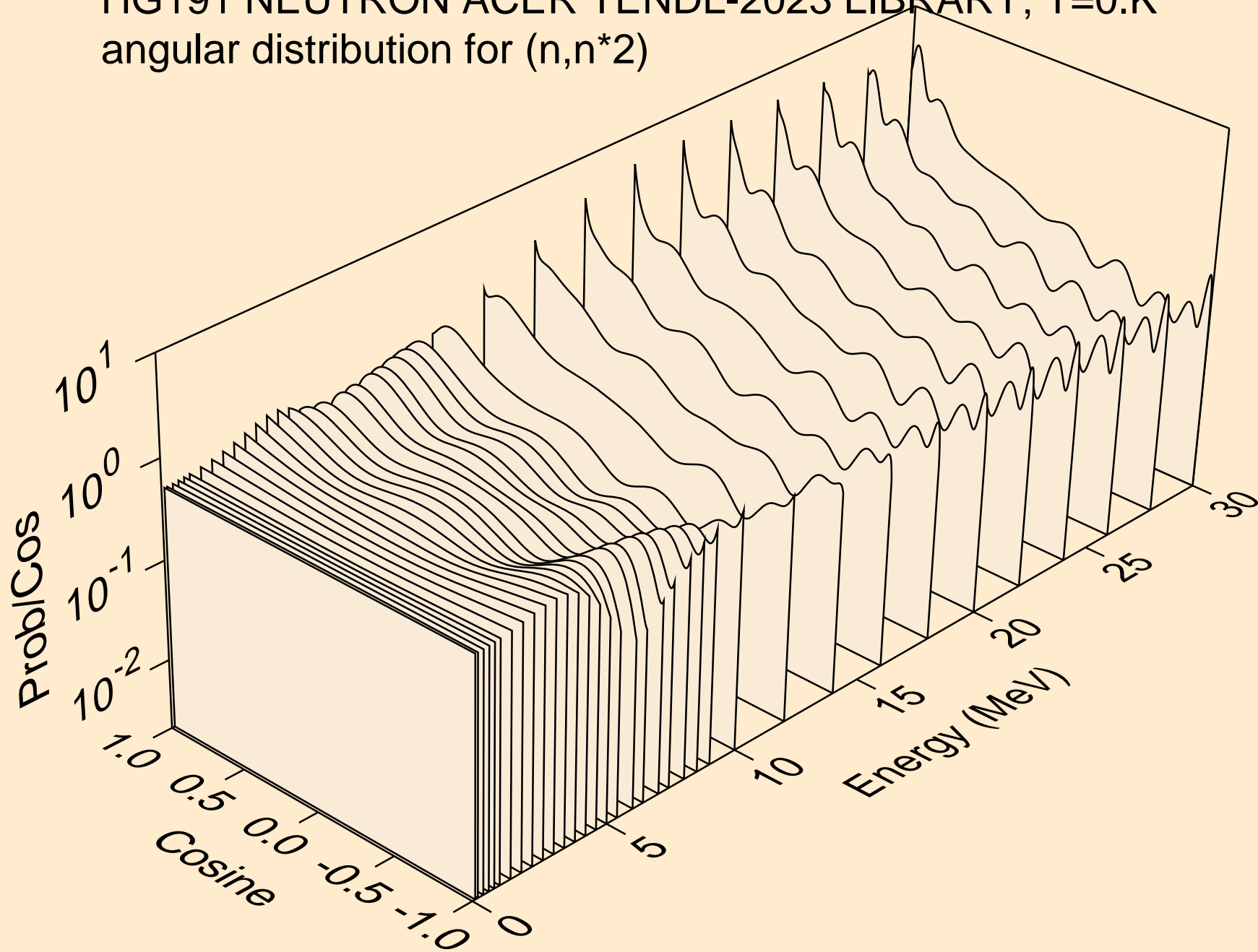

HG191 NEUTRON ACER TENDL-2023 LIBRARY; T=0.K
angular distribution for (n,n*3)

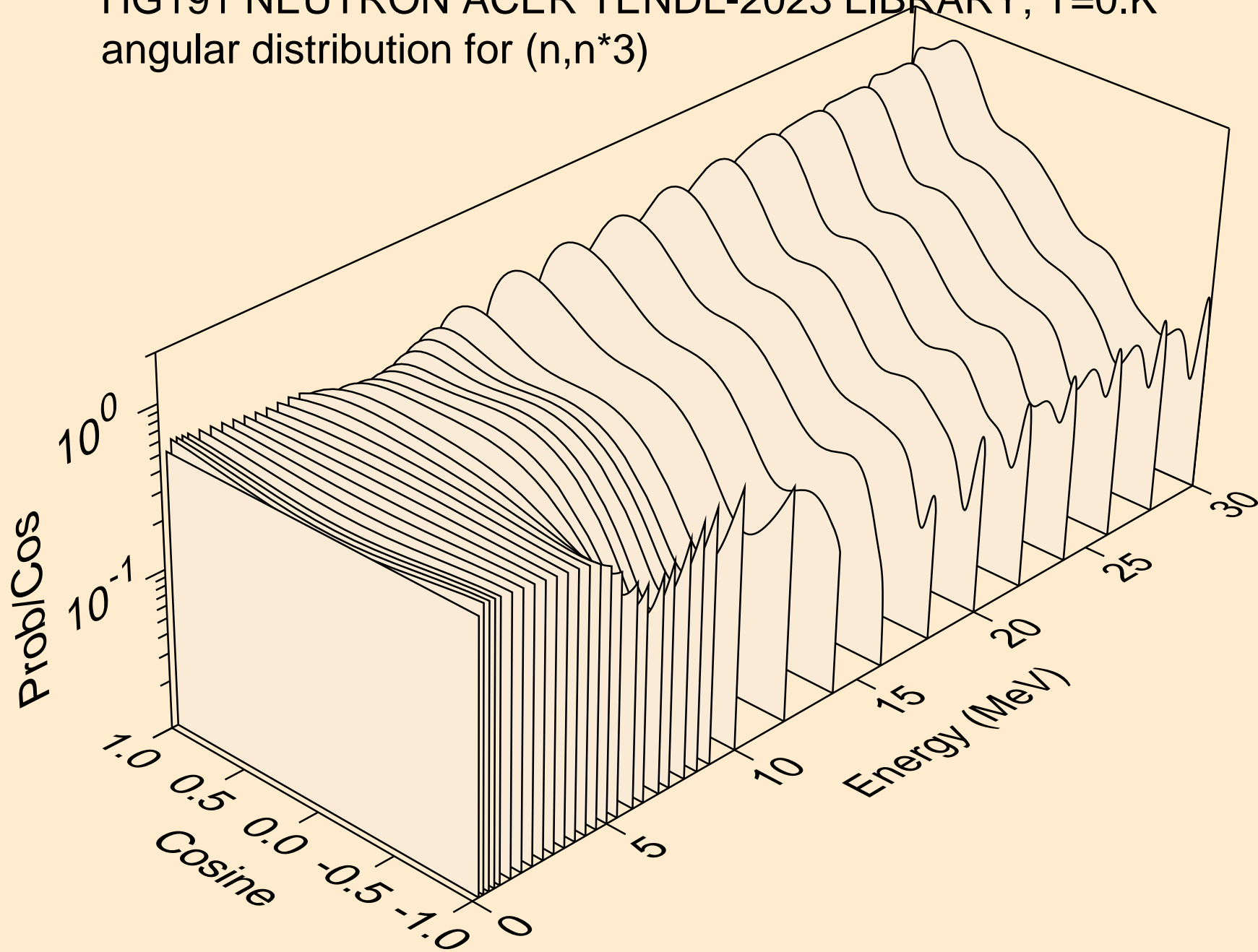

HG191 NEUTRON ACER TENDL-2023 LIBRARY; T=0.K
angular distribution for (n,n*4)

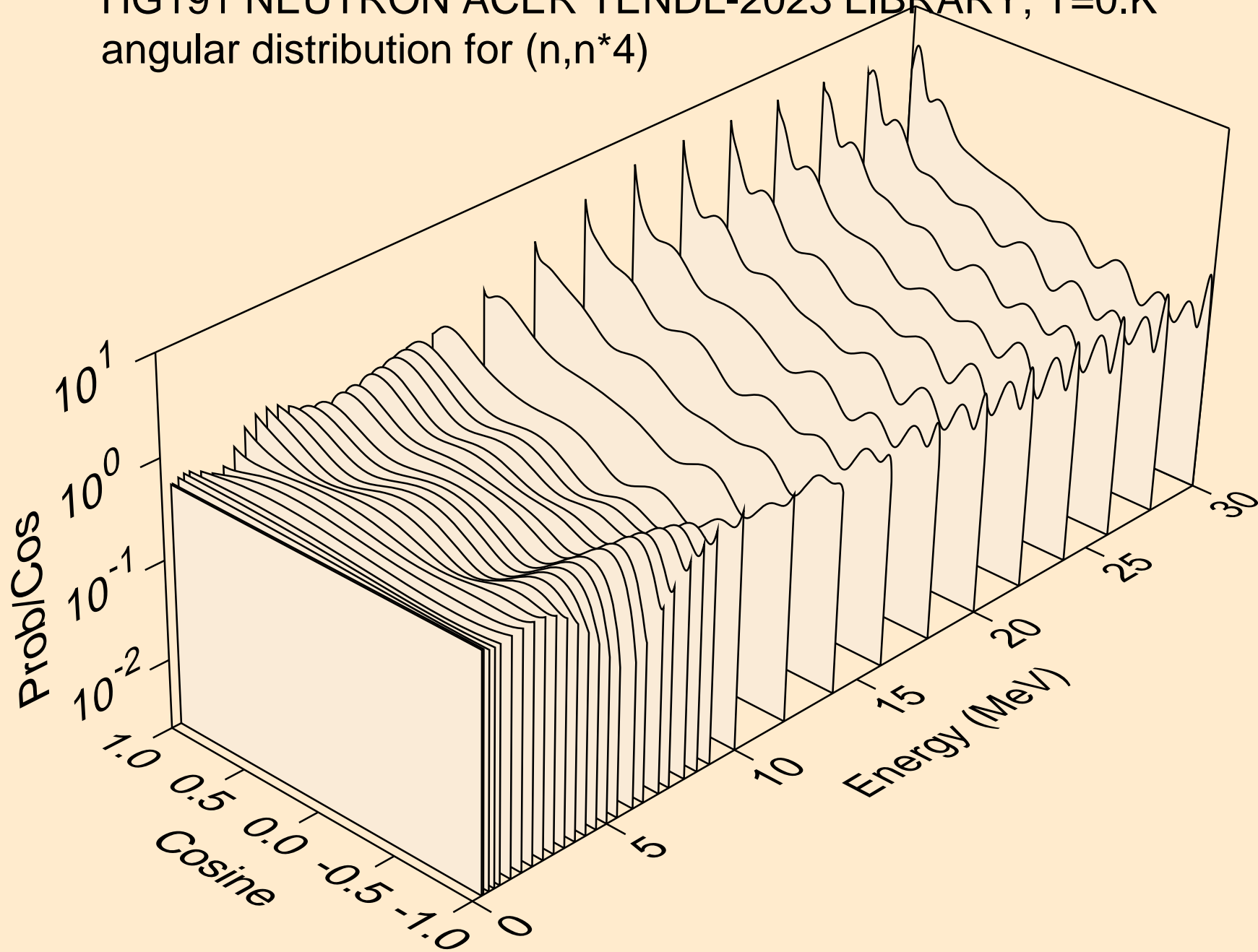

HG191 NEUTRON ACER TENDL-2023 LIBRARY; T=0.K
angular distribution for (n,n*5)

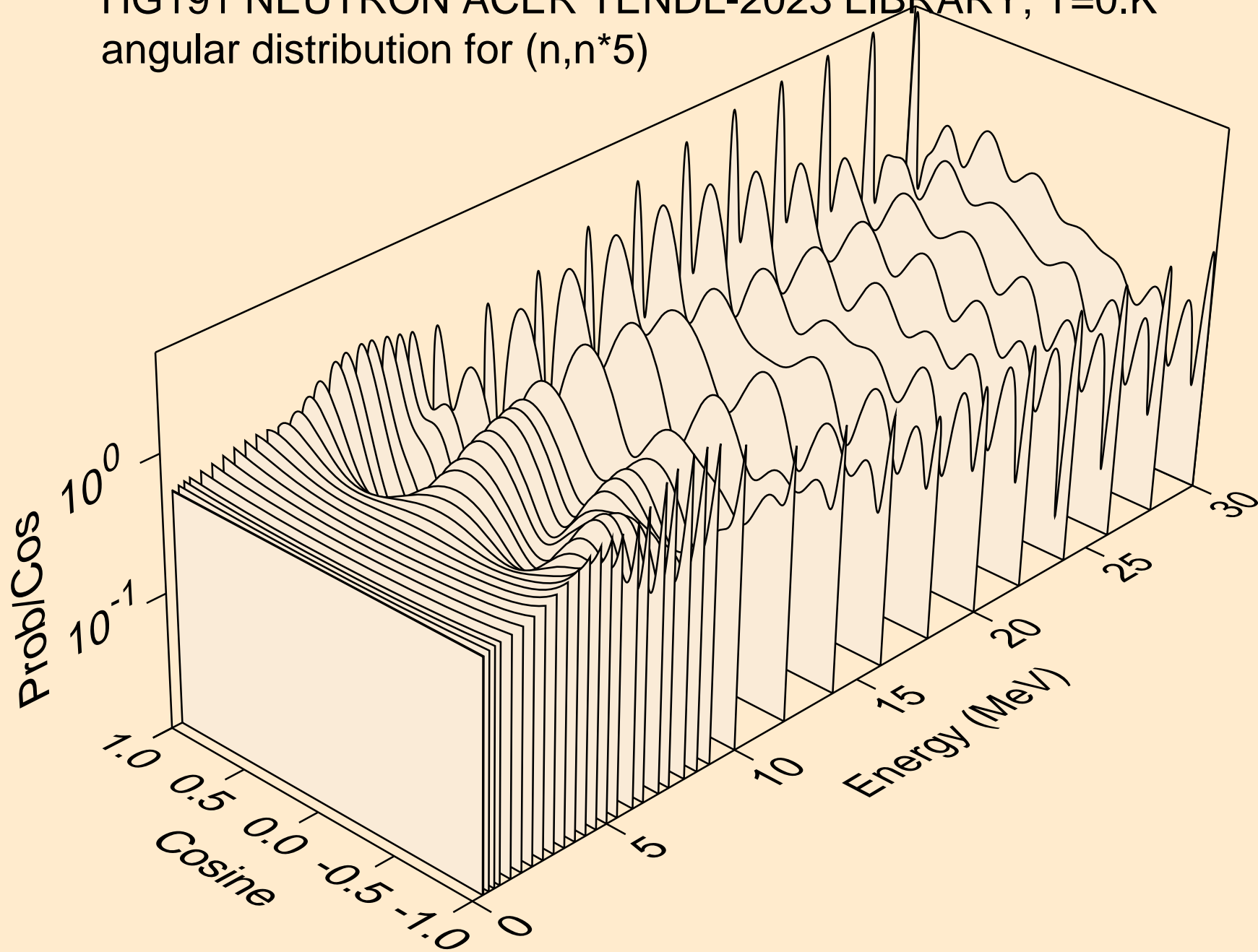

HG191 NEUTRON ACER TENDL-2023 LIBRARY; T=0.K
angular distribution for (n,n*6)

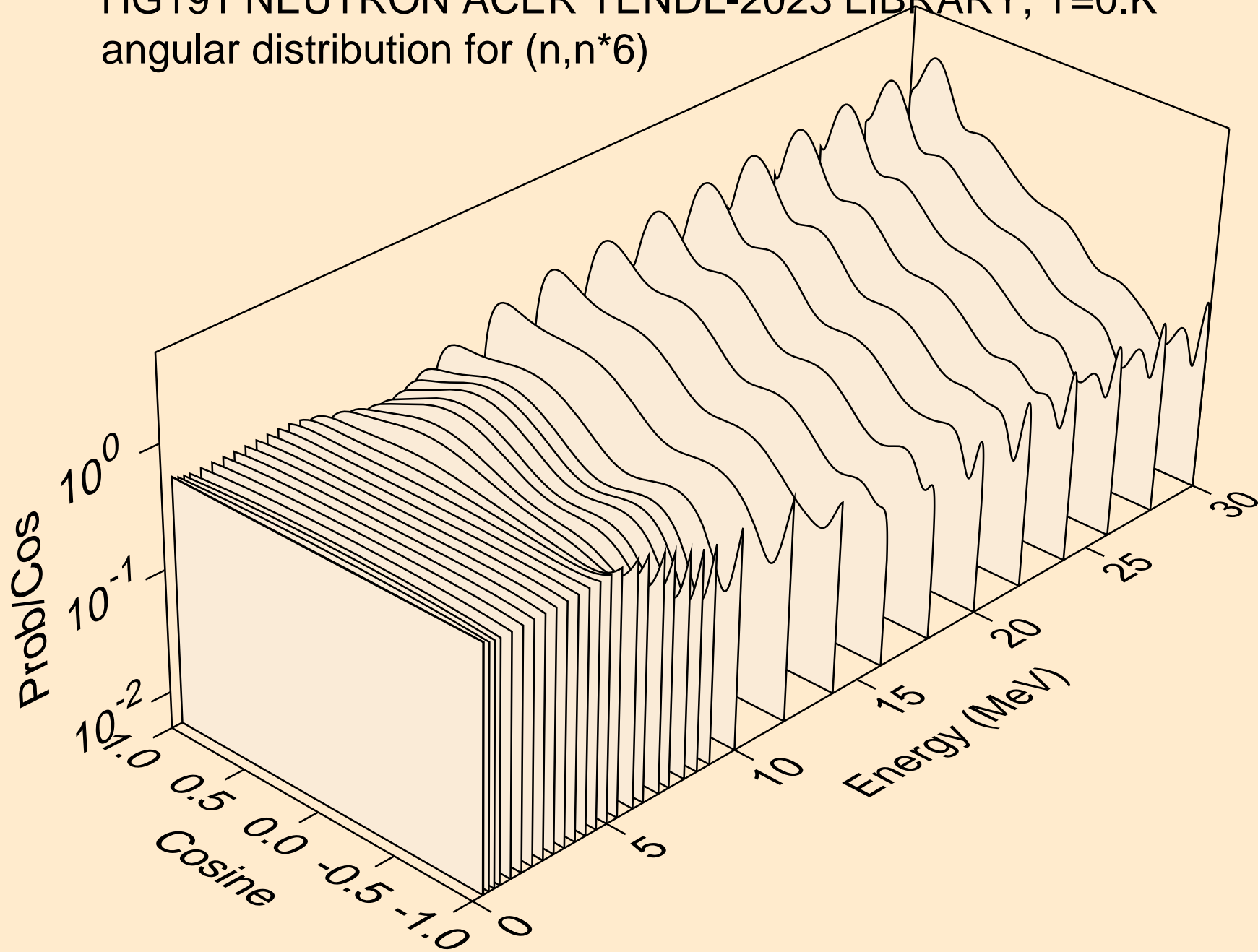

HG191 NEUTRON ACER TENDL-2023 LIBRARY; T=0.K
angular distribution for (n,n*7)

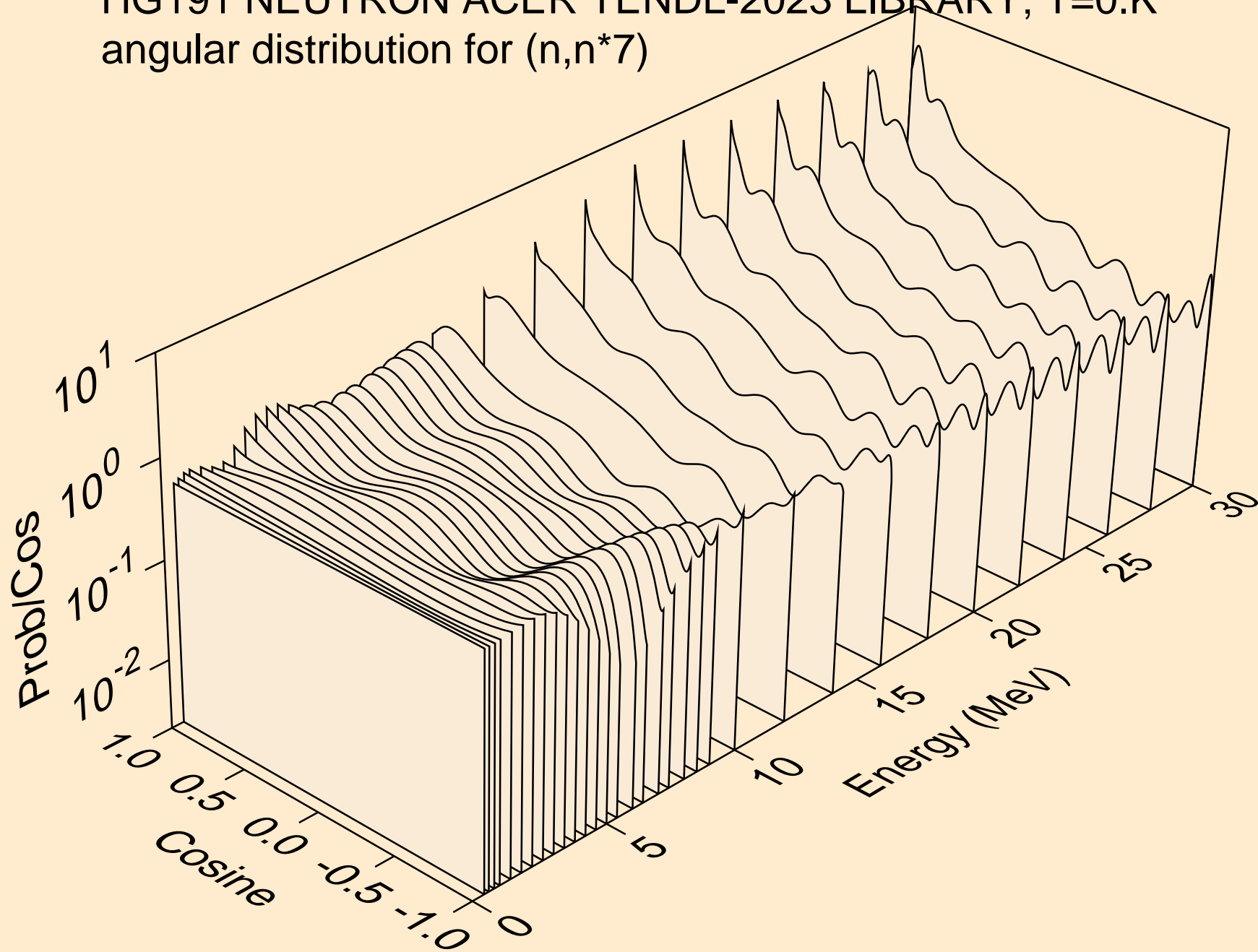

HG191 NEUTRON ACER TENDL-2023 LIBRARY; T=0.K
angular distribution for (n,n*8)

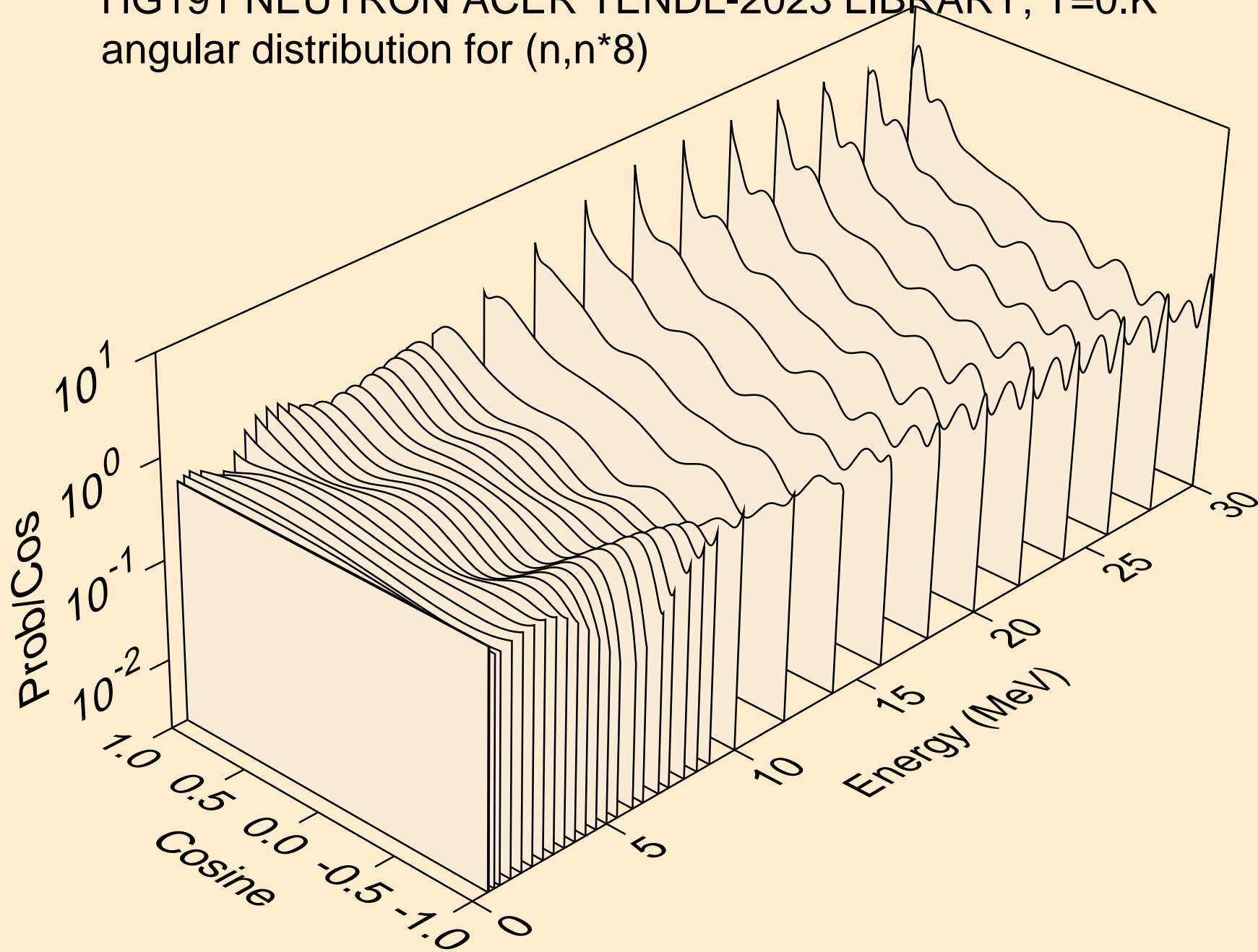

HG191 NEUTRON ACER TENDL-2023 LIBRARY; T=0.K
angular distribution for (n,n*9)

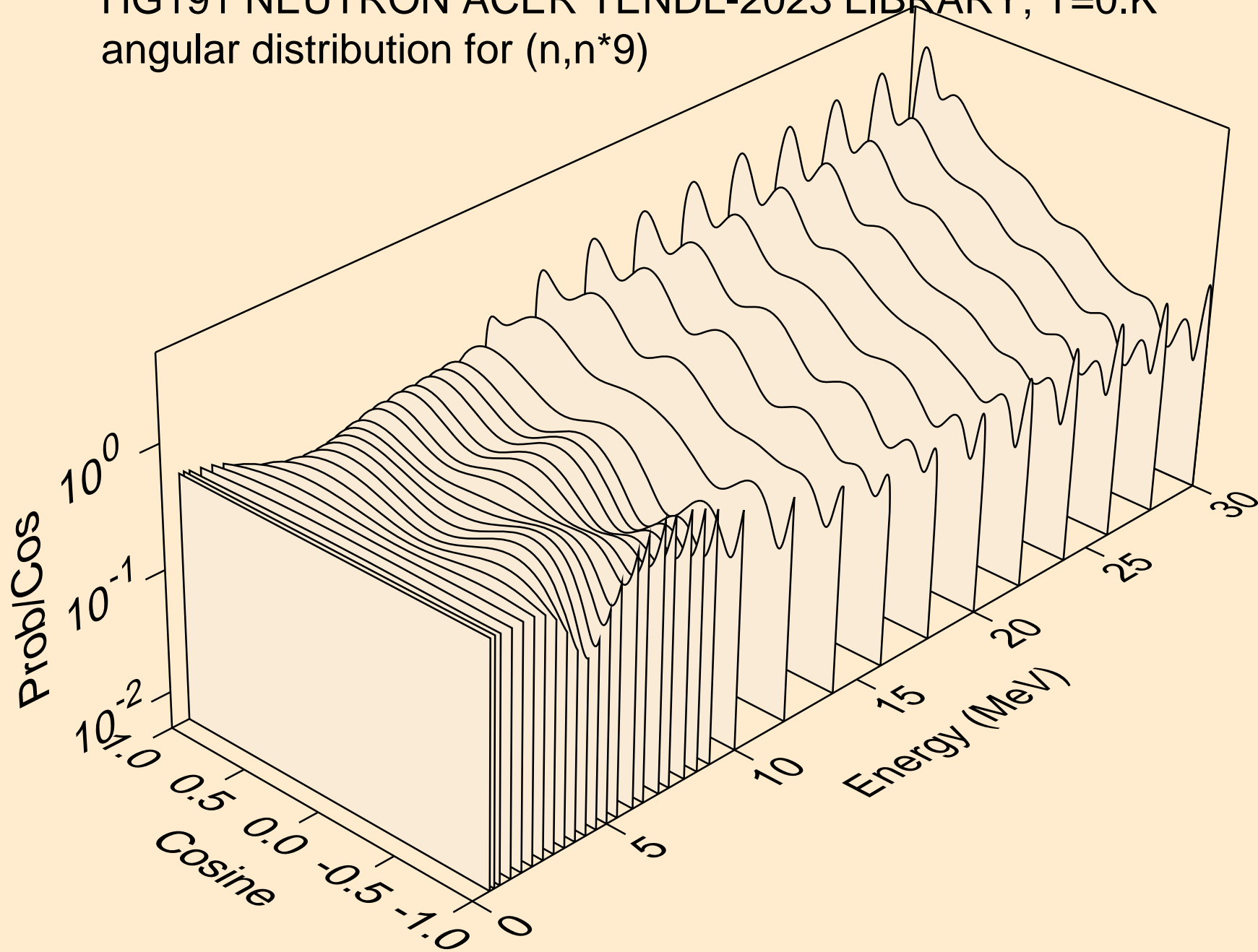

HG191 NEUTRON ACER TENDL-2023 LIBRARY; T=0.K
angular distribution for (n,n*10)

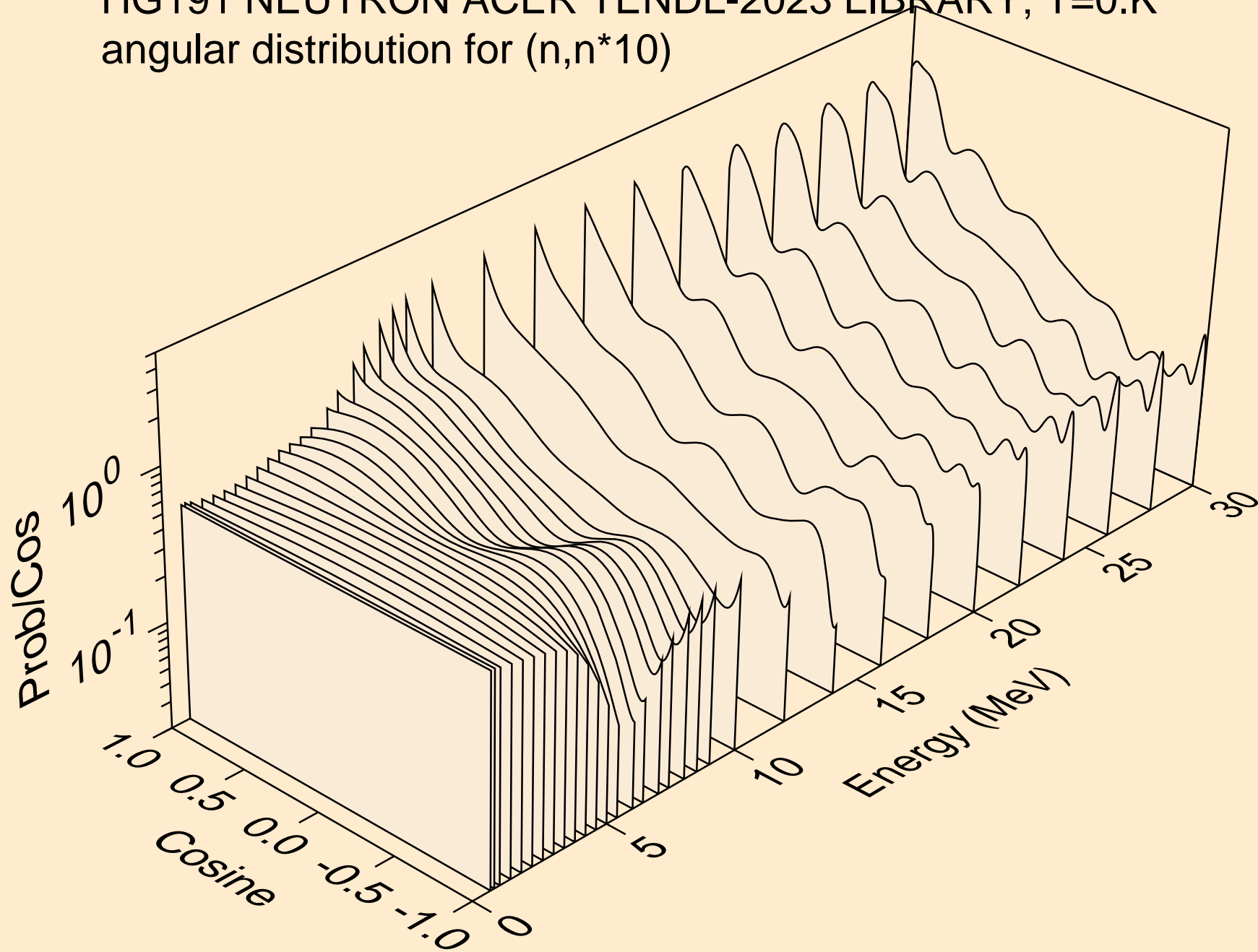

HG191 NEUTRON ACER TENDL-2023 LIBRARY; T=0.K
angular distribution for (n,n*11)

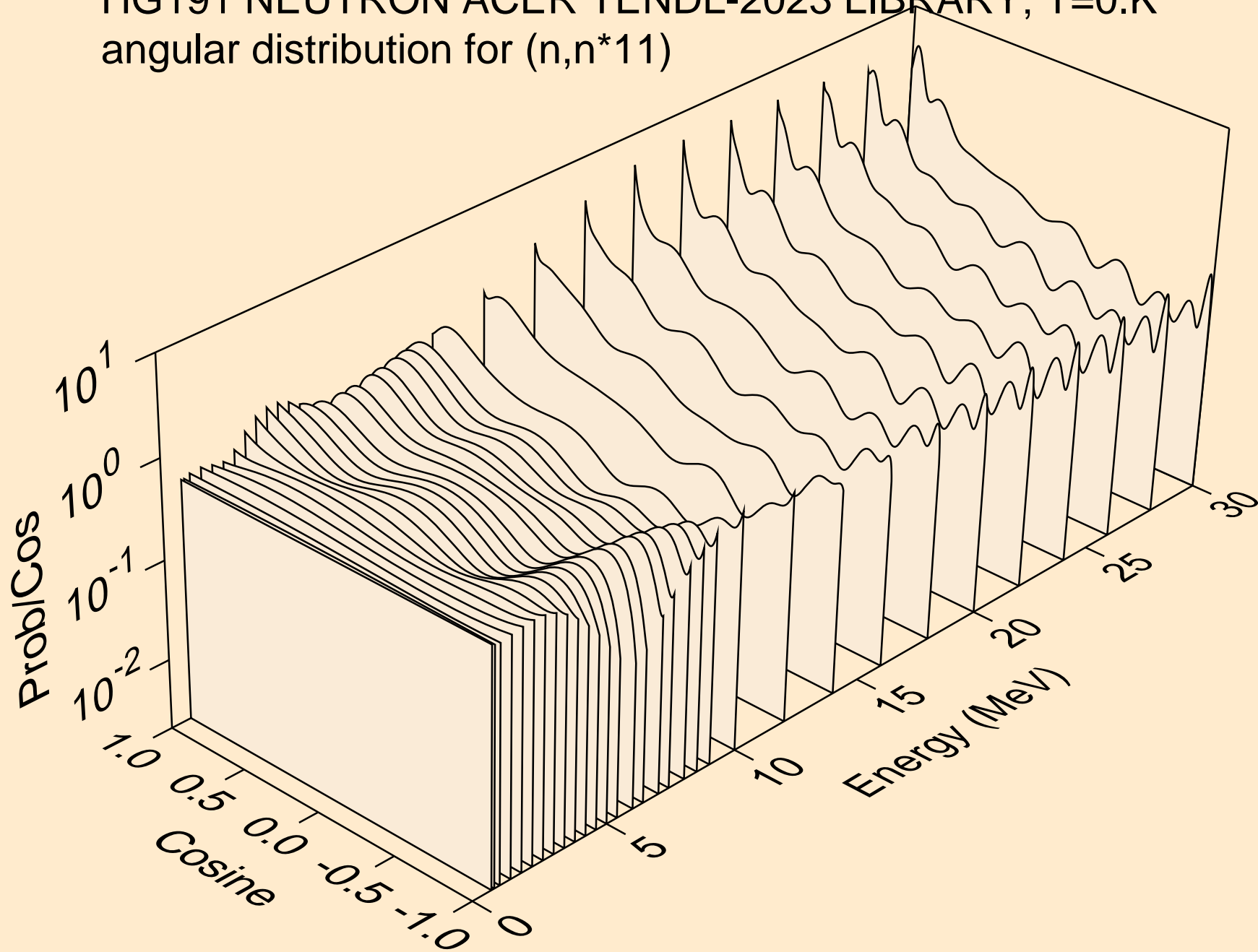

HG191 NEUTRON ACER TENDL-2023 LIBRARY; T=0.K
angular distribution for (n,n*12)

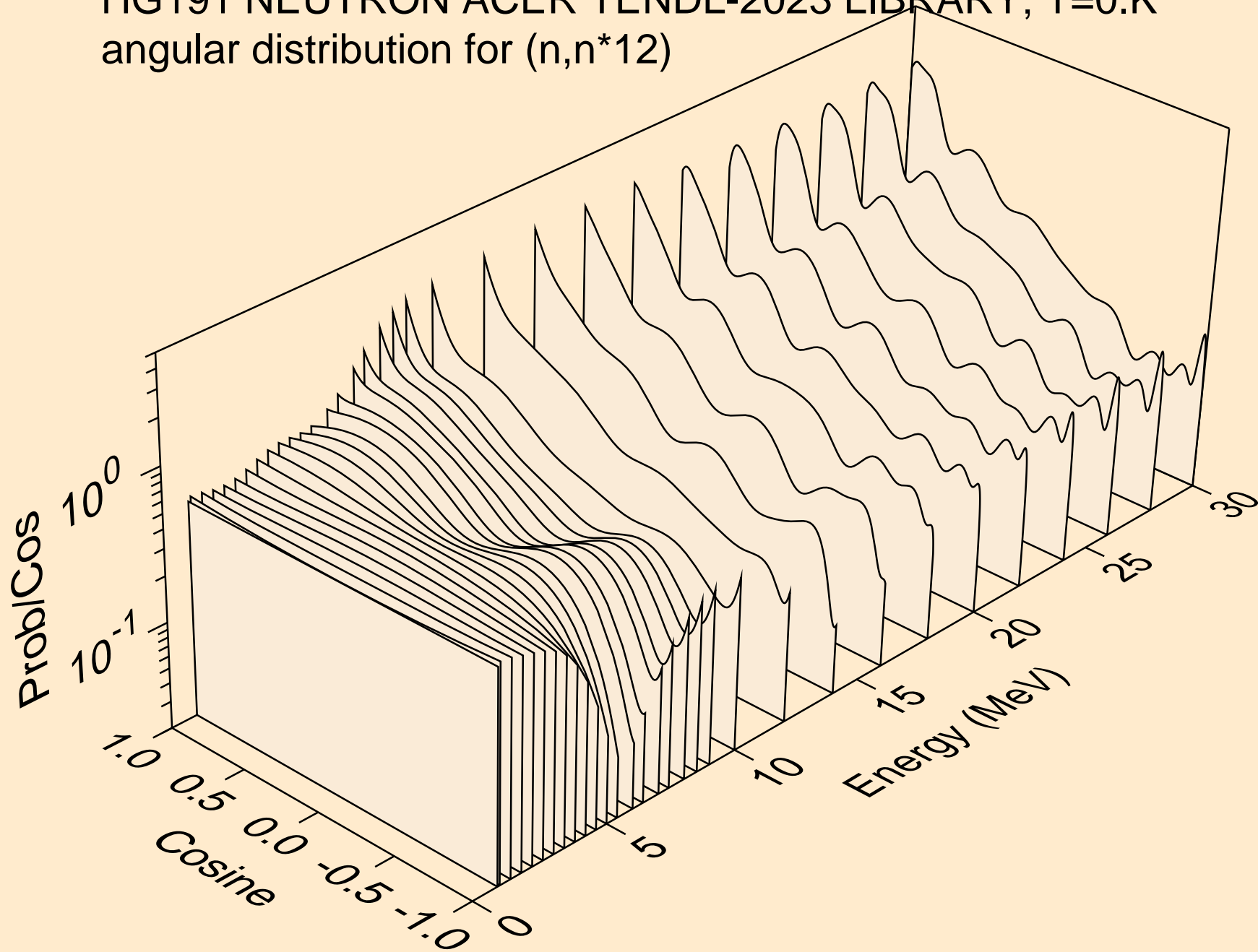

HG191 NEUTRON ACER TENDL-2023 LIBRARY; T=0.K
angular distribution for (n,n*13)

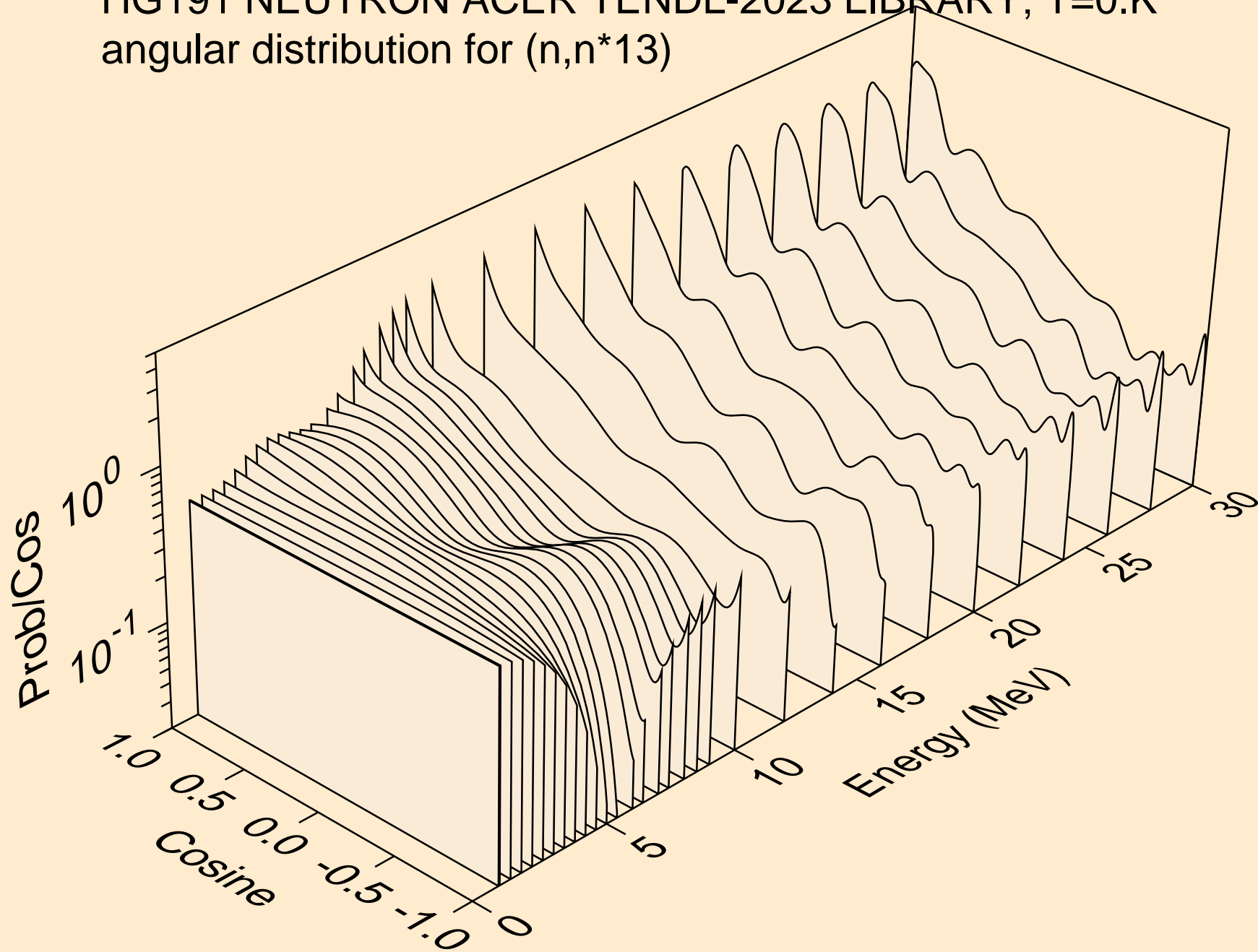

HG191 NEUTRON ACER TENDL-2023 LIBRARY; T=0.K
angular distribution for (n,n*14)

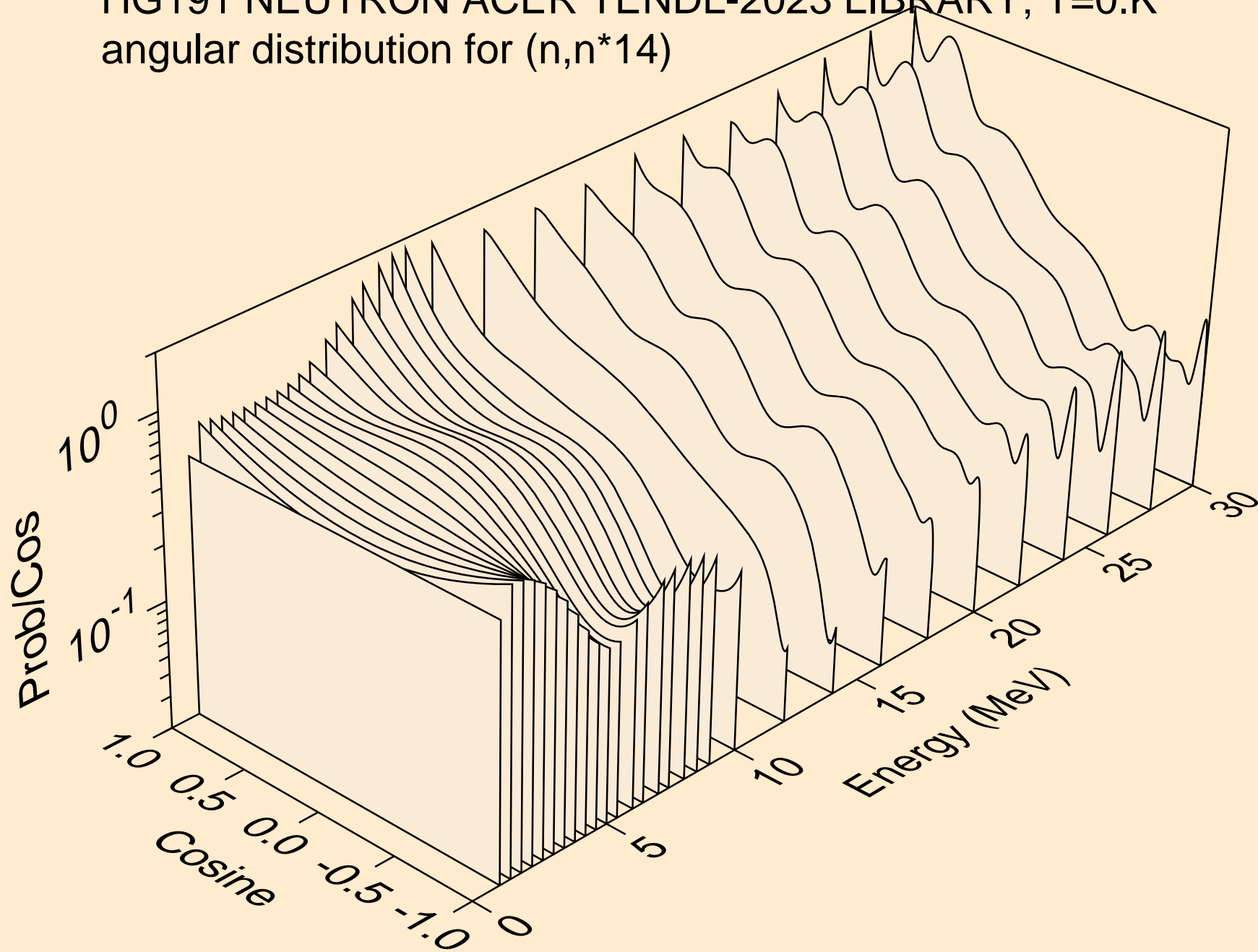

HG191 NEUTRON ACER TENDL-2023 LIBRARY; T=0.K
angular distribution for (n,n*15)

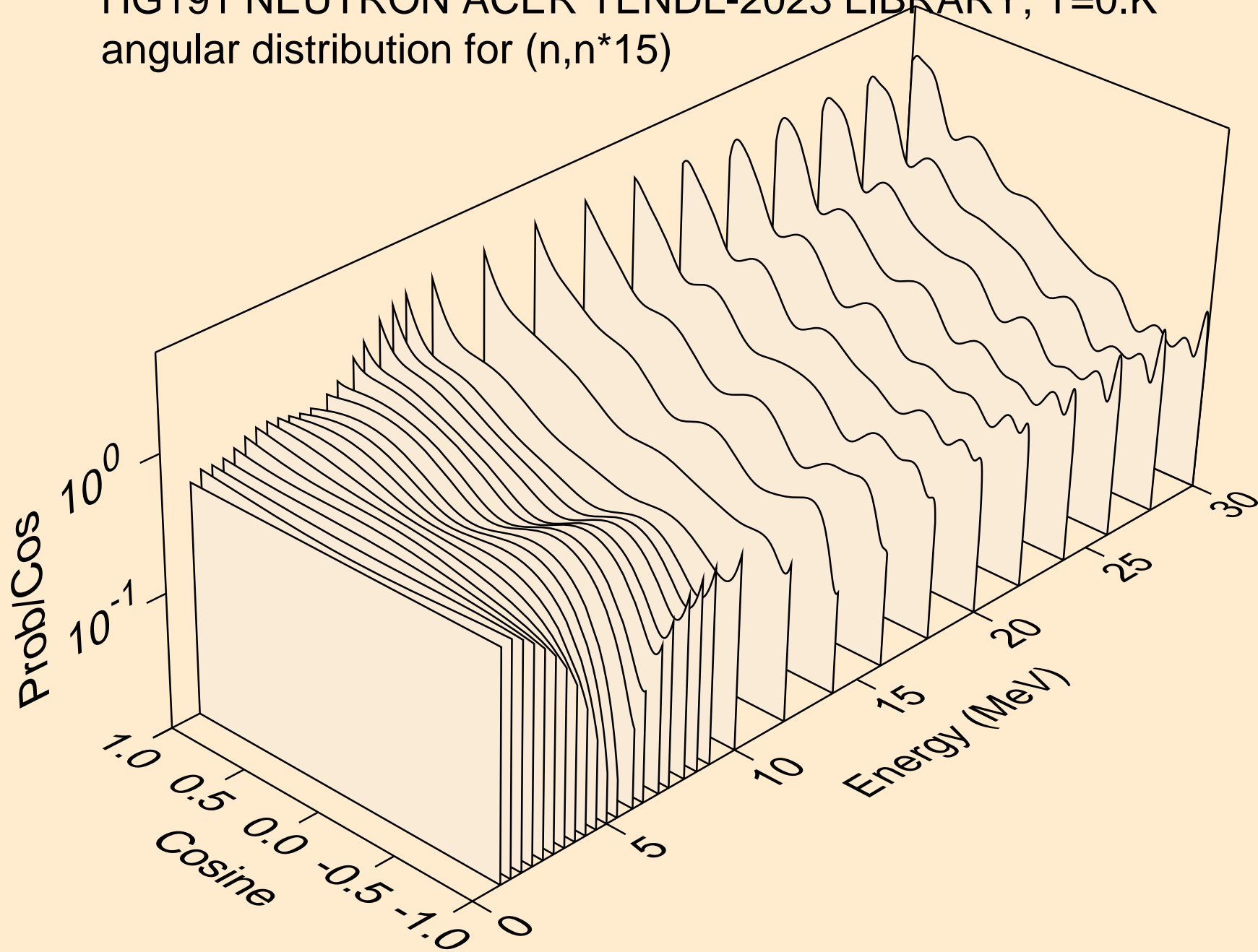

HG191 NEUTRON ACER TENDL-2023 LIBRARY; T=0.K
angular distribution for (n,n*16)

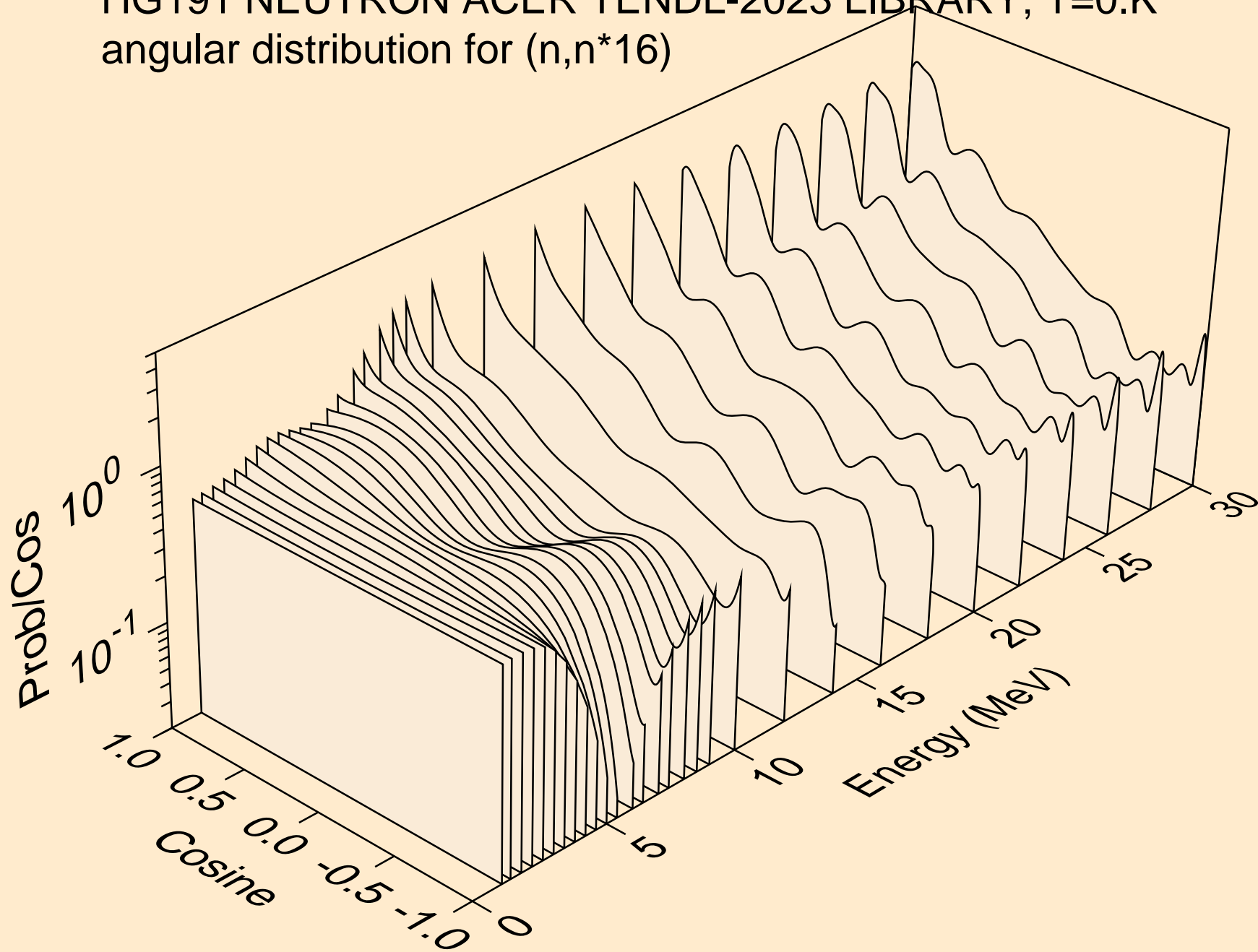

HG191 NEUTRON ACER TENDL-2023 LIBRARY; T=0.K
angular distribution for (n,n*17)

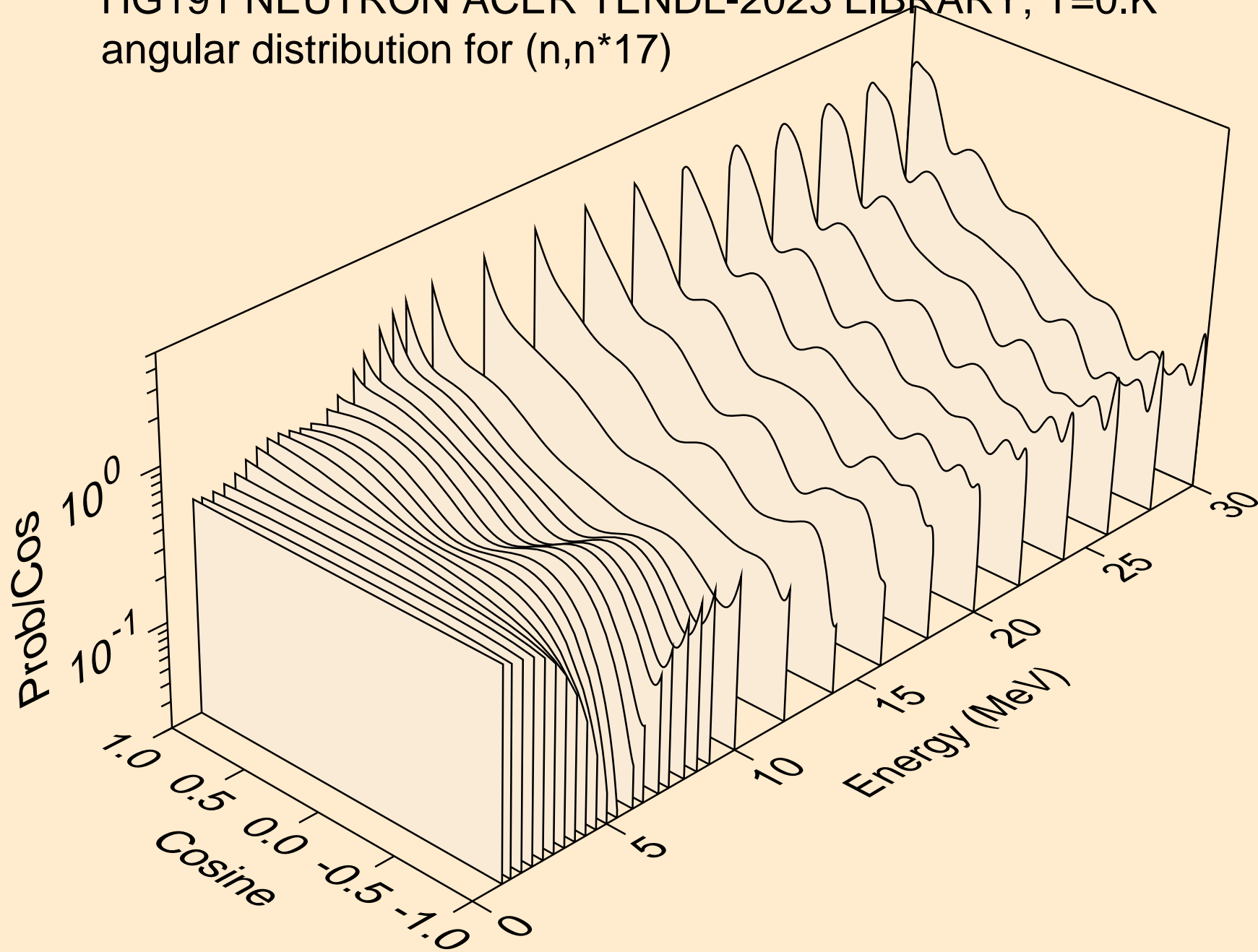

HG191 NEUTRON ACER TENDL-2023 LIBRARY; T=0.K
angular distribution for (n,n*18)

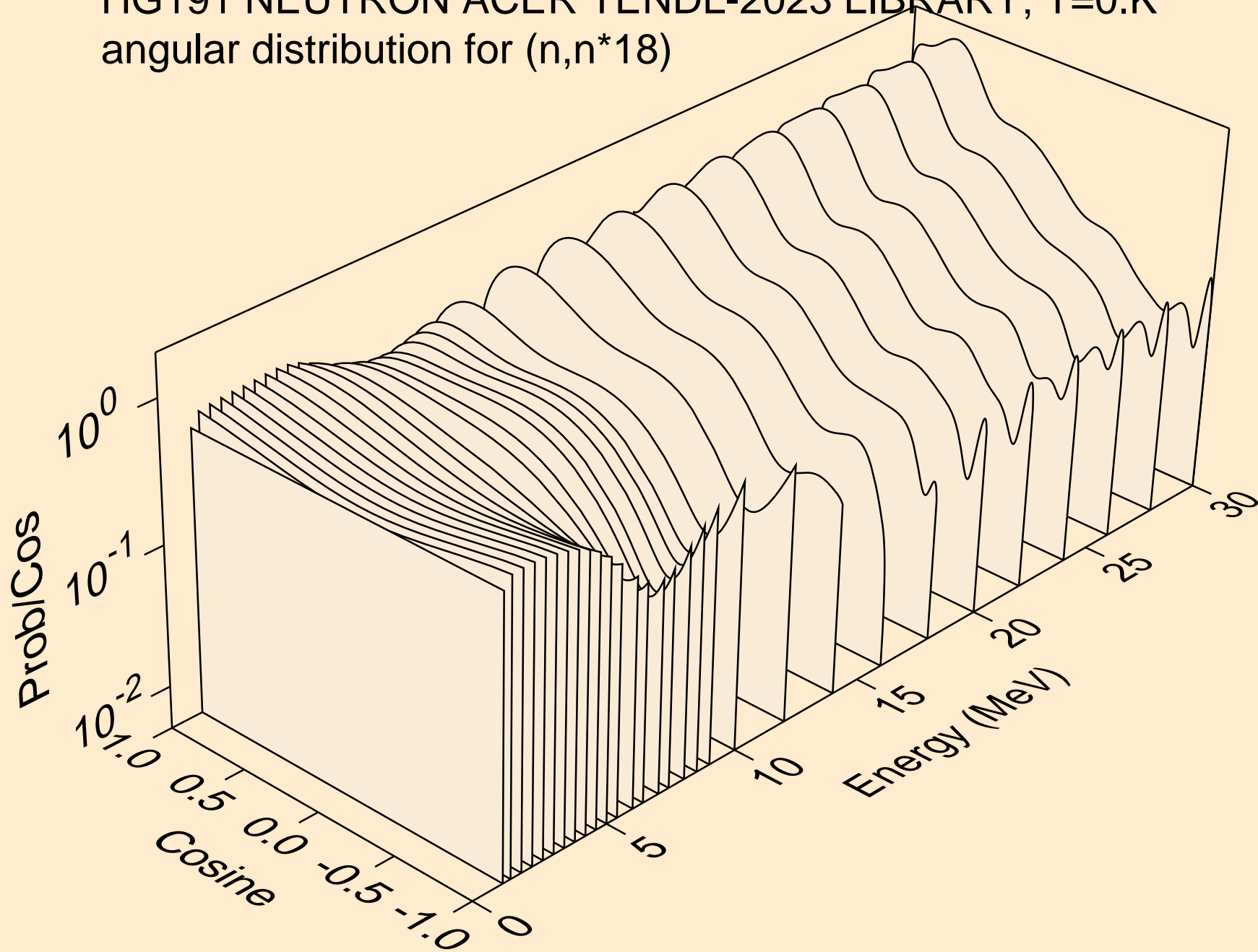

HG191 NEUTRON ACER TENDL-2023 LIBRARY; T=0.K
angular distribution for (n,n*19)

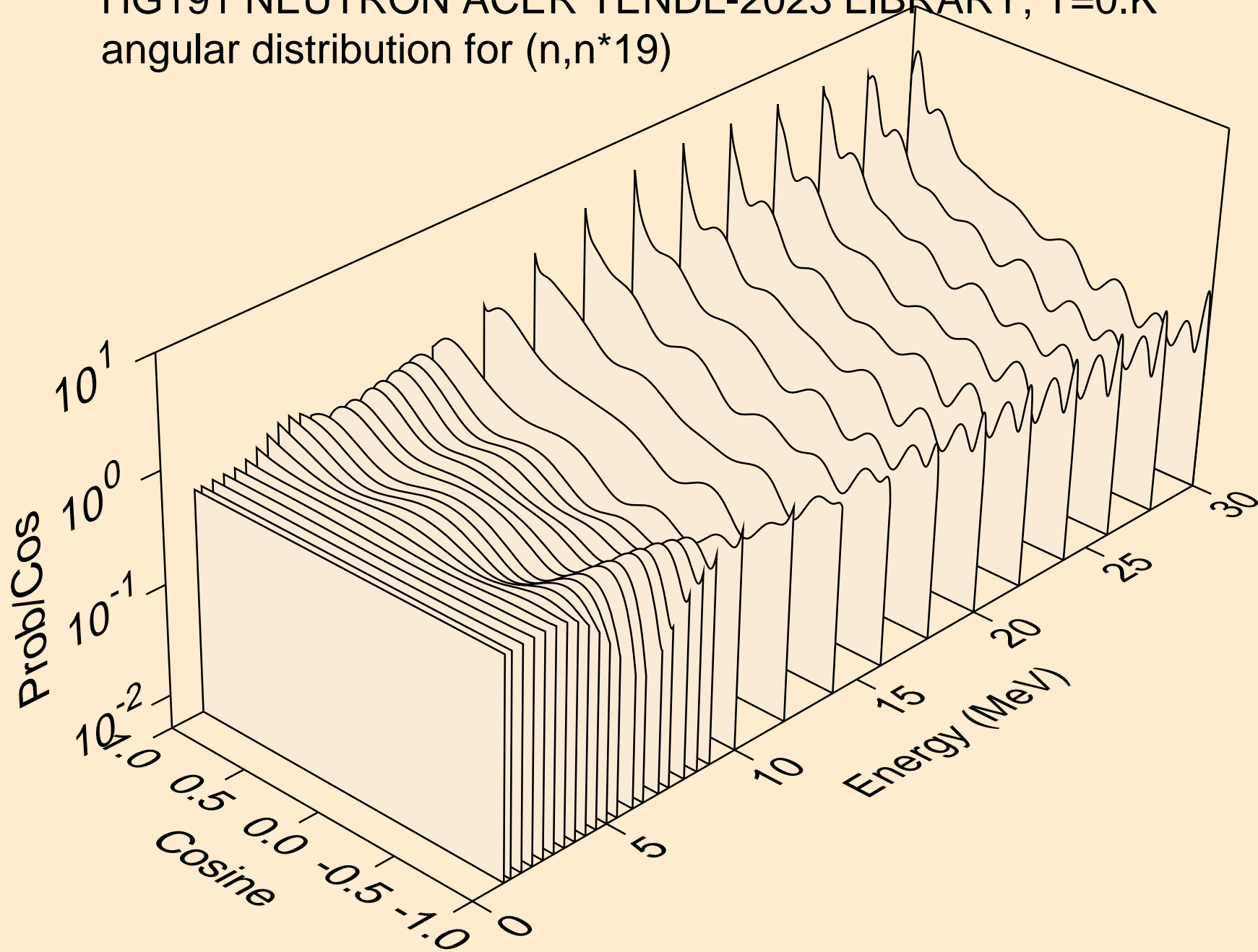

HG191 NEUTRON ACER TENDL-2023 LIBRARY; T=0.K
angular distribution for (n,n*20)

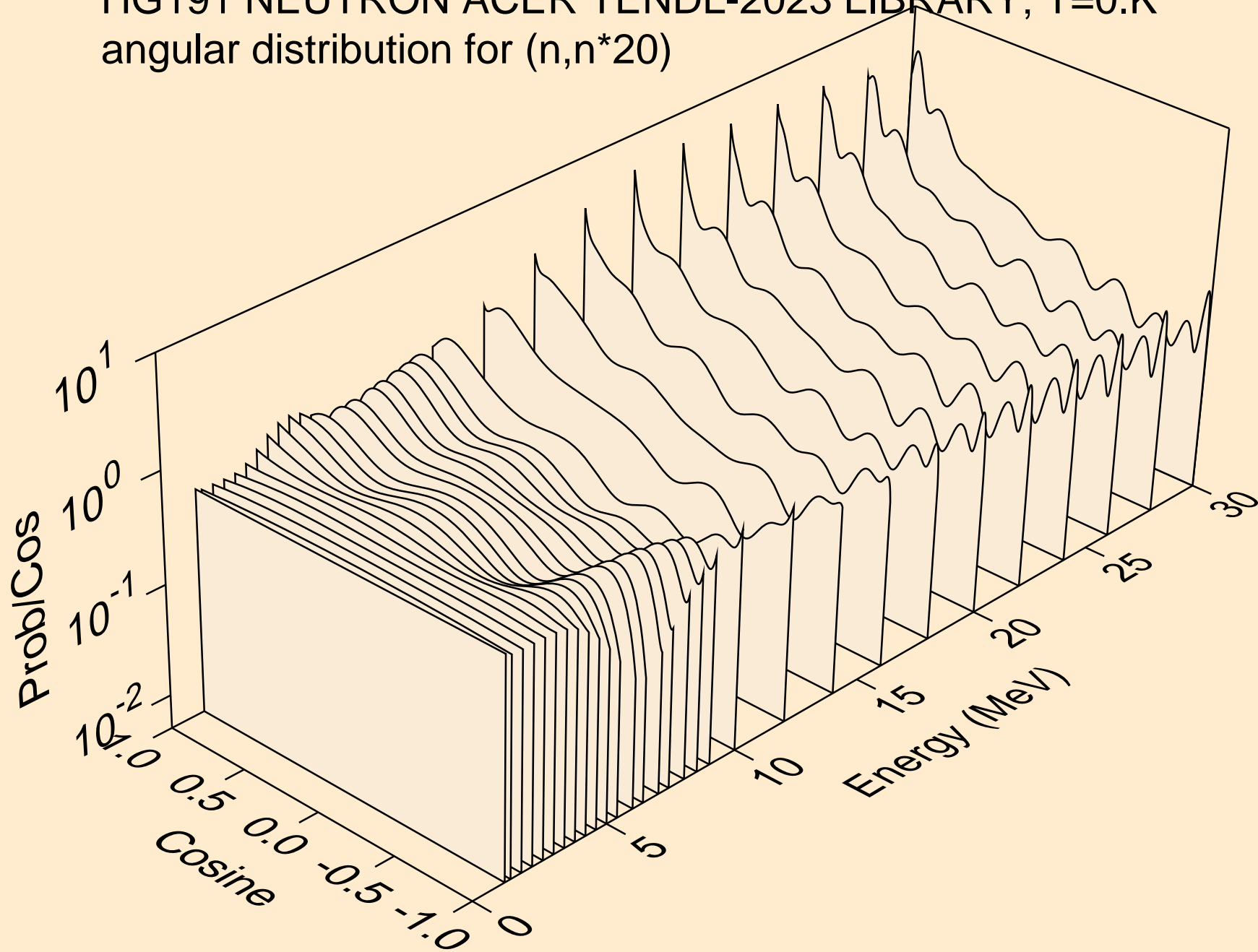

HG191 NEUTRON ACER TENDL-2023 LIBRARY; T=0.K
angular distribution for (n,n*21)

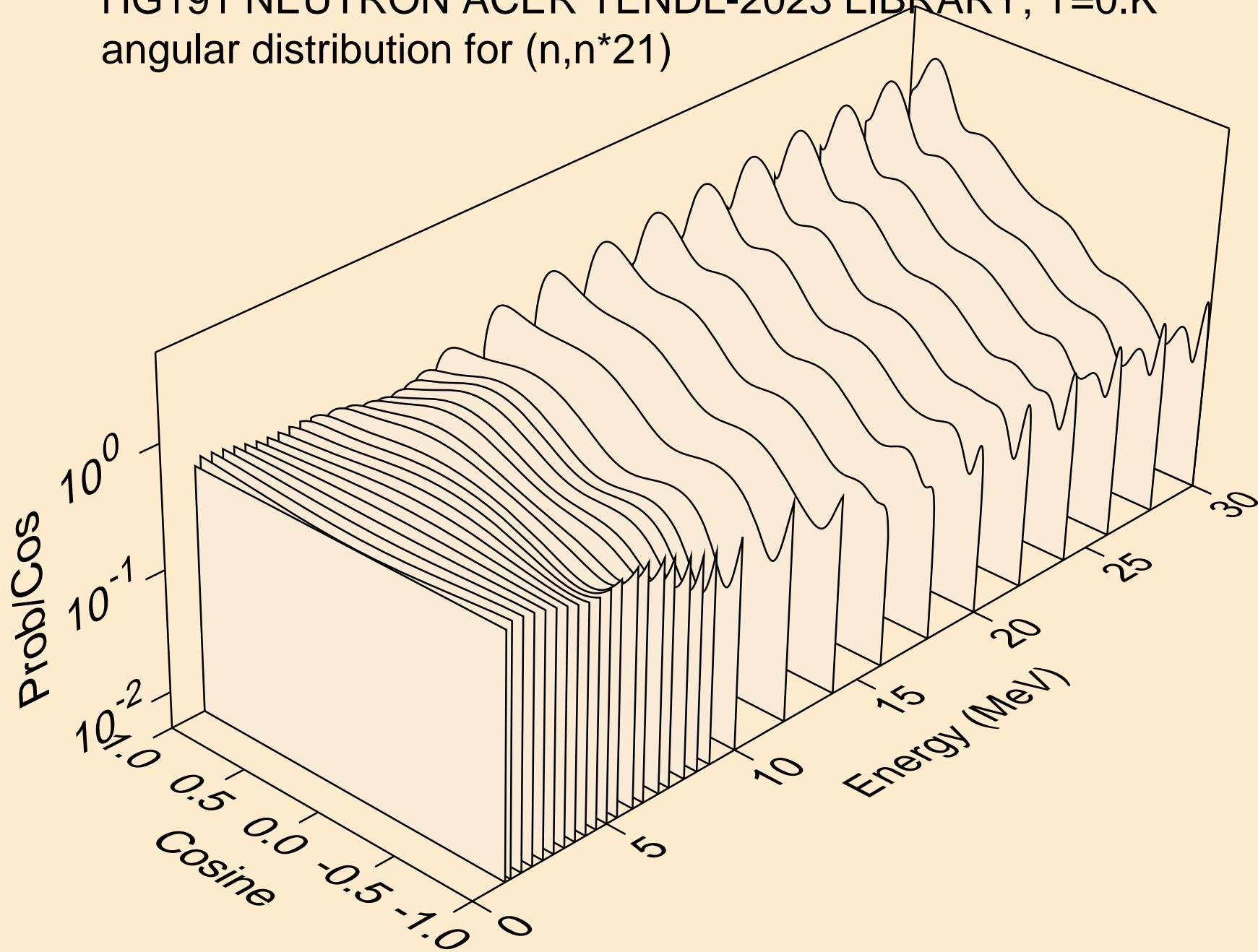

HG191 NEUTRON ACER TENDL-2023 LIBRARY; T=0.K
angular distribution for (n,n*22)

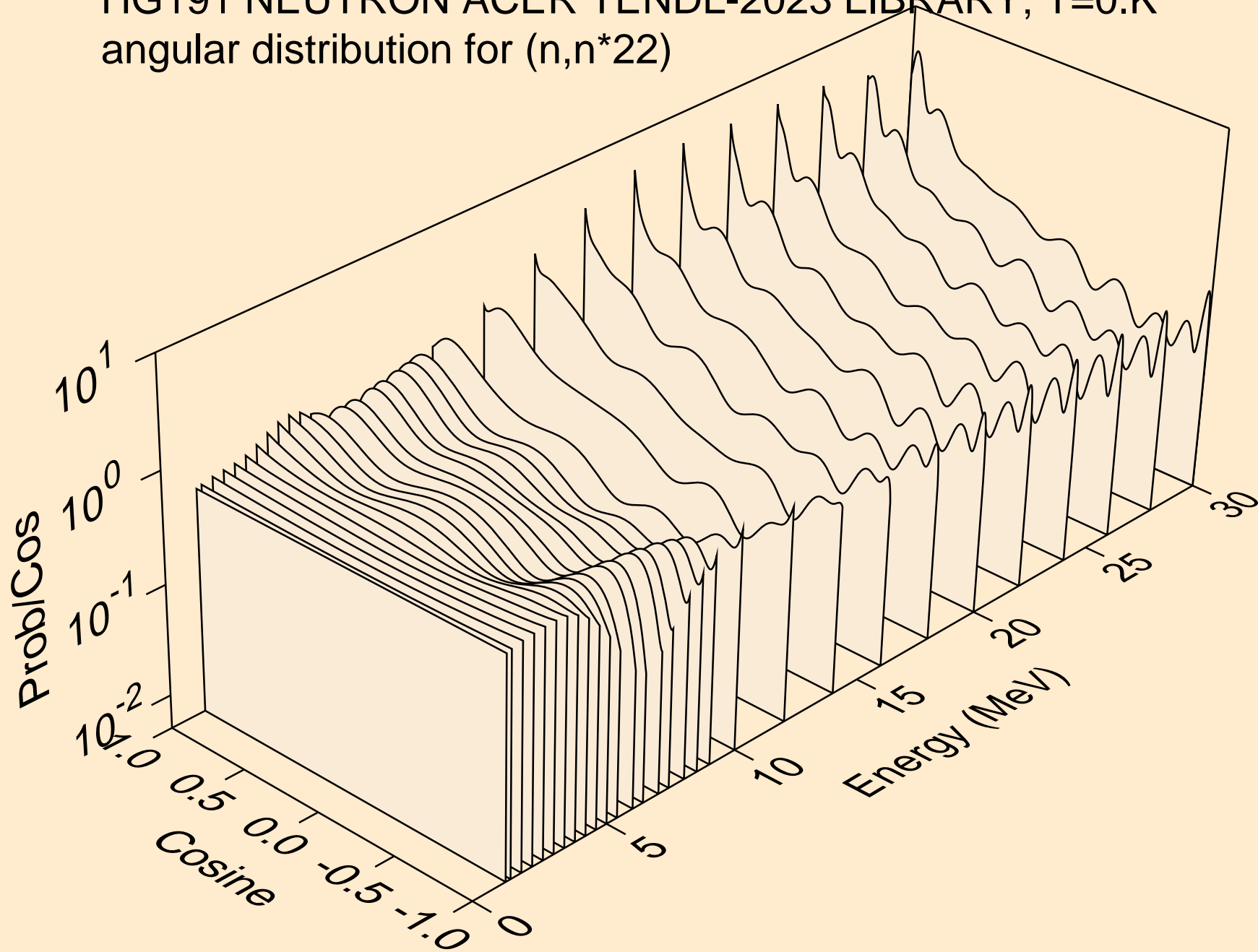

HG191 NEUTRON ACER TENDL-2023 LIBRARY; T=0.K
Neutron emission for (n,x)

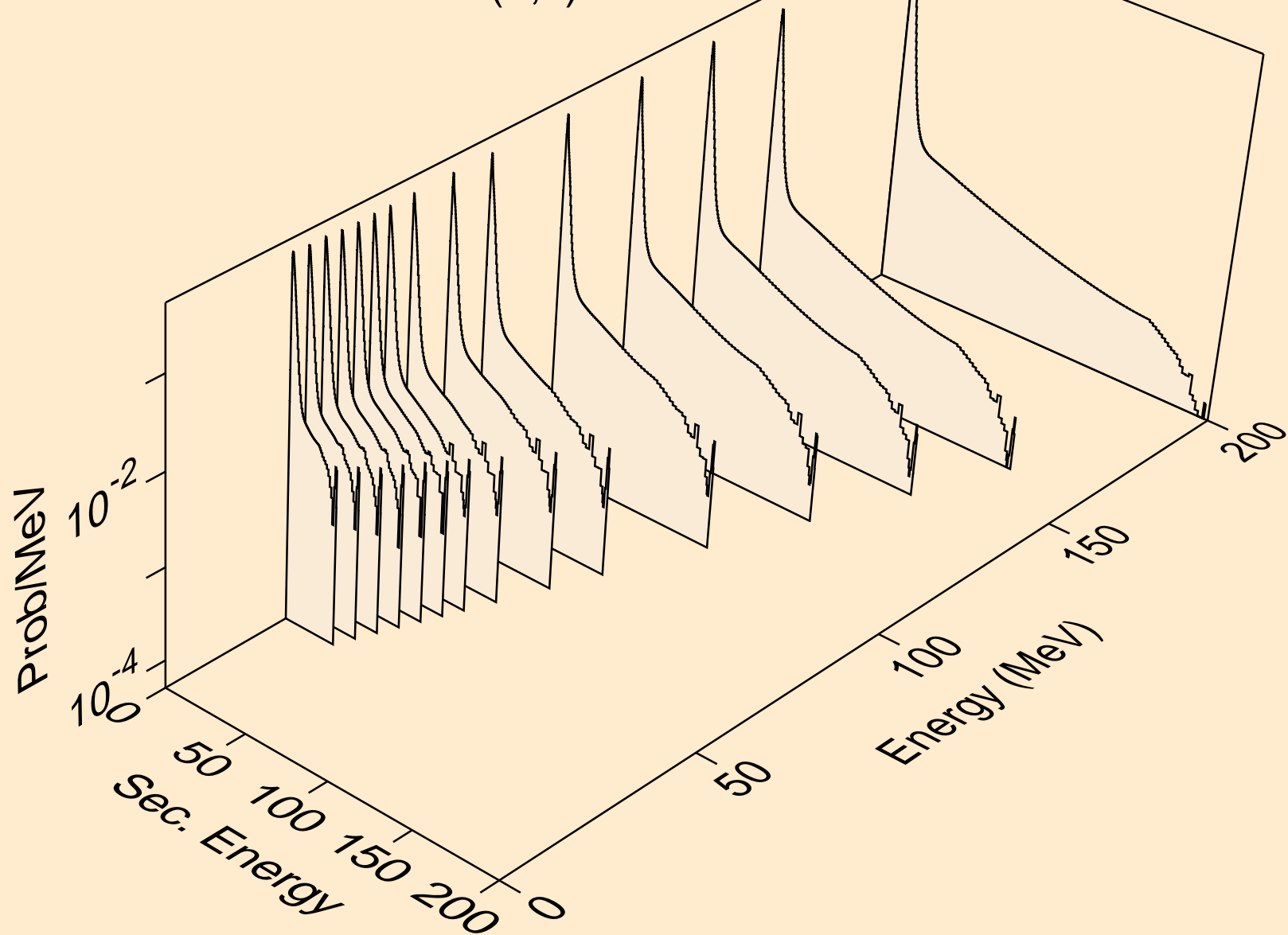

HG191 NEUTRON ACER TENDL-2023 LIBRARY; T=0.K
Neutron emission for (n,2nd)

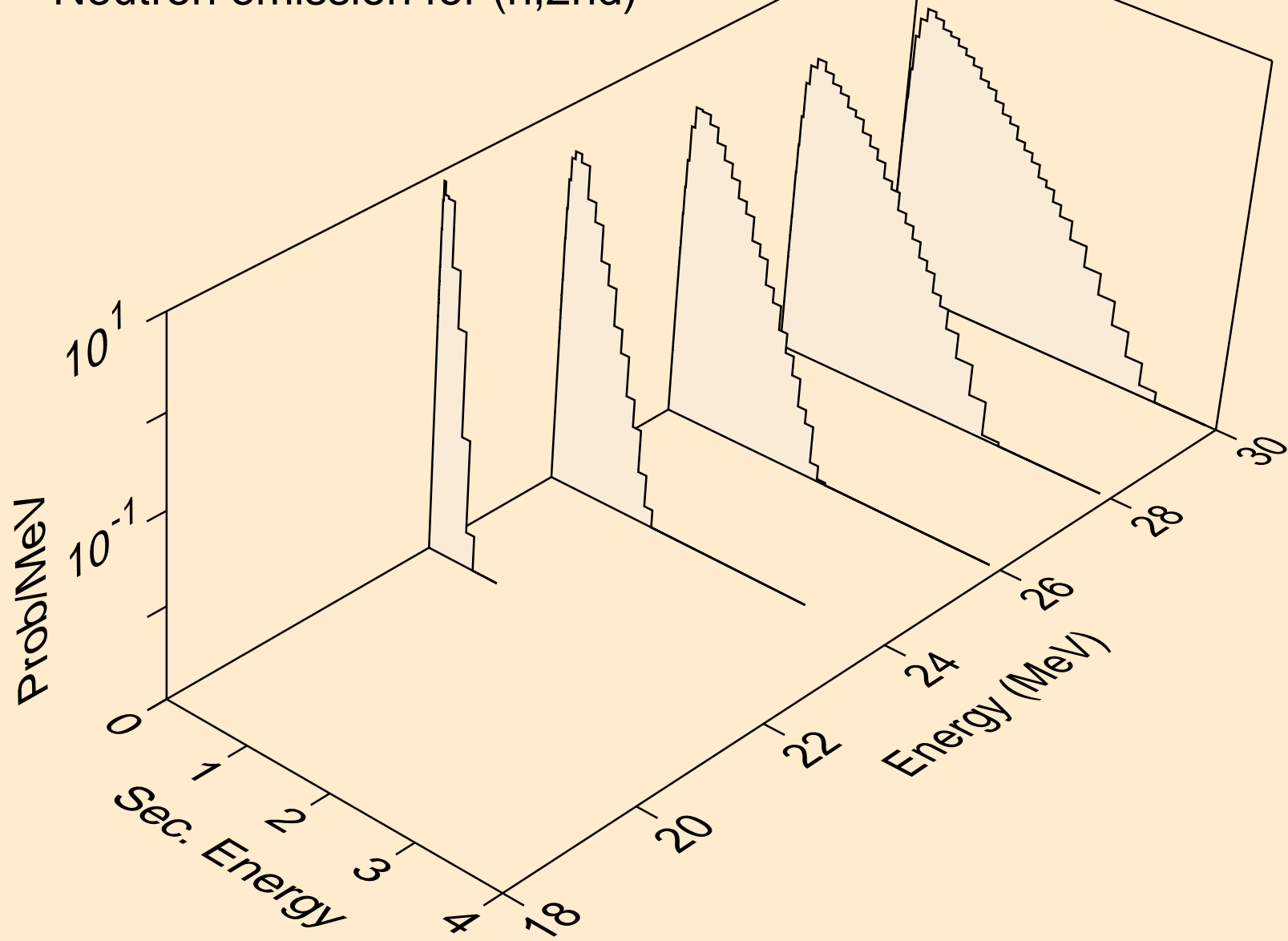

HG191 NEUTRON ACER TENDL-2023 LIBRARY; T=0.K
Neutron emission for (n,2n)

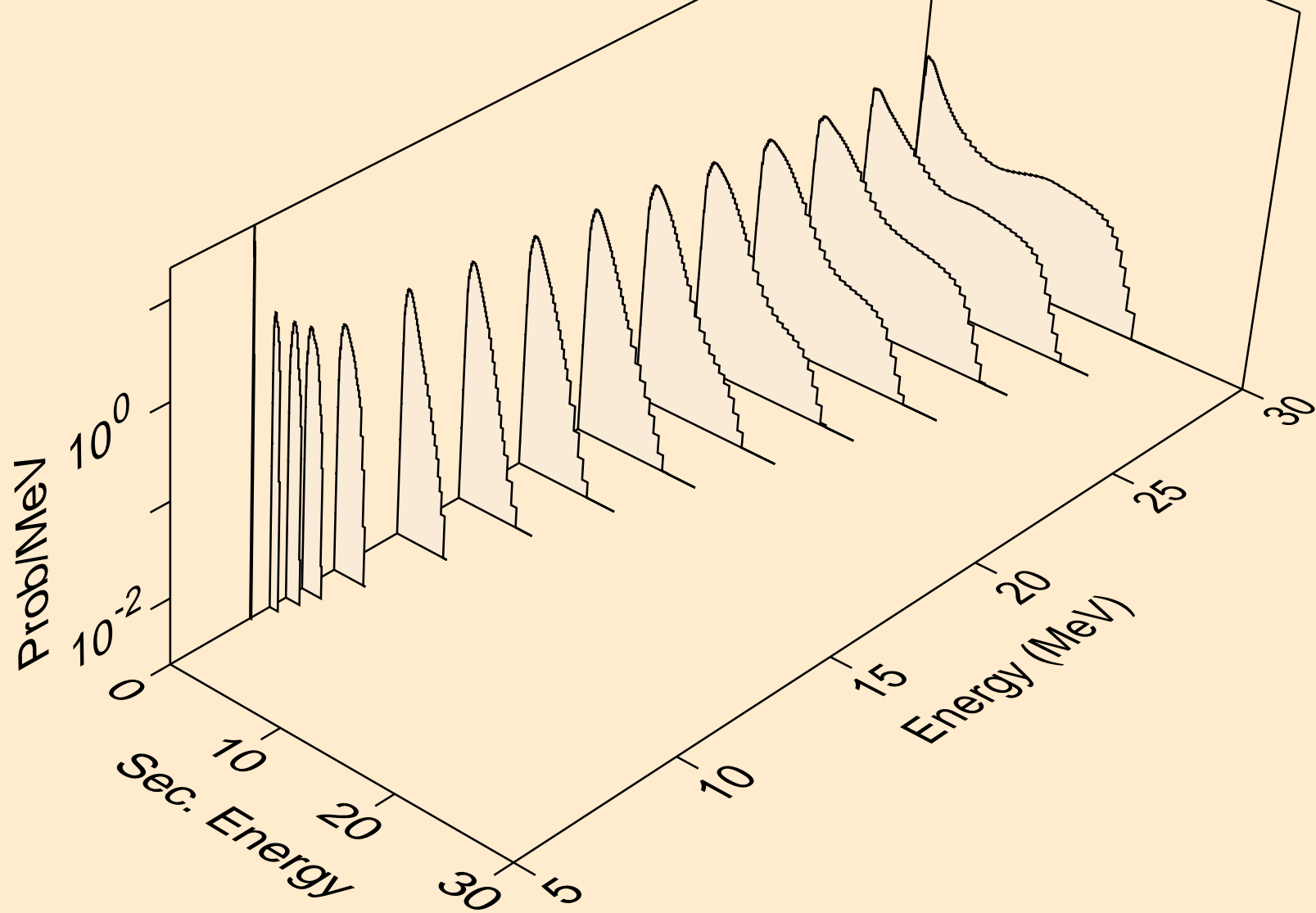

HG191 NEUTRON ACER TENDL-2023 LIBRARY; T=0.K
Neutron emission for (n,3n)

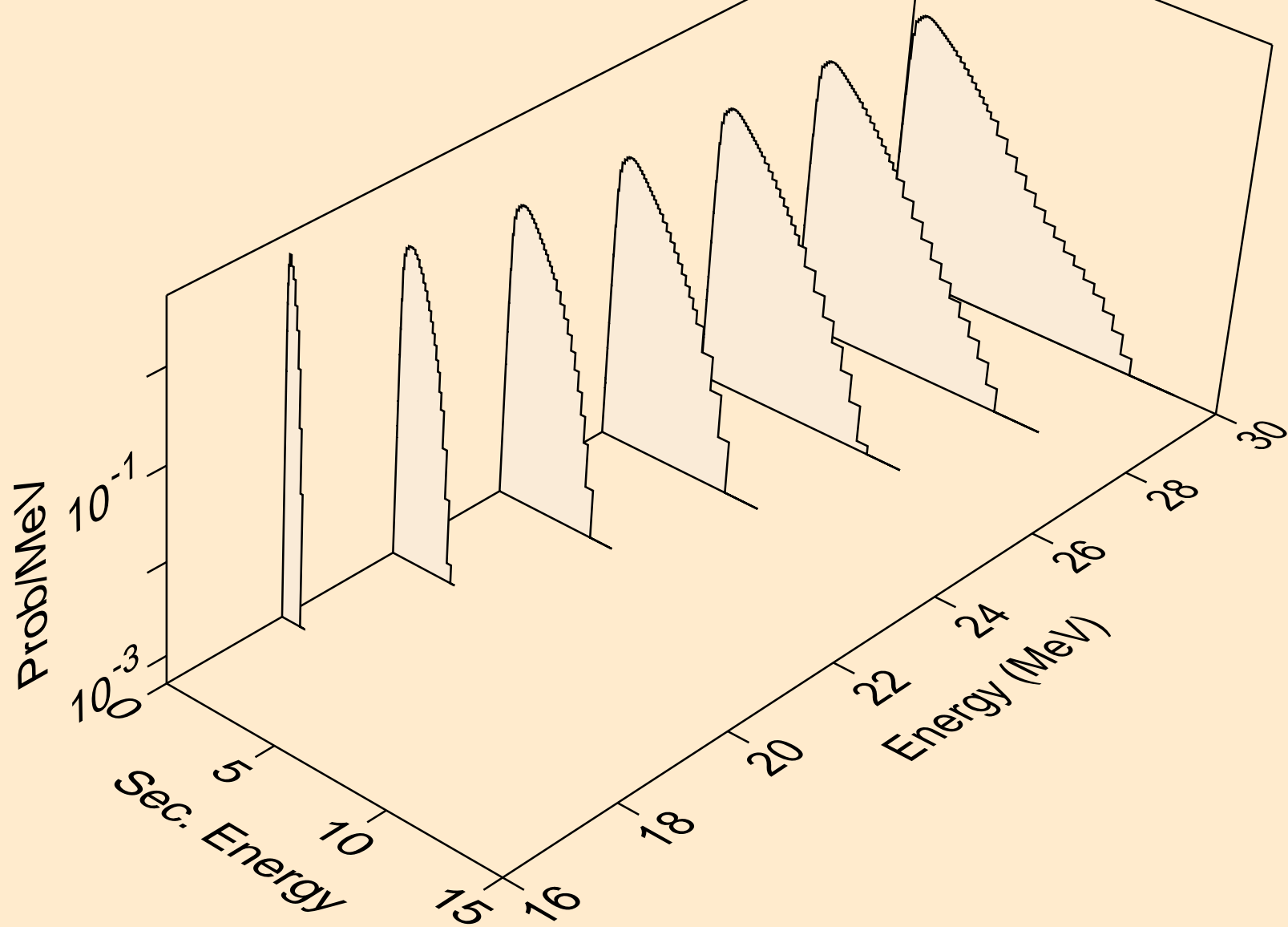

HG191 NEUTRON ACER TENDL-2023 LIBRARY; T=0.K
Neutron emission for (n,n*)a

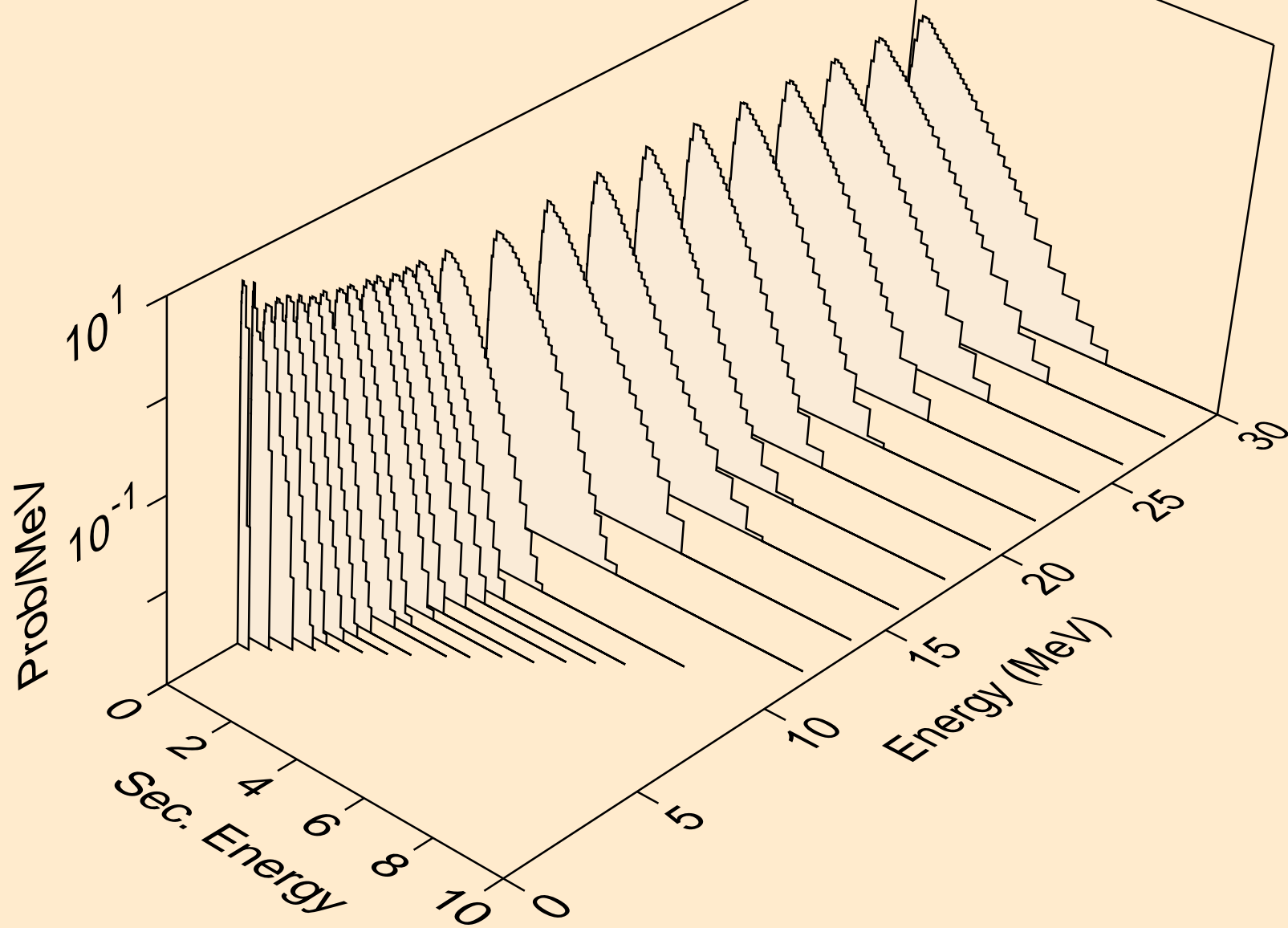

HG191 NEUTRON ACER TENDL-2023 LIBRARY; T=0.K
Neutron emission for (n,2n)a

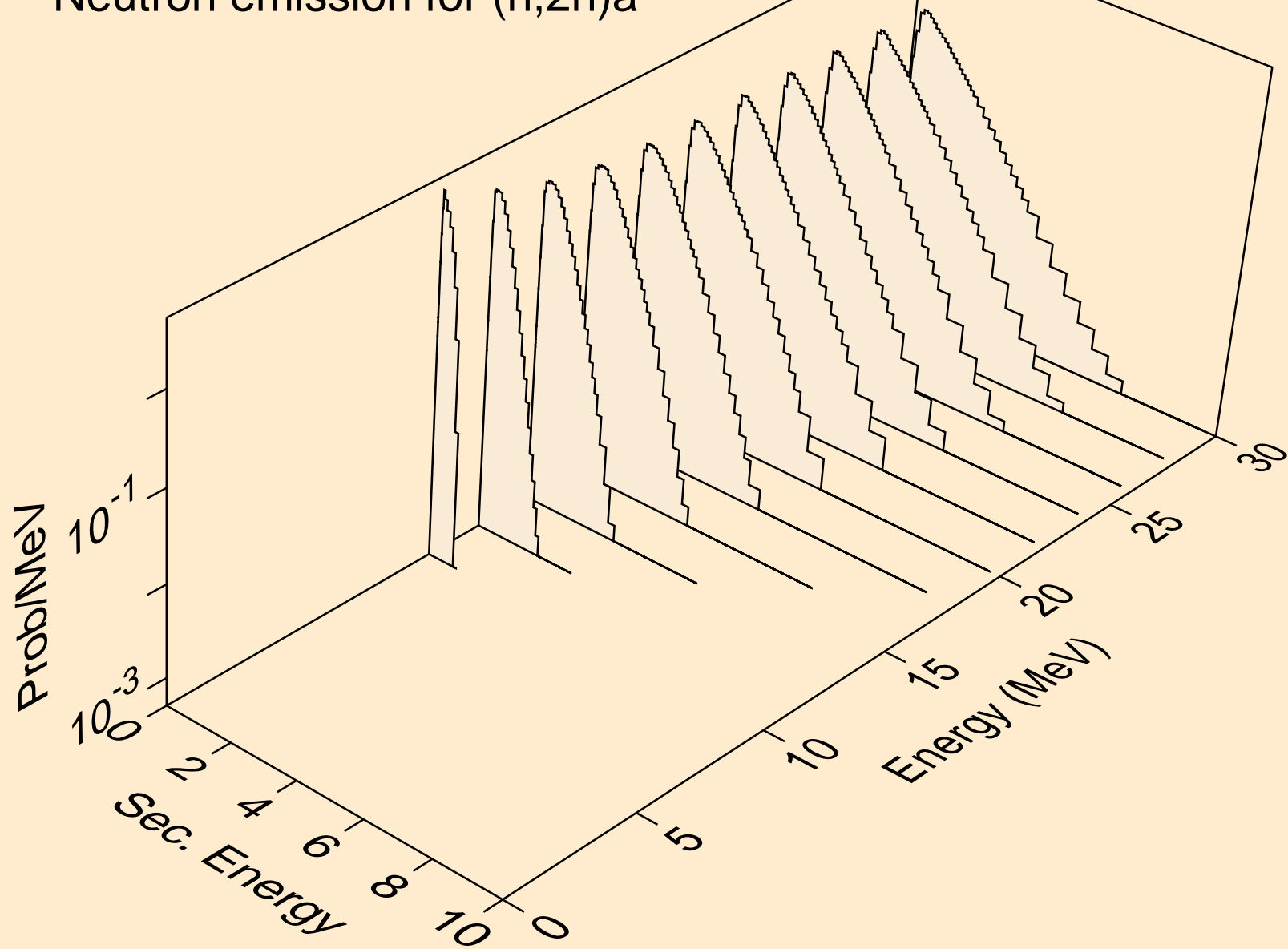

HG191 NEUTRON ACER TENDL-2023 LIBRARY; T=0.K
Neutron emission for (n,3n)a

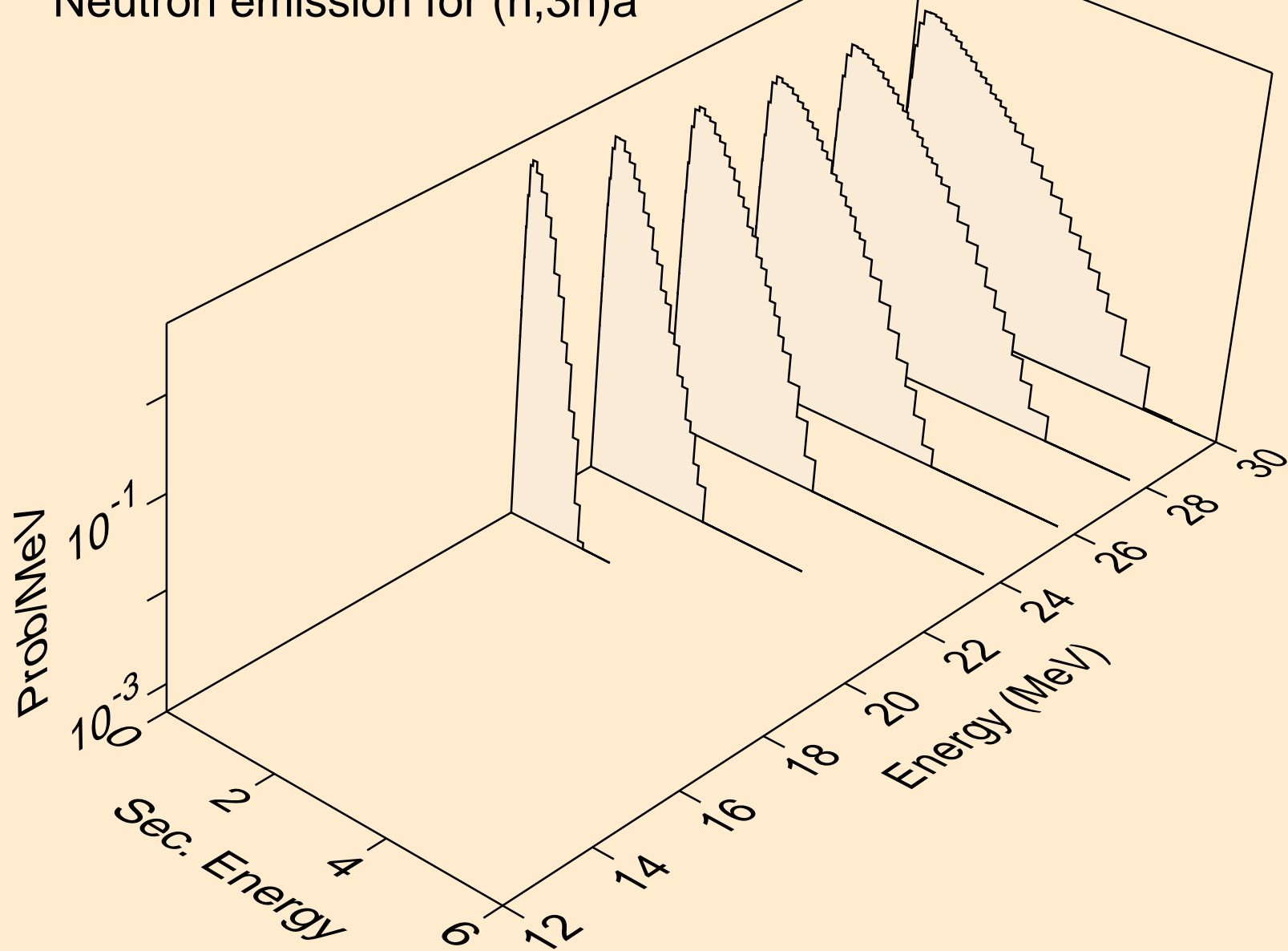

HG191 NEUTRON ACER TENDL-2023 LIBRARY; T=0.K
Neutron emission for (n,n*)p

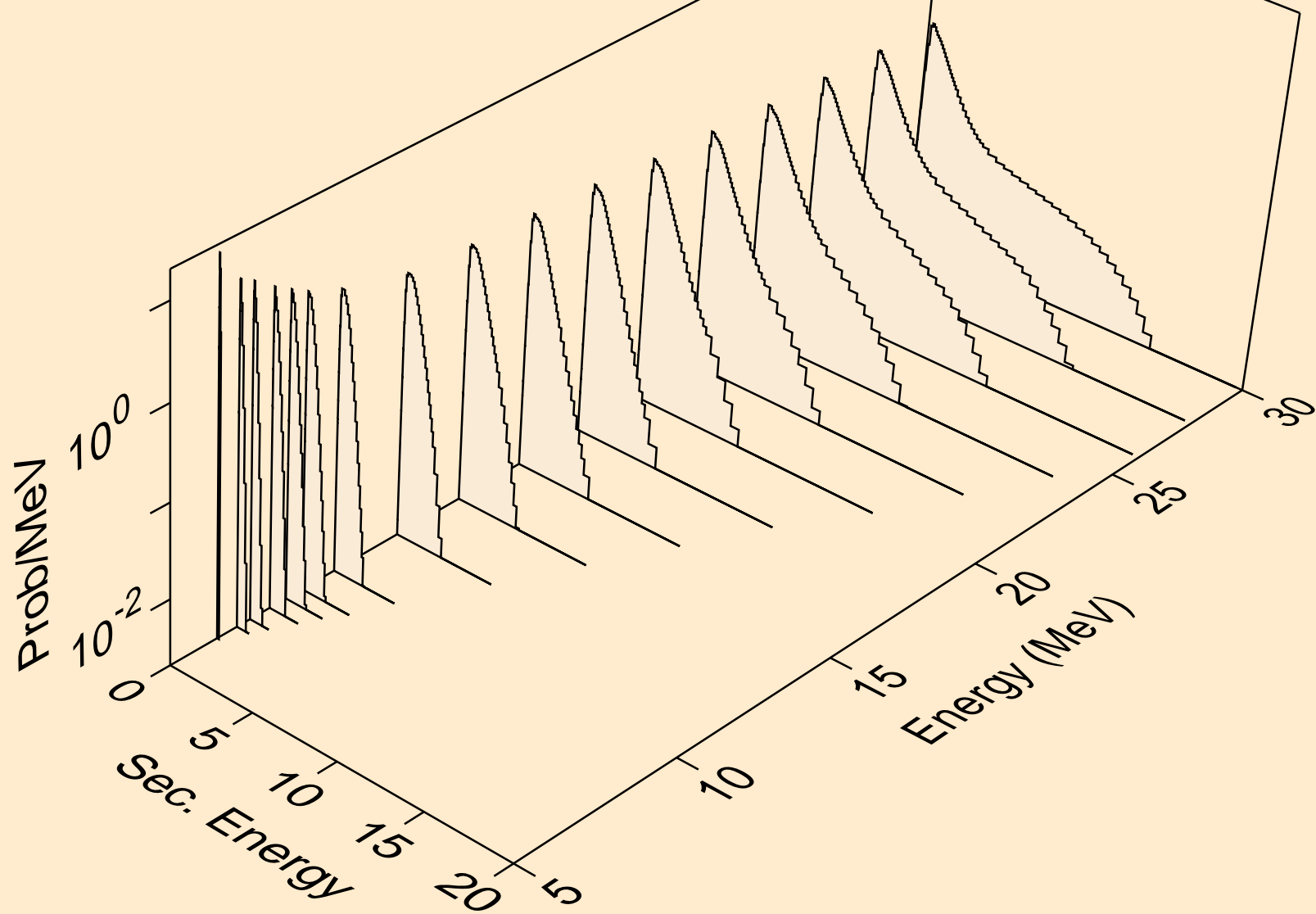

HG191 NEUTRON ACER TENDL-2023 LIBRARY; T=0.K
Neutron emission for (n,n*)2a

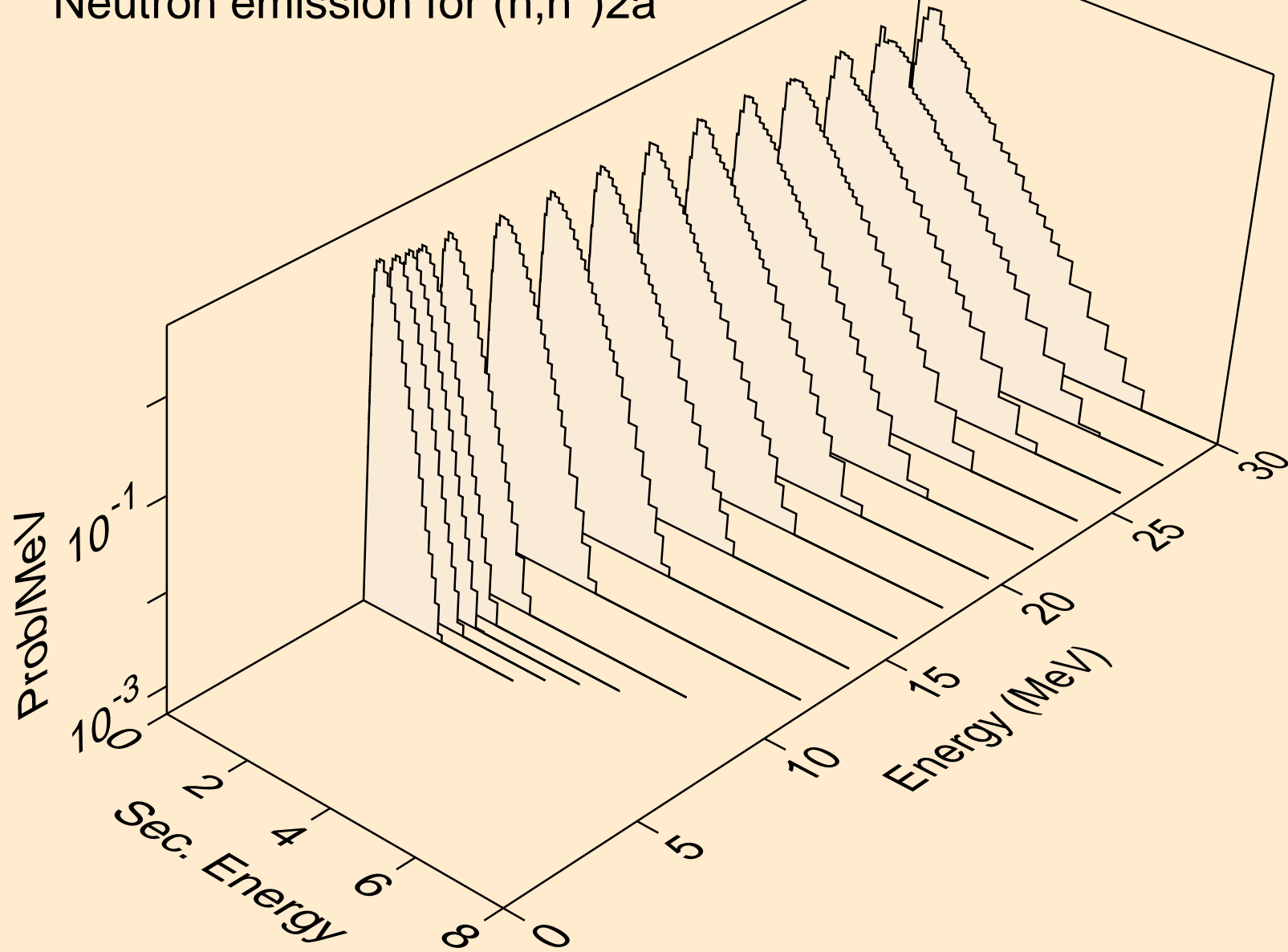

HG191 NEUTRON ACER TENDL-2023 LIBRARY; T=0.K
Neutron emission for (n,2n)2a

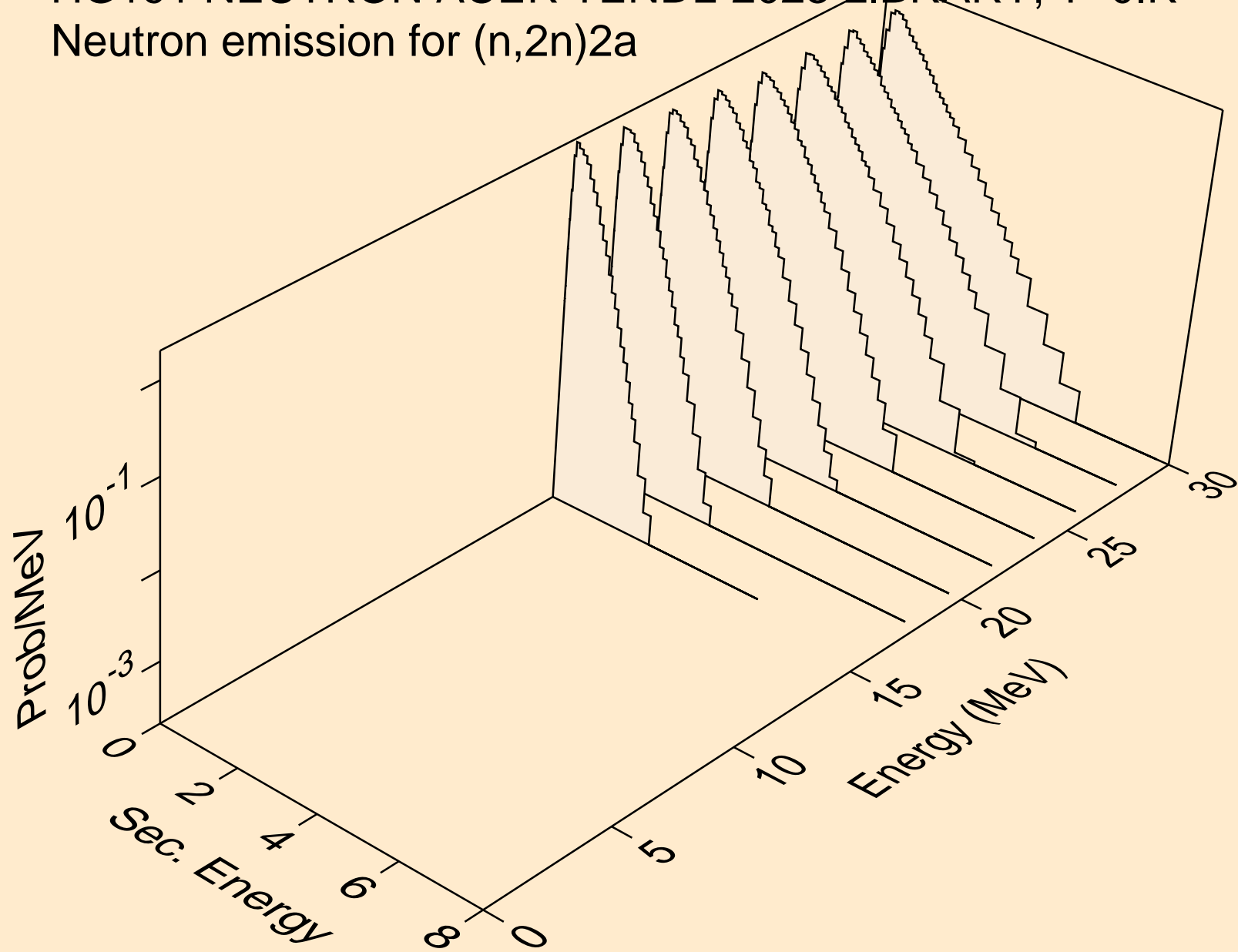

HG191 NEUTRON ACER TENDL-2023 LIBRARY; T=0.K
Neutron emission for (n,n*)d

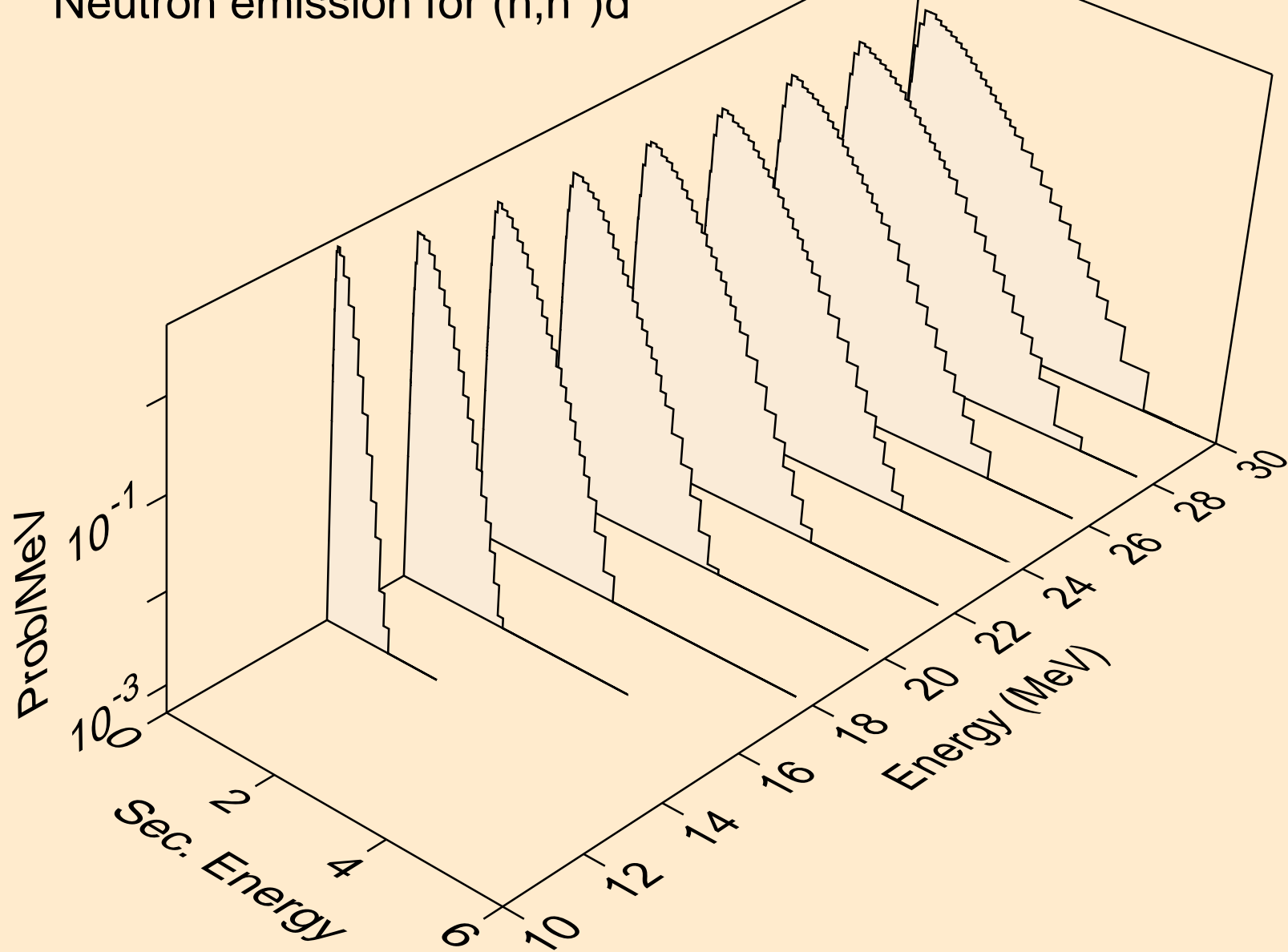

HG191 NEUTRON ACER TENDL-2023 LIBRARY; T=0.K
Neutron emission for (n,n*)t

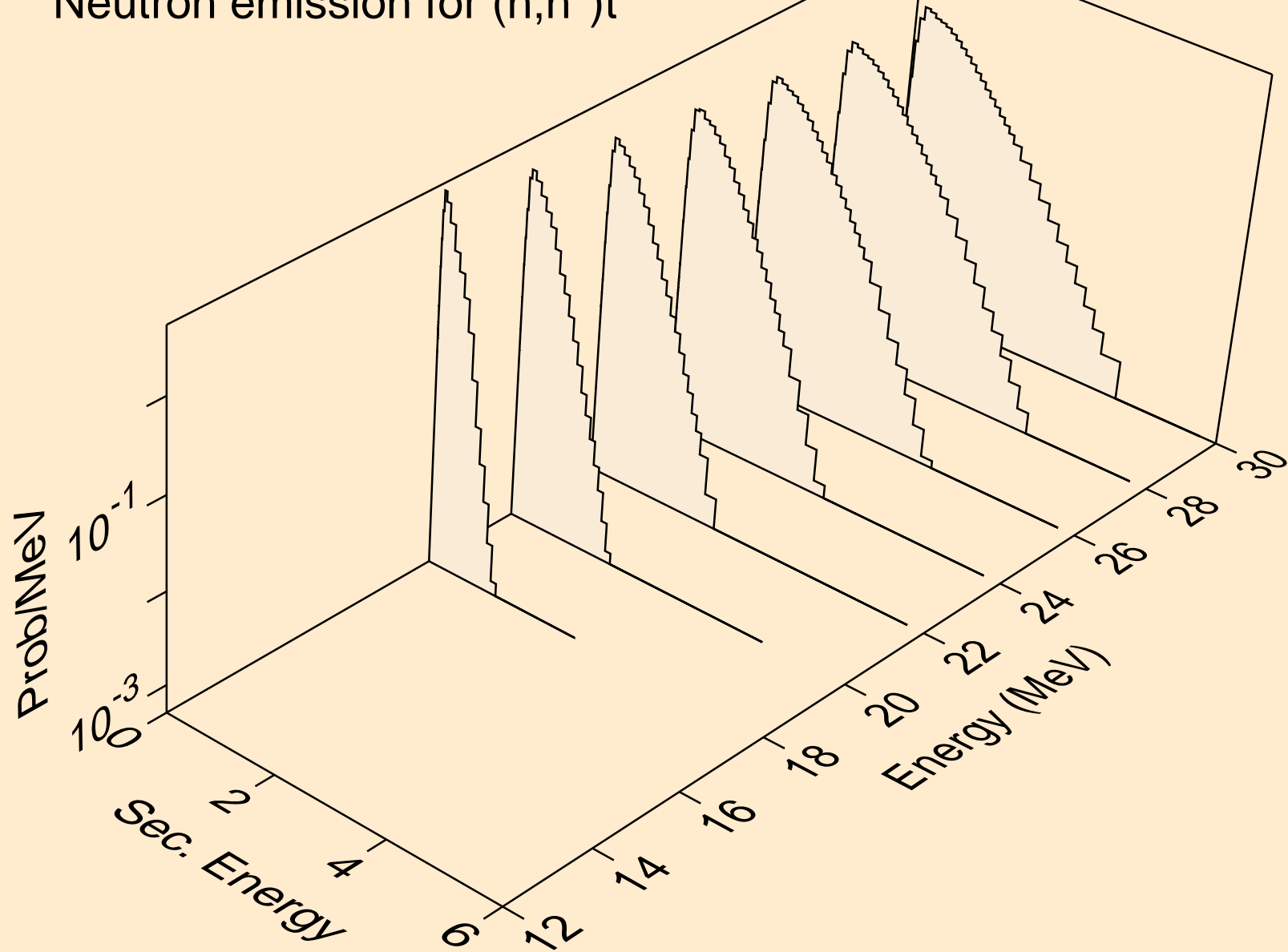

HG191 NEUTRON ACER TENDL-2023 LIBRARY; T=0.K
Neutron emission for (n,n*)he3

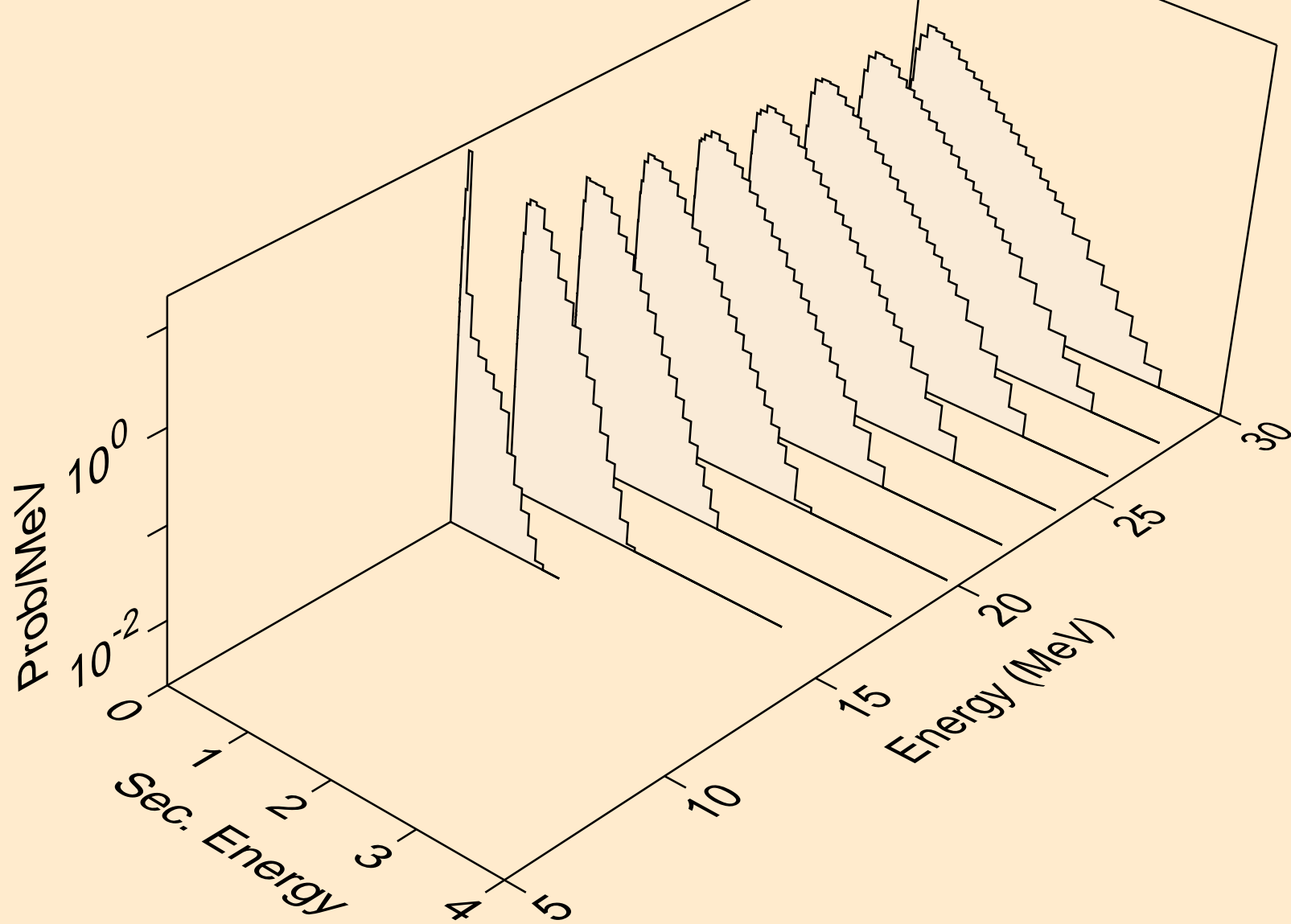

HG191 NEUTRON ACER TENDL-2023 LIBRARY; T=0.K
Neutron emission for (n,4n)

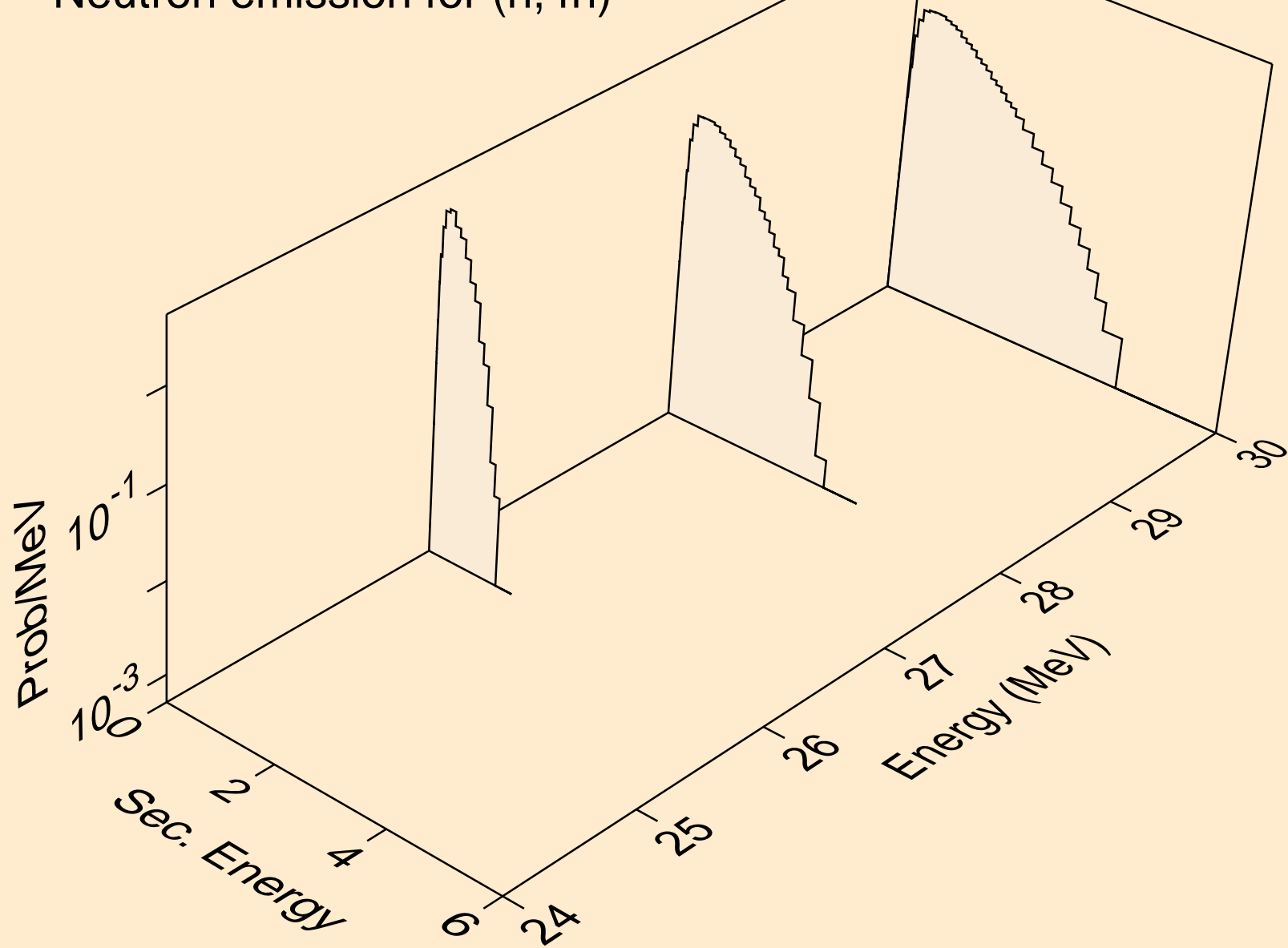

HG191 NEUTRON ACER TENDL-2023 LIBRARY; T=0.K
Neutron emission for (n,2np)

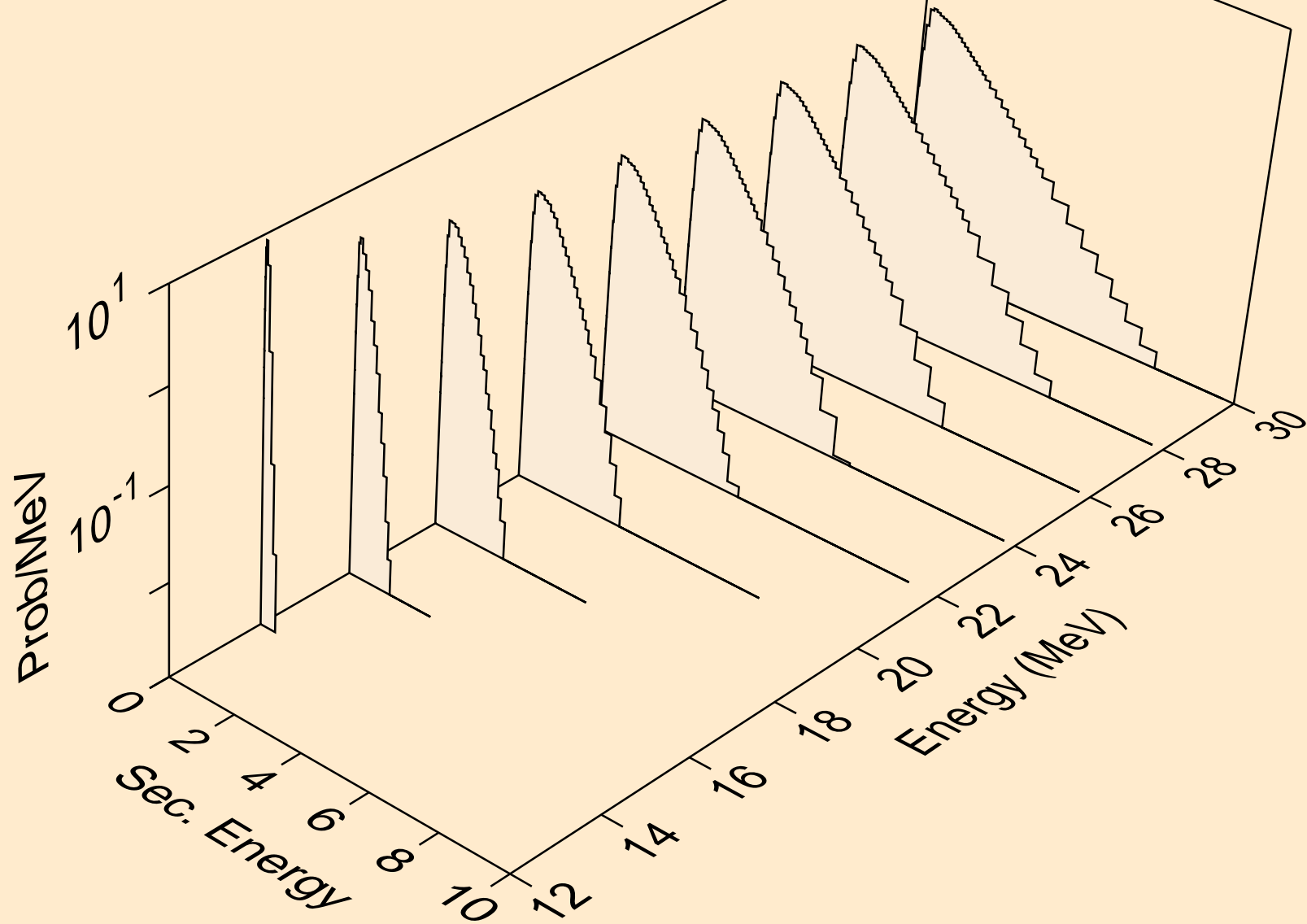

HG191 NEUTRON ACER TENDL-2023 LIBRARY; T=0.K
Neutron emission for (n,3np)

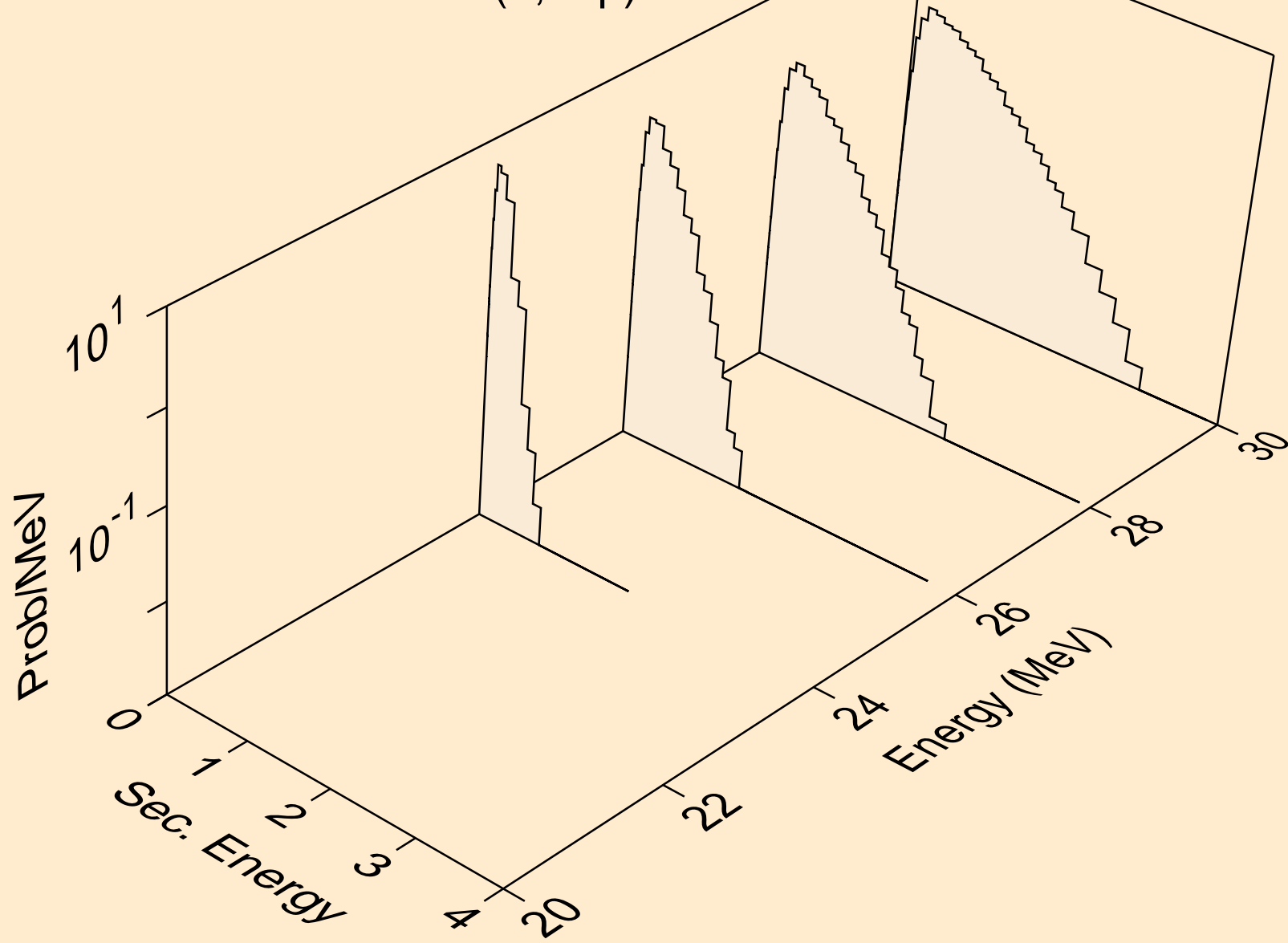

HG191 NEUTRON ACER TENDL-2023 LIBRARY; T=0.K
Neutron emission for (n,n2p)

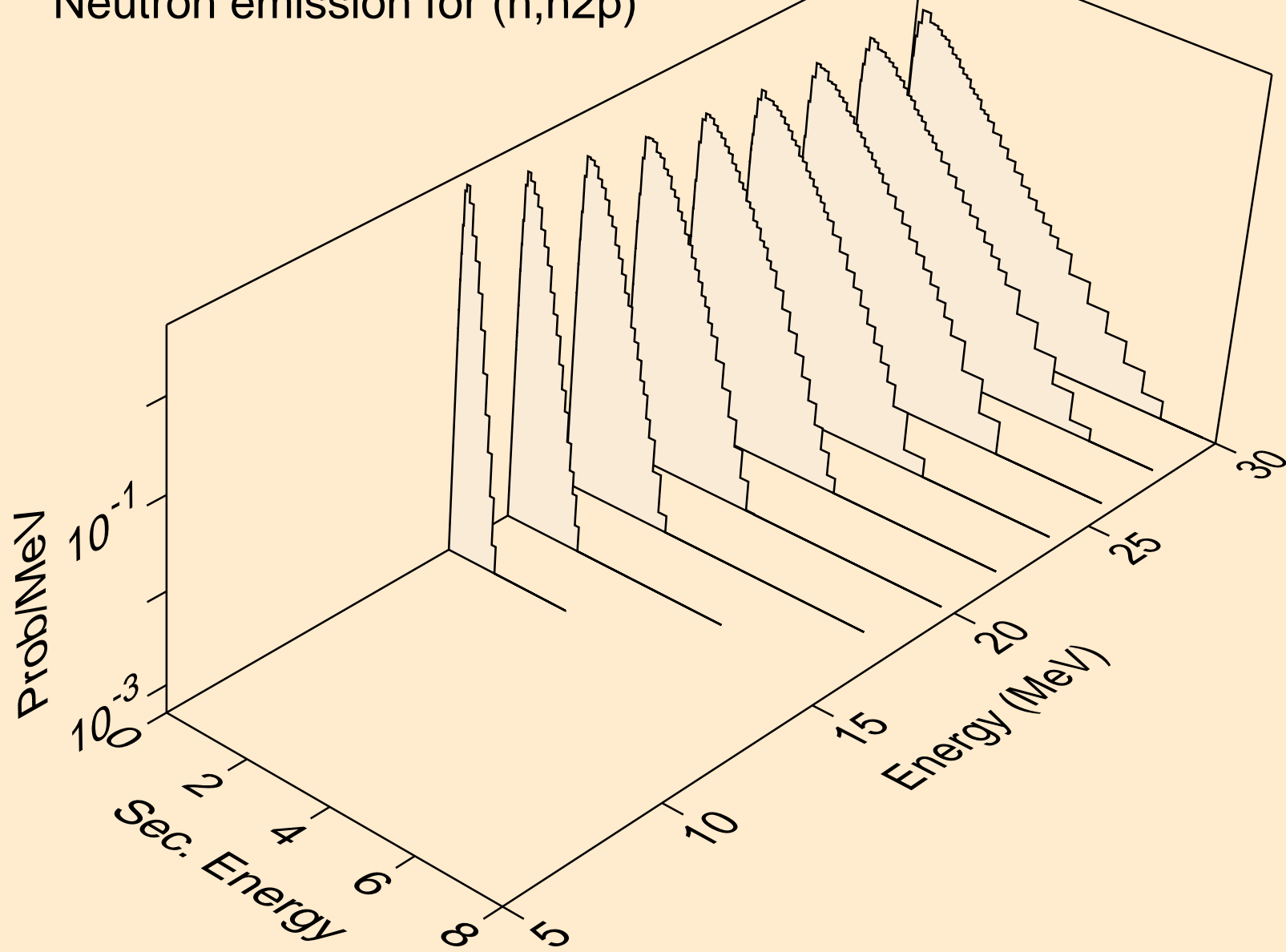

HG191 NEUTRON ACER TENDL-2023 LIBRARY; T=0.K
Neutron emission for (n,npa)

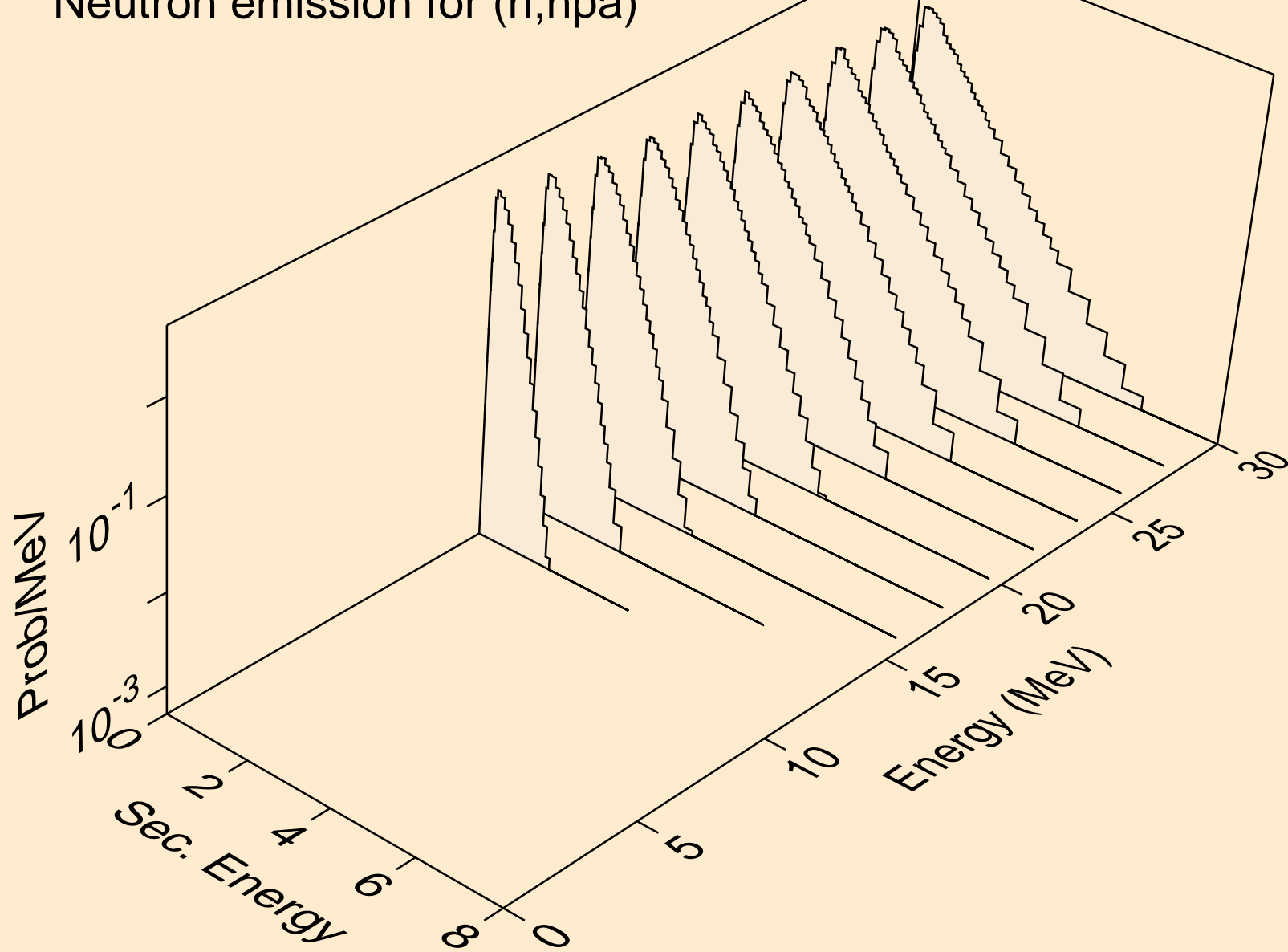

HG191 NEUTRON ACER TENDL-2023 LIBRARY; T=0.K
Neutron emission for (n,n*c)

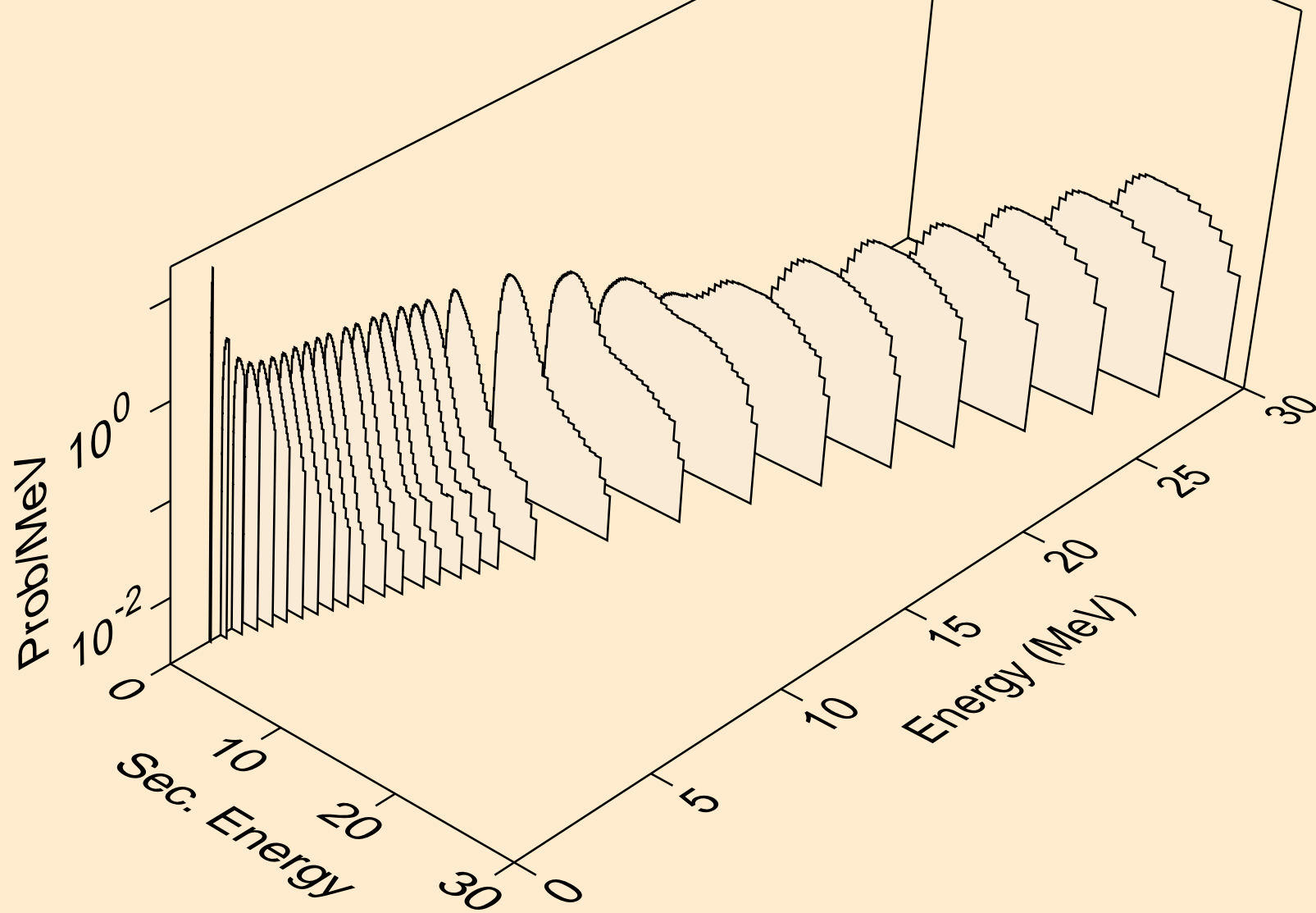

HG191 NEUTRON ACER TENDL-2023 LIBRARY; T=0.K
Photon emission for (n,x)

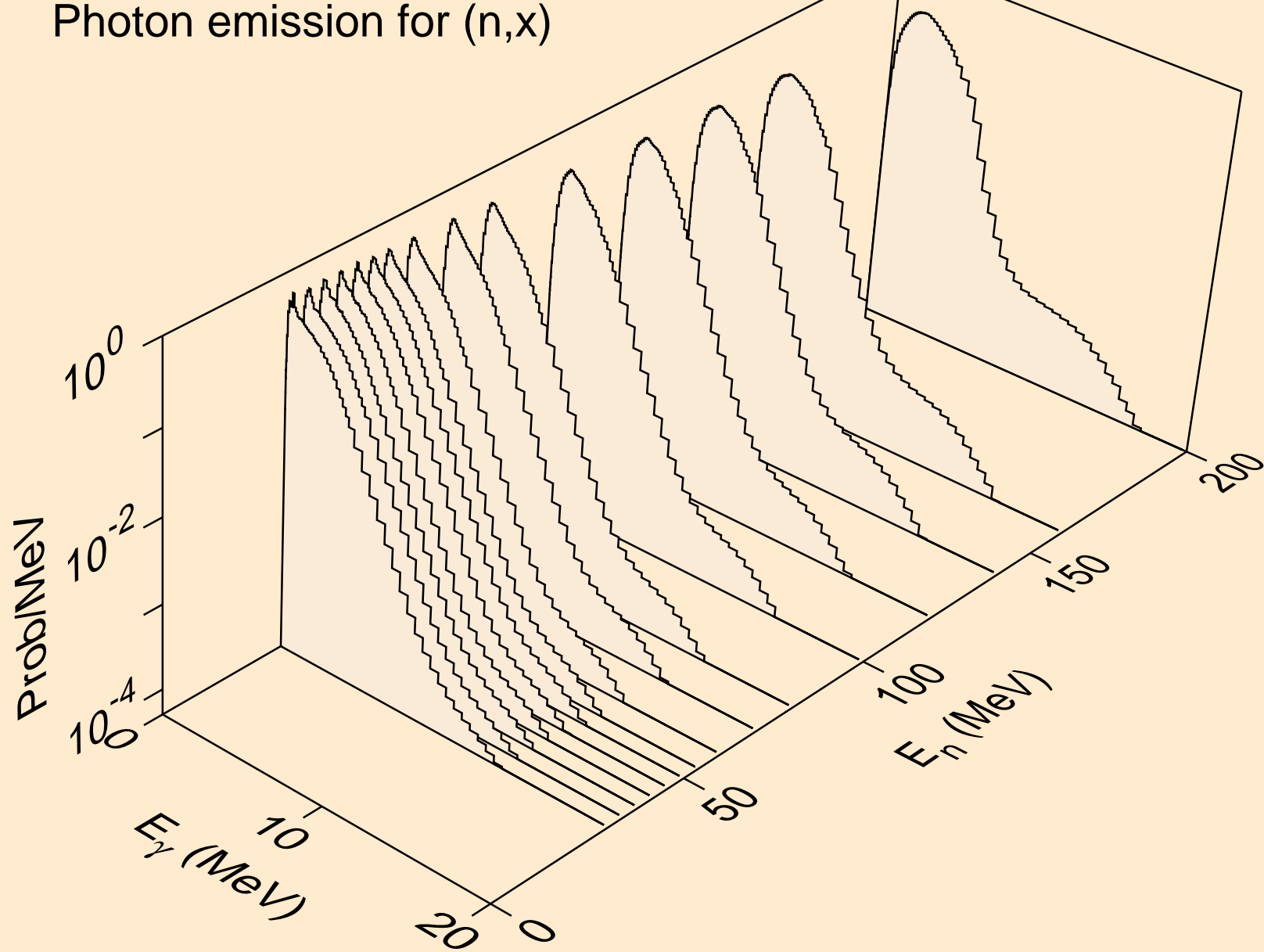

HG191 NEUTRON ACER TENDL-2023 LIBRARY; T=0.K
Photon emission for (n,2nd)

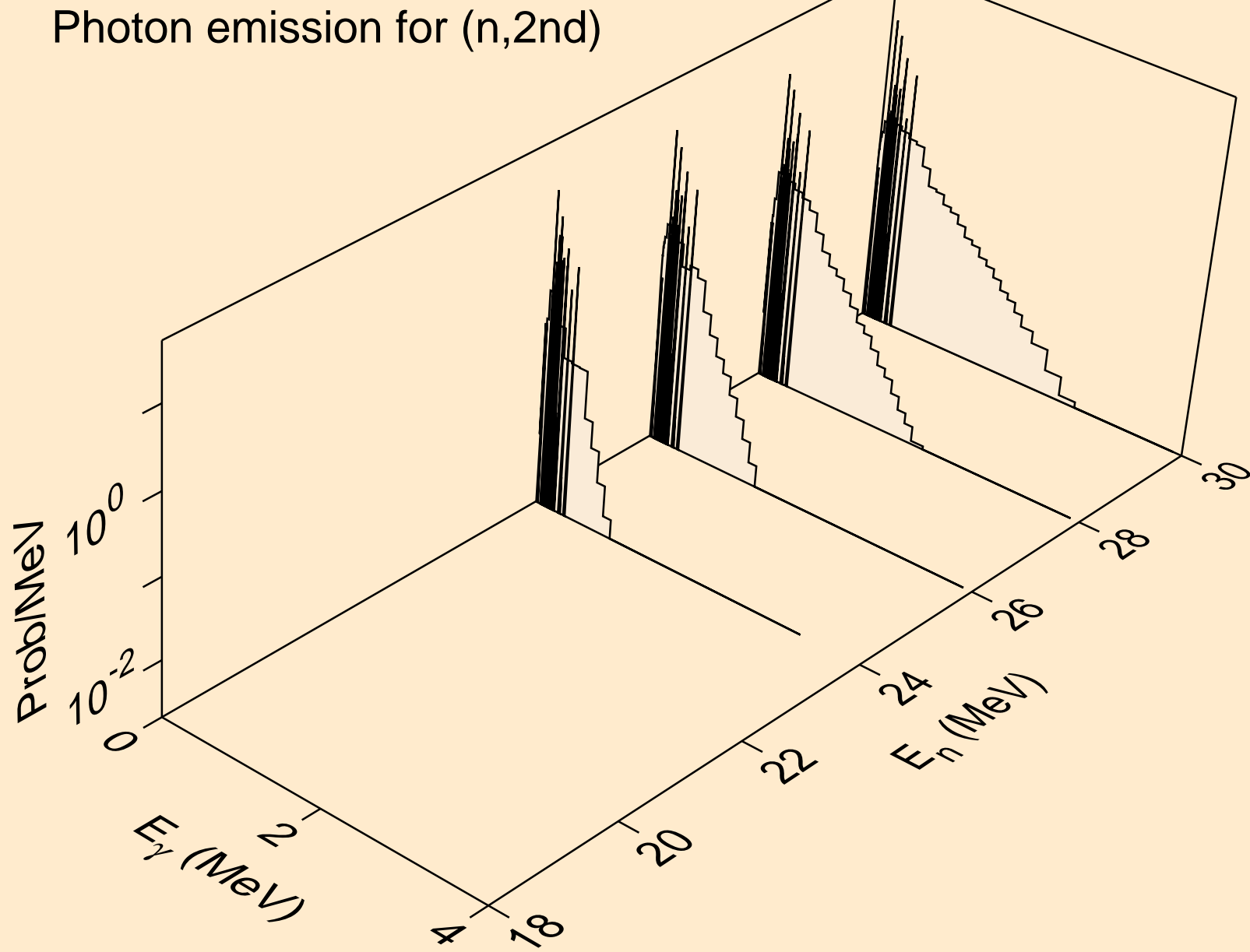

HG191 NEUTRON ACER TENDL-2023 LIBRARY; T=0.K
Photon emission for (n,2n)

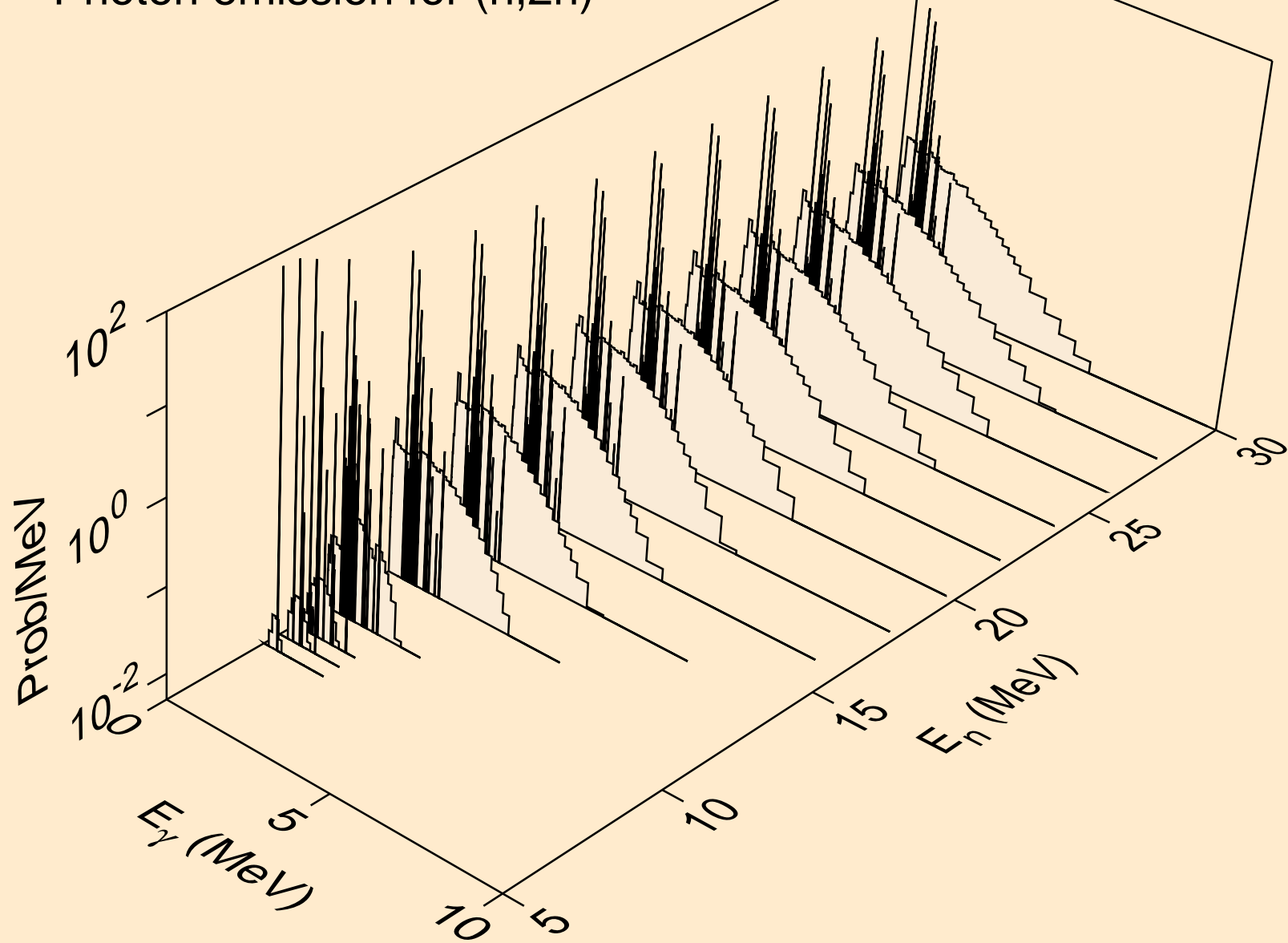

HG191 NEUTRON ACER TENDL-2023 LIBRARY; T=0.K
Photon emission for (n,3n)

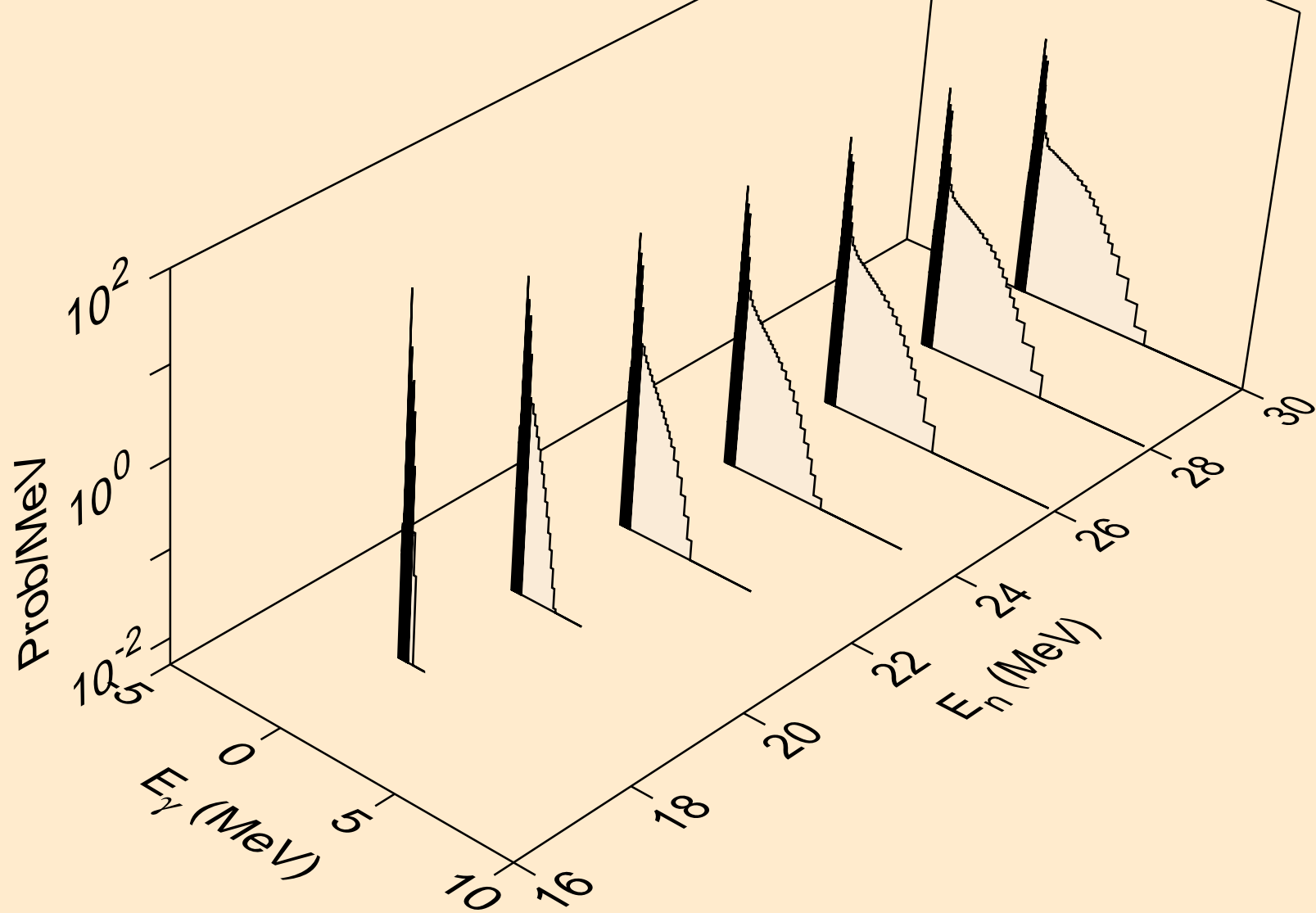

HG191 NEUTRON ACER TENDL-2023 LIBRARY; T=0.K
Photon emission for (n,n*)a

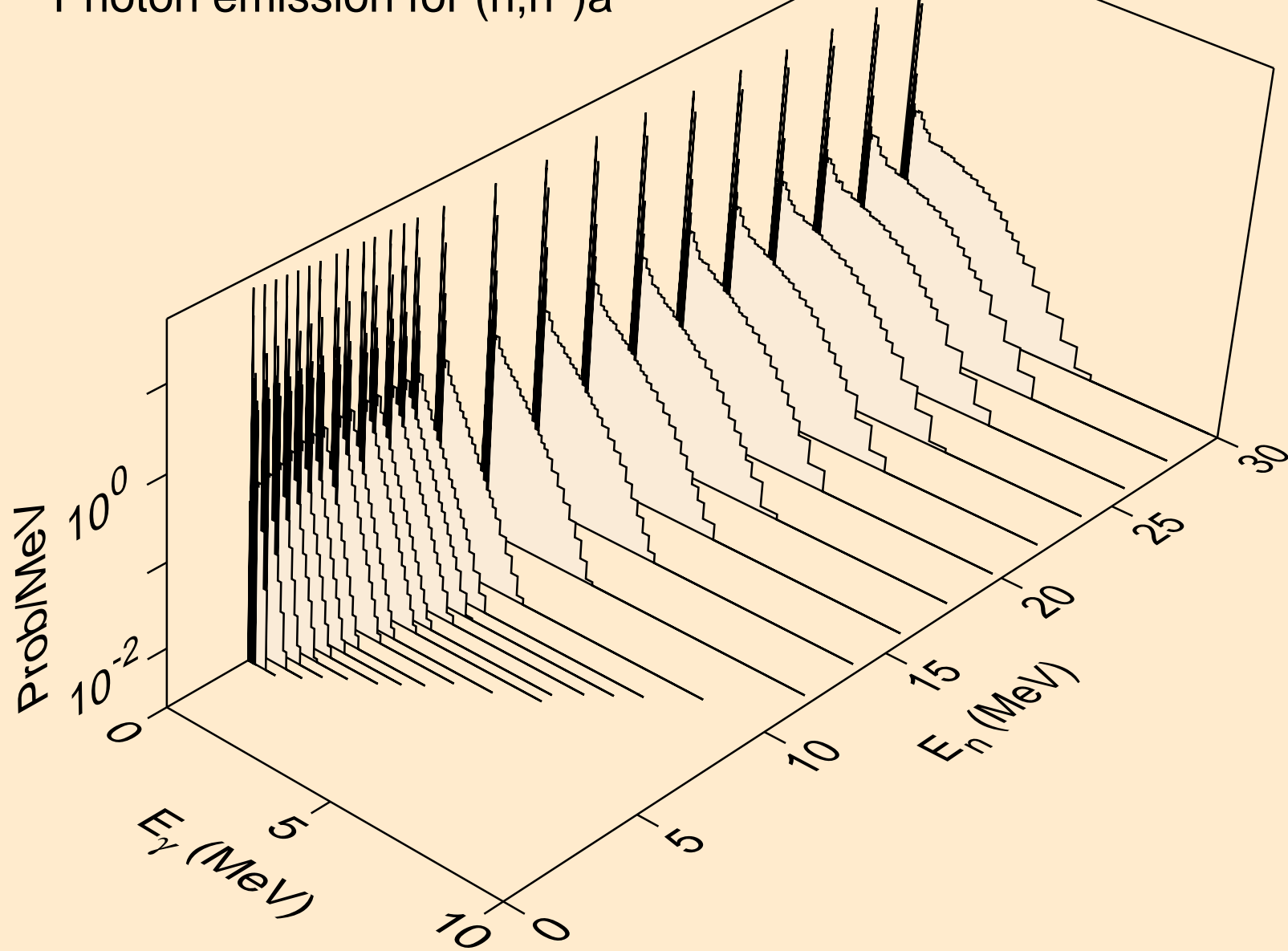

HG191 NEUTRON ACER TENDL-2023 LIBRARY; T=0.K
Photon emission for (n,2n)a

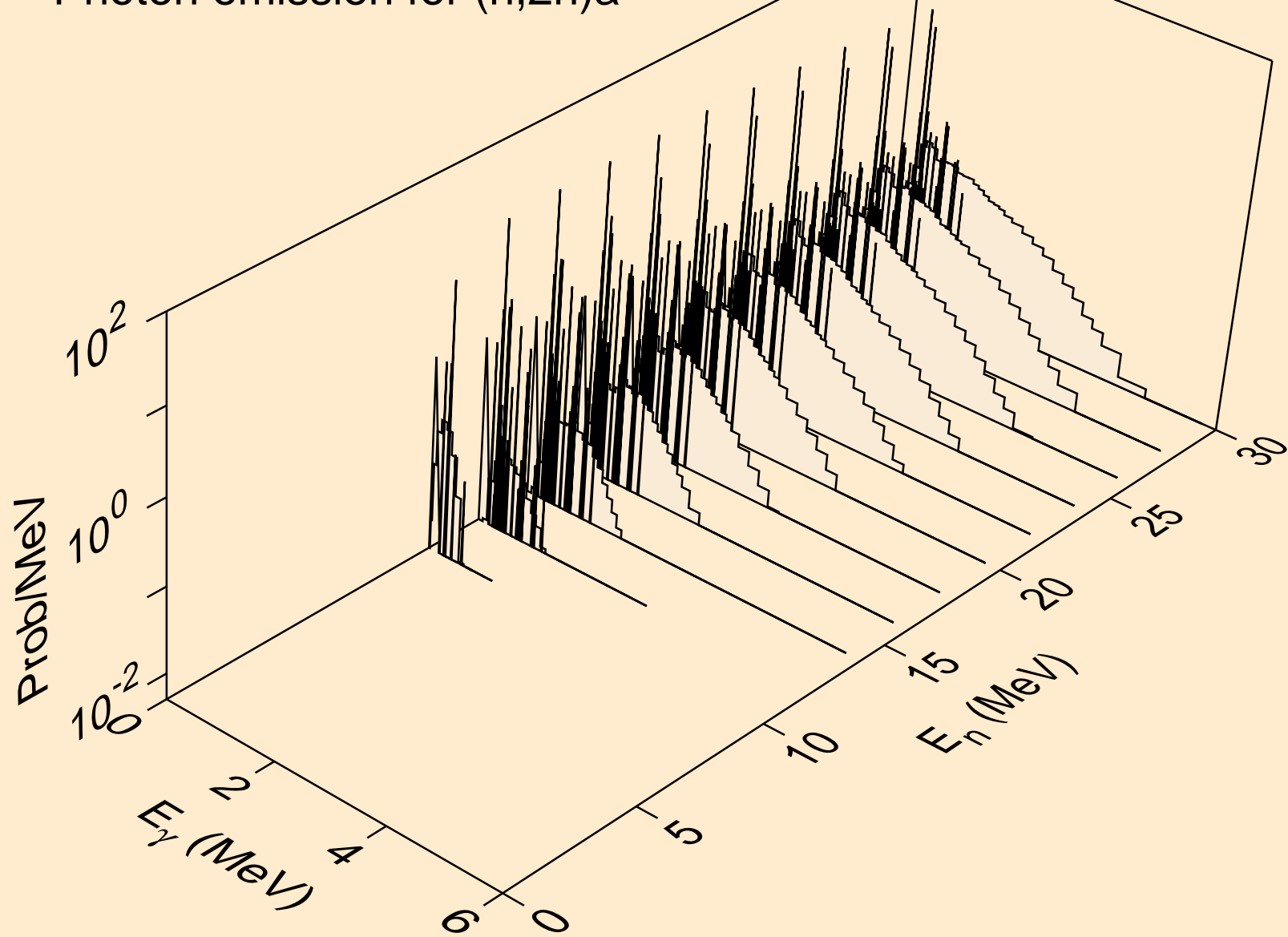

HG191 NEUTRON ACER TENDL-2023 LIBRARY; T=0.K
Photon emission for (n,3n)a

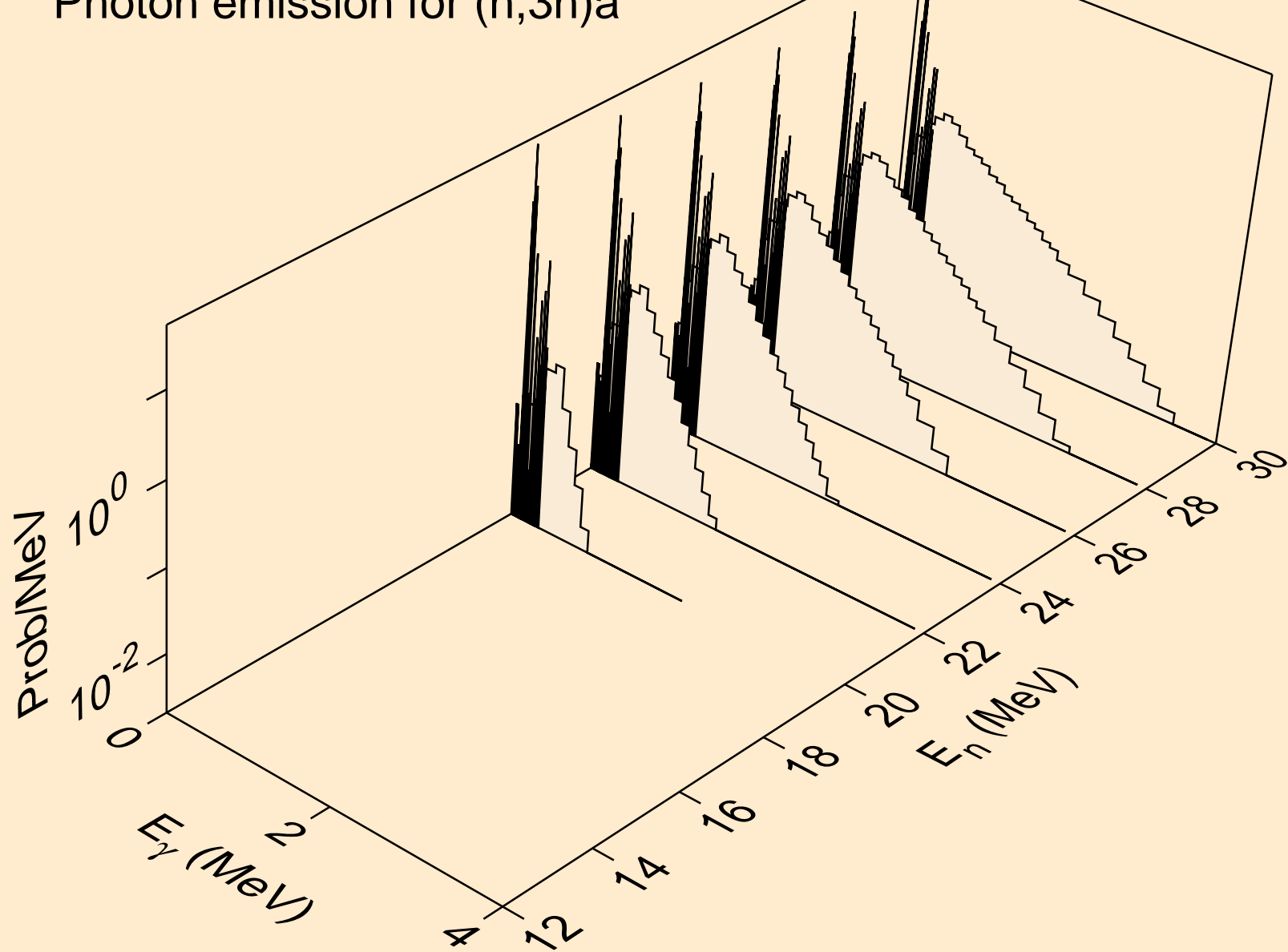

HG191 NEUTRON ACER TENDL-2023 LIBRARY; T=0.K
Photon emission for (n,n*)p

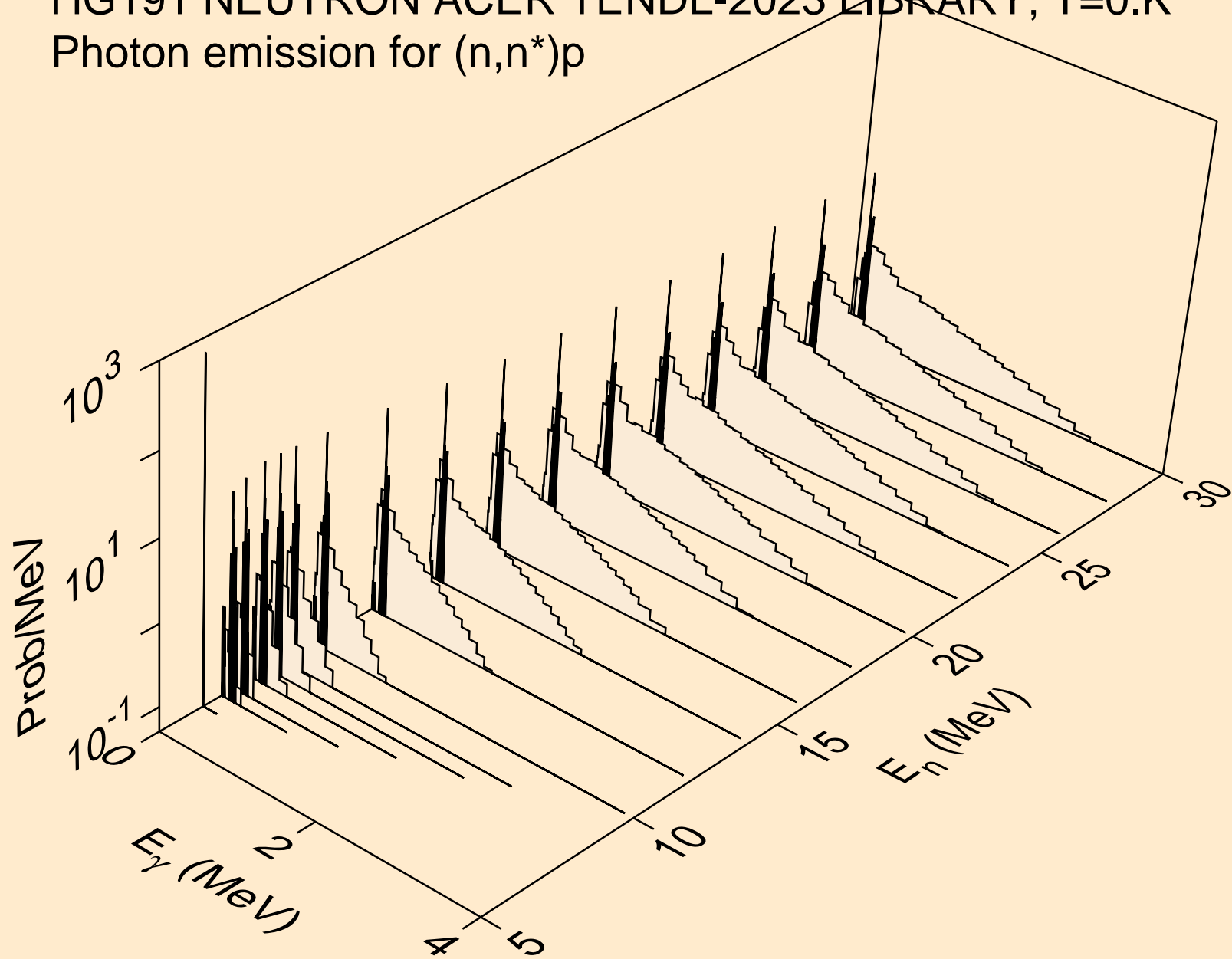

HG191 NEUTRON ACER TENDL-2023 LIBRARY; T=0.K
Photon emission for (n,n*)2a

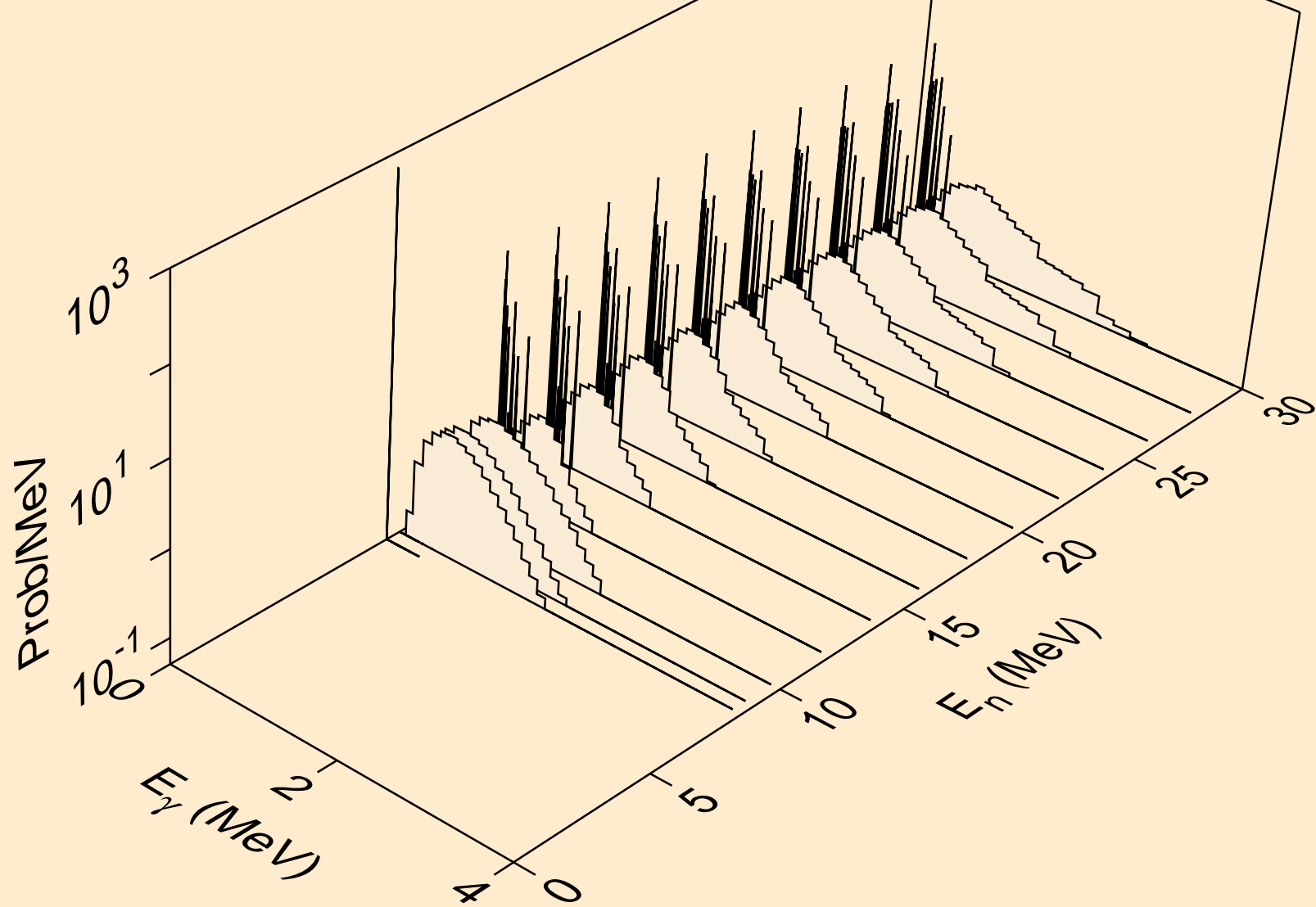

HG191 NEUTRON ACER TENDL-2023 LIBRARY; T=0.K
Photon emission for (n,2n)2a

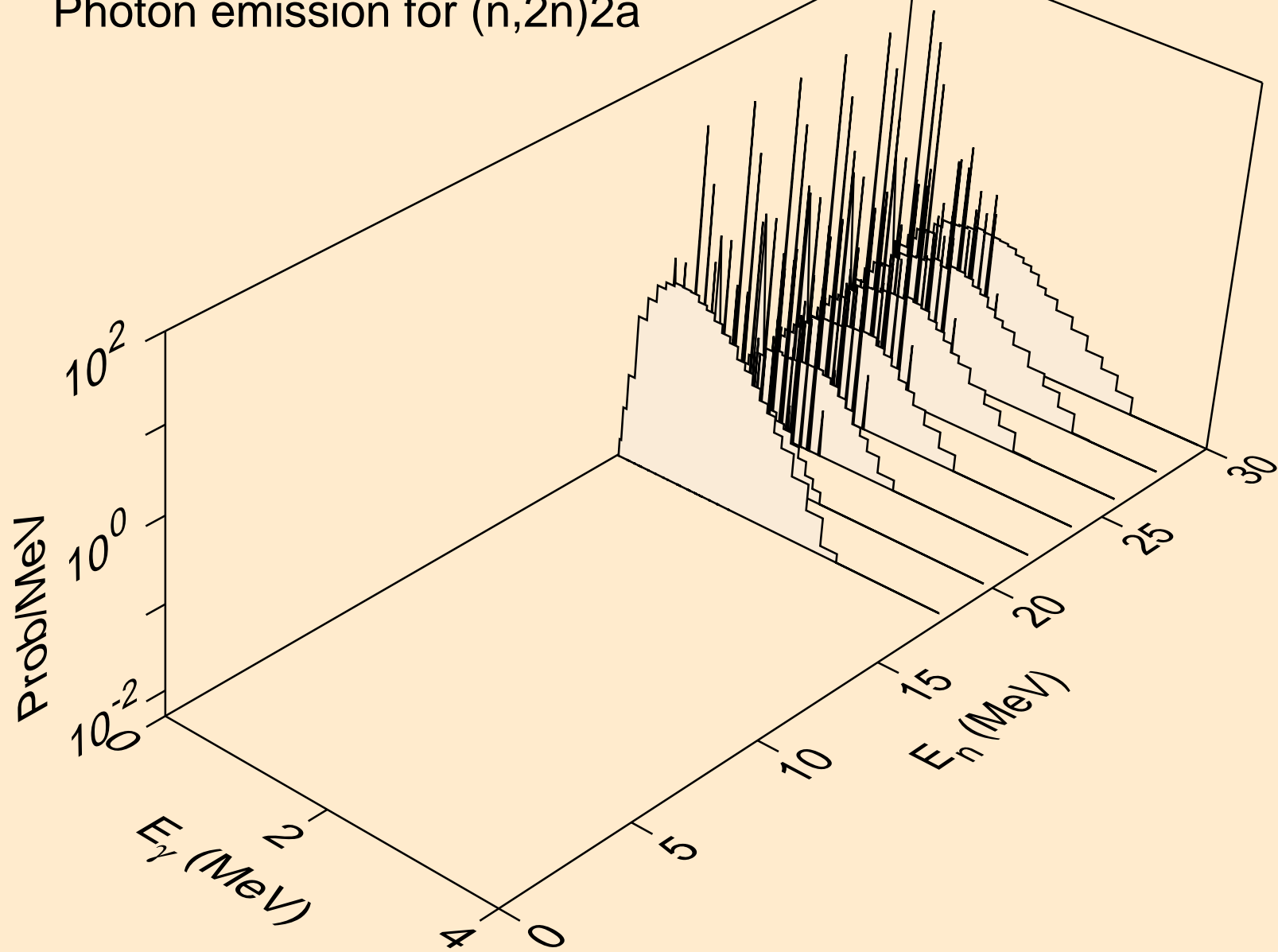

HG191 NEUTRON ACER TENDL-2023 LIBRARY; T=0.K
Photon emission for (n,n*)d

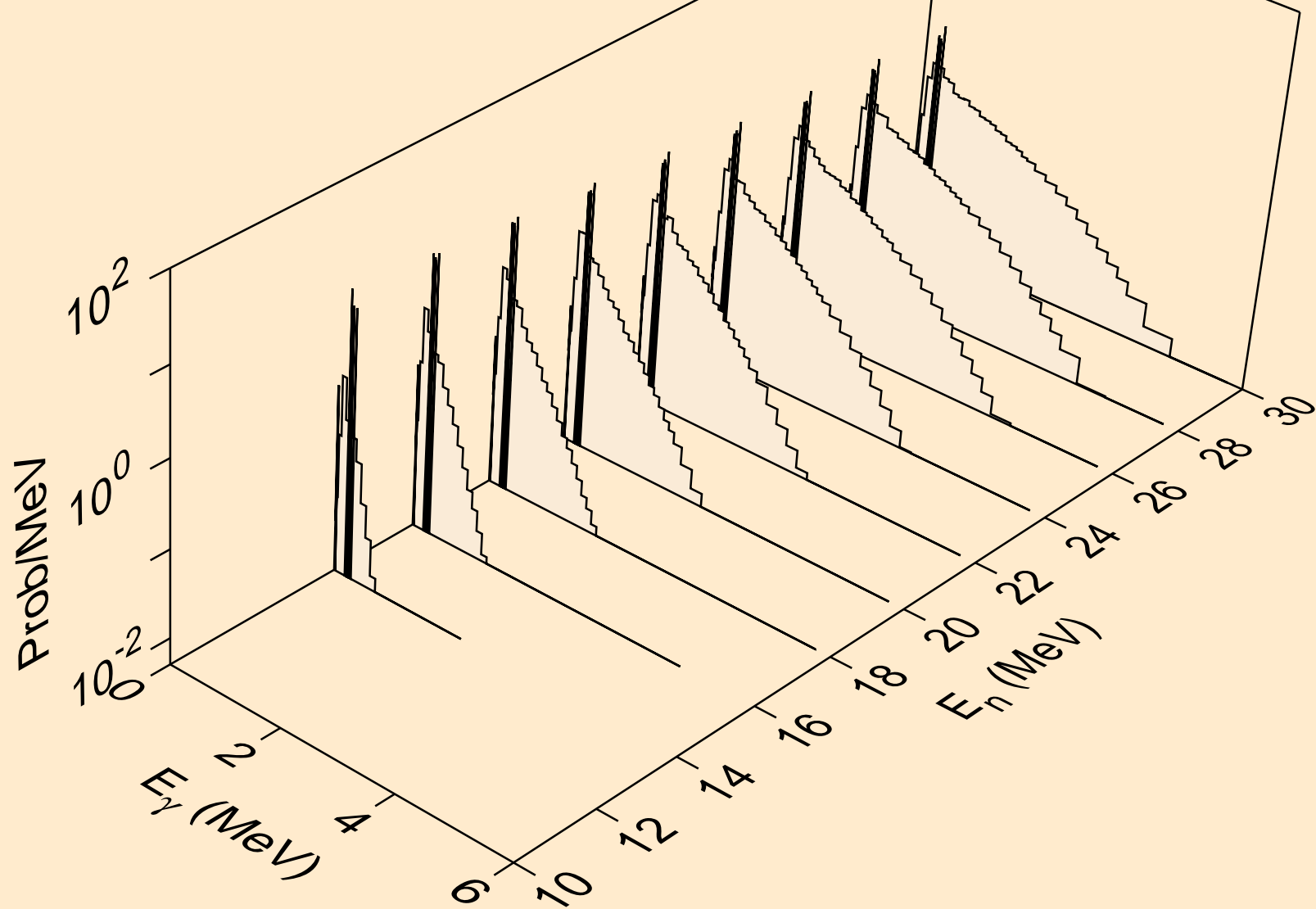

HG191 NEUTRON ACER TENDL-2023 LIBRARY; T=0.K
Photon emission for (n,n*)t

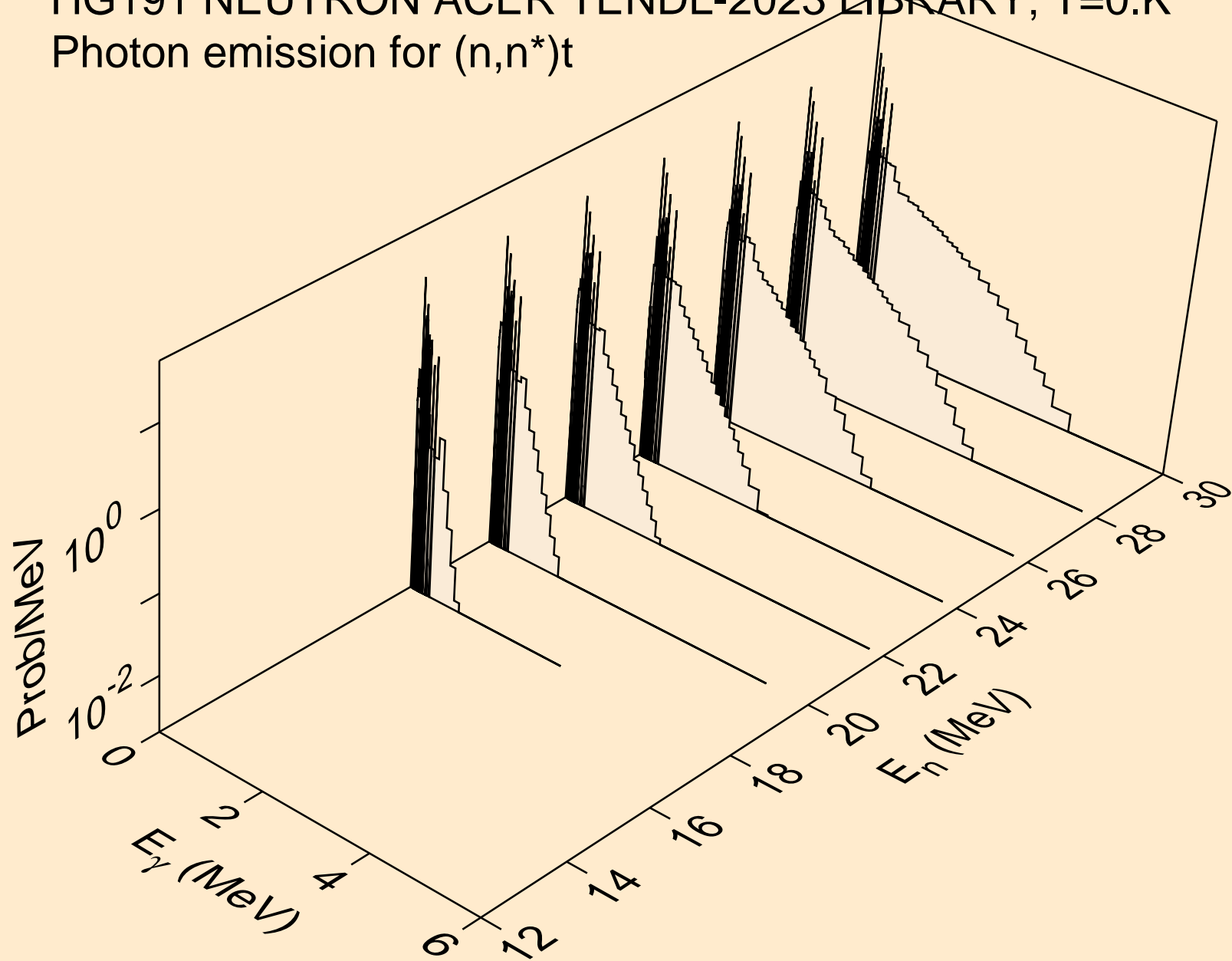

HG191 NEUTRON ACER TENDL-2023 LIBRARY; T=0.K
Photon emission for (n,n*)he3

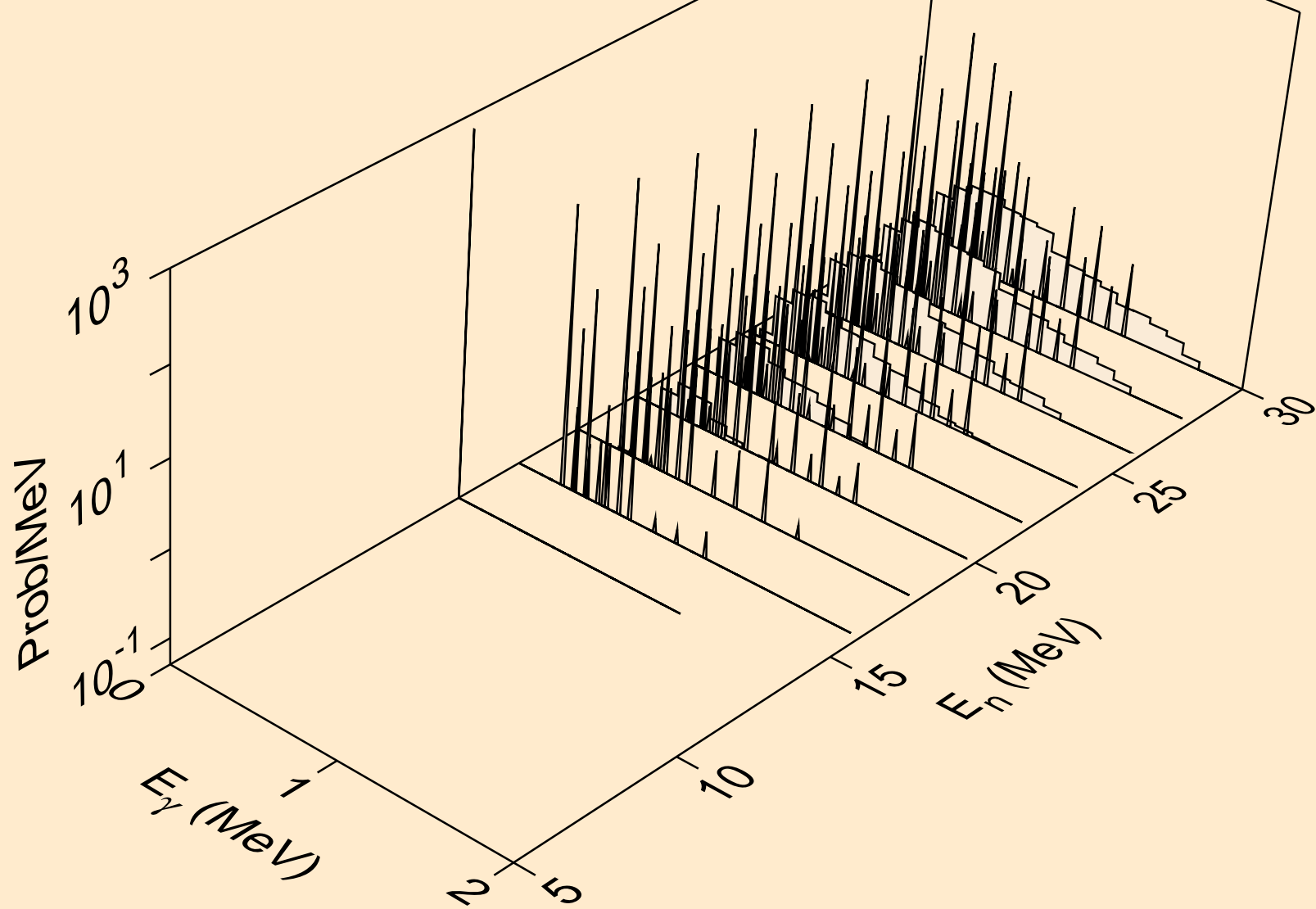

HG191 NEUTRON ACER TENDL-2023 LIBRARY; T=0.K
Photon emission for (n,4n)

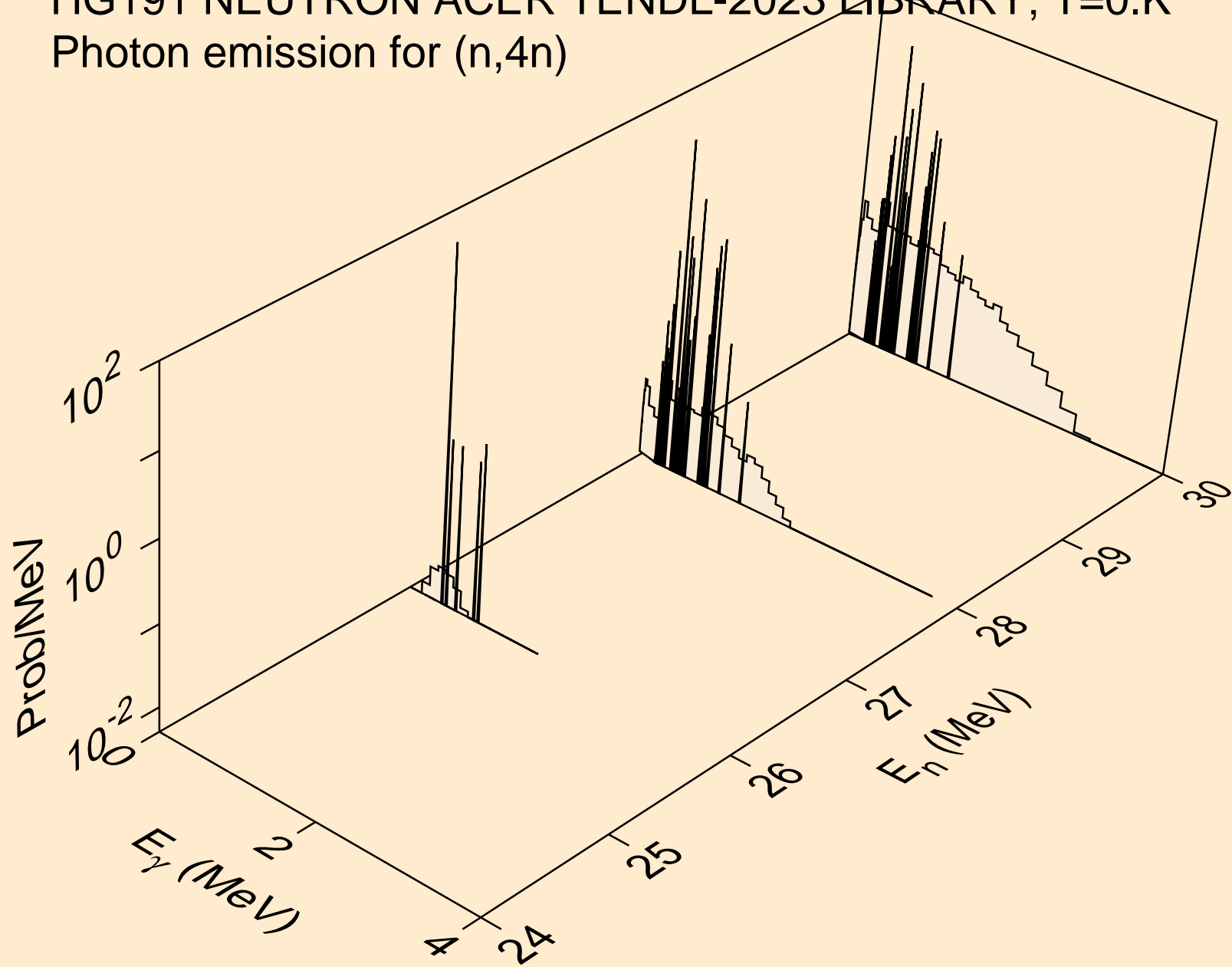

HG191 NEUTRON ACER TENDL-2023 LIBRARY; T=0.K
Photon emission for (n,2np)

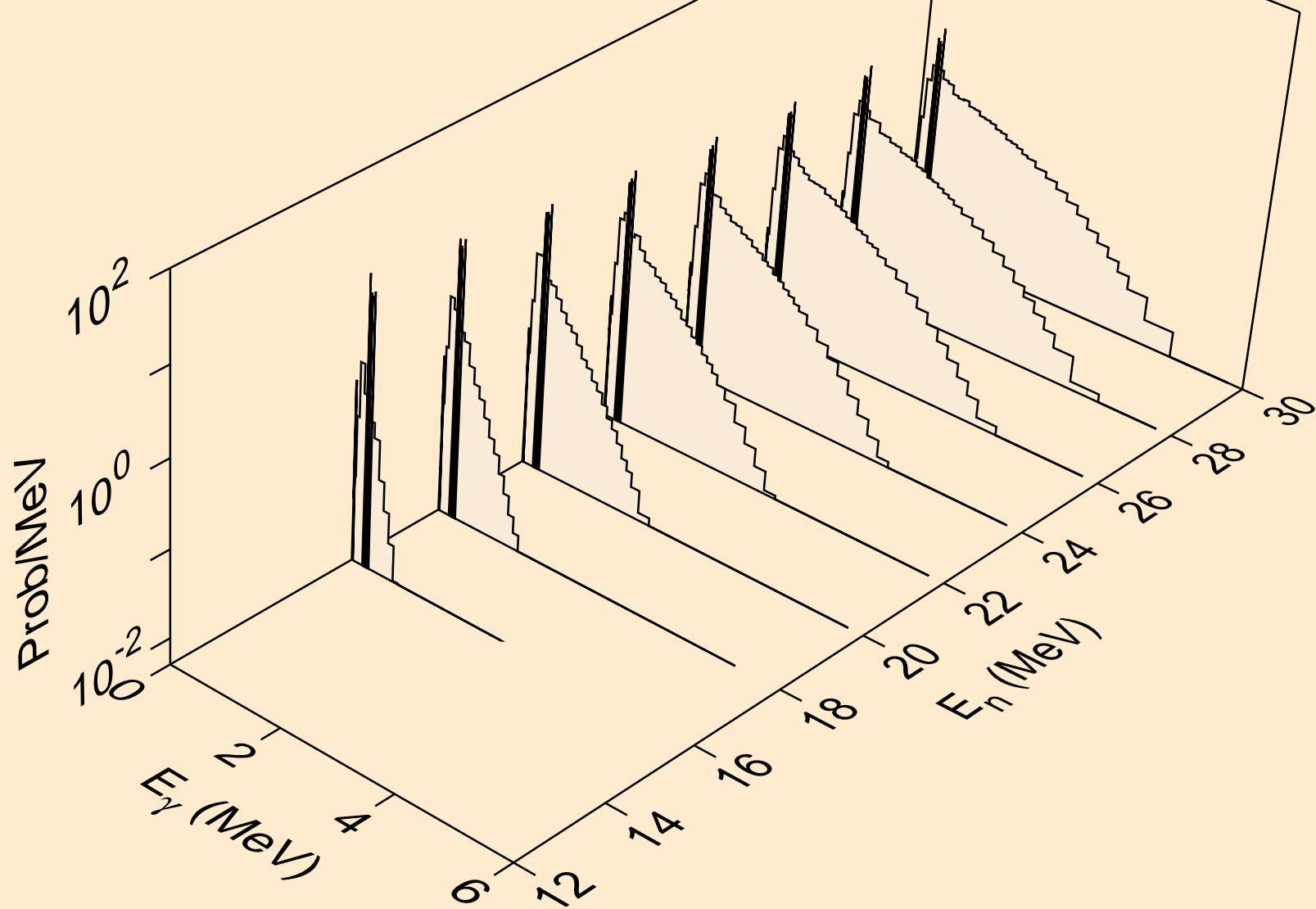

HG191 NEUTRON ACER TENDL-2023 LIBRARY; T=0.K
Photon emission for (n,3np)

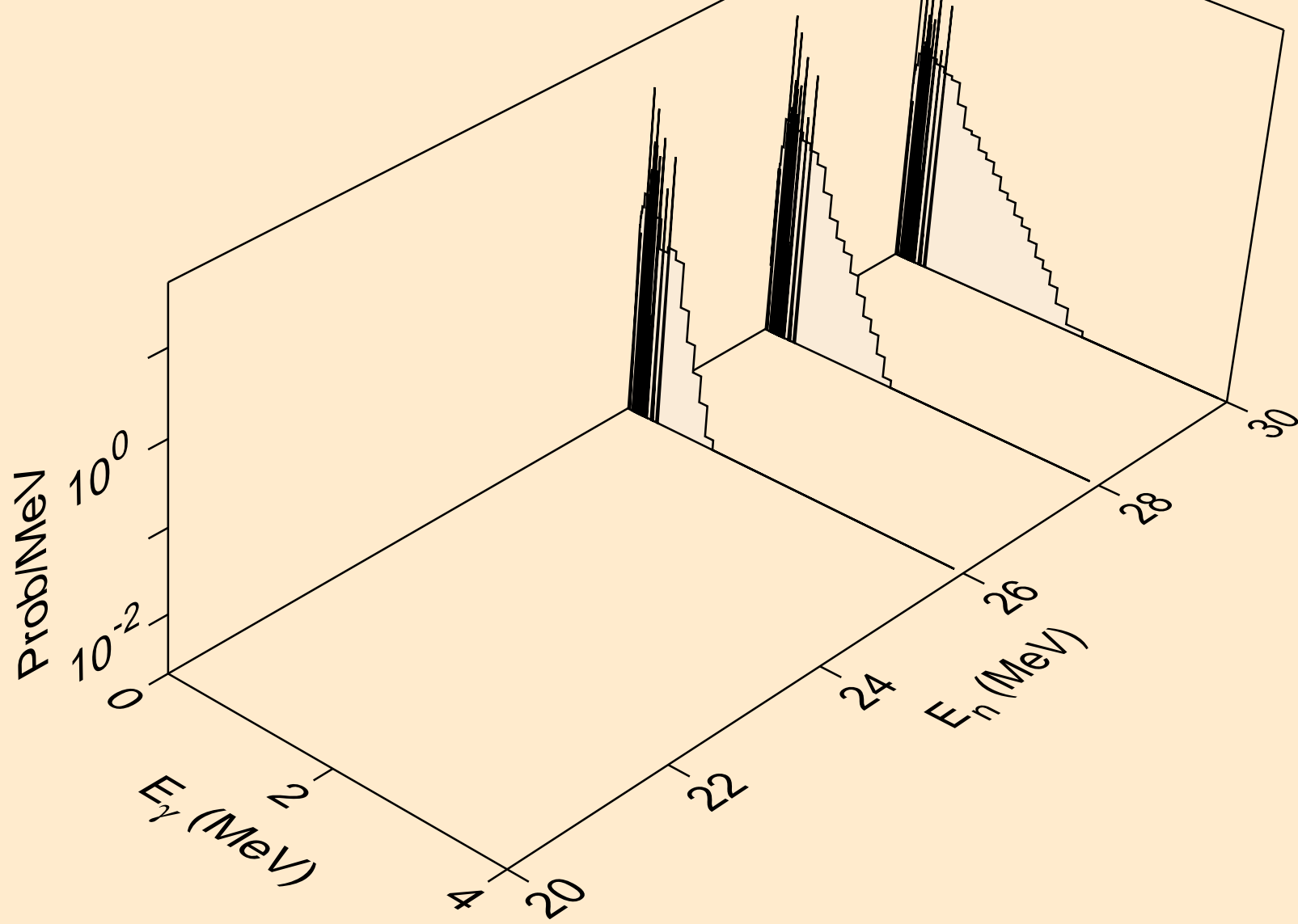

HG191 NEUTRON ACER TENDL-2023 LIBRARY; T=0.K
Photon emission for (n,n2p)

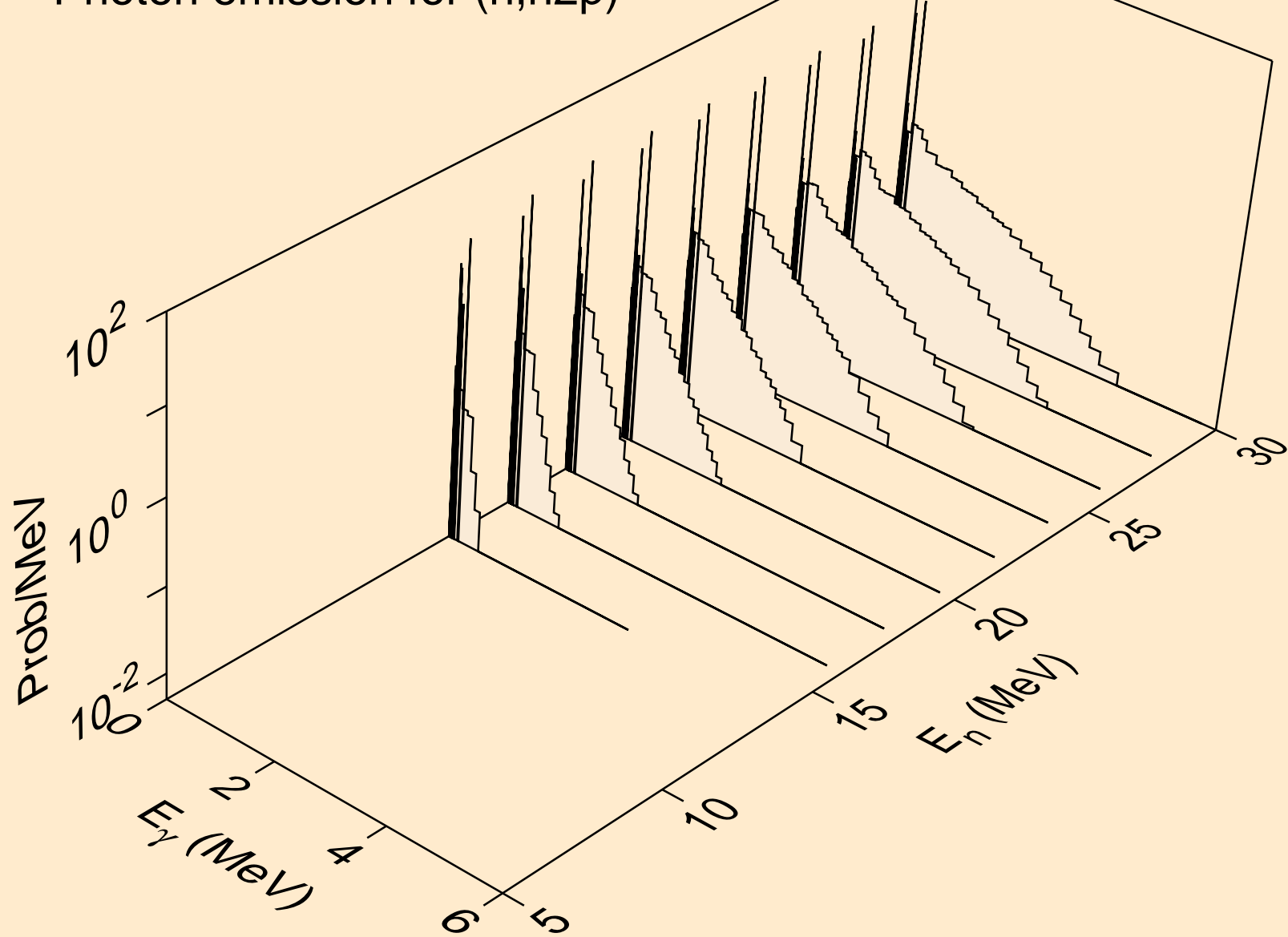

HG191 NEUTRON ACER TENDL-2023 LIBRARY; T=0.K
Photon emission for (n,npa)

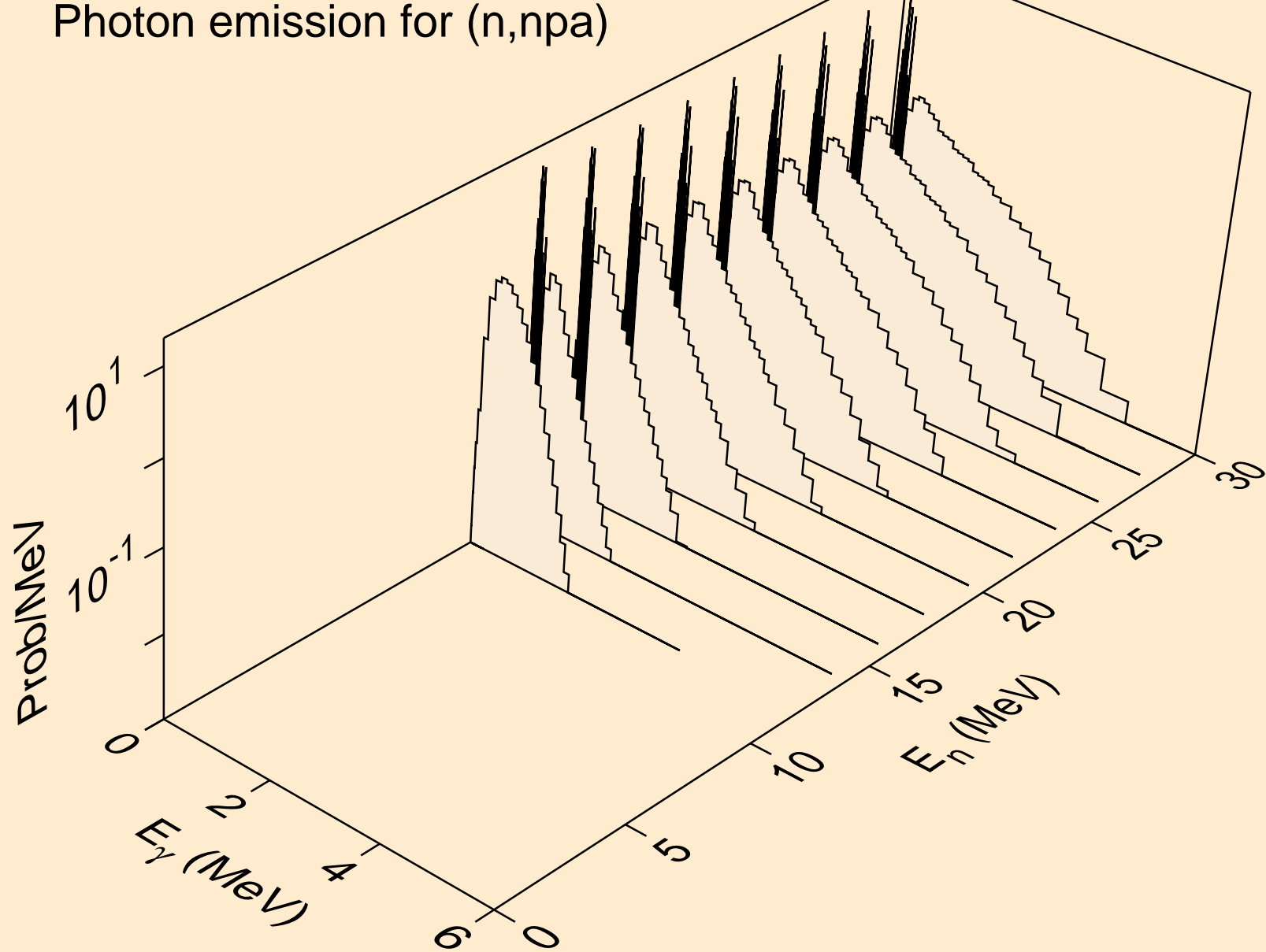

HG191 NEUTRON ACER TENDL-2023 LIBRARY; T=0.K
Photon emission for (n,n*c)

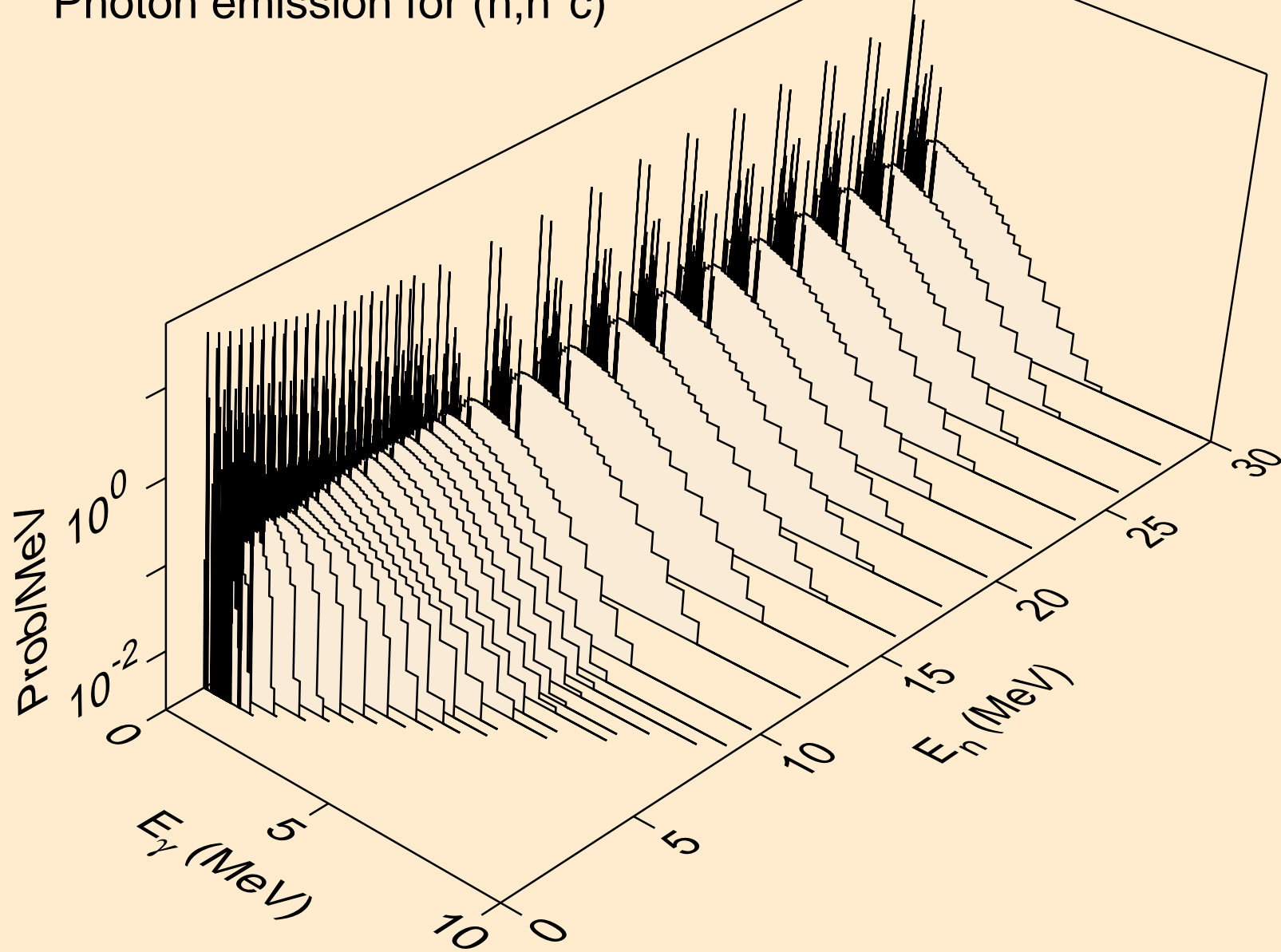

HG191 NEUTRON ACER TENDL-2023 LIBRARY; T=0.K
Photon emission for (n,gma)

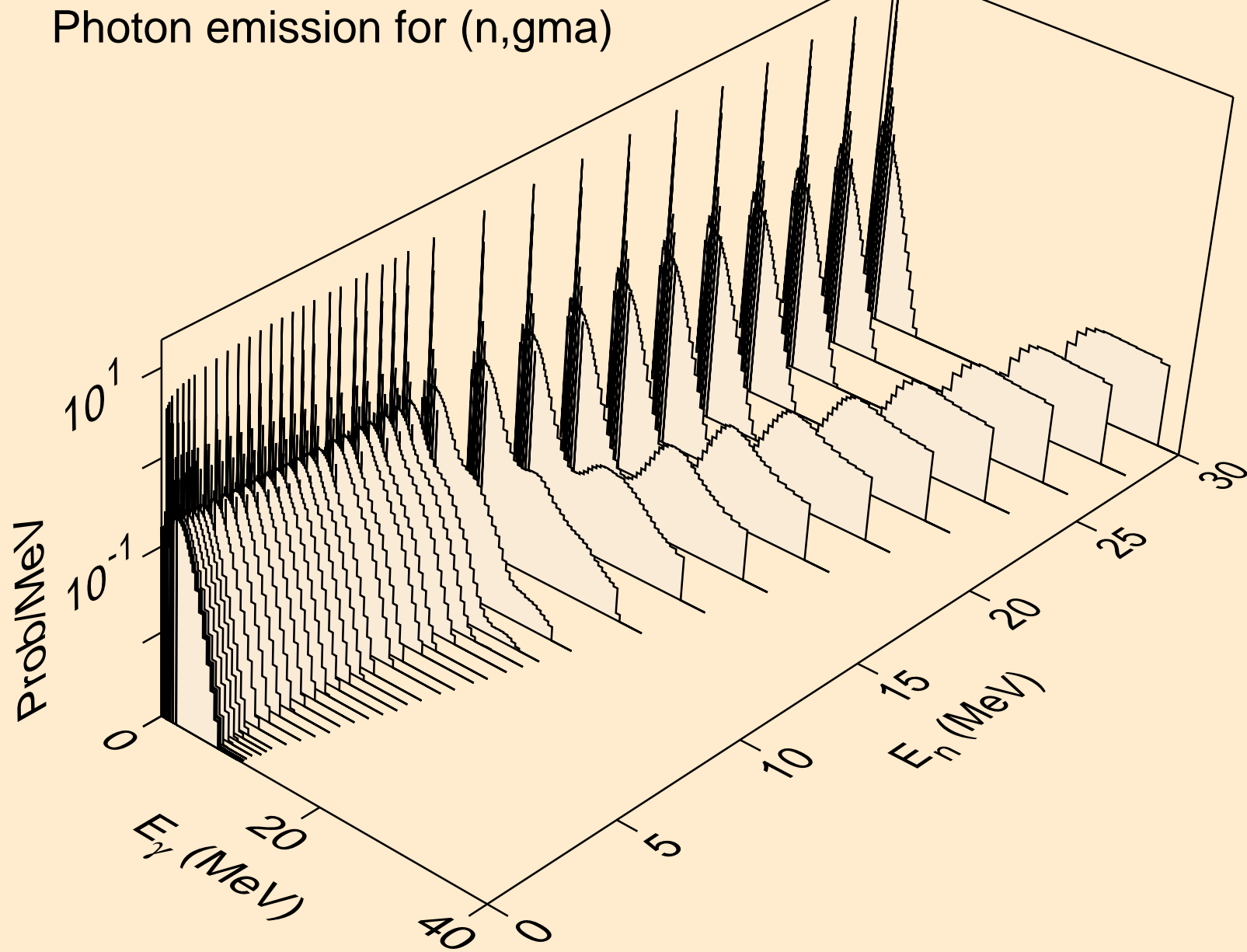

HG191 NEUTRON ACER TENDL-2023 LIBRARY; T=0.K
Photon emission for (n,p)

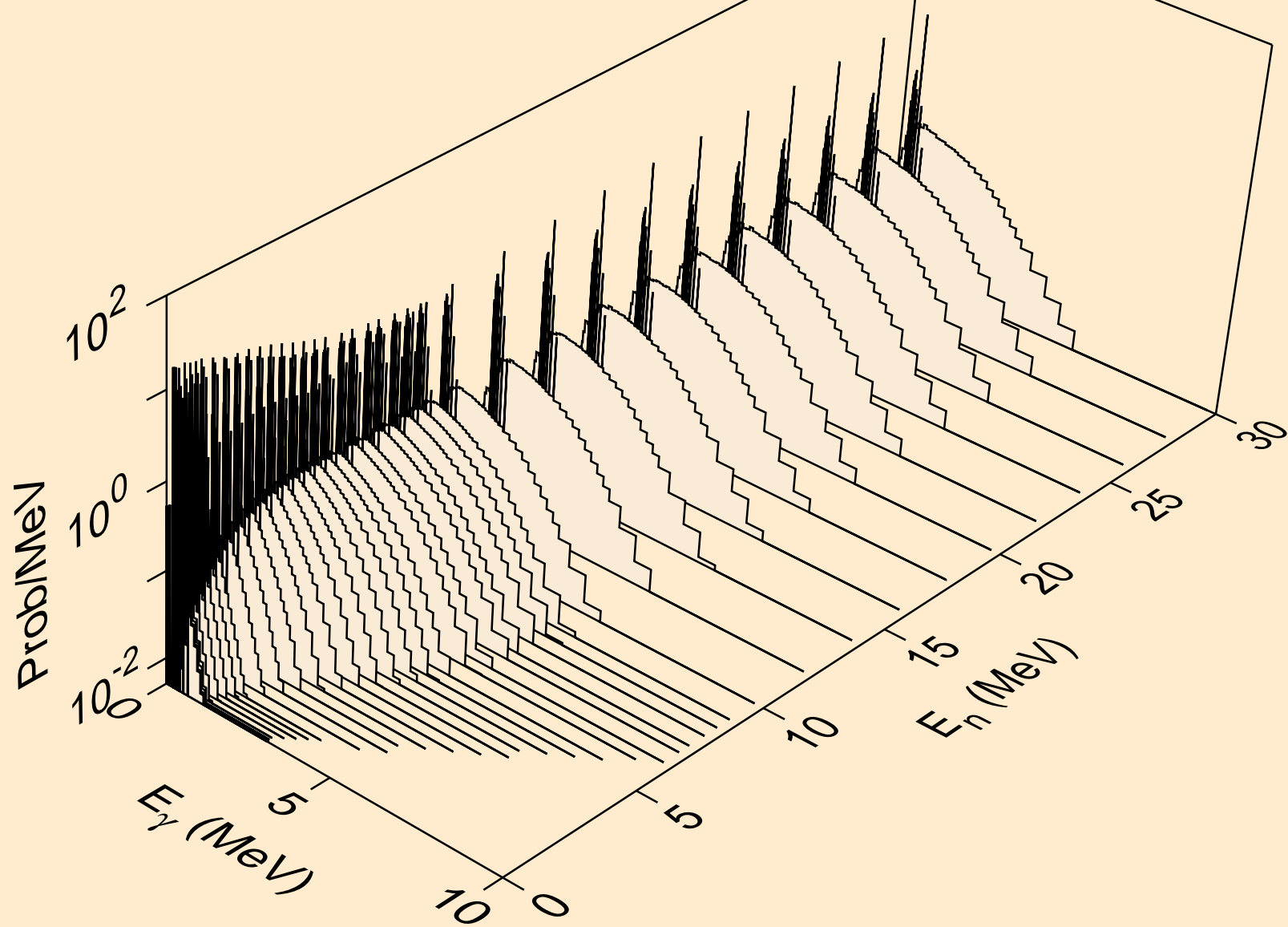

HG191 NEUTRON ACER TENDL-2023 LIBRARY; T=0.K
Photon emission for (n,d)

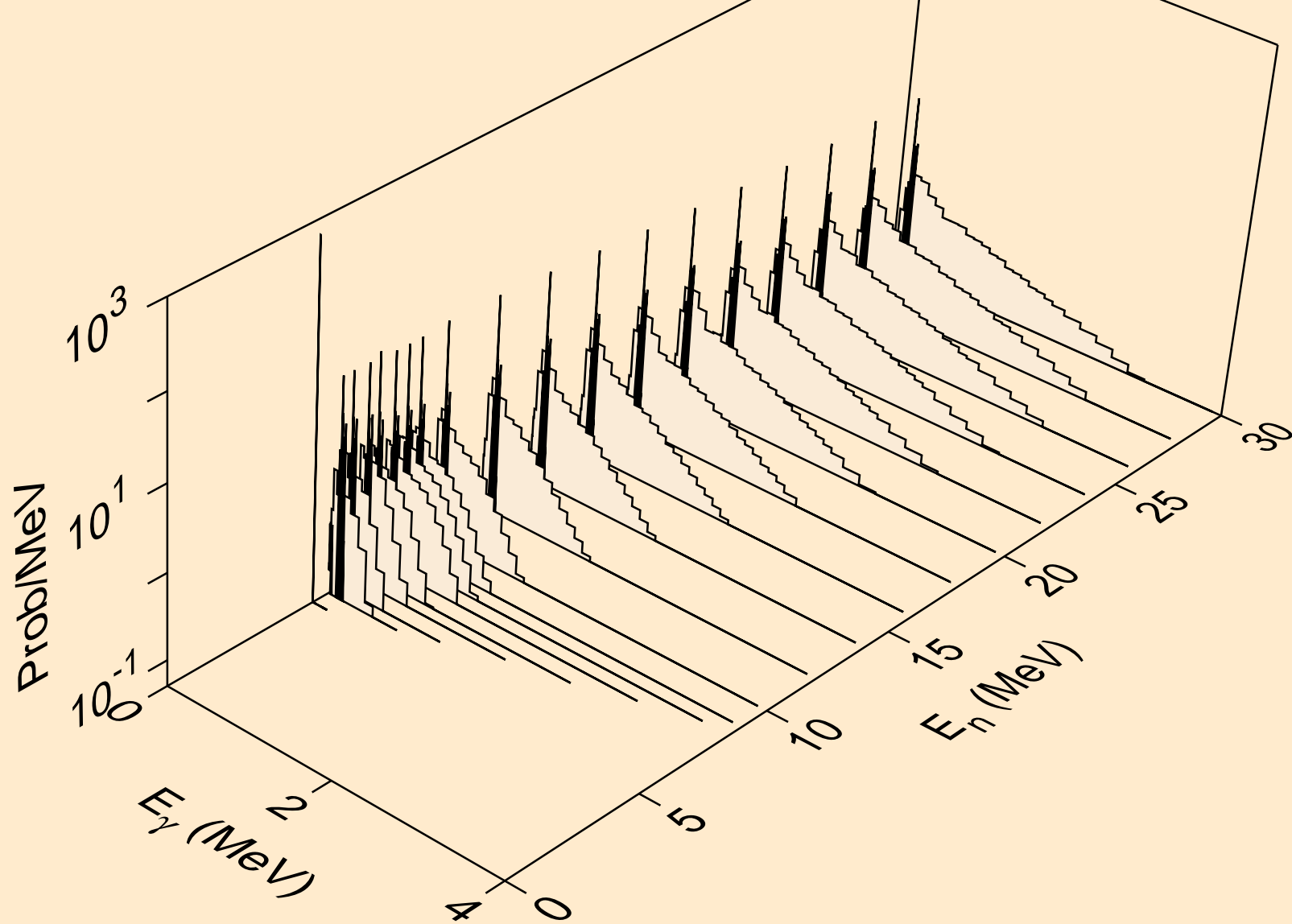

HG191 NEUTRON ACER TENDL-2023 LIBRARY; T=0.K
Photon emission for (n,t)

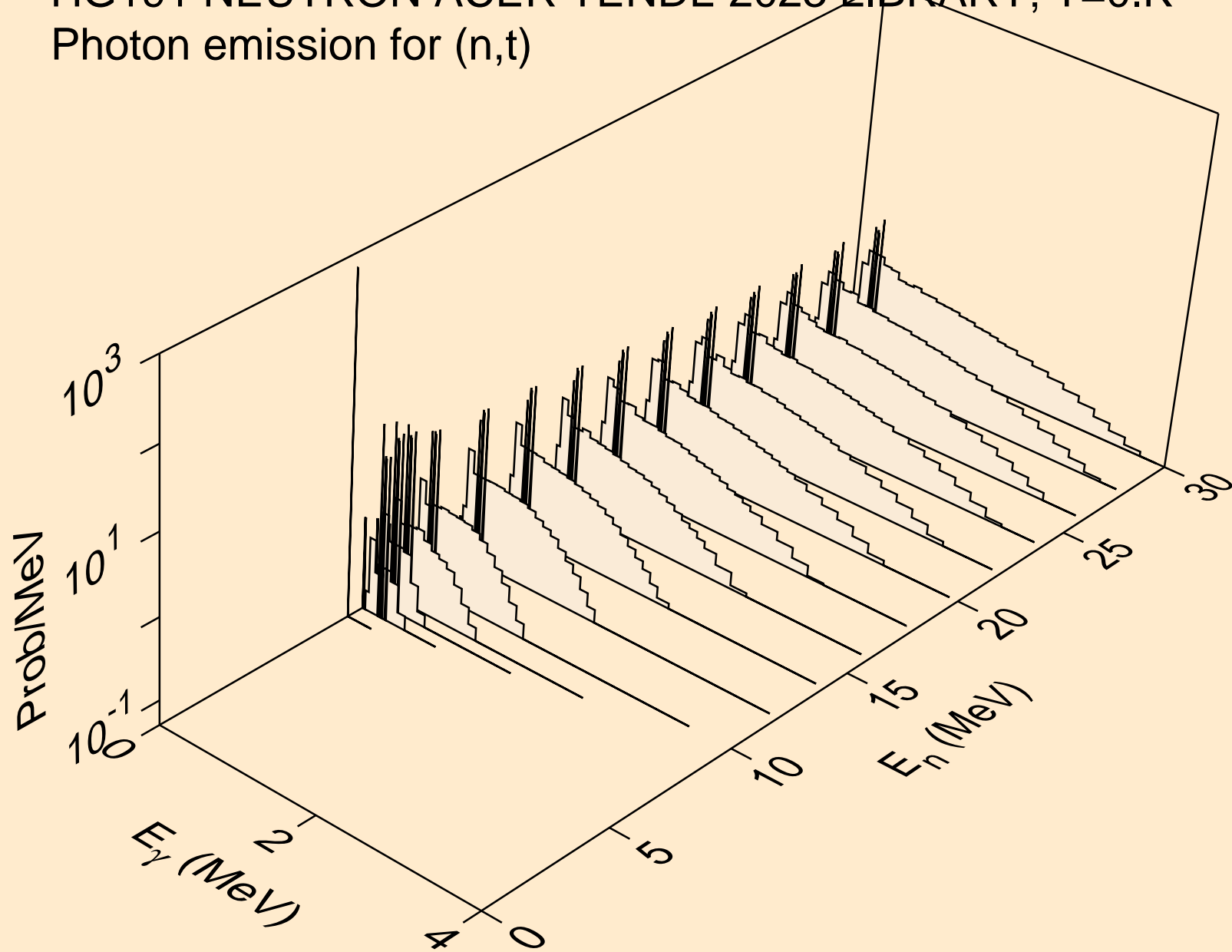

HG191 NEUTRON ACER TENDL-2023 LIBRARY; T=0.K
Photon emission for (n,he3)

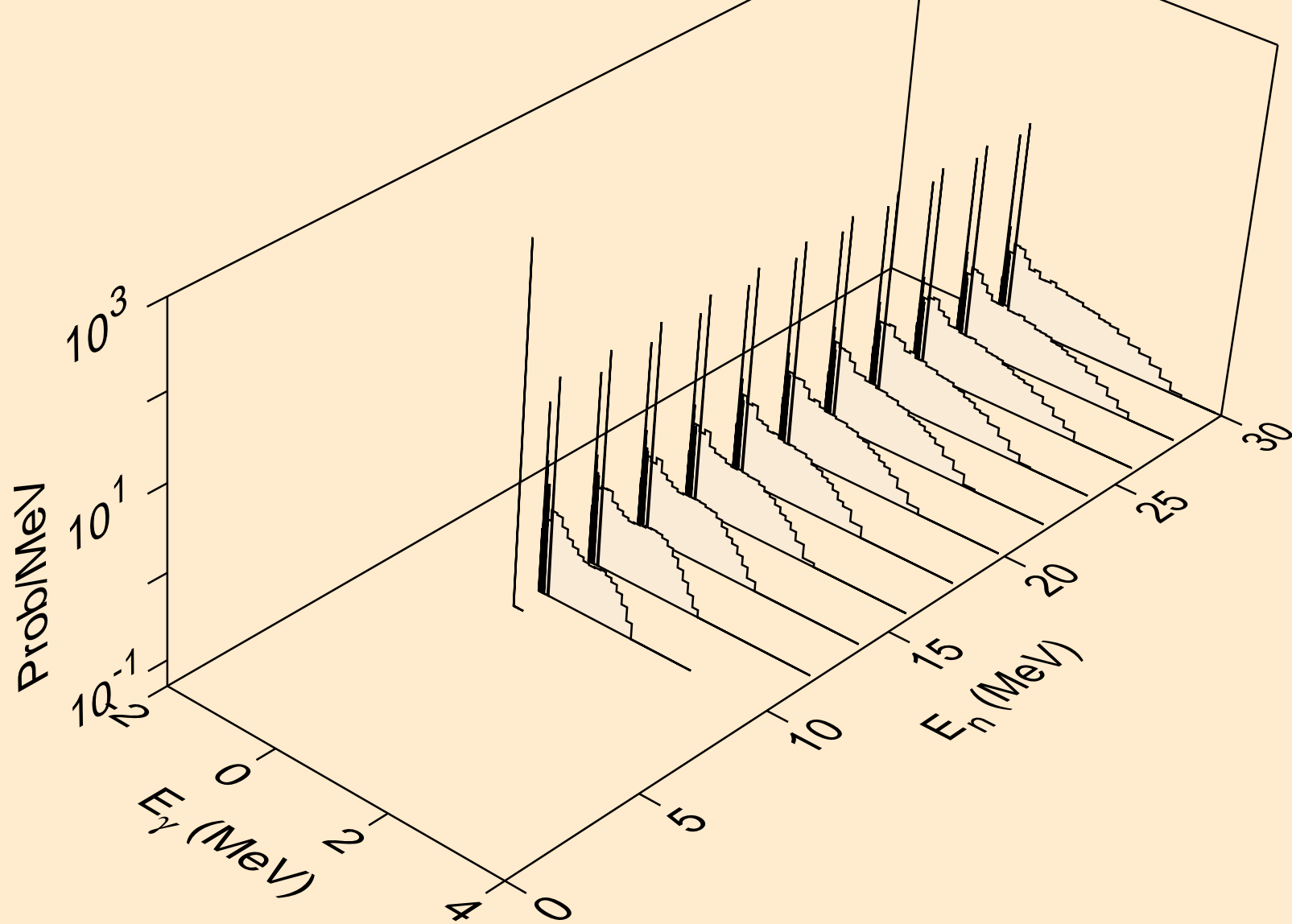

HG191 NEUTRON ACER TENDL-2023 LIBRARY; T=0.K
Photon emission for (n,a)

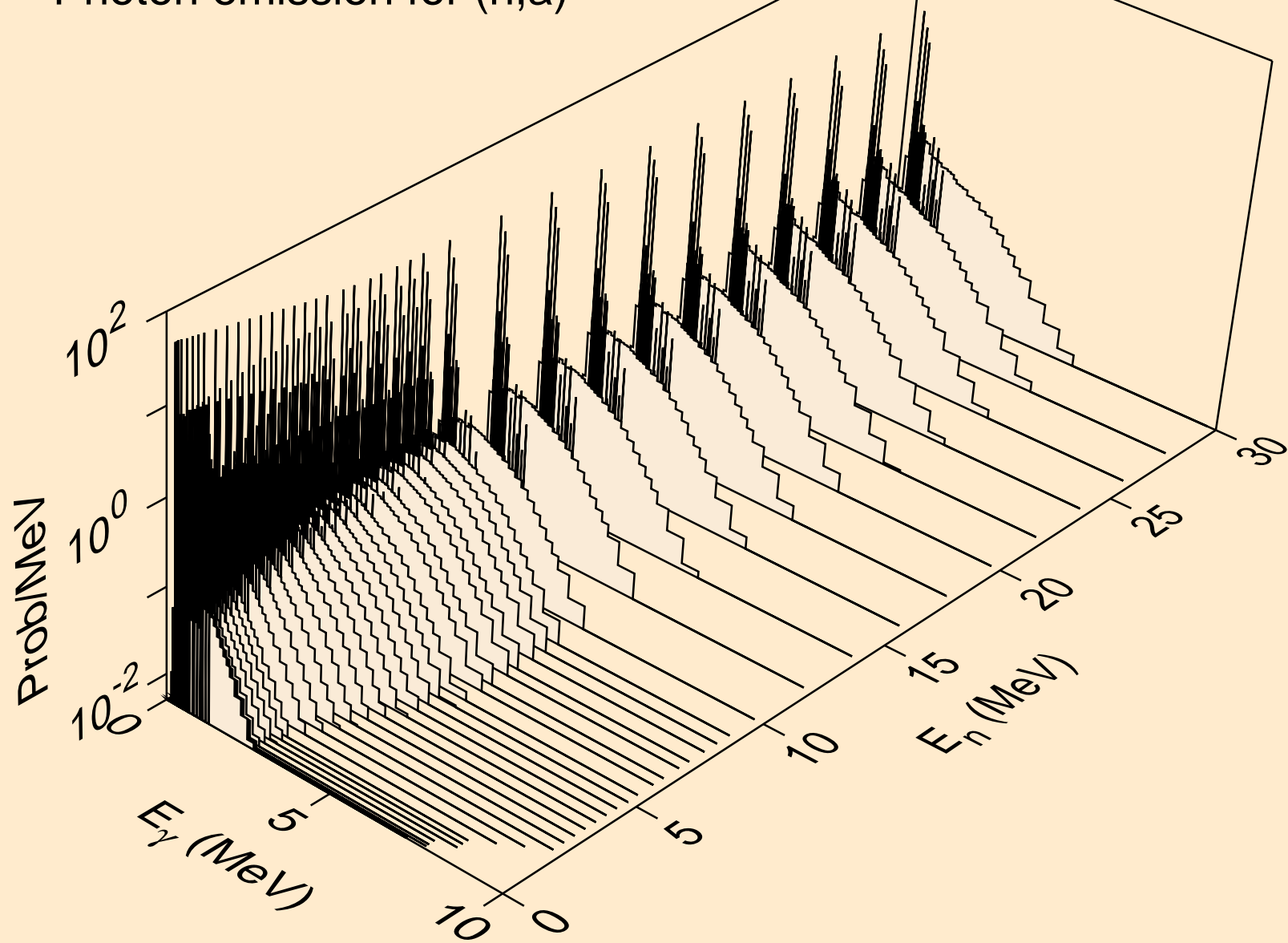

HG191 NEUTRON ACER TENDL-2023 LIBRARY; T=0.K
Photon emission for (n,2a)

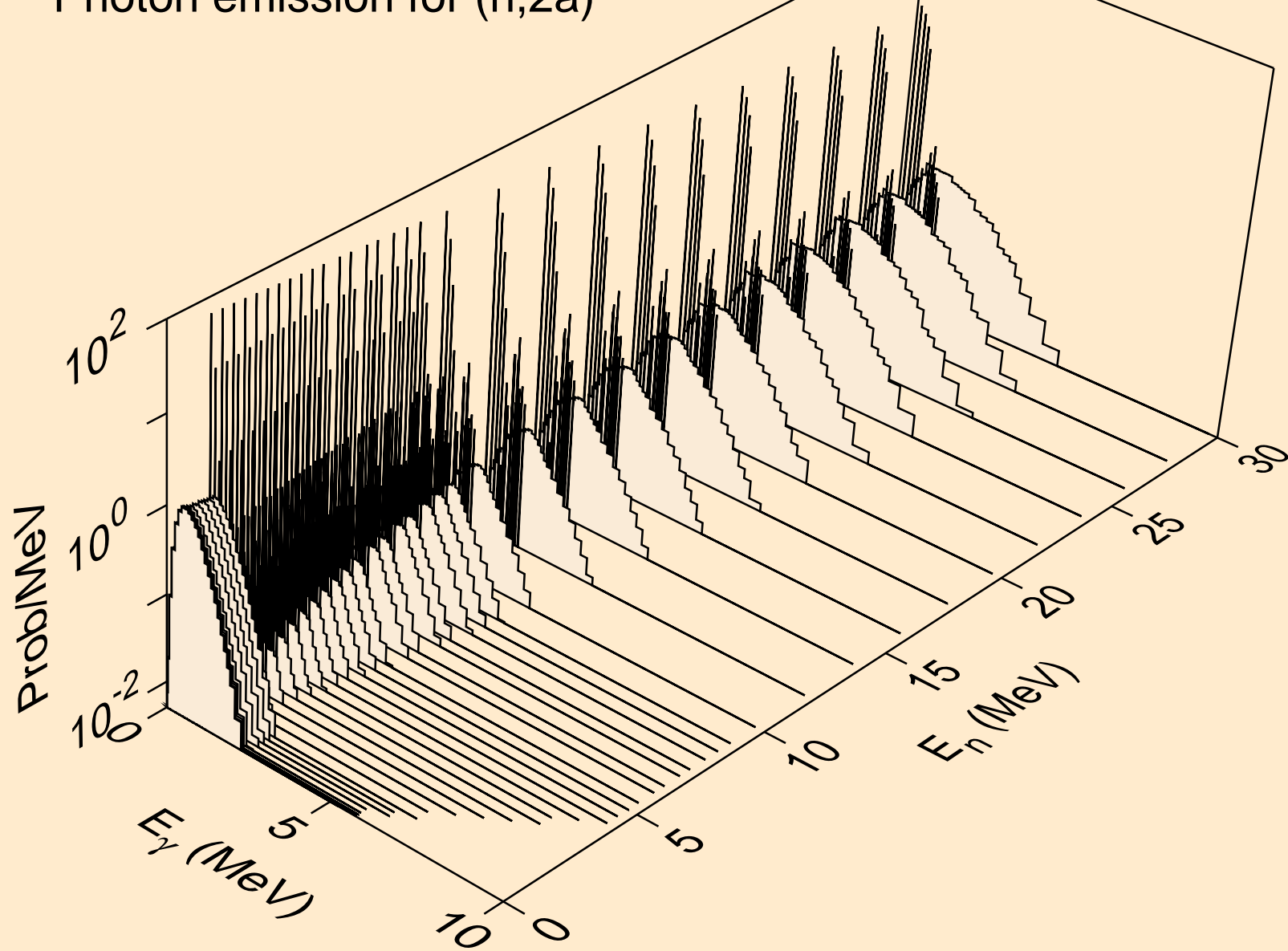

HG191 NEUTRON ACER TENDL-2023 LIBRARY; T=0.K
Photon emission for (n,2p)

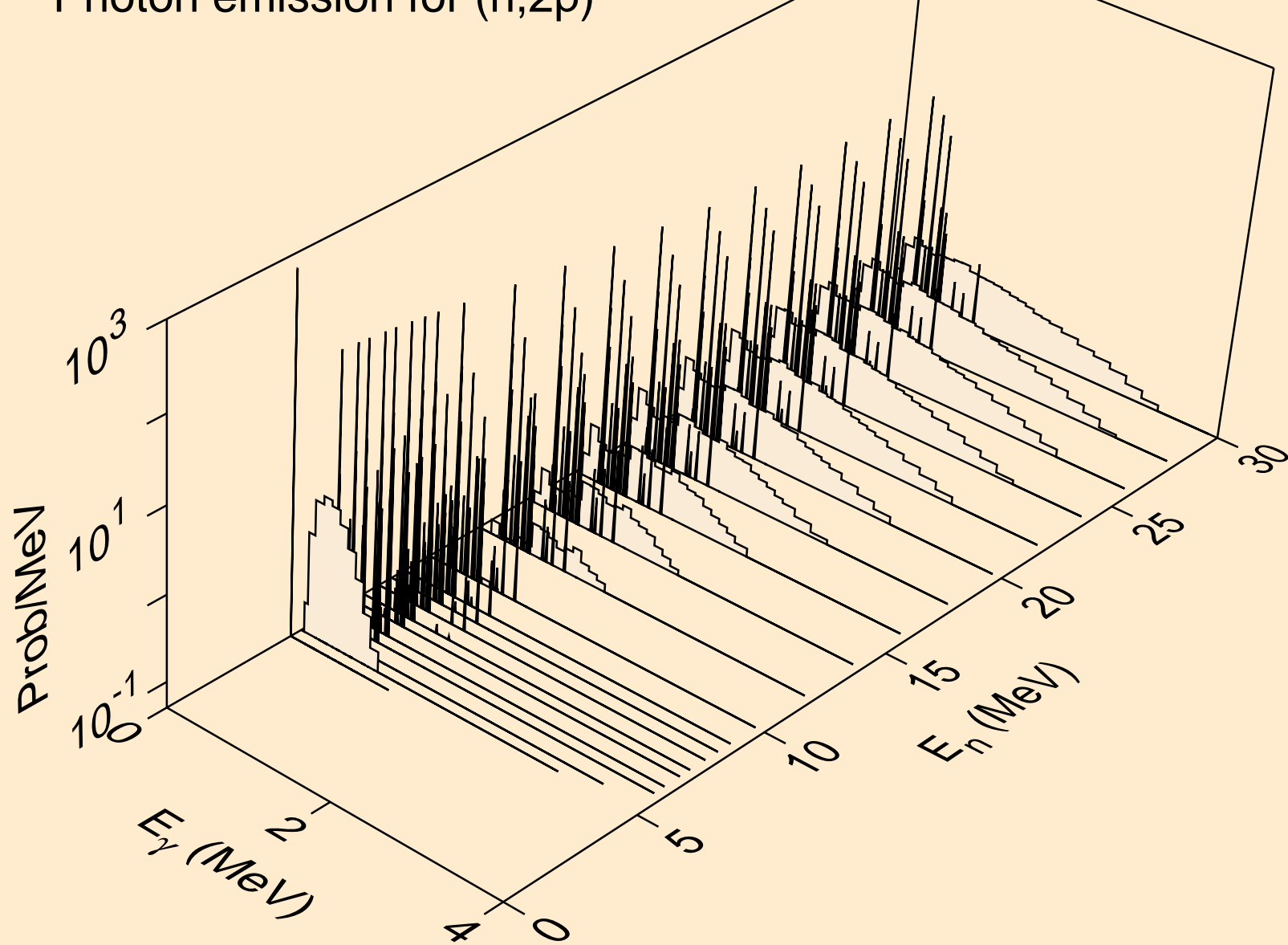

HG191 NEUTRON ACER TENDL-2023 LIBRARY; T=0.K
Photon emission for (n,p α)

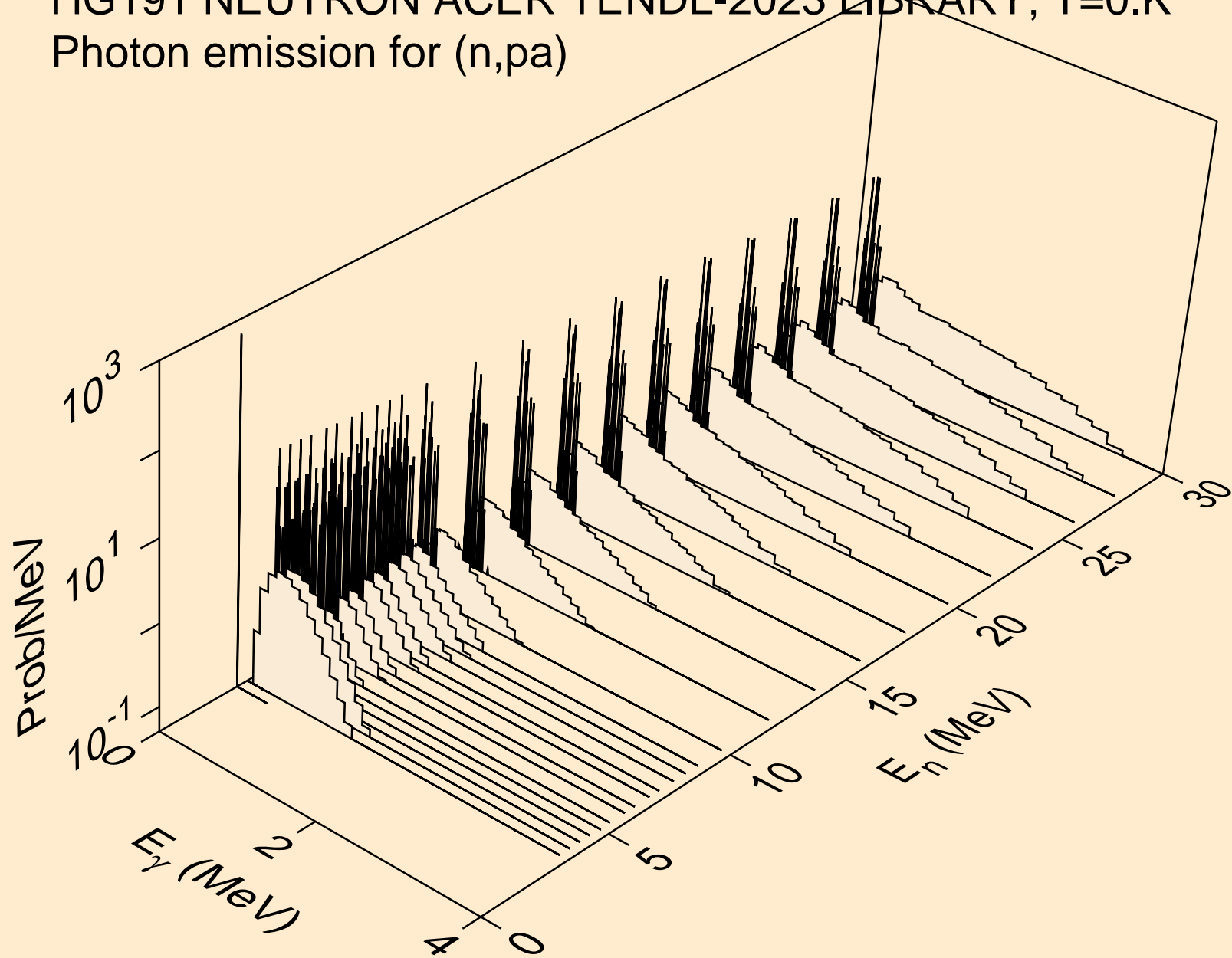

HG191 NEUTRON ACER TENDL-2023 LIBRARY; T=0.K
Photon emission for (n,pd)

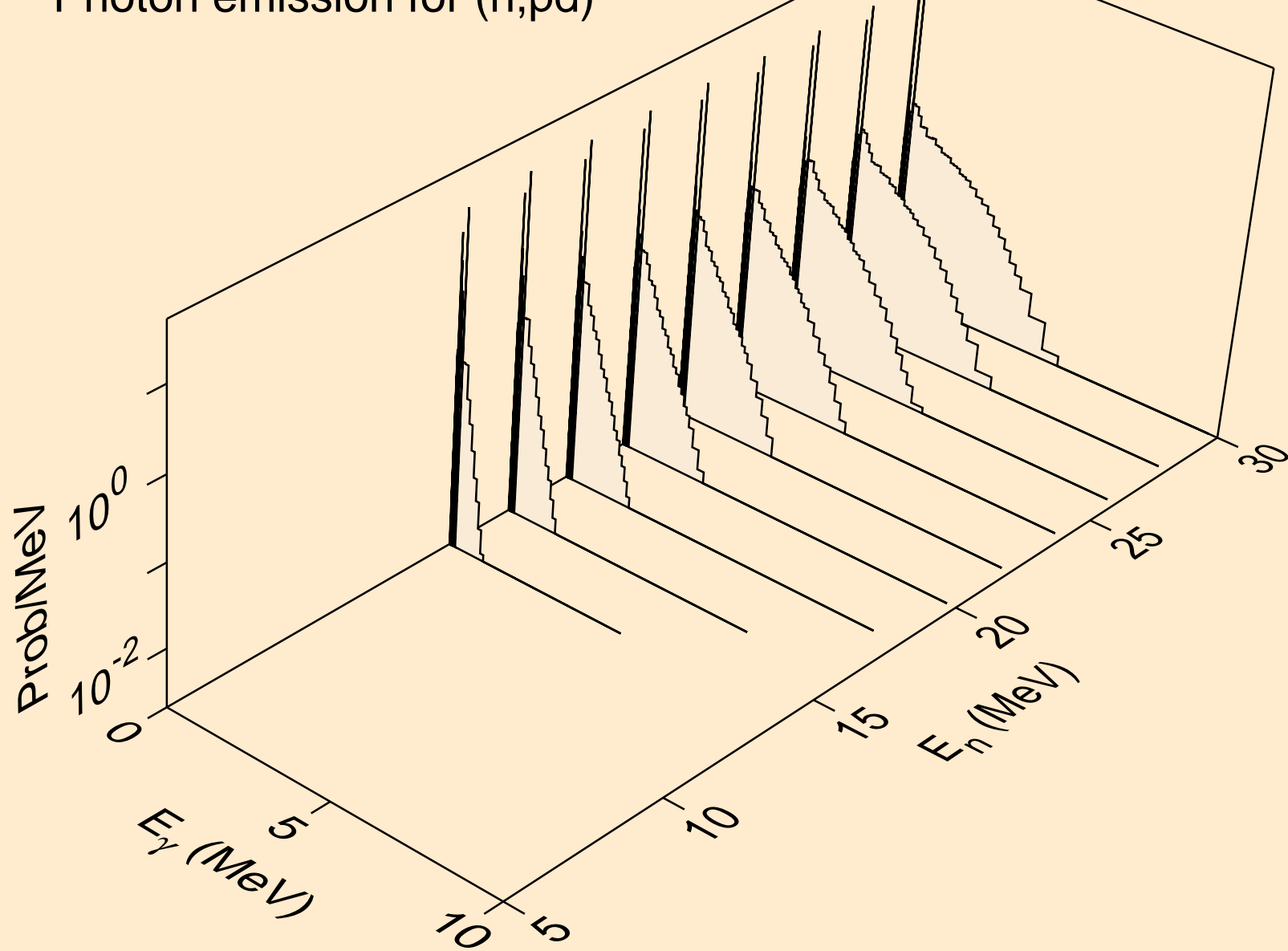

HG191 NEUTRON ACER TENDL-2023 LIBRARY; T=0.K
Photon emission for (n,pt)

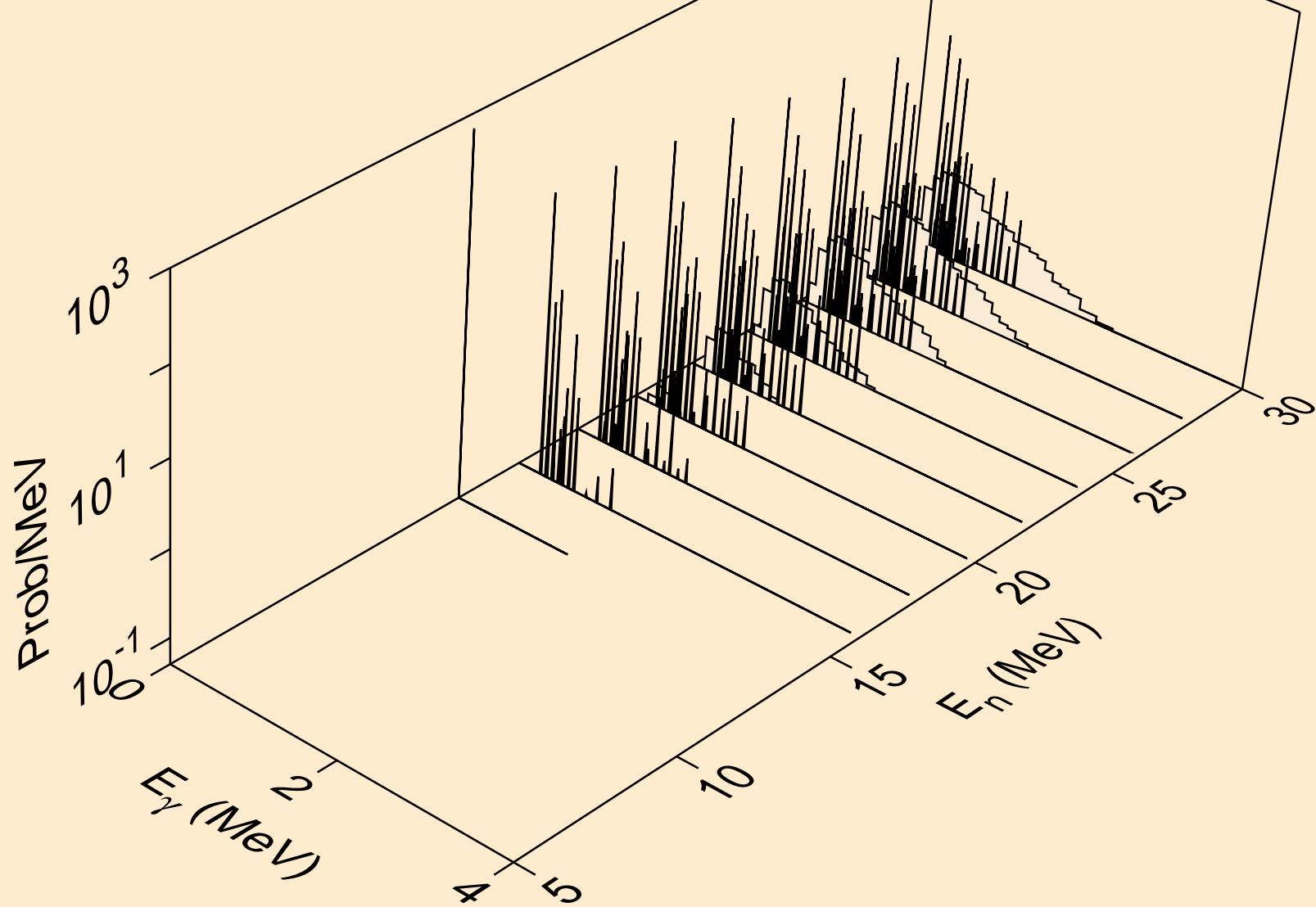

HG191 NEUTRON ACER TENDL-2023 LIBRARY; T=0.K
Photon emission for (n,da)

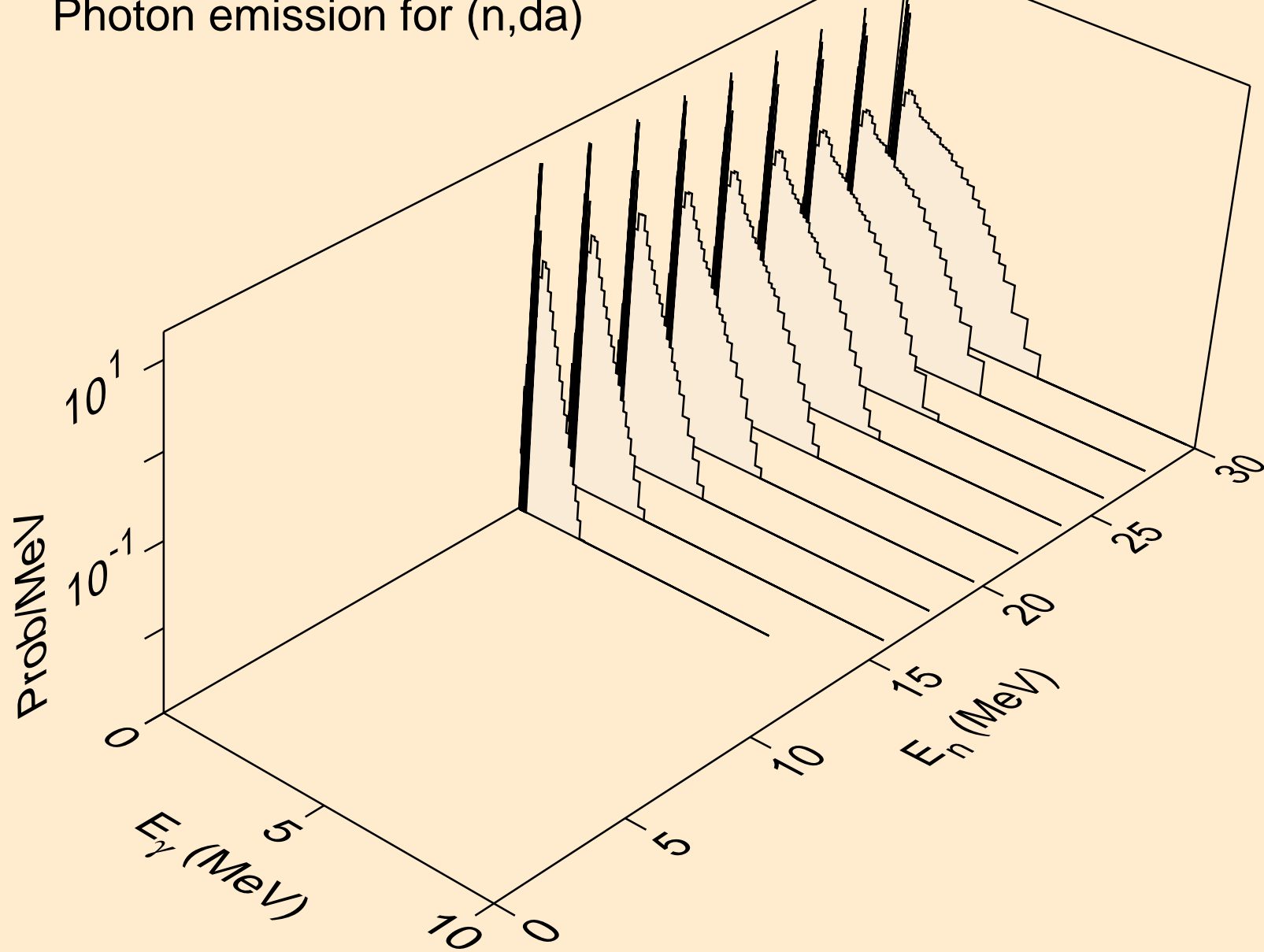

HG191 NEUTRON ACER TENDL-2023 LIBRARY; T=0.K
thermal capture photon spectrum

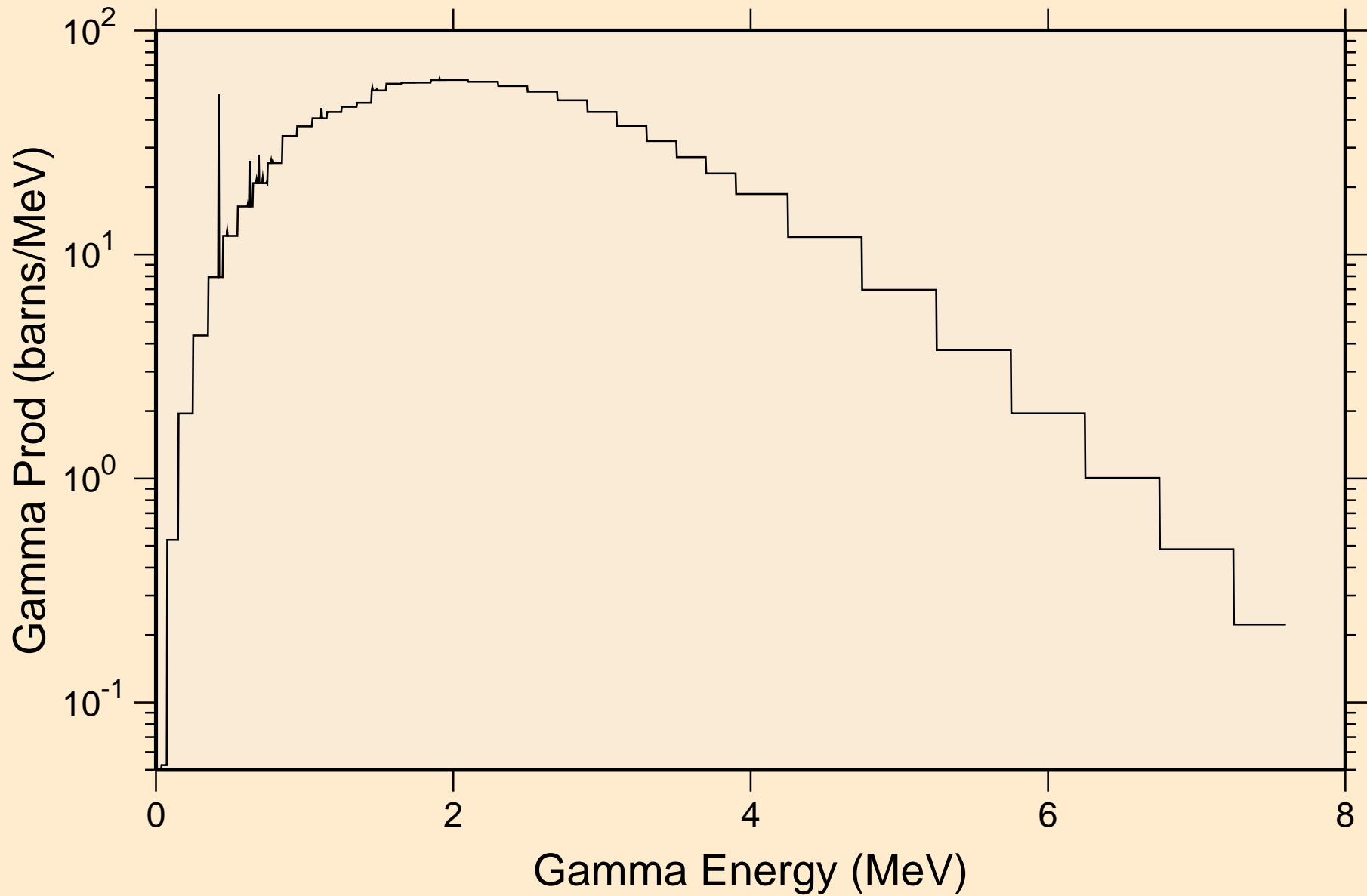

HG191 NEUTRON ACER TENDL-2023 LIBRARY; T=0.K
14 MeV photon spectrum

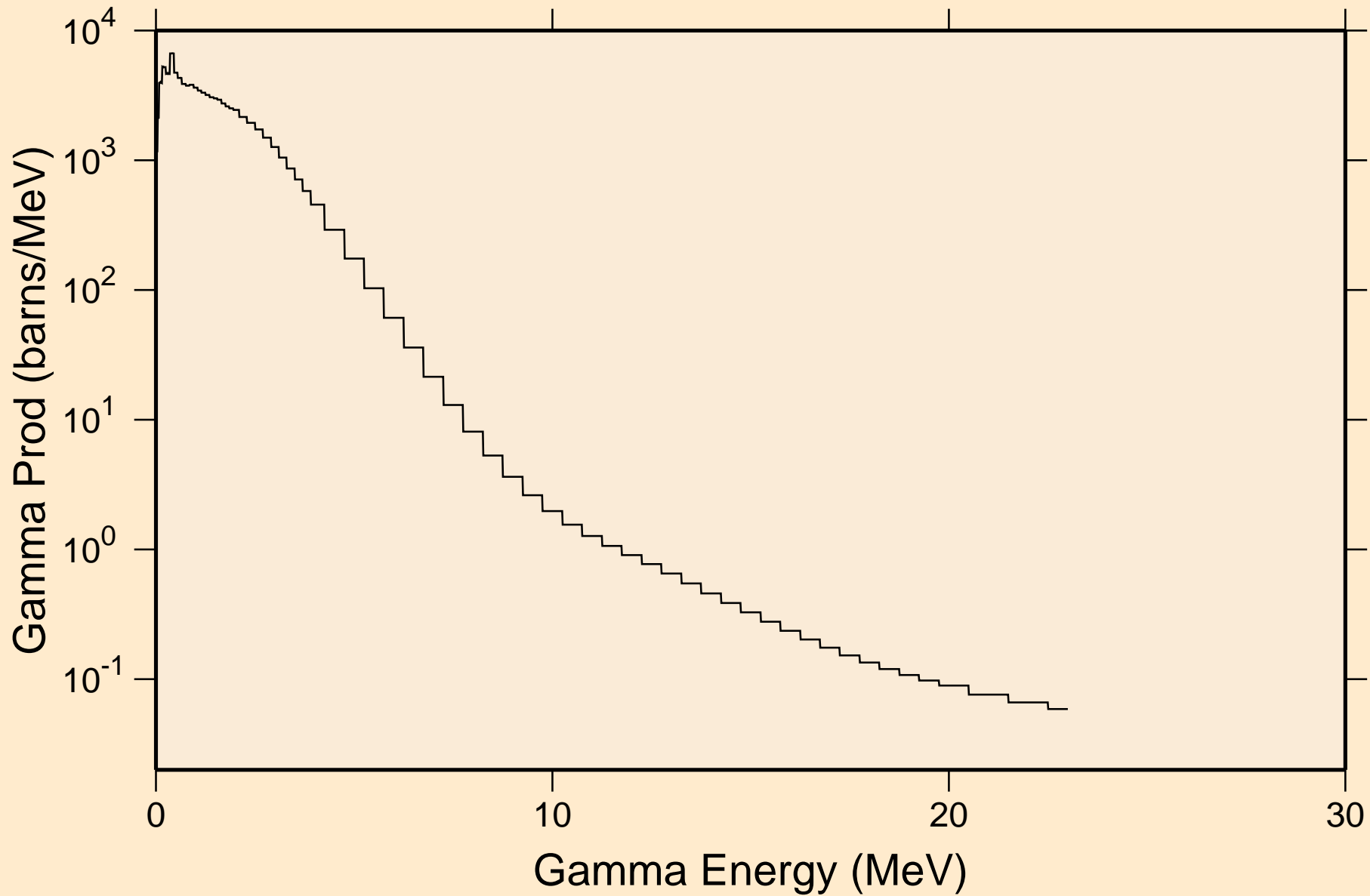

HG191 NEUTRON ACER TENDL-2023 LIBRARY; T=0.K

Particle heating contributions

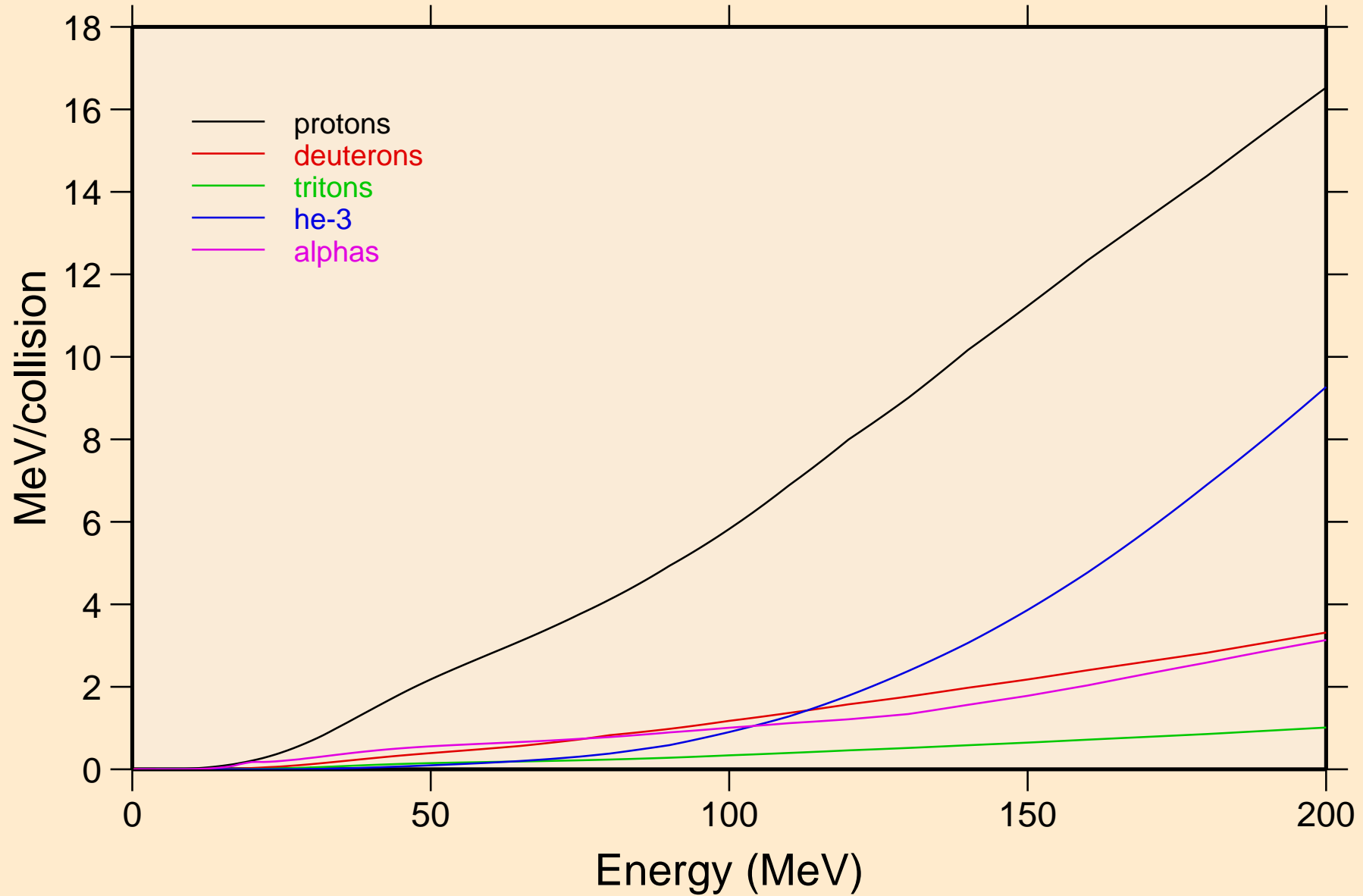

HG191 NEUTRON ACER TENDL-2023 LIBRARY; T=0.K

Recoil Heating

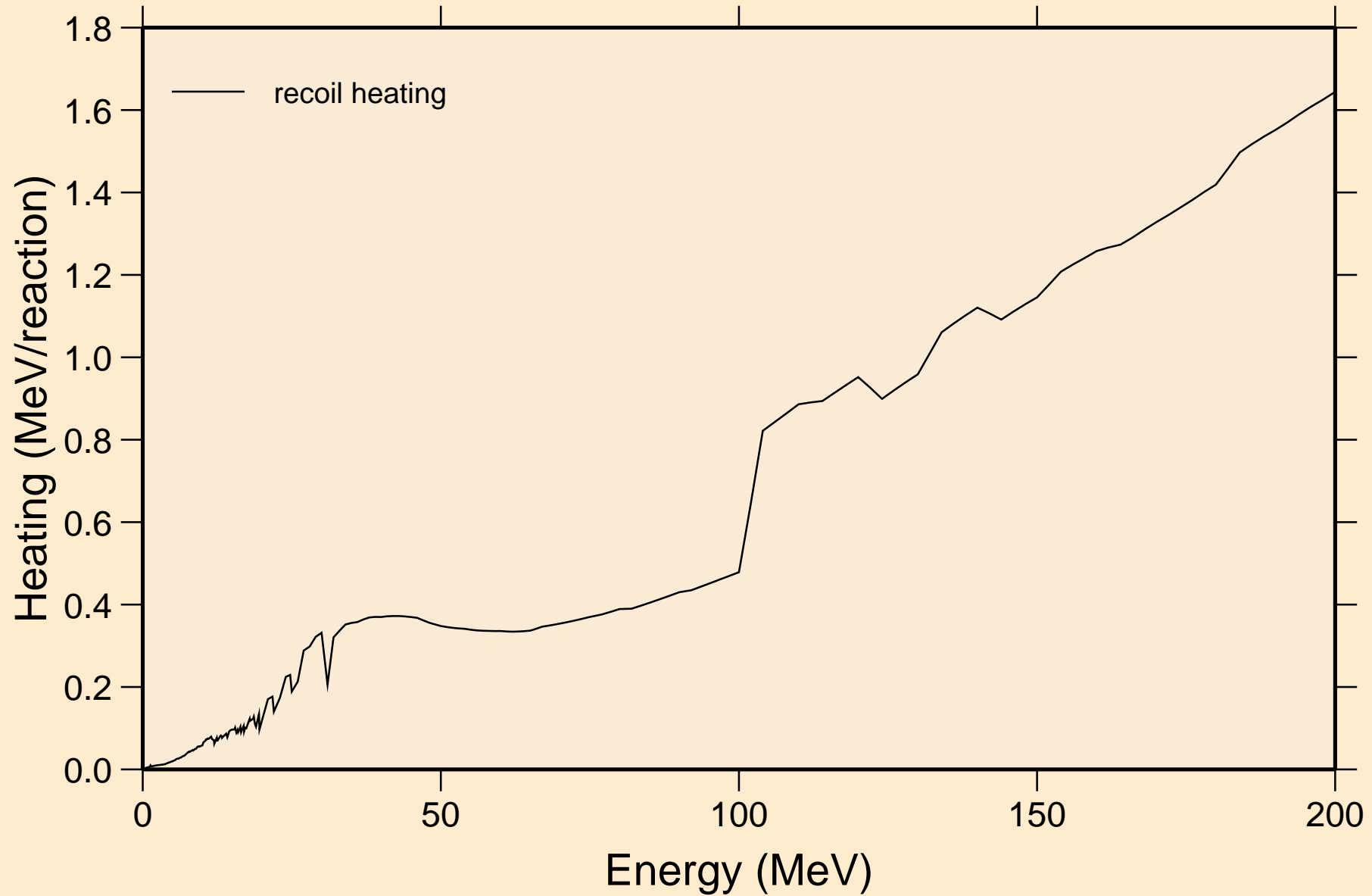

HG191 NEUTRON ACER TENDL-2023 LIBRARY; T=0.K

Particle production cross sections

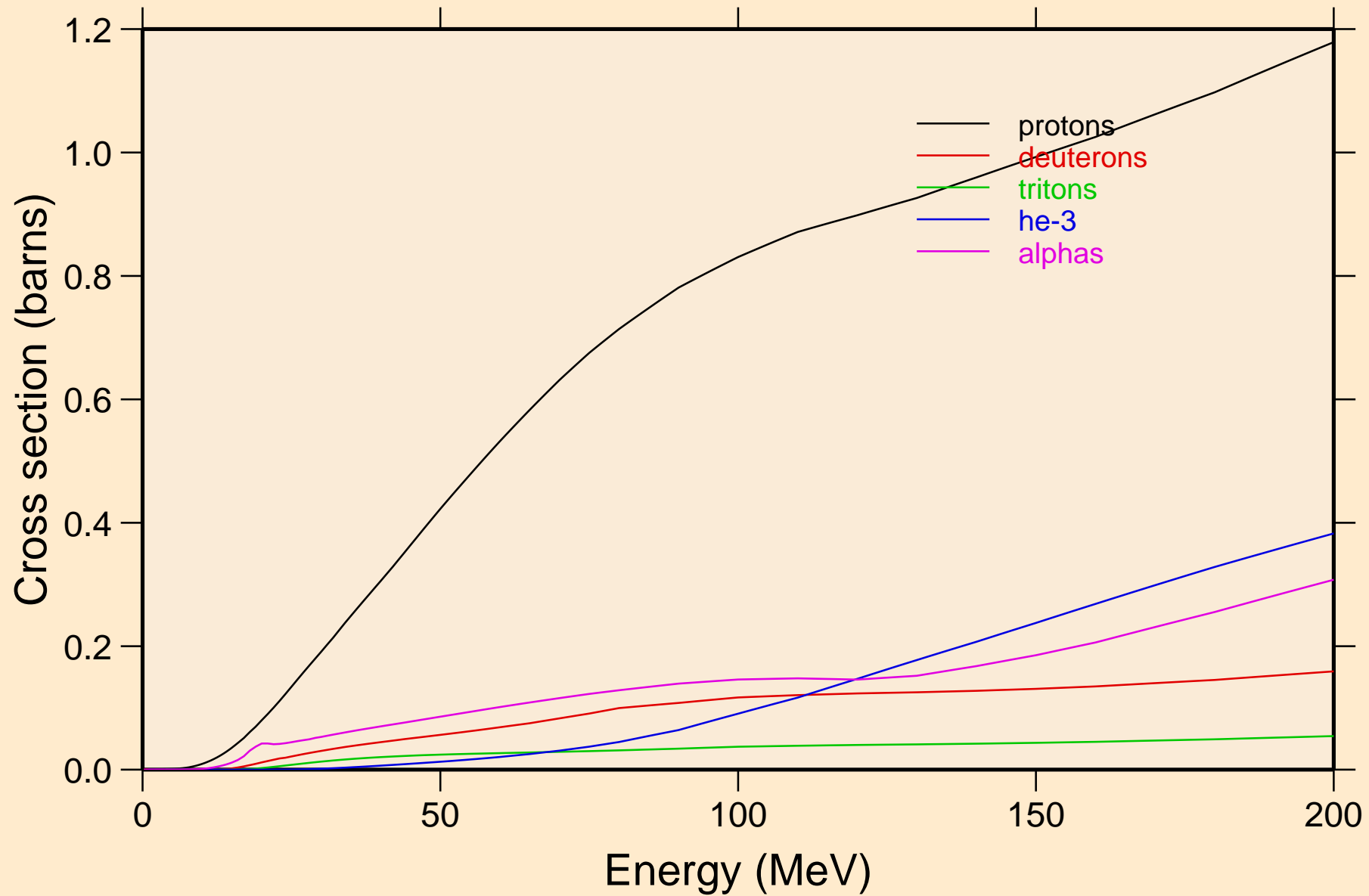

HG191 NEUTRON ACER TENDL-2023 LIBRARY; T=0.K
protons from (n,x)

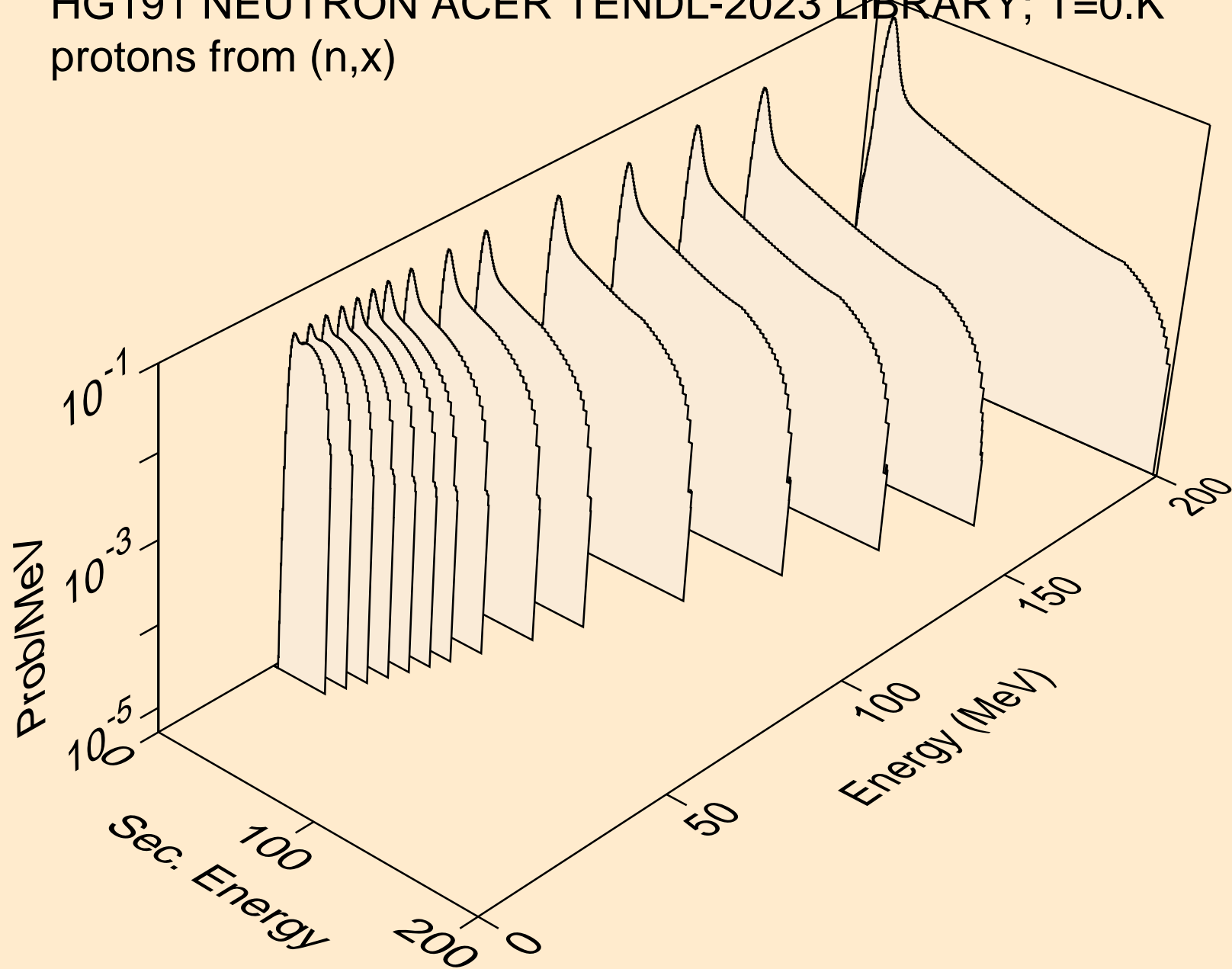

HG191 NEUTRON ACER TENDL-2023 LIBRARY; T=0.K
protons from (n,n*)p

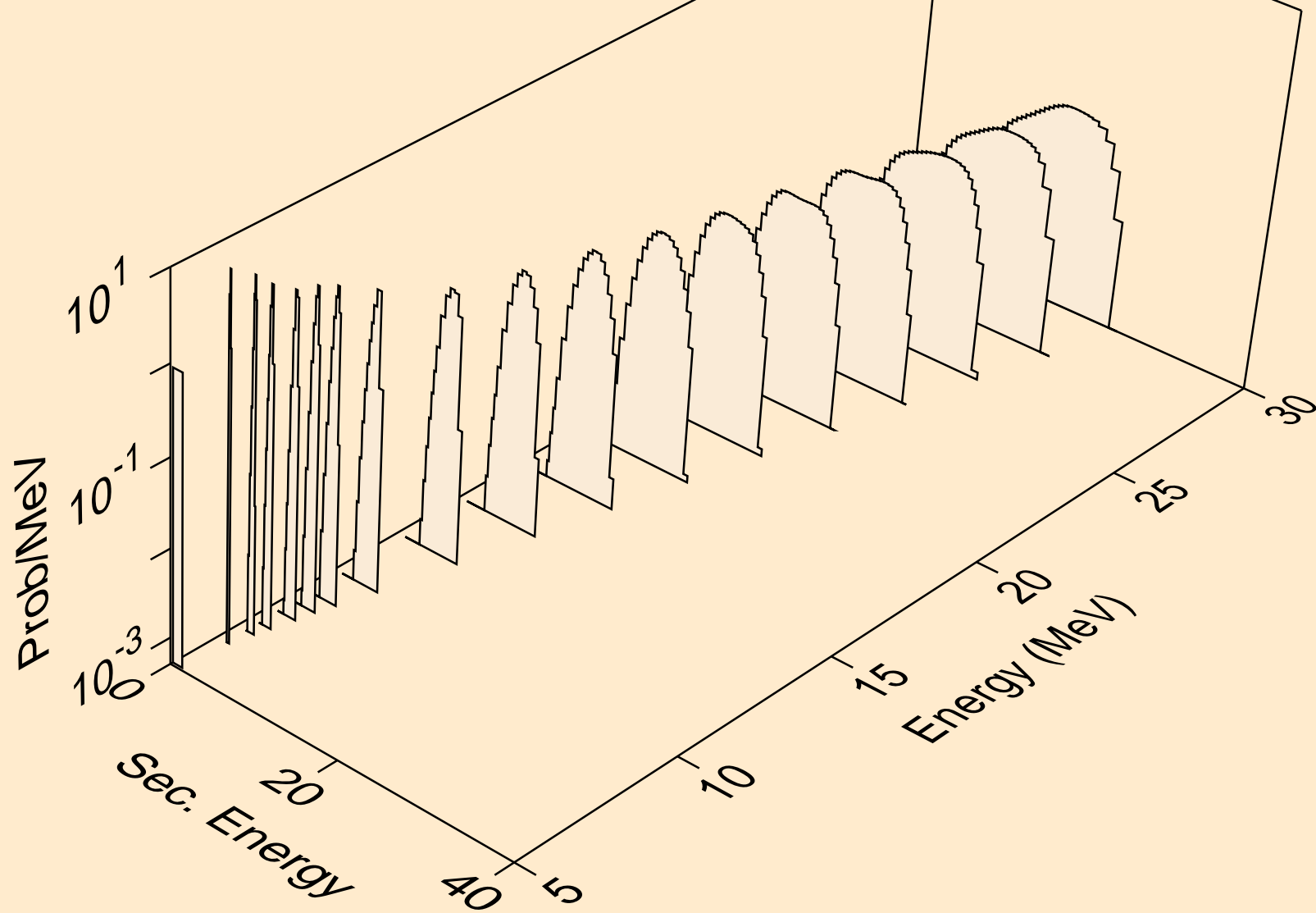

HG191 NEUTRON ACER TENDL-2023 LIBRARY; T=0.K
protons from (n,2np)

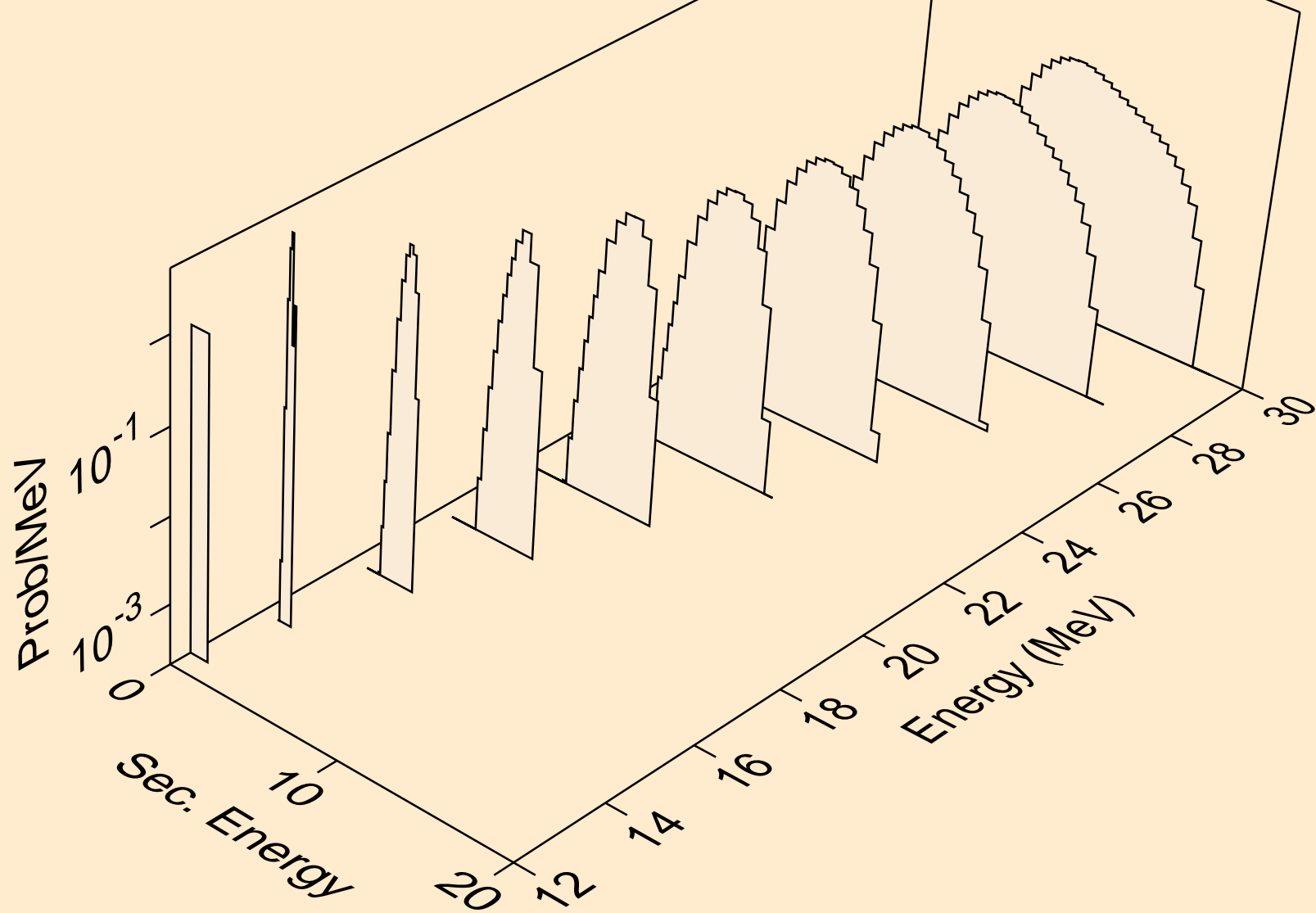

HG191 NEUTRON ACER TENDL-2023 LIBRARY; T=0.K
protons from (n,3np)

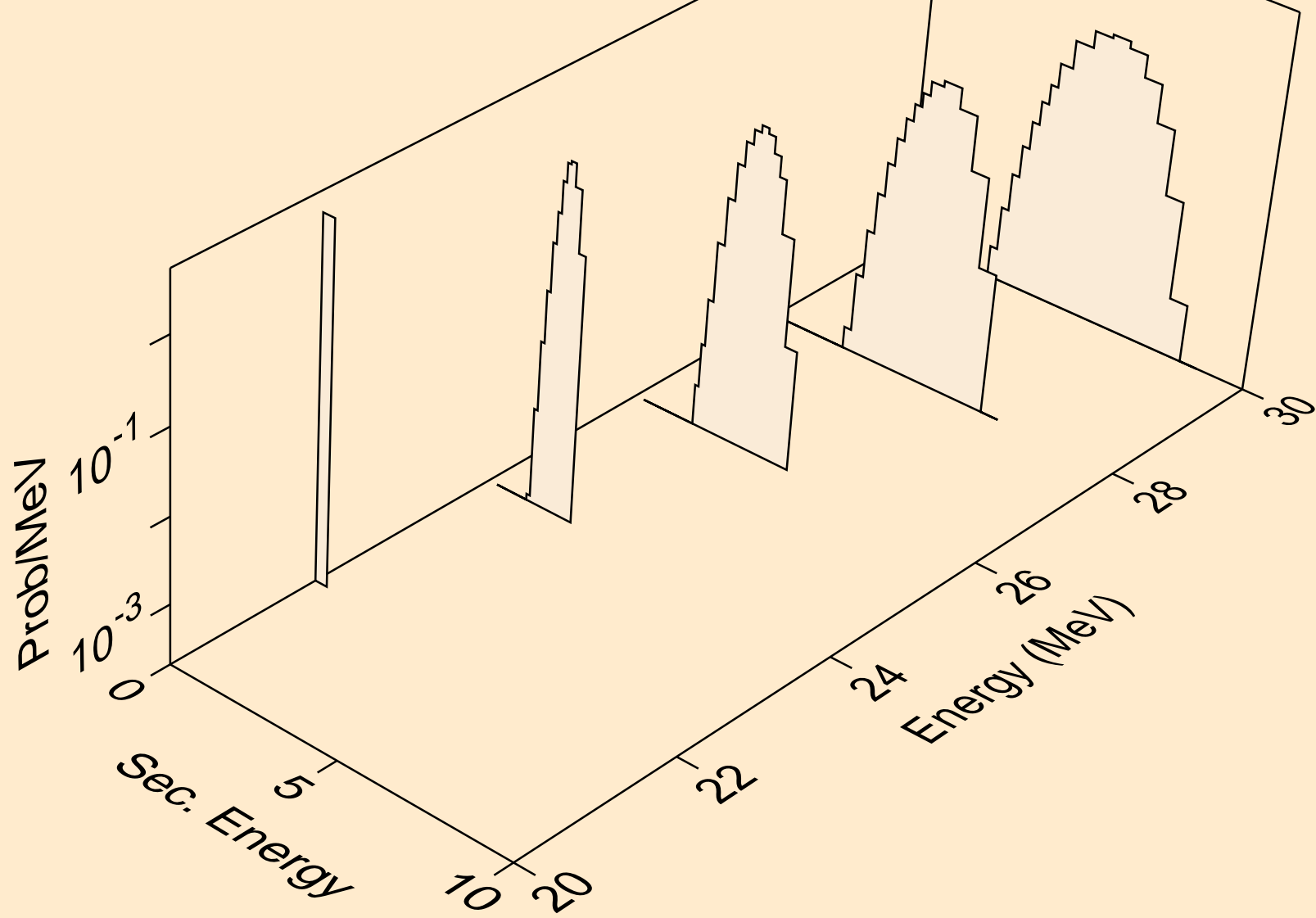

HG191 NEUTRON ACER TENDL-2023 LIBRARY; T=0.K
protons from (n,n2p)

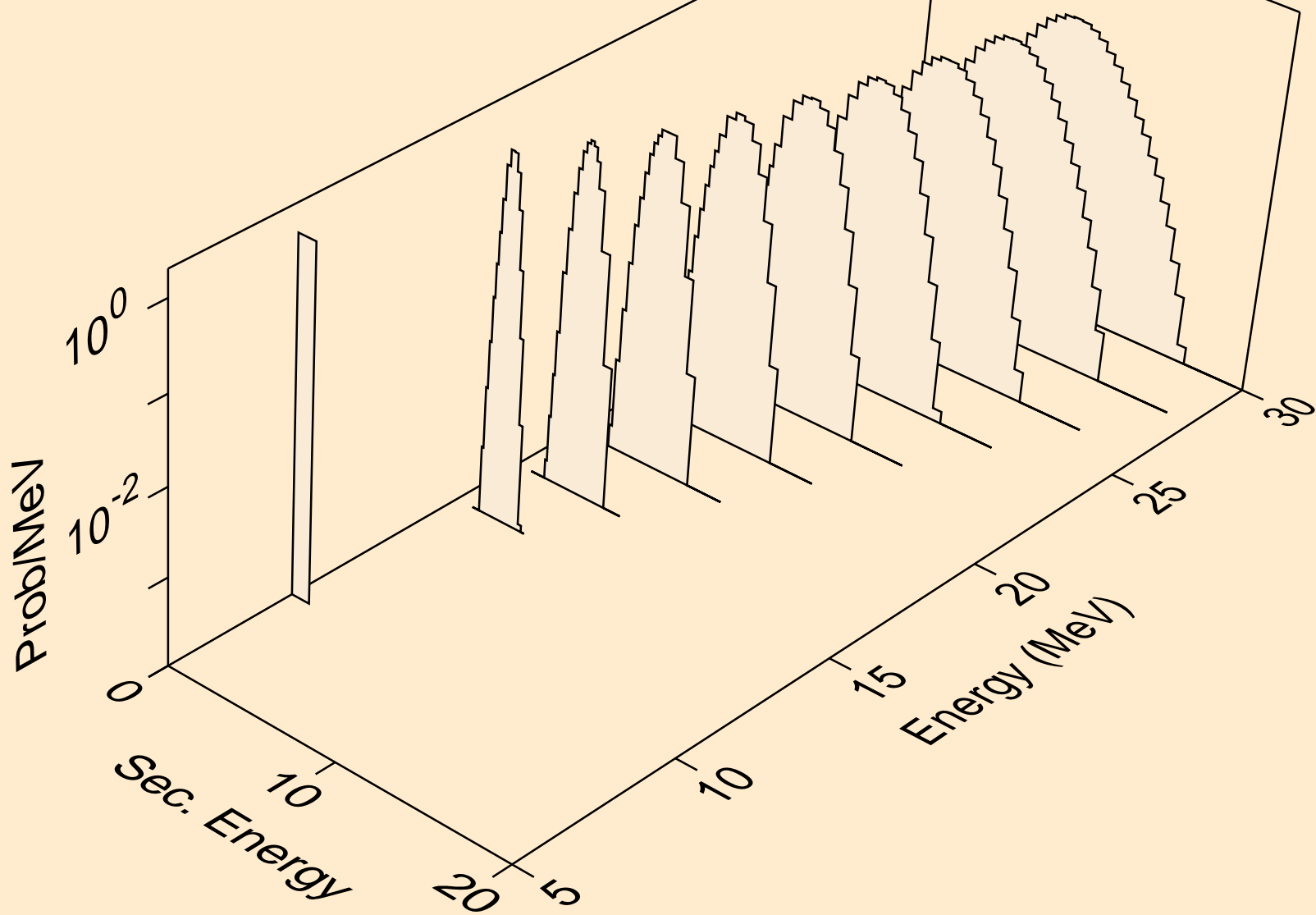

HG191 NEUTRON ACER TENDL-2023 LIBRARY; T=0.K
protons from (n,npa)

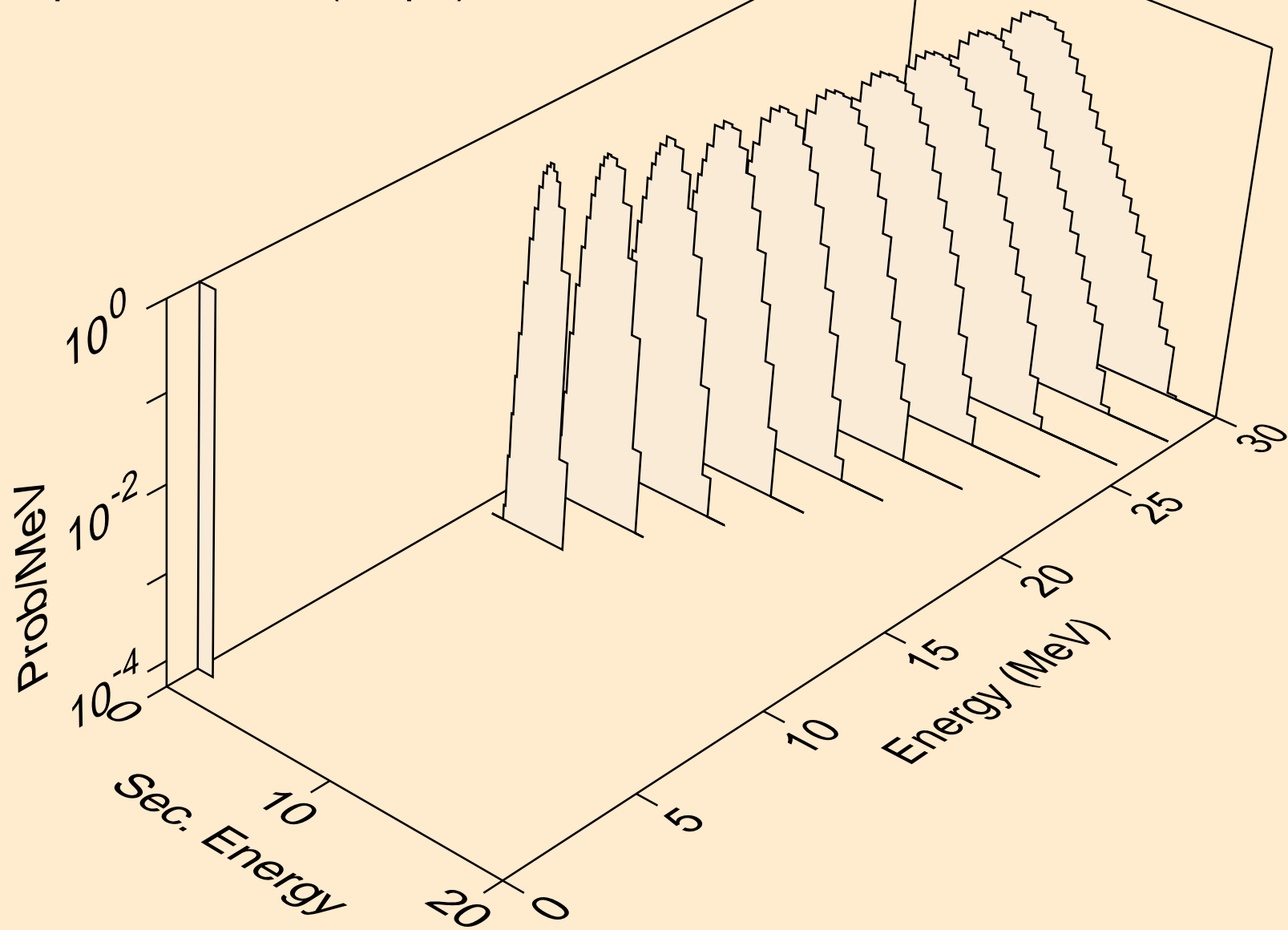

HG191 NEUTRON ACER TENDL-2023 LIBRARY; T=0.K
protons from (n,p)

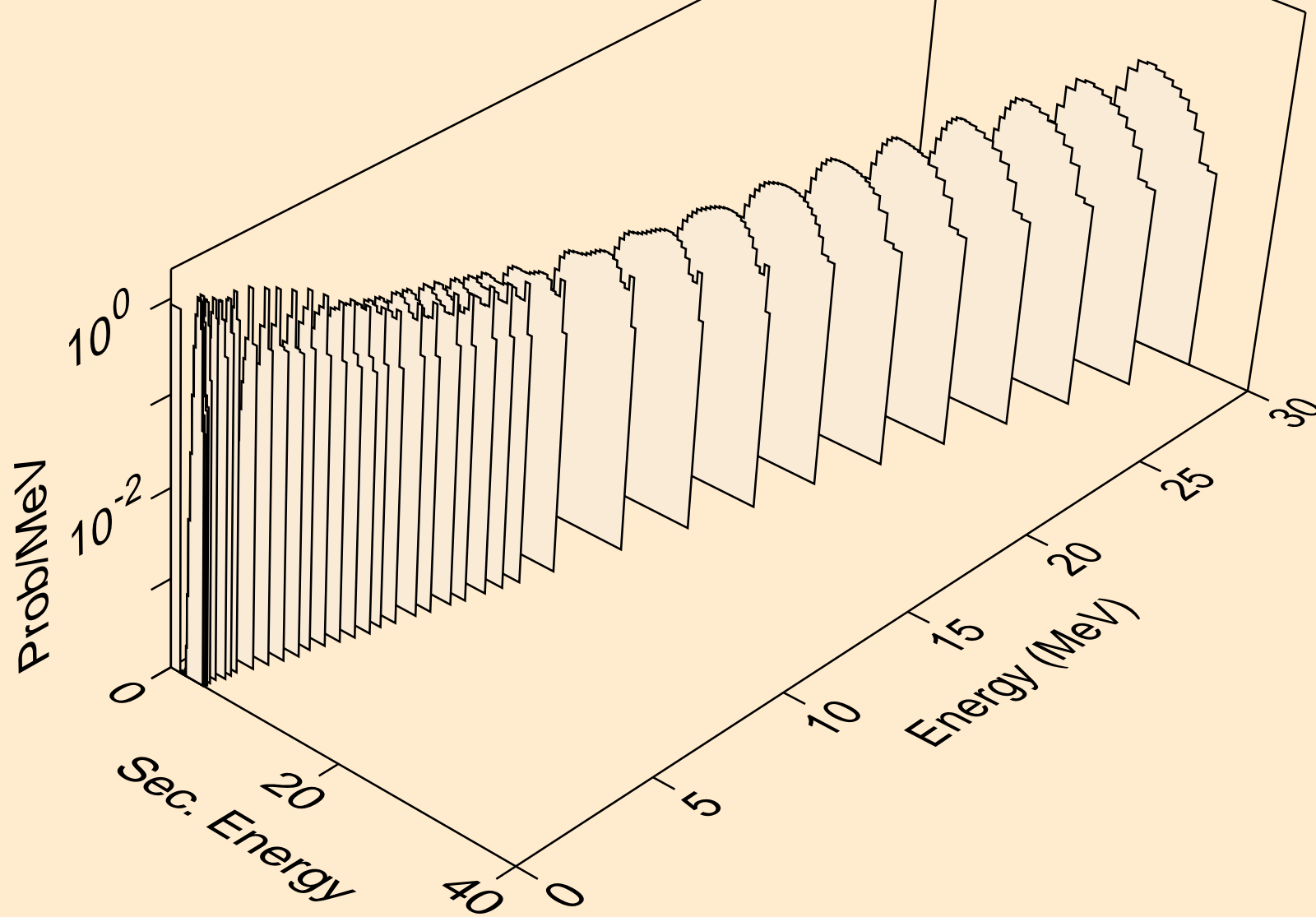

HG191 NEUTRON ACER TENDL-2023 LIBRARY; T=0.K
protons from (n,2p)

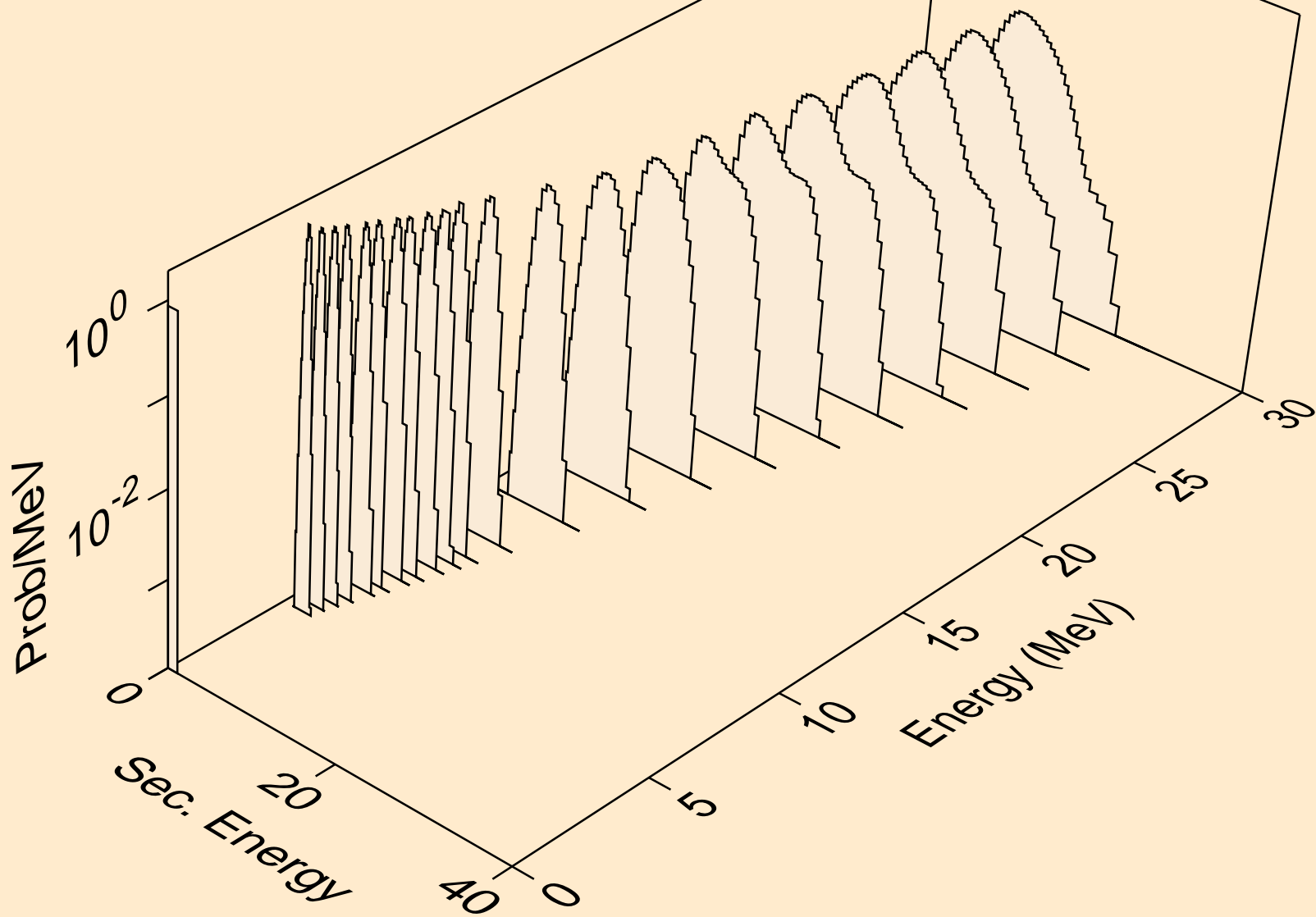

HG191 NEUTRON ACER TENDL-2023 LIBRARY; T=0.K
protons from (n,p)

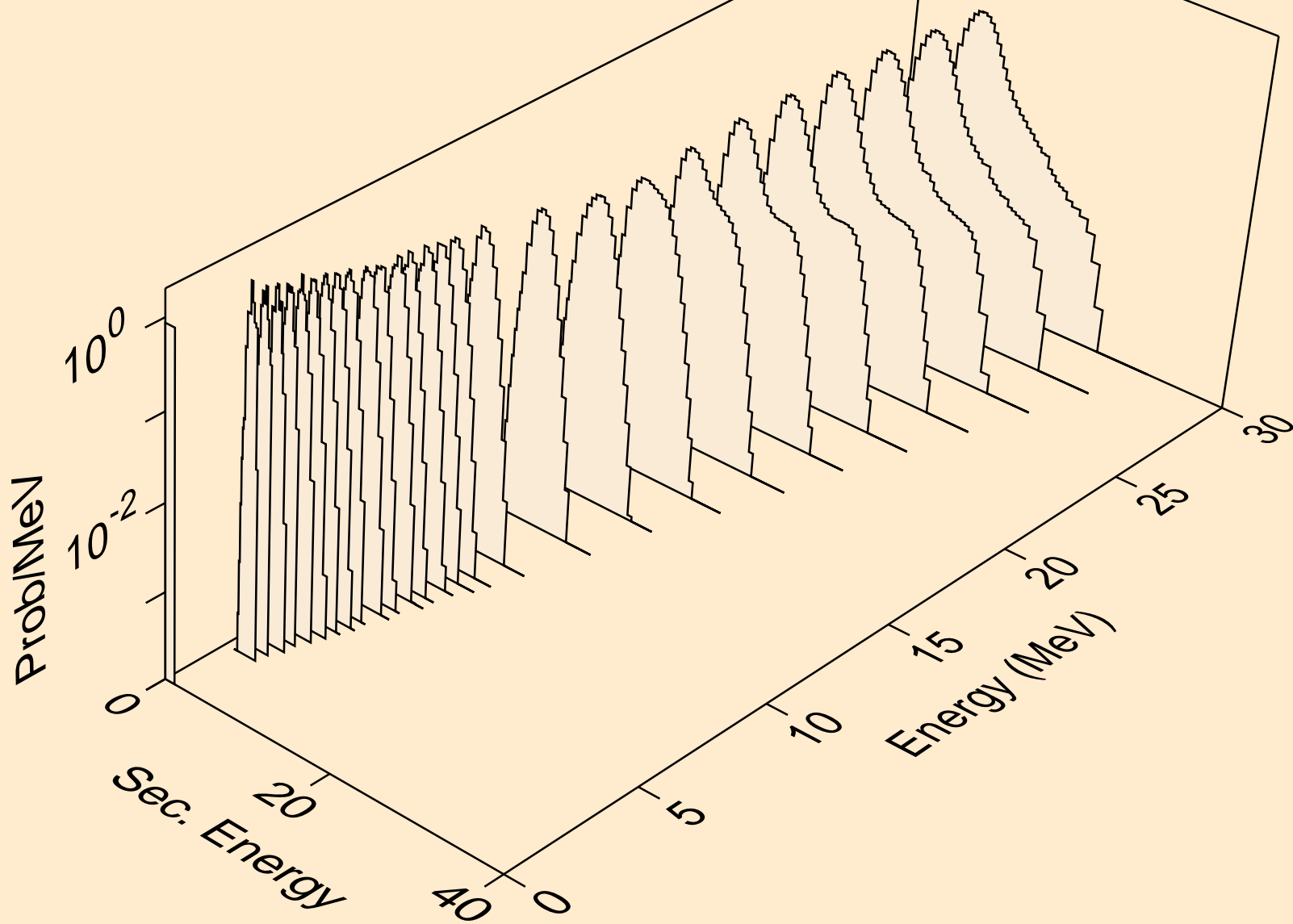

HG191 NEUTRON ACER TENDL-2023 LIBRARY; T=0.K
protons from (n,pd)

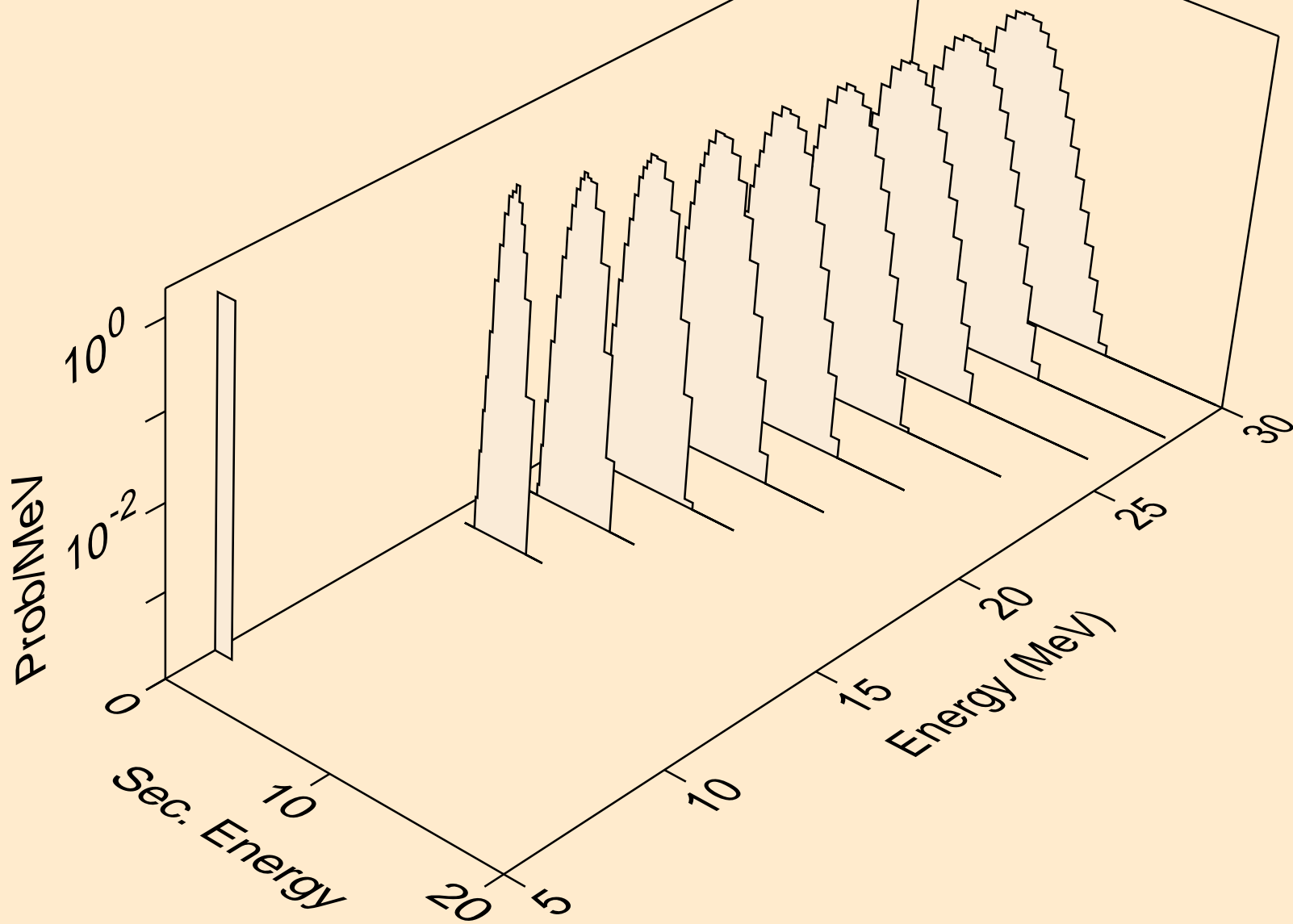

HG191 NEUTRON ACER TENDL-2023 LIBRARY; T=0.K
protons from (n,pt)

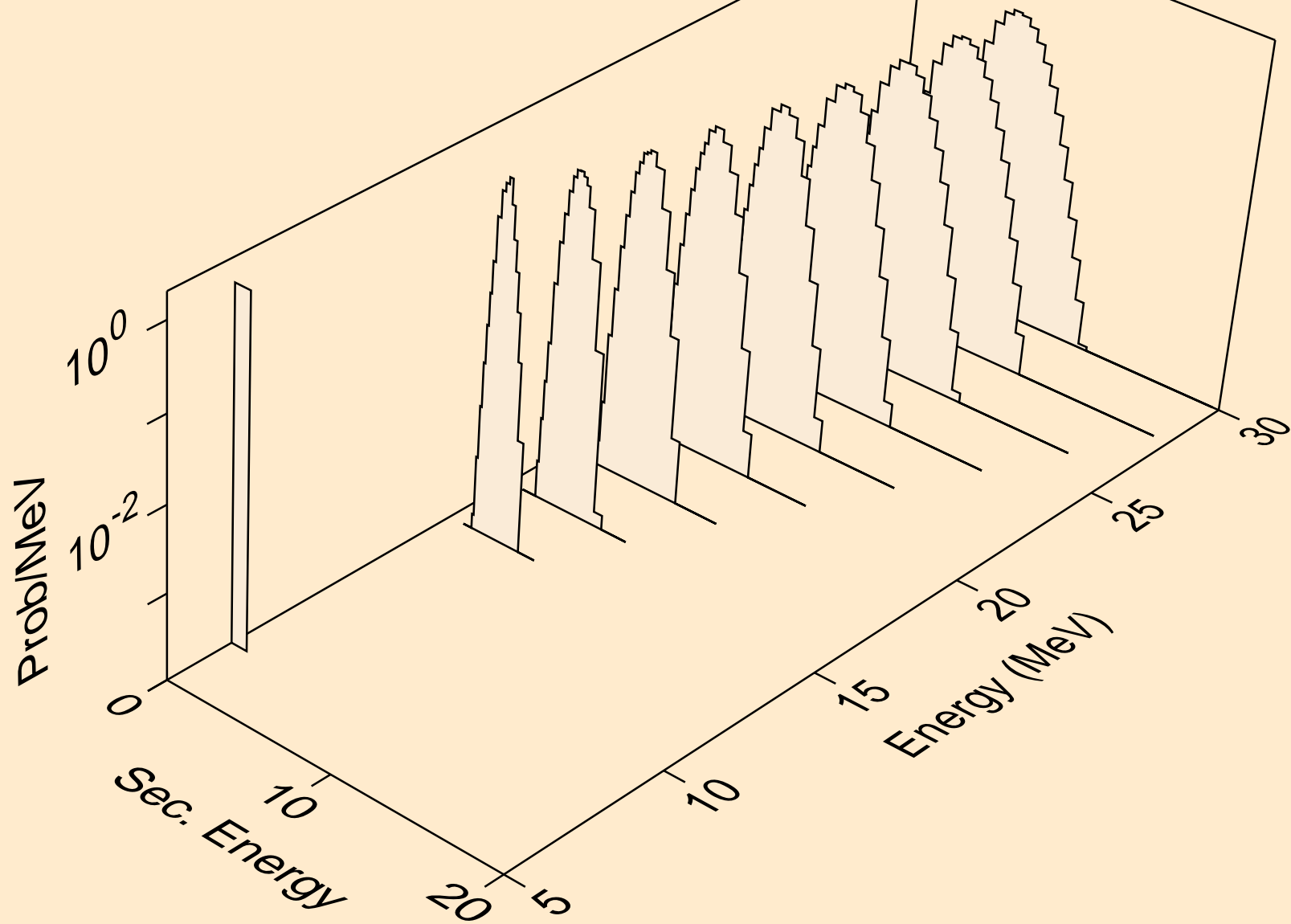

HG191 NEUTRON ACER TENDL-2023 LIBRARY; T=0.K
deuterons from (n,x)

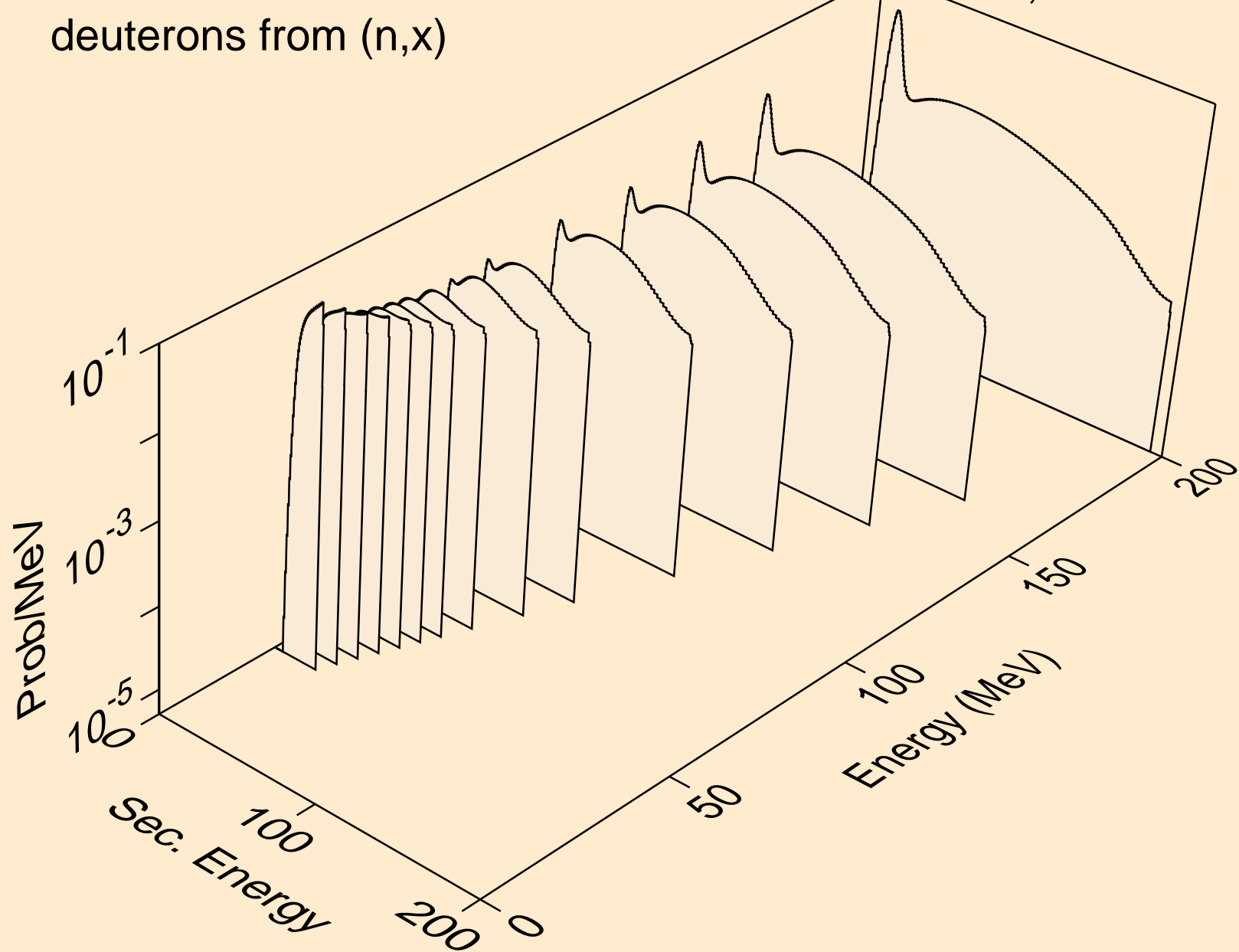

HG191 NEUTRON ACER TENDL-2023 LIBRARY; T=0.K
deuterons from (n,2nd)

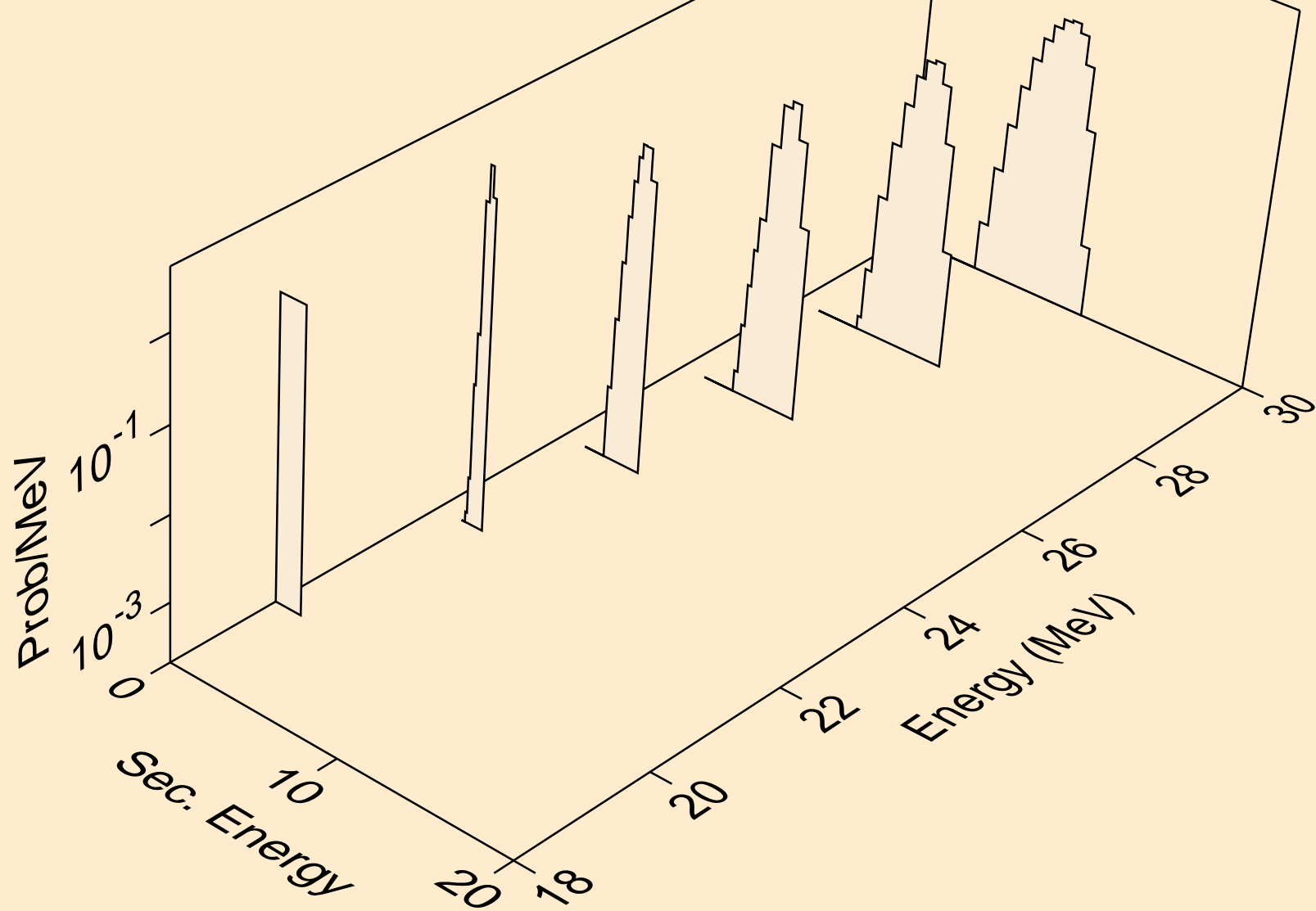

HG191 NEUTRON ACER TENDL-2023 LIBRARY; T=0.K
deuterons from (n,n*)d

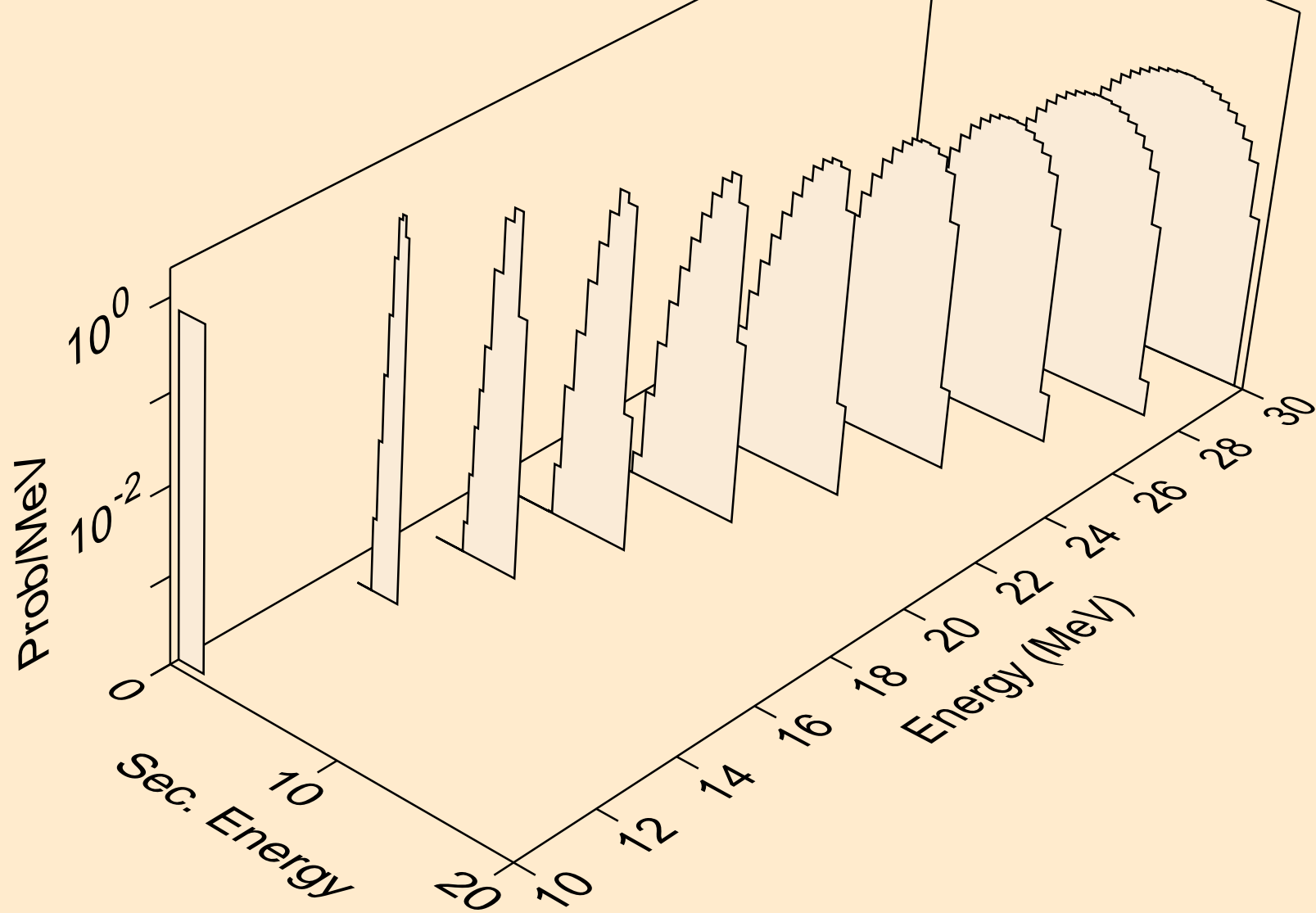

HG191 NEUTRON ACER TENDL-2023 LIBRARY; T=0.K
deuterons from (n,d)

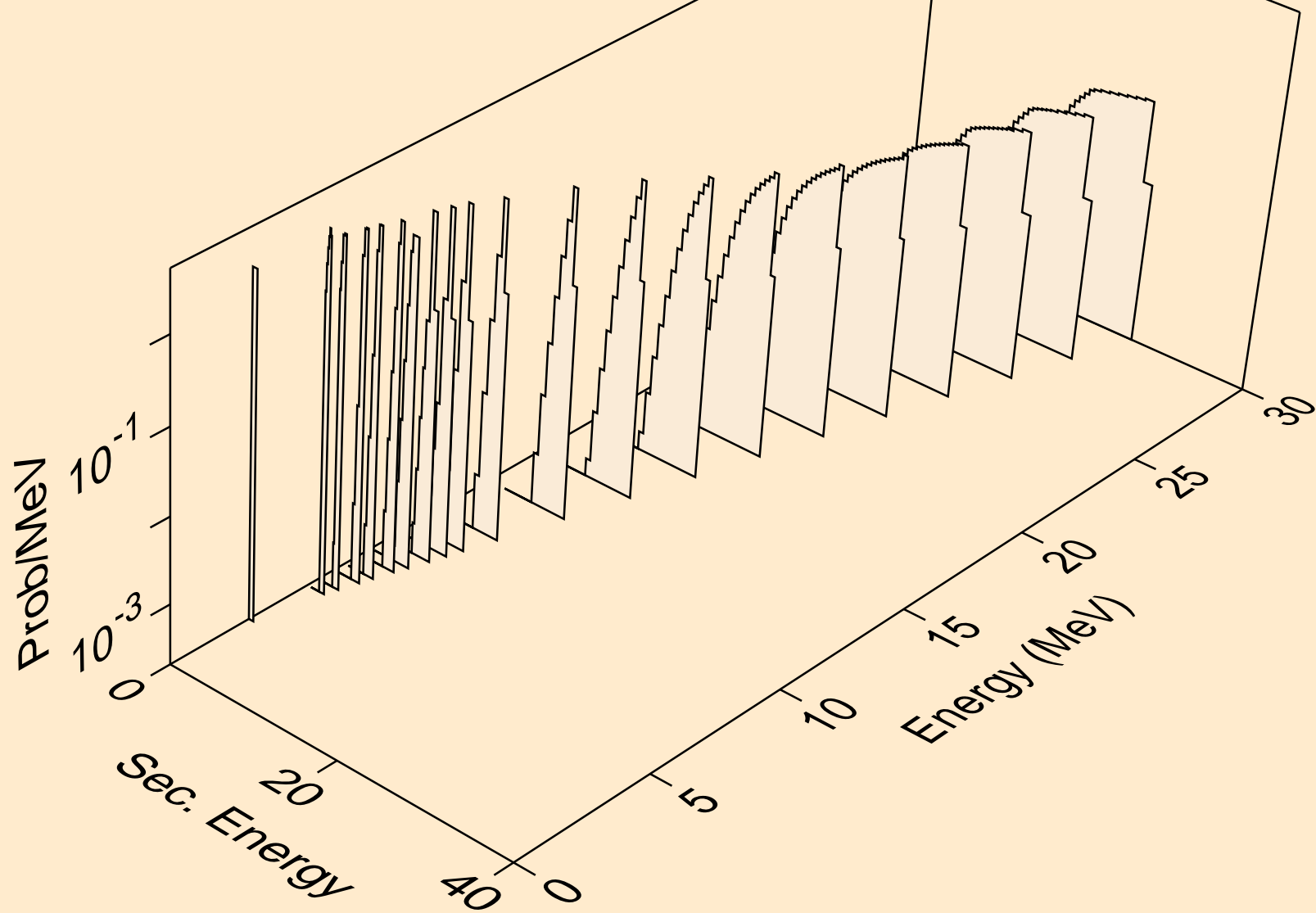

HG191 NEUTRON ACER TENDL-2023 LIBRARY; T=0.K
deuterons from (n,pd)

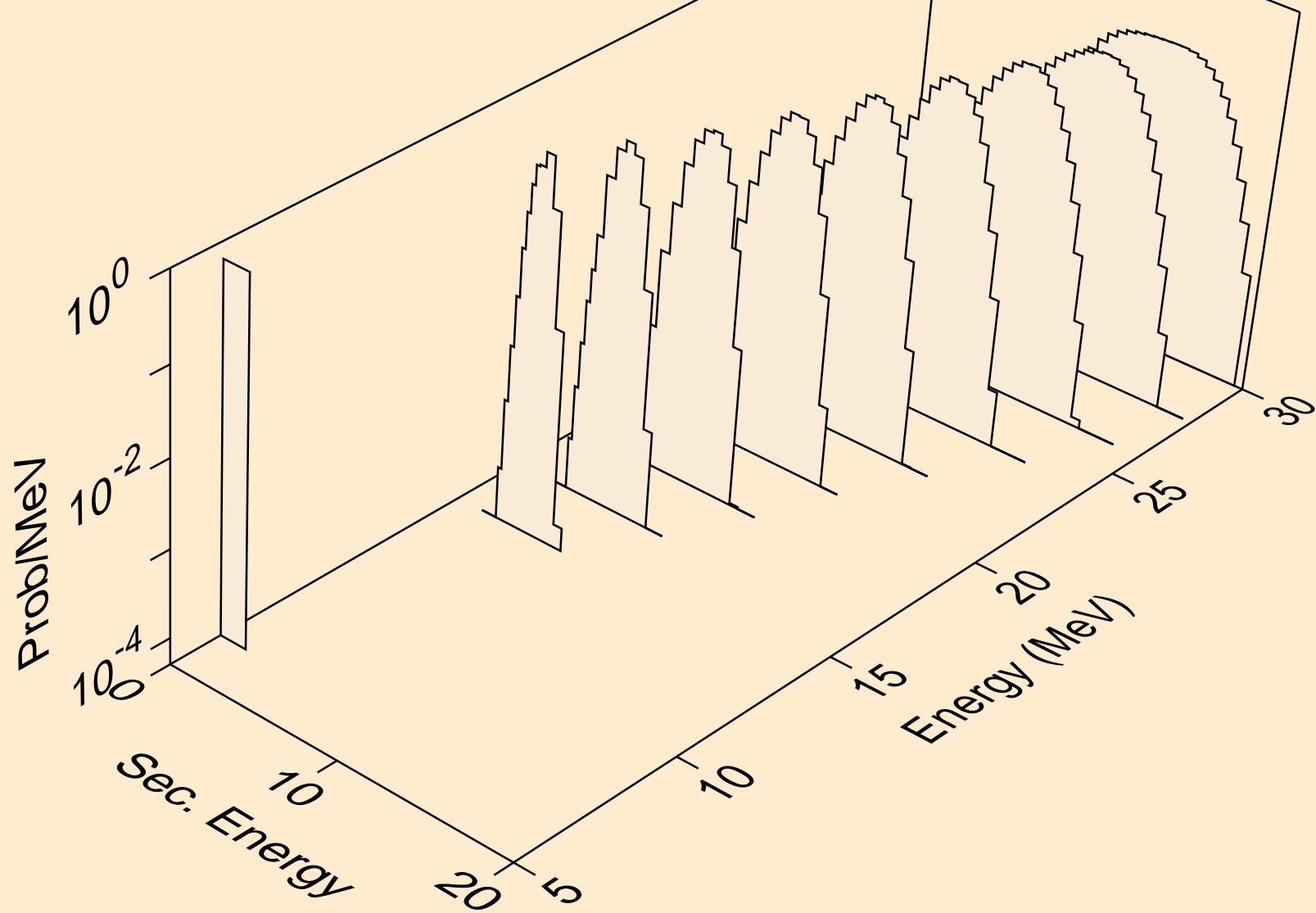

HG191 NEUTRON ACER TENDL-2023 LIBRARY; T=0.K
deuterons from (n,da)

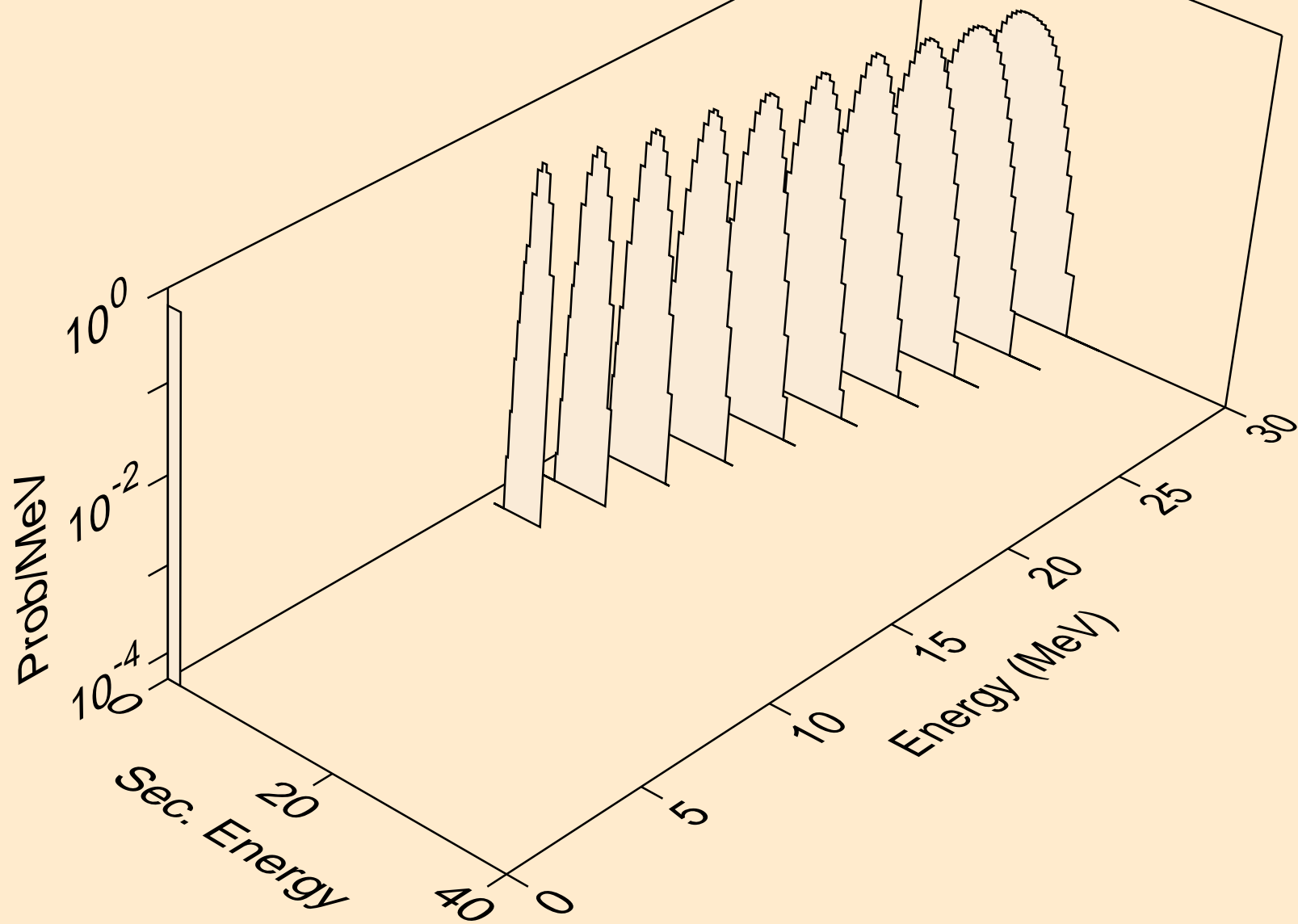

HG191 NEUTRON ACER TENDL-2023 LIBRARY; T=0.K
tritons from (n,x)

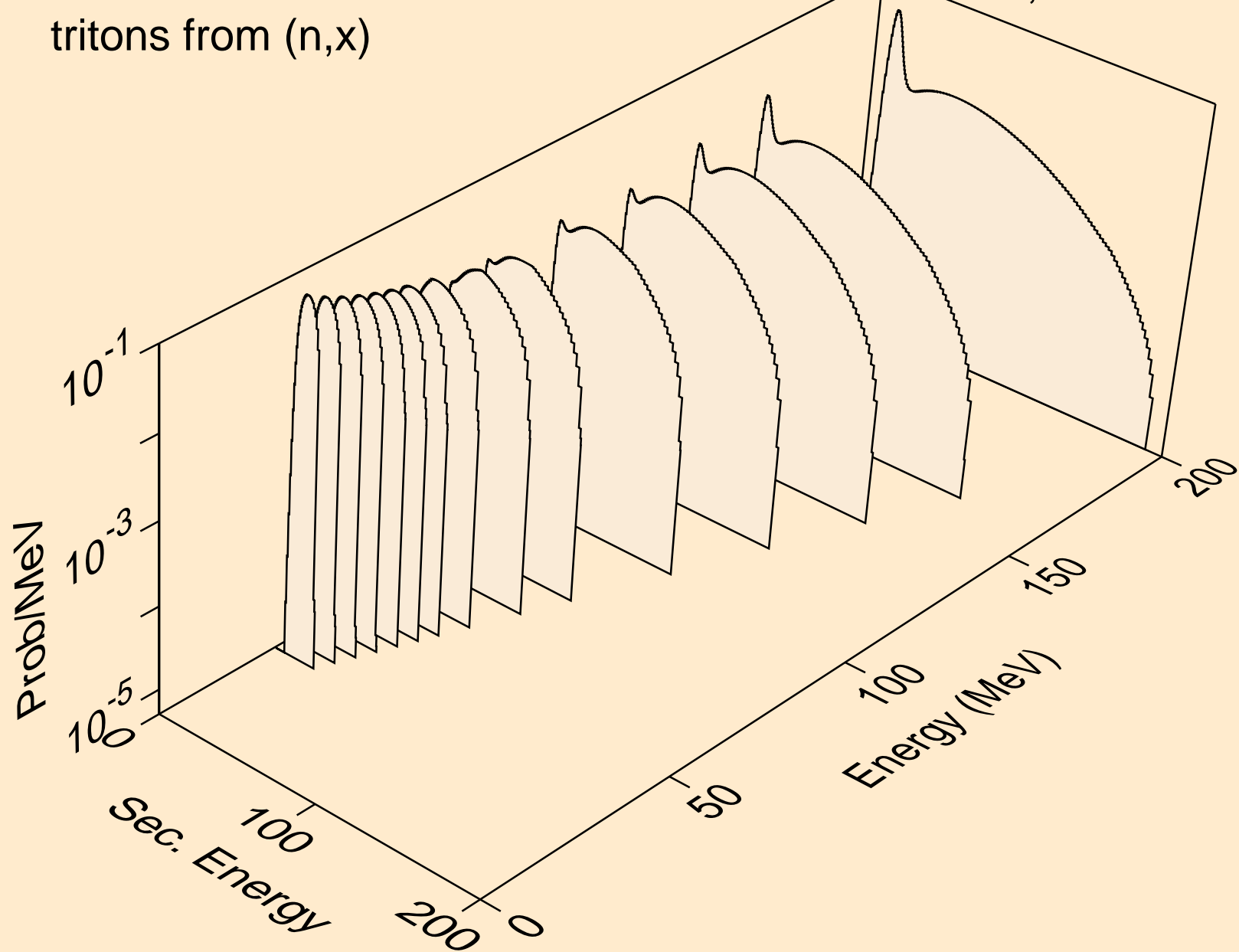

HG191 NEUTRON ACER TENDL-2023 LIBRARY; T=0.K
tritons from (n,n*)t

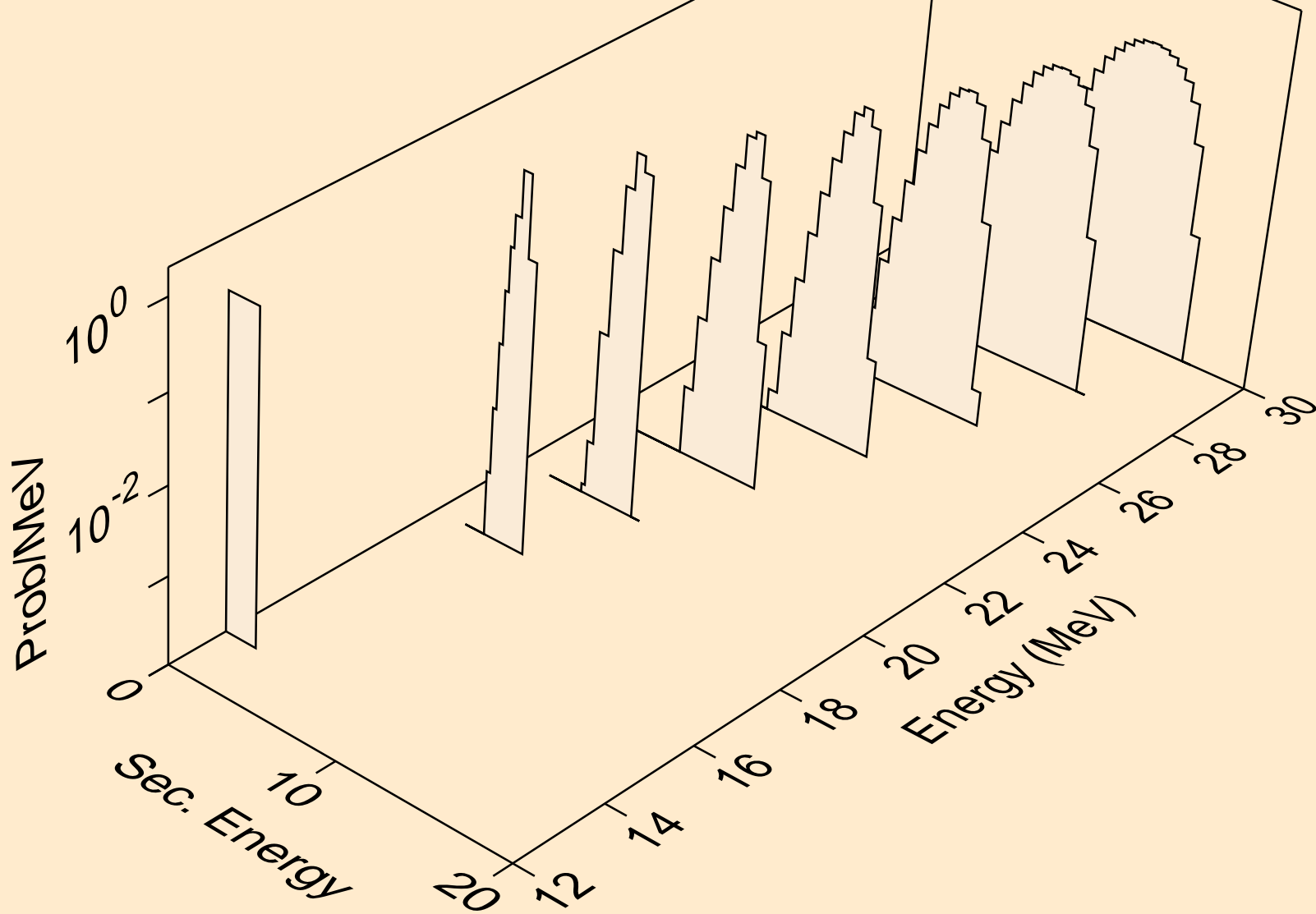

HG191 NEUTRON ACER TENDL-2023 LIBRARY; T=0.K
tritons from (n,t)

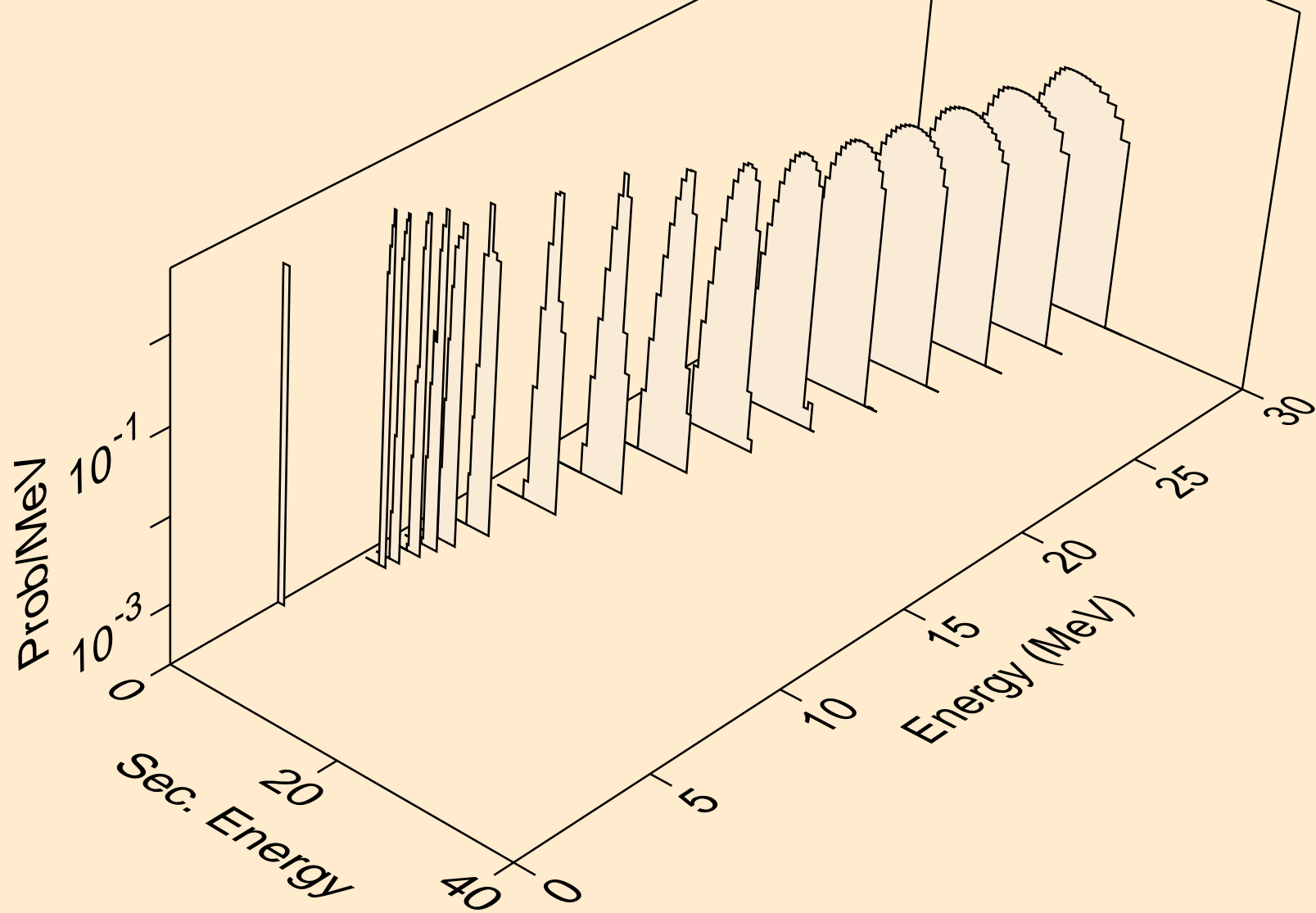

HG191 NEUTRON ACER TENDL-2023 LIBRARY; T=0.K
tritons from (n,pt)

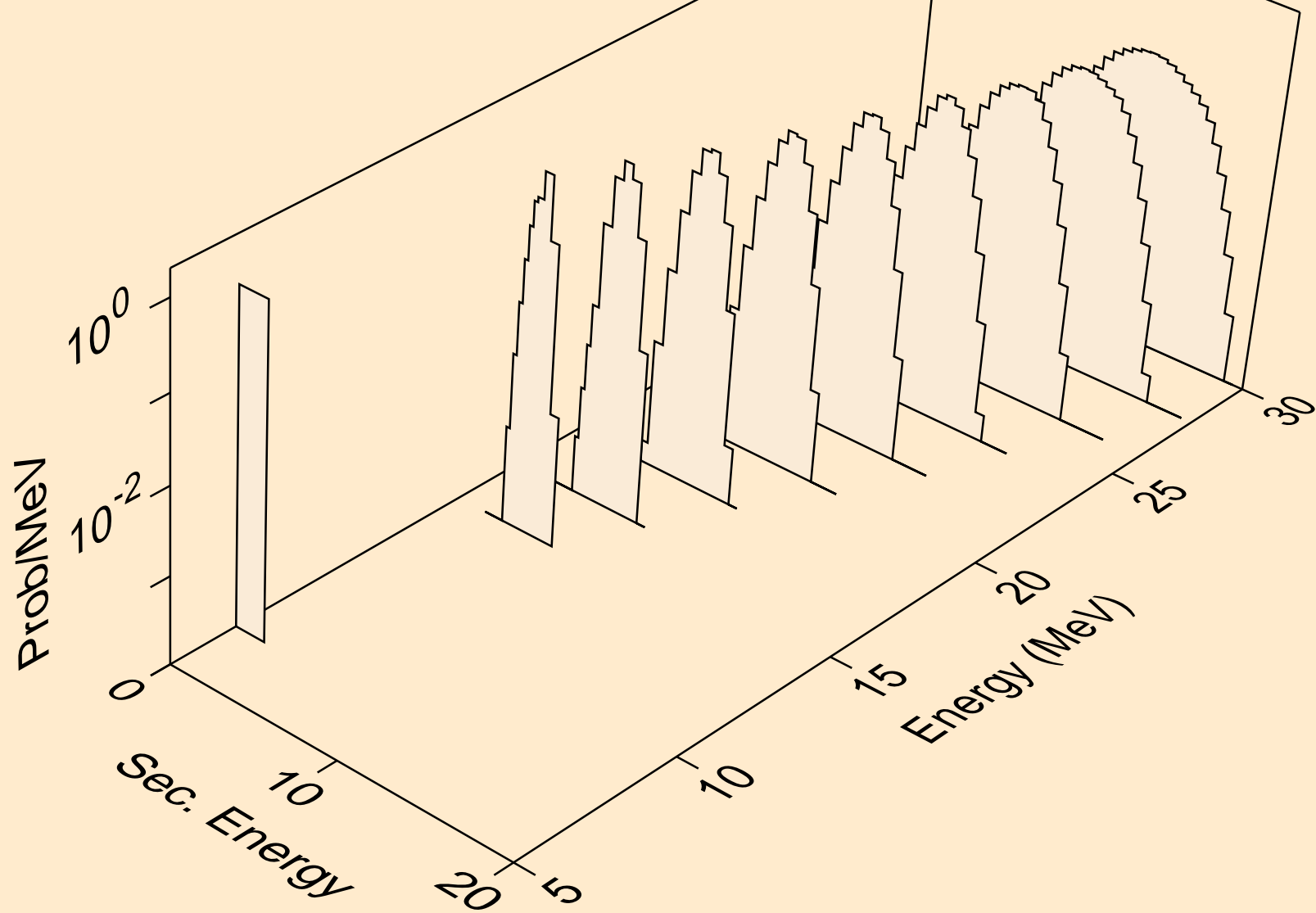

HG191 NEUTRON ACER TENDL-2023 LIBRARY; T=0.K
he3s from (n,x)

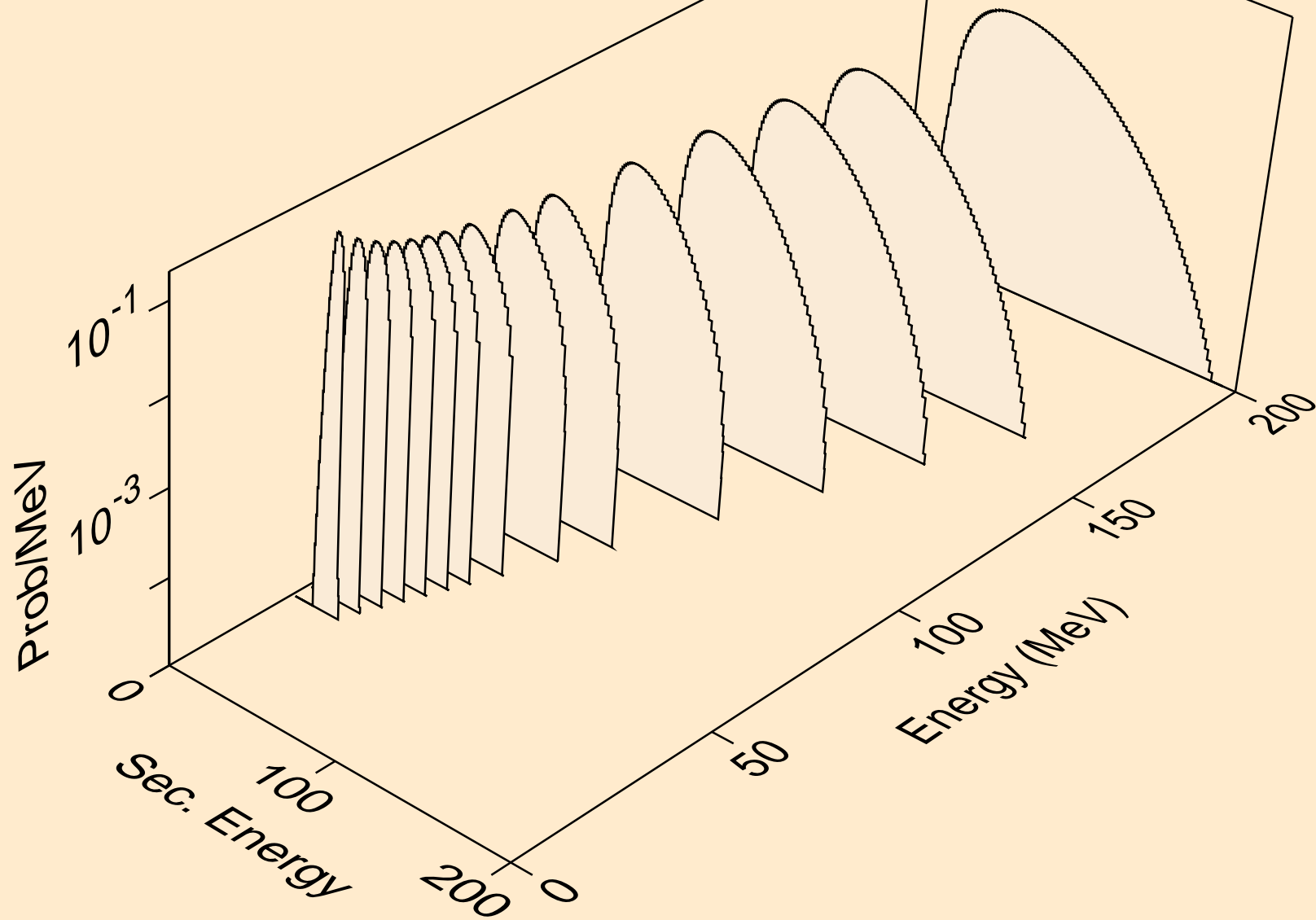

HG191 NEUTRON ACER TENDL-2023 LIBRARY; T=0.K
he3s from (n,n*)he3

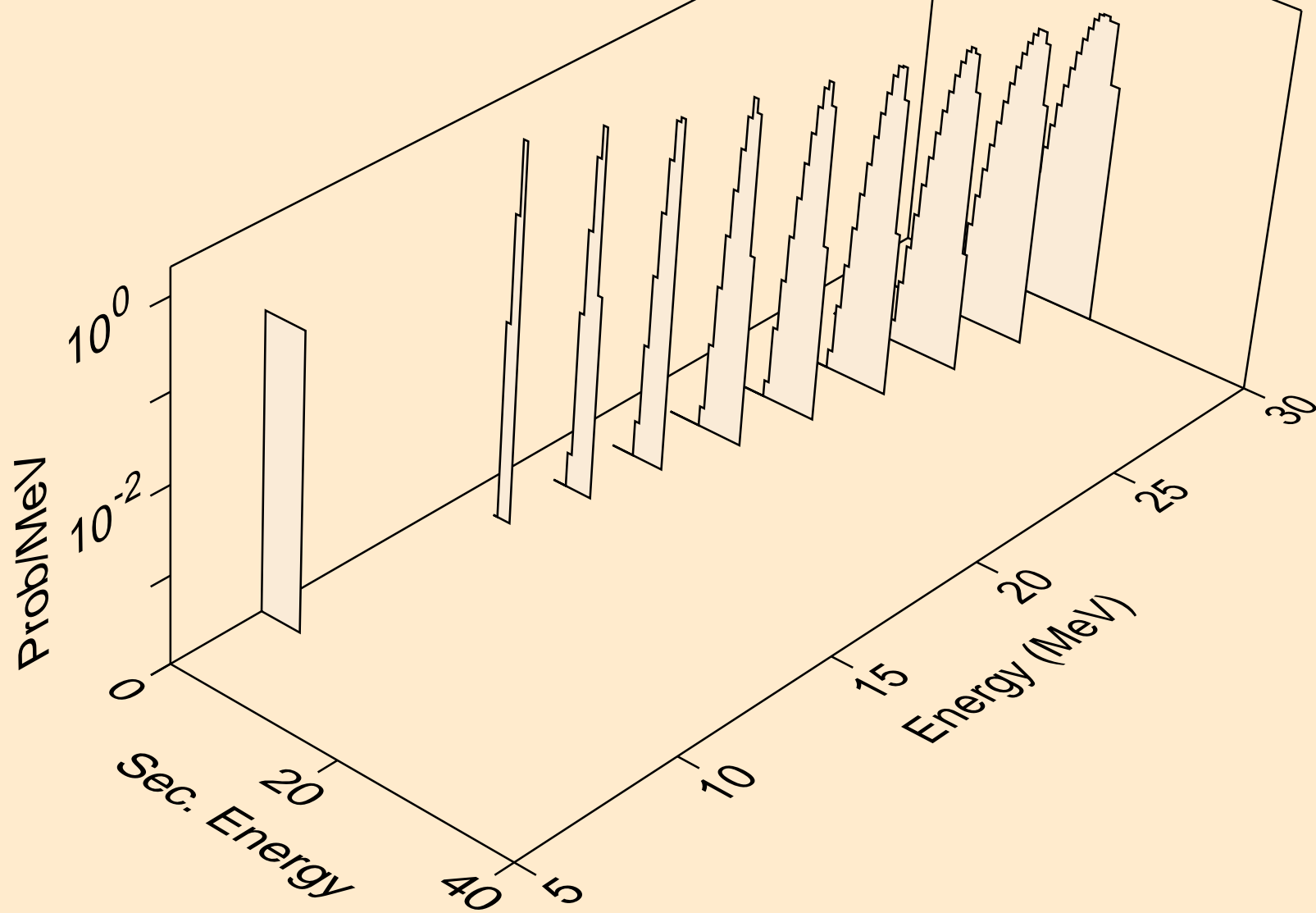

HG191 NEUTRON ACER TENDL-2023 LIBRARY; T=0.K
he3s from (n,he3)

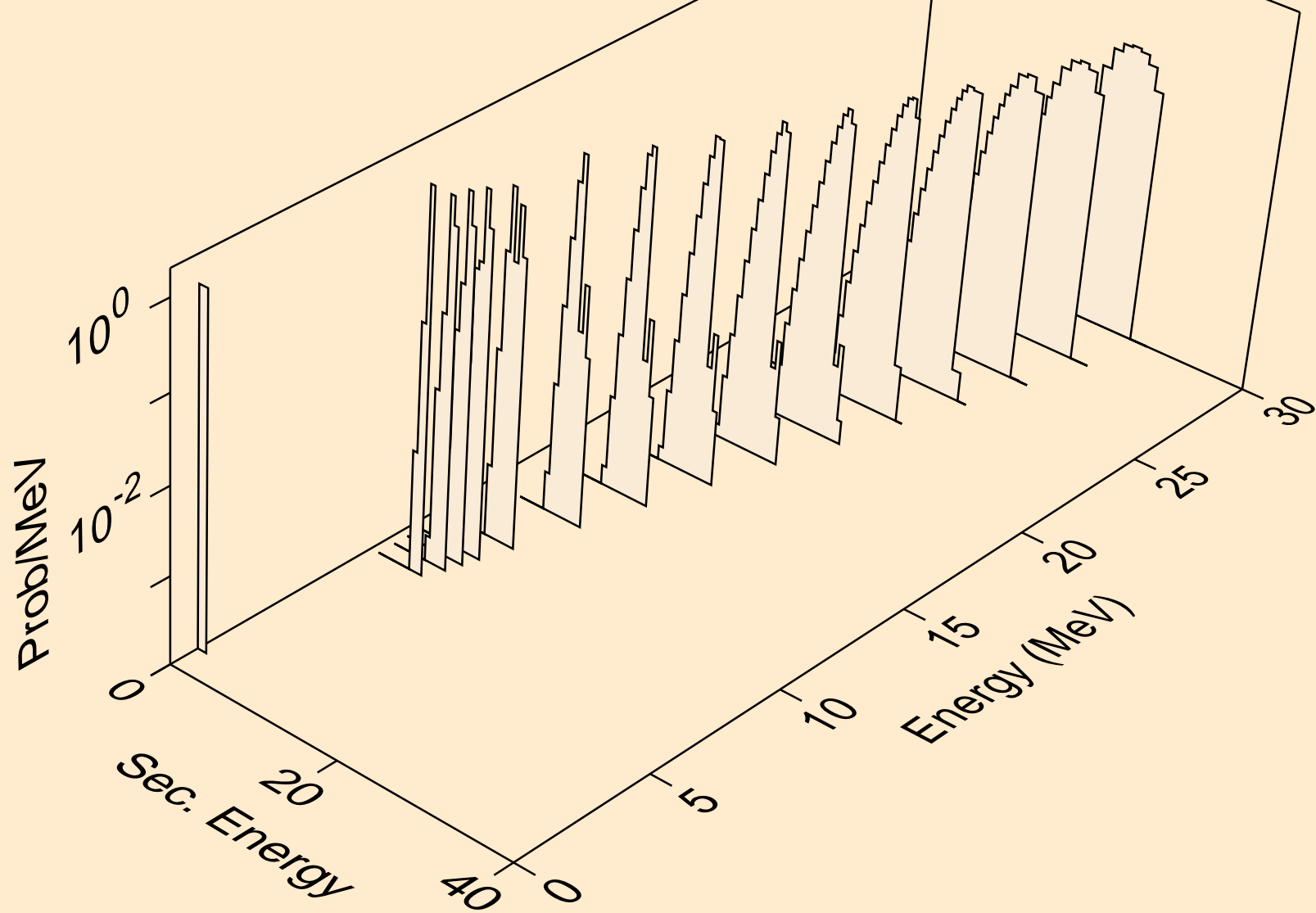

HG191 NEUTRON ACER TENDL-2023 LIBRARY; T=0.K
alphas from (n,x)

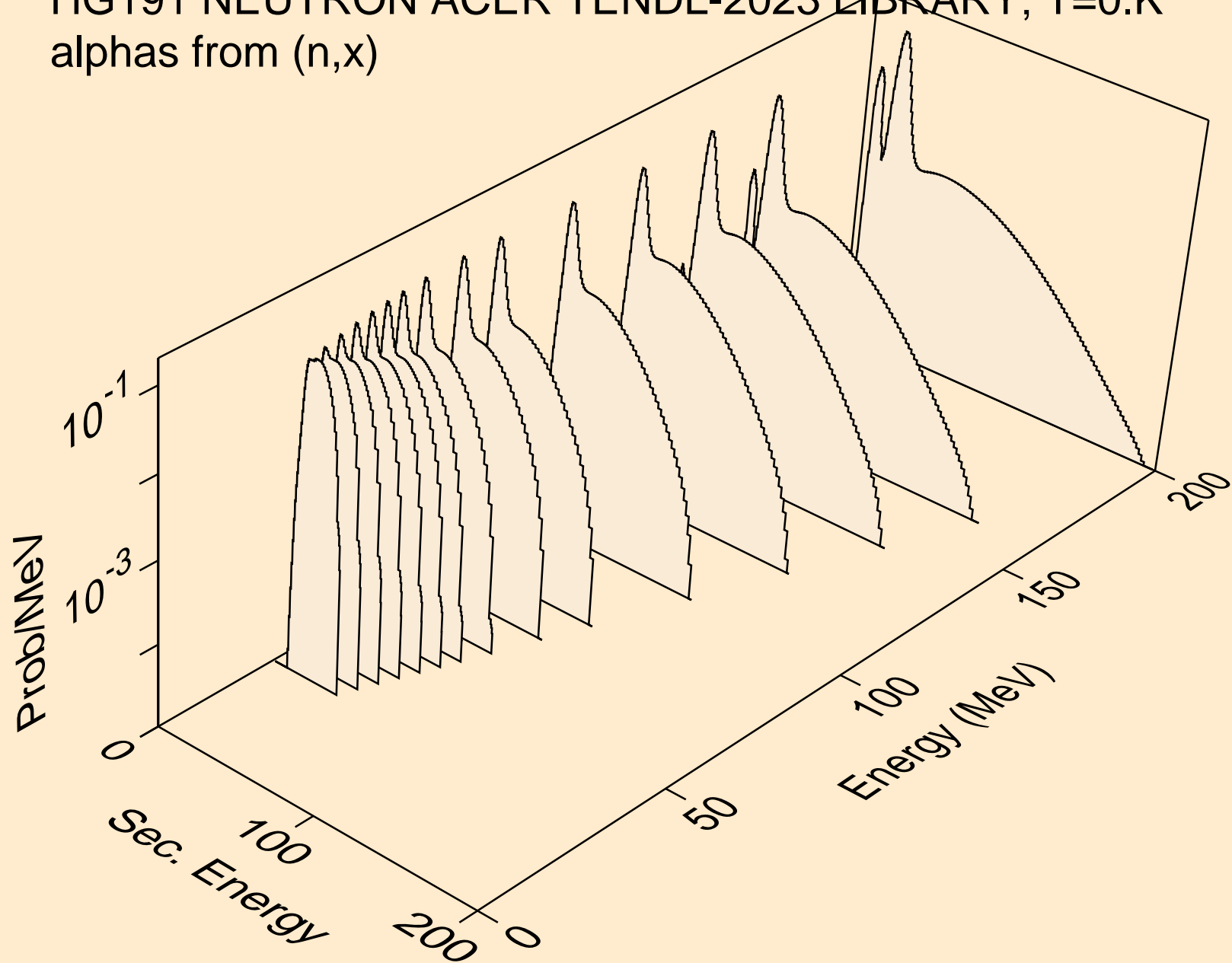

HG191 NEUTRON ACER TENDL-2023 LIBRARY; T=0.K
alphas from (n,n*)a

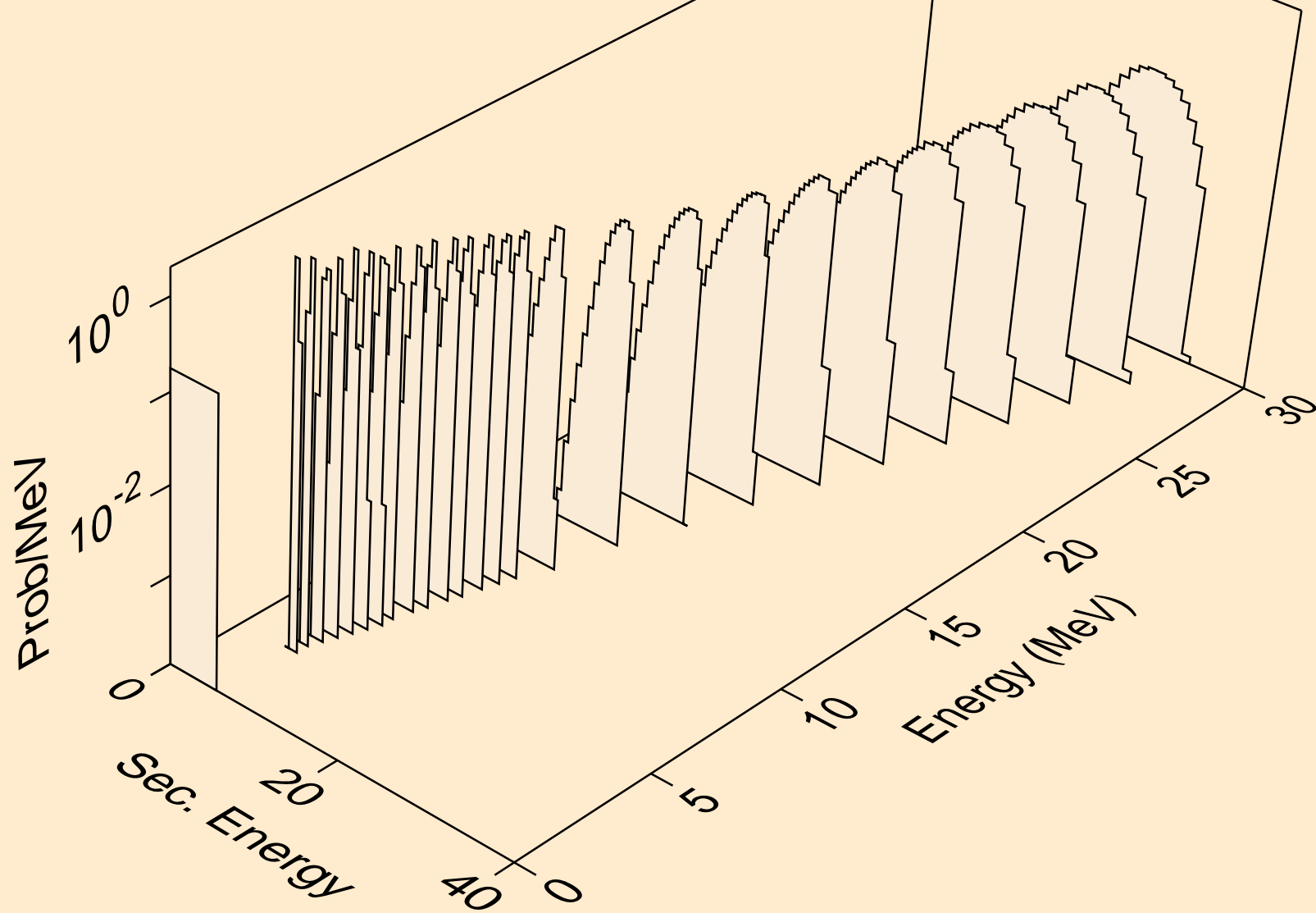

HG191 NEUTRON ACER TENDL-2023 LIBRARY; T=0.K
alphas from (n,2n)a

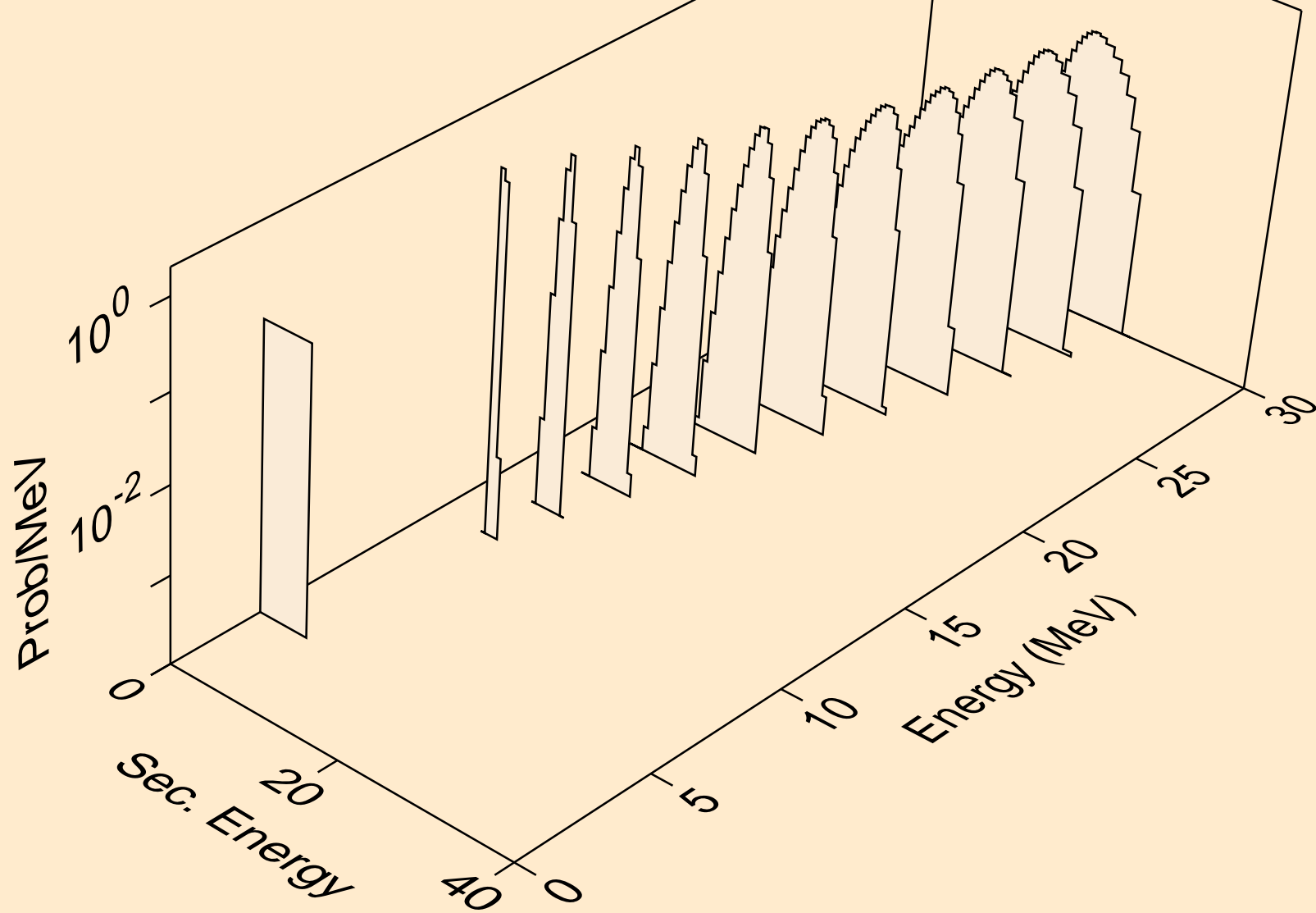

HG191 NEUTRON ACER TENDL-2023 LIBRARY; T=0.K
alphas from (n,3n)a

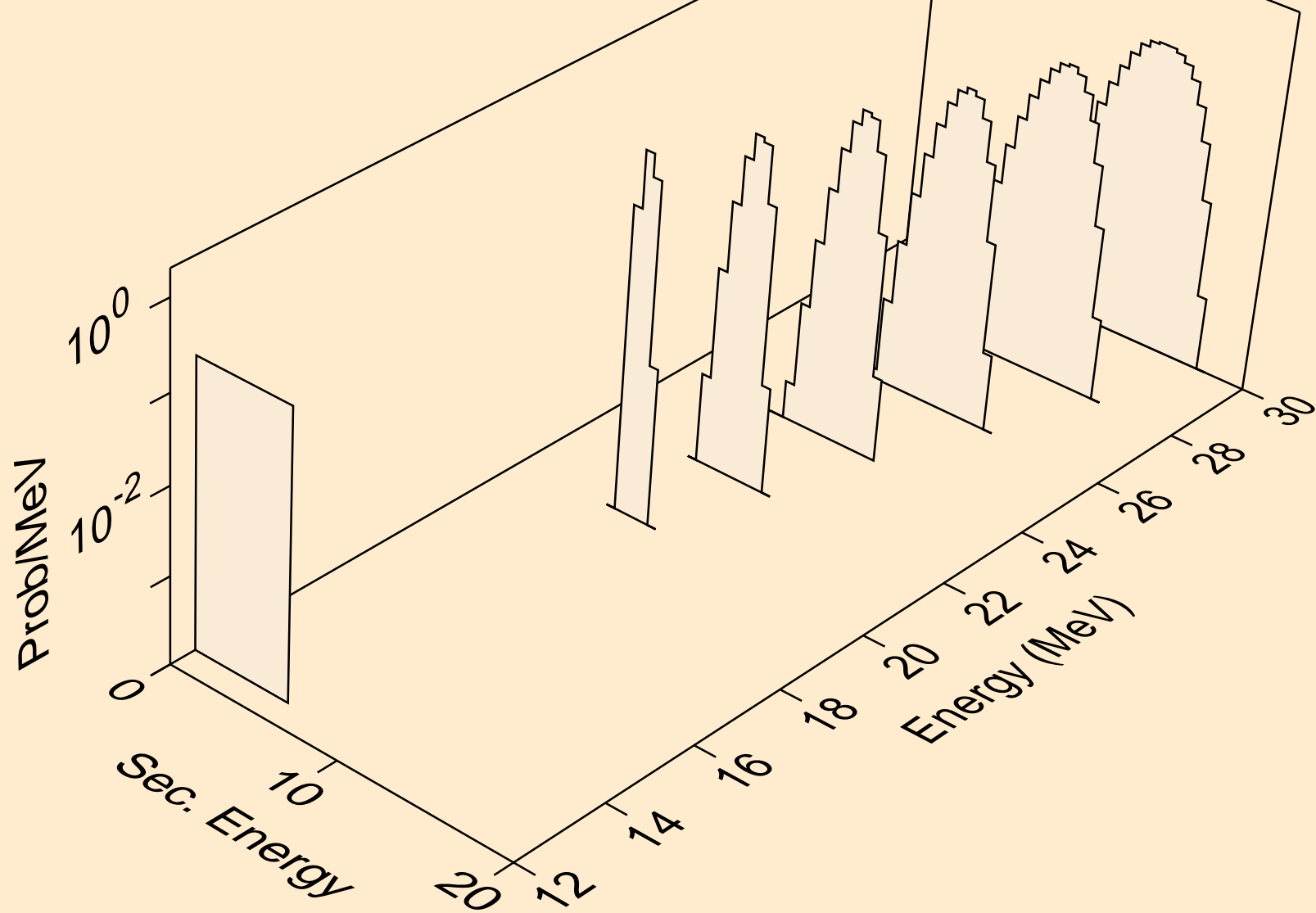

HG191 NEUTRON ACER TENDL-2023 LIBRARY; T=0.K
alphas from (n,n*)2a

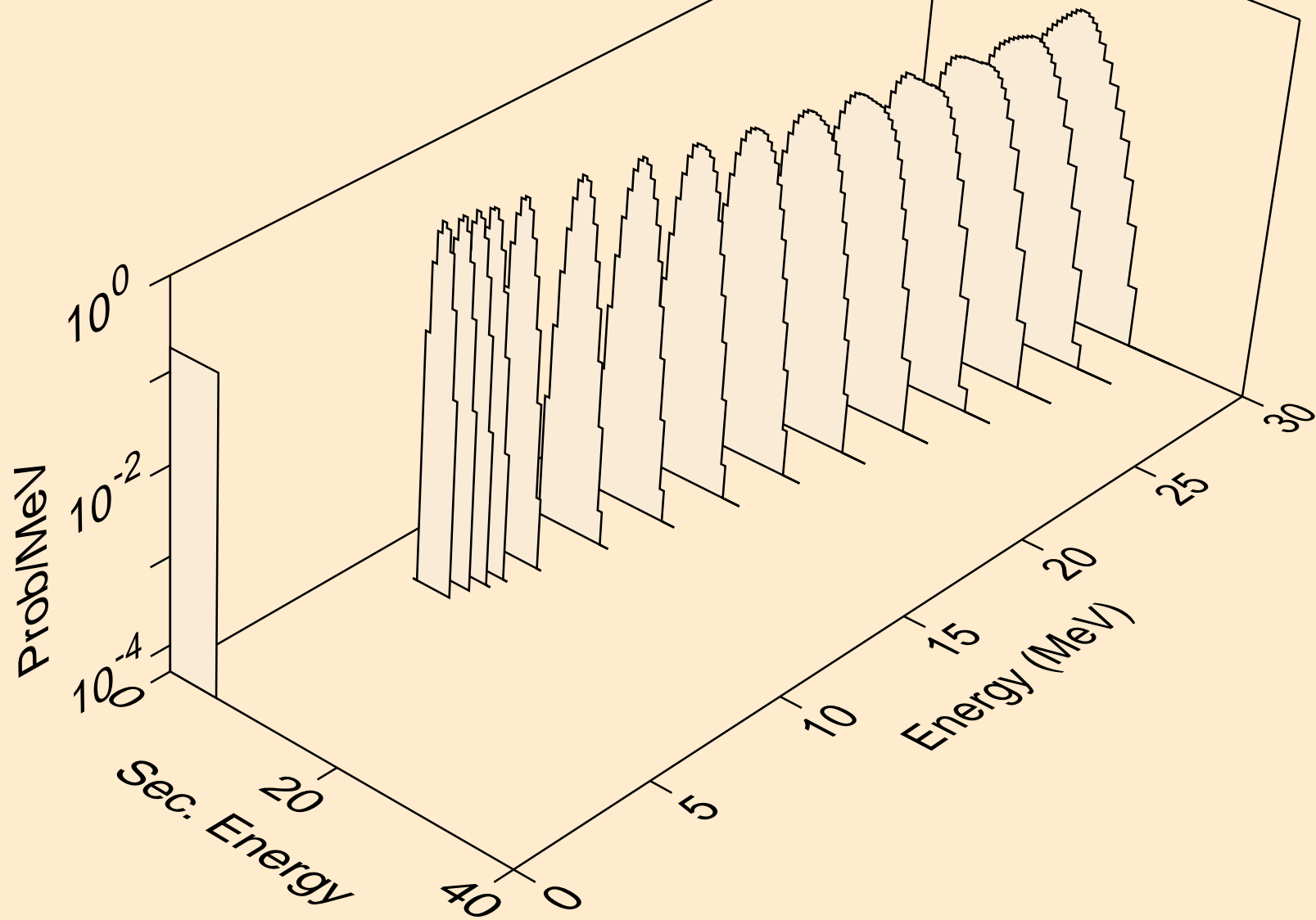

HG191 NEUTRON ACER TENDL-2023 LIBRARY; T=0.K
alphas from (n,2n)2a

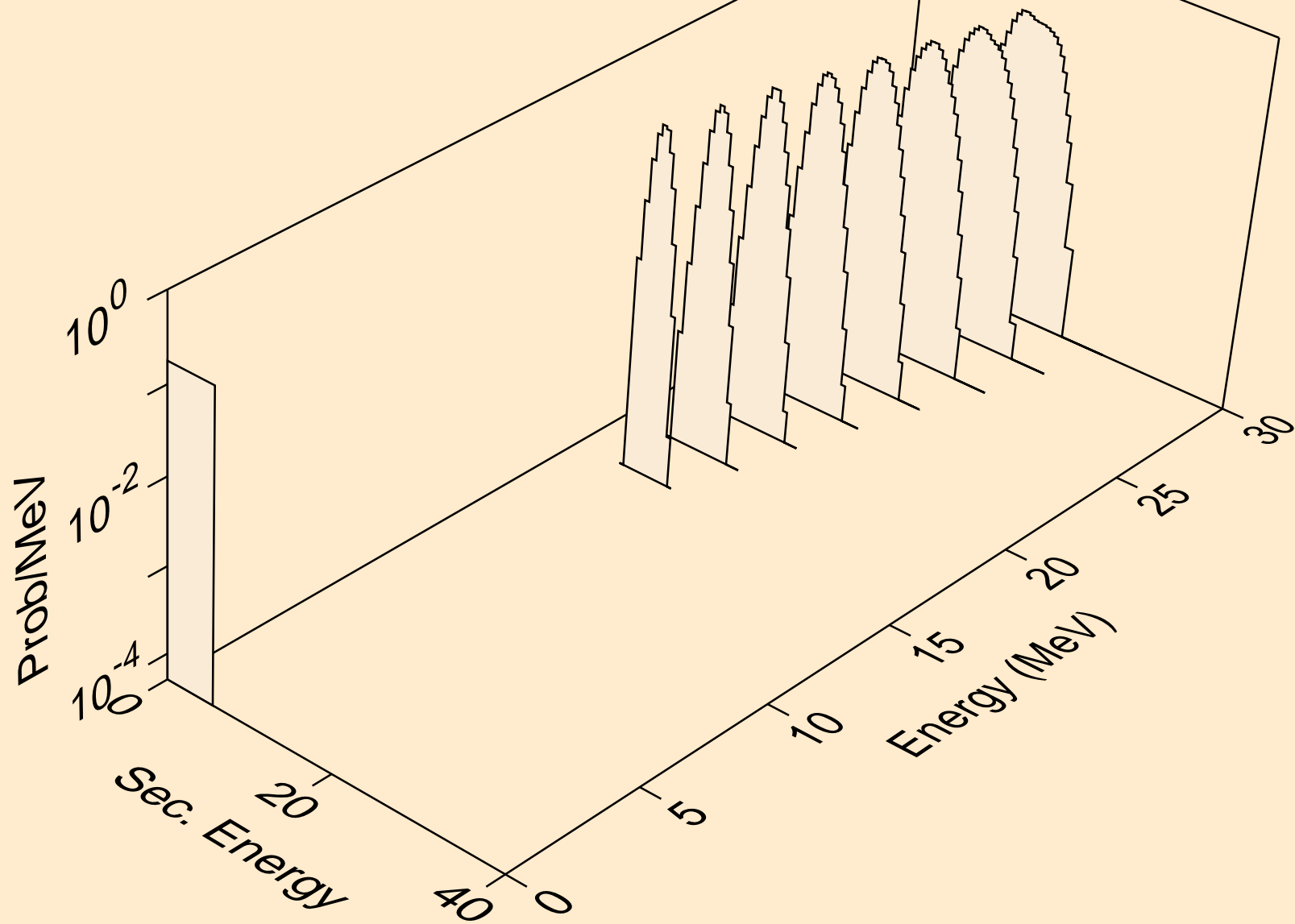

HG191 NEUTRON ACER TENDL-2023 LIBRARY; T=0.K
alphas from (n,npa)

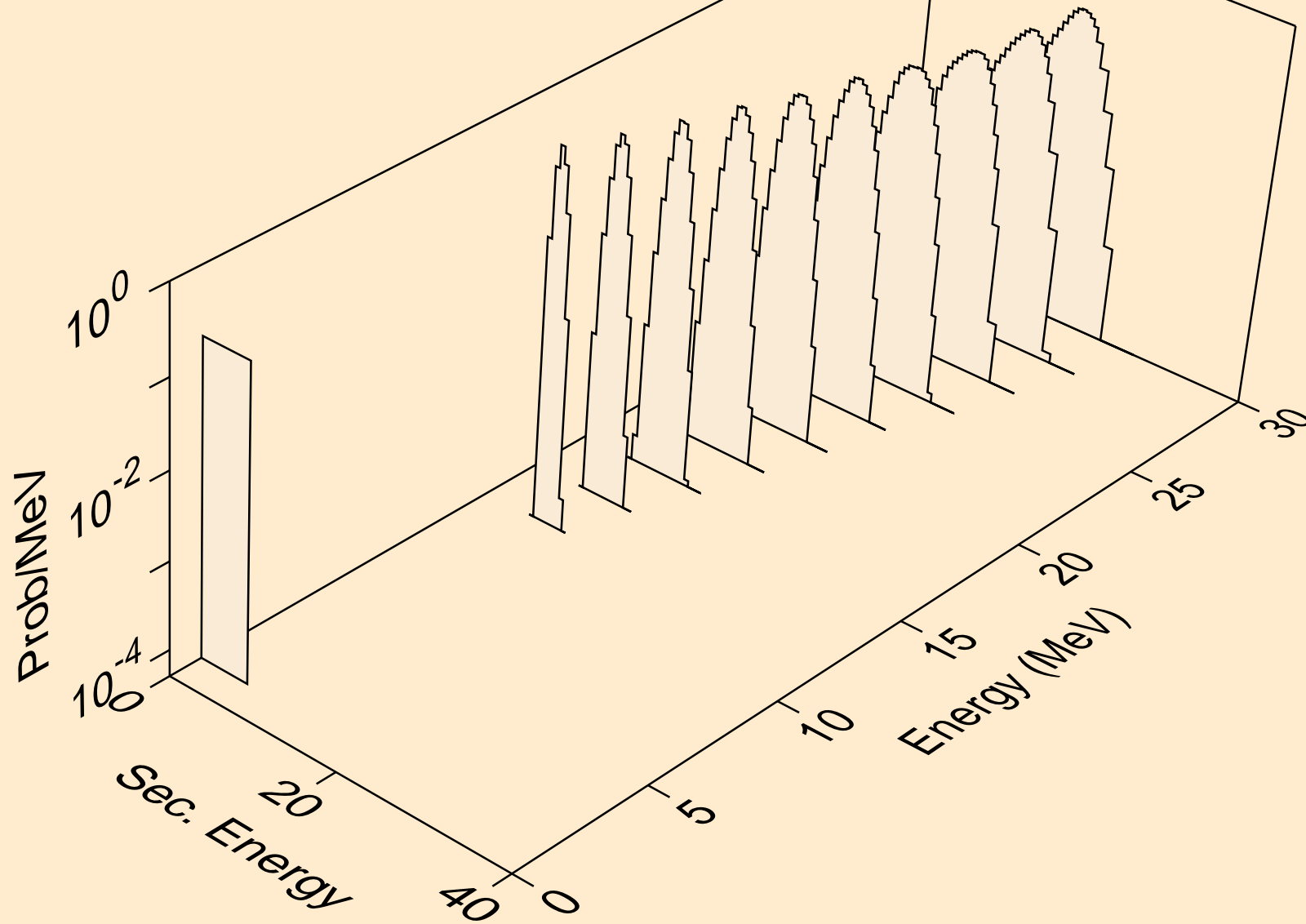

HG191 NEUTRON ACER TENDL-2023 LIBRARY; T=0.K
alphas from (n,a)

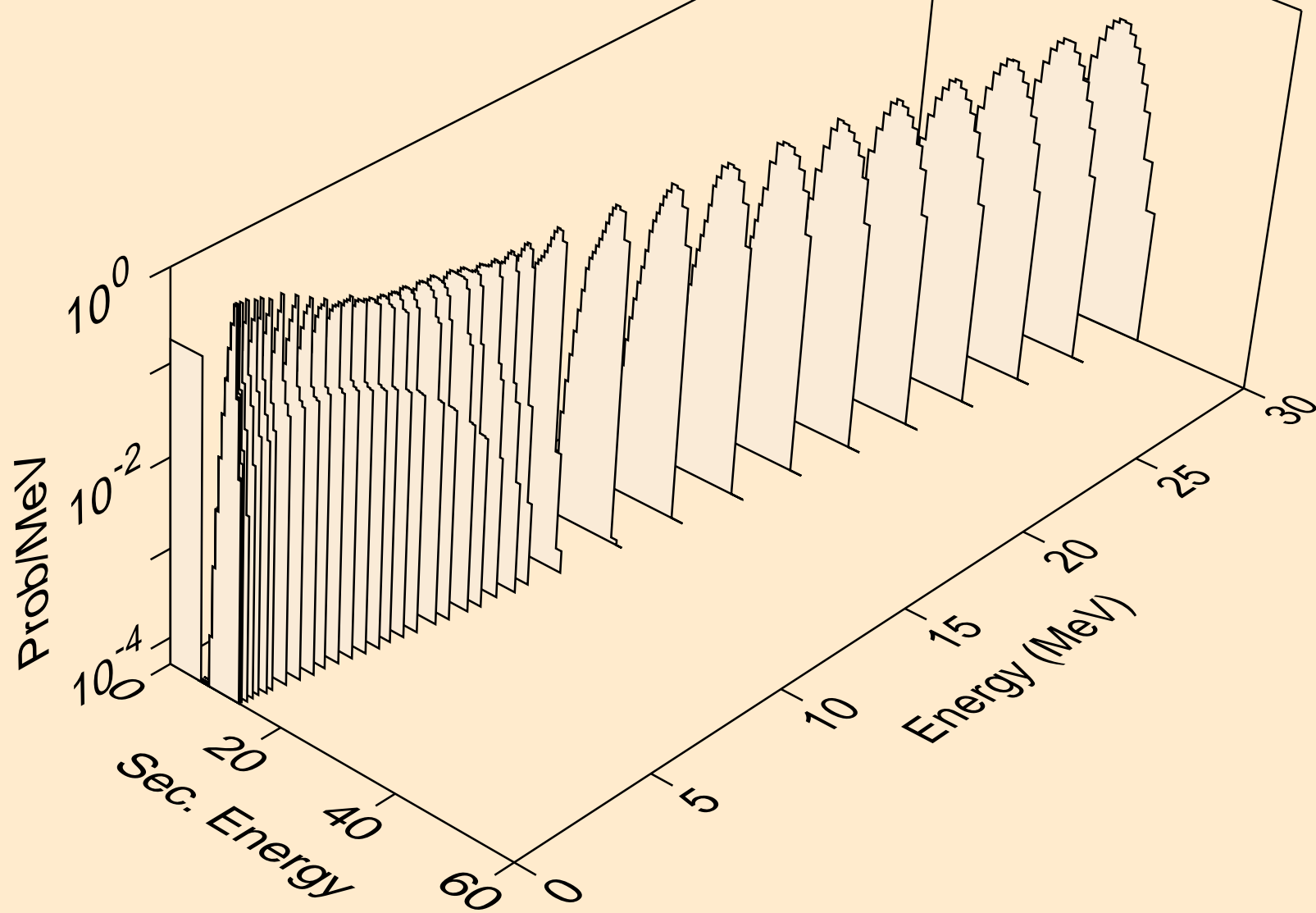

HG191 NEUTRON ACER TENDL-2023 LIBRARY; T=0.K
alphas from (n,2a)

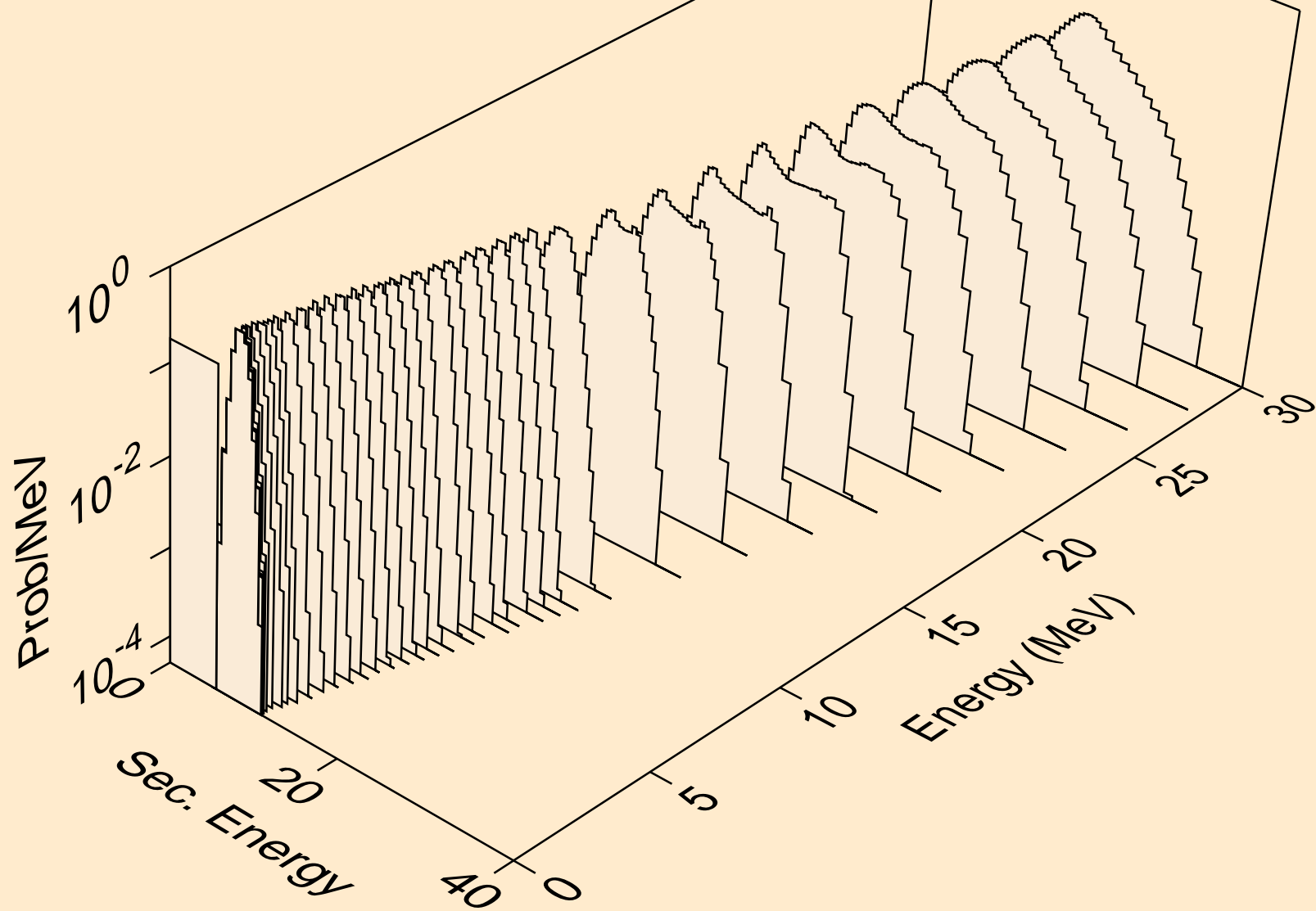

HG191 NEUTRON ACER TENDL-2023 LIBRARY; T=0.K
alphas from (n,pa)

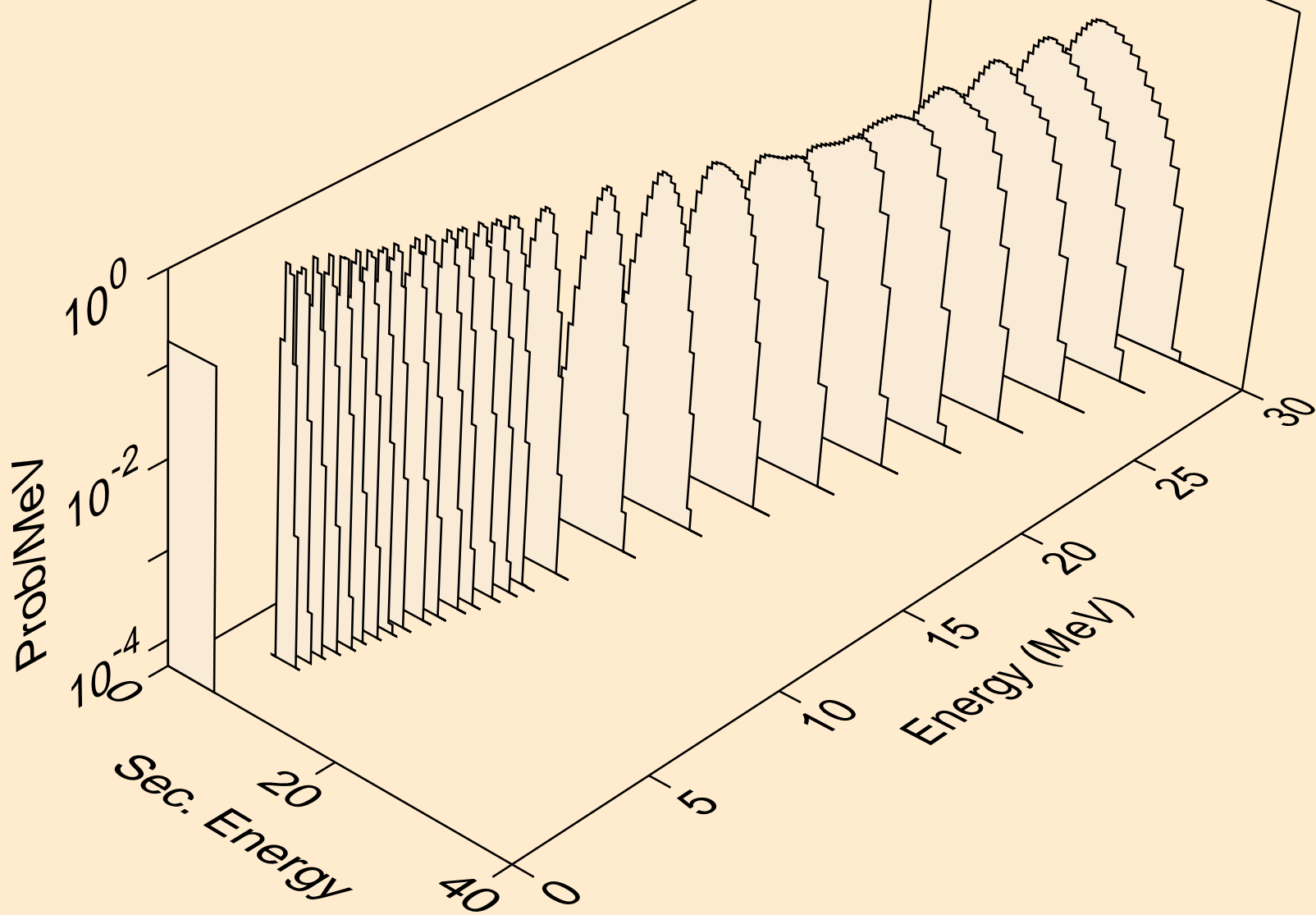

HG191 NEUTRON ACER TENDL-2023 LIBRARY; T=0.K
alphas from (n,da)

