

# HG196 NEUTRON ACER TENDL-2023 LIBRARY; T=0.K

## Principal cross sections

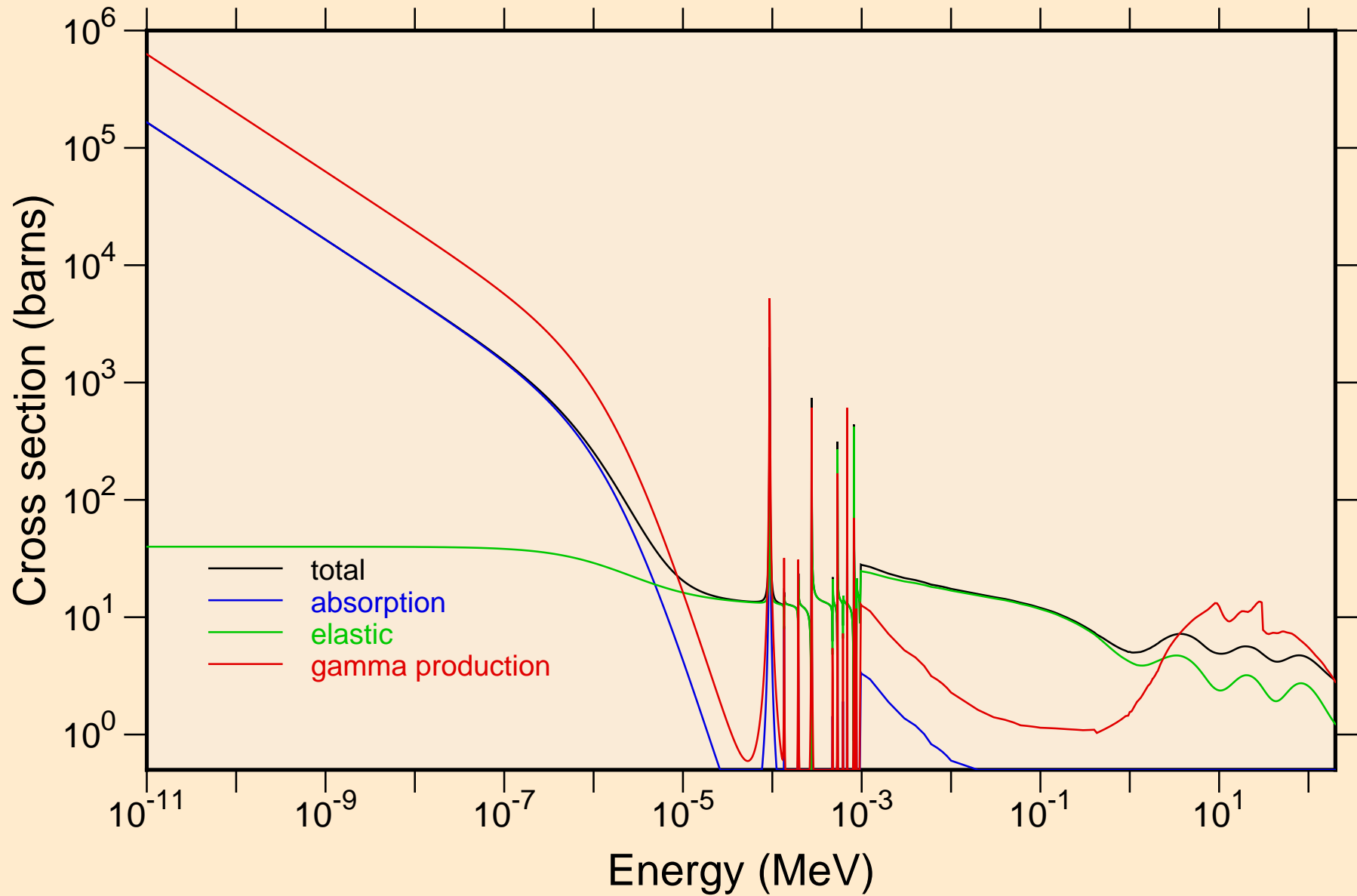

HG196 NEUTRON ACER TENDL-2023 LIBRARY; T=0.K  
resonance total cross section

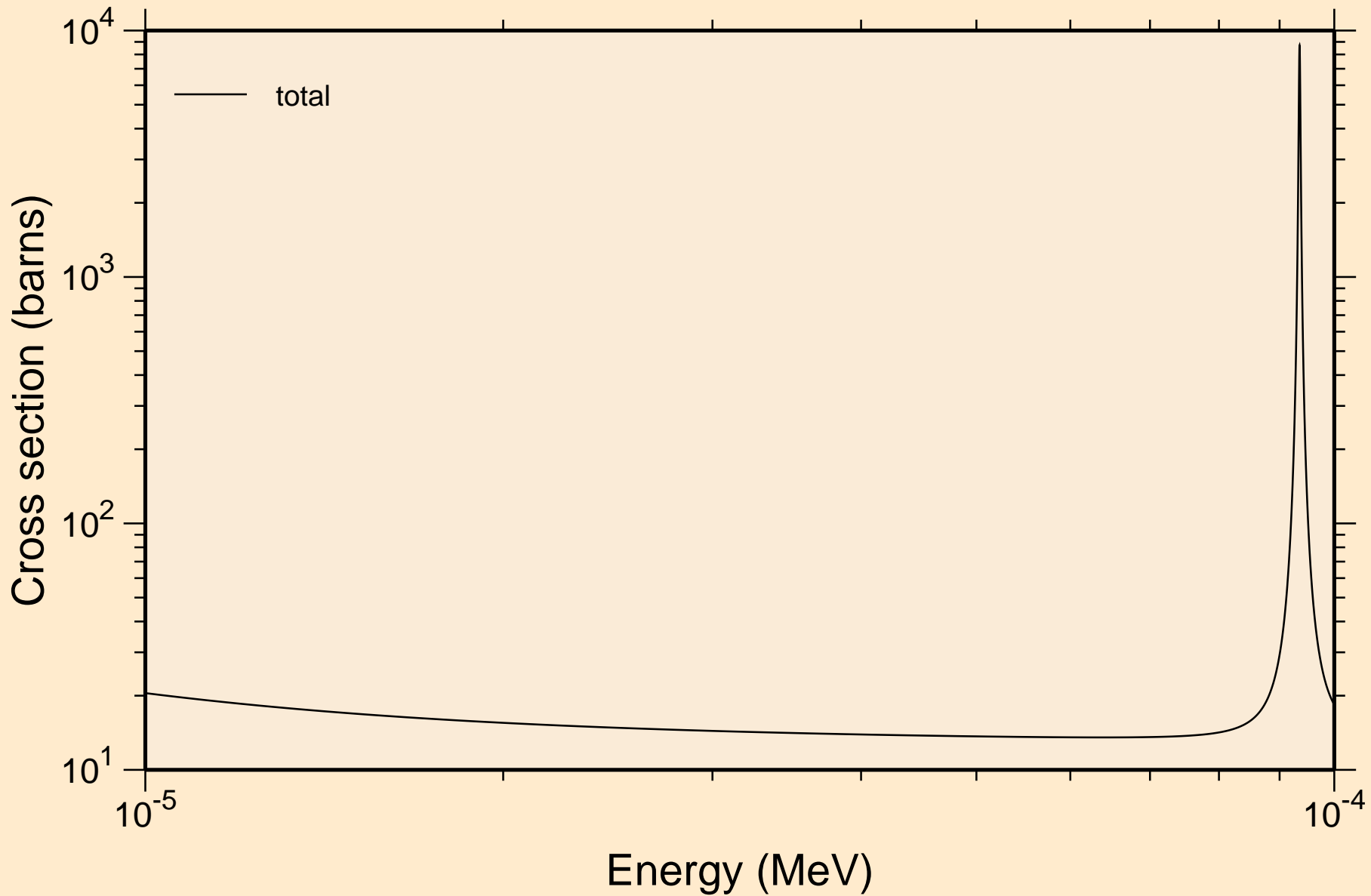

HG196 NEUTRON ACER TENDL-2023 LIBRARY; T=0.K  
resonance total cross section

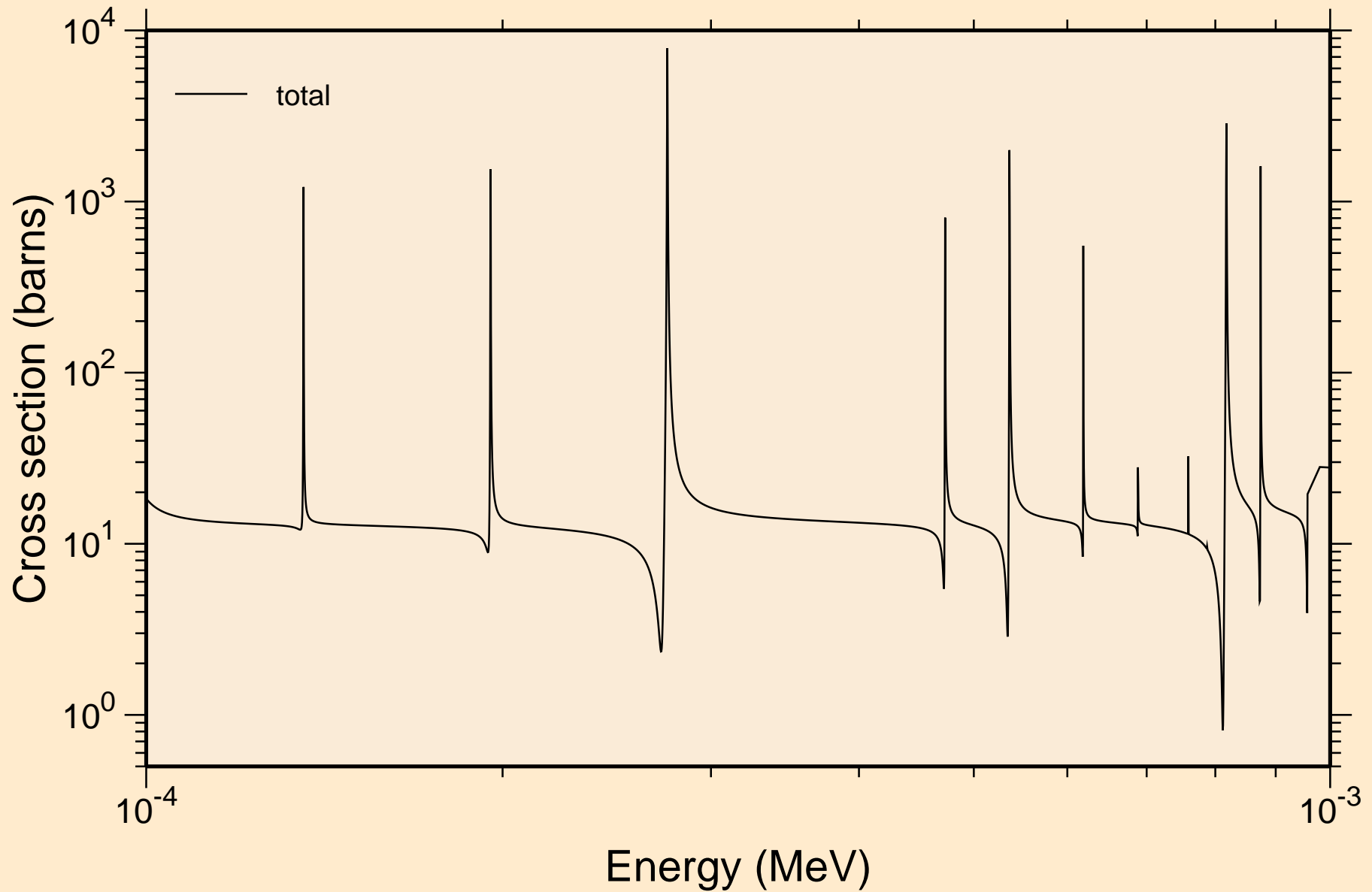

HG196 NEUTRON ACER TENDL-2023 LIBRARY; T=0.K  
resonance total cross section

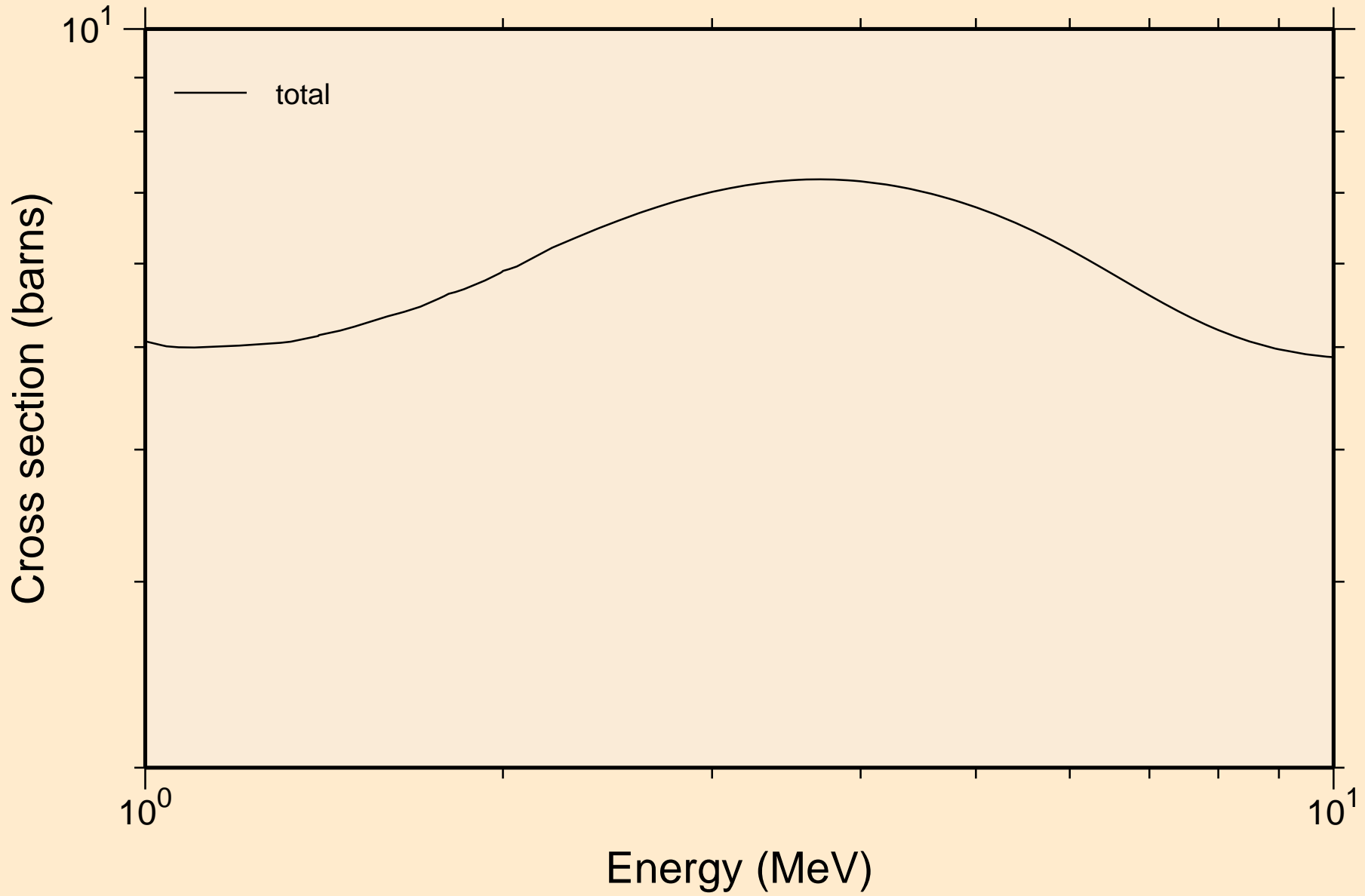

HG196 NEUTRON ACER TENDL-2023 LIBRARY; T=0.K  
resonance absorption cross sections

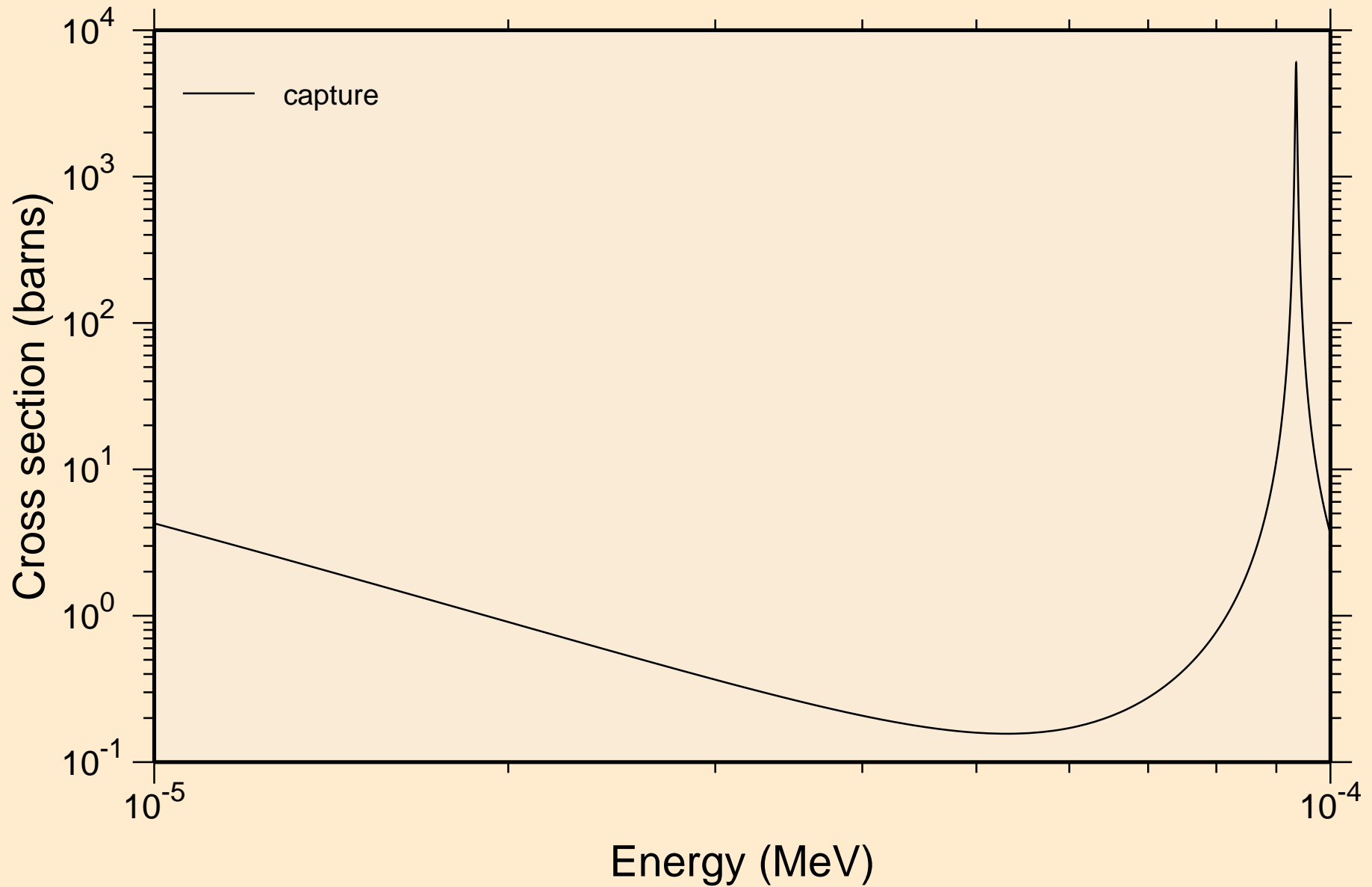

HG196 NEUTRON ACER TENDL-2023 LIBRARY; T=0.K  
resonance absorption cross sections

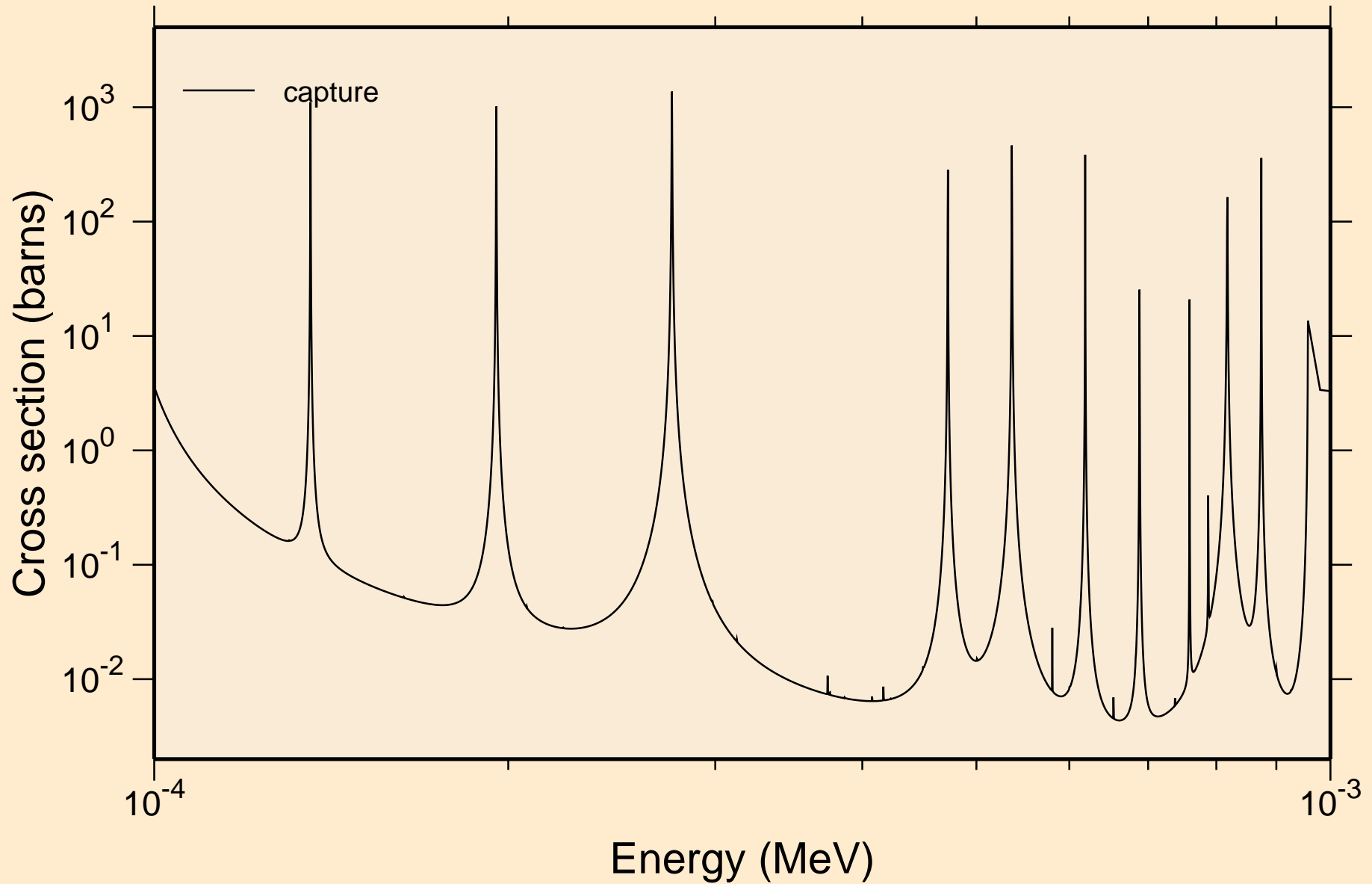

HG196 NEUTRON ACER TENDL-2023 LIBRARY; T=0.K  
resonance absorption cross sections

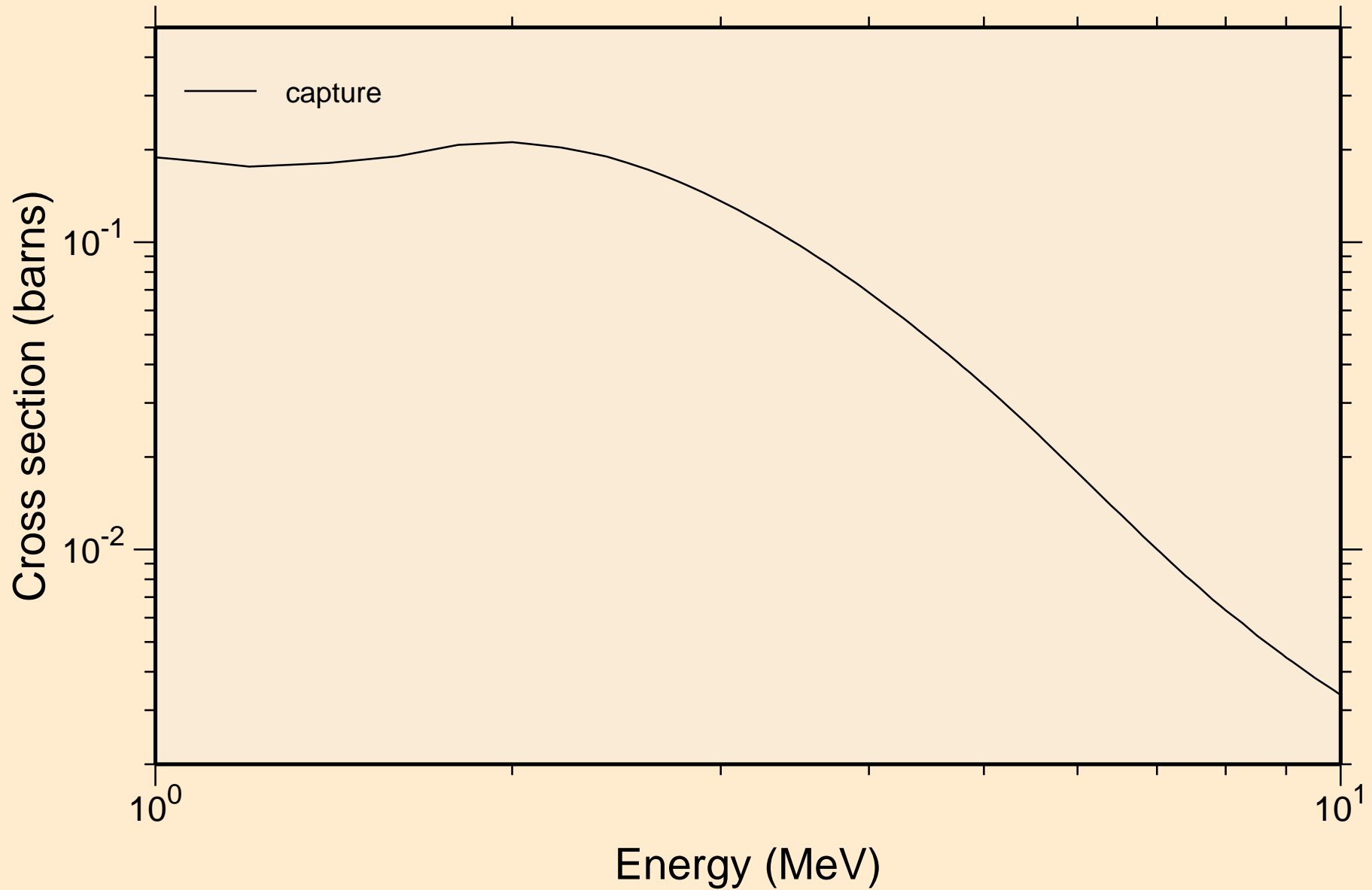

HG196 NEUTRON ACER TENDL-2023 LIBRARY; T=0.K  
Heating

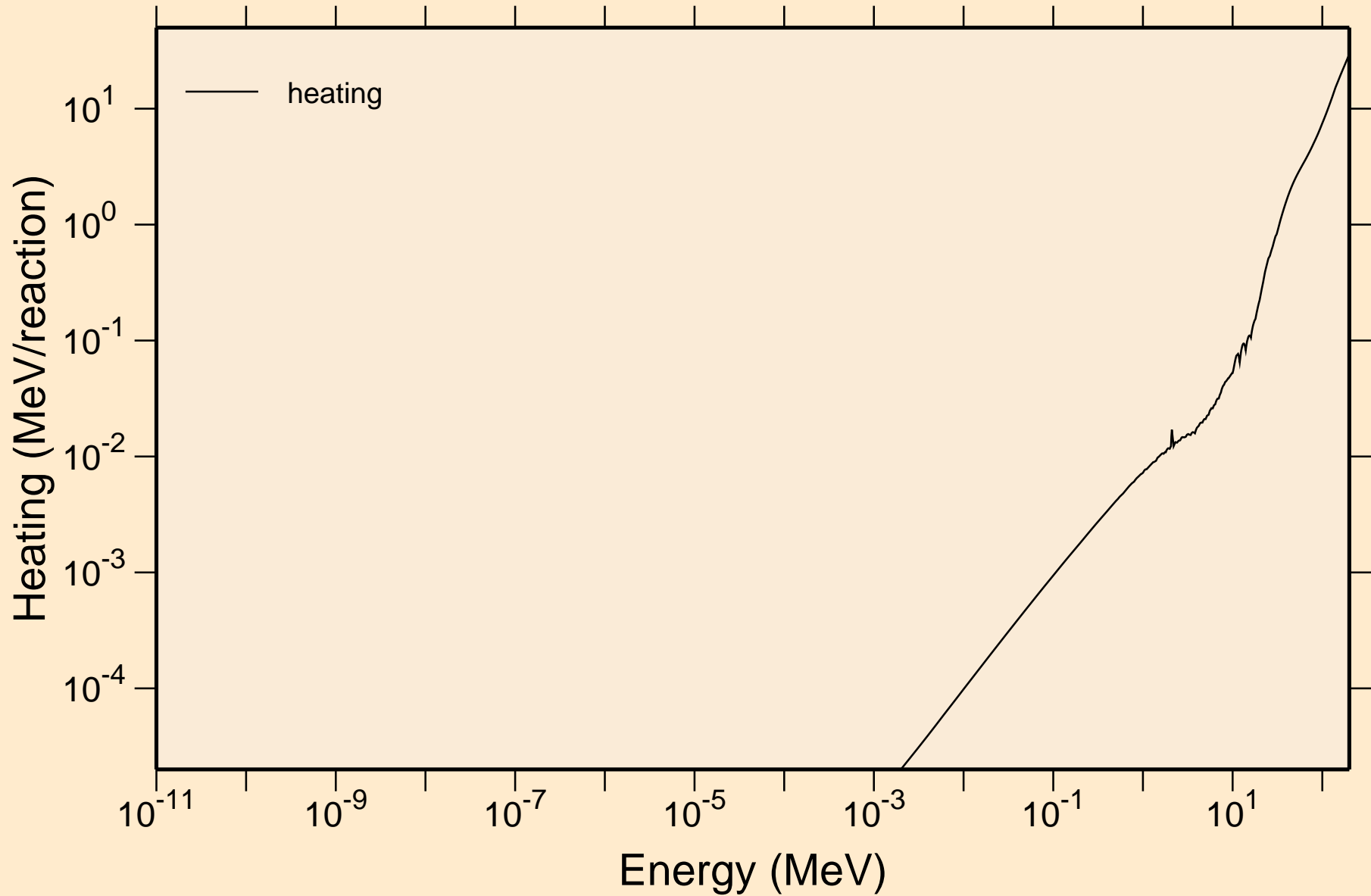



# HG196 NEUTRON ACER TENDL-2023 LIBRARY; T=0.K

## Damage

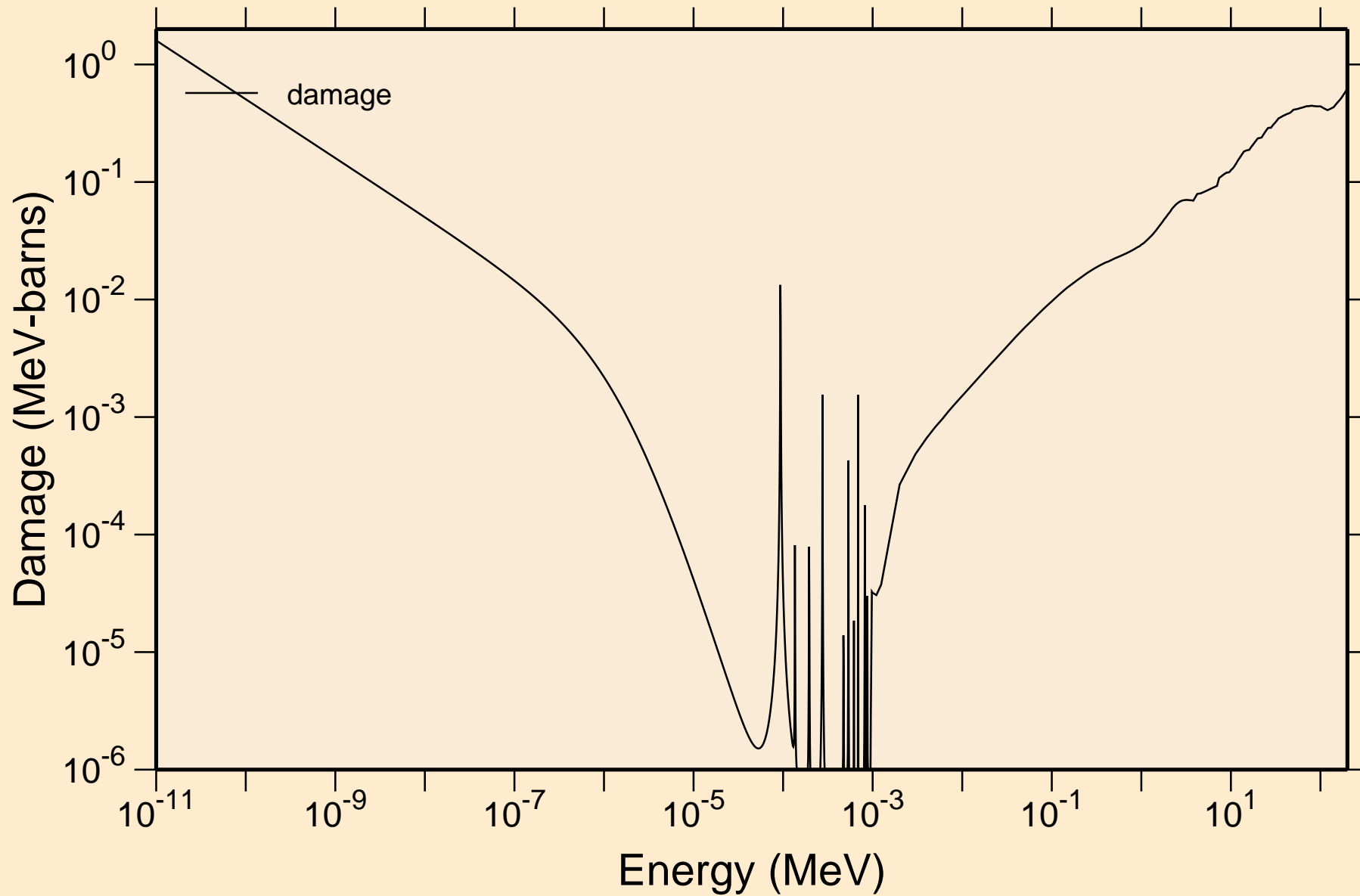

# HG196 NEUTRON ACER TENDL-2023 LIBRARY; T=0.K

## Non-threshold reactions

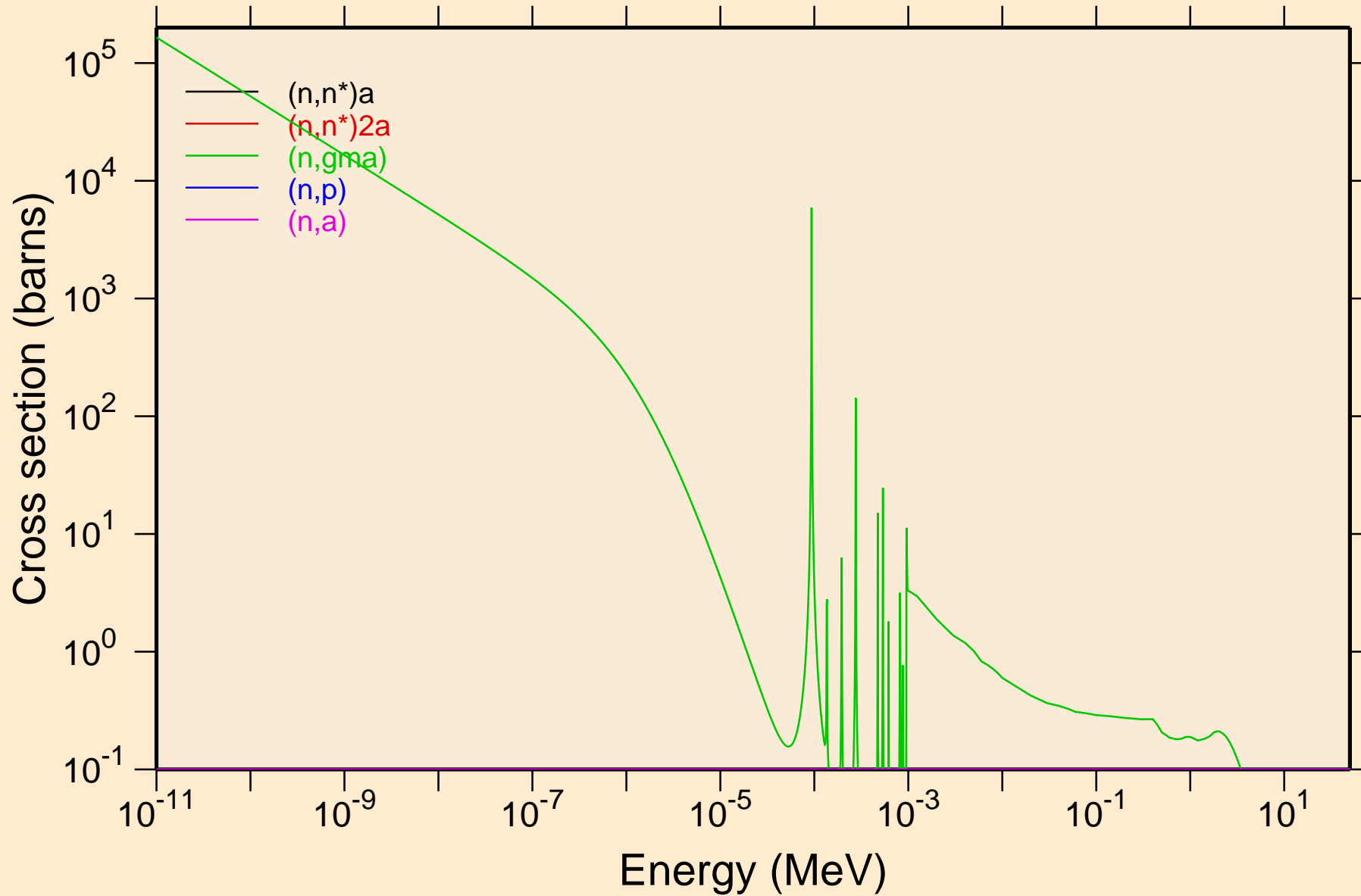

HG196 NEUTRON ACER TENDL-2023 LIBRARY; T=0.K  
Non-threshold reactions

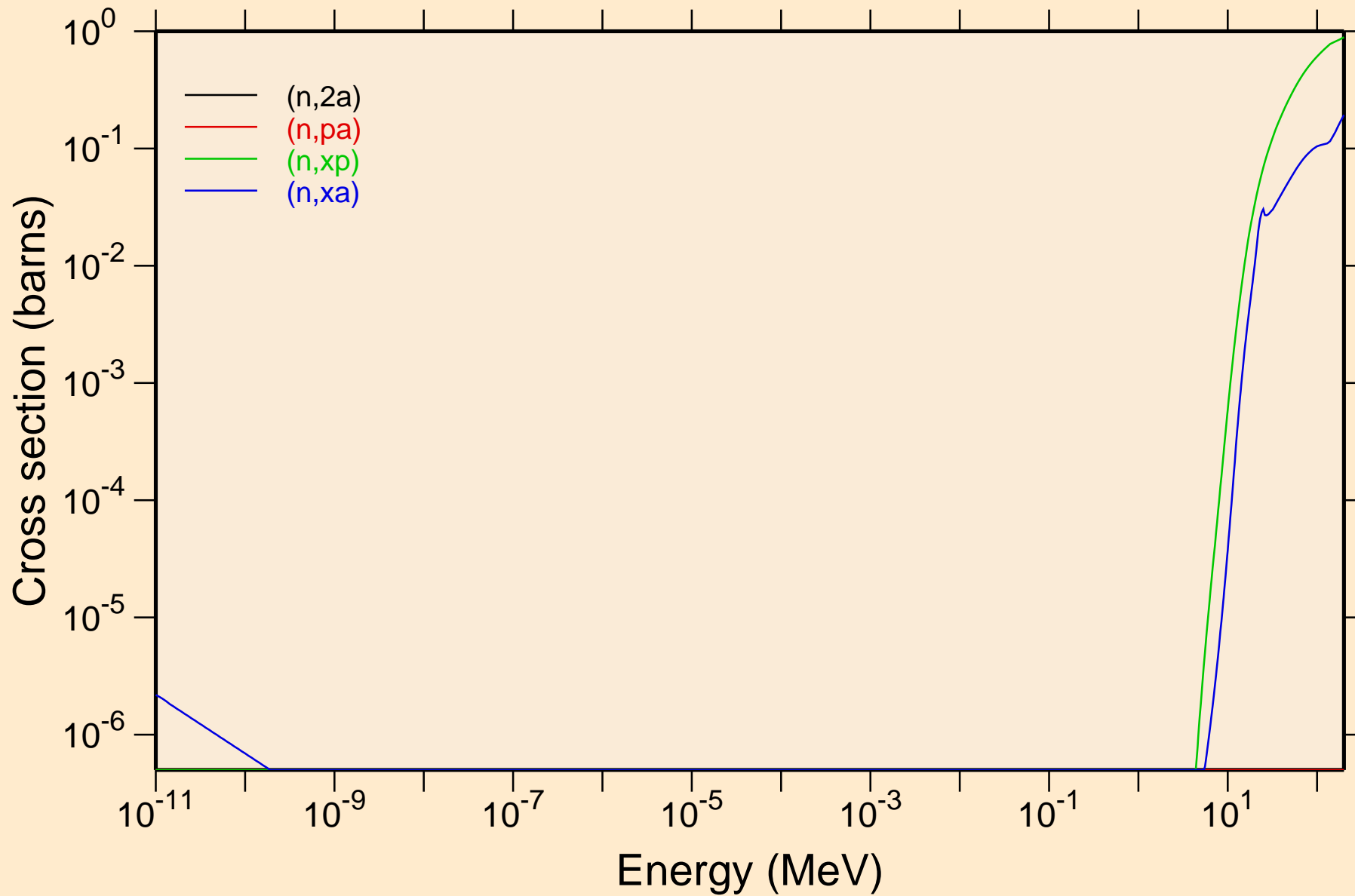

# HG196 NEUTRON ACER TENDL-2023 LIBRARY; T=0.K

## Principal cross sections

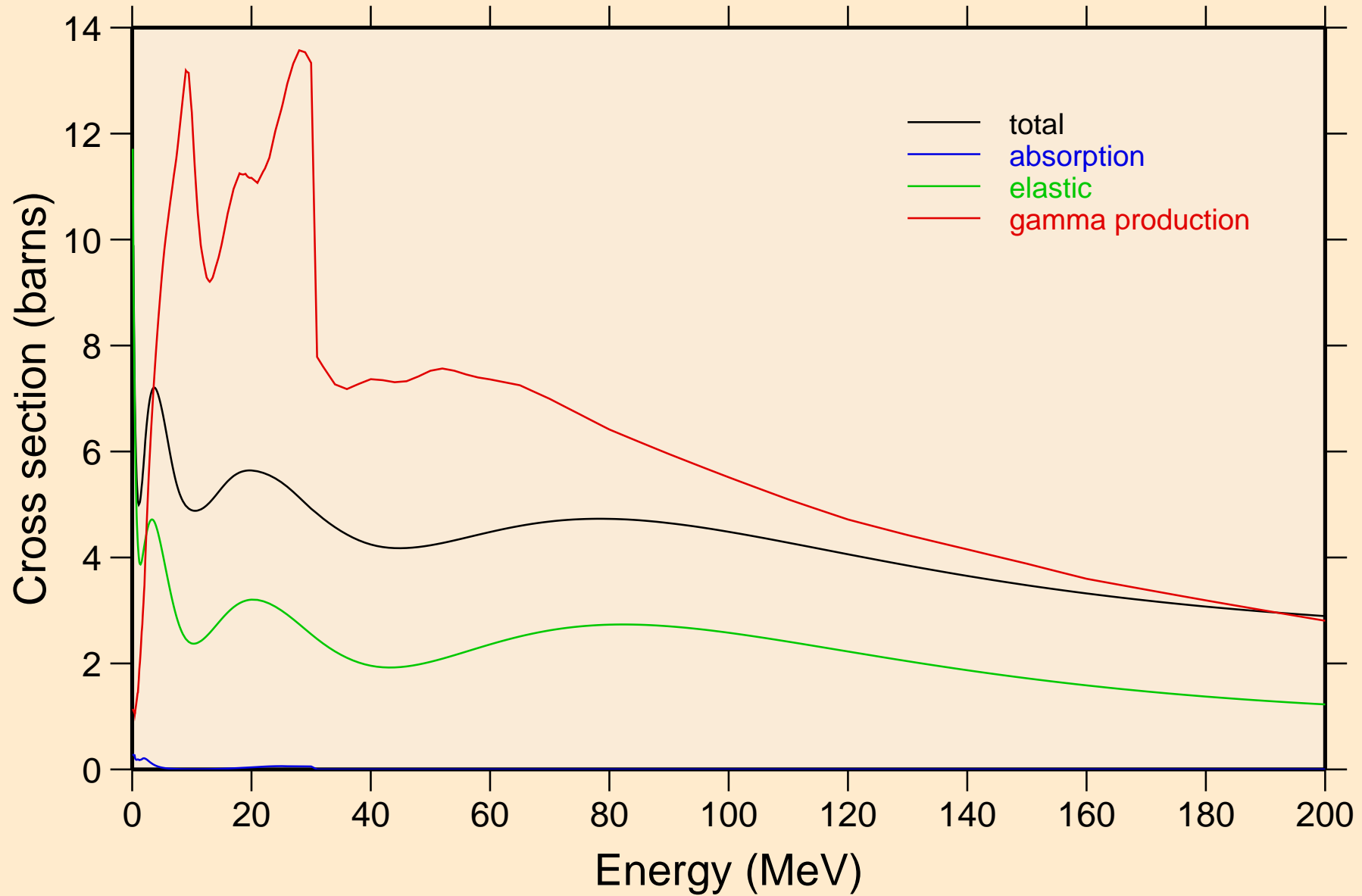

# HG196 NEUTRON ACER TENDL-2023 LIBRARY; T=0.K

## Heating

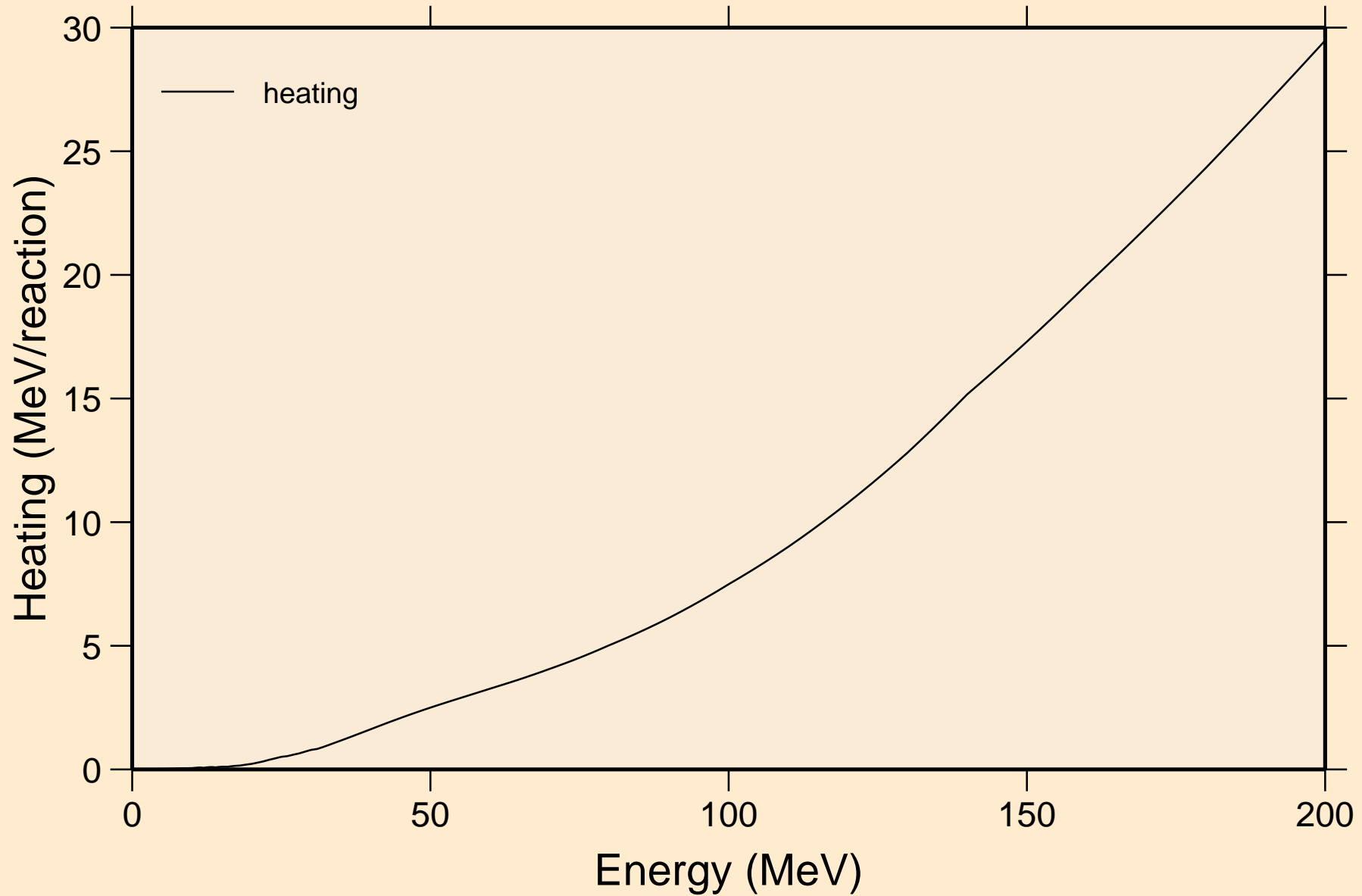

# HG196 NEUTRON ACER TENDL-2023 LIBRARY; T=0.K

## Damage

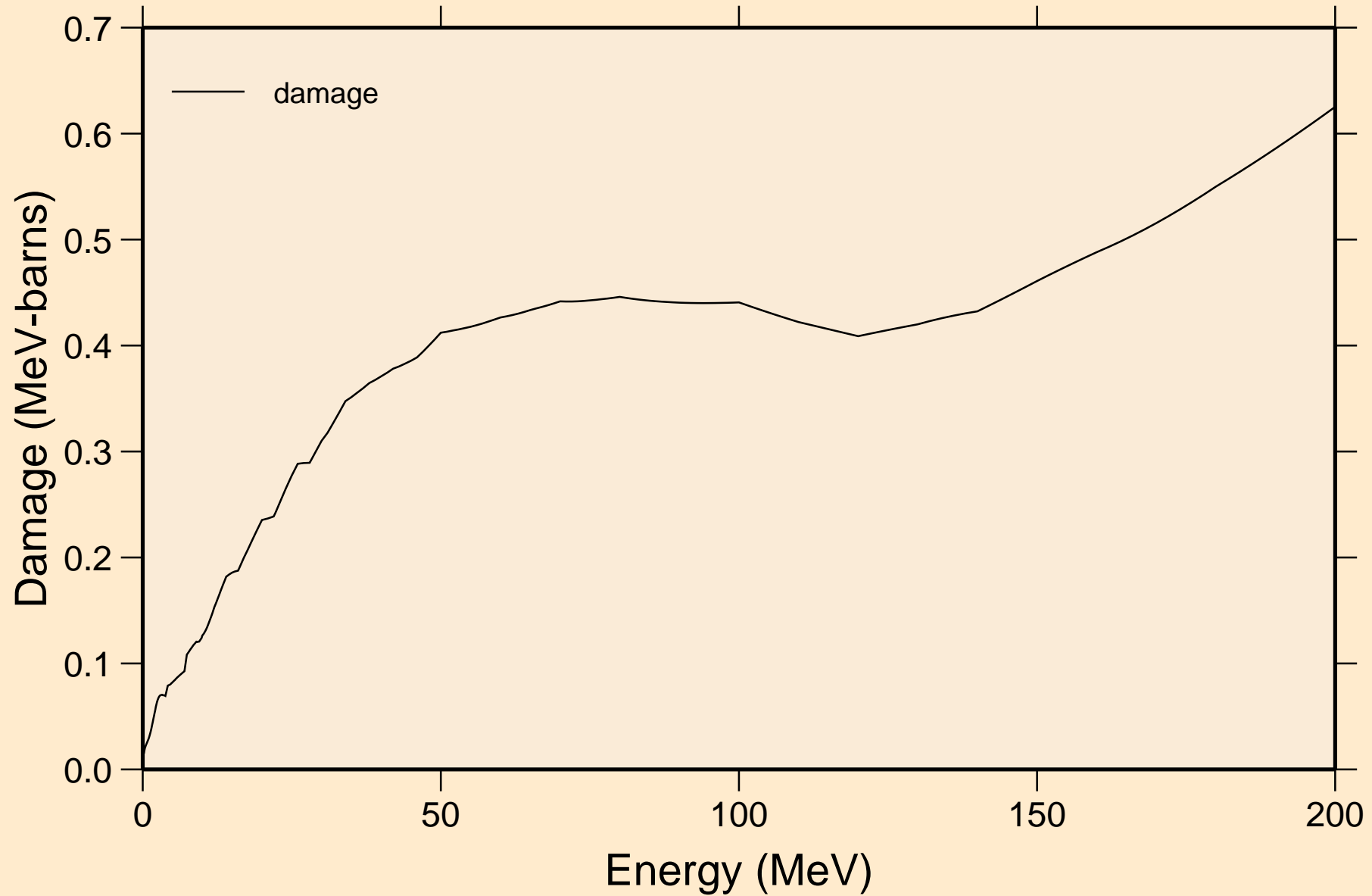

# HG196 NEUTRON ACER TENDL-2023 LIBRARY; T=0.K

## Non-threshold reactions

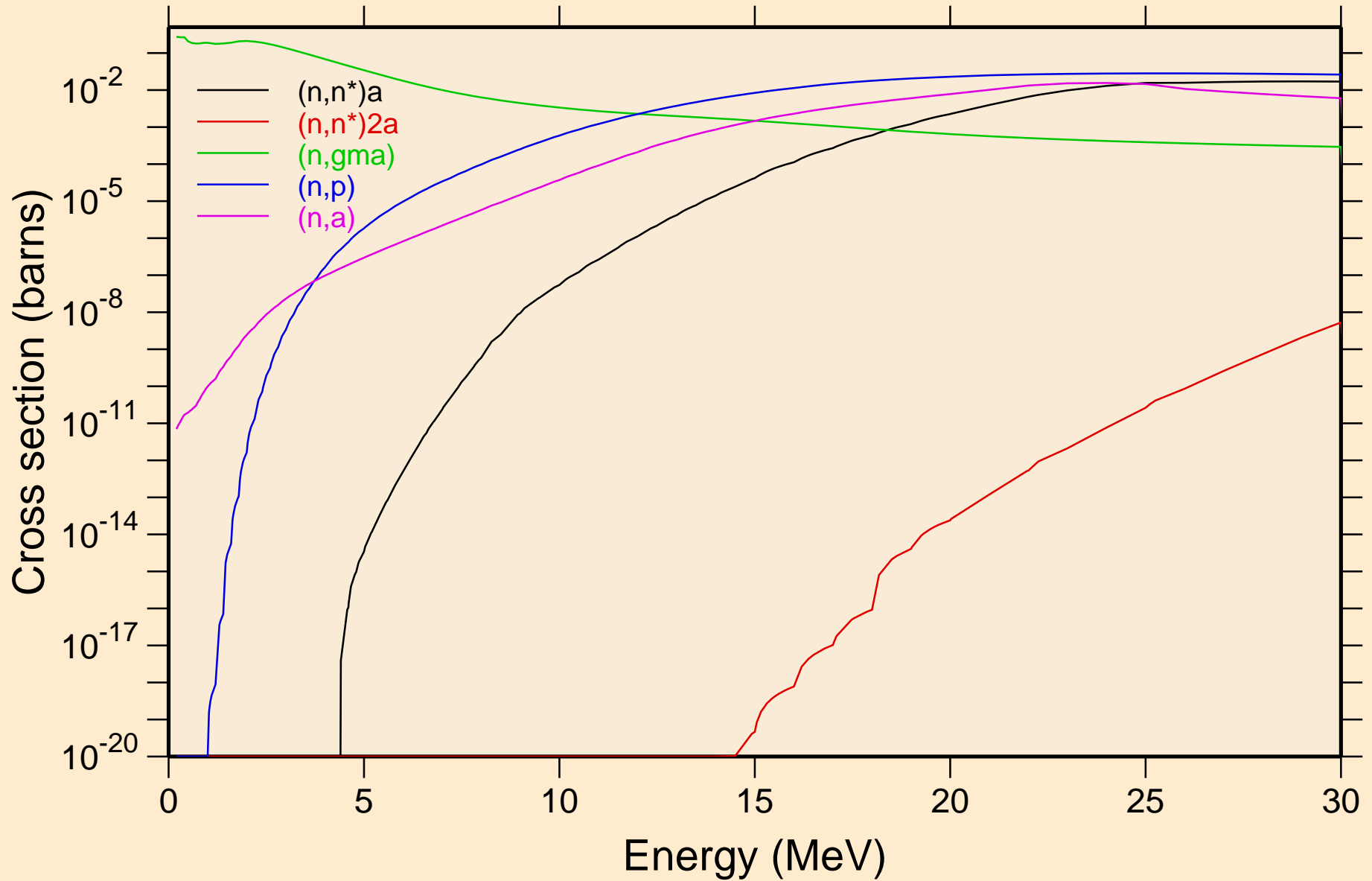

HG196 NEUTRON ACER TENDL-2023 LIBRARY; T=0.K  
Non-threshold reactions

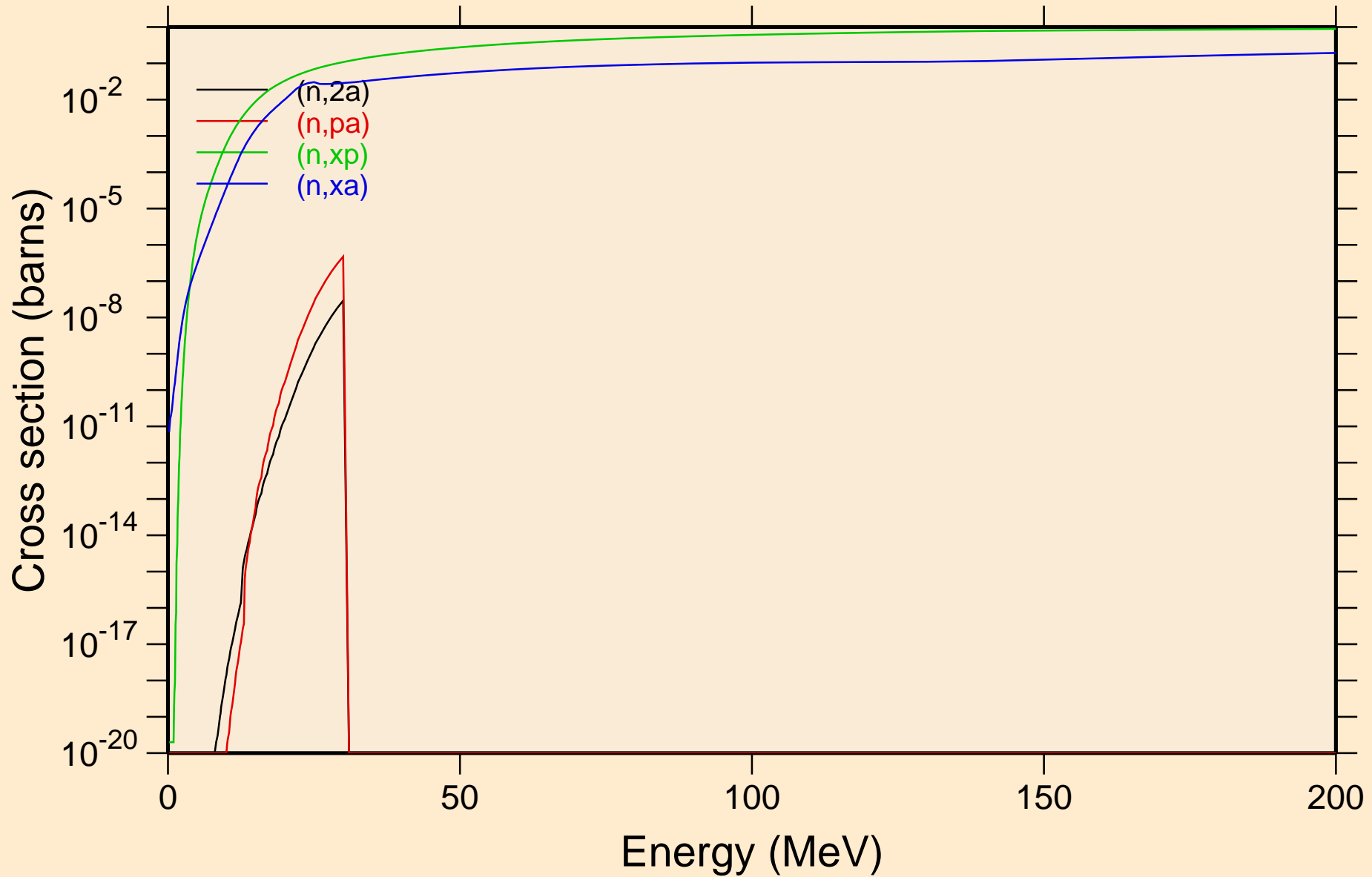



HG196 NEUTRON ACER TENDL-2023 LIBRARY; T=0.K  
Inelastic levels

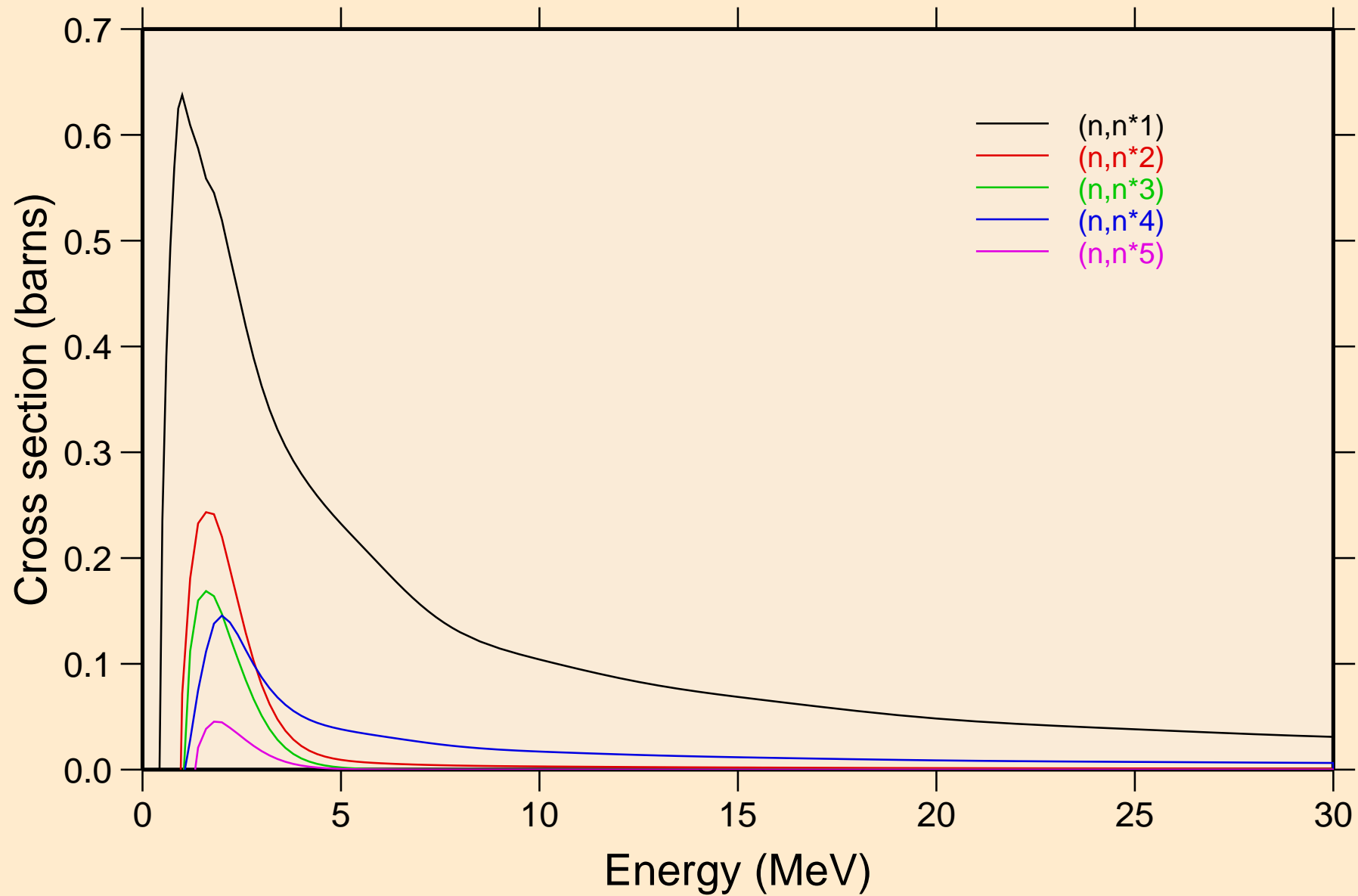

# HG196 NEUTRON ACER TENDL-2023 LIBRARY; T=0.K

## Inelastic levels

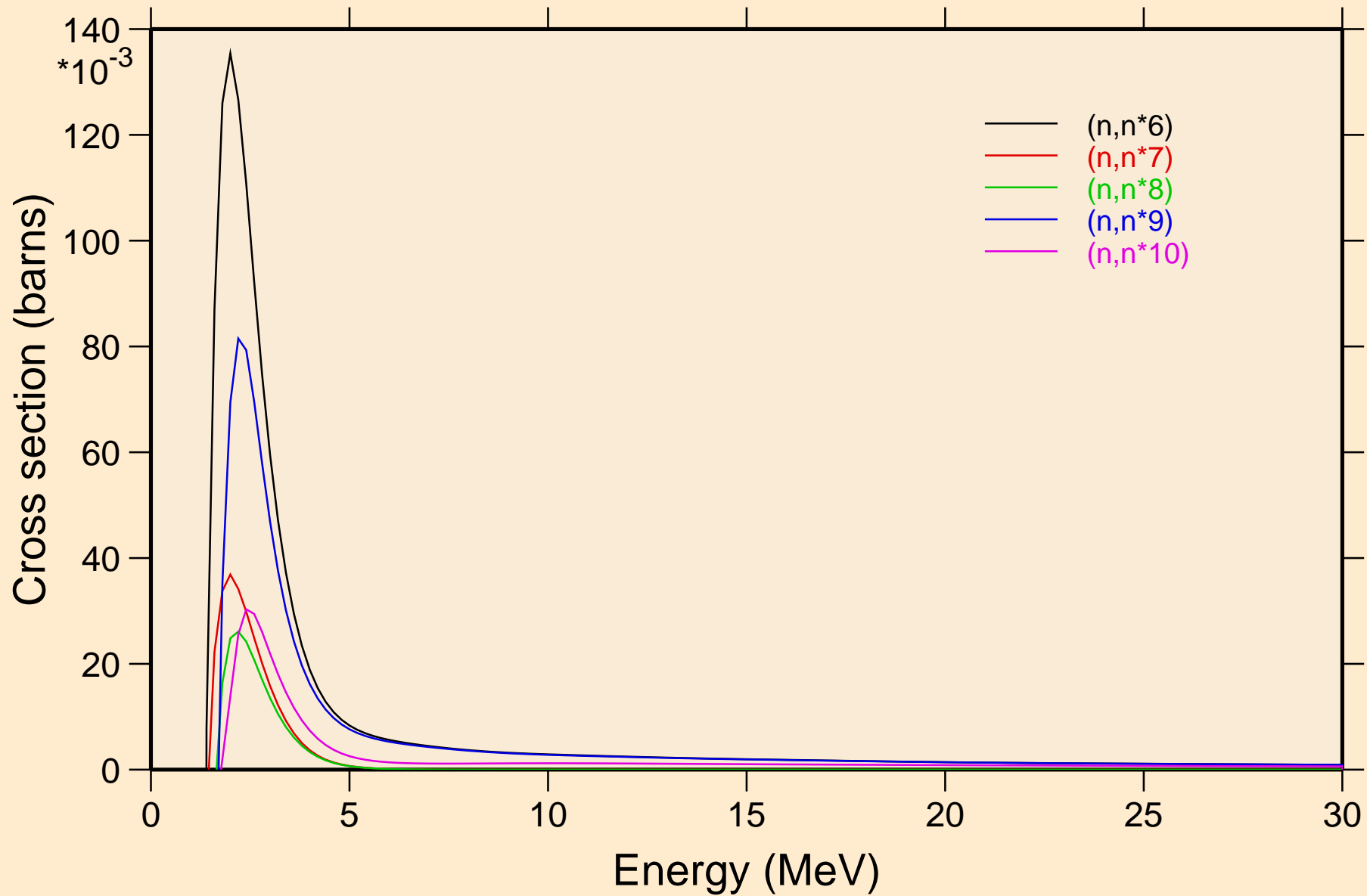

HG196 NEUTRON ACER TENDL-2023 LIBRARY; T=0.K  
Inelastic levels

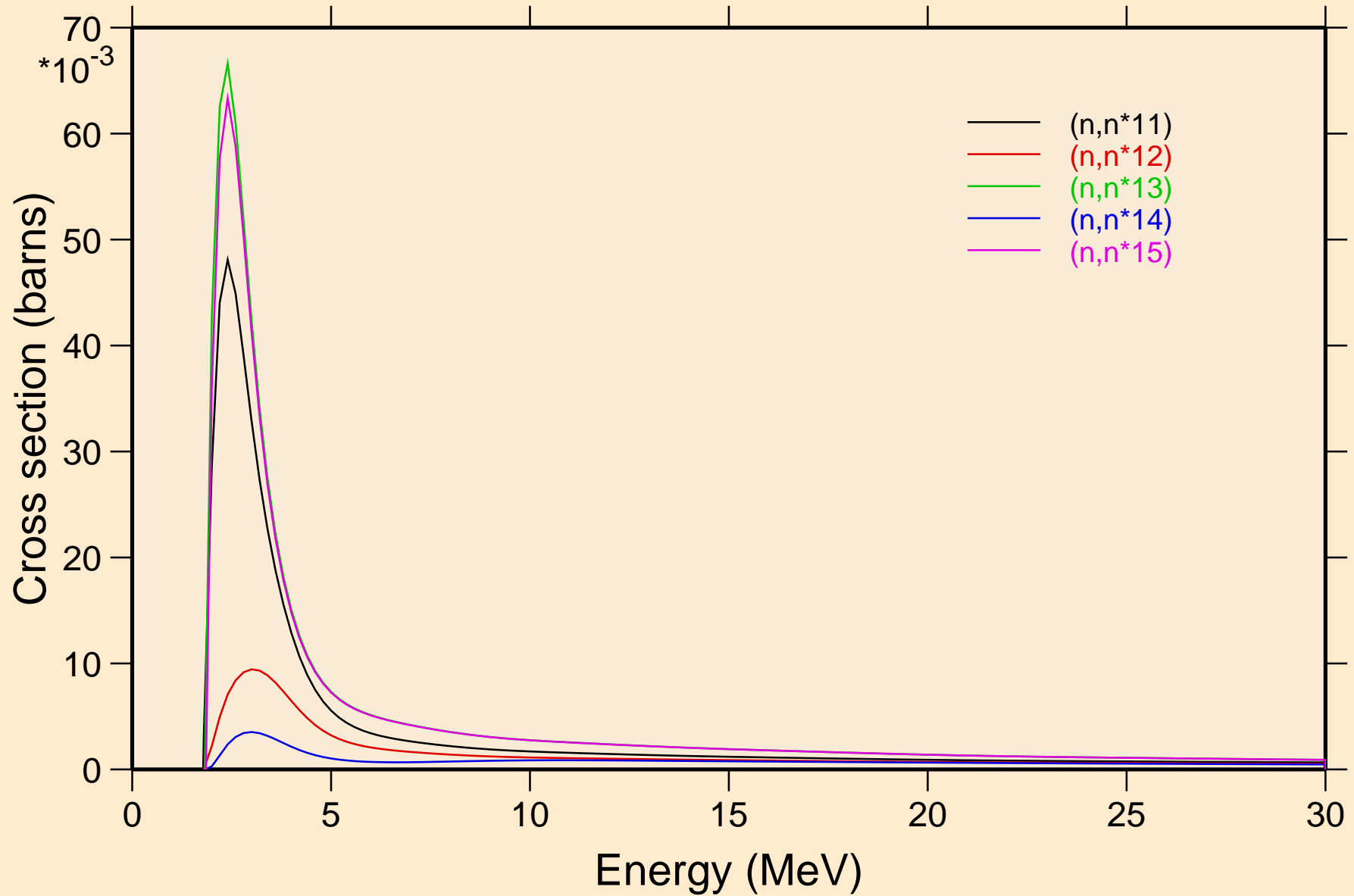

HG196 NEUTRON ACER TENDL-2023 LIBRARY; T=0.K  
Inelastic levels

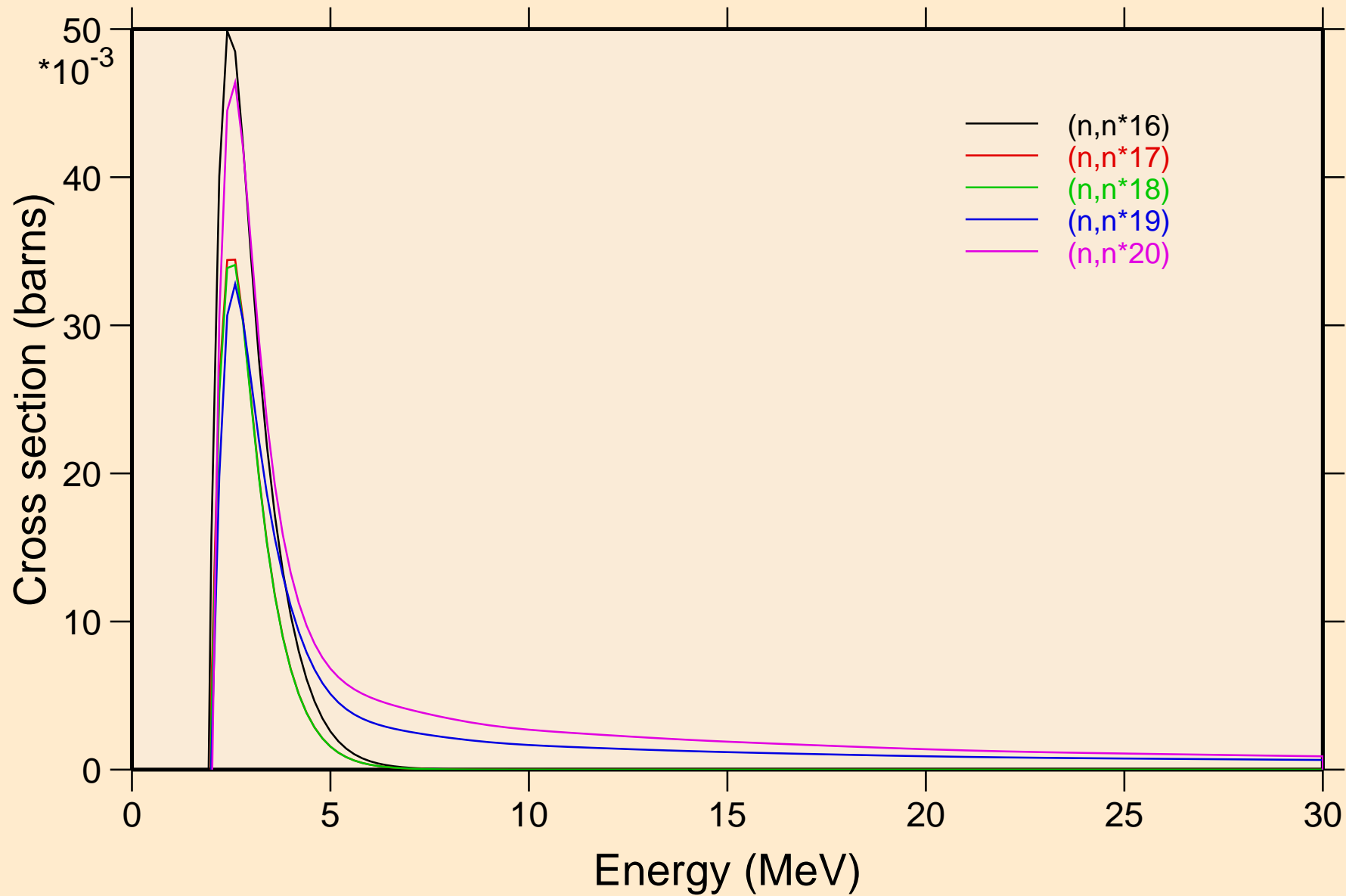

HG196 NEUTRON ACER TENDL-2023 LIBRARY; T=0.K  
Inelastic levels

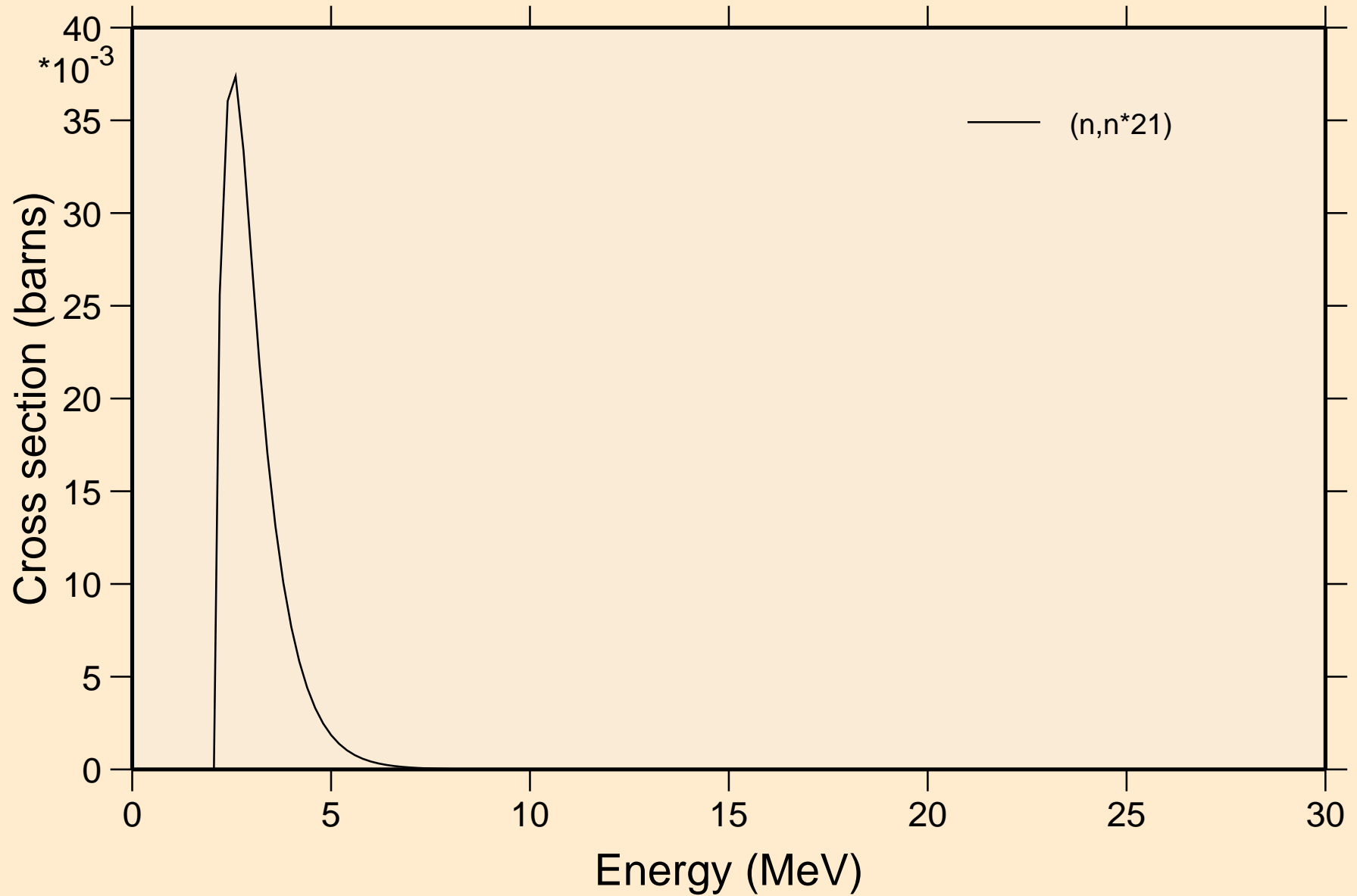

# HG196 NEUTRON ACER TENDL-2023 LIBRARY; T=0.K

## Threshold reactions

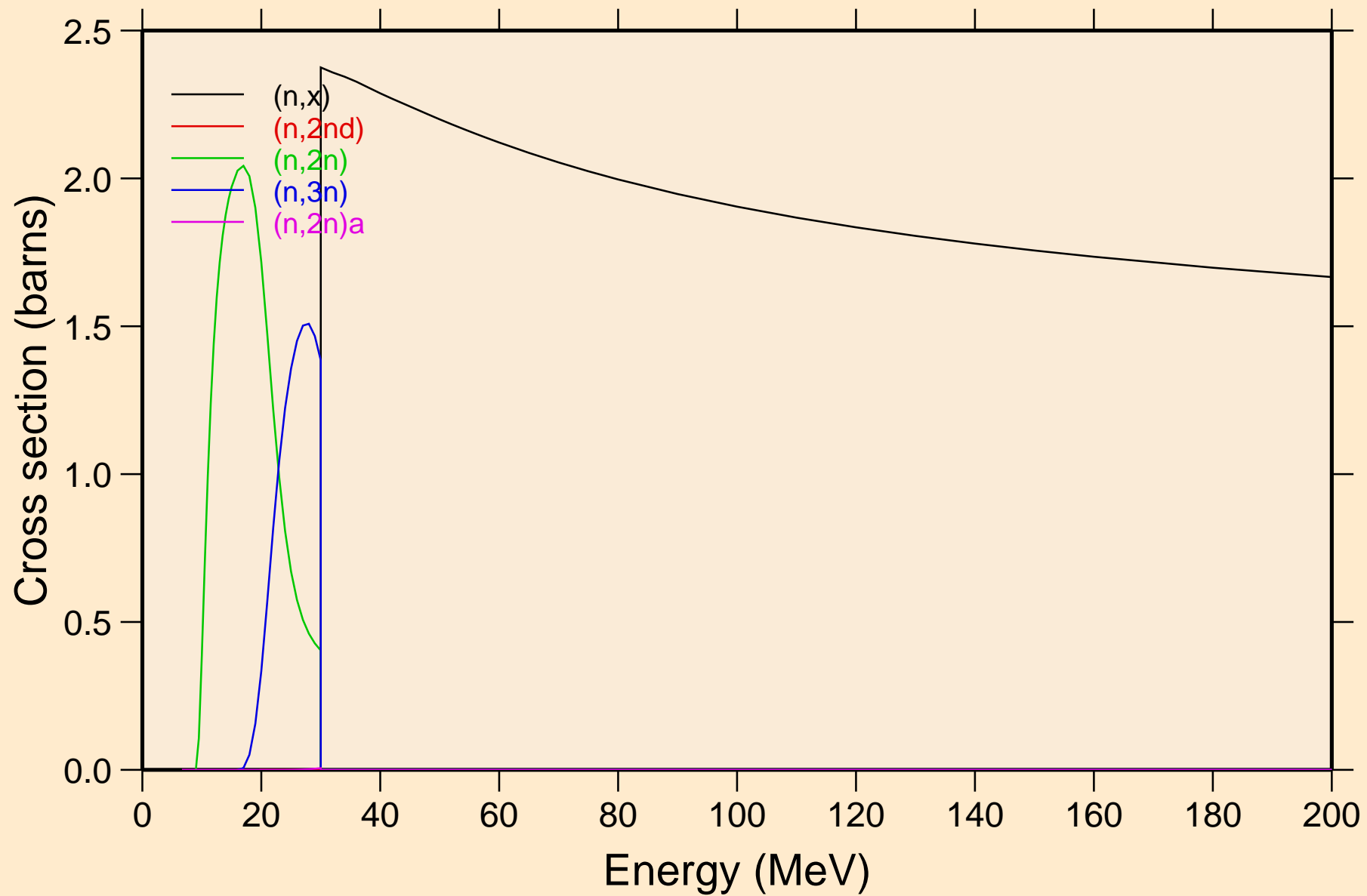

# HG196 NEUTRON ACER TENDL-2023 LIBRARY; T=0.K

## Threshold reactions

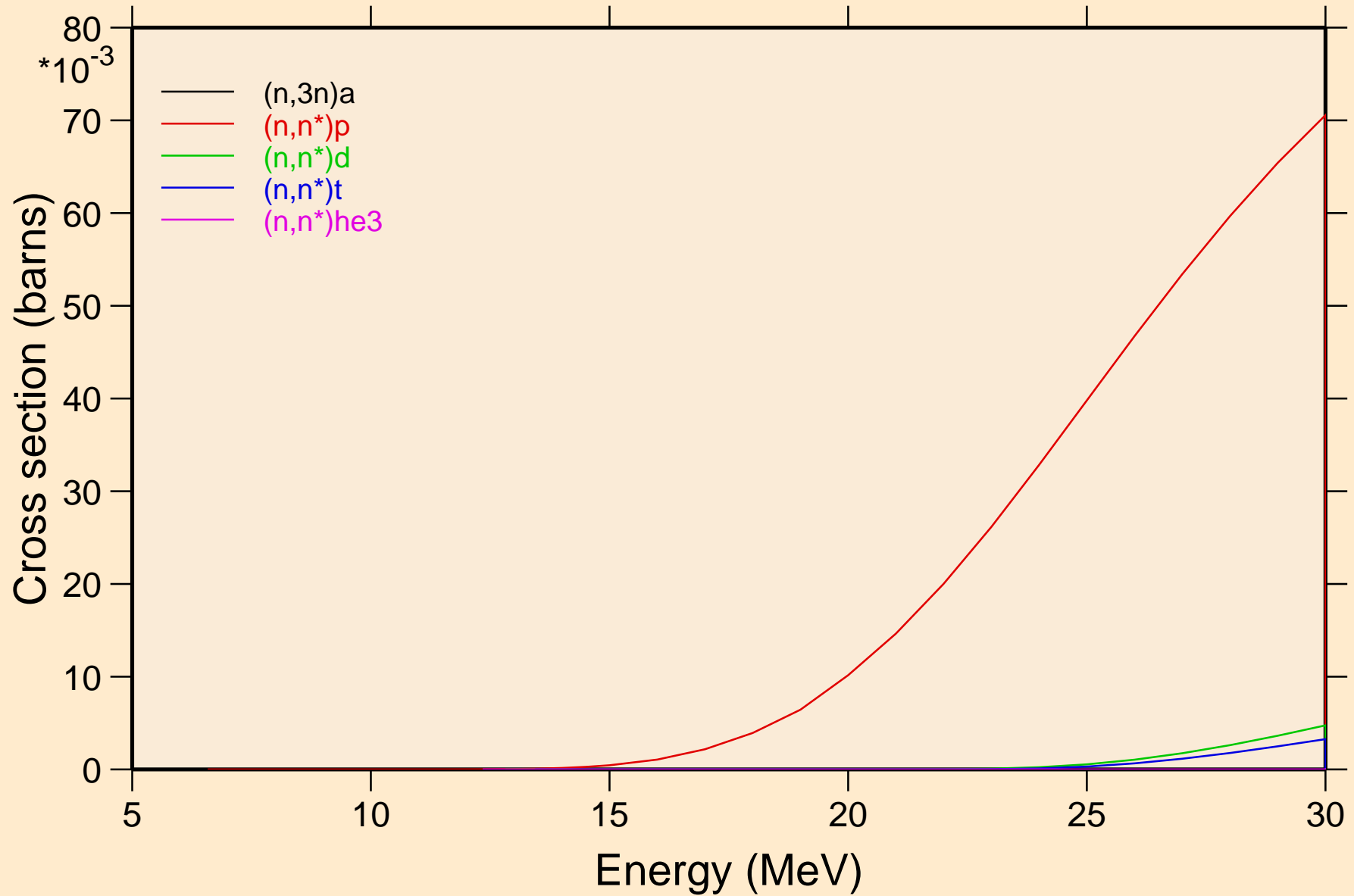

# HG196 NEUTRON ACER TENDL-2023 LIBRARY; T=0.K

## Threshold reactions

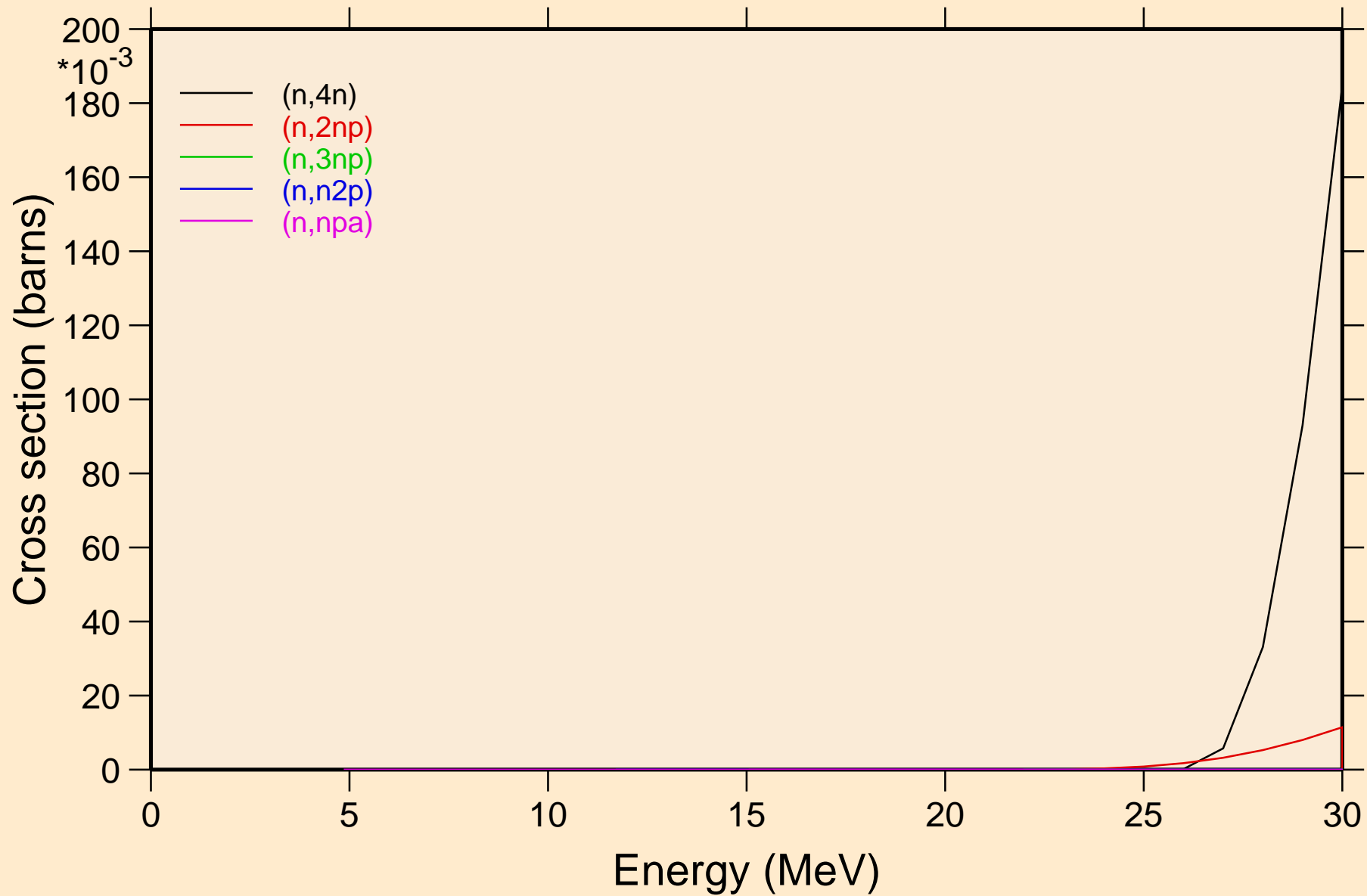



# HG196 NEUTRON ACER TENDL-2023 LIBRARY; T=0.K

## Threshold reactions

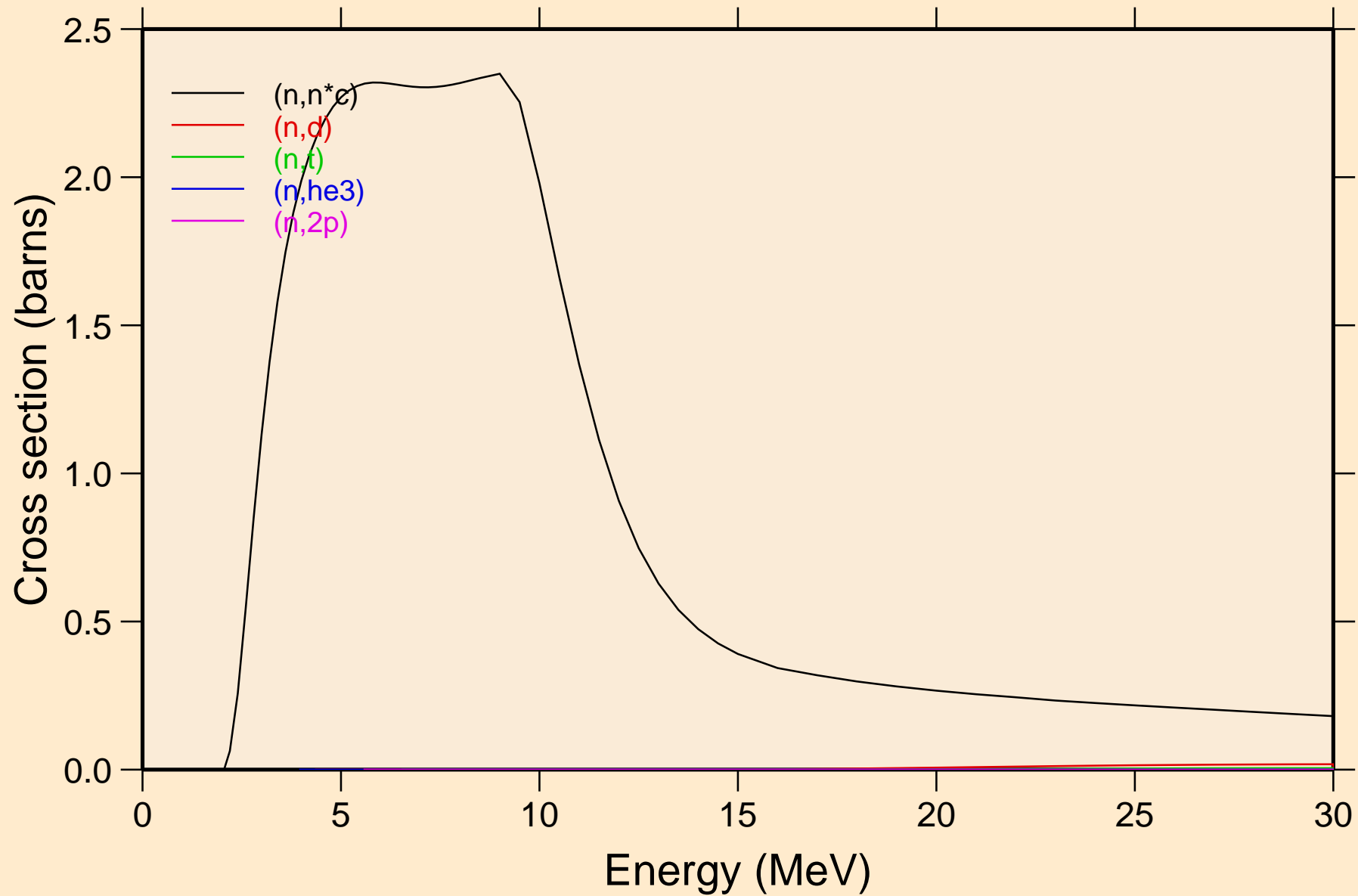

# HG196 NEUTRON ACER TENDL-2023 LIBRARY; T=0.K

## Threshold reactions

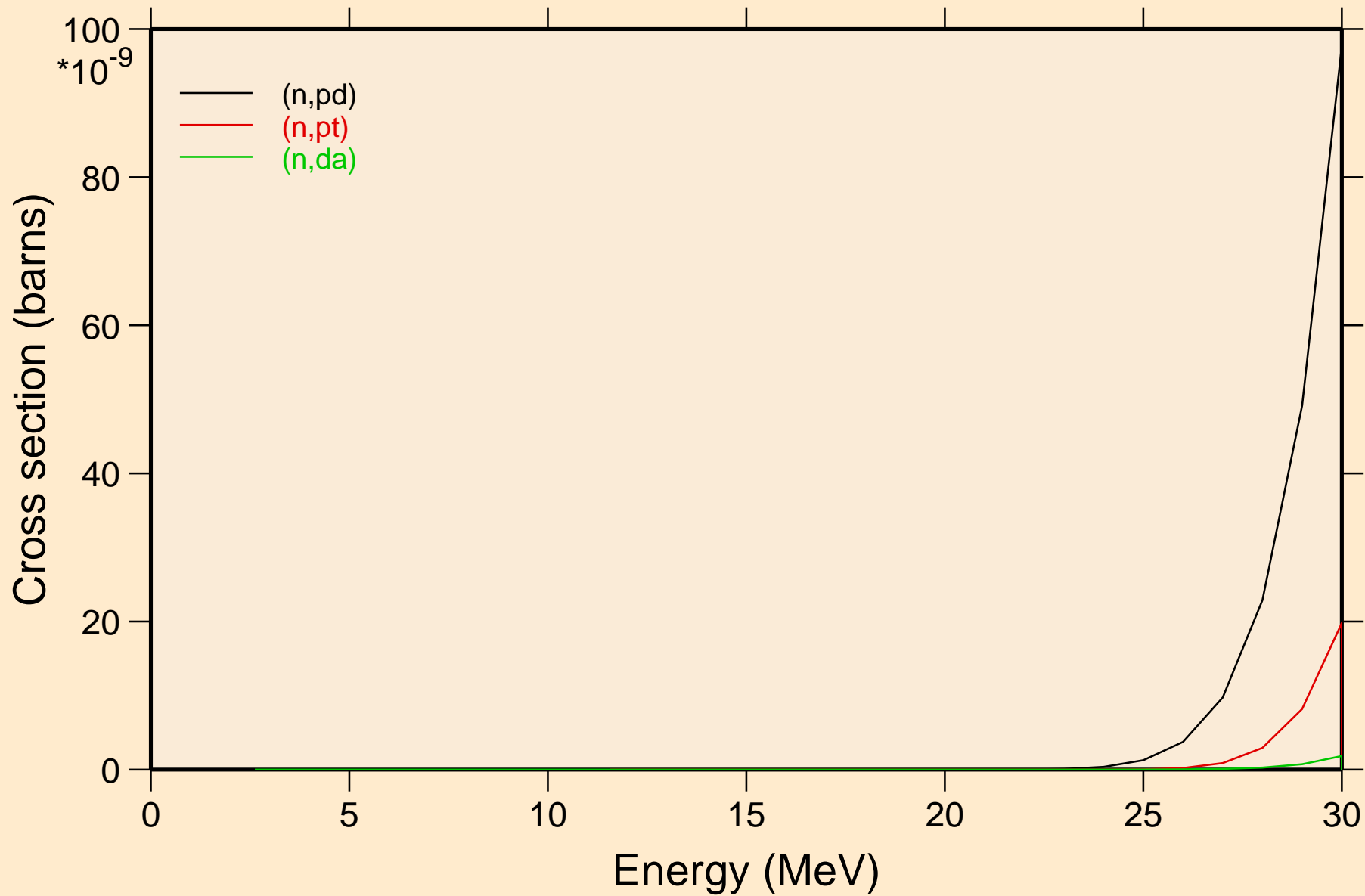

# HG196 NEUTRON ACER TENDL-2023 LIBRARY; T=0.K

## Threshold reactions

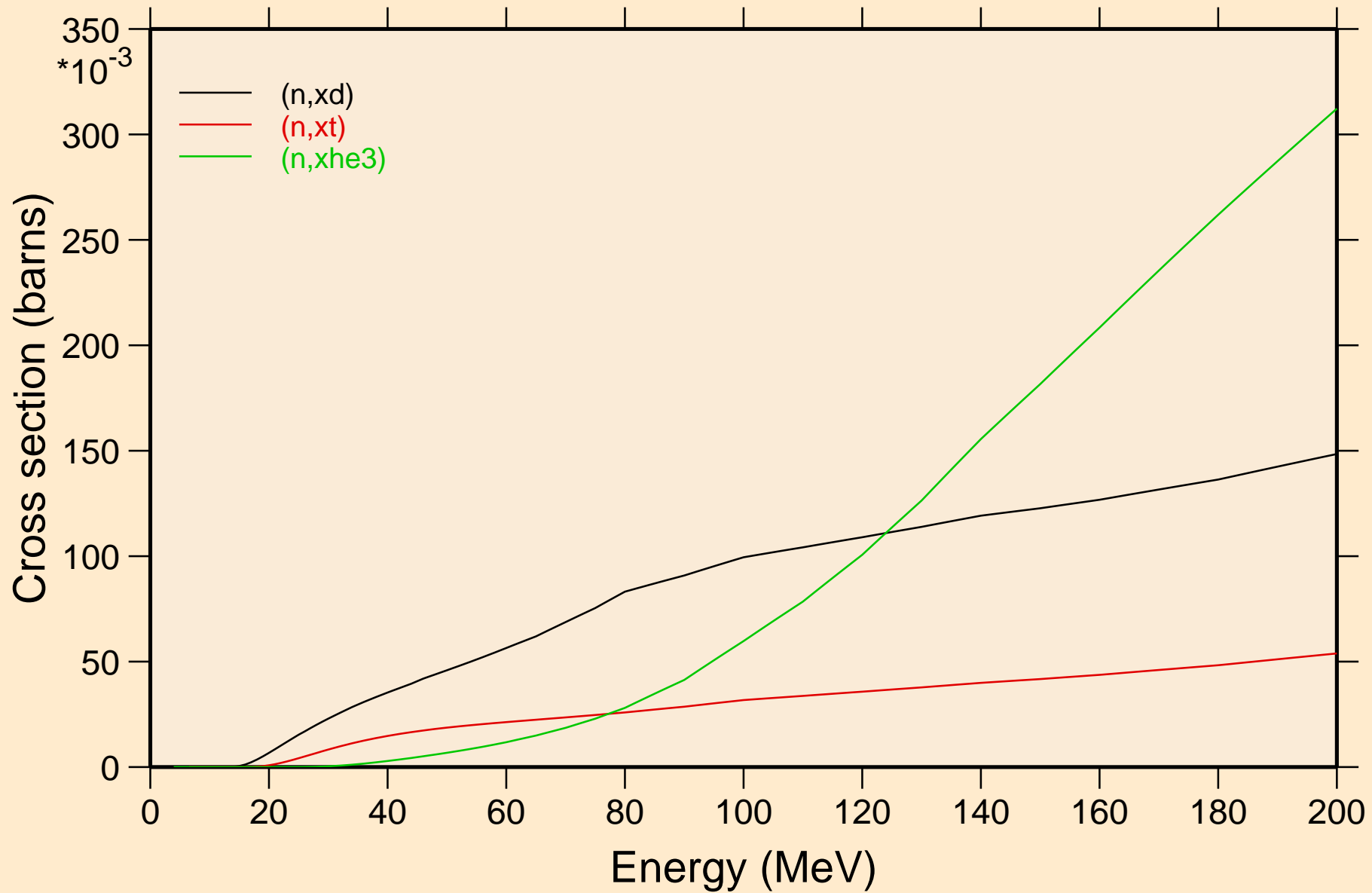

HG196 NEUTRON ACER TENDL-2023 LIBRARY; T=0.K  
angular distribution for elastic

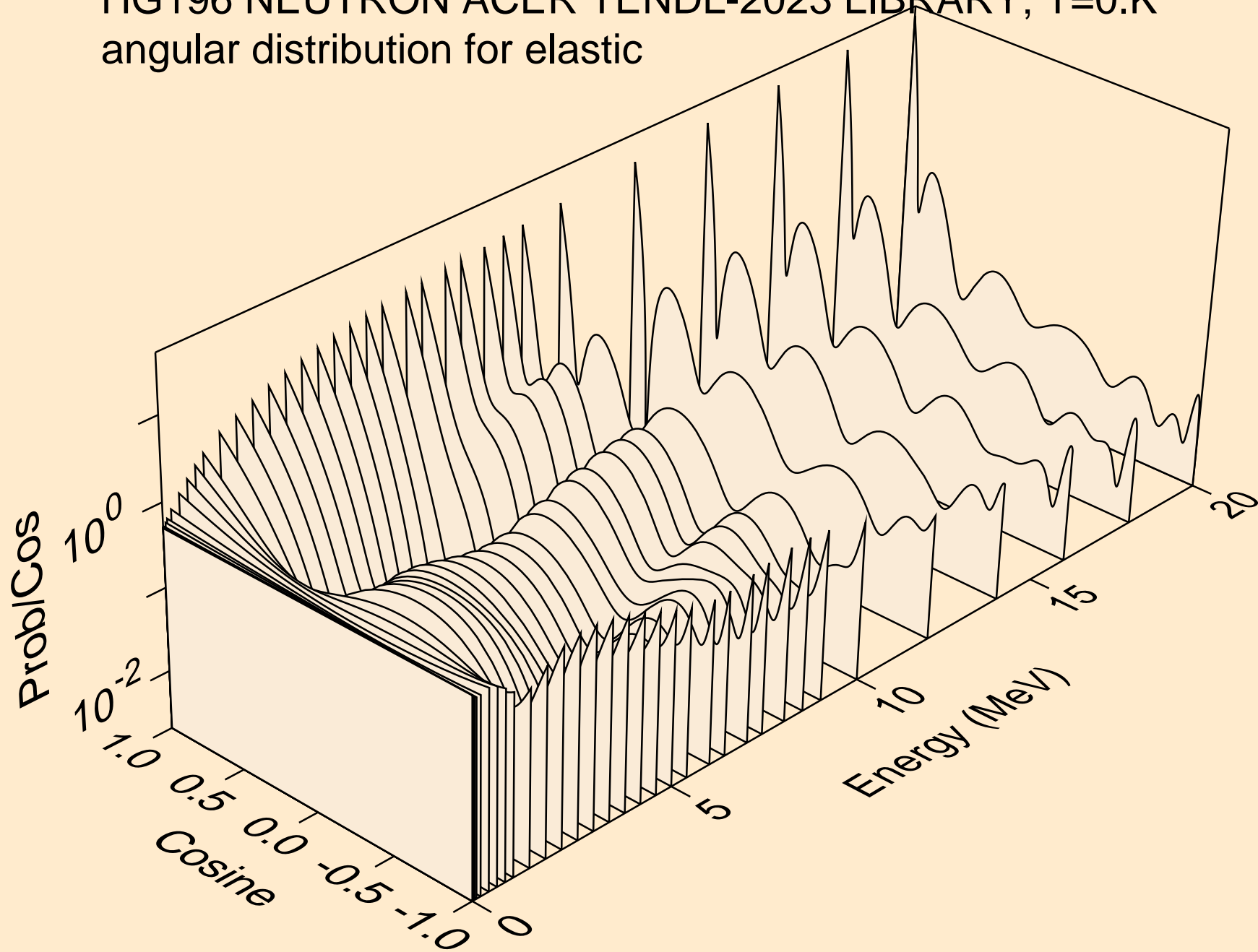

HG196 NEUTRON ACER TENDL-2023 LIBRARY; T=0.K  
angular distribution for elastic

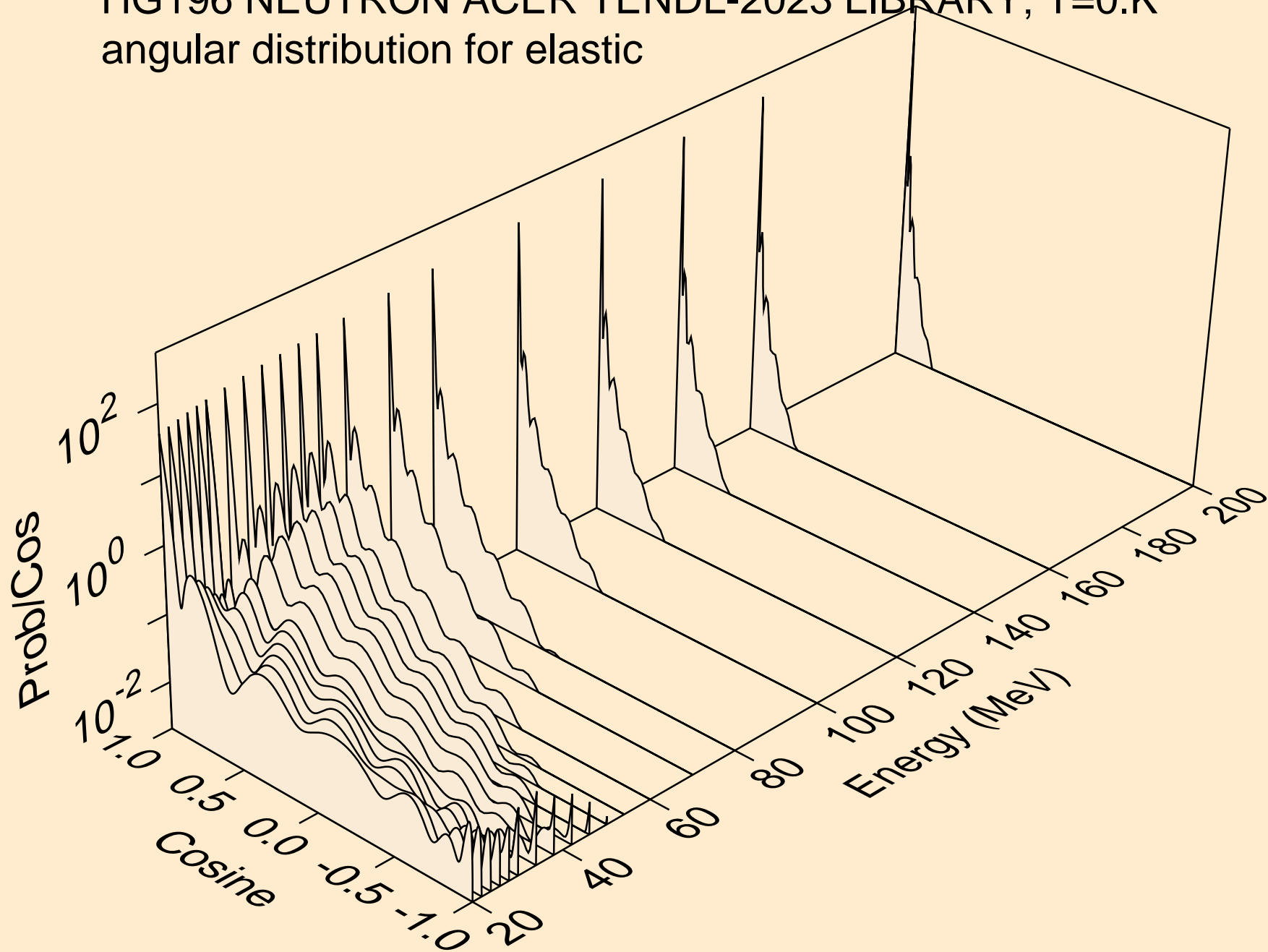

HG196 NEUTRON ACER TENDL-2023 LIBRARY; T=0.K  
angular distribution for (n,n\*1)

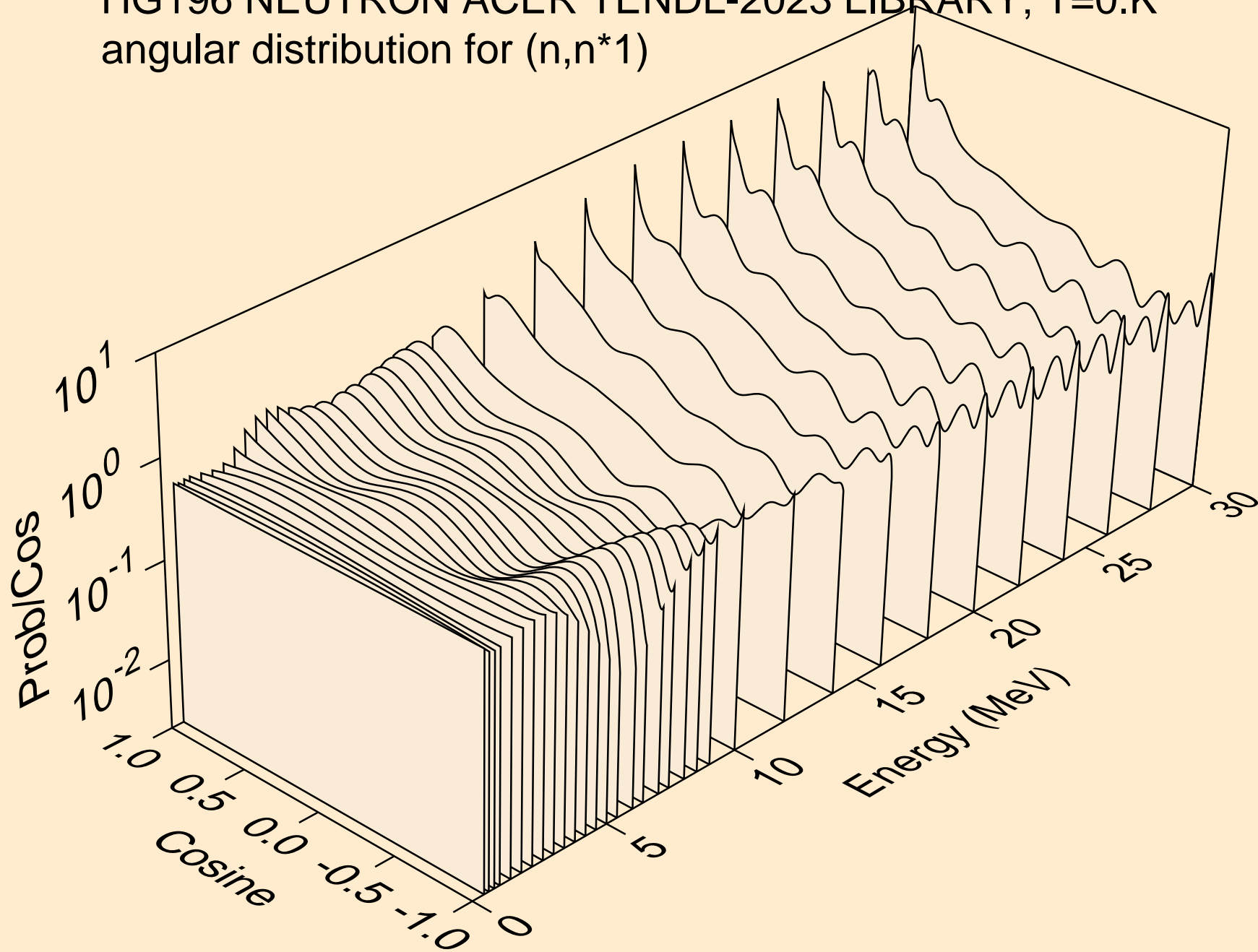

HG196 NEUTRON ACER TENDL-2023 LIBRARY; T=0.K  
angular distribution for (n,n\*2)

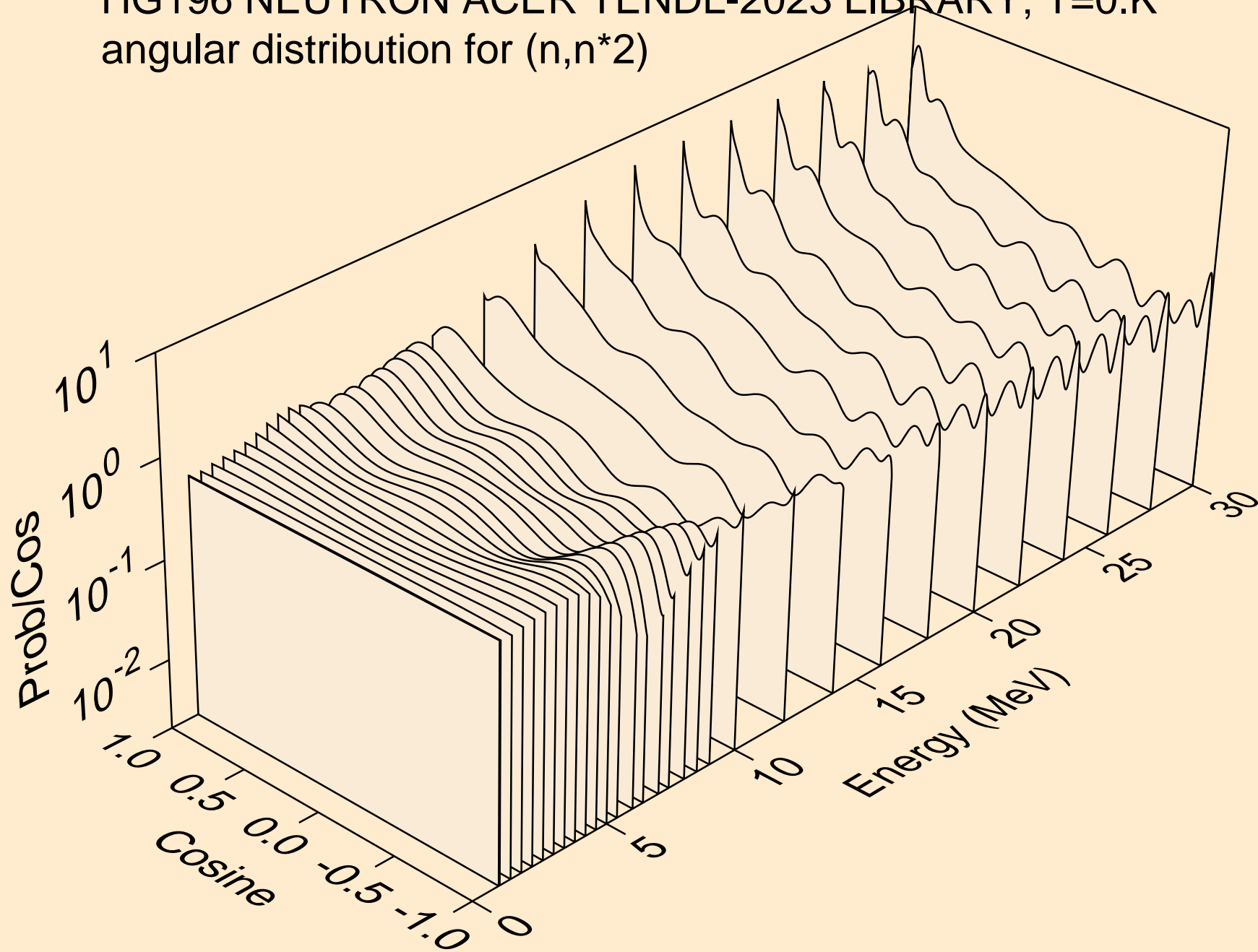

HG196 NEUTRON ACER TENDL-2023 LIBRARY; T=0.K  
angular distribution for (n,n\*3)

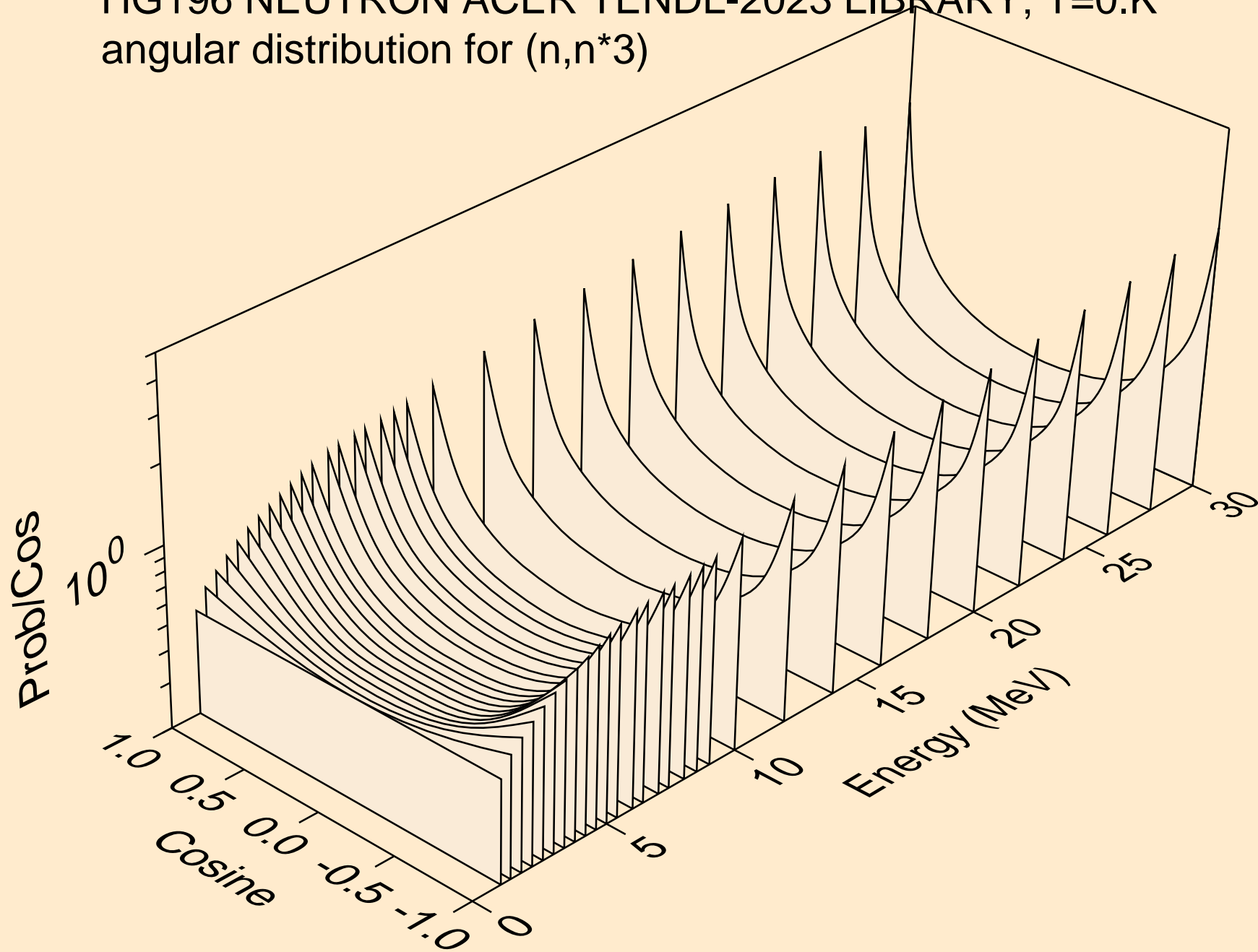



HG196 NEUTRON ACER TENDL-2023 LIBRARY; T=0.K  
angular distribution for (n,n\*4)

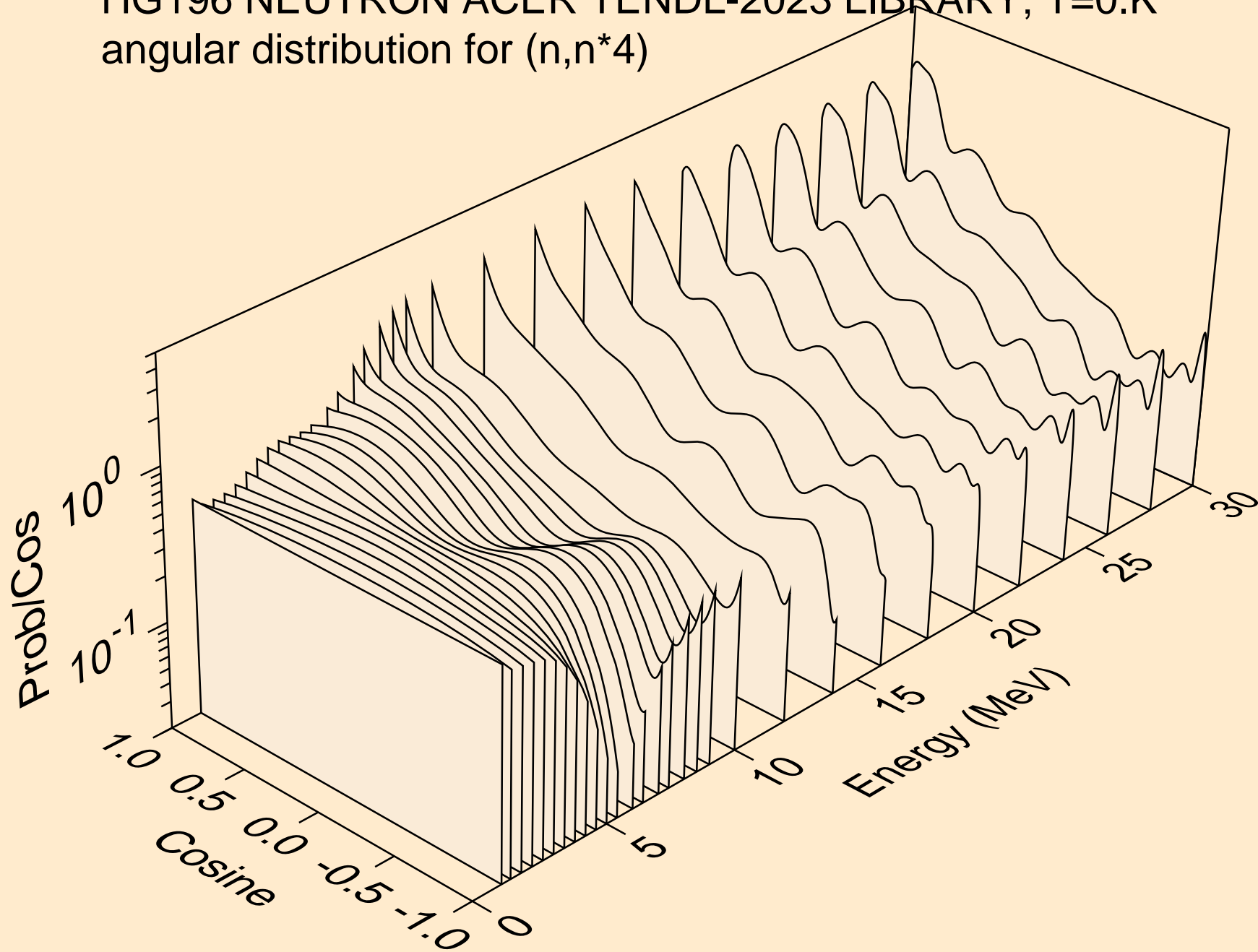

HG196 NEUTRON ACER TENDL-2023 LIBRARY; T=0.K  
angular distribution for (n,n\*5)

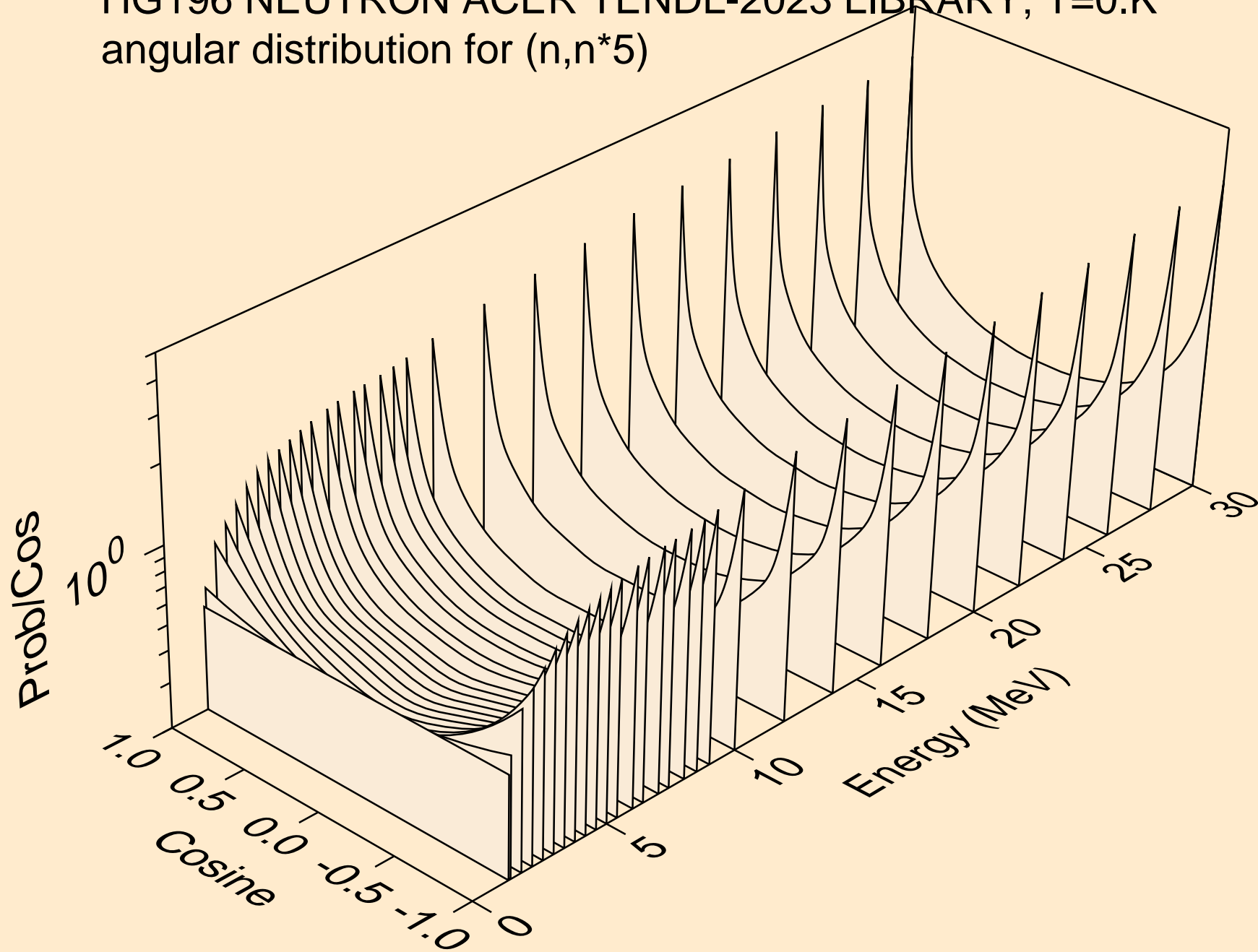

HG196 NEUTRON ACER TENDL-2023 LIBRARY; T=0.K  
angular distribution for (n,n\*6)

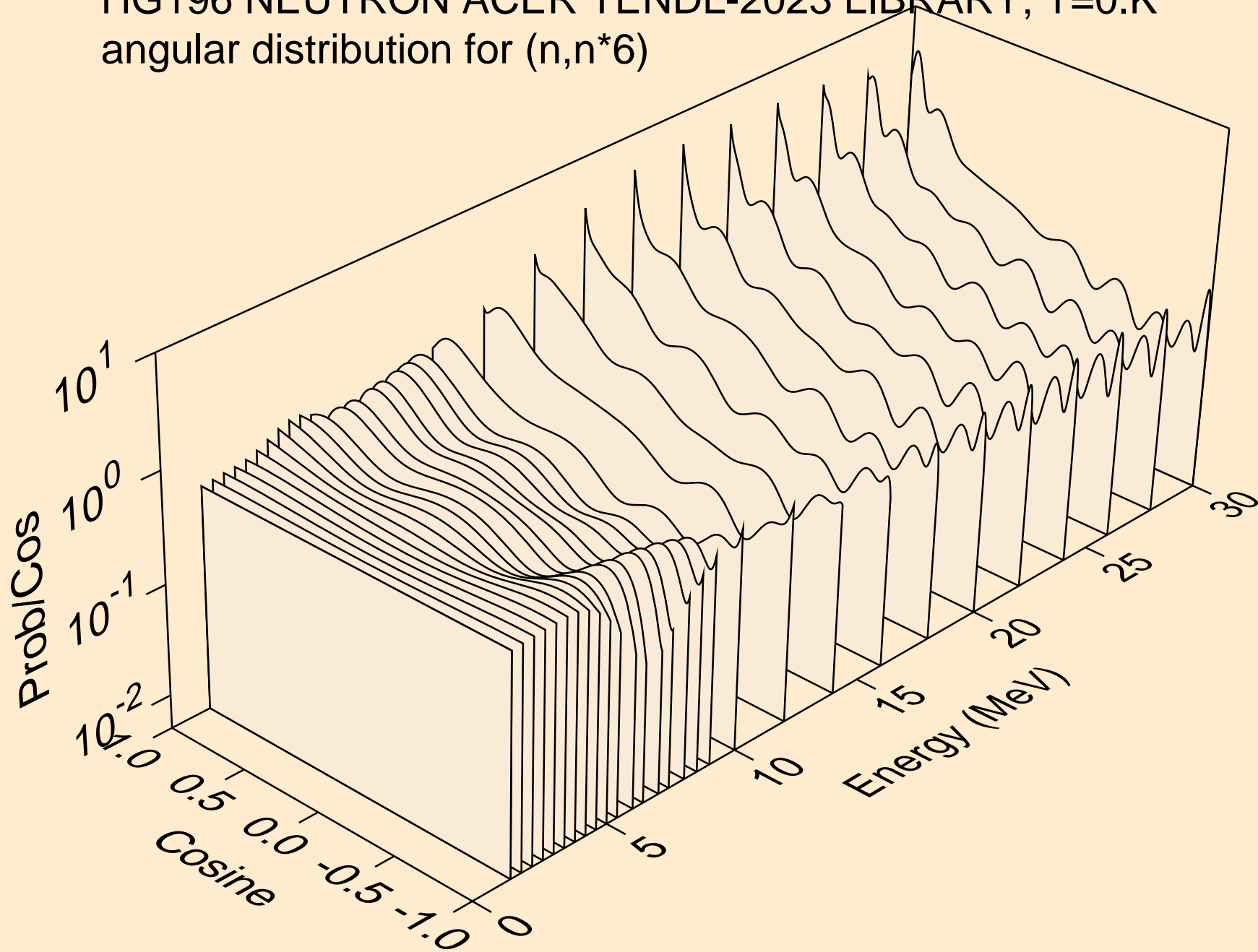

HG196 NEUTRON ACER TENDL-2023 LIBRARY; T=0.K  
angular distribution for (n,n\*7)

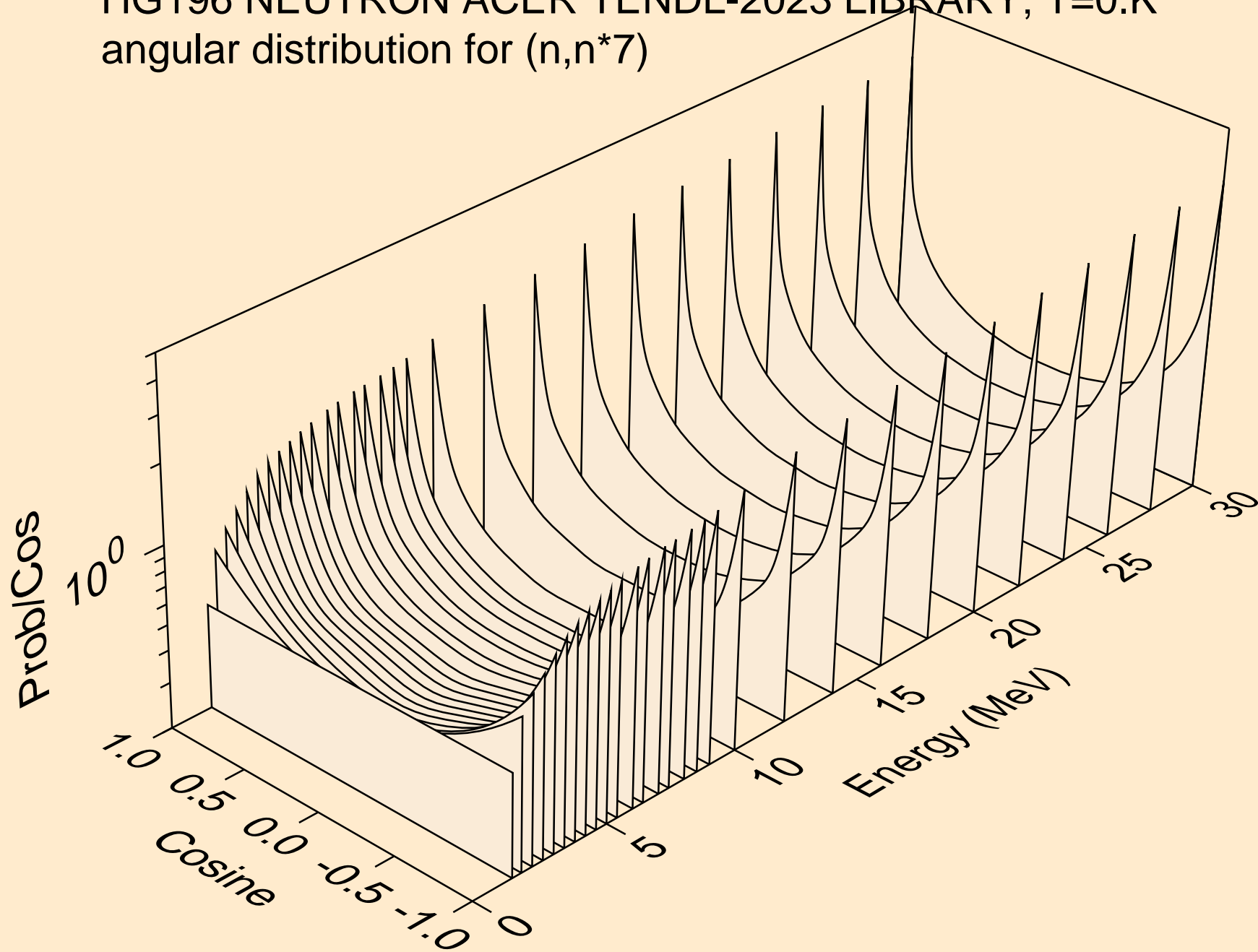

HG196 NEUTRON ACER TENDL-2023 LIBRARY; T=0.K  
angular distribution for (n,n\*8)

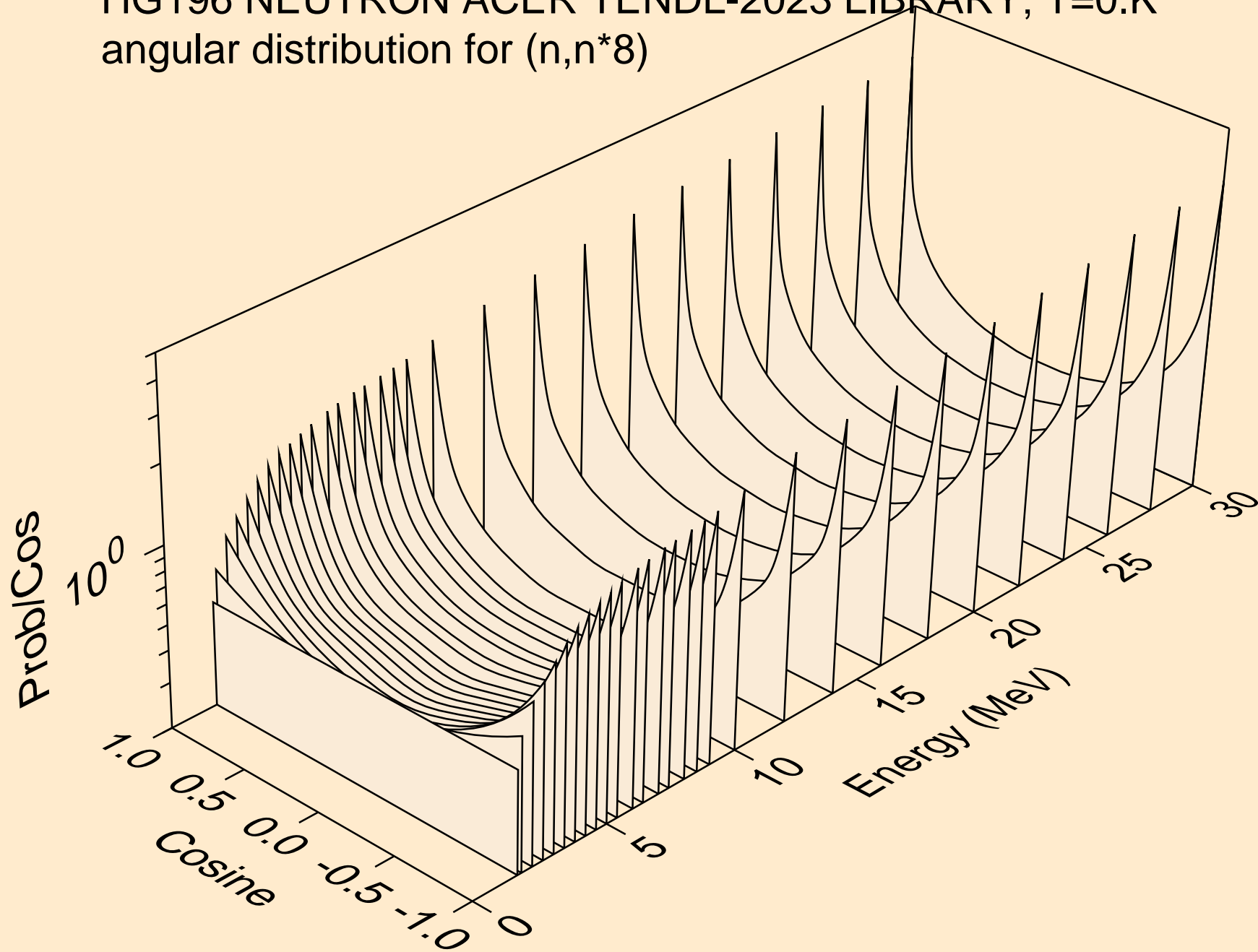

HG196 NEUTRON ACER TENDL-2023 LIBRARY; T=0.K  
angular distribution for (n,n\*9)

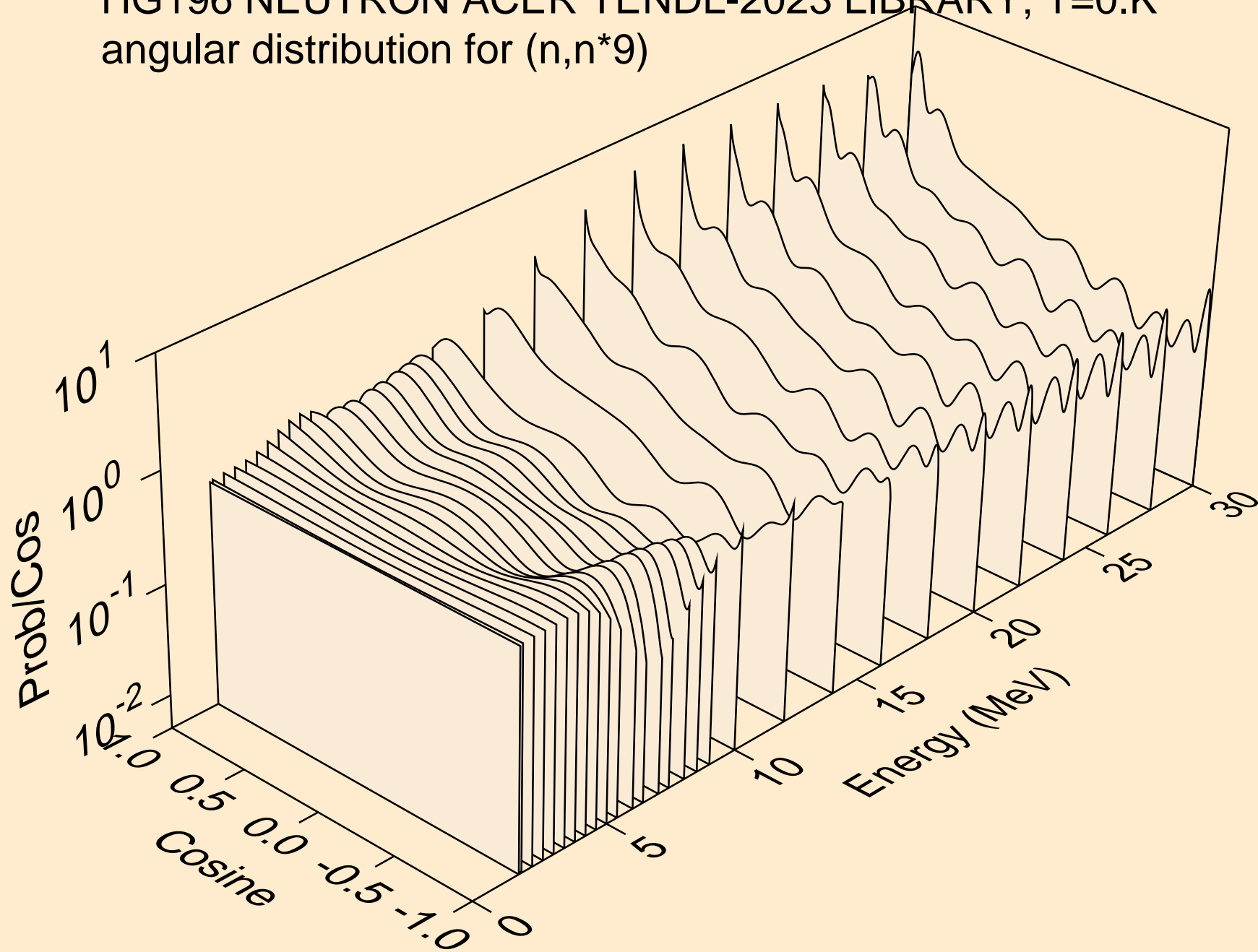

HG196 NEUTRON ACER TENDL-2023 LIBRARY; T=0.K  
angular distribution for (n,n\*10)

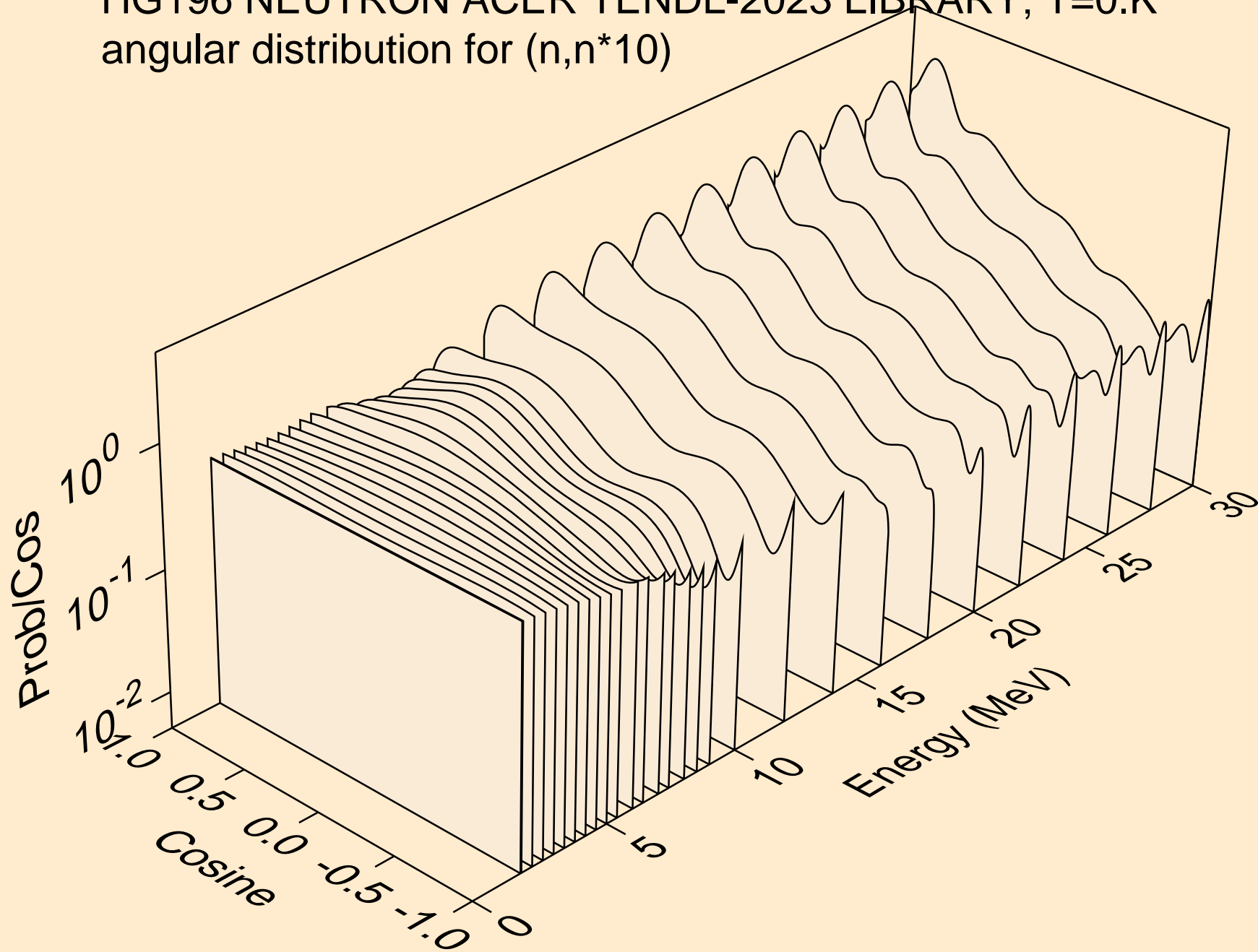

HG196 NEUTRON ACER TENDL-2023 LIBRARY; T=0.K  
angular distribution for (n,n\*11)

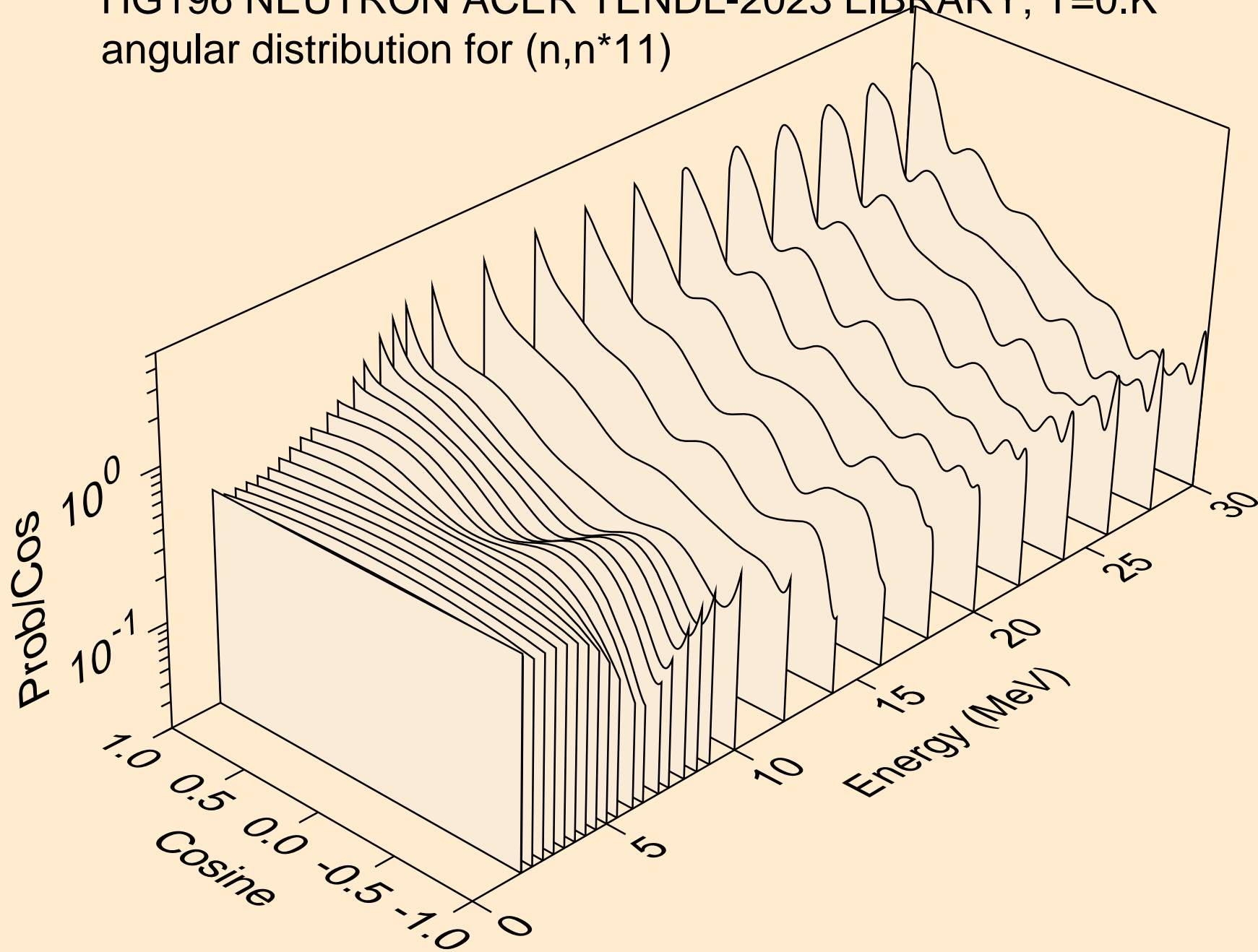



HG196 NEUTRON ACER TENDL-2023 LIBRARY; T=0.K  
angular distribution for (n,n\*12)

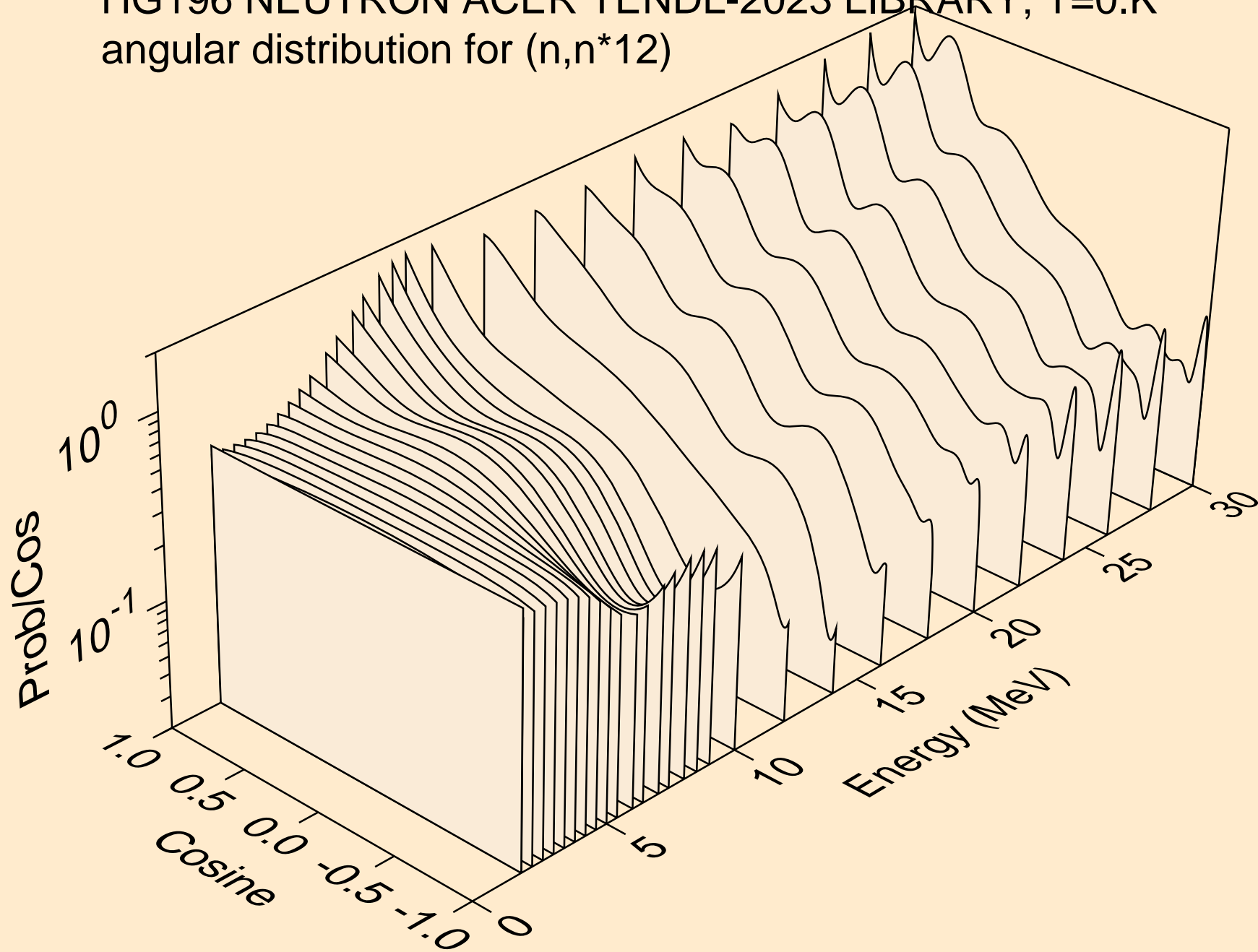

HG196 NEUTRON ACER TENDL-2023 LIBRARY; T=0.K  
angular distribution for (n,n\*13)

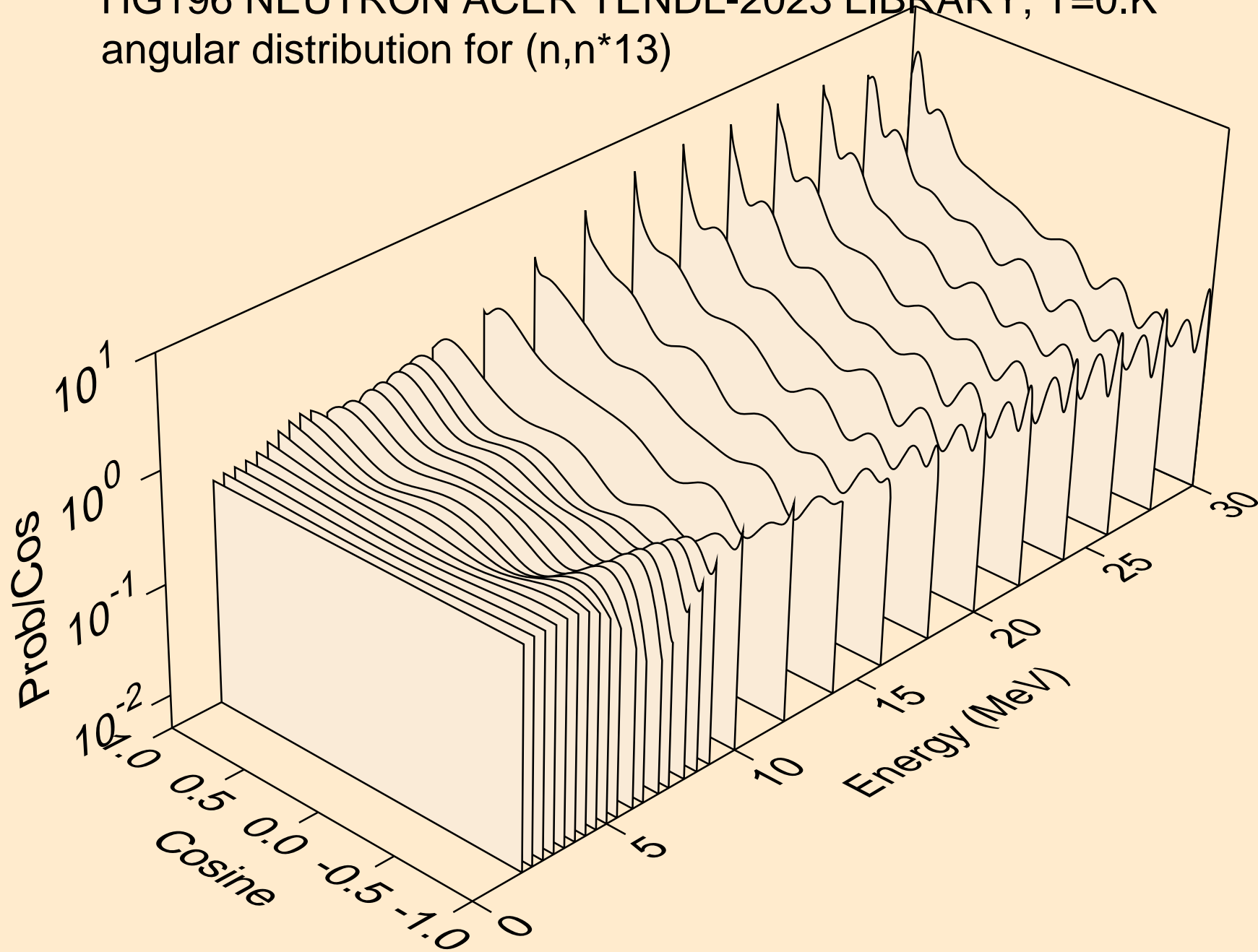

HG196 NEUTRON ACER TENDL-2023 LIBRARY; T=0.K  
angular distribution for (n,n\*14)

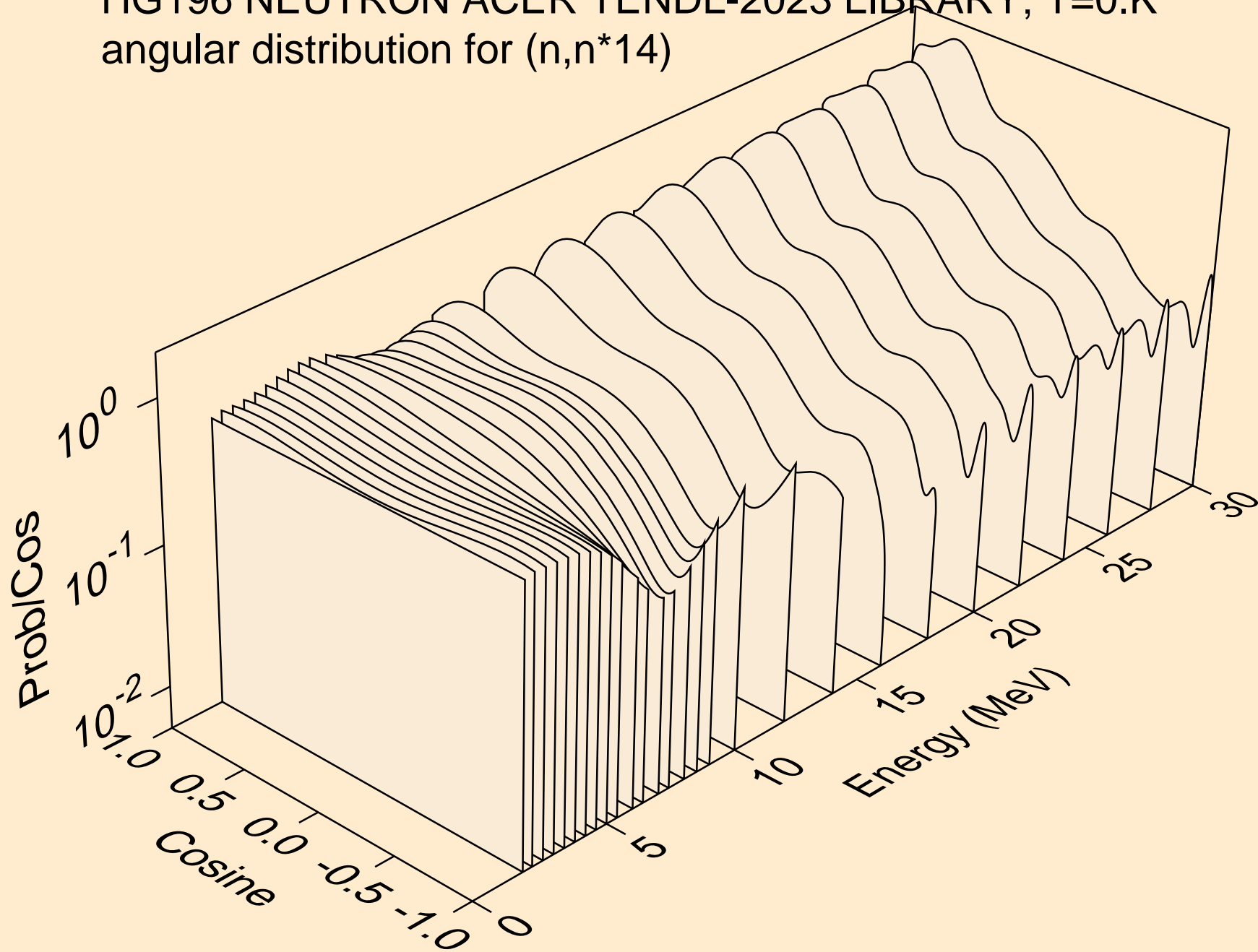

HG196 NEUTRON ACER TENDL-2023 LIBRARY; T=0.K  
angular distribution for (n,n\*15)

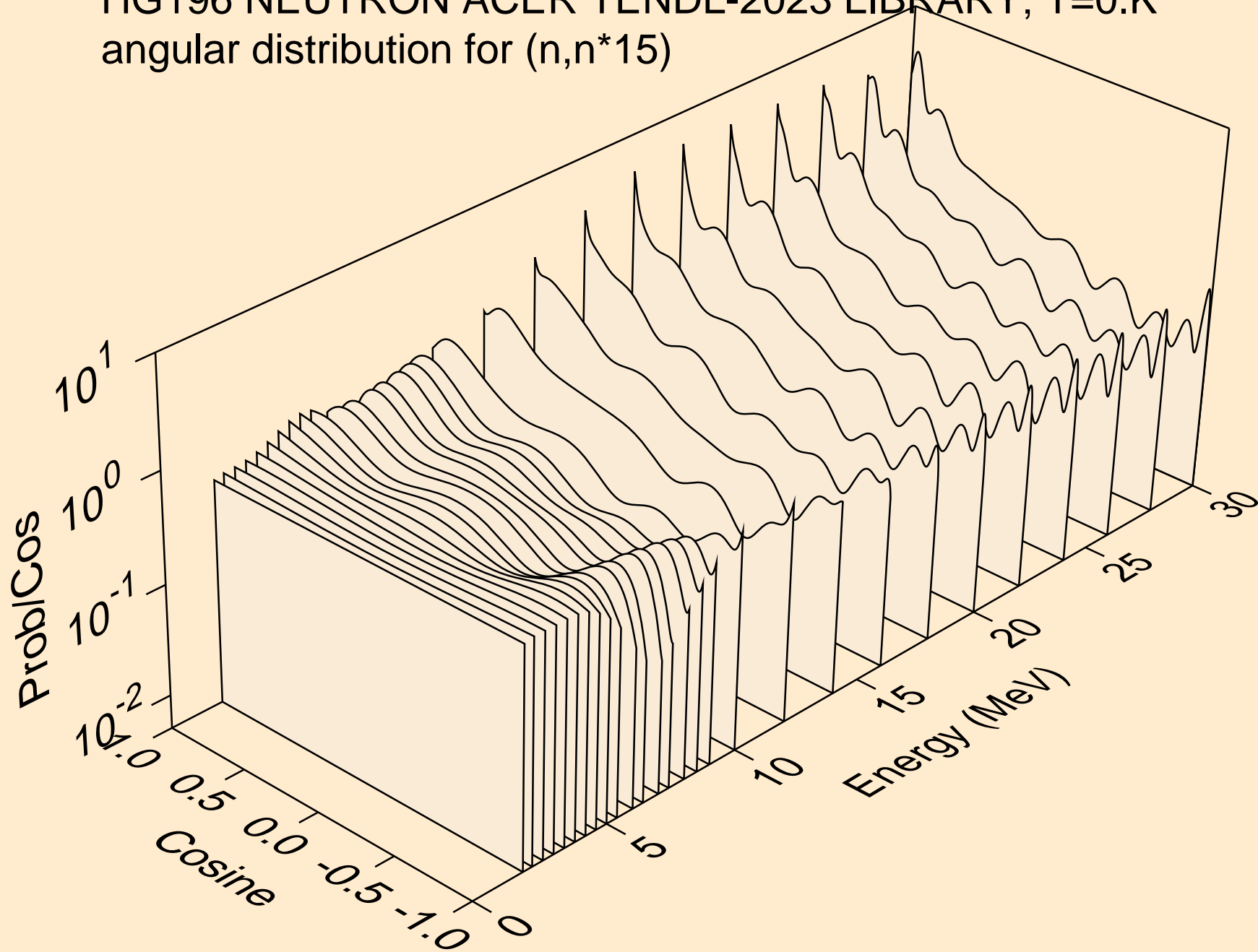

HG196 NEUTRON ACER TENDL-2023 LIBRARY; T=0.K  
angular distribution for (n,n\*16)

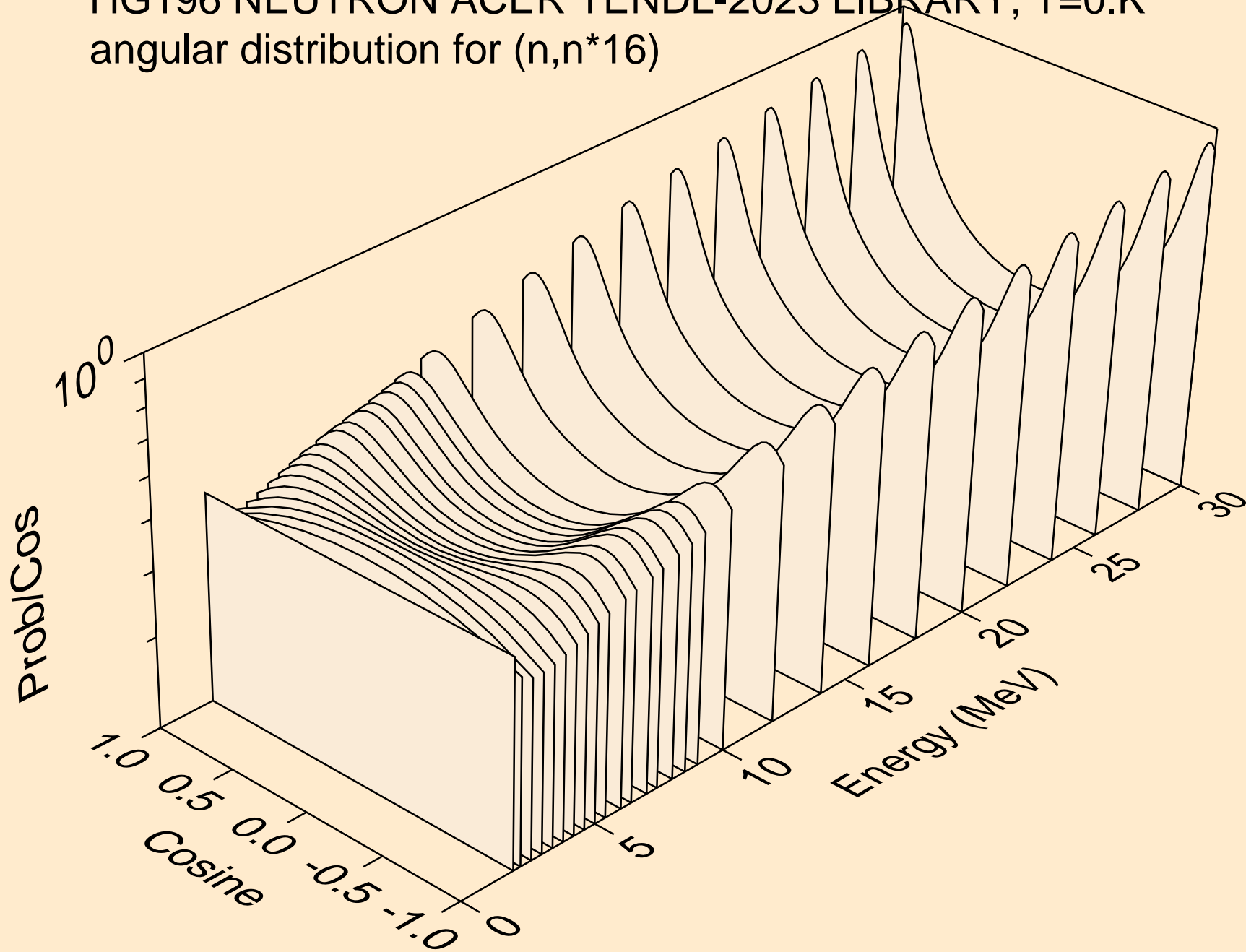

HG196 NEUTRON ACER TENDL-2023 LIBRARY; T=0.K  
angular distribution for (n,n\*17)

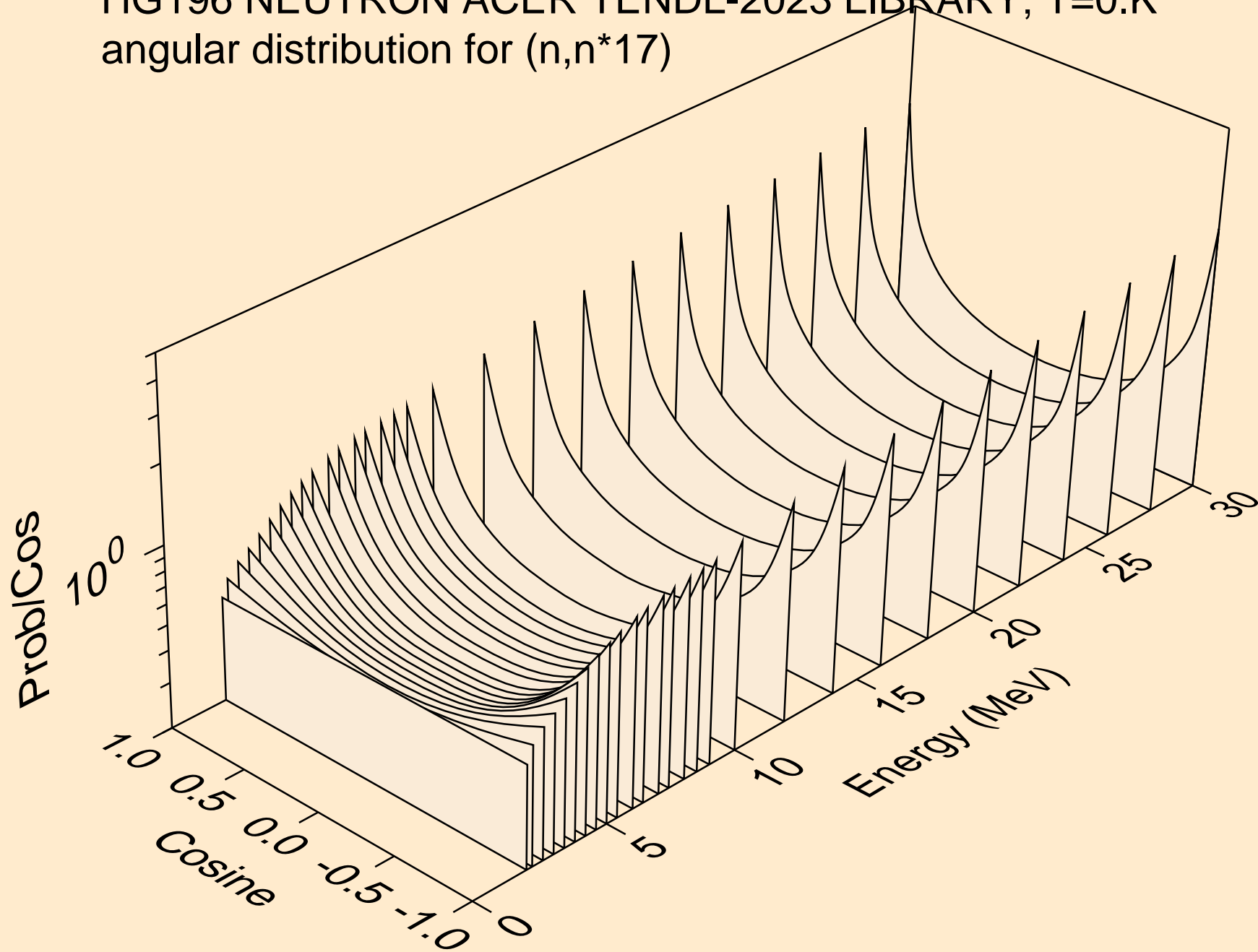

HG196 NEUTRON ACER TENDL-2023 LIBRARY; T=0.K  
angular distribution for (n,n\*18)

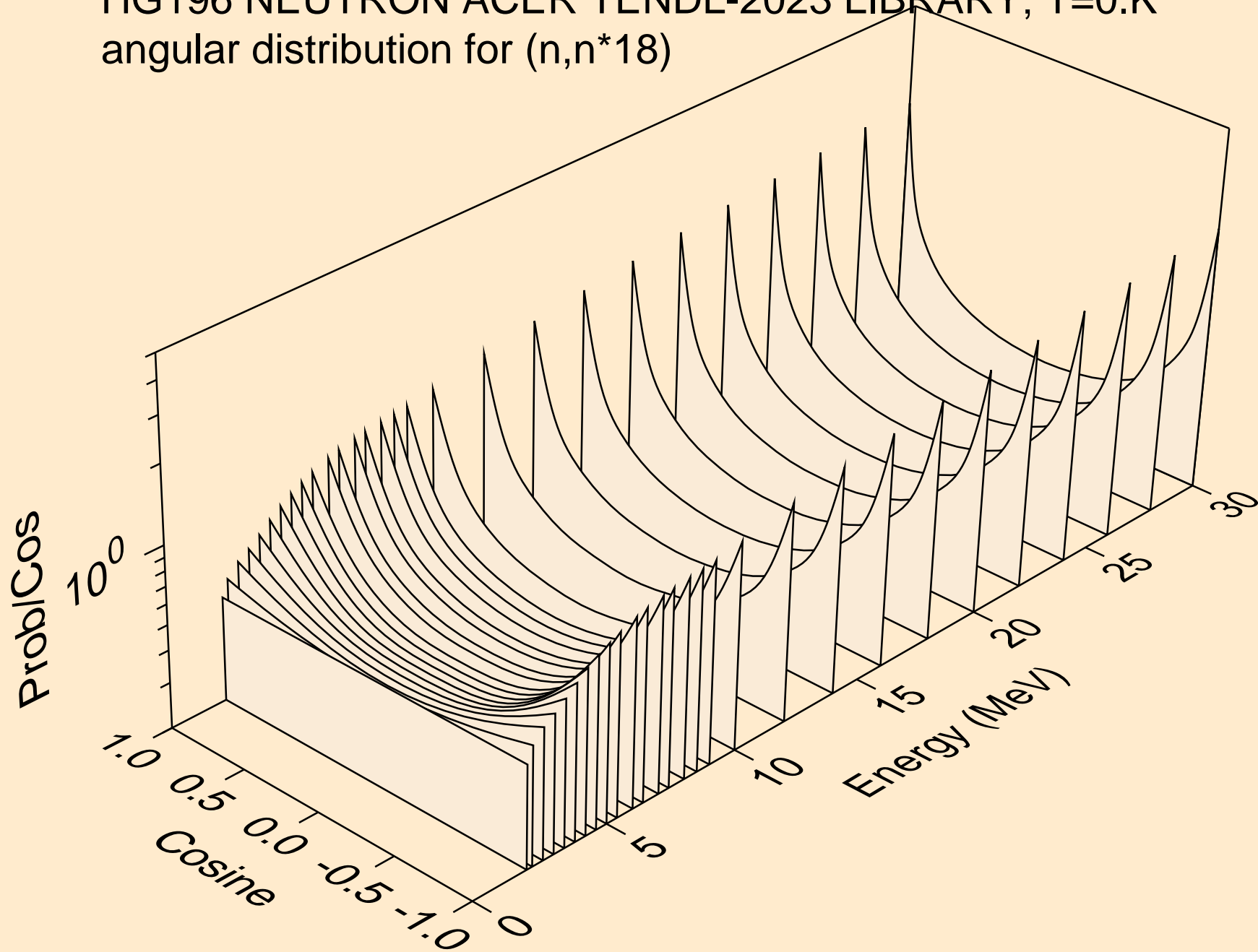

HG196 NEUTRON ACER TENDL-2023 LIBRARY; T=0.K  
angular distribution for (n,n\*19)

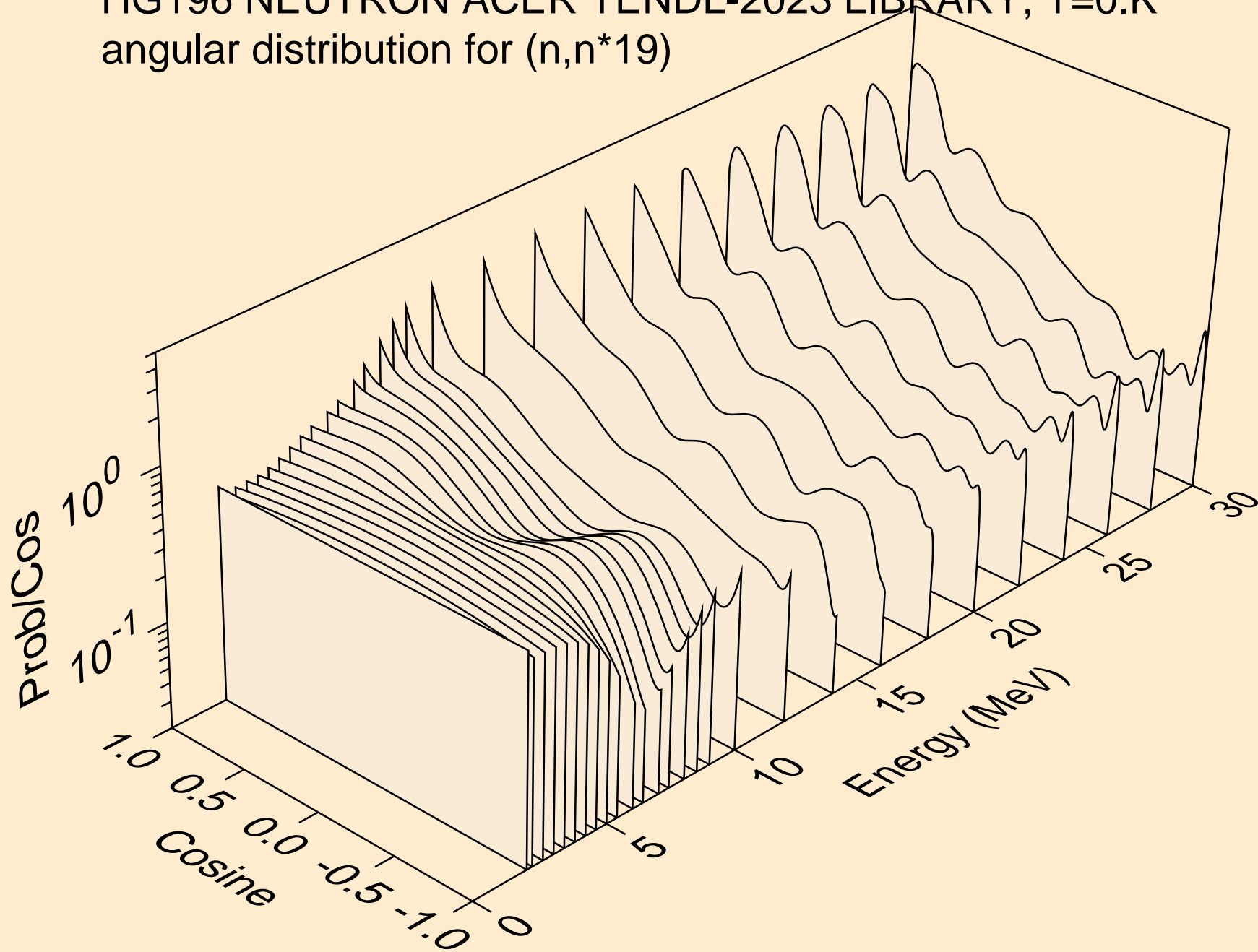



HG196 NEUTRON ACER TENDL-2023 LIBRARY; T=0.K  
angular distribution for (n,n\*20)

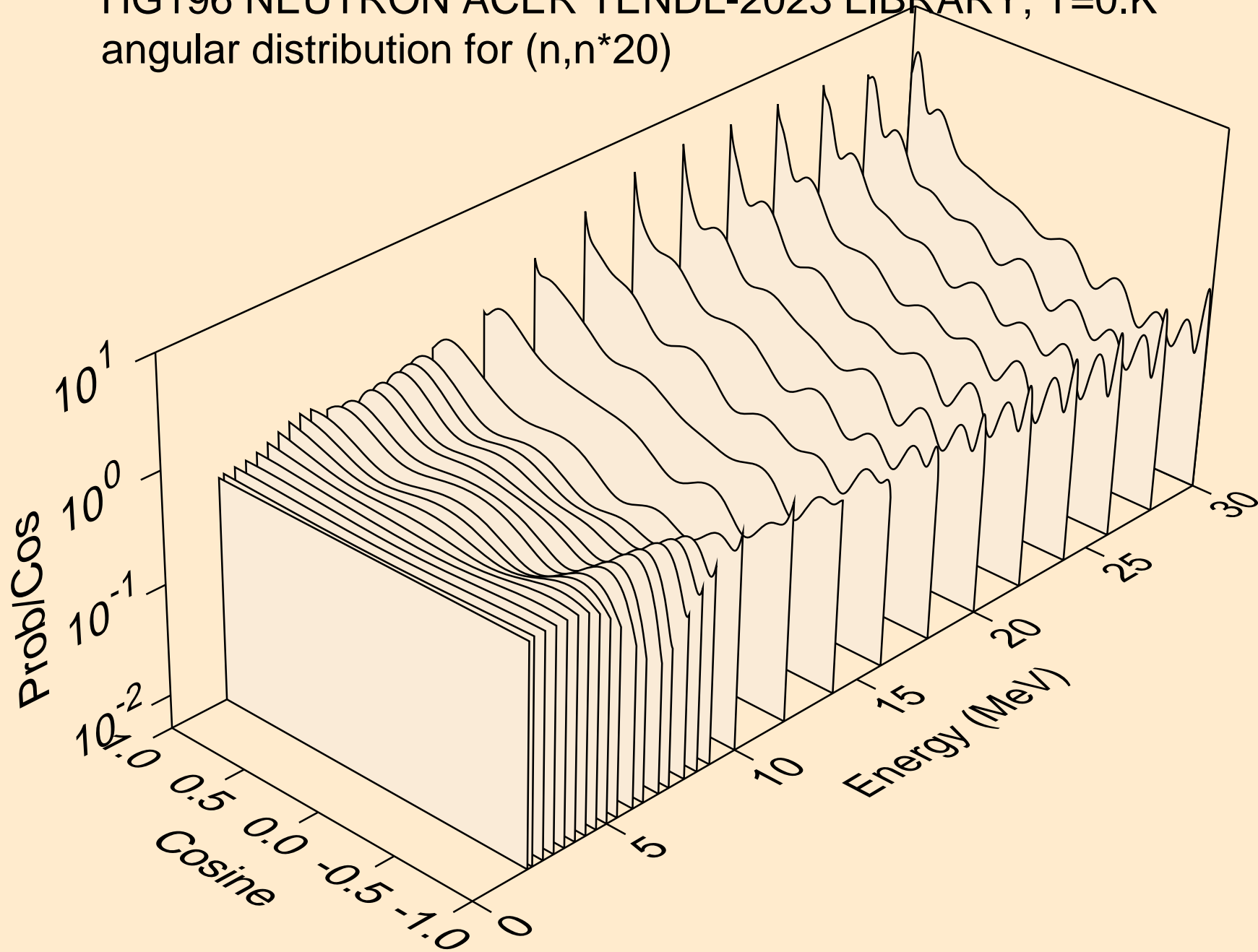

HG196 NEUTRON ACER TENDL-2023 LIBRARY; T=0.K  
angular distribution for (n,n\*21)

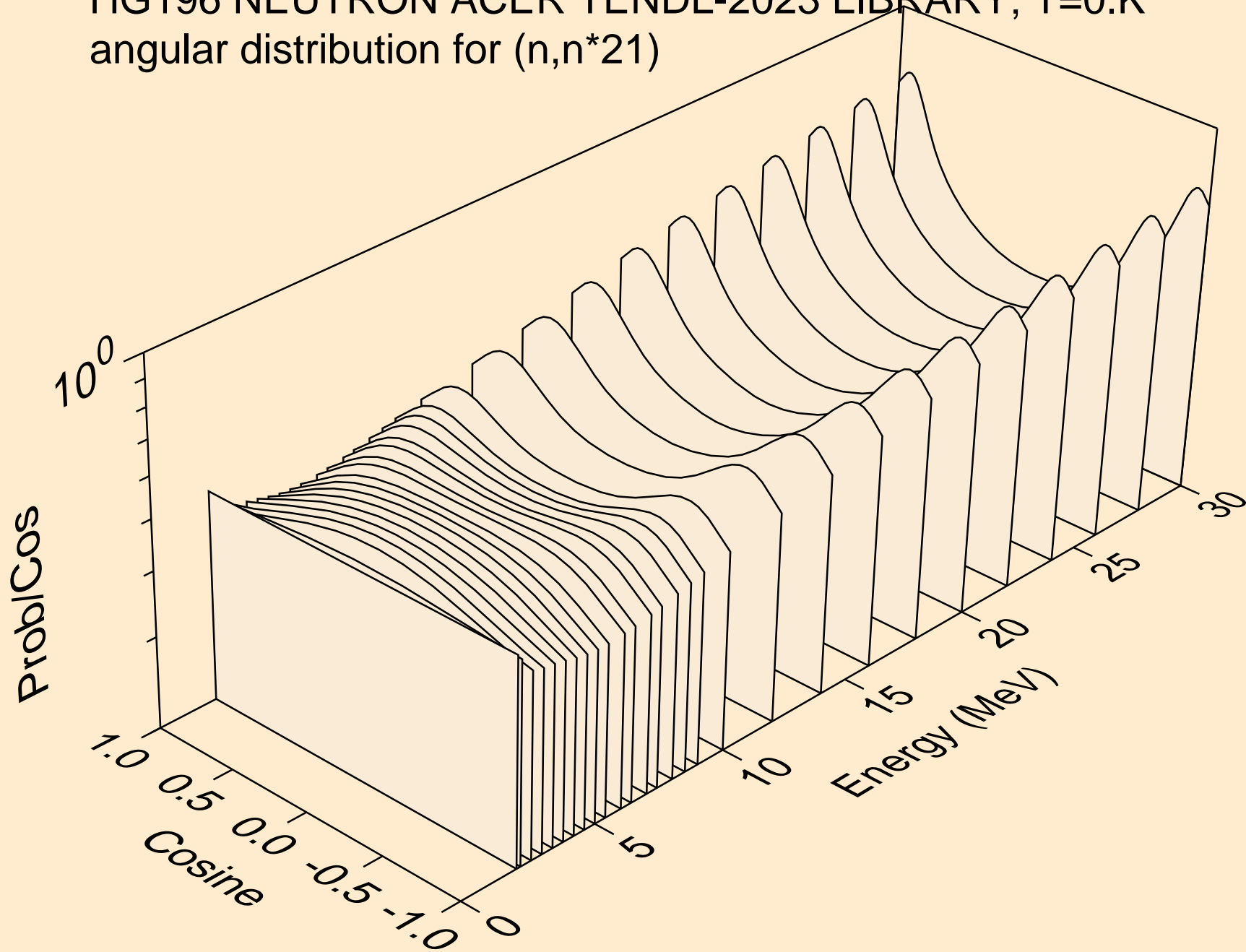

HG196 NEUTRON ACER TENDL-2023 LIBRARY; T=0.K  
Neutron emission for (n,x)

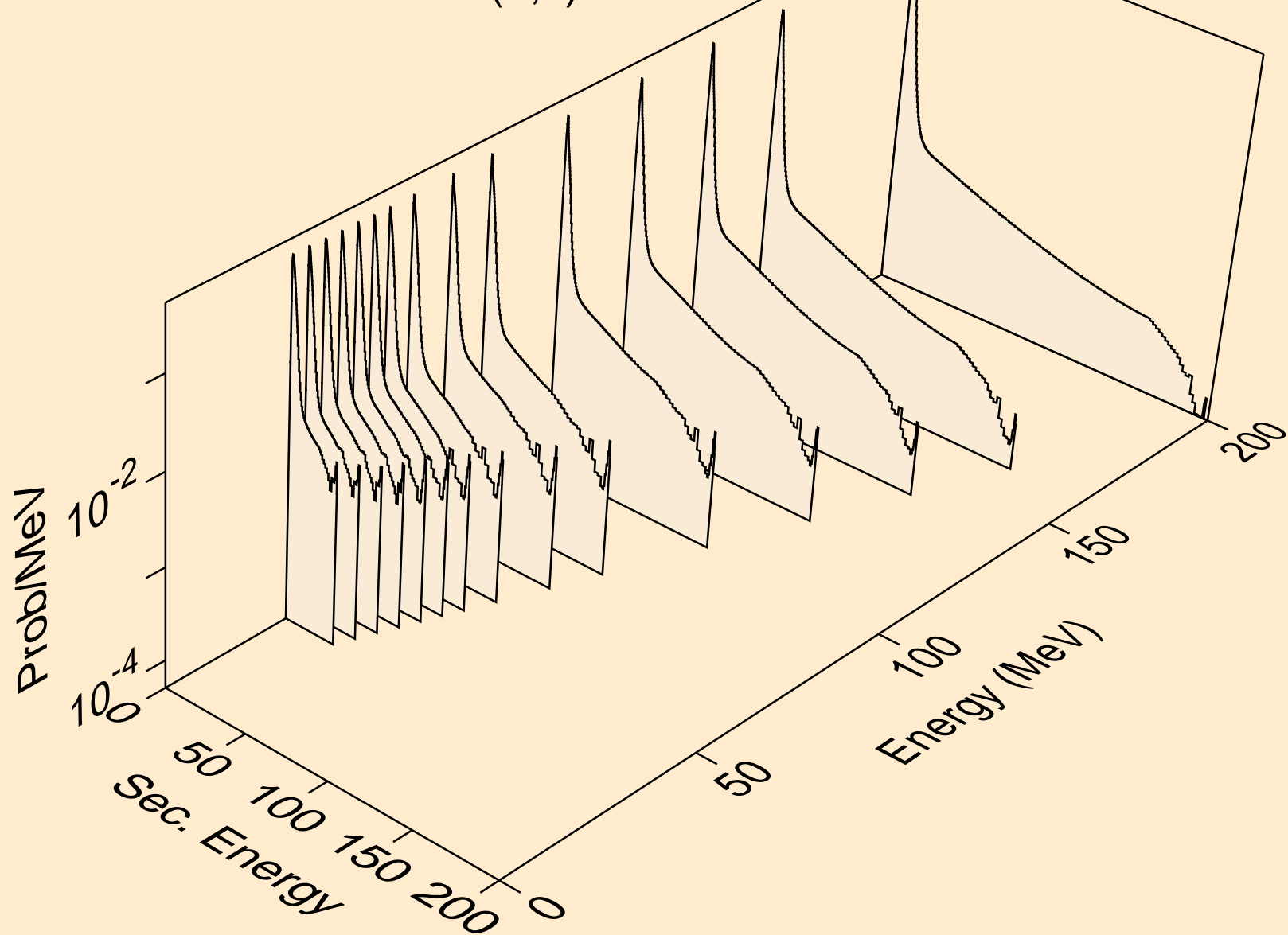

HG196 NEUTRON ACER TENDL-2023 LIBRARY; T=0.K  
Neutron emission for (n,2nd)

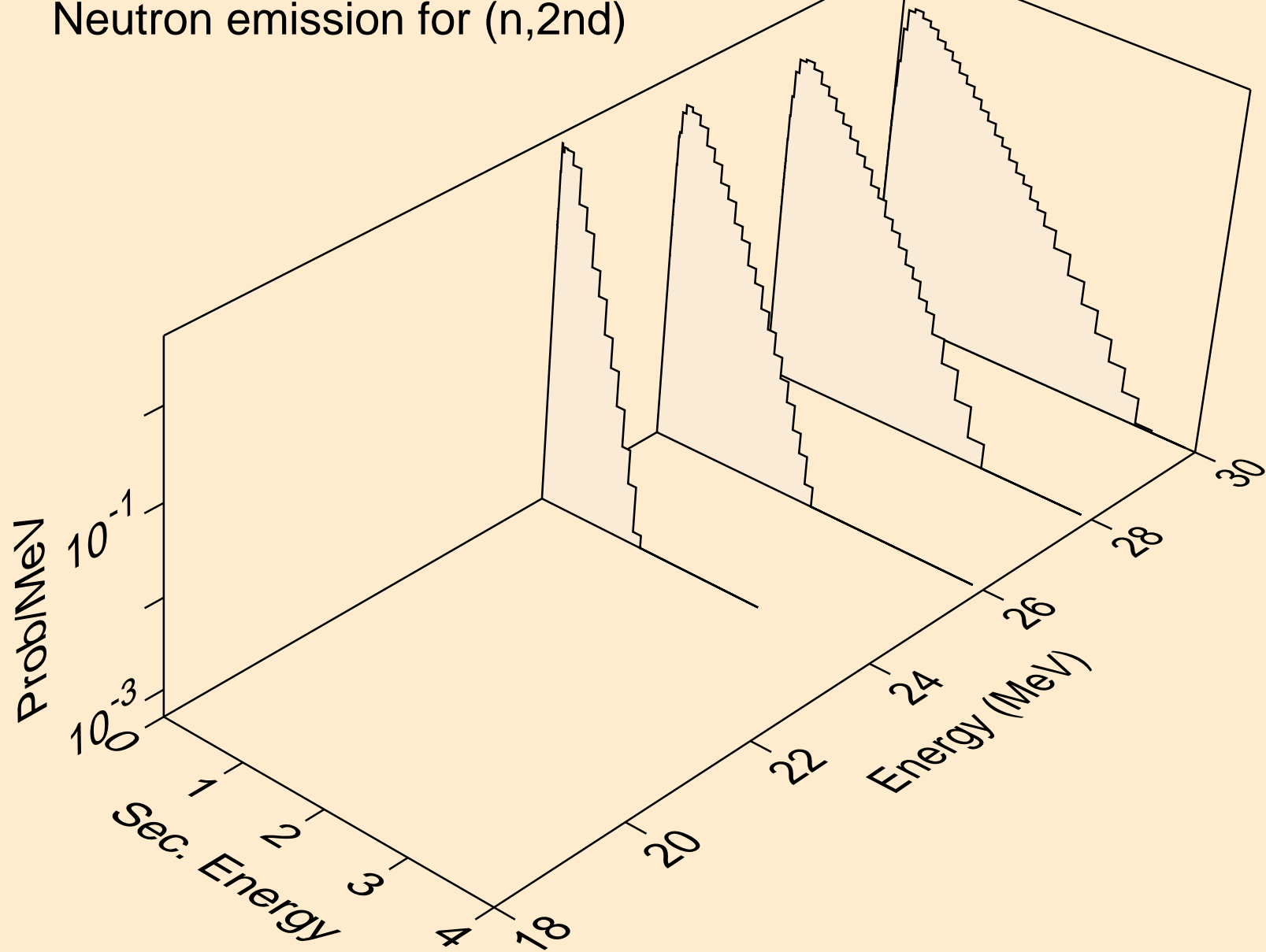

HG196 NEUTRON ACER TENDL-2023 LIBRARY; T=0.K  
Neutron emission for (n,2n)

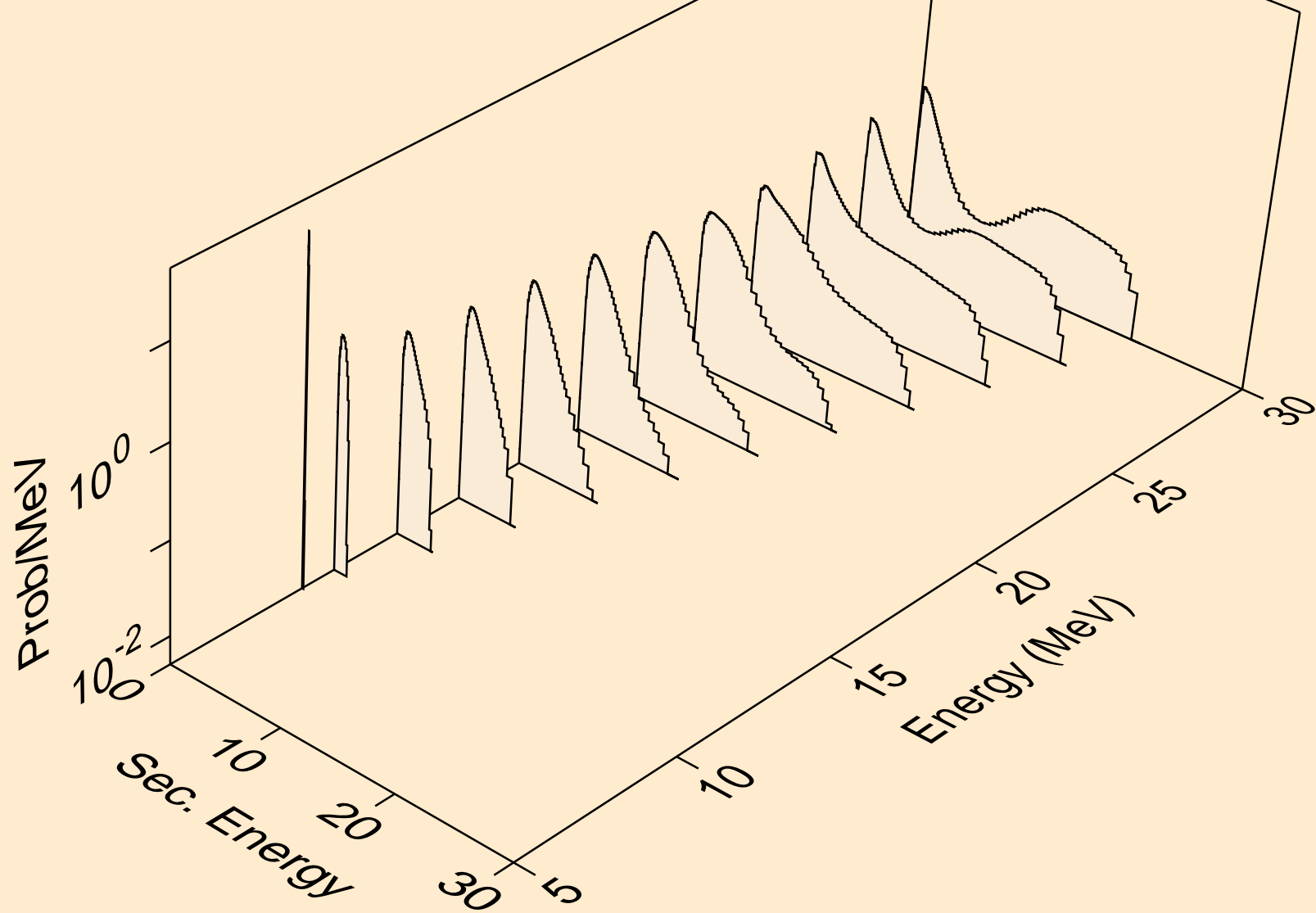

HG196 NEUTRON ACER TENDL-2023 LIBRARY; T=0.K  
Neutron emission for (n,3n)

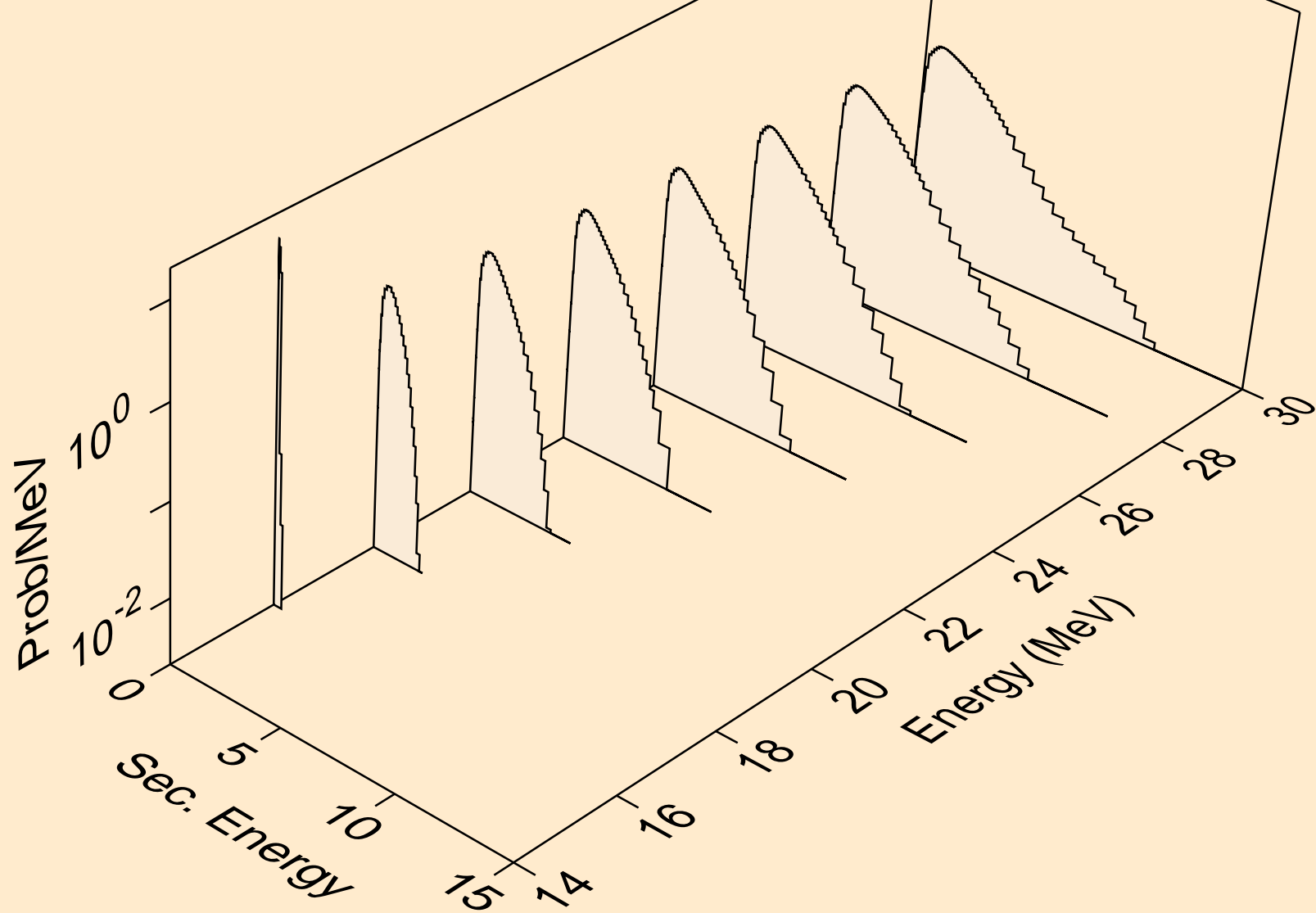

HG196 NEUTRON ACER TENDL-2023 LIBRARY; T=0.K  
Neutron emission for (n,n\*)a

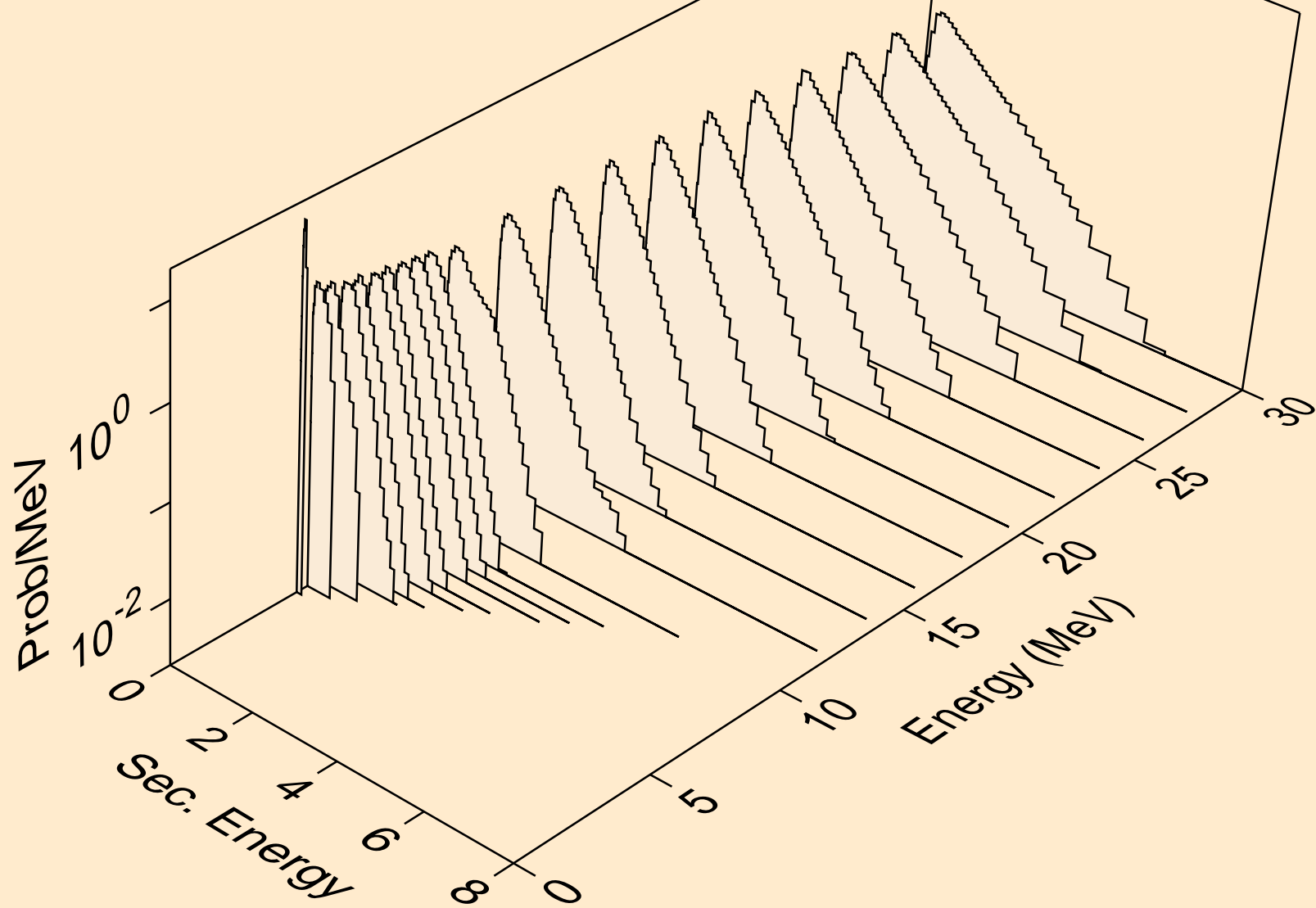

HG196 NEUTRON ACER TENDL-2023 LIBRARY; T=0.K  
Neutron emission for (n,2n)a

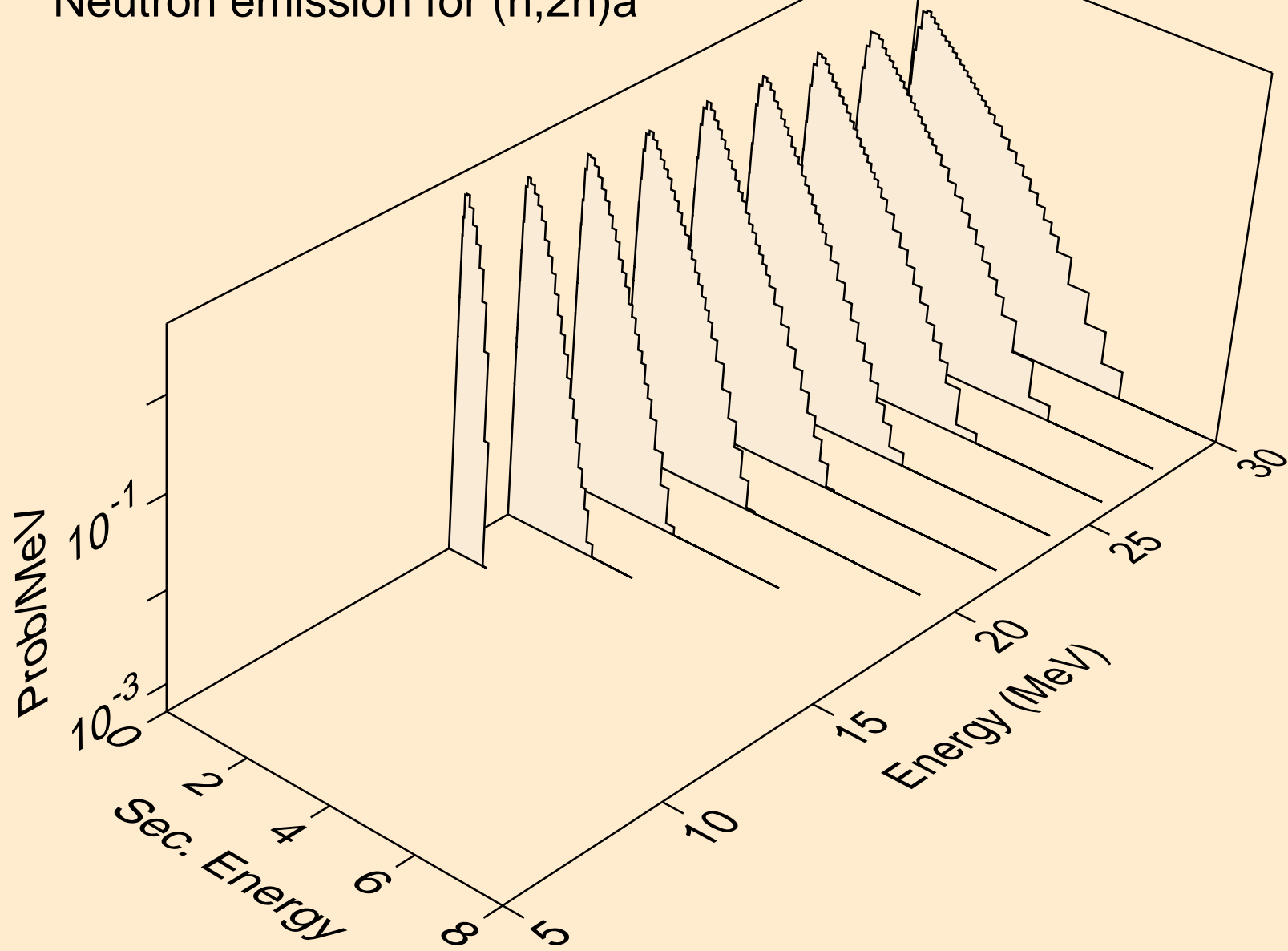



HG196 NEUTRON ACER TENDL-2023 LIBRARY; T=0.K  
Neutron emission for (n,3n)a

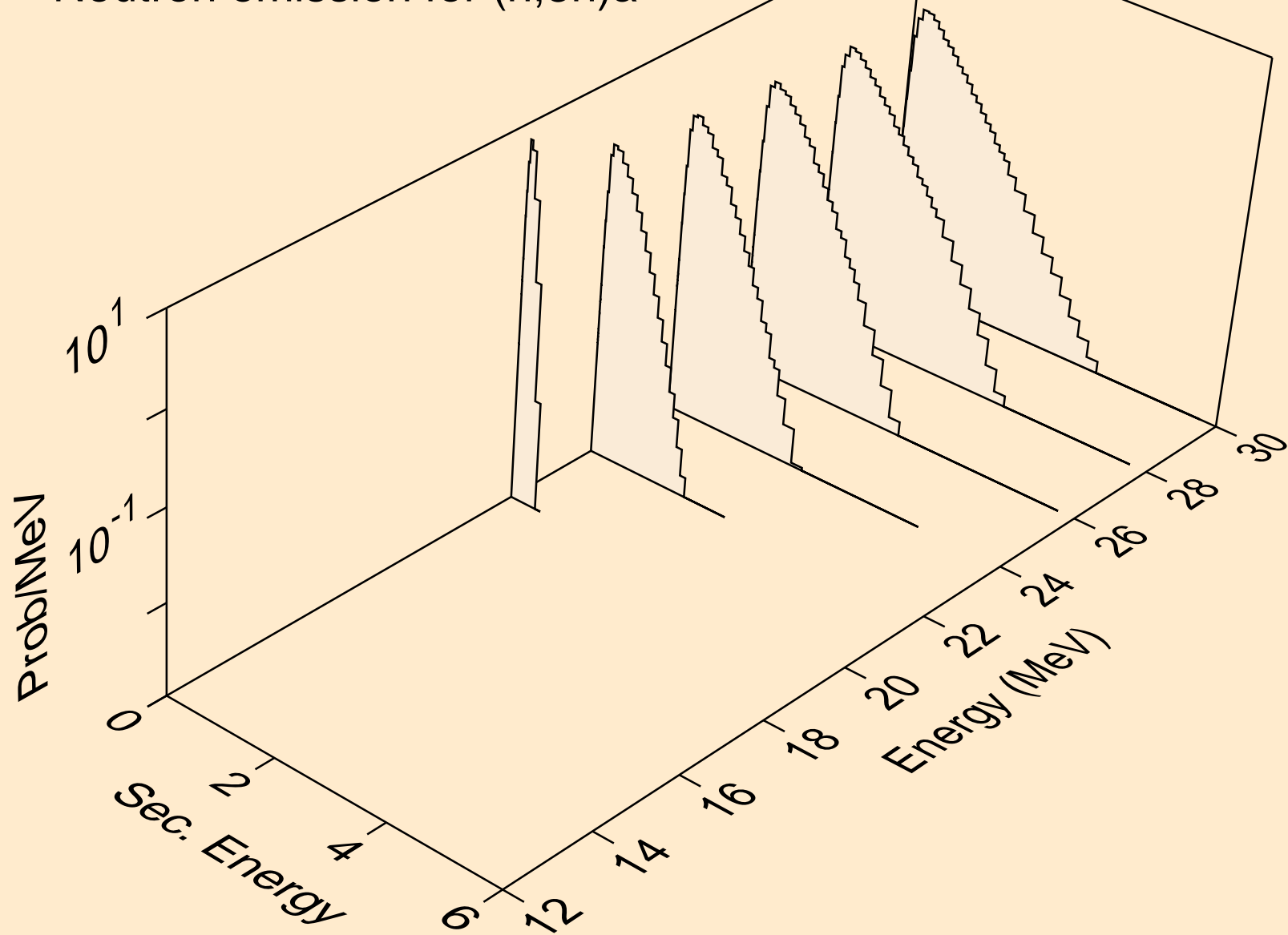

HG196 NEUTRON ACER TENDL-2023 LIBRARY; T=0.K  
Neutron emission for (n,n\*)p

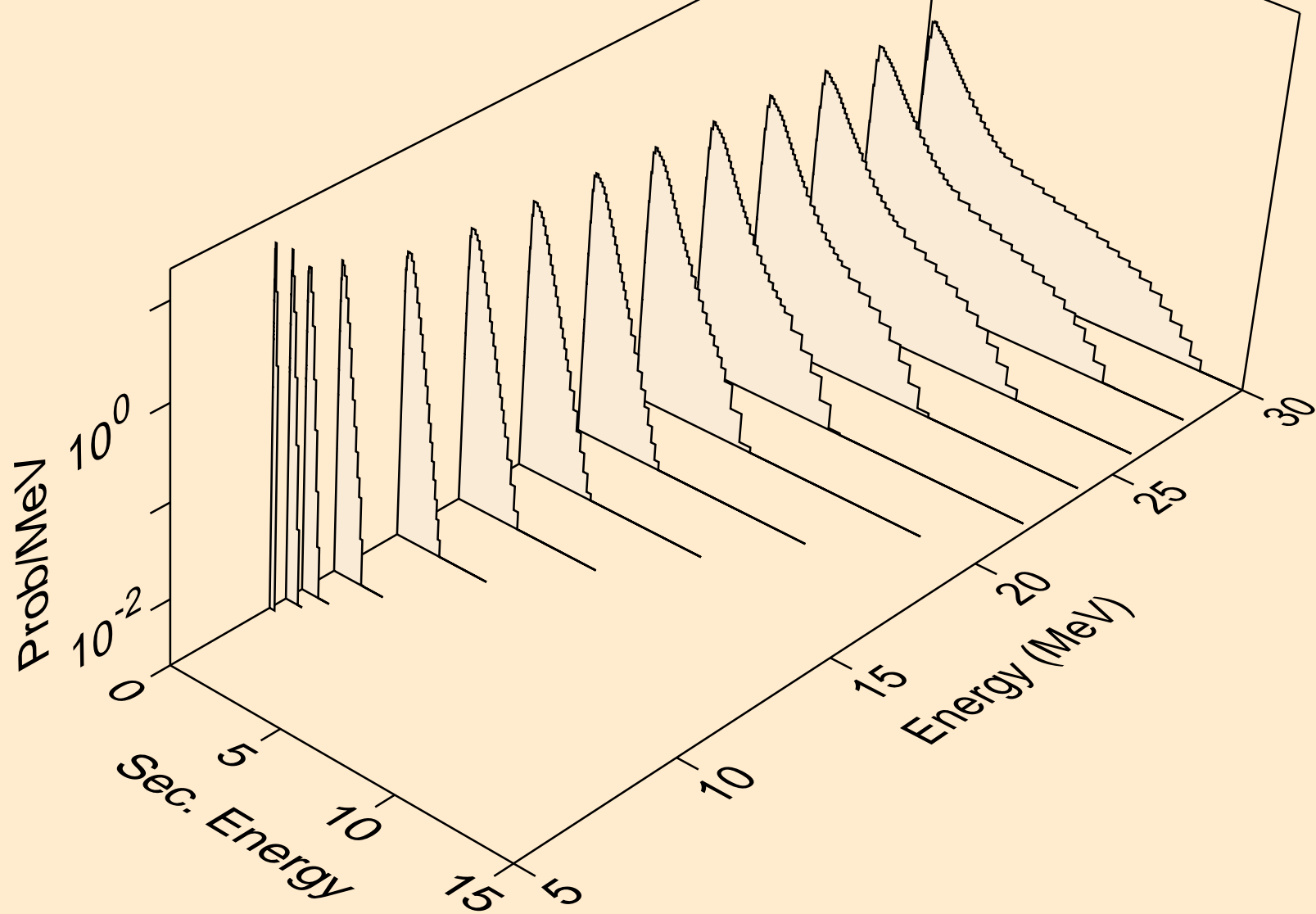

HG196 NEUTRON ACER TENDL-2023 LIBRARY; T=0.K  
Neutron emission for (n,n\*)2a

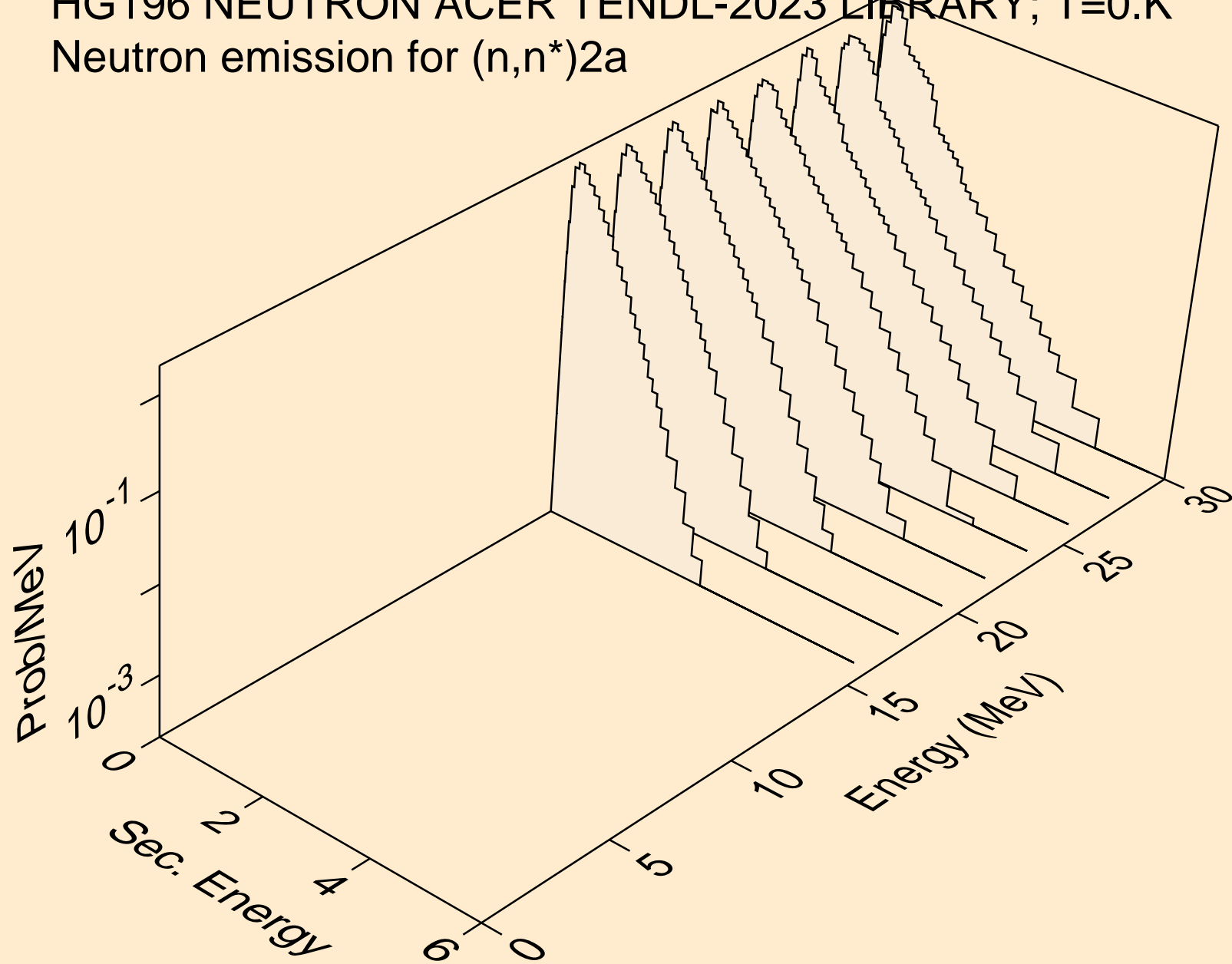

HG196 NEUTRON ACER TENDL-2023 LIBRARY; T=0.K  
Neutron emission for (n,n\*)d

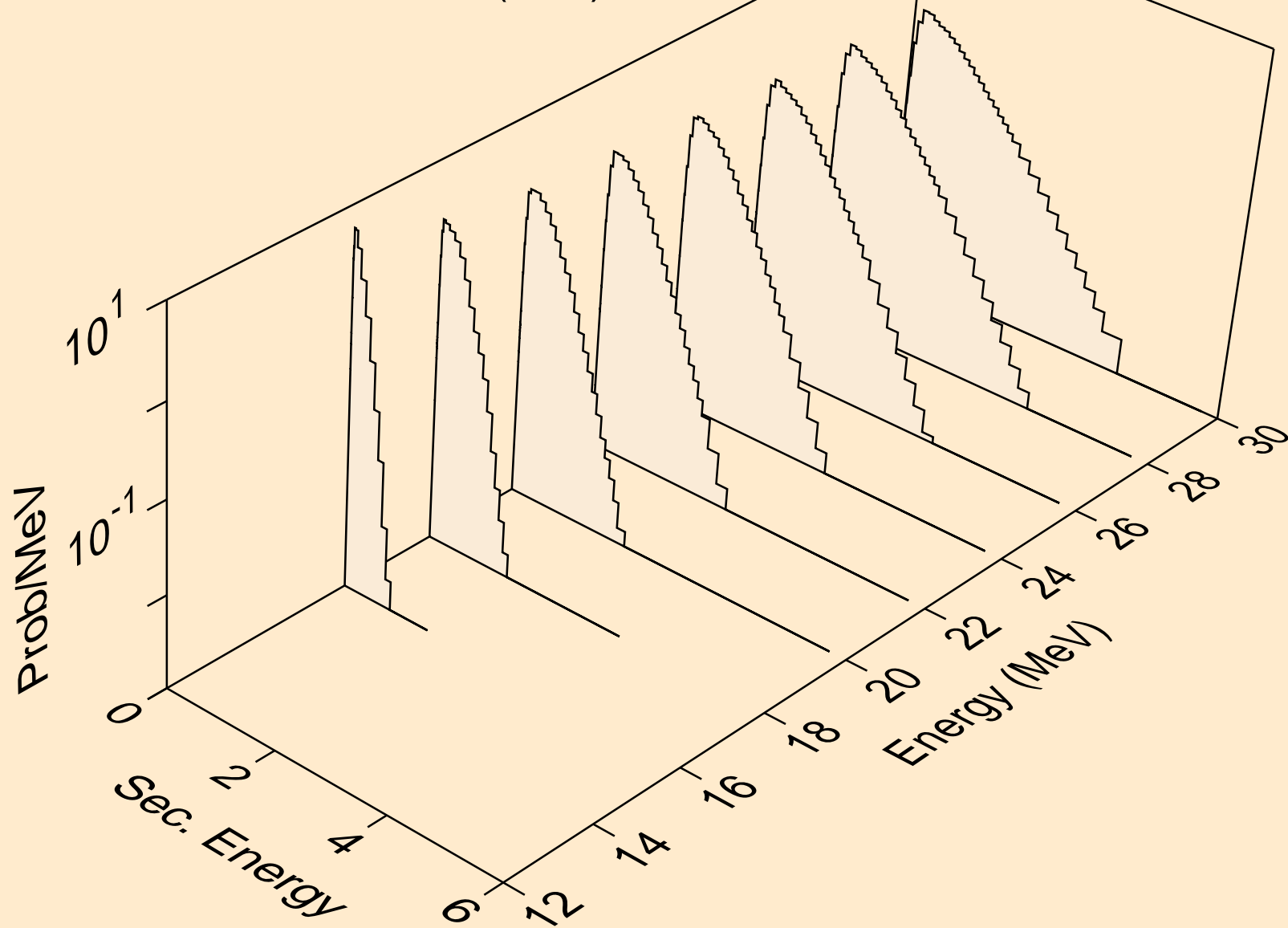

HG196 NEUTRON ACER TENDL-2023 LIBRARY; T=0.K  
Neutron emission for (n,n\*)t

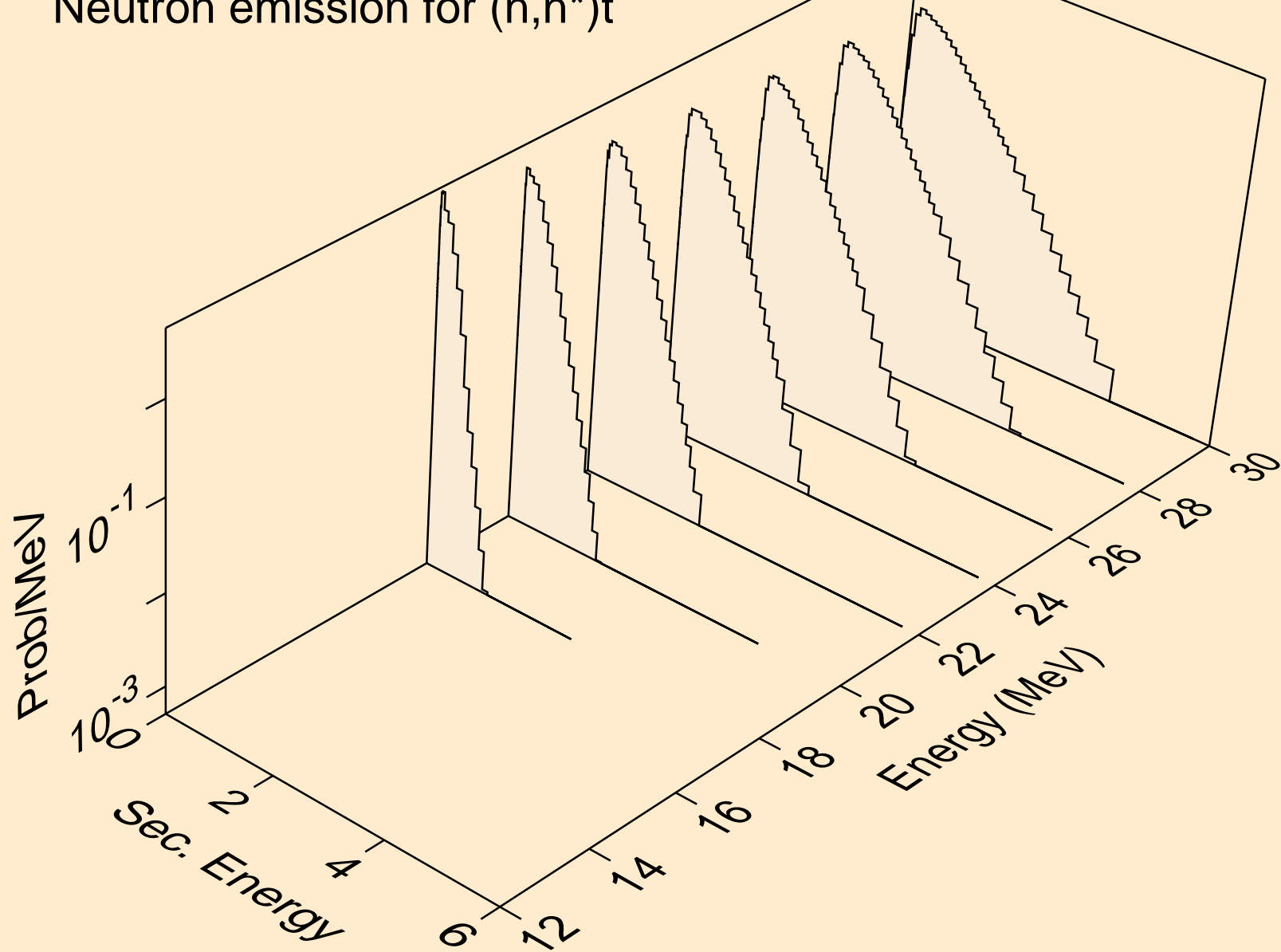

HG196 NEUTRON ACER TENDL-2023 LIBRARY; T=0.K  
Neutron emission for (n,n\*)he3

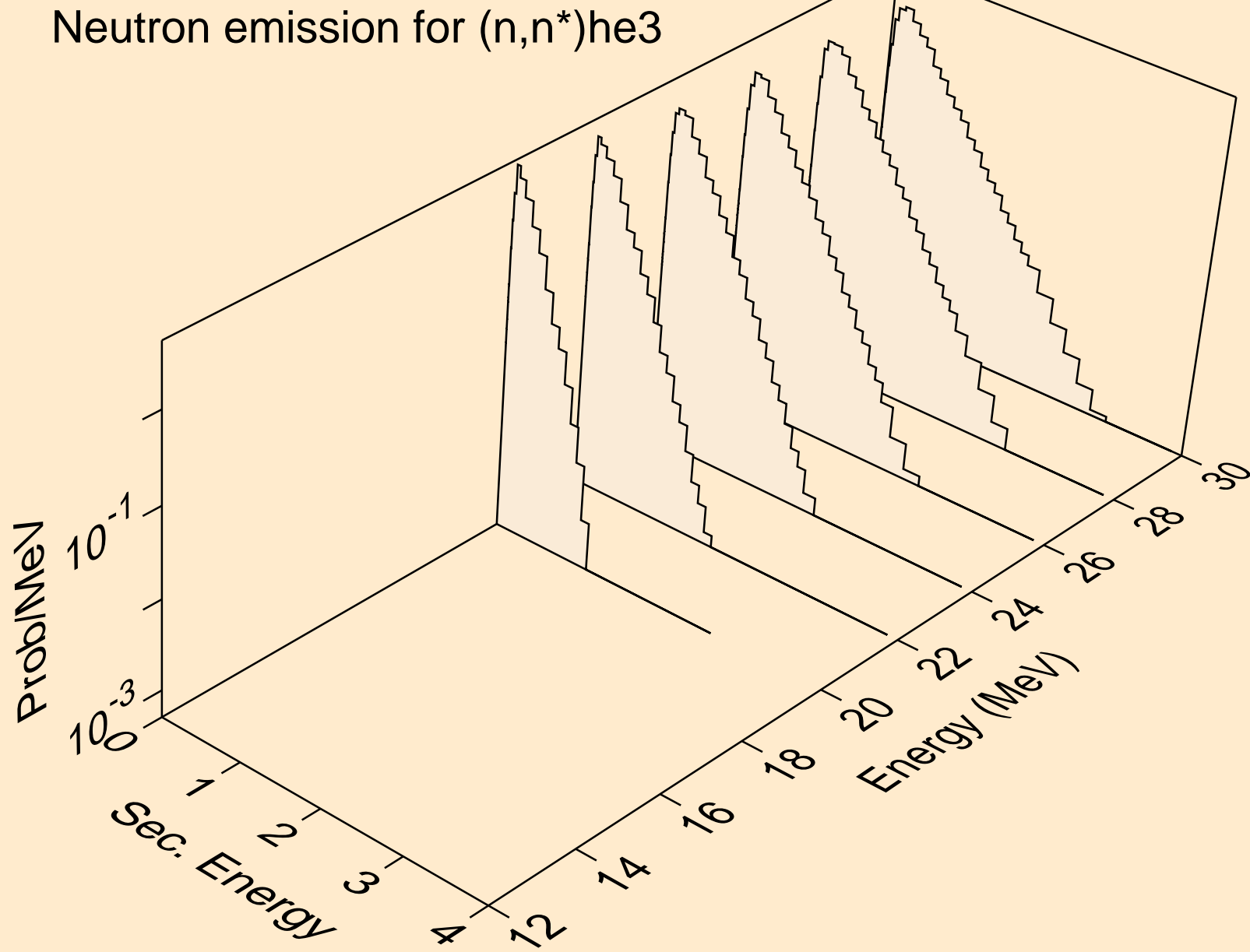

HG196 NEUTRON ACER TENDL-2023 LIBRARY; T=0.K  
Neutron emission for (n,4n)

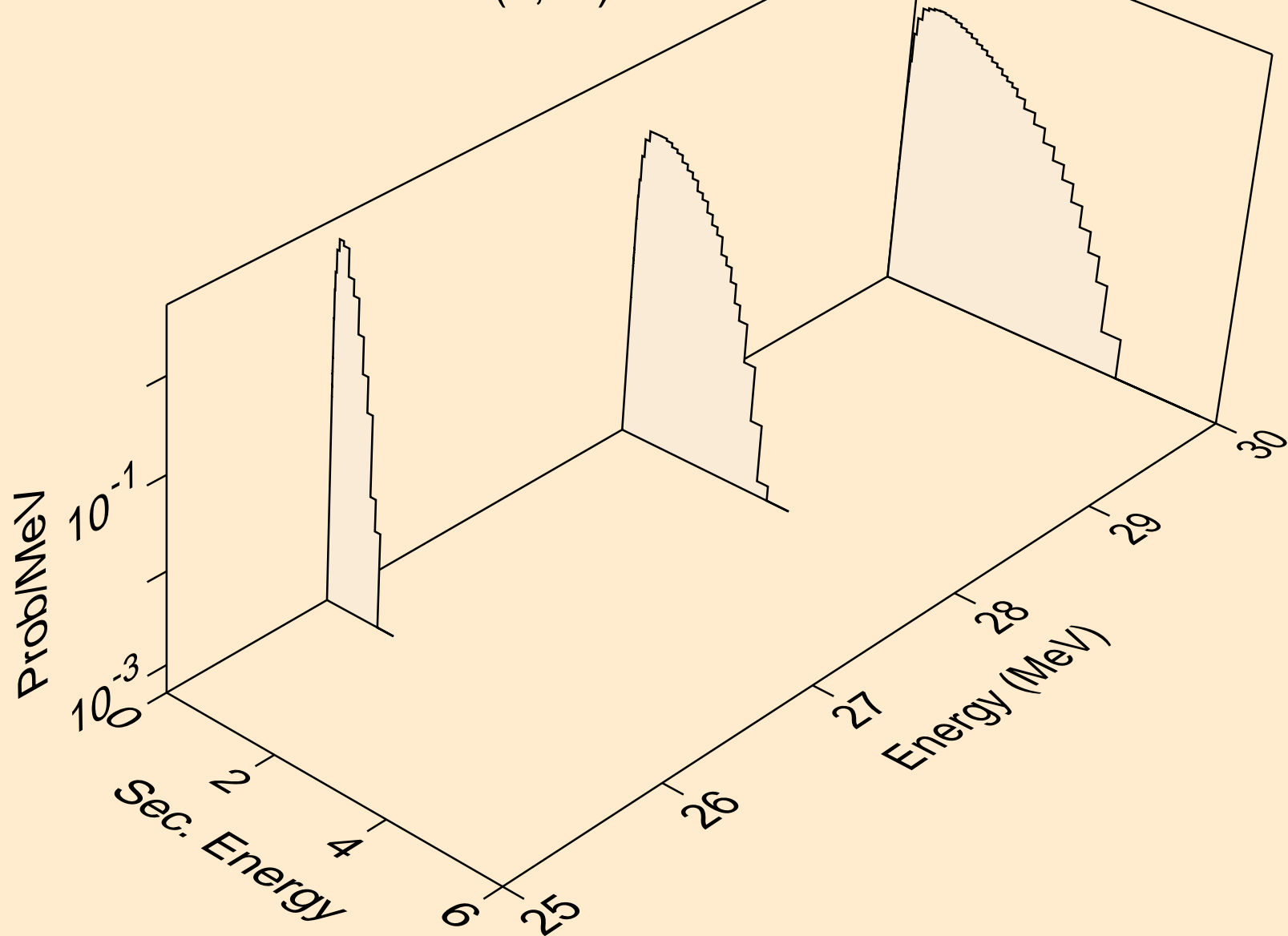

HG196 NEUTRON ACER TENDL-2023 LIBRARY; T=0.K  
Neutron emission for (n,2np)

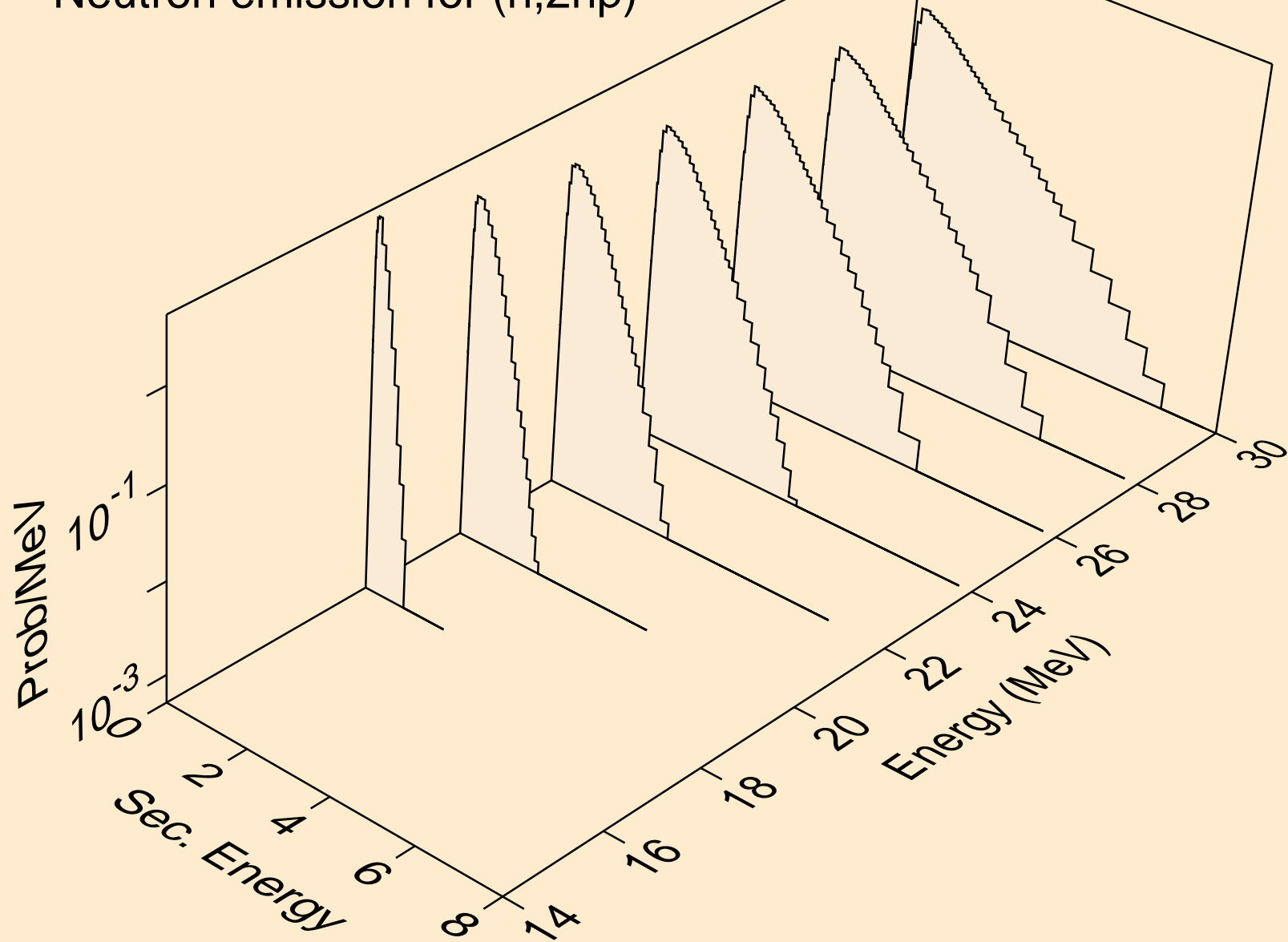



HG196 NEUTRON ACER TENDL-2023 LIBRARY; T=0.K  
Neutron emission for (n,3np)

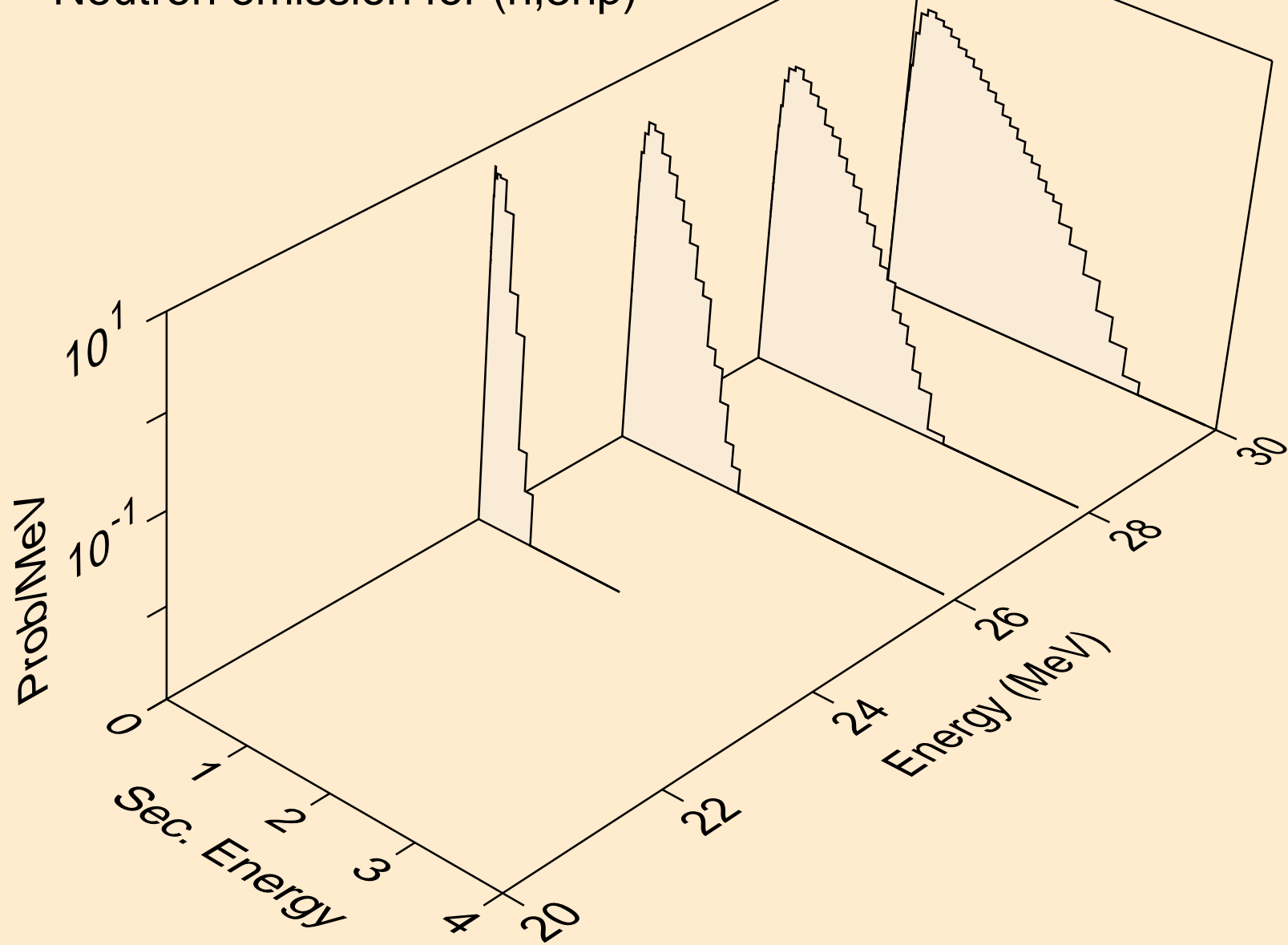

HG196 NEUTRON ACER TENDL-2023 LIBRARY; T=0.K  
Neutron emission for (n,n2p)

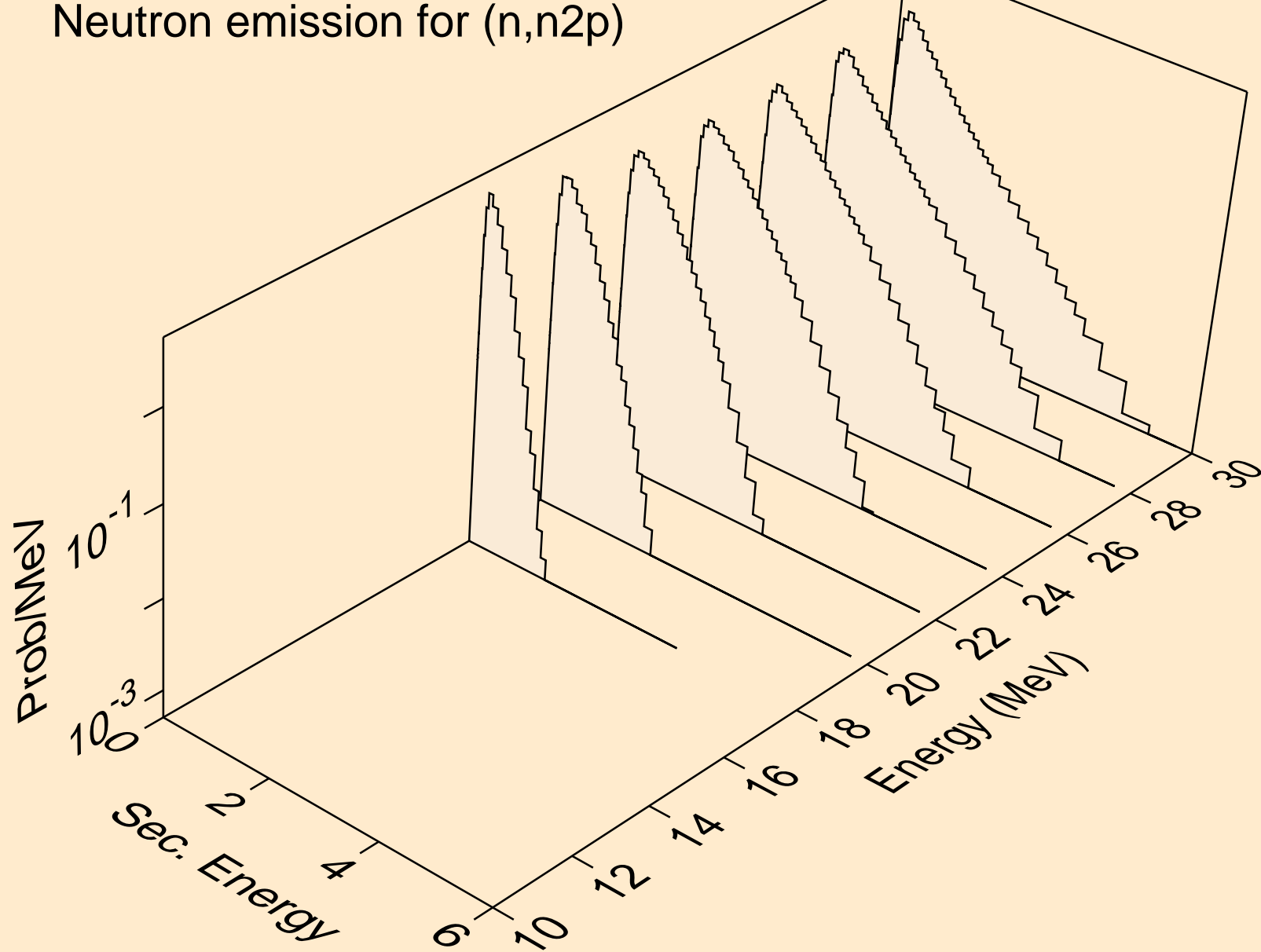

HG196 NEUTRON ACER TENDL-2023 LIBRARY; T=0.K  
Neutron emission for (n,npa)

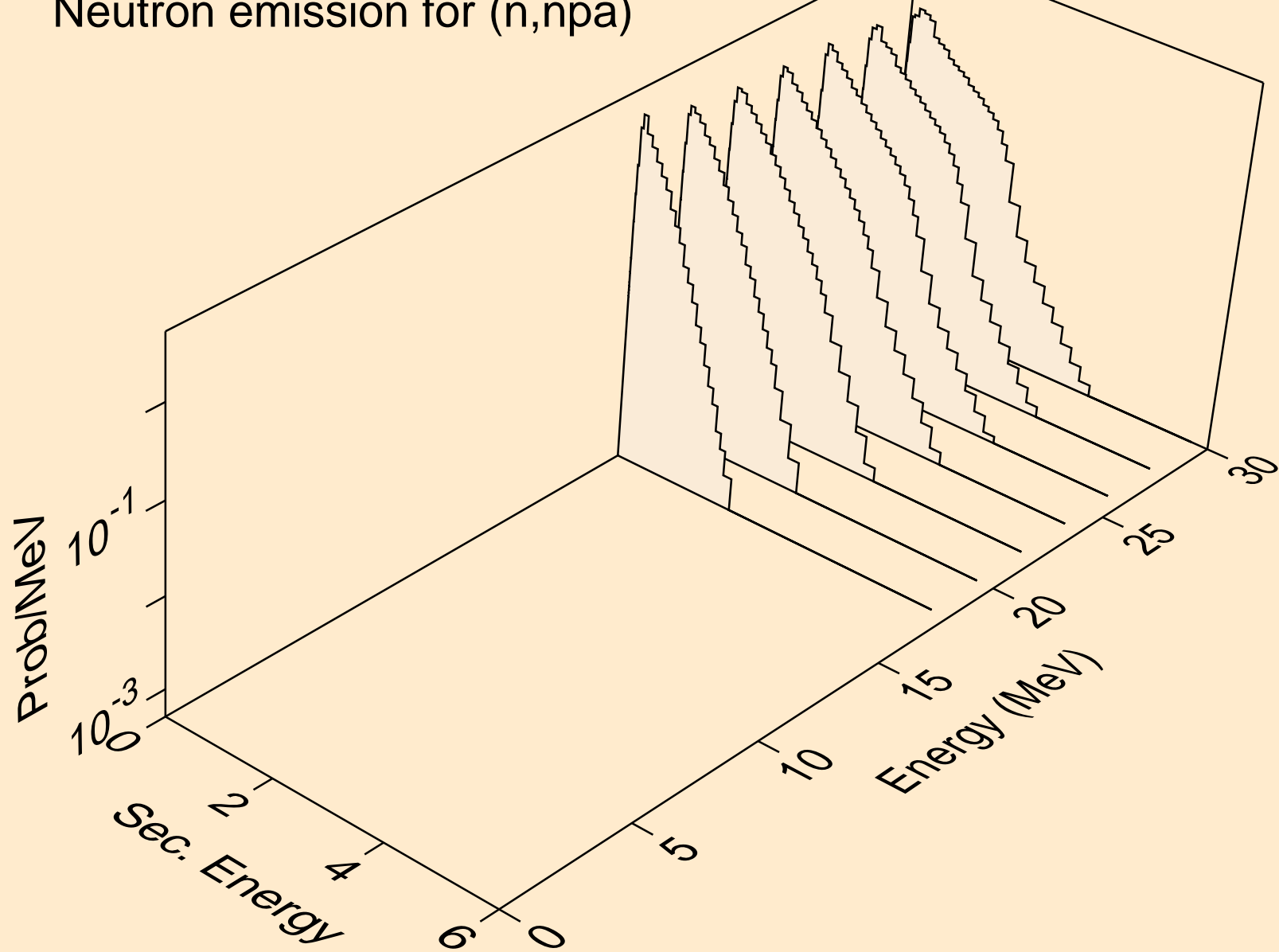

HG196 NEUTRON ACER TENDL-2023 LIBRARY; T=0.K  
Neutron emission for (n,n\*c)

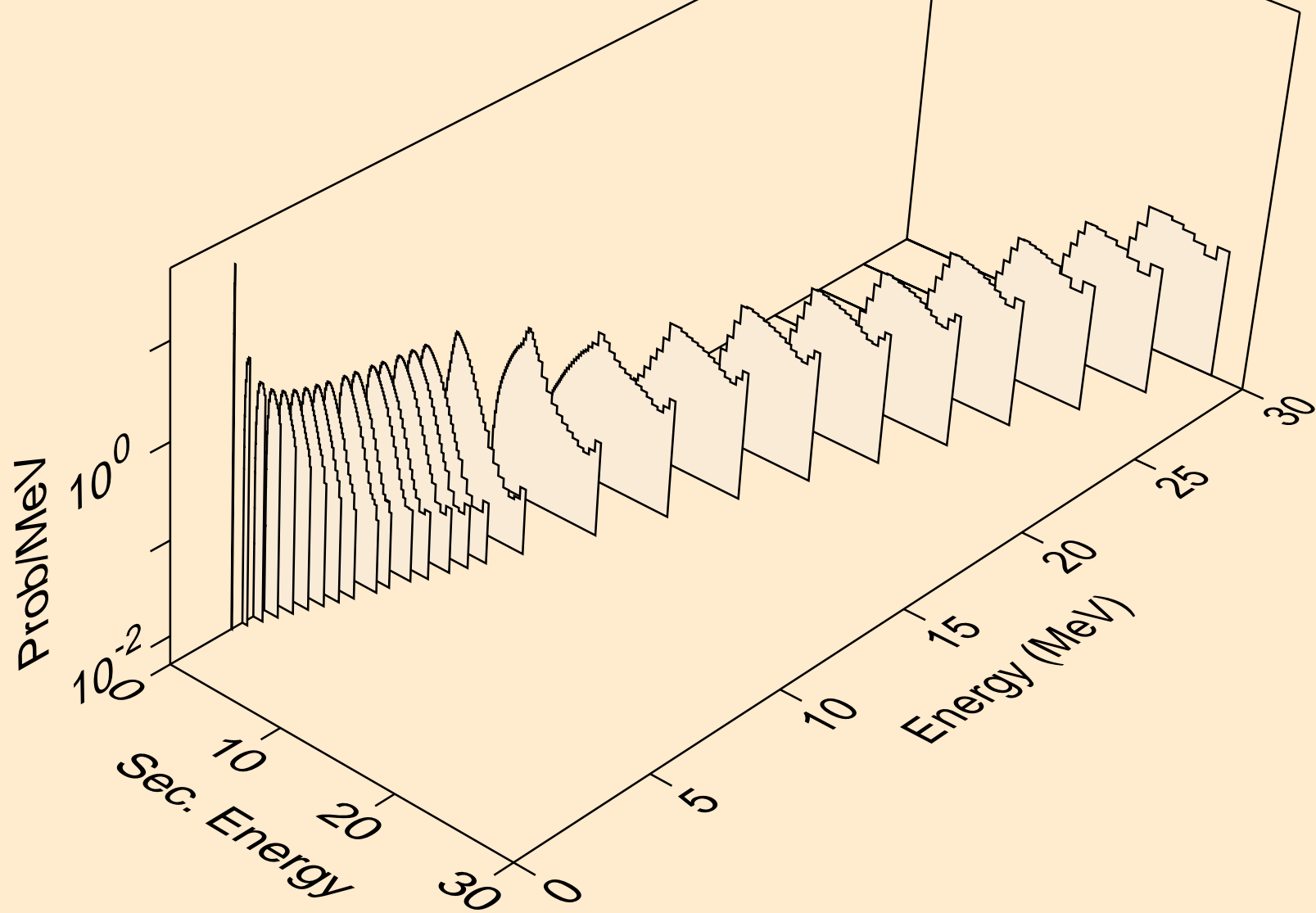

HG196 NEUTRON ACER TENDL-2023 LIBRARY; T=0.K  
Photon emission for (n,x)

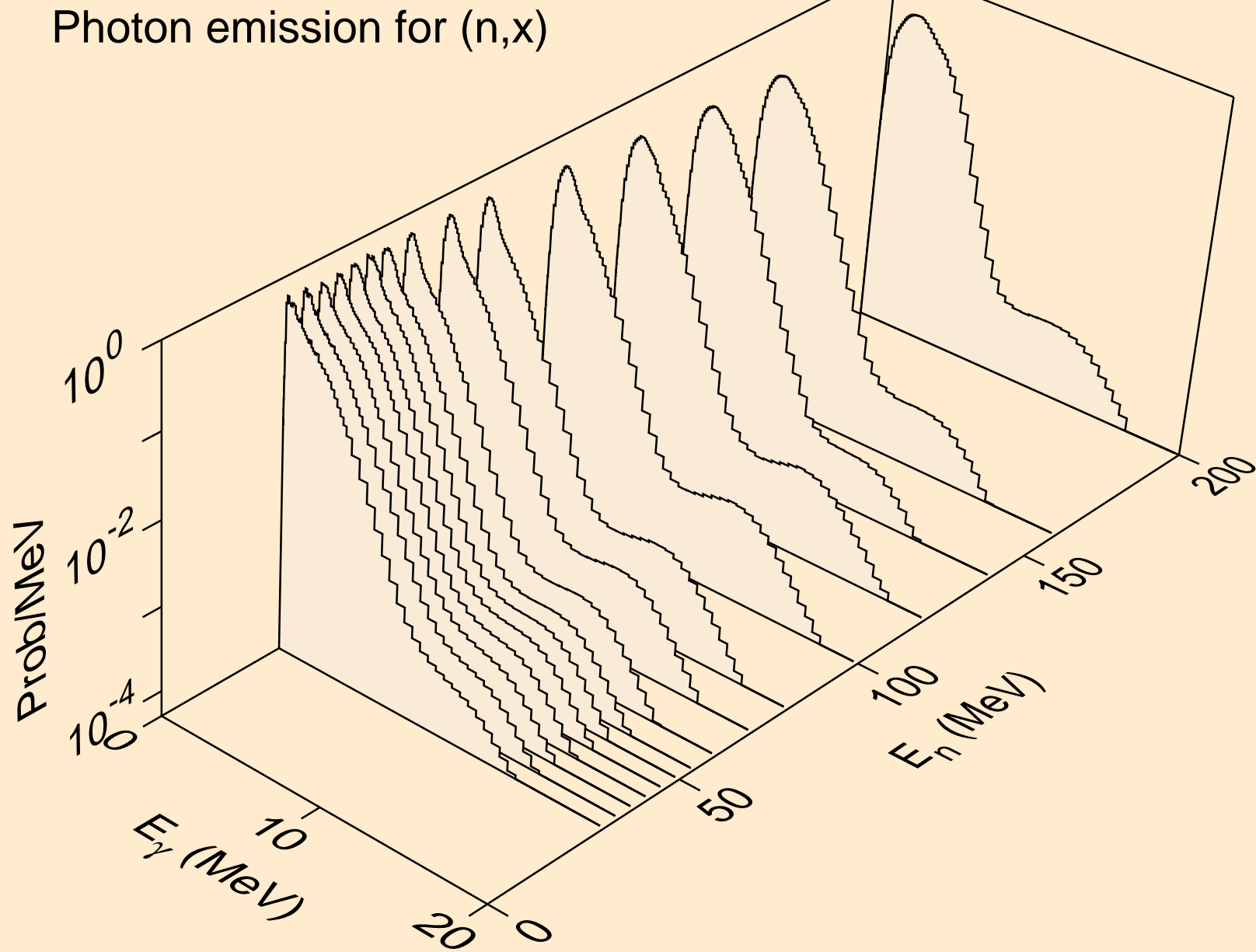

HG196 NEUTRON ACER TENDL-2023 LIBRARY; T=0.K  
Photon emission for (n,2nd)

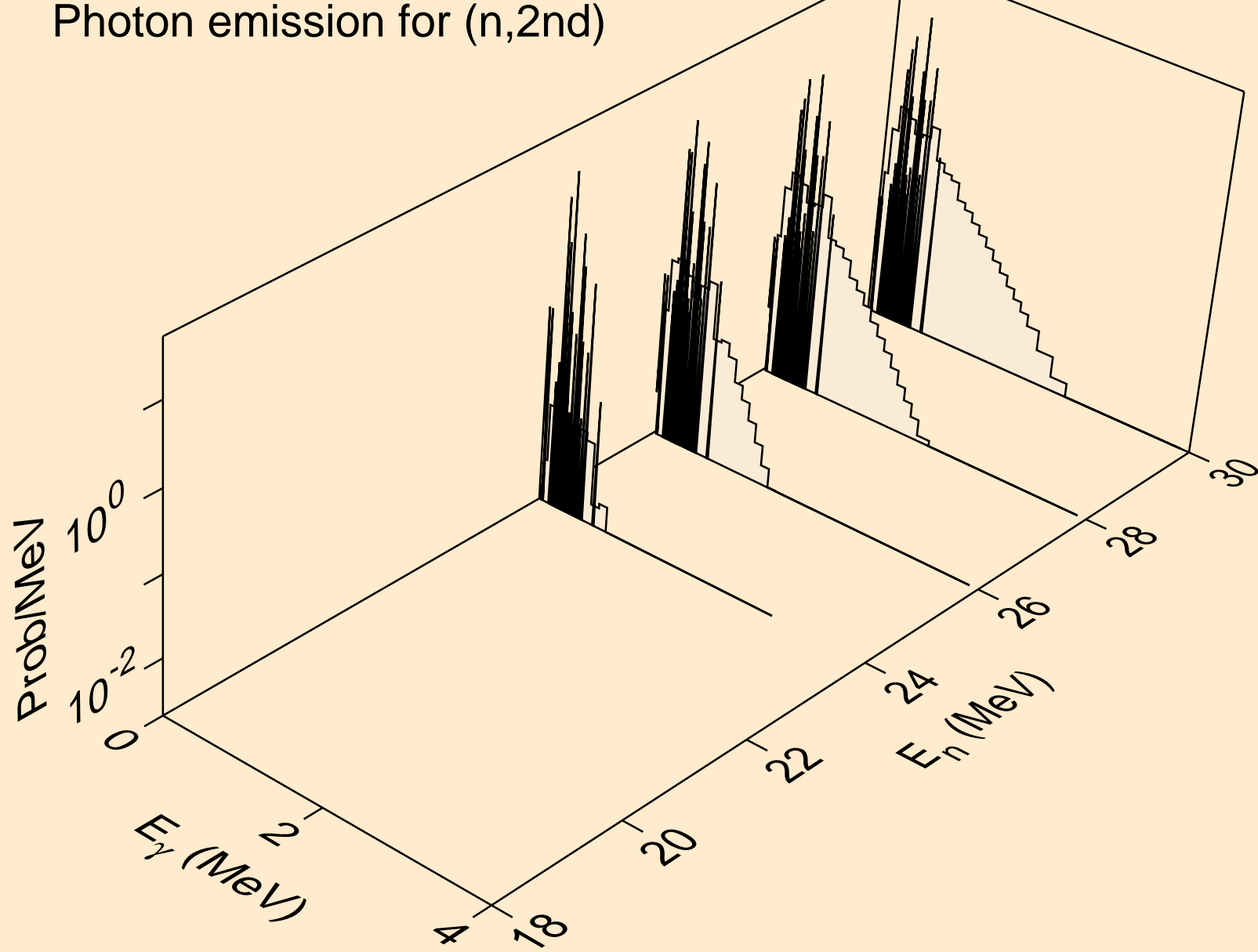

HG196 NEUTRON ACER TENDL-2023 LIBRARY; T=0.K  
Photon emission for (n,2n)

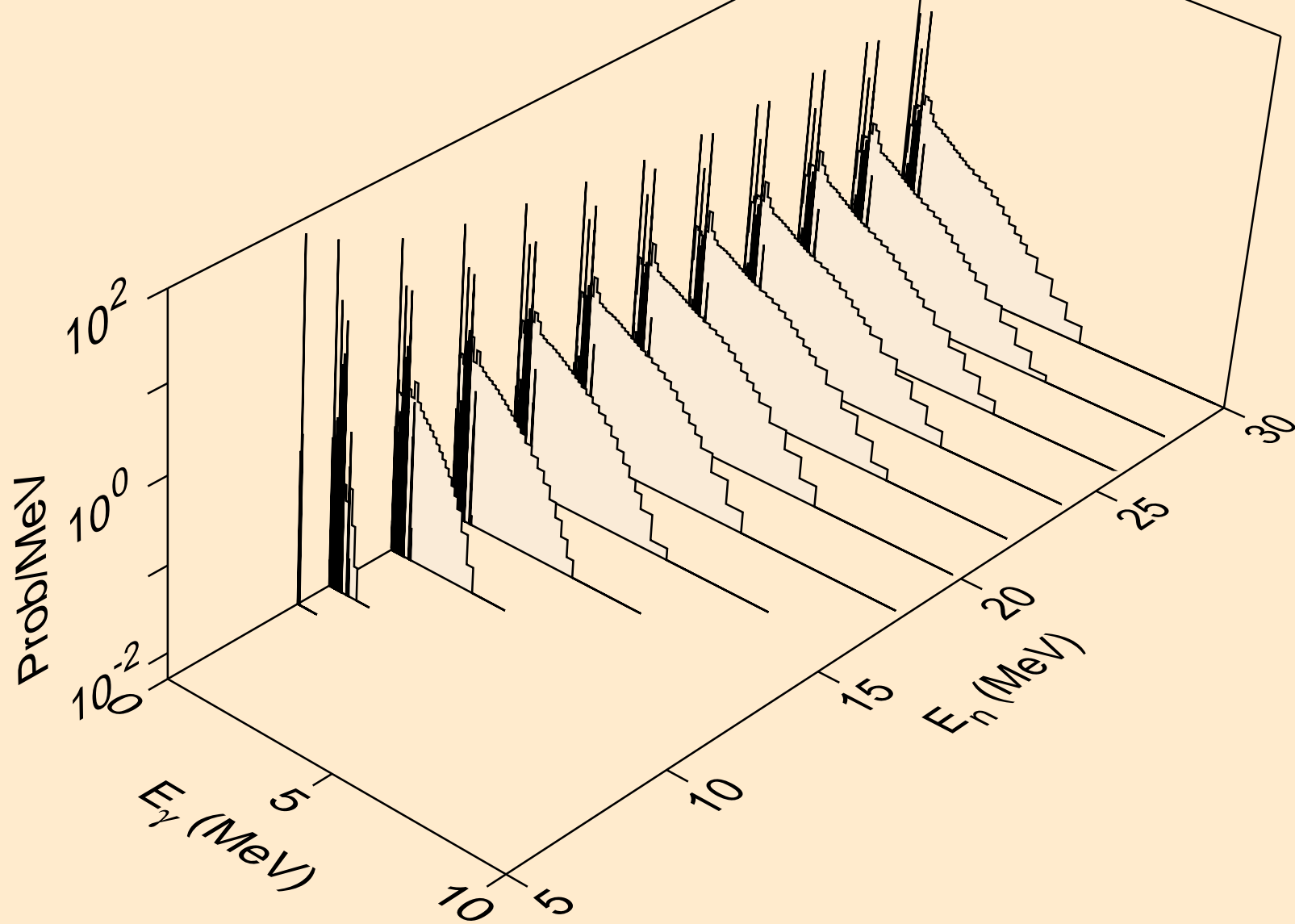

HG196 NEUTRON ACER TENDL-2023 LIBRARY; T=0.K  
Photon emission for (n,3n)

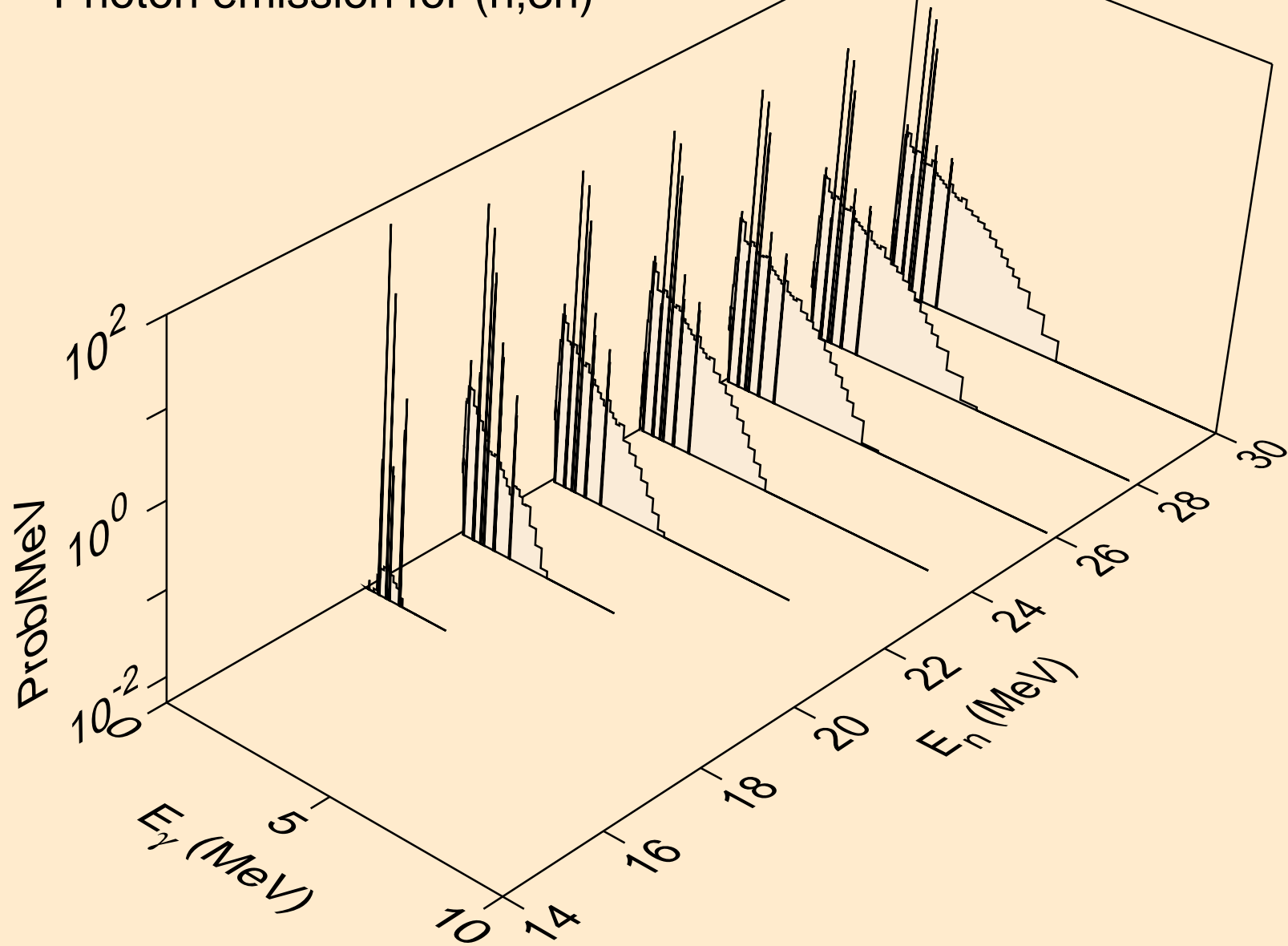



HG196 NEUTRON ACER TENDL-2023 LIBRARY; T=0.K  
Photon emission for (n,n\*)a

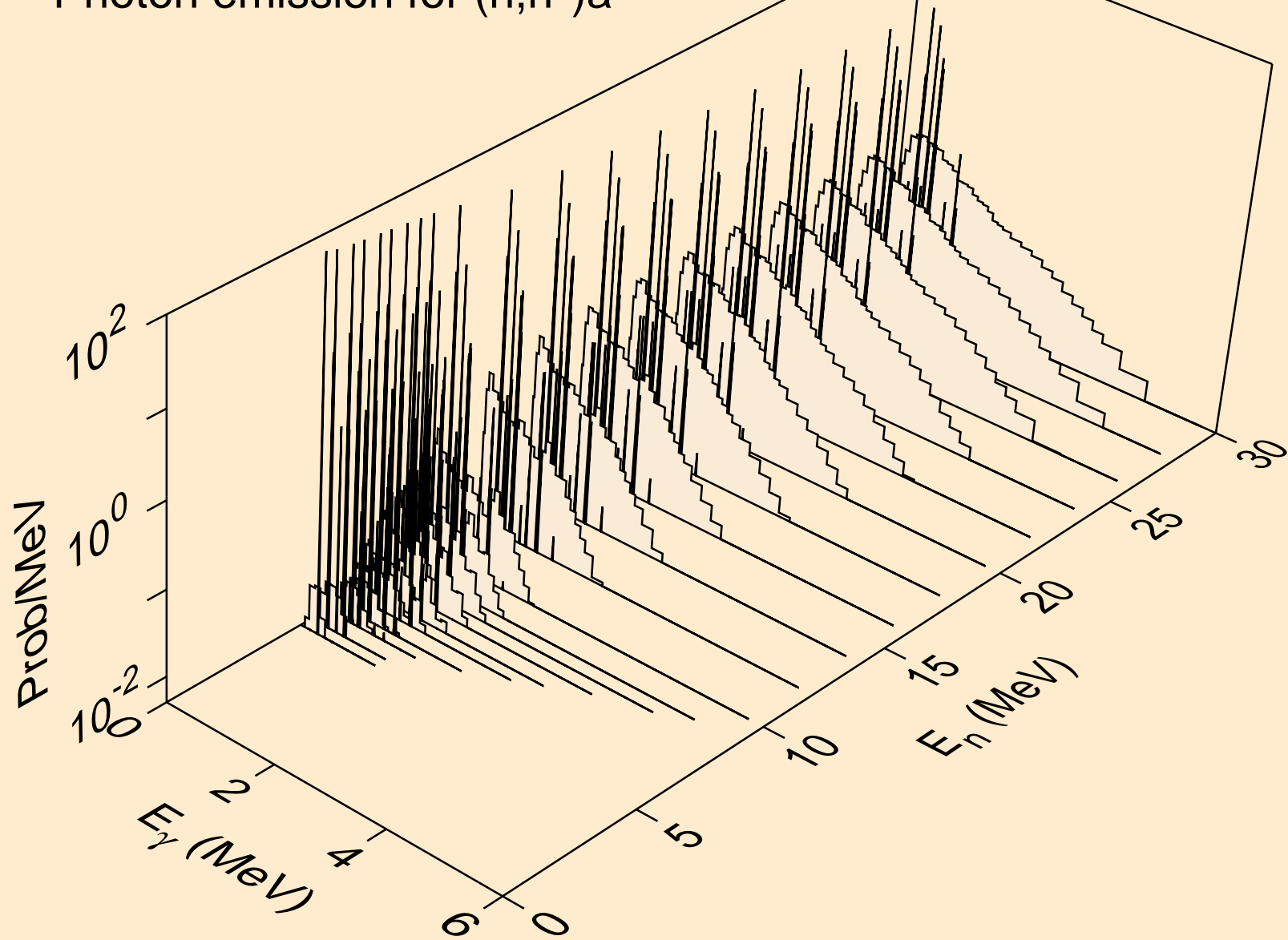

HG196 NEUTRON ACER TENDL-2023 LIBRARY; T=0.K  
Photon emission for (n,2n)a

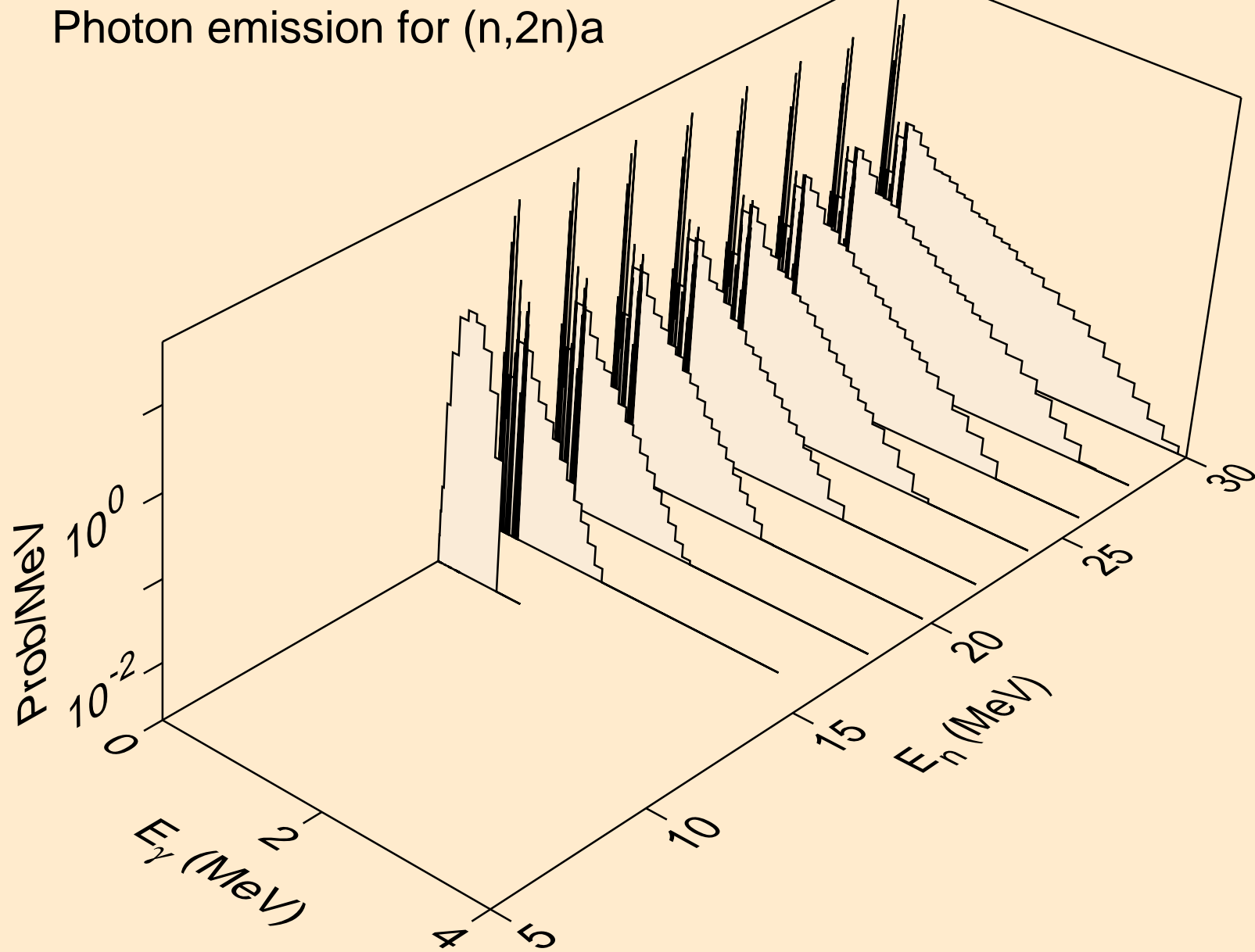

HG196 NEUTRON ACER TENDL-2023 LIBRARY; T=0.K  
Photon emission for (n,3n)a

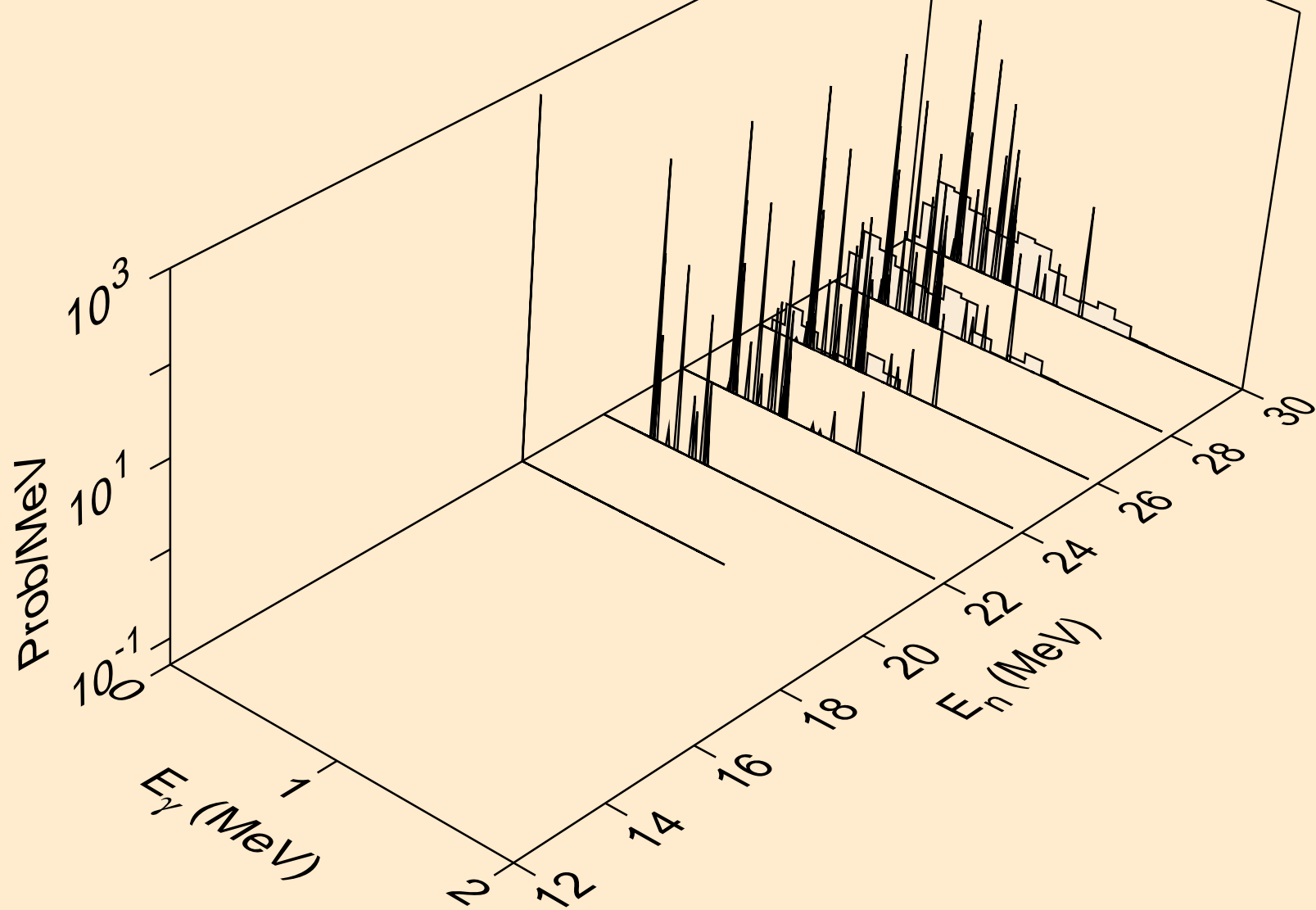

HG196 NEUTRON ACER TENDL-2023 LIBRARY; T=0.K  
Photon emission for (n,n\*)p

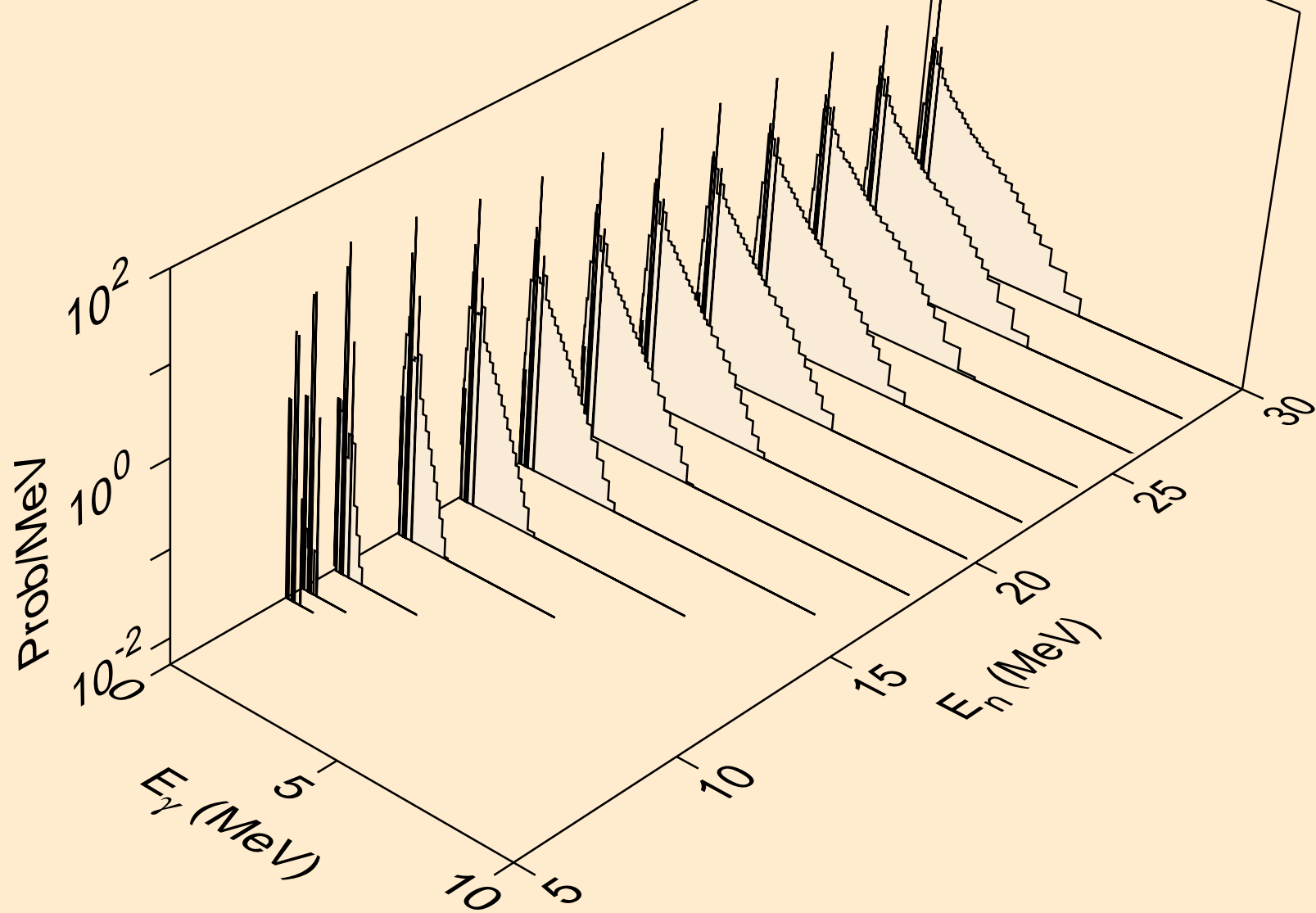

HG196 NEUTRON ACER TENDL-2023 LIBRARY; T=0.K  
Photon emission for (n,n\*)2a

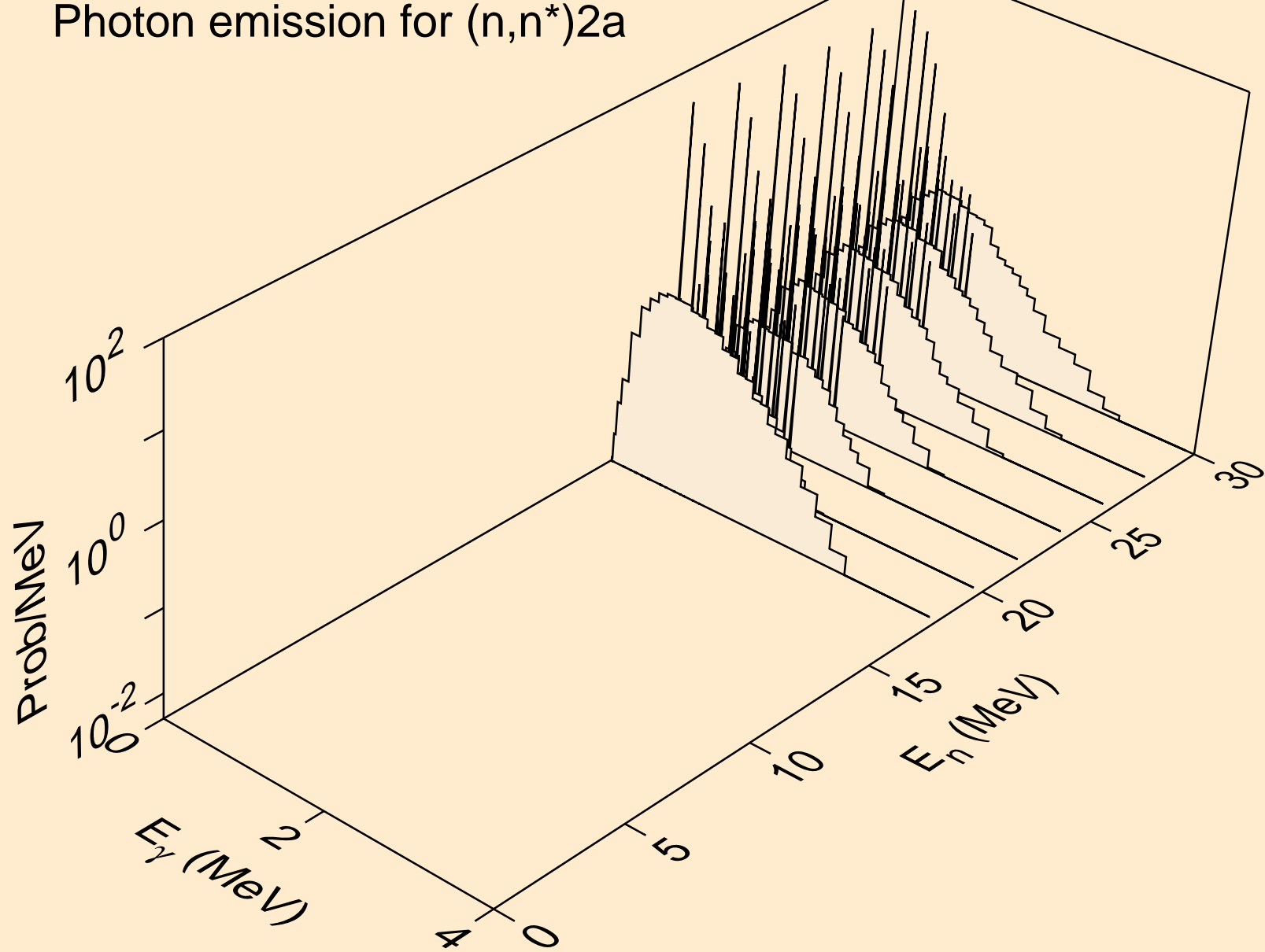

HG196 NEUTRON ACER TENDL-2023 LIBRARY; T=0.K  
Photon emission for (n,n\*)d

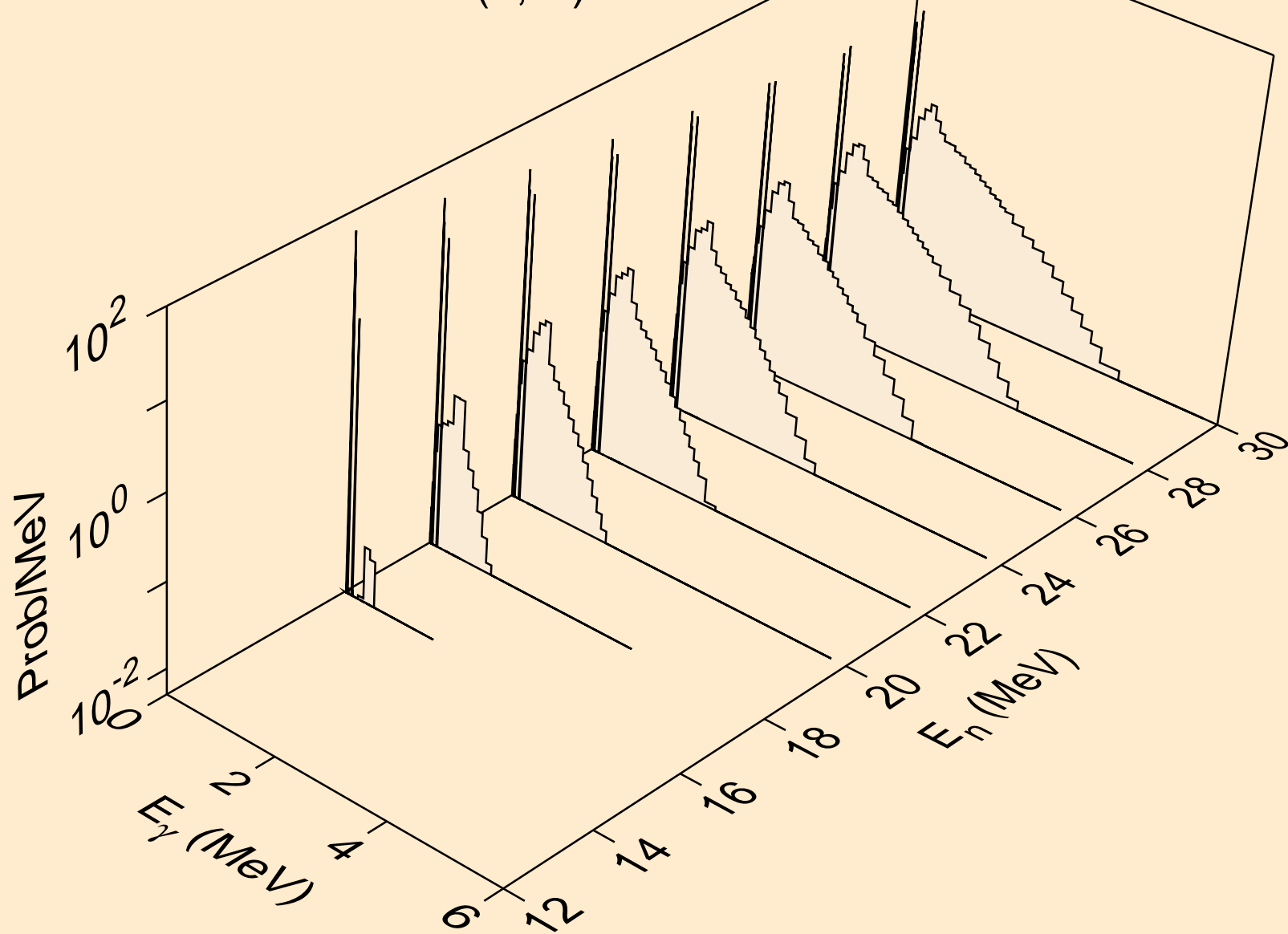

HG196 NEUTRON ACER TENDL-2023 LIBRARY; T=0.K  
Photon emission for (n,n\*)t

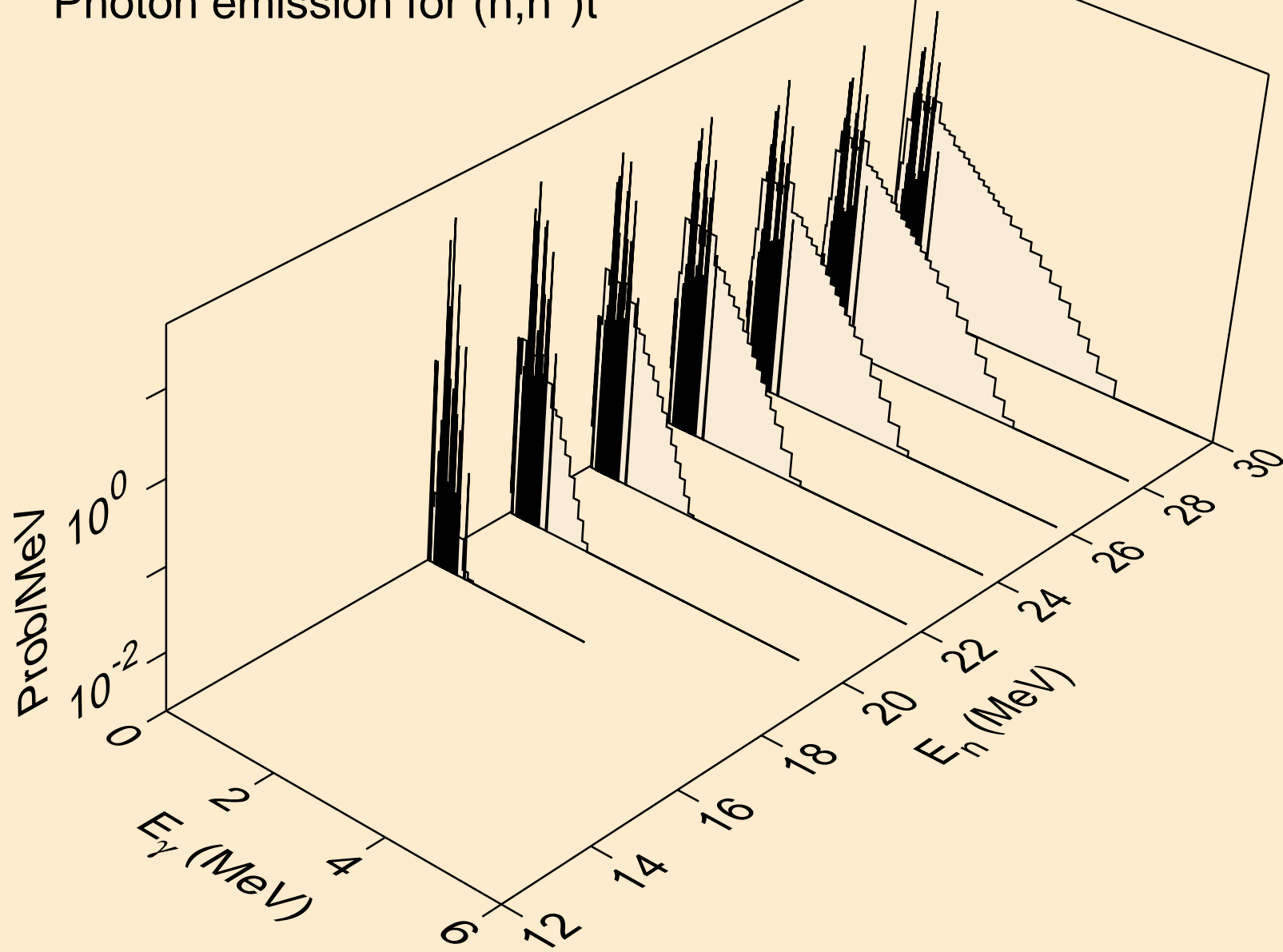

HG196 NEUTRON ACER TENDL-2023 LIBRARY; T=0.K  
Photon emission for (n,n\*)he3

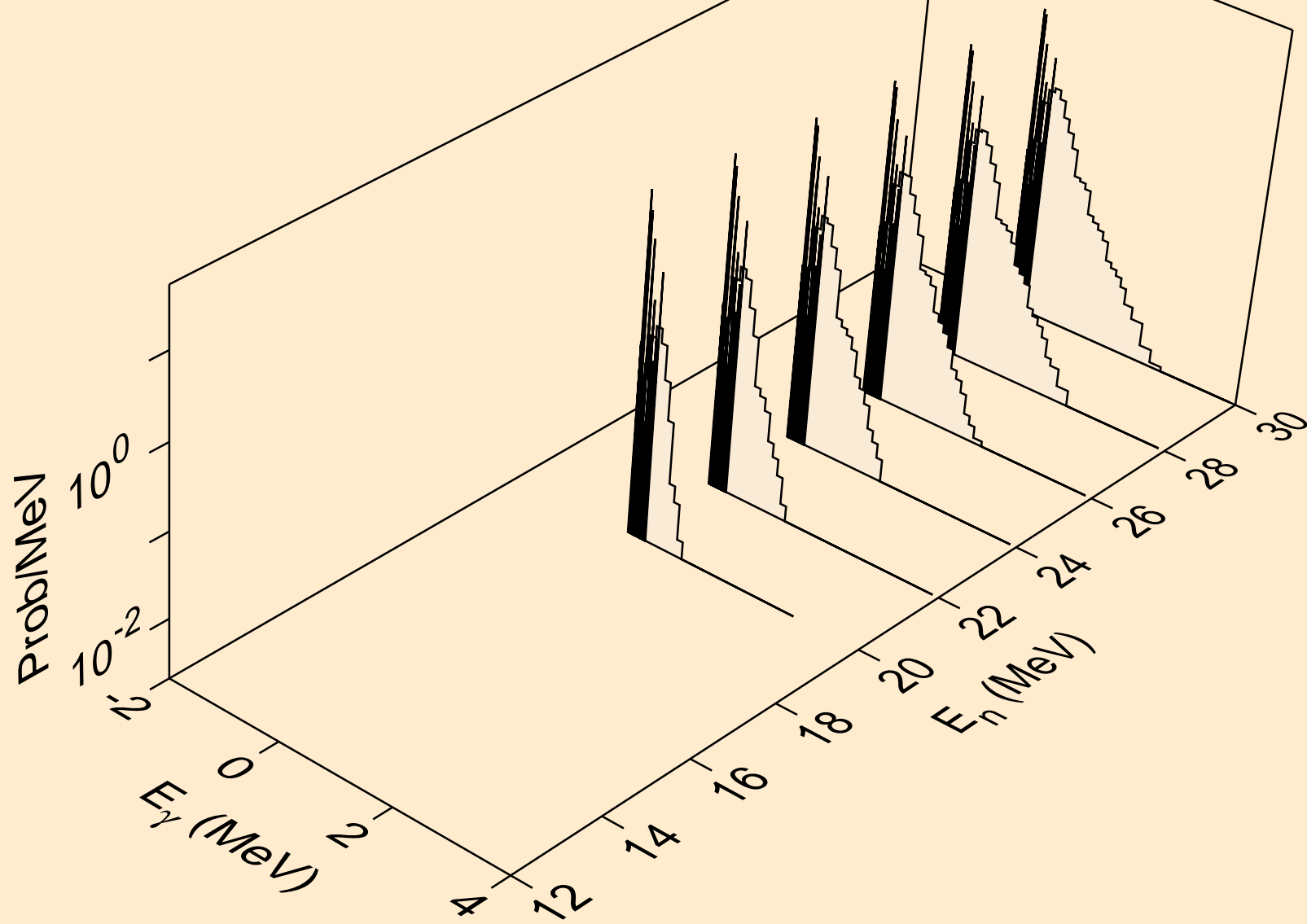



HG196 NEUTRON ACER TENDL-2023 LIBRARY; T=0.K  
Photon emission for (n,4n)

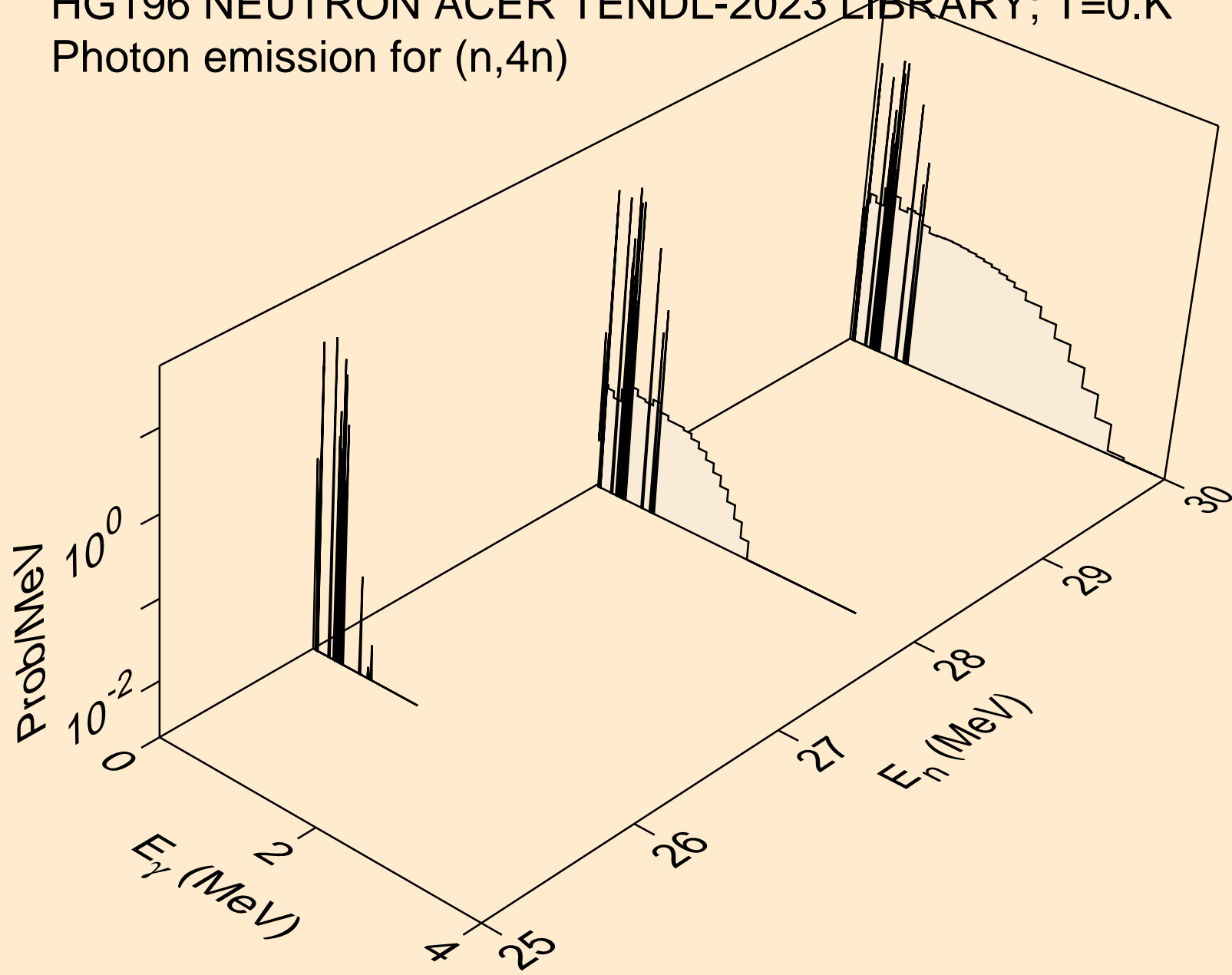

HG196 NEUTRON ACER TENDL-2023 LIBRARY; T=0.K  
Photon emission for (n,2np)

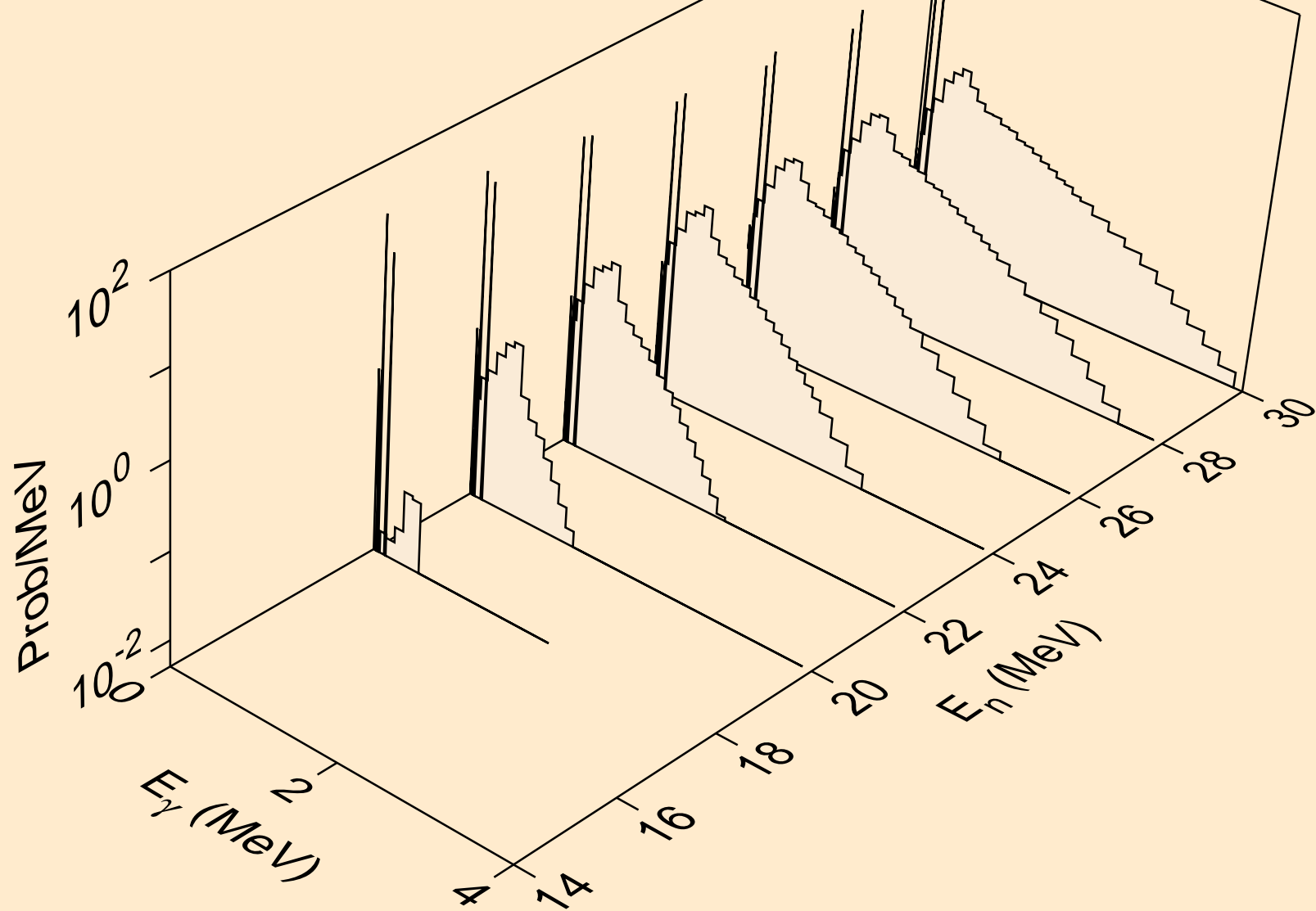

HG196 NEUTRON ACER TENDL-2023 LIBRARY; T=0.K  
Photon emission for (n,3np)

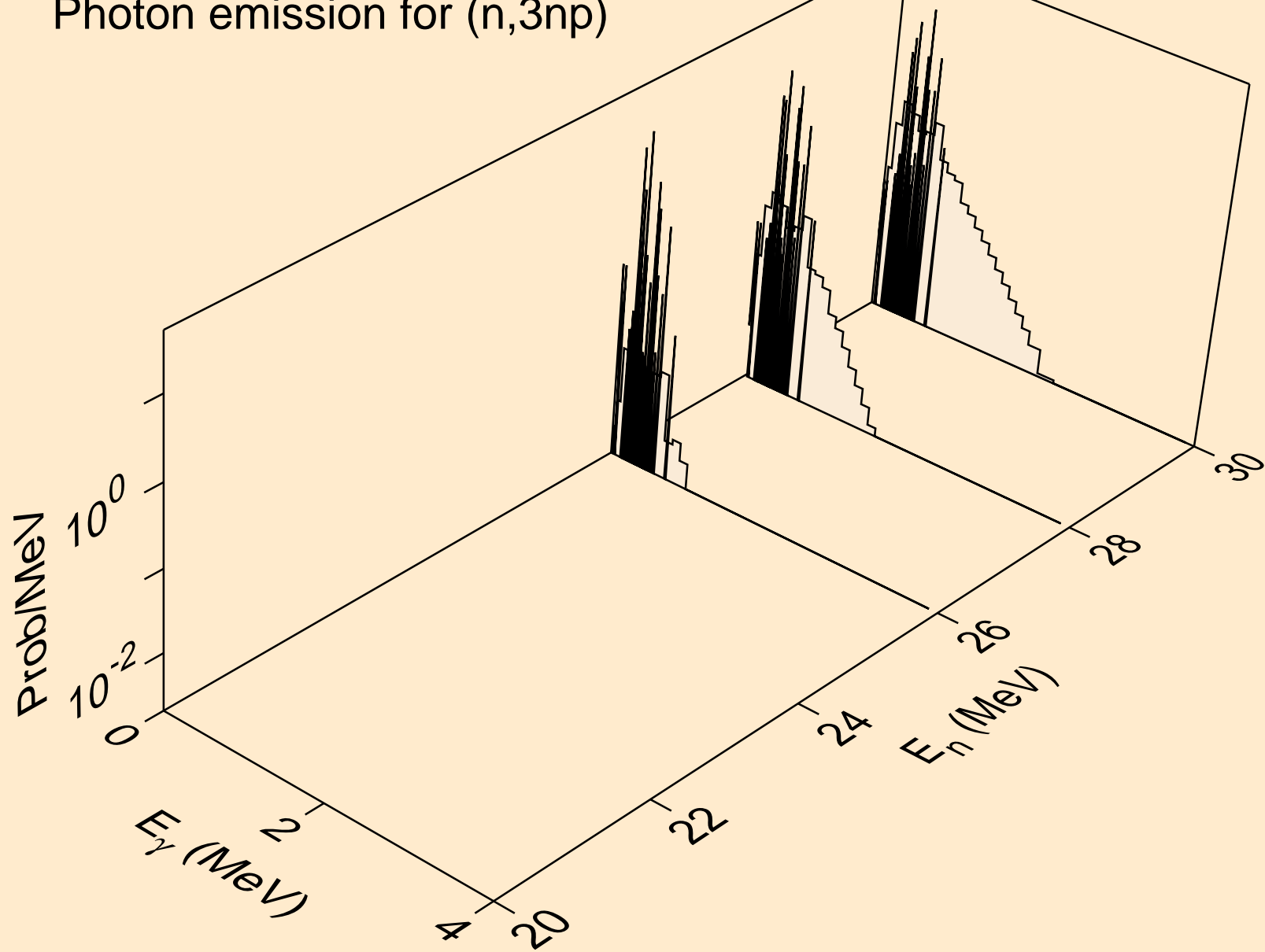

HG196 NEUTRON ACER TENDL-2023 LIBRARY; T=0.K  
Photon emission for (n,n2p)

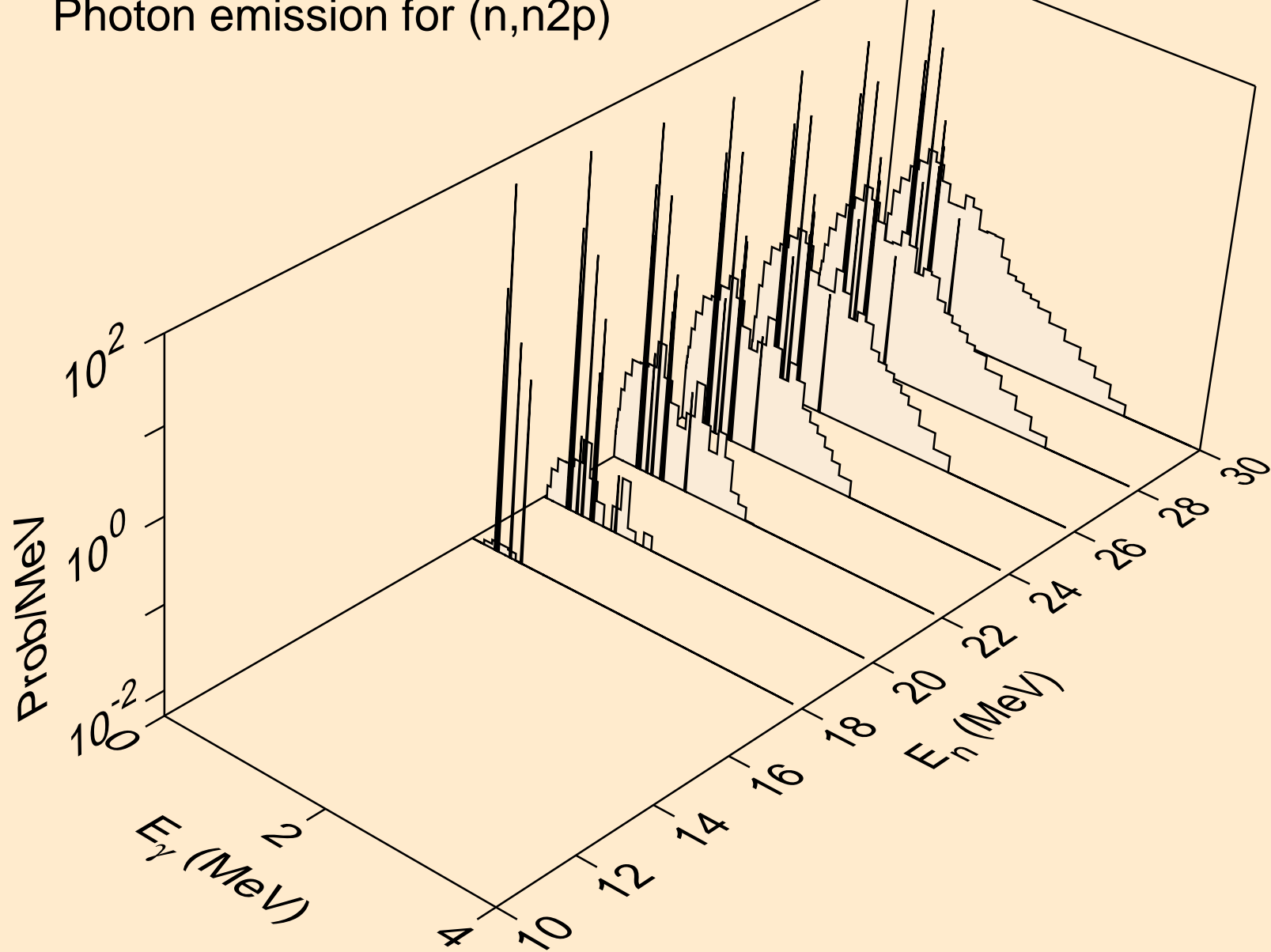

HG196 NEUTRON ACER TENDL-2023 LIBRARY; T=0.K  
Photon emission for (n,npa)

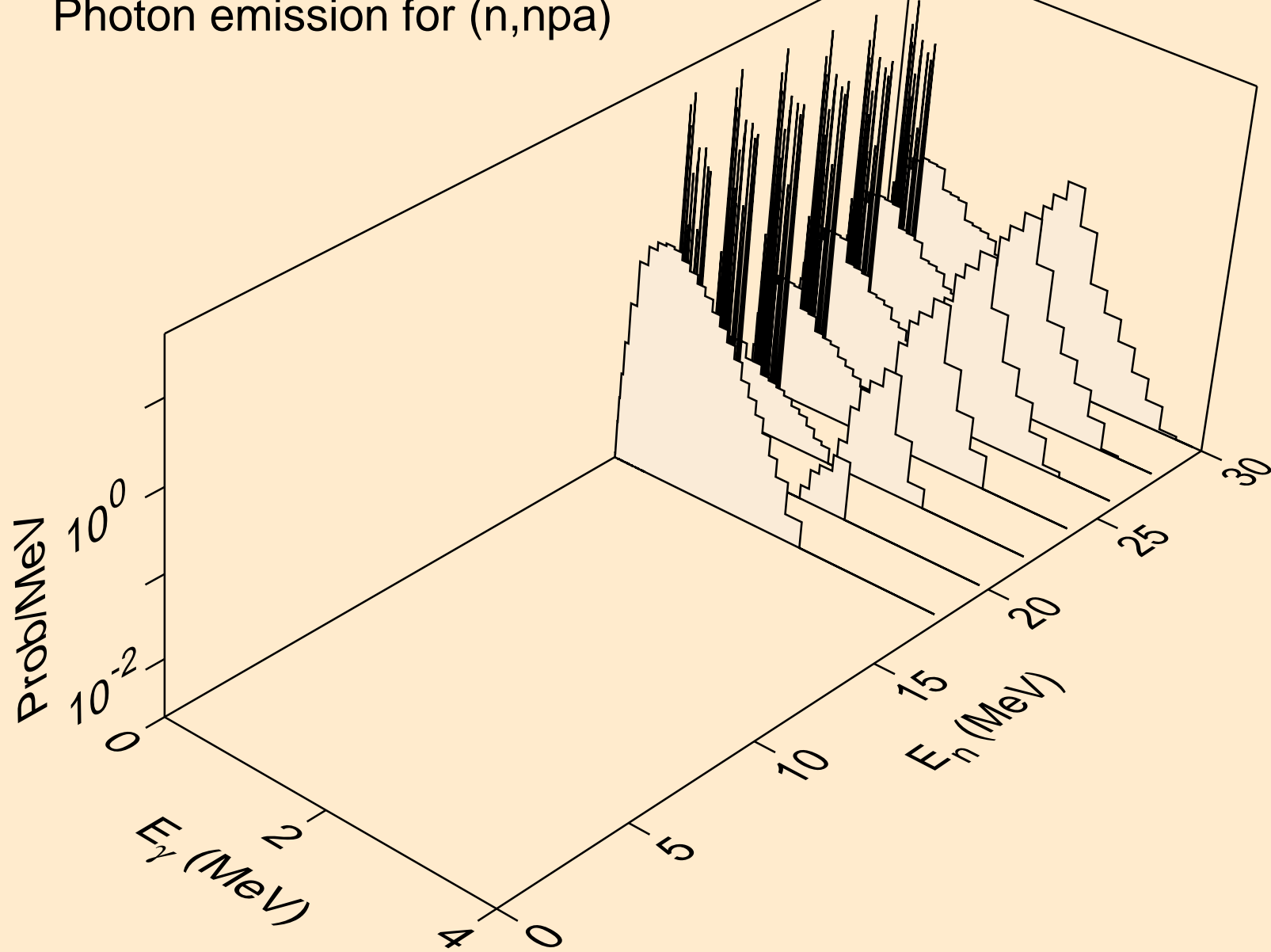

HG196 NEUTRON ACER TENDL-2023 LIBRARY; T=0.K  
Photon emission for (n,n\*c)

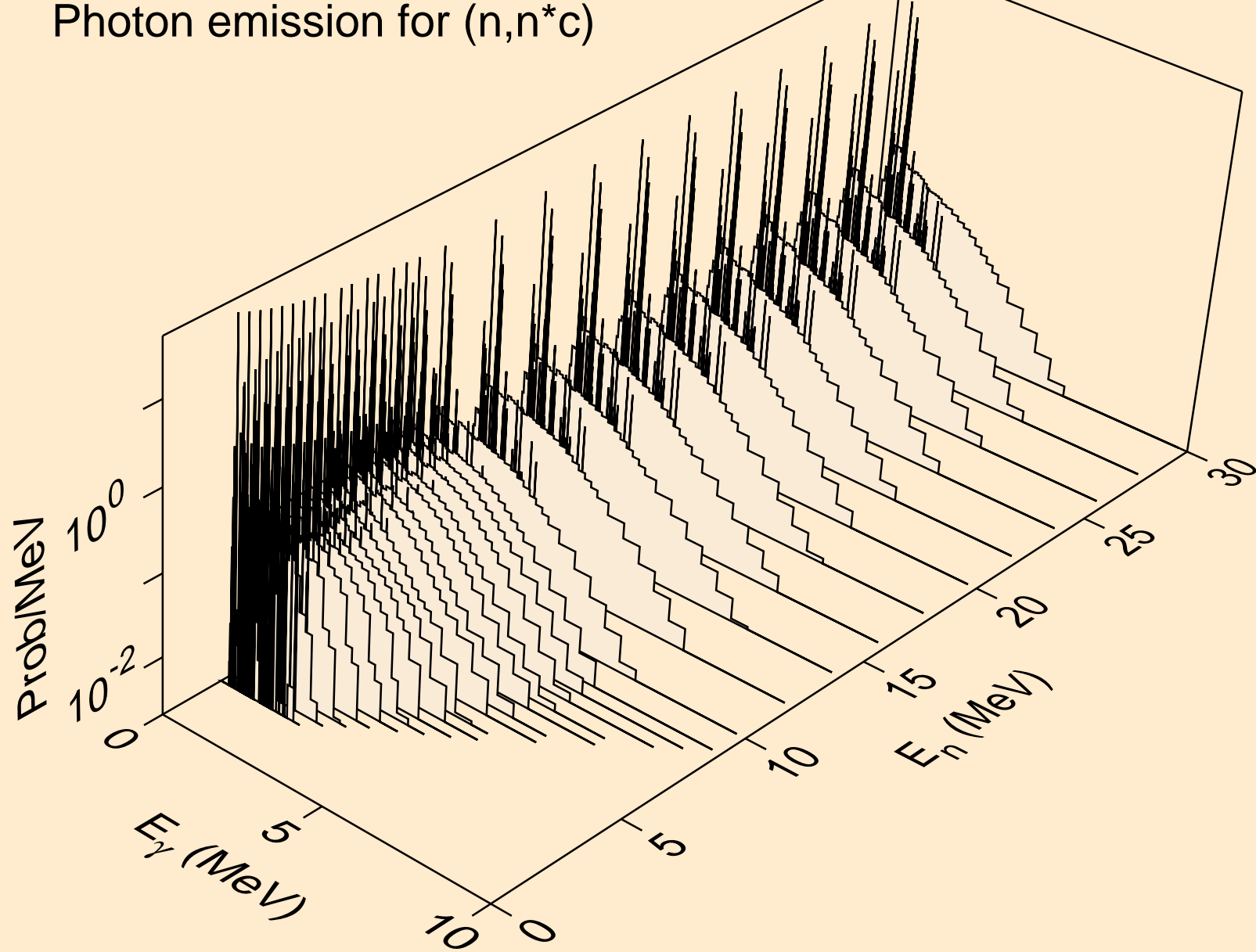

HG196 NEUTRON ACER TENDL-2023 LIBRARY; T=0.K  
Photon emission for (n,gma)

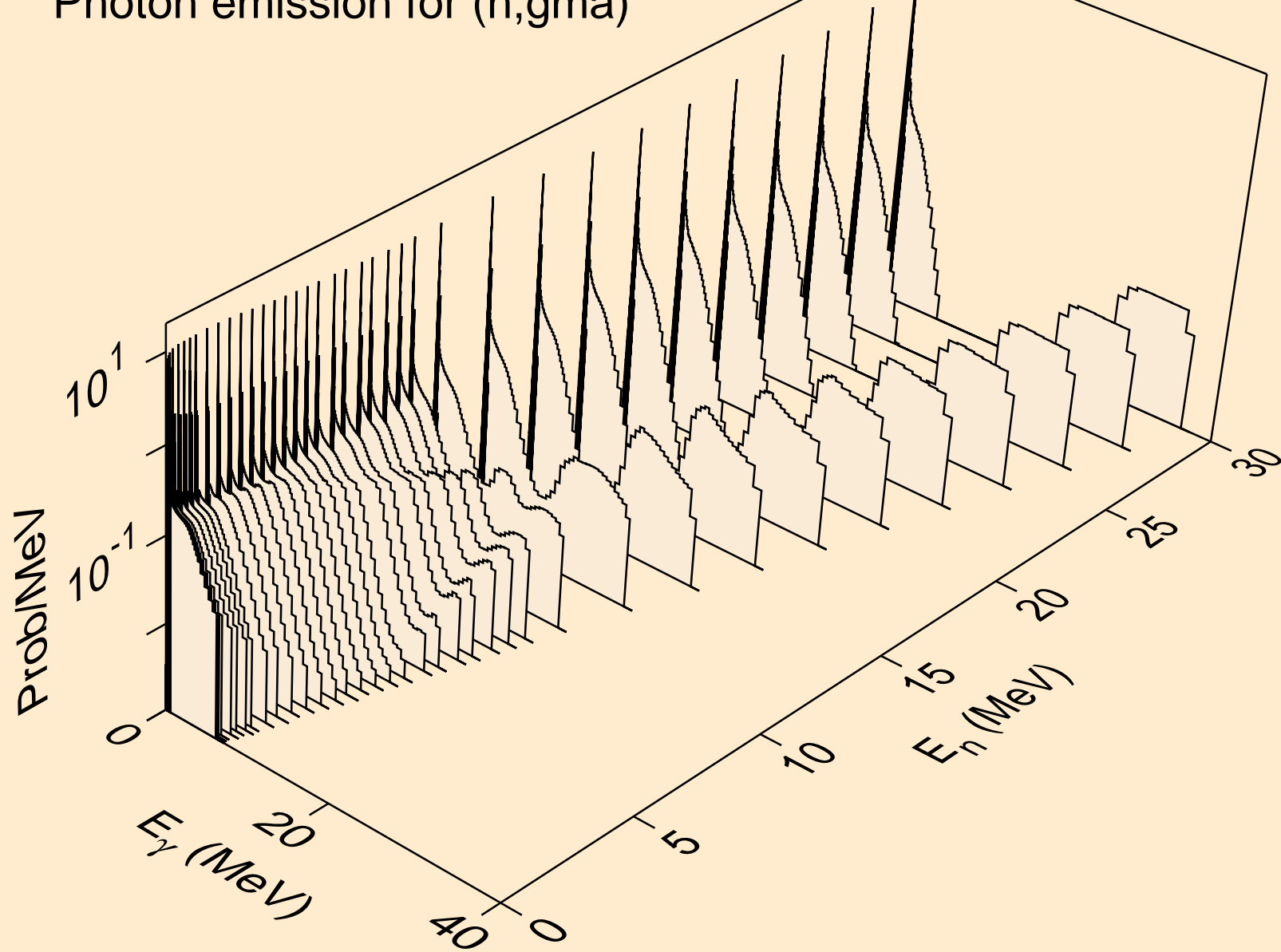

HG196 NEUTRON ACER TENDL-2023 LIBRARY; T=0.K  
Photon emission for (n,p)

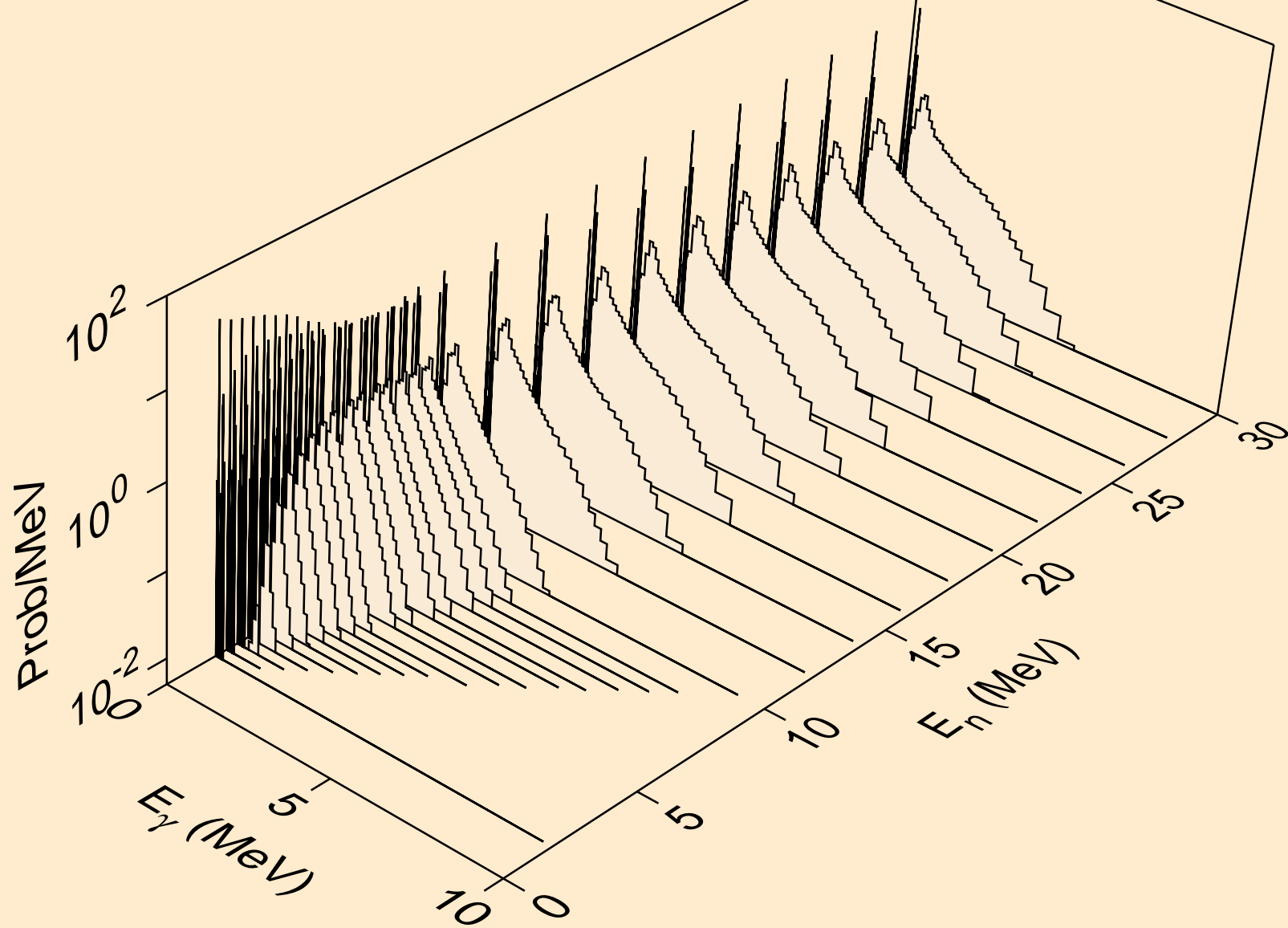



HG196 NEUTRON ACER TENDL-2023 LIBRARY; T=0.K  
Photon emission for (n,d)

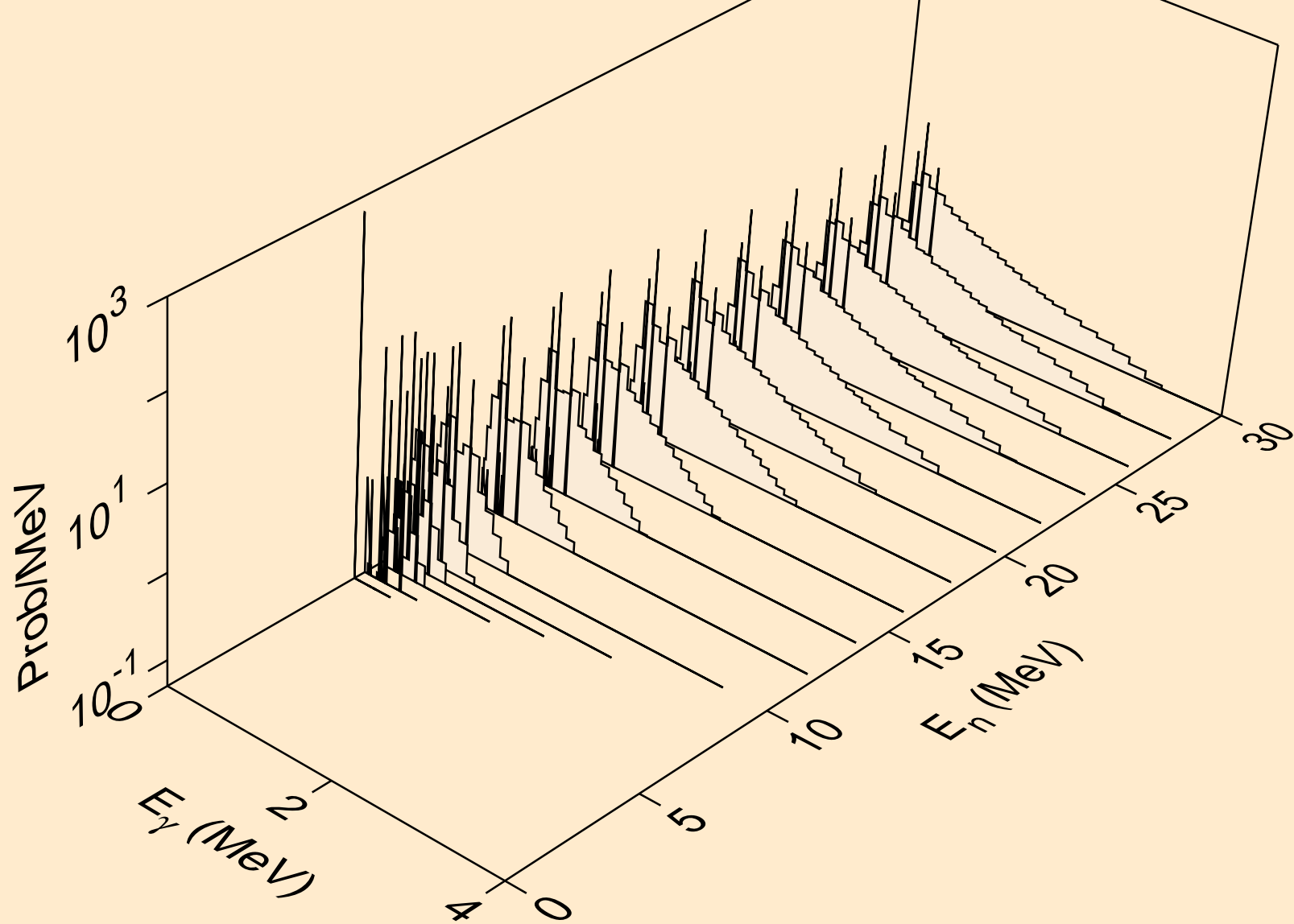

HG196 NEUTRON ACER TENDL-2023 LIBRARY; T=0.K  
Photon emission for (n,t)

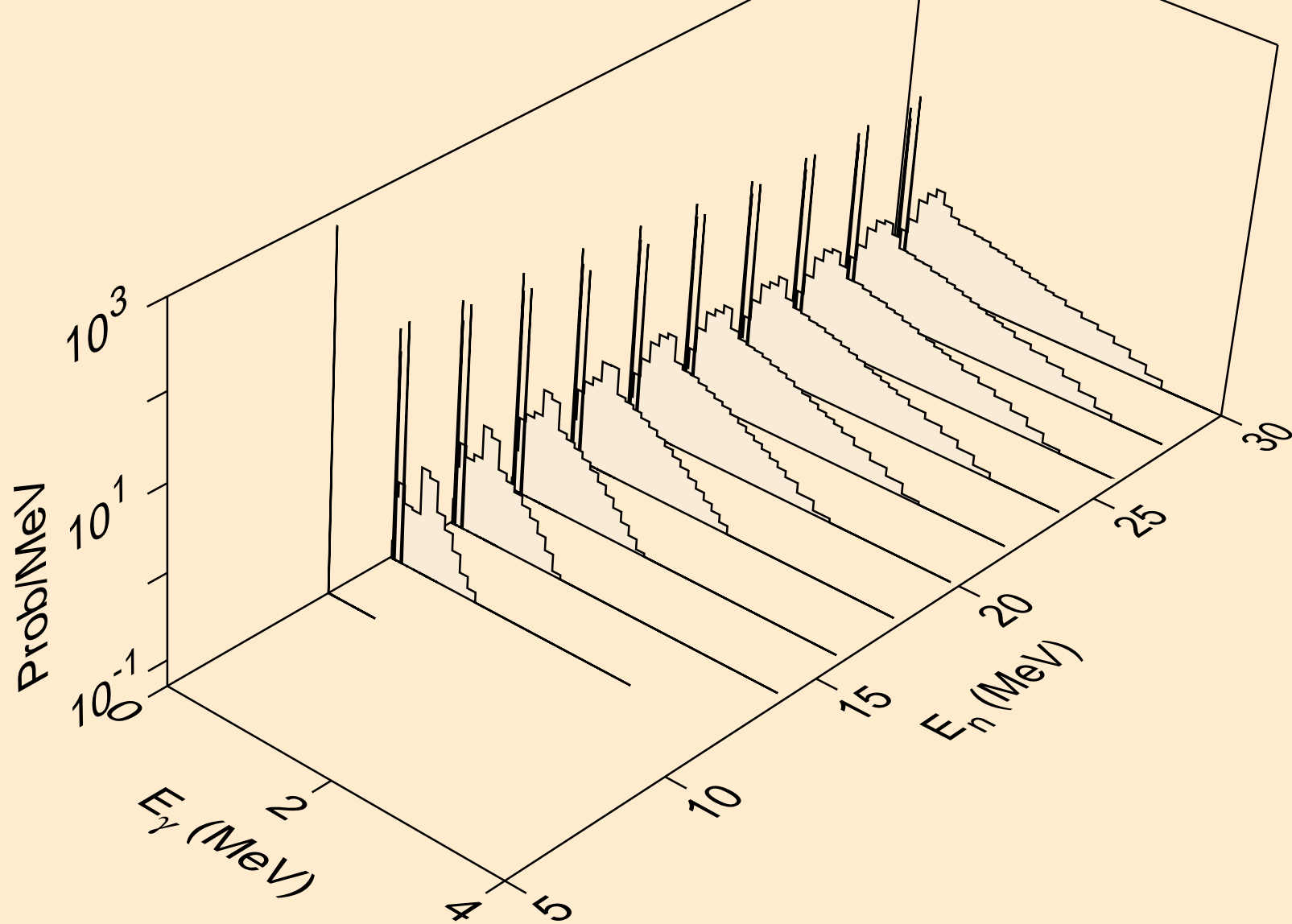

HG196 NEUTRON ACER TENDL-2023 LIBRARY; T=0.K  
Photon emission for (n,he3)

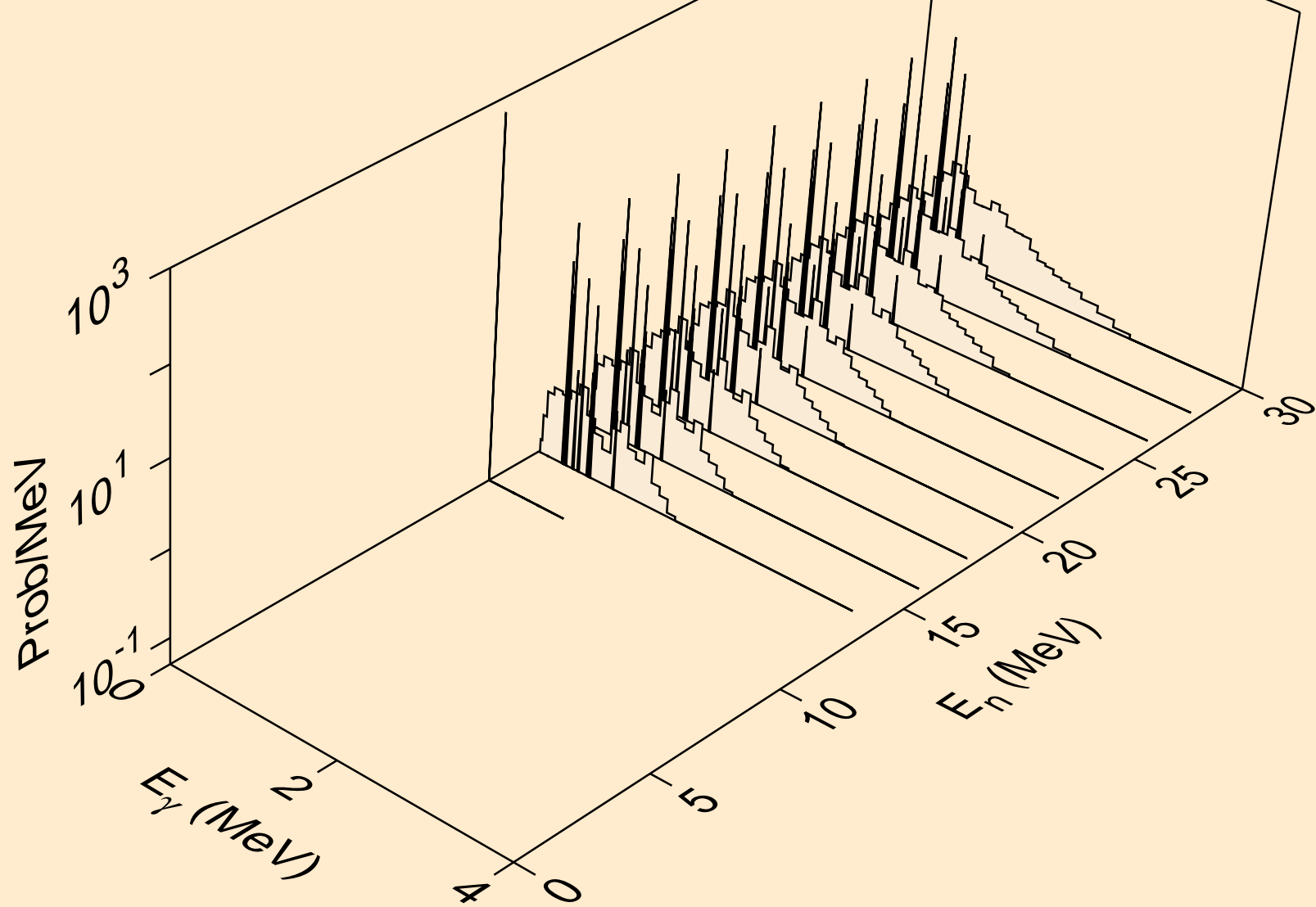

HG196 NEUTRON ACER TENDL-2023 LIBRARY; T=0.K  
Photon emission for (n,a)

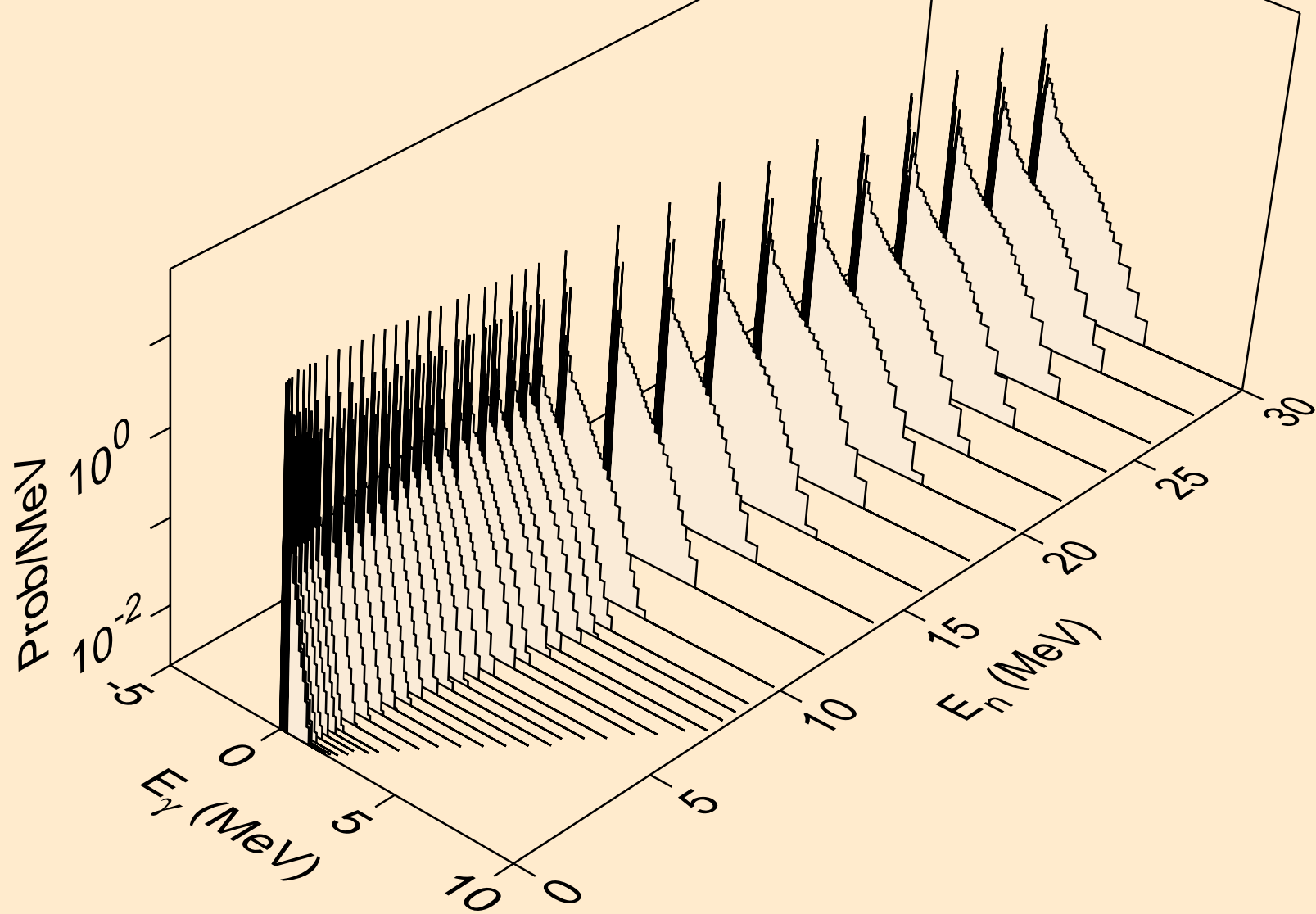

HG196 NEUTRON ACER TENDL-2023 LIBRARY; T=0.K  
Photon emission for (n,2a)

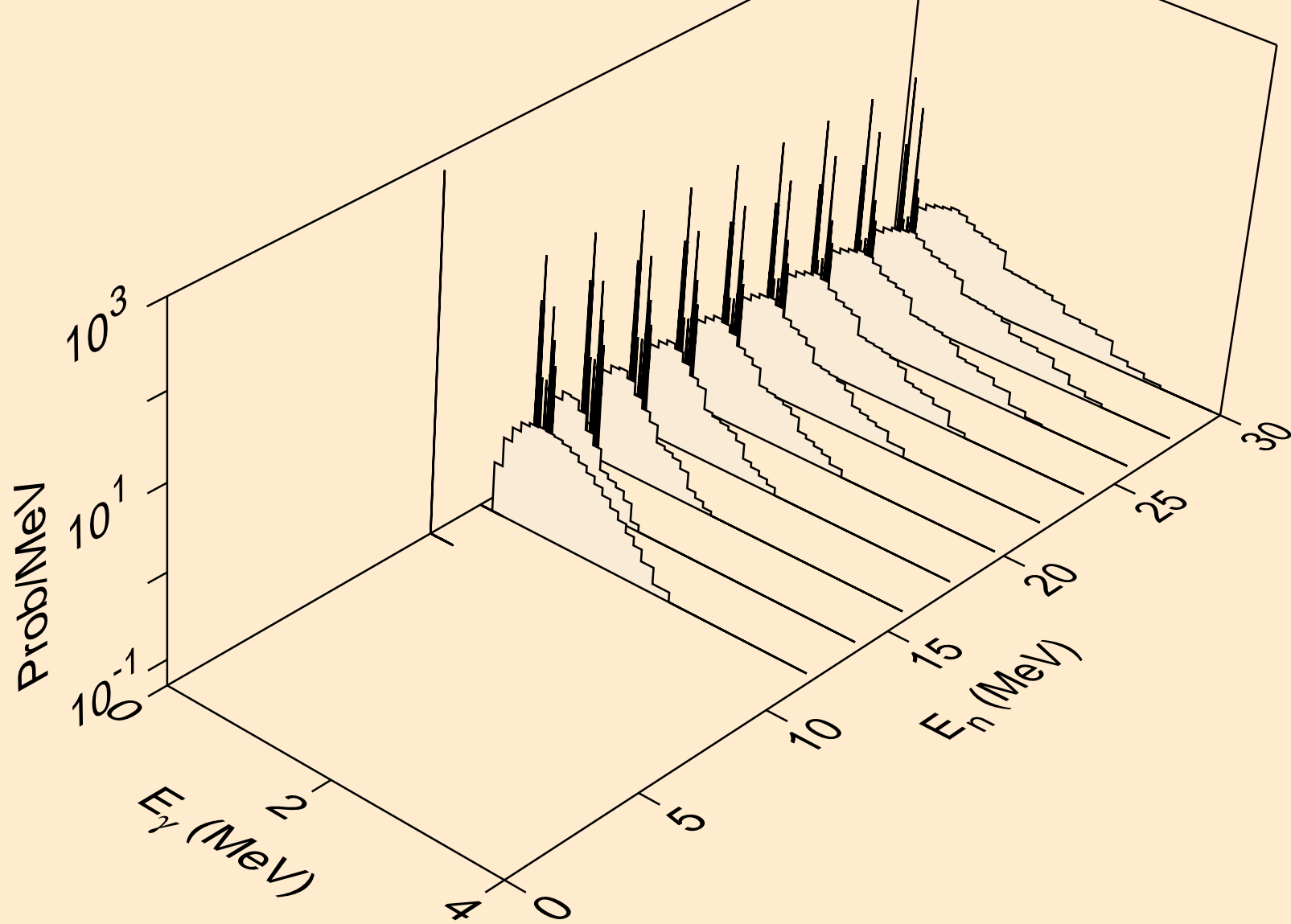

HG196 NEUTRON ACER TENDL-2023 LIBRARY; T=0.K  
Photon emission for (n,2p)

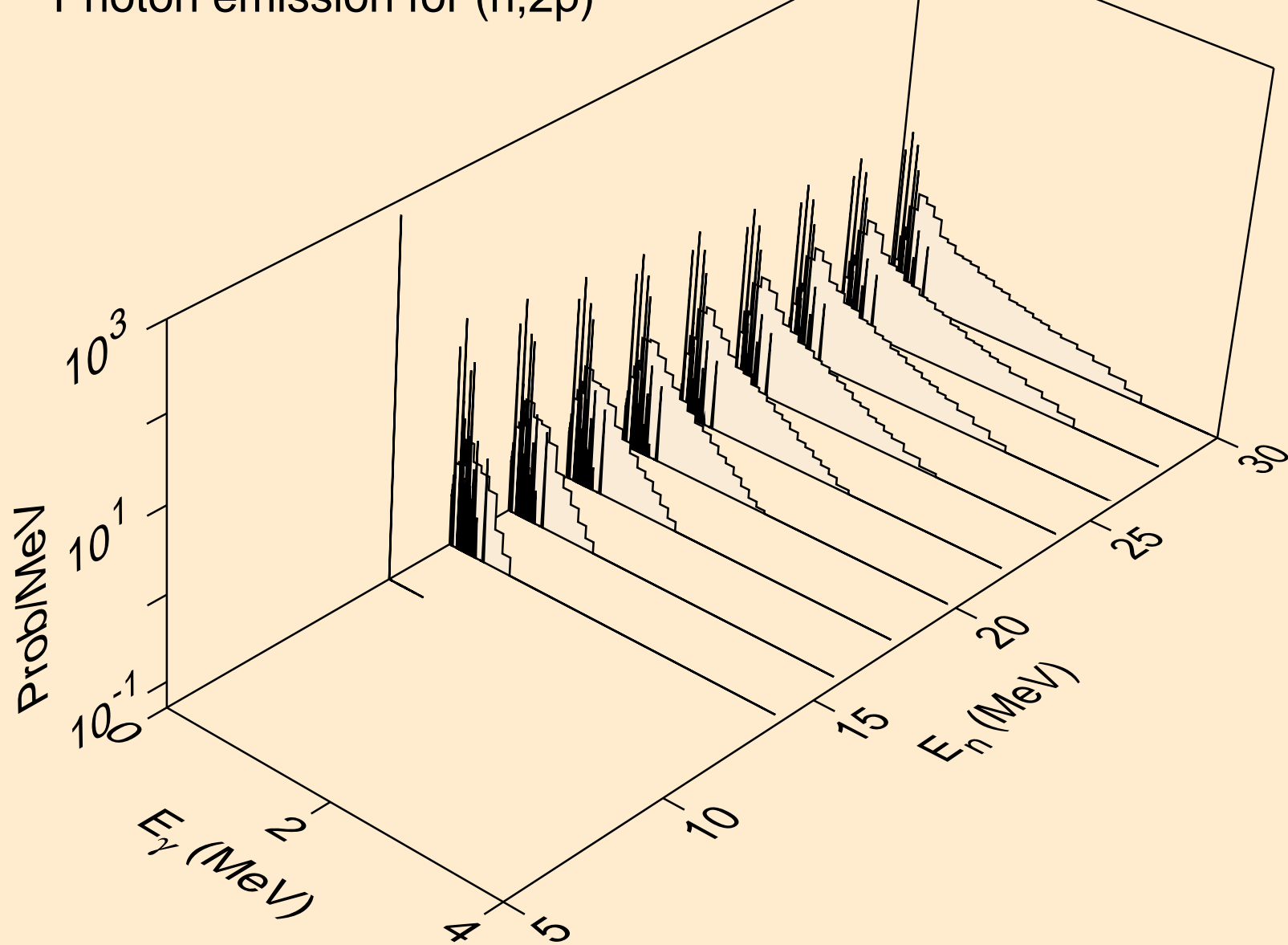

HG196 NEUTRON ACER TENDL-2023 LIBRARY; T=0.K  
Photon emission for (n,p $\alpha$ )

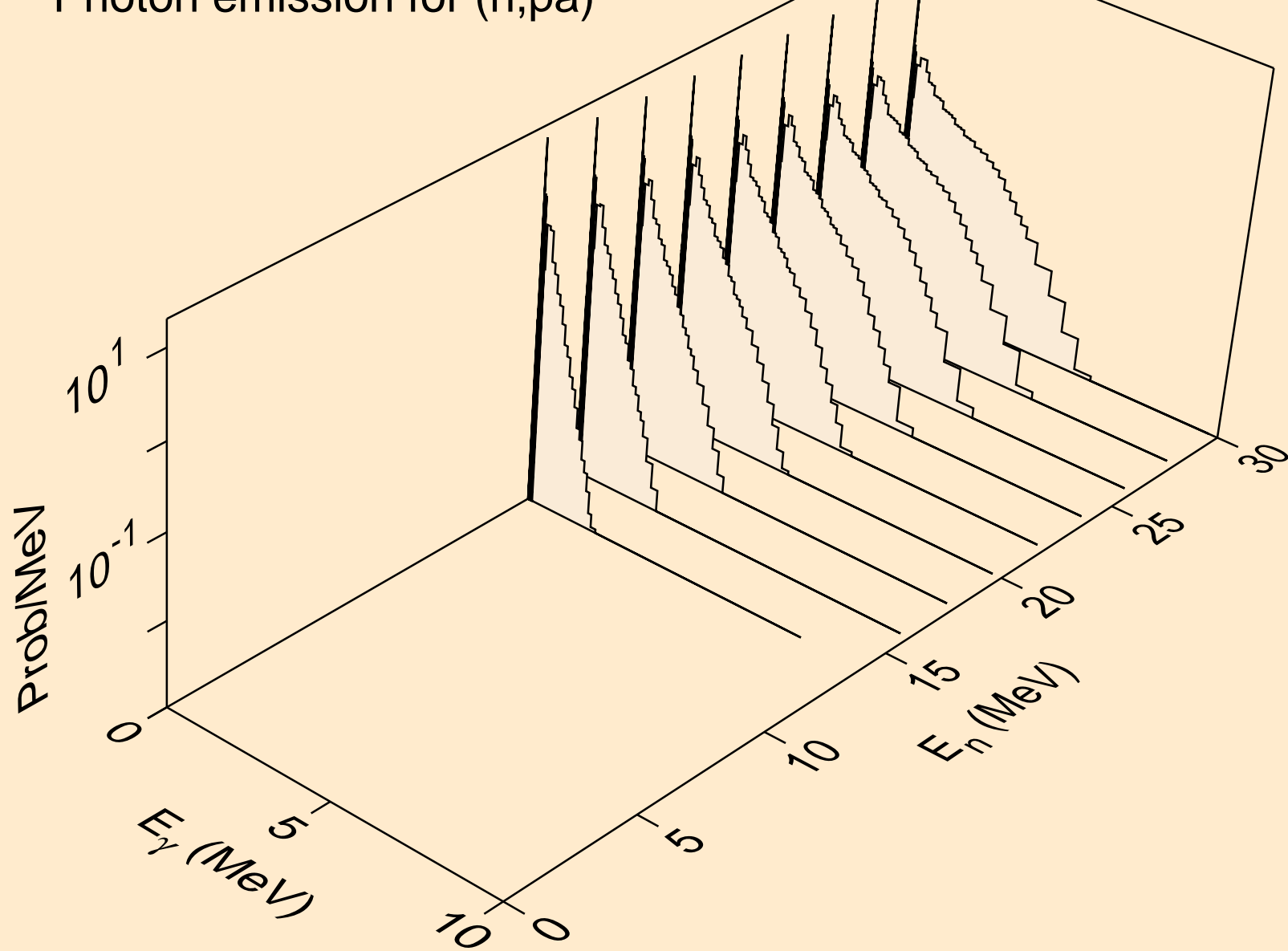

HG196 NEUTRON ACER TENDL-2023 LIBRARY; T=0.K  
Photon emission for (n,pd)

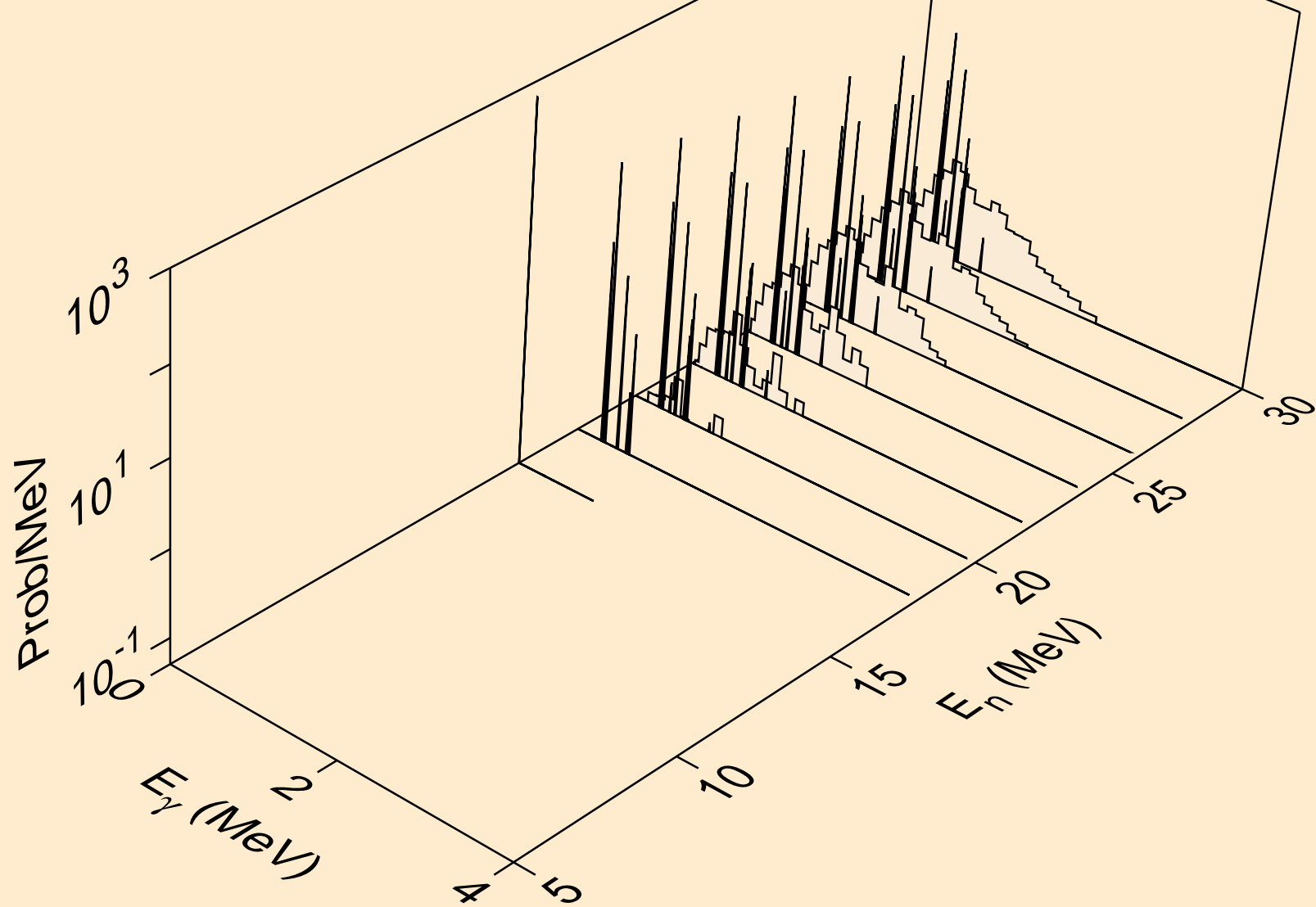



HG196 NEUTRON ACER TENDL-2023 LIBRARY; T=0.K  
Photon emission for (n,pt)

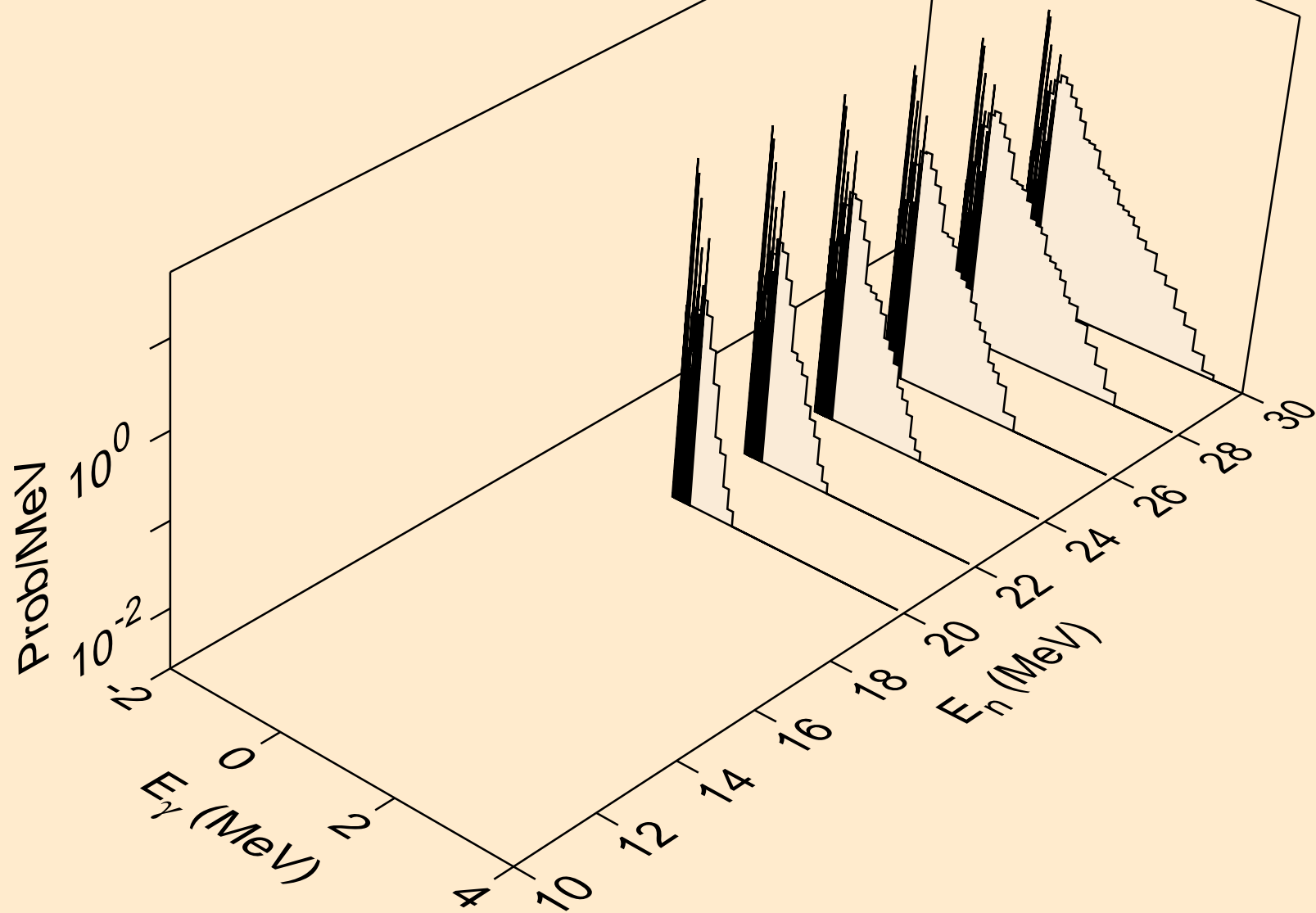

HG196 NEUTRON ACER TENDL-2023 LIBRARY; T=0.K  
Photon emission for (n,da)

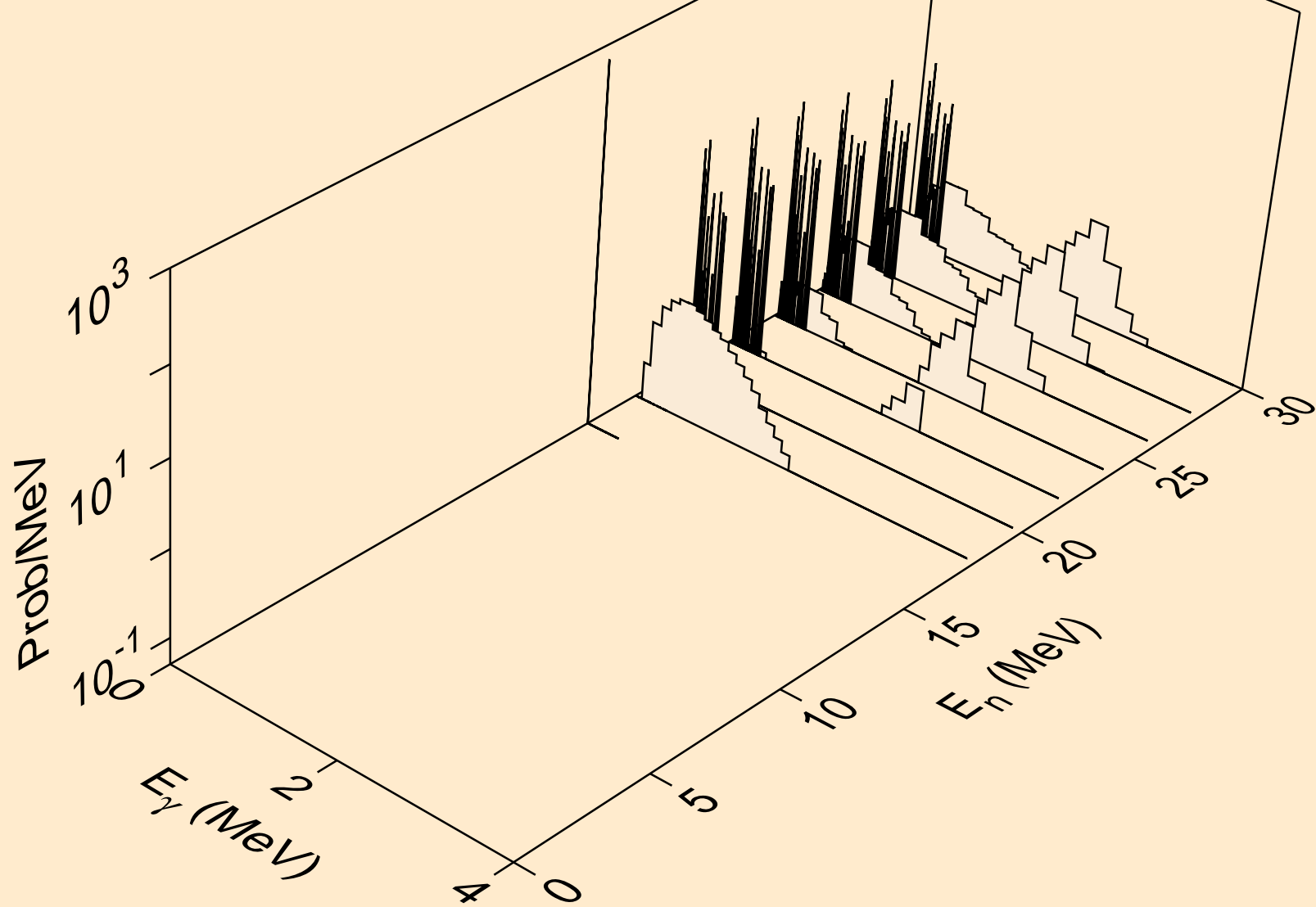

HG196 NEUTRON ACER TENDL-2023 LIBRARY; T=0.K  
thermal capture photon spectrum

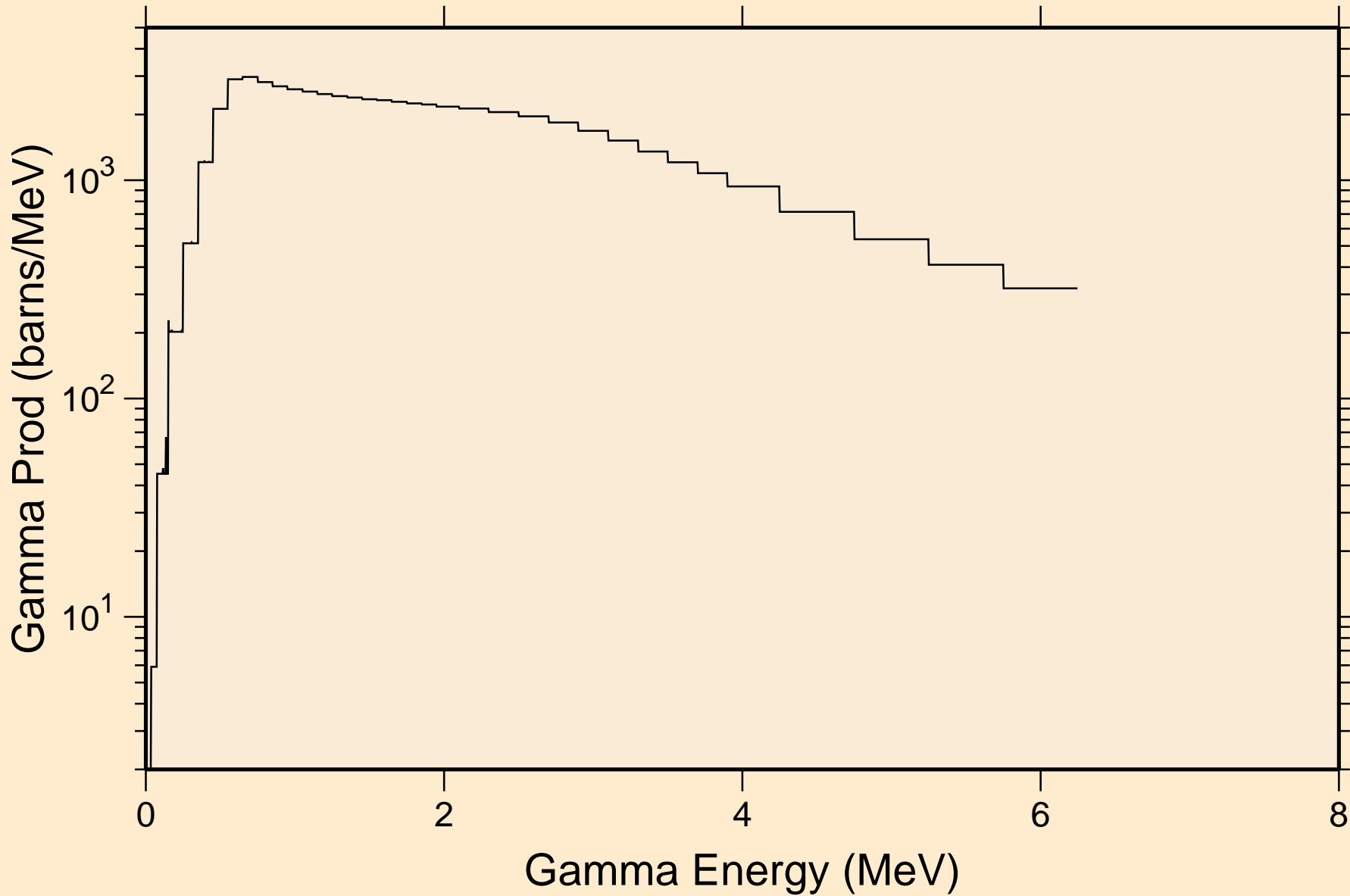

HG196 NEUTRON ACER TENDL-2023 LIBRARY; T=0.K  
14 MeV photon spectrum

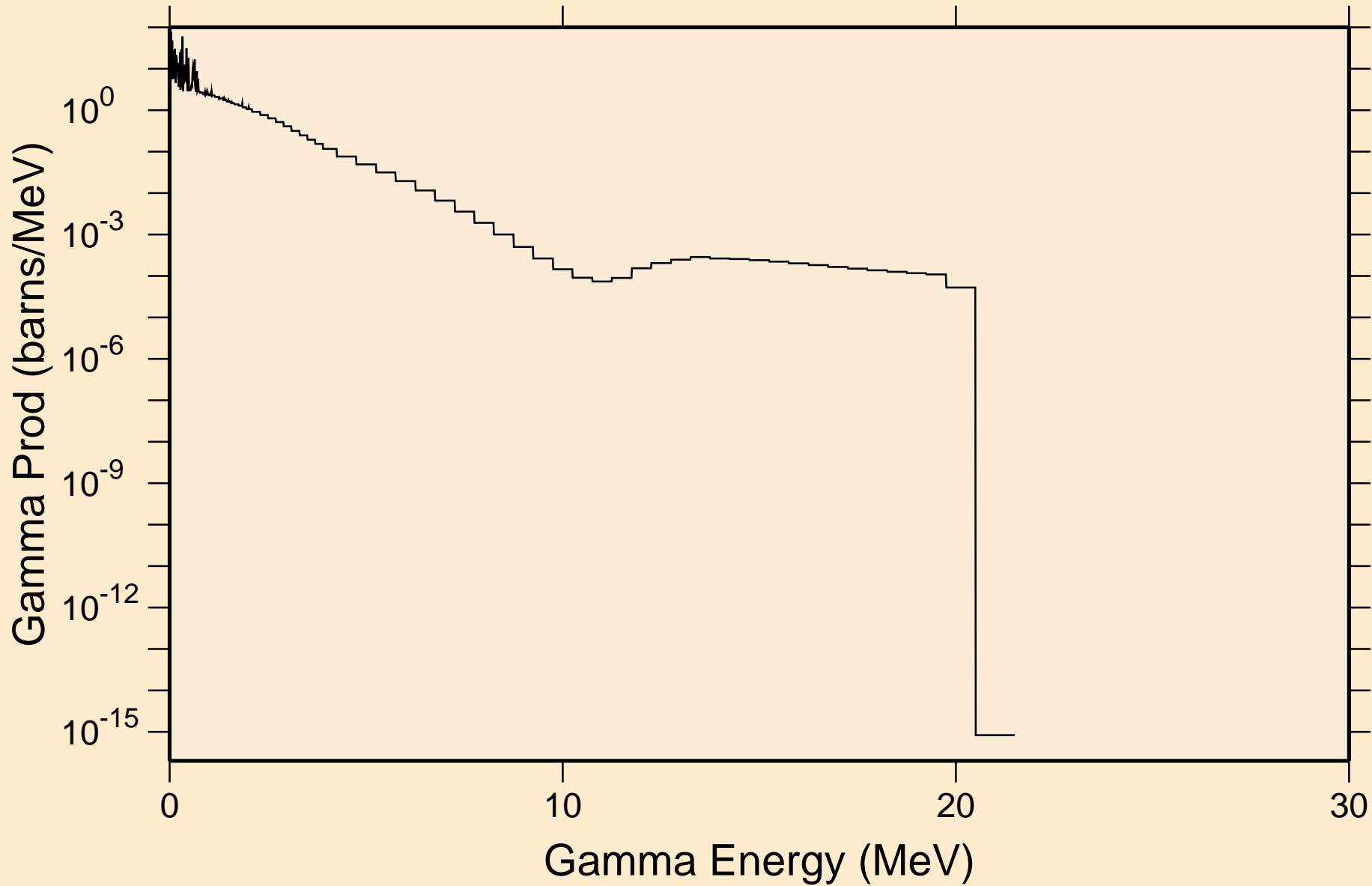

# HG196 NEUTRON ACER TENDL-2023 LIBRARY; T=0.K

## Particle heating contributions

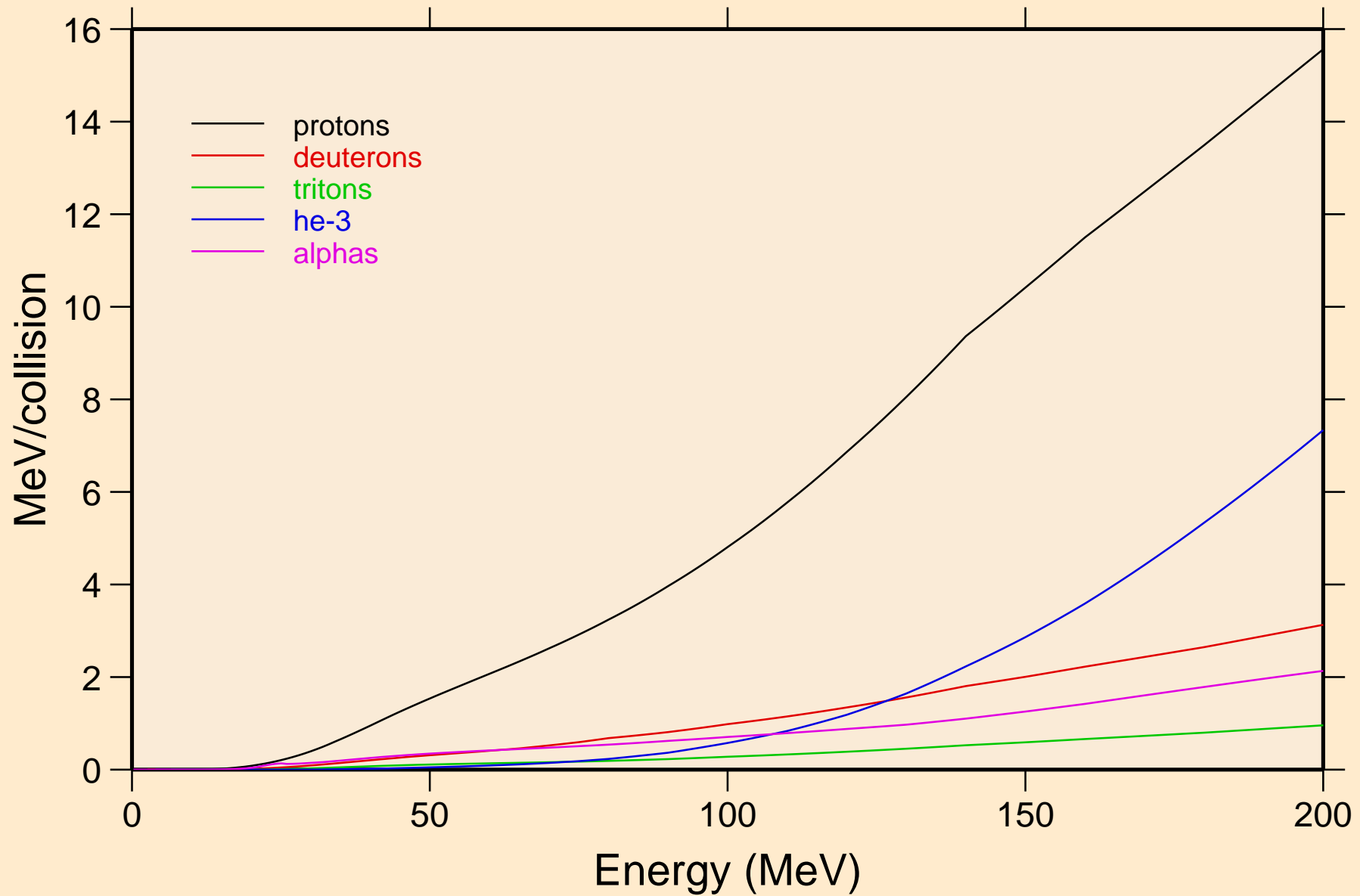

HG196 NEUTRON ACER TENDL-2023 LIBRARY; T=0.K  
Recoil Heating

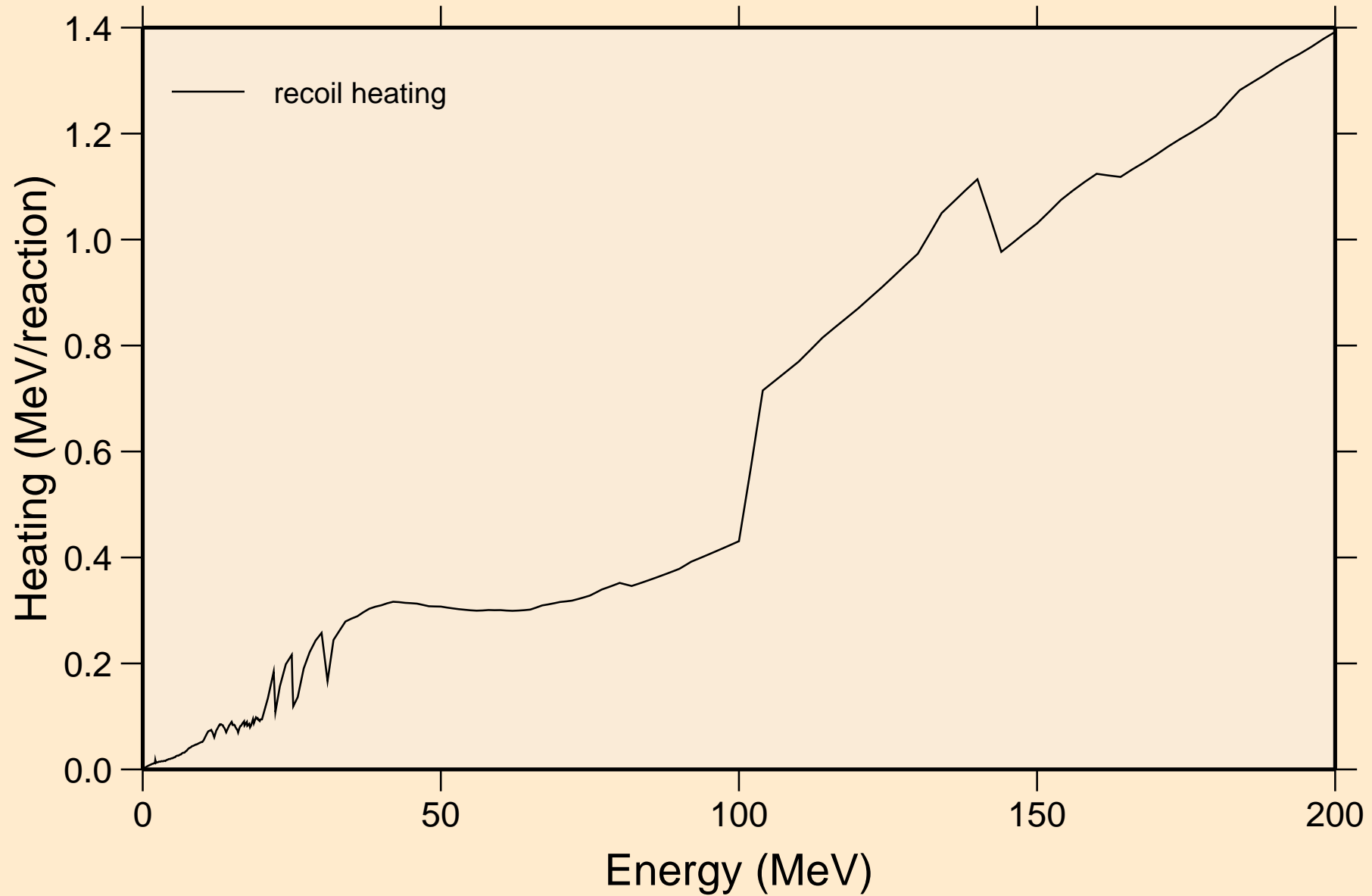

# HG196 NEUTRON ACER TENDL-2023 LIBRARY; T=0.K

## Particle production cross sections

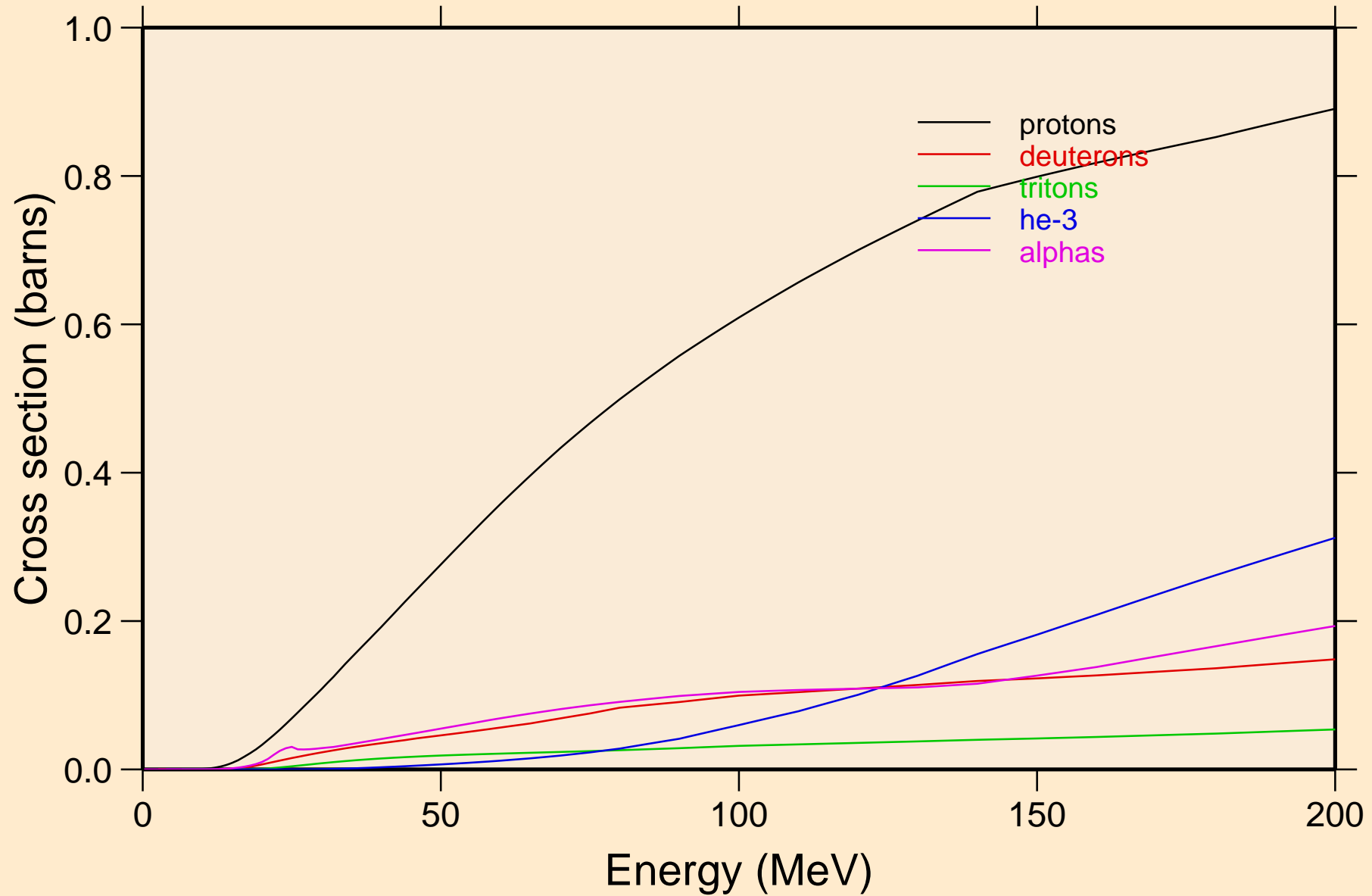

HG196 NEUTRON ACER TENDL-2023 LIBRARY; T=0.K  
protons from (n,x)

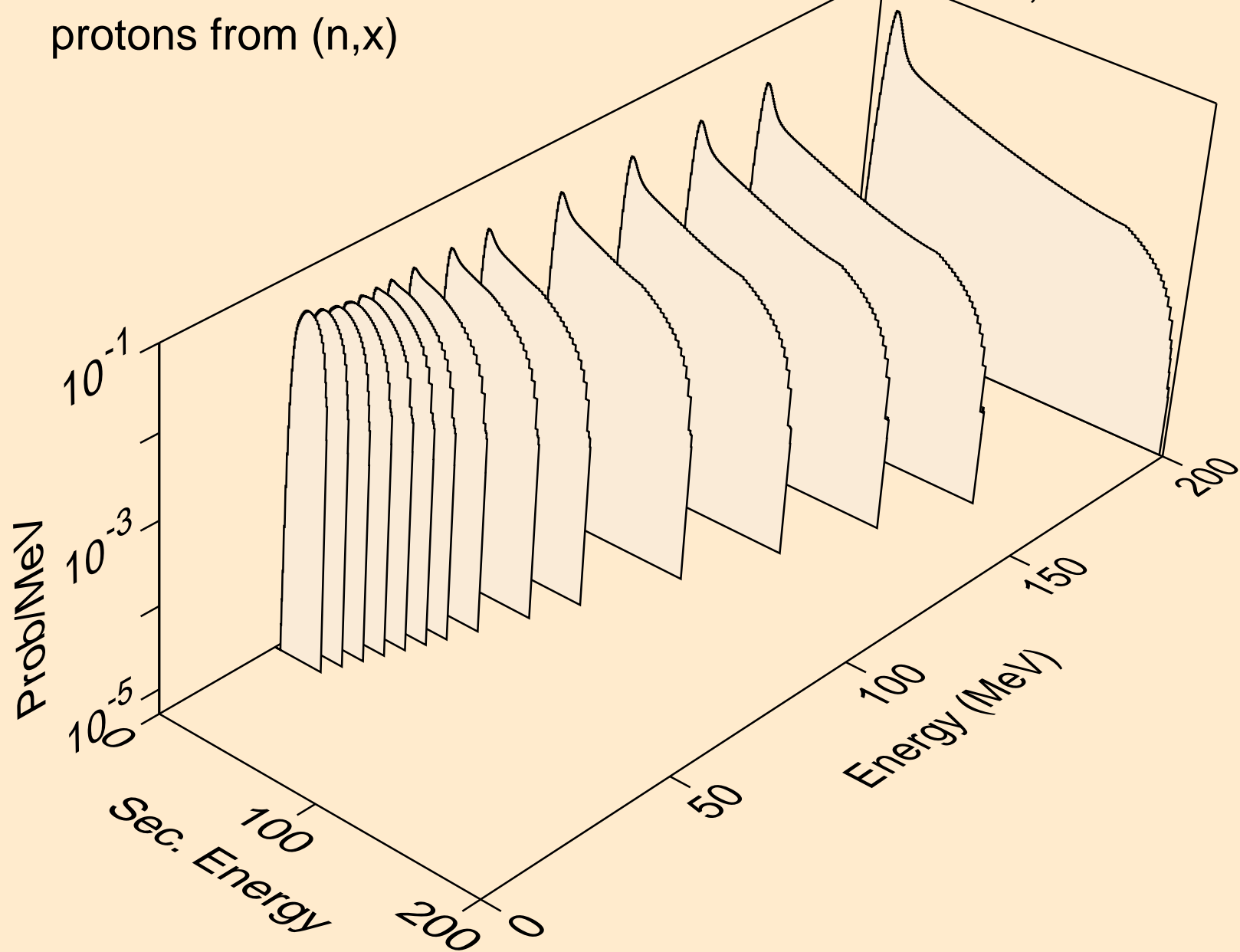



HG196 NEUTRON ACER TENDL-2023 LIBRARY; T=0.K  
protons from (n,n\*)p

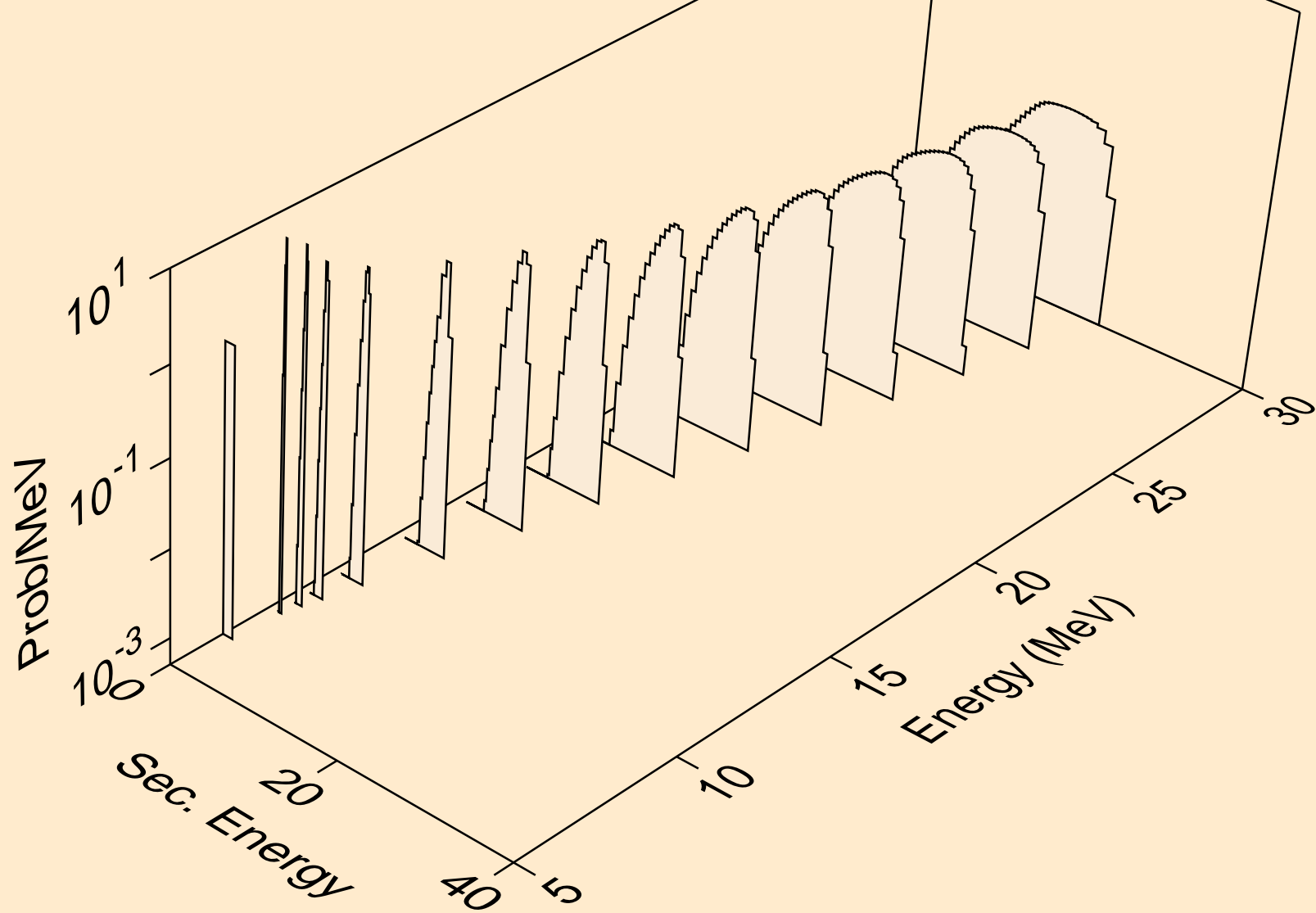

HG196 NEUTRON ACER TENDL-2023 LIBRARY; T=0.K  
protons from (n,2np)

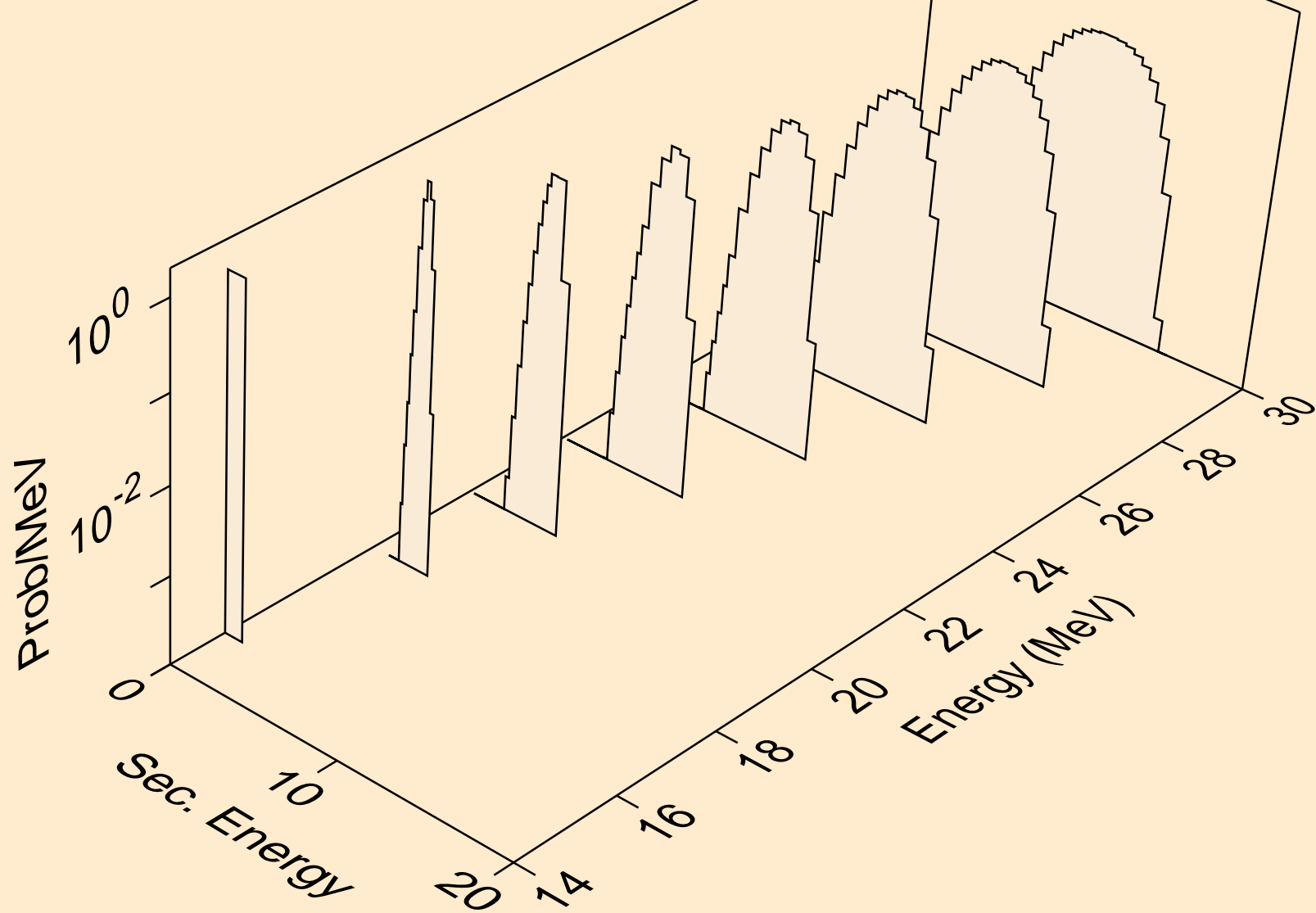

HG196 NEUTRON ACER TENDL-2023 LIBRARY; T=0.K  
protons from (n,3np)

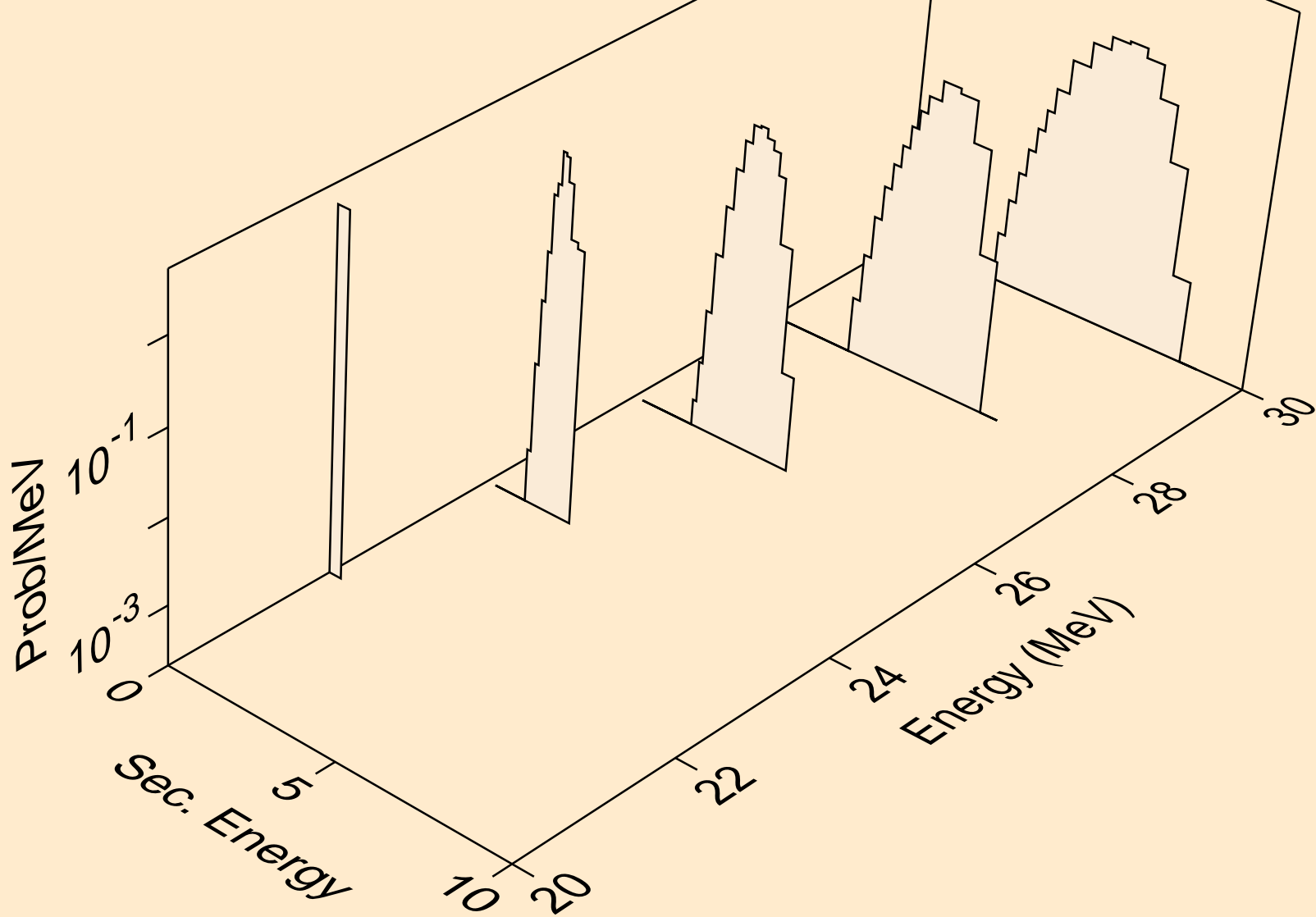

HG196 NEUTRON ACER TENDL-2023 LIBRARY; T=0.K  
protons from (n,n2p)

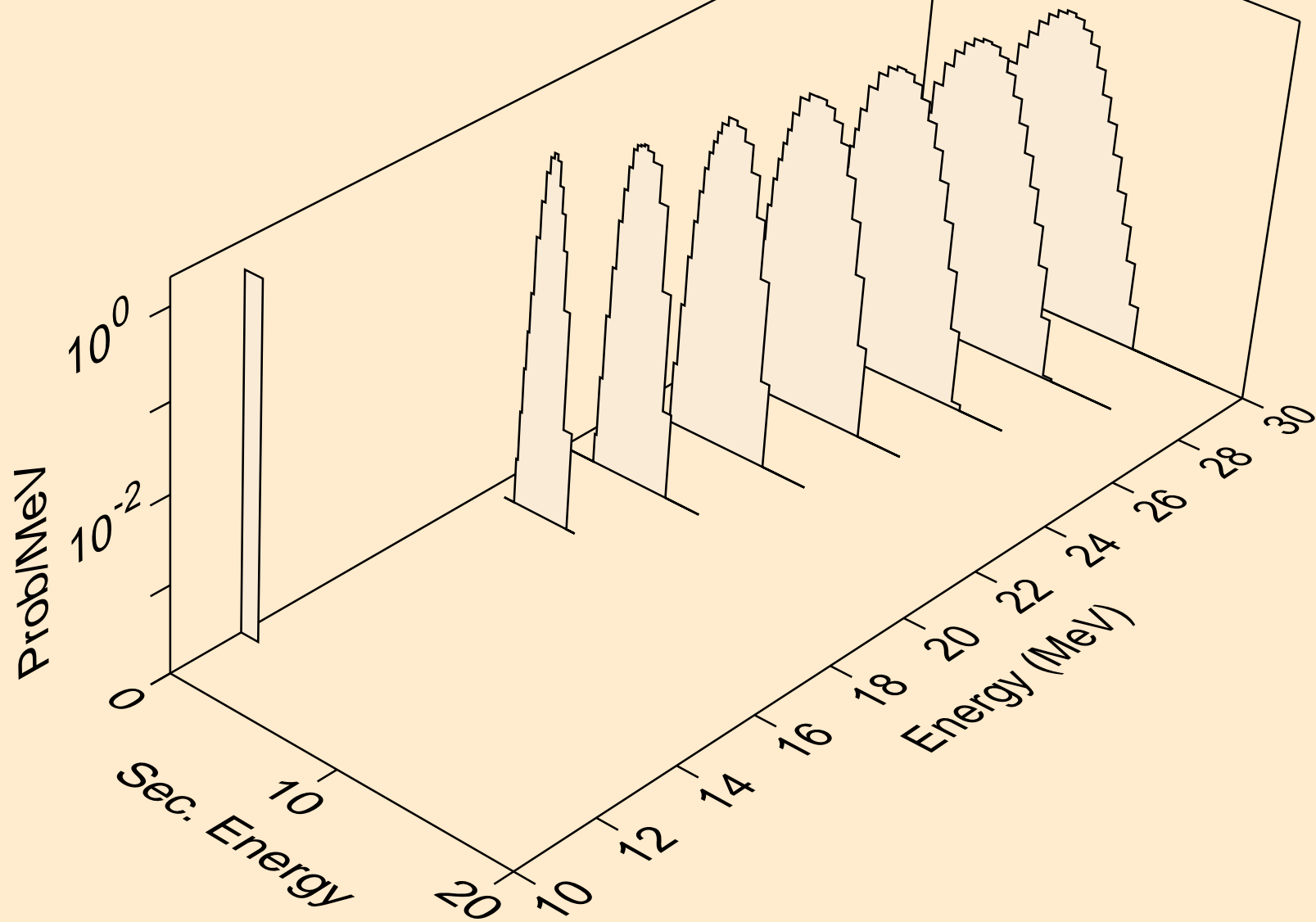

HG196 NEUTRON ACER TENDL-2023 LIBRARY; T=0.K  
protons from (n,npa)

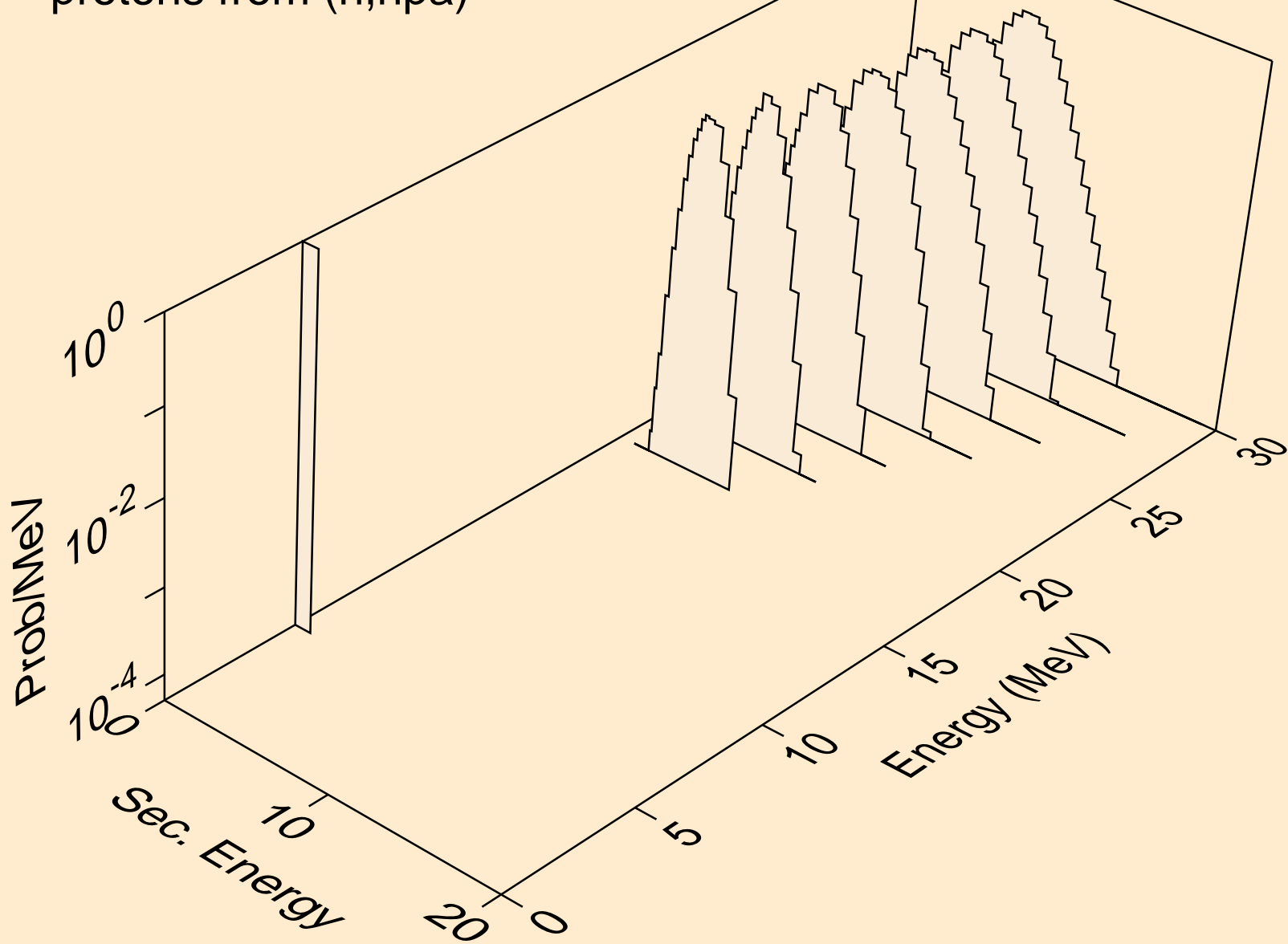

HG196 NEUTRON ACER TENDL-2023 LIBRARY; T=0.K  
protons from (n,p)

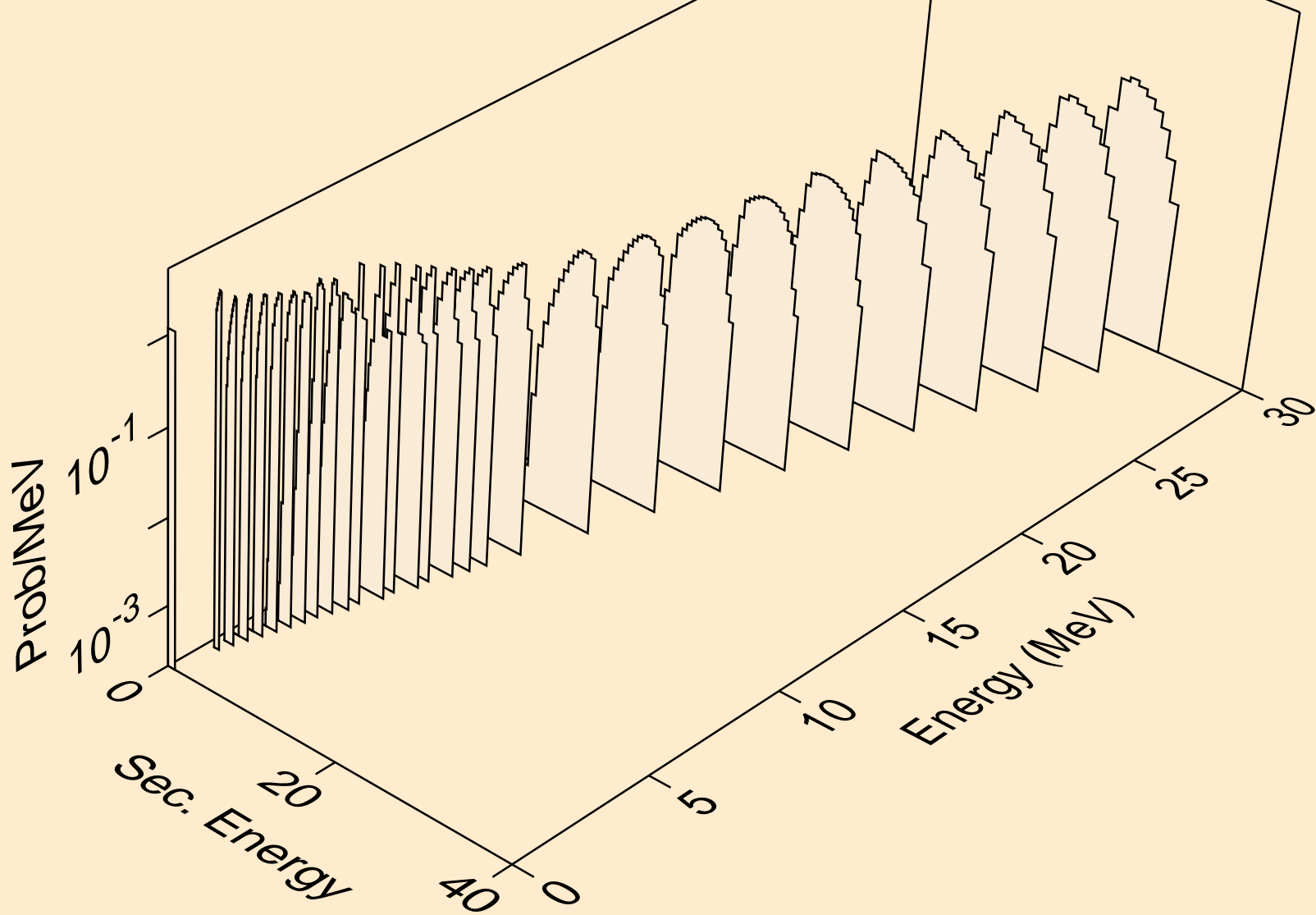

HG196 NEUTRON ACER TENDL-2023 LIBRARY; T=0.K  
protons from (n,2p)

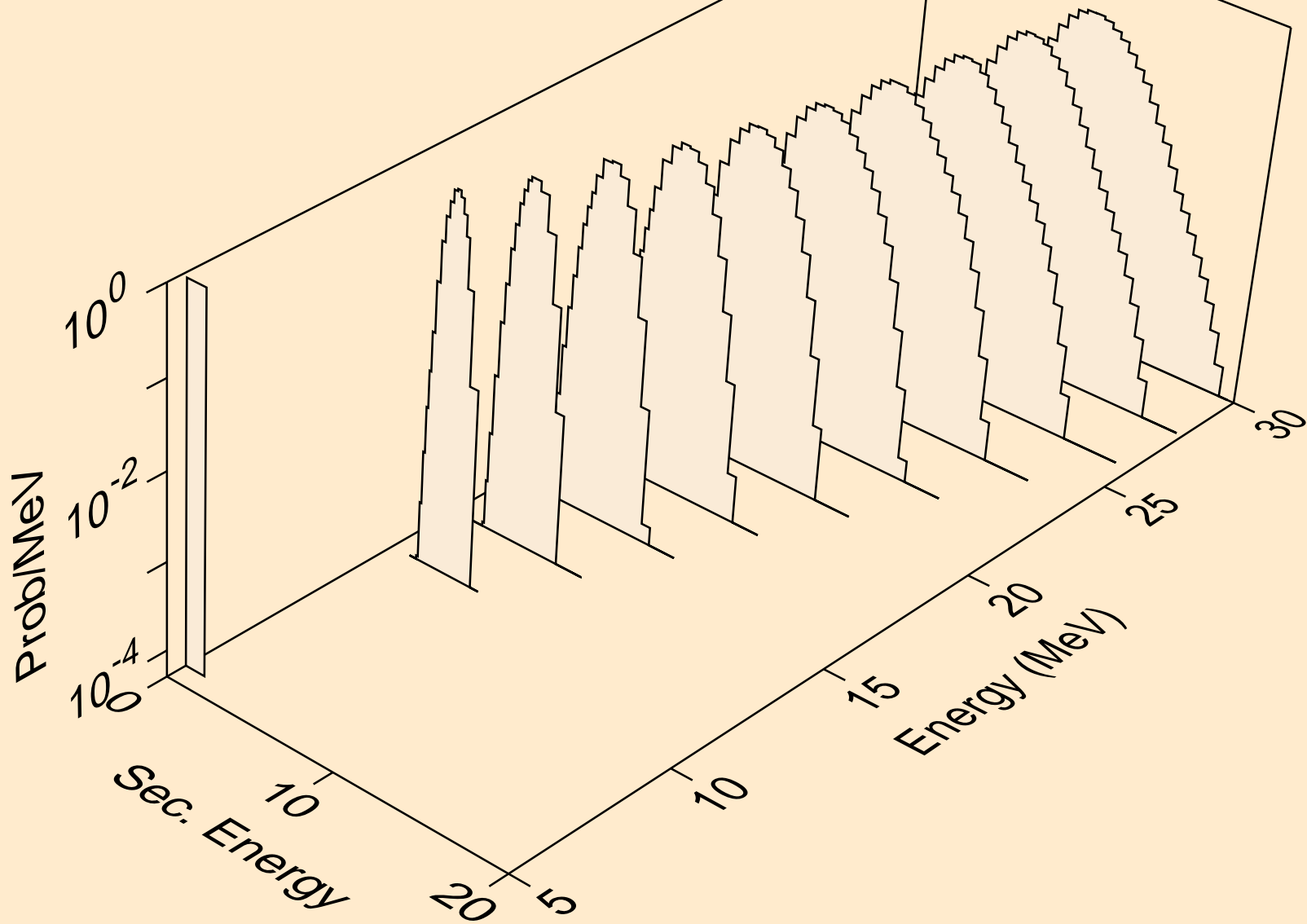

HG196 NEUTRON ACER TENDL-2023 LIBRARY; T=0.K  
protons from (n,pa)

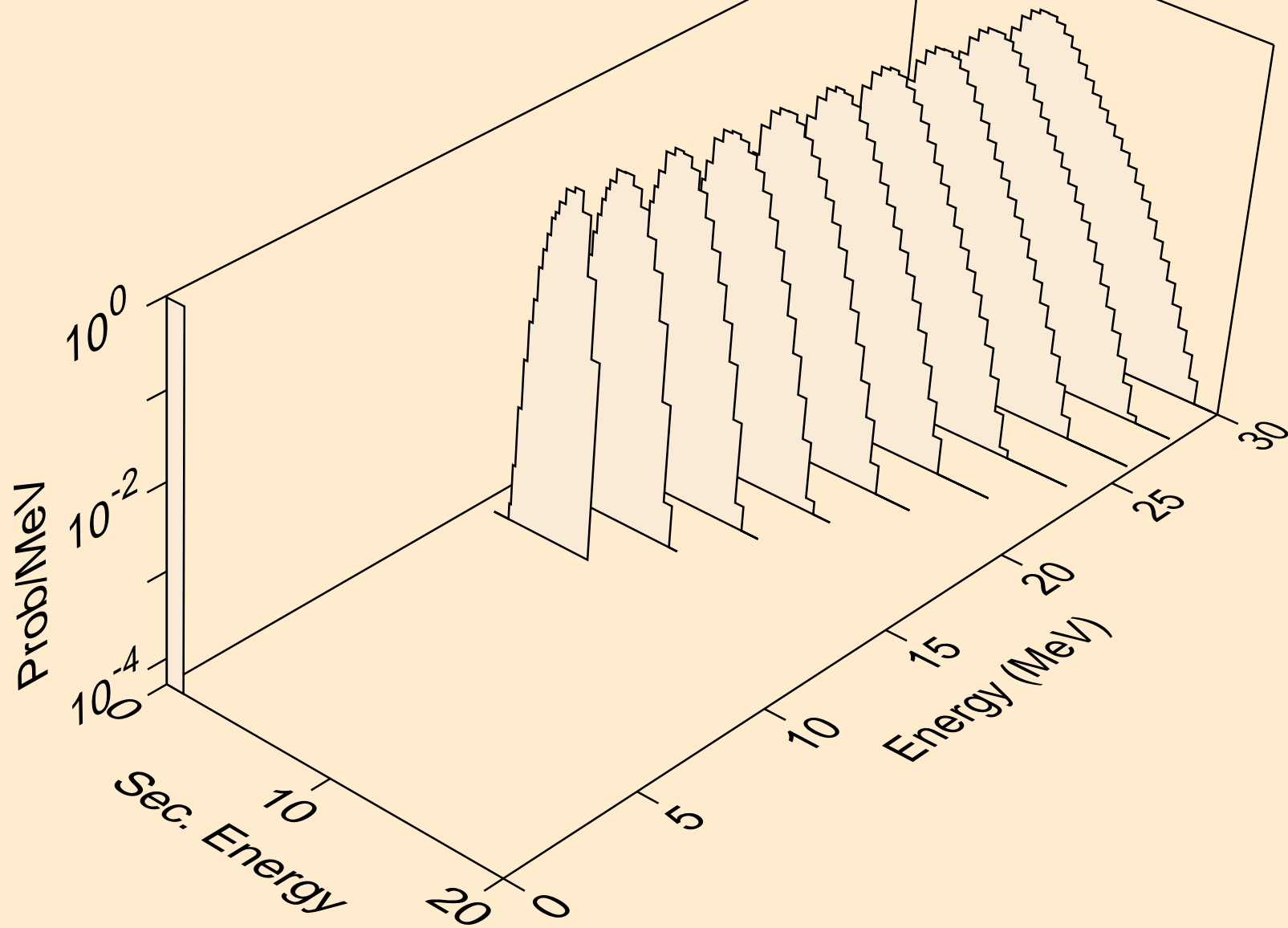



HG196 NEUTRON ACER TENDL-2023 LIBRARY; T=0.K  
protons from (n,pd)

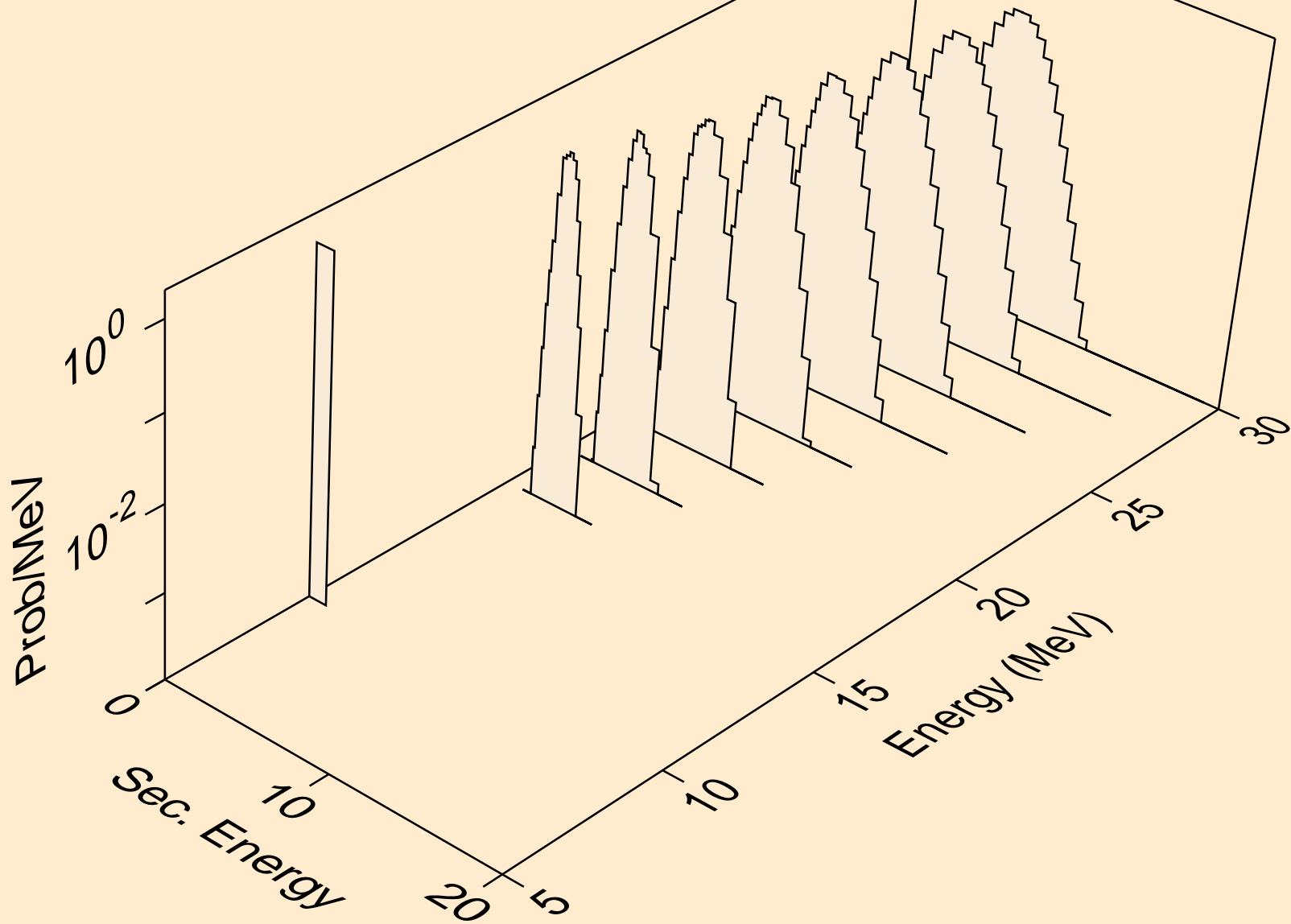

HG196 NEUTRON ACER TENDL-2023 LIBRARY; T=0.K  
protons from (n,pt)

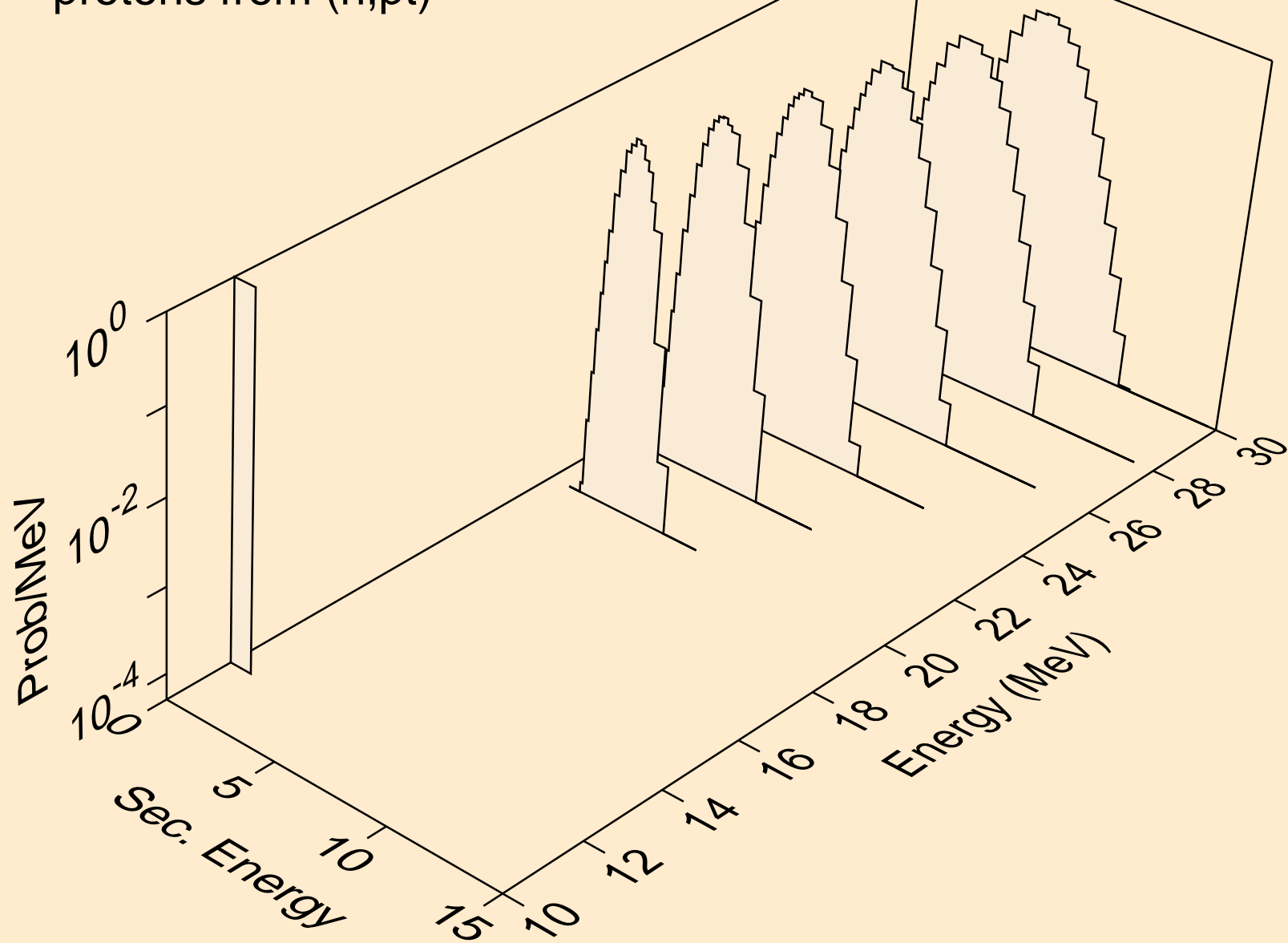

HG196 NEUTRON ACER TENDL-2023 LIBRARY; T=0.K  
deuterons from (n,x)

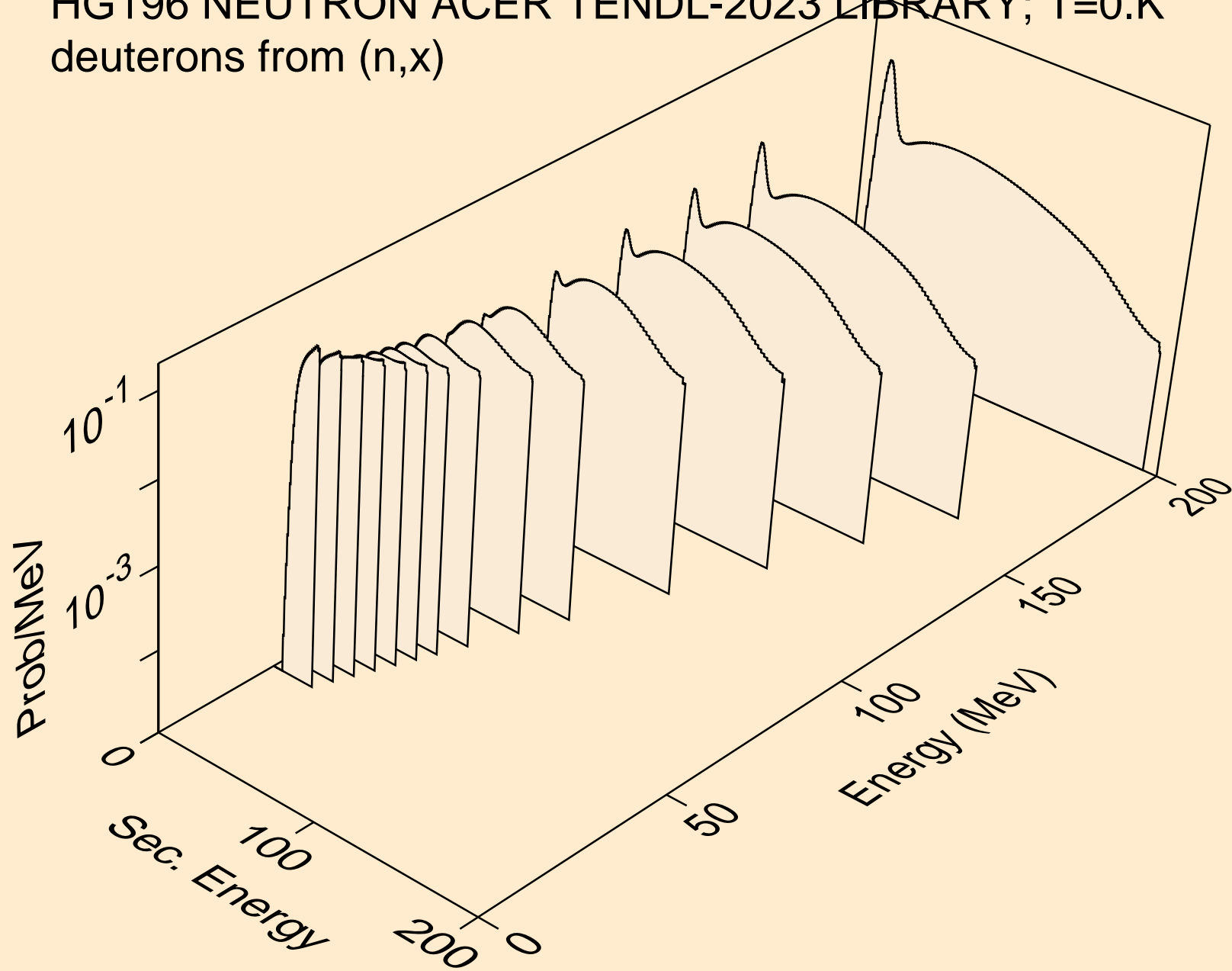

HG196 NEUTRON ACER TENDL-2023 LIBRARY; T=0.K  
deuterons from (n,2nd)

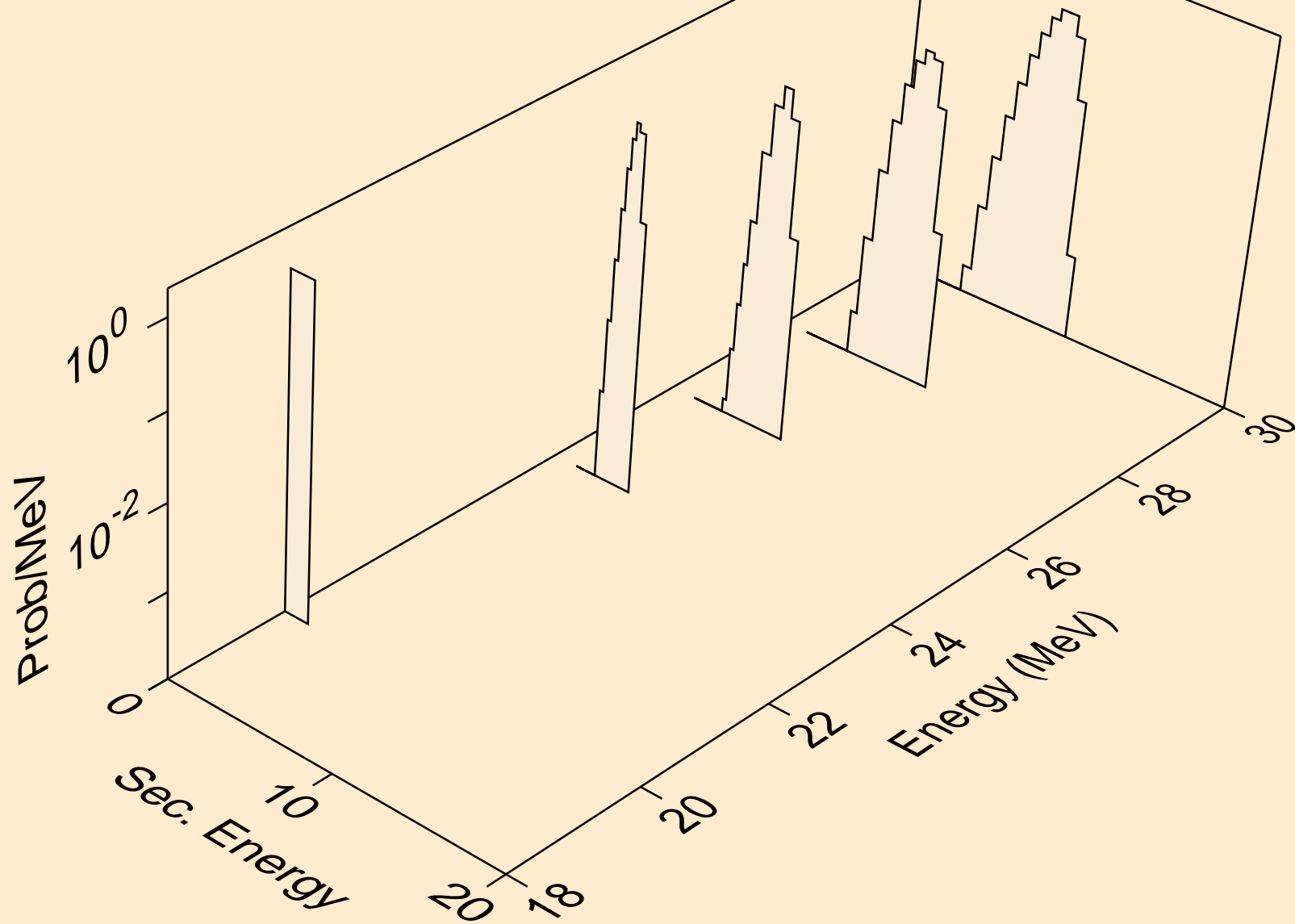

HG196 NEUTRON ACER TENDL-2023 LIBRARY; T=0.K  
deuterons from (n,n\*)d

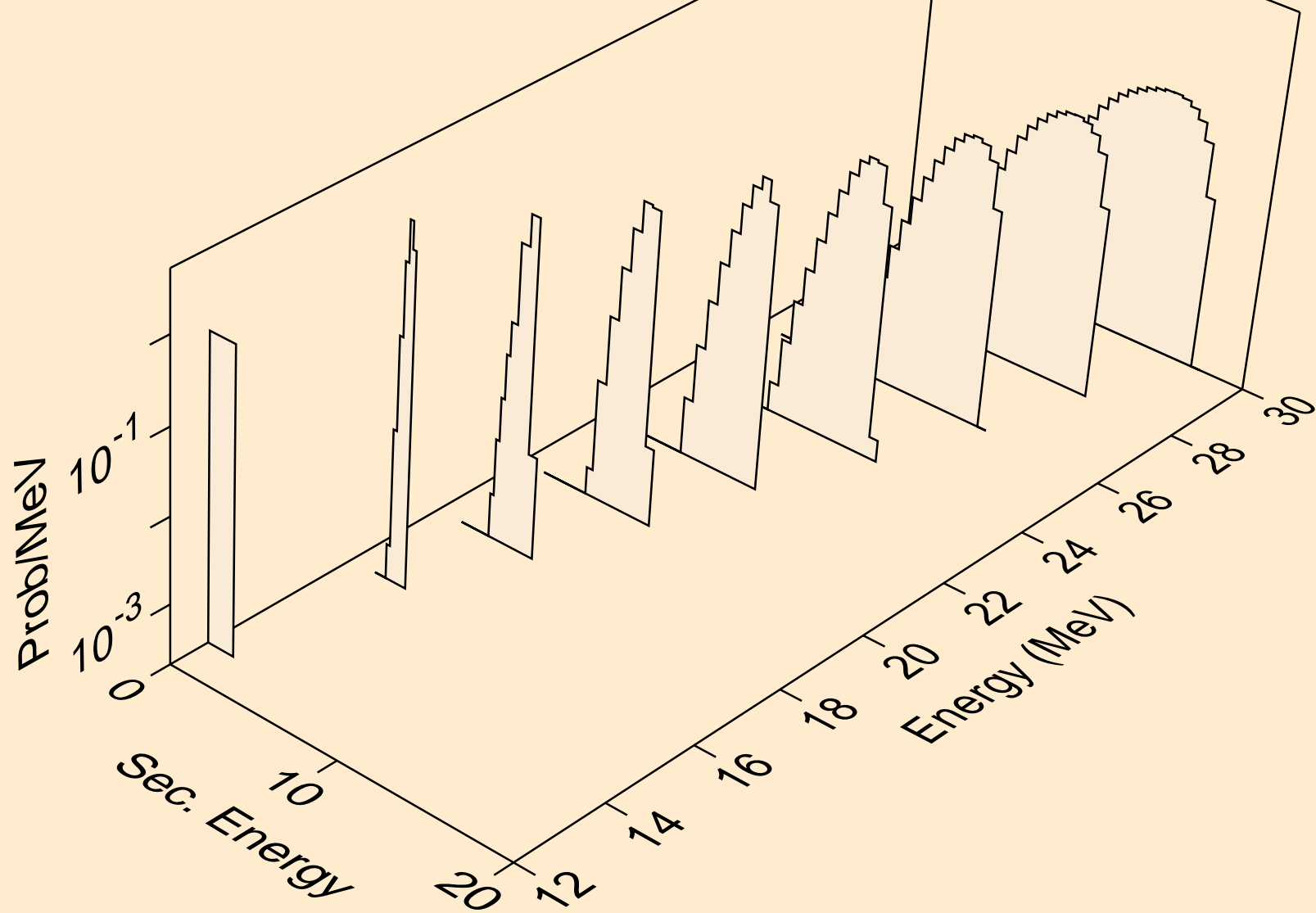

HG196 NEUTRON ACER TENDL-2023 LIBRARY; T=0.K  
deuterons from (n,d)

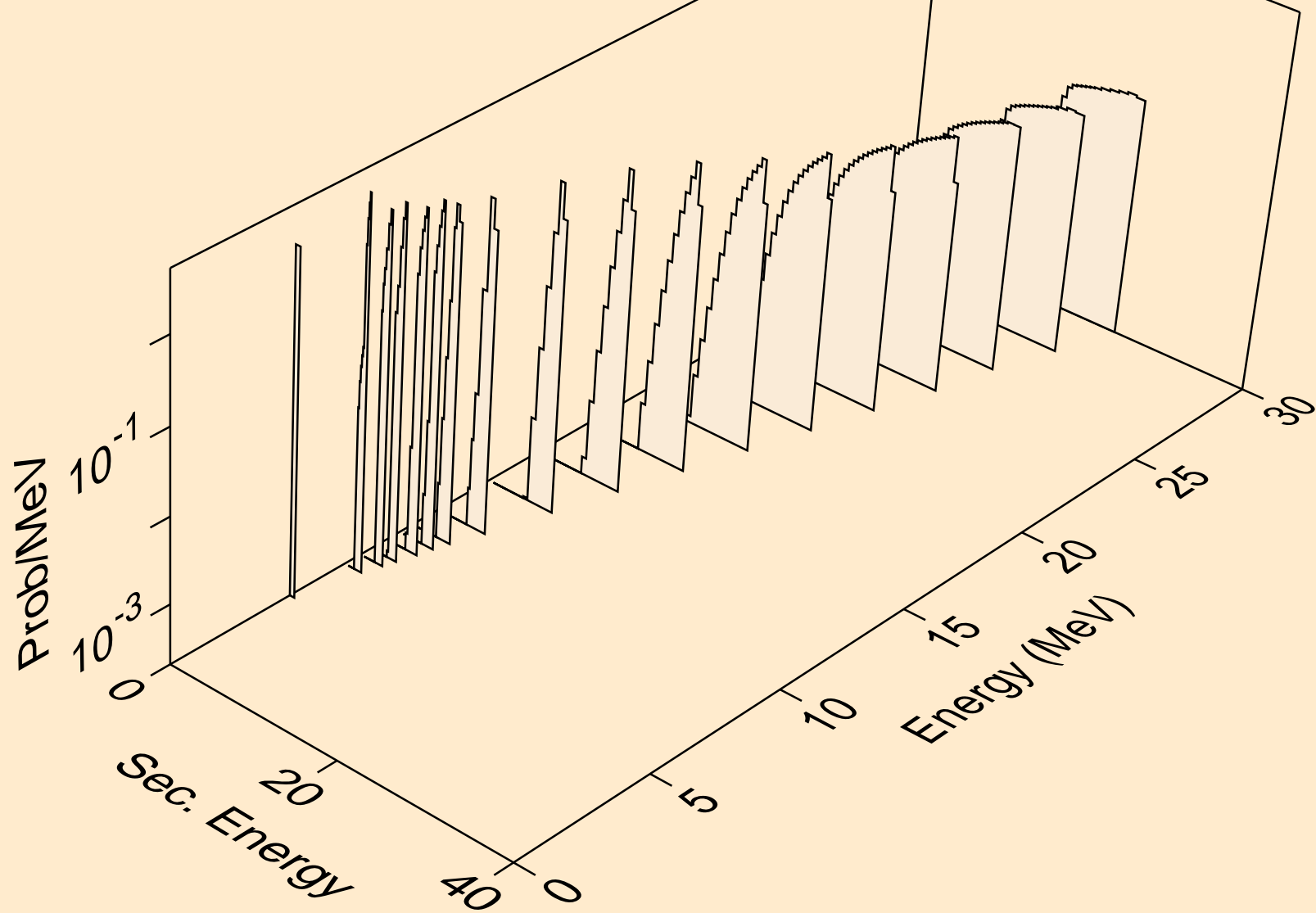

HG196 NEUTRON ACER TENDL-2023 LIBRARY; T=0.K  
deuterons from (n,pd)

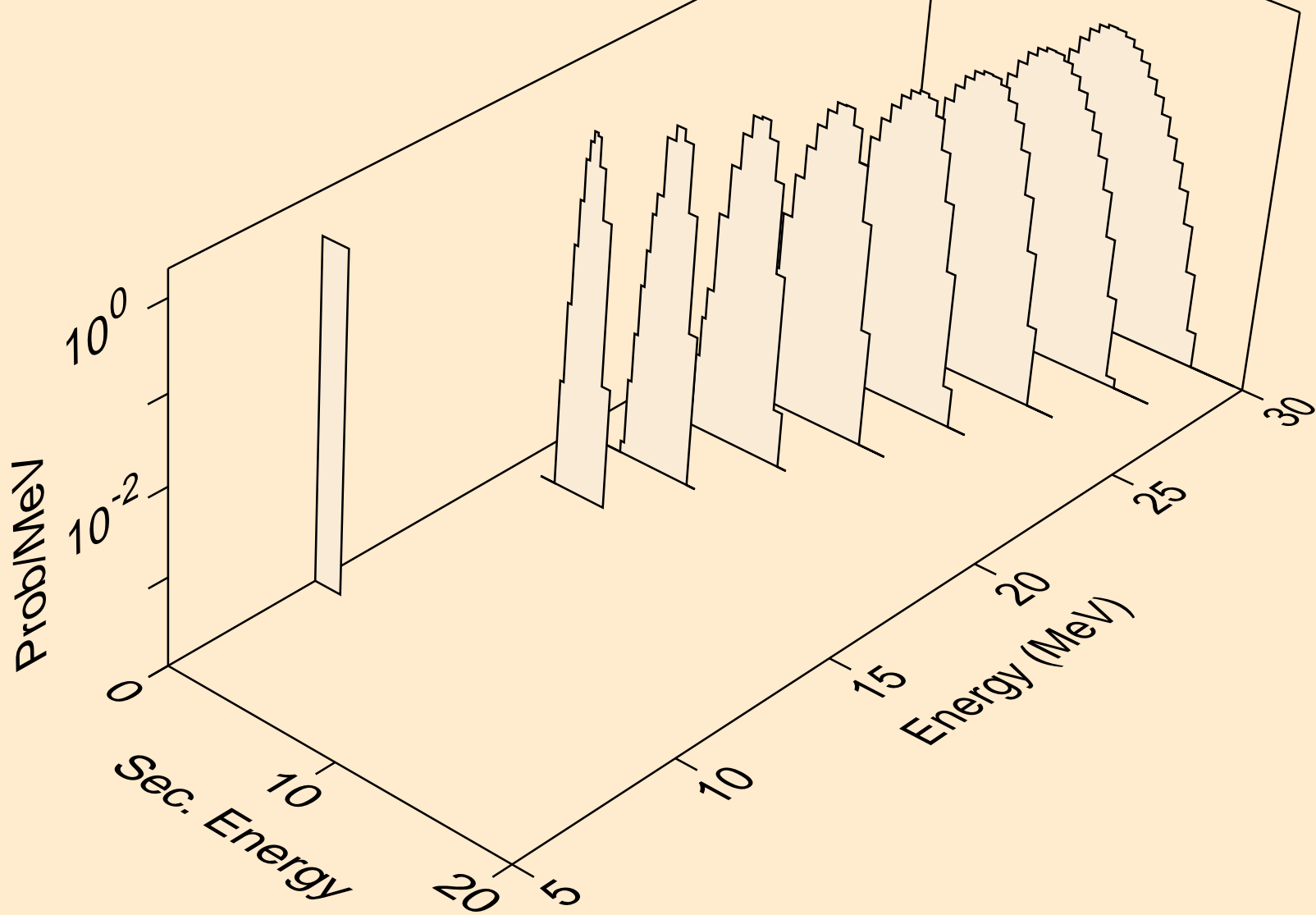

HG196 NEUTRON ACER TENDL-2023 LIBRARY; T=0.K  
deuterons from (n,da)

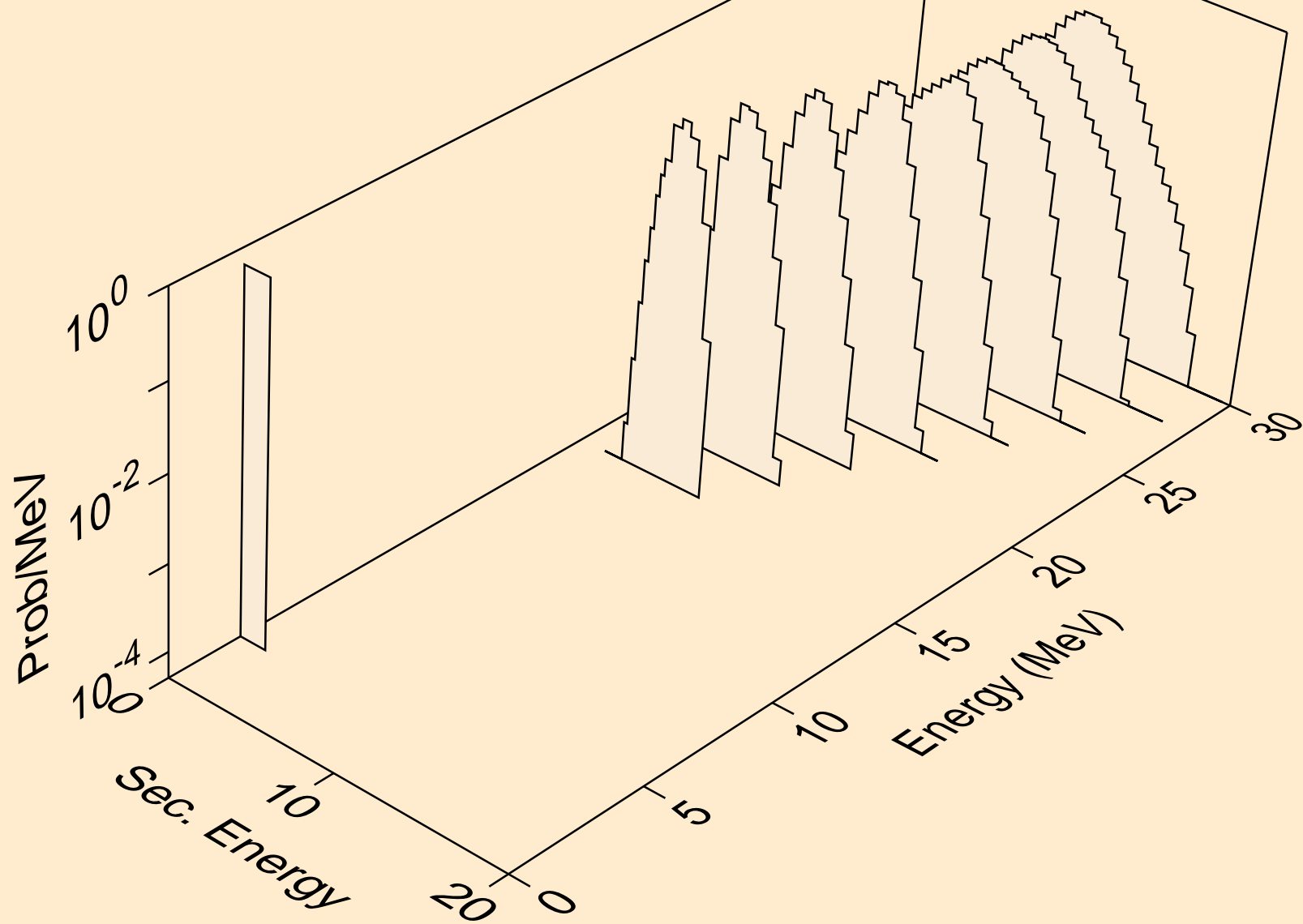



HG196 NEUTRON ACER TENDL-2023 LIBRARY; T=0.K  
tritons from (n,x)

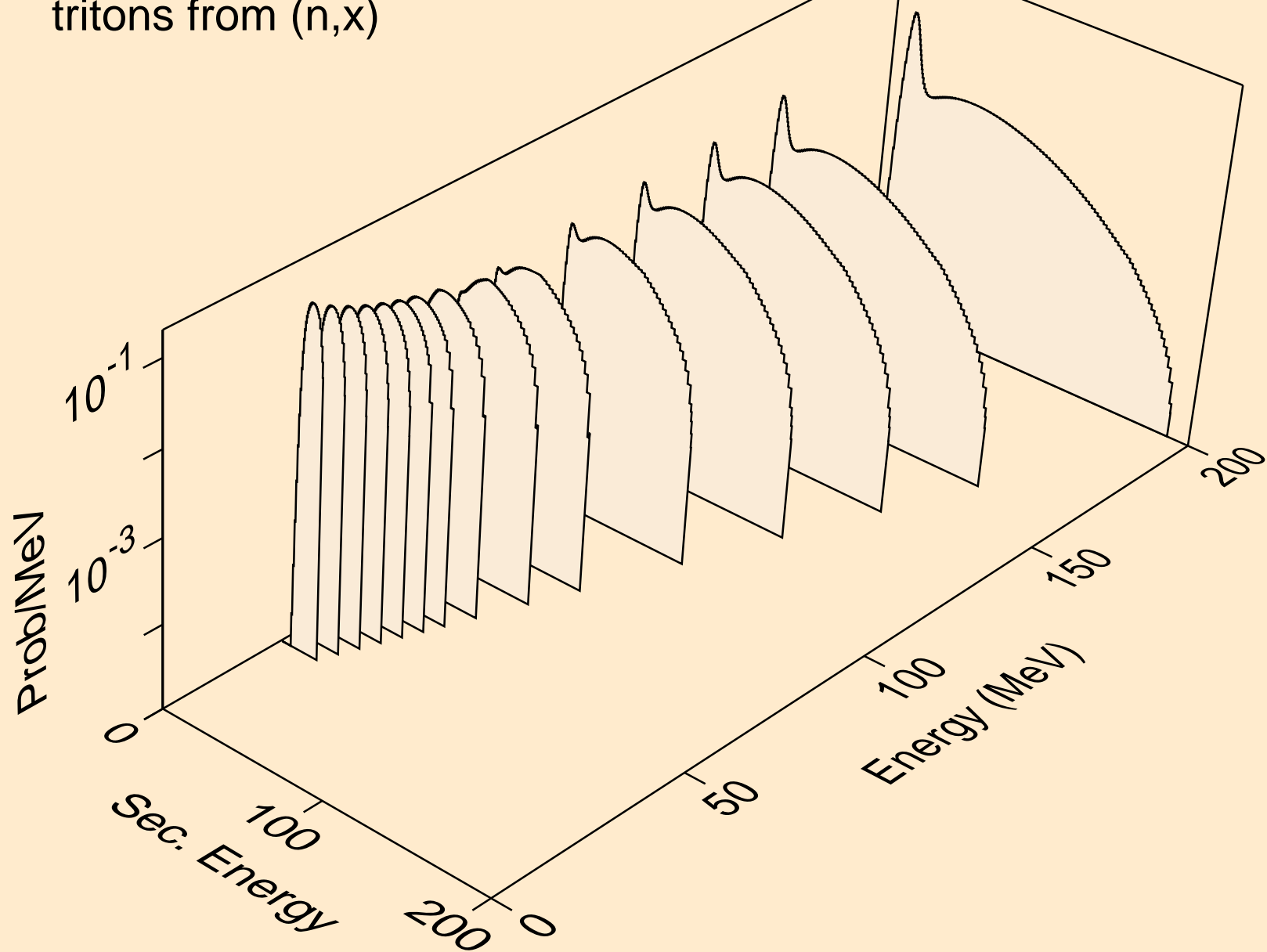

HG196 NEUTRON ACER TENDL-2023 LIBRARY; T=0.K  
tritons from (n,n\*)t

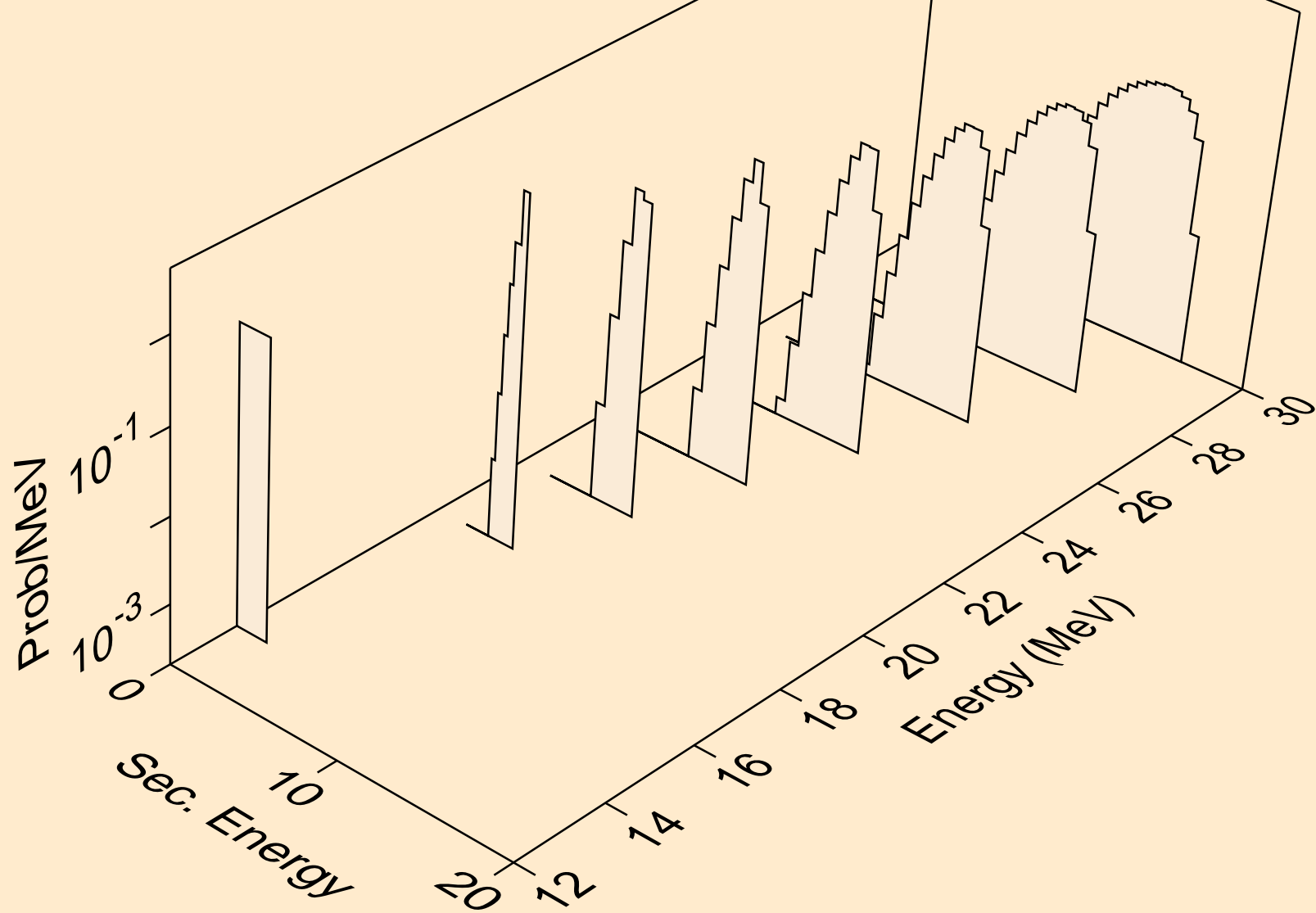

HG196 NEUTRON ACER TENDL-2023 LIBRARY; T=0.K  
tritons from (n,t)

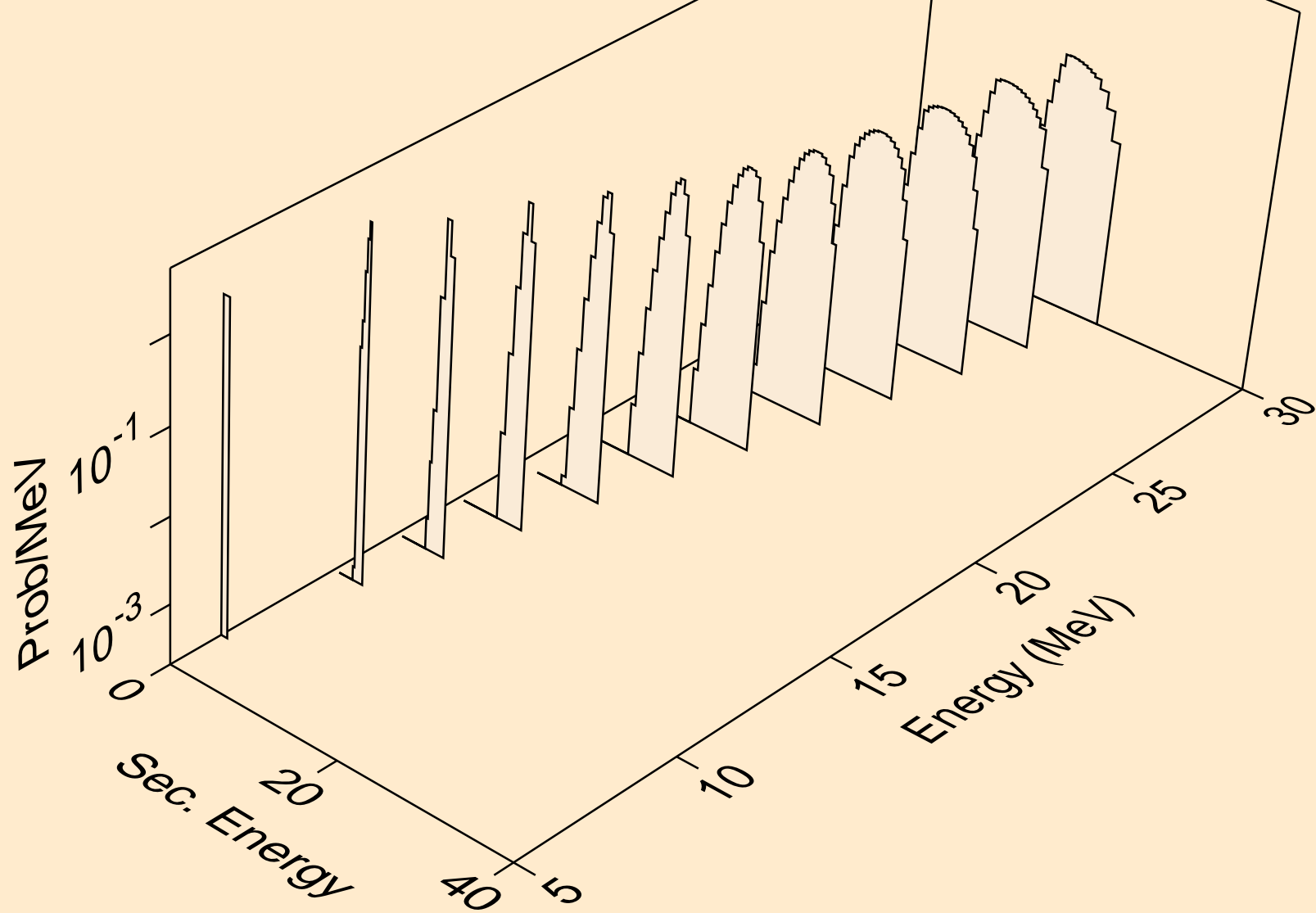

HG196 NEUTRON ACER TENDL-2023 LIBRARY; T=0.K  
tritons from (n,pt)

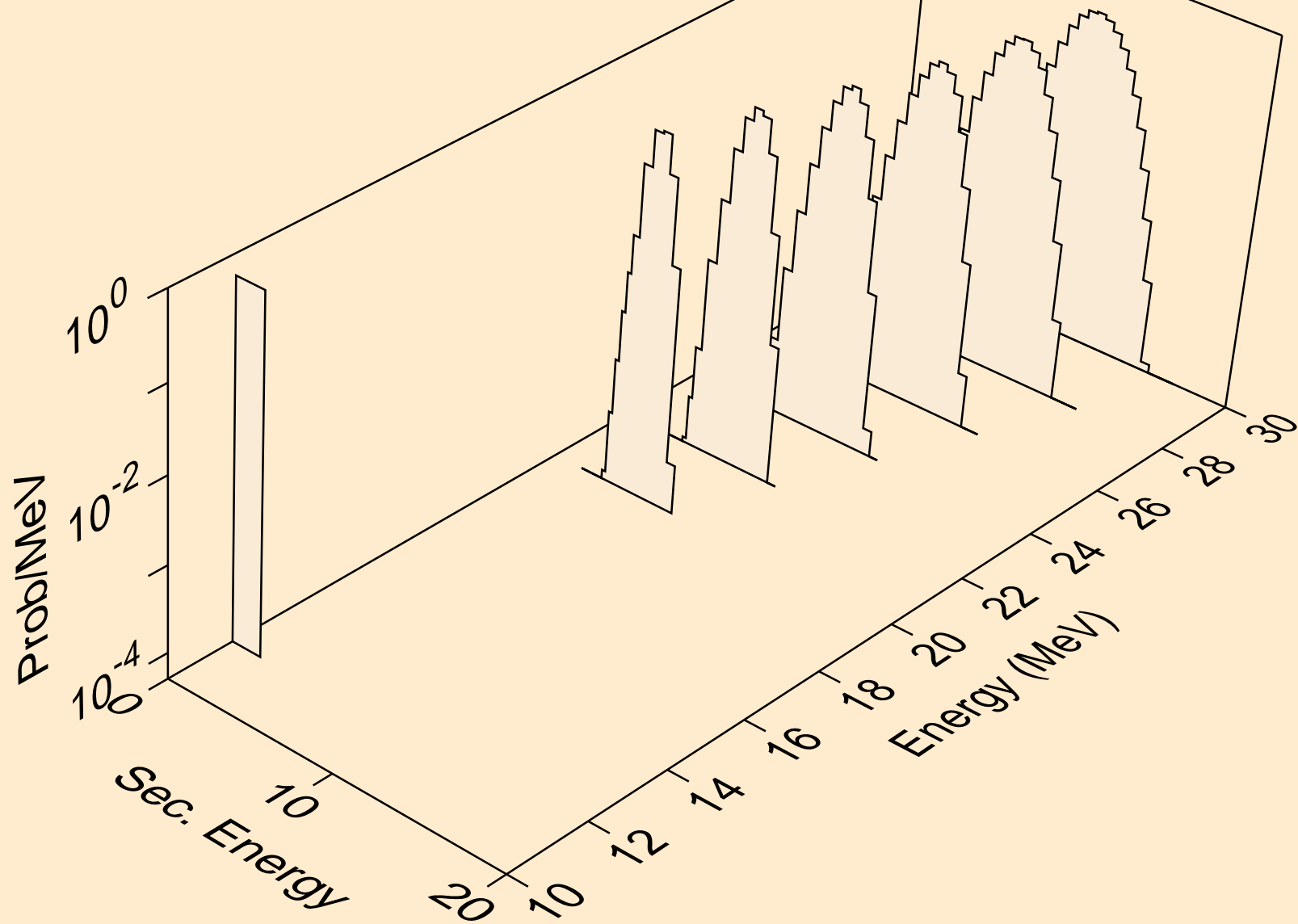

HG196 NEUTRON ACER TENDL-2023 LIBRARY; T=0.K  
he3s from (n,x)

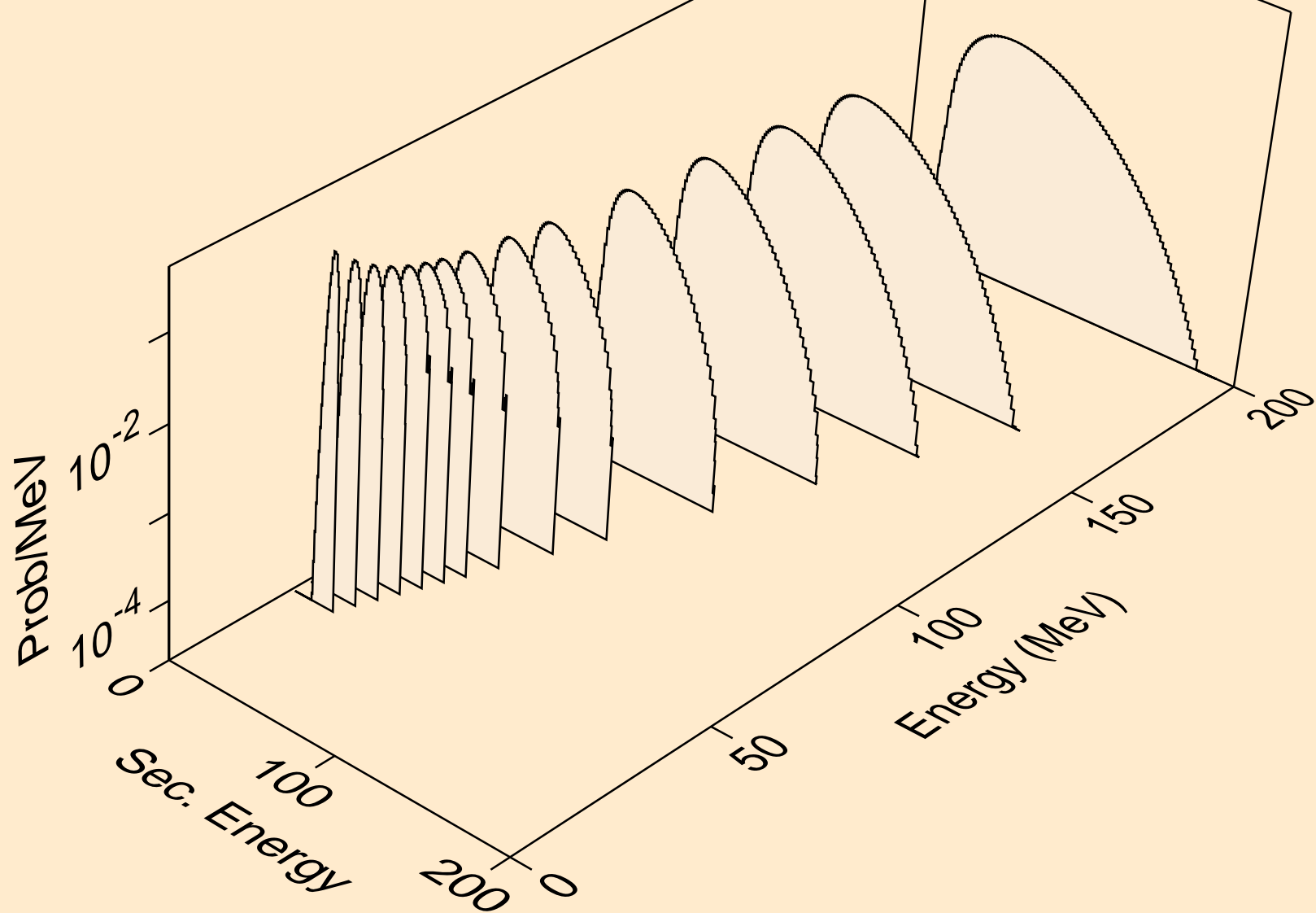

HG196 NEUTRON ACER TENDL-2023 LIBRARY; T=0.K  
he3s from (n,n\*)he3

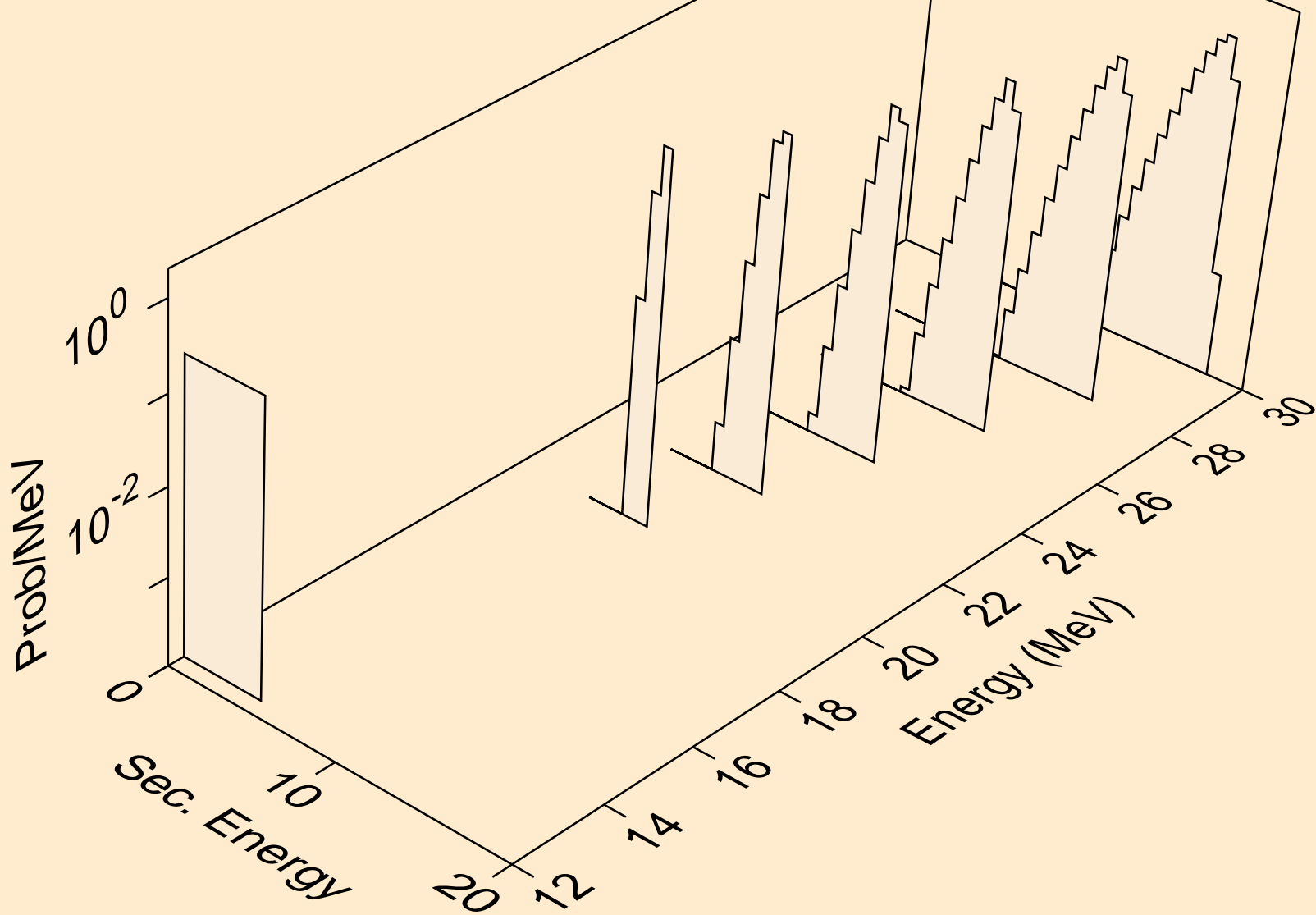

HG196 NEUTRON ACER TENDL-2023 LIBRARY; T=0.K  
he3s from (n,he3)

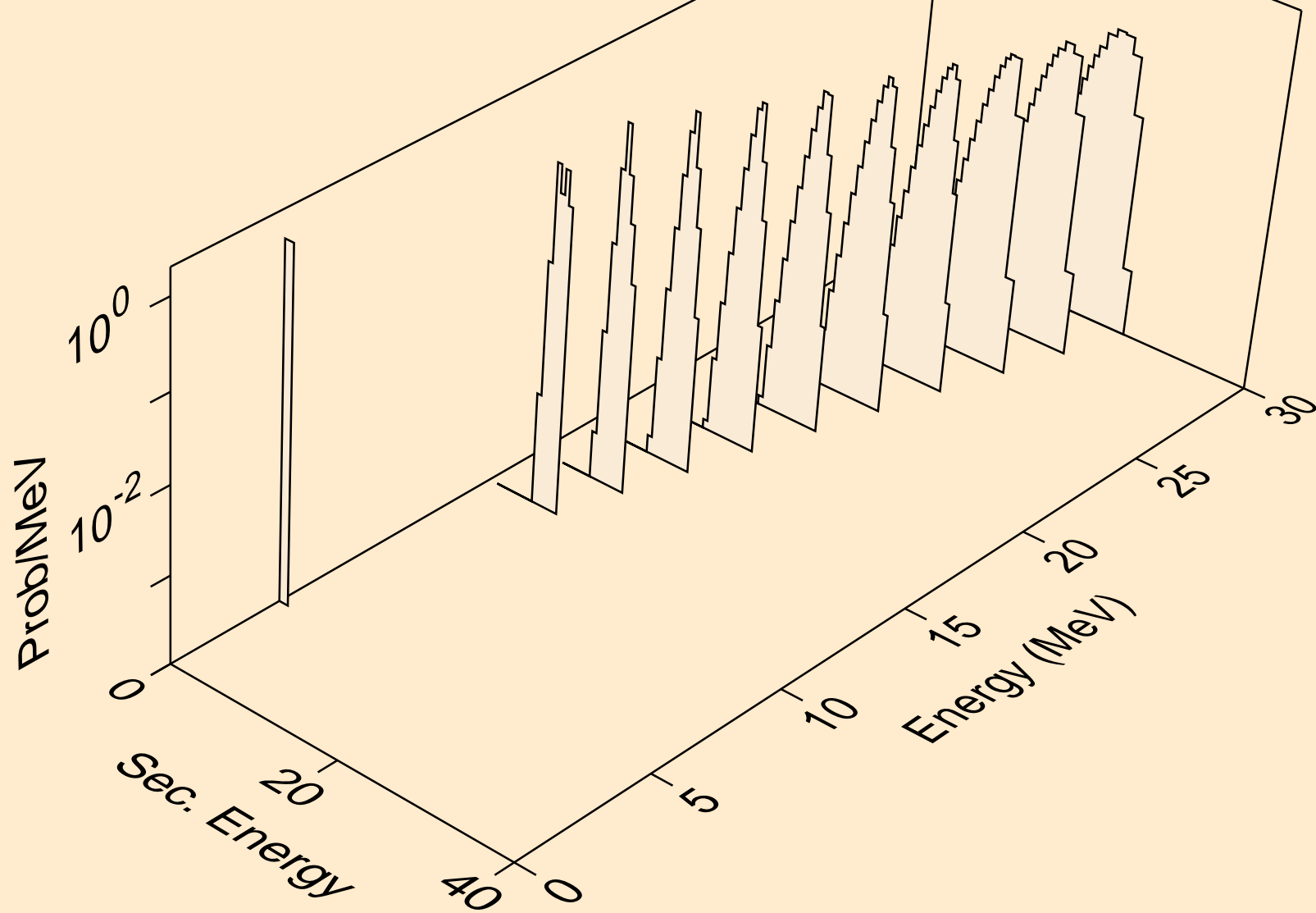

HG196 NEUTRON ACER TENDL-2023 LIBRARY; T=0.K  
alphas from (n,x)

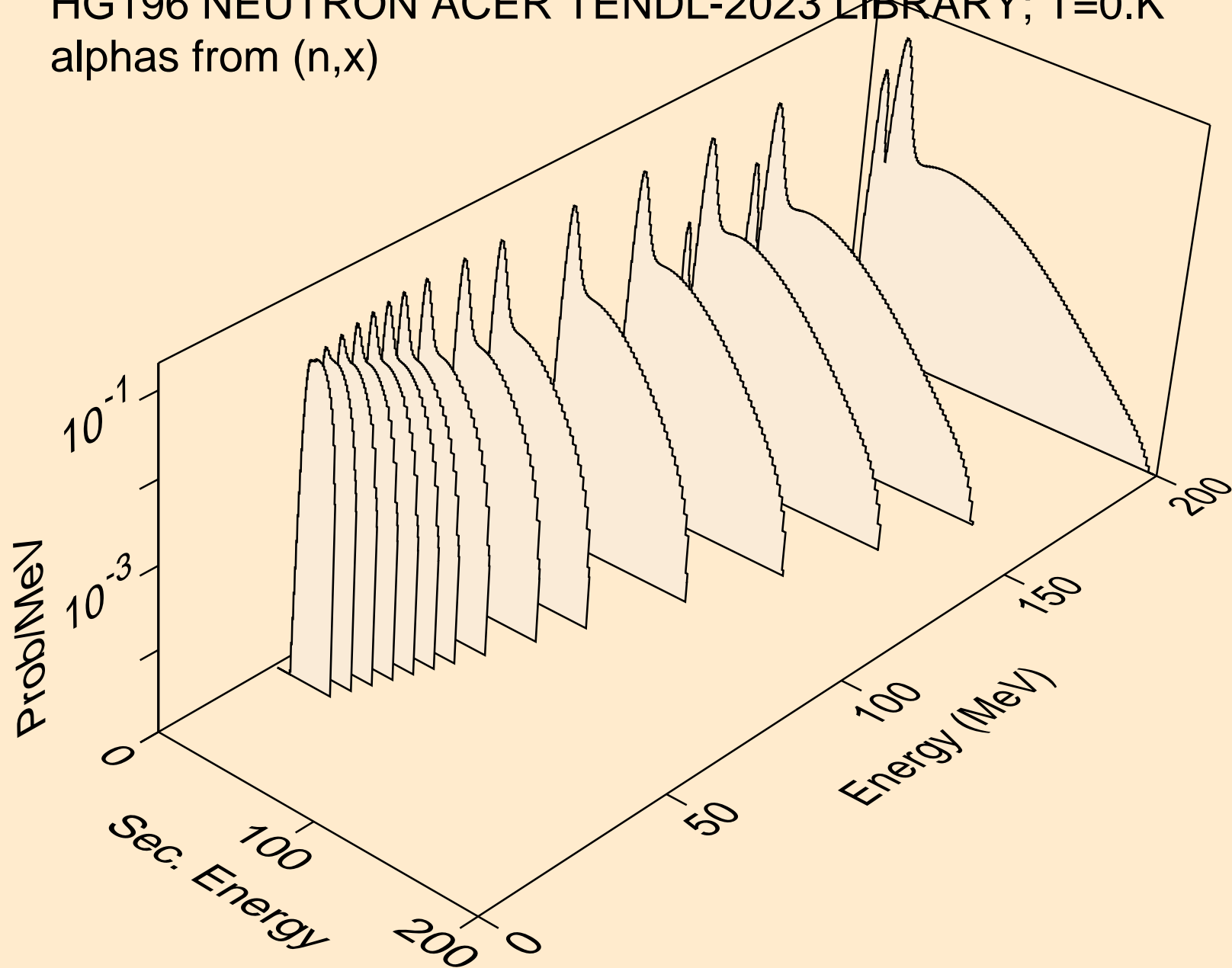



HG196 NEUTRON ACER TENDL-2023 LIBRARY; T=0.K  
alphas from (n,n\*)a

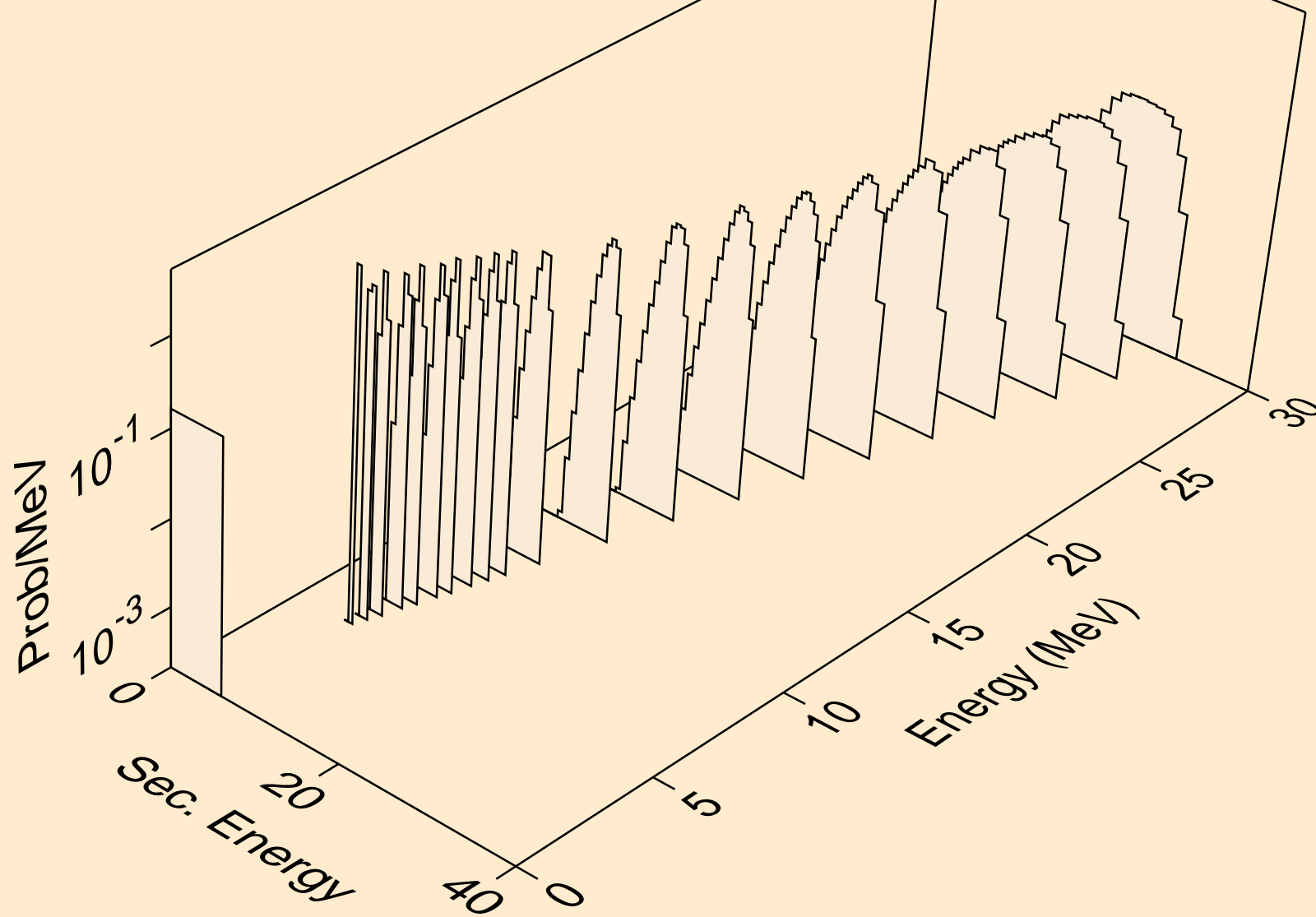

HG196 NEUTRON ACER TENDL-2023 LIBRARY; T=0.K  
alphas from (n,2n)a

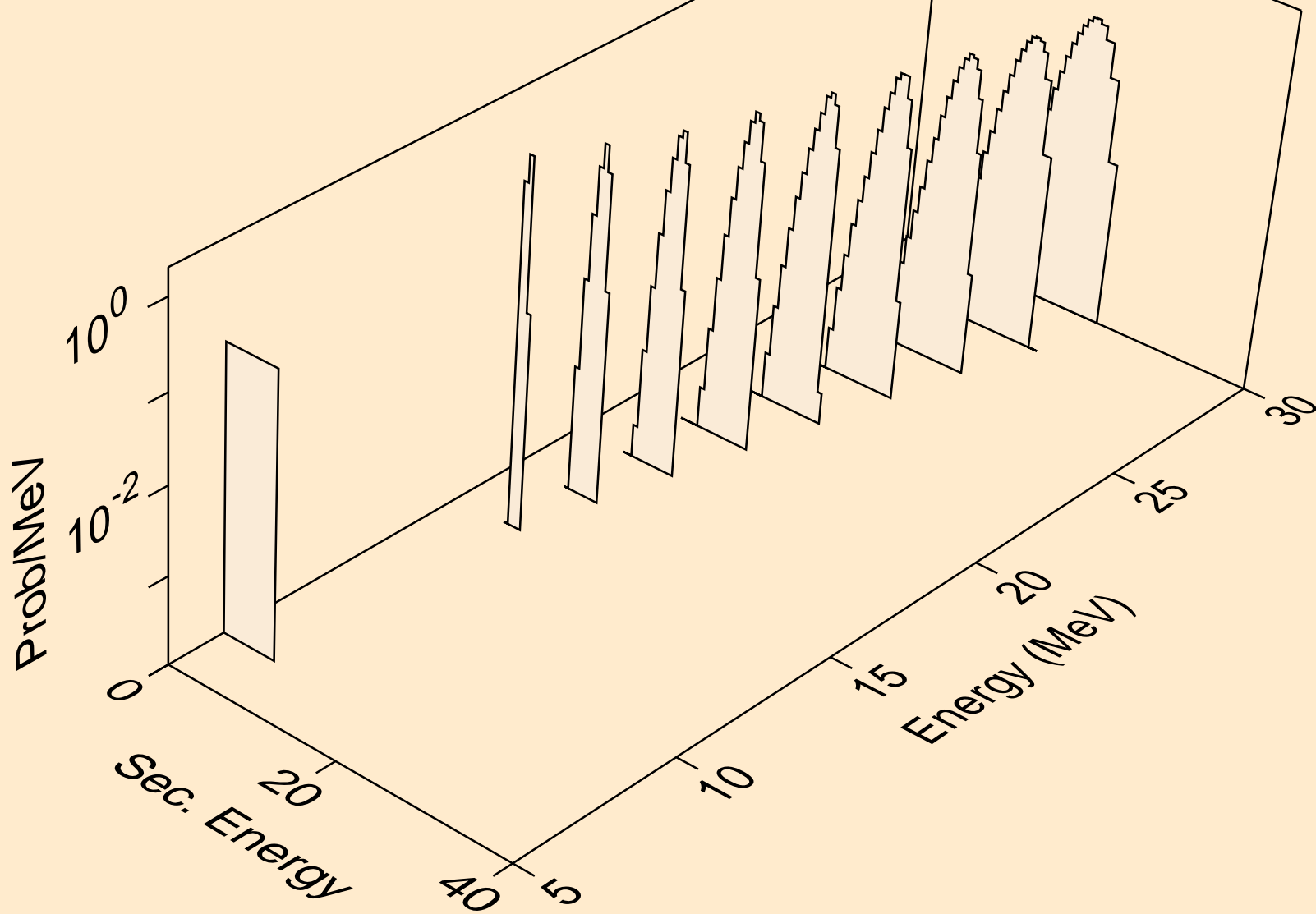

HG196 NEUTRON ACER TENDL-2023 LIBRARY; T=0.K  
alphas from (n,3n)a

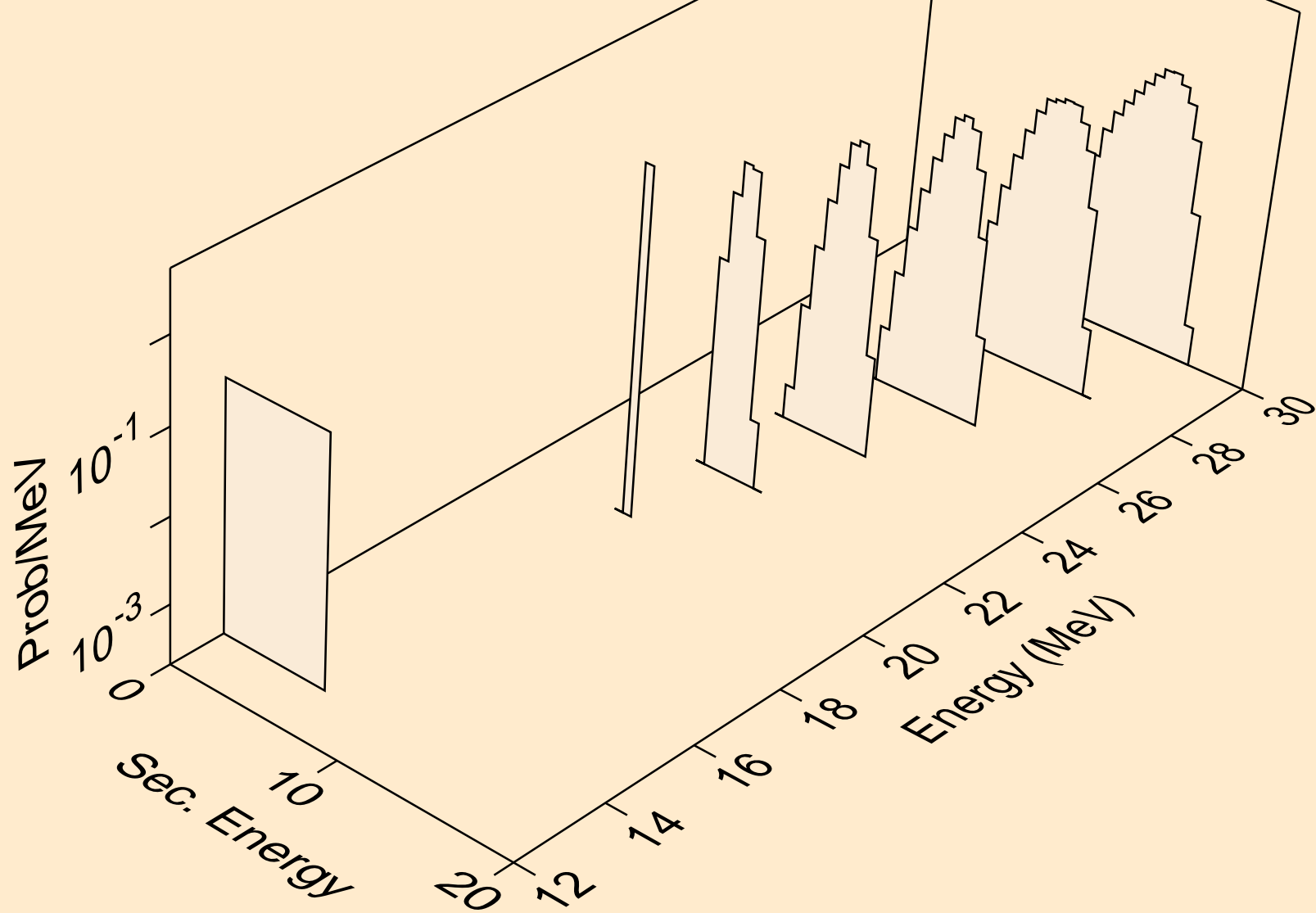

HG196 NEUTRON ACER TENDL-2023 LIBRARY; T=0.K  
alphas from (n,n\*)2a

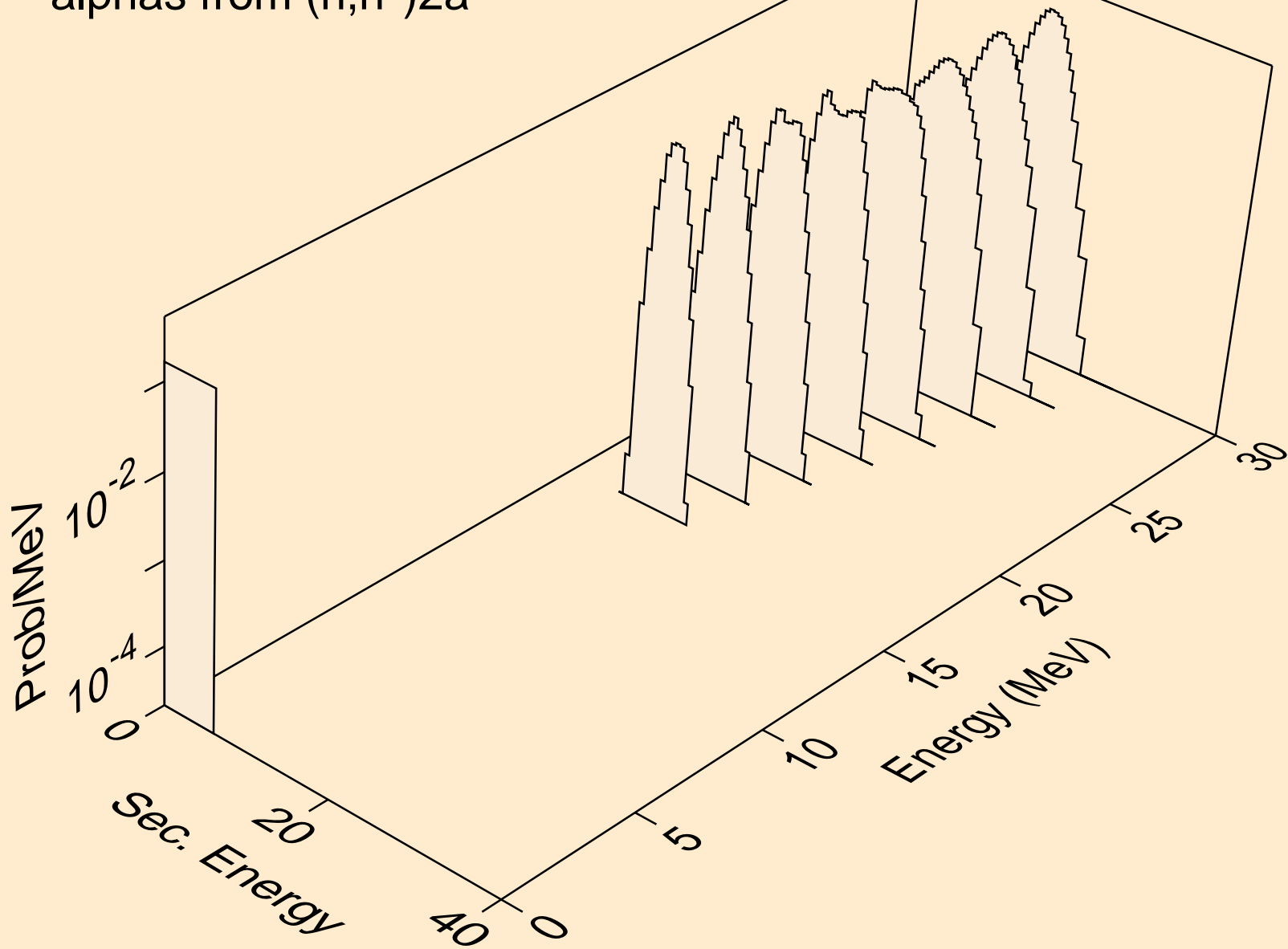

HG196 NEUTRON ACER TENDL-2023 LIBRARY; T=0.K  
alphas from (n,npa)

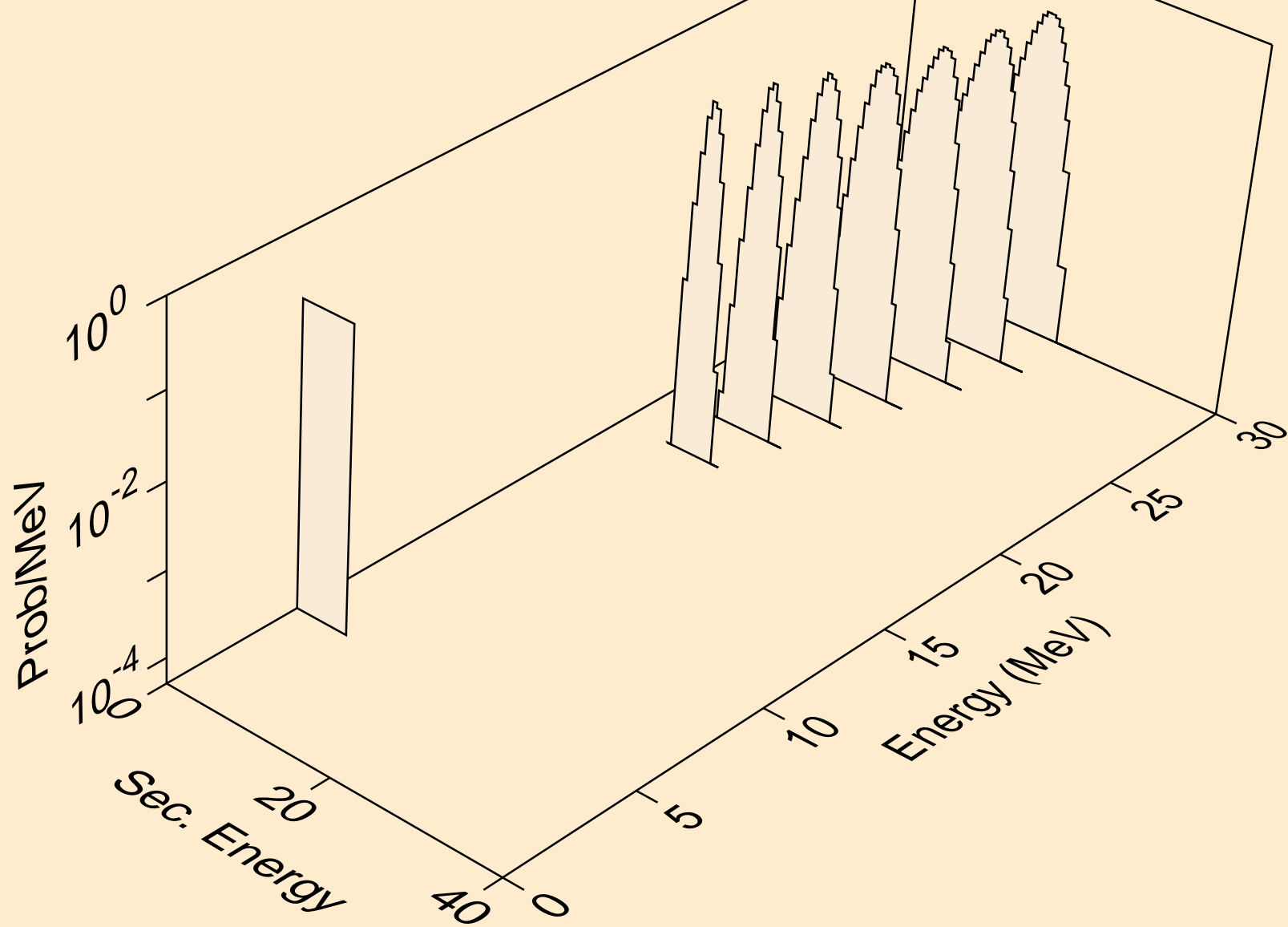

HG196 NEUTRON ACER TENDL-2023 LIBRARY; T=0.K  
alphas from (n,a)

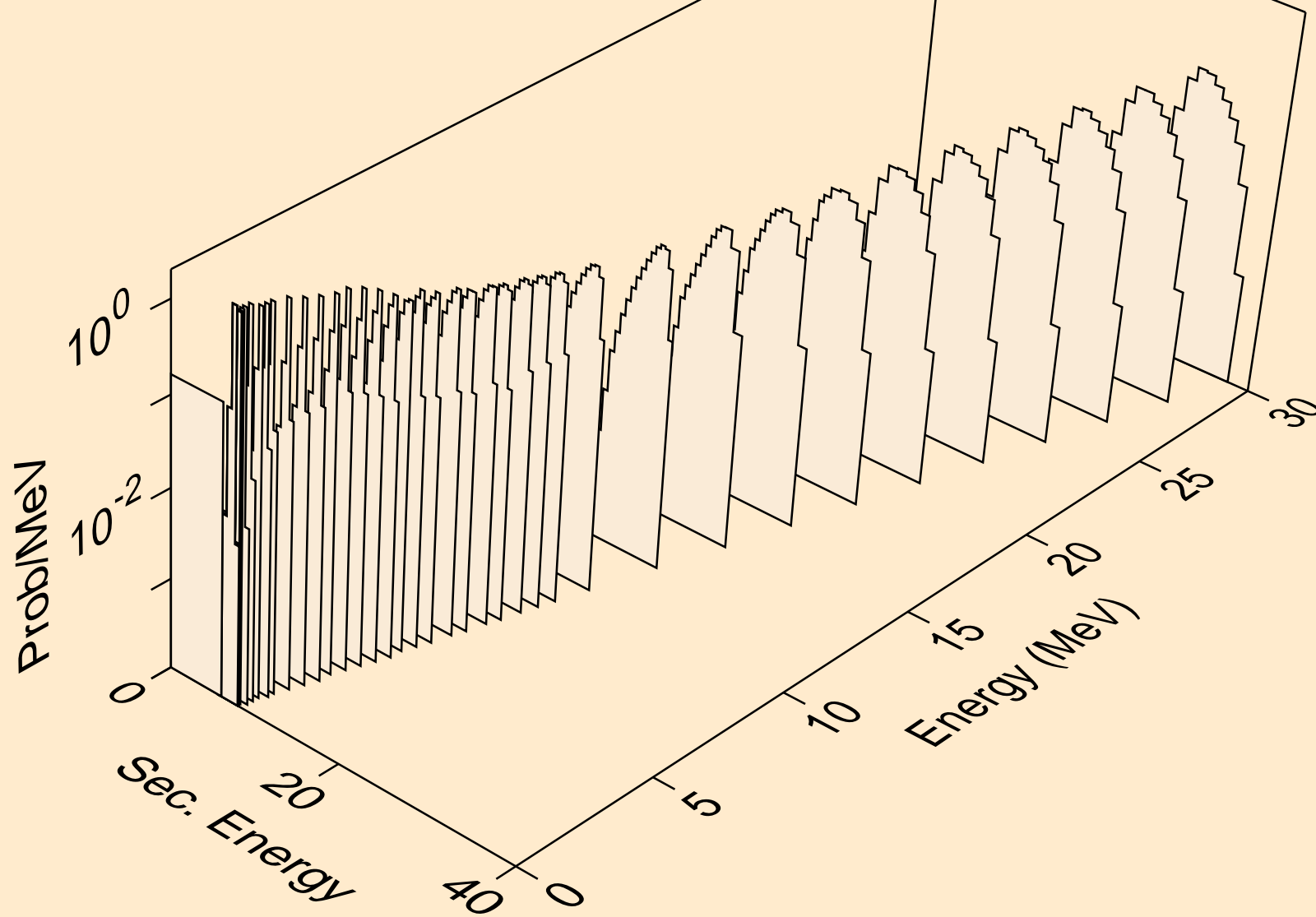

HG196 NEUTRON ACER TENDL-2023 LIBRARY; T=0.K  
alphas from (n,2a)

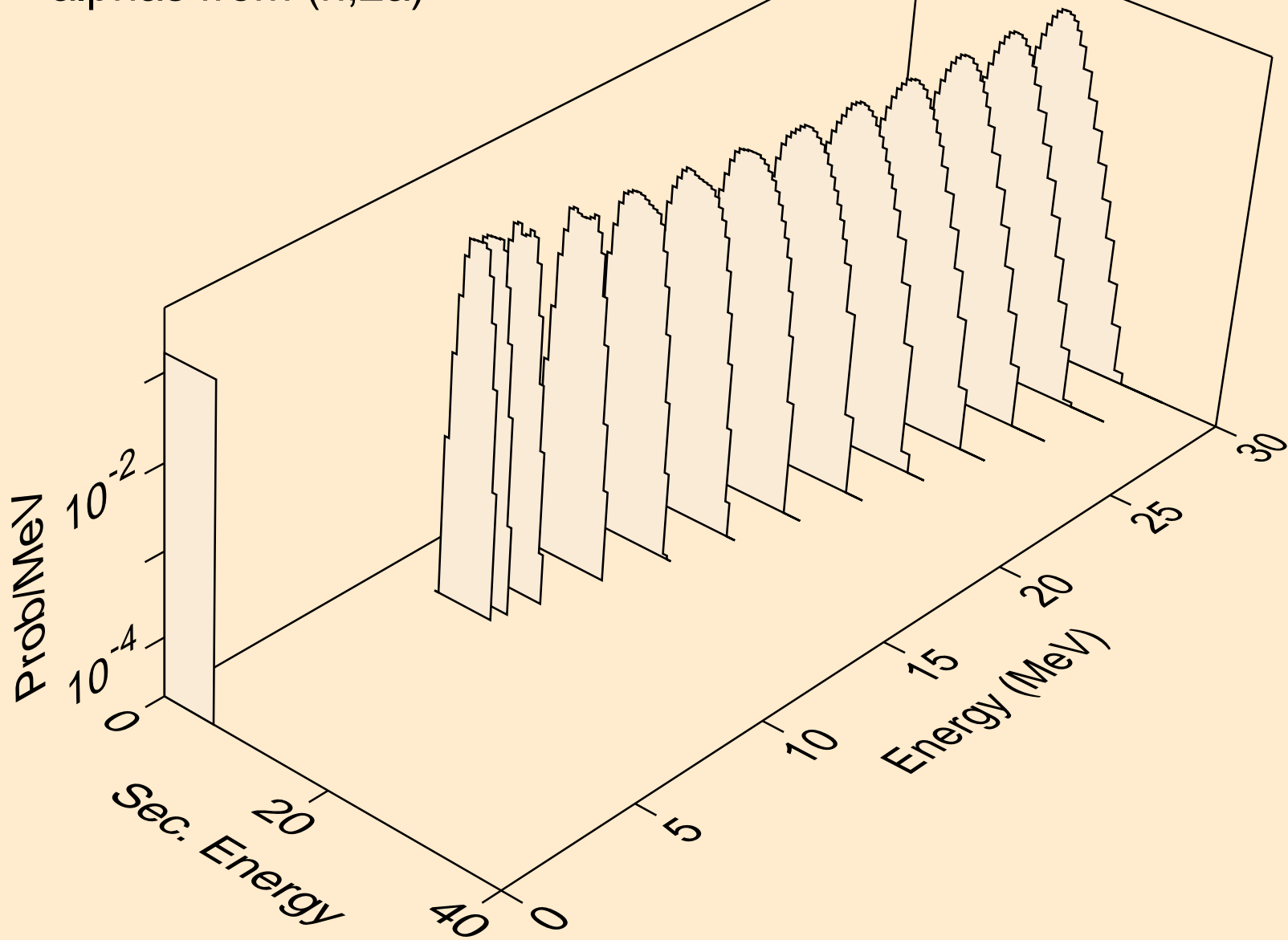

HG196 NEUTRON ACER TENDL-2023 LIBRARY; T=0.K  
alphas from (n,pa)

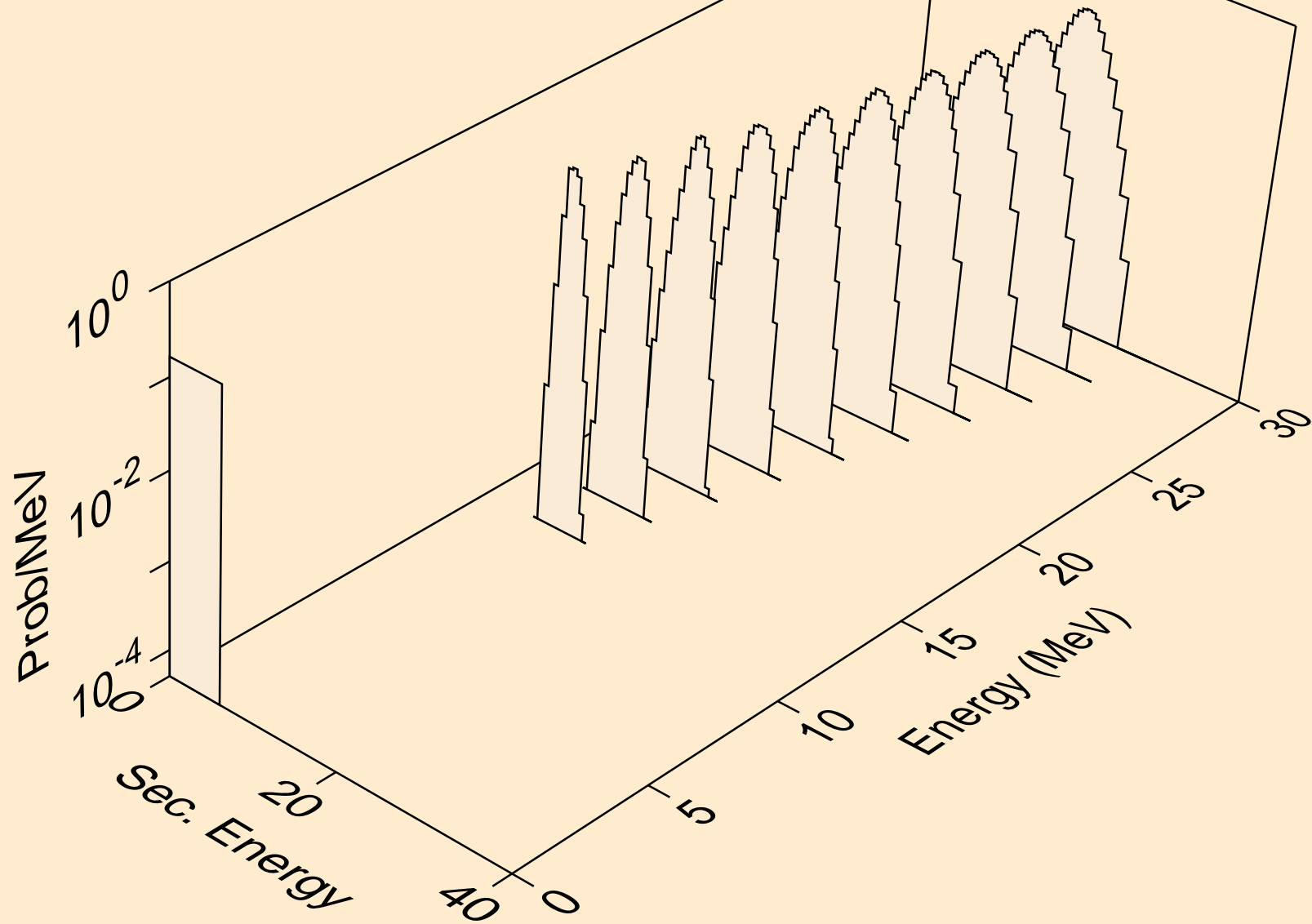



HG196 NEUTRON ACER TENDL-2023 LIBRARY; T=0.K  
alphas from (n,da)

