

HG197M NEUTRON ACER TENDL-2023 LIBRARY; T=0.K

Principal cross sections

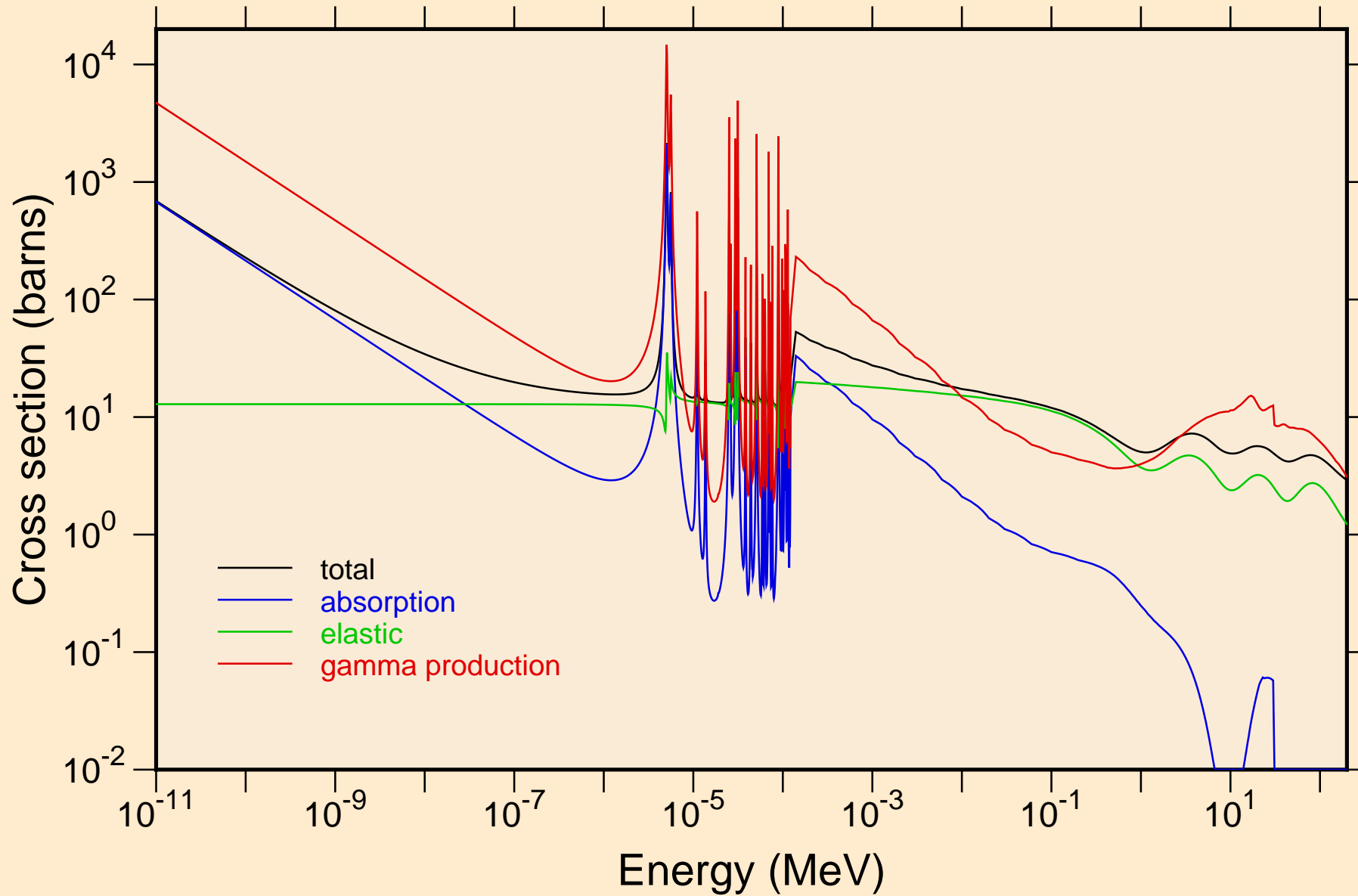

HG197M NEUTRON ACER TENDL-2023 LIBRARY; T=0.K
resonance total cross section

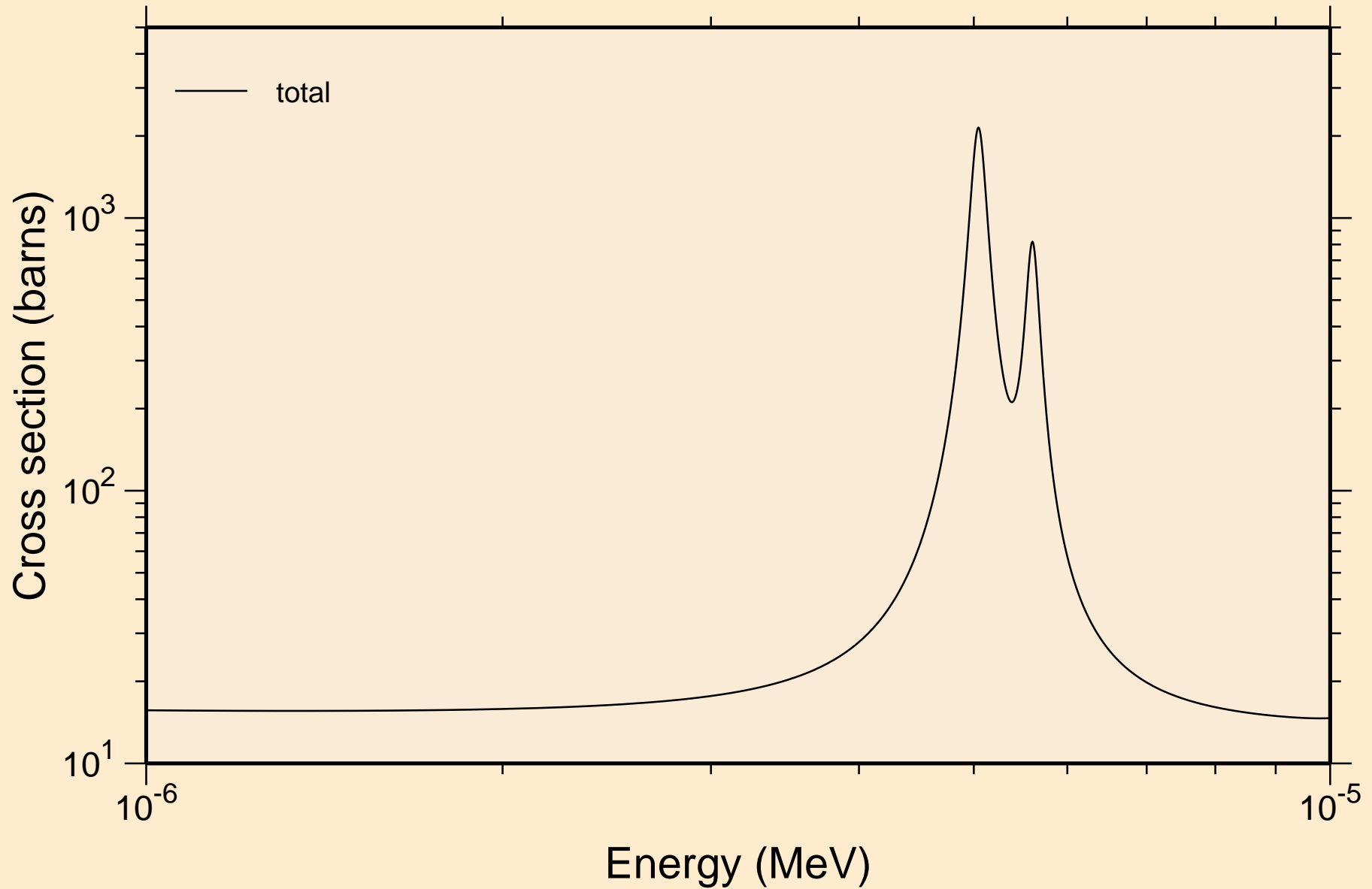

HG197M NEUTRON ACER TENDL-2023 LIBRARY; T=0.K
resonance total cross section

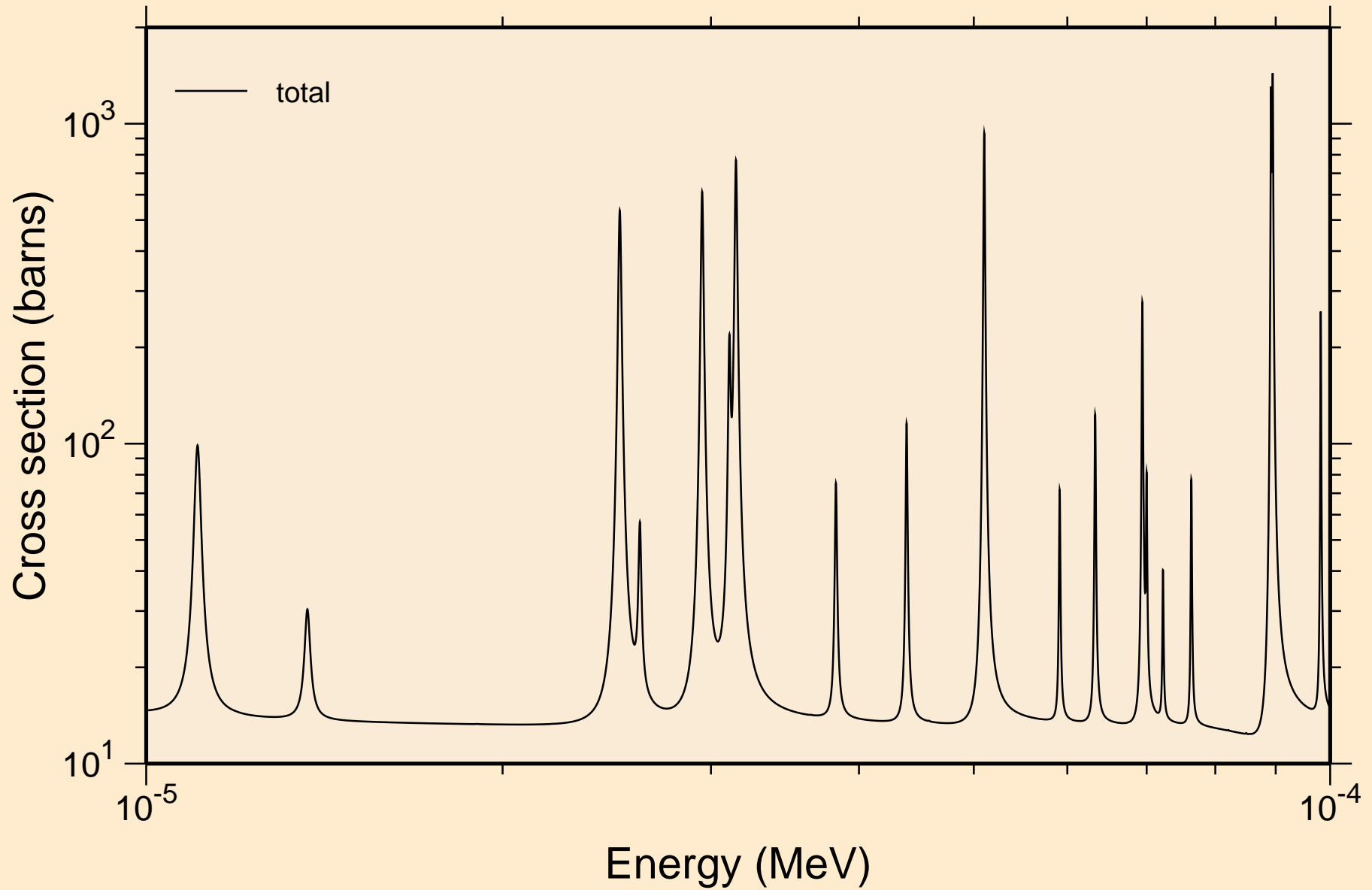

HG197M NEUTRON ACER TENDL-2023 LIBRARY; T=0.K
resonance total cross section

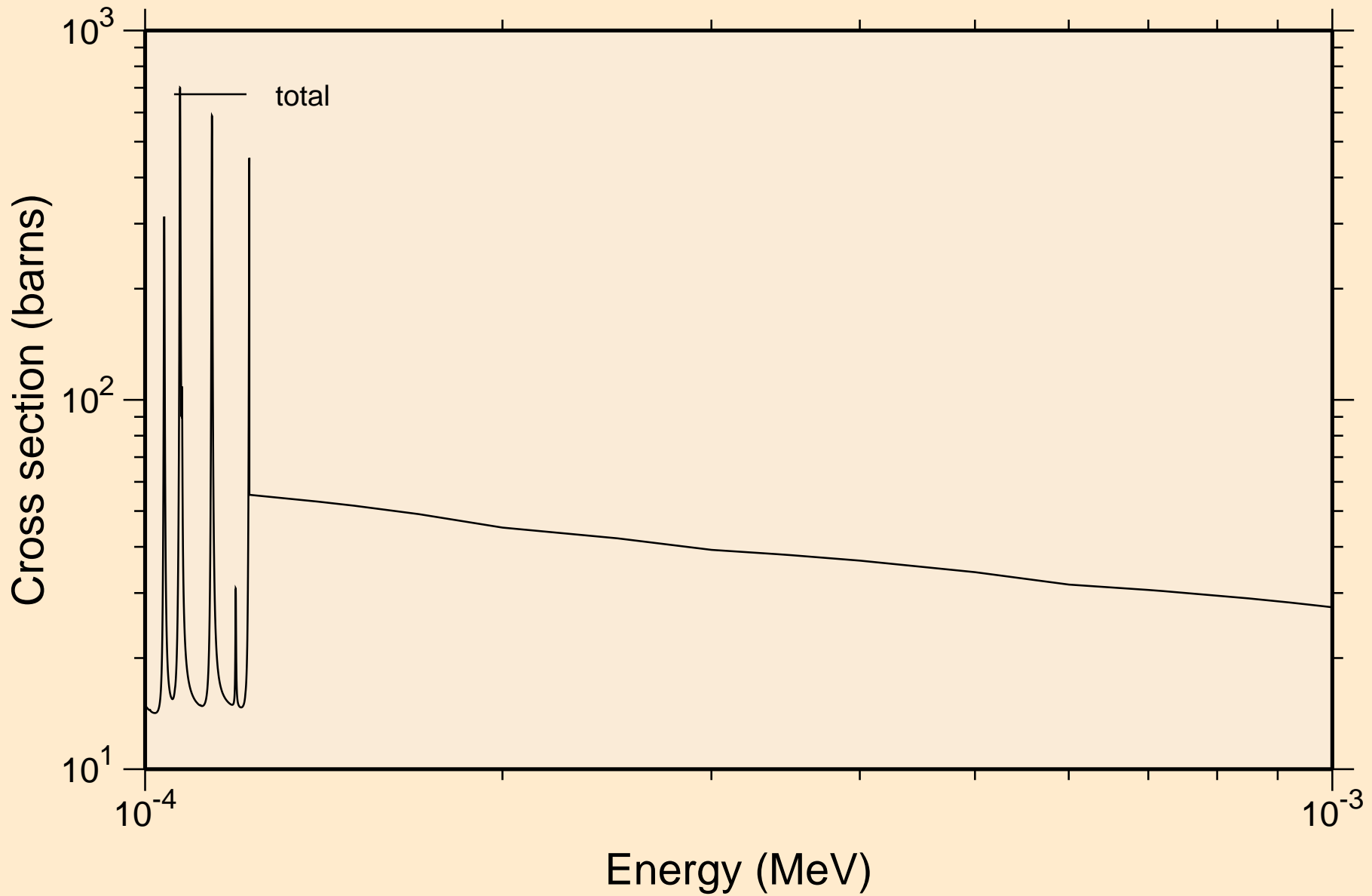

HG197M NEUTRON ACER TENDL-2023 LIBRARY; T=0.K
resonance total cross section

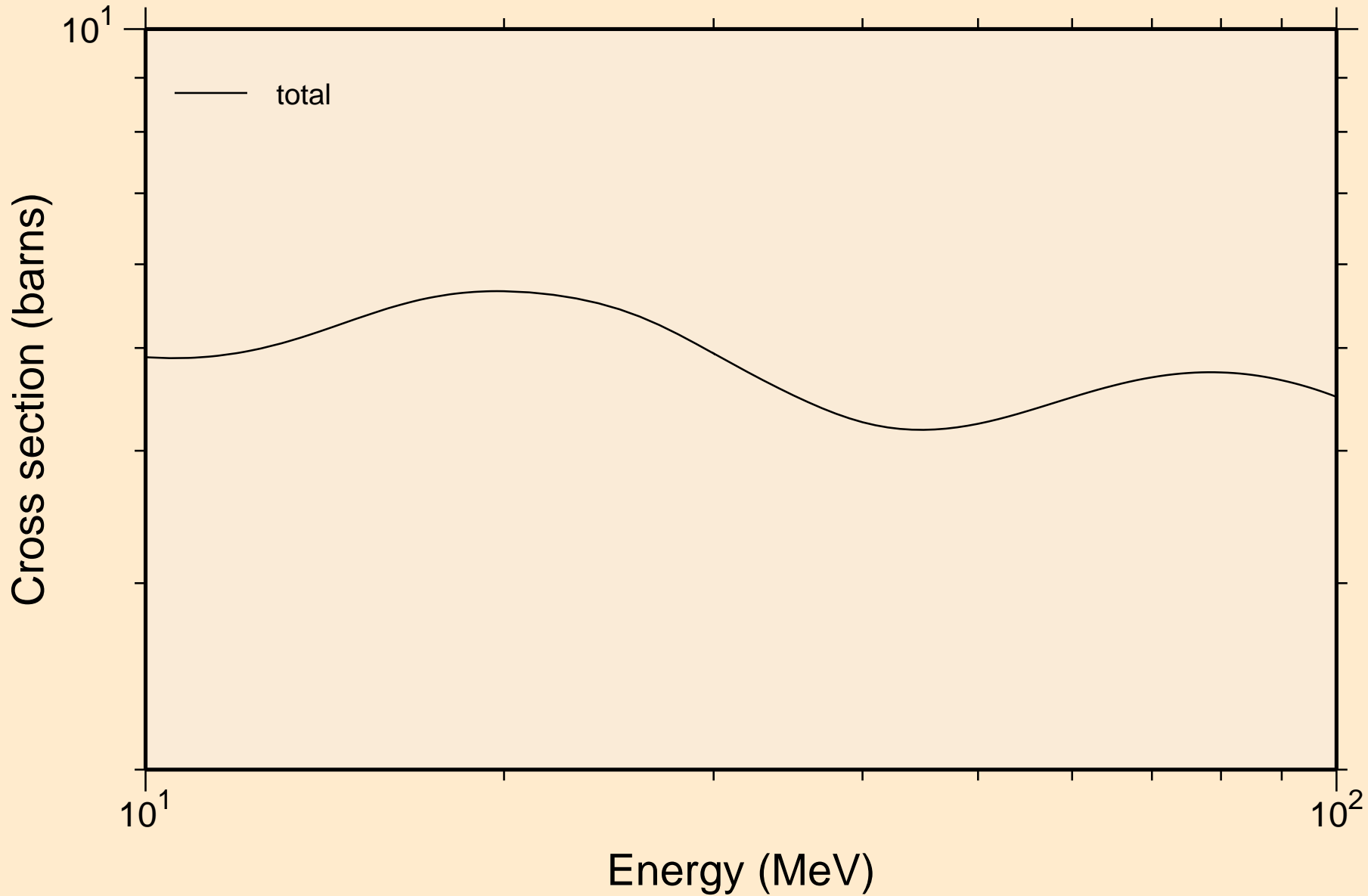

HG197M NEUTRON ACER TENDL-2023 LIBRARY; T=0.K
resonance absorption cross sections

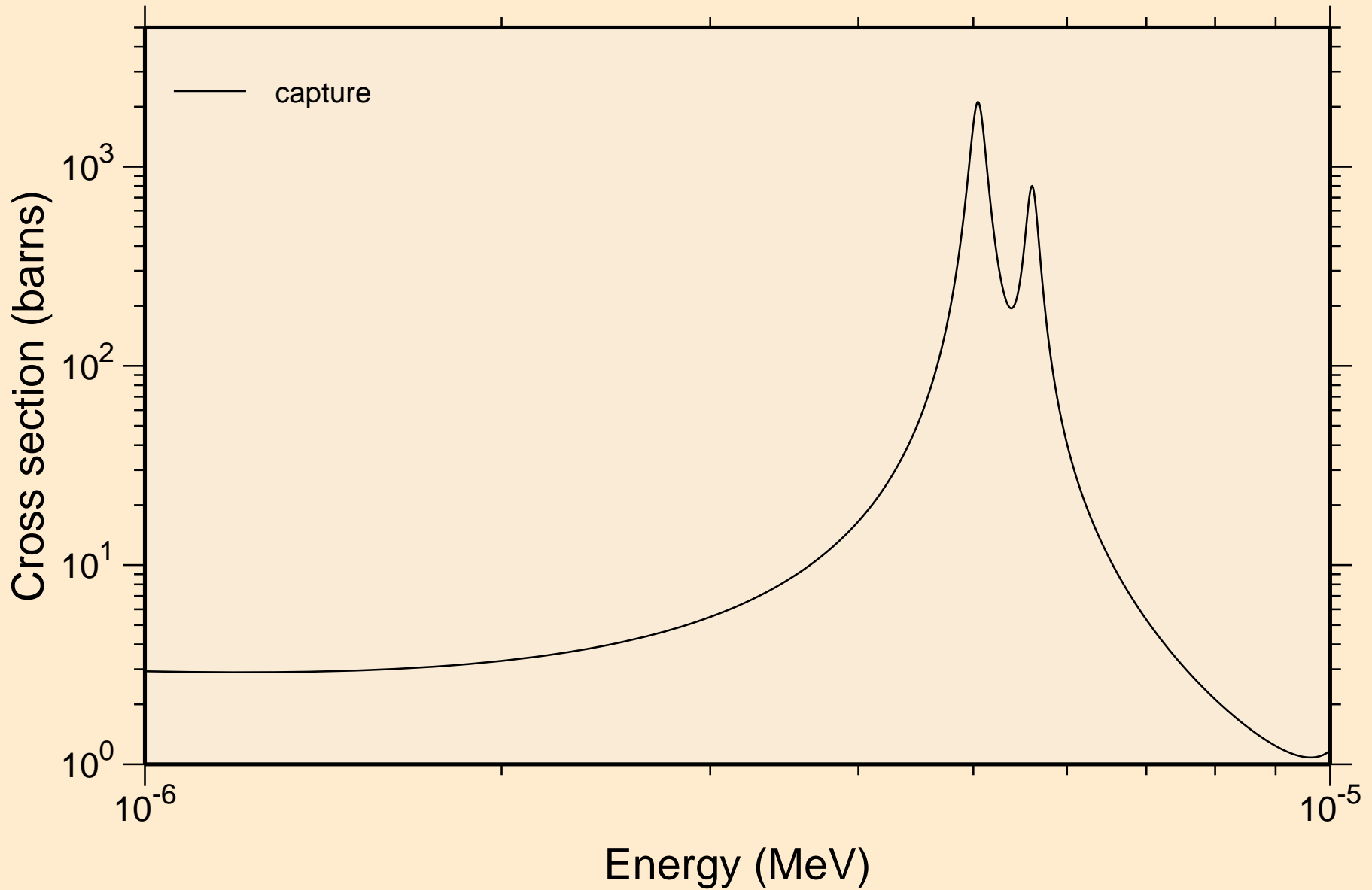

HG197M NEUTRON ACER TENDL-2023 LIBRARY; T=0.K
resonance absorption cross sections

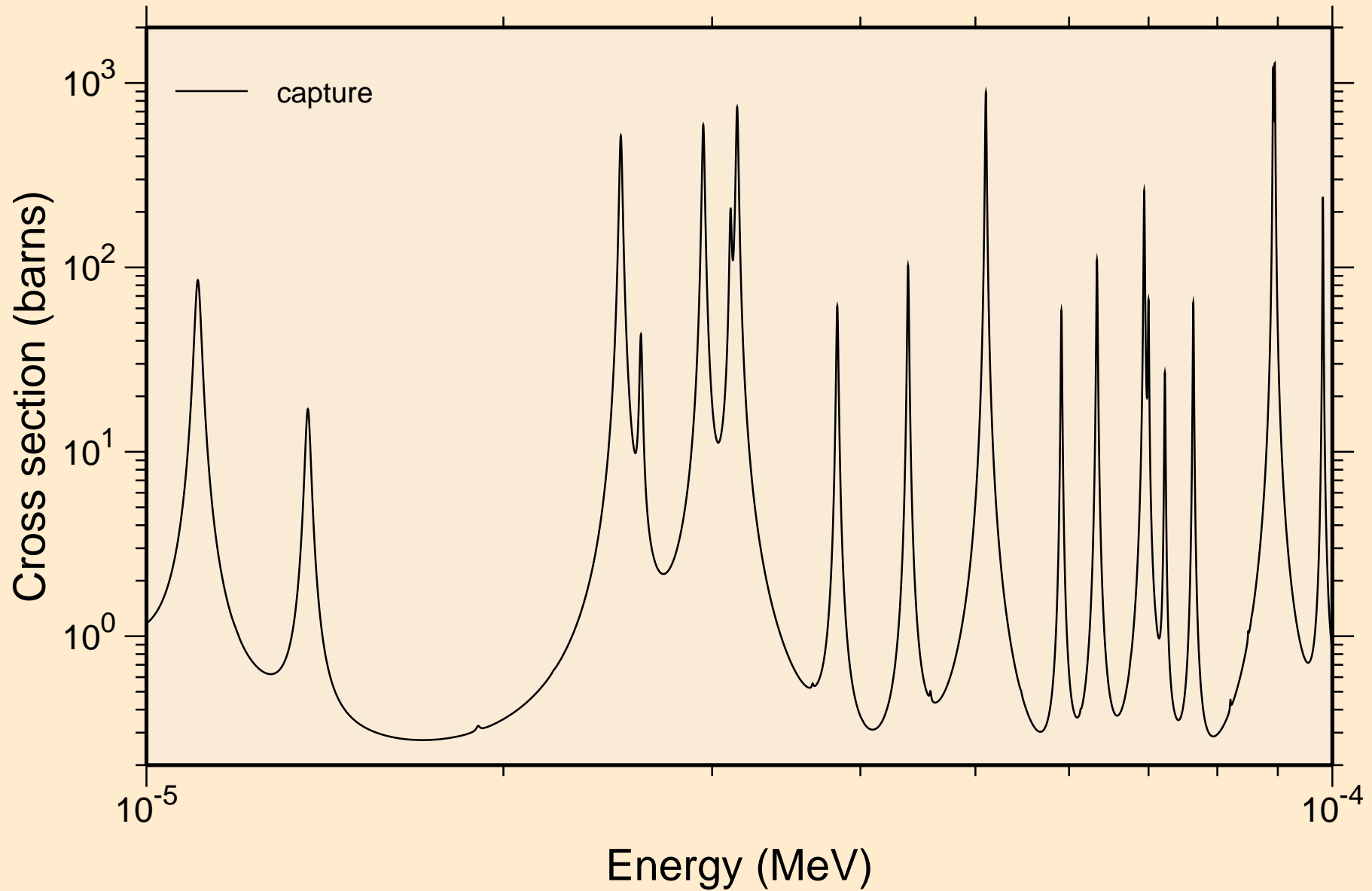

HG197M NEUTRON ACER TENDL-2023 LIBRARY; T=0.K
resonance absorption cross sections

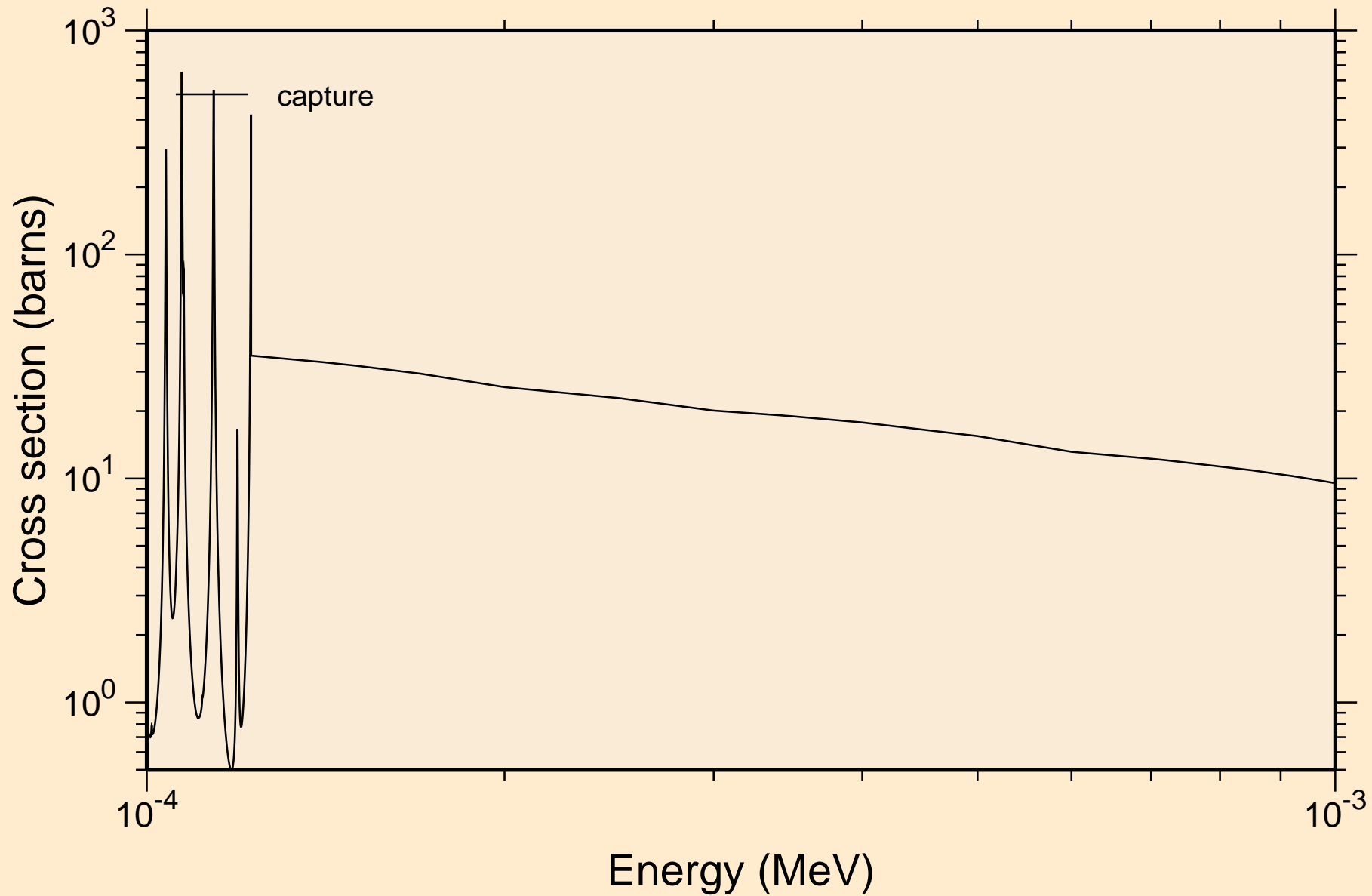

HG197M NEUTRON ACER TENDL-2023 LIBRARY; T=0.K
resonance absorption cross sections

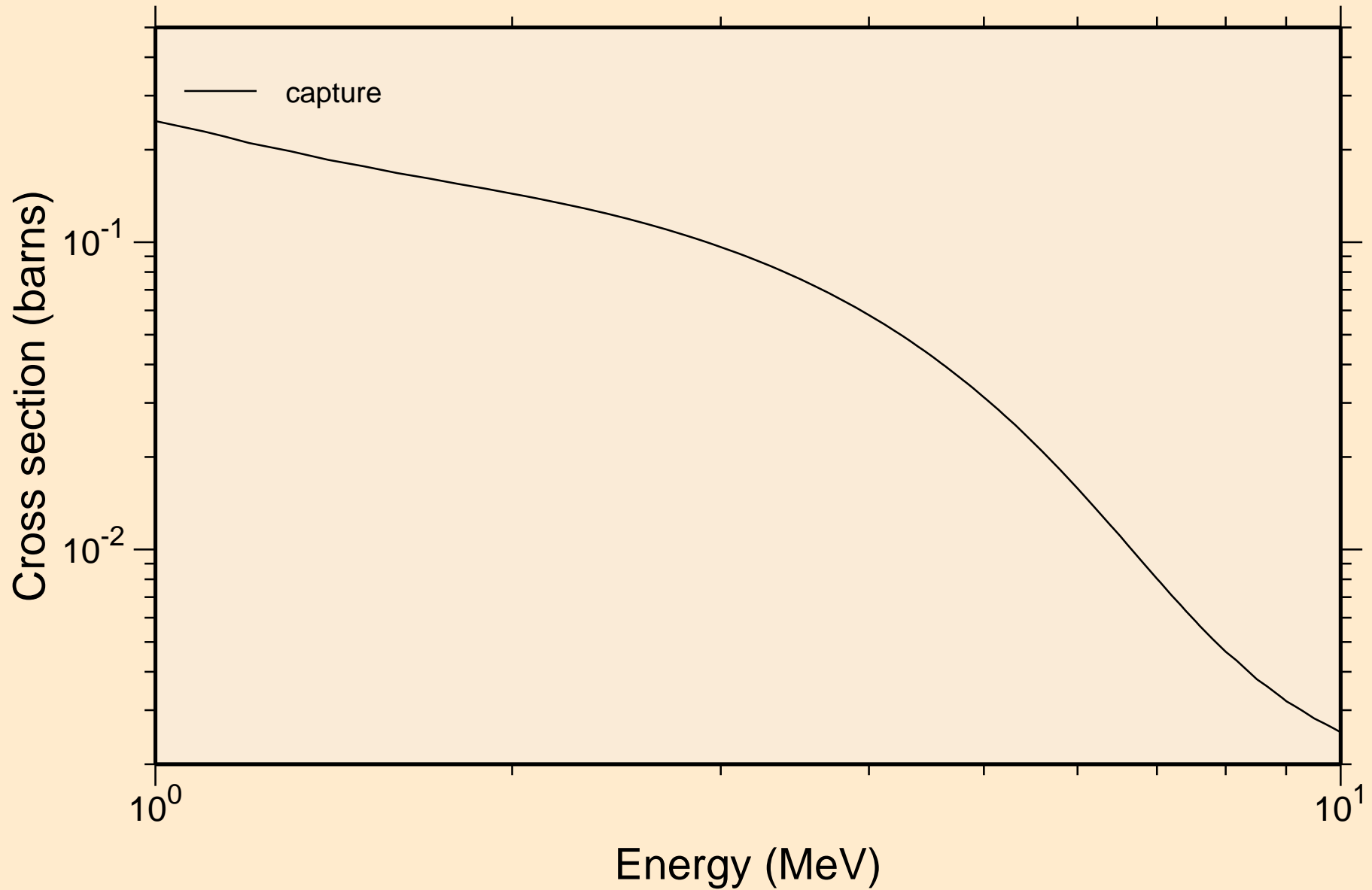

HG197M NEUTRON ACER TENDL-2023 LIBRARY; T=0.K
Heating

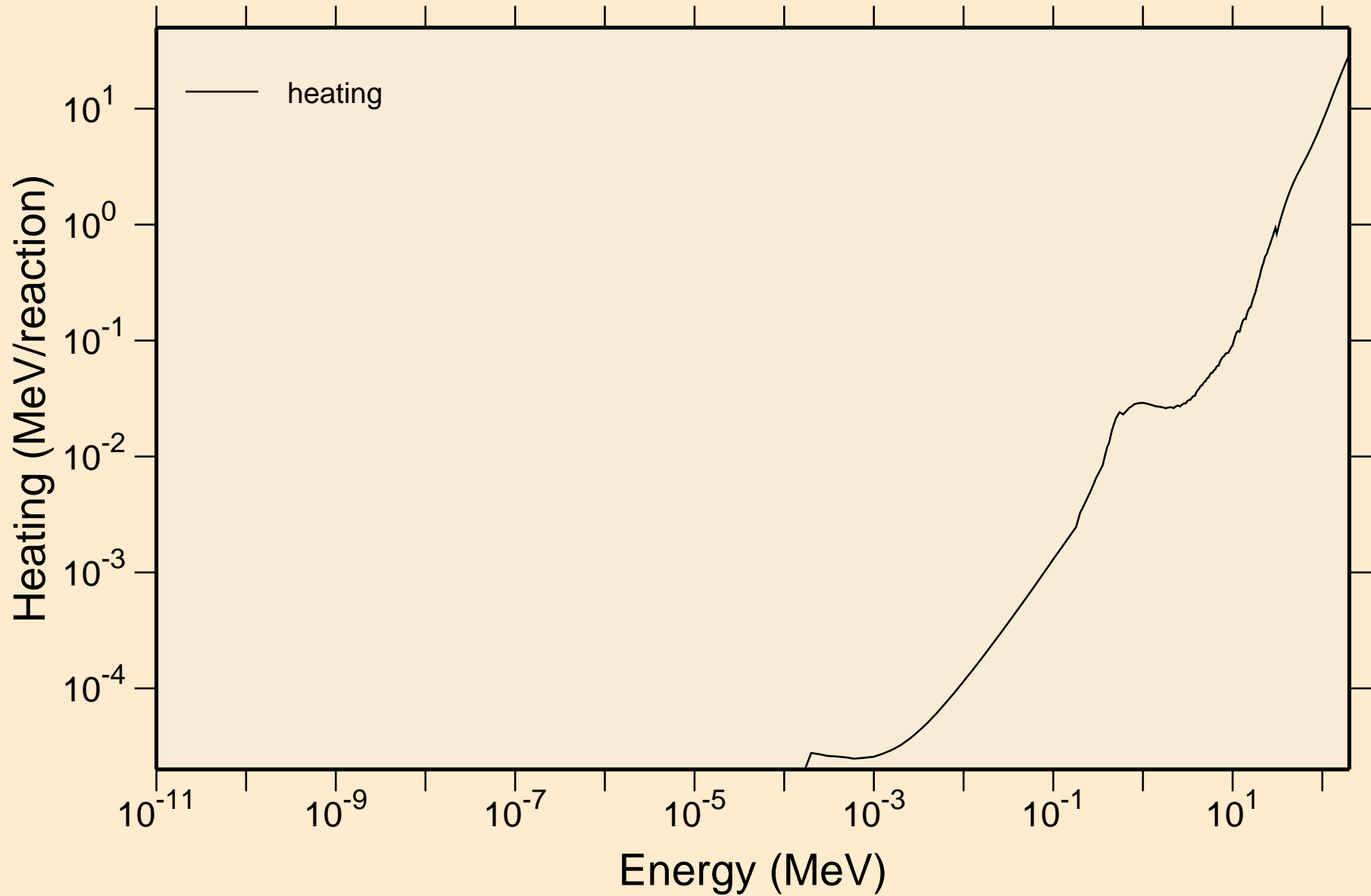

HG197M NEUTRON ACER TENDL-2023 LIBRARY; T=0.K

Damage

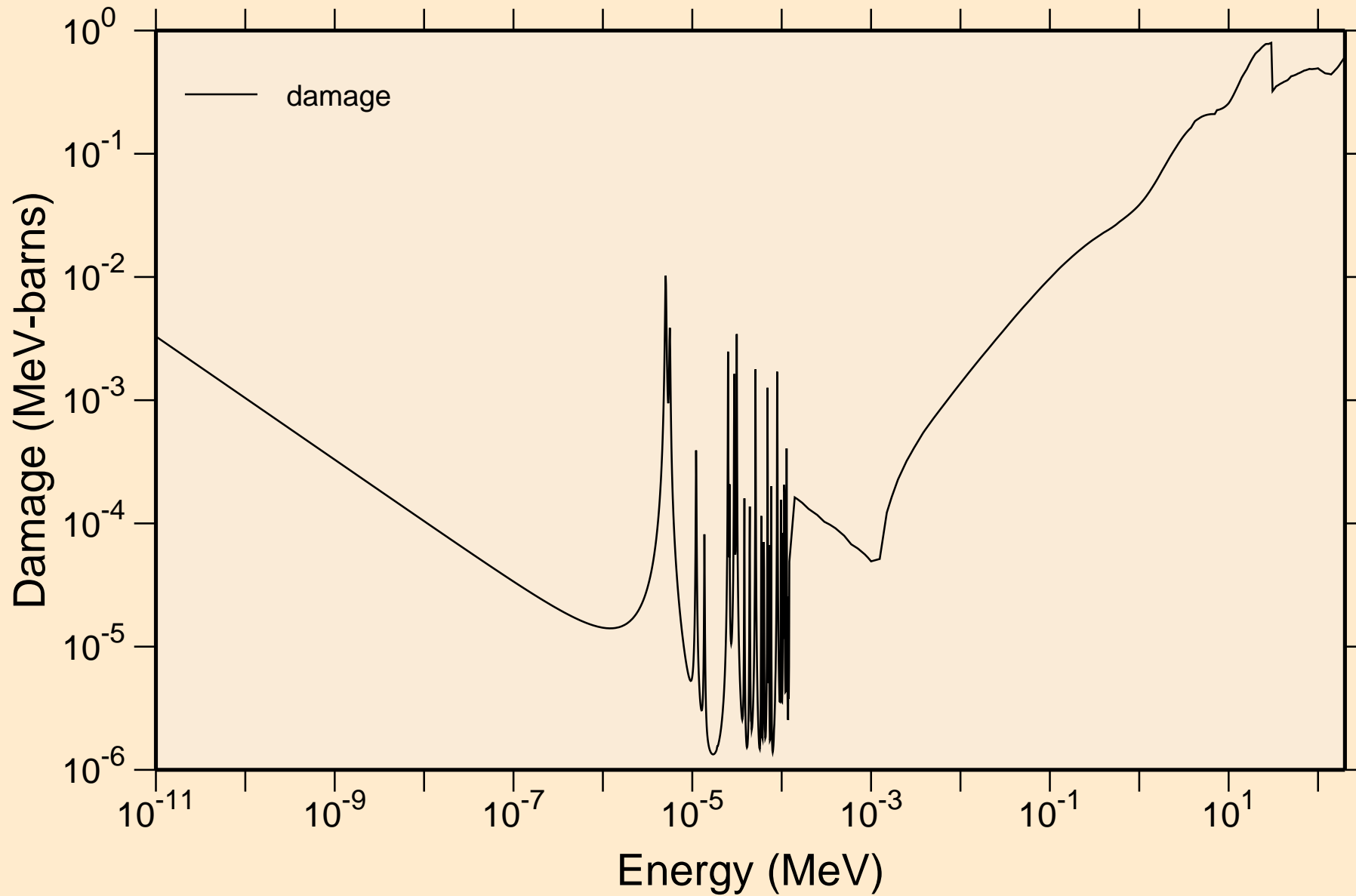

HG197M NEUTRON ACER TENDL-2023 LIBRARY; T=0.K

Non-threshold reactions

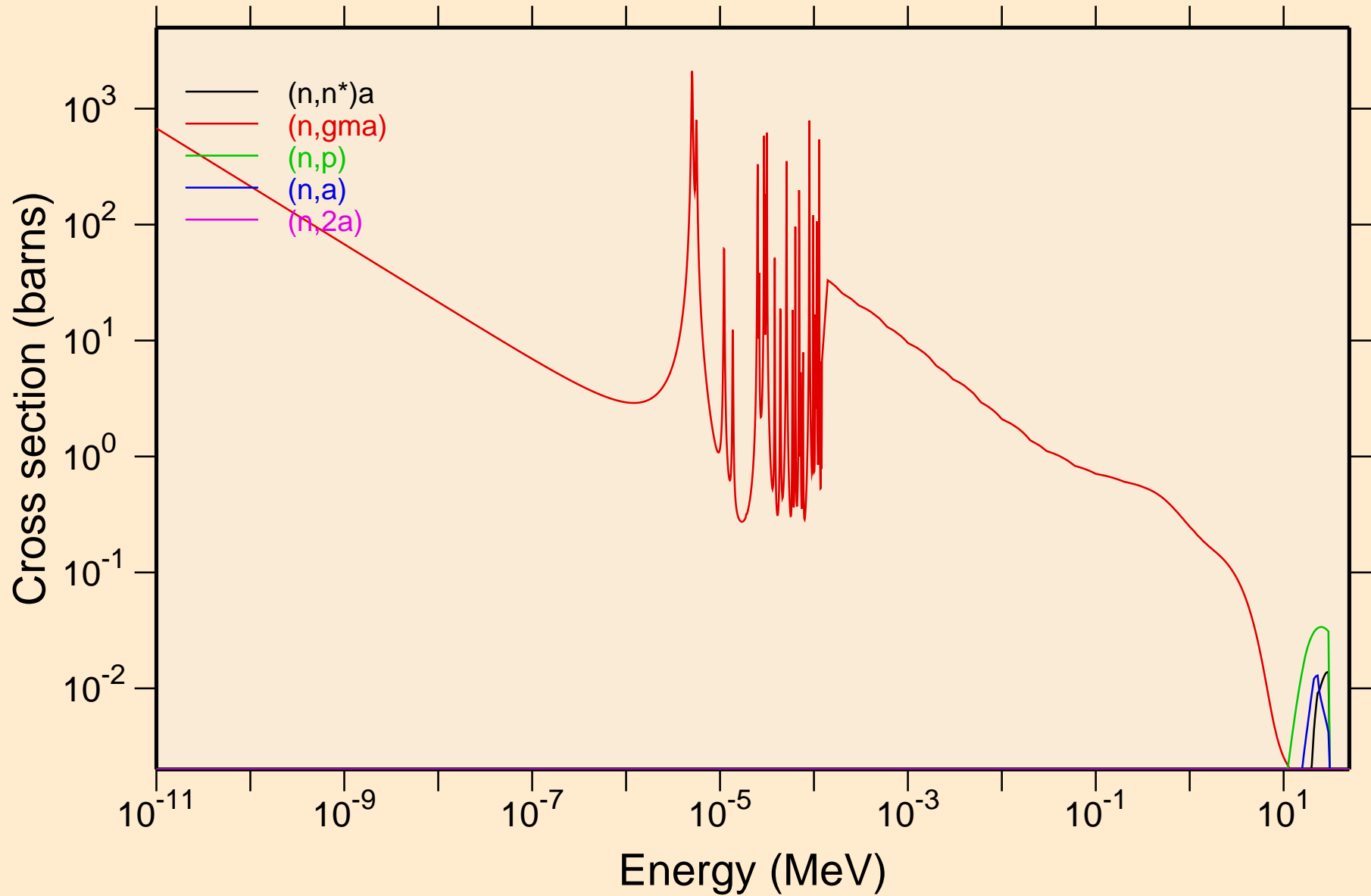

HG197M NEUTRON ACER TENDL-2023 LIBRARY; T=0.K
Non-threshold reactions

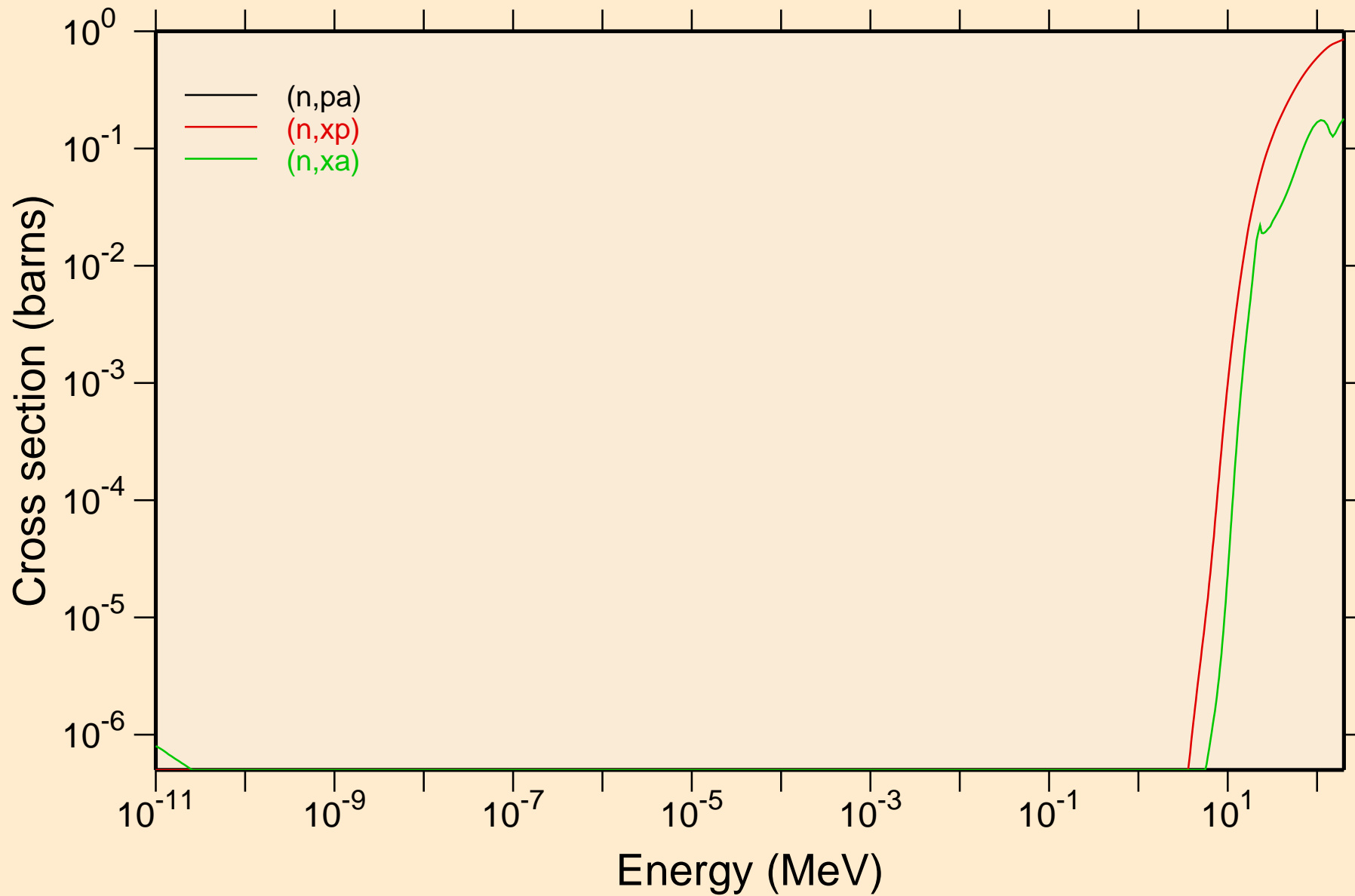

HG197M NEUTRON ACER TENDL-2023 LIBRARY; T=0.K

Principal cross sections

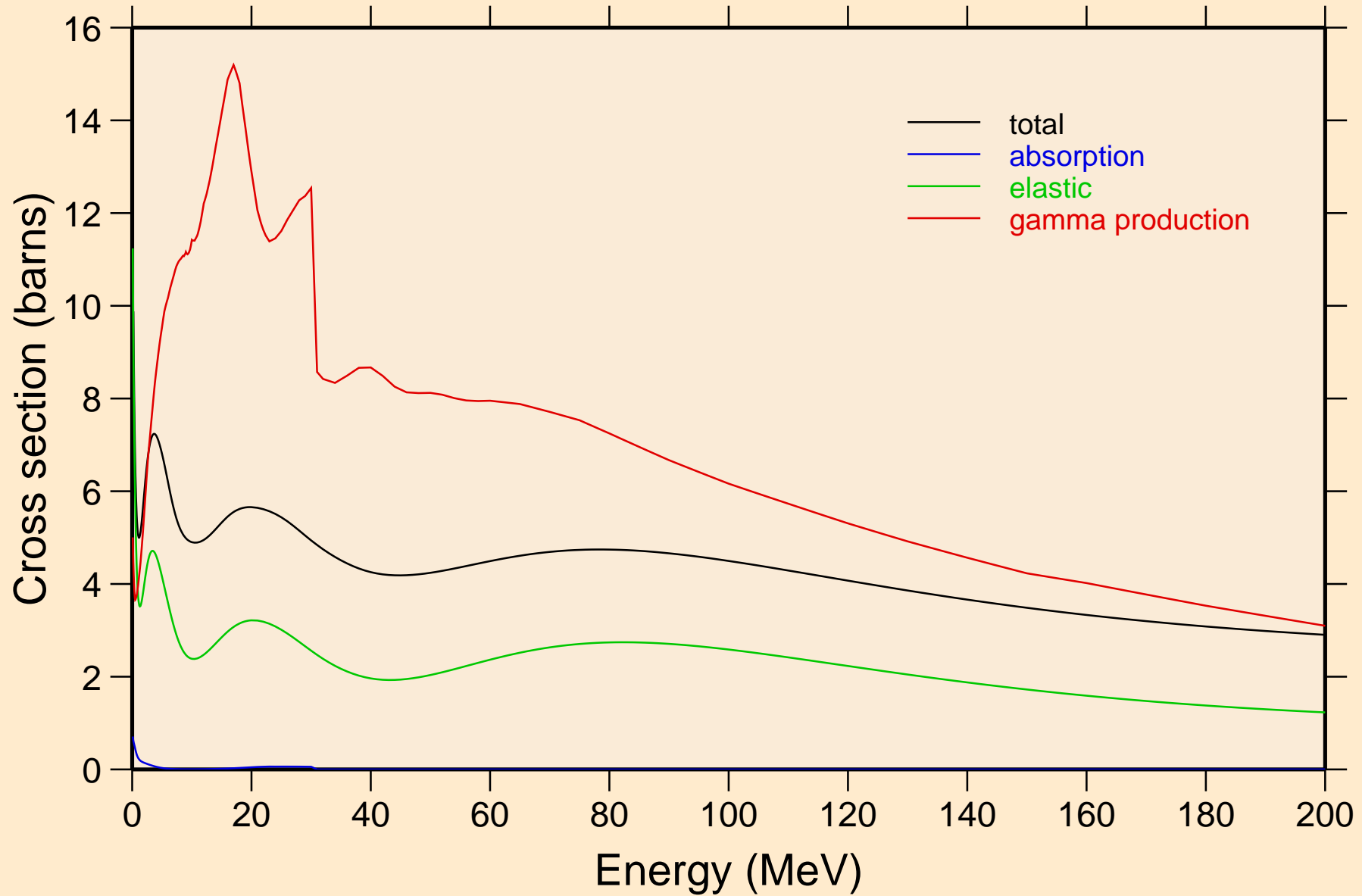

HG197M NEUTRON ACER TENDL-2023 LIBRARY; T=0.K

Heating

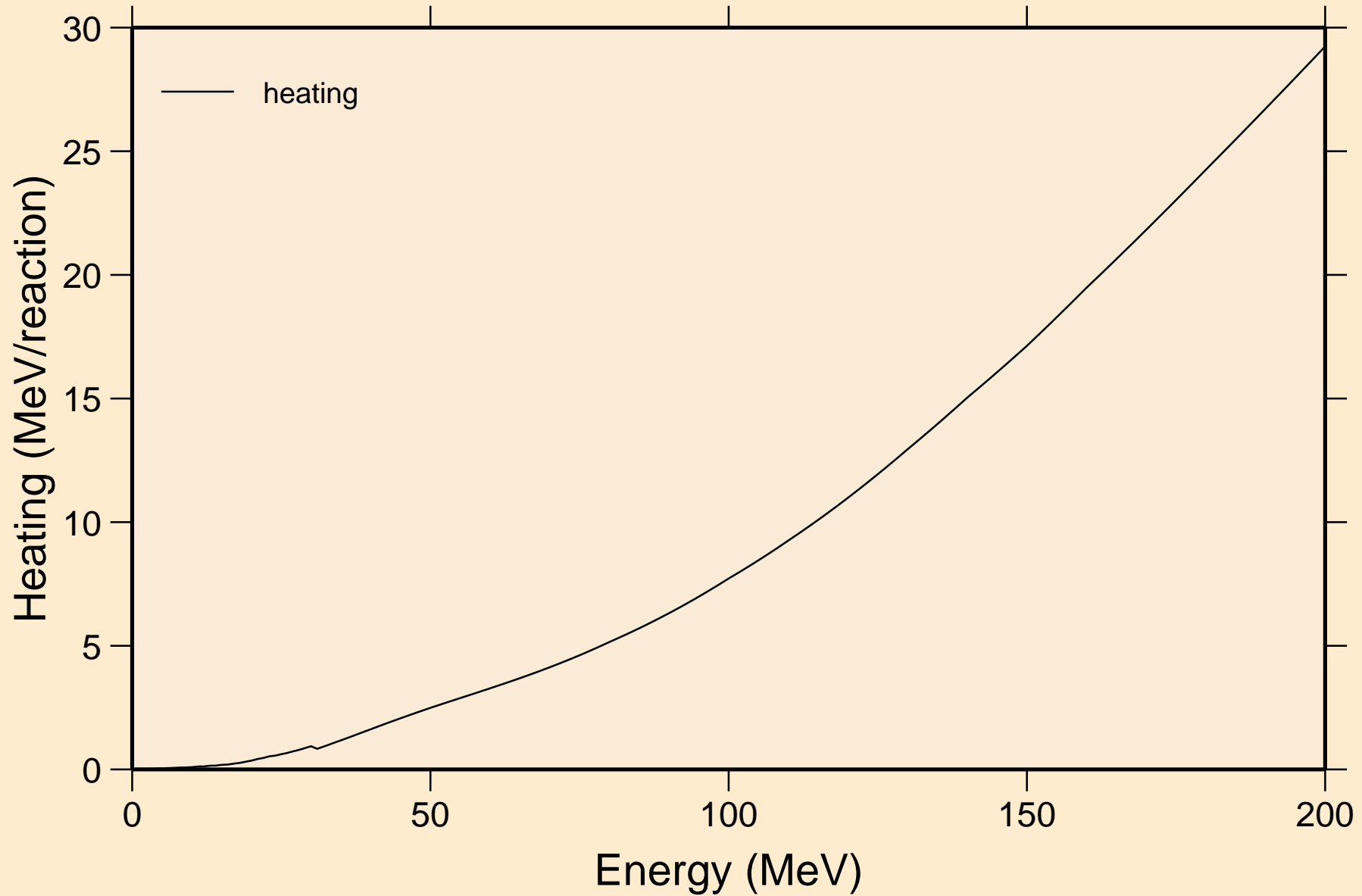

HG197M NEUTRON ACER TENDL-2023 LIBRARY; T=0.K

Damage

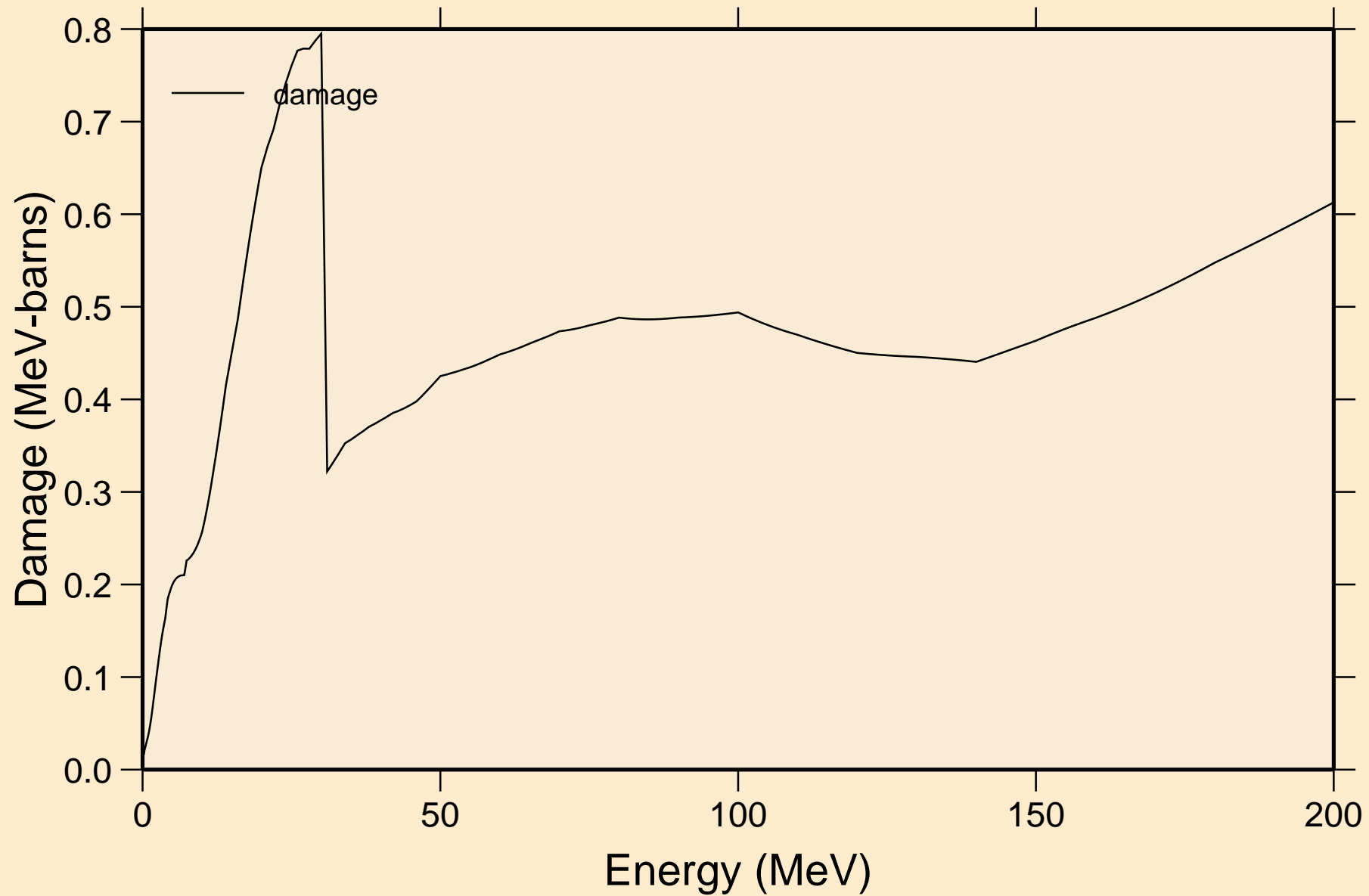

HG197M NEUTRON ACER TENDL-2023 LIBRARY; T=0.K

Non-threshold reactions

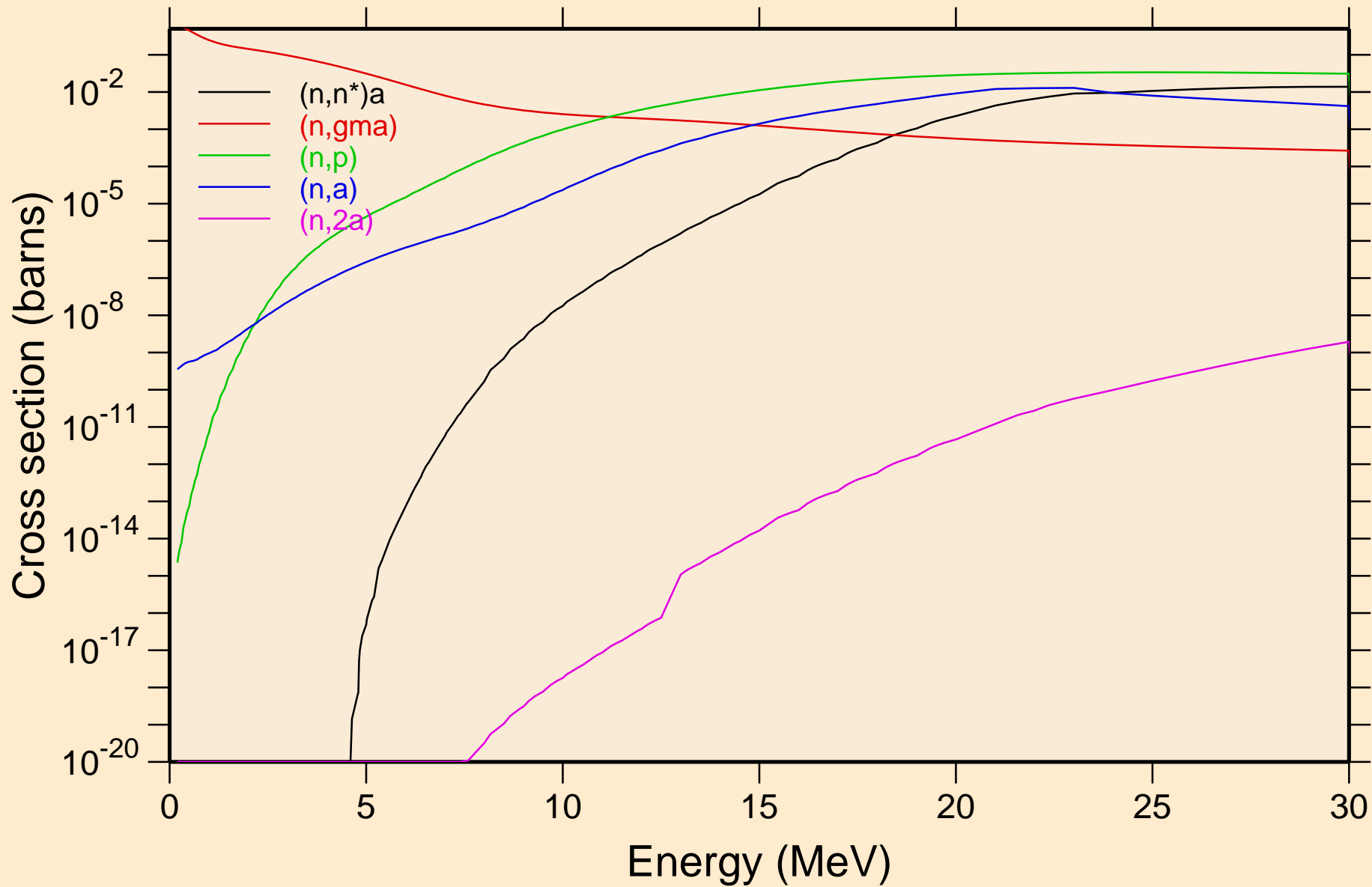

HG197M NEUTRON ACER TENDL-2023 LIBRARY; T=0.K

Non-threshold reactions

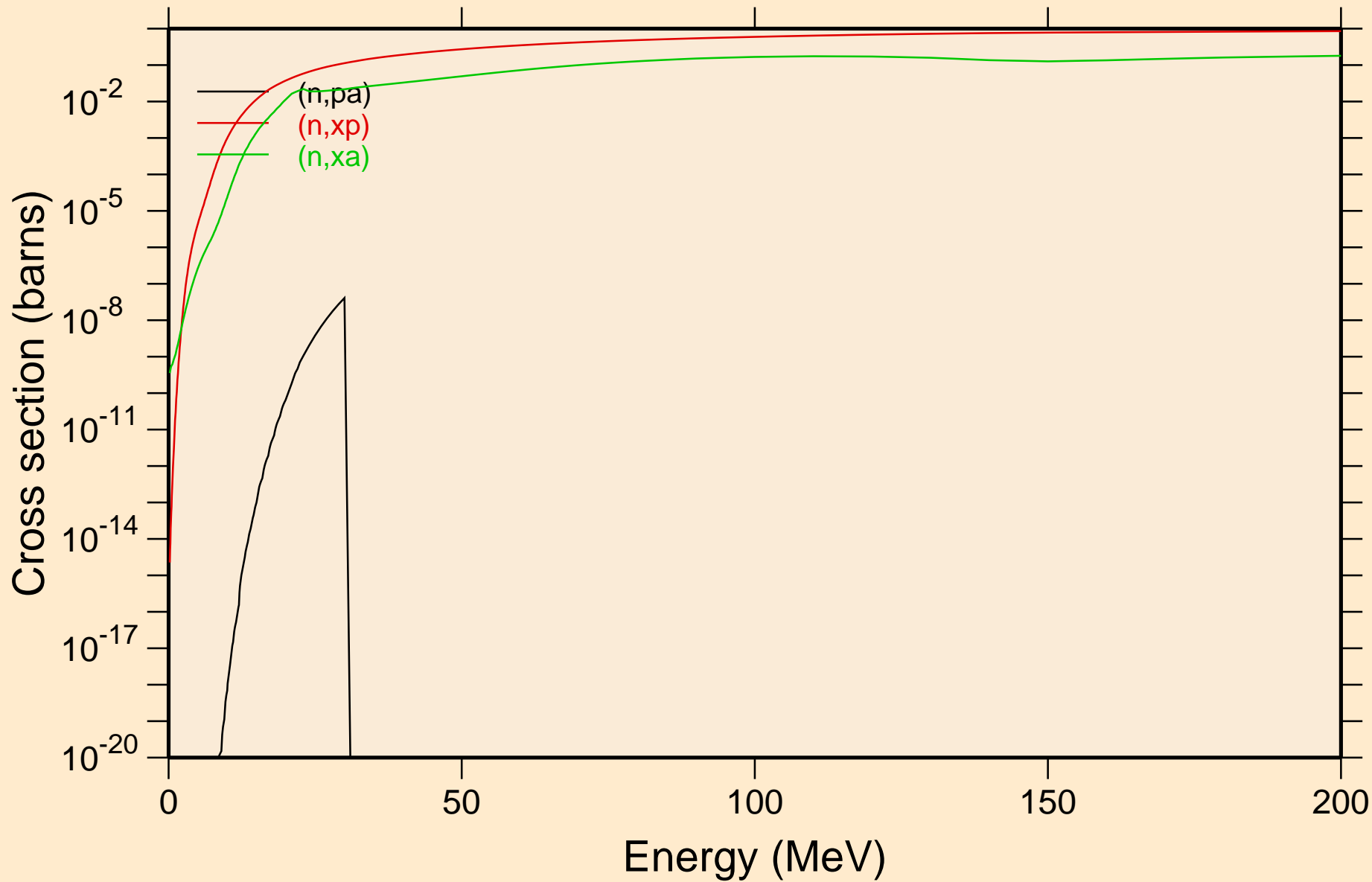

HG197M NEUTRON ACER TENDL-2023 LIBRARY; T=0.K
Inelastic levels

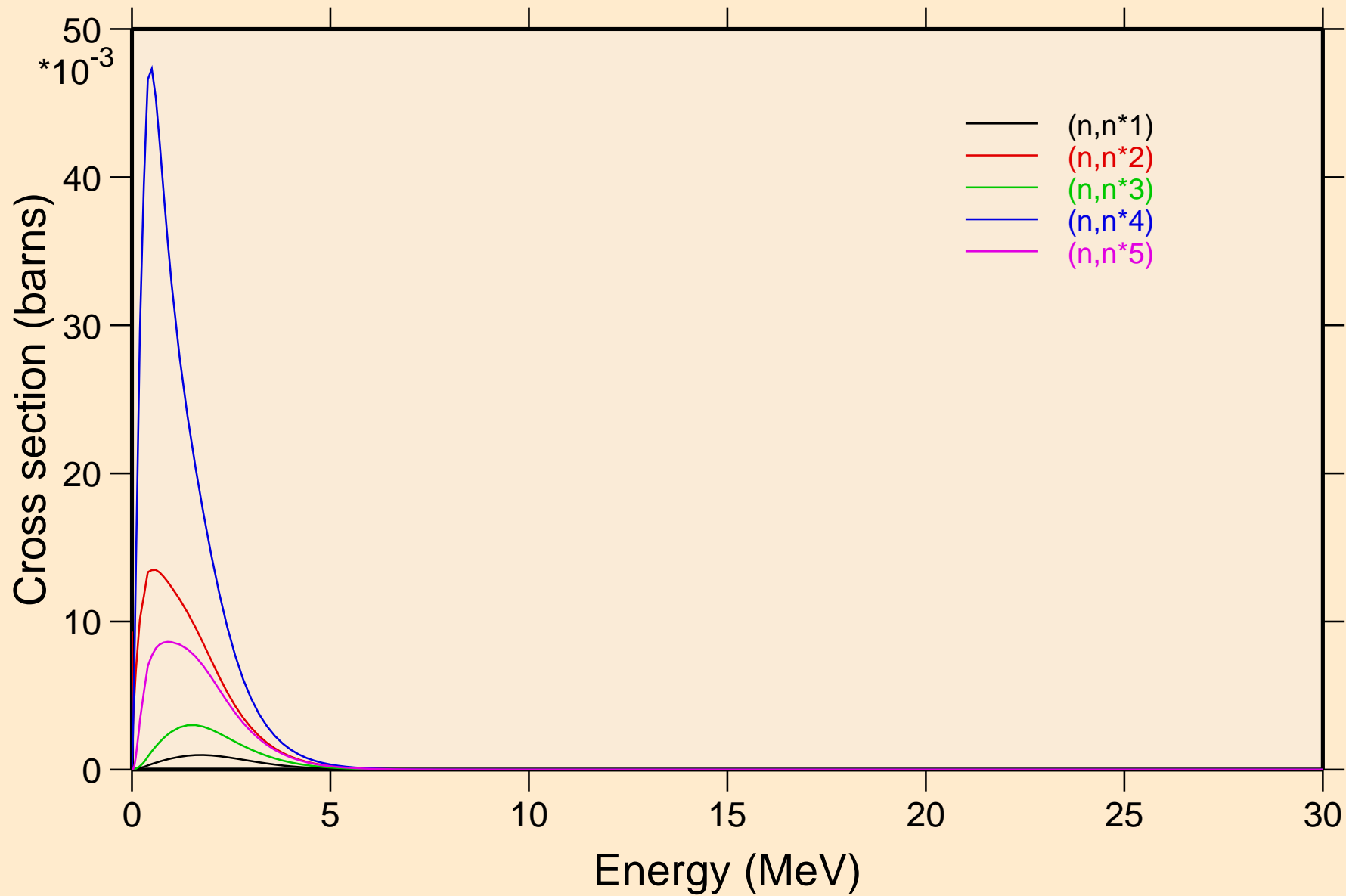

HG197M NEUTRON ACER TENDL-2023 LIBRARY; T=0.K
Inelastic levels

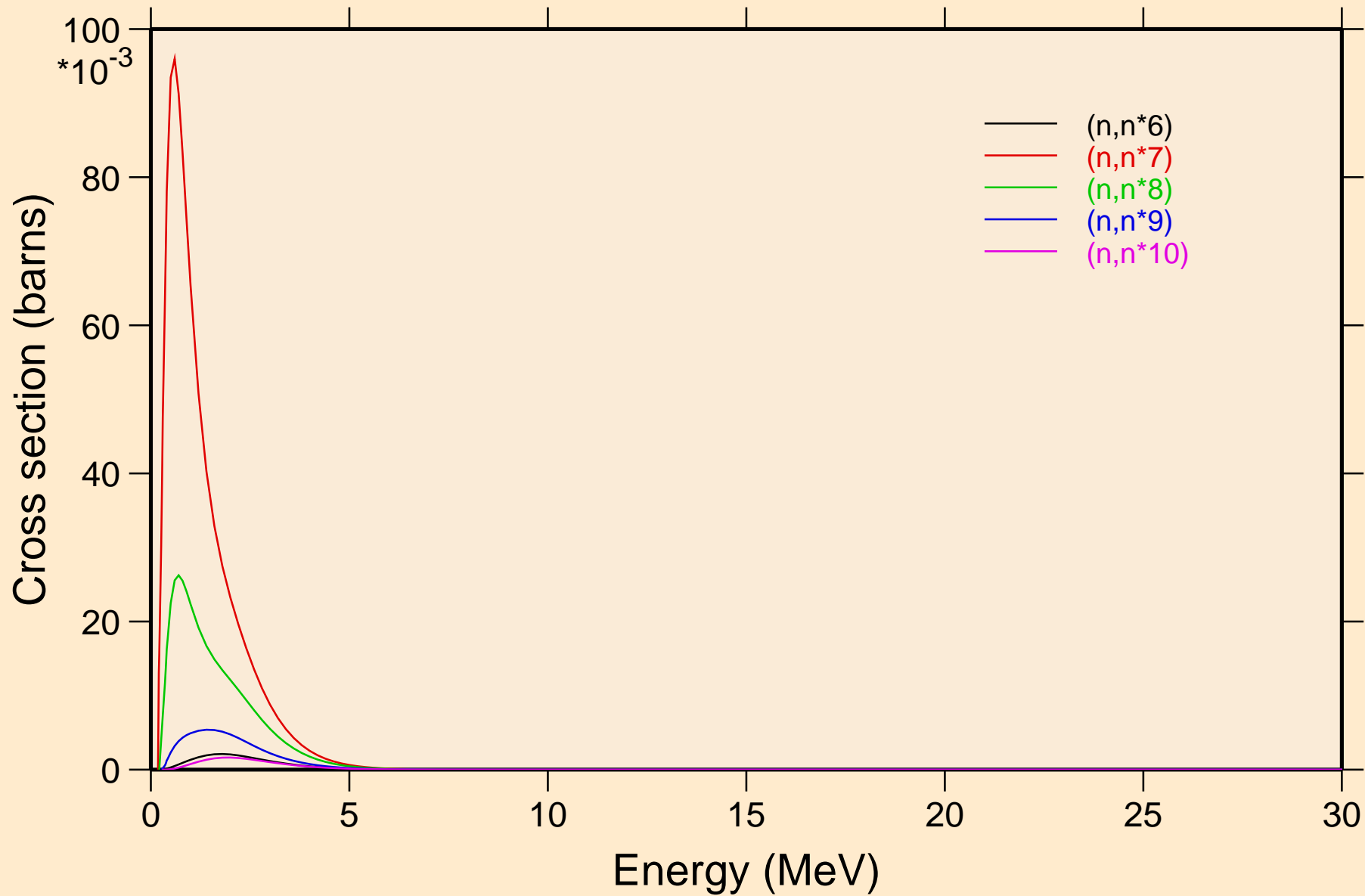

HG197M NEUTRON ACER TENDL-2023 LIBRARY; T=0.K

Inelastic levels

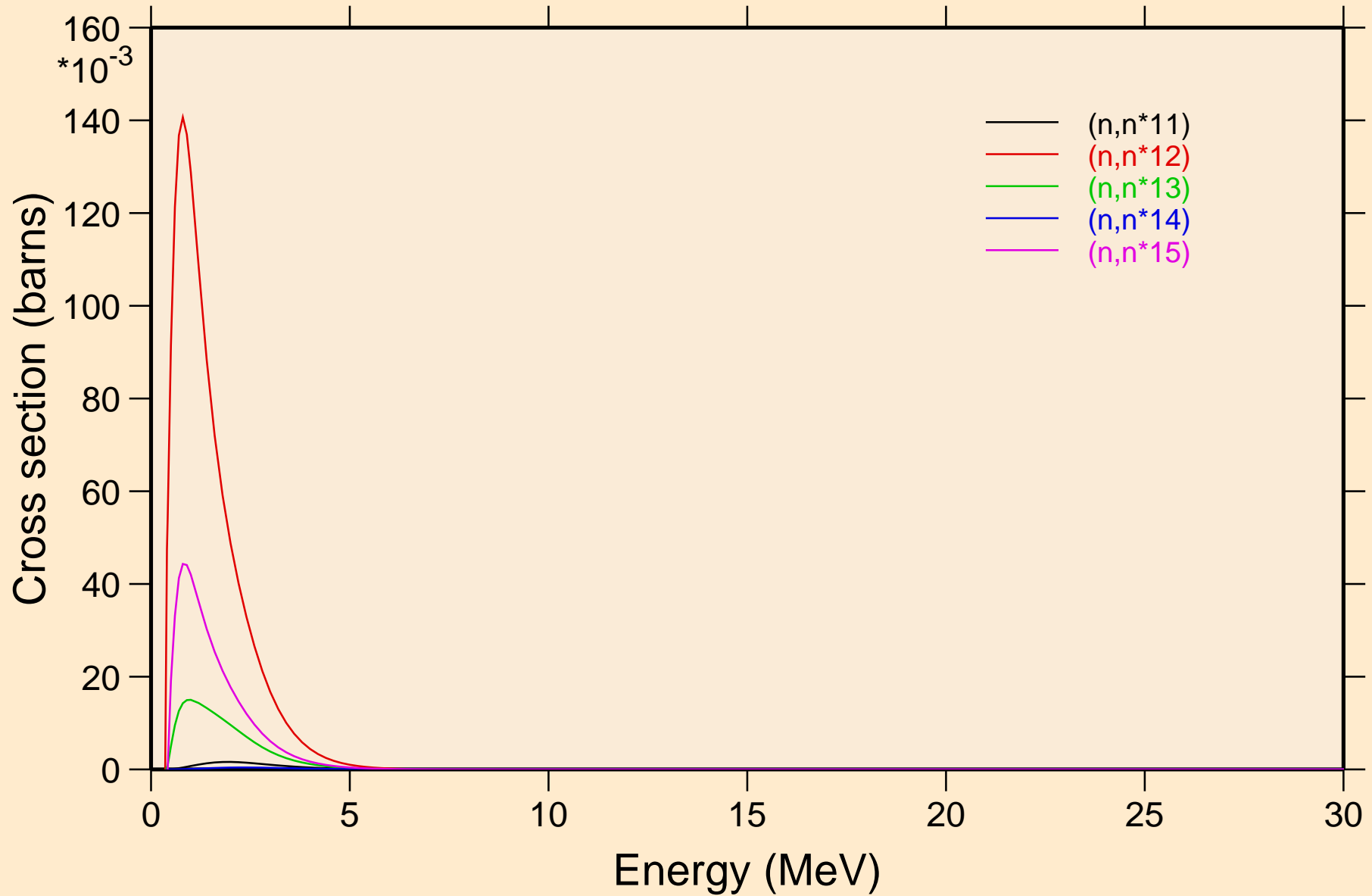

HG197M NEUTRON ACER TENDL-2023 LIBRARY; T=0.K

Threshold reactions

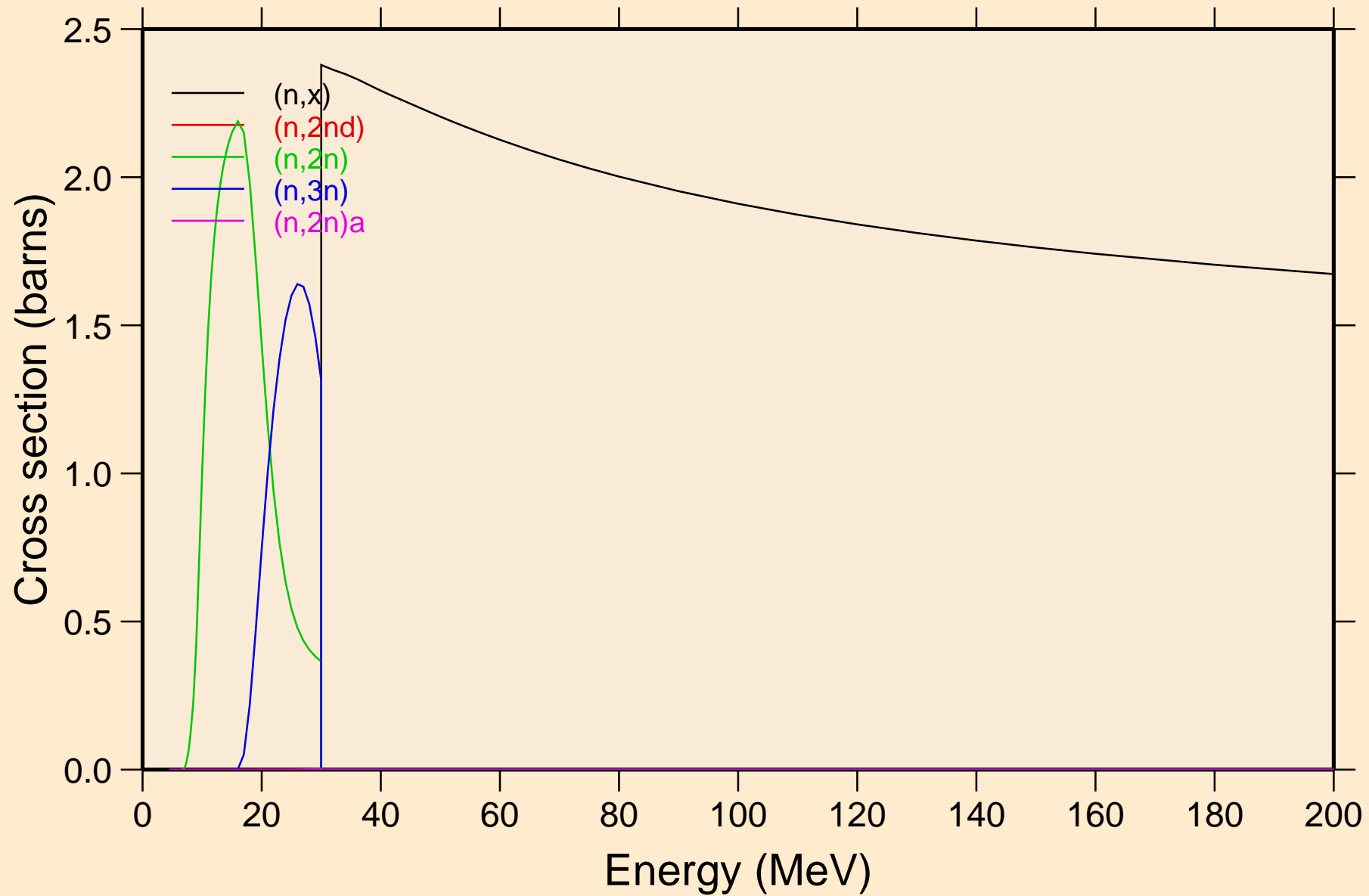

HG197M NEUTRON ACER TENDL-2023 LIBRARY; T=0.K

Threshold reactions

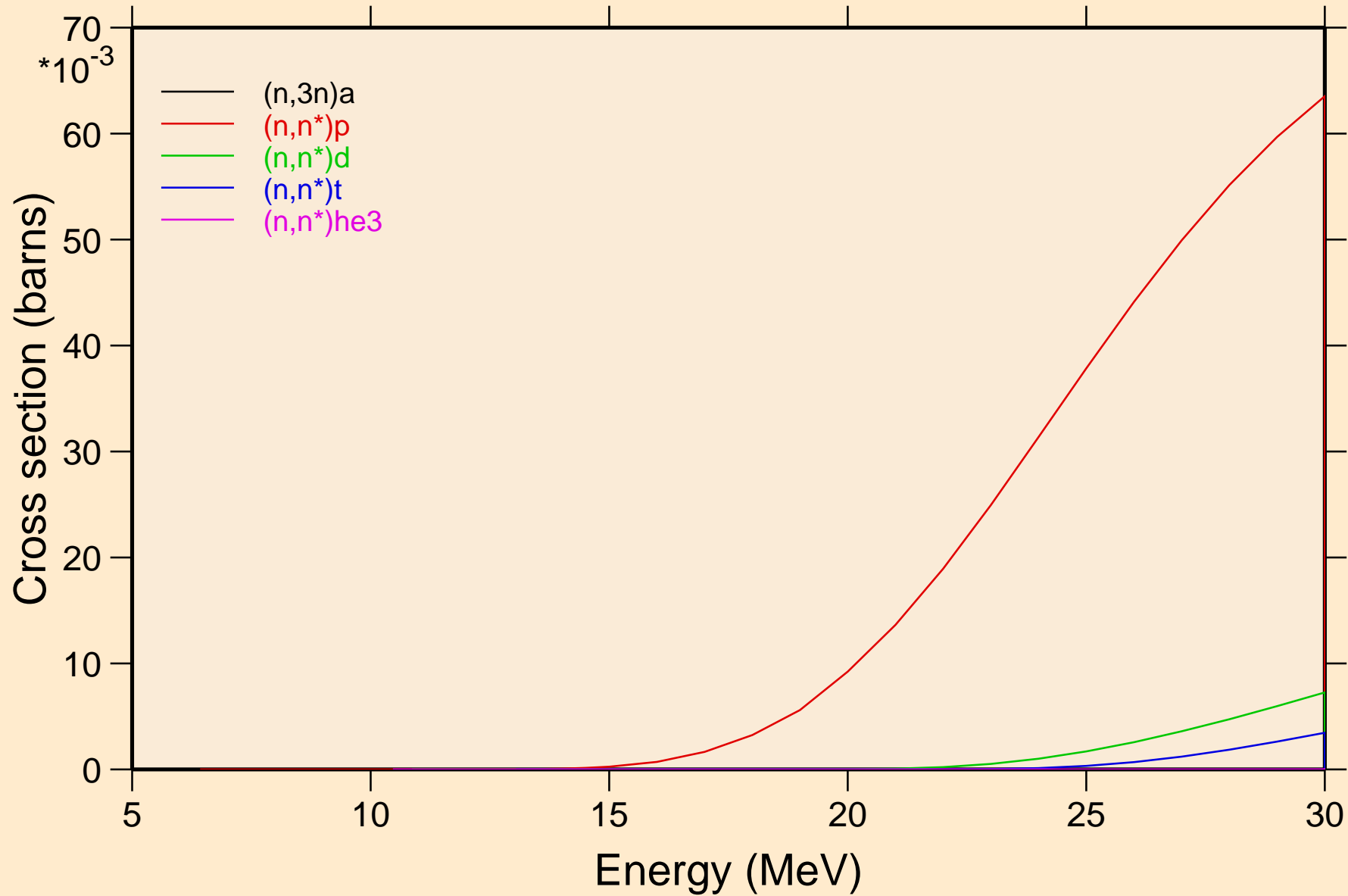

HG197M NEUTRON ACER TENDL-2023 LIBRARY; T=0.K

Threshold reactions

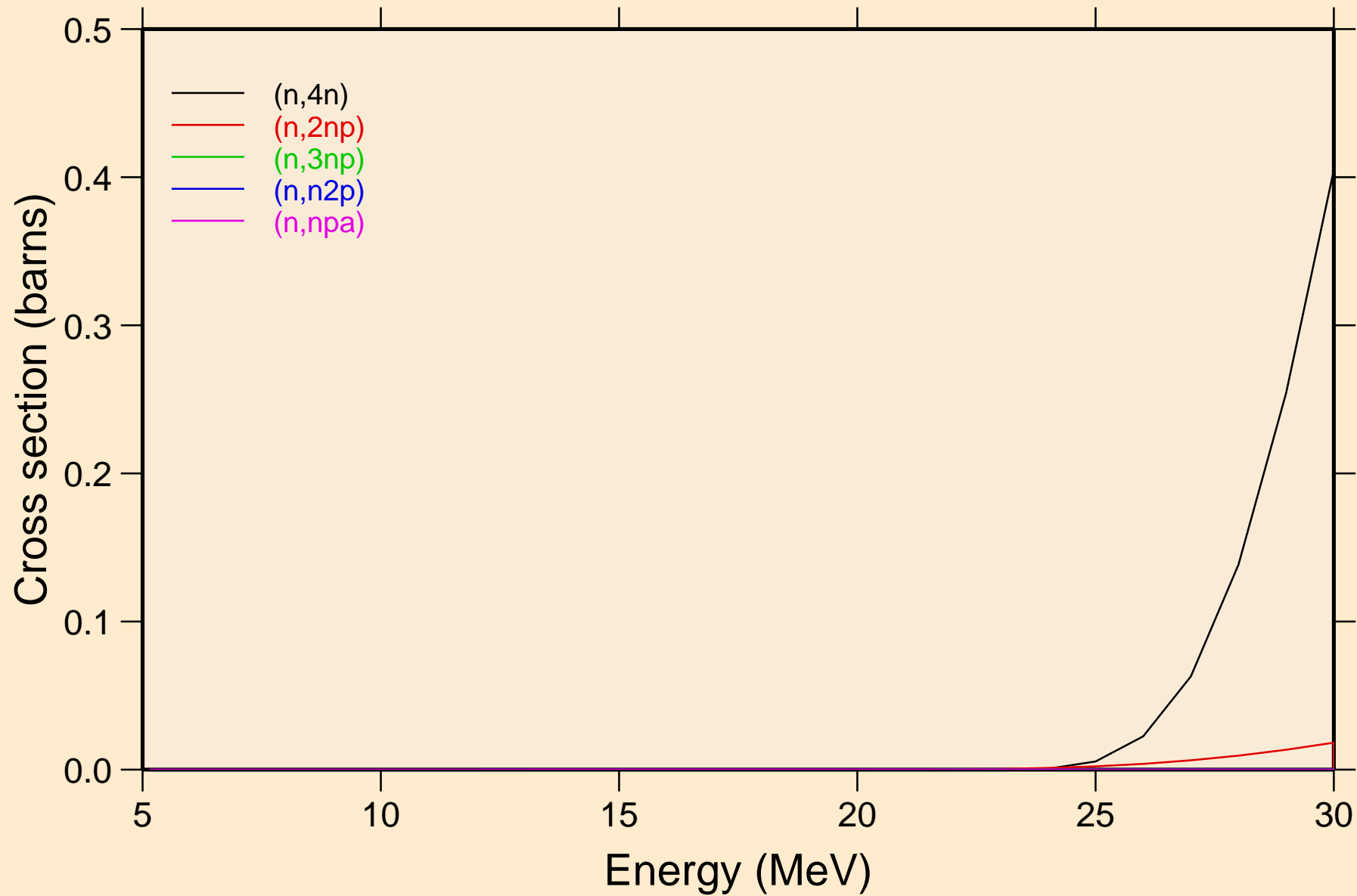

HG197M NEUTRON ACER TENDL-2023 LIBRARY; T=0.K

Threshold reactions

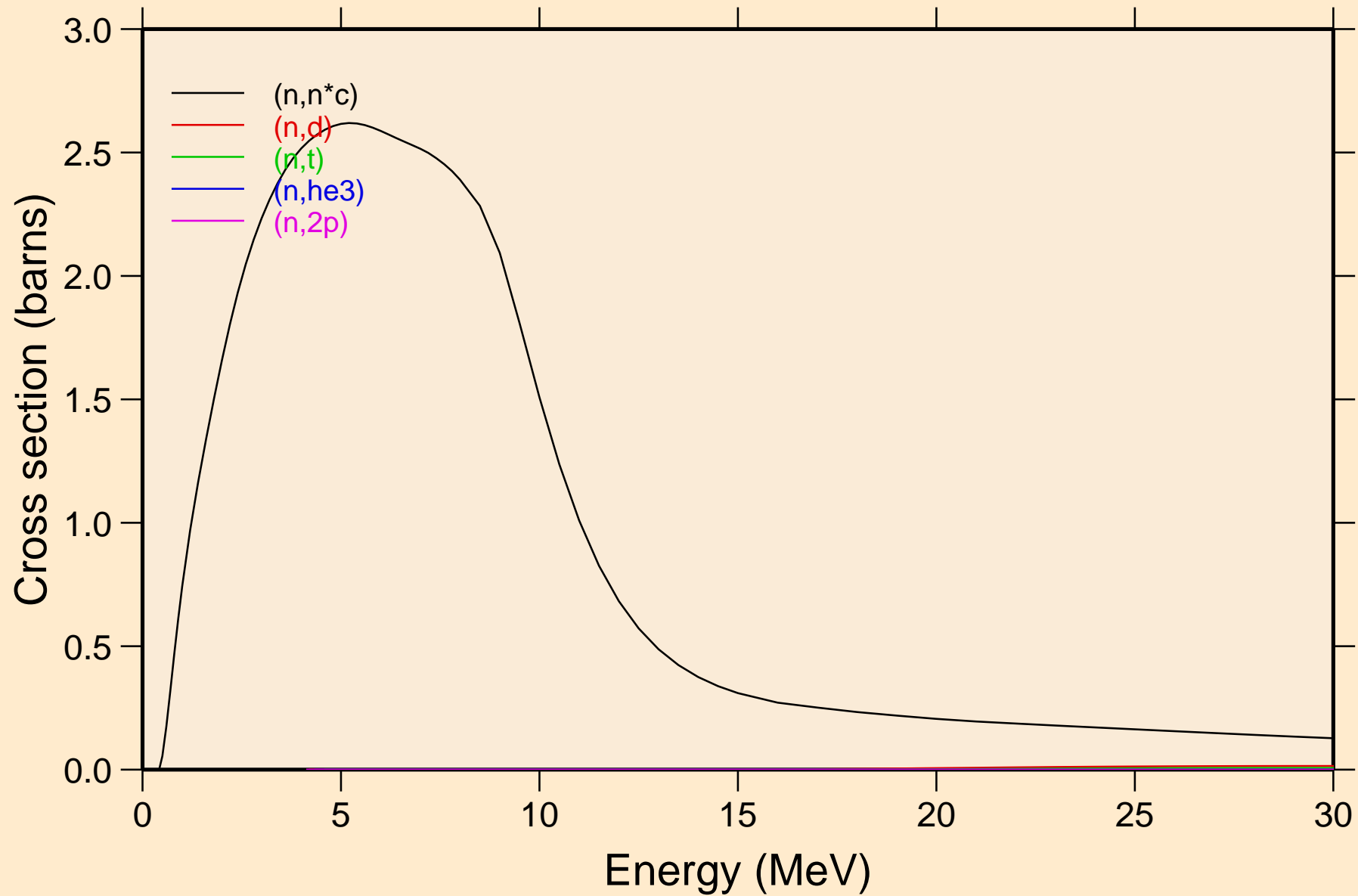

HG197M NEUTRON ACER TENDL-2023 LIBRARY; T=0.K

Threshold reactions

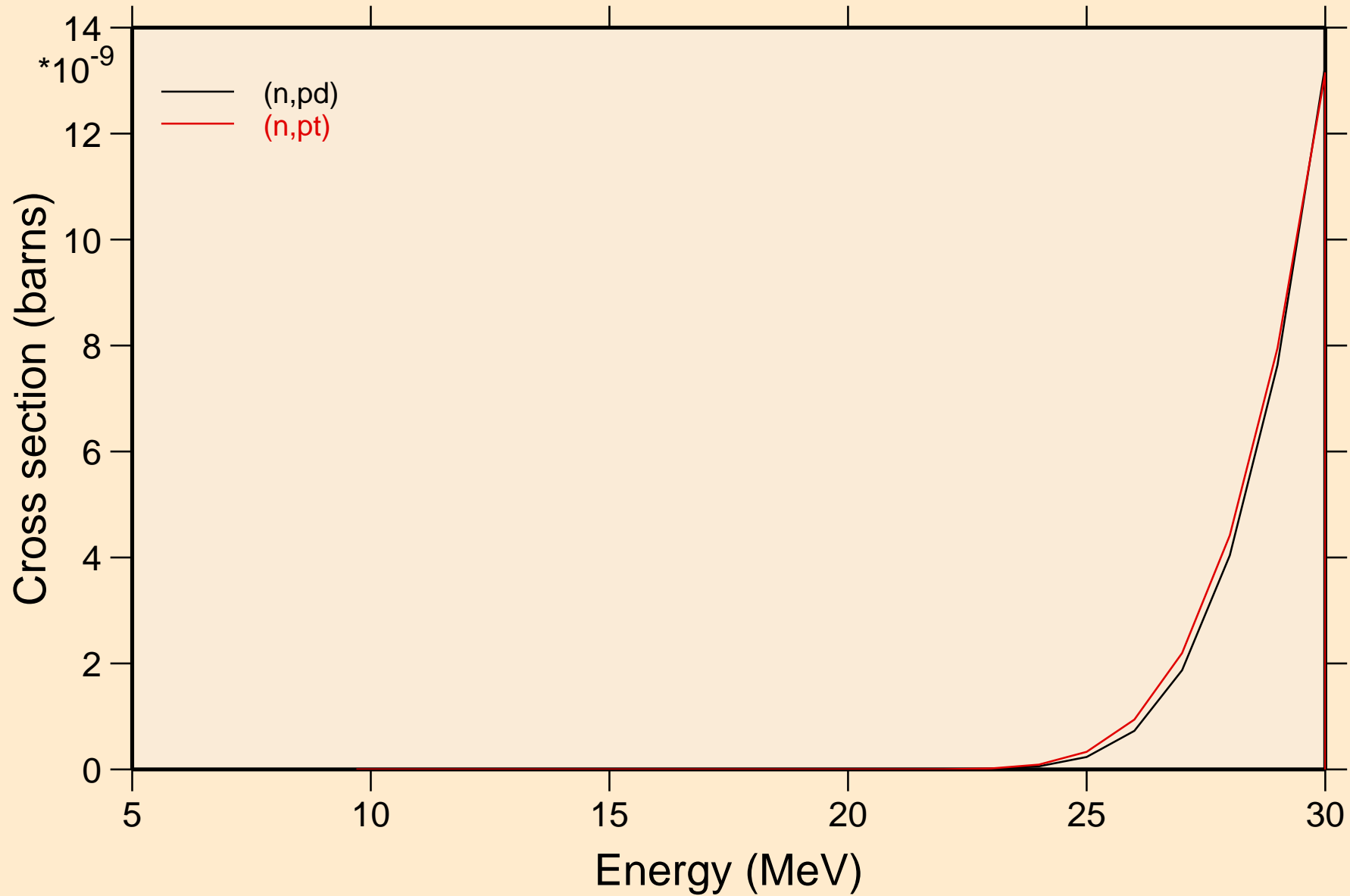

HG197M NEUTRON ACER TENDL-2023 LIBRARY; T=0.K

Threshold reactions

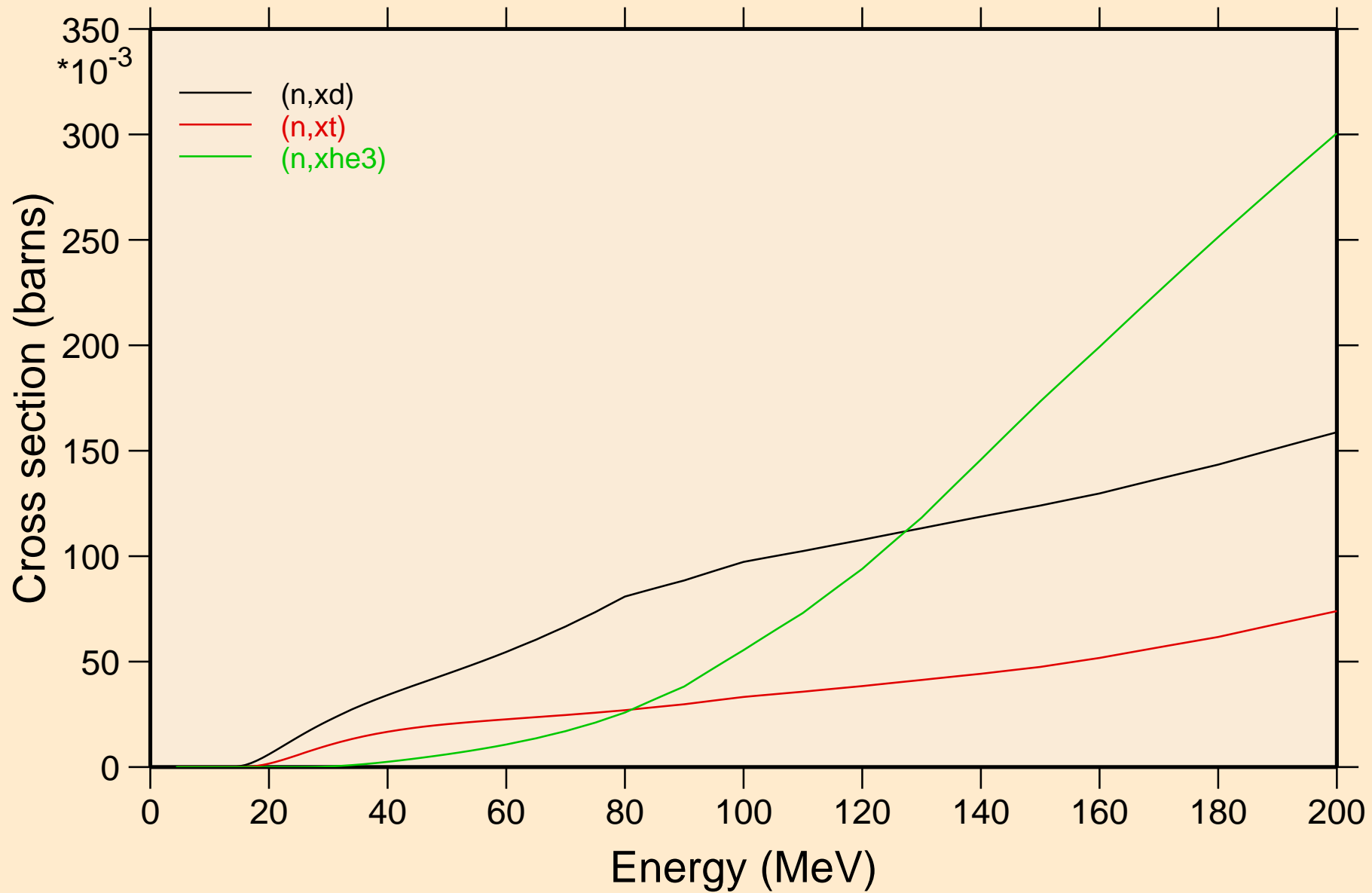

HG197M NEUTRON ACER TENDL-2023 LIBRARY; T=0.K
angular distribution for elastic

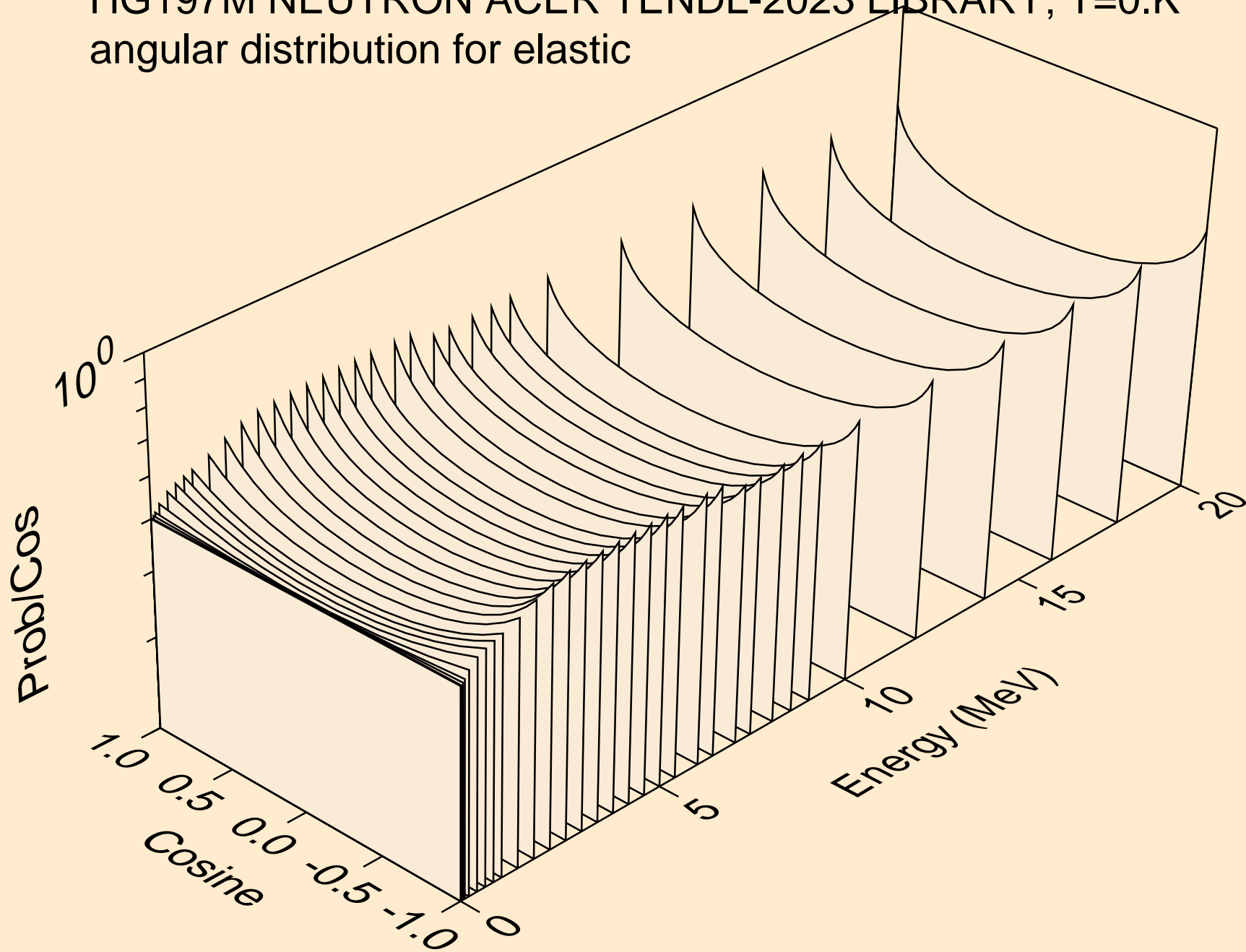

HG197M NEUTRON ACER TENDL-2023 LIBRARY; T=0.K
angular distribution for elastic

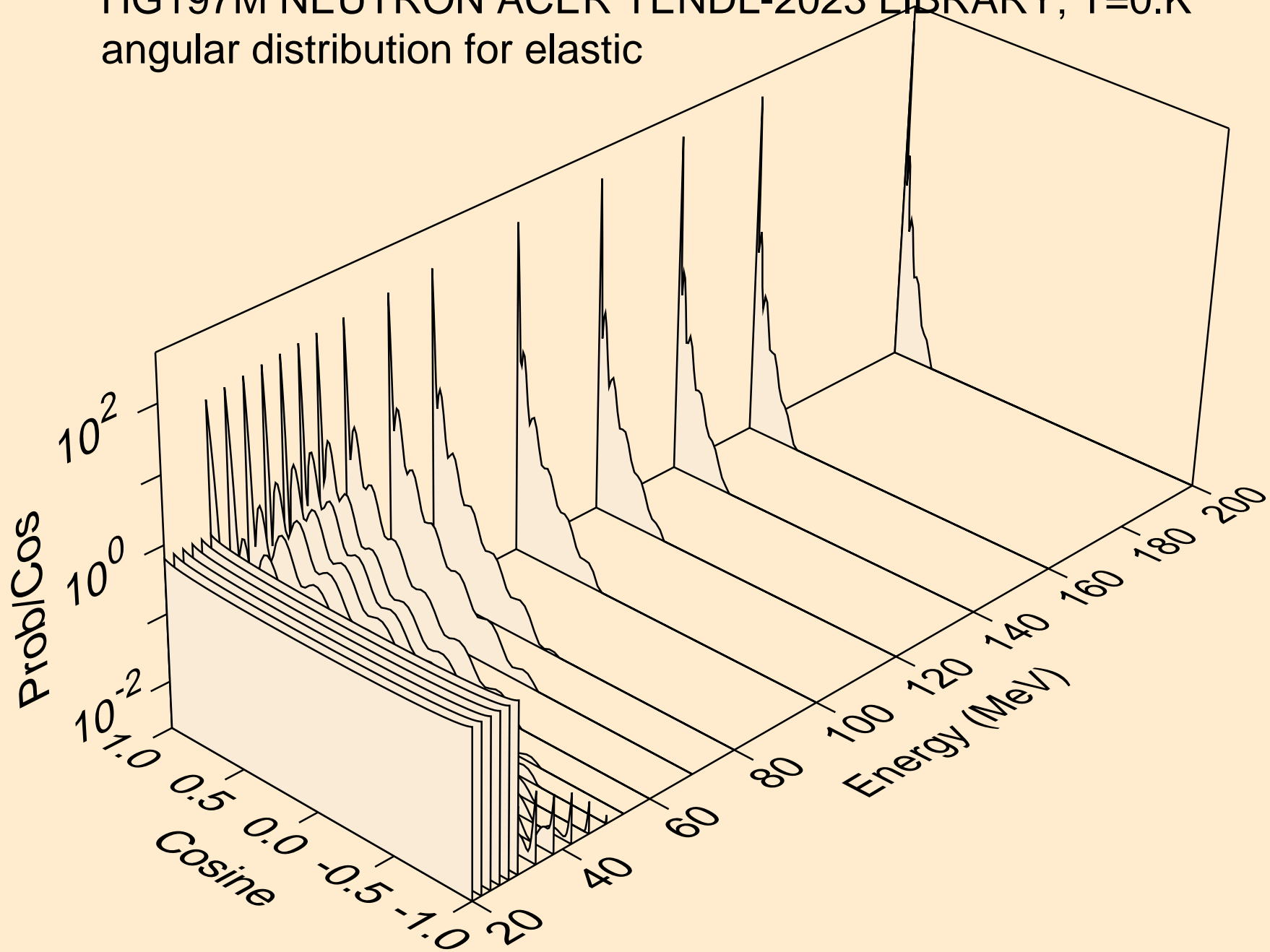

HG197M NEUTRON ACER TENDL-2023 LIBRARY; T=0.K
angular distribution for (n,n*1)

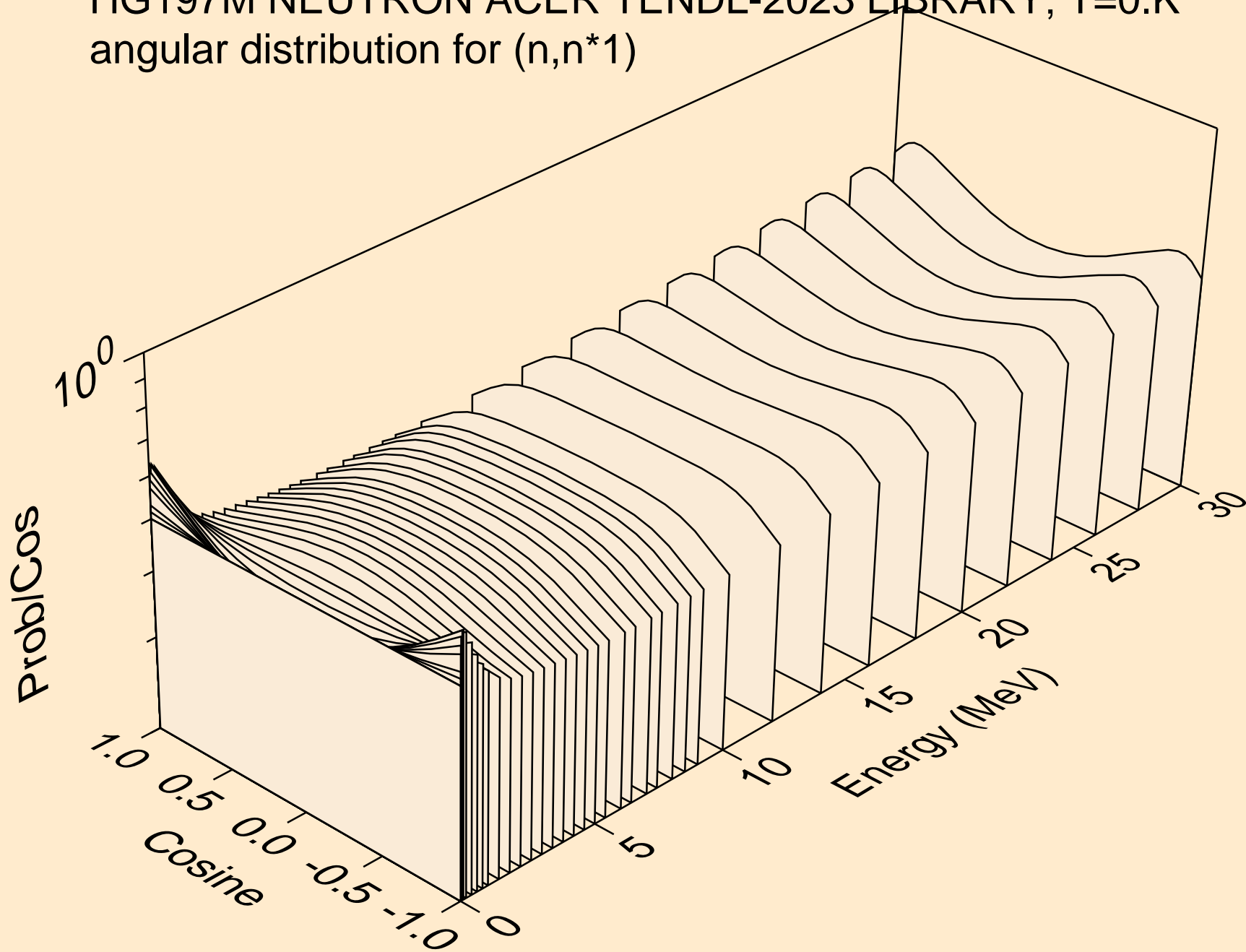

HG197M NEUTRON ACER TENDL-2023 LIBRARY; T=0.K
angular distribution for (n,n*2)

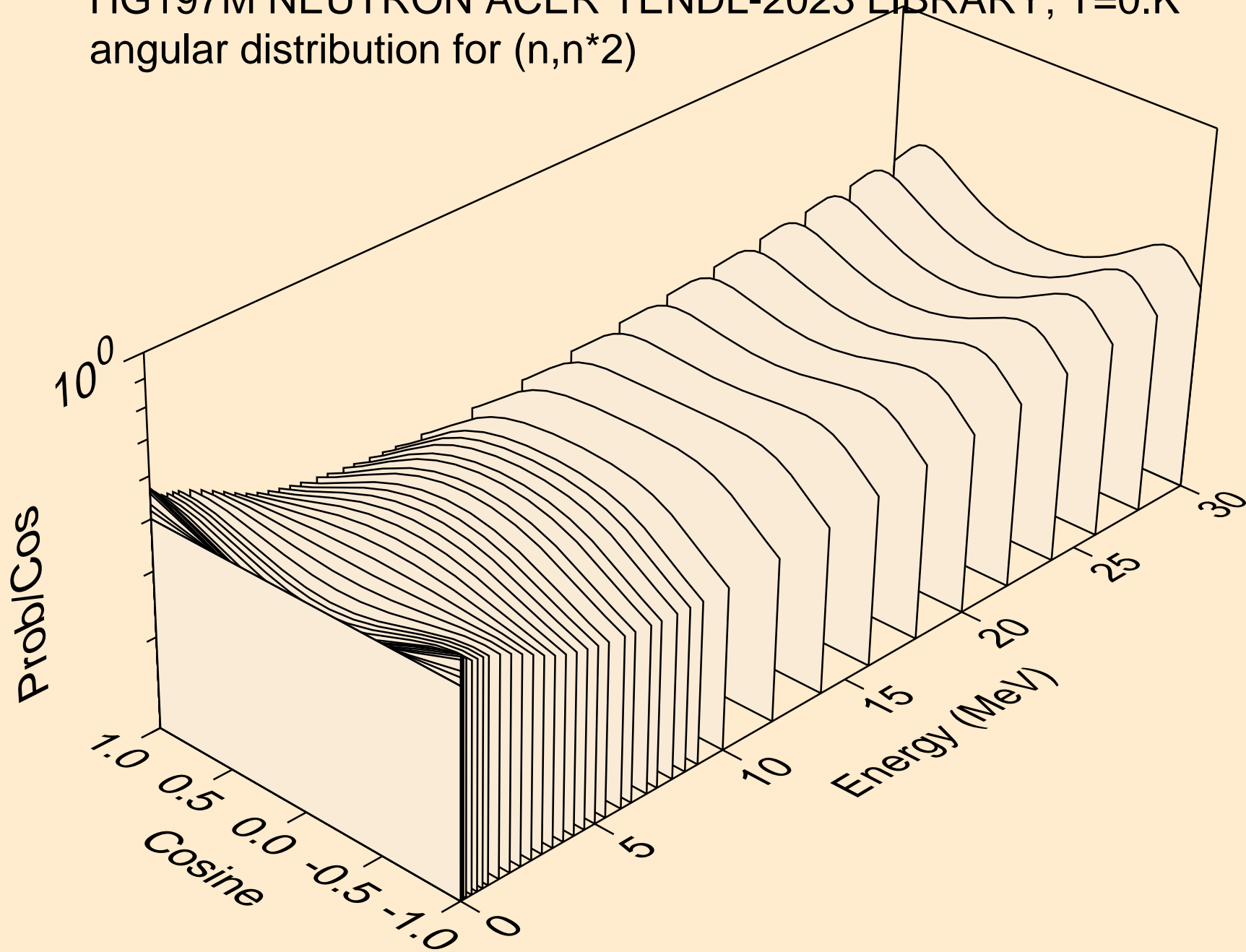

HG197M NEUTRON ACER TENDL-2023 LIBRARY; T=0.K
angular distribution for (n,n*3)

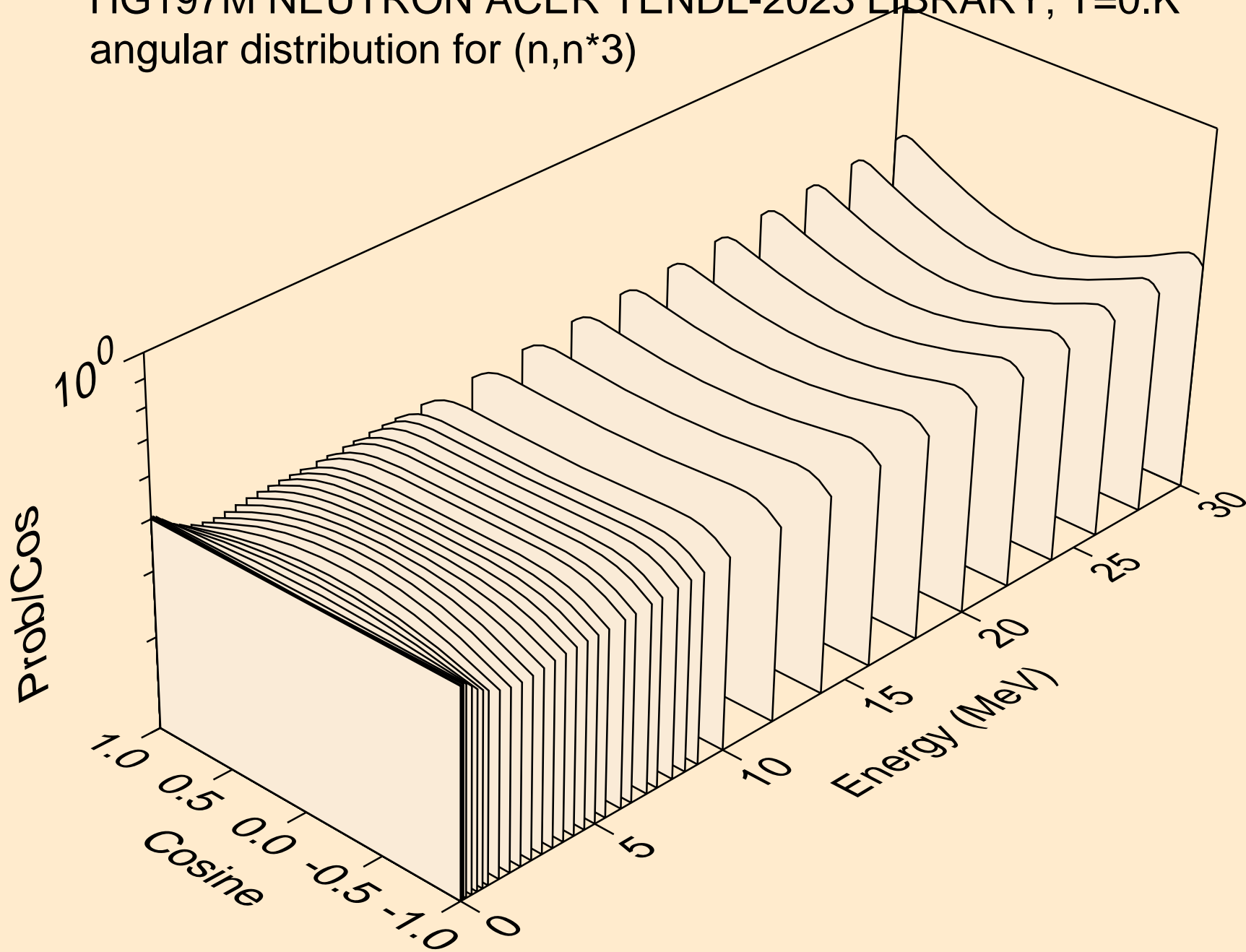

HG197M NEUTRON ACER TENDL-2023 LIBRARY; T=0.K
angular distribution for (n,n*4)

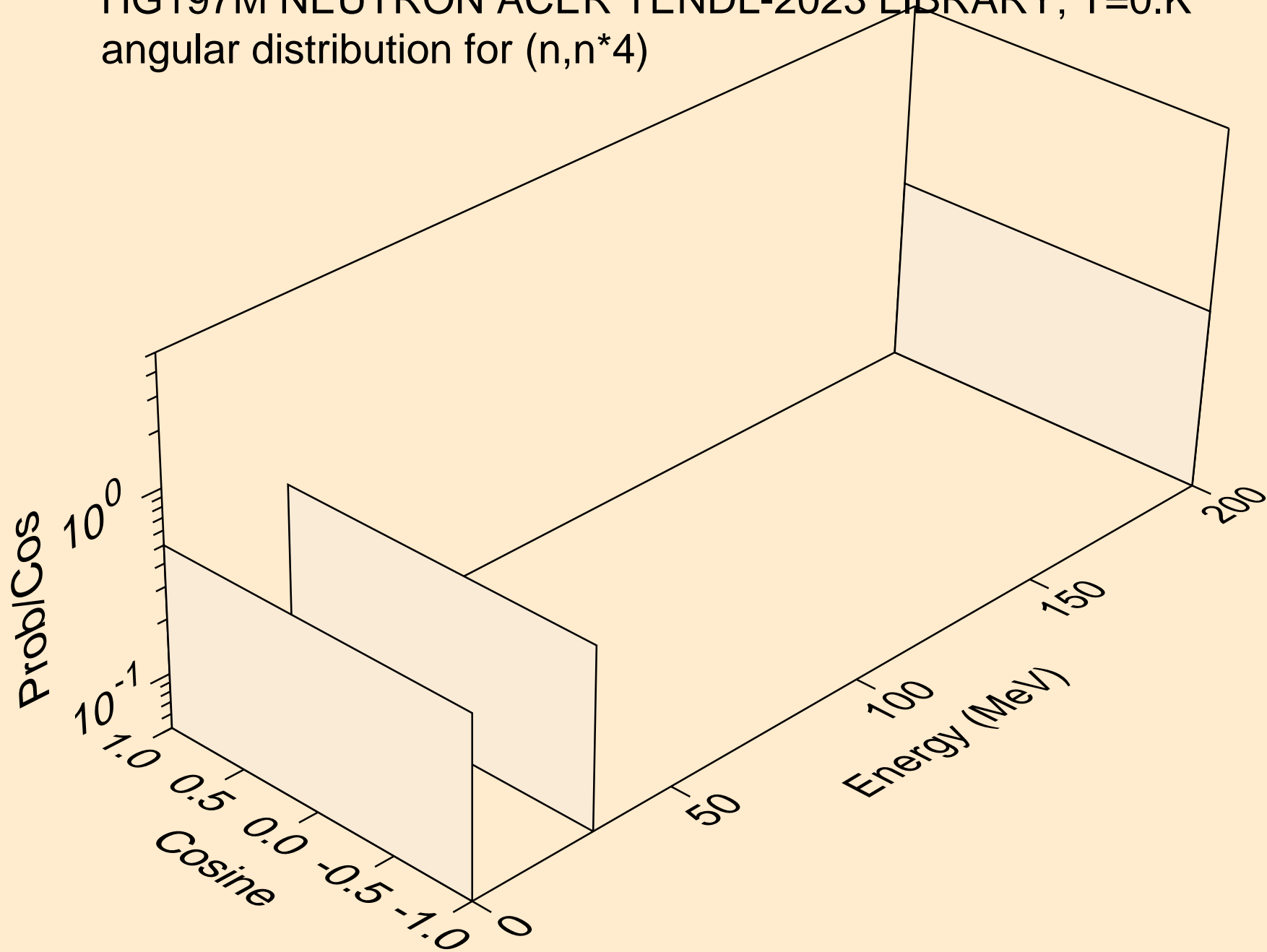

HG197M NEUTRON ACER TENDL-2023 LIBRARY; T=0.K
angular distribution for (n,n*5)

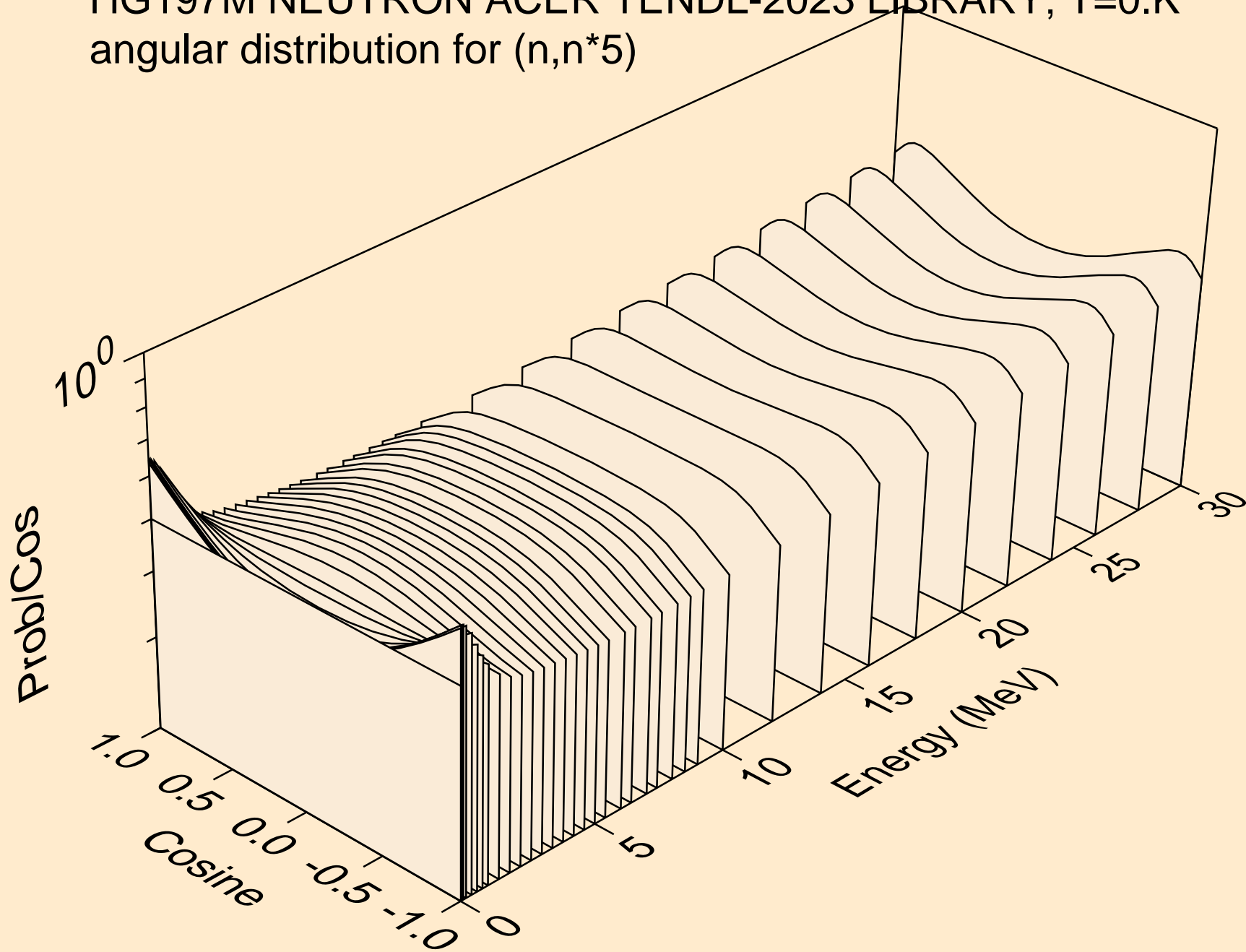

HG197M NEUTRON ACER TENDL-2023 LIBRARY; T=0.K
angular distribution for (n,n*6)

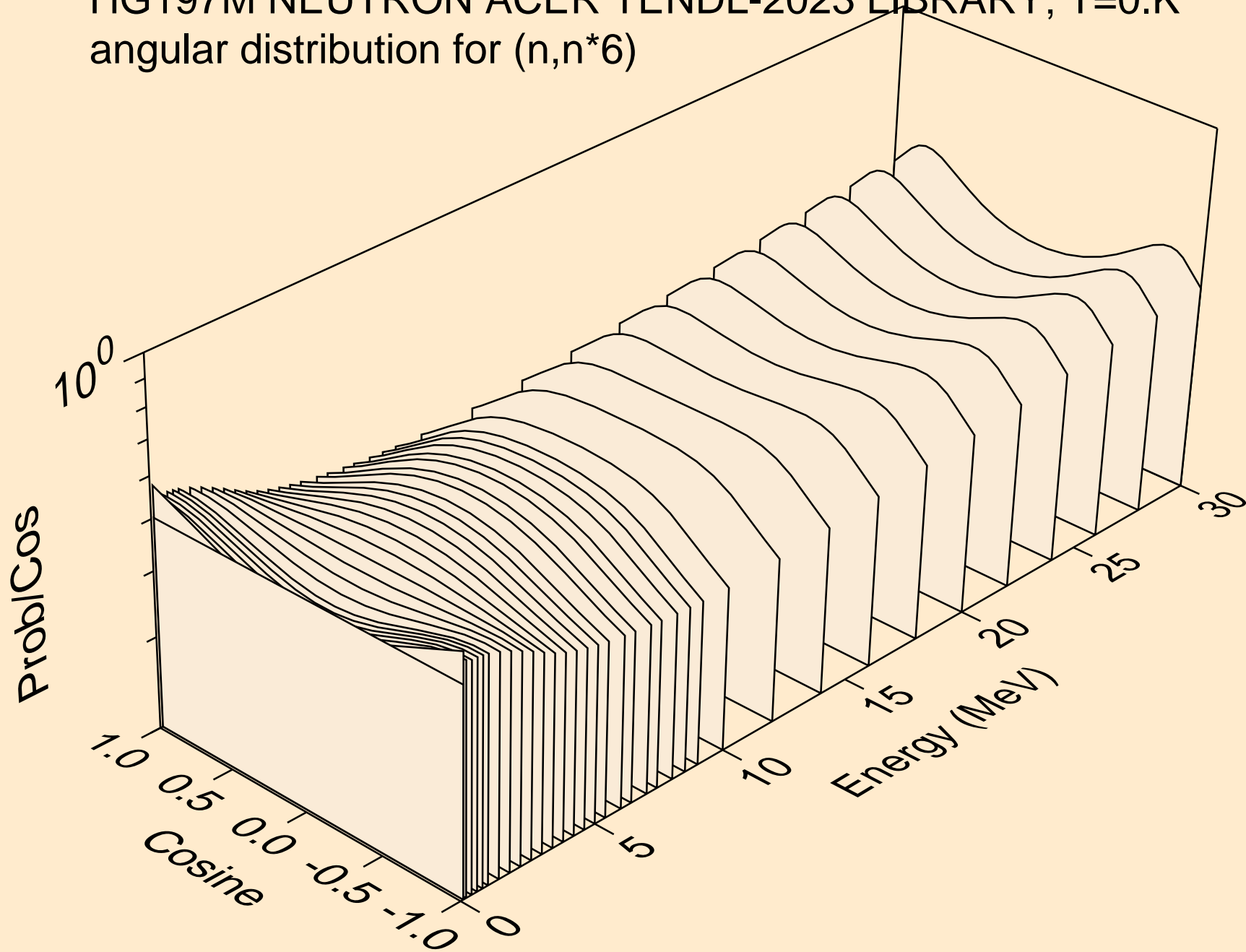

HG197M NEUTRON ACER TENDL-2023 LIBRARY; T=0.K
angular distribution for (n,n*7)

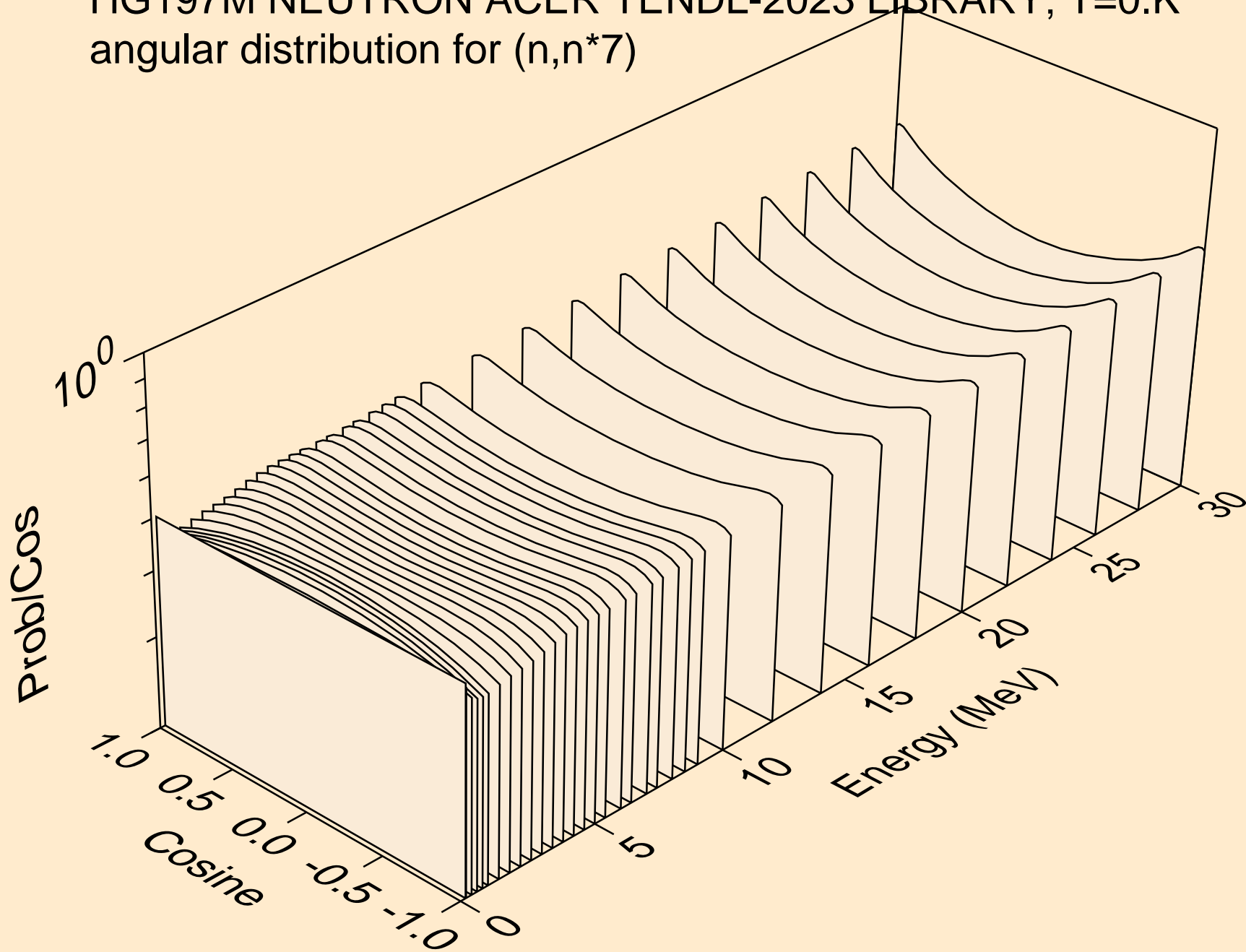

HG197M NEUTRON ACER TENDL-2023 LIBRARY; T=0.K
angular distribution for (n,n*8)

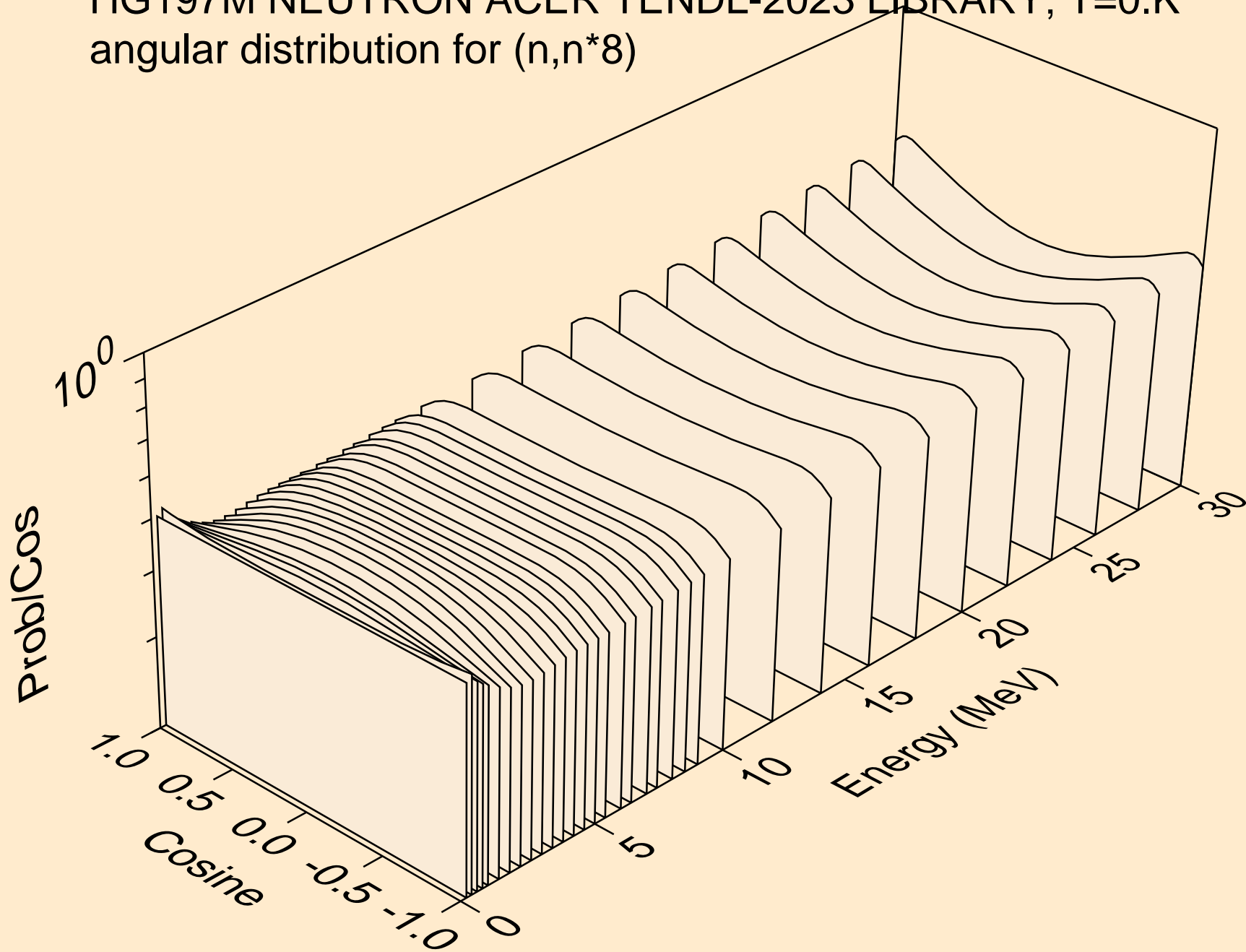

HG197M NEUTRON ACER TENDL-2023 LIBRARY; T=0.K
angular distribution for (n,n*9)

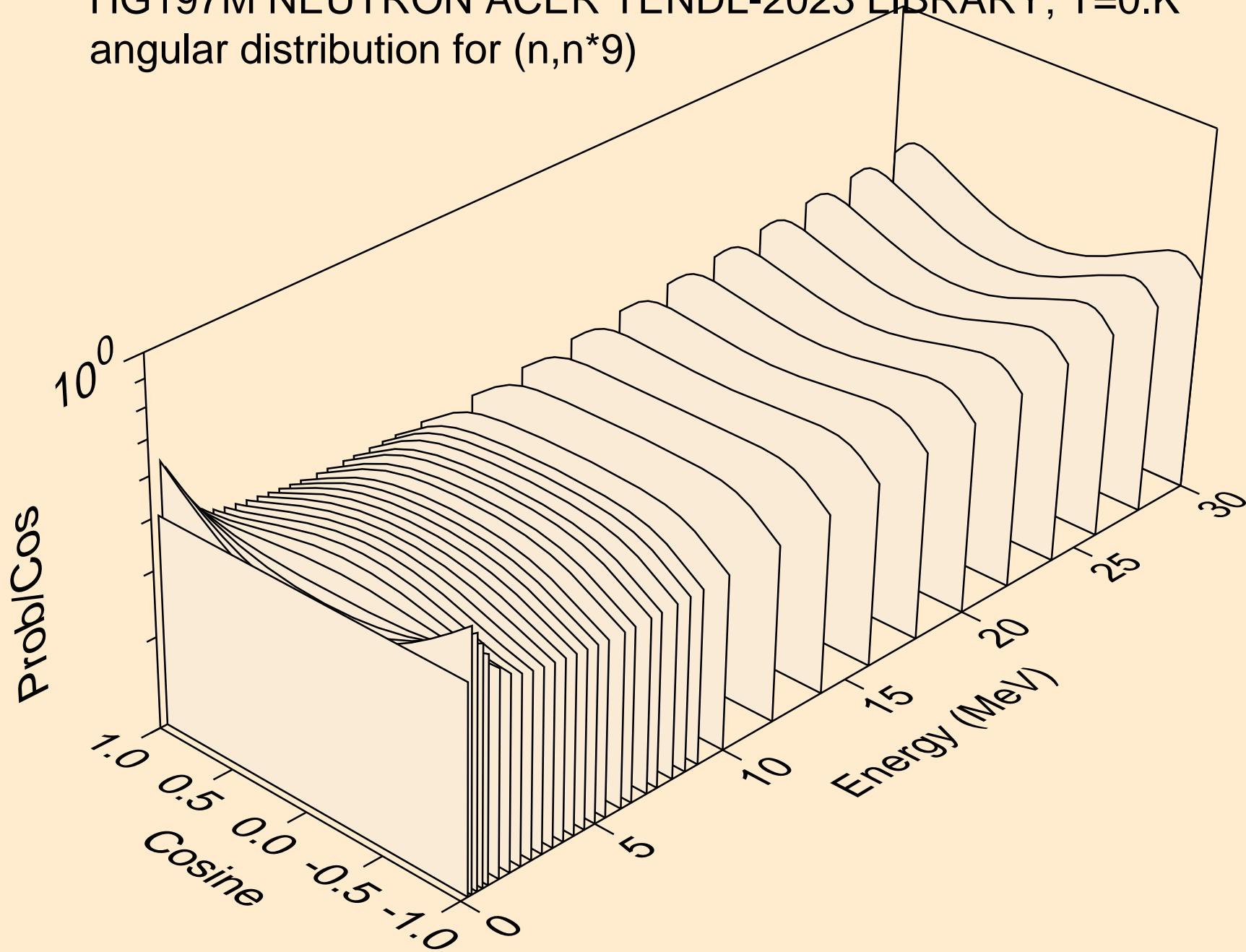

HG197M NEUTRON ACER TENDL-2023 LIBRARY; T=0.K
angular distribution for (n,n*10)

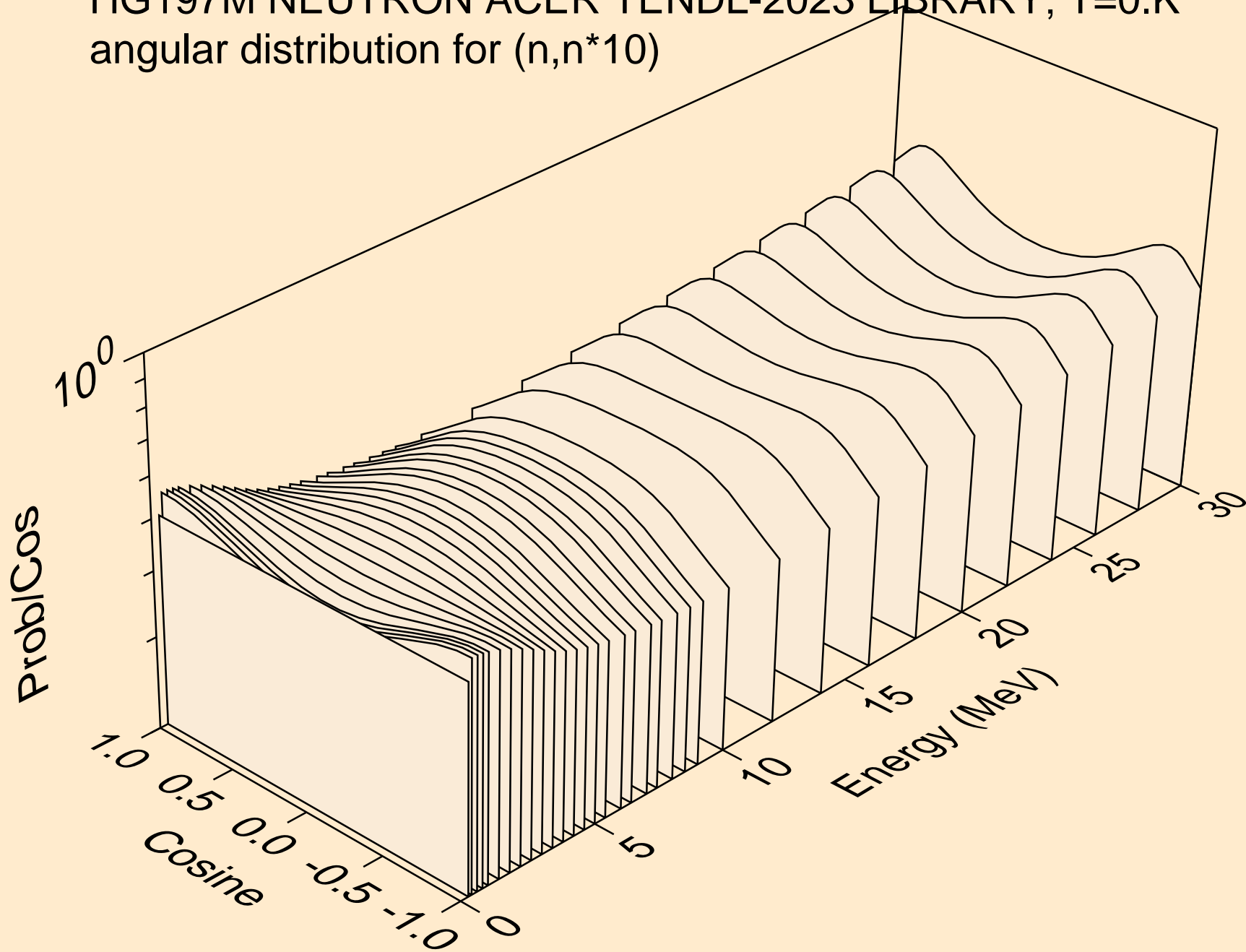

HG197M NEUTRON ACER TENDL-2023 LIBRARY; T=0.K
angular distribution for (n,n*11)

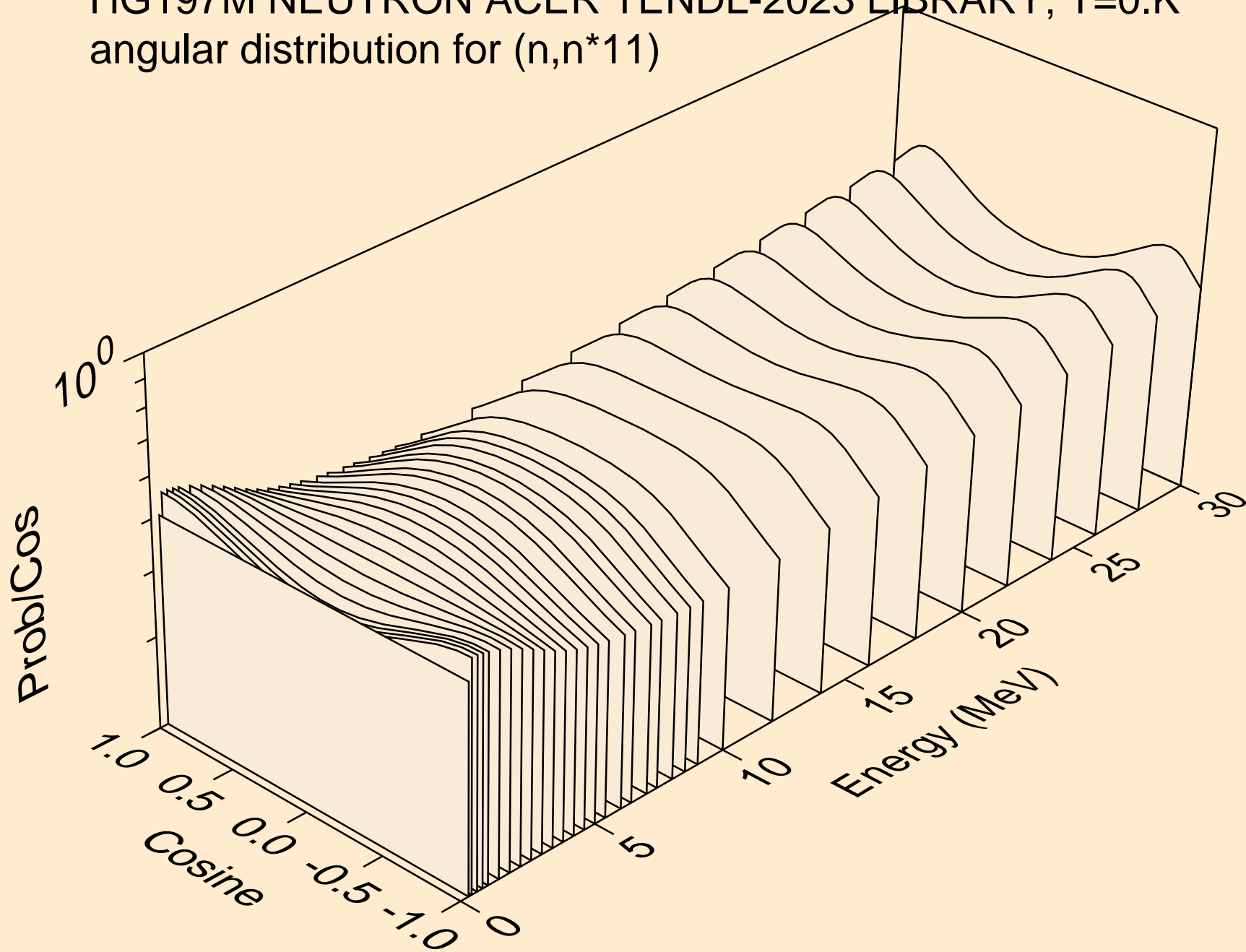

HG197M NEUTRON ACER TENDL-2023 LIBRARY; T=0.K
angular distribution for (n,n*12)

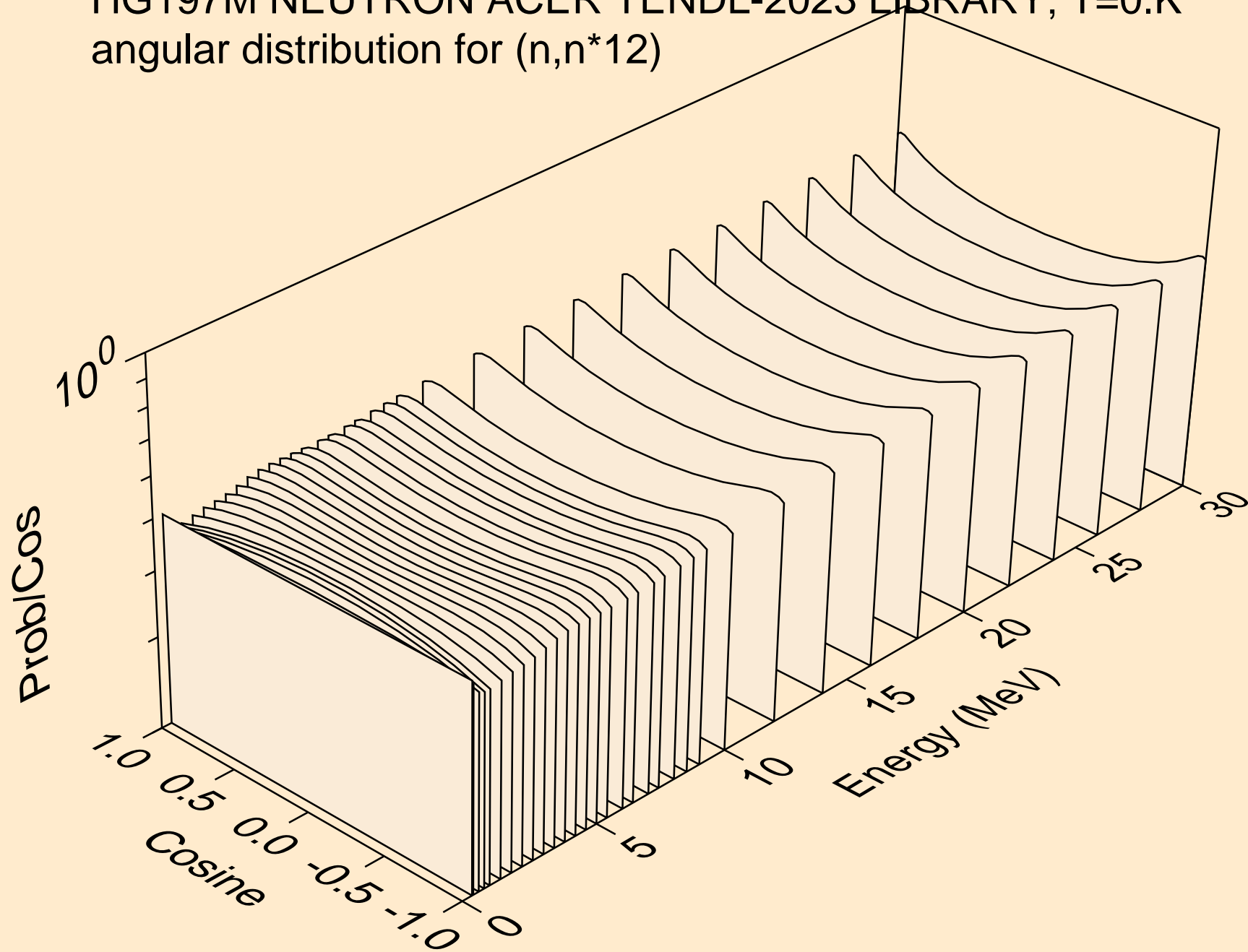

HG197M NEUTRON ACER TENDL-2023 LIBRARY; T=0.K
angular distribution for (n,n*13)

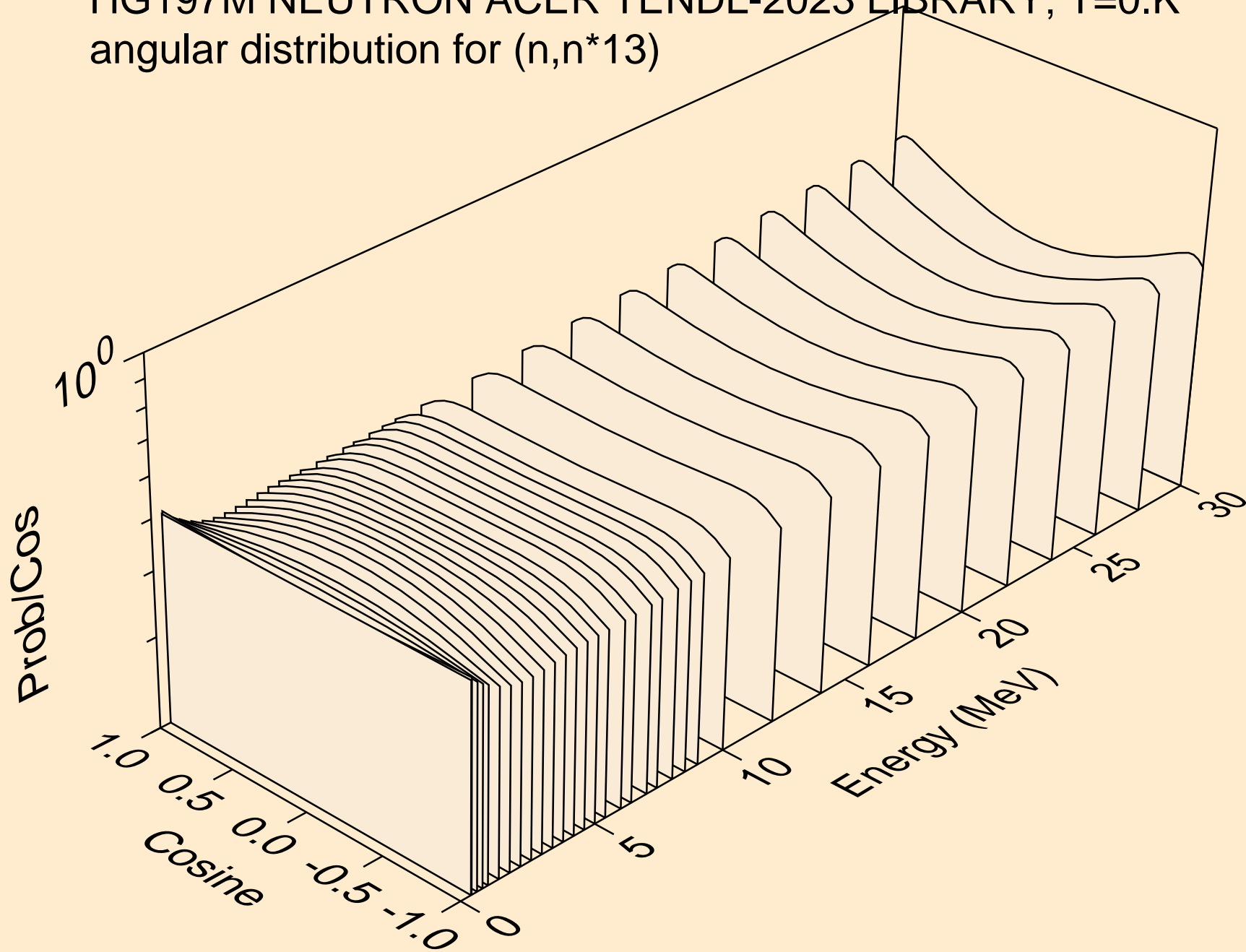

HG197M NEUTRON ACER TENDL-2023 LIBRARY; T=0.K
angular distribution for (n,n*14)

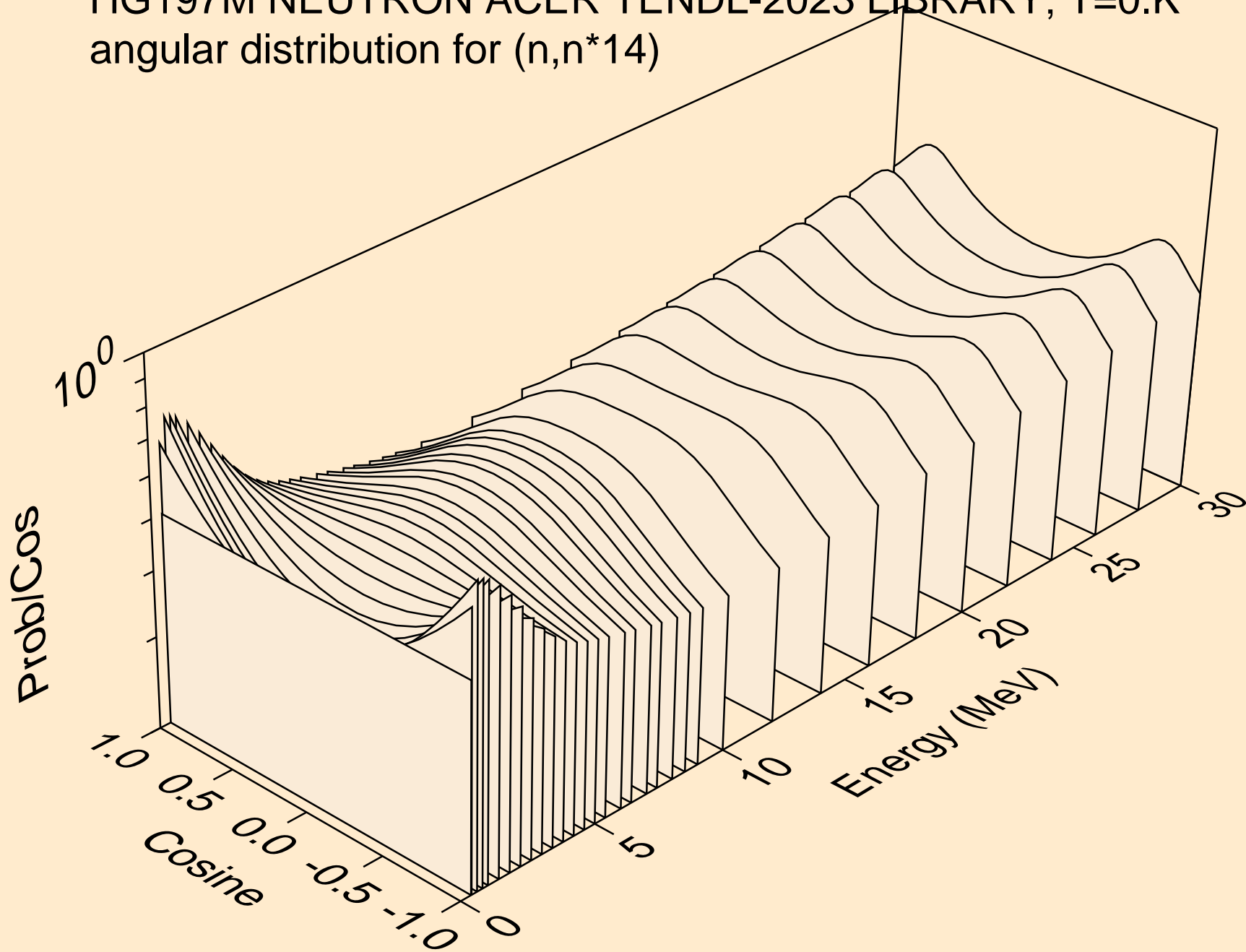

HG197M NEUTRON ACER TENDL-2023 LIBRARY; T=0.K
angular distribution for (n,n*15)

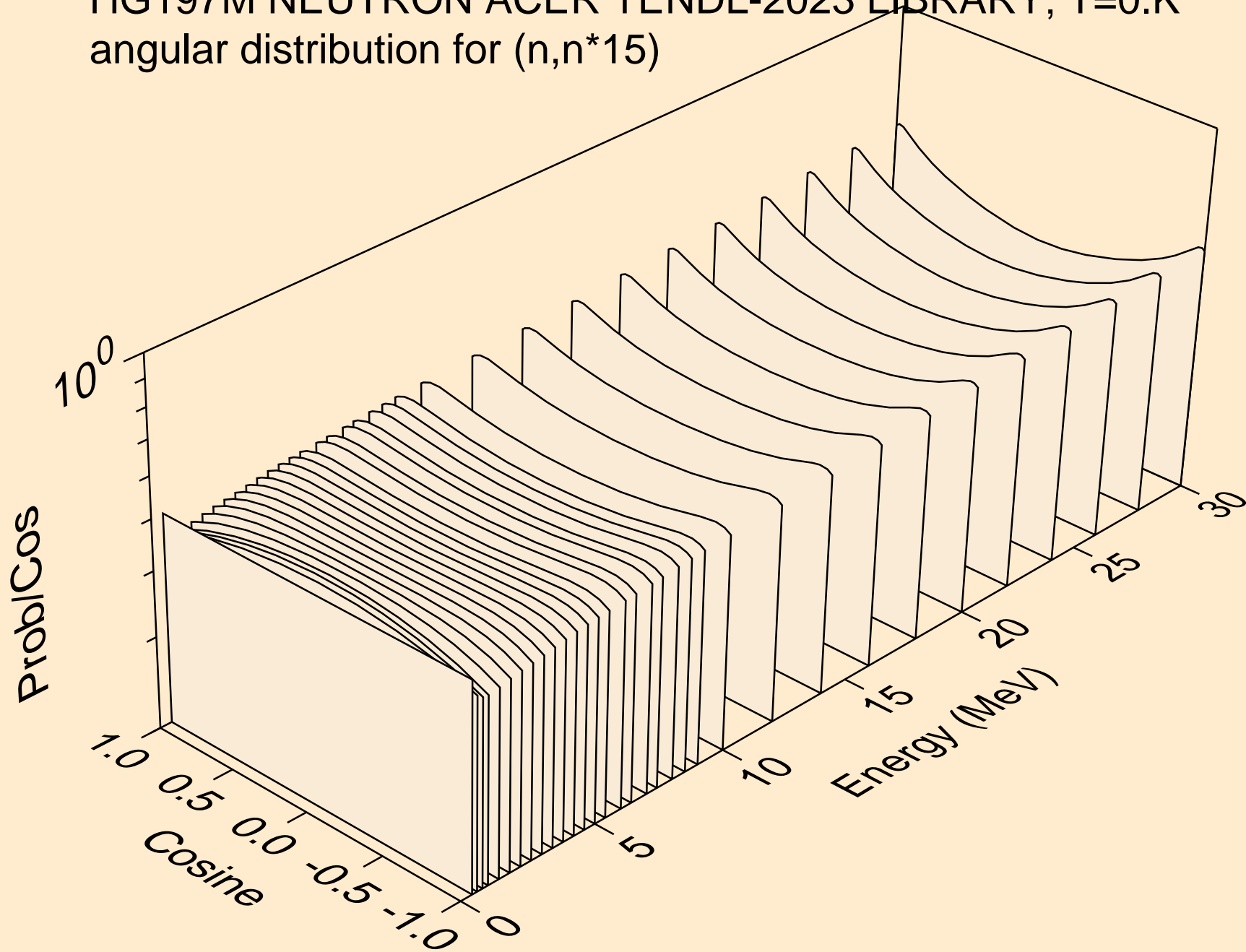

HG197M NEUTRON ACER TENDL-2023 LIBRARY; T=0.K
Neutron emission for (n,x)

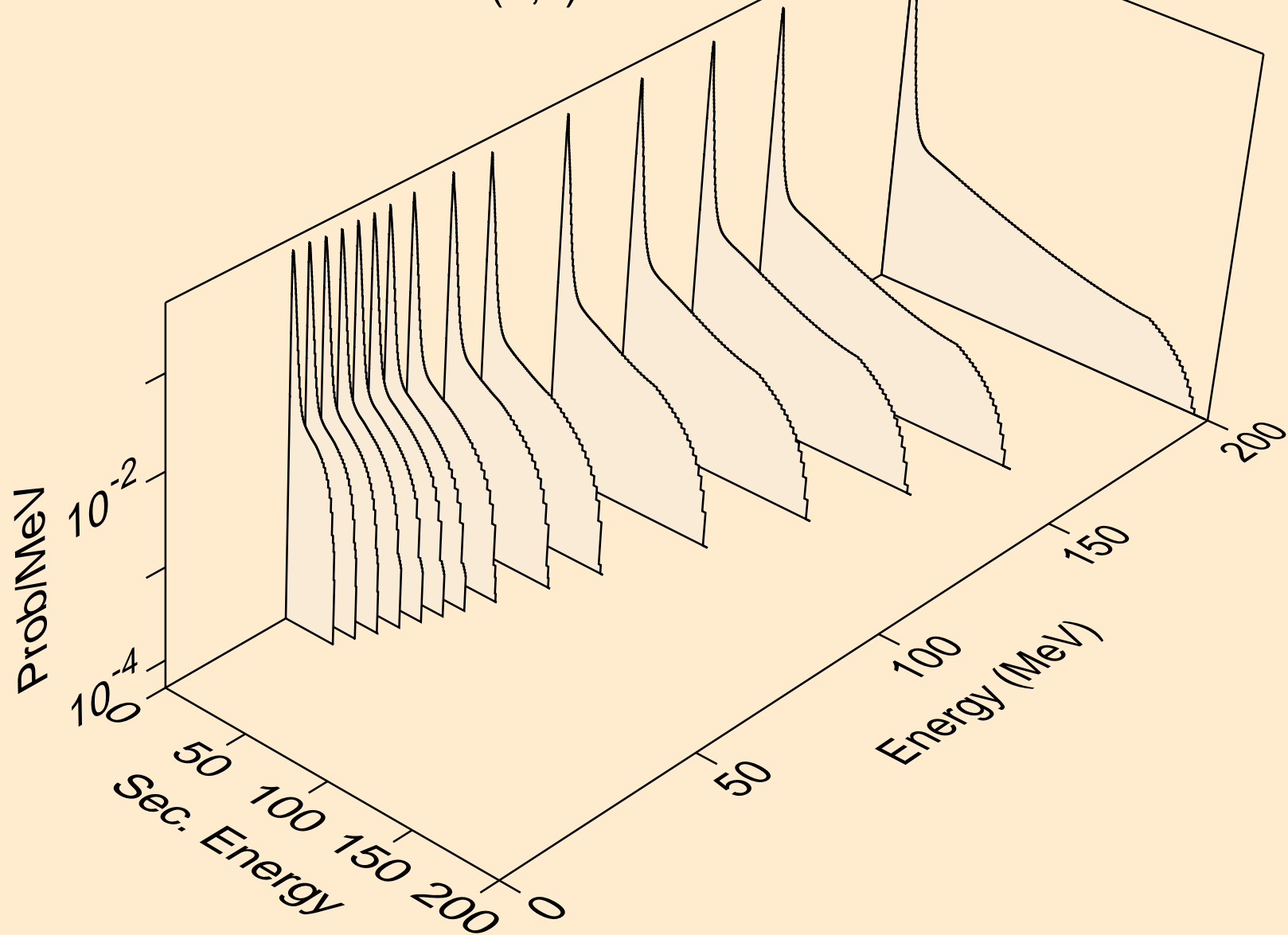

HG197M NEUTRON ACER TENDL-2023 LIBRARY; T=0.K
Neutron emission for (n,2nd)

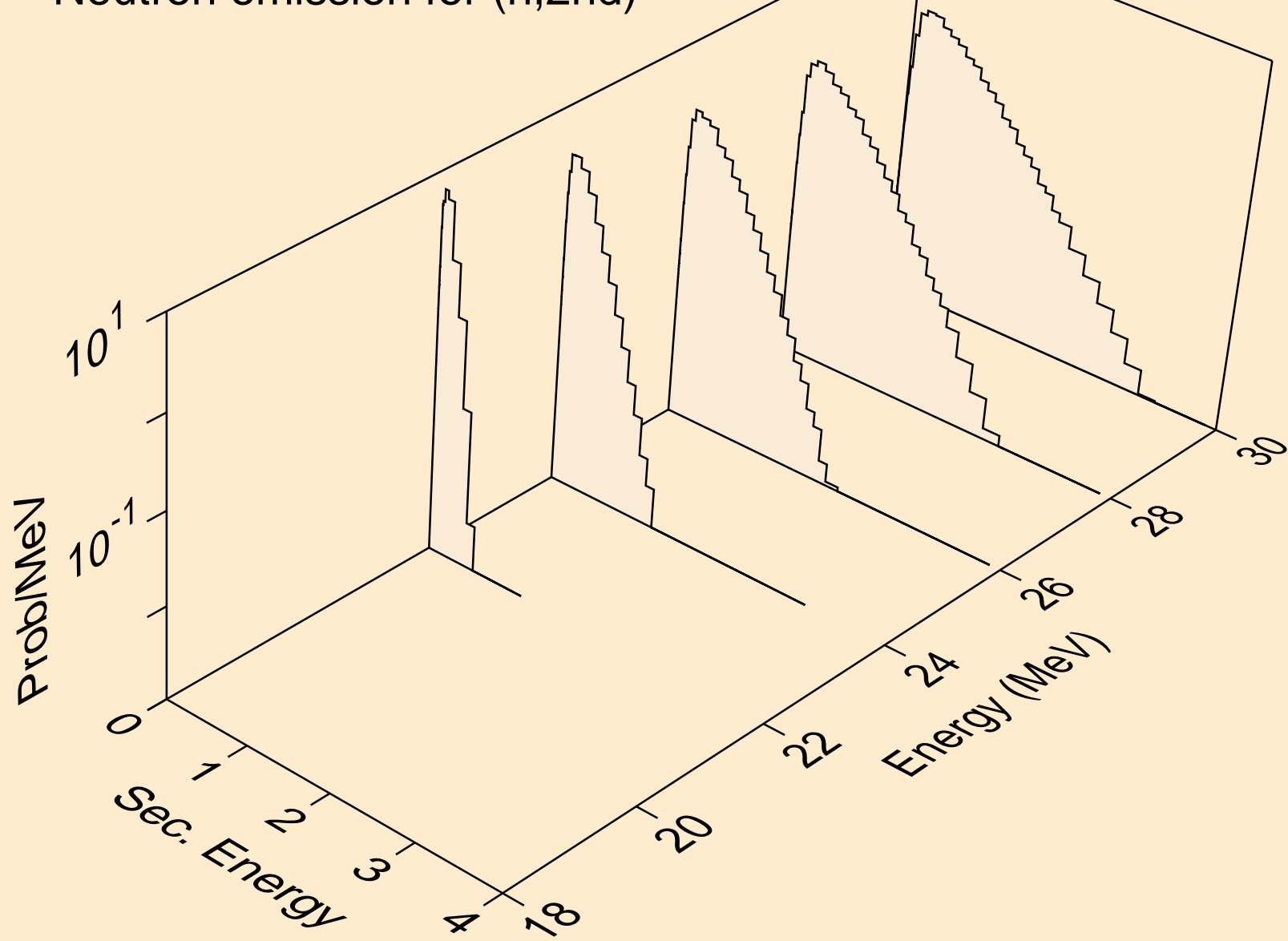

HG197M NEUTRON ACER TENDL-2023 LIBRARY; T=0.K
Neutron emission for (n,2n)

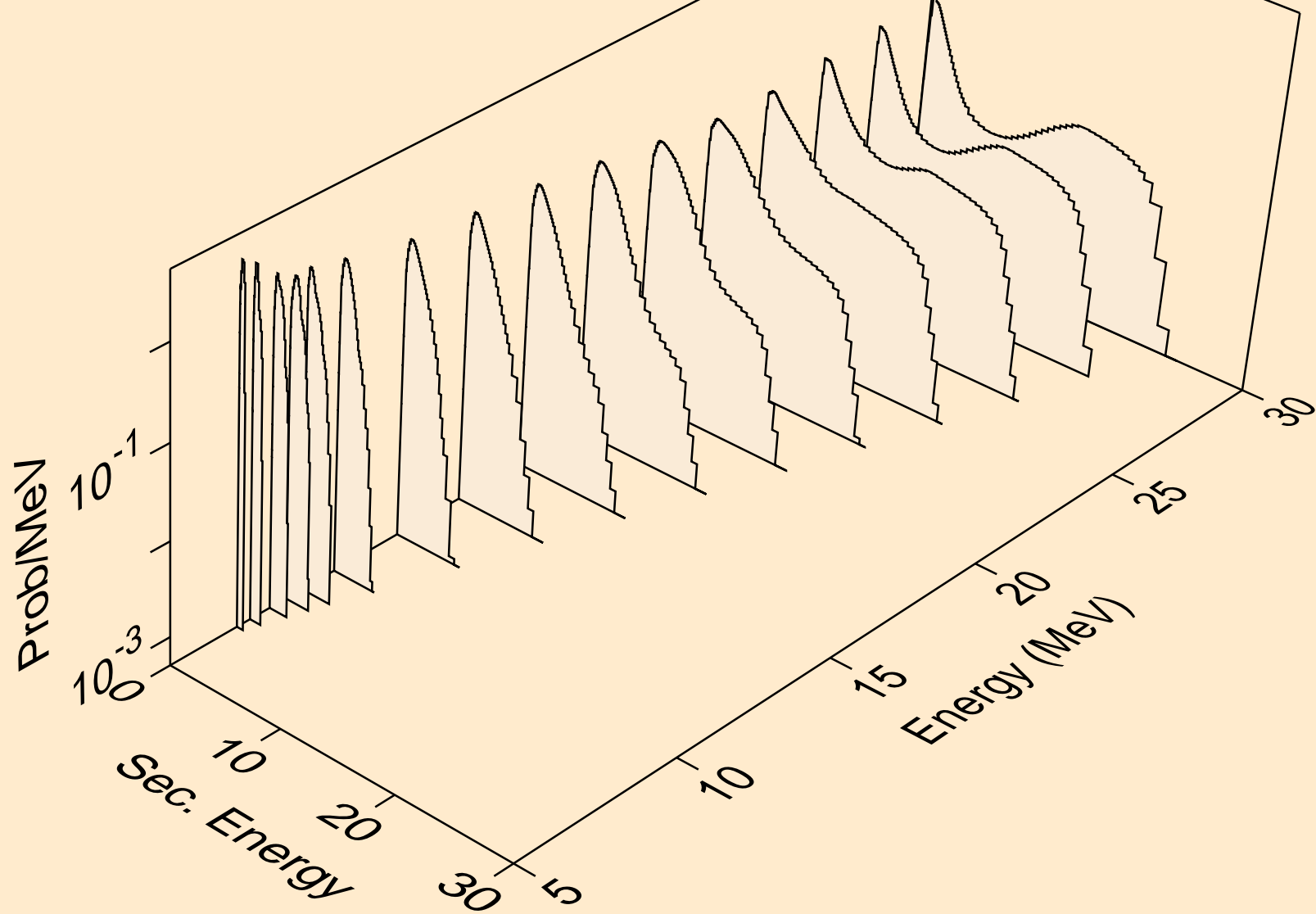

HG197M NEUTRON ACER TENDL-2023 LIBRARY; T=0.K
Neutron emission for (n,3n)

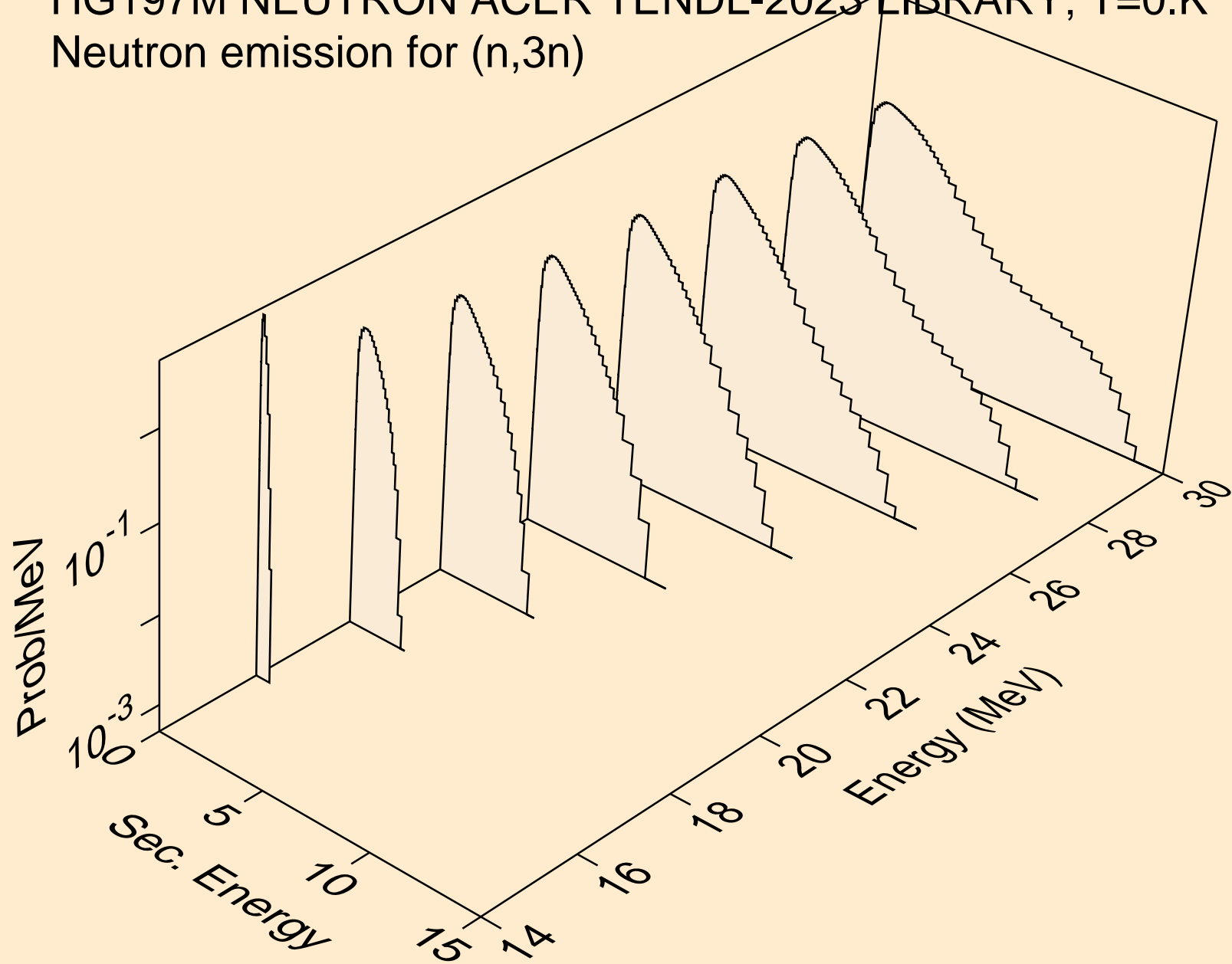

HG197M NEUTRON ACER TENDL-2023 LIBRARY; T=0.K
Neutron emission for (n,n*)a

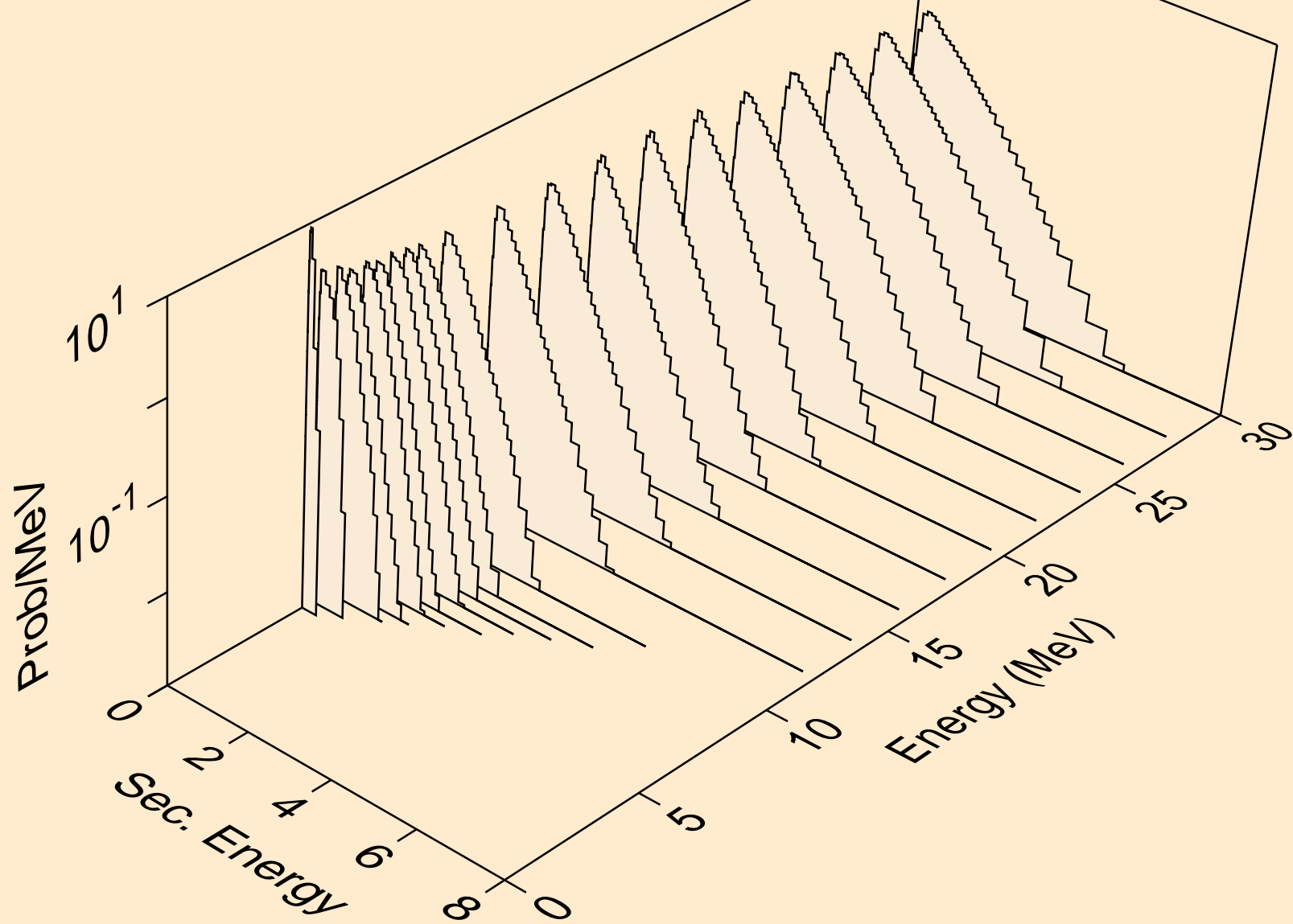

HG197M NEUTRON ACER TENDL-2023 LIBRARY; T=0.K
Neutron emission for (n,2n)a

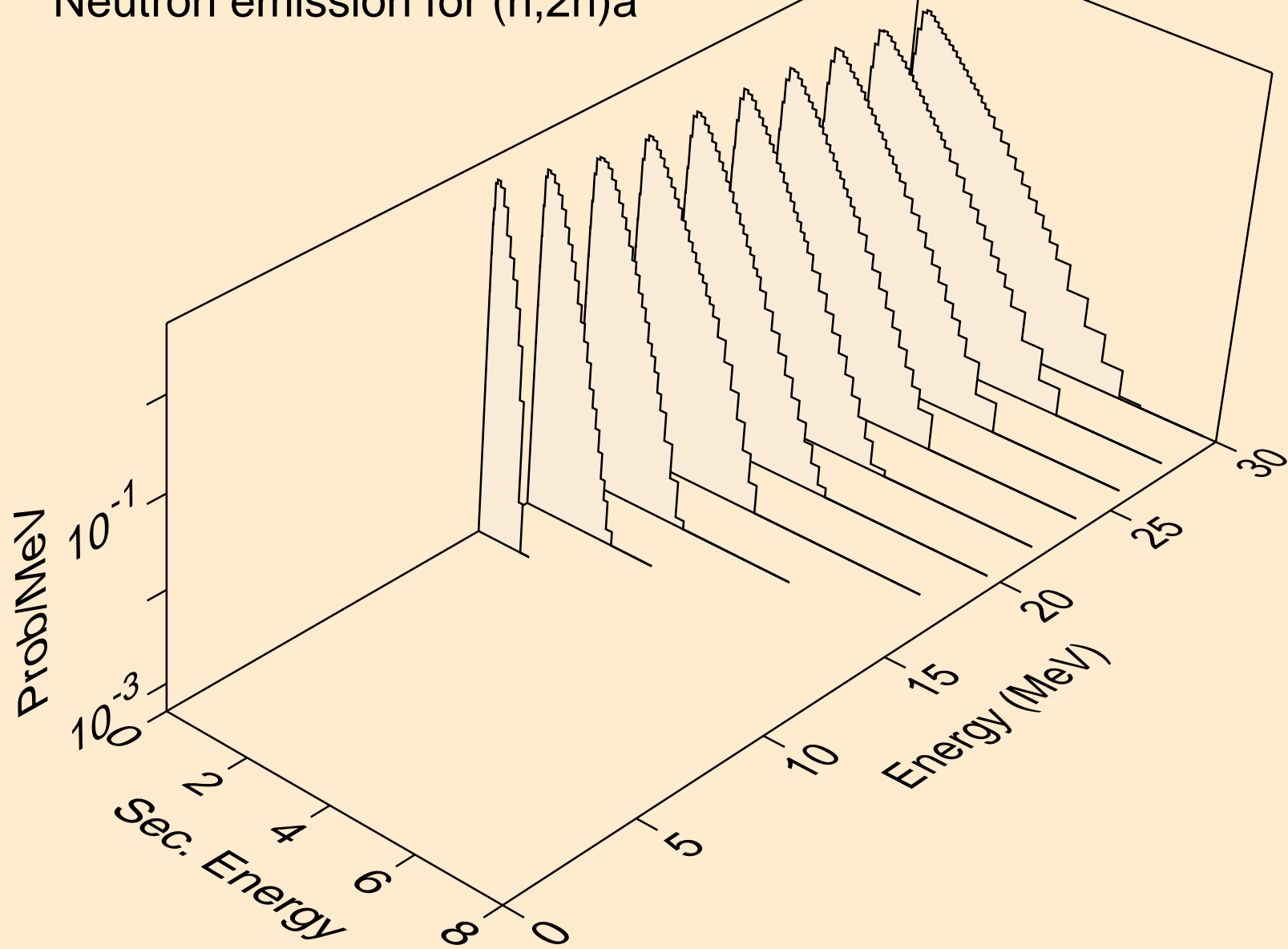

HG197M NEUTRON ACER TENDL-2023 LIBRARY; T=0.K
Neutron emission for (n,3n)_a

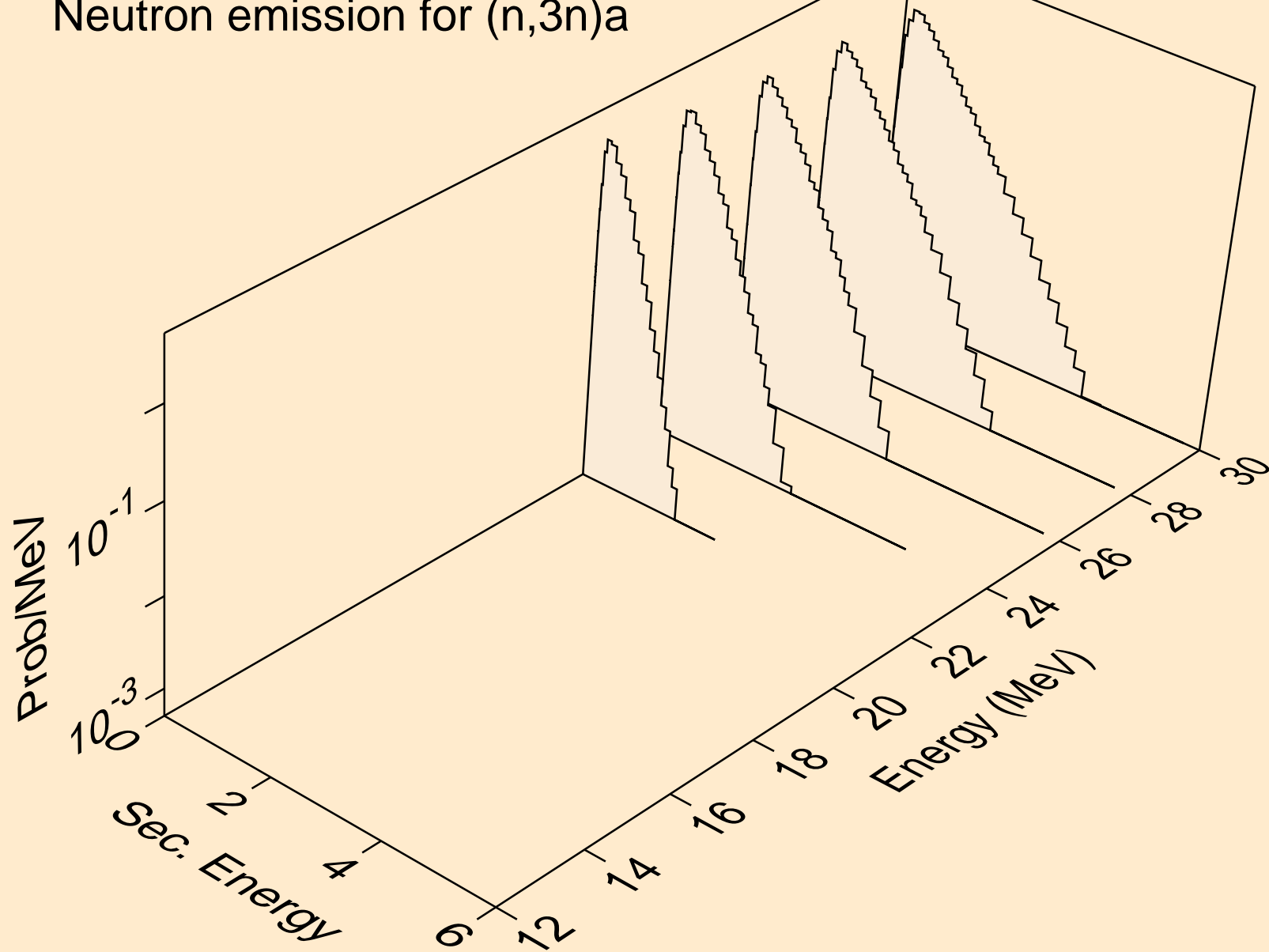

HG197M NEUTRON ACER TENDL-2023 LIBRARY; T=0.K
Neutron emission for (n,n*)p

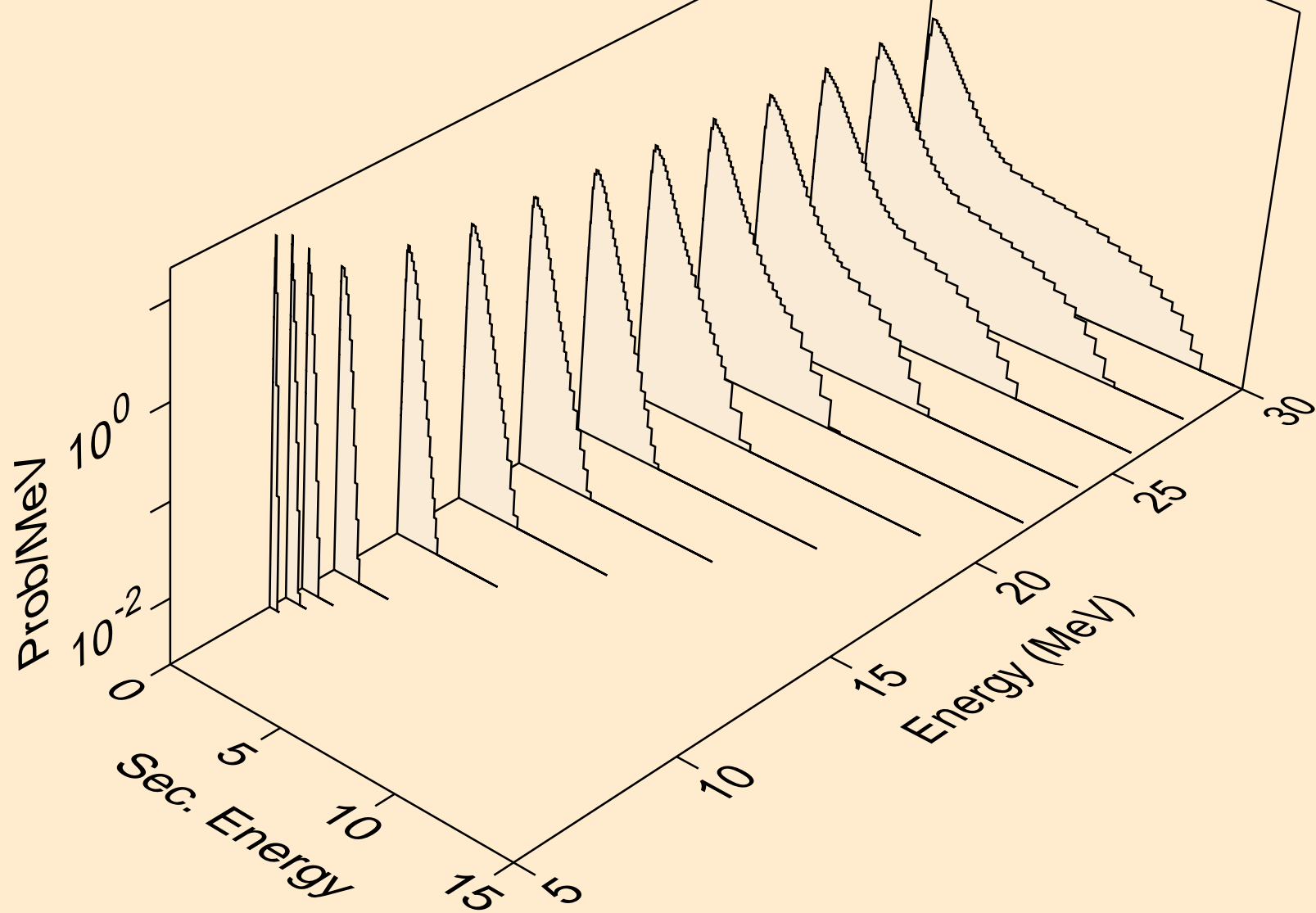

HG197M NEUTRON ACER TENDL-2023 LIBRARY; T=0.K
Neutron emission for (n,n*)d

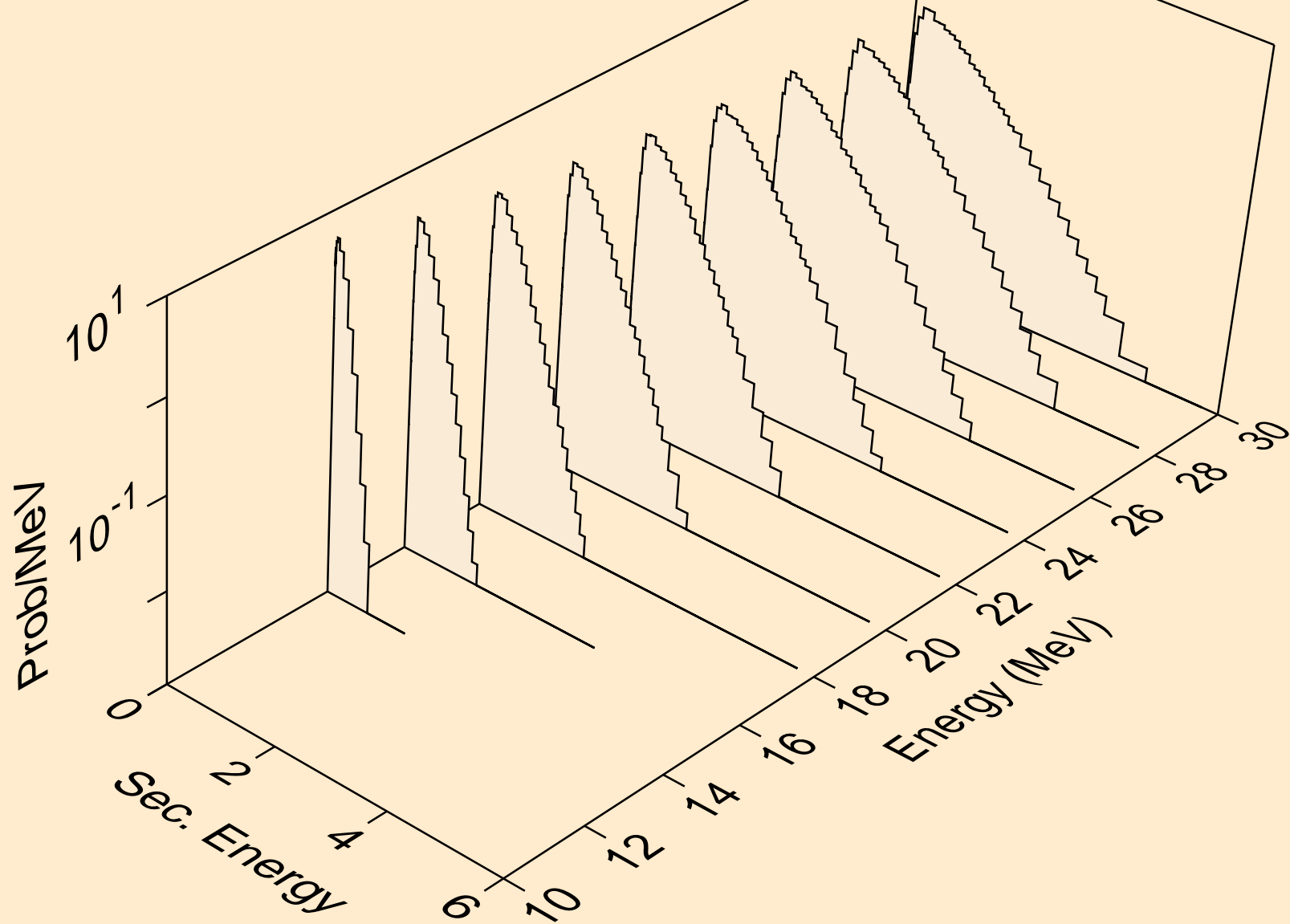

HG197M NEUTRON ACER TENDL-2023 LIBRARY; T=0.K
Neutron emission for (n,n*)t

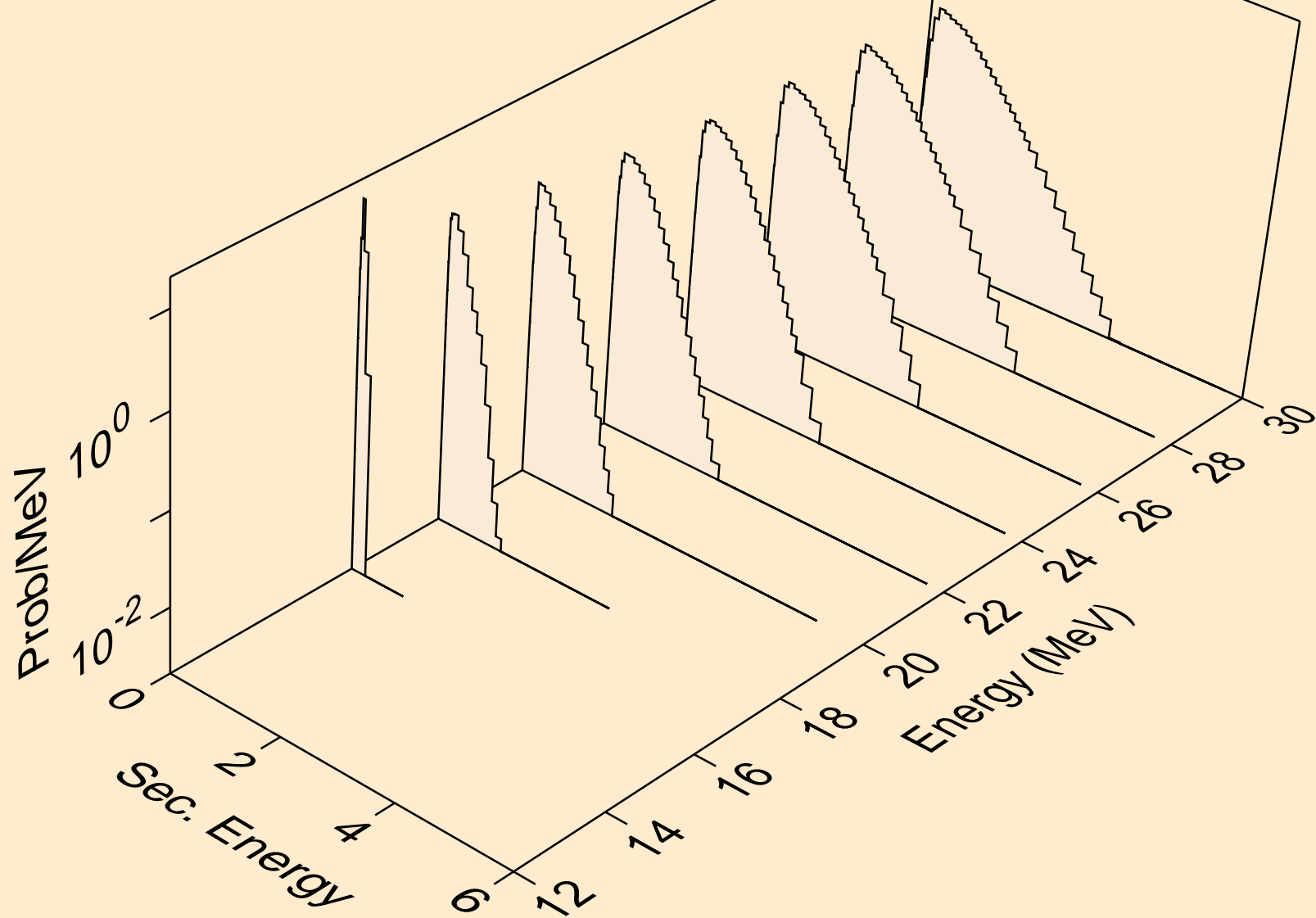

HG197M NEUTRON ACER TENDL-2023 LIBRARY; T=0.K
Neutron emission for (n,n*)he3

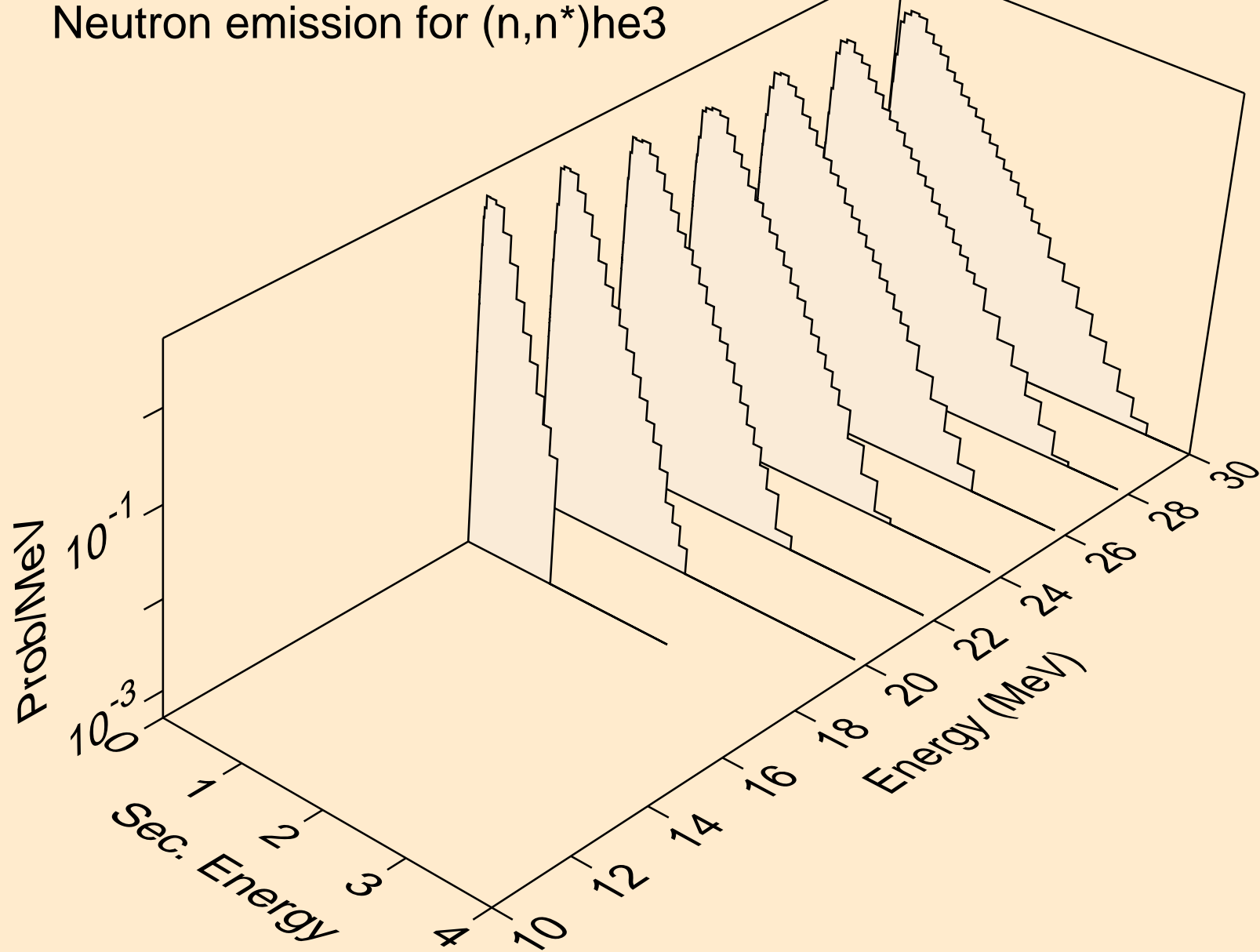

HG197M NEUTRON ACER TENDL-2023 LIBRARY; T=0.K
Neutron emission for (n,4n)

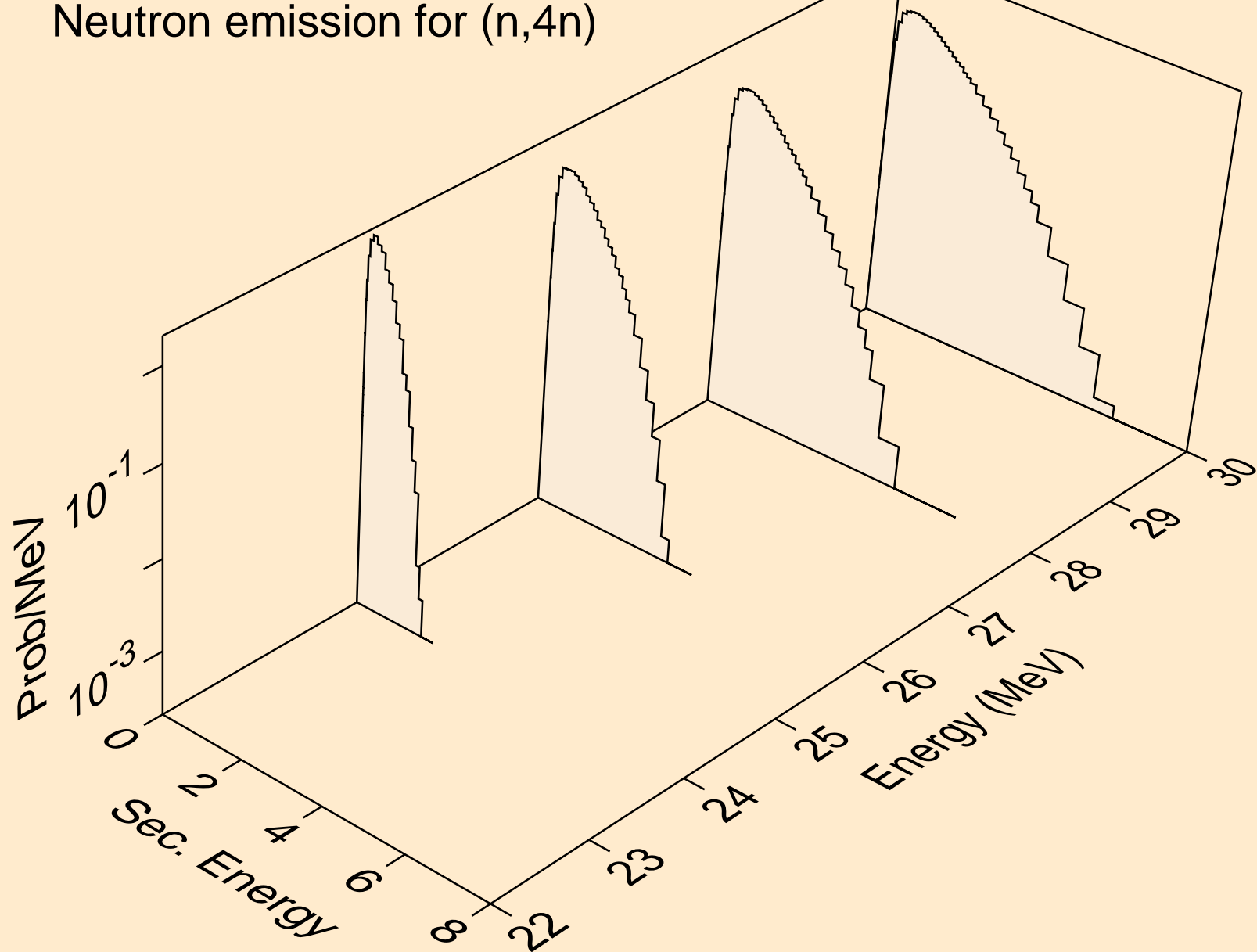

HG197M NEUTRON ACER TENDL-2023 LIBRARY; T=0.K
Neutron emission for (n,2np)

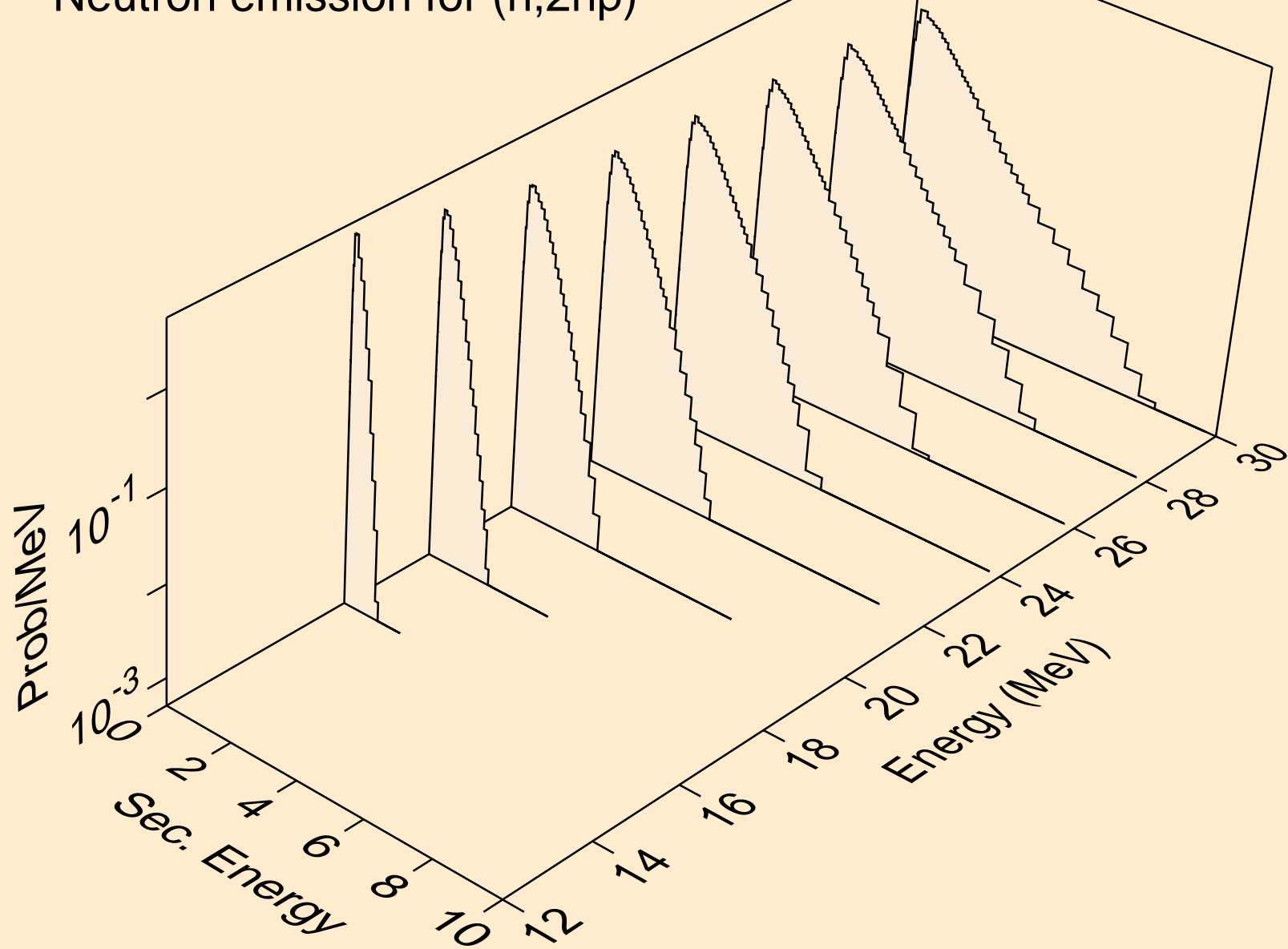

HG197M NEUTRON ACER TENDL-2023 LIBRARY; T=0.K
Neutron emission for (n,3np)

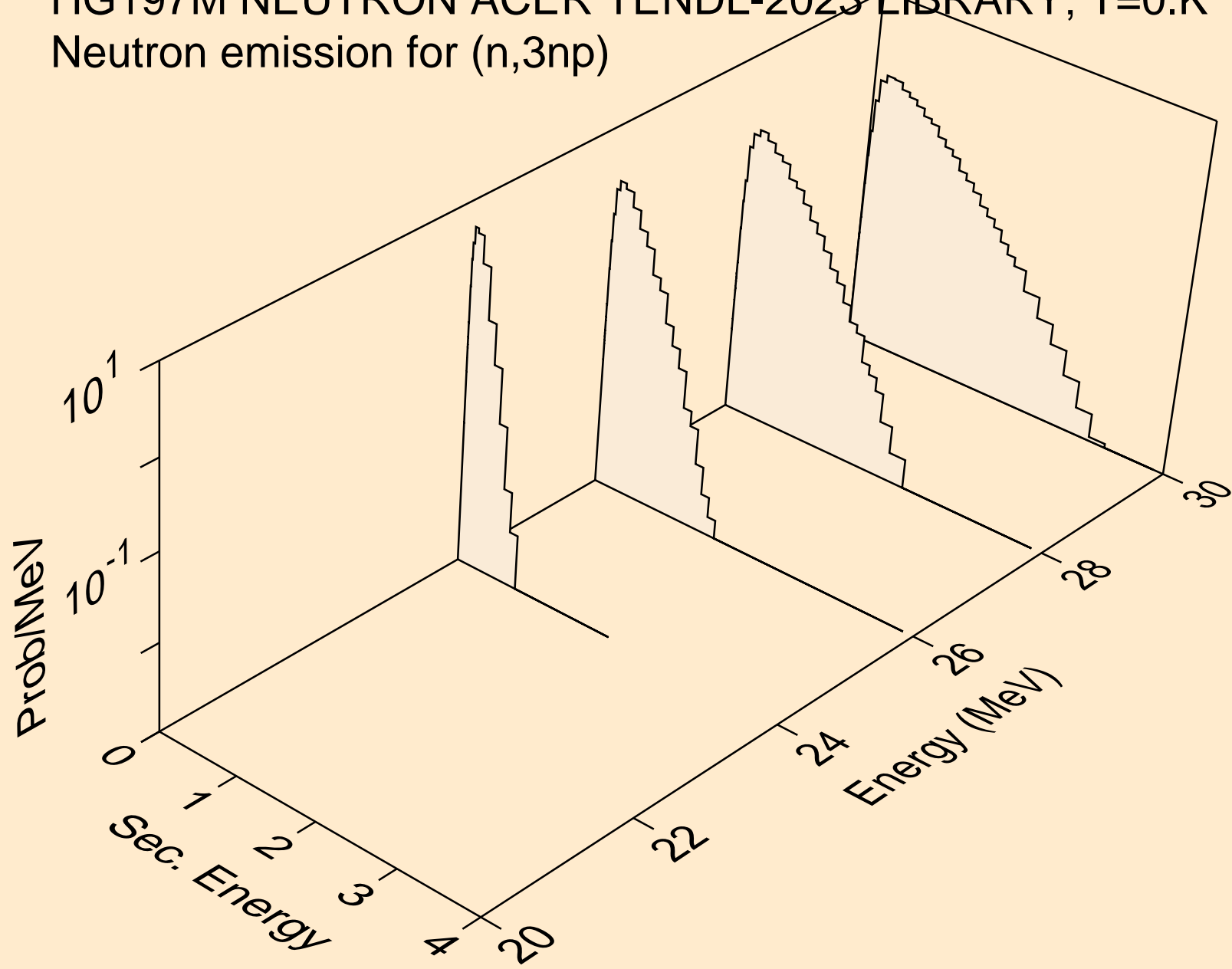

HG197M NEUTRON ACER TENDL-2023 LIBRARY; T=0.K
Neutron emission for (n,n2p)

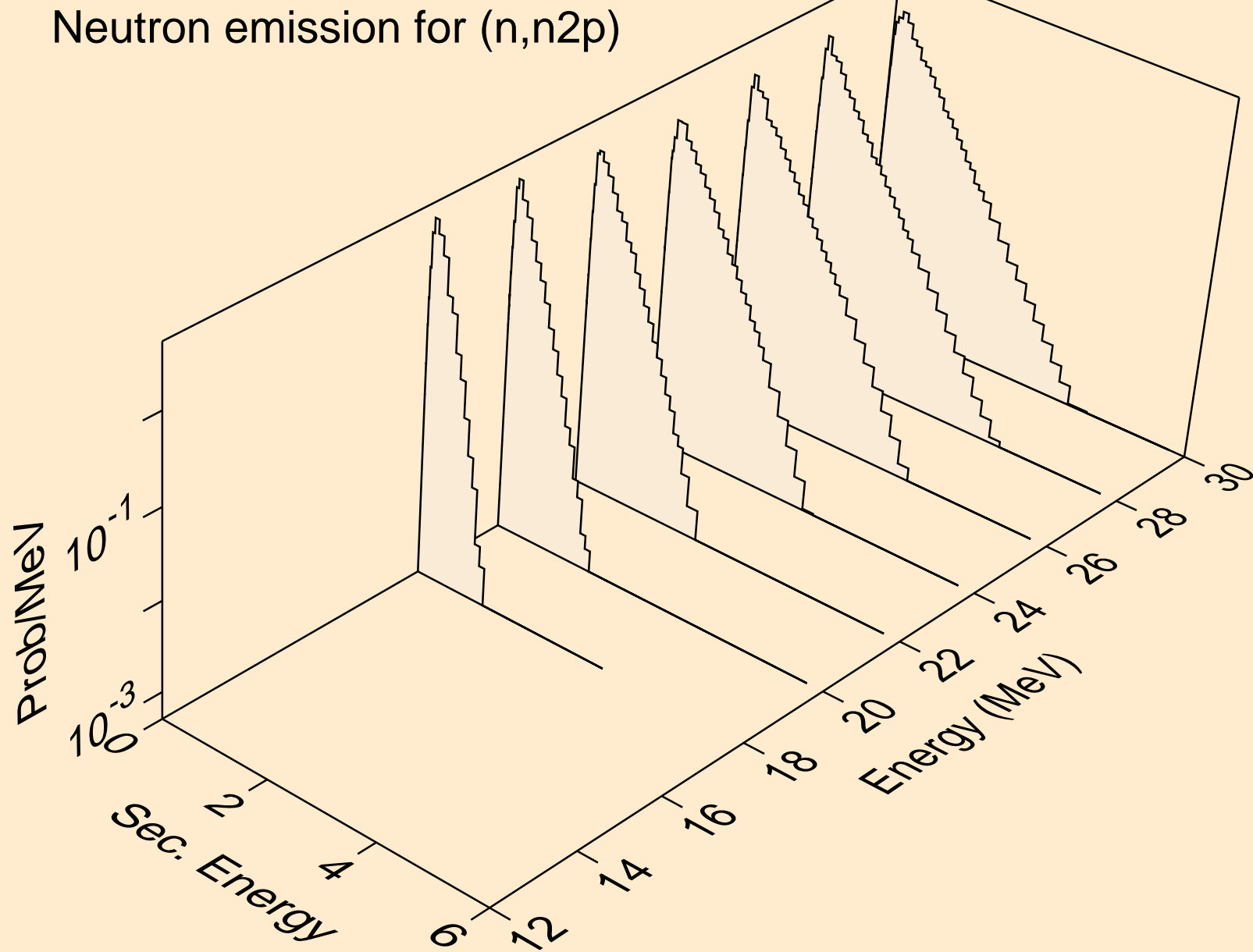

HG197M NEUTRON ACER TENDL-2023 LIBRARY; T=0.K
Neutron emission for (n,npa)

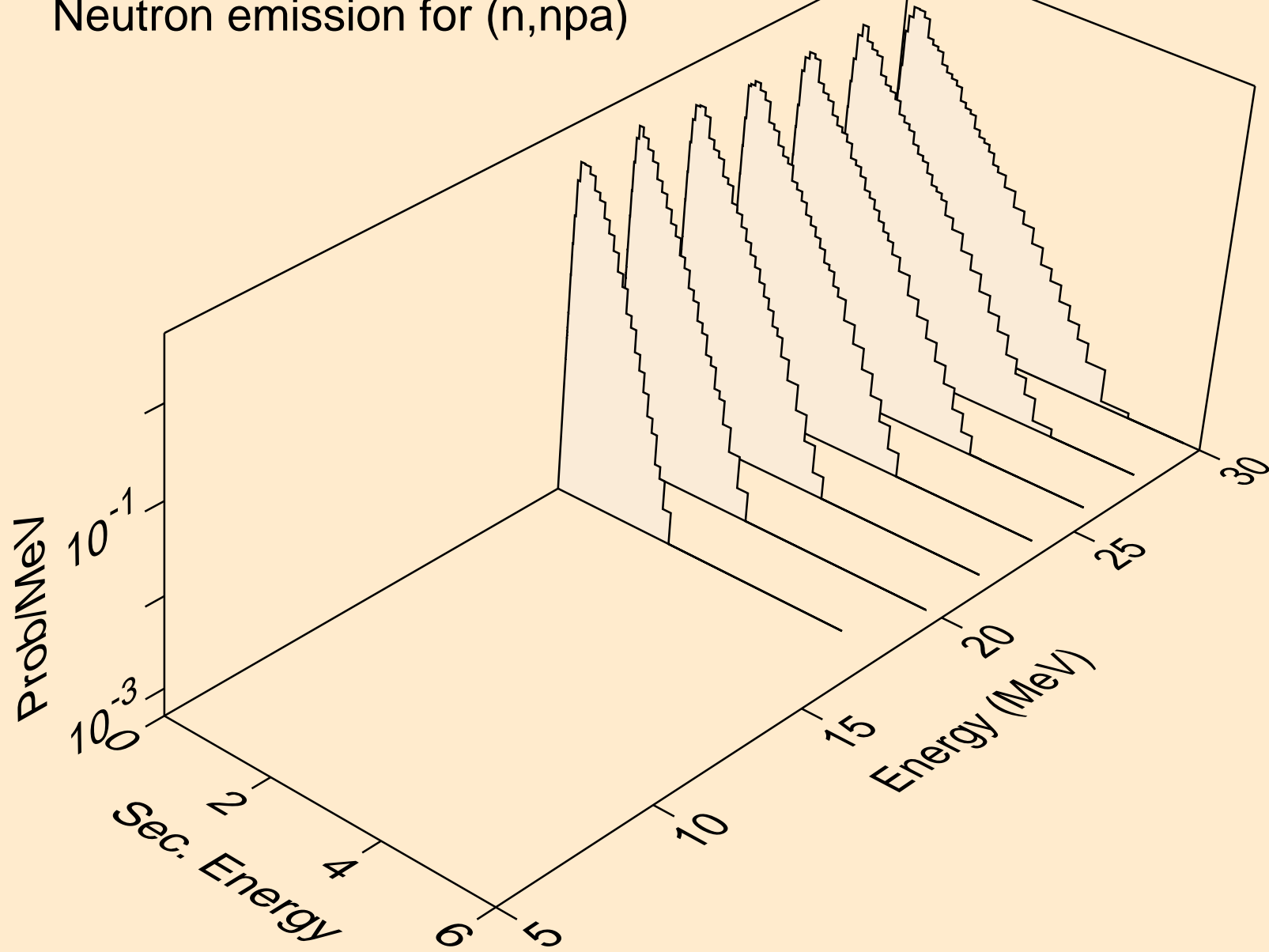

HG197M NEUTRON ACER TENDL-2023 LIBRARY; T=0.K
Neutron emission for (n,n*c)

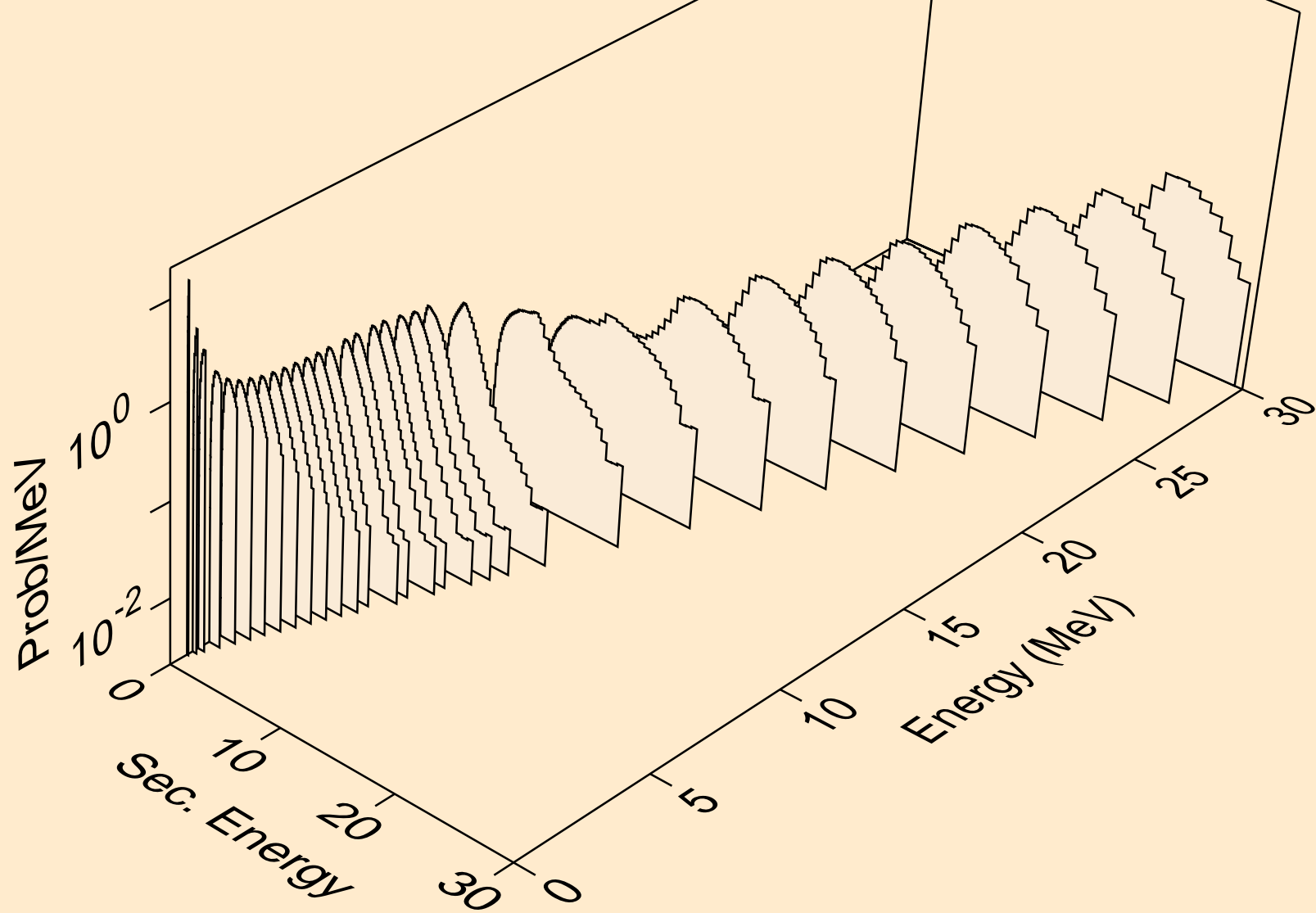

HG197M NEUTRON ACER TENDL-2023 LIBRARY; T=0.K
Photon emission for (n,x)

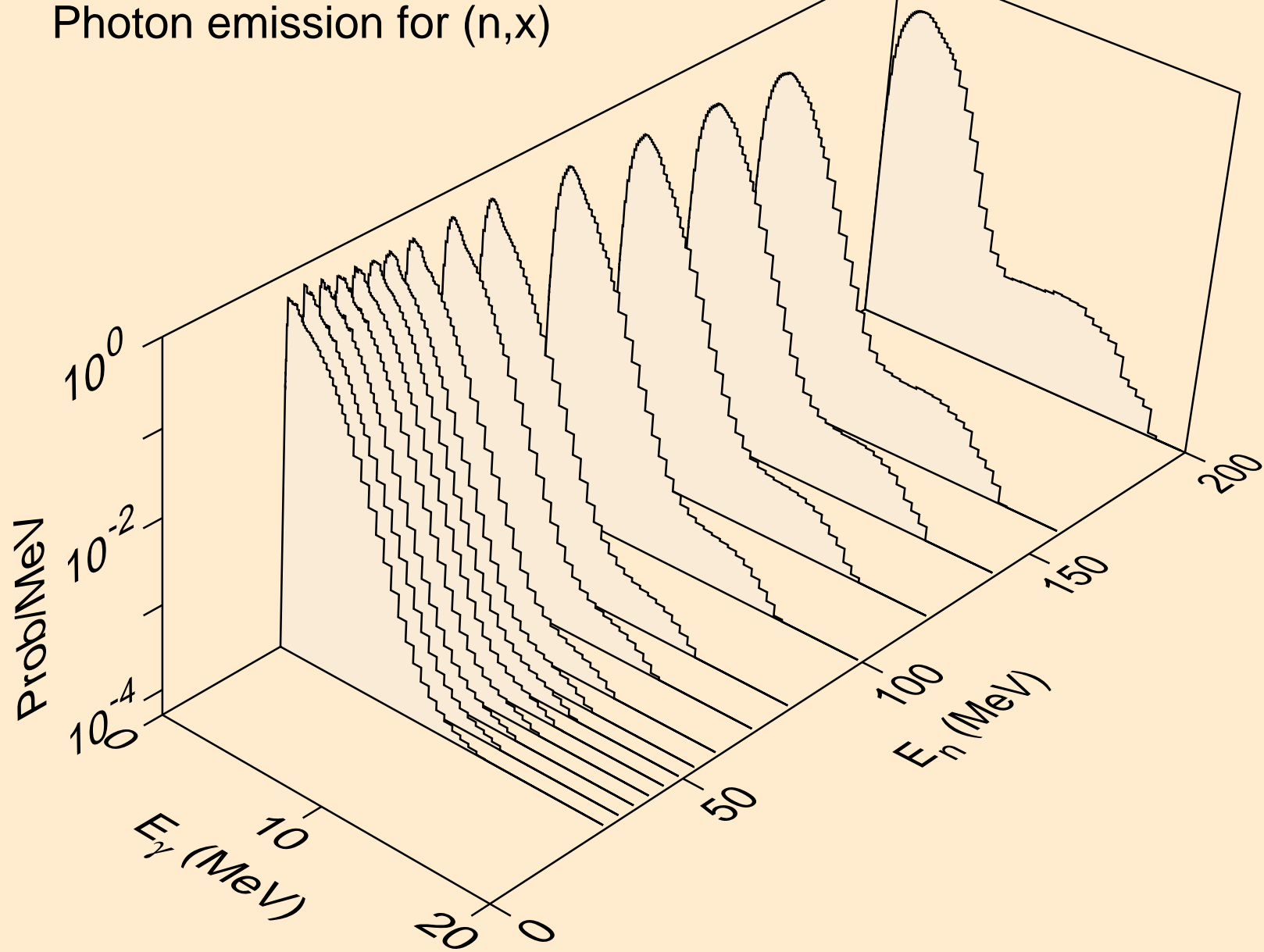

HG197M NEUTRON ACER TENDL-2023 LIBRARY; T=0.K
Photon emission for (n,2nd)

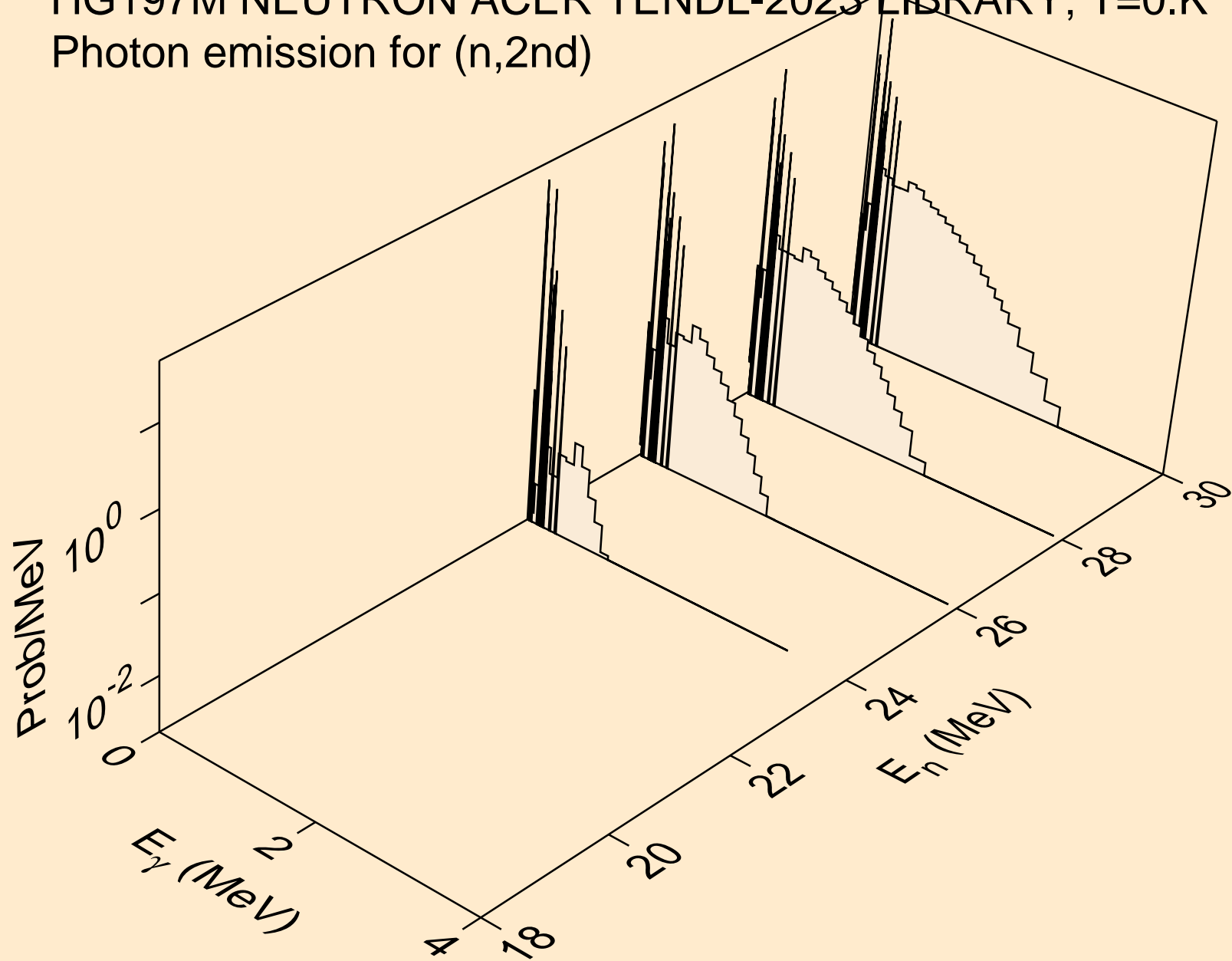

HG197M NEUTRON ACER TENDL-2023 LIBRARY; T=0.K
Photon emission for (n,2n)

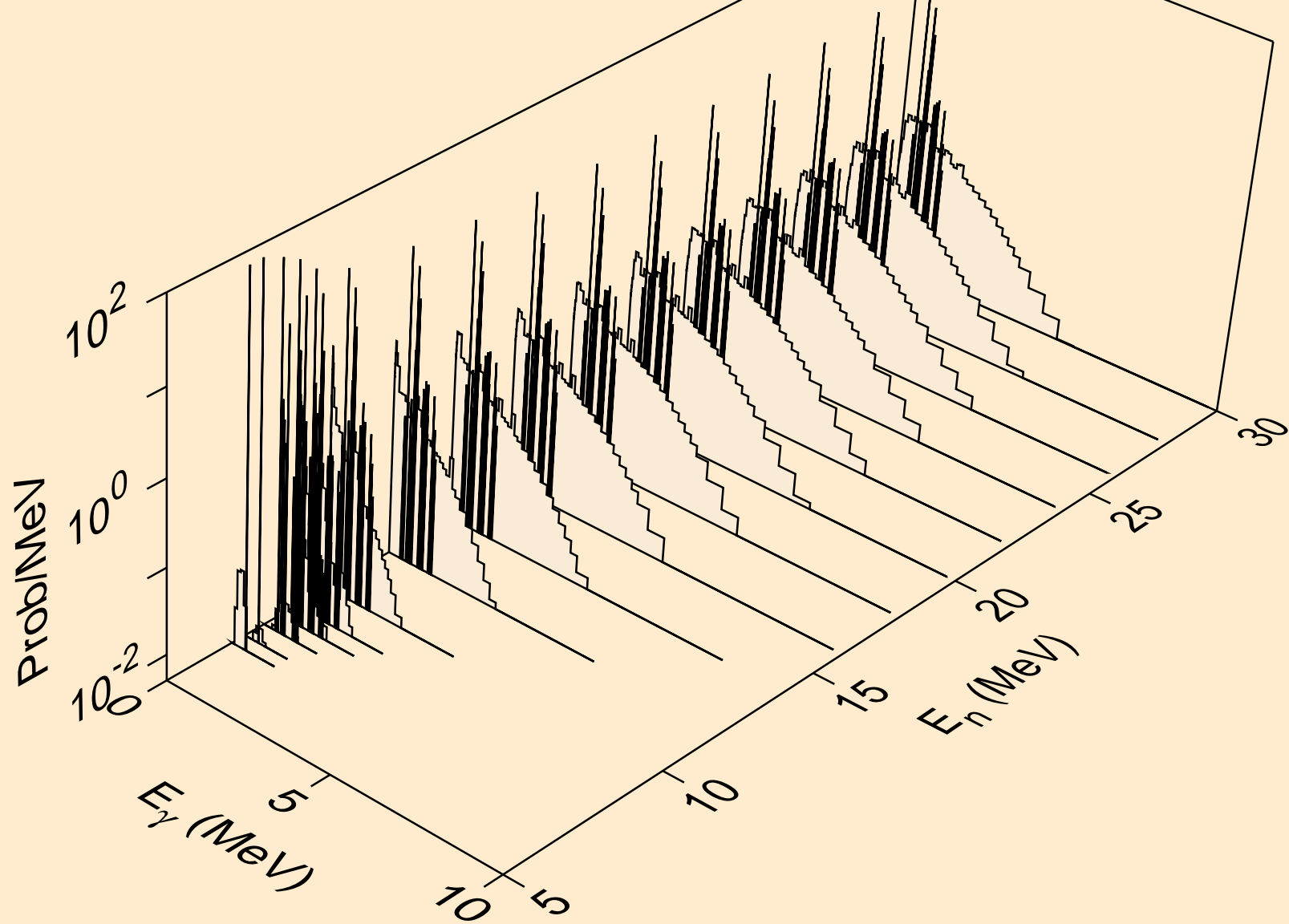

HG197M NEUTRON ACER TENDL-2023 LIBRARY; T=0.K
Photon emission for (n,3n)

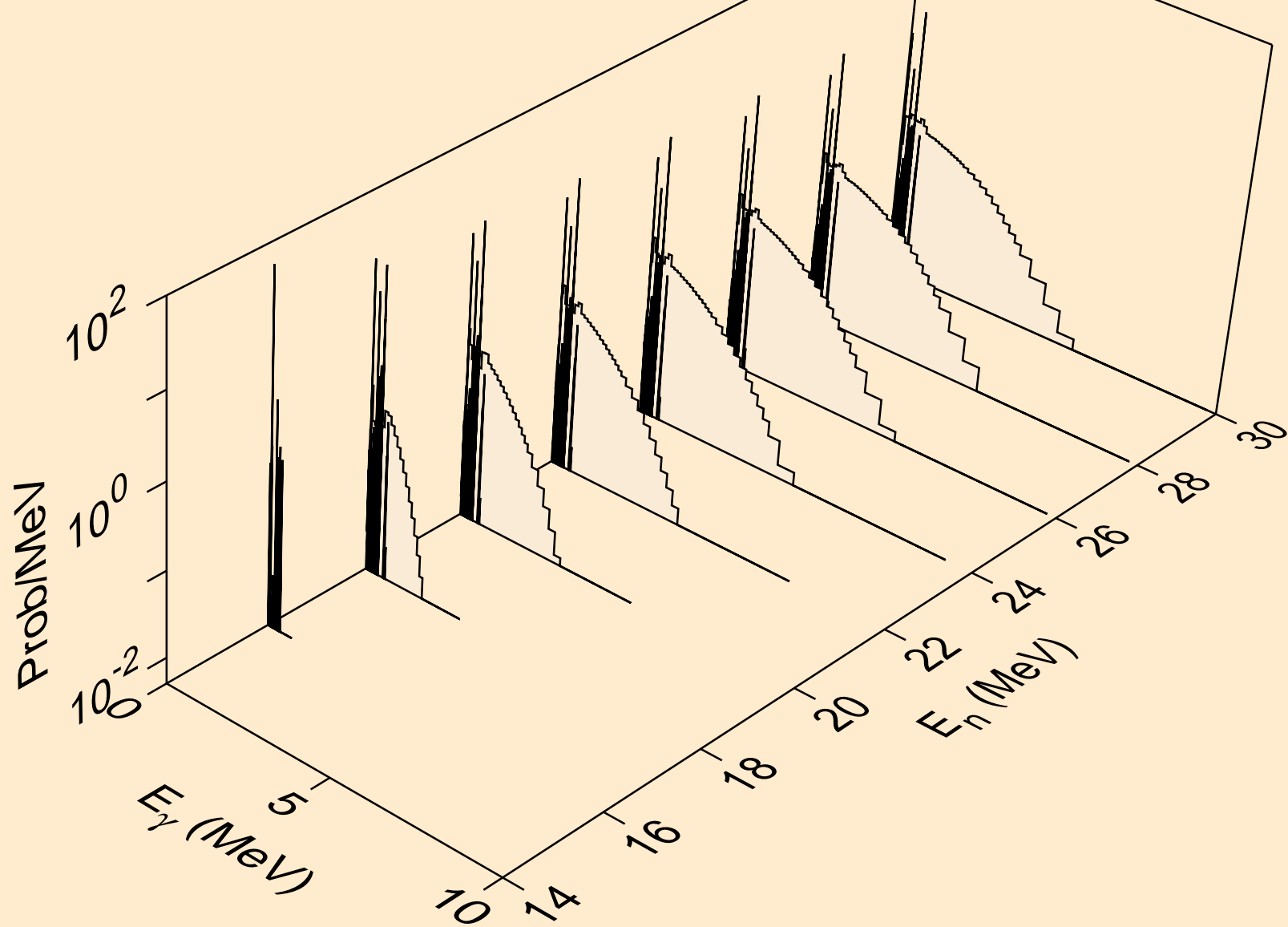

HG197M NEUTRON ACER TENDL-2023 LIBRARY; T=0.K
Photon emission for (n,n*)a

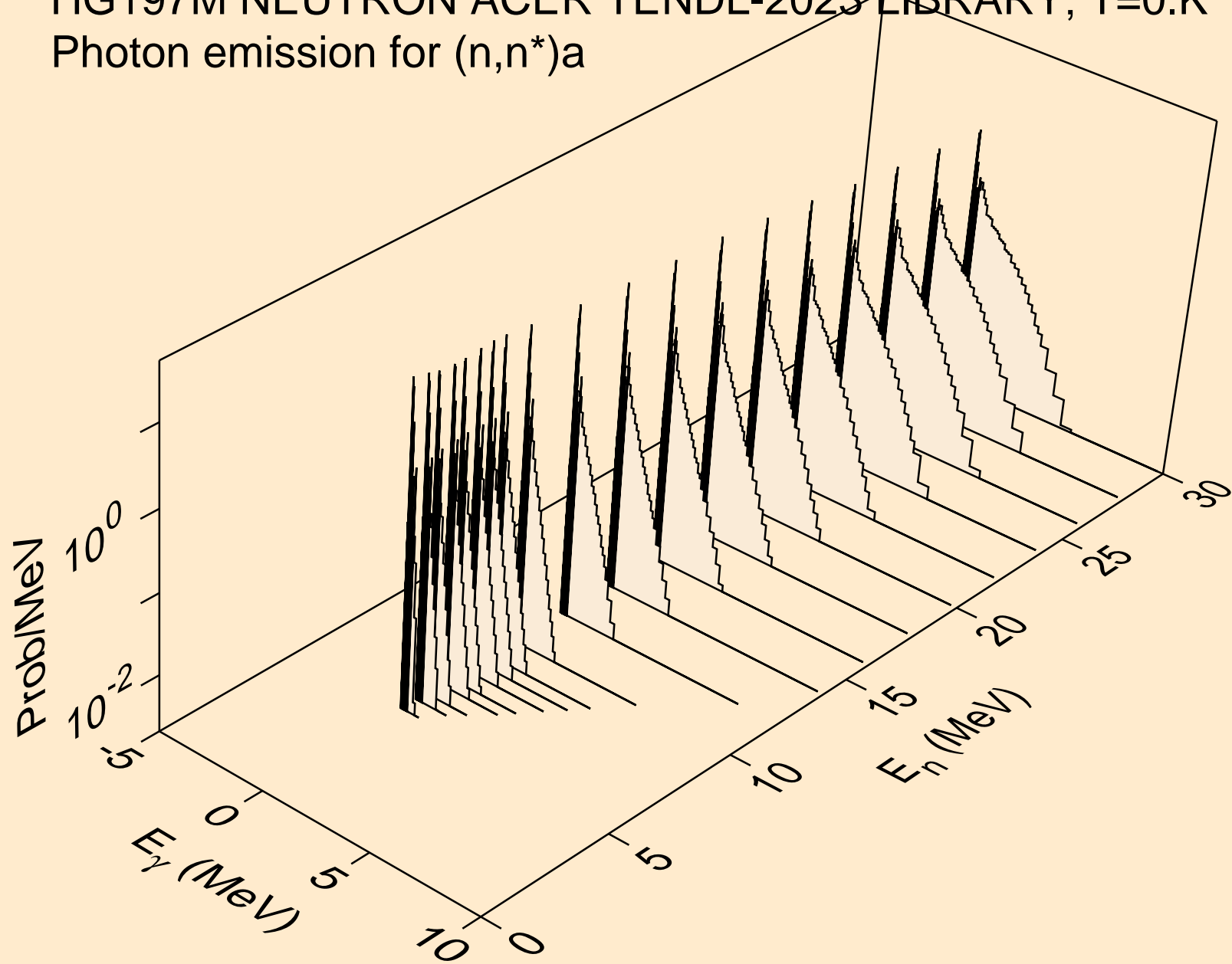

HG197M NEUTRON ACER TENDL-2023 LIBRARY; T=0.K
Photon emission for (n,2n)a

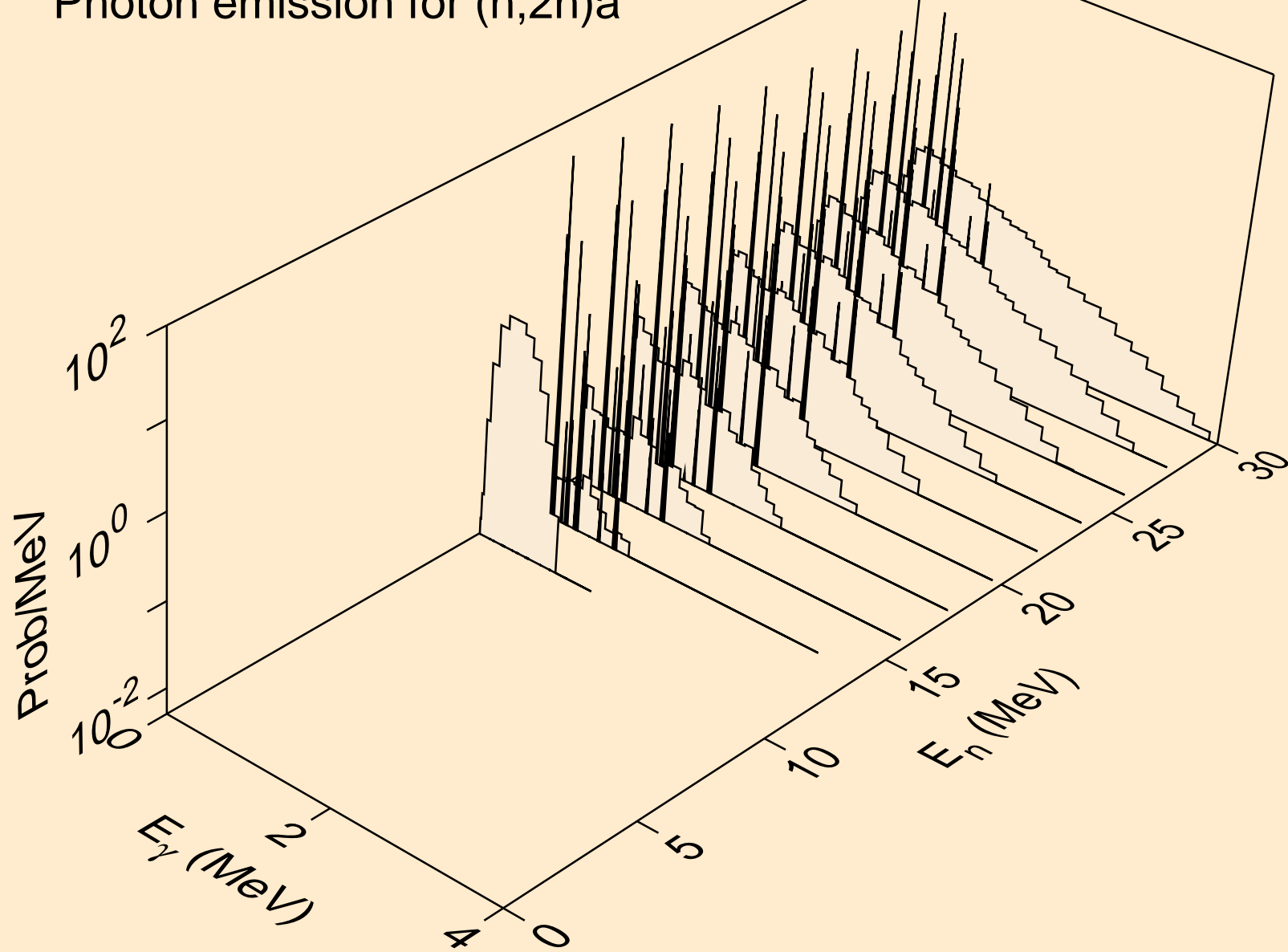

HG197M NEUTRON ACER TENDL-2023 LIBRARY; T=0.K
Photon emission for (n,3n)a

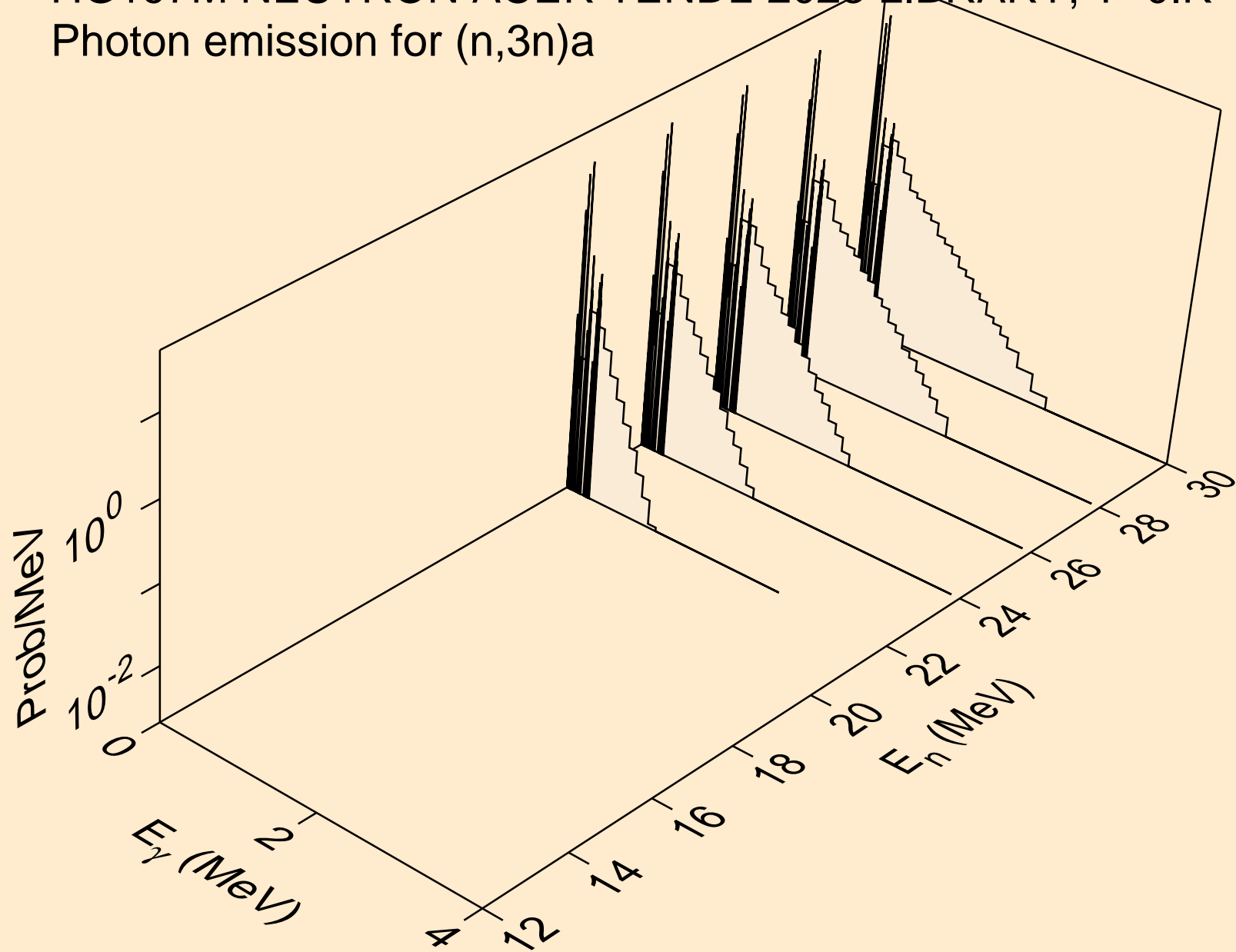

HG197M NEUTRON ACER TENDL-2023 LIBRARY; T=0.K
Photon emission for (n,n*)p

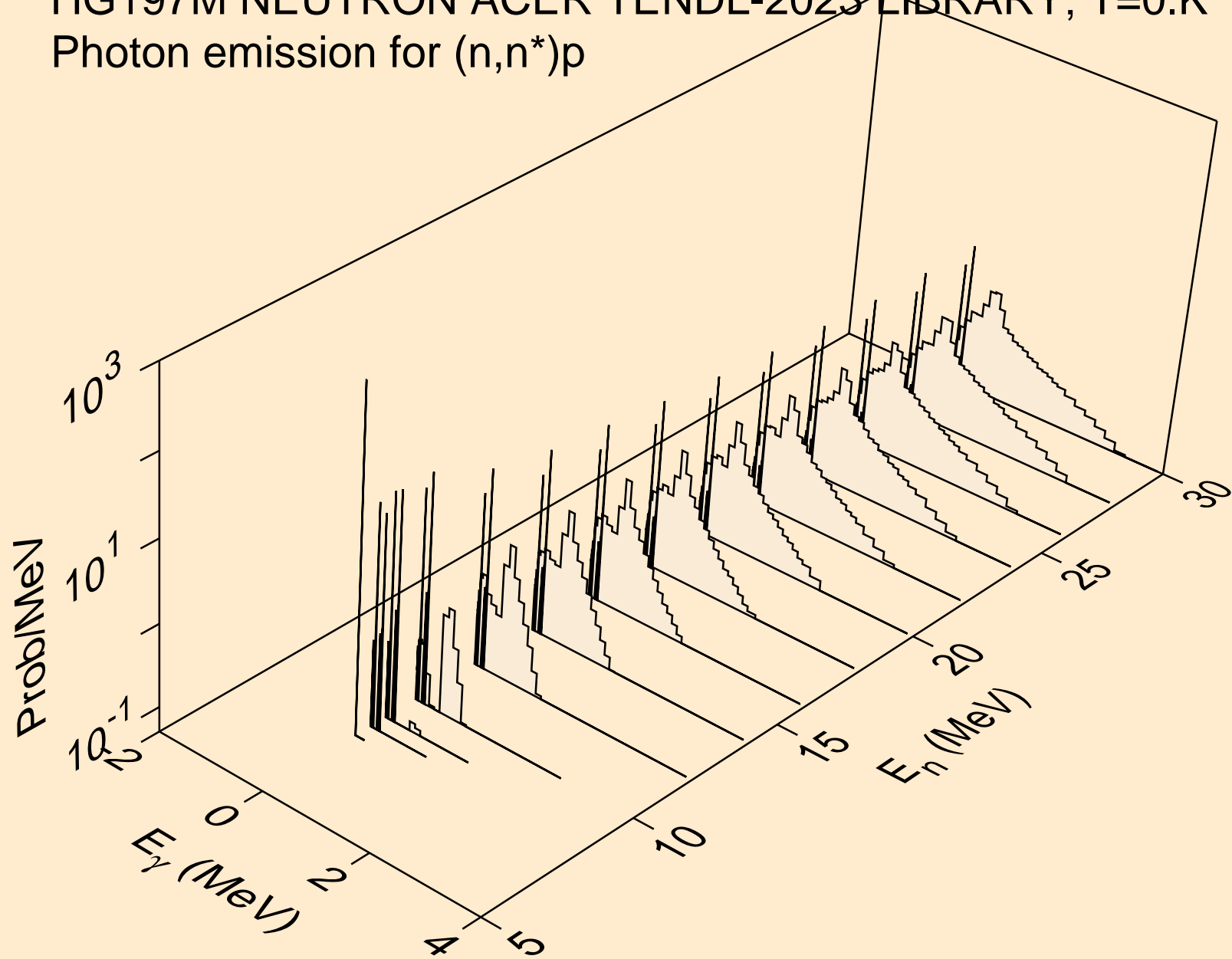

HG197M NEUTRON ACER TENDL-2023 LIBRARY; T=0.K
Photon emission for (n,n*)d

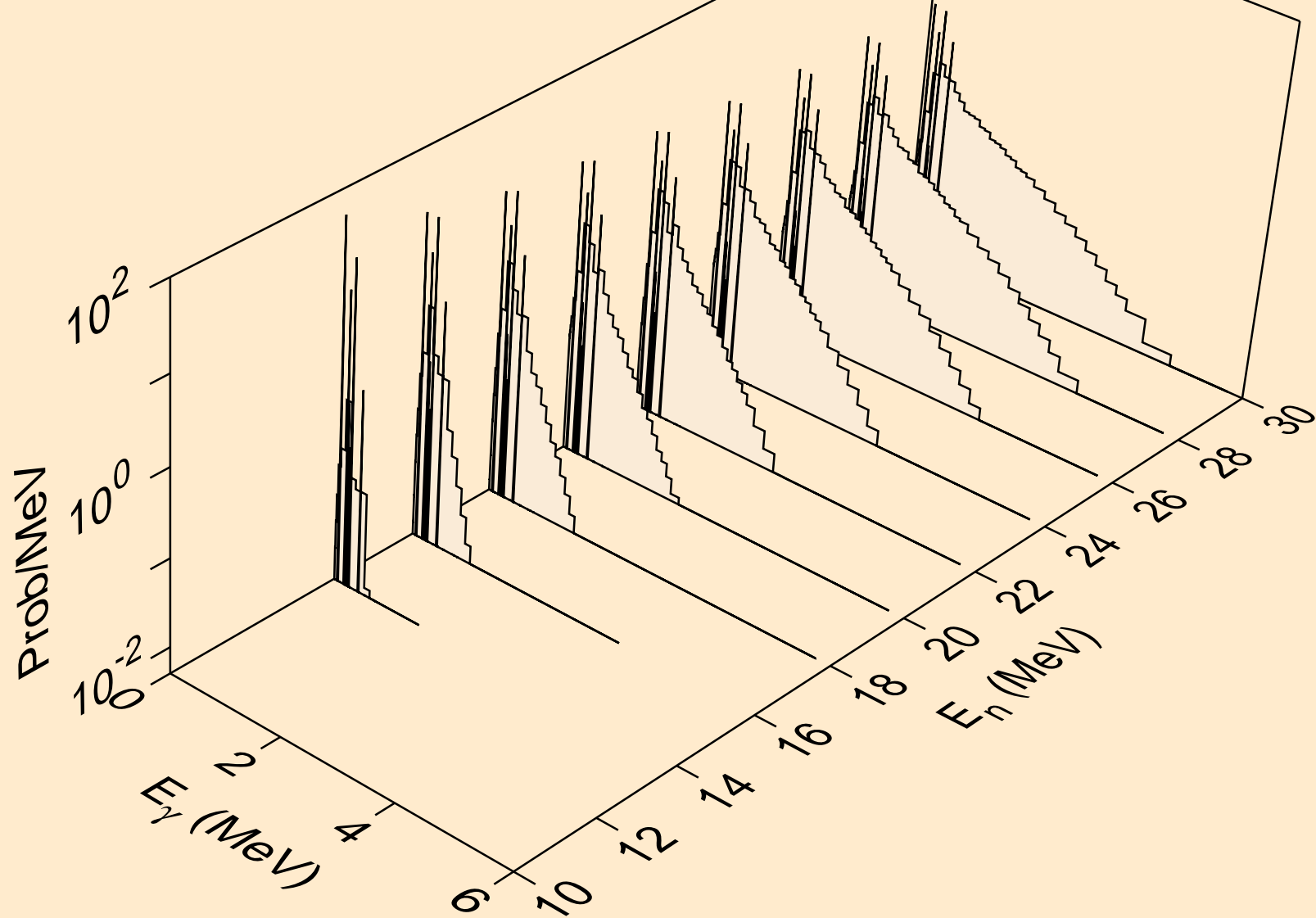

HG197M NEUTRON ACER TENDL-2023 LIBRARY; T=0.K
Photon emission for (n,n*)t

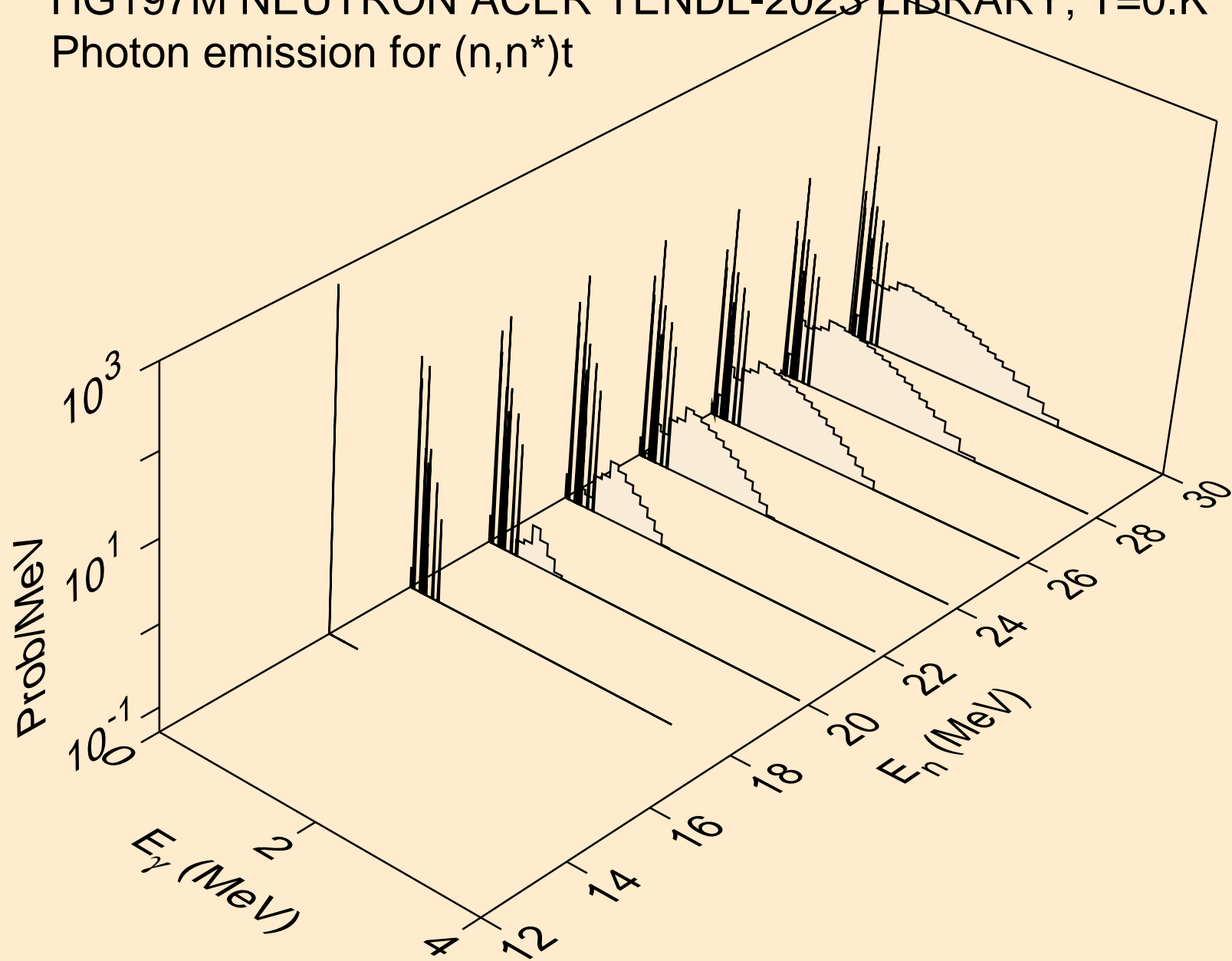

HG197M NEUTRON ACER TENDL-2023 LIBRARY; T=0.K
Photon emission for (n,n*)he3

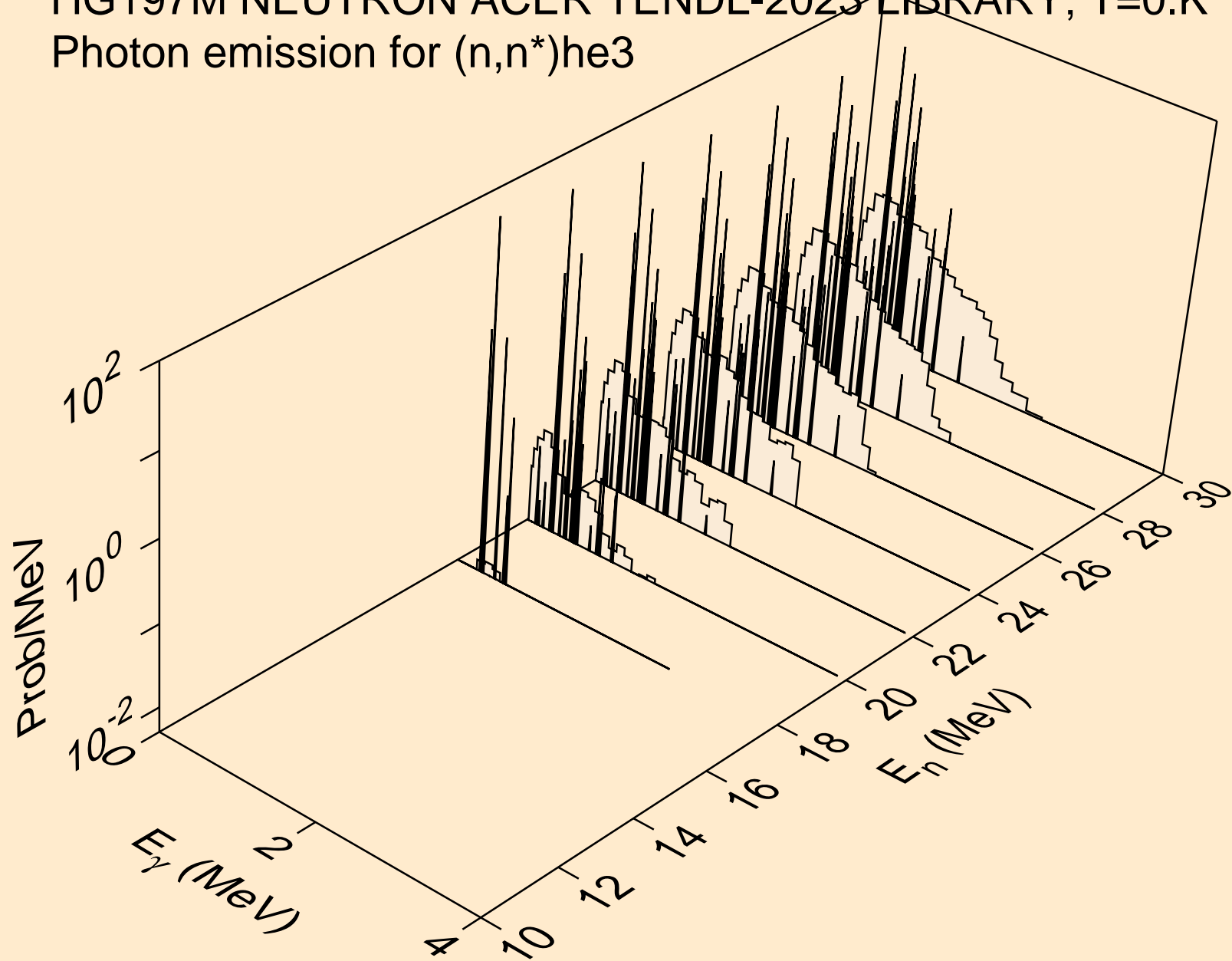

HG197M NEUTRON ACER TENDL-2023 LIBRARY; T=0.K
Photon emission for (n,4n)

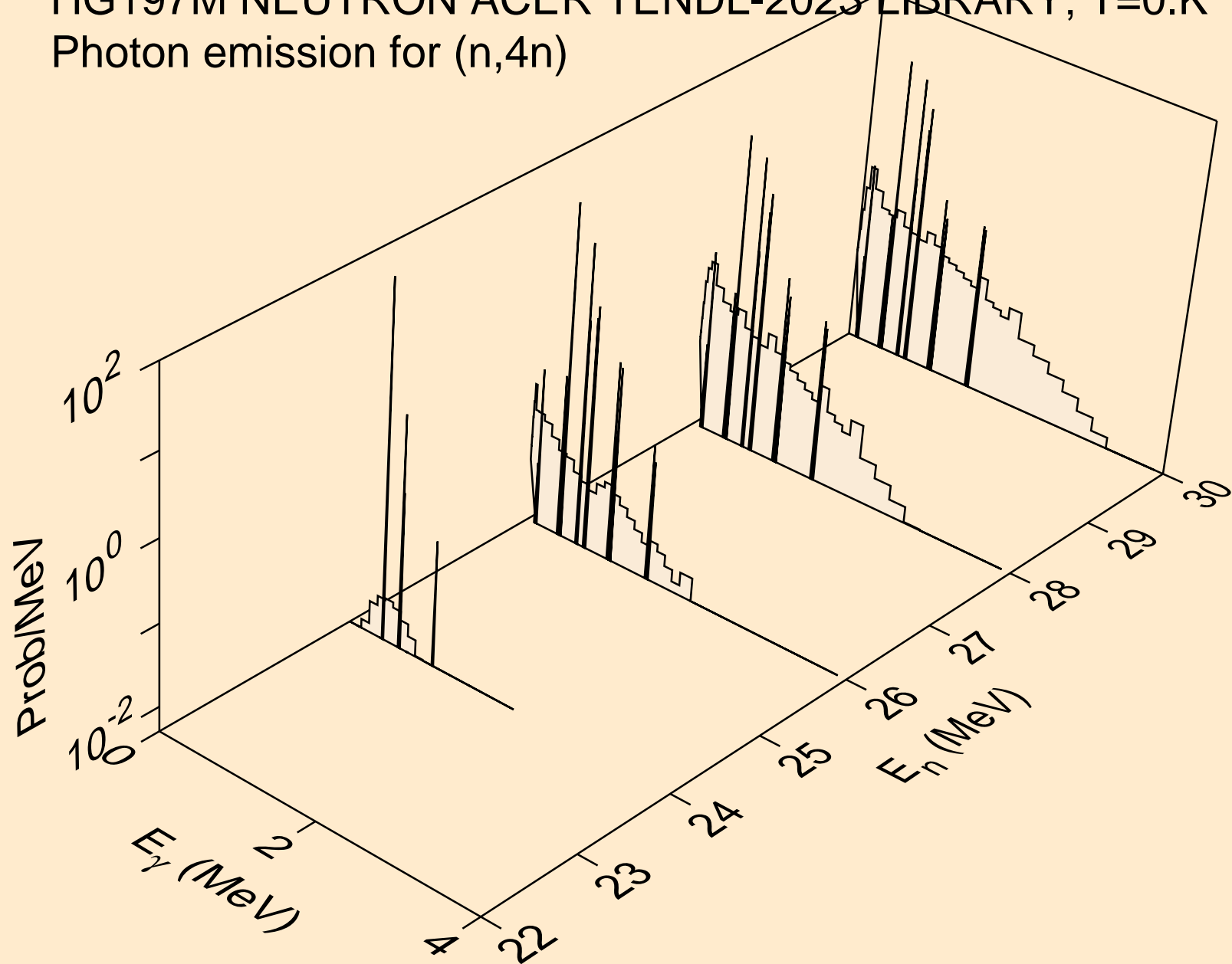

HG197M NEUTRON ACER TENDL-2023 LIBRARY; T=0.K
Photon emission for (n,2np)

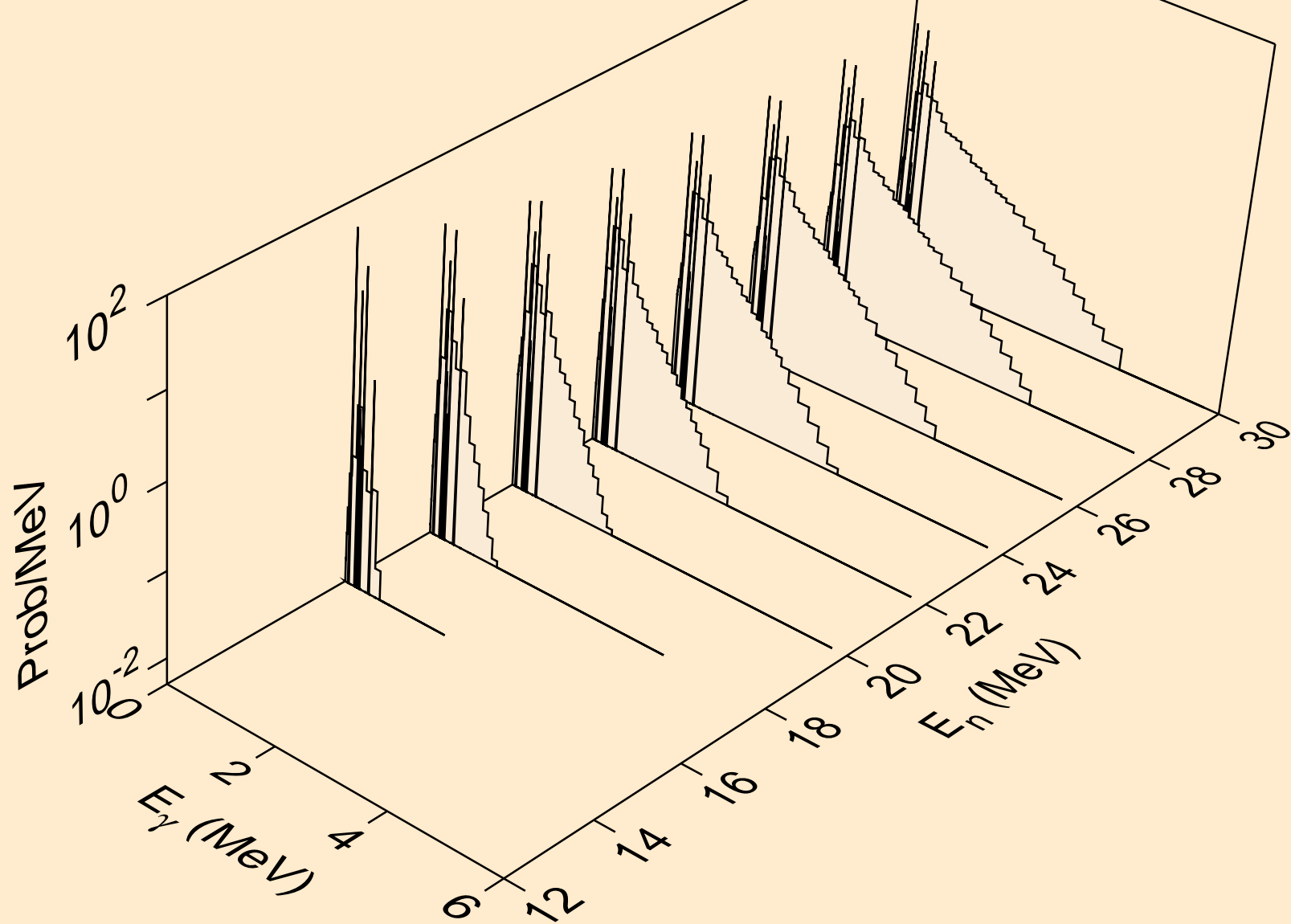

HG197M NEUTRON ACER TENDL-2023 LIBRARY; T=0.K
Photon emission for (n,3np)

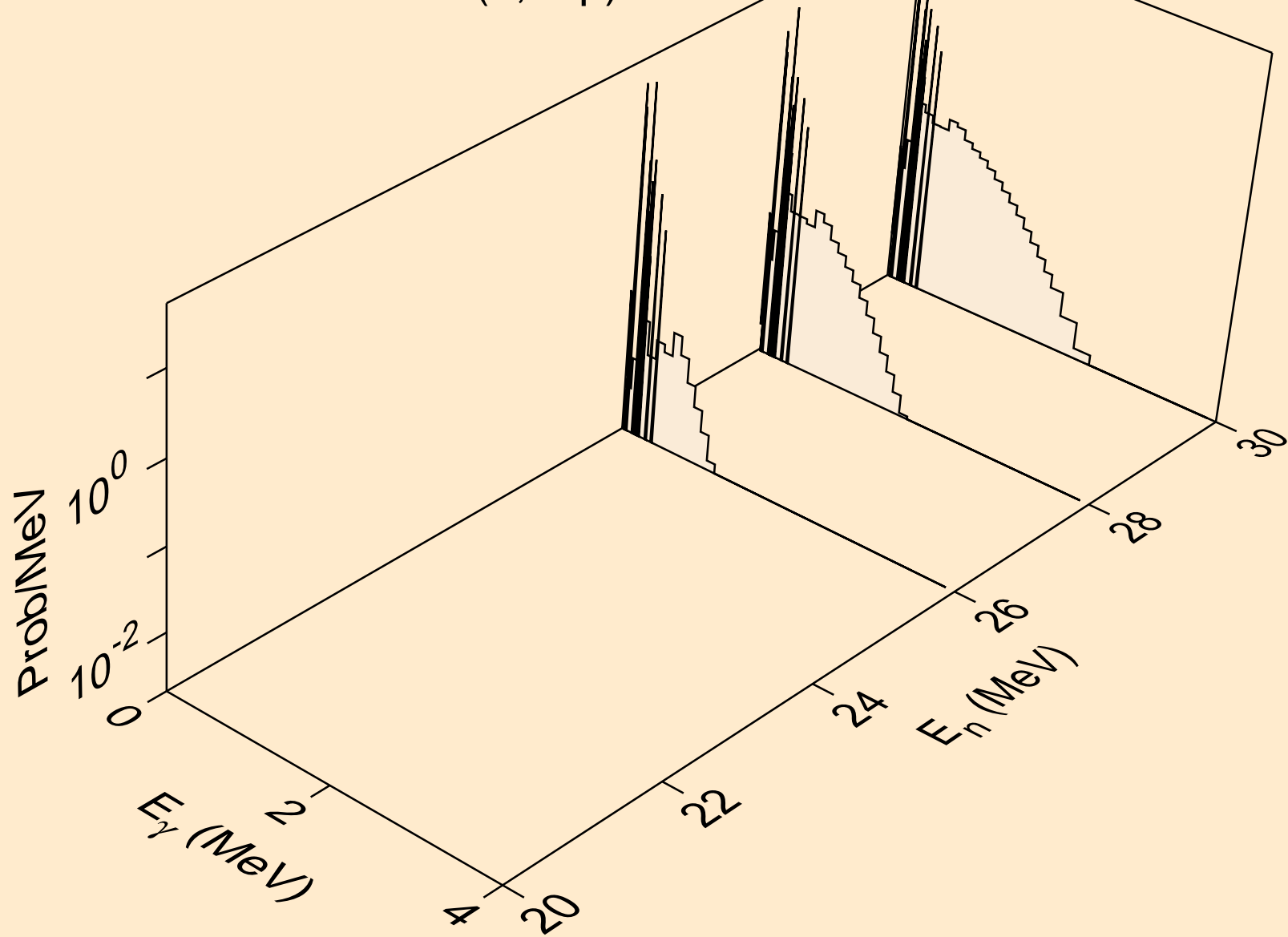

HG197M NEUTRON ACER TENDL-2023 LIBRARY; T=0.K
Photon emission for (n,n2p)

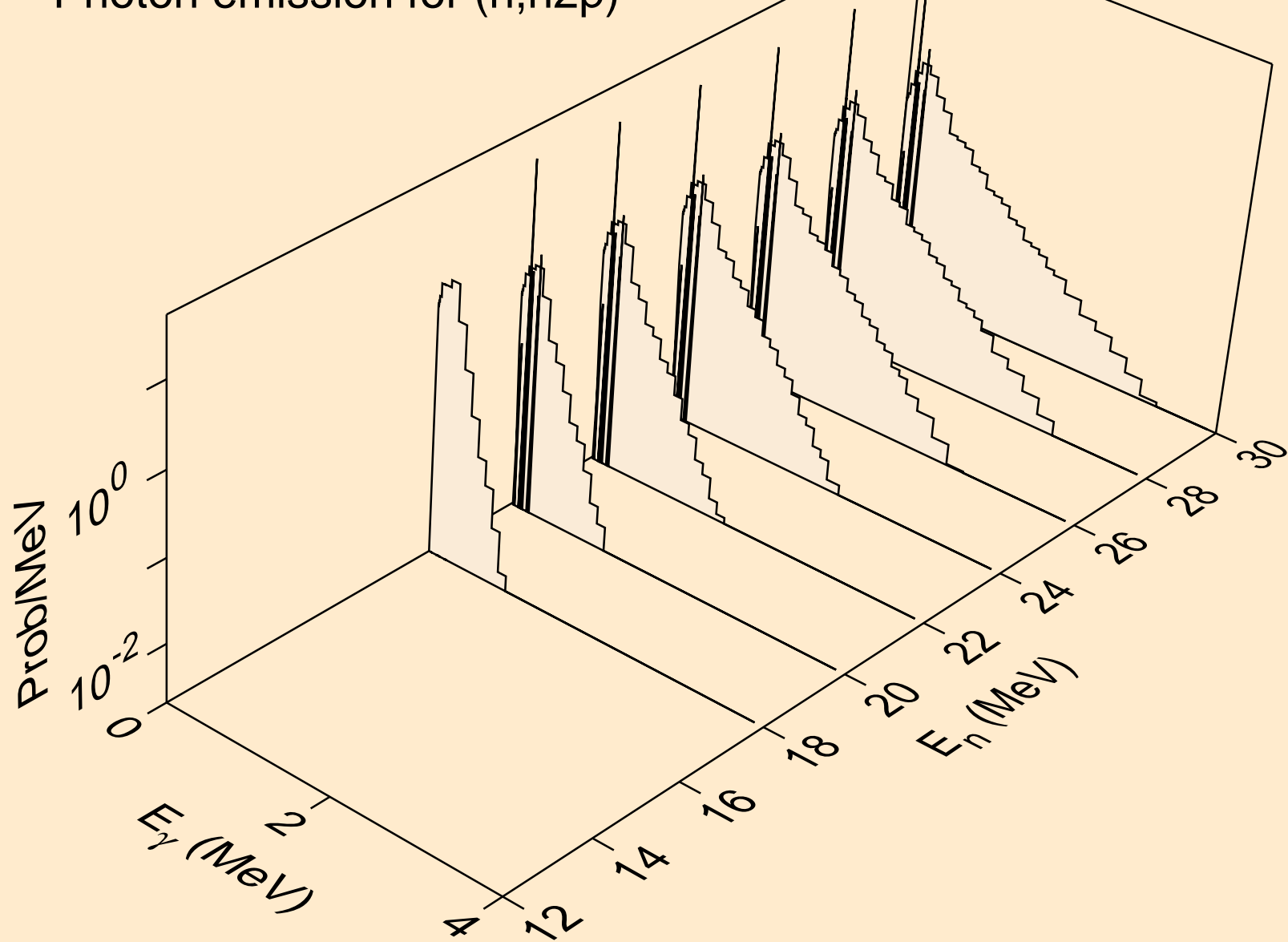

HG197M NEUTRON ACER TENDL-2023 LIBRARY; T=0.K
Photon emission for (n,npa)

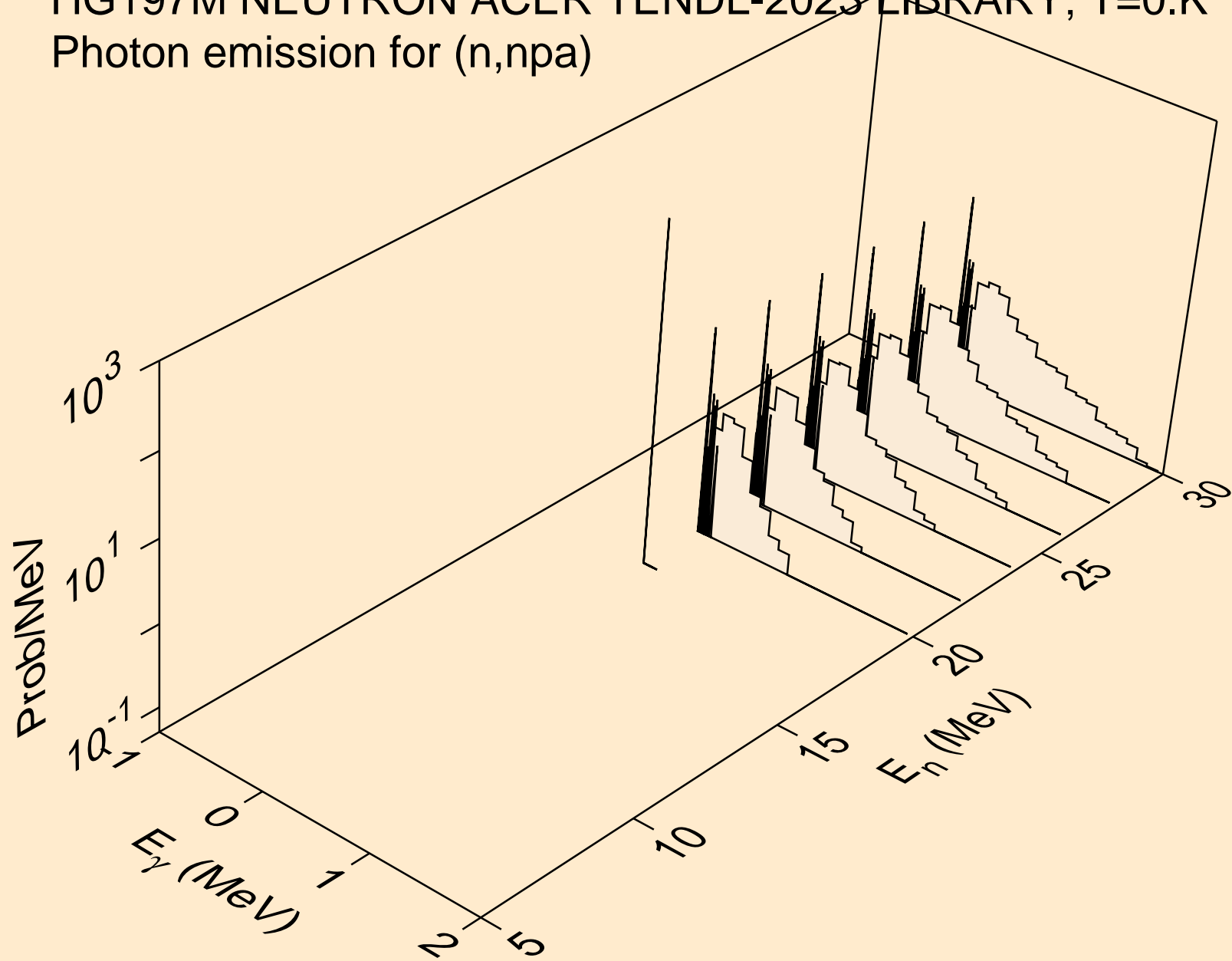

HG197M NEUTRON ACER TENDL-2023 LIBRARY; T=0.K
Photon emission for (n,n*1)

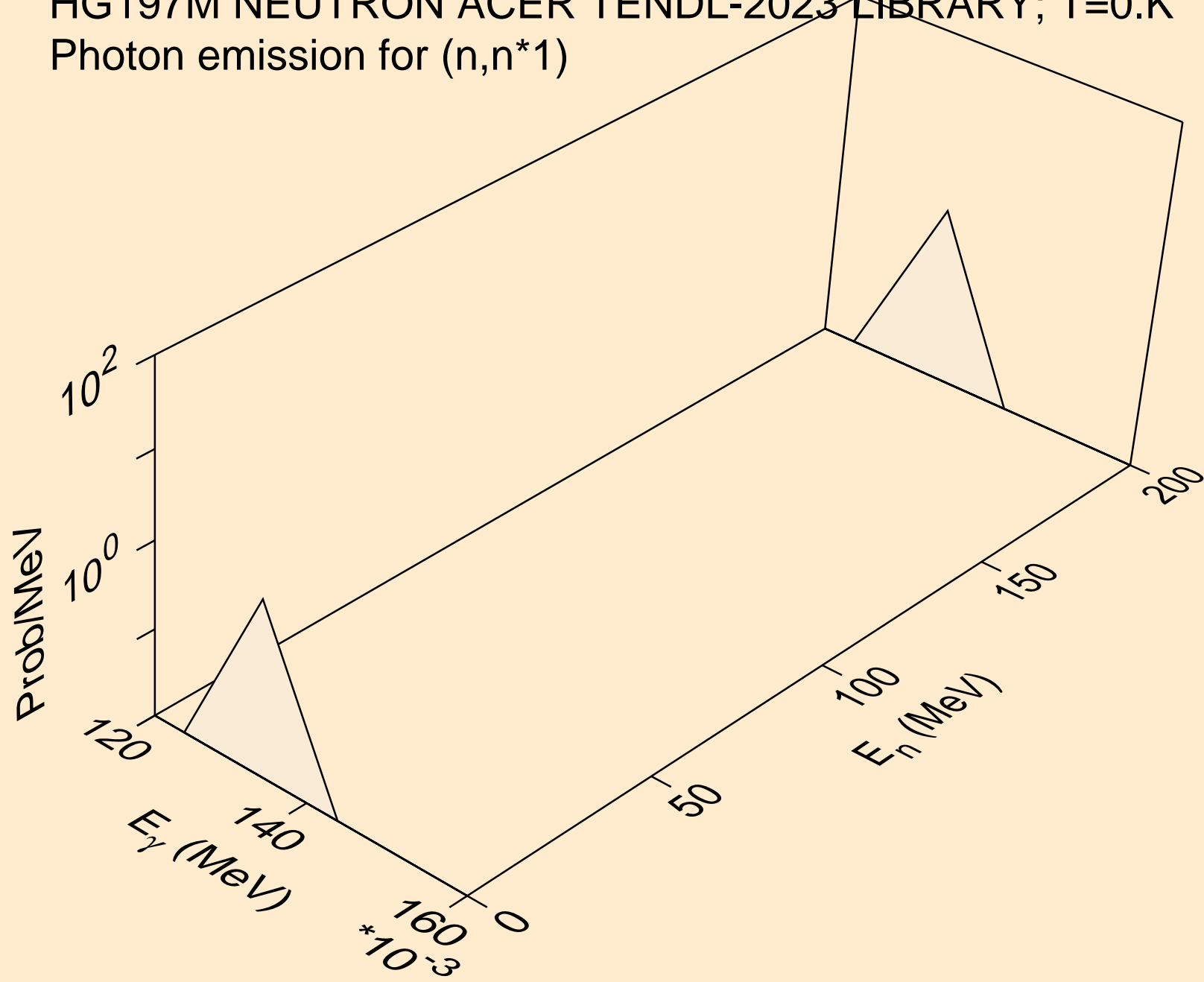

HG197M NEUTRON ACER TENDL-2023 LIBRARY; T=0.K
Photon emission for (n,n*2)

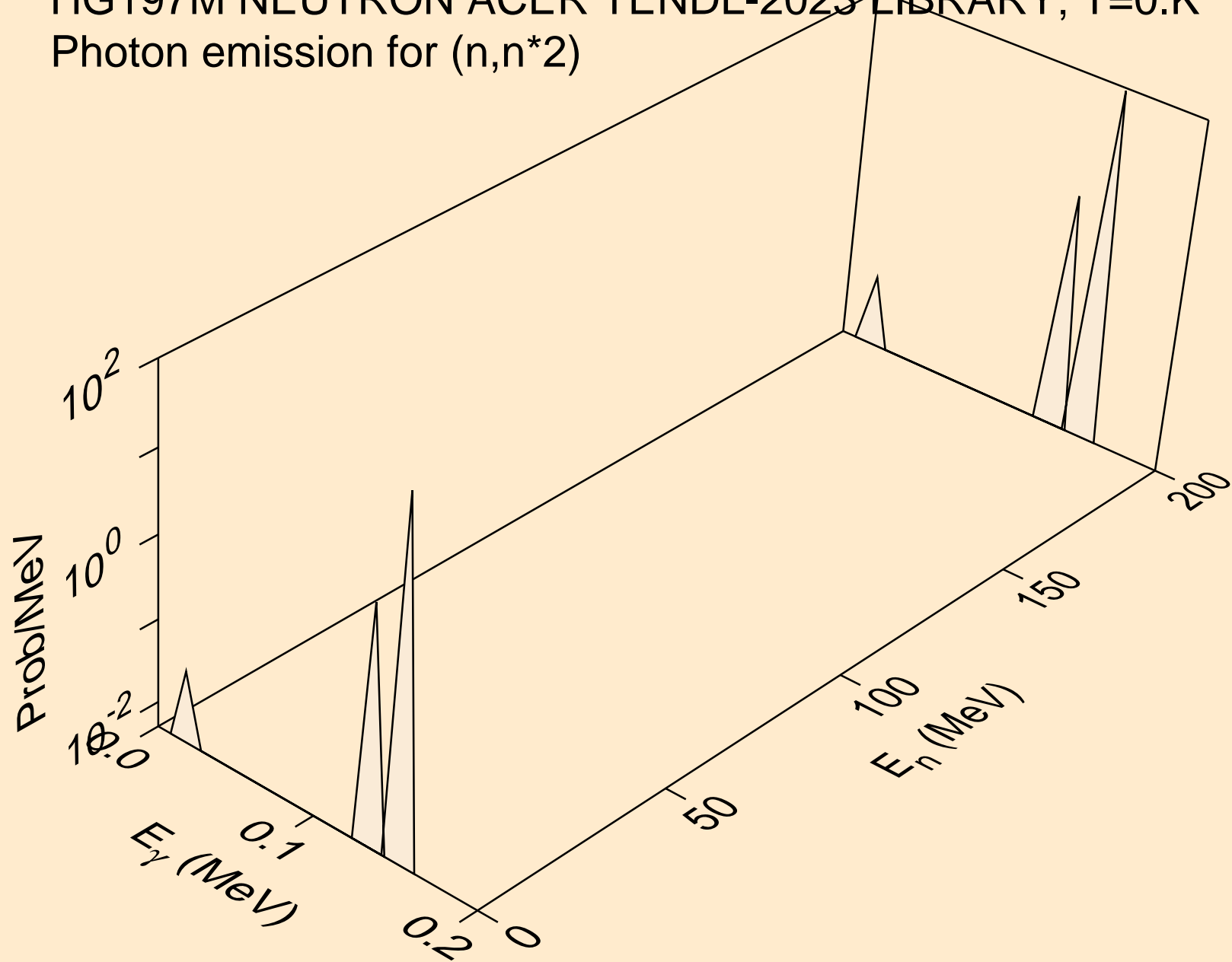

HG197M NEUTRON ACER TENDL-2023 LIBRARY; T=0.K
Photon emission for (n,n*3)

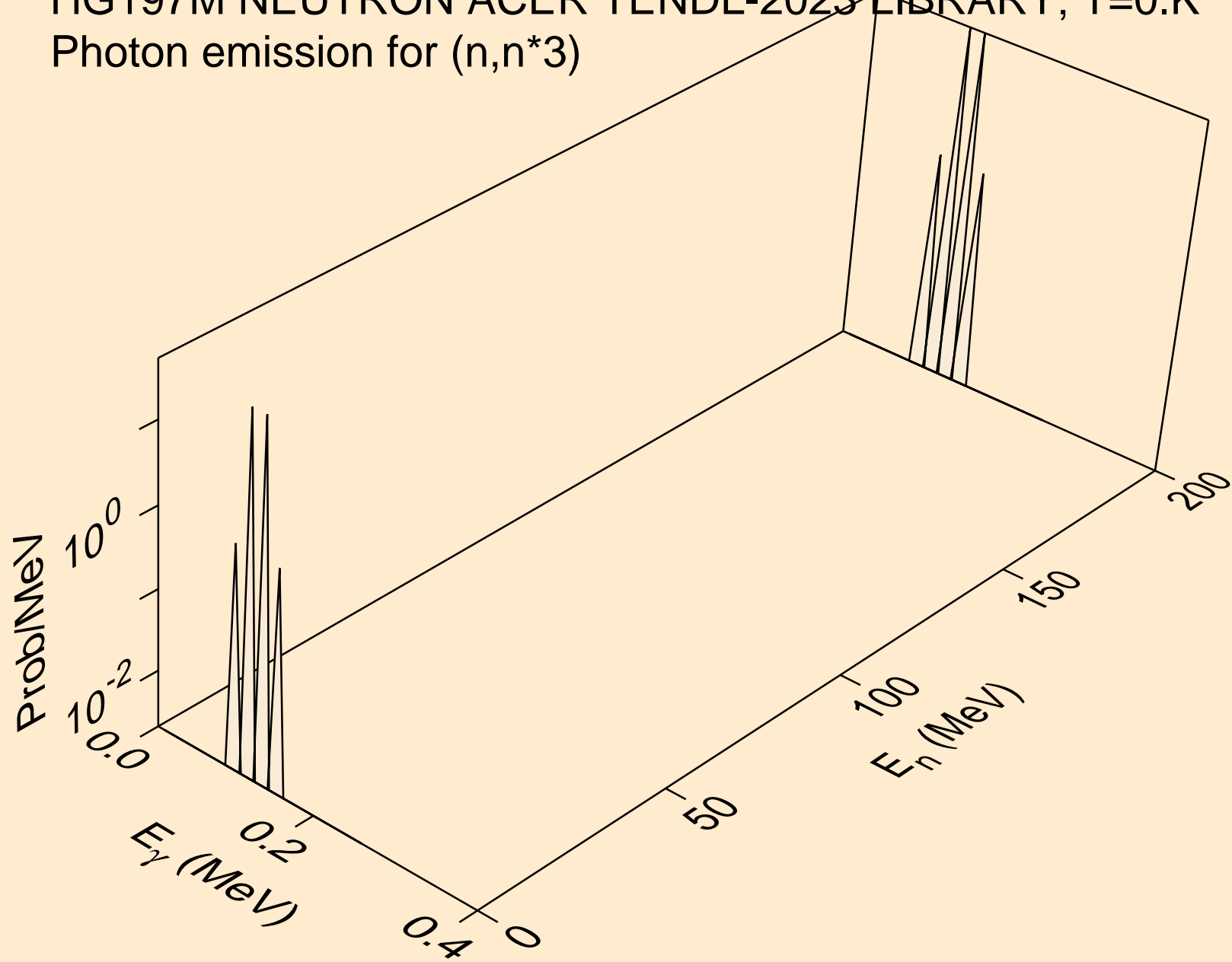

HG197M NEUTRON ACER TENDL-2023 LIBRARY; T=0.K
Photon emission for (n,n*5)

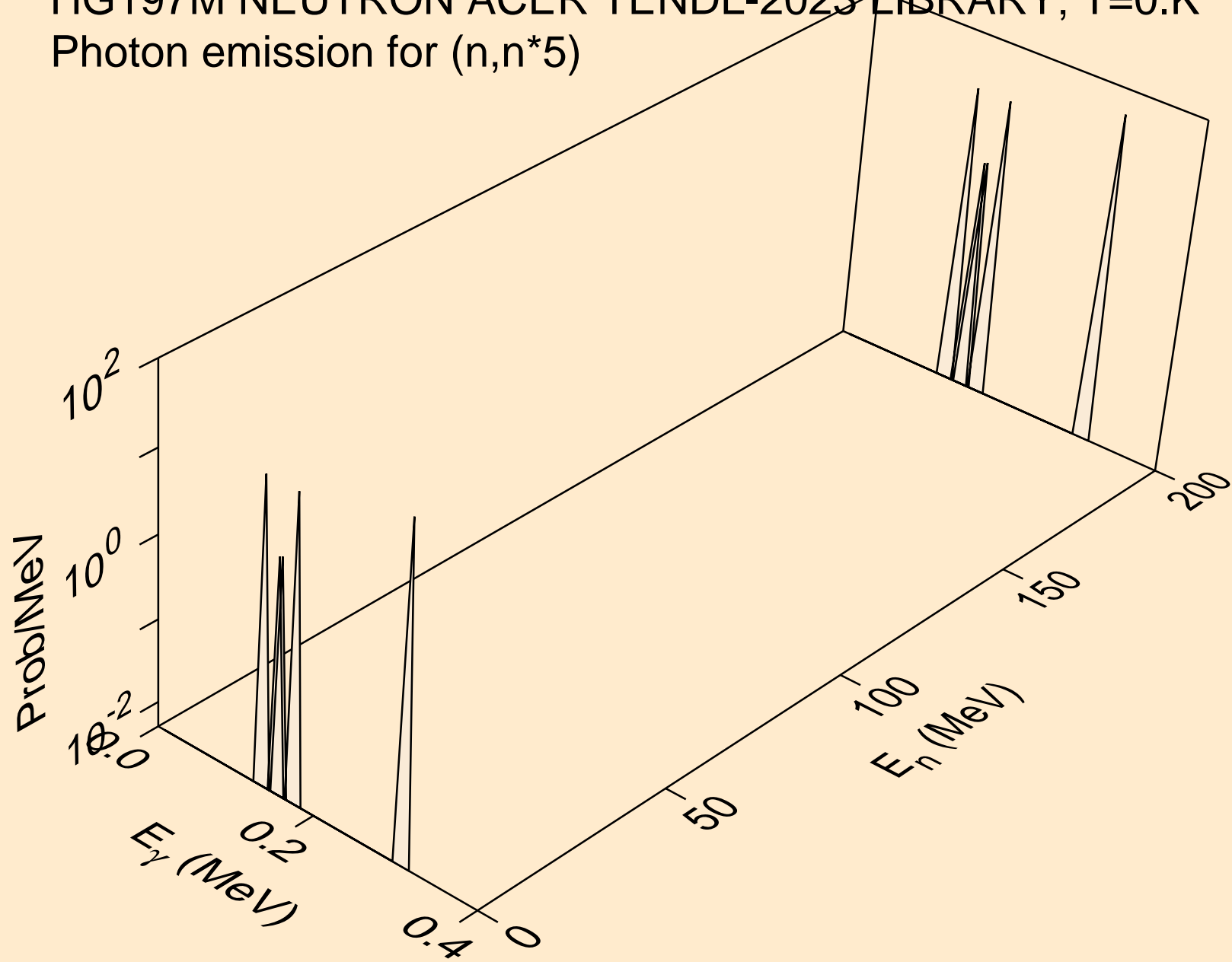

HG197M NEUTRON ACER TENDL-2023 LIBRARY; T=0.K
Photon emission for (n,n*6)

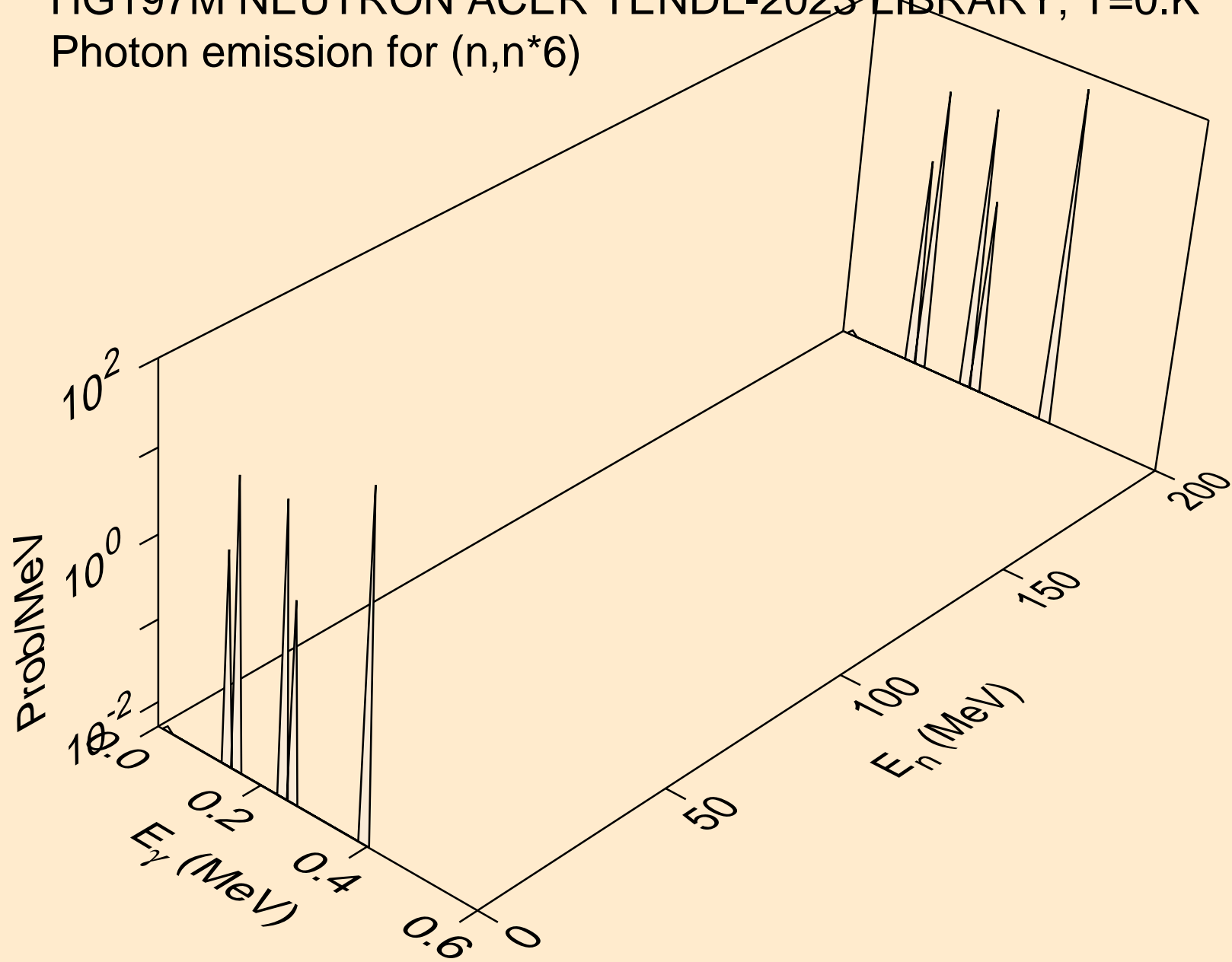

HG197M NEUTRON ACER TENDL-2023 LIBRARY; T=0.K
Photon emission for (n,n*7)

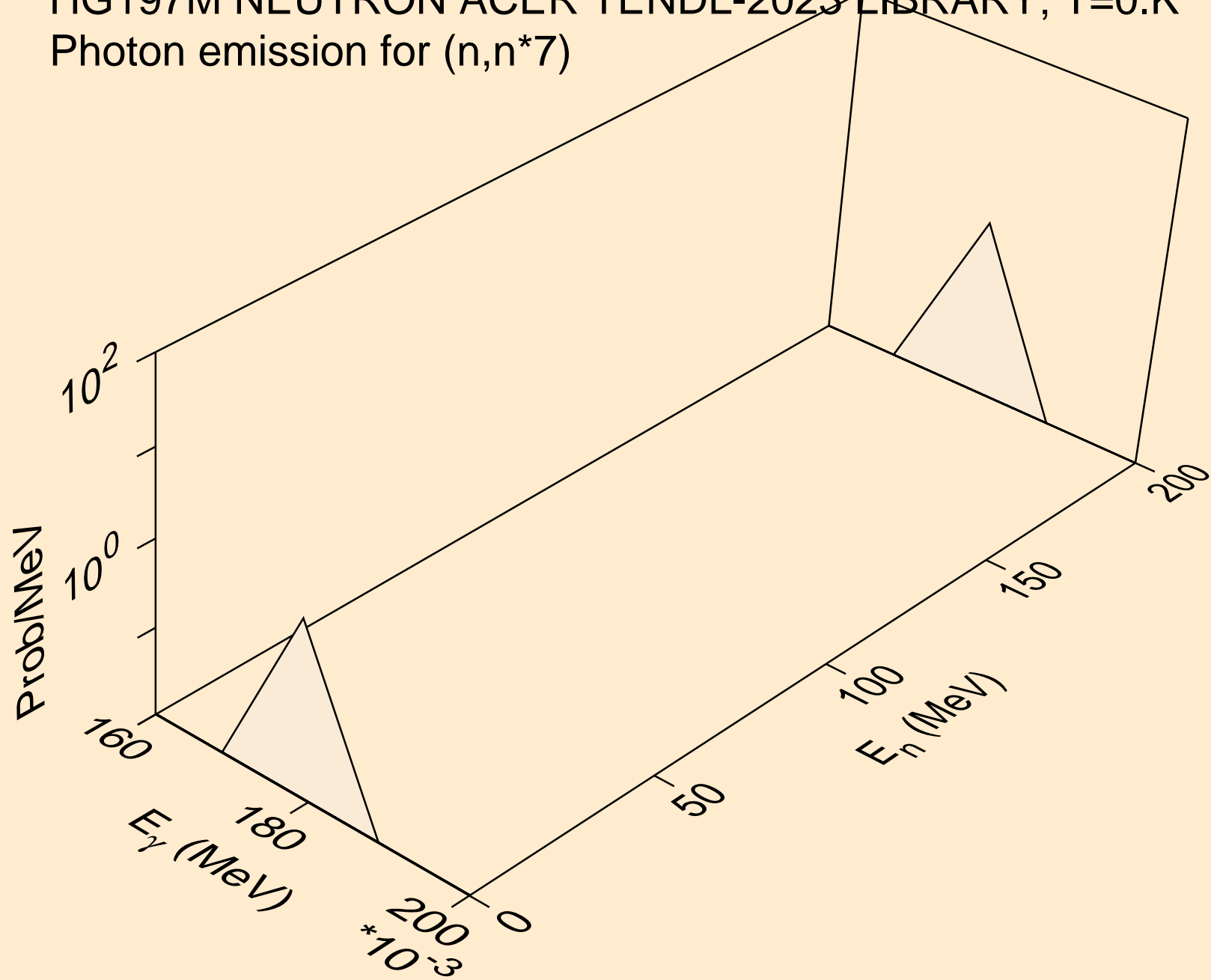

HG197M NEUTRON ACER TENDL-2023 LIBRARY; T=0.K
Photon emission for (n,n*8)

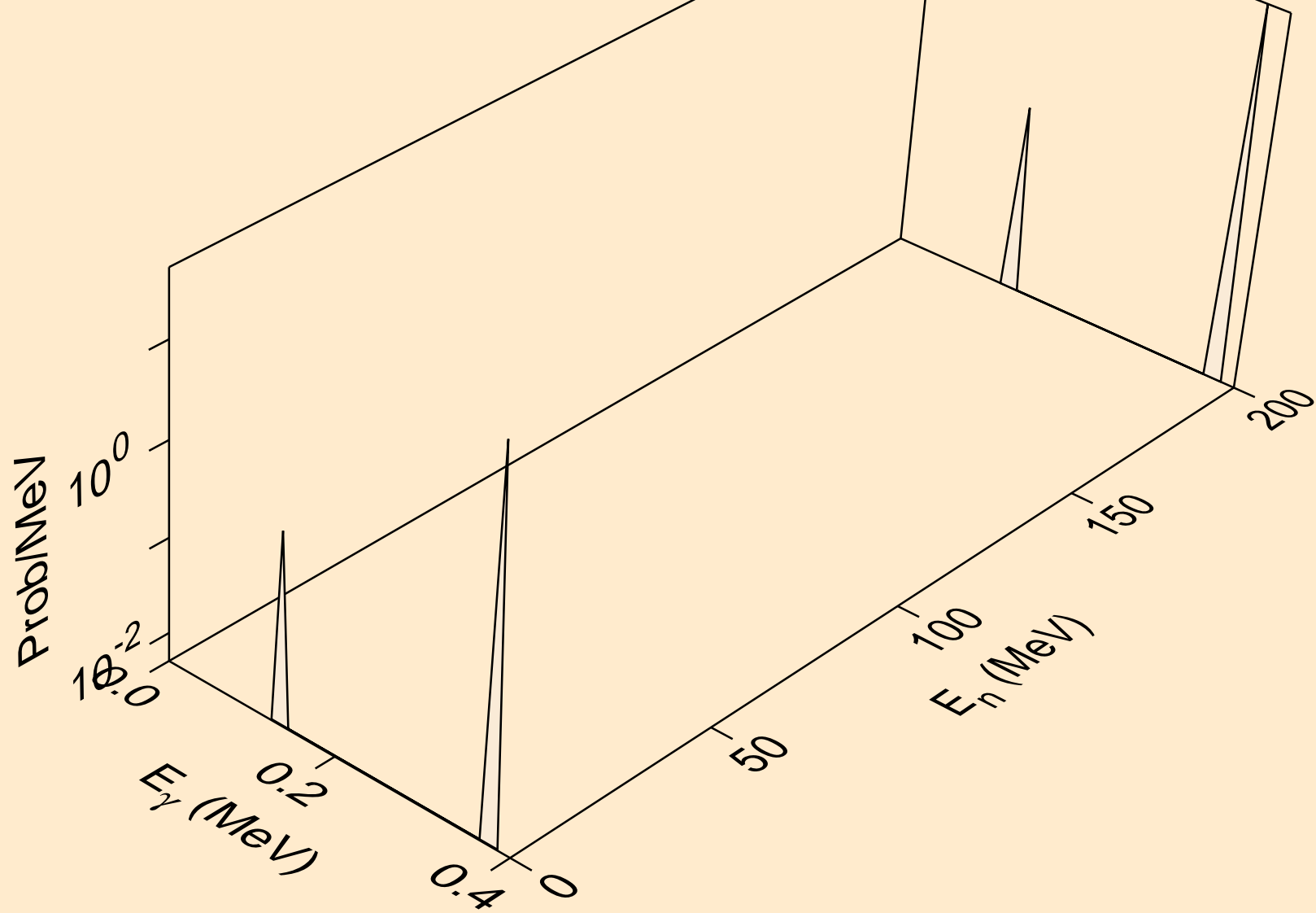

HG197M NEUTRON ACER TENDL-2023 LIBRARY; T=0.K
Photon emission for (n,n*9)

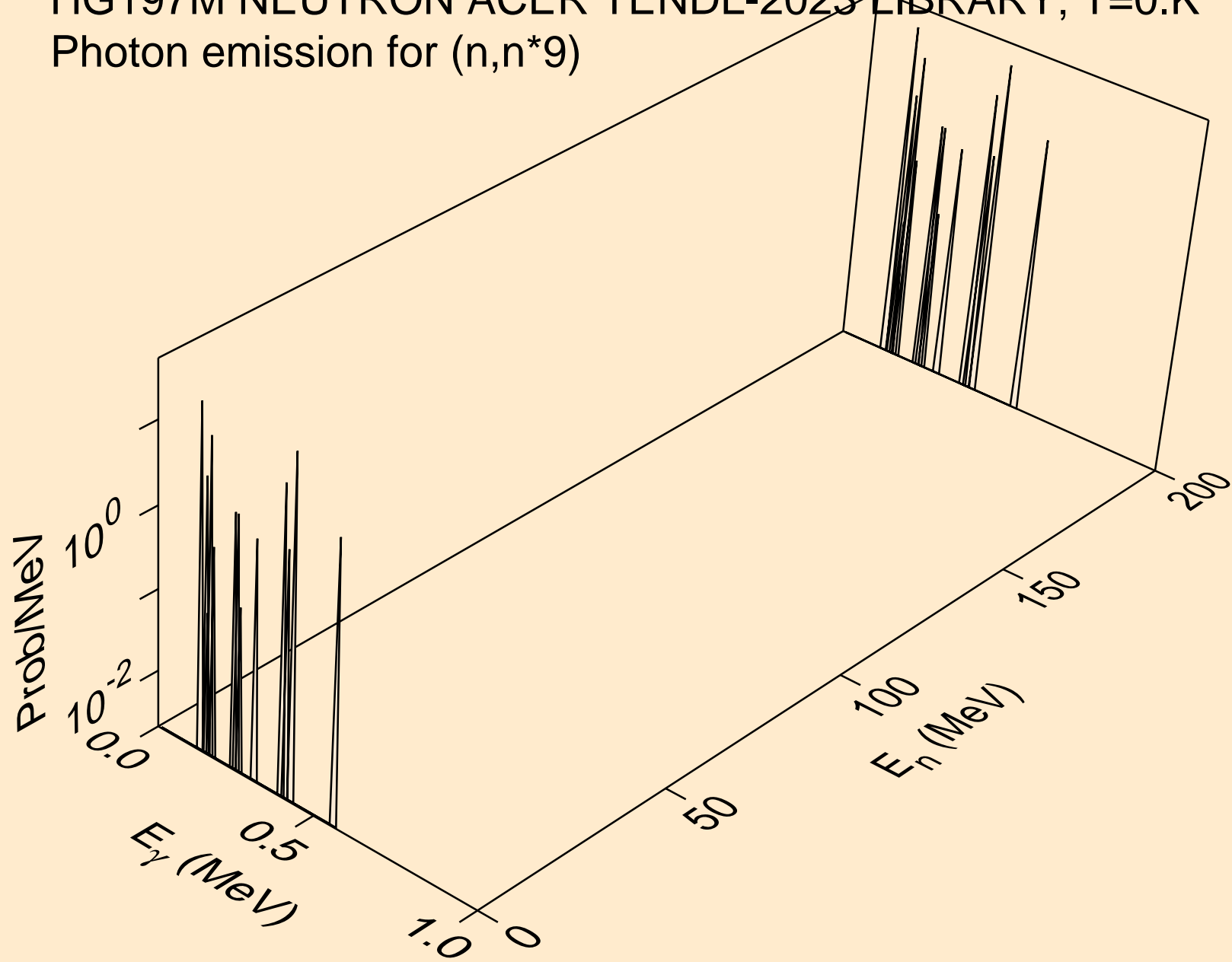

HG197M NEUTRON ACER TENDL-2023 LIBRARY; T=0.K
Photon emission for (n,n*10)

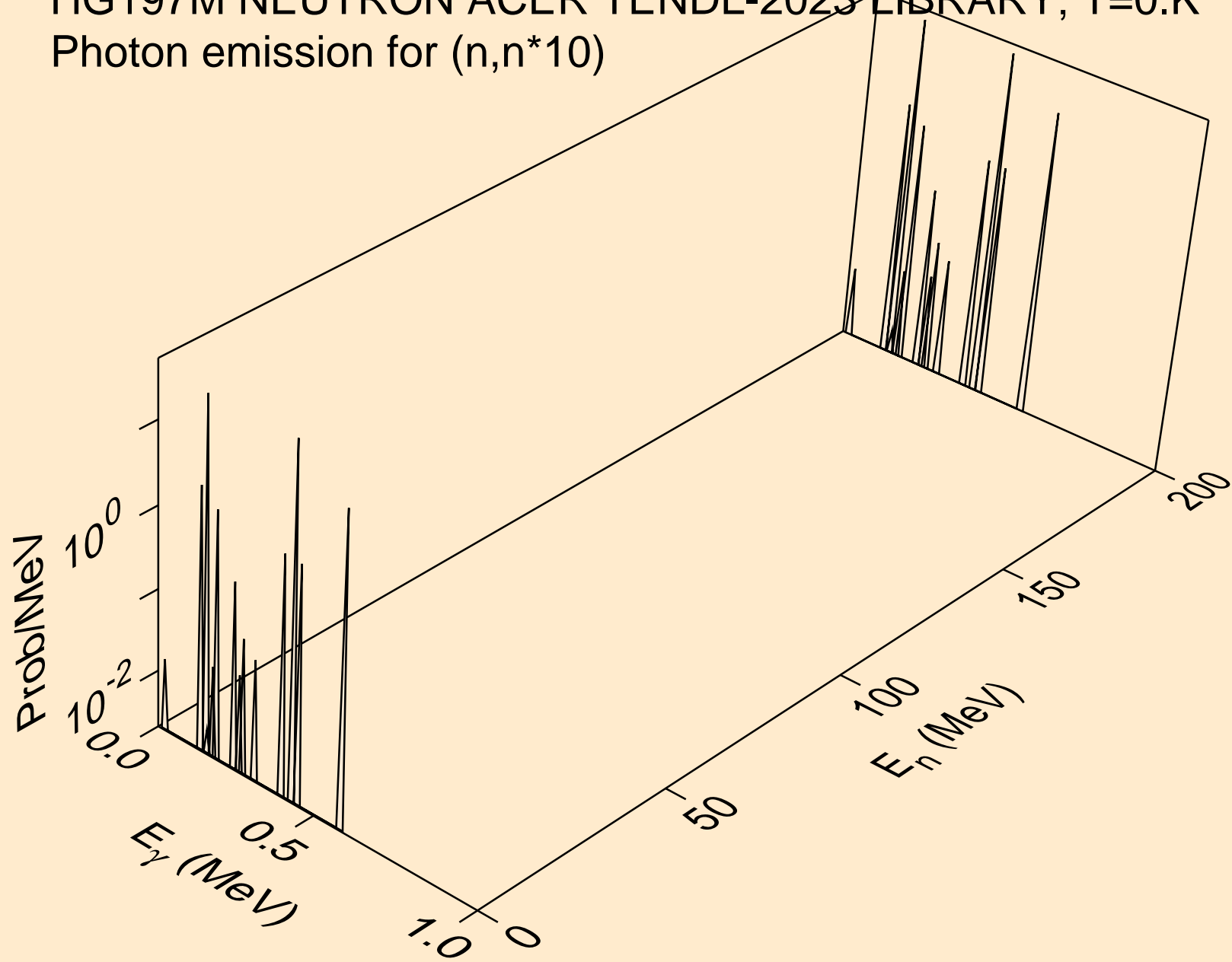

HG197M NEUTRON ACER TENDL-2023 LIBRARY; T=0.K
Photon emission for (n,n*11)

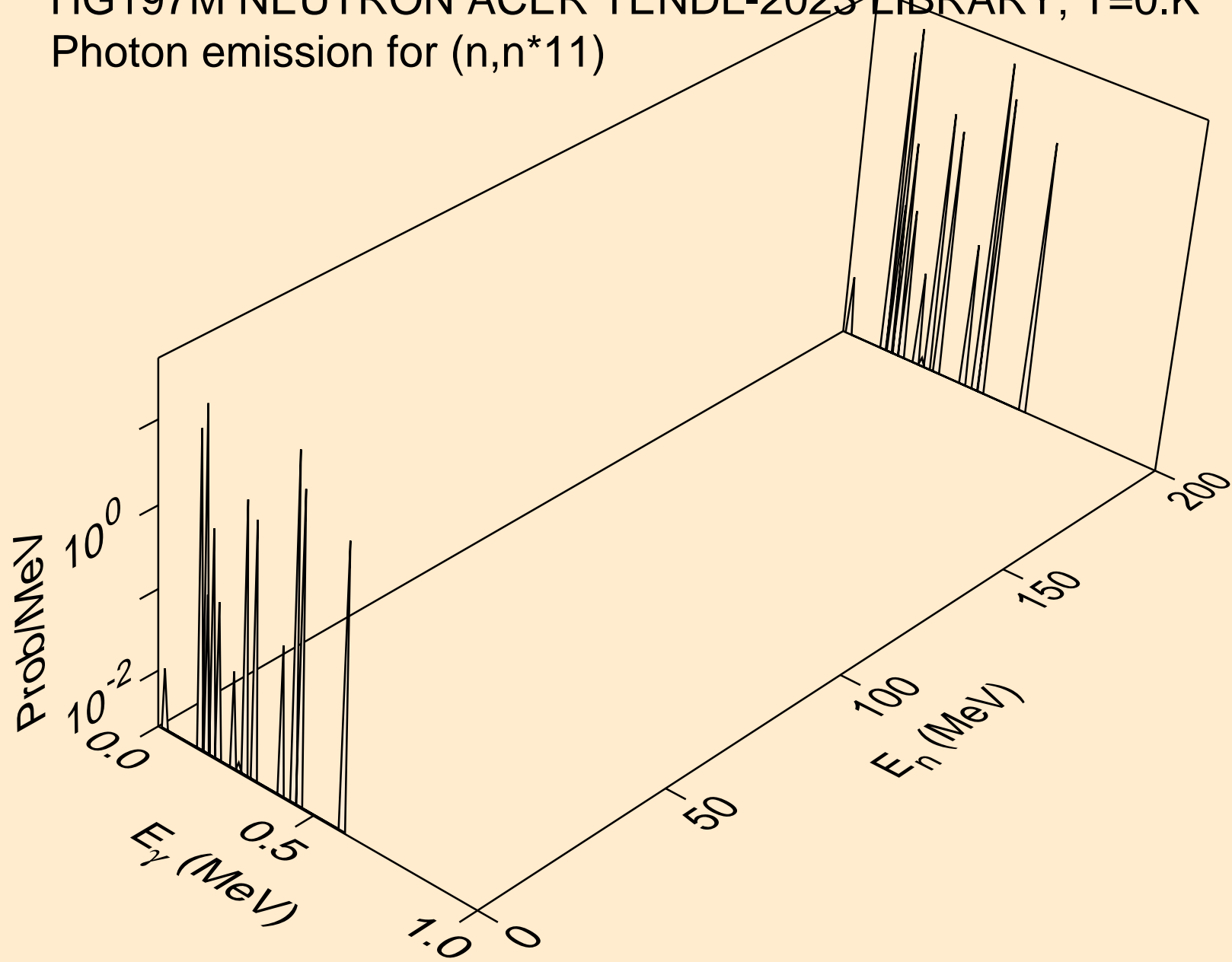

HG197M NEUTRON ACER TENDL-2023 LIBRARY; T=0.K
Photon emission for (n,n*12)

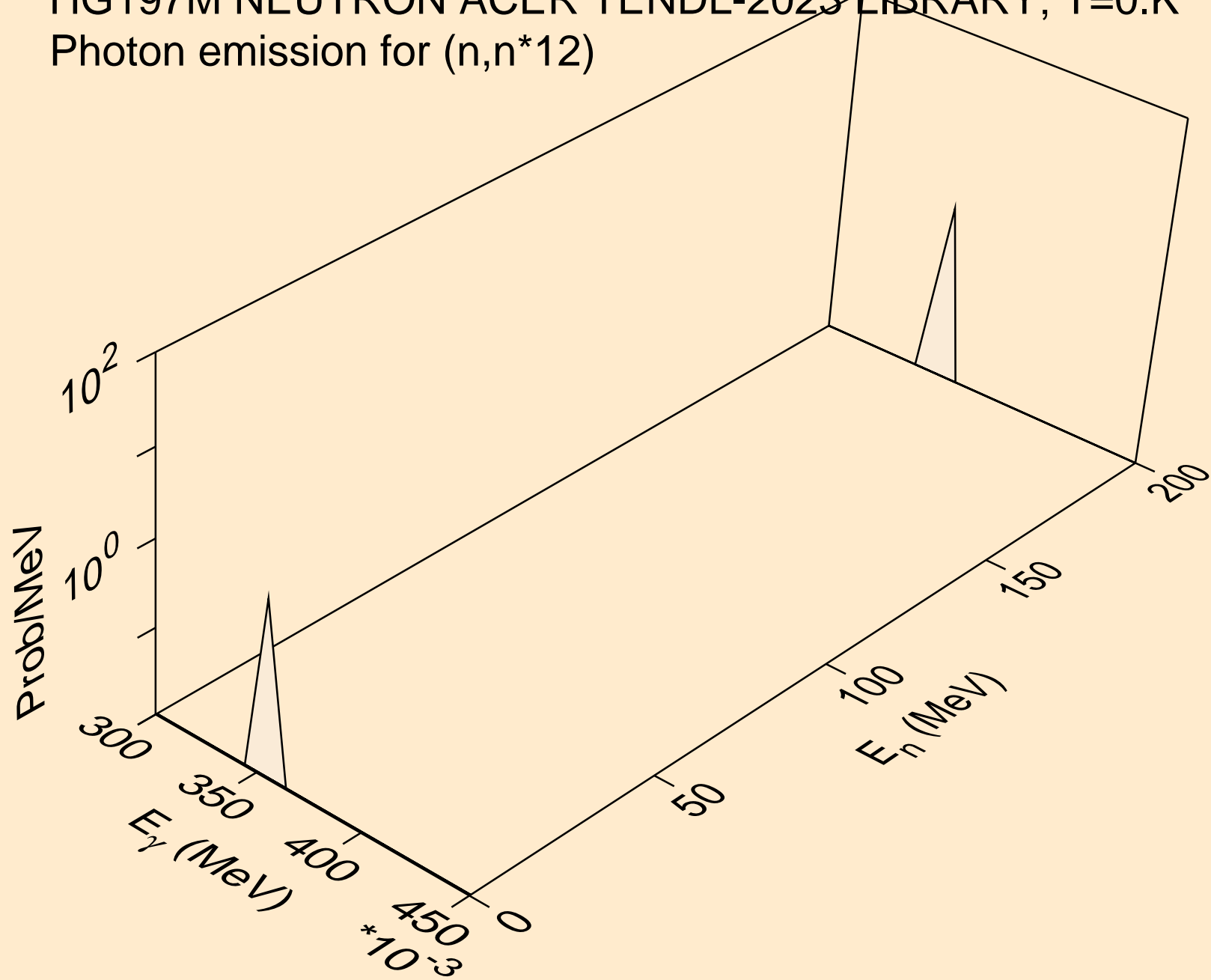

HG197M NEUTRON ACER TENDL-2023 LIBRARY; T=0.K
Photon emission for (n,n*13)

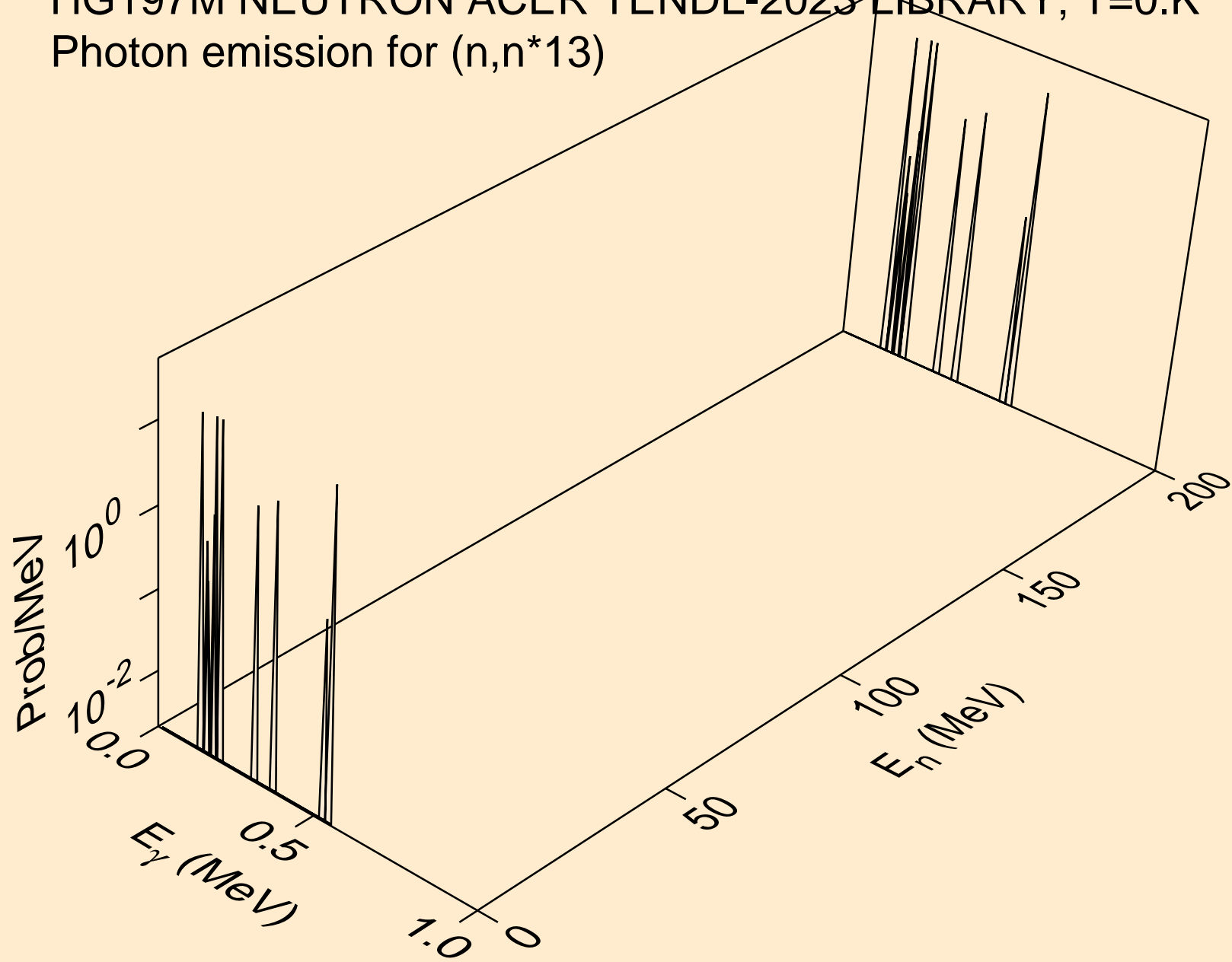

HG197M NEUTRON ACER TENDL-2023 LIBRARY; T=0.K
Photon emission for (n,n*14)

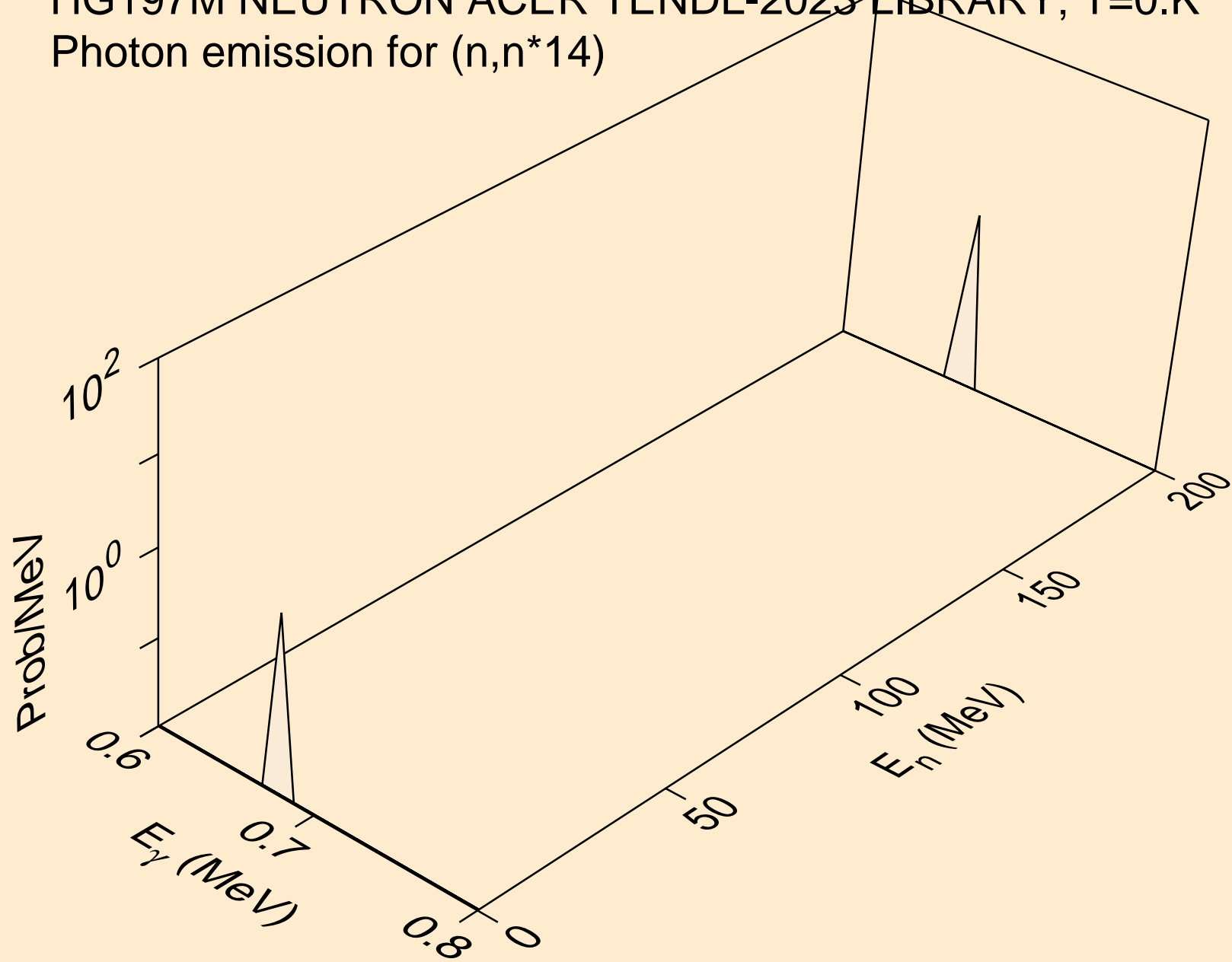

HG197M NEUTRON ACER TENDL-2023 LIBRARY; T=0.K
Photon emission for (n,n*15)

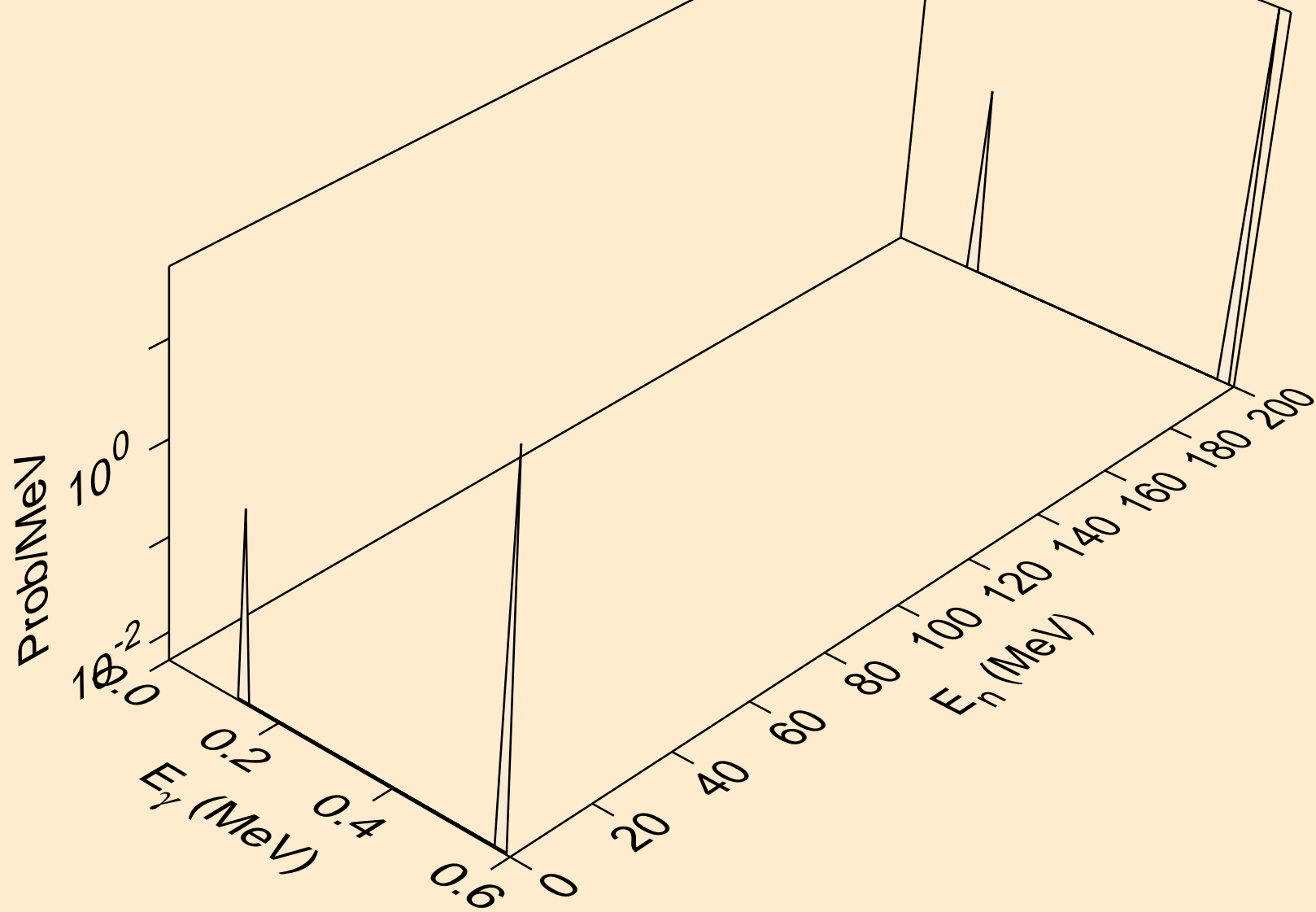

HG197M NEUTRON ACER TENDL-2023 LIBRARY; T=0.K
Photon emission for (n,n*c)

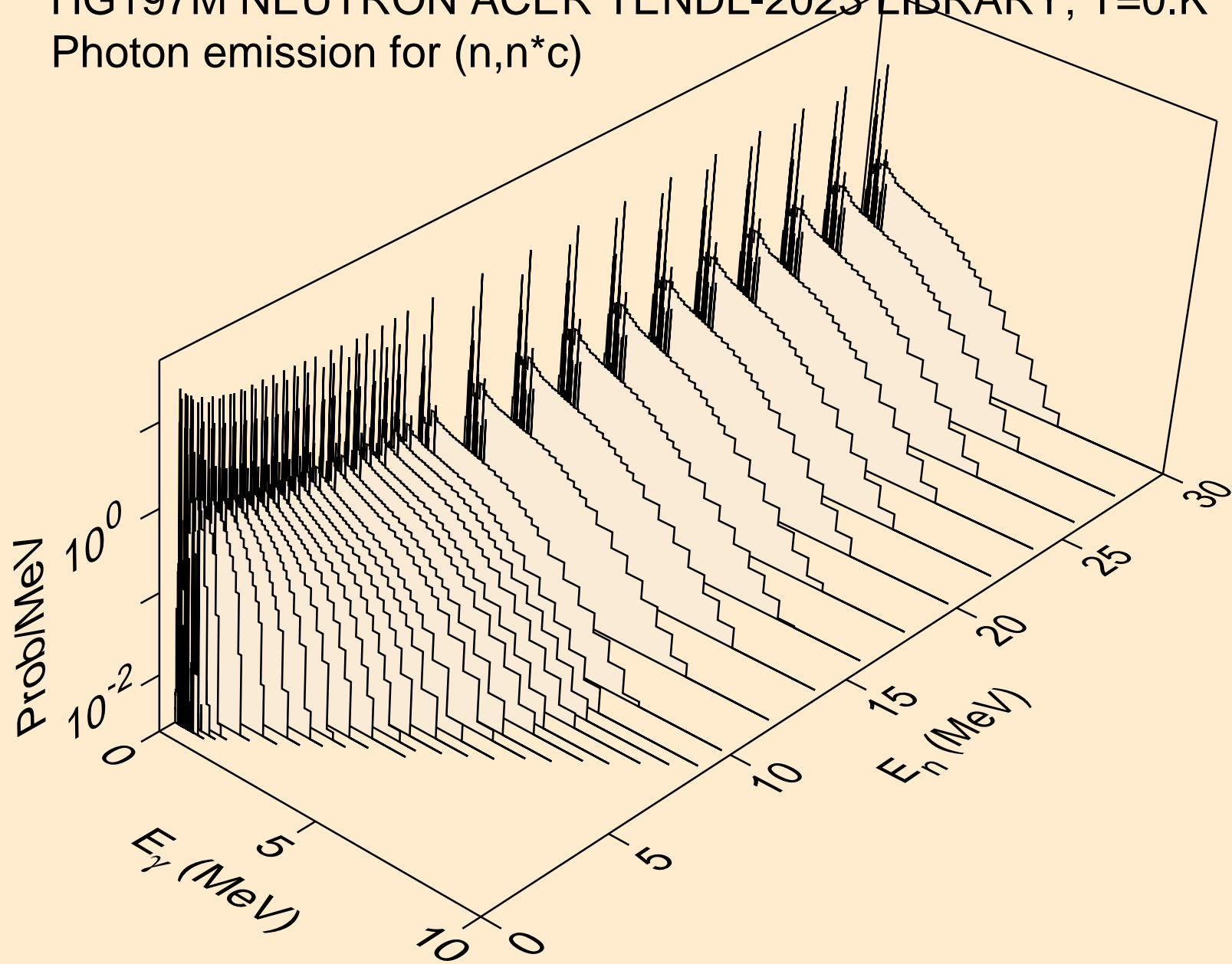

HG197M NEUTRON ACER TENDL-2023 LIBRARY; T=0.K
Photon emission for (n,gma)

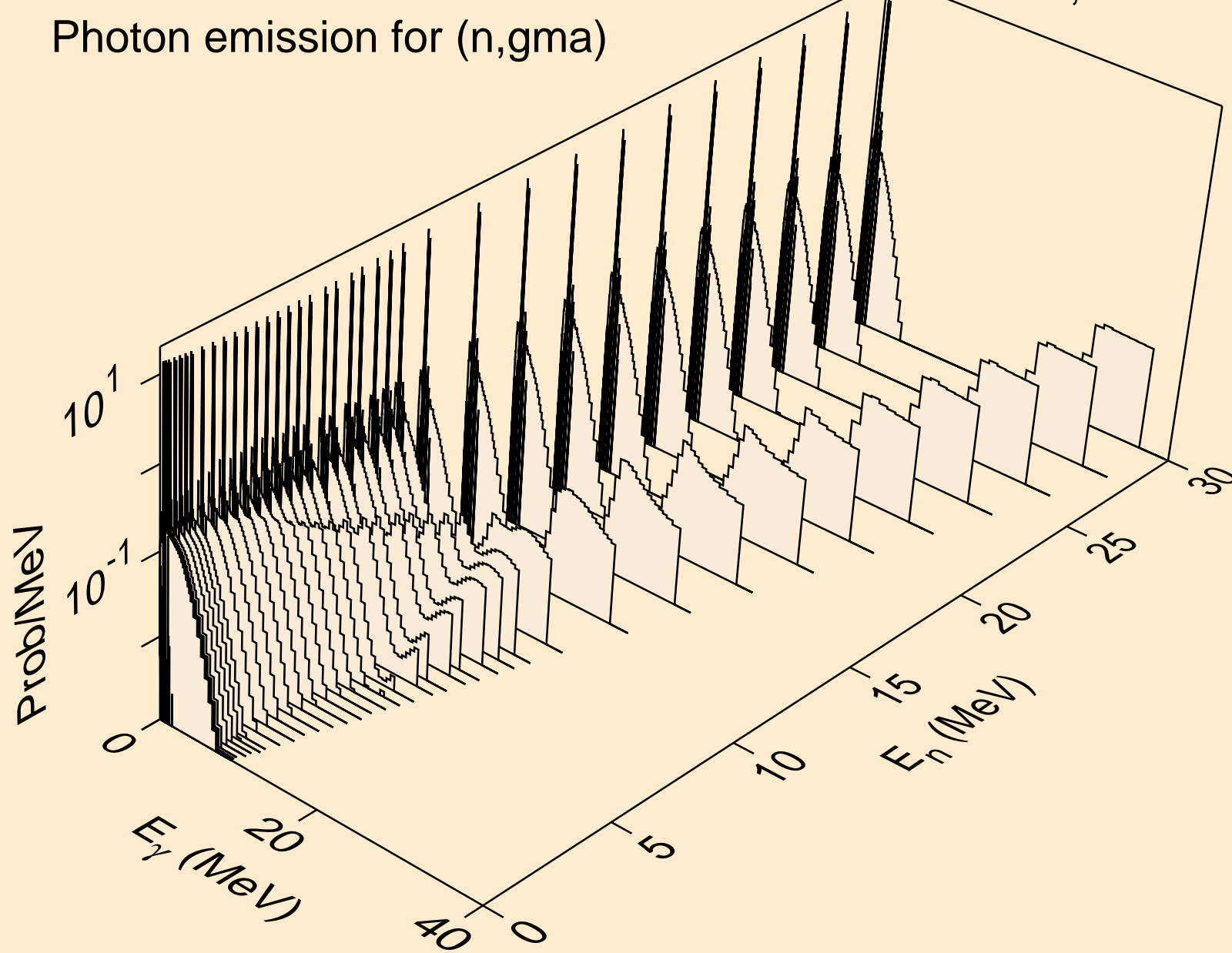

HG197M NEUTRON ACER TENDL-2023 LIBRARY; T=0.K
Photon emission for (n,p)

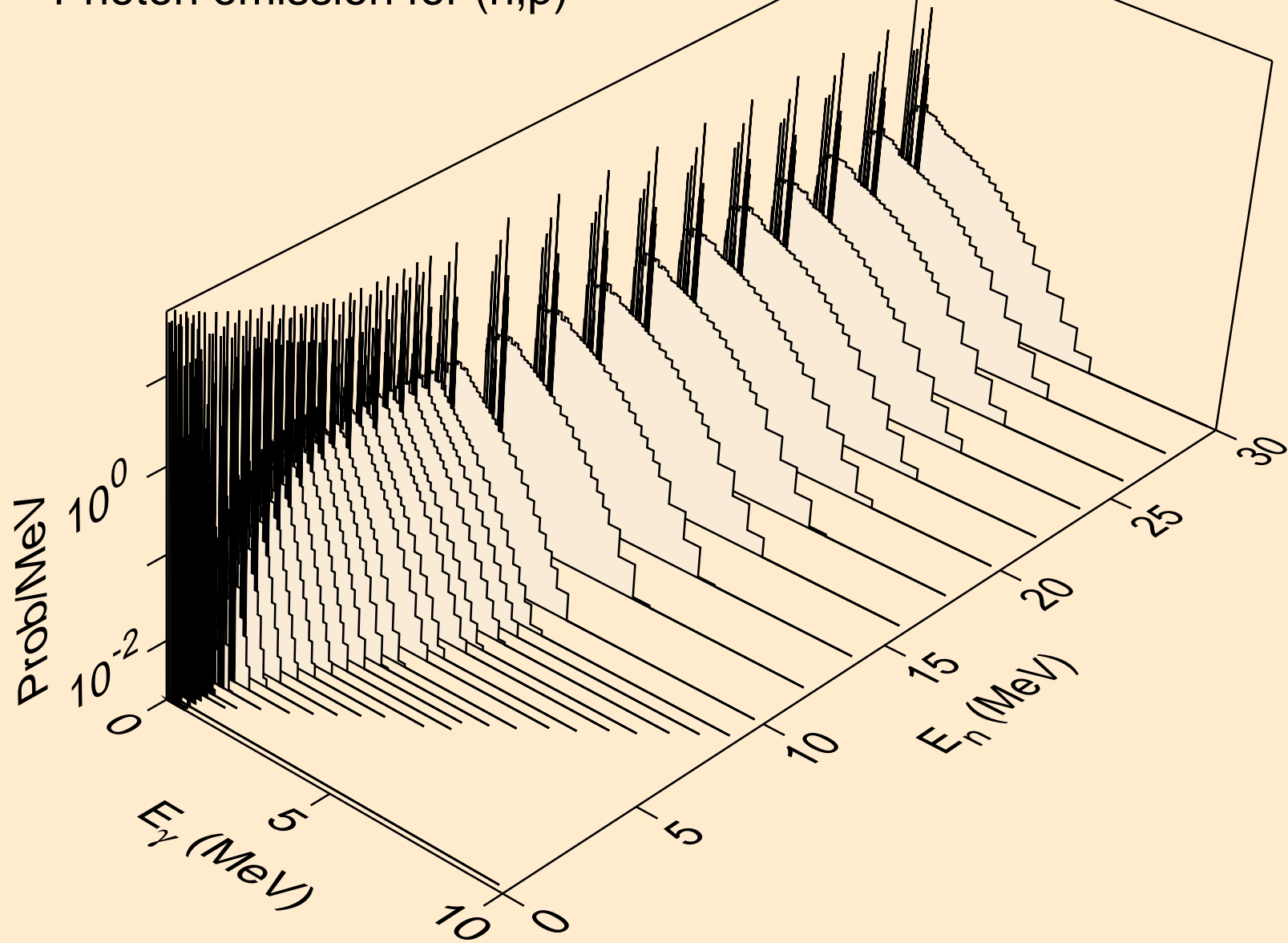

HG197M NEUTRON ACER TENDL-2023 LIBRARY; T=0.K
Photon emission for (n,d)

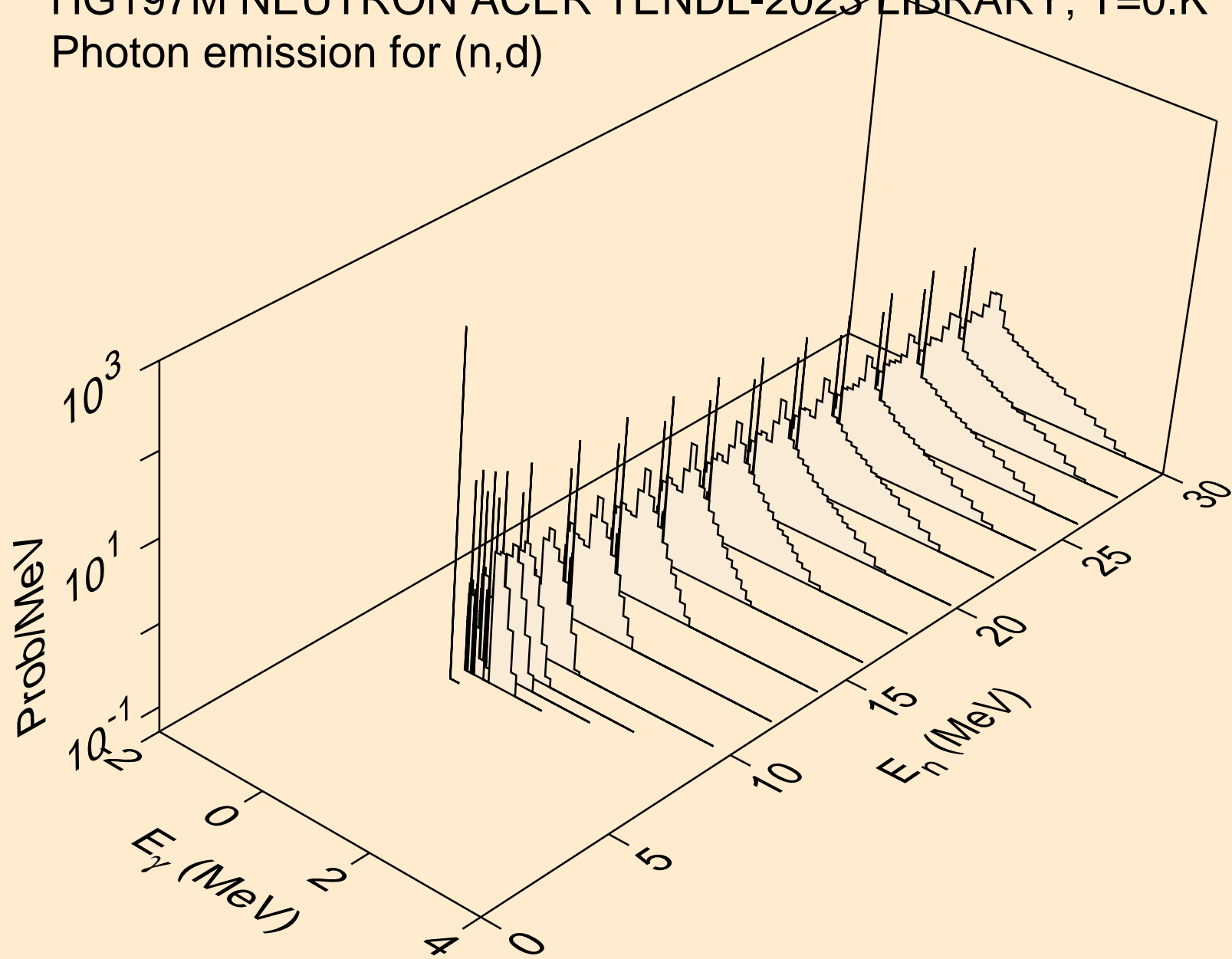

HG197M NEUTRON ACER TENDL-2023 LIBRARY; T=0.K
Photon emission for (n,t)

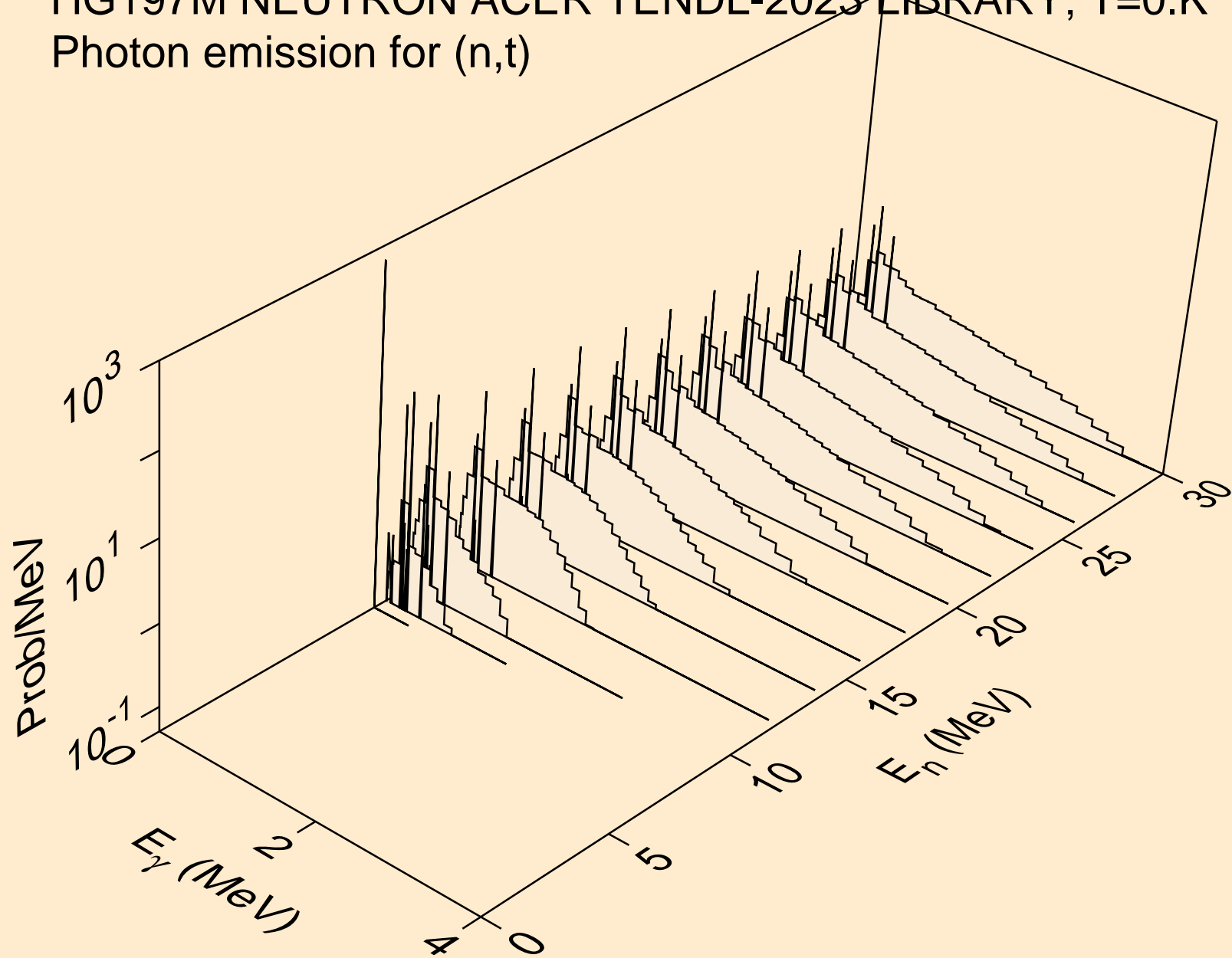

HG197M NEUTRON ACER TENDL-2023 LIBRARY; T=0.K
Photon emission for (n,he3)

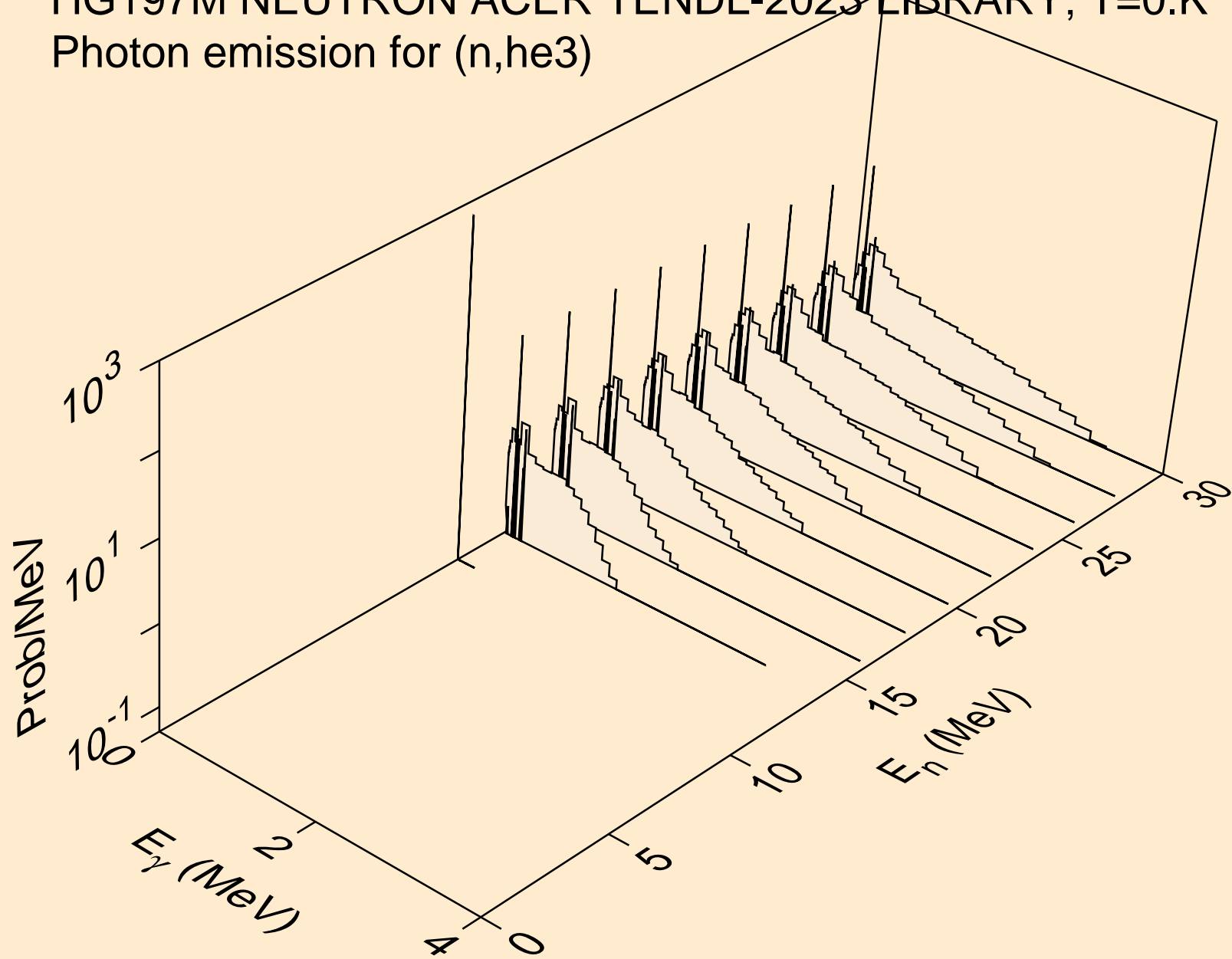

HG197M NEUTRON ACER TENDL-2023 LIBRARY; T=0.K
Photon emission for (n,a)

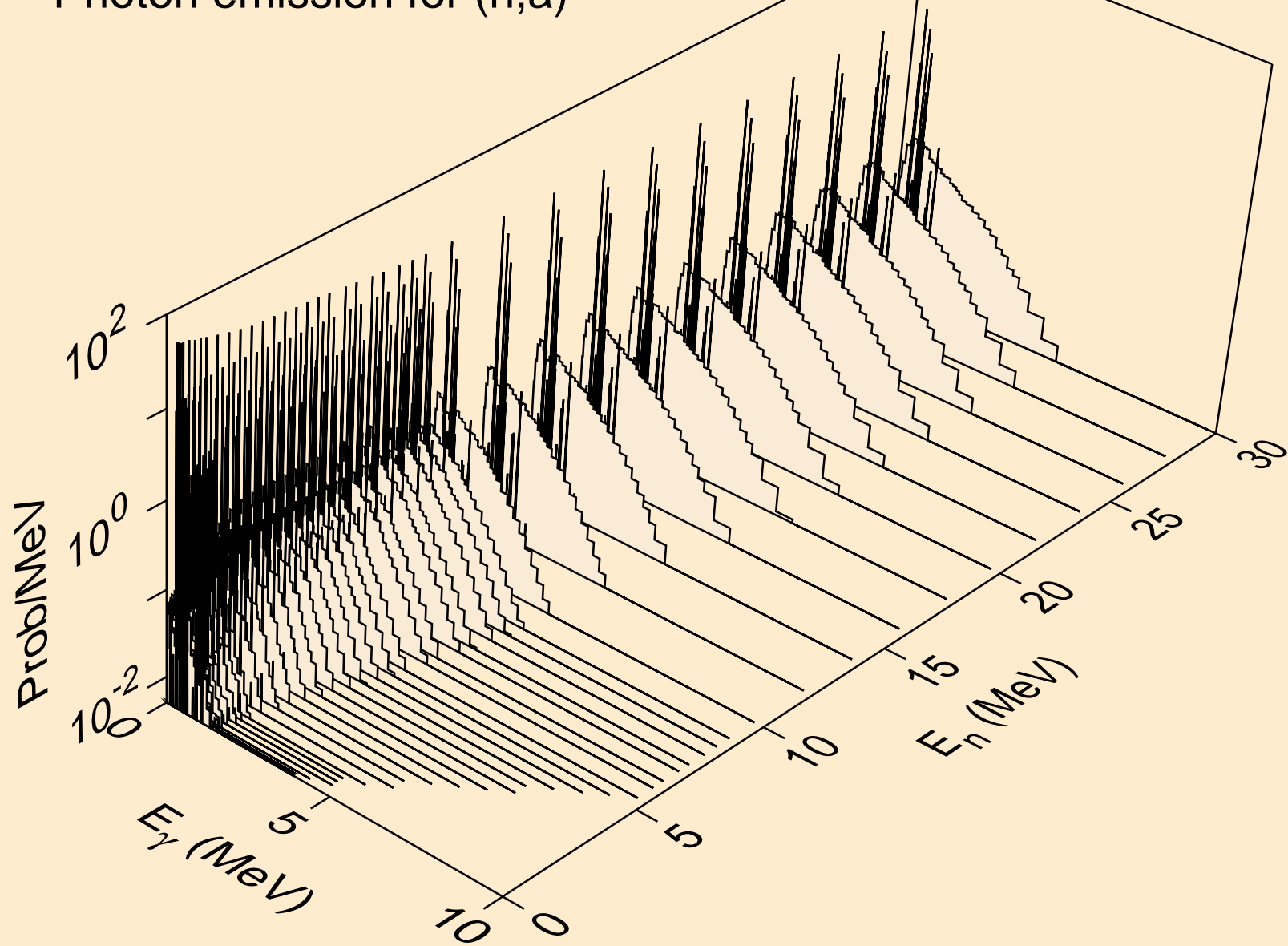

HG197M NEUTRON ACER TENDL-2023 LIBRARY; T=0.K
Photon emission for (n,2a)

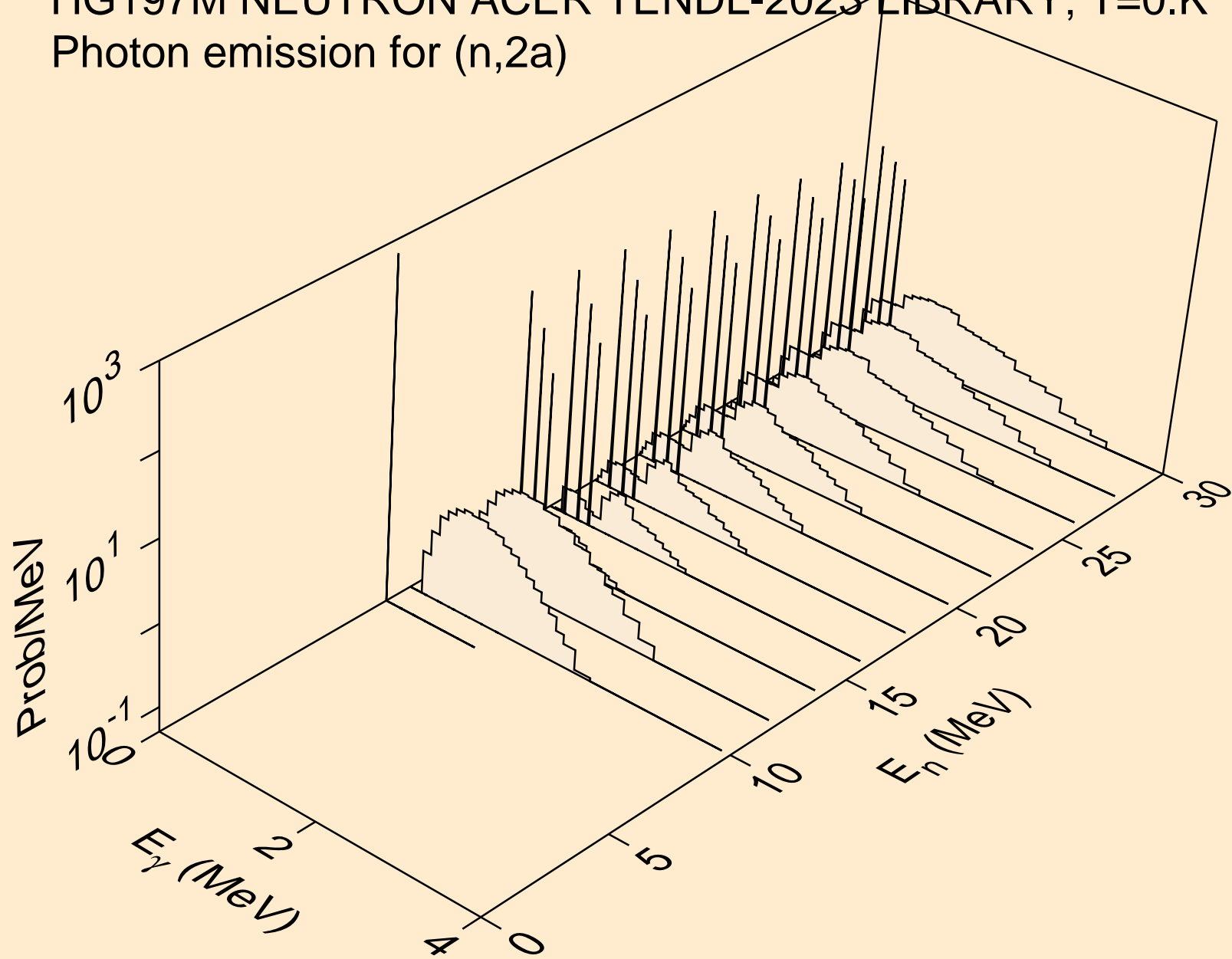

HG197M NEUTRON ACER TENDL-2023 LIBRARY; T=0.K
Photon emission for (n,2p)

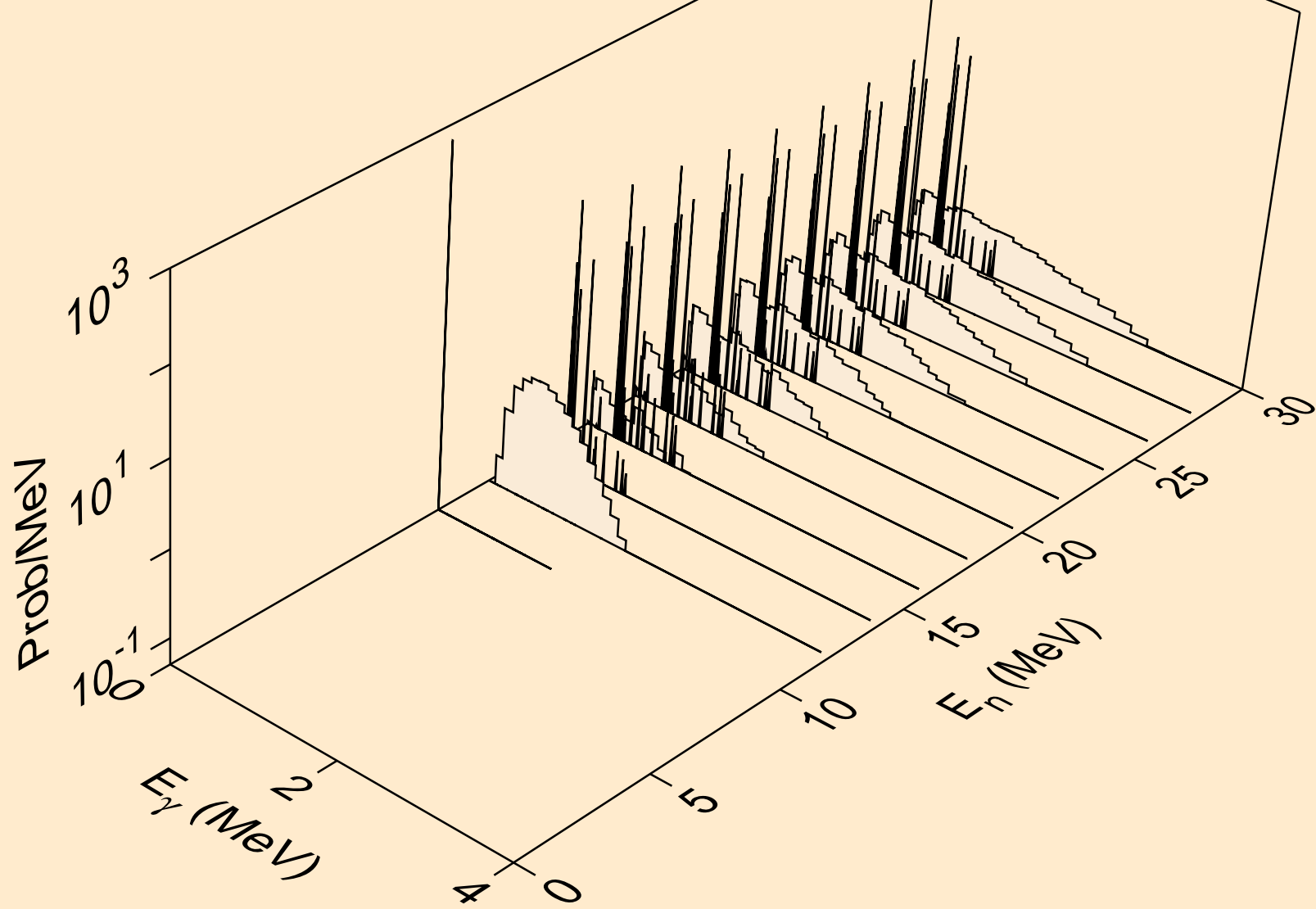

HG197M NEUTRON ACER TENDL-2023 LIBRARY; T=0.K
Photon emission for (n,p)

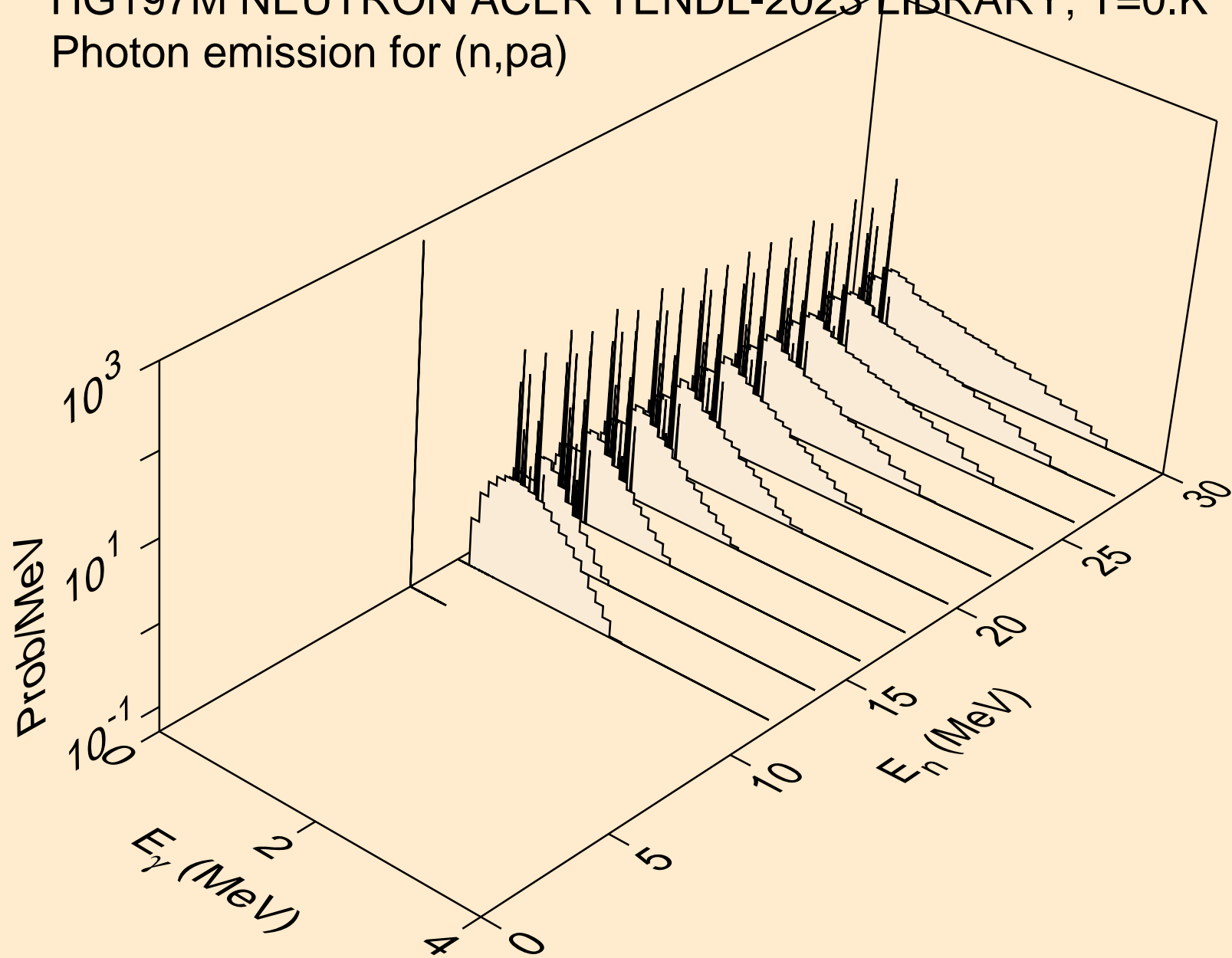

HG197M NEUTRON ACER TENDL-2023 LIBRARY; T=0.K
Photon emission for (n,pd)

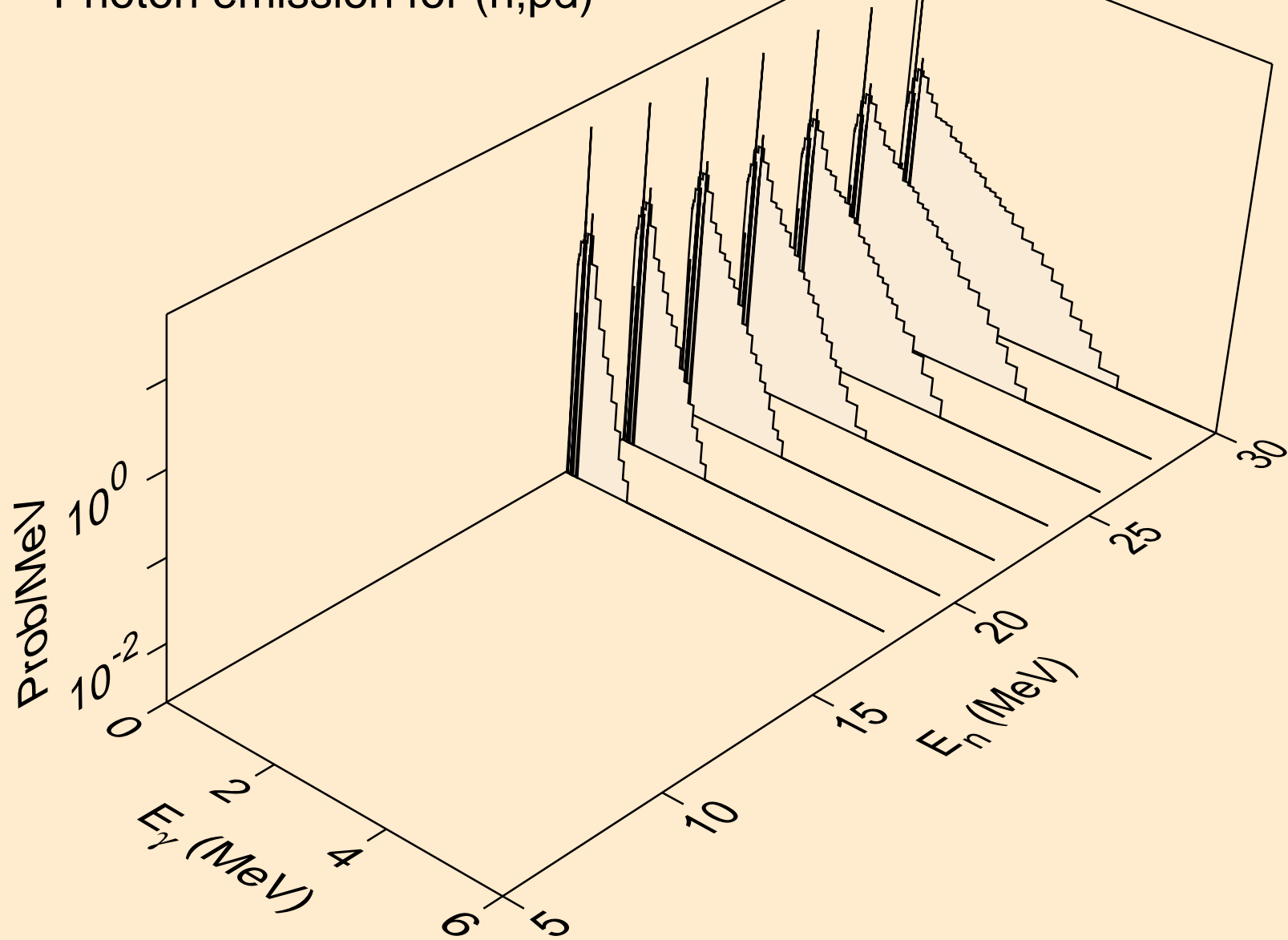

HG197M NEUTRON ACER TENDL-2023 LIBRARY; T=0.K
Photon emission for (n,pt)

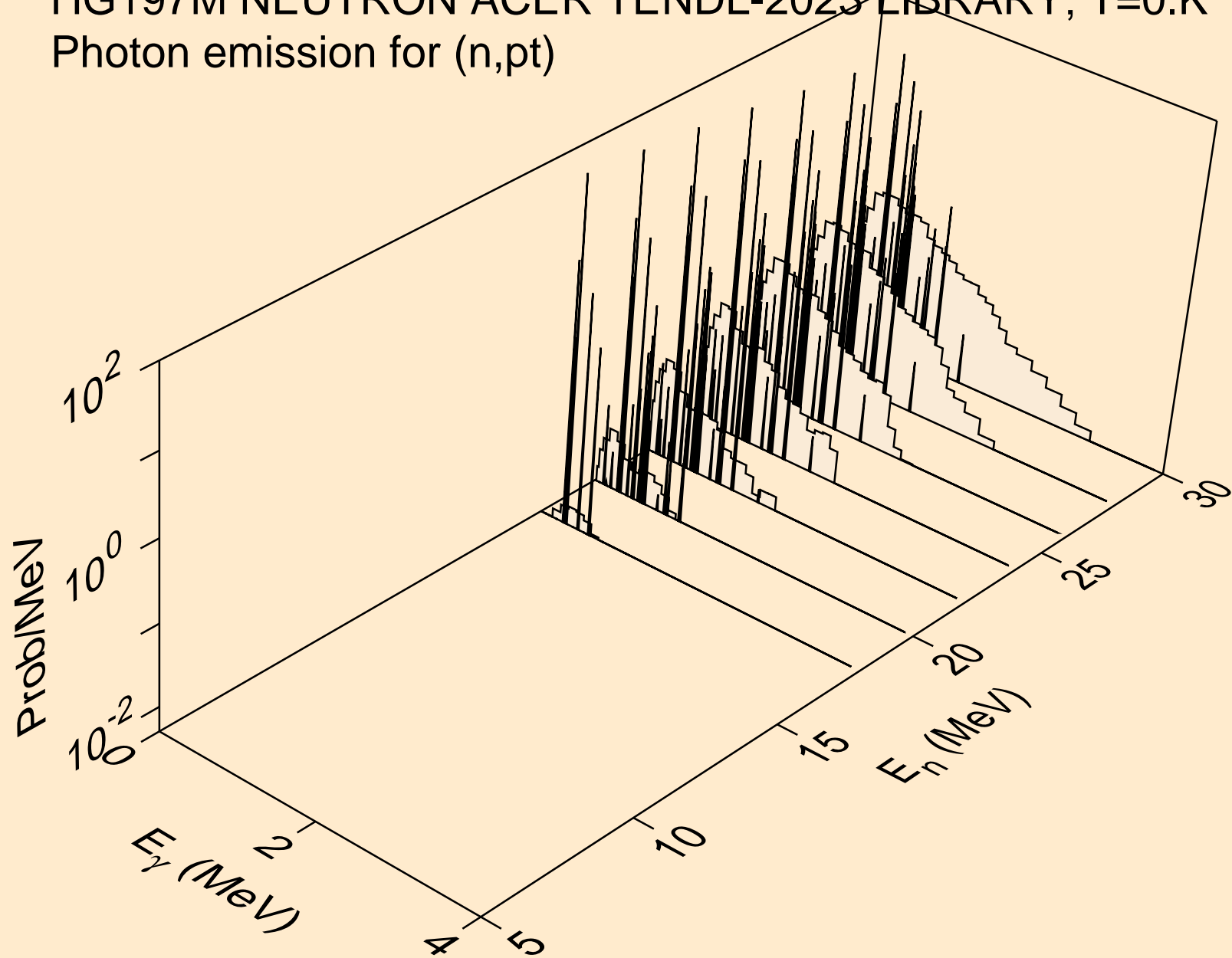

HG197M NEUTRON ACER TENDL-2023 LIBRARY; T=0.K
thermal capture photon spectrum

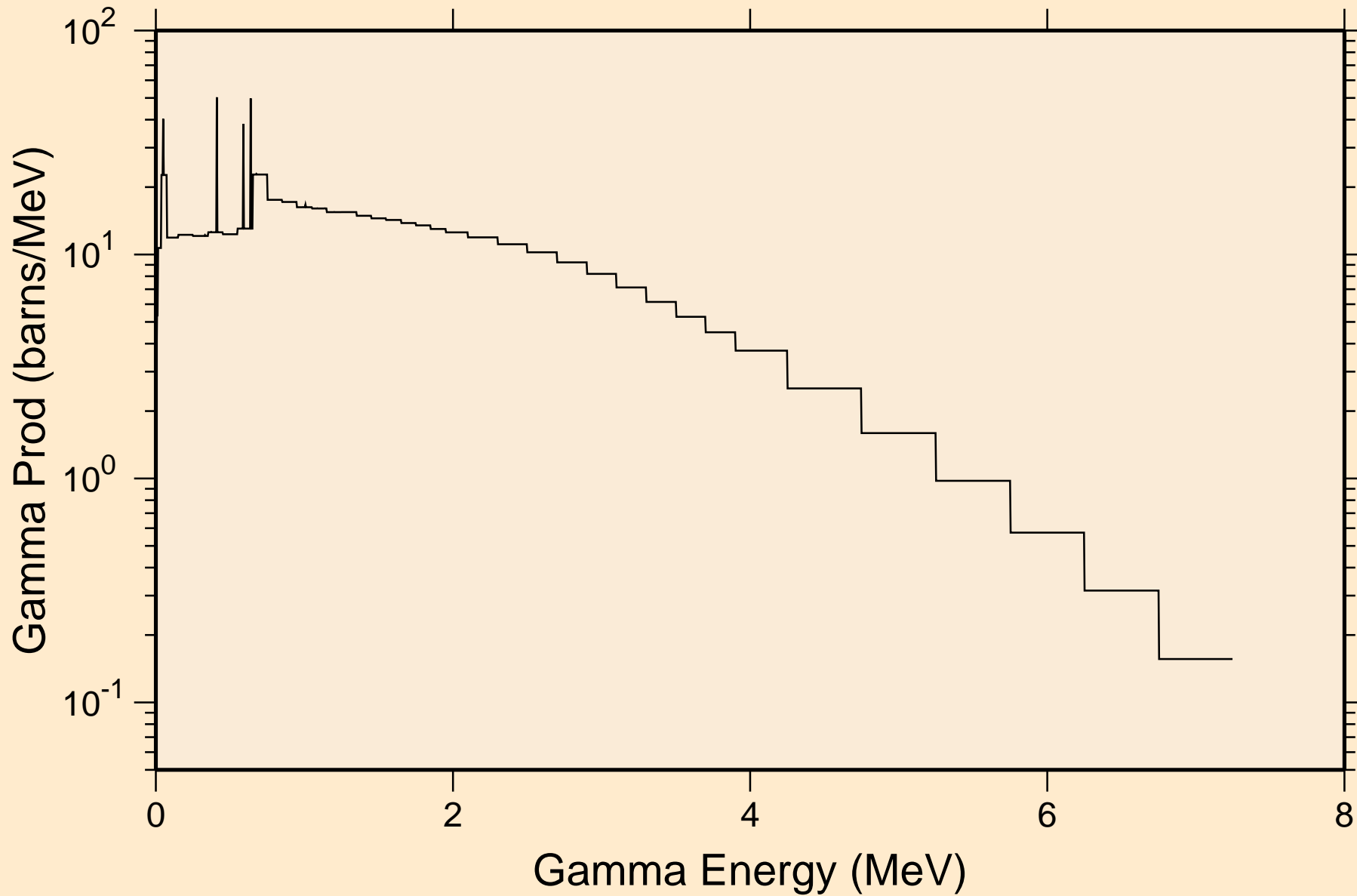

HG197M NEUTRON ACER TENDL-2023 LIBRARY; T=0.K
14 MeV photon spectrum

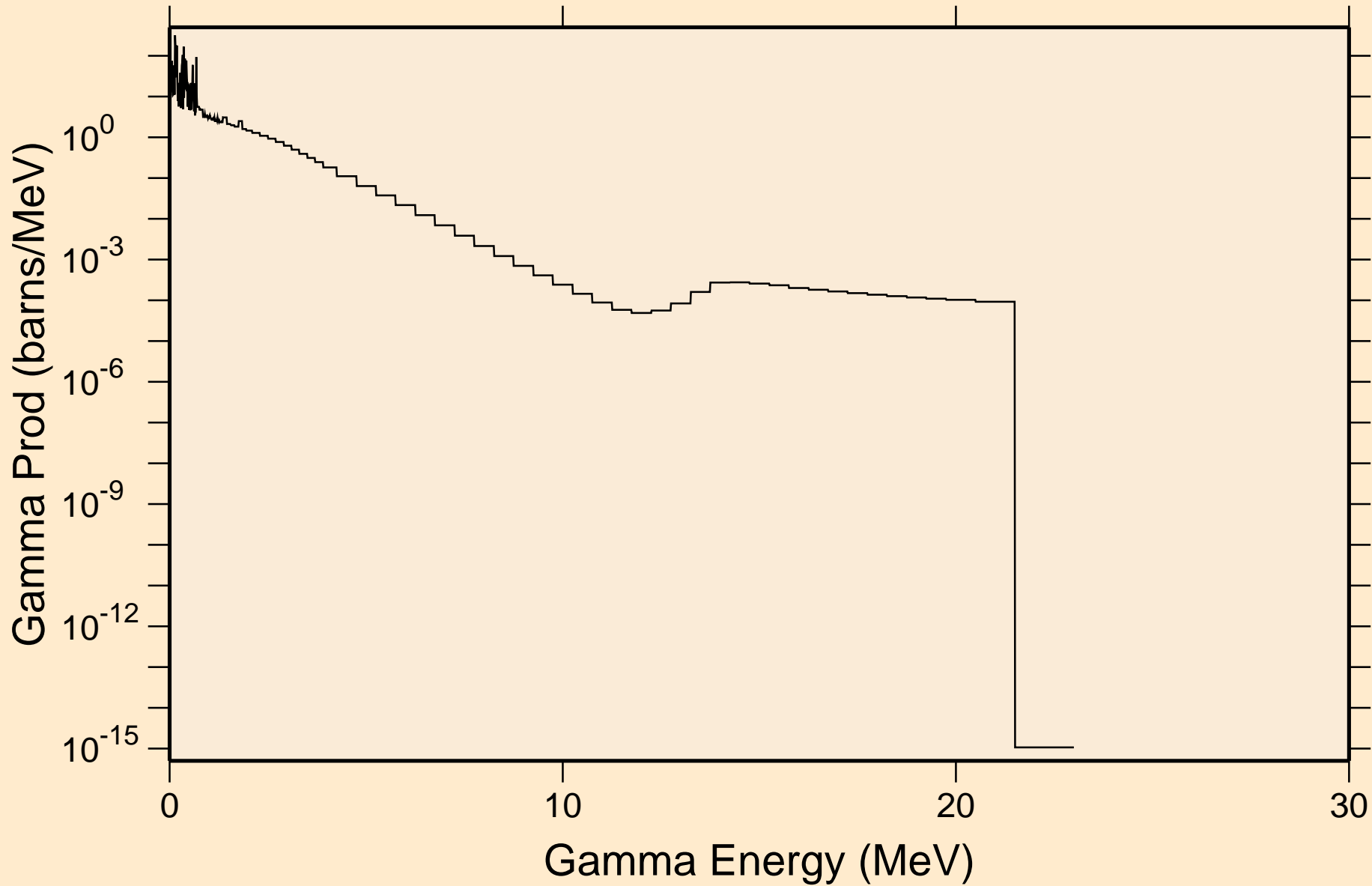

HG197M NEUTRON ACER TENDL-2023 LIBRARY; T=0.K

Particle heating contributions

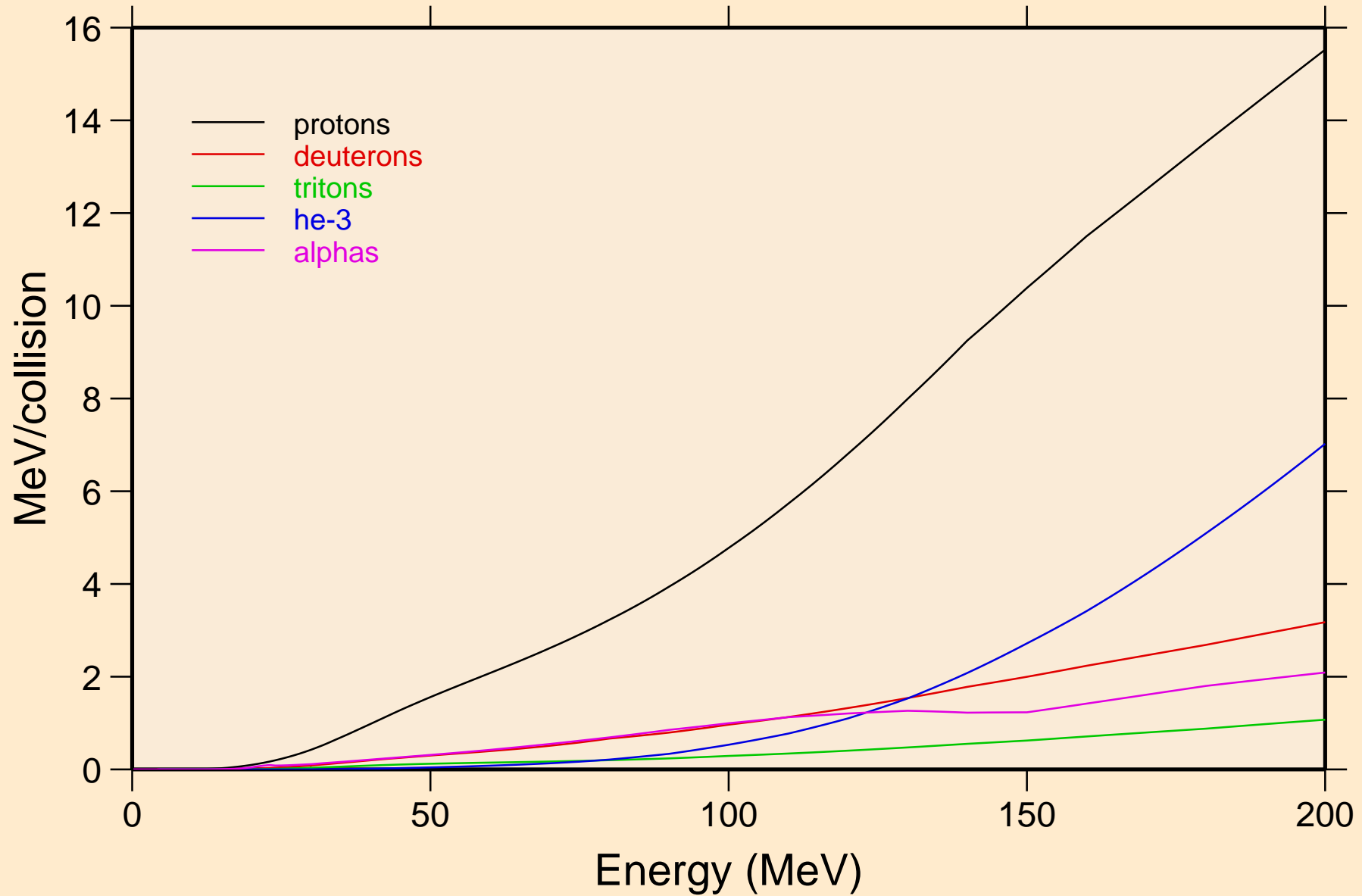

HG197M NEUTRON ACER TENDL-2023 LIBRARY; T=0.K
Recoil Heating

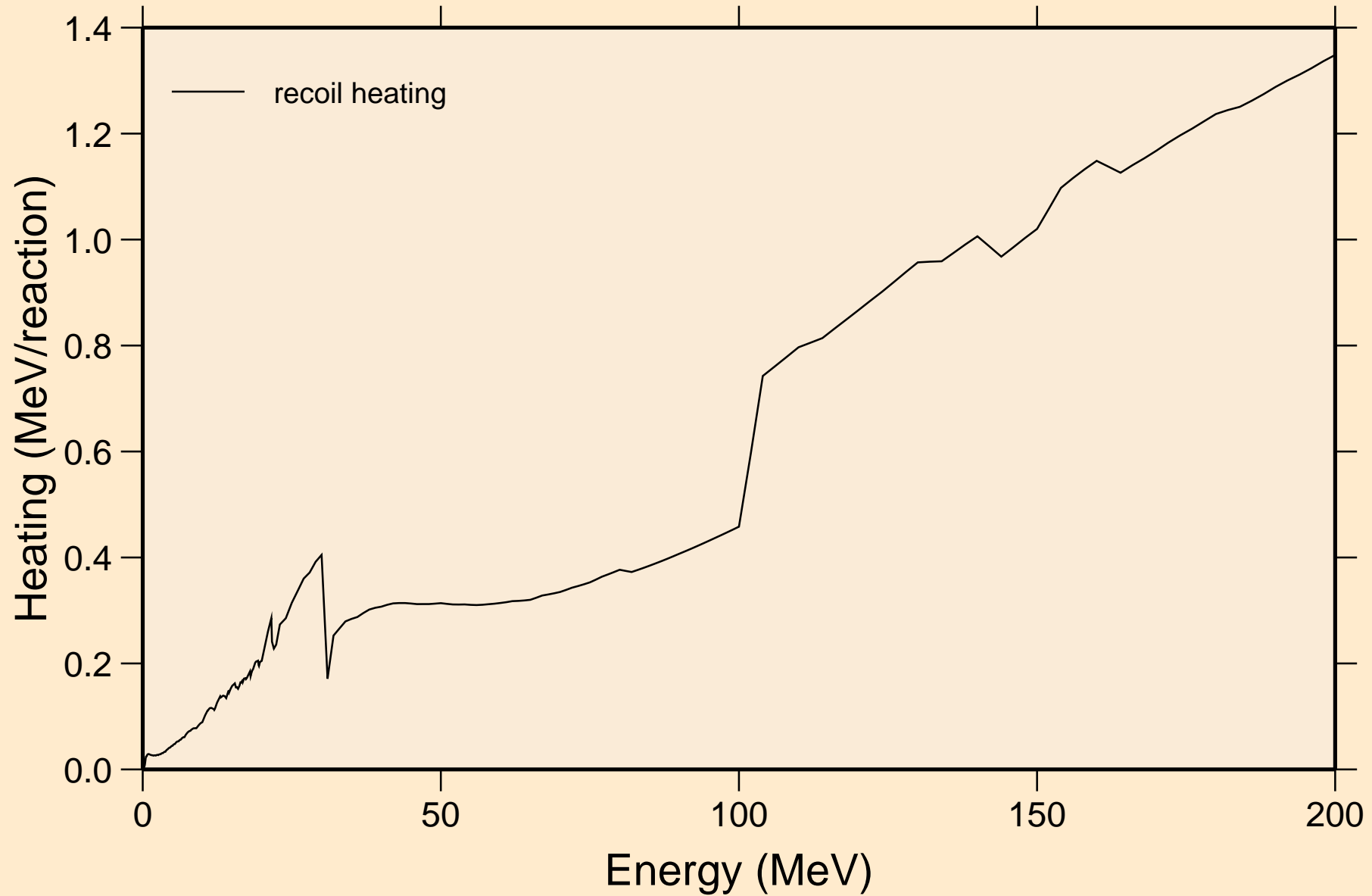

HG197M NEUTRON ACER TENDL-2023 LIBRARY; T=0.K

Particle production cross sections

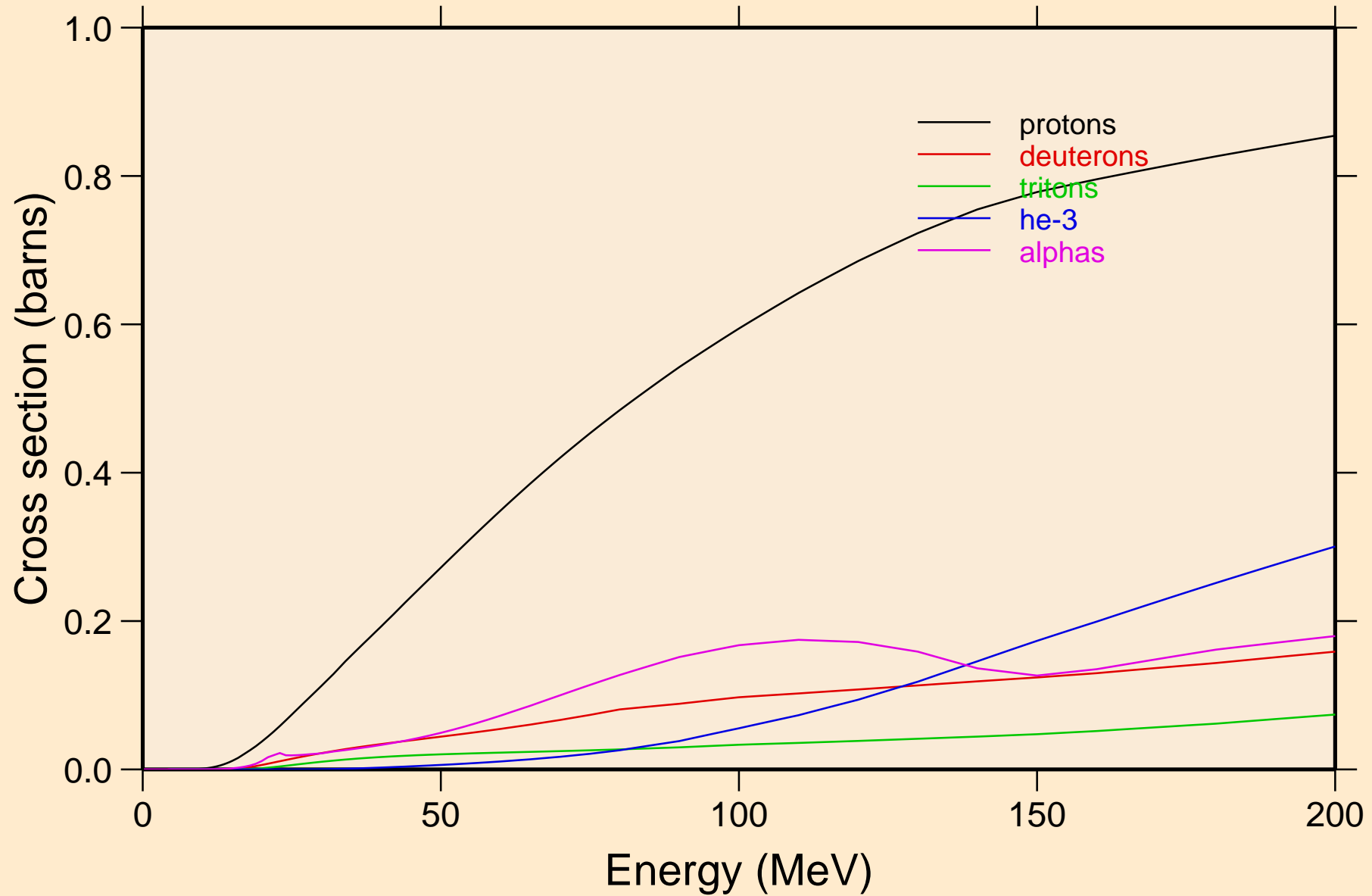

HG197M NEUTRON ACER TENDL-2023 LIBRARY; T=0.K
protons from (n,x)

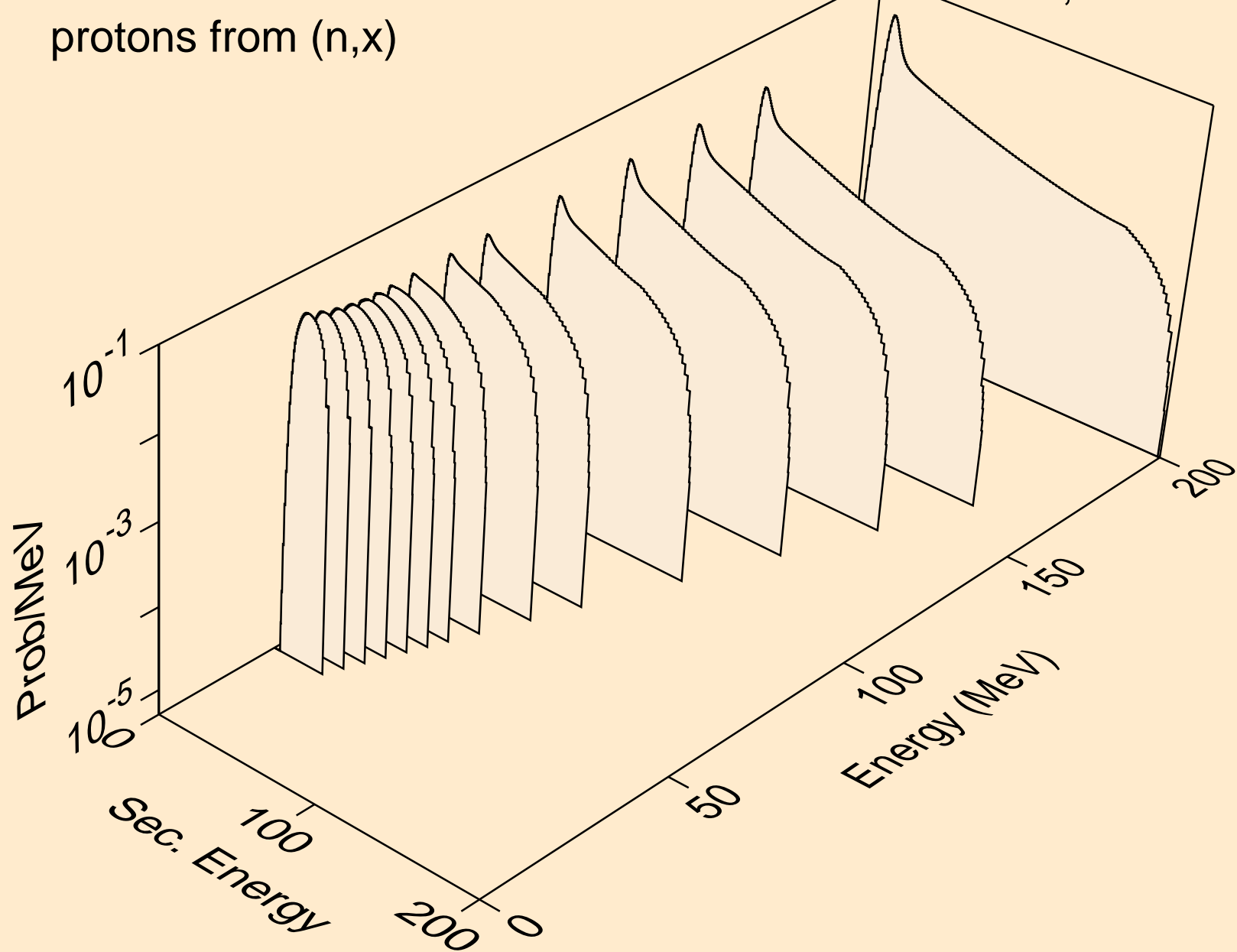

HG197M NEUTRON ACER TENDL-2023 LIBRARY; T=0.K
protons from (n,n*)p

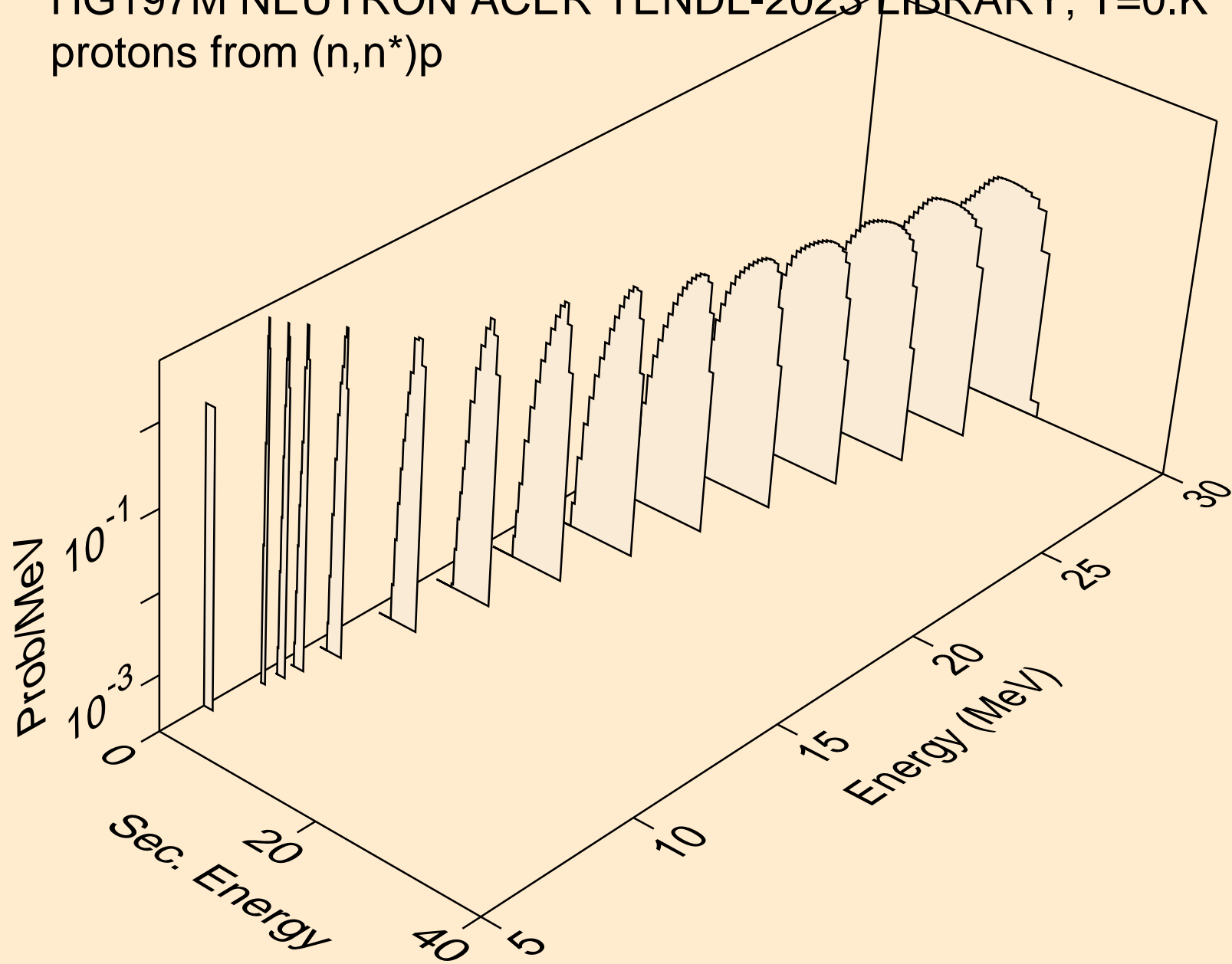

HG197M NEUTRON ACER TENDL-2023 LIBRARY; T=0.K
protons from (n,2np)

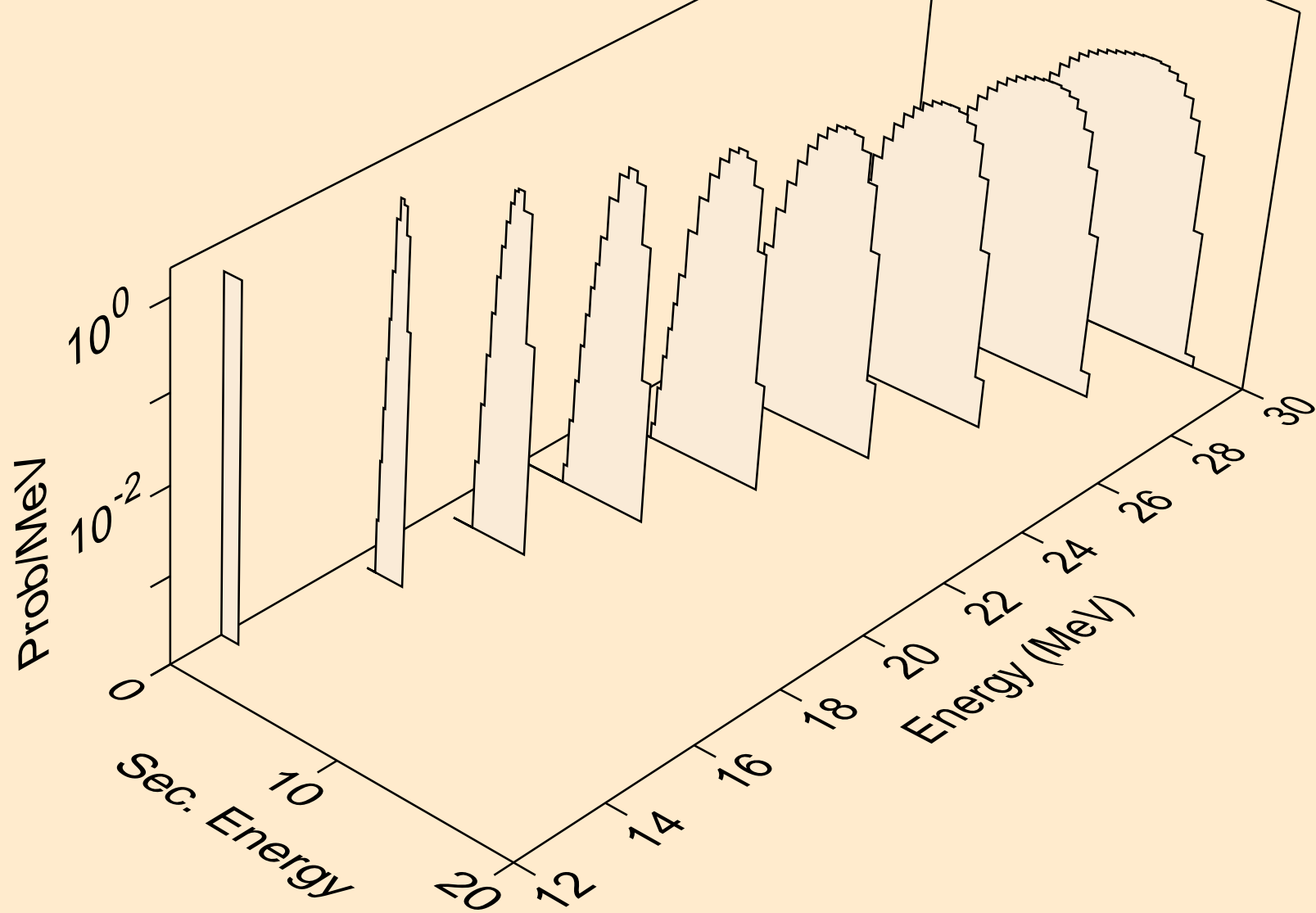

HG197M NEUTRON ACER TENDL-2023 LIBRARY; T=0.K
protons from (n,3np)

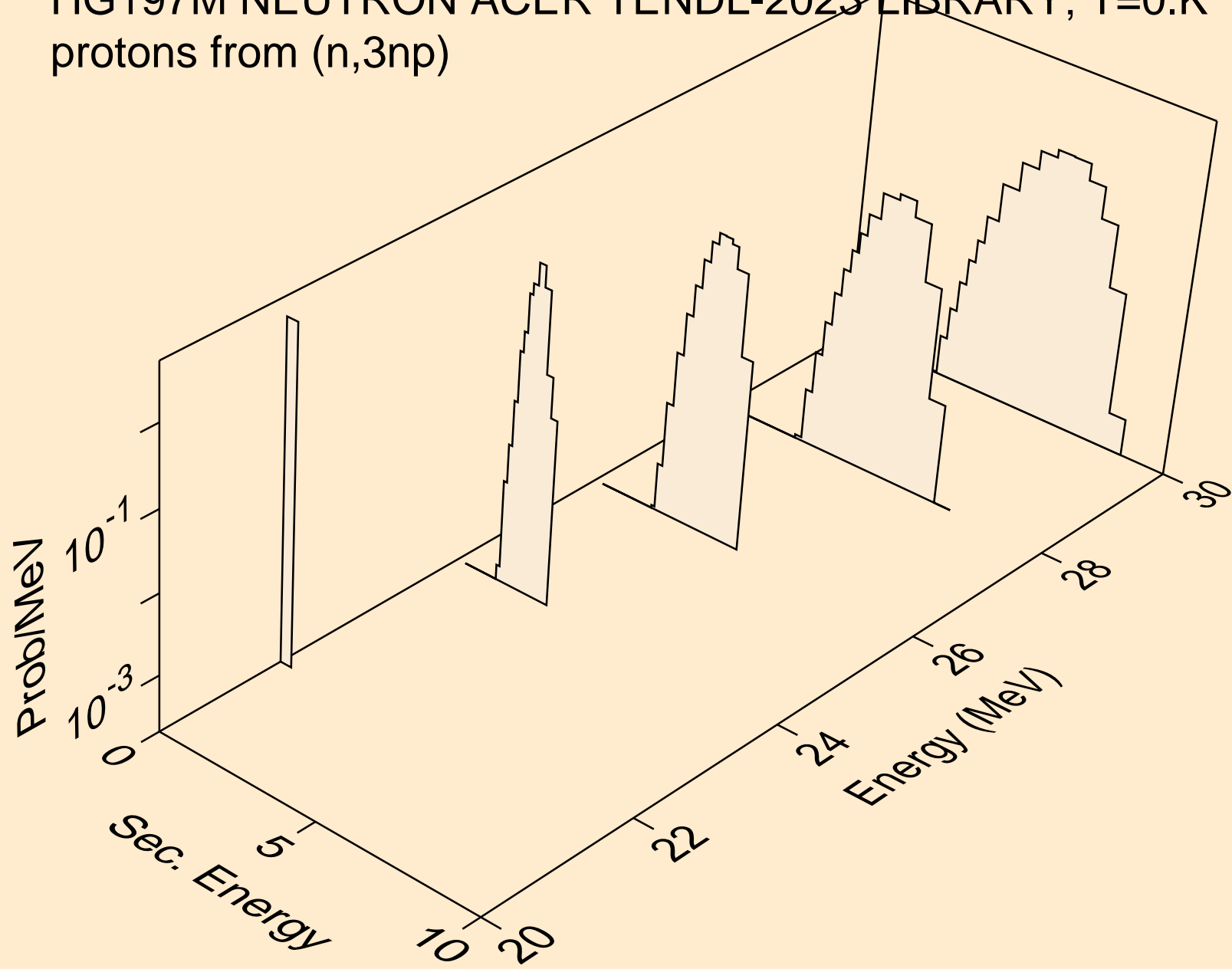

HG197M NEUTRON ACER TENDL-2023 LIBRARY; T=0.K
protons from (n,n2p)

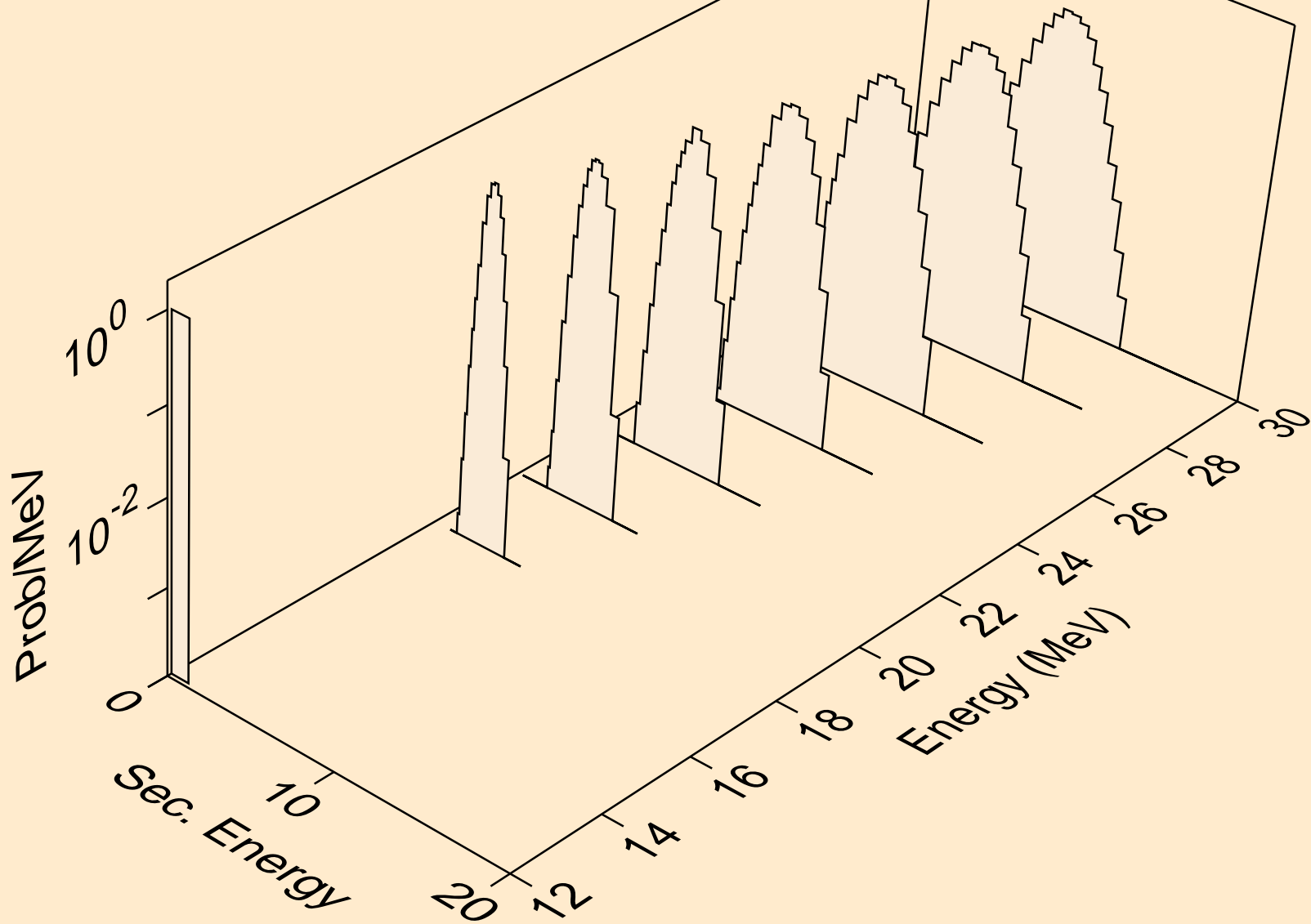

HG197M NEUTRON ACER TENDL-2023 LIBRARY; T=0.K
protons from (n,npa)

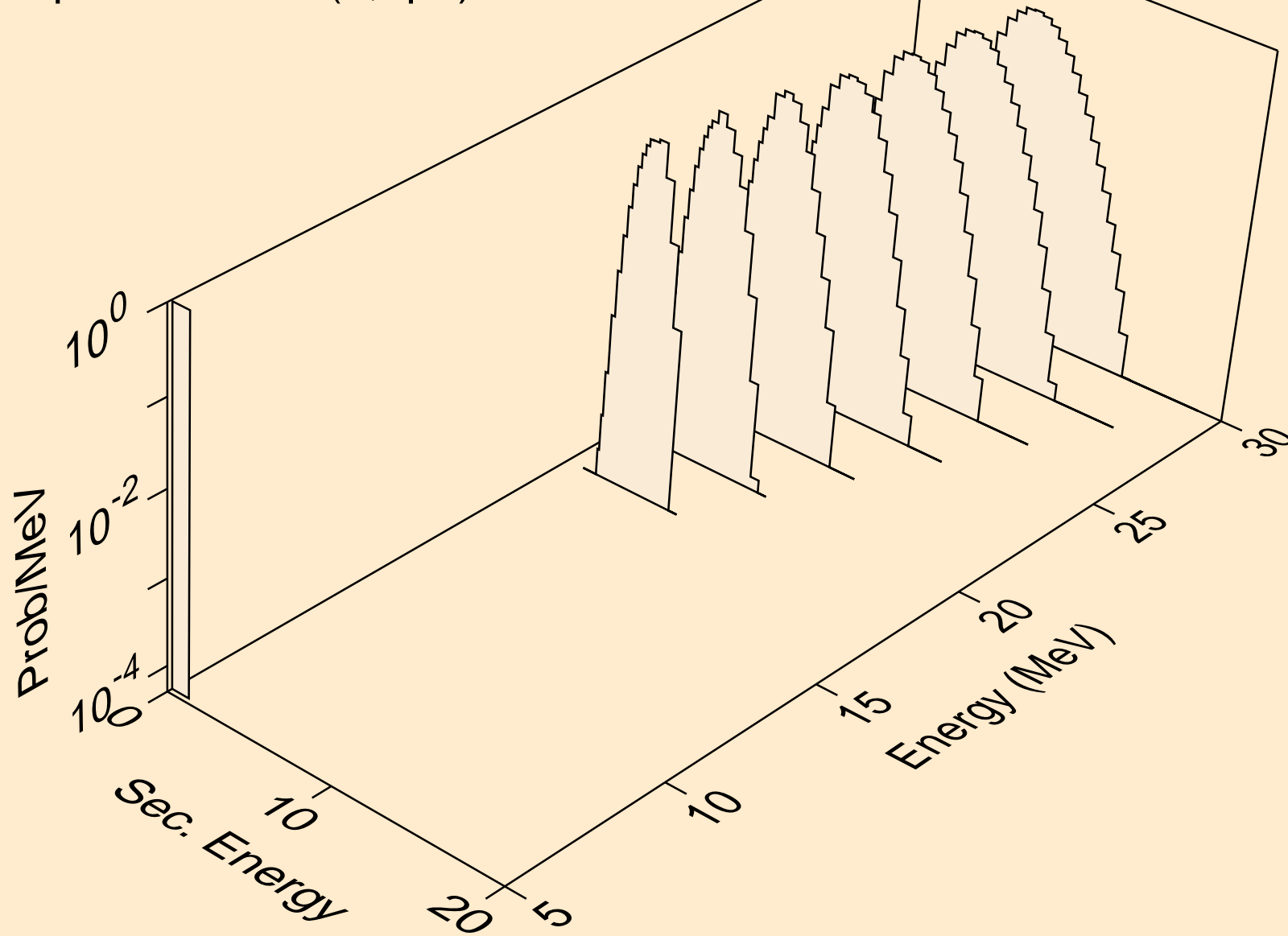

HG197M NEUTRON ACER TENDL-2023 LIBRARY; T=0.K
protons from (n,p)

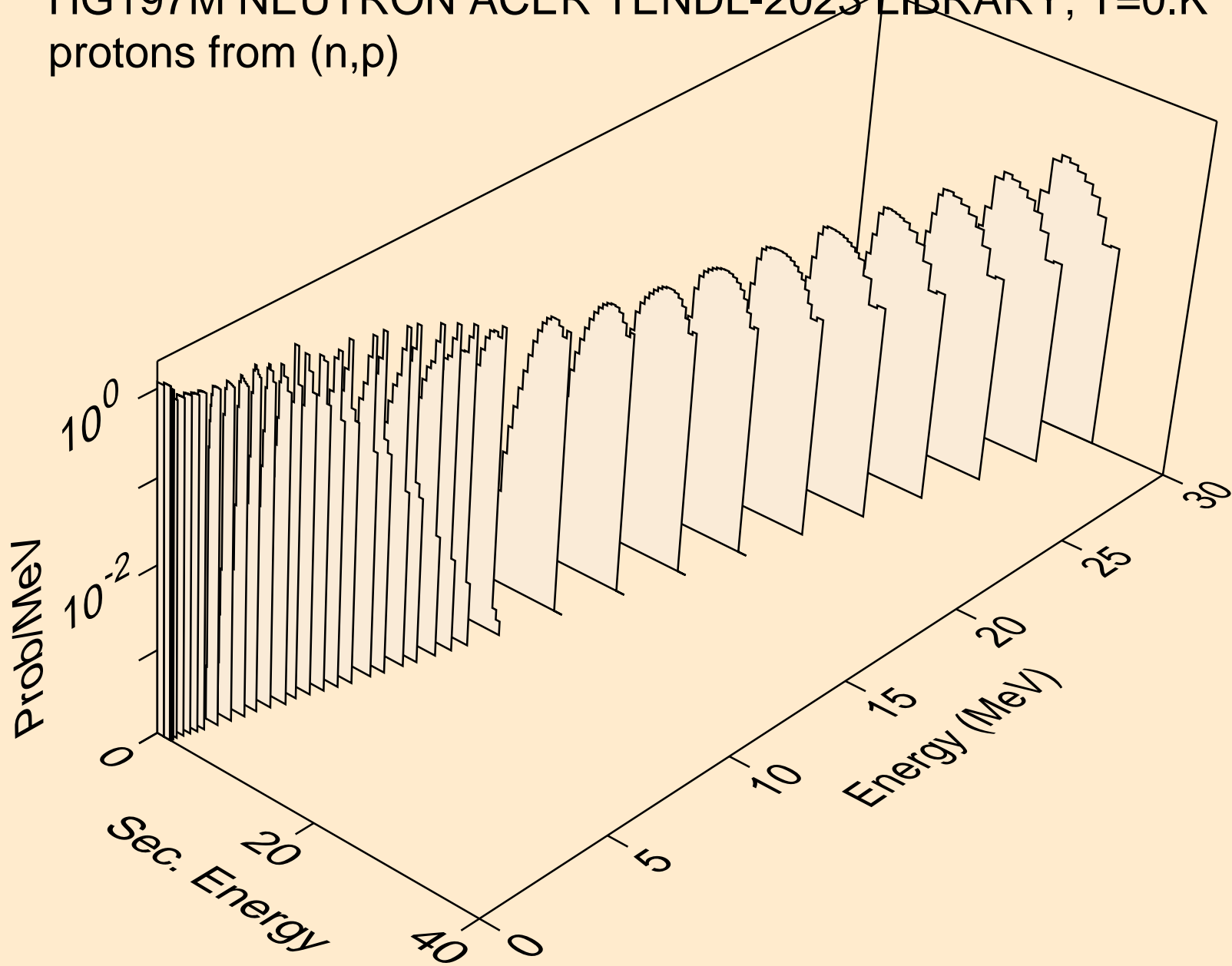

HG197M NEUTRON ACER TENDL-2023 LIBRARY; T=0.K
protons from (n,2p)

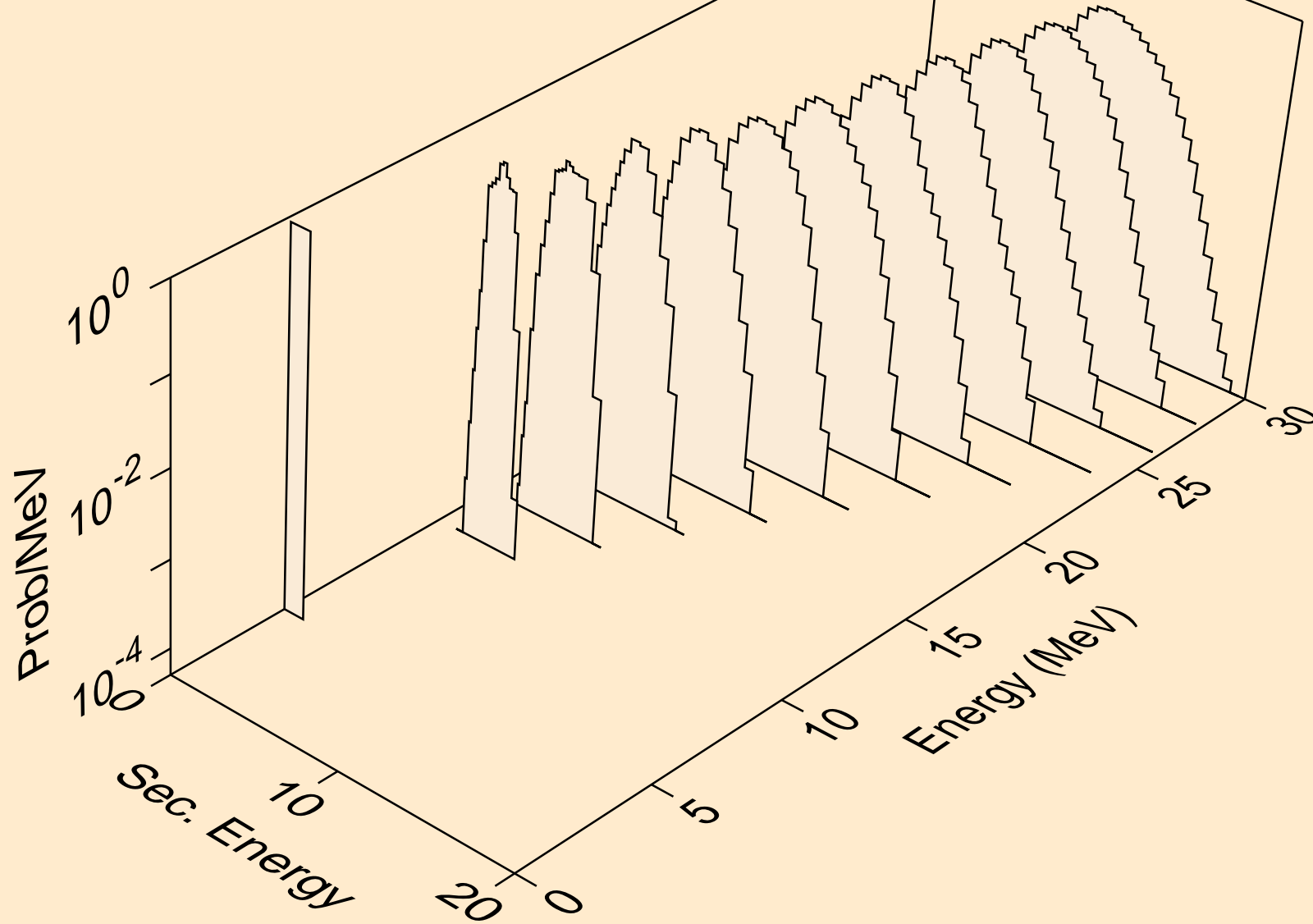

HG197M NEUTRON ACER TENDL-2023 LIBRARY; T=0.K
protons from (n,p)

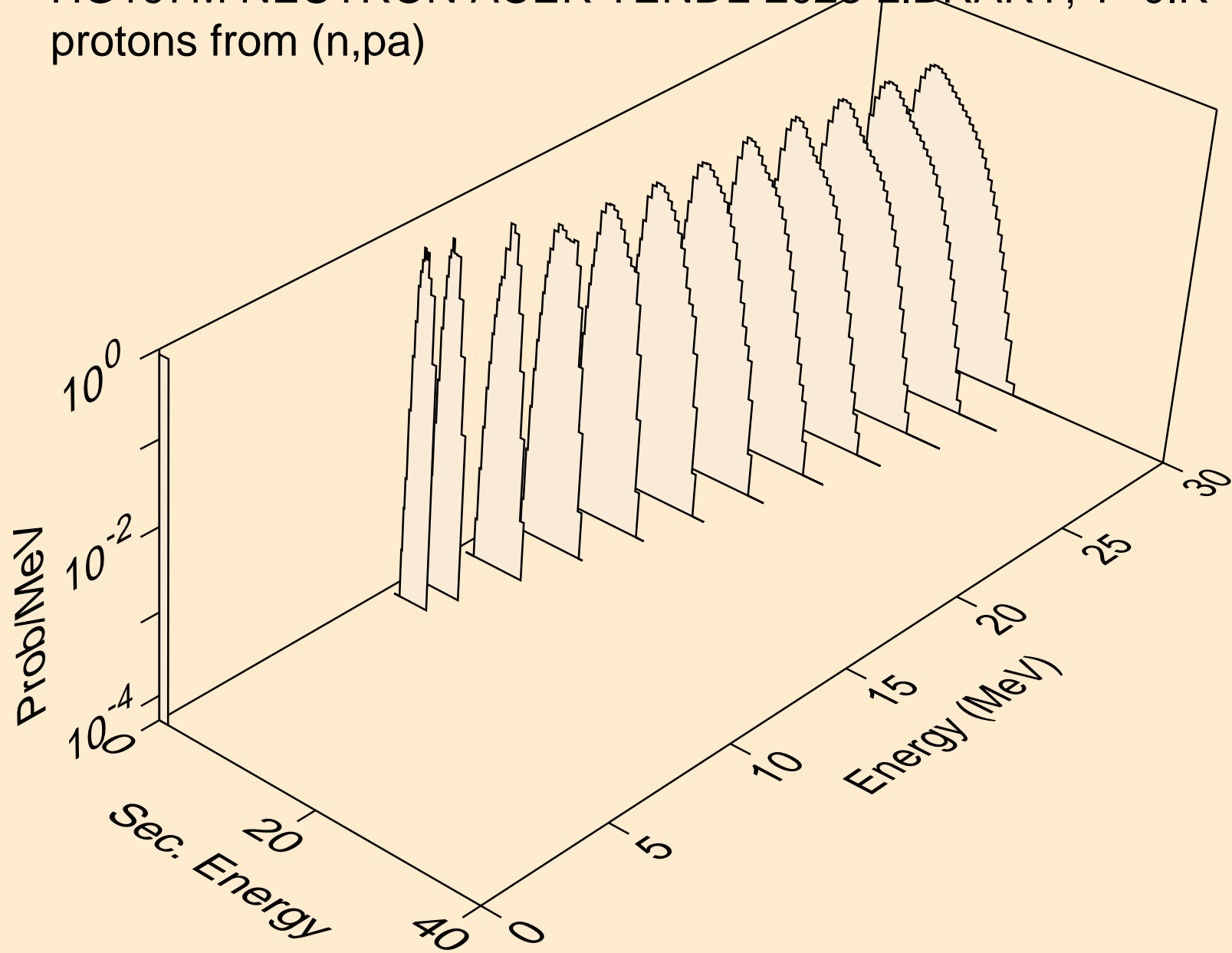

HG197M NEUTRON ACER TENDL-2023 LIBRARY; T=0.K
protons from (n,pd)

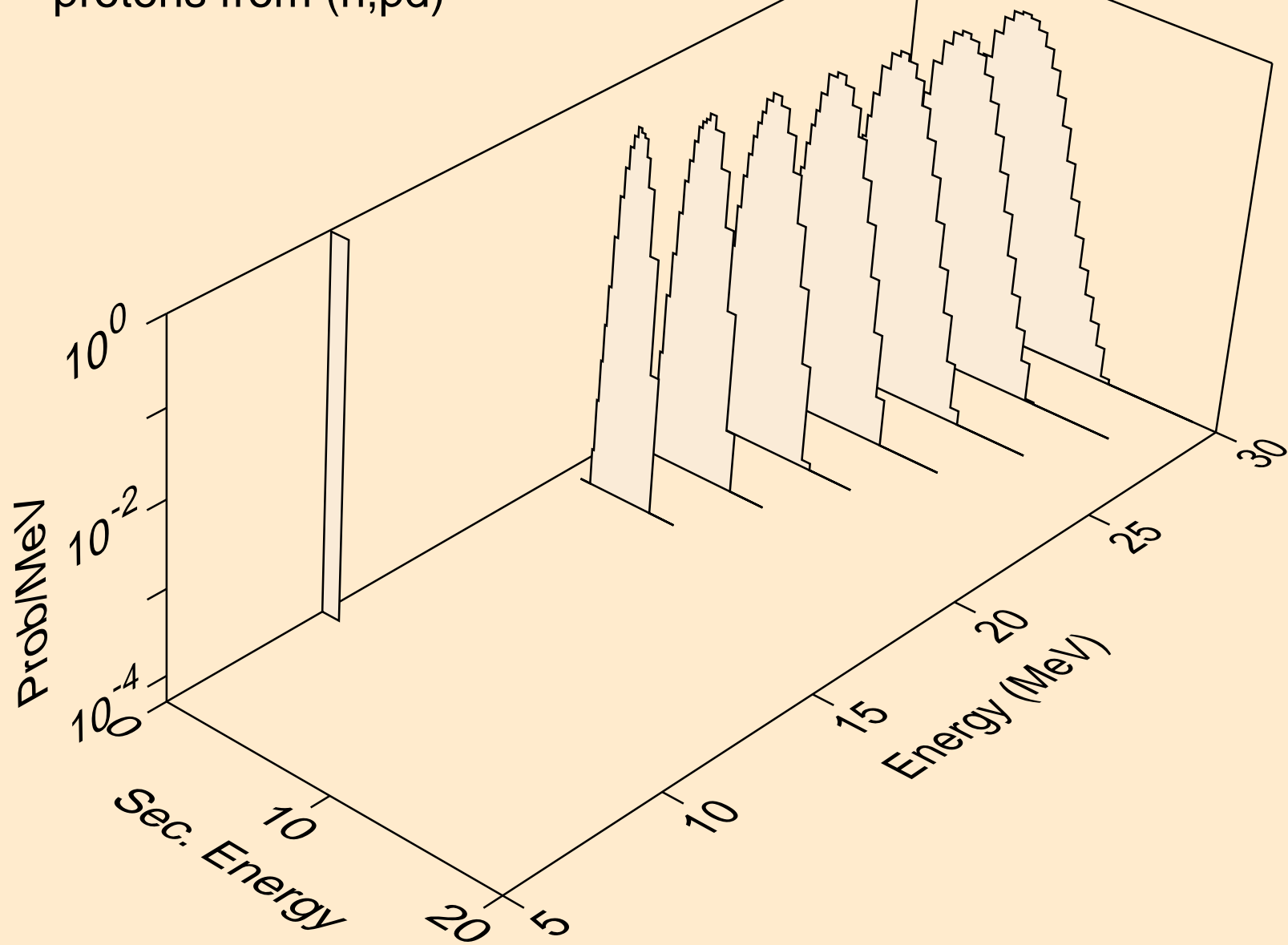

HG197M NEUTRON ACER TENDL-2023 LIBRARY; T=0.K
protons from (n,pt)

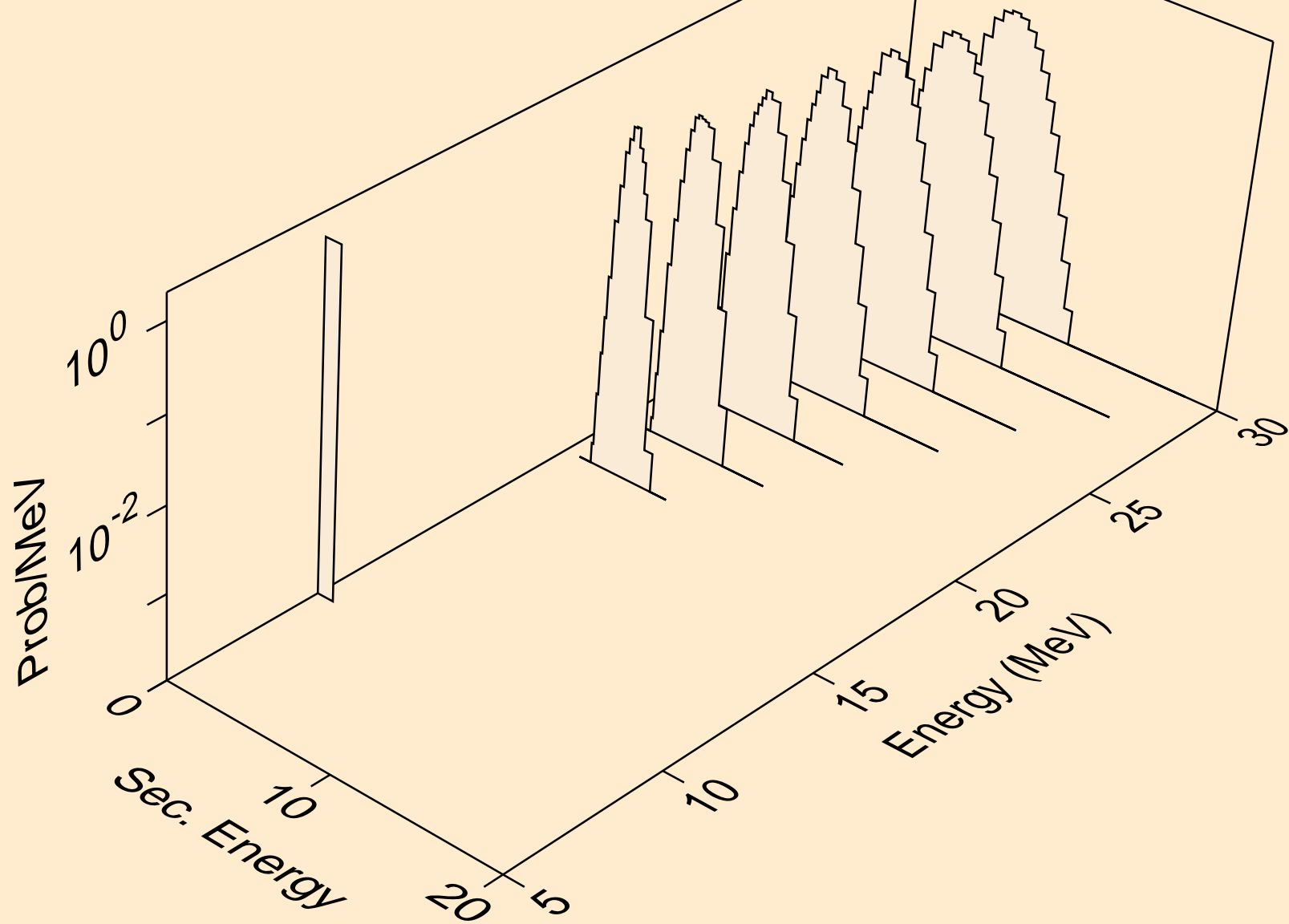

HG197M NEUTRON ACER TENDL-2023 LIBRARY; T=0.K
deuterons from (n,x)

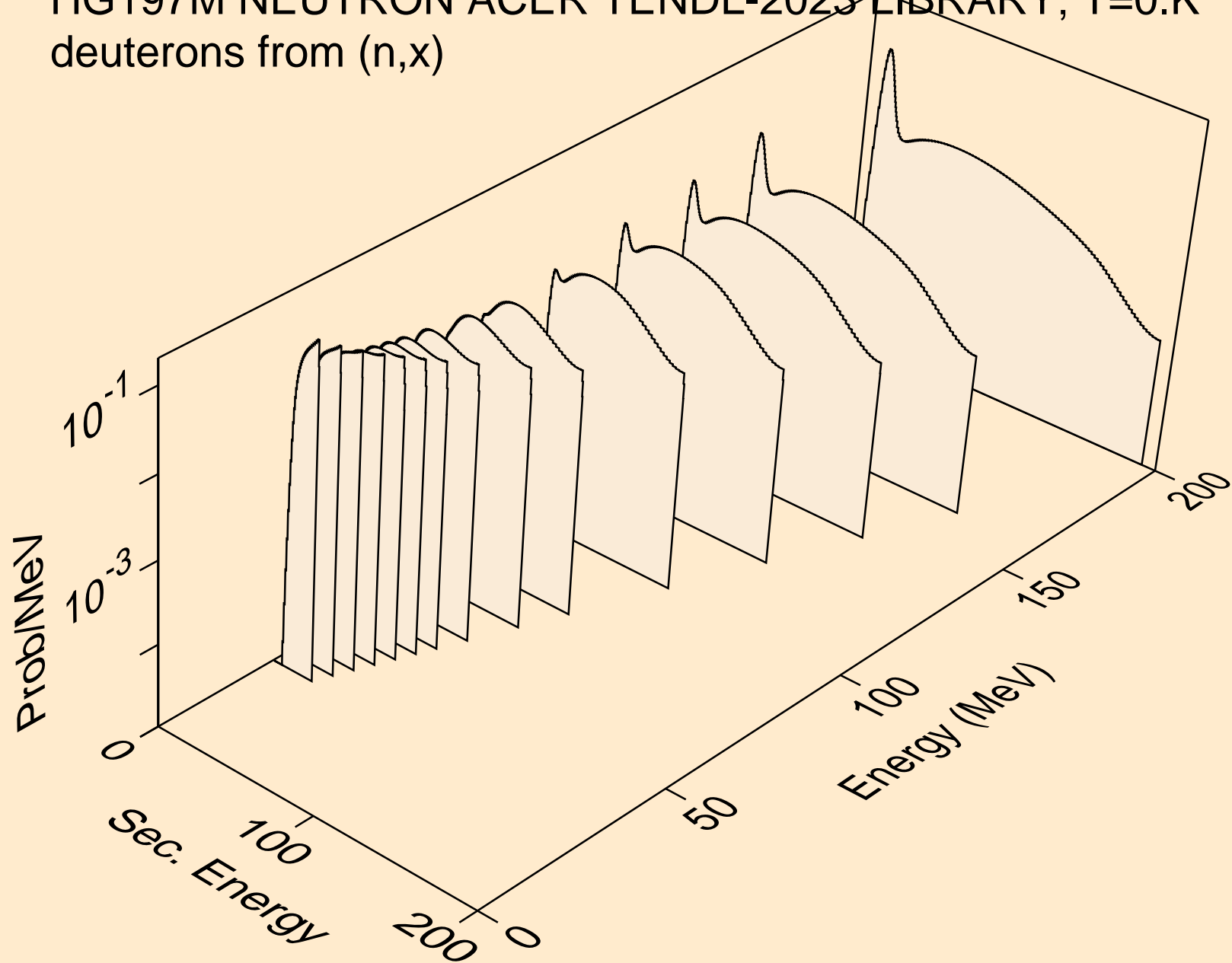

HG197M NEUTRON ACER TENDL-2023 LIBRARY; T=0.K
deuterons from (n,2nd)

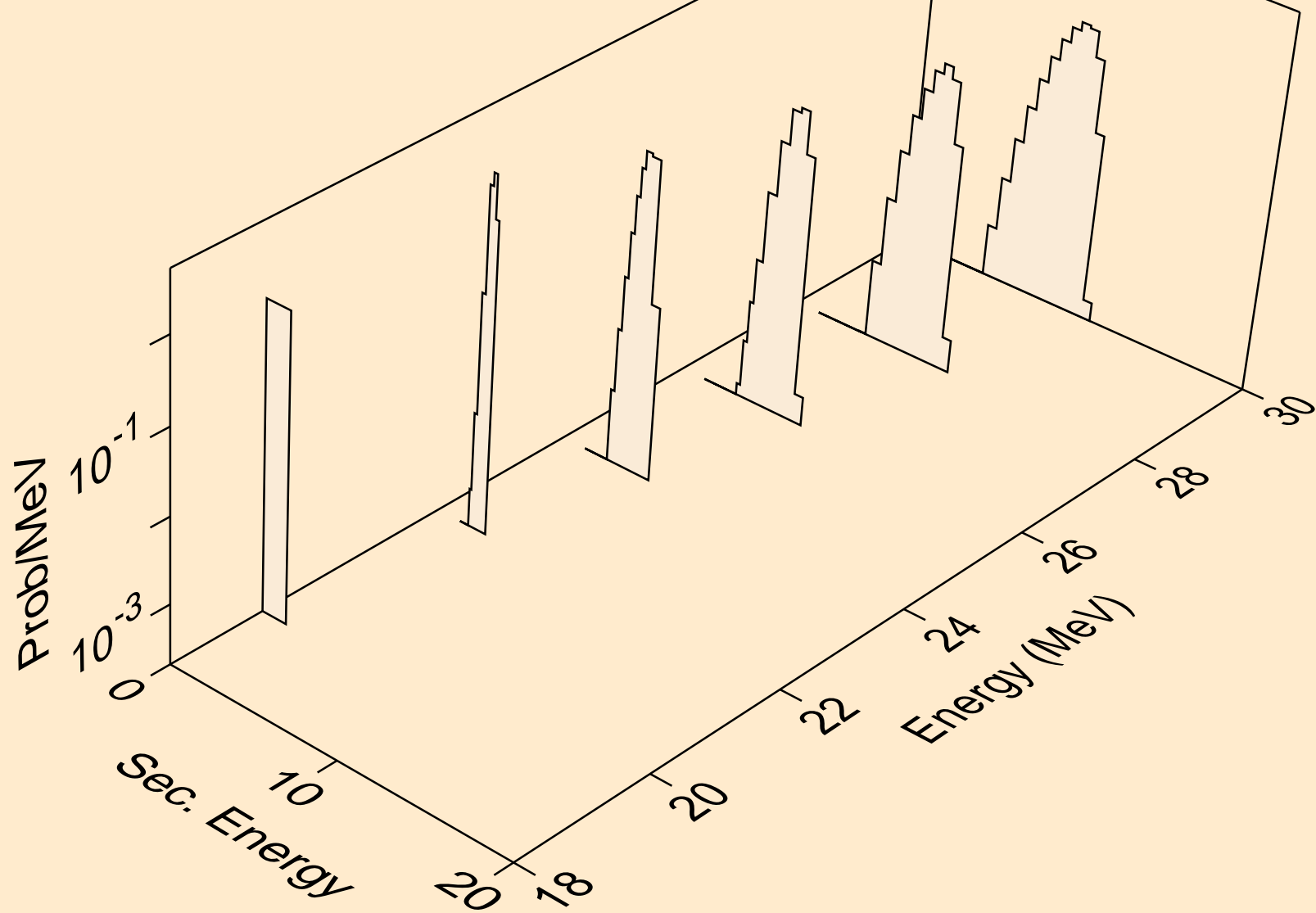

HG197M NEUTRON ACER TENDL-2023 LIBRARY; T=0.K
deuterons from (n,n*)d

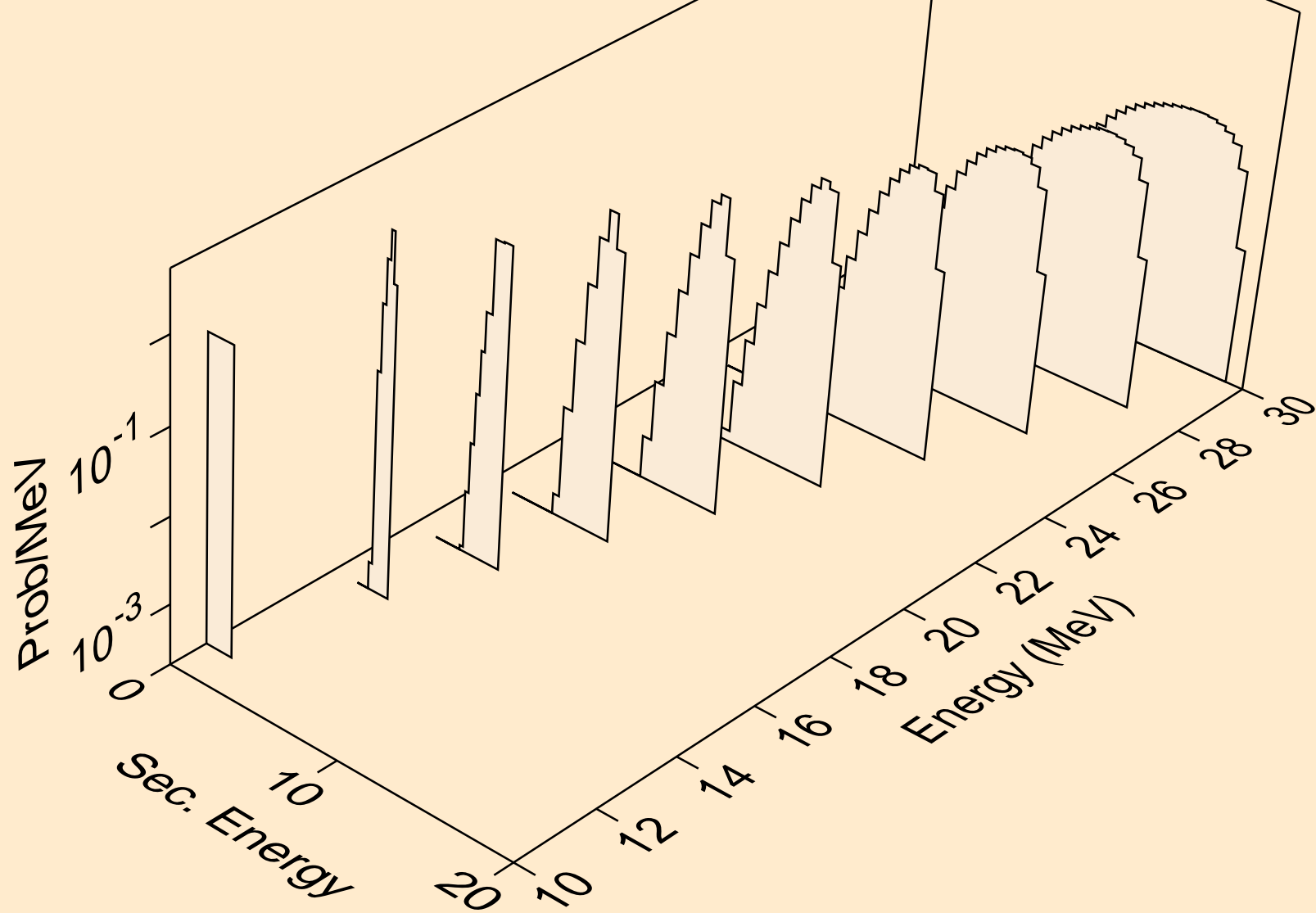

HG197M NEUTRON ACER TENDL-2023 LIBRARY; T=0.K
deuterons from (n,d)

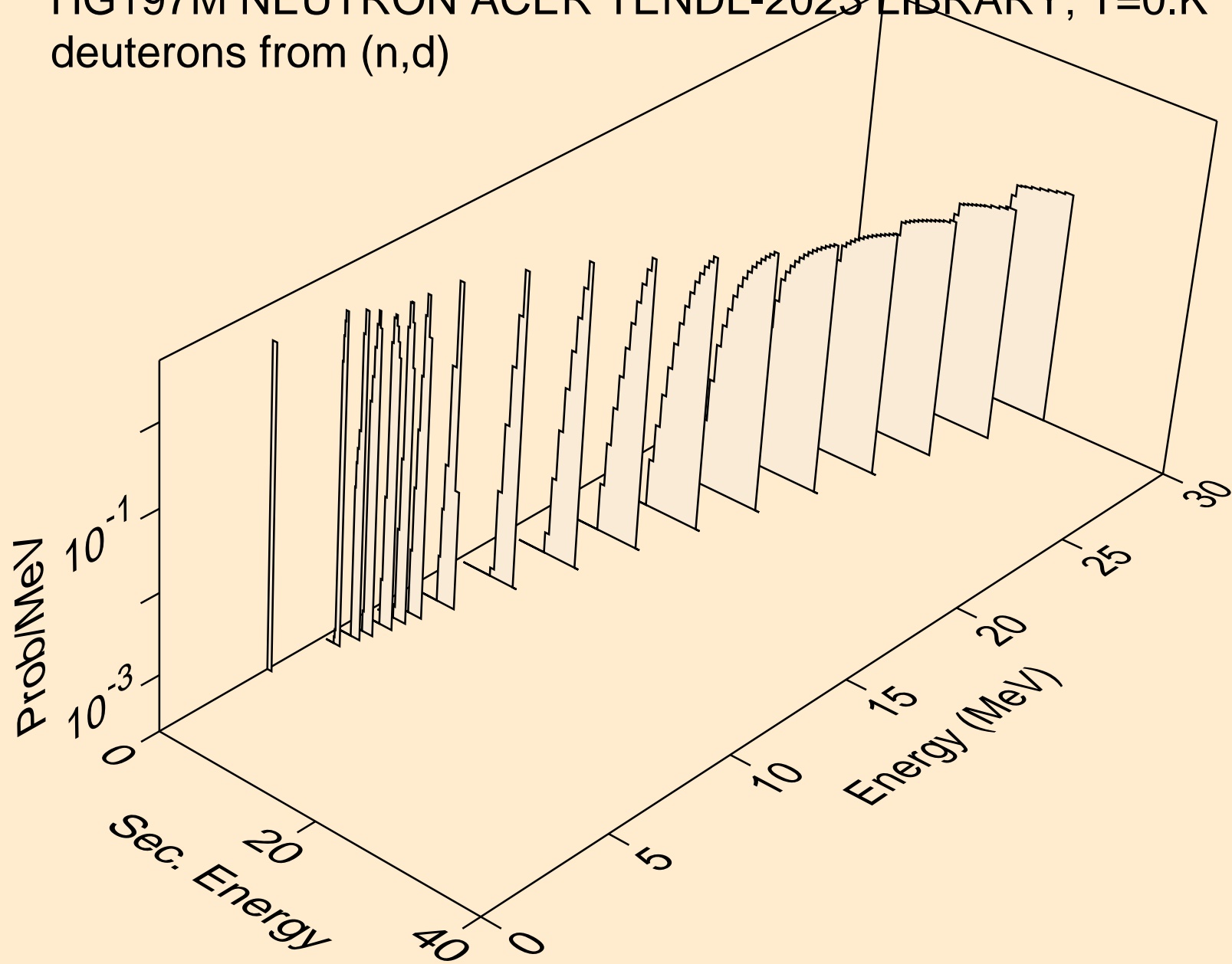

HG197M NEUTRON ACER TENDL-2023 LIBRARY; T=0.K
deuterons from (n,pd)

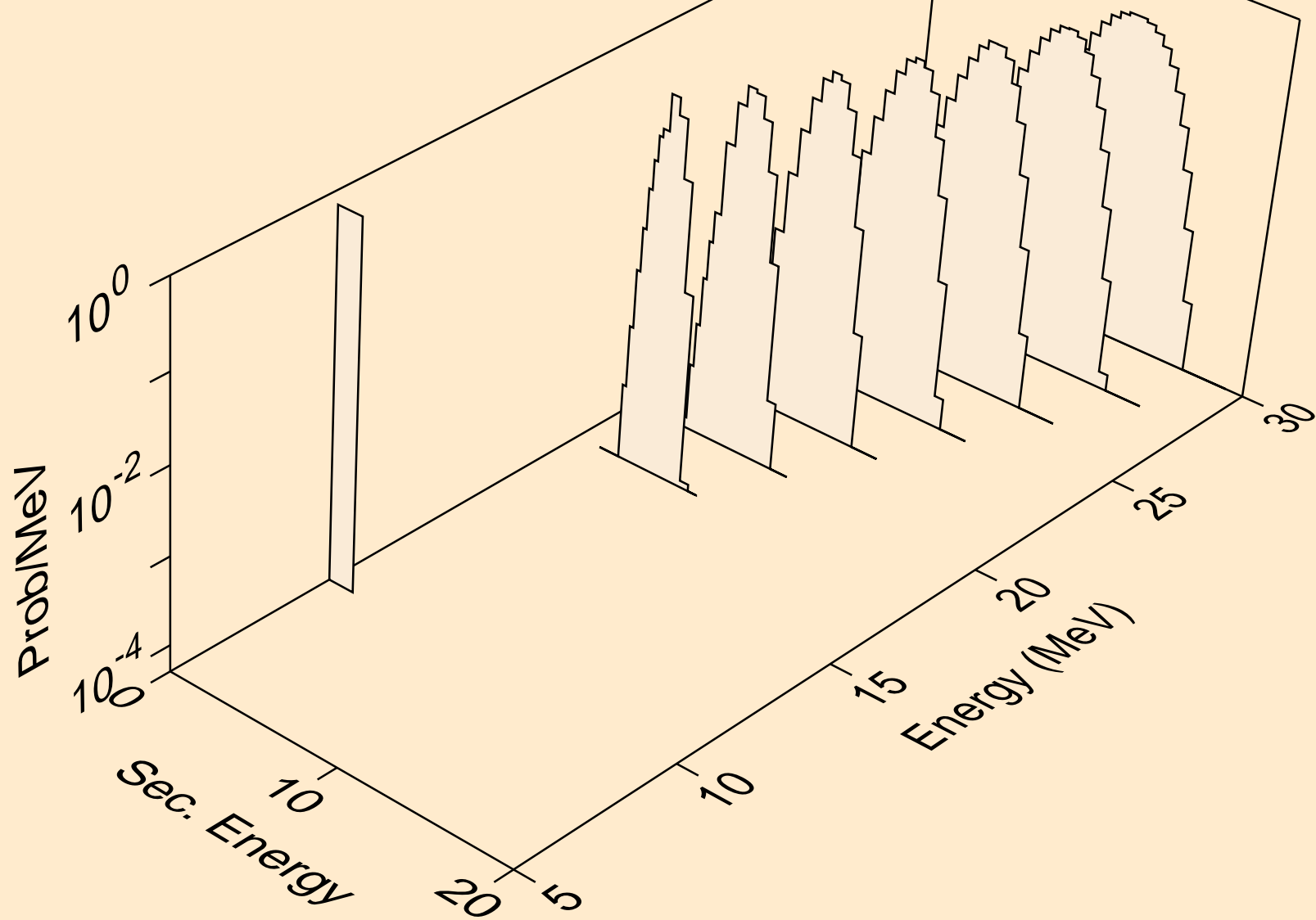

HG197M NEUTRON ACER TENDL-2023 LIBRARY; T=0.K
tritons from (n,x)

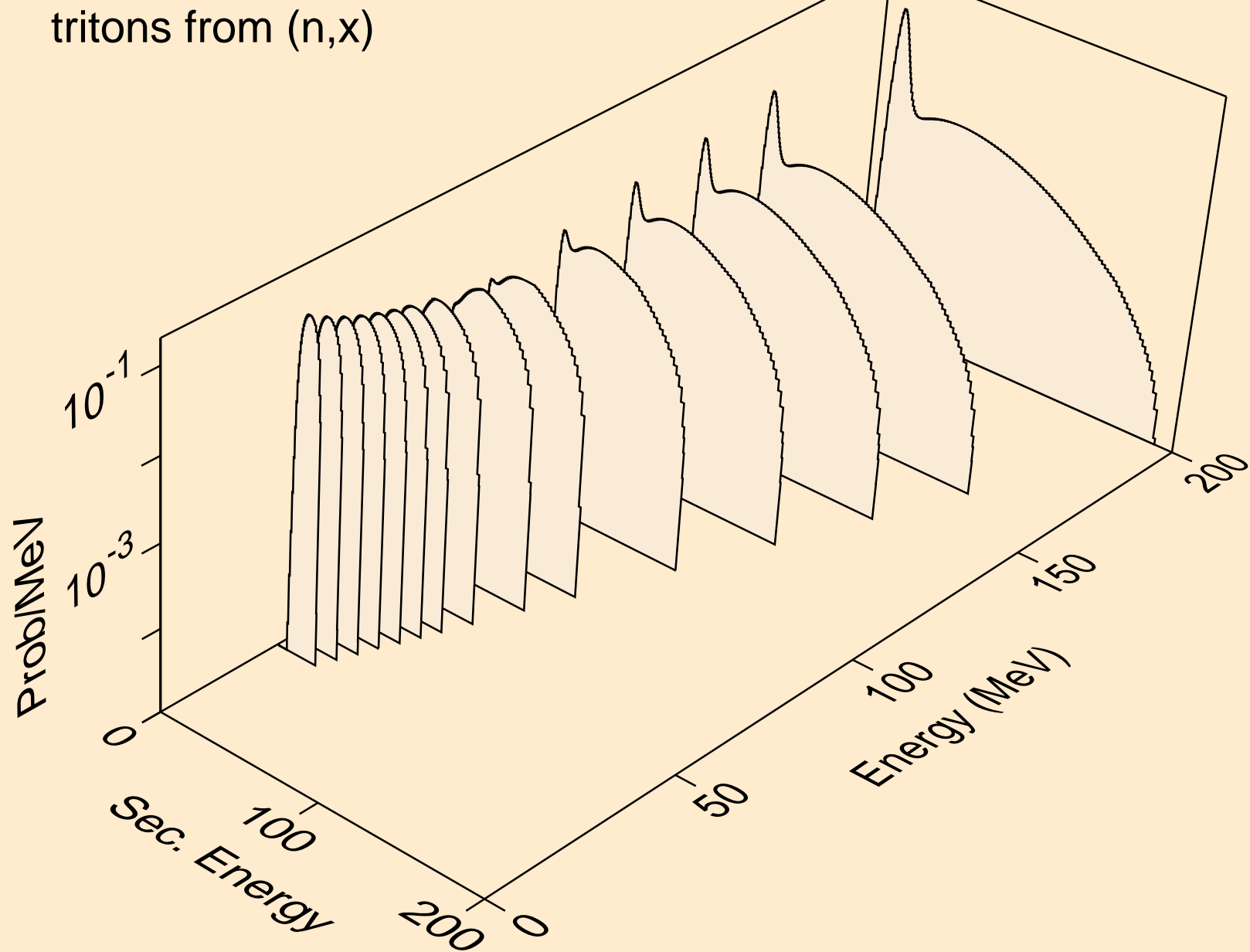

HG197M NEUTRON ACER TENDL-2023 LIBRARY; T=0.K
tritons from (n,n*)t

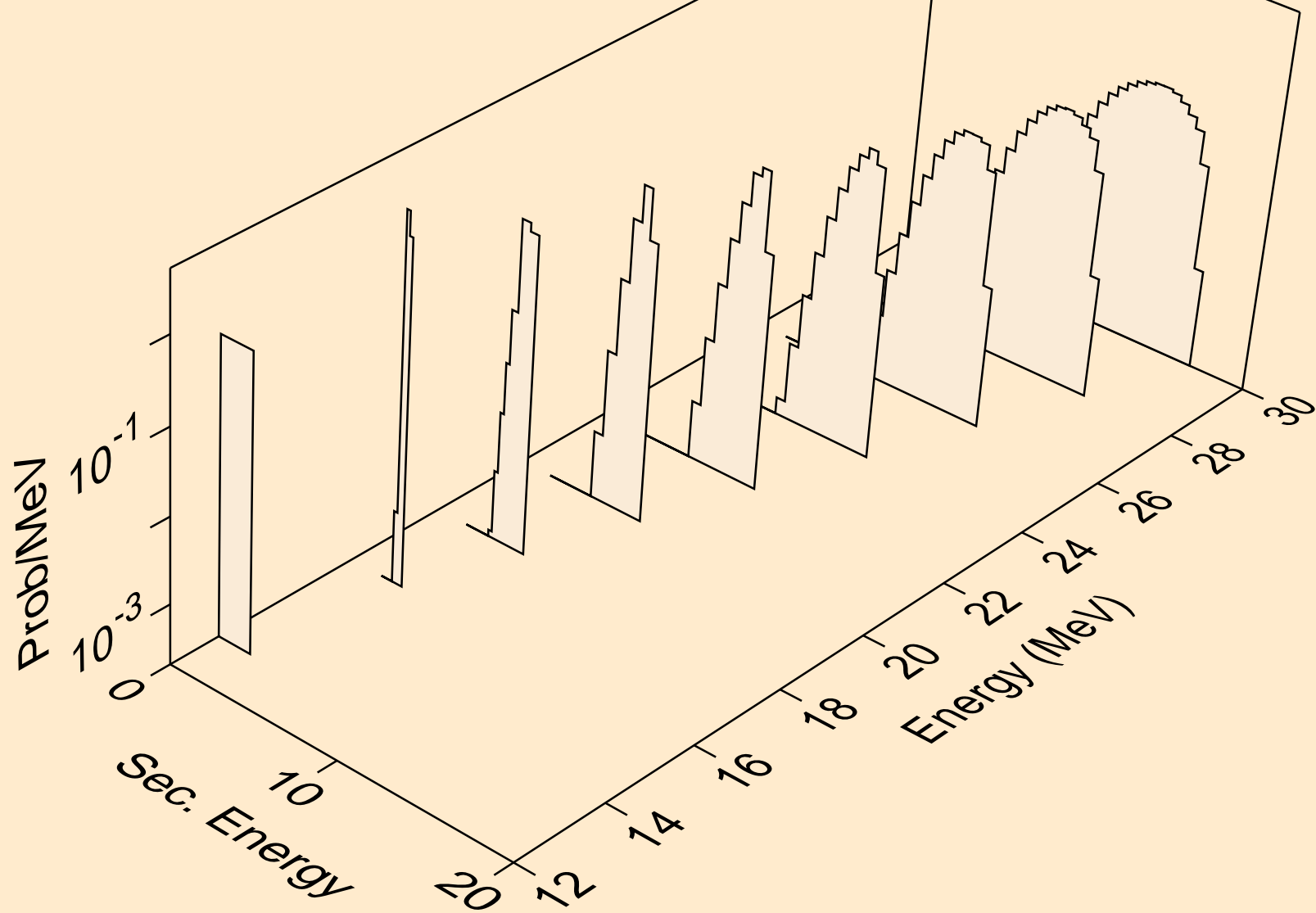

HG197M NEUTRON ACER TENDL-2023 LIBRARY; T=0.K
tritons from (n,t)

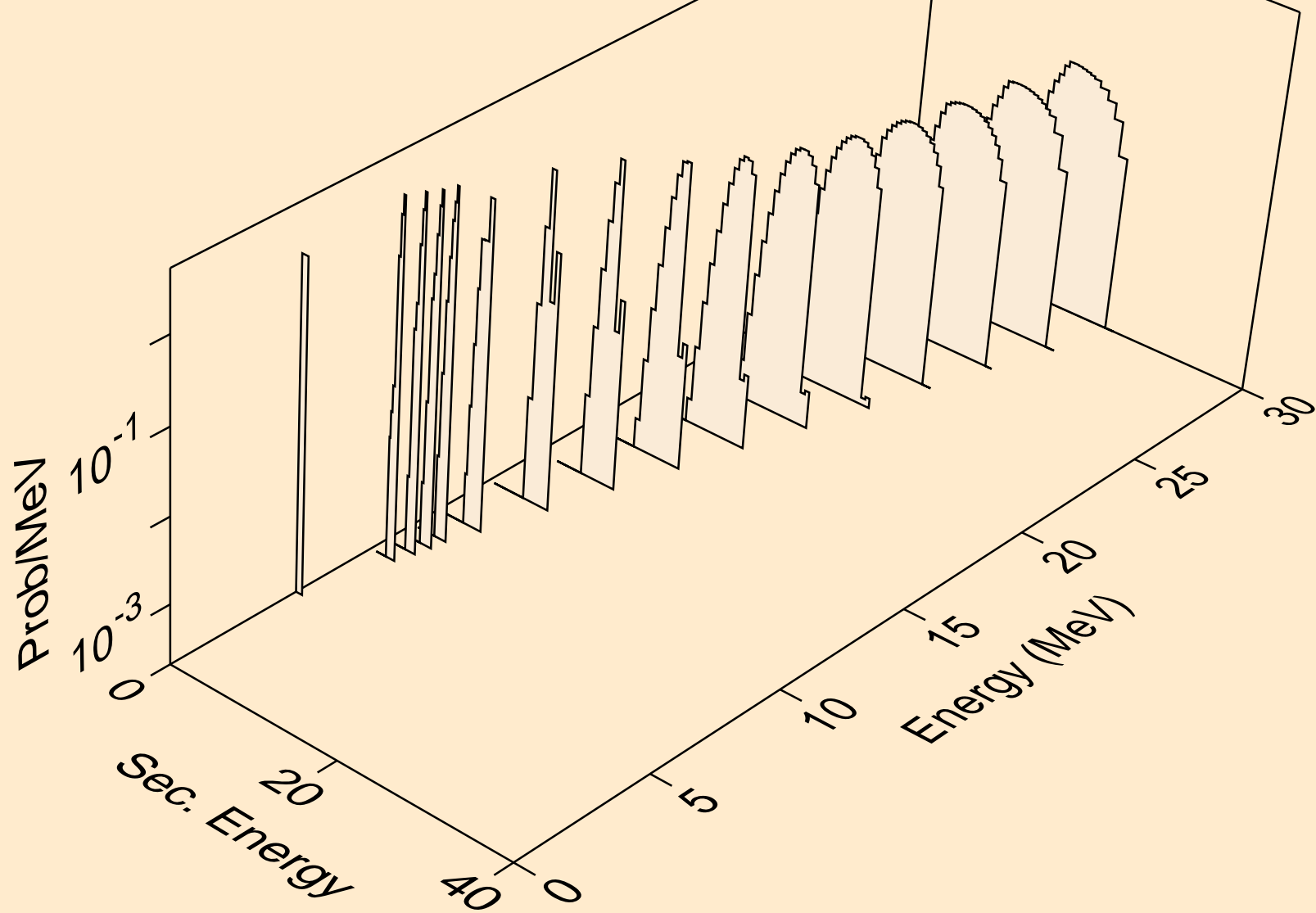

HG197M NEUTRON ACER TENDL-2023 LIBRARY; T=0.K
tritons from (n,pt)

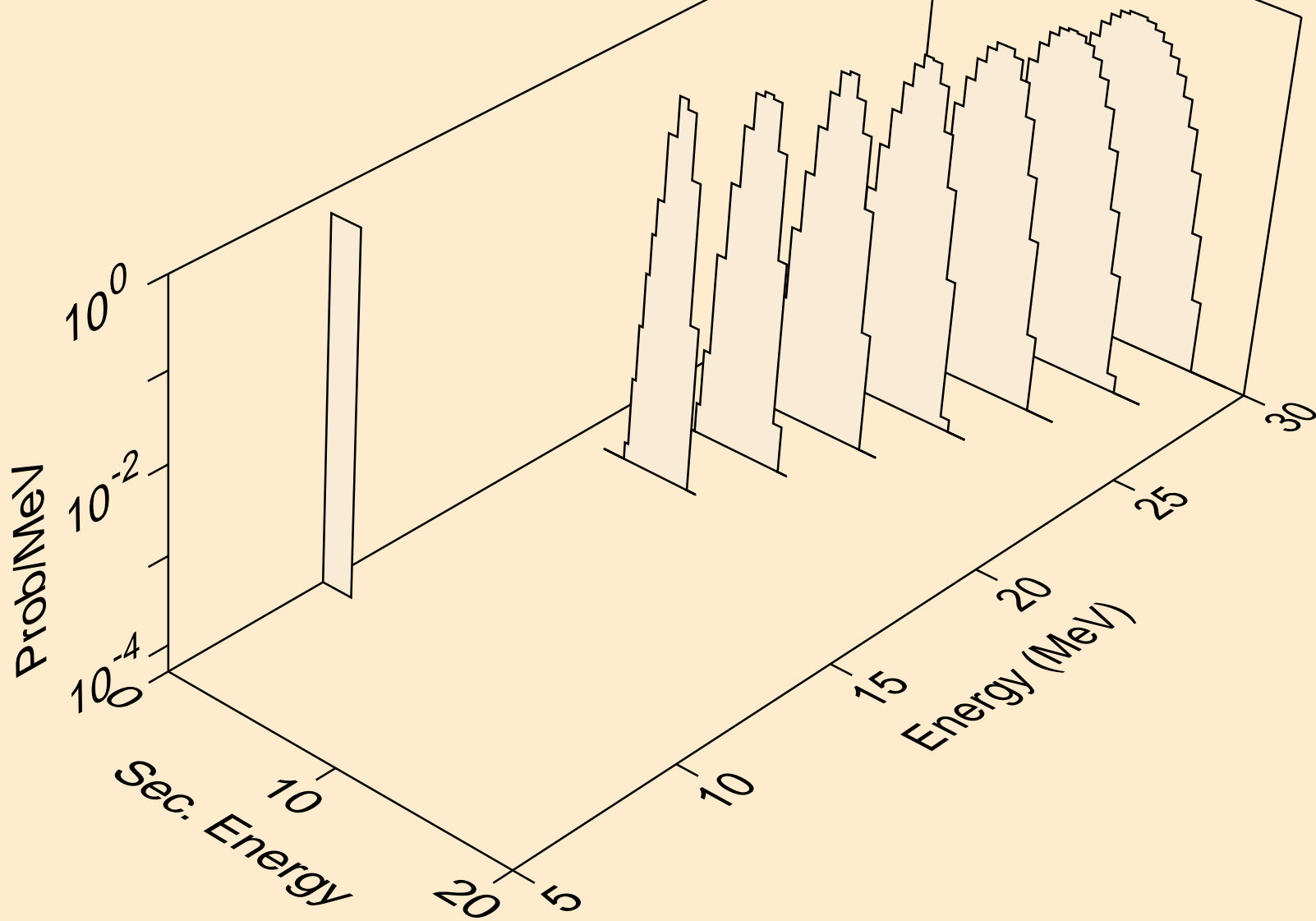

HG197M NEUTRON ACER TENDL-2023 LIBRARY; T=0.K
he3s from (n,x)

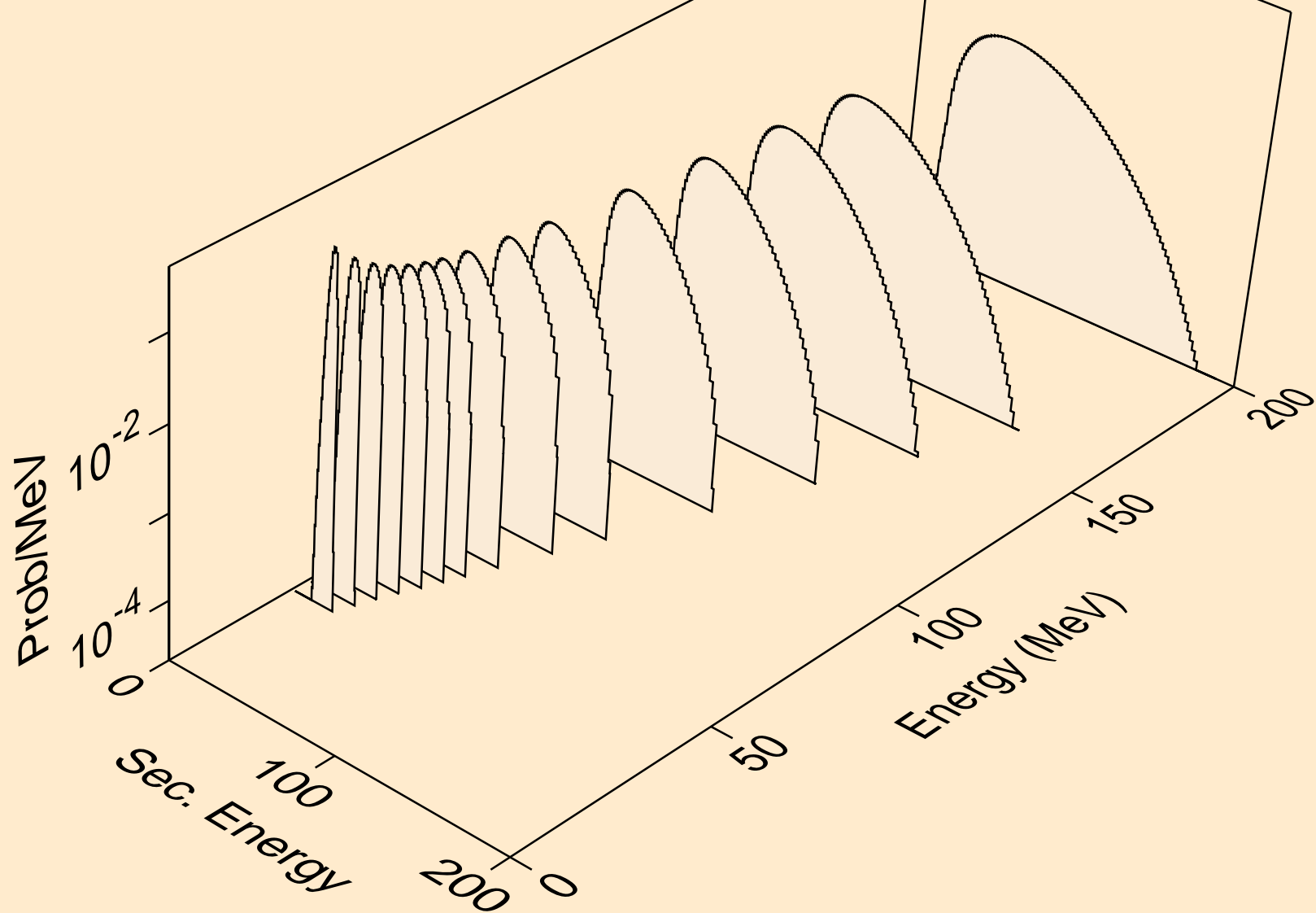

HG197M NEUTRON ACER TENDL-2023 LIBRARY; T=0.K
he3s from (n,n*)he3

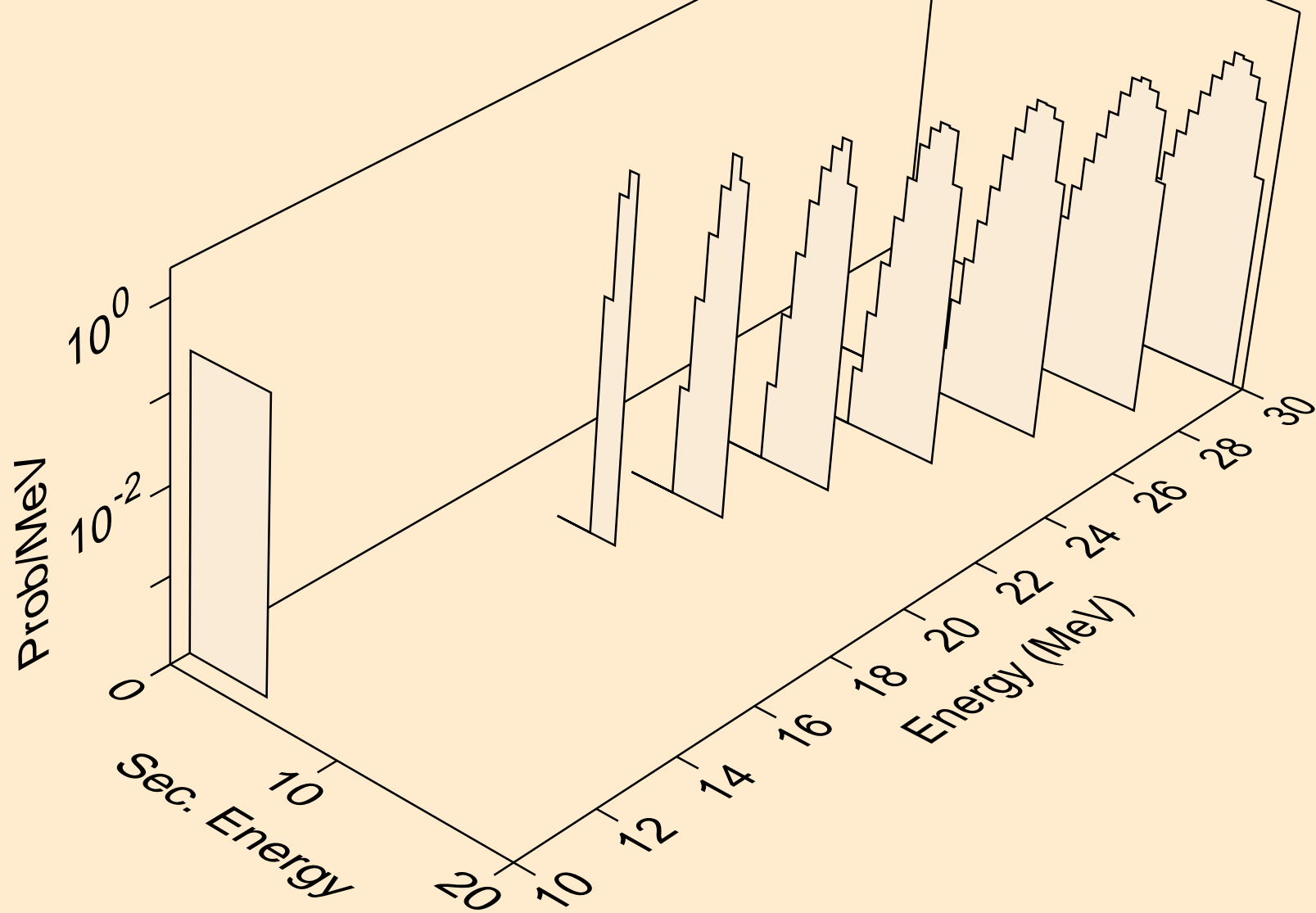

HG197M NEUTRON ACER TENDL-2023 LIBRARY; T=0.K
he3s from (n,he3)

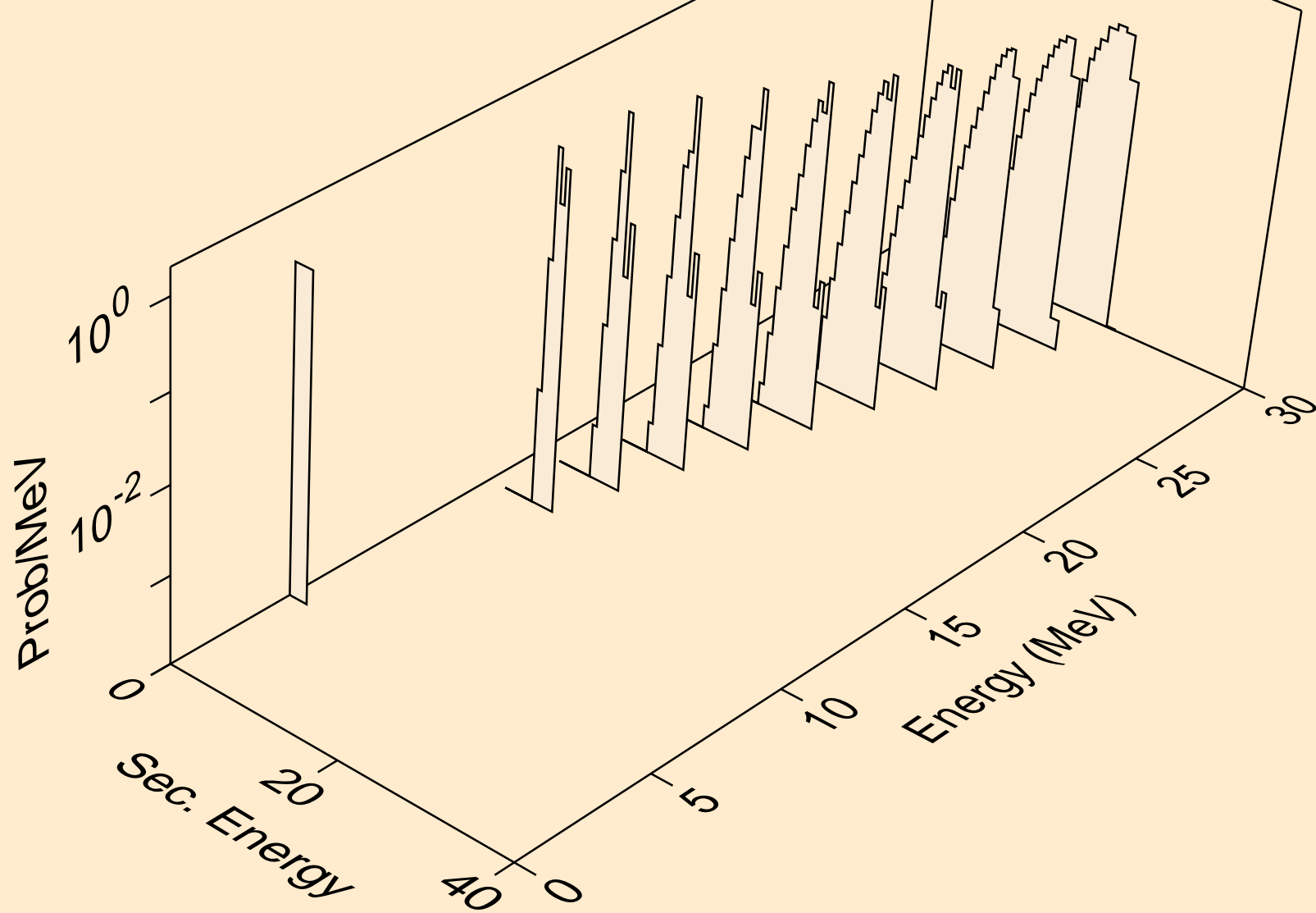

HG197M NEUTRON ACER TENDL-2023 LIBRARY; T=0.K
alphas from (n,x)

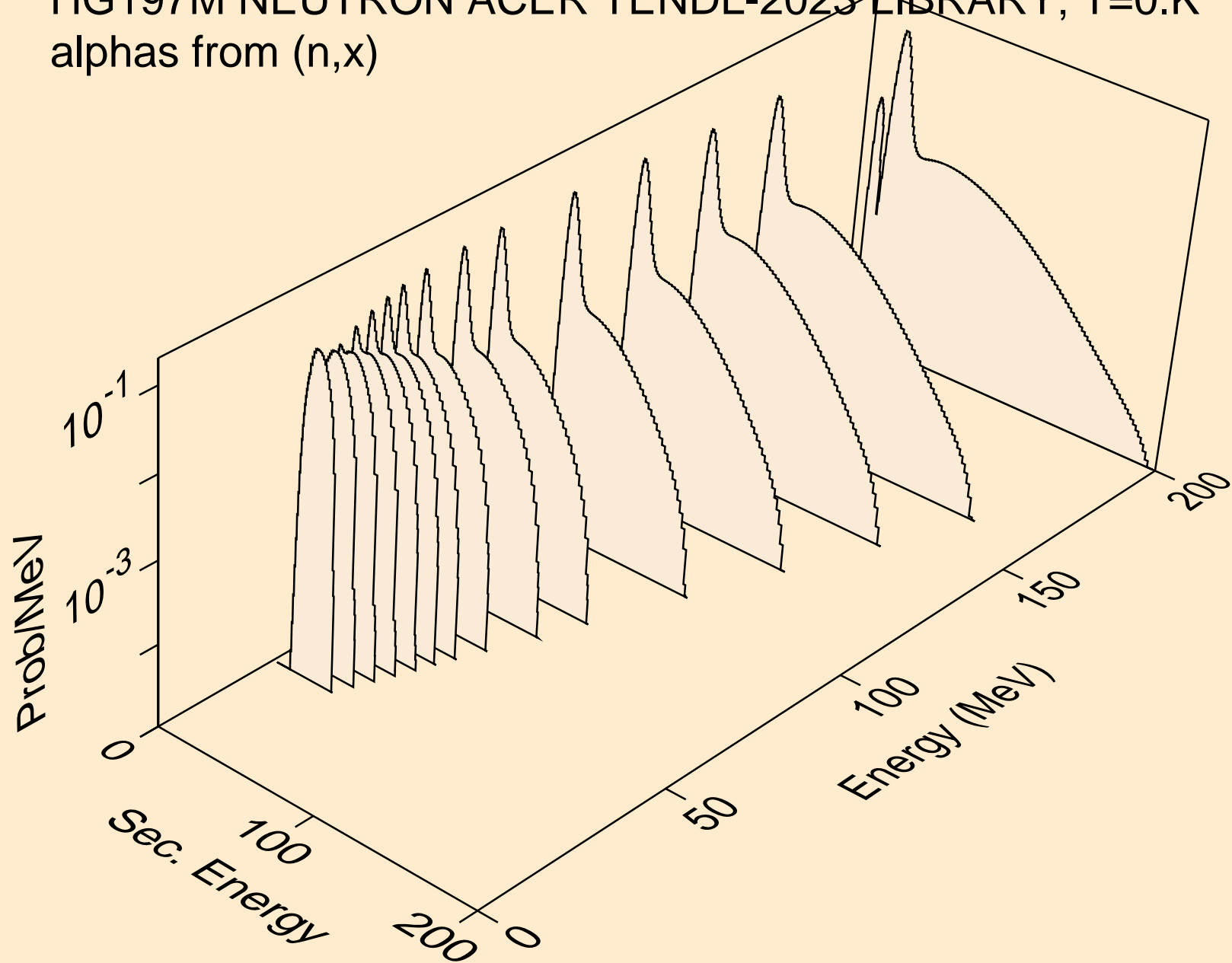

HG197M NEUTRON ACER TENDL-2023 LIBRARY; T=0.K
alphas from (n,n*)a

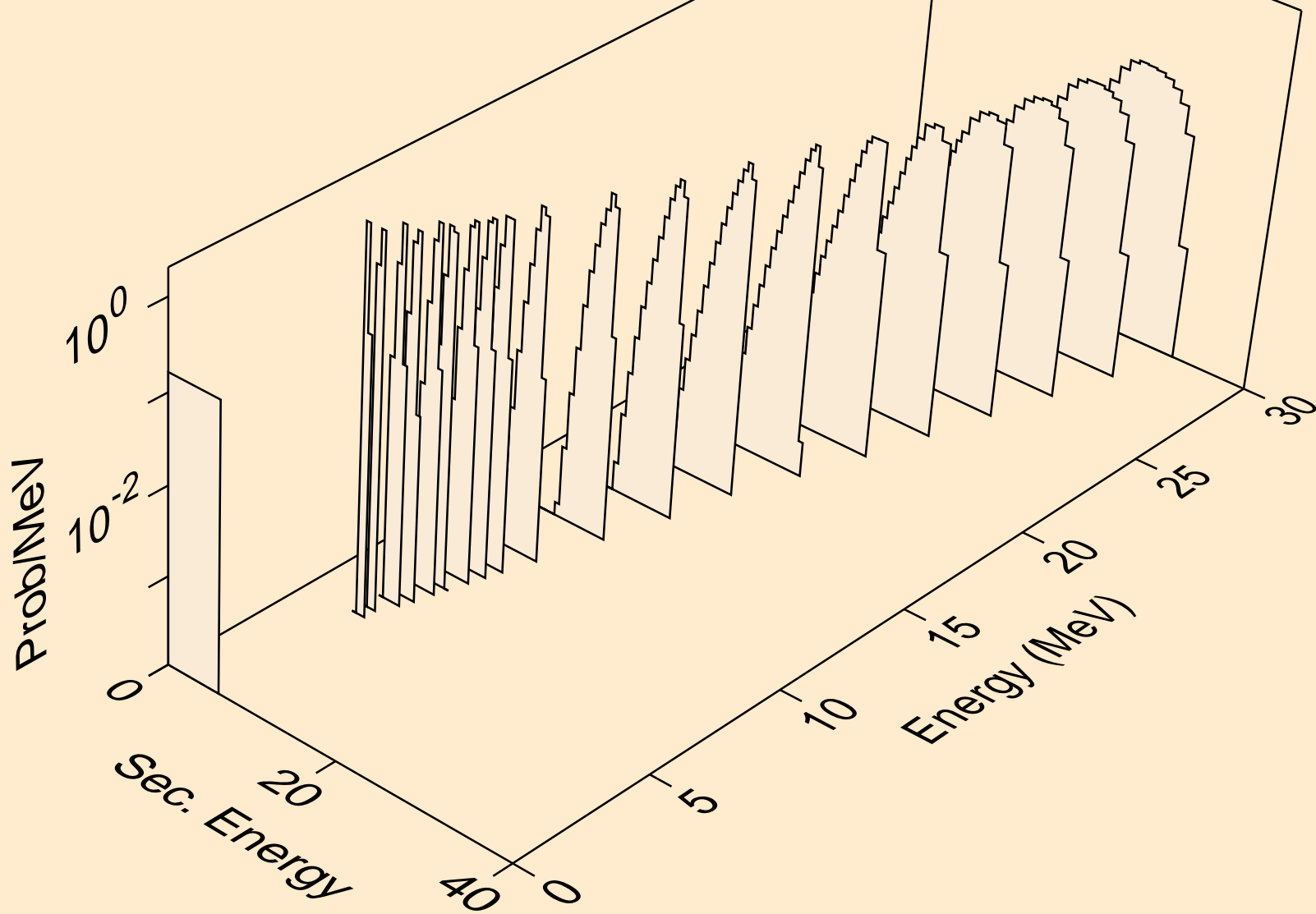

HG197M NEUTRON ACER TENDL-2023 LIBRARY; T=0.K
alphas from (n,2n)a

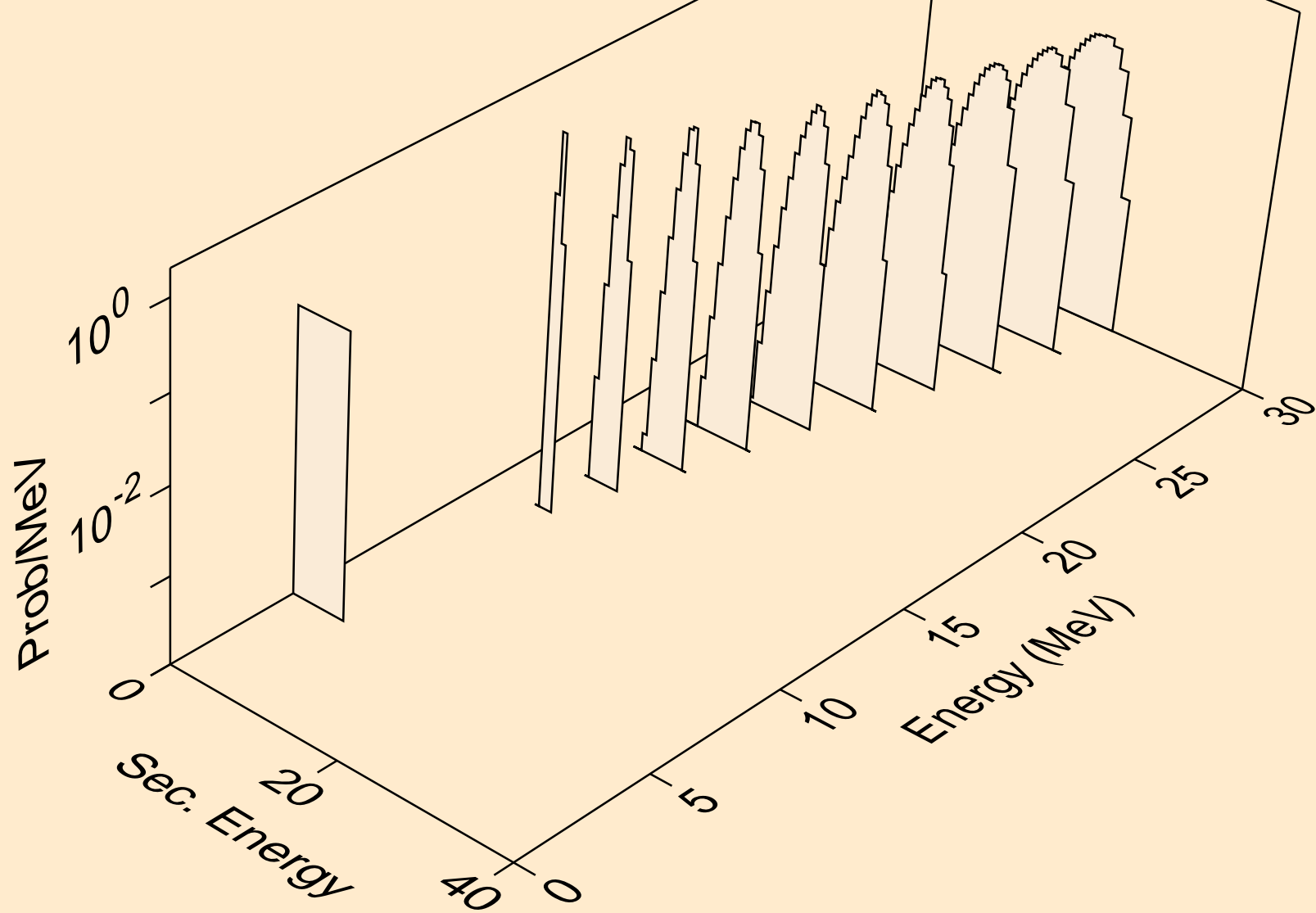

HG197M NEUTRON ACER TENDL-2023 LIBRARY; T=0.K
alphas from (n,3n)a

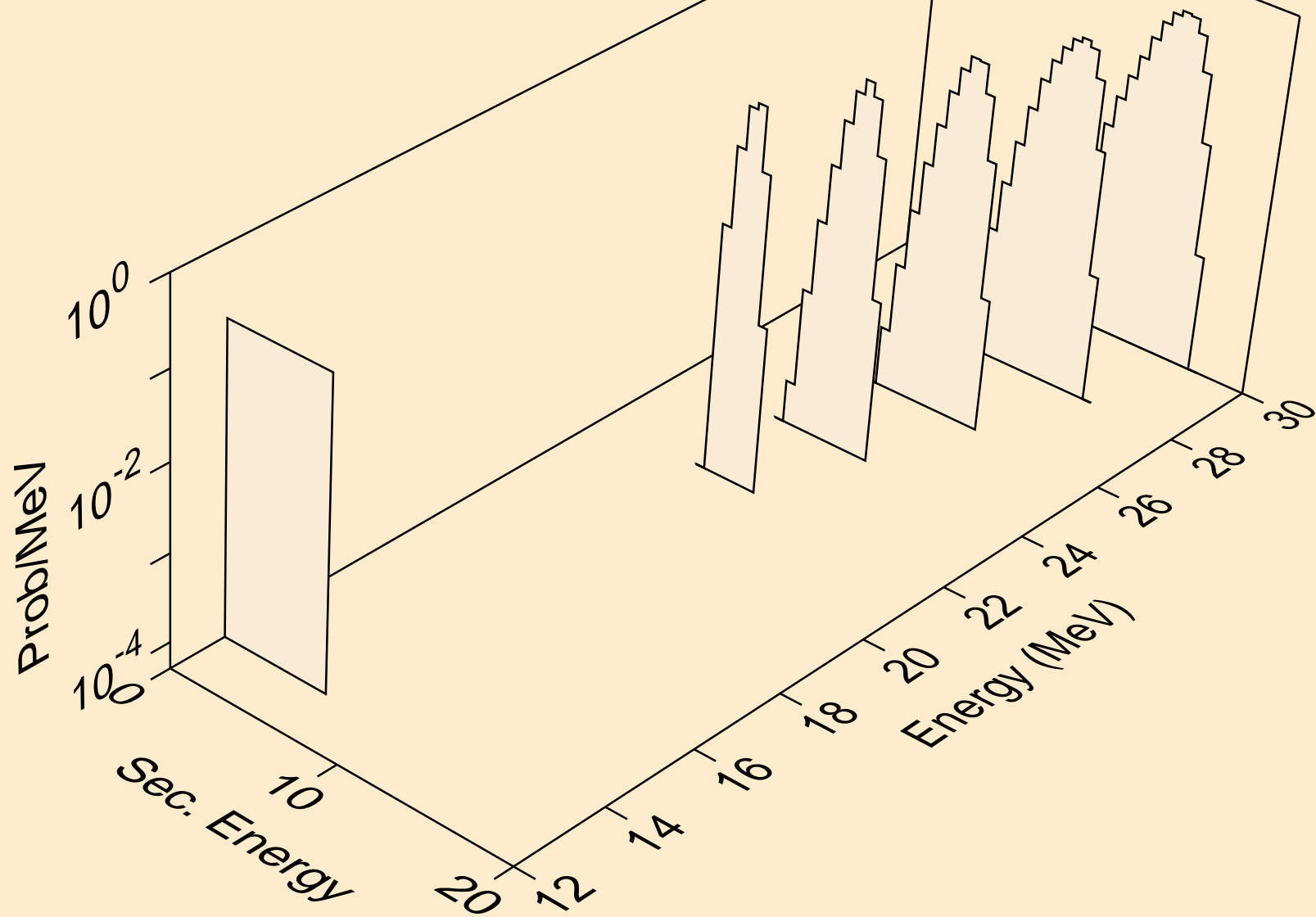

HG197M NEUTRON ACER TENDL-2023 LIBRARY; T=0.K
alphas from (n,npa)

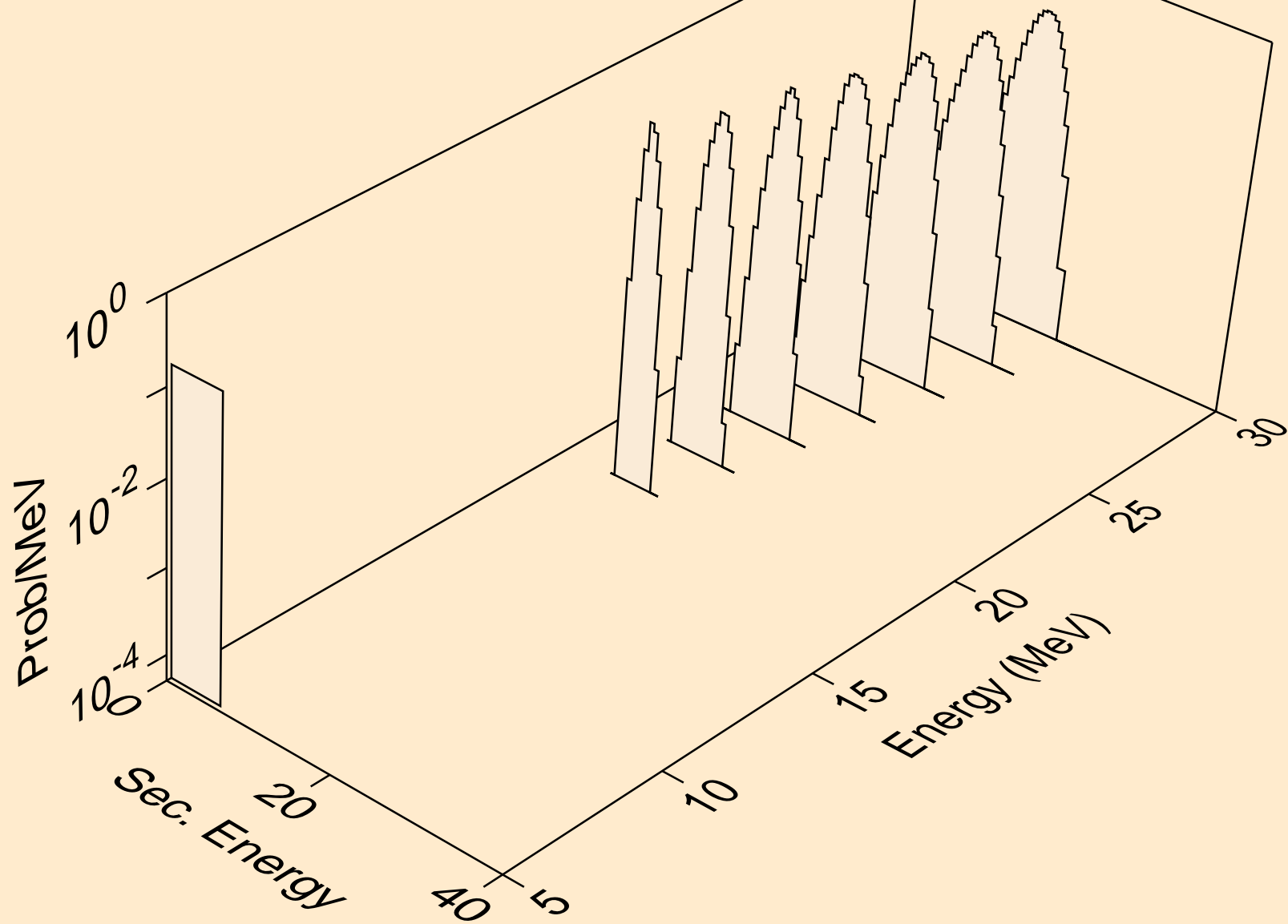

HG197M NEUTRON ACER TENDL-2023 LIBRARY; T=0.K
alphas from (n,a)

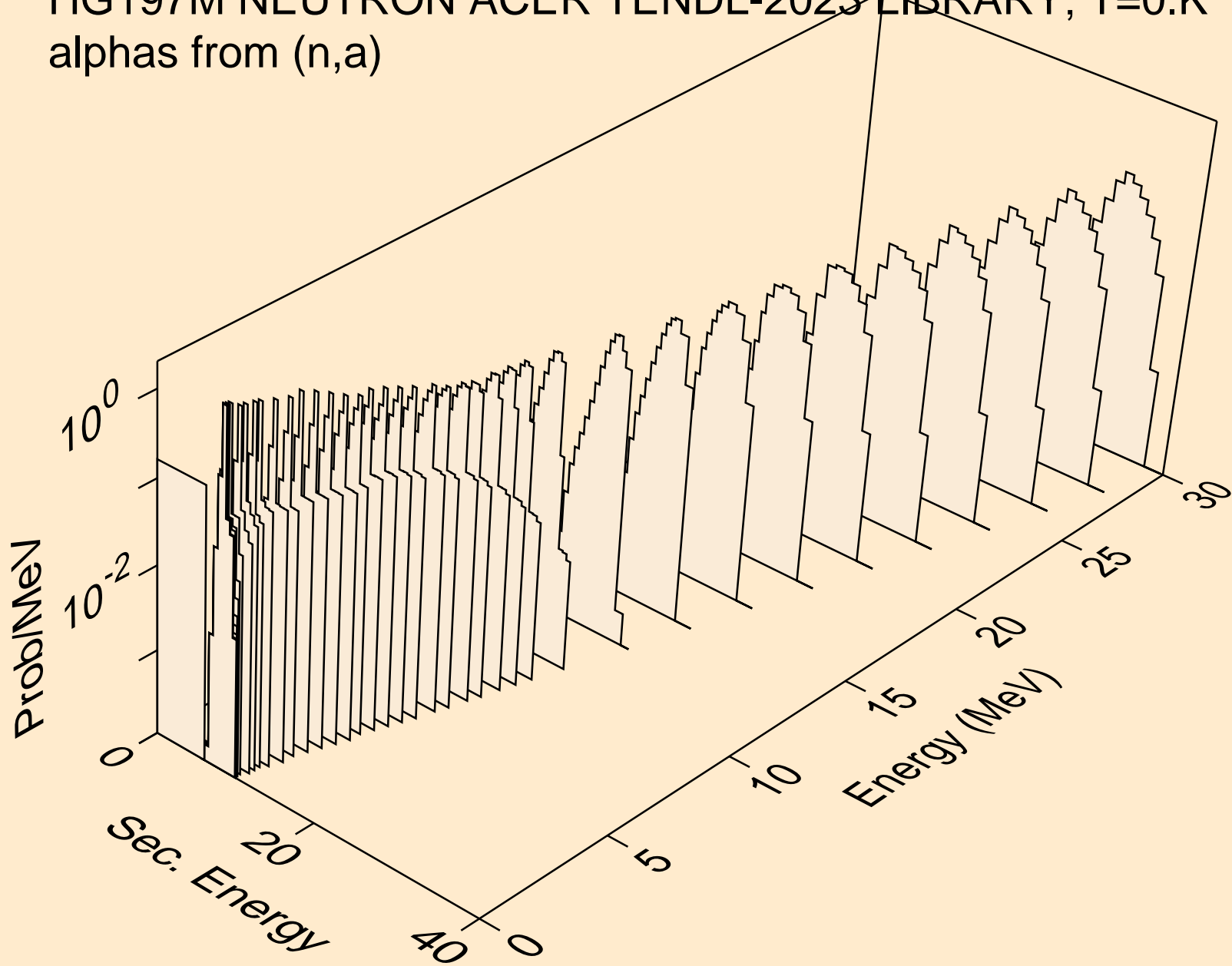

HG197M NEUTRON ACER TENDL-2023 LIBRARY; T=0.K
alphas from (n,2a)

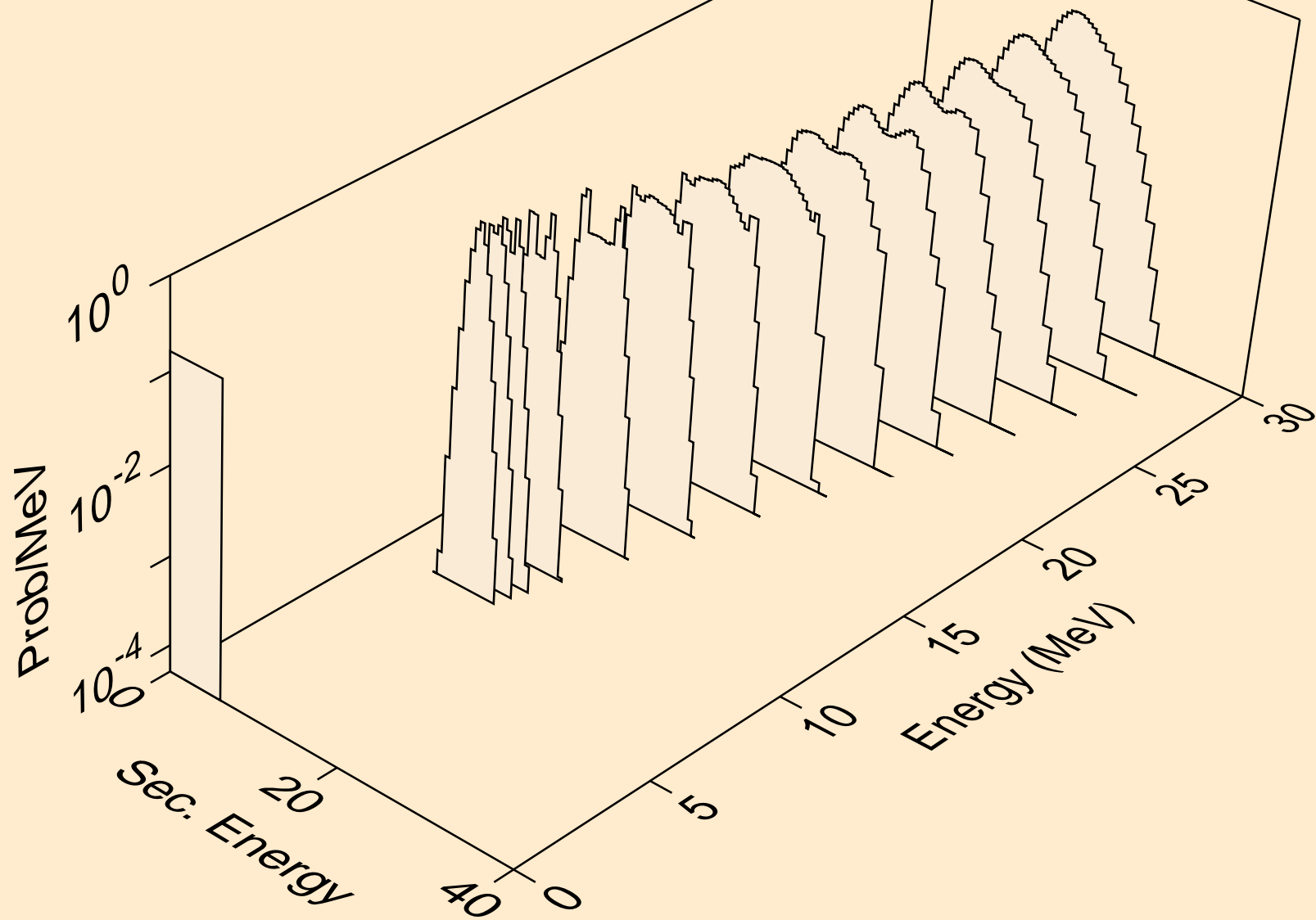

HG197M NEUTRON ACER TENDL-2023 LIBRARY; T=0.K
alphas from (n,pa)

