

# HG203 NEUTRON ACER TENDL-2023 LIBRARY; T=0.K

## Principal cross sections

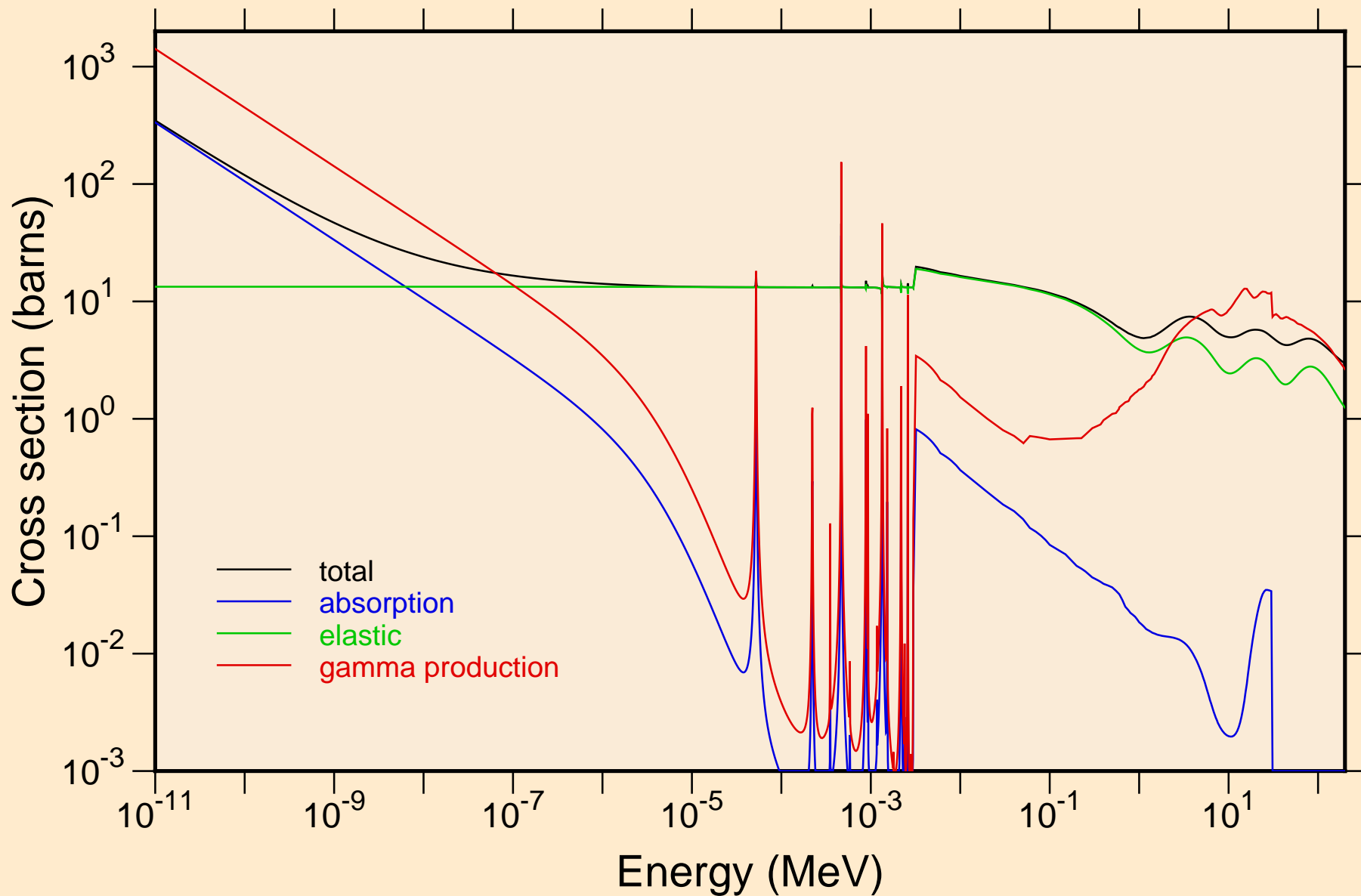

HG203 NEUTRON ACER TENDL-2023 LIBRARY; T=0.K  
resonance total cross section

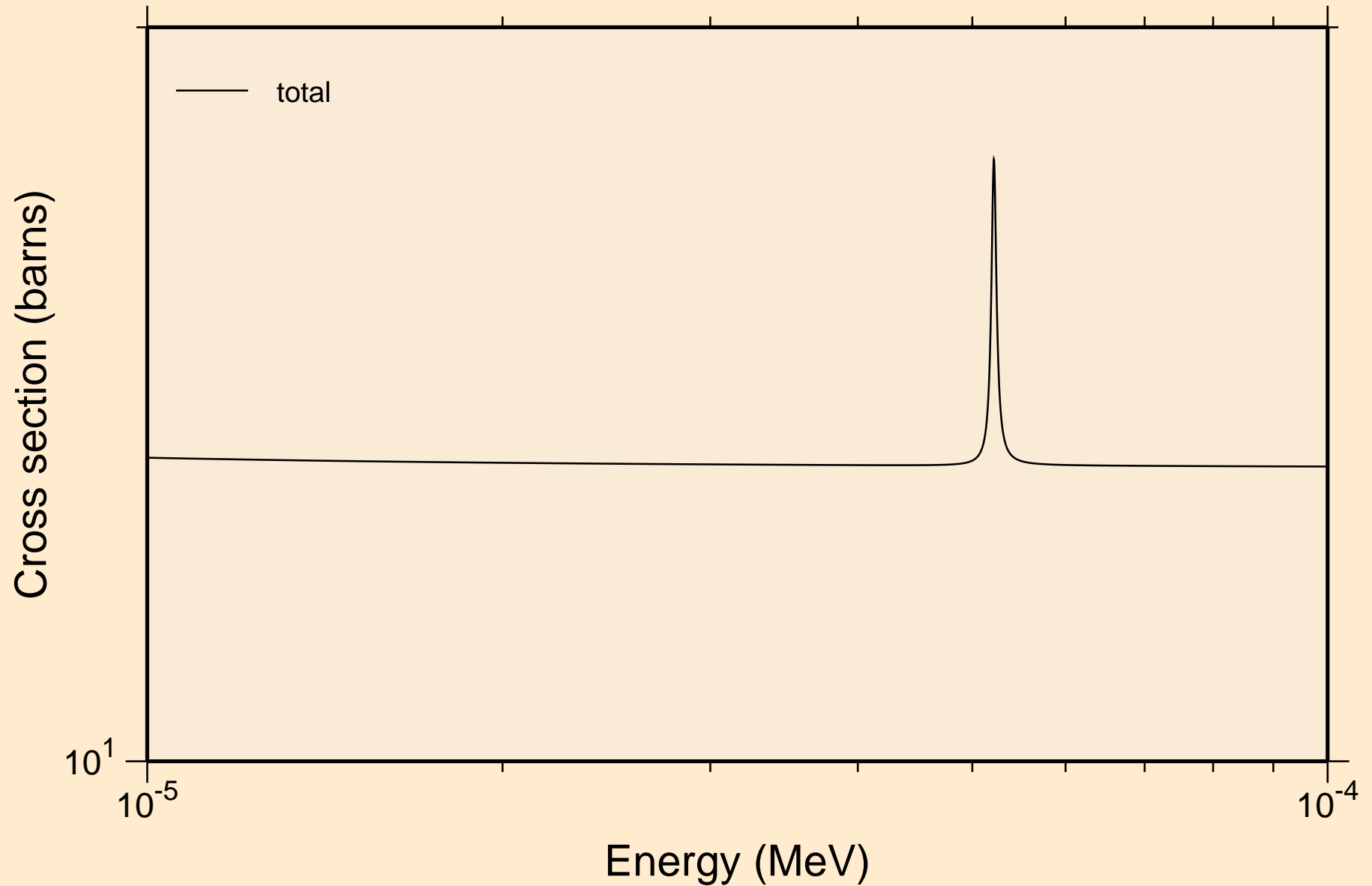

HG203 NEUTRON ACER TENDL-2023 LIBRARY; T=0.K  
resonance total cross section

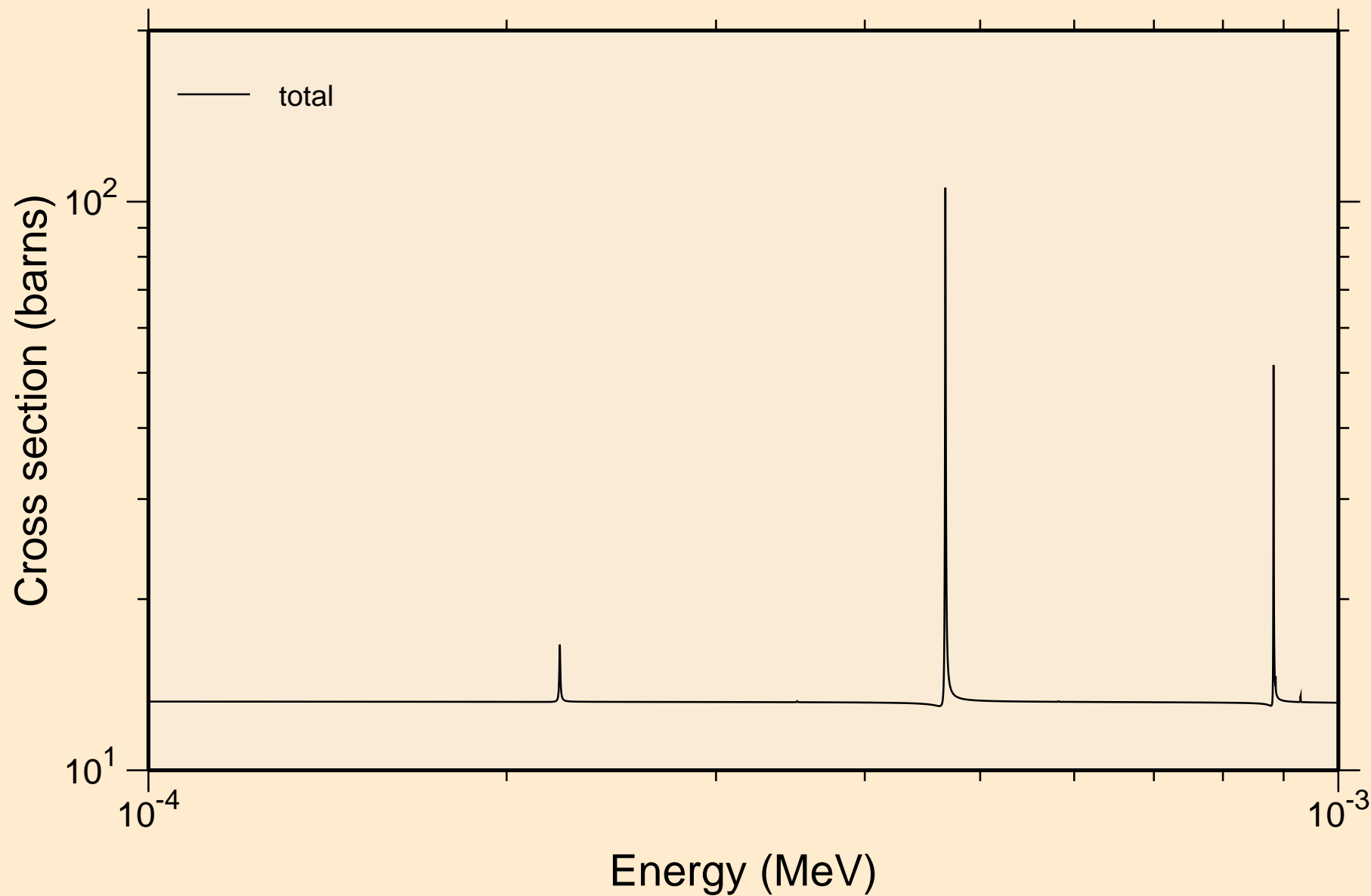

HG203 NEUTRON ACER TENDL-2023 LIBRARY; T=0.K  
resonance total cross section

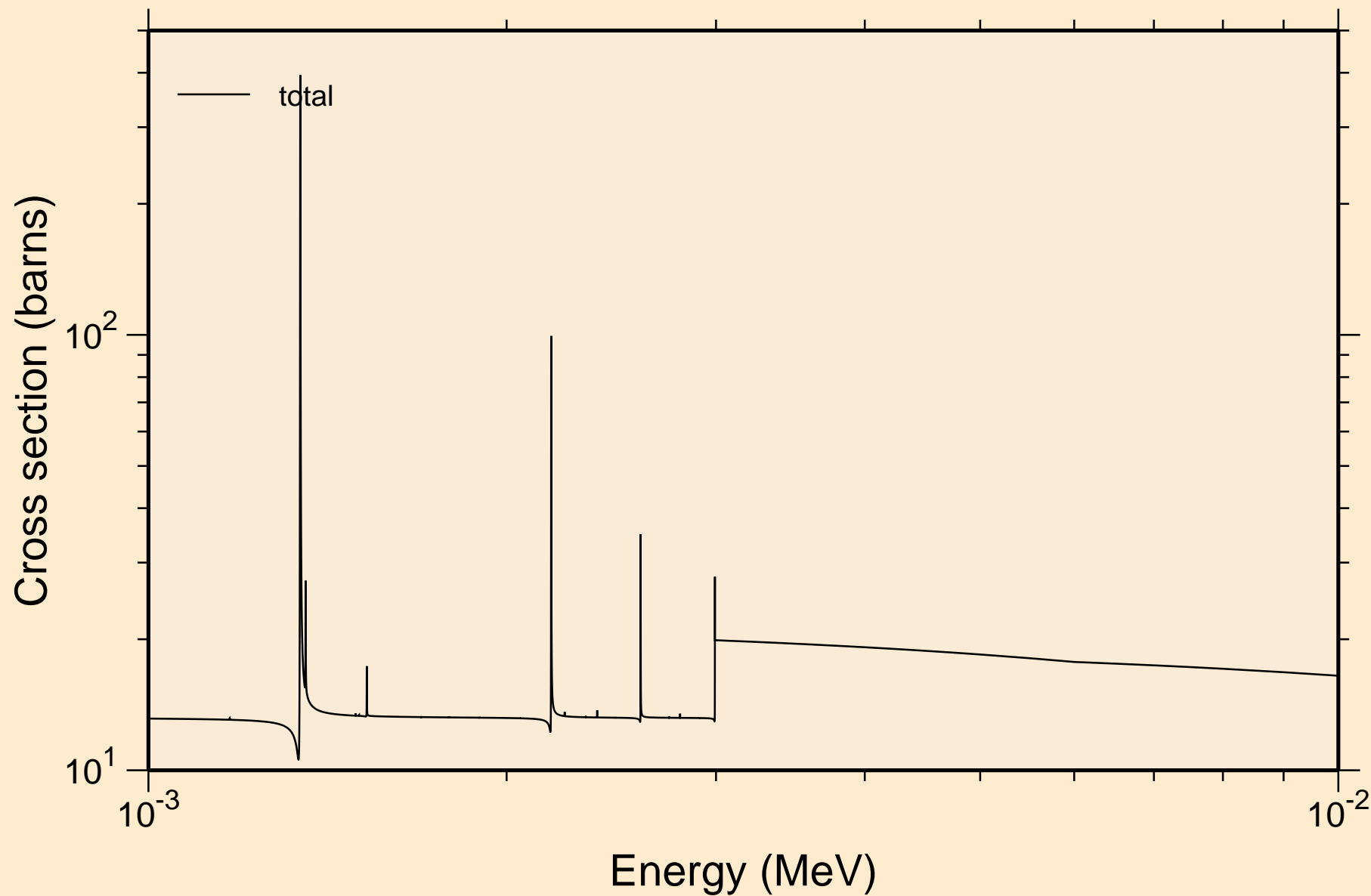

HG203 NEUTRON ACER TENDL-2023 LIBRARY; T=0.K  
resonance total cross section

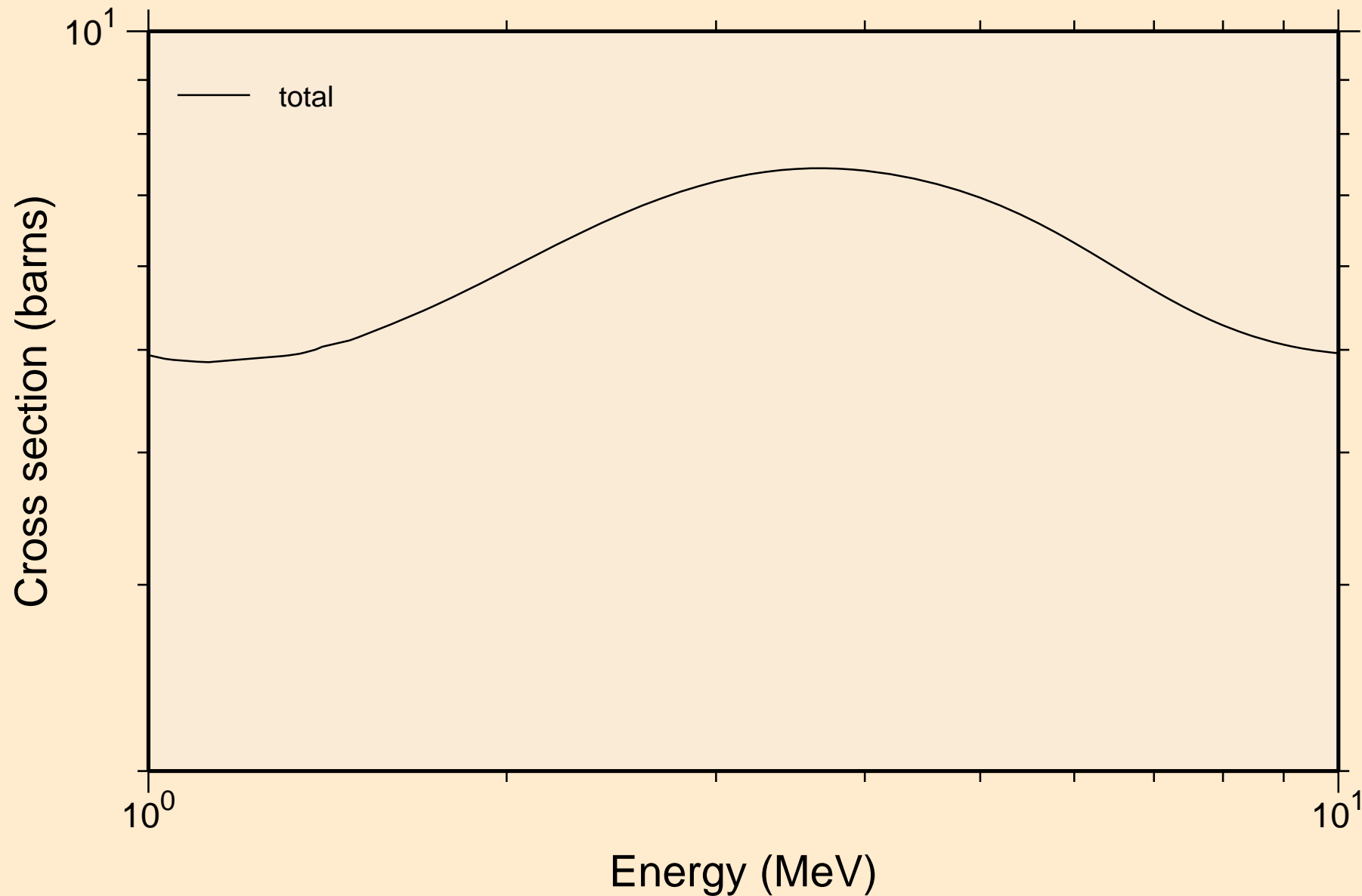

HG203 NEUTRON ACER TENDL-2023 LIBRARY; T=0.K  
resonance absorption cross sections

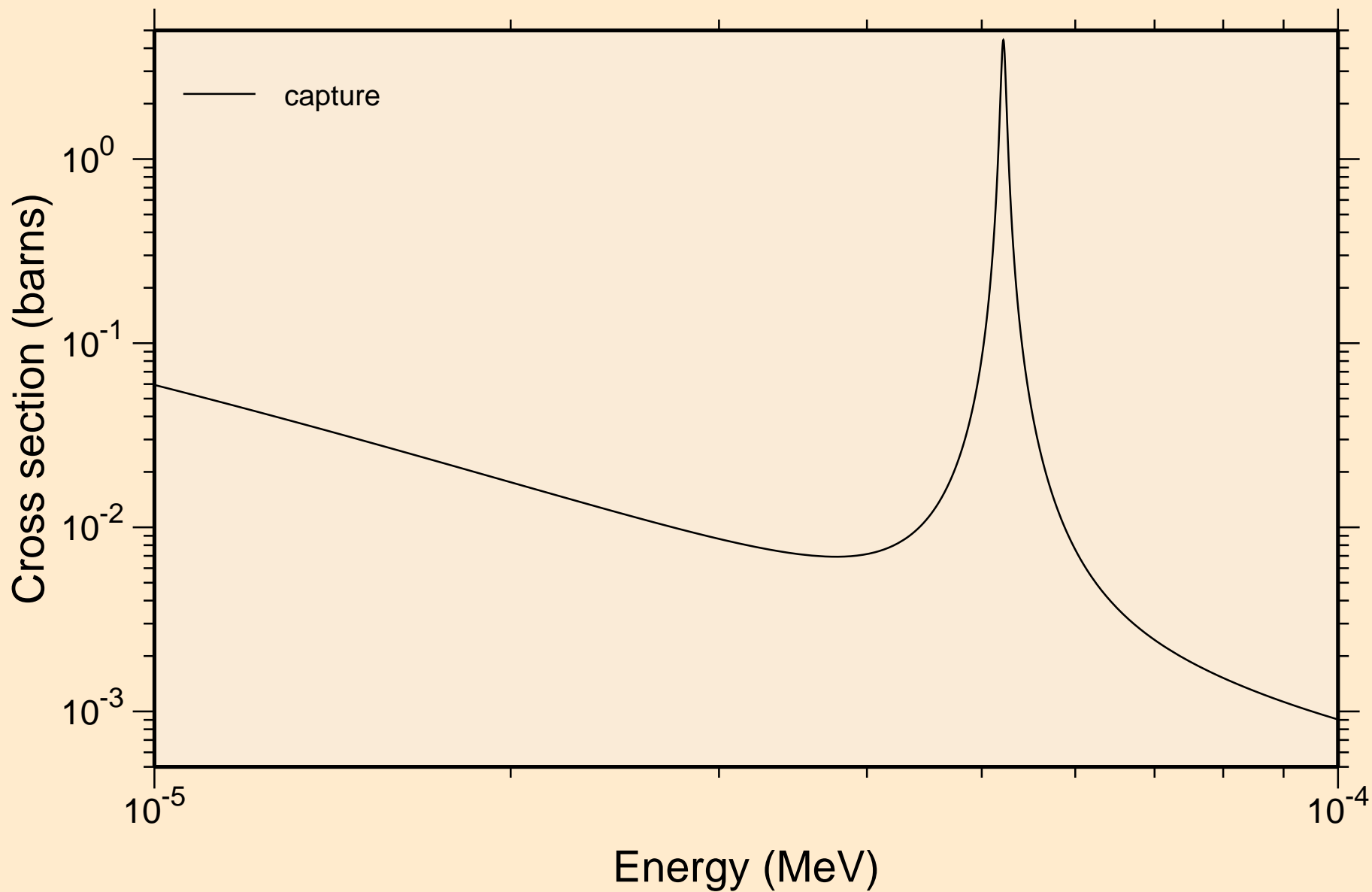

HG203 NEUTRON ACER TENDL-2023 LIBRARY; T=0.K  
resonance absorption cross sections

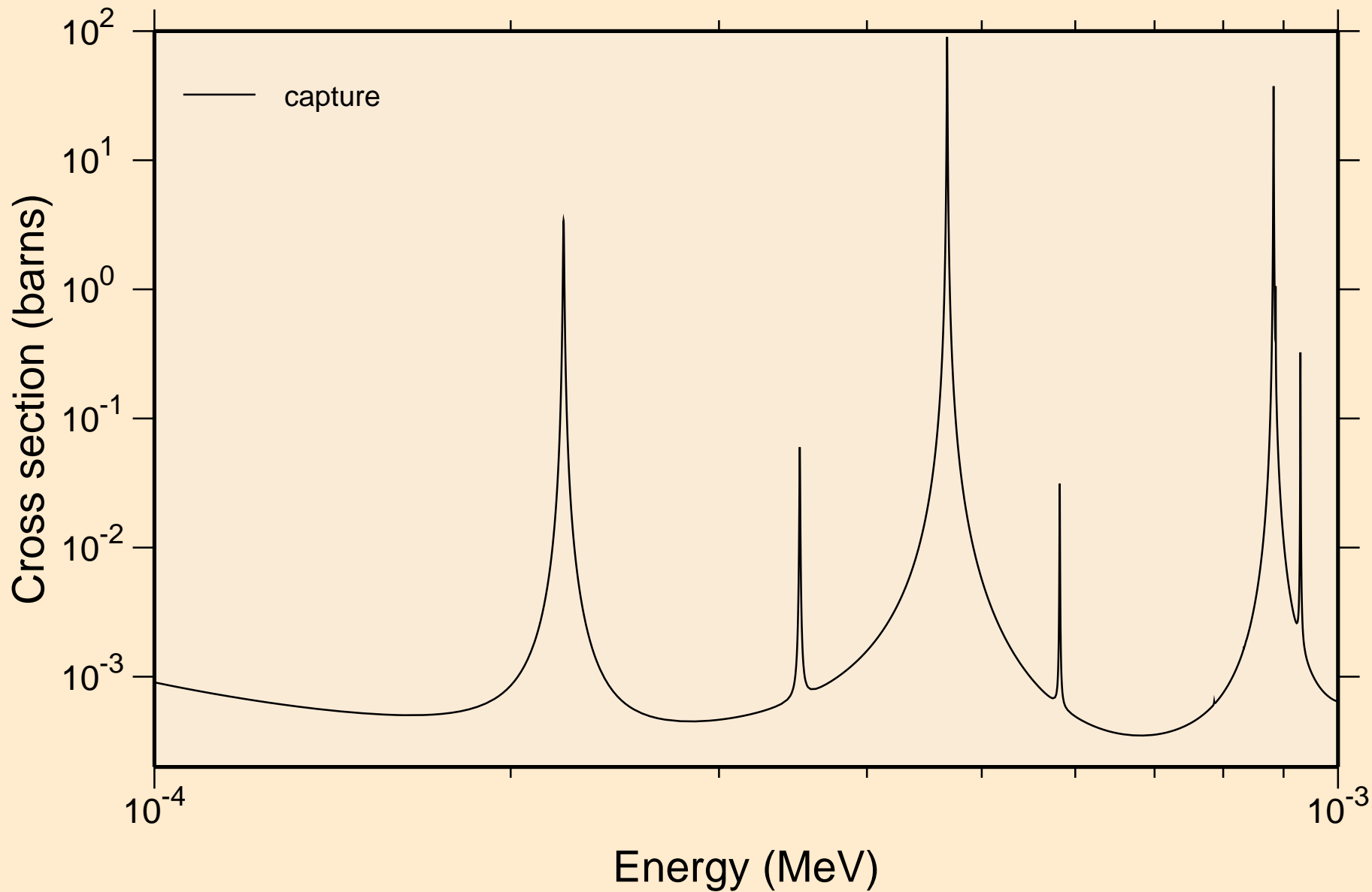

# HG203 NEUTRON ACER TENDL-2023 LIBRARY; T=0.K

## resonance absorption cross sections

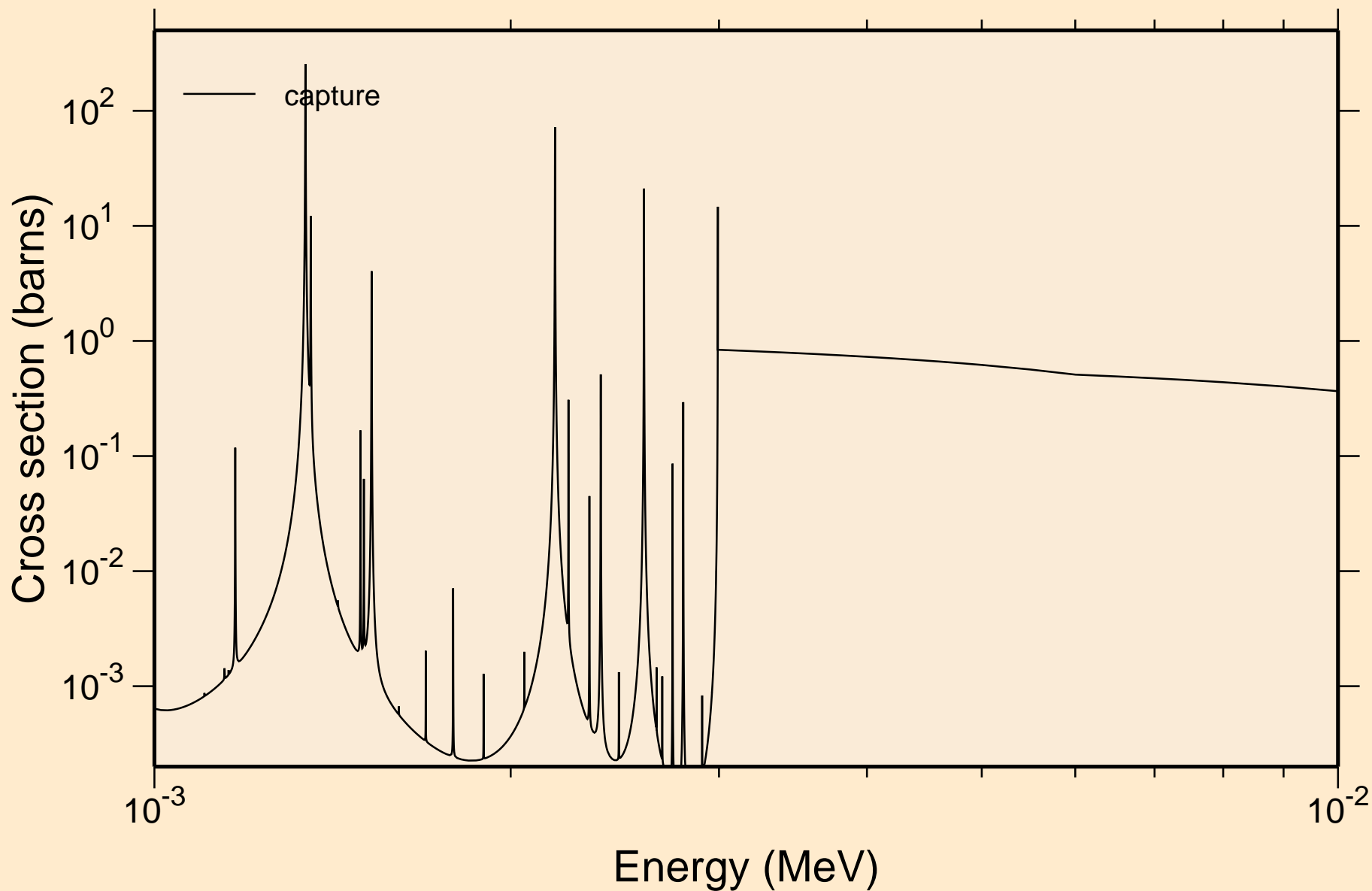



HG203 NEUTRON ACER TENDL-2023 LIBRARY; T=0.K  
resonance absorption cross sections

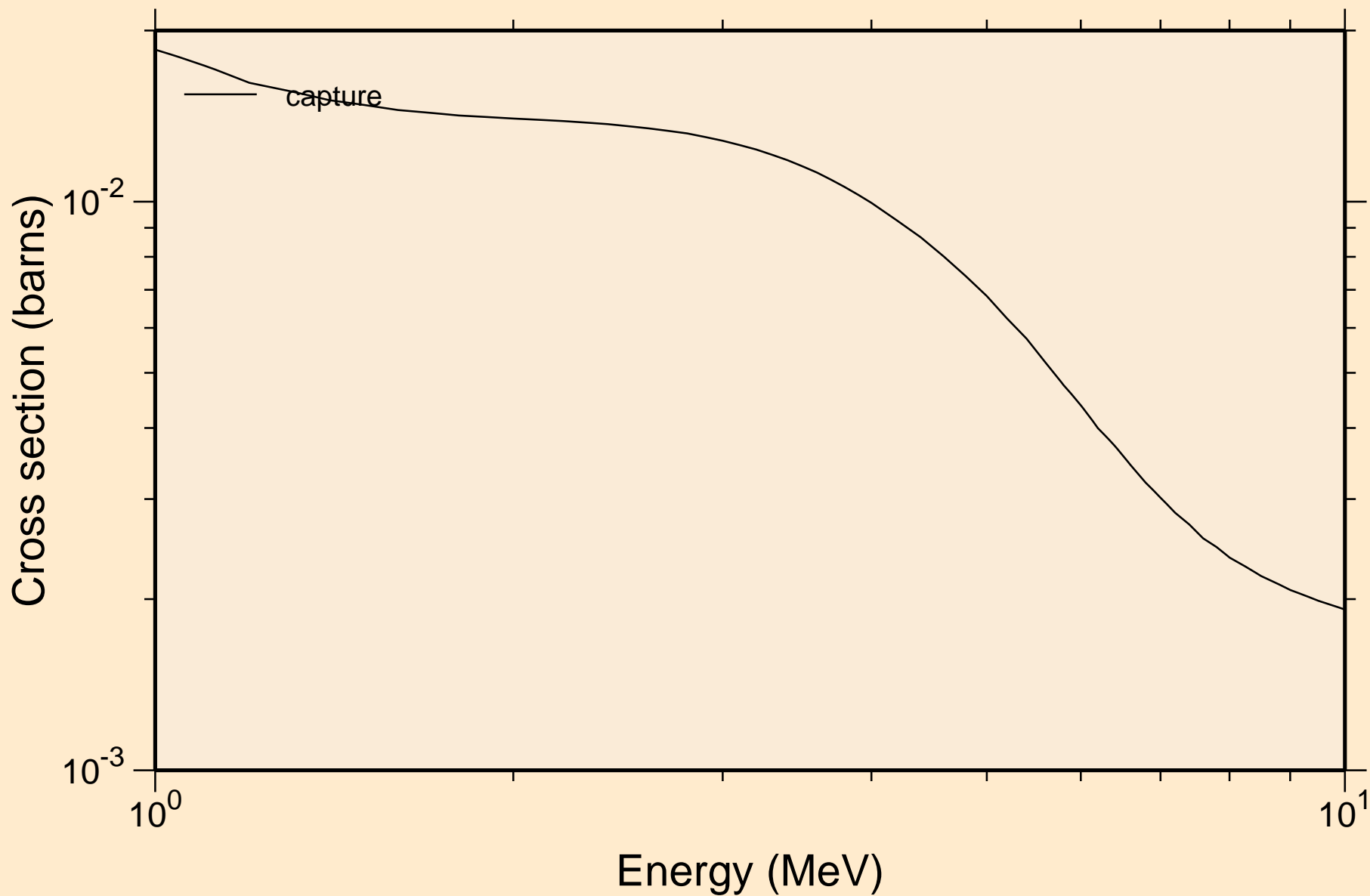

# HG203 NEUTRON ACER TENDL-2023 LIBRARY; T=0.K

## Heating

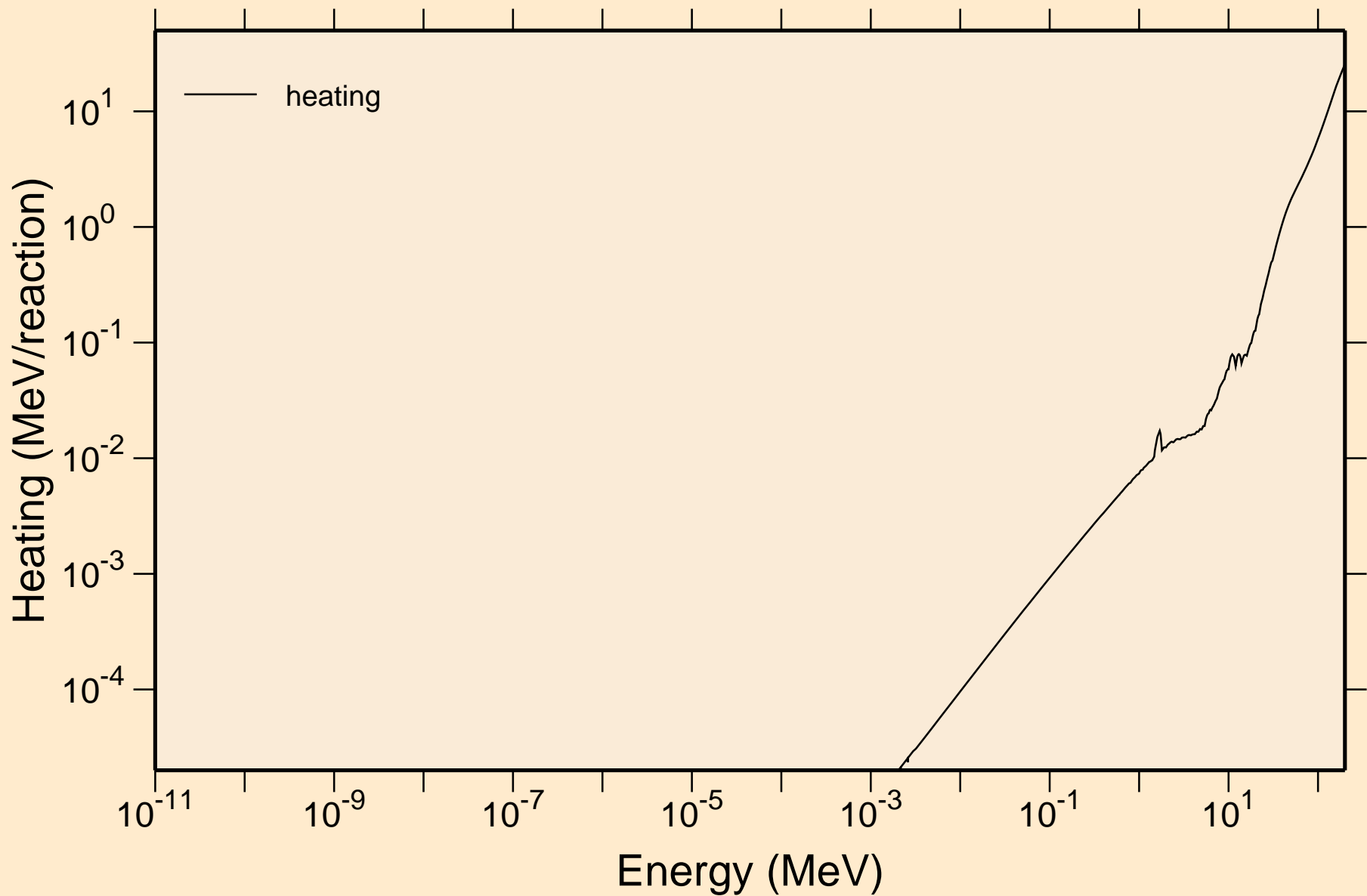

# HG203 NEUTRON ACER TENDL-2023 LIBRARY; T=0.K

## Damage

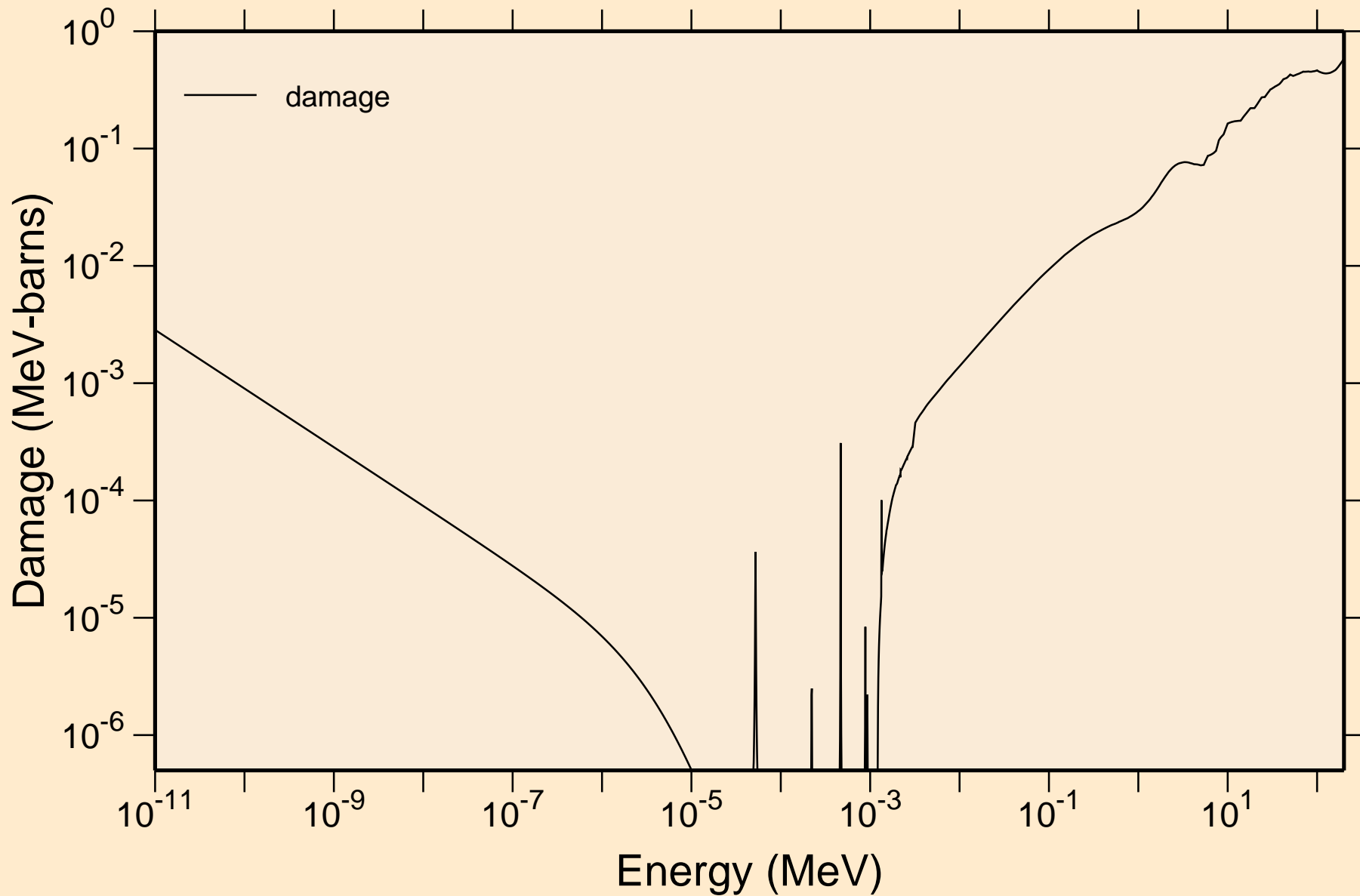

# HG203 NEUTRON ACER TENDL-2023 LIBRARY; T=0.K

## Non-threshold reactions

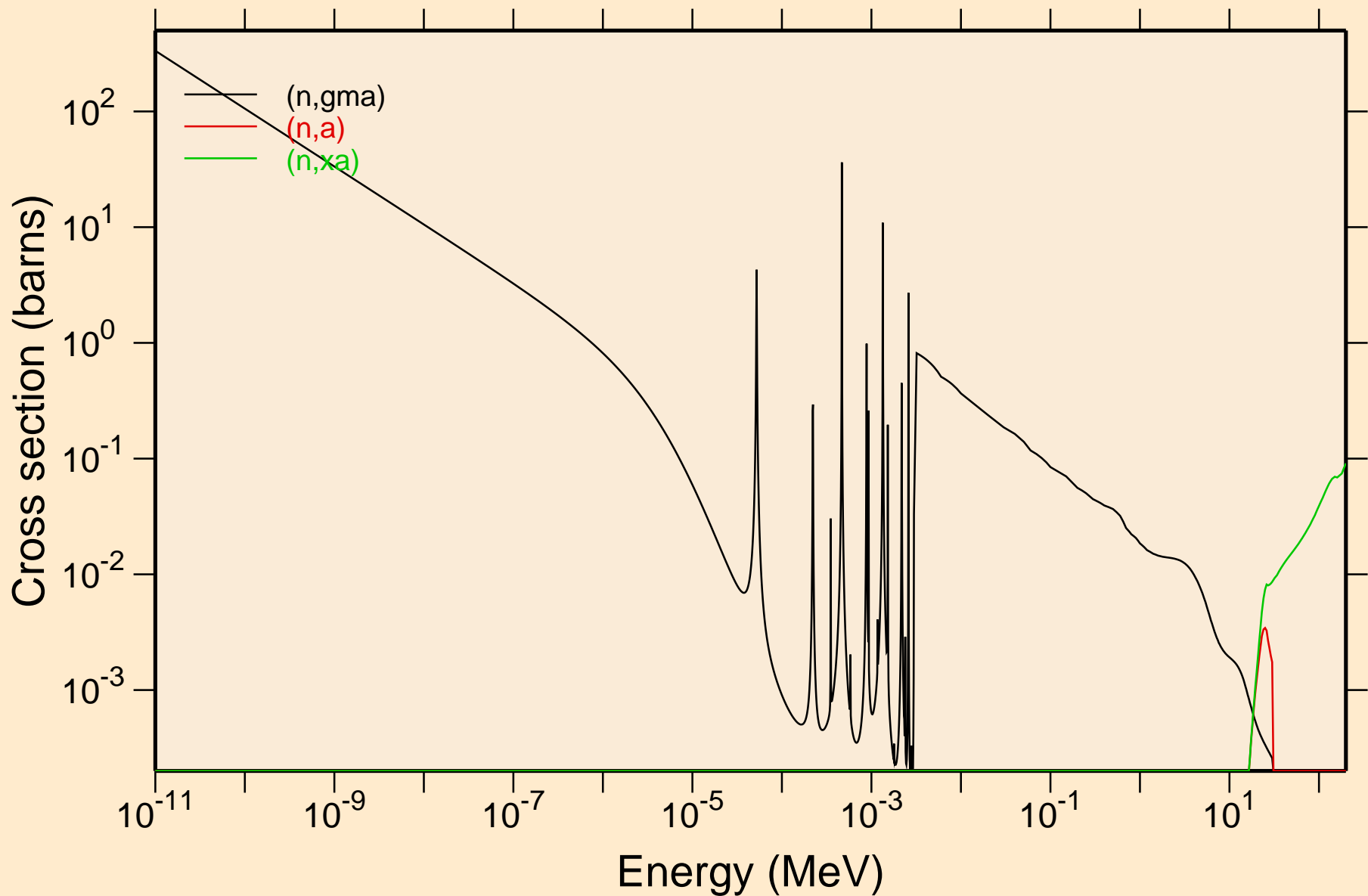

# HG203 NEUTRON ACER TENDL-2023 LIBRARY; T=0.K

## Principal cross sections

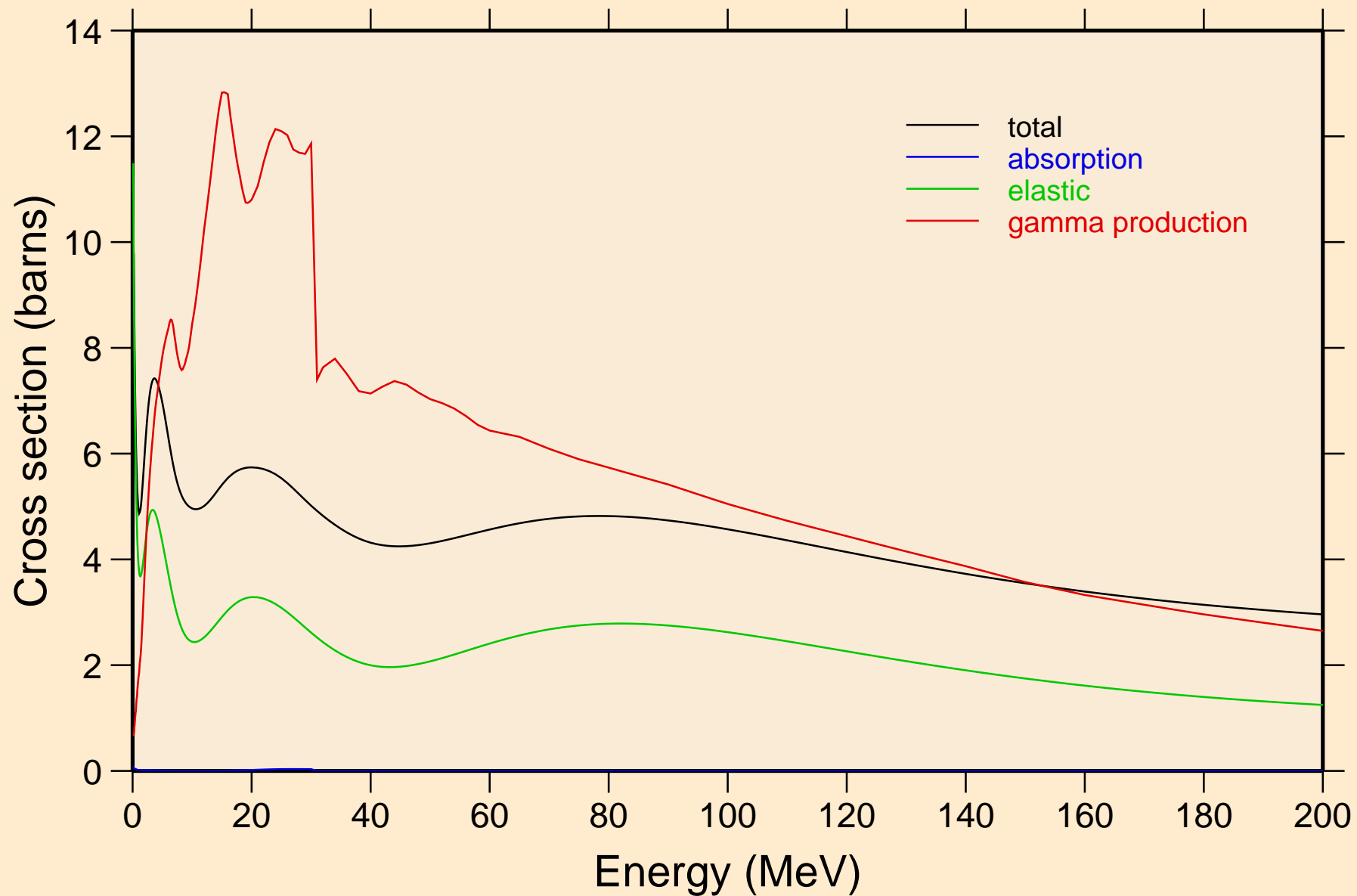

# HG203 NEUTRON ACER TENDL-2023 LIBRARY; T=0.K

## Heating

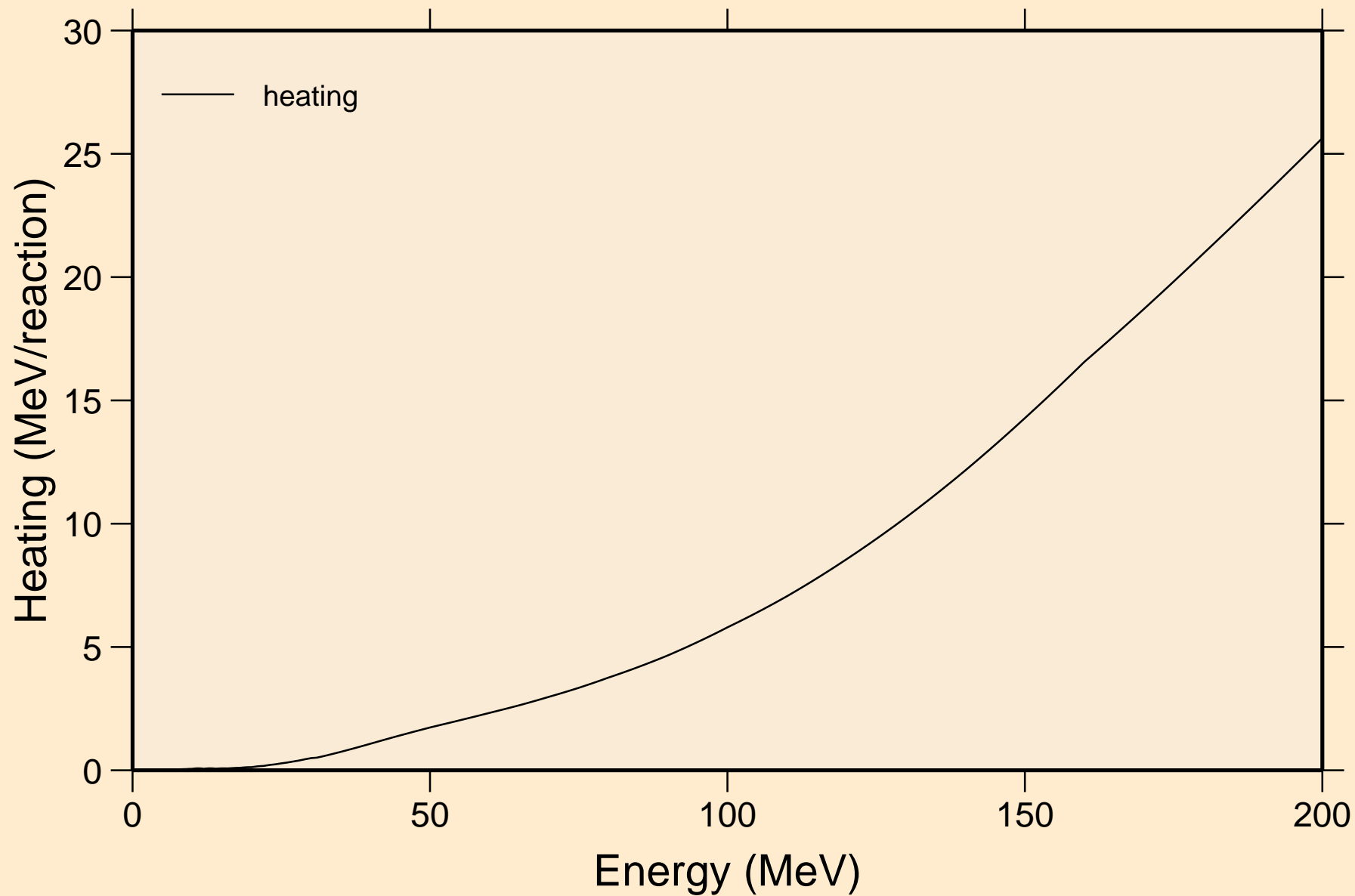

# HG203 NEUTRON ACER TENDL-2023 LIBRARY; T=0.K

## Damage

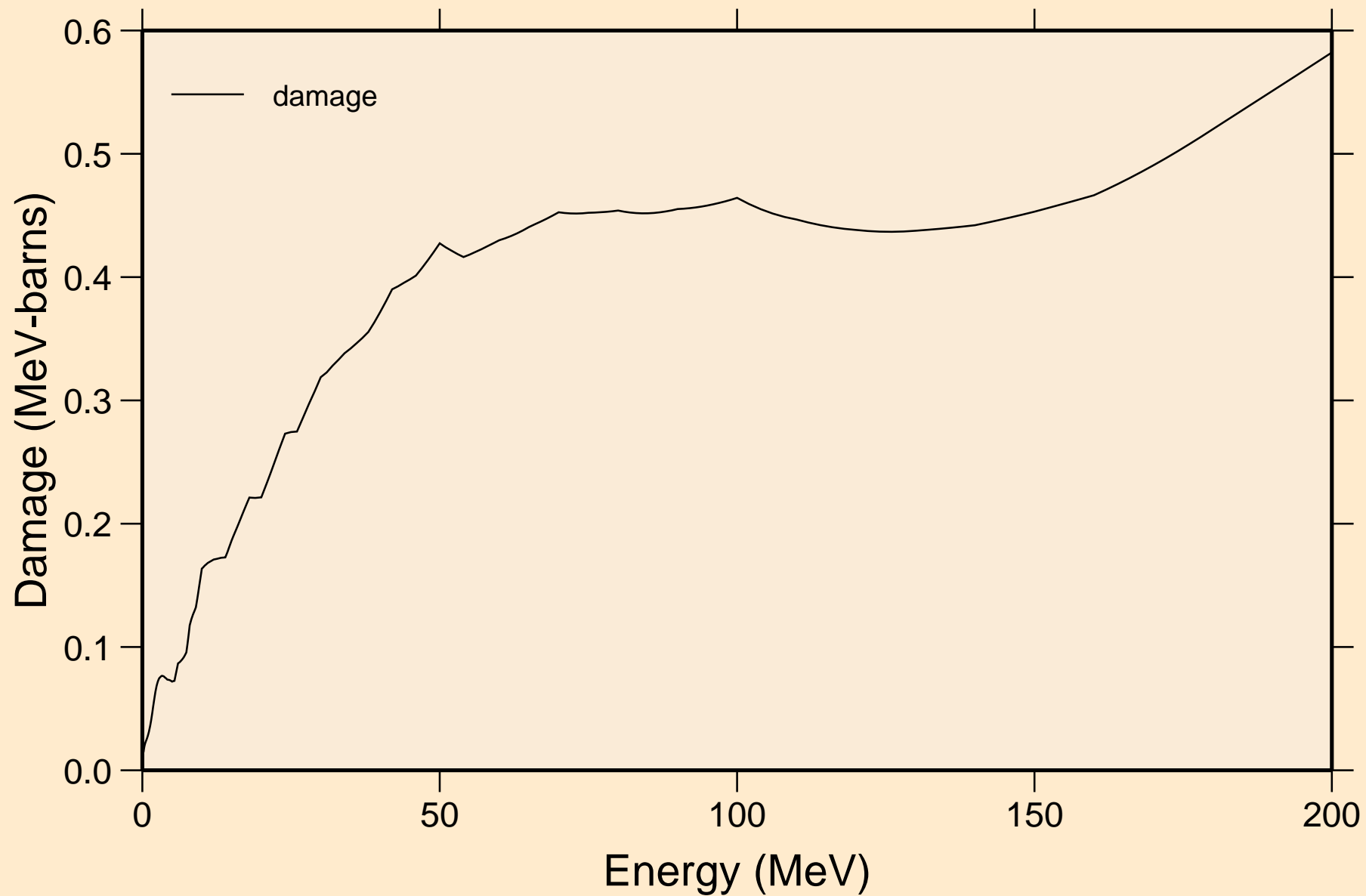

# HG203 NEUTRON ACER TENDL-2023 LIBRARY; T=0.K

## Non-threshold reactions

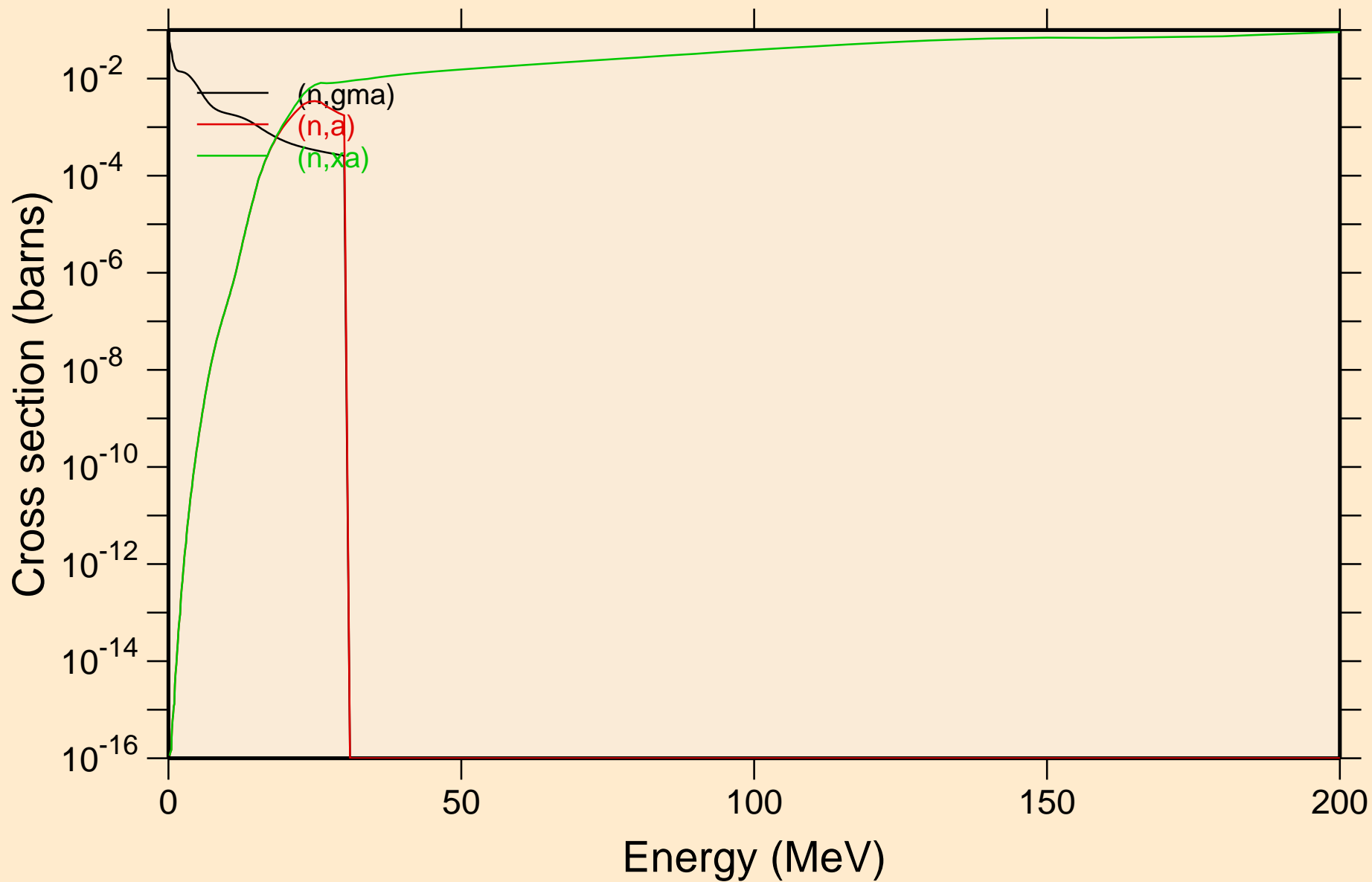



# HG203 NEUTRON ACER TENDL-2023 LIBRARY; T=0.K

## Inelastic levels

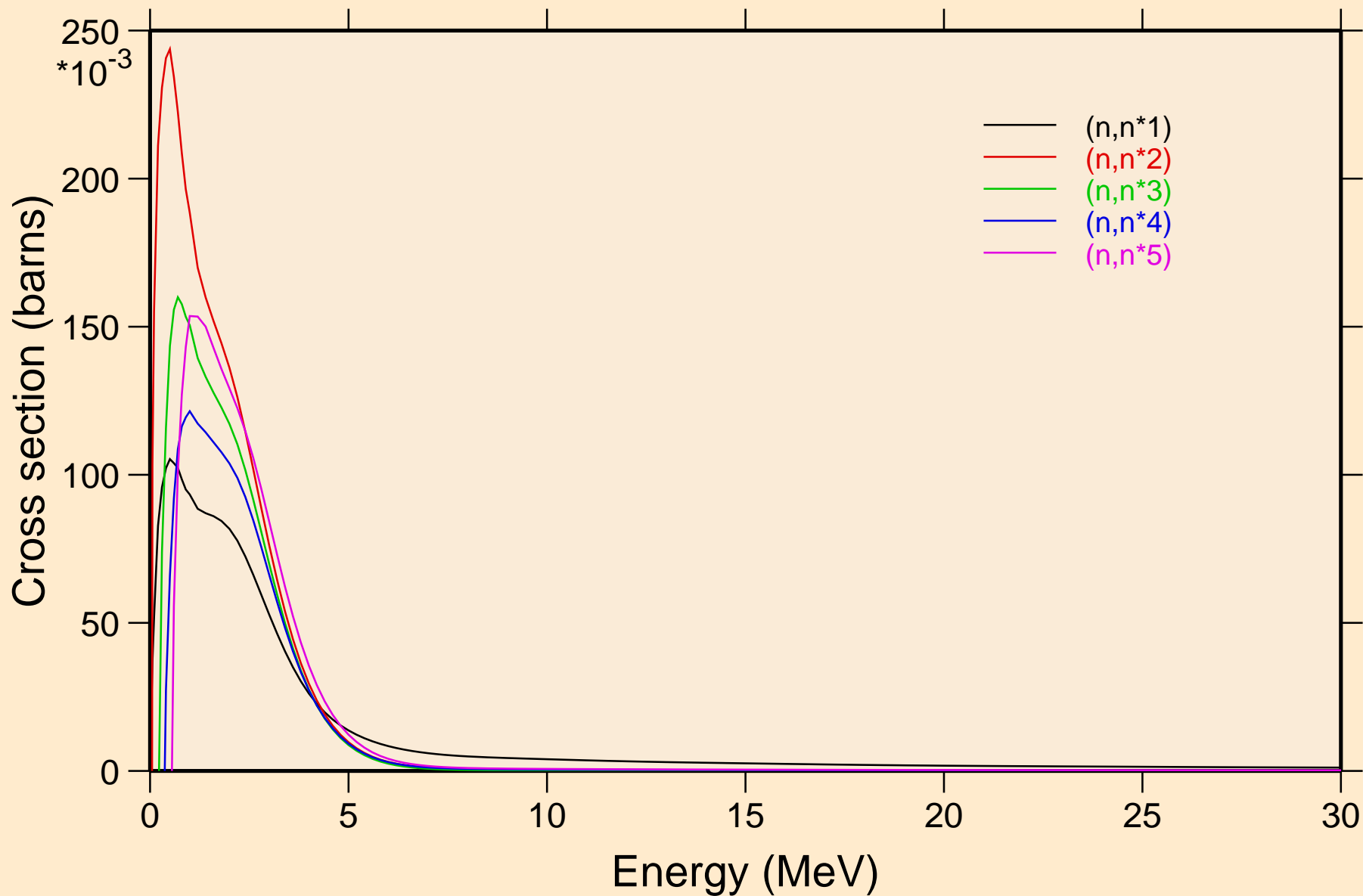

# HG203 NEUTRON ACER TENDL-2023 LIBRARY; T=0.K

## Inelastic levels

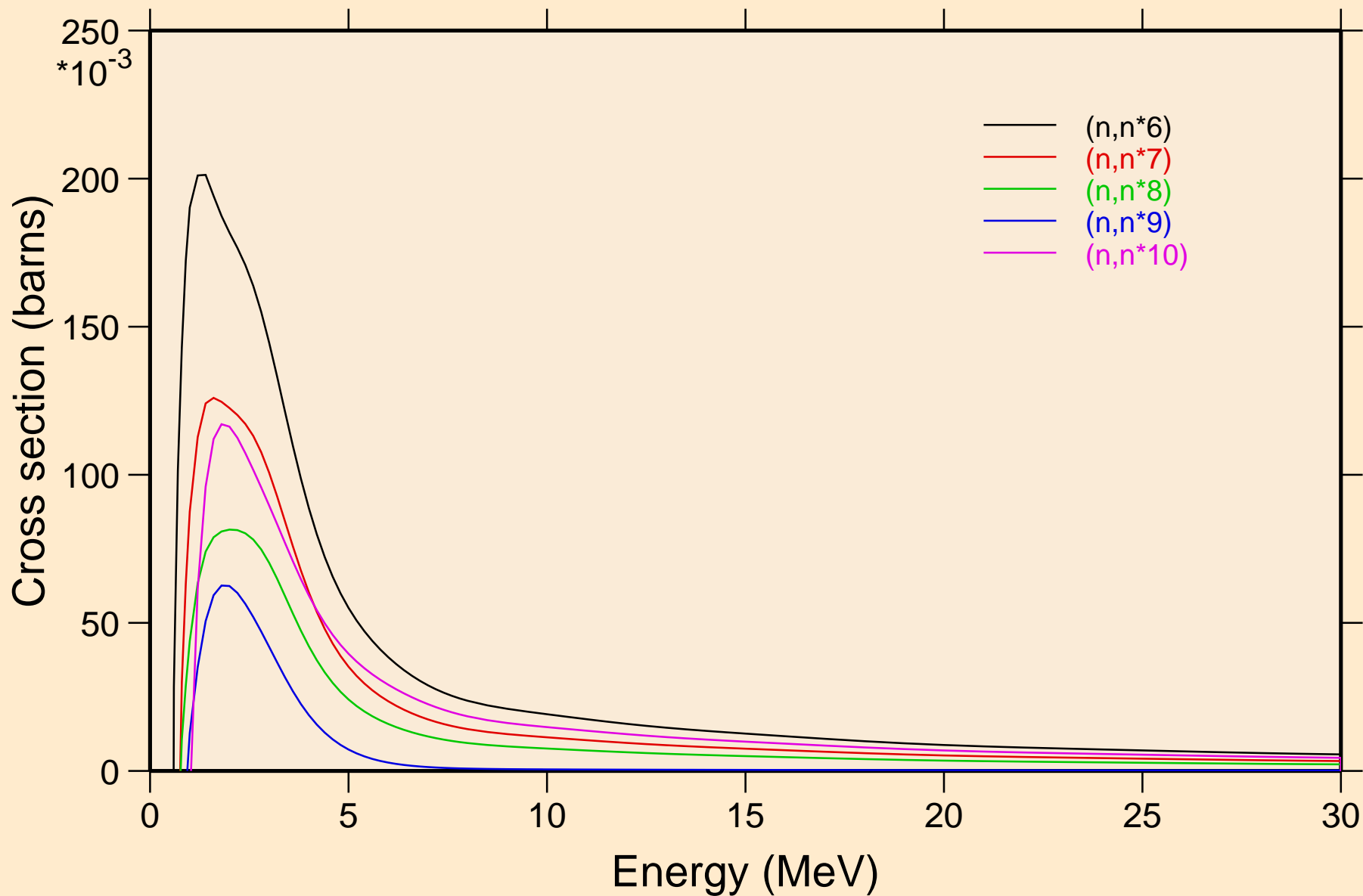

# HG203 NEUTRON ACER TENDL-2023 LIBRARY; T=0.K

## Inelastic levels

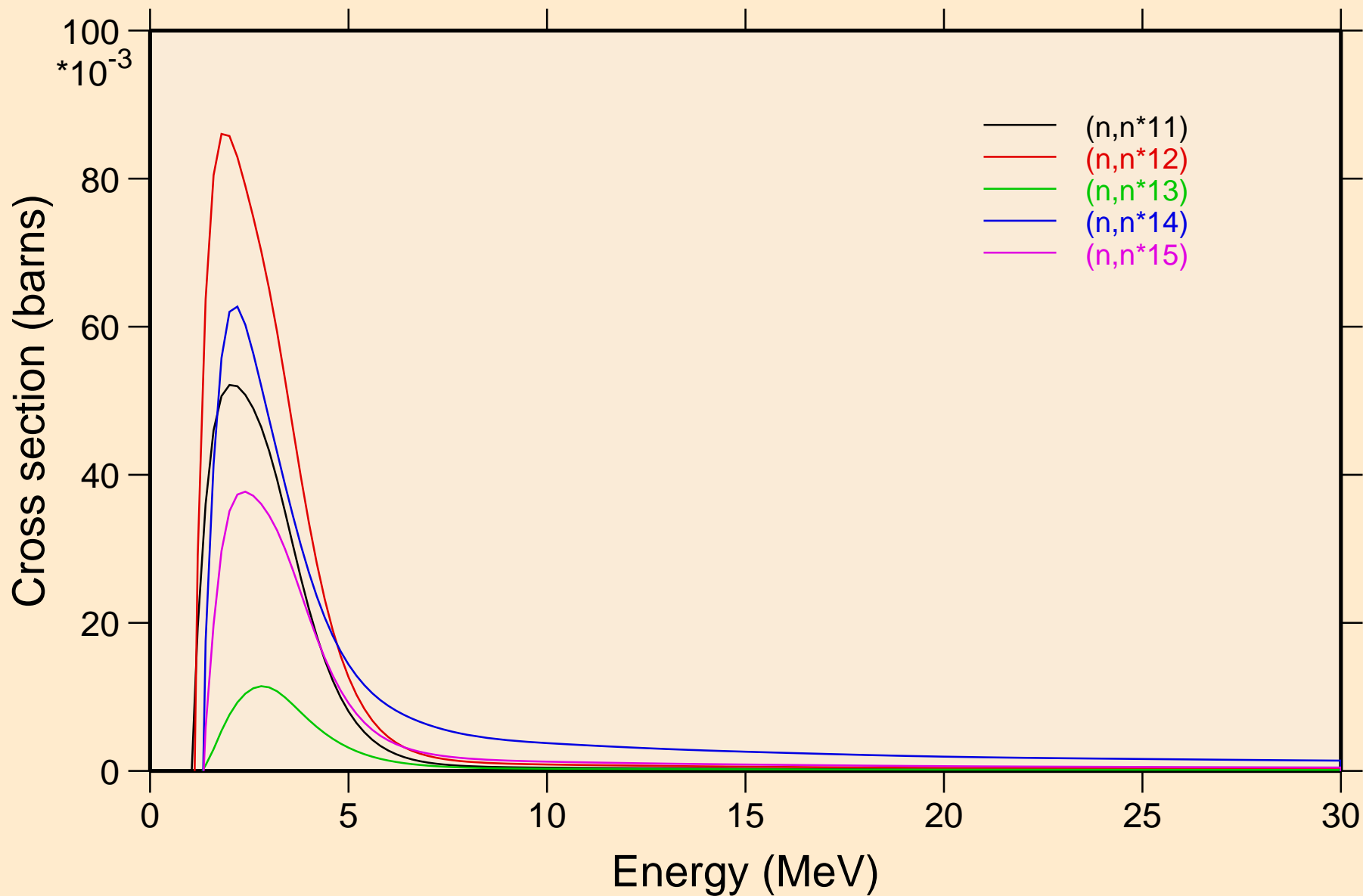

HG203 NEUTRON ACER TENDL-2023 LIBRARY; T=0.K  
Inelastic levels

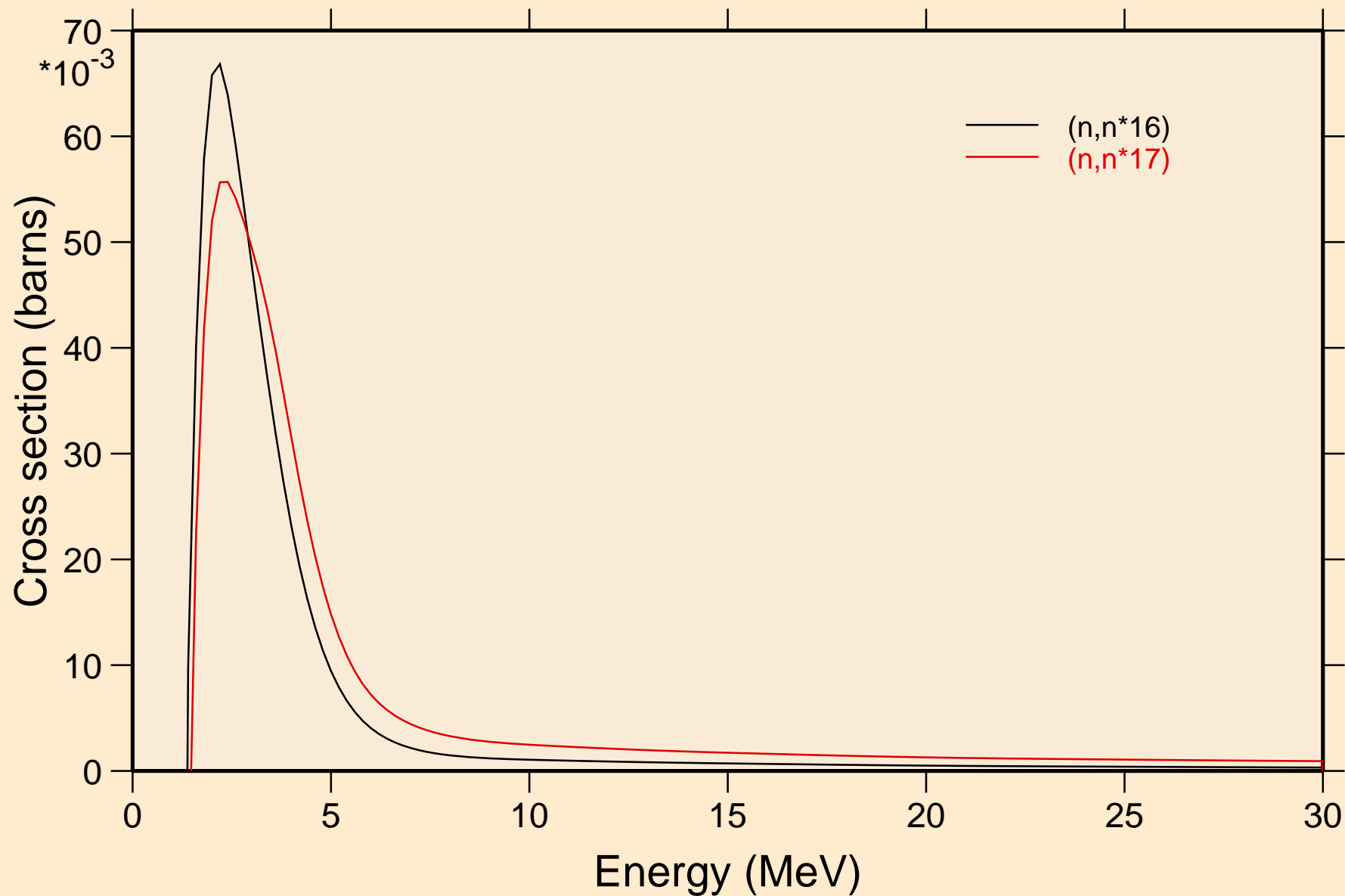

# HG203 NEUTRON ACER TENDL-2023 LIBRARY; T=0.K

## Threshold reactions

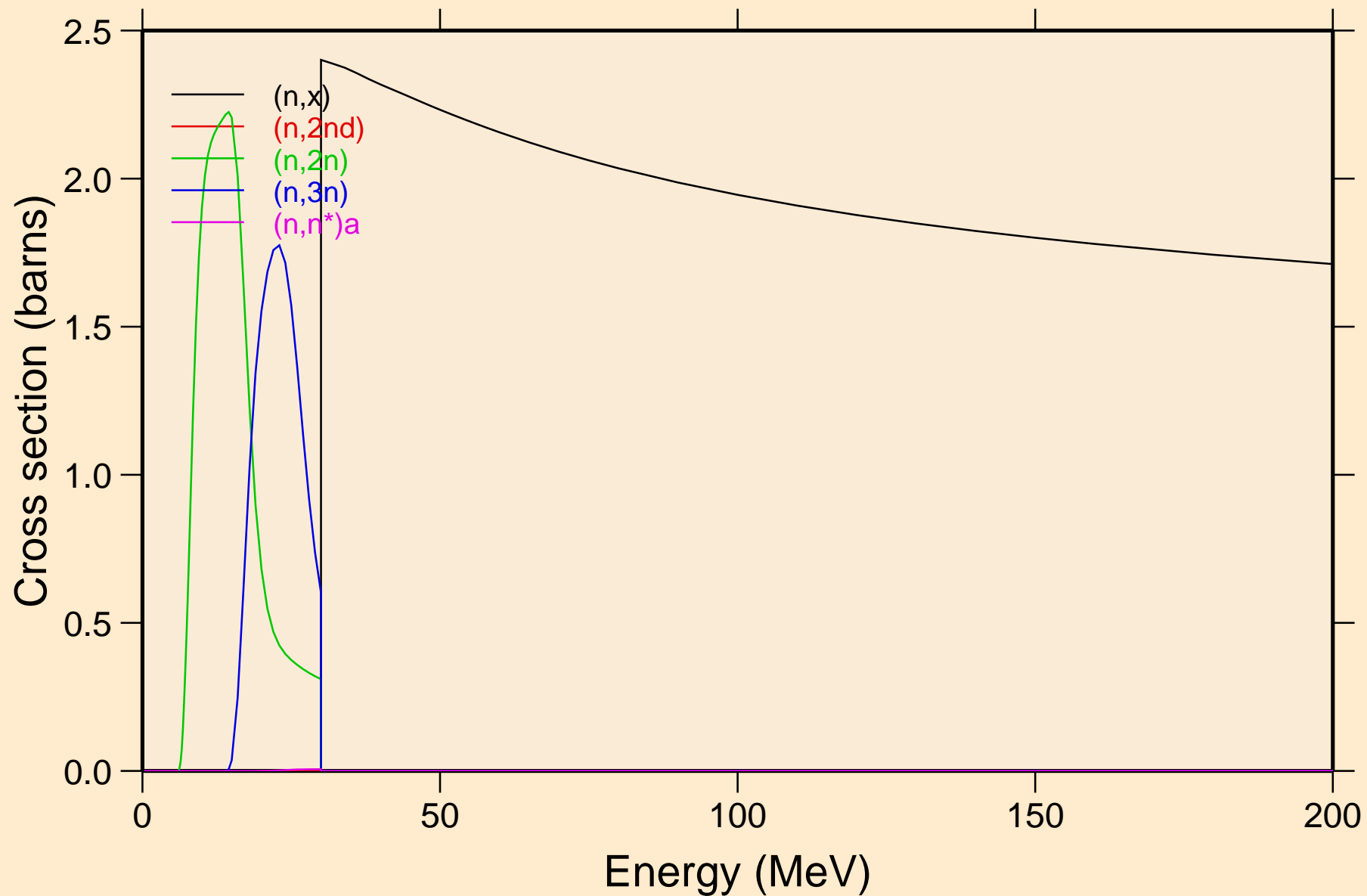

# HG203 NEUTRON ACER TENDL-2023 LIBRARY; T=0.K

## Threshold reactions

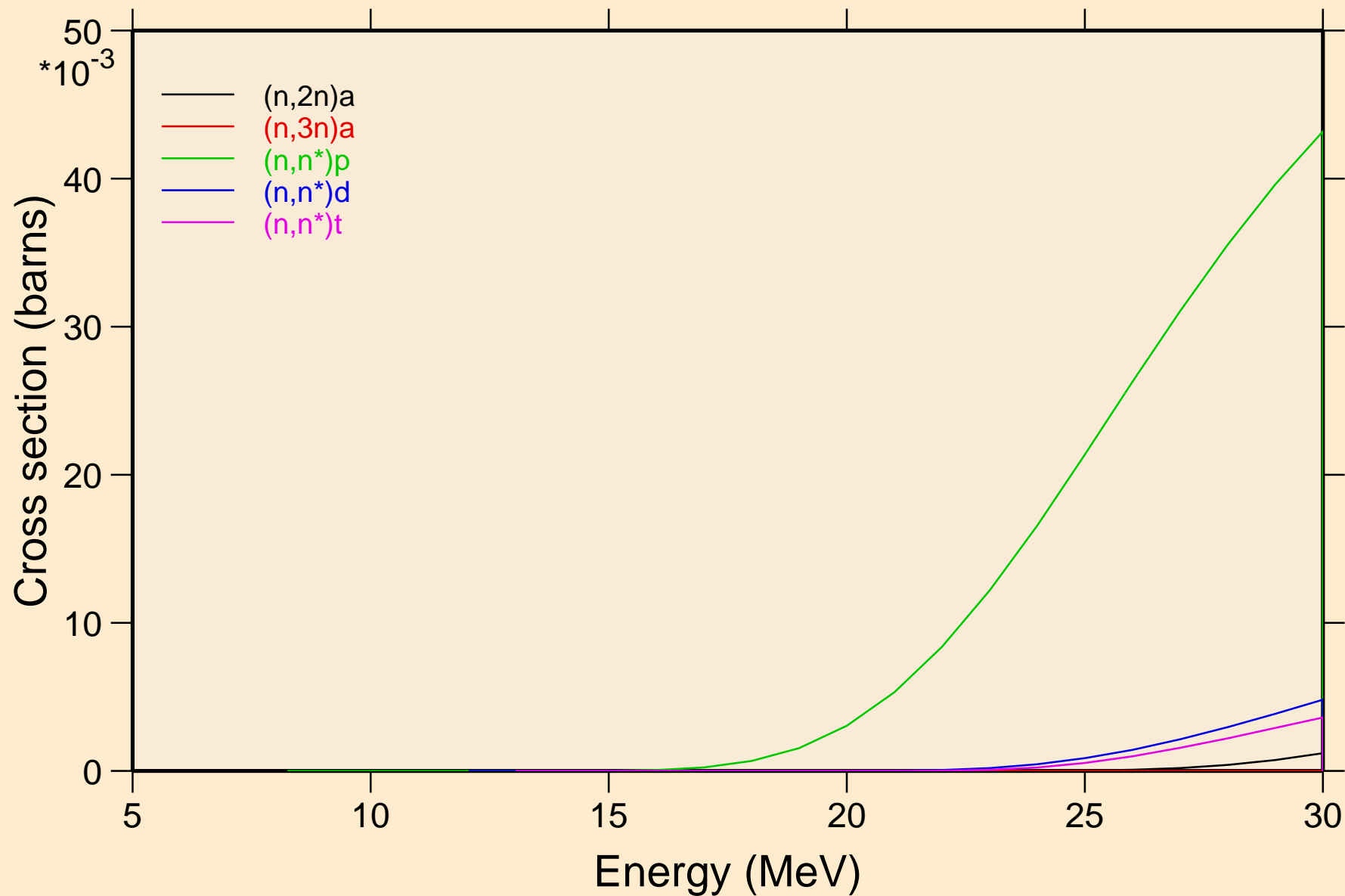

# HG203 NEUTRON ACER TENDL-2023 LIBRARY; T=0.K

## Threshold reactions

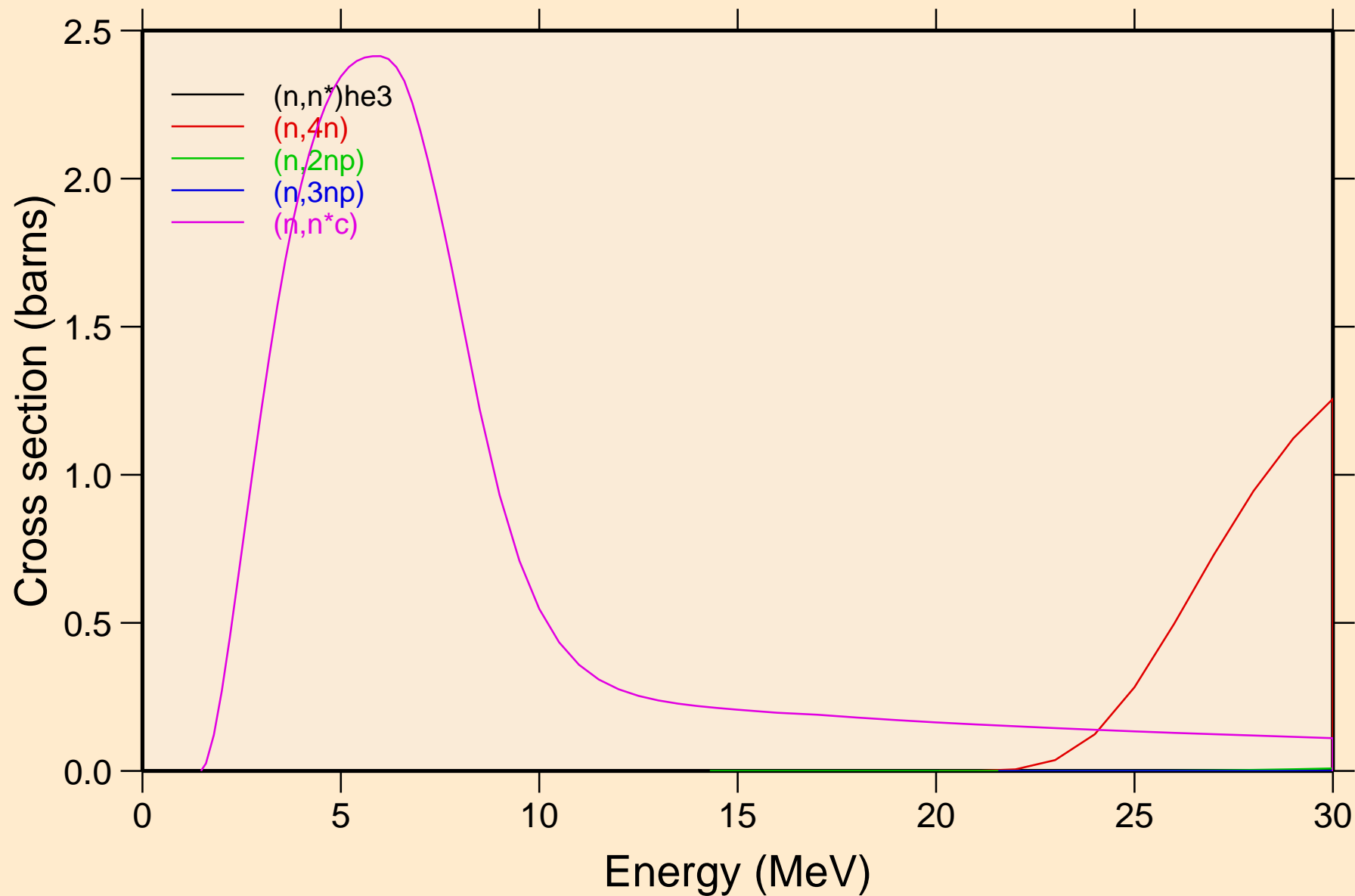

# HG203 NEUTRON ACER TENDL-2023 LIBRARY; T=0.K

## Threshold reactions

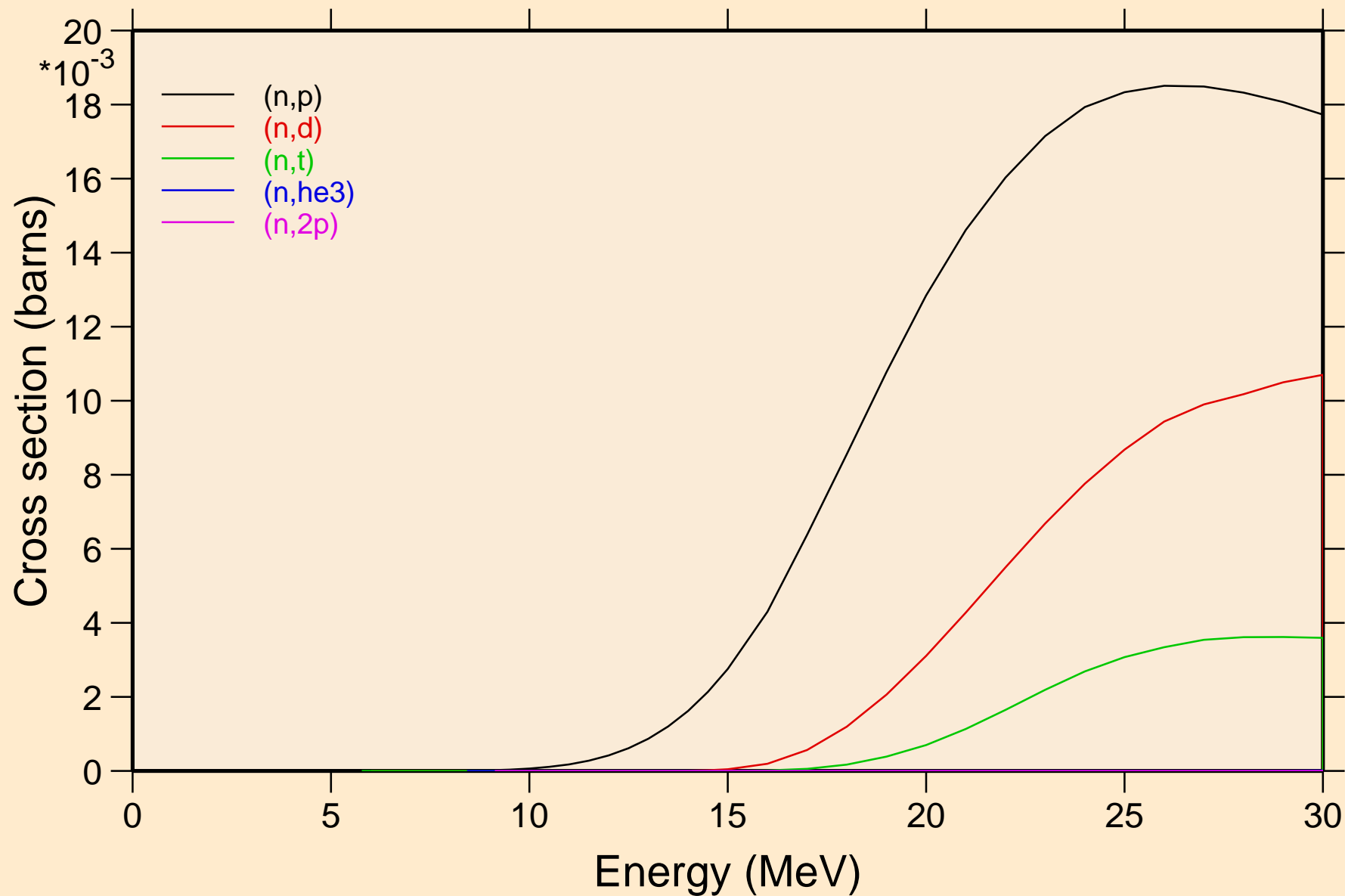



# HG203 NEUTRON ACER TENDL-2023 LIBRARY; T=0.K

## Threshold reactions

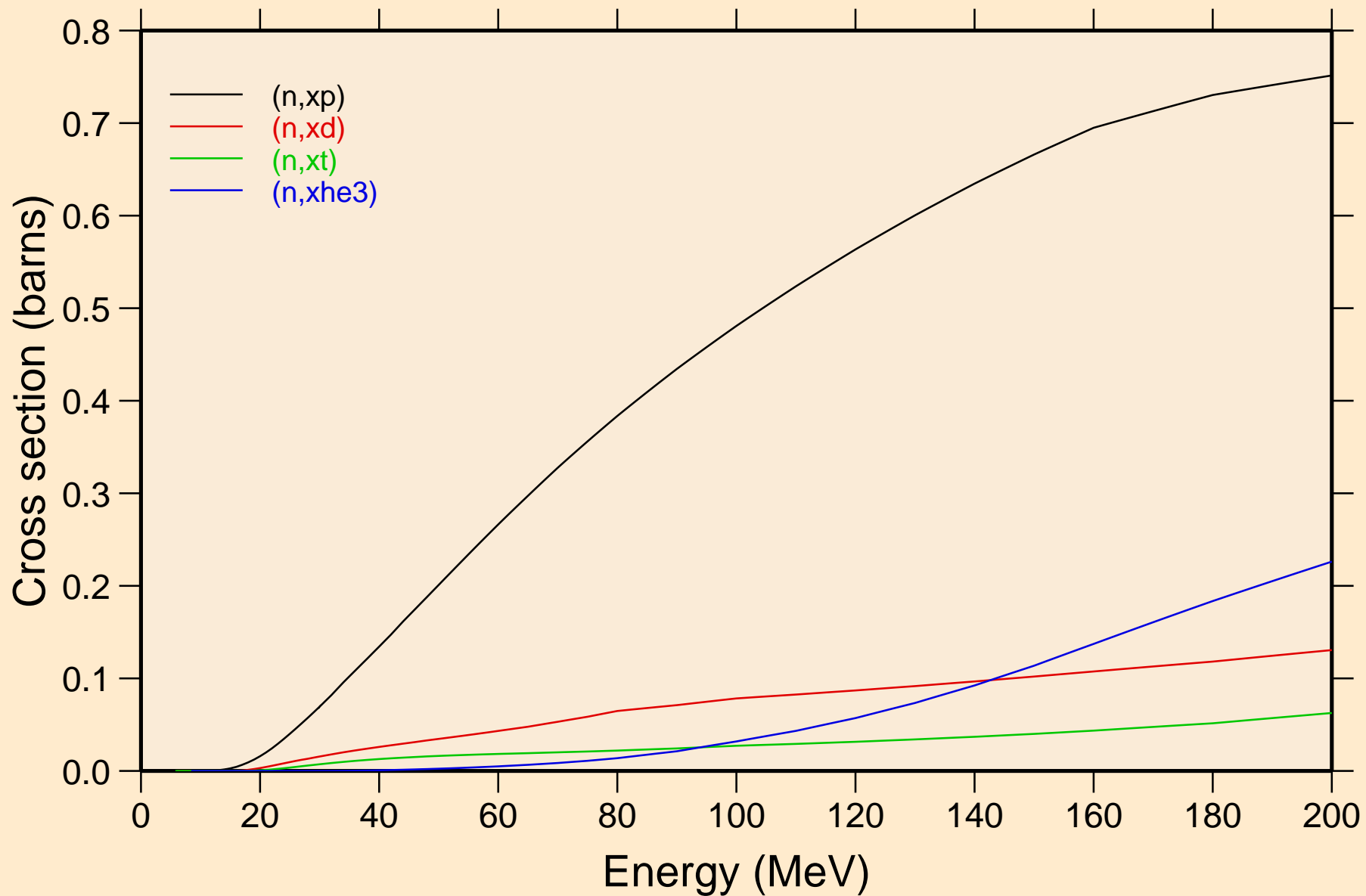

HG203 NEUTRON ACER TENDL-2023 LIBRARY; T=0.K  
angular distribution for elastic

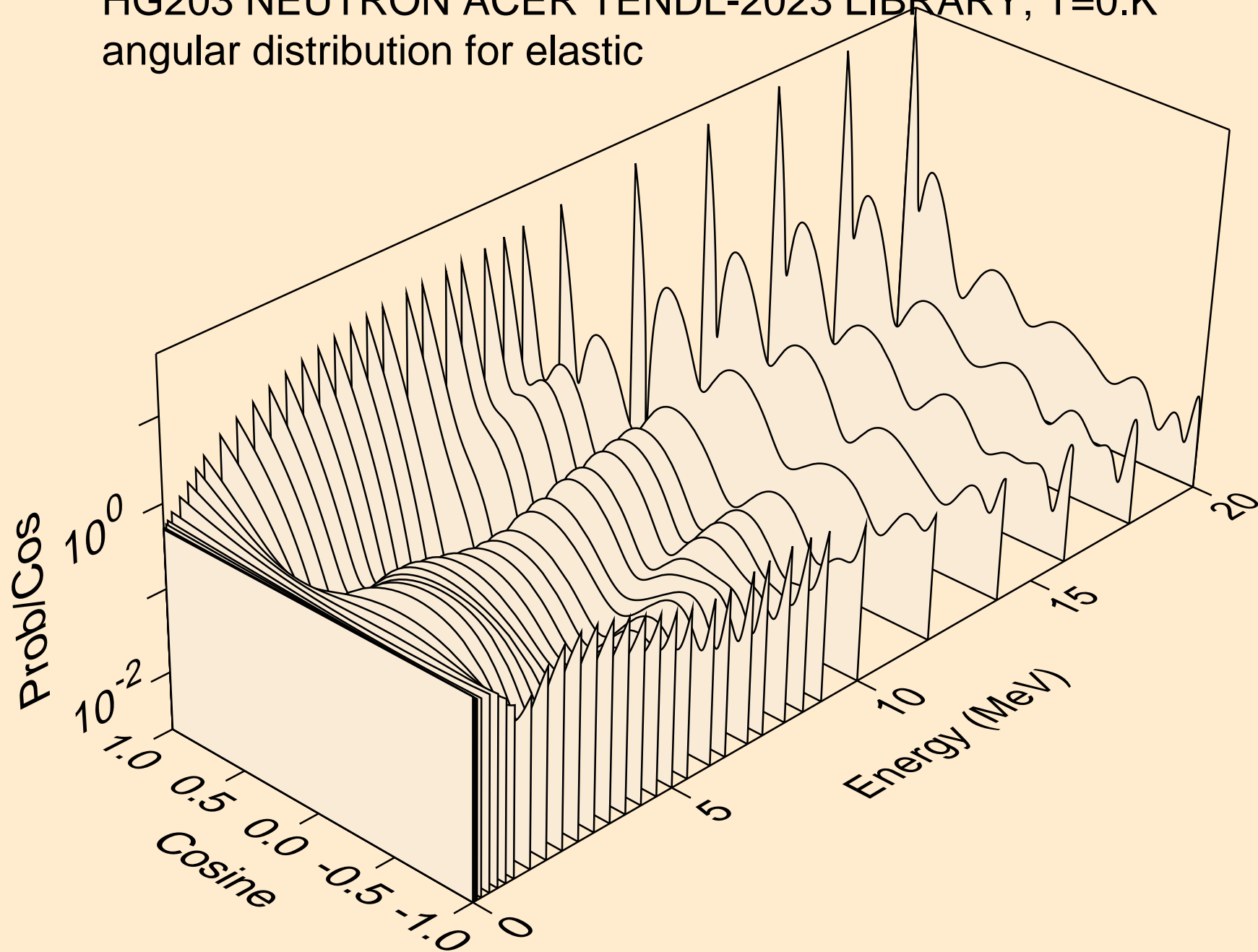

HG203 NEUTRON ACER TENDL-2023 LIBRARY; T=0.K  
angular distribution for elastic

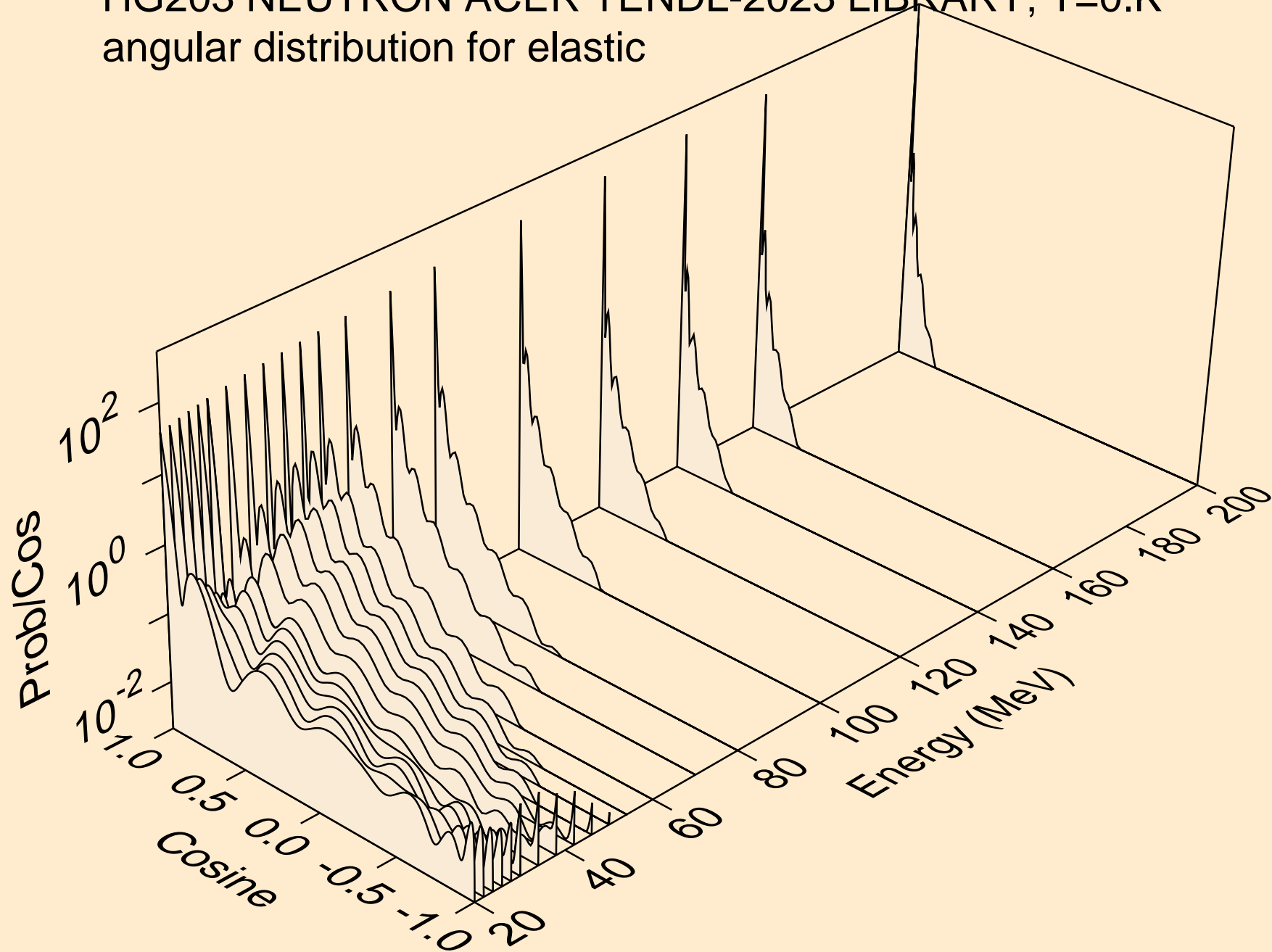

HG203 NEUTRON ACER TENDL-2023 LIBRARY; T=0.K  
angular distribution for (n,n\*1)

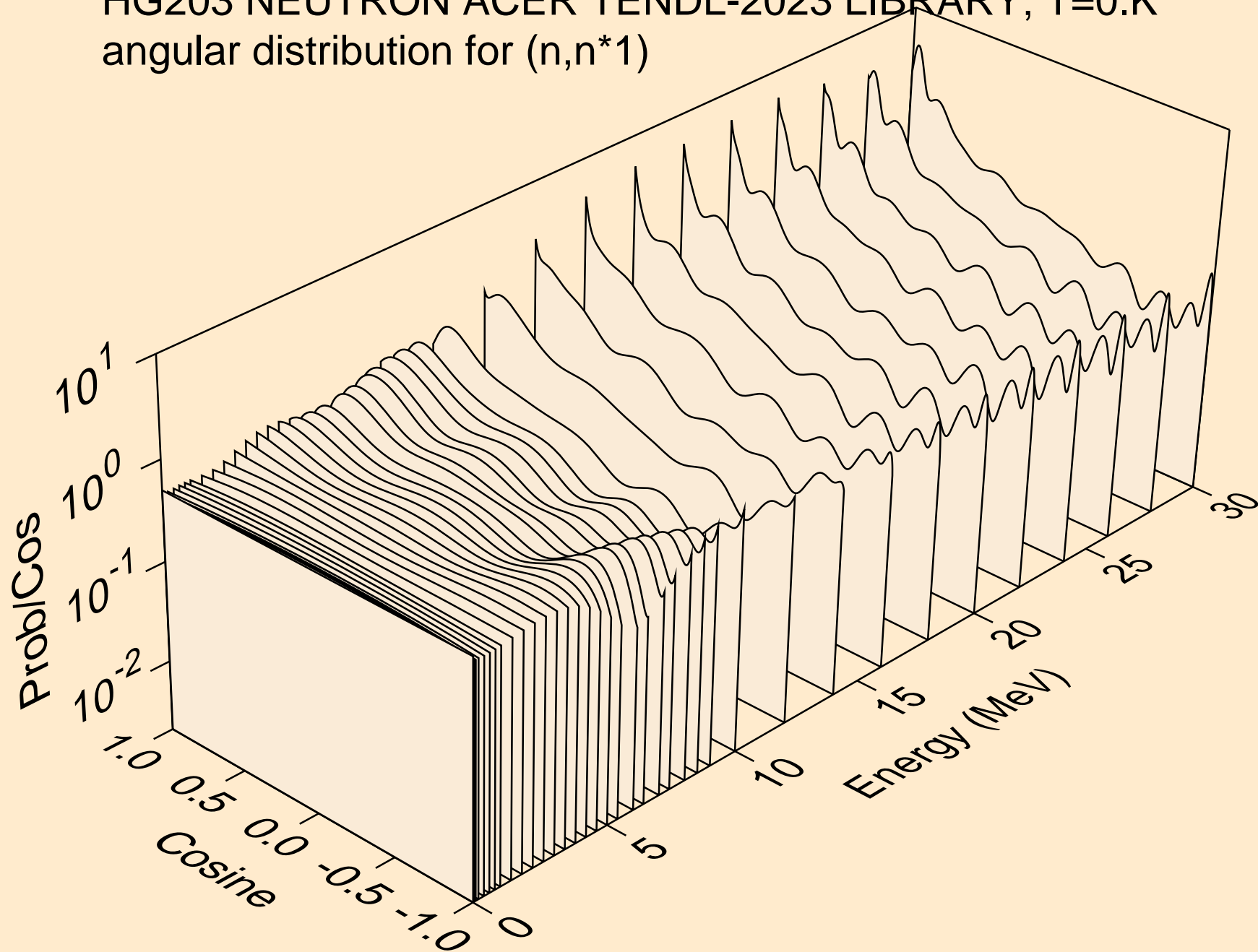

HG203 NEUTRON ACER TENDL-2023 LIBRARY; T=0.K  
angular distribution for (n,n\*2)

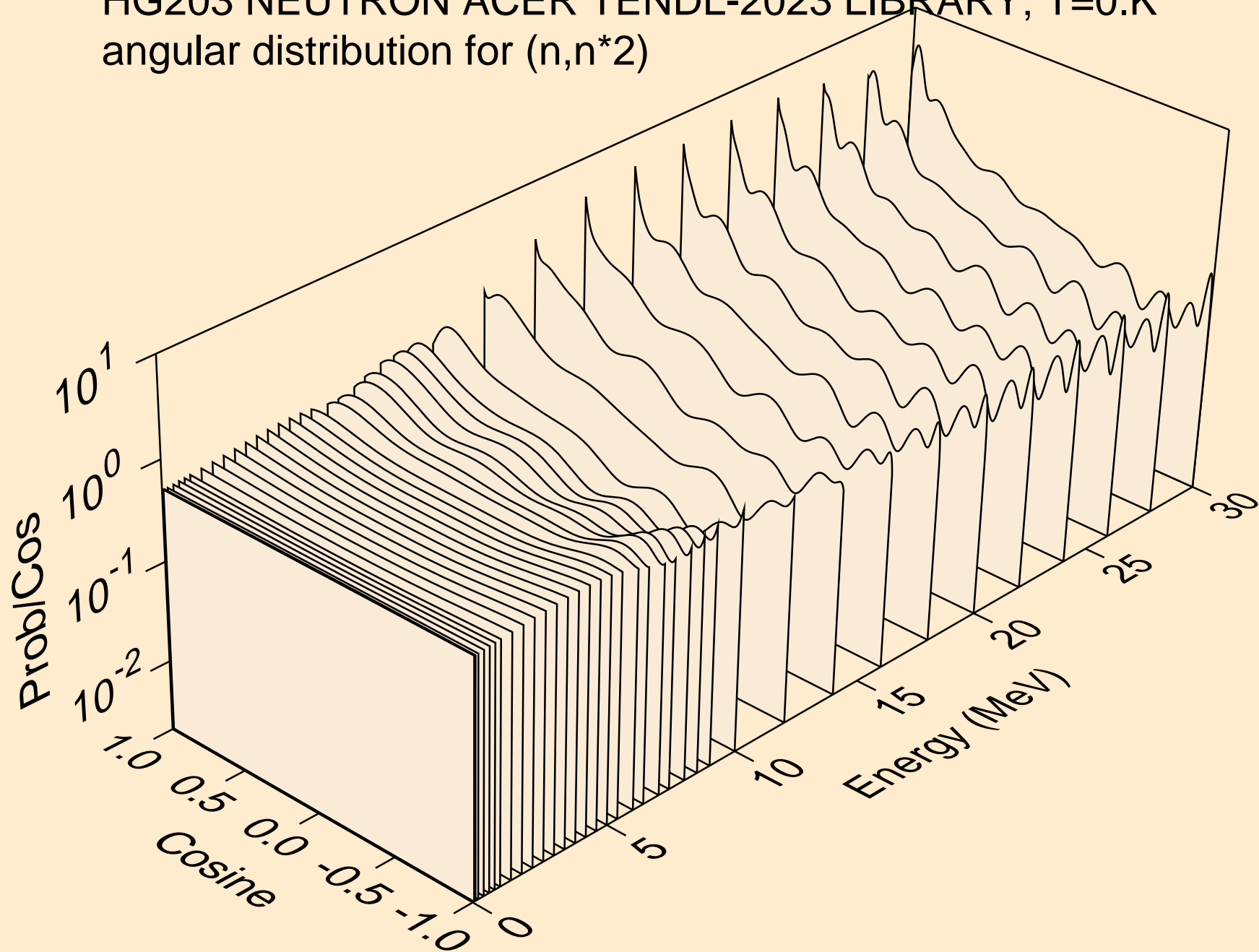

HG203 NEUTRON ACER TENDL-2023 LIBRARY; T=0.K  
angular distribution for (n,n\*3)

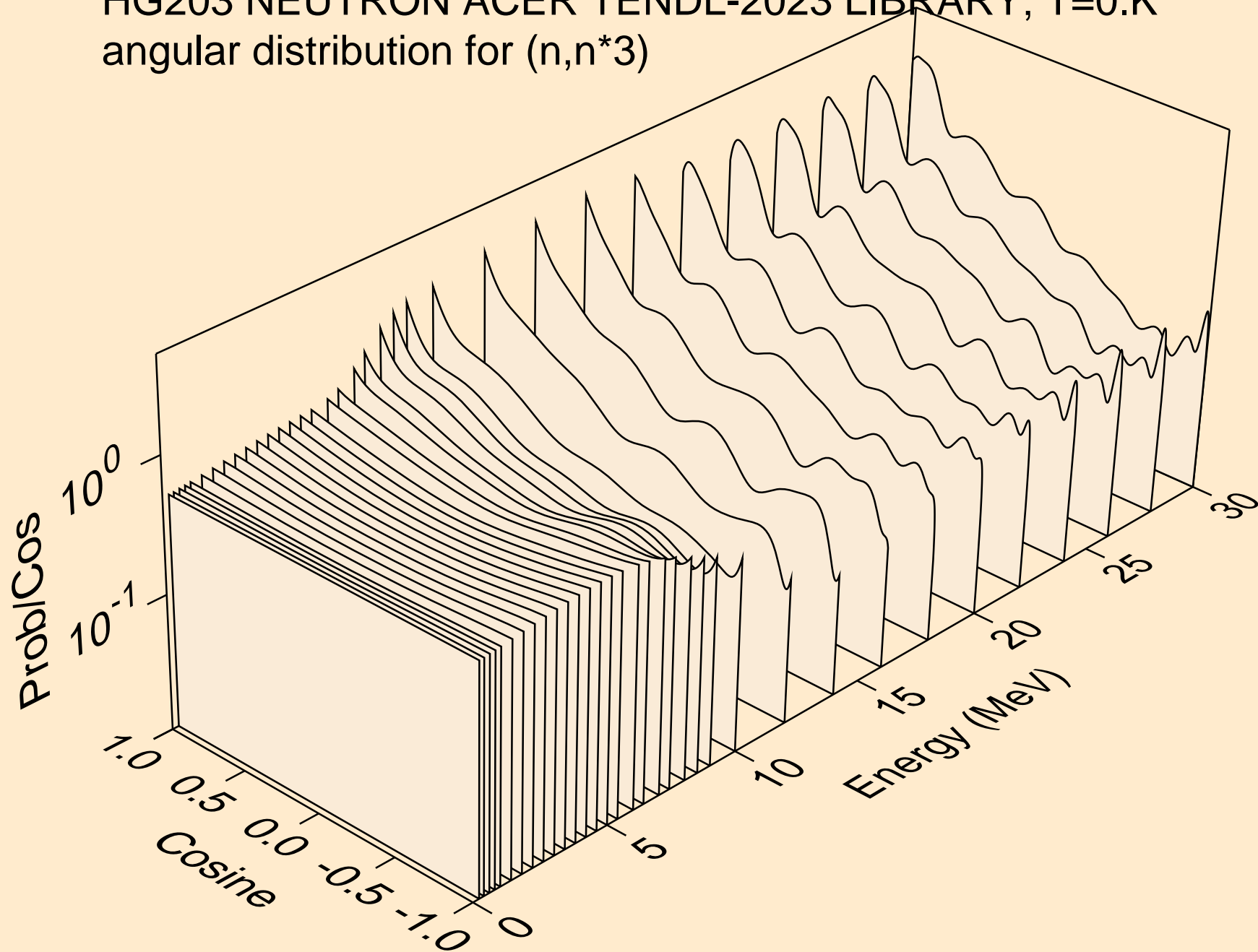

HG203 NEUTRON ACER TENDL-2023 LIBRARY; T=0.K  
angular distribution for (n,n\*4)

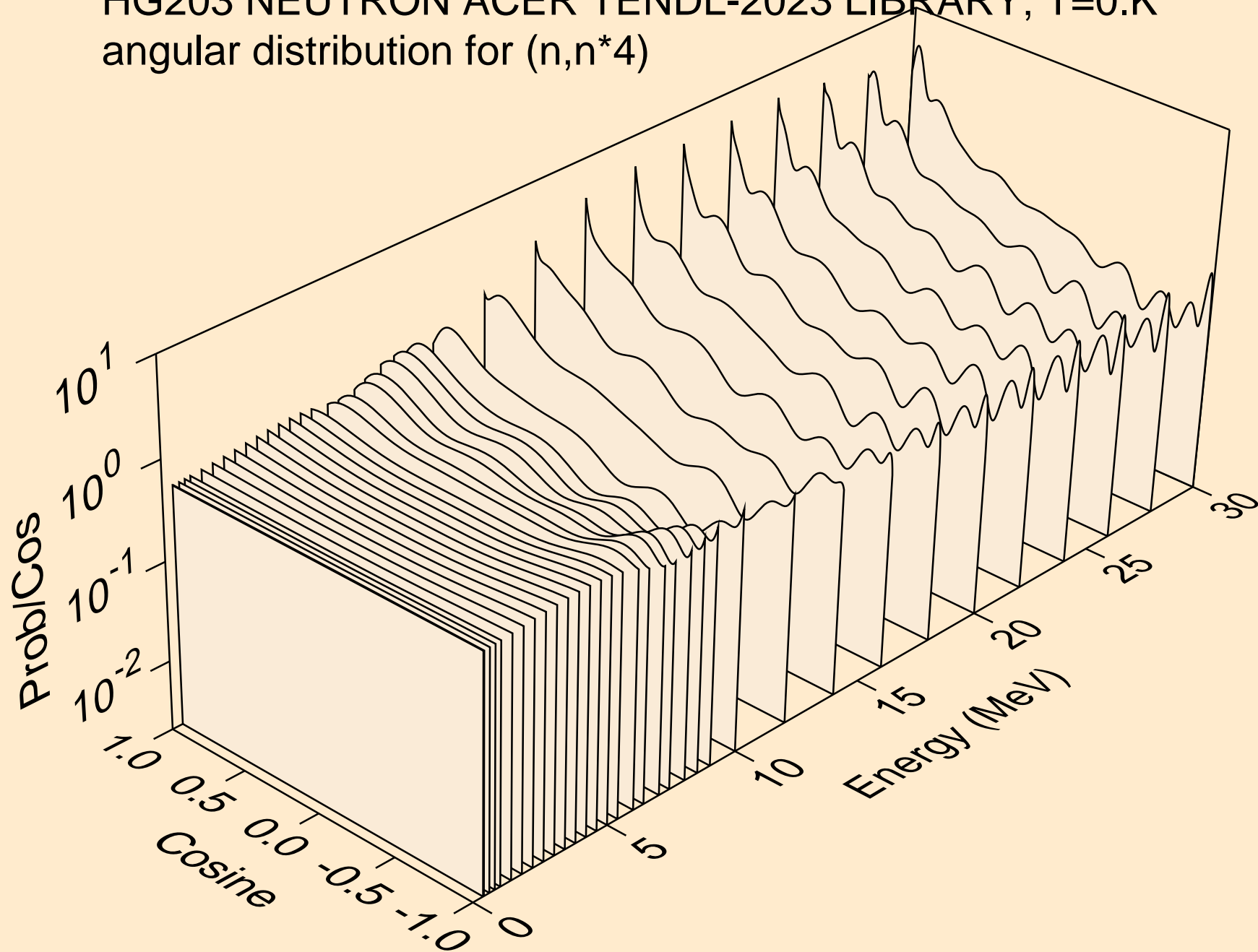

HG203 NEUTRON ACER TENDL-2023 LIBRARY; T=0.K  
angular distribution for (n,n\*5)

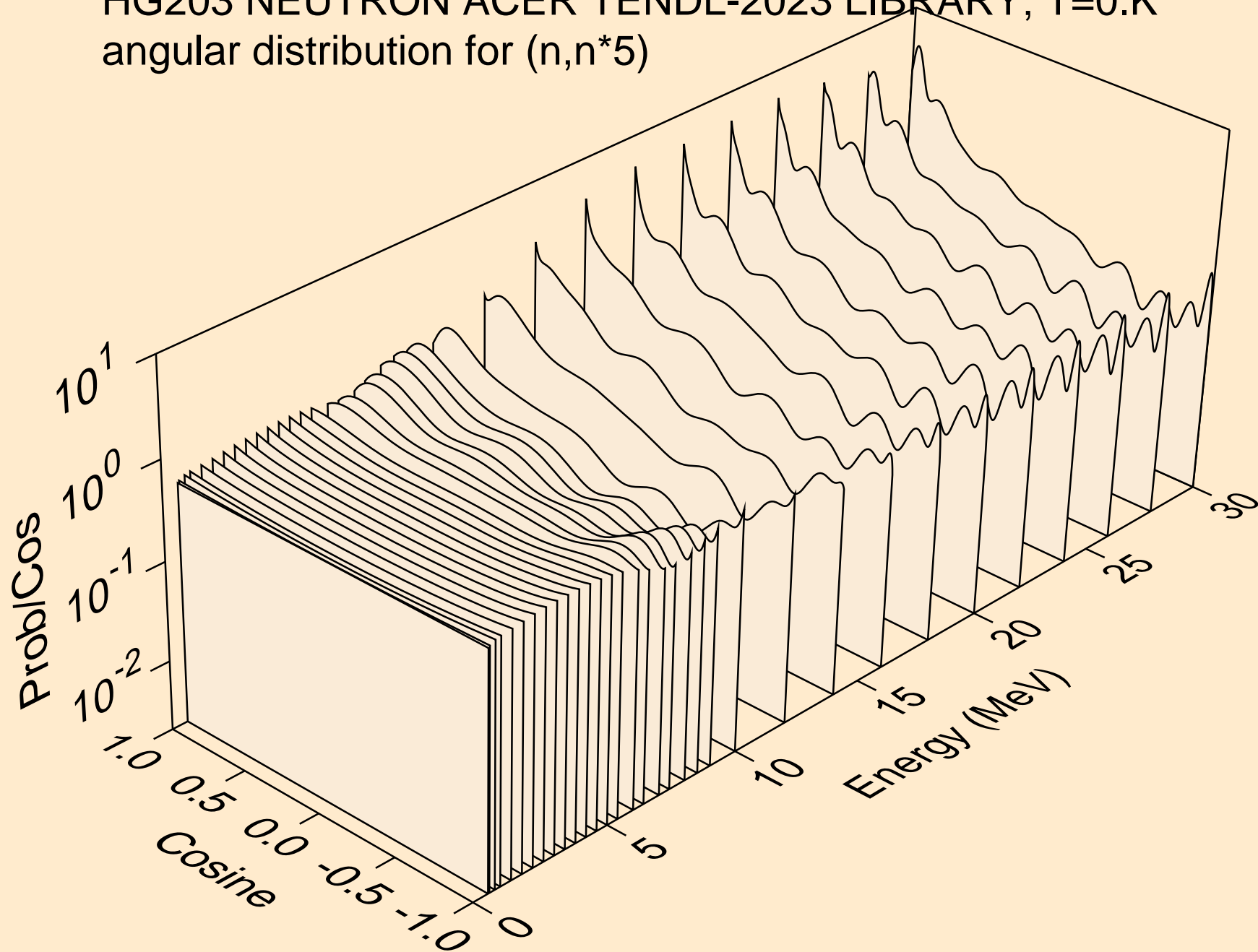



HG203 NEUTRON ACER TENDL-2023 LIBRARY; T=0.K  
angular distribution for (n,n\*6)

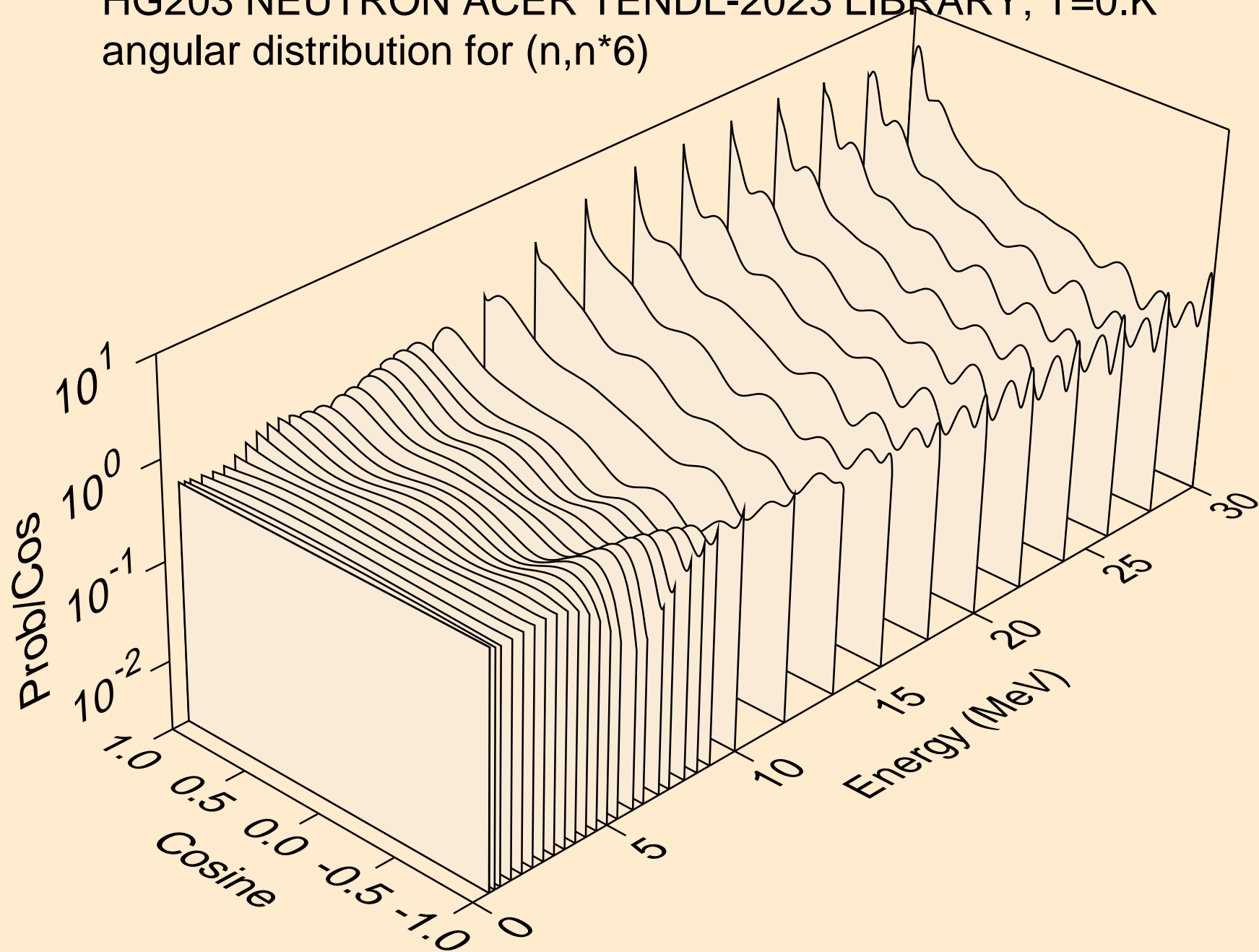

HG203 NEUTRON ACER TENDL-2023 LIBRARY; T=0.K  
angular distribution for (n,n\*7)

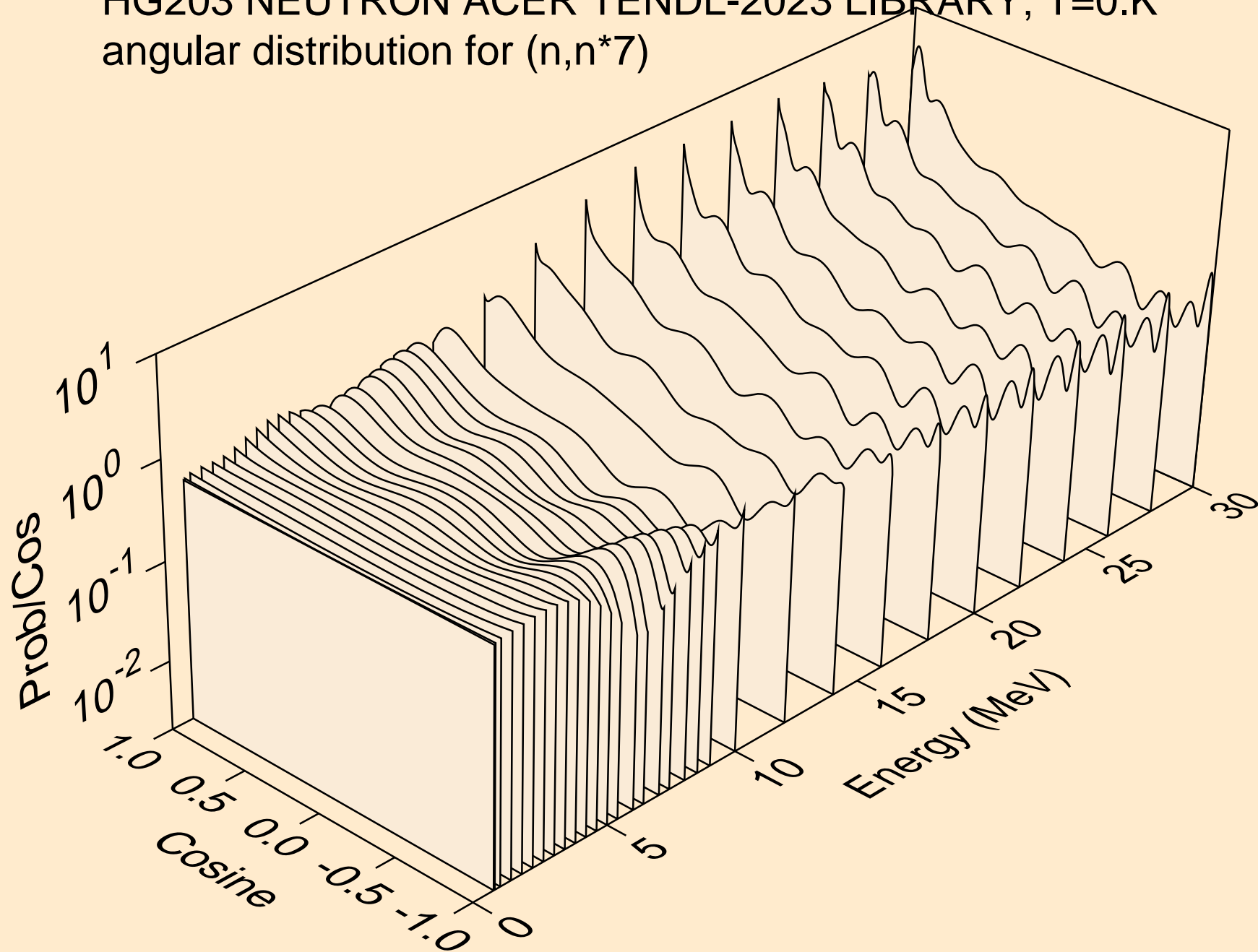

HG203 NEUTRON ACER TENDL-2023 LIBRARY; T=0.K  
angular distribution for (n,n\*8)

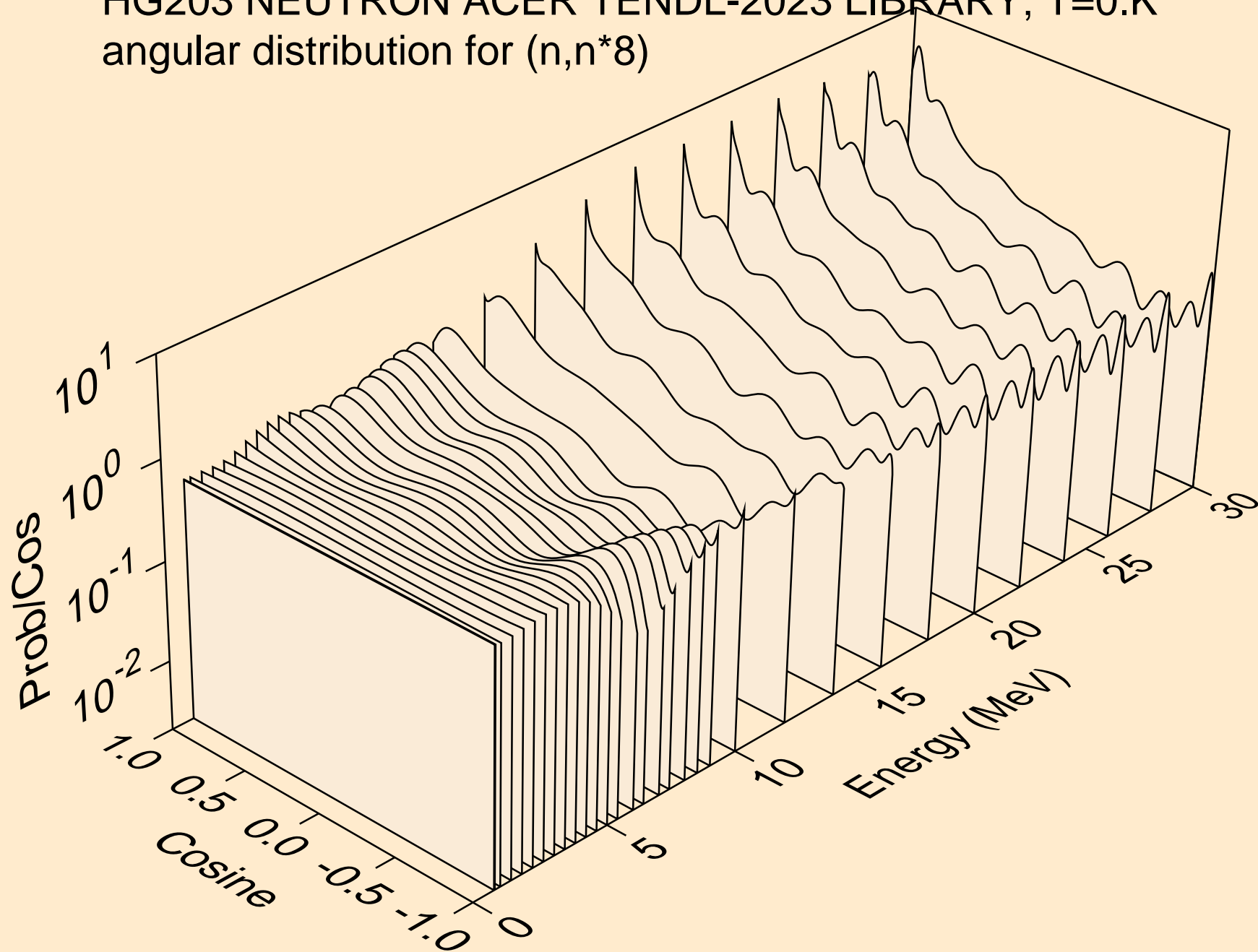

HG203 NEUTRON ACER TENDL-2023 LIBRARY; T=0.K  
angular distribution for (n,n\*9)

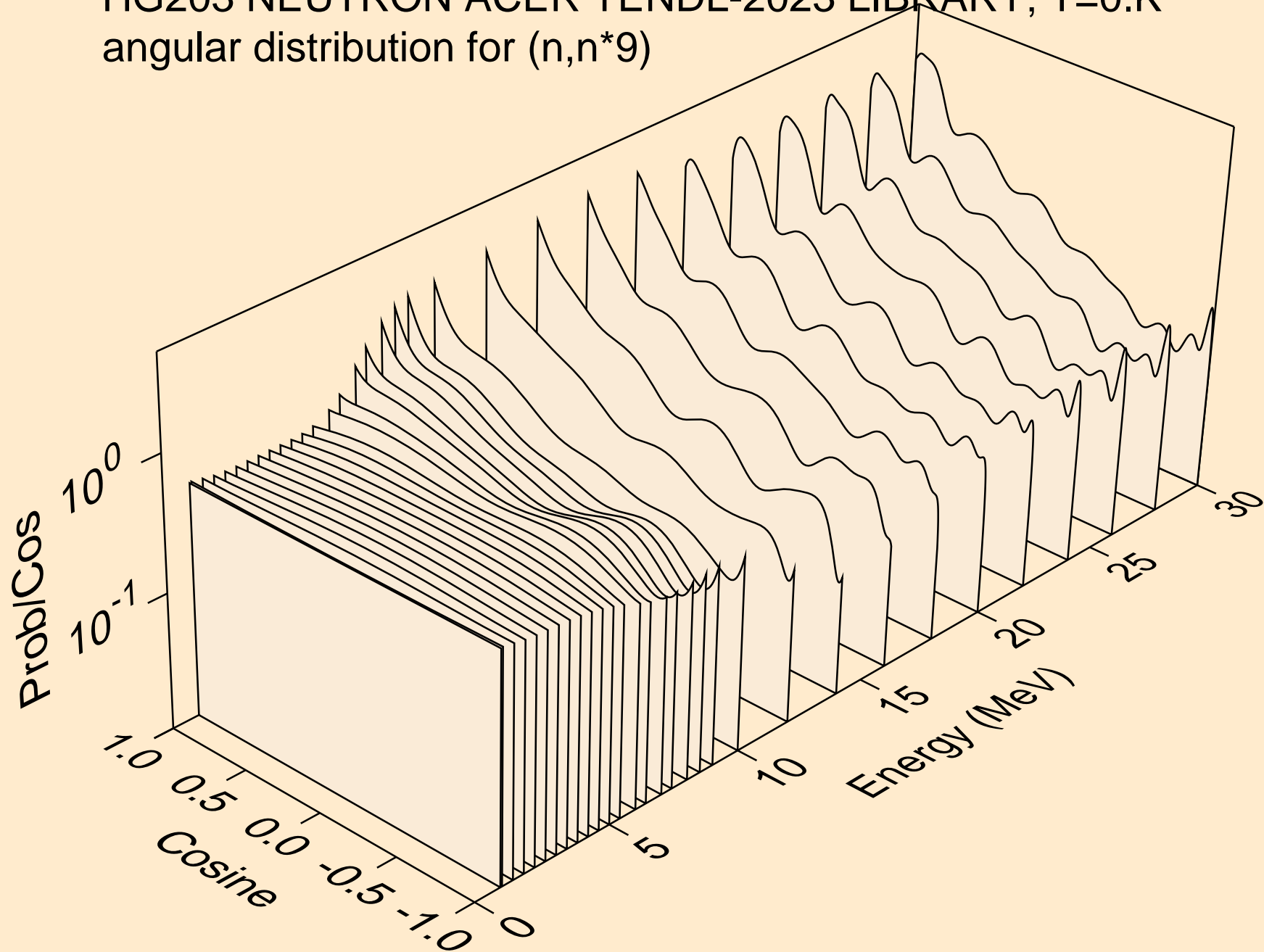

HG203 NEUTRON ACER TENDL-2023 LIBRARY; T=0.K  
angular distribution for (n,n\*10)

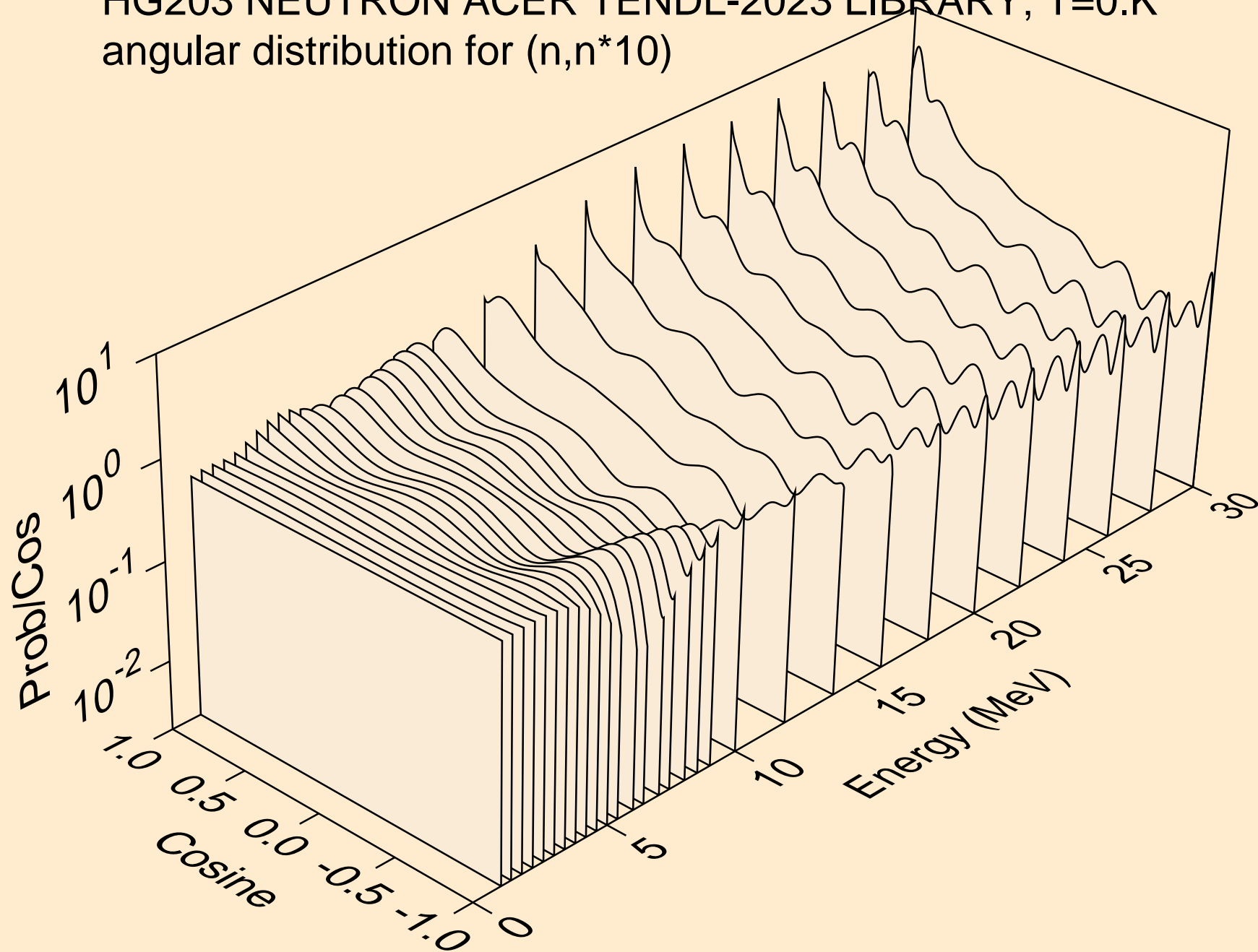

HG203 NEUTRON ACER TENDL-2023 LIBRARY; T=0.K  
angular distribution for (n,n\*11)

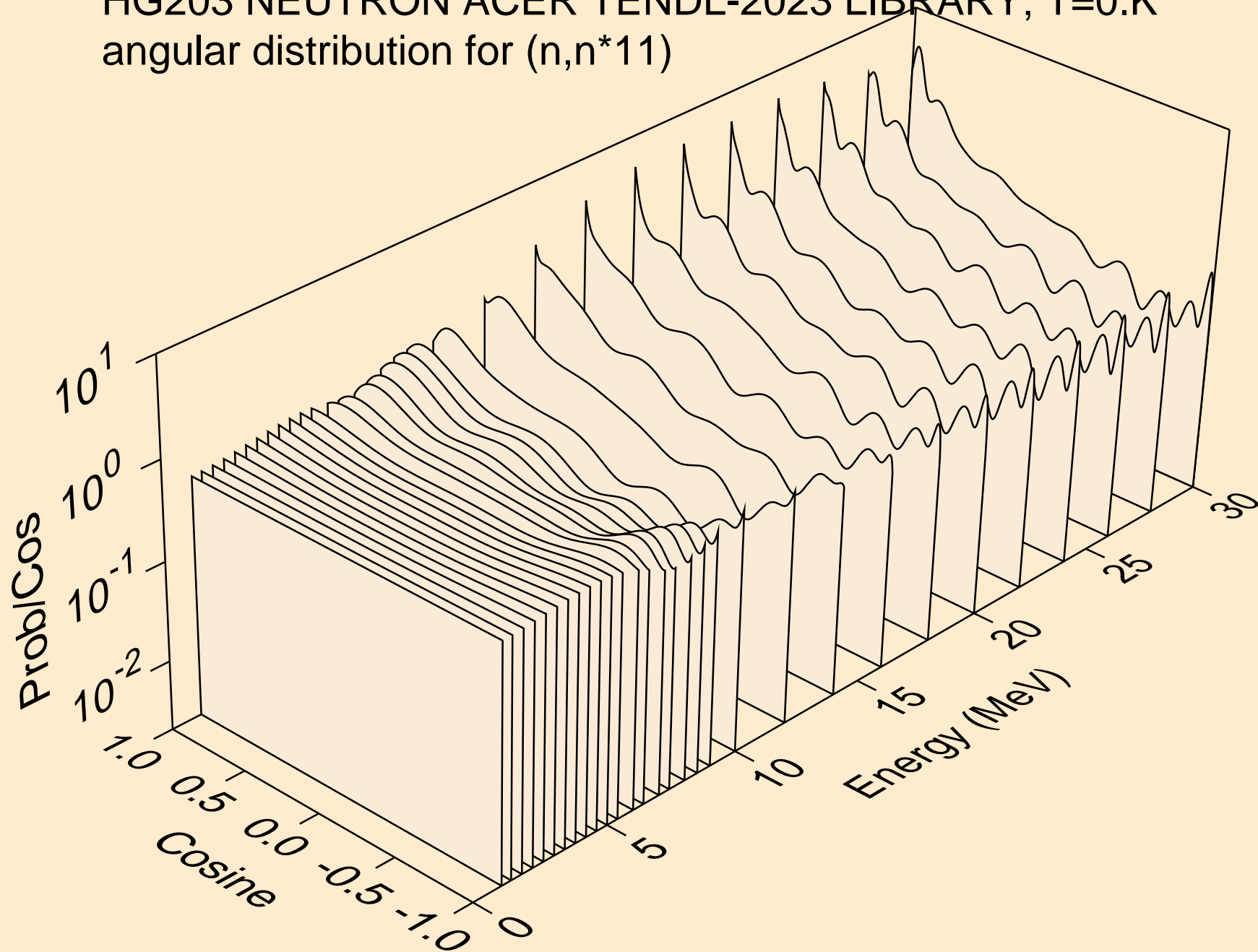

HG203 NEUTRON ACER TENDL-2023 LIBRARY; T=0.K  
angular distribution for (n,n\*12)

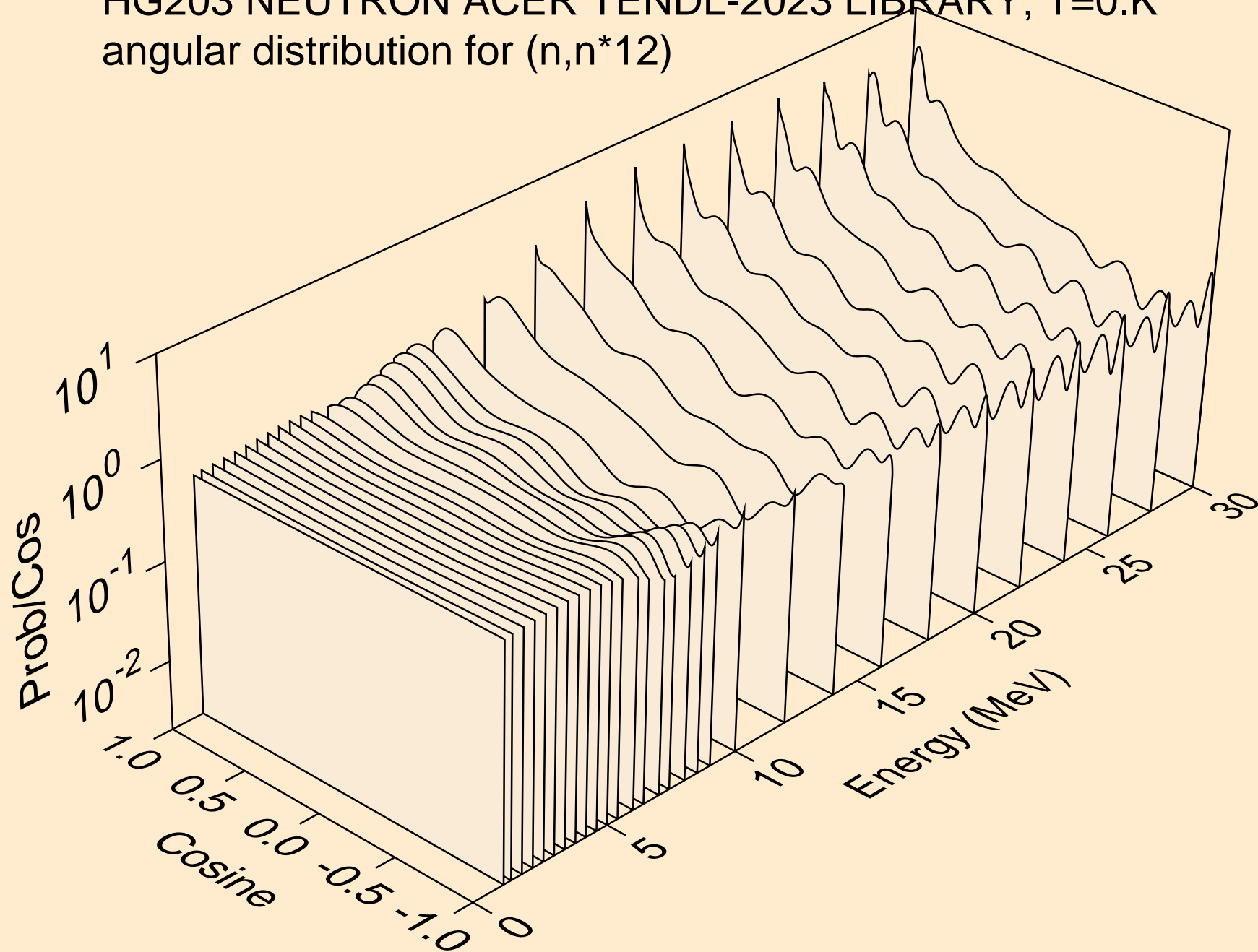

HG203 NEUTRON ACER TENDL-2023 LIBRARY; T=0.K  
angular distribution for (n,n\*13)

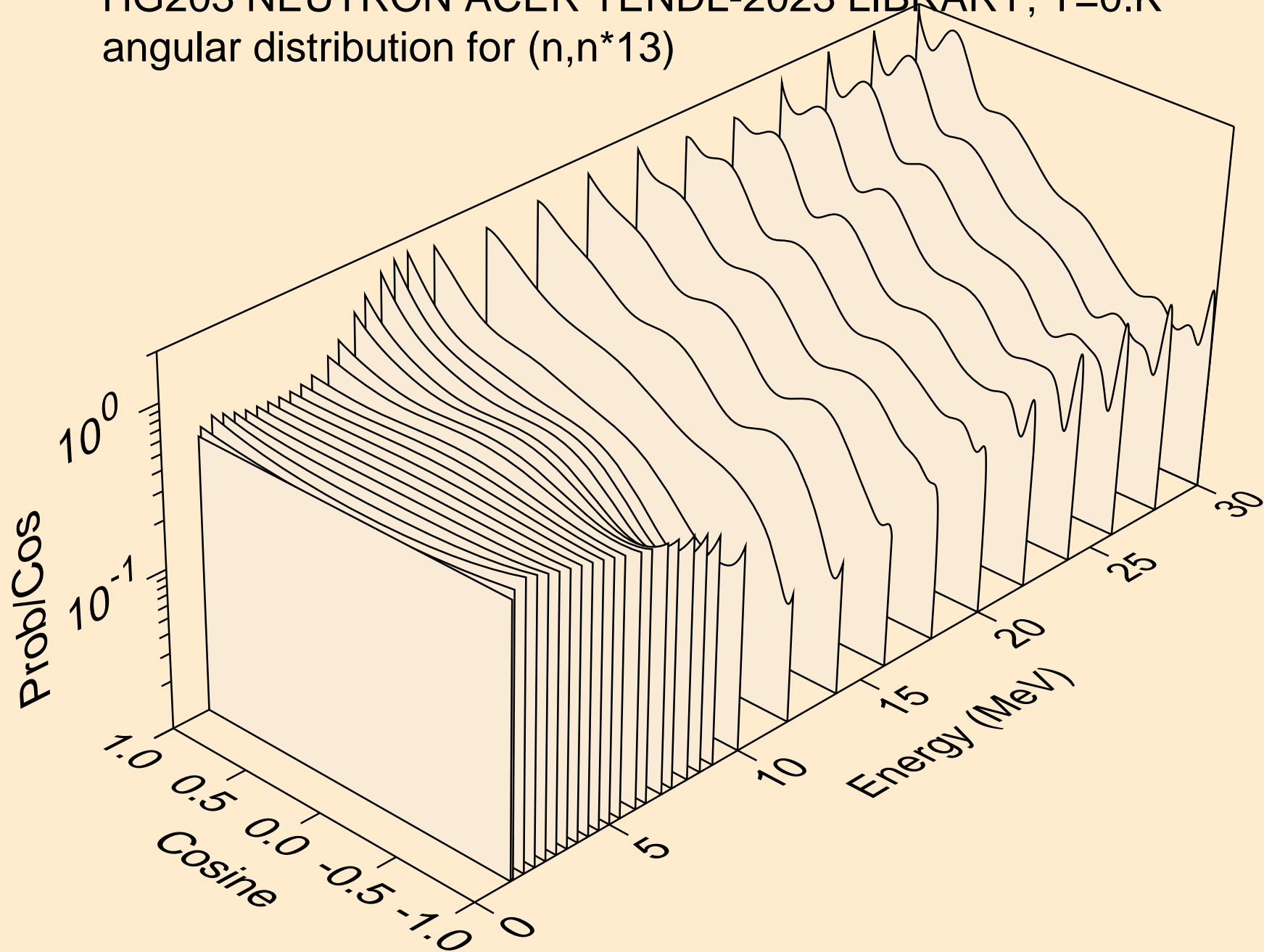



HG203 NEUTRON ACER TENDL-2023 LIBRARY; T=0.K  
angular distribution for (n,n\*14)

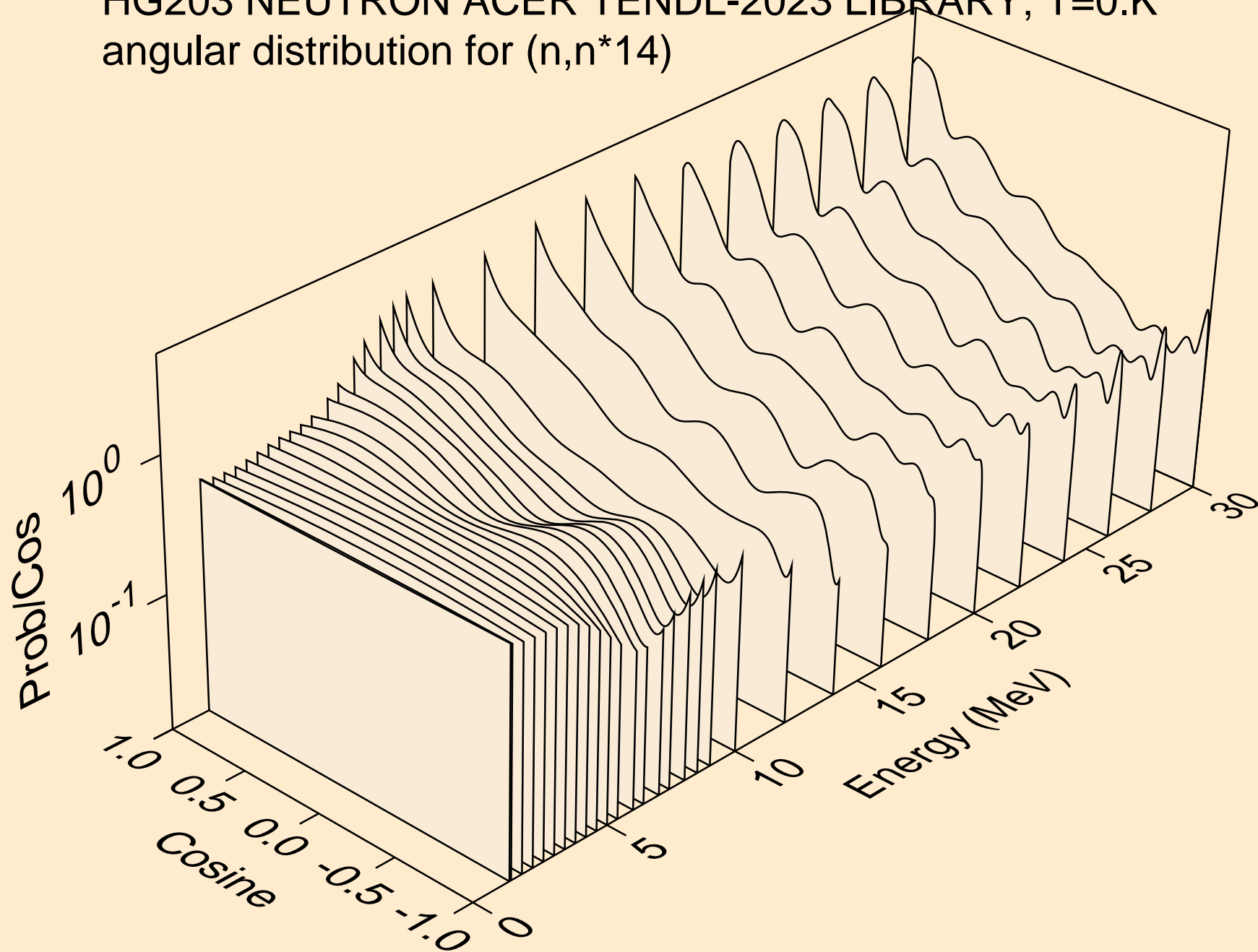

HG203 NEUTRON ACER TENDL-2023 LIBRARY; T=0.K  
angular distribution for (n,n\*15)

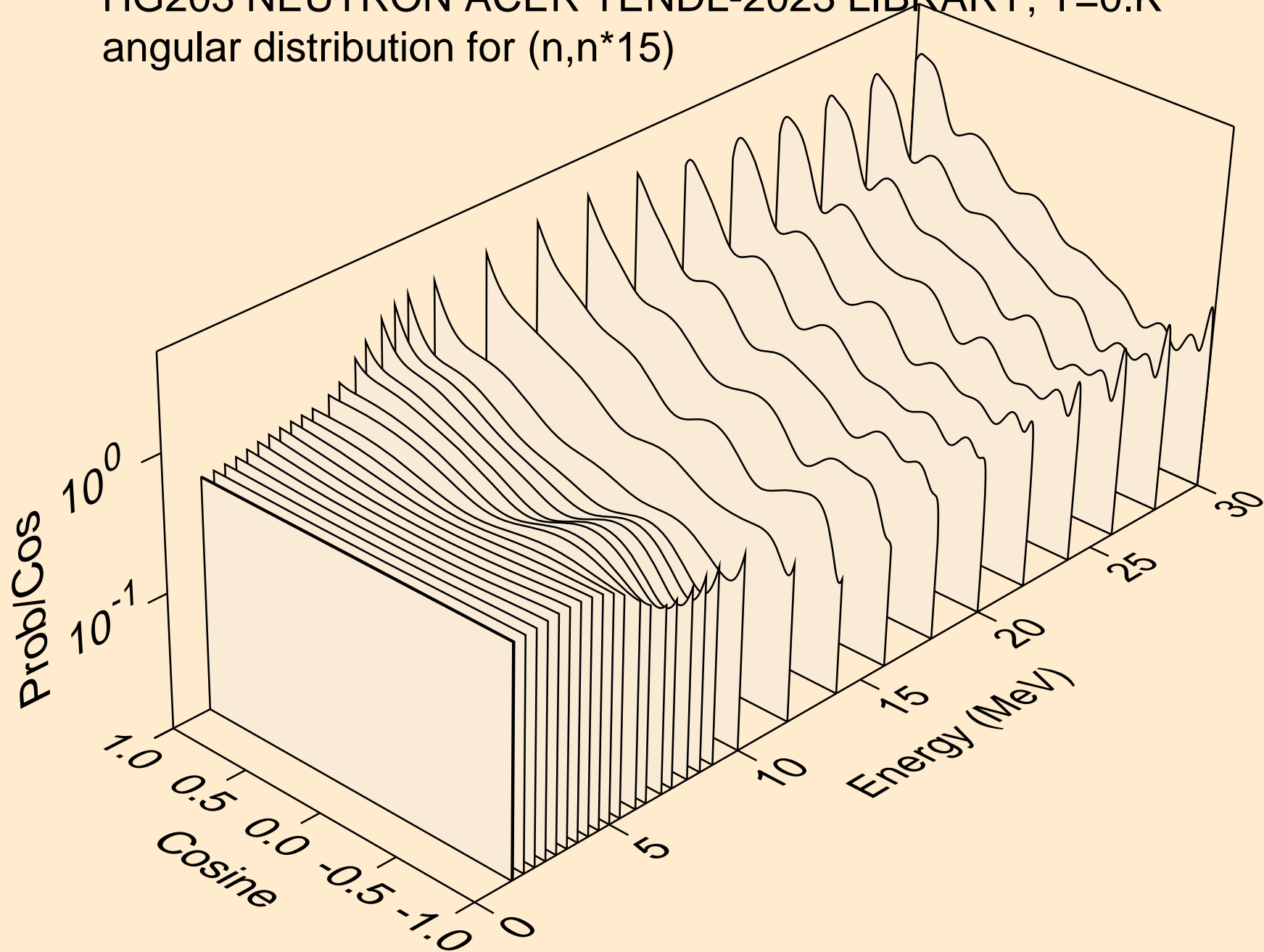

HG203 NEUTRON ACER TENDL-2023 LIBRARY; T=0.K  
angular distribution for (n,n\*16)

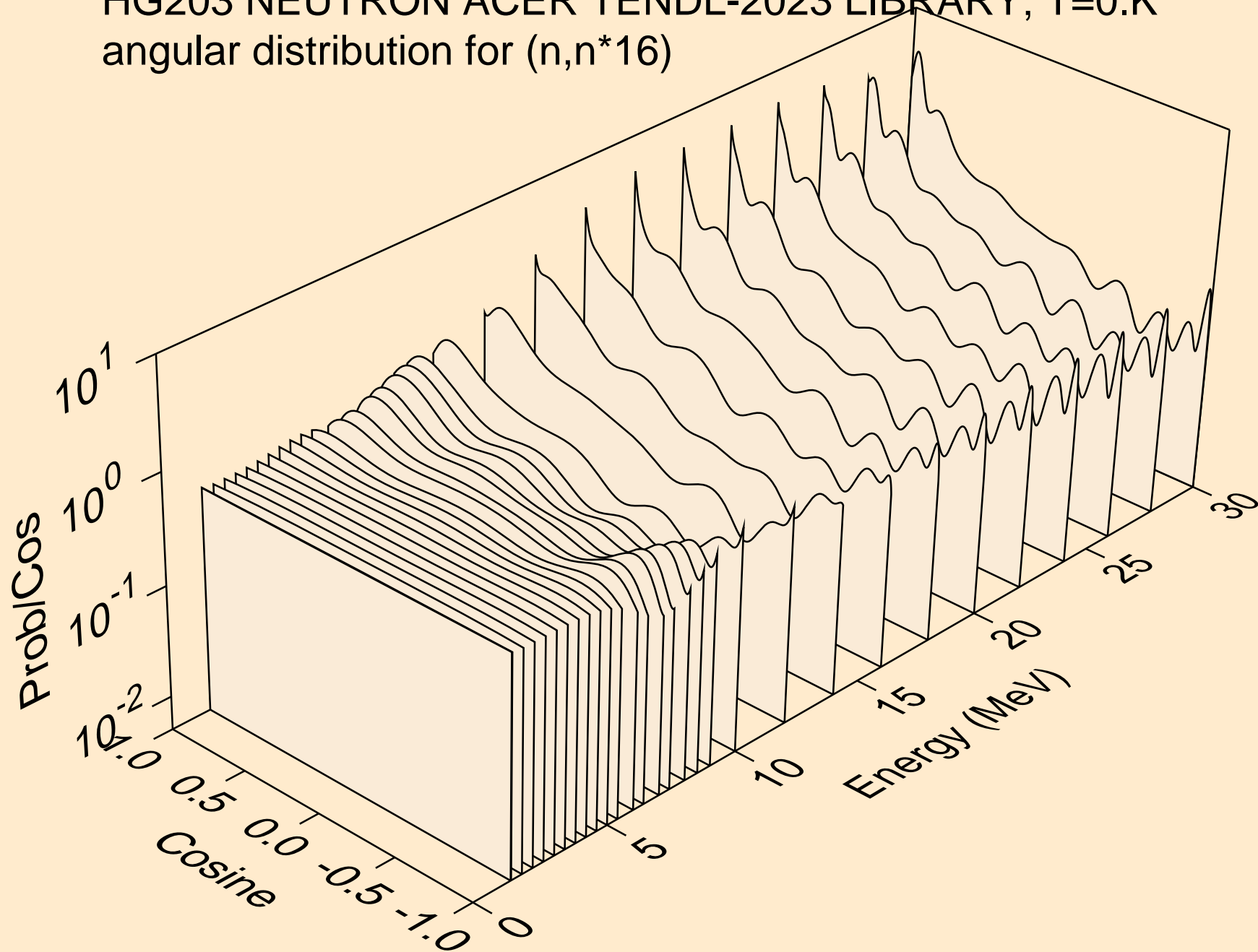

HG203 NEUTRON ACER TENDL-2023 LIBRARY; T=0.K  
angular distribution for (n,n\*17)

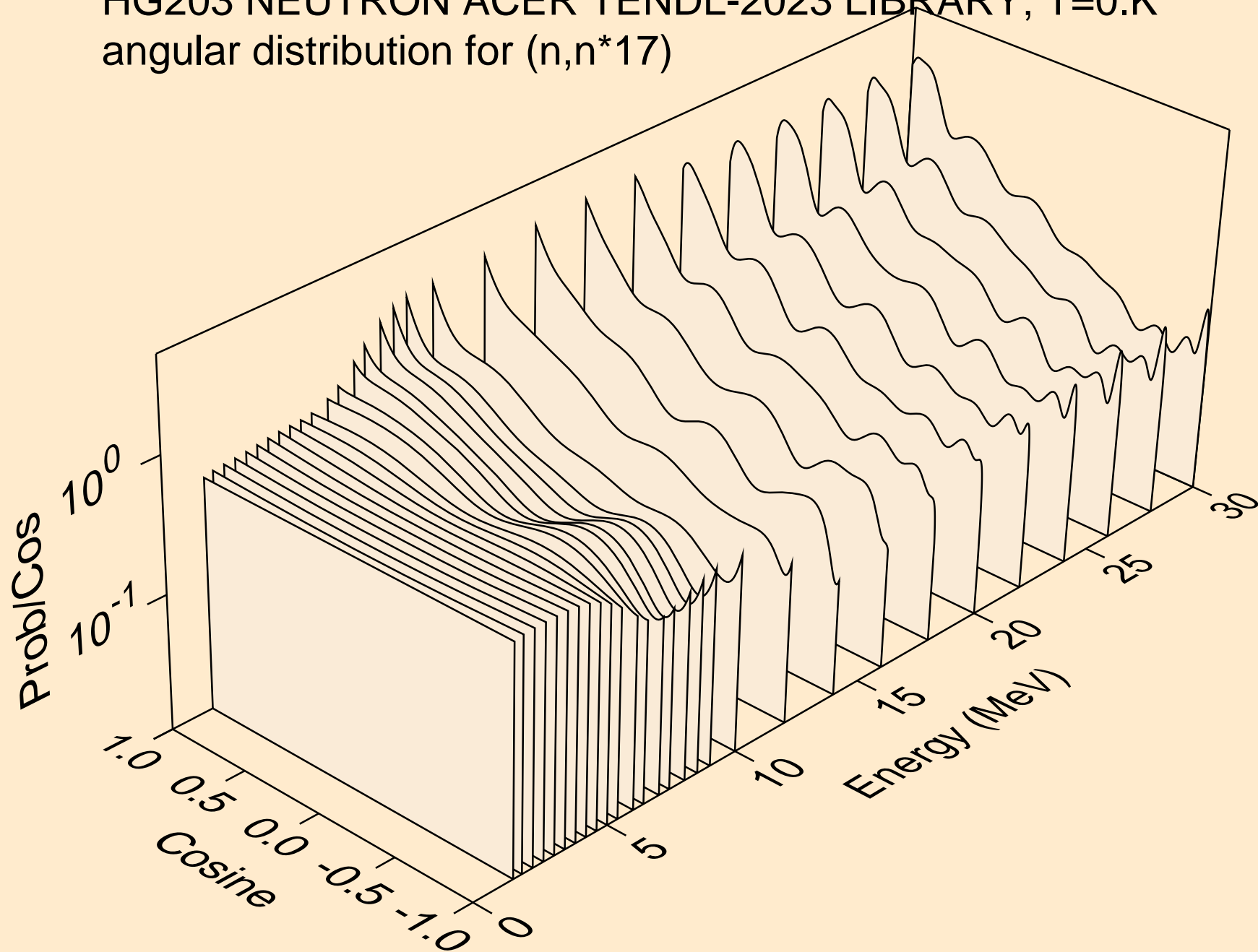

HG203 NEUTRON ACER TENDL-2023 LIBRARY; T=0.K  
Neutron emission for (n,x)

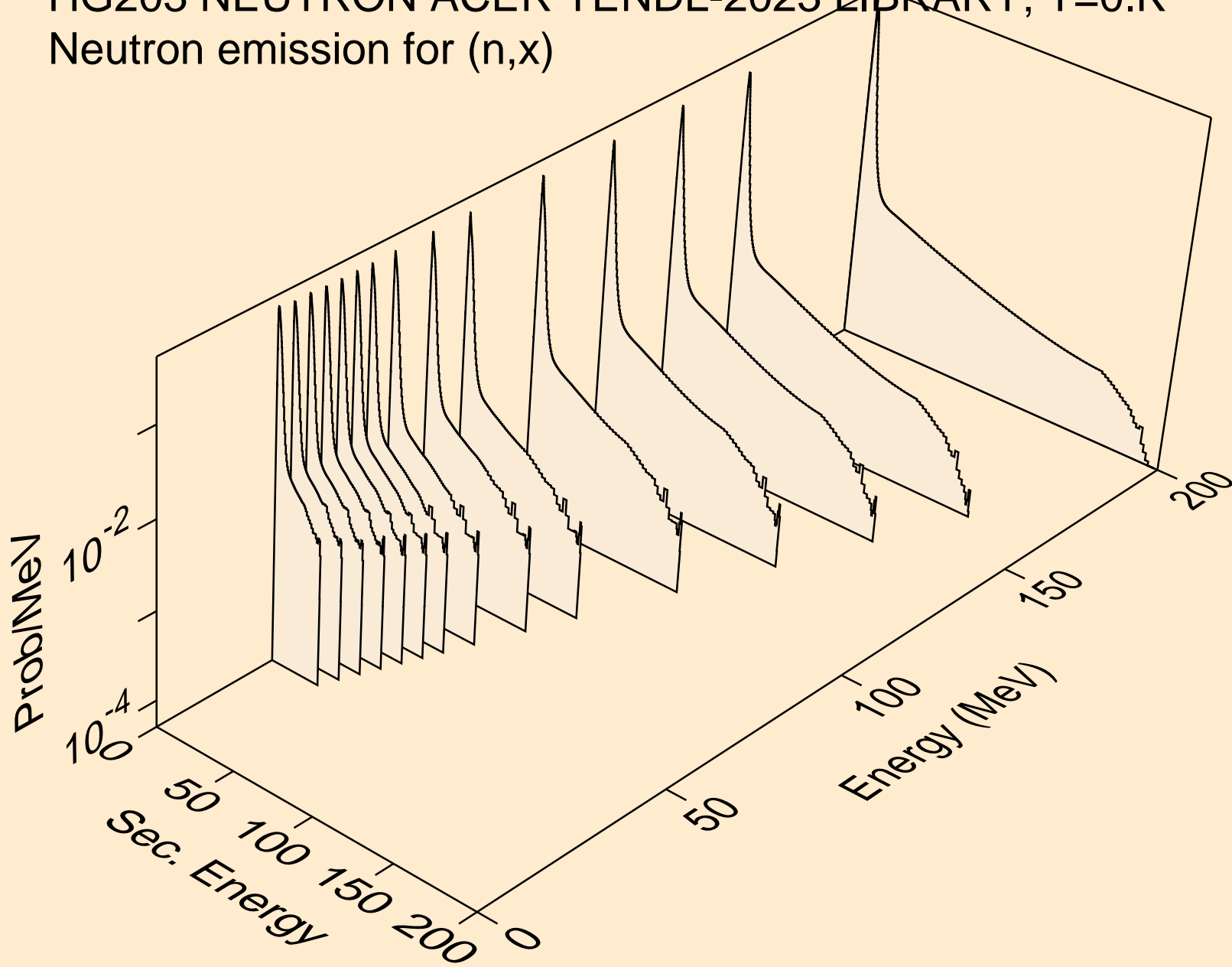

HG203 NEUTRON ACER TENDL-2023 LIBRARY; T=0.K  
Neutron emission for (n,2nd)

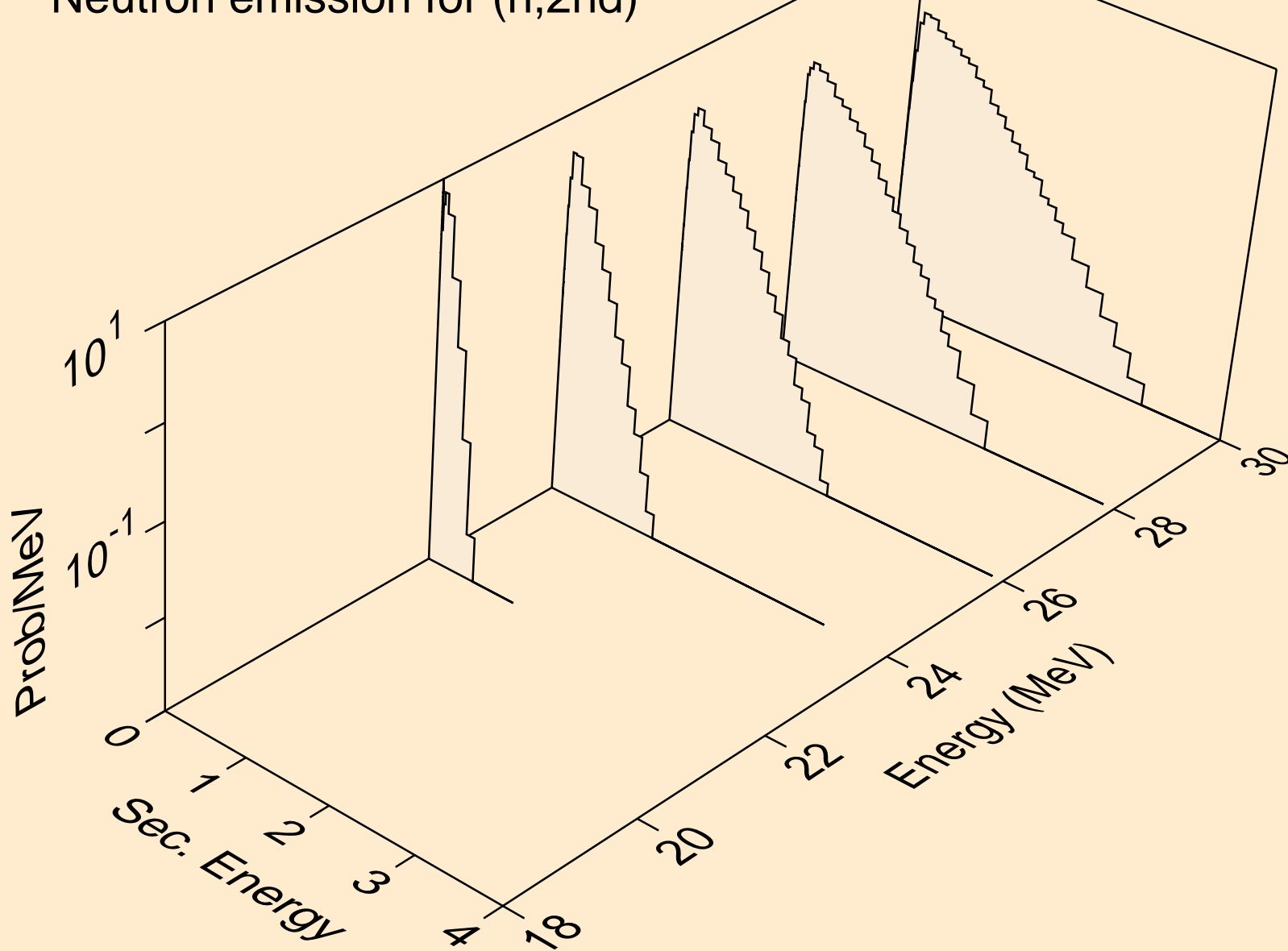

HG203 NEUTRON ACER TENDL-2023 LIBRARY; T=0.K  
Neutron emission for (n,2n)

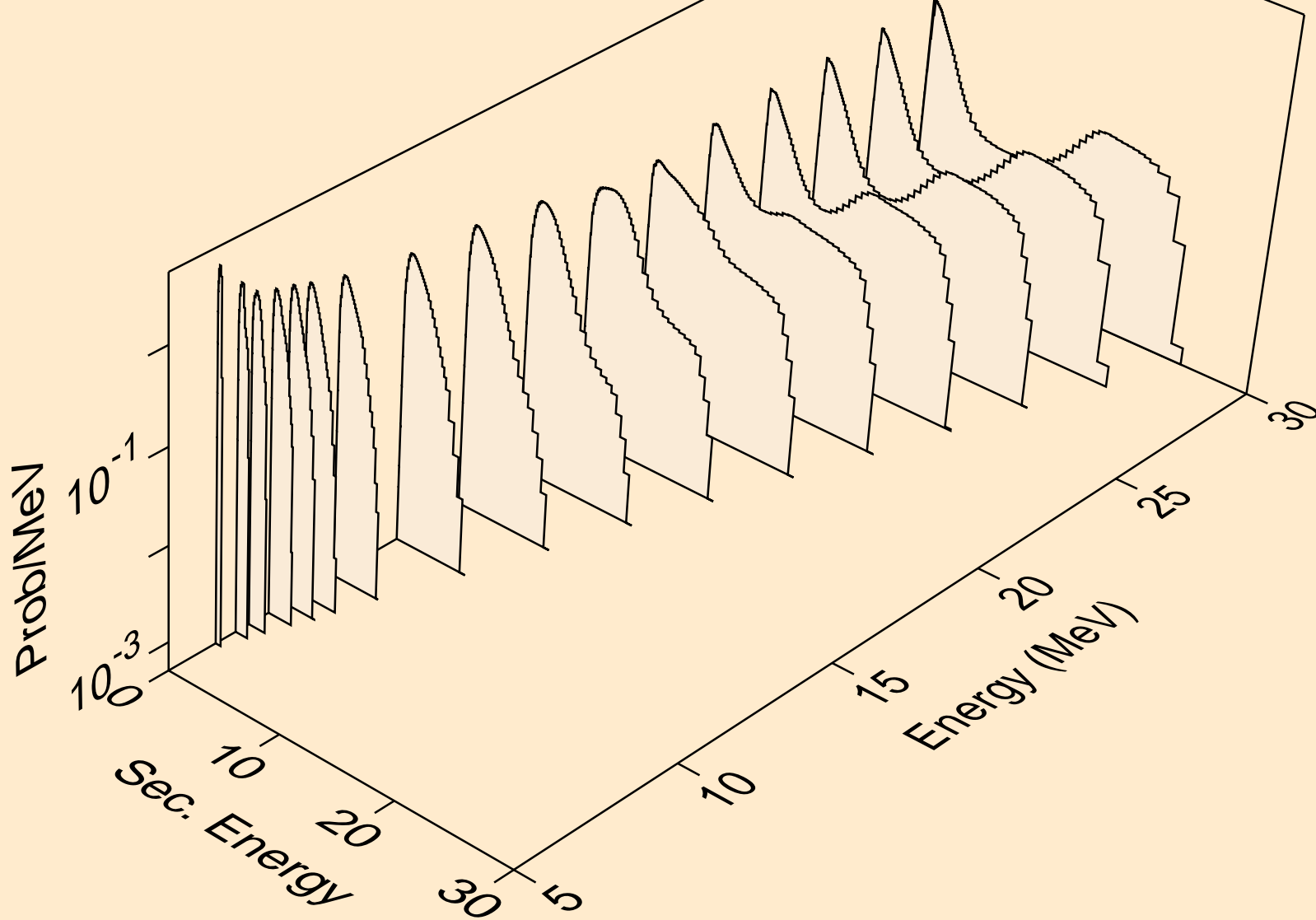

HG203 NEUTRON ACER TENDL-2023 LIBRARY; T=0.K  
Neutron emission for (n,3n)

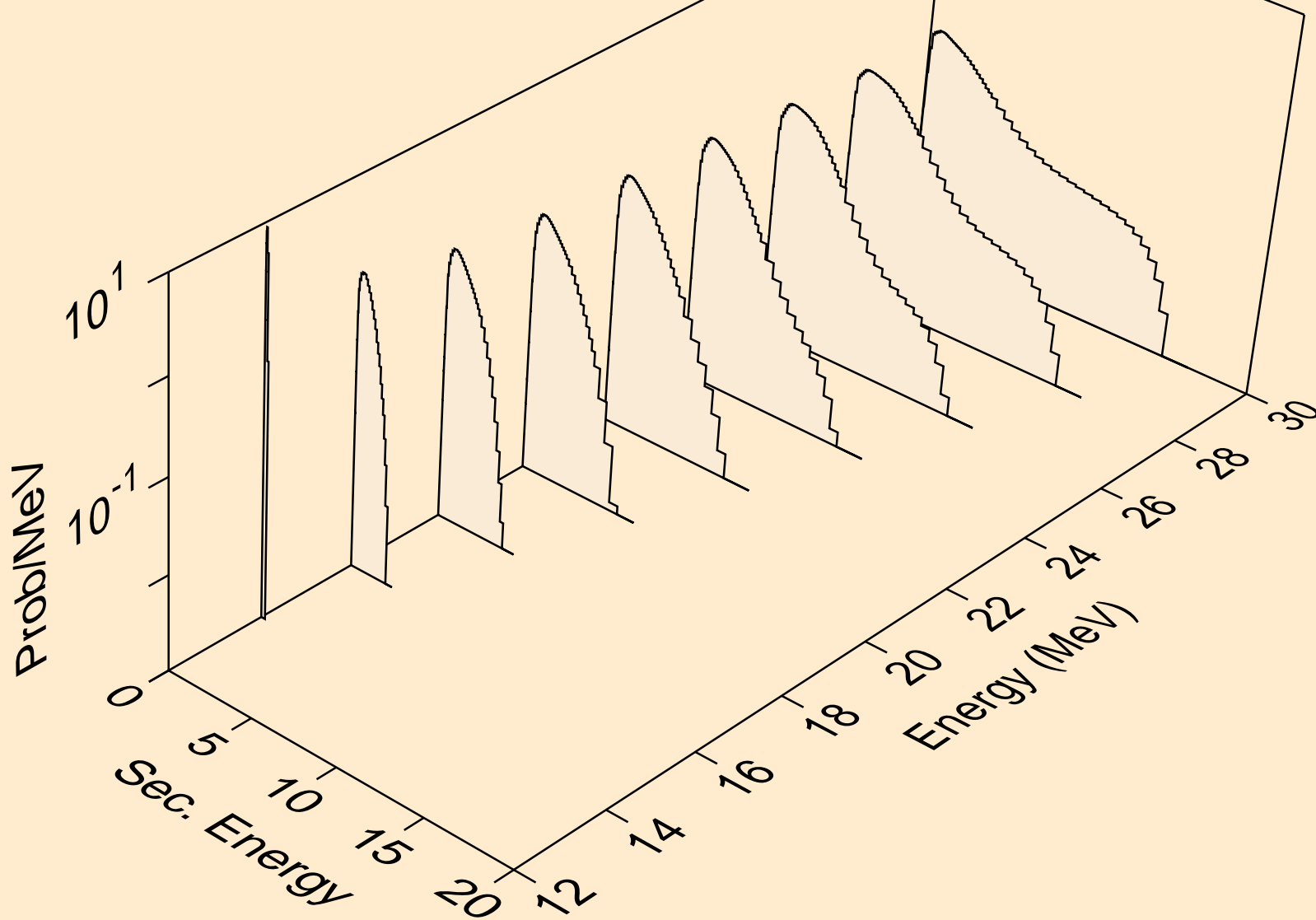



HG203 NEUTRON ACER TENDL-2023 LIBRARY; T=0.K  
Neutron emission for (n,n\*)a

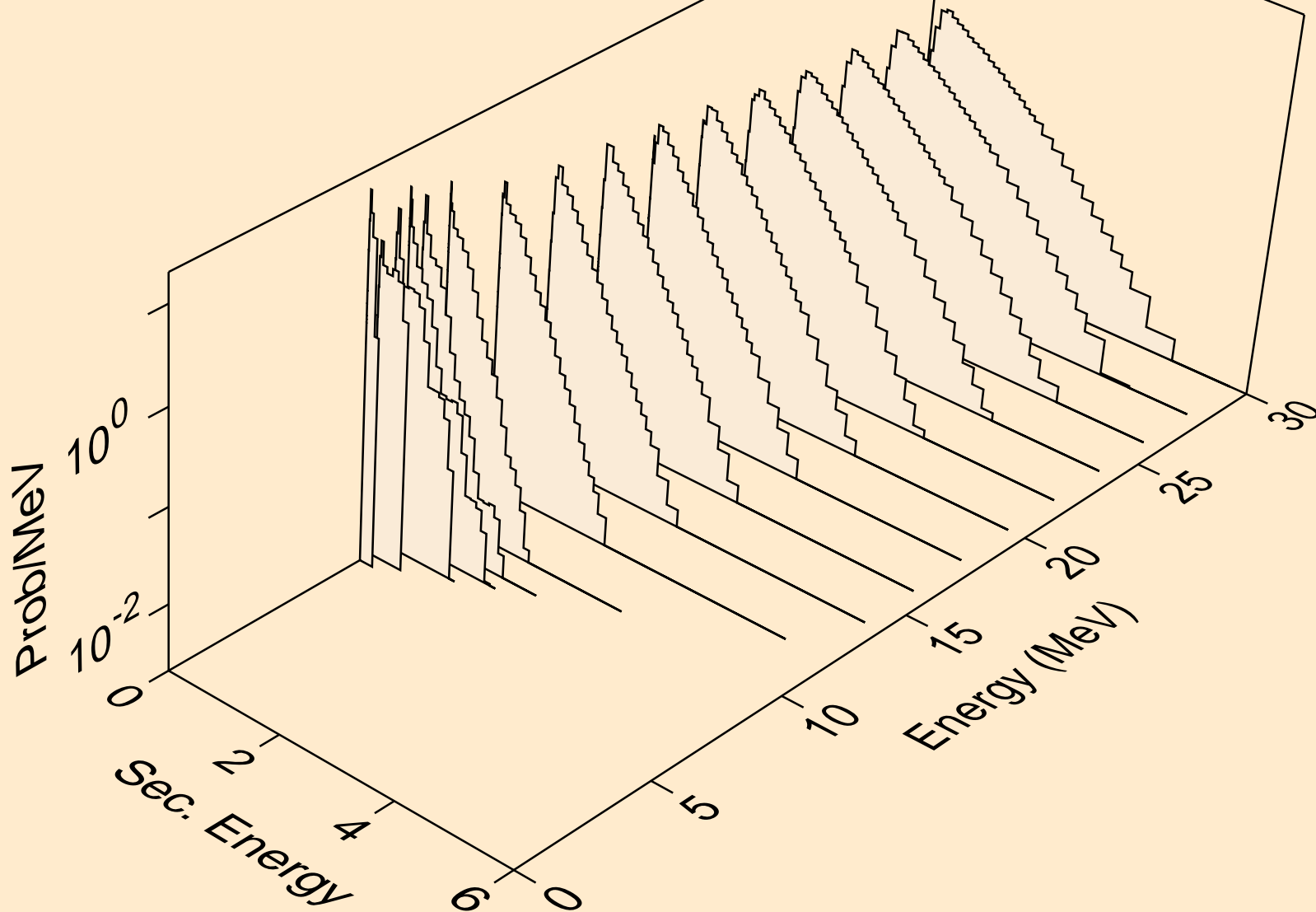

HG203 NEUTRON ACER TENDL-2023 LIBRARY; T=0.K  
Neutron emission for (n,2n)a

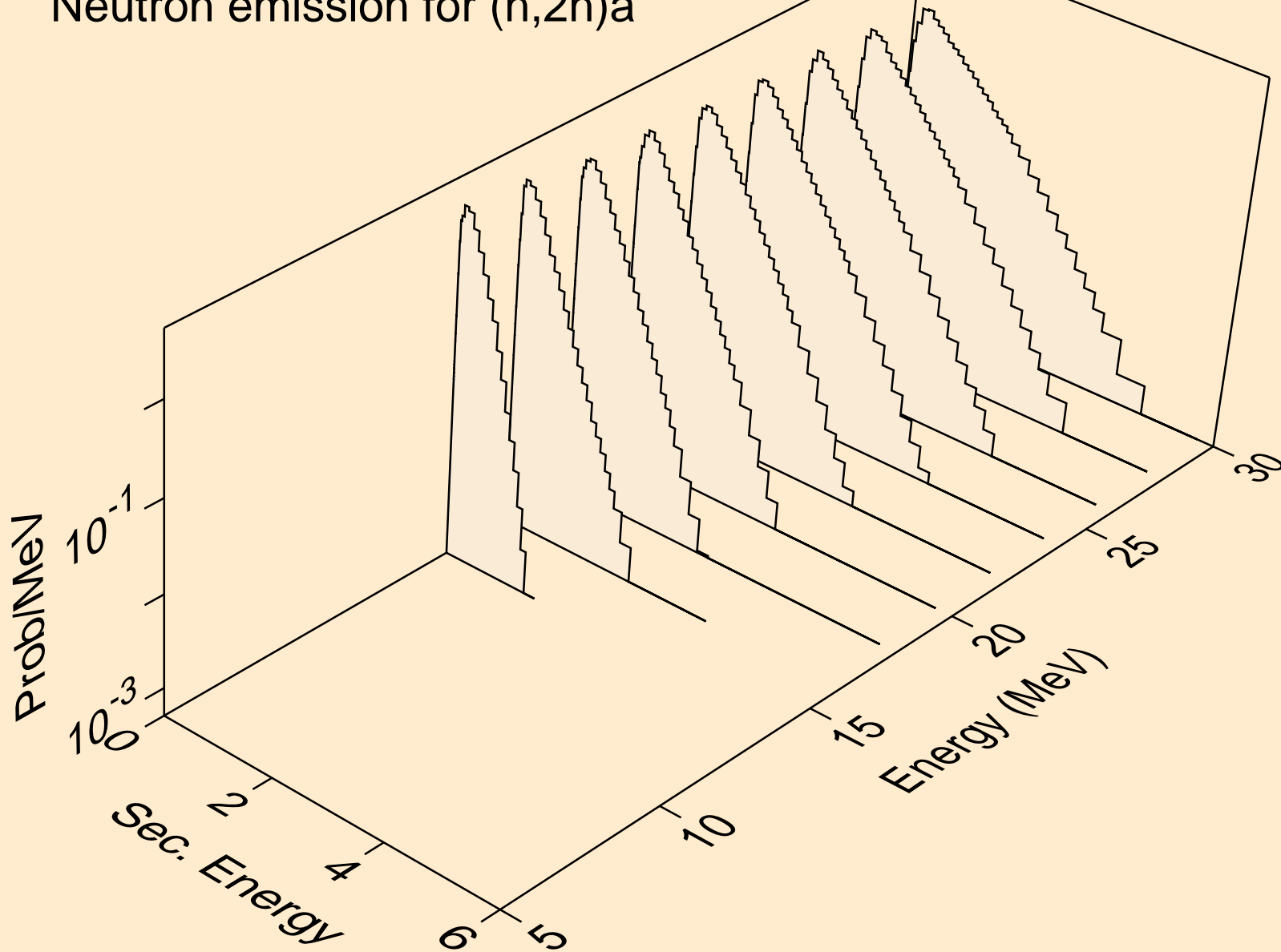

HG203 NEUTRON ACER TENDL-2023 LIBRARY; T=0.K  
Neutron emission for (n,3n)a

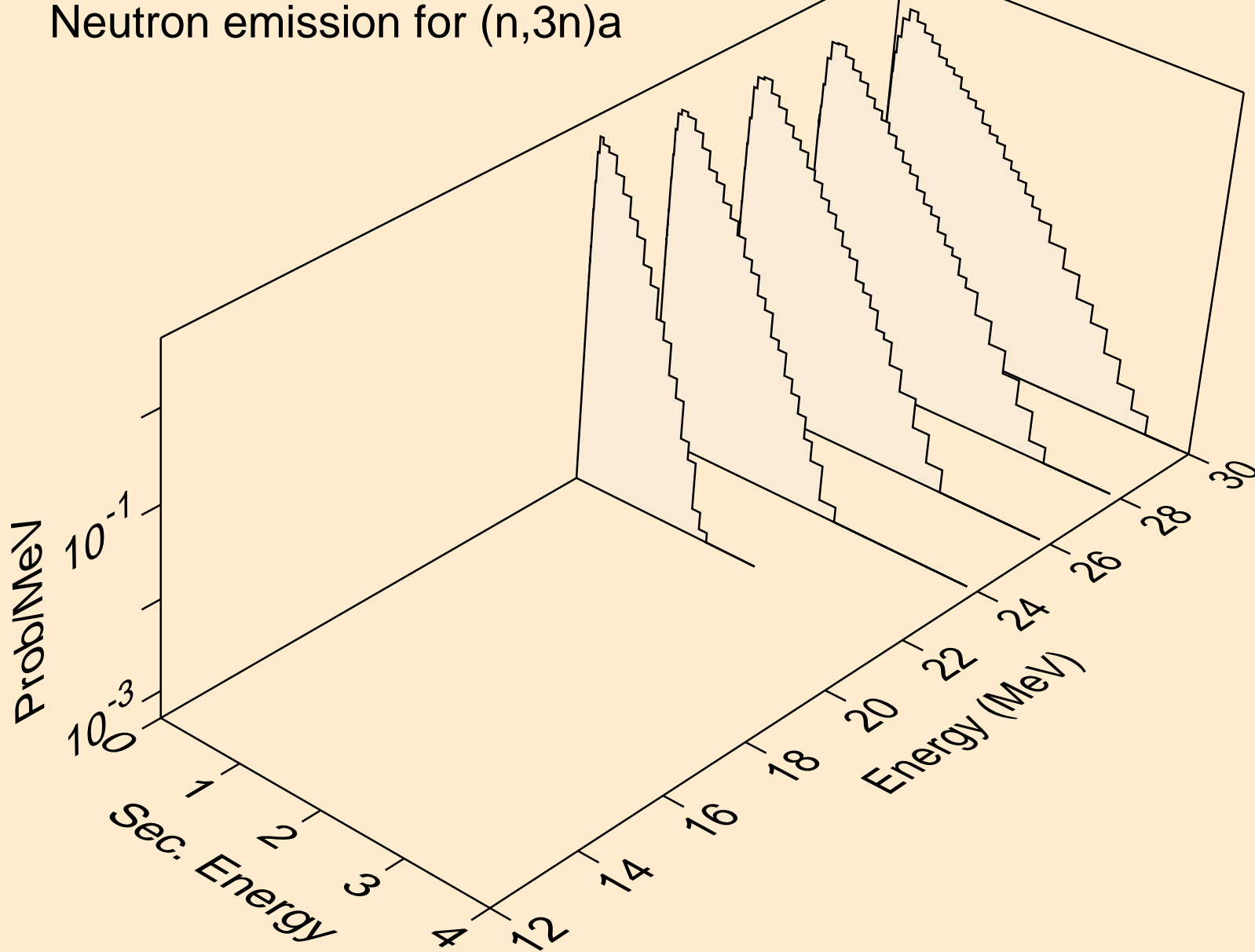

HG203 NEUTRON ACER TENDL-2023 LIBRARY; T=0.K  
Neutron emission for (n,n\*)p

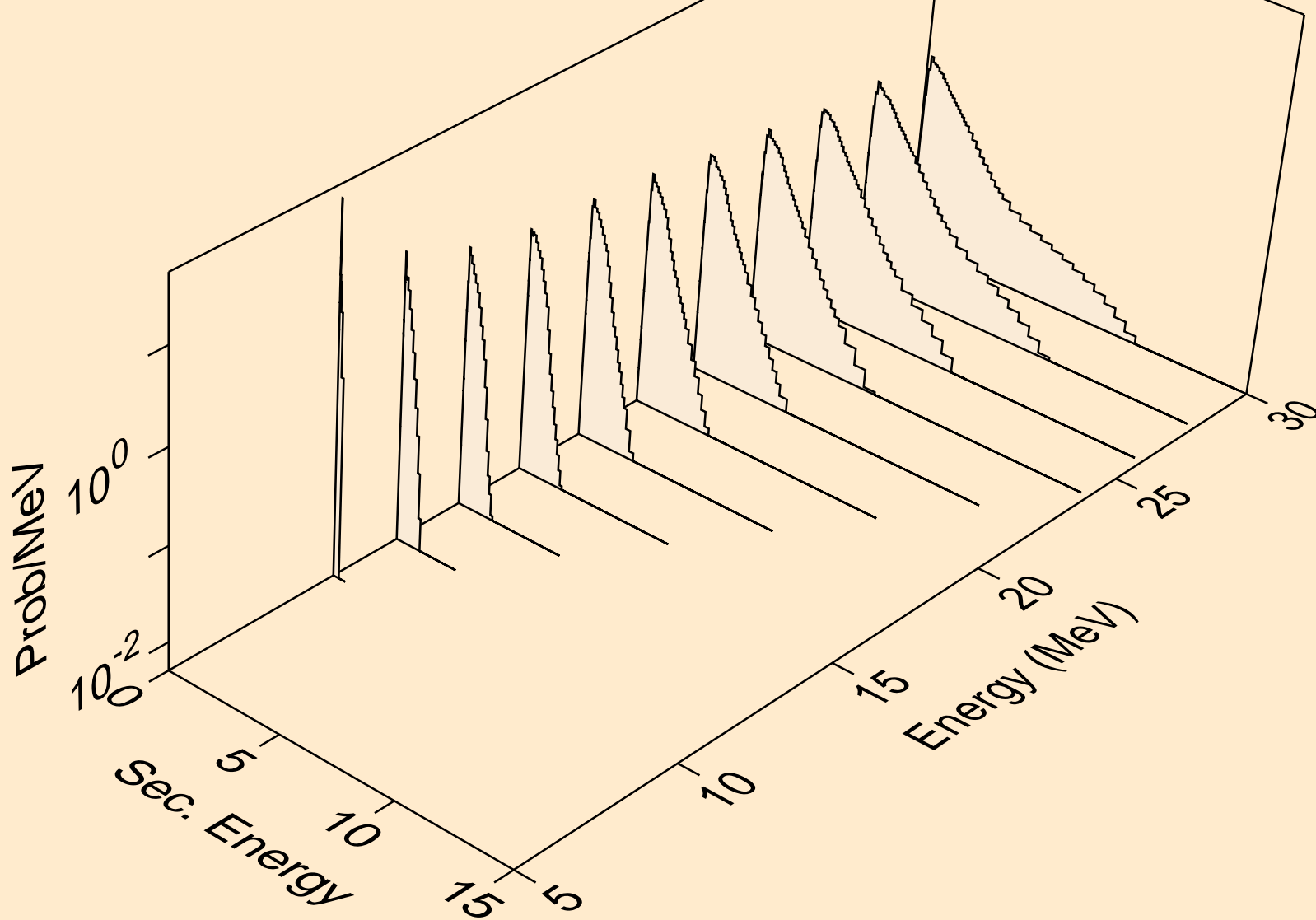

HG203 NEUTRON ACER TENDL-2023 LIBRARY; T=0.K  
Neutron emission for (n,n\*)d

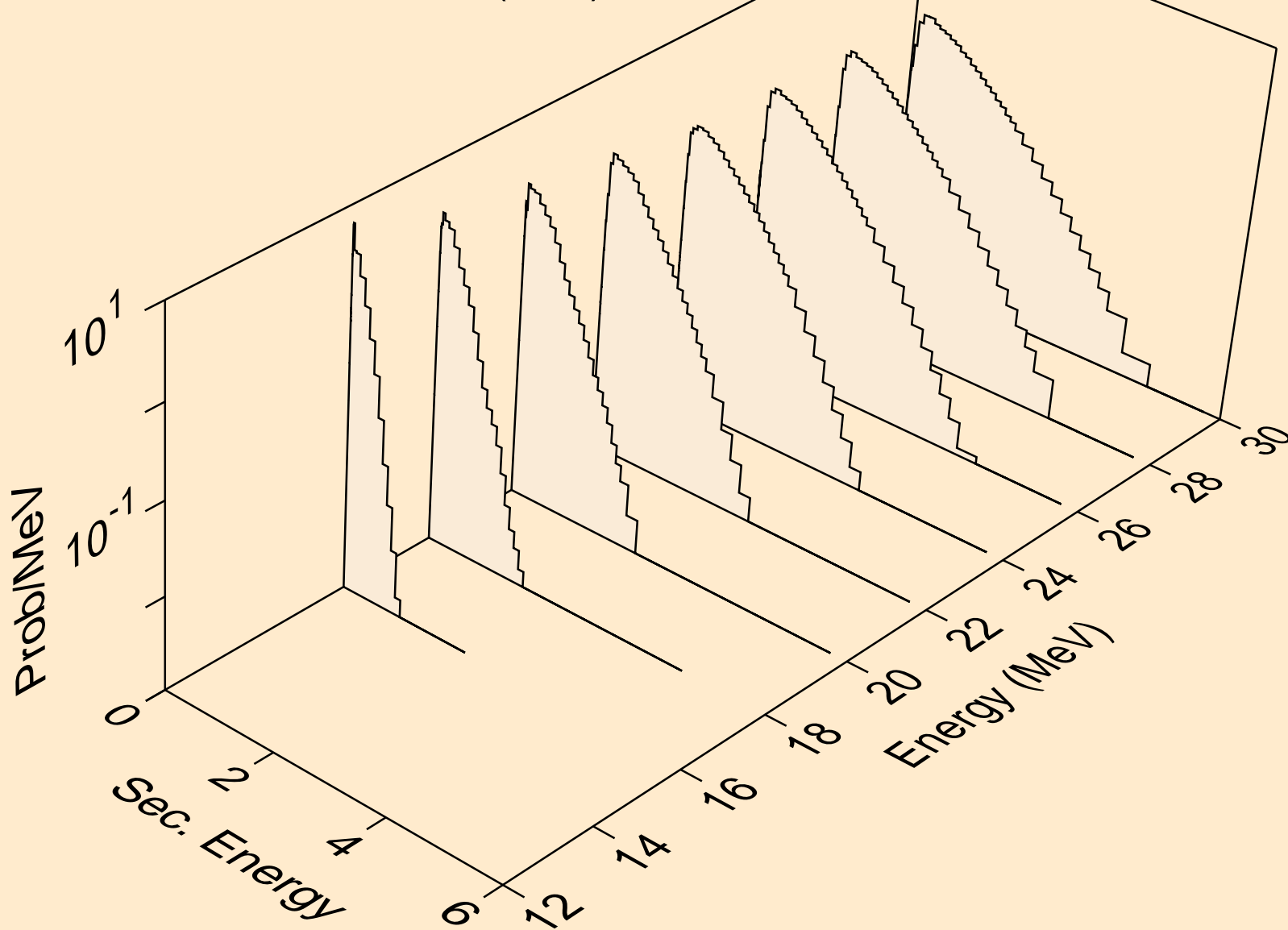

HG203 NEUTRON ACER TENDL-2023 LIBRARY; T=0.K  
Neutron emission for (n,n\*)t

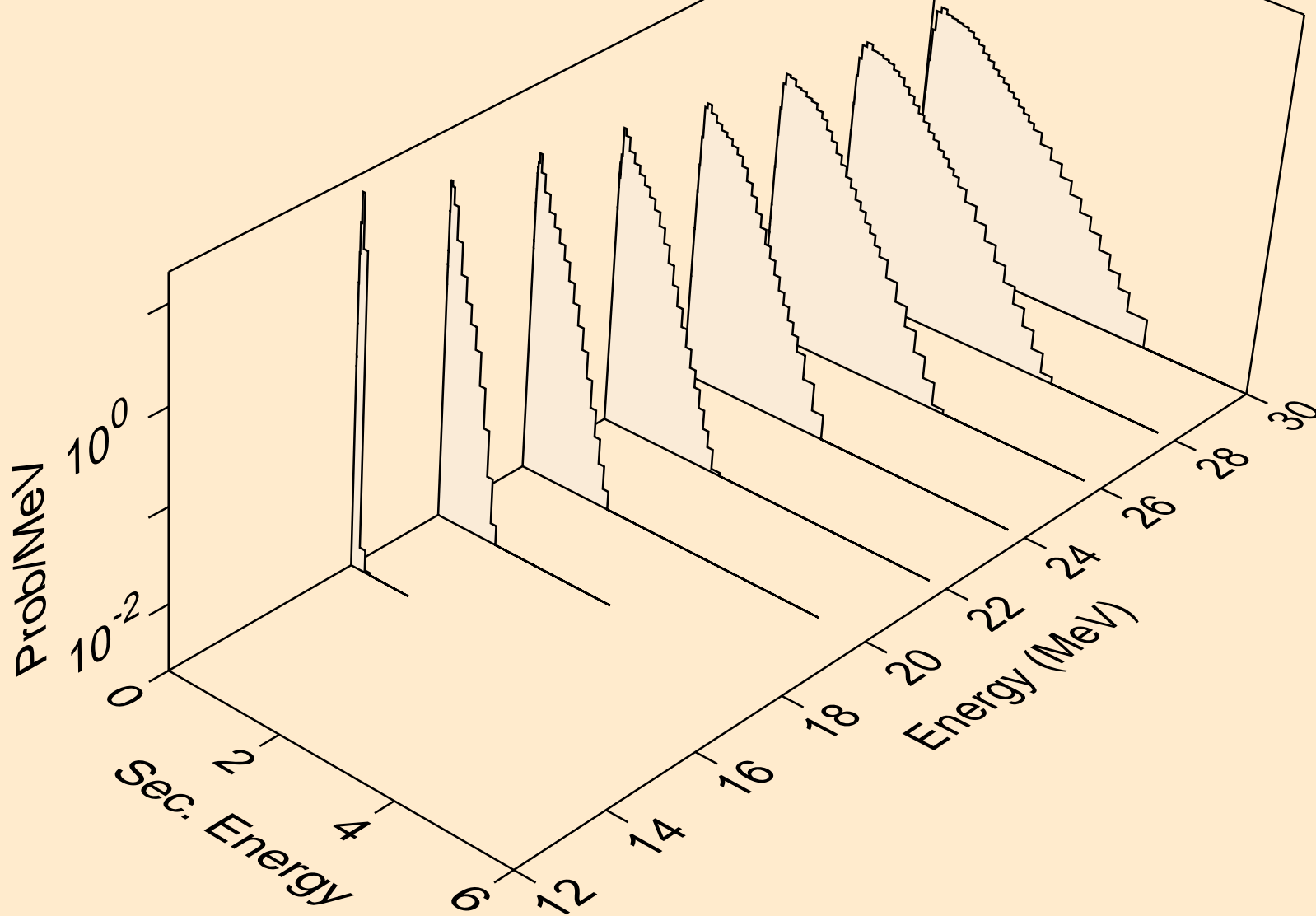

HG203 NEUTRON ACER TENDL-2023 LIBRARY; T=0.K  
Neutron emission for (n,n\*)he3

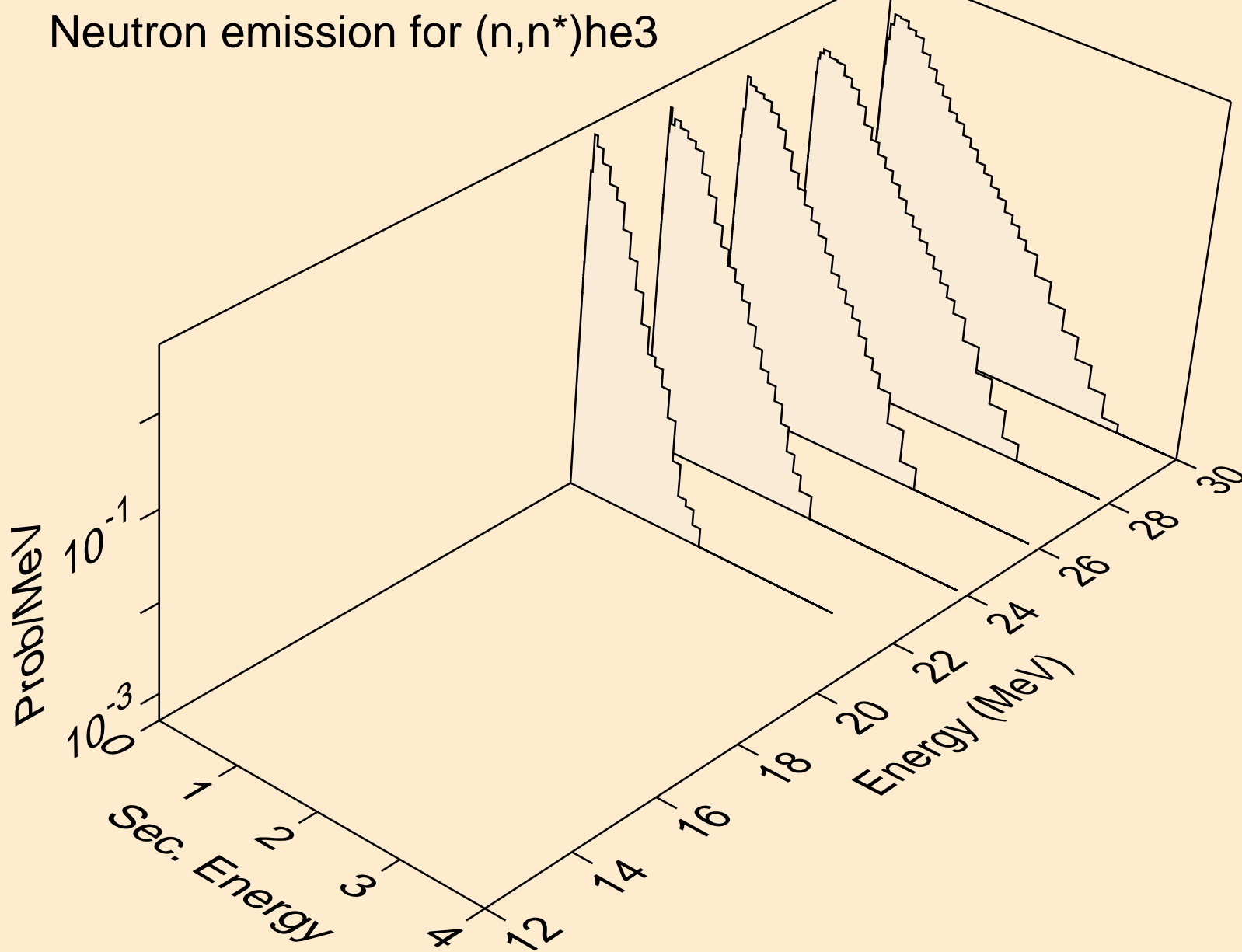

HG203 NEUTRON ACER TENDL-2023 LIBRARY; T=0.K  
Neutron emission for (n,4n)

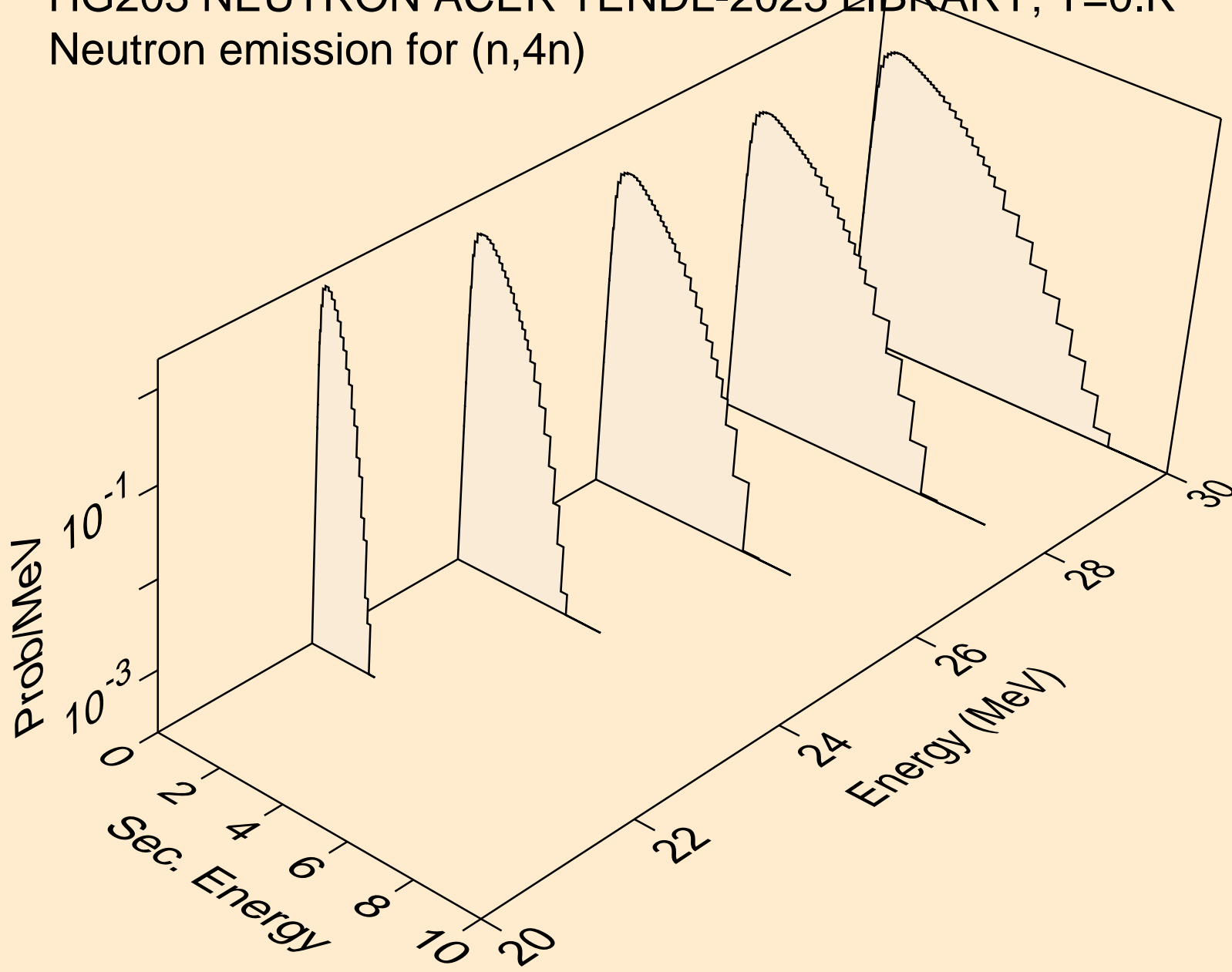



HG203 NEUTRON ACER TENDL-2023 LIBRARY; T=0.K  
Neutron emission for (n,2np)

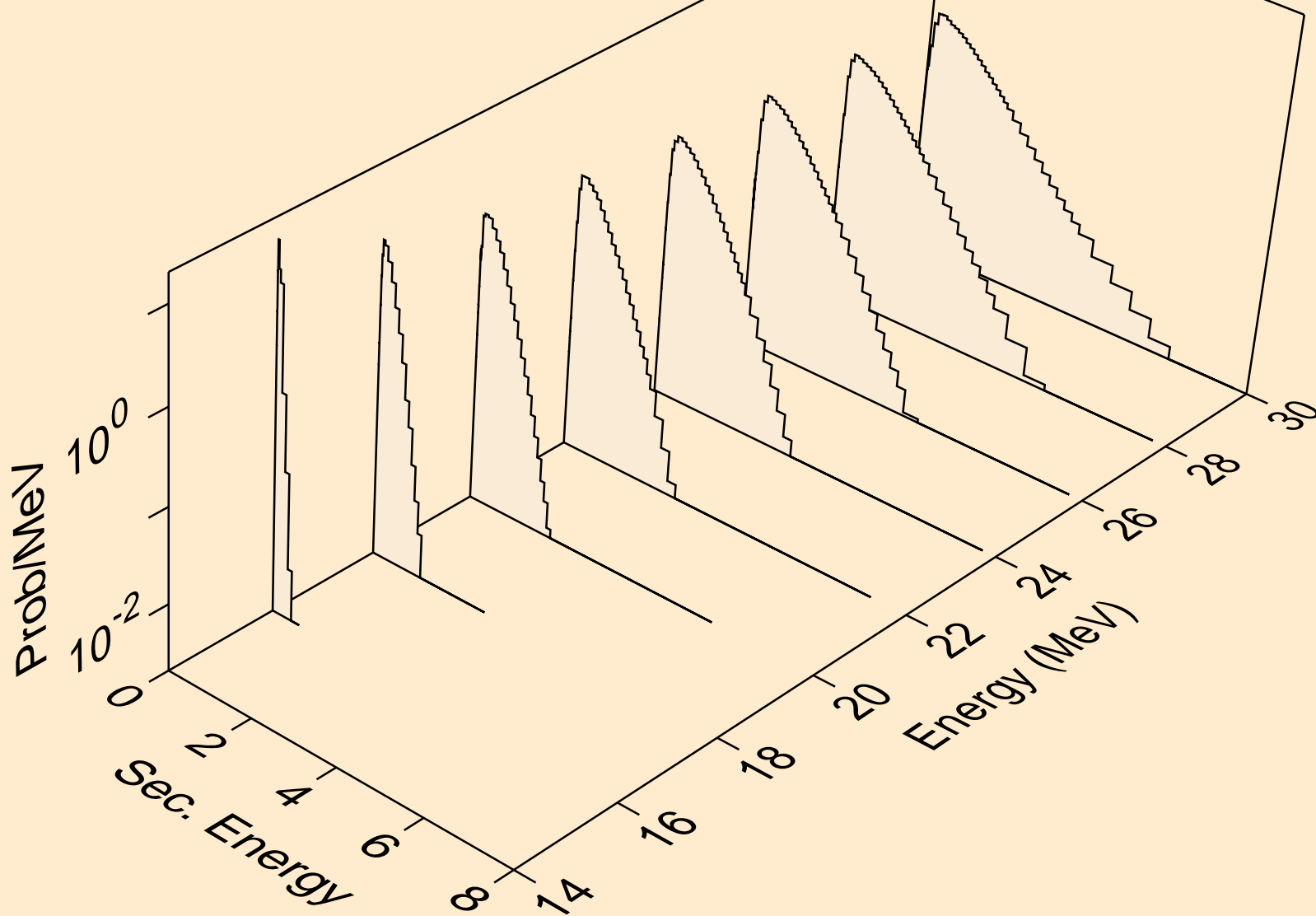

HG203 NEUTRON ACER TENDL-2023 LIBRARY; T=0.K  
Neutron emission for (n,3np)

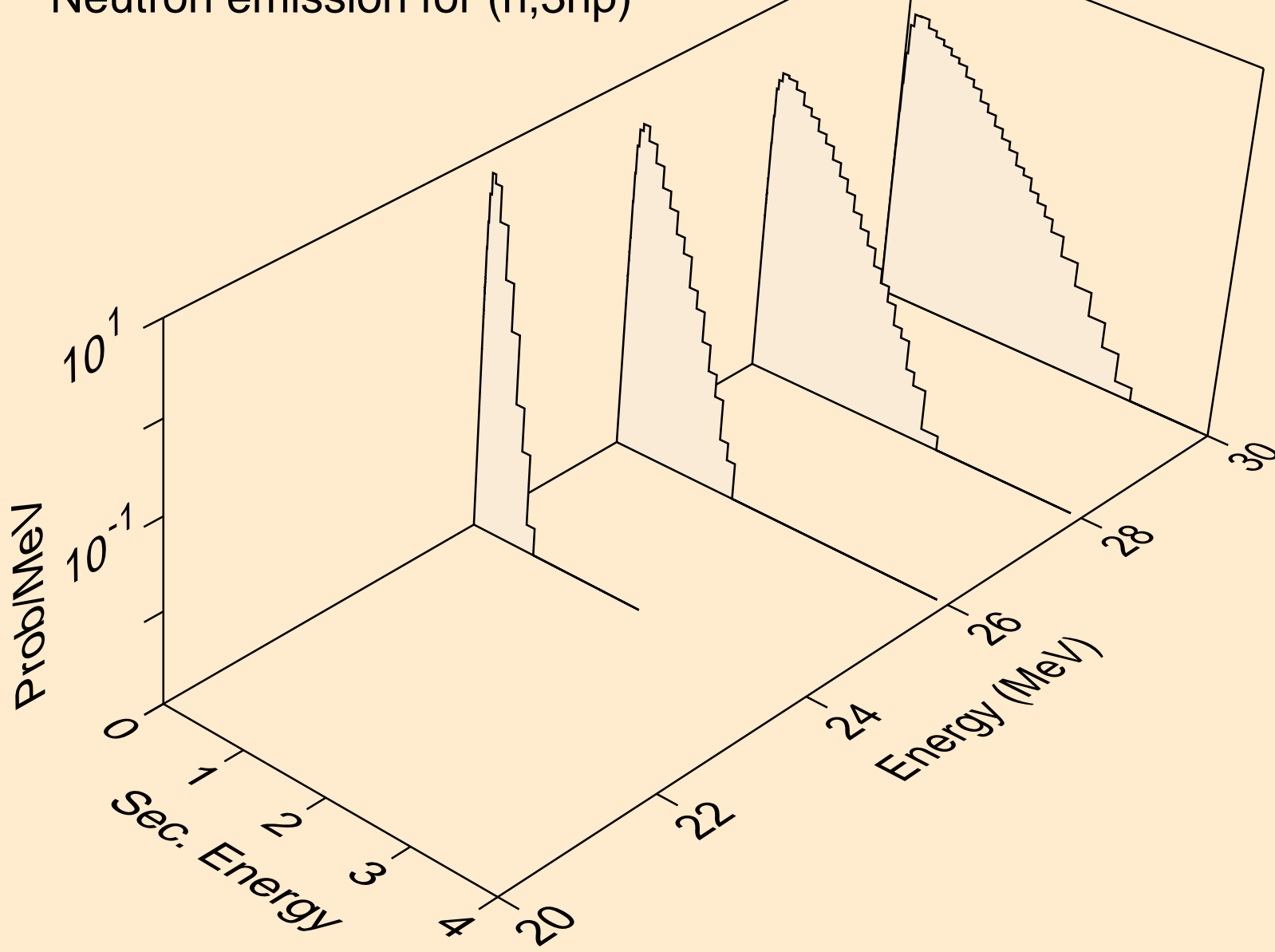

HG203 NEUTRON ACER TENDL-2023 LIBRARY; T=0.K  
Neutron emission for (n,n\*c)

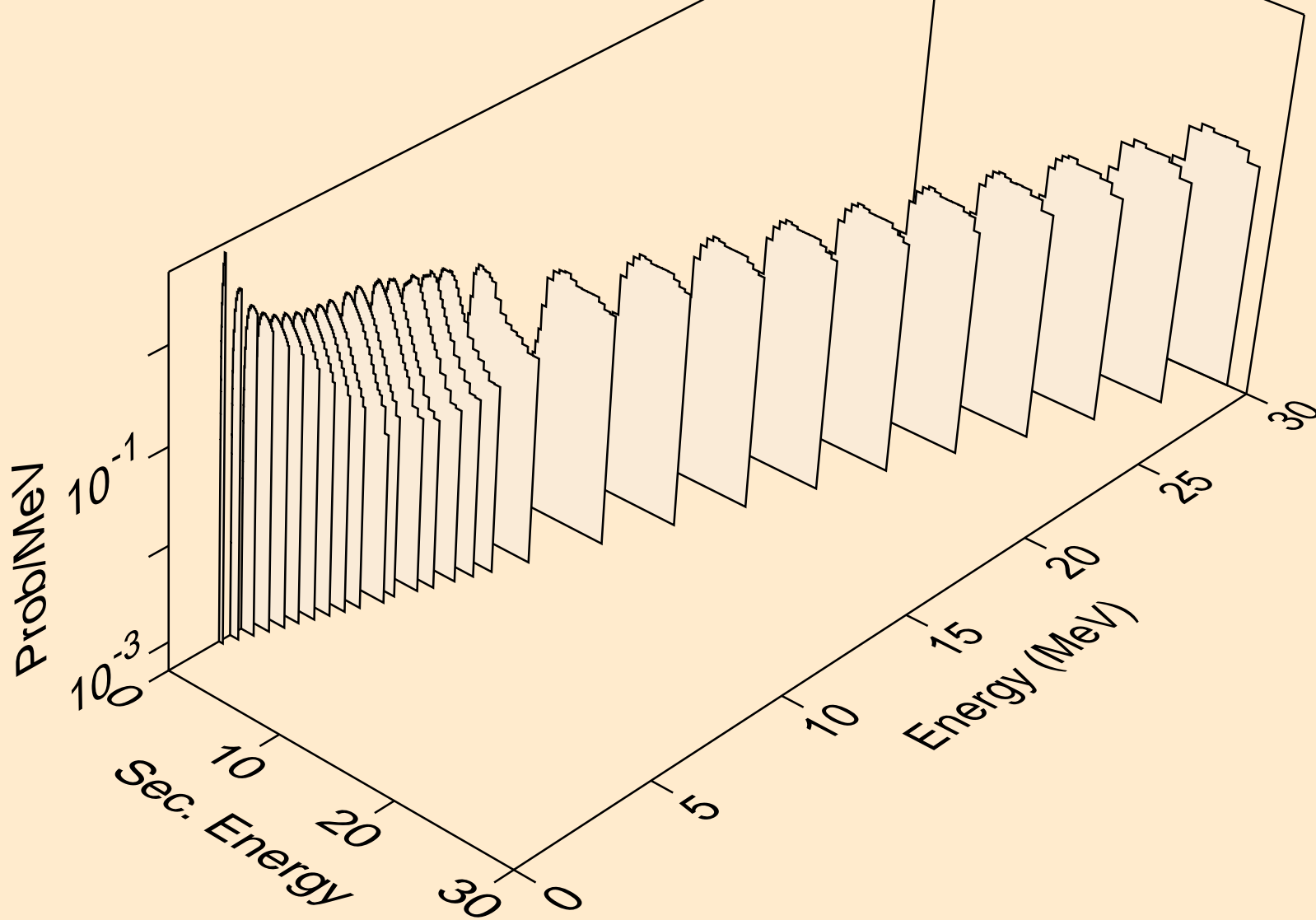

HG203 NEUTRON ACER TENDL-2023 LIBRARY; T=0.K  
Photon emission for (n,x)

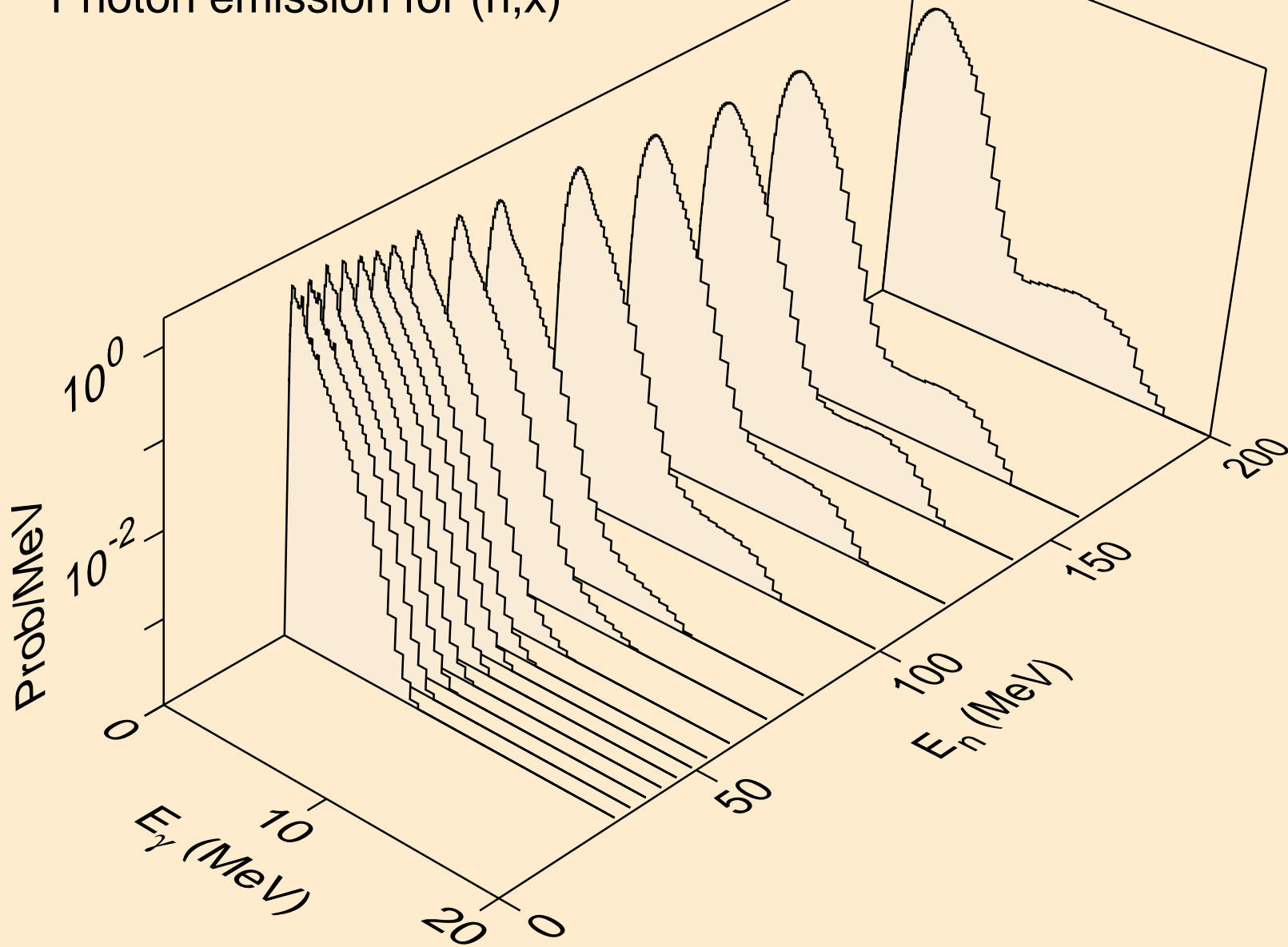

HG203 NEUTRON ACER TENDL-2023 LIBRARY; T=0.K  
Photon emission for (n,2nd)

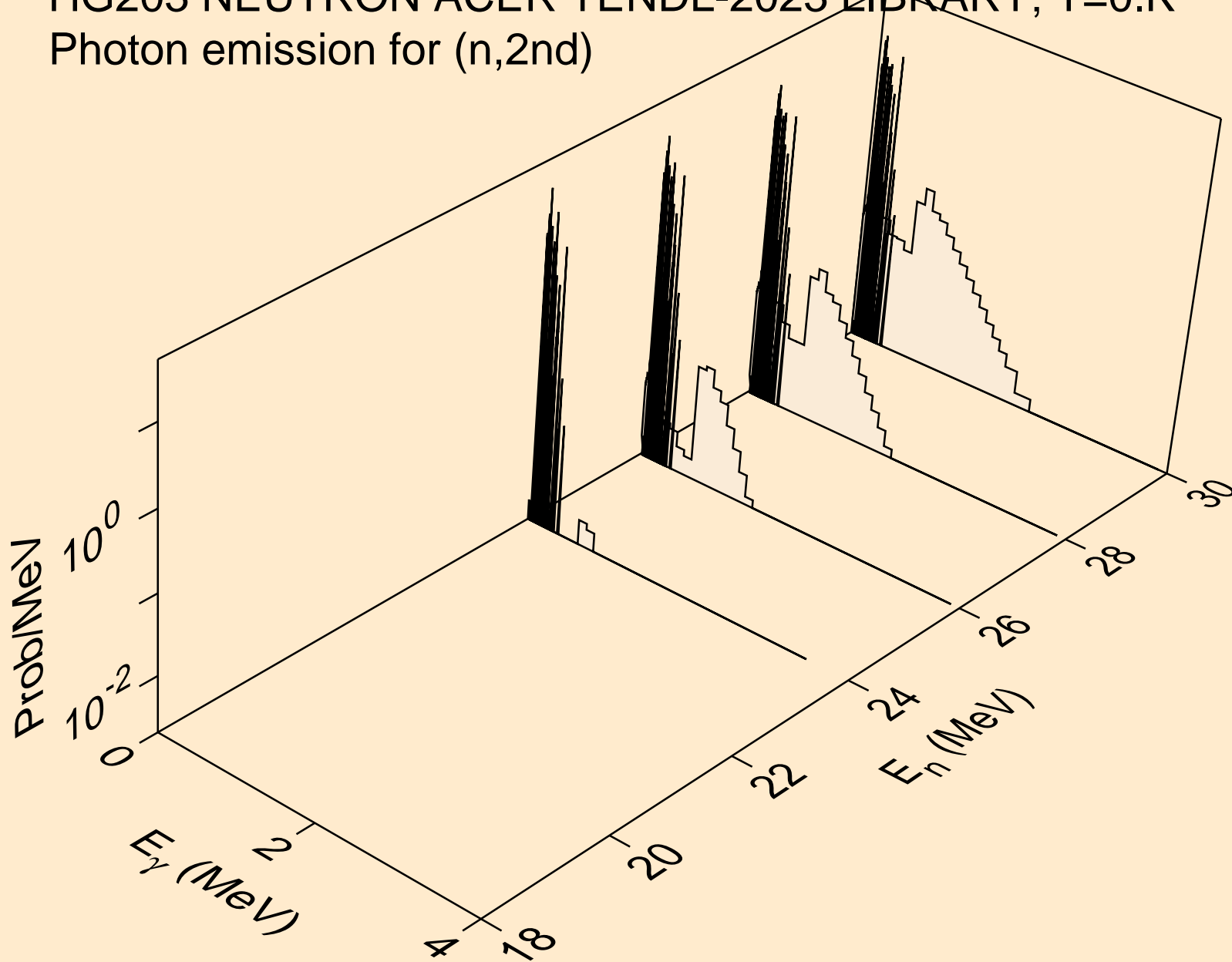

HG203 NEUTRON ACER TENDL-2023 LIBRARY; T=0.K  
Photon emission for (n,2n)

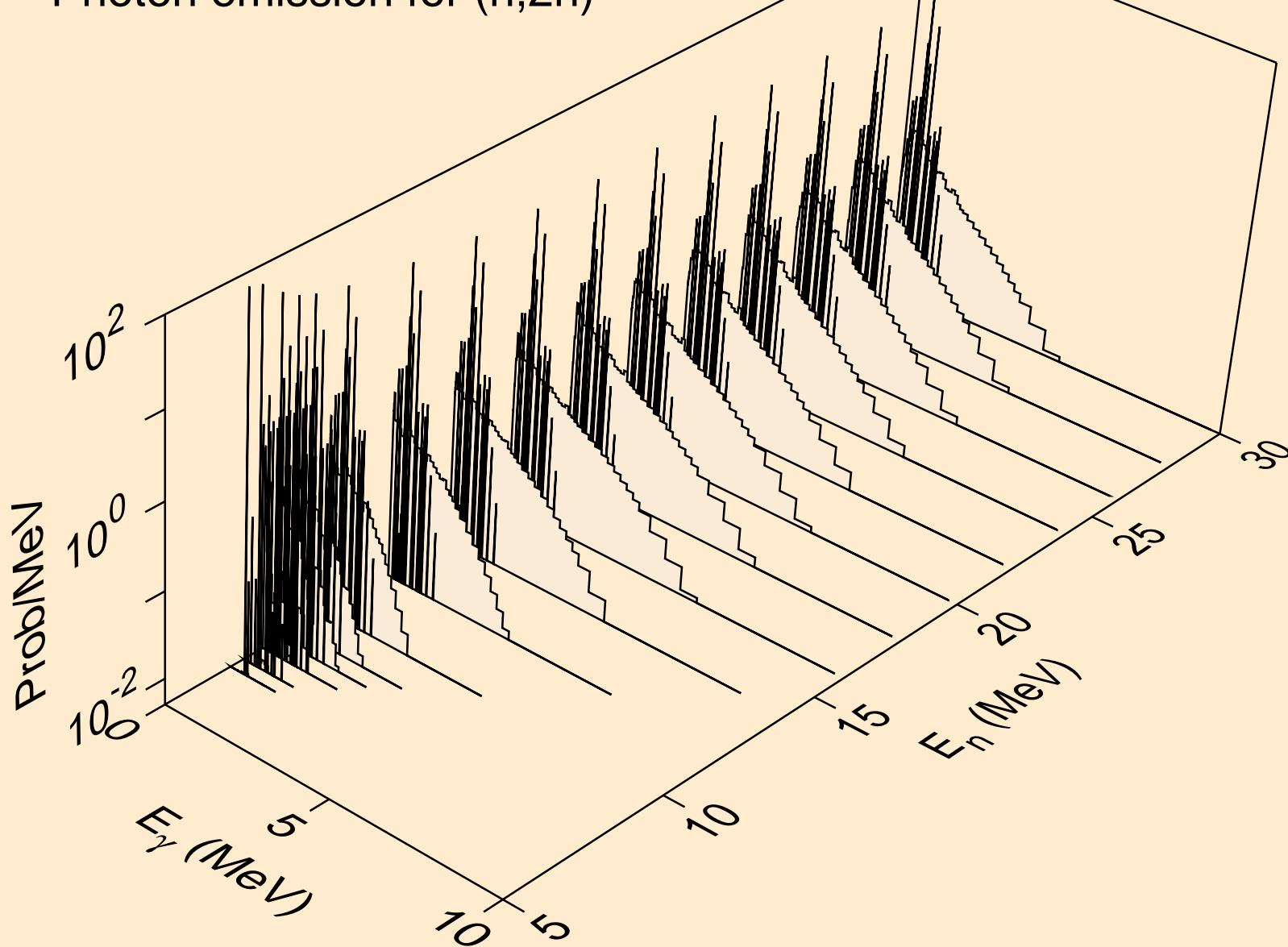

HG203 NEUTRON ACER TENDL-2023 LIBRARY; T=0.K  
Photon emission for (n,3n)

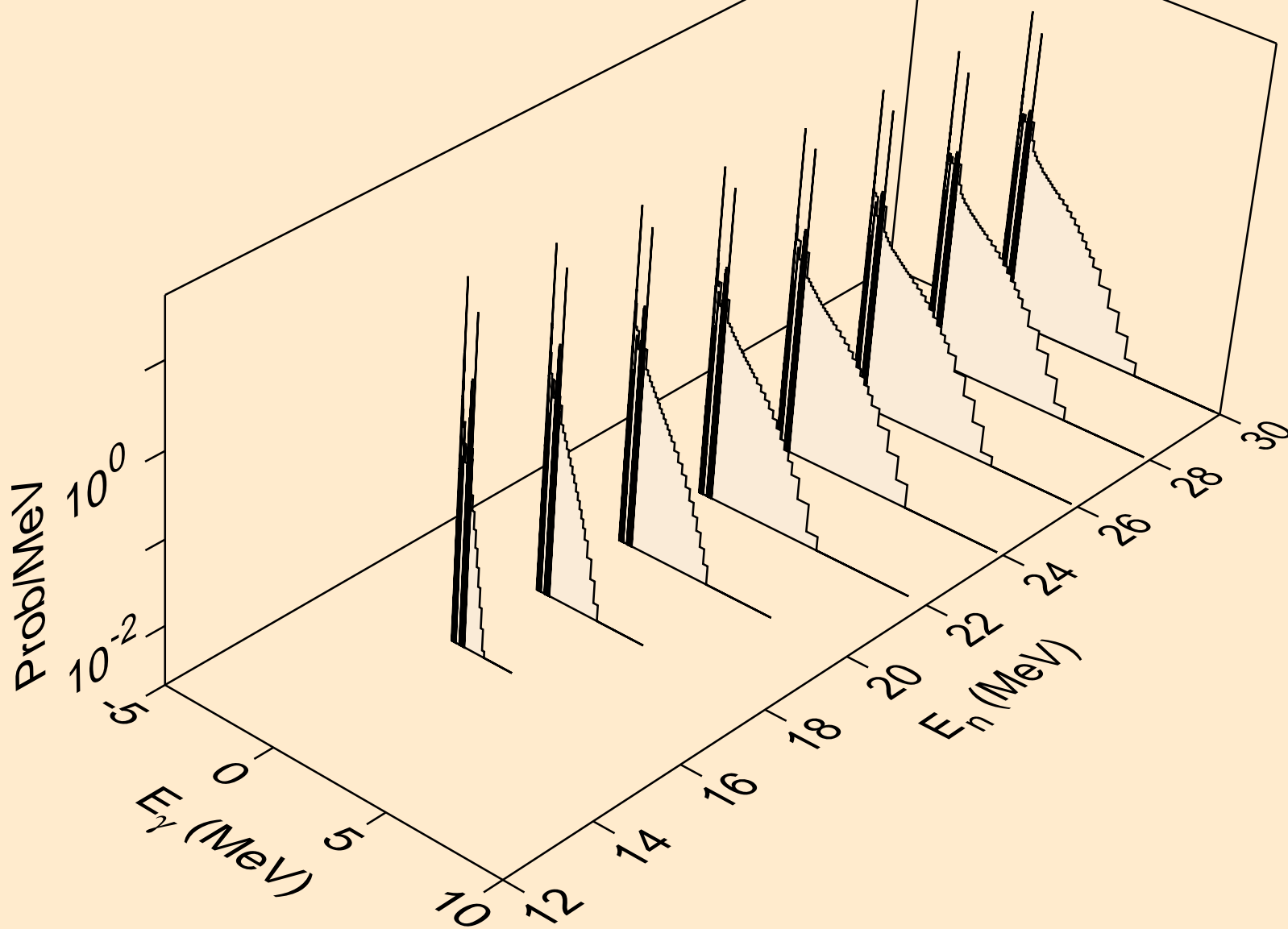

HG203 NEUTRON ACER TENDL-2023 LIBRARY; T=0.K  
Photon emission for (n,n\*)a

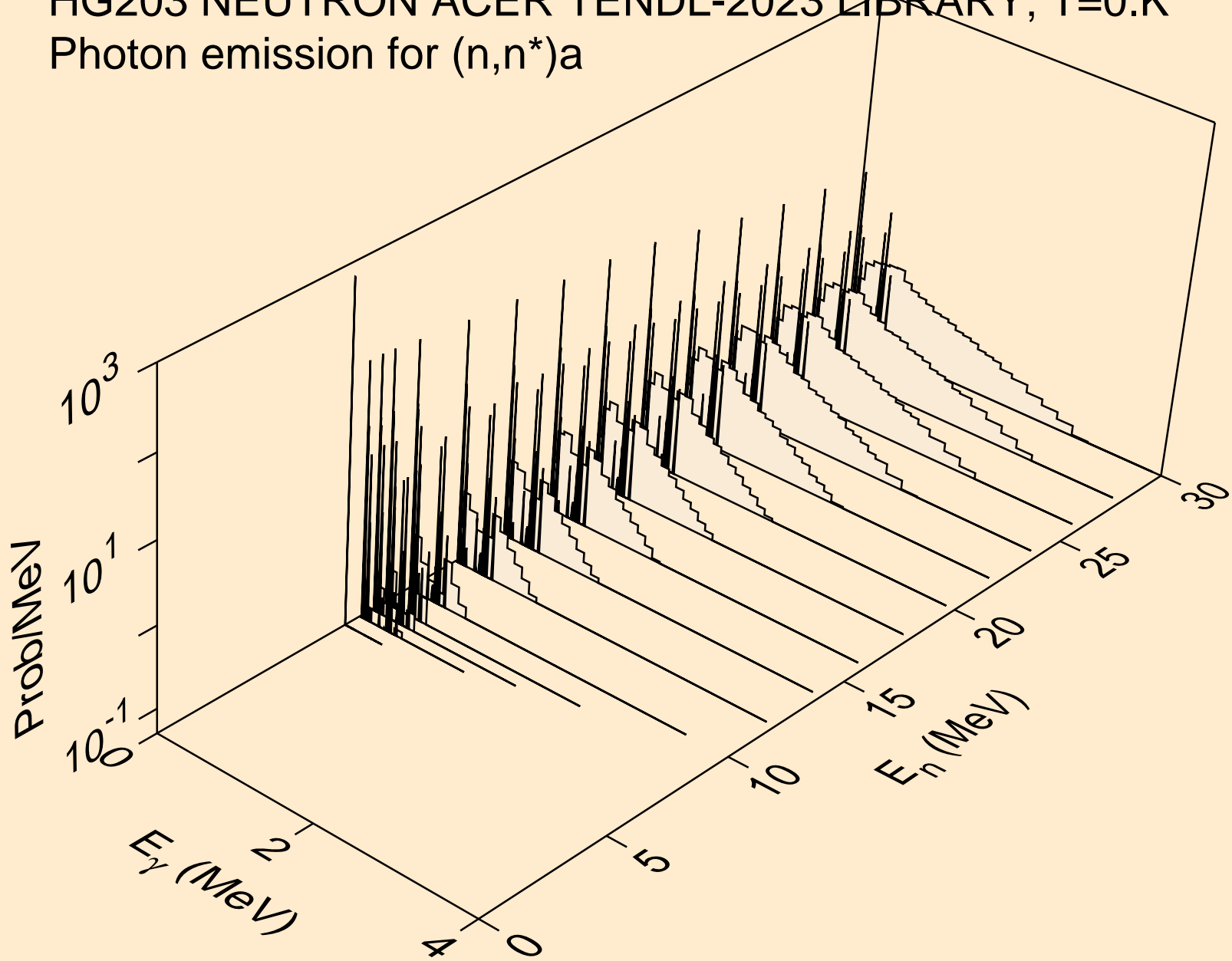



HG203 NEUTRON ACER TENDL-2023 LIBRARY; T=0.K  
Photon emission for (n,2n)a

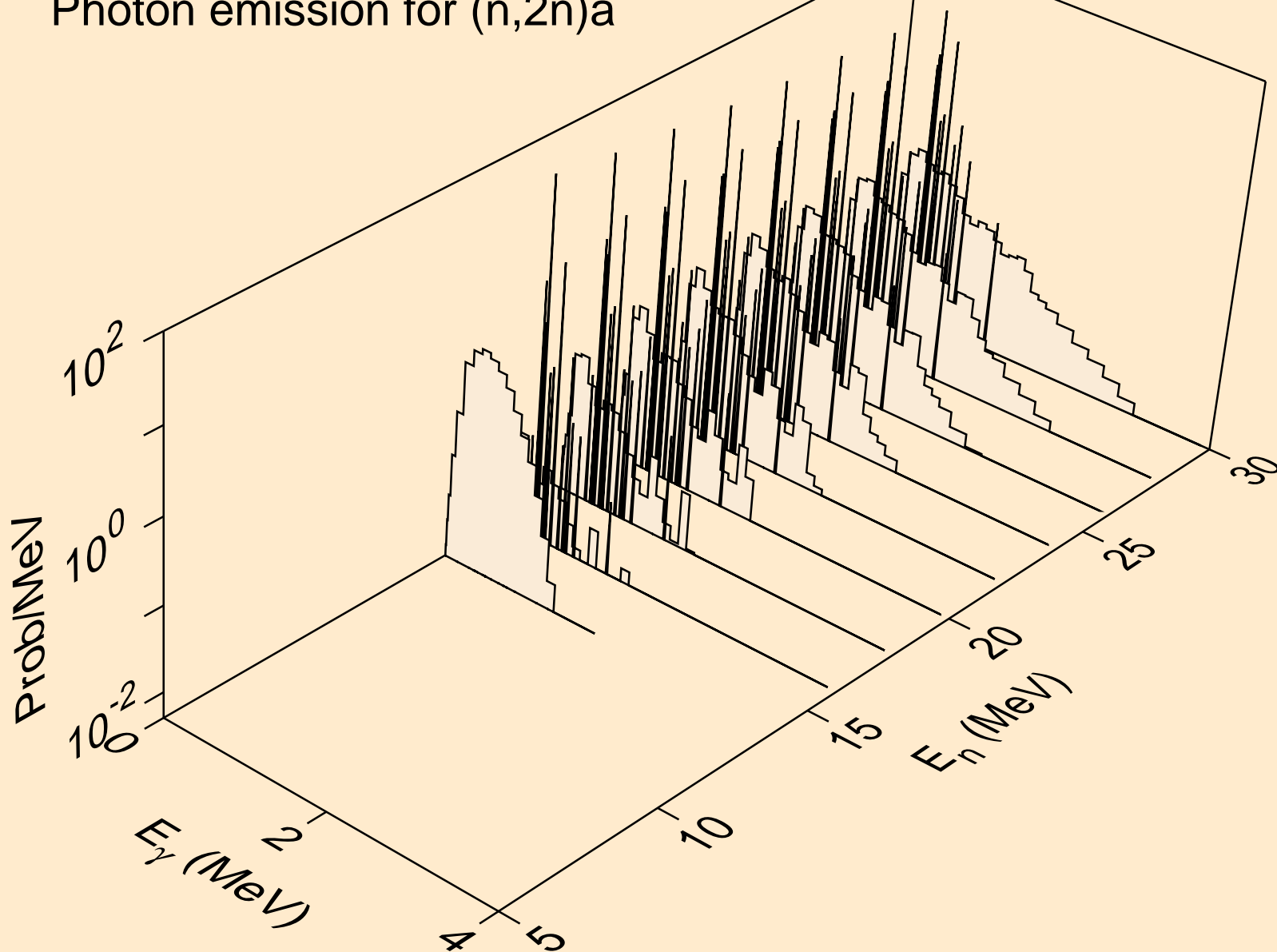

HG203 NEUTRON ACER TENDL-2023 LIBRARY; T=0.K  
Photon emission for (n,3n)a

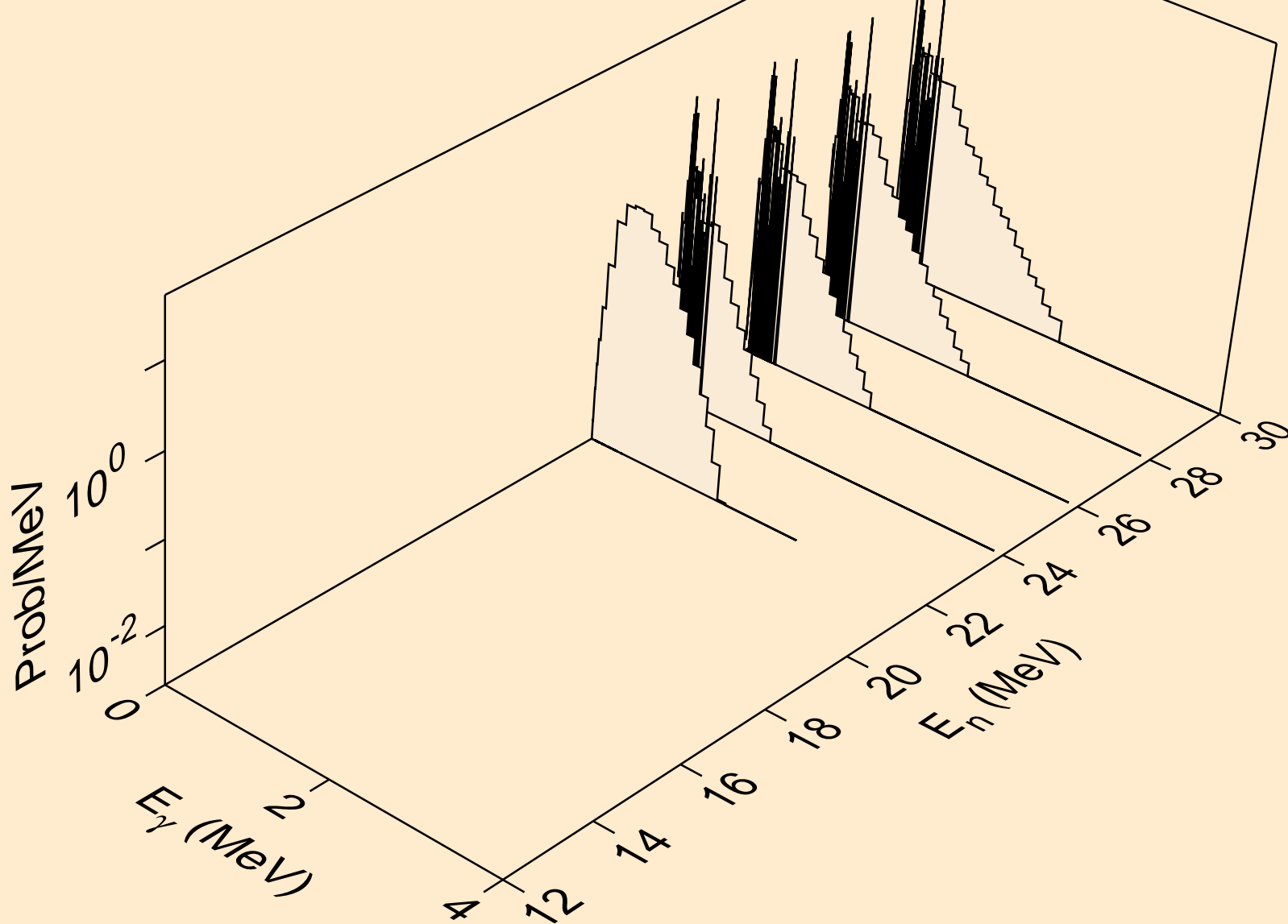

HG203 NEUTRON ACER TENDL-2023 LIBRARY; T=0.K  
Photon emission for (n,n\*)p

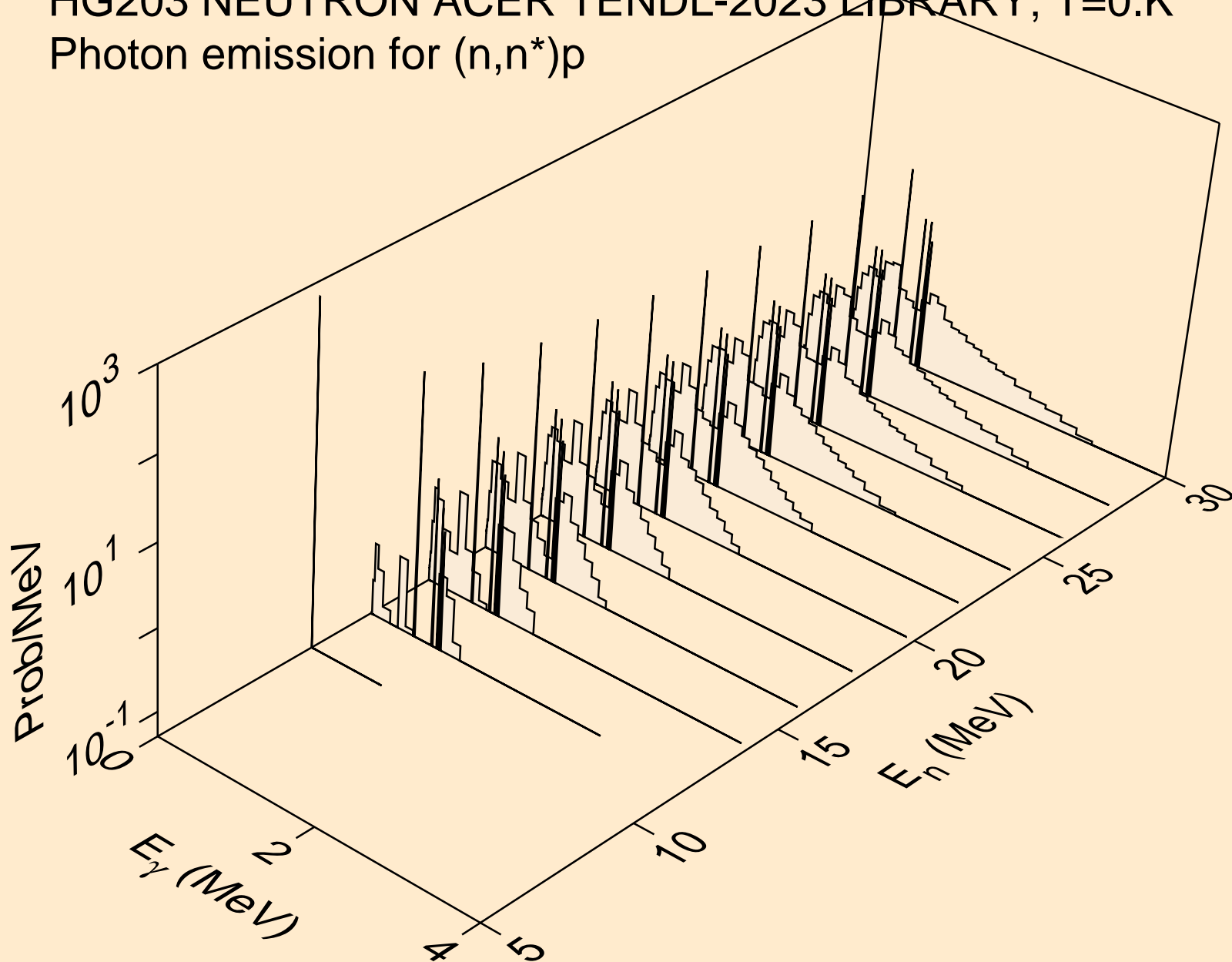

HG203 NEUTRON ACER TENDL-2023 LIBRARY; T=0.K  
Photon emission for (n,n\*)d

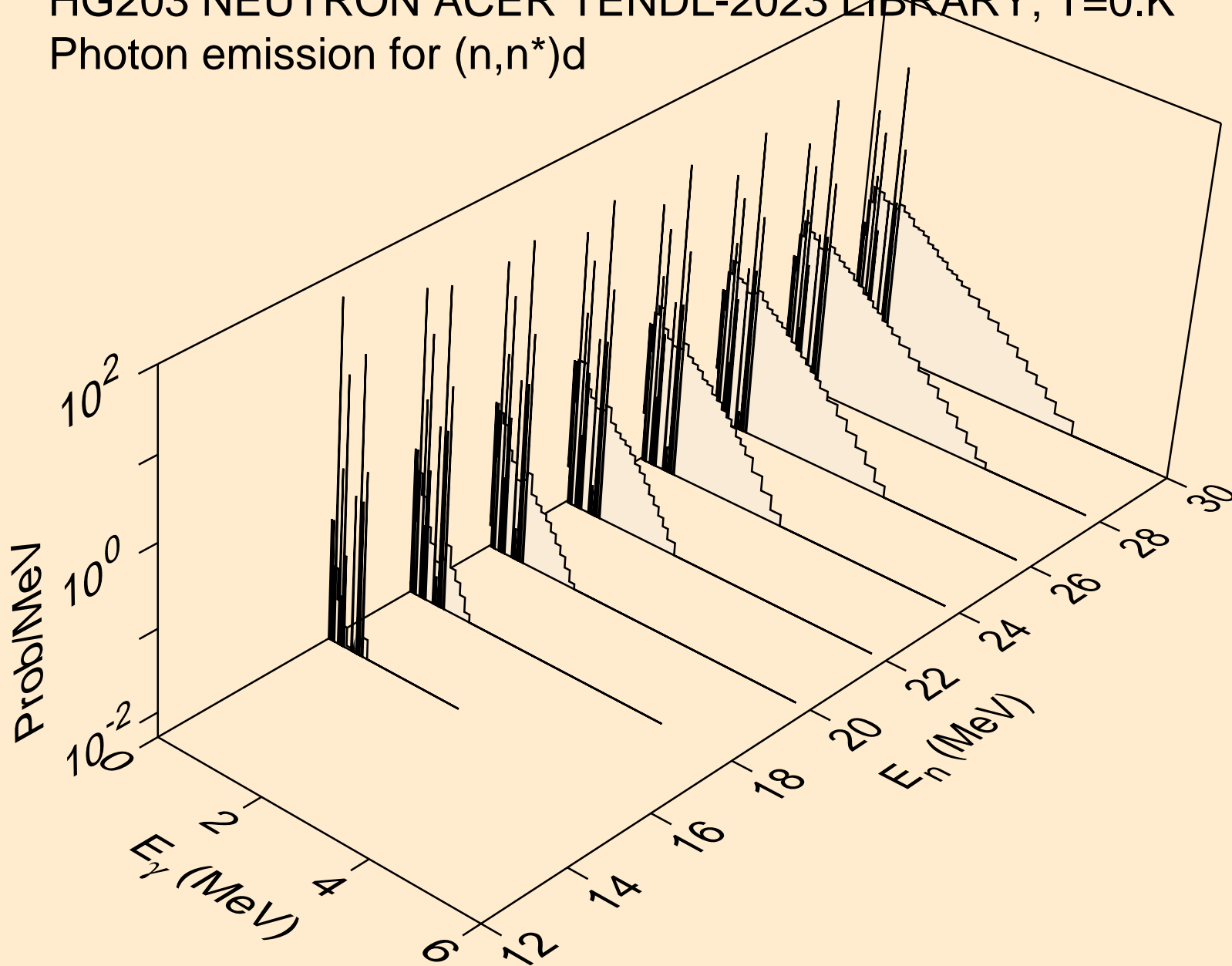

HG203 NEUTRON ACER TENDL-2023 LIBRARY; T=0.K  
Photon emission for (n,n\*)t

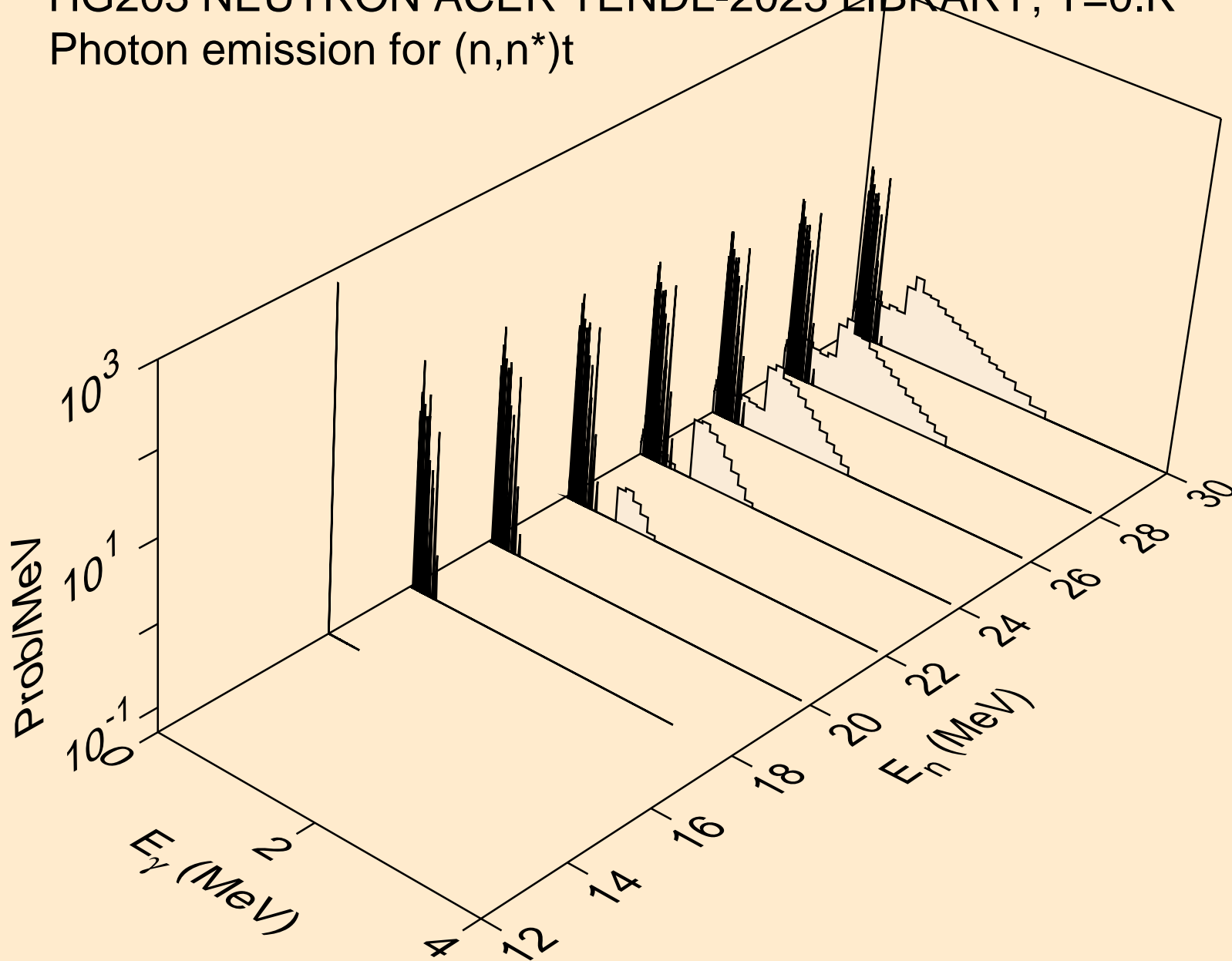

HG203 NEUTRON ACER TENDL-2023 LIBRARY; T=0.K  
Photon emission for (n,n\*)he3

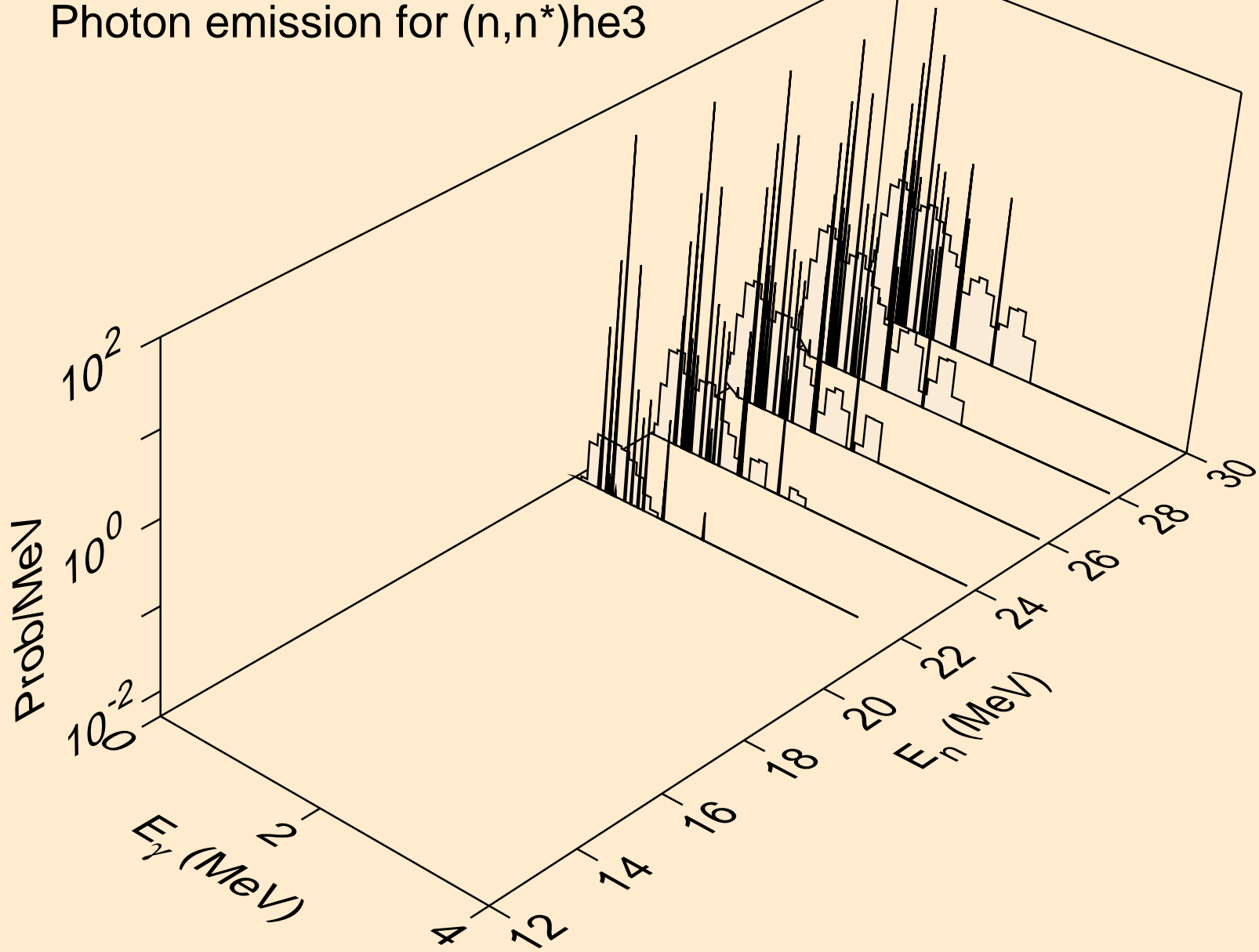

HG203 NEUTRON ACER TENDL-2023 LIBRARY; T=0.K  
Photon emission for (n,4n)

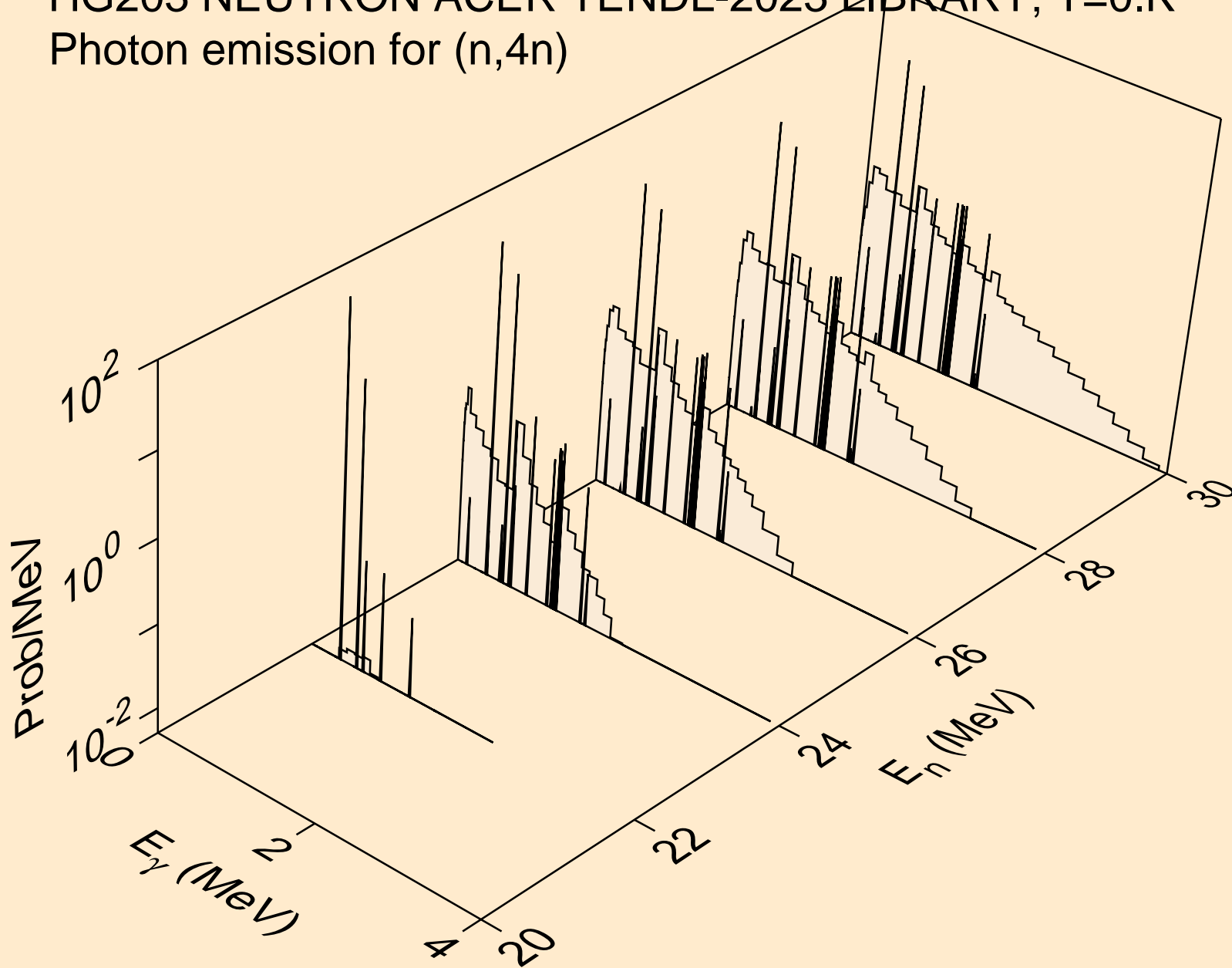

HG203 NEUTRON ACER TENDL-2023 LIBRARY; T=0.K  
Photon emission for (n,2np)

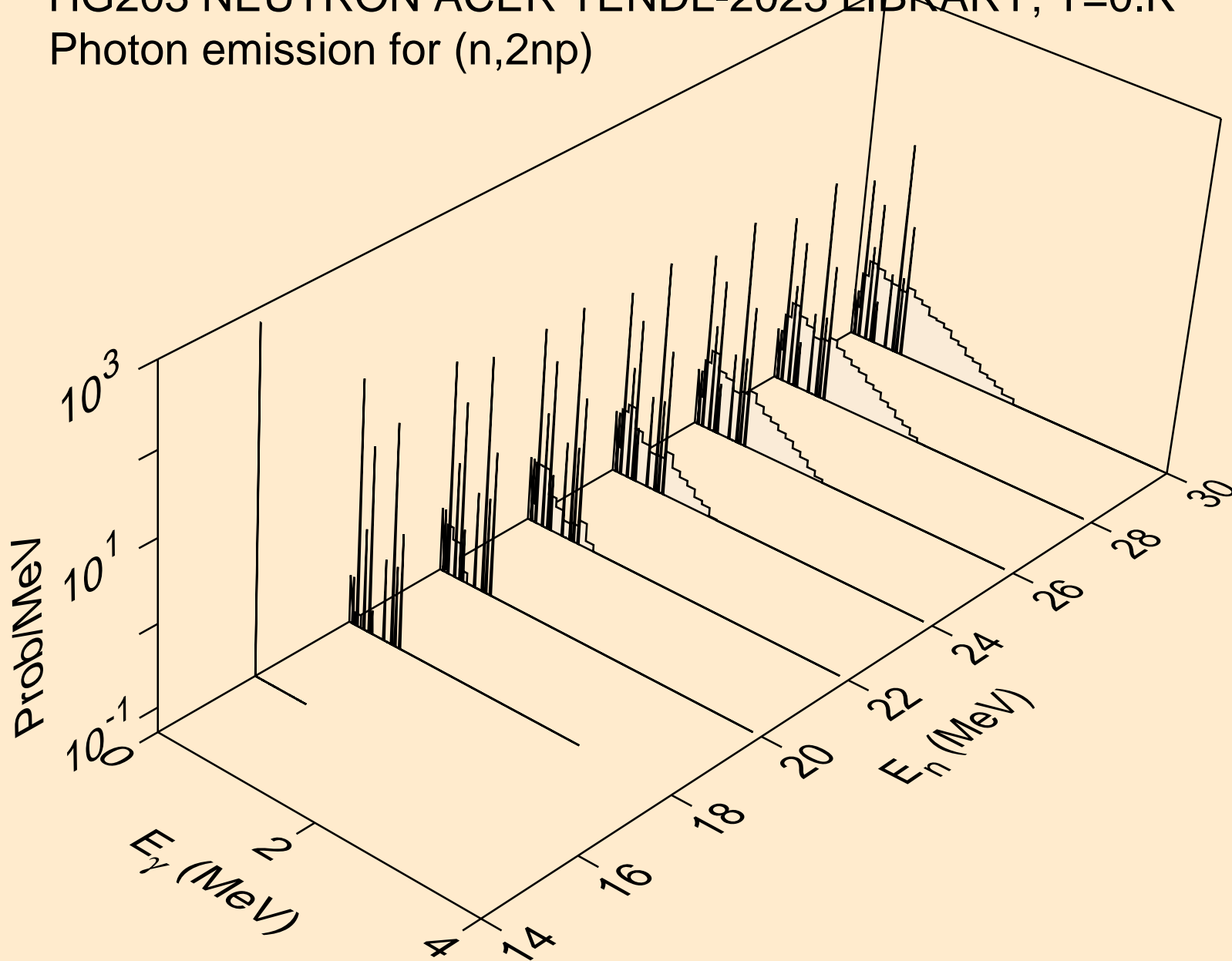



HG203 NEUTRON ACER TENDL-2023 LIBRARY; T=0.K  
Photon emission for (n,3np)

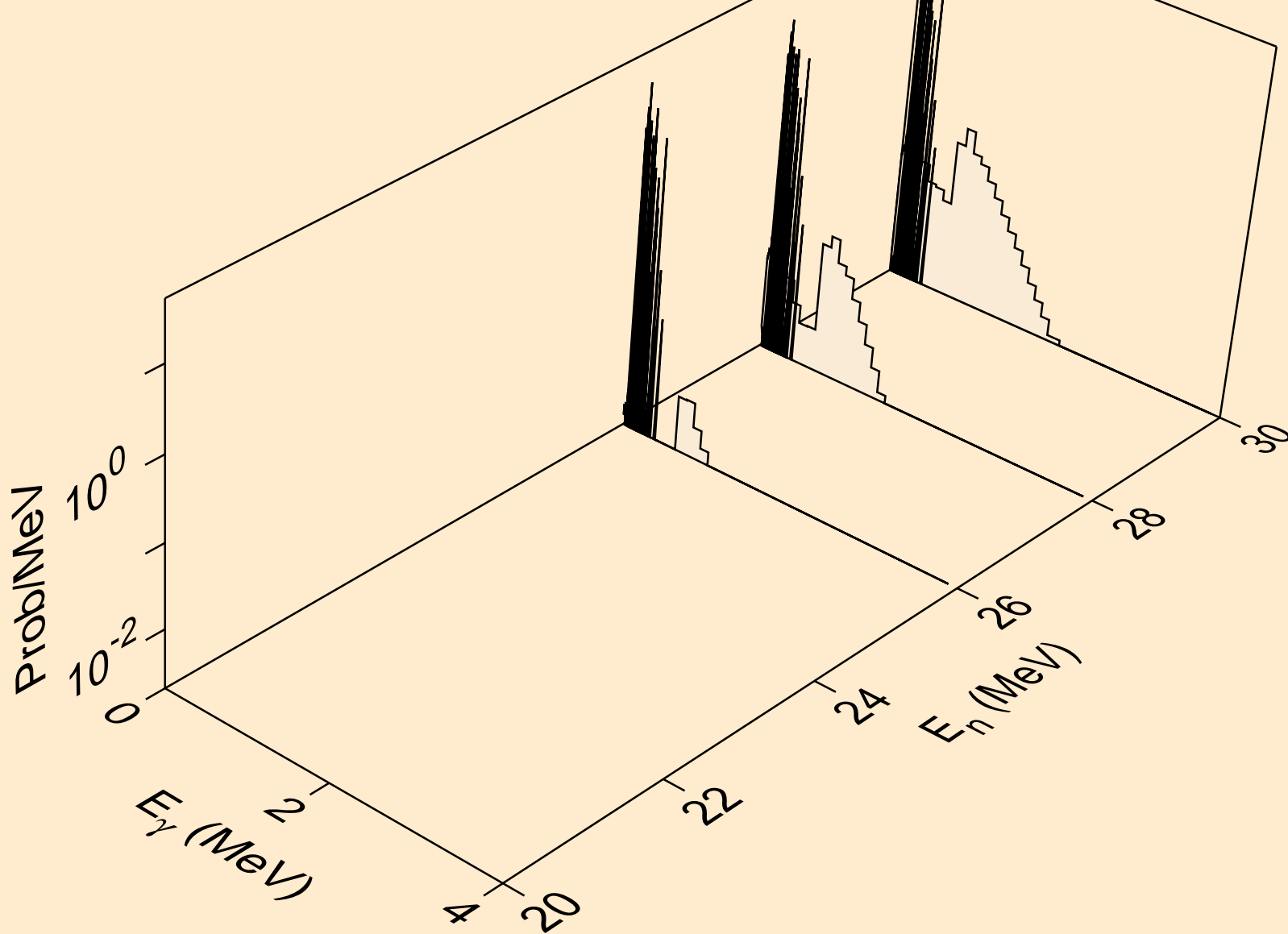

HG203 NEUTRON ACER TENDL-2023 LIBRARY; T=0.K  
Photon emission for (n,n\*c)

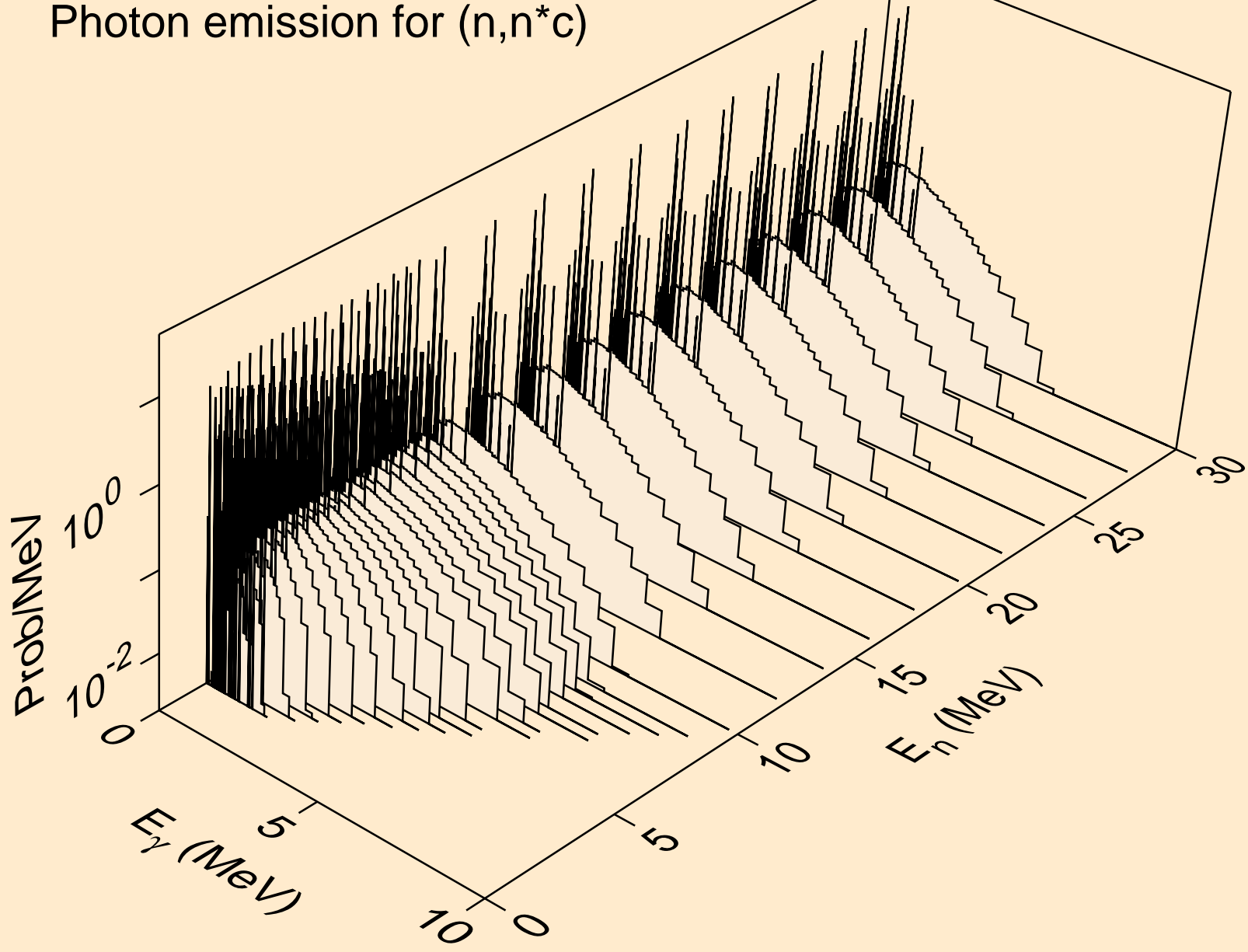

HG203 NEUTRON ACER TENDL-2023 LIBRARY; T=0.K  
Photon emission for (n,gma)

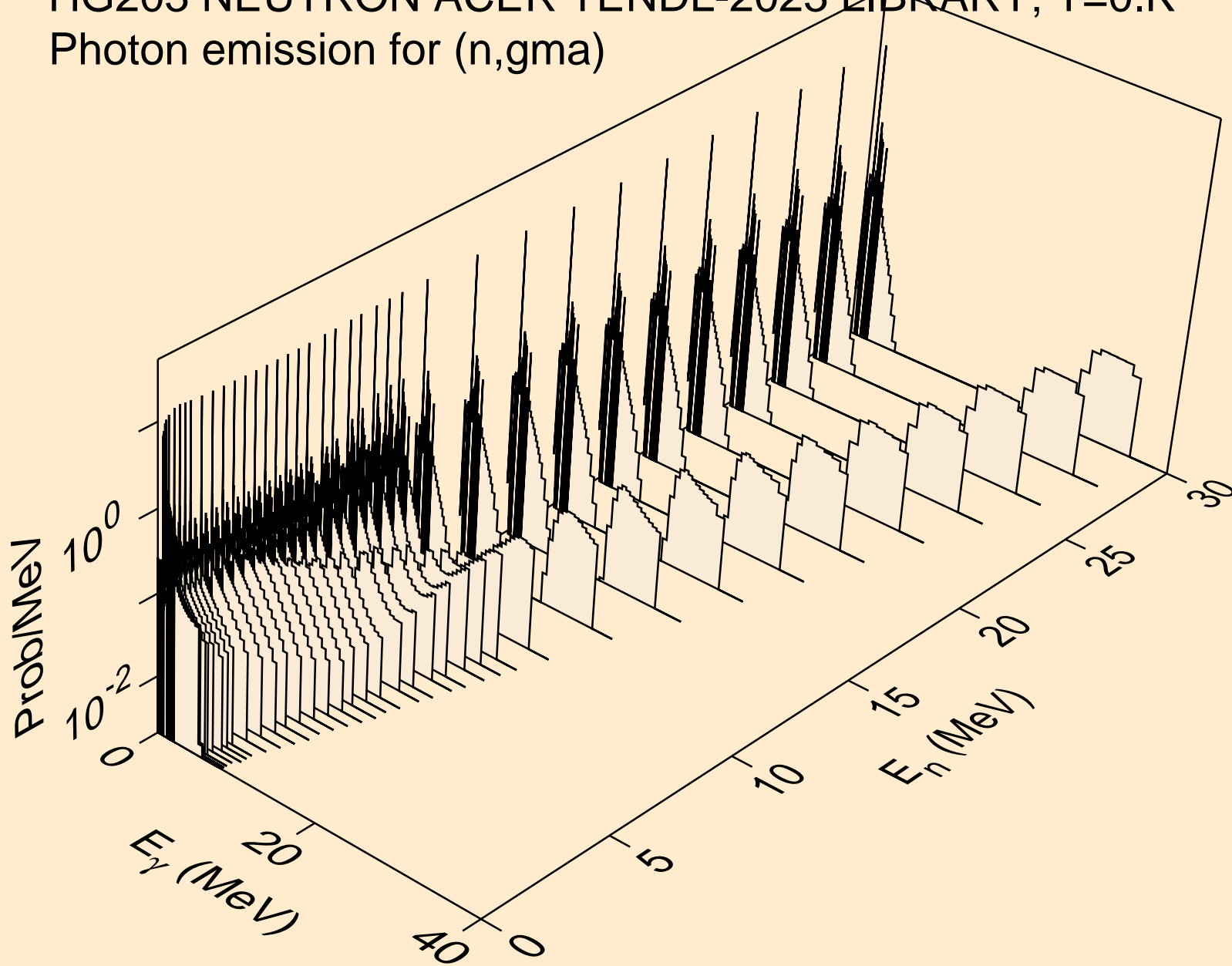

HG203 NEUTRON ACER TENDL-2023 LIBRARY; T=0.K  
Photon emission for (n,p)

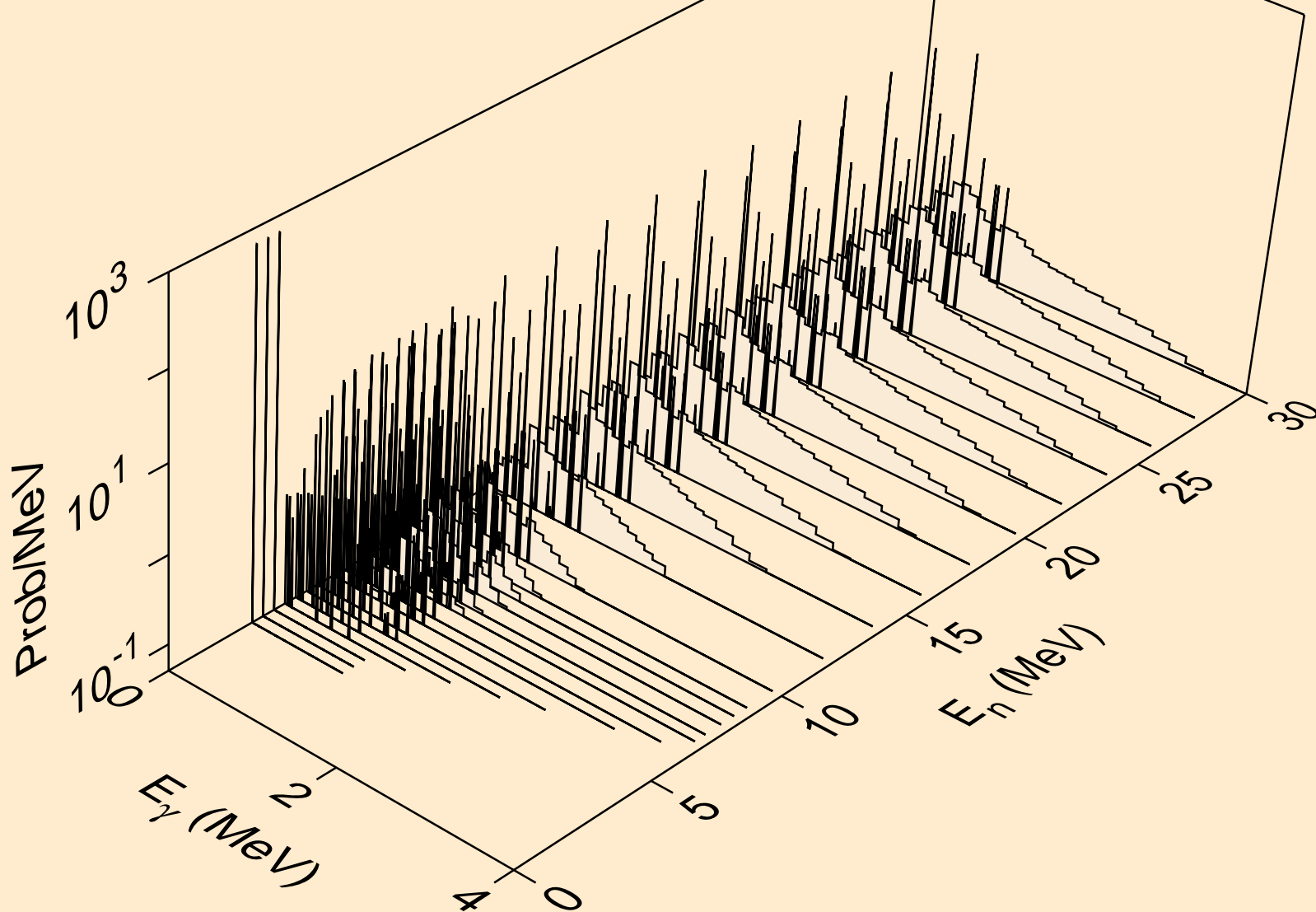

HG203 NEUTRON ACER TENDL-2023 LIBRARY; T=0.K  
Photon emission for (n,d)

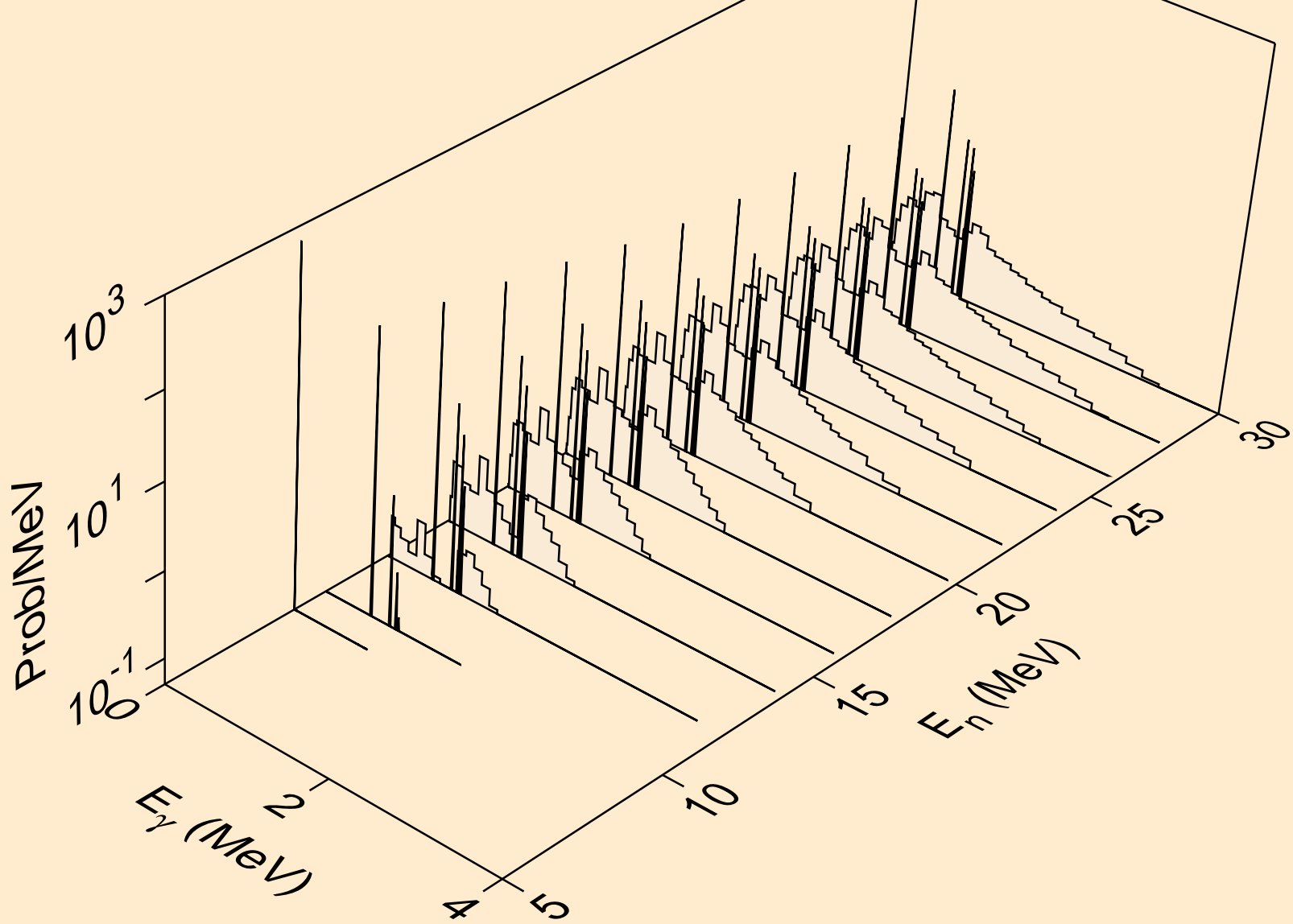

HG203 NEUTRON ACER TENDL-2023 LIBRARY; T=0.K  
Photon emission for (n,t)

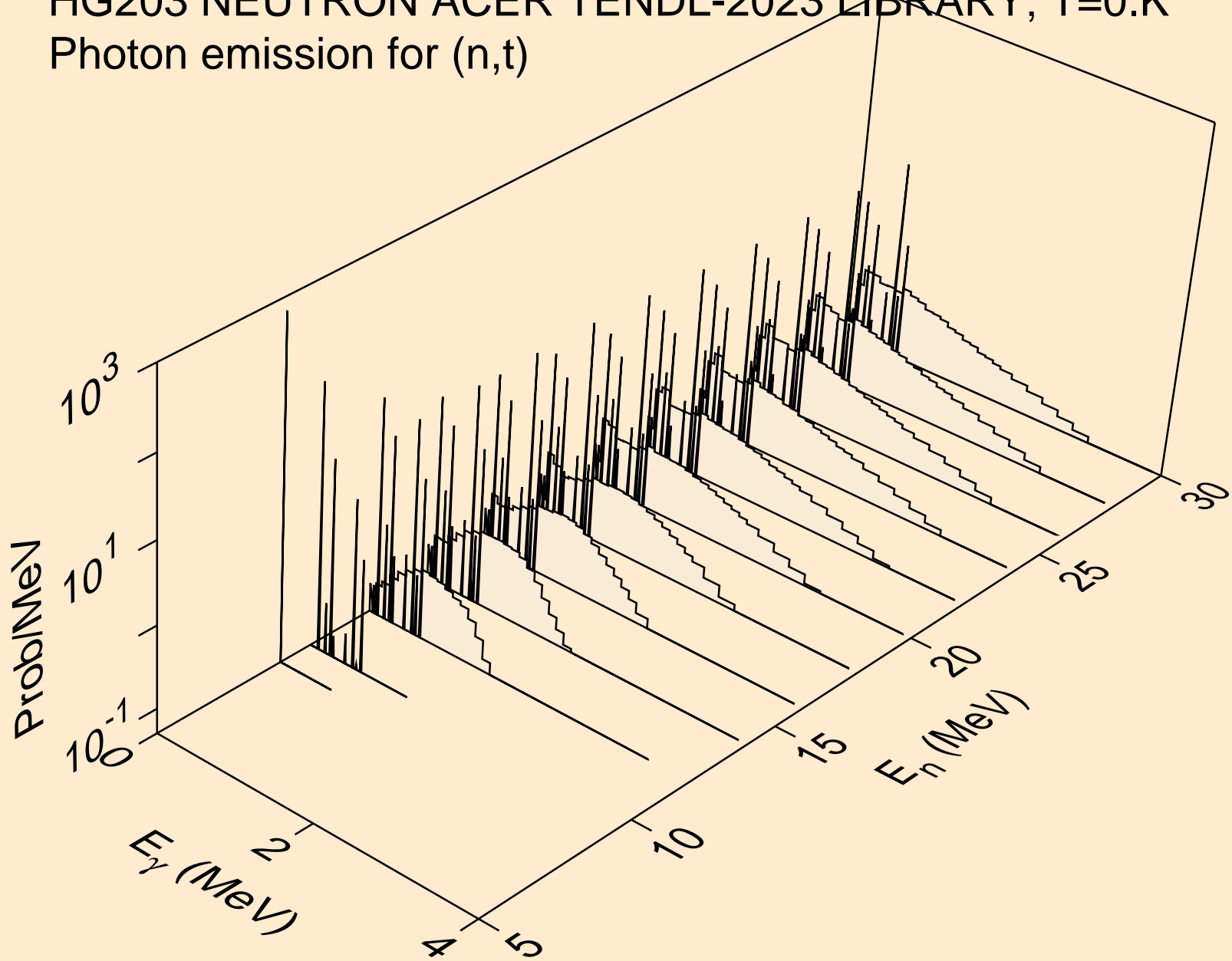

HG203 NEUTRON ACER TENDL-2023 LIBRARY; T=0.K  
Photon emission for (n,he3)

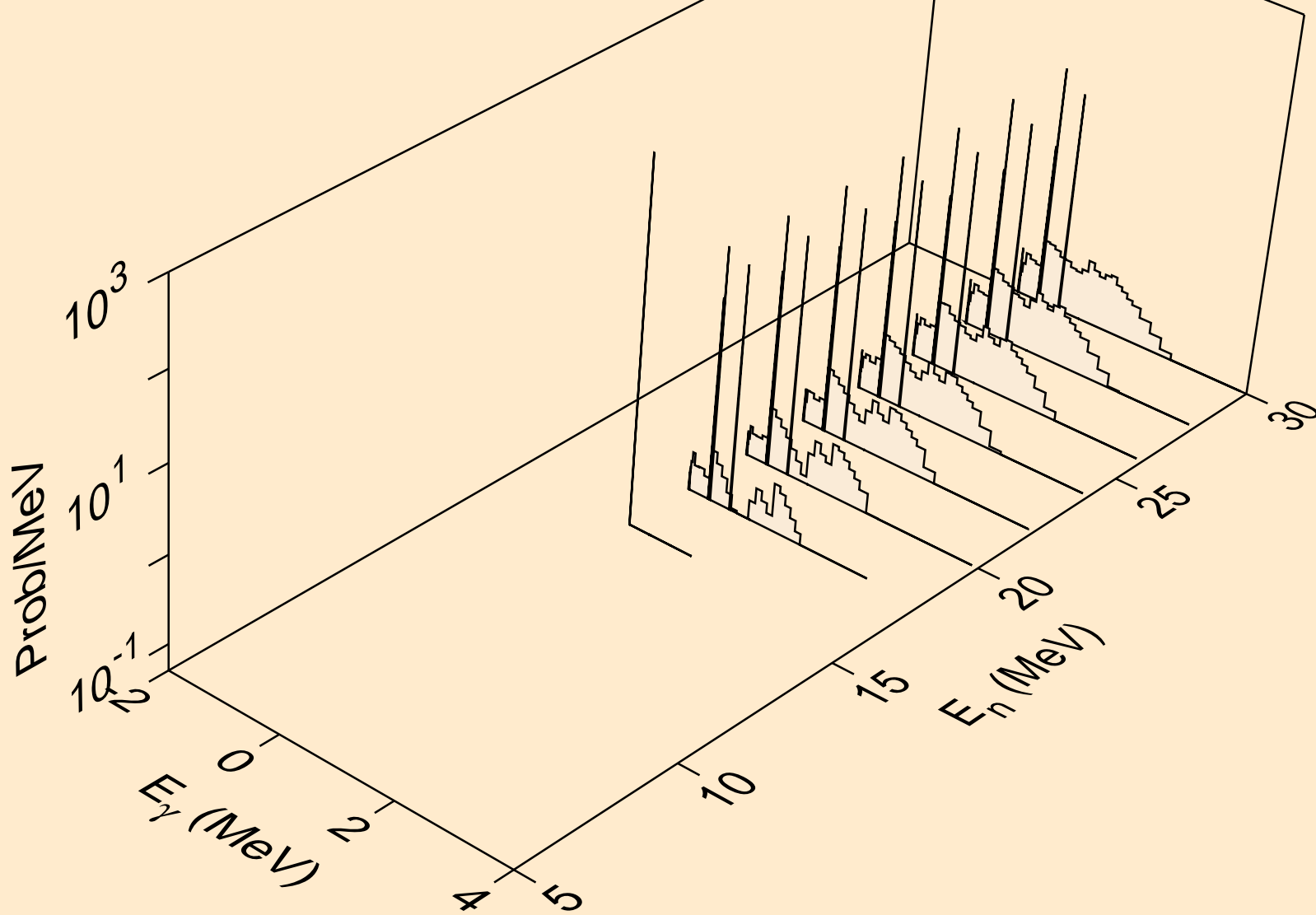

HG203 NEUTRON ACER TENDL-2023 LIBRARY; T=0.K  
Photon emission for (n,a)

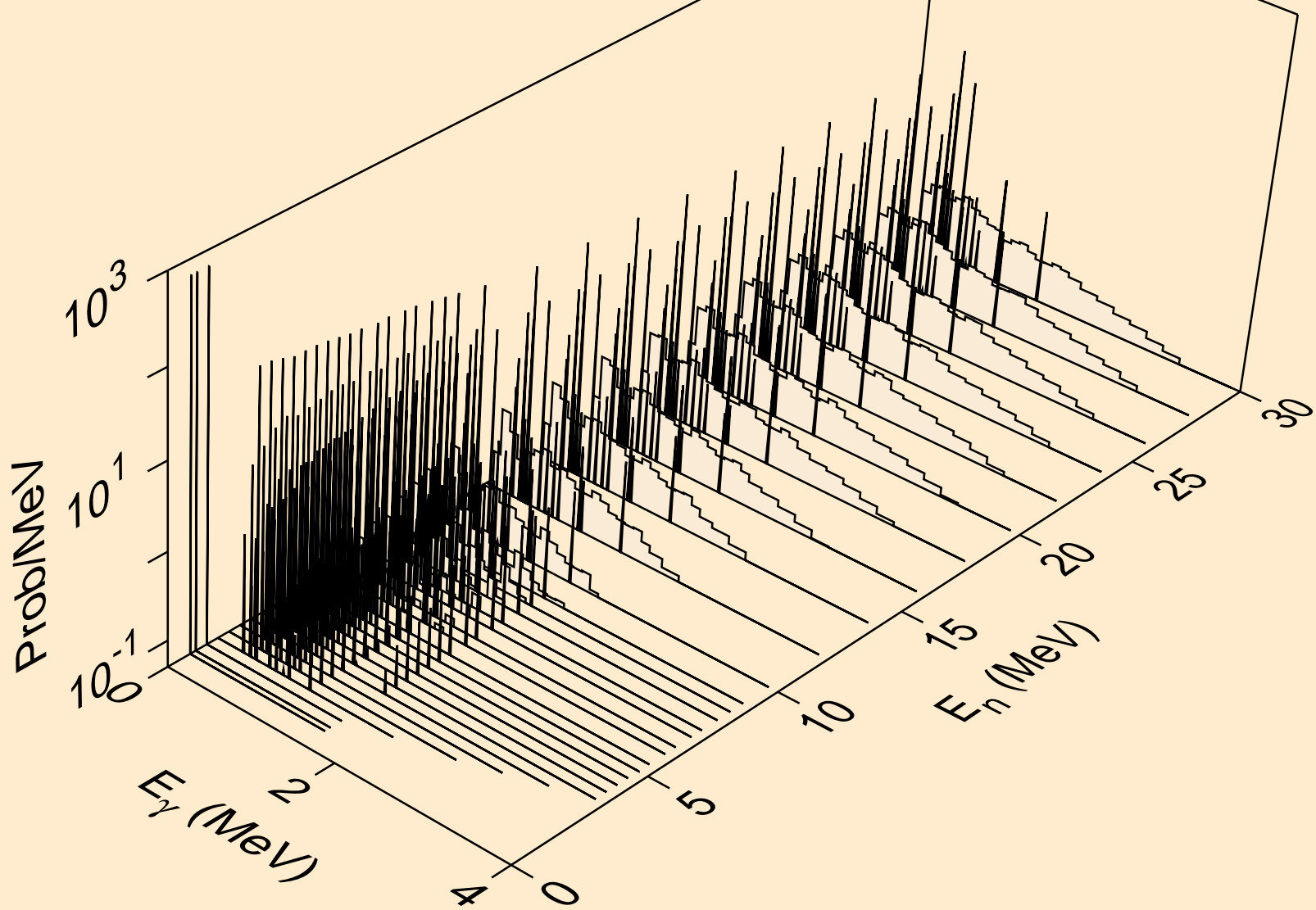



HG203 NEUTRON ACER TENDL-2023 LIBRARY; T=0.K  
Photon emission for (n,2p)

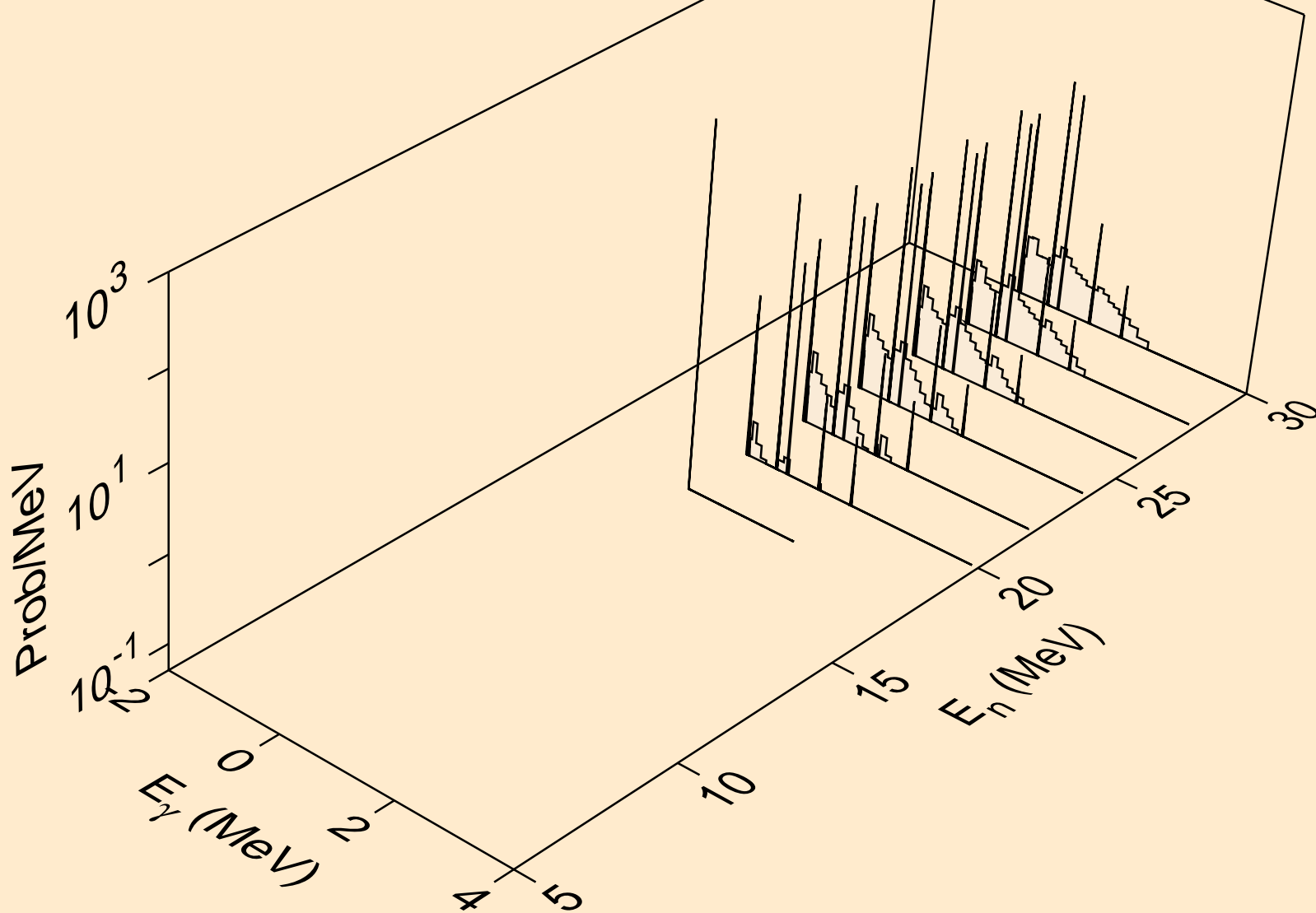

HG203 NEUTRON ACER TENDL-2023 LIBRARY; T=0.K  
thermal capture photon spectrum

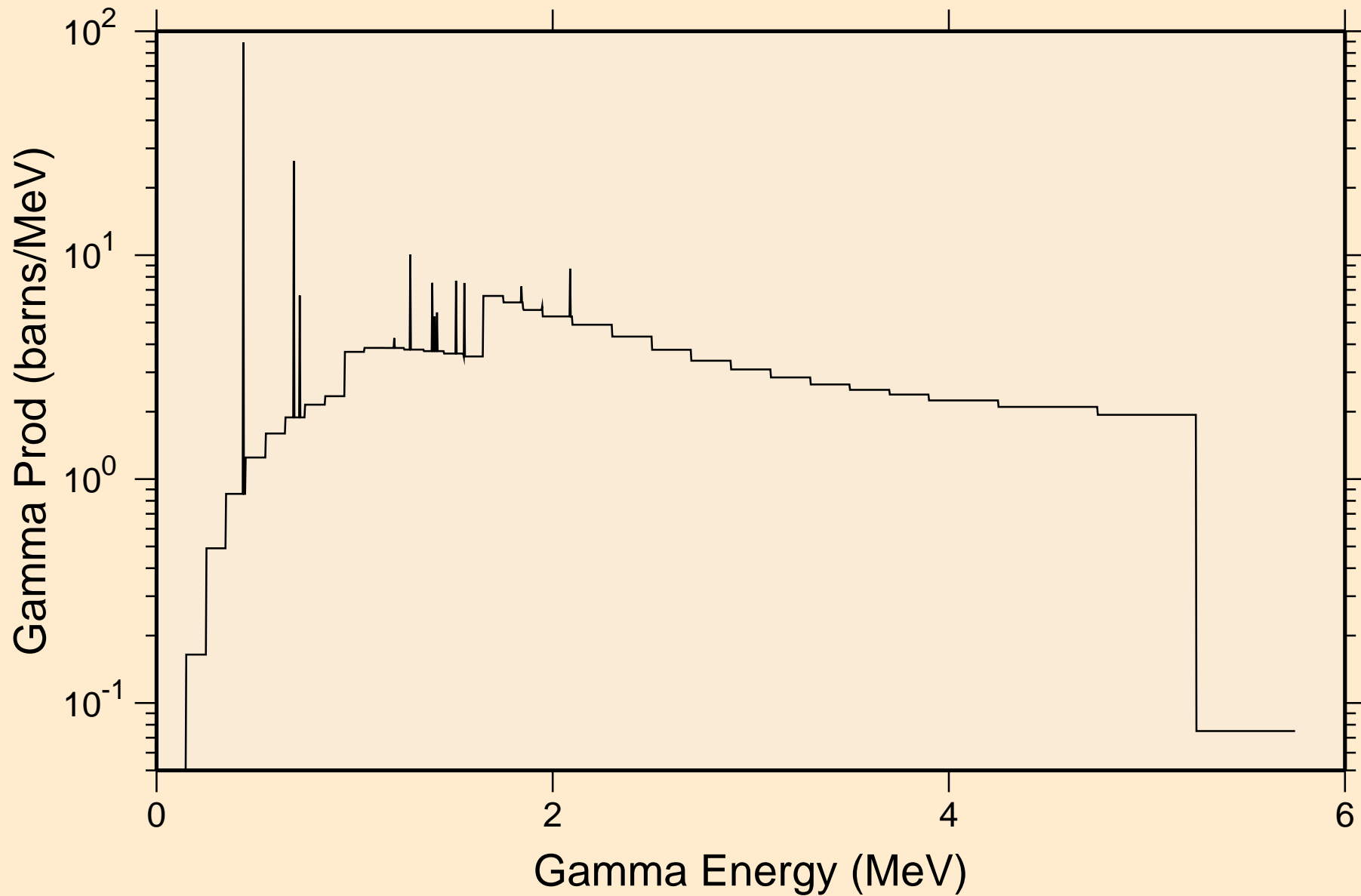

HG203 NEUTRON ACER TENDL-2023 LIBRARY; T=0.K  
14 MeV photon spectrum

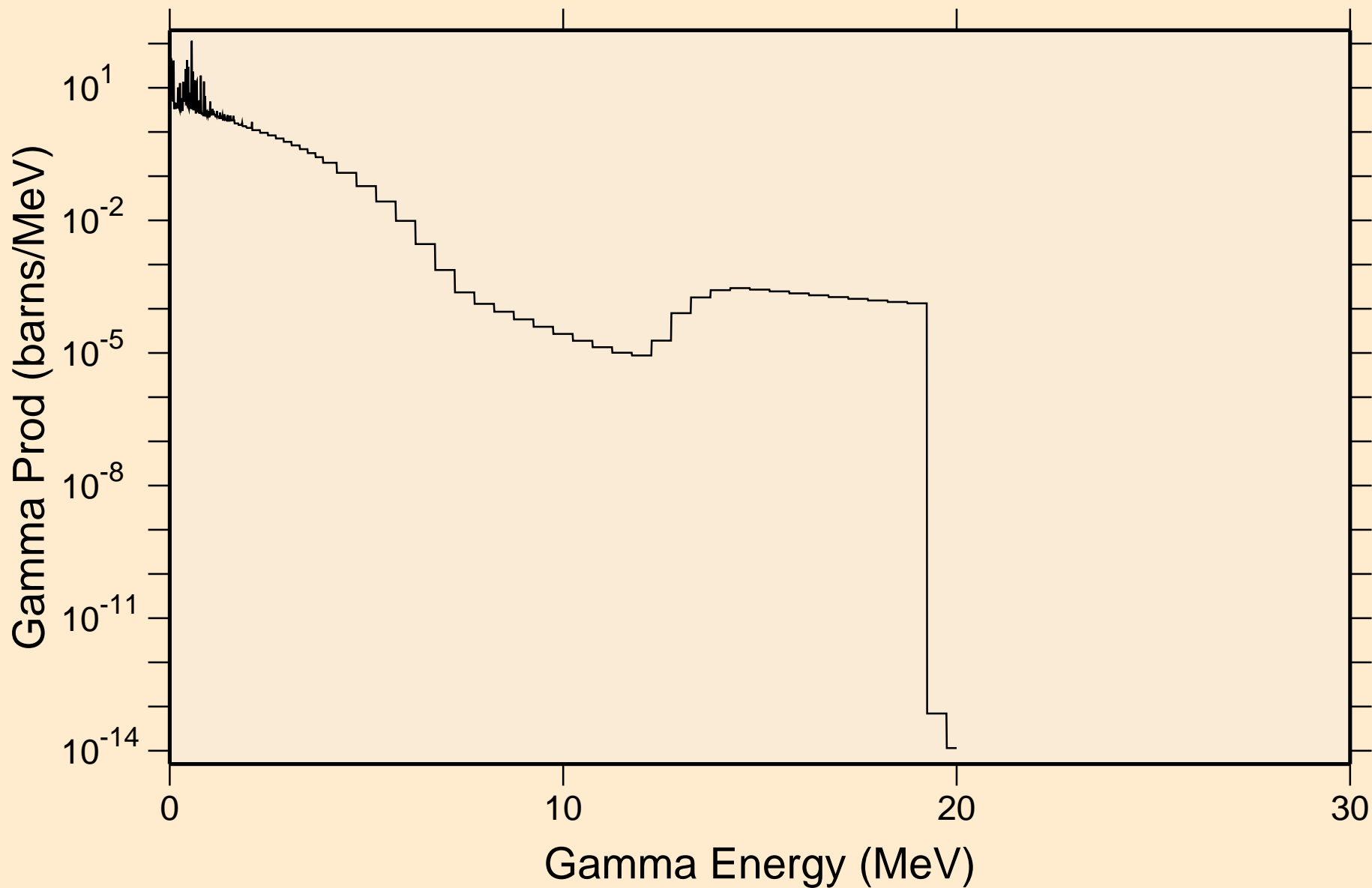

# HG203 NEUTRON ACER TENDL-2023 LIBRARY; T=0.K

## Particle heating contributions

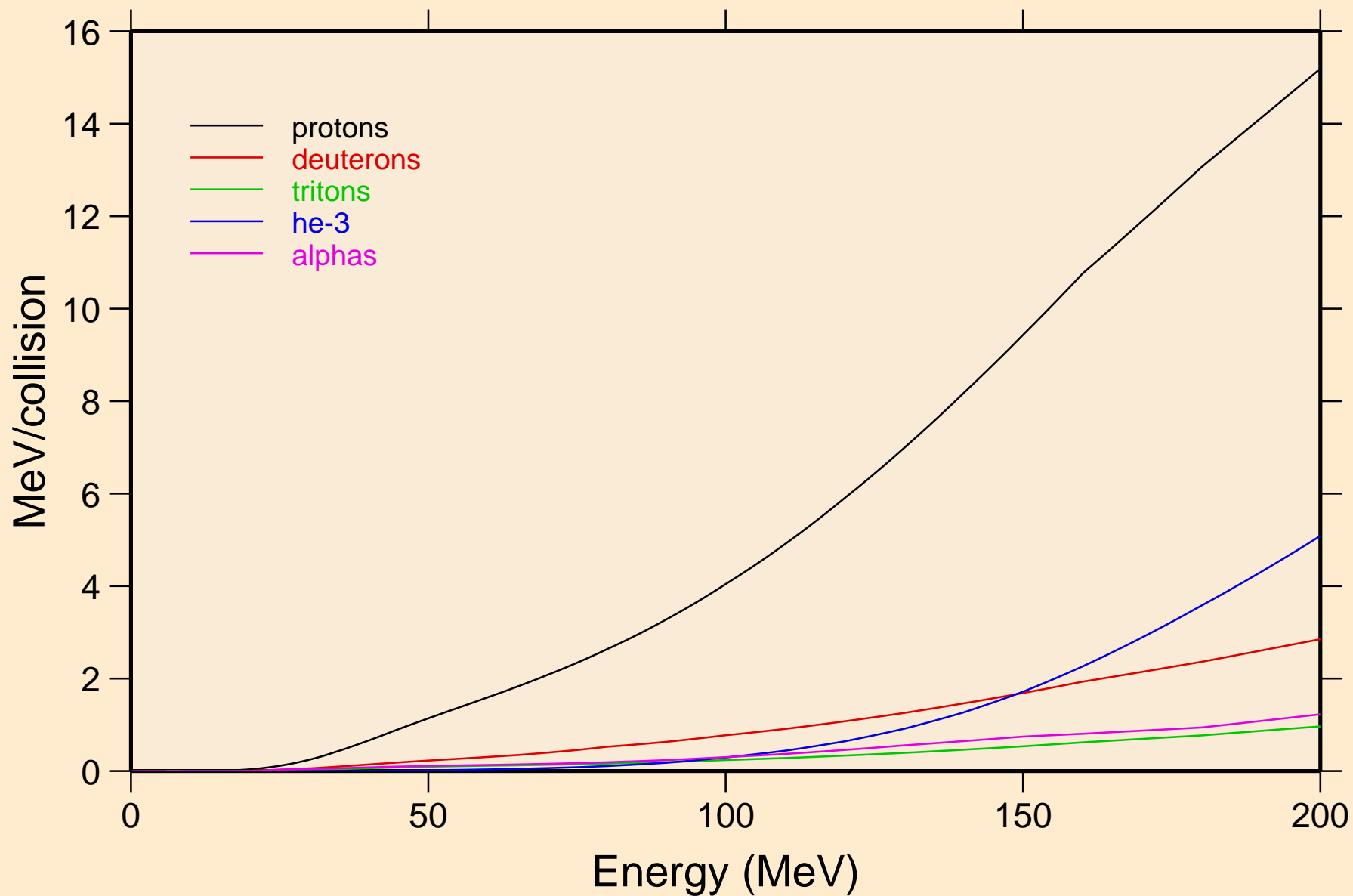

HG203 NEUTRON ACER TENDL-2023 LIBRARY; T=0.K  
Recoil Heating

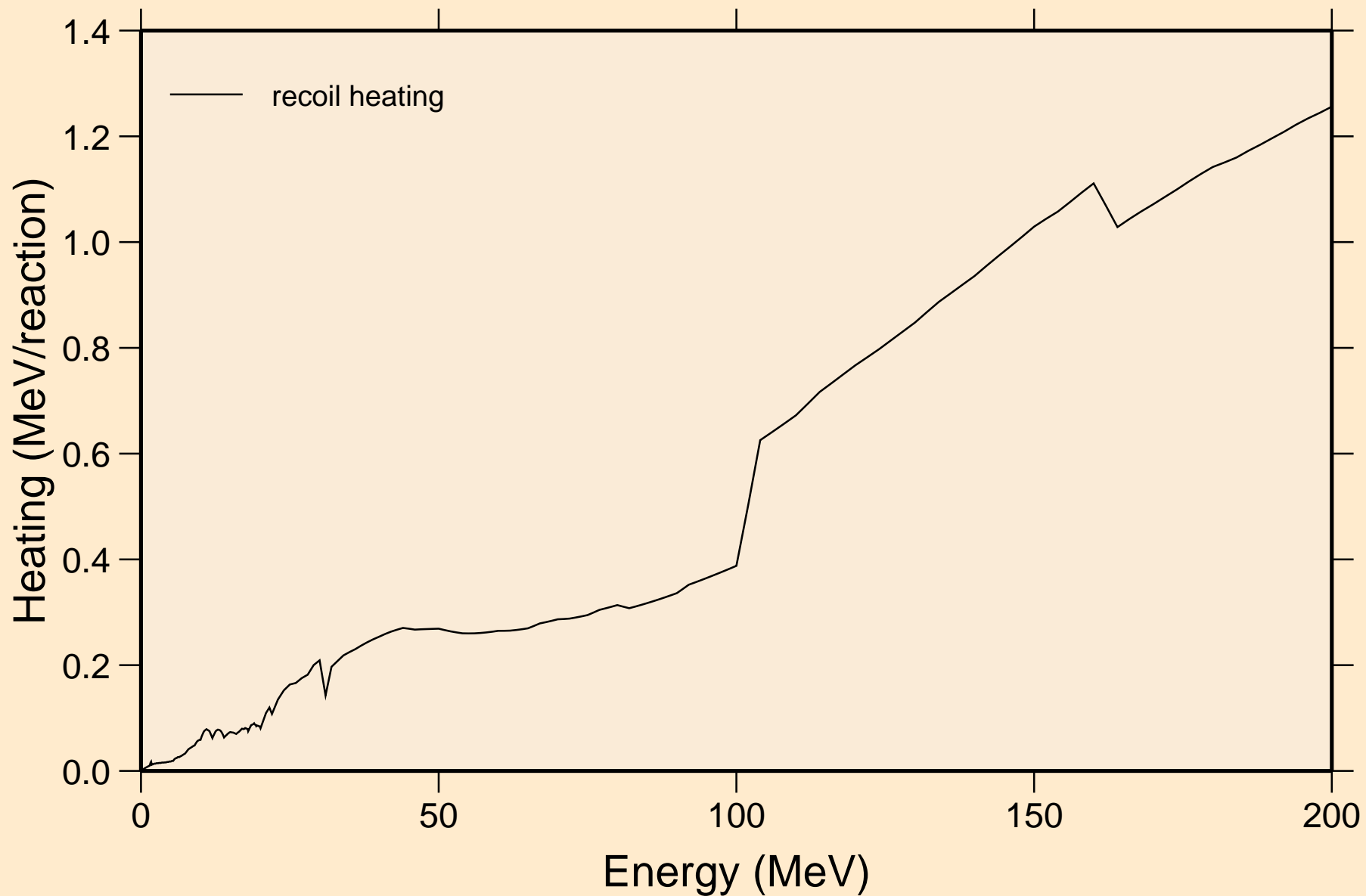

# HG203 NEUTRON ACER TENDL-2023 LIBRARY; T=0.K

## Particle production cross sections

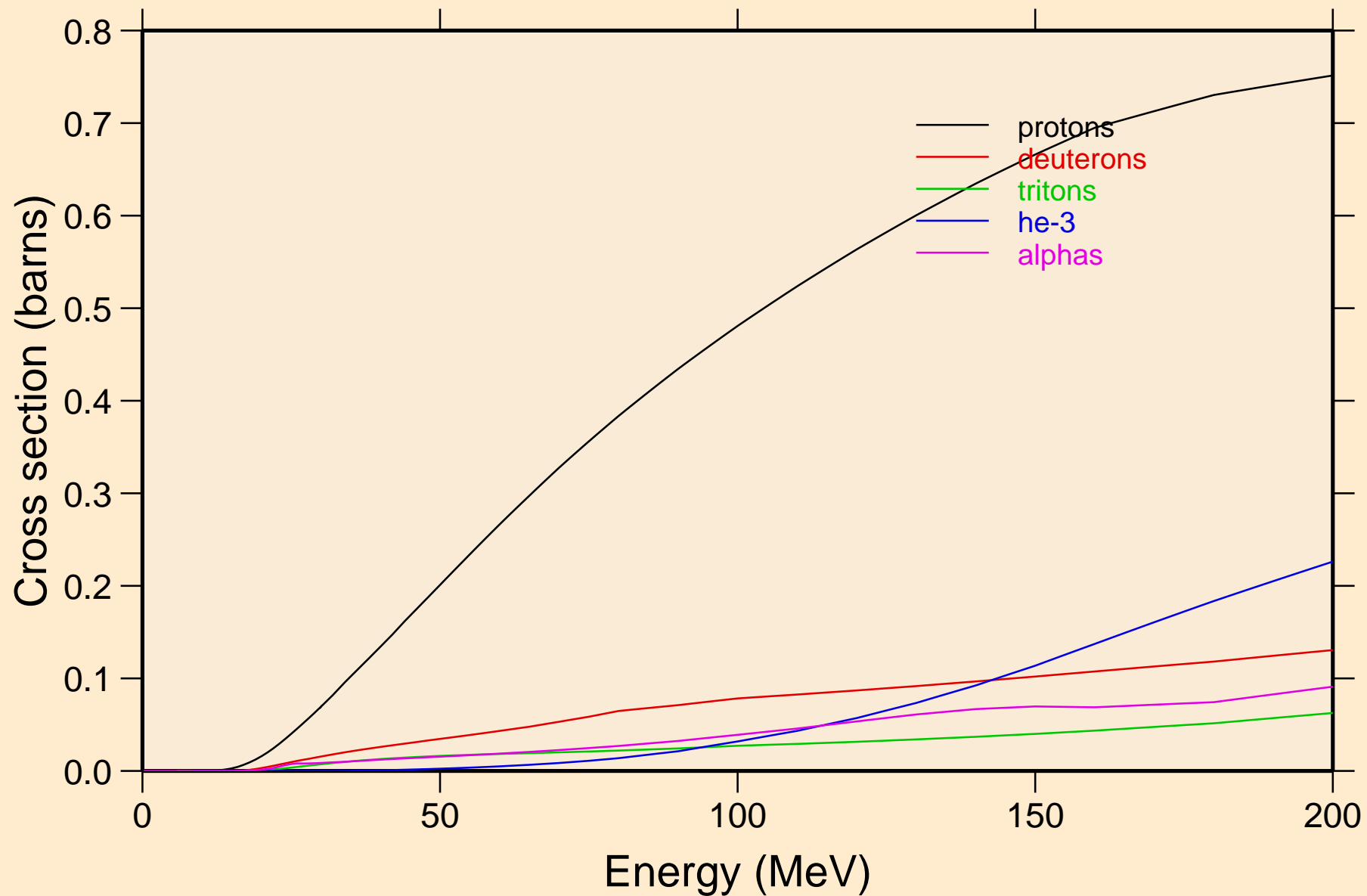

HG203 NEUTRON ACER TENDL-2023 LIBRARY; T=0.K  
protons from (n,x)

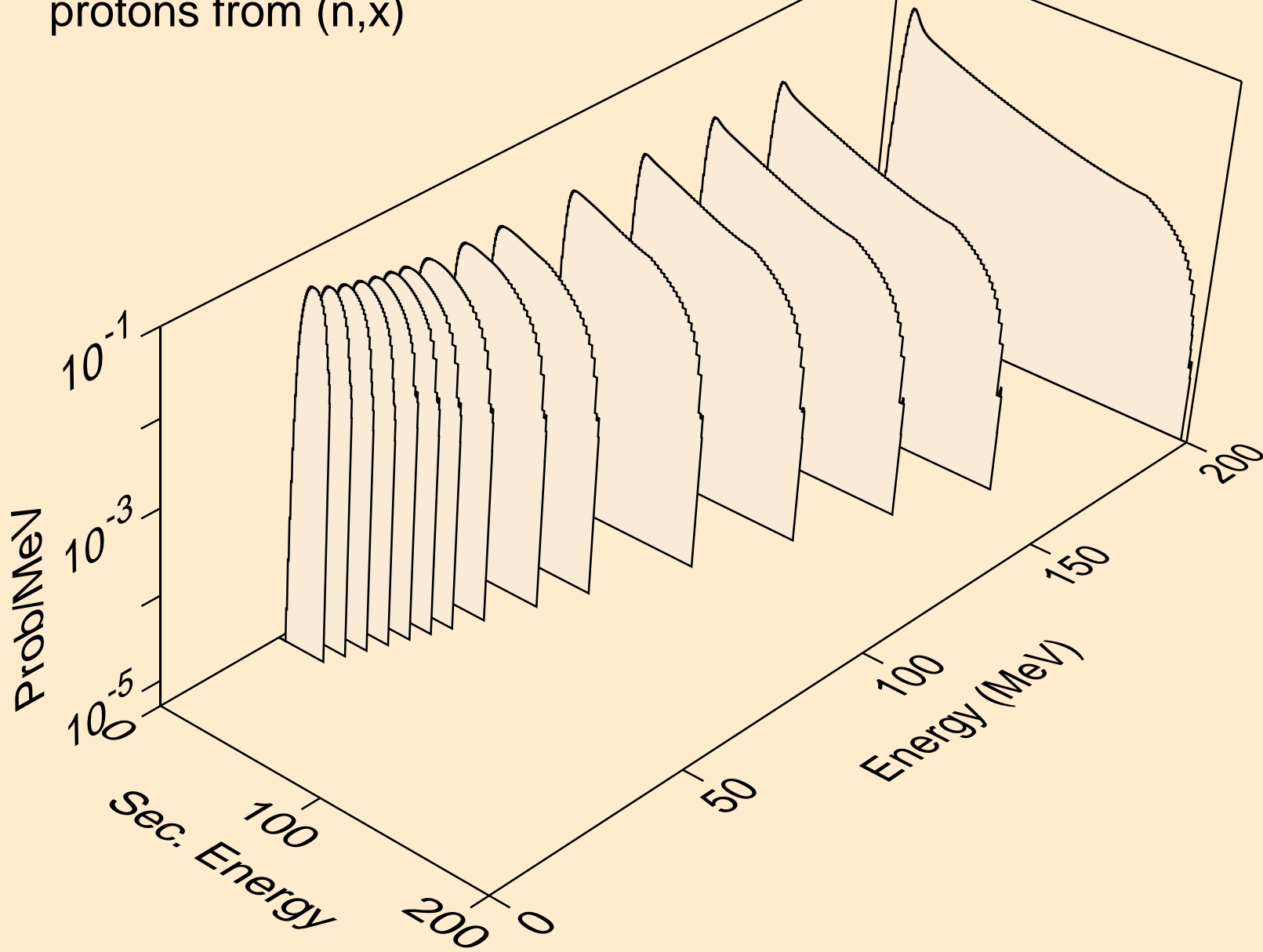

HG203 NEUTRON ACER TENDL-2023 LIBRARY; T=0.K  
protons from (n,n\*)p

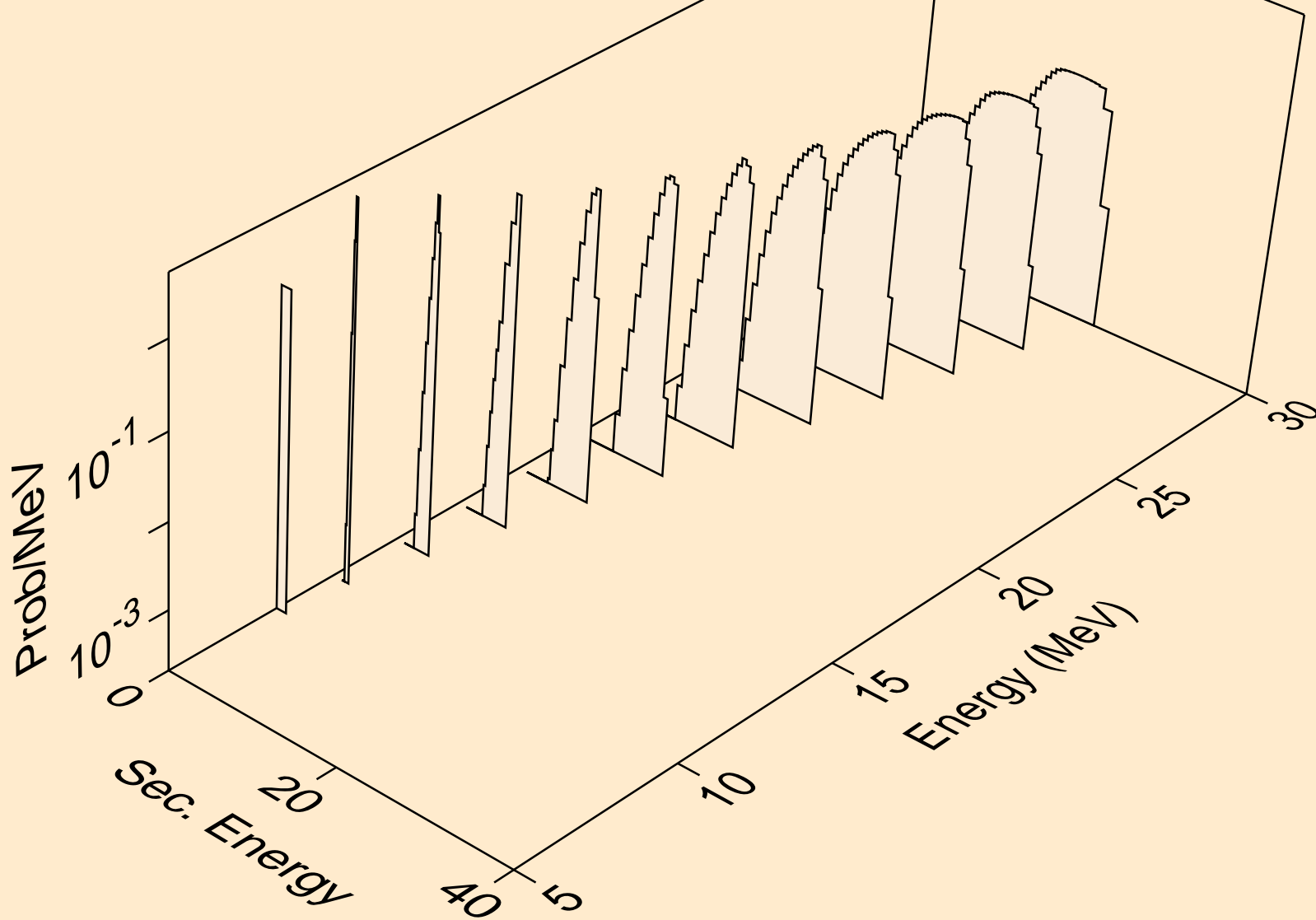



HG203 NEUTRON ACER TENDL-2023 LIBRARY; T=0.K  
protons from (n,2np)

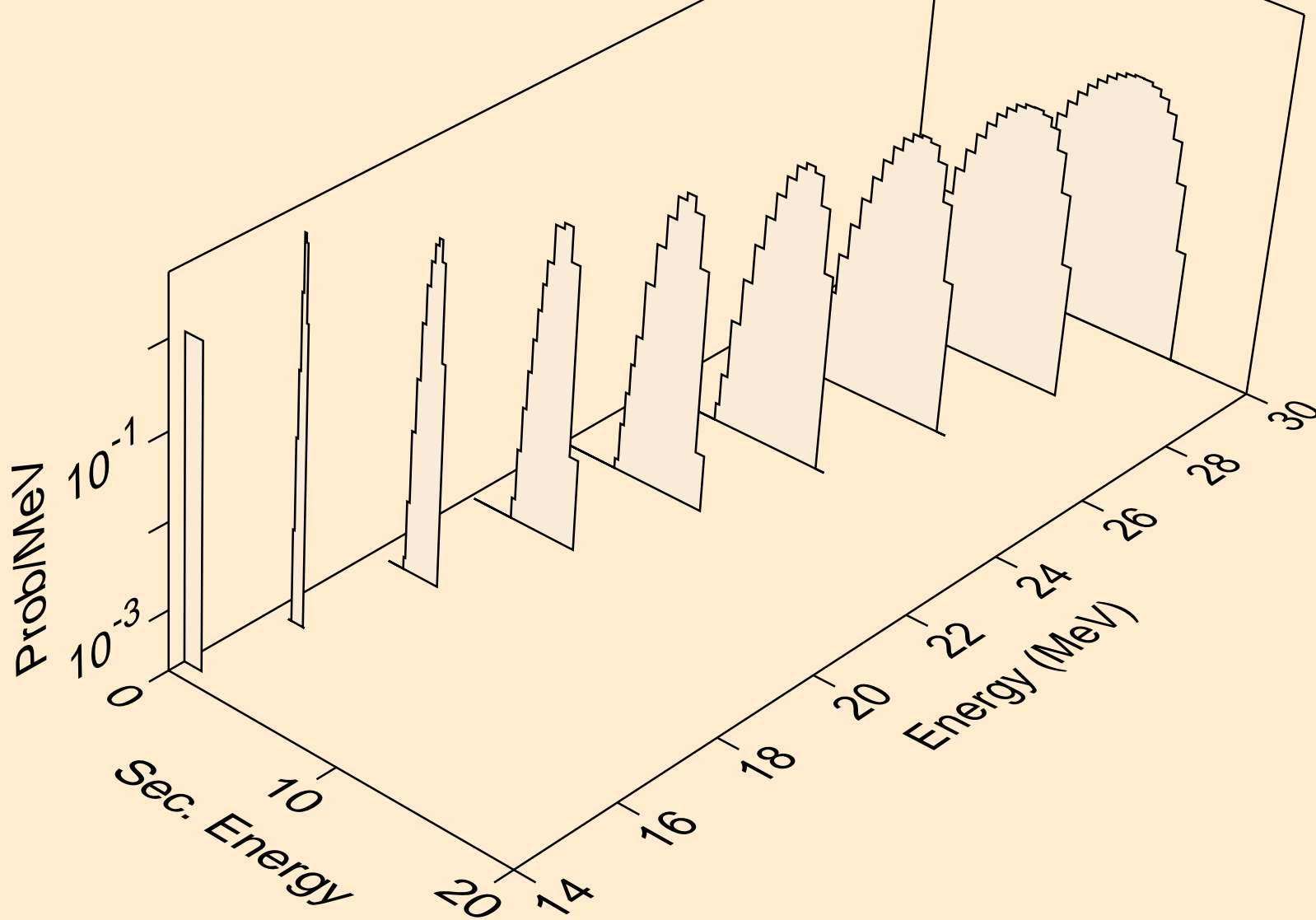

HG203 NEUTRON ACER TENDL-2023 LIBRARY; T=0.K  
protons from (n,3np)

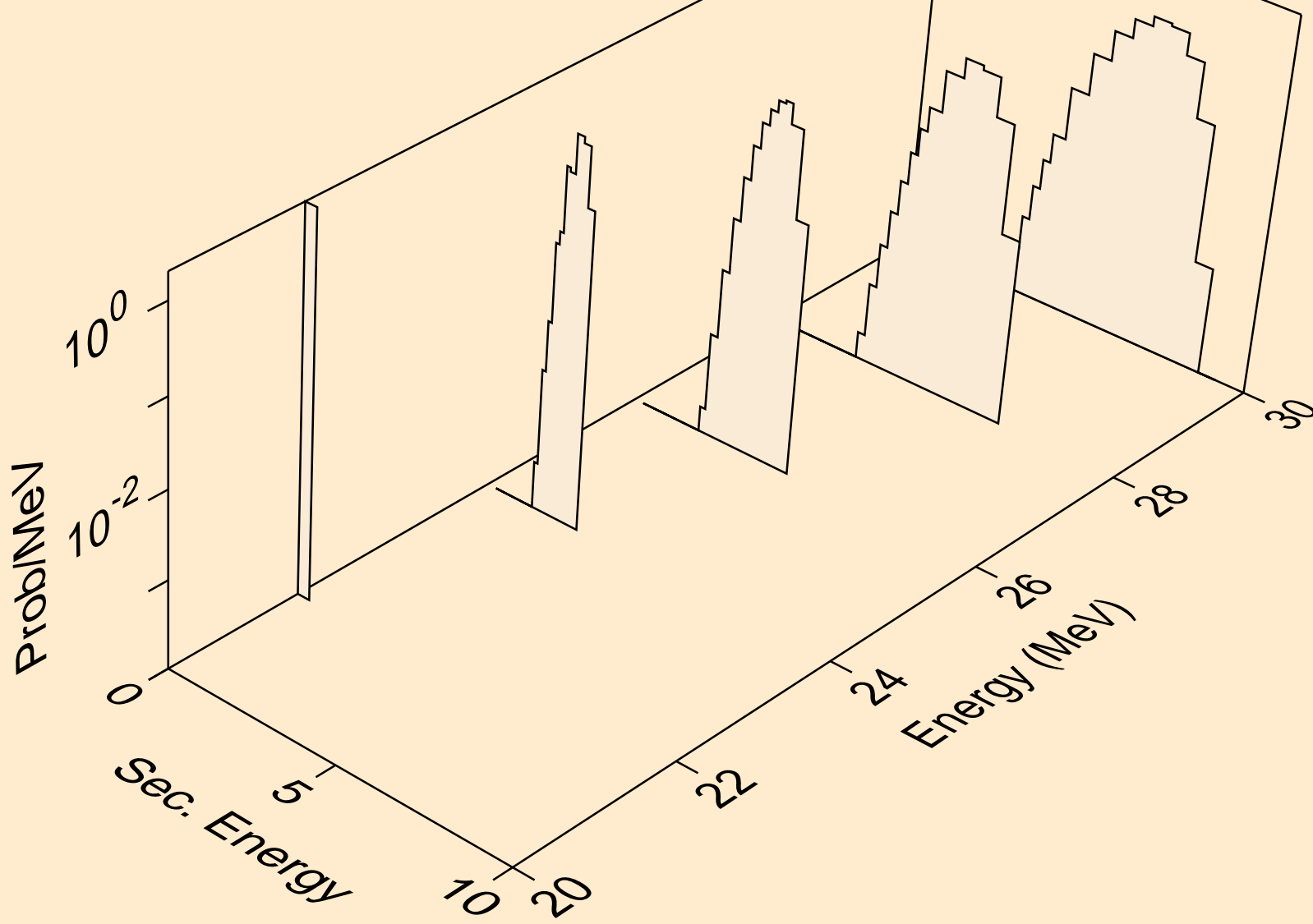

HG203 NEUTRON ACER TENDL-2023 LIBRARY; T=0.K  
protons from (n,p)

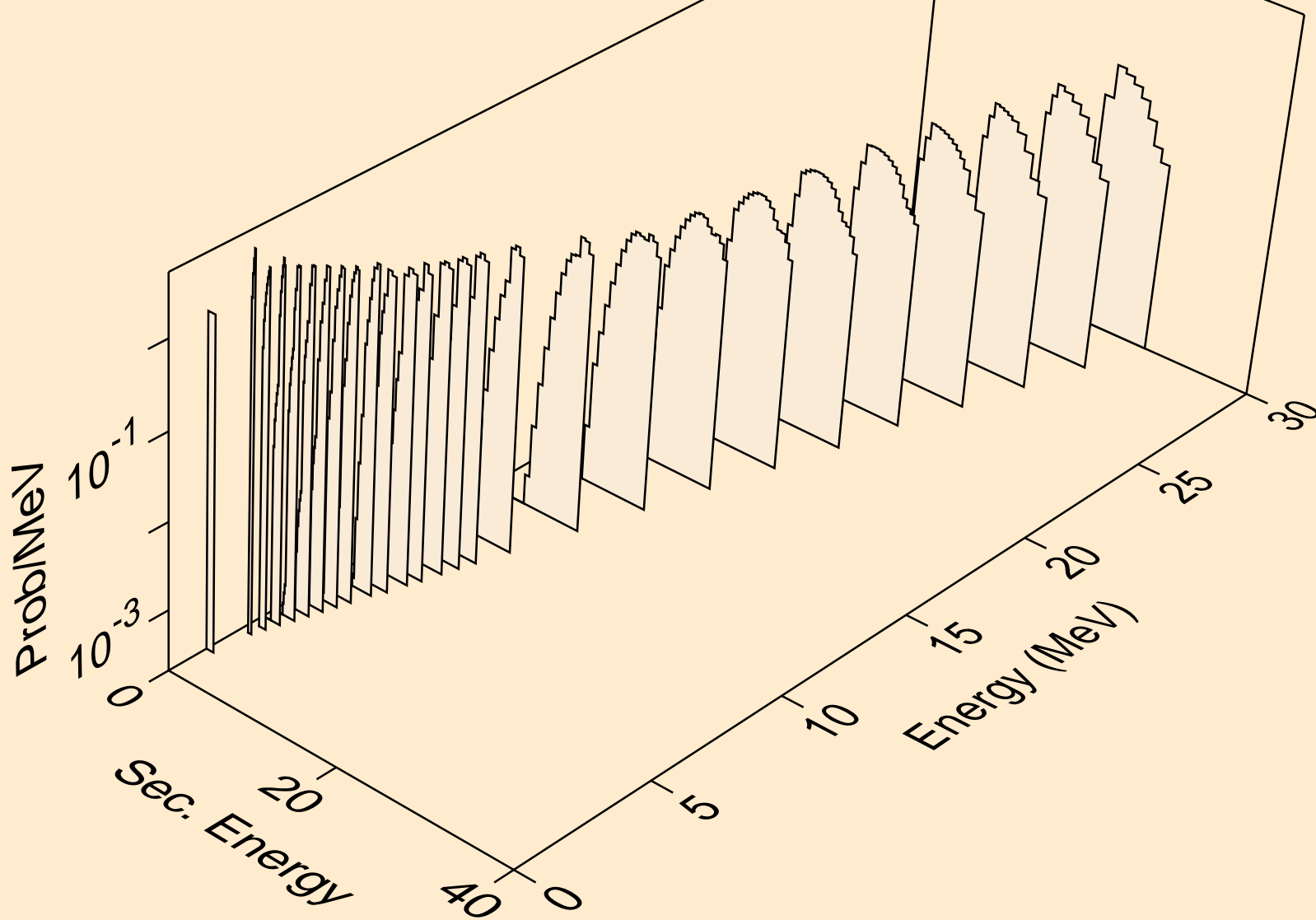

HG203 NEUTRON ACER TENDL-2023 LIBRARY; T=0.K  
protons from (n,2p)

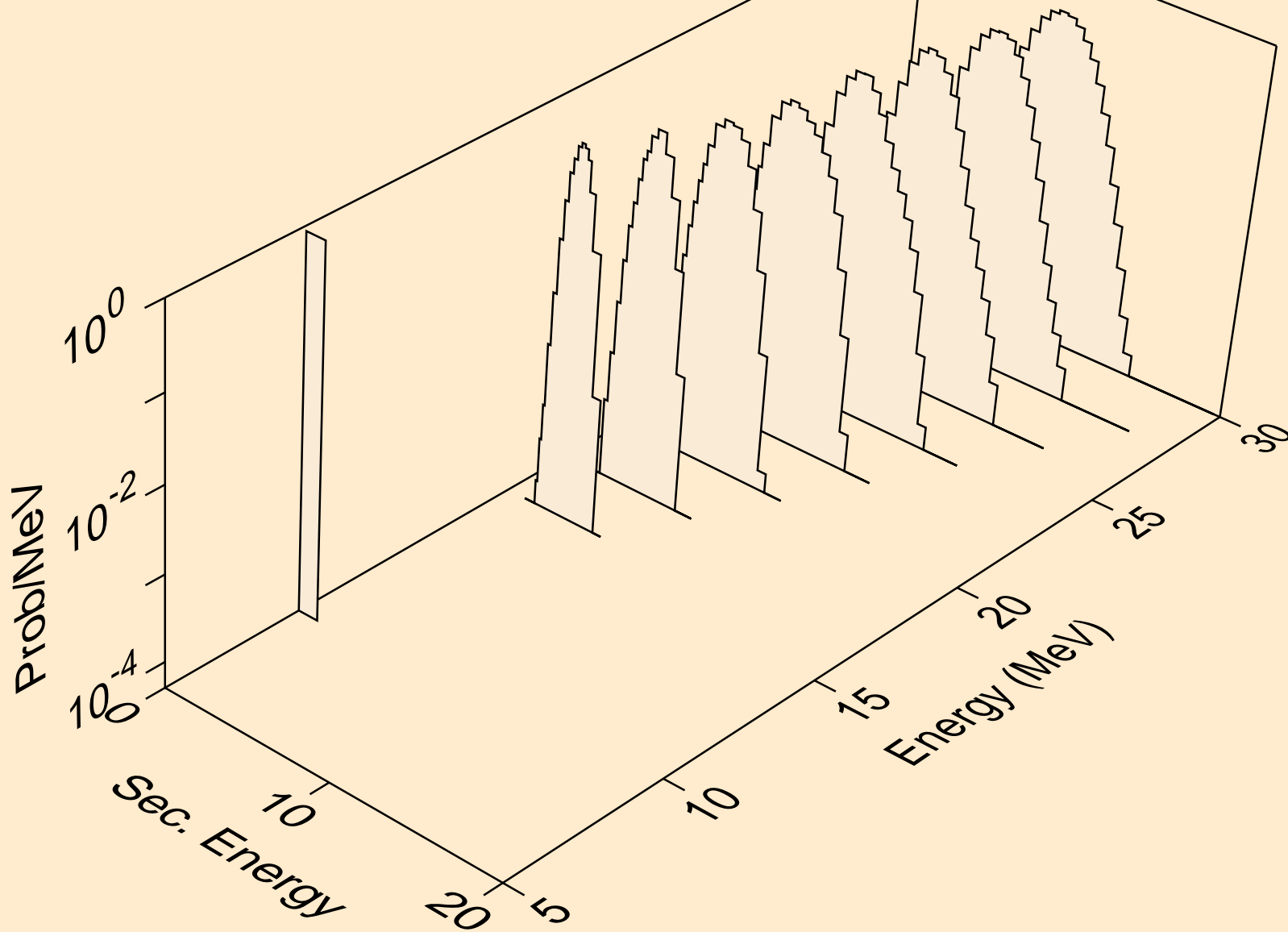

HG203 NEUTRON ACER TENDL-2023 LIBRARY; T=0.K  
deuterons from (n,x)

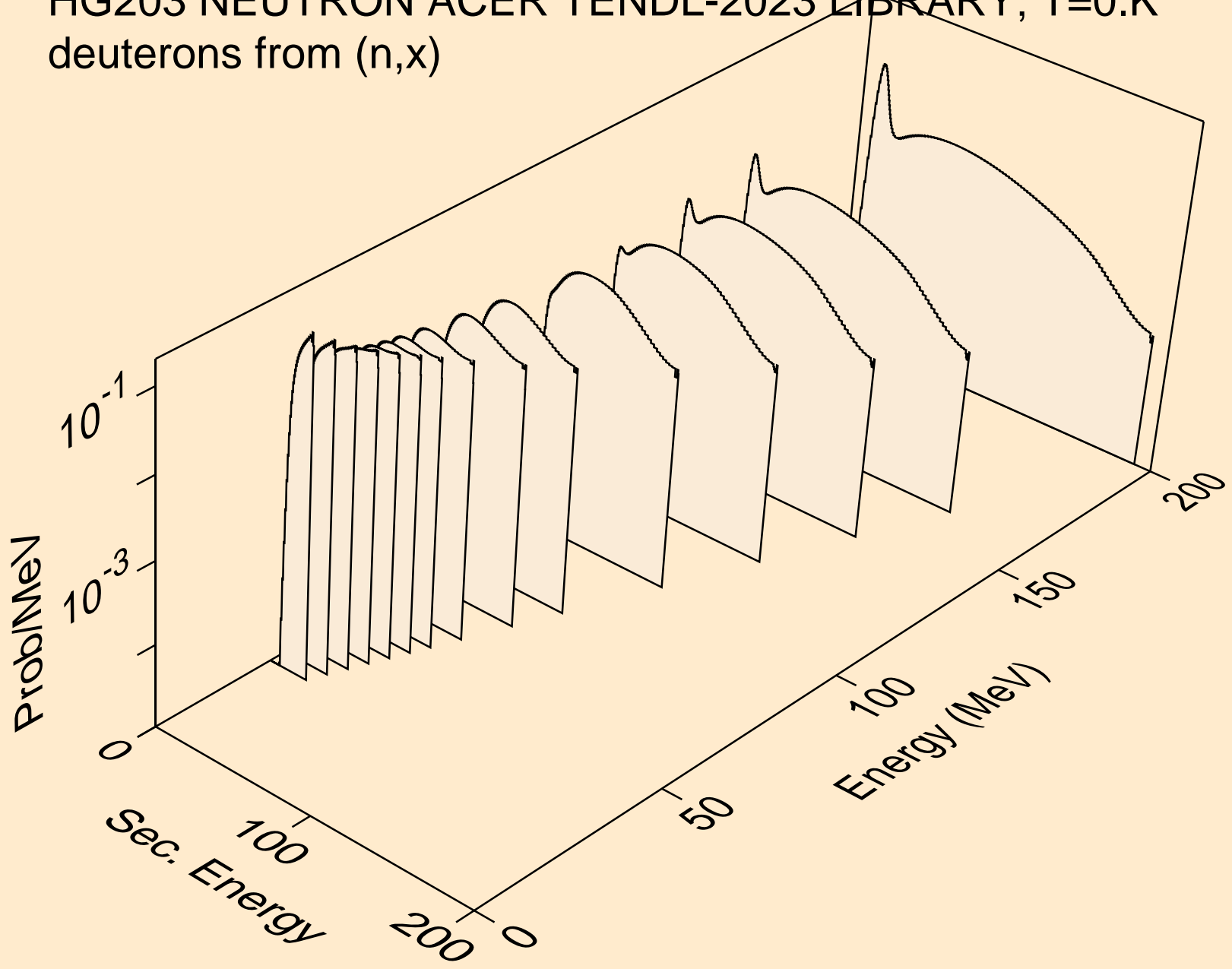

HG203 NEUTRON ACER TENDL-2023 LIBRARY; T=0.K  
deuterons from (n,2nd)

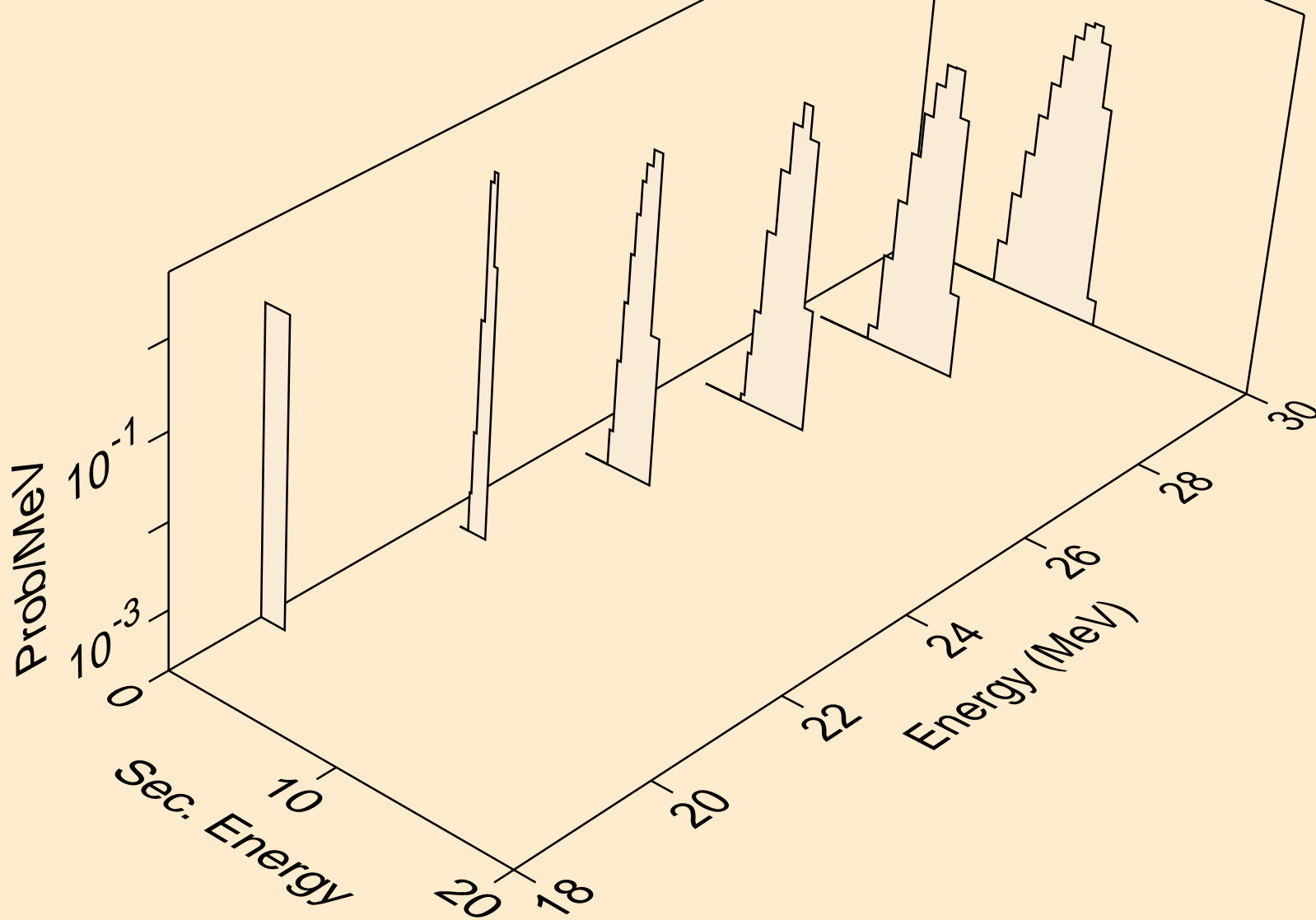

HG203 NEUTRON ACER TENDL-2023 LIBRARY; T=0.K  
deuterons from (n,n\*)d

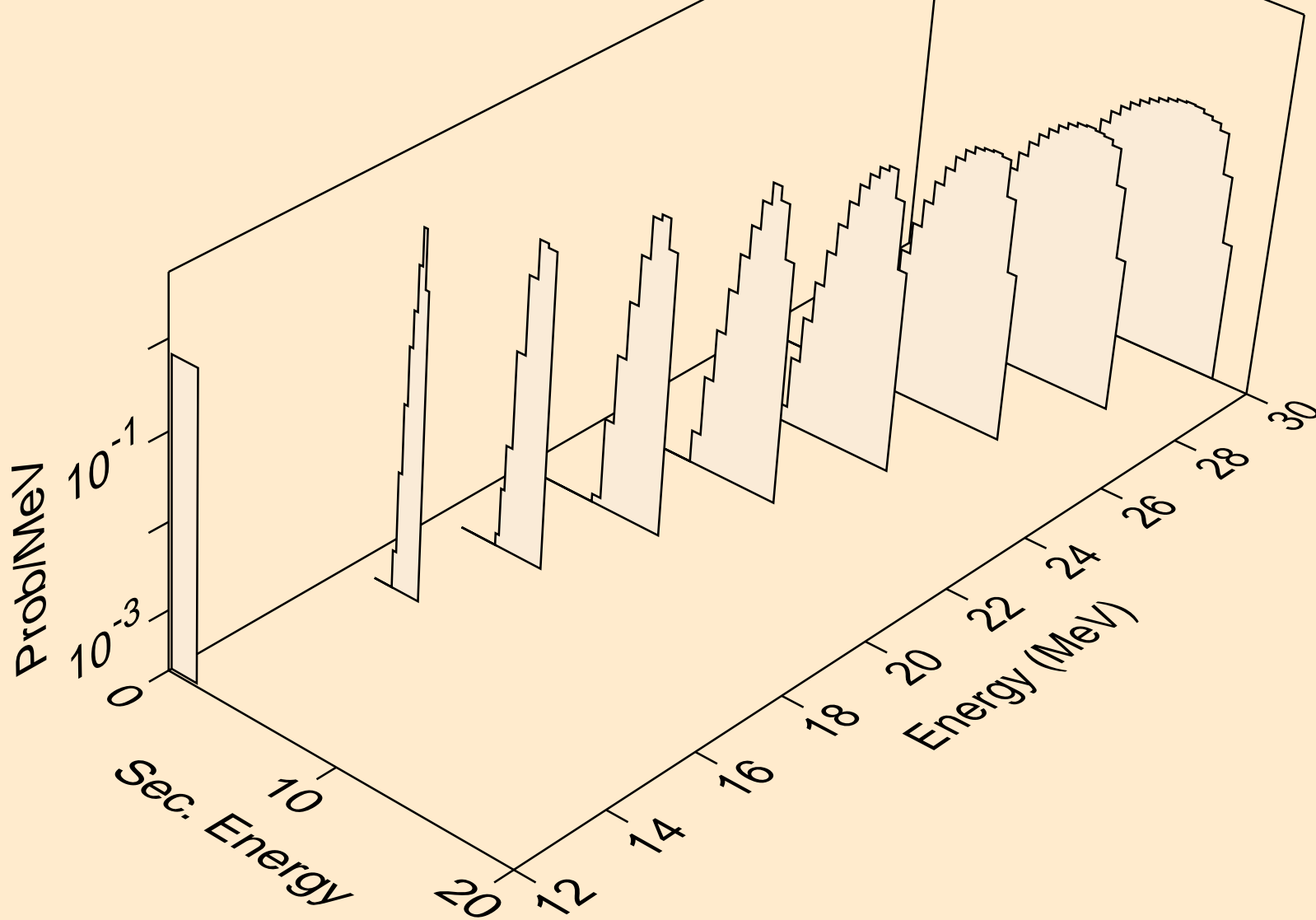

HG203 NEUTRON ACER TENDL-2023 LIBRARY; T=0.K  
deuterons from (n,d)

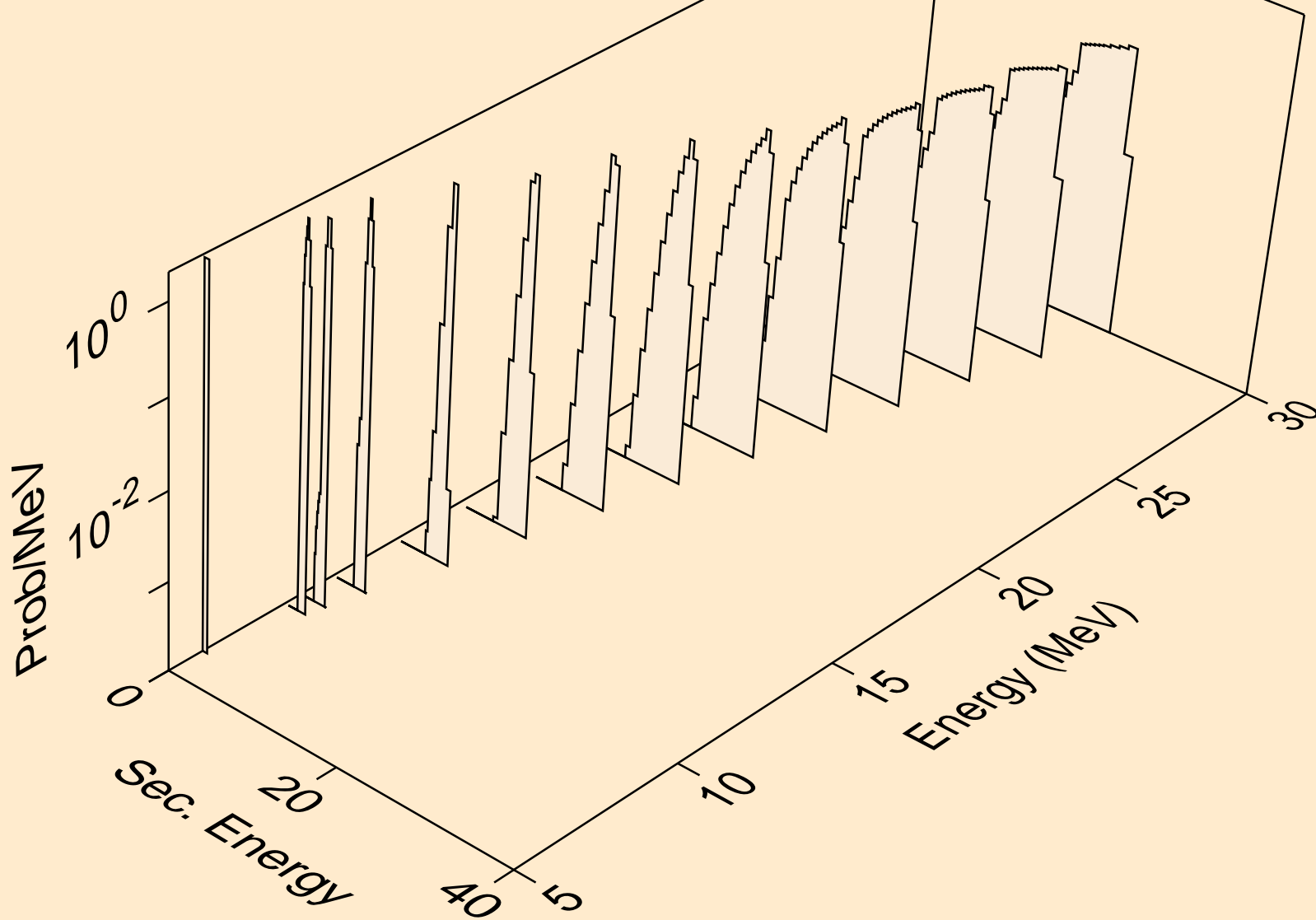



HG203 NEUTRON ACER TENDL-2023 LIBRARY; T=0.K  
tritons from (n,x)

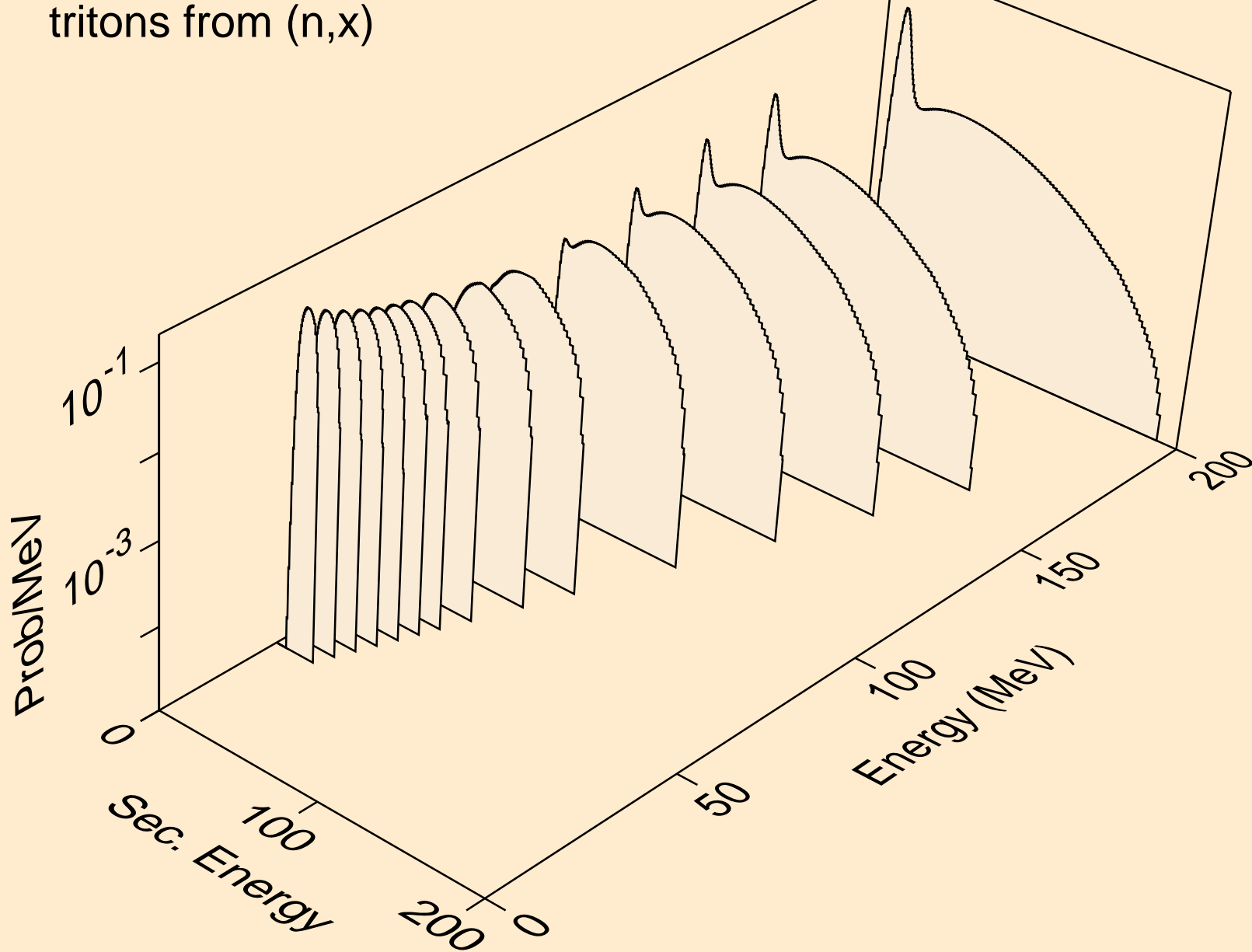

HG203 NEUTRON ACER TENDL-2023 LIBRARY; T=0.K  
tritons from (n,n\*)t

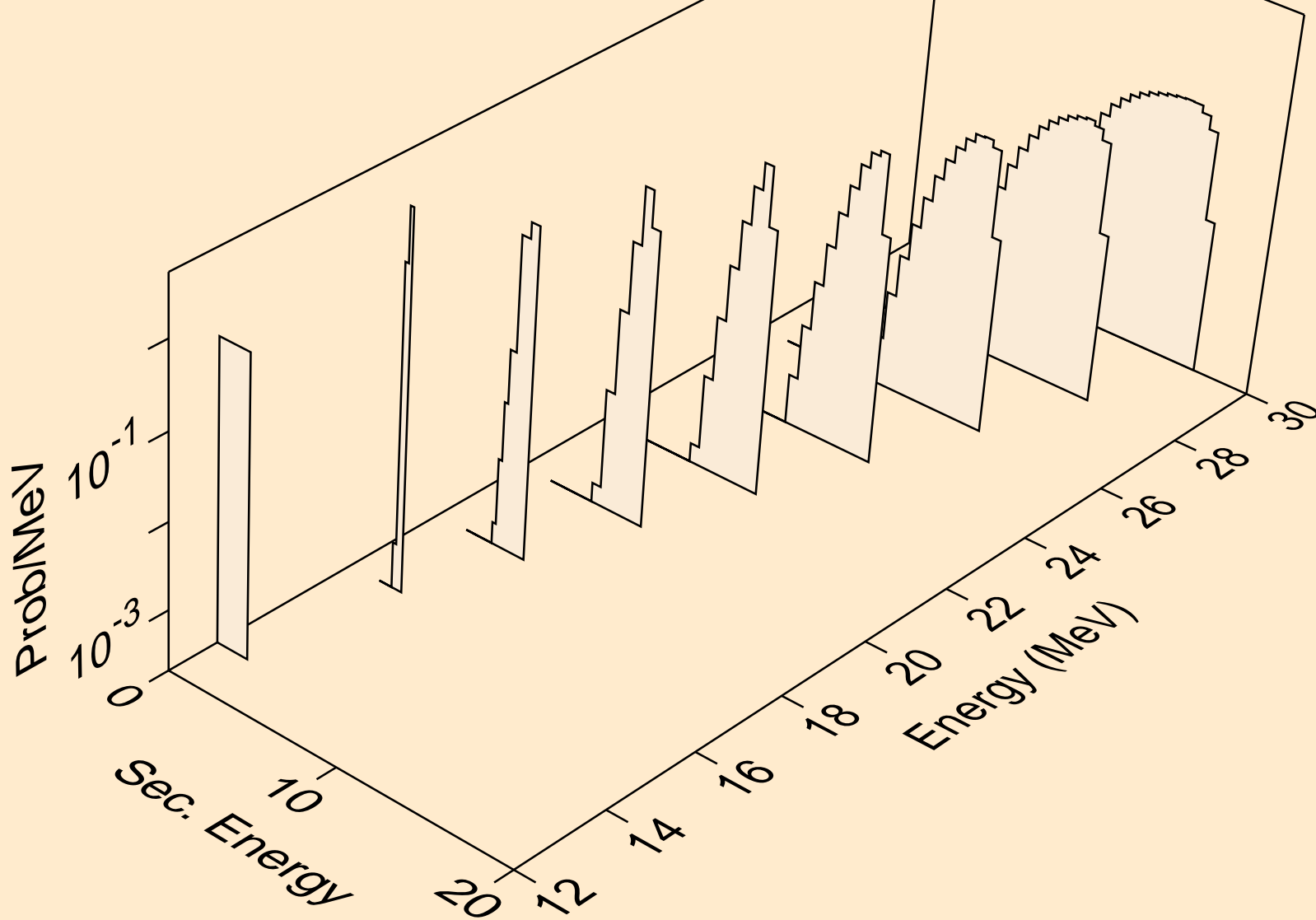

HG203 NEUTRON ACER TENDL-2023 LIBRARY; T=0.K  
tritons from (n,t)

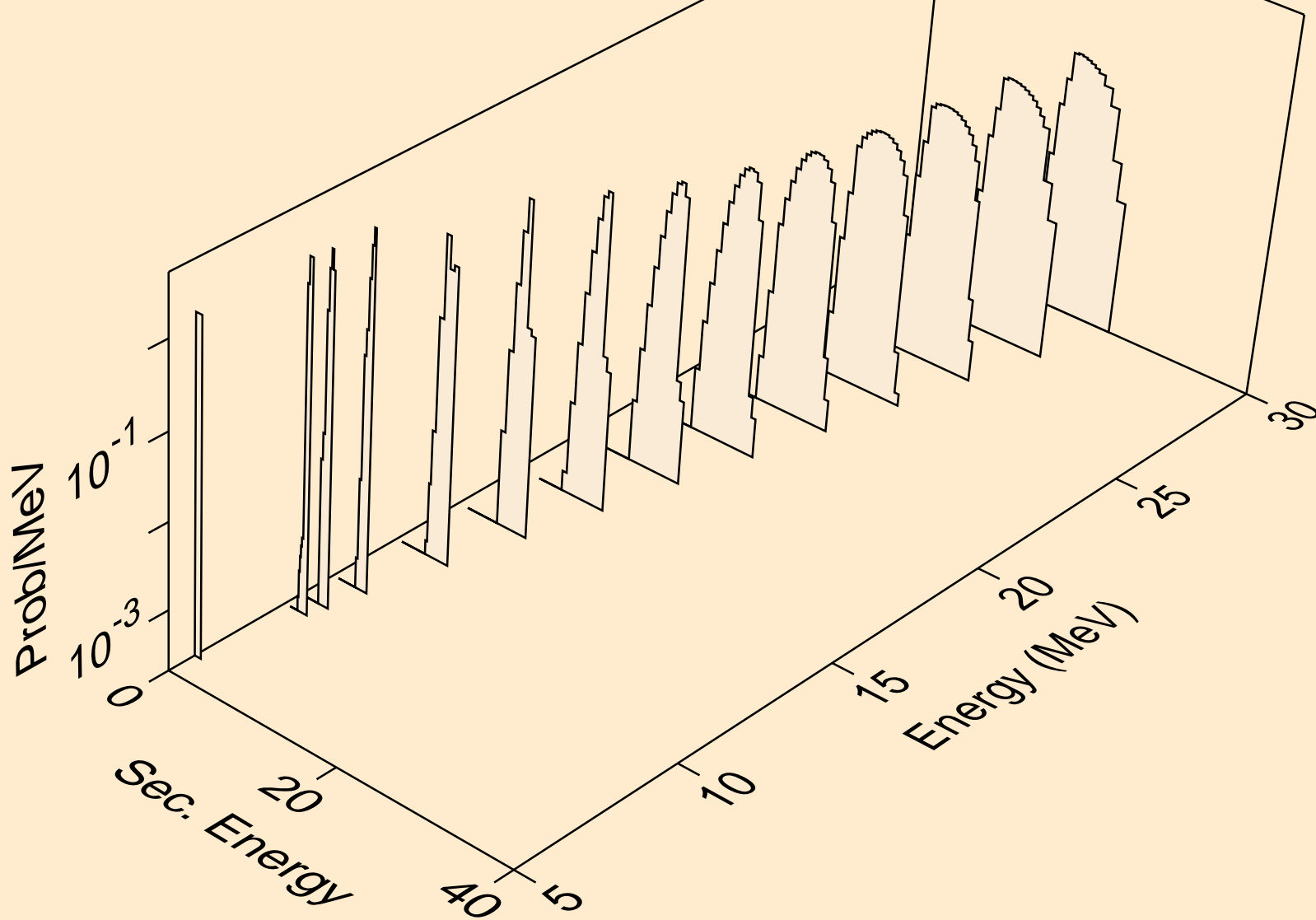

HG203 NEUTRON ACER TENDL-2023 LIBRARY; T=0.K  
he3s from (n,x)

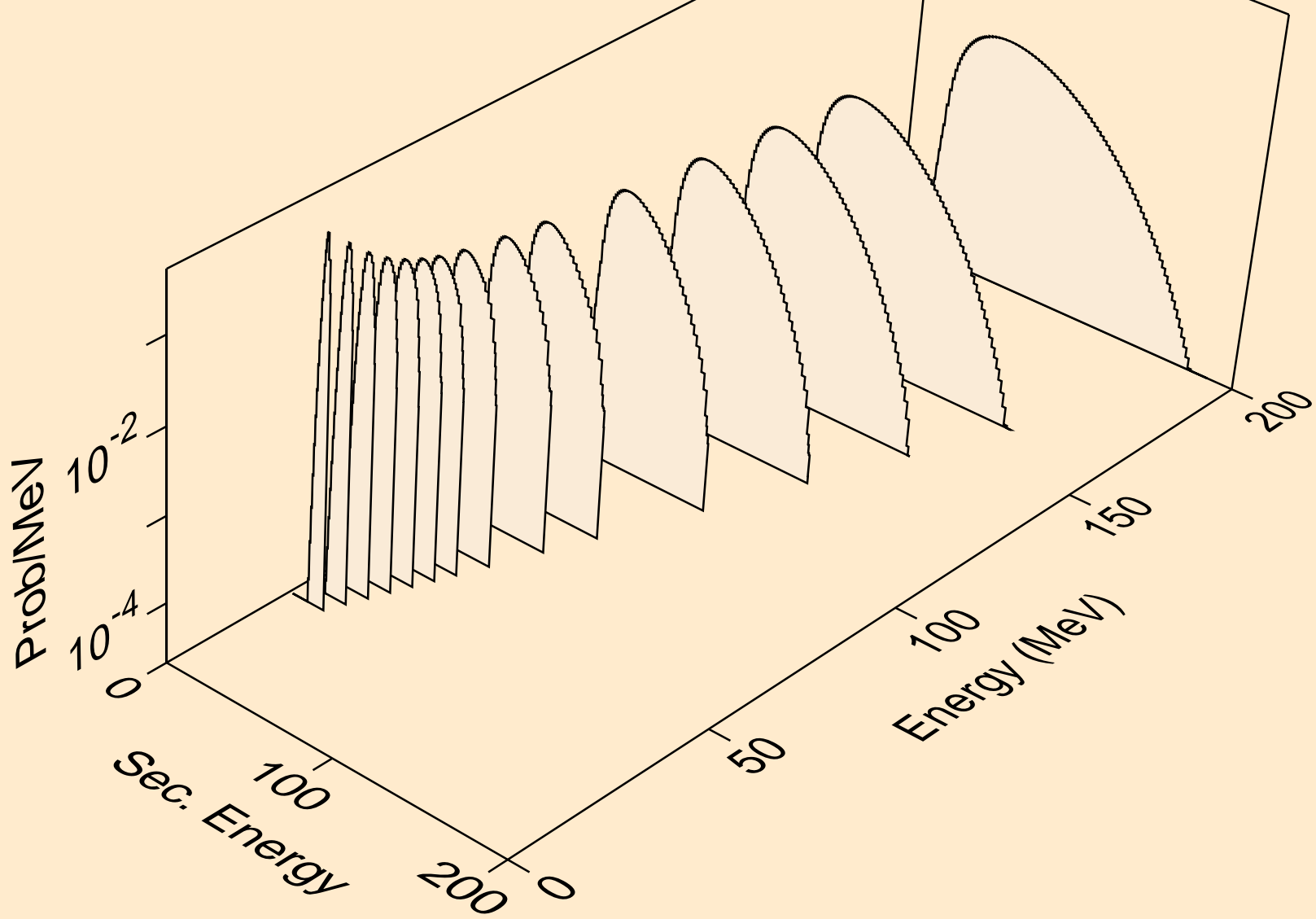

HG203 NEUTRON ACER TENDL-2023 LIBRARY; T=0.K  
he3s from (n,n\*)he3

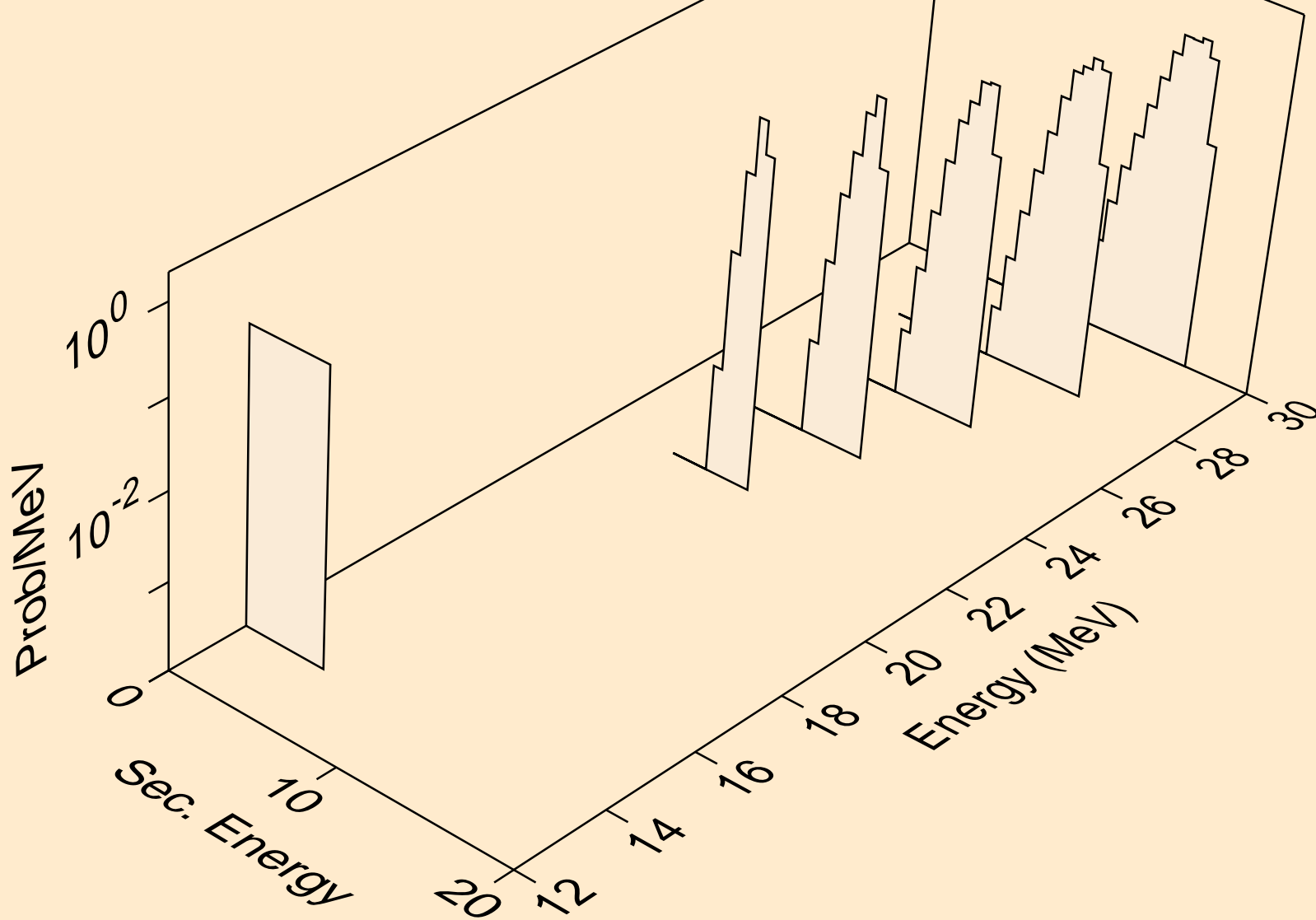

HG203 NEUTRON ACER TENDL-2023 LIBRARY; T=0.K  
he3s from (n,he3)

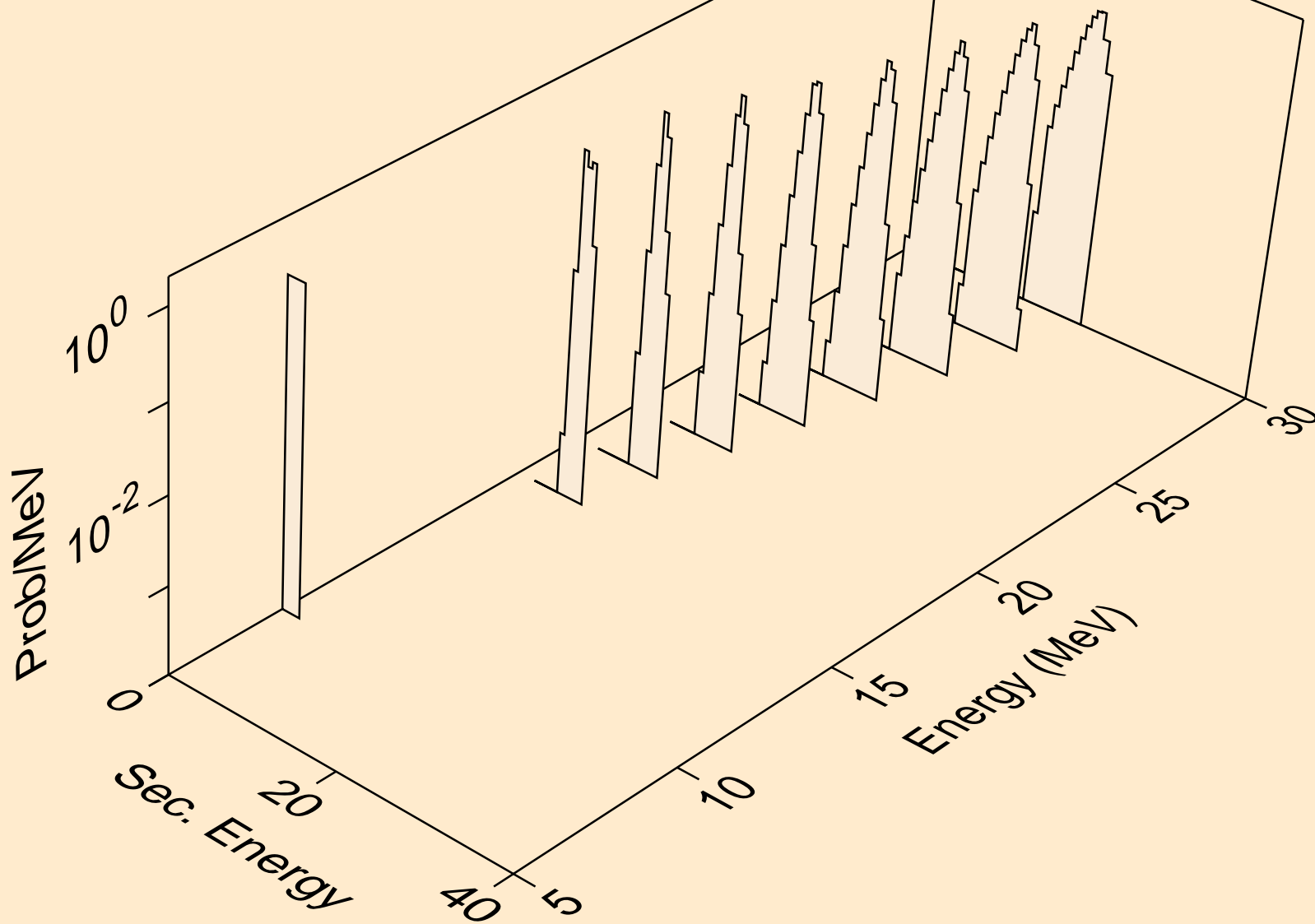

HG203 NEUTRON ACER TENDL-2023 LIBRARY; T=0.K  
alphas from (n,x)

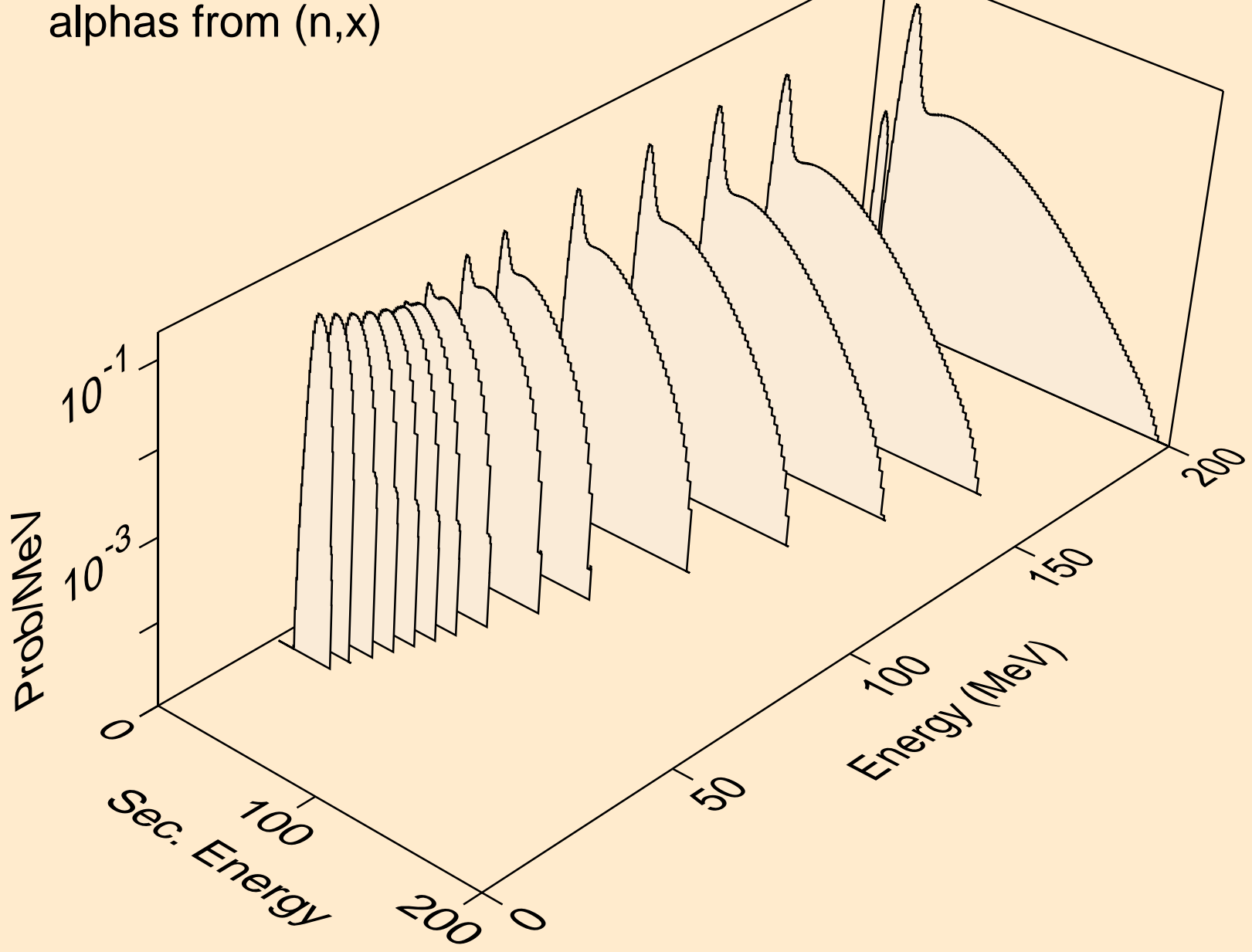

HG203 NEUTRON ACER TENDL-2023 LIBRARY; T=0.K  
alphas from (n,n\*)a

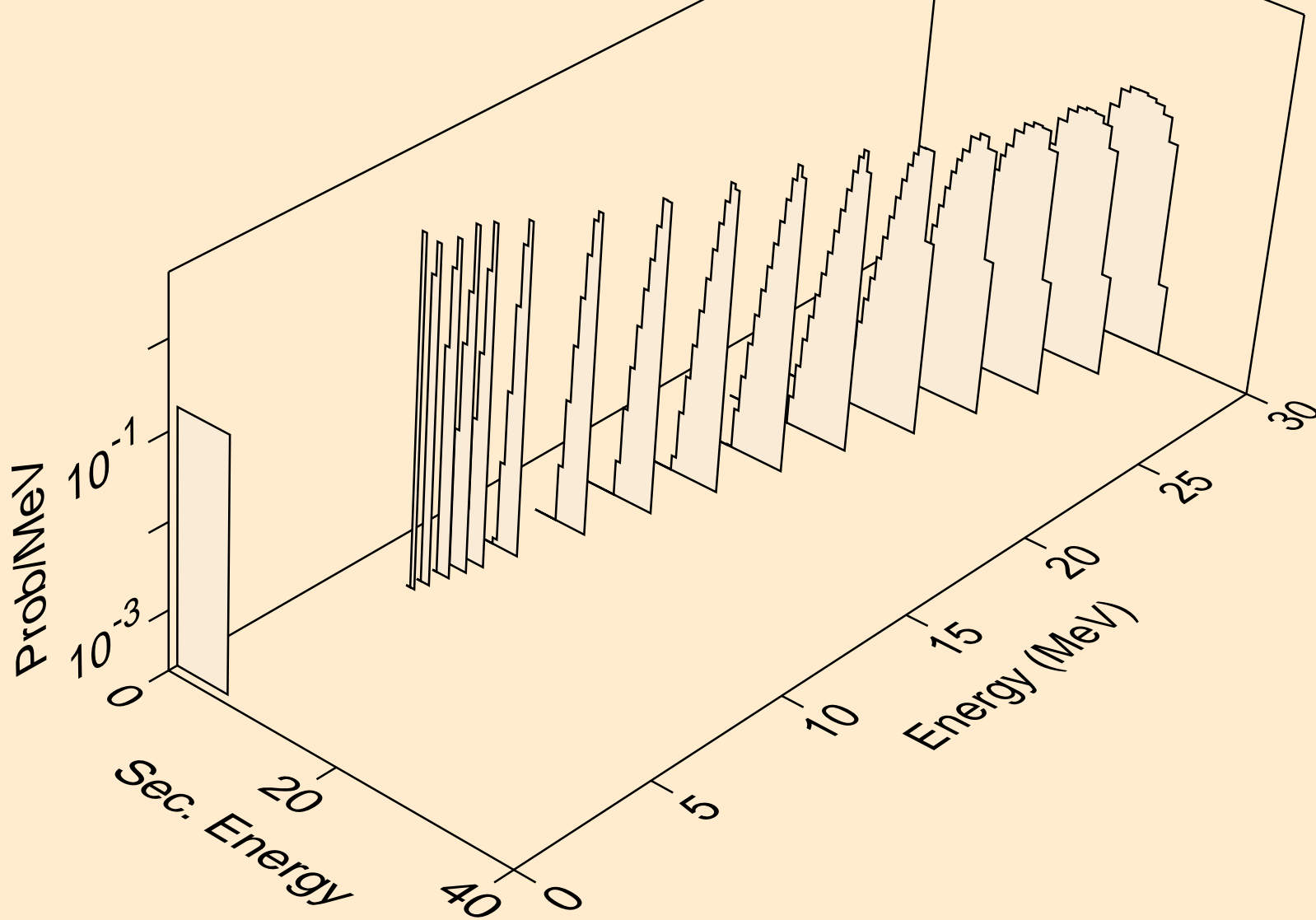



HG203 NEUTRON ACER TENDL-2023 LIBRARY; T=0.K  
alphas from (n,2n)a

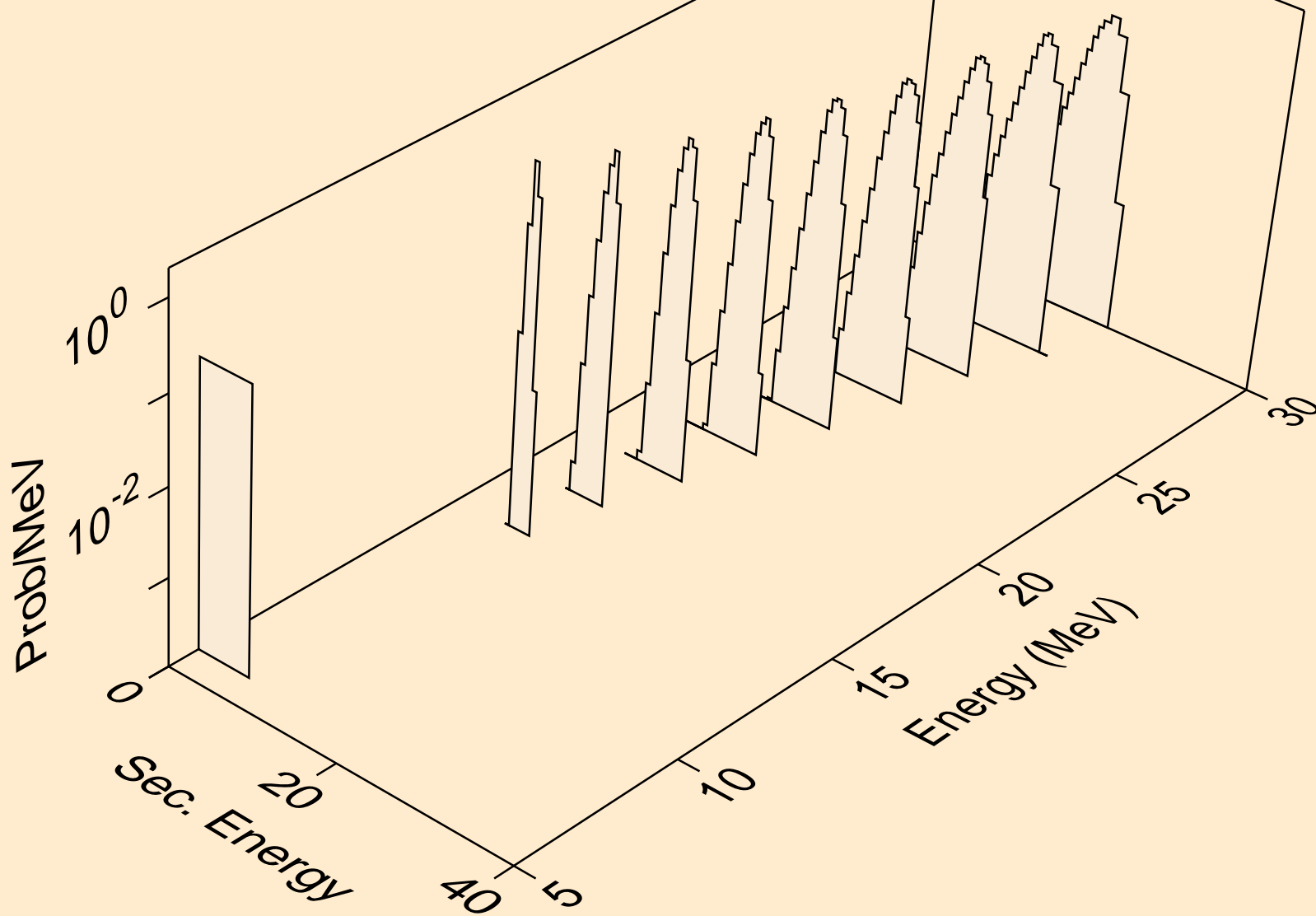

HG203 NEUTRON ACER TENDL-2023 LIBRARY; T=0.K  
alphas from (n,3n)a

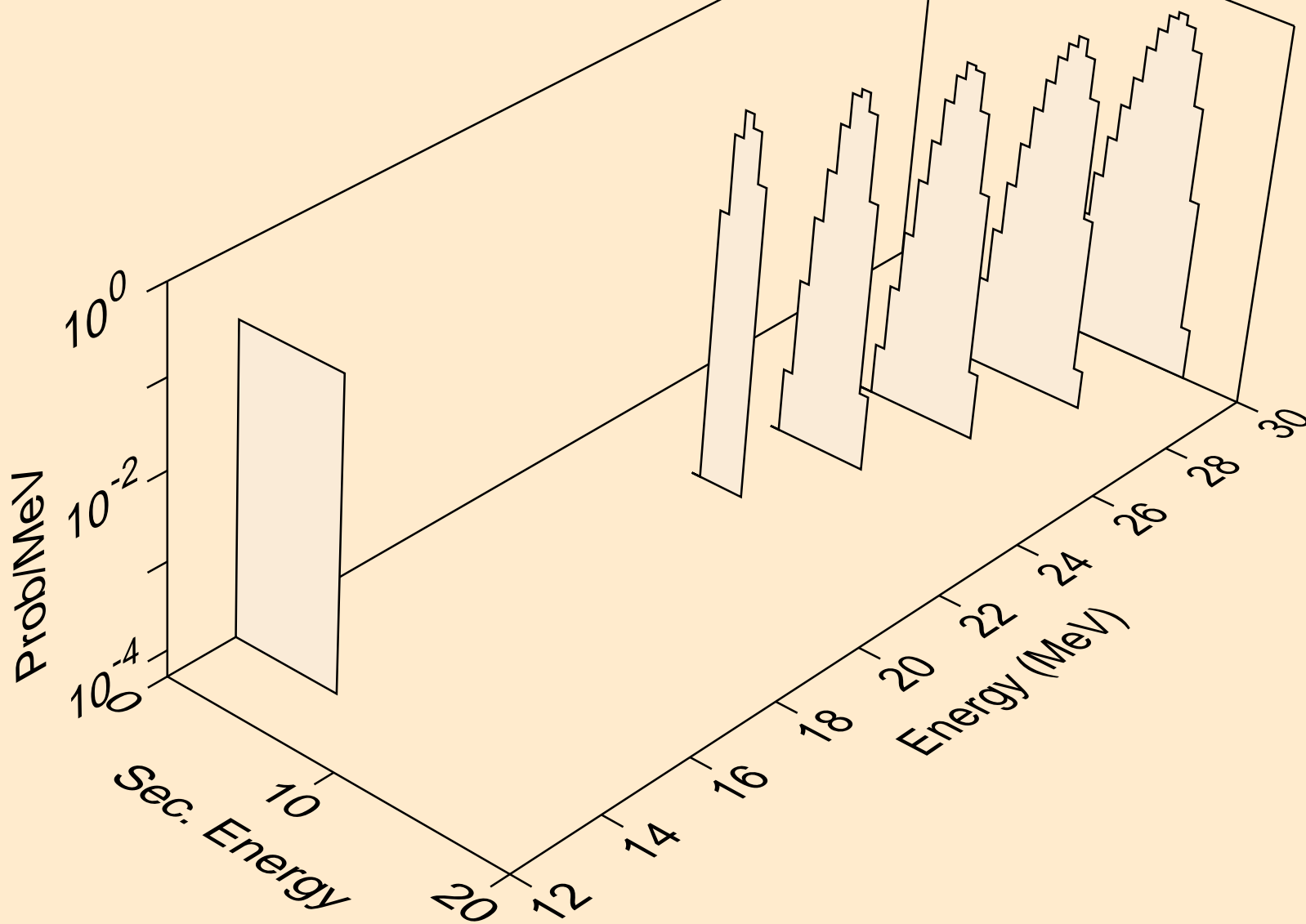

HG203 NEUTRON ACER TENDL-2023 LIBRARY; T=0.K  
alphas from (n,a)

