

HG214 NEUTRON ACER TENDL-2023 LIBRARY; T=0.K

Principal cross sections

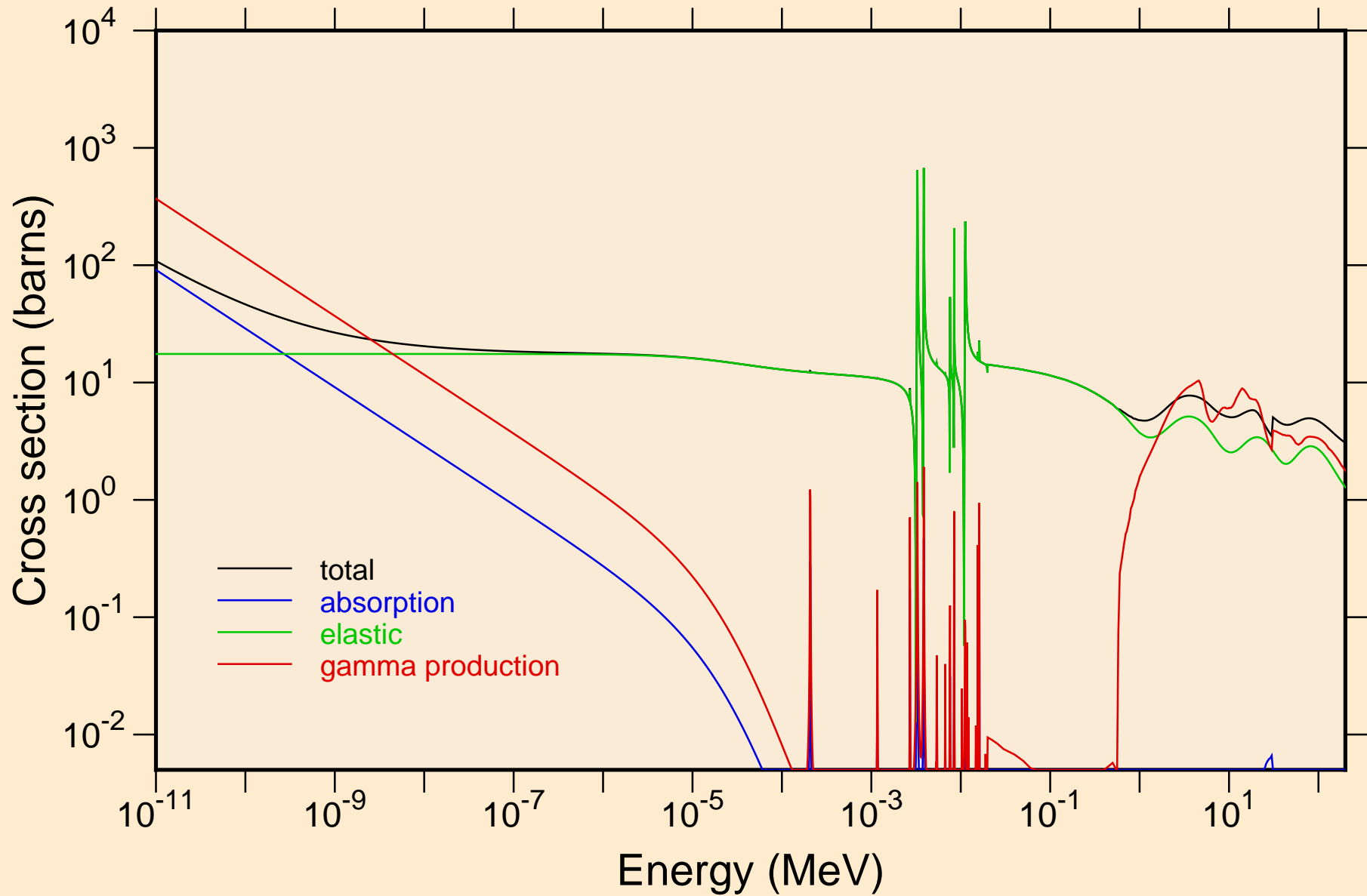

HG214 NEUTRON ACER TENDL-2023 LIBRARY; T=0.K
resonance total cross section

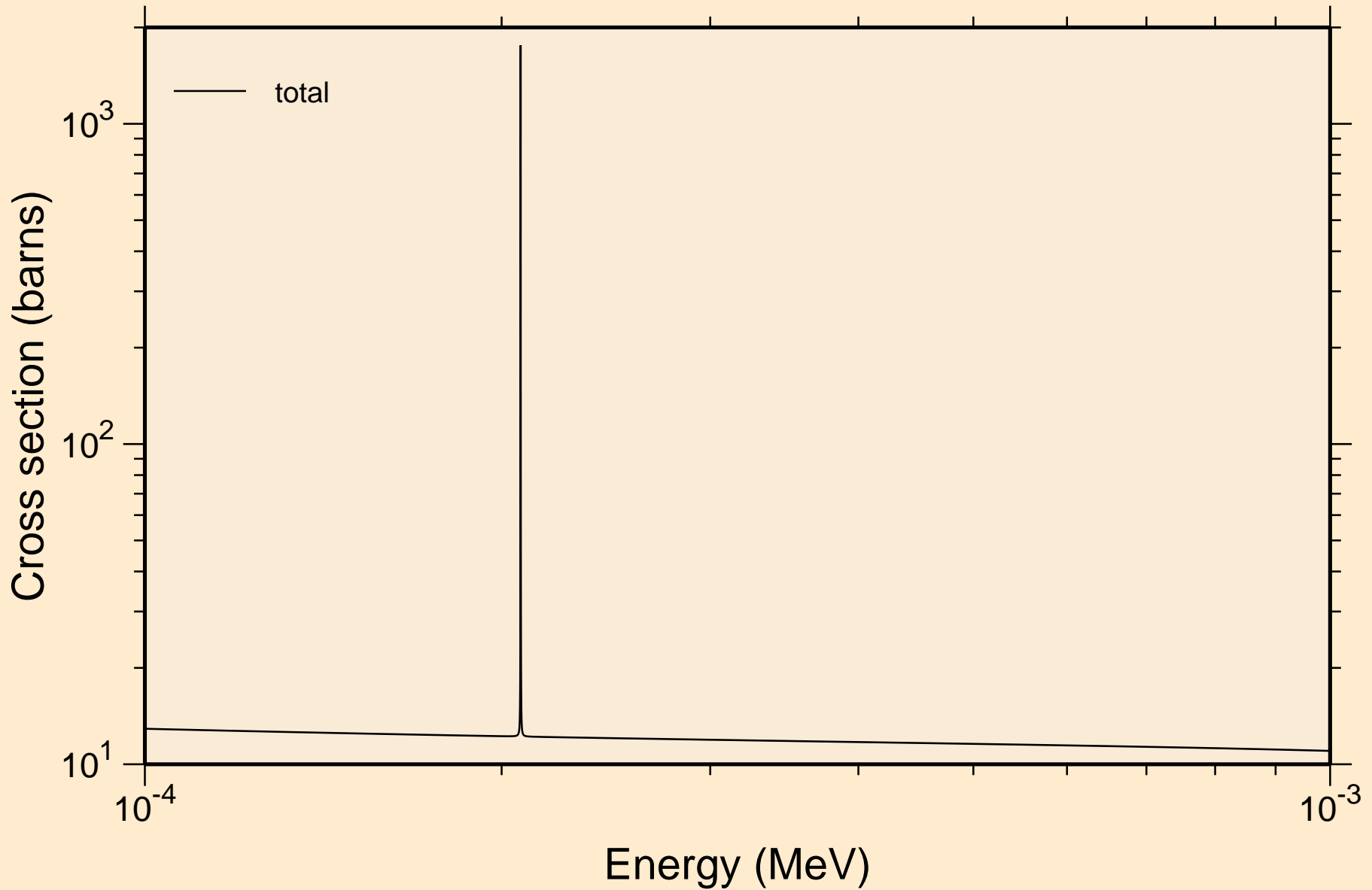

HG214 NEUTRON ACER TENDL-2023 LIBRARY; T=0.K
resonance total cross section

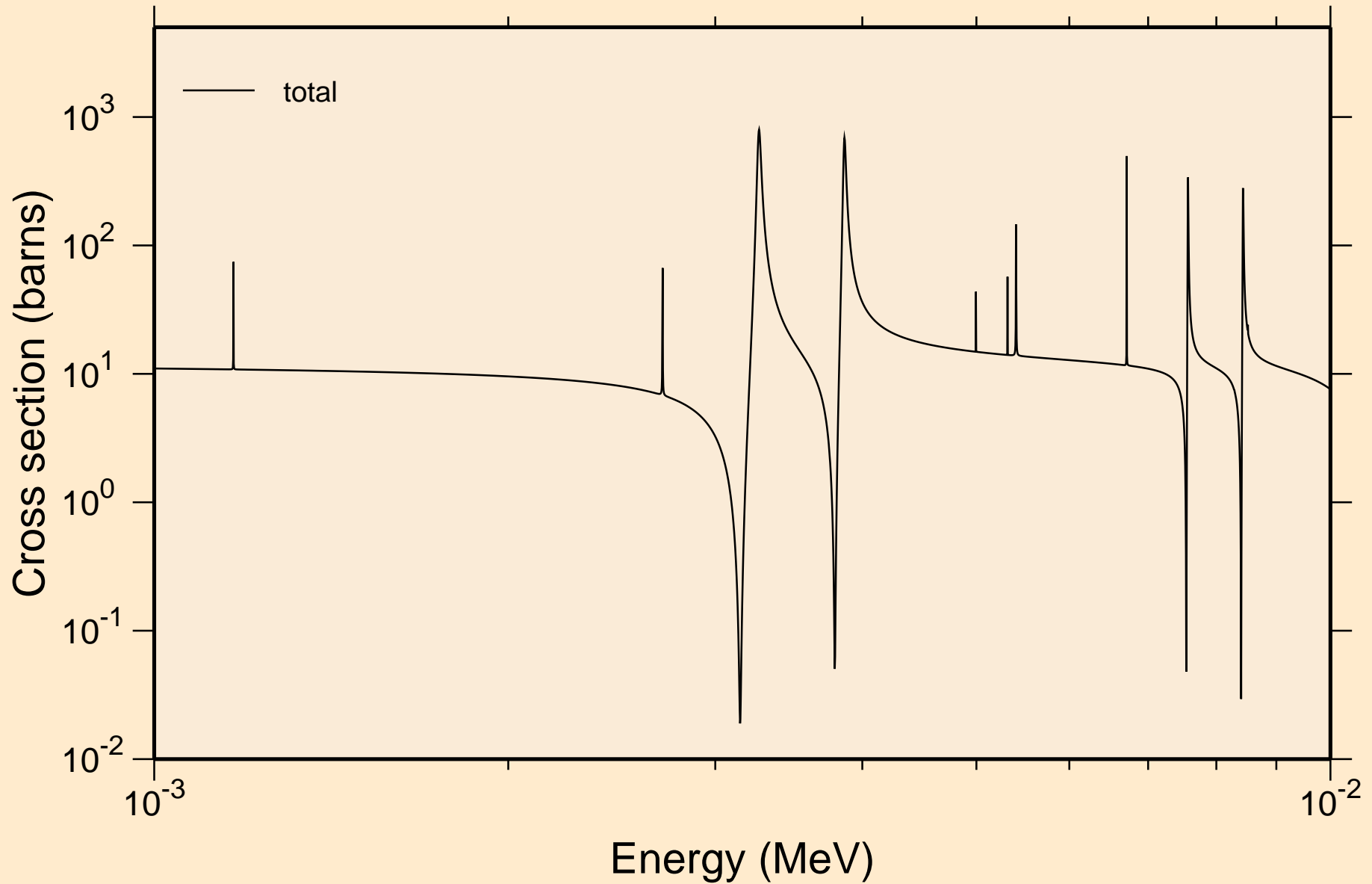

HG214 NEUTRON ACER TENDL-2023 LIBRARY; T=0.K
resonance total cross section

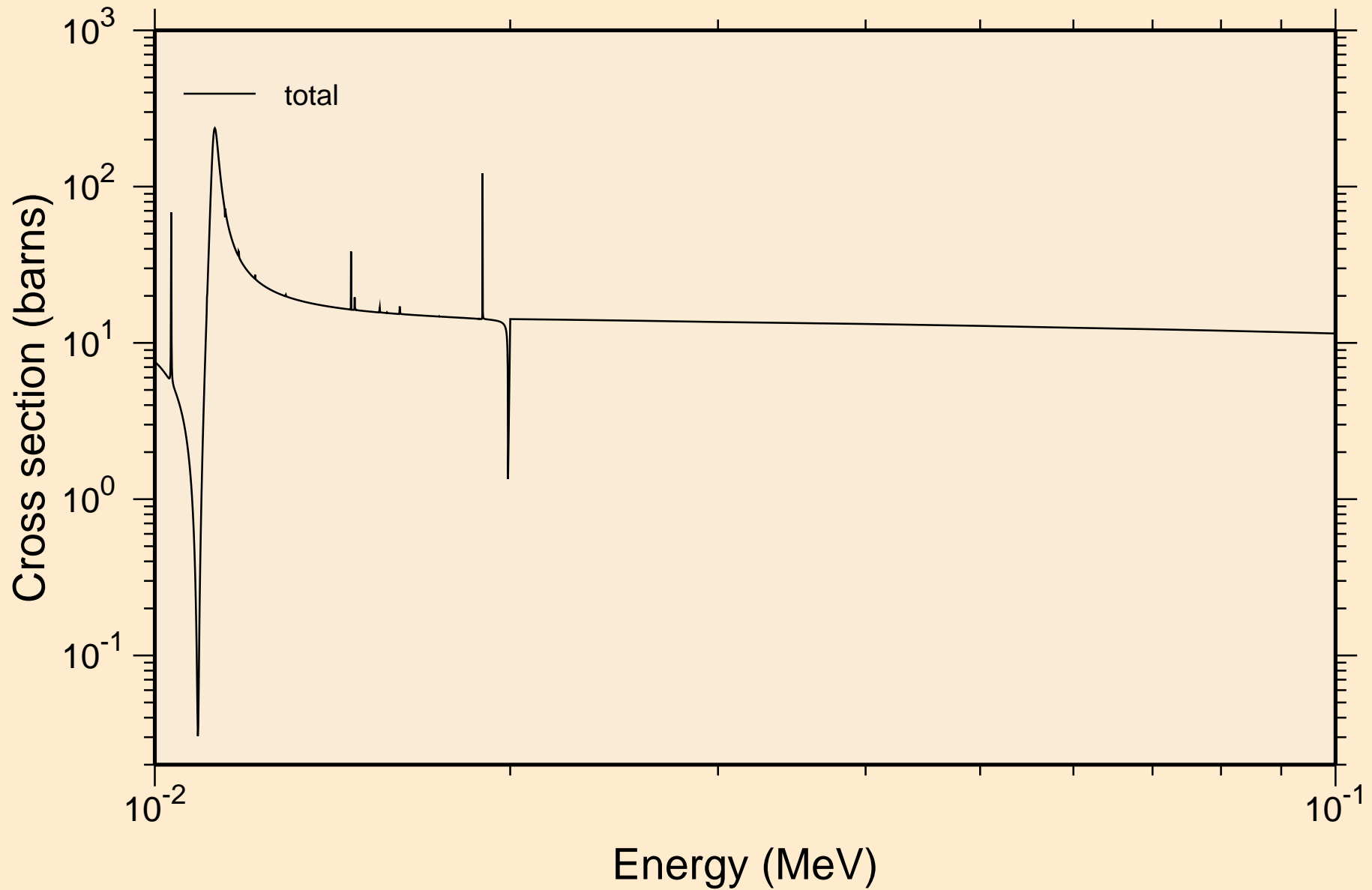

HG214 NEUTRON ACER TENDL-2023 LIBRARY; T=0.K
resonance total cross section

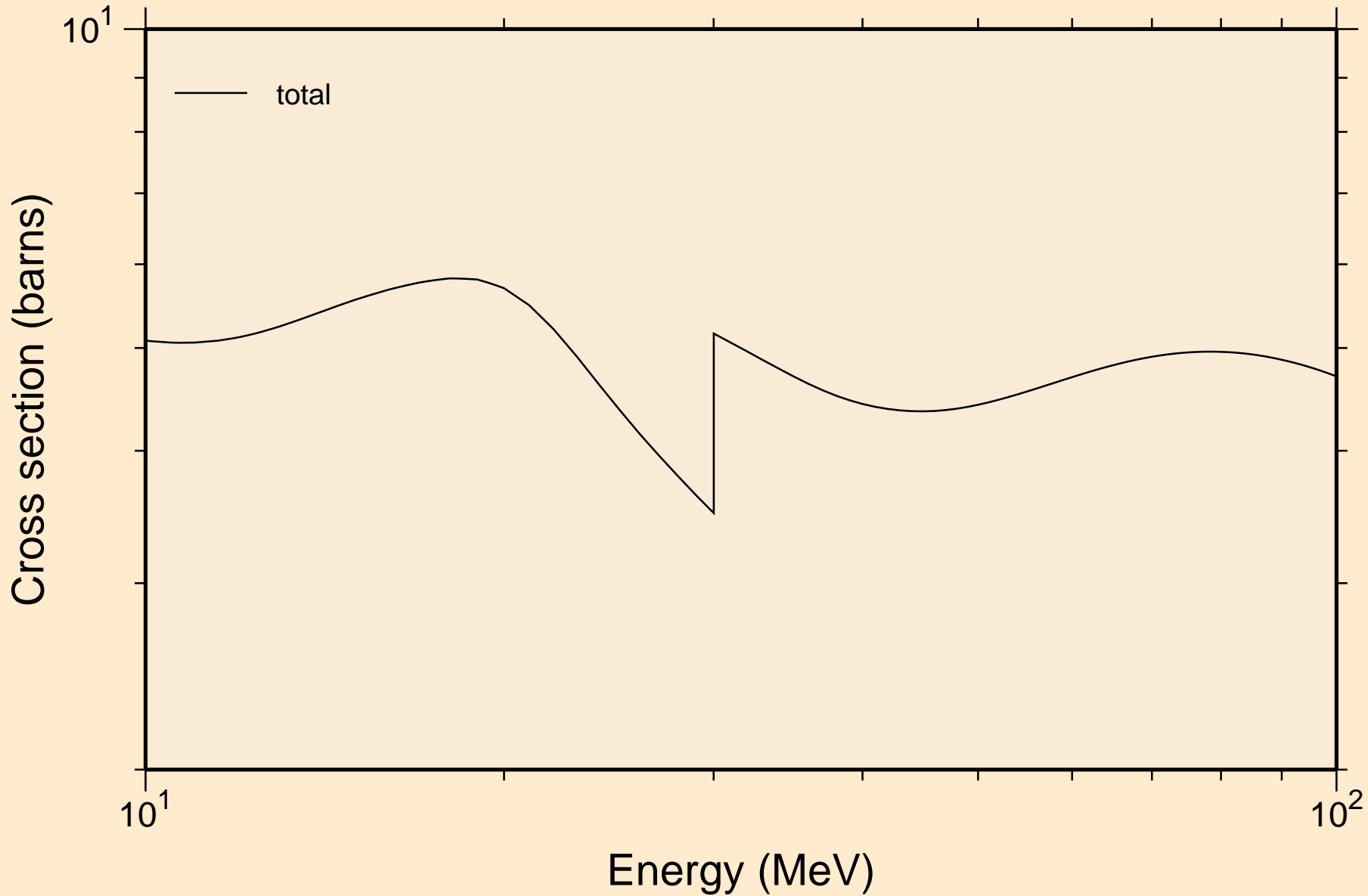

HG214 NEUTRON ACER TENDL-2023 LIBRARY; T=0.K
resonance absorption cross sections

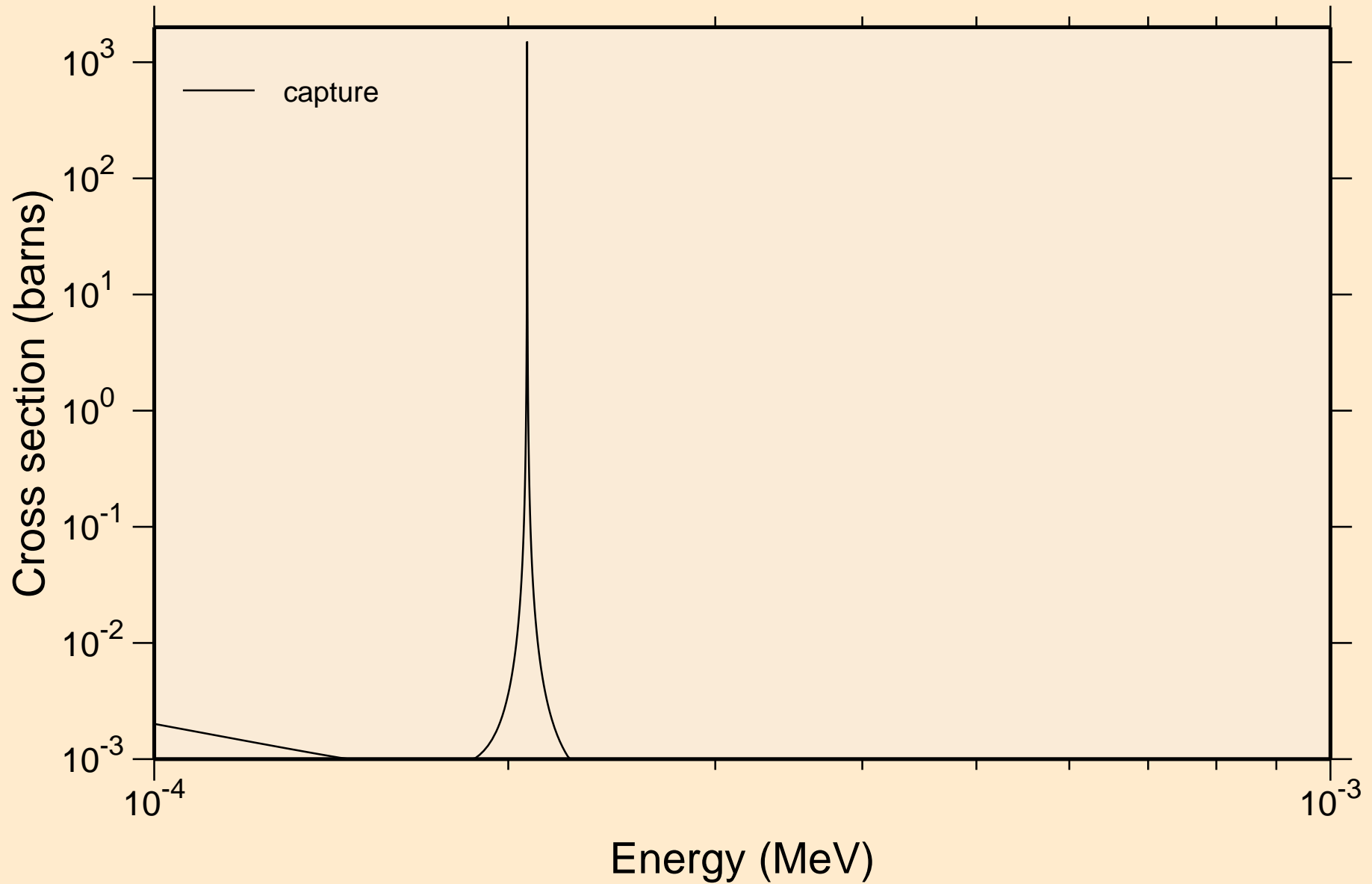

HG214 NEUTRON ACER TENDL-2023 LIBRARY; T=0.K
resonance absorption cross sections

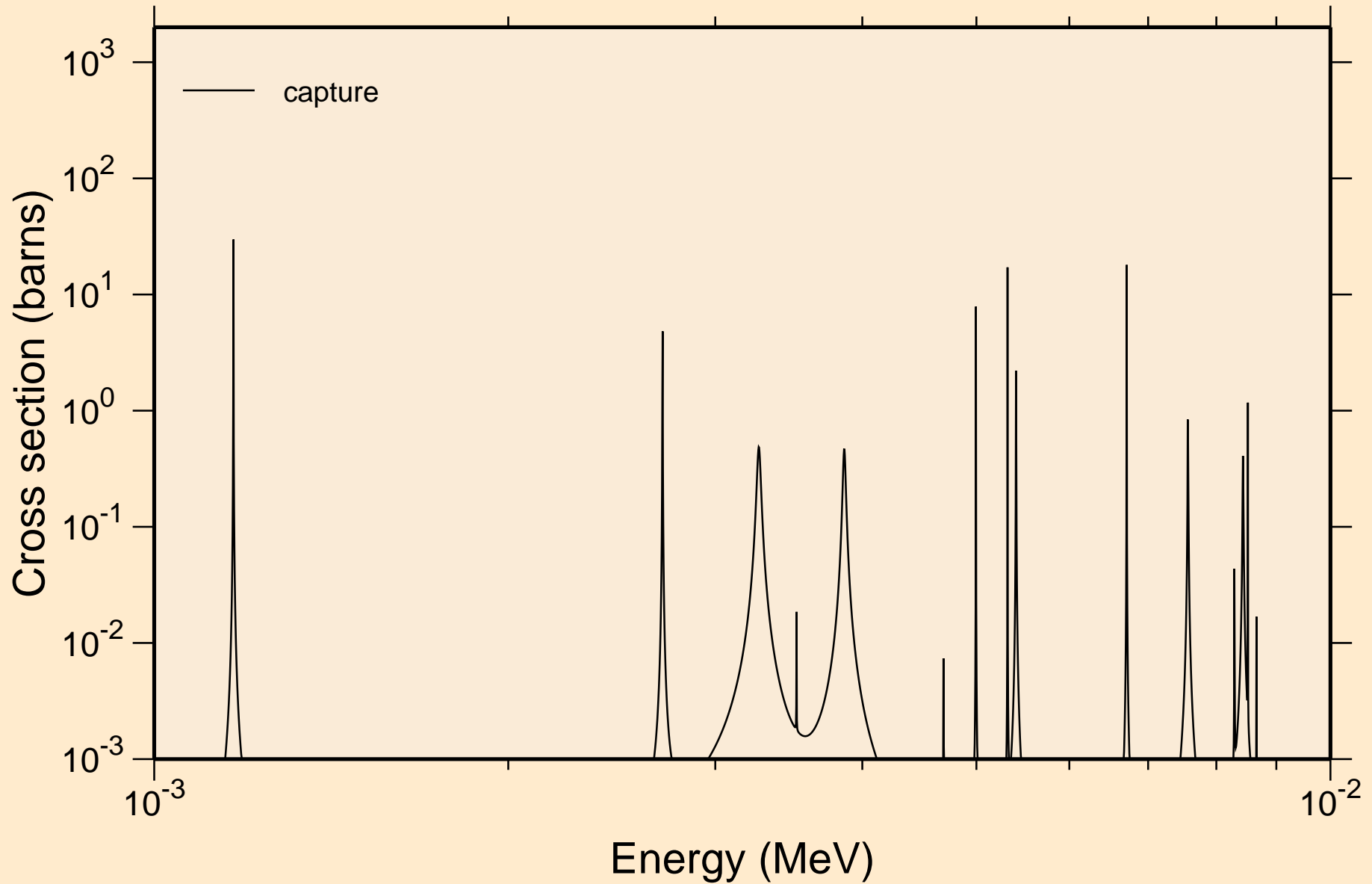

HG214 NEUTRON ACER TENDL-2023 LIBRARY; T=0.K
resonance absorption cross sections

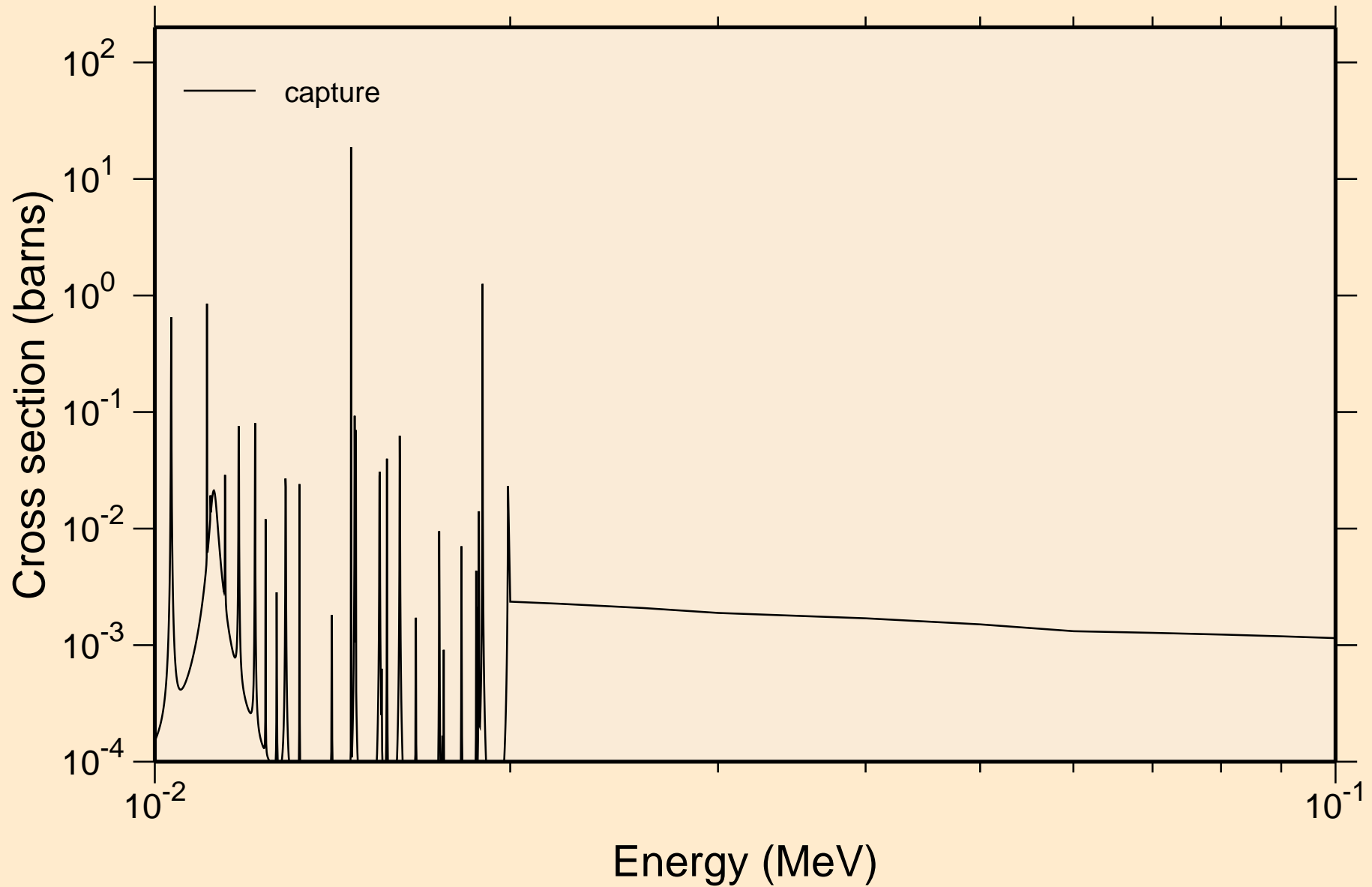

HG214 NEUTRON ACER TENDL-2023 LIBRARY; T=0.K
resonance absorption cross sections

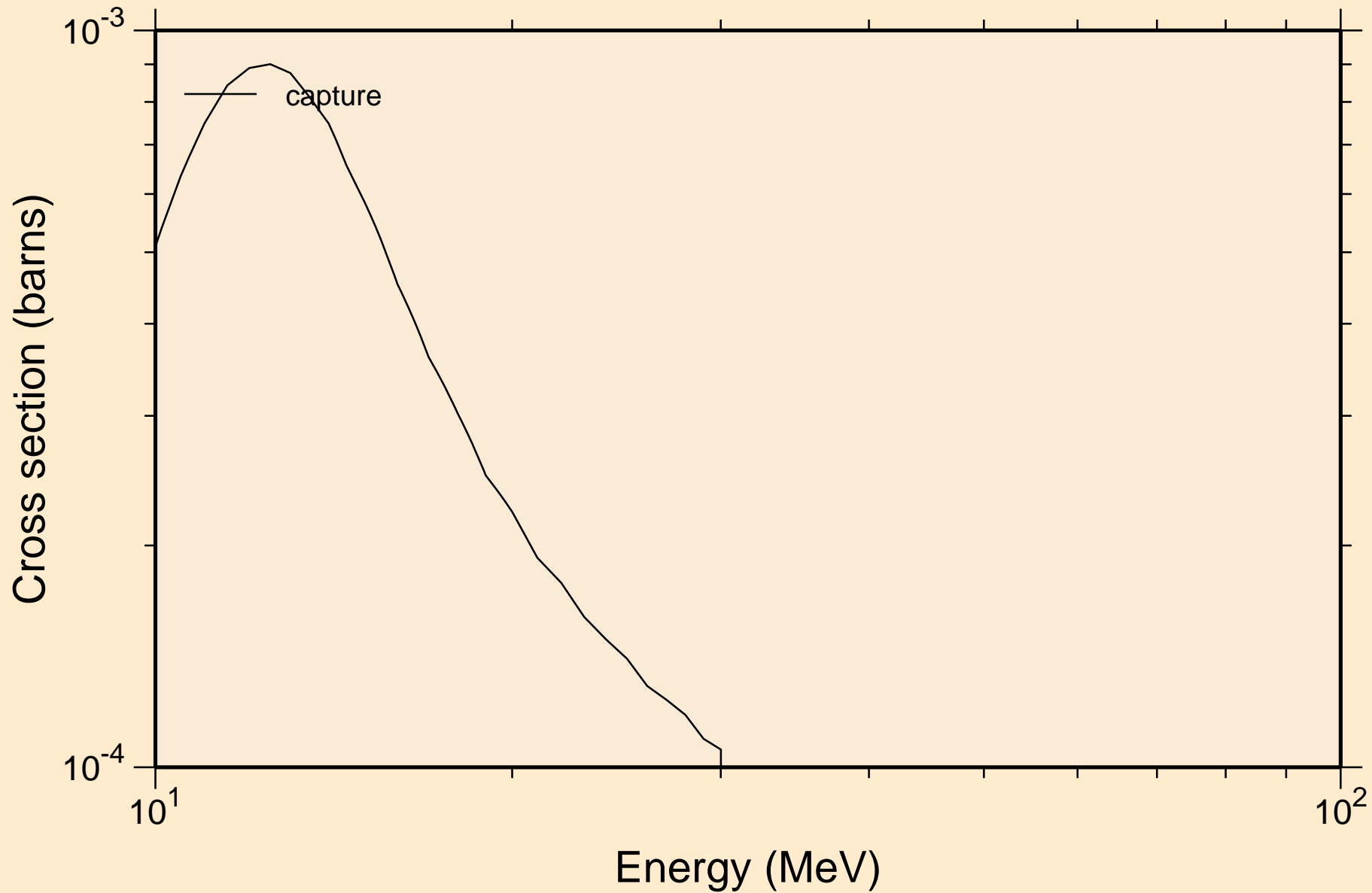

HG214 NEUTRON ACER TENDL-2023 LIBRARY; T=0.K

Heating

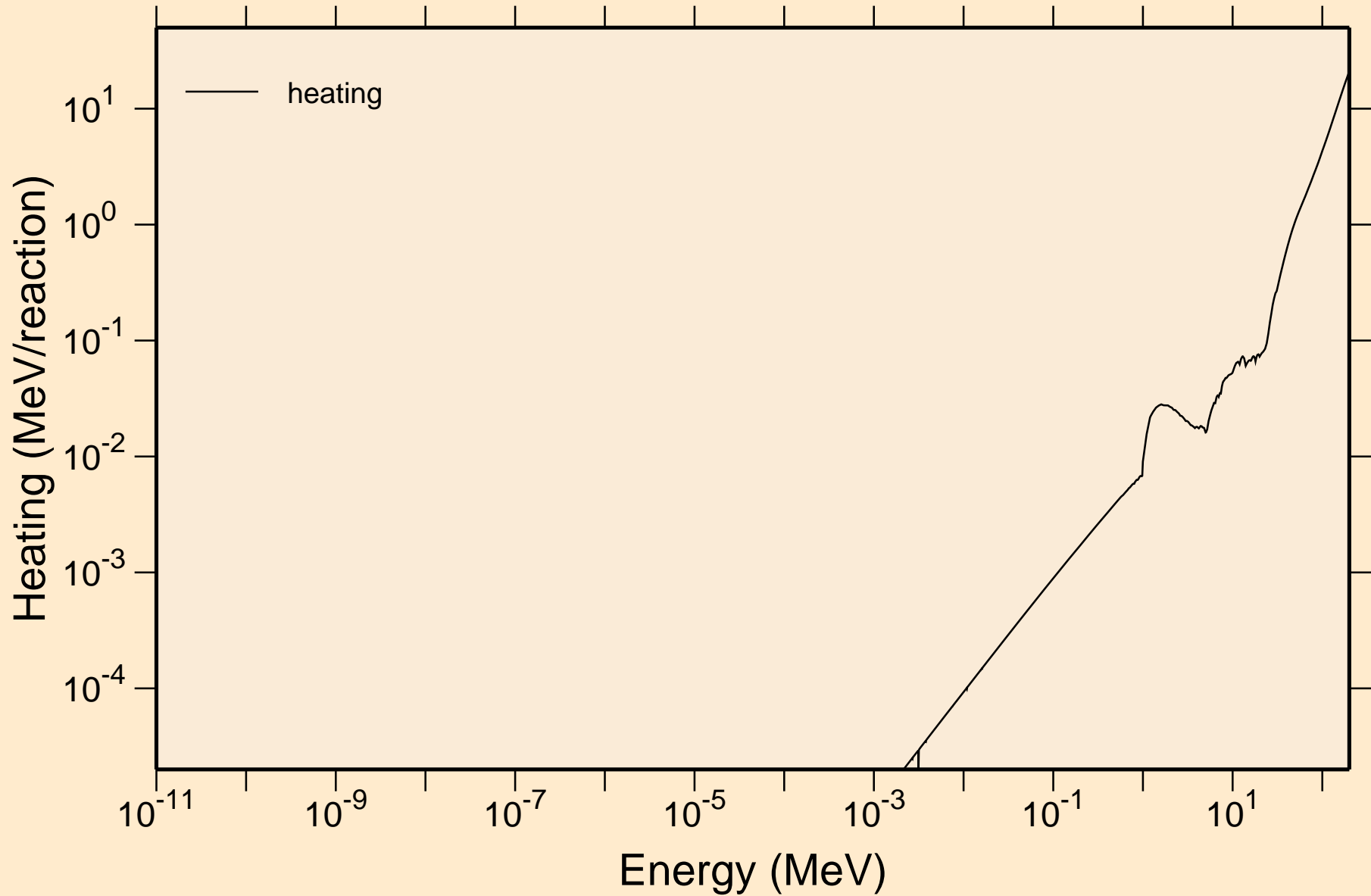

HG214 NEUTRON ACER TENDL-2023 LIBRARY; T=0.K

Damage

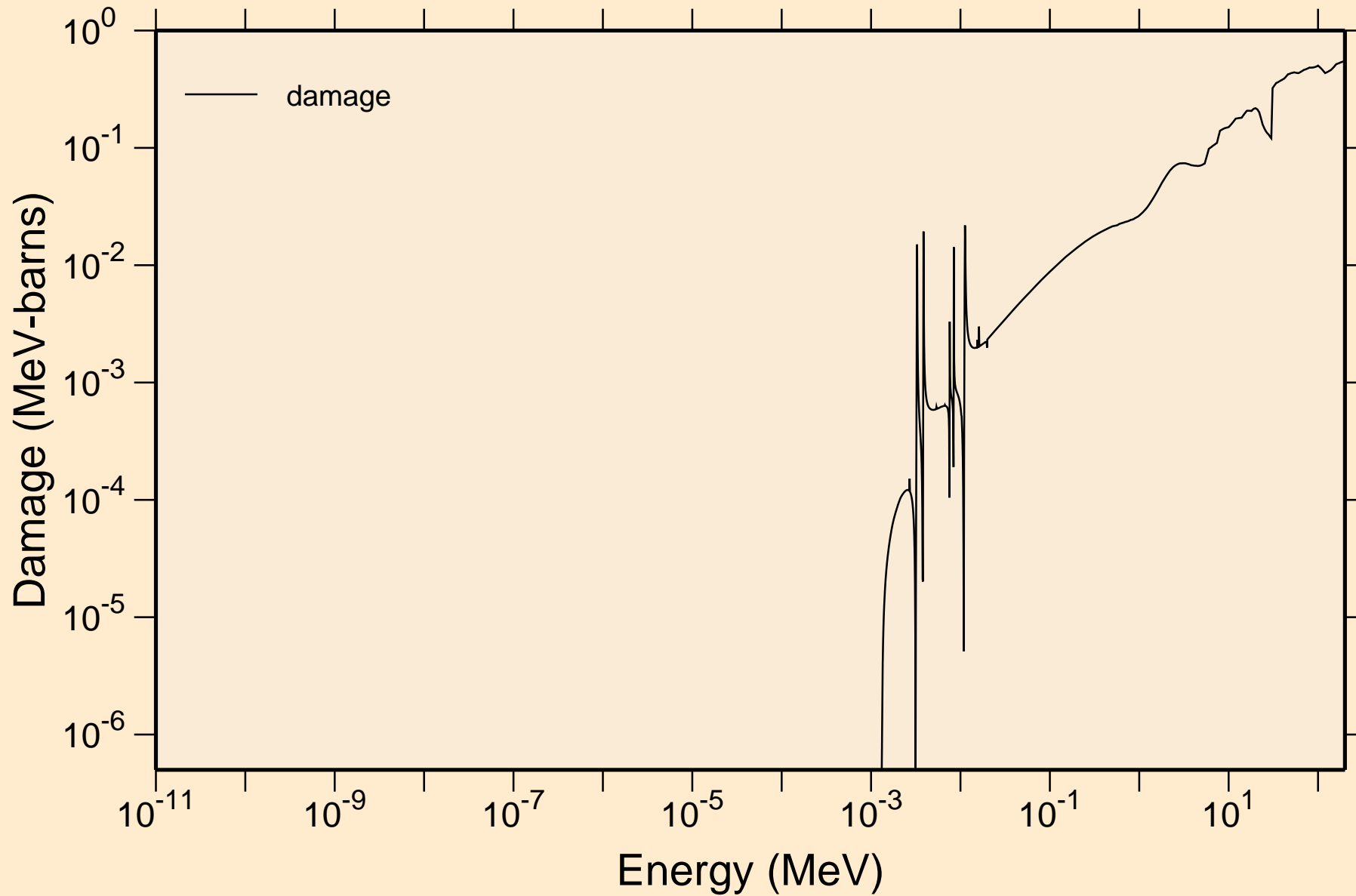

HG214 NEUTRON ACER TENDL-2023 LIBRARY; T=0.K

Non-threshold reactions

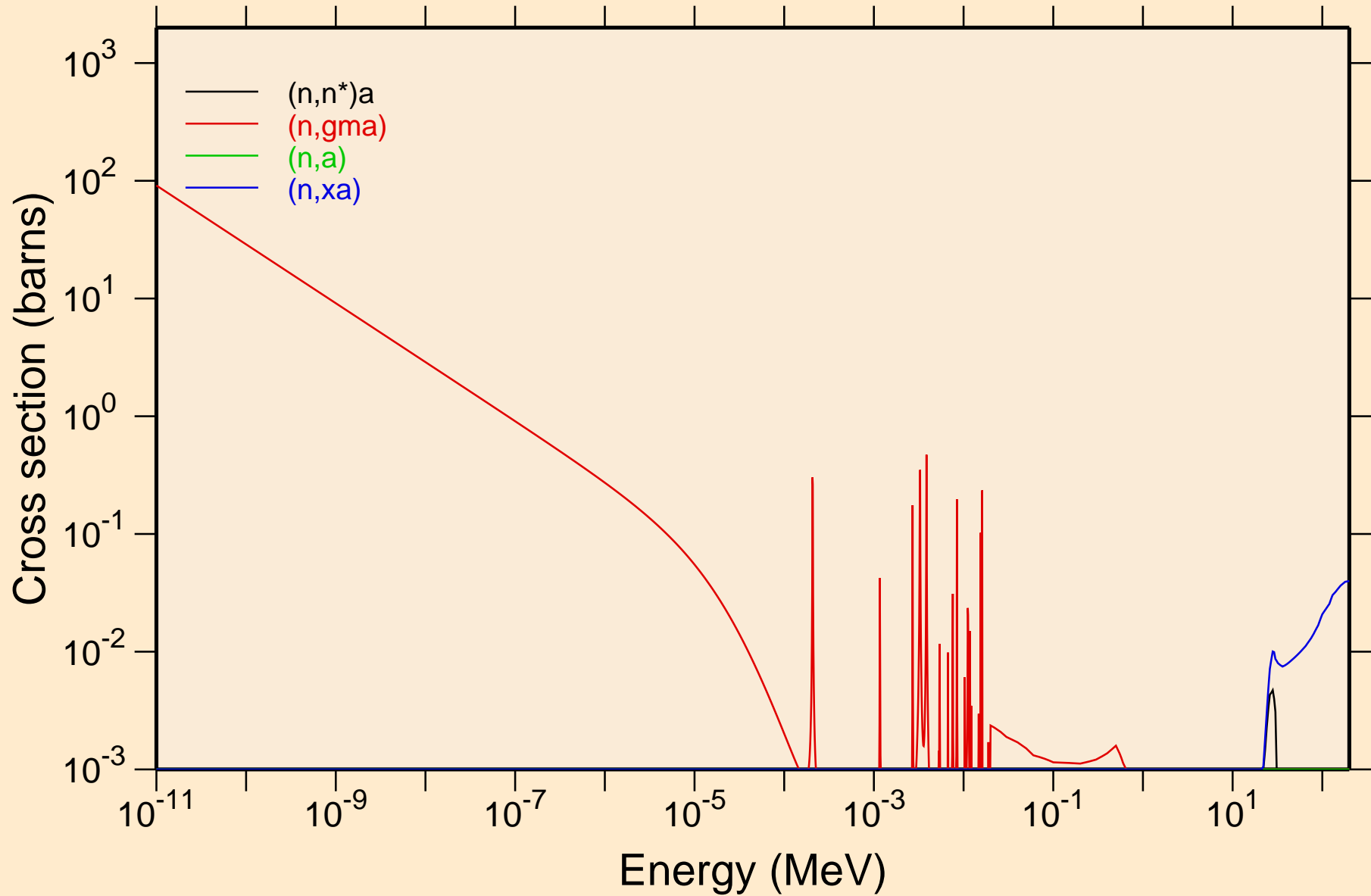

HG214 NEUTRON ACER TENDL-2023 LIBRARY; T=0.K

Principal cross sections

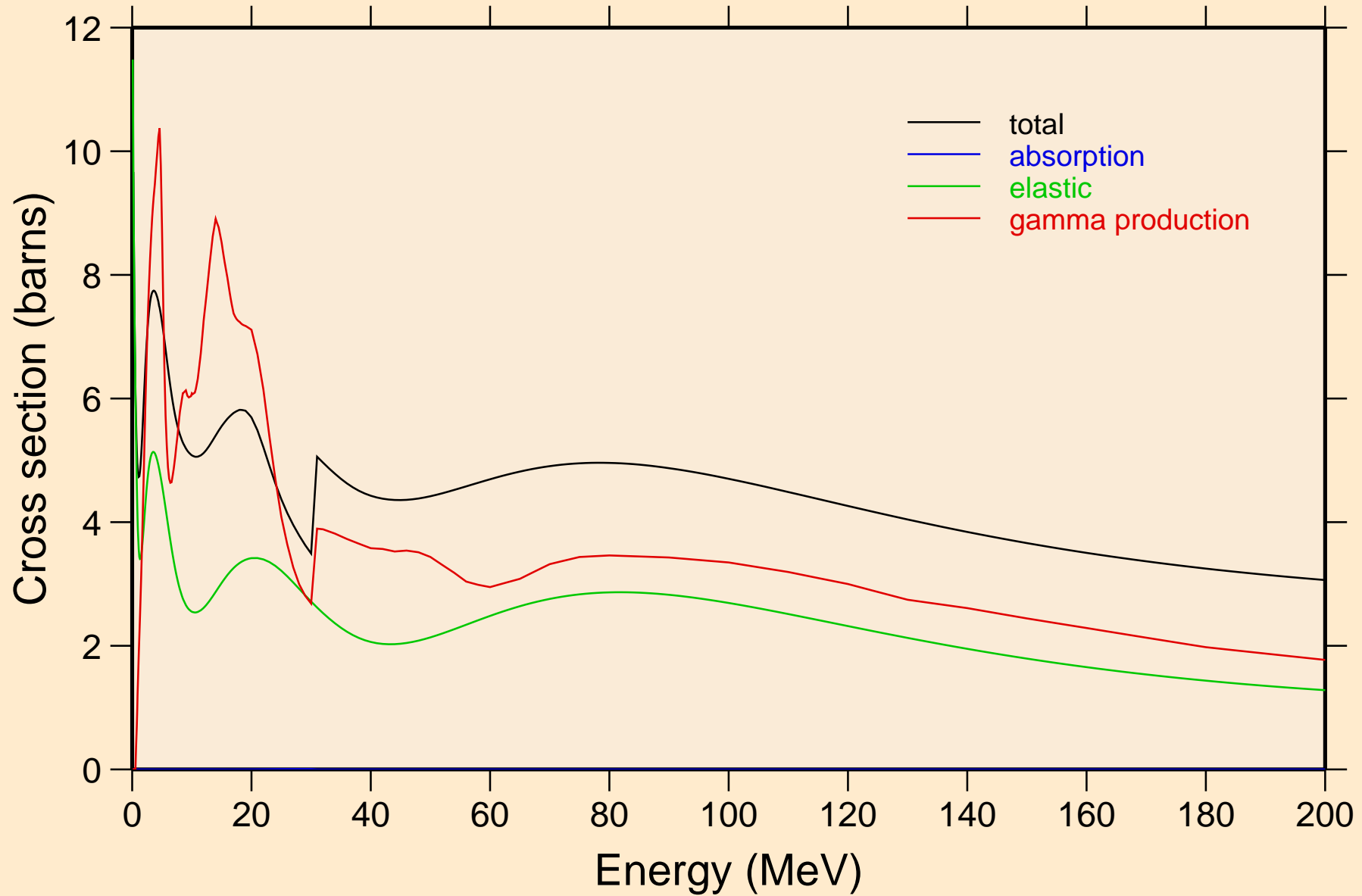

HG214 NEUTRON ACER TENDL-2023 LIBRARY; T=0.K

Heating

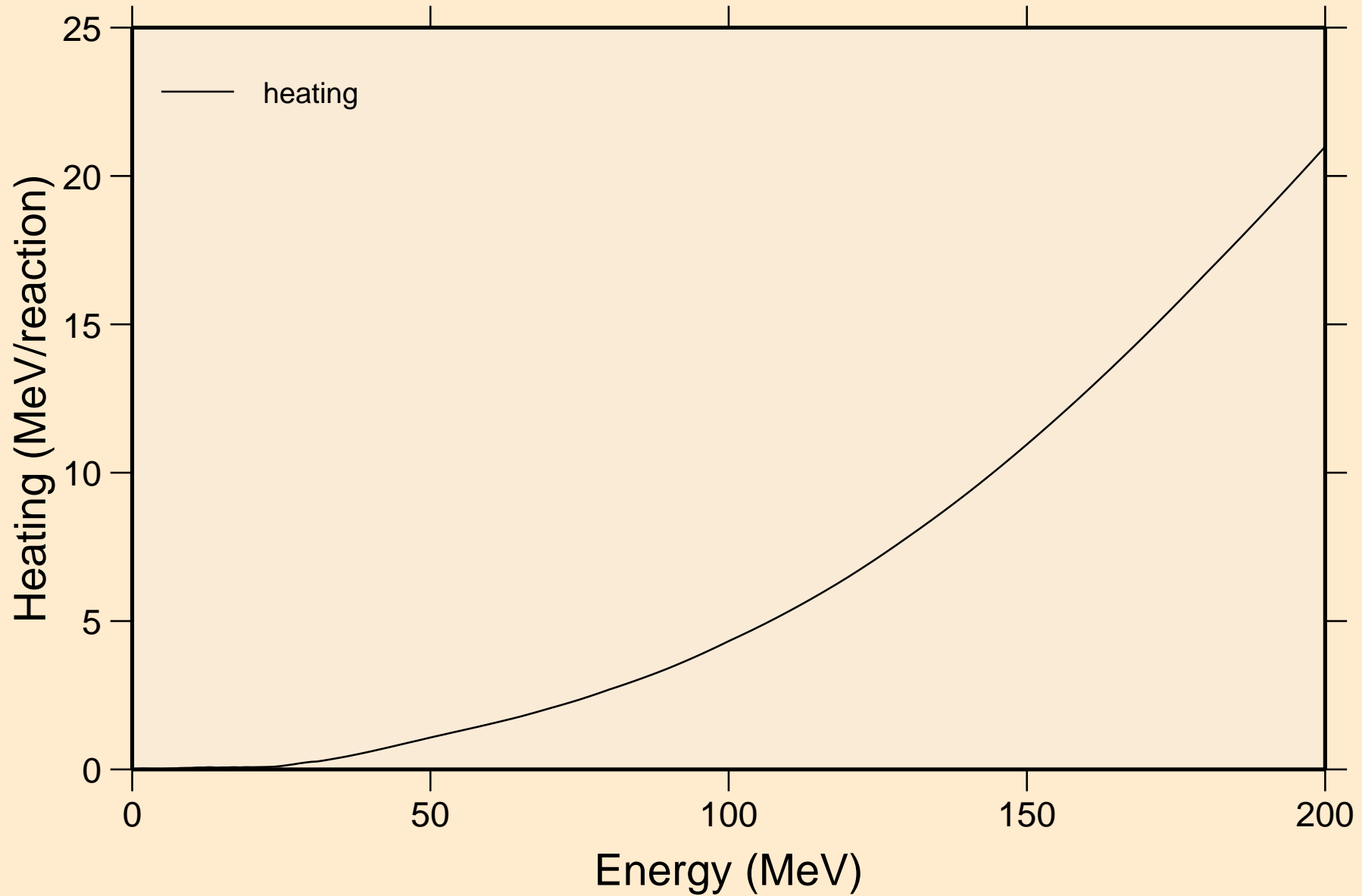

HG214 NEUTRON ACER TENDL-2023 LIBRARY; T=0.K

Damage

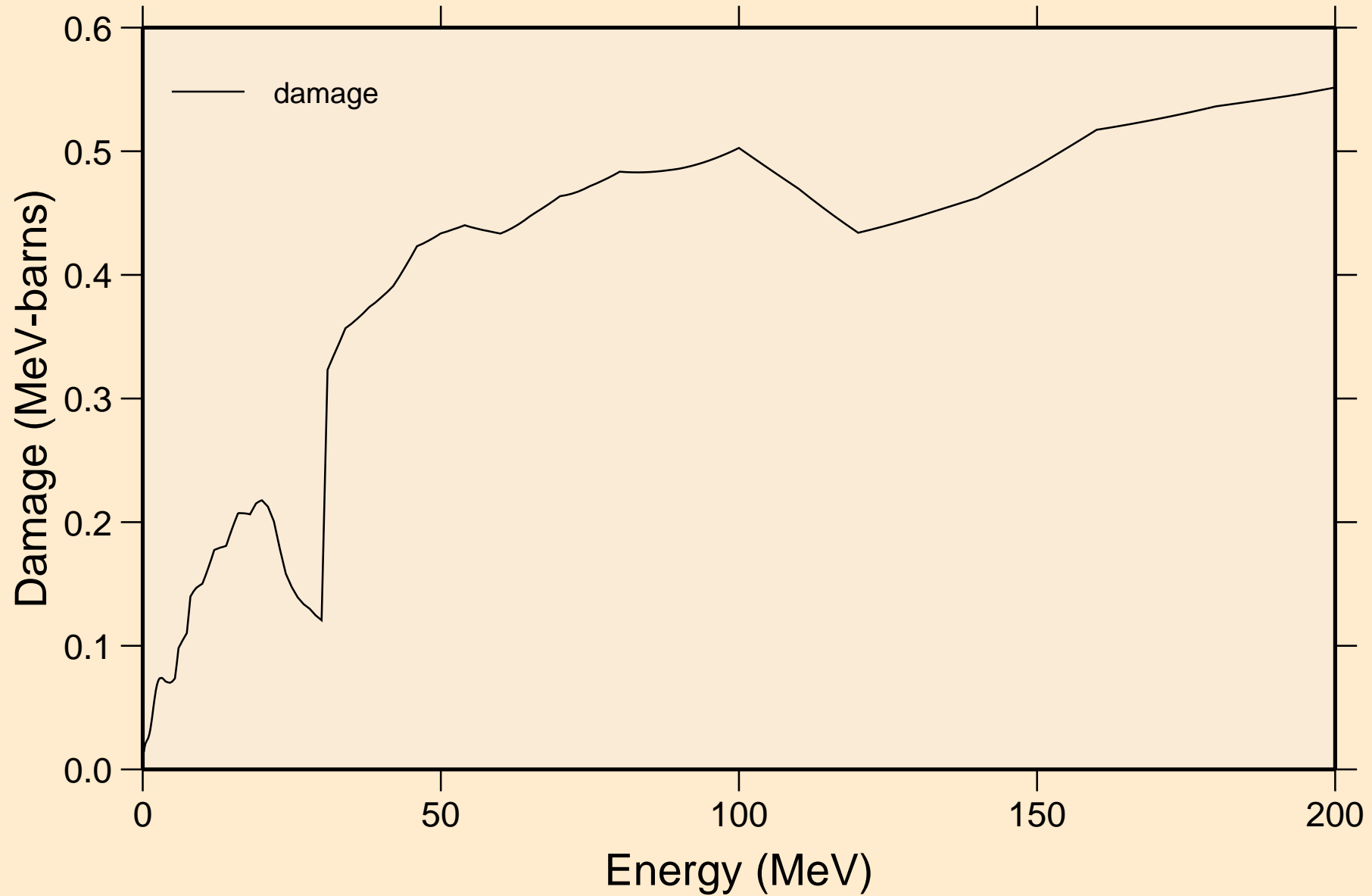

HG214 NEUTRON ACER TENDL-2023 LIBRARY; T=0.K

Non-threshold reactions

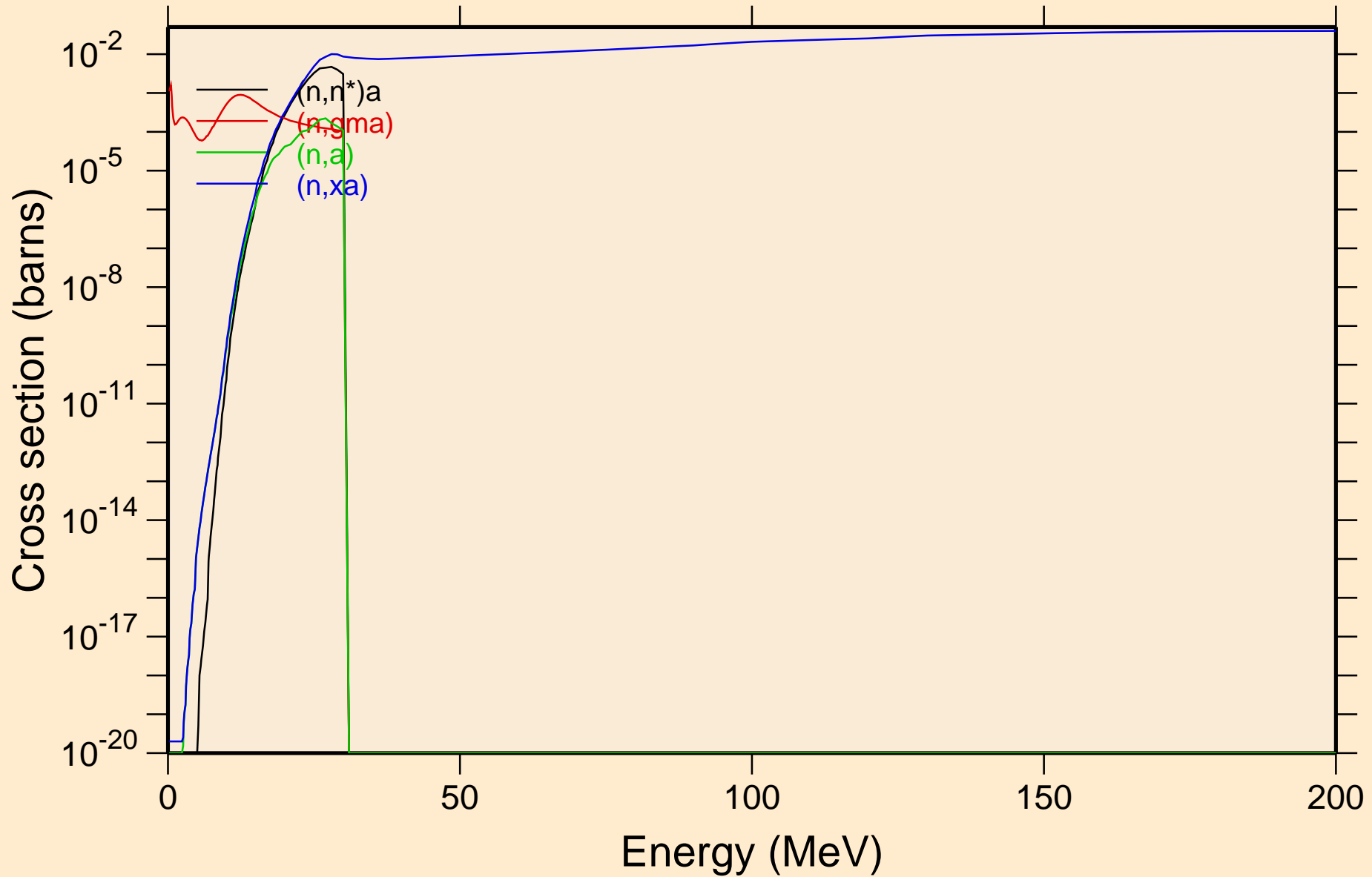

HG214 NEUTRON ACER TENDL-2023 LIBRARY; T=0.K

Inelastic levels

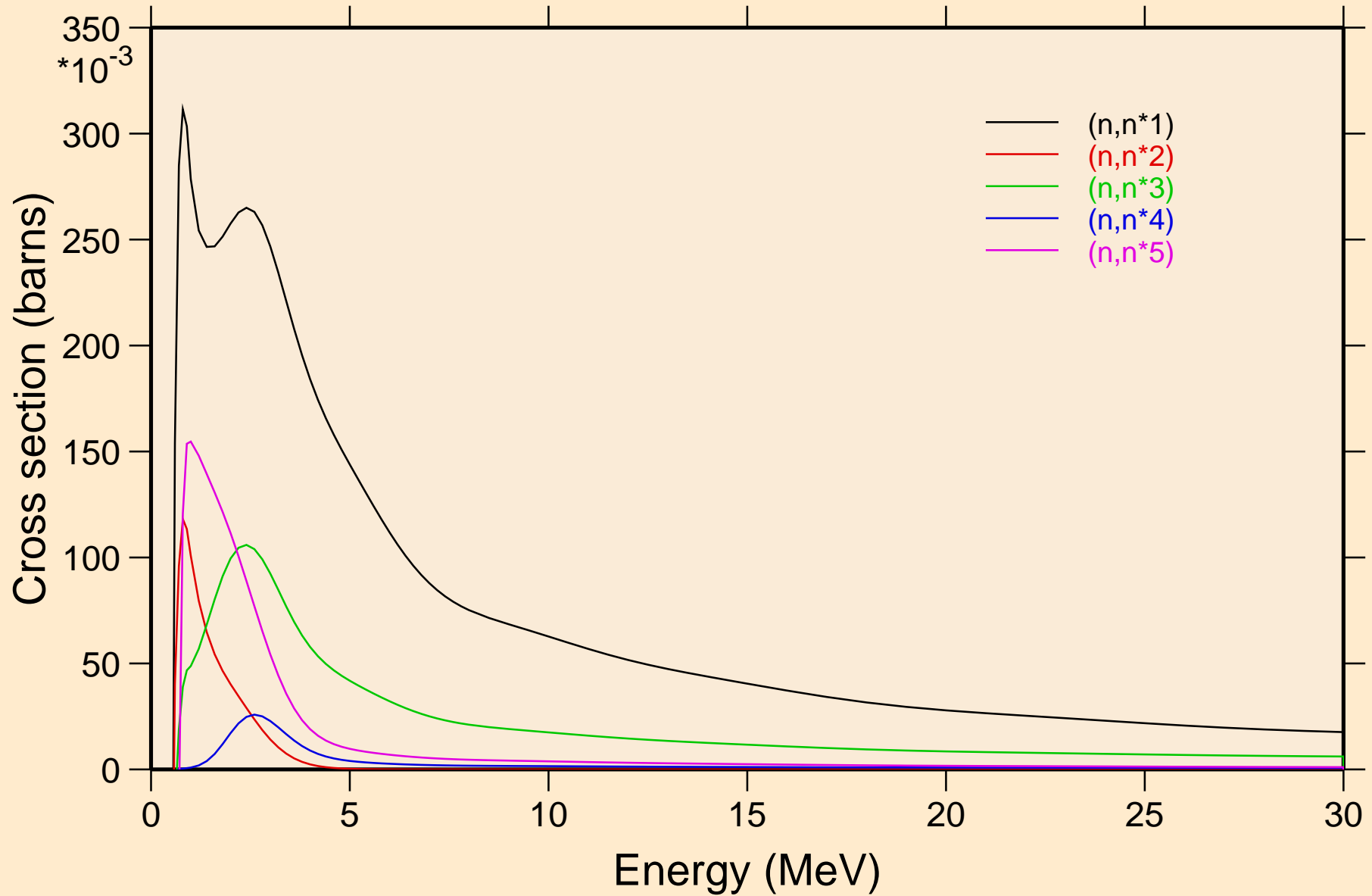

HG214 NEUTRON ACER TENDL-2023 LIBRARY; T=0.K

Inelastic levels

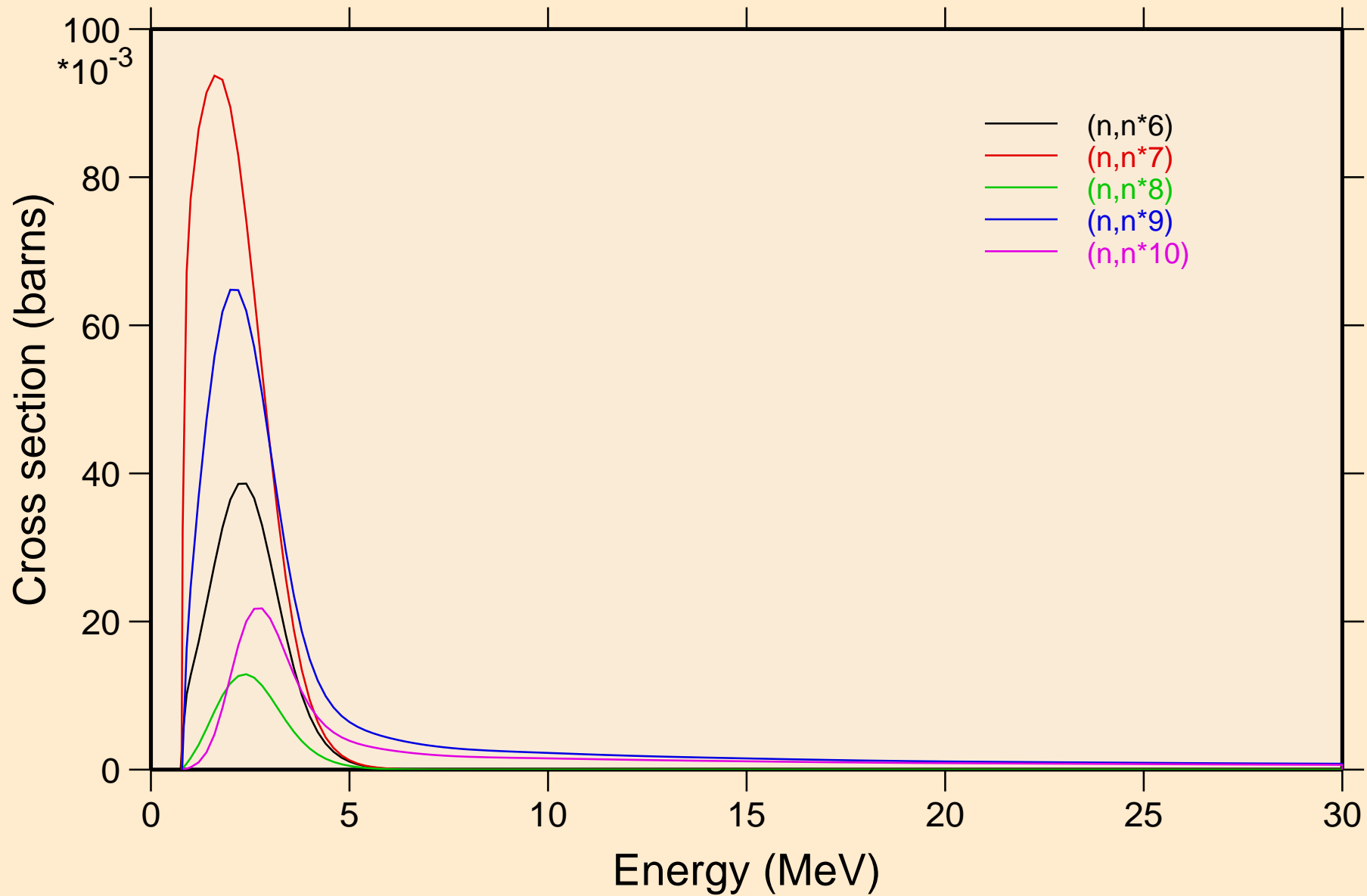

HG214 NEUTRON ACER TENDL-2023 LIBRARY; T=0.K

Inelastic levels

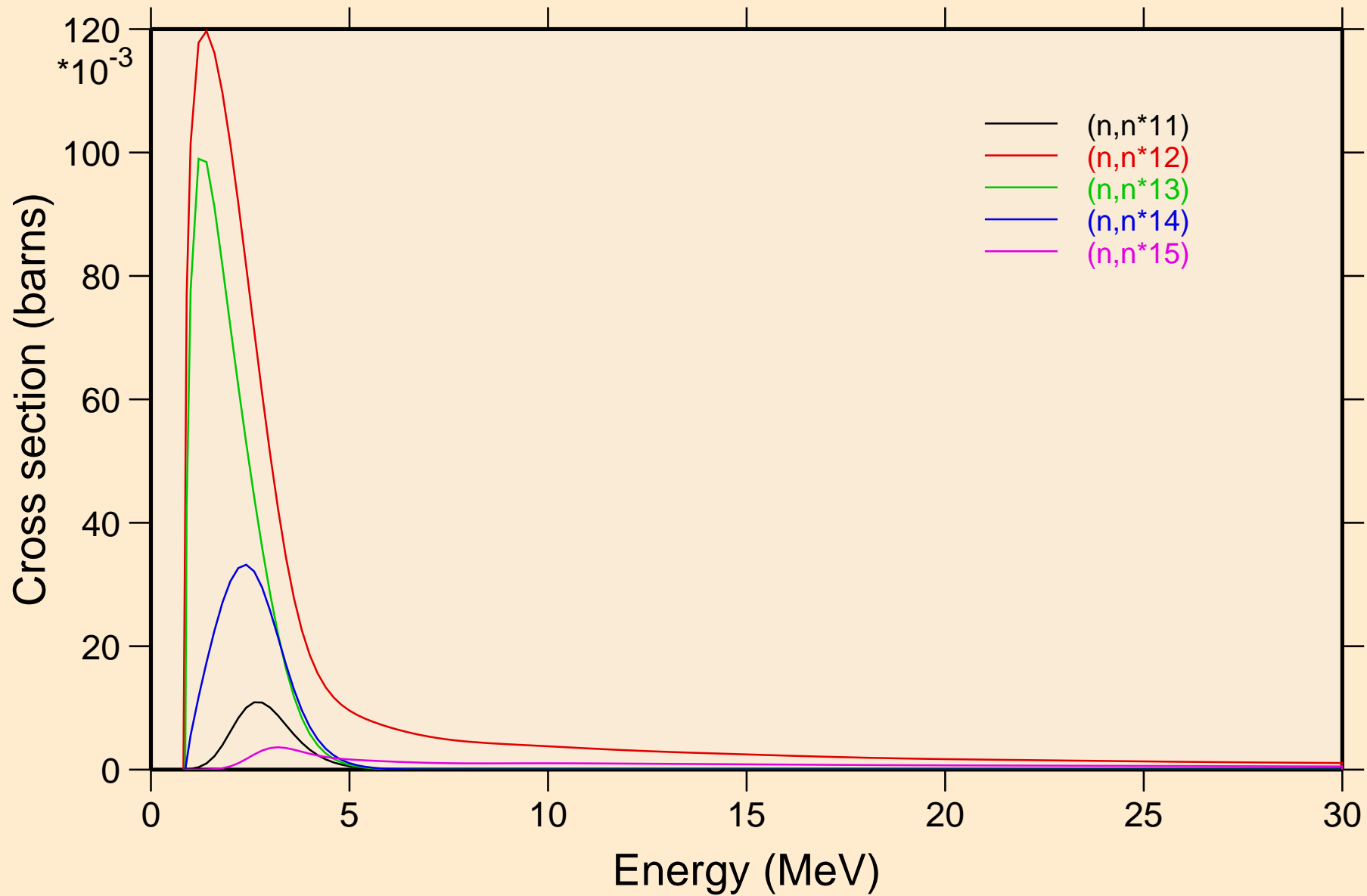

HG214 NEUTRON ACER TENDL-2023 LIBRARY; T=0.K

Inelastic levels

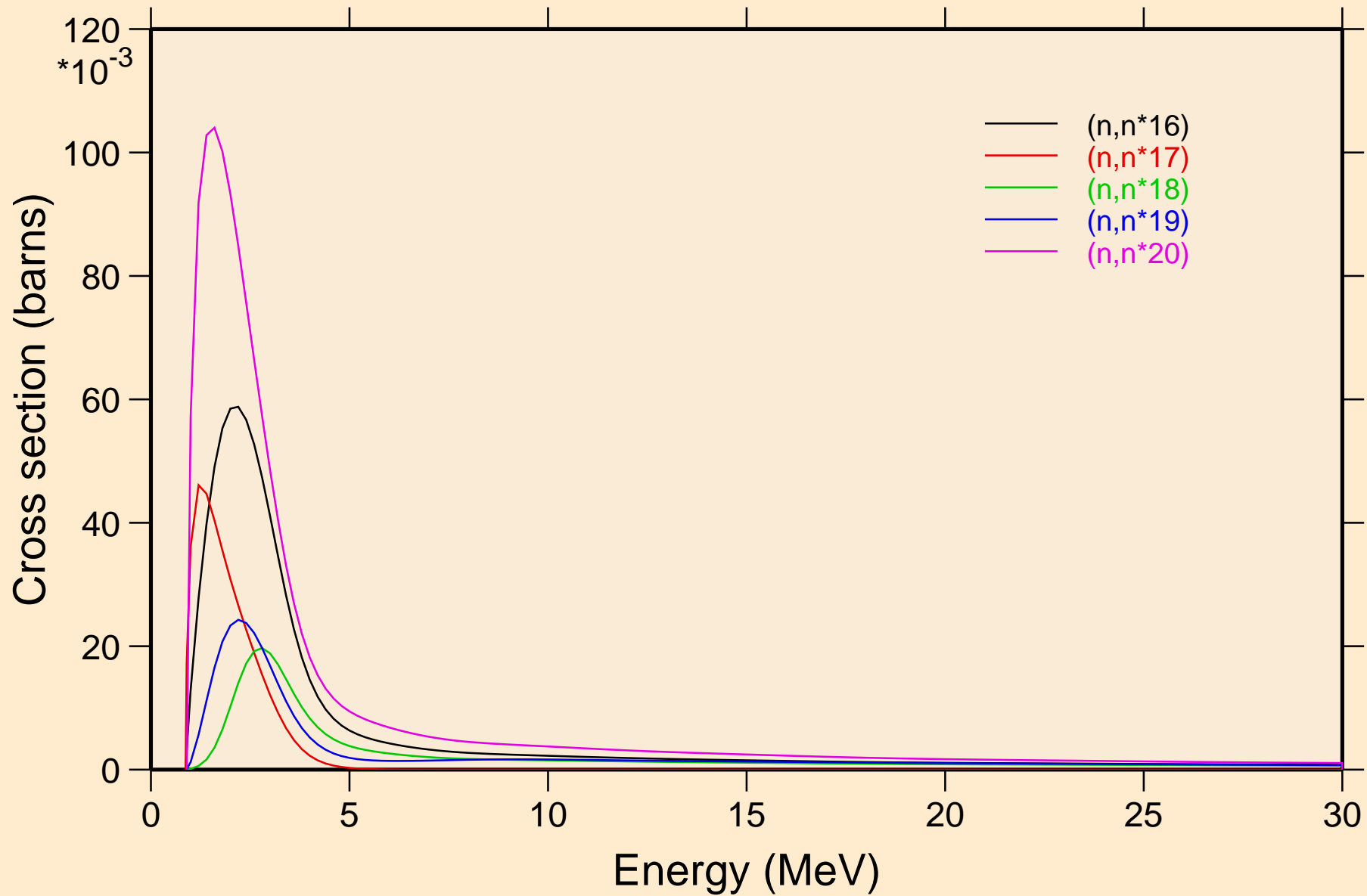

HG214 NEUTRON ACER TENDL-2023 LIBRARY; T=0.K

Inelastic levels

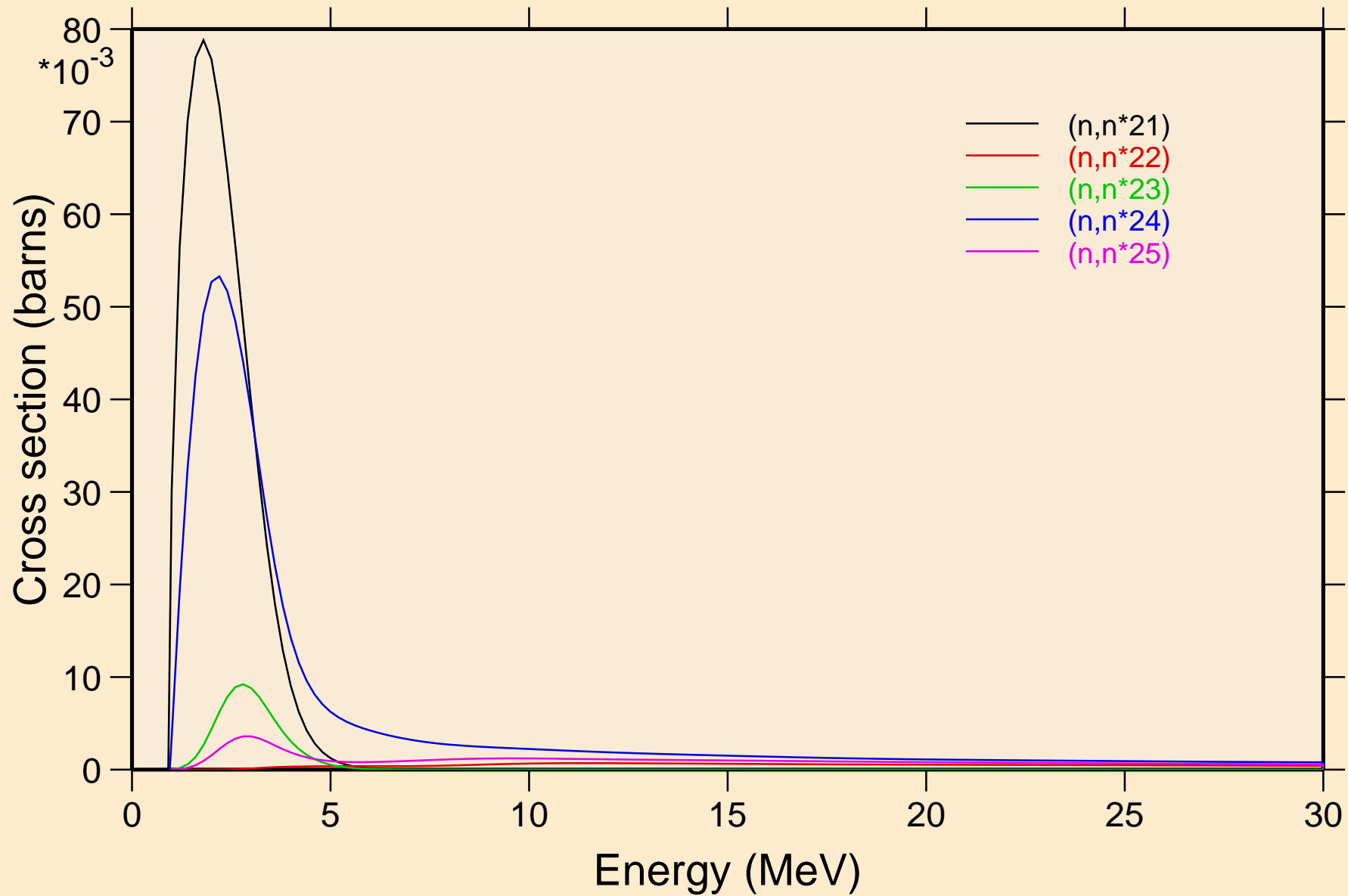

HG214 NEUTRON ACER TENDL-2023 LIBRARY; T=0.K
Inelastic levels

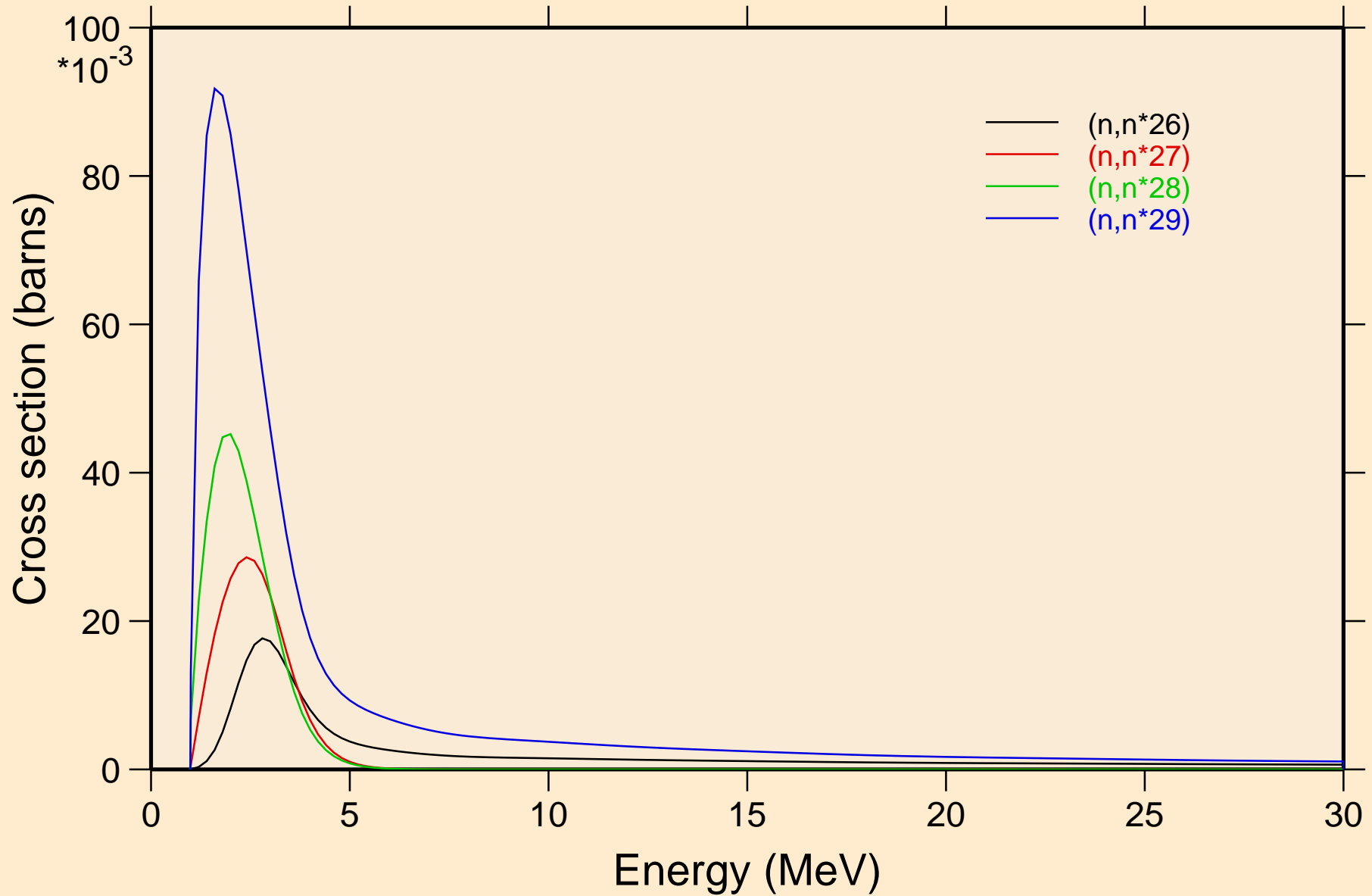

HG214 NEUTRON ACER TENDL-2023 LIBRARY; T=0.K

Threshold reactions

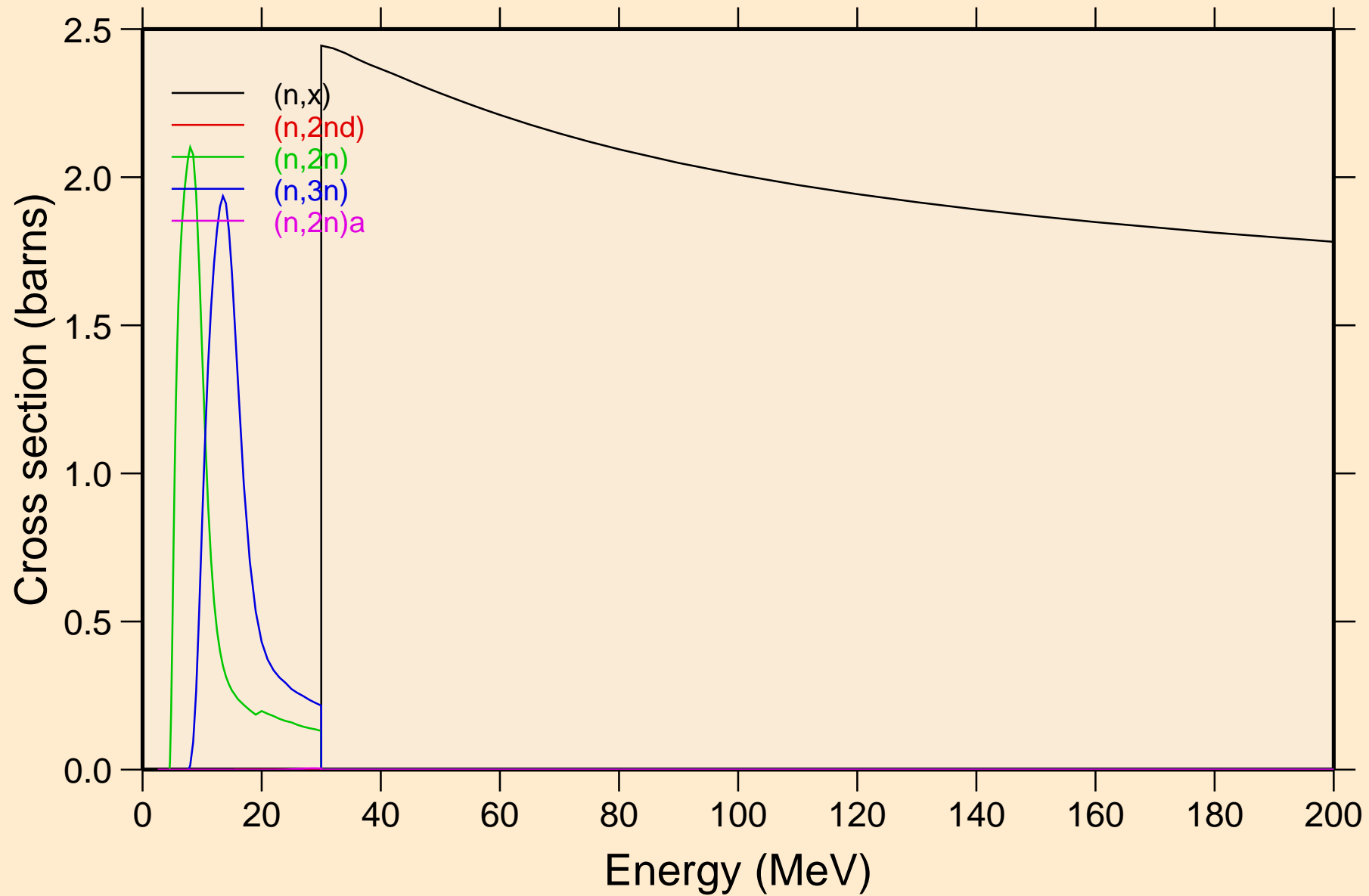

HG214 NEUTRON ACER TENDL-2023 LIBRARY; T=0.K

Threshold reactions

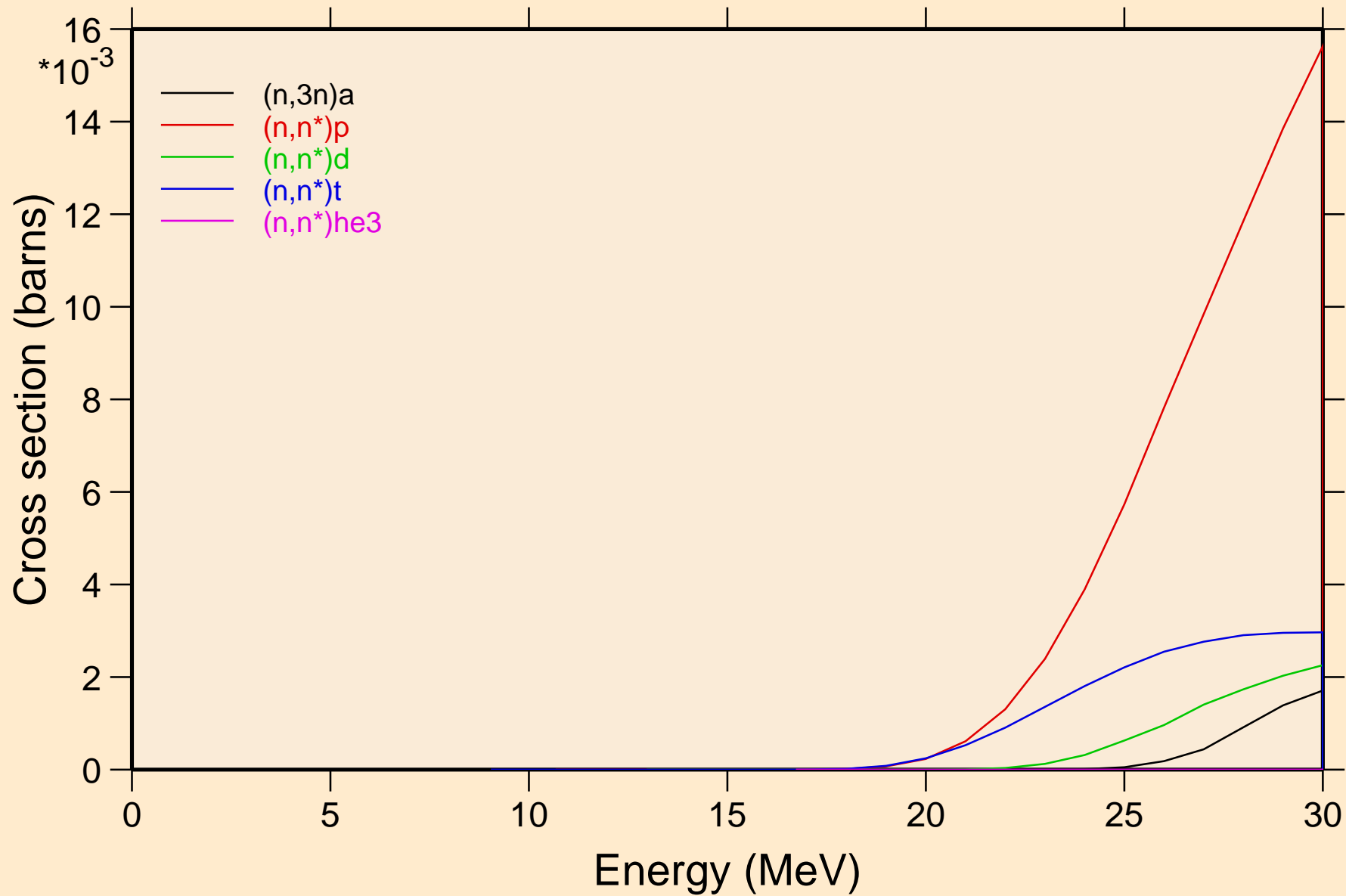

HG214 NEUTRON ACER TENDL-2023 LIBRARY; T=0.K

Threshold reactions

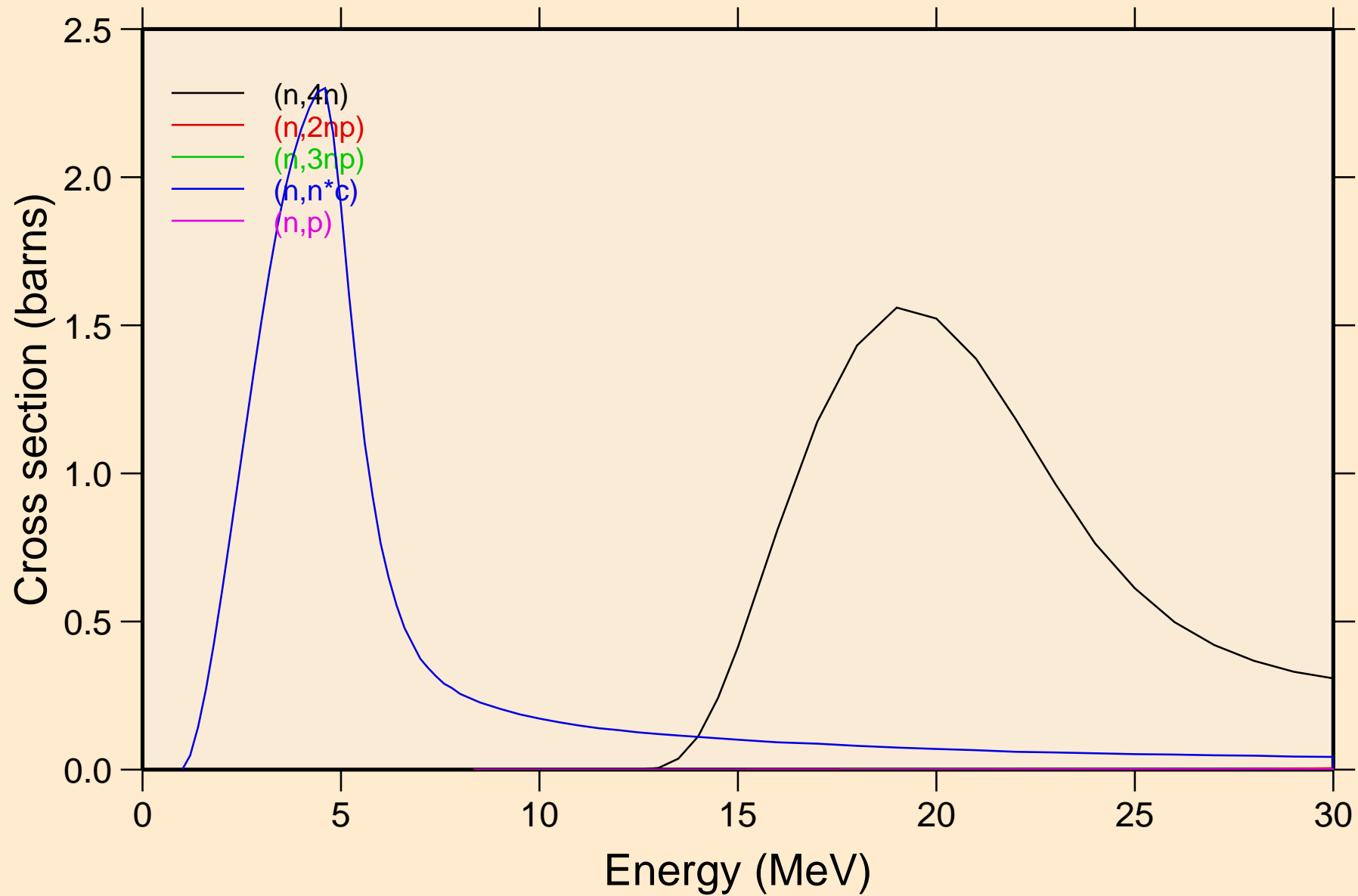

HG214 NEUTRON ACER TENDL-2023 LIBRARY; T=0.K

Threshold reactions

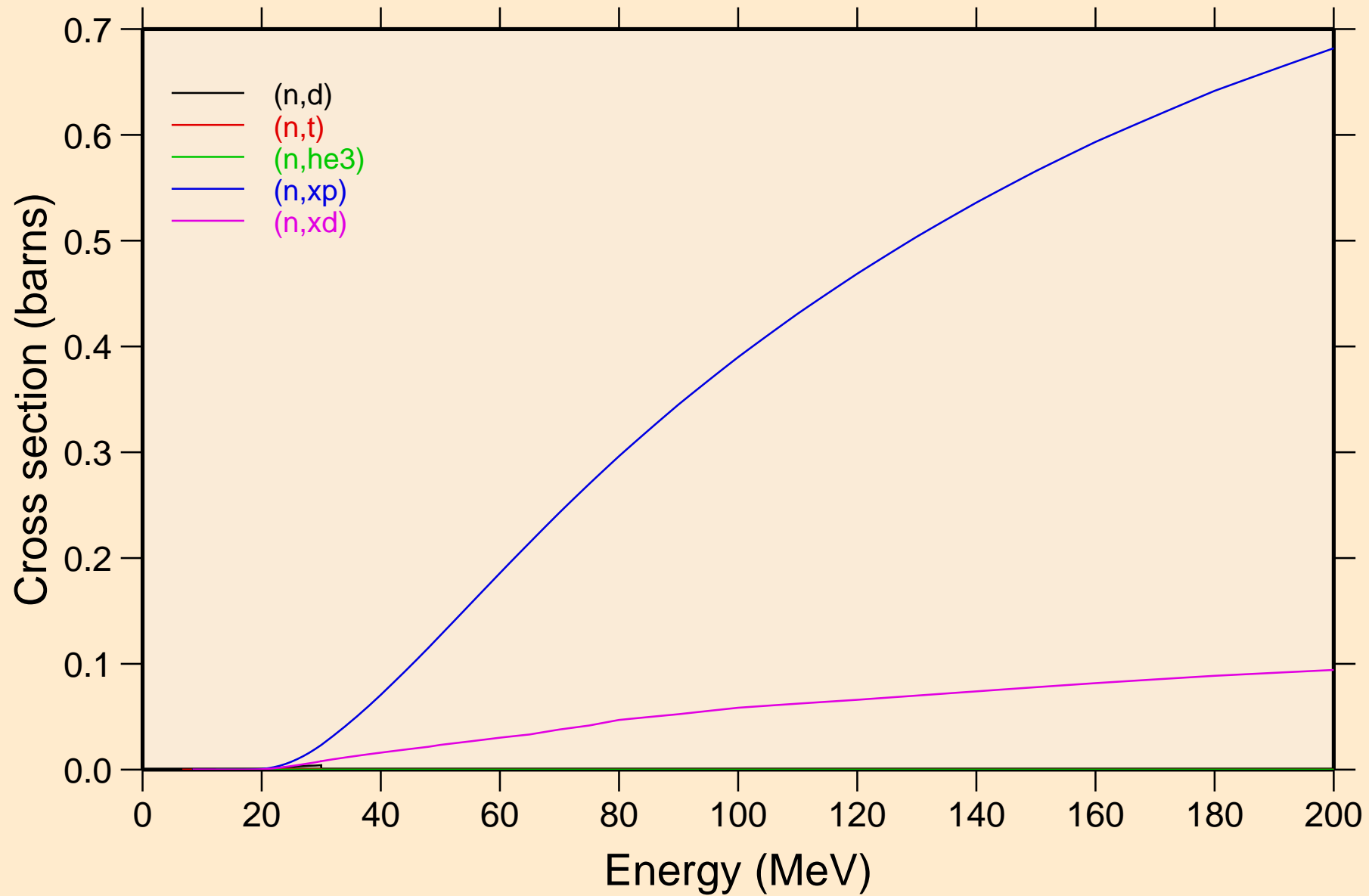

HG214 NEUTRON ACER TENDL-2023 LIBRARY; T=0.K

Threshold reactions

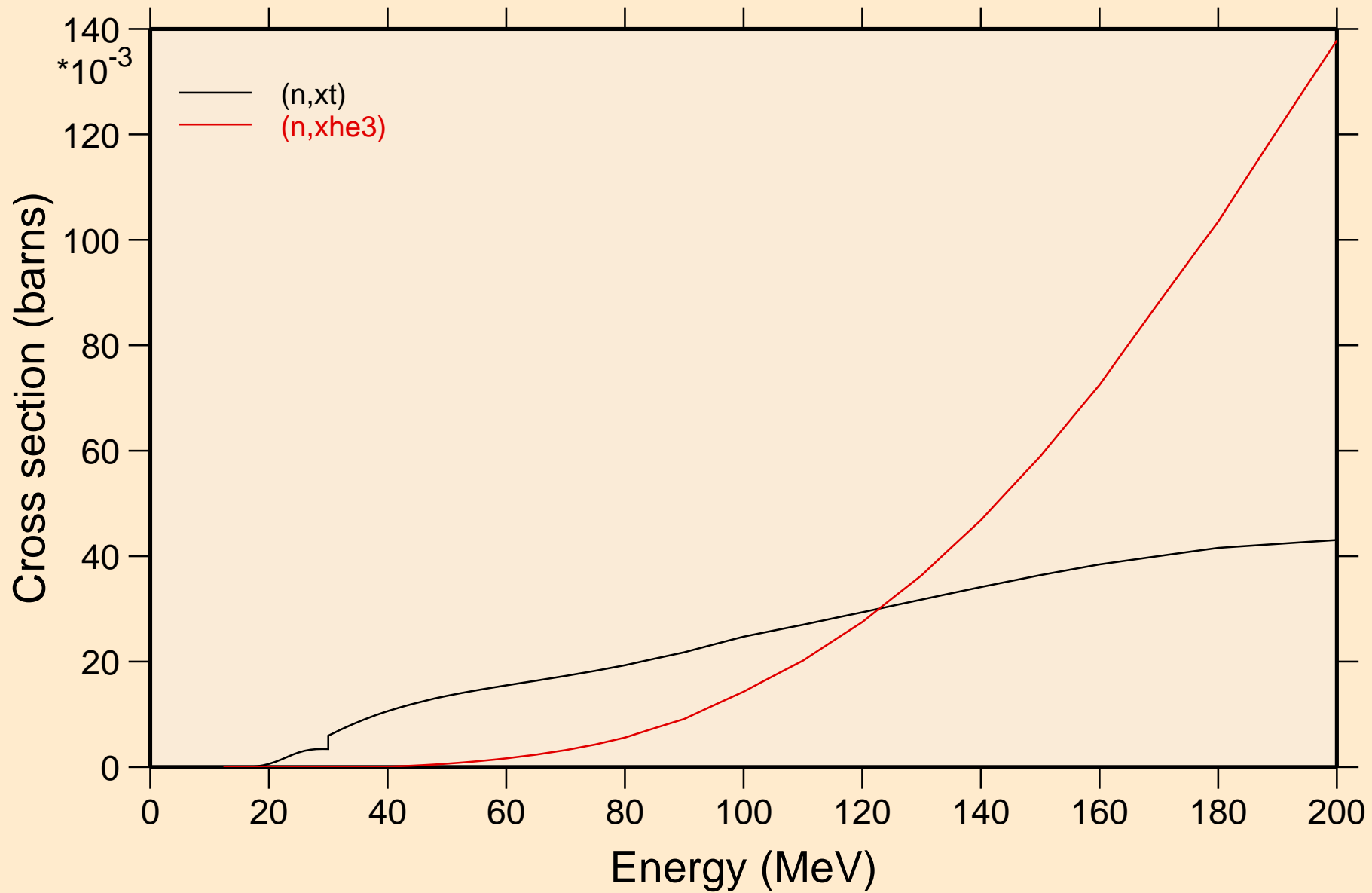

HG214 NEUTRON ACER TENDL-2023 LIBRARY; T=0.K
angular distribution for elastic

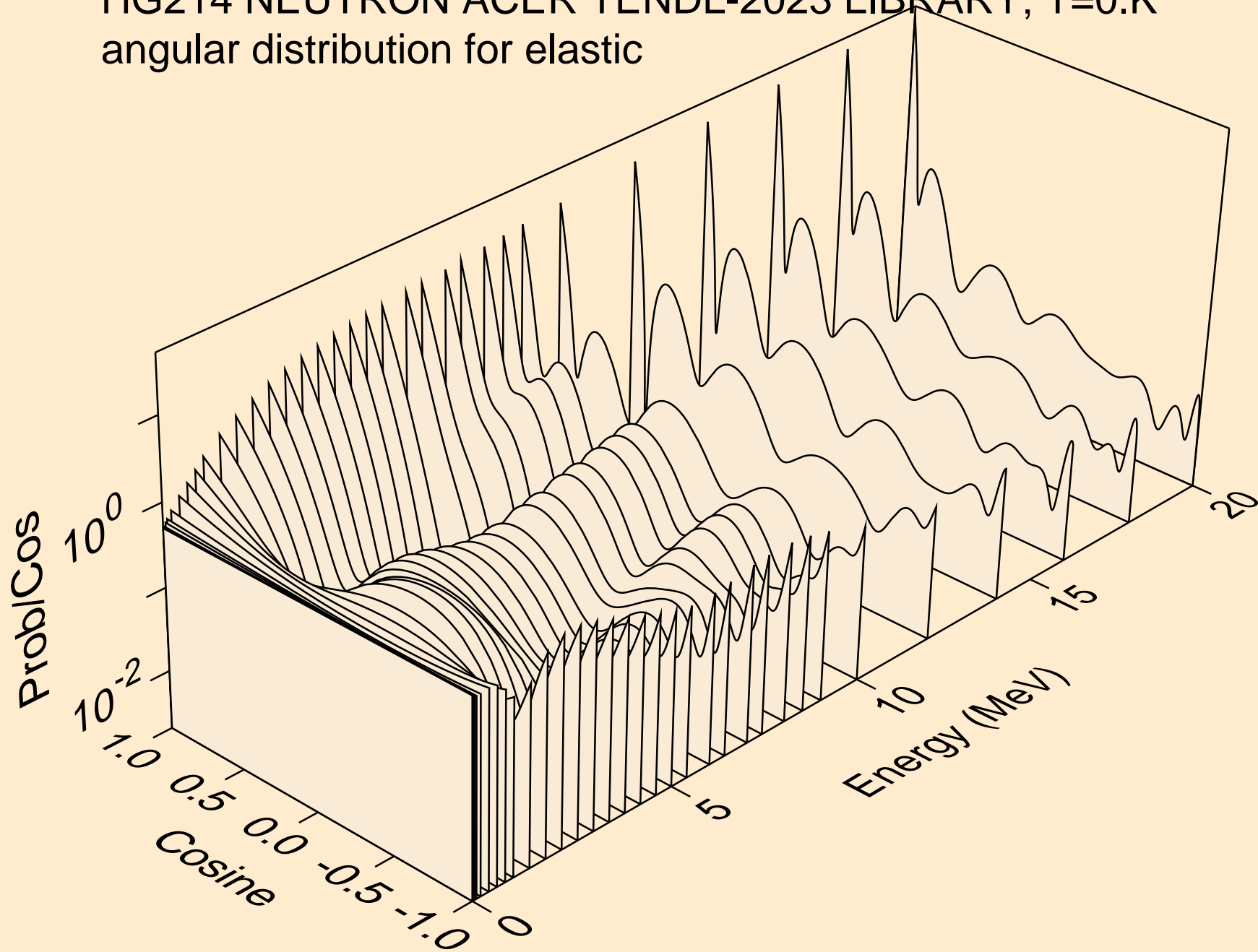

HG214 NEUTRON ACER TENDL-2023 LIBRARY; T=0.K
angular distribution for elastic

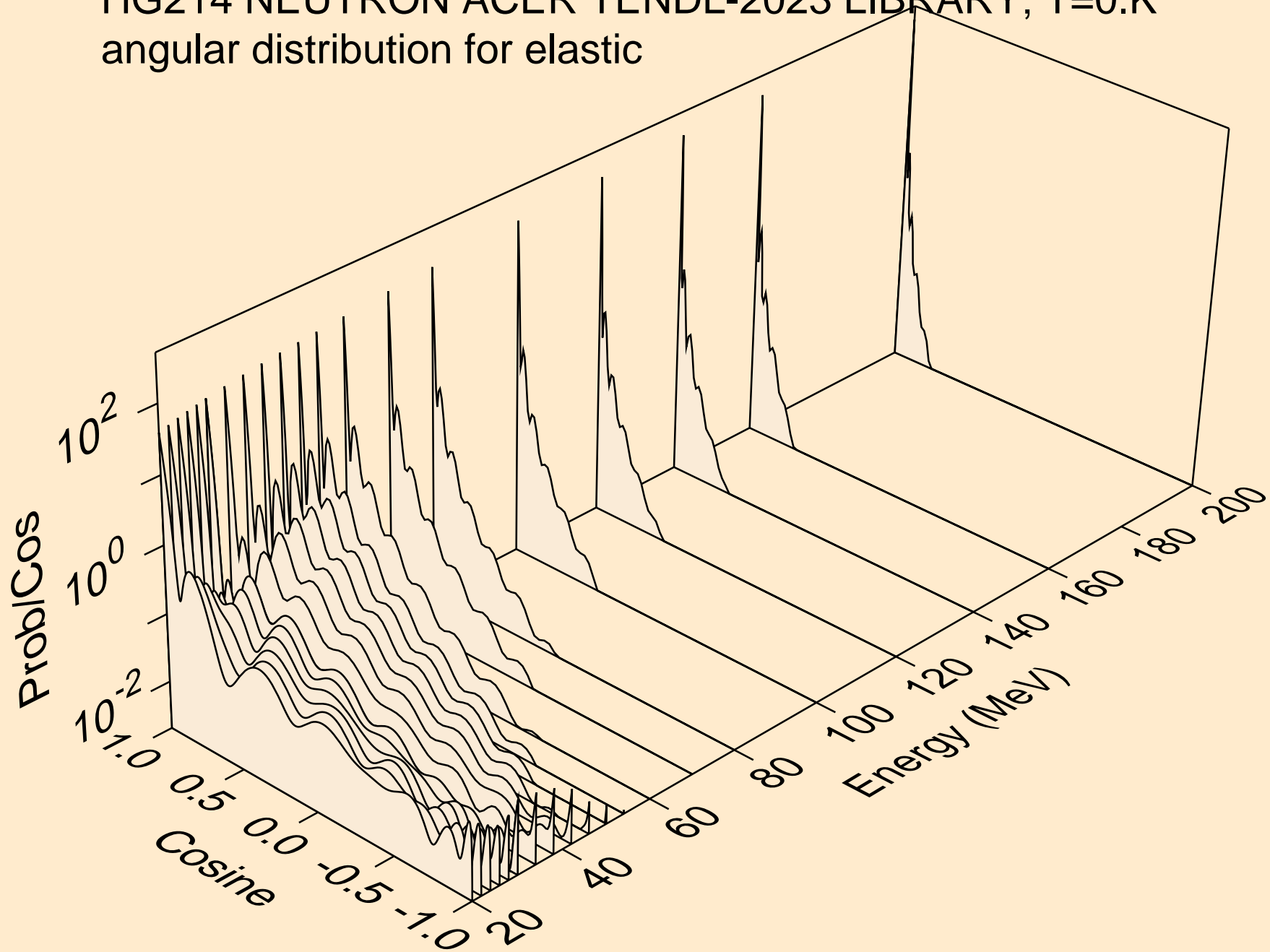

HG214 NEUTRON ACER TENDL-2023 LIBRARY; T=0.K
angular distribution for (n,n*1)

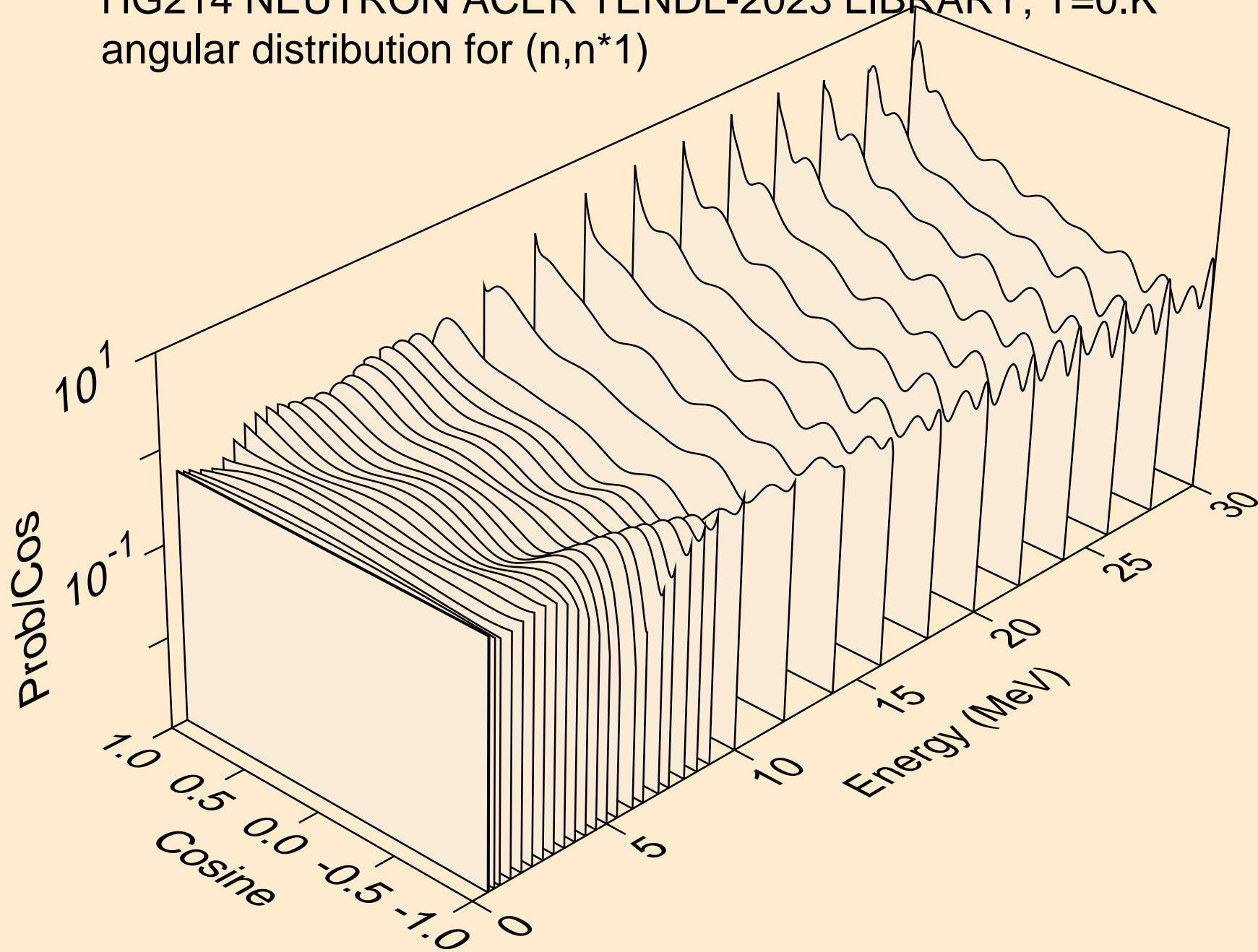

HG214 NEUTRON ACER TENDL-2023 LIBRARY; T=0.K
angular distribution for (n,n*2)

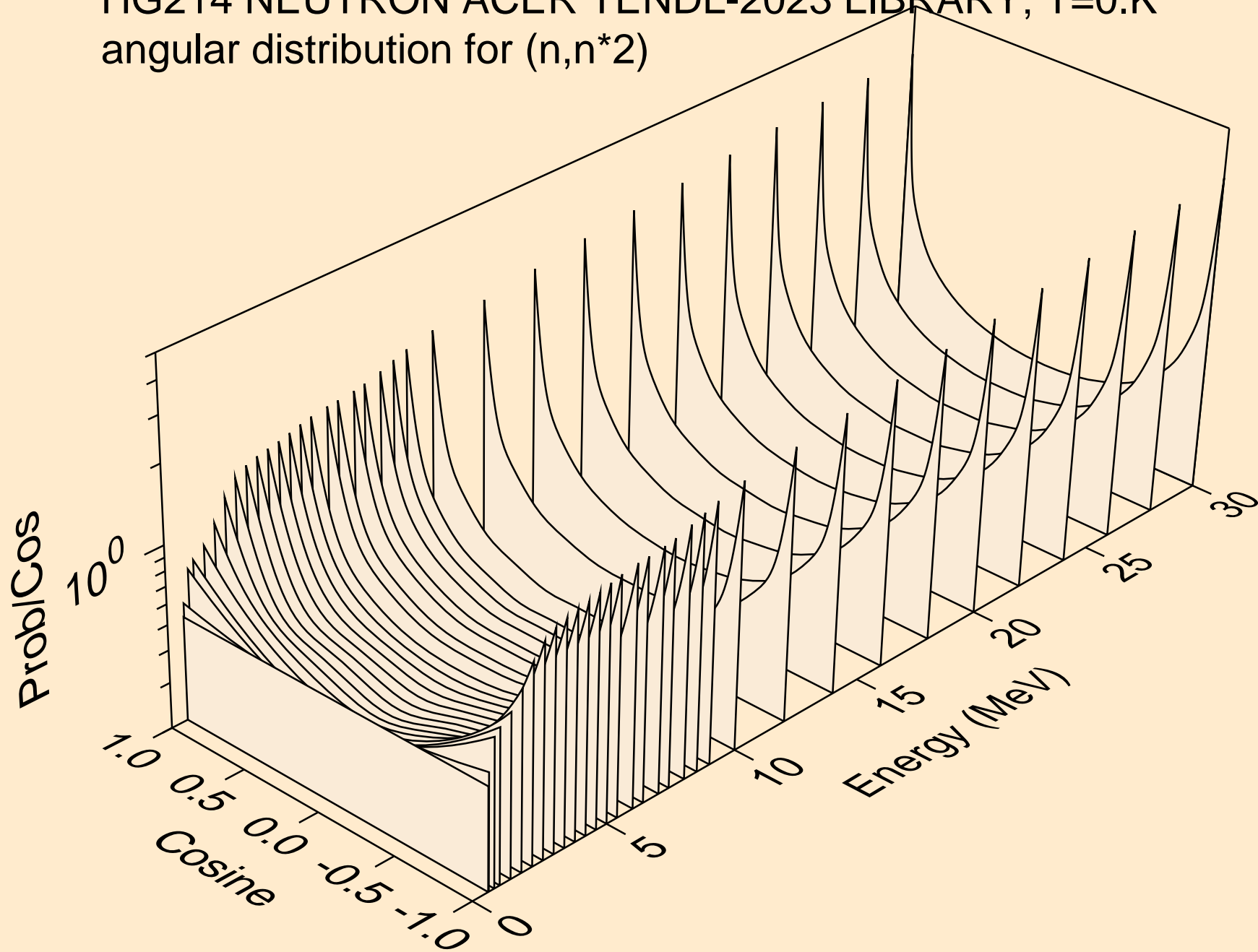

HG214 NEUTRON ACER TENDL-2023 LIBRARY; T=0.K
angular distribution for (n,n*3)

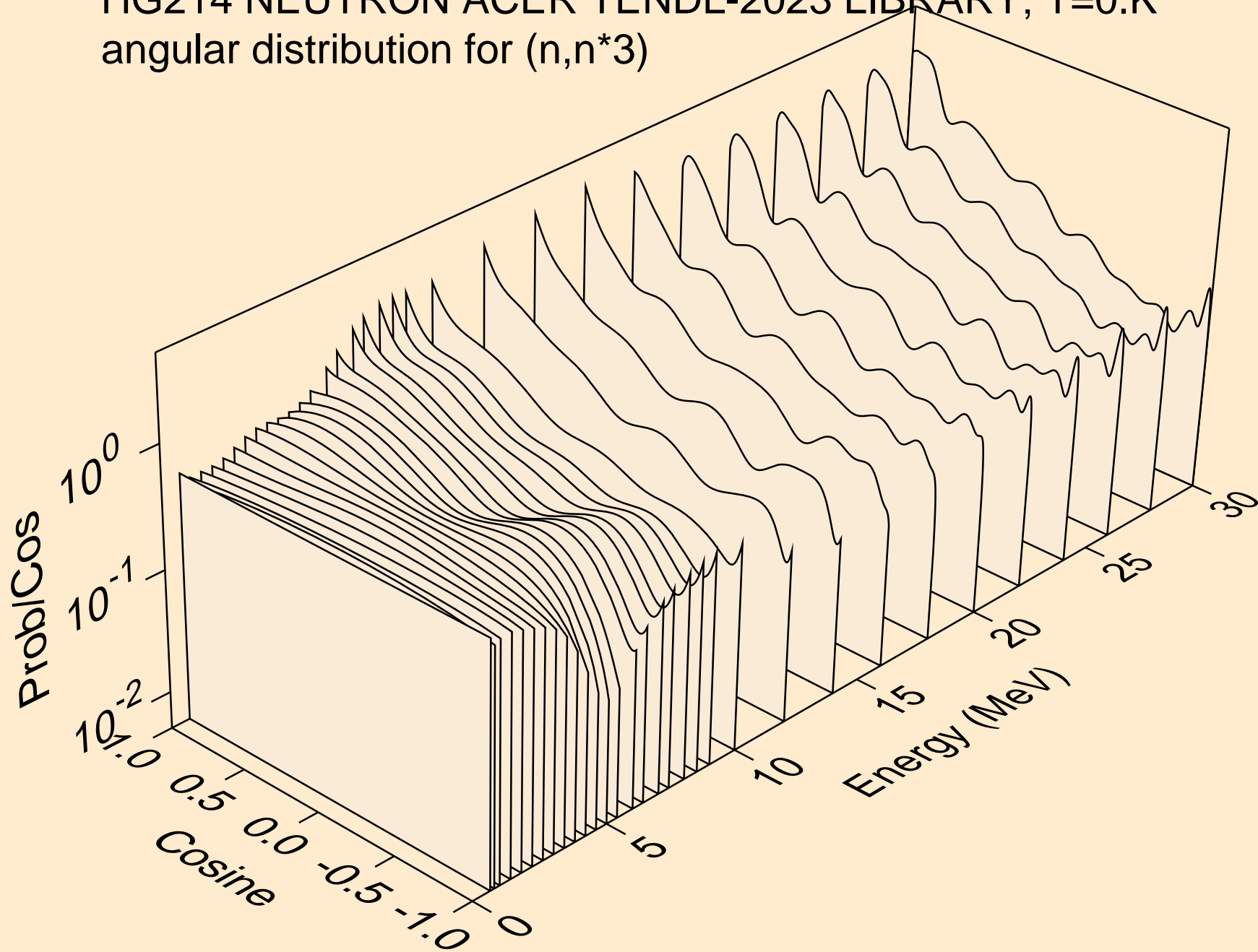

HG214 NEUTRON ACER TENDL-2023 LIBRARY; T=0.K
angular distribution for (n,n*4)

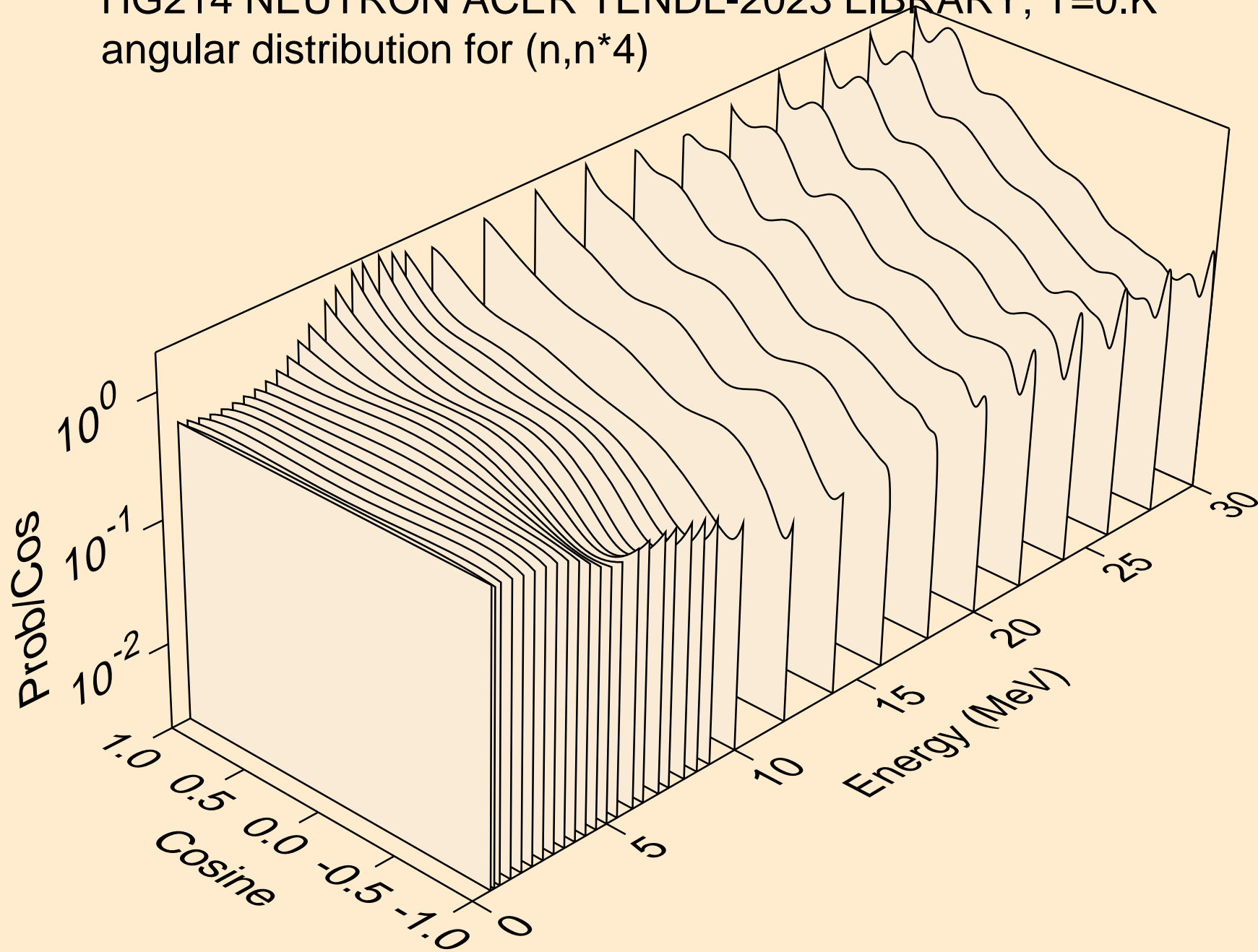

HG214 NEUTRON ACER TENDL-2023 LIBRARY; T=0.K
angular distribution for (n,n*5)

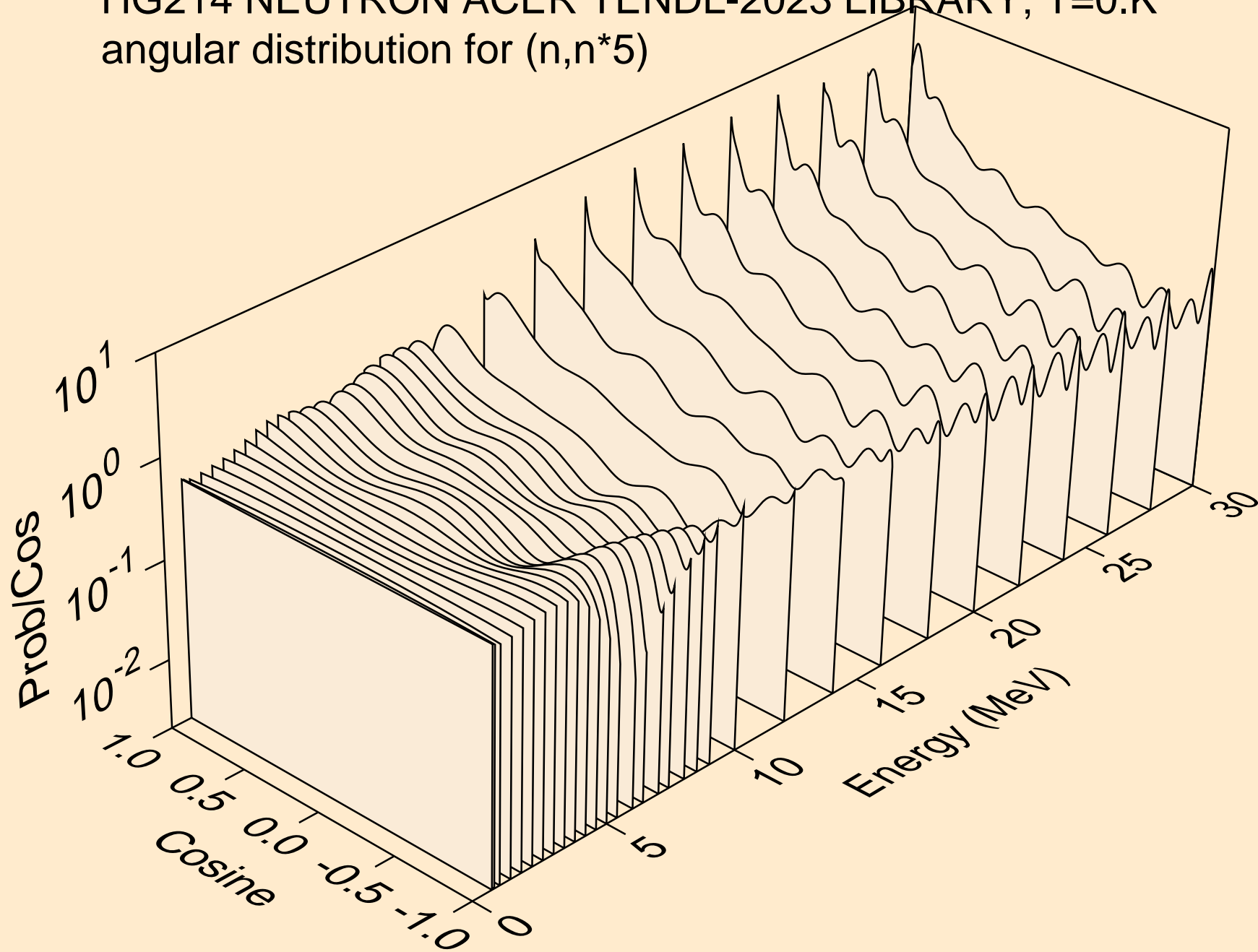

HG214 NEUTRON ACER TENDL-2023 LIBRARY; T=0.K
angular distribution for (n,n*6)

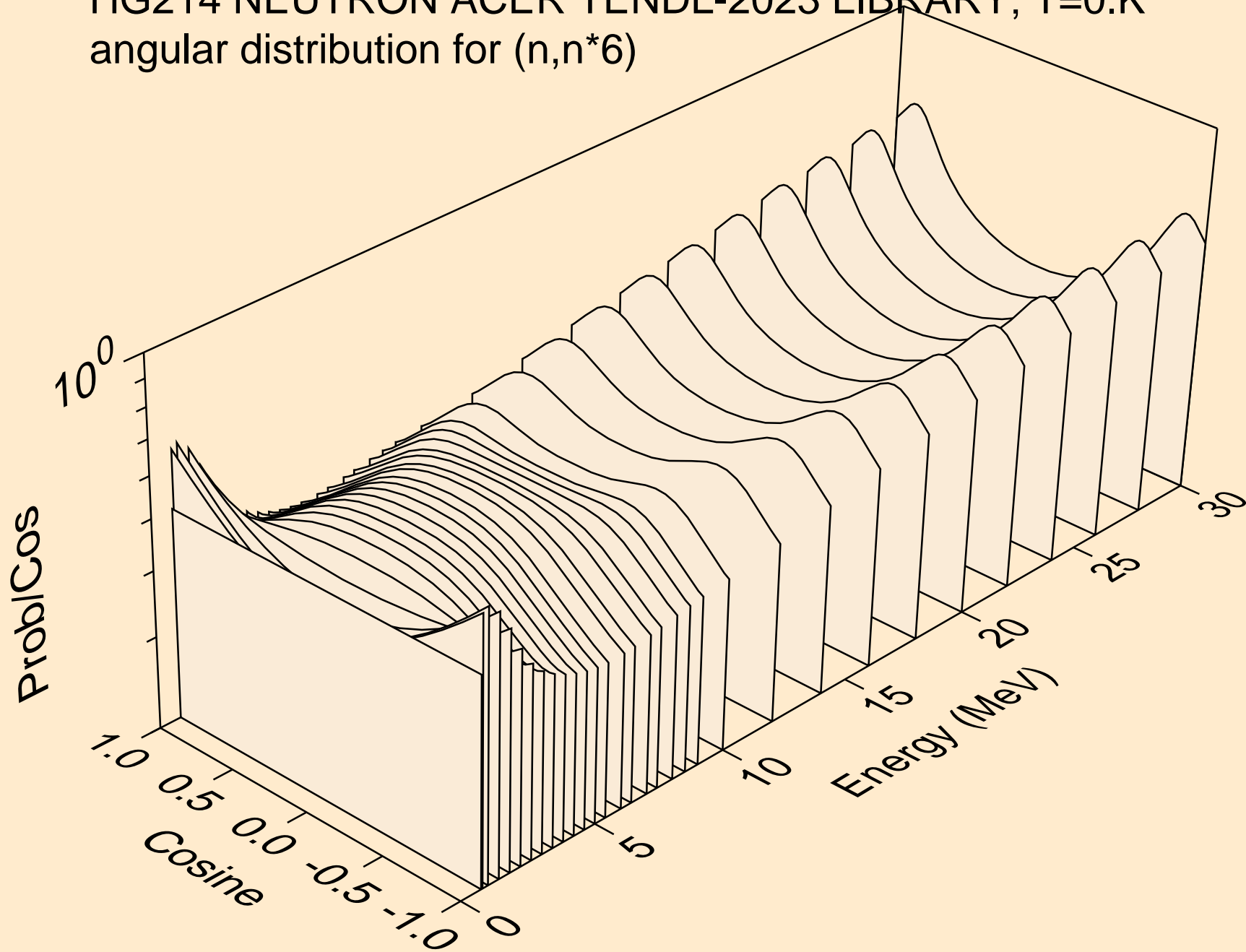

HG214 NEUTRON ACER TENDL-2023 LIBRARY; T=0.K
angular distribution for (n,n*7)

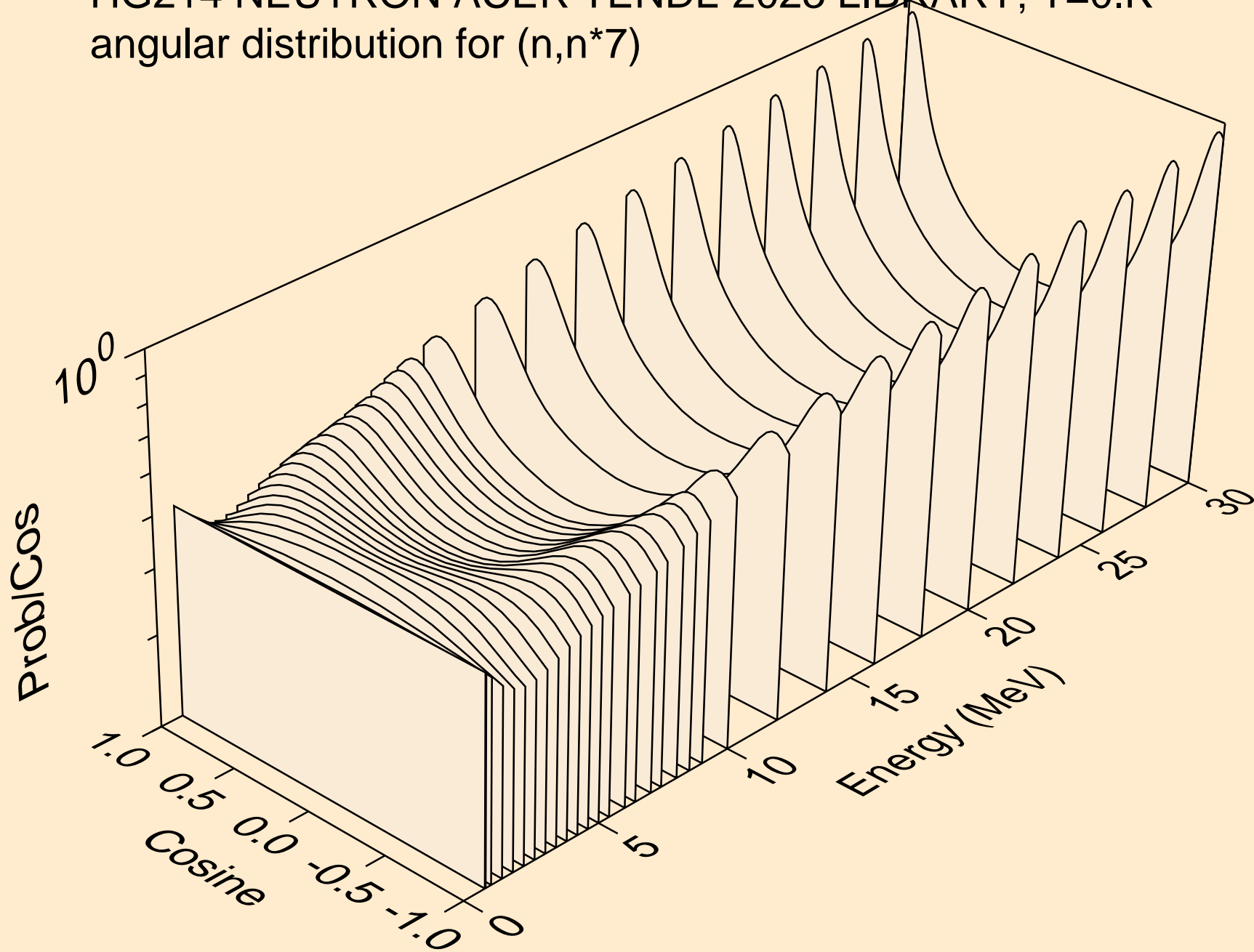

HG214 NEUTRON ACER TENDL-2023 LIBRARY; T=0.K
angular distribution for (n,n*8)

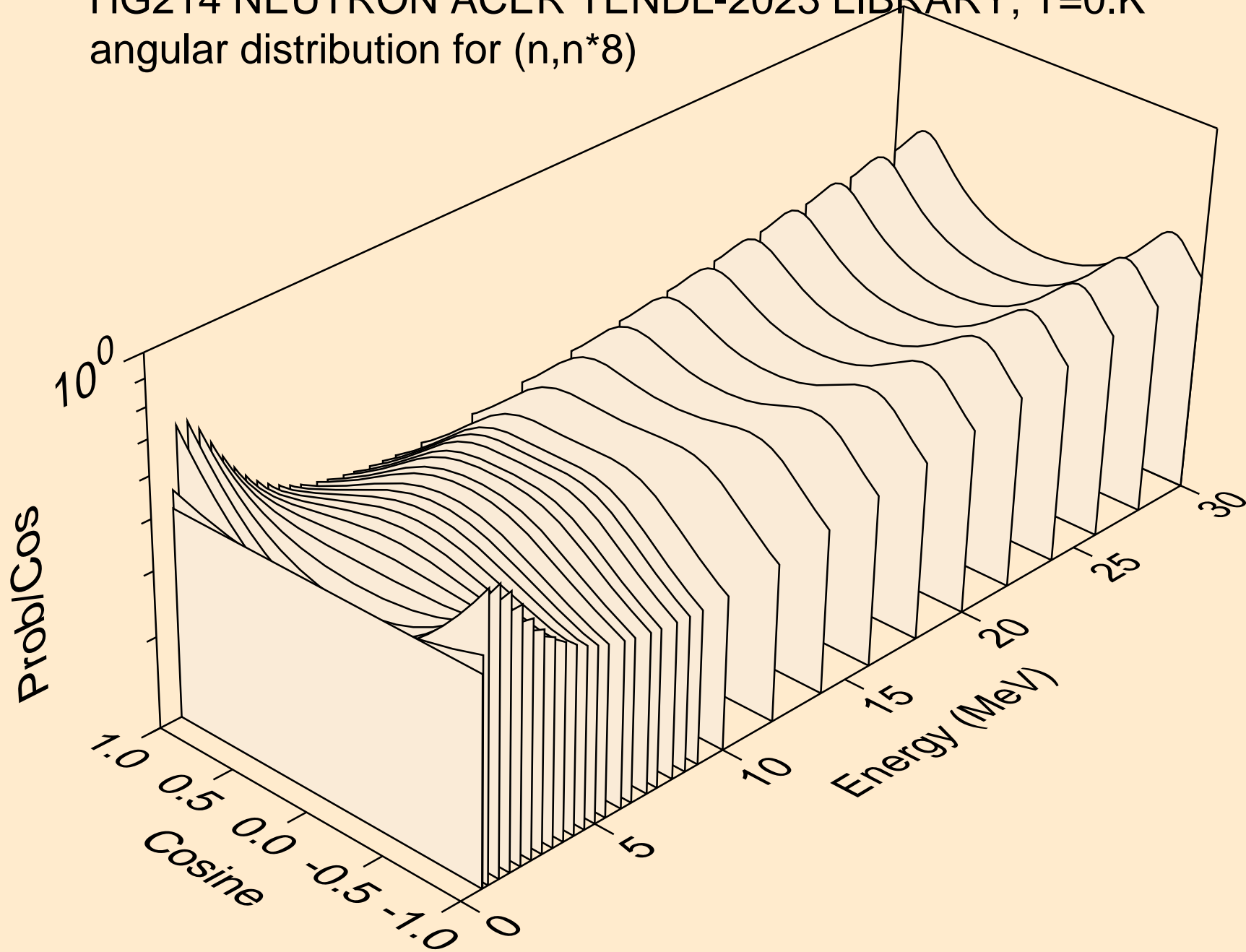

HG214 NEUTRON ACER TENDL-2023 LIBRARY; T=0.K
angular distribution for (n,n*9)

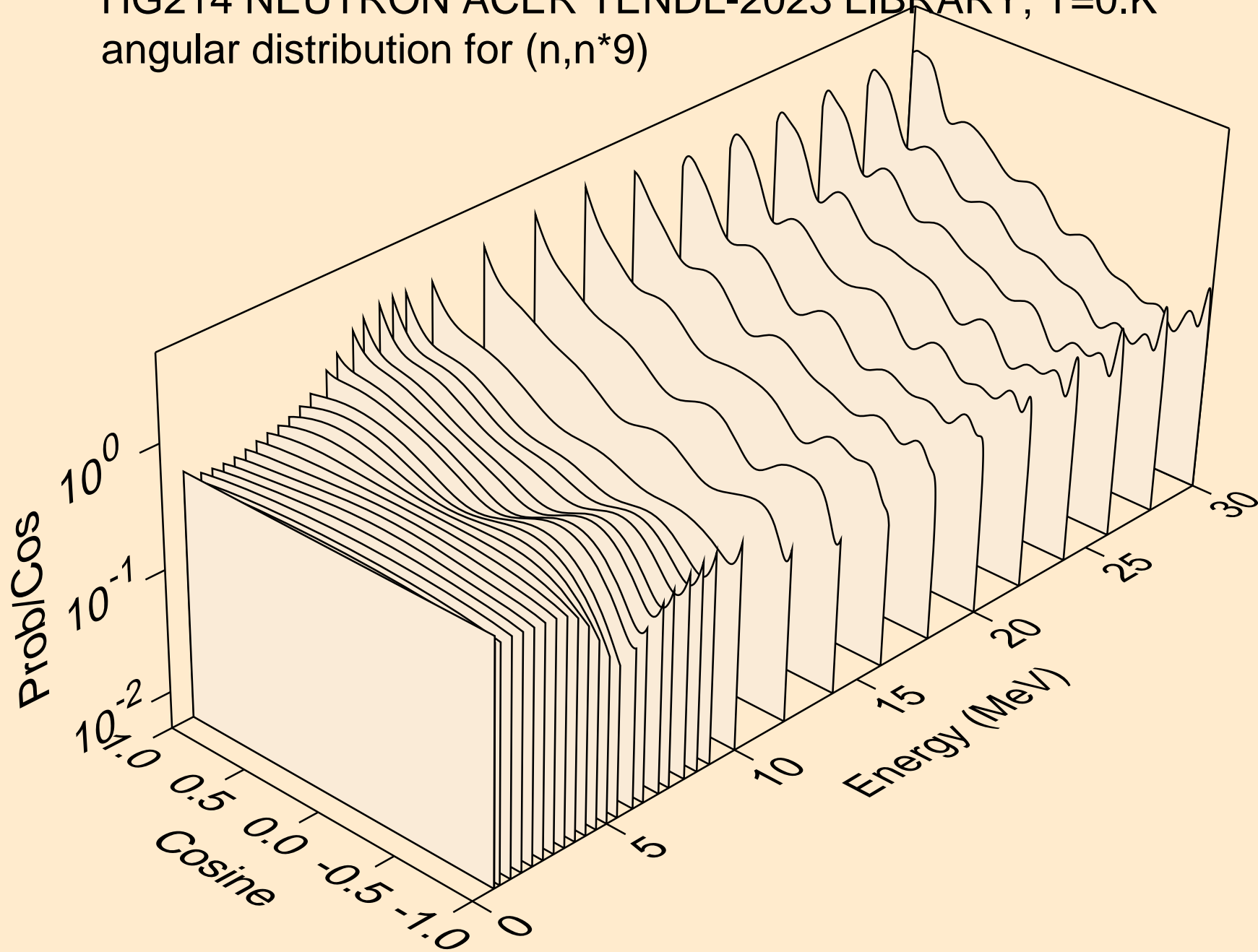

HG214 NEUTRON ACER TENDL-2023 LIBRARY; T=0.K
angular distribution for (n,n*10)

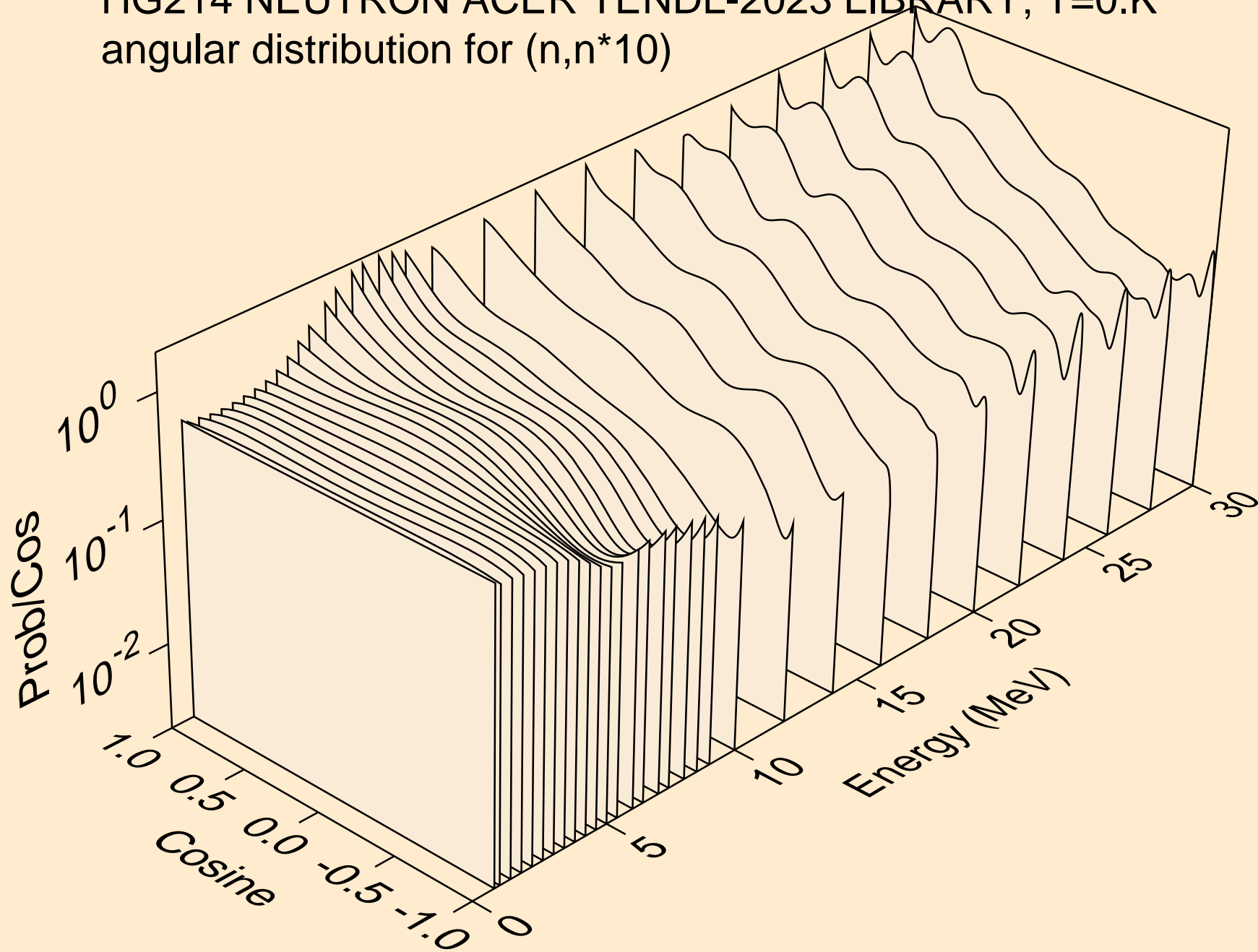

HG214 NEUTRON ACER TENDL-2023 LIBRARY; T=0.K
angular distribution for (n,n*11)

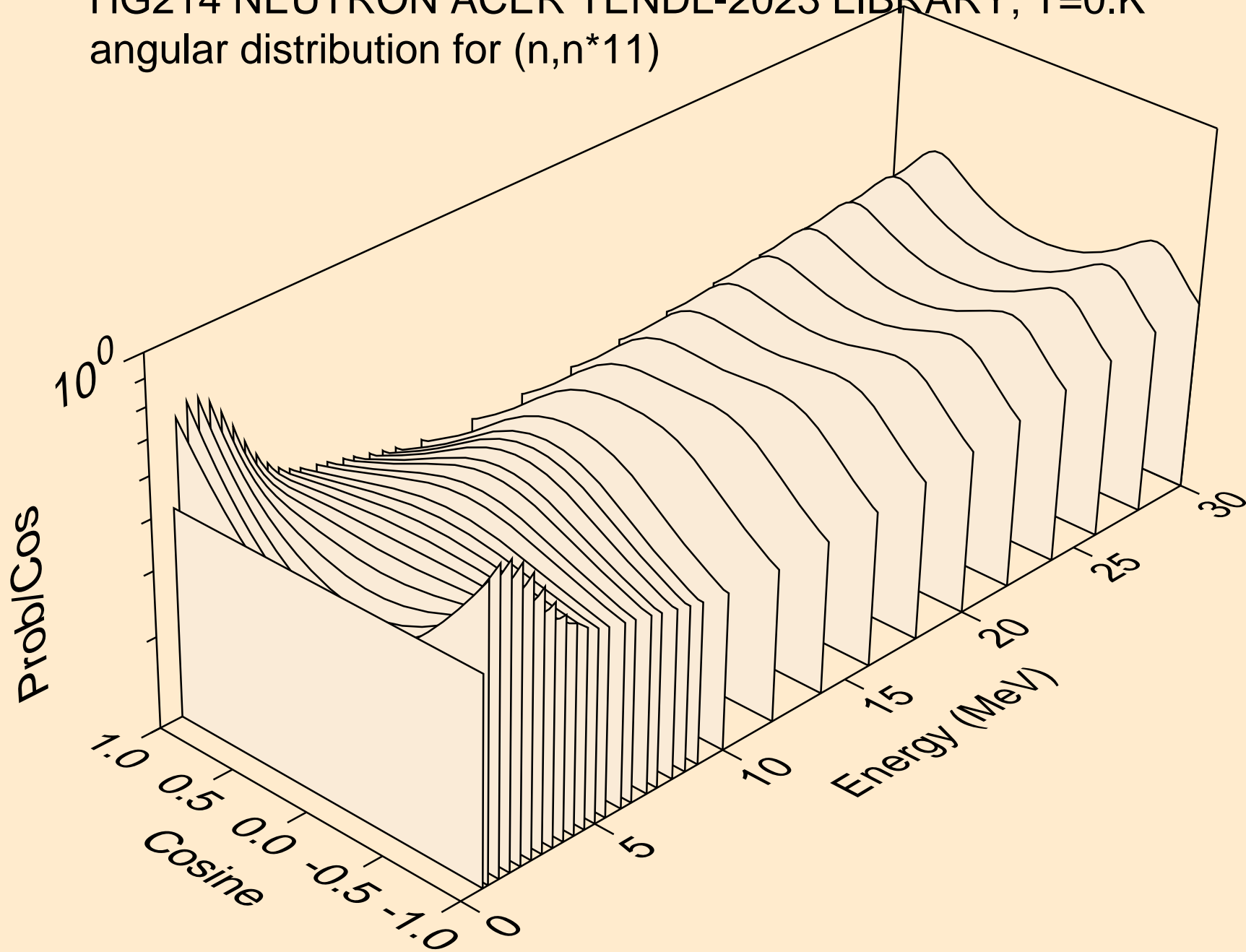

HG214 NEUTRON ACER TENDL-2023 LIBRARY; T=0.K
angular distribution for (n,n*12)

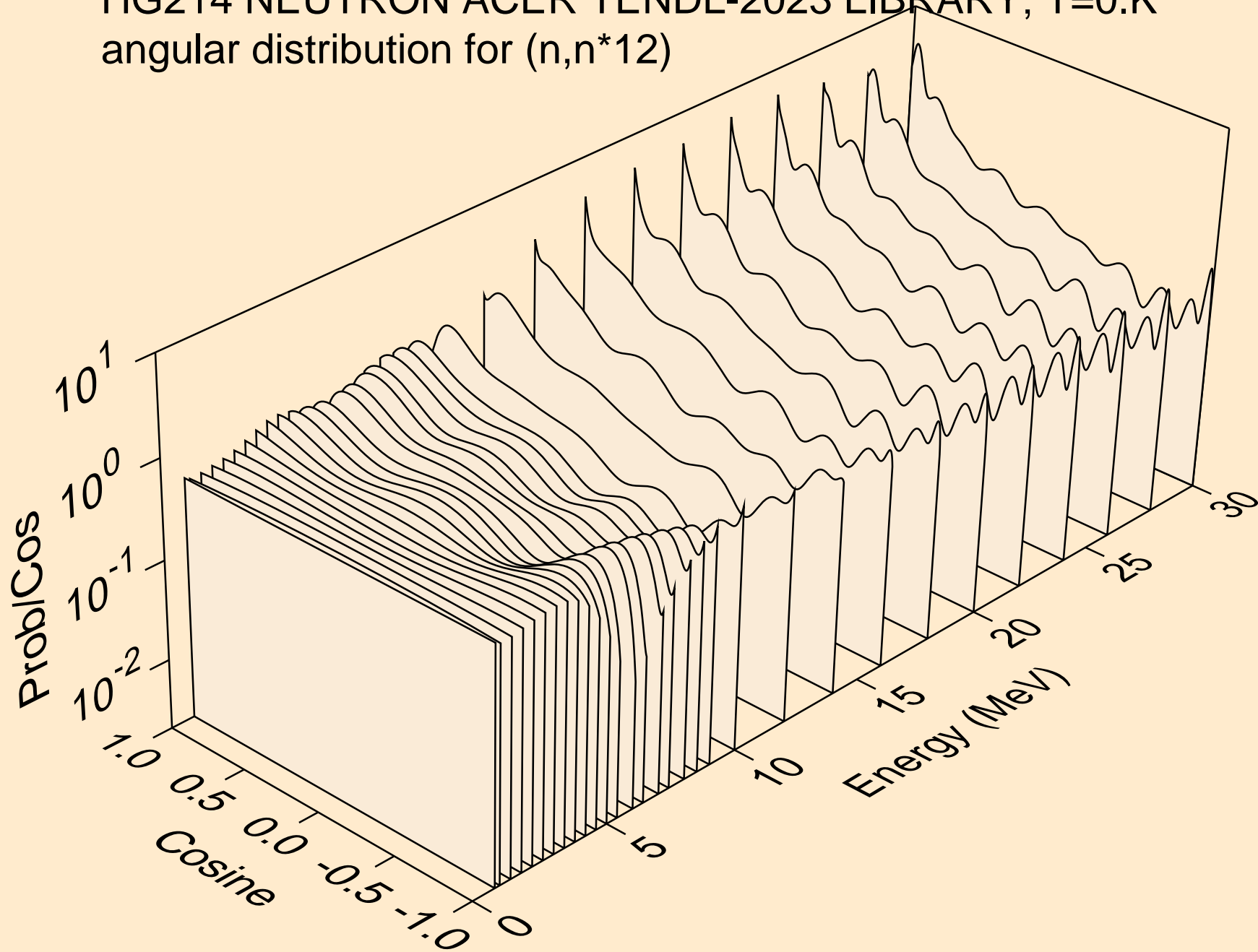

HG214 NEUTRON ACER TENDL-2023 LIBRARY; T=0.K
angular distribution for (n,n*13)

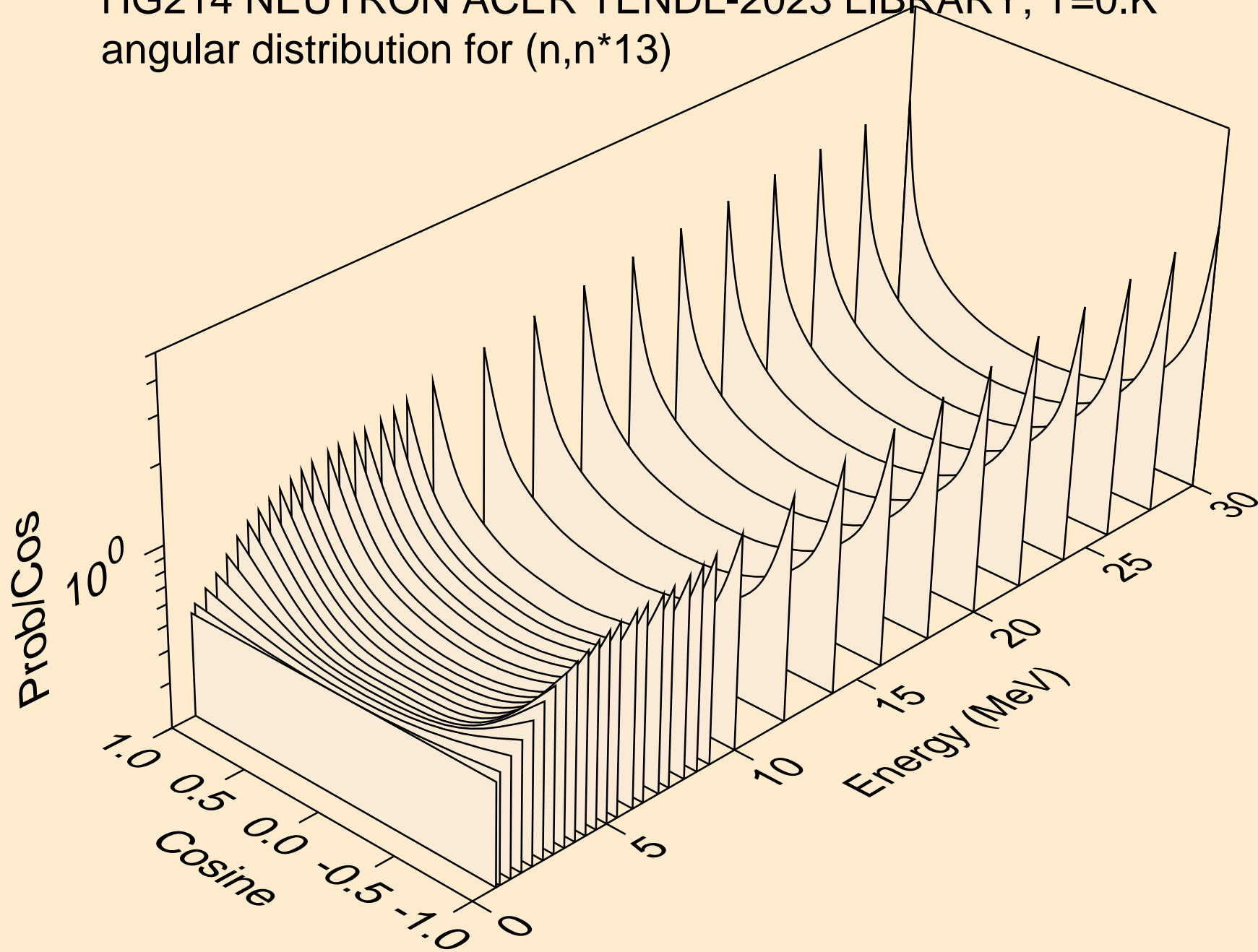

HG214 NEUTRON ACER TENDL-2023 LIBRARY; T=0.K
angular distribution for (n,n*14)

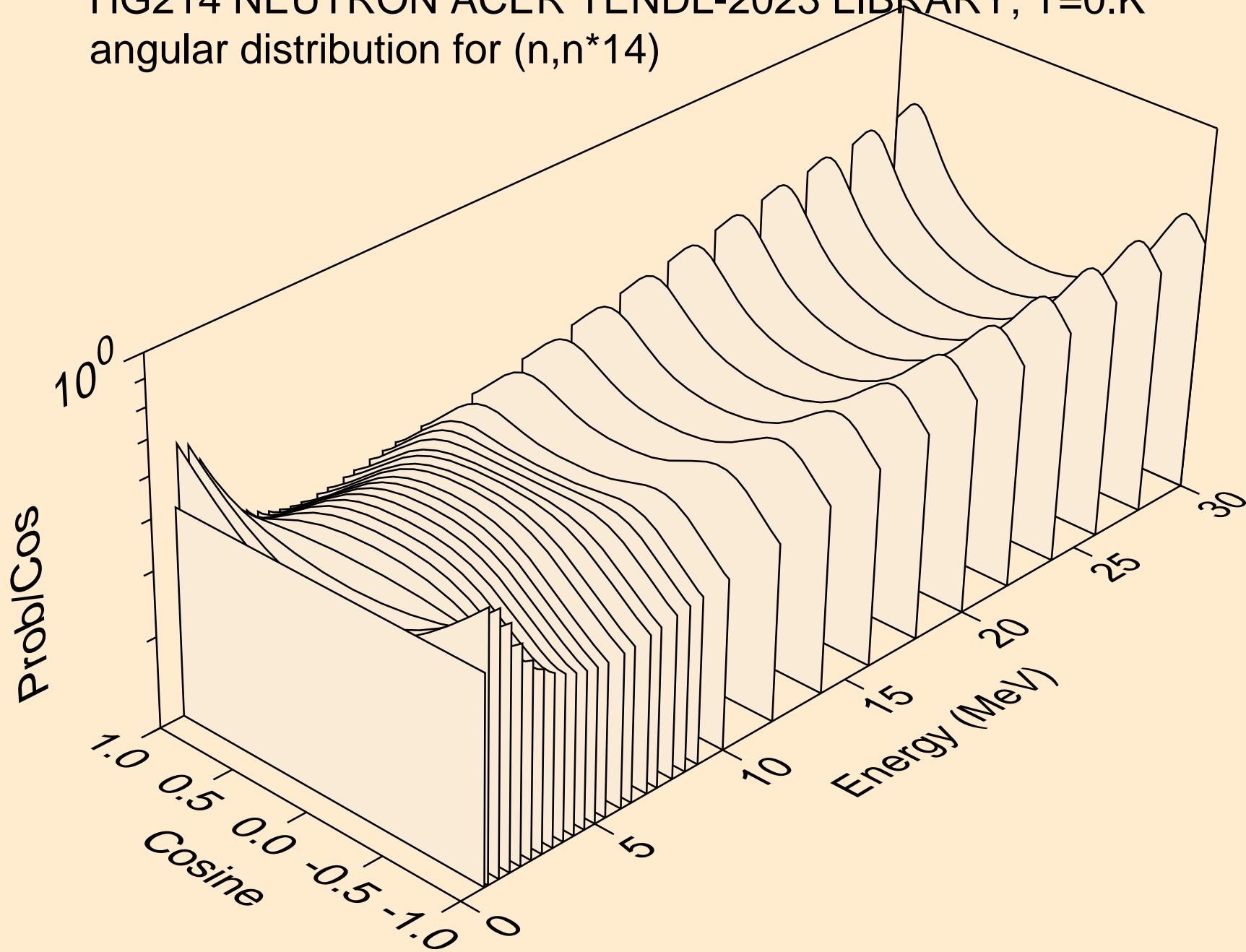

HG214 NEUTRON ACER TENDL-2023 LIBRARY; T=0.K
angular distribution for (n,n*15)

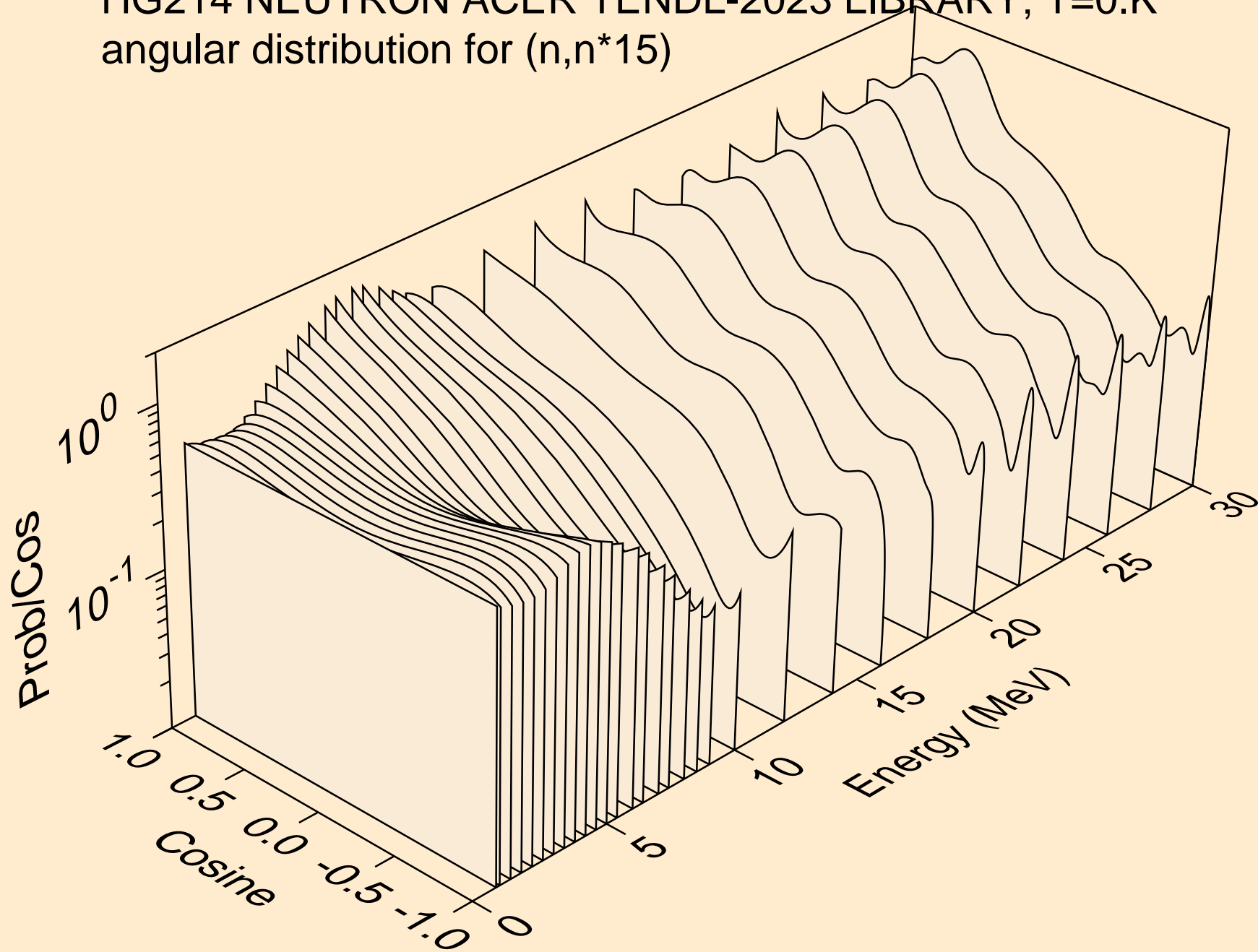

HG214 NEUTRON ACER TENDL-2023 LIBRARY; T=0.K
angular distribution for (n,n*16)

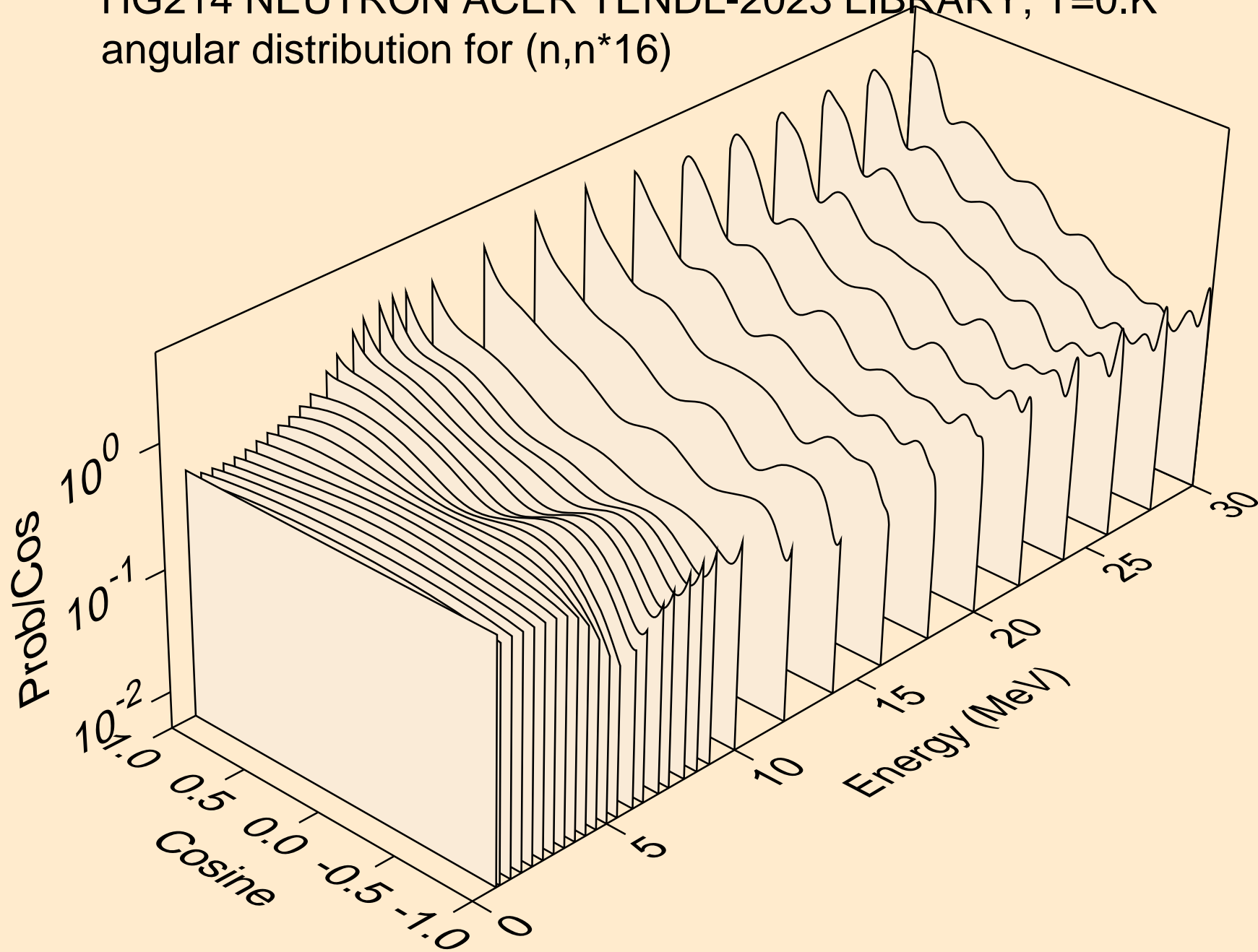

HG214 NEUTRON ACER TENDL-2023 LIBRARY; T=0.K
angular distribution for (n,n*17)

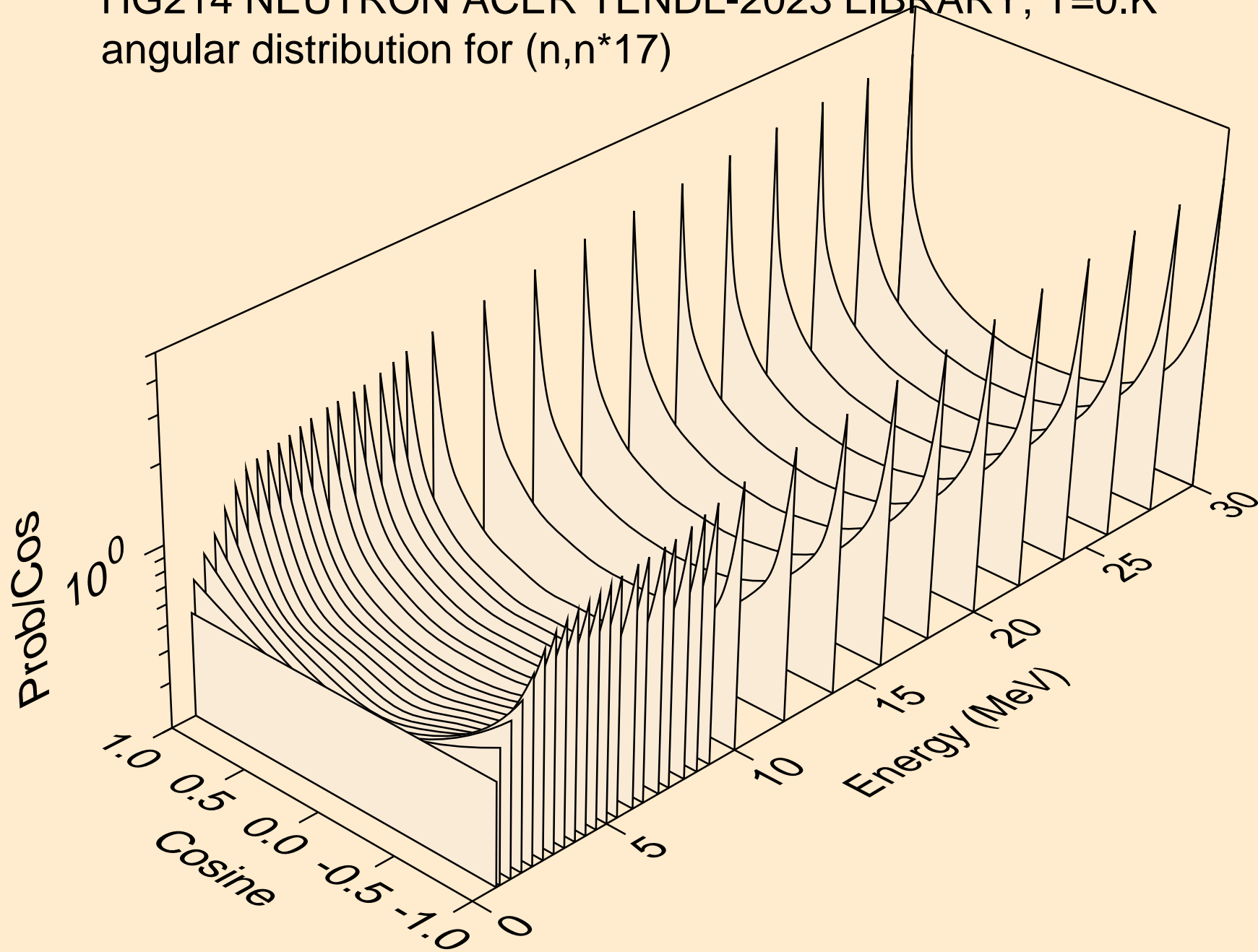

HG214 NEUTRON ACER TENDL-2023 LIBRARY; T=0.K
angular distribution for (n,n*18)

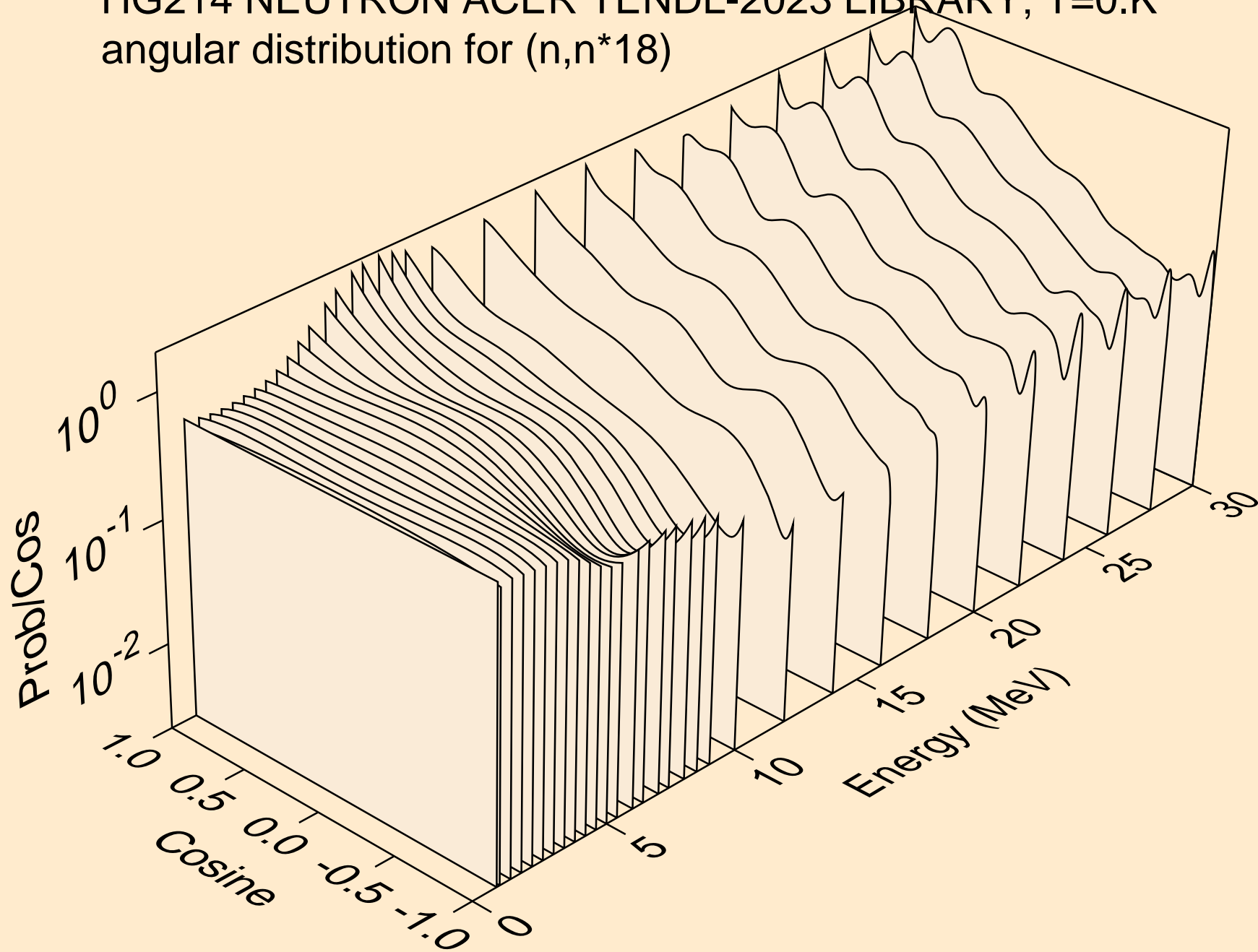

HG214 NEUTRON ACER TENDL-2023 LIBRARY; T=0.K
angular distribution for (n,n*19)

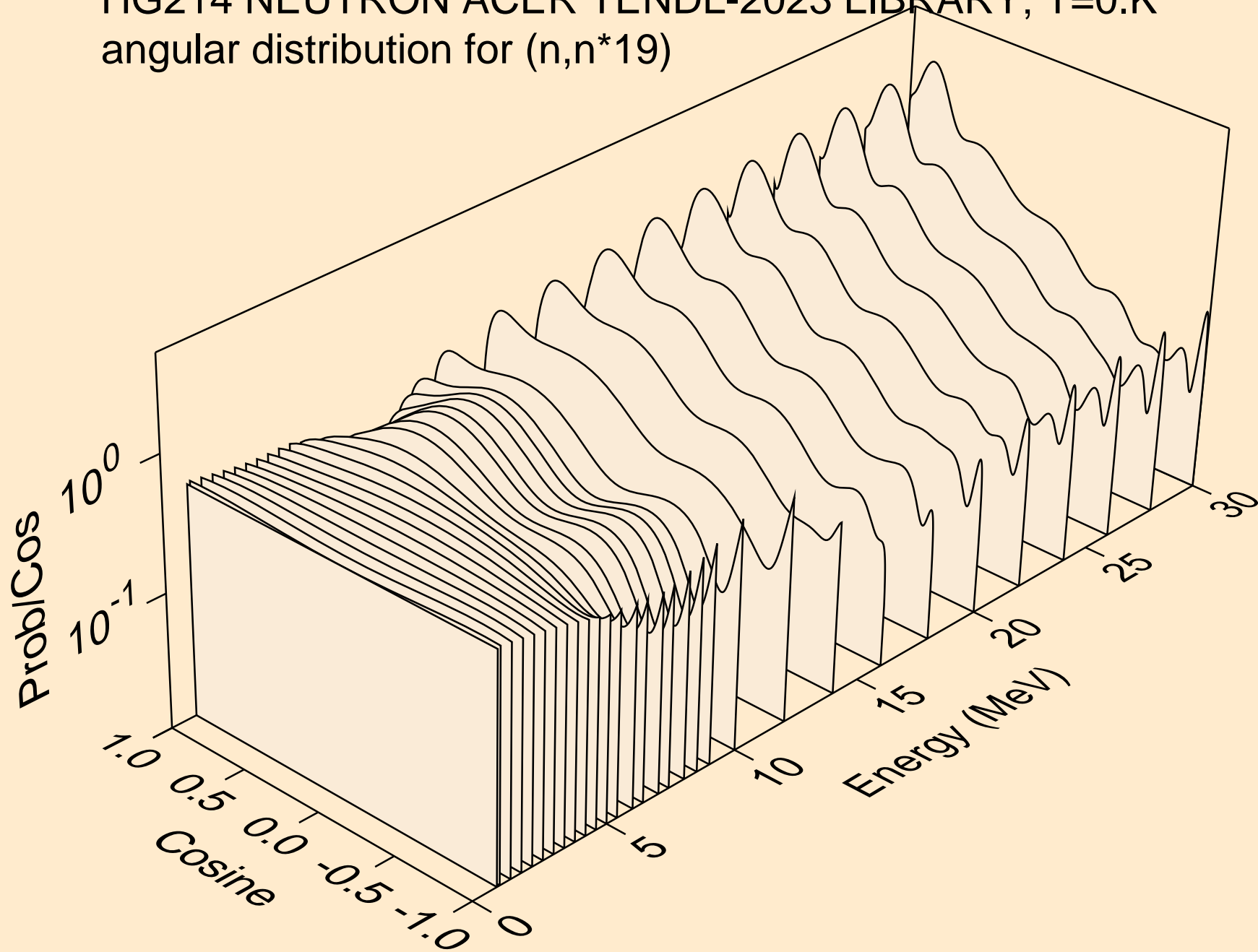

HG214 NEUTRON ACER TENDL-2023 LIBRARY; T=0.K
angular distribution for (n,n*20)

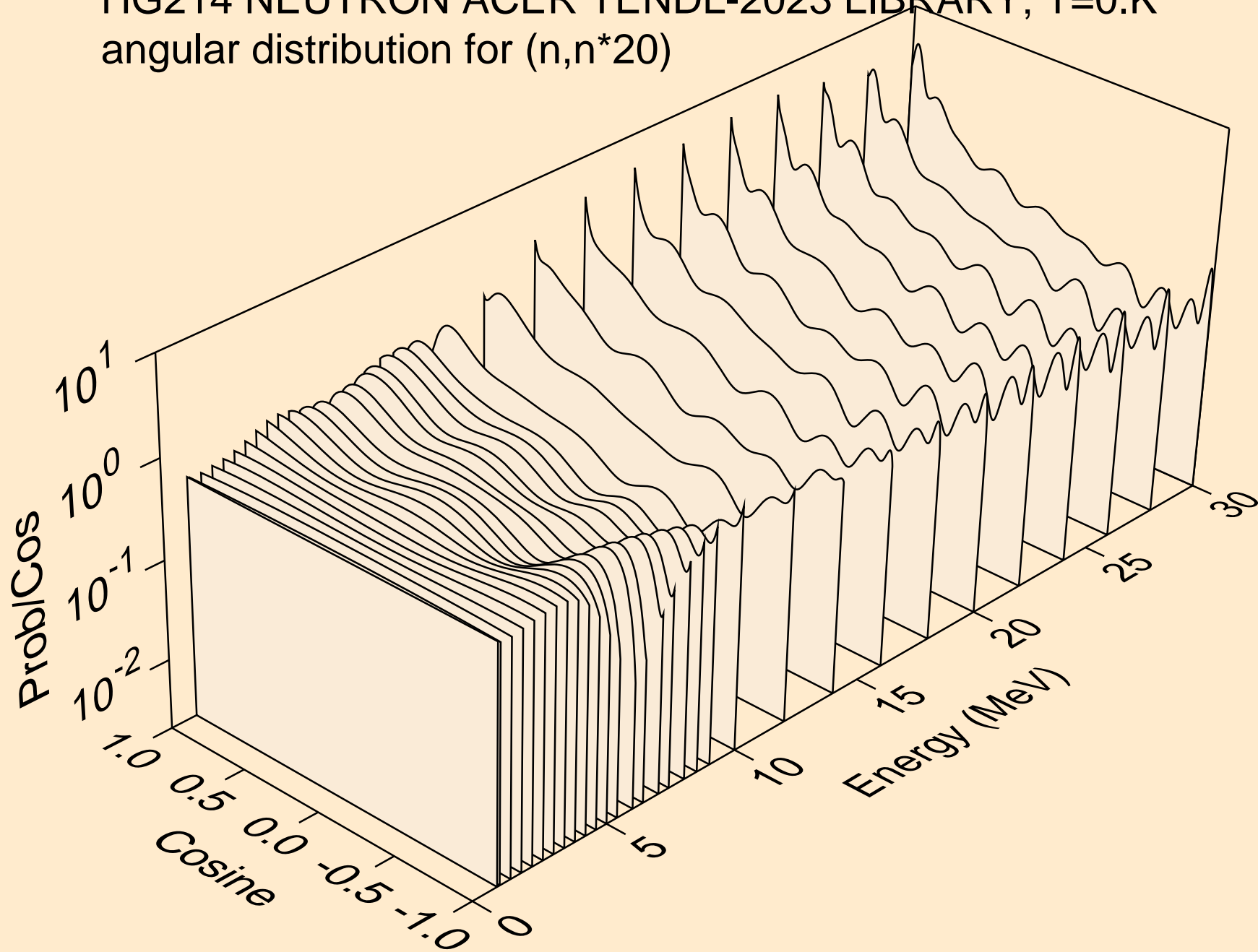

HG214 NEUTRON ACER TENDL-2023 LIBRARY; T=0.K
angular distribution for (n,n*21)

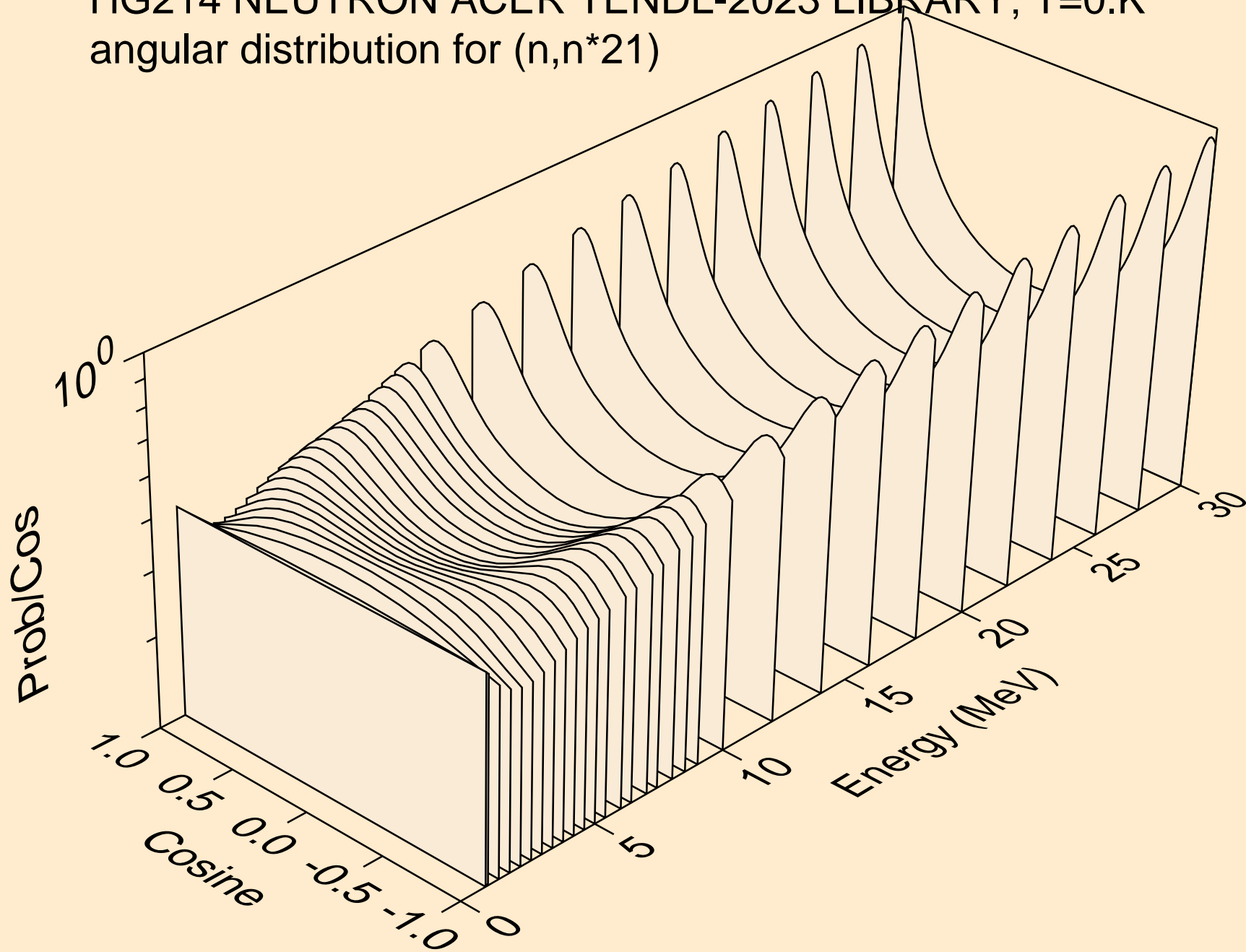

HG214 NEUTRON ACER TENDL-2023 LIBRARY; T=0.K
angular distribution for (n,n*22)

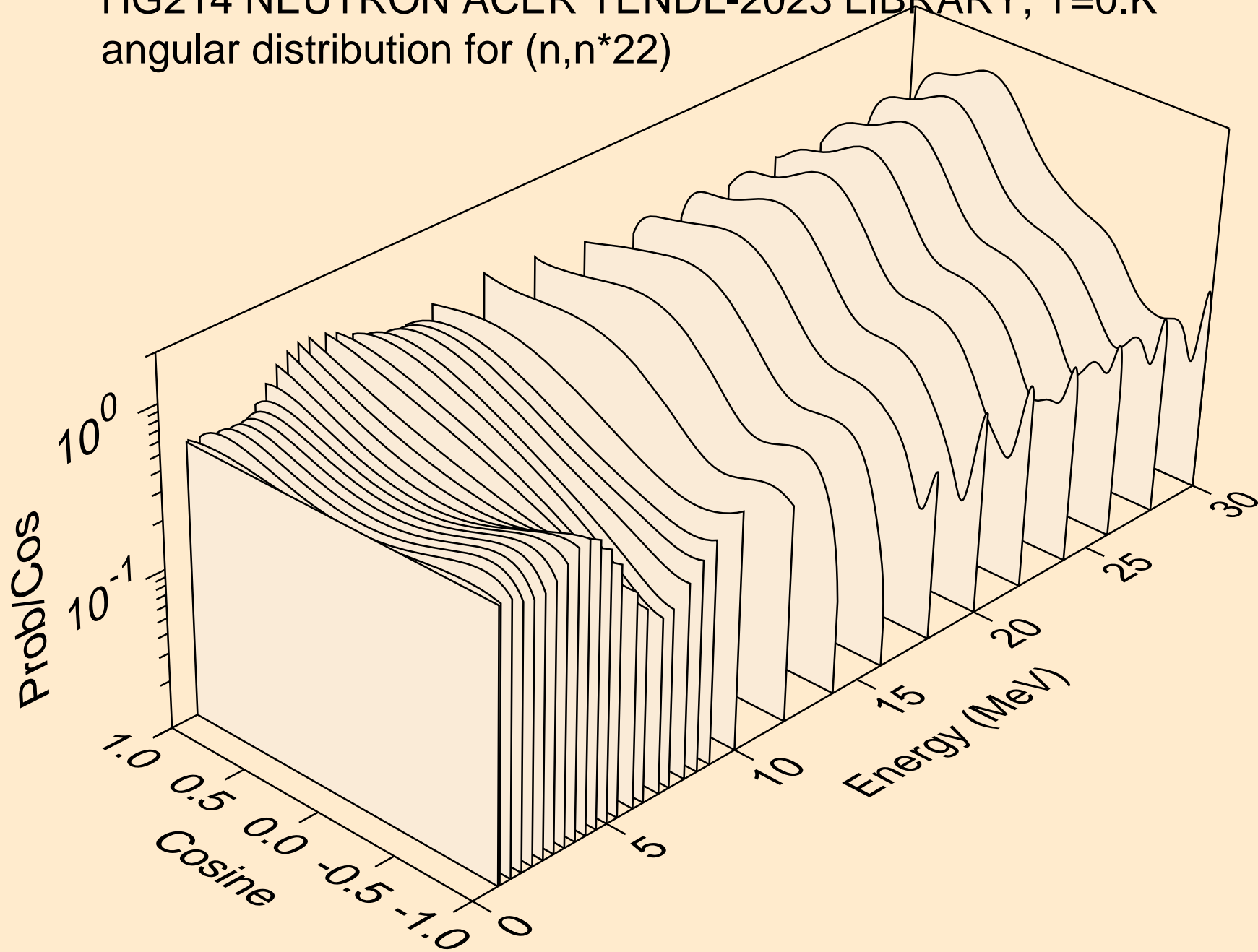

HG214 NEUTRON ACER TENDL-2023 LIBRARY; T=0.K
angular distribution for (n,n*23)

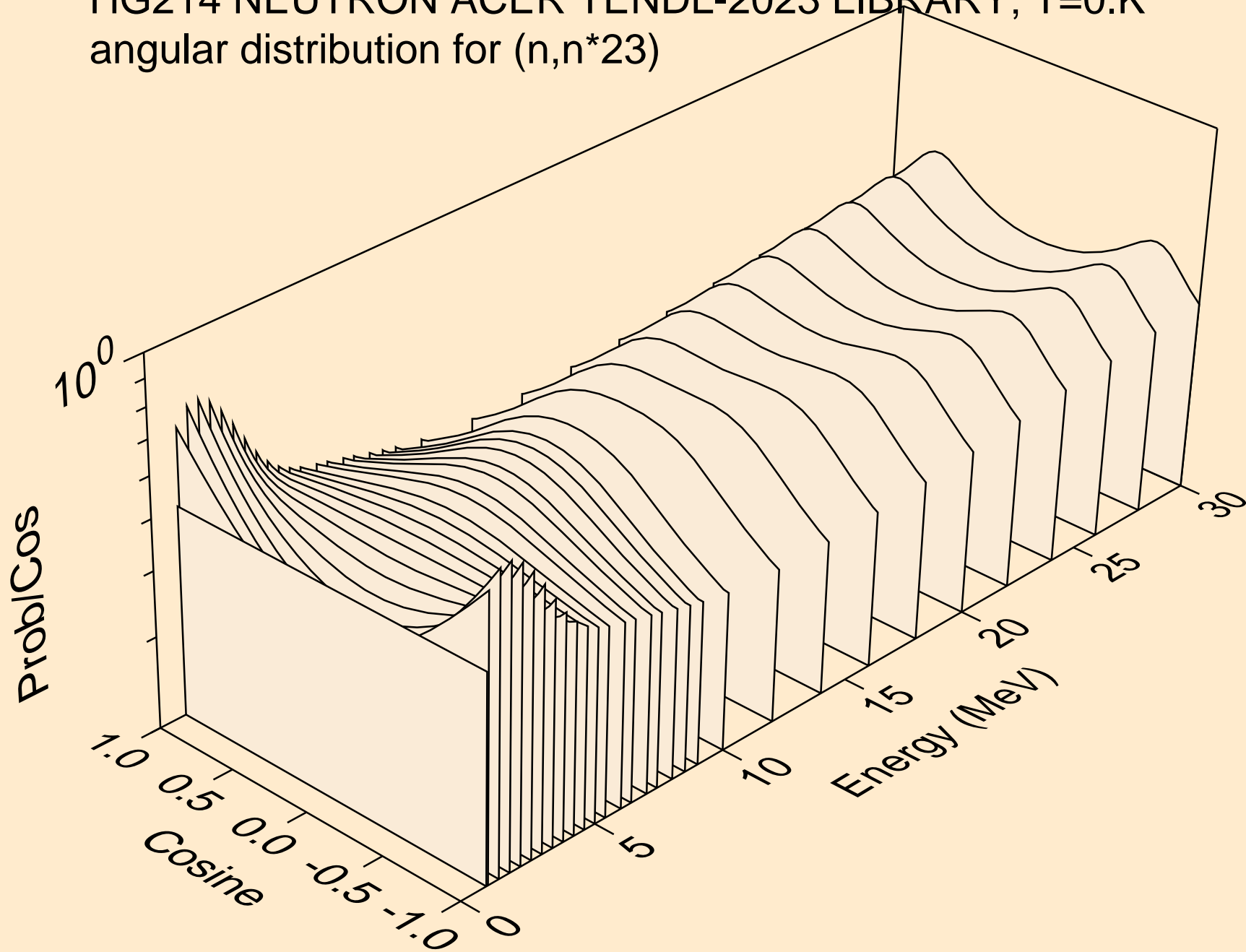

HG214 NEUTRON ACER TENDL-2023 LIBRARY; T=0.K
angular distribution for (n,n*24)

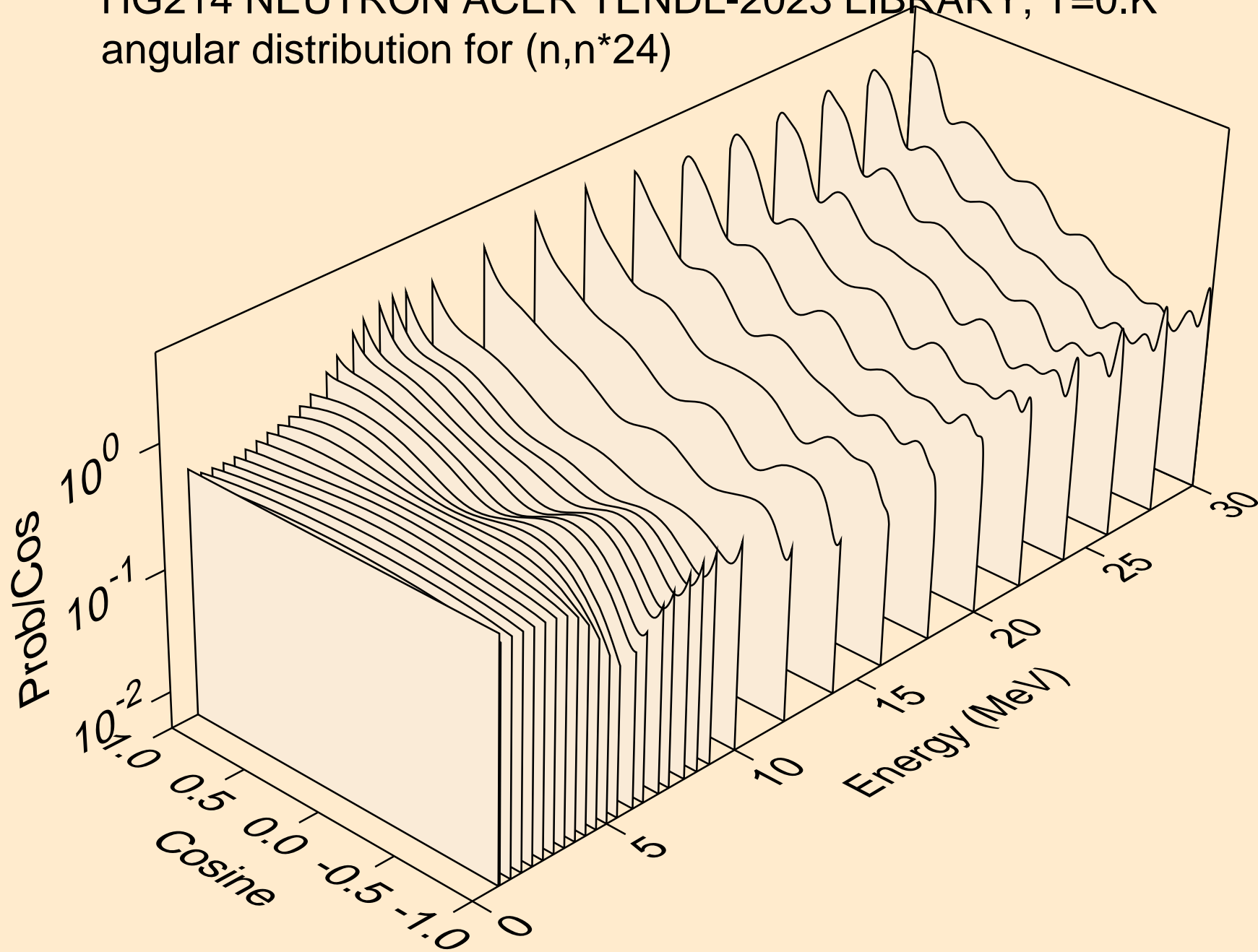

HG214 NEUTRON ACER TENDL-2023 LIBRARY; T=0.K
angular distribution for (n,n*25)

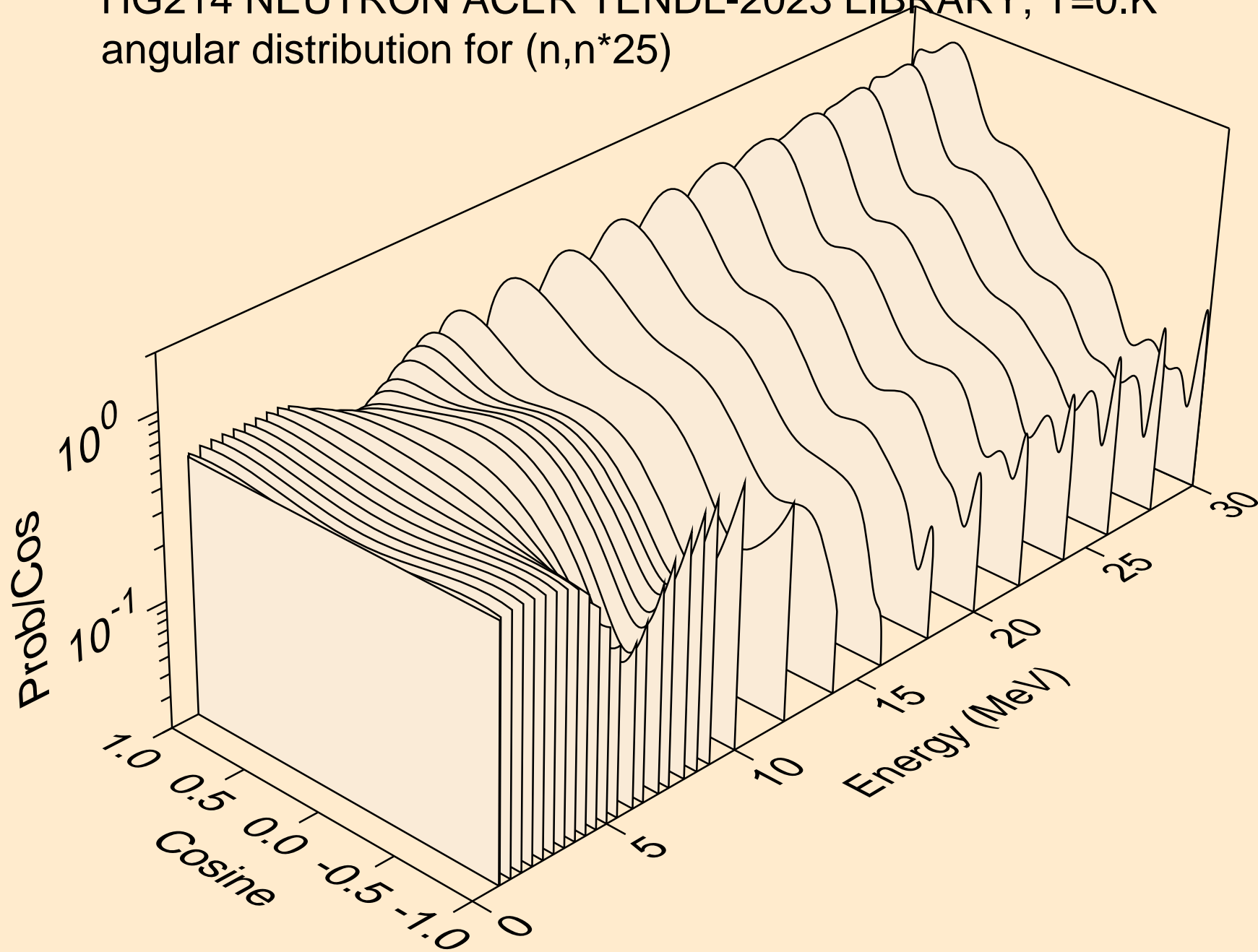

HG214 NEUTRON ACER TENDL-2023 LIBRARY; T=0.K
angular distribution for (n,n*26)

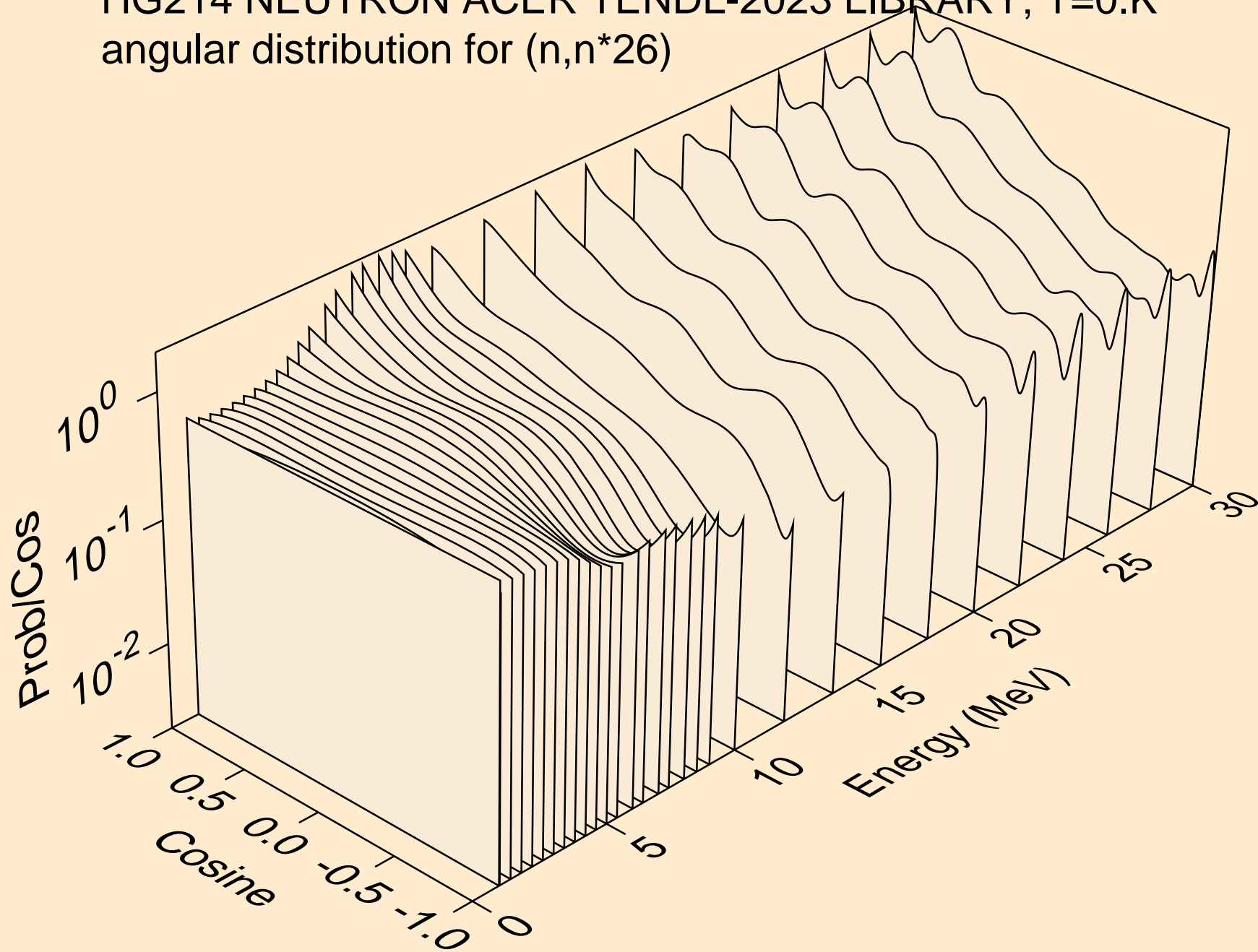

HG214 NEUTRON ACER TENDL-2023 LIBRARY; T=0.K
angular distribution for (n,n*27)

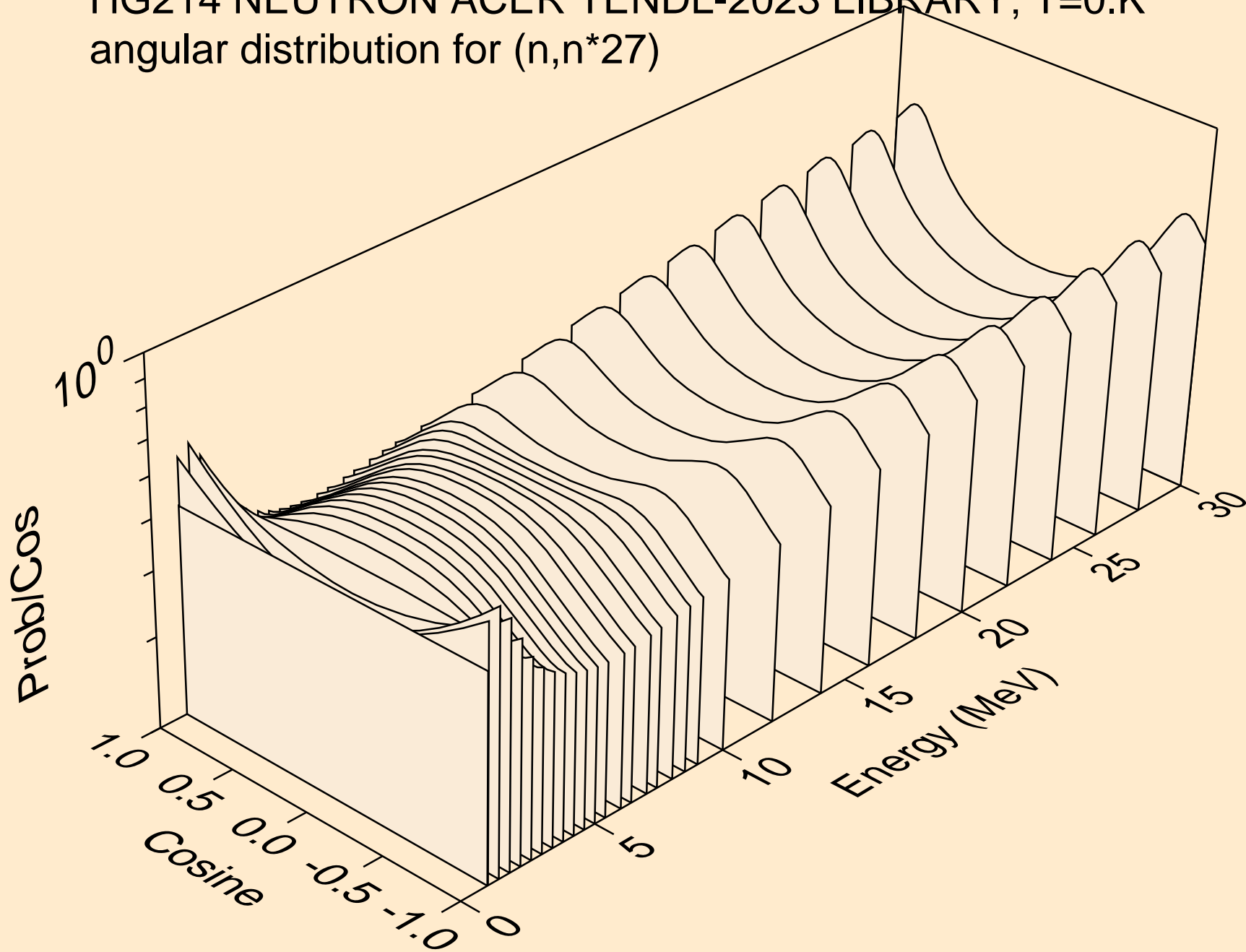

HG214 NEUTRON ACER TENDL-2023 LIBRARY; T=0.K
angular distribution for (n,n*28)

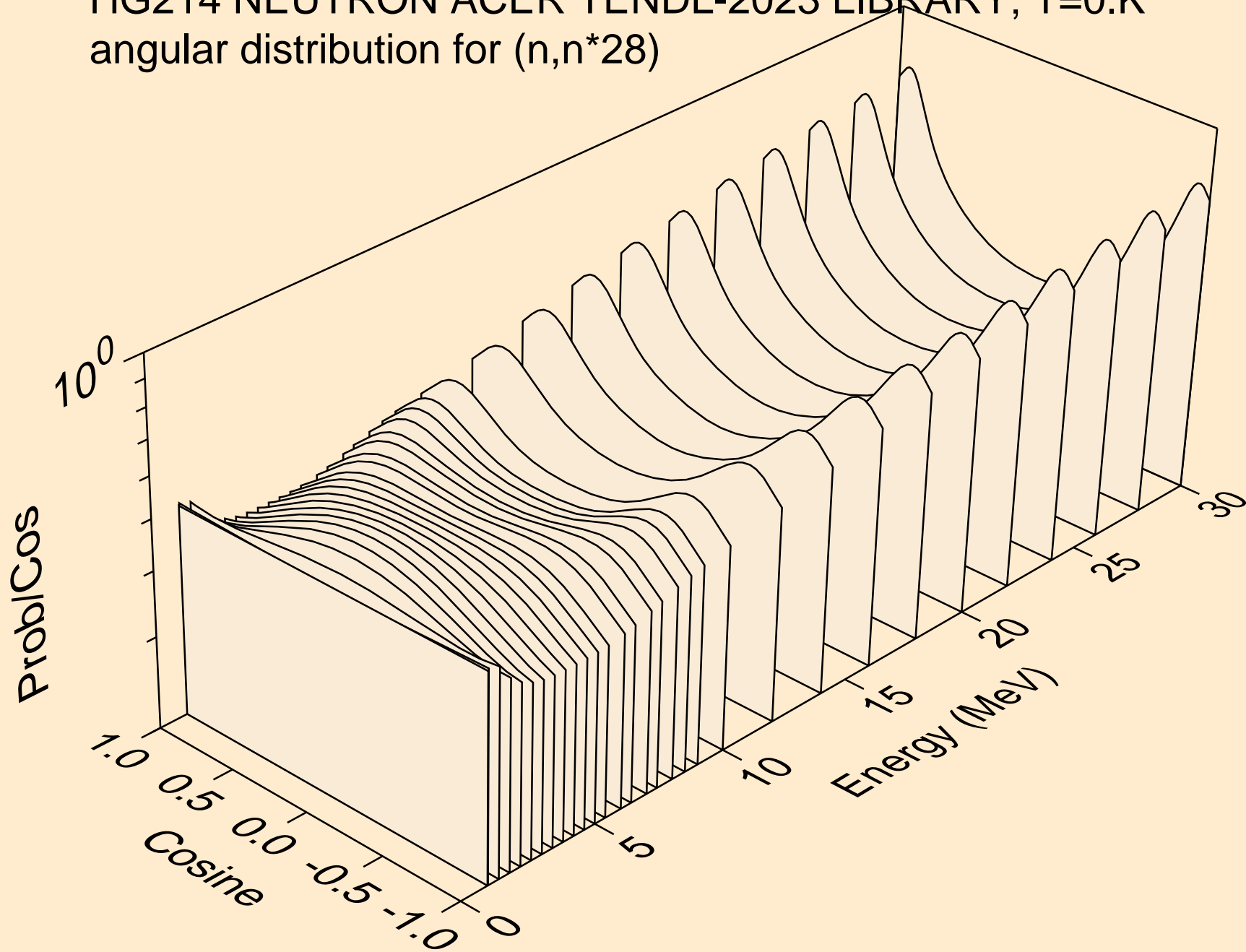

HG214 NEUTRON ACER TENDL-2023 LIBRARY; T=0.K
angular distribution for (n,n*29)

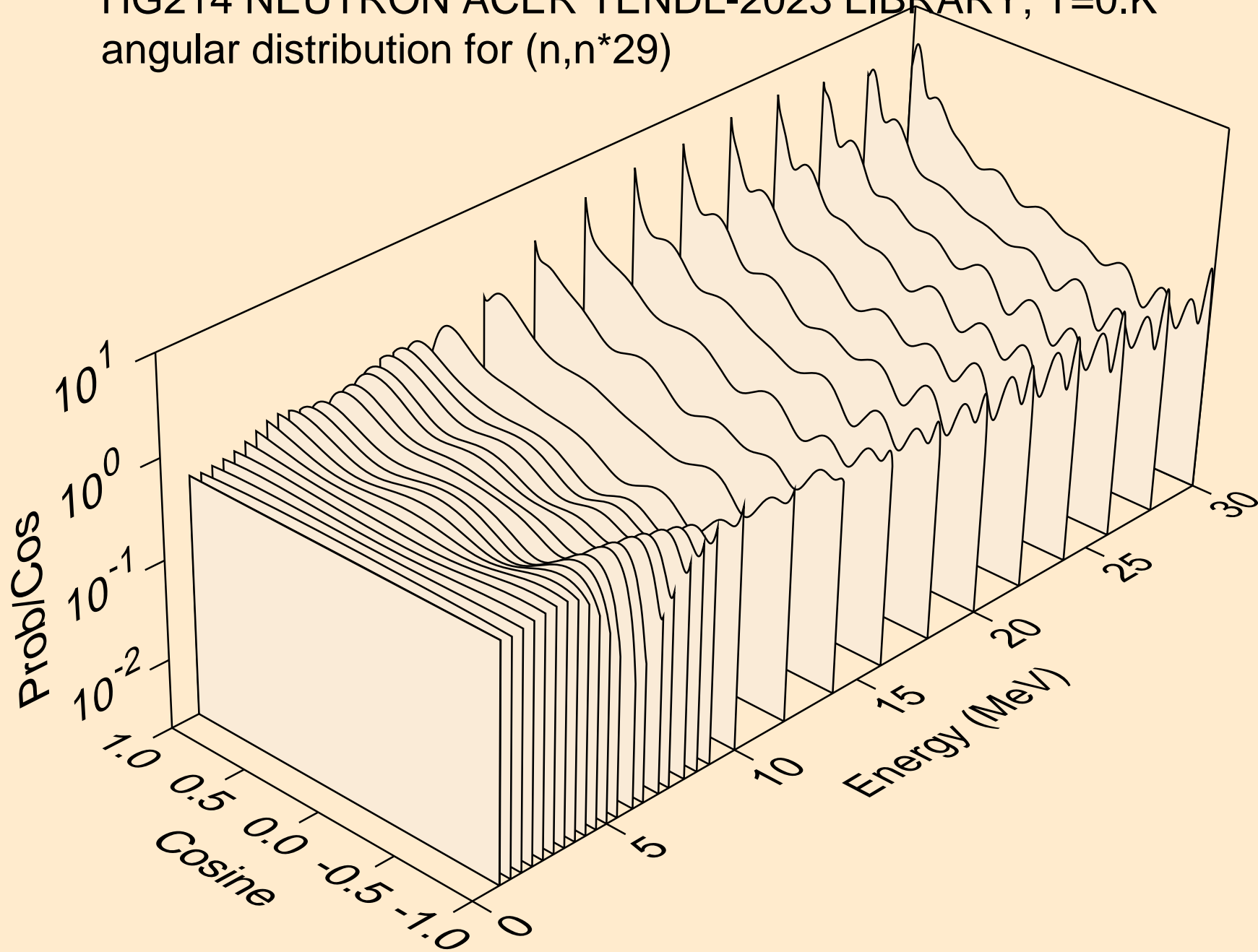

HG214 NEUTRON ACER TENDL-2023 LIBRARY; T=0.K
Neutron emission for (n,x)

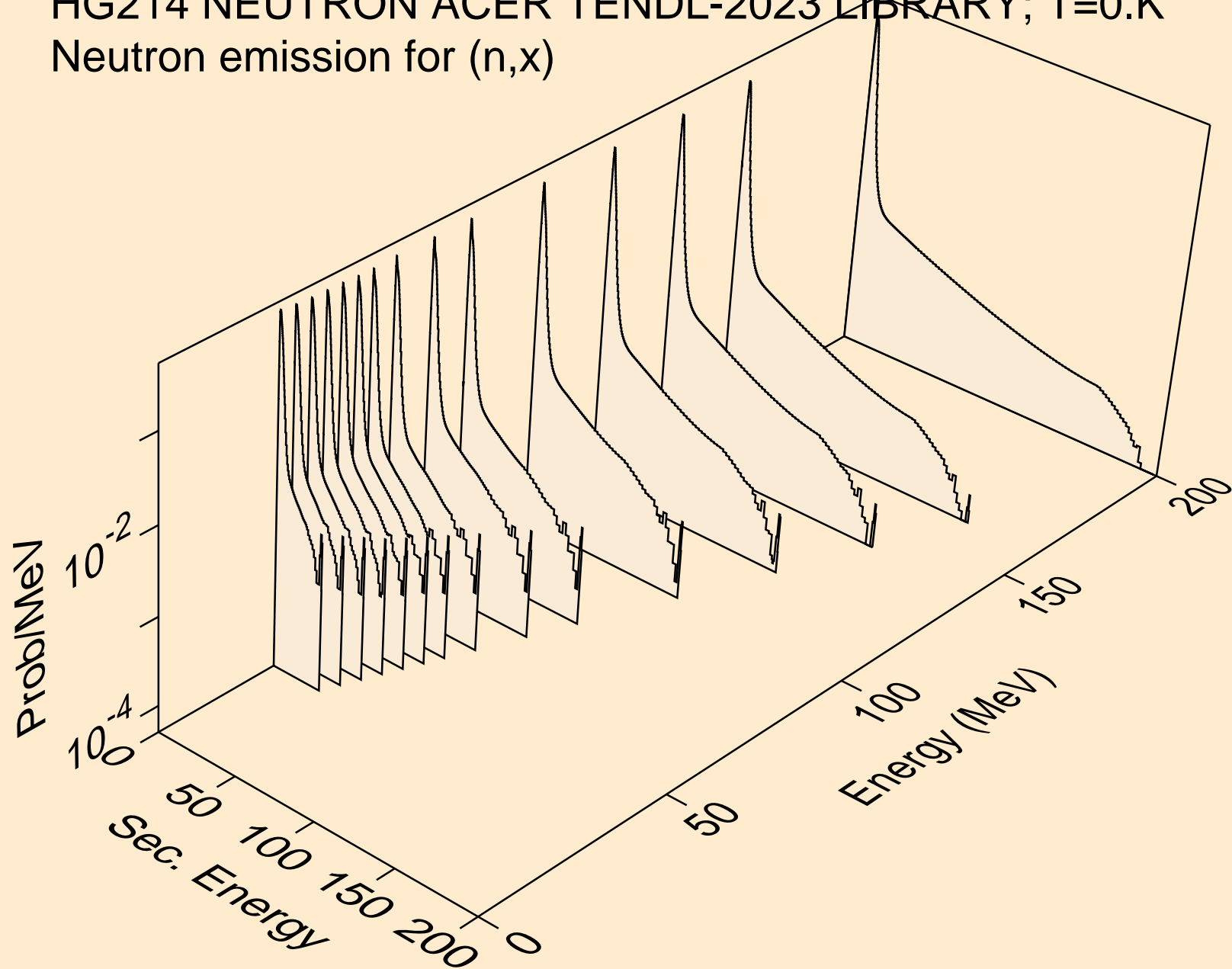

HG214 NEUTRON ACER TENDL-2023 LIBRARY; T=0.K
Neutron emission for (n,2nd)

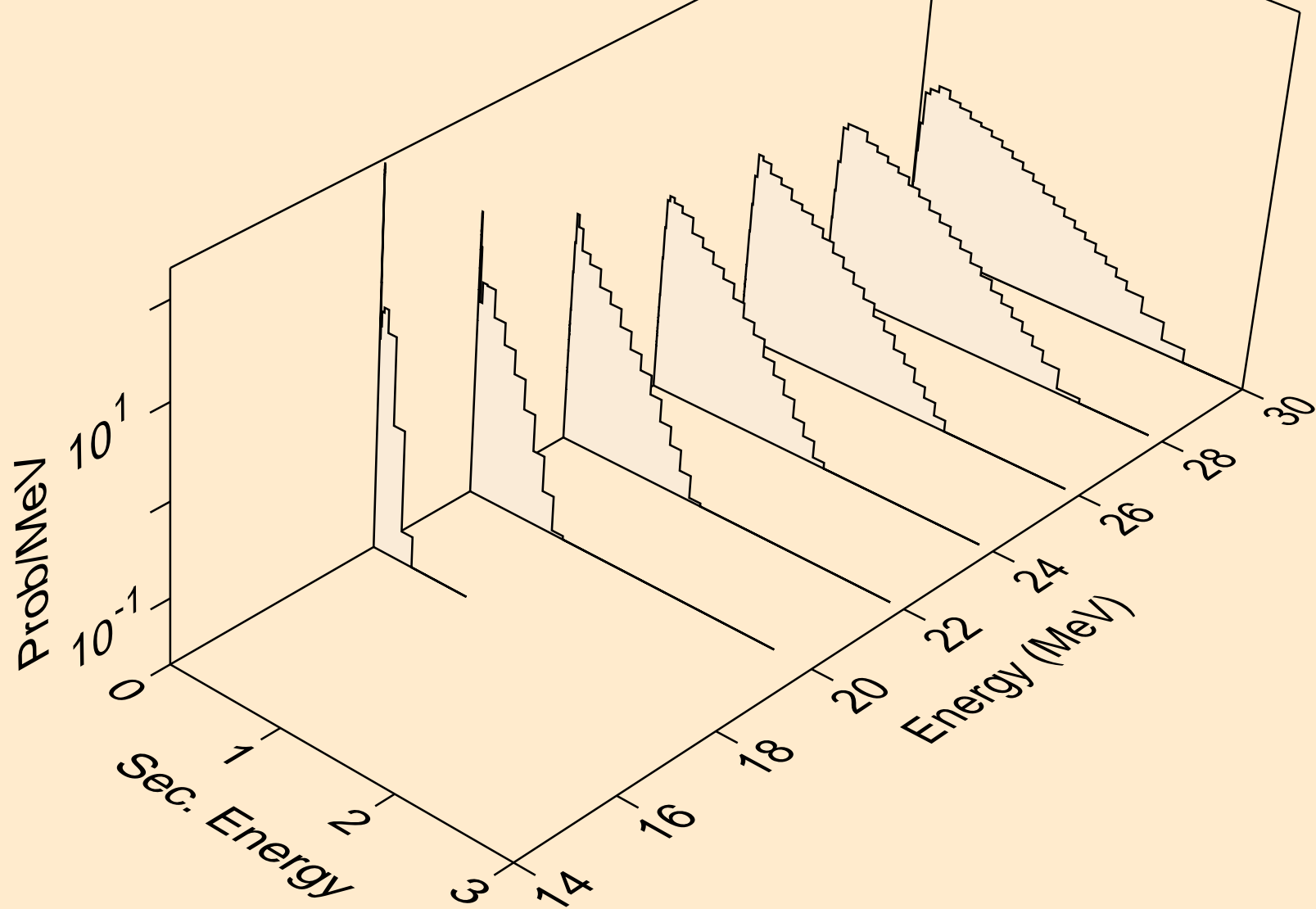

HG214 NEUTRON ACER TENDL-2023 LIBRARY; T=0.K
Neutron emission for (n,2n)

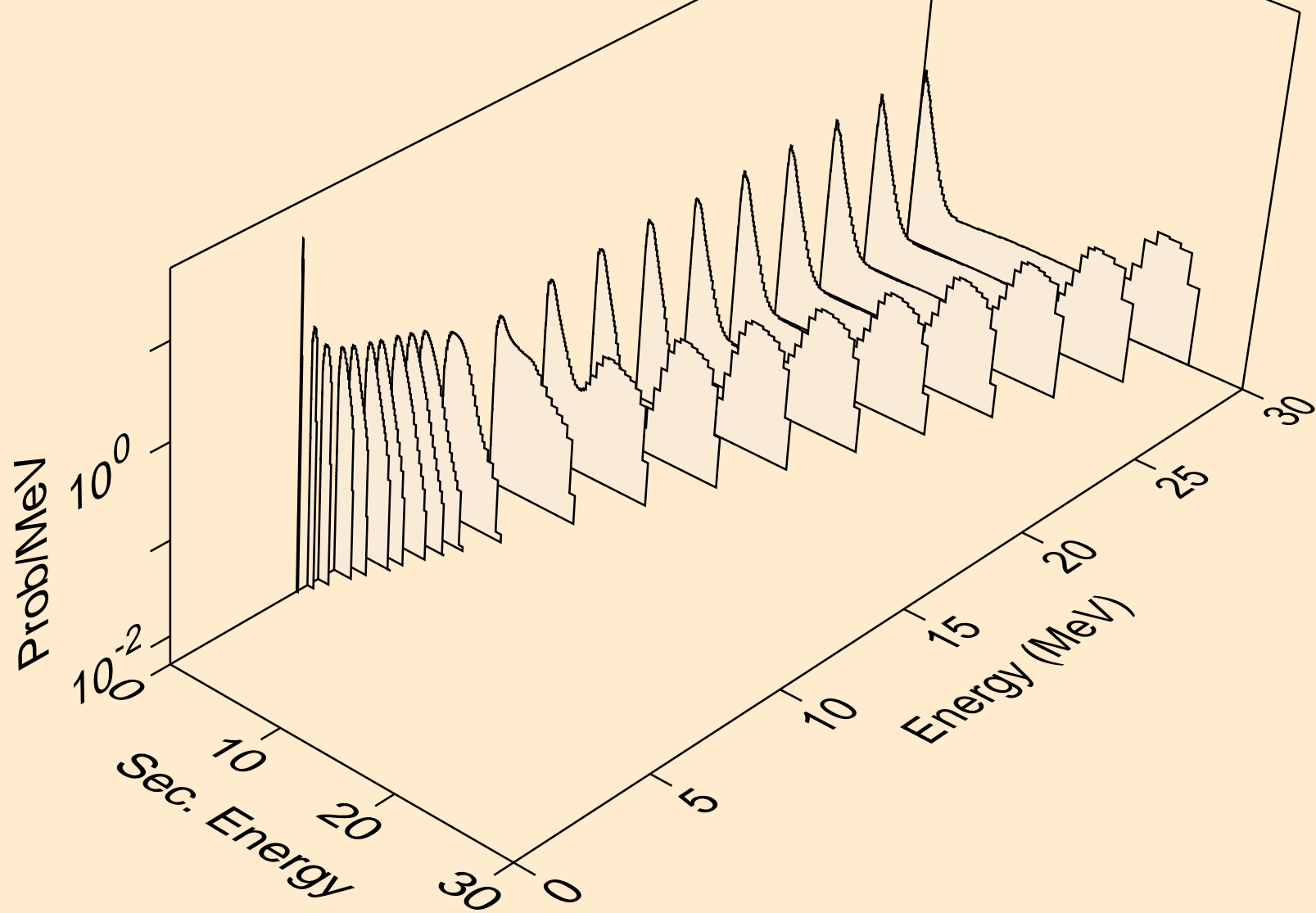

HG214 NEUTRON ACER TENDL-2023 LIBRARY; T=0.K
Neutron emission for (n,3n)

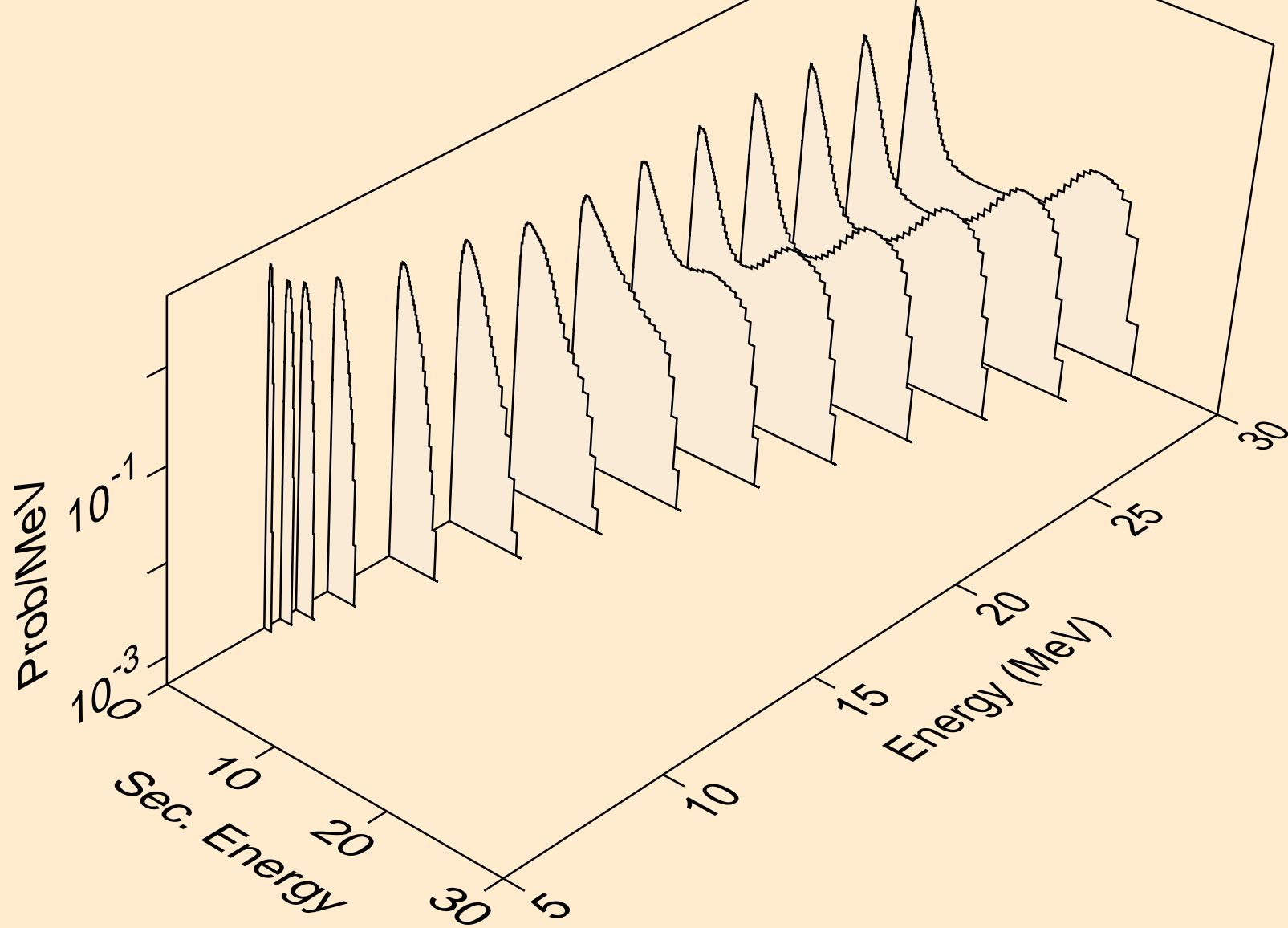

HG214 NEUTRON ACER TENDL-2023 LIBRARY; T=0.K
Neutron emission for (n,n*)a

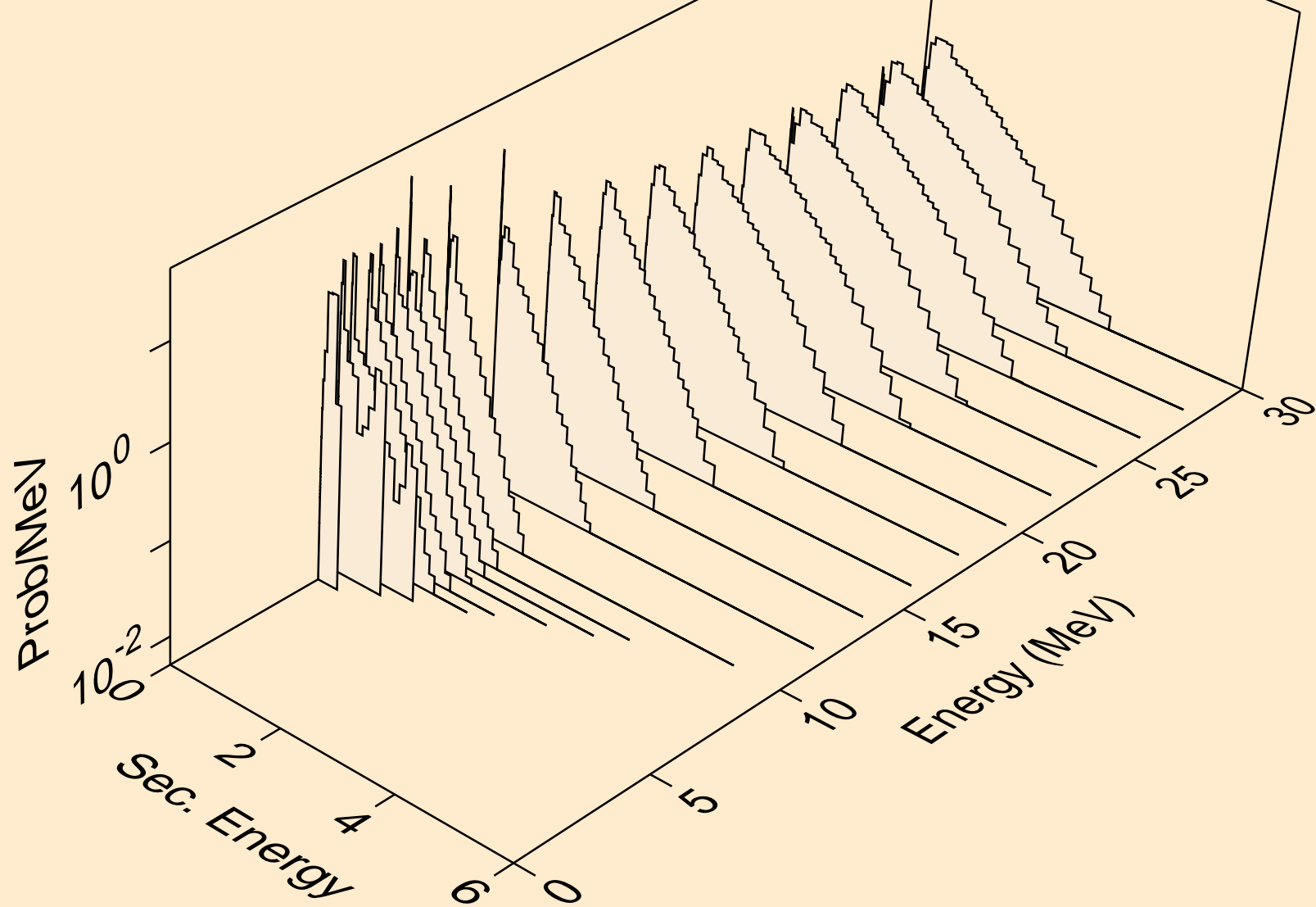

HG214 NEUTRON ACER TENDL-2023 LIBRARY; T=0.K
Neutron emission for (n,2n)a

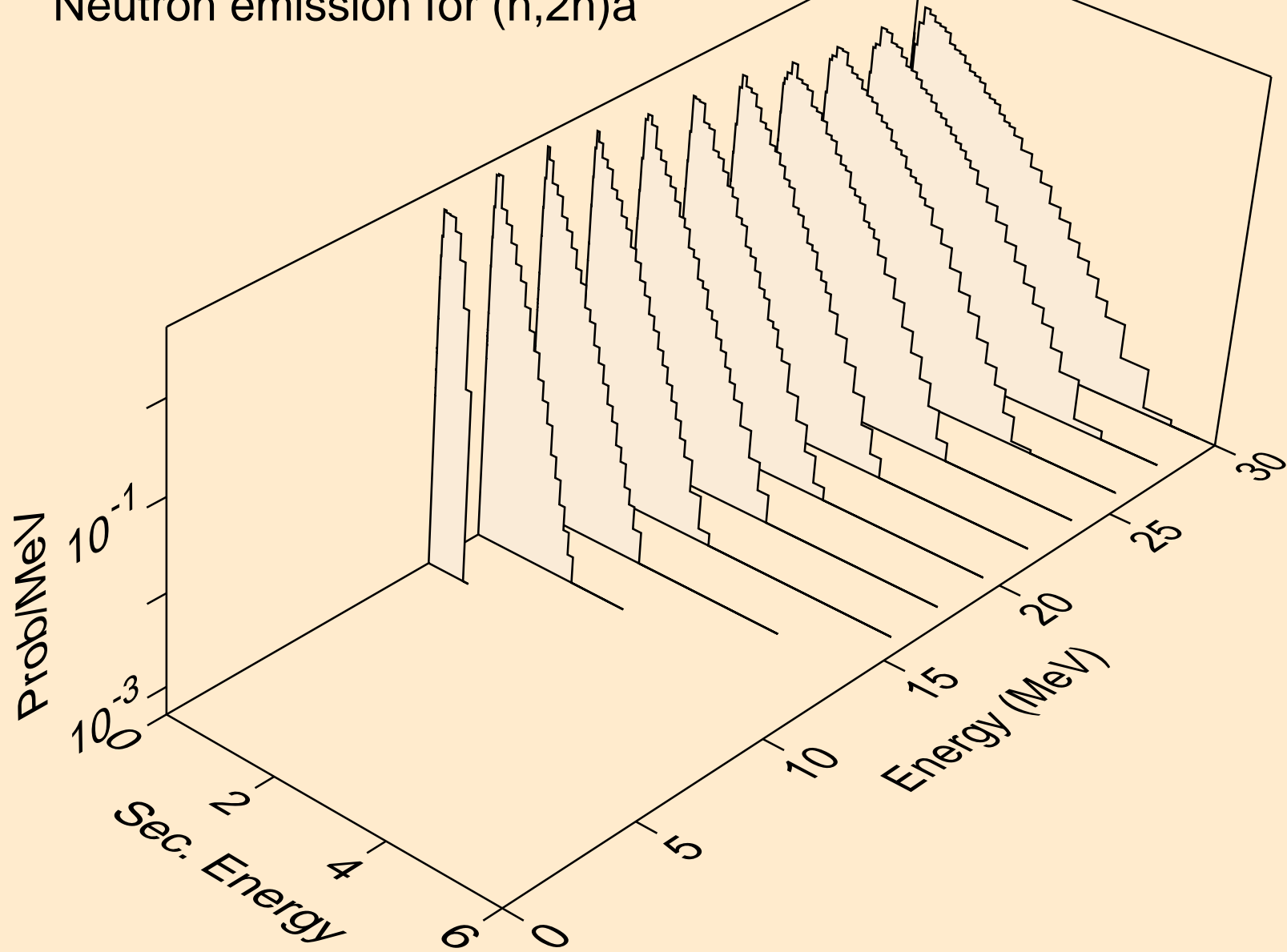

HG214 NEUTRON ACER TENDL-2023 LIBRARY; T=0.K
Neutron emission for (n,3n)a

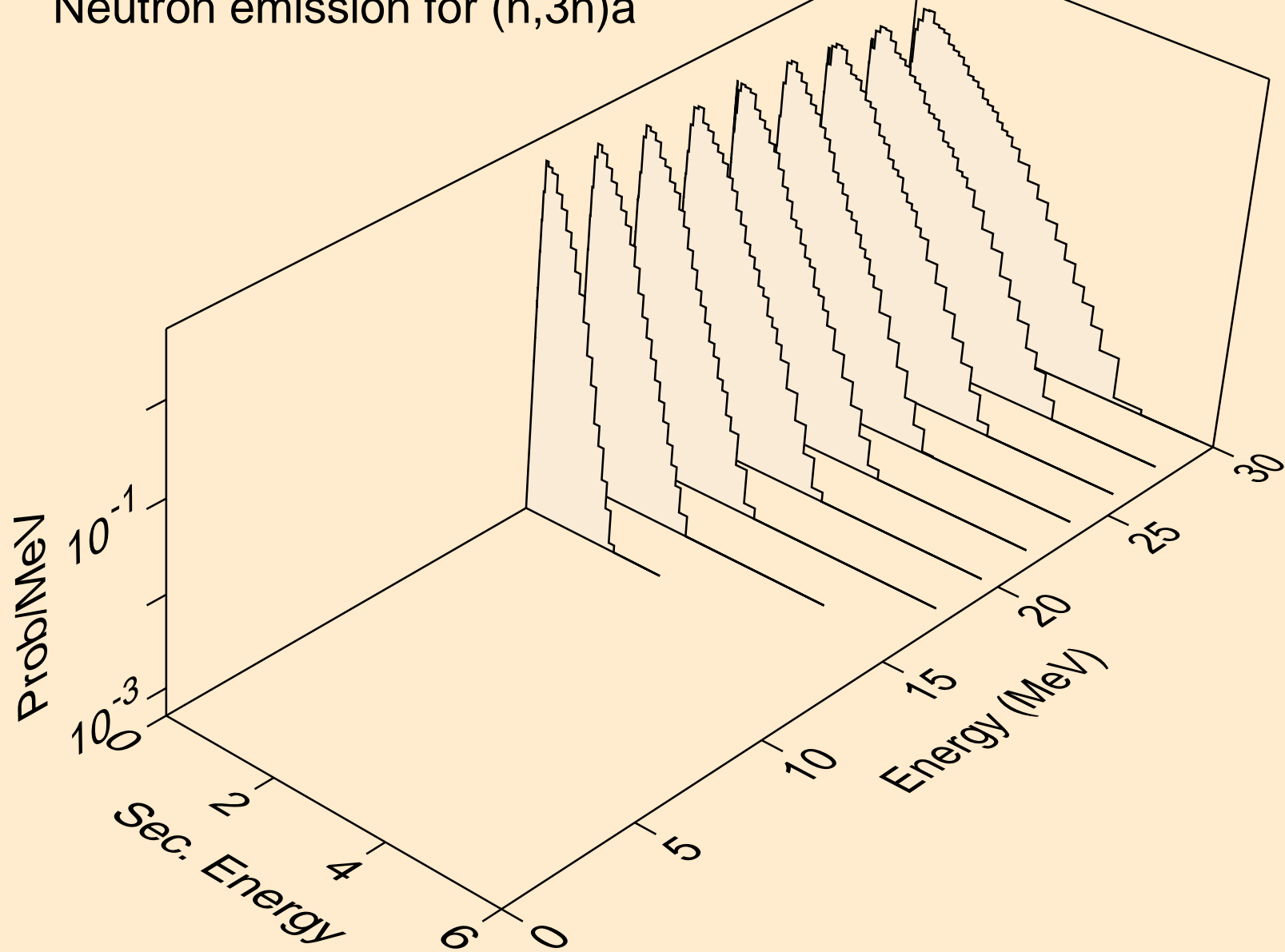

HG214 NEUTRON ACER TENDL-2023 LIBRARY; T=0.K
Neutron emission for (n,n*)p

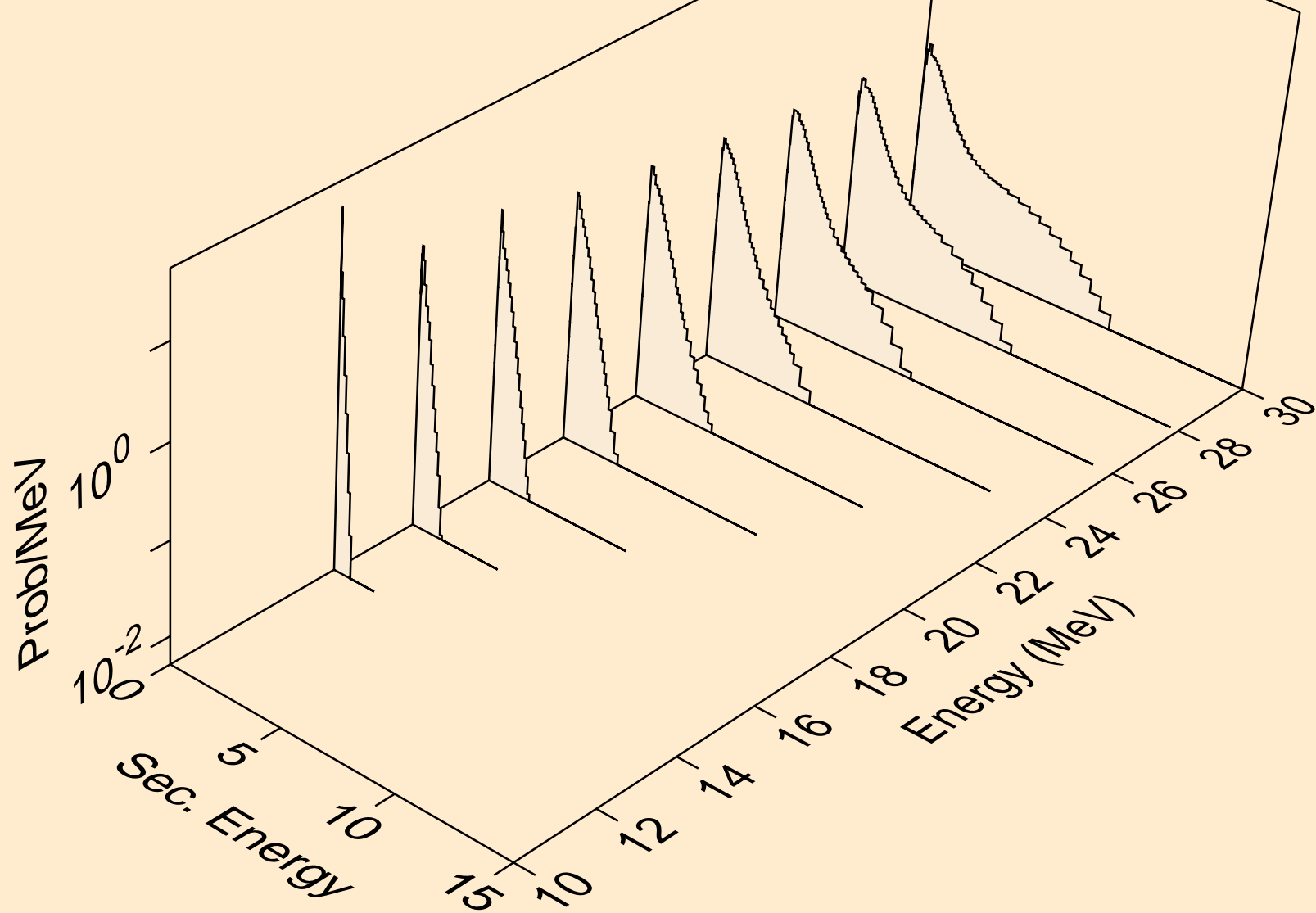

HG214 NEUTRON ACER TENDL-2023 LIBRARY; T=0.K
Neutron emission for (n,n*)d

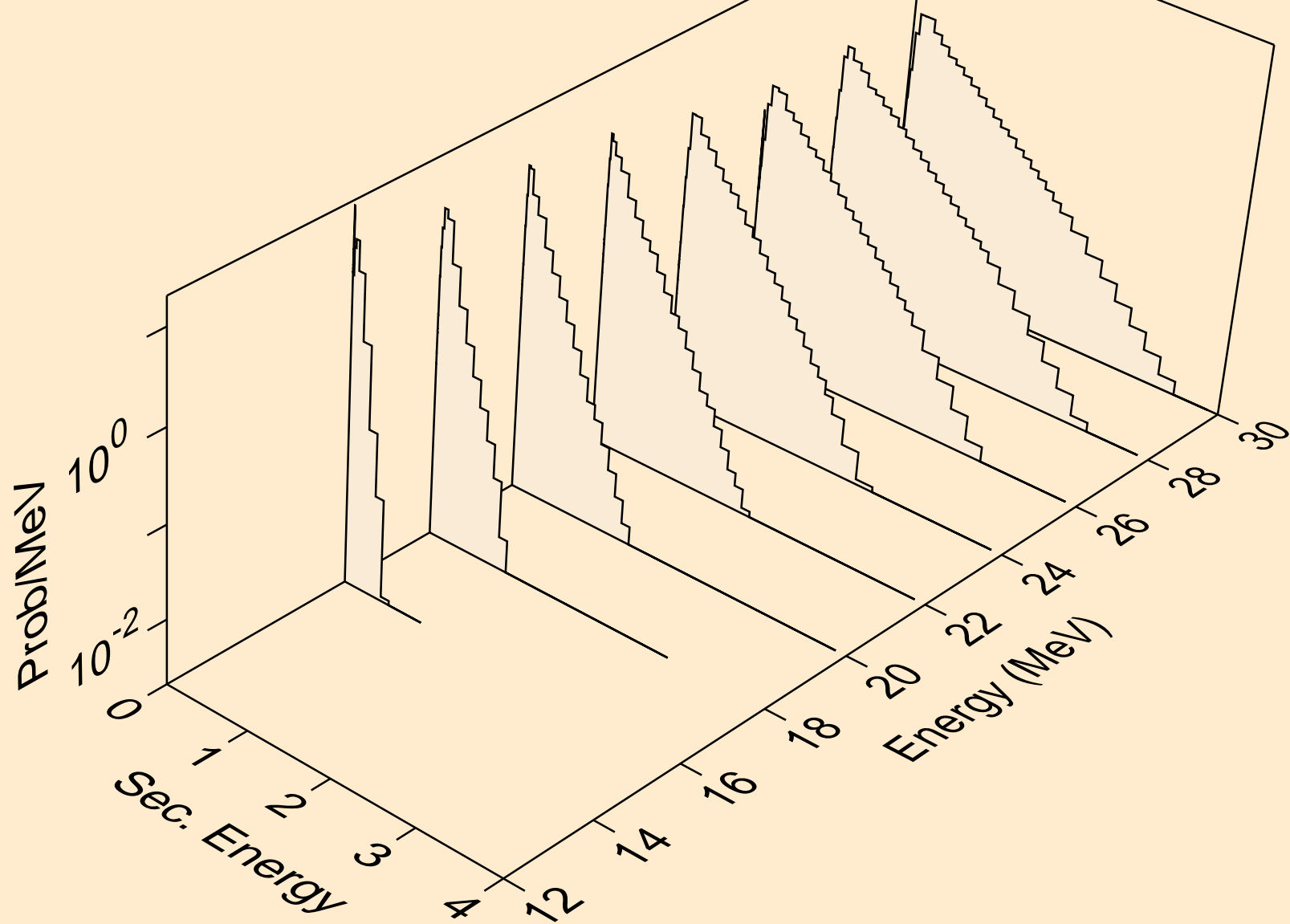

HG214 NEUTRON ACER TENDL-2023 LIBRARY; T=0.K
Neutron emission for (n,n*)t

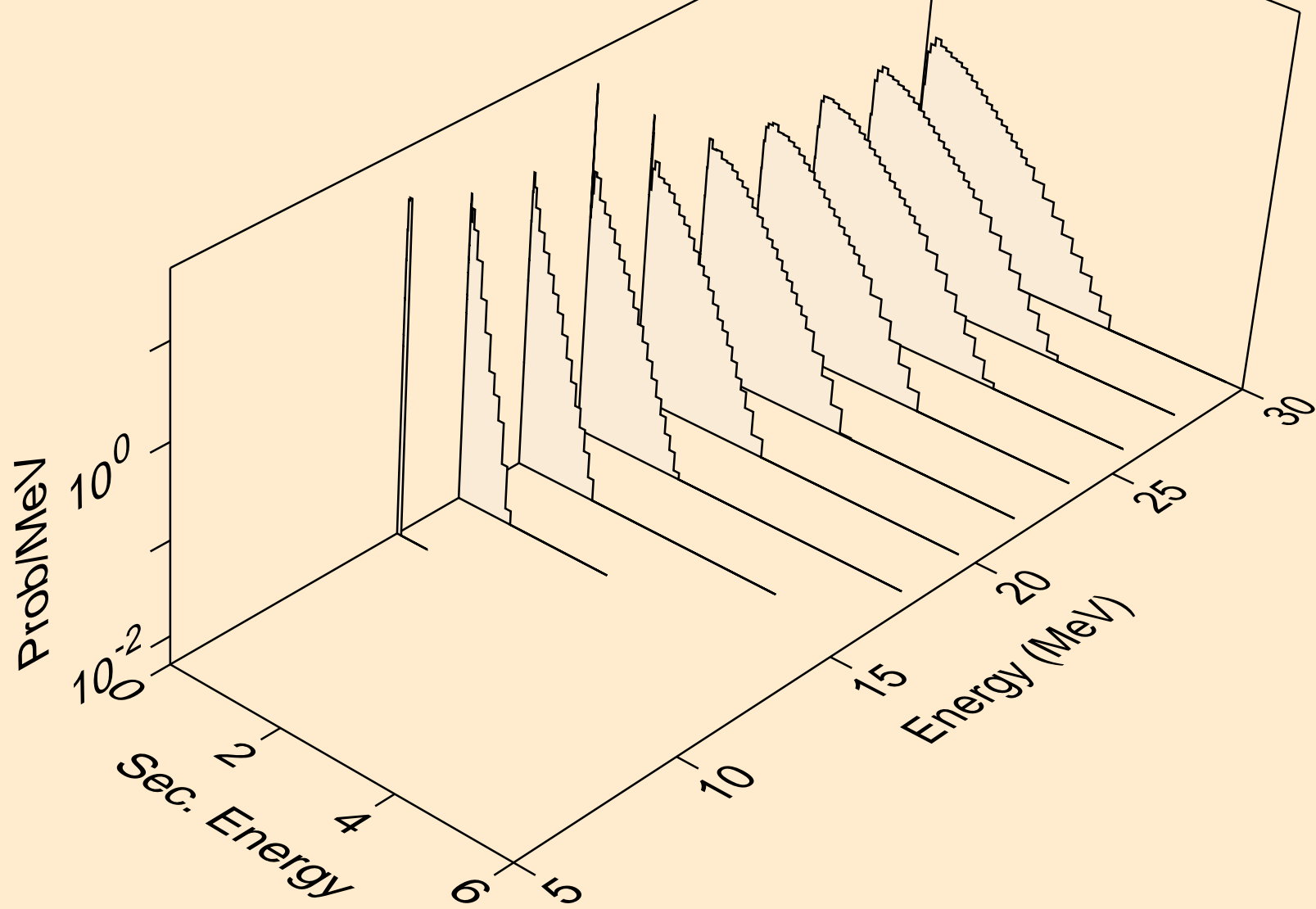

HG214 NEUTRON ACER TENDL-2023 LIBRARY; T=0.K
Neutron emission for (n,n*)he3

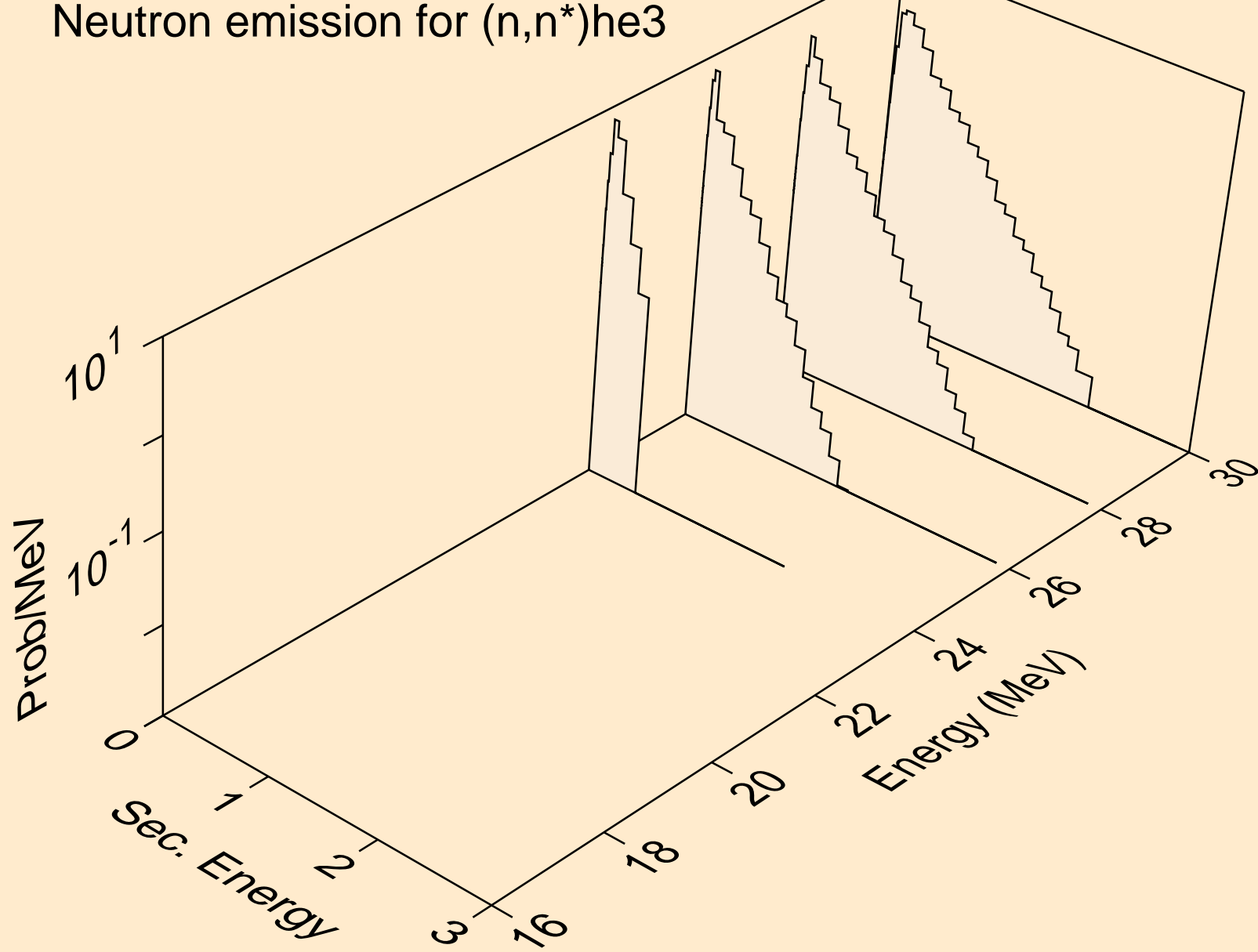

HG214 NEUTRON ACER TENDL-2023 LIBRARY; T=0.K
Neutron emission for (n,4n)

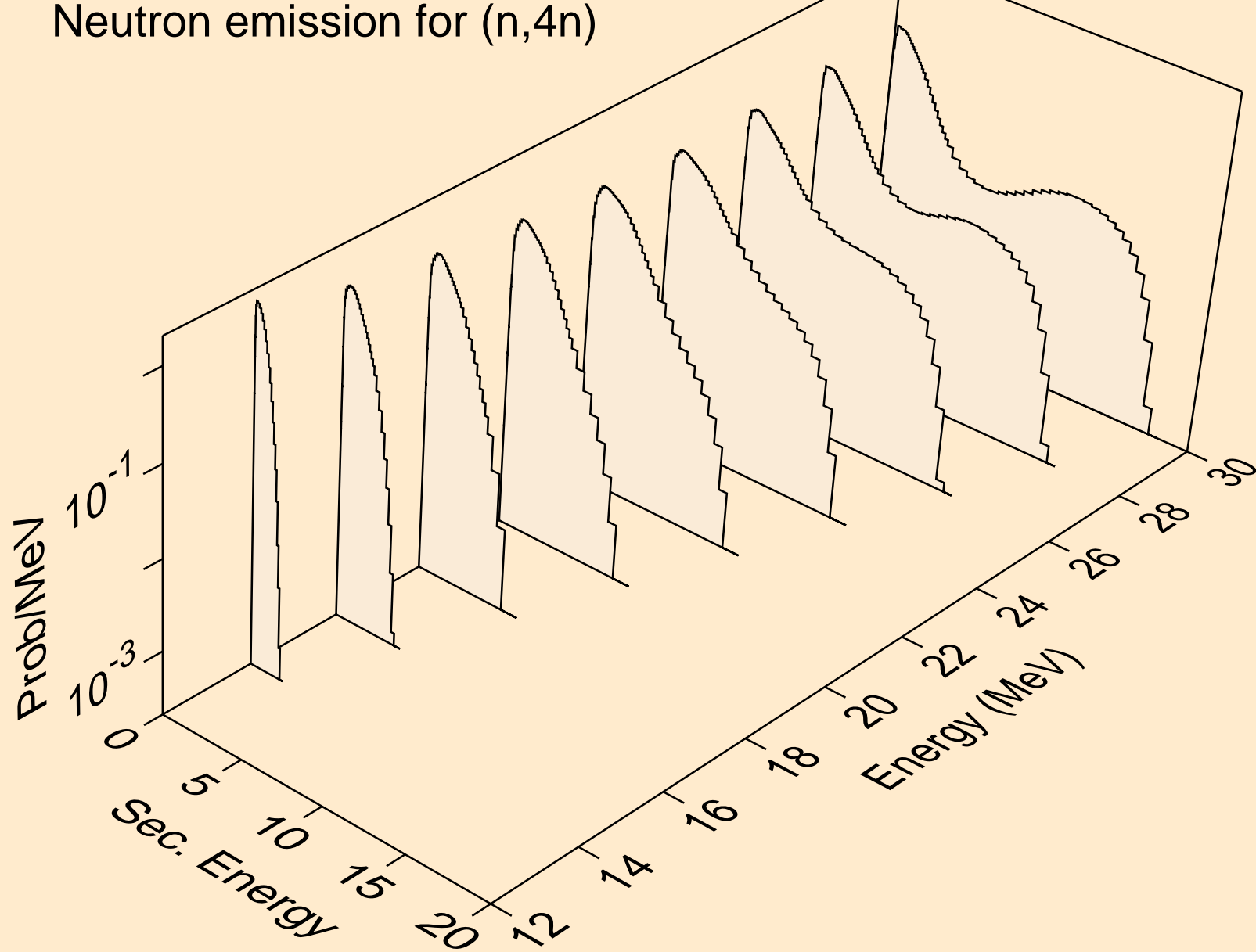

HG214 NEUTRON ACER TENDL-2023 LIBRARY; T=0.K
Neutron emission for (n,2np)

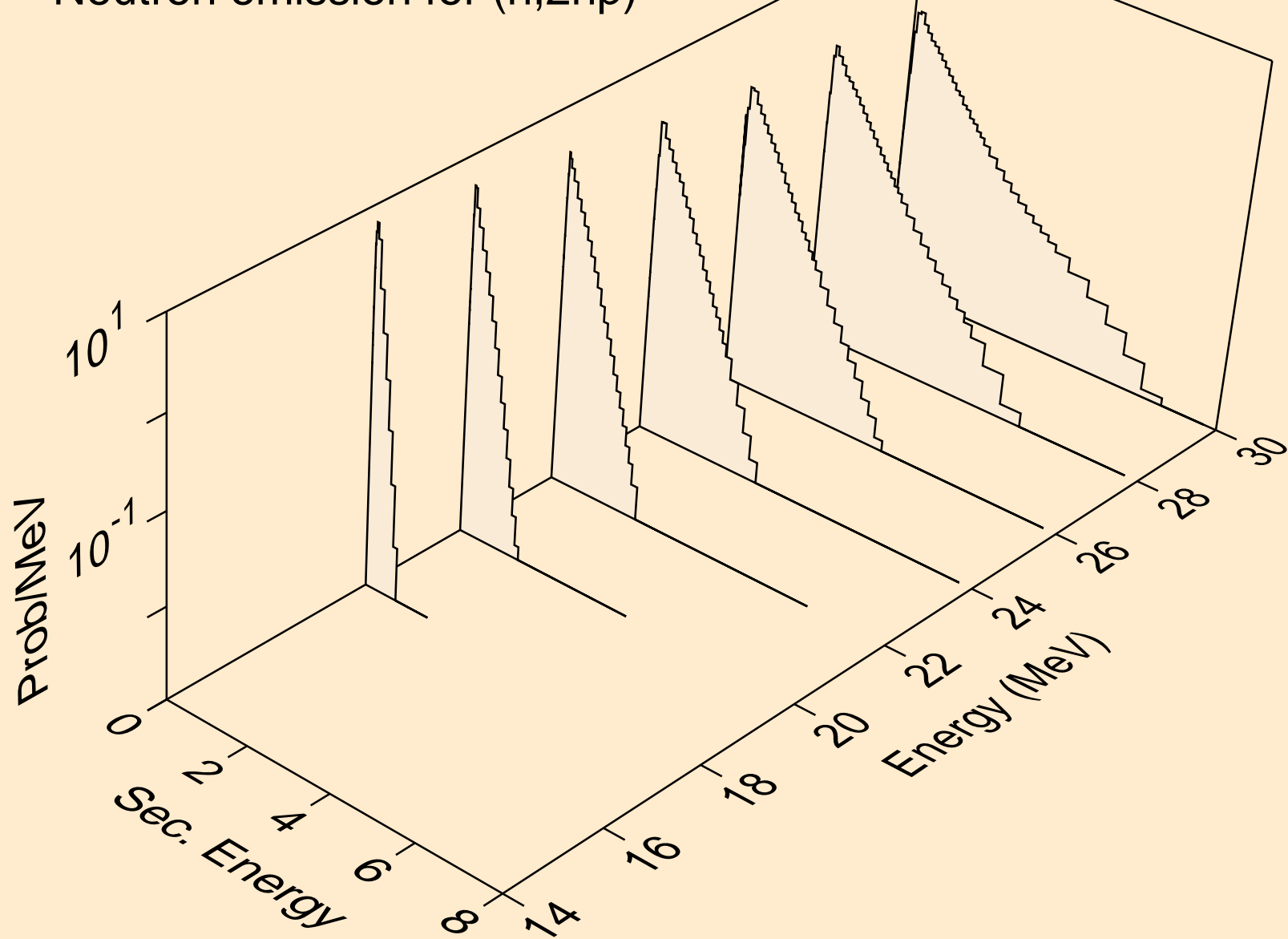

HG214 NEUTRON ACER TENDL-2023 LIBRARY; T=0.K
Neutron emission for (n,3np)

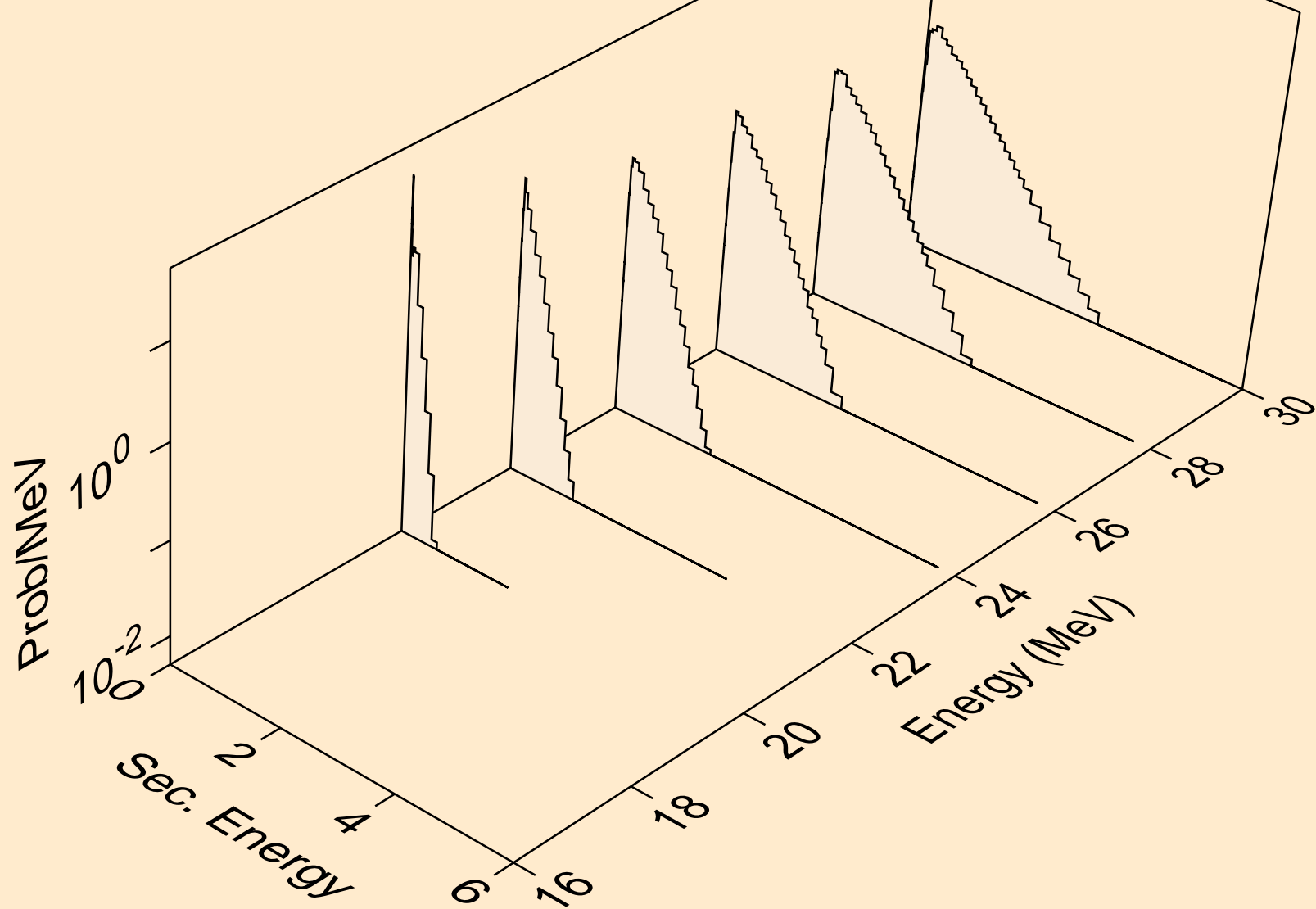

HG214 NEUTRON ACER TENDL-2023 LIBRARY; T=0.K
Neutron emission for (n,n*c)

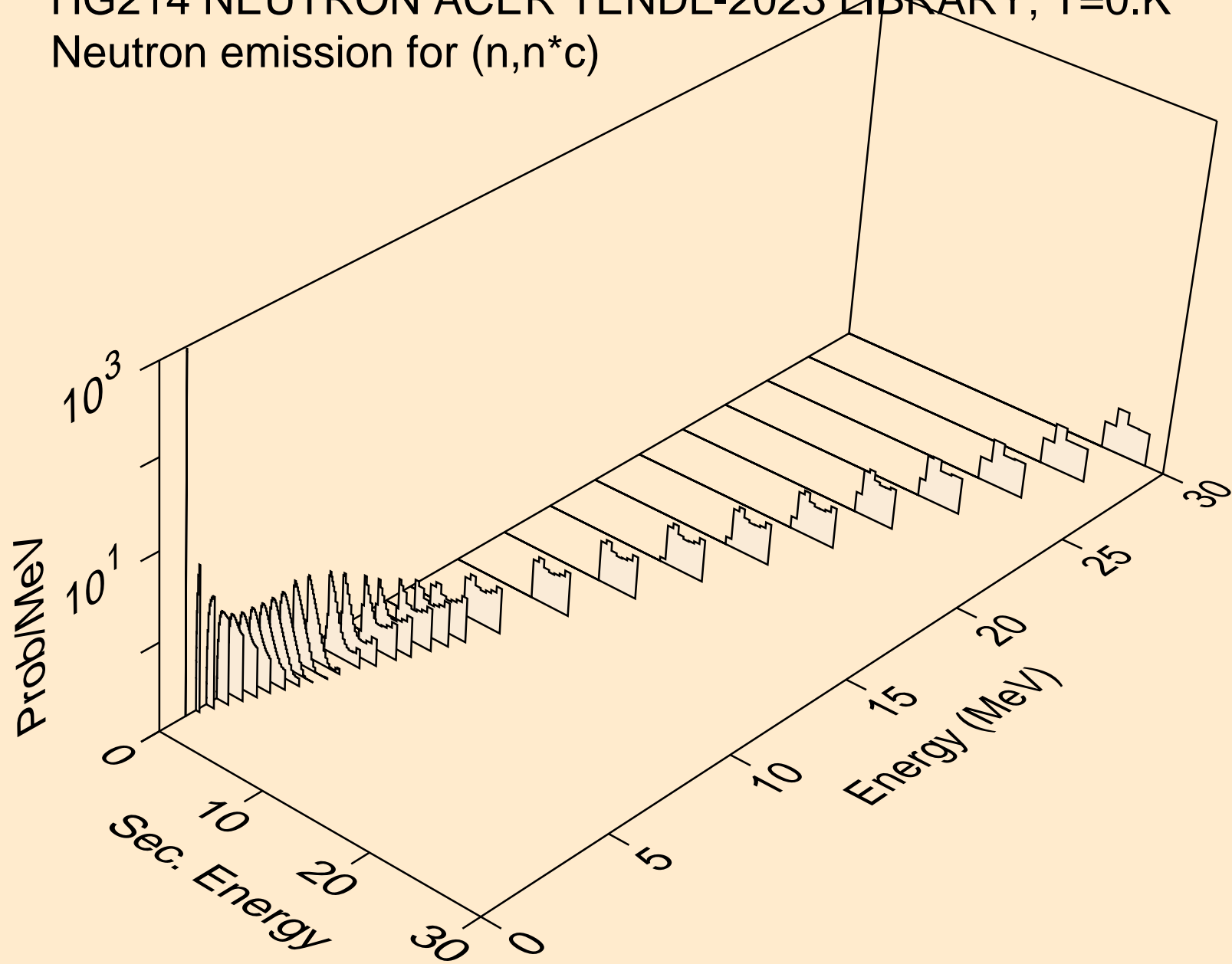

HG214 NEUTRON ACER TENDL-2023 LIBRARY; T=0.K
Photon emission for (n,x)

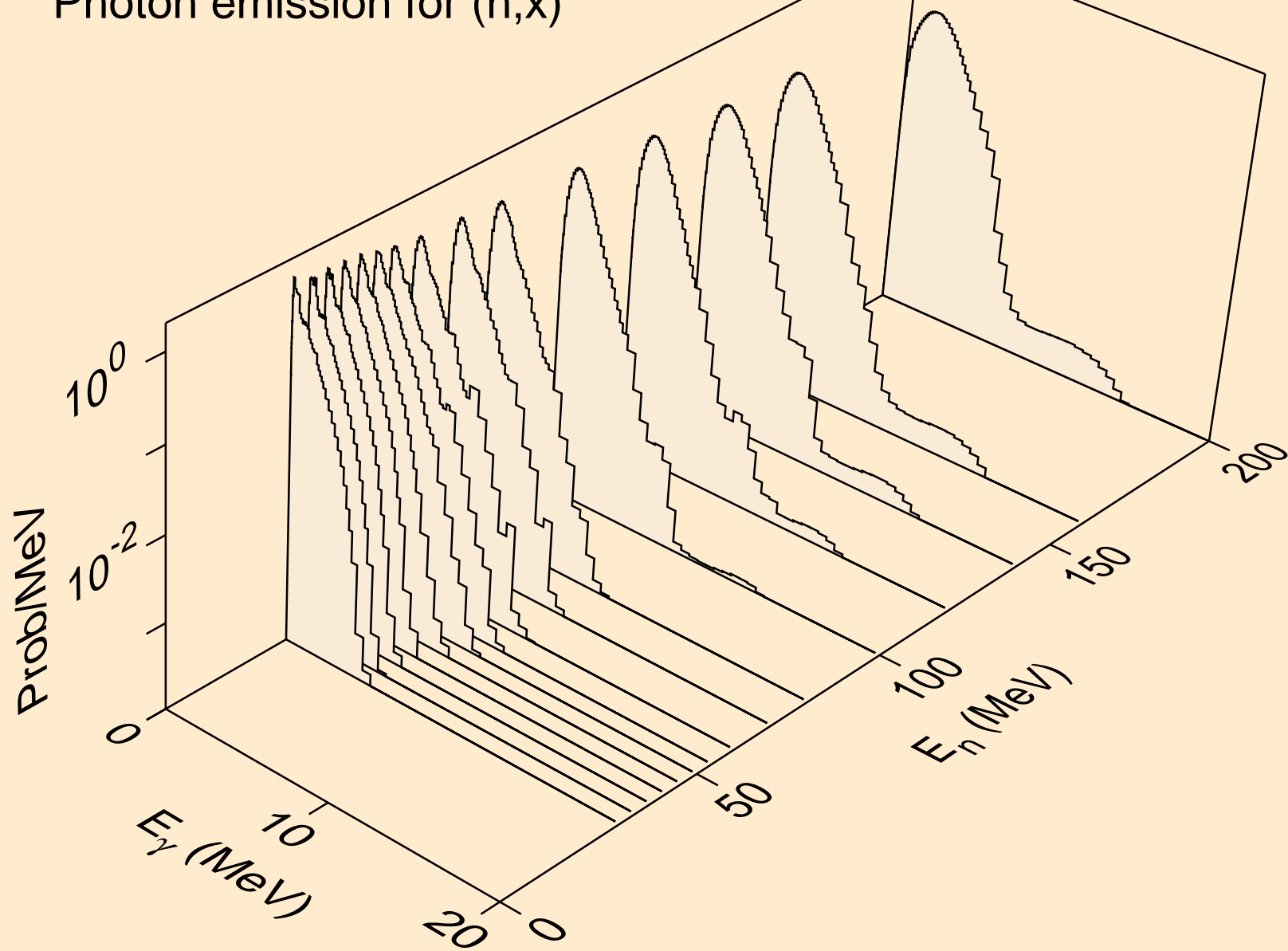

HG214 NEUTRON ACER TENDL-2023 LIBRARY; T=0.K
Photon emission for (n,2nd)

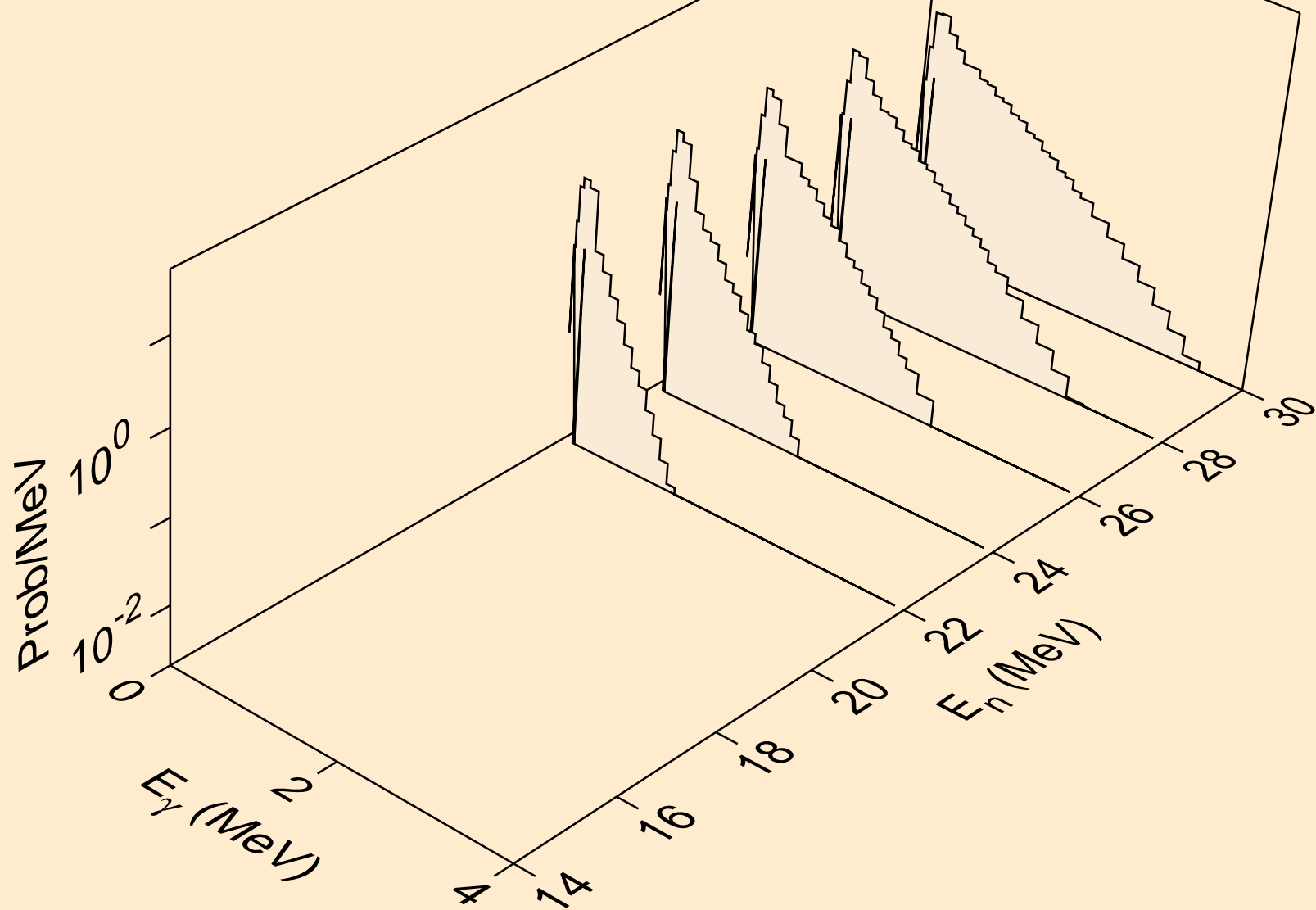

HG214 NEUTRON ACER TENDL-2023 LIBRARY; T=0.K
Photon emission for (n,2n)

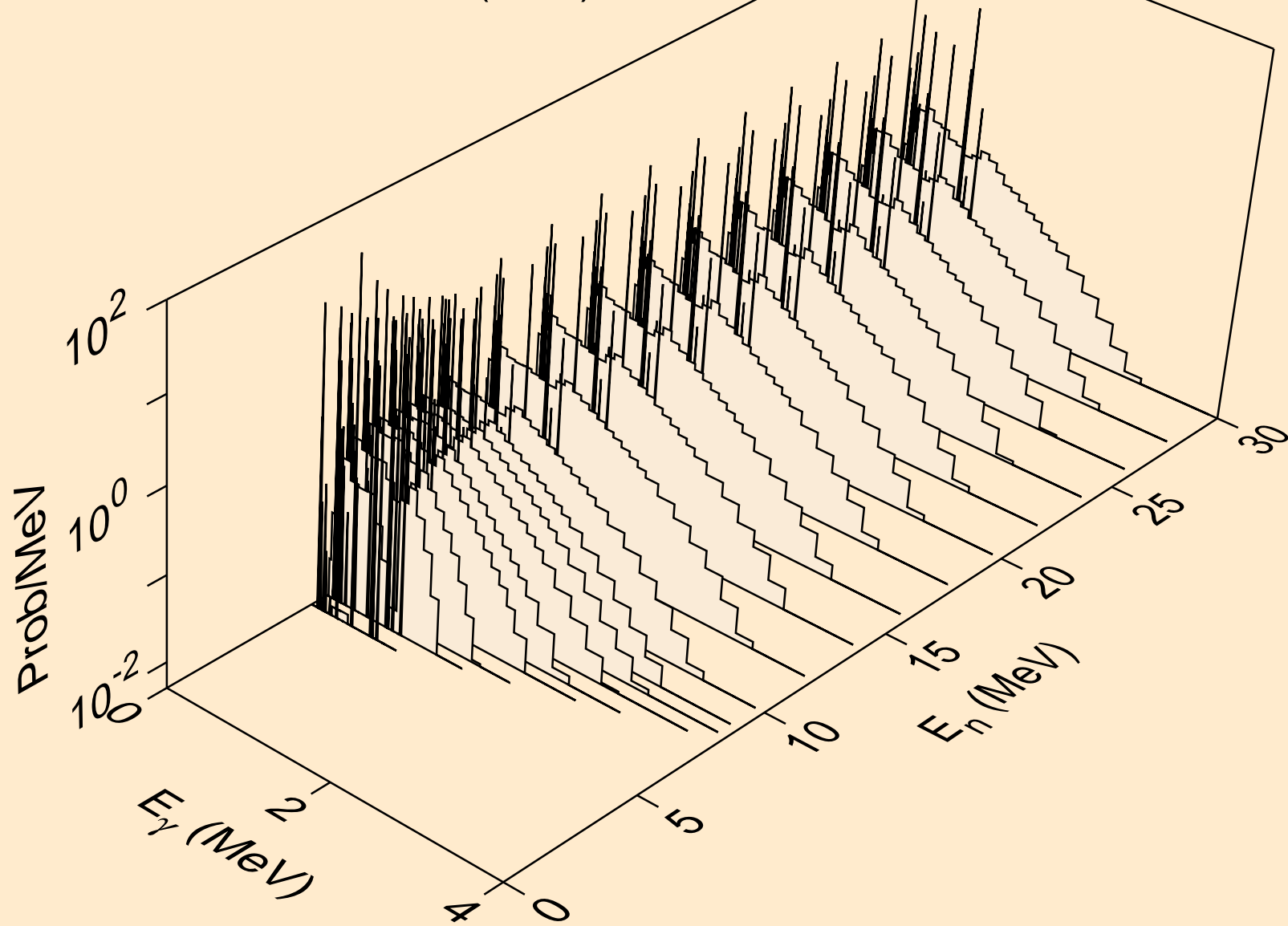

HG214 NEUTRON ACER TENDL-2023 LIBRARY; T=0.K
Photon emission for (n,3n)

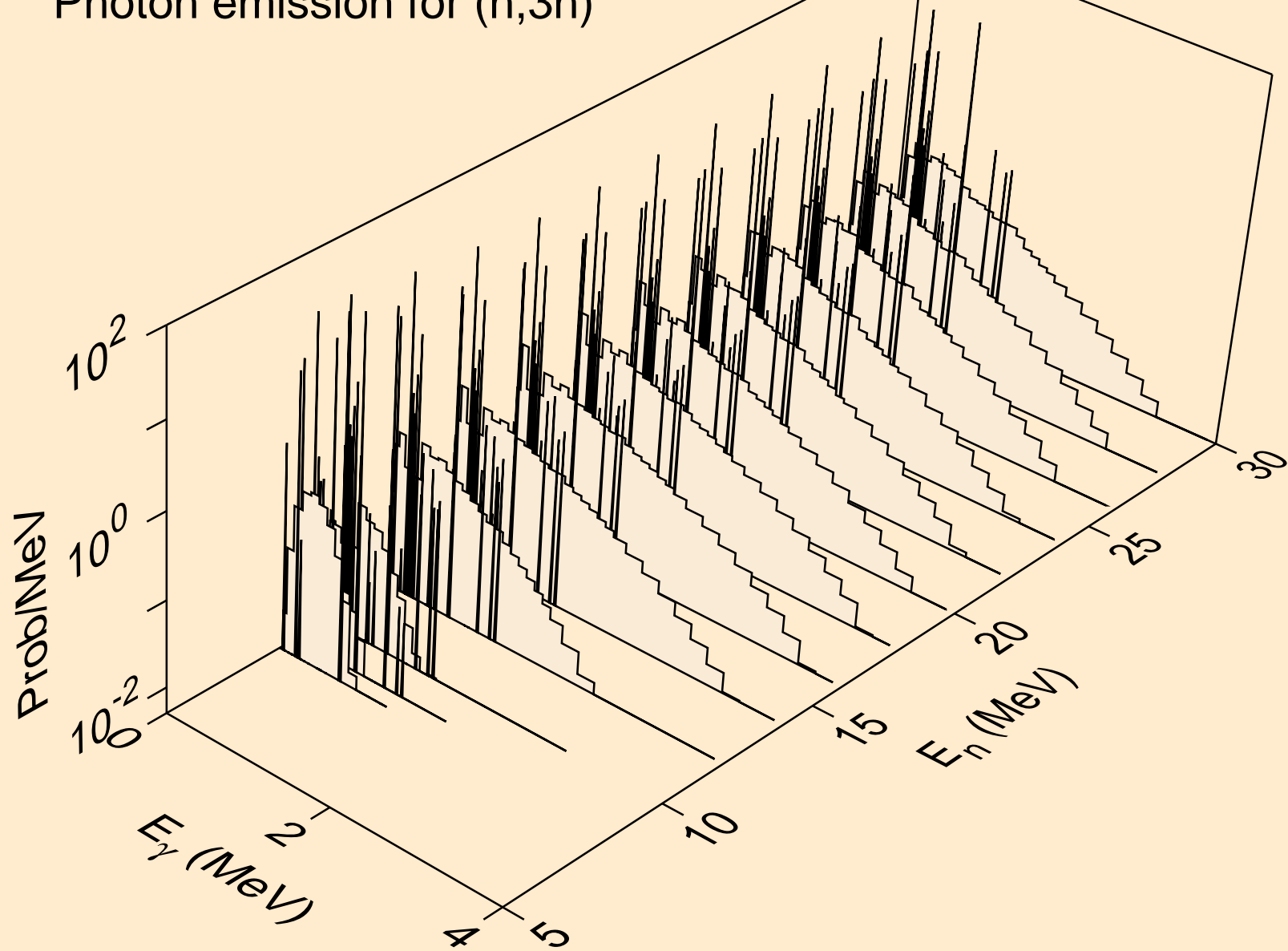

HG214 NEUTRON ACER TENDL-2023 LIBRARY; T=0.K
Photon emission for (n,n*)a

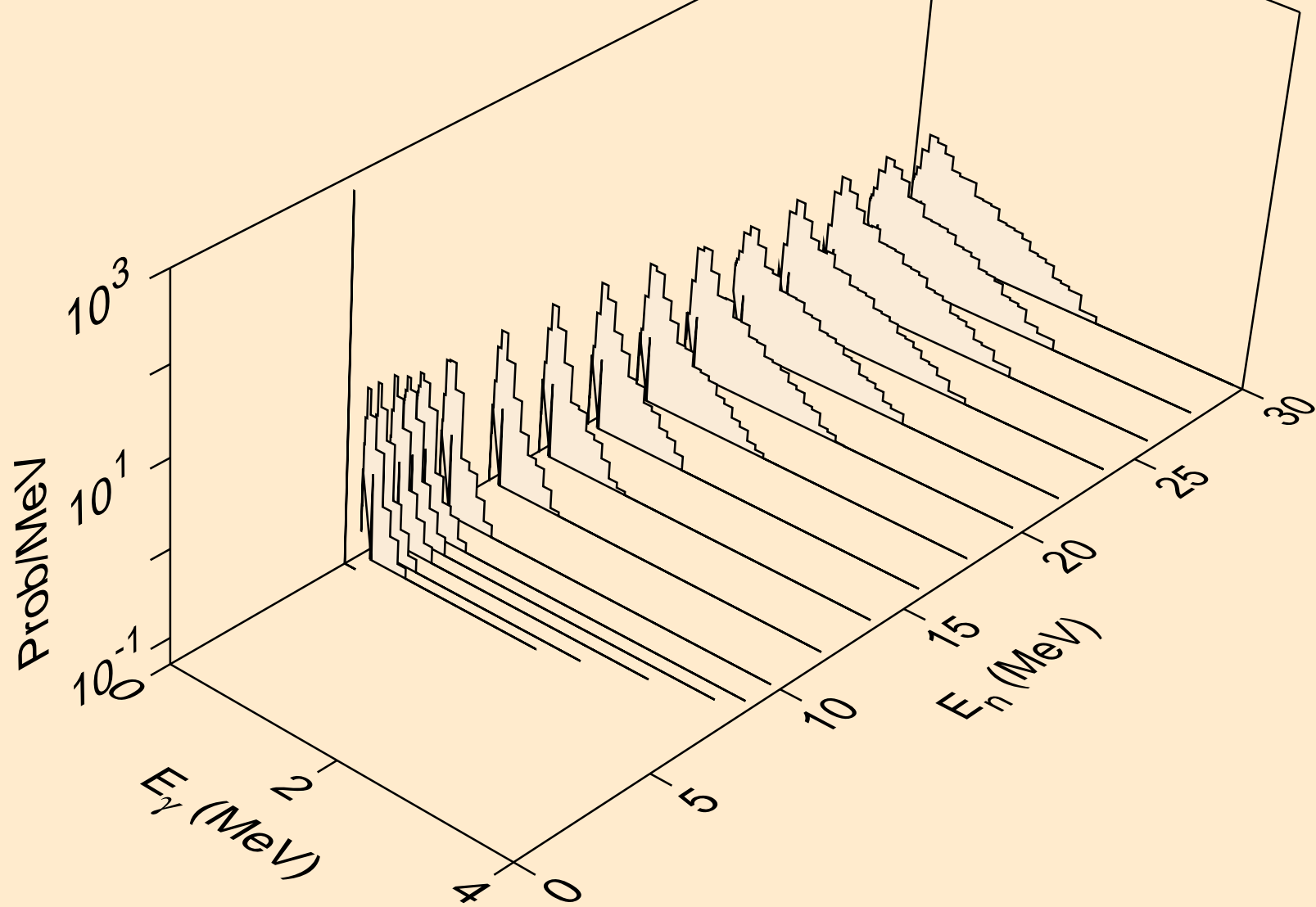

HG214 NEUTRON ACER TENDL-2023 LIBRARY; T=0.K
Photon emission for (n,2n) α

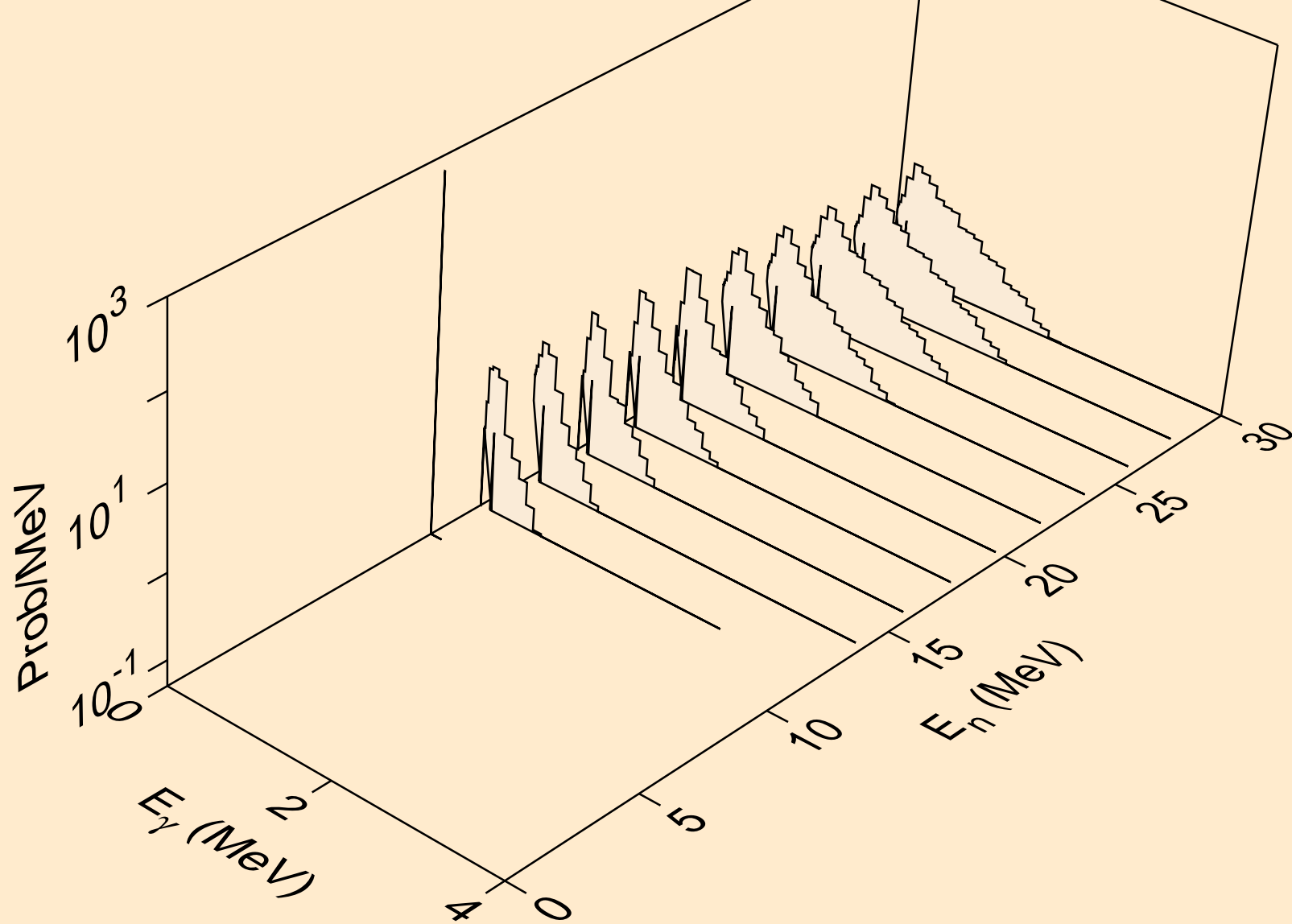

HG214 NEUTRON ACER TENDL-2023 LIBRARY; T=0.K
Photon emission for (n,3n)a

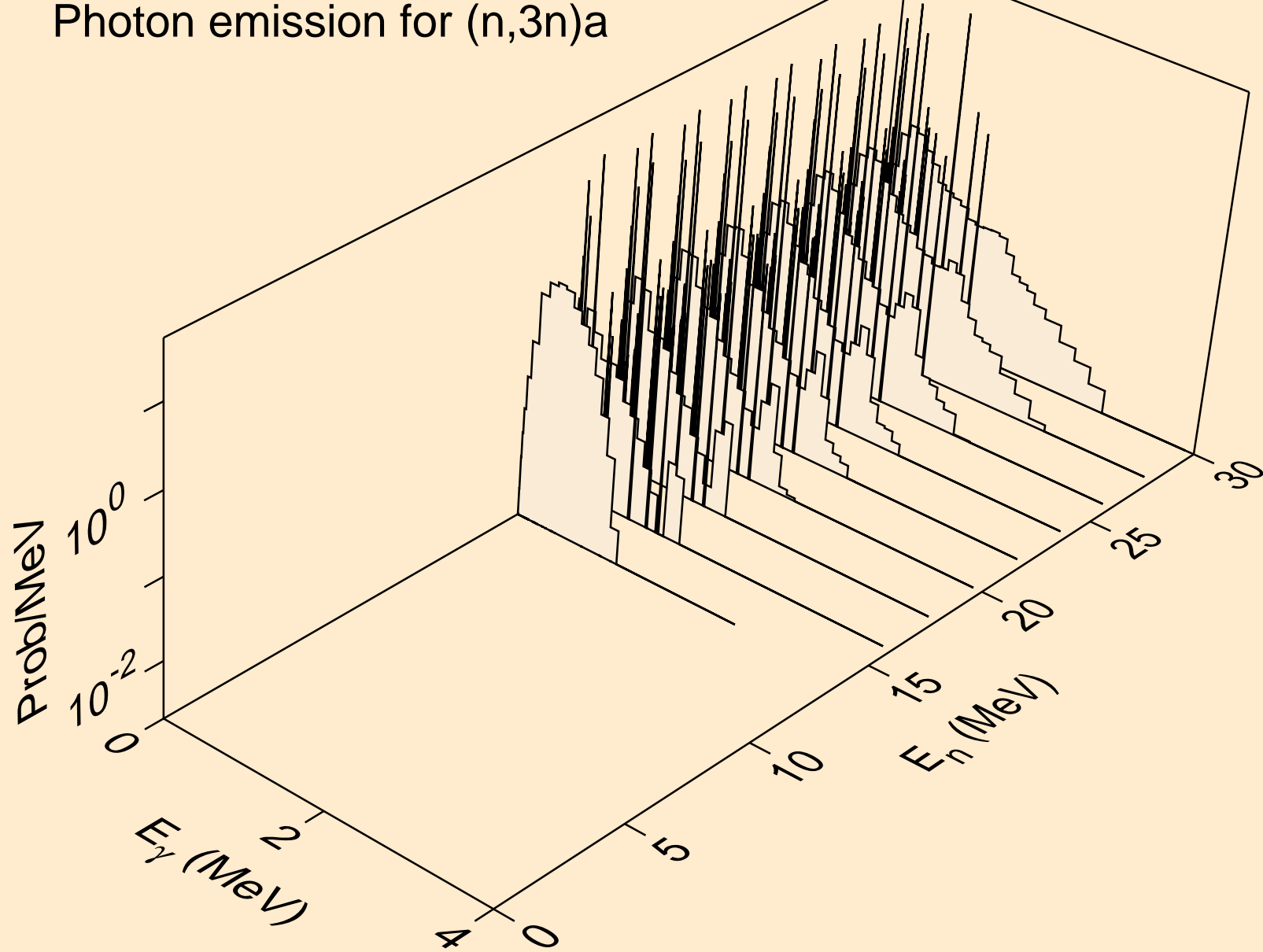

HG214 NEUTRON ACER TENDL-2023 LIBRARY; T=0.K
Photon emission for (n,n*)p

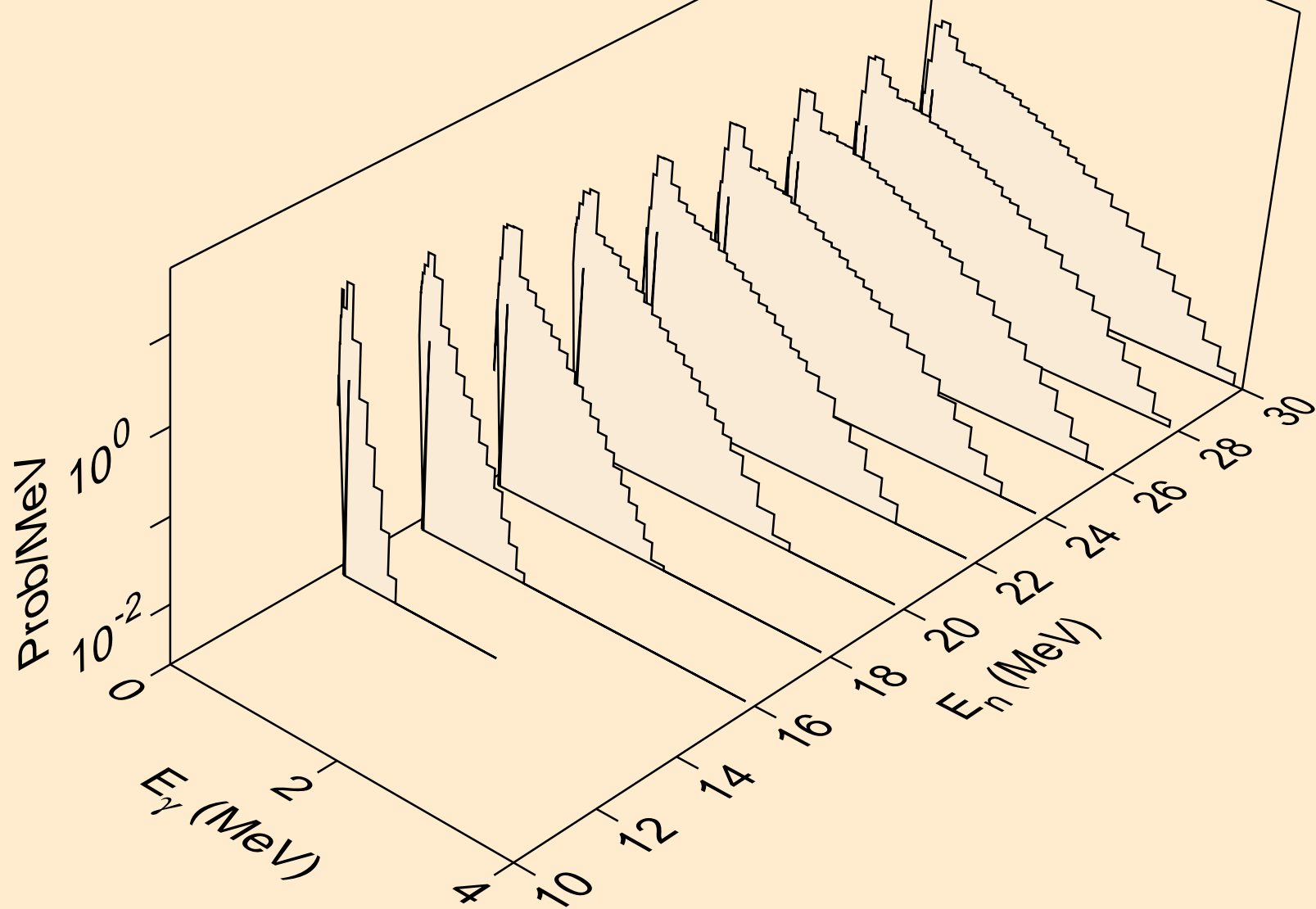

HG214 NEUTRON ACER TENDL-2023 LIBRARY; T=0.K
Photon emission for (n,n*)d

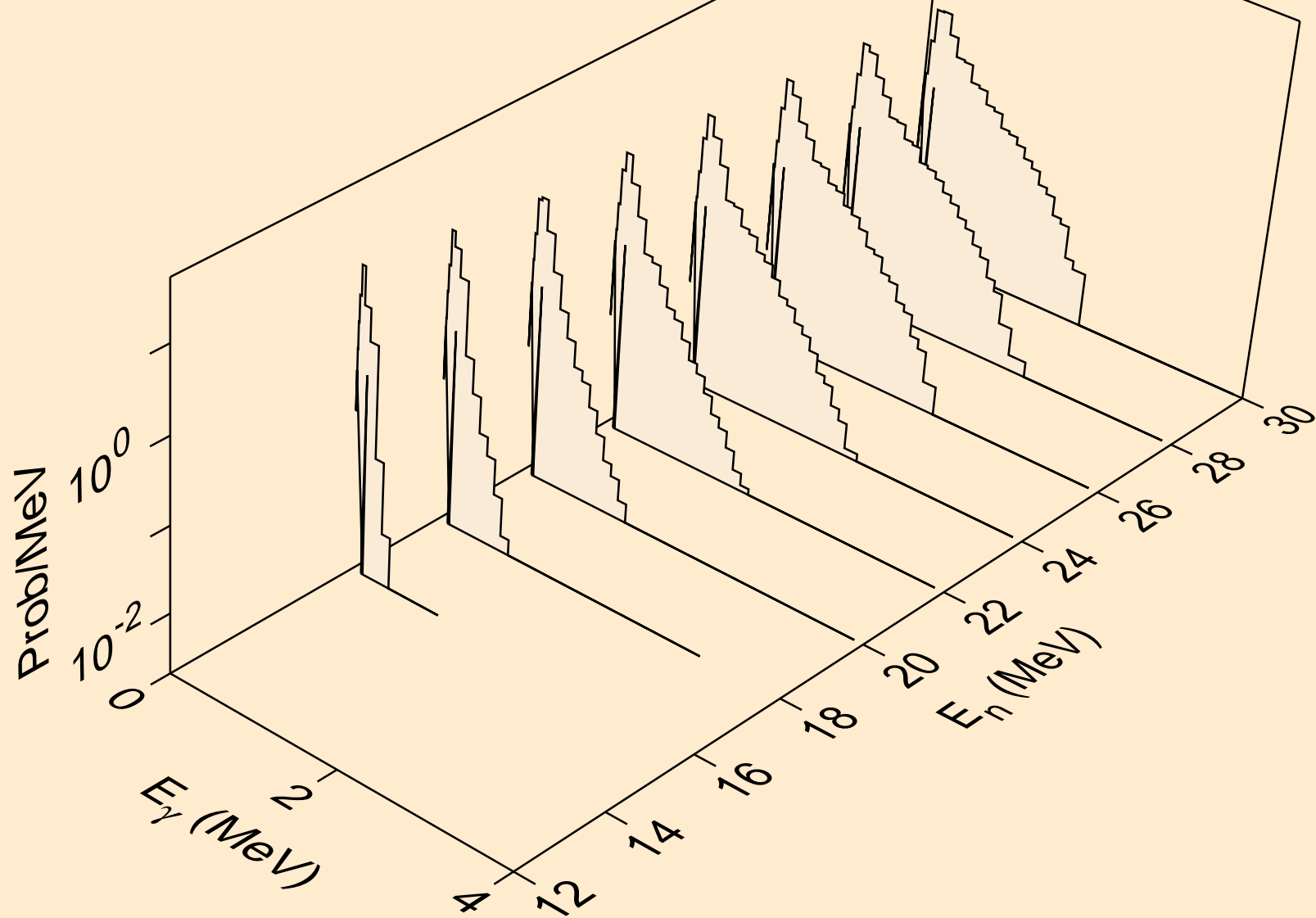

HG214 NEUTRON ACER TENDL-2023 LIBRARY; T=0.K
Photon emission for (n,n*)t

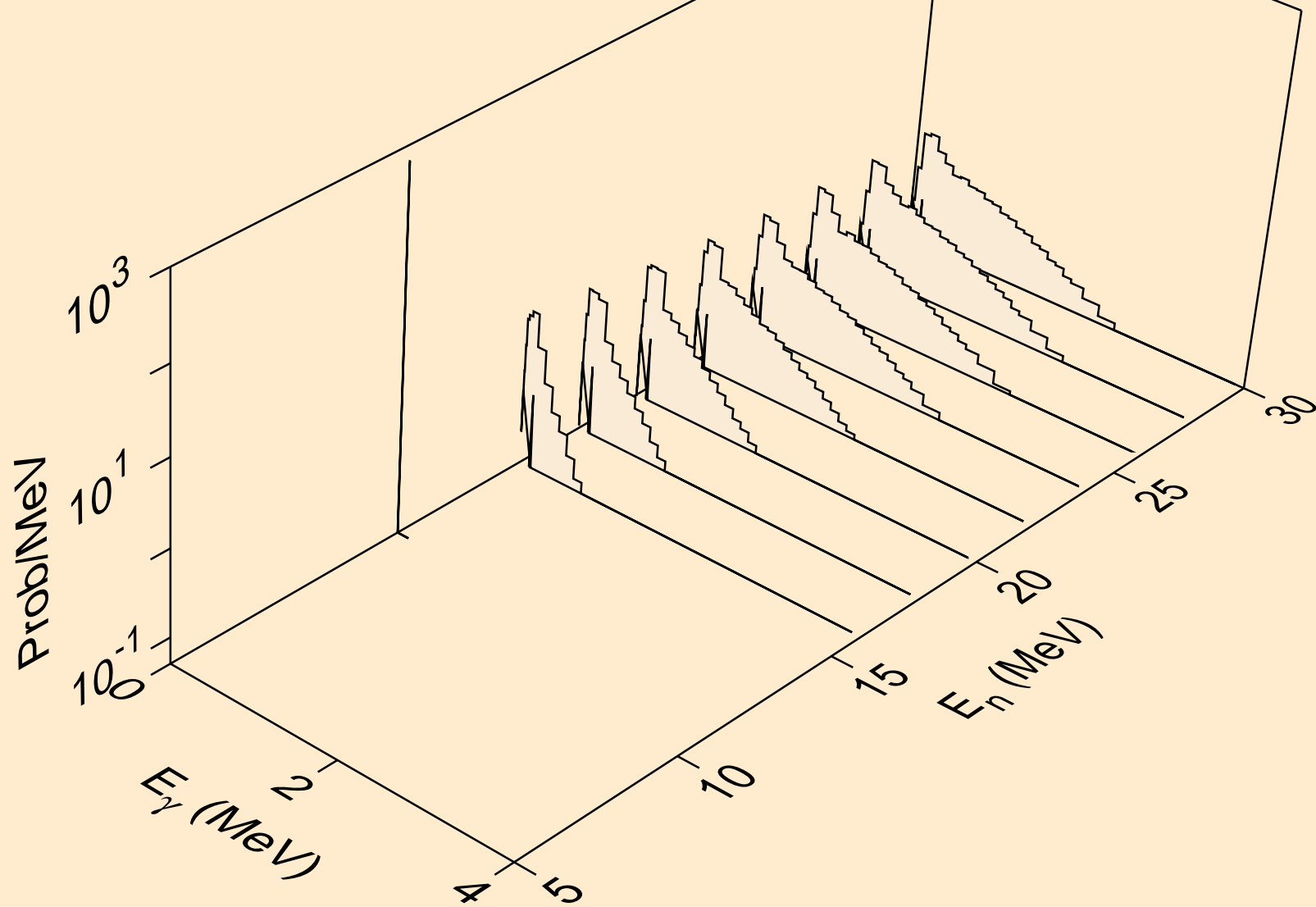

HG214 NEUTRON ACER TENDL-2023 LIBRARY; T=0.K
Photon emission for (n,n*)he3

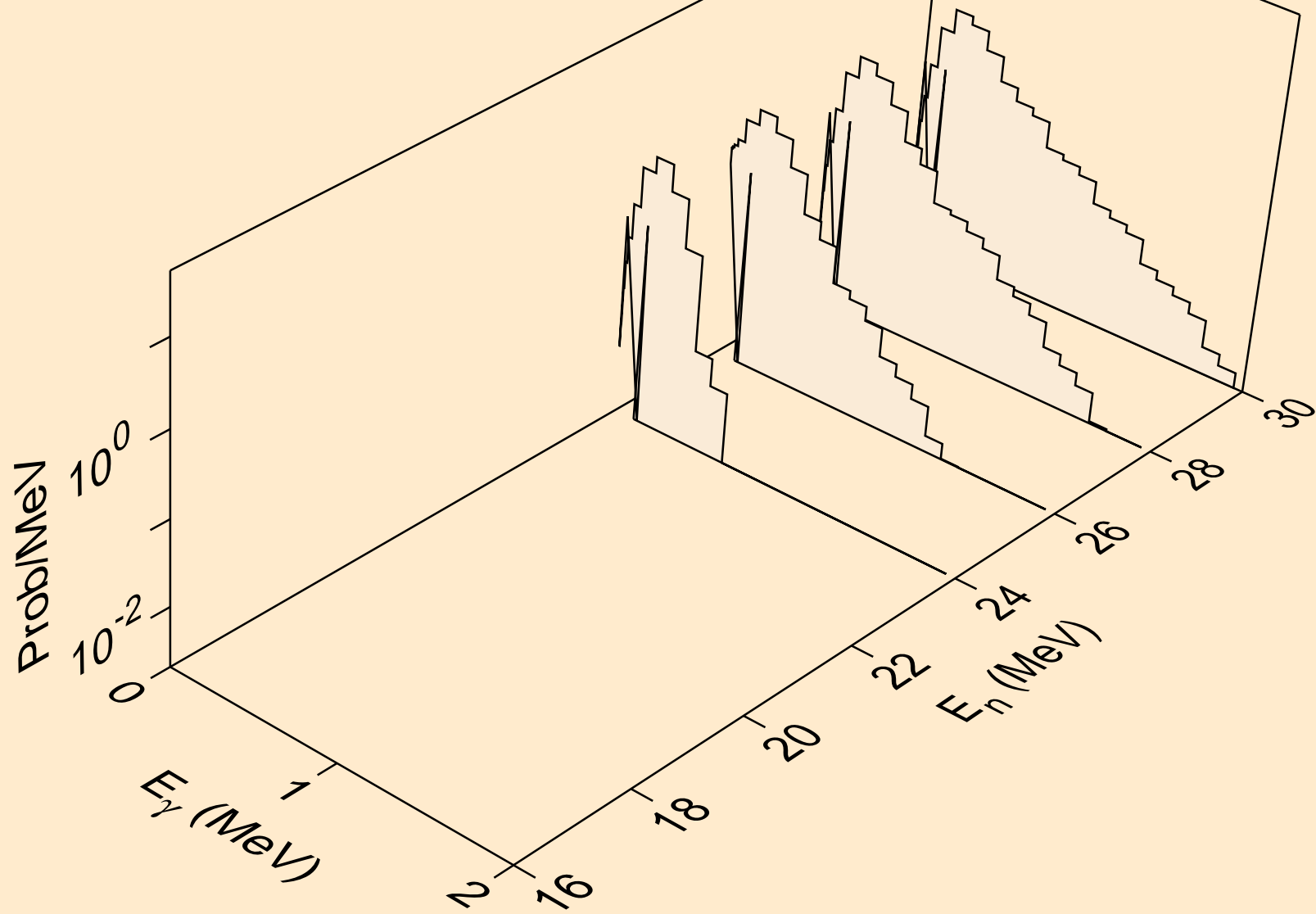

HG214 NEUTRON ACER TENDL-2023 LIBRARY; T=0.K
Photon emission for (n,4n)

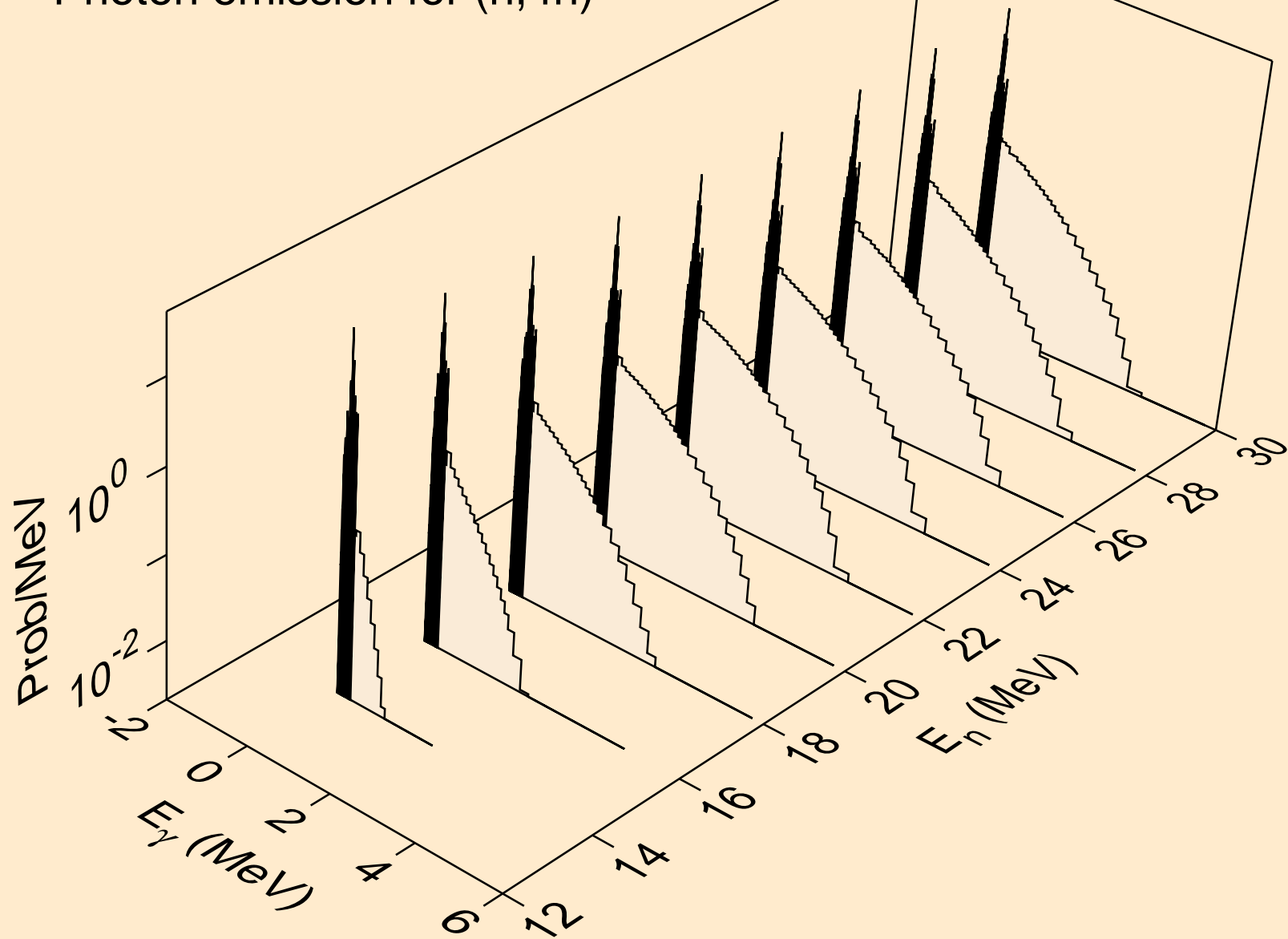

HG214 NEUTRON ACER TENDL-2023 LIBRARY; T=0.K
Photon emission for (n,2np)

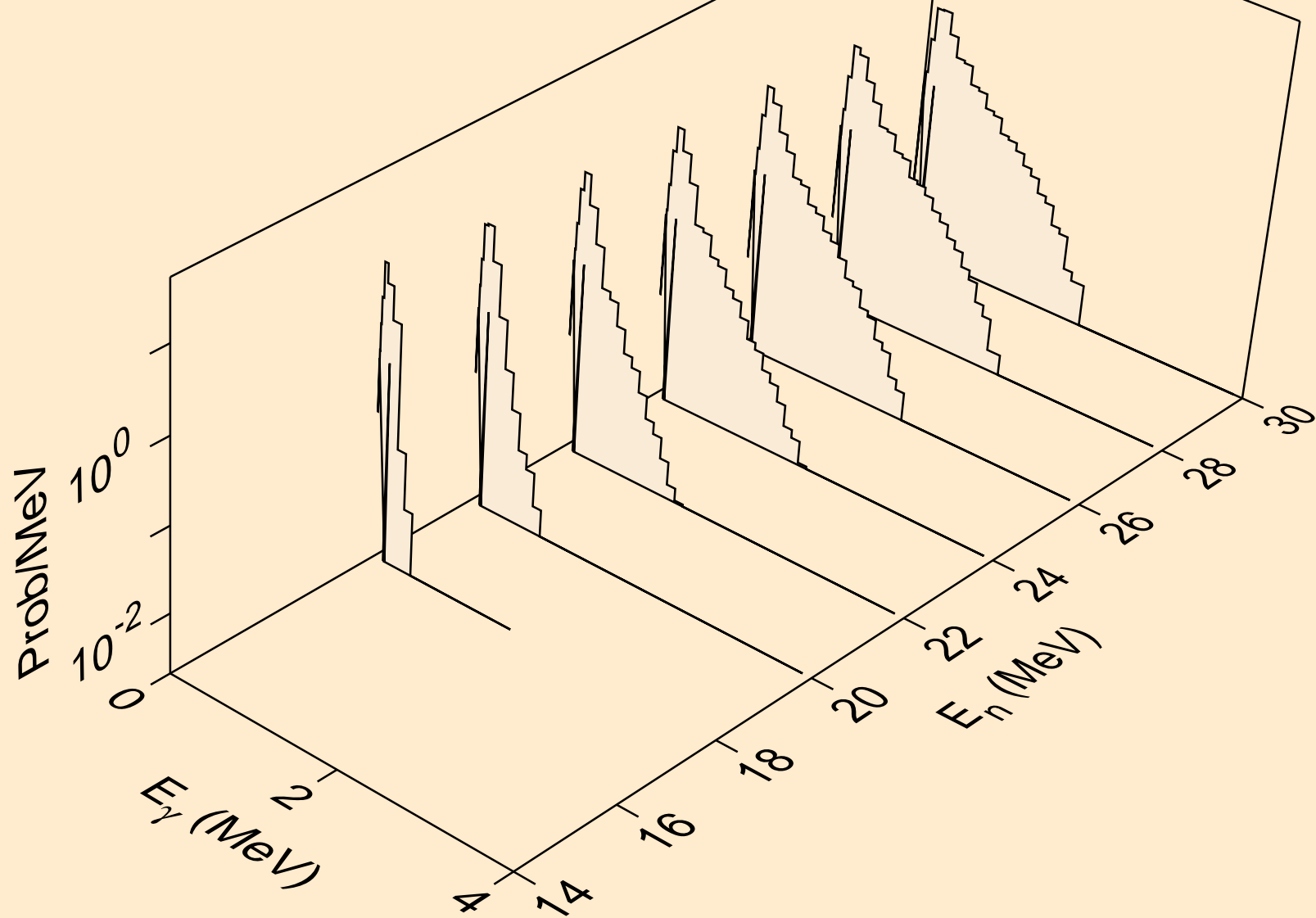

HG214 NEUTRON ACER TENDL-2023 LIBRARY; T=0.K
Photon emission for (n,3np)

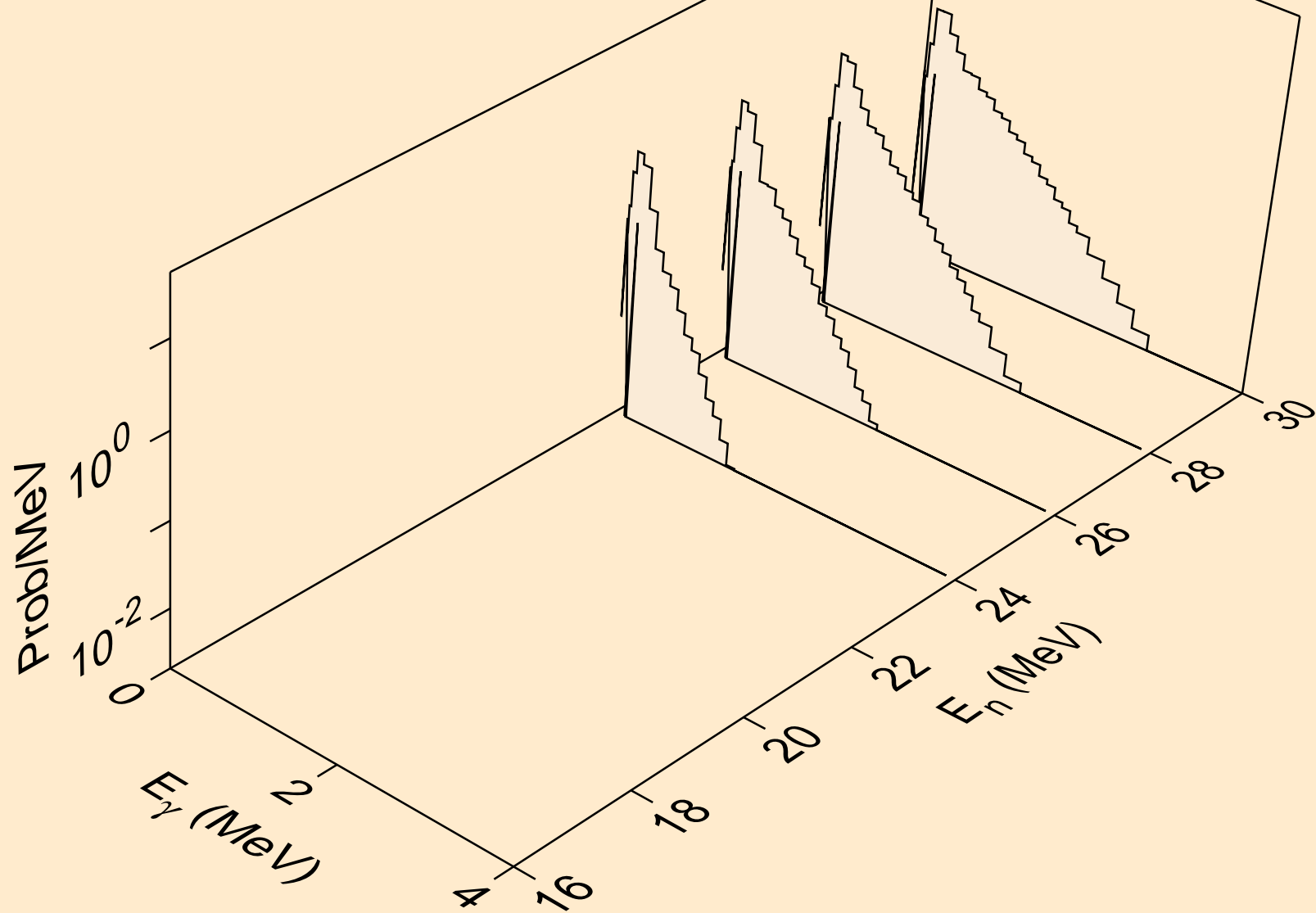

HG214 NEUTRON ACER TENDL-2023 LIBRARY; T=0.K
Photon emission for (n,n*c)

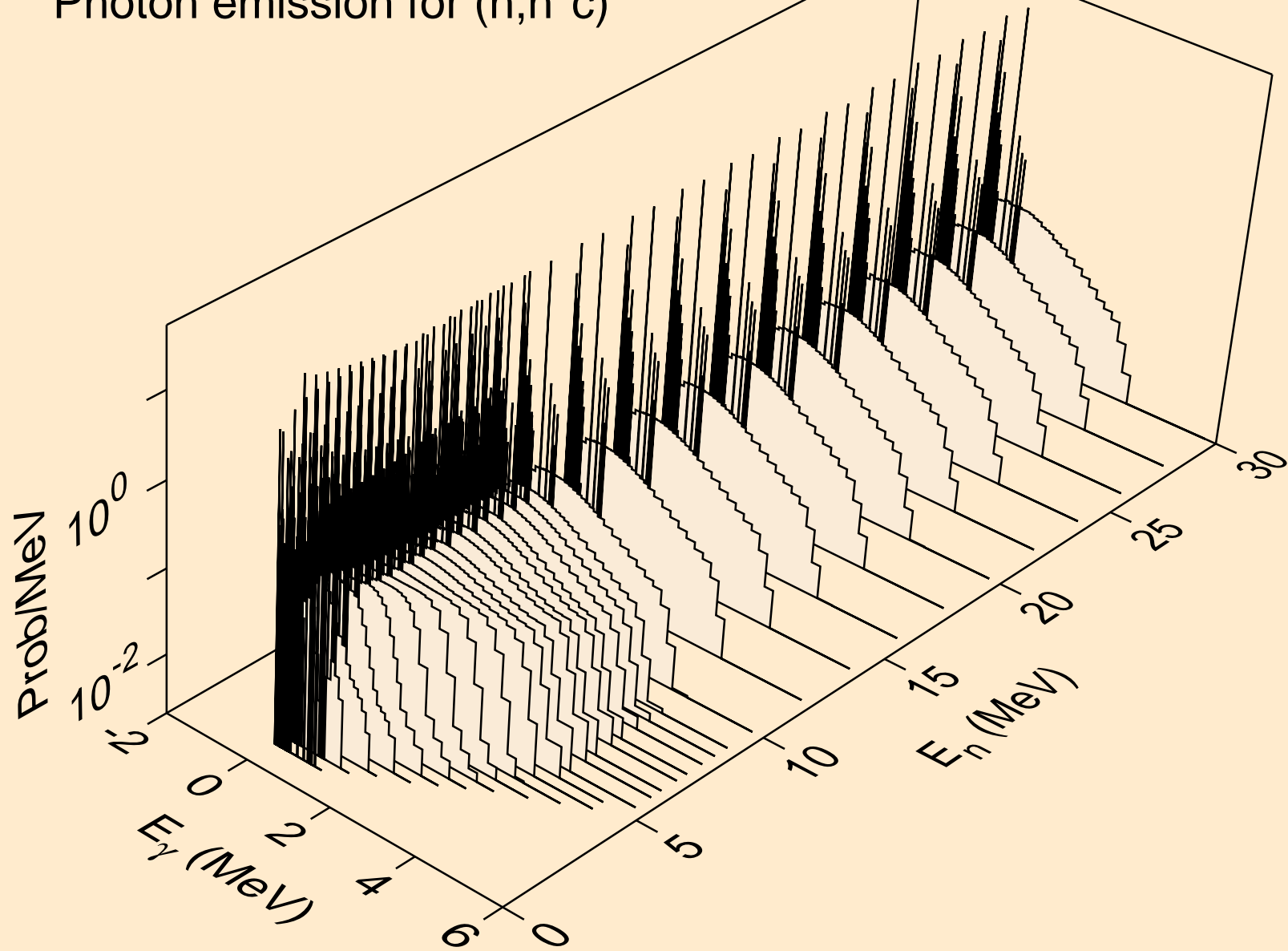

HG214 NEUTRON ACER TENDL-2023 LIBRARY; T=0.K
Photon emission for (n,gma)

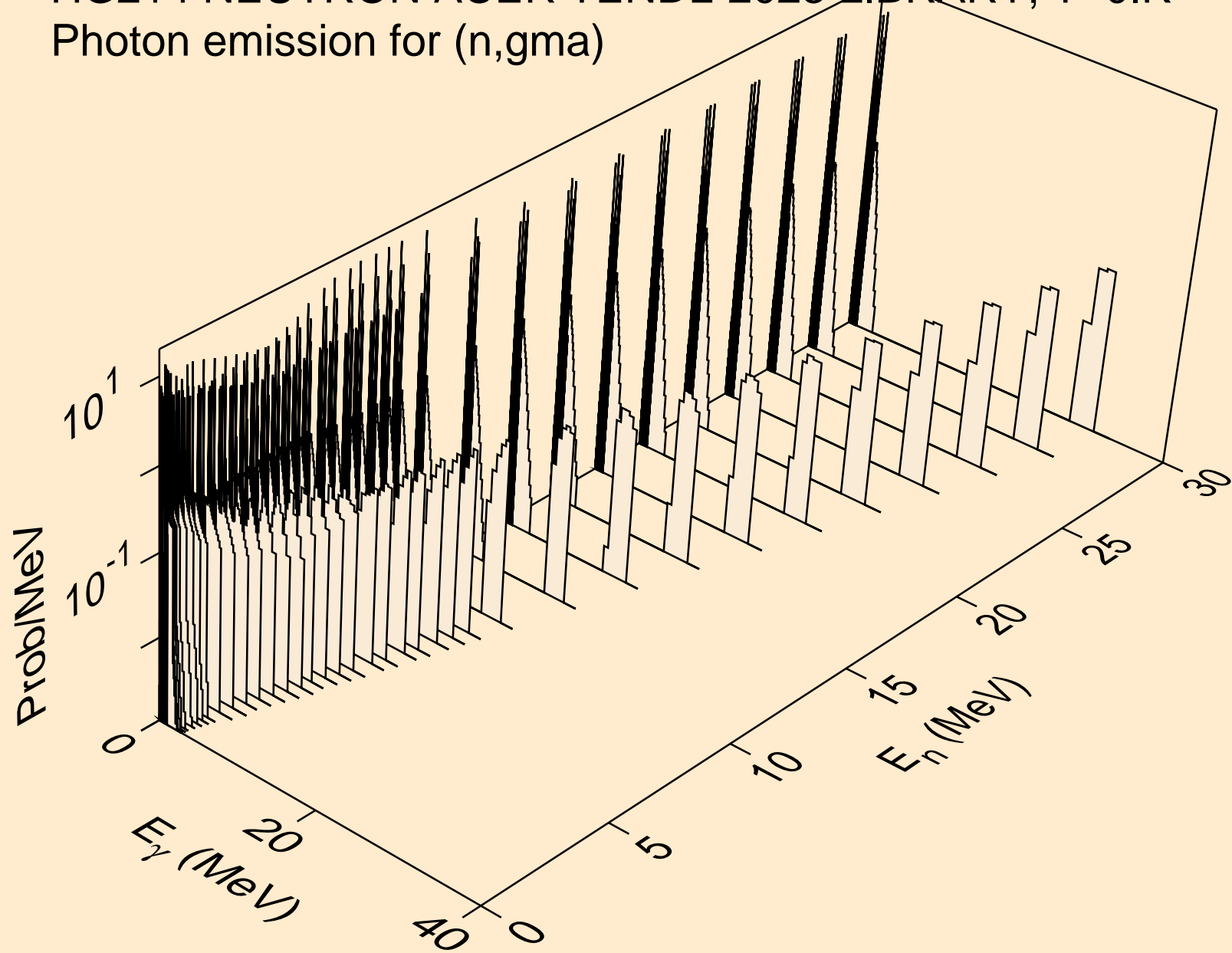

HG214 NEUTRON ACER TENDL-2023 LIBRARY; T=0.K
Photon emission for (n,p)

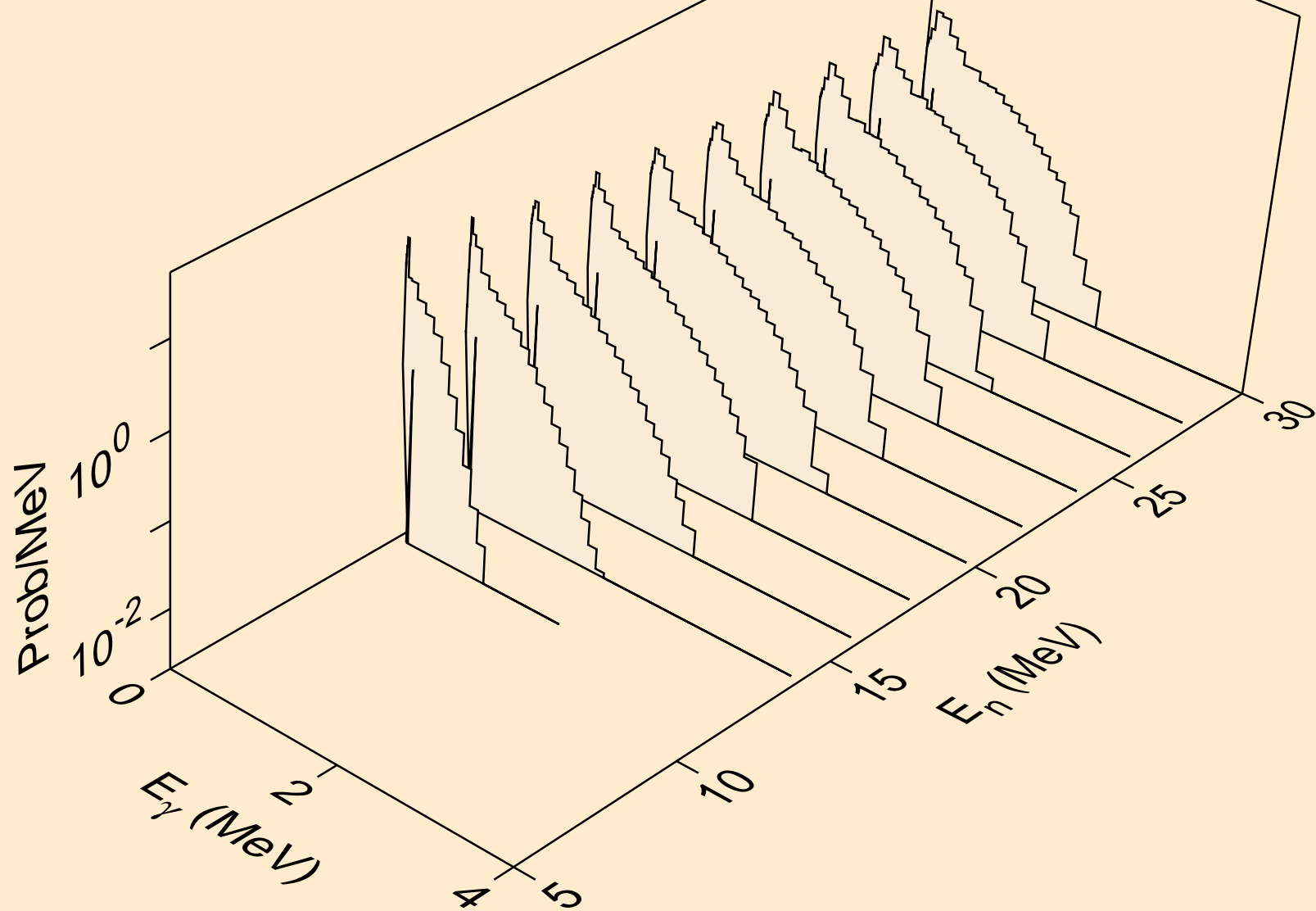

HG214 NEUTRON ACER TENDL-2023 LIBRARY; T=0.K
Photon emission for (n,d)

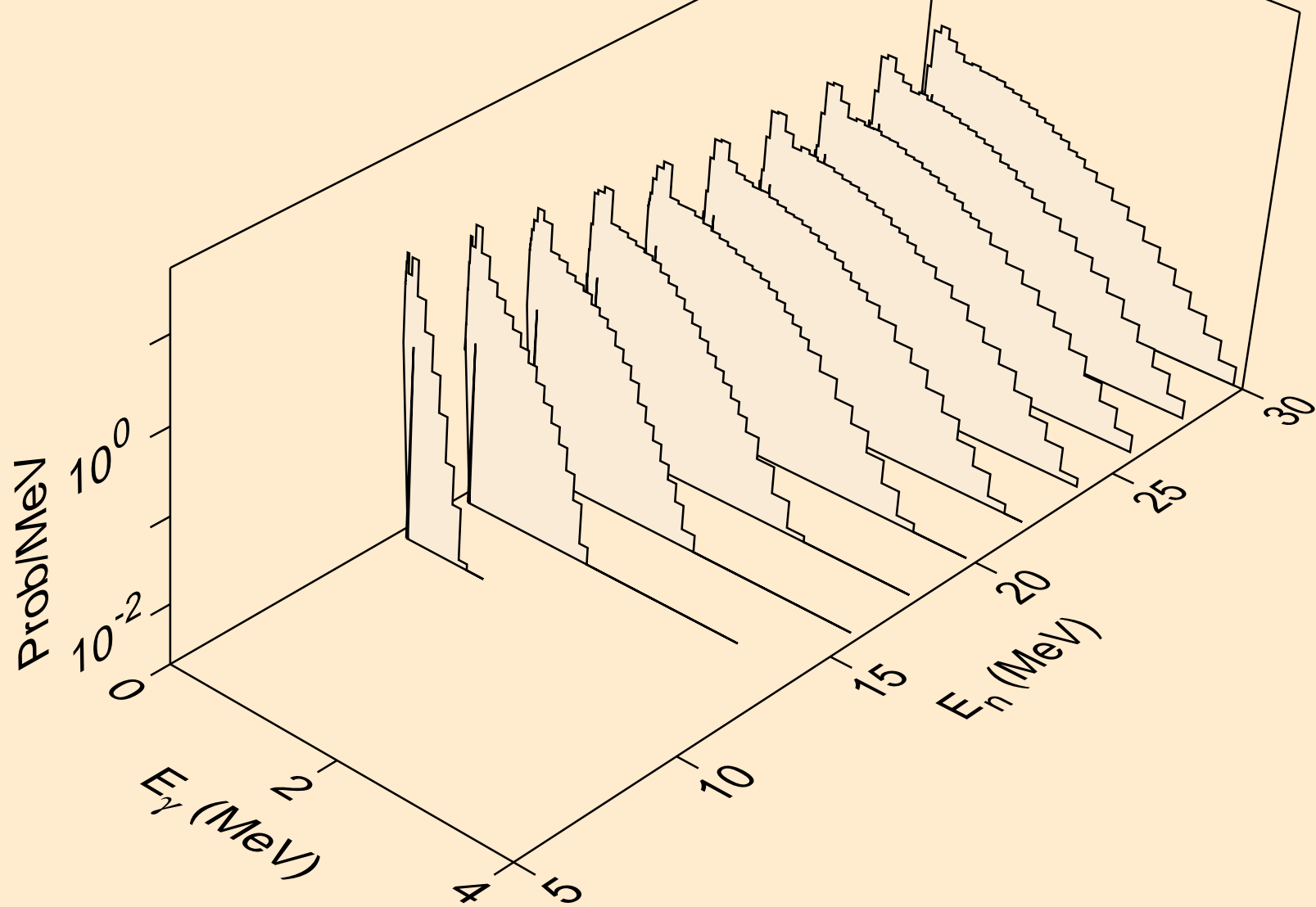

HG214 NEUTRON ACER TENDL-2023 LIBRARY; T=0.K
Photon emission for (n,t)

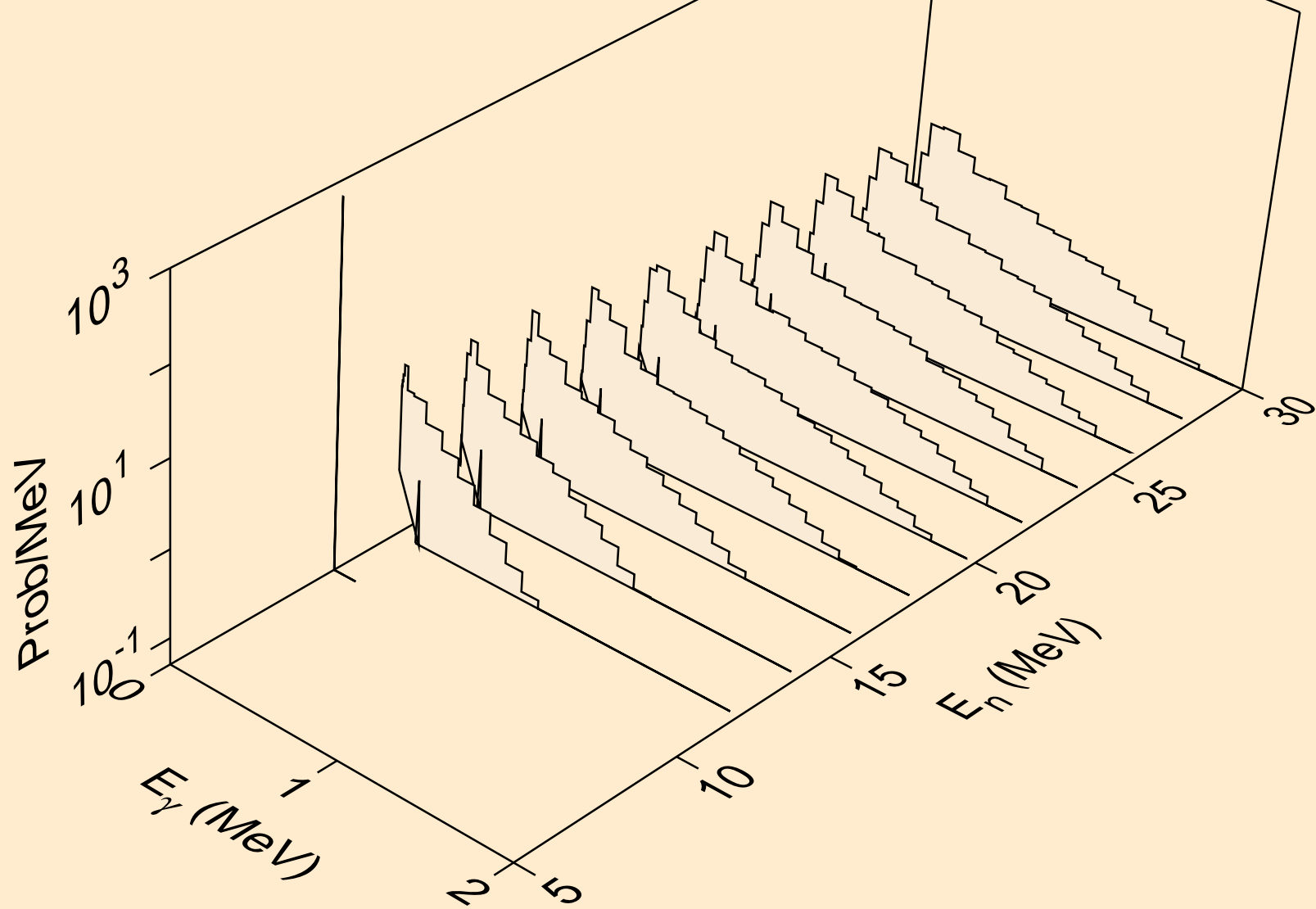

HG214 NEUTRON ACER TENDL-2023 LIBRARY; T=0.K
Photon emission for (n,he3)

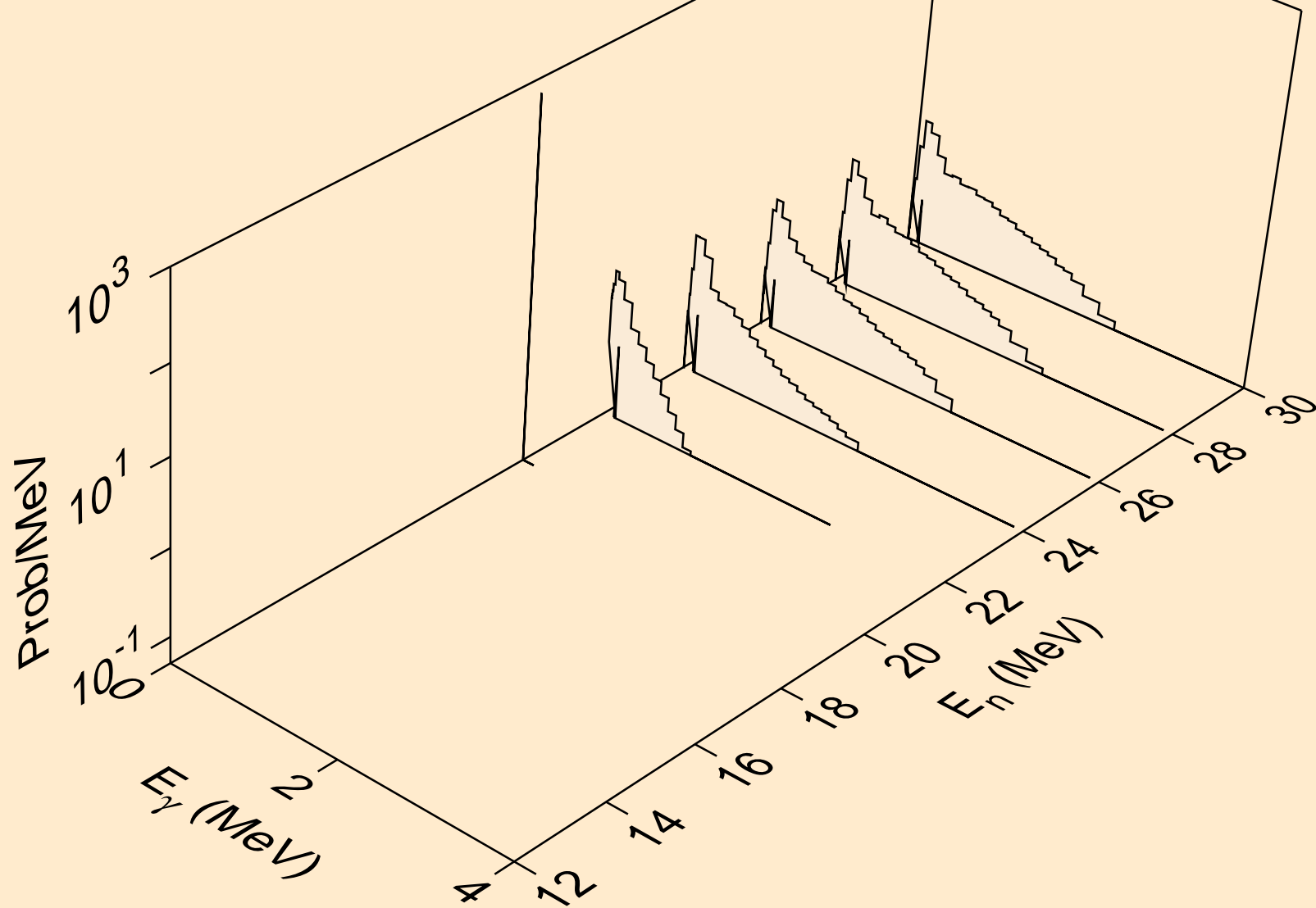

HG214 NEUTRON ACER TENDL-2023 LIBRARY; T=0.K
Photon emission for (n,a)

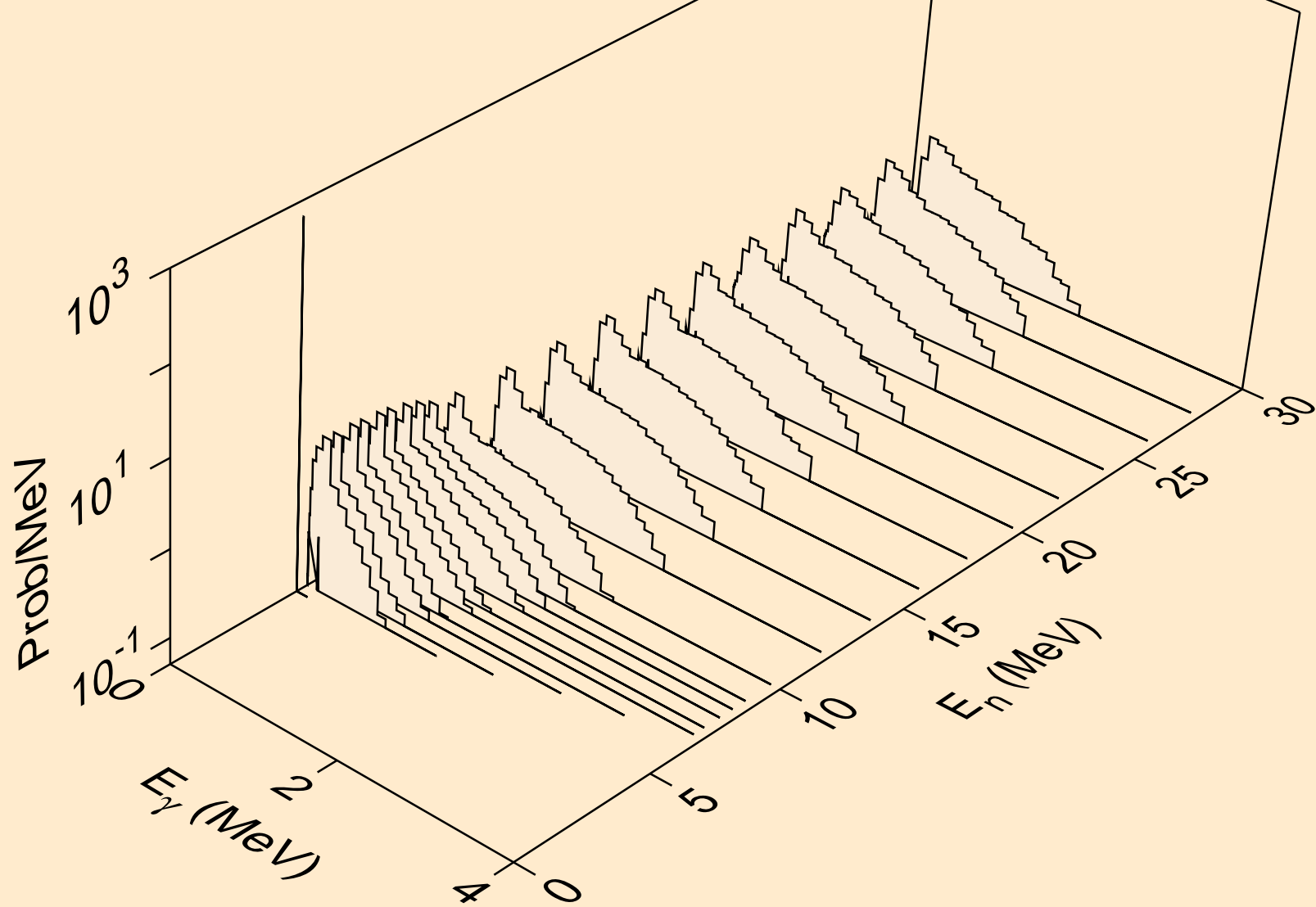

HG214 NEUTRON ACER TENDL-2023 LIBRARY; T=0.K
thermal capture photon spectrum

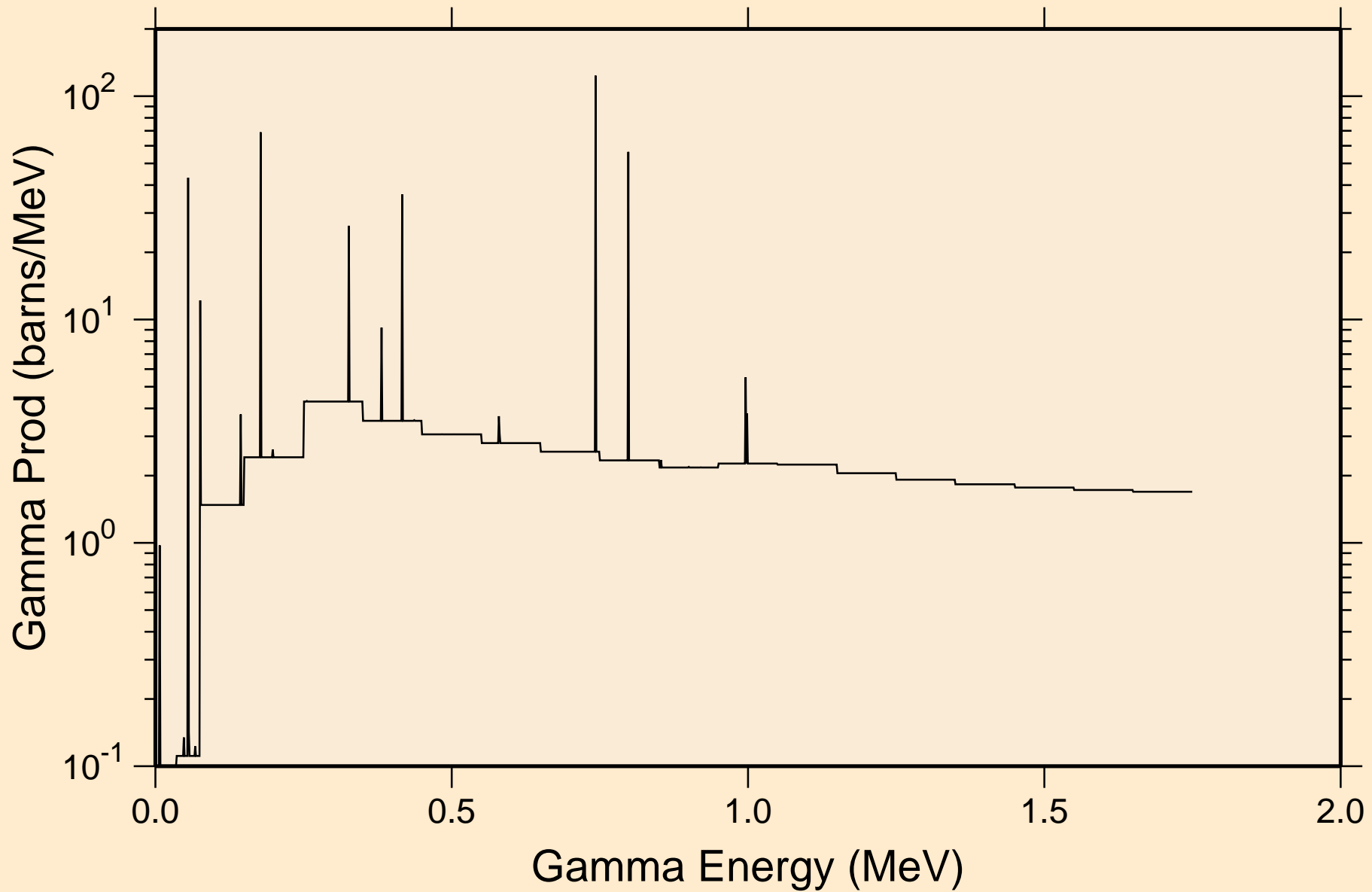

HG214 NEUTRON ACER TENDL-2023 LIBRARY; T=0.K
14 MeV photon spectrum

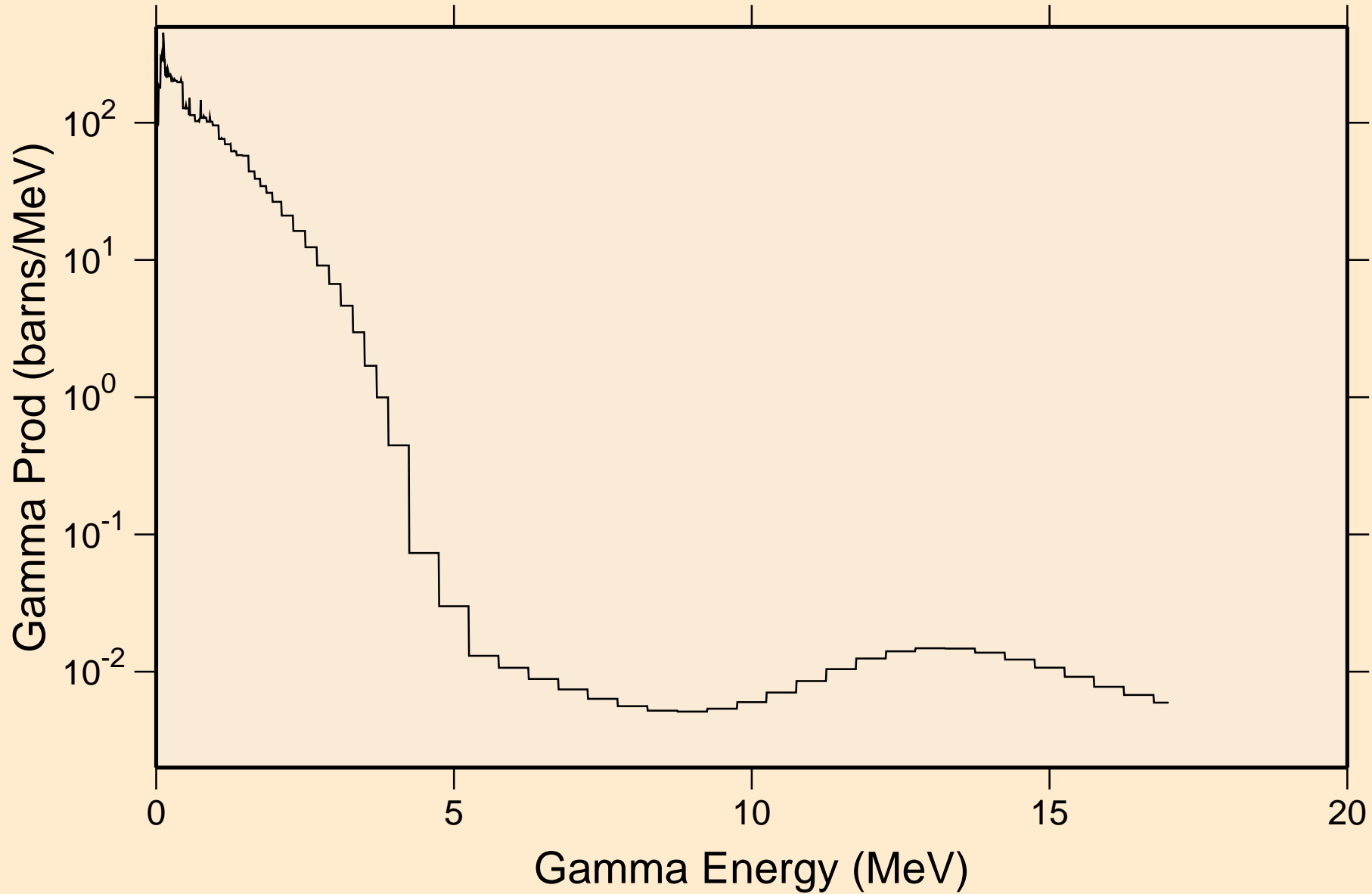

HG214 NEUTRON ACER TENDL-2023 LIBRARY; T=0.K

Particle heating contributions

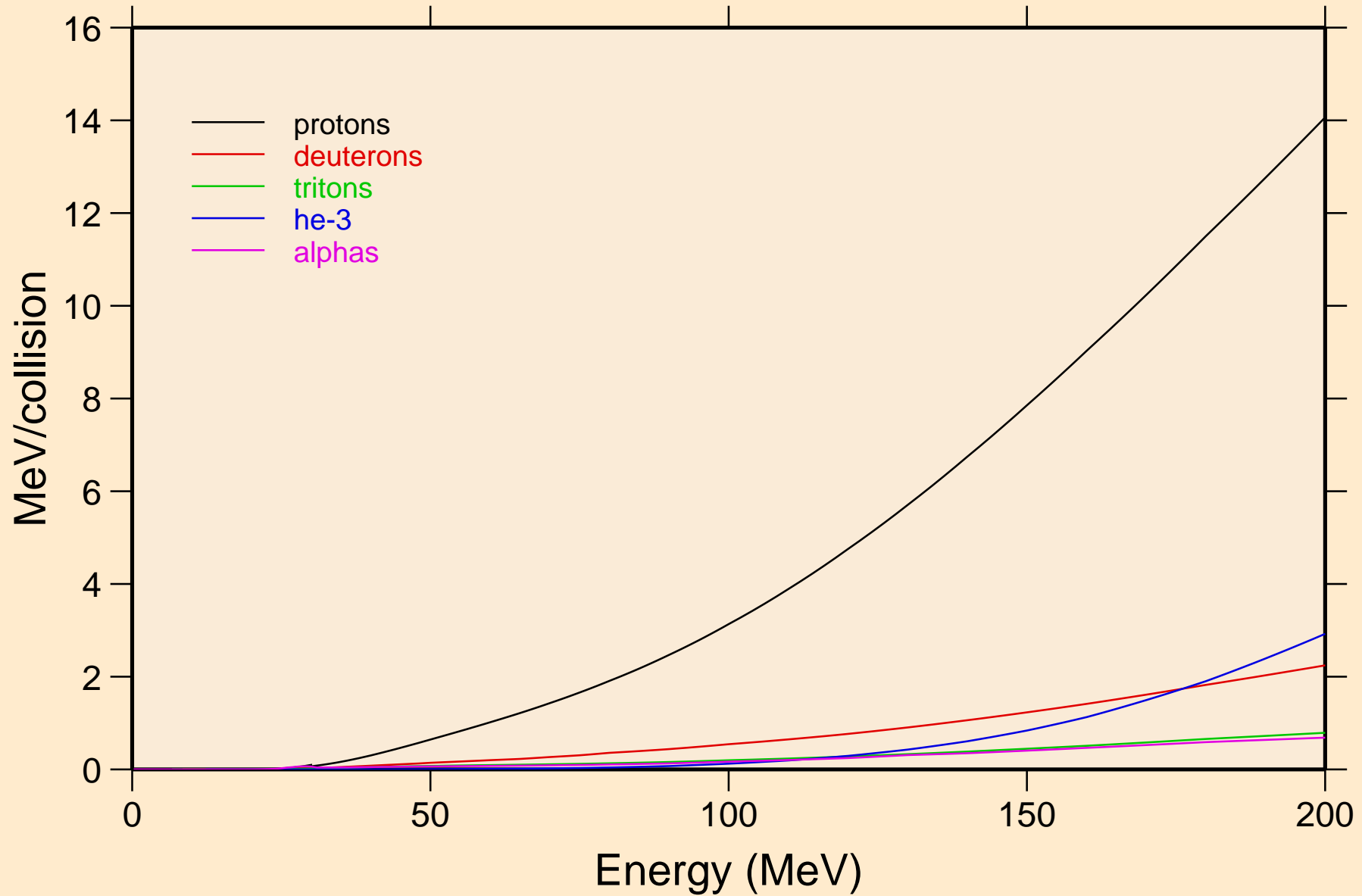

HG214 NEUTRON ACER TENDL-2023 LIBRARY; T=0.K
Recoil Heating

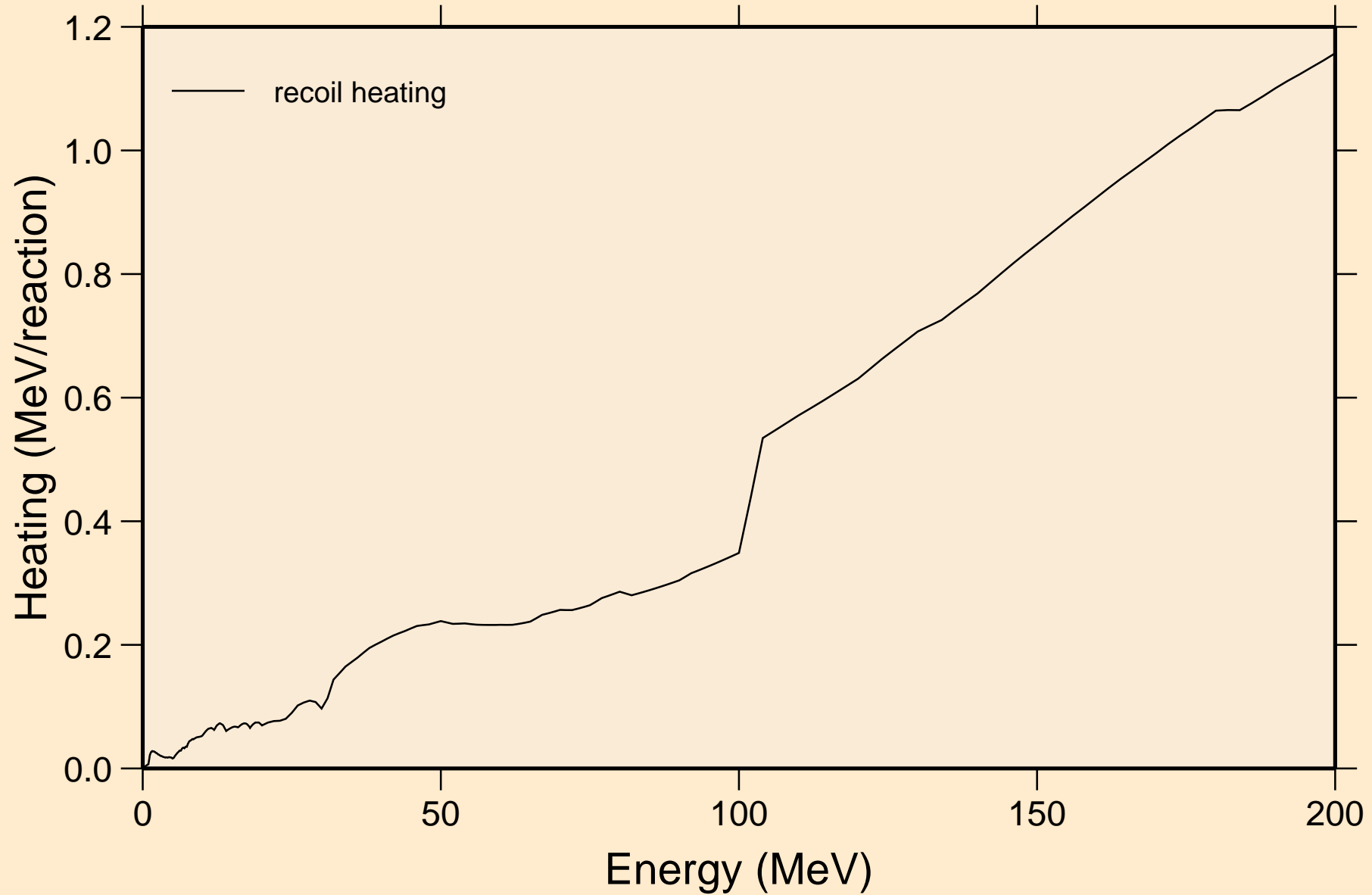

HG214 NEUTRON ACER TENDL-2023 LIBRARY; T=0.K

Particle production cross sections

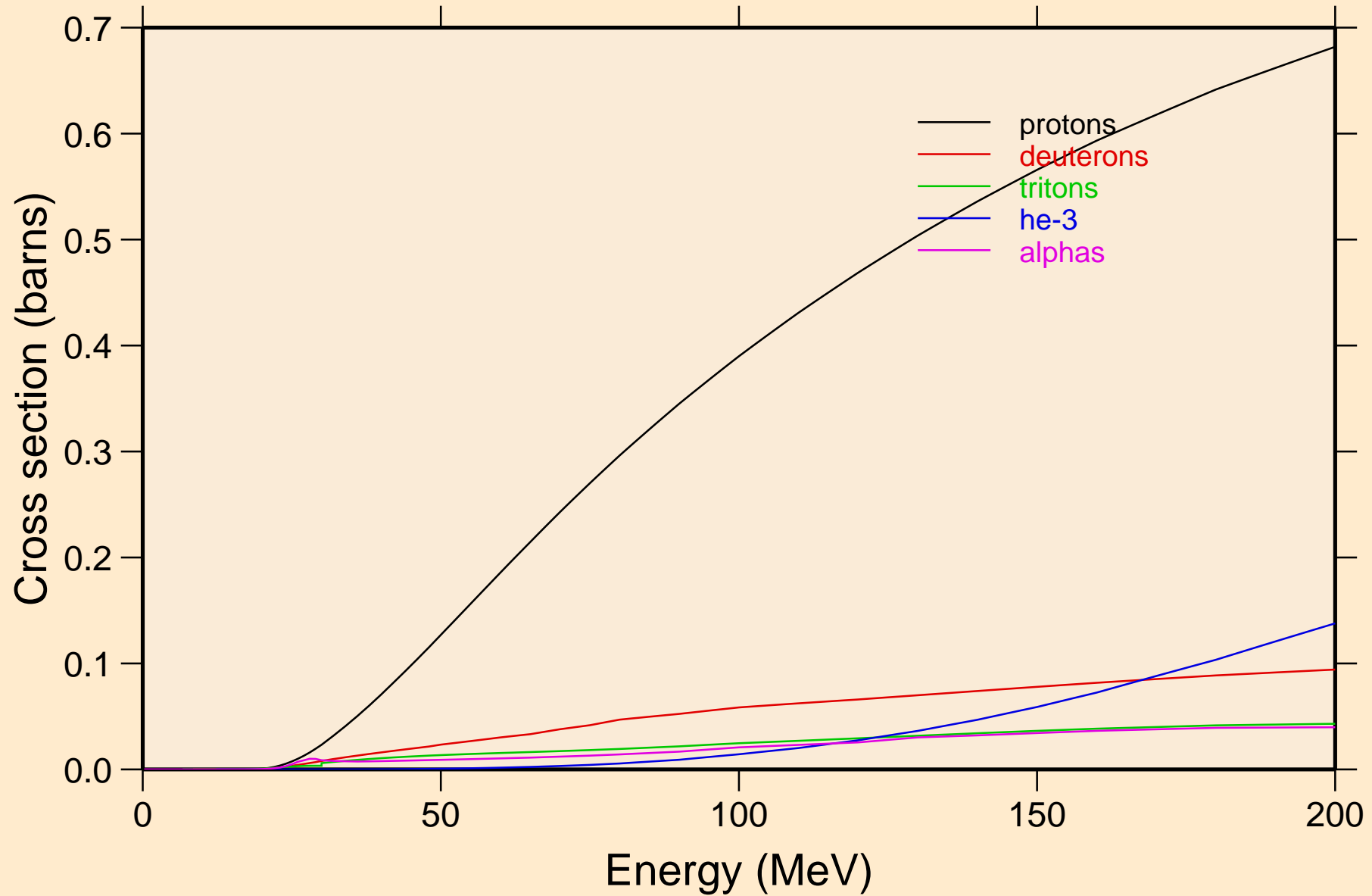

HG214 NEUTRON ACER TENDL-2023 LIBRARY; T=0.K
protons from (n,x)

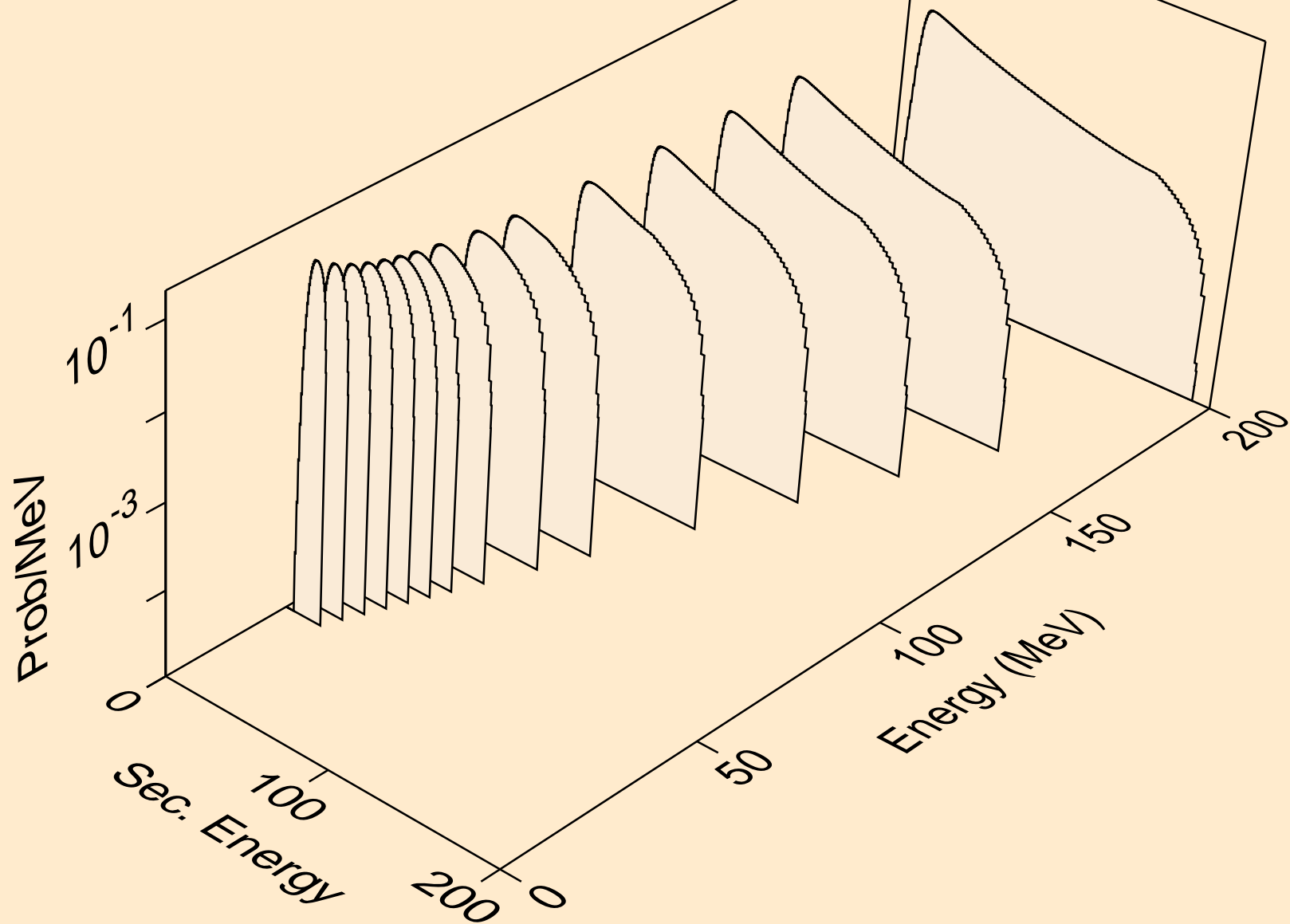

HG214 NEUTRON ACER TENDL-2023 LIBRARY; T=0.K
protons from (n,n*)p

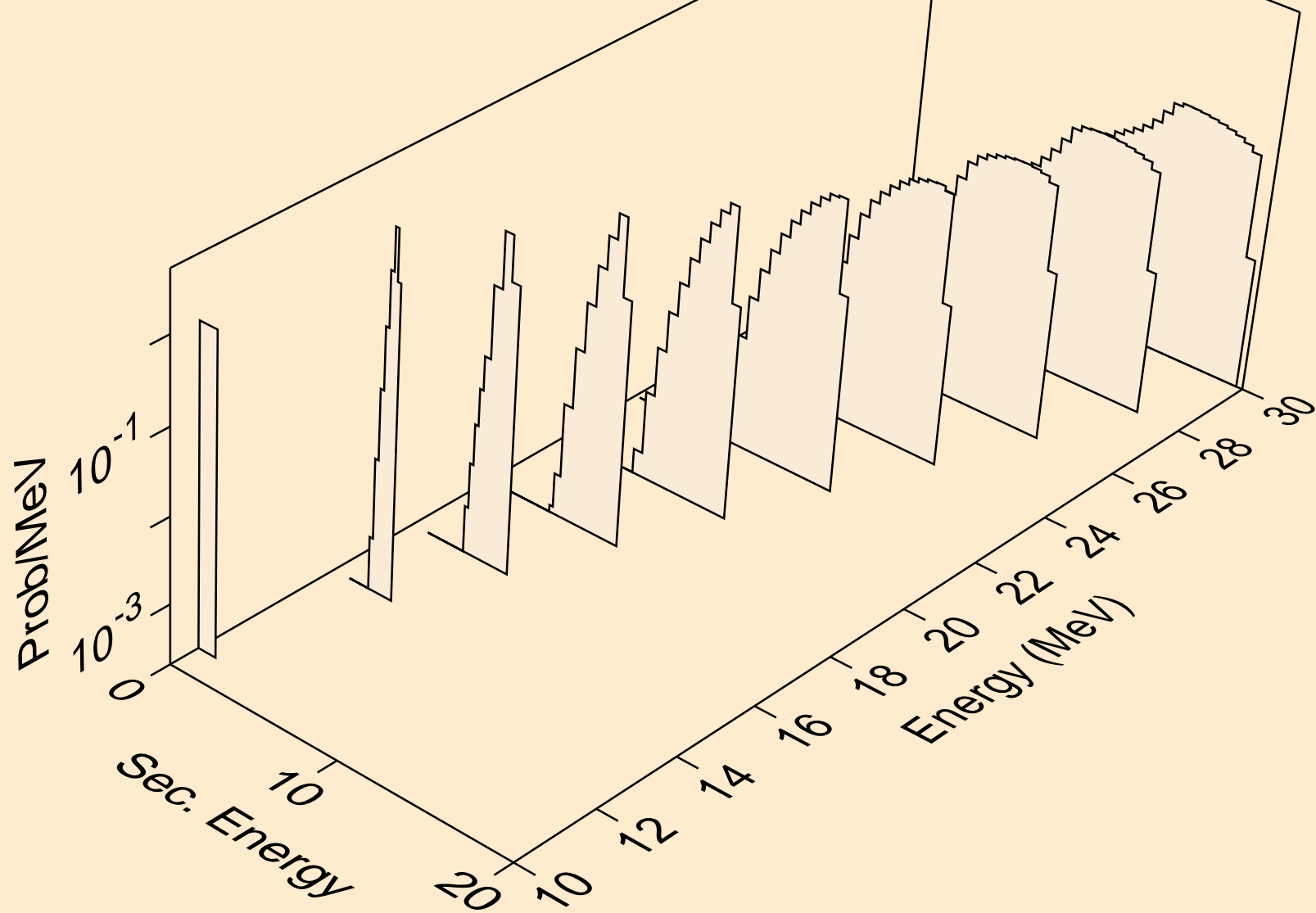

HG214 NEUTRON ACER TENDL-2023 LIBRARY; T=0.K
protons from (n,2np)

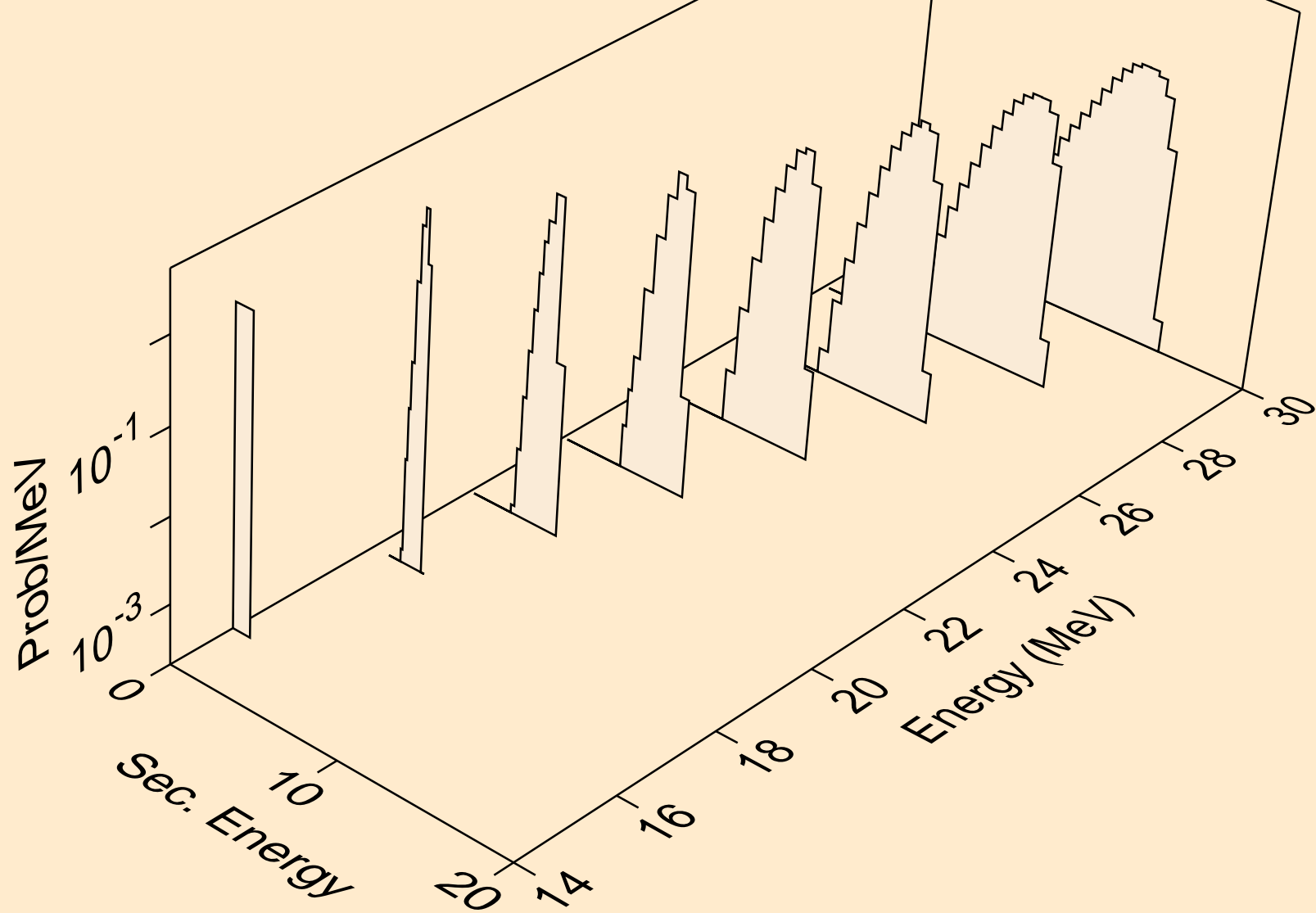

HG214 NEUTRON ACER TENDL-2023 LIBRARY; T=0.K
protons from (n,3np)

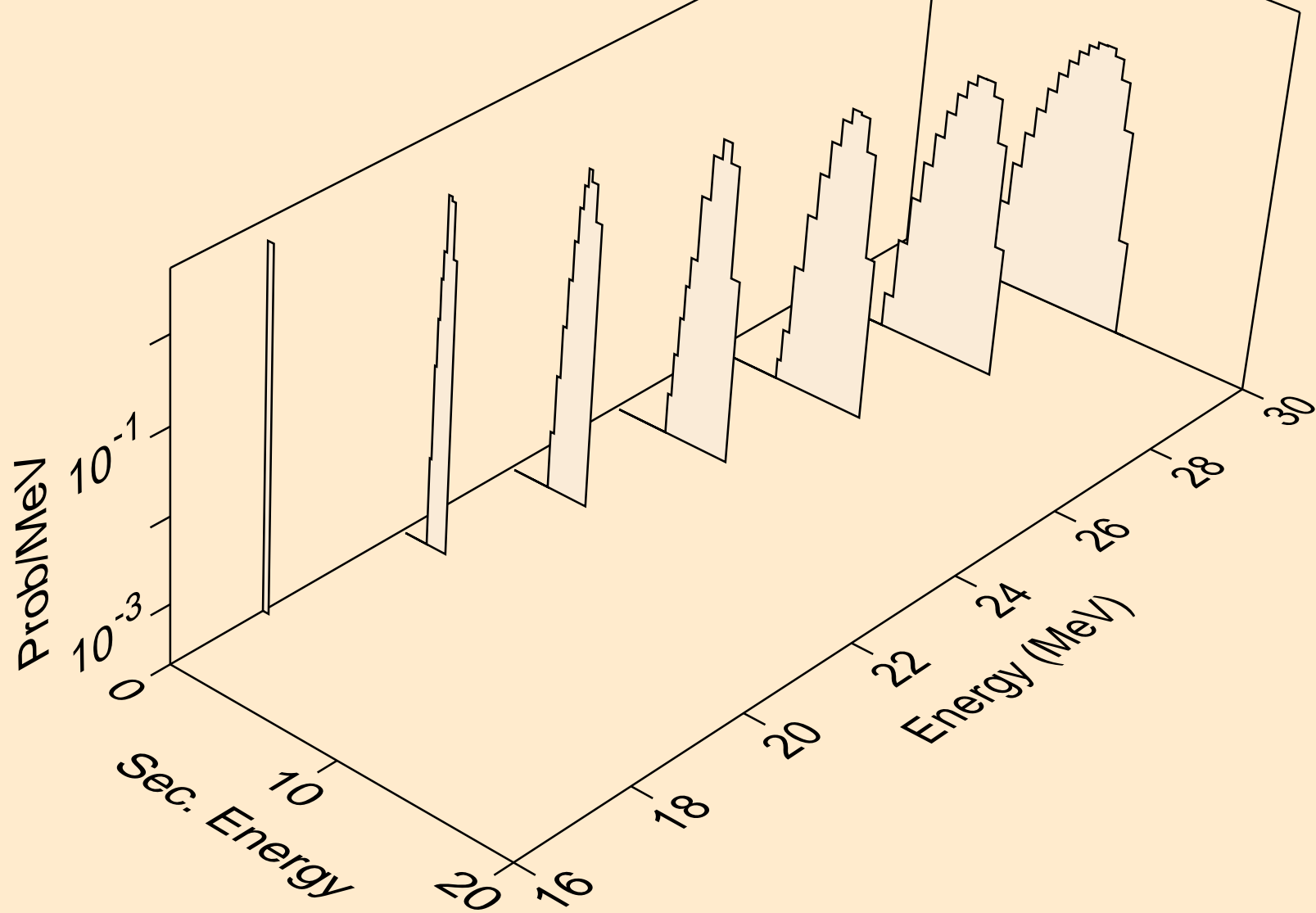

HG214 NEUTRON ACER TENDL-2023 LIBRARY; T=0.K
protons from (n,p)

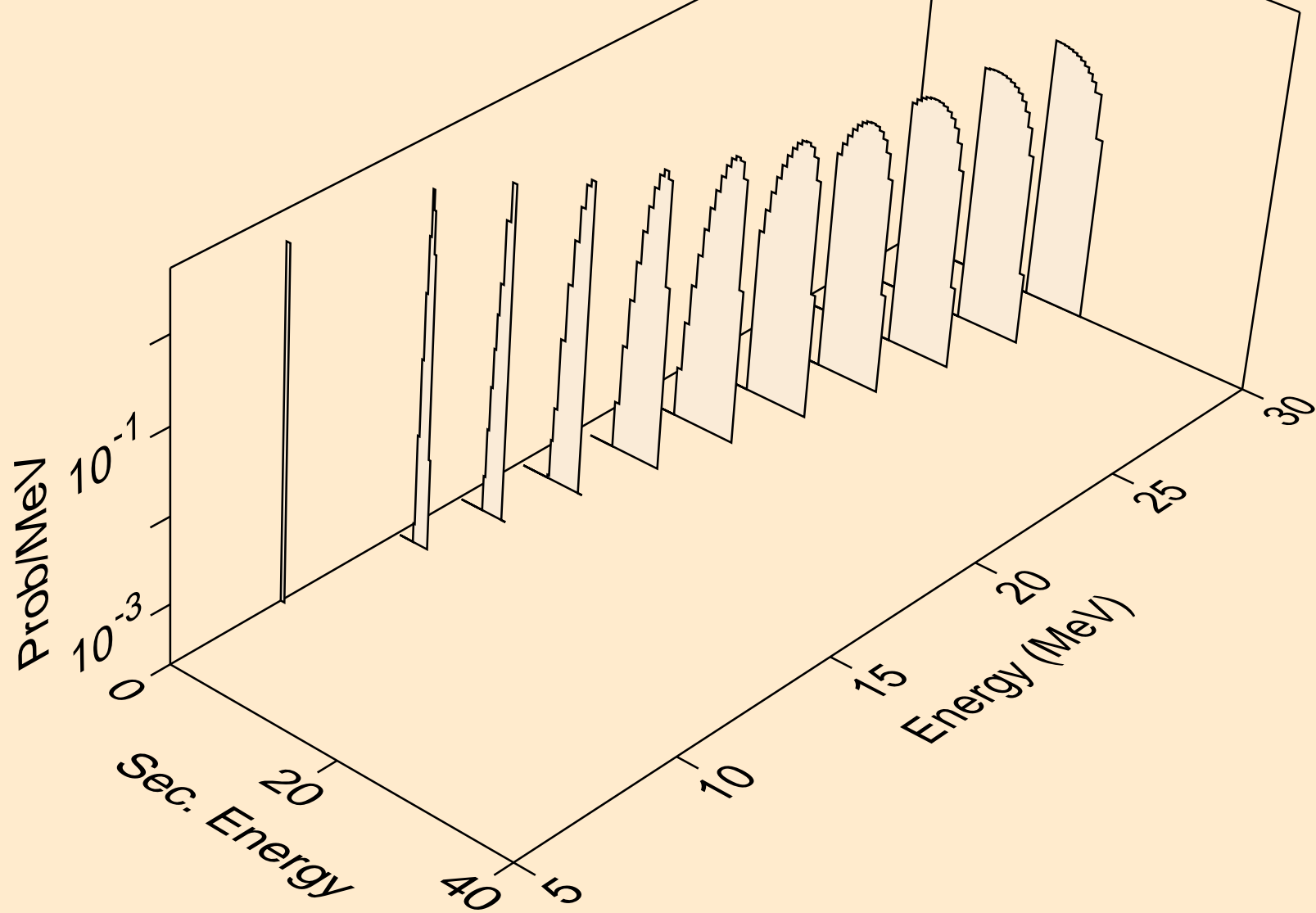

HG214 NEUTRON ACER TENDL-2023 LIBRARY; T=0.K
deuterons from (n,x)

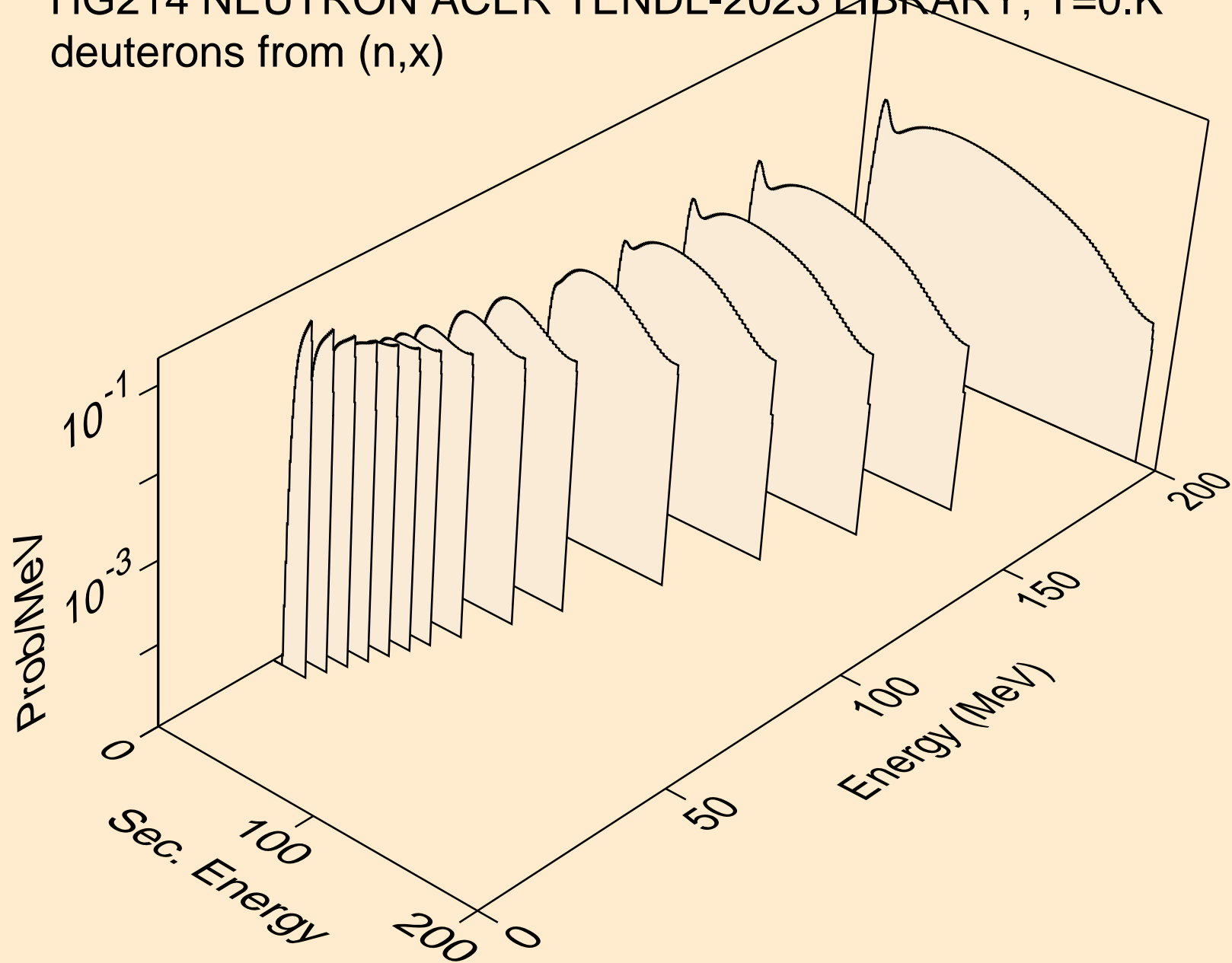

HG214 NEUTRON ACER TENDL-2023 LIBRARY; T=0.K
deuterons from (n,2nd)

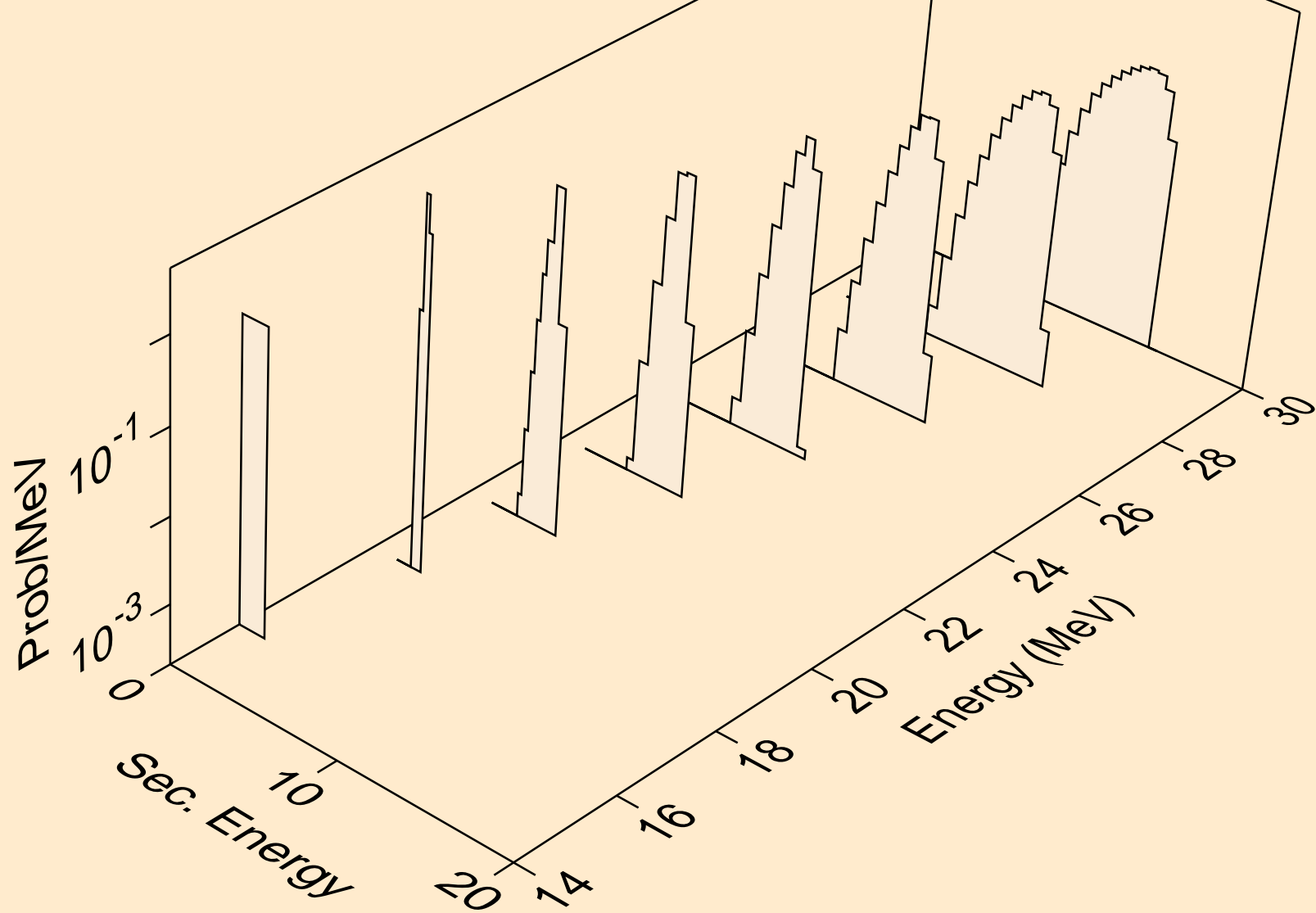

HG214 NEUTRON ACER TENDL-2023 LIBRARY; T=0.K
deuterons from (n,n*)d

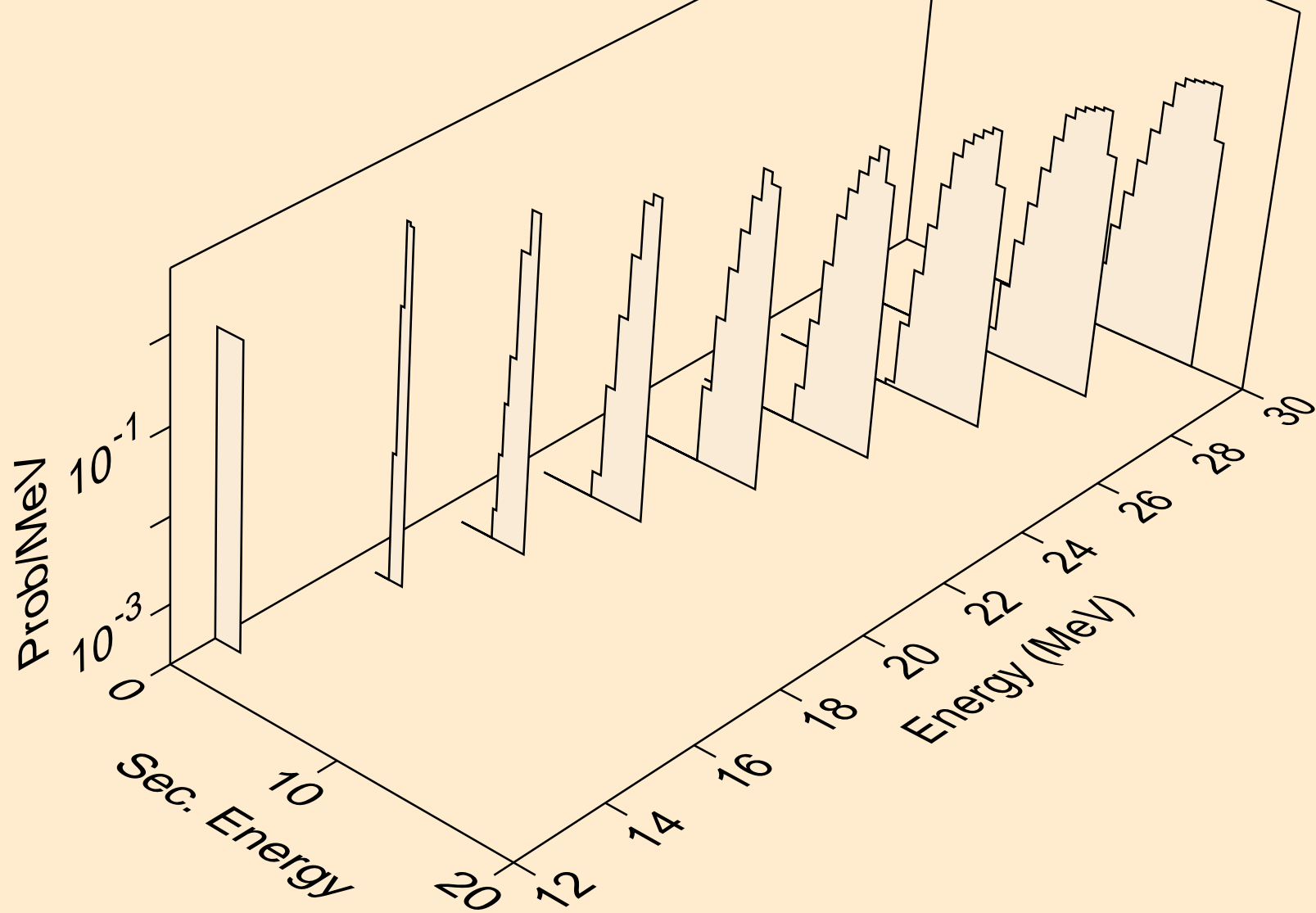

HG214 NEUTRON ACER TENDL-2023 LIBRARY; T=0.K
deuterons from (n,d)

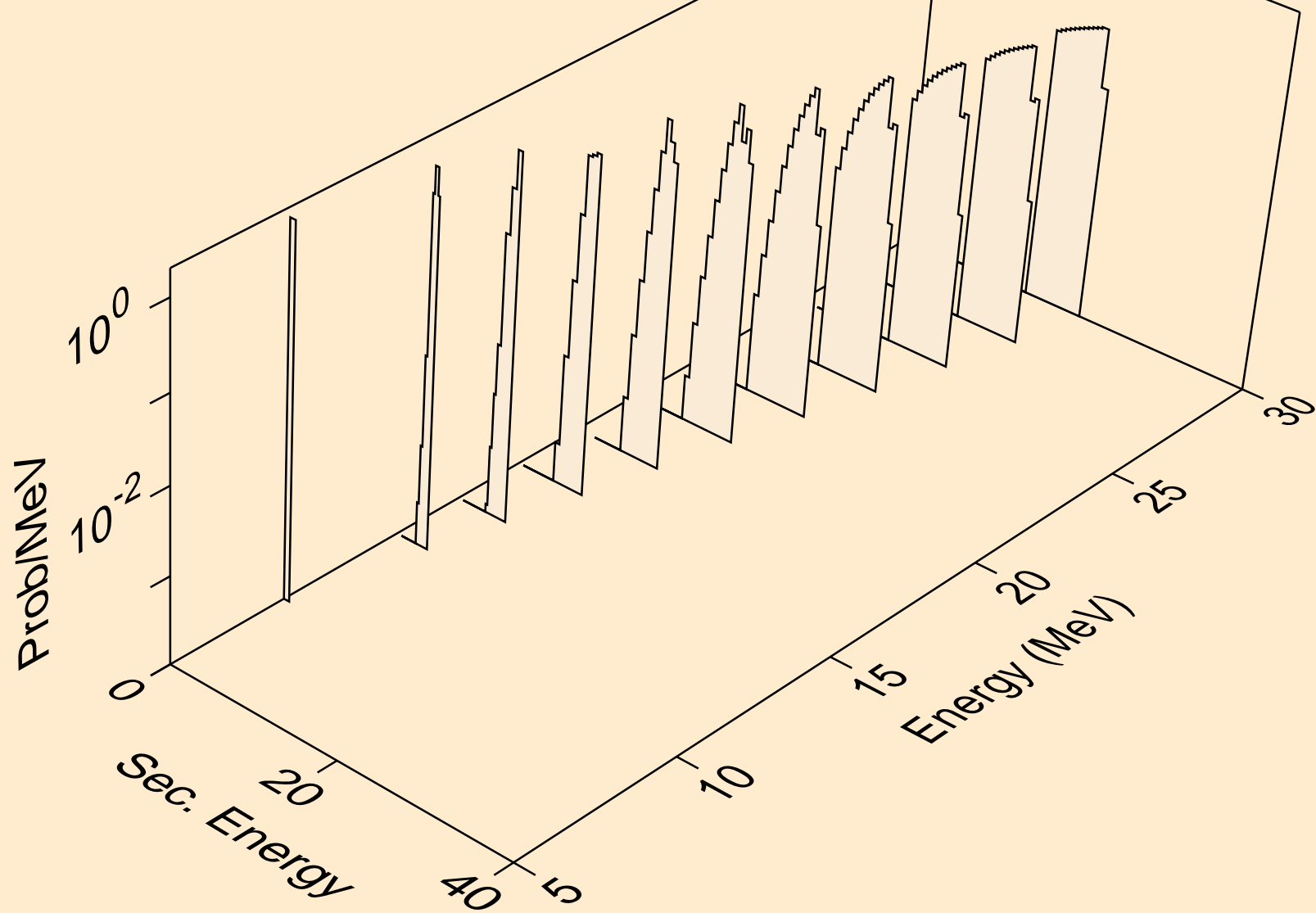

HG214 NEUTRON ACER TENDL-2023 LIBRARY; T=0.K
tritons from (n,x)

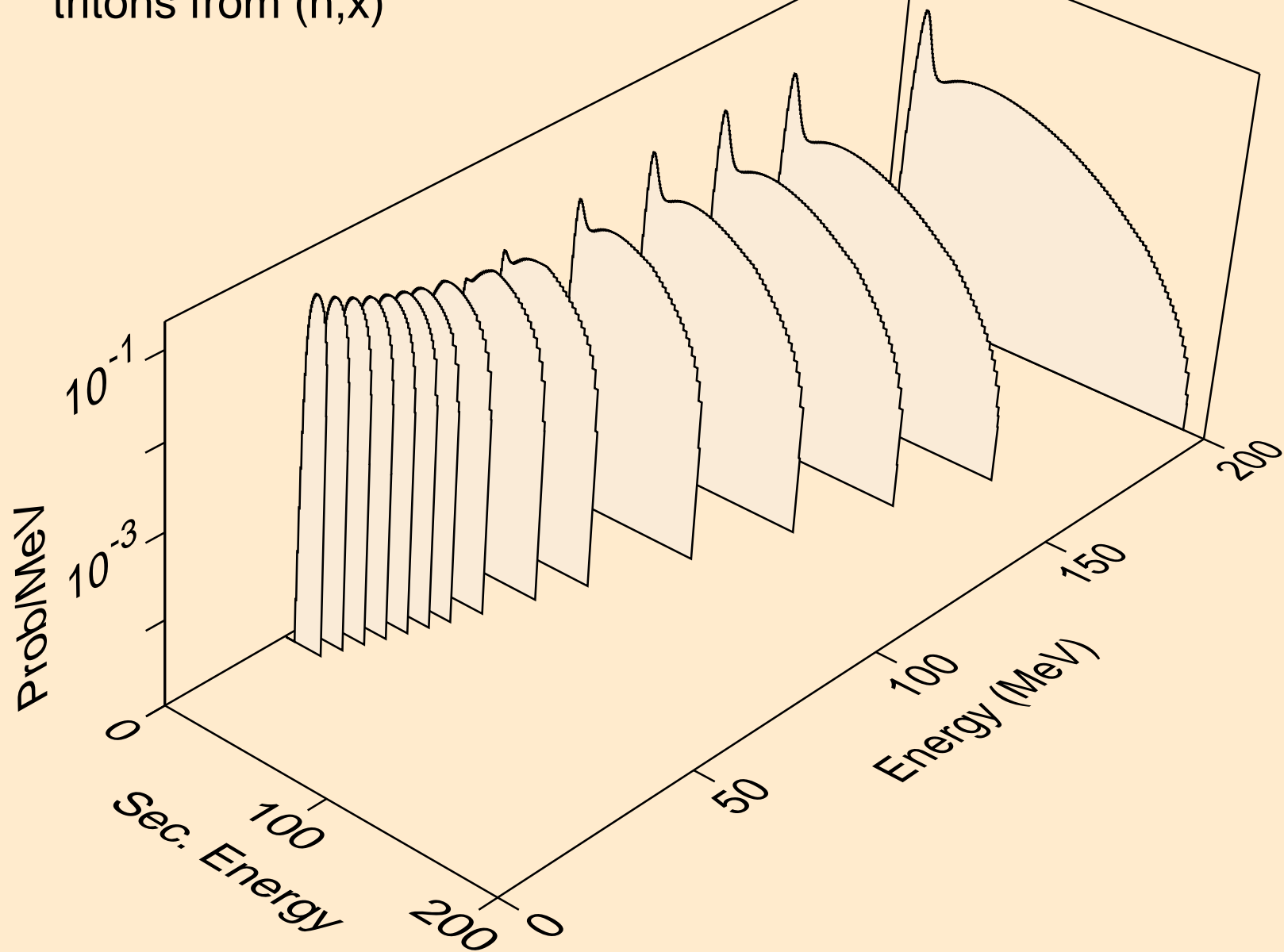

HG214 NEUTRON ACER TENDL-2023 LIBRARY; T=0.K
tritons from (n,n*)t

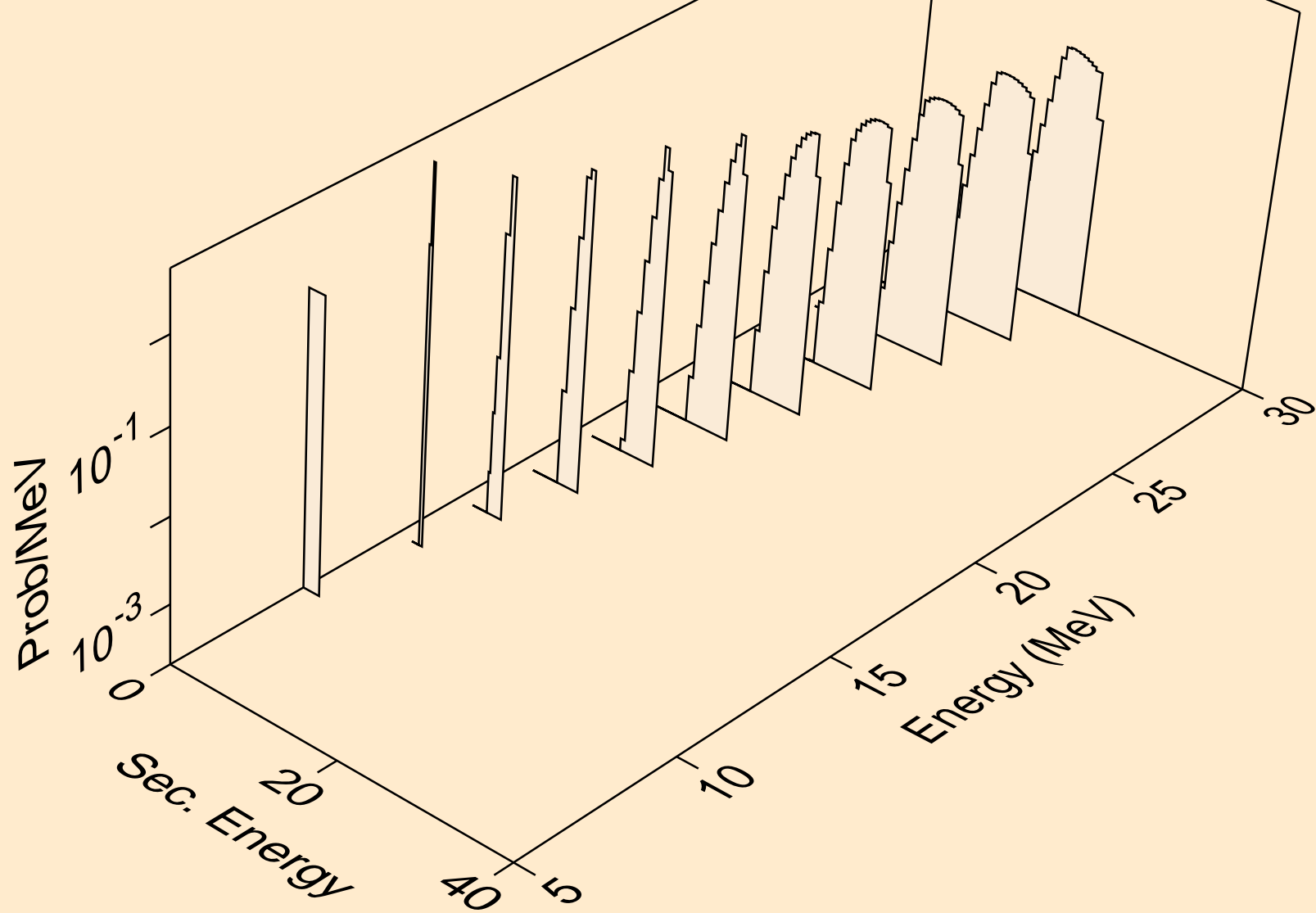

HG214 NEUTRON ACER TENDL-2023 LIBRARY; T=0.K
tritons from (n,t)

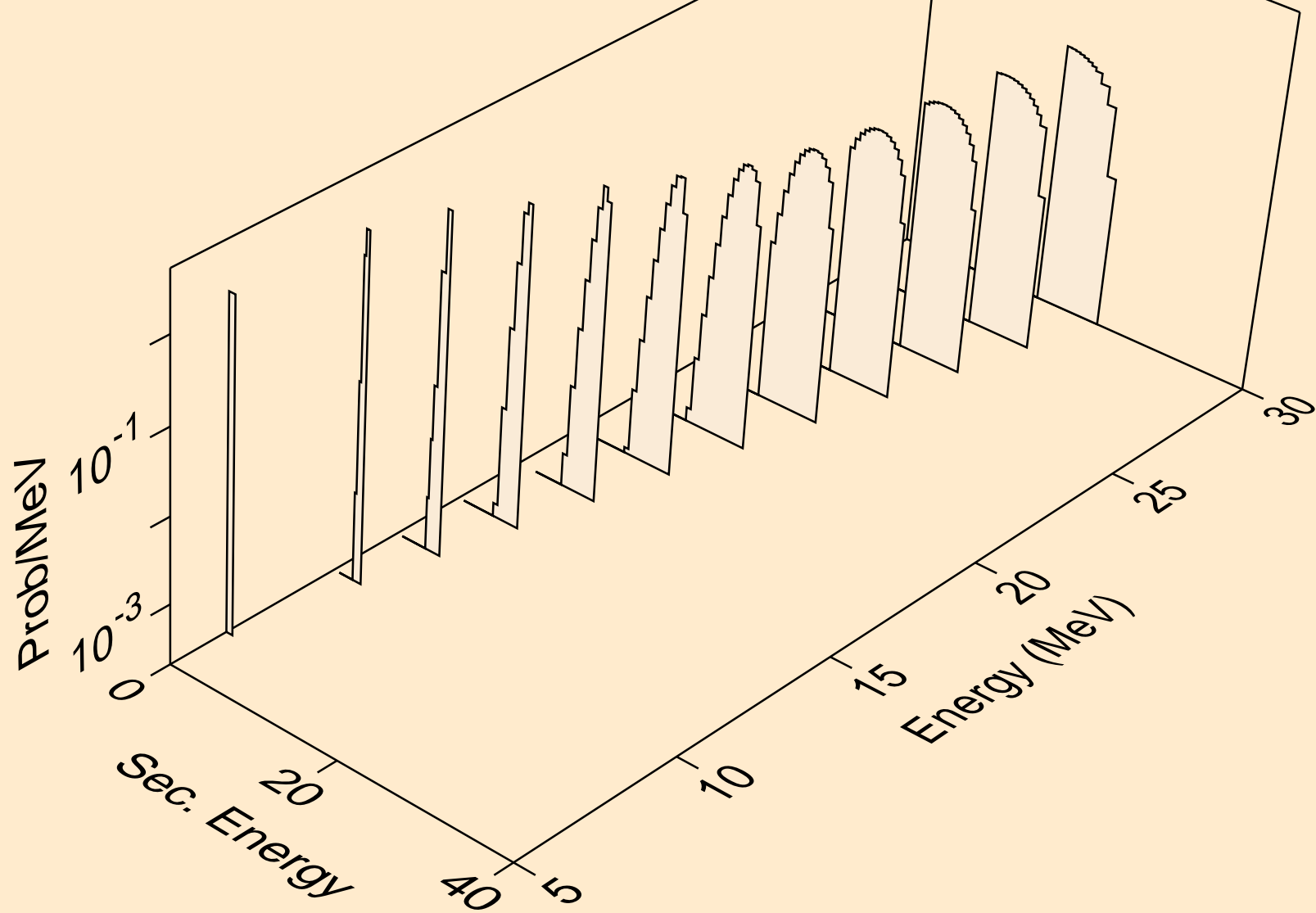

HG214 NEUTRON ACER TENDL-2023 LIBRARY; T=0.K
he3s from (n,x)

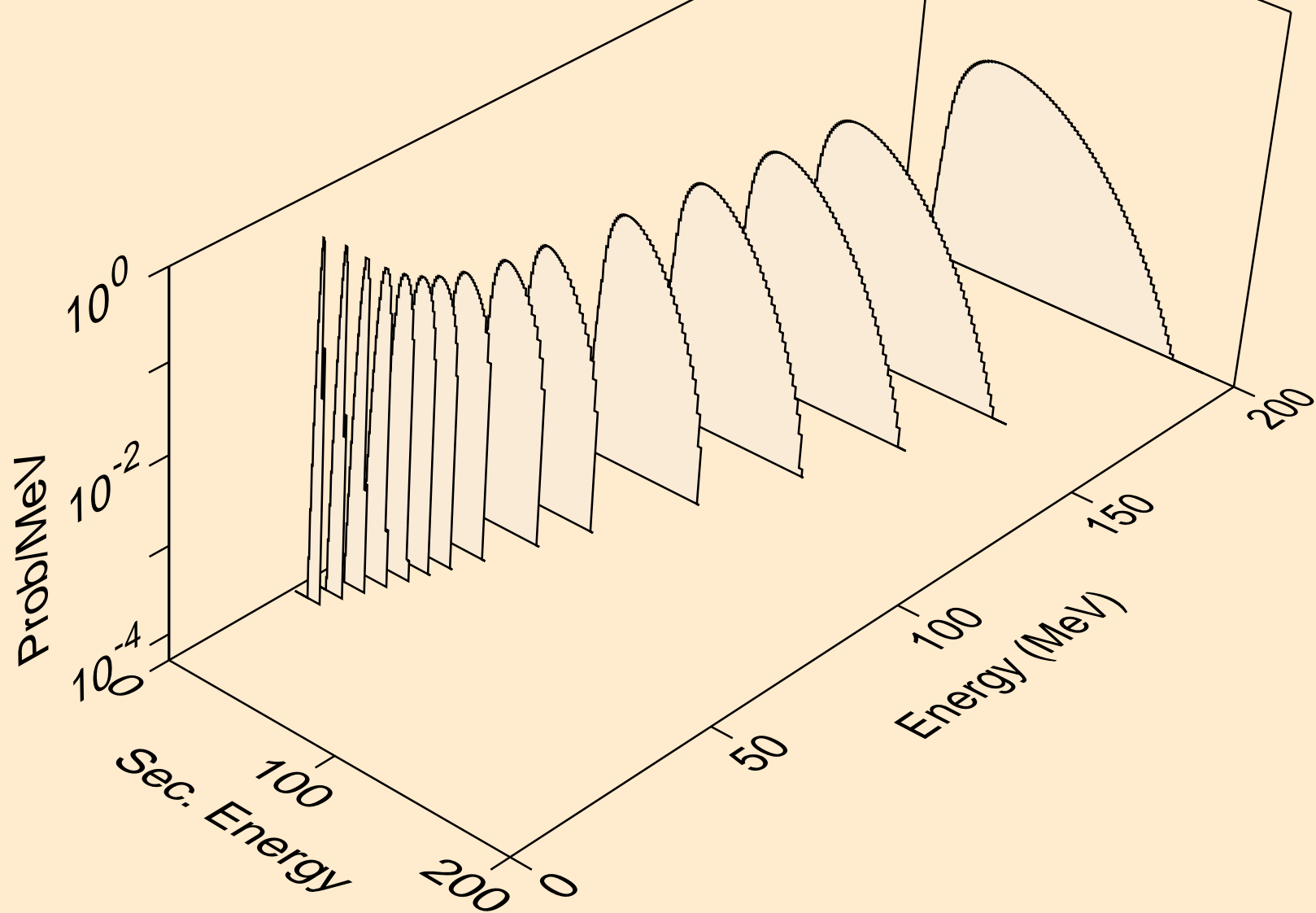

HG214 NEUTRON ACER TENDL-2023 LIBRARY; T=0.K
he3s from (n,n*)he3

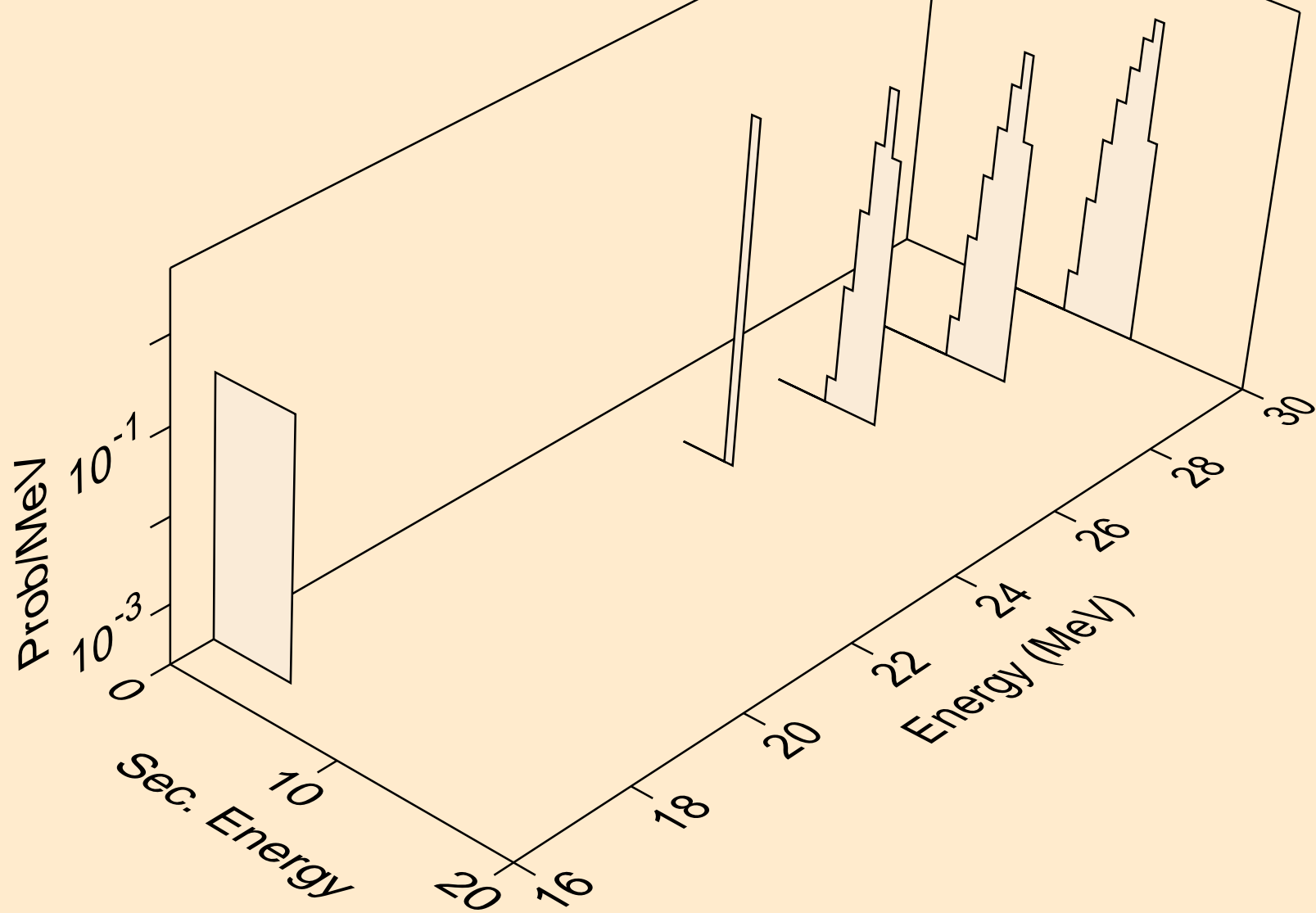

HG214 NEUTRON ACER TENDL-2023 LIBRARY; T=0.K
he3s from (n,he3)

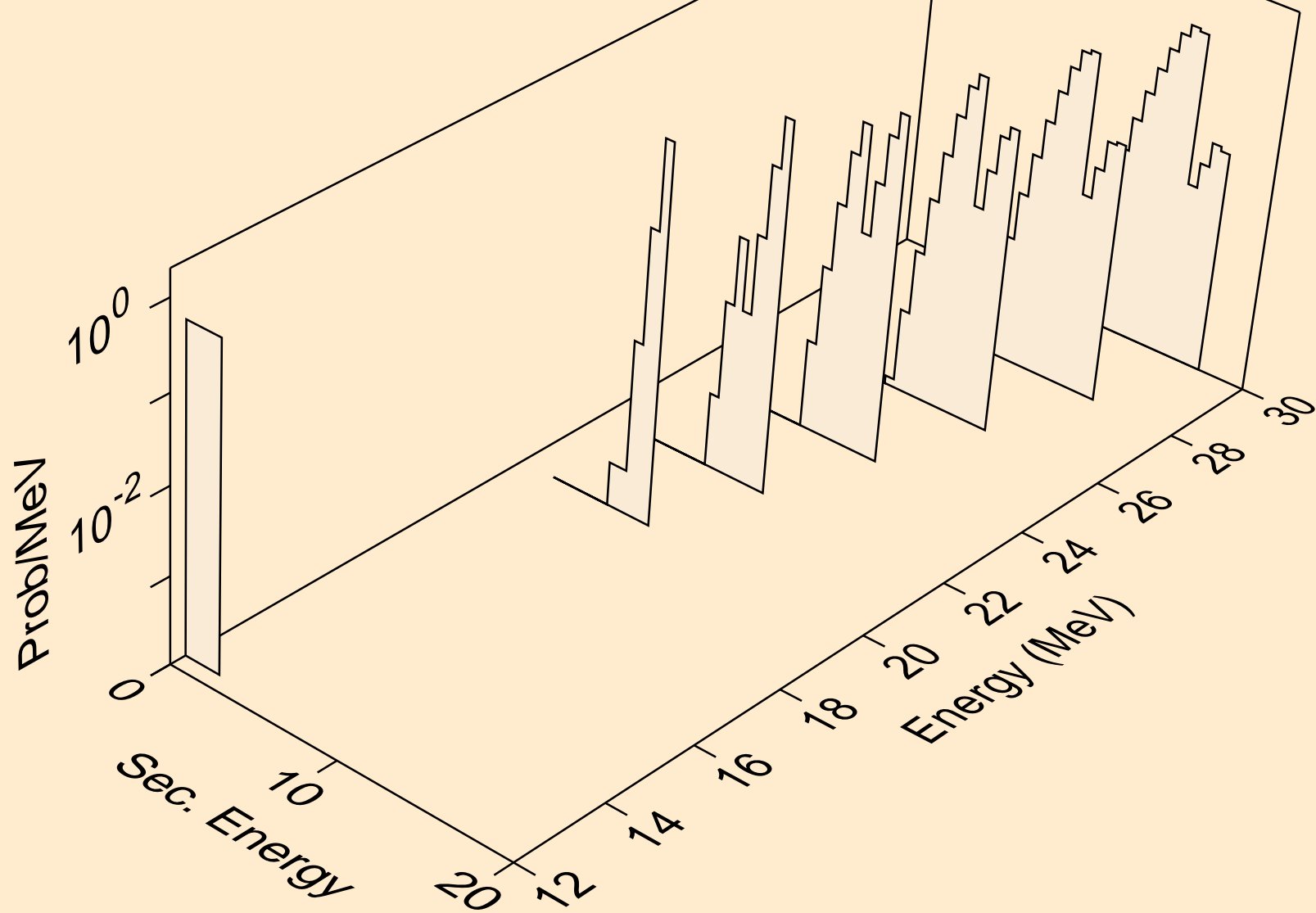

HG214 NEUTRON ACER TENDL-2023 LIBRARY; T=0.K
alphas from (n,x)

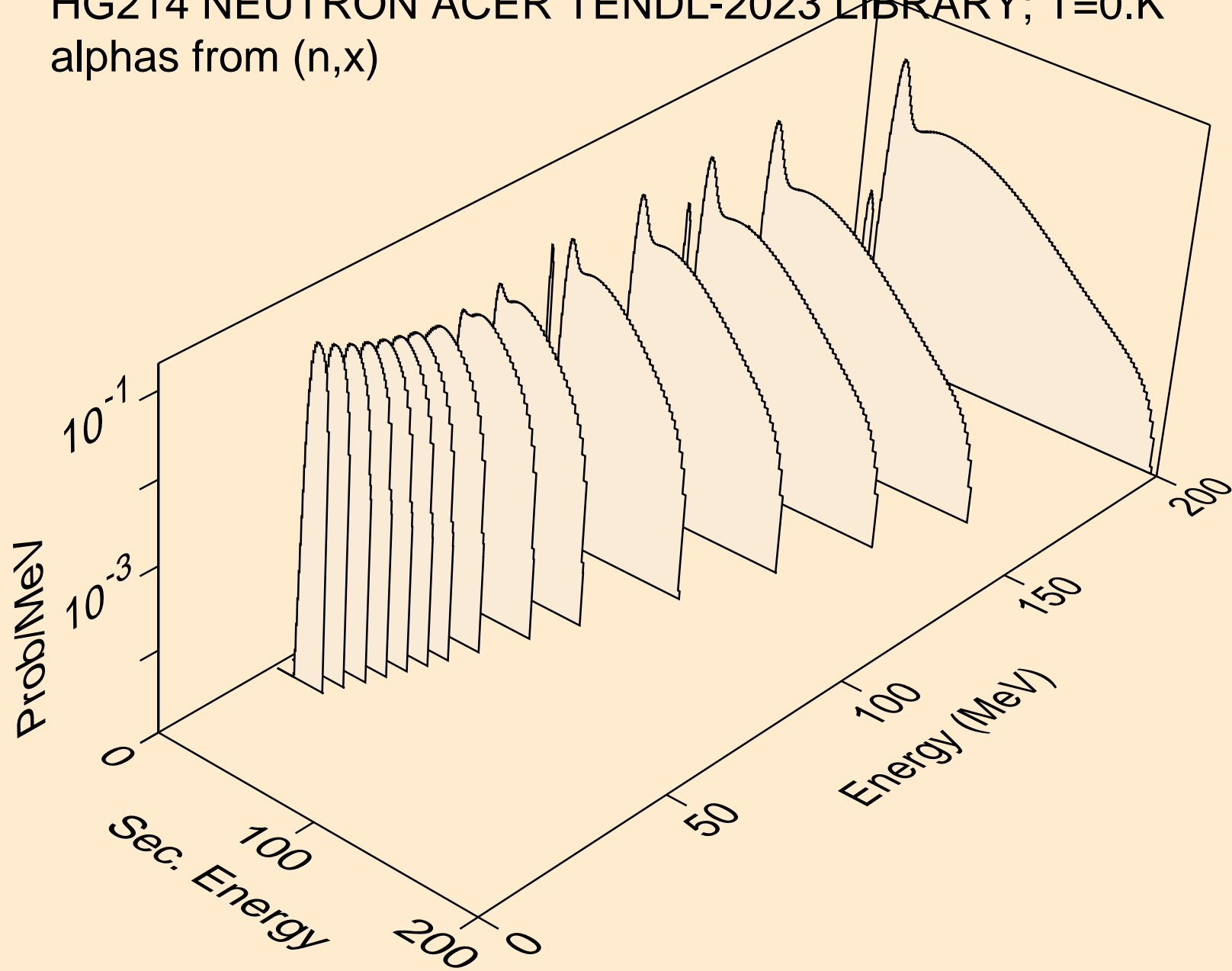

HG214 NEUTRON ACER TENDL-2023 LIBRARY; T=0.K
alphas from (n,n*)a

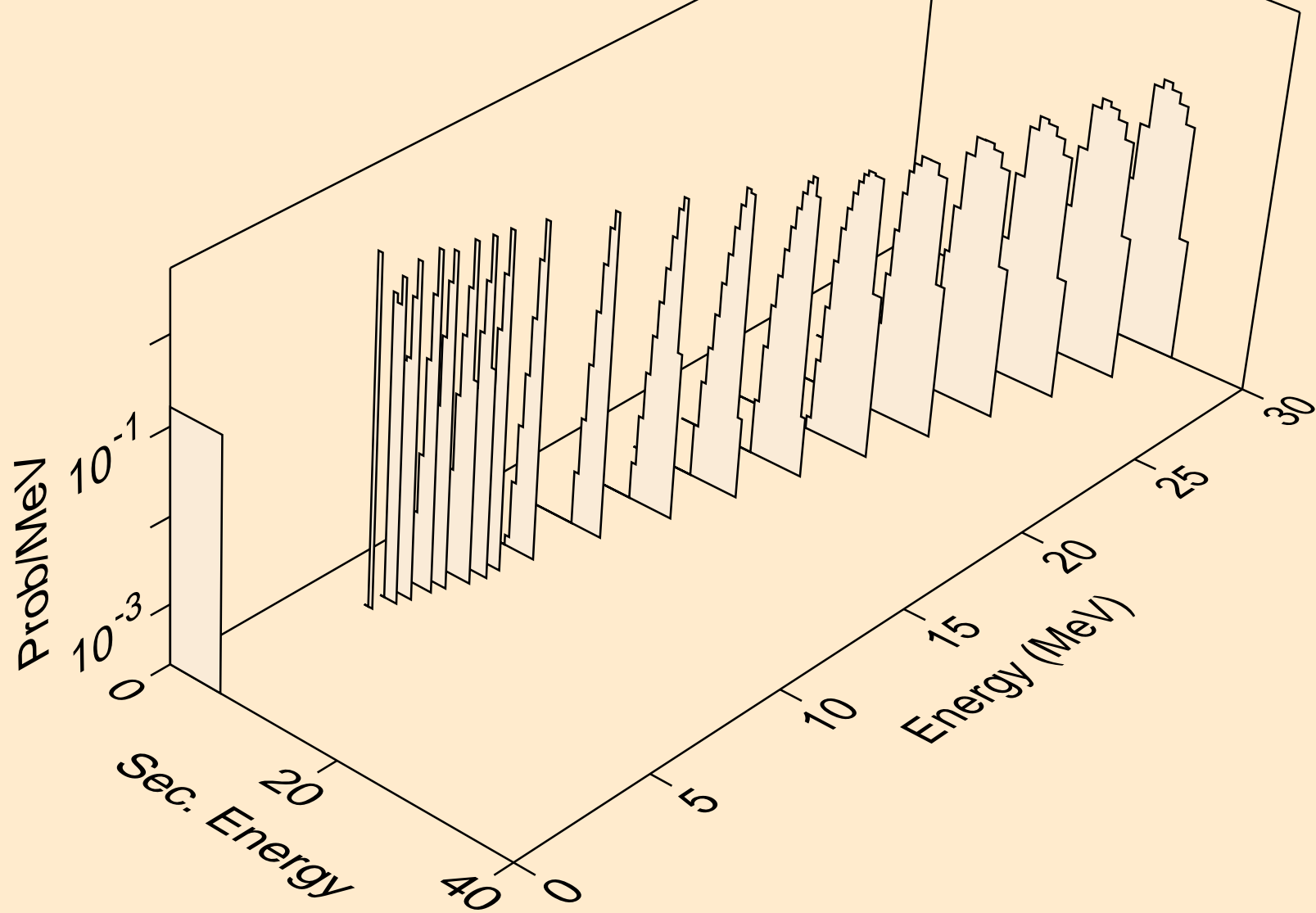

HG214 NEUTRON ACER TENDL-2023 LIBRARY; T=0.K
alphas from (n,2n)a

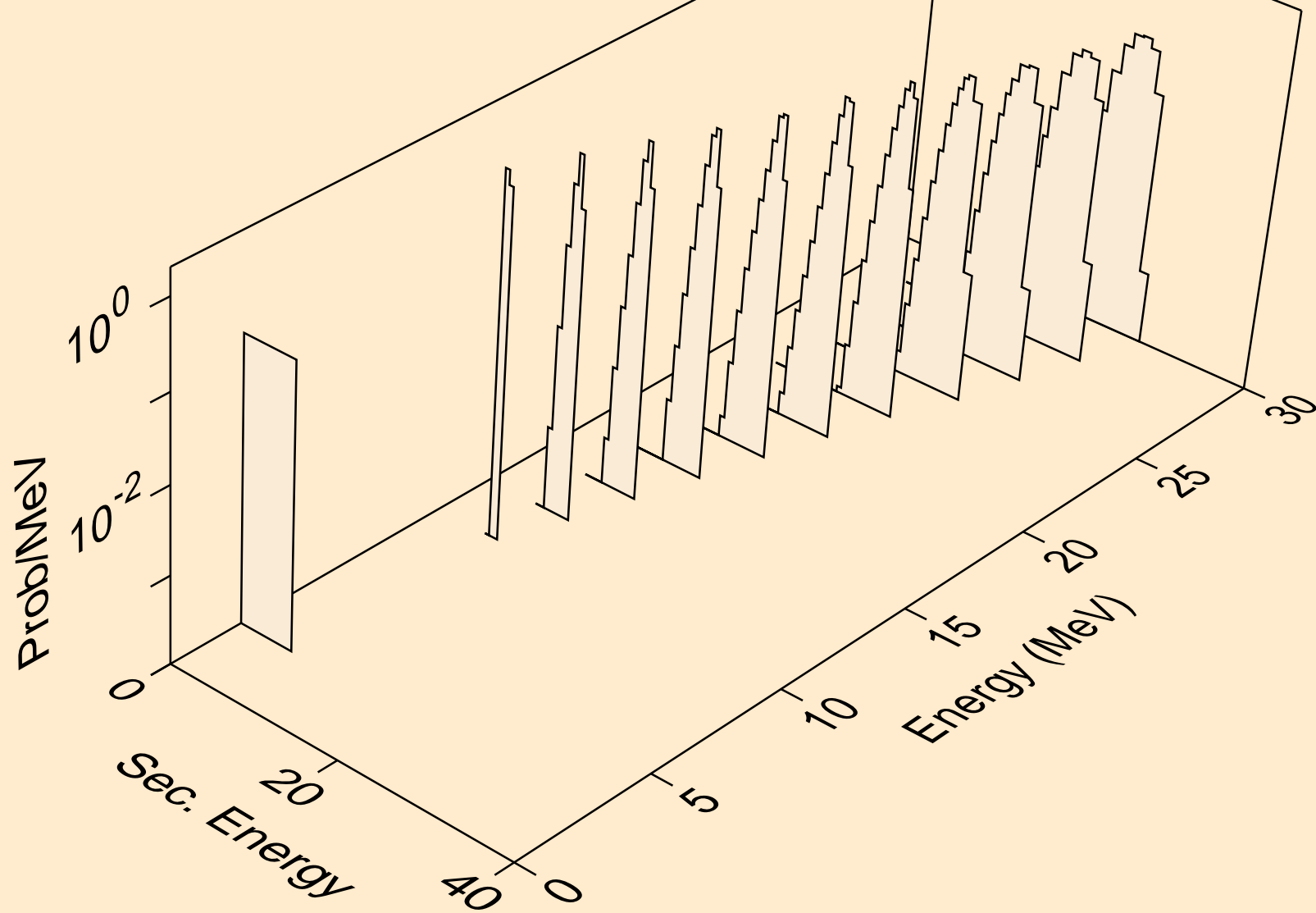

HG214 NEUTRON ACER TENDL-2023 LIBRARY; T=0.K
alphas from (n,3n)a

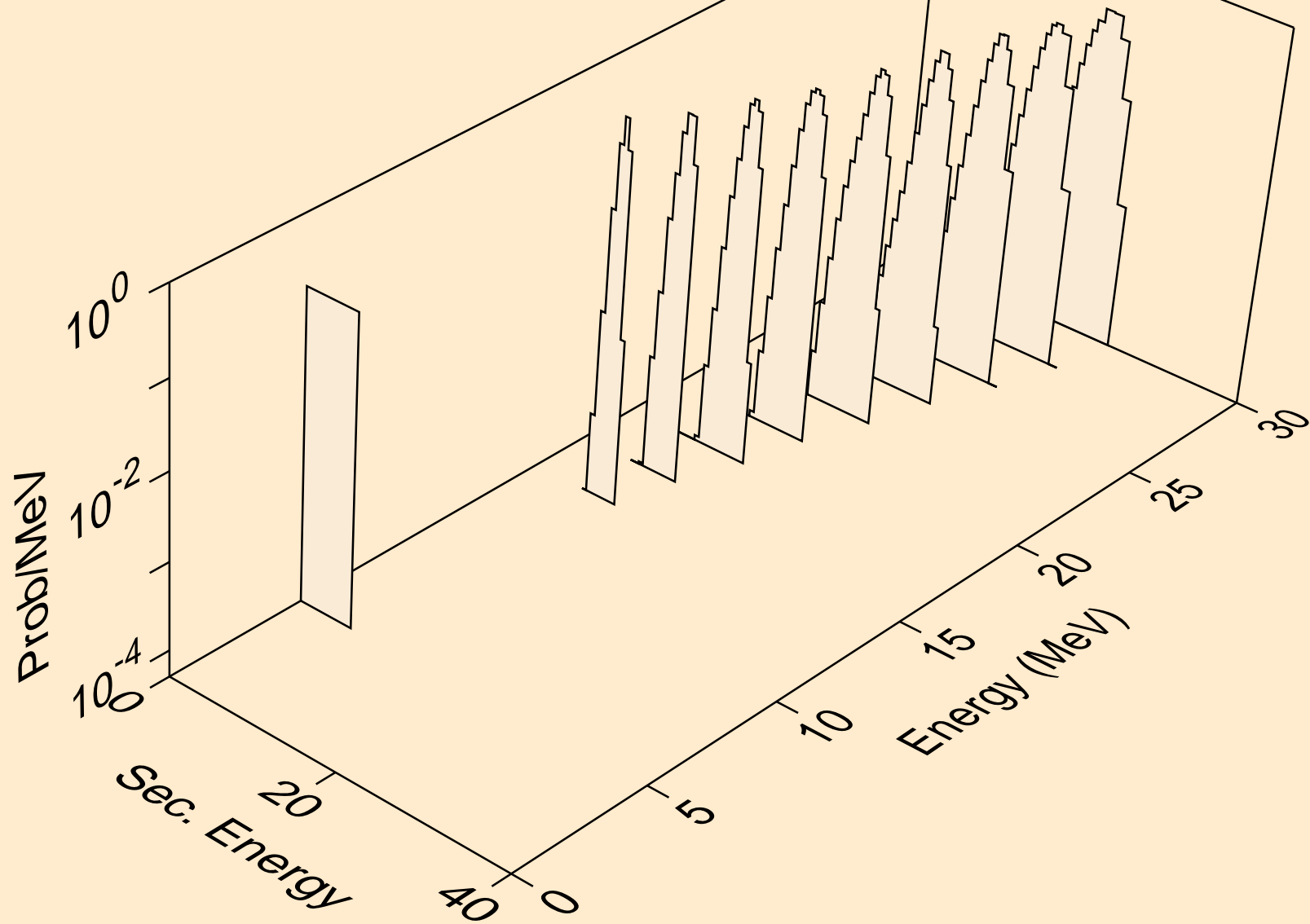

HG214 NEUTRON ACER TENDL-2023 LIBRARY; T=0.K
alphas from (n,a)

