

HO158 NEUTRON ACER TENDL-2023 LIBRARY; T=0.K

Principal cross sections

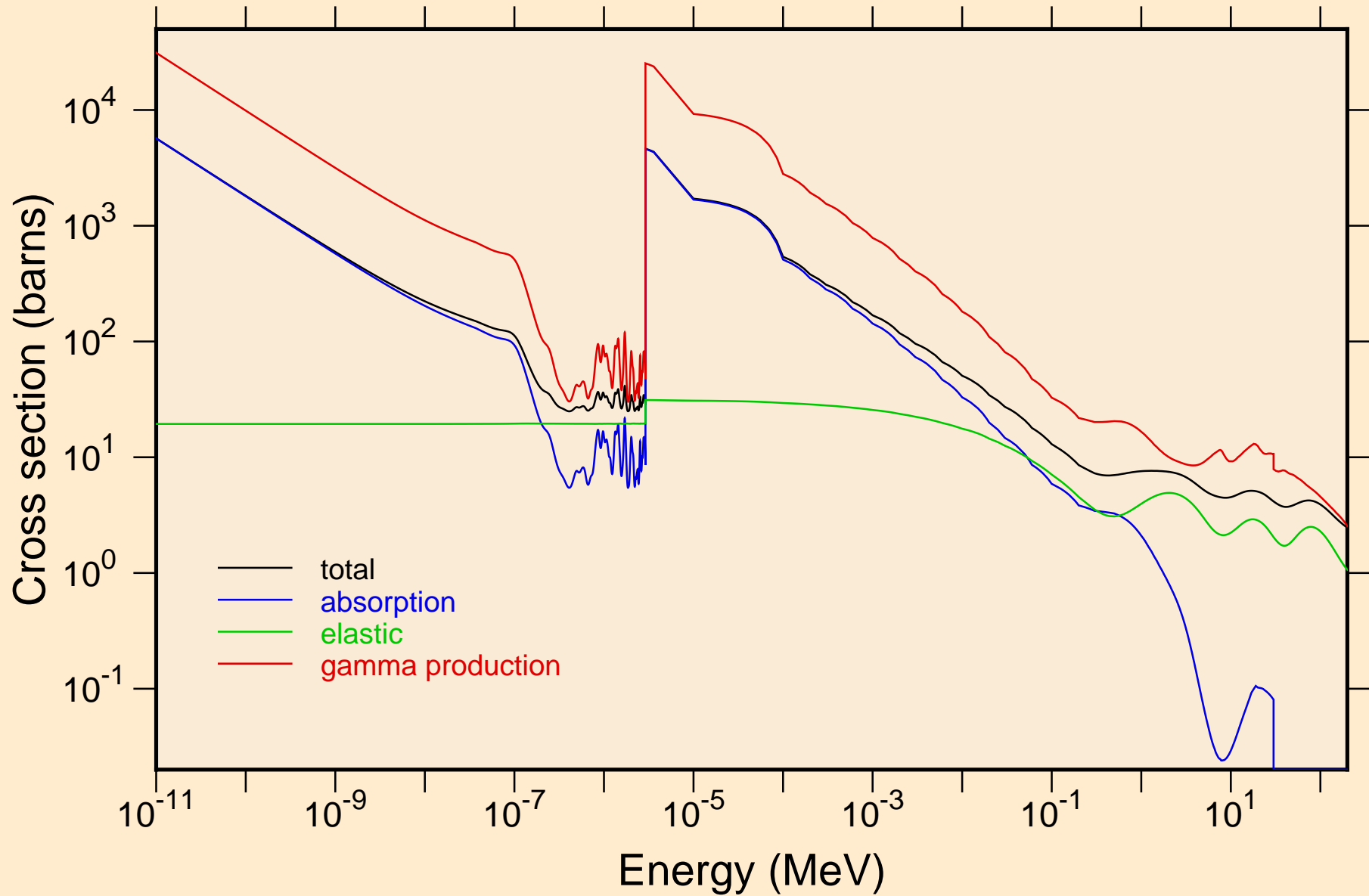

HO158 NEUTRON ACER TENDL-2023 LIBRARY; T=0.K
Heating

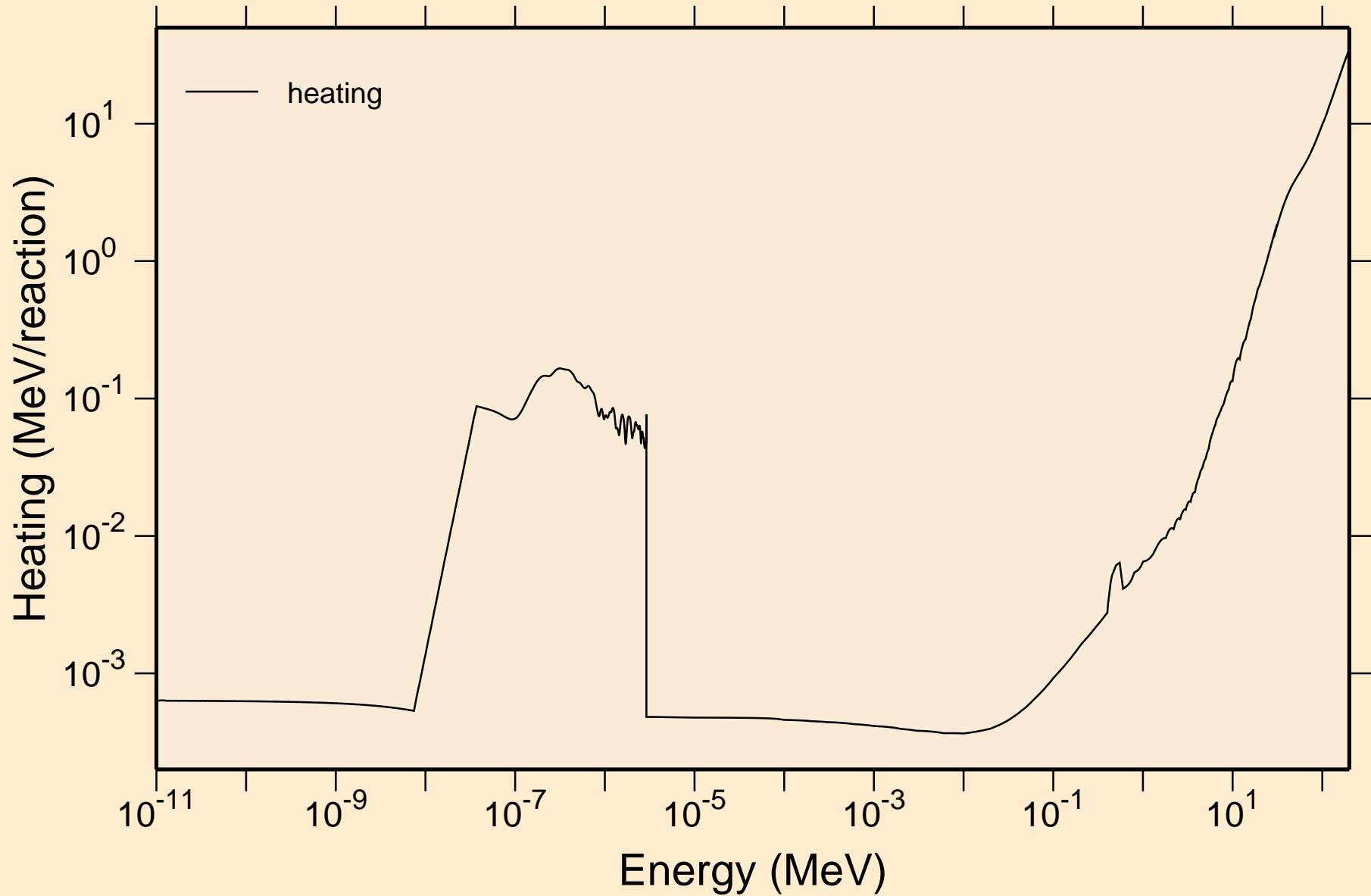

HO158 NEUTRON ACER TENDL-2023 LIBRARY; T=0.K

Damage

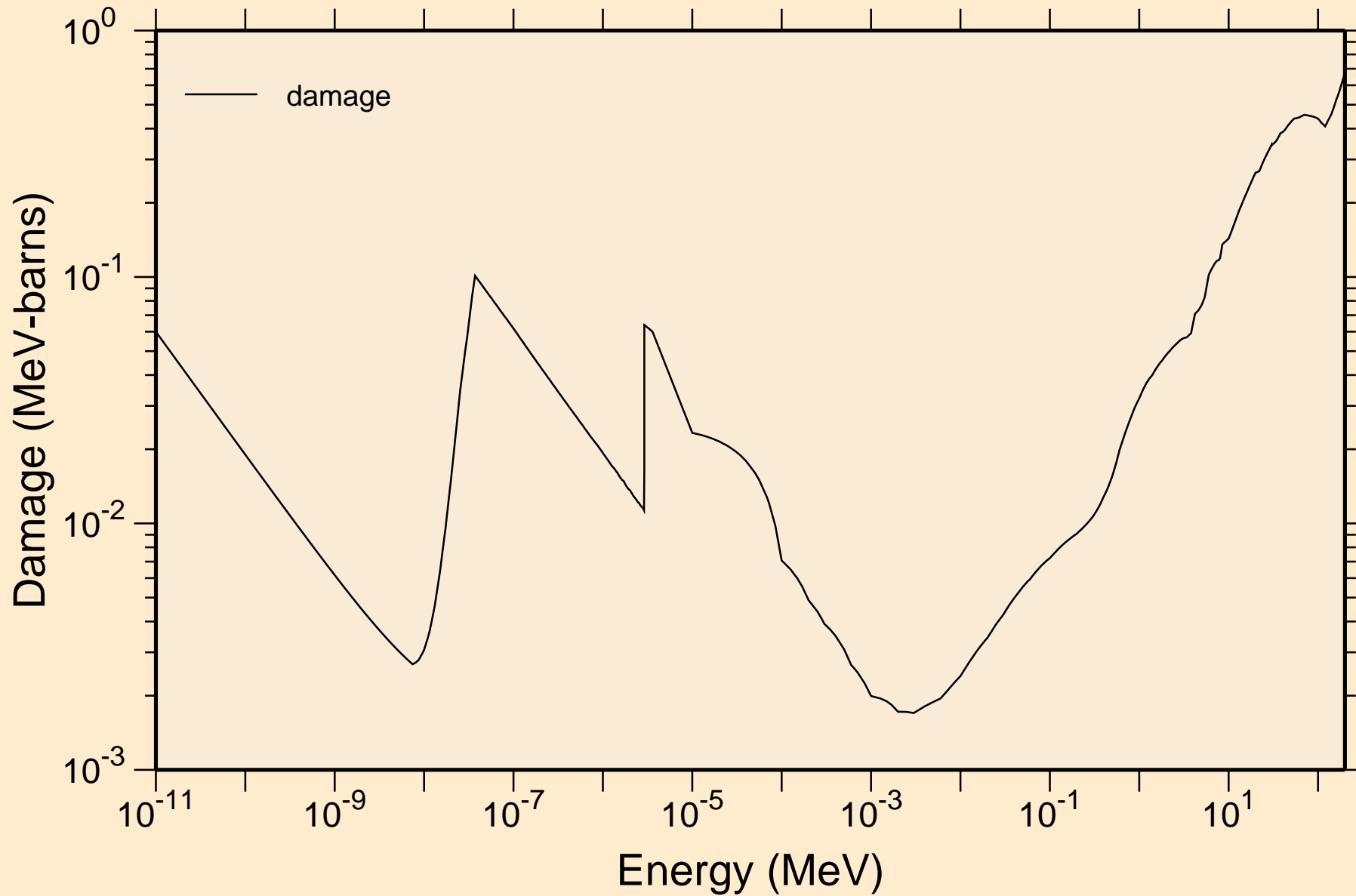

HO158 NEUTRON ACER TENDL-2023 LIBRARY; T=0.K

Non-threshold reactions

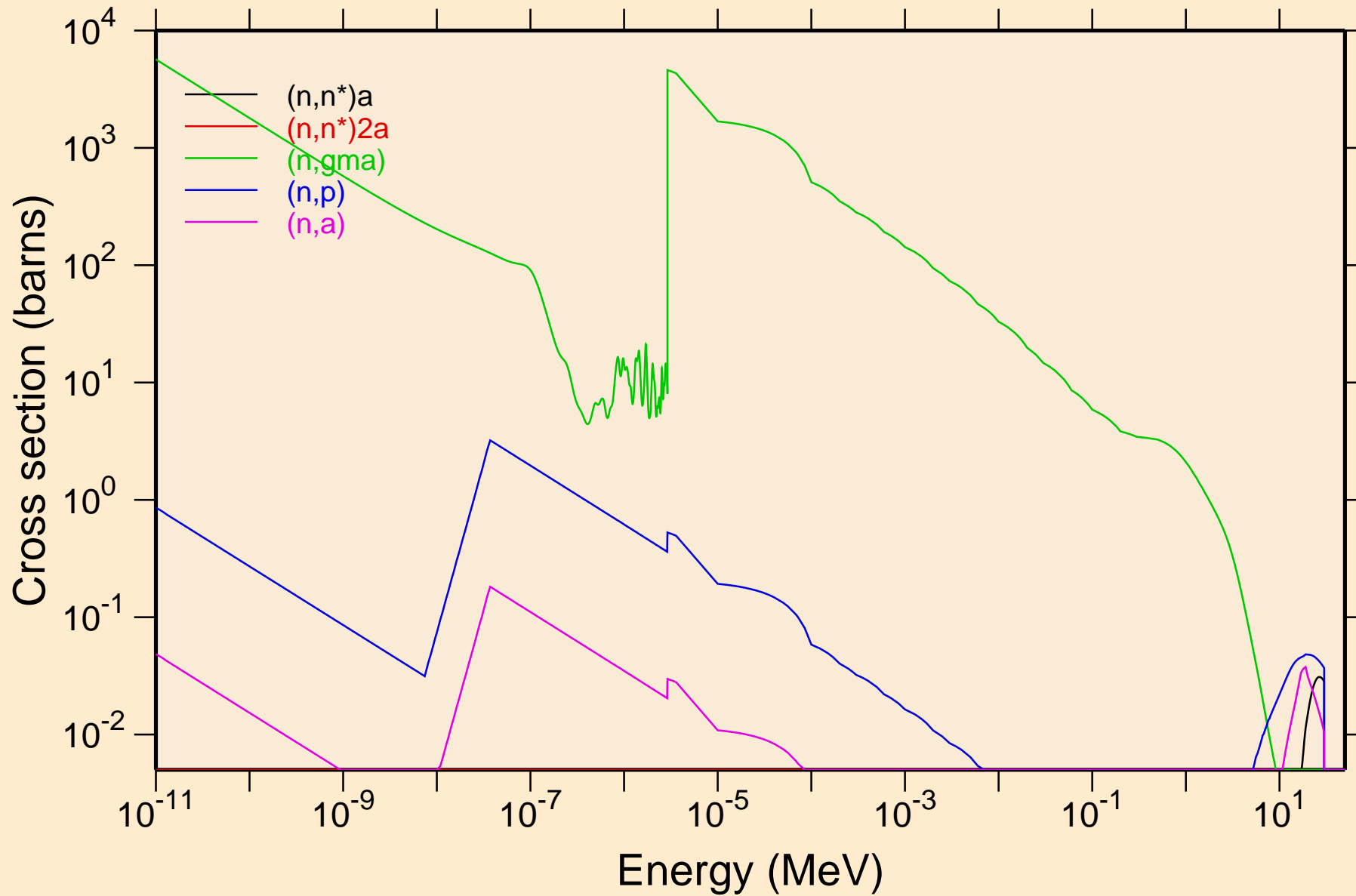

HO158 NEUTRON ACER TENDL-2023 LIBRARY; T=0.K

Non-threshold reactions

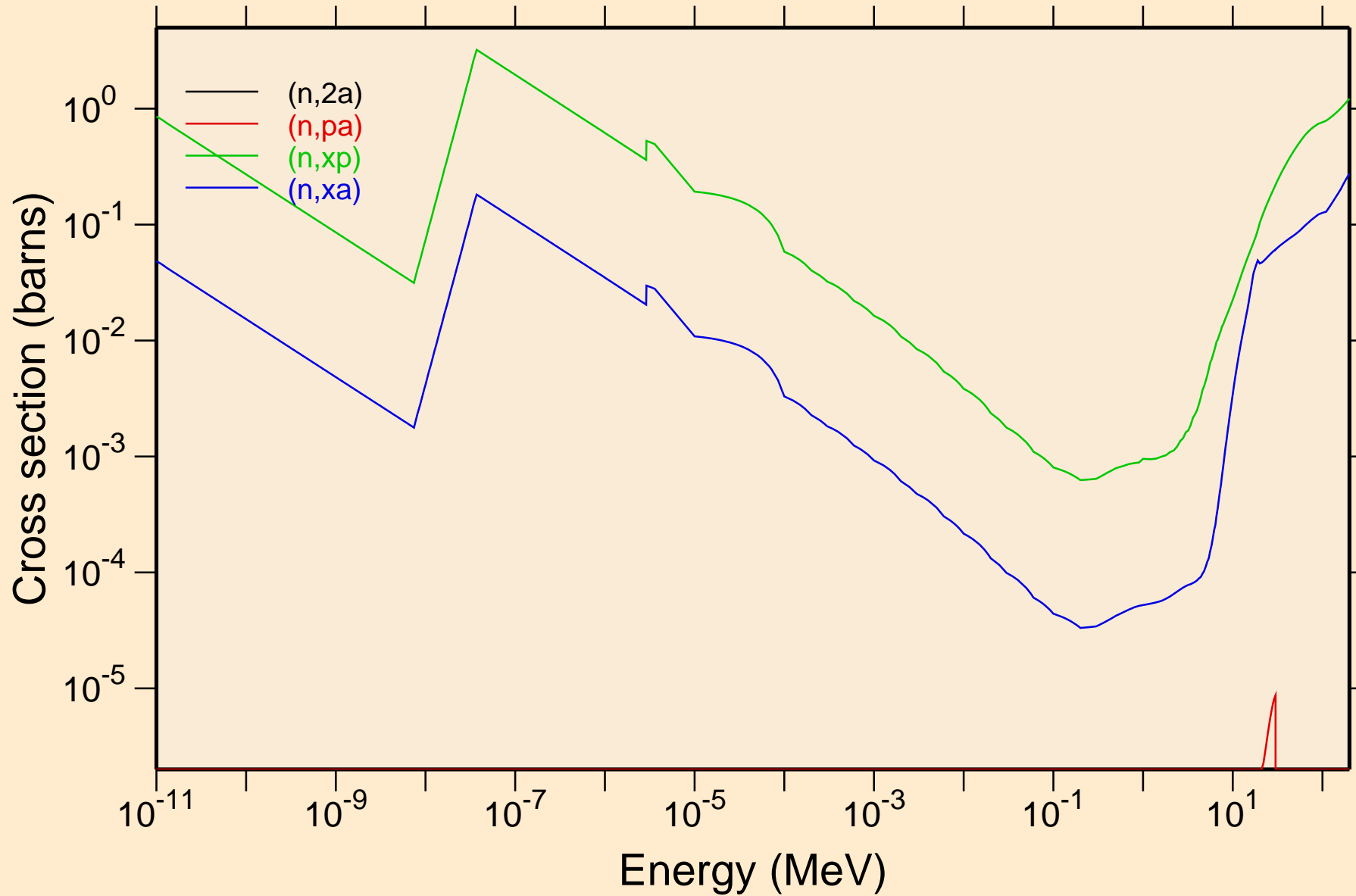

HO158 NEUTRON ACER TENDL-2023 LIBRARY; T=0.K

Principal cross sections

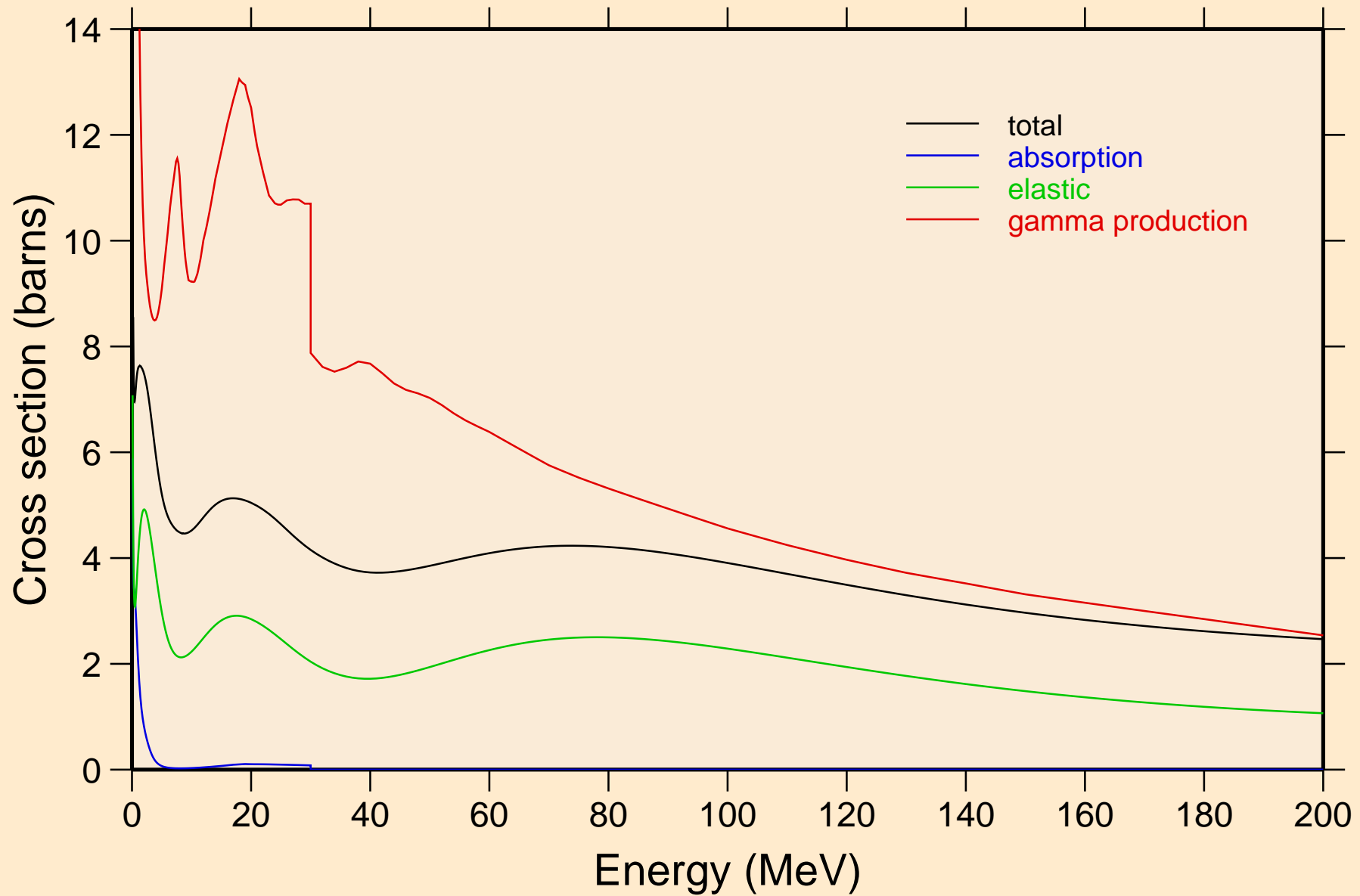

HO158 NEUTRON ACER TENDL-2023 LIBRARY; T=0.K

Heating

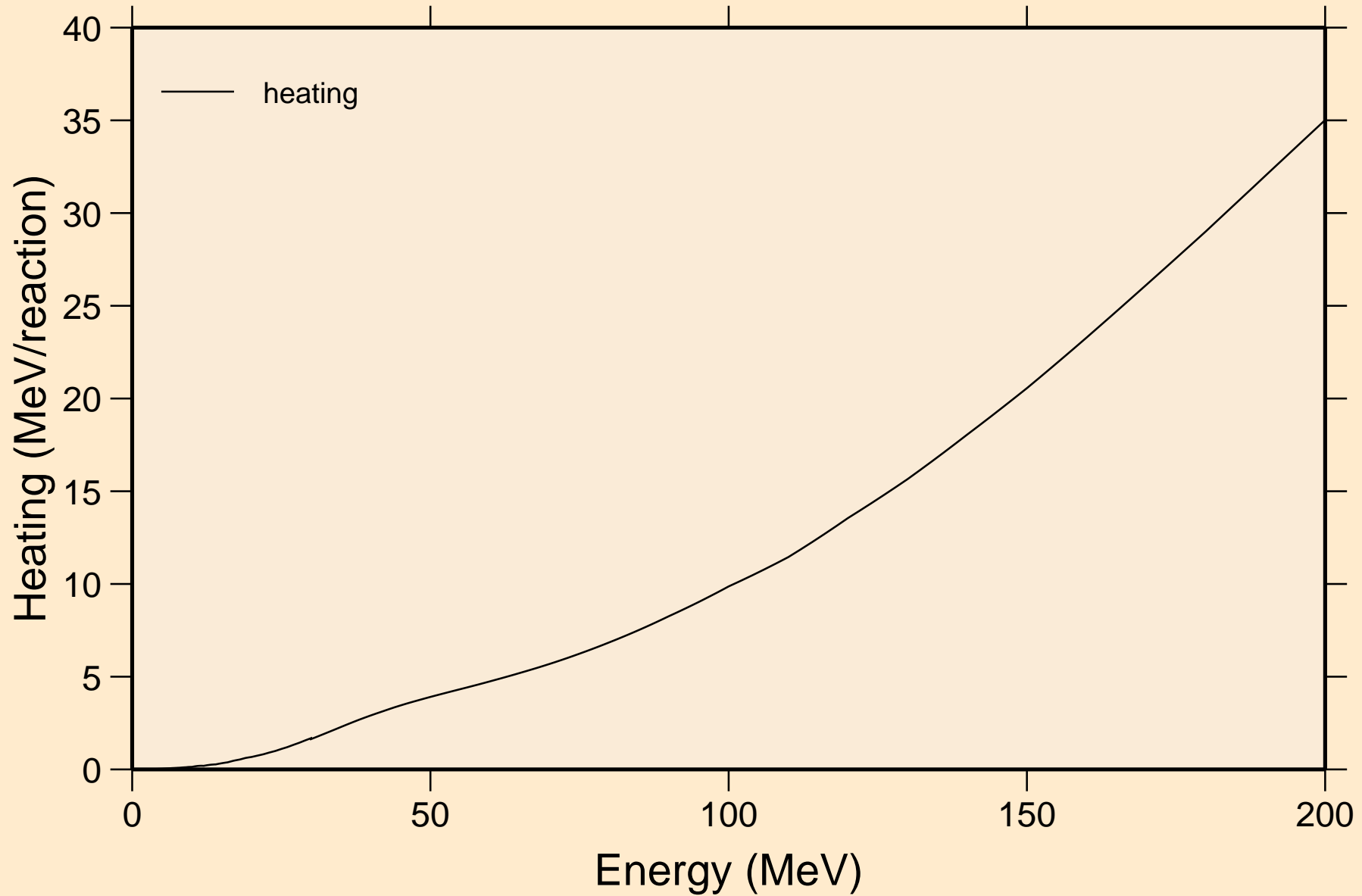

HO158 NEUTRON ACER TENDL-2023 LIBRARY; T=0.K

Damage

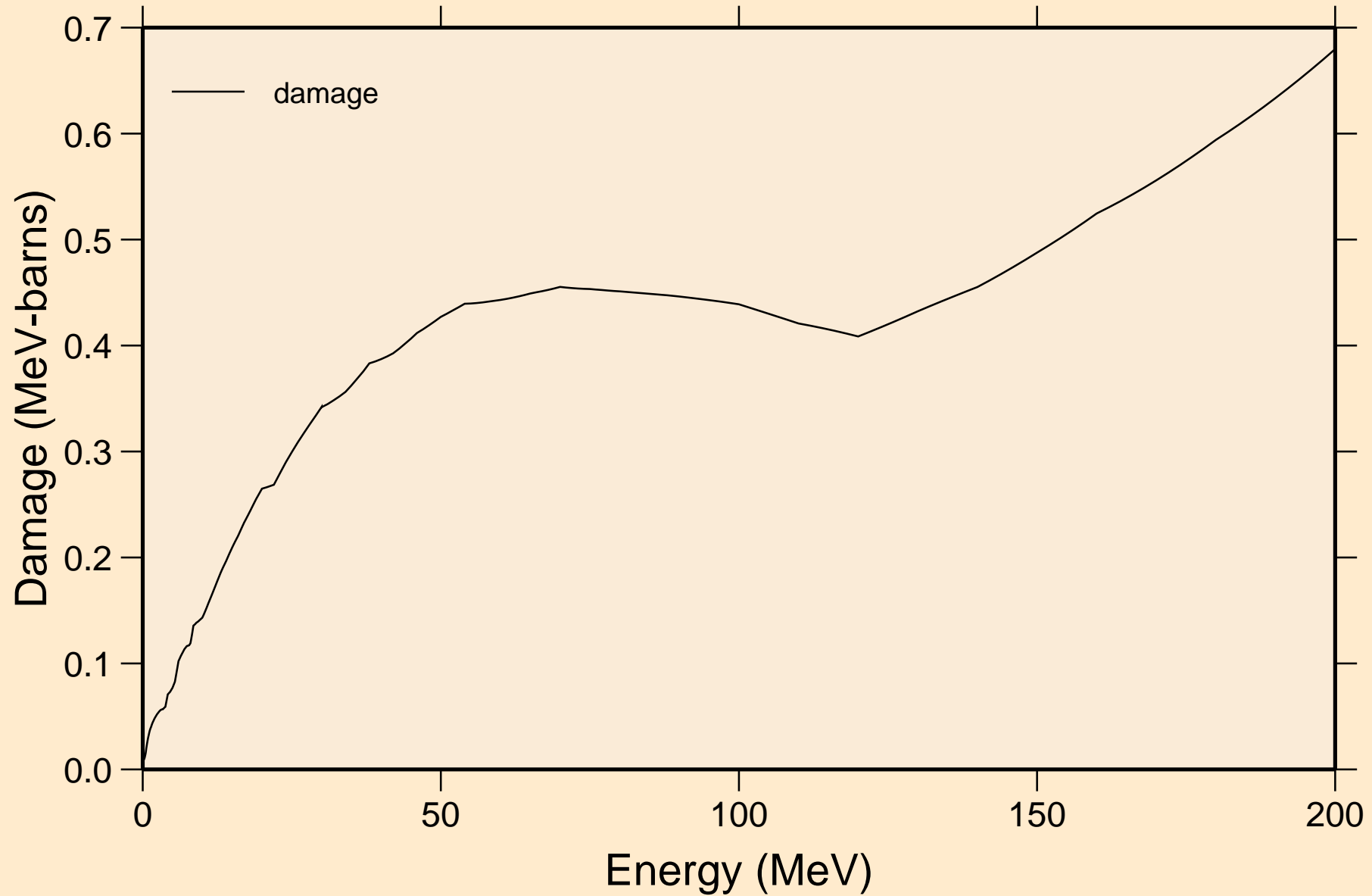

HO158 NEUTRON ACER TENDL-2023 LIBRARY; T=0.K

Non-threshold reactions

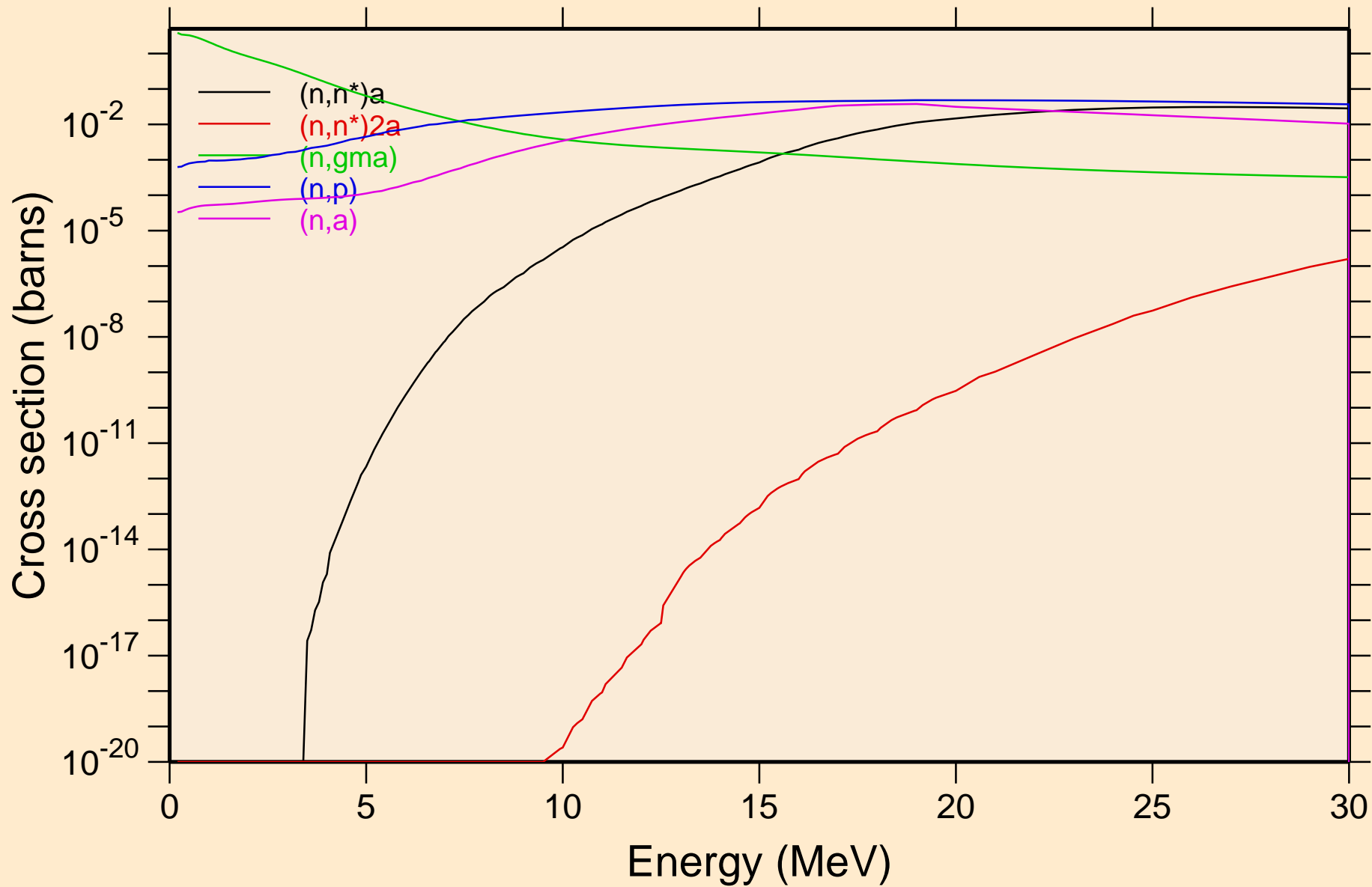

HO158 NEUTRON ACER TENDL-2023 LIBRARY; T=0.K

Non-threshold reactions

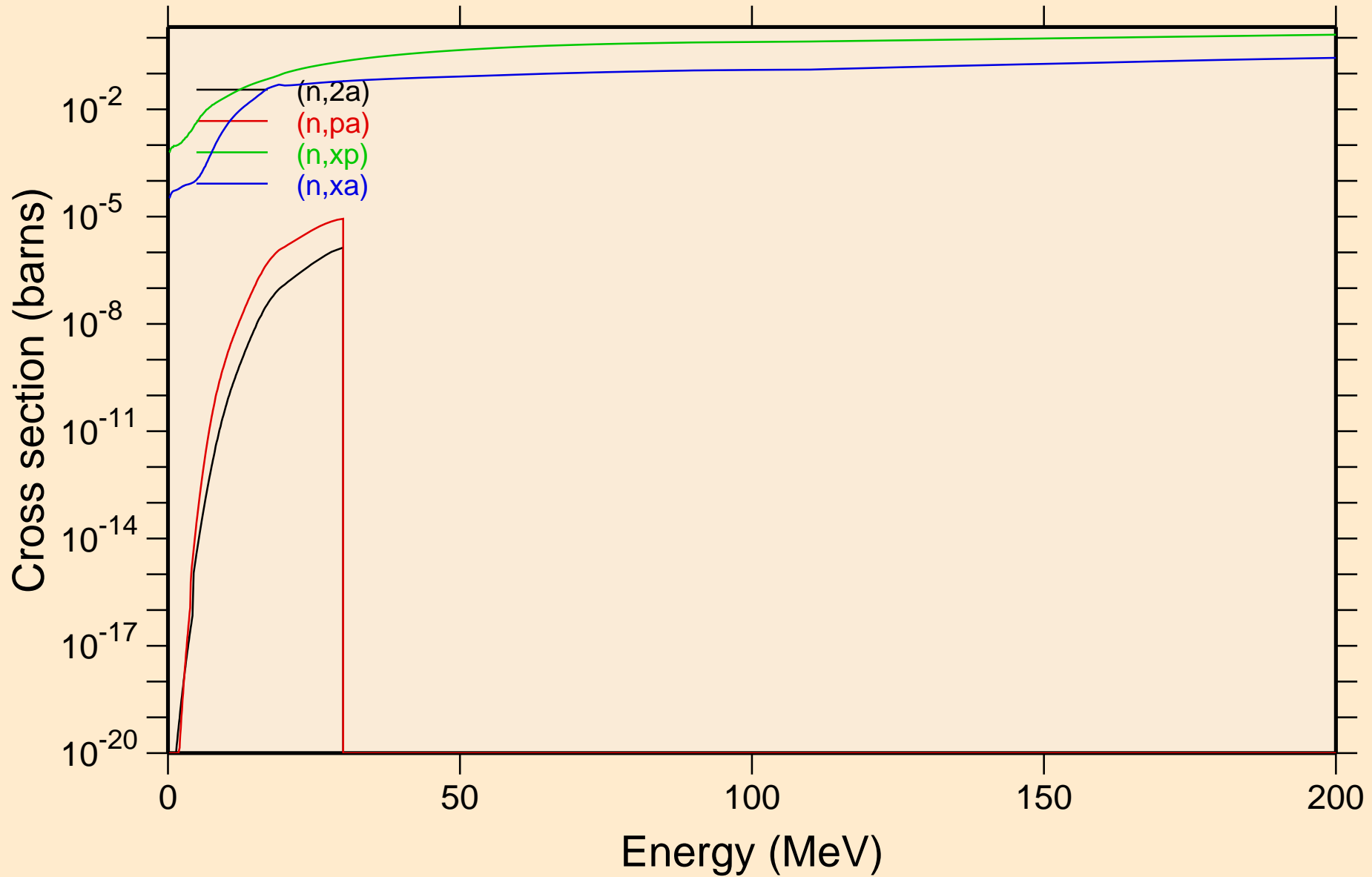

HO158 NEUTRON ACER TENDL-2023 LIBRARY; T=0.K
Inelastic levels

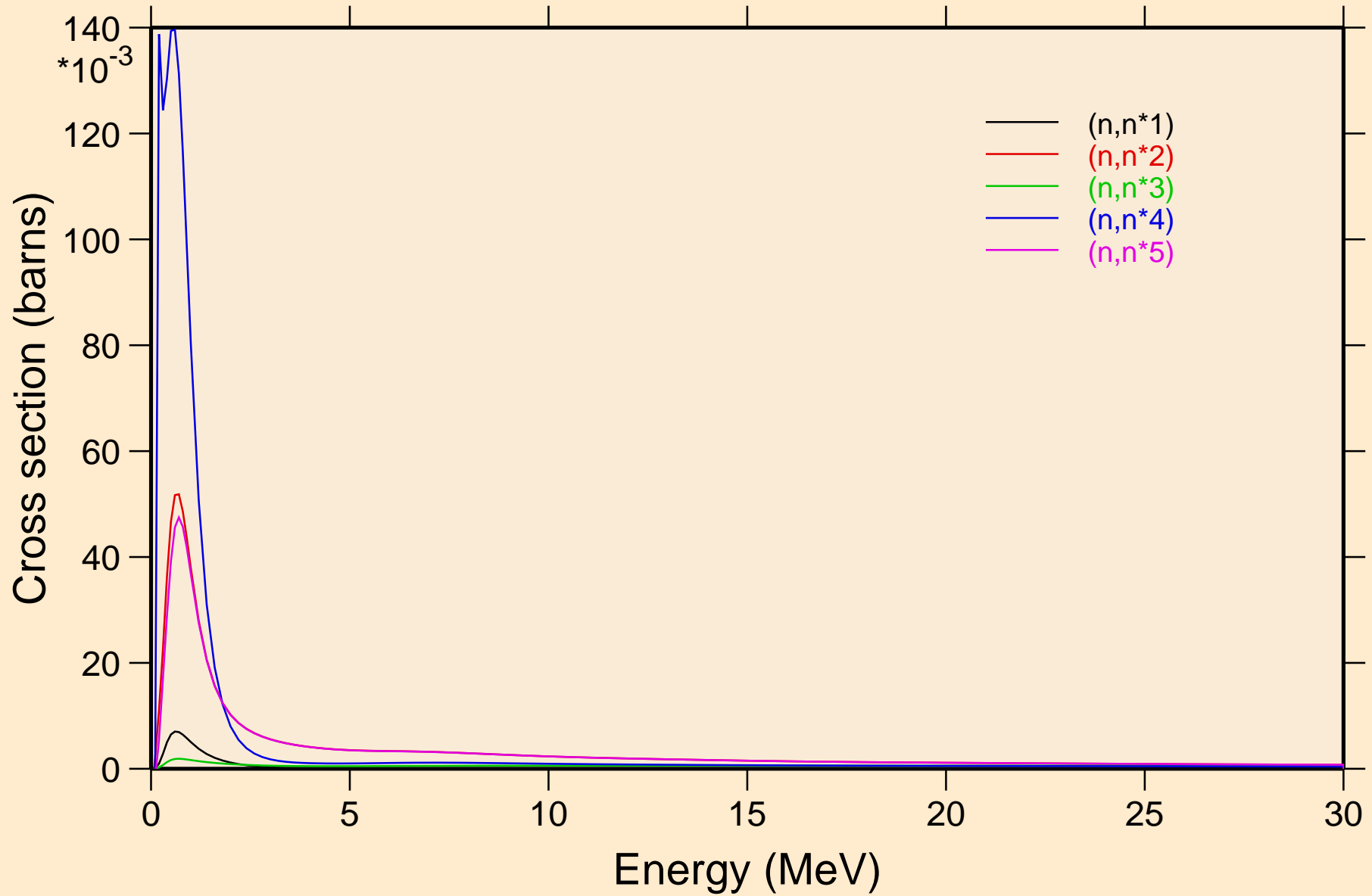

HO158 NEUTRON ACER TENDL-2023 LIBRARY; T=0.K
Inelastic levels

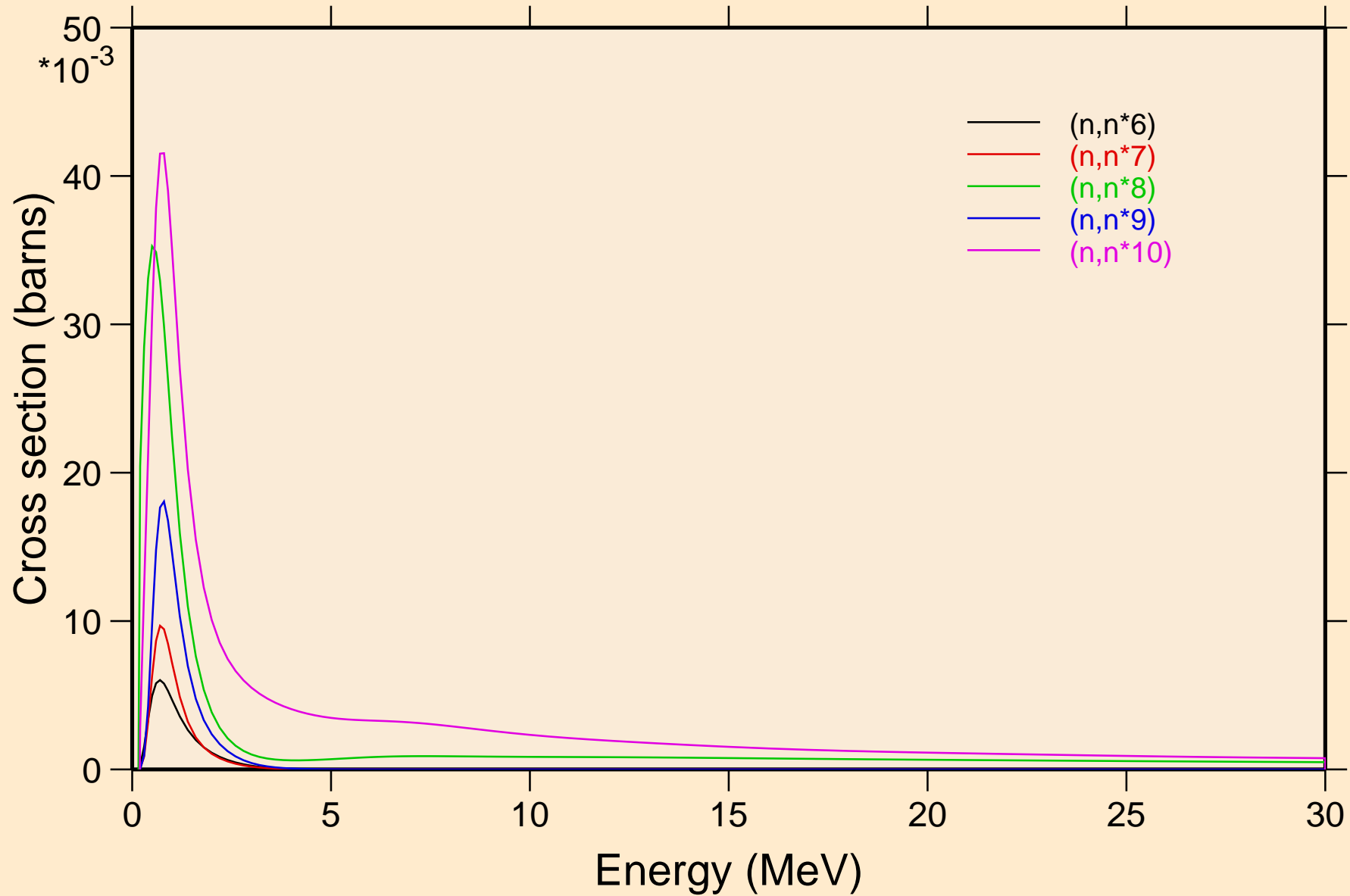

HO158 NEUTRON ACER TENDL-2023 LIBRARY; T=0.K

Inelastic levels

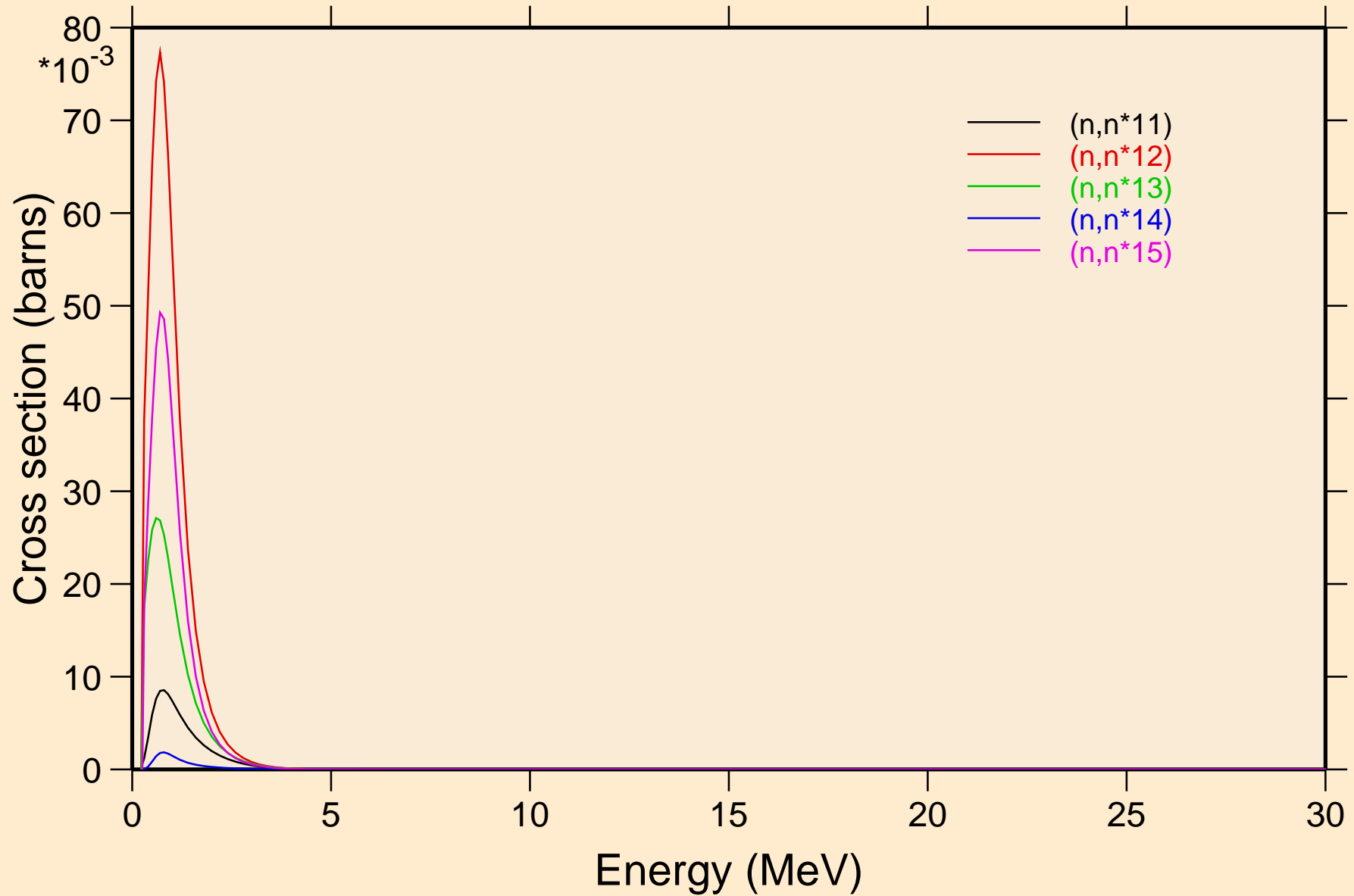

HO158 NEUTRON ACER TENDL-2023 LIBRARY; T=0.K
Inelastic levels

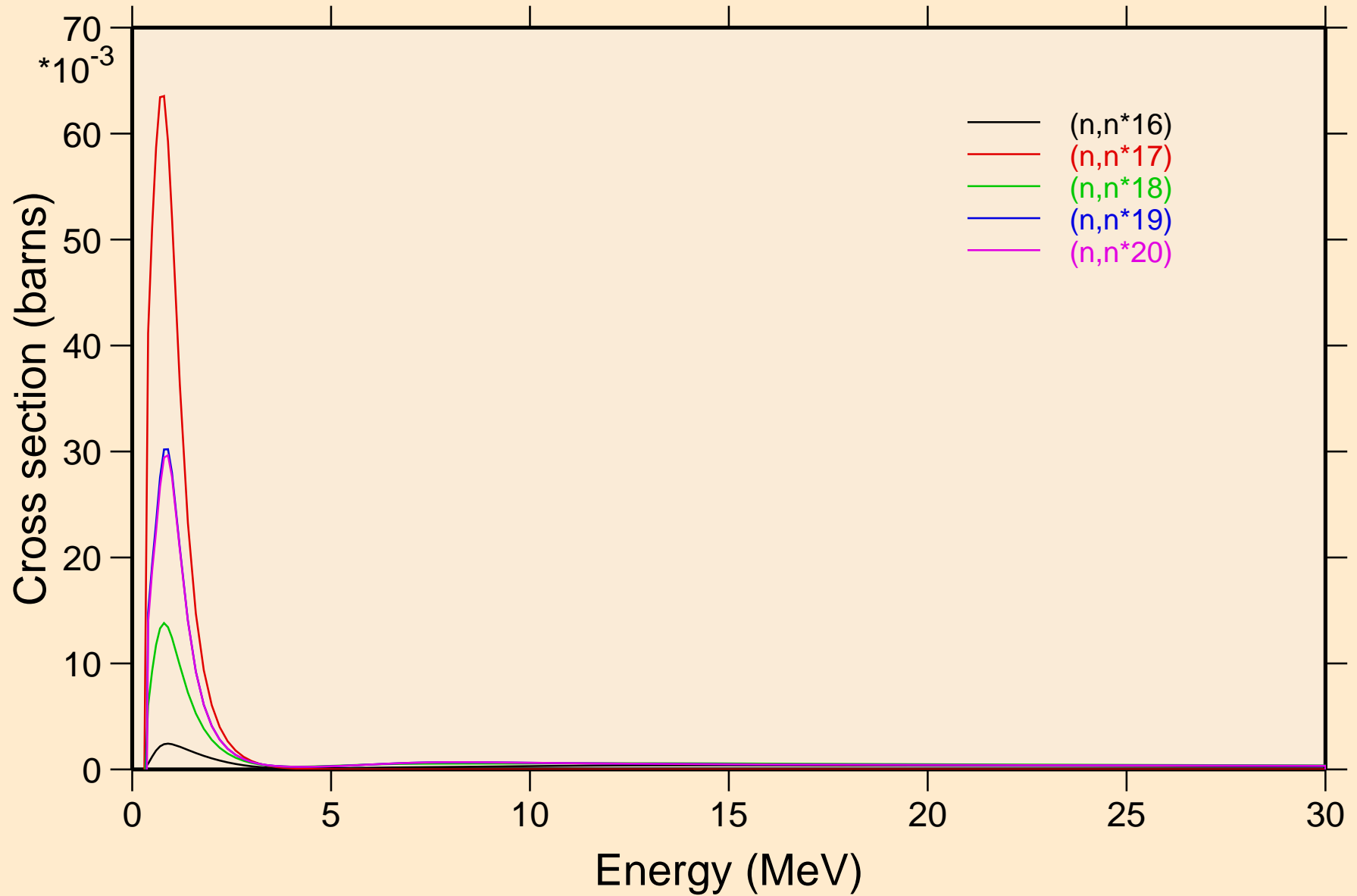

HO158 NEUTRON ACER TENDL-2023 LIBRARY; T=0.K
Inelastic levels

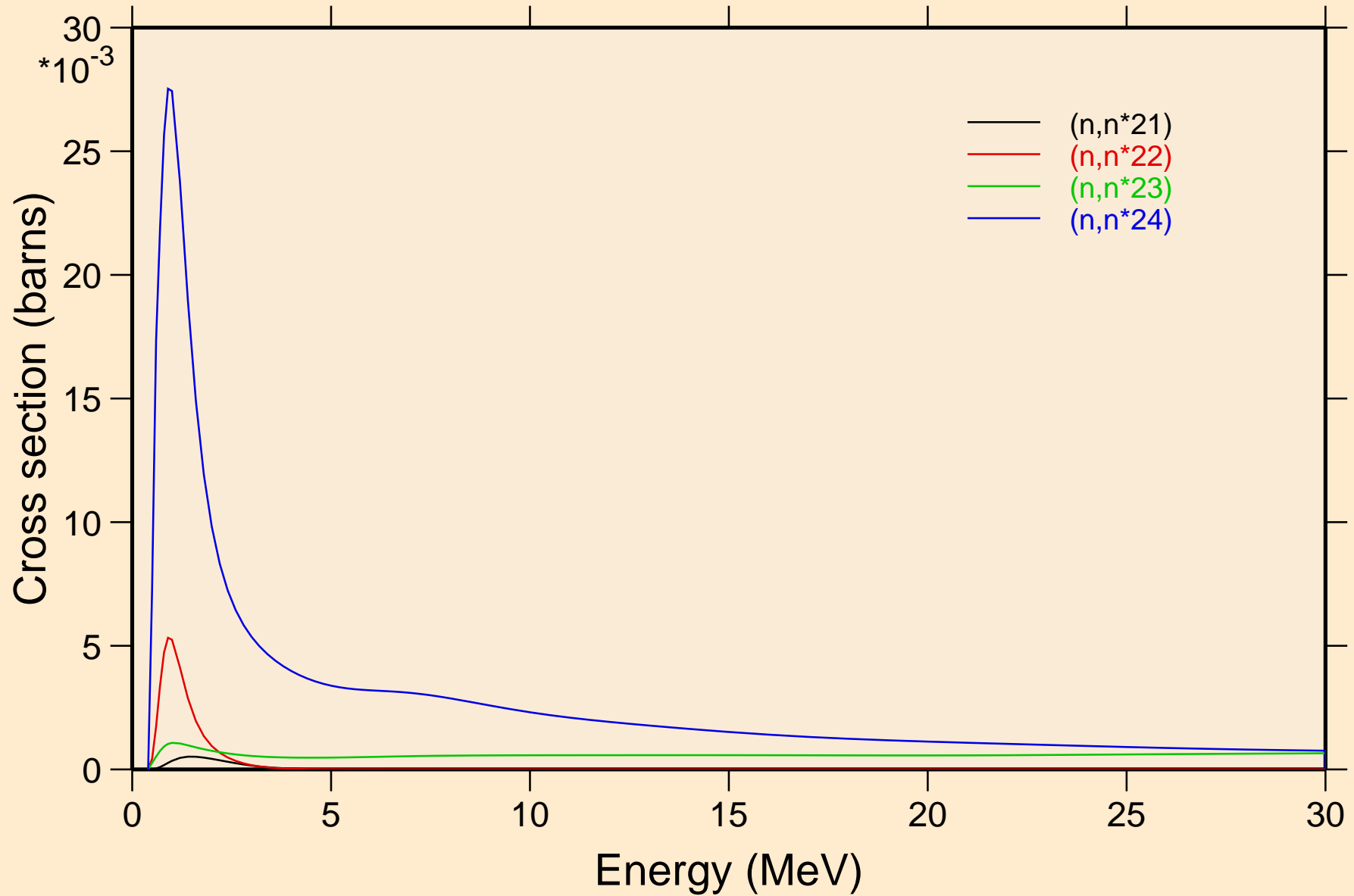

HO158 NEUTRON ACER TENDL-2023 LIBRARY; T=0.K

Threshold reactions

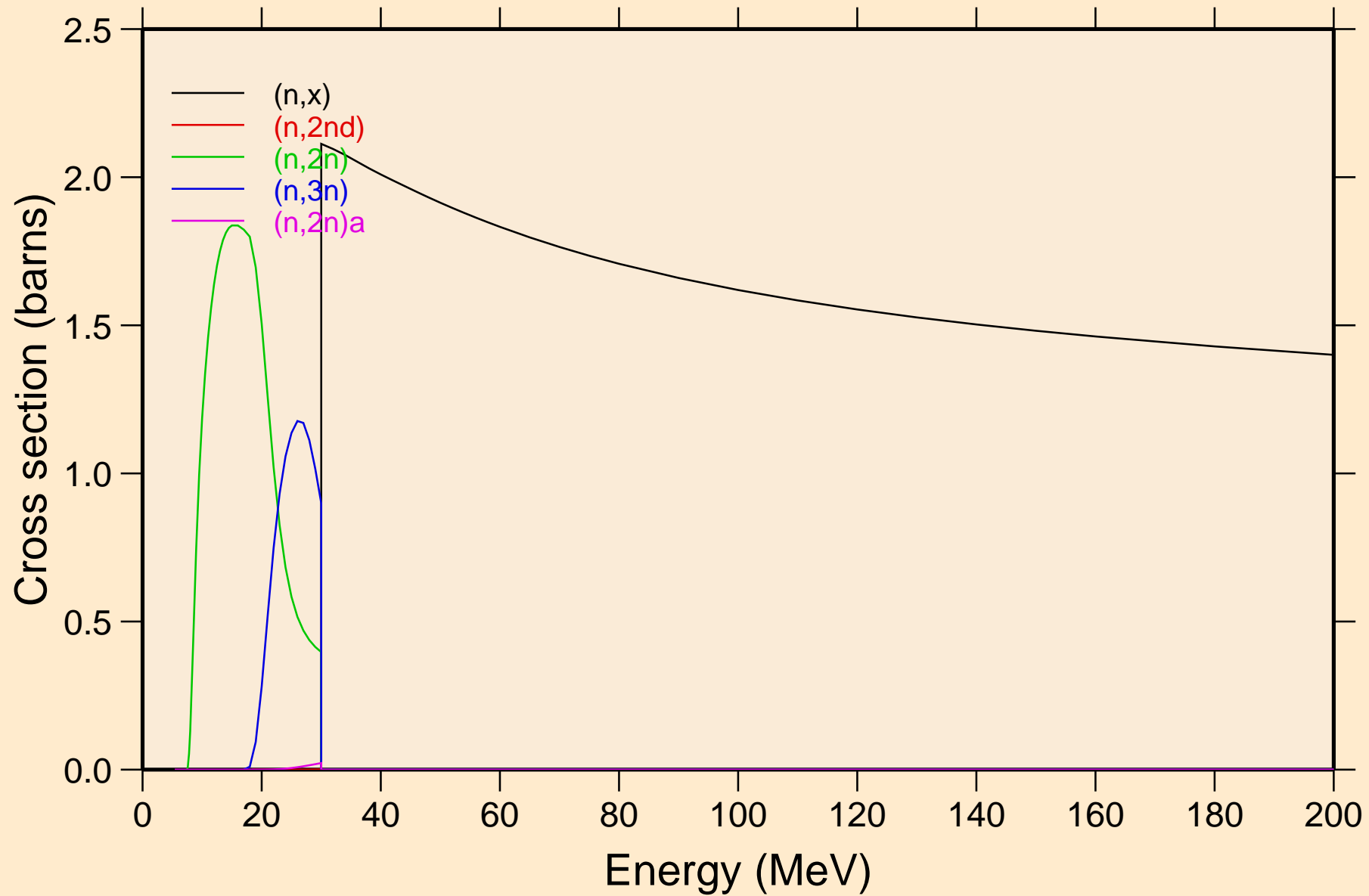

HO158 NEUTRON ACER TENDL-2023 LIBRARY; T=0.K

Threshold reactions

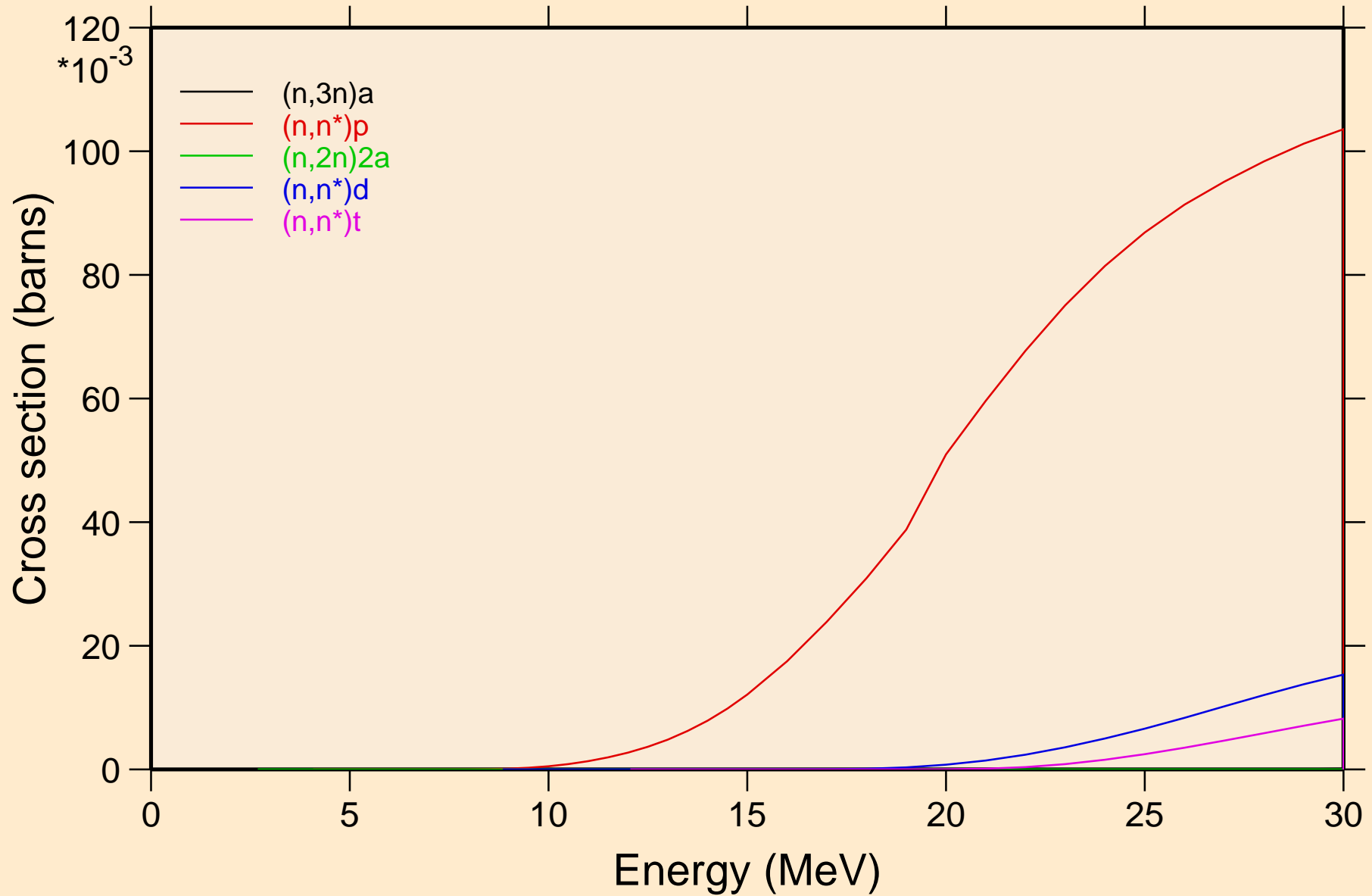

HO158 NEUTRON ACER TENDL-2023 LIBRARY; T=0.K

Threshold reactions

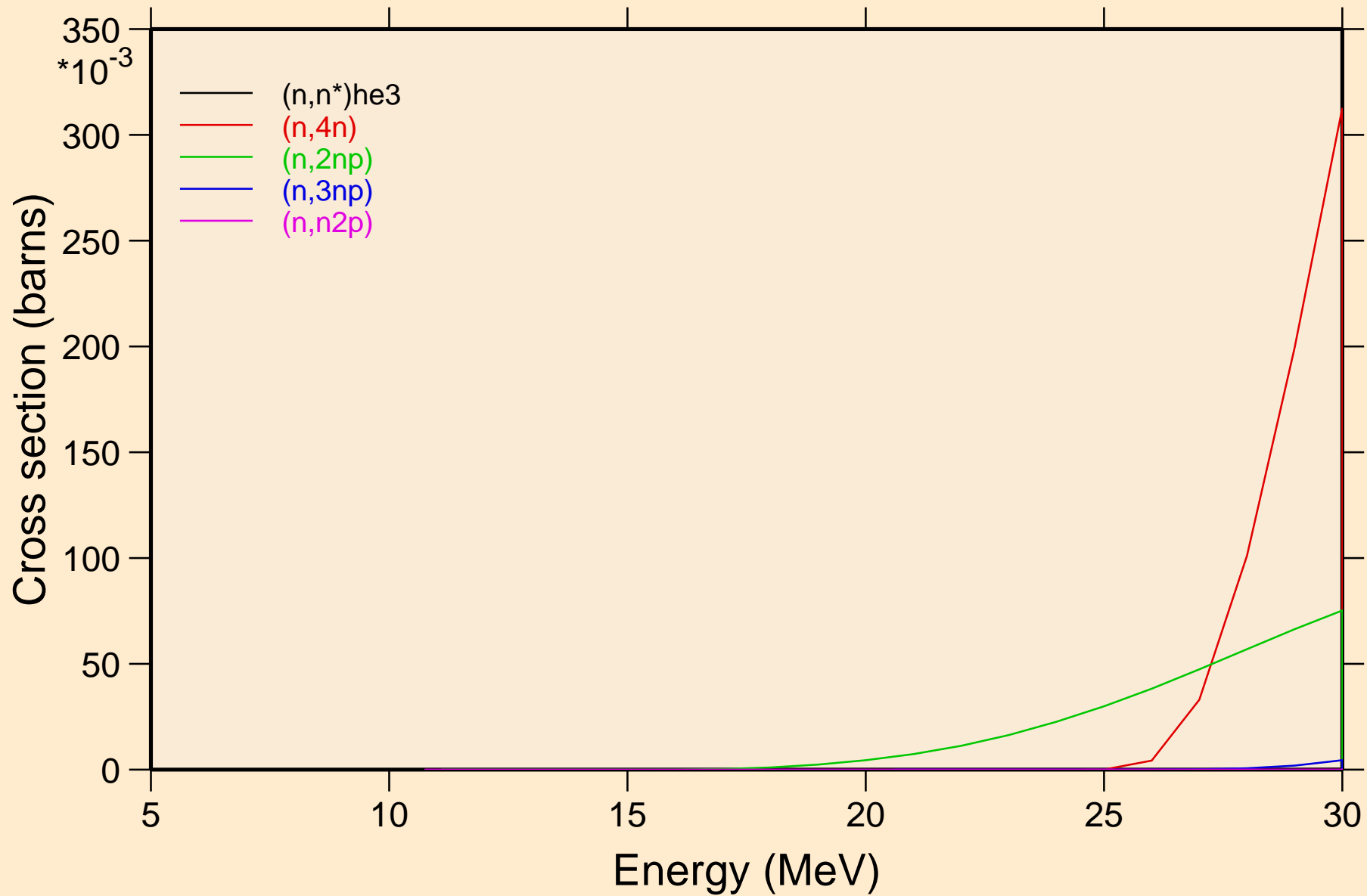

HO158 NEUTRON ACER TENDL-2023 LIBRARY; T=0.K

Threshold reactions

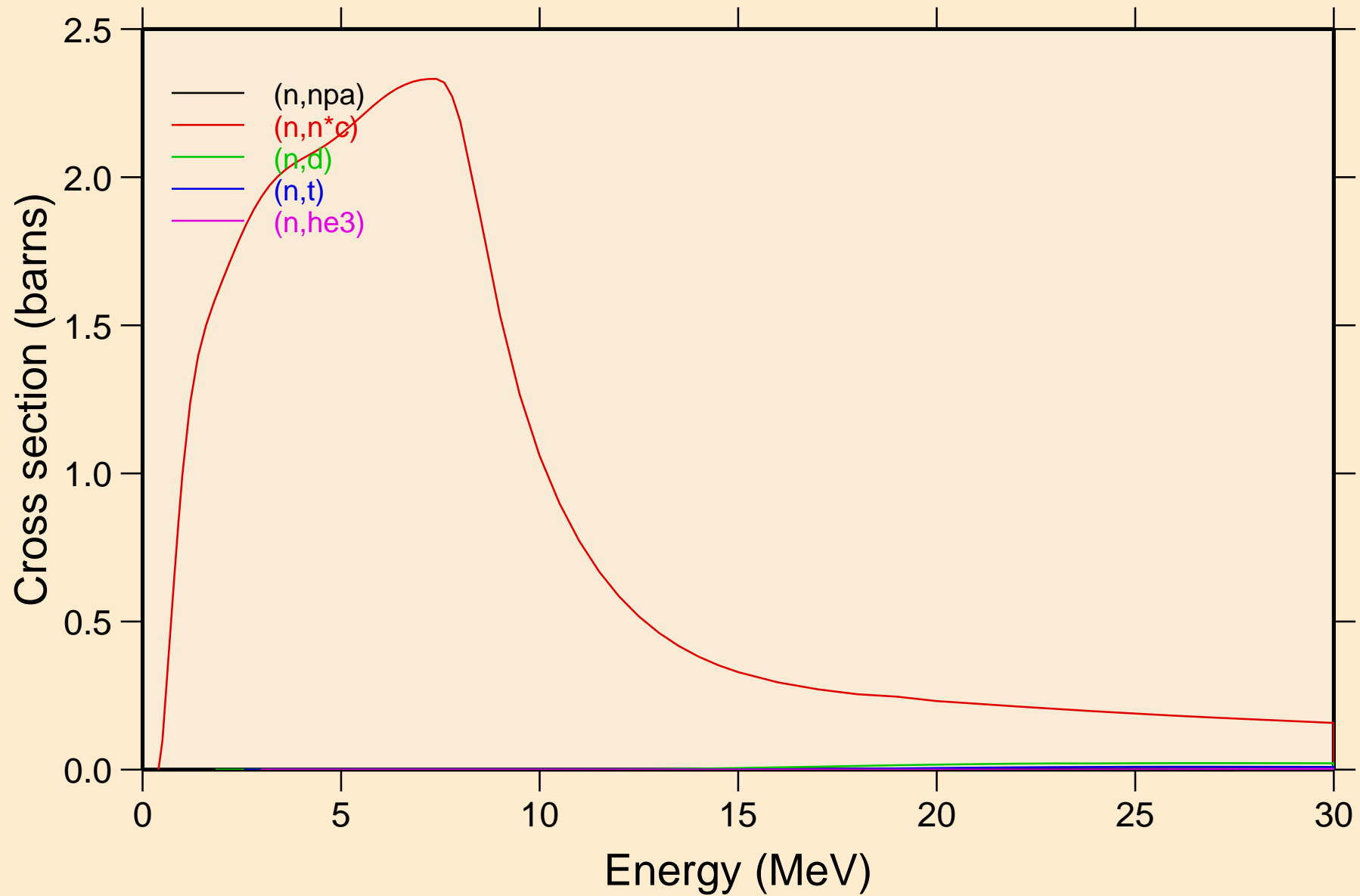

HO158 NEUTRON ACER TENDL-2023 LIBRARY; T=0.K

Threshold reactions

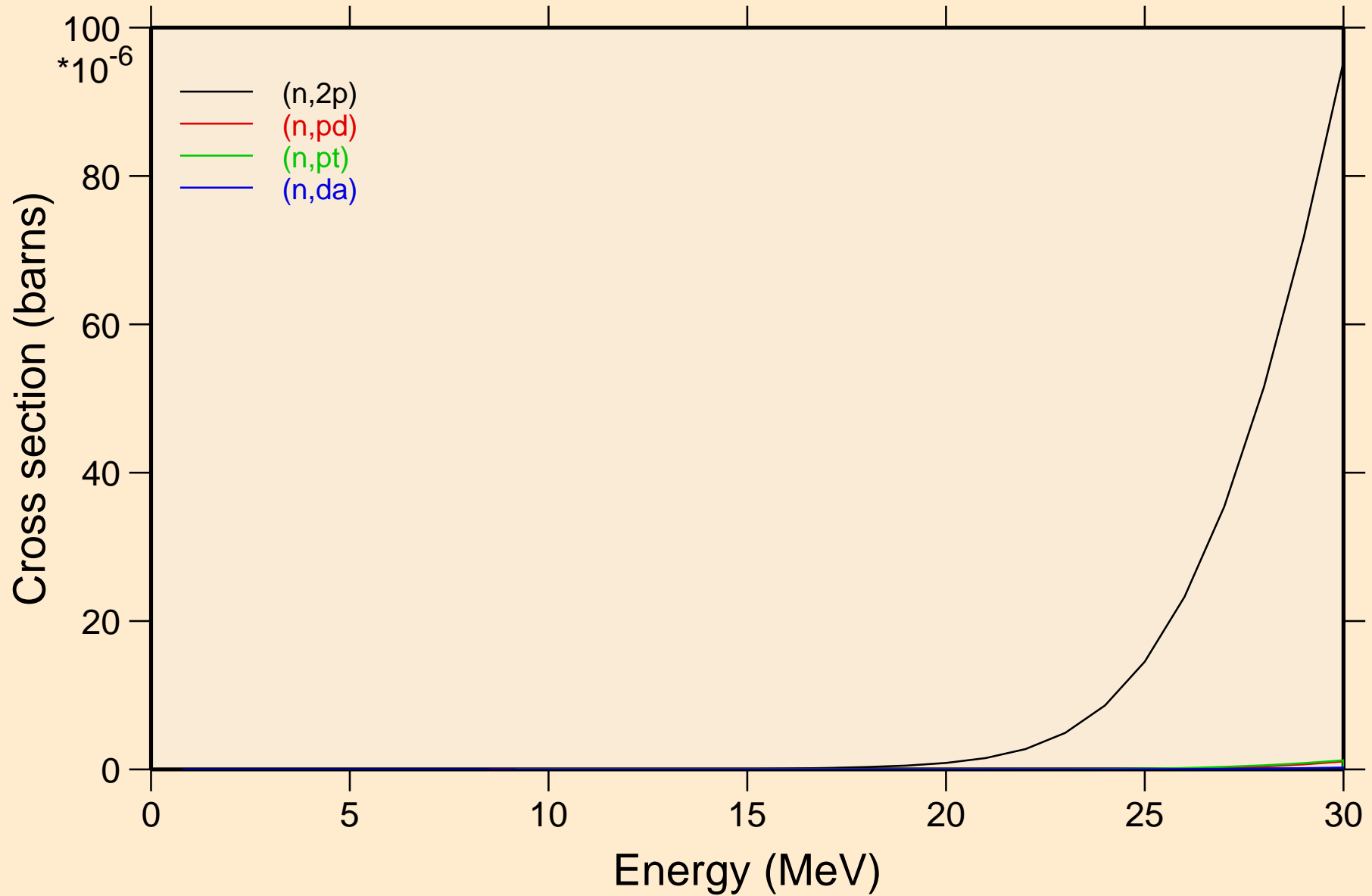

HO158 NEUTRON ACER TENDL-2023 LIBRARY; T=0.K

Threshold reactions

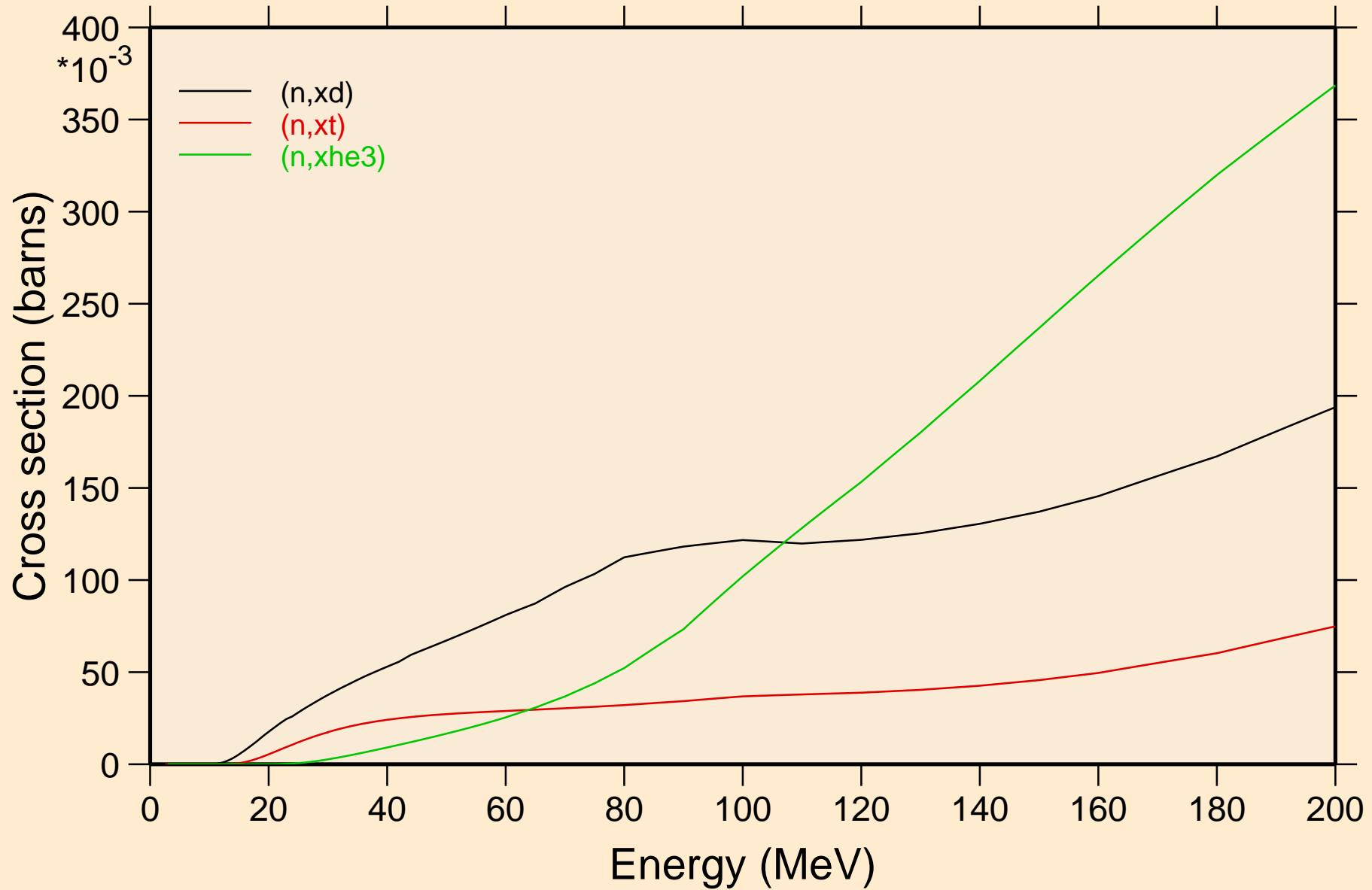

HO158 NEUTRON ACER TENDL-2023 LIBRARY; T=0.K
angular distribution for elastic

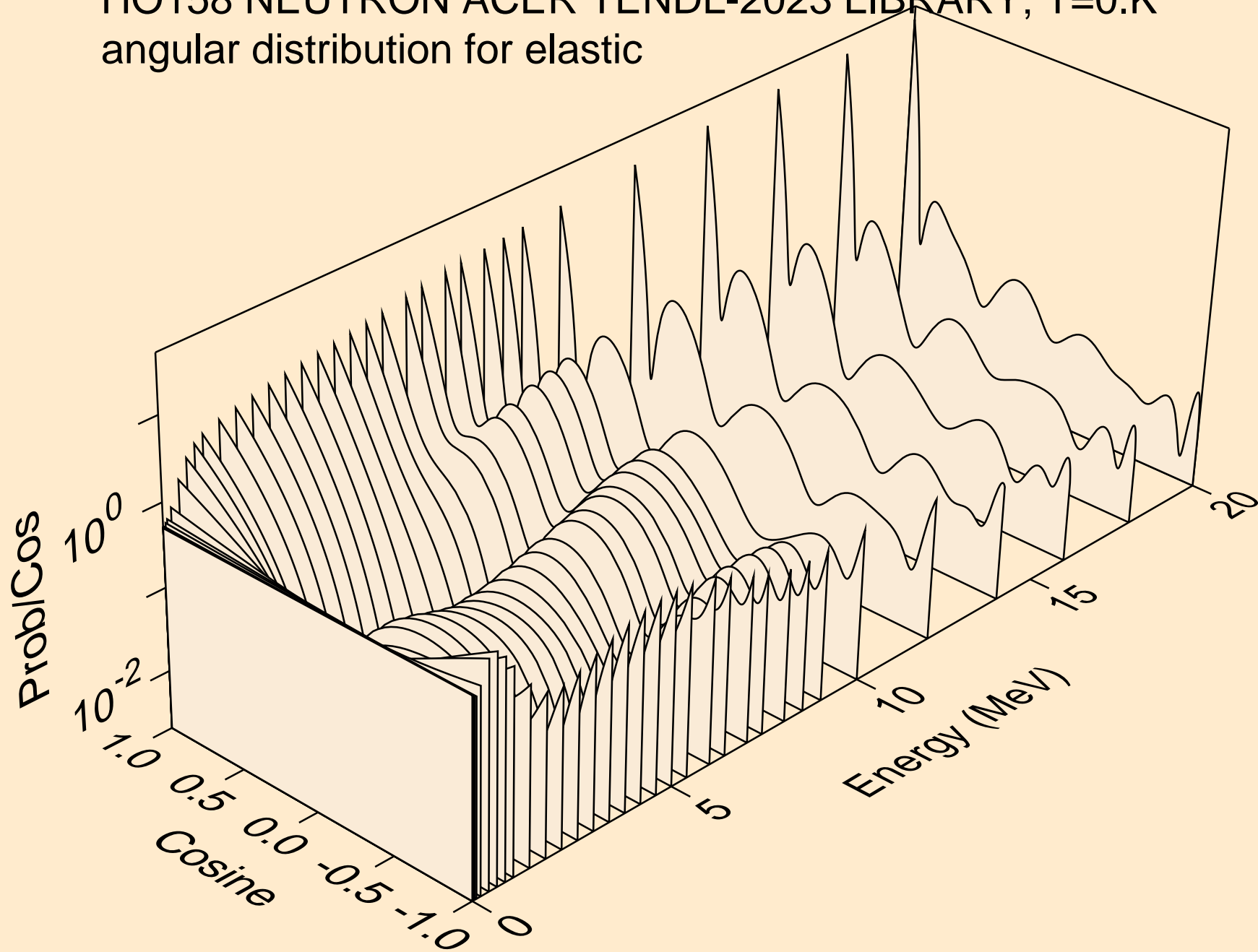

HO158 NEUTRON ACER TENDL-2023 LIBRARY; T=0.K
angular distribution for elastic

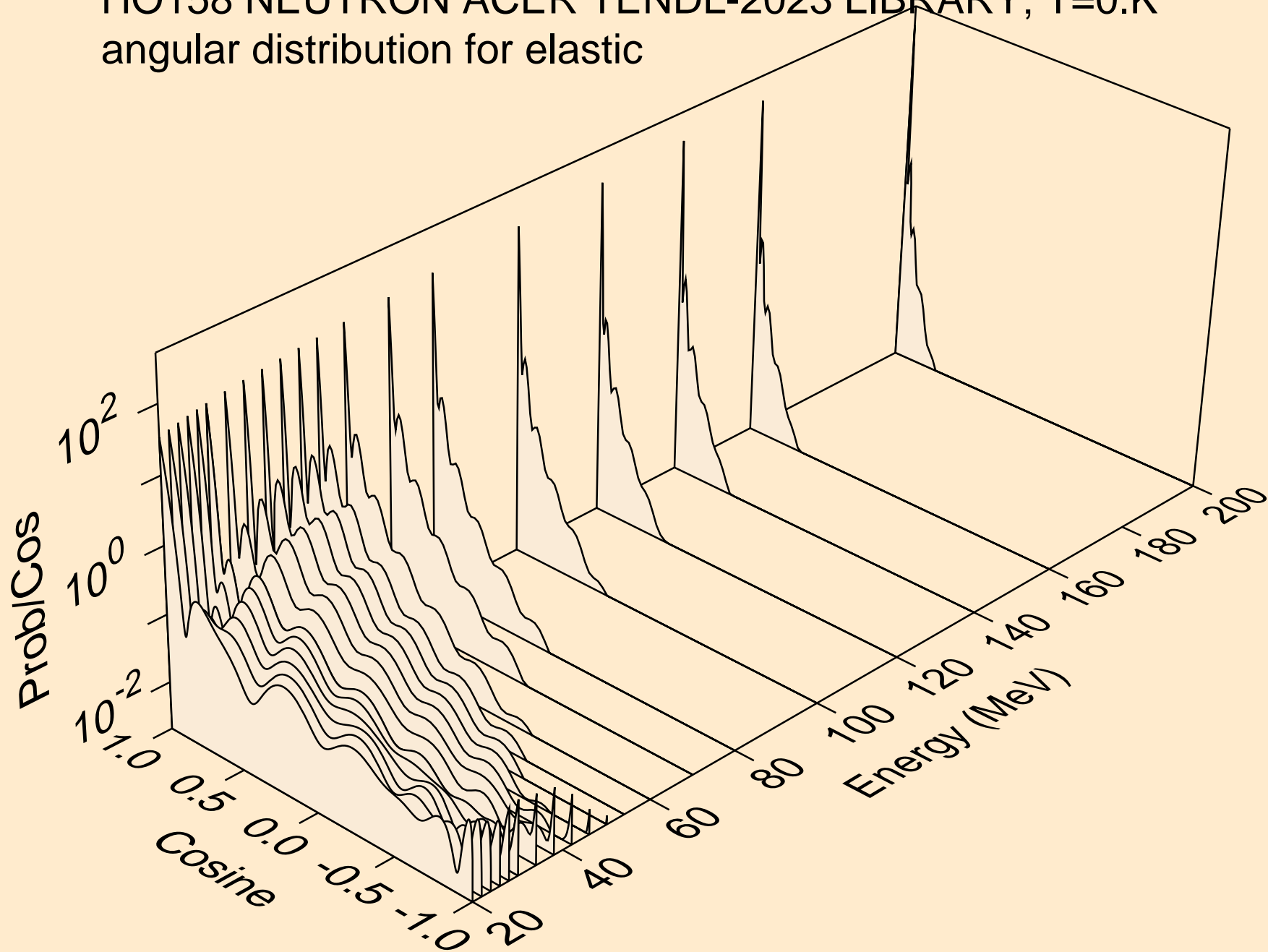

HO158 NEUTRON ACER TENDL-2023 LIBRARY; T=0.K
angular distribution for (n,n*1)

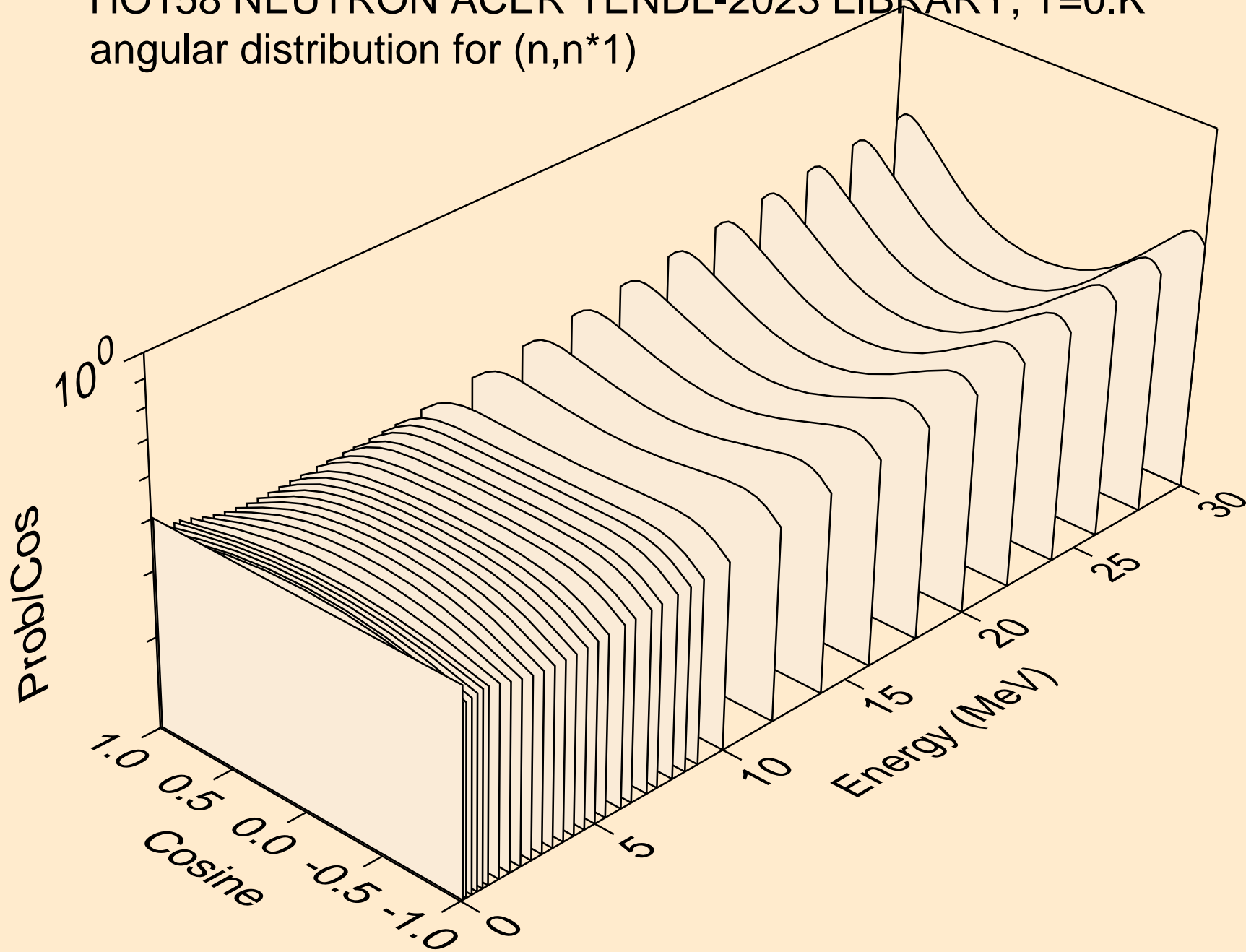

HO158 NEUTRON ACER TENDL-2023 LIBRARY; T=0.K
angular distribution for (n,n*2)

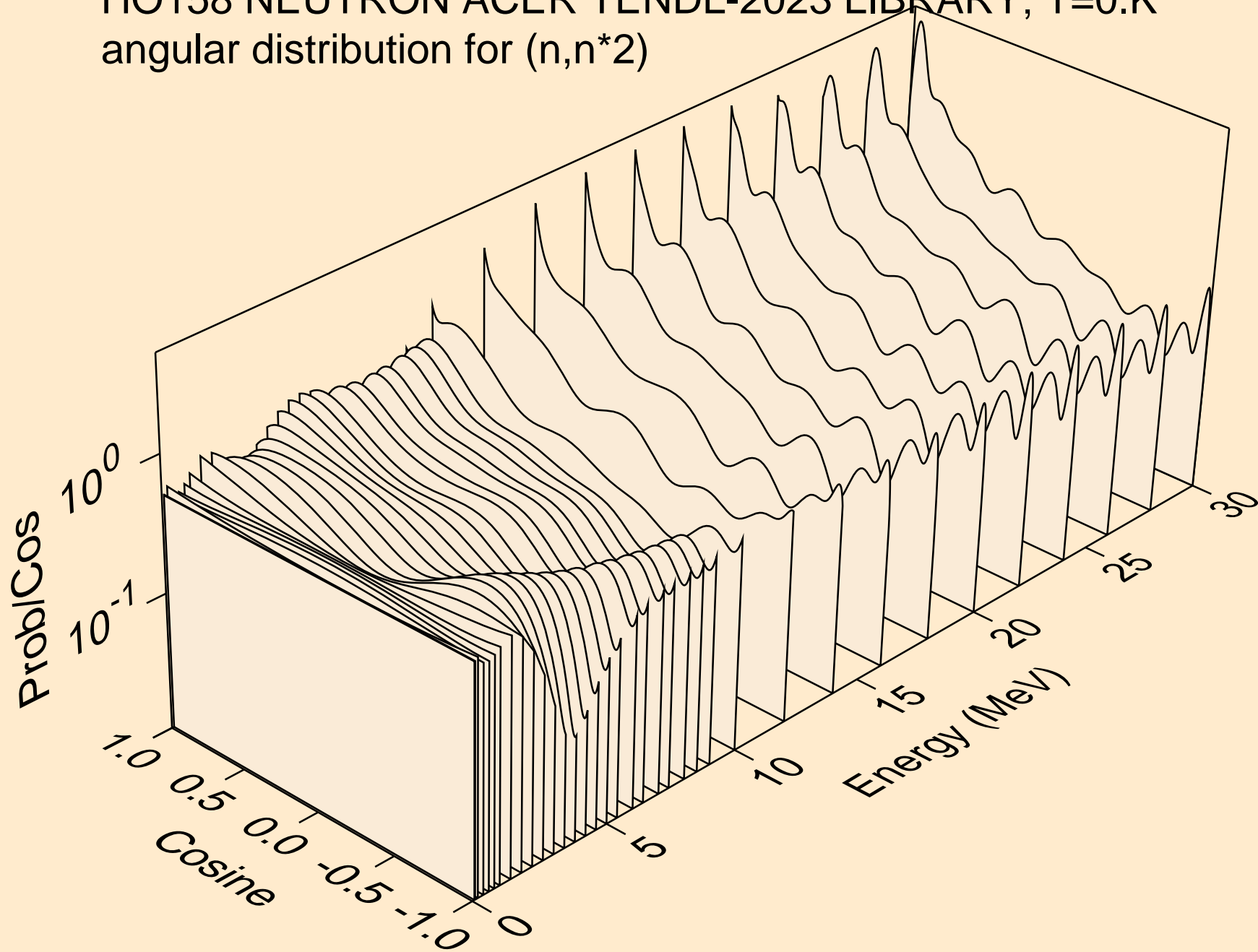

HO158 NEUTRON ACER TENDL-2023 LIBRARY; T=0.K
angular distribution for (n,n*3)

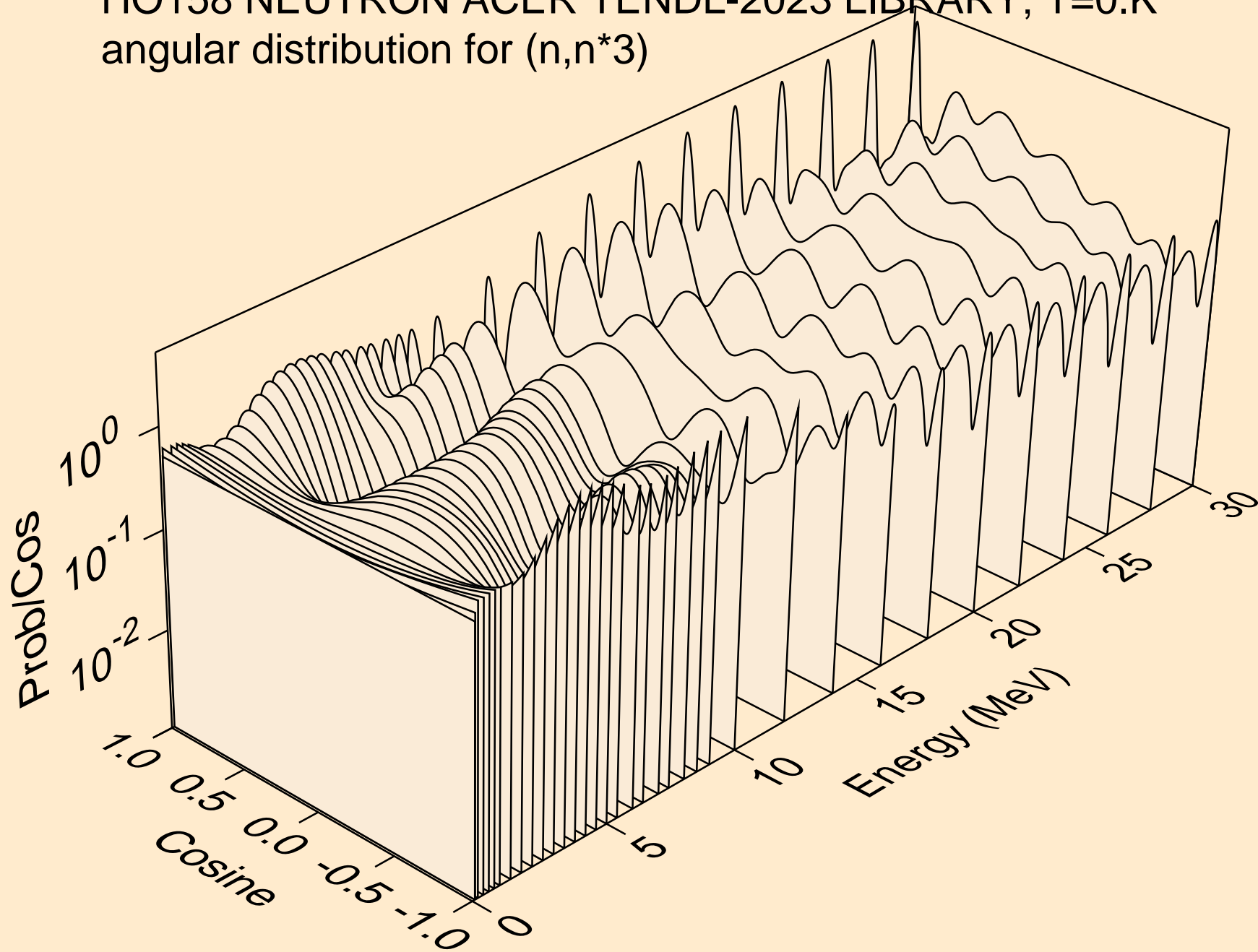

HO158 NEUTRON ACER TENDL-2023 LIBRARY; T=0.K
angular distribution for (n,n*4)

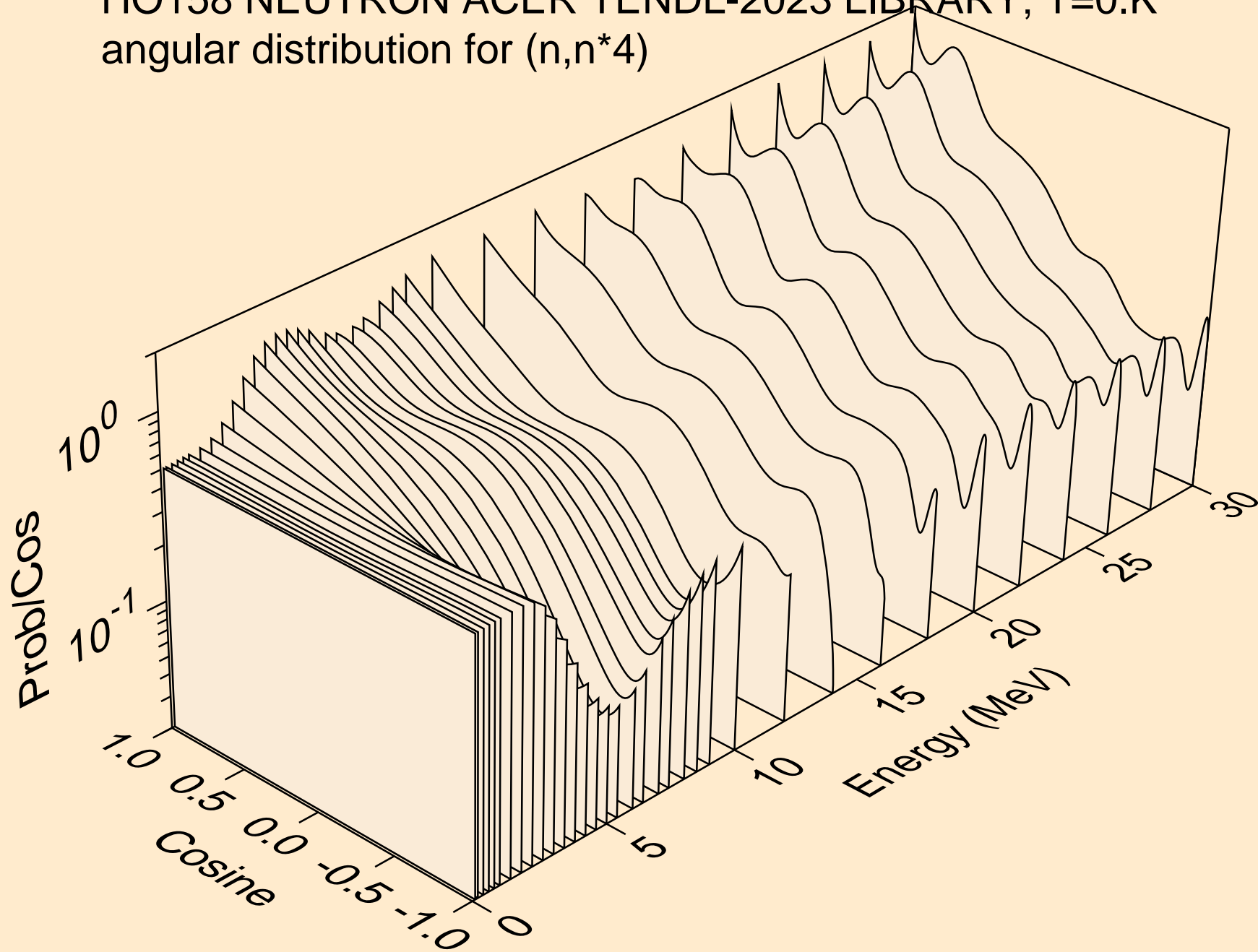

HO158 NEUTRON ACER TENDL-2023 LIBRARY; T=0.K
angular distribution for (n,n*5)

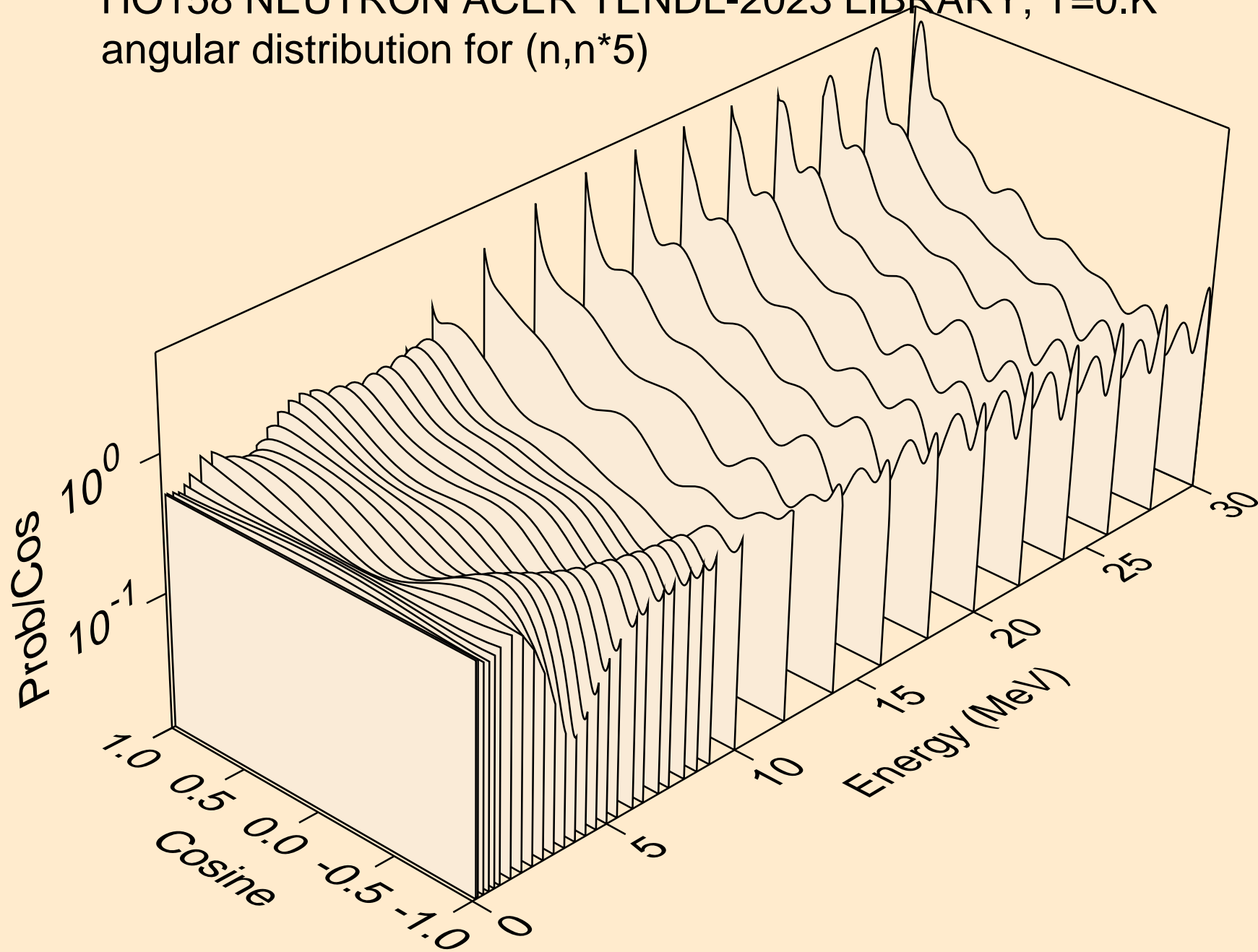

HO158 NEUTRON ACER TENDL-2023 LIBRARY; T=0.K
angular distribution for (n,n*6)

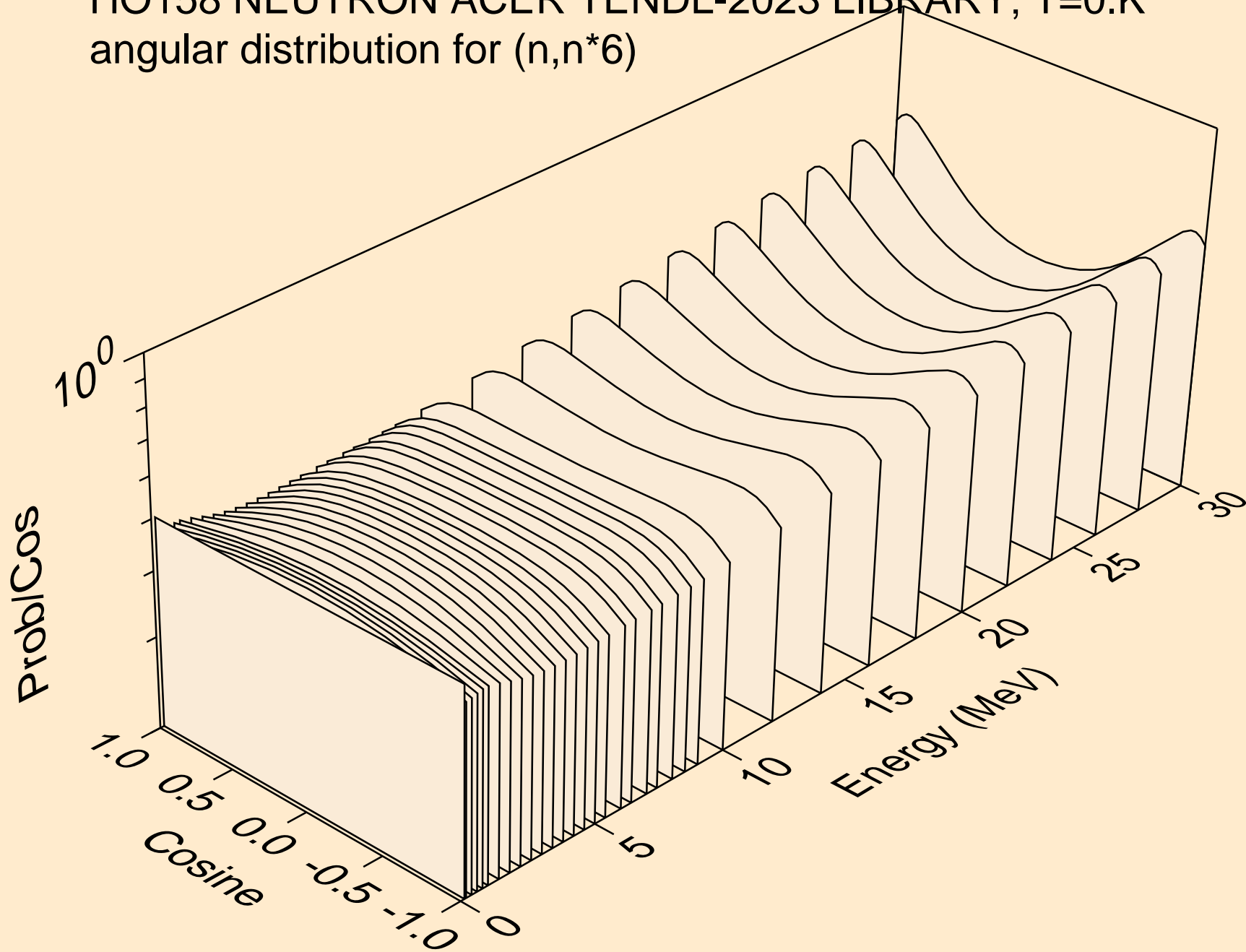

HO158 NEUTRON ACER TENDL-2023 LIBRARY; T=0.K
angular distribution for (n,n*7)

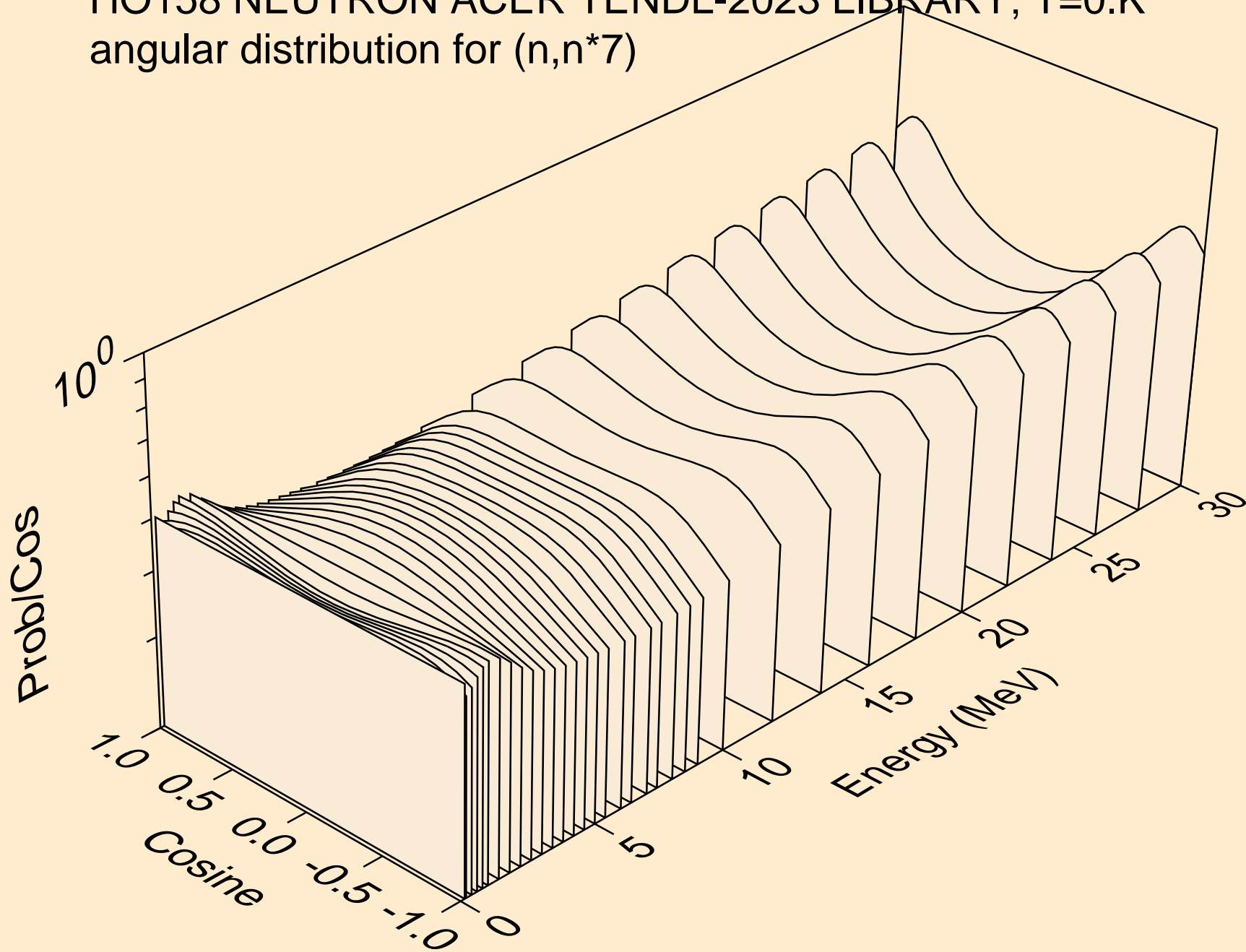

HO158 NEUTRON ACER TENDL-2023 LIBRARY; T=0.K
angular distribution for (n,n*8)

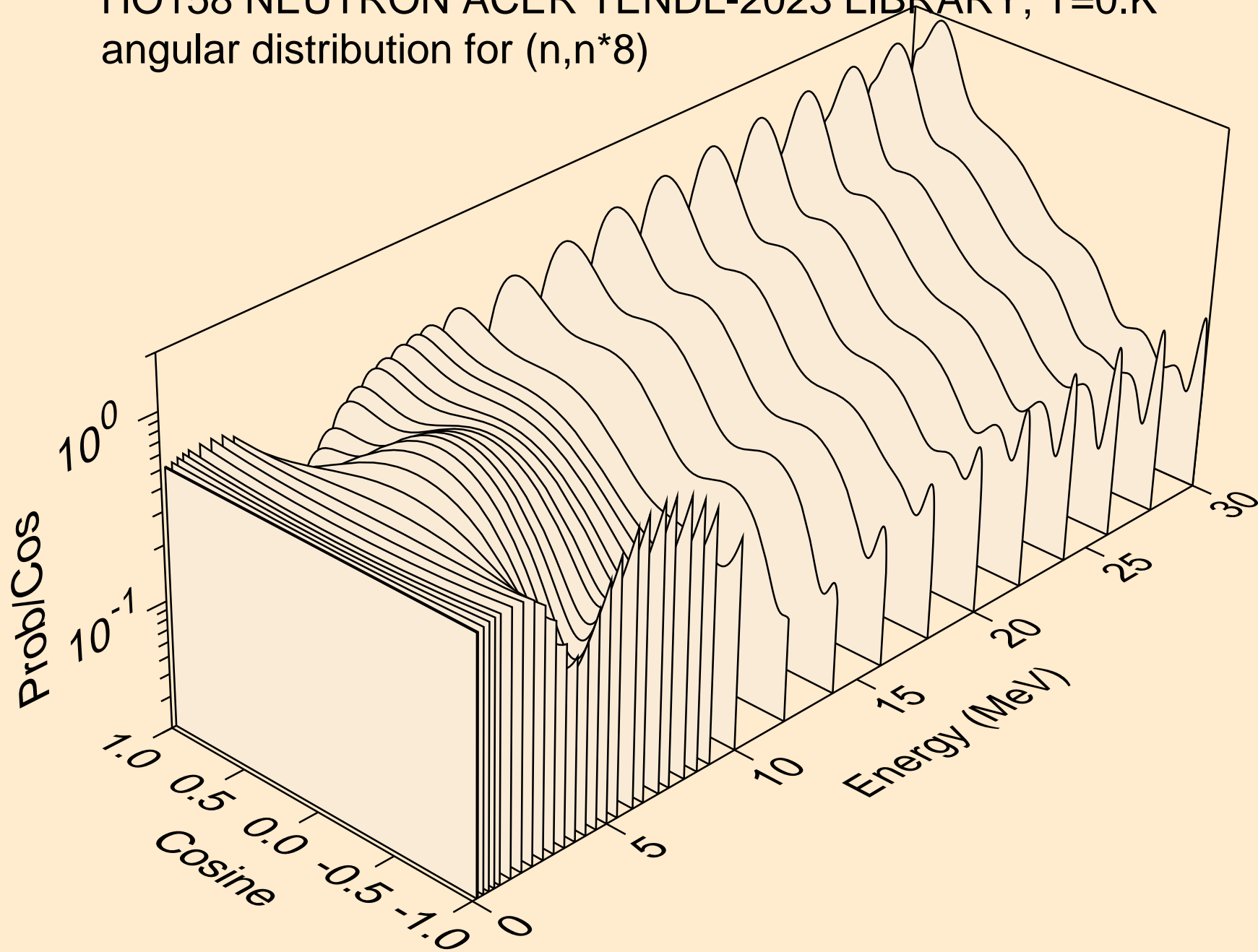

HO158 NEUTRON ACER TENDL-2023 LIBRARY; T=0.K
angular distribution for (n,n*9)

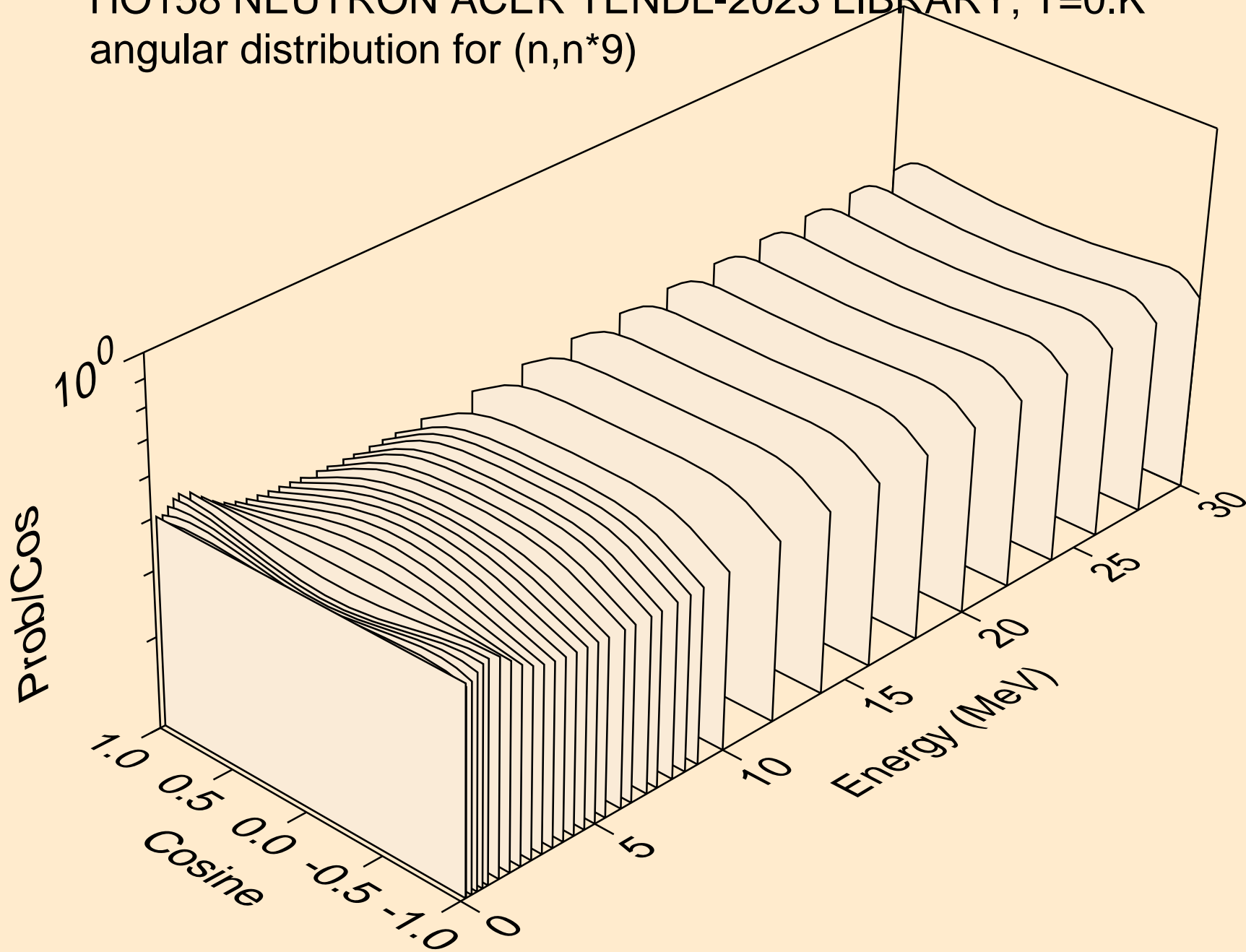

HO158 NEUTRON ACER TENDL-2023 LIBRARY; T=0.K
angular distribution for (n,n*10)

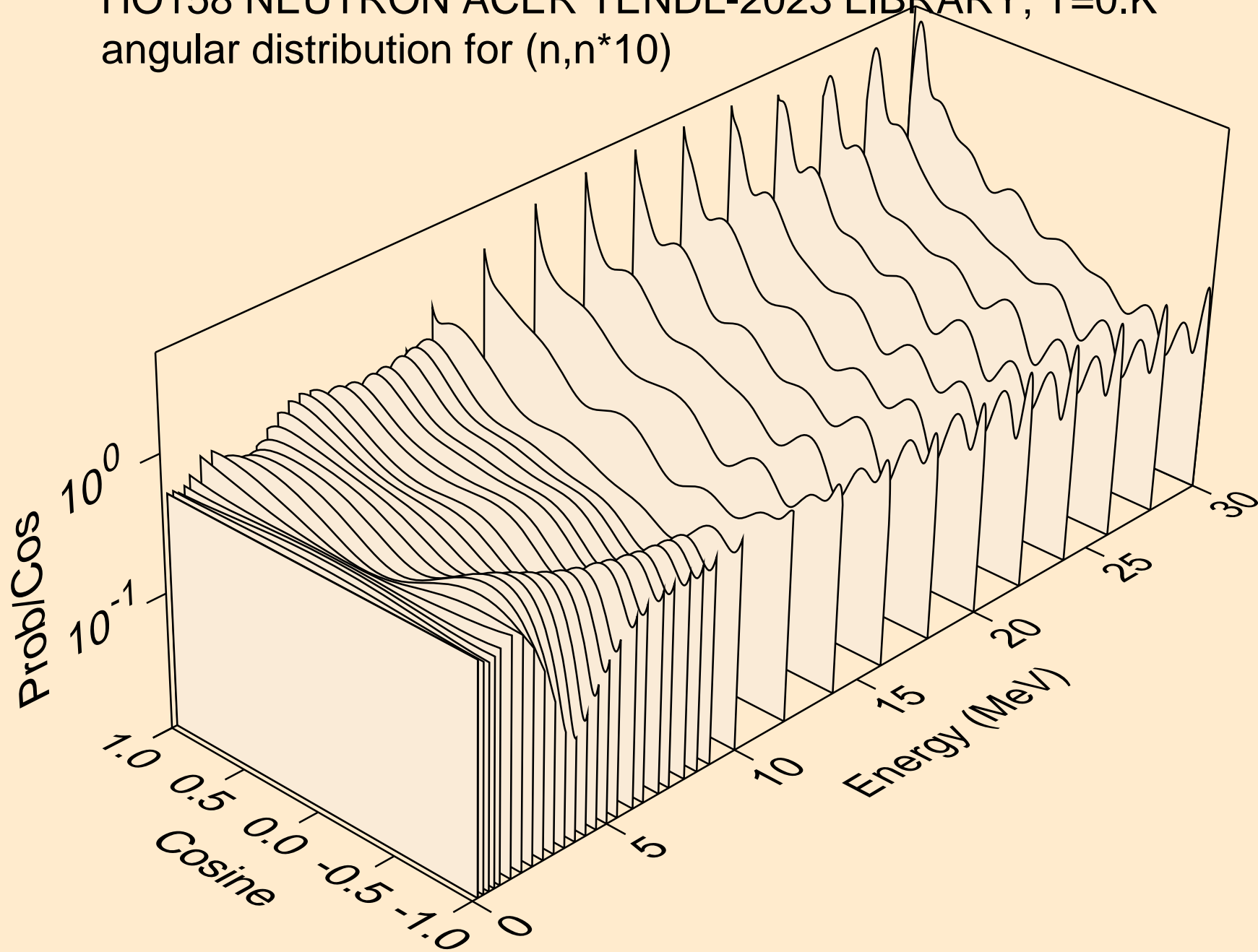

HO158 NEUTRON ACER TENDL-2023 LIBRARY; T=0.K
angular distribution for (n,n*11)

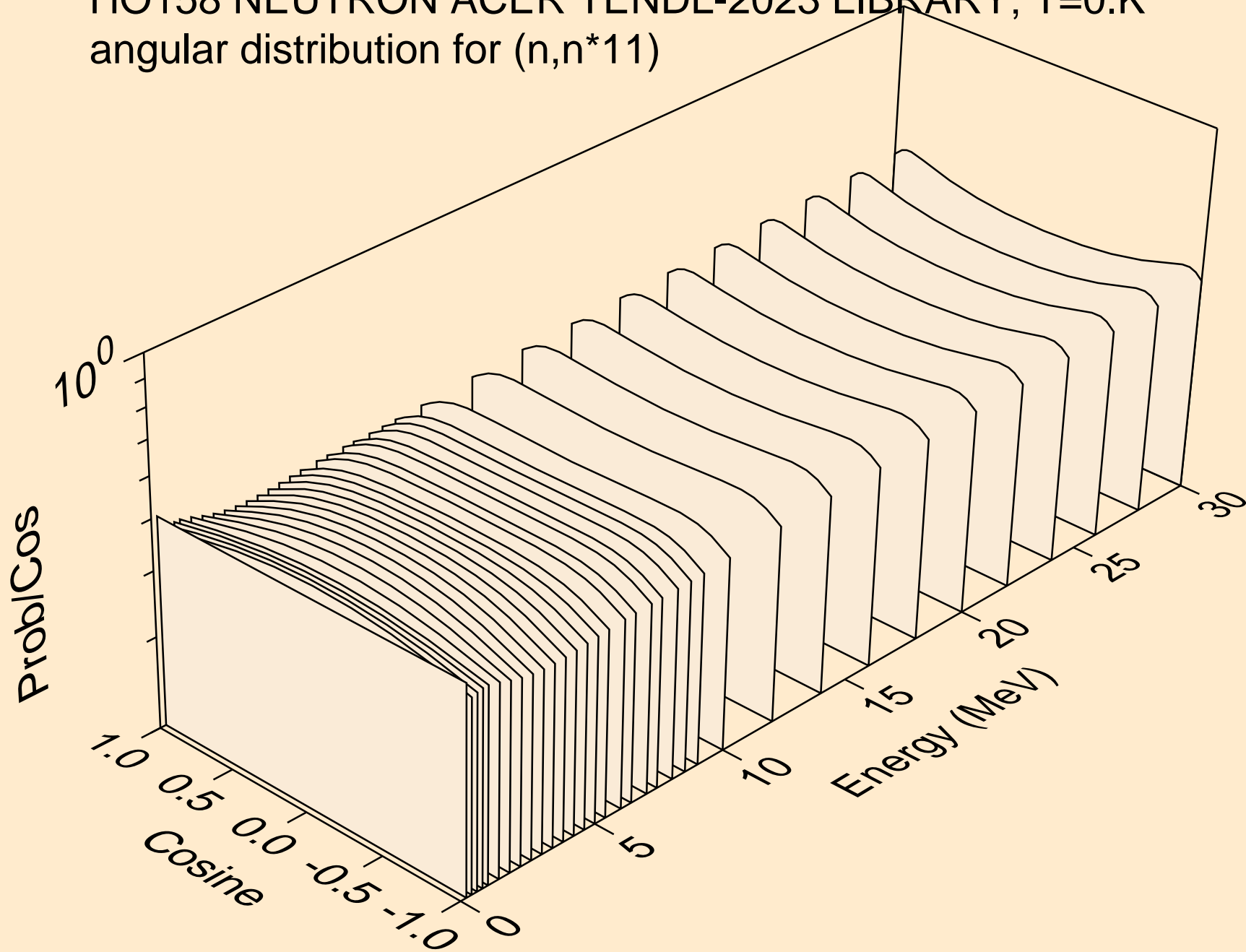

HO158 NEUTRON ACER TENDL-2023 LIBRARY; T=0.K
angular distribution for (n,n*12)

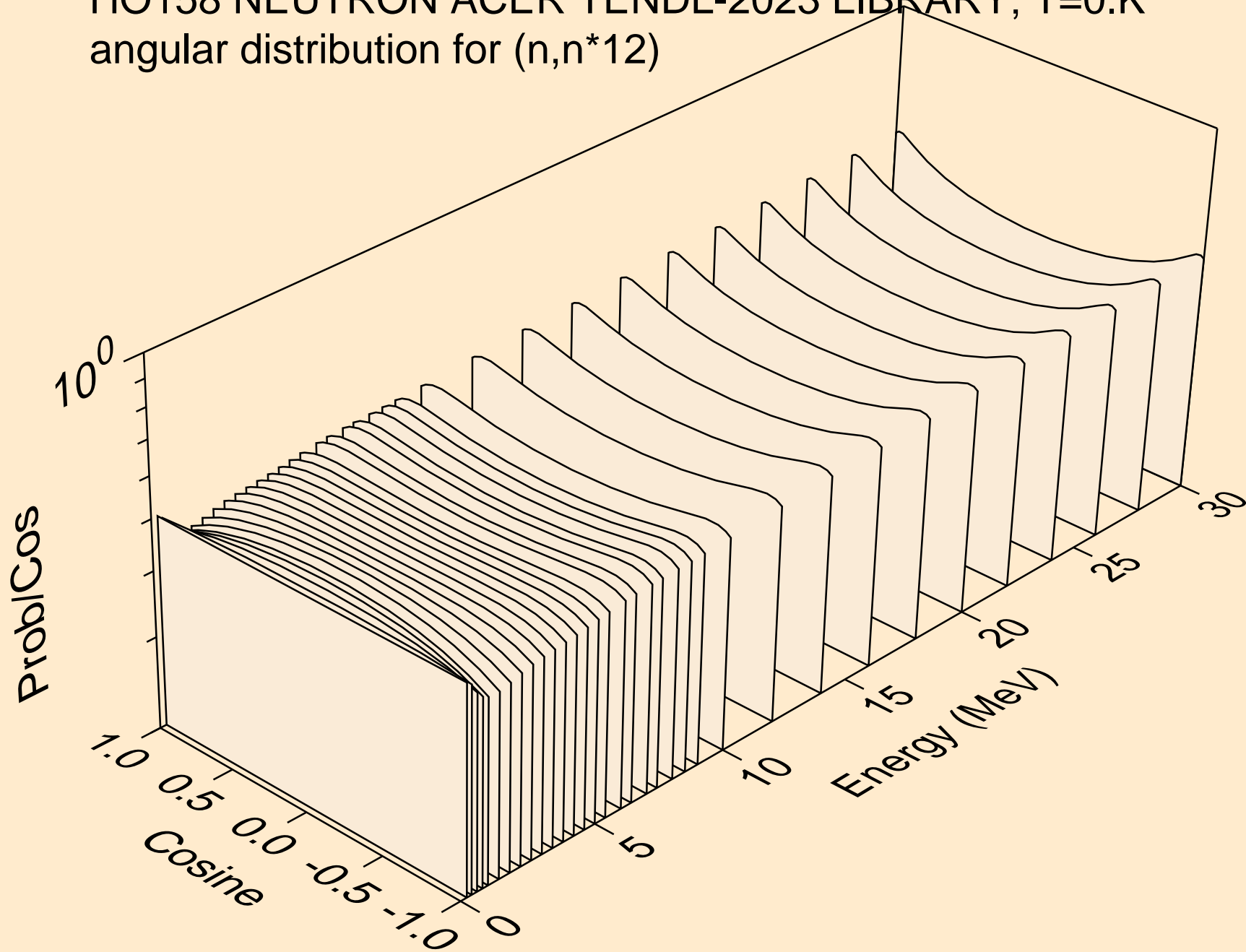

HO158 NEUTRON ACER TENDL-2023 LIBRARY; T=0.K
angular distribution for (n,n*13)

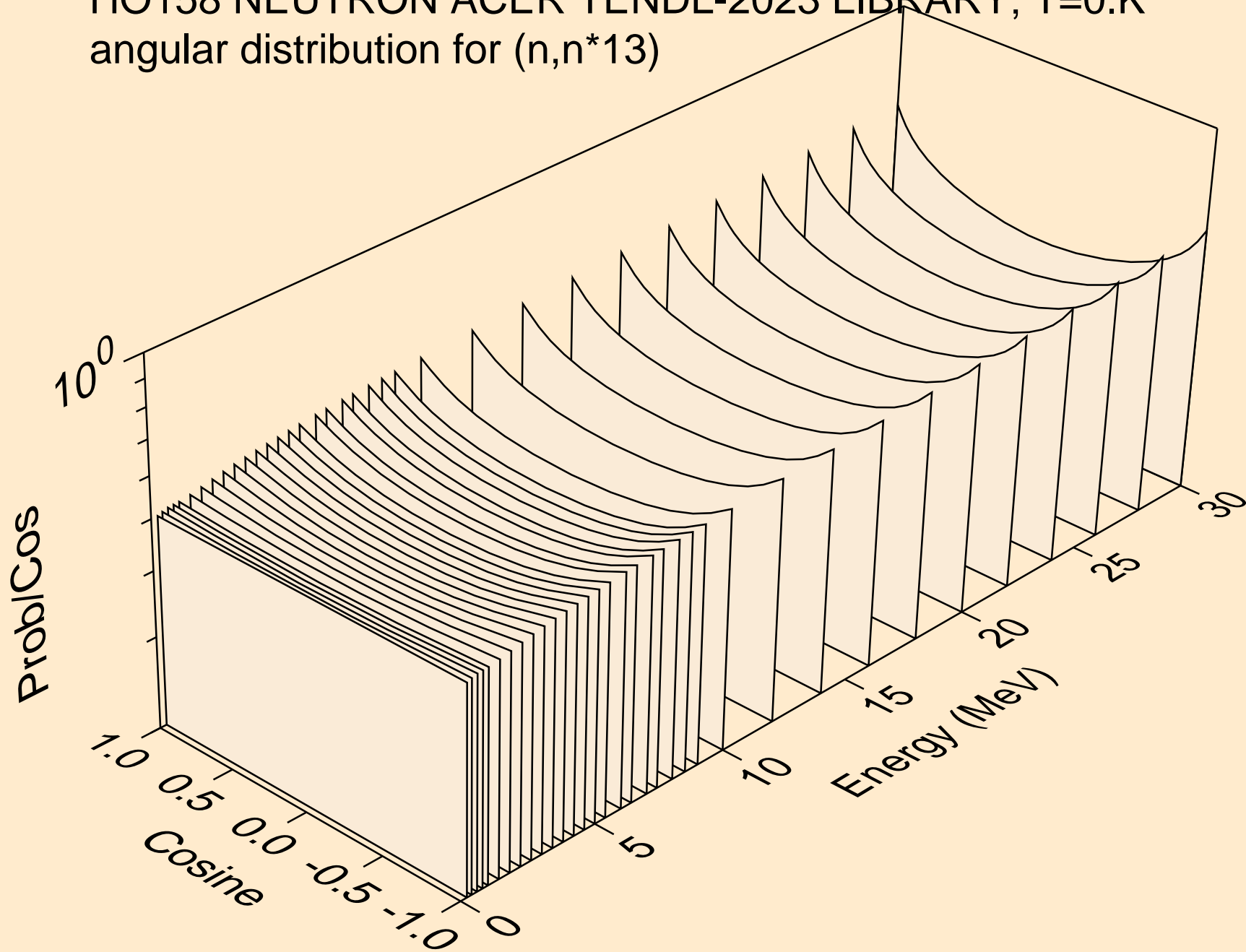

HO158 NEUTRON ACER TENDL-2023 LIBRARY; T=0.K
angular distribution for (n,n*14)

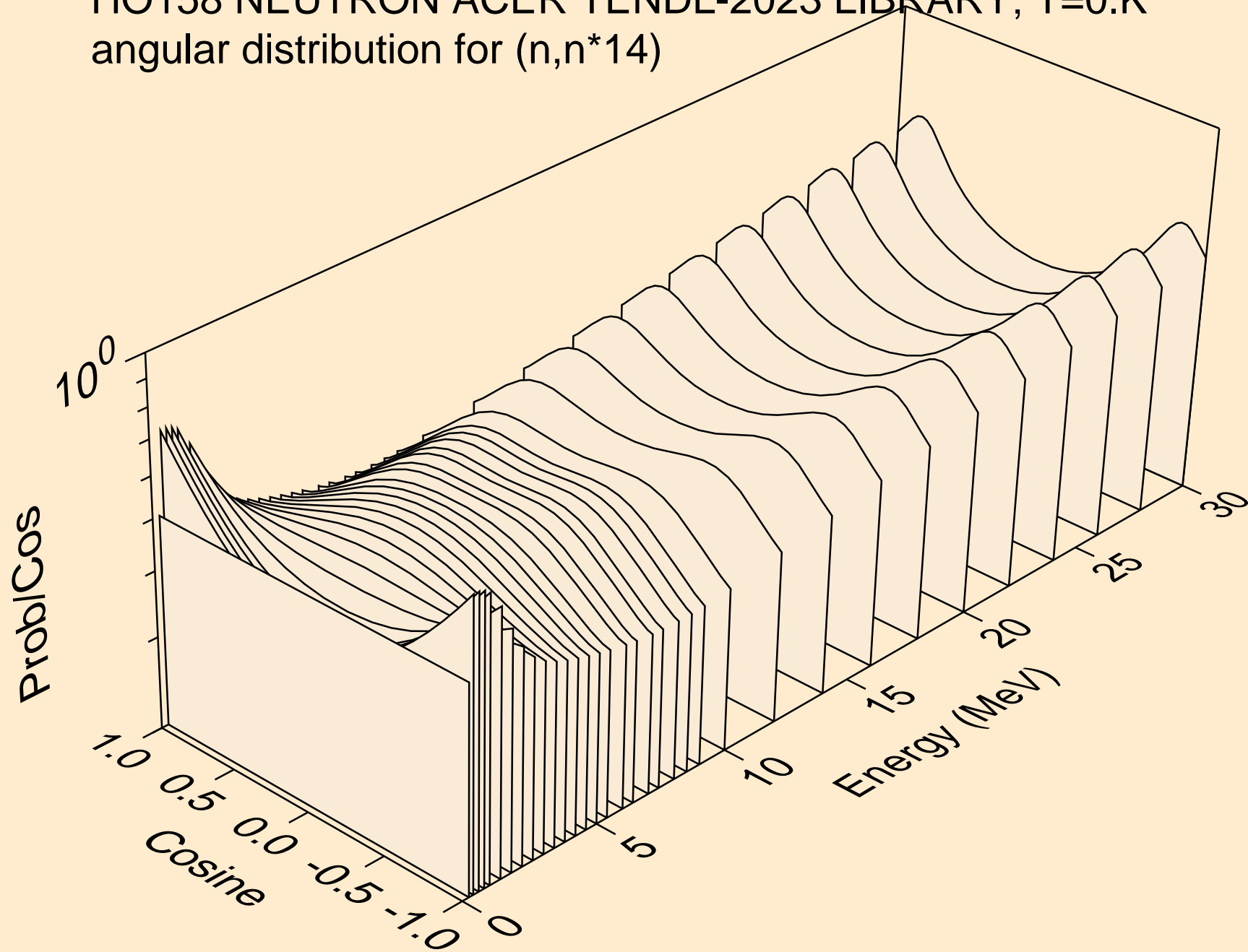

HO158 NEUTRON ACER TENDL-2023 LIBRARY; T=0.K
angular distribution for (n,n*15)

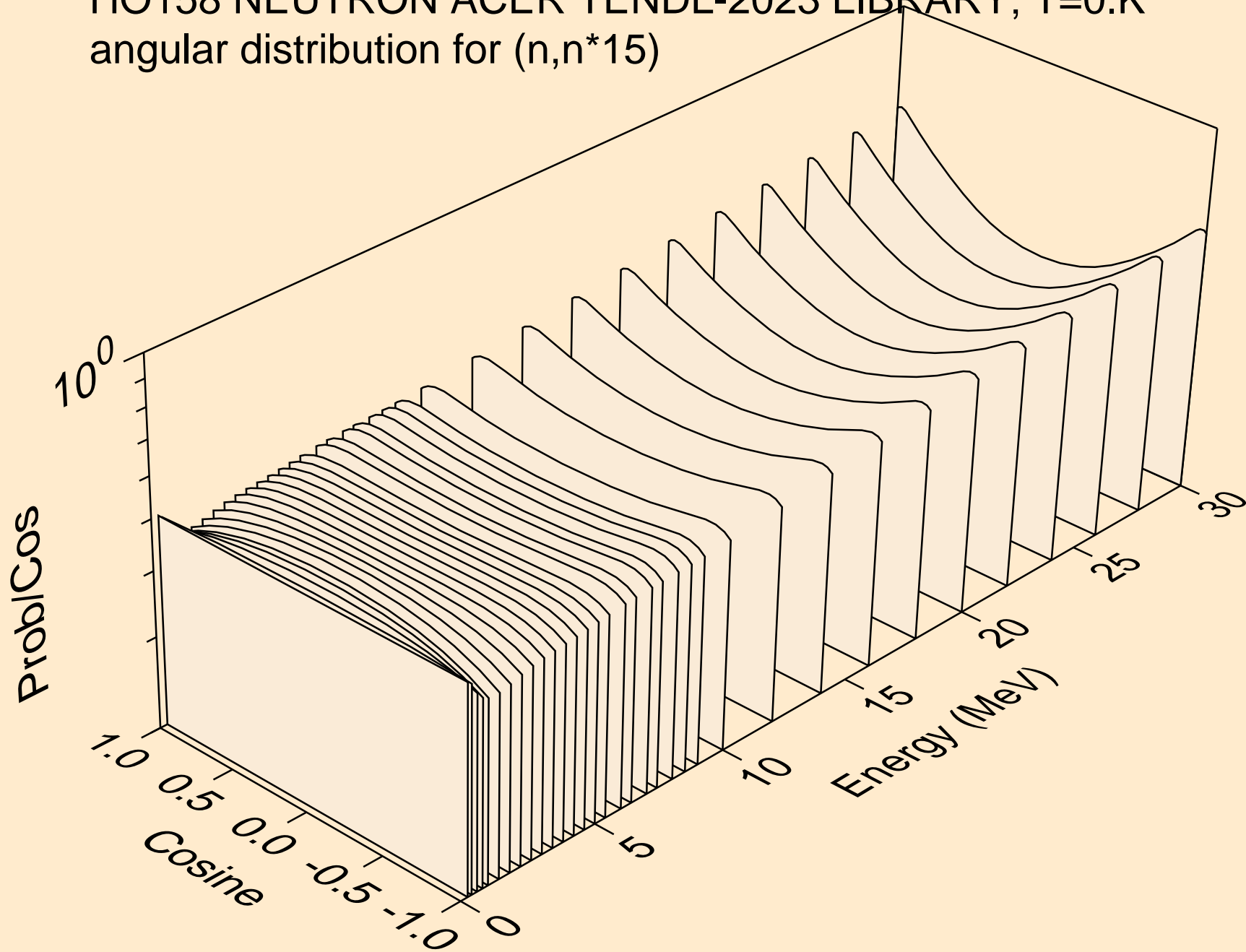

HO158 NEUTRON ACER TENDL-2023 LIBRARY; T=0.K
angular distribution for (n,n*16)

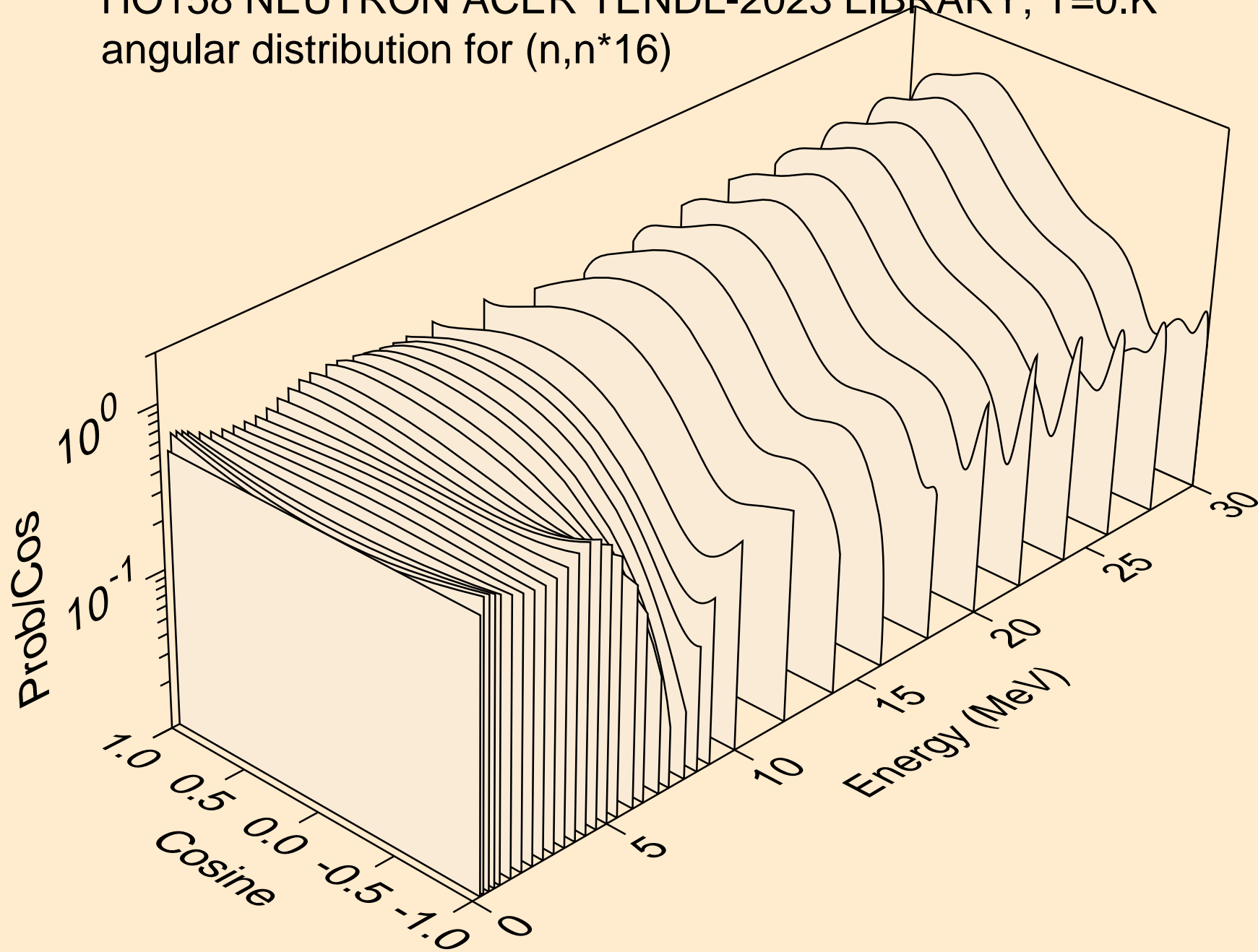

HO158 NEUTRON ACER TENDL-2023 LIBRARY; T=0.K
angular distribution for (n,n*17)

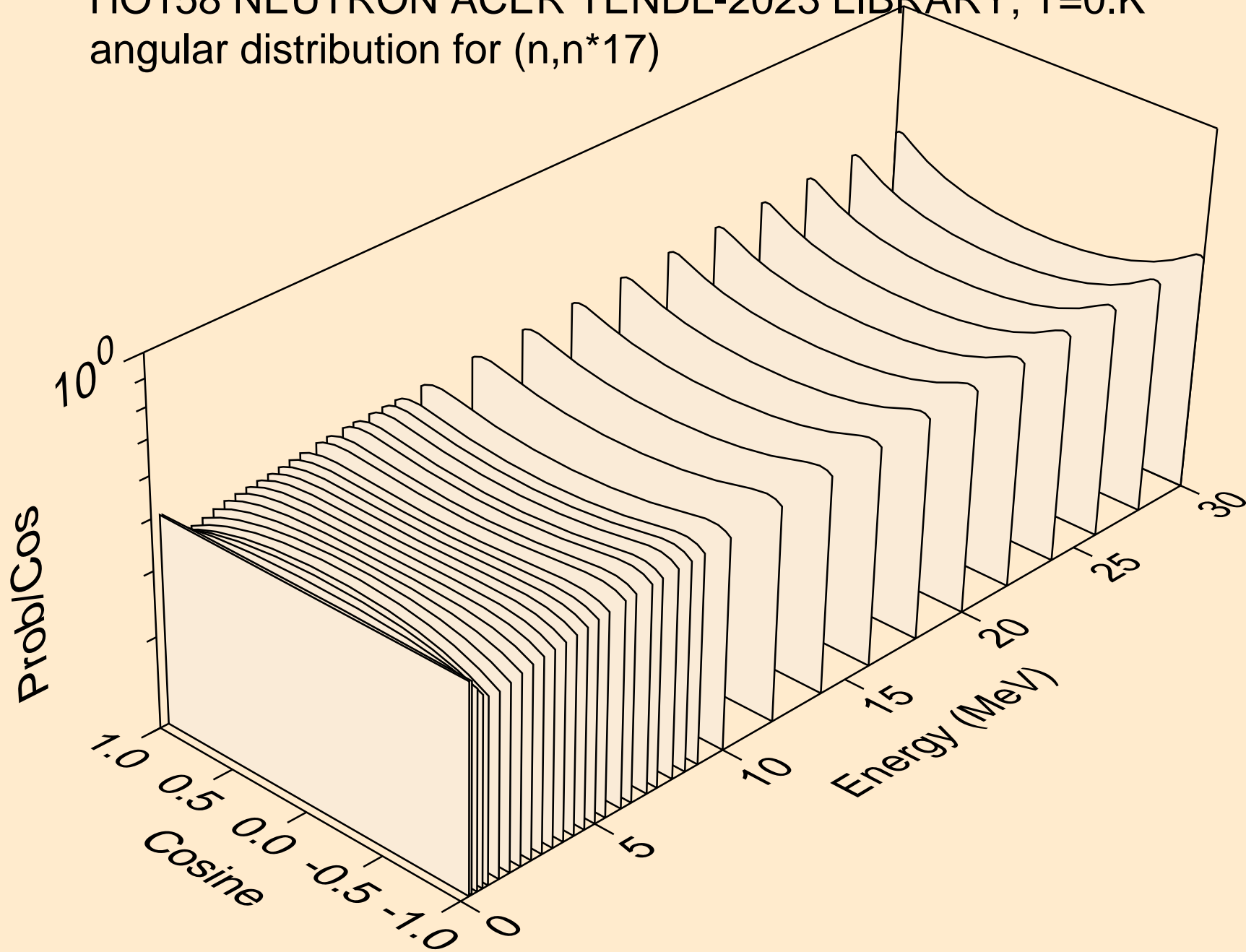

HO158 NEUTRON ACER TENDL-2023 LIBRARY; T=0.K
angular distribution for (n,n*18)

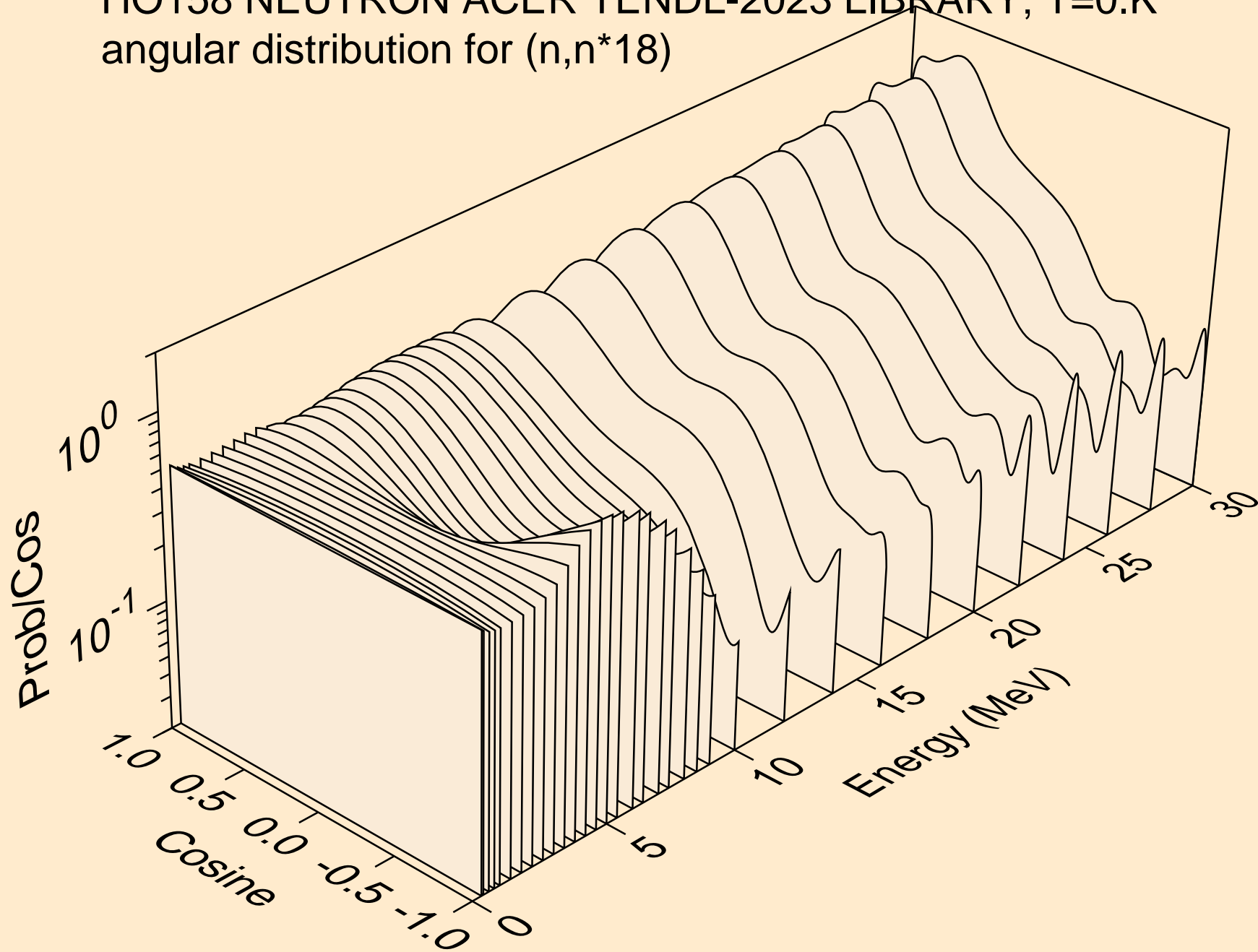

HO158 NEUTRON ACER TENDL-2023 LIBRARY; T=0.K
angular distribution for (n,n*19)

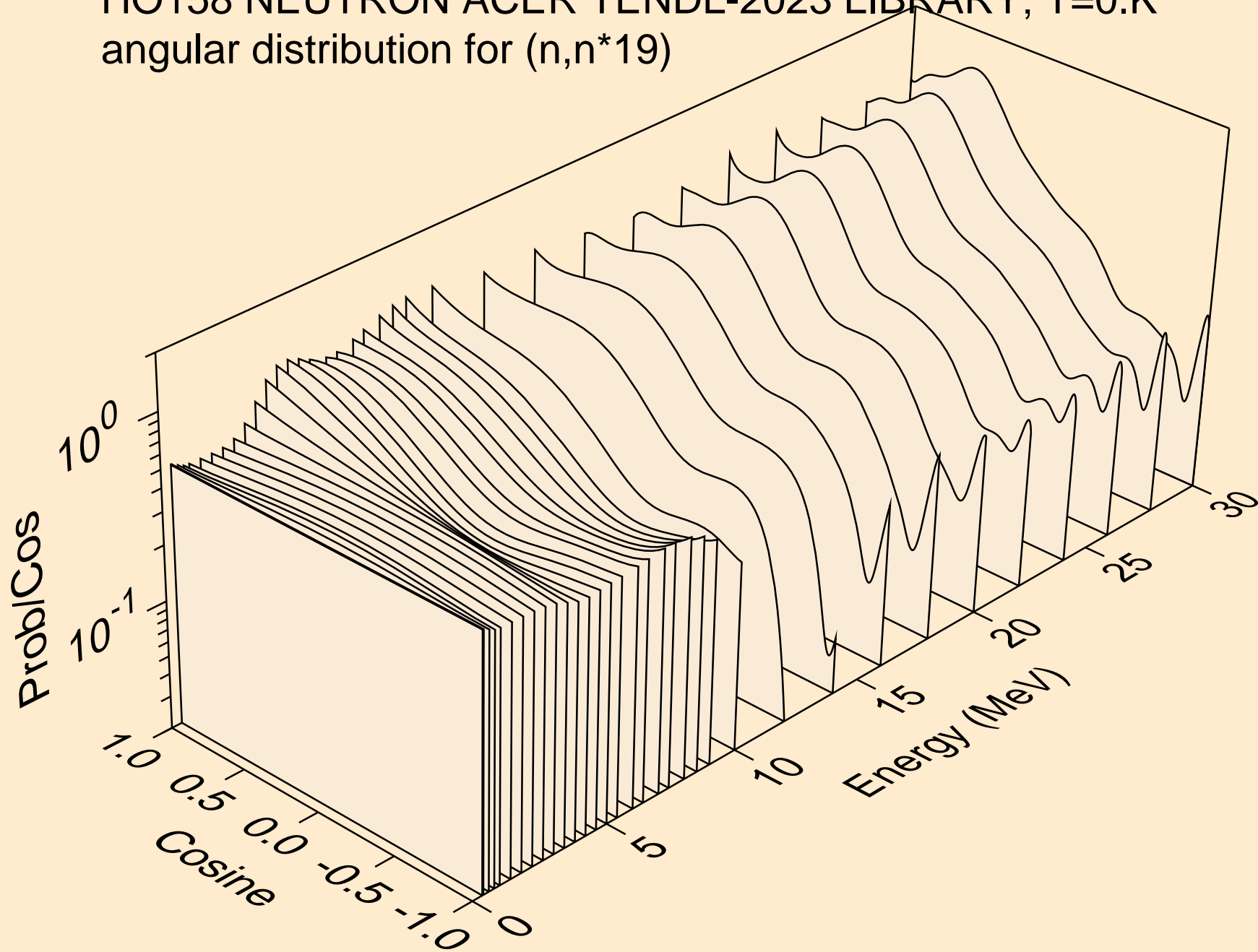

HO158 NEUTRON ACER TENDL-2023 LIBRARY; T=0.K
angular distribution for (n,n*20)

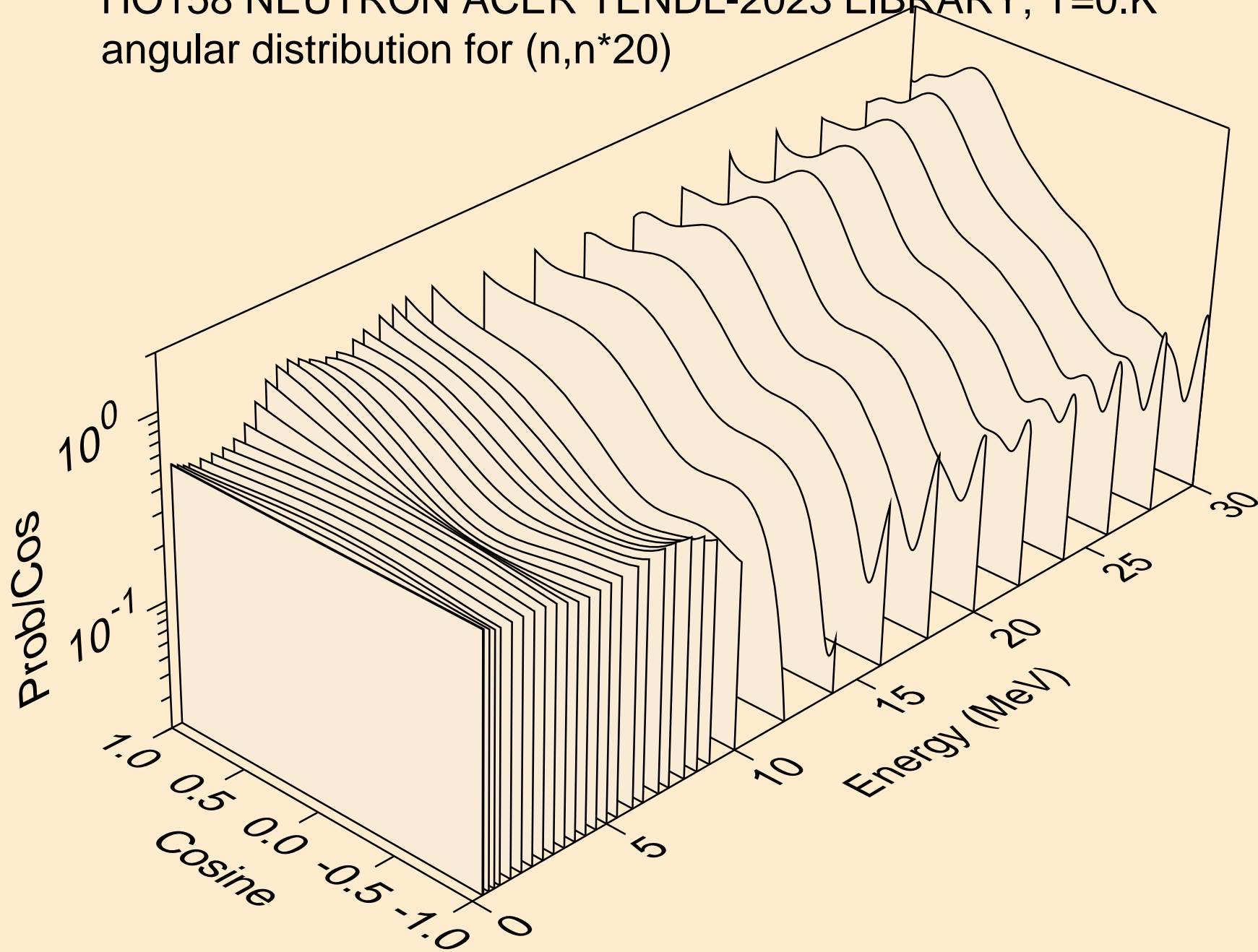

HO158 NEUTRON ACER TENDL-2023 LIBRARY; T=0.K
angular distribution for (n,n*21)

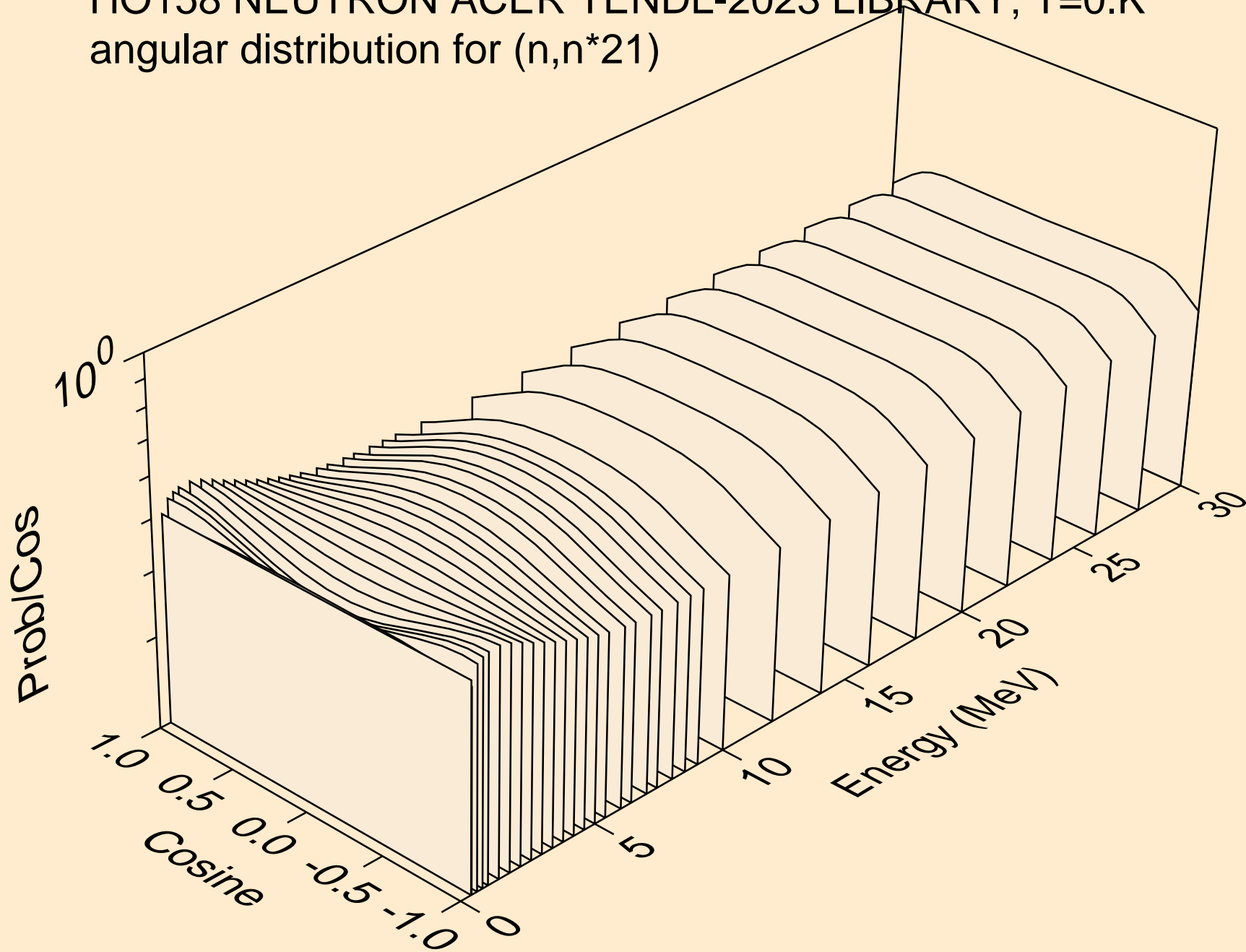

HO158 NEUTRON ACER TENDL-2023 LIBRARY; T=0.K
angular distribution for (n,n*22)

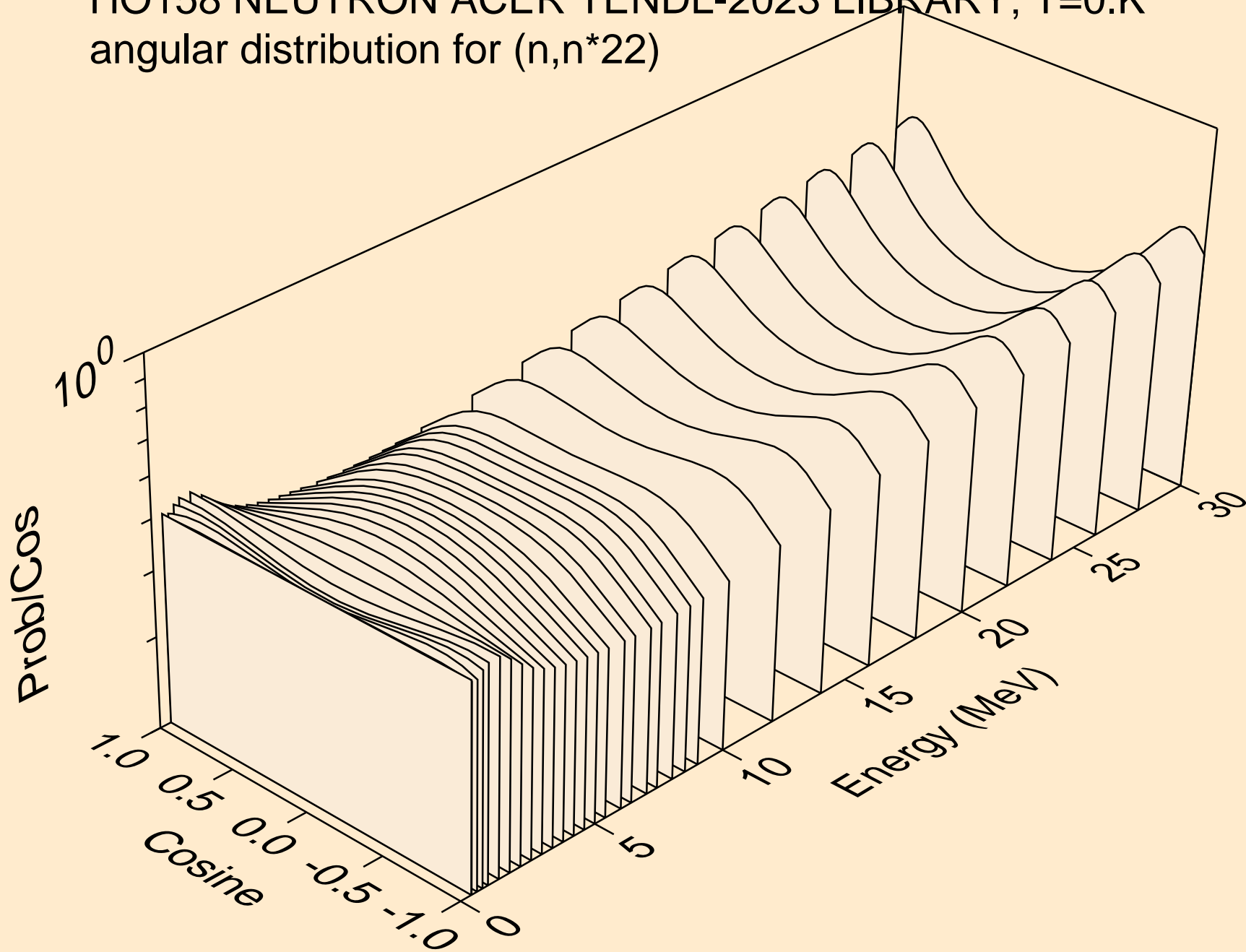

HO158 NEUTRON ACER TENDL-2023 LIBRARY; T=0.K
angular distribution for (n,n*23)

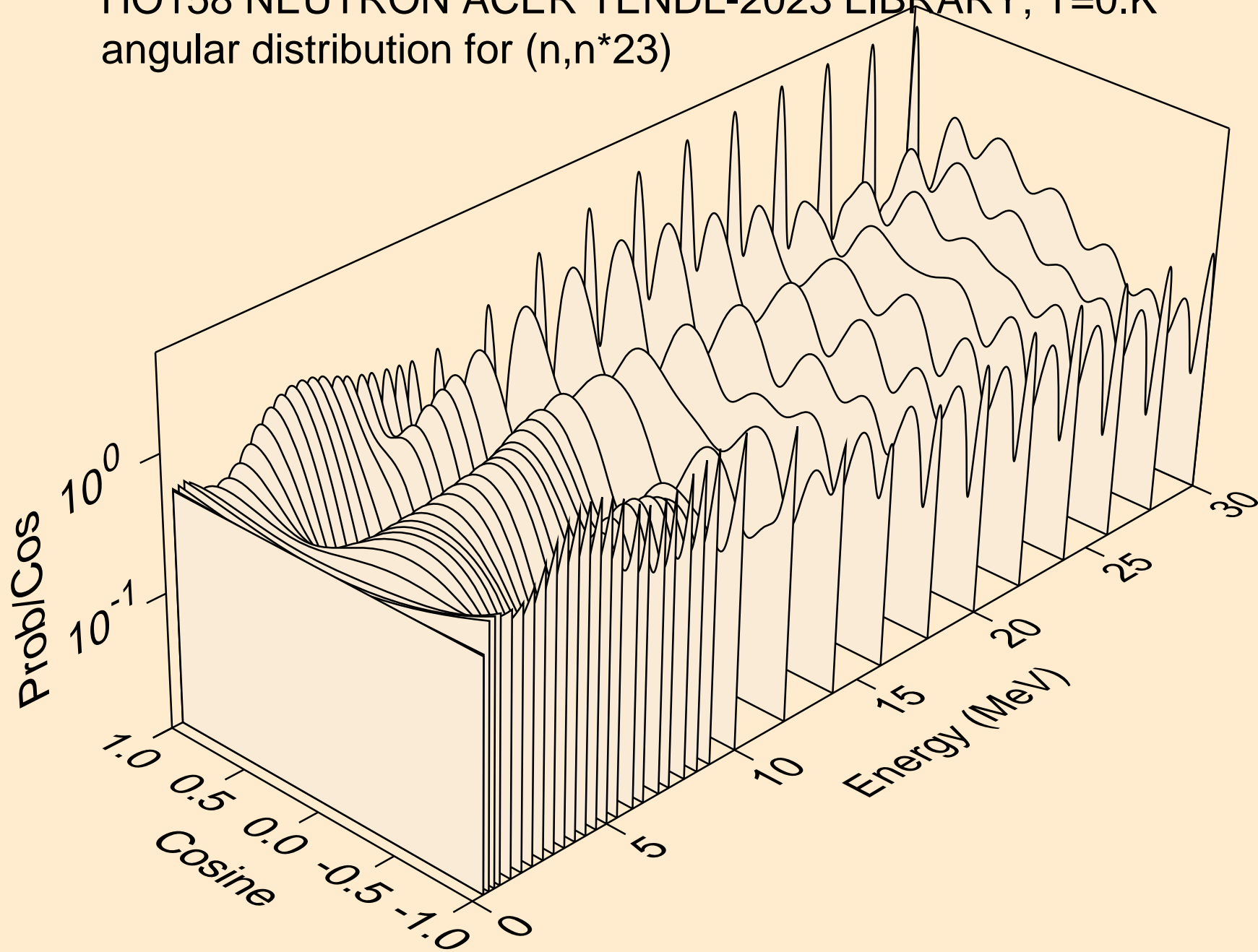

HO158 NEUTRON ACER TENDL-2023 LIBRARY; T=0.K
angular distribution for (n,n*24)

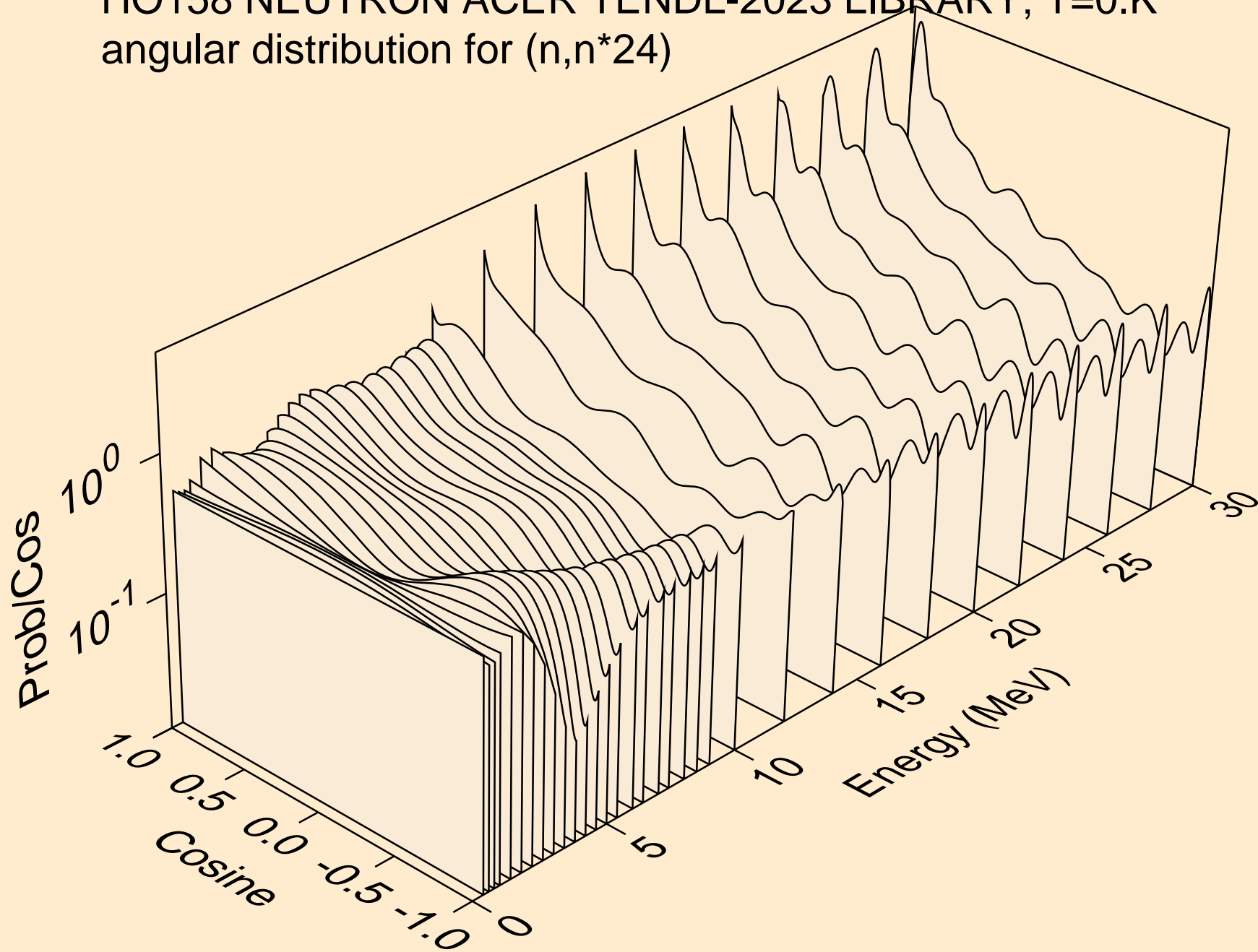

HO158 NEUTRON ACER TENDL-2023 LIBRARY; T=0.K
Neutron emission for (n,x)

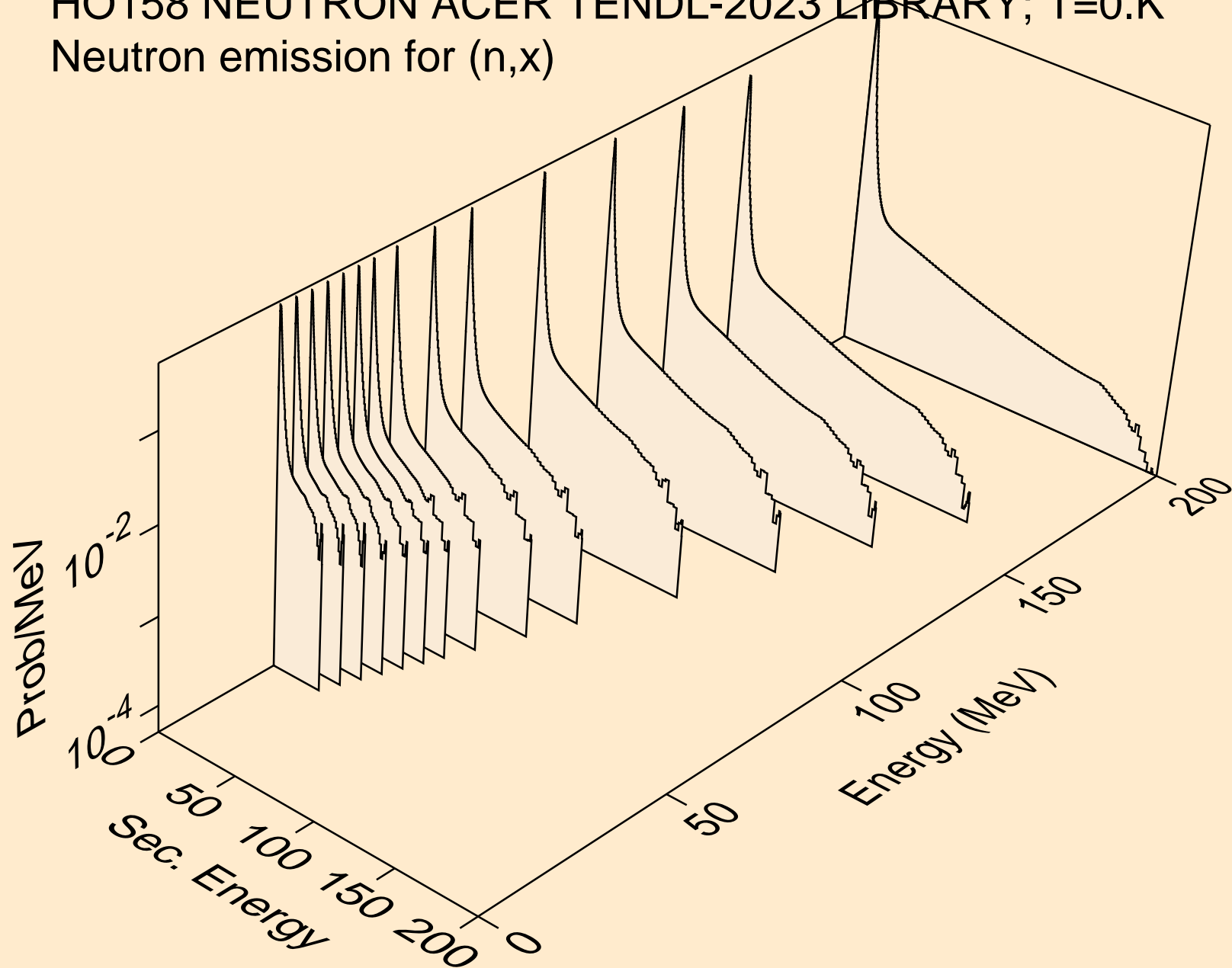

HO158 NEUTRON ACER TENDL-2023 LIBRARY; T=0.K
Neutron emission for (n,2nd)

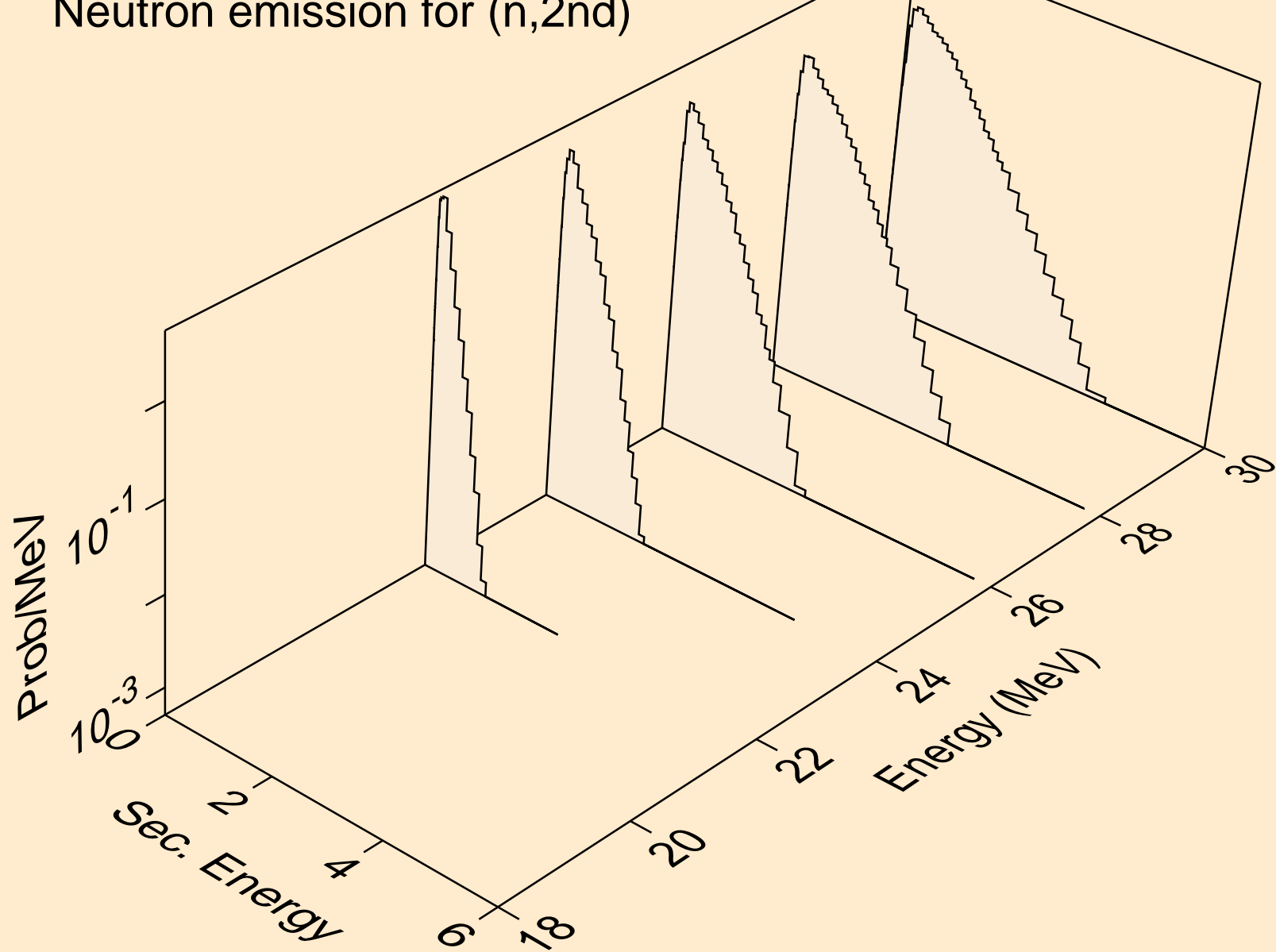

HO158 NEUTRON ACER TENDL-2023 LIBRARY; T=0.K
Neutron emission for (n,2n)

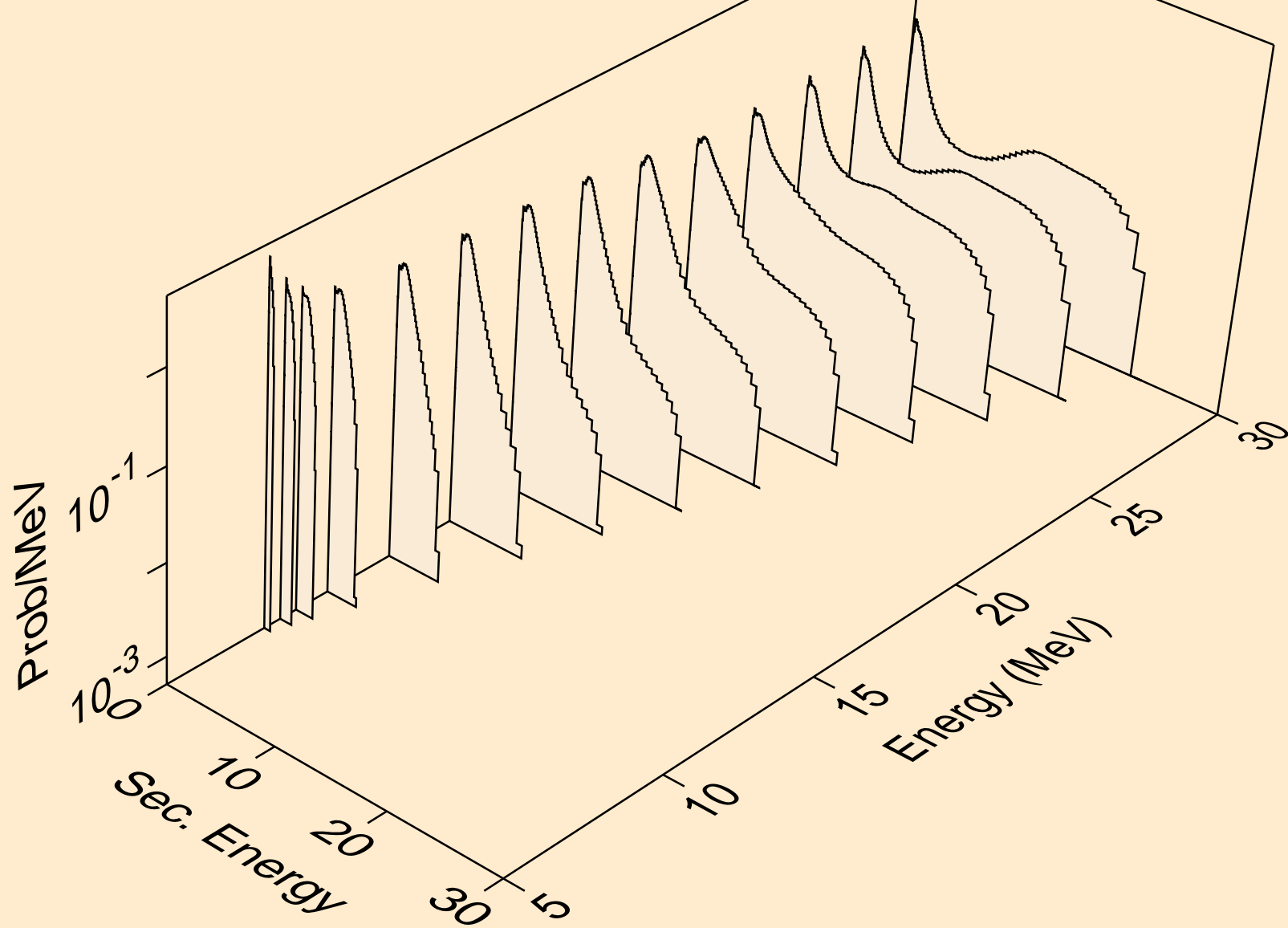

HO158 NEUTRON ACER TENDL-2023 LIBRARY; T=0.K
Neutron emission for (n,3n)

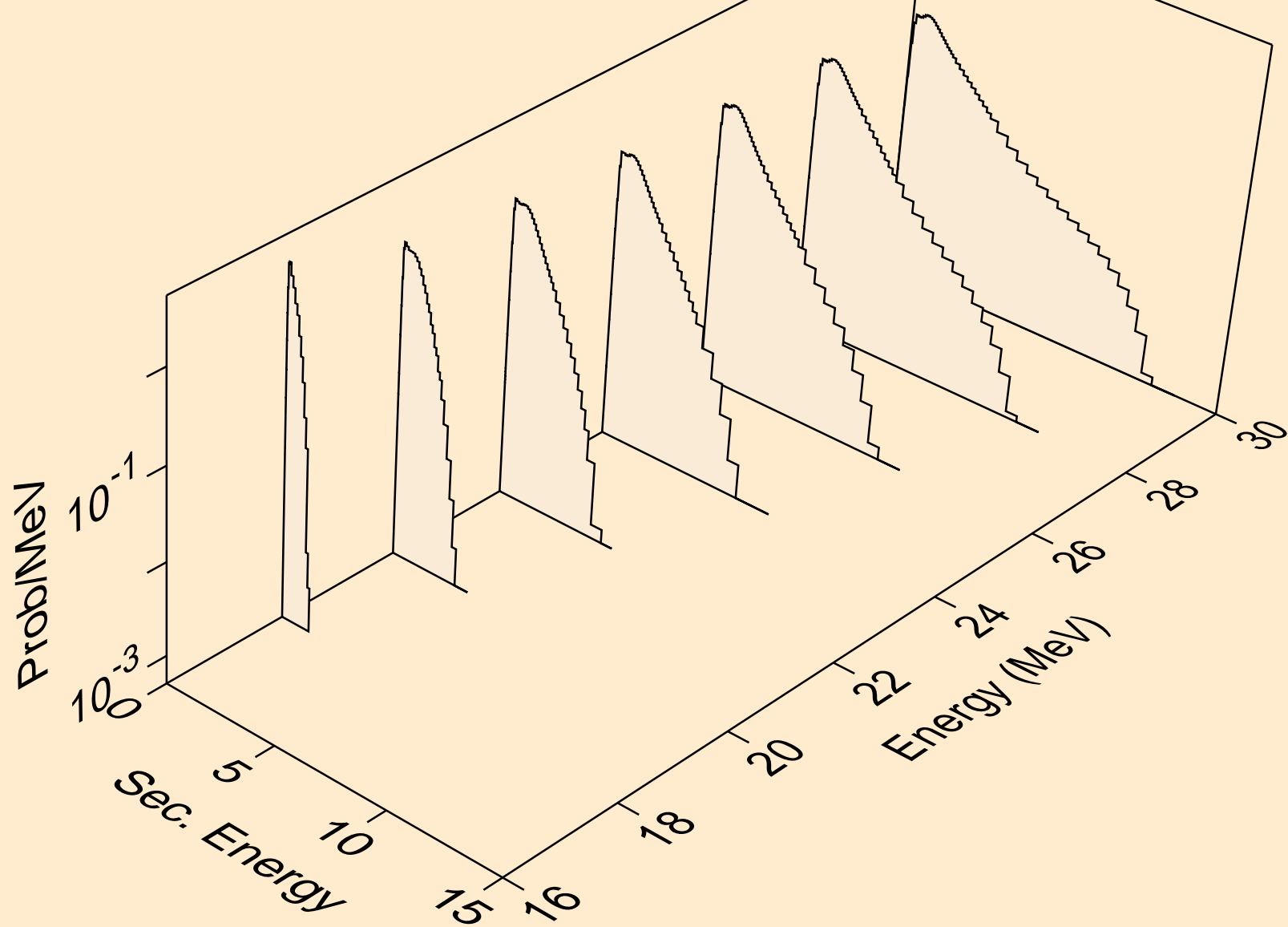

HO158 NEUTRON ACER TENDL-2023 LIBRARY; T=0.K
Neutron emission for (n,n*)a

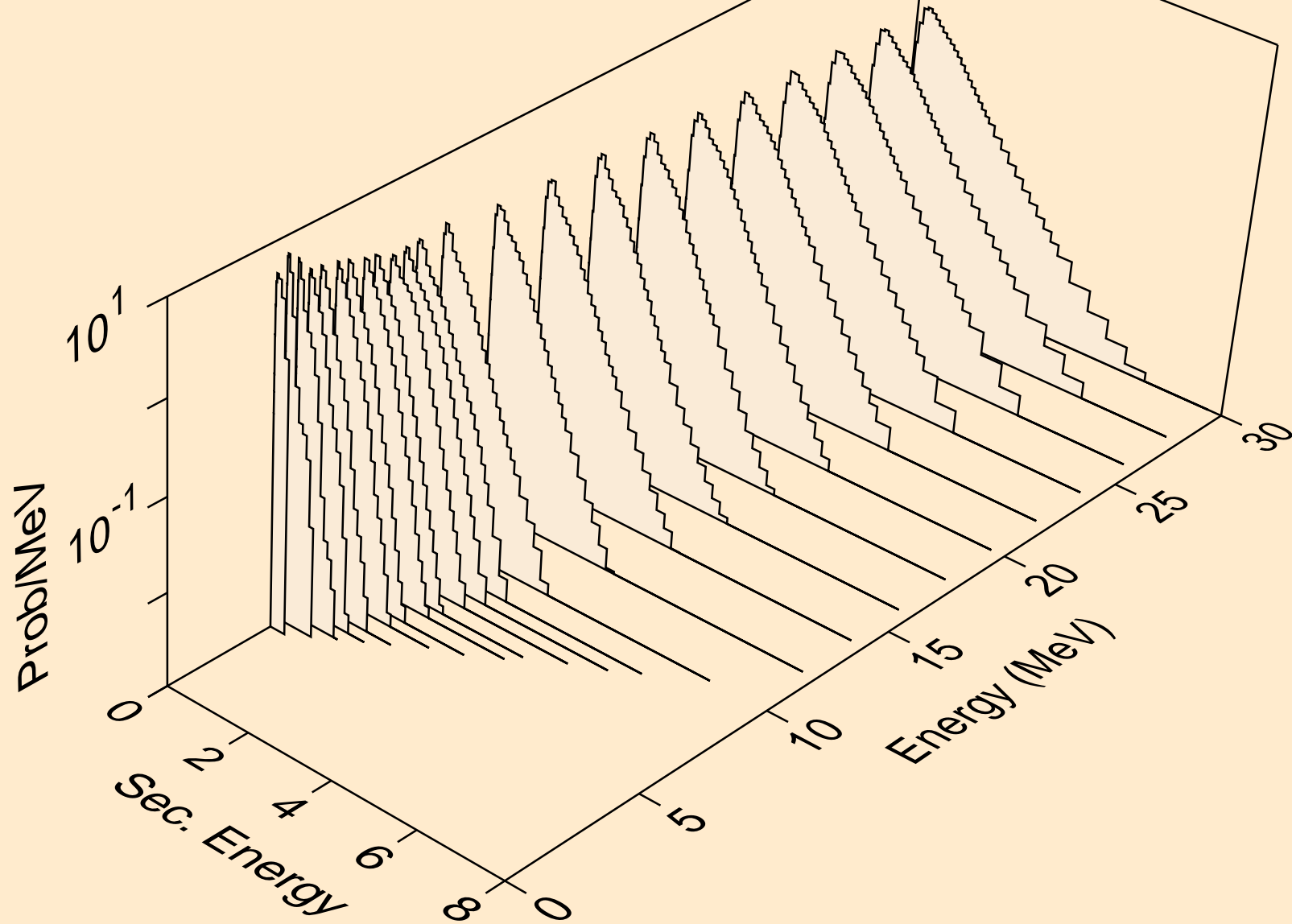

HO158 NEUTRON ACER TENDL-2023 LIBRARY; T=0.K
Neutron emission for (n,2n)a

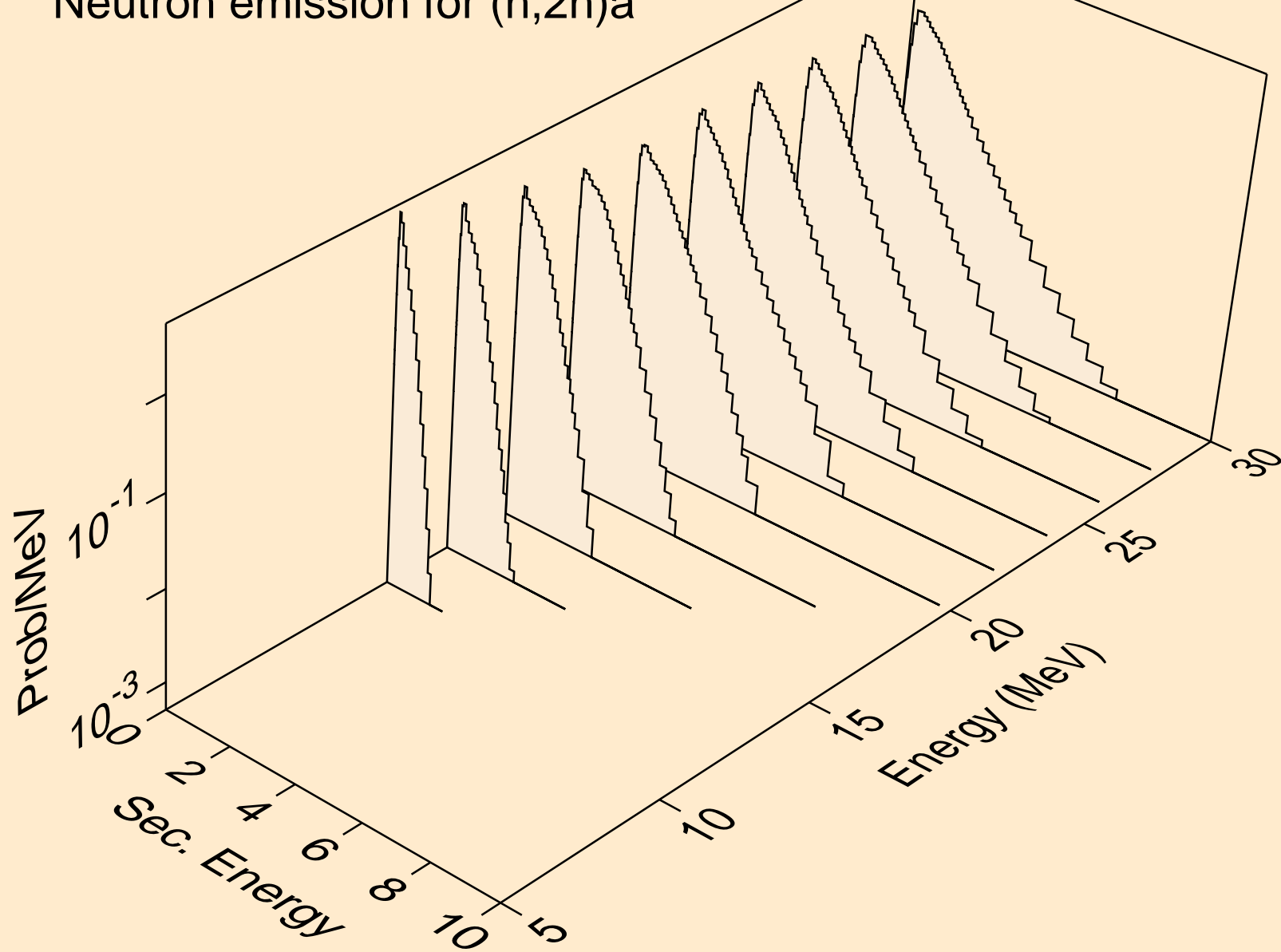

HO158 NEUTRON ACER TENDL-2023 LIBRARY; T=0.K
Neutron emission for (n,3n)a

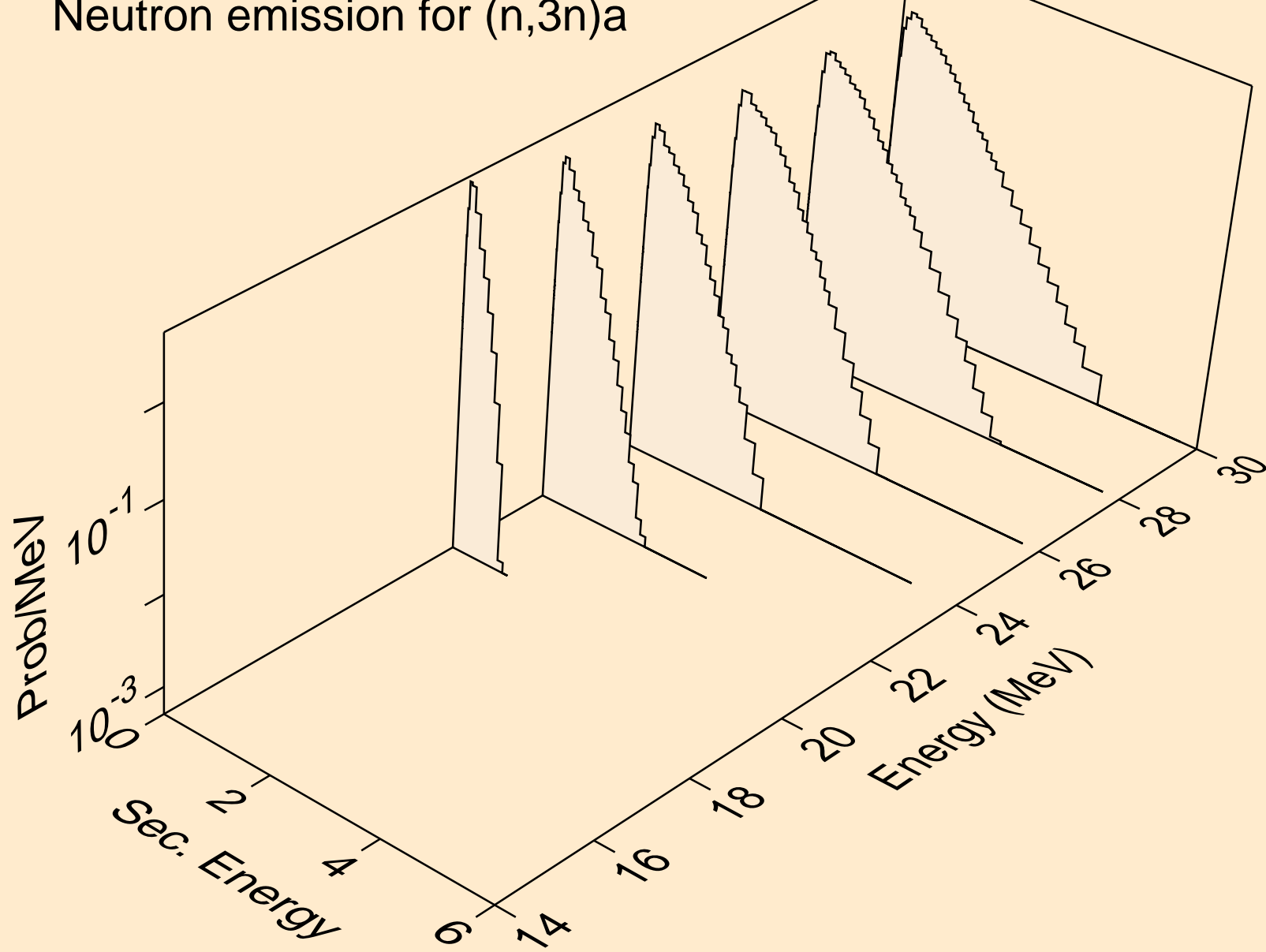

HO158 NEUTRON ACER TENDL-2023 LIBRARY; T=0.K
Neutron emission for (n,n*)p

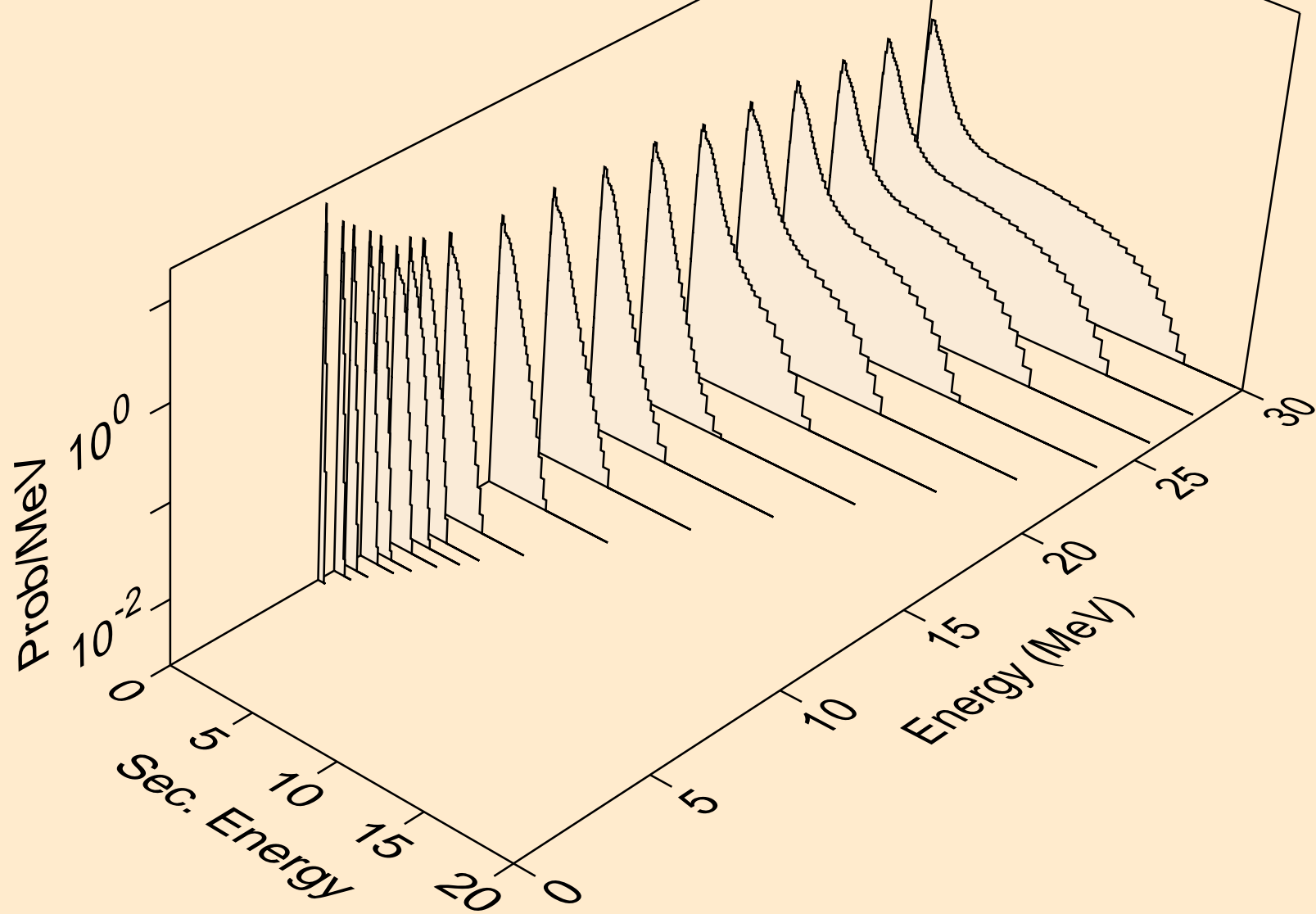

HO158 NEUTRON ACER TENDL-2023 LIBRARY; T=0.K
Neutron emission for (n,n*)2a

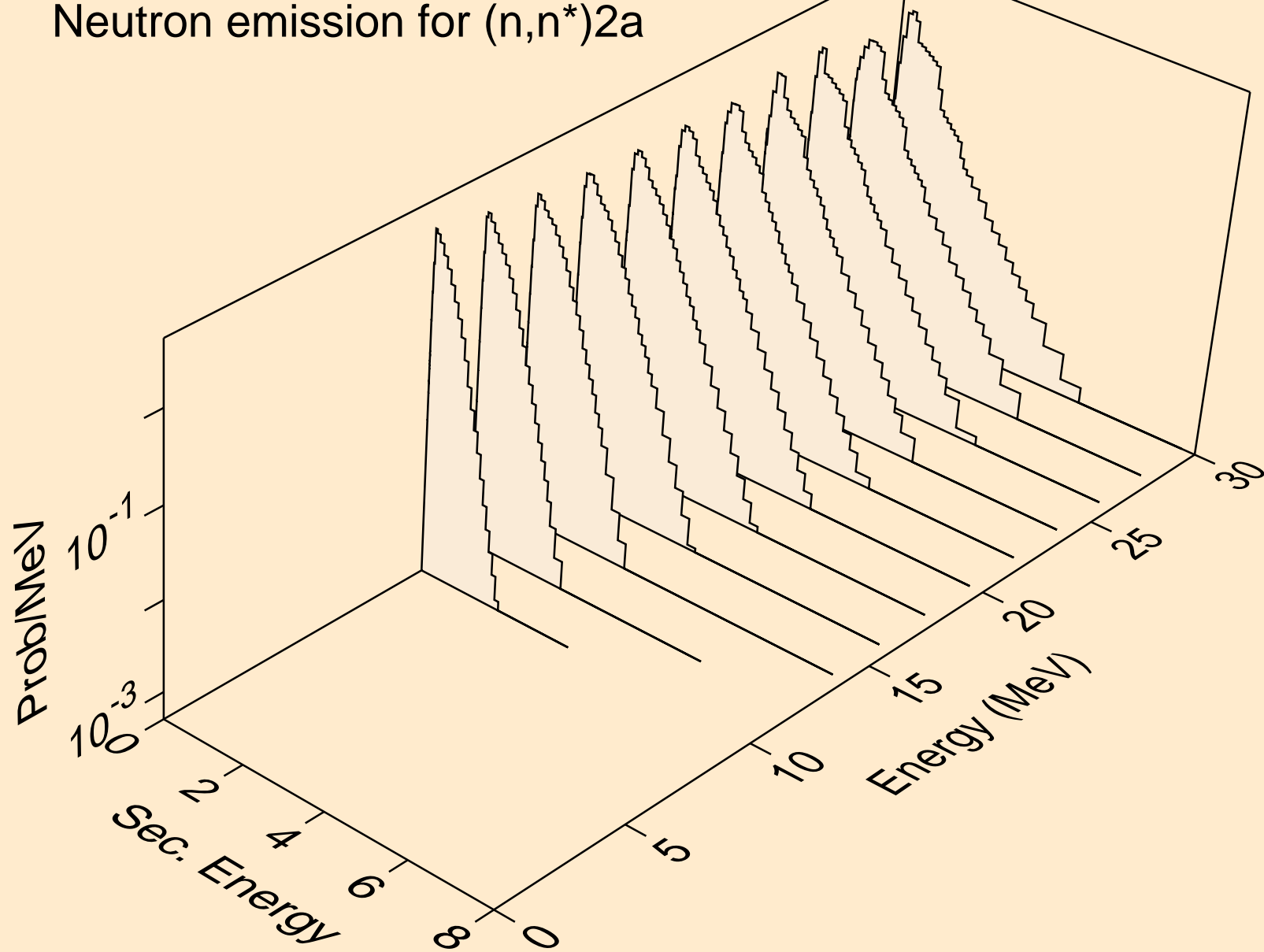

HO158 NEUTRON ACER TENDL-2023 LIBRARY; T=0.K
Neutron emission for (n,2n)2a

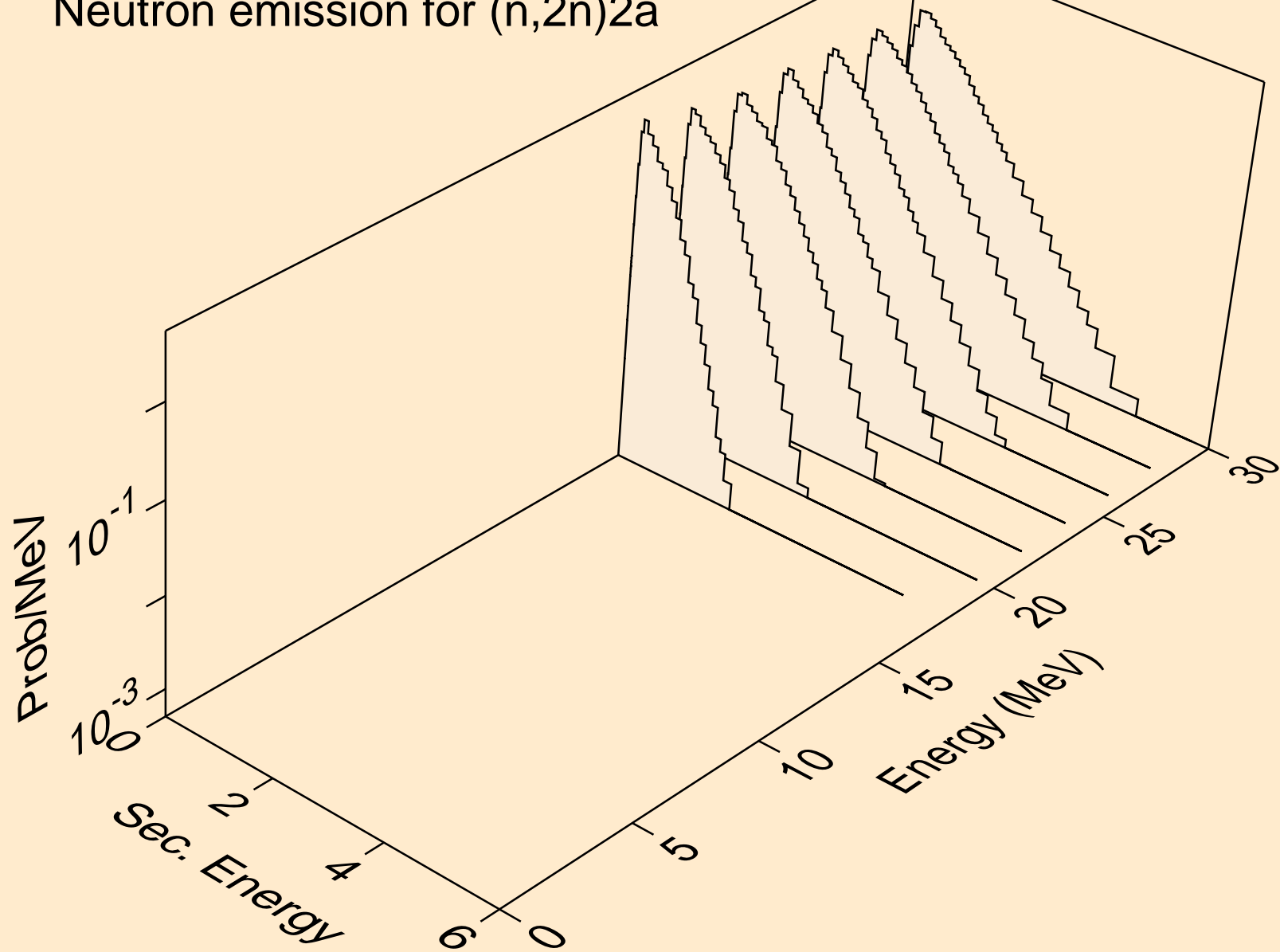

HO158 NEUTRON ACER TENDL-2023 LIBRARY; T=0.K
Neutron emission for (n,n*)d

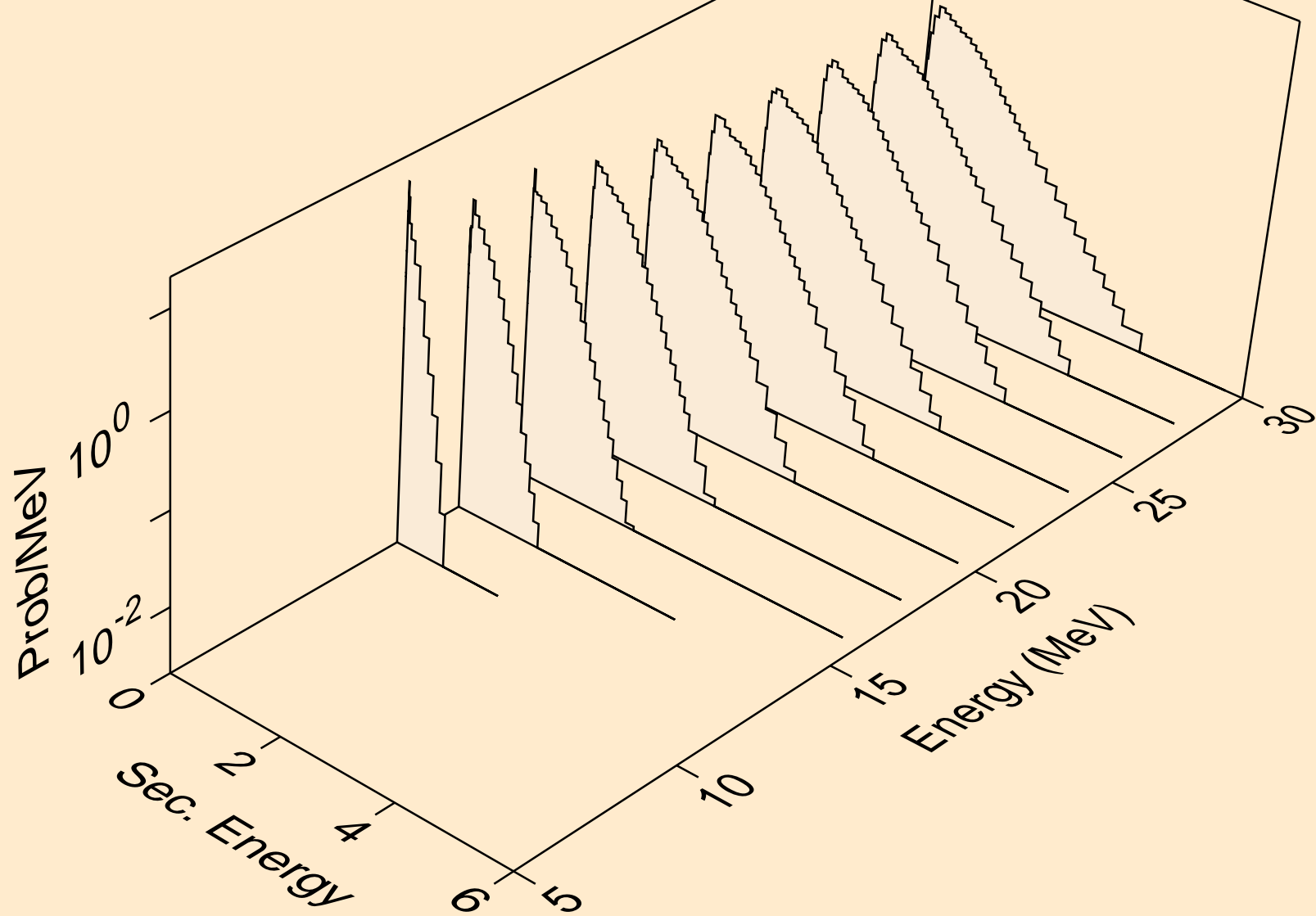

HO158 NEUTRON ACER TENDL-2023 LIBRARY; T=0.K
Neutron emission for (n,n*)t

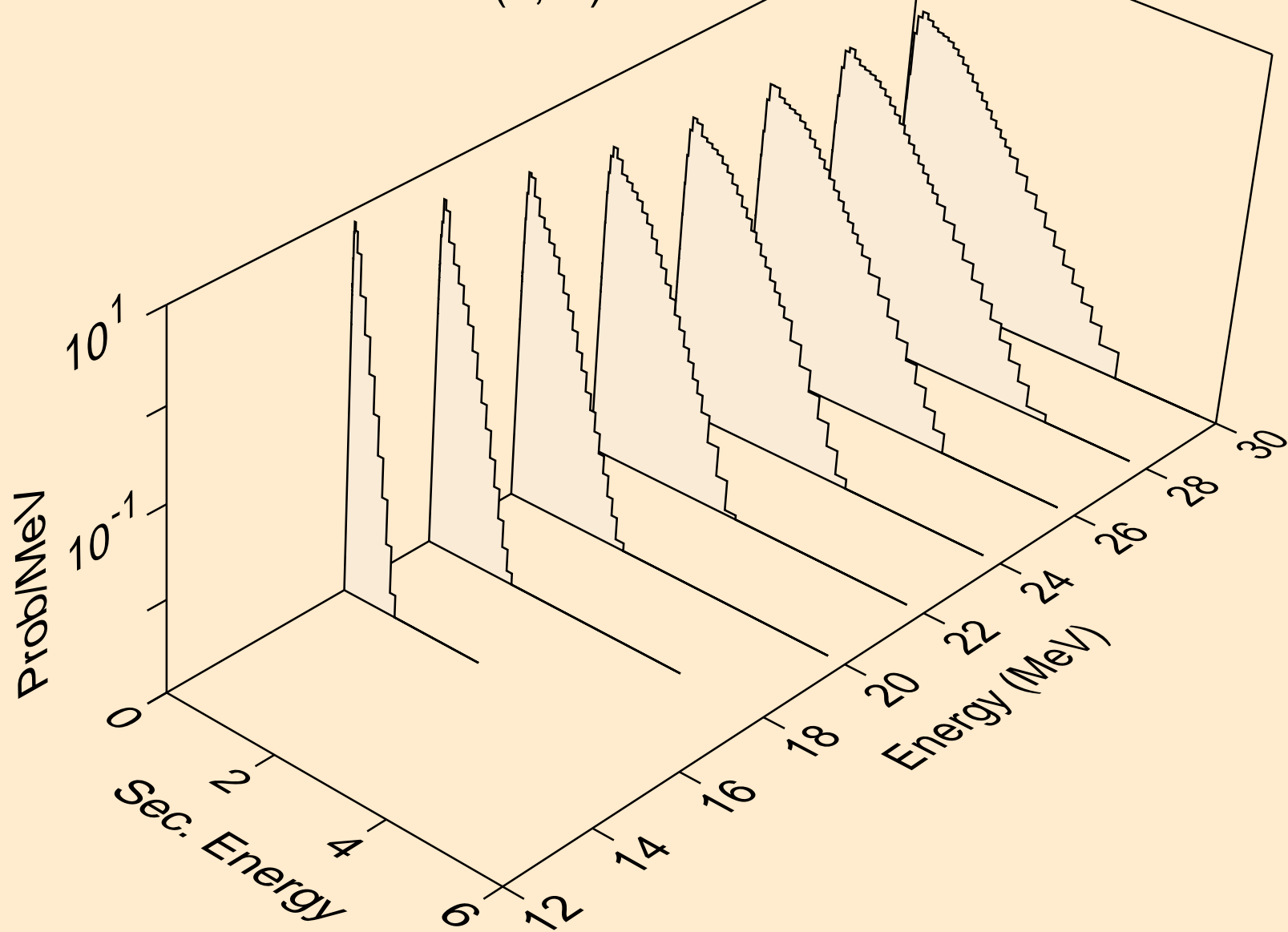

HO158 NEUTRON ACER TENDL-2023 LIBRARY; T=0.K
Neutron emission for (n,n*)he3

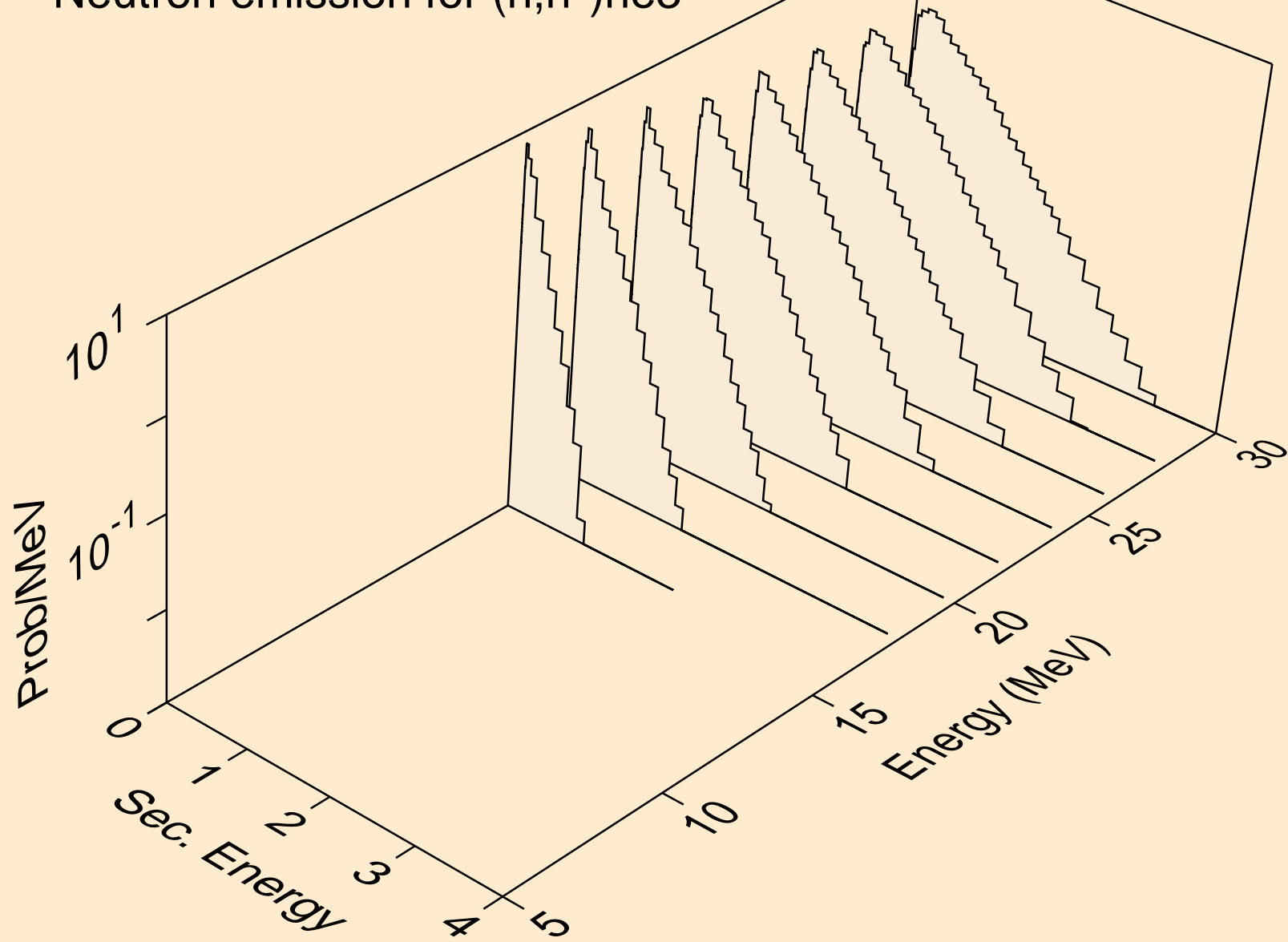

HO158 NEUTRON ACER TENDL-2023 LIBRARY; T=0.K
Neutron emission for (n,4n)

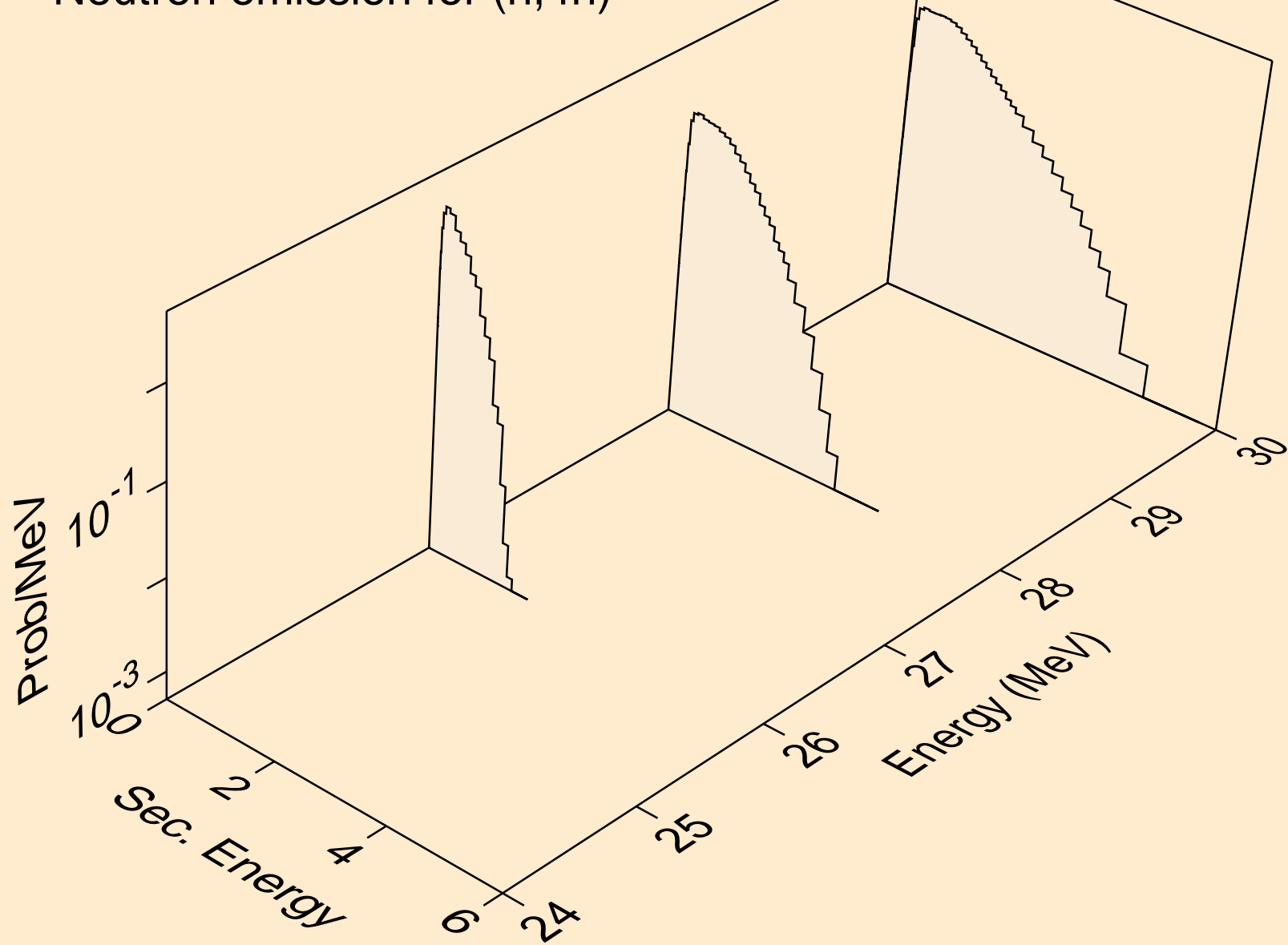

HO158 NEUTRON ACER TENDL-2023 LIBRARY; T=0.K
Neutron emission for (n,2np)

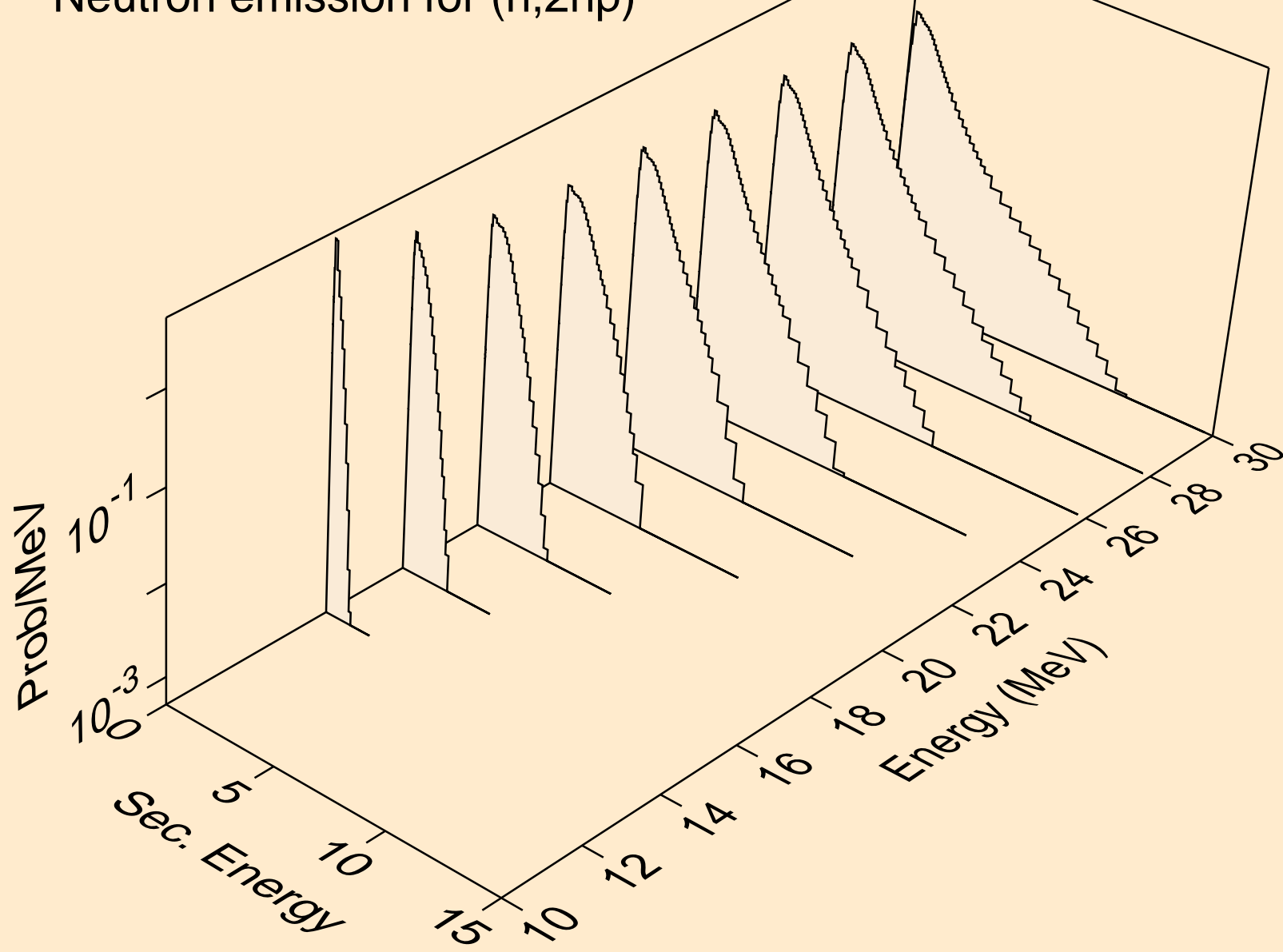

HO158 NEUTRON ACER TENDL-2023 LIBRARY; T=0.K
Neutron emission for (n,3np)

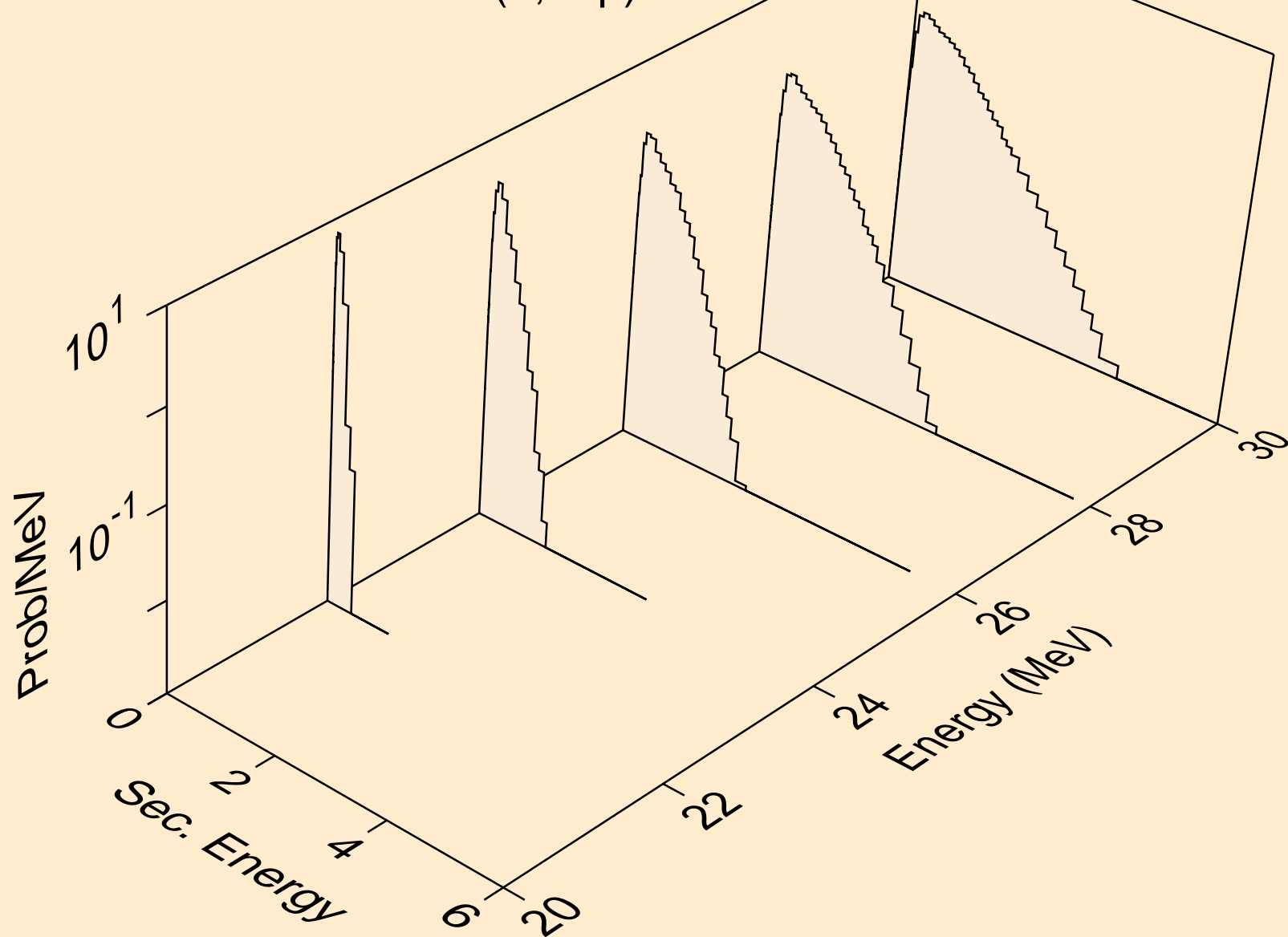

HO158 NEUTRON ACER TENDL-2023 LIBRARY; T=0.K
Neutron emission for (n,n2p)

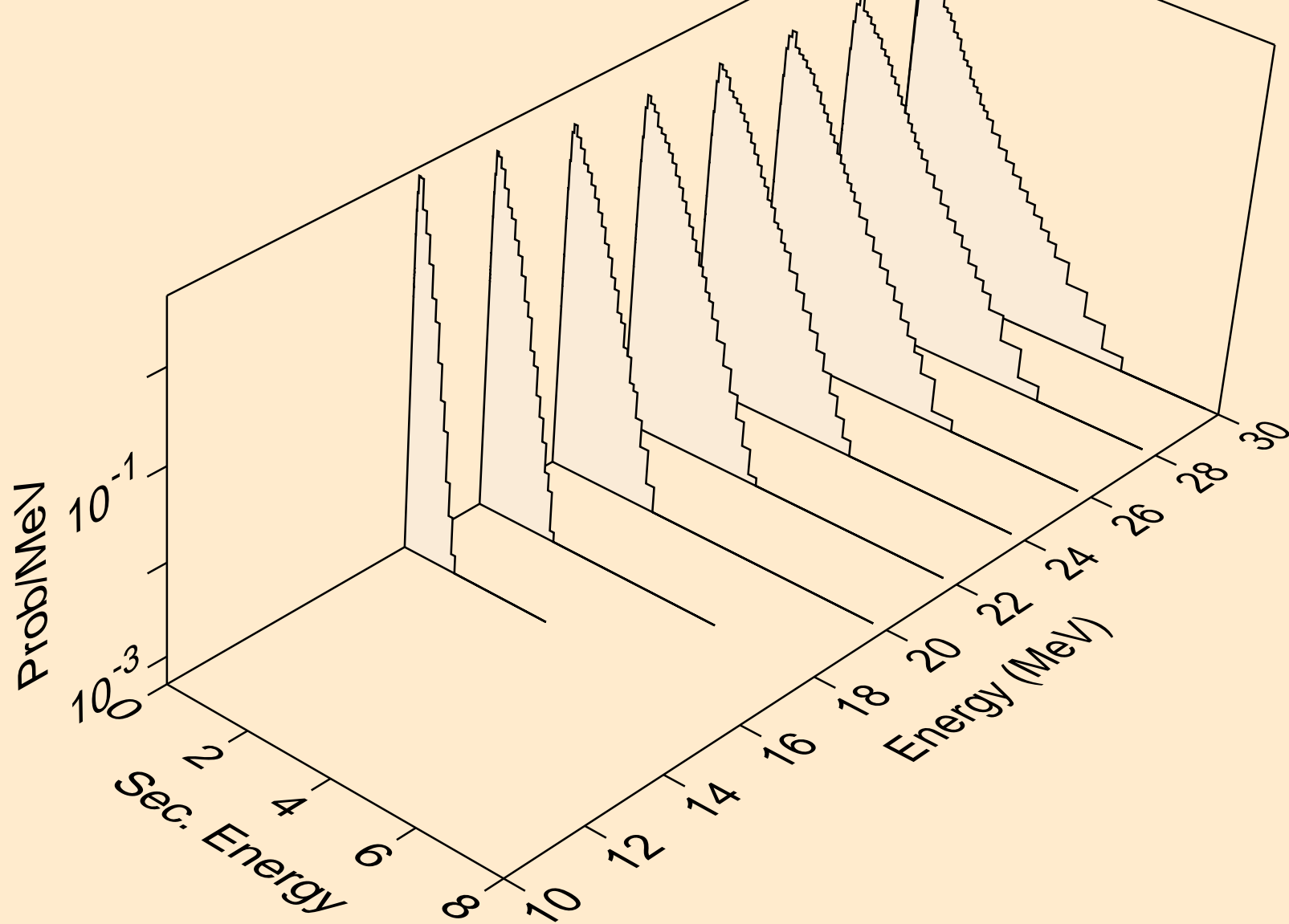

HO158 NEUTRON ACER TENDL-2023 LIBRARY; T=0.K
Neutron emission for (n,npa)

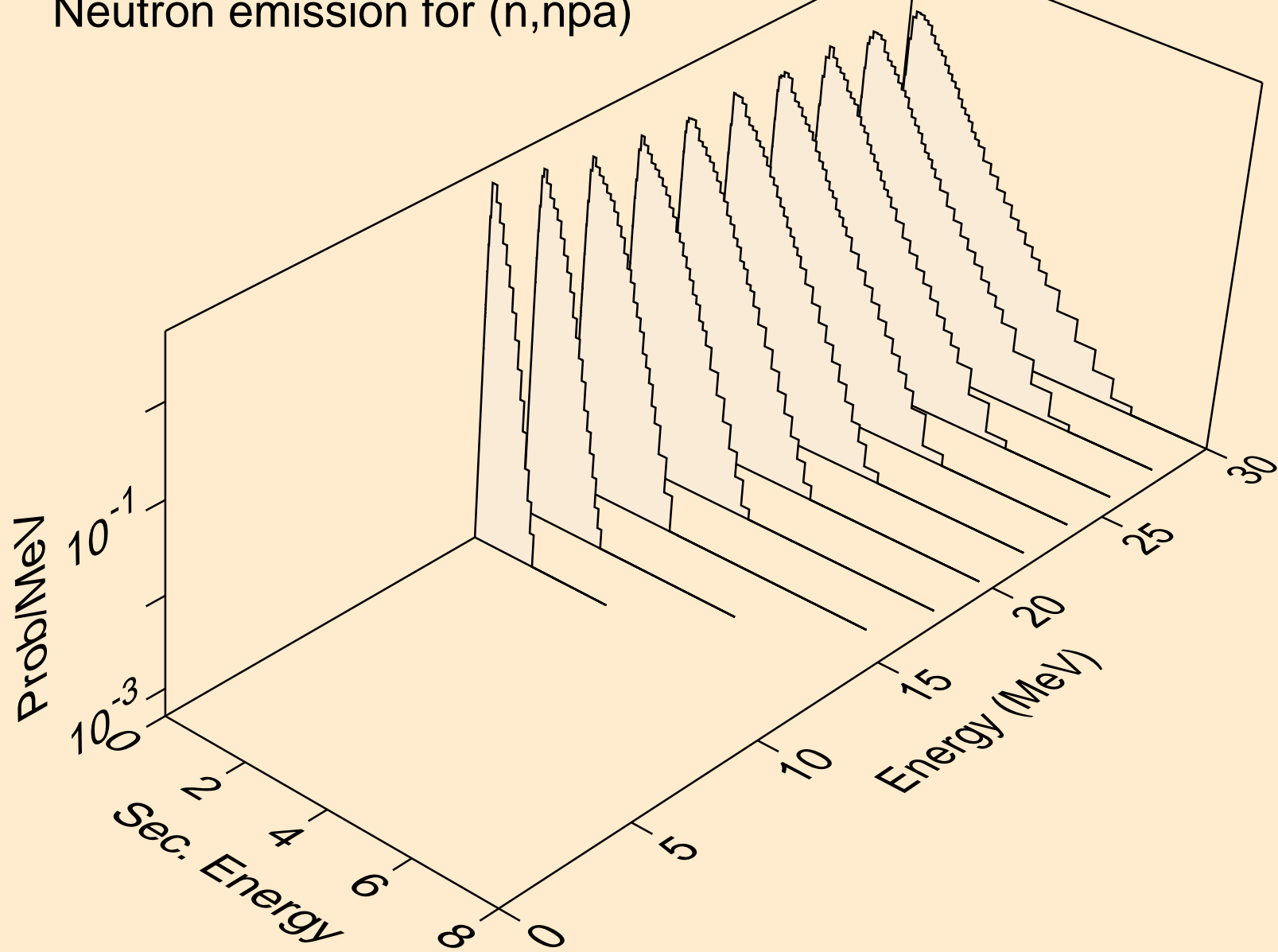

HO158 NEUTRON ACER TENDL-2023 LIBRARY; T=0.K
Neutron emission for (n,n*c)

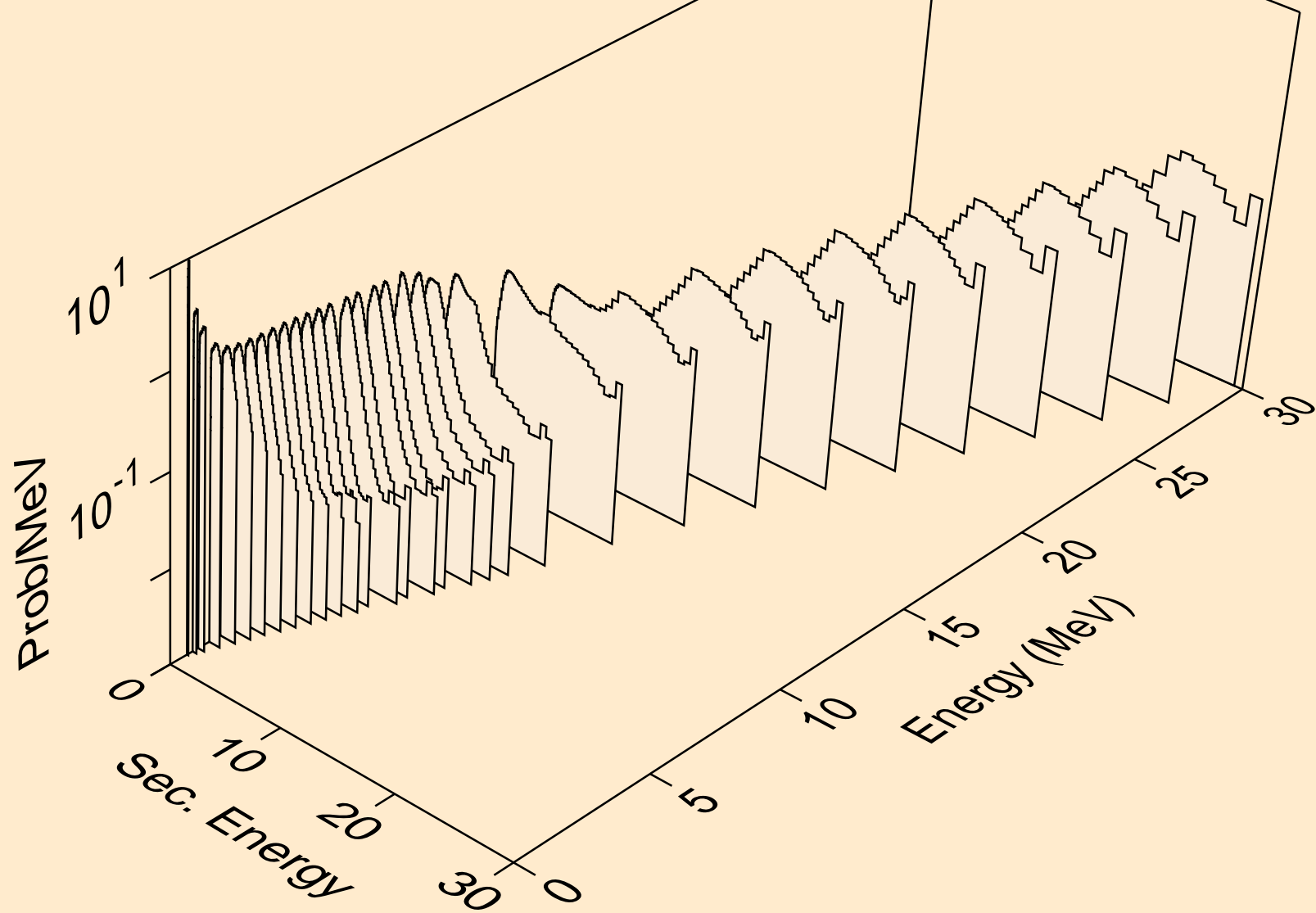

HO158 NEUTRON ACER TENDL-2023 LIBRARY; T=0.K
Photon emission for (n,x)

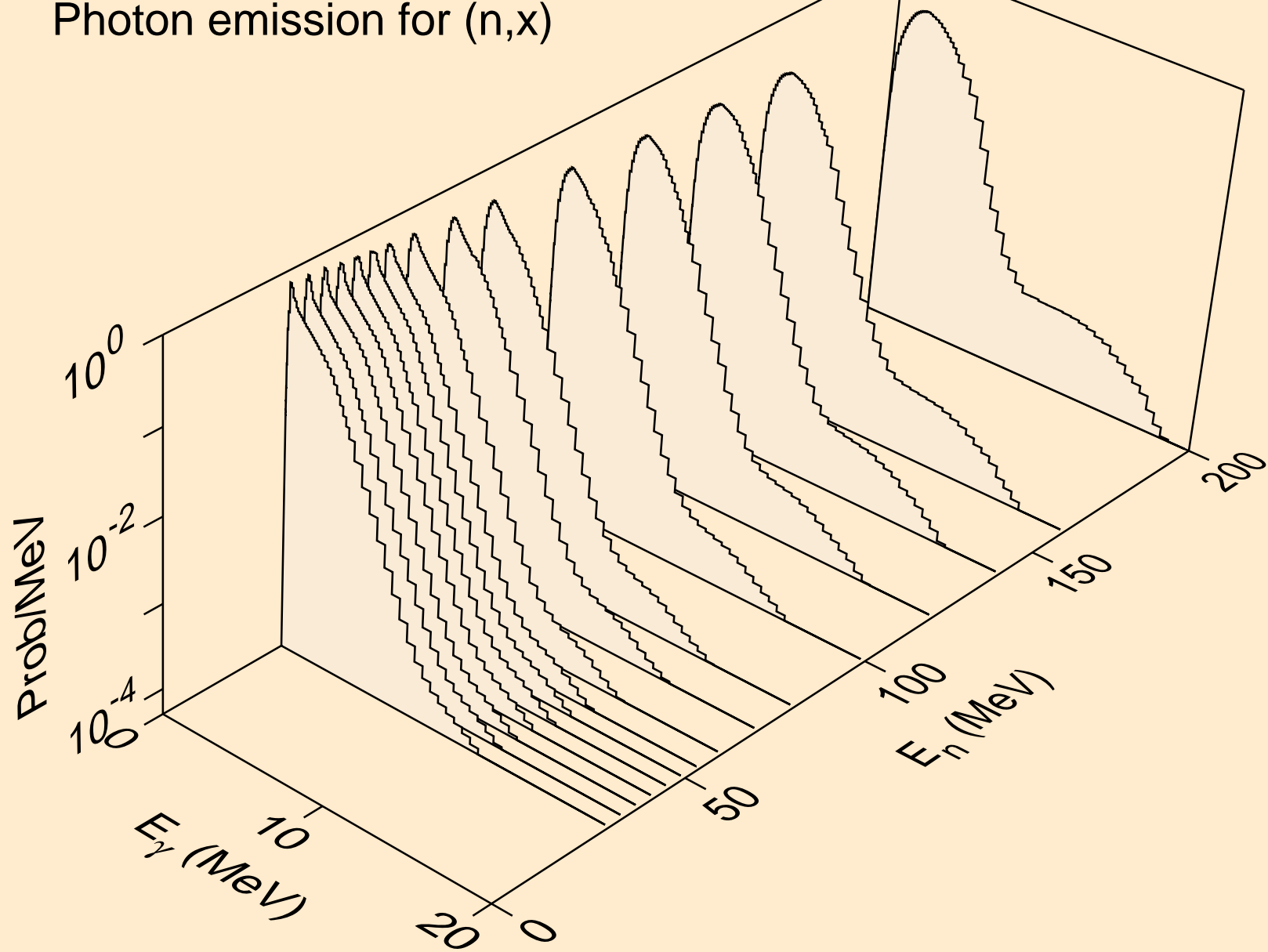

HO158 NEUTRON ACER TENDL-2023 LIBRARY; T=0.K
Photon emission for (n,2nd)

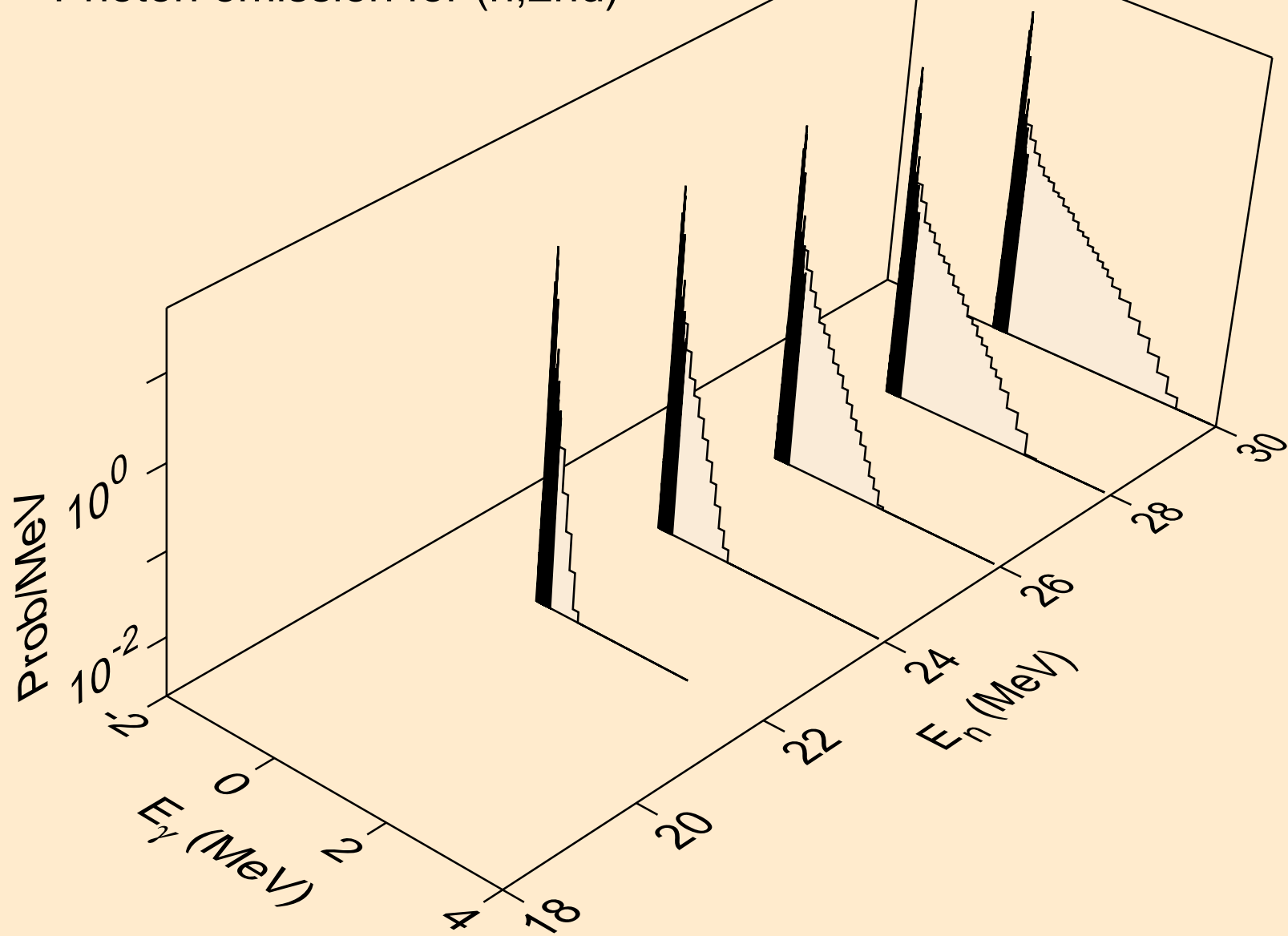

HO158 NEUTRON ACER TENDL-2023 LIBRARY; T=0.K
Photon emission for (n,2n)

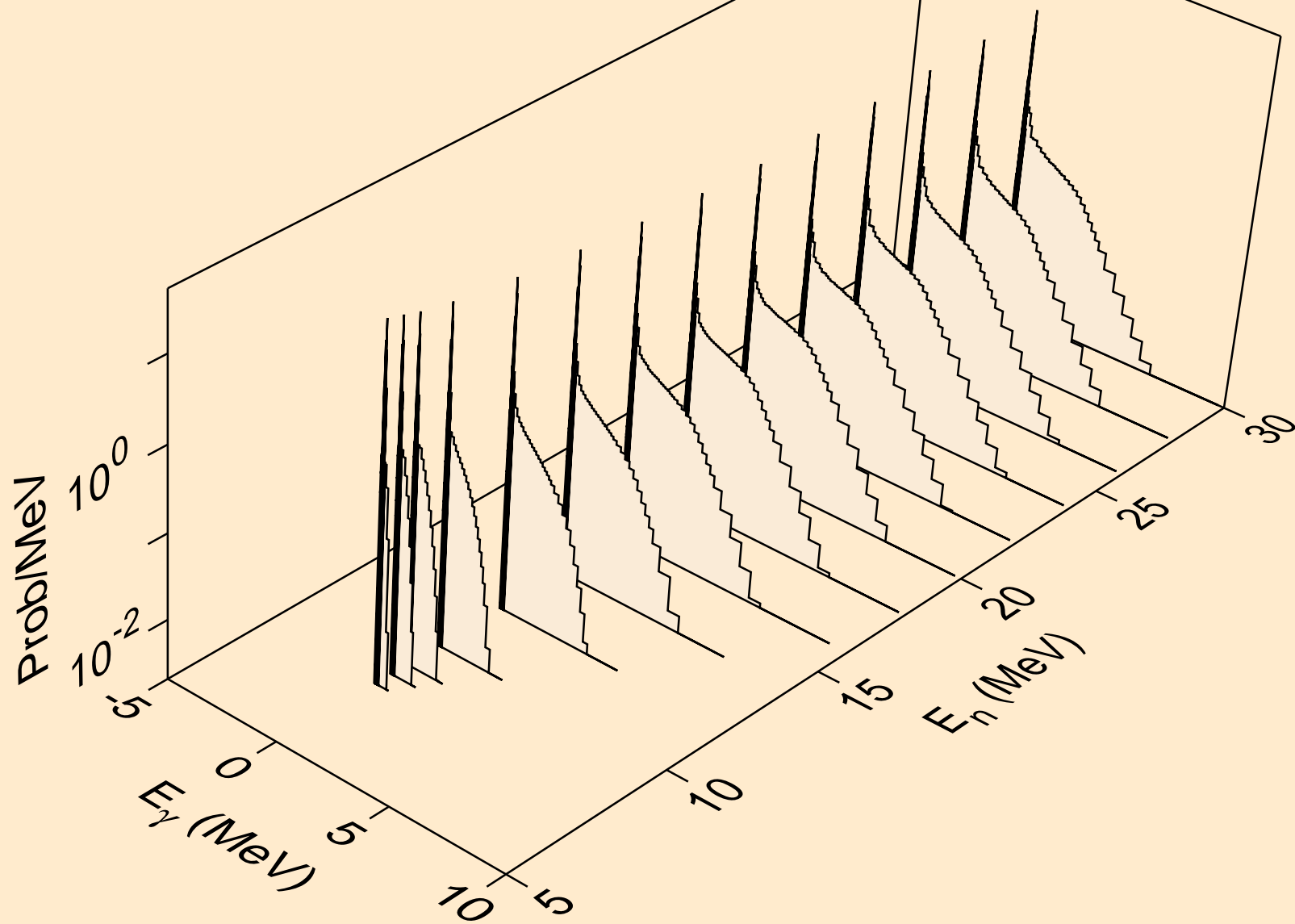

HO158 NEUTRON ACER TENDL-2023 LIBRARY; T=0.K
Photon emission for (n,3n)

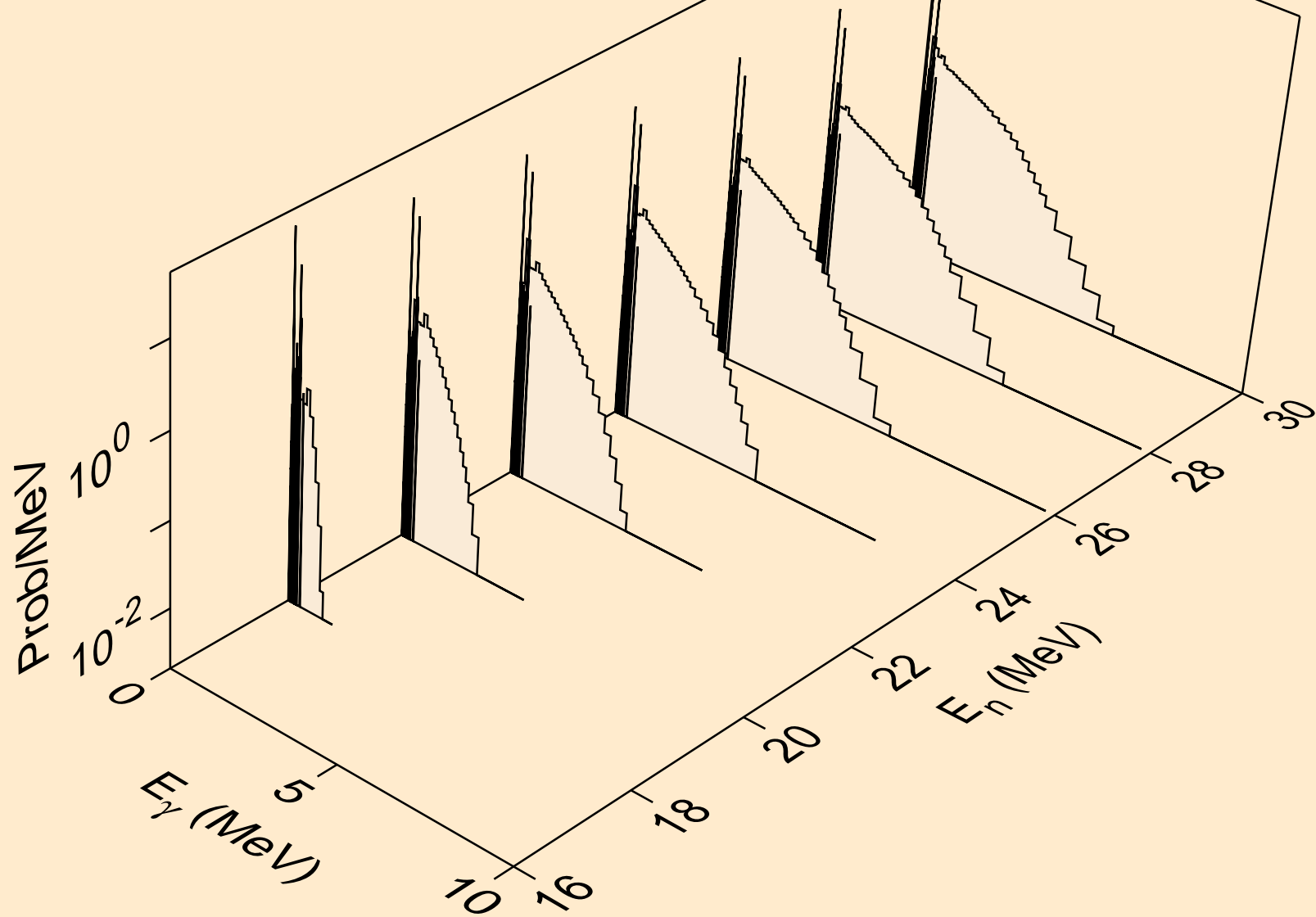

HO158 NEUTRON ACER TENDL-2023 LIBRARY; T=0.K
Photon emission for (n,n*)a

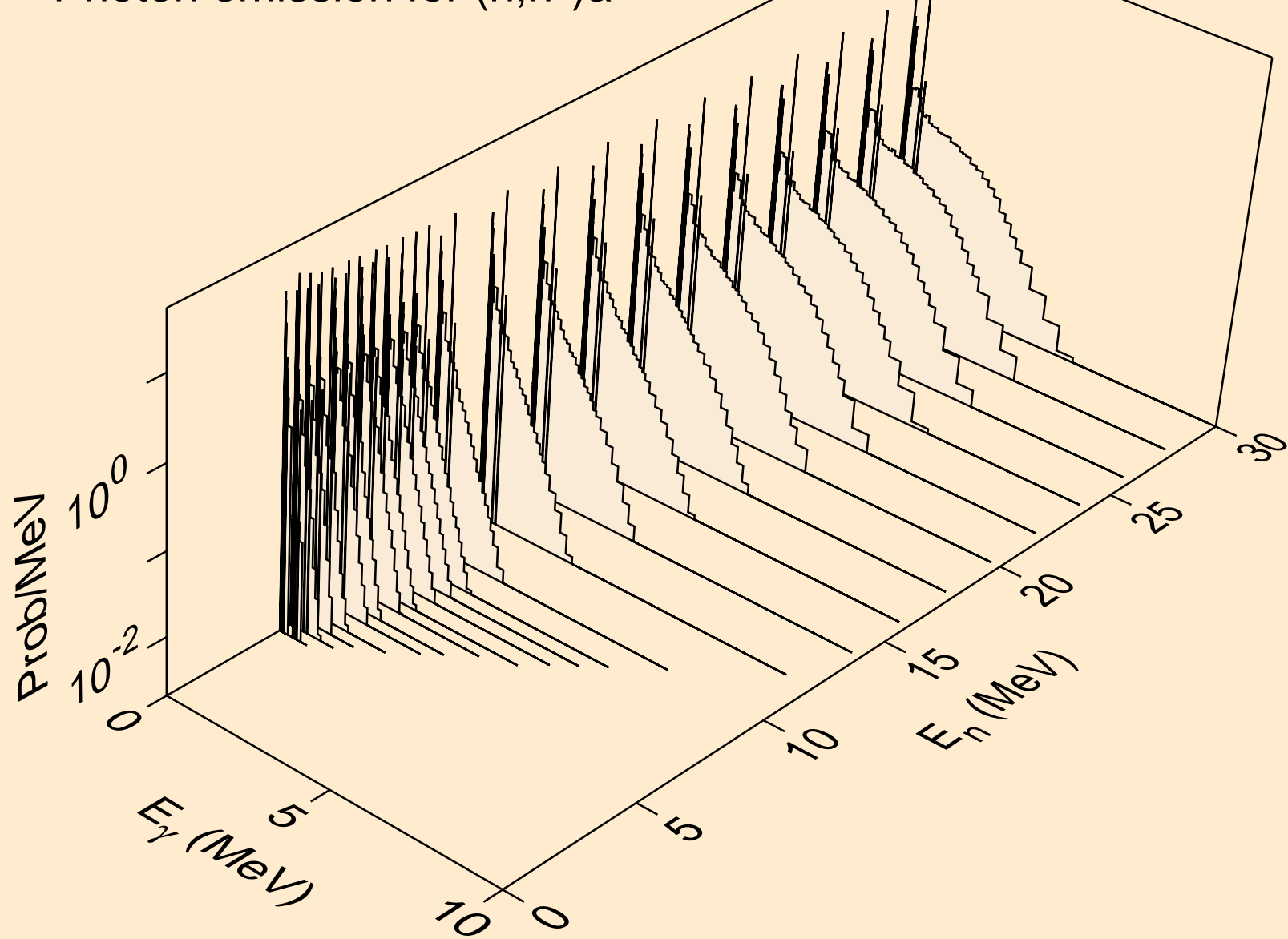

HO158 NEUTRON ACER TENDL-2023 LIBRARY; T=0.K
Photon emission for (n,2n)a

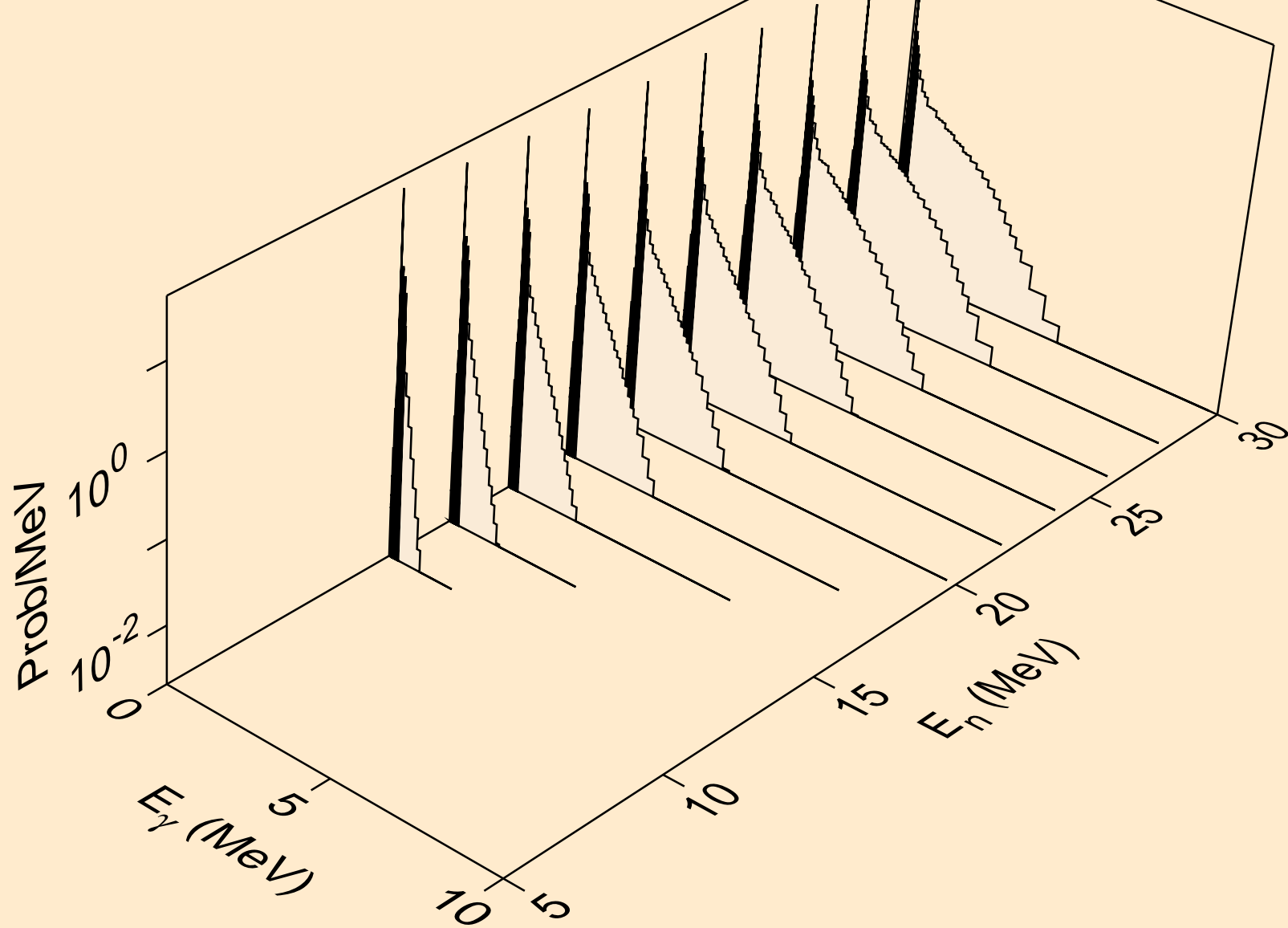

HO158 NEUTRON ACER TENDL-2023 LIBRARY; T=0.K
Photon emission for (n,3n)a

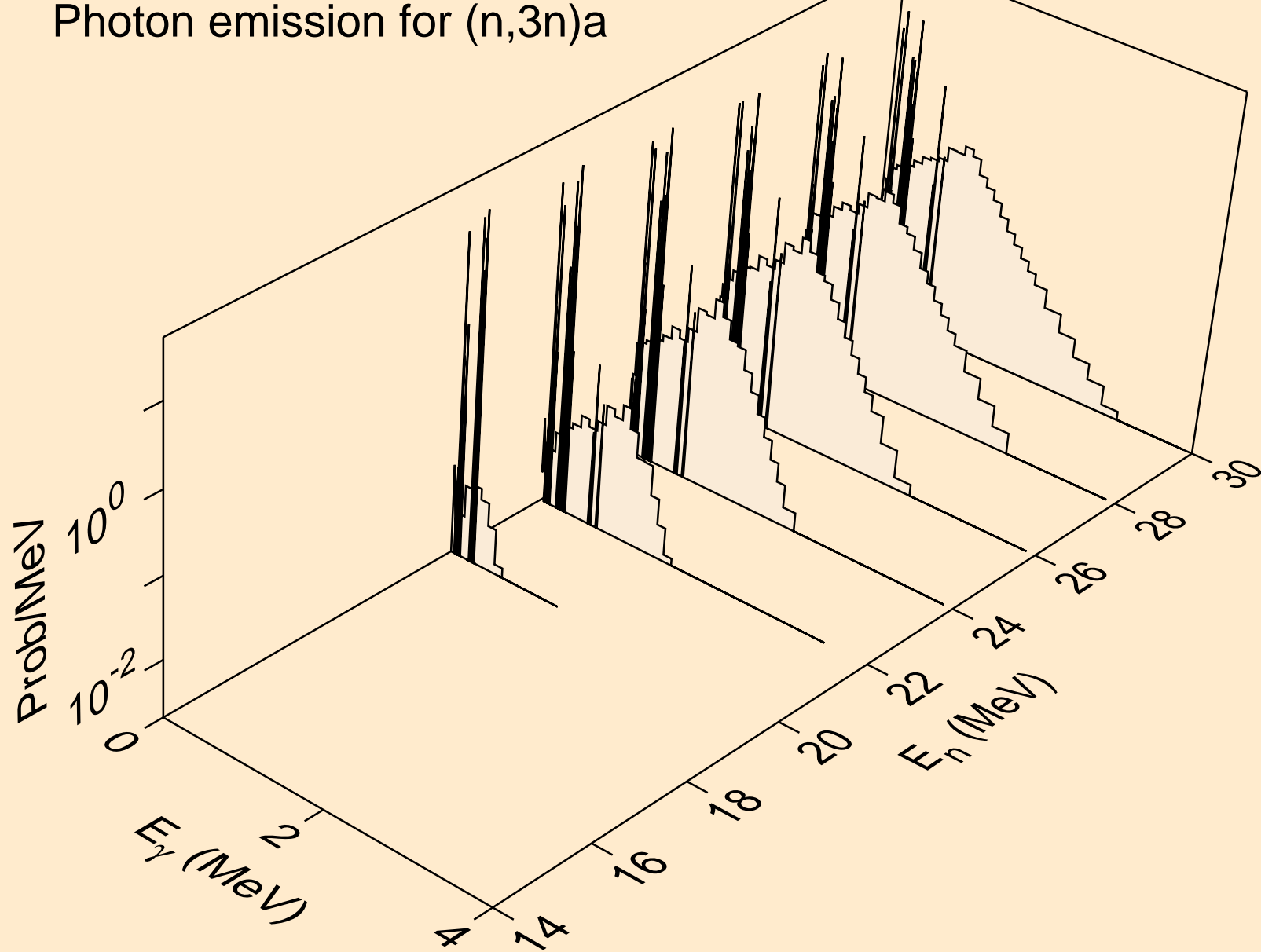

HO158 NEUTRON ACER TENDL-2023 LIBRARY; T=0.K
Photon emission for (n,n*)p

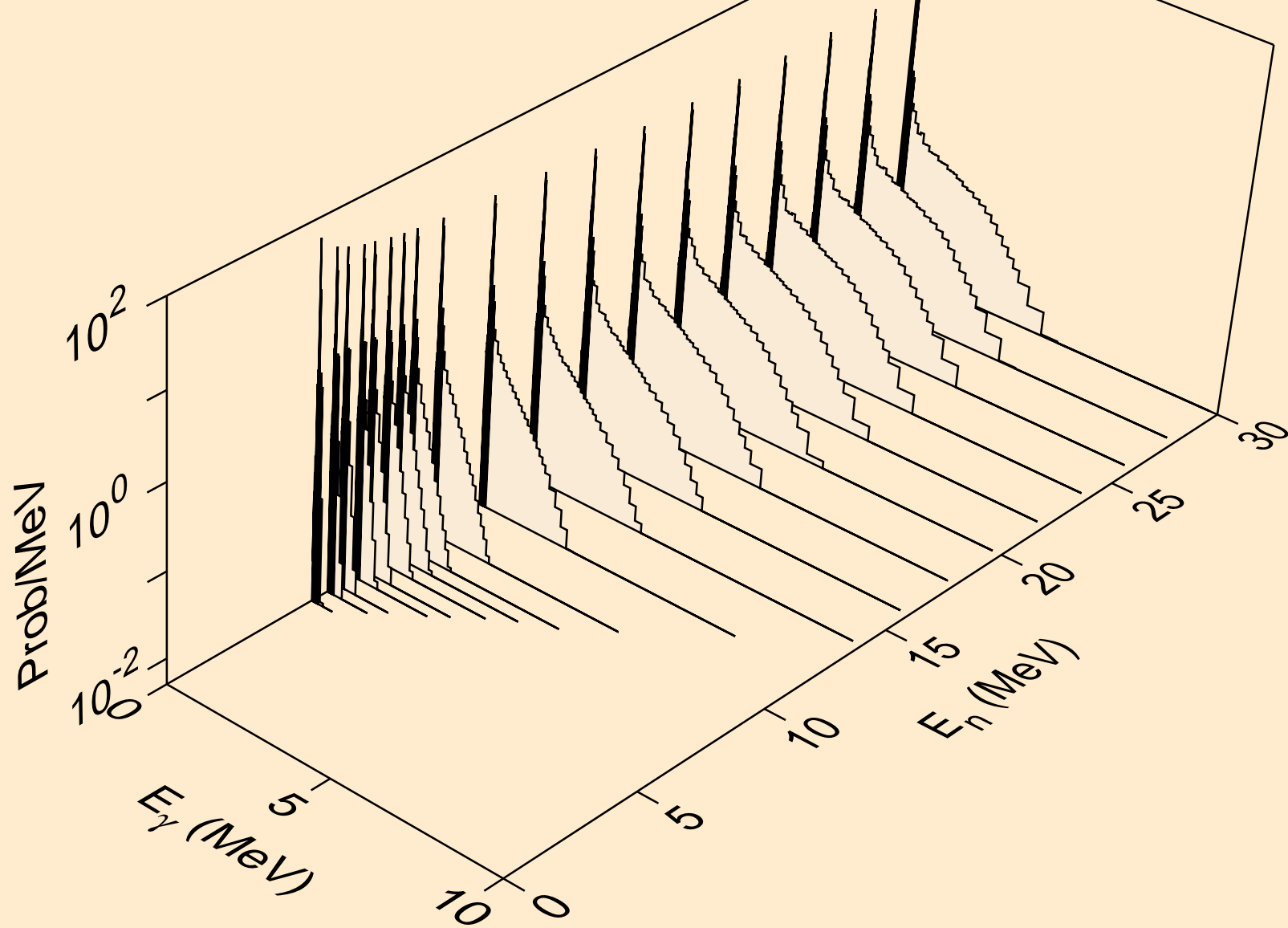

HO158 NEUTRON ACER TENDL-2023 LIBRARY; T=0.K
Photon emission for (n,n*)2a

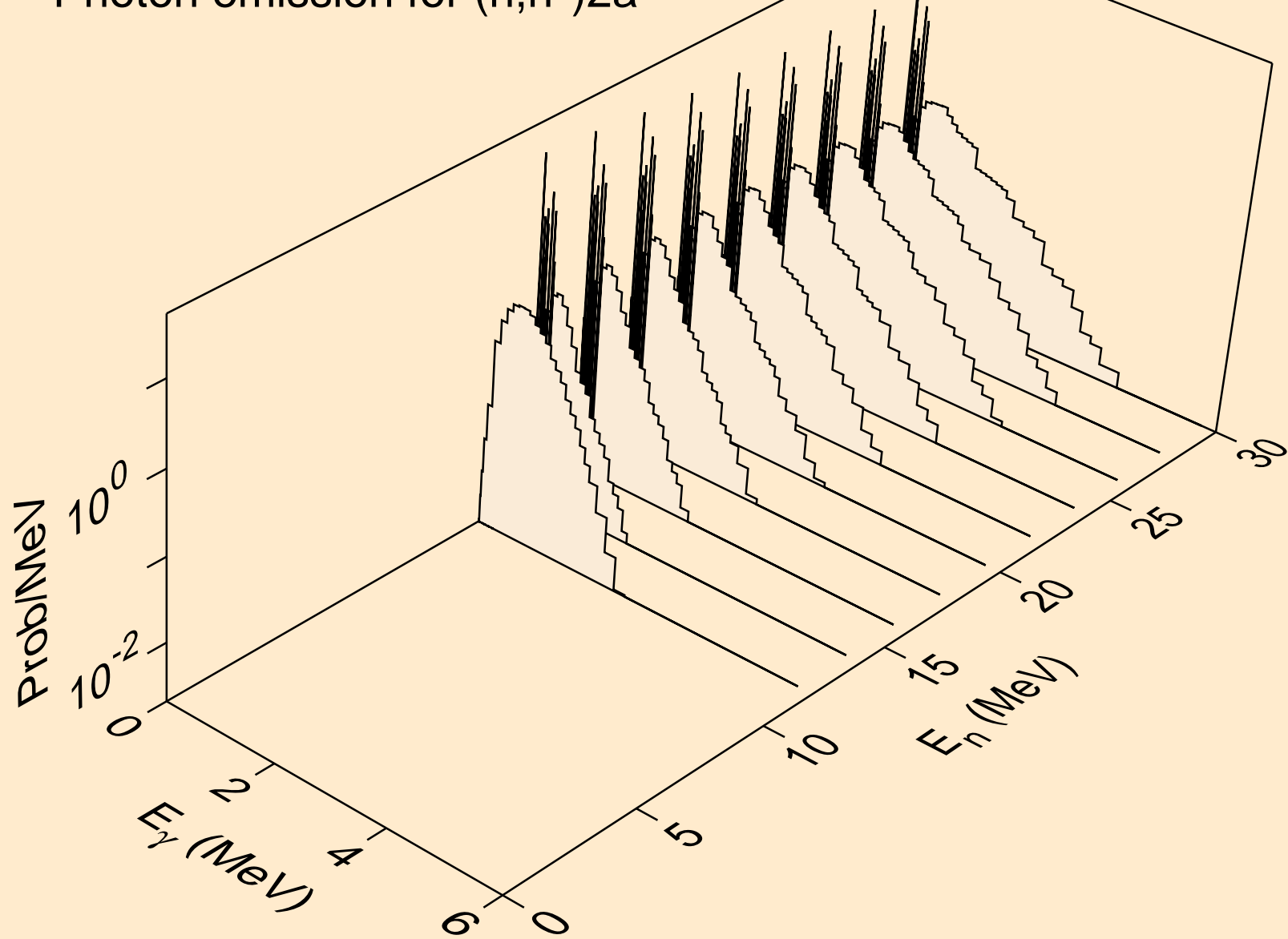

HO158 NEUTRON ACER TENDL-2023 LIBRARY; T=0.K
Photon emission for (n,2n)2a

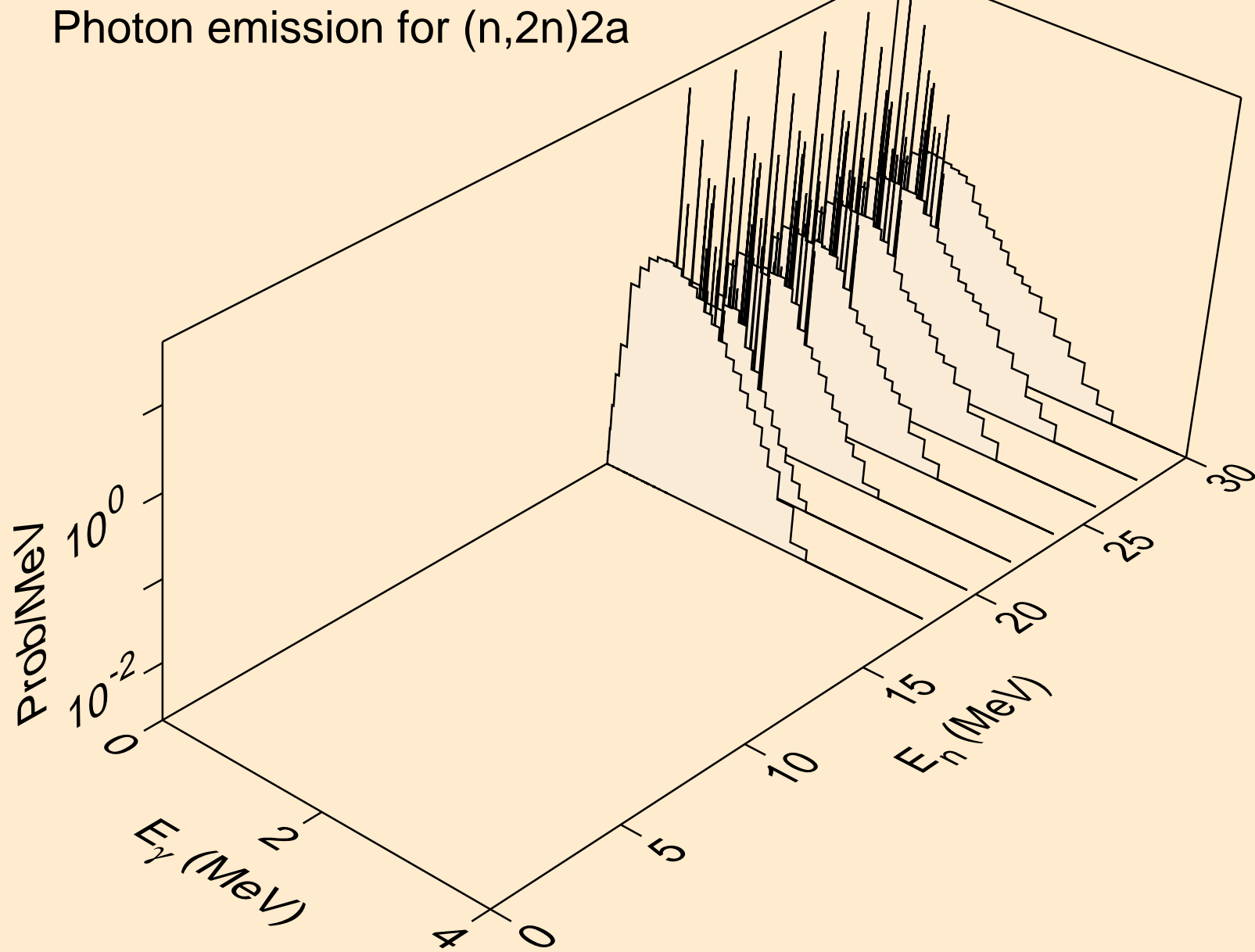

HO158 NEUTRON ACER TENDL-2023 LIBRARY; T=0.K
Photon emission for (n,n*)d

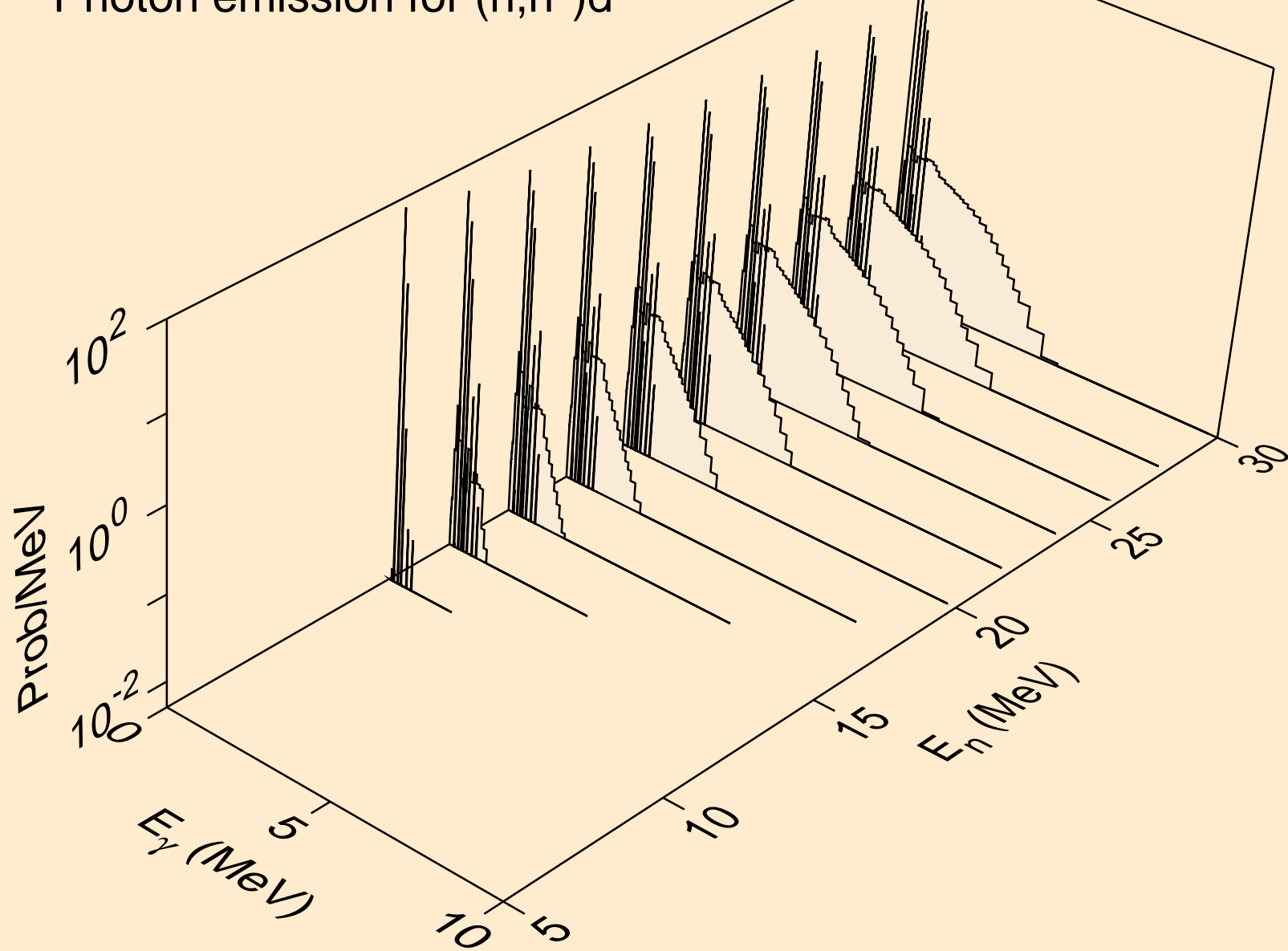

HO158 NEUTRON ACER TENDL-2023 LIBRARY; T=0.K
Photon emission for (n,n*)t

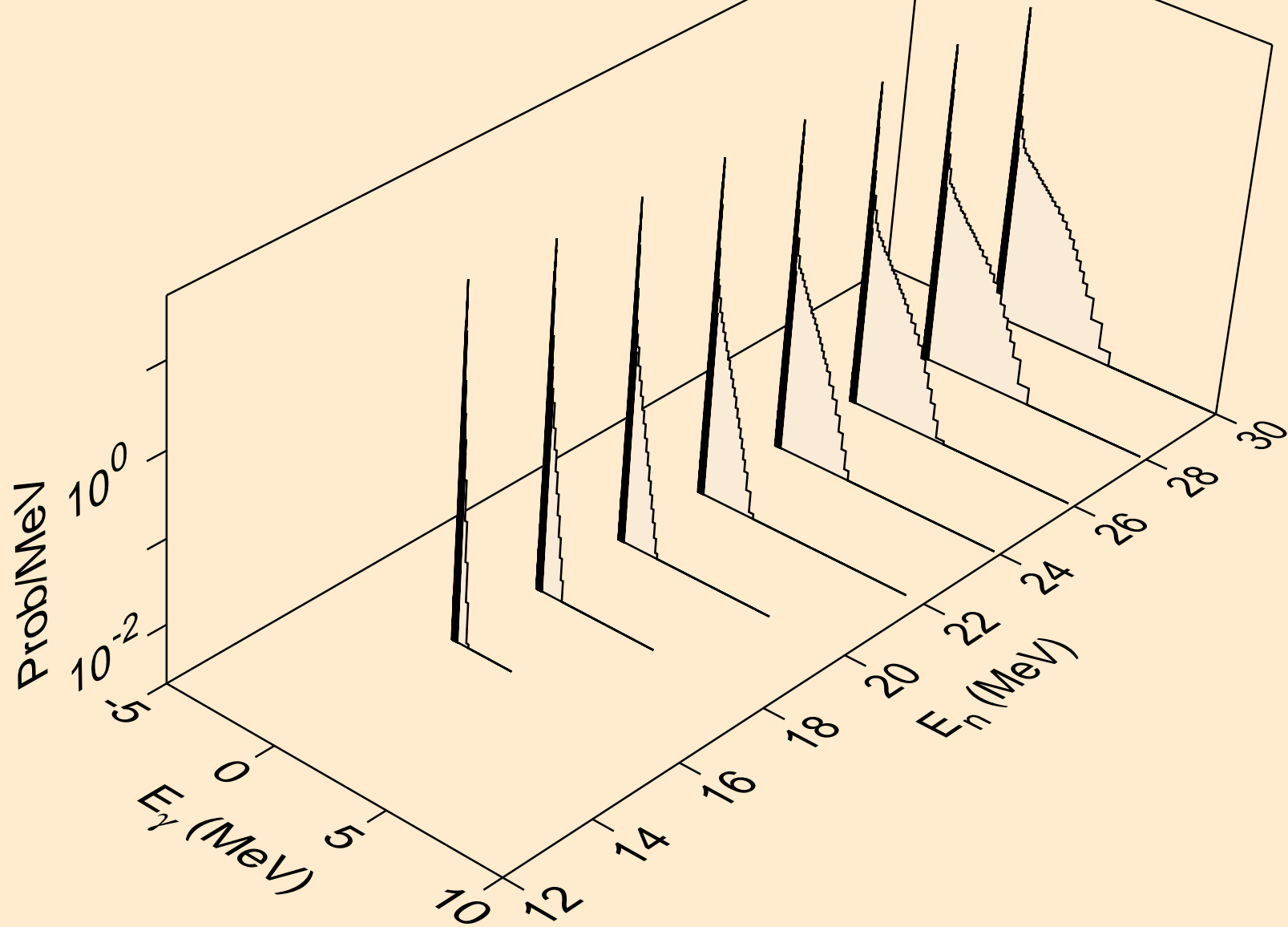

HO158 NEUTRON ACER TENDL-2023 LIBRARY; T=0.K
Photon emission for (n,n*)he3

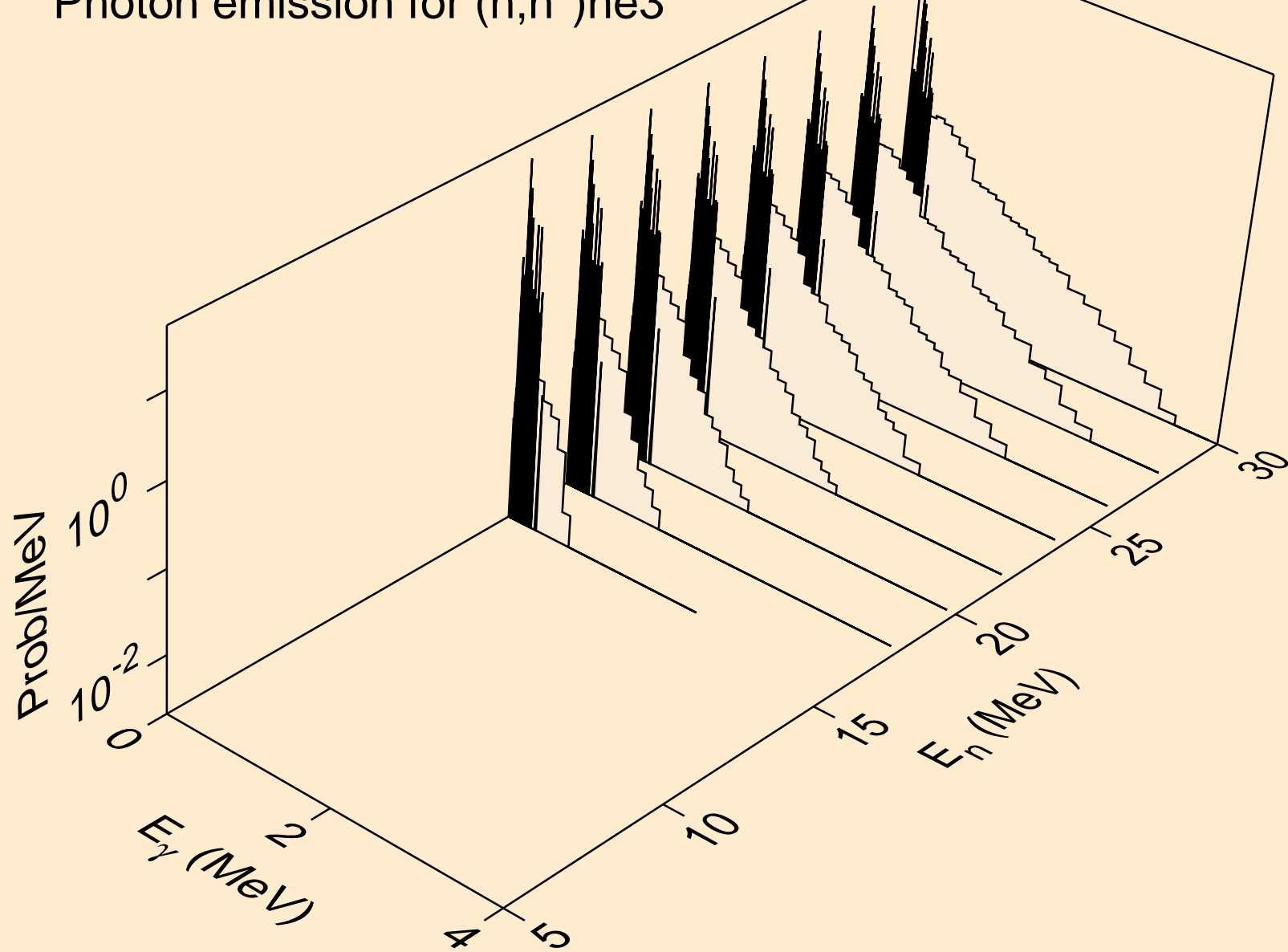

HO158 NEUTRON ACER TENDL-2023 LIBRARY; T=0.K
Photon emission for (n,4n)

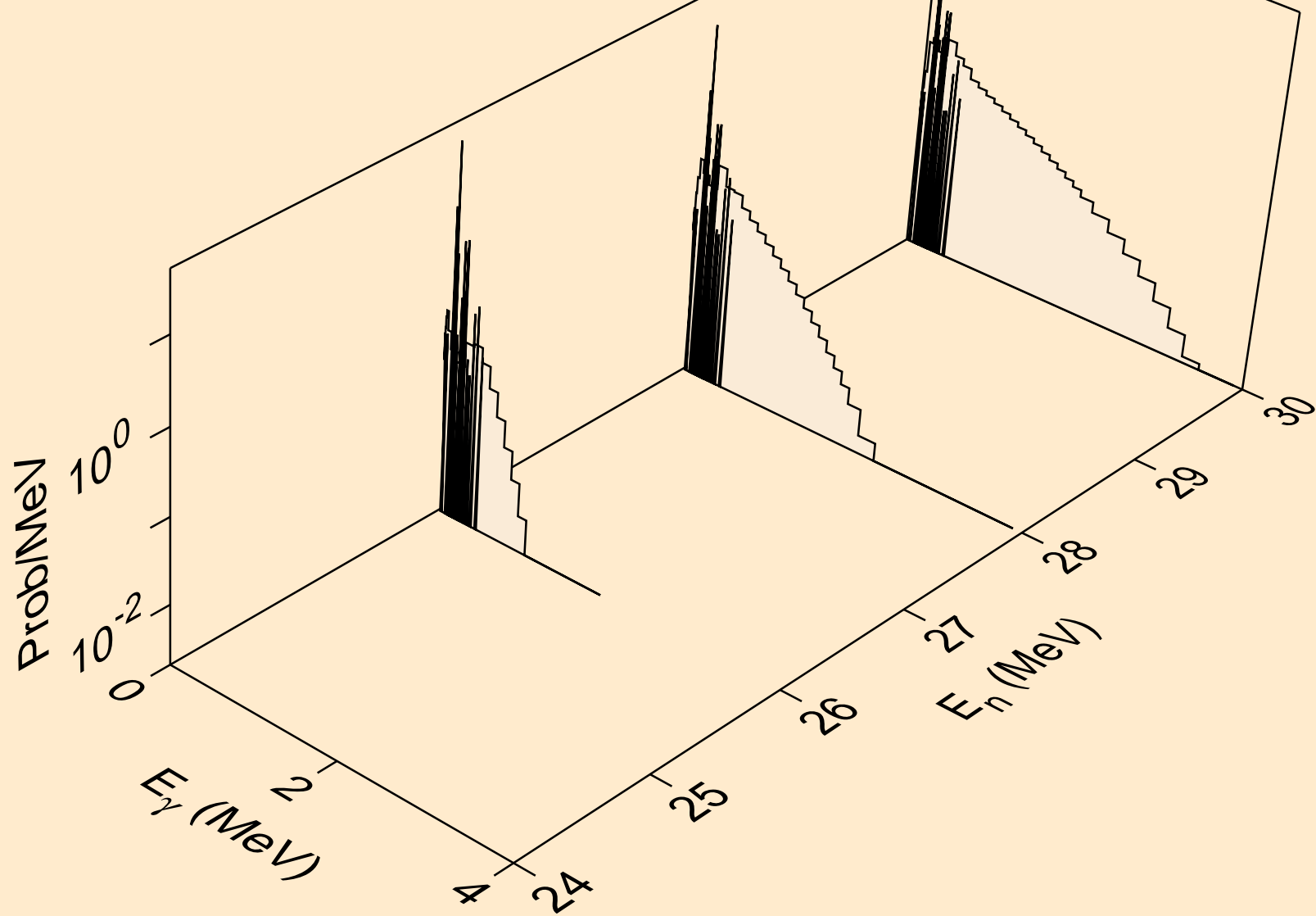

HO158 NEUTRON ACER TENDL-2023 LIBRARY; T=0.K
Photon emission for (n,2np)

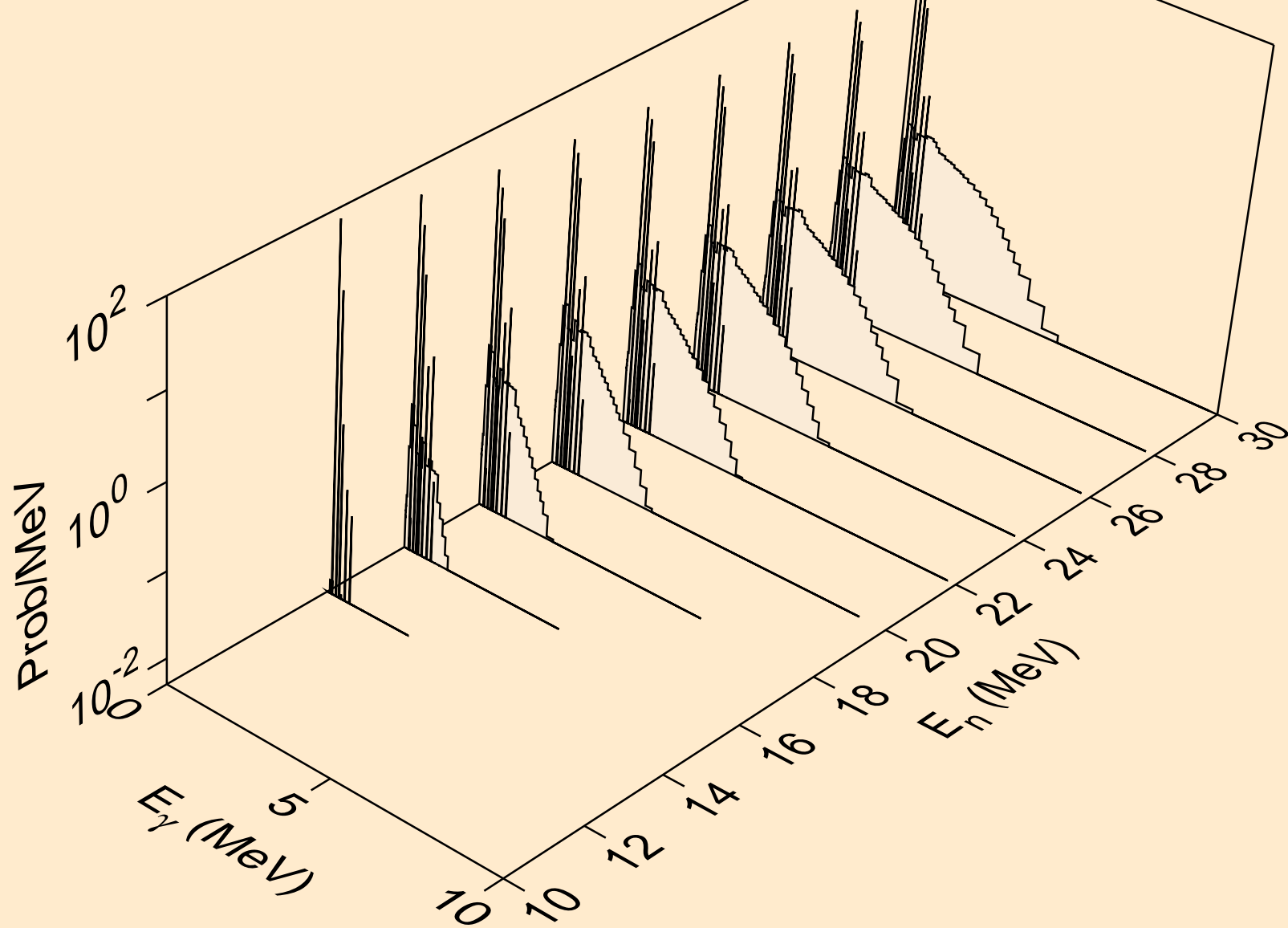

HO158 NEUTRON ACER TENDL-2023 LIBRARY; T=0.K
Photon emission for (n,3np)

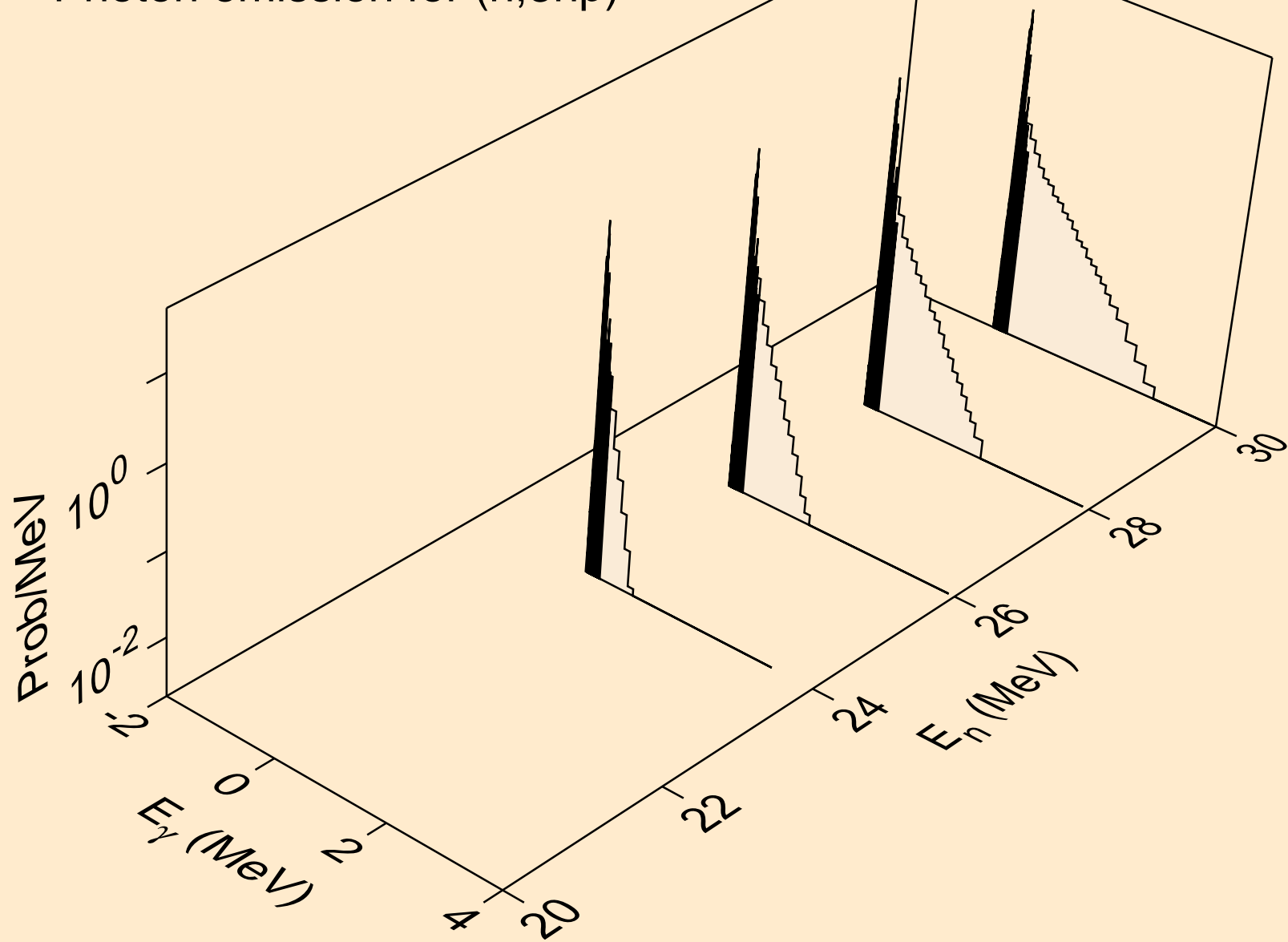

HO158 NEUTRON ACER TENDL-2023 LIBRARY; T=0.K
Photon emission for (n,n2p)

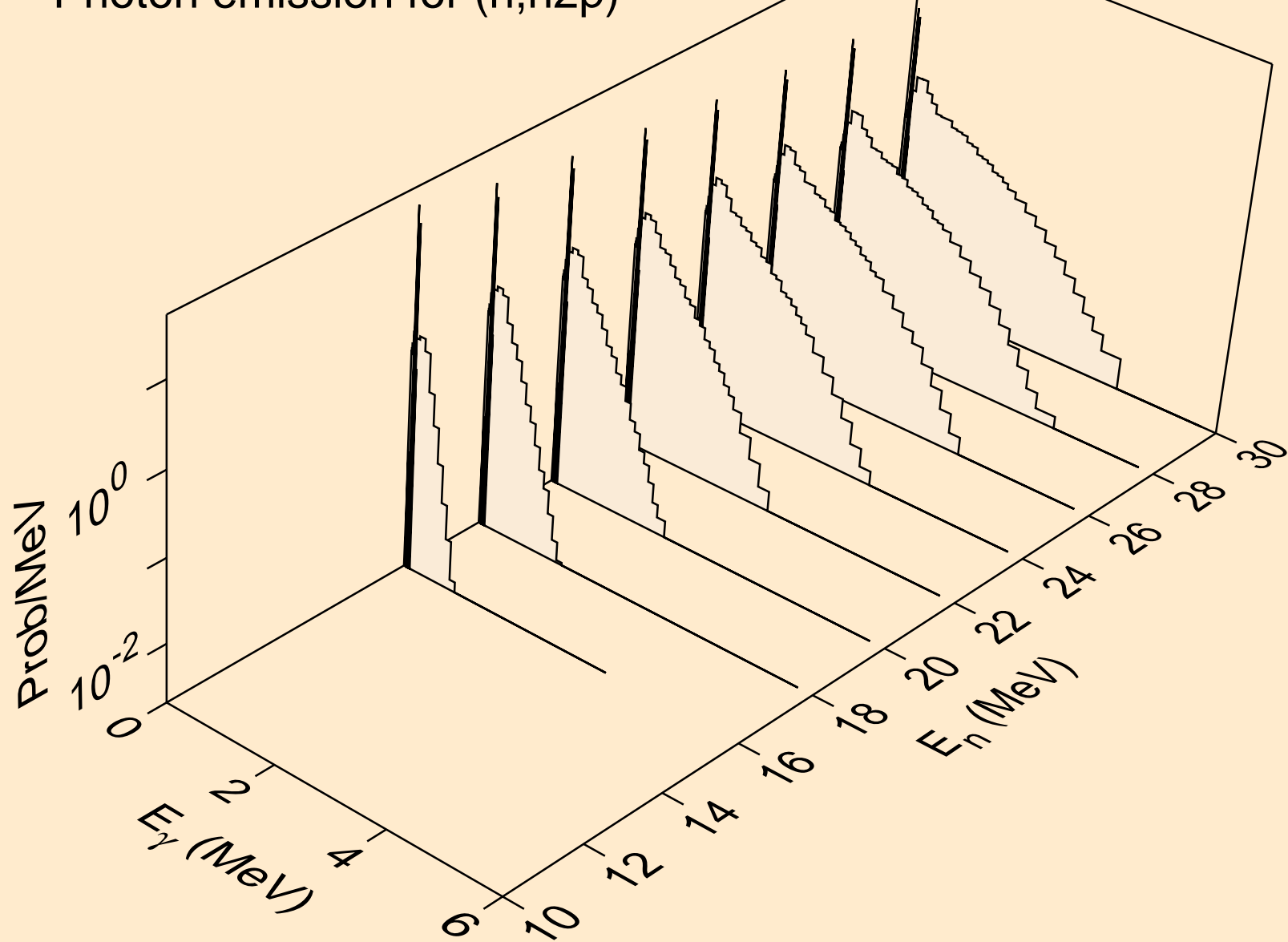

HO158 NEUTRON ACER TENDL-2023 LIBRARY; T=0.K
Photon emission for (n,npa)

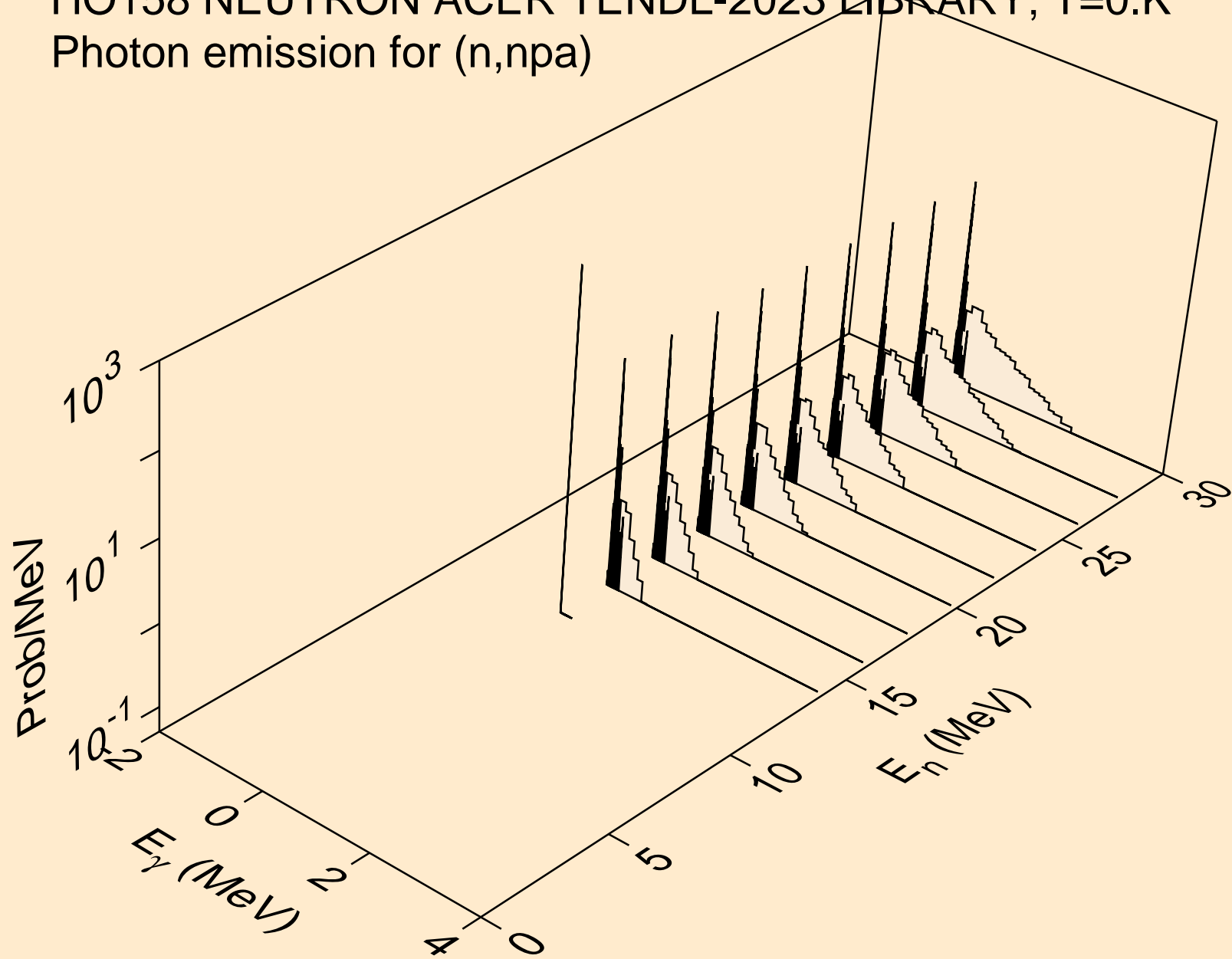

HO158 NEUTRON ACER TENDL-2023 LIBRARY; T=0.K
Photon emission for (n,n*c)

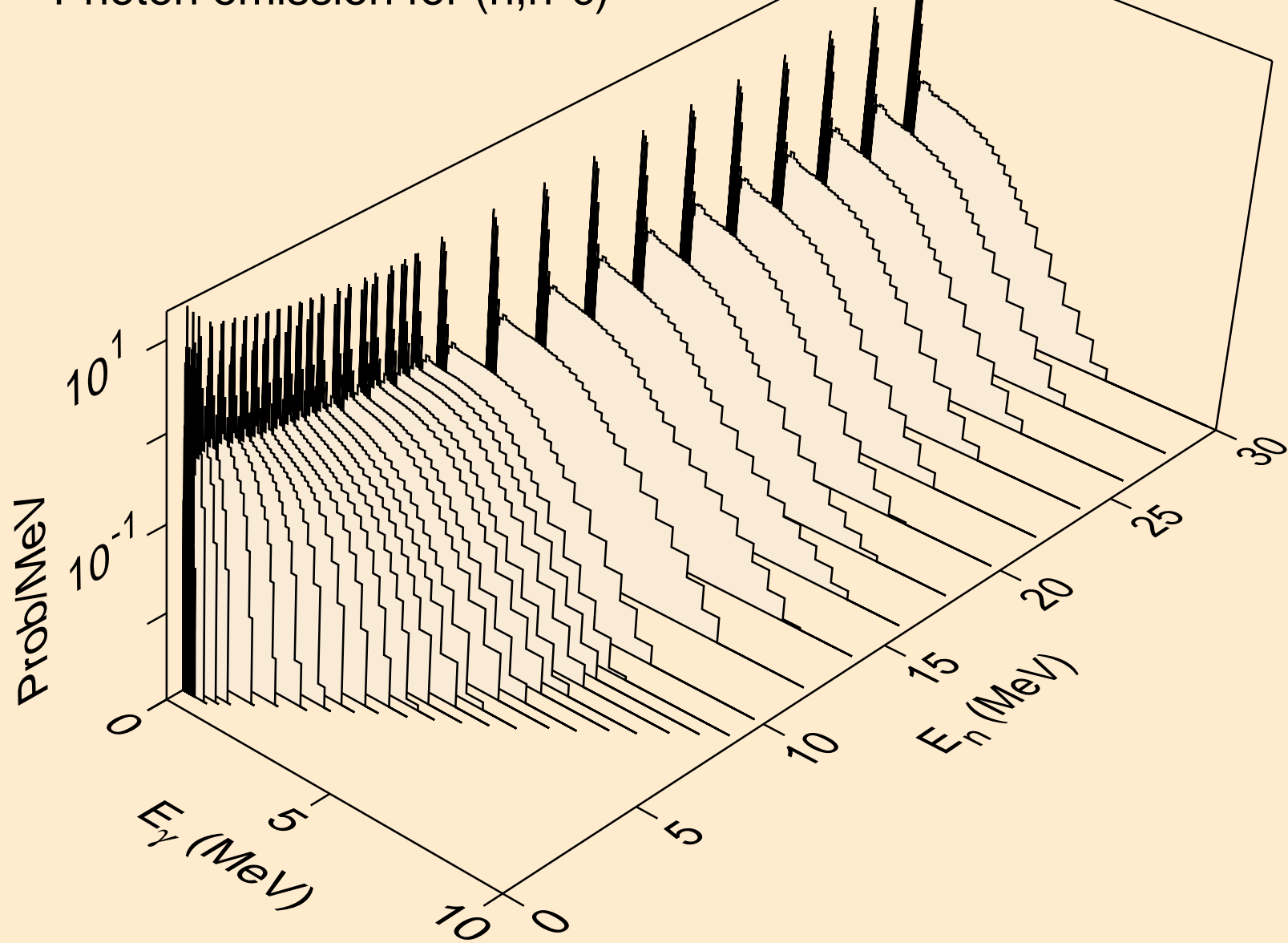

HO158 NEUTRON ACER TENDL-2023 LIBRARY; T=0.K
Photon emission for (n,gma)

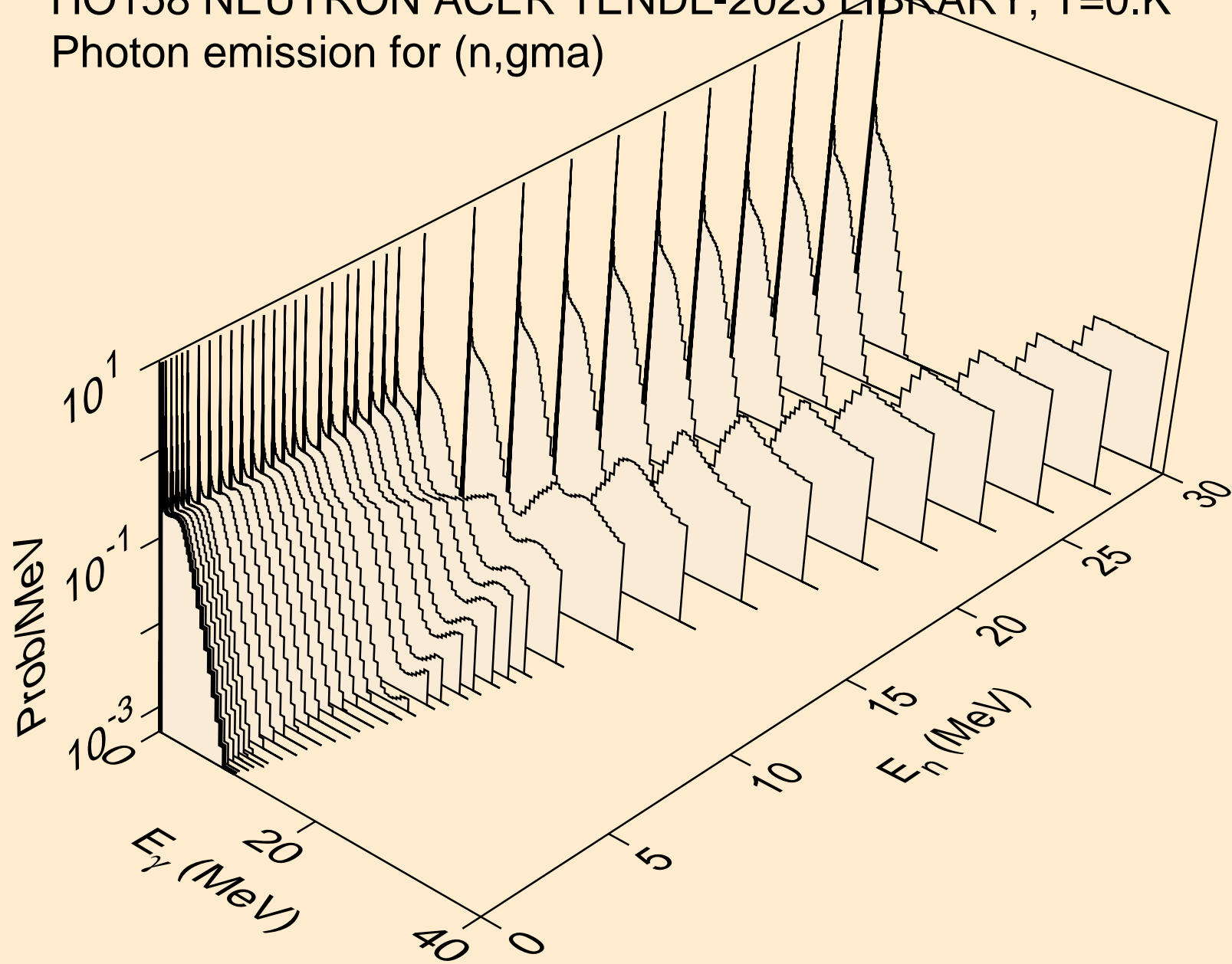

HO158 NEUTRON ACER TENDL-2023 LIBRARY; T=0.K
Photon emission for (n,p)

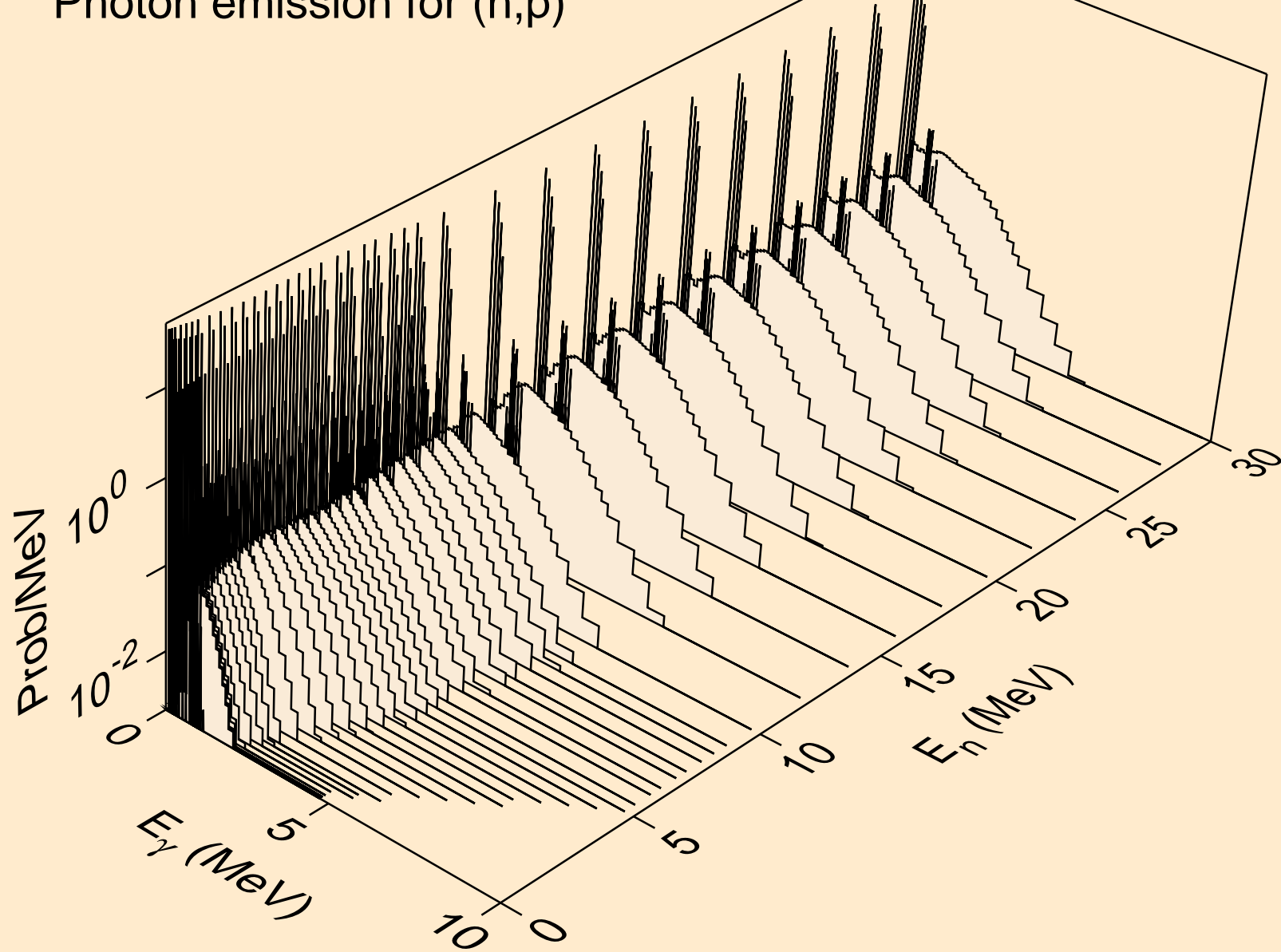

HO158 NEUTRON ACER TENDL-2023 LIBRARY; T=0.K
Photon emission for (n,d)

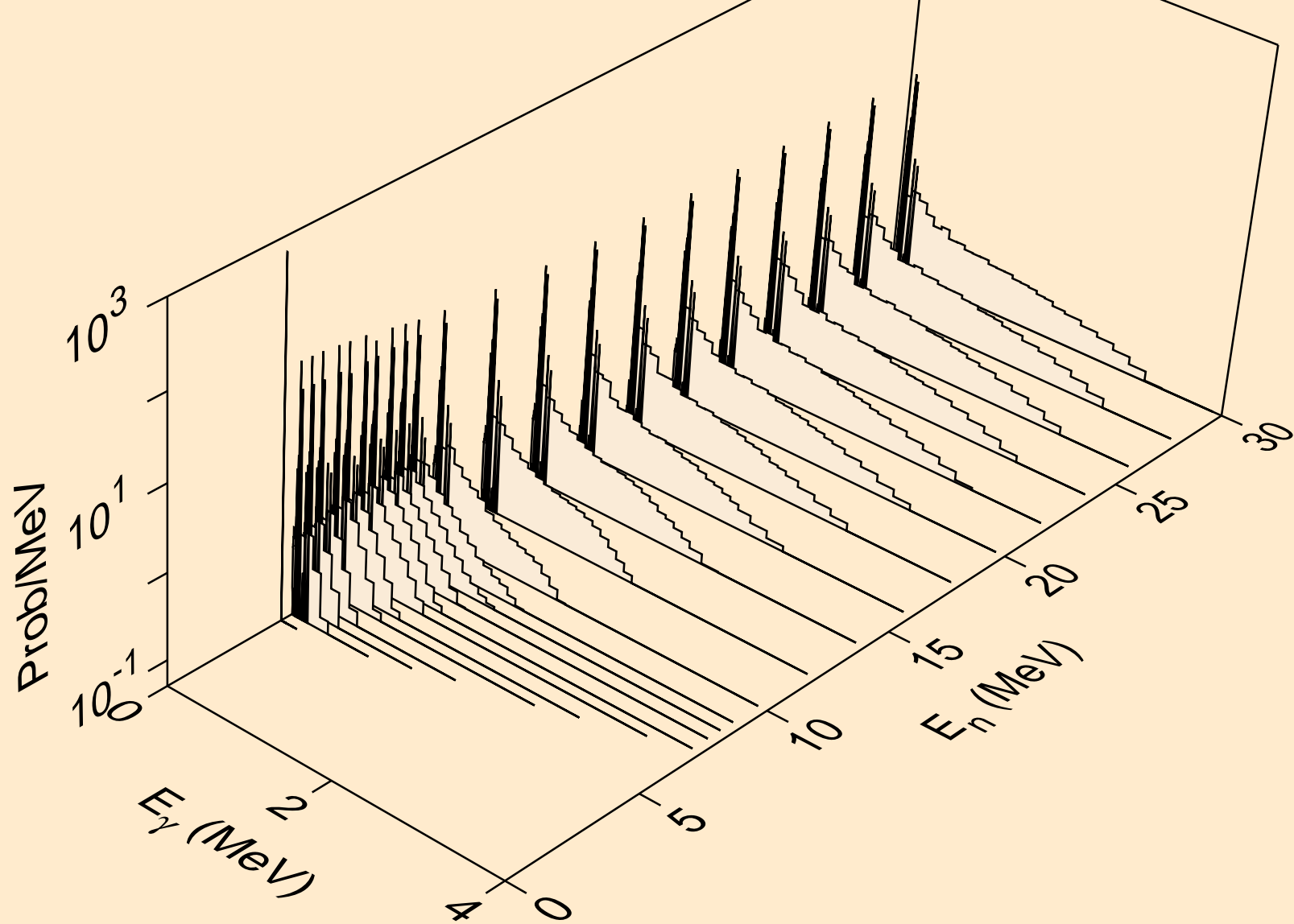

HO158 NEUTRON ACER TENDL-2023 LIBRARY; T=0.K
Photon emission for (n,t)

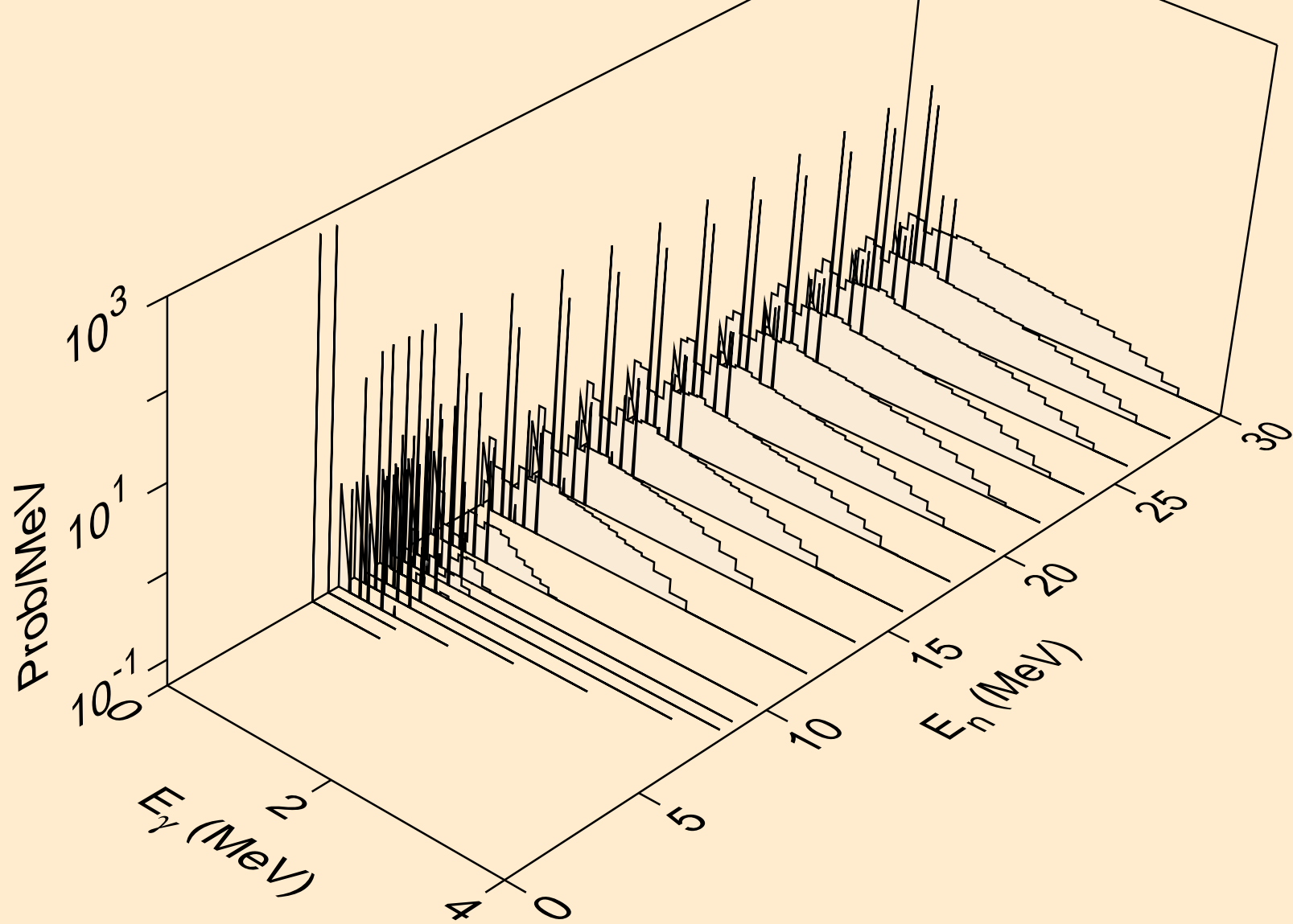

HO158 NEUTRON ACER TENDL-2023 LIBRARY; T=0.K
Photon emission for (n,he3)

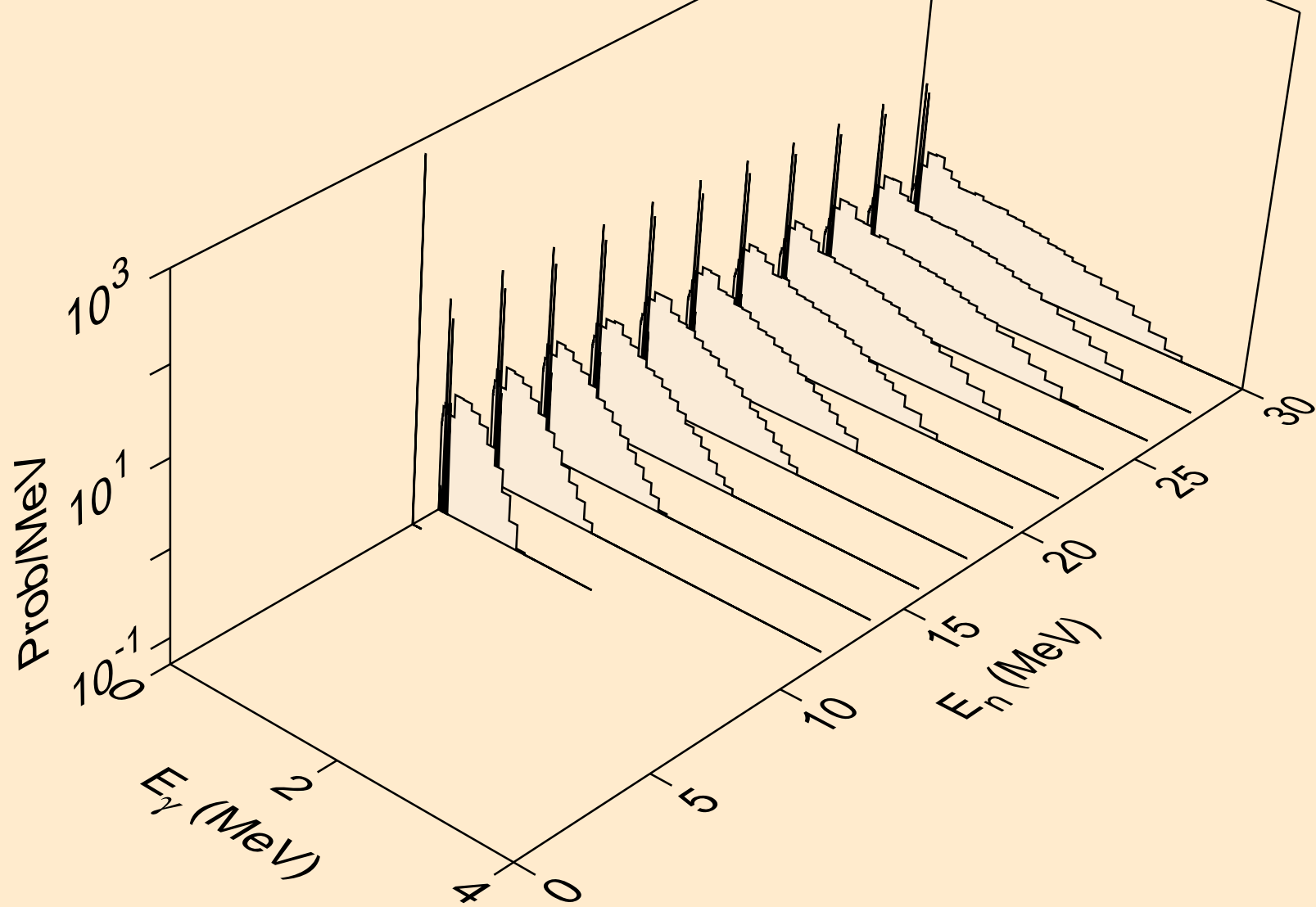

HO158 NEUTRON ACER TENDL-2023 LIBRARY; T=0.K
Photon emission for (n,a)

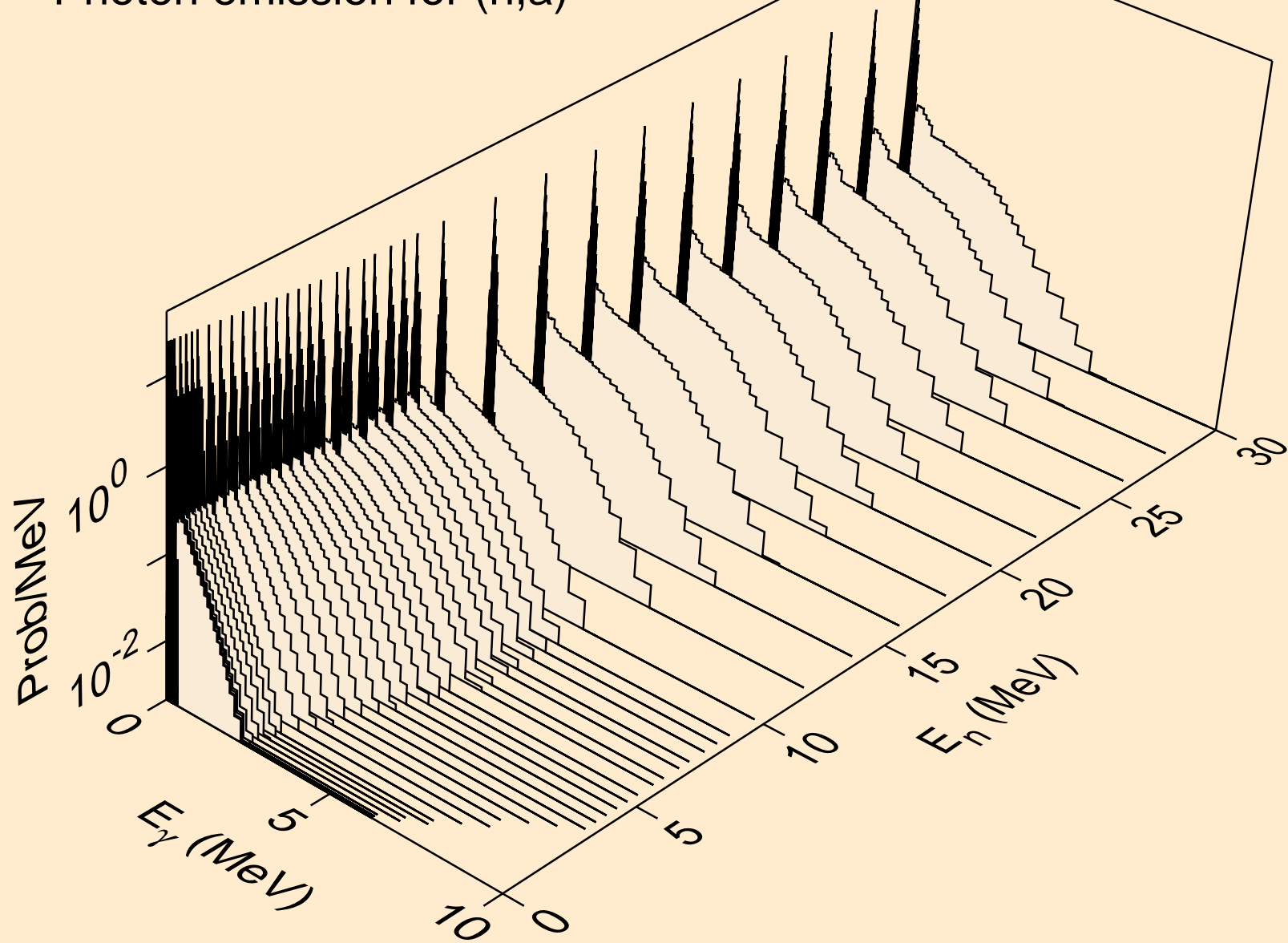

HO158 NEUTRON ACER TENDL-2023 LIBRARY; T=0.K
Photon emission for (n,2a)

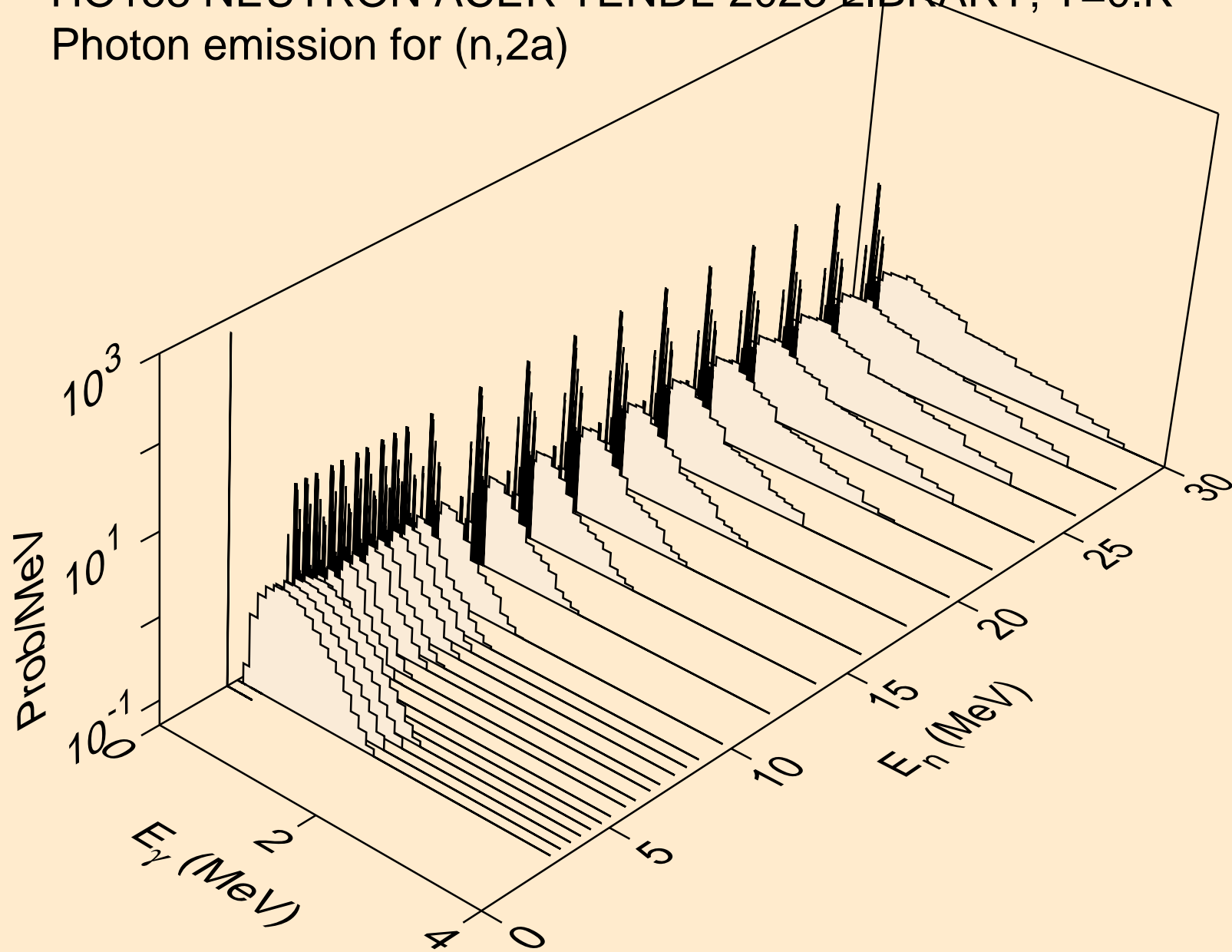

HO158 NEUTRON ACER TENDL-2023 LIBRARY; T=0.K
Photon emission for (n,2p)

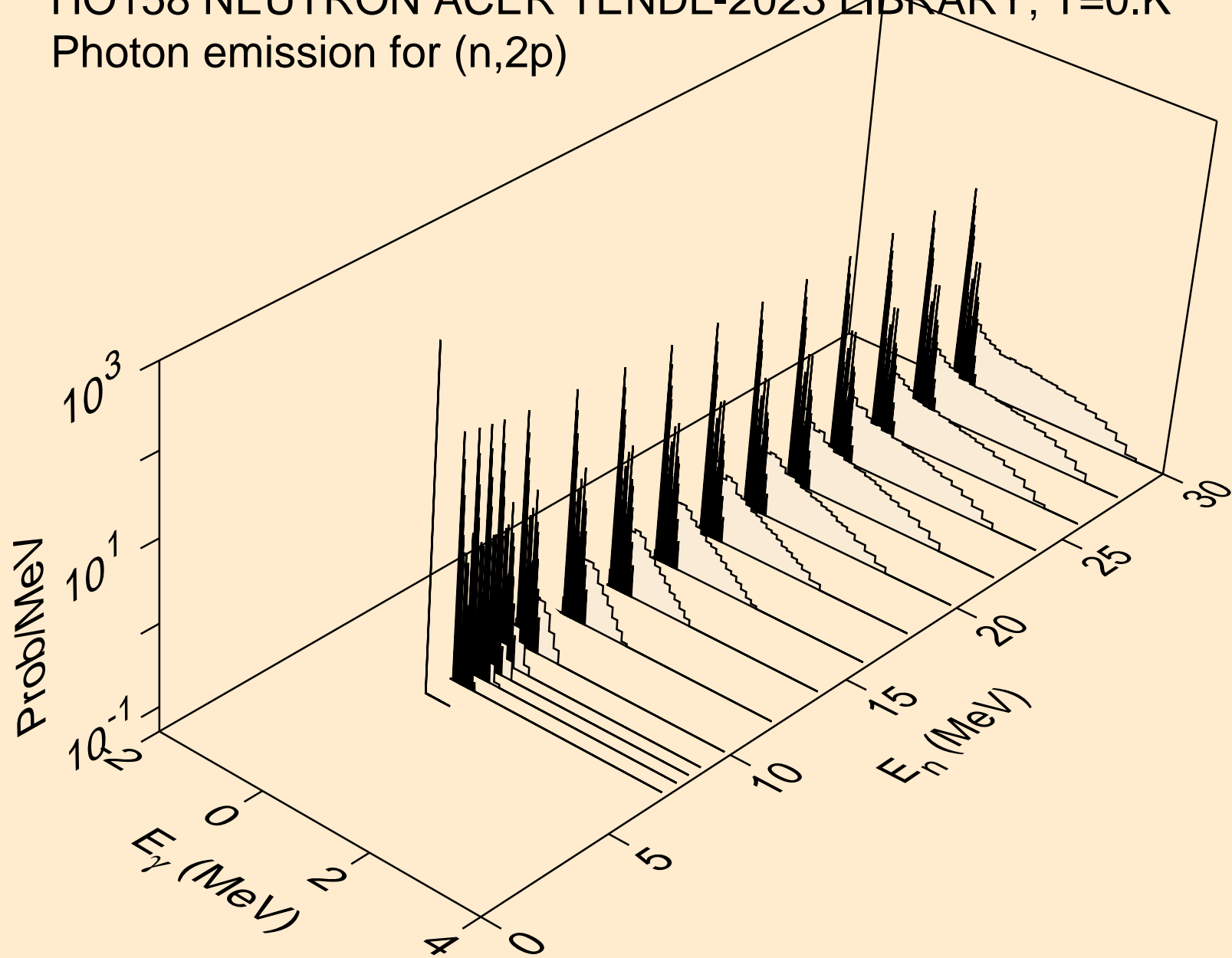

HO158 NEUTRON ACER TENDL-2023 LIBRARY; T=0.K
Photon emission for (n,p)

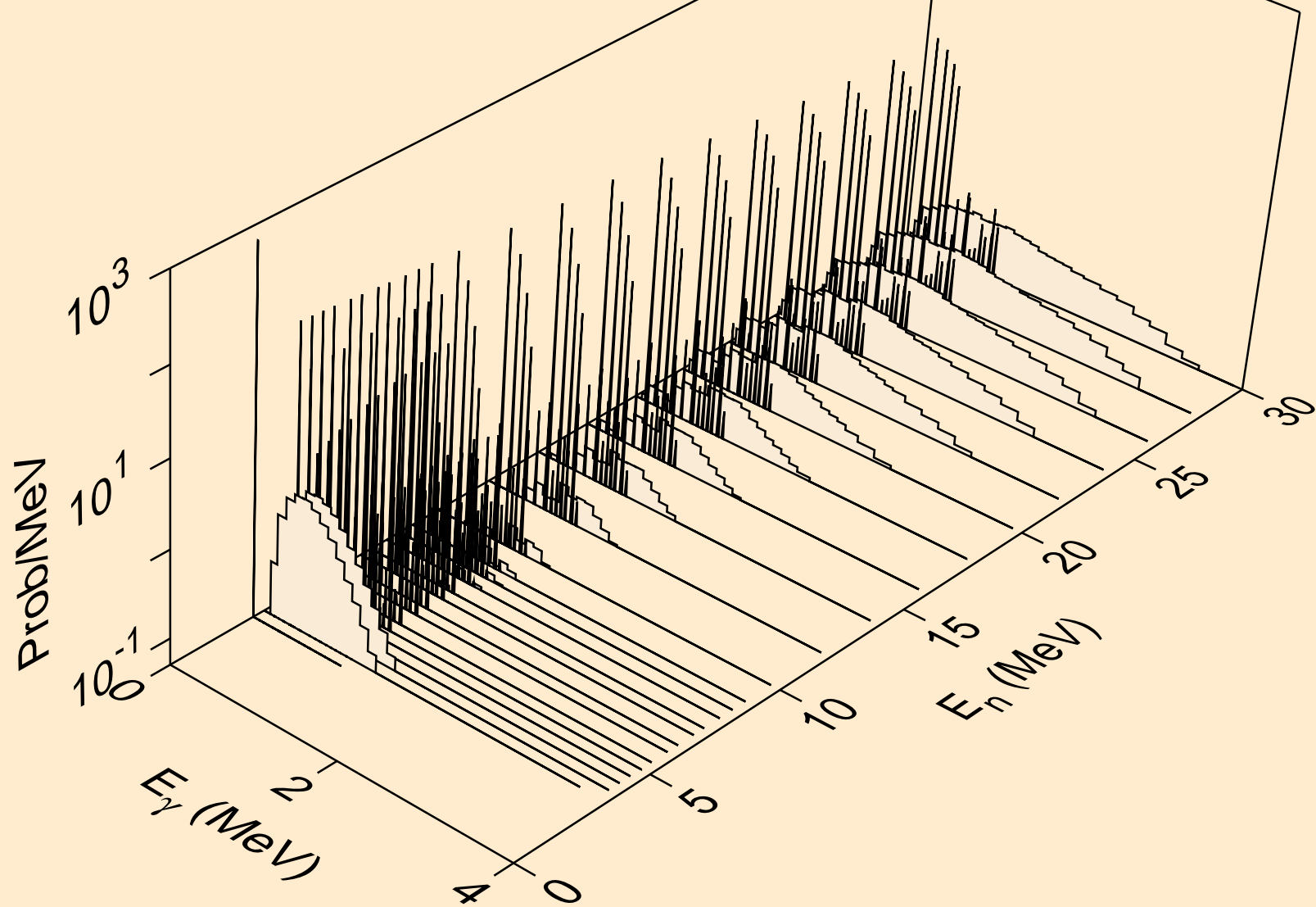

HO158 NEUTRON ACER TENDL-2023 LIBRARY; T=0.K
Photon emission for (n,pd)

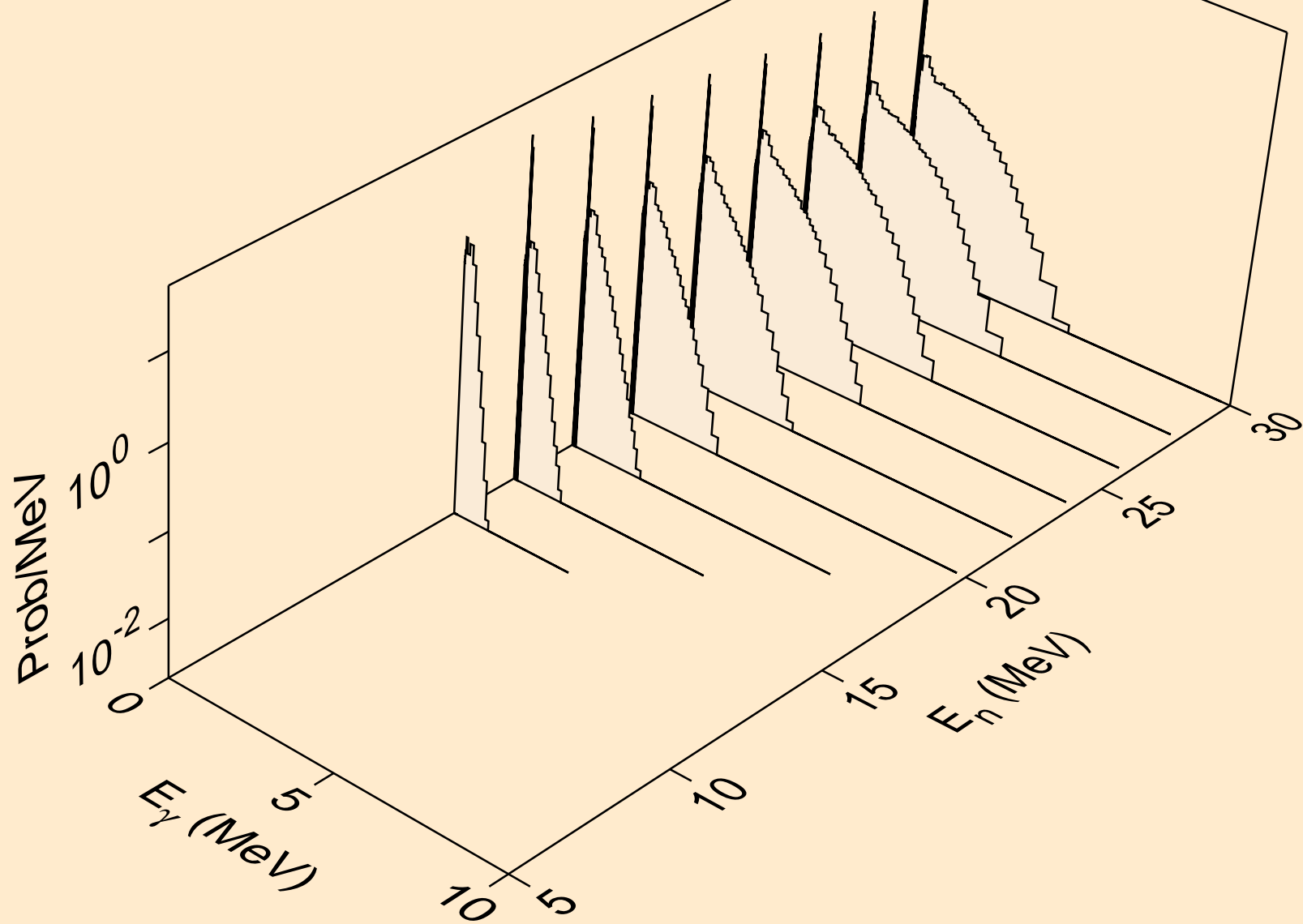

HO158 NEUTRON ACER TENDL-2023 LIBRARY; T=0.K
Photon emission for (n,pt)

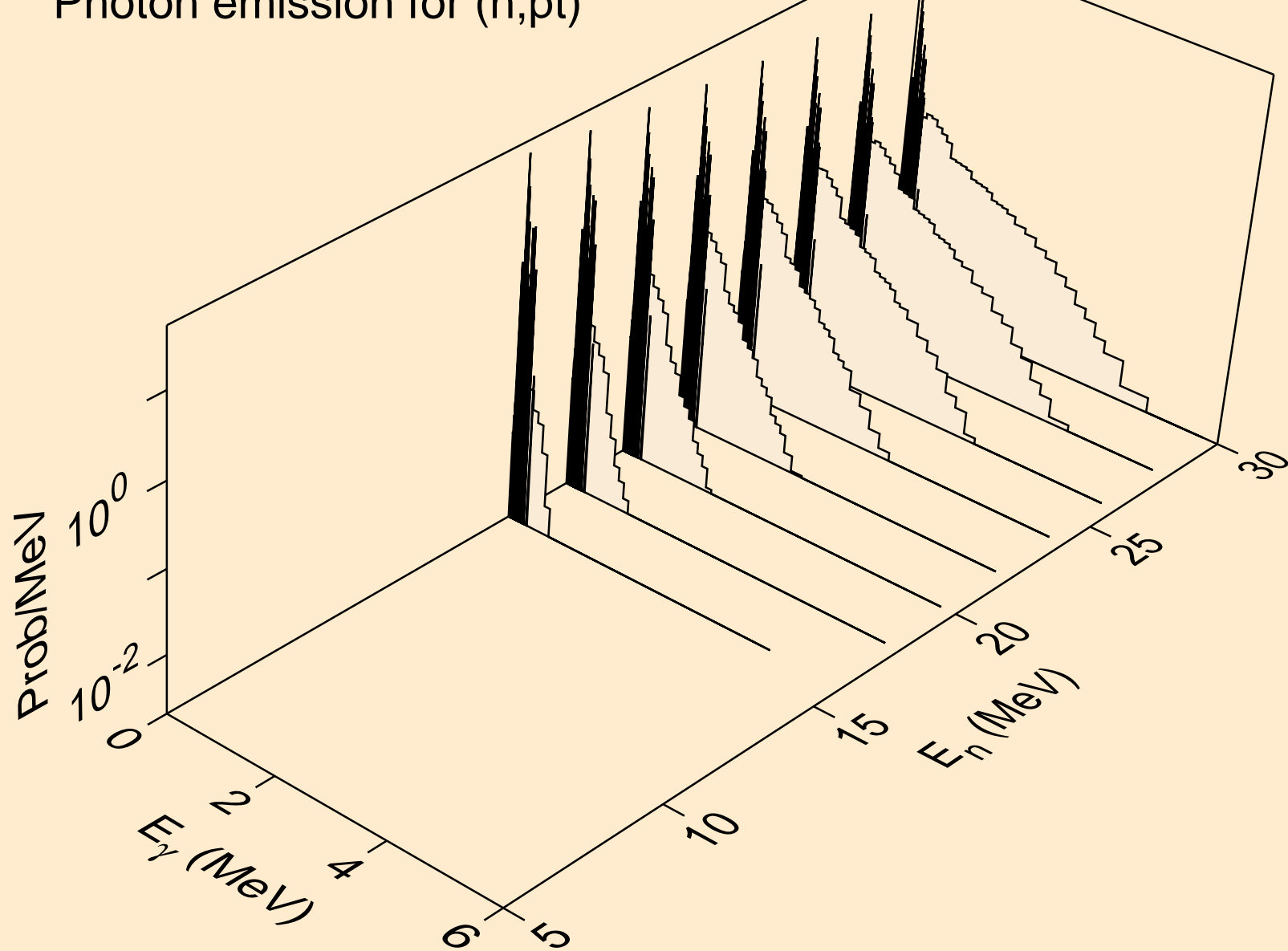

HO158 NEUTRON ACER TENDL-2023 LIBRARY; T=0.K
Photon emission for (n,da)

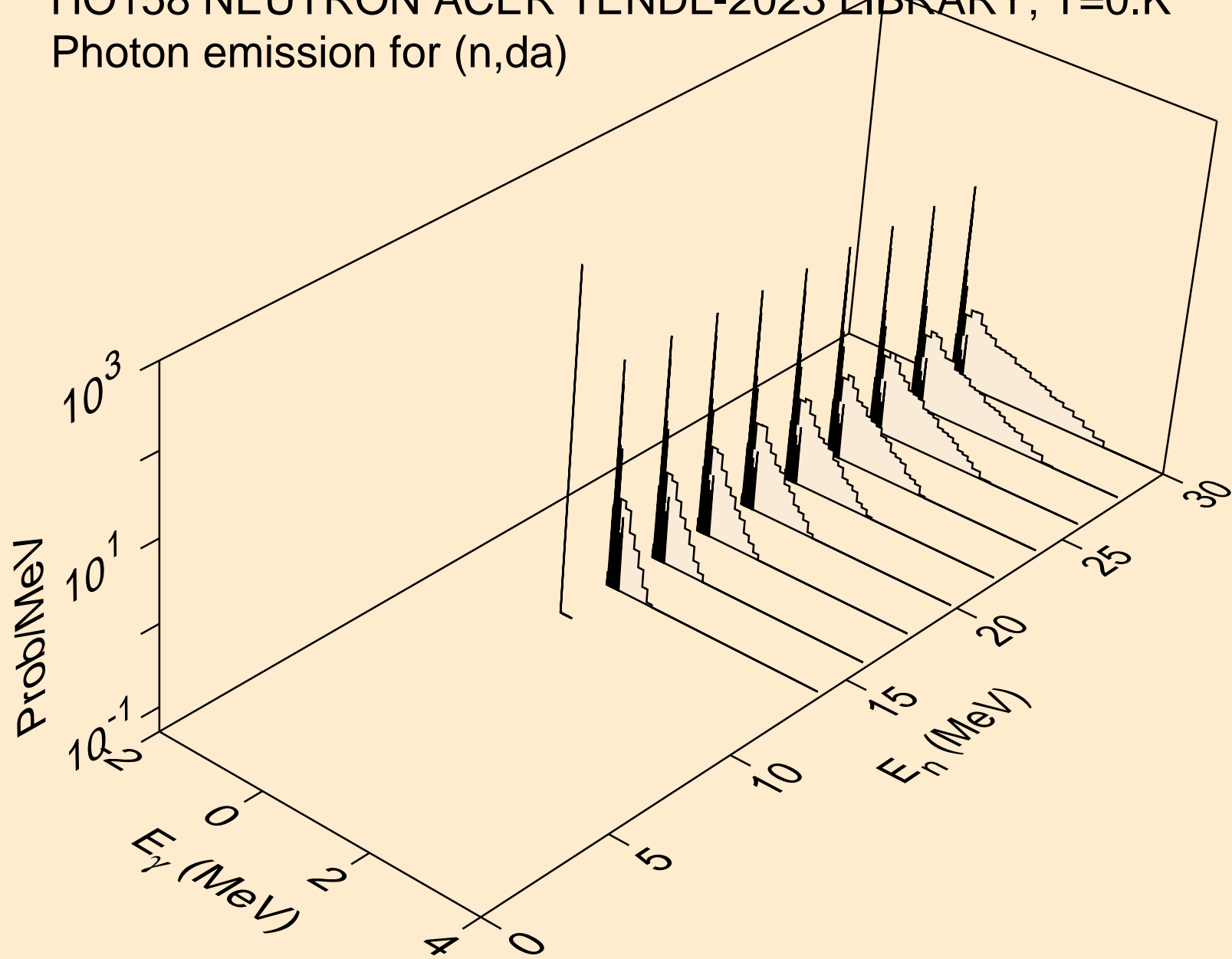

HO158 NEUTRON ACER TENDL-2023 LIBRARY; T=0.K
thermal capture photon spectrum

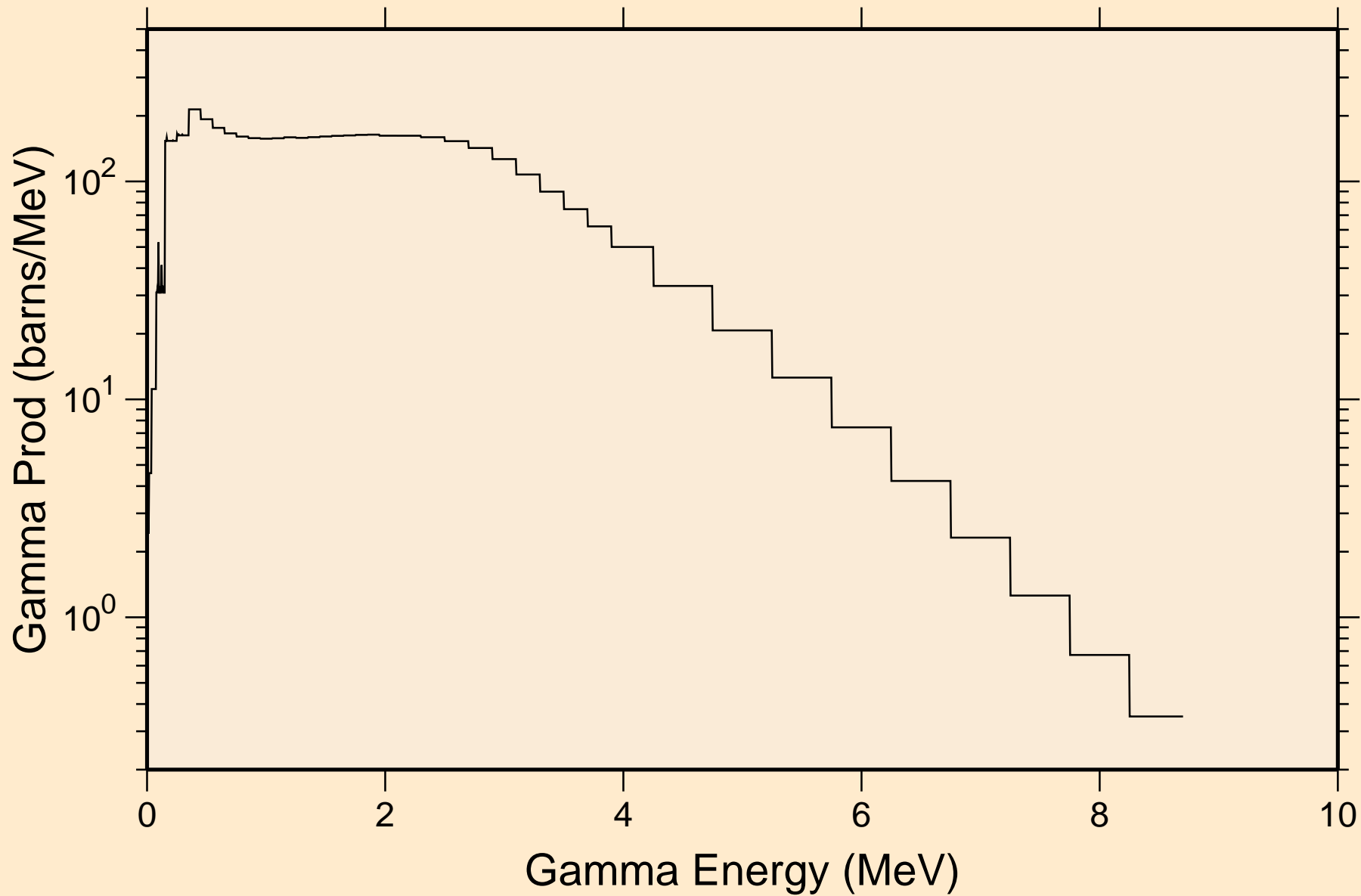

HO158 NEUTRON ACER TENDL-2023 LIBRARY; T=0.K
14 MeV photon spectrum

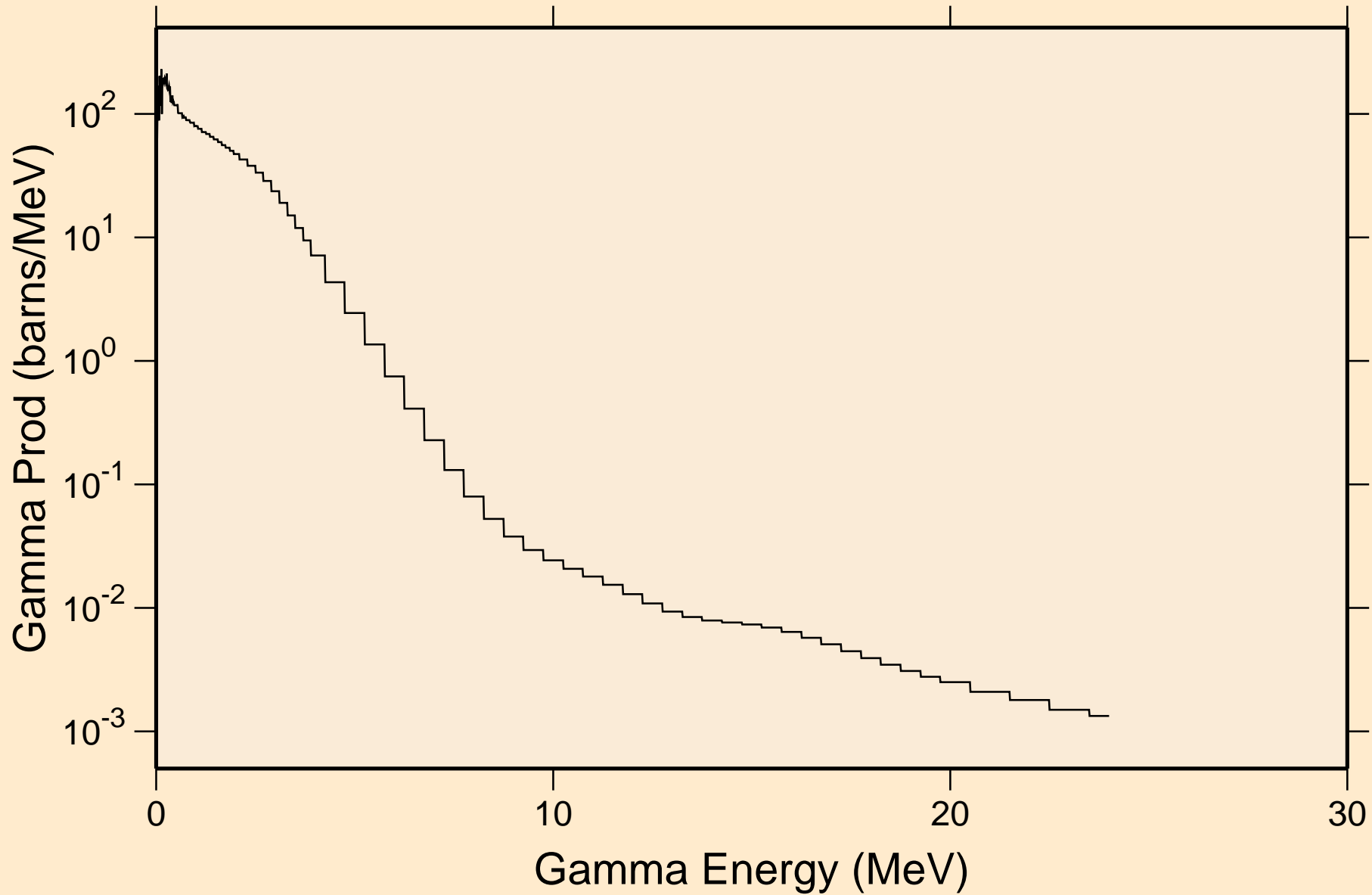

HO158 NEUTRON ACER TENDL-2023 LIBRARY; T=0.K

Particle heating contributions

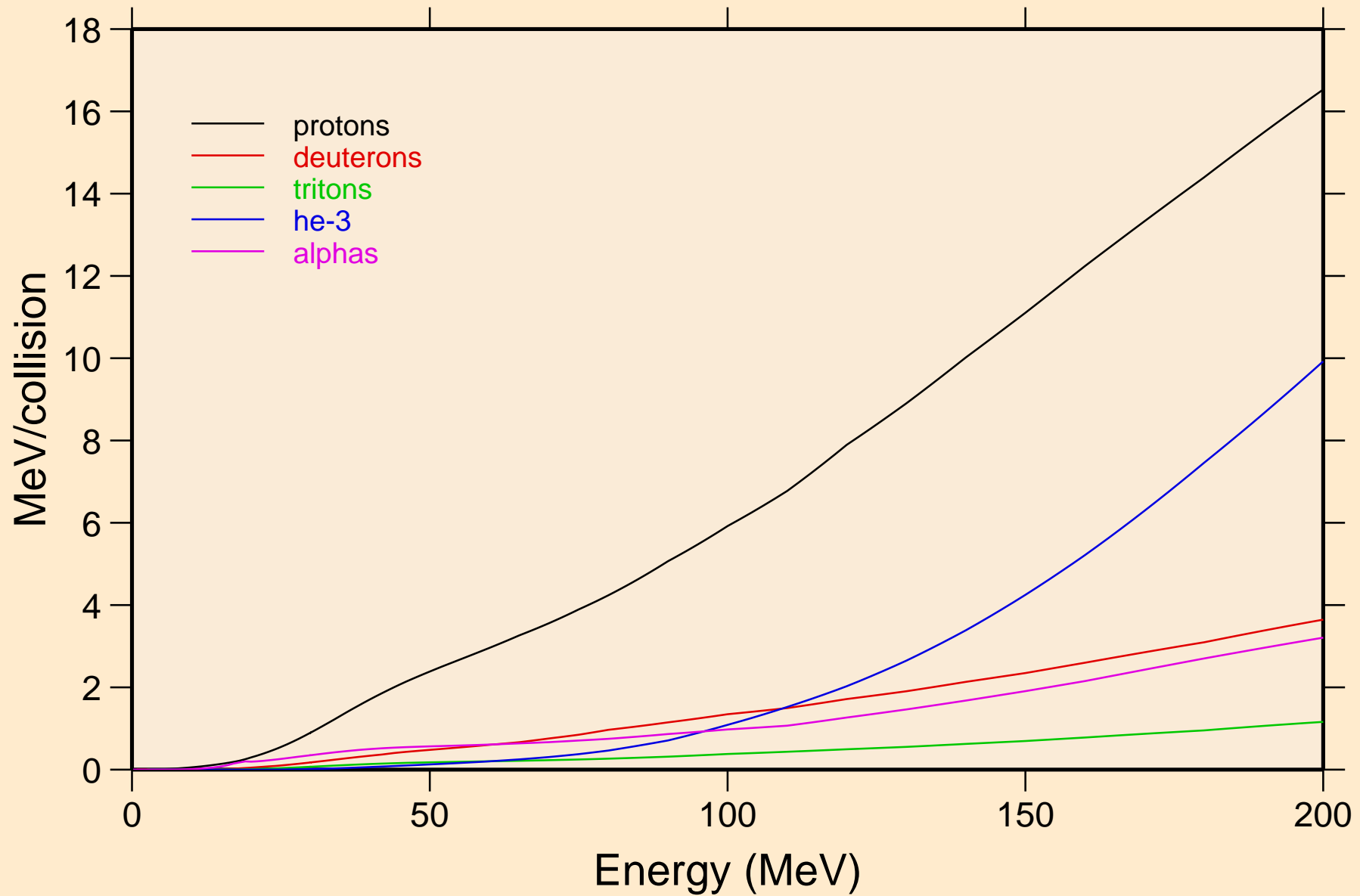

HO158 NEUTRON ACER TENDL-2023 LIBRARY; T=0.K

Recoil Heating

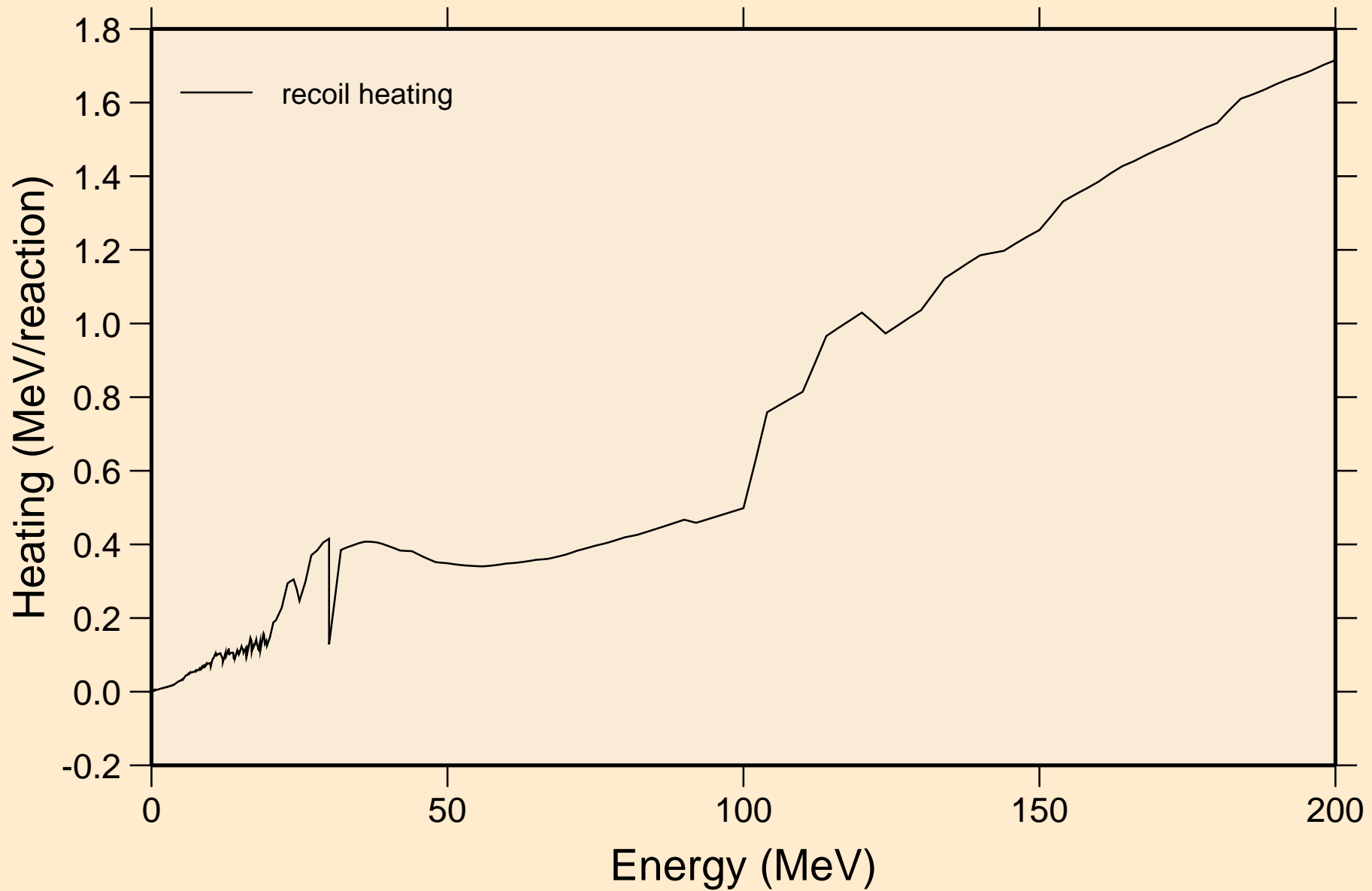

HO158 NEUTRON ACER TENDL-2023 LIBRARY; T=0.K

Particle production cross sections

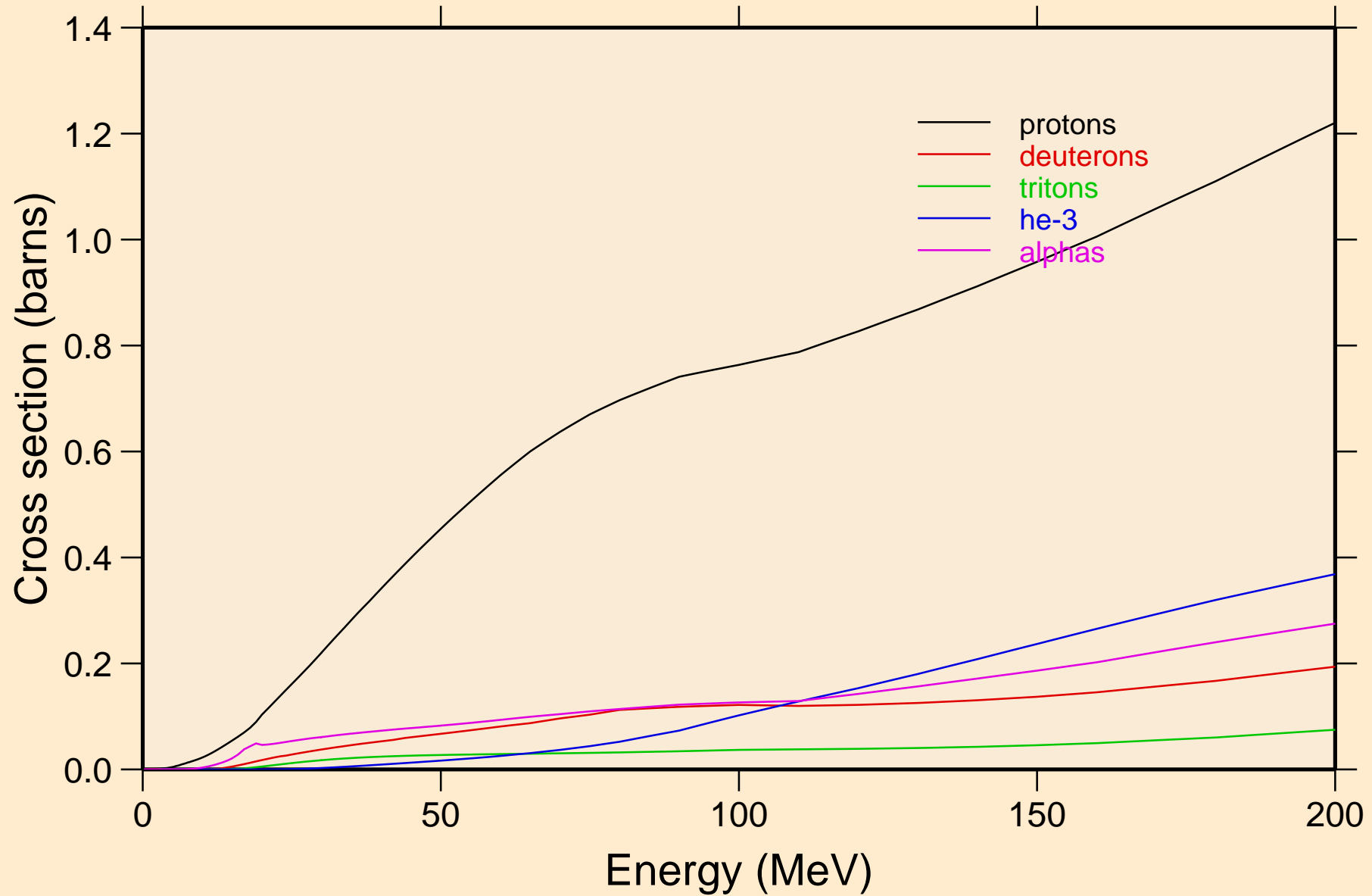

HO158 NEUTRON ACER TENDL-2023 LIBRARY; T=0.K
protons from (n,x)

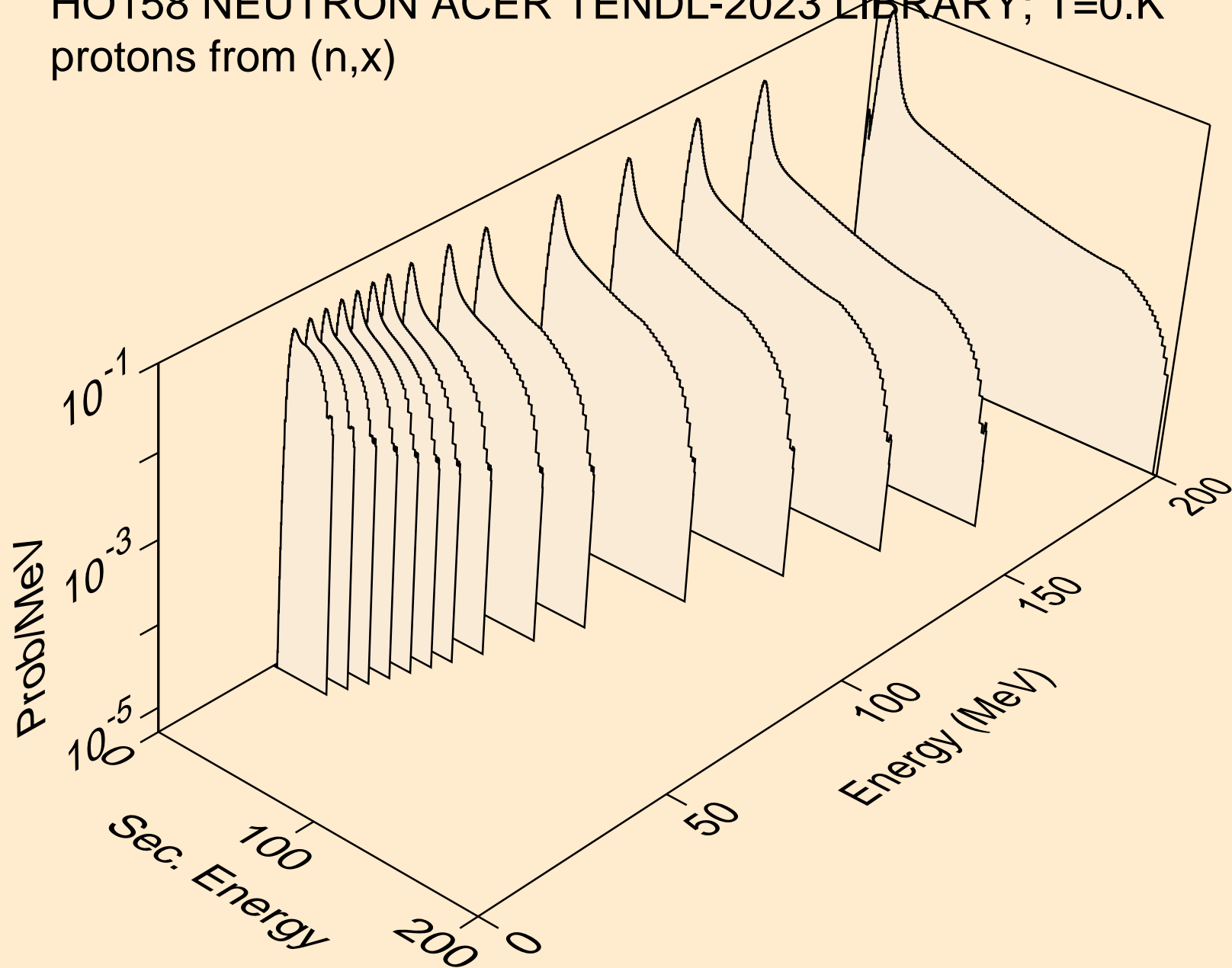

HO158 NEUTRON ACER TENDL-2023 LIBRARY; T=0.K
protons from (n,n*)p

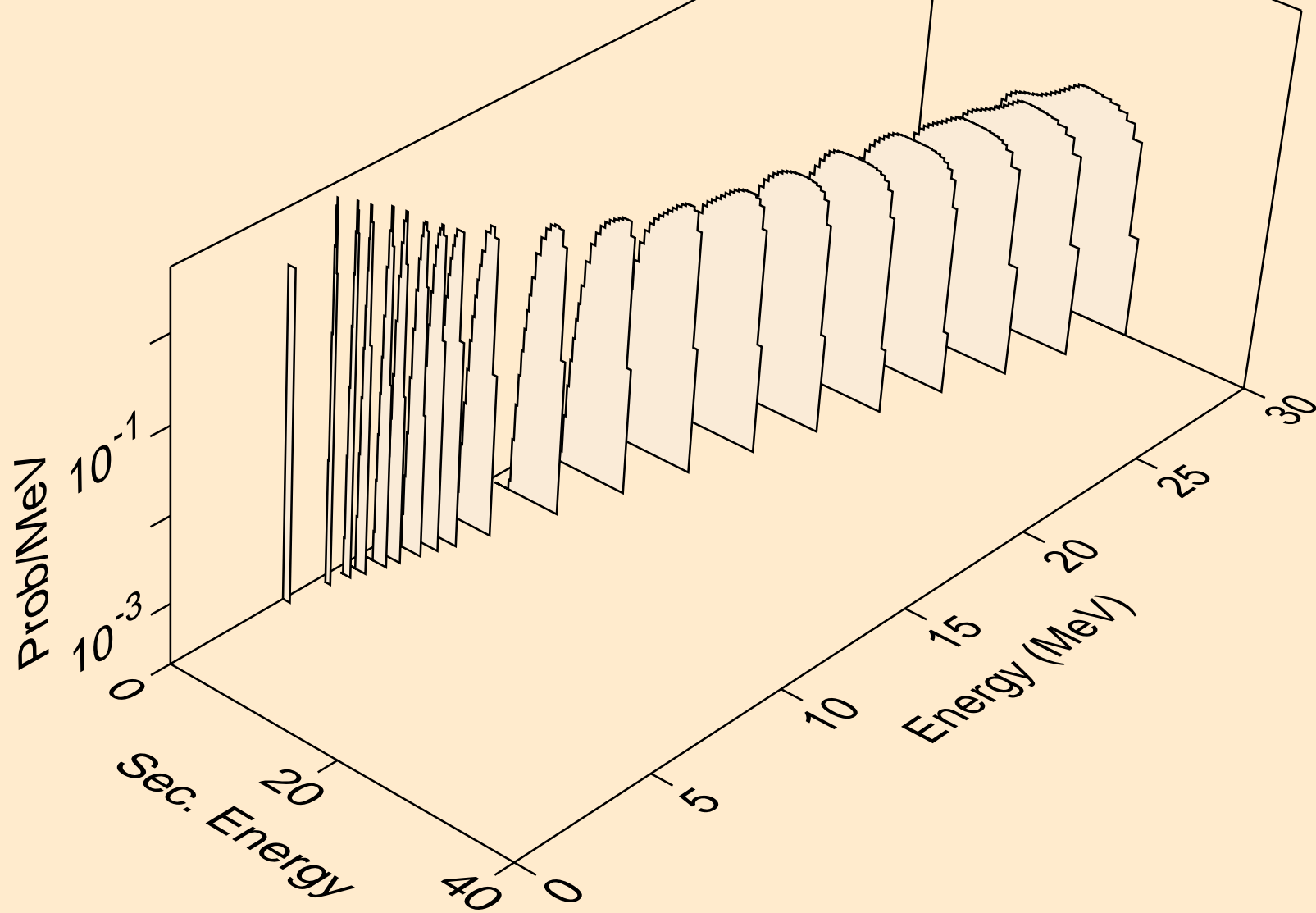

HO158 NEUTRON ACER TENDL-2023 LIBRARY; T=0.K
protons from (n,2np)

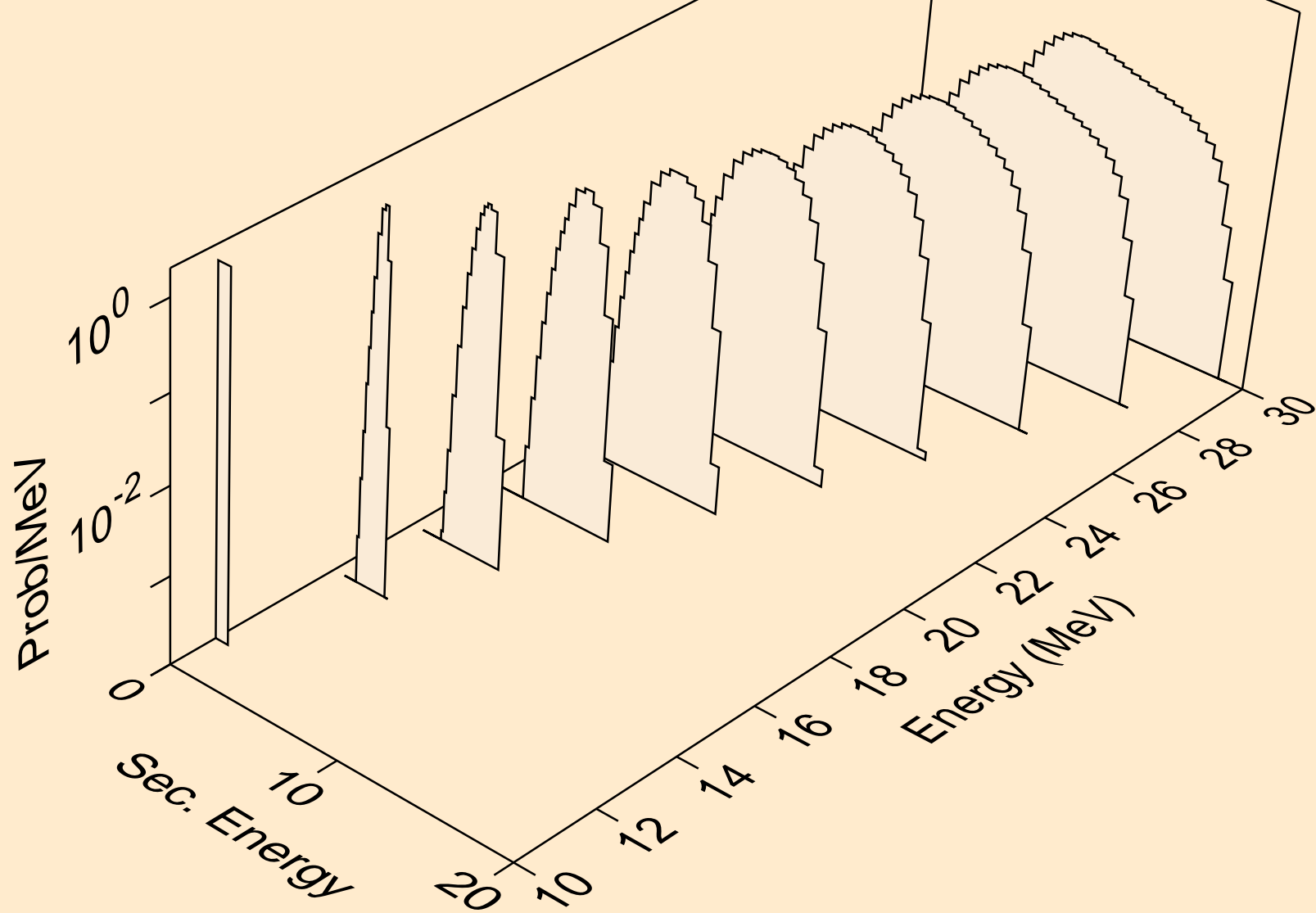

HO158 NEUTRON ACER TENDL-2023 LIBRARY; T=0.K
protons from (n,3np)

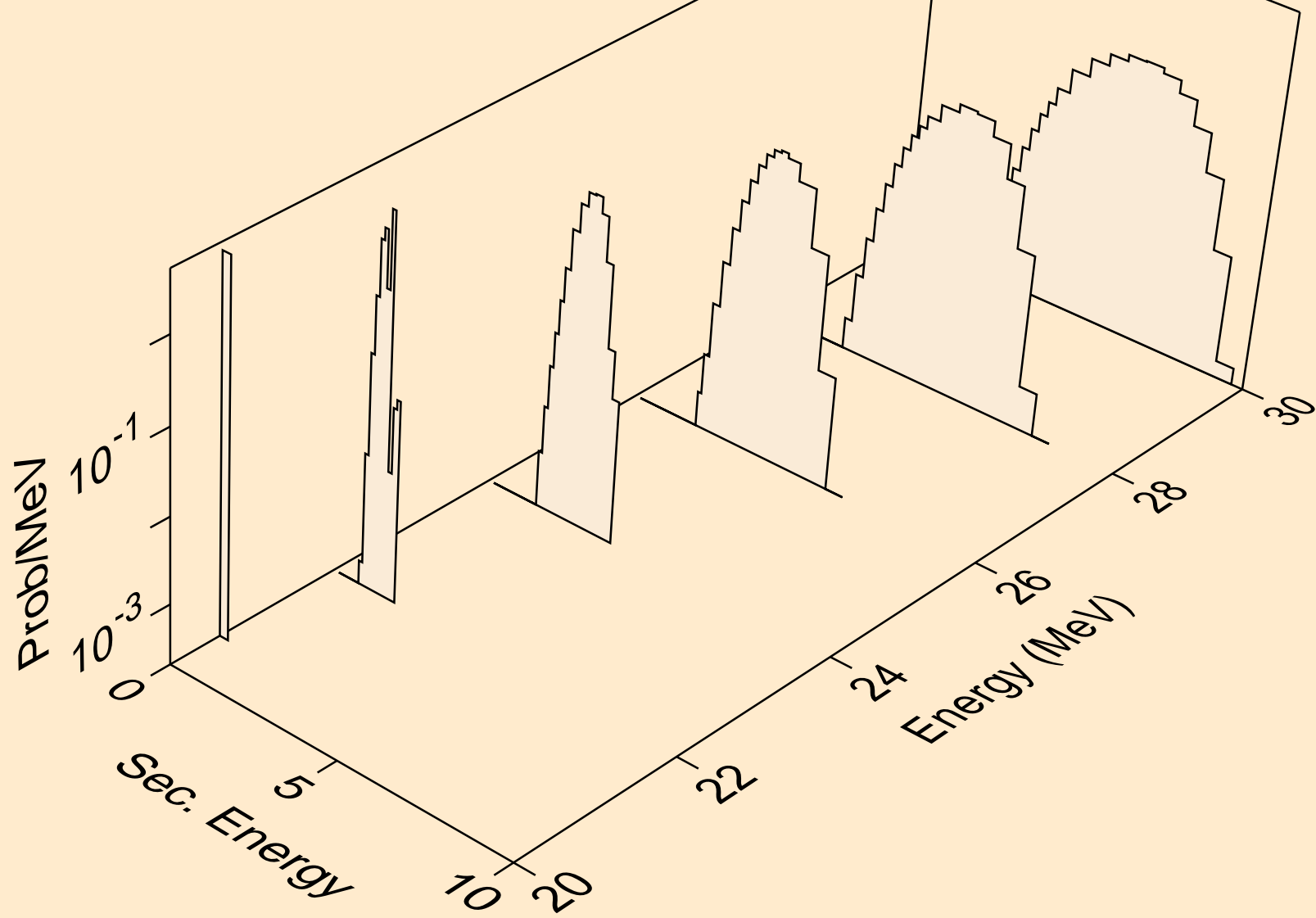

HO158 NEUTRON ACER TENDL-2023 LIBRARY; T=0.K
protons from (n,n2p)

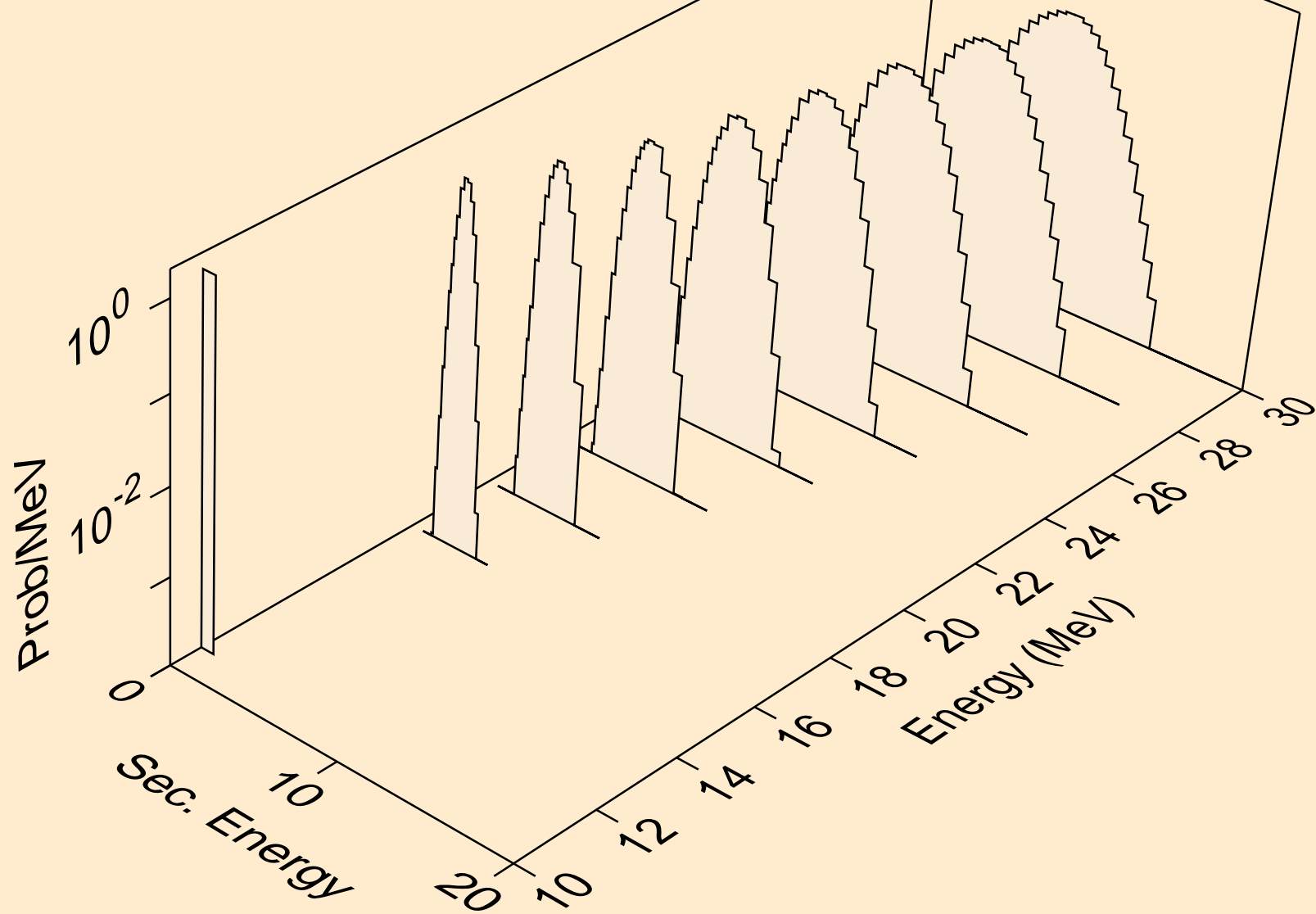

HO158 NEUTRON ACER TENDL-2023 LIBRARY; T=0.K
protons from (n,npa)

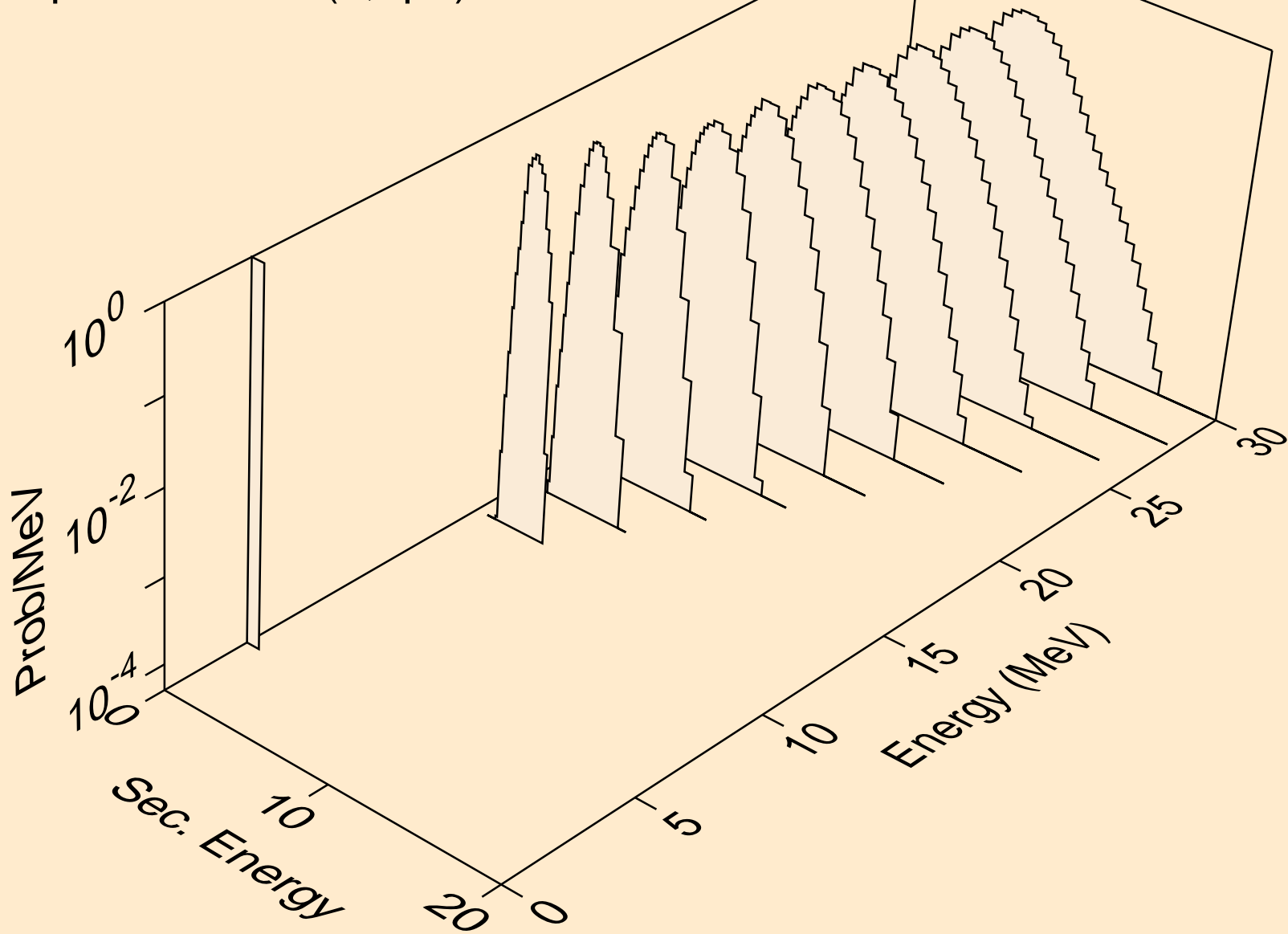

HO158 NEUTRON ACER TENDL-2023 LIBRARY; T=0.K
protons from (n,p)

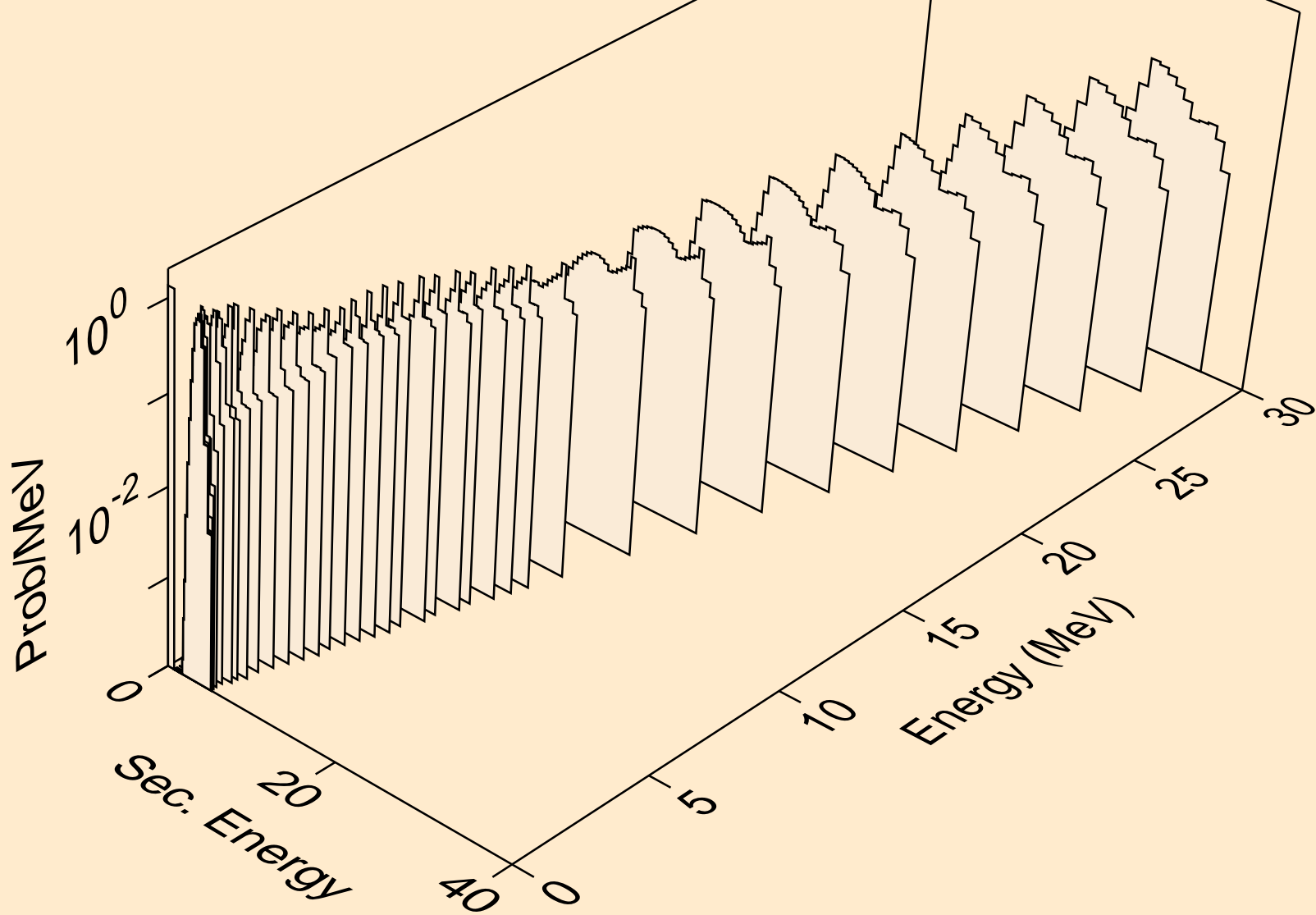

HO158 NEUTRON ACER TENDL-2023 LIBRARY; T=0.K
protons from (n,2p)

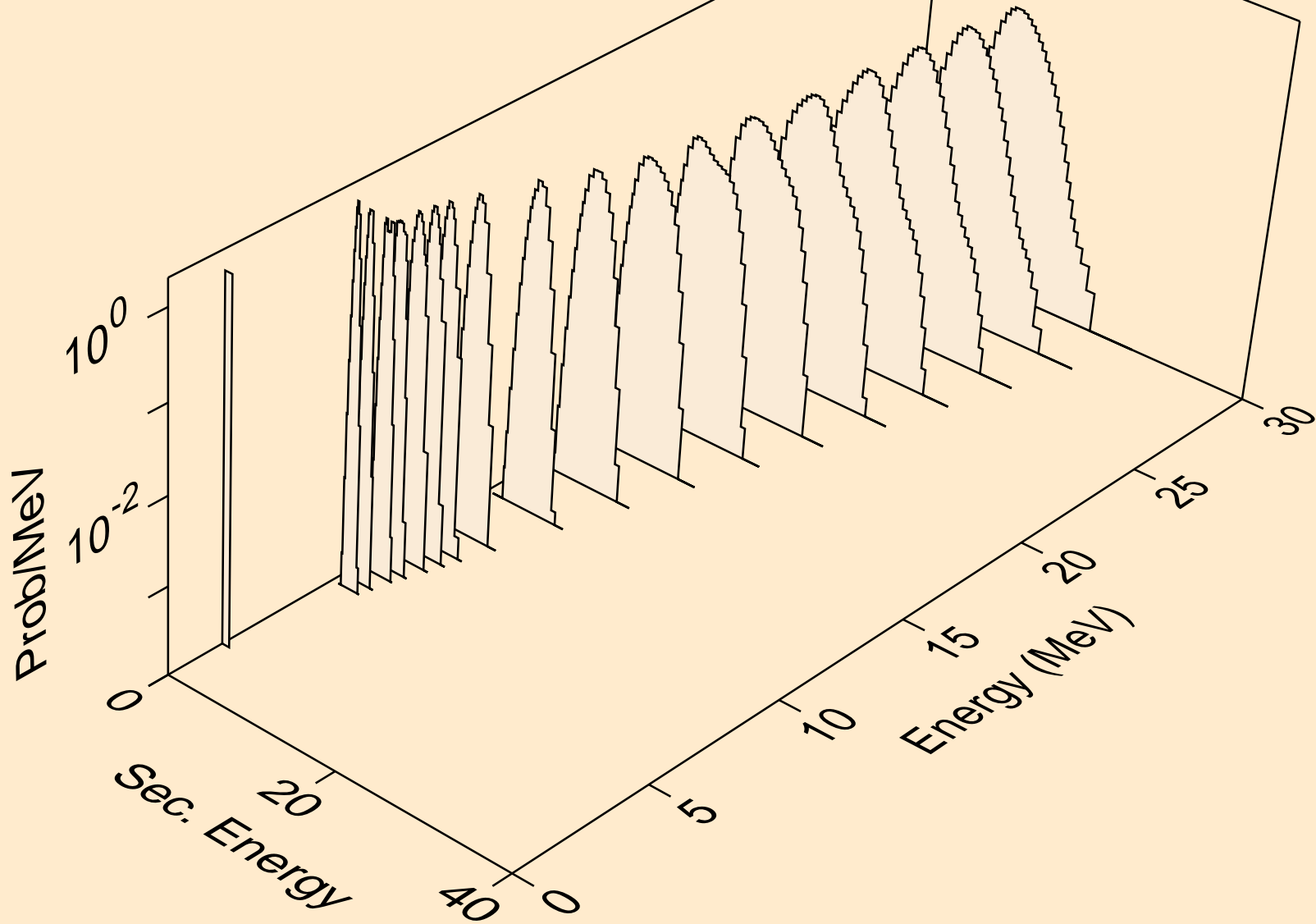

HO158 NEUTRON ACER TENDL-2023 LIBRARY; T=0.K
protons from (n,p)

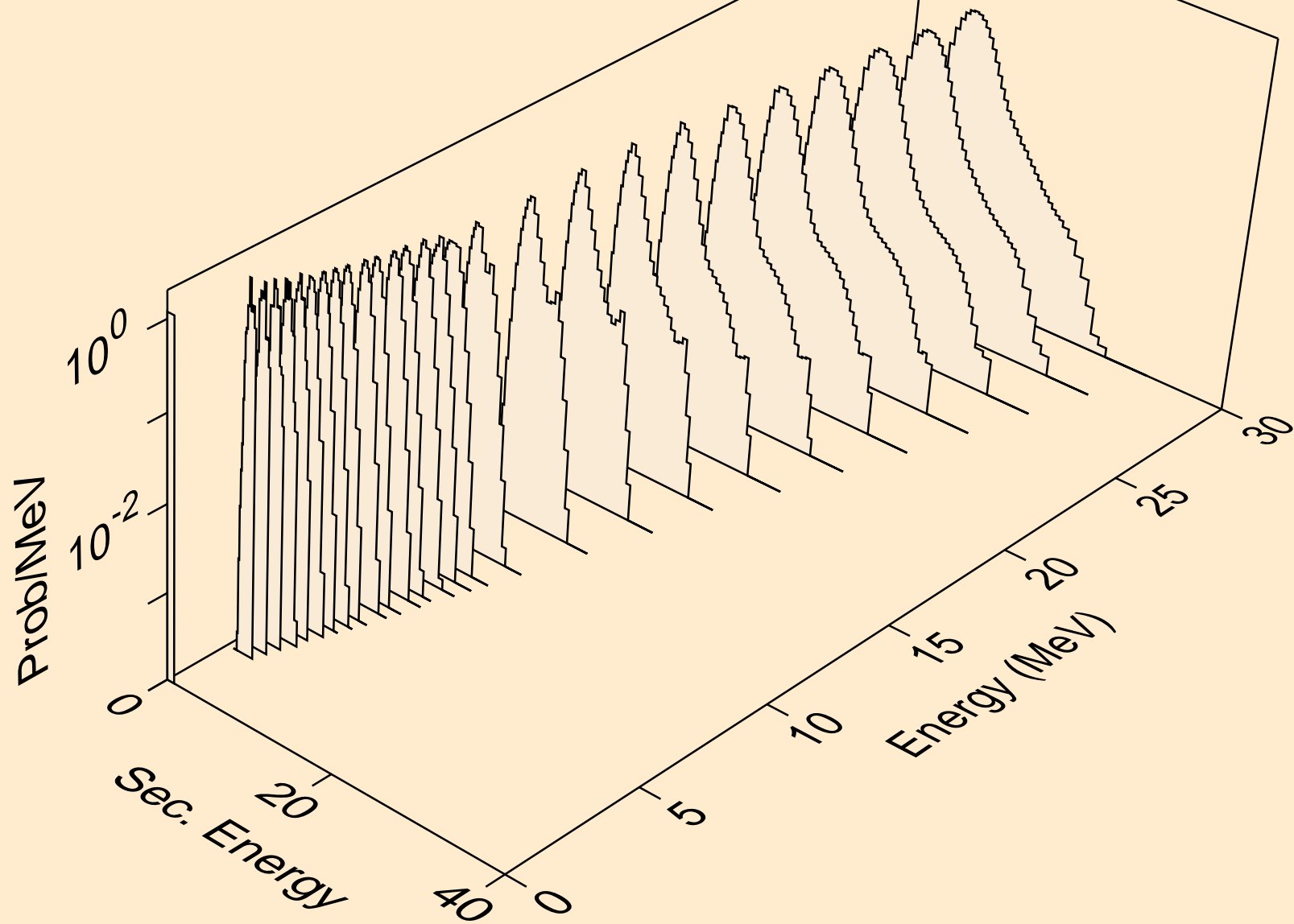

HO158 NEUTRON ACER TENDL-2023 LIBRARY; T=0.K
protons from (n,pd)

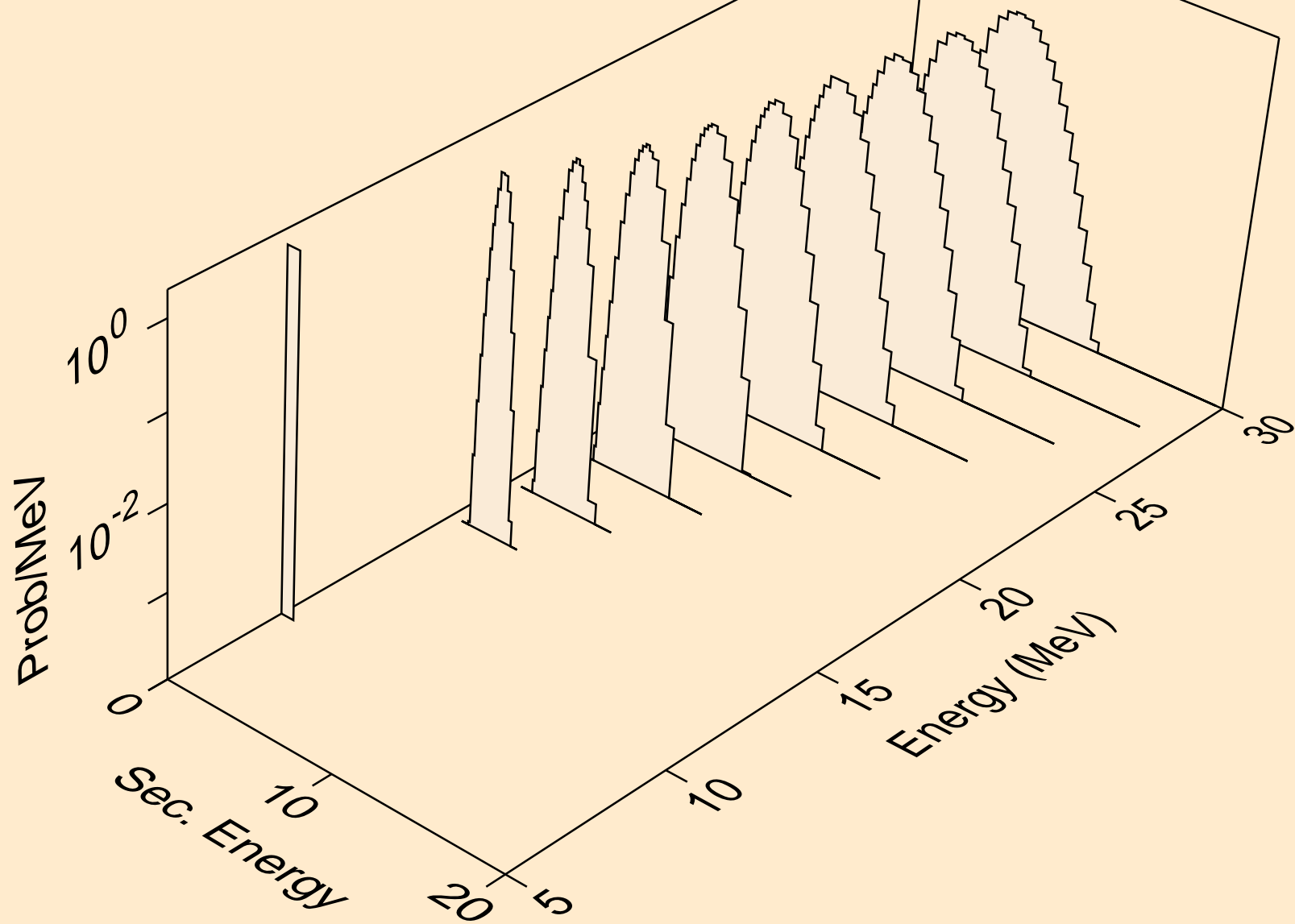

HO158 NEUTRON ACER TENDL-2023 LIBRARY; T=0.K
protons from (n,pt)

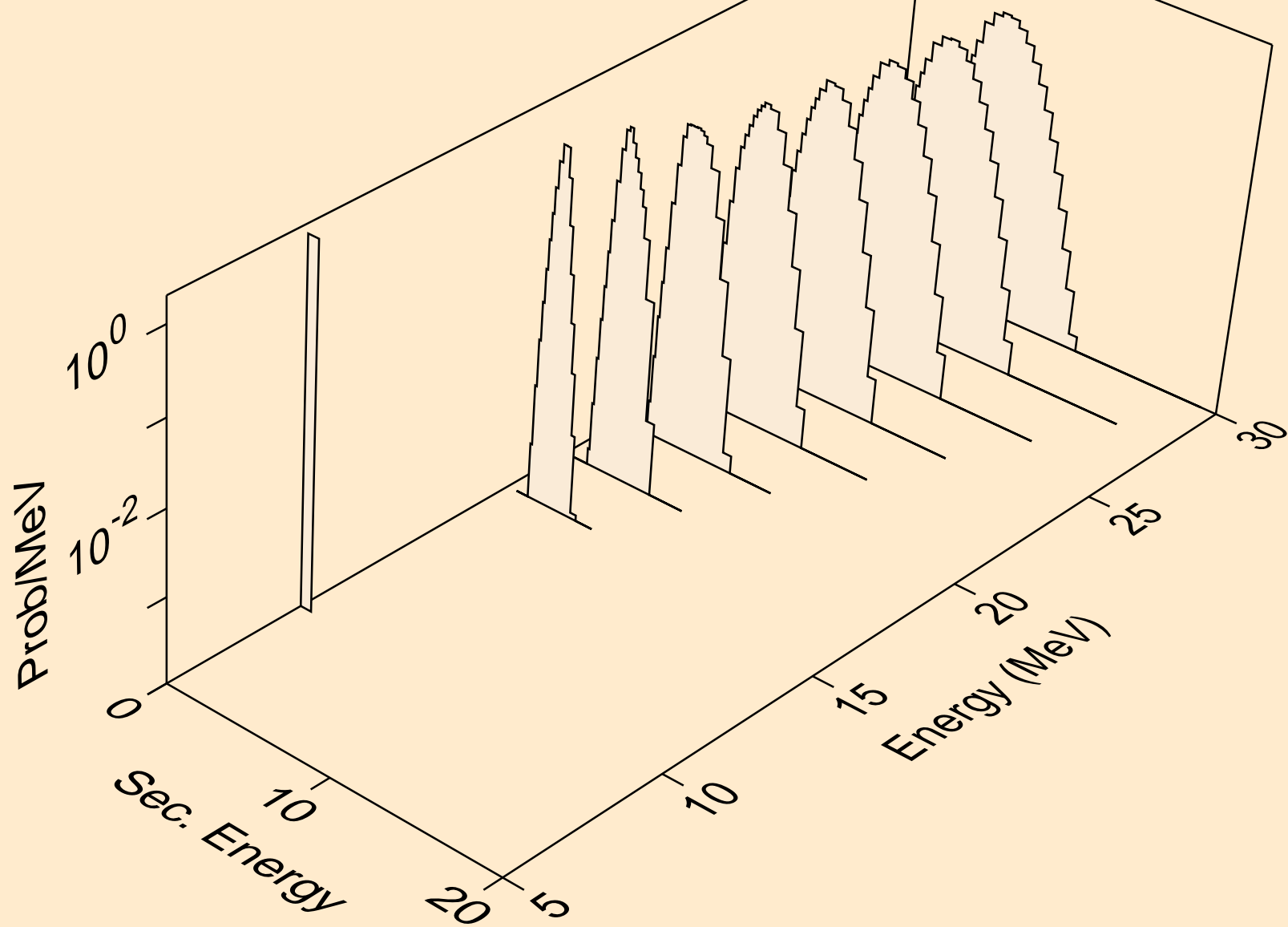

HO158 NEUTRON ACER TENDL-2023 LIBRARY; T=0.K
deuterons from (n,x)

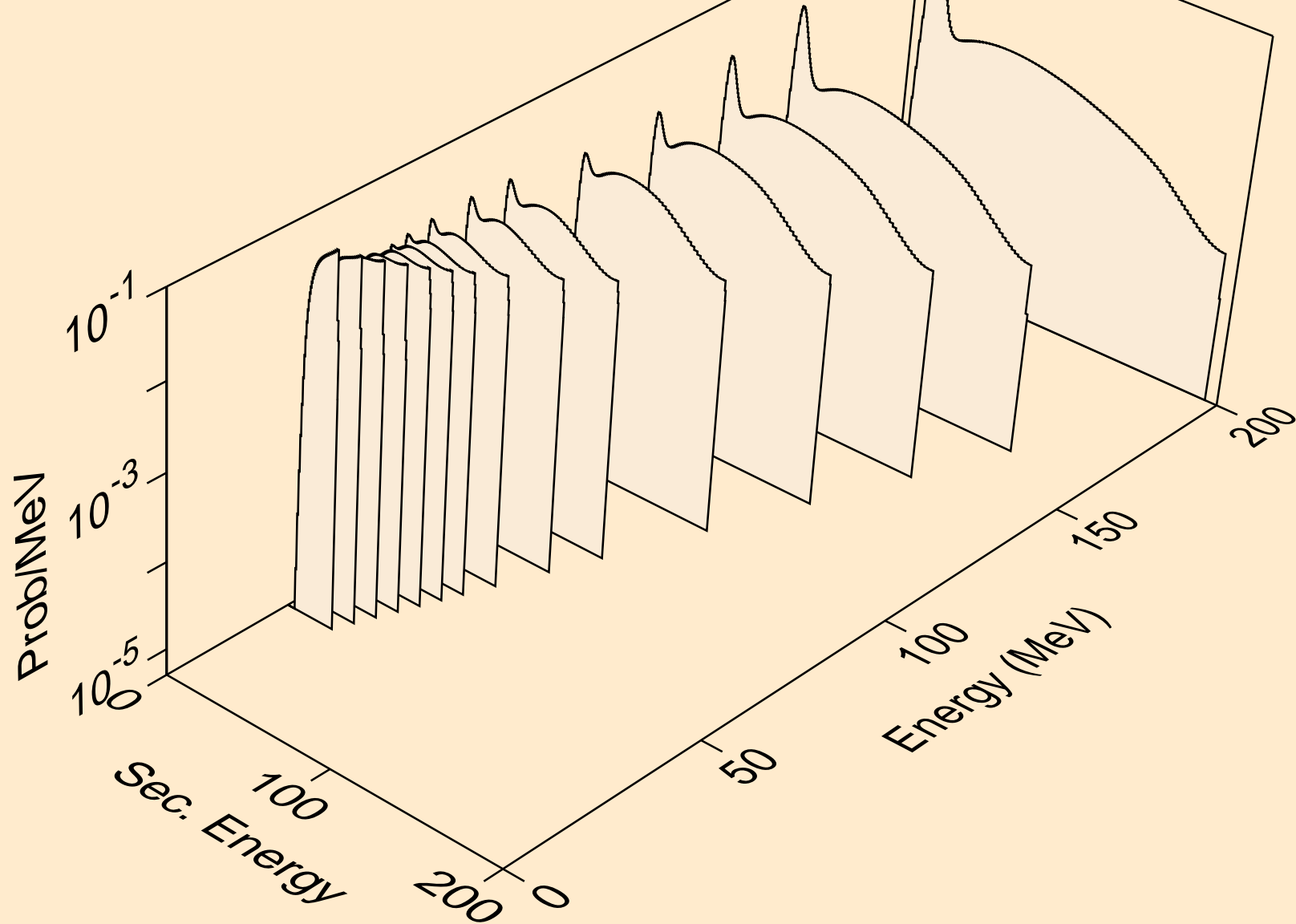

HO158 NEUTRON ACER TENDL-2023 LIBRARY; T=0.K
deuterons from (n,2nd)

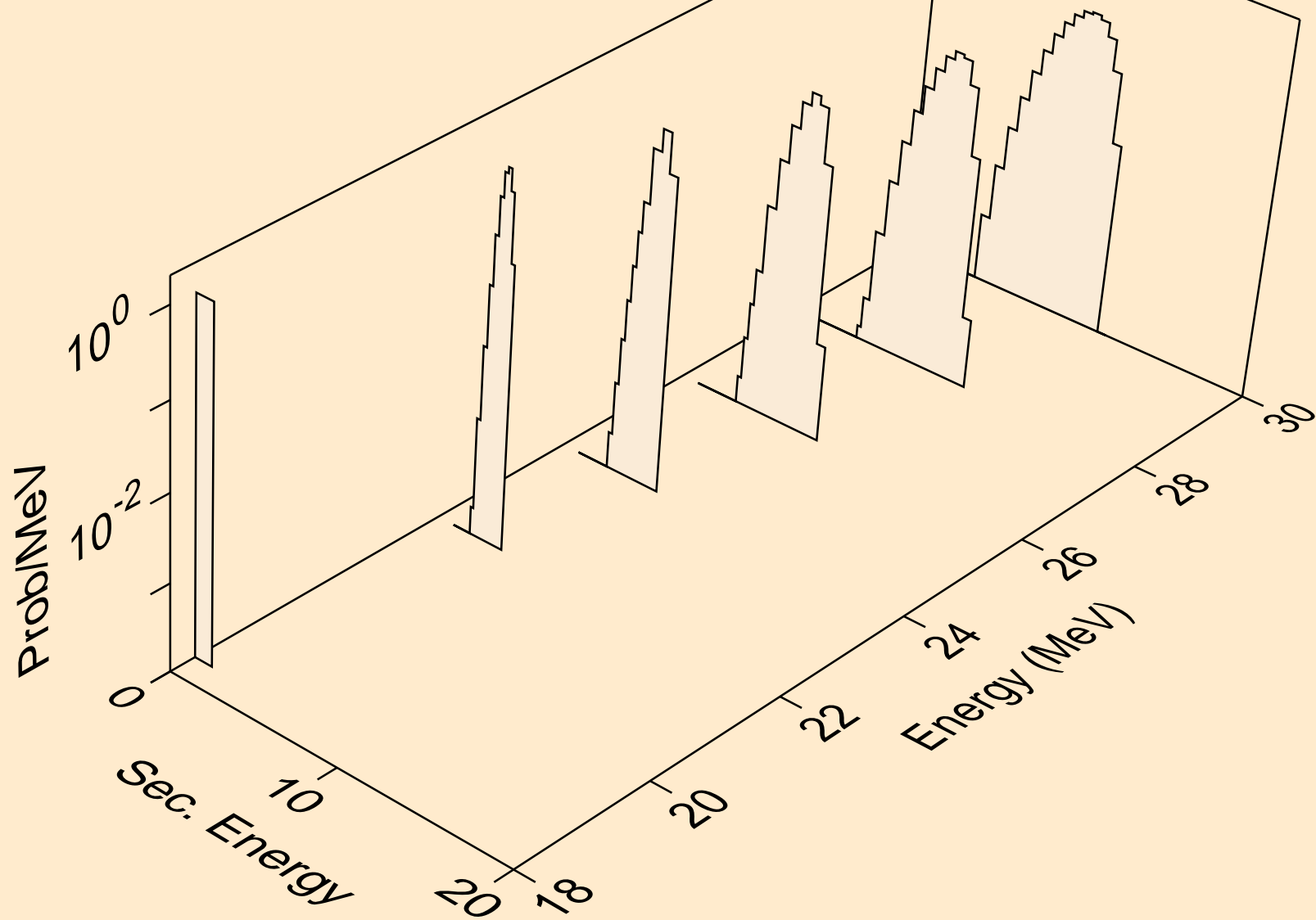

HO158 NEUTRON ACER TENDL-2023 LIBRARY; T=0.K
deuterons from (n,n*)d

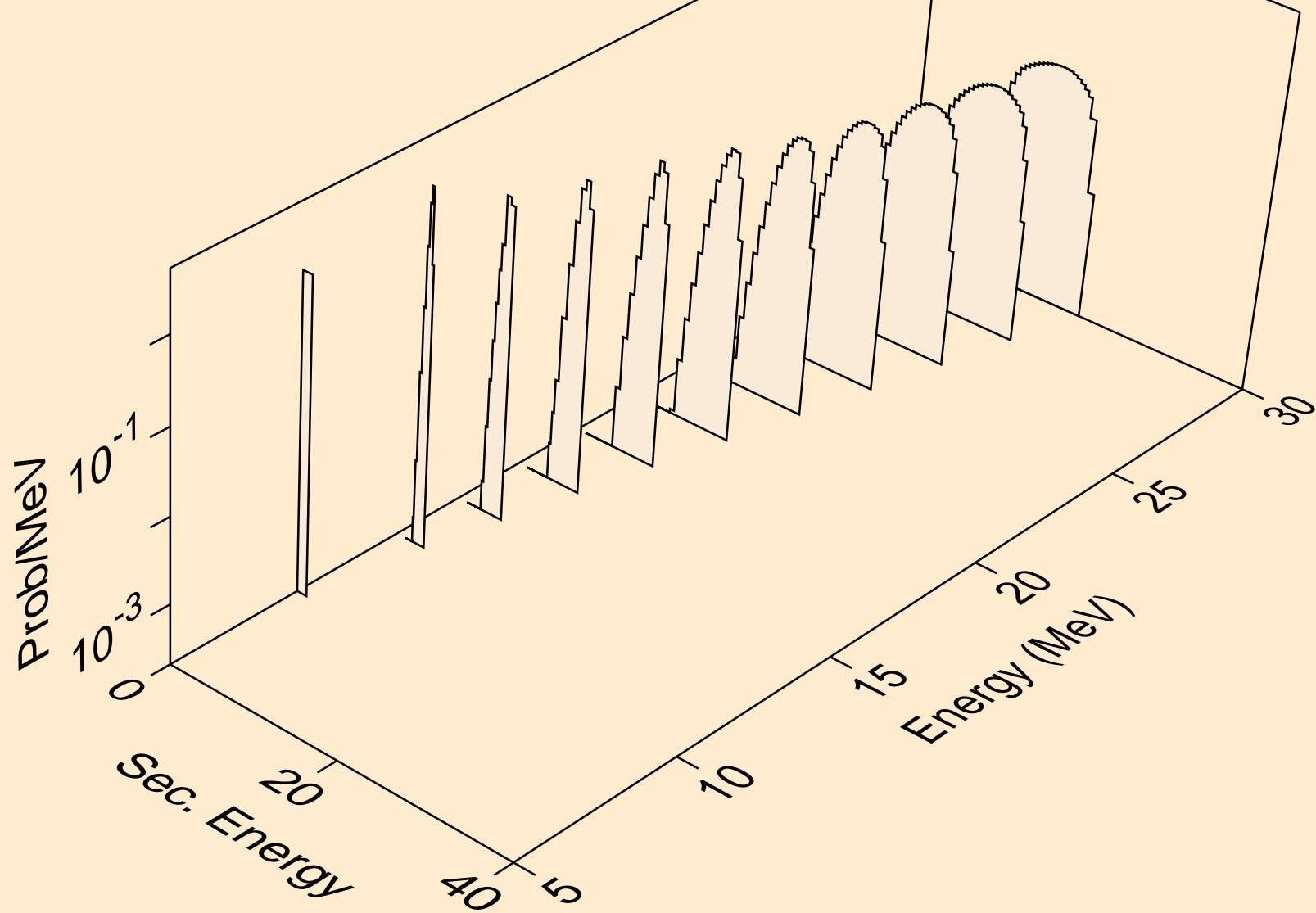

HO158 NEUTRON ACER TENDL-2023 LIBRARY; T=0.K
deuterons from (n,d)

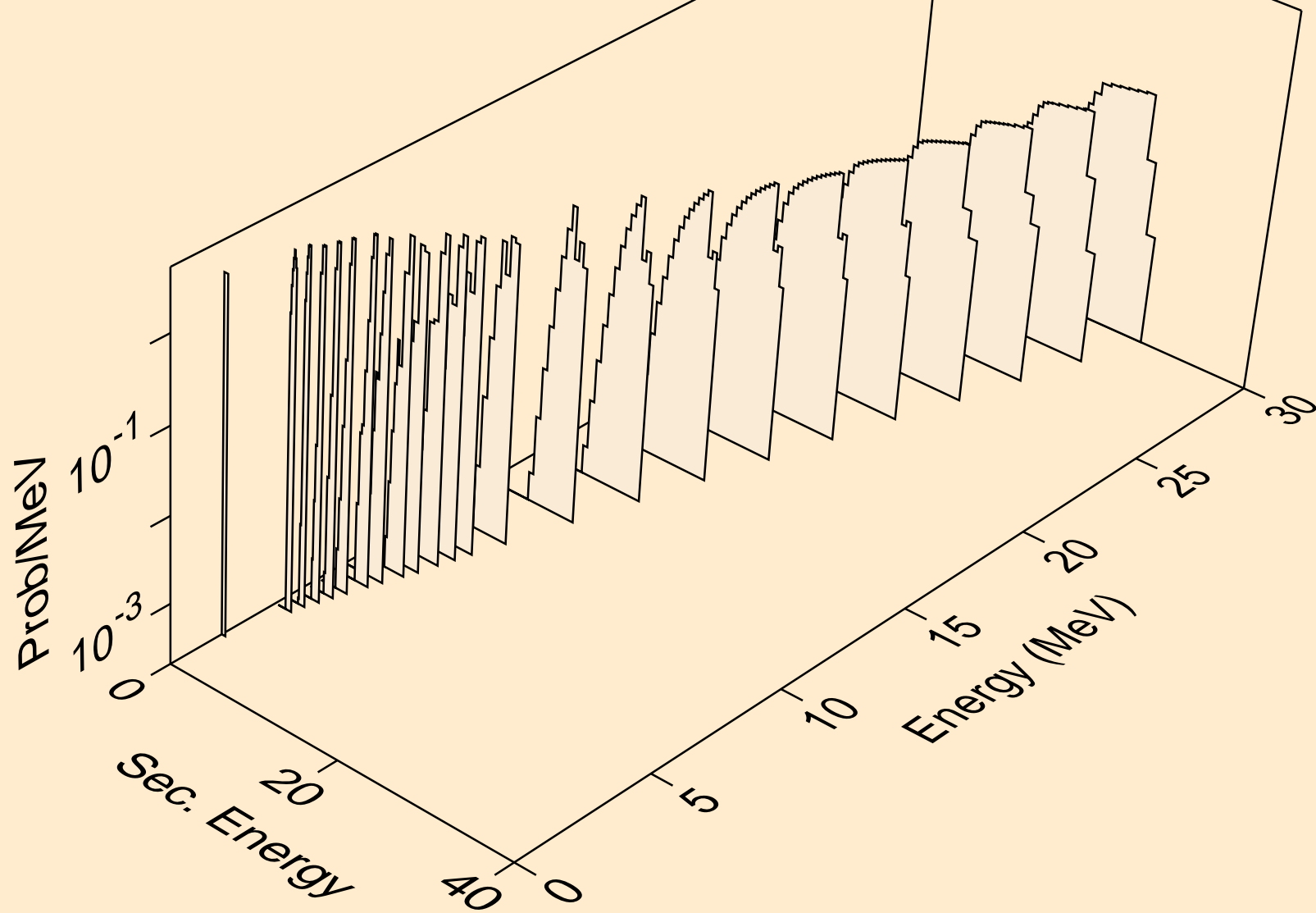

HO158 NEUTRON ACER TENDL-2023 LIBRARY; T=0.K
deuterons from (n,pd)

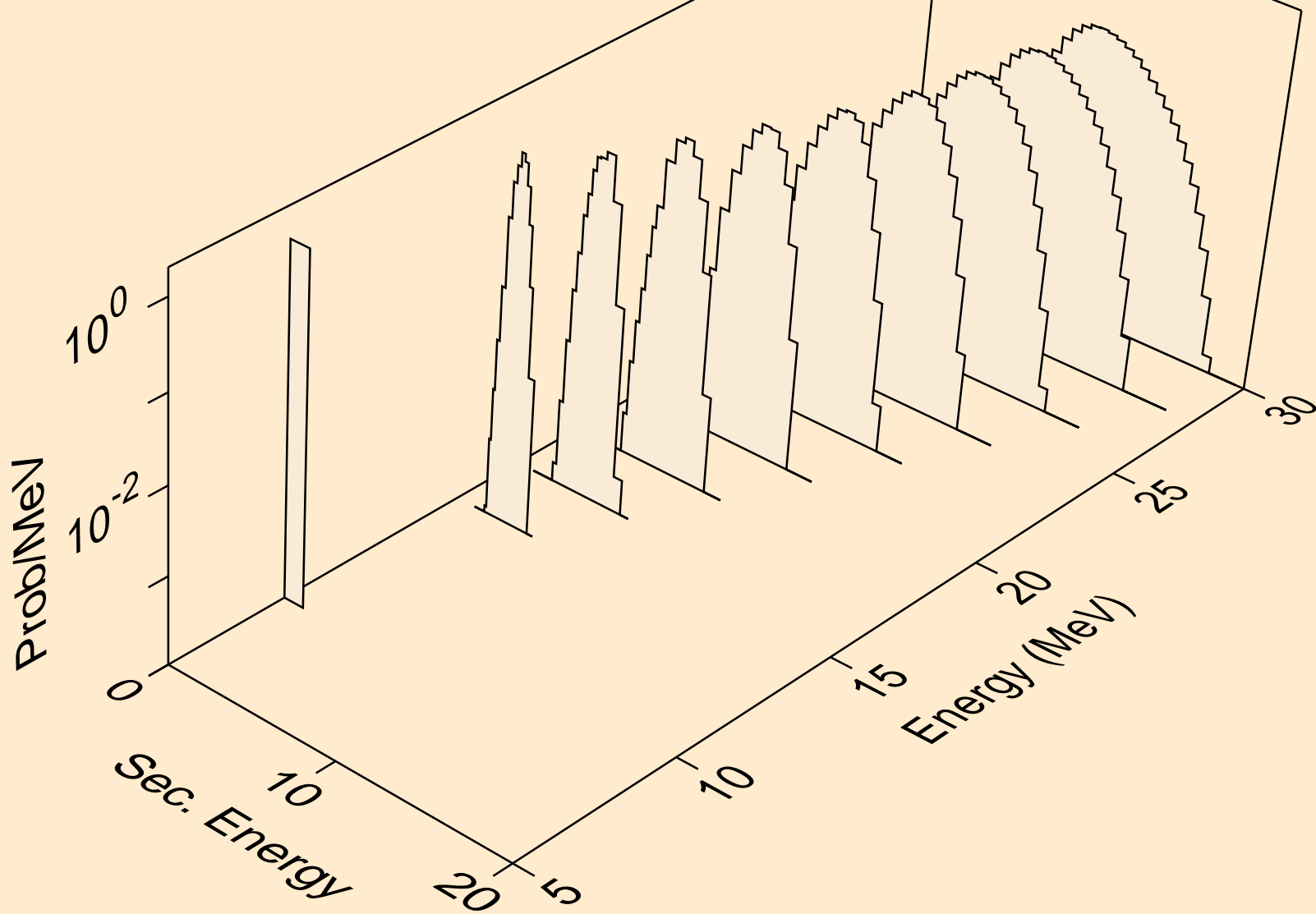

HO158 NEUTRON ACER TENDL-2023 LIBRARY; T=0.K
deuterons from (n,da)

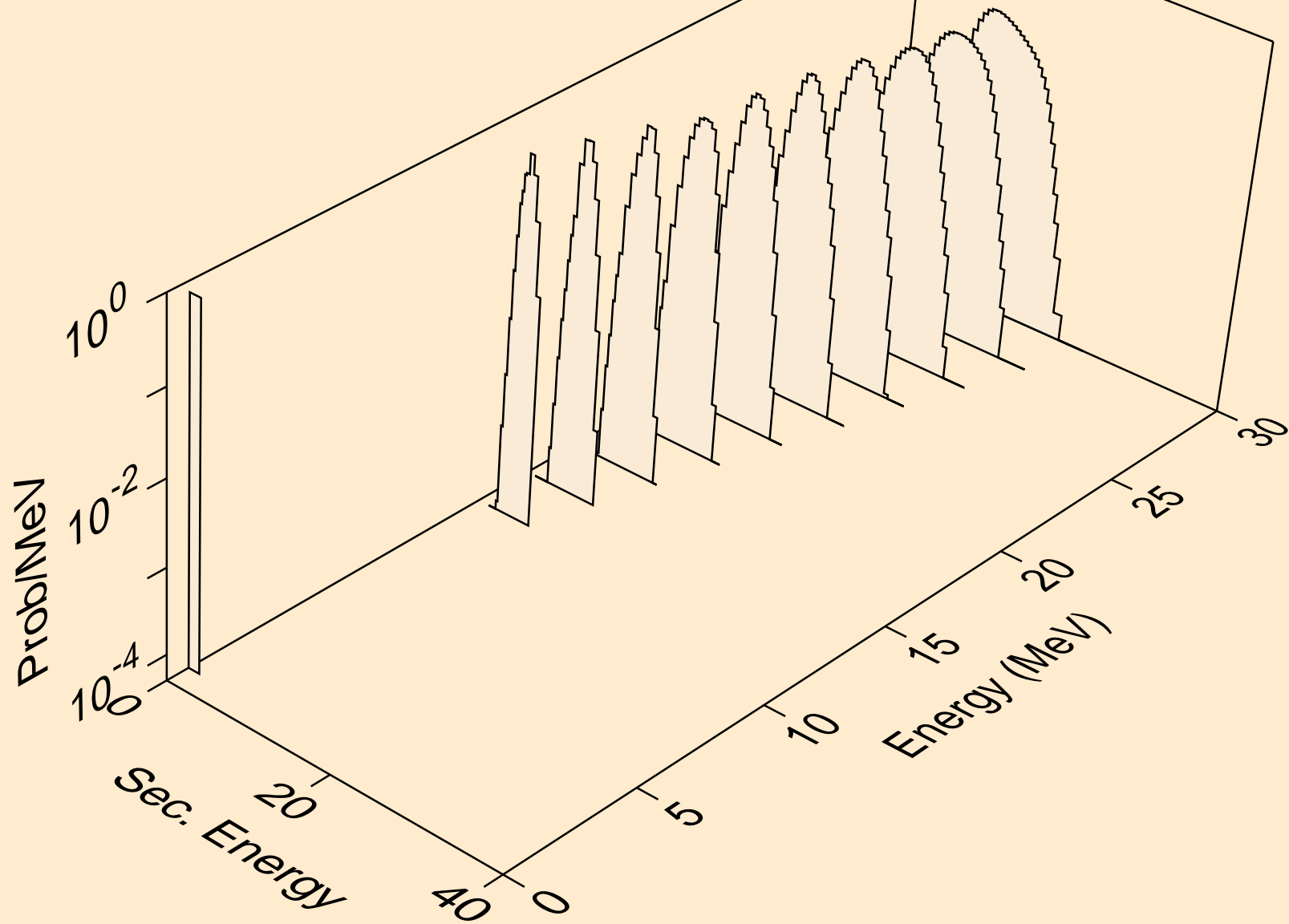

HO158 NEUTRON ACER TENDL-2023 LIBRARY; T=0.K
tritons from (n,x)

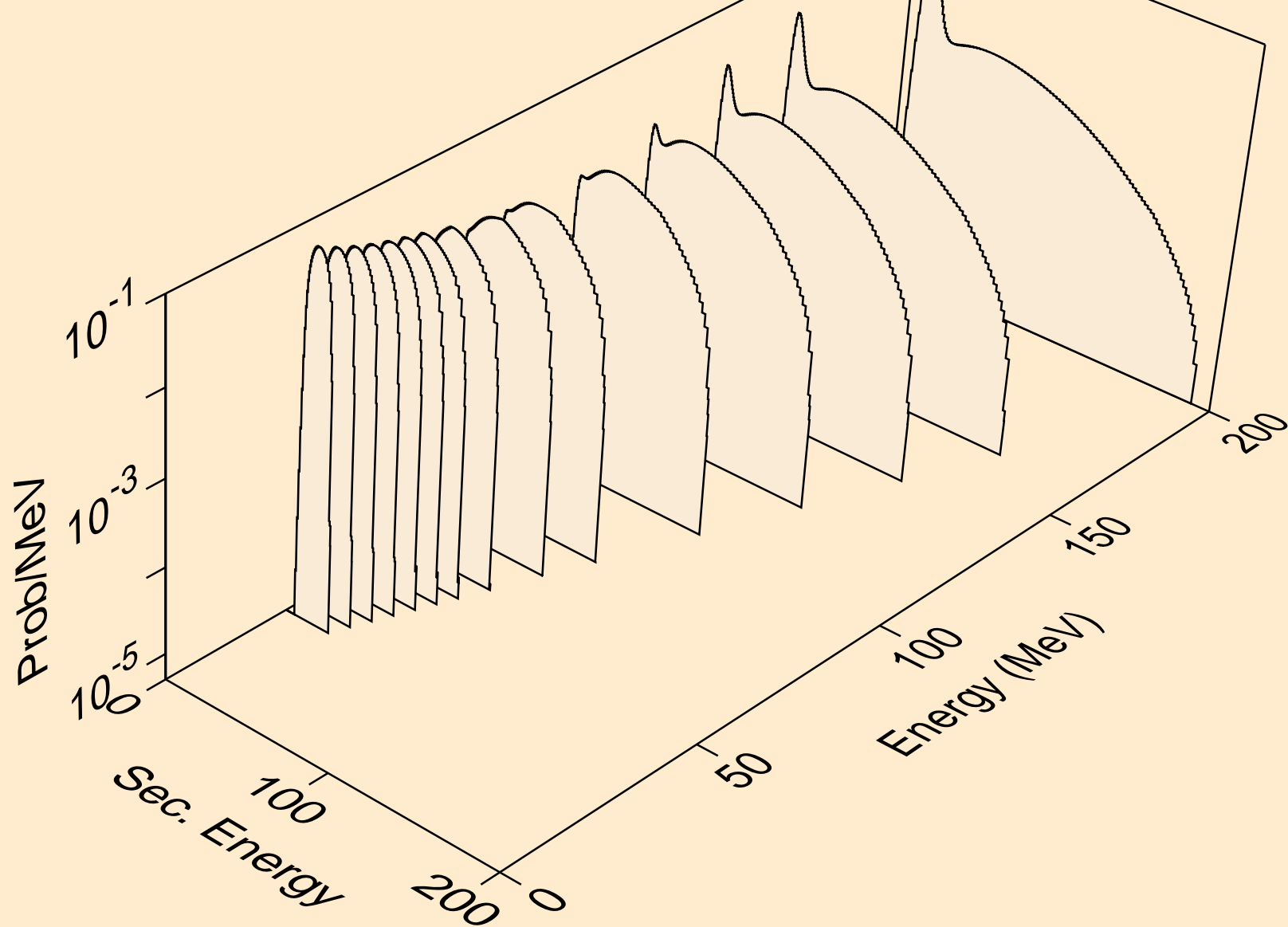

HO158 NEUTRON ACER TENDL-2023 LIBRARY; T=0.K
tritons from (n,n*)t

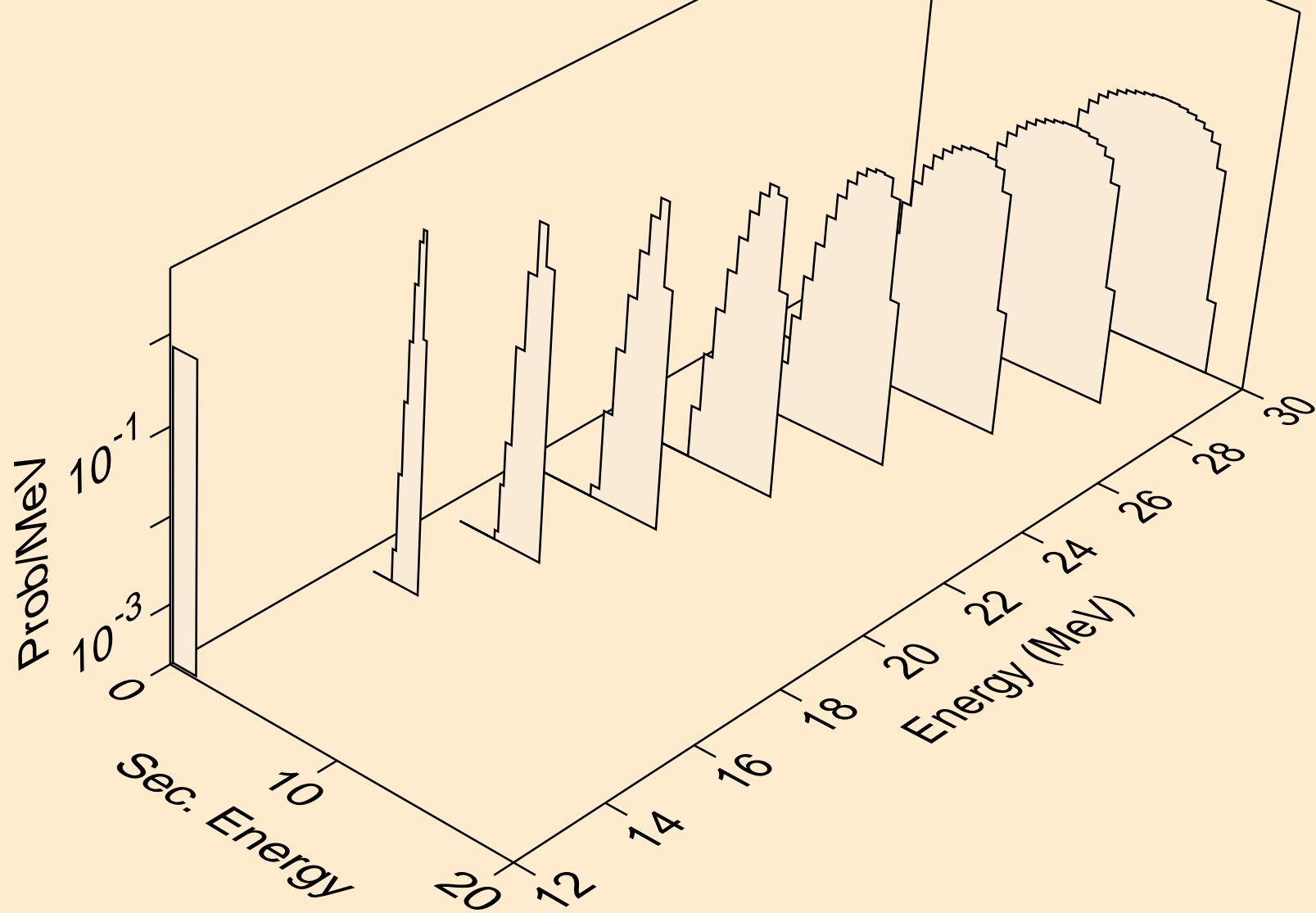

HO158 NEUTRON ACER TENDL-2023 LIBRARY; T=0.K
tritons from (n,t)

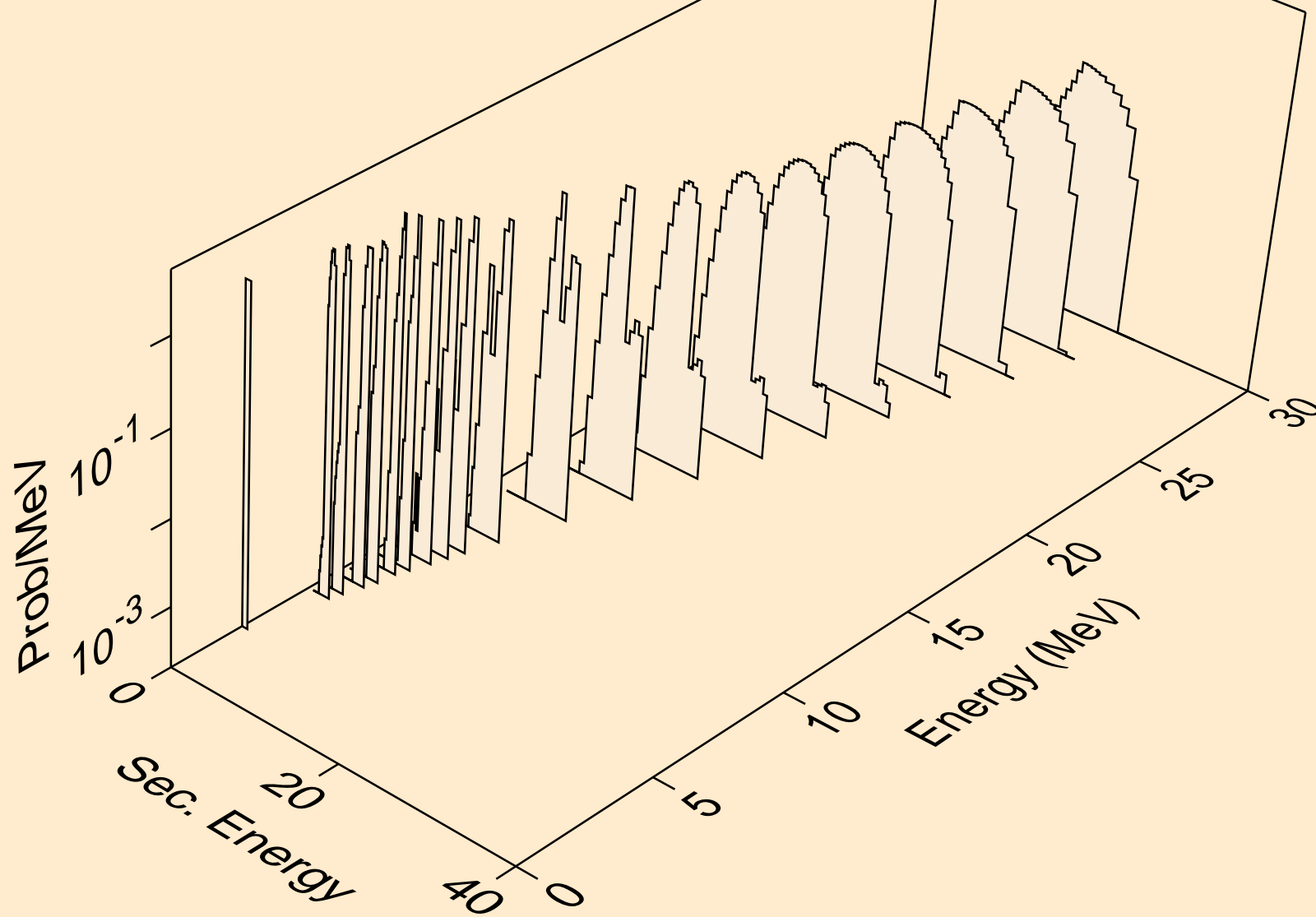

HO158 NEUTRON ACER TENDL-2023 LIBRARY; T=0.K
tritons from (n,pt)

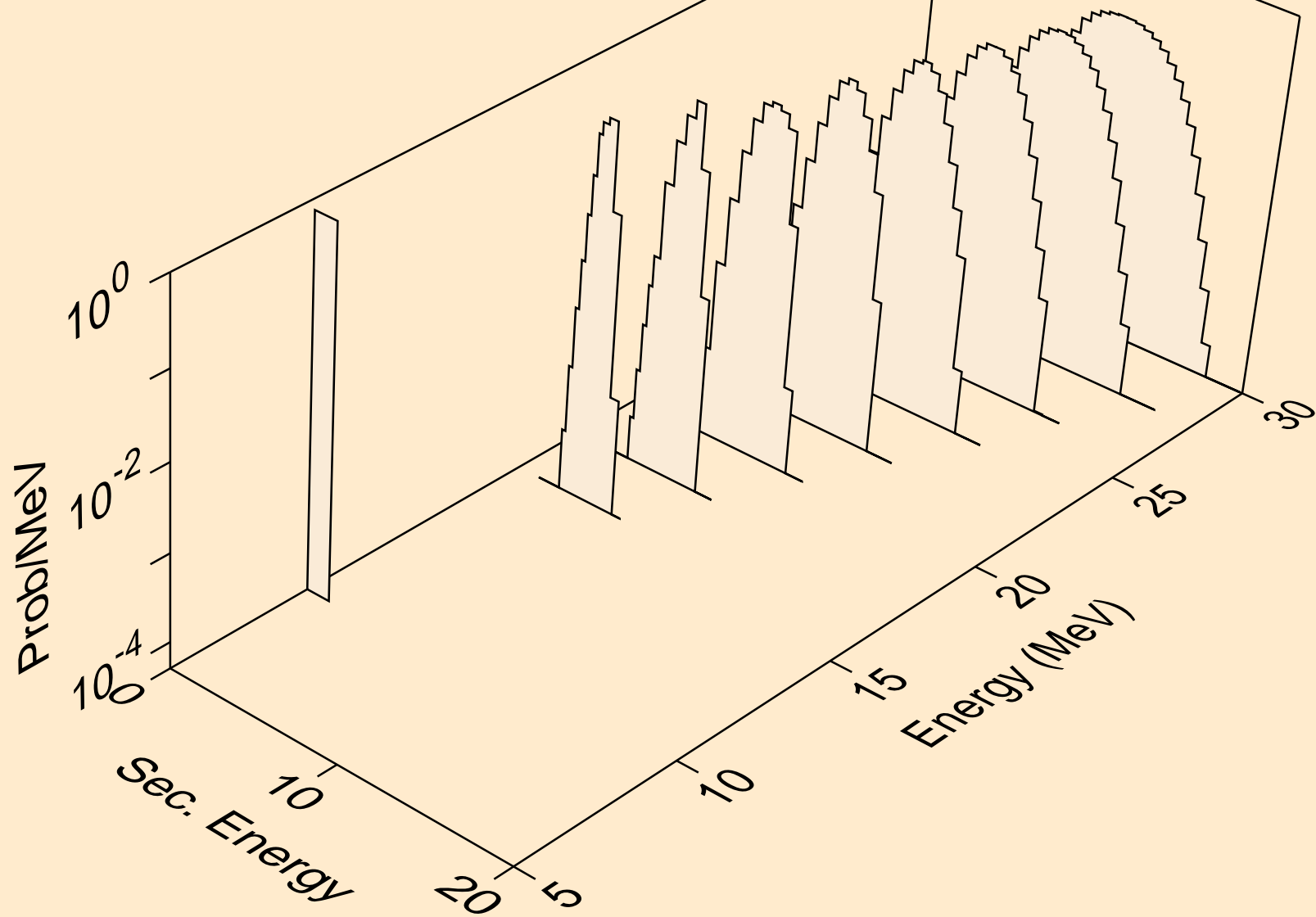

HO158 NEUTRON ACER TENDL-2023 LIBRARY; T=0.K
he3s from (n,x)

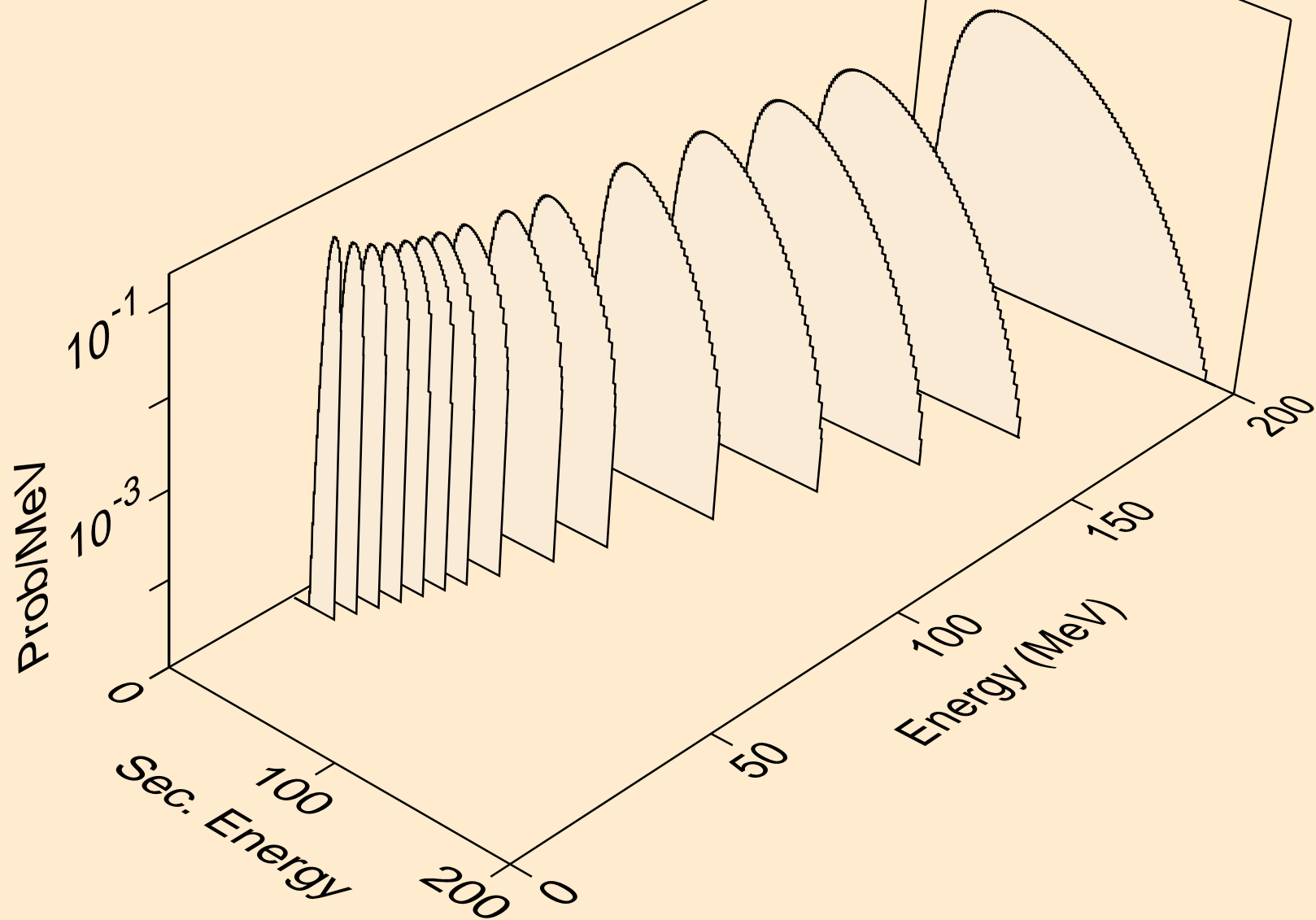

HO158 NEUTRON ACER TENDL-2023 LIBRARY; T=0.K
he3s from (n,n*)he3

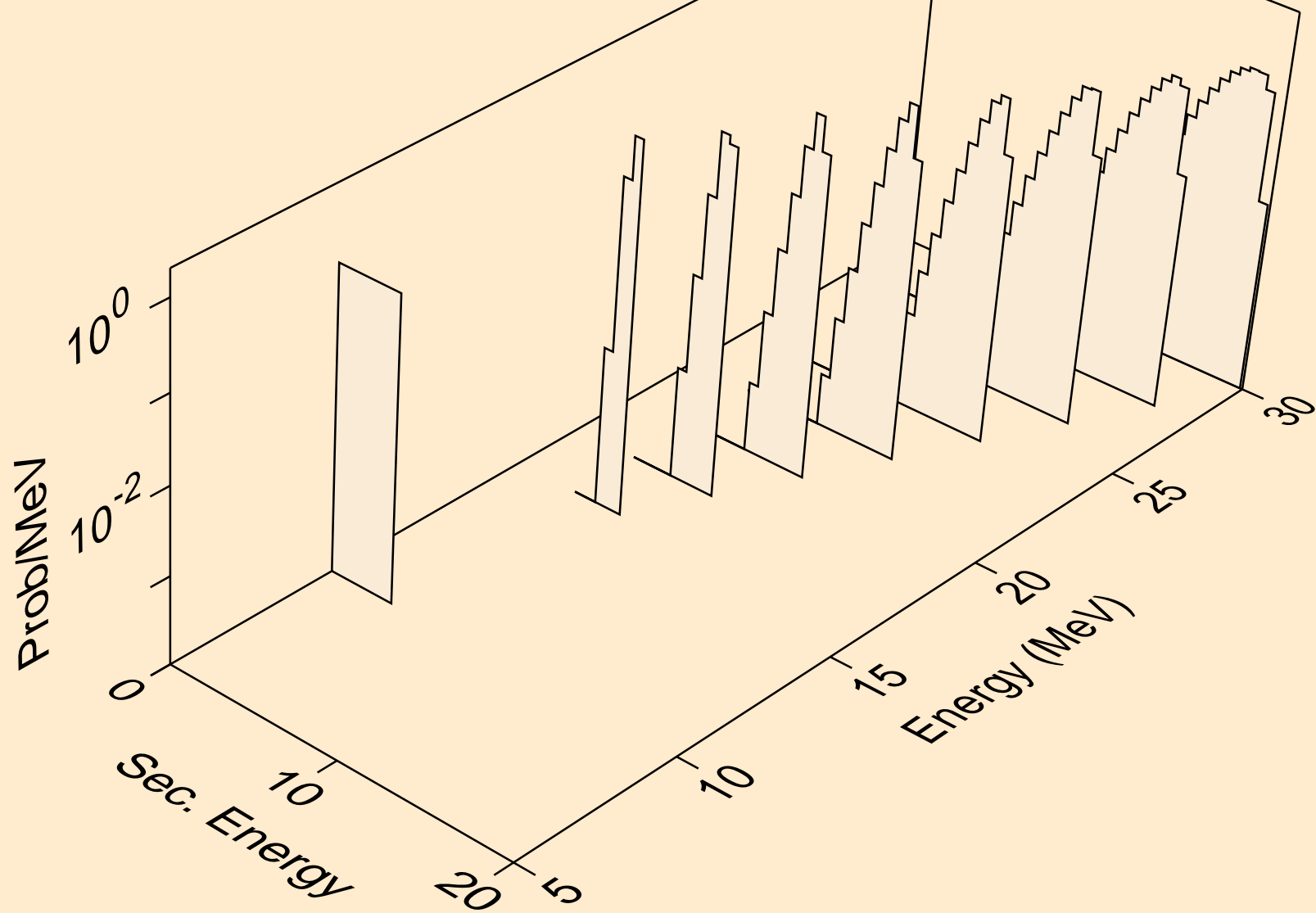

HO158 NEUTRON ACER TENDL-2023 LIBRARY; T=0.K
he3s from (n,he3)

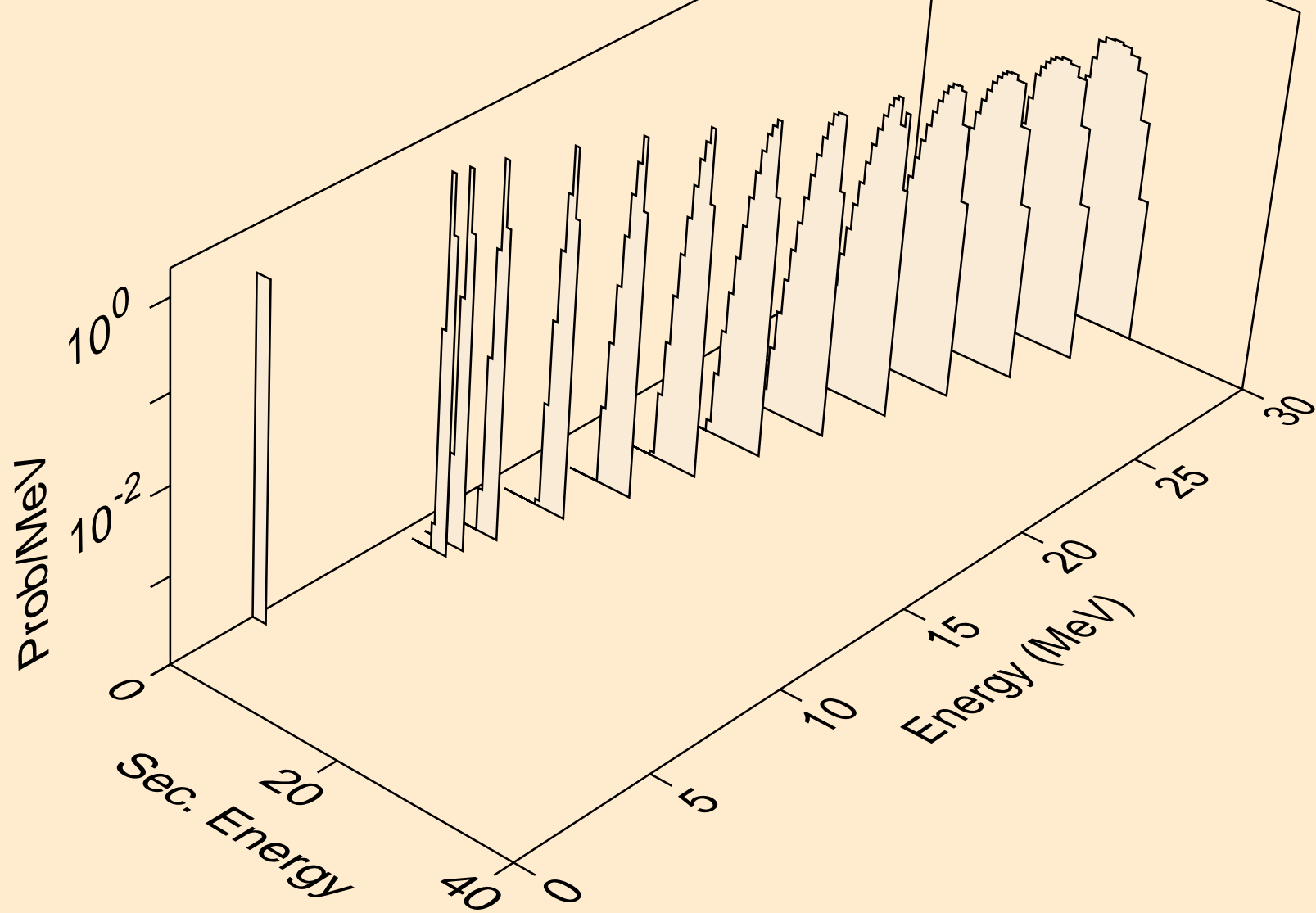

HO158 NEUTRON ACER TENDL-2023 LIBRARY; T=0.K
alphas from (n,x)

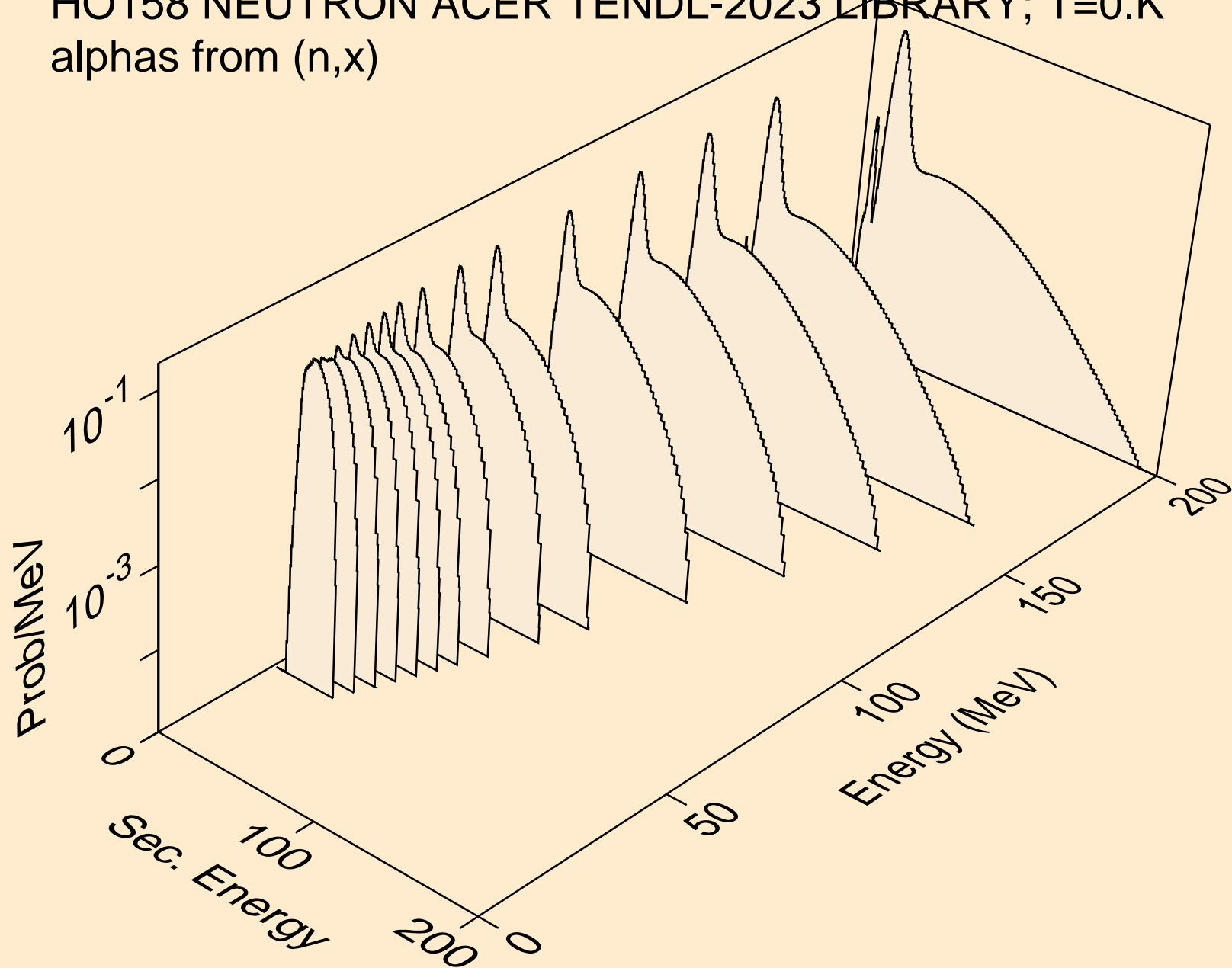

HO158 NEUTRON ACER TENDL-2023 LIBRARY; T=0.K
alphas from (n,n*)a

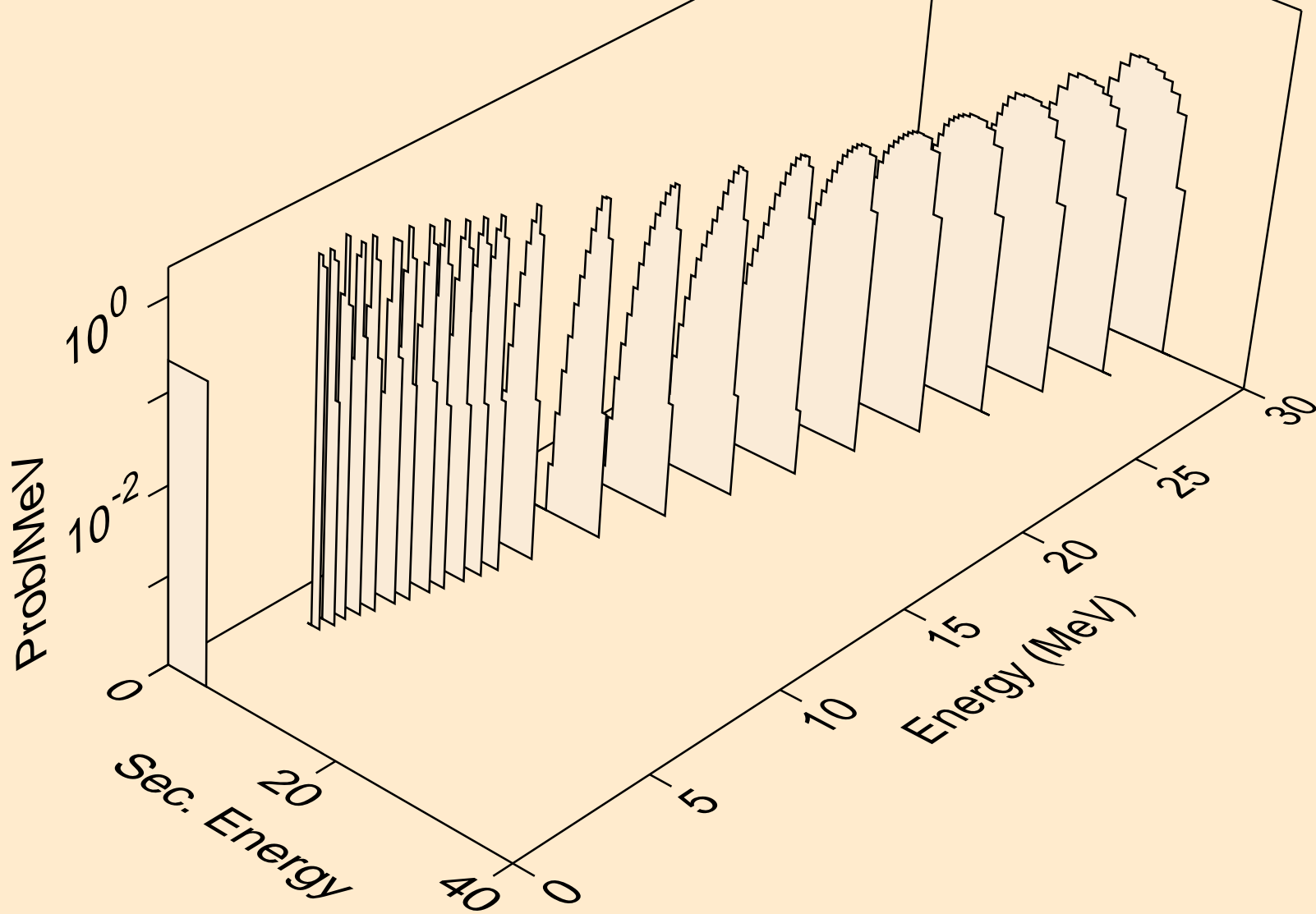

HO158 NEUTRON ACER TENDL-2023 LIBRARY; T=0.K
alphas from (n,2n)a

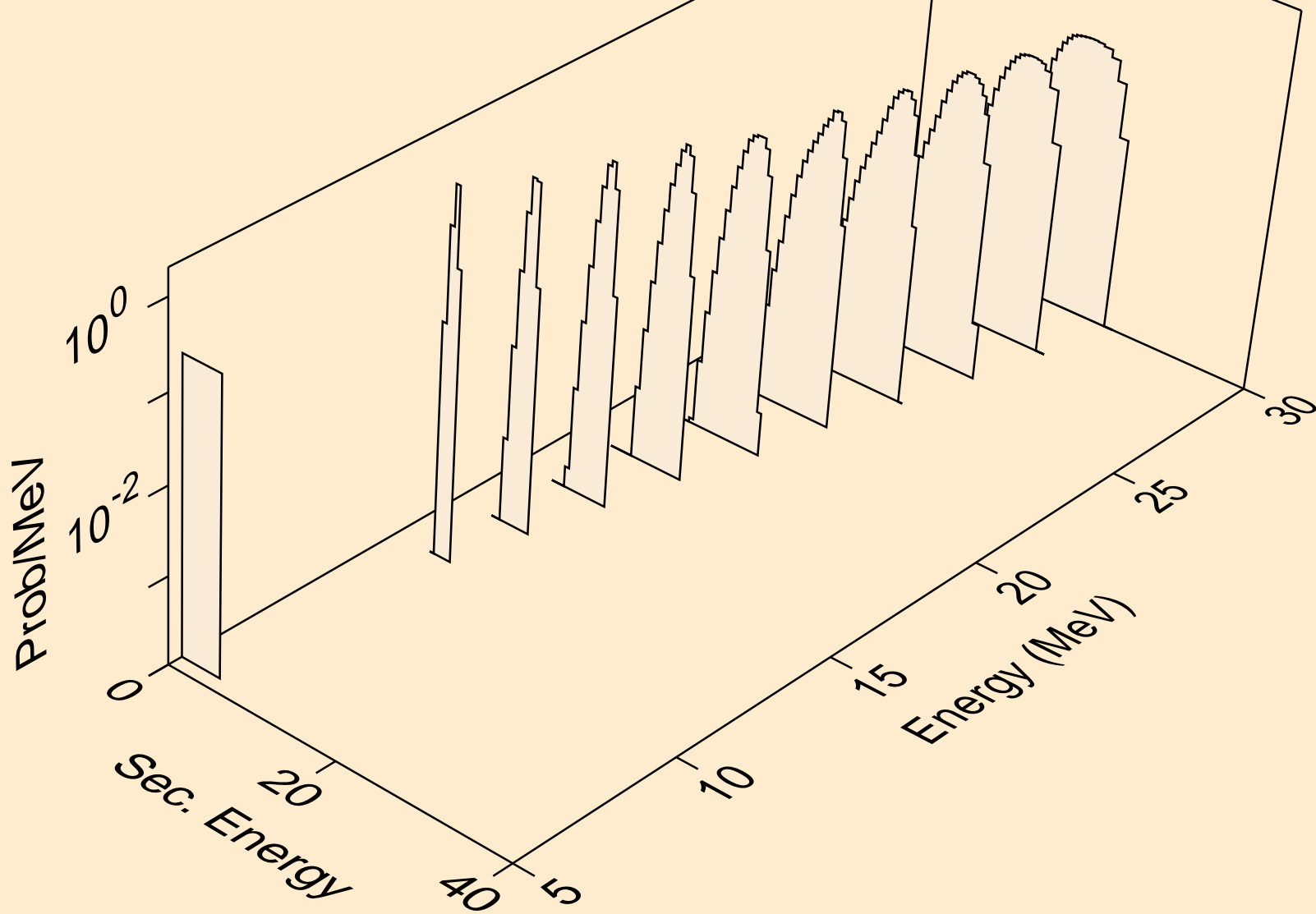

HO158 NEUTRON ACER TENDL-2023 LIBRARY; T=0.K
alphas from (n,3n)a

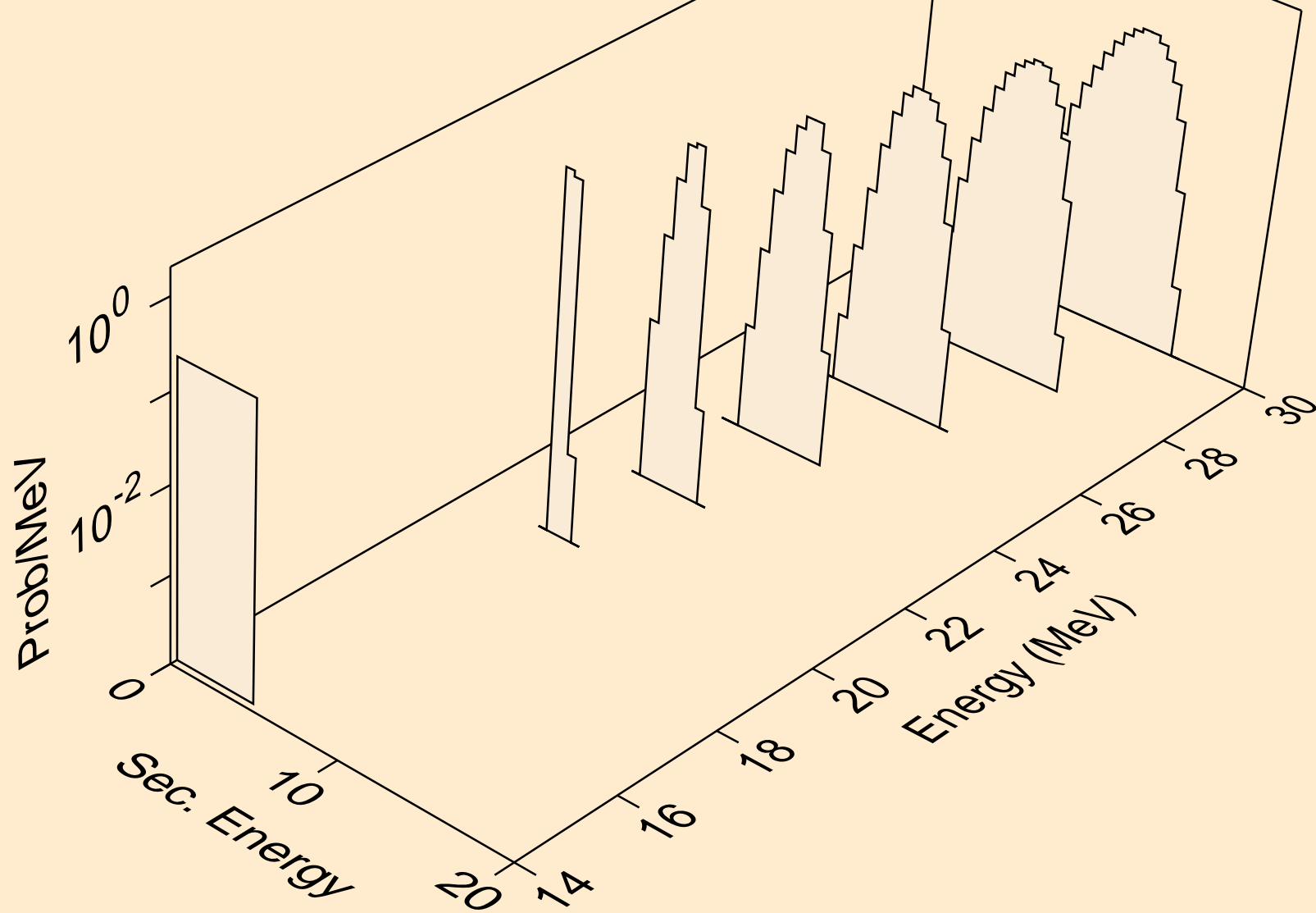

HO158 NEUTRON ACER TENDL-2023 LIBRARY; T=0.K
alphas from (n,n*)2a

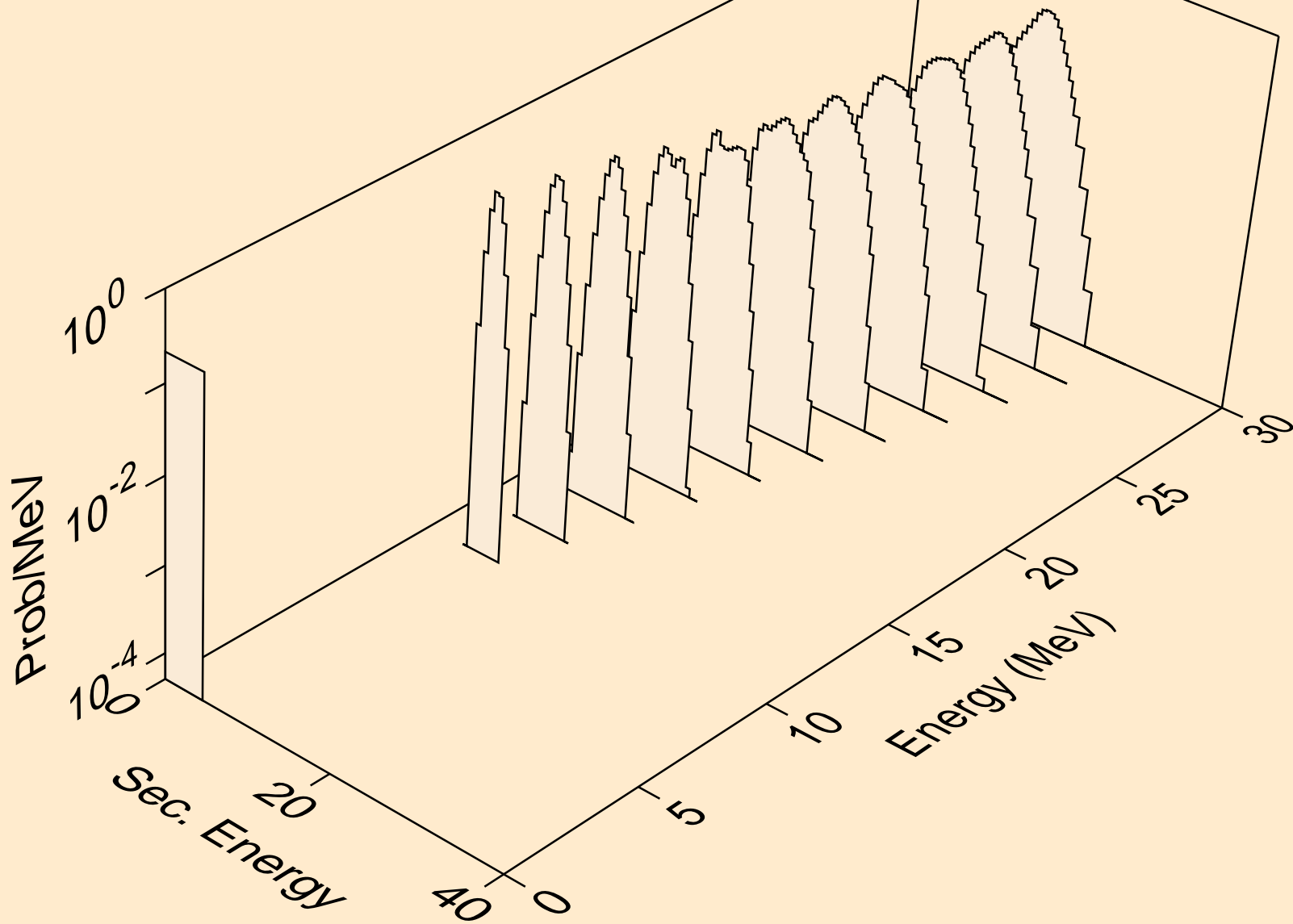

HO158 NEUTRON ACER TENDL-2023 LIBRARY; T=0.K
alphas from (n,2n)2a

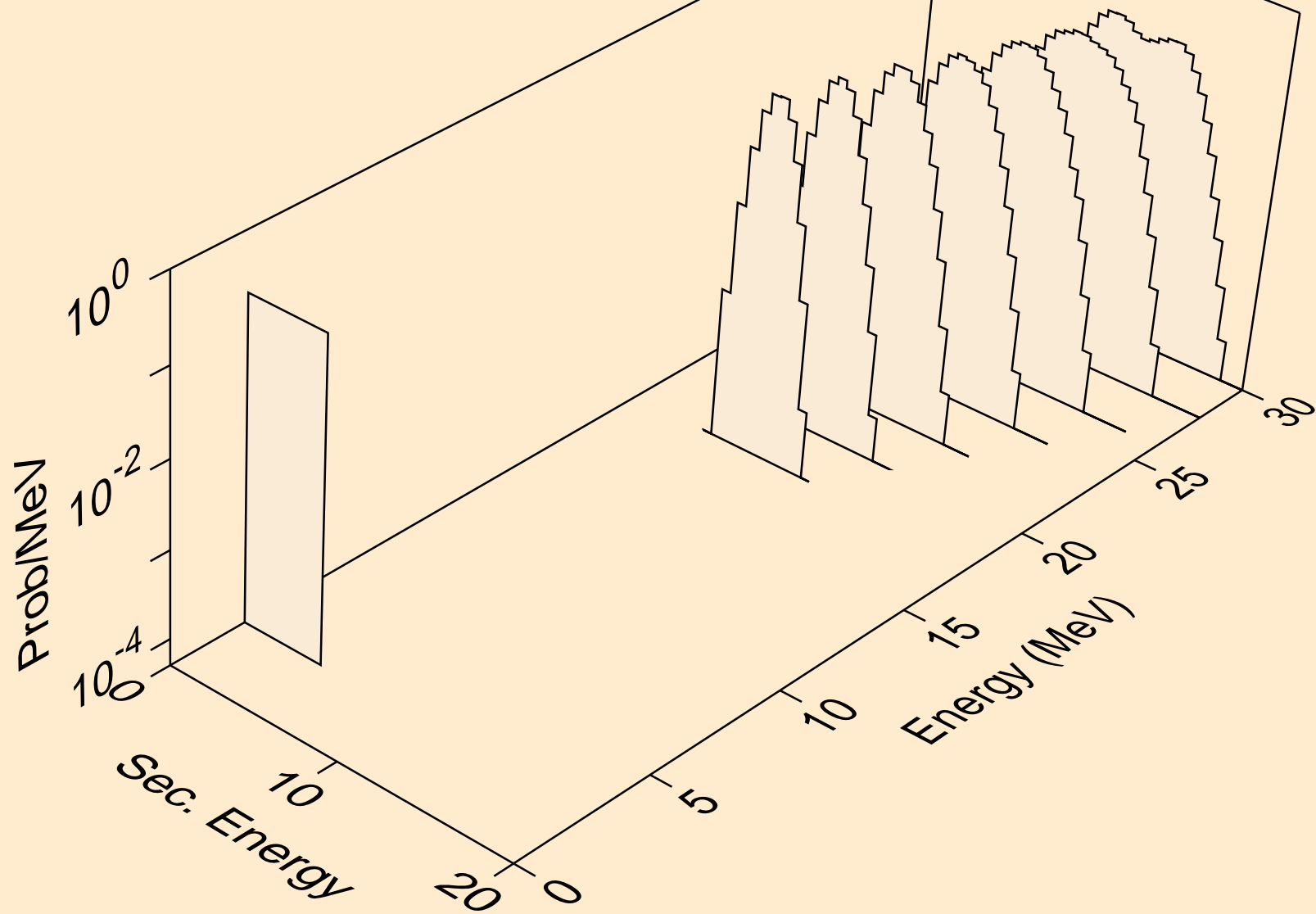

HO158 NEUTRON ACER TENDL-2023 LIBRARY; T=0.K
alphas from (n,npa)

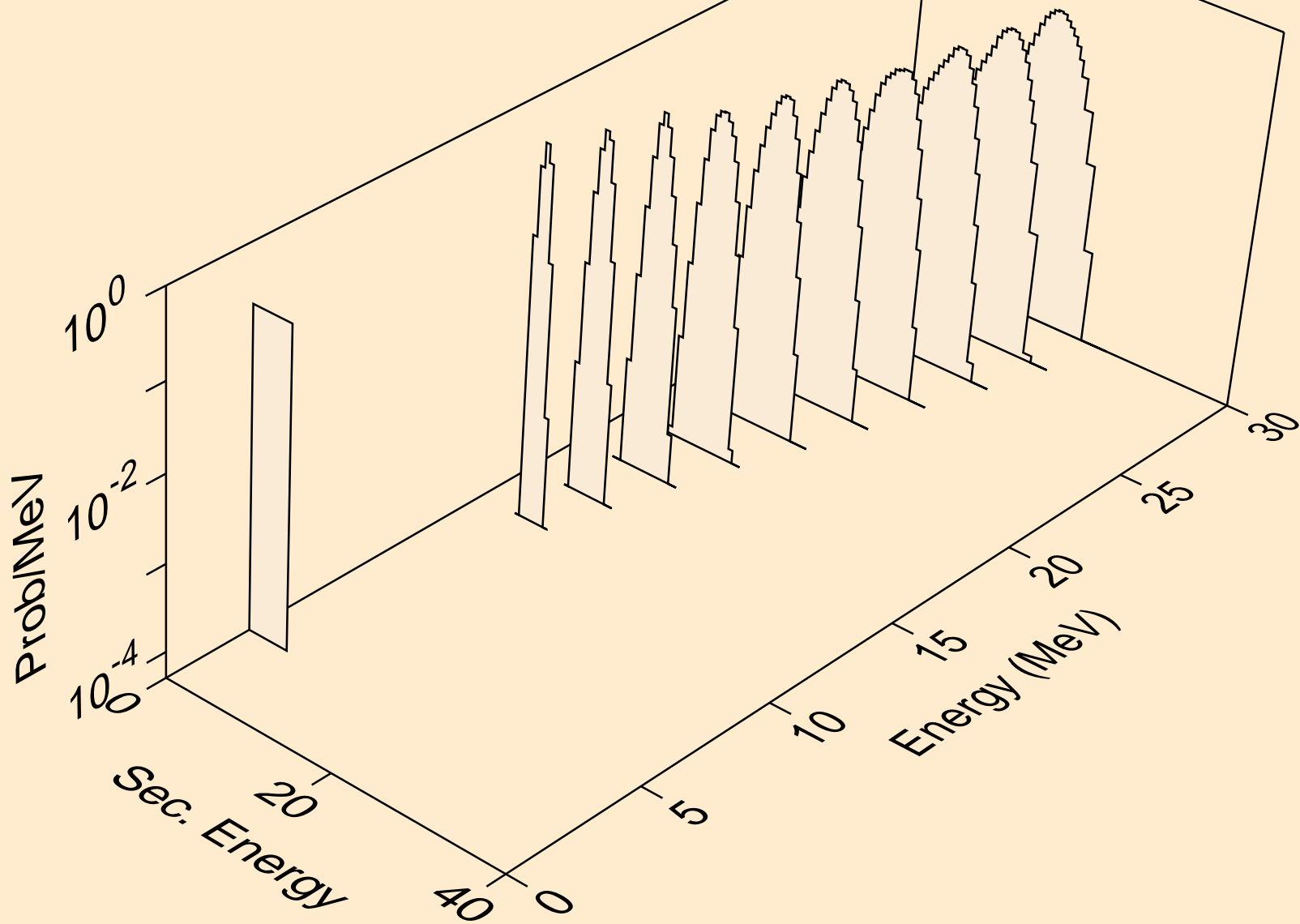

HO158 NEUTRON ACER TENDL-2023 LIBRARY; T=0.K
alphas from (n,a)

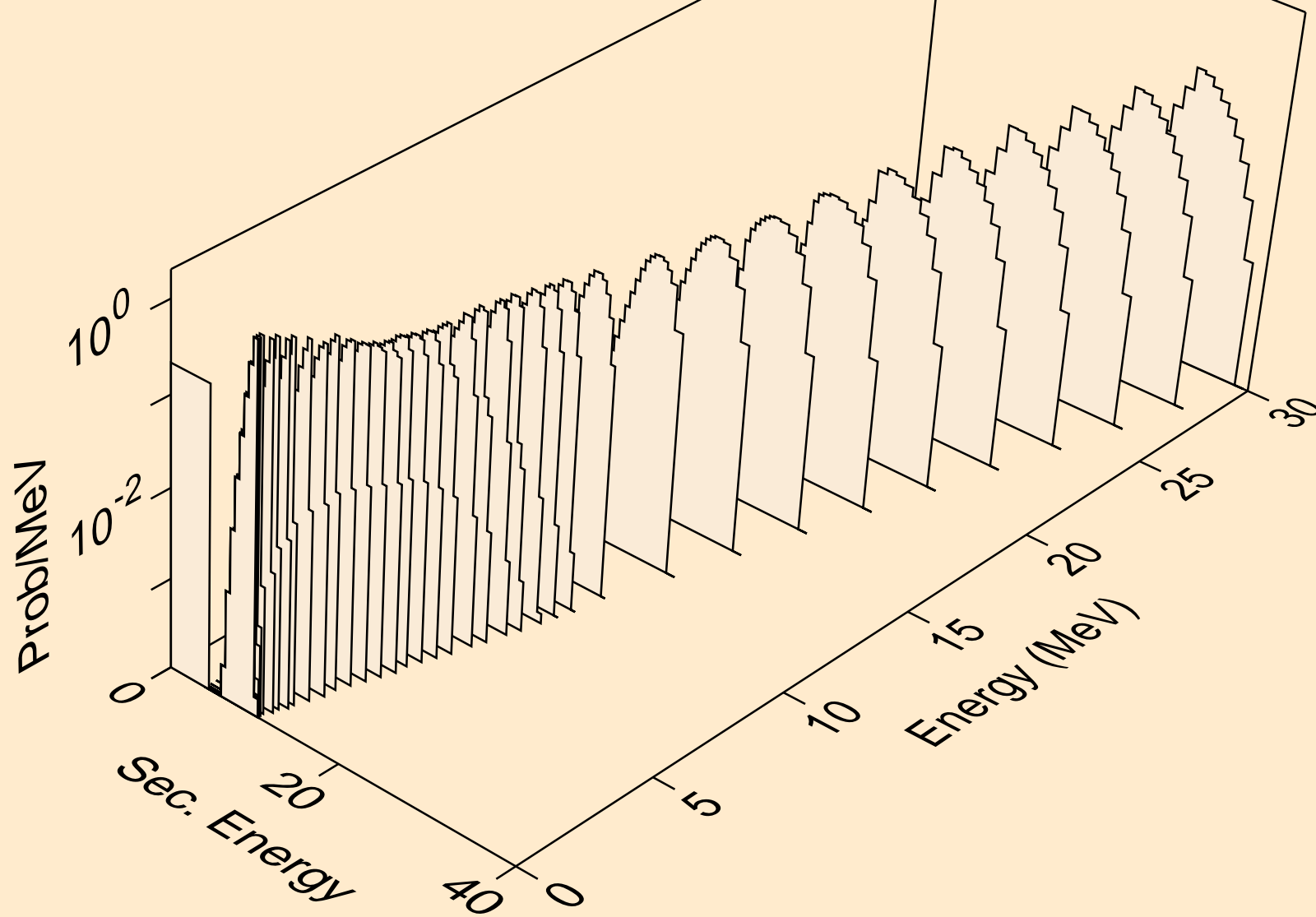

HO158 NEUTRON ACER TENDL-2023 LIBRARY; T=0.K
alphas from (n,2a)

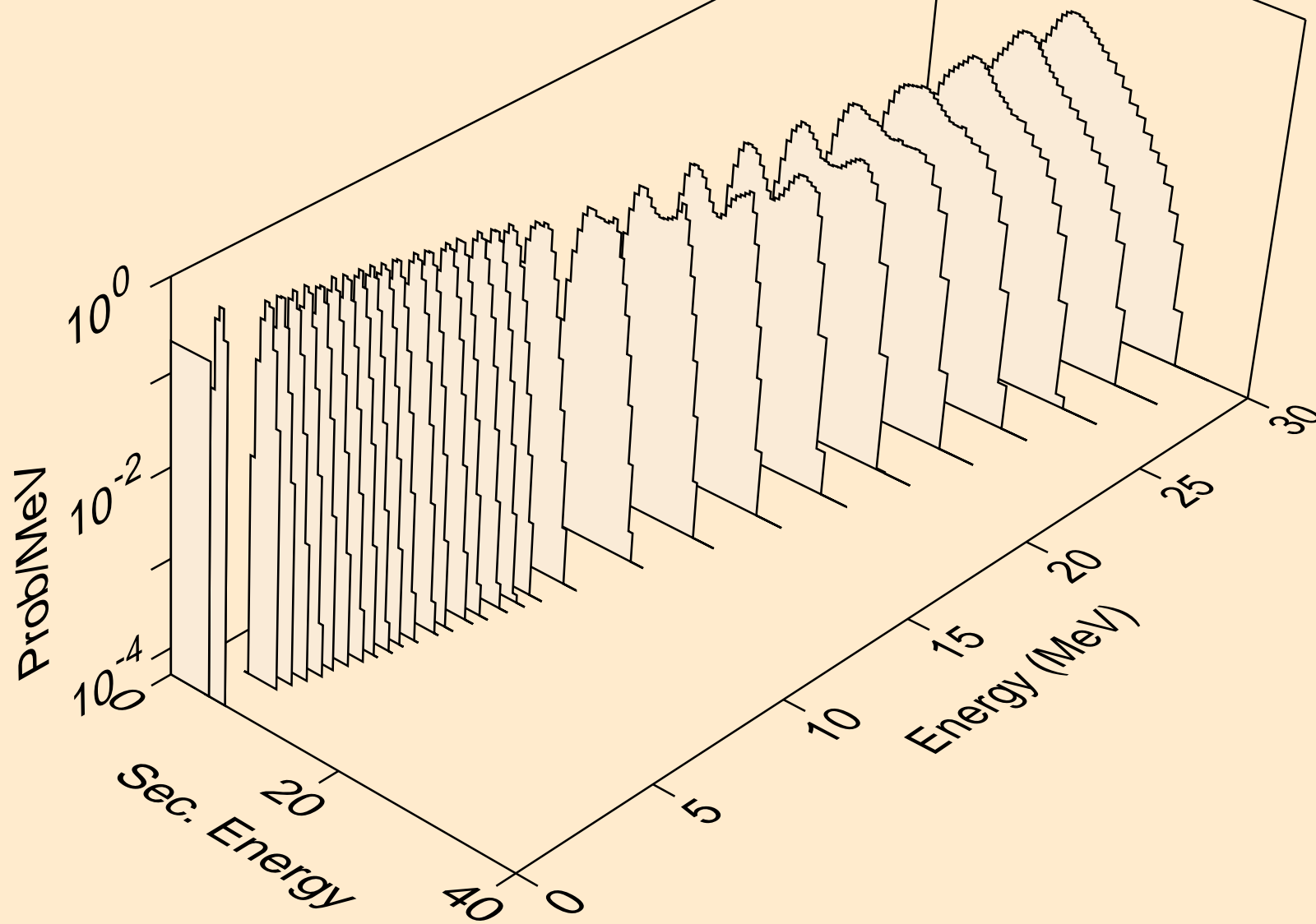

HO158 NEUTRON ACER TENDL-2023 LIBRARY; T=0.K
alphas from (n,pa)

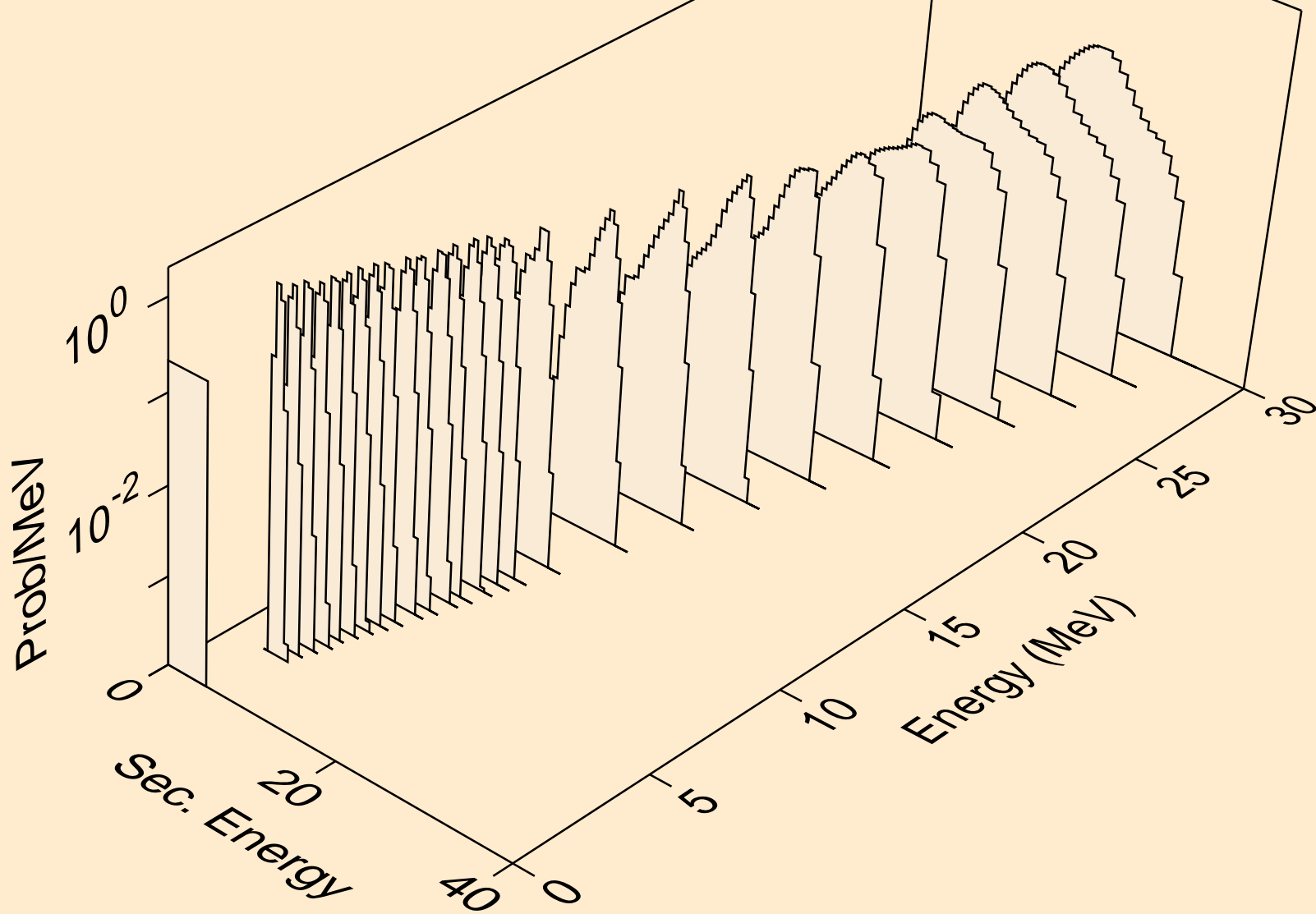

HO158 NEUTRON ACER TENDL-2023 LIBRARY; T=0.K
alphas from (n,da)

