

# K043 NEUTRON ACER TENDL-2023 LIBRARY; T=0.K

## Principal cross sections

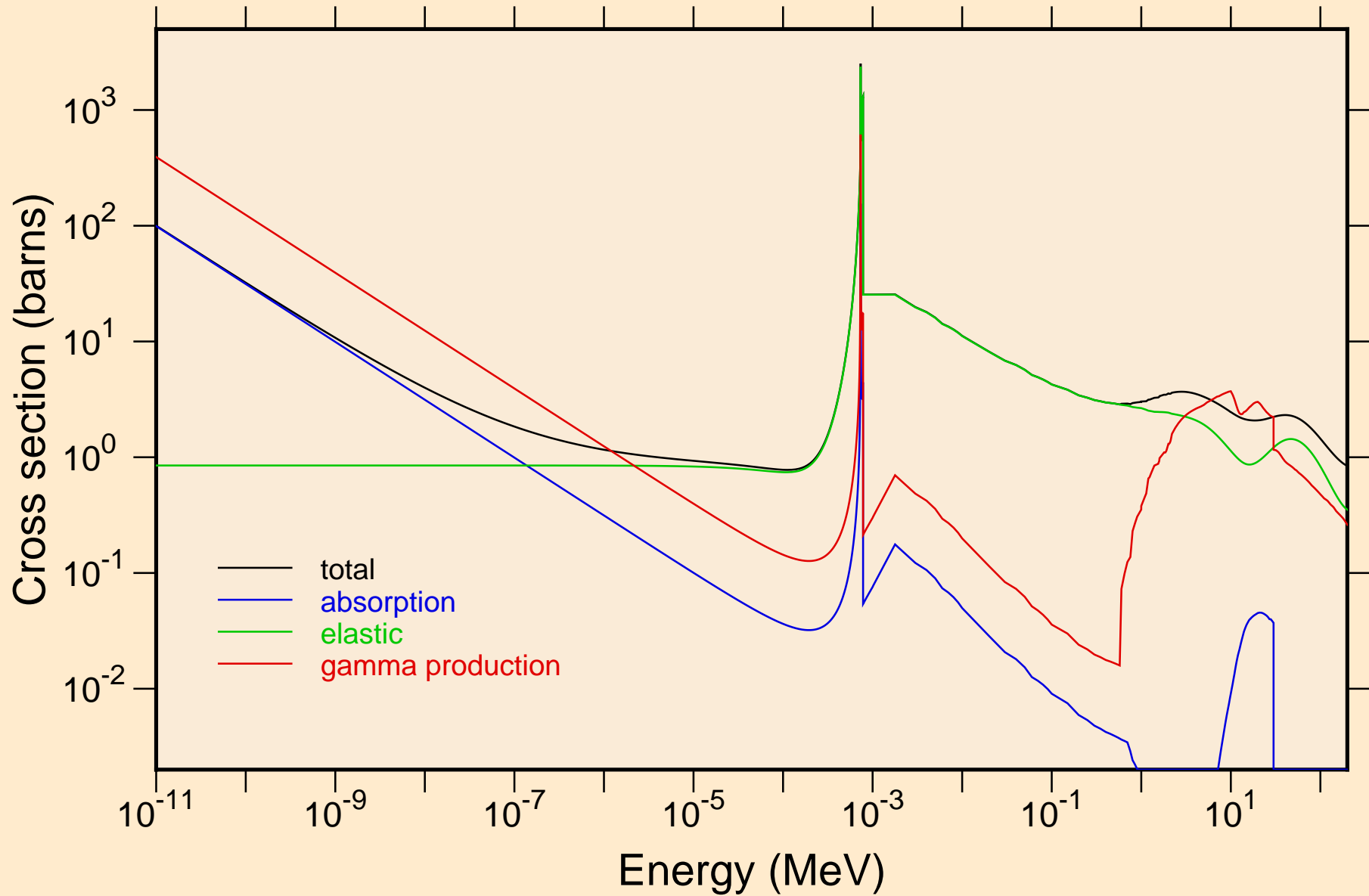

# K043 NEUTRON ACER TENDL-2023 LIBRARY; T=0.K

## Heating

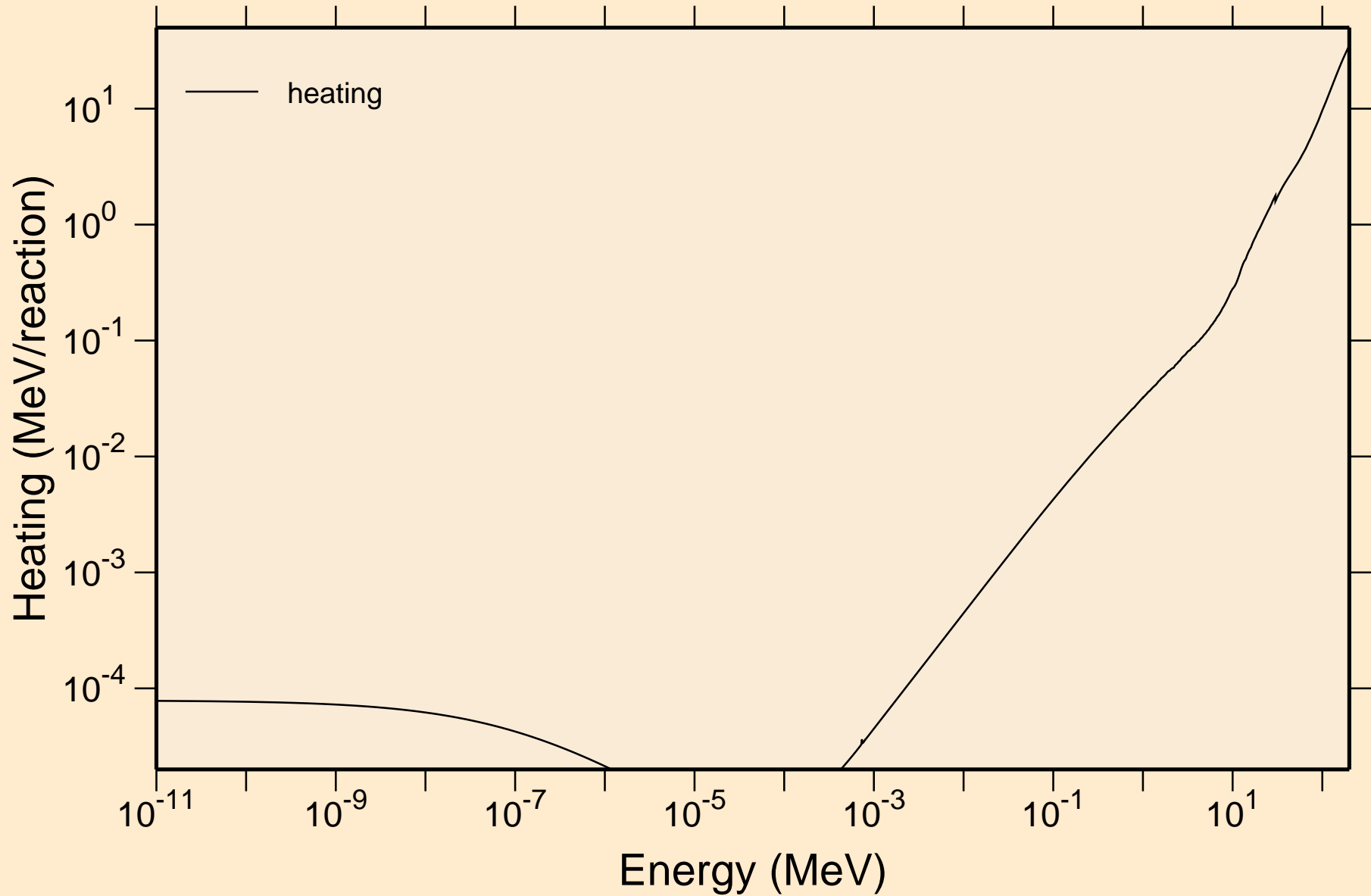

K043 NEUTRON ACER TENDL-2023 LIBRARY; T=0.K  
Damage

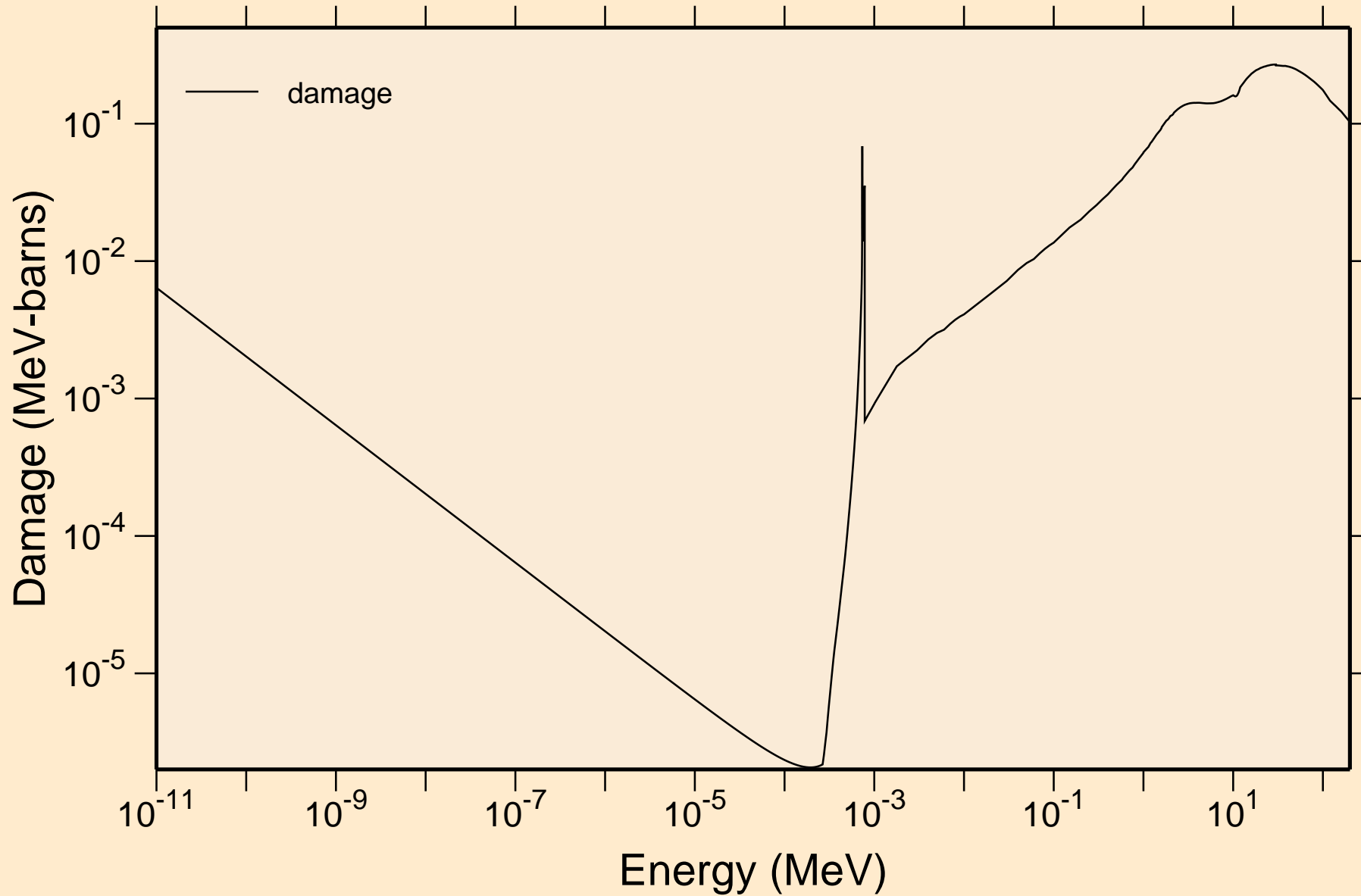

K043 NEUTRON ACER TENDL-2023 LIBRARY; T=0.K  
Non-threshold reactions

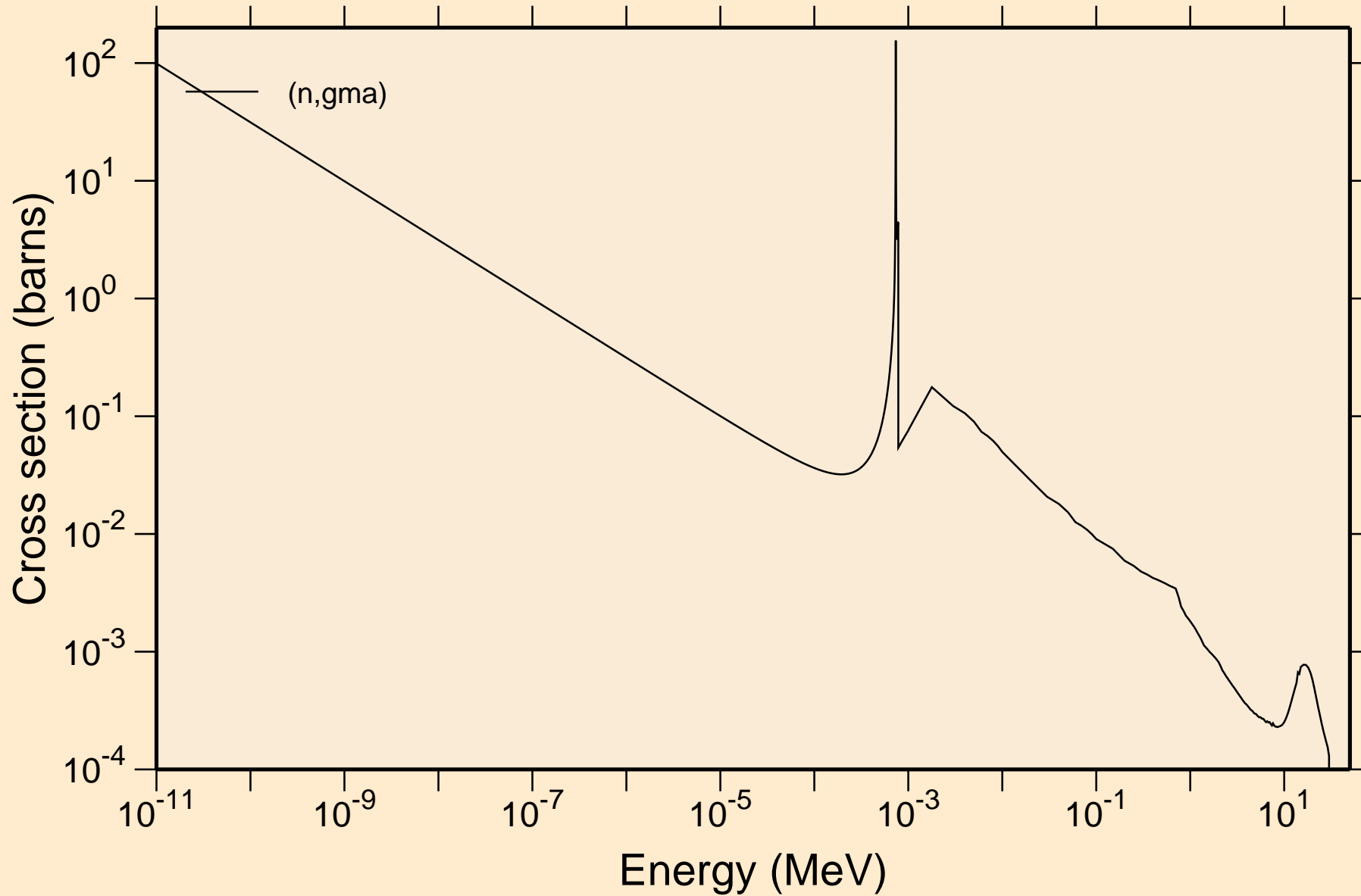

# K043 NEUTRON ACER TENDL-2023 LIBRARY; T=0.K

## Principal cross sections

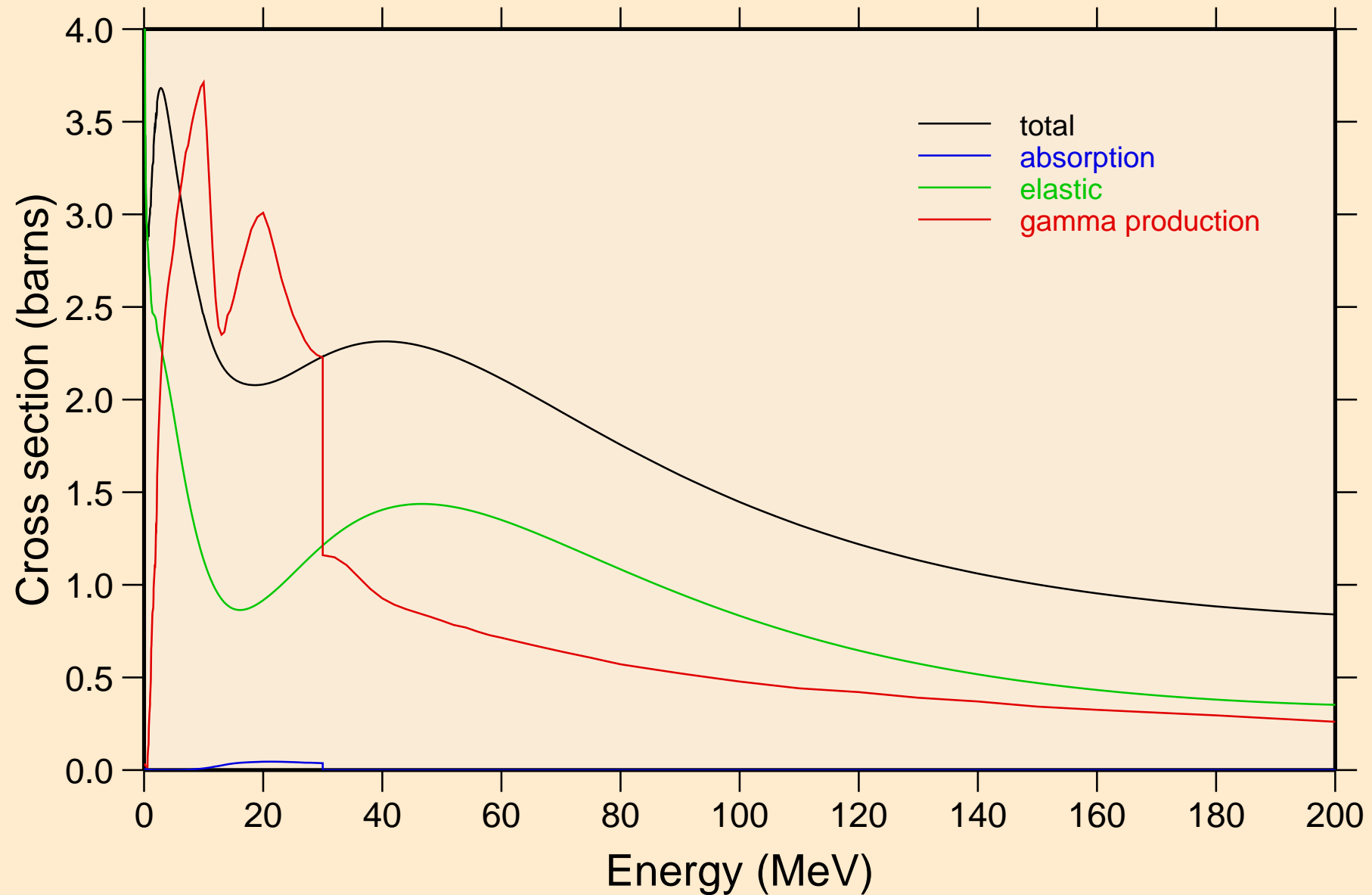

# K043 NEUTRON ACER TENDL-2023 LIBRARY; T=0.K

## Heating

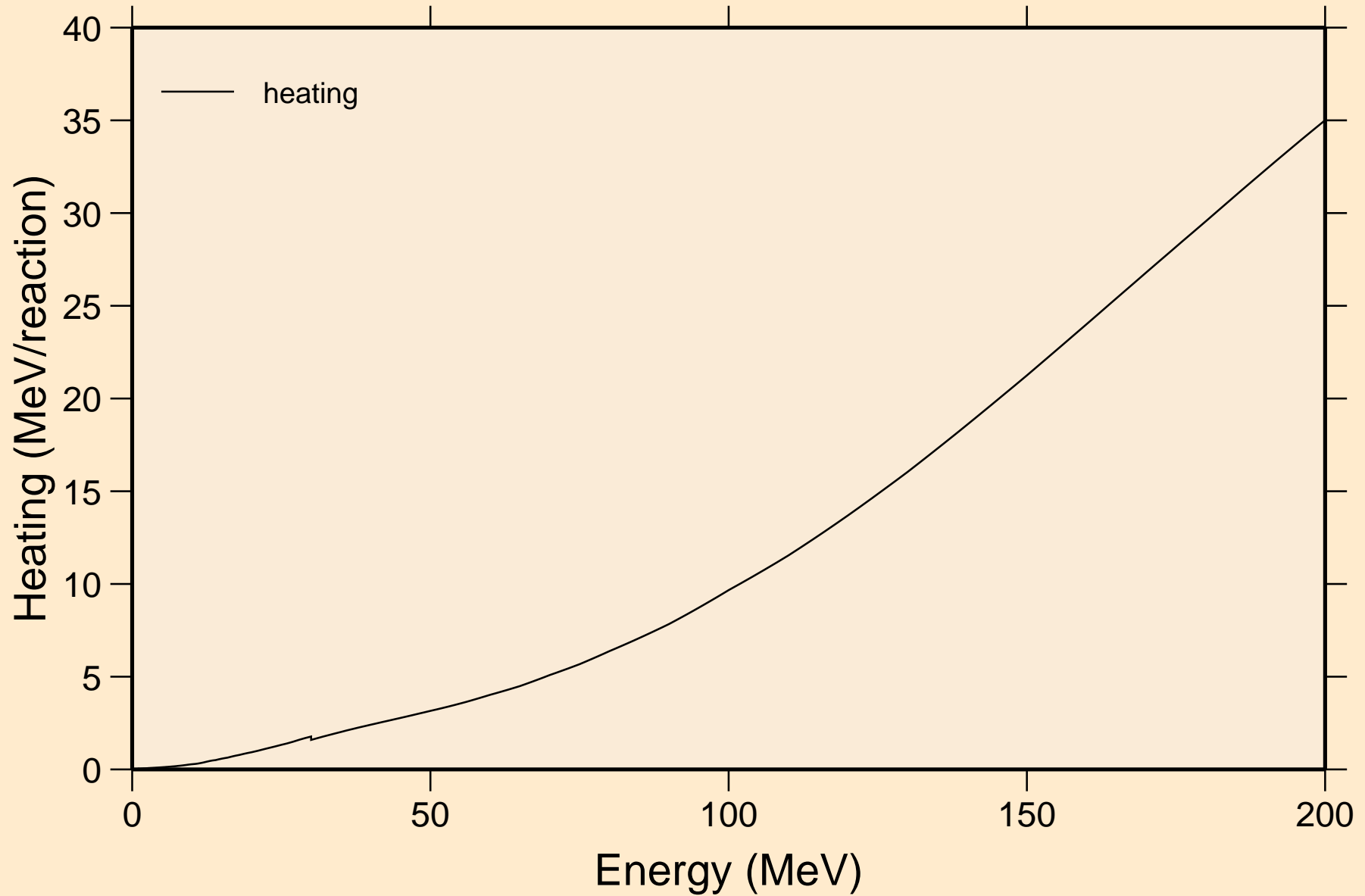

# K043 NEUTRON ACER TENDL-2023 LIBRARY; T=0.K

## Damage

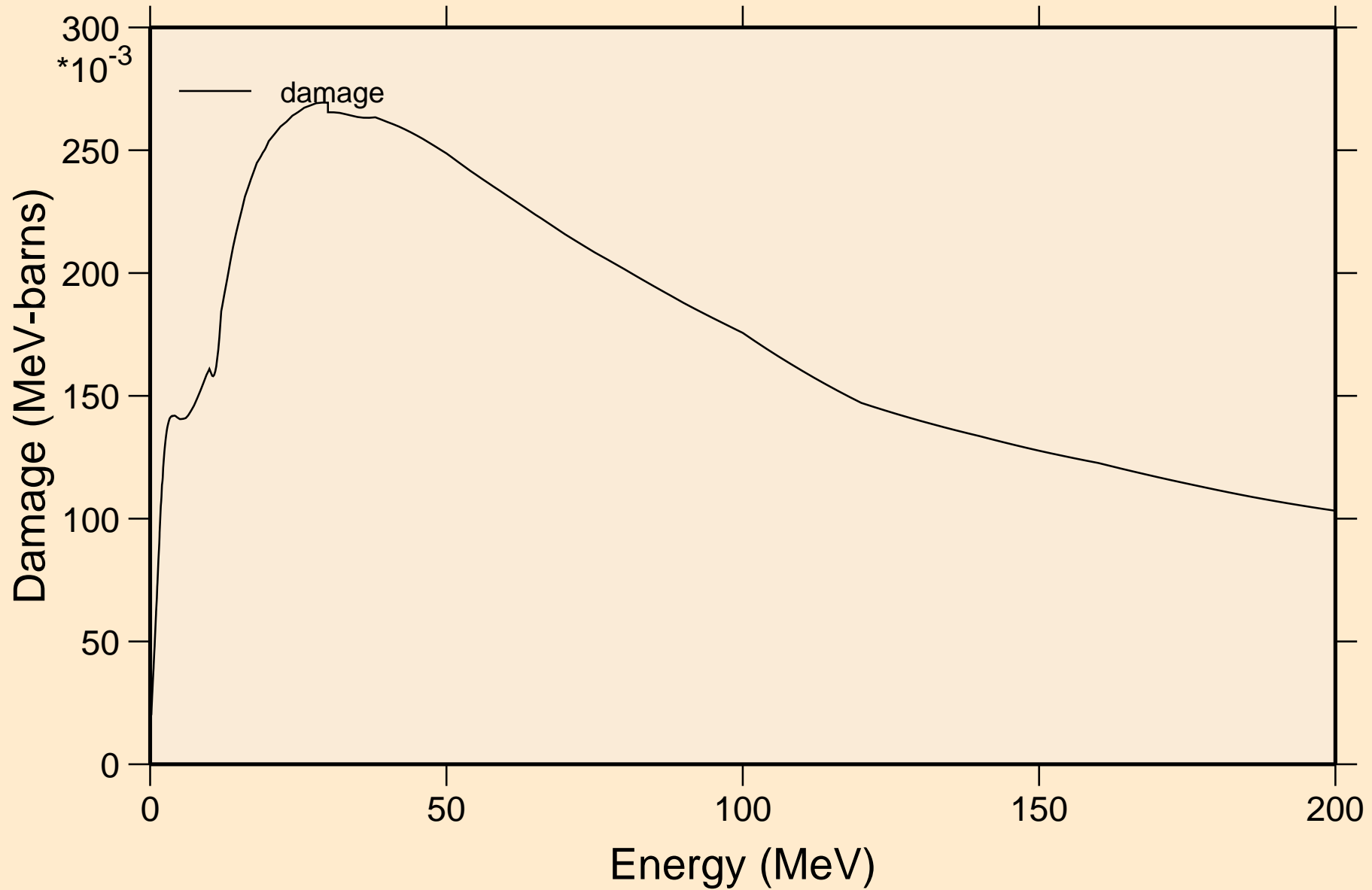

K043 NEUTRON ACER TENDL-2023 LIBRARY; T=0.K  
Non-threshold reactions

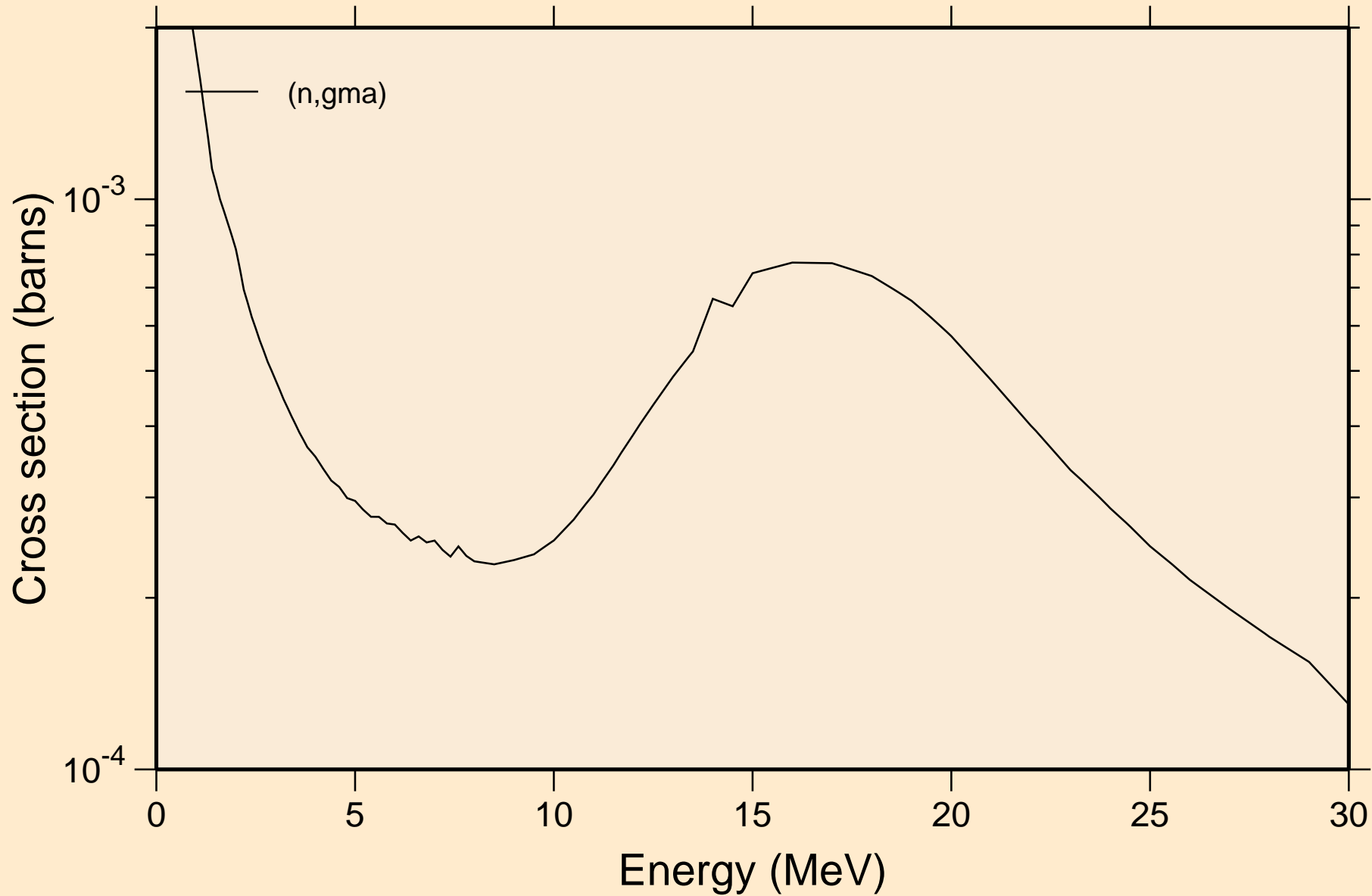



K043 NEUTRON ACER TENDL-2023 LIBRARY; T=0.K  
Inelastic levels

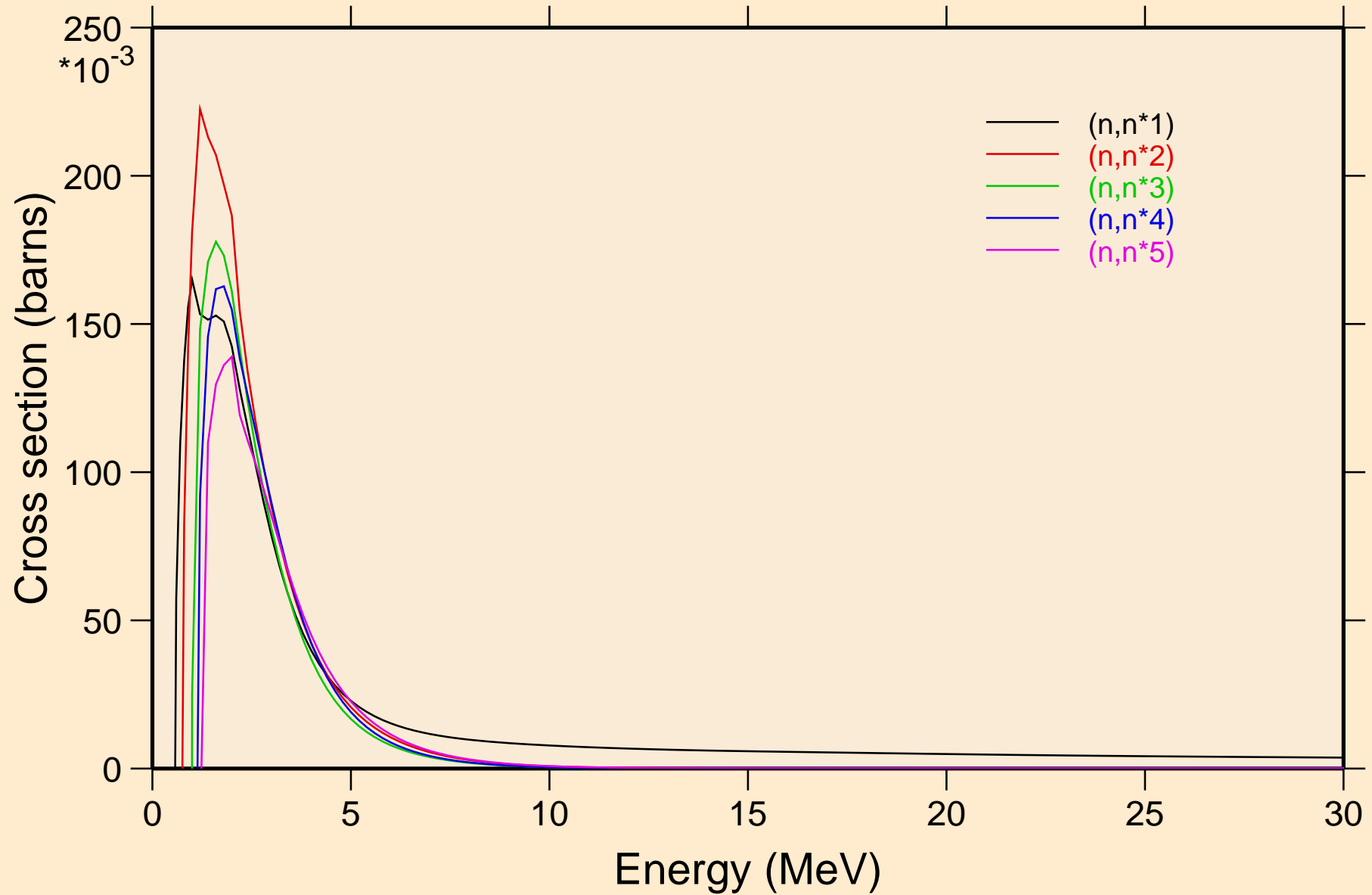

K043 NEUTRON ACER TENDL-2023 LIBRARY; T=0.K  
Inelastic levels

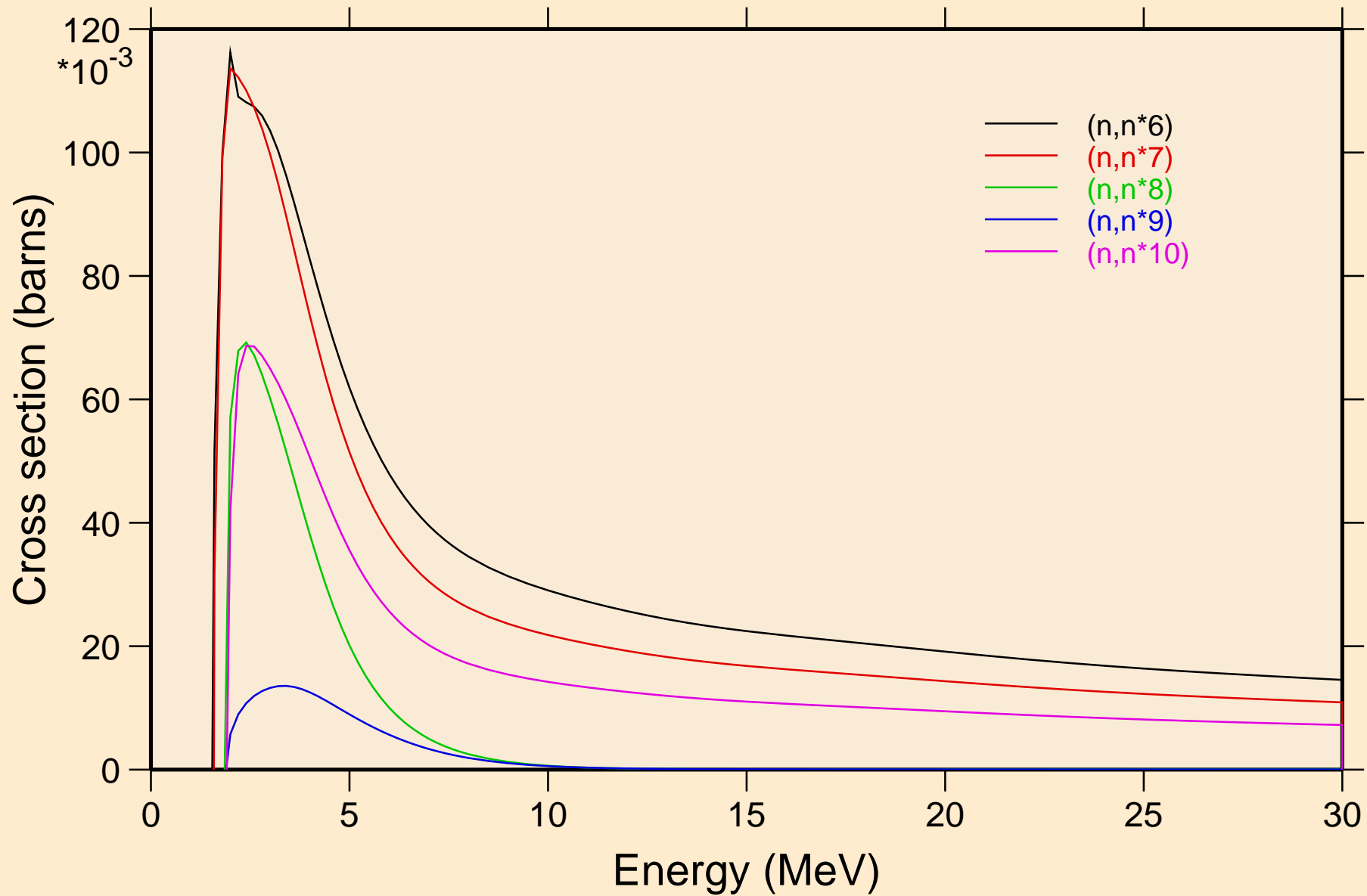

K043 NEUTRON ACER TENDL-2023 LIBRARY; T=0.K  
Inelastic levels

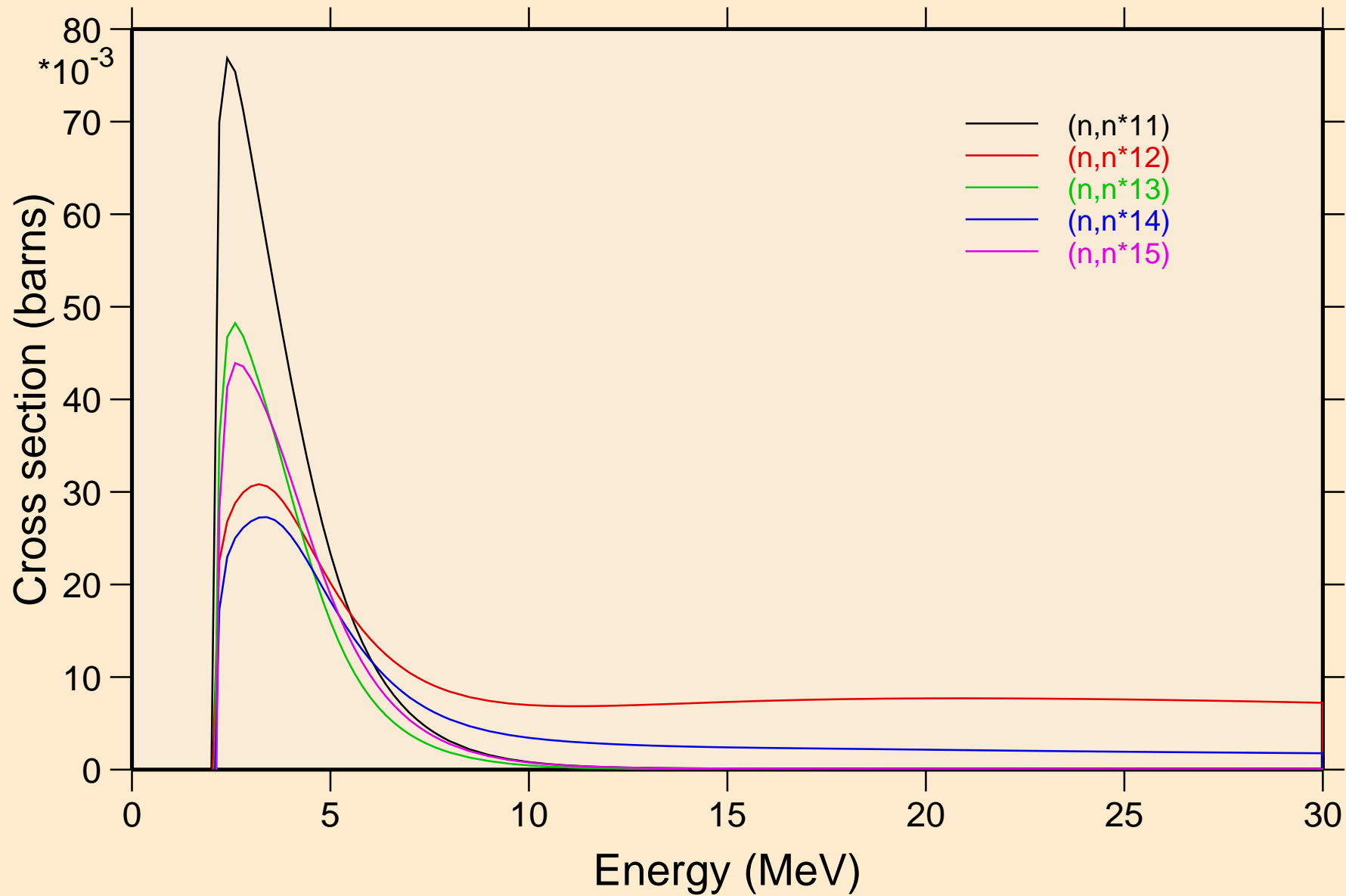

# K043 NEUTRON ACER TENDL-2023 LIBRARY; T=0.K

## Threshold reactions

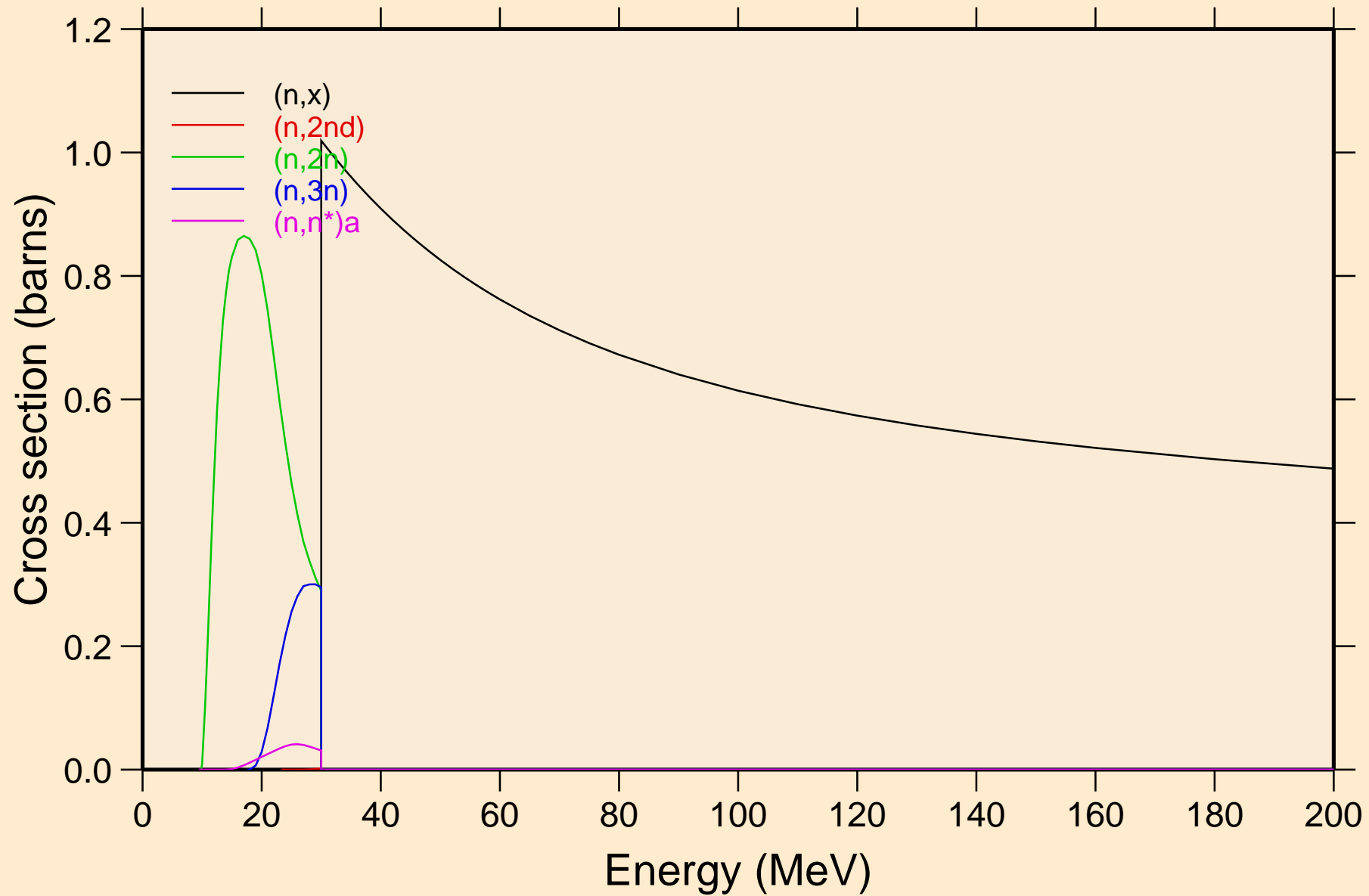

# K043 NEUTRON ACER TENDL-2023 LIBRARY; T=0.K

## Threshold reactions

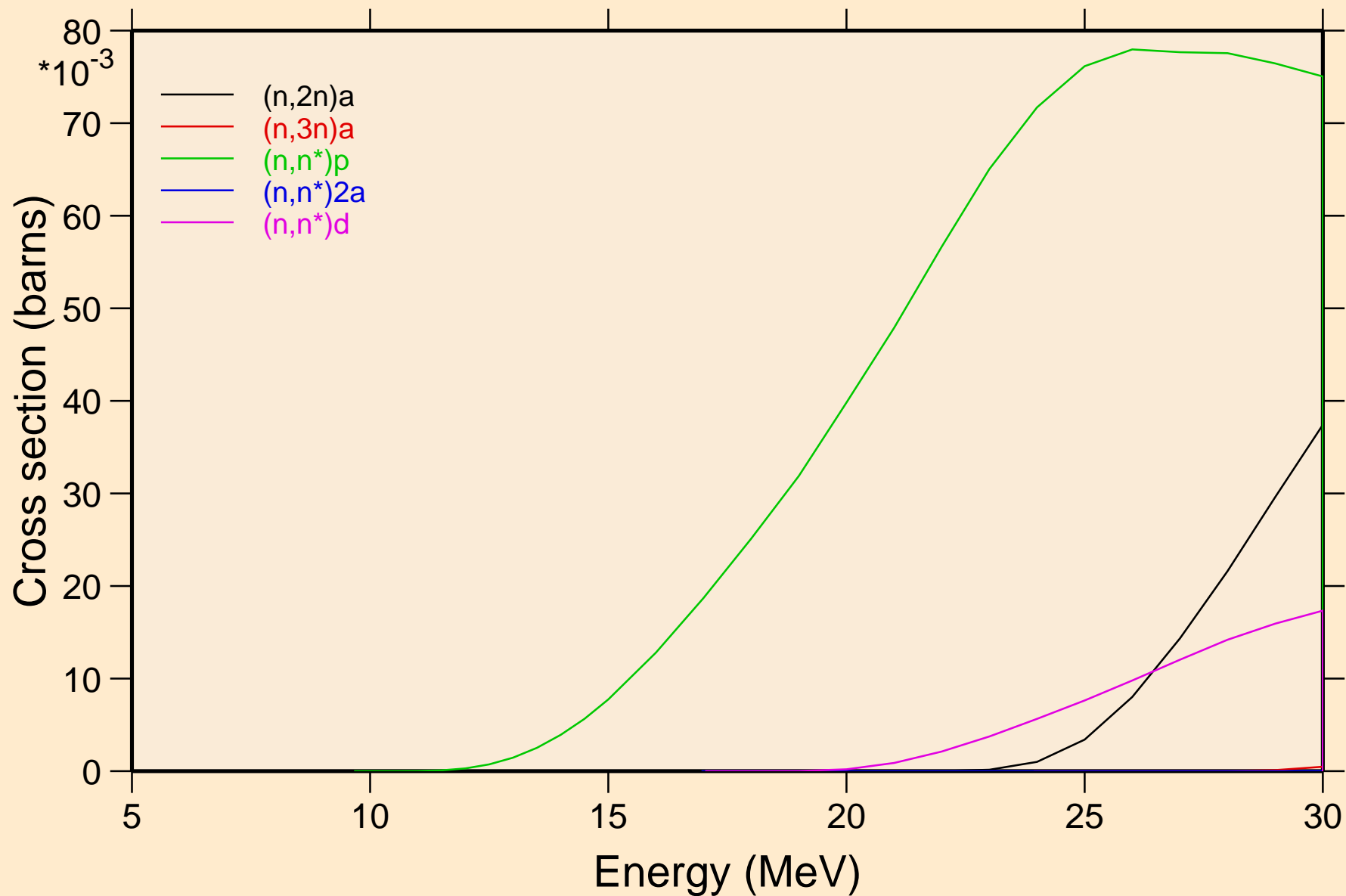

# K043 NEUTRON ACER TENDL-2023 LIBRARY; T=0.K

## Threshold reactions

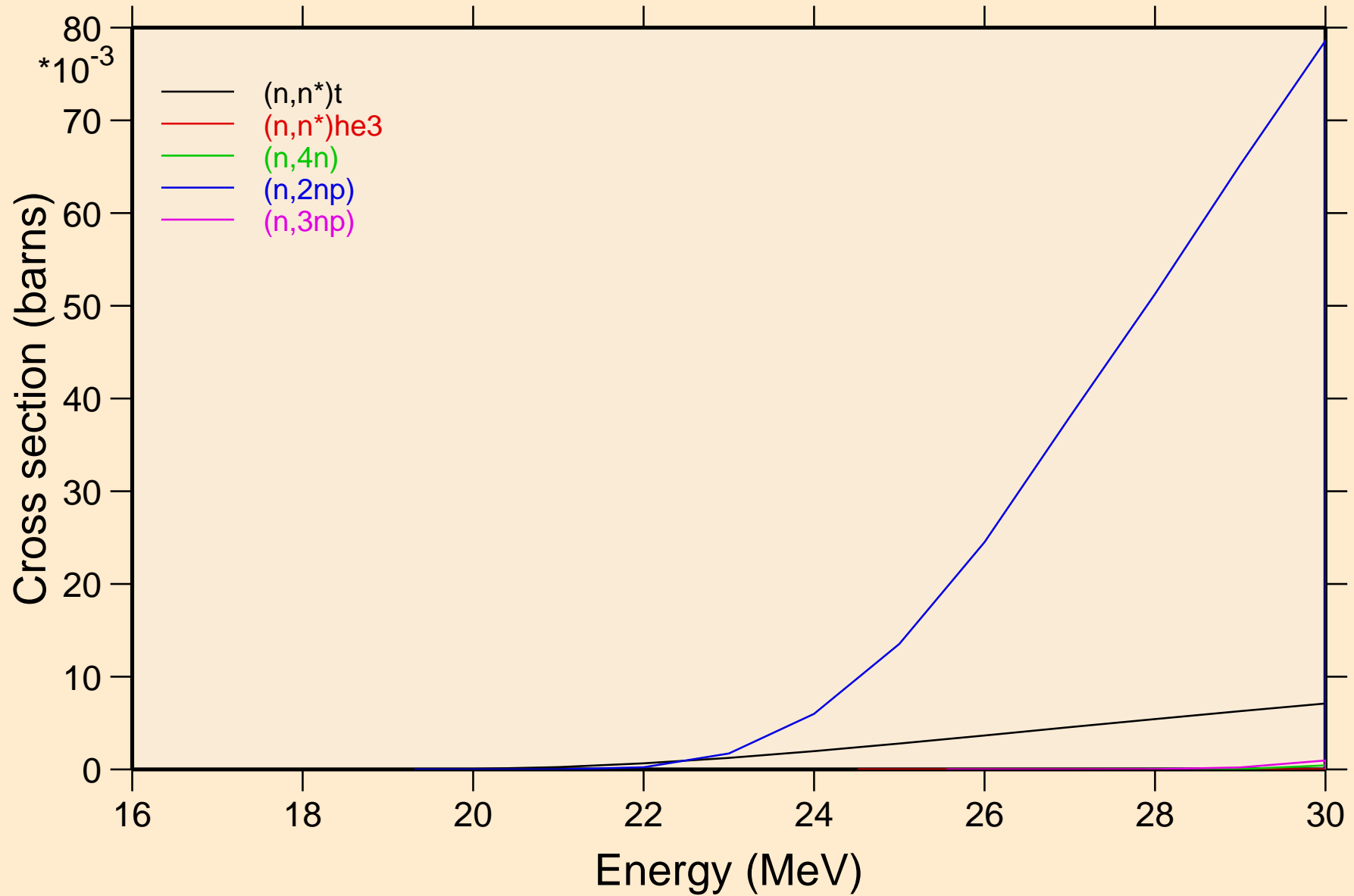

K043 NEUTRON ACER TENDL-2023 LIBRARY; T=0.K  
Threshold reactions

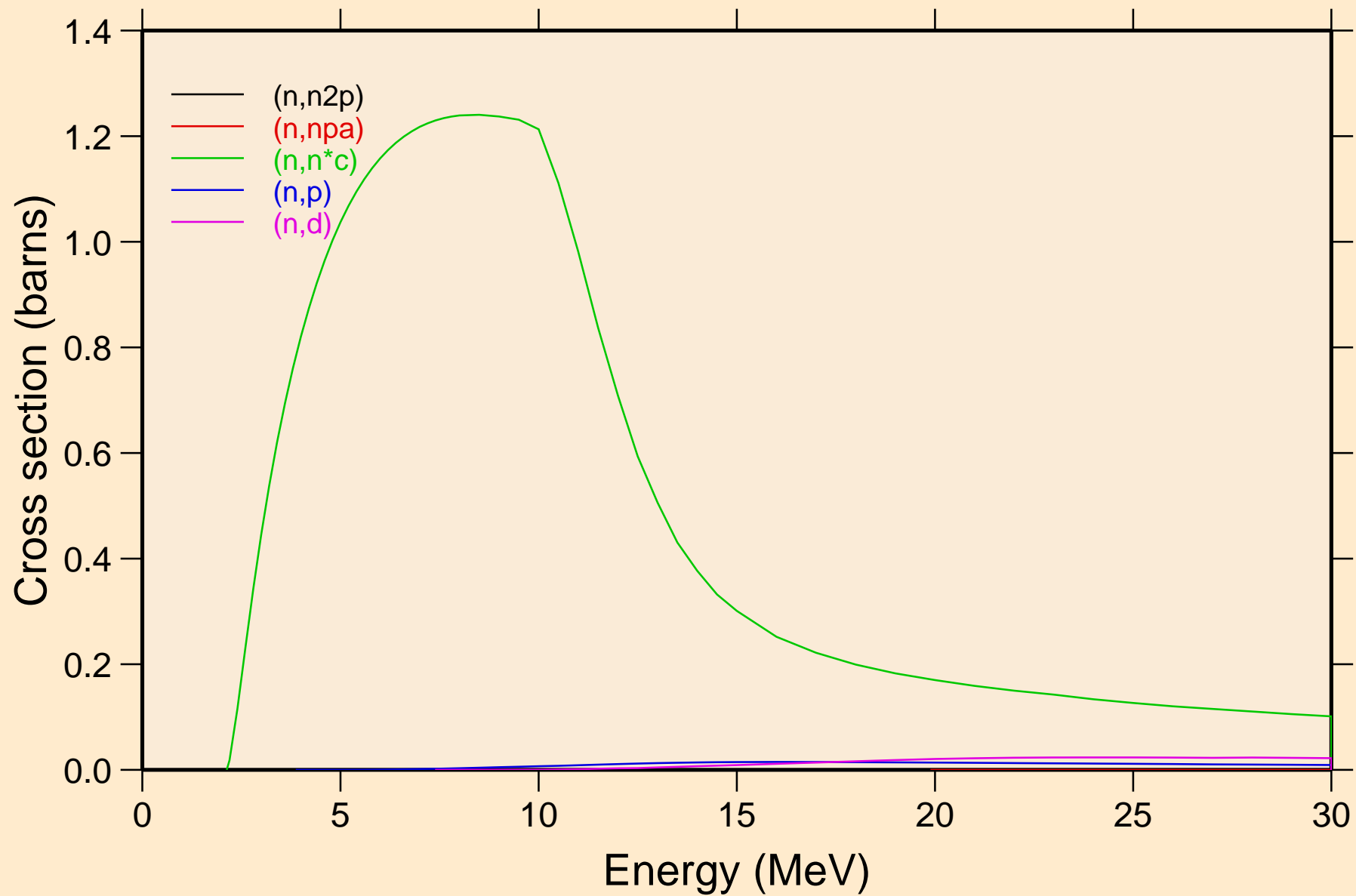

K043 NEUTRON ACER TENDL-2023 LIBRARY; T=0.K  
Threshold reactions

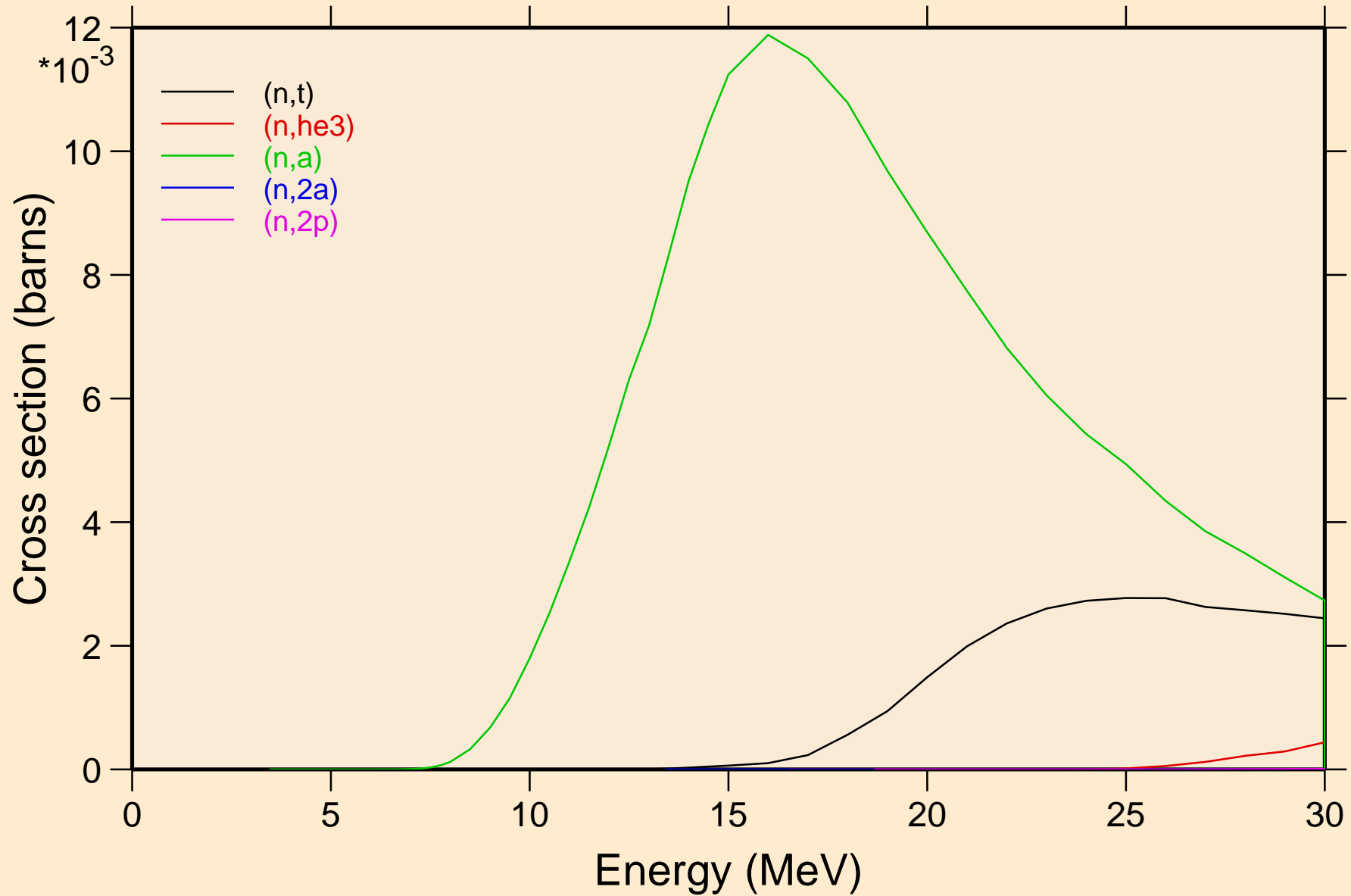



# K043 NEUTRON ACER TENDL-2023 LIBRARY; T=0.K

## Threshold reactions

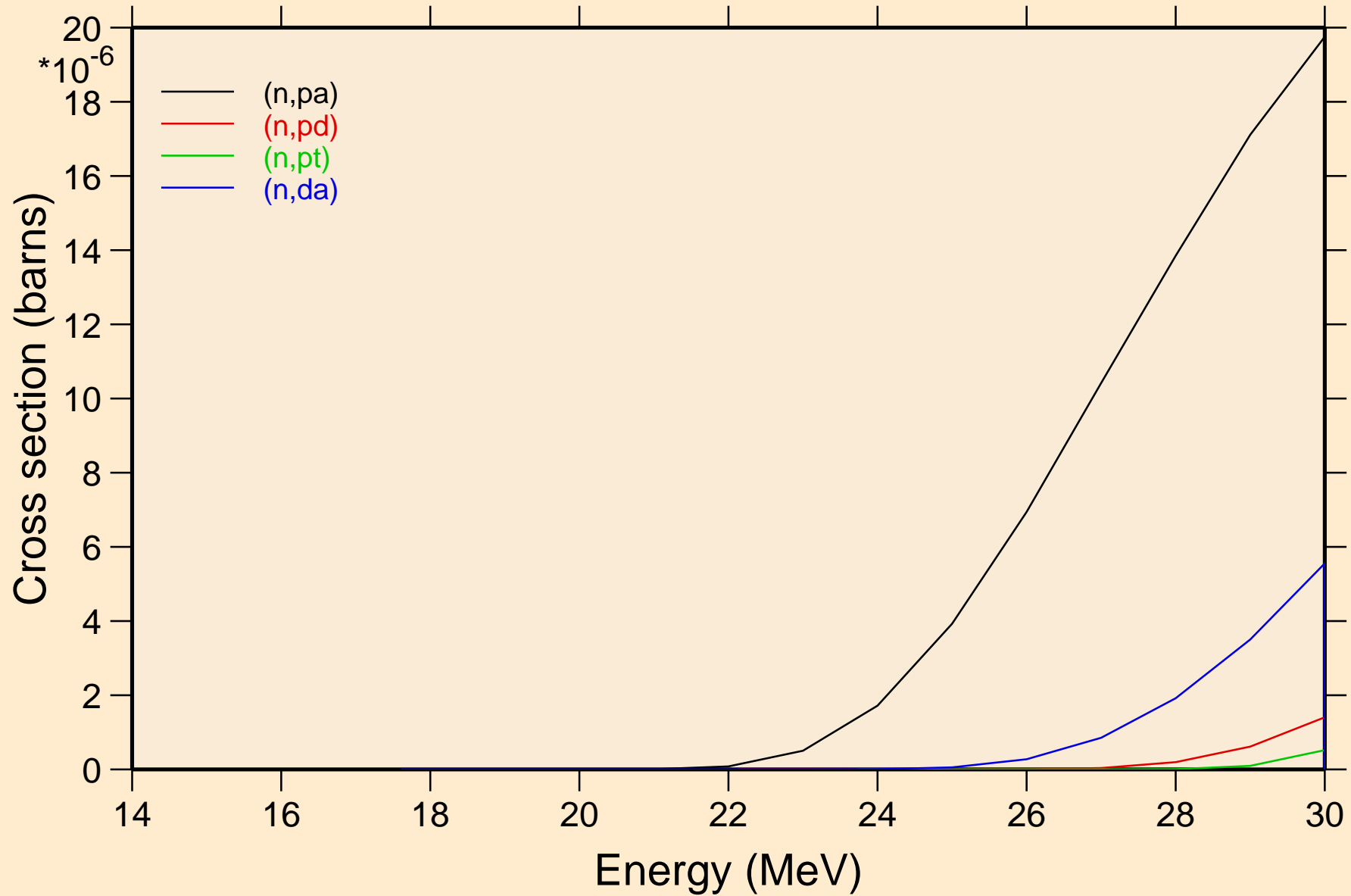

# K043 NEUTRON ACER TENDL-2023 LIBRARY; T=0.K

## Threshold reactions

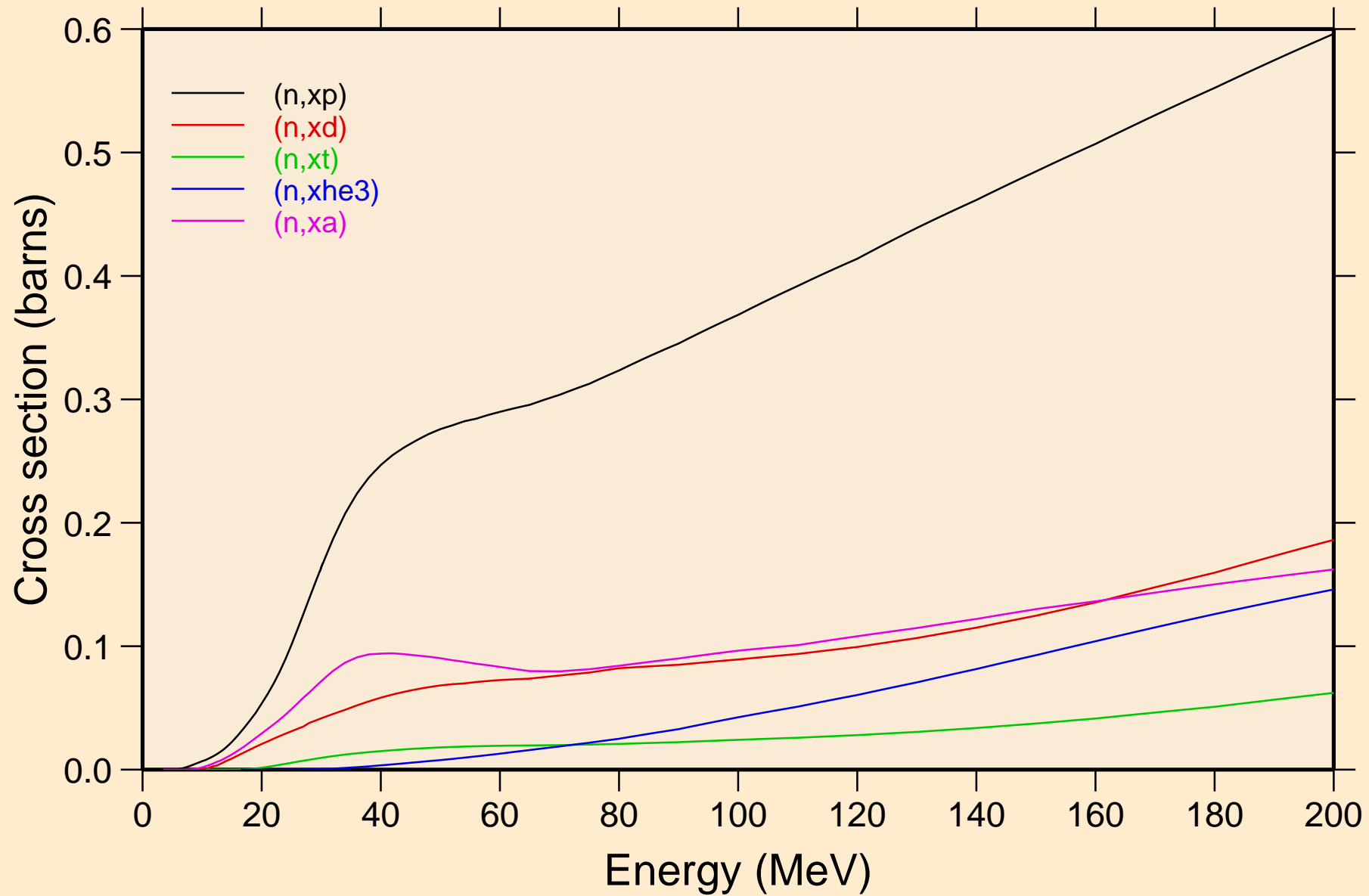

K043 NEUTRON ACER TENDL-2023 LIBRARY; T=0.K  
angular distribution for elastic

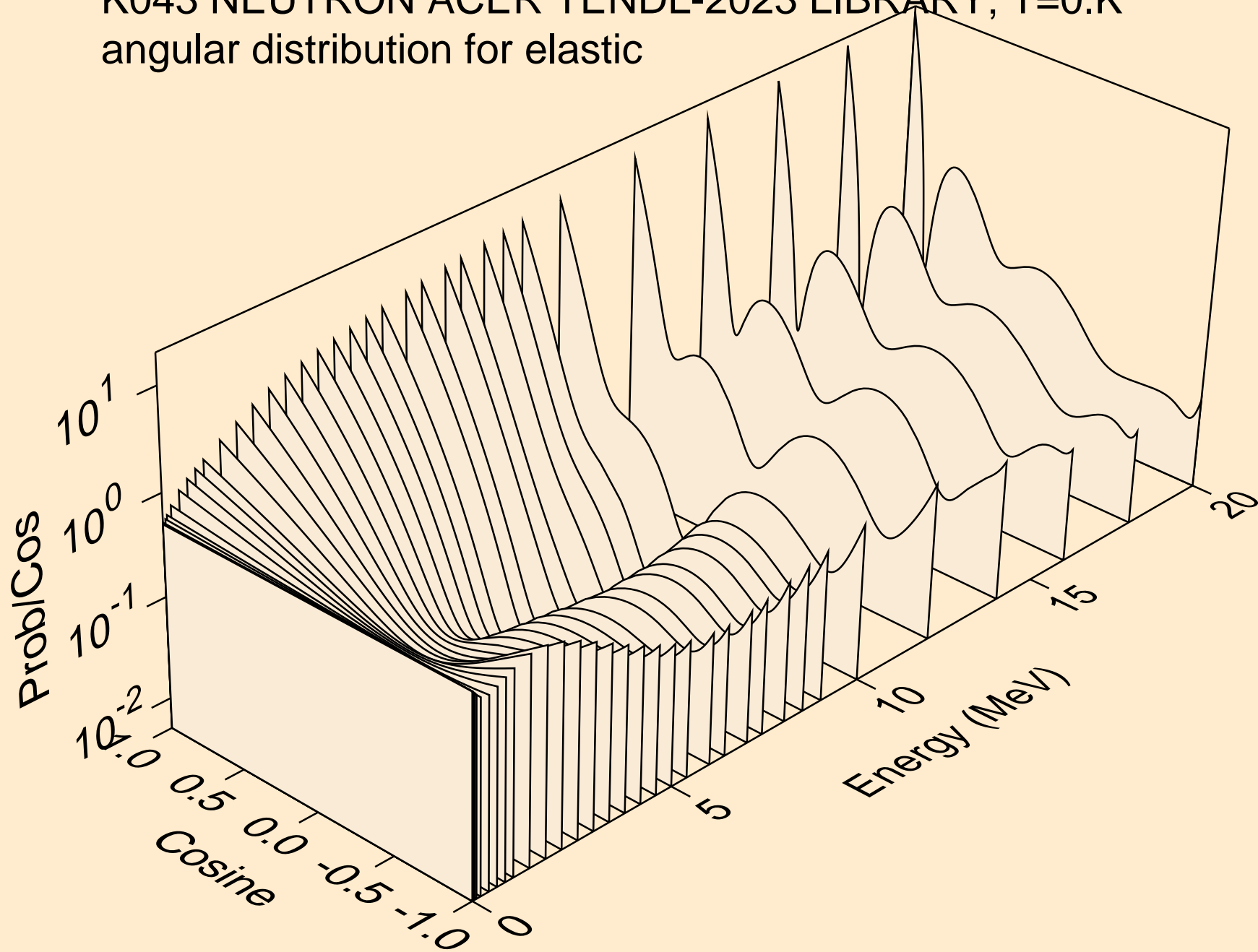

K043 NEUTRON ACER TENDL-2023 LIBRARY; T=0.K  
angular distribution for elastic

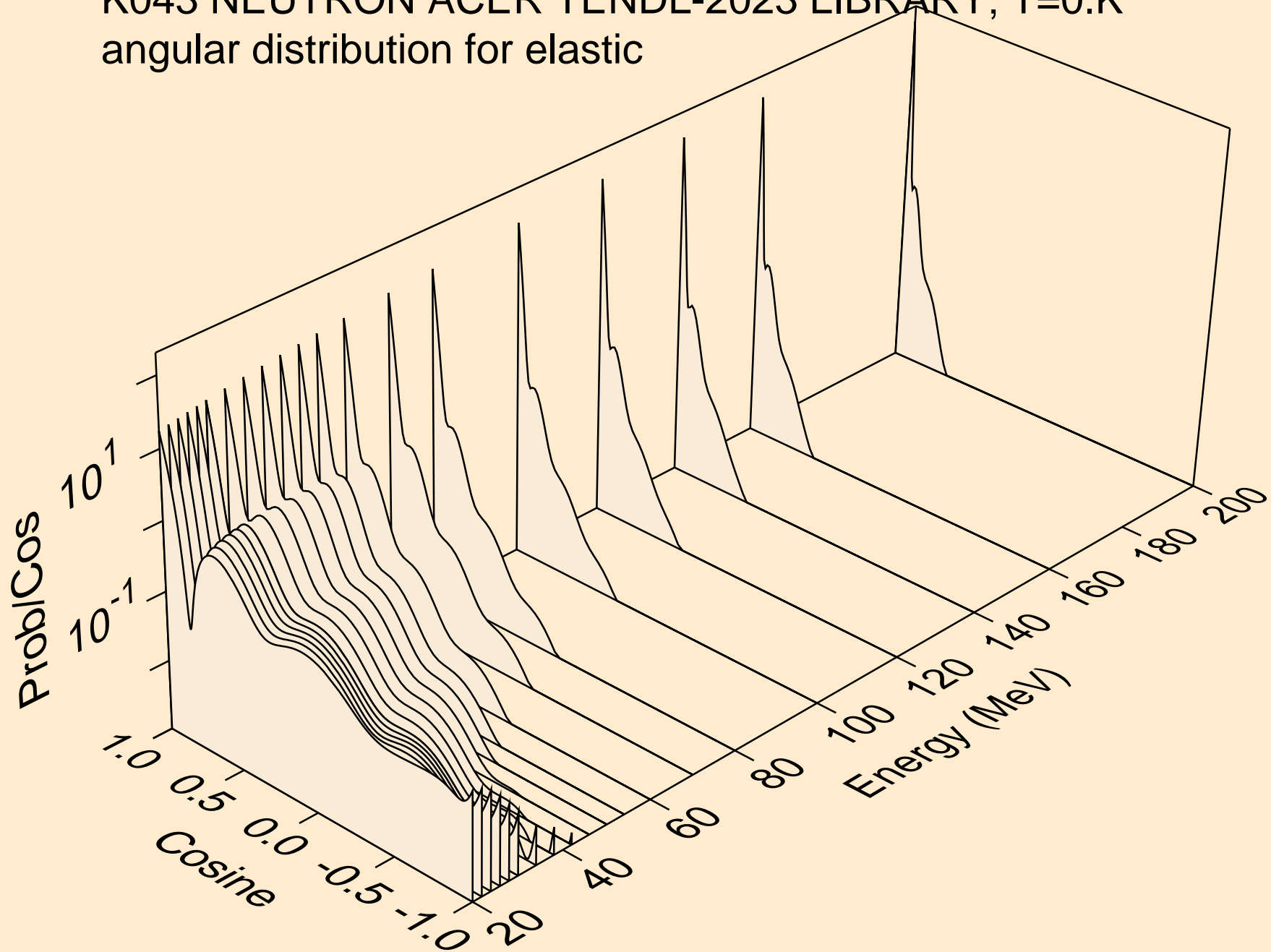

K043 NEUTRON ACER TENDL-2023 LIBRARY; T=0.K  
angular distribution for (n,n\*1)

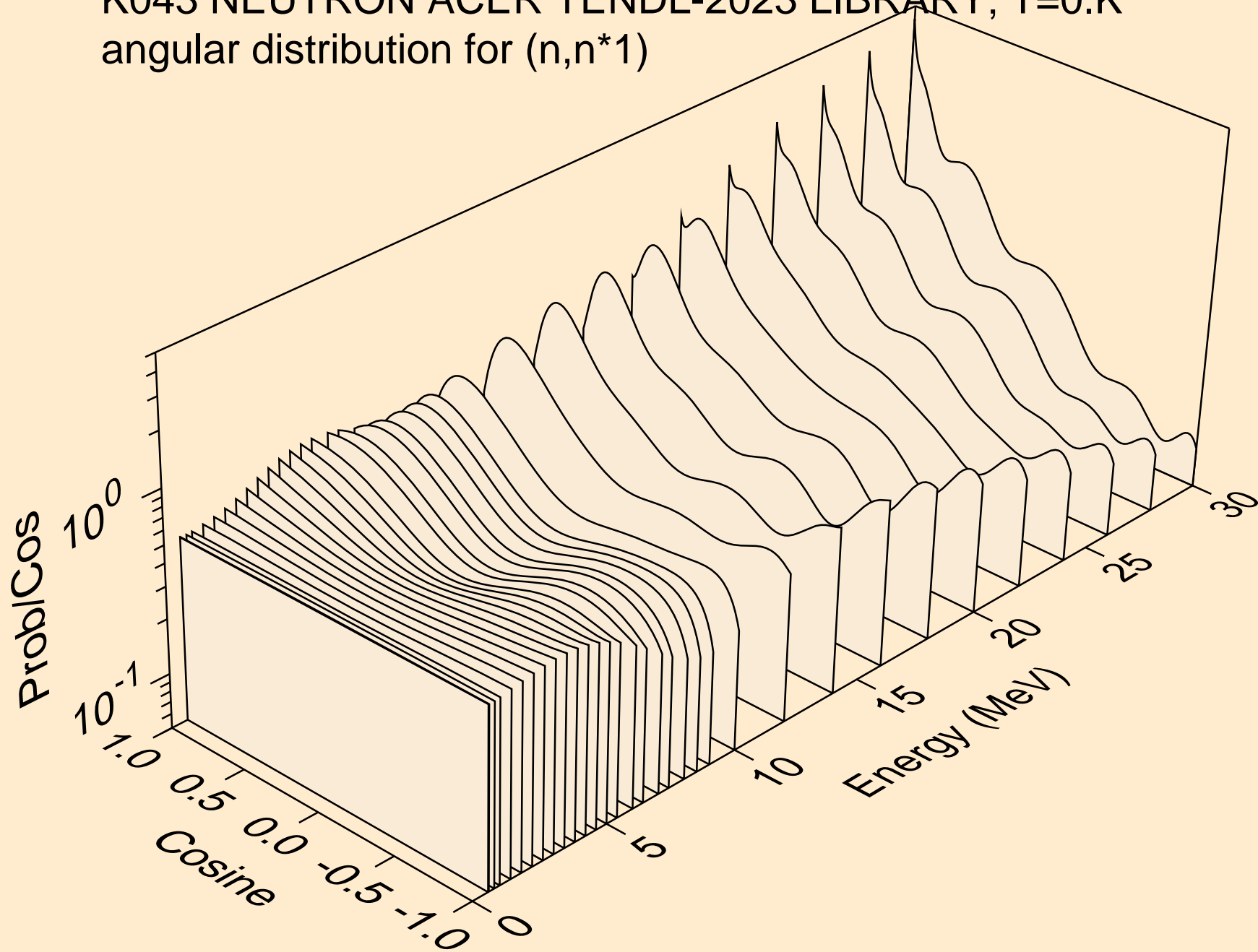

K043 NEUTRON ACER TENDL-2023 LIBRARY; T=0.K  
angular distribution for (n,n\*2)

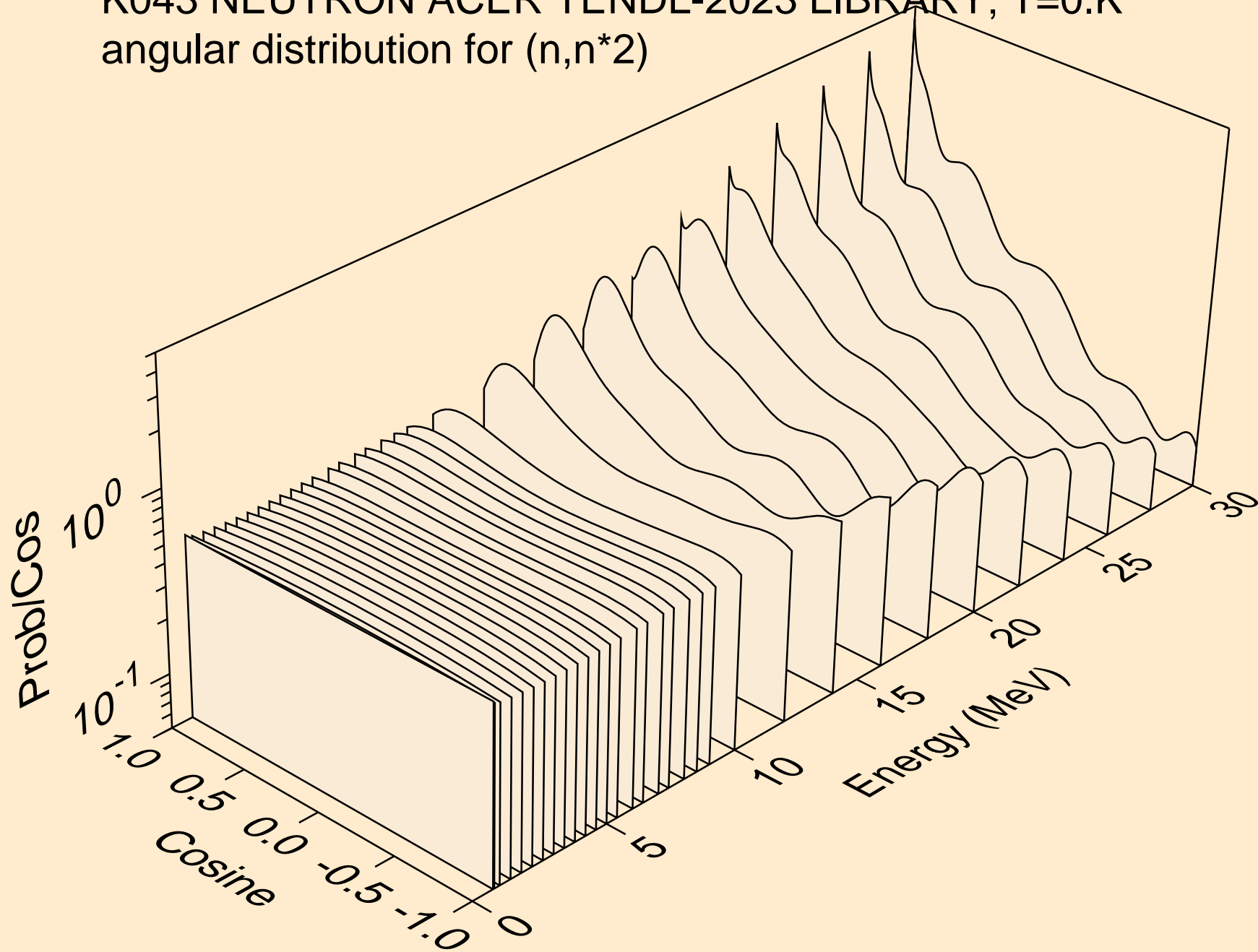

K043 NEUTRON ACER TENDL-2023 LIBRARY; T=0.K  
angular distribution for (n,n\*3)

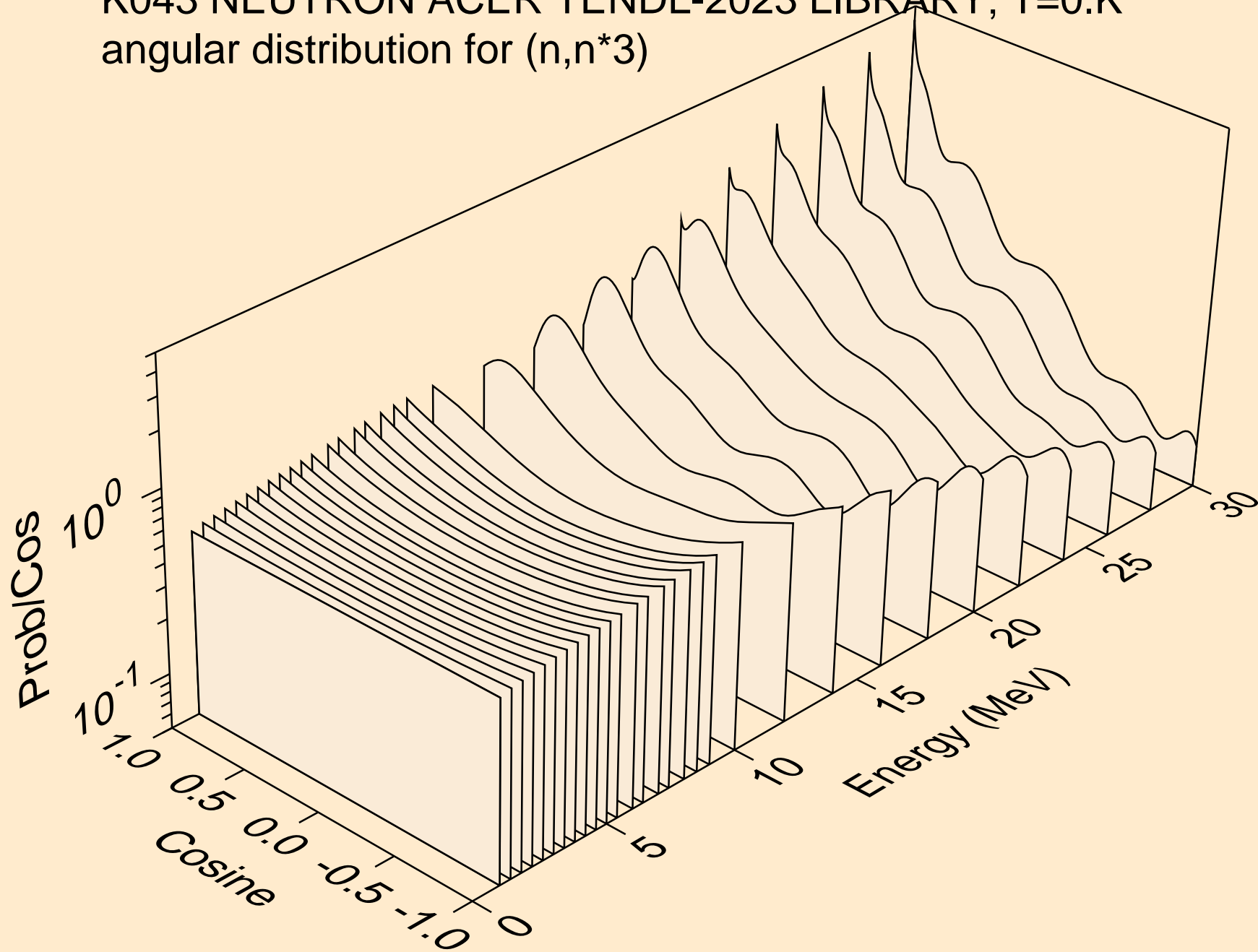

K043 NEUTRON ACER TENDL-2023 LIBRARY; T=0.K  
angular distribution for (n,n\*4)

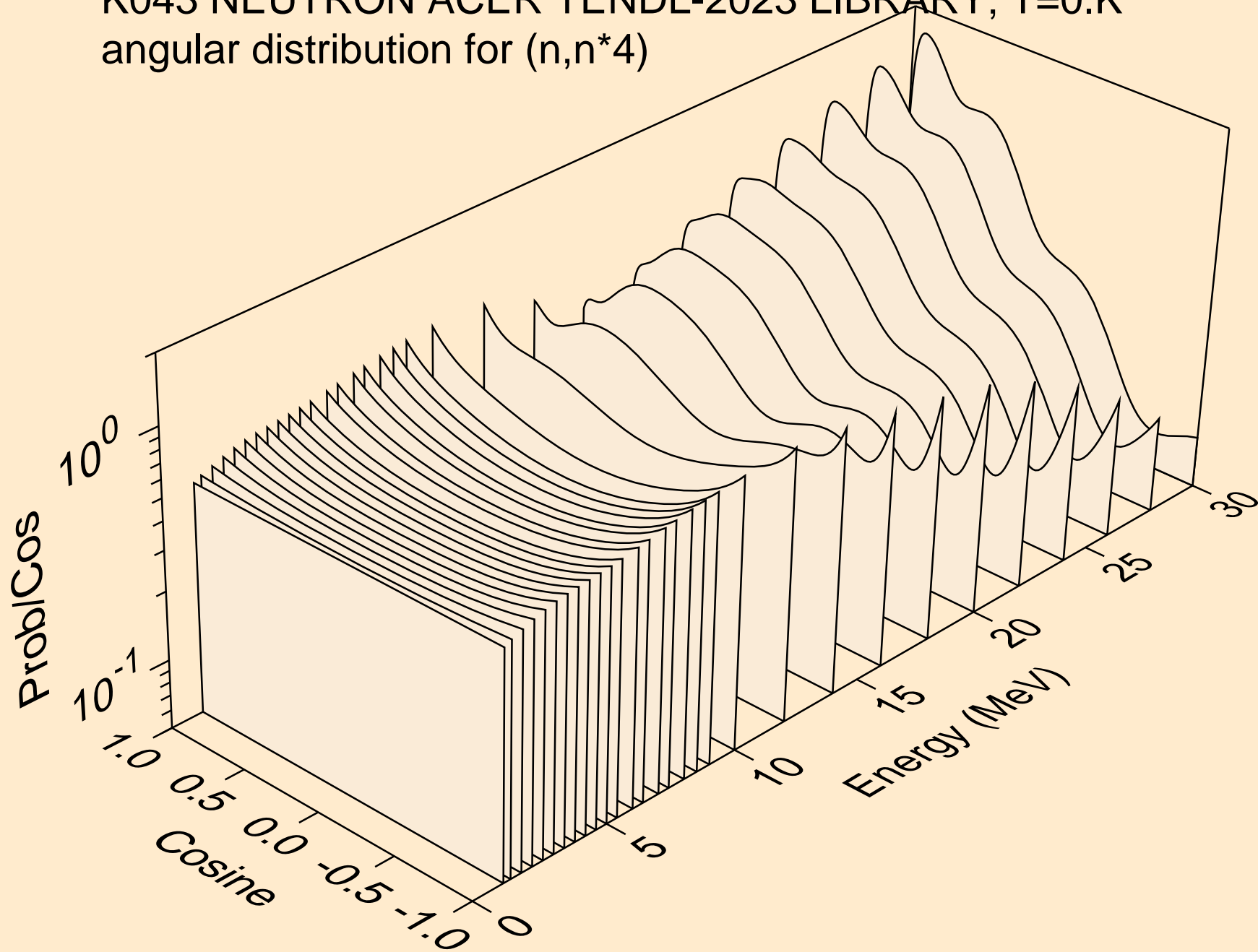



K043 NEUTRON ACER TENDL-2023 LIBRARY; T=0.K  
angular distribution for (n,n\*5)

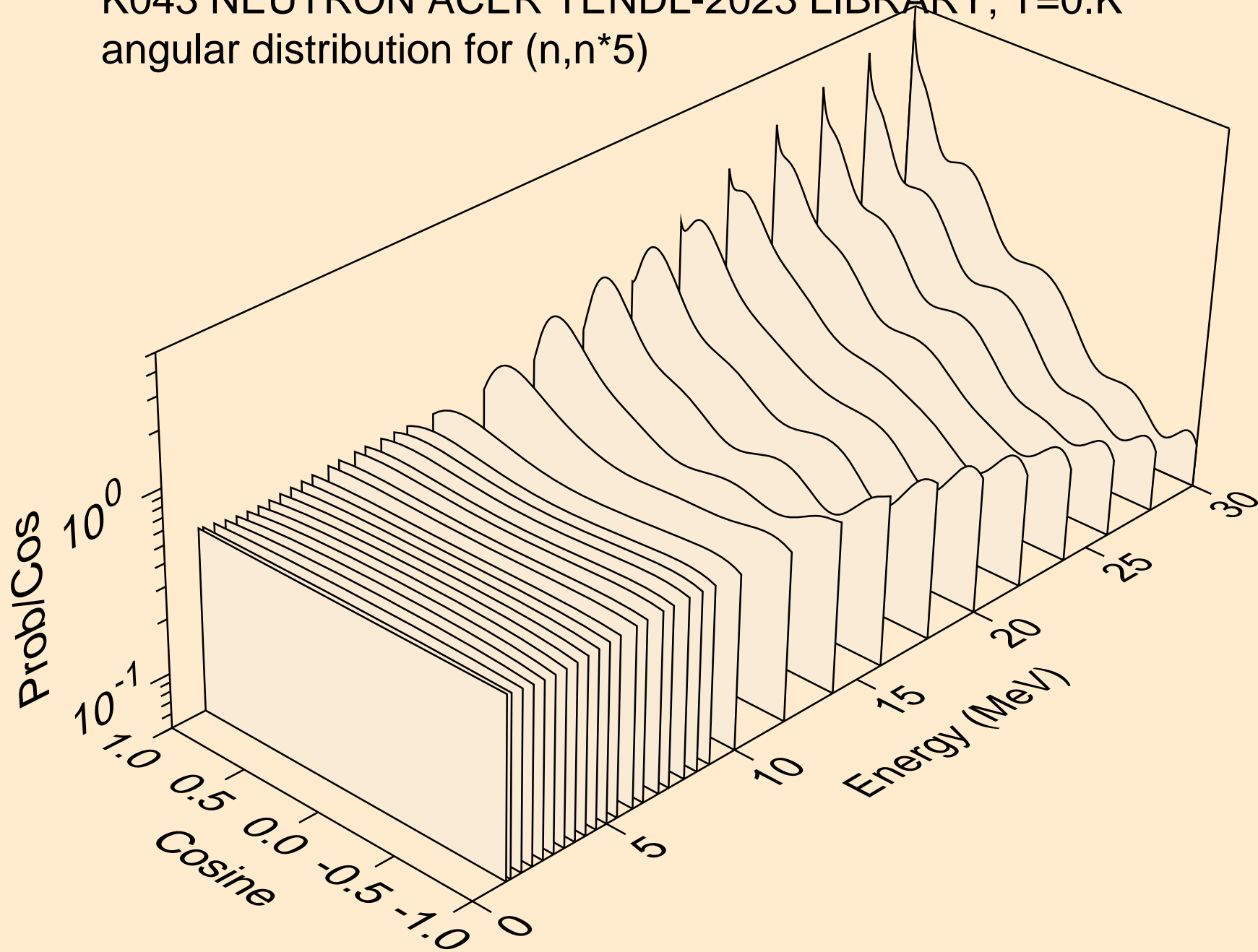

K043 NEUTRON ACER TENDL-2023 LIBRARY; T=0.K  
angular distribution for (n,n\*6)

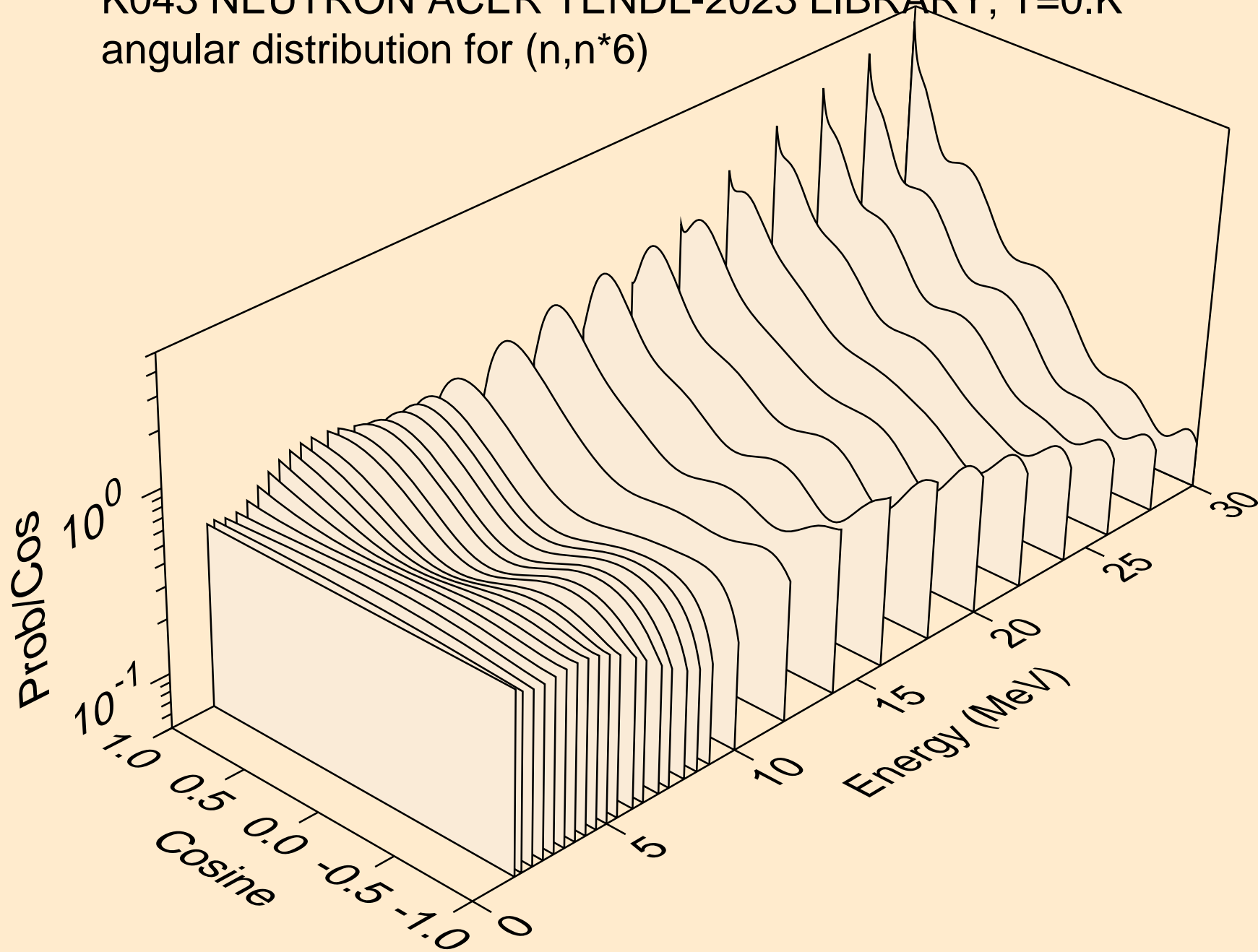

K043 NEUTRON ACER TENDL-2023 LIBRARY; T=0.K  
angular distribution for (n,n\*7)

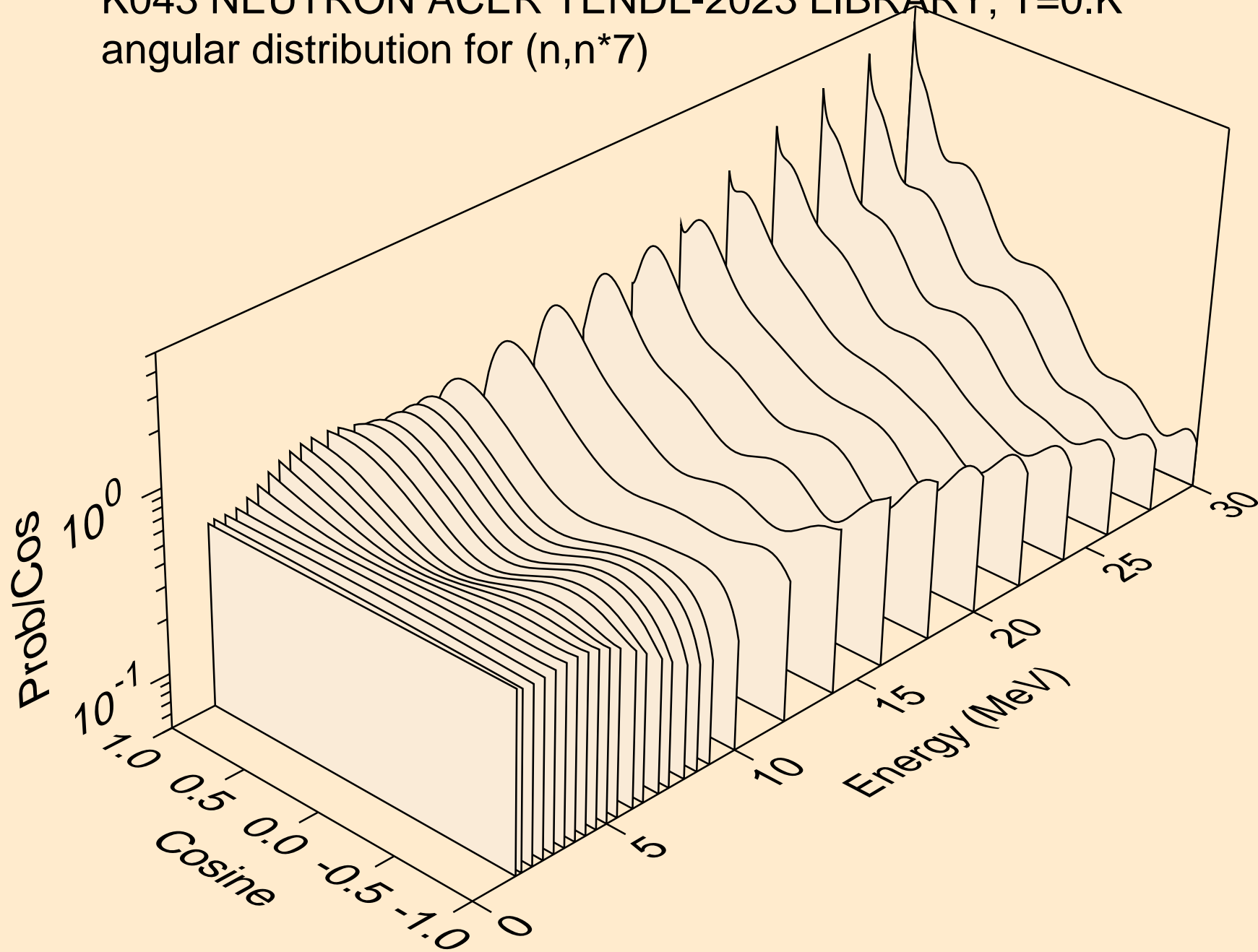

K043 NEUTRON ACER TENDL-2023 LIBRARY; T=0.K  
angular distribution for (n,n\*8)

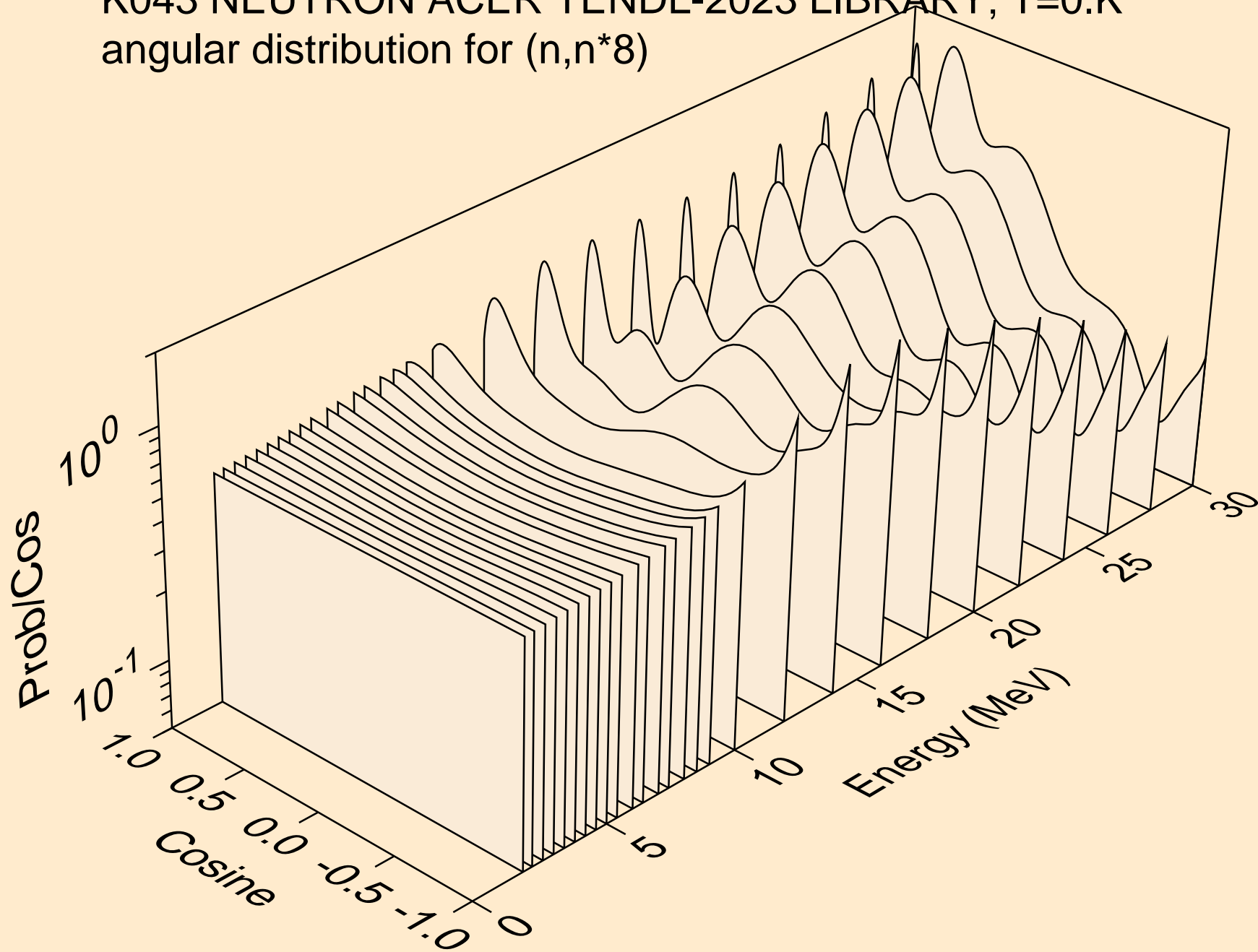

K043 NEUTRON ACER TENDL-2023 LIBRARY; T=0.K  
angular distribution for (n,n\*9)

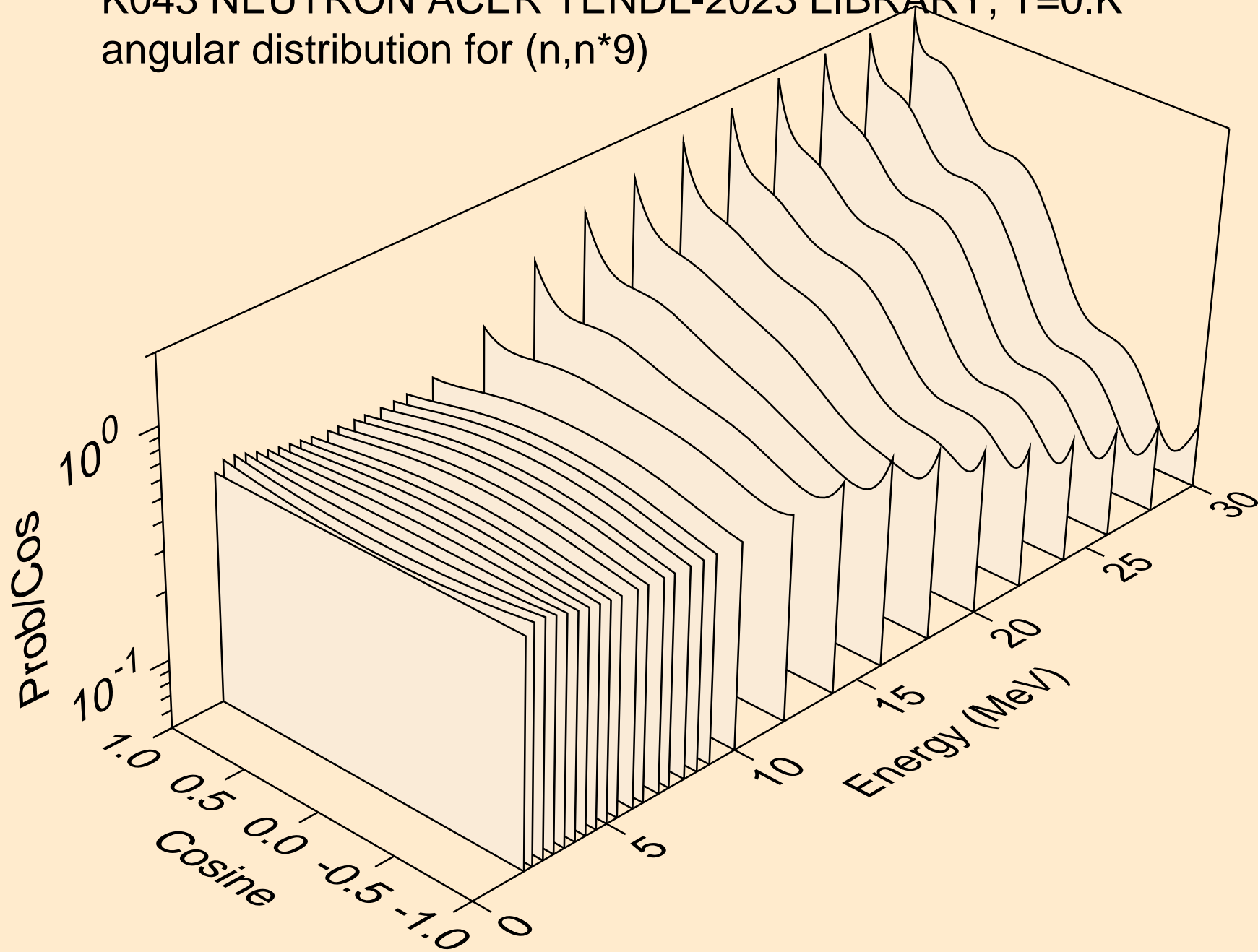

K043 NEUTRON ACER TENDL-2023 LIBRARY; T=0.K  
angular distribution for (n,n\*10)

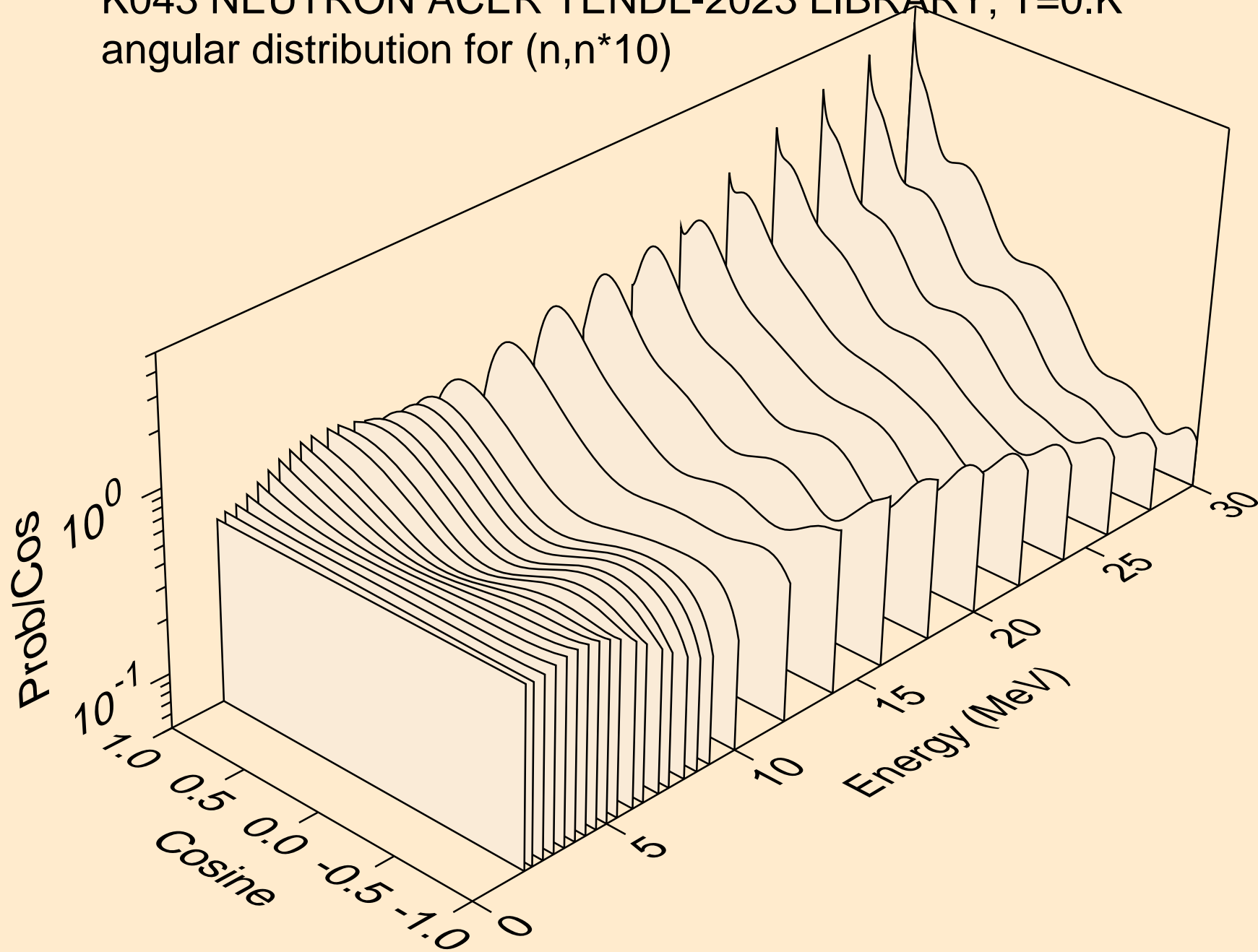

K043 NEUTRON ACER TENDL-2023 LIBRARY; T=0.K  
angular distribution for (n,n\*11)

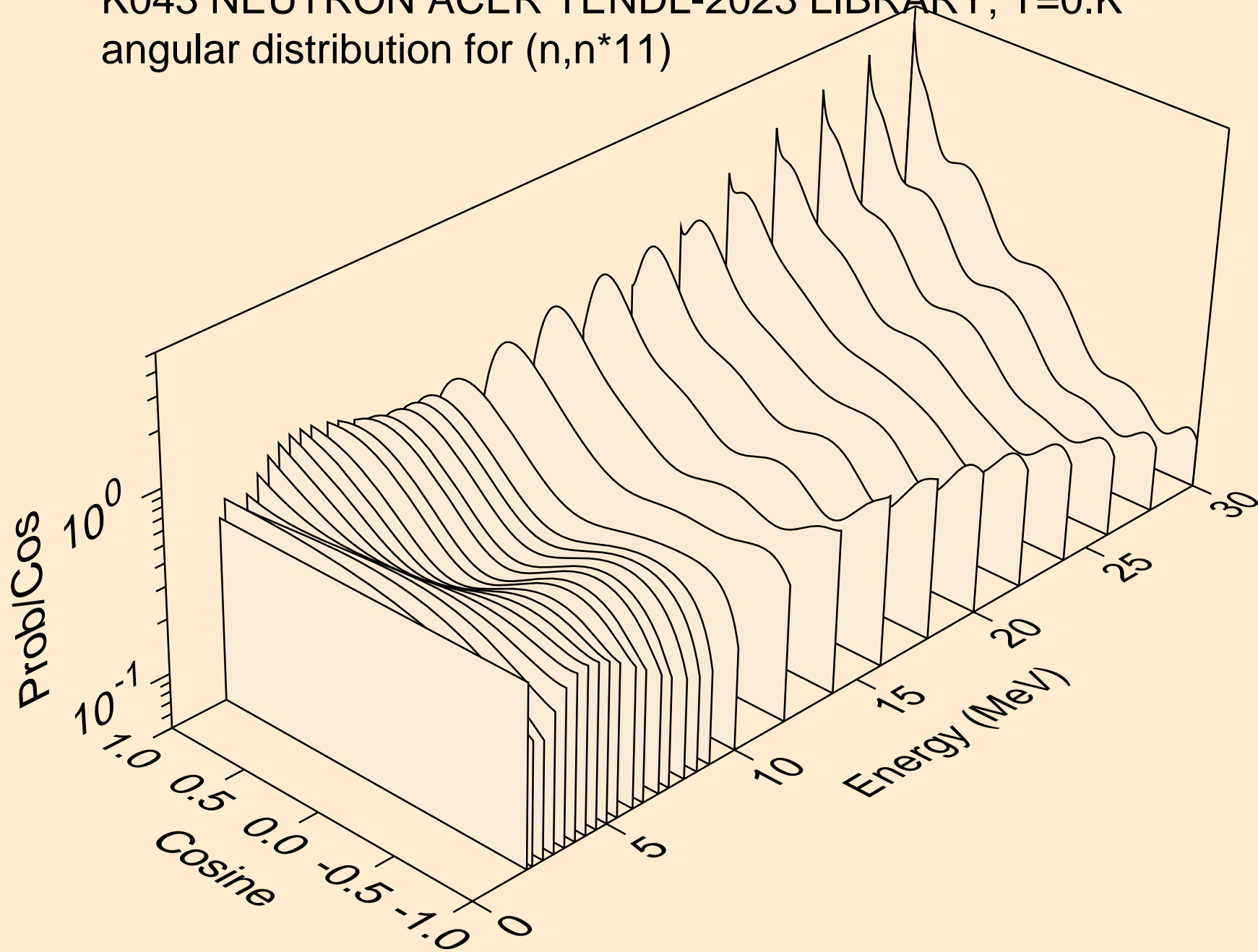

K043 NEUTRON ACER TENDL-2023 LIBRARY; T=0.K  
angular distribution for (n,n\*12)

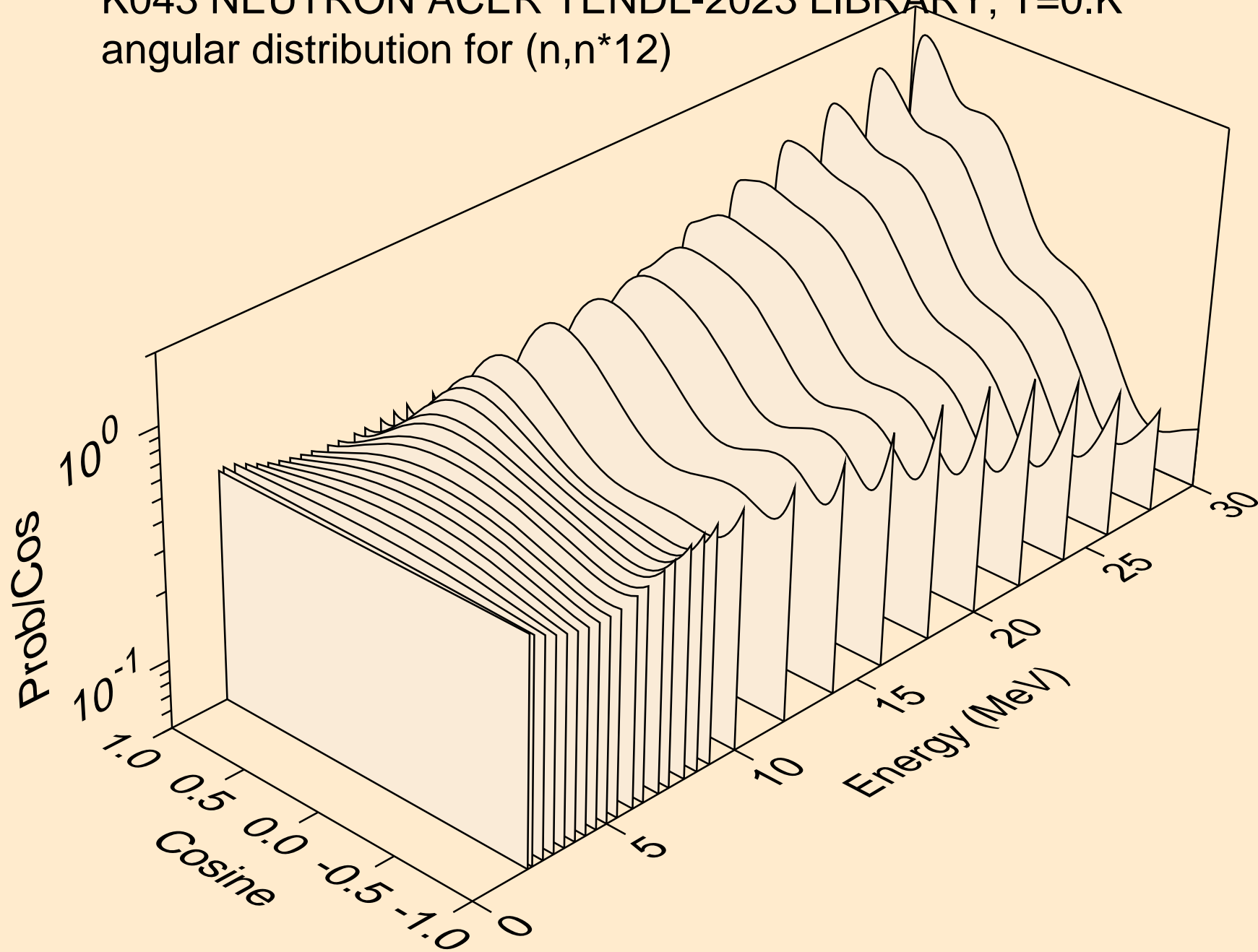



K043 NEUTRON ACER TENDL-2023 LIBRARY; T=0.K  
angular distribution for (n,n\*13)

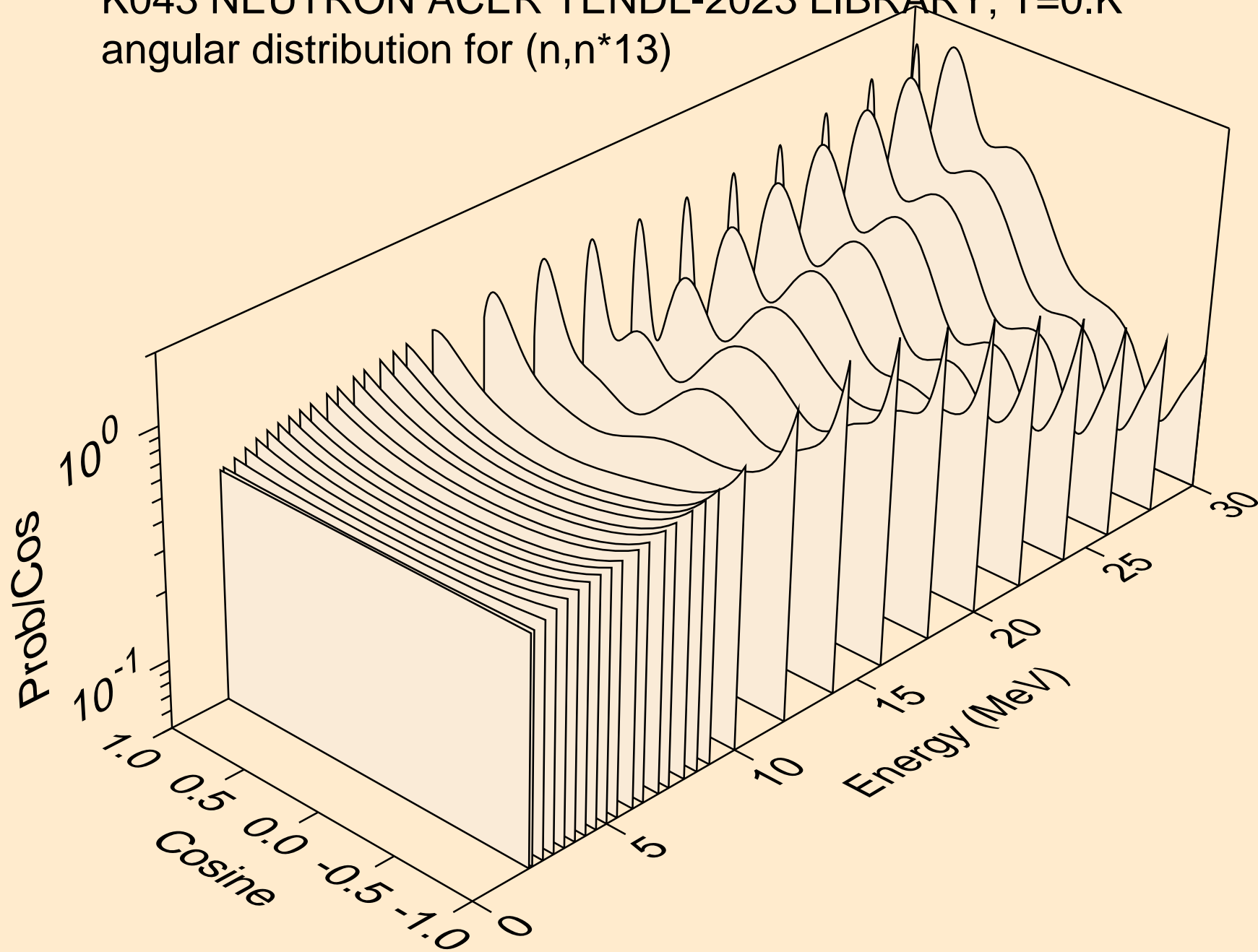

K043 NEUTRON ACER TENDL-2023 LIBRARY; T=0.K  
angular distribution for (n,n\*14)

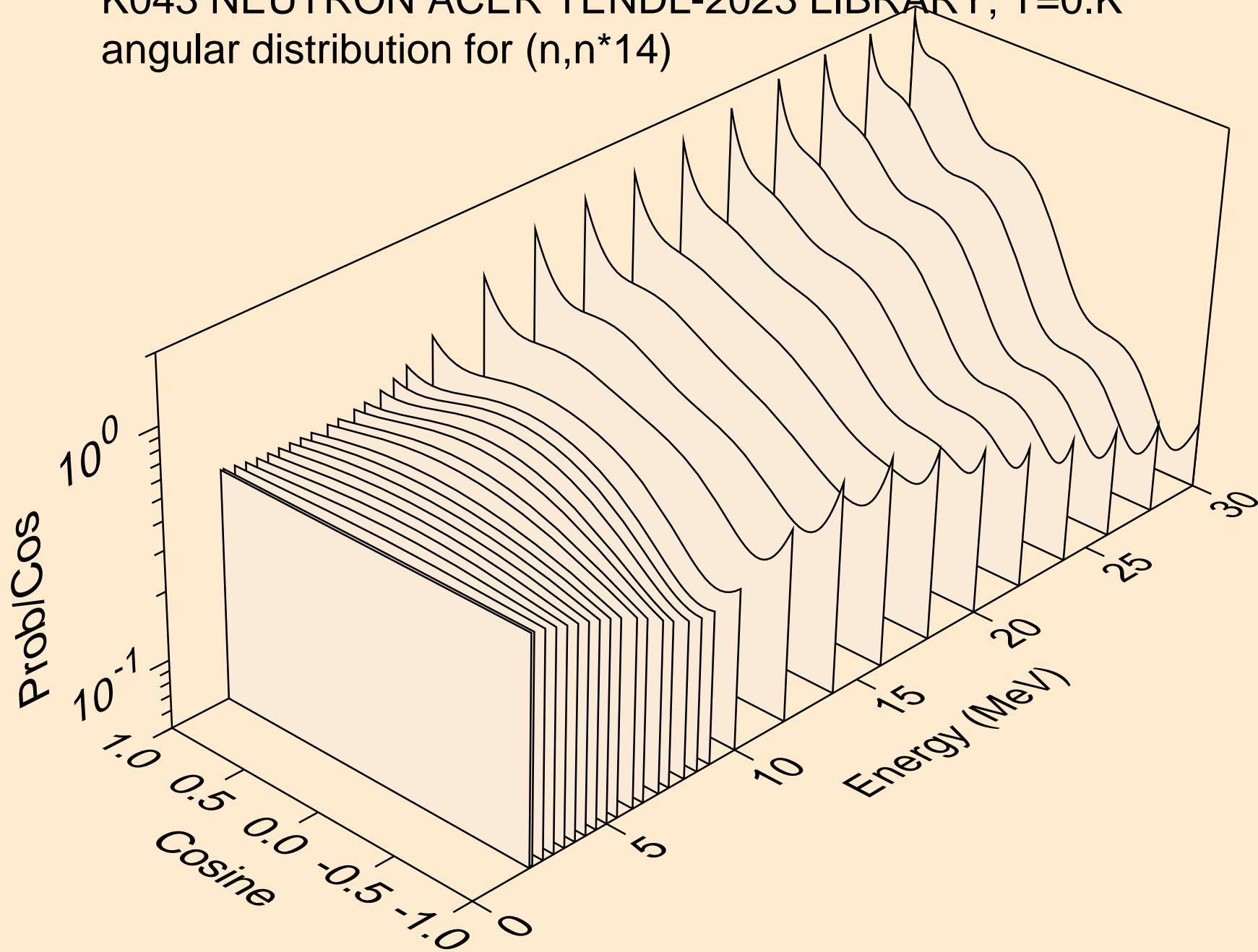

K043 NEUTRON ACER TENDL-2023 LIBRARY; T=0.K  
angular distribution for (n,n\*15)

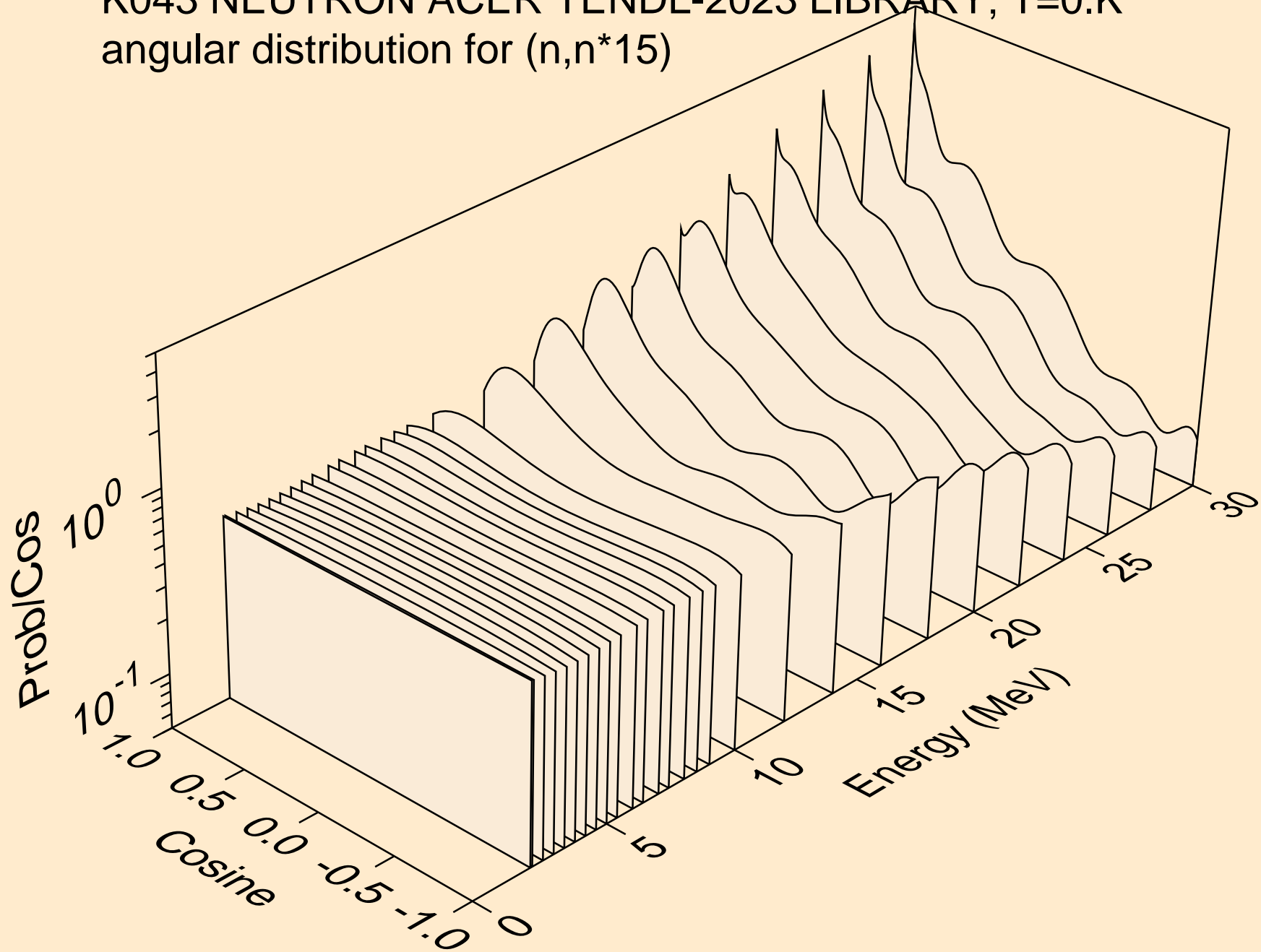

K043 NEUTRON ACER TENDL-2023 LIBRARY; T=0.K  
Neutron emission for (n,x)

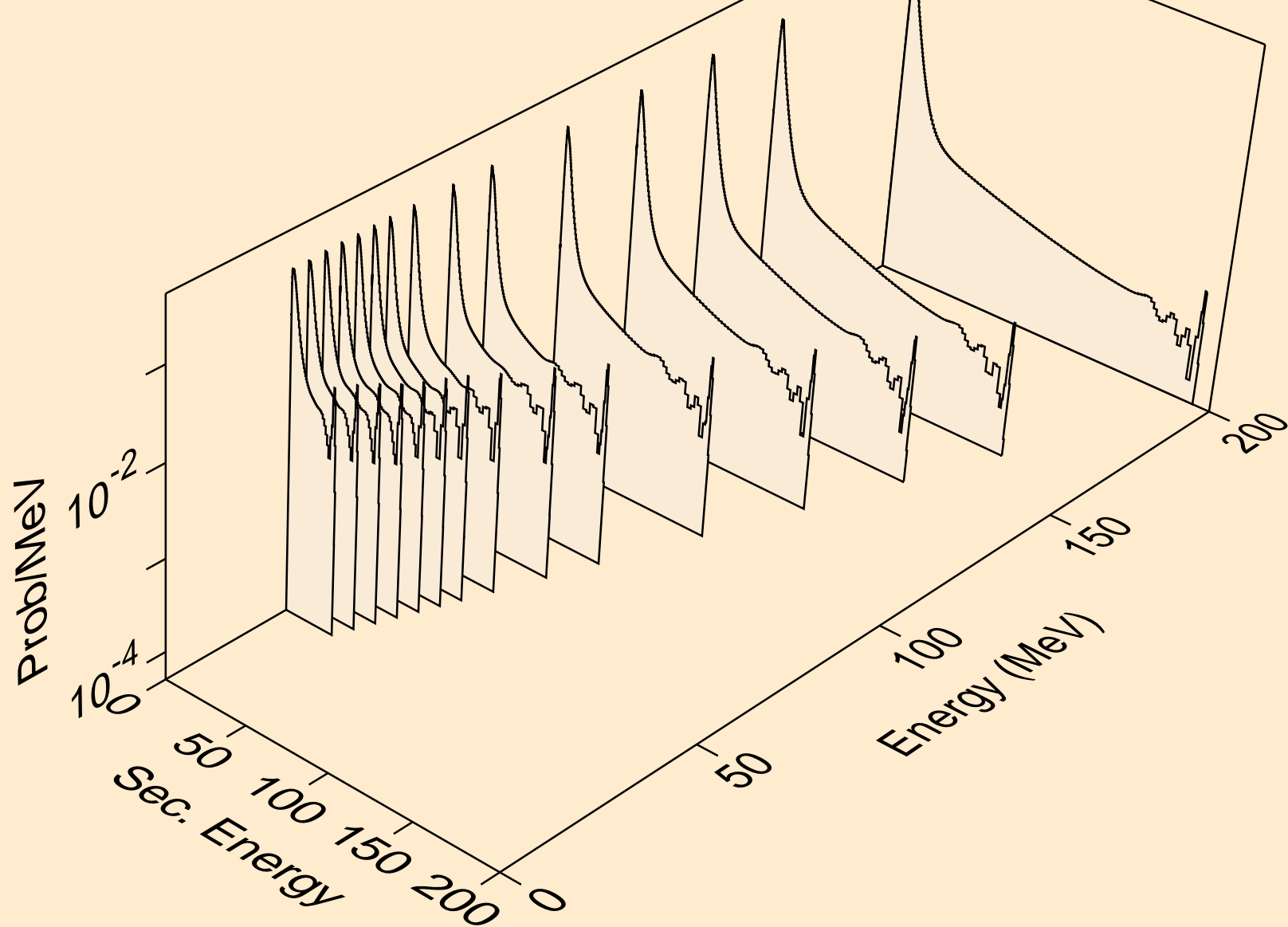

K043 NEUTRON ACER TENDL-2023 LIBRARY; T=0.K  
Neutron emission for (n,2nd)

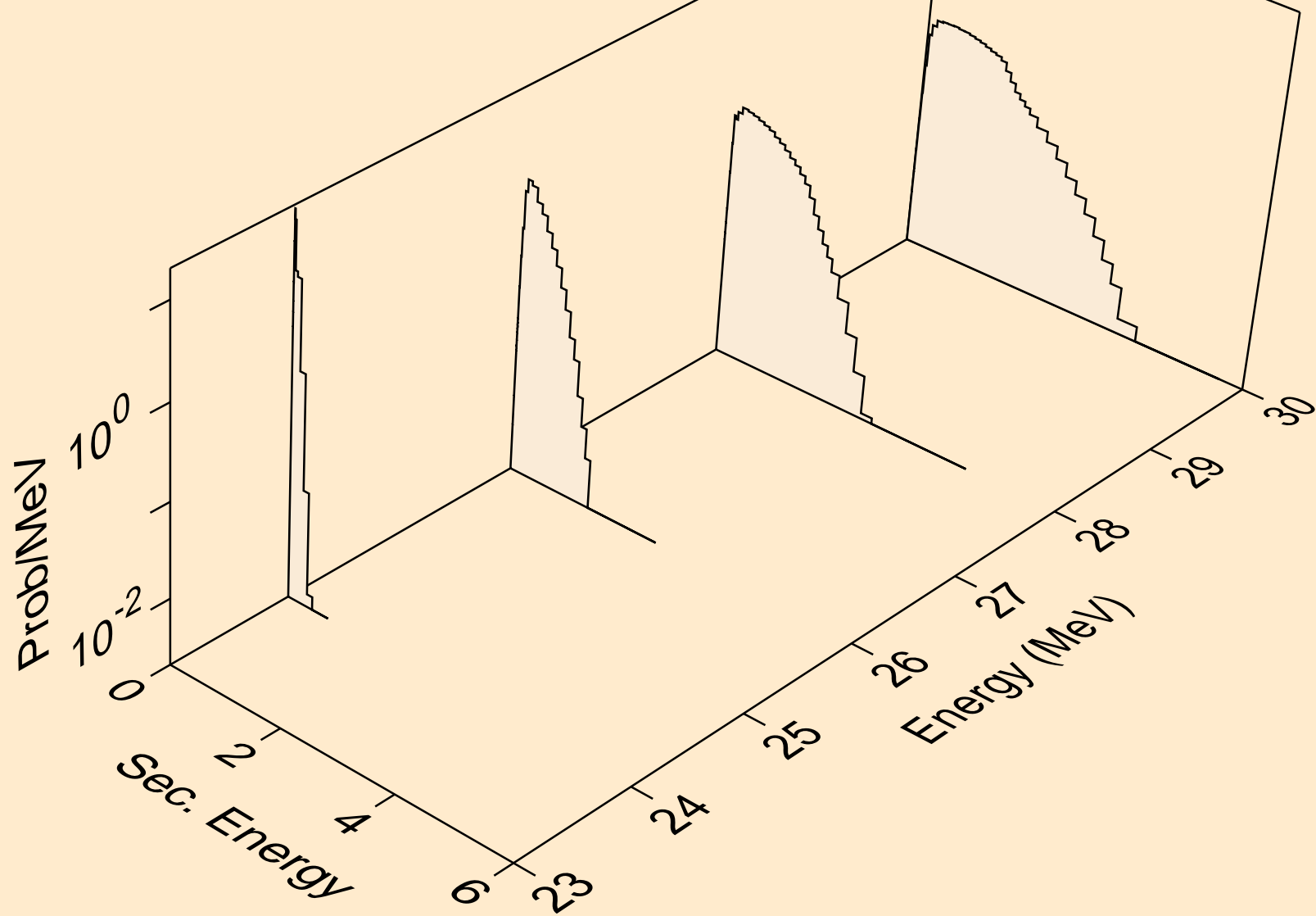

K043 NEUTRON ACER TENDL-2023 LIBRARY; T=0.K  
Neutron emission for (n,2n)

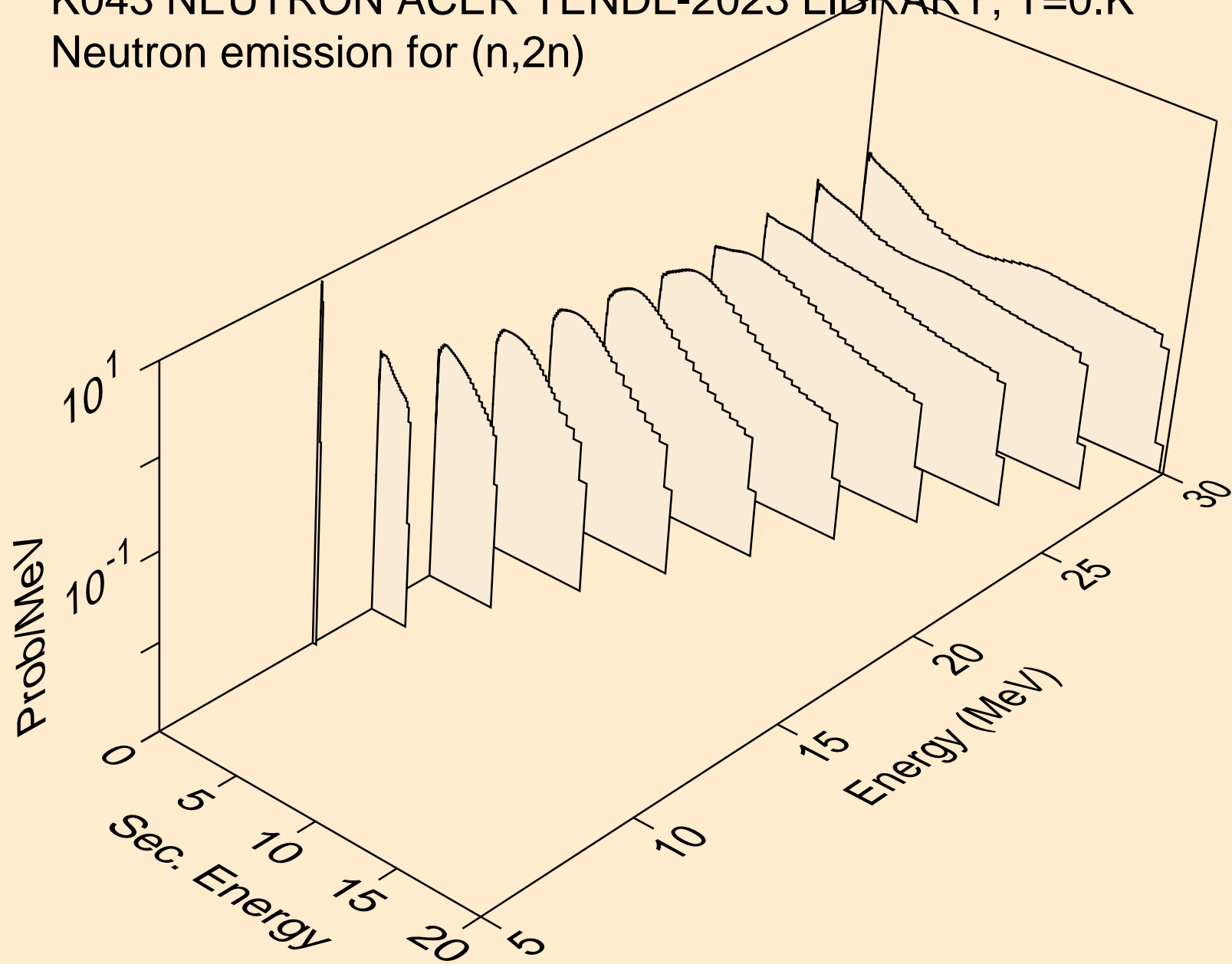

K043 NEUTRON ACER TENDL-2023 LIBRARY; T=0.K  
Neutron emission for (n,3n)

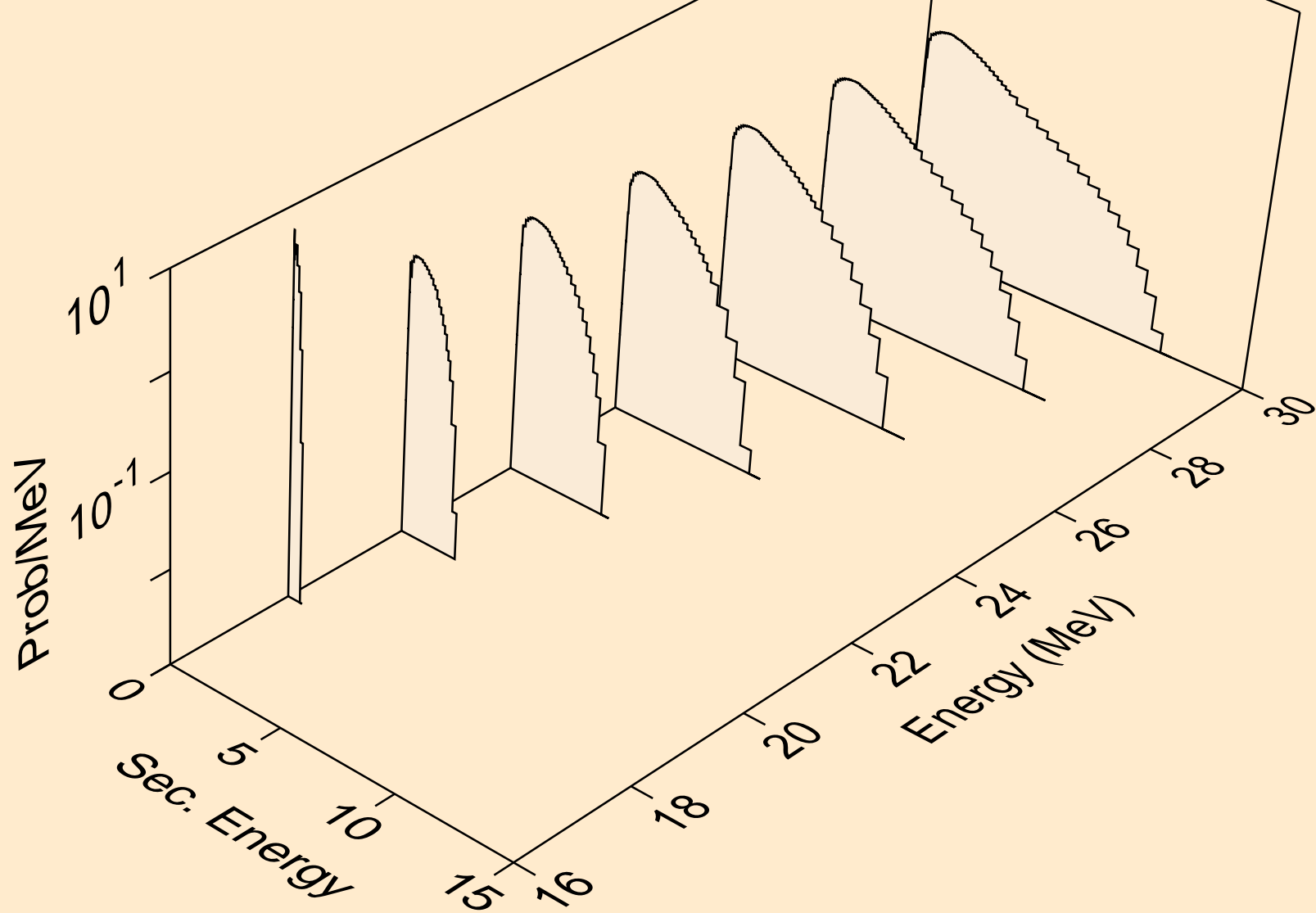

K043 NEUTRON ACER TENDL-2023 LIBRARY; T=0.K  
Neutron emission for (n,n\*)a

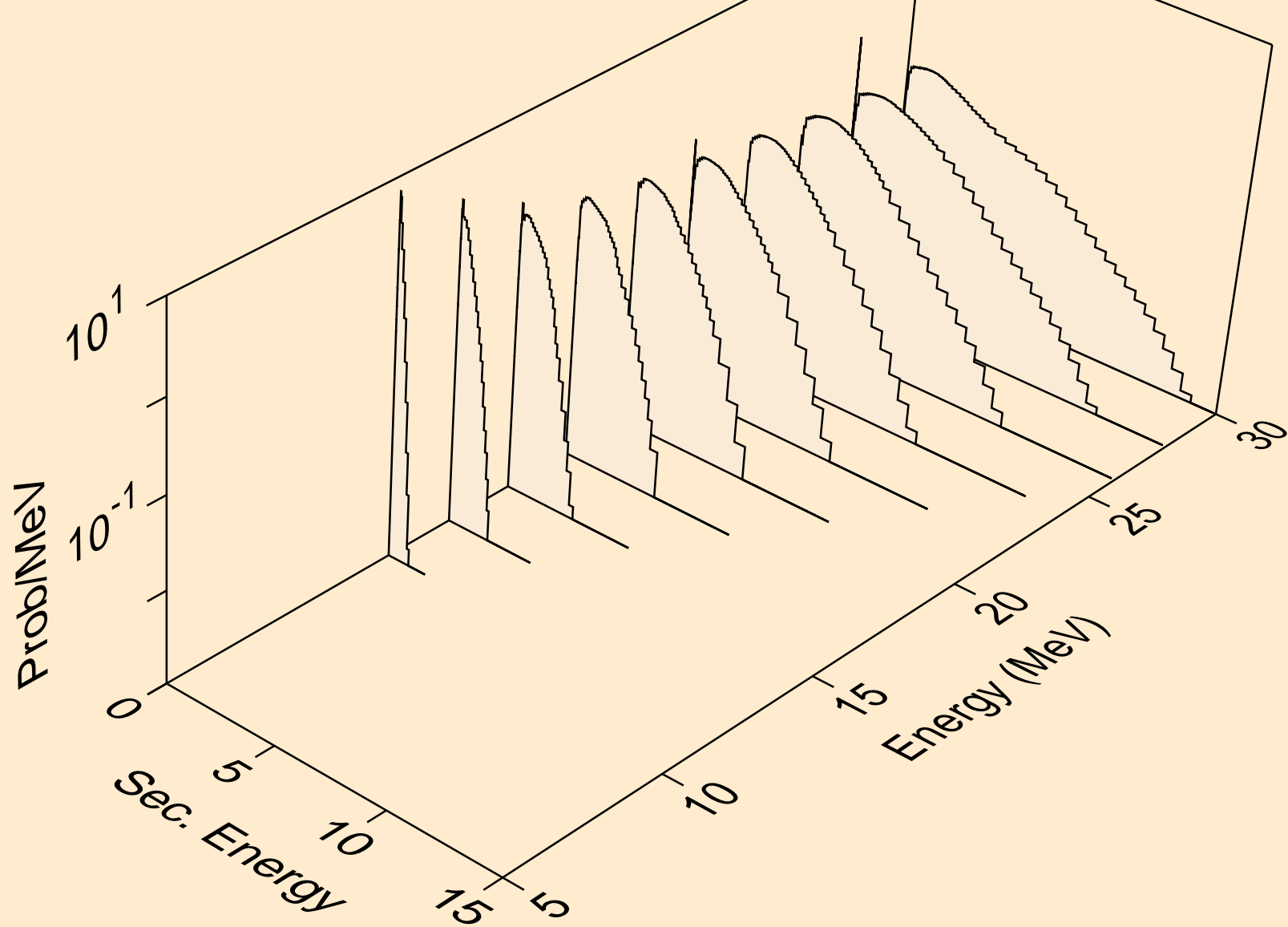



K043 NEUTRON ACER TENDL-2023 LIBRARY; T=0.K  
Neutron emission for (n,2n)a

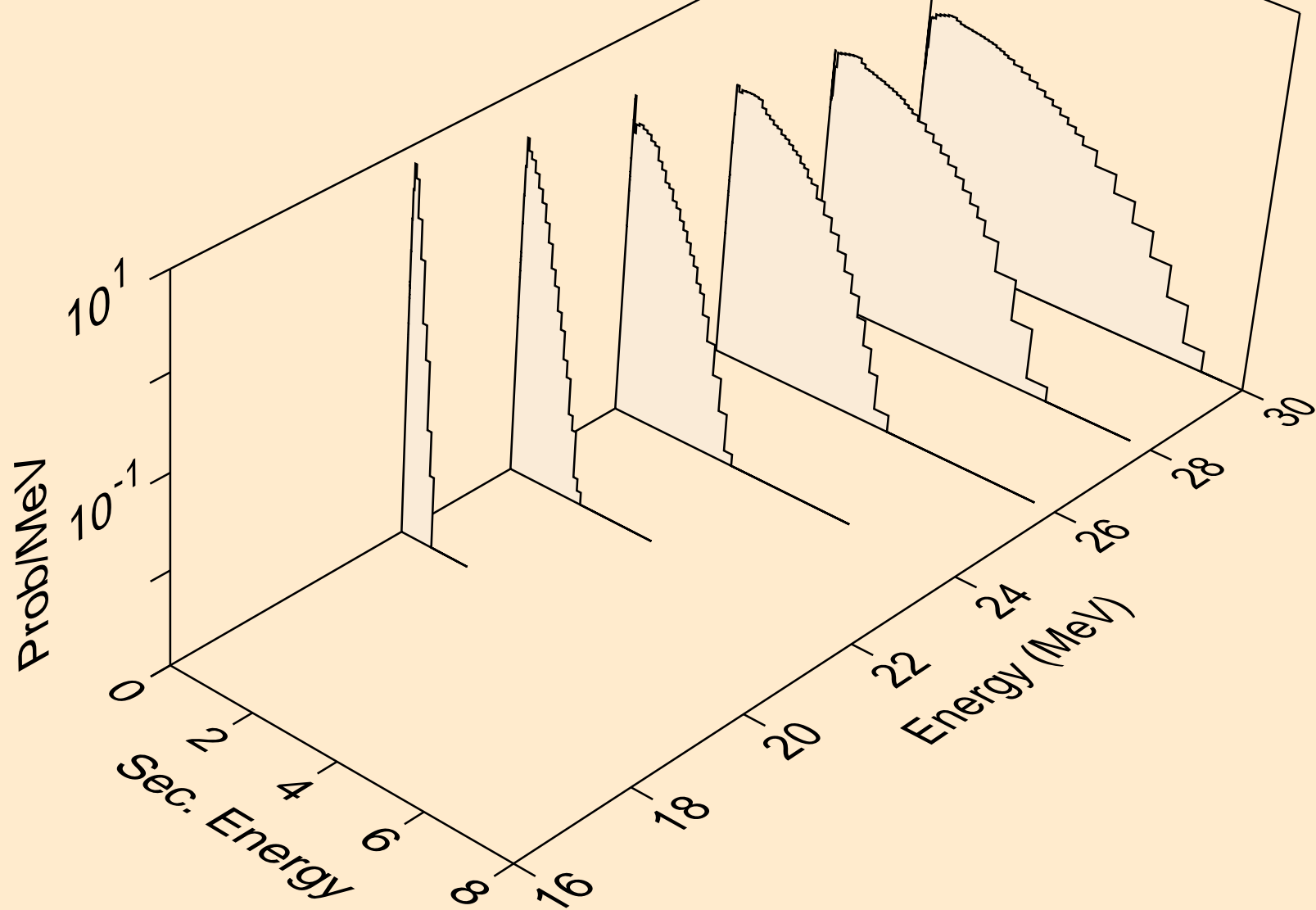

K043 NEUTRON ACER TENDL-2023 LIBRARY; T=0.K  
Neutron emission for (n,3n)a

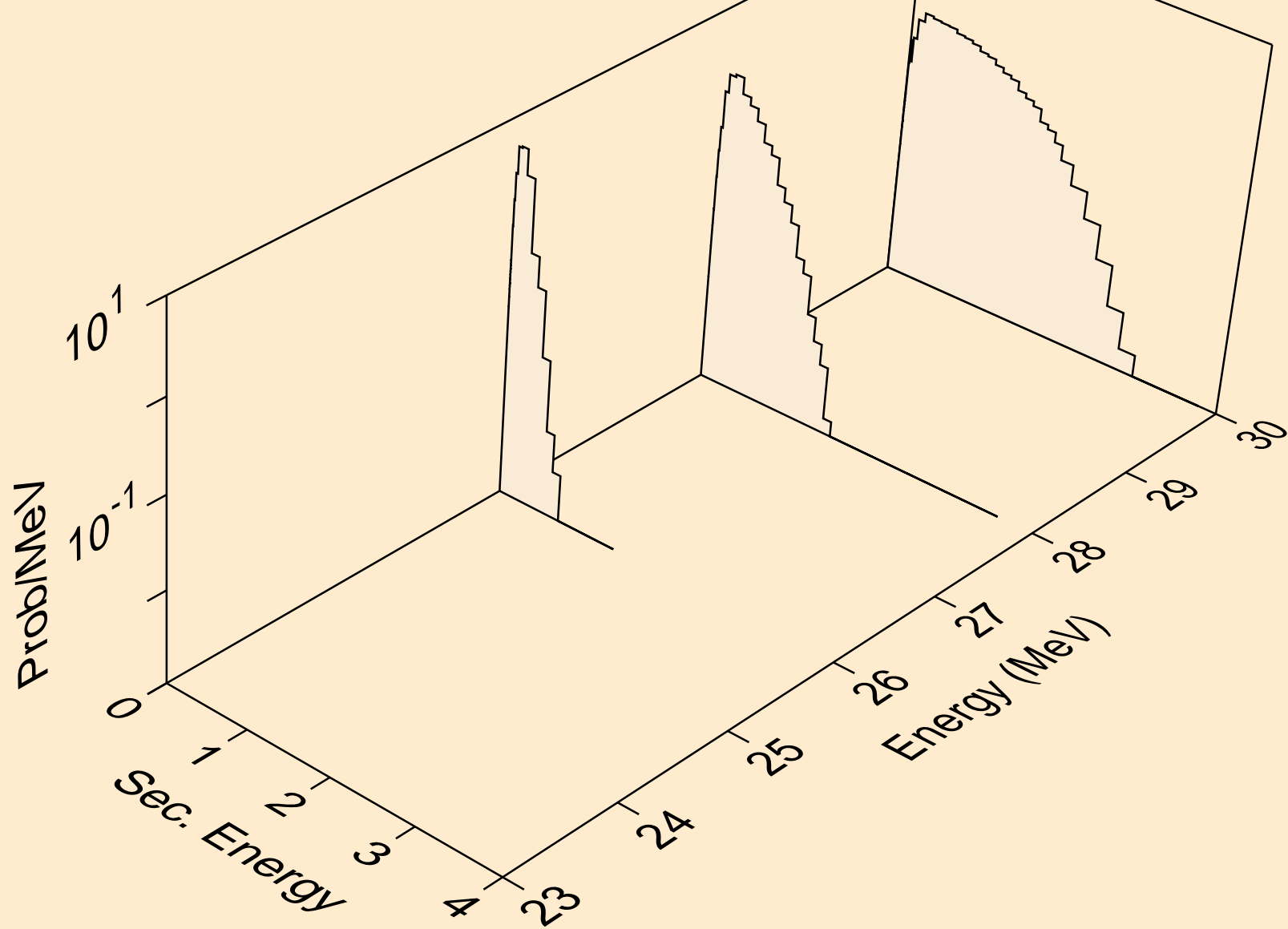

K043 NEUTRON ACER TENDL-2023 LIBRARY; T=0.K  
Neutron emission for (n,n\*)p

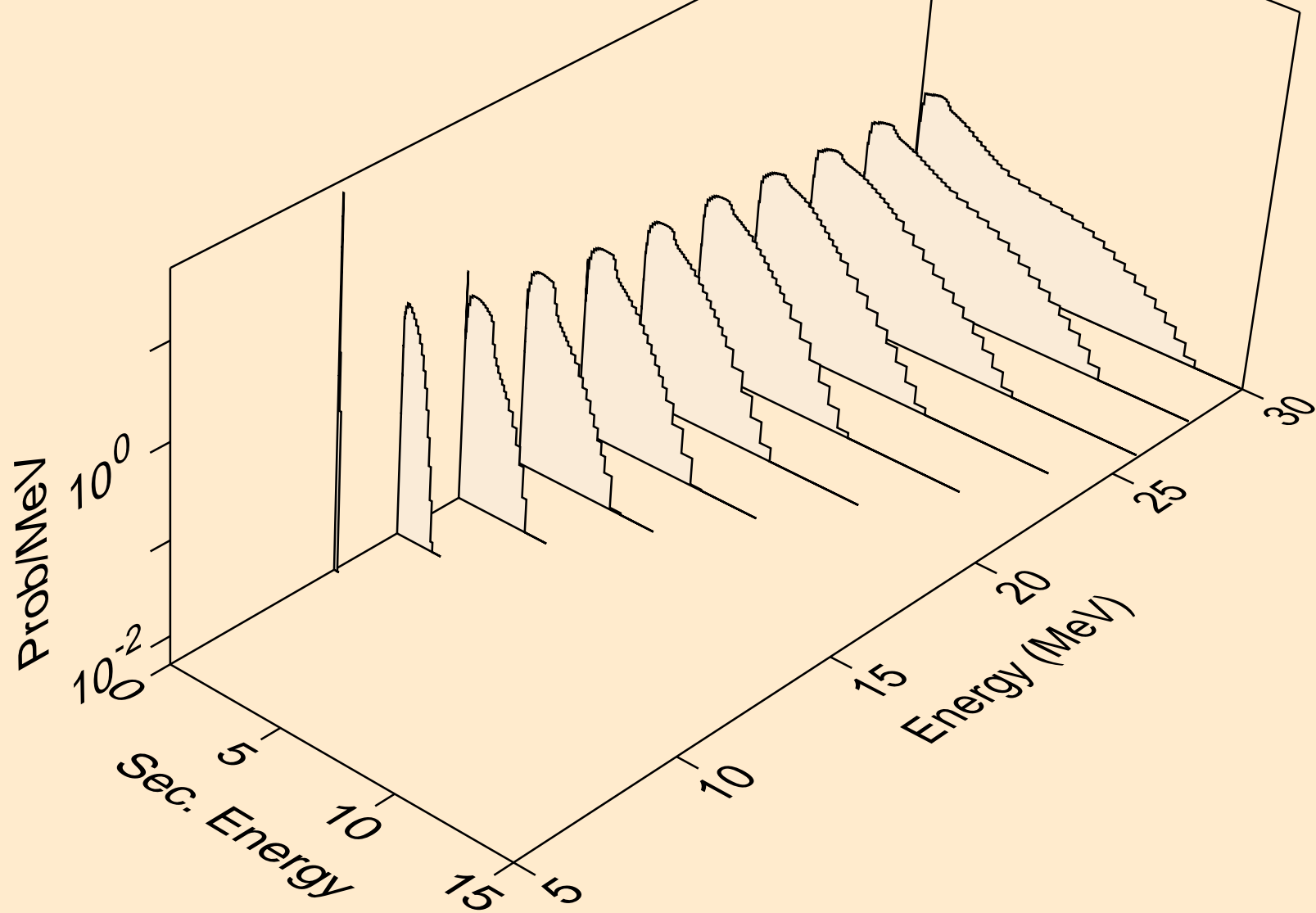

K043 NEUTRON ACER TENDL-2023 LIBRARY; T=0.K  
Neutron emission for (n,n\*)2a

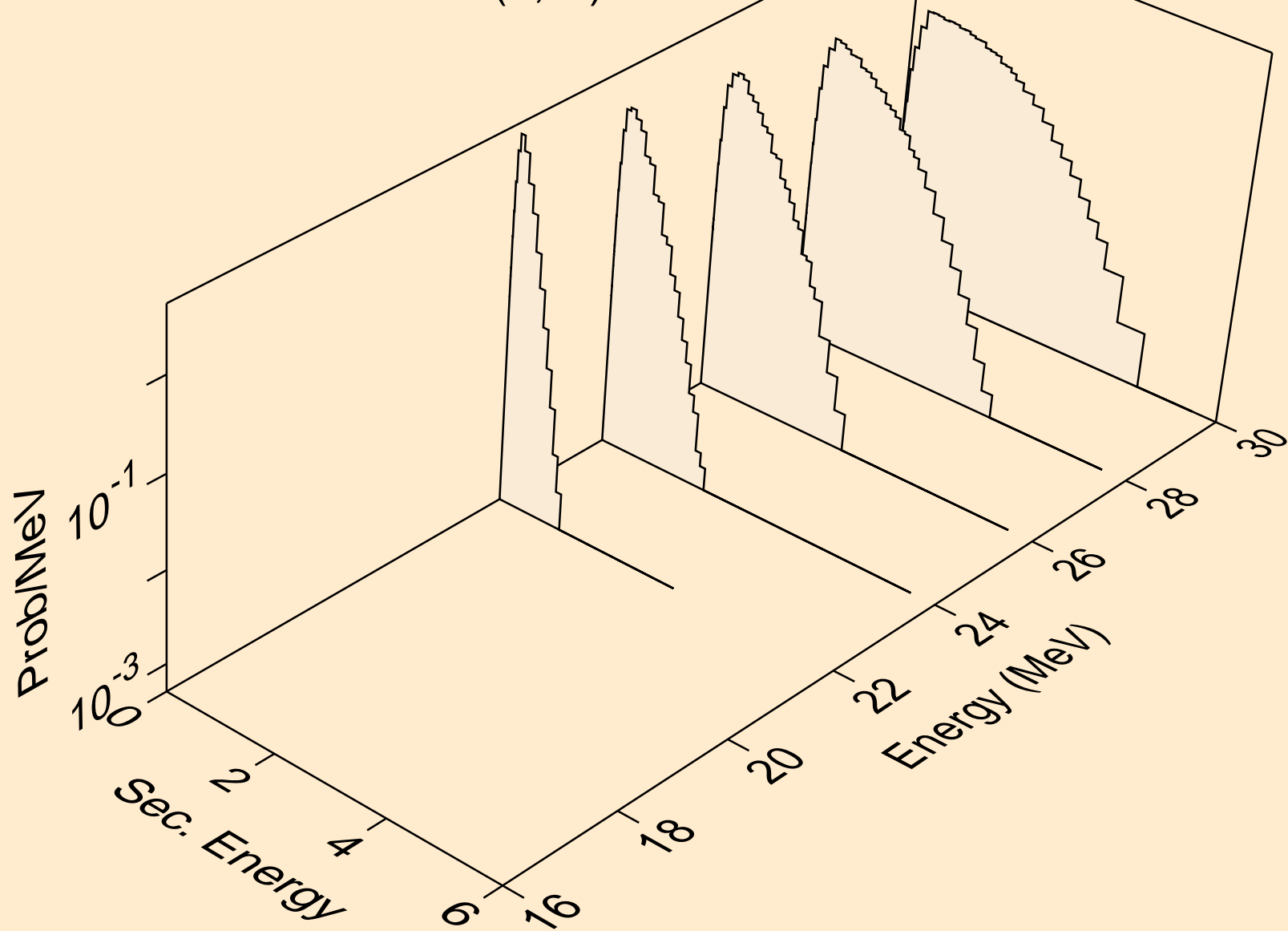

K043 NEUTRON ACER TENDL-2023 LIBRARY; T=0.K  
Neutron emission for (n,n\*)d

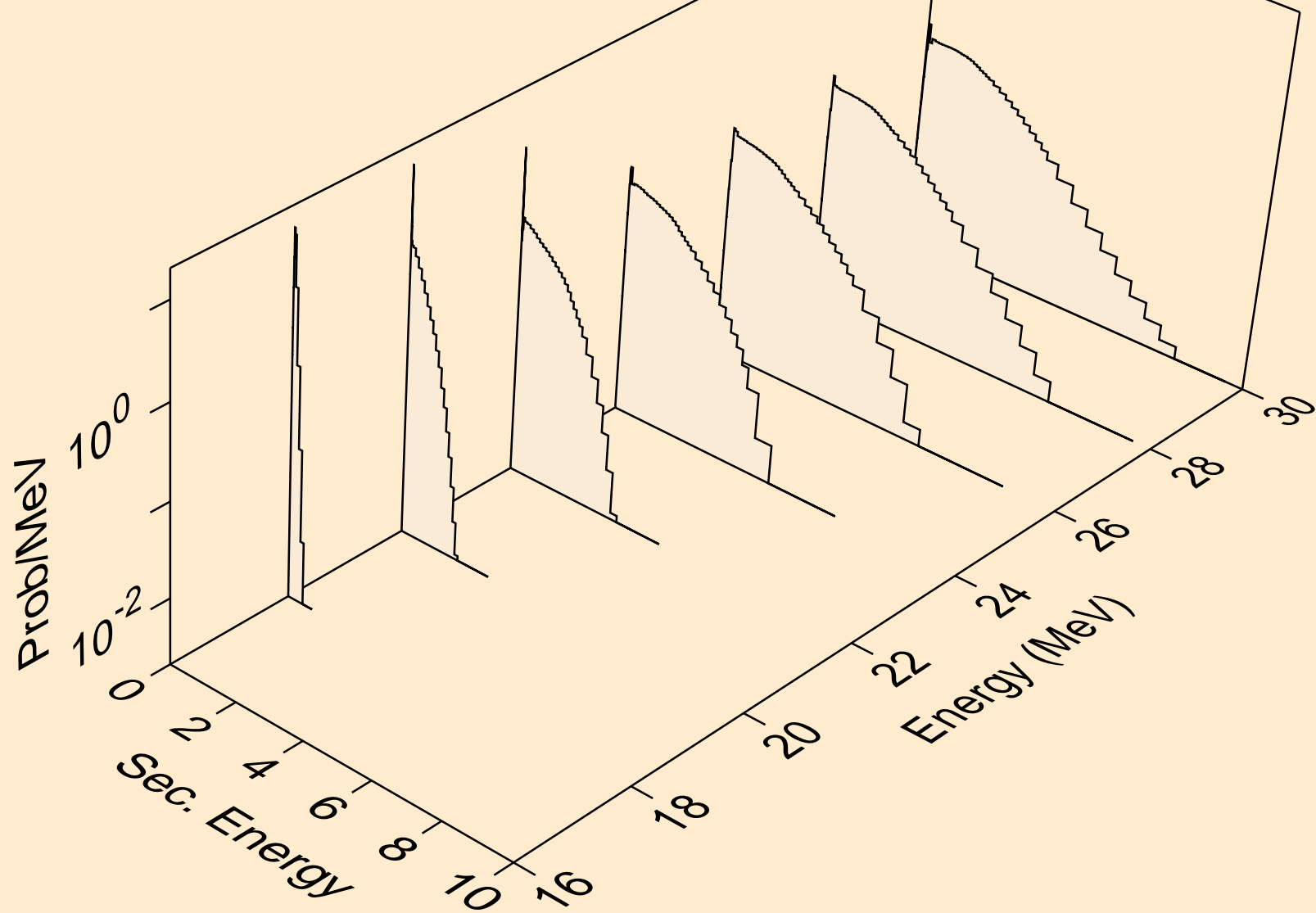

K043 NEUTRON ACER TENDL-2023 LIBRARY; T=0.K  
Neutron emission for (n,n\*)t

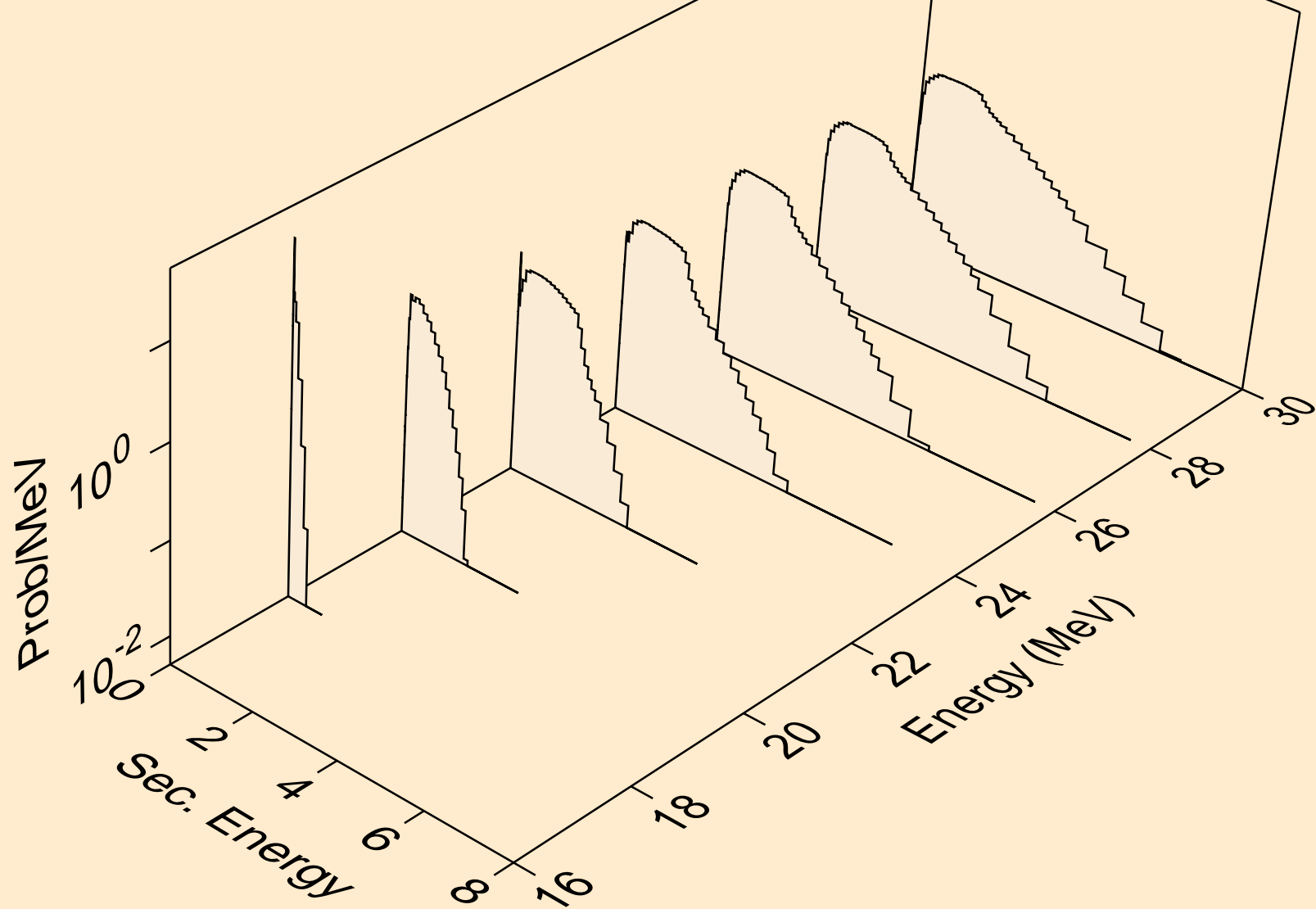

K043 NEUTRON ACER TENDL-2023 LIBRARY; T=0.K  
Neutron emission for (n,n\*)he3

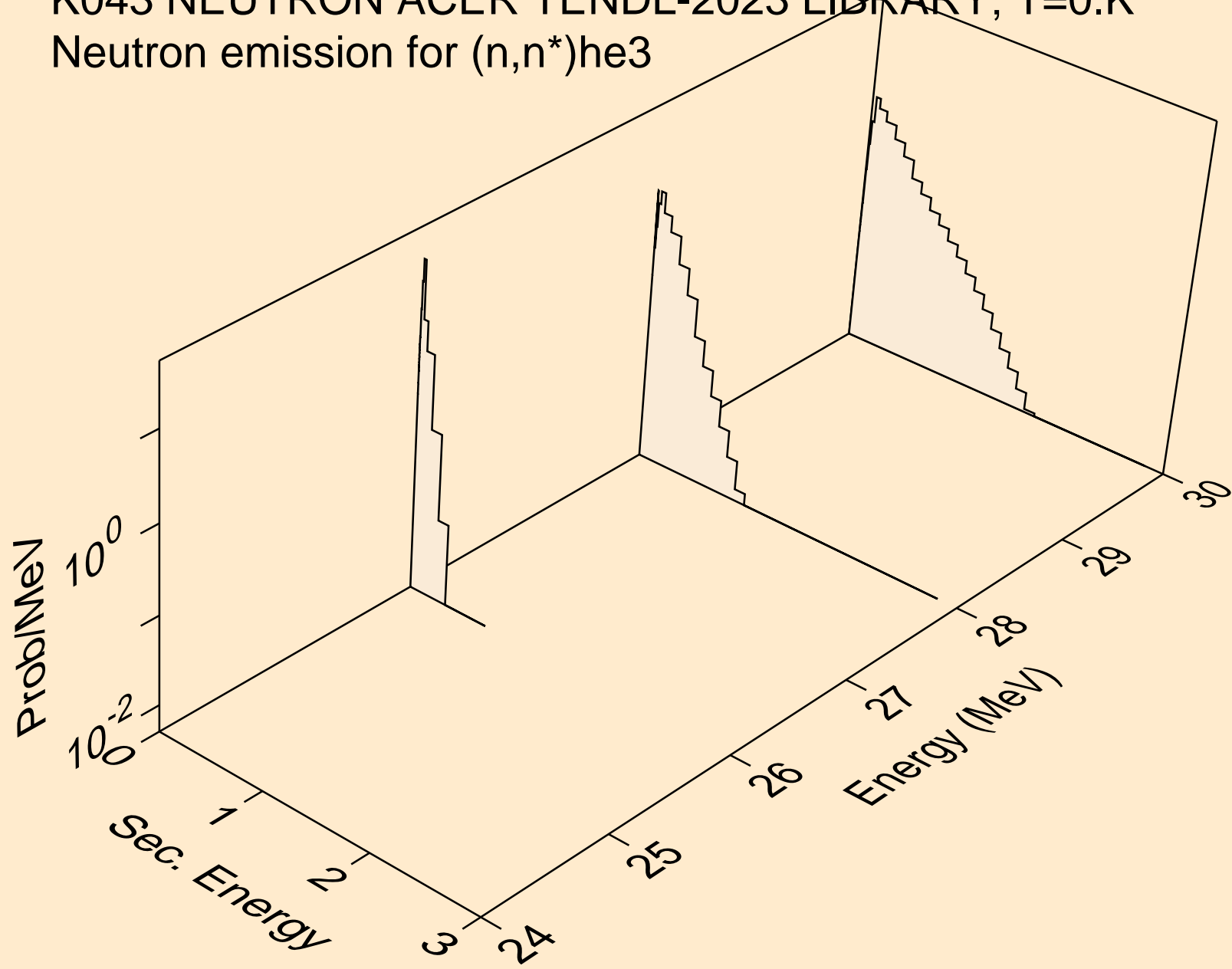

K043 NEUTRON ACER TENDL-2023 LIBRARY; T=0.K  
Neutron emission for (n,4n)

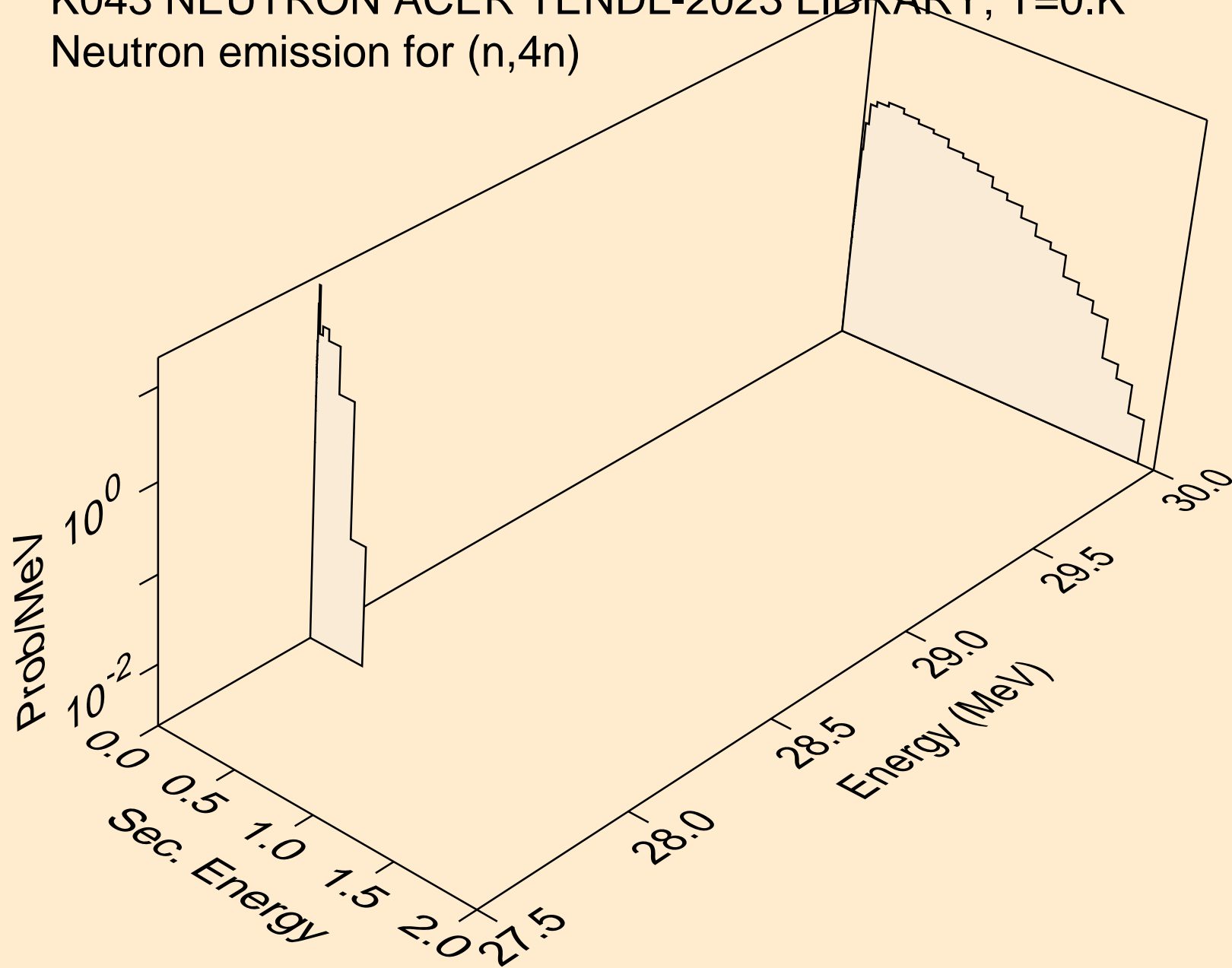



K043 NEUTRON ACER TENDL-2023 LIBRARY; T=0.K  
Neutron emission for (n,2np)

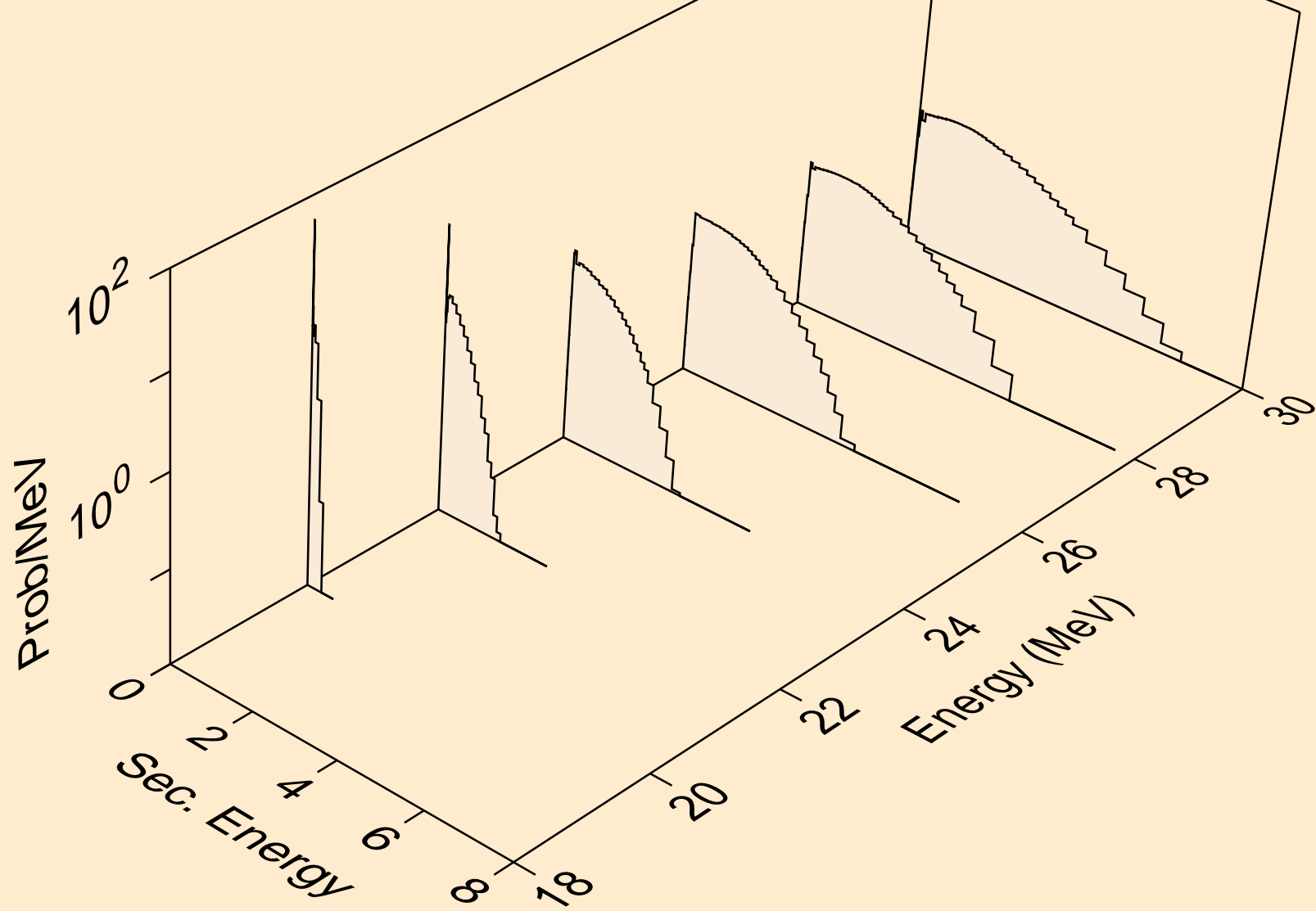

K043 NEUTRON ACER TENDL-2023 LIBRARY; T=0.K  
Neutron emission for (n,3np)

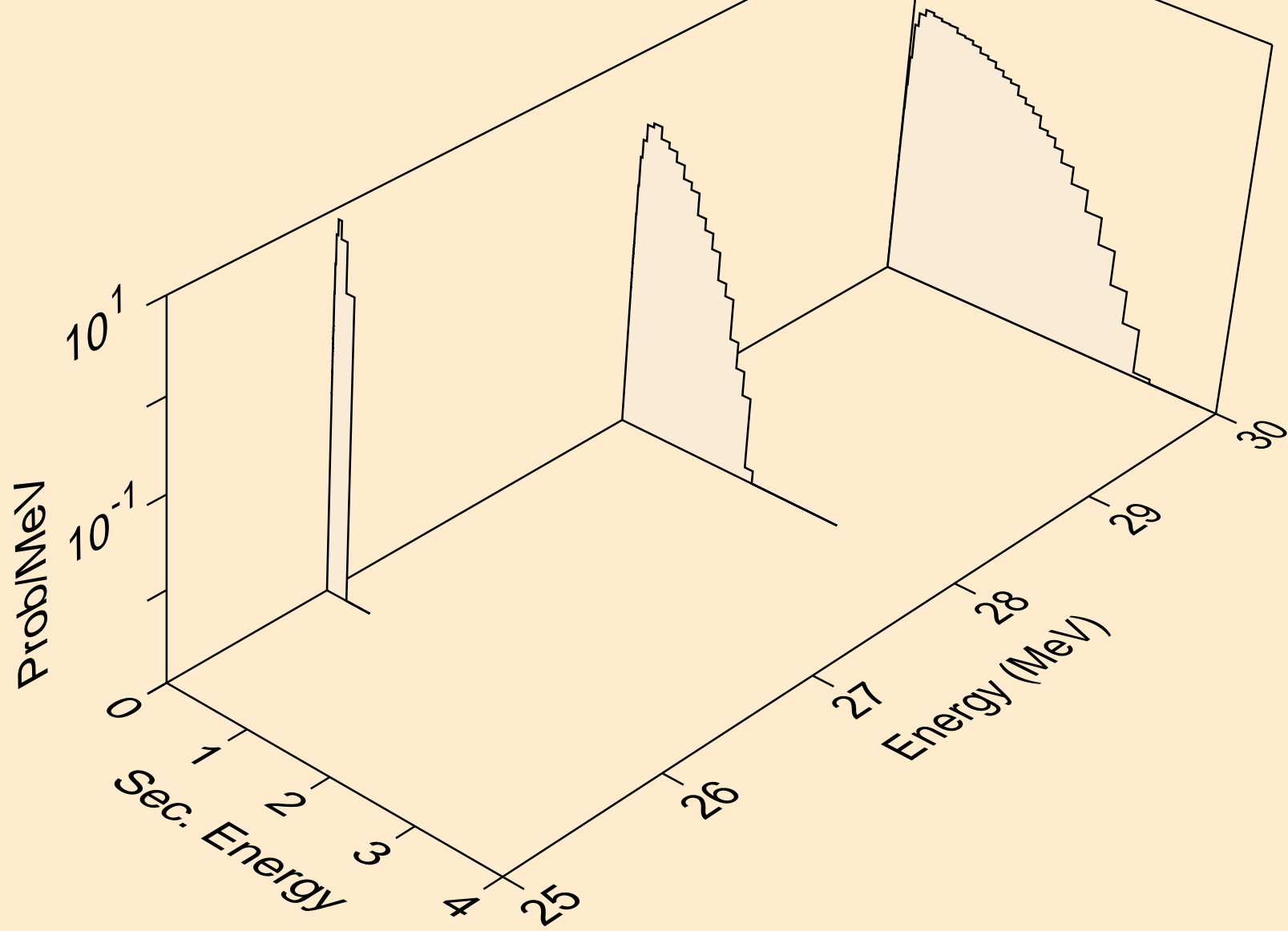

K043 NEUTRON ACER TENDL-2023 LIBRARY; T=0.K  
Neutron emission for (n,n2p)

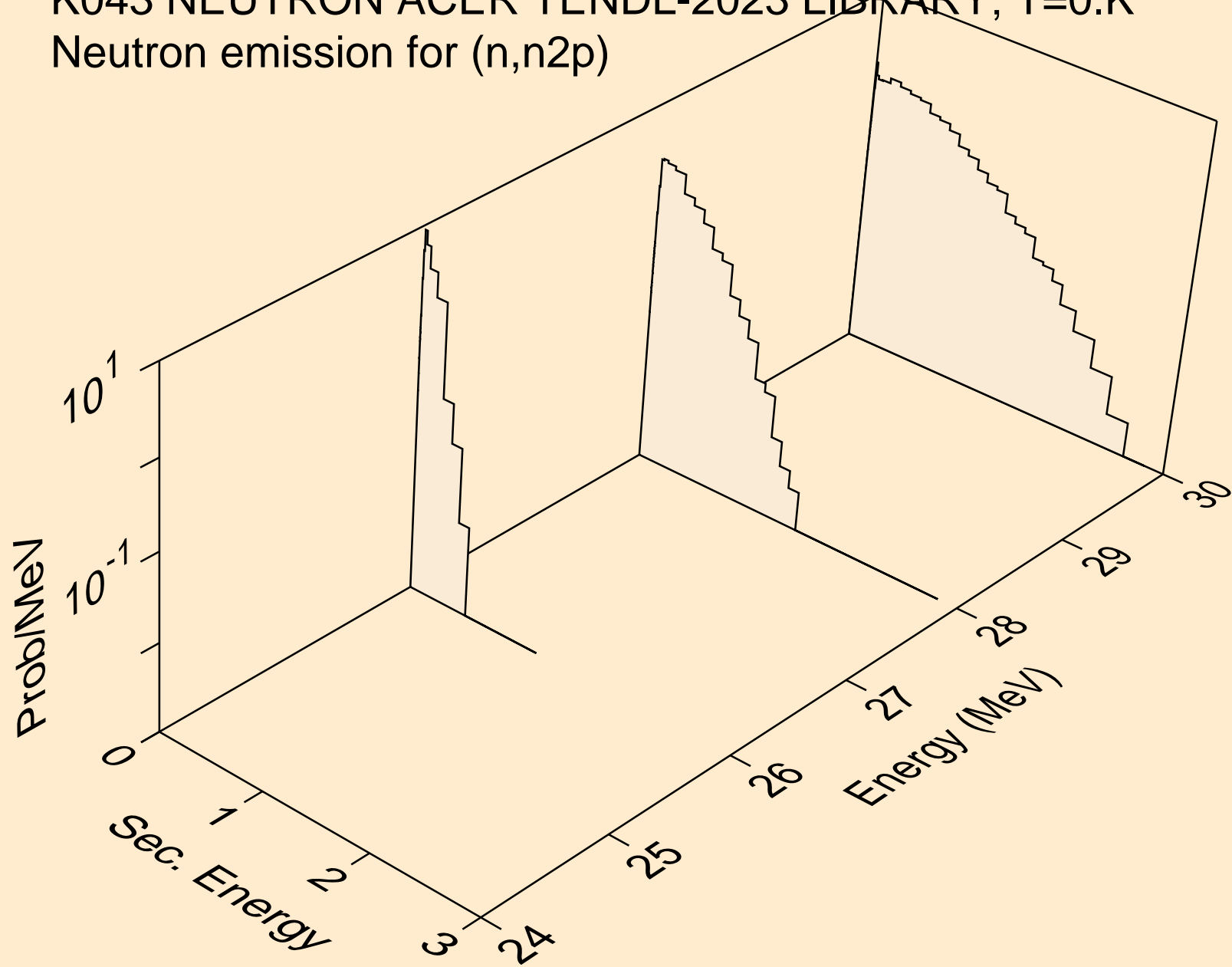

K043 NEUTRON ACER TENDL-2023 LIBRARY; T=0.K  
Neutron emission for (n,npa)

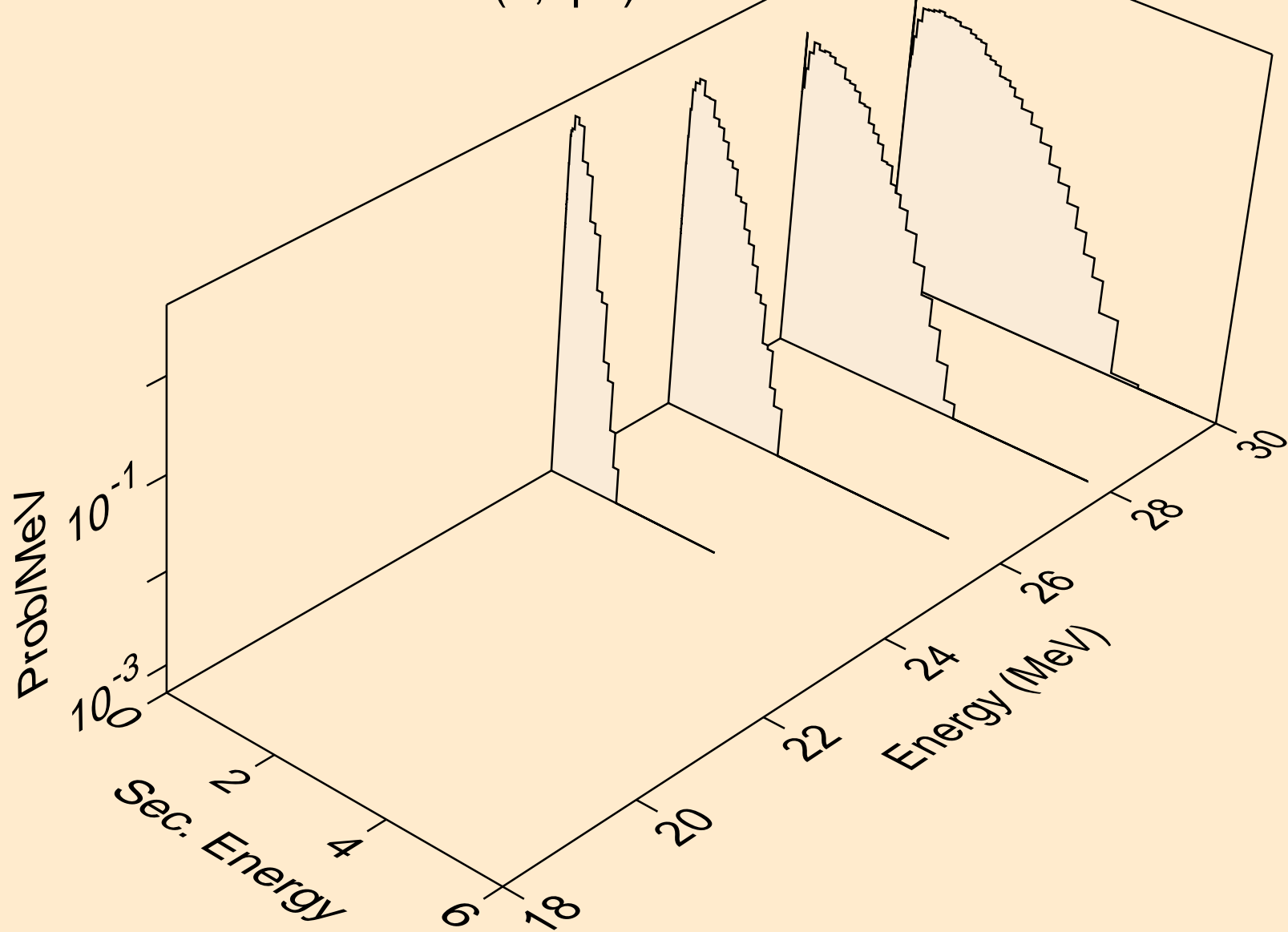

K043 NEUTRON ACER TENDL-2023 LIBRARY; T=0.K  
Neutron emission for (n,n\*c)

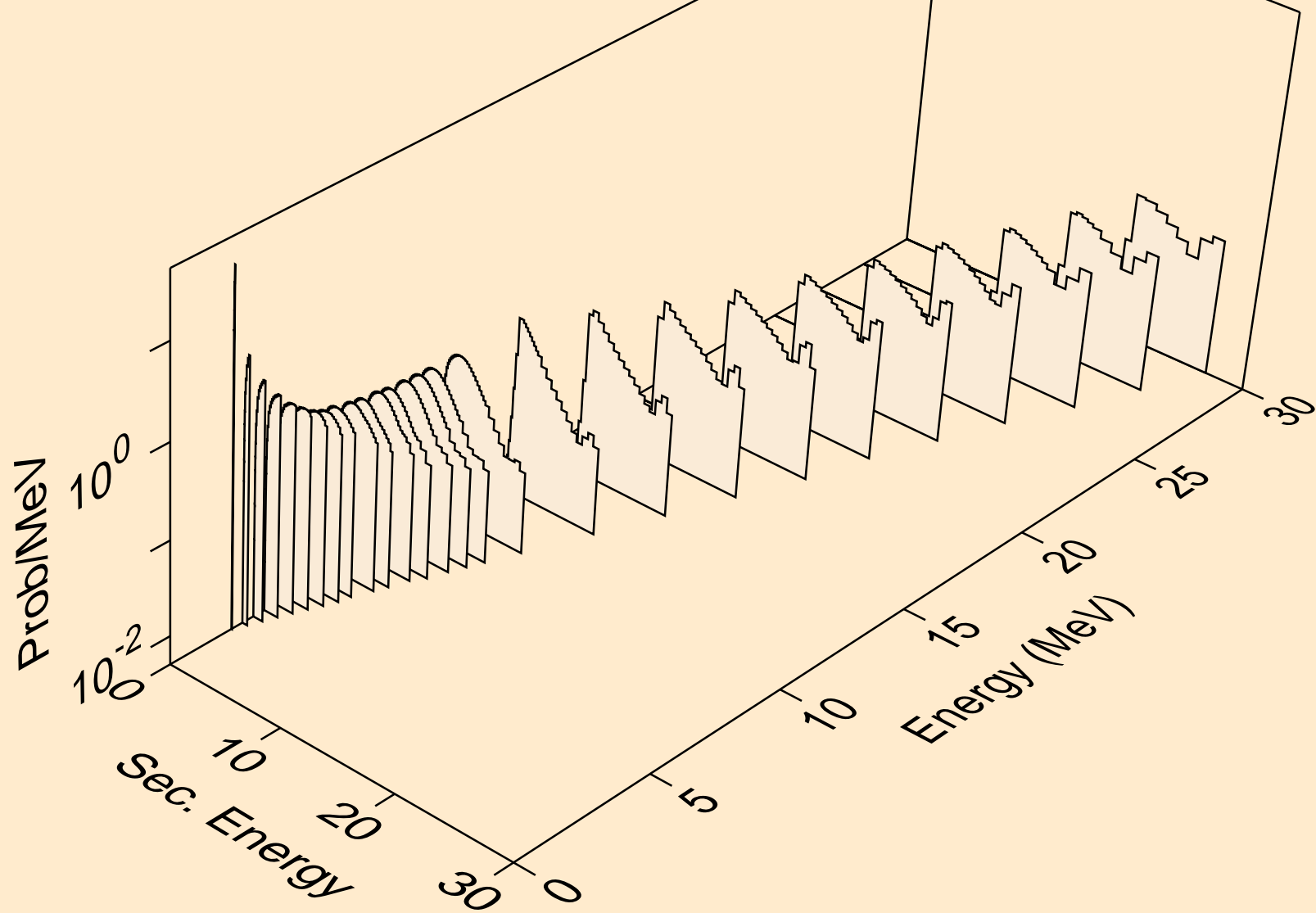

K043 NEUTRON ACER TENDL-2023 LIBRARY; T=0.K  
Photon emission for (n,x)

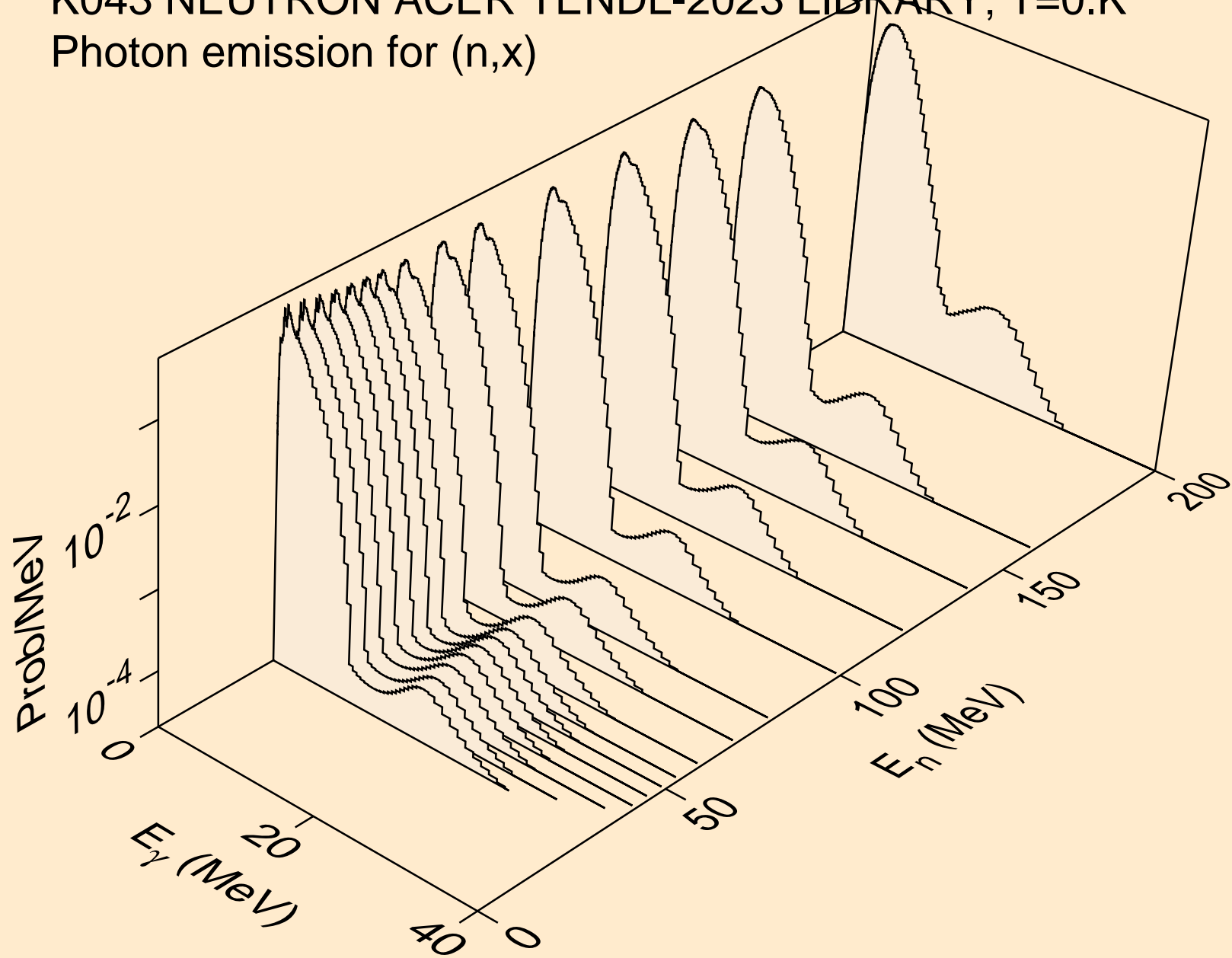

K043 NEUTRON ACER TENDL-2023 LIBRARY; T=0.K  
Photon emission for (n,2nd)

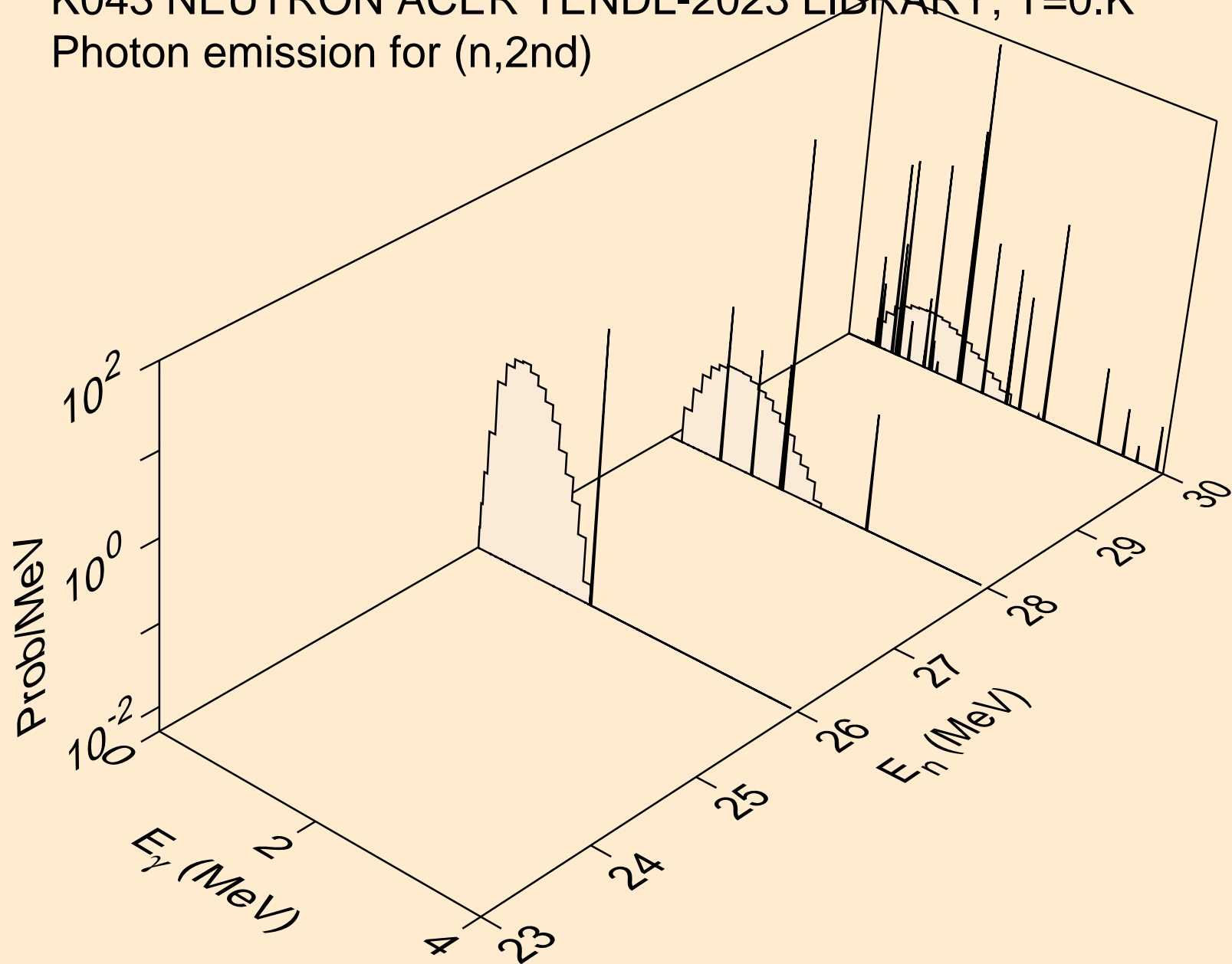

K043 NEUTRON ACER TENDL-2023 LIBRARY; T=0.K  
Photon emission for (n,2n)

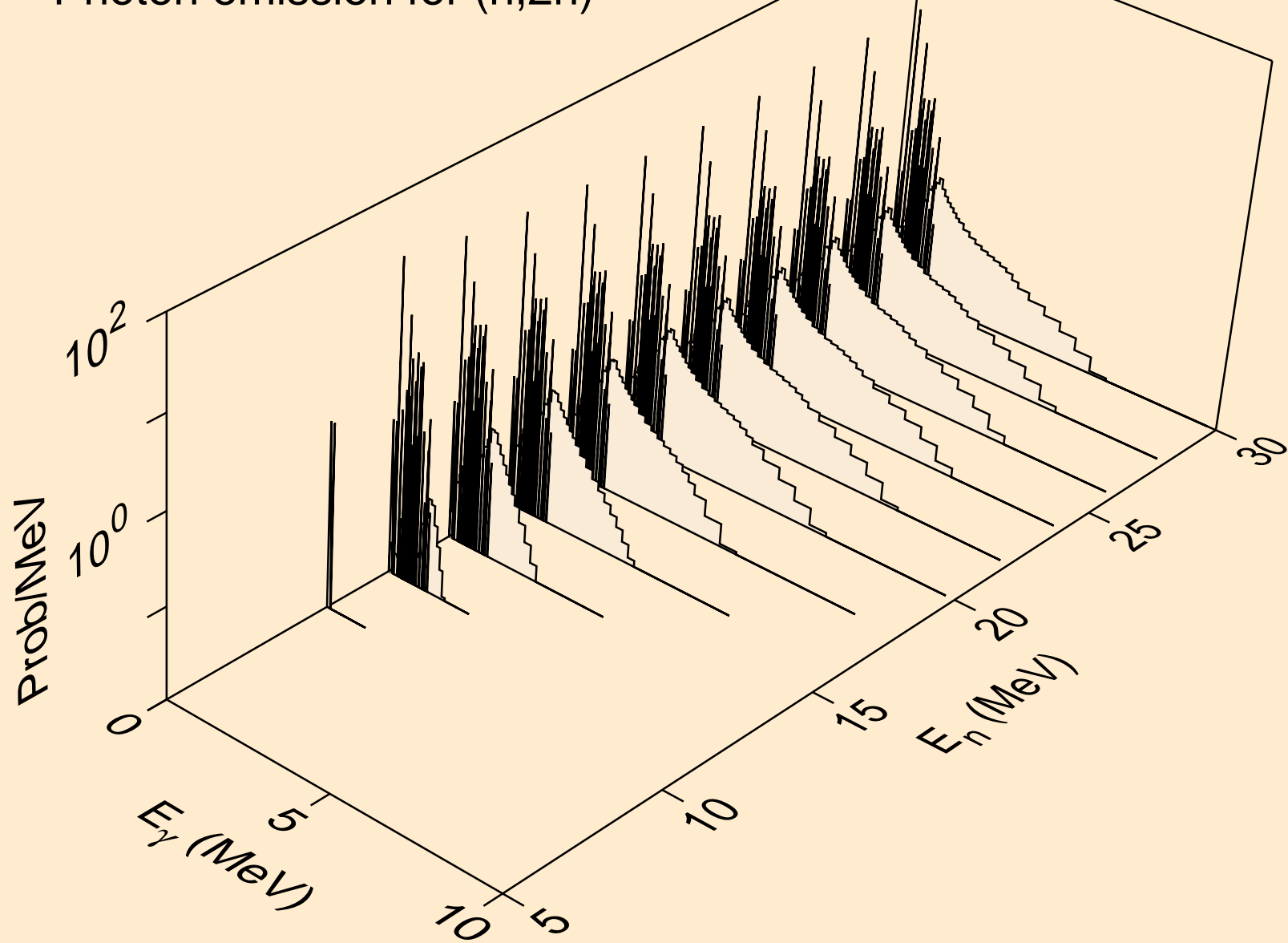



K043 NEUTRON ACER TENDL-2023 LIBRARY; T=0.K  
Photon emission for (n,3n)

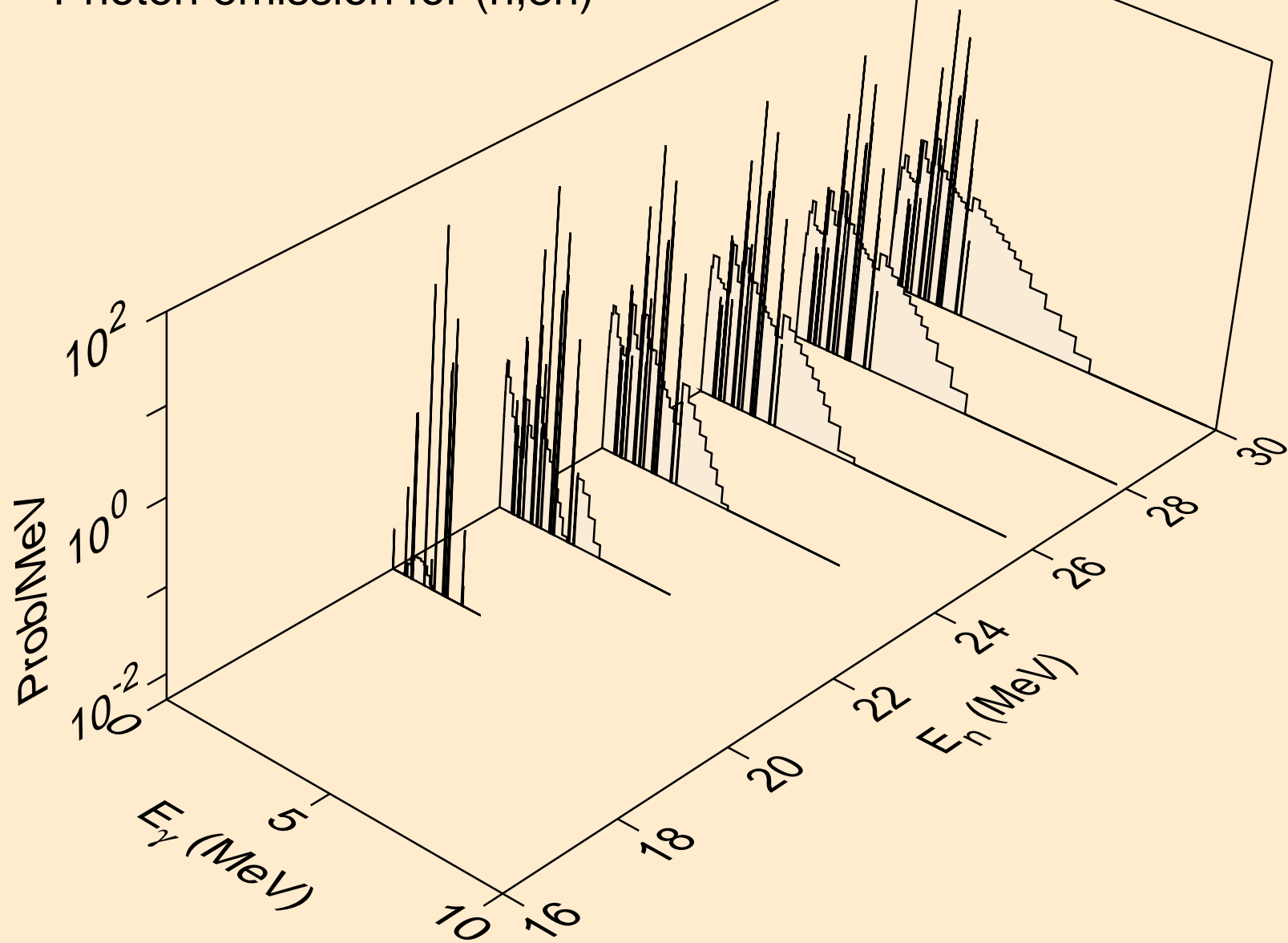

K043 NEUTRON ACER TENDL-2023 LIBRARY; T=0.K  
Photon emission for (n,n\*)a

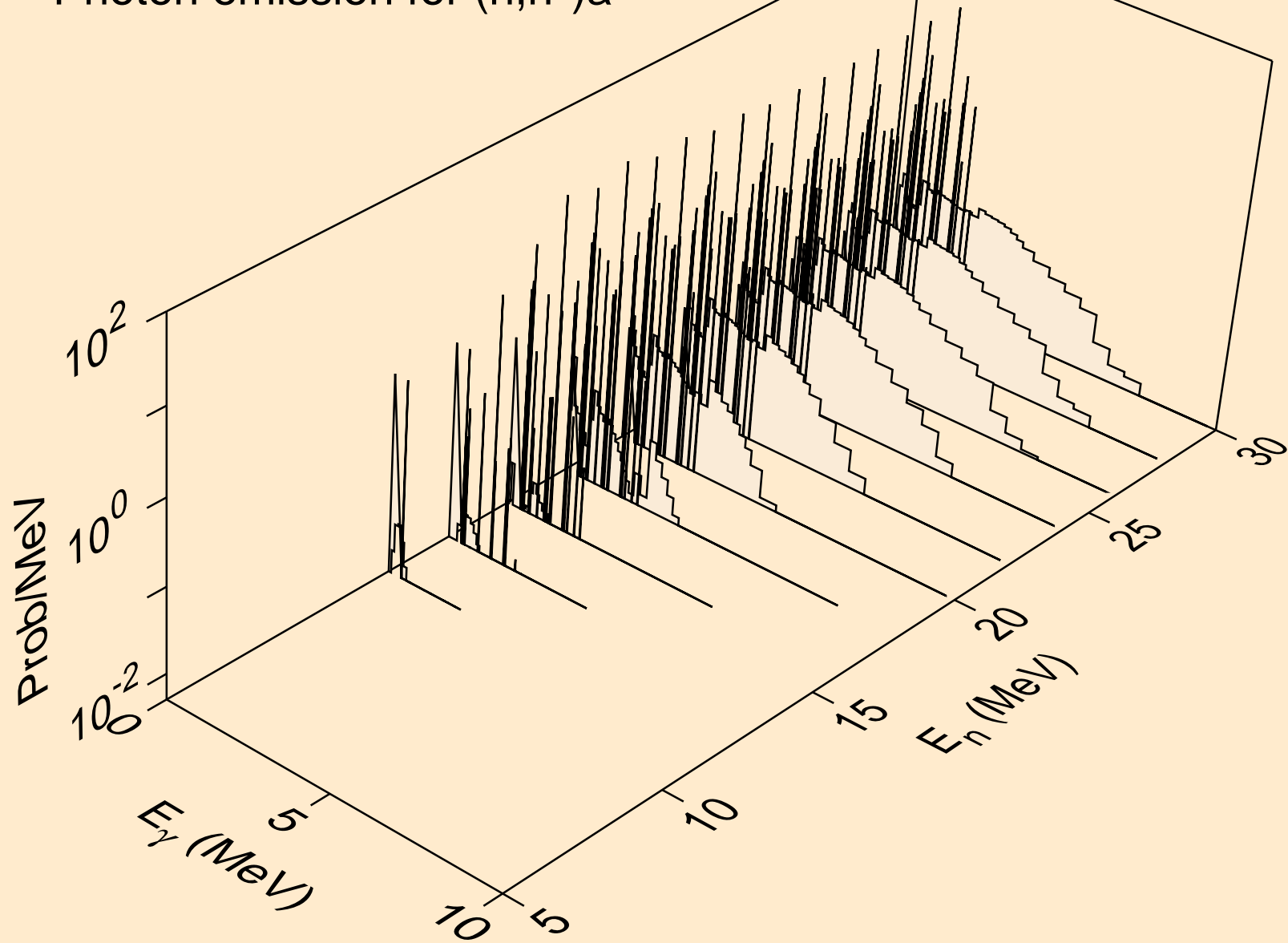

K043 NEUTRON ACER TENDL-2023 LIBRARY; T=0.K  
Photon emission for (n,2n)a

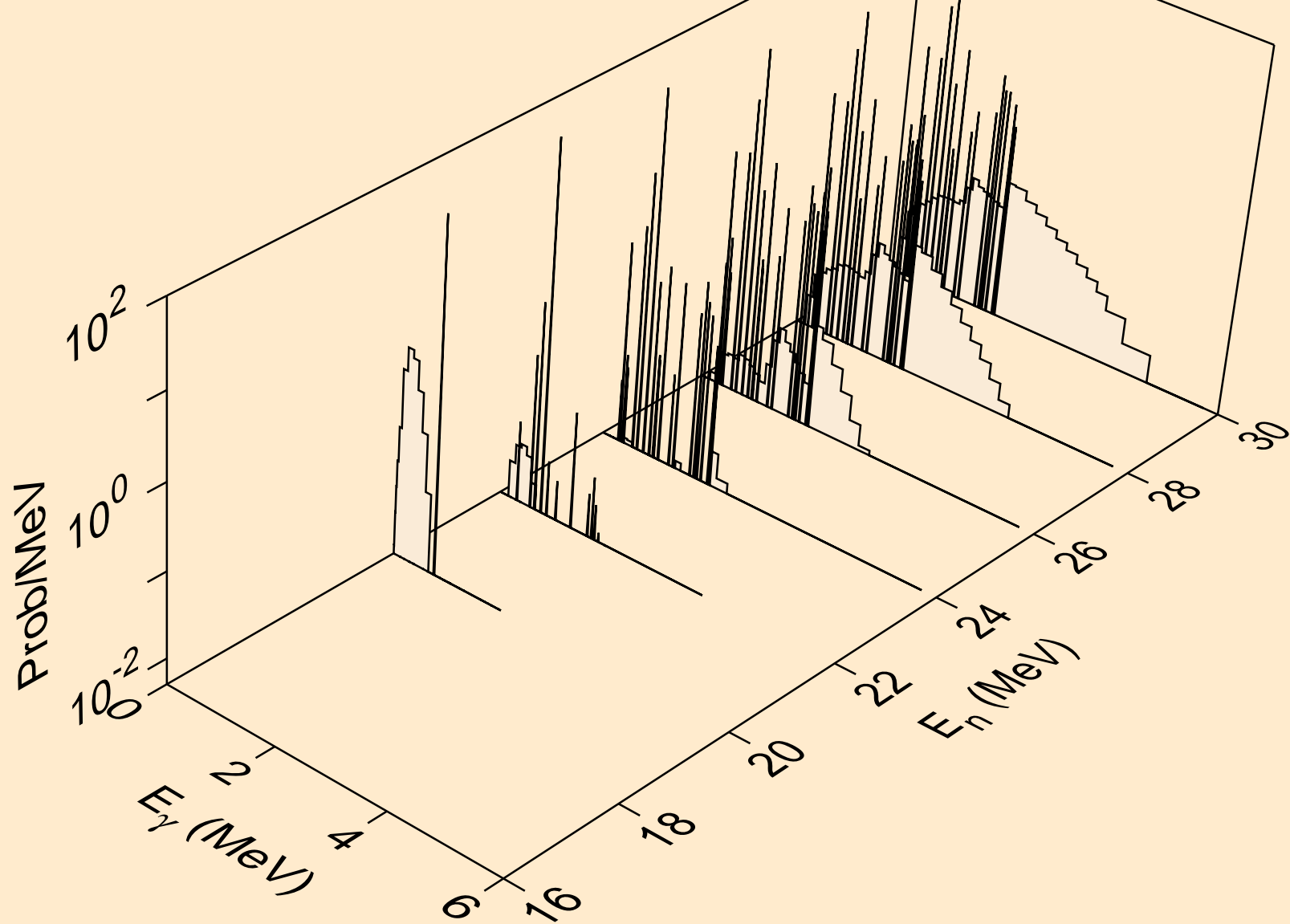

K043 NEUTRON ACER TENDL-2023 LIBRARY; T=0.K  
Photon emission for (n,3n)a

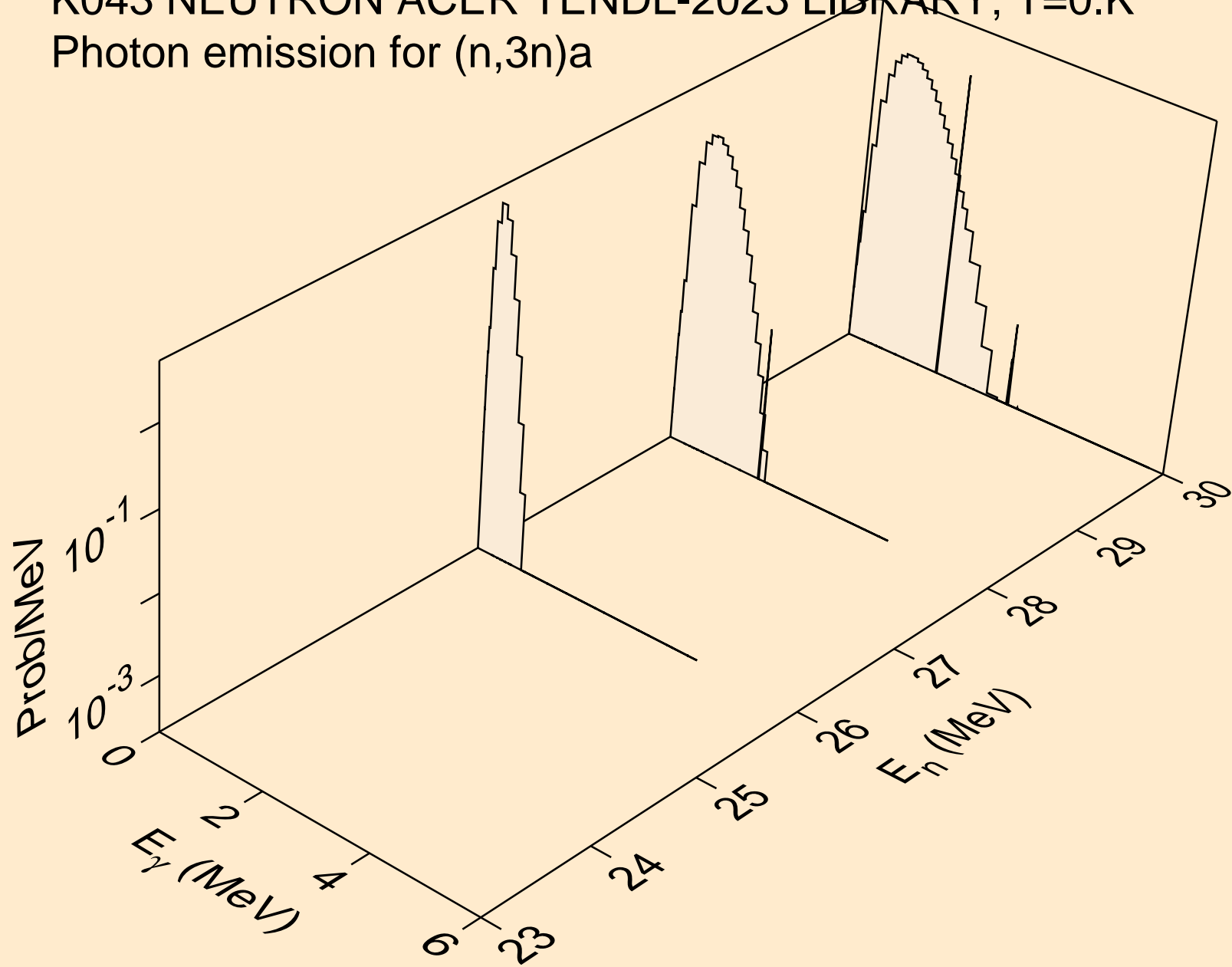

K043 NEUTRON ACER TENDL-2023 LIBRARY; T=0.K  
Photon emission for (n,n\*)p

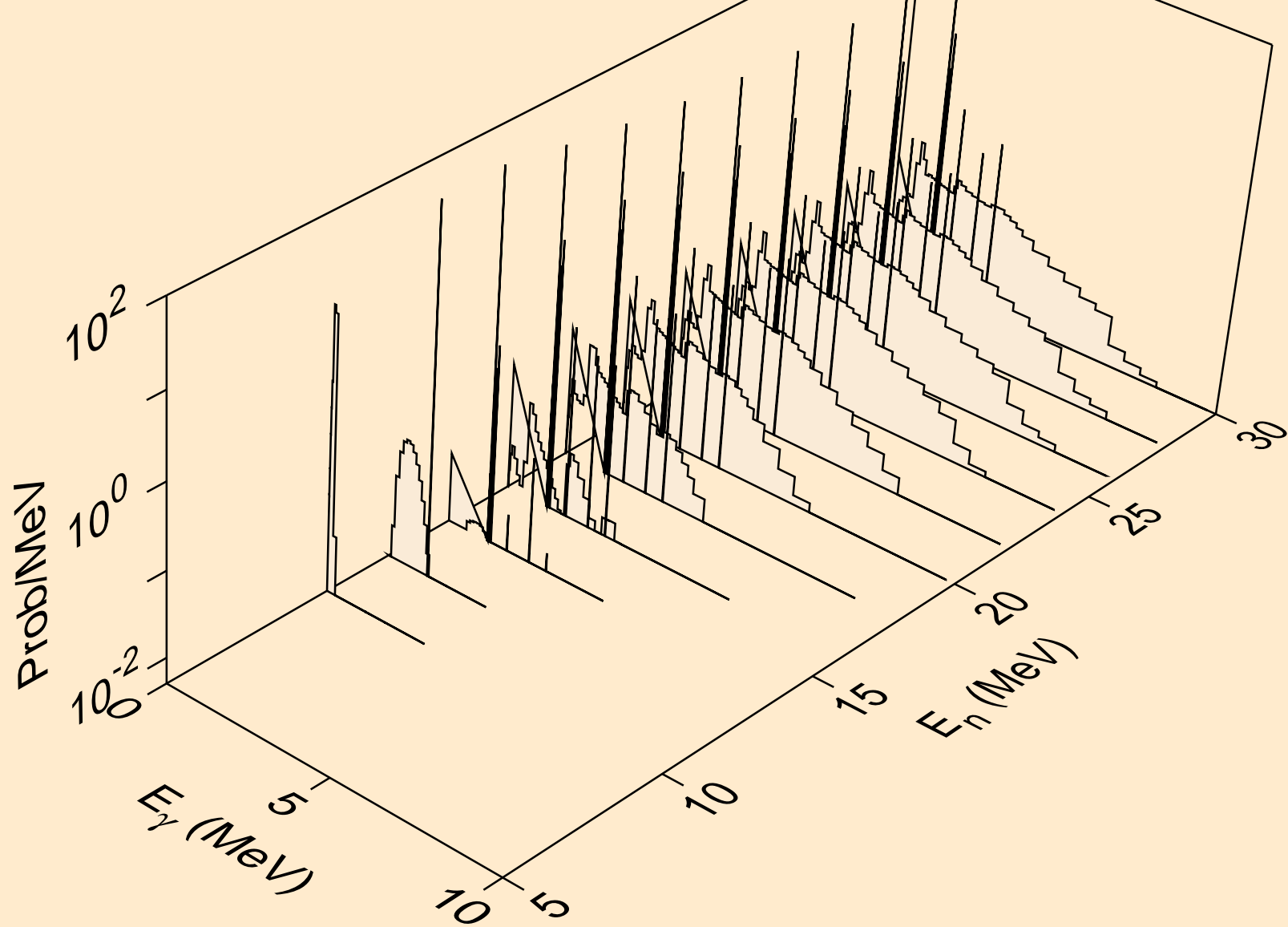

K043 NEUTRON ACER TENDL-2023 LIBRARY; T=0.K  
Photon emission for (n,n\*)2a

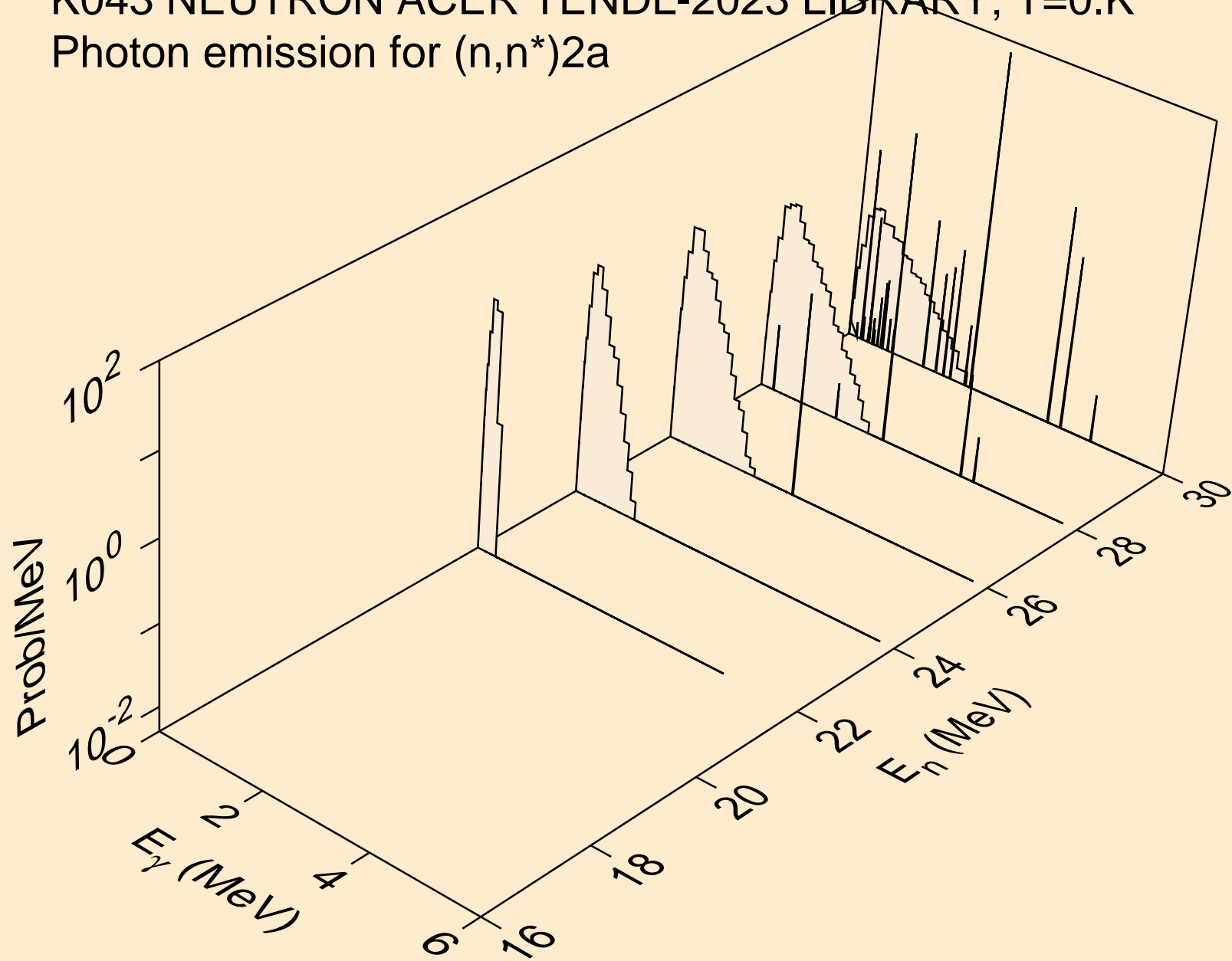

K043 NEUTRON ACER TENDL-2023 LIBRARY; T=0.K  
Photon emission for (n,n\*)d

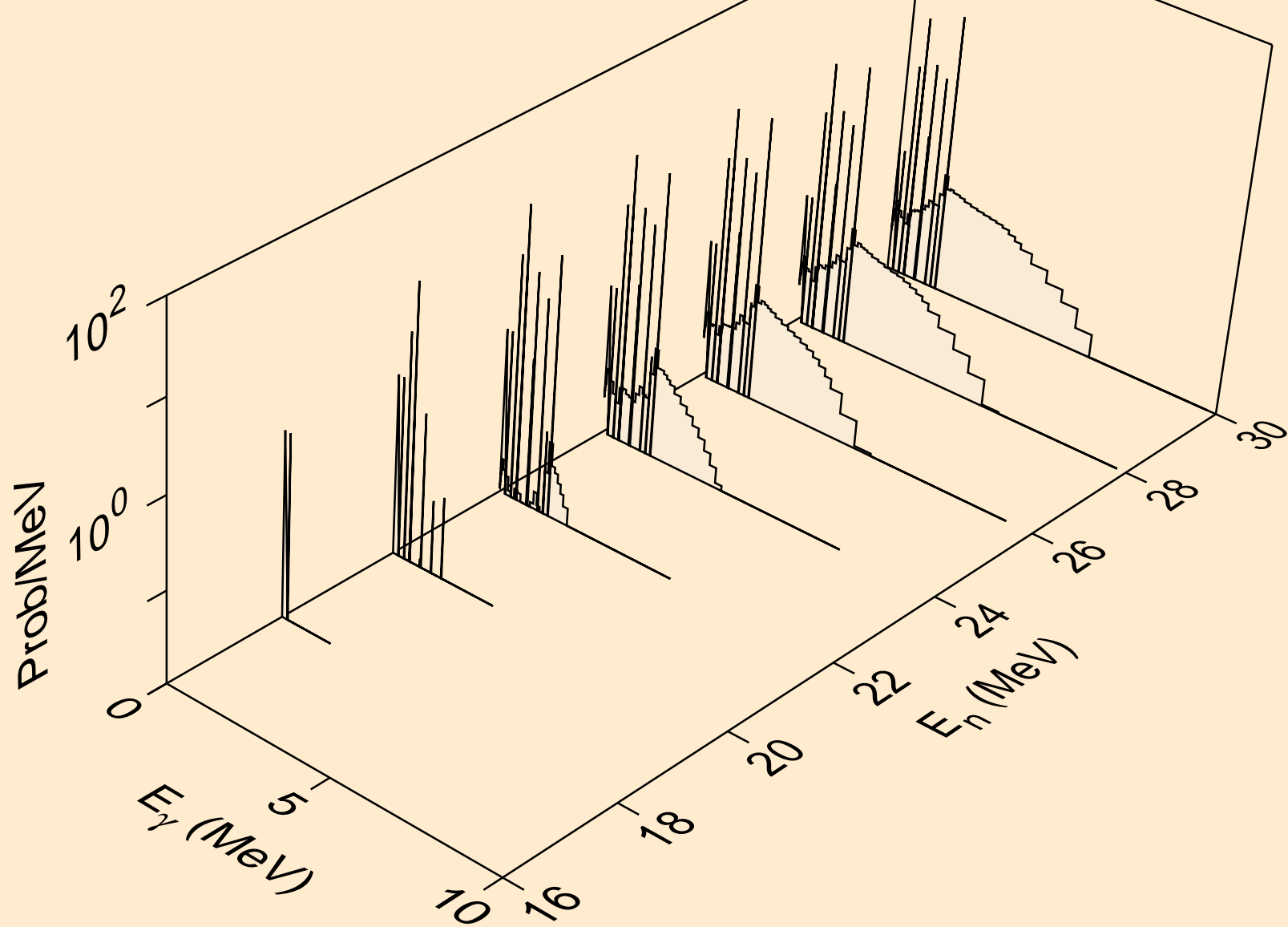

K043 NEUTRON ACER TENDL-2023 LIBRARY; T=0.K  
Photon emission for (n,n\*)t

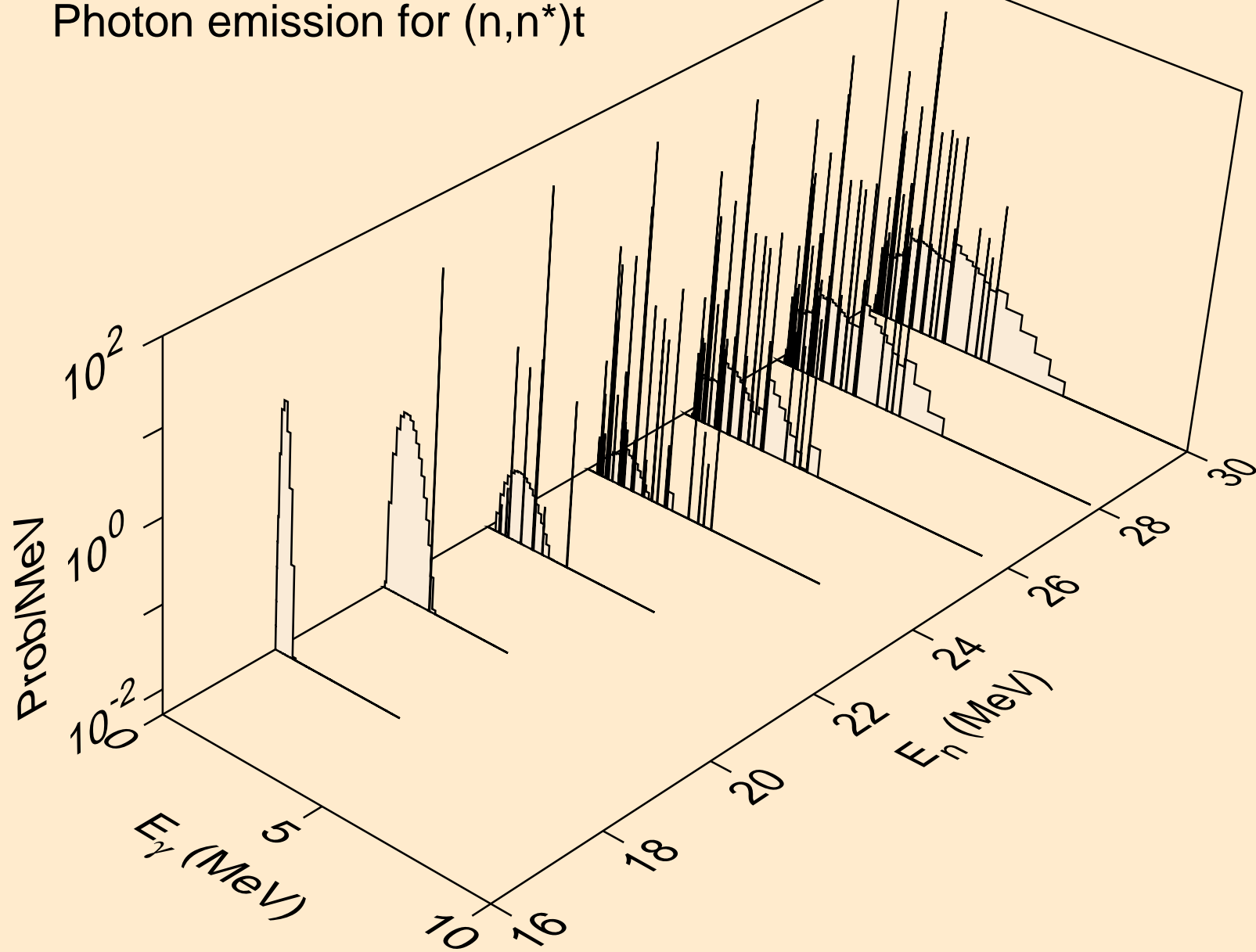



K043 NEUTRON ACER TENDL-2023 LIBRARY; T=0.K  
Photon emission for (n,n\*)he3

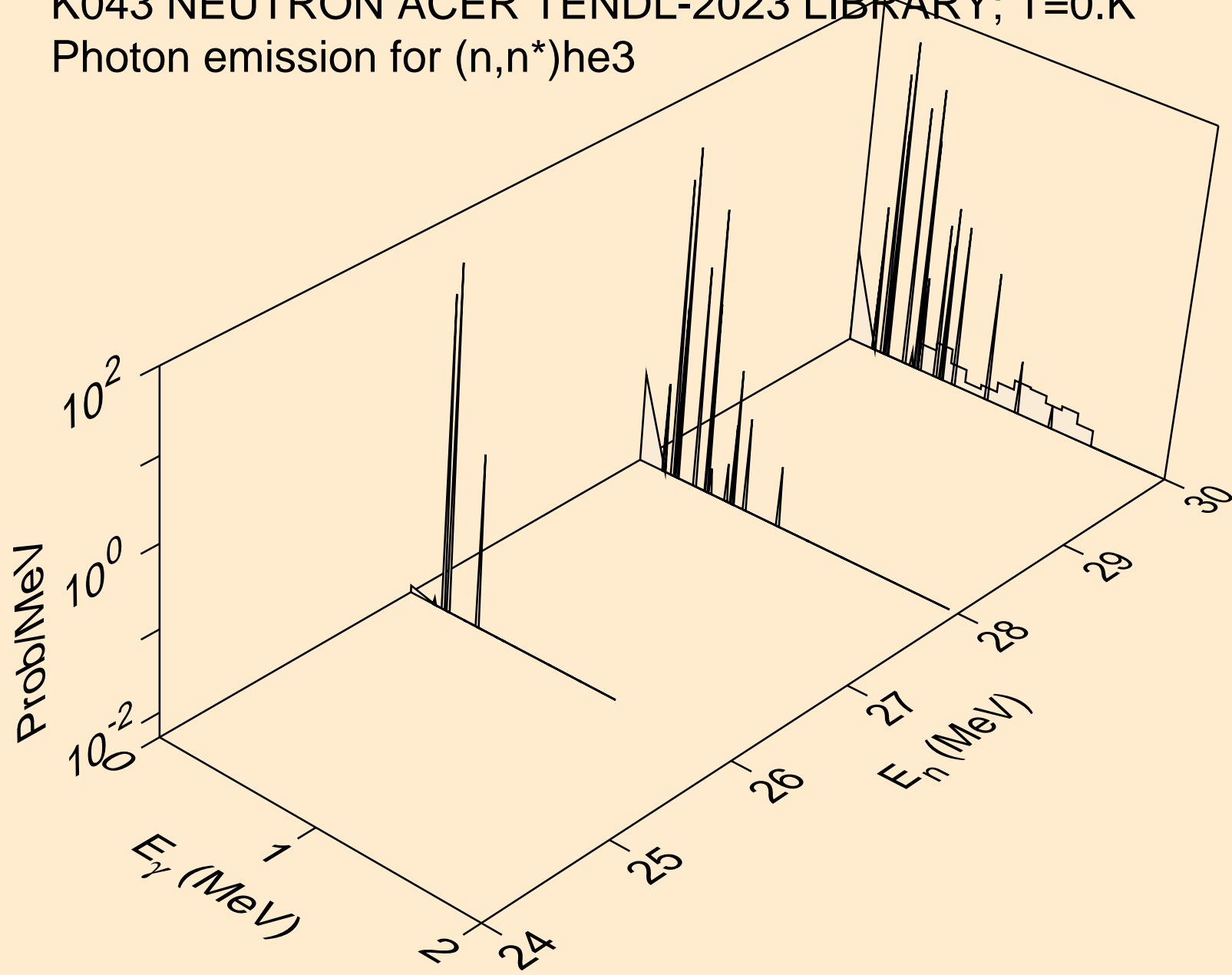

K043 NEUTRON ACER TENDL-2023 LIBRARY; T=0.K  
Photon emission for (n,4n)

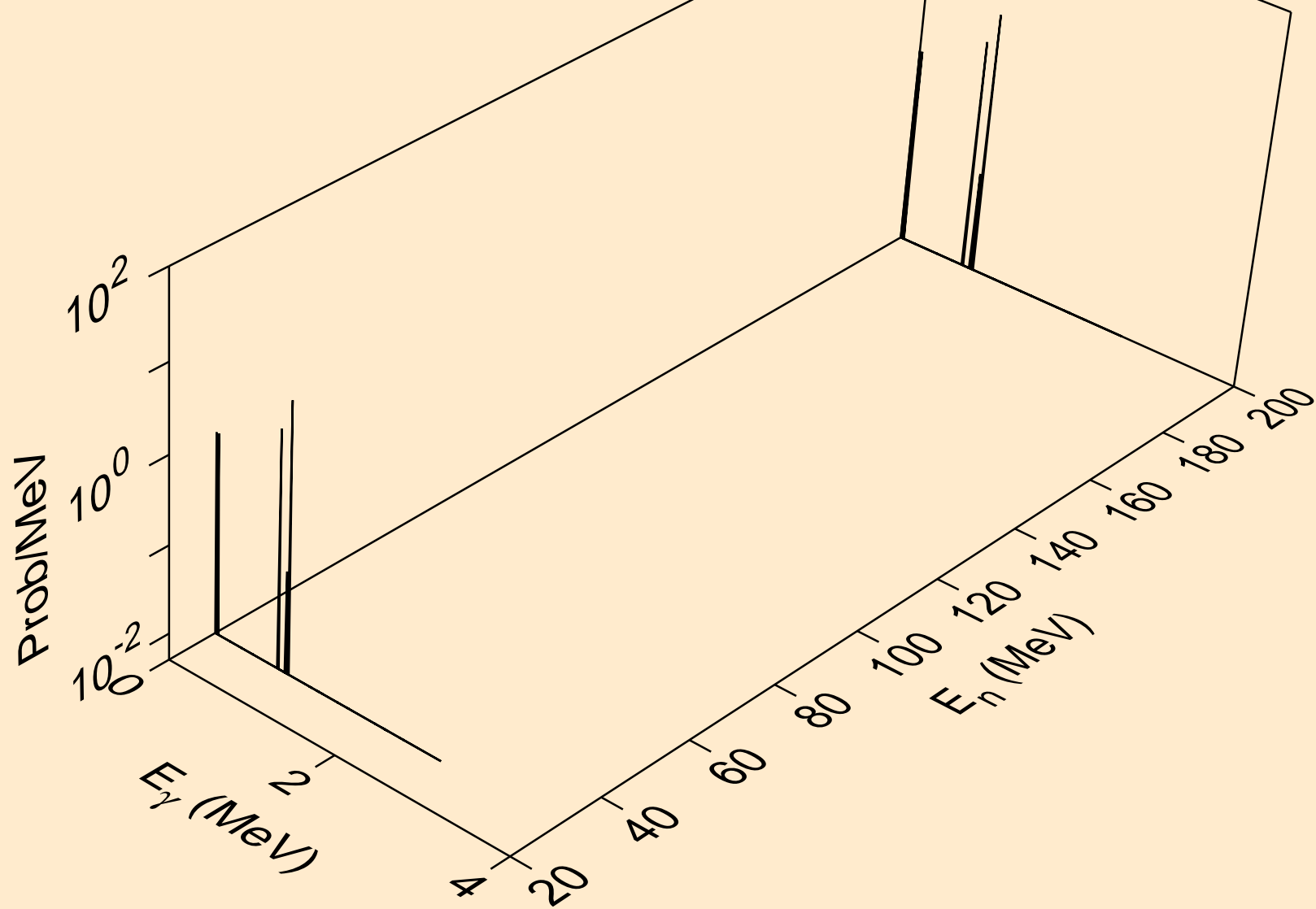

K043 NEUTRON ACER TENDL-2023 LIBRARY; T=0.K  
Photon emission for (n,2np)

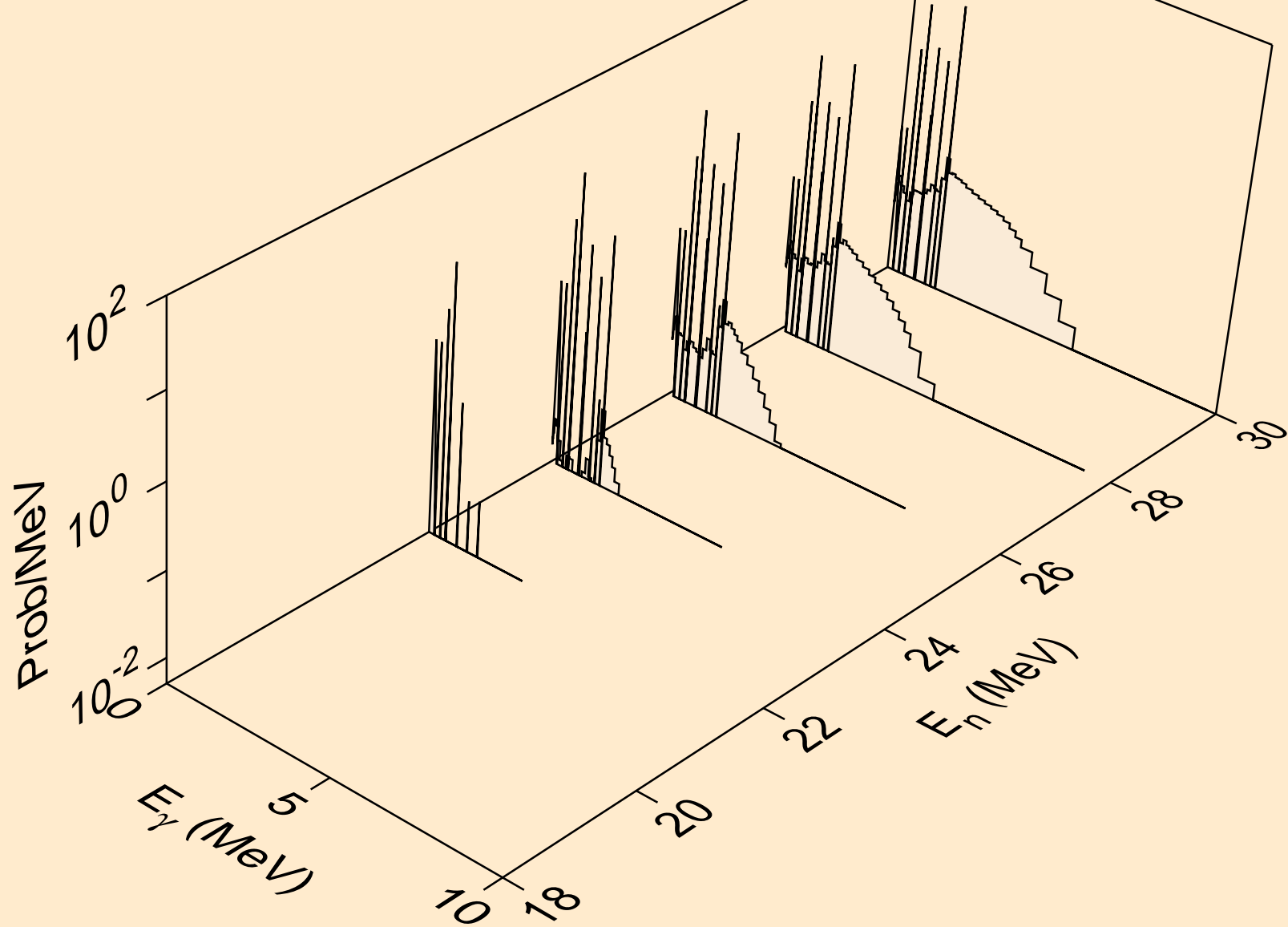

K043 NEUTRON ACER TENDL-2023 LIBRARY; T=0.K  
Photon emission for (n,3np)

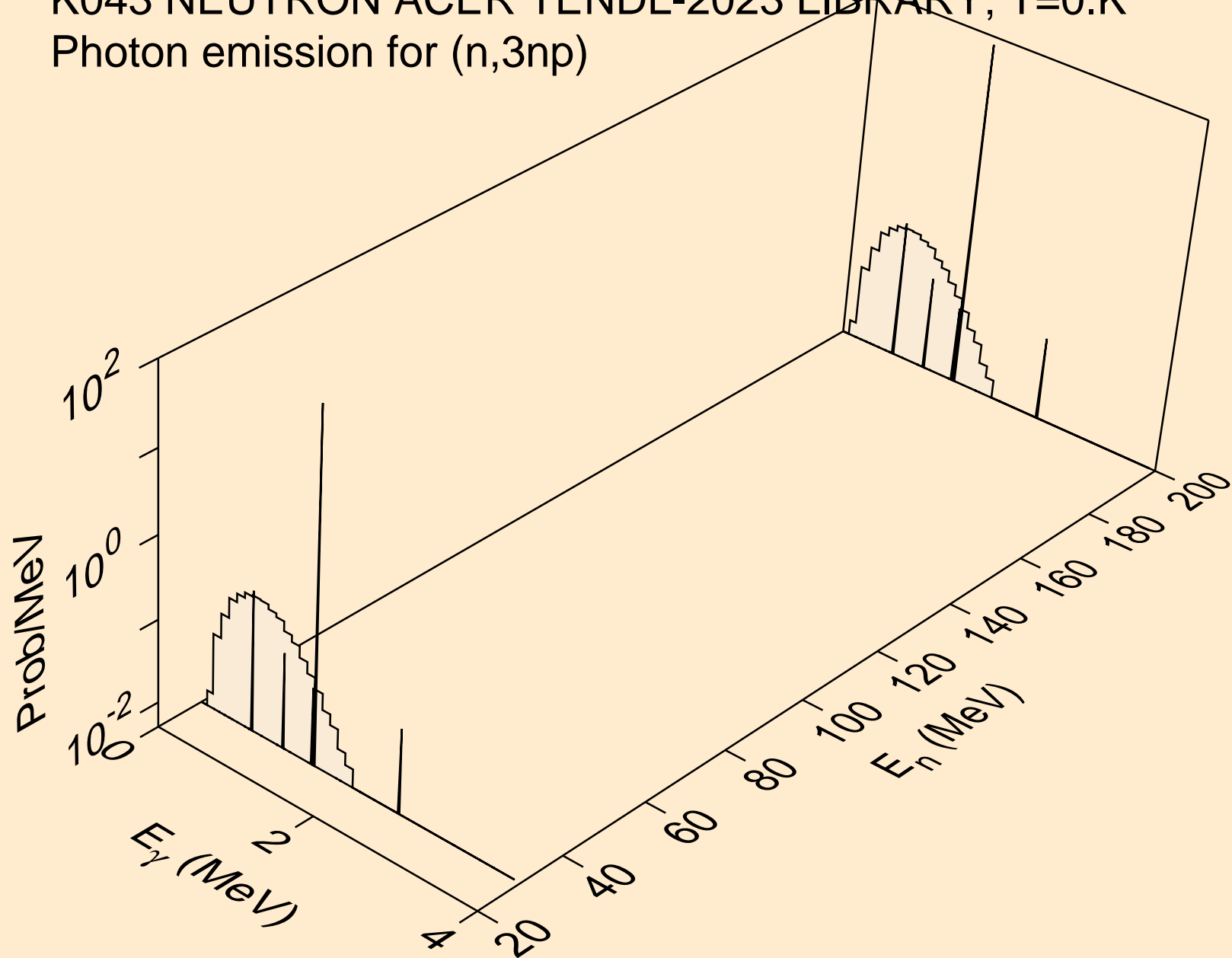

K043 NEUTRON ACER TENDL-2023 LIBRARY; T=0.K  
Photon emission for (n,n2p)

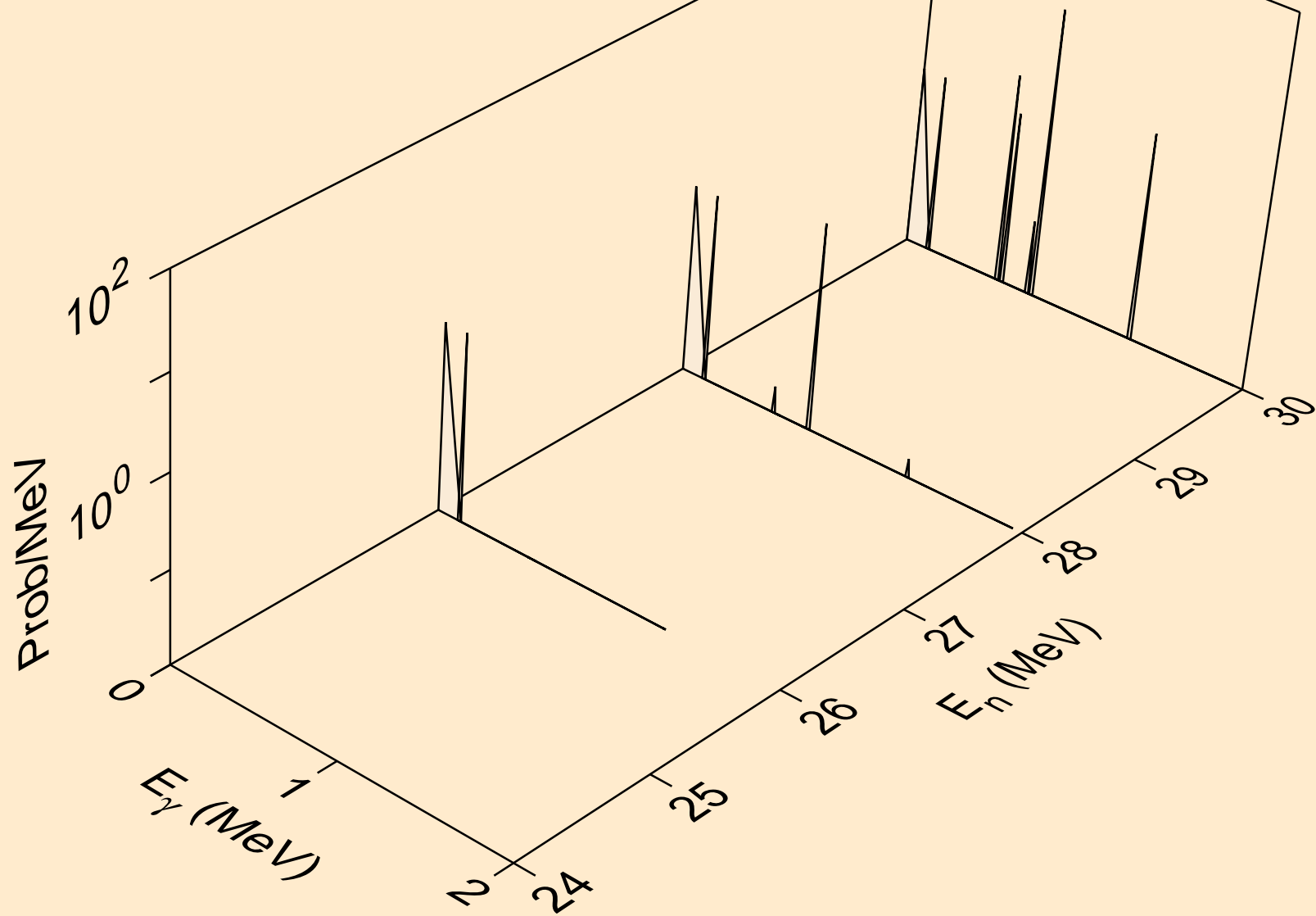

K043 NEUTRON ACER TENDL-2023 LIBRARY; T=0.K  
Photon emission for (n,npa)

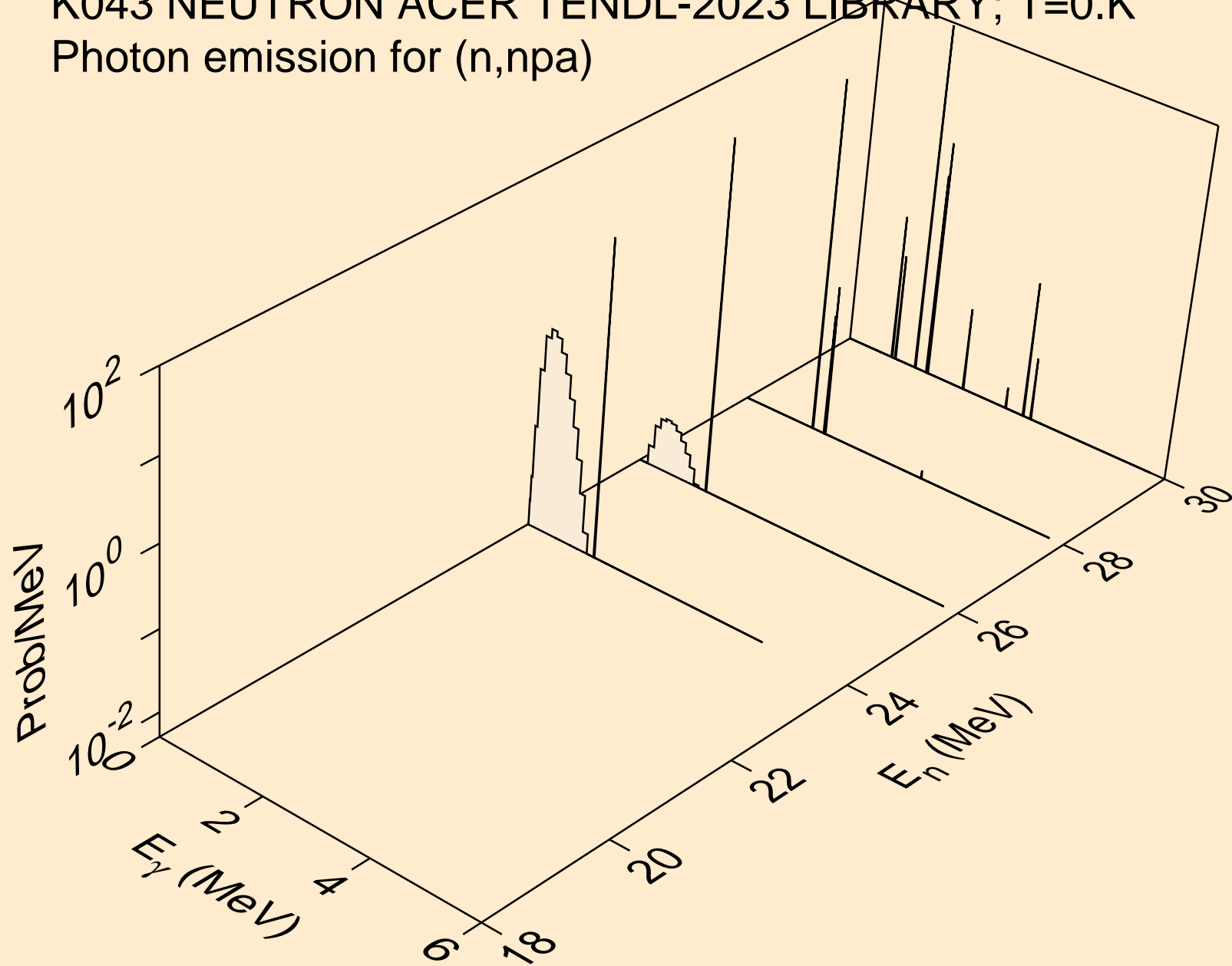

K043 NEUTRON ACER TENDL-2023 LIBRARY; T=0.K  
Photon emission for (n,n\*c)

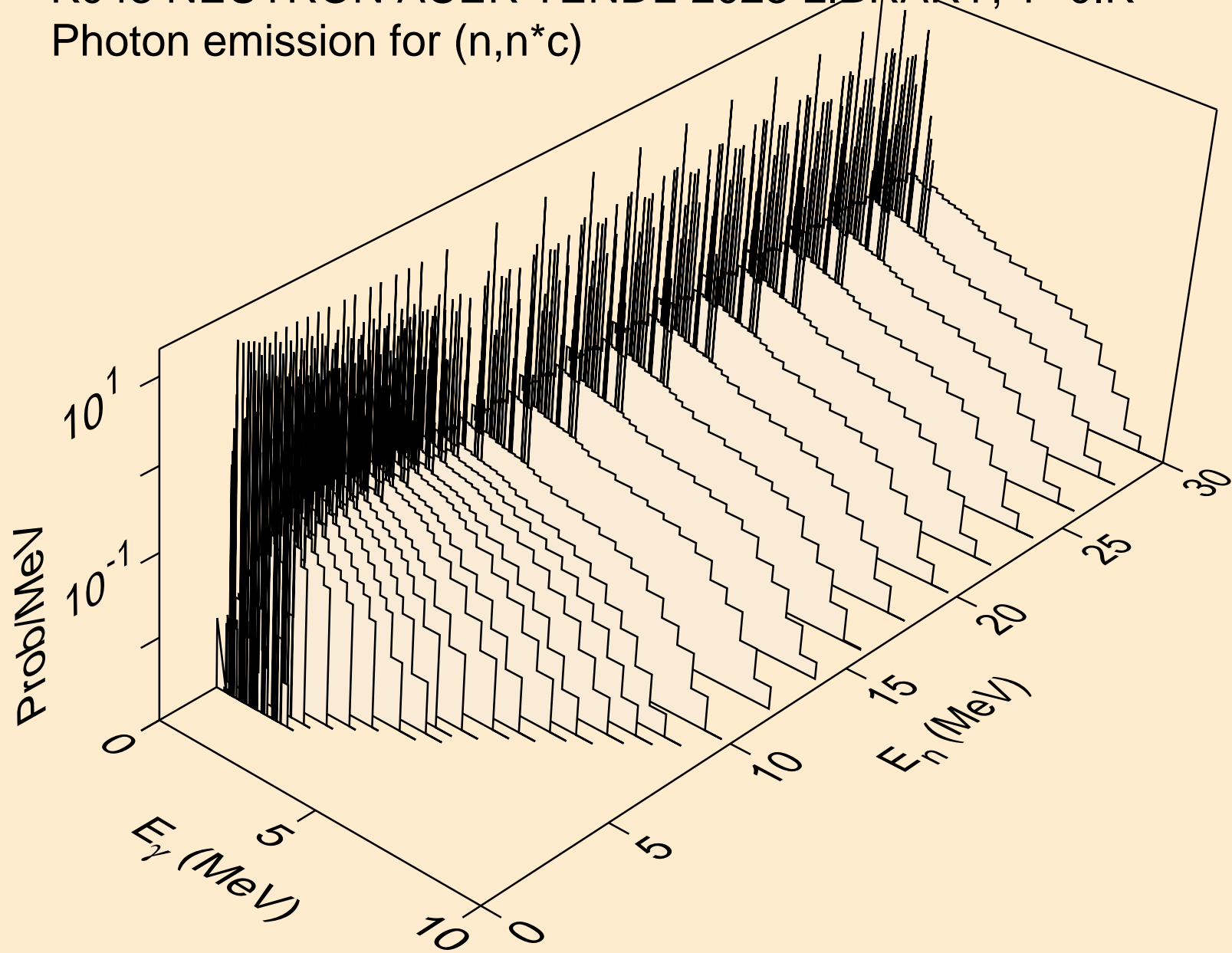

K043 NEUTRON ACER TENDL-2023 LIBRARY; T=0.K  
Photon emission for (n,gma)

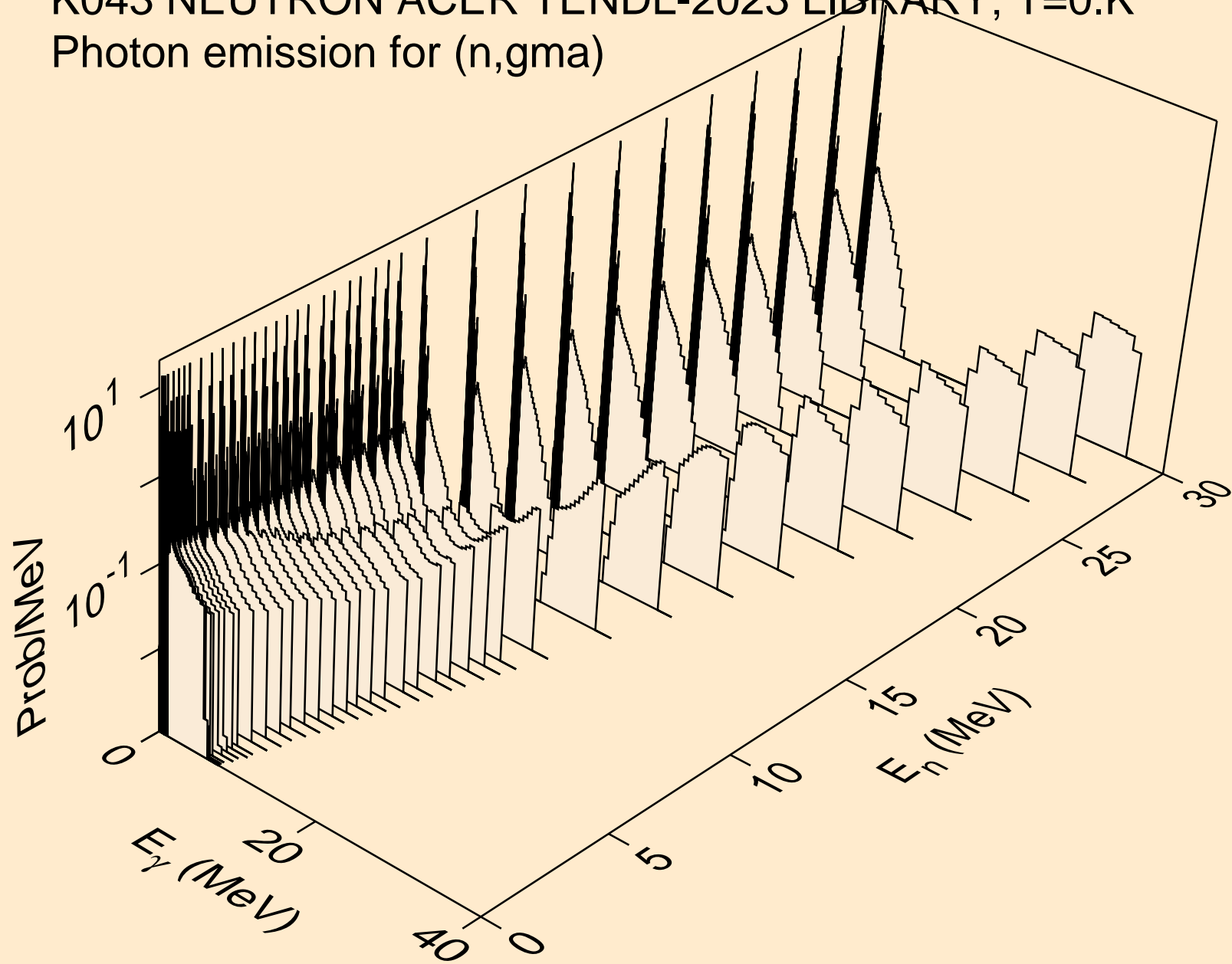



K043 NEUTRON ACER TENDL-2023 LIBRARY; T=0.K  
Photon emission for (n,p)

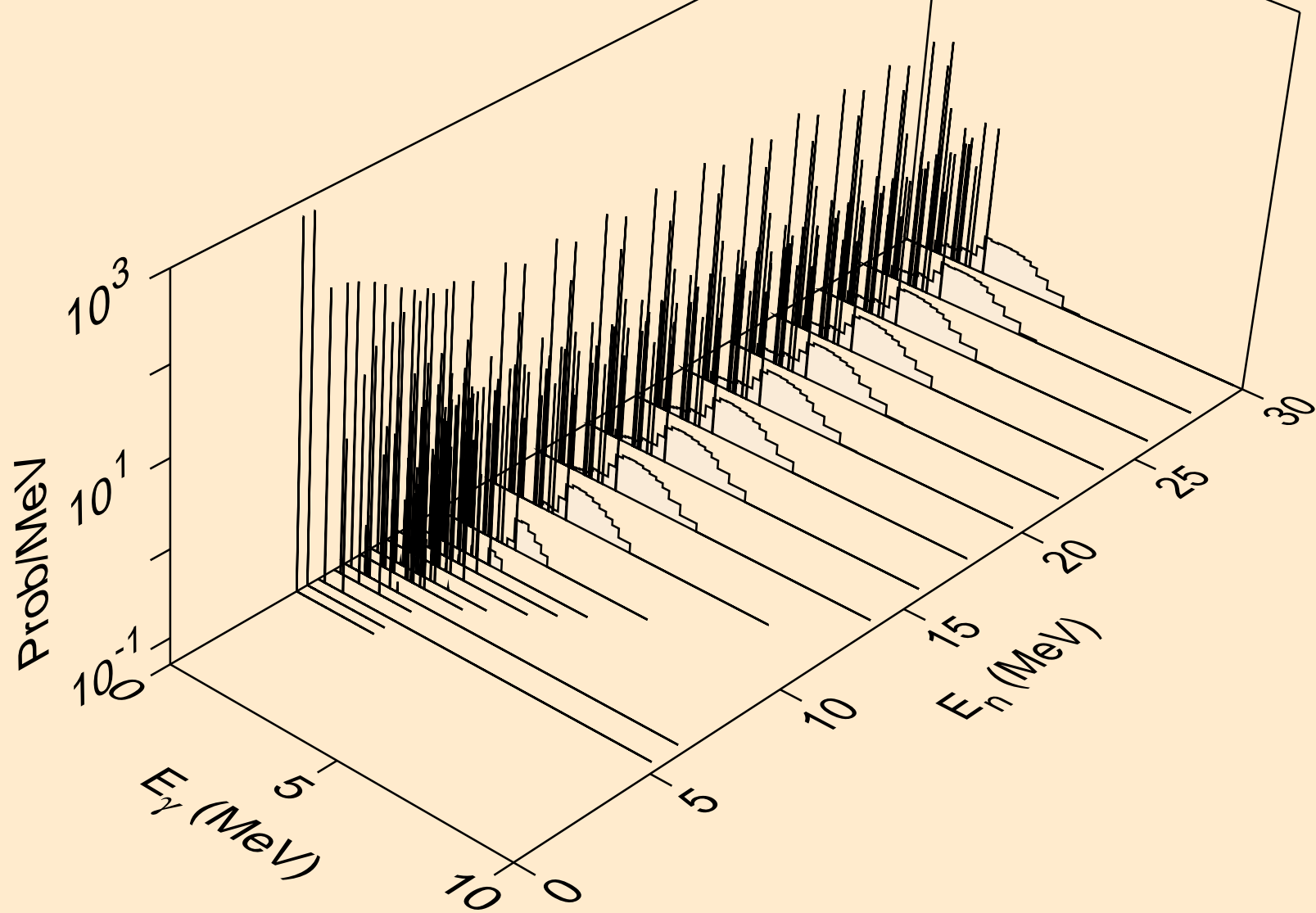

K043 NEUTRON ACER TENDL-2023 LIBRARY; T=0.K  
Photon emission for (n,d)

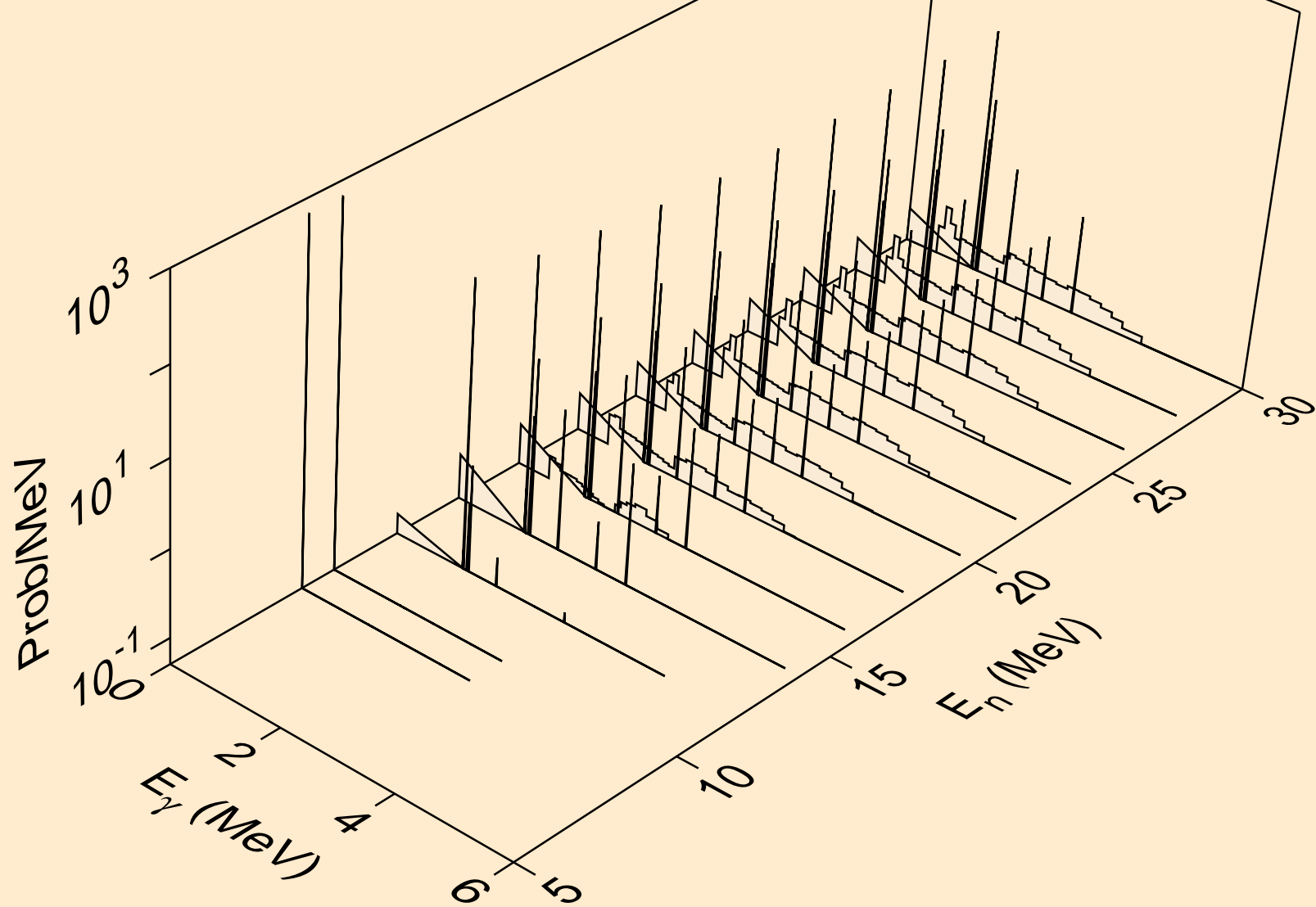

K043 NEUTRON ACER TENDL-2023 LIBRARY; T=0.K  
Photon emission for (n,t)

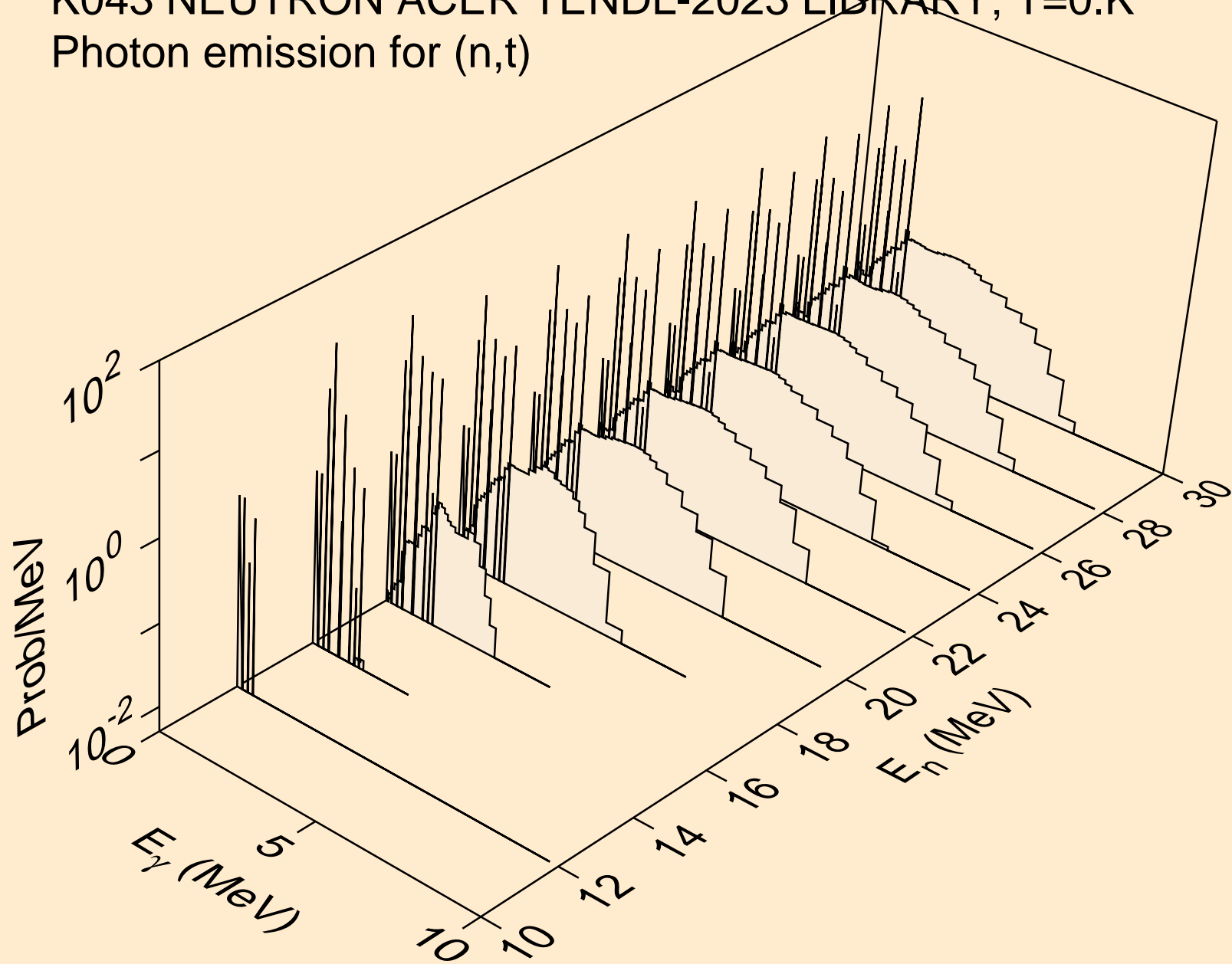

K043 NEUTRON ACER TENDL-2023 LIBRARY; T=0.K  
Photon emission for (n,he3)

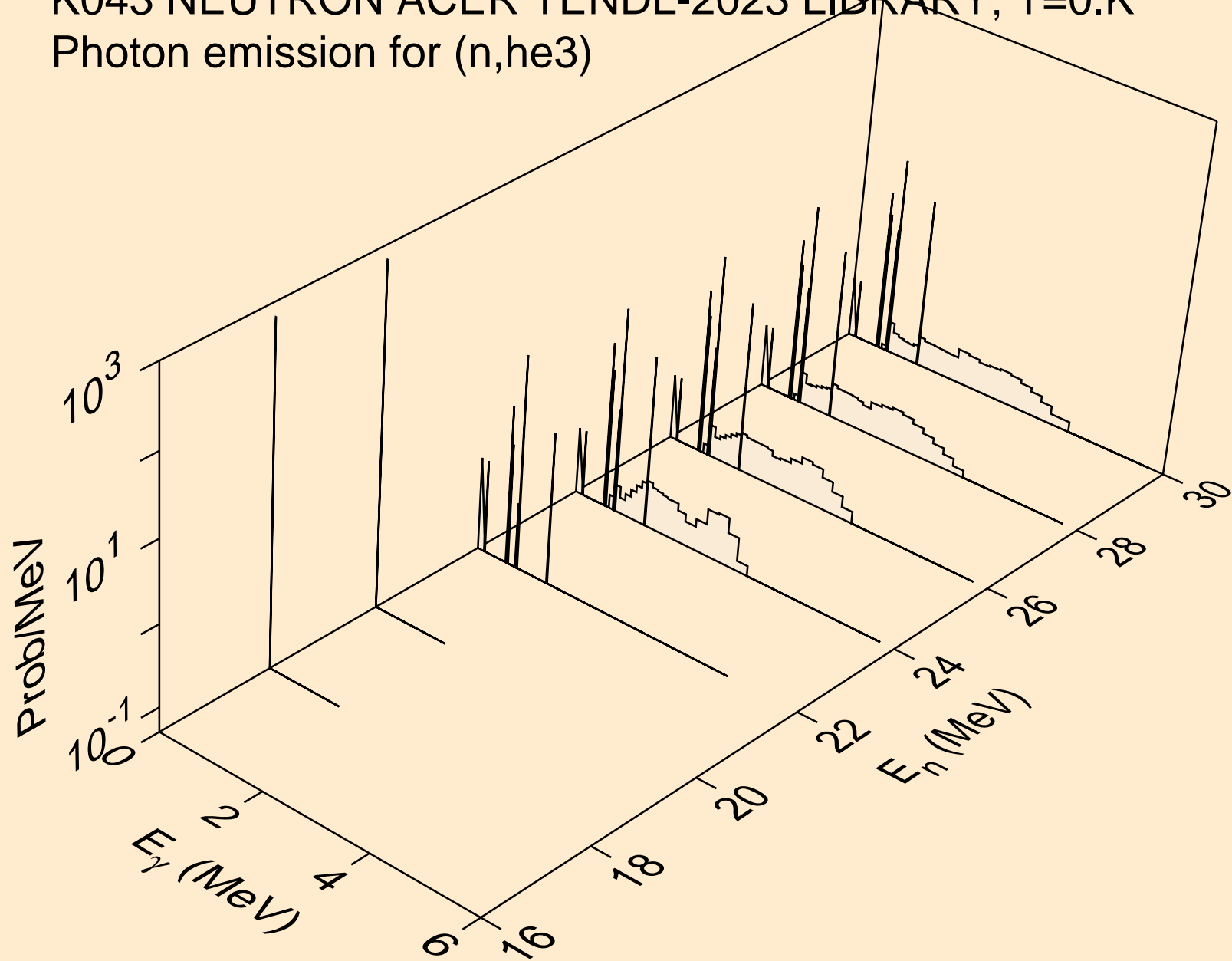

K043 NEUTRON ACER TENDL-2023 LIBRARY; T=0.K  
Photon emission for (n,a)

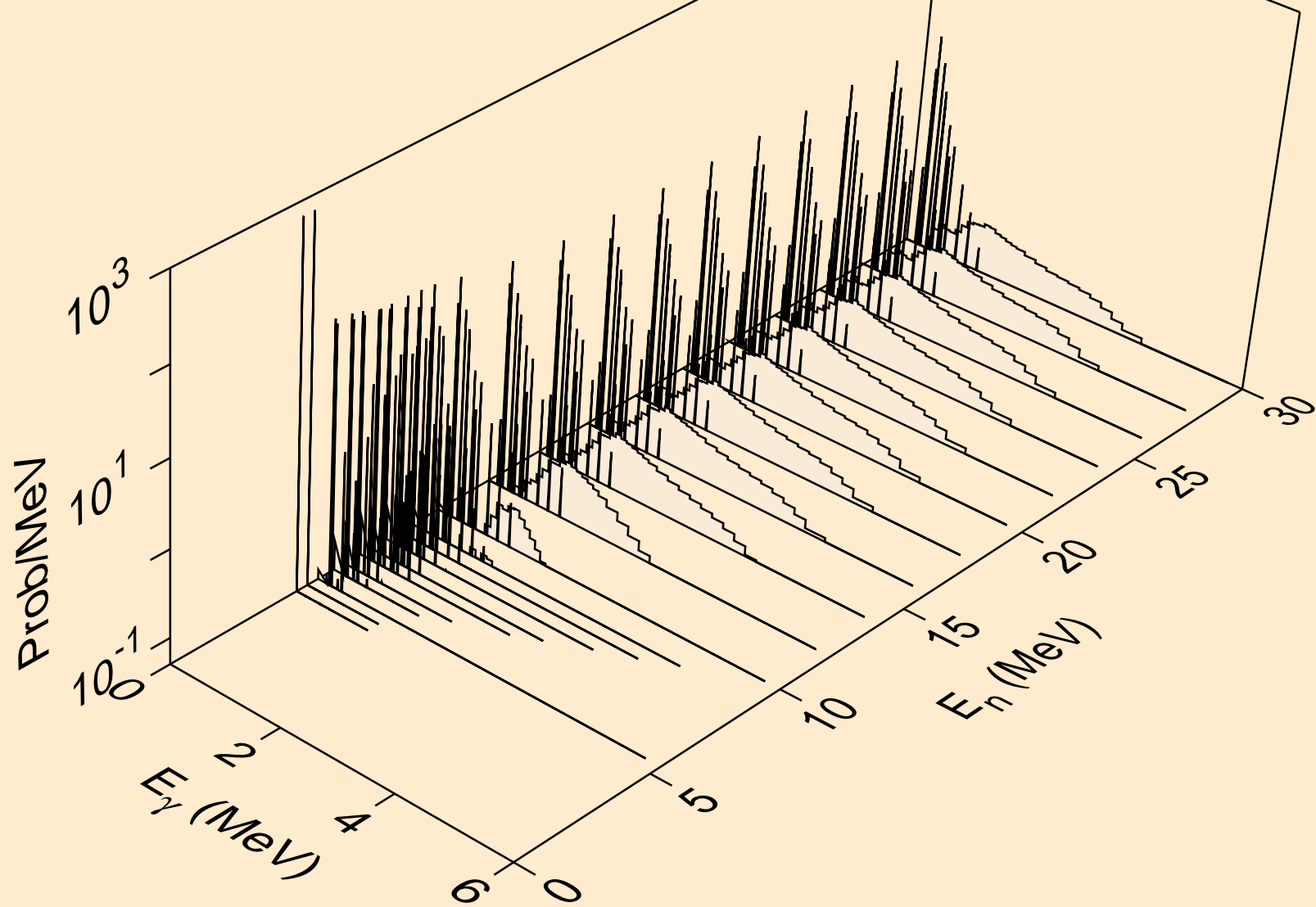

K043 NEUTRON ACER TENDL-2023 LIBRARY; T=0.K  
Photon emission for (n,2a)

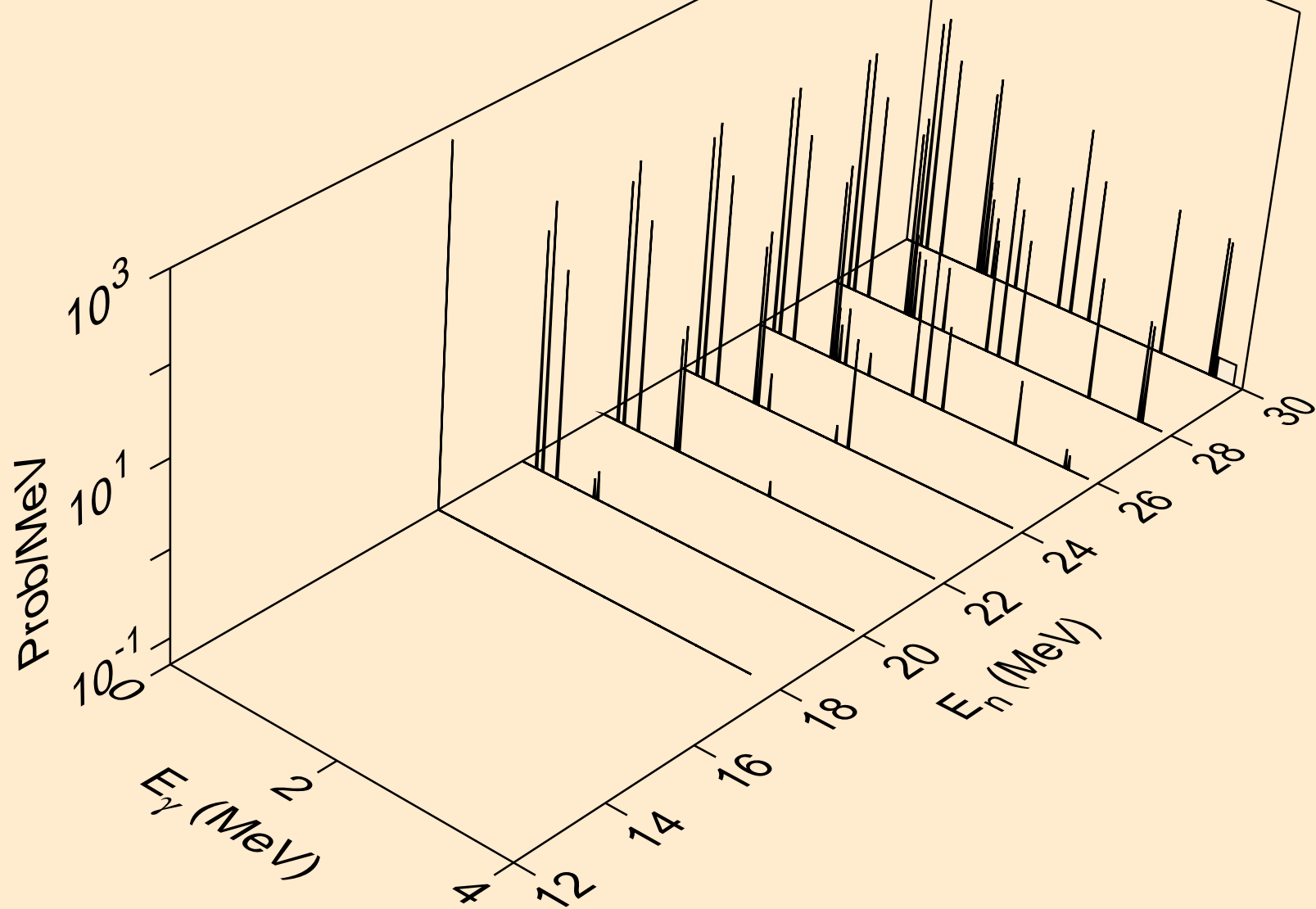

K043 NEUTRON ACER TENDL-2023 LIBRARY; T=0.K  
Photon emission for (n,2p)

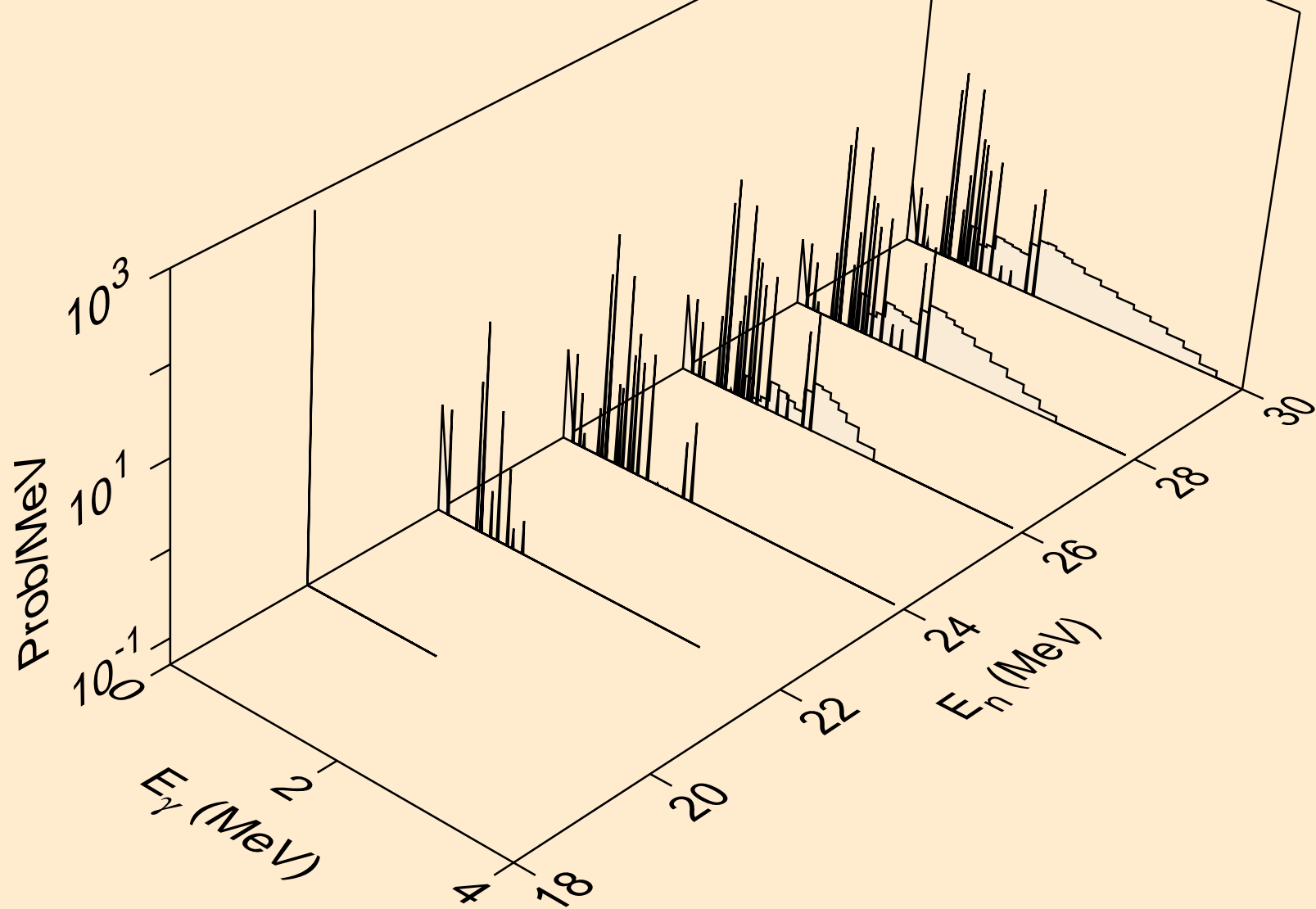

K043 NEUTRON ACER TENDL-2023 LIBRARY; T=0.K  
Photon emission for (n,p $\alpha$ )

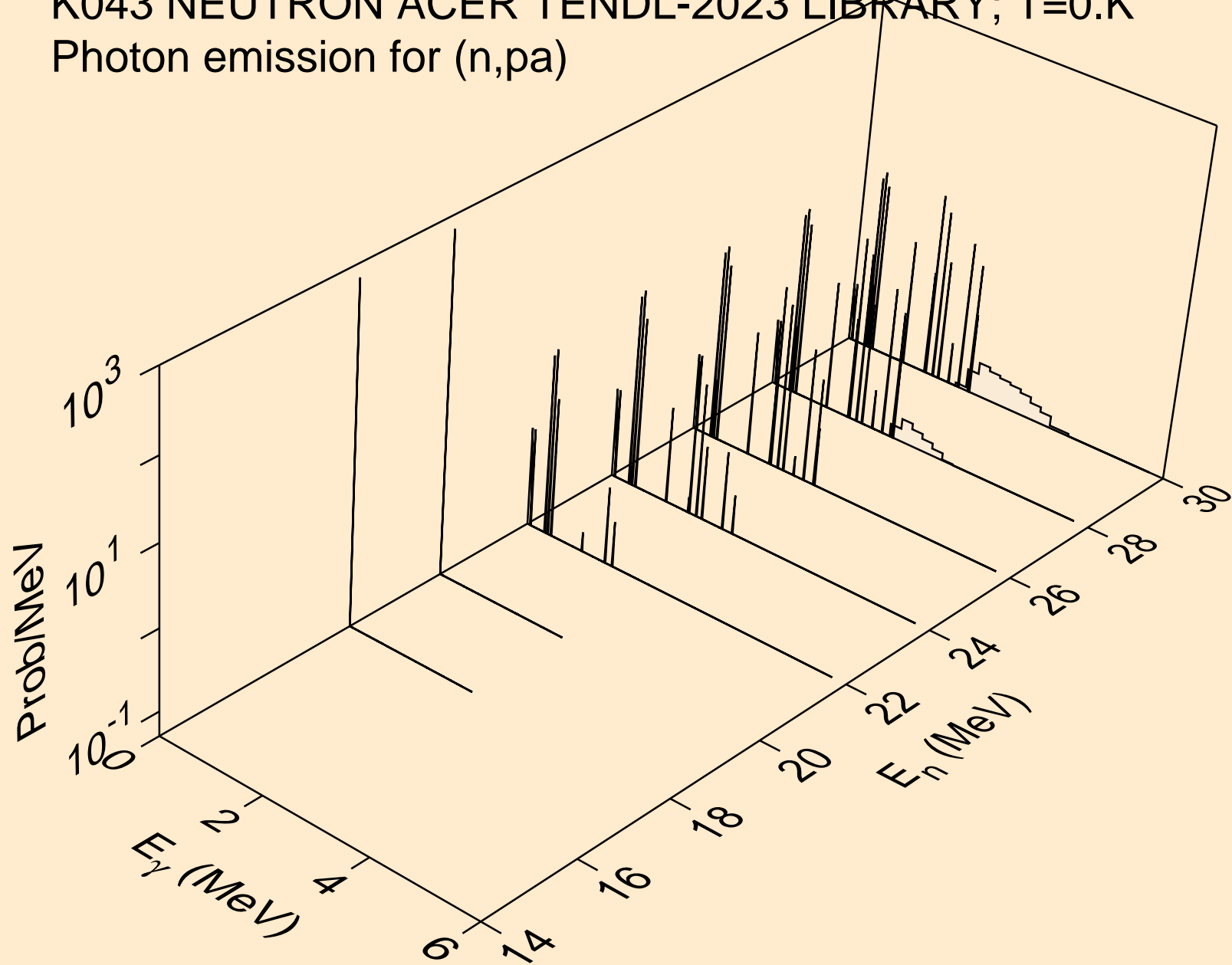



K043 NEUTRON ACER TENDL-2023 LIBRARY; T=0.K  
Photon emission for (n,pd)

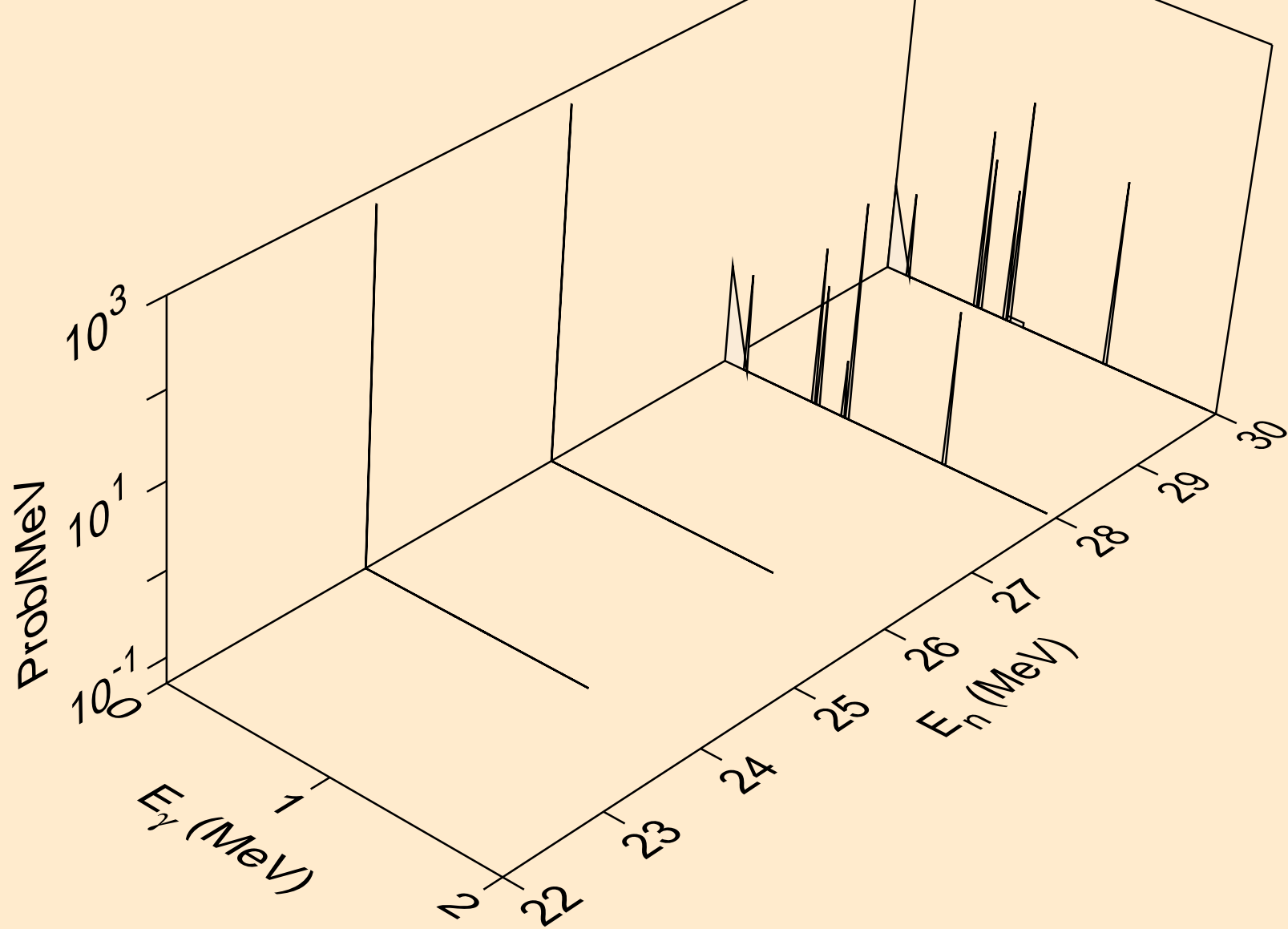

K043 NEUTRON ACER TENDL-2023 LIBRARY; T=0.K  
Photon emission for (n,pt)

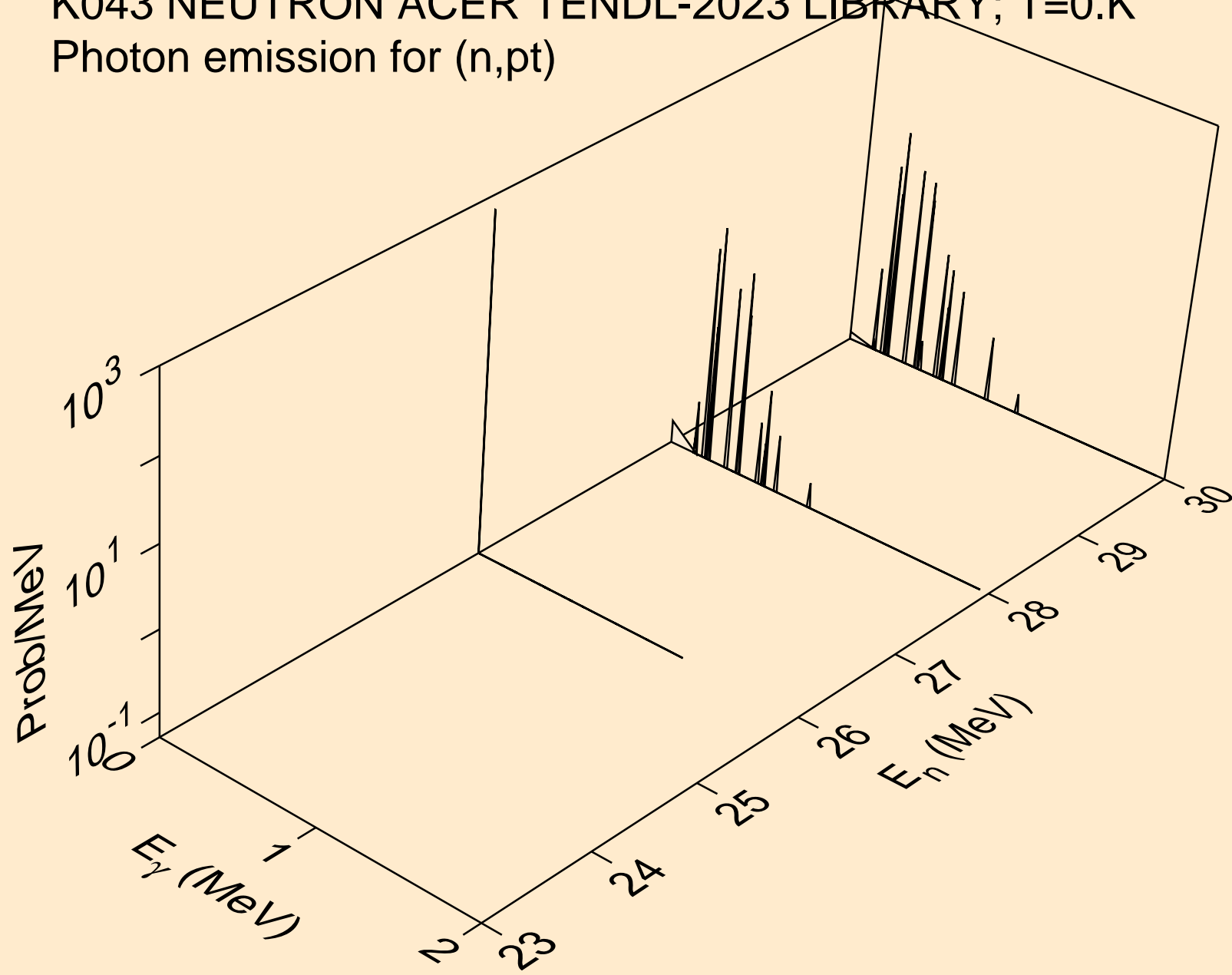

K043 NEUTRON ACER TENDL-2023 LIBRARY; T=0.K  
Photon emission for (n,da)

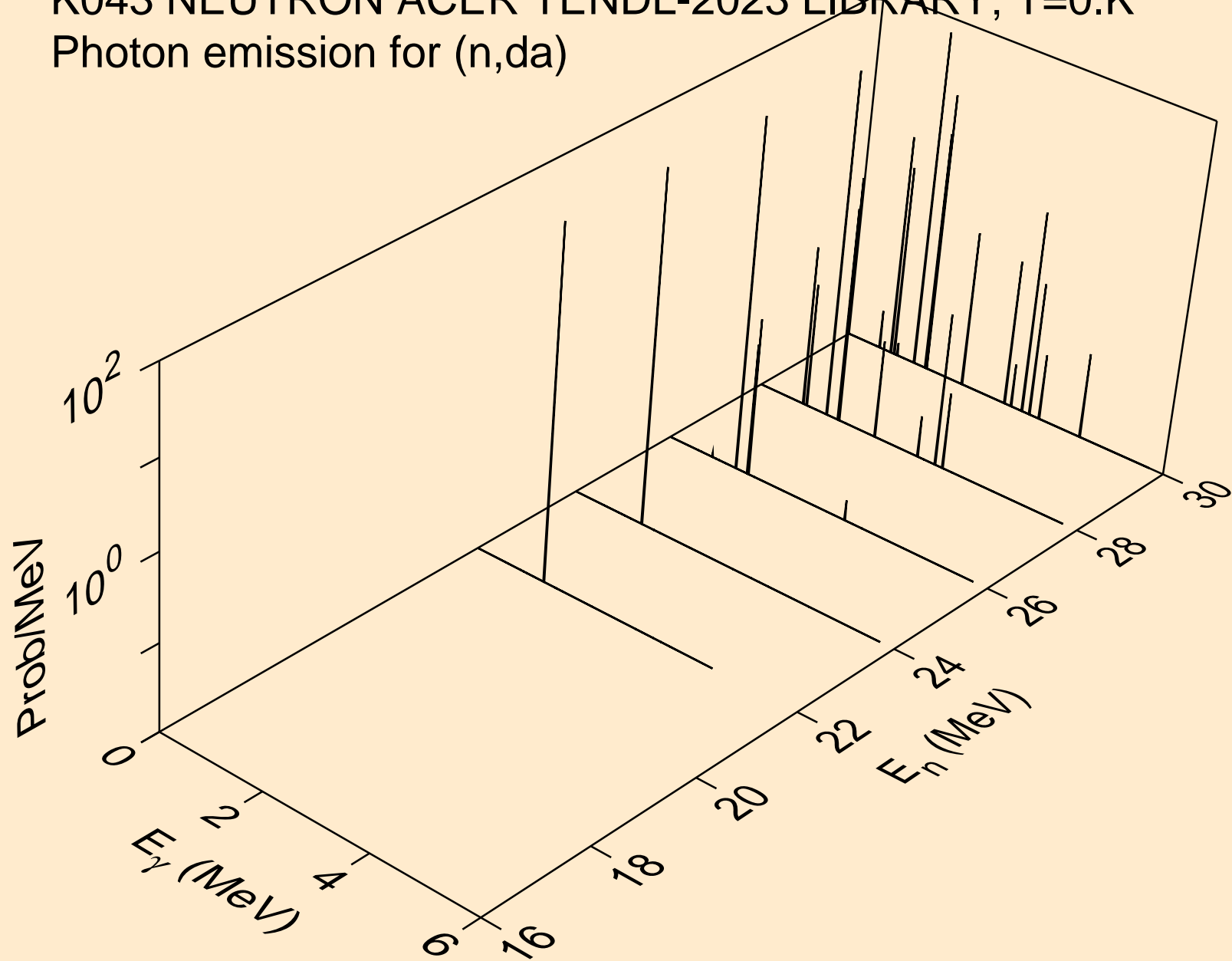

K043 NEUTRON ACER TENDL-2023 LIBRARY; T=0.K  
thermal capture photon spectrum

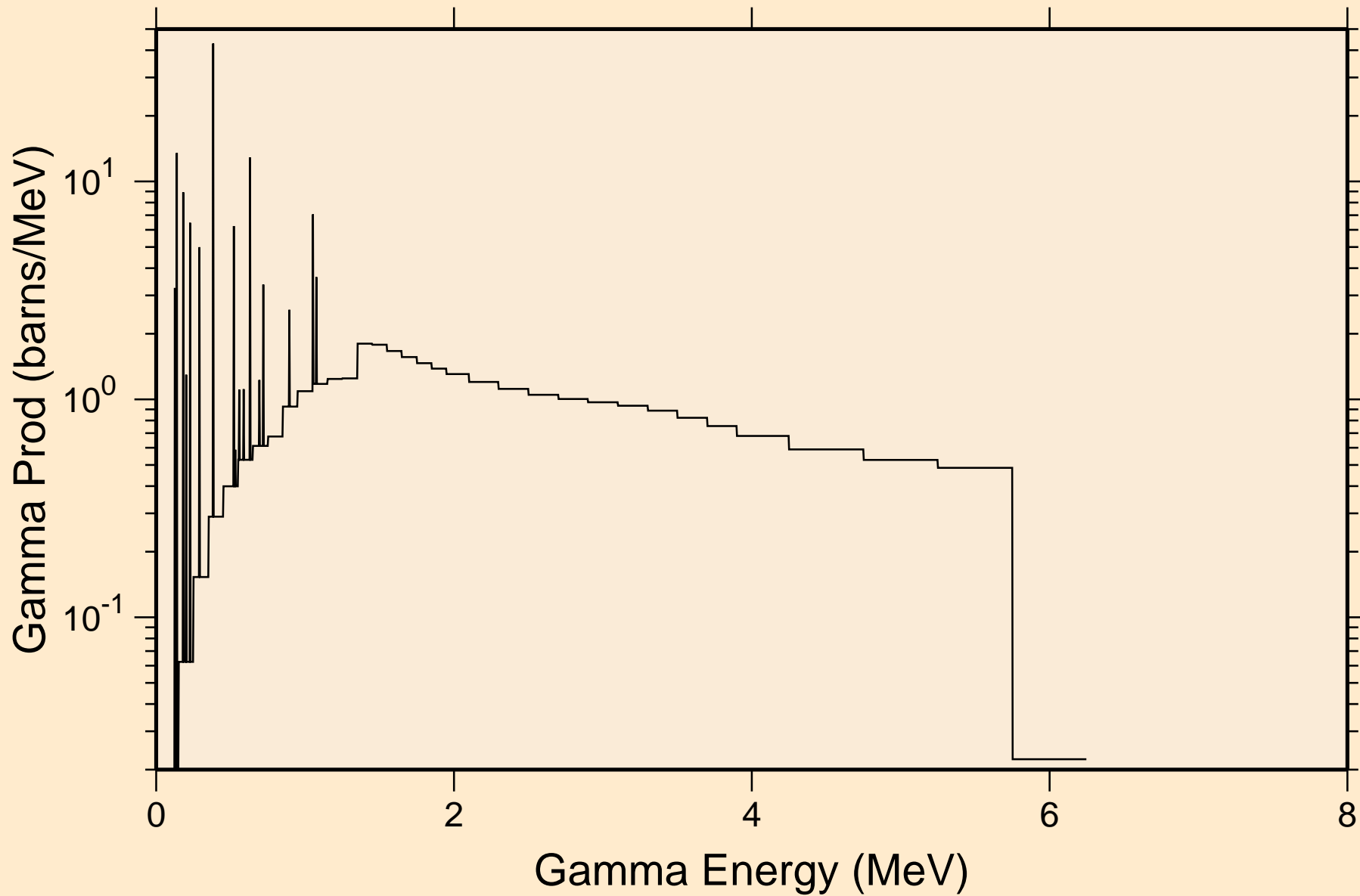

K043 NEUTRON ACER TENDL-2023 LIBRARY; T=0.K  
14 MeV photon spectrum

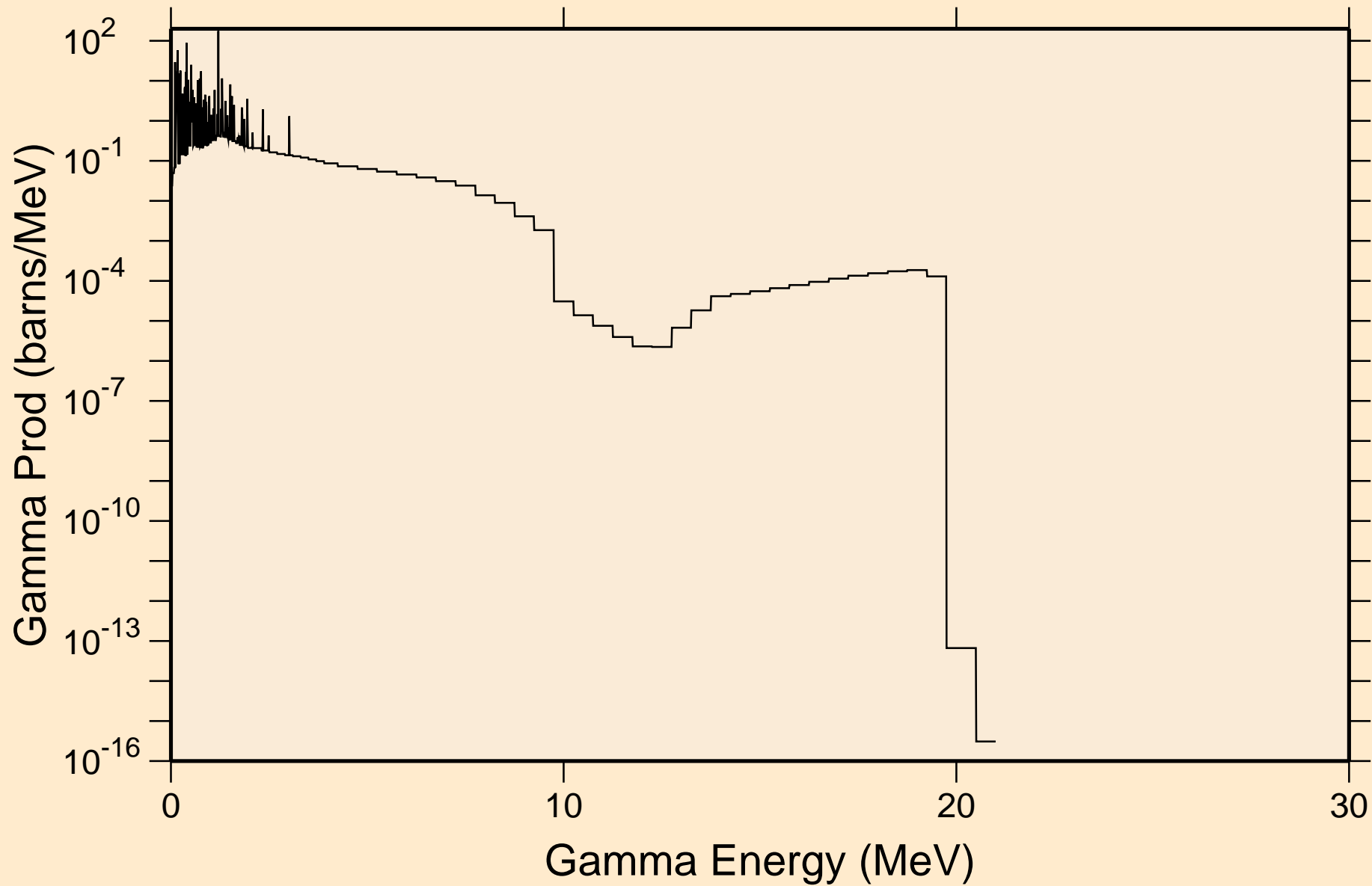

K043 NEUTRON ACER TENDL-2023 LIBRARY; T=0.K  
Particle heating contributions

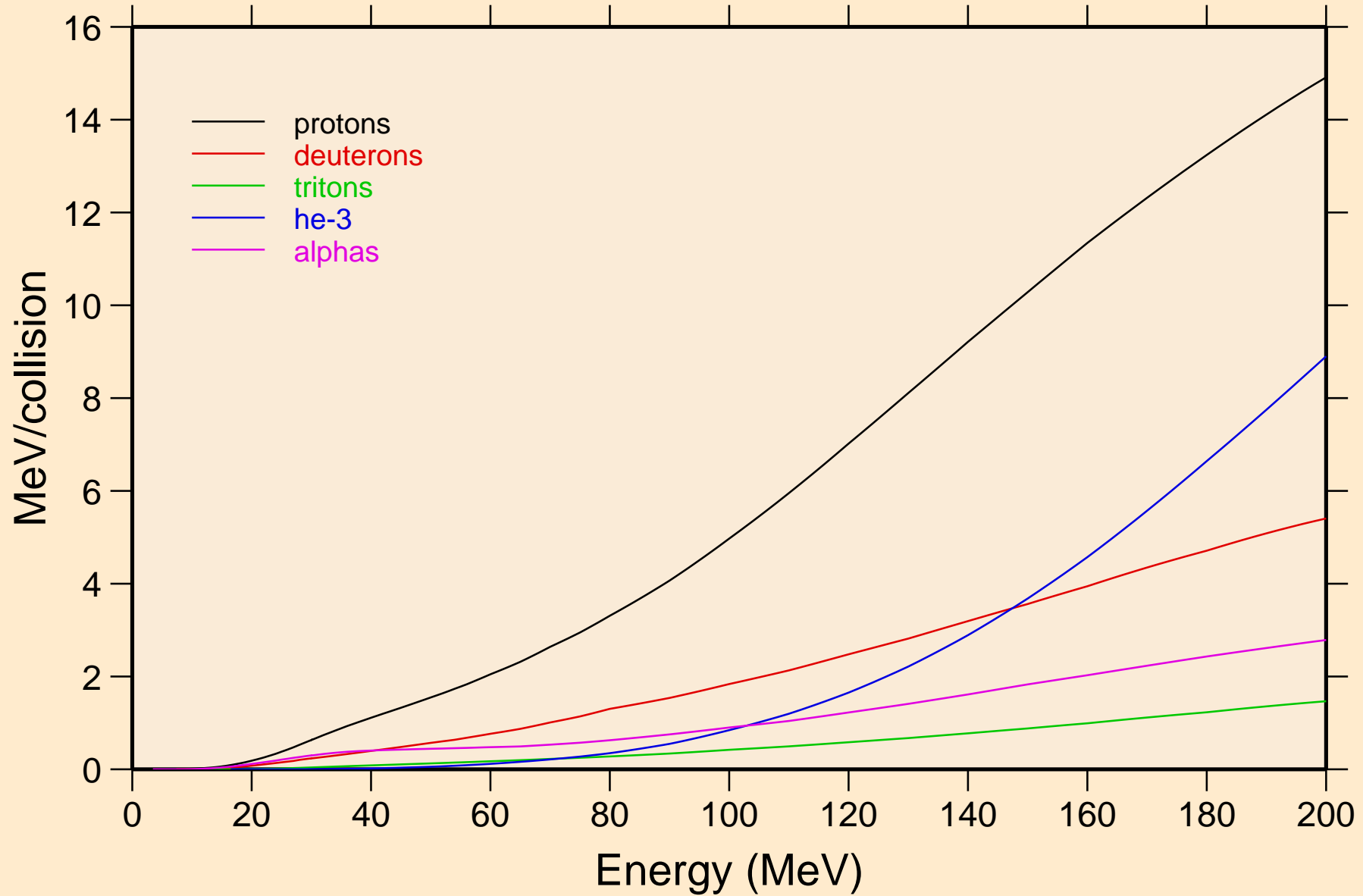

K043 NEUTRON ACER TENDL-2023 LIBRARY; T=0.K  
Recoil Heating

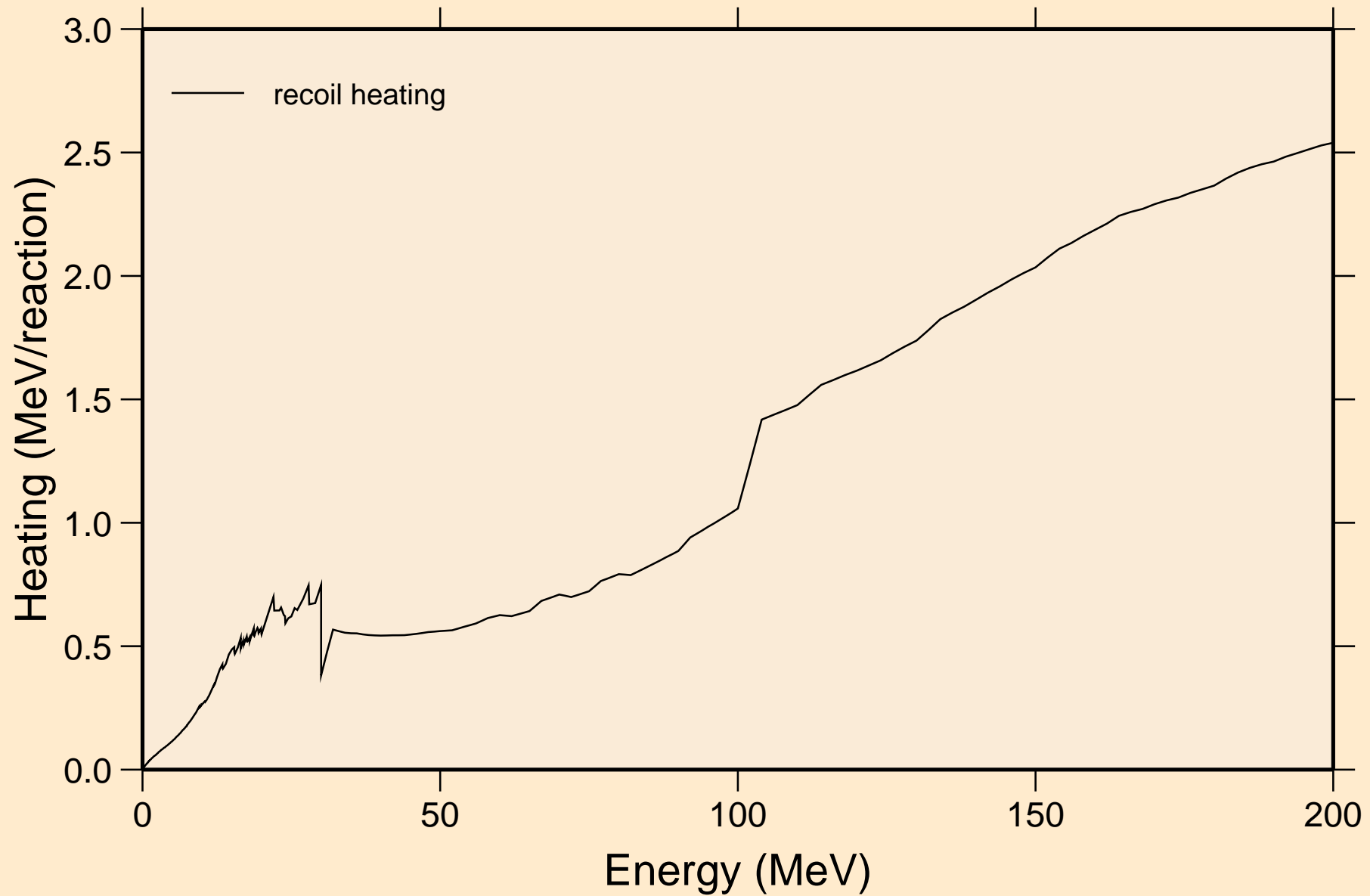

K043 NEUTRON ACER TENDL-2023 LIBRARY; T=0.K  
Particle production cross sections

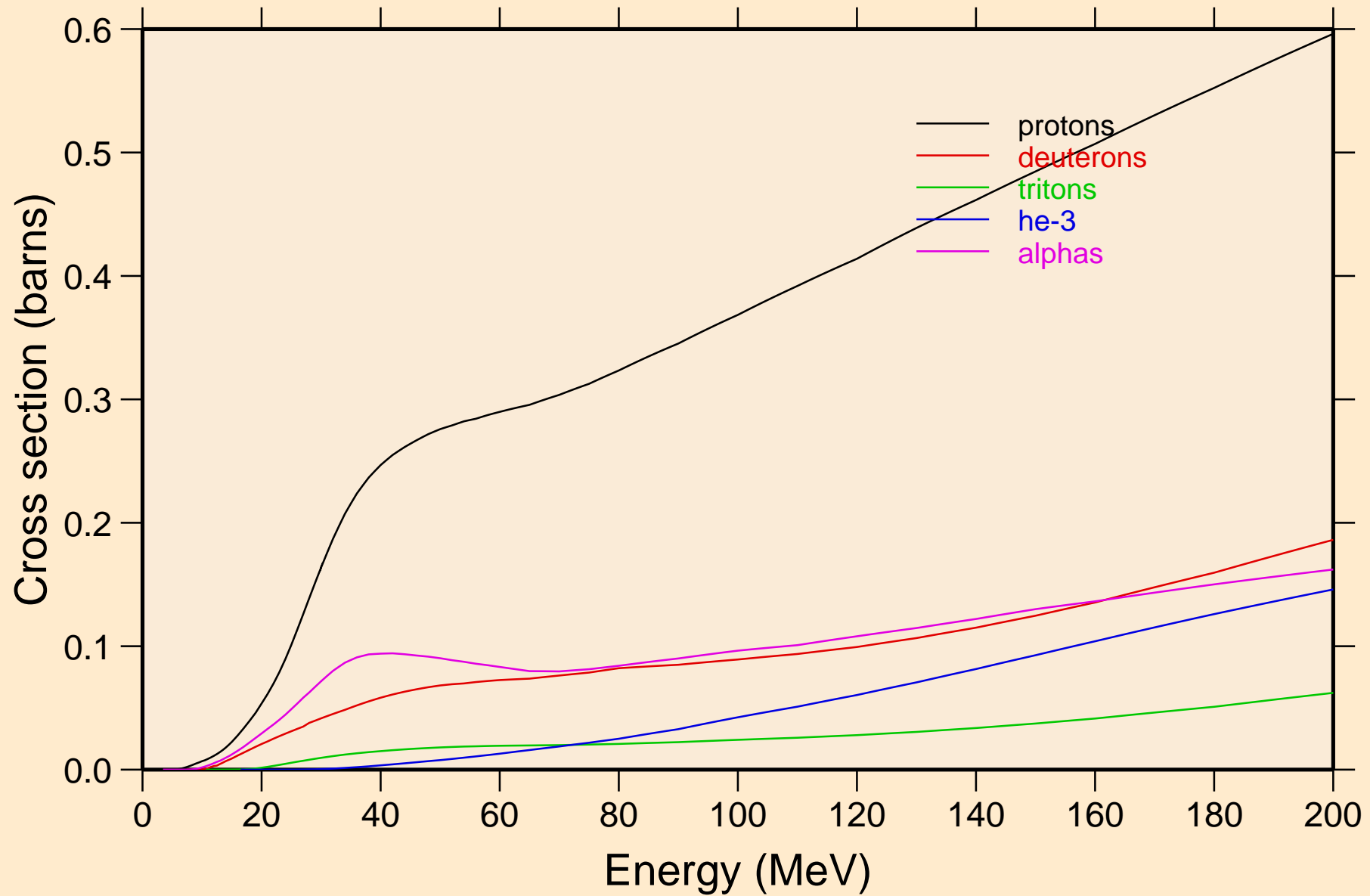



K043 NEUTRON ACER TENDL-2023 LIBRARY; T=0.K  
protons from (n,x)

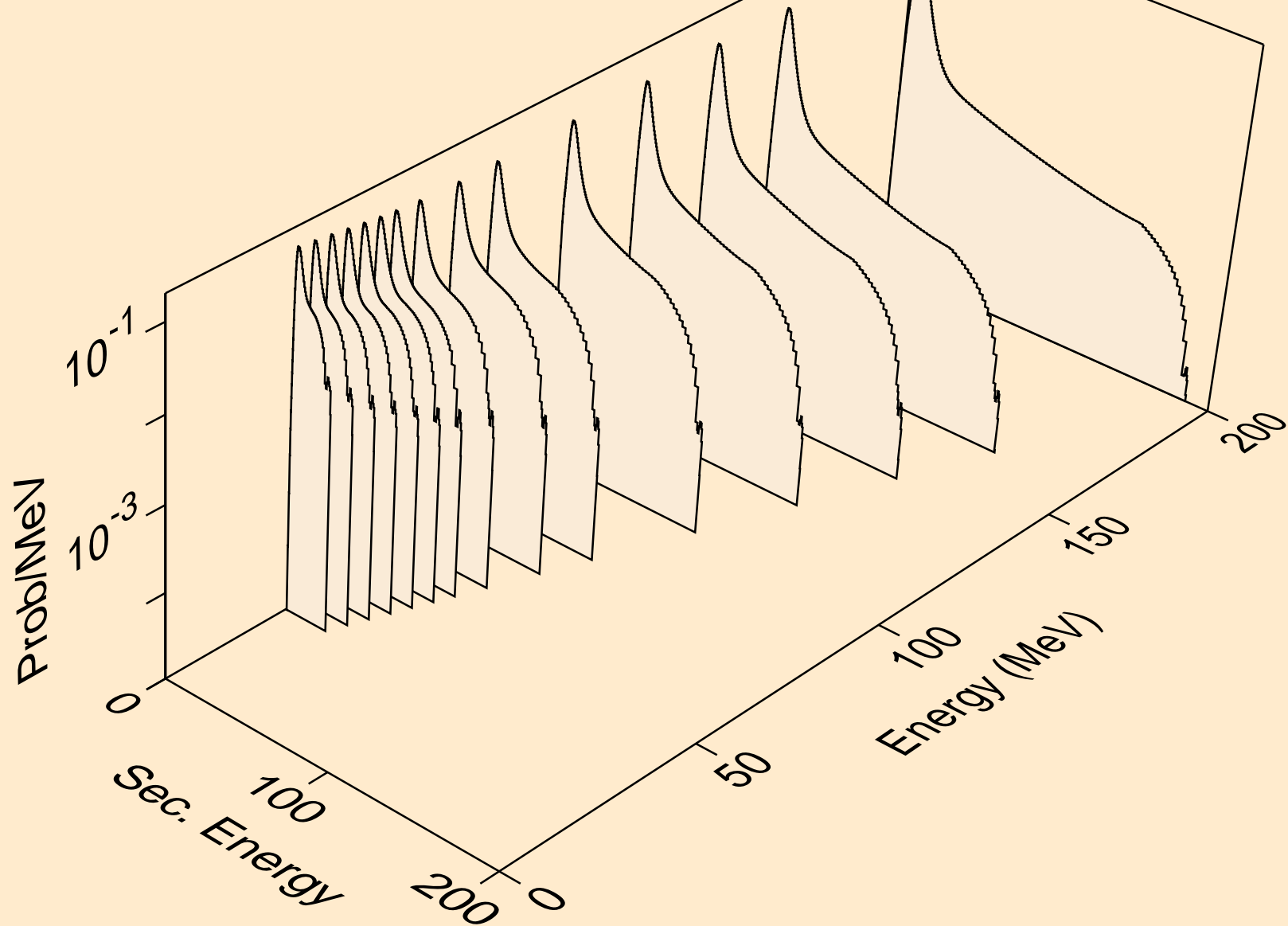

K043 NEUTRON ACER TENDL-2023 LIBRARY; T=0.K  
protons from (n,n\*)p

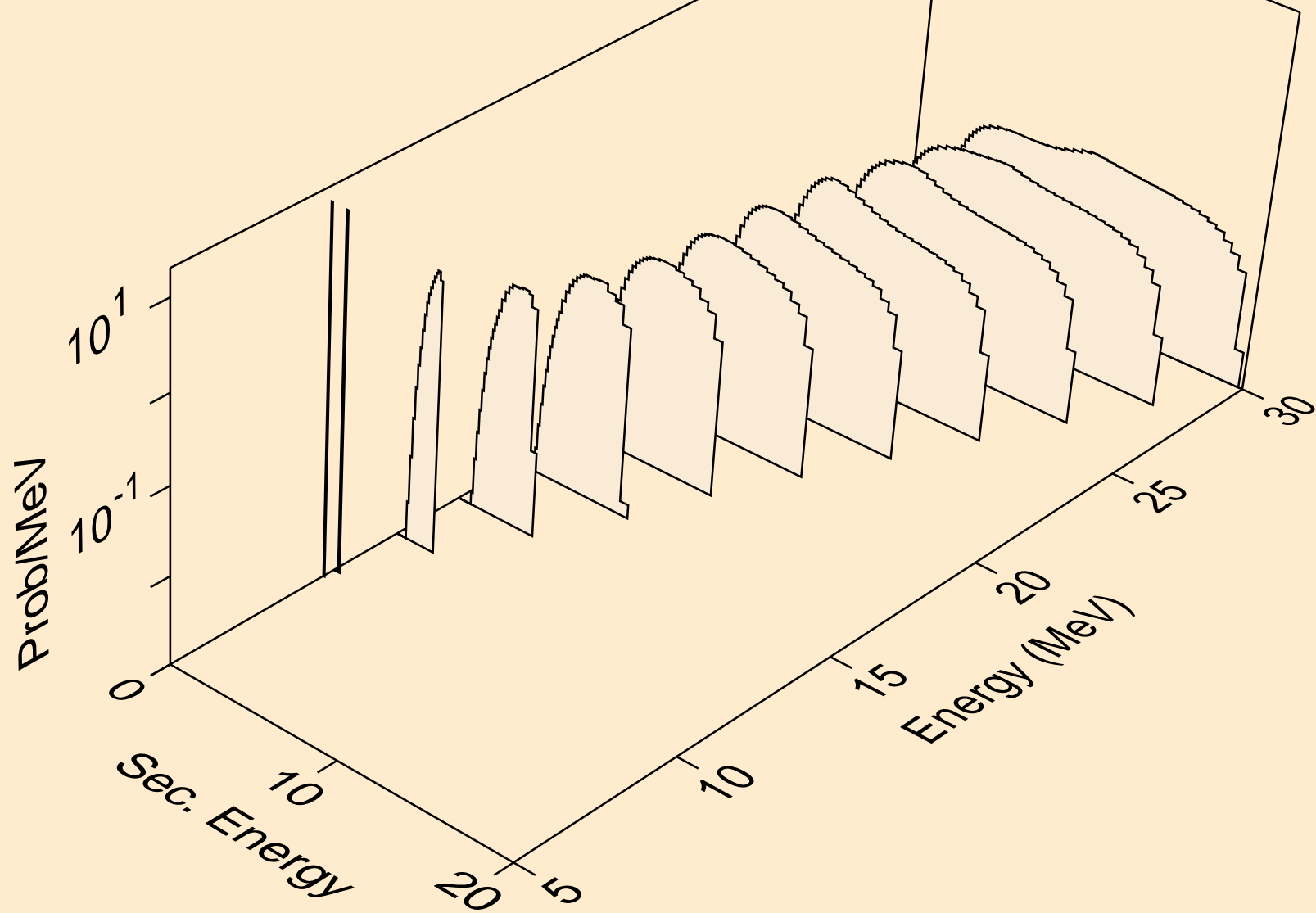

K043 NEUTRON ACER TENDL-2023 LIBRARY; T=0.K  
protons from (n,2np)

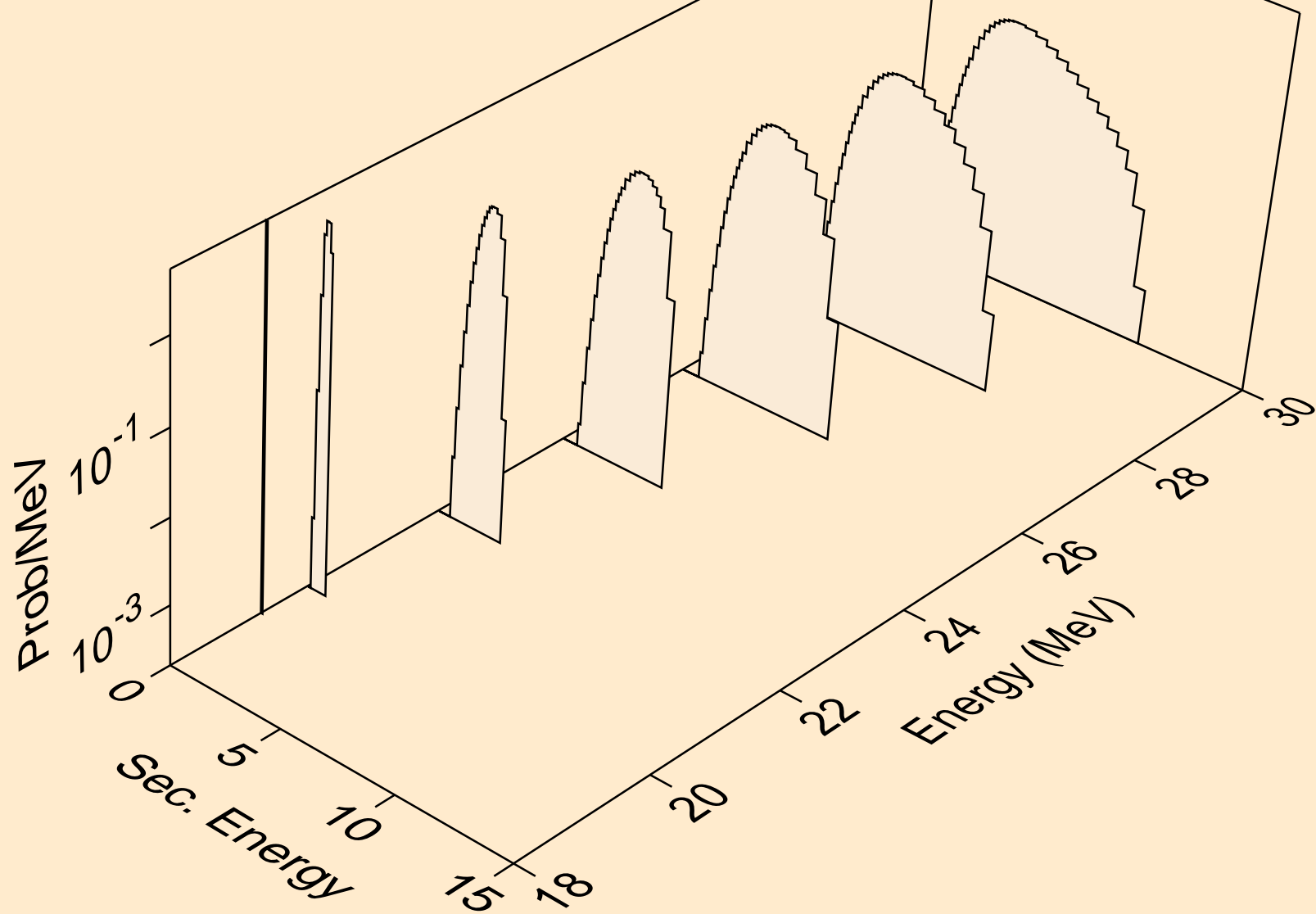

K043 NEUTRON ACER TENDL-2023 LIBRARY; T=0.K  
protons from (n,3np)

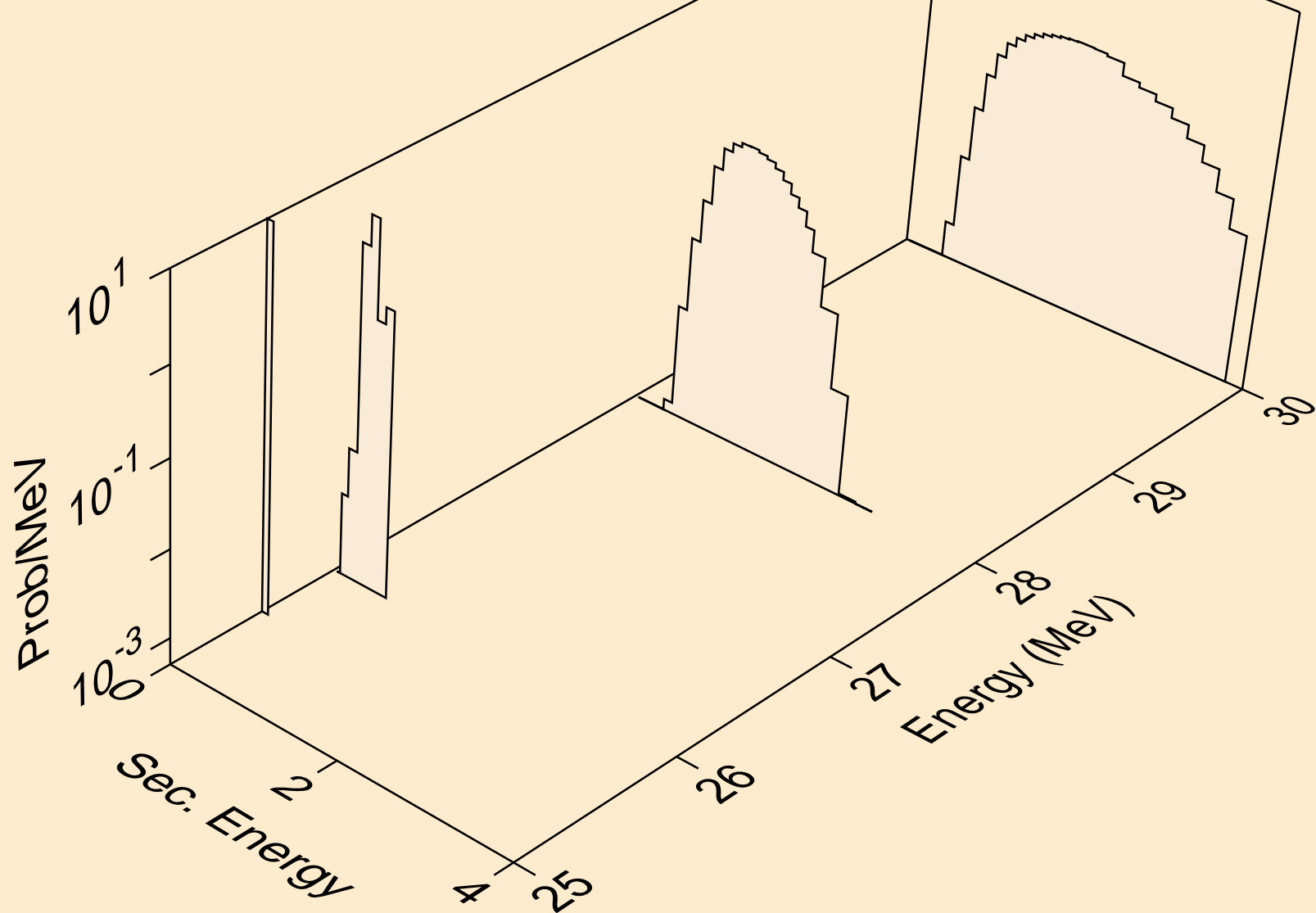

K043 NEUTRON ACER TENDL-2023 LIBRARY; T=0.K  
protons from (n,n2p)

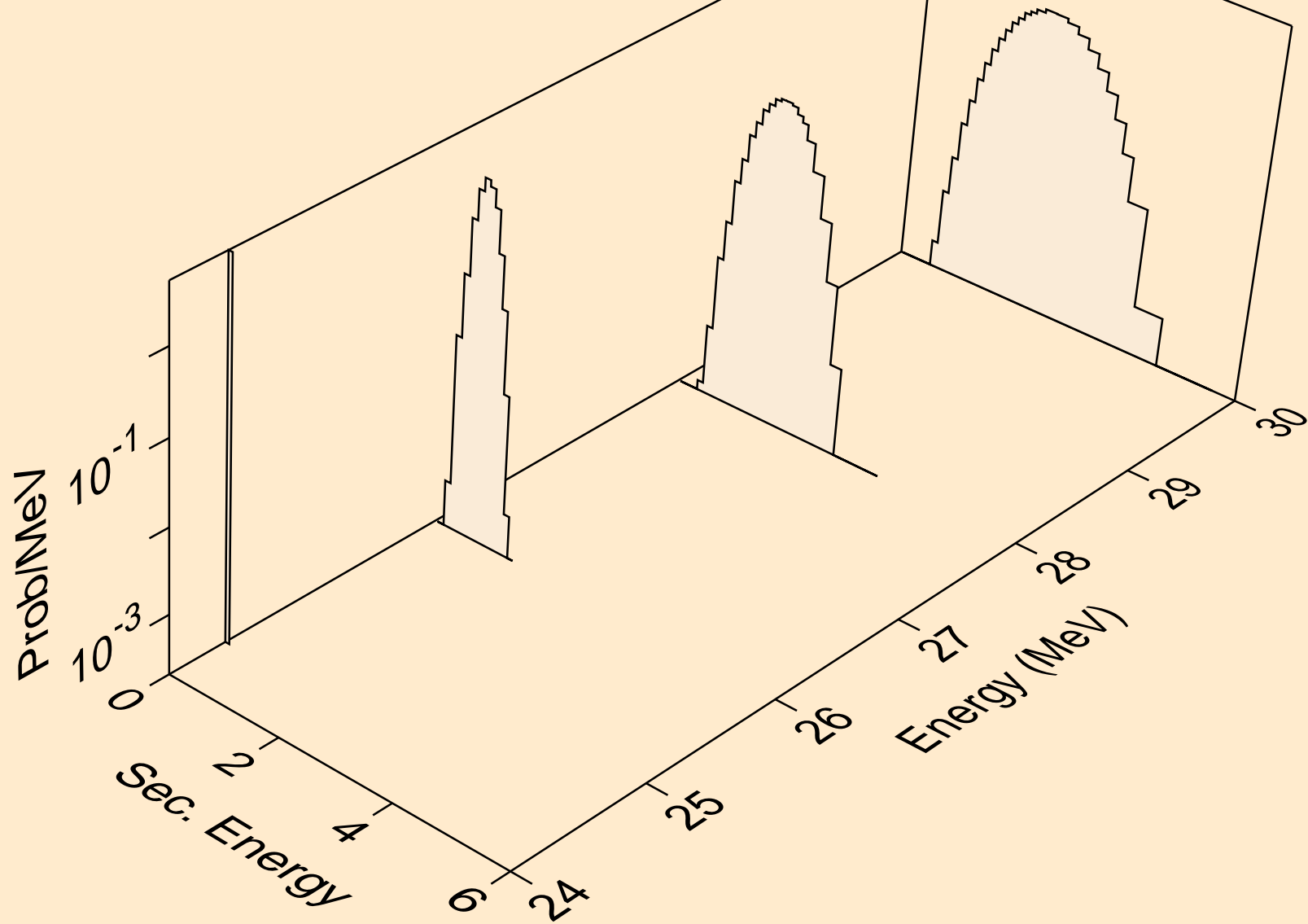

K043 NEUTRON ACER TENDL-2023 LIBRARY; T=0.K  
protons from (n,npa)

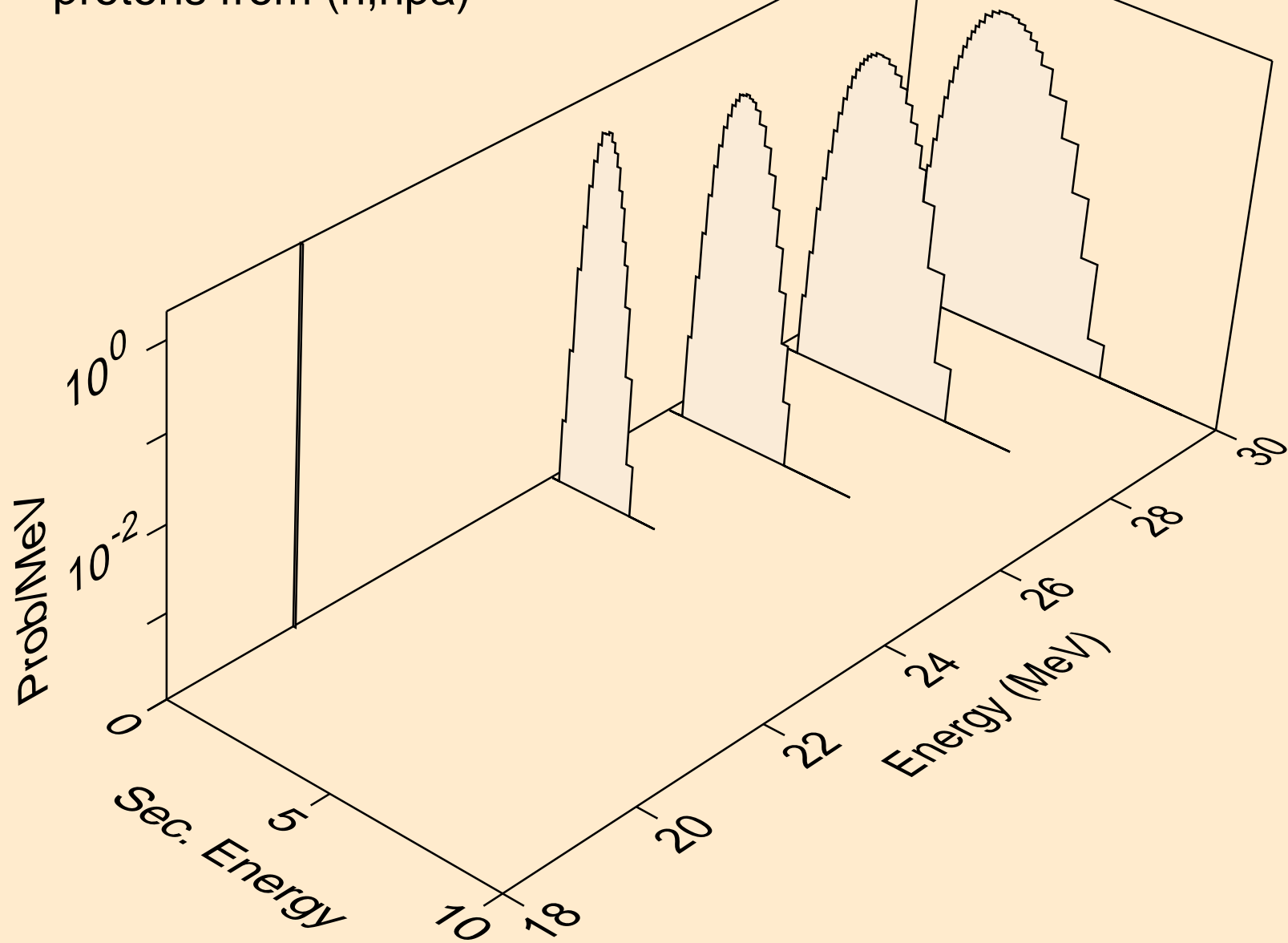

K043 NEUTRON ACER TENDL-2023 LIBRARY; T=0.K  
protons from (n,p)

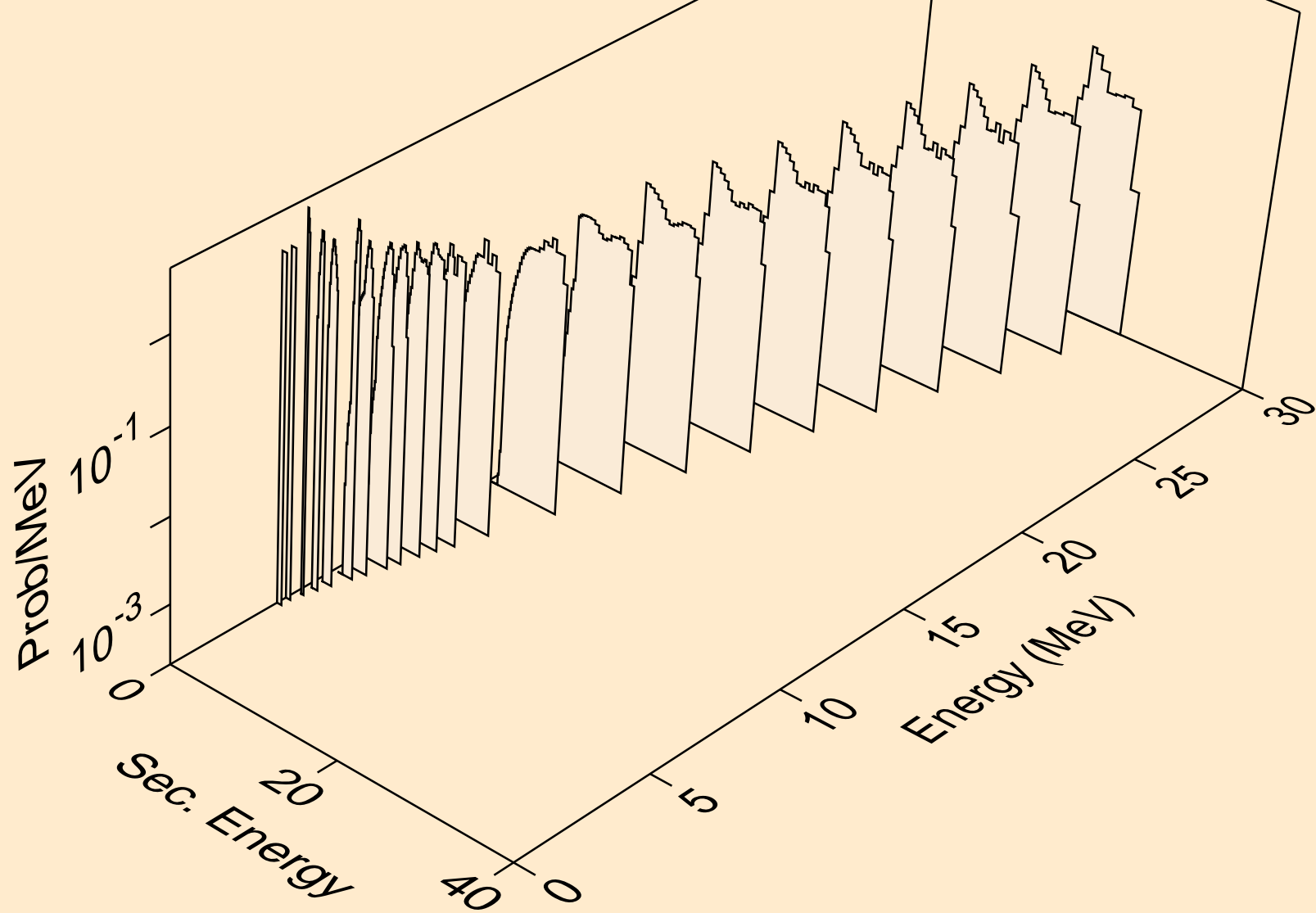

K043 NEUTRON ACER TENDL-2023 LIBRARY; T=0.K  
protons from (n,2p)

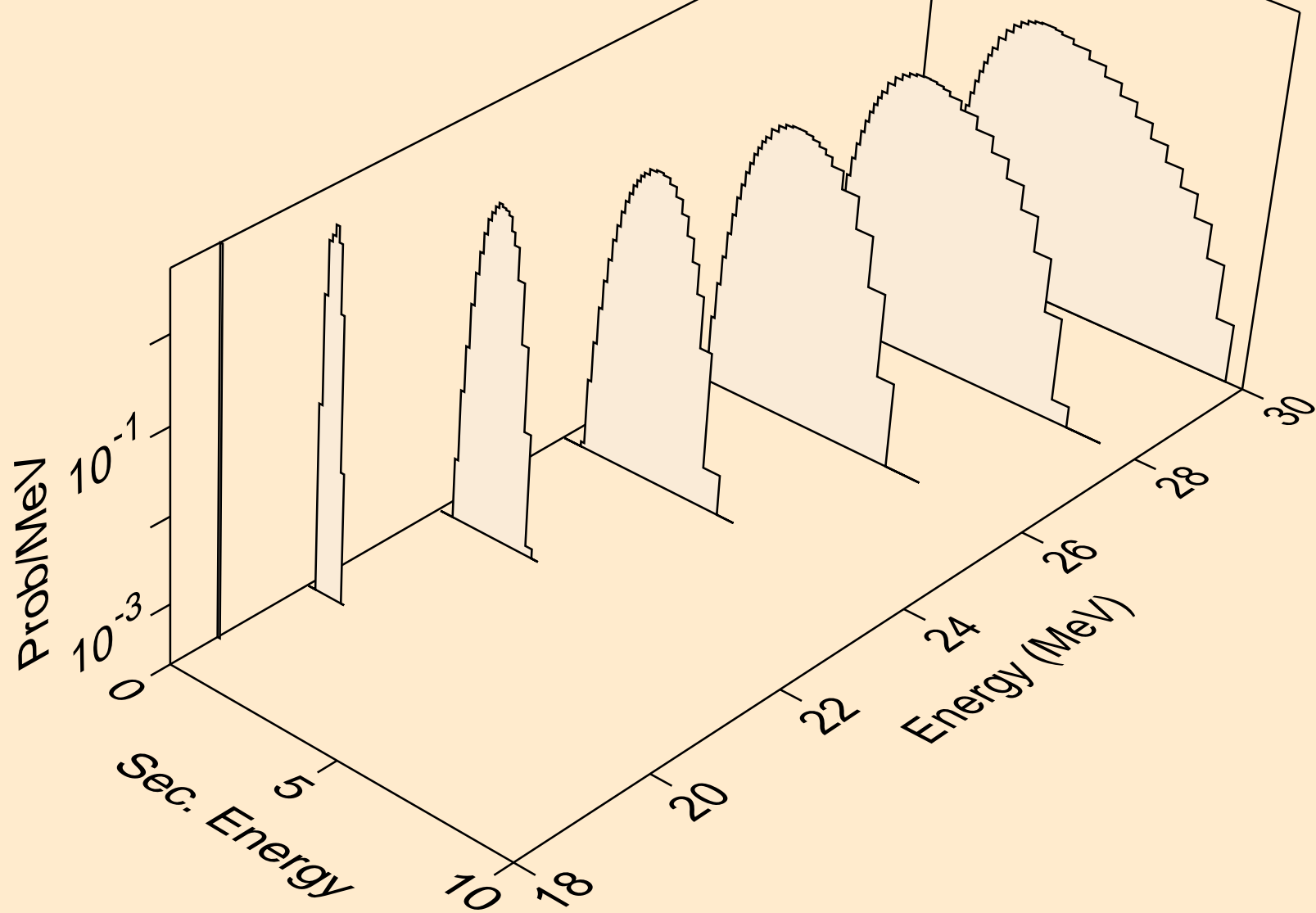



K043 NEUTRON ACER TENDL-2023 LIBRARY; T=0.K  
protons from (n,p)

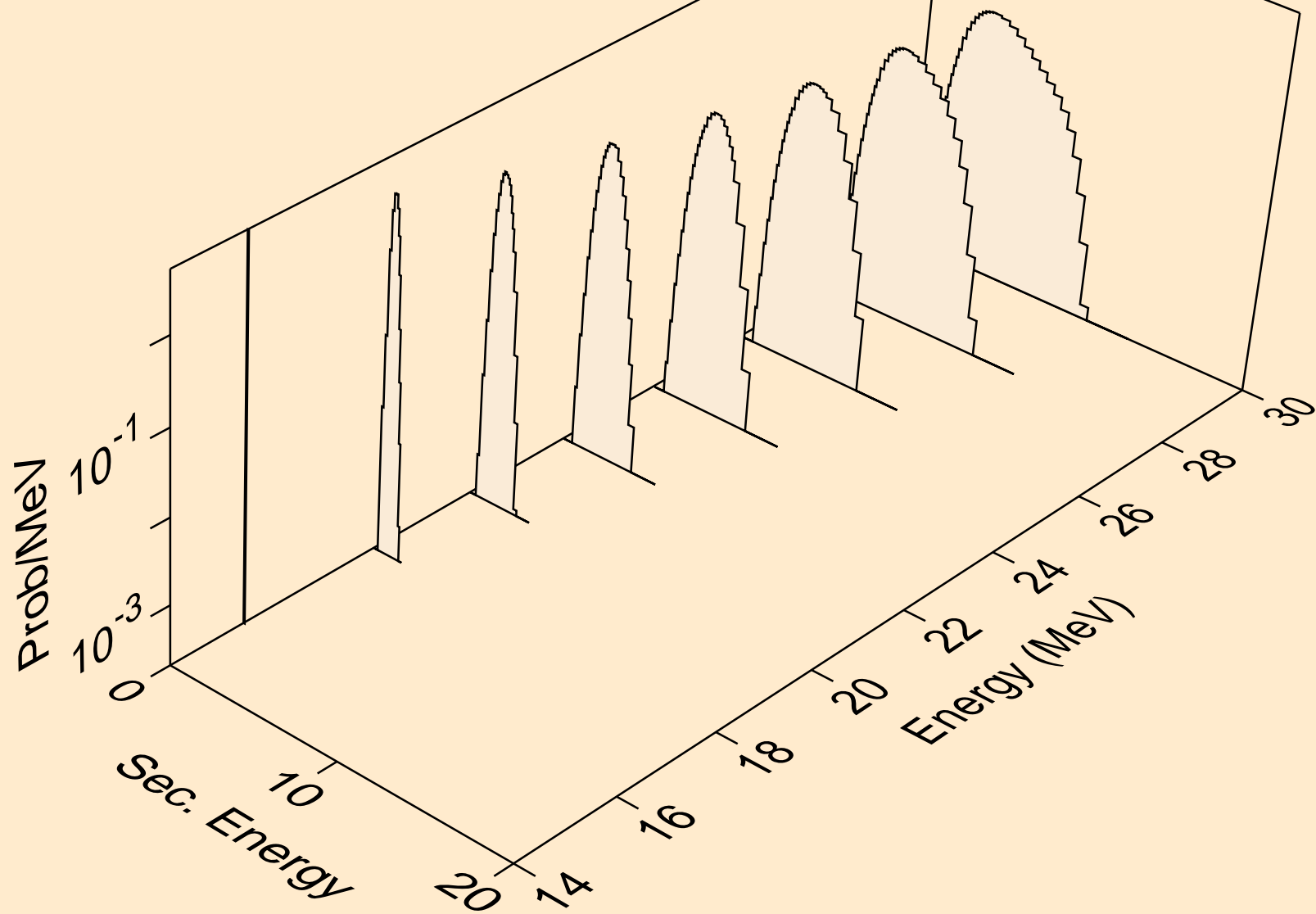

K043 NEUTRON ACER TENDL-2023 LIBRARY; T=0.K  
protons from (n,pd)

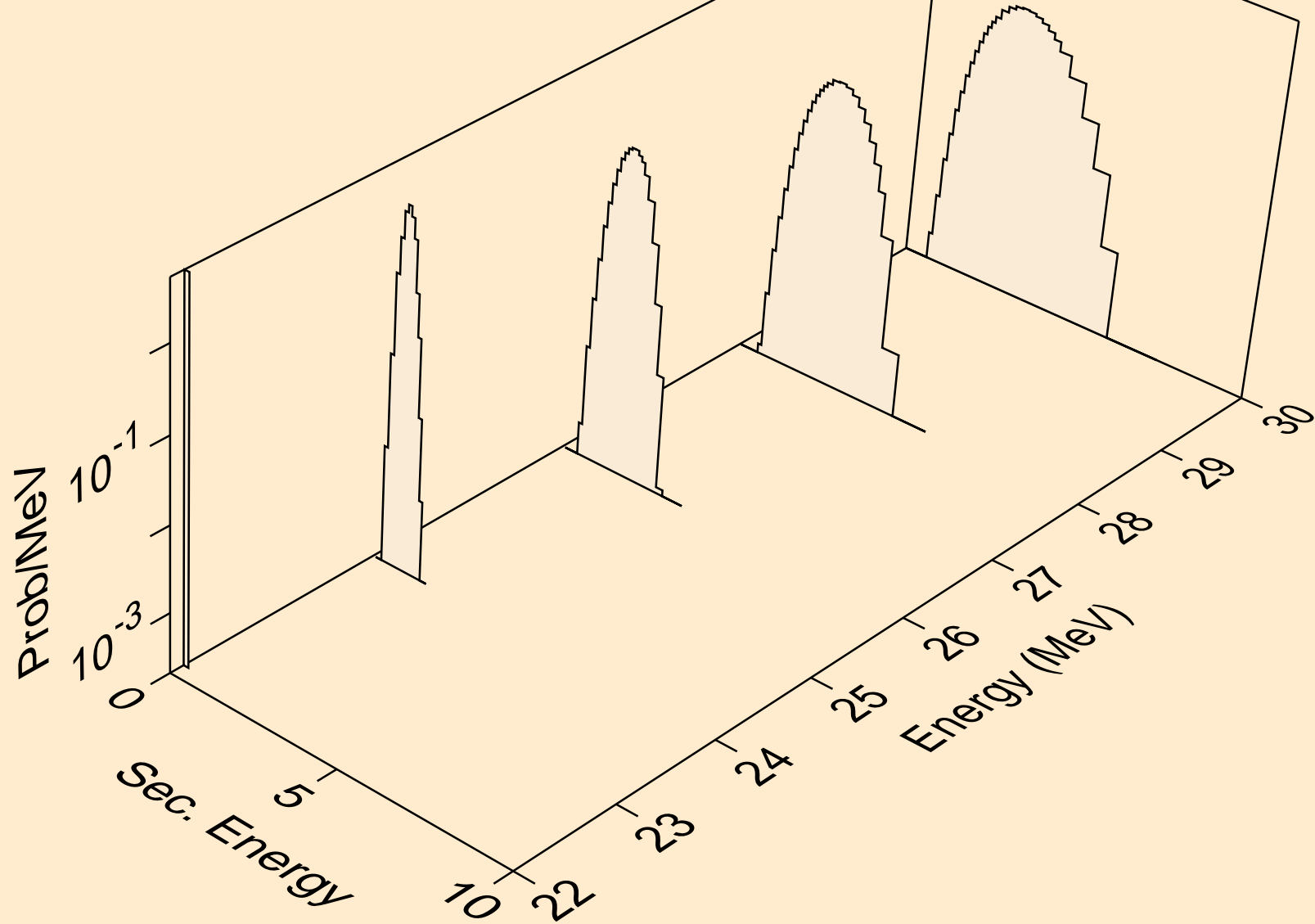

K043 NEUTRON ACER TENDL-2023 LIBRARY; T=0.K  
protons from (n,pt)

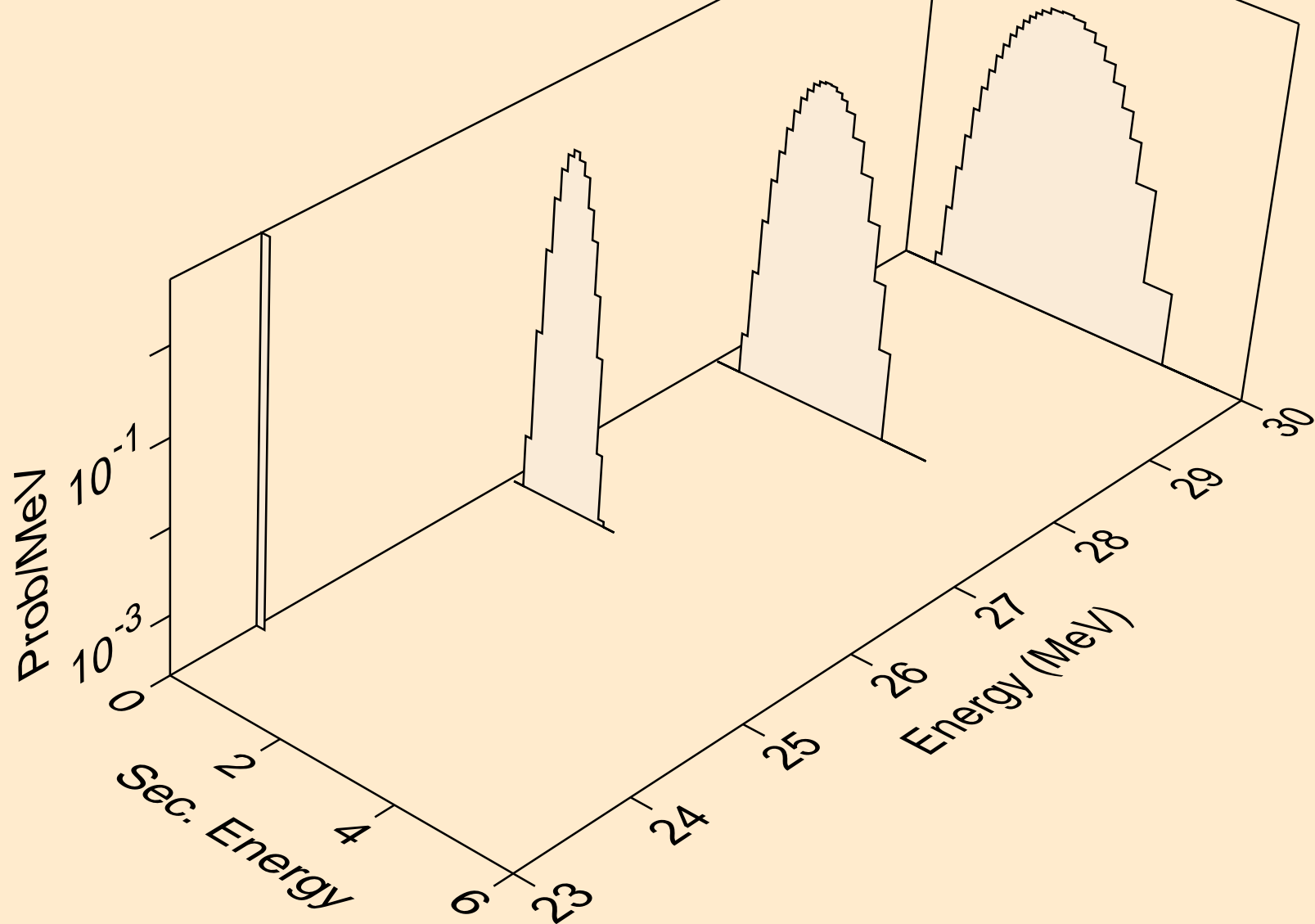

K043 NEUTRON ACER TENDL-2023 LIBRARY; T=0.K  
deuterons from (n,x)

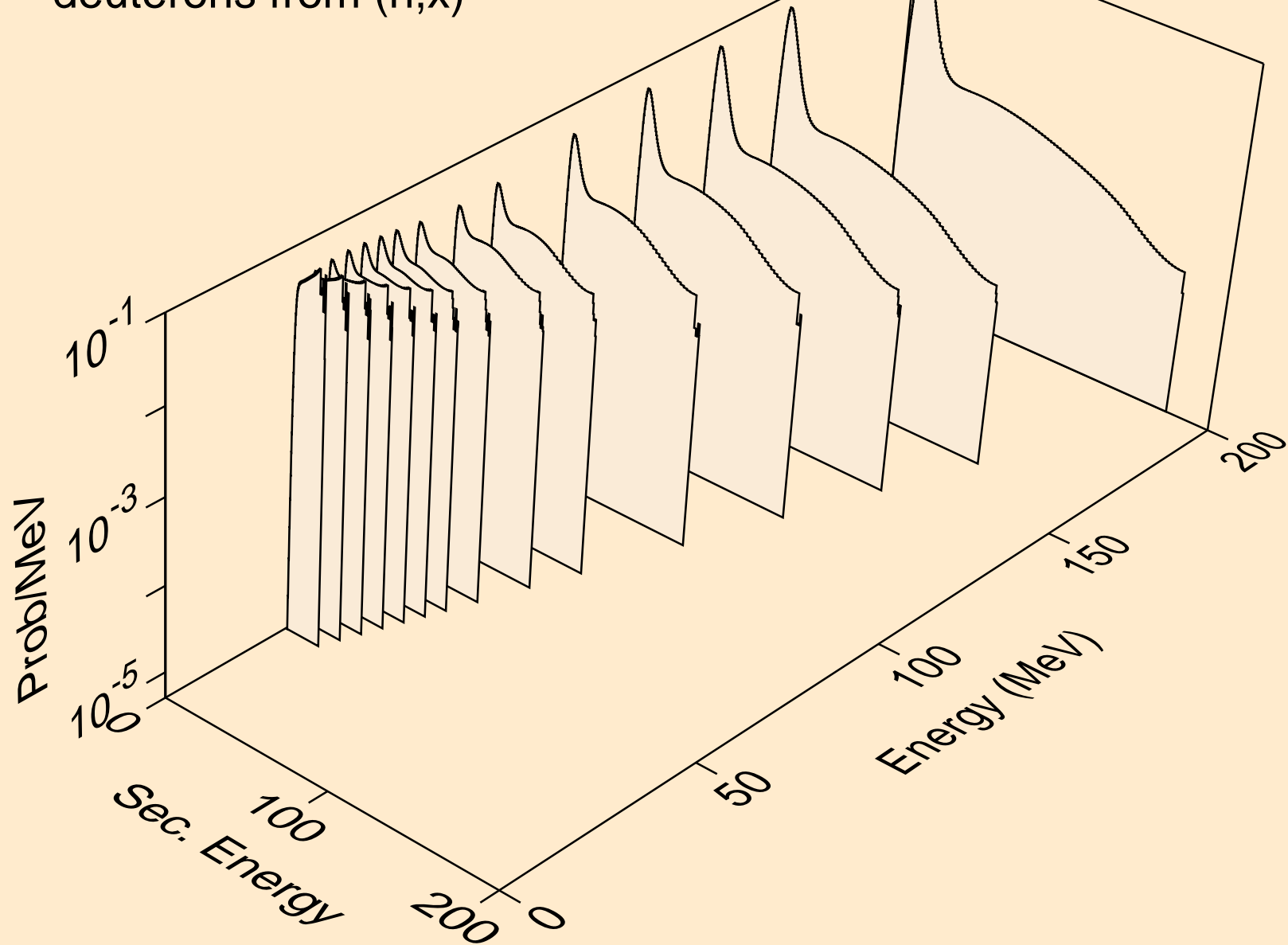

K043 NEUTRON ACER TENDL-2023 LIBRARY; T=0.K  
deuterons from (n,2nd)

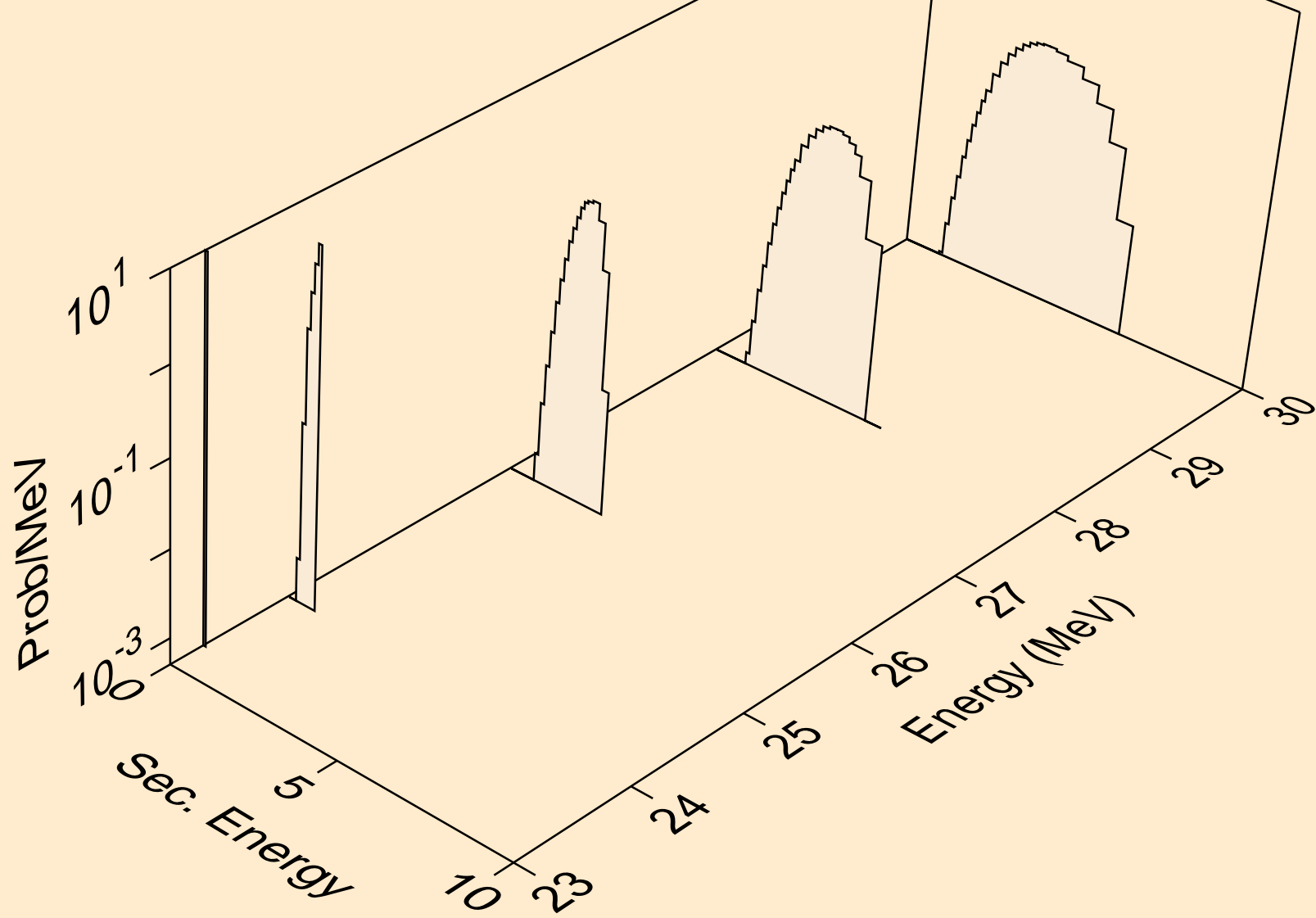

K043 NEUTRON ACER TENDL-2023 LIBRARY; T=0.K  
deuterons from (n,n\*)d

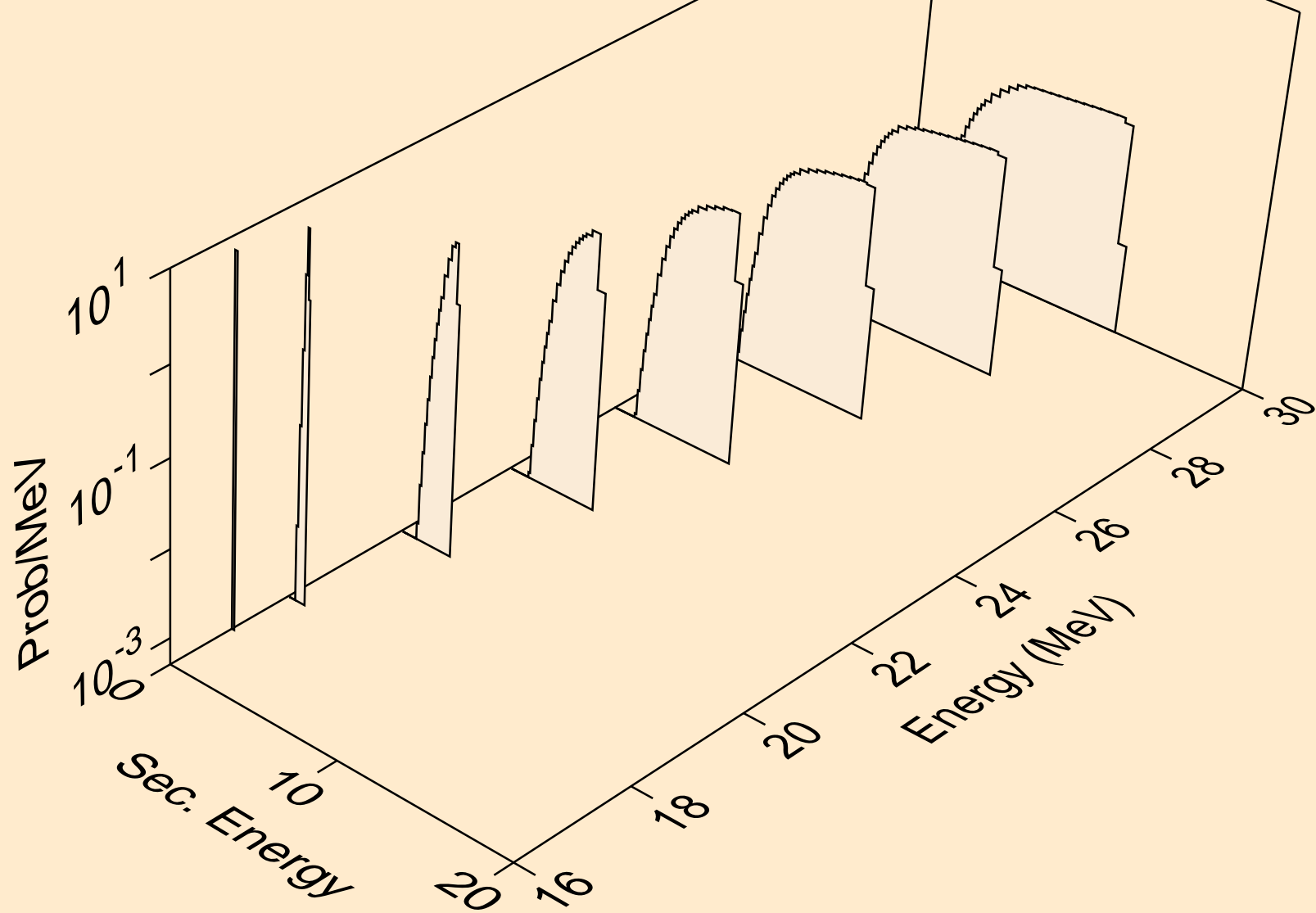

K043 NEUTRON ACER TENDL-2023 LIBRARY; T=0.K  
deuterons from (n,d)

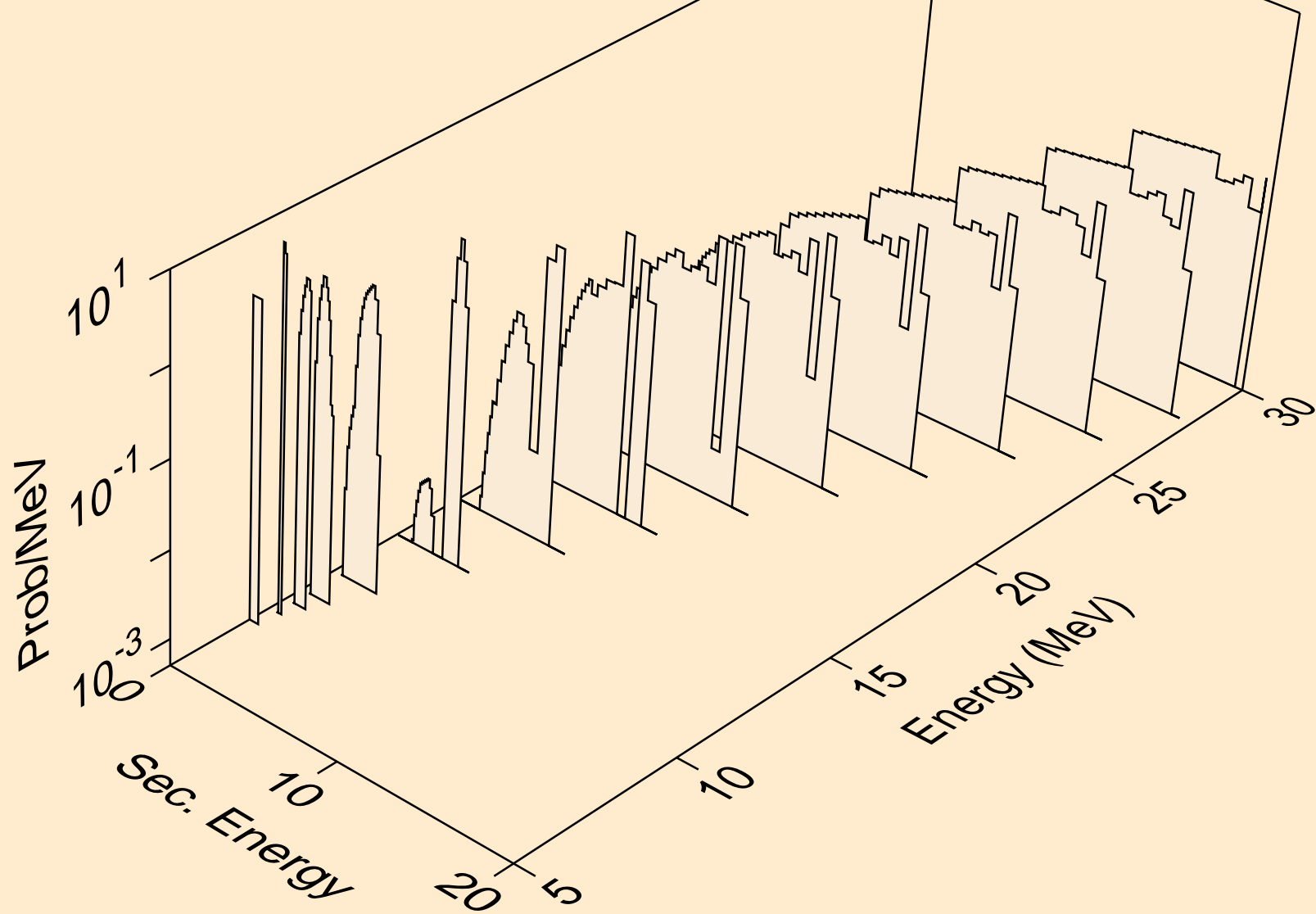

K043 NEUTRON ACER TENDL-2023 LIBRARY; T=0.K  
deuterons from (n,pd)

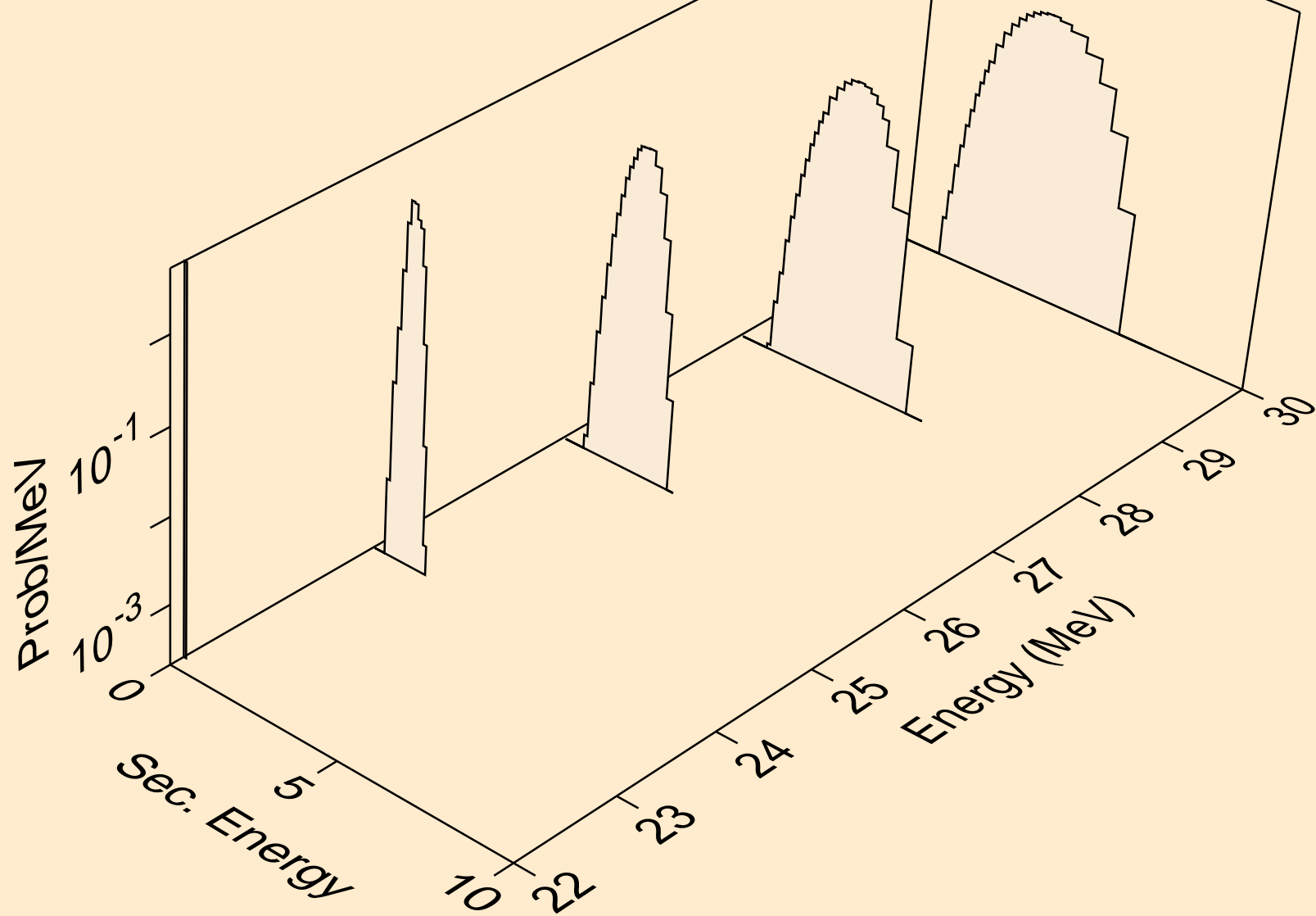



K043 NEUTRON ACER TENDL-2023 LIBRARY; T=0.K  
deuterons from (n,da)

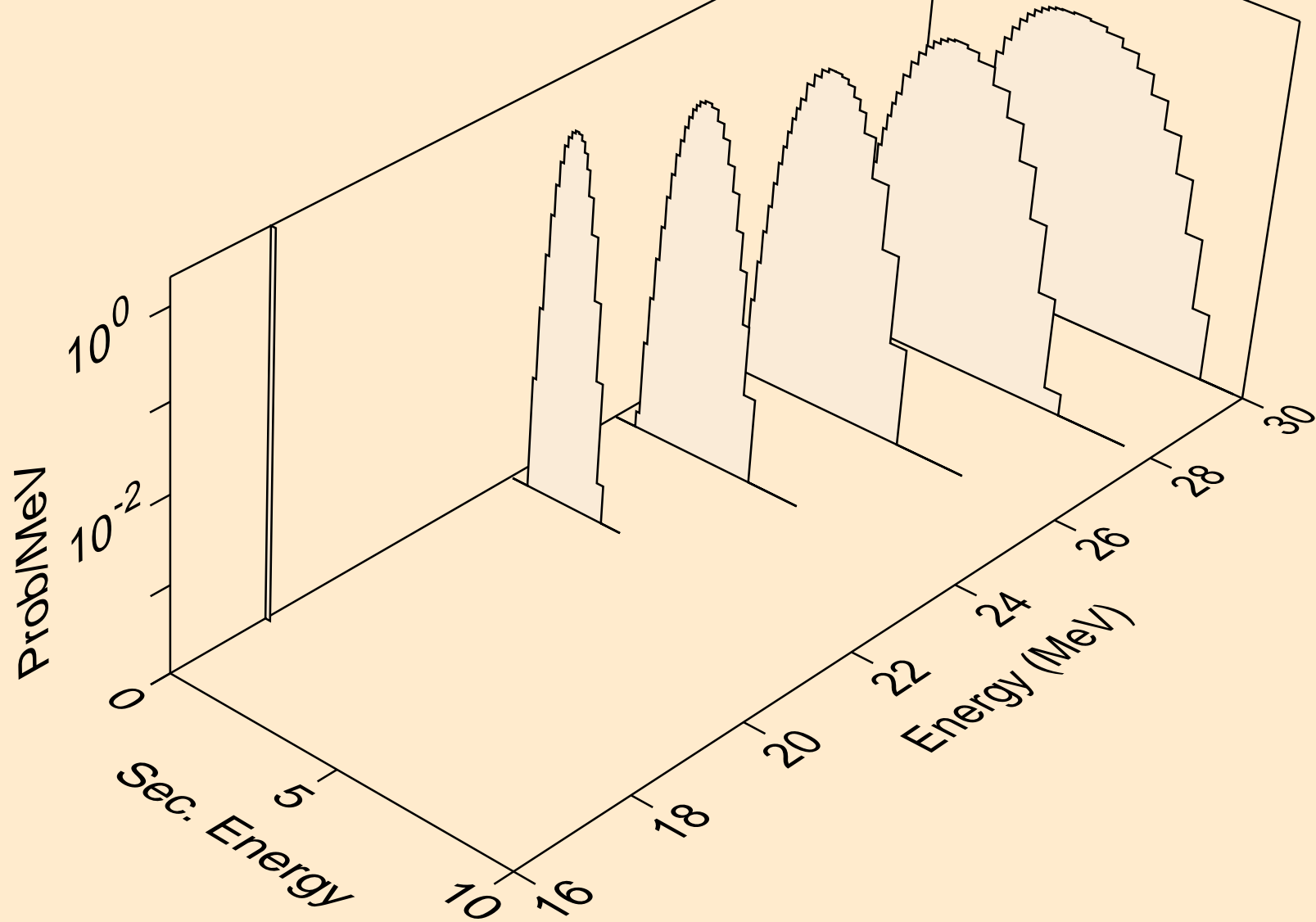

K043 NEUTRON ACER TENDL-2023 LIBRARY; T=0.K  
tritons from (n,x)

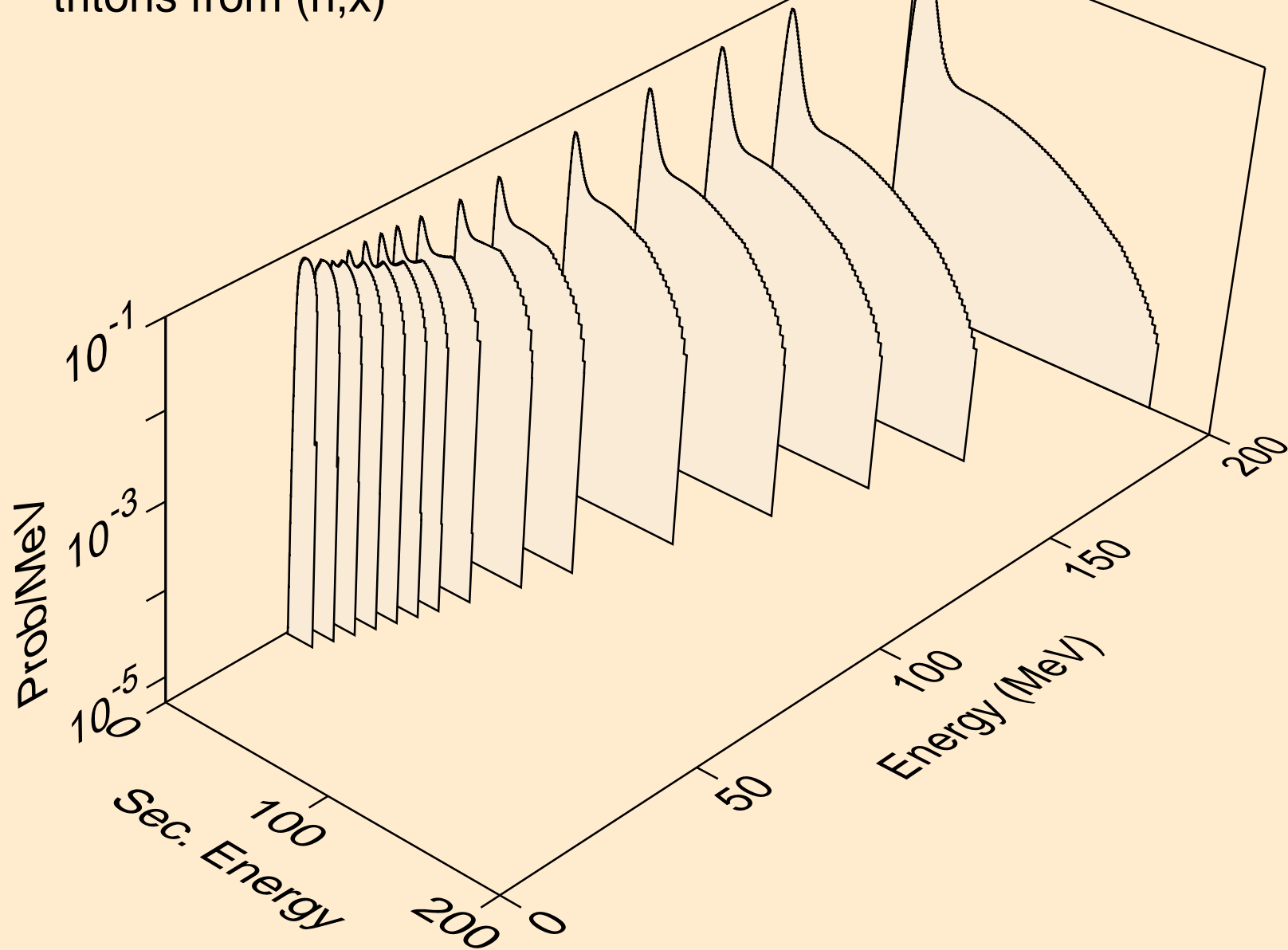

K043 NEUTRON ACER TENDL-2023 LIBRARY; T=0.K  
tritons from (n,n\*)t

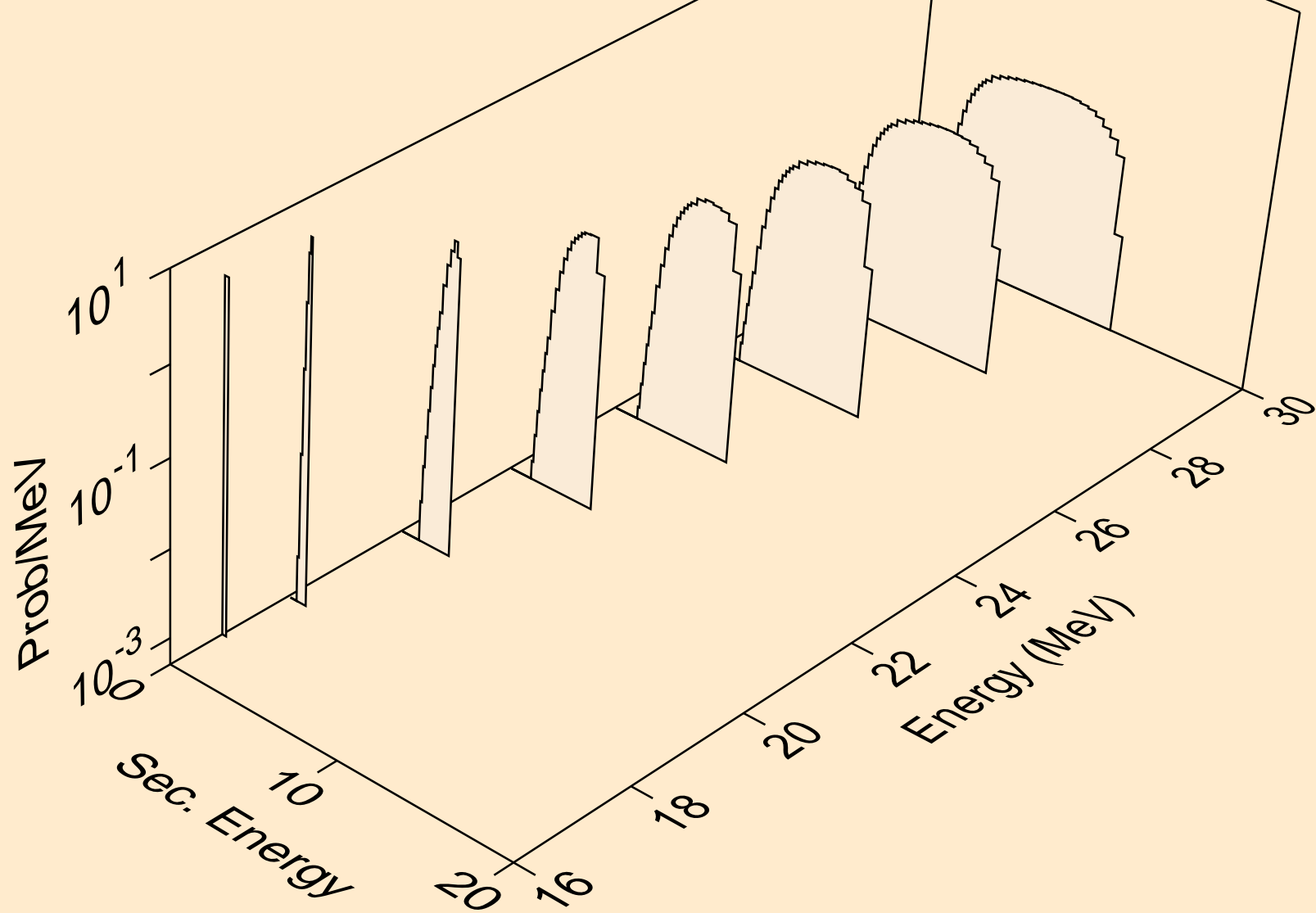

K043 NEUTRON ACER TENDL-2023 LIBRARY; T=0.K  
tritons from (n,t)

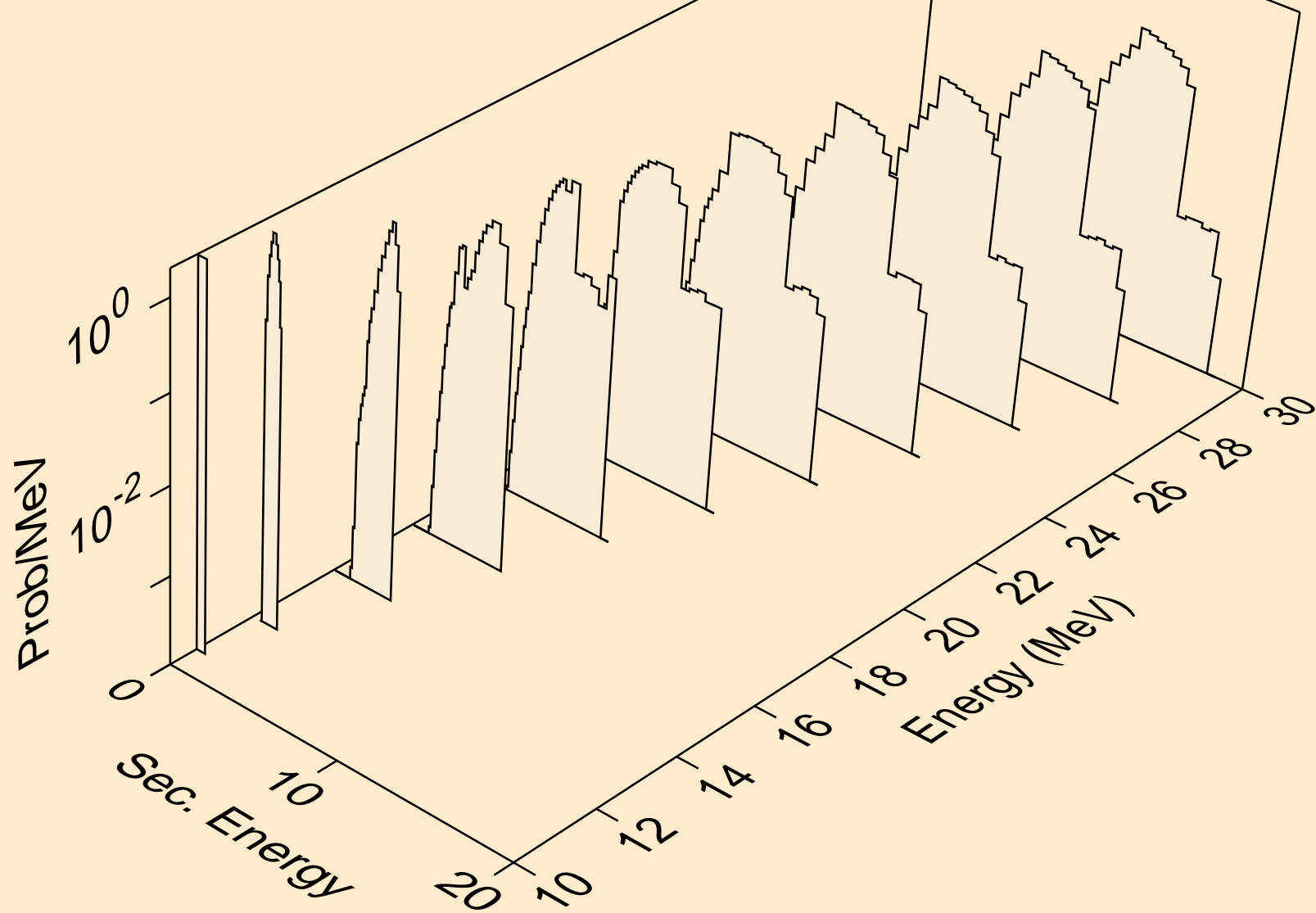

K043 NEUTRON ACER TENDL-2023 LIBRARY; T=0.K  
tritons from (n,pt)

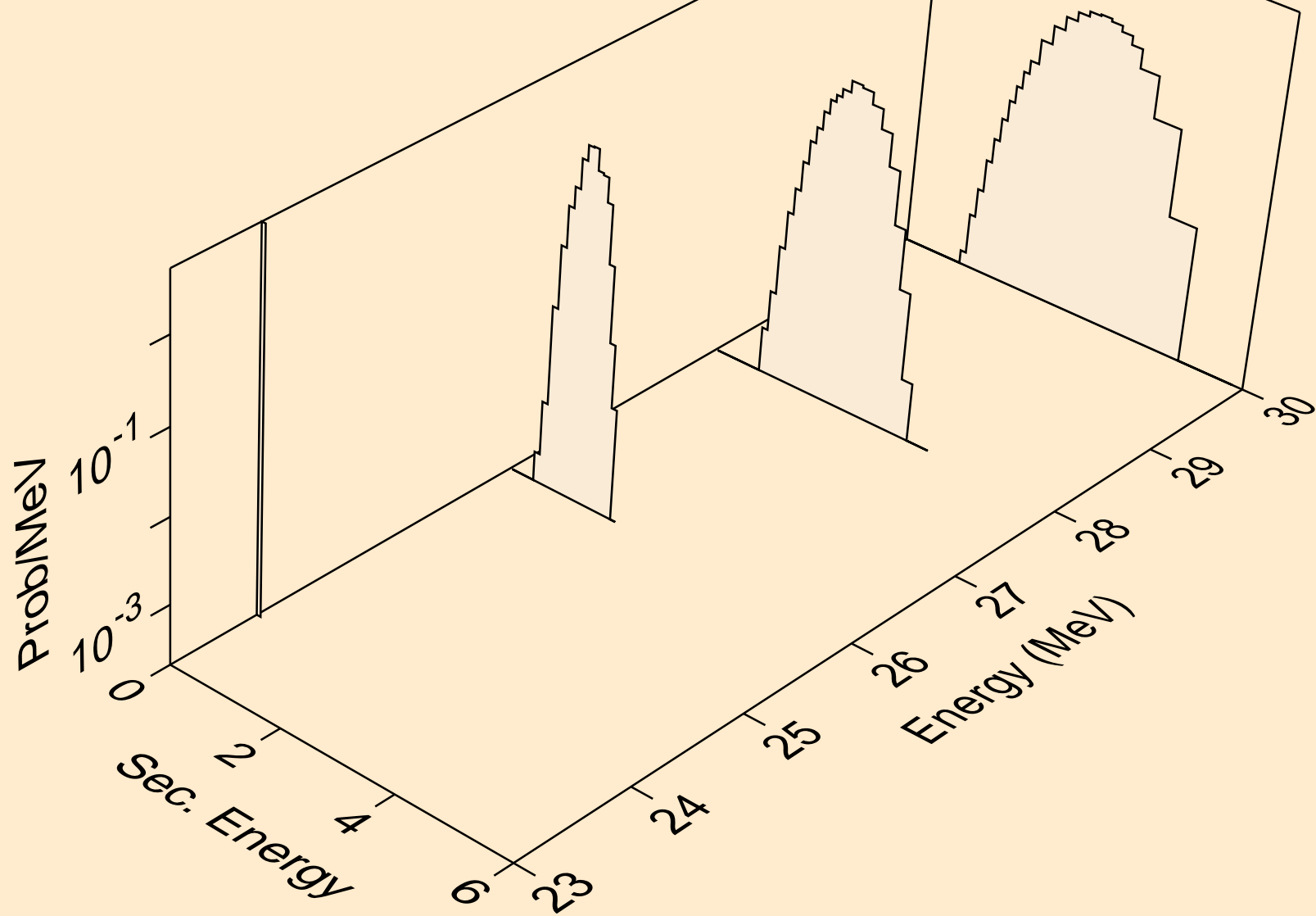

K043 NEUTRON ACER TENDL-2023 LIBRARY; T=0.K  
he3s from (n,x)

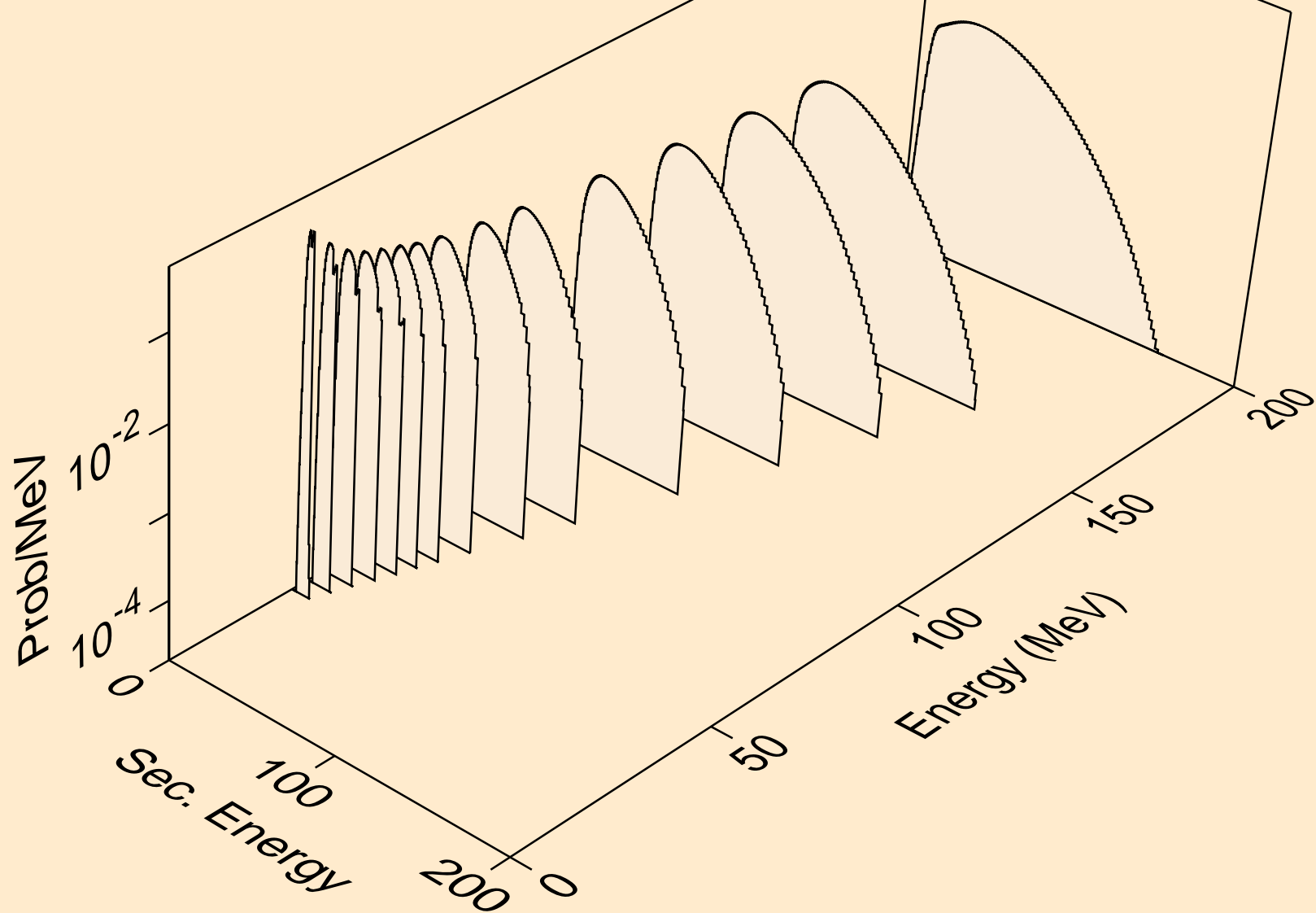

K043 NEUTRON ACER TENDL-2023 LIBRARY; T=0.K  
he3s from (n,n\*)he3

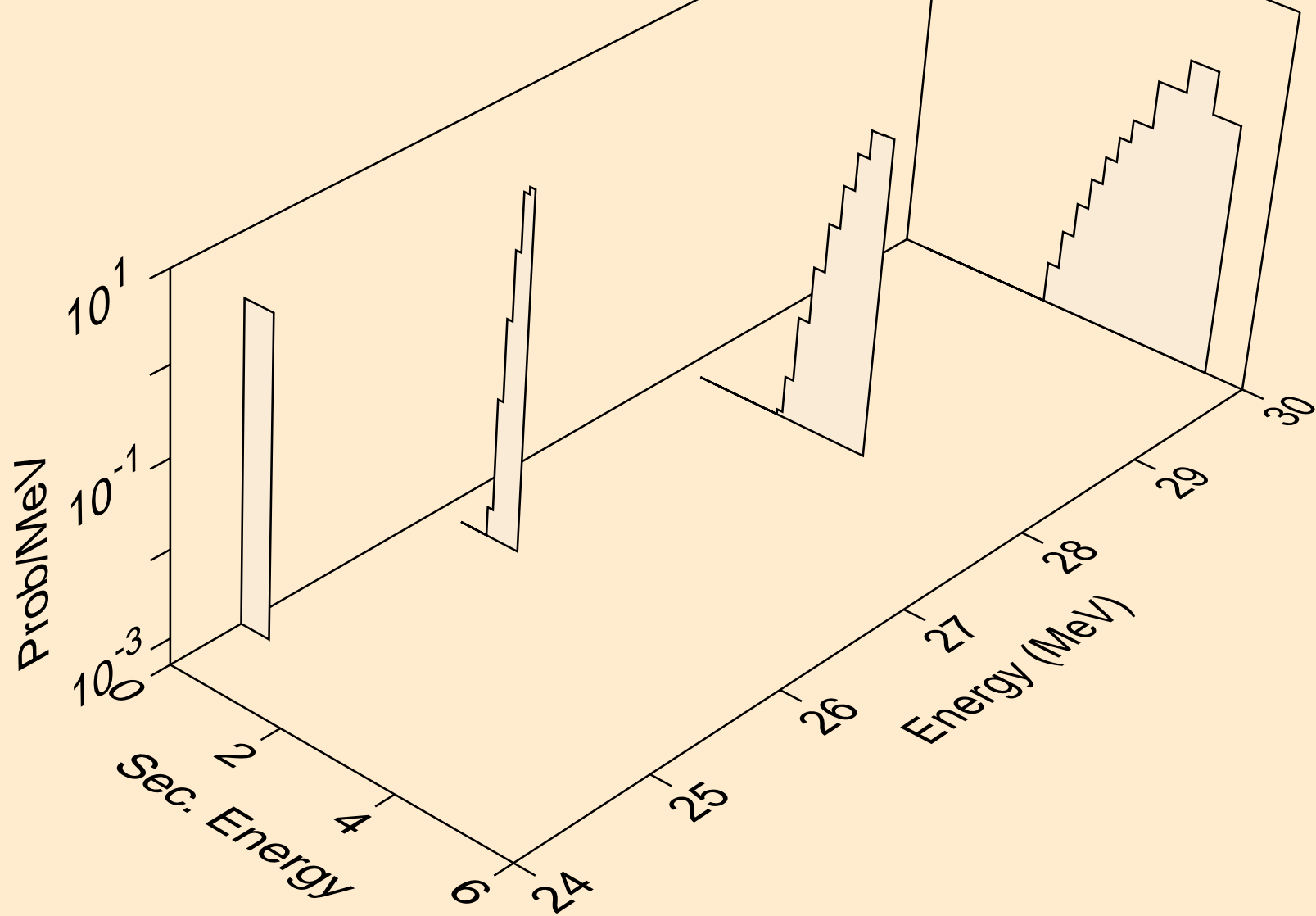

K043 NEUTRON ACER TENDL-2023 LIBRARY; T=0.K  
he3s from (n,he3)

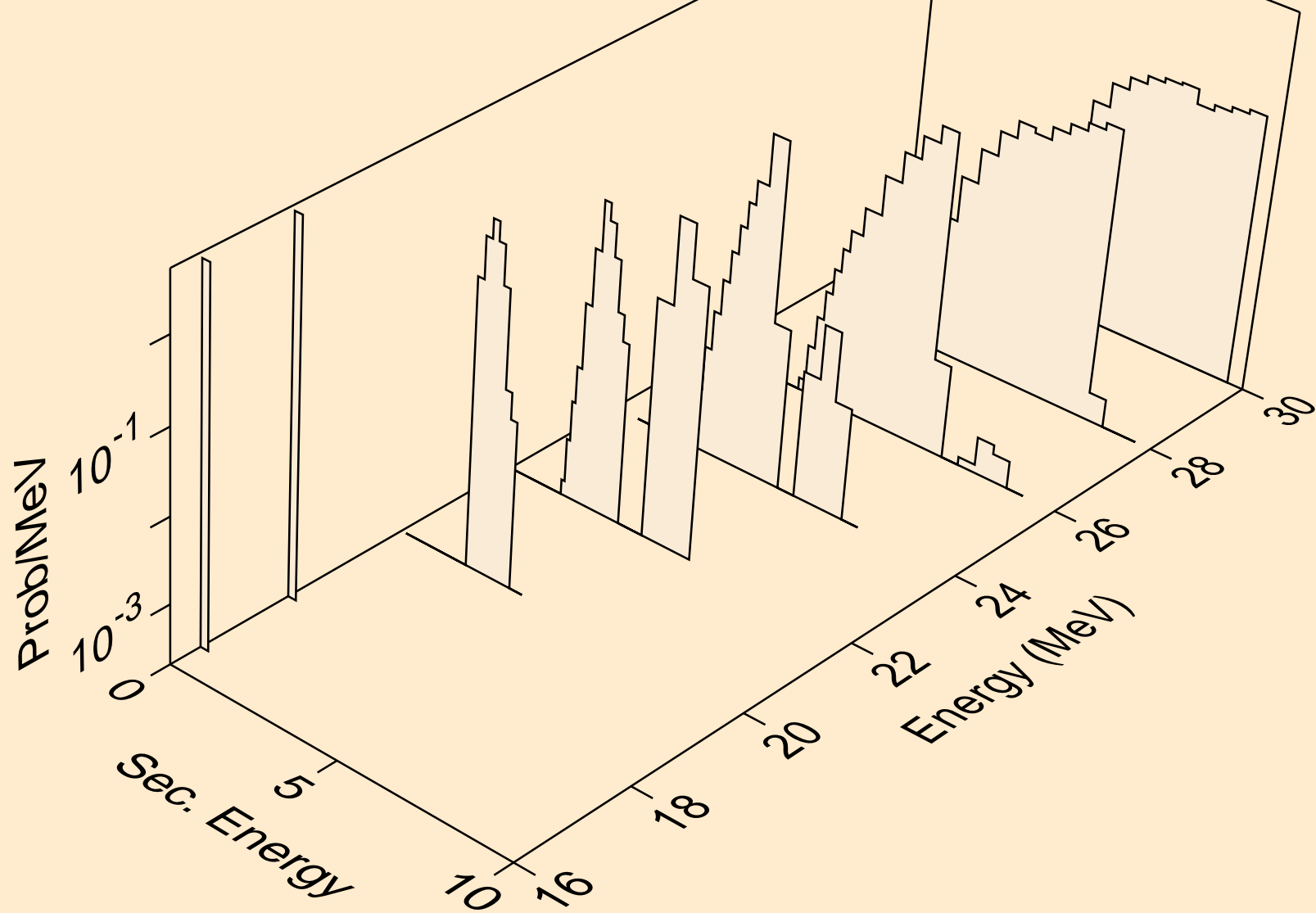



K043 NEUTRON ACER TENDL-2023 LIBRARY; T=0.K  
alphas from (n,x)

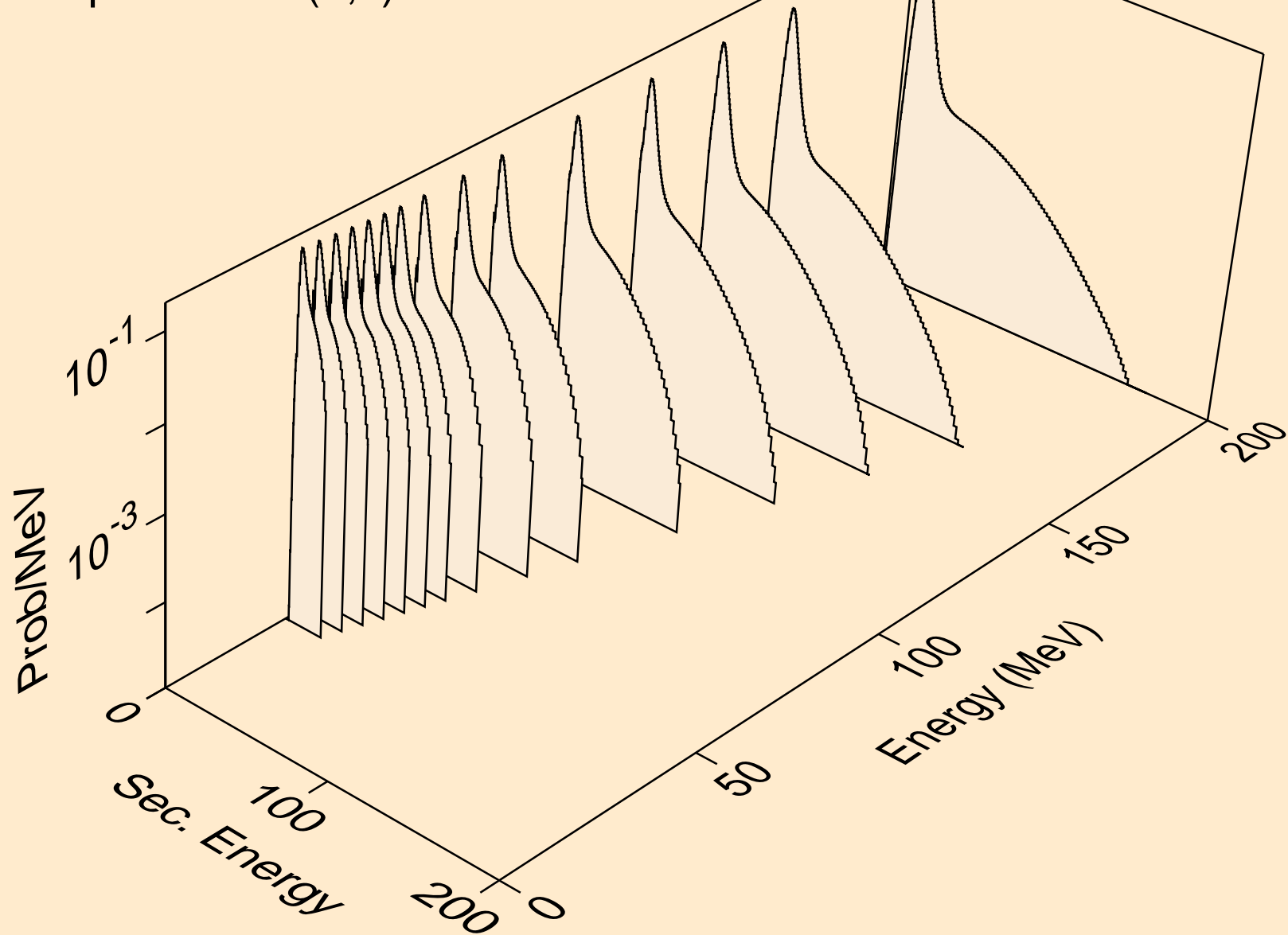

K043 NEUTRON ACER TENDL-2023 LIBRARY; T=0.K  
alphas from (n,n\*)a

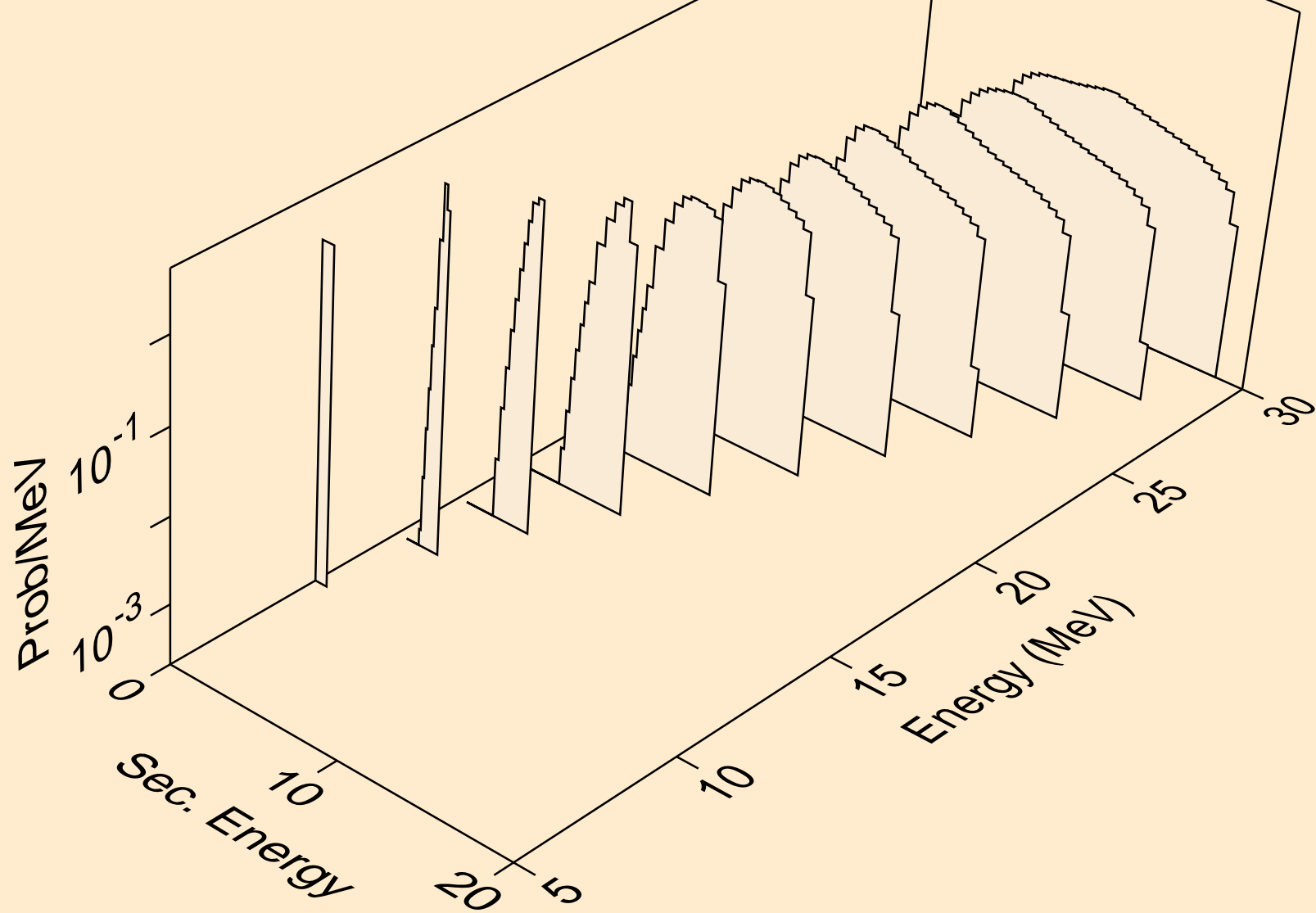

K043 NEUTRON ACER TENDL-2023 LIBRARY; T=0.K  
alphas from (n,2n)a

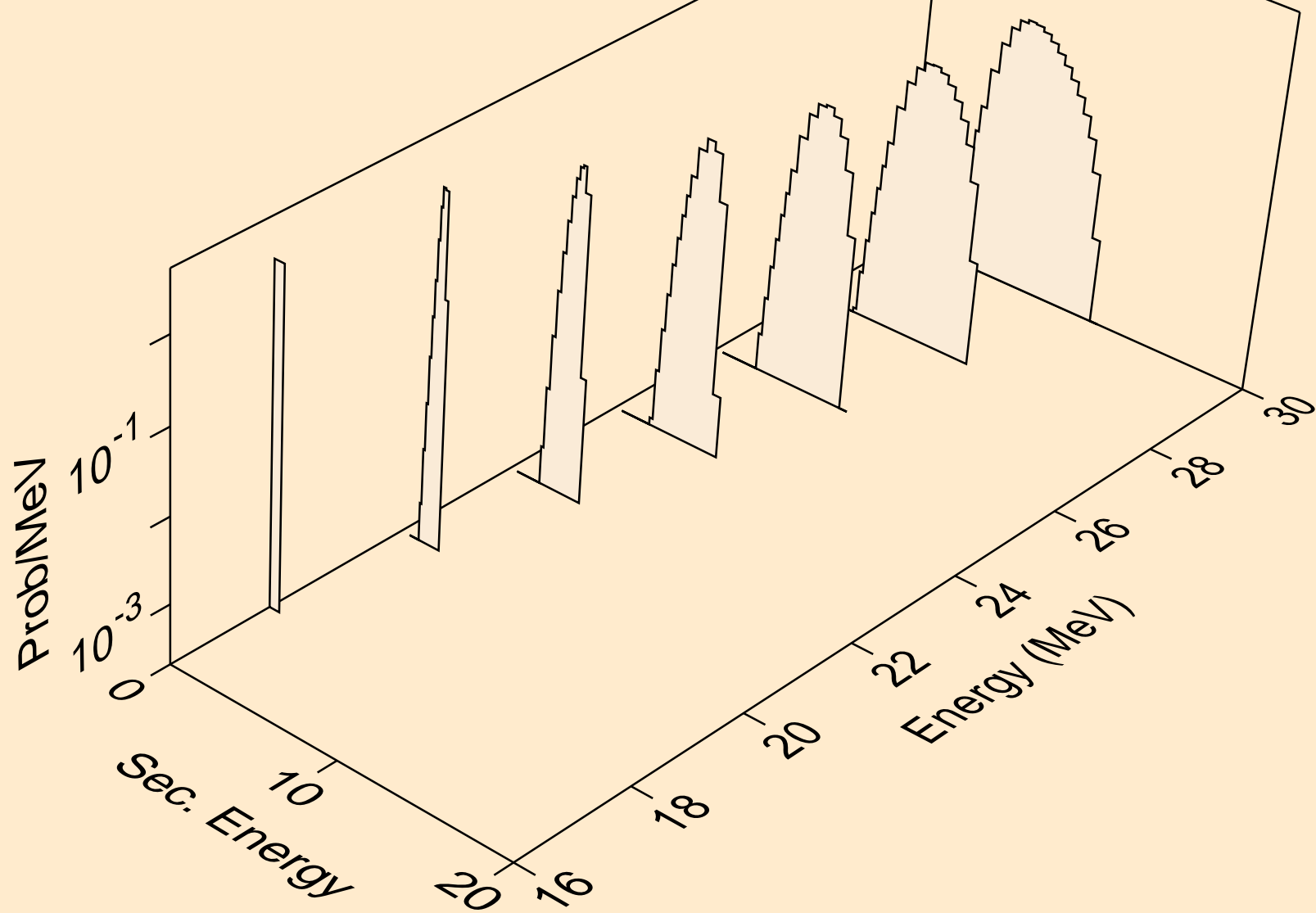

K043 NEUTRON ACER TENDL-2023 LIBRARY; T=0.K  
alphas from (n,3n)a

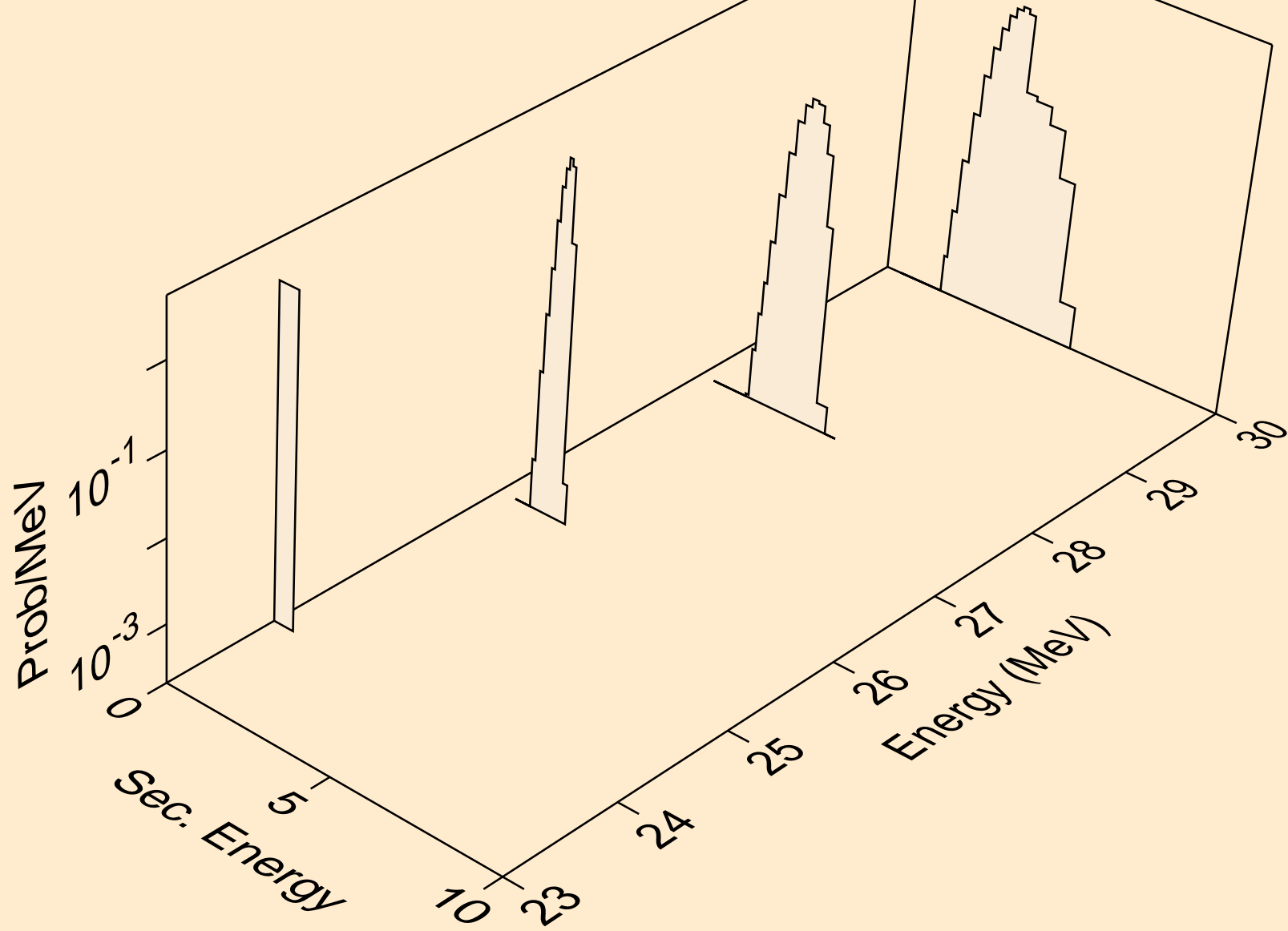

K043 NEUTRON ACER TENDL-2023 LIBRARY; T=0.K  
alphas from (n,n\*)2a

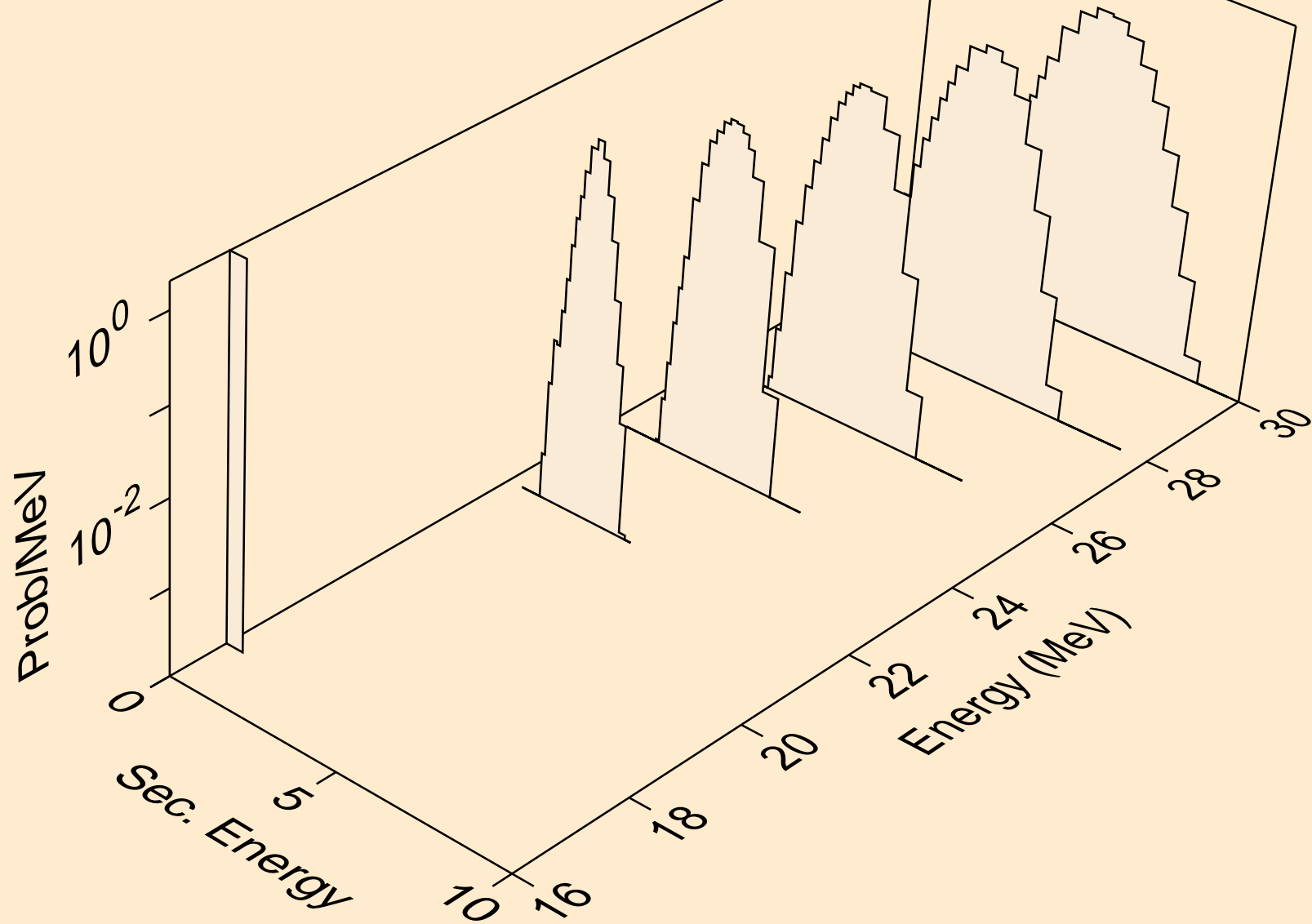

K043 NEUTRON ACER TENDL-2023 LIBRARY; T=0.K  
alphas from (n,npa)

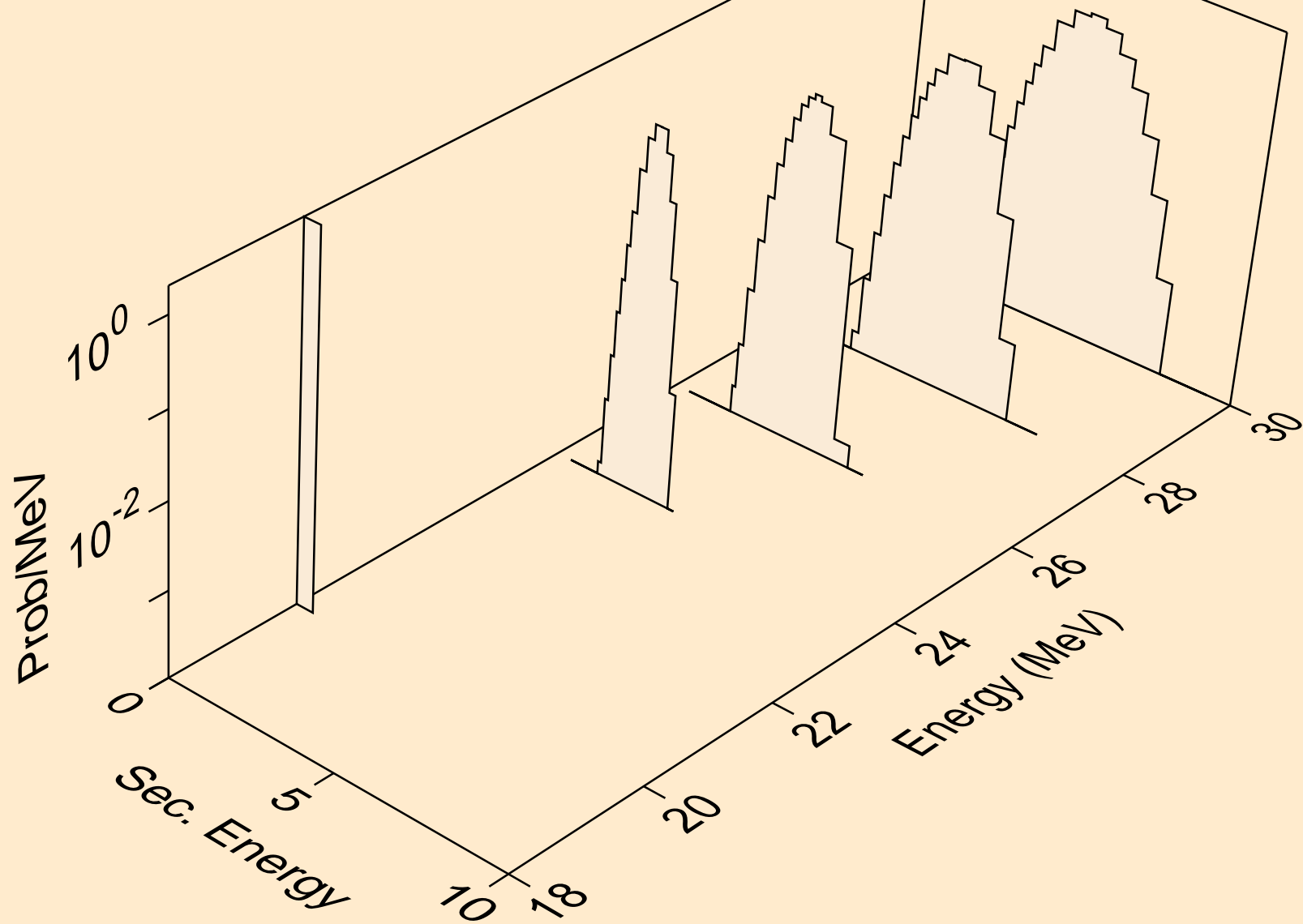

K043 NEUTRON ACER TENDL-2023 LIBRARY; T=0.K  
alphas from (n,a)

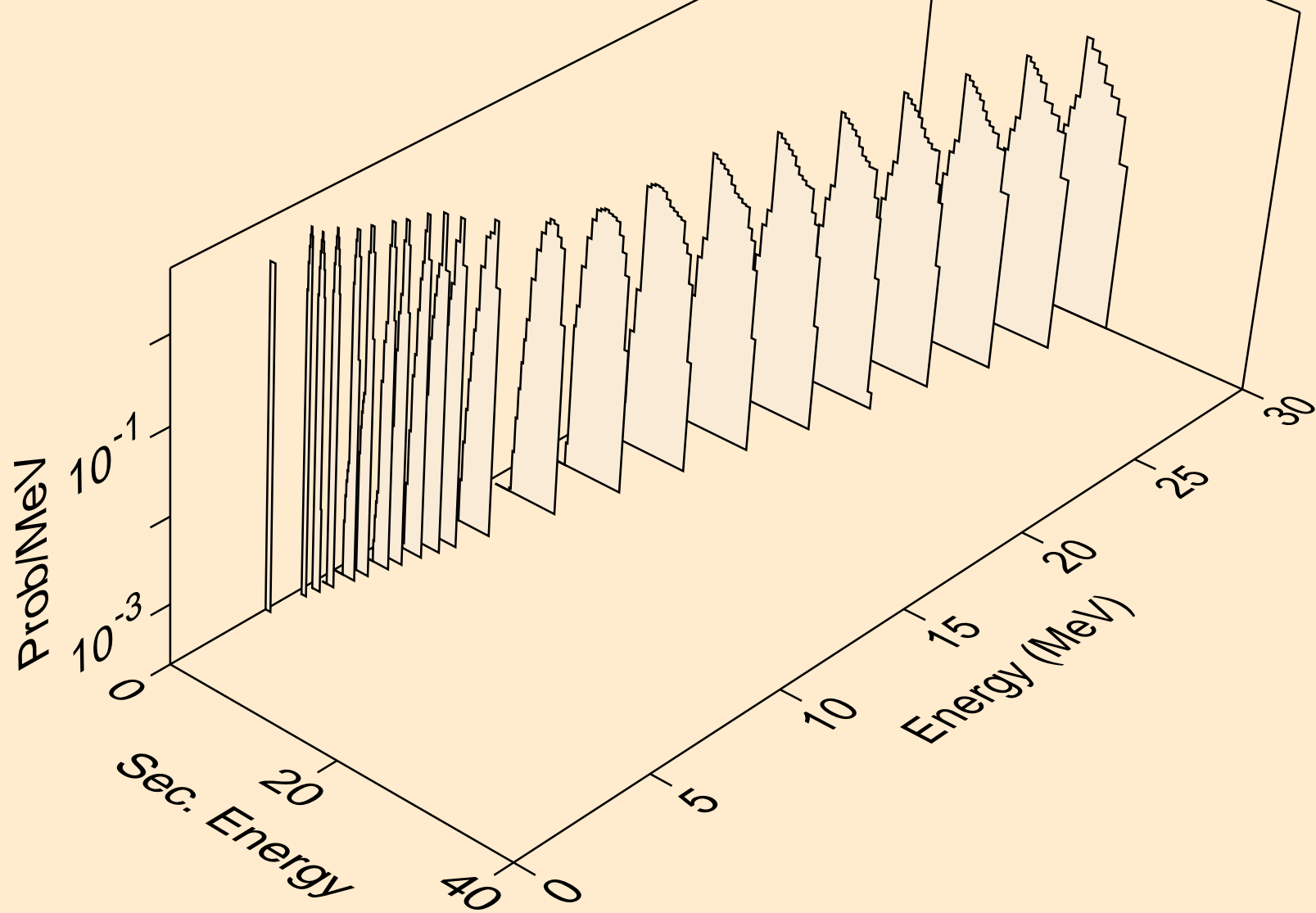

K043 NEUTRON ACER TENDL-2023 LIBRARY; T=0.K  
alphas from (n,2a)

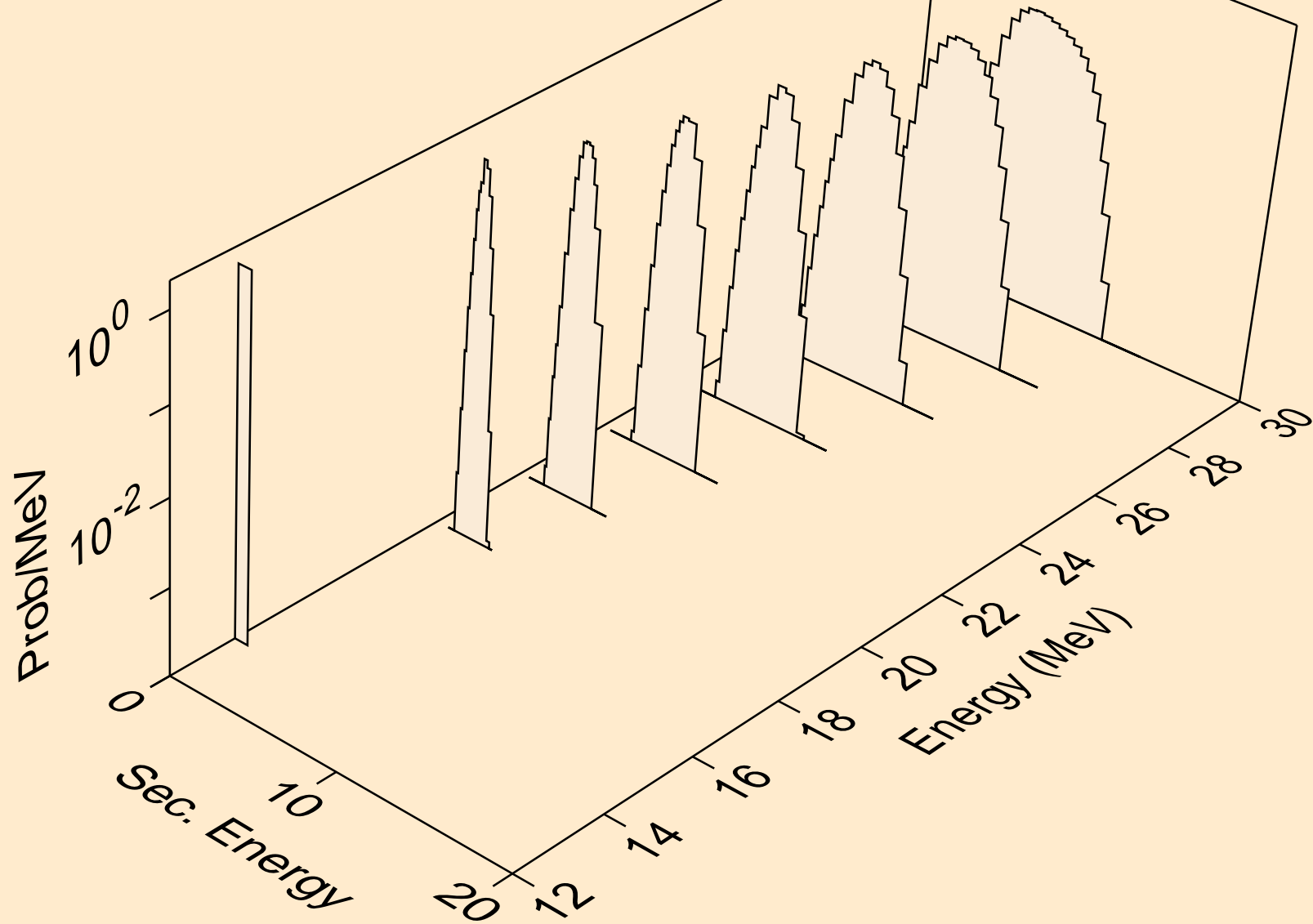



K043 NEUTRON ACER TENDL-2023 LIBRARY; T=0.K  
alphas from (n,pa)

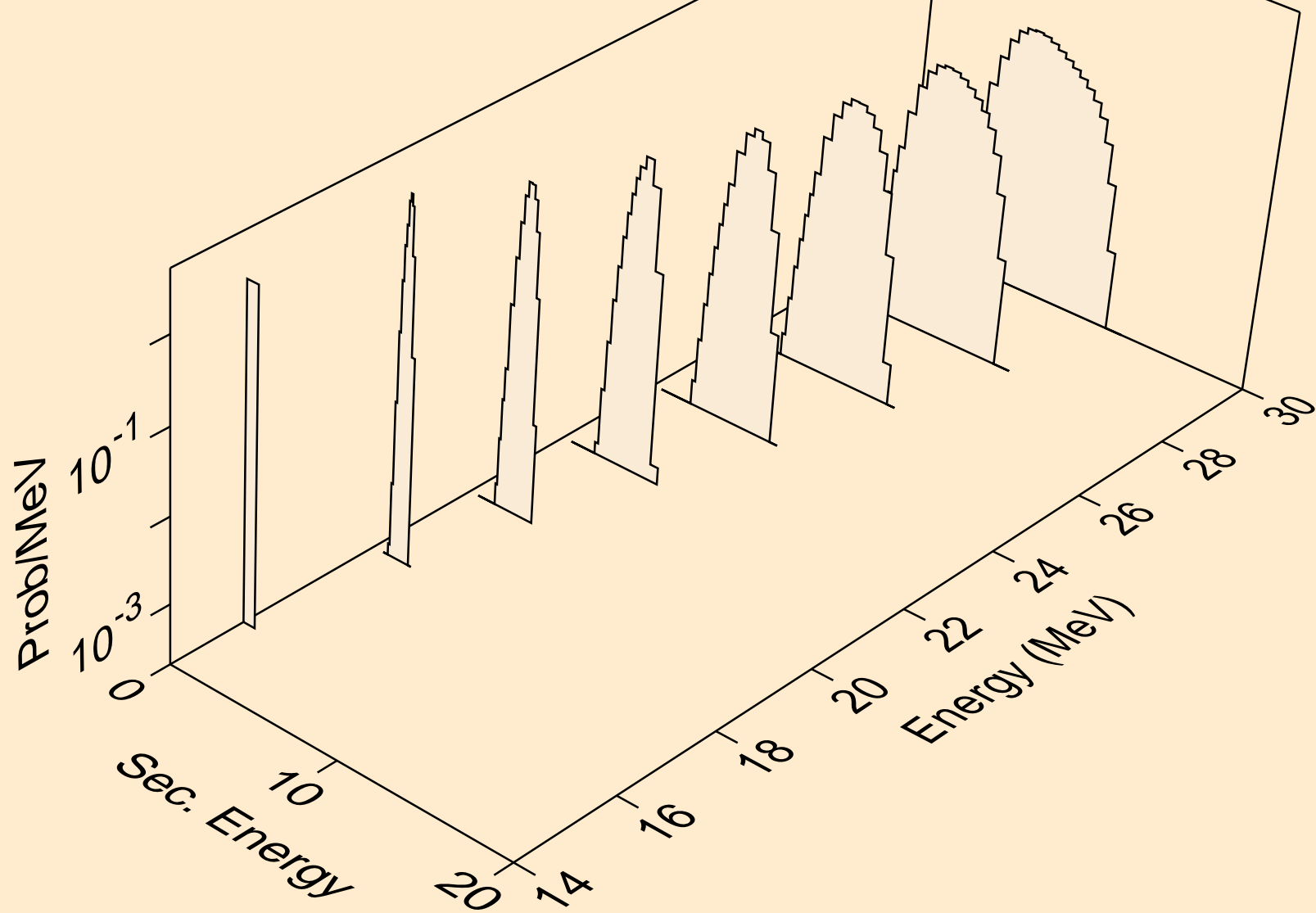

K043 NEUTRON ACER TENDL-2023 LIBRARY; T=0.K  
alphas from (n,da)

