

# KR083 NEUTRON ACER TENDL-2023 LIBRARY; T=0.K

## Principal cross sections

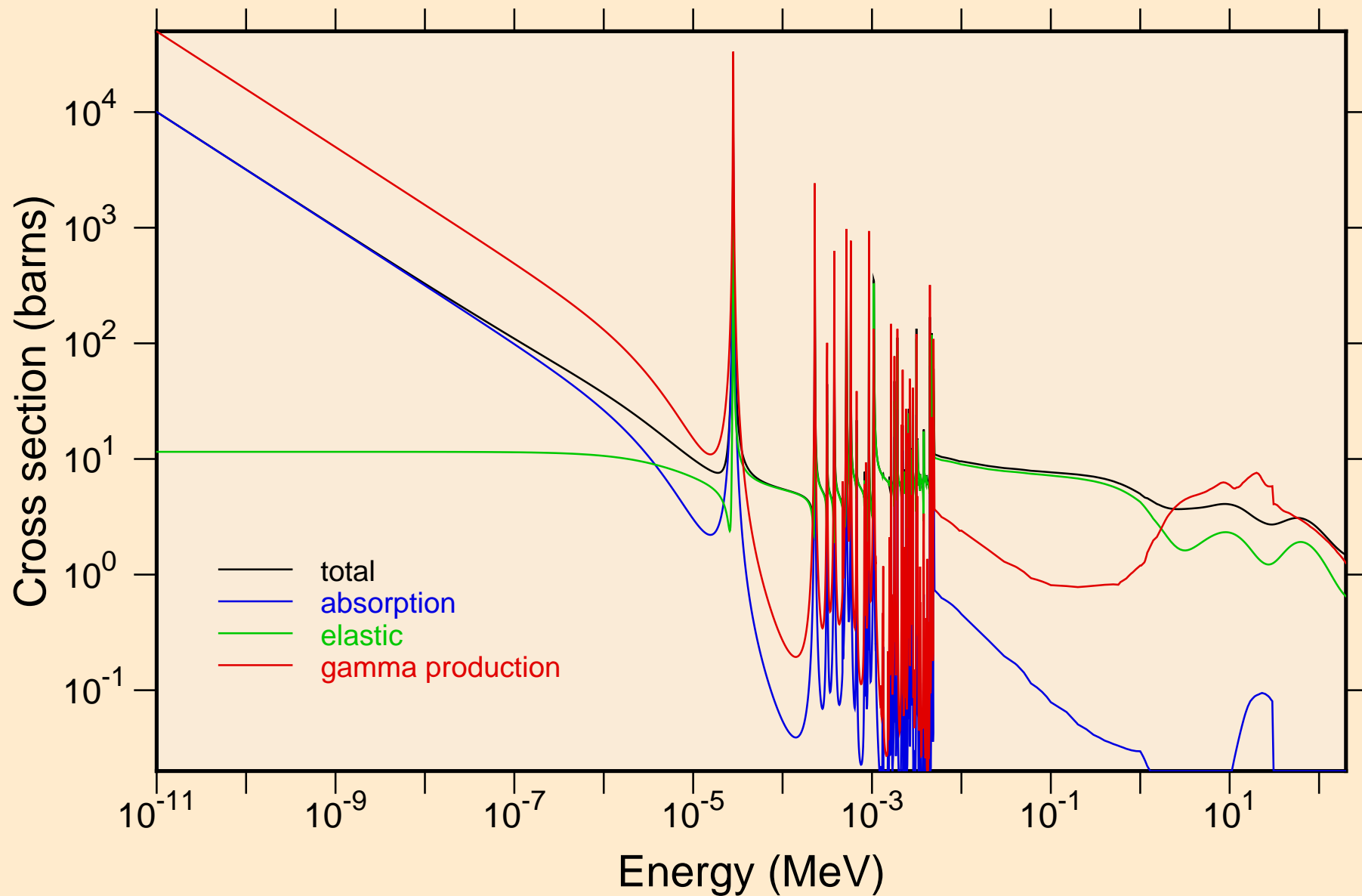

KR083 NEUTRON ACER TENDL-2023 LIBRARY; T=0.K  
resonance total cross section

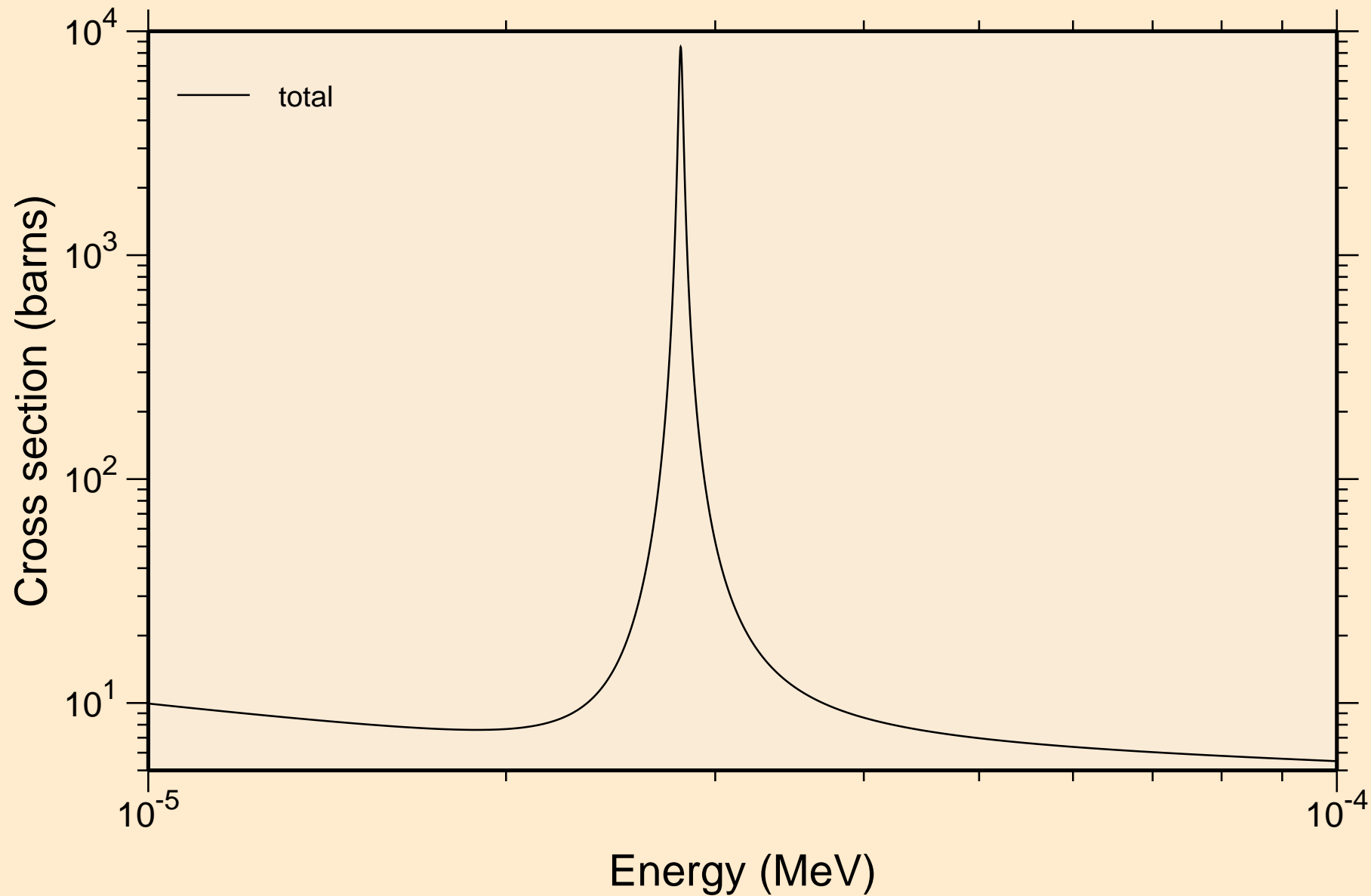

KR083 NEUTRON ACER TENDL-2023 LIBRARY; T=0.K  
resonance total cross section

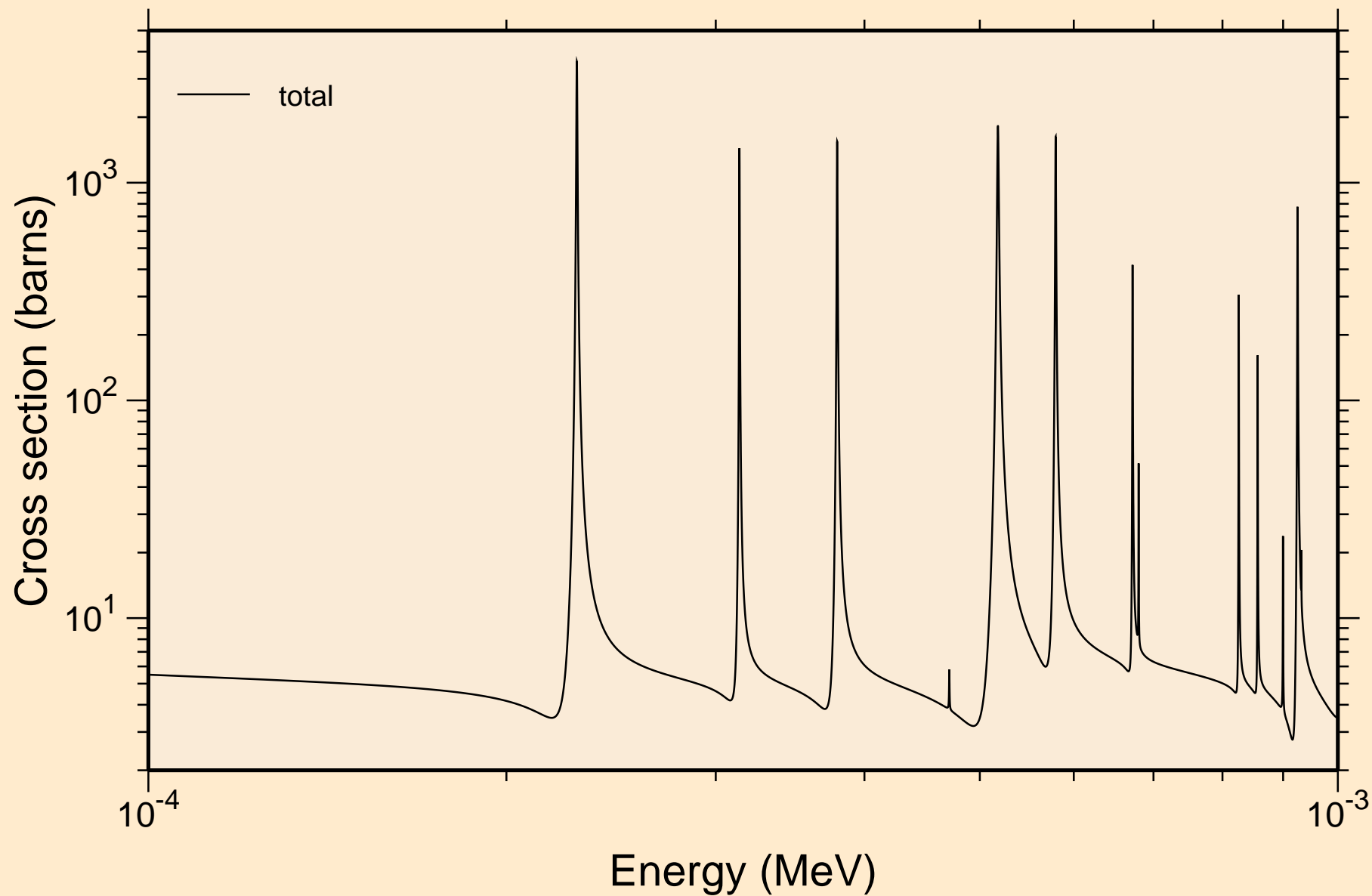

KR083 NEUTRON ACER TENDL-2023 LIBRARY; T=0.K  
resonance total cross section

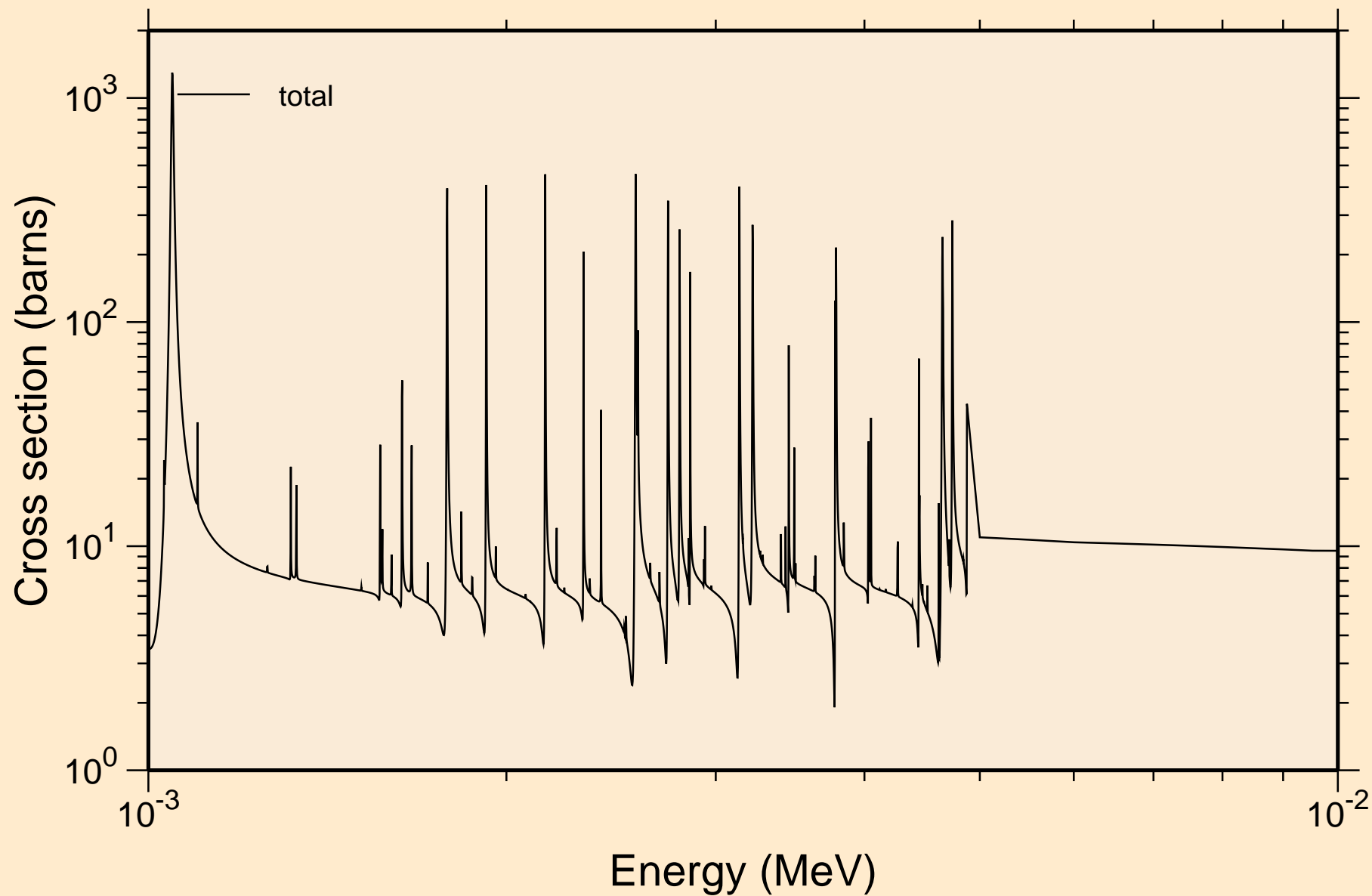

KR083 NEUTRON ACER TENDL-2023 LIBRARY; T=0.K  
resonance total cross section

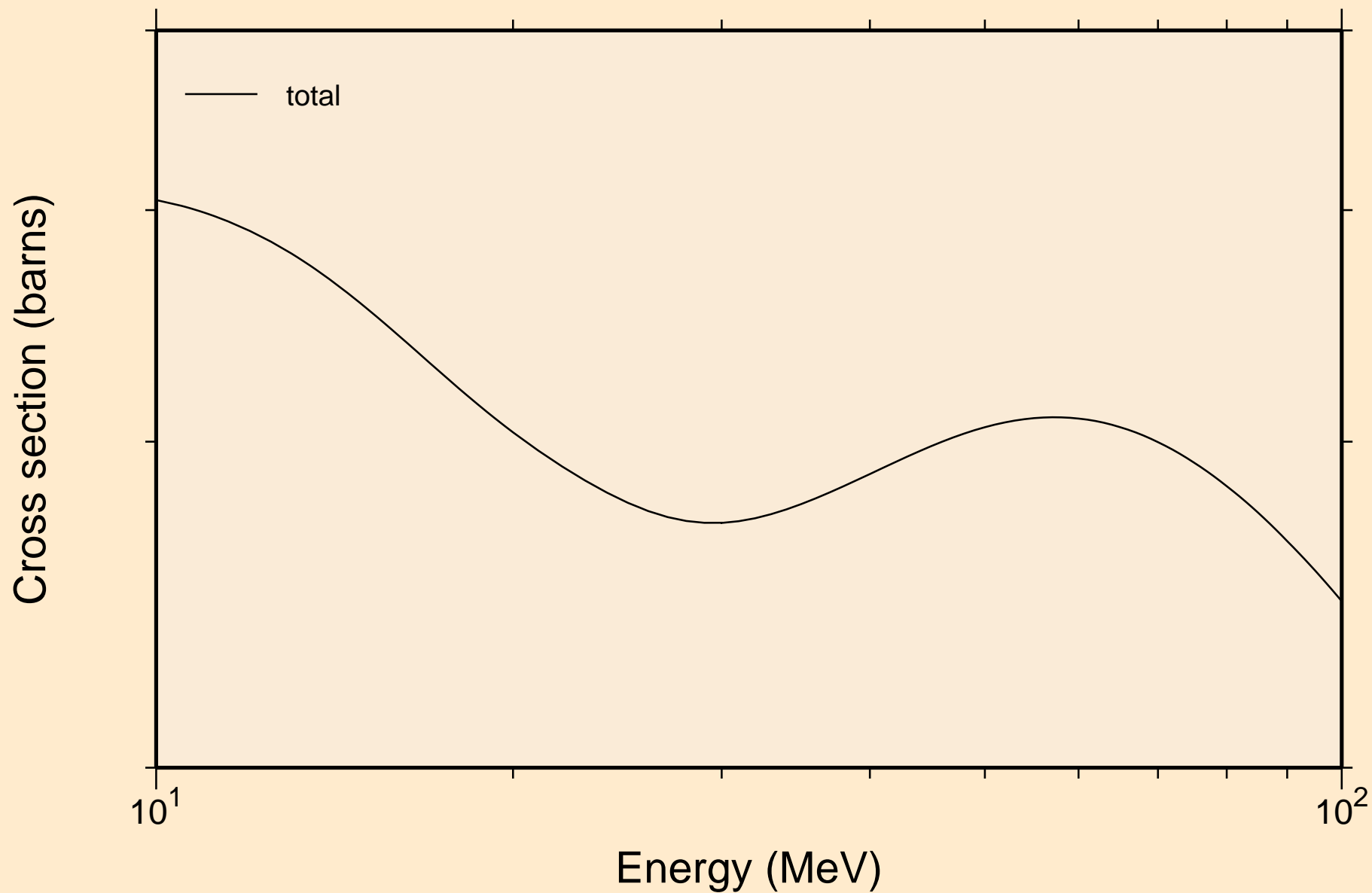

KR083 NEUTRON ACER TENDL-2023 LIBRARY; T=0.K  
resonance absorption cross sections

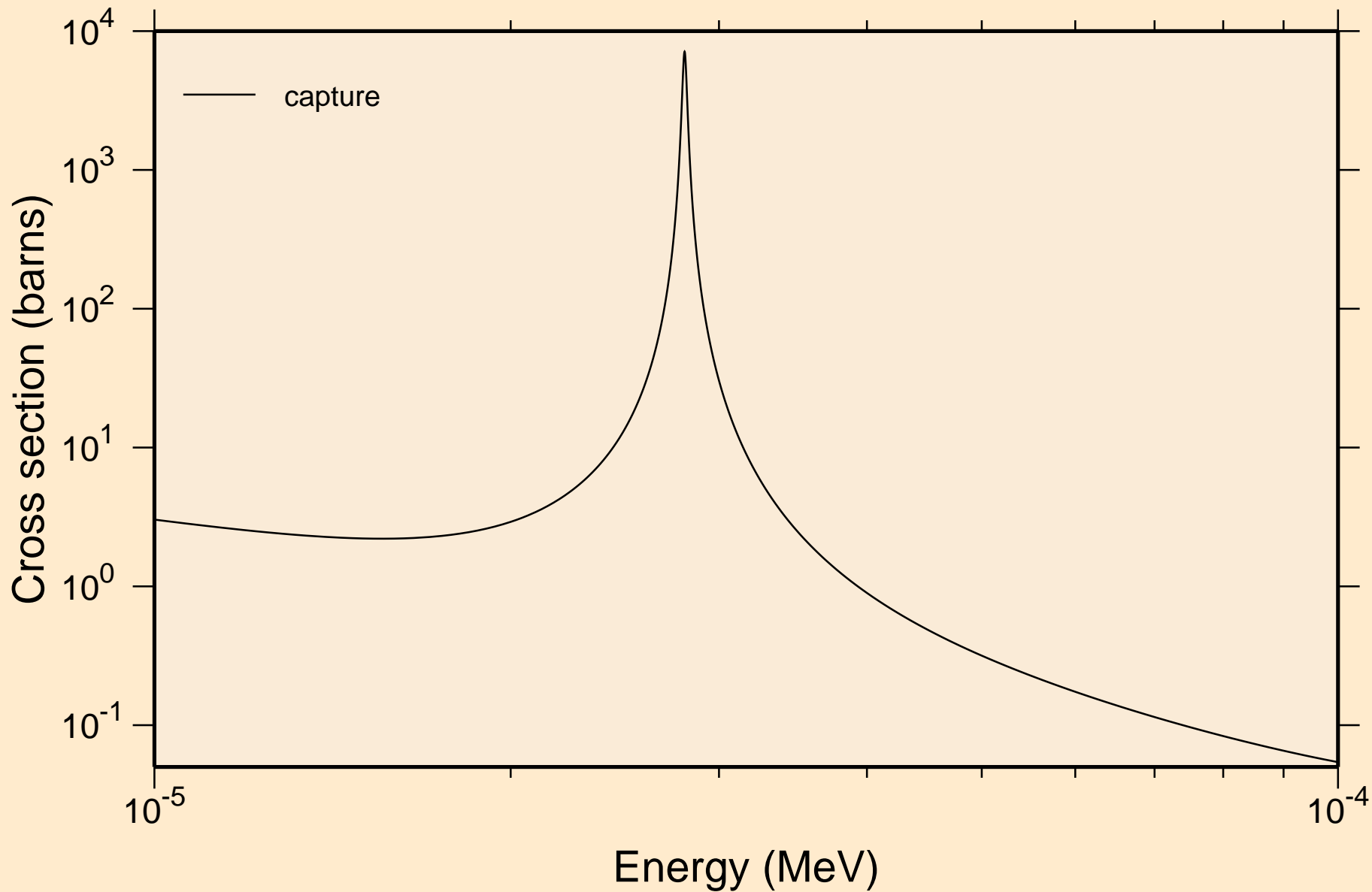

KR083 NEUTRON ACER TENDL-2023 LIBRARY; T=0.K  
resonance absorption cross sections

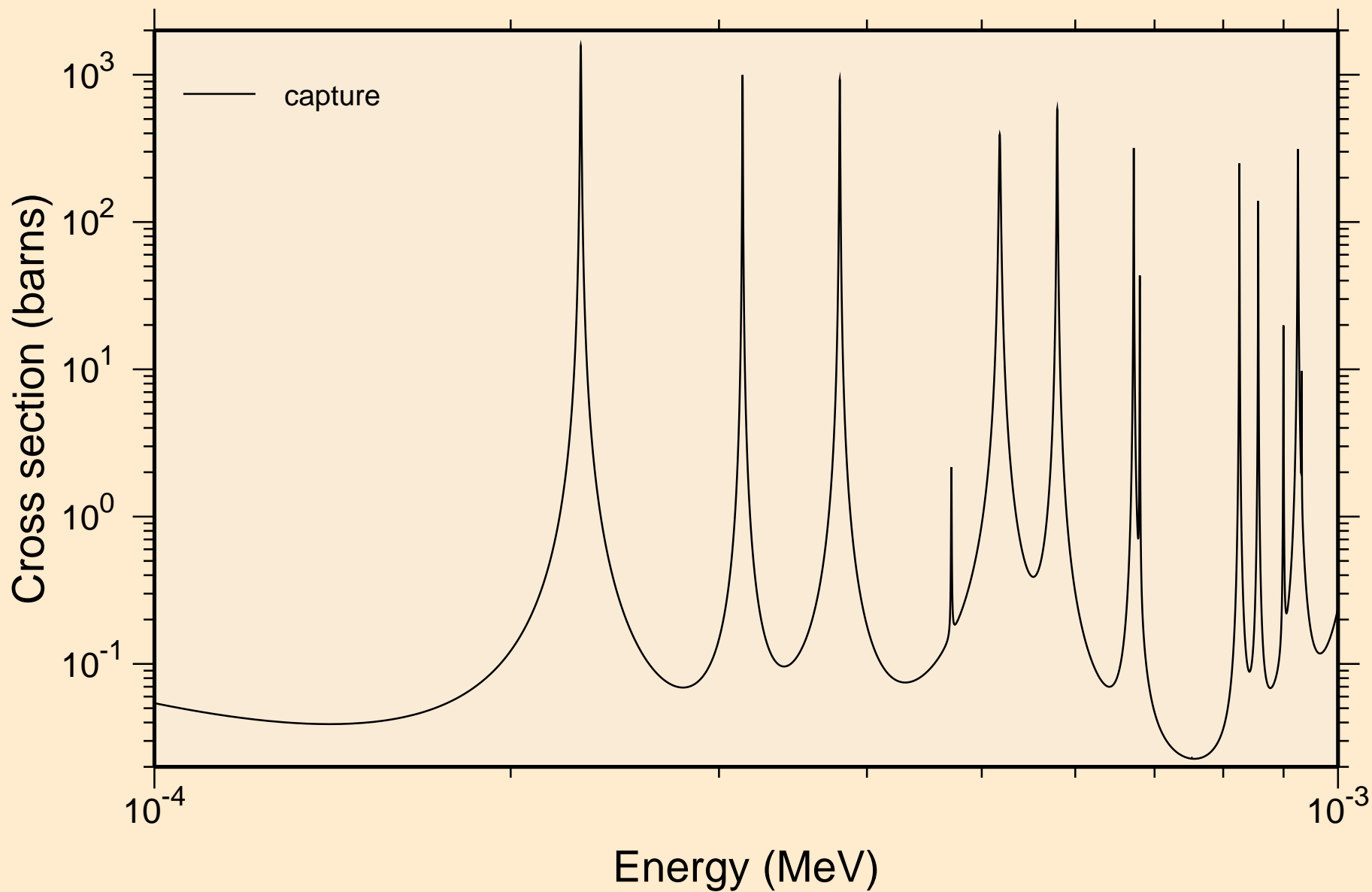

KR083 NEUTRON ACER TENDL-2023 LIBRARY; T=0.K  
resonance absorption cross sections

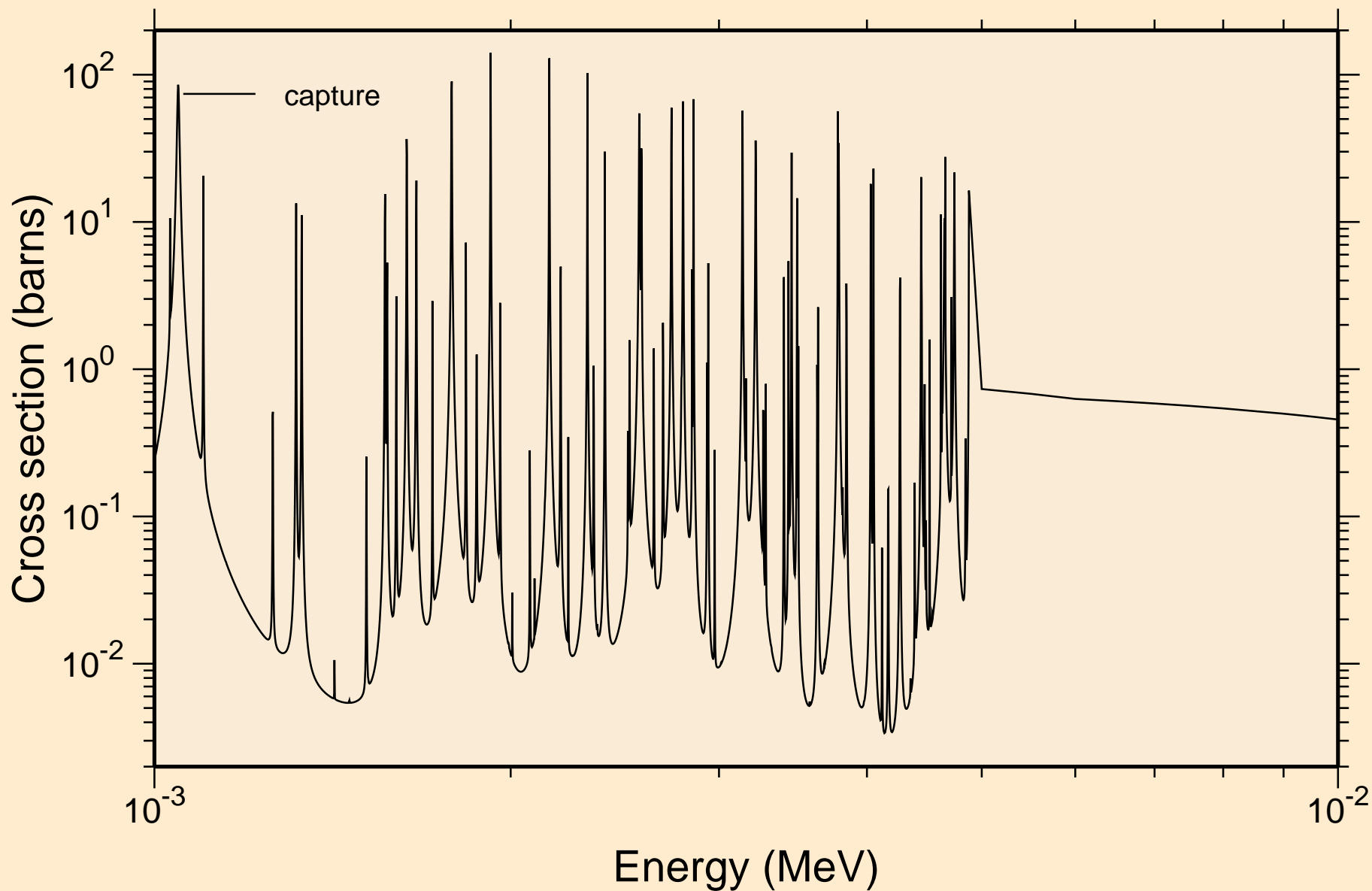



KR083 NEUTRON ACER TENDL-2023 LIBRARY; T=0.K  
resonance absorption cross sections

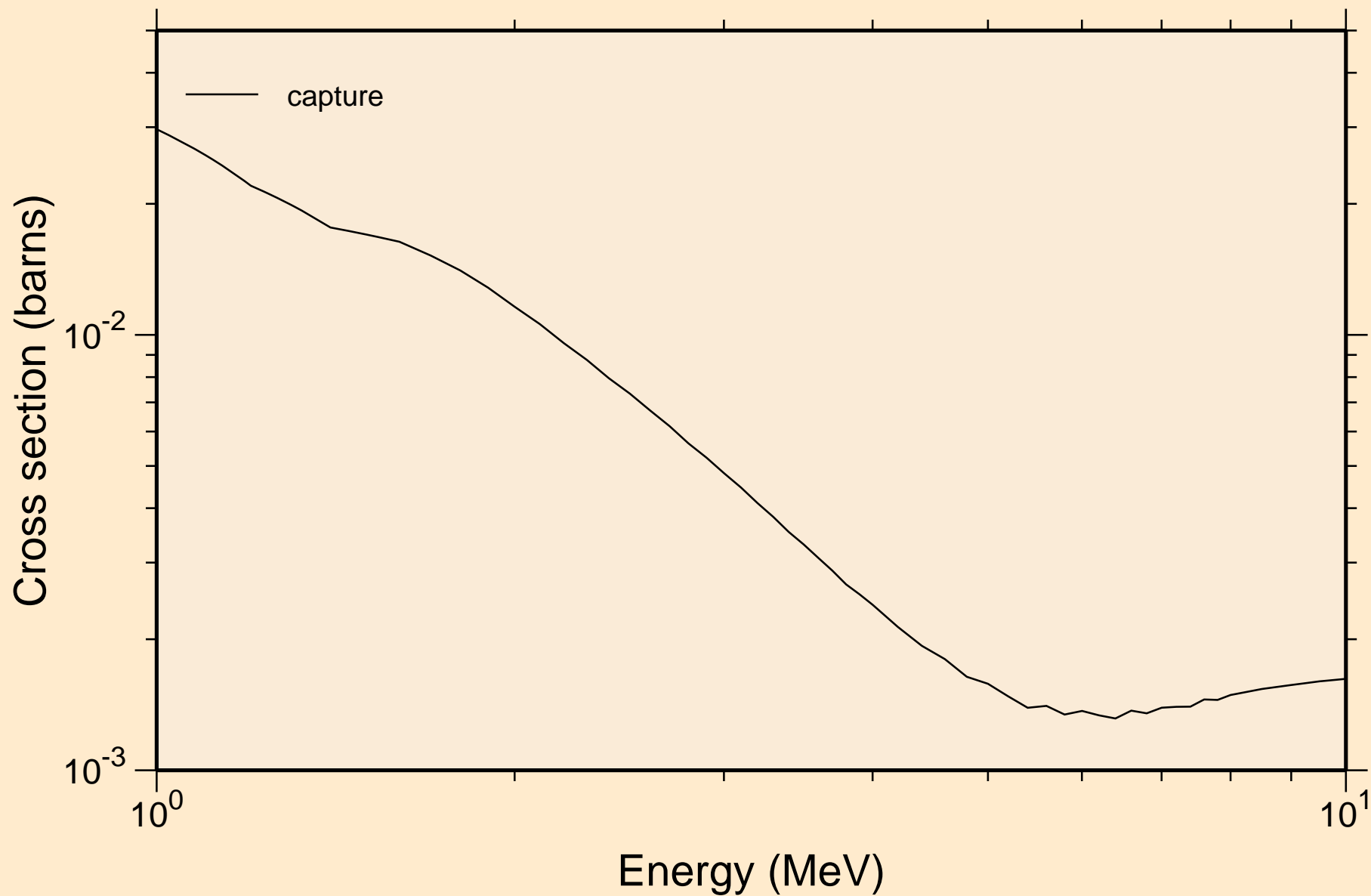

KR083 NEUTRON ACER TENDL-2023 LIBRARY; T=0.K  
Heating

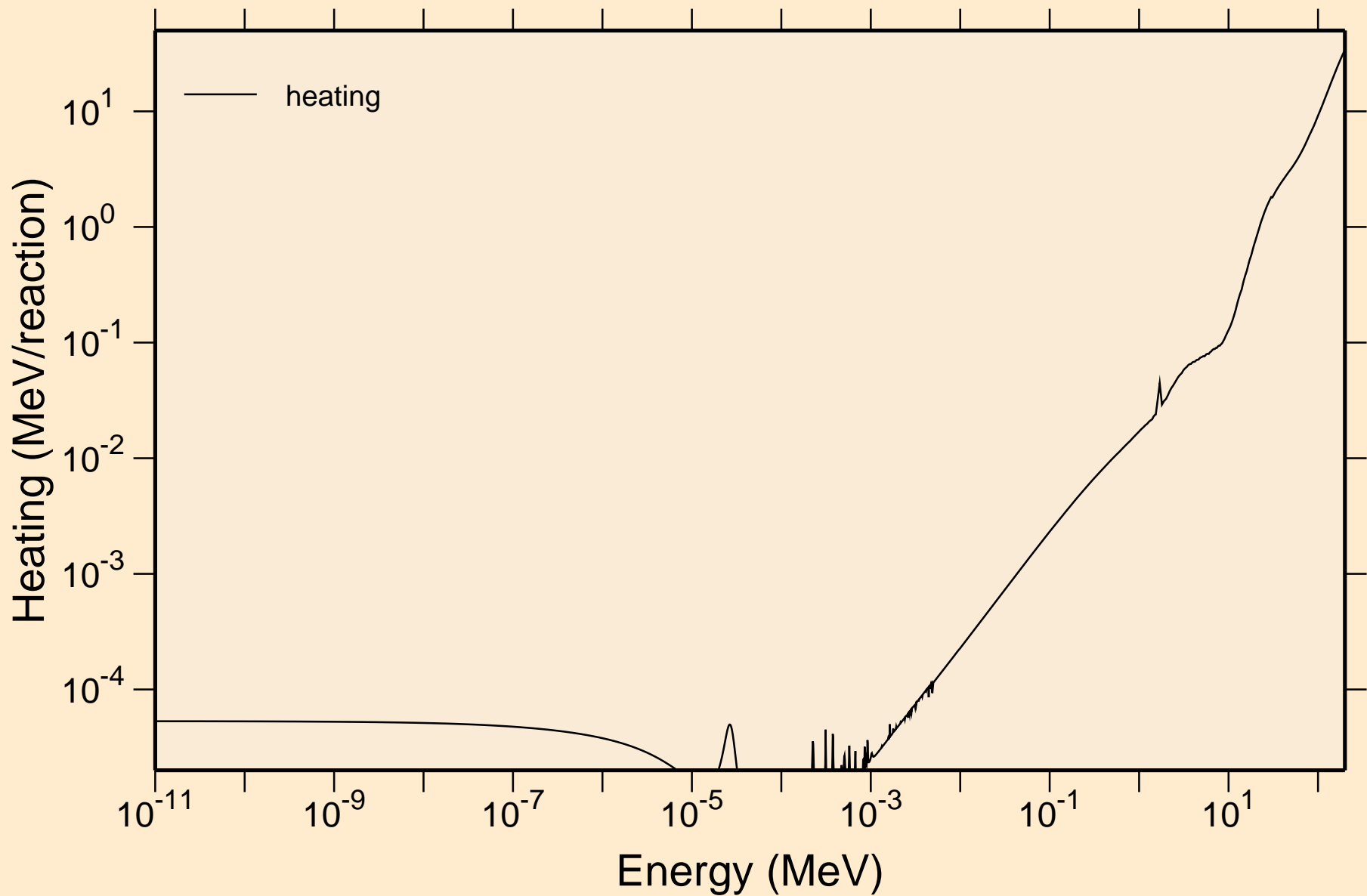

KR083 NEUTRON ACER TENDL-2023 LIBRARY; T=0.K  
Damage

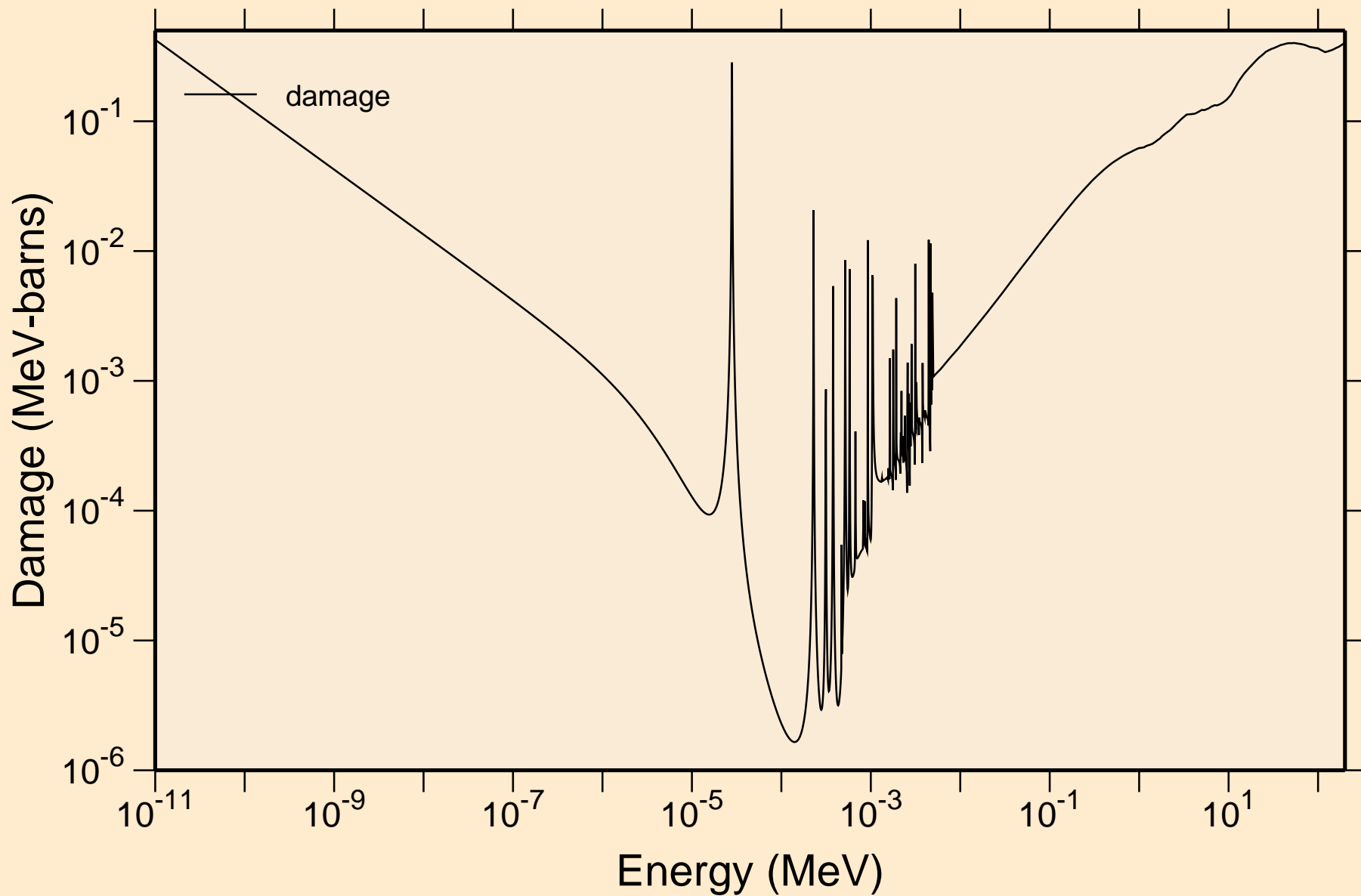

KR083 NEUTRON ACER TENDL-2023 LIBRARY; T=0.K  
Non-threshold reactions

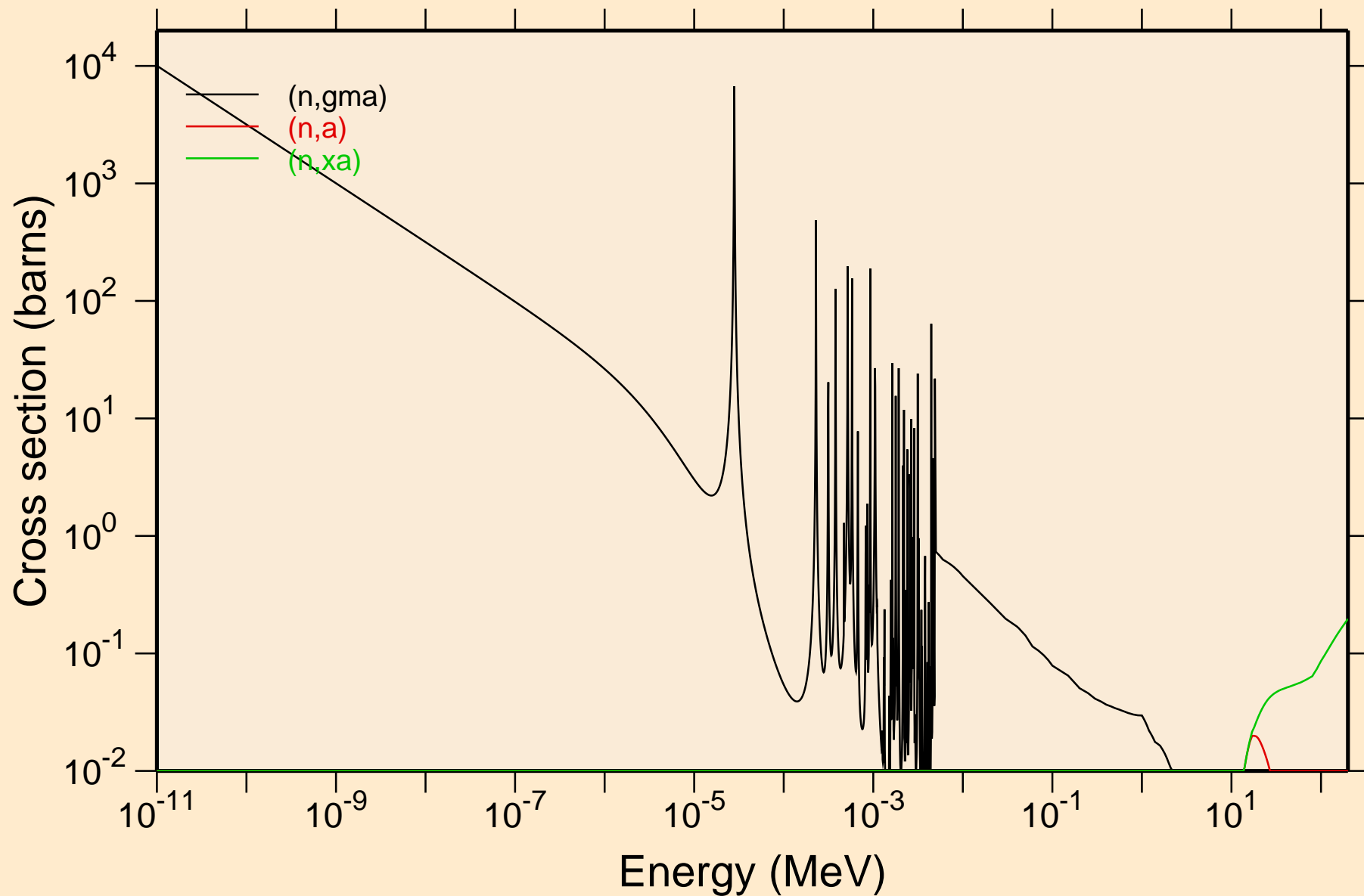

# KR083 NEUTRON ACER TENDL-2023 LIBRARY; T=0.K

## Principal cross sections

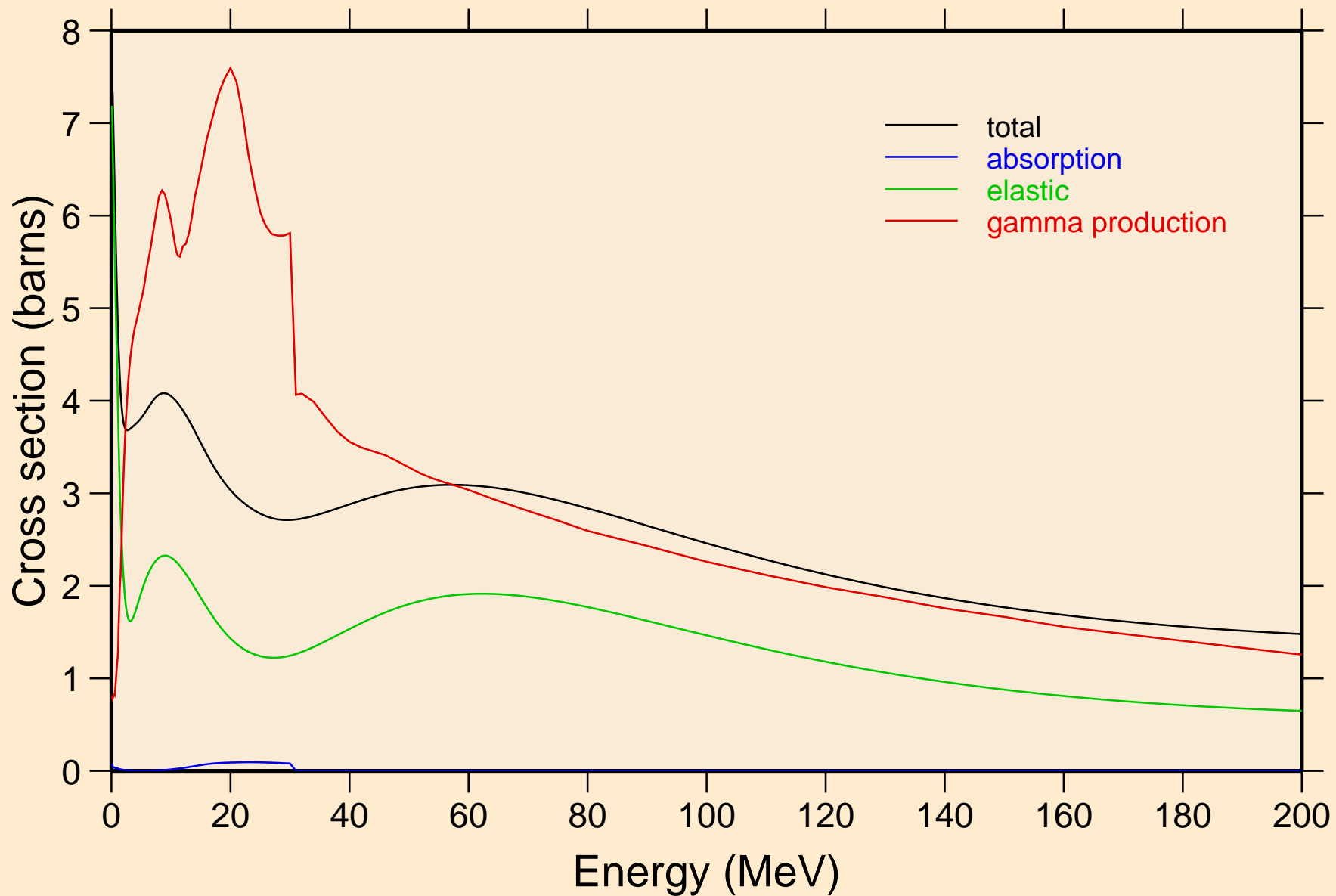

KR083 NEUTRON ACER TENDL-2023 LIBRARY; T=0.K  
Heating

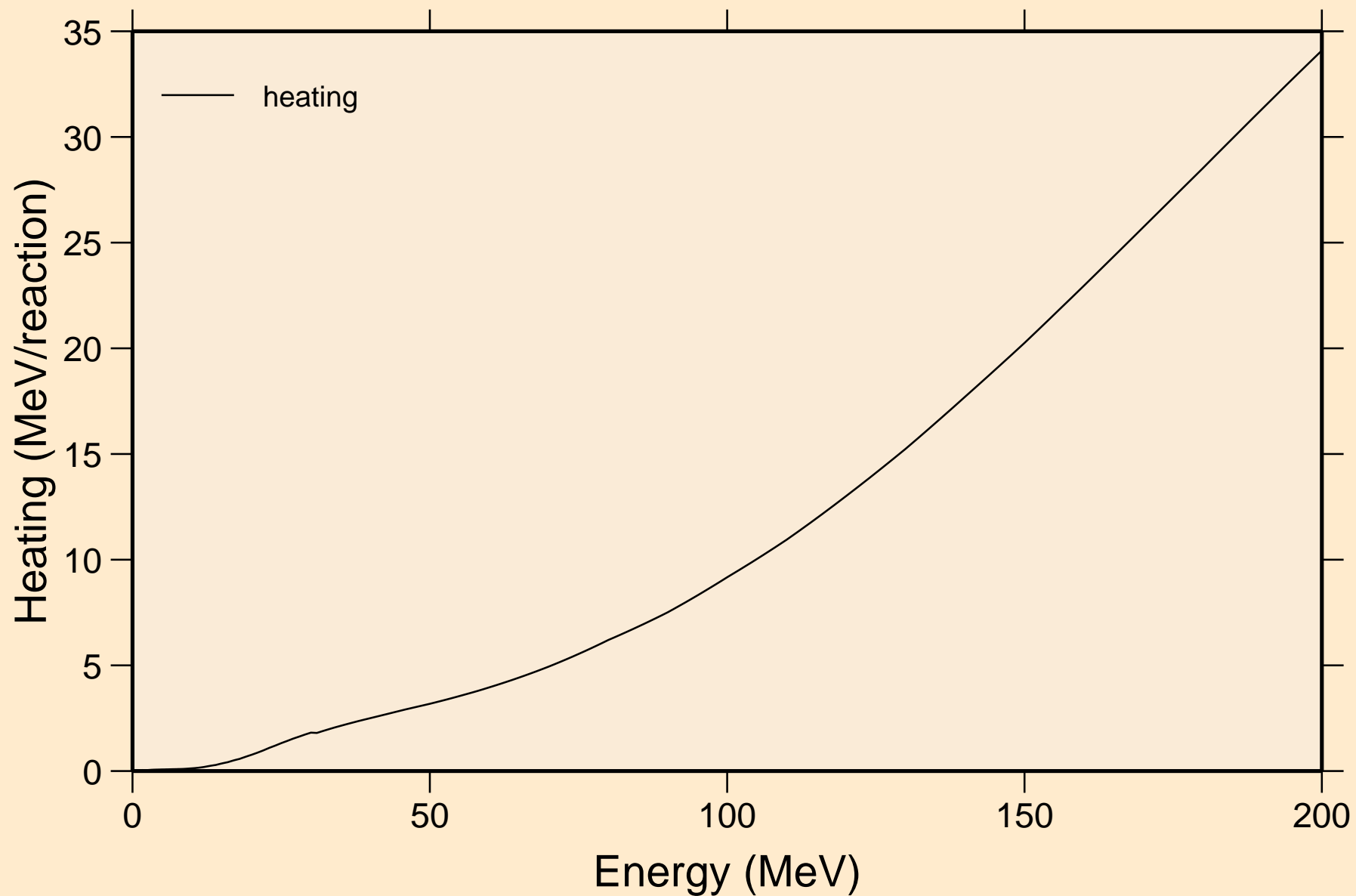

KR083 NEUTRON ACER TENDL-2023 LIBRARY; T=0.K  
Damage

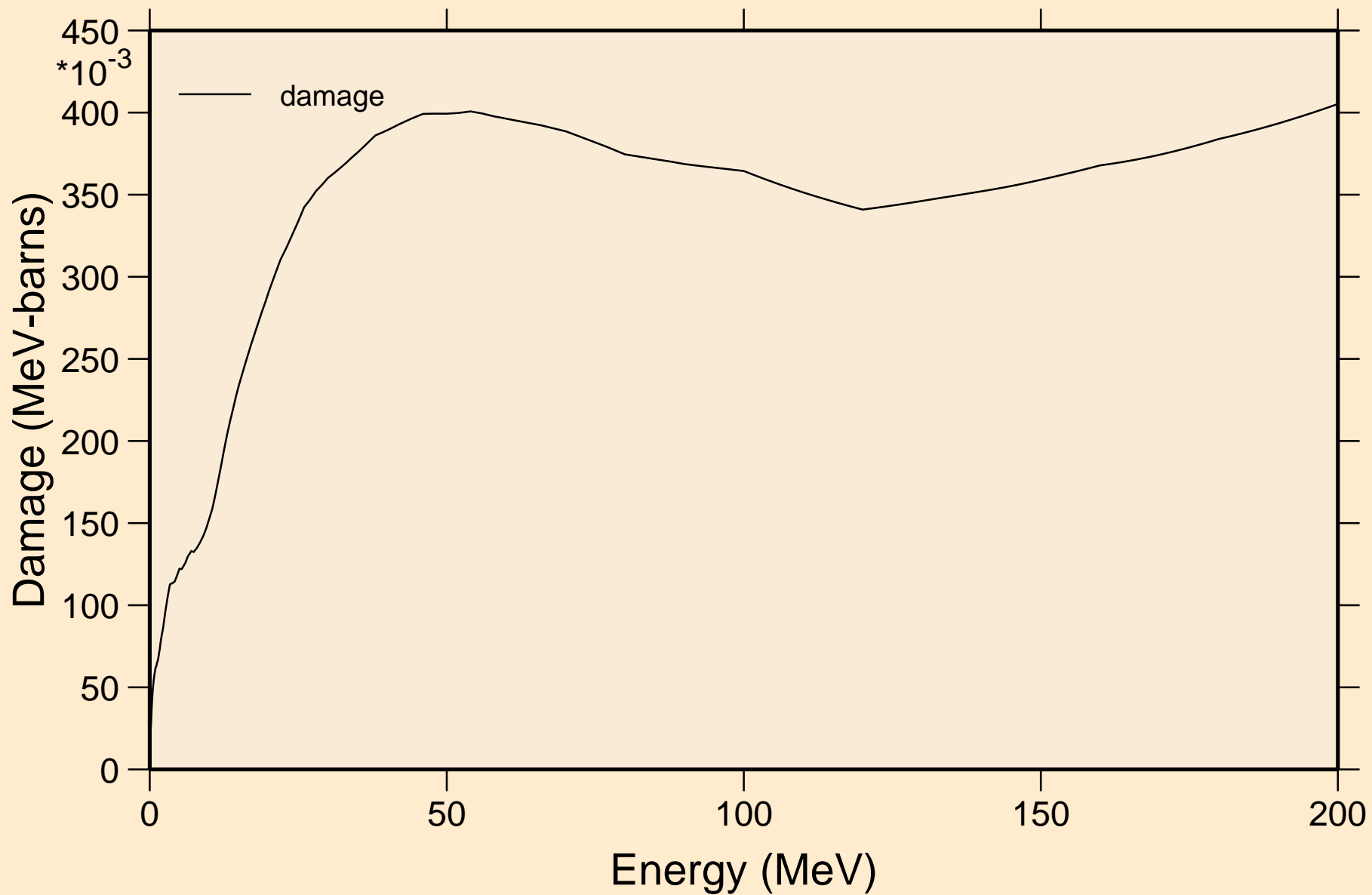

KR083 NEUTRON ACER TENDL-2023 LIBRARY; T=0.K  
Non-threshold reactions

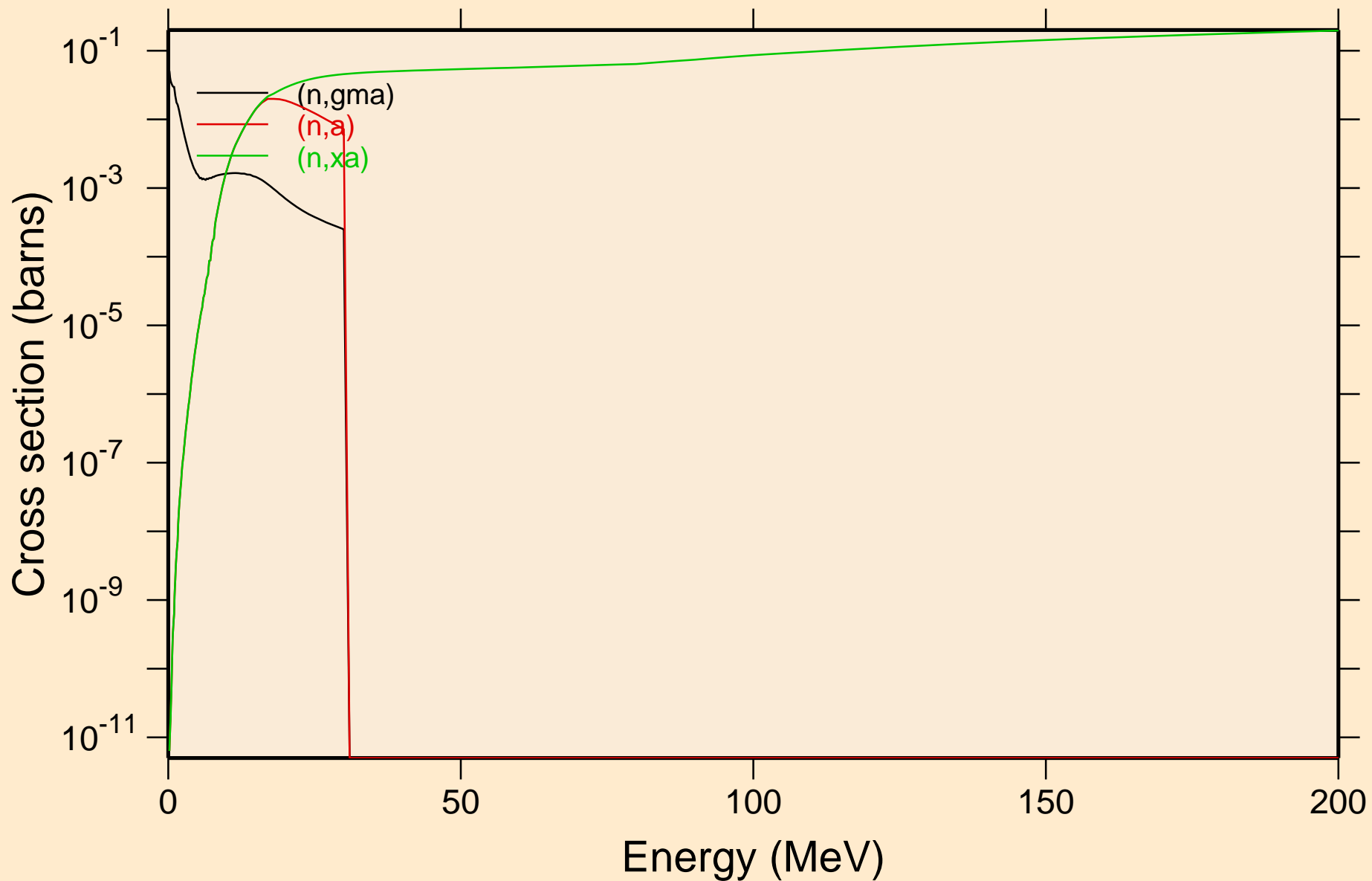



KR083 NEUTRON ACER TENDL-2023 LIBRARY; T=0.K  
Inelastic levels

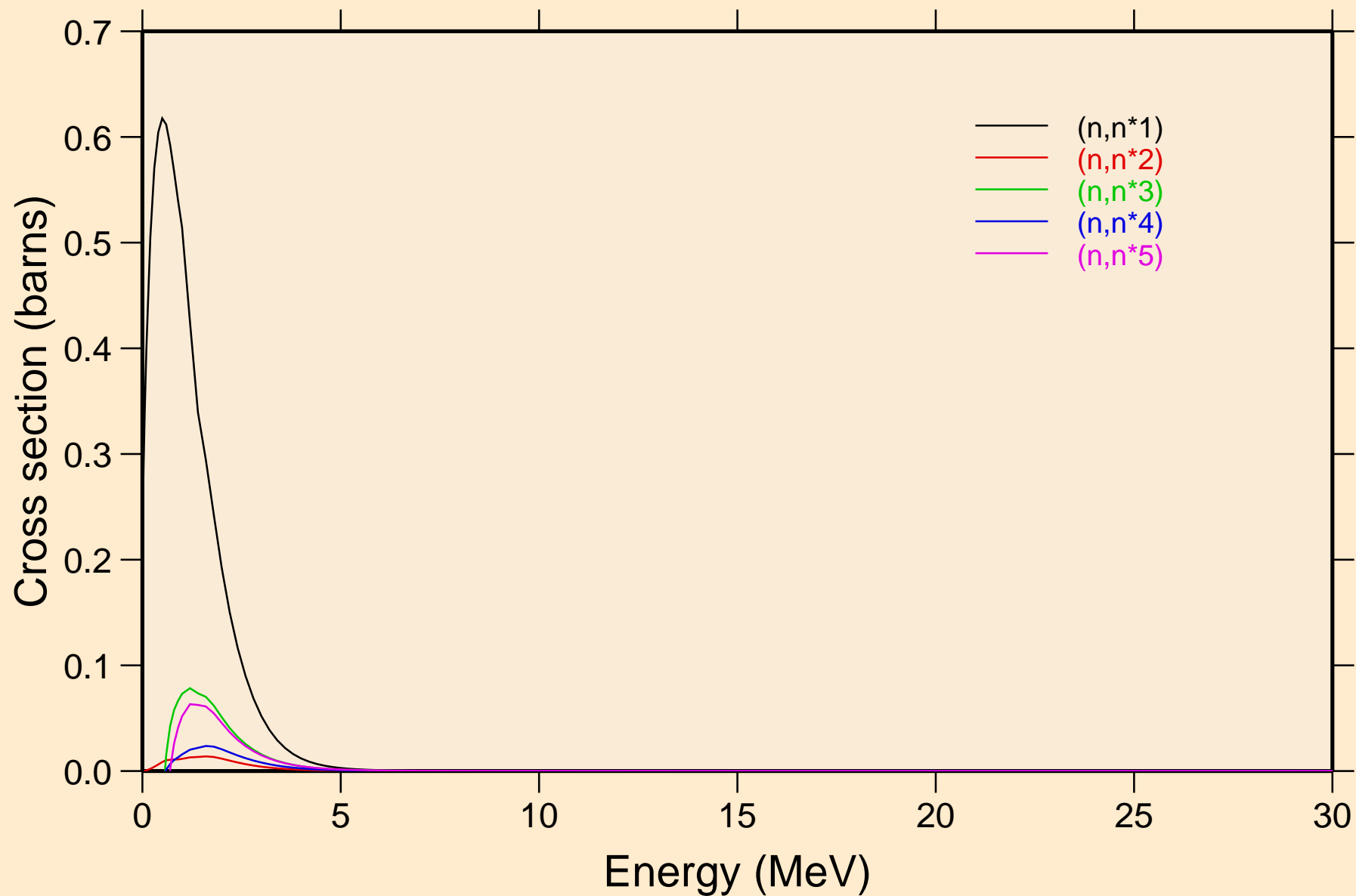

KR083 NEUTRON ACER TENDL-2023 LIBRARY; T=0.K  
Inelastic levels

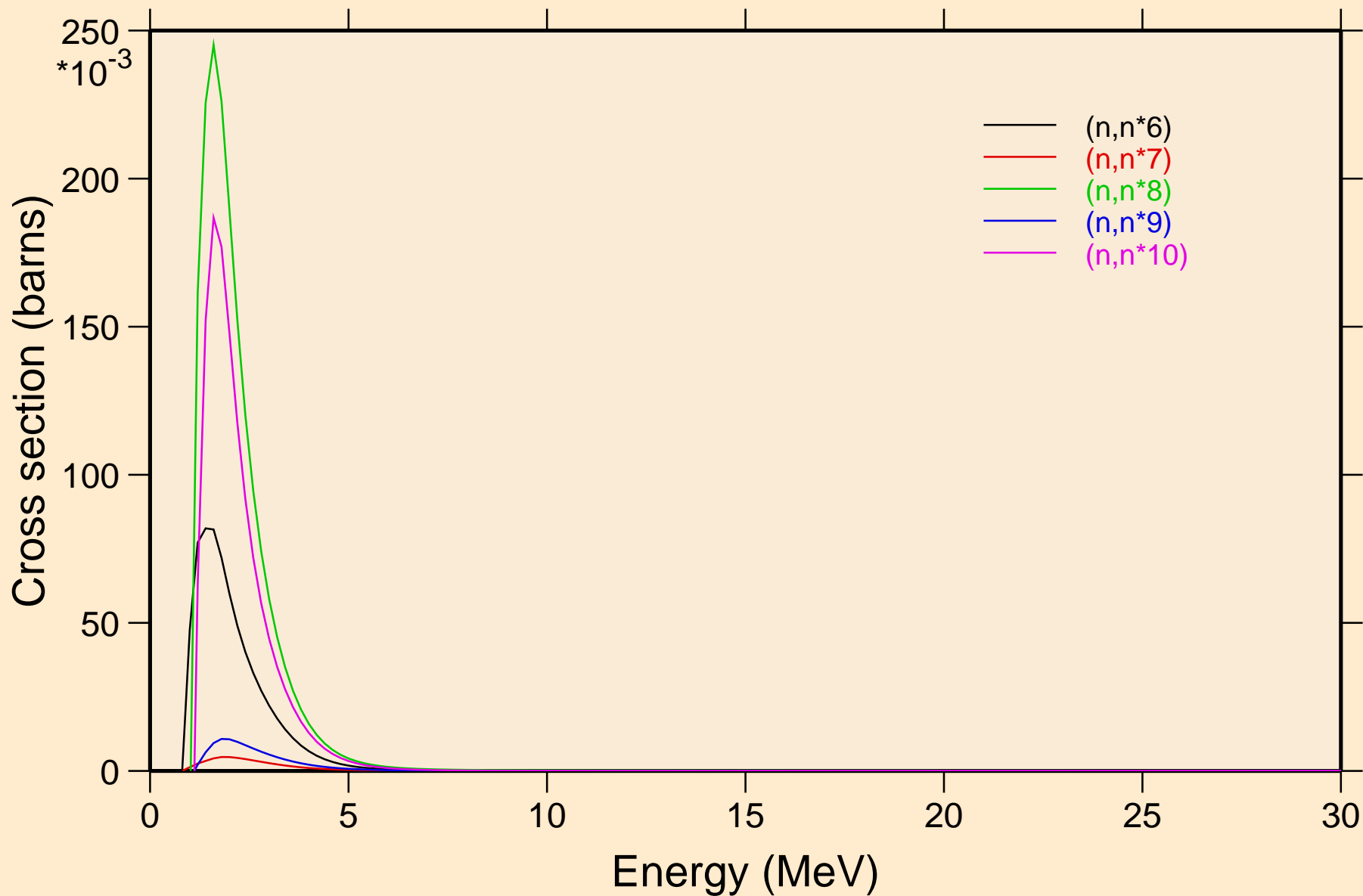

# KR083 NEUTRON ACER TENDL-2023 LIBRARY; T=0.K

## Inelastic levels

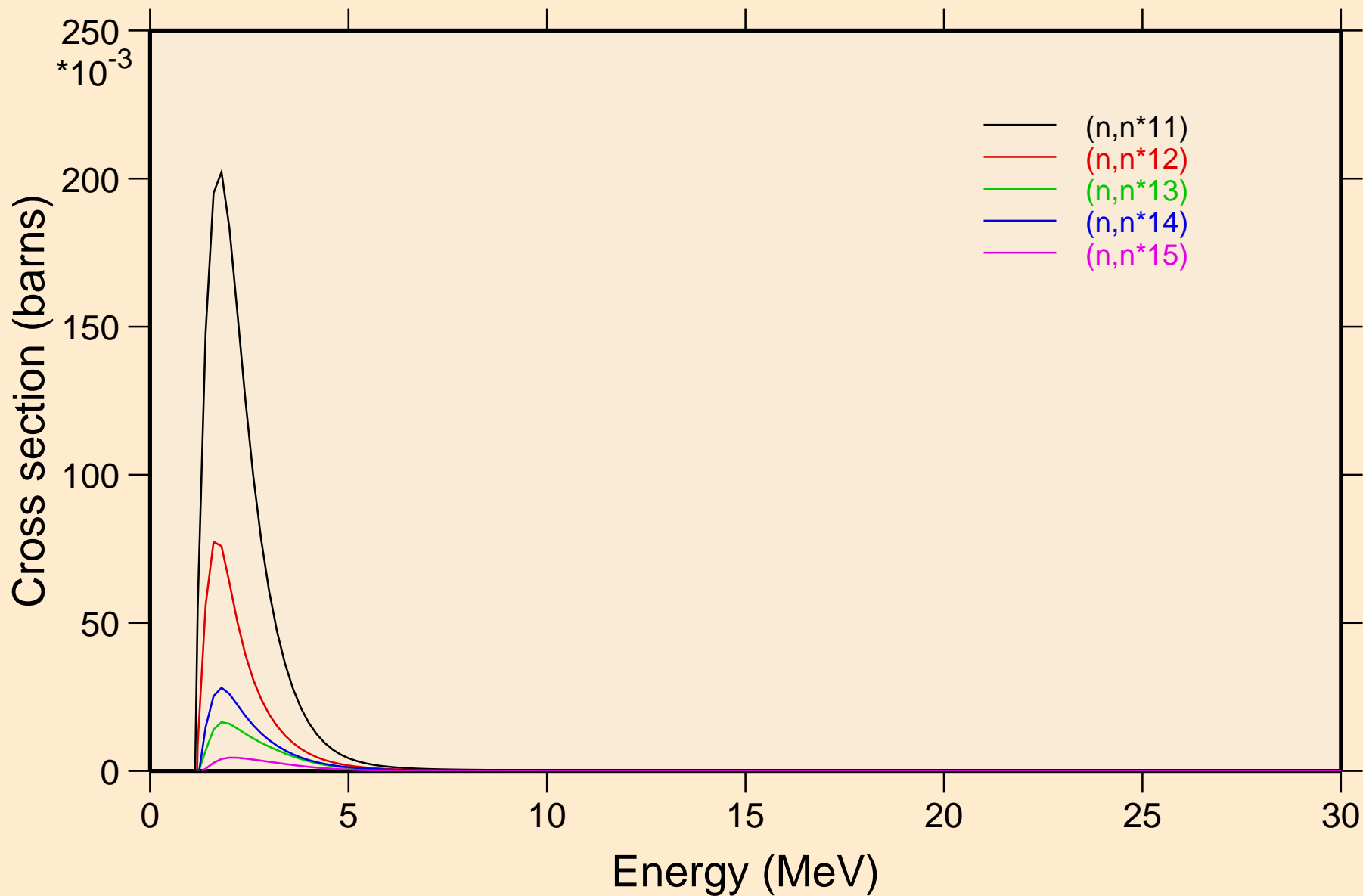

KR083 NEUTRON ACER TENDL-2023 LIBRARY; T=0.K  
Inelastic levels

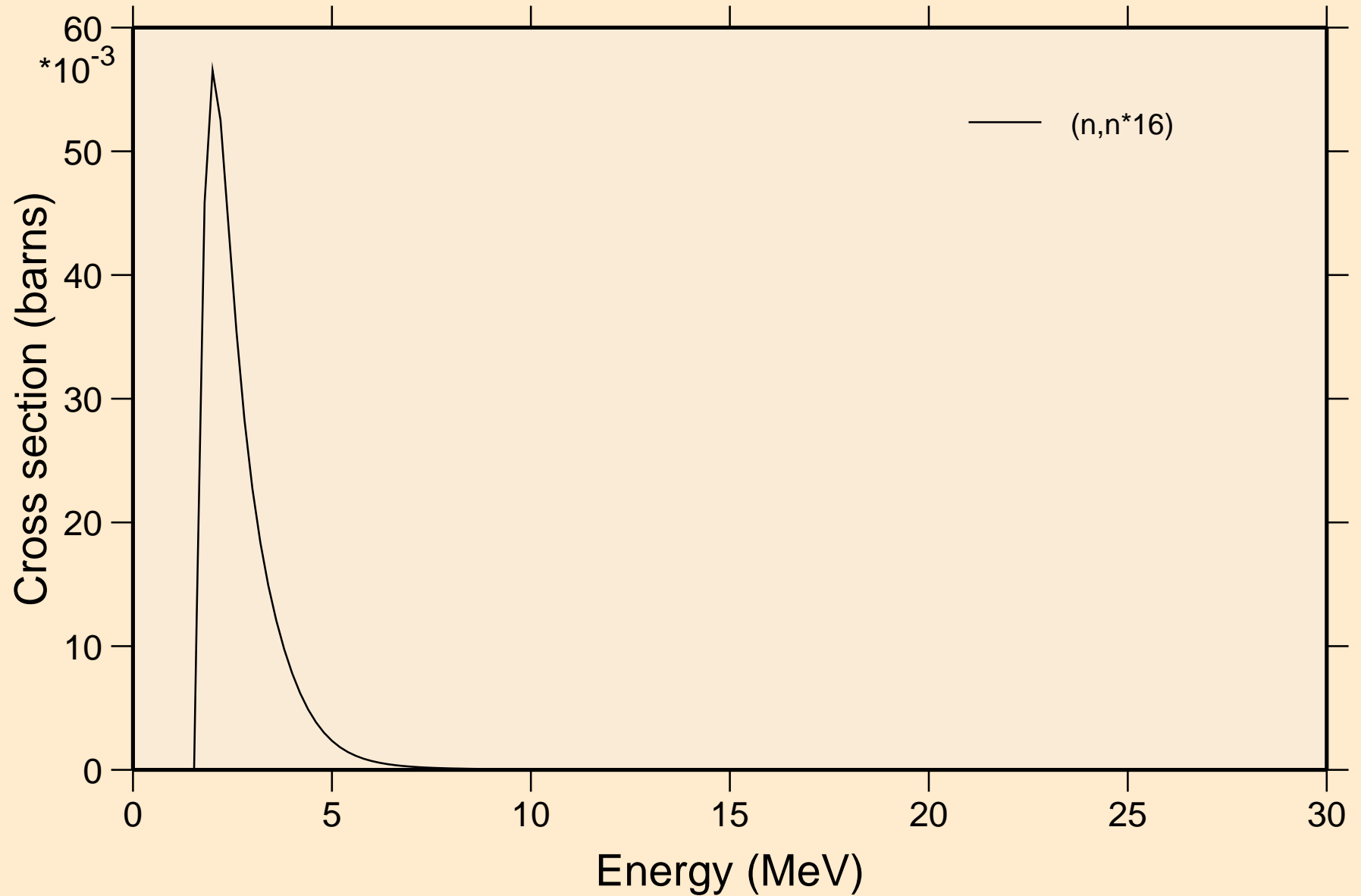

KR083 NEUTRON ACER TENDL-2023 LIBRARY; T=0.K  
Threshold reactions

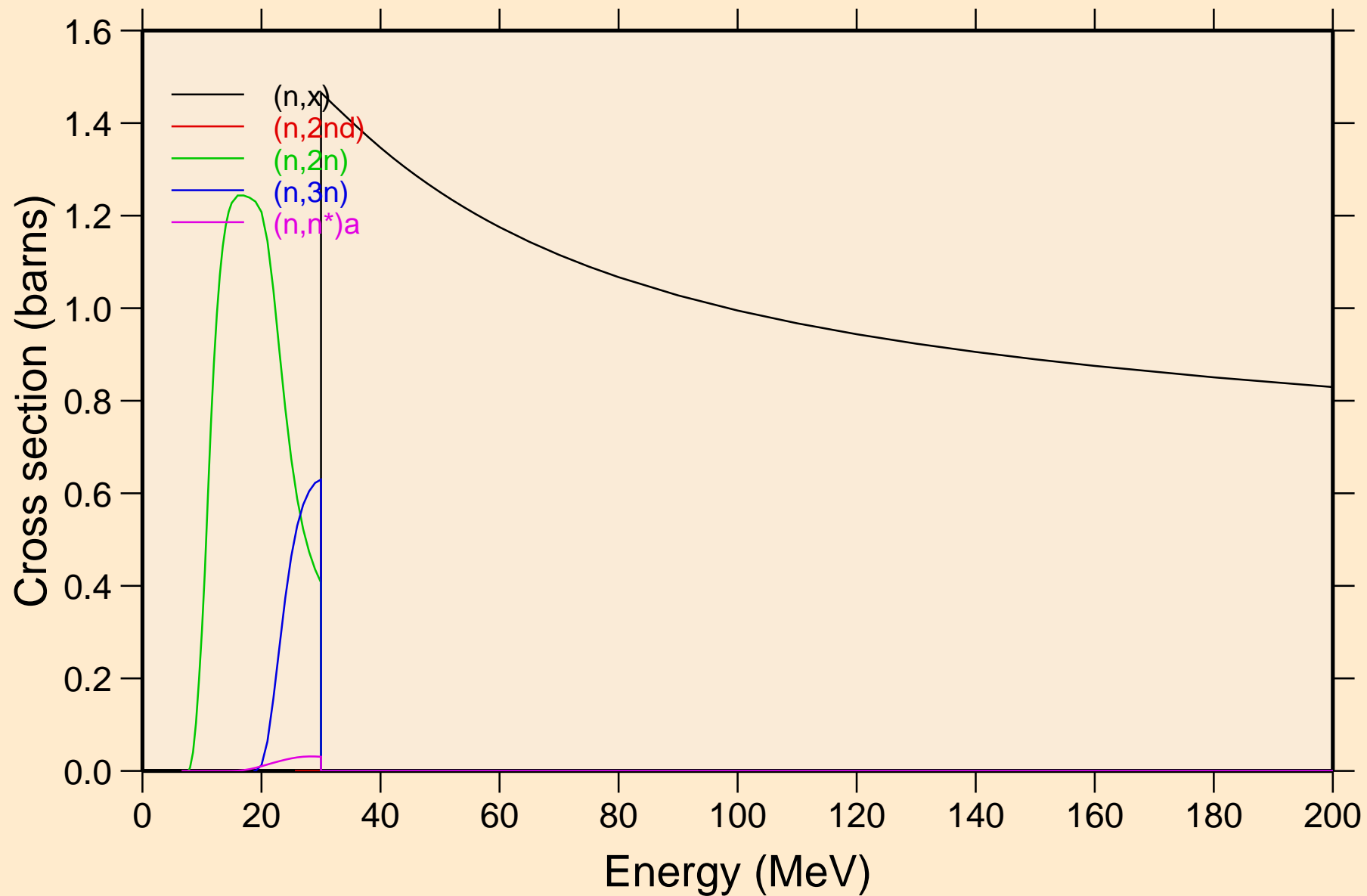

# KR083 NEUTRON ACER TENDL-2023 LIBRARY; T=0.K

## Threshold reactions

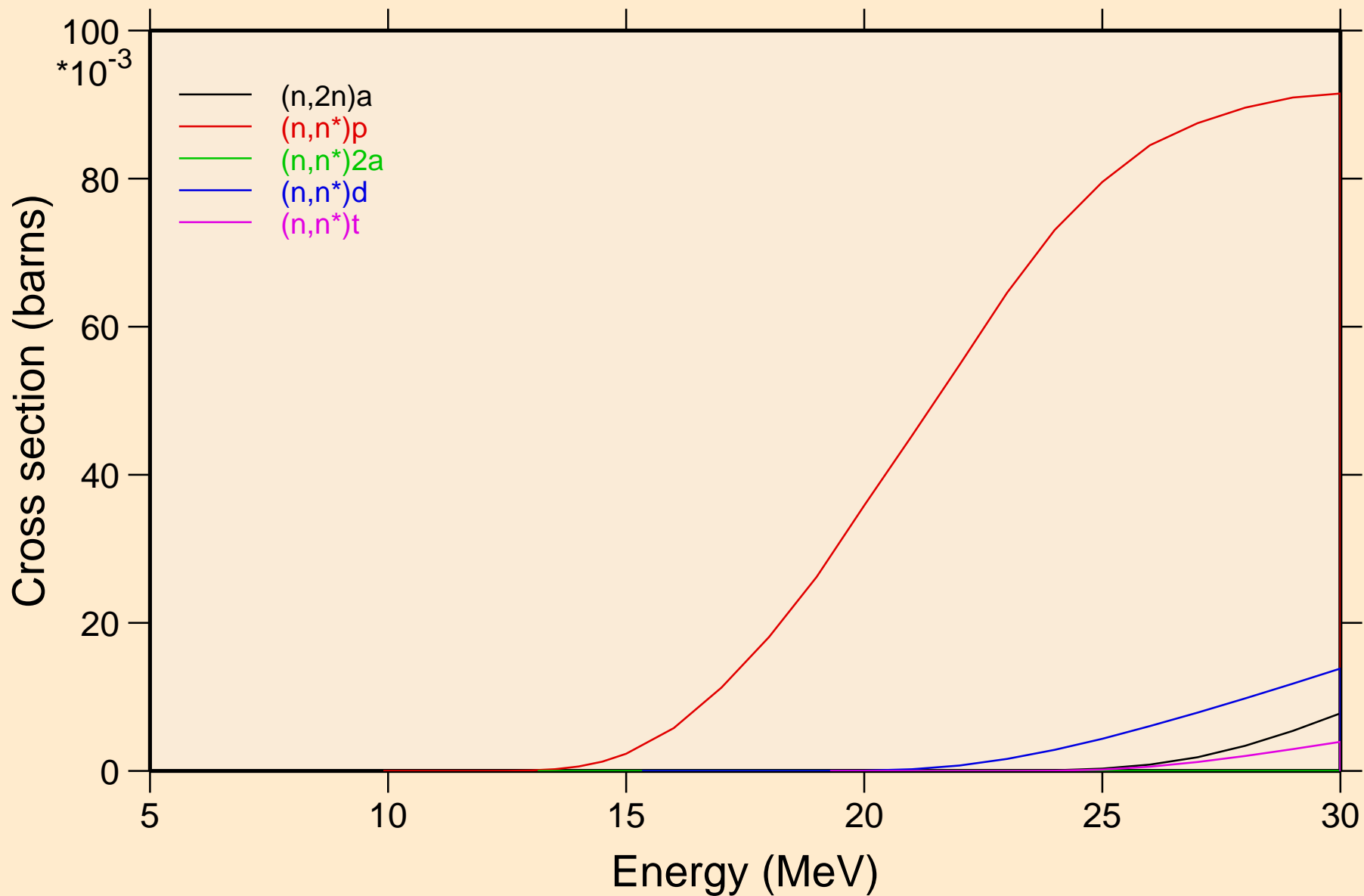

KR083 NEUTRON ACER TENDL-2023 LIBRARY; T=0.K  
Threshold reactions

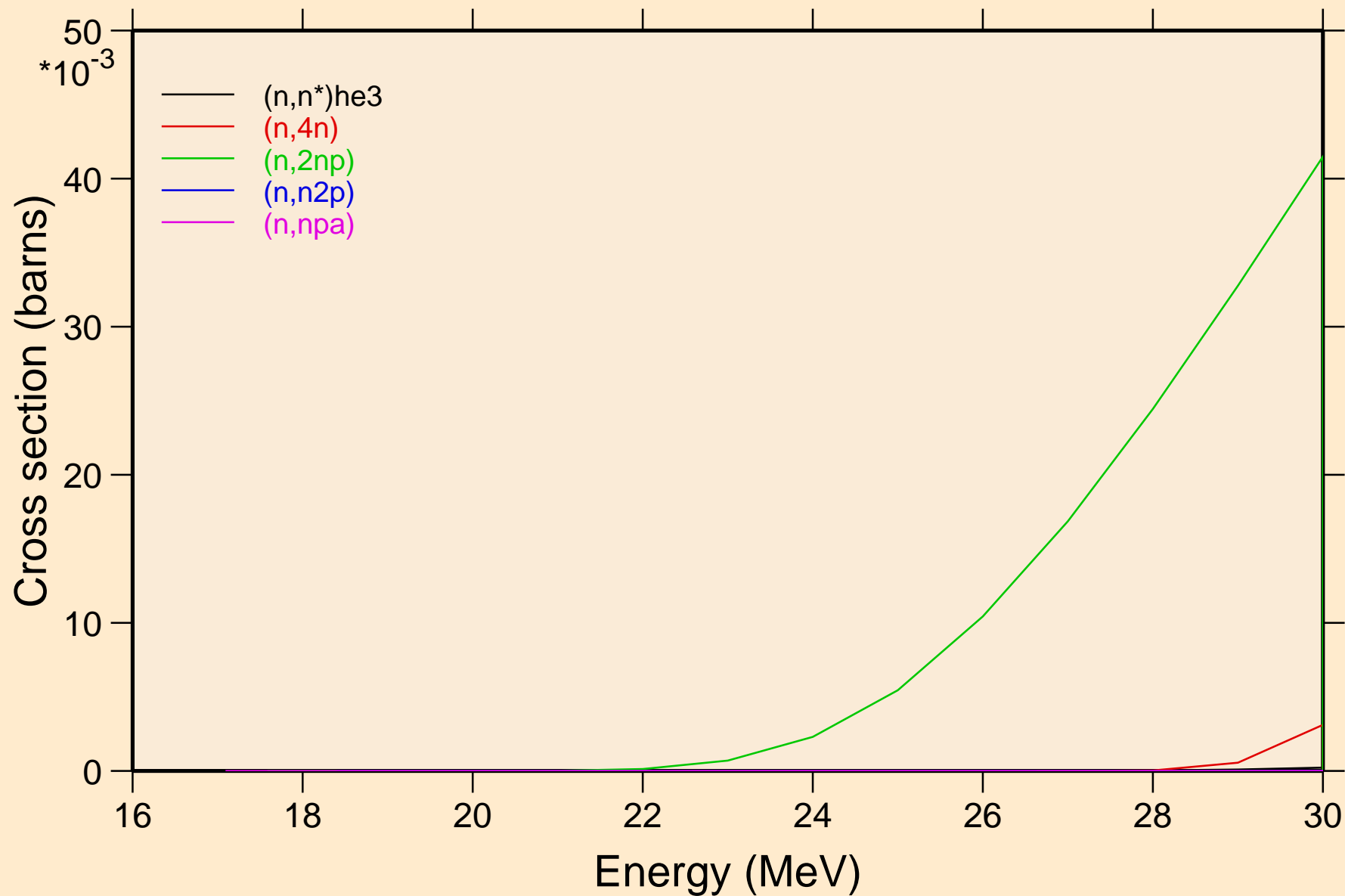

KR083 NEUTRON ACER TENDL-2023 LIBRARY; T=0.K  
Threshold reactions

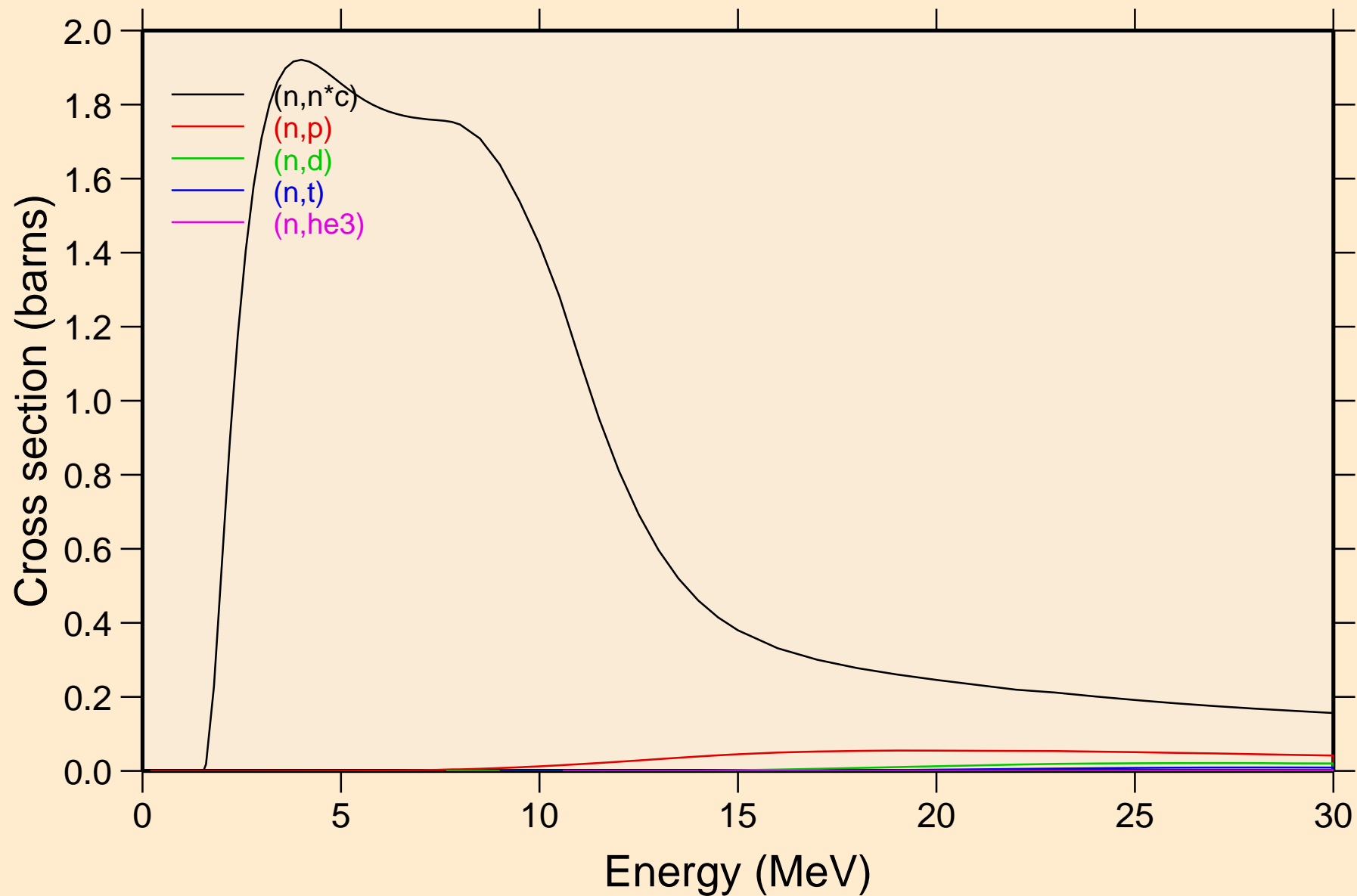



# KR083 NEUTRON ACER TENDL-2023 LIBRARY; T=0.K

## Threshold reactions

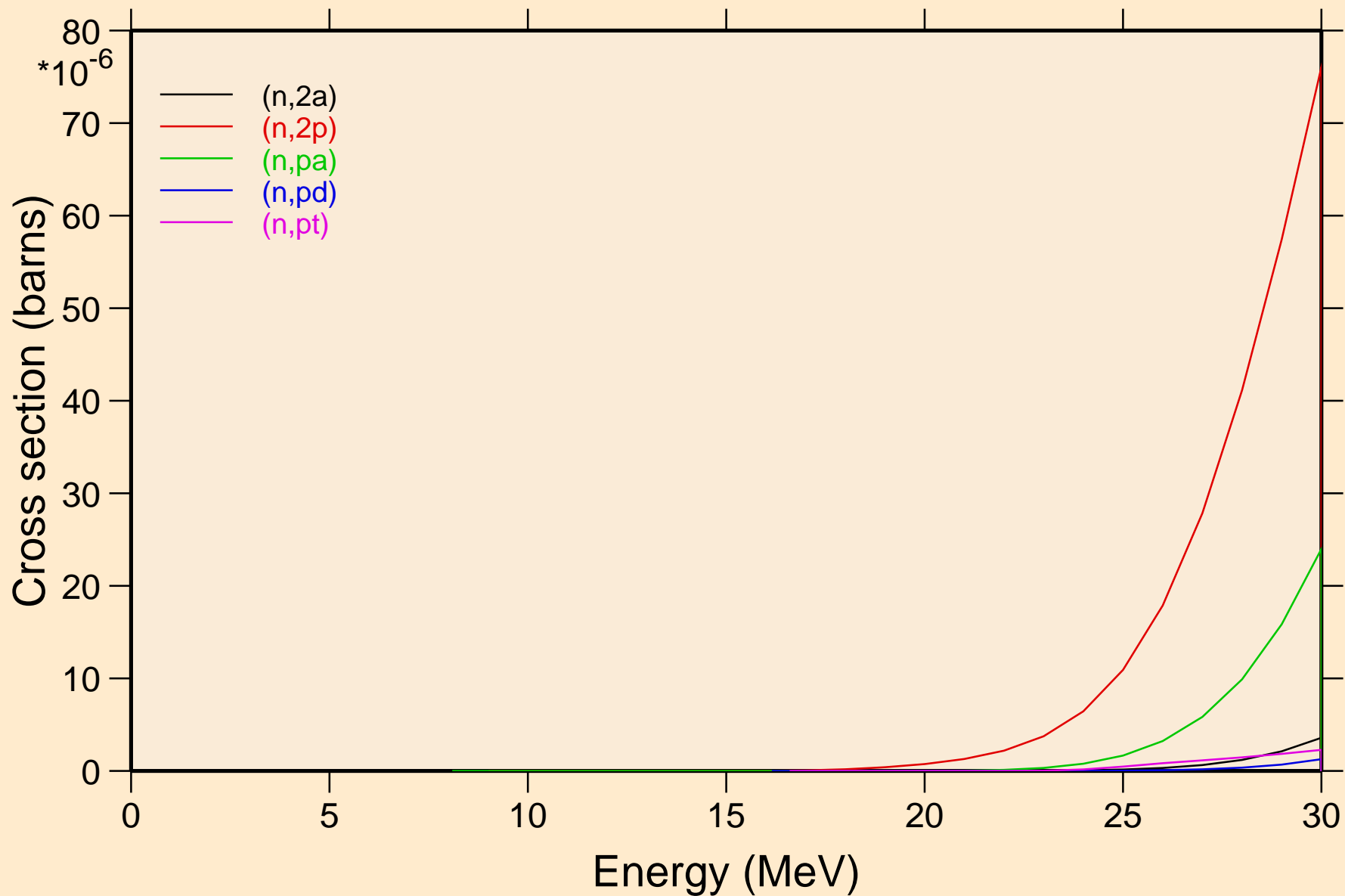

KR083 NEUTRON ACER TENDL-2023 LIBRARY; T=0.K  
Threshold reactions

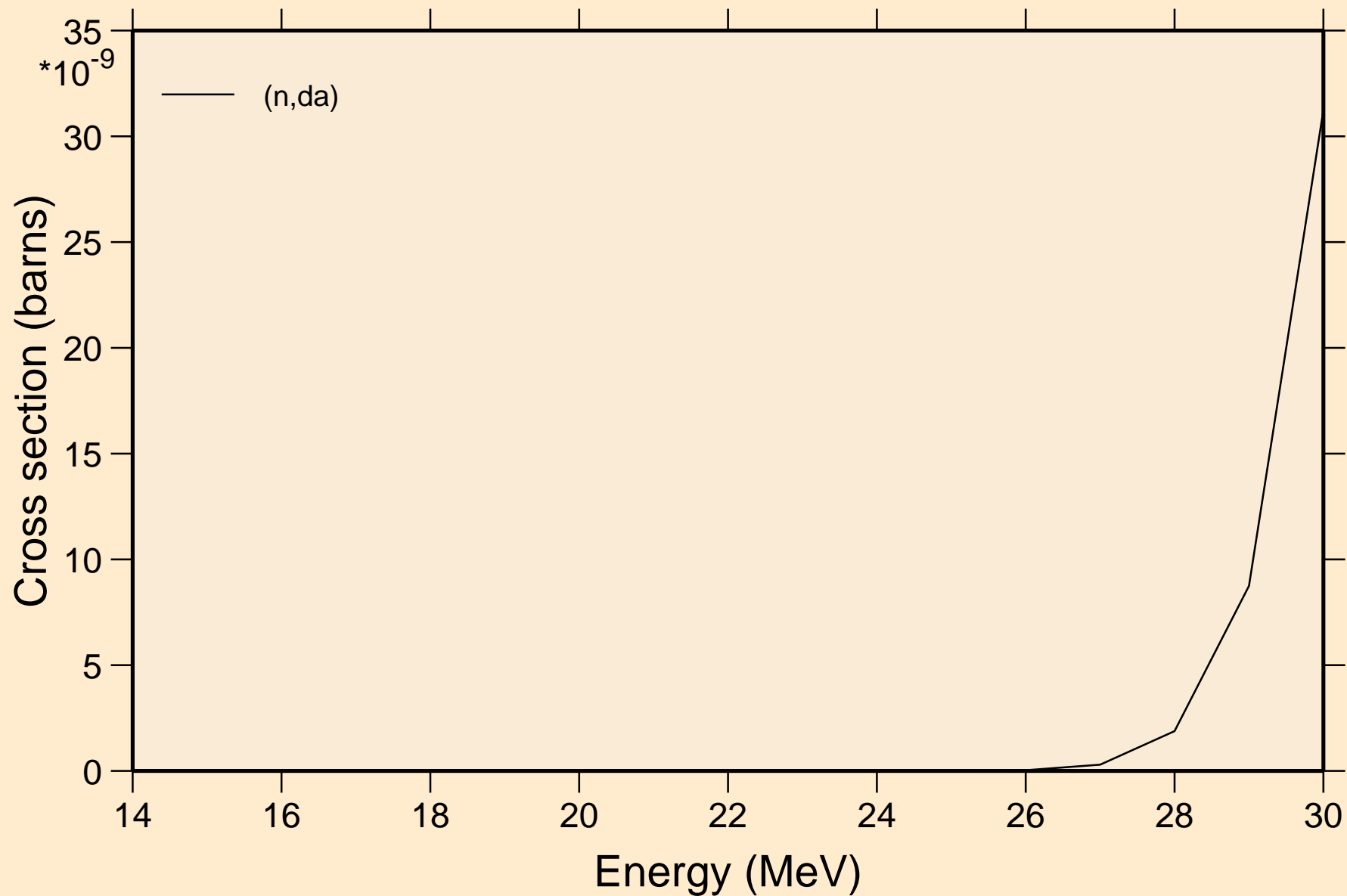

KR083 NEUTRON ACER TENDL-2023 LIBRARY; T=0.K  
Threshold reactions

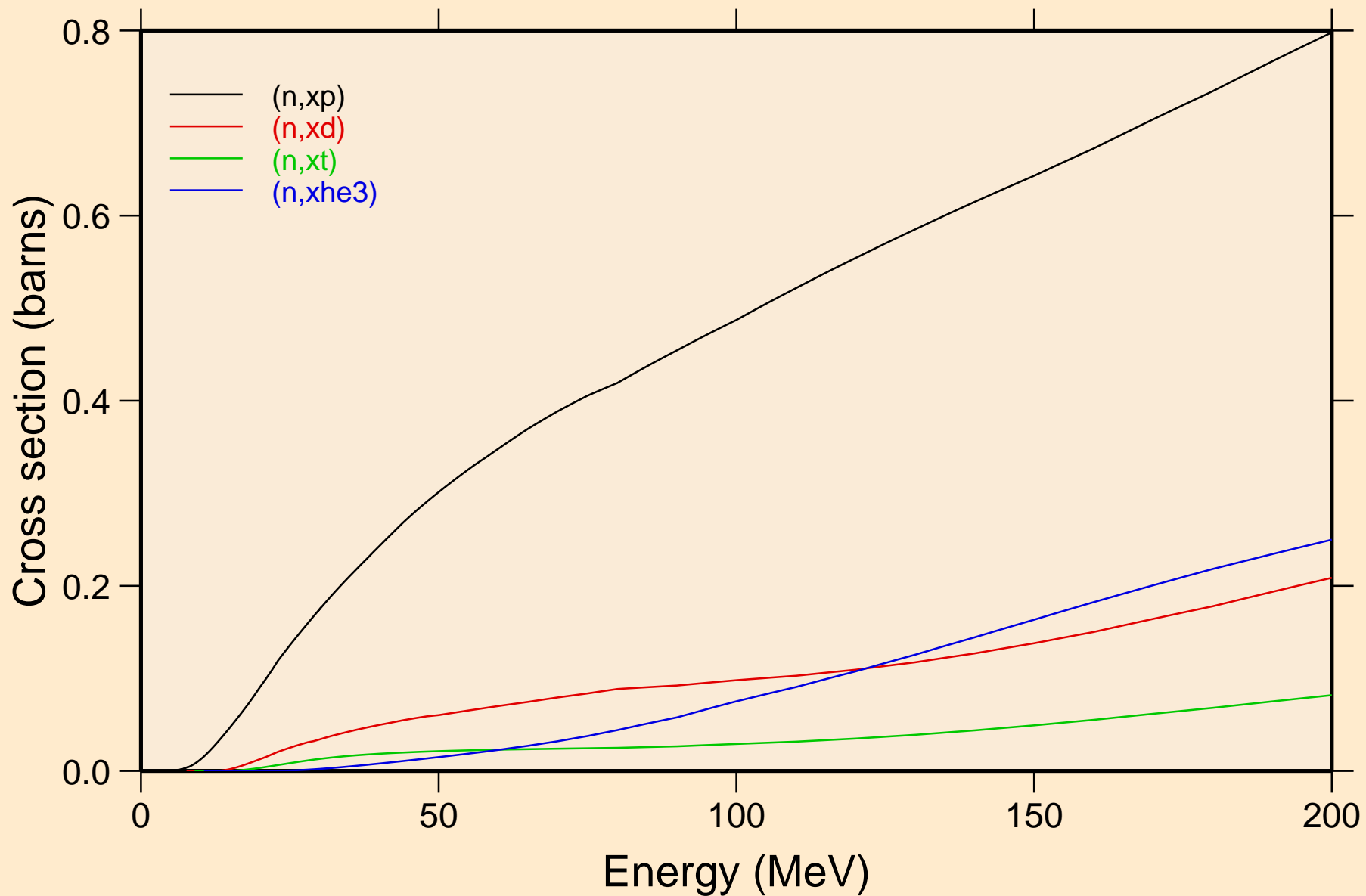

KR083 NEUTRON ACER TENDL-2023 LIBRARY; T=0.K  
angular distribution for elastic

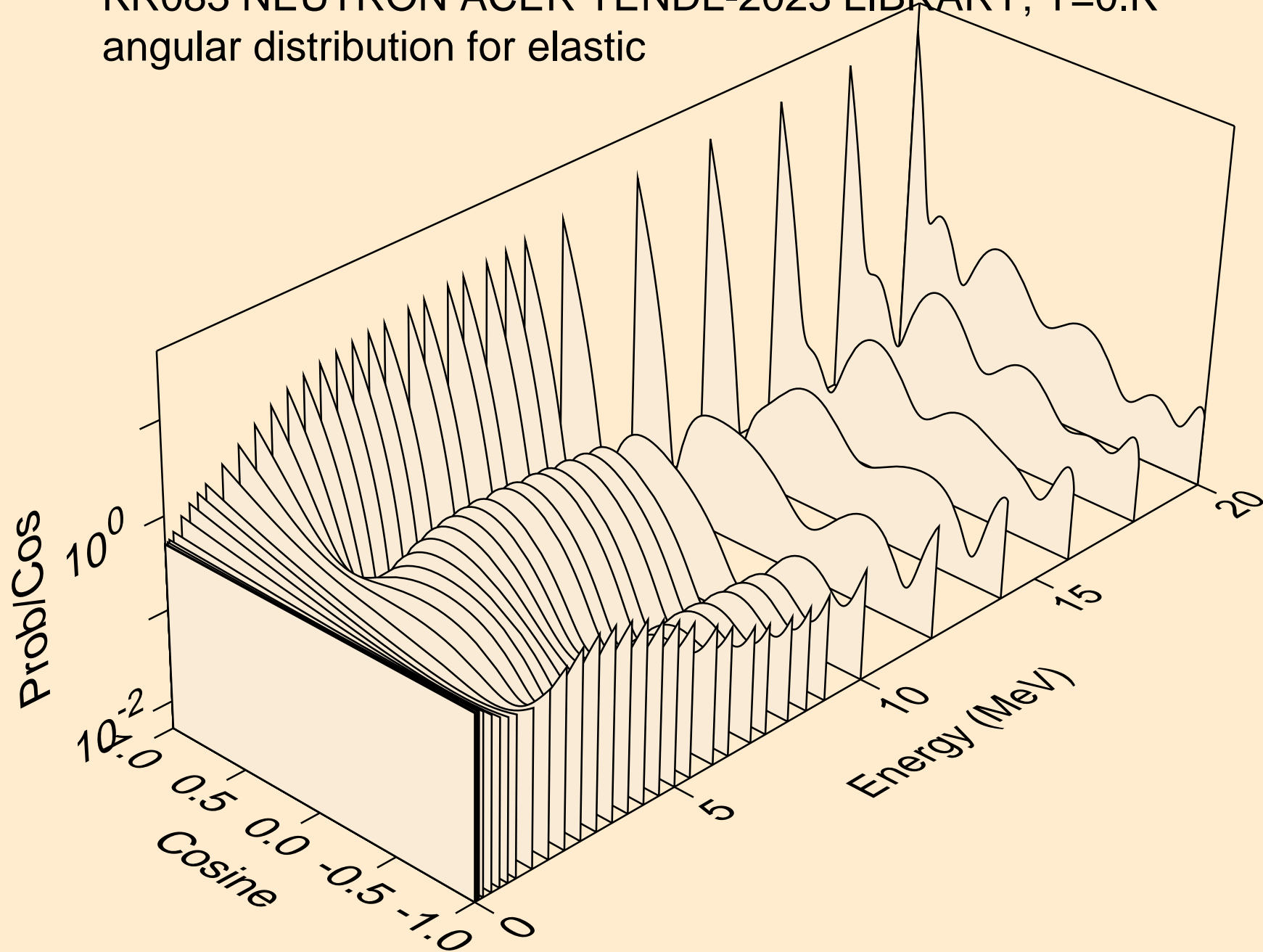

KR083 NEUTRON ACER TENDL-2023 LIBRARY; T=0.K  
angular distribution for elastic

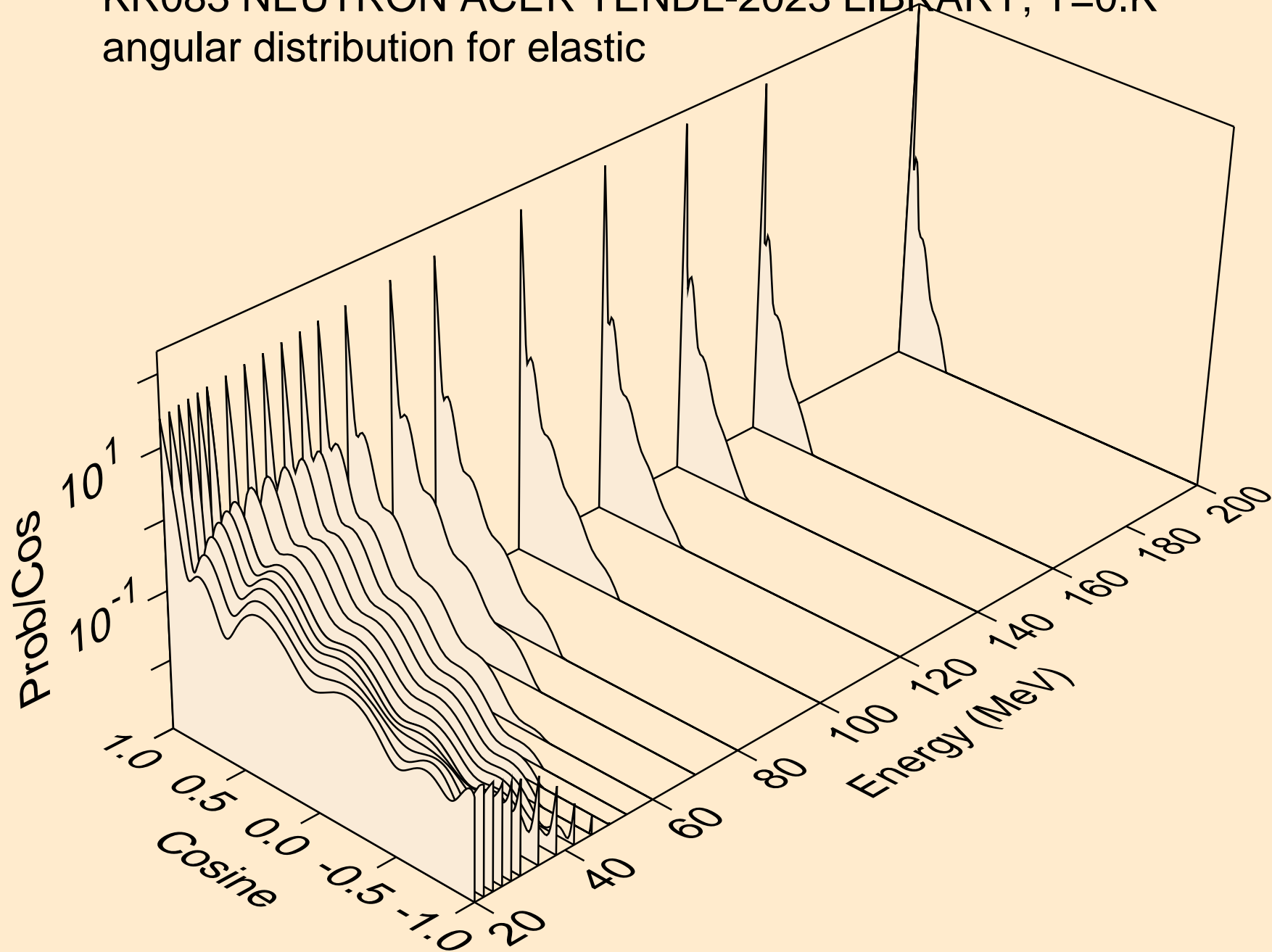

KR083 NEUTRON ACER TENDL-2023 LIBRARY; T=0.K  
angular distribution for (n,n\*1)

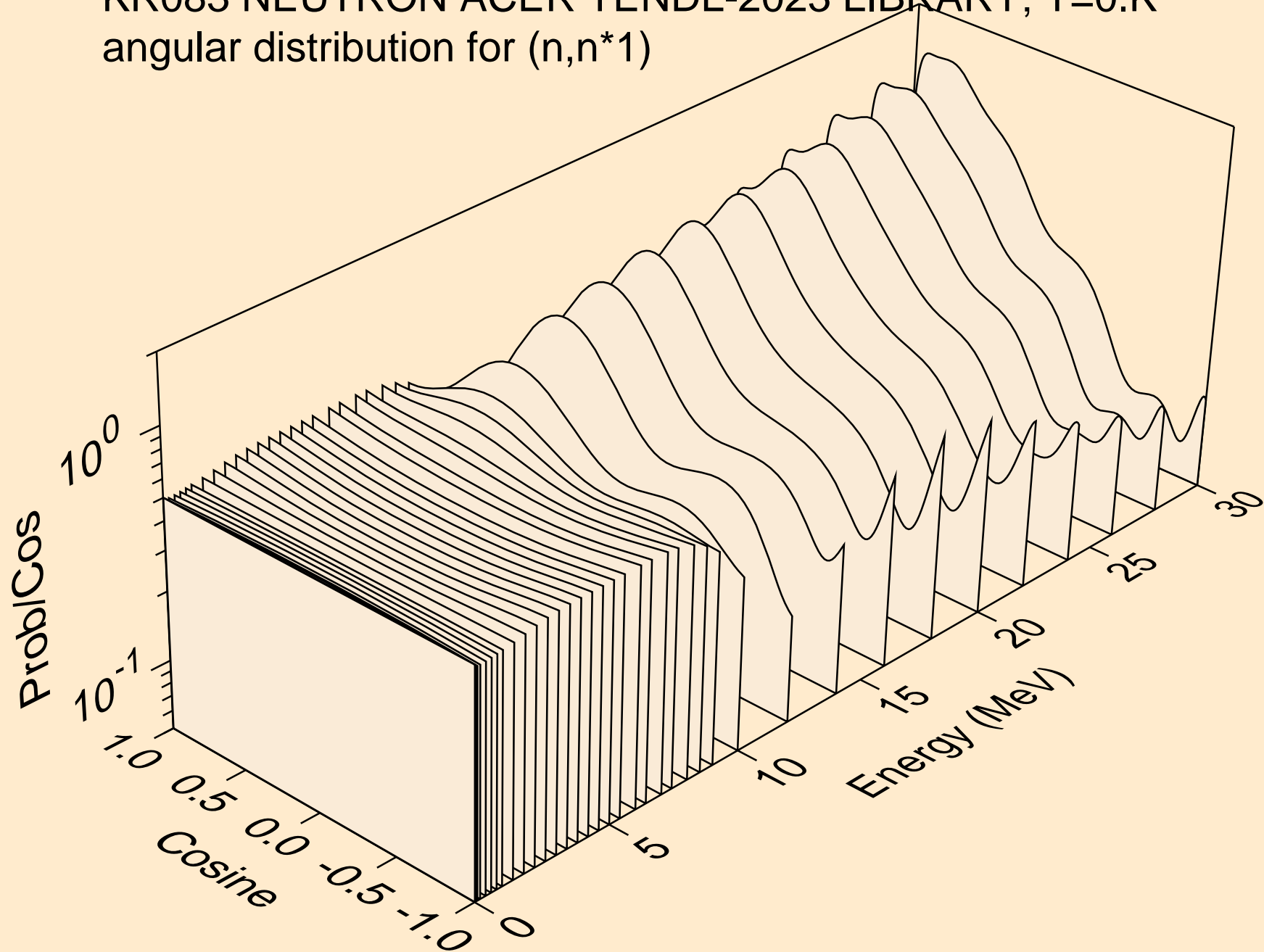

KR083 NEUTRON ACER TENDL-2023 LIBRARY; T=0.K  
angular distribution for (n,n\*2)

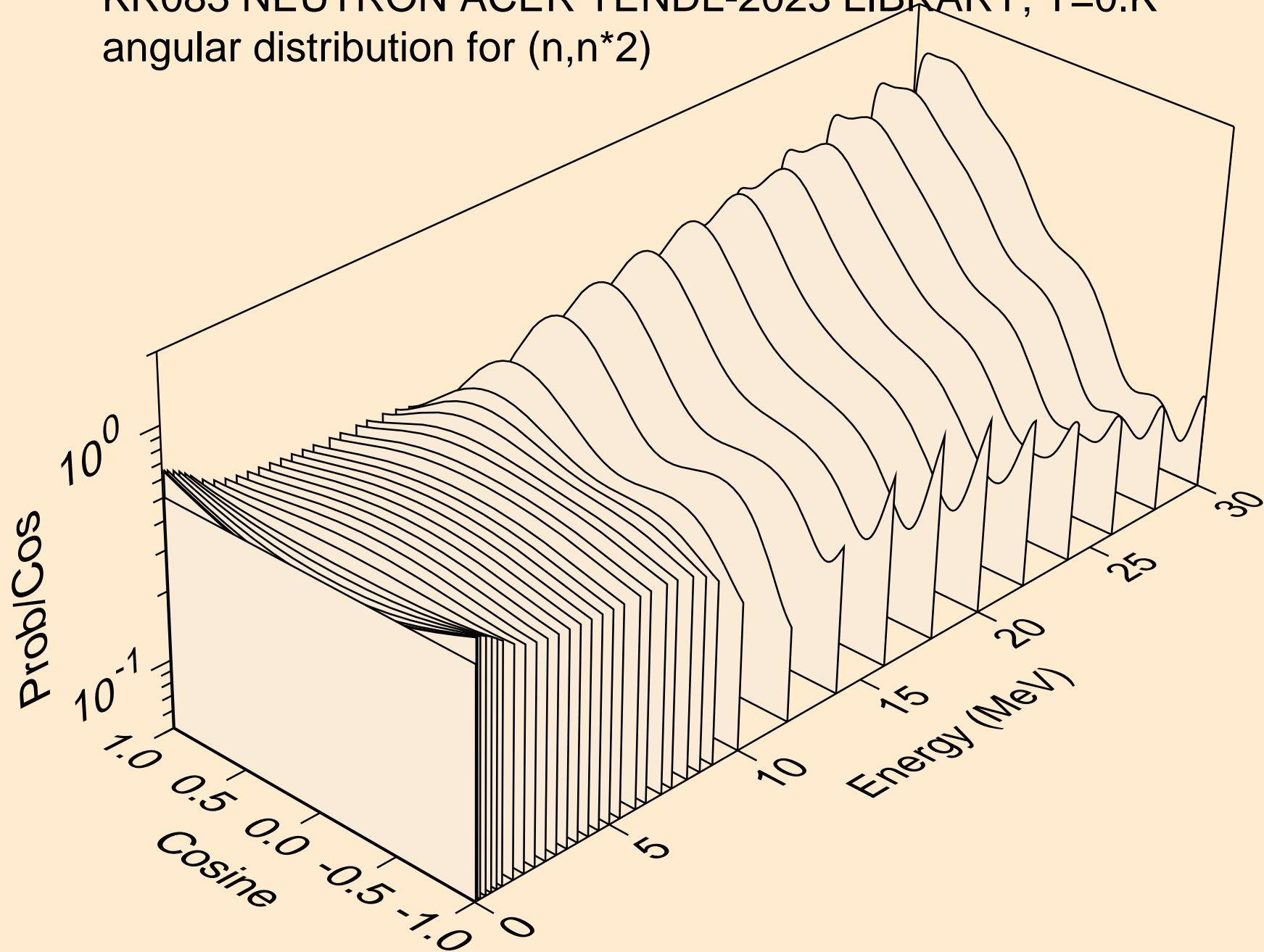

KR083 NEUTRON ACER TENDL-2023 LIBRARY; T=0.K  
angular distribution for (n,n\*3)

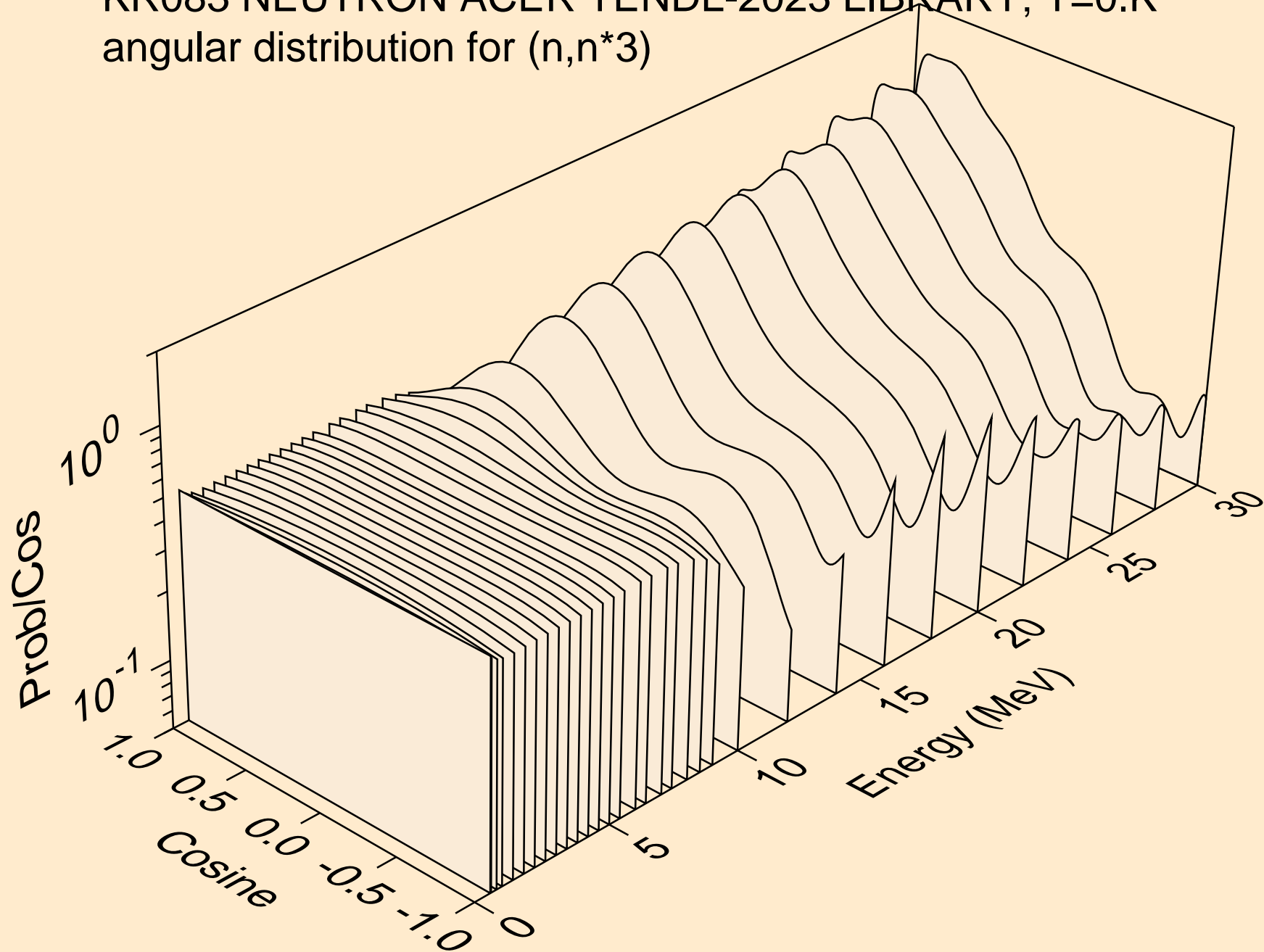



KR083 NEUTRON ACER TENDL-2023 LIBRARY; T=0.K  
angular distribution for (n,n\*4)

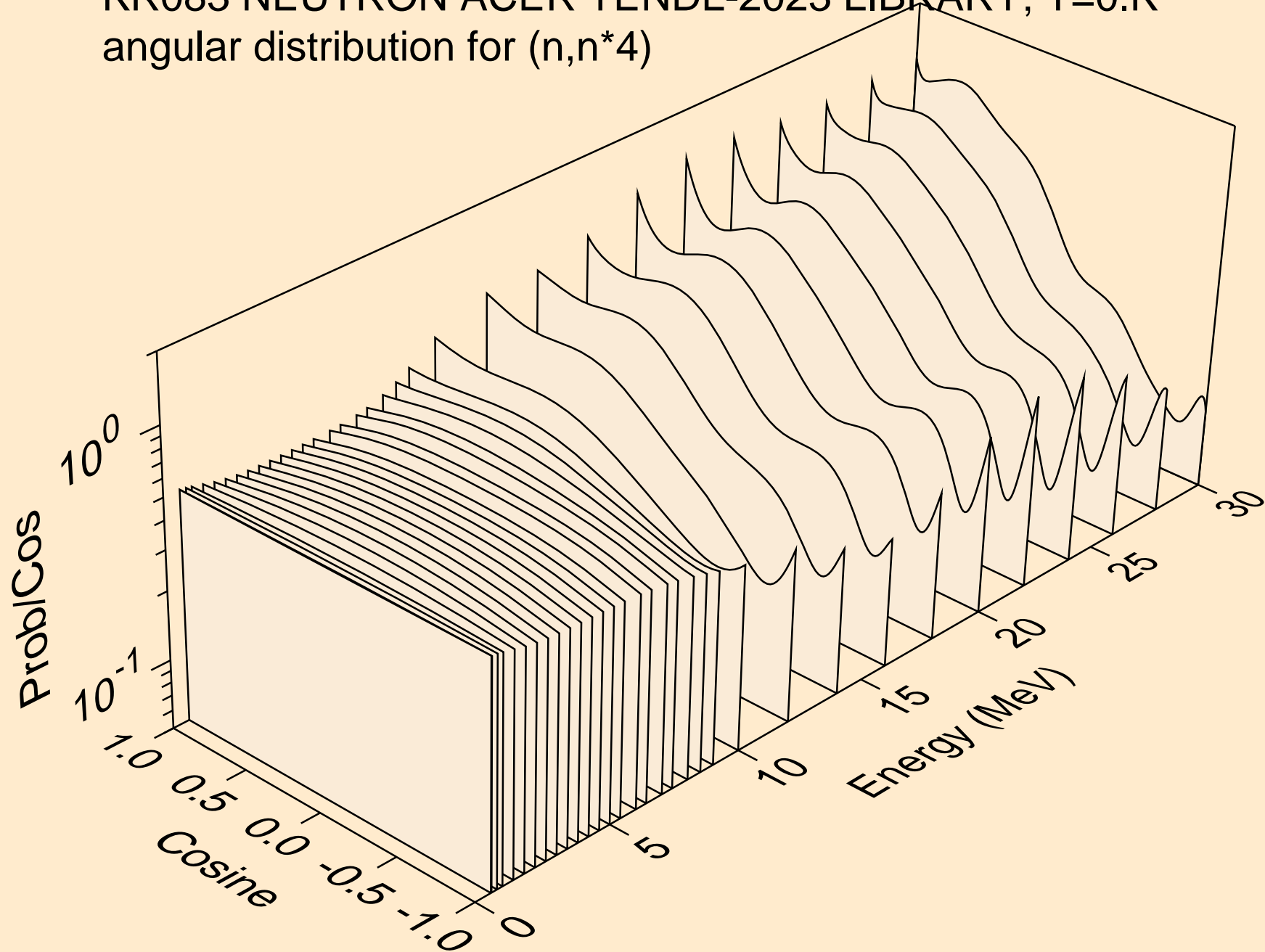

KR083 NEUTRON ACER TENDL-2023 LIBRARY; T=0.K  
angular distribution for (n,n\*5)

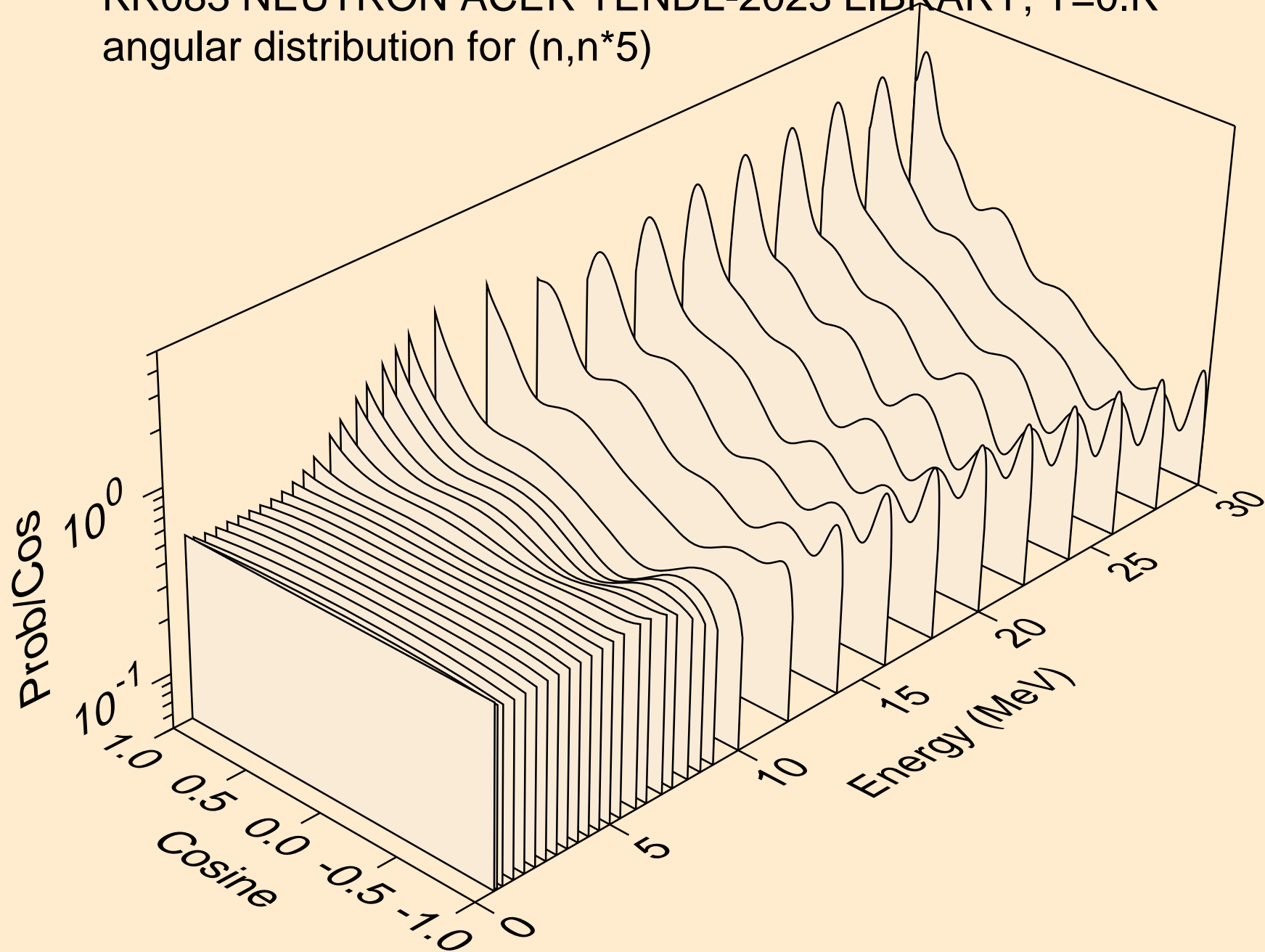

KR083 NEUTRON ACER TENDL-2023 LIBRARY; T=0.K  
angular distribution for (n,n\*6)

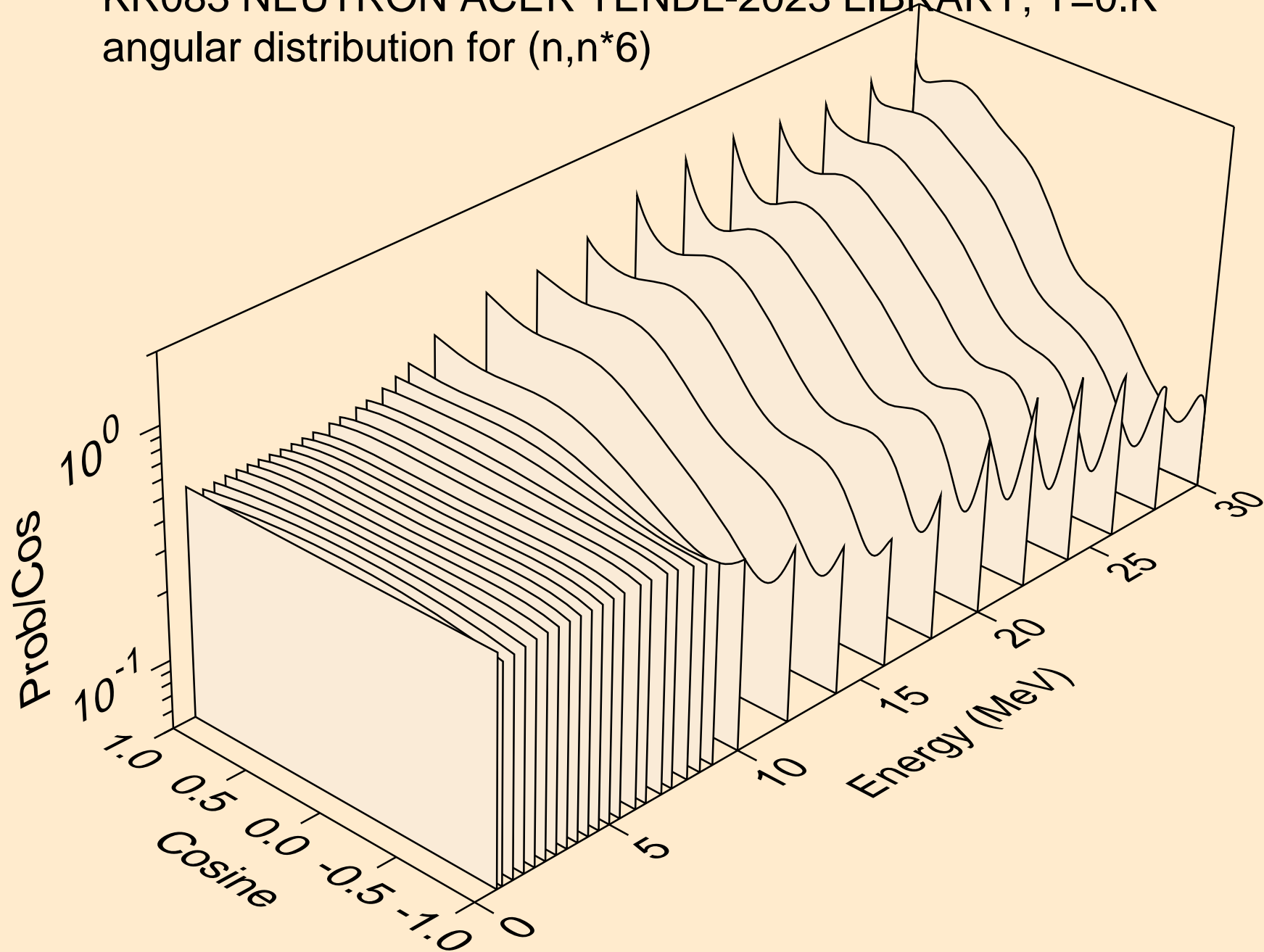

KR083 NEUTRON ACER TENDL-2023 LIBRARY; T=0.K  
angular distribution for (n,n\*7)

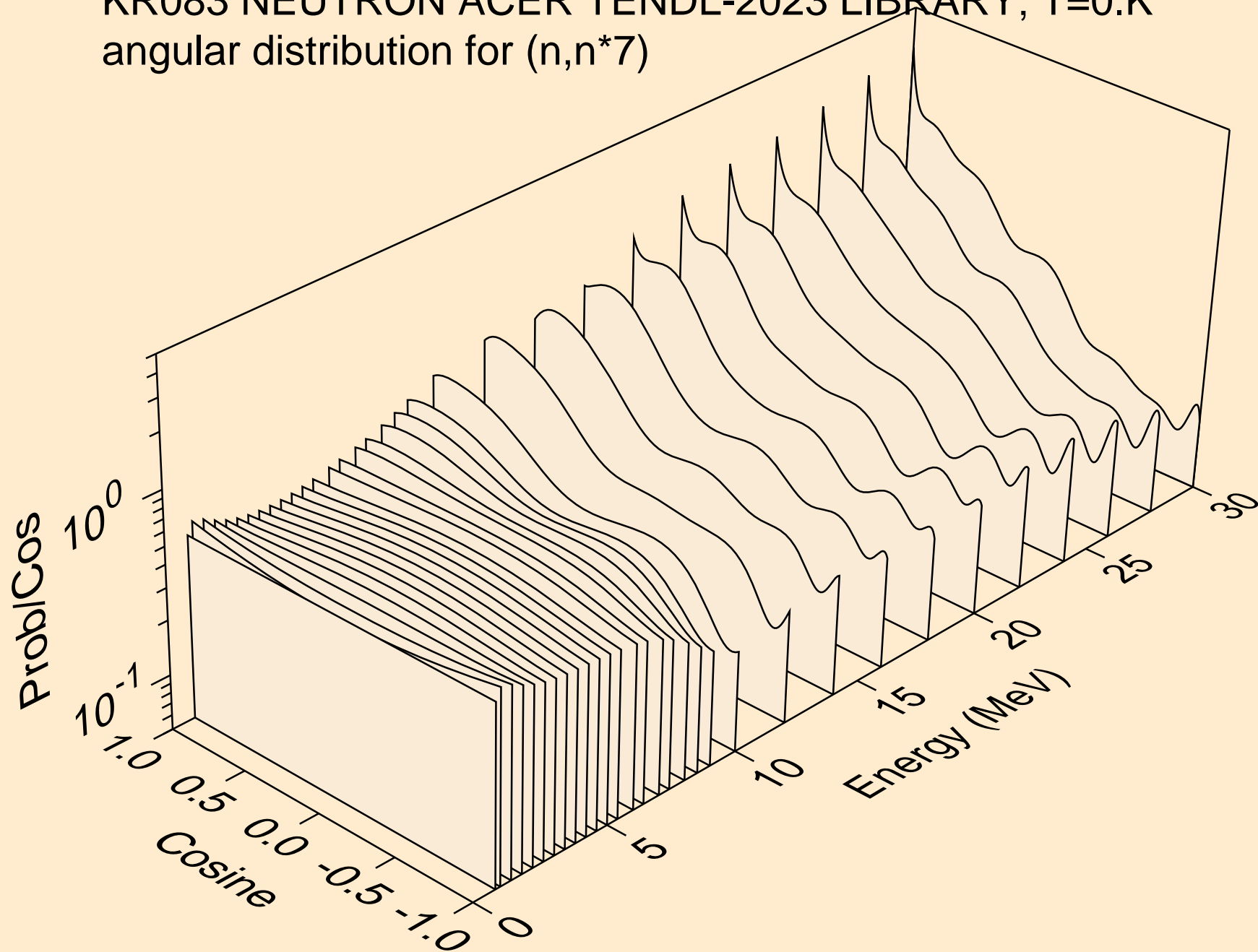

KR083 NEUTRON ACER TENDL-2023 LIBRARY; T=0.K  
angular distribution for (n,n\*8)

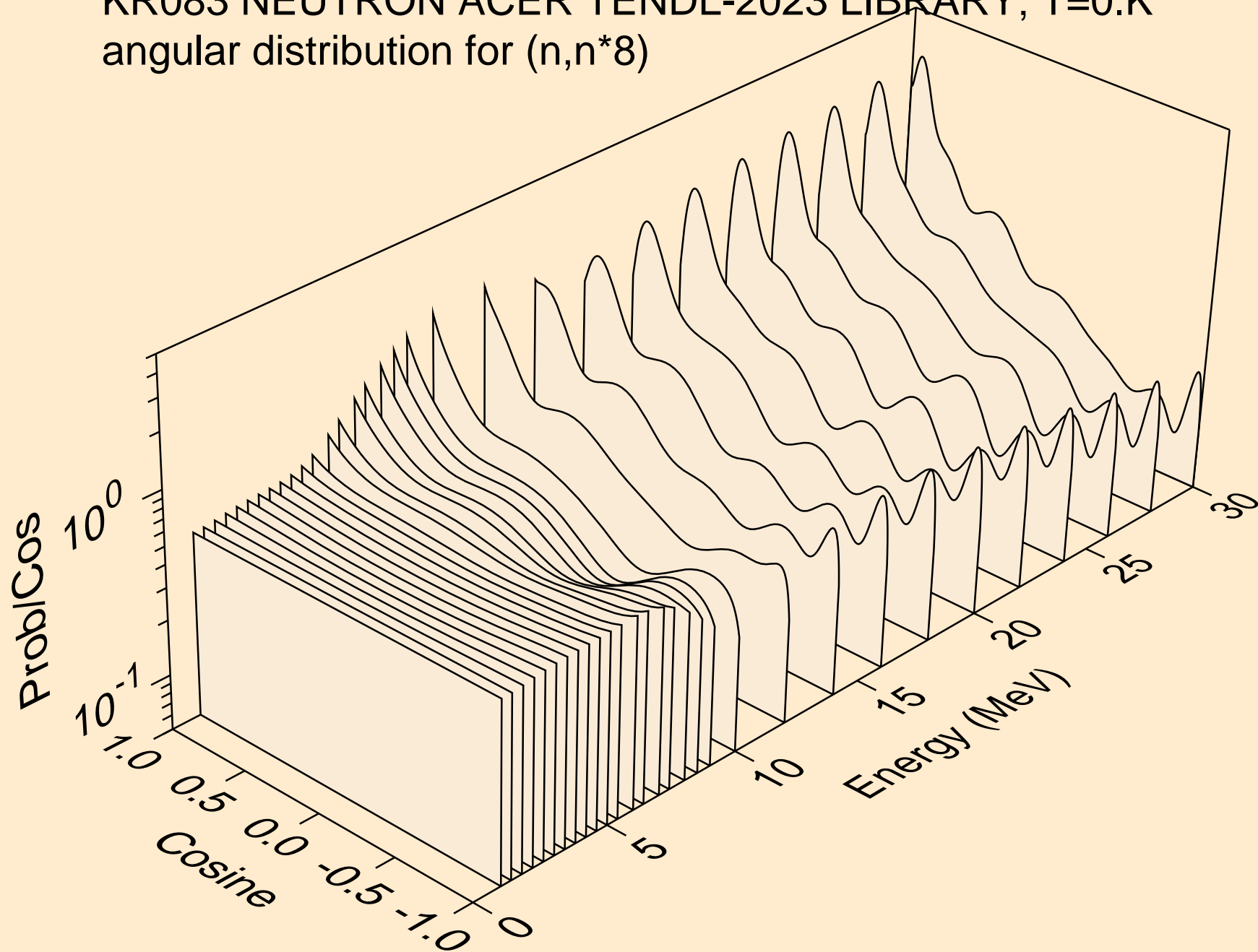

KR083 NEUTRON ACER TENDL-2023 LIBRARY; T=0.K  
angular distribution for (n,n\*9)

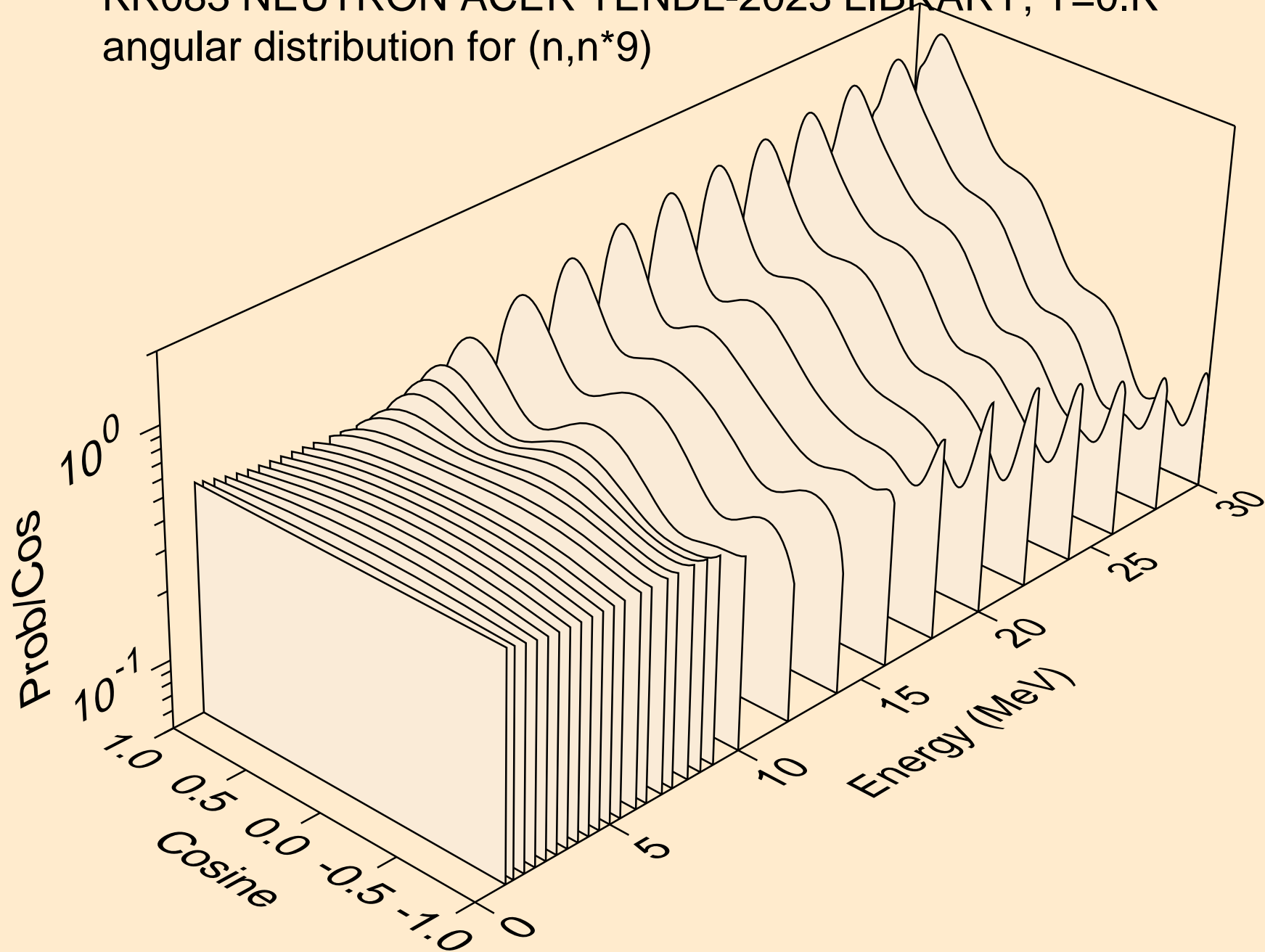

KR083 NEUTRON ACER TENDL-2023 LIBRARY; T=0.K  
angular distribution for (n,n\*10)

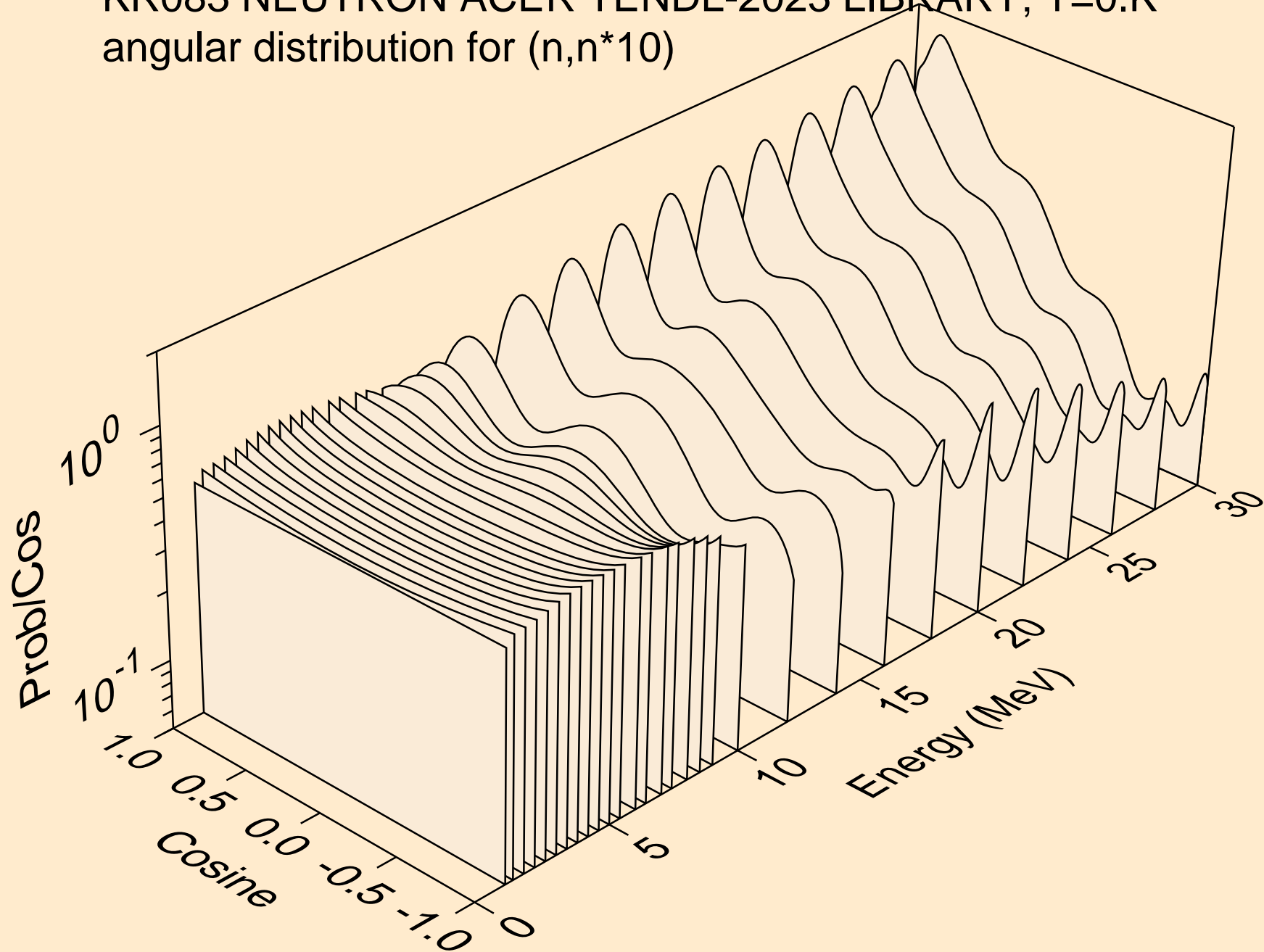

KR083 NEUTRON ACER TENDL-2023 LIBRARY; T=0.K  
angular distribution for (n,n\*11)

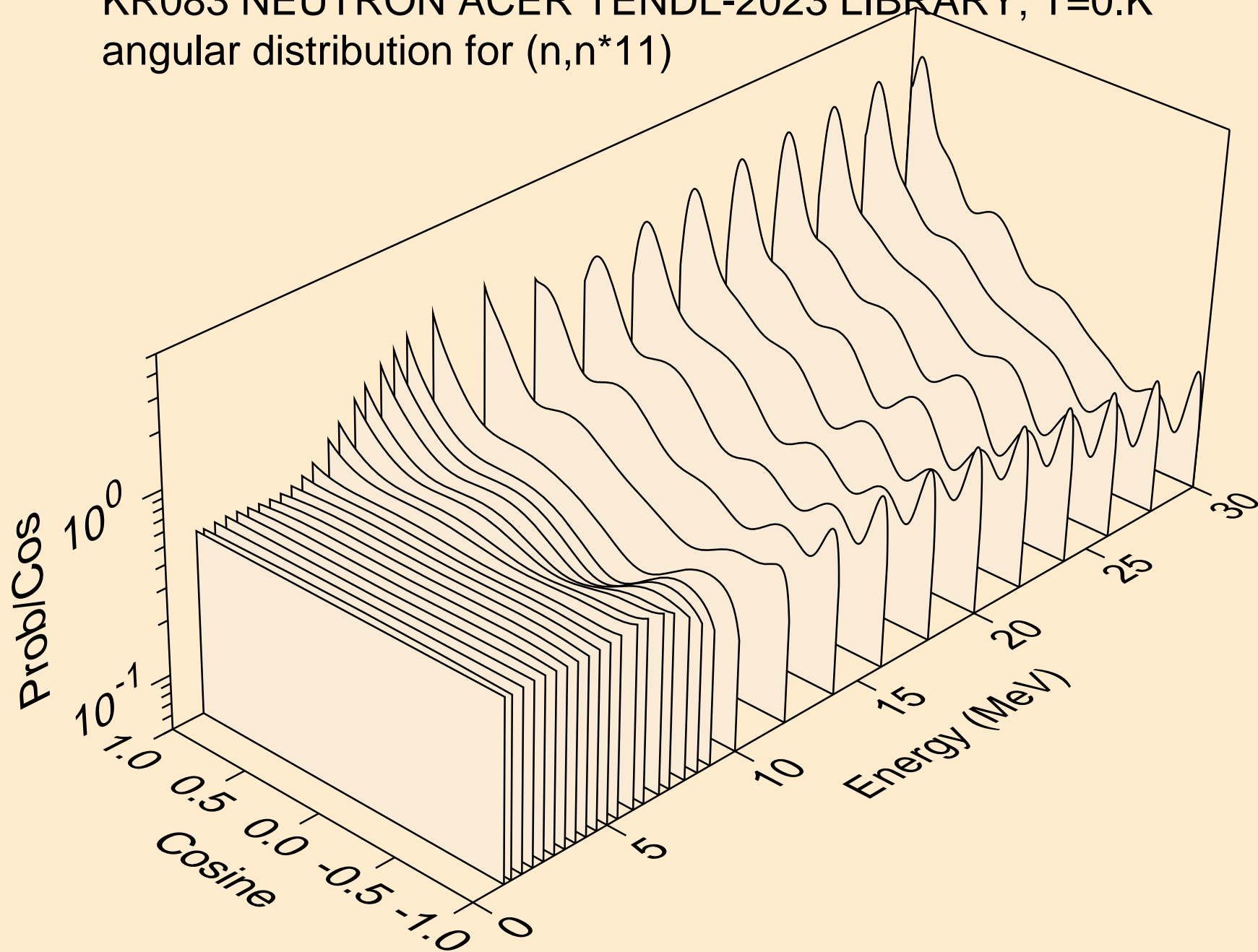



KR083 NEUTRON ACER TENDL-2023 LIBRARY; T=0.K  
angular distribution for (n,n\*12)

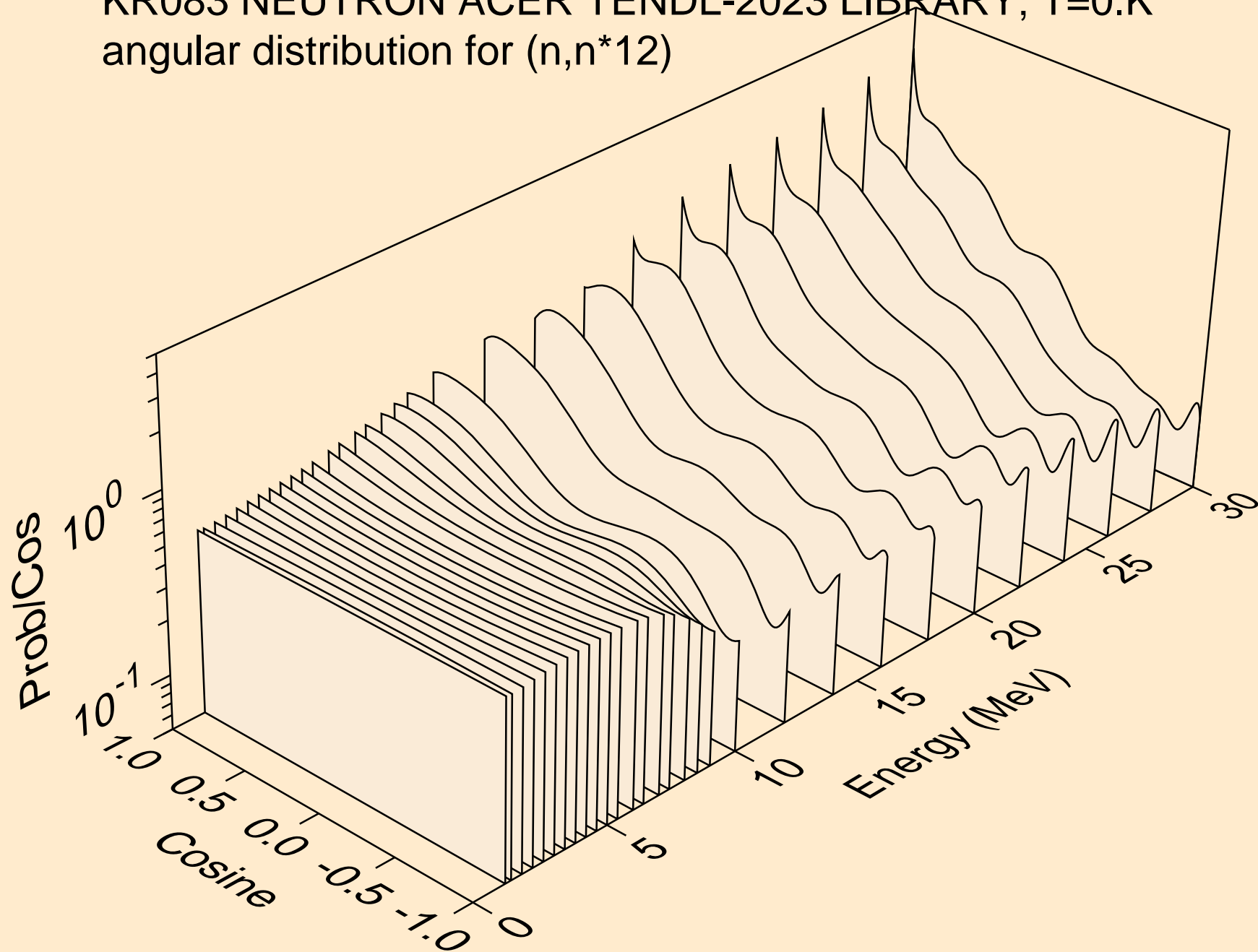

KR083 NEUTRON ACER TENDL-2023 LIBRARY; T=0.K  
angular distribution for (n,n\*13)

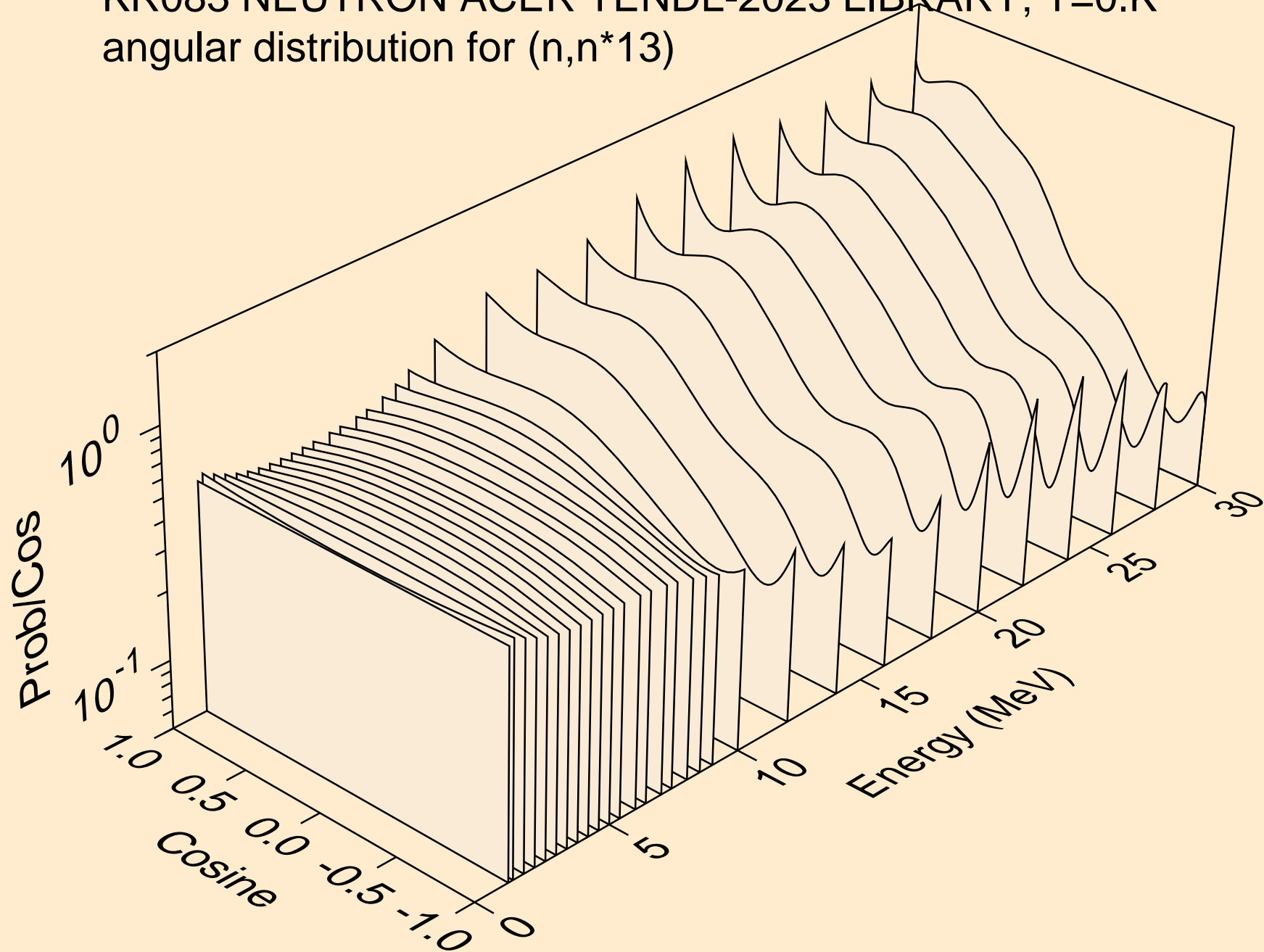

KR083 NEUTRON ACER TENDL-2023 LIBRARY; T=0.K  
angular distribution for (n,n\*14)

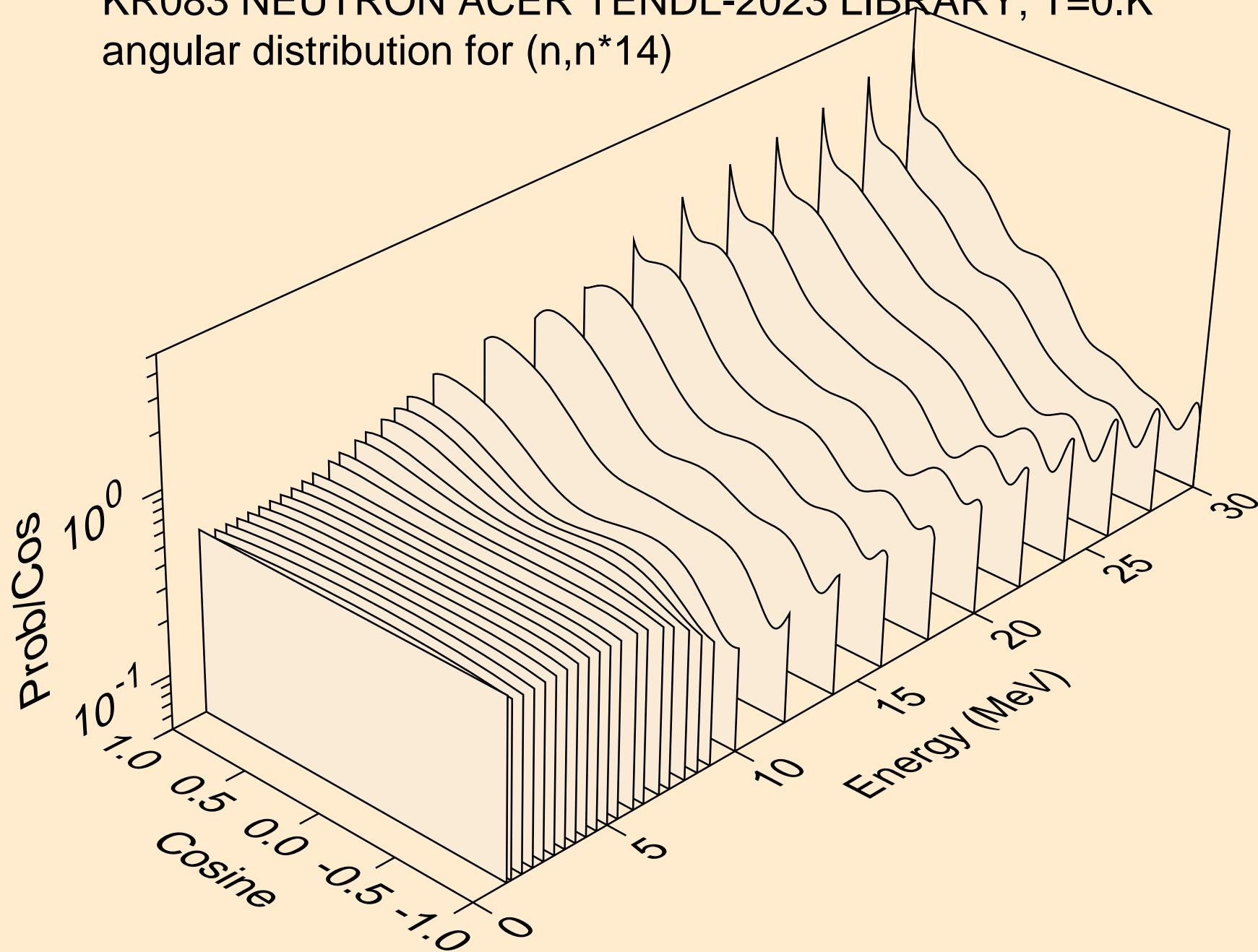

KR083 NEUTRON ACER TENDL-2023 LIBRARY; T=0.K  
angular distribution for (n,n\*15)

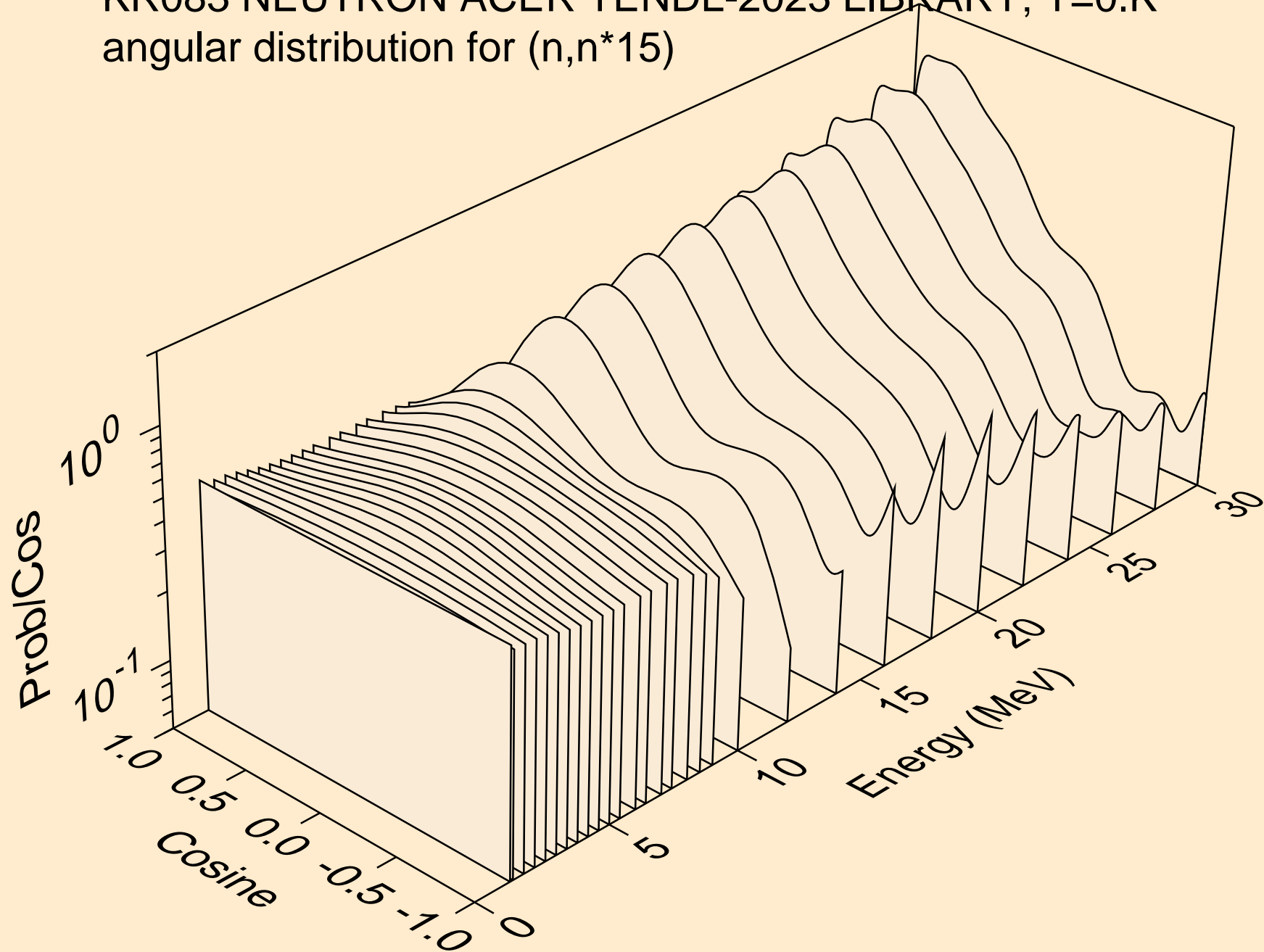

KR083 NEUTRON ACER TENDL-2023 LIBRARY; T=0.K  
angular distribution for (n,n\*16)

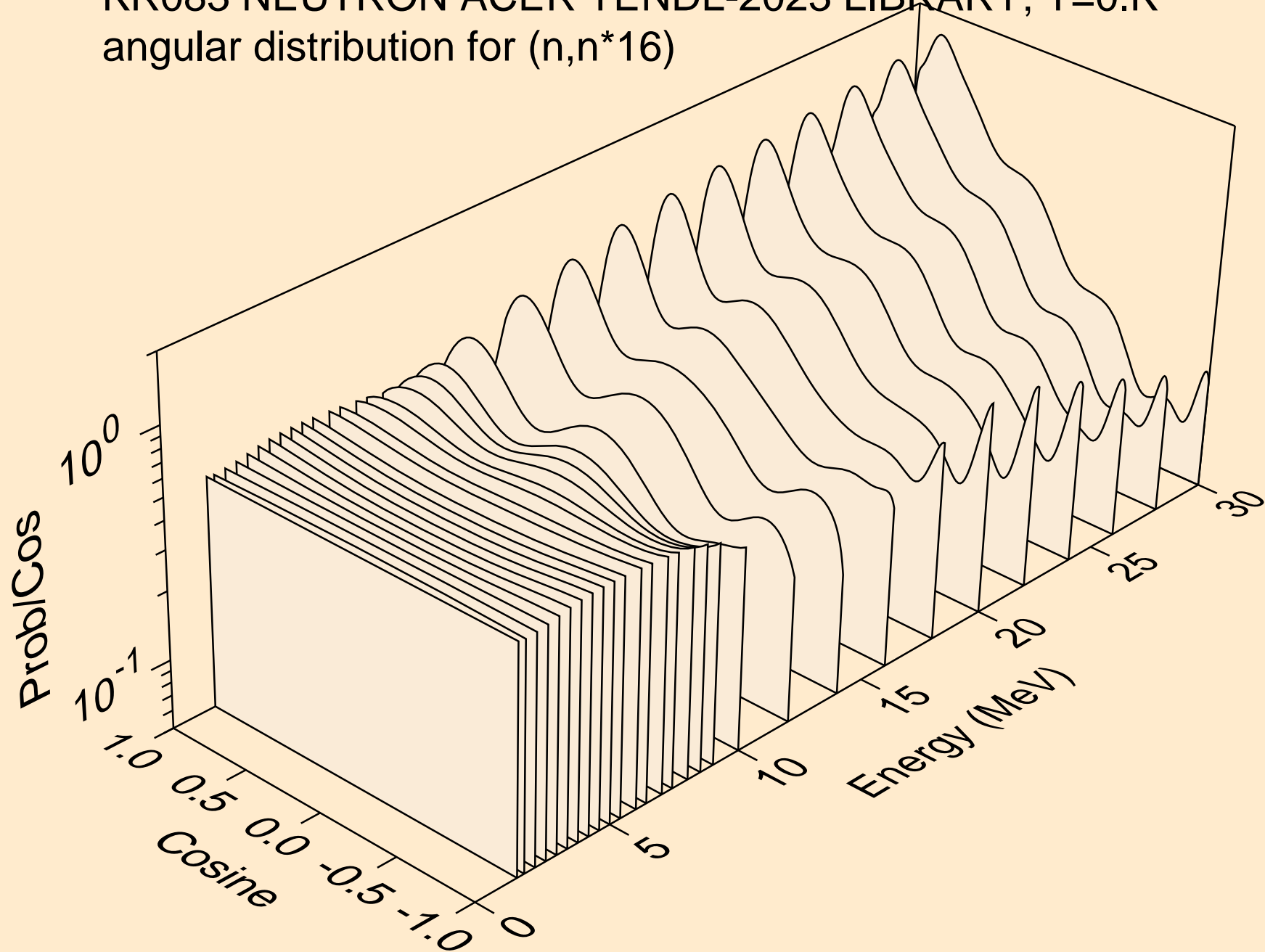

KR083 NEUTRON ACER TENDL-2023 LIBRARY; T=0.K  
Neutron emission for (n,x)

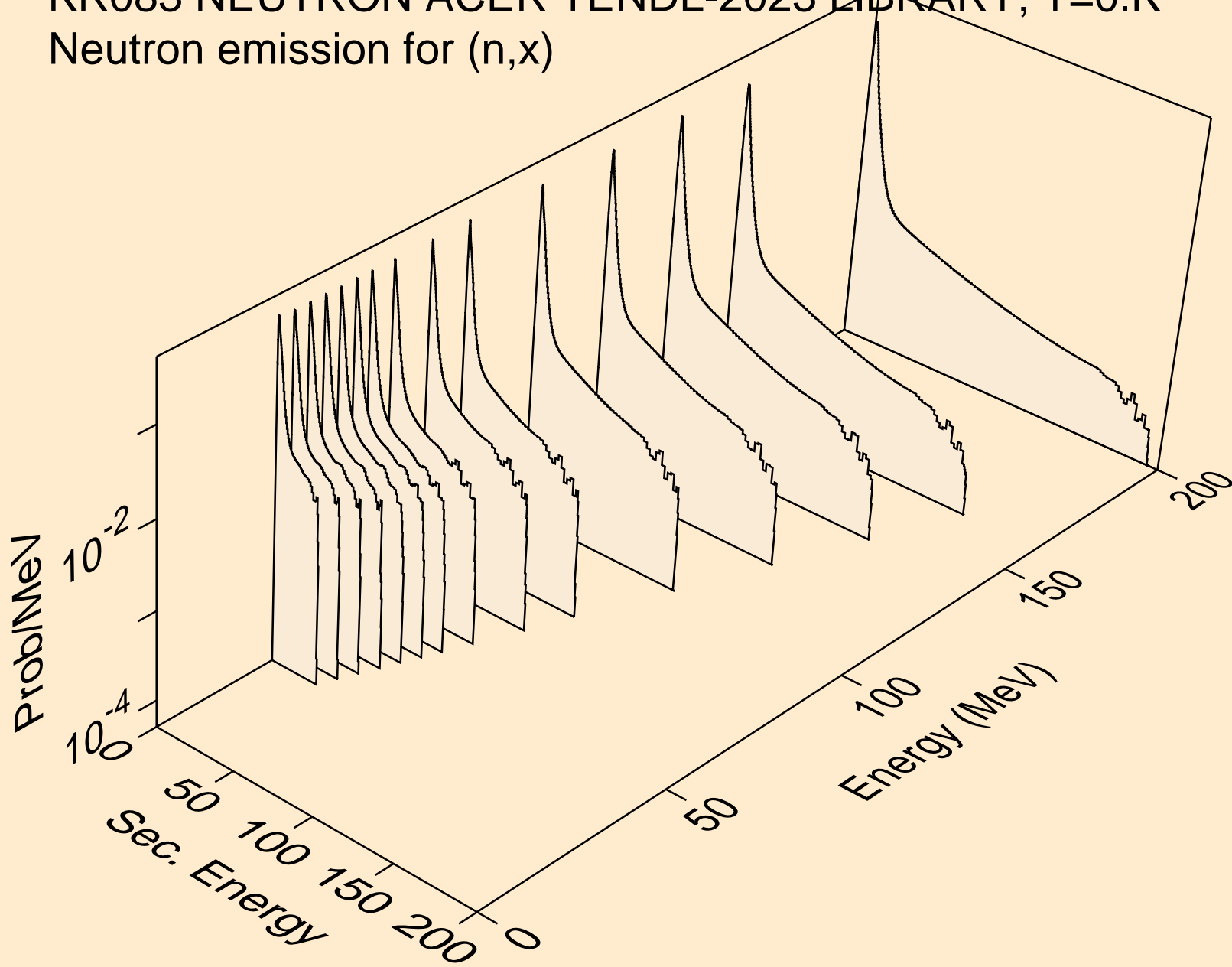

KR083 NEUTRON ACER TENDL-2023 LIBRARY; T=0.K  
Neutron emission for (n,2nd)

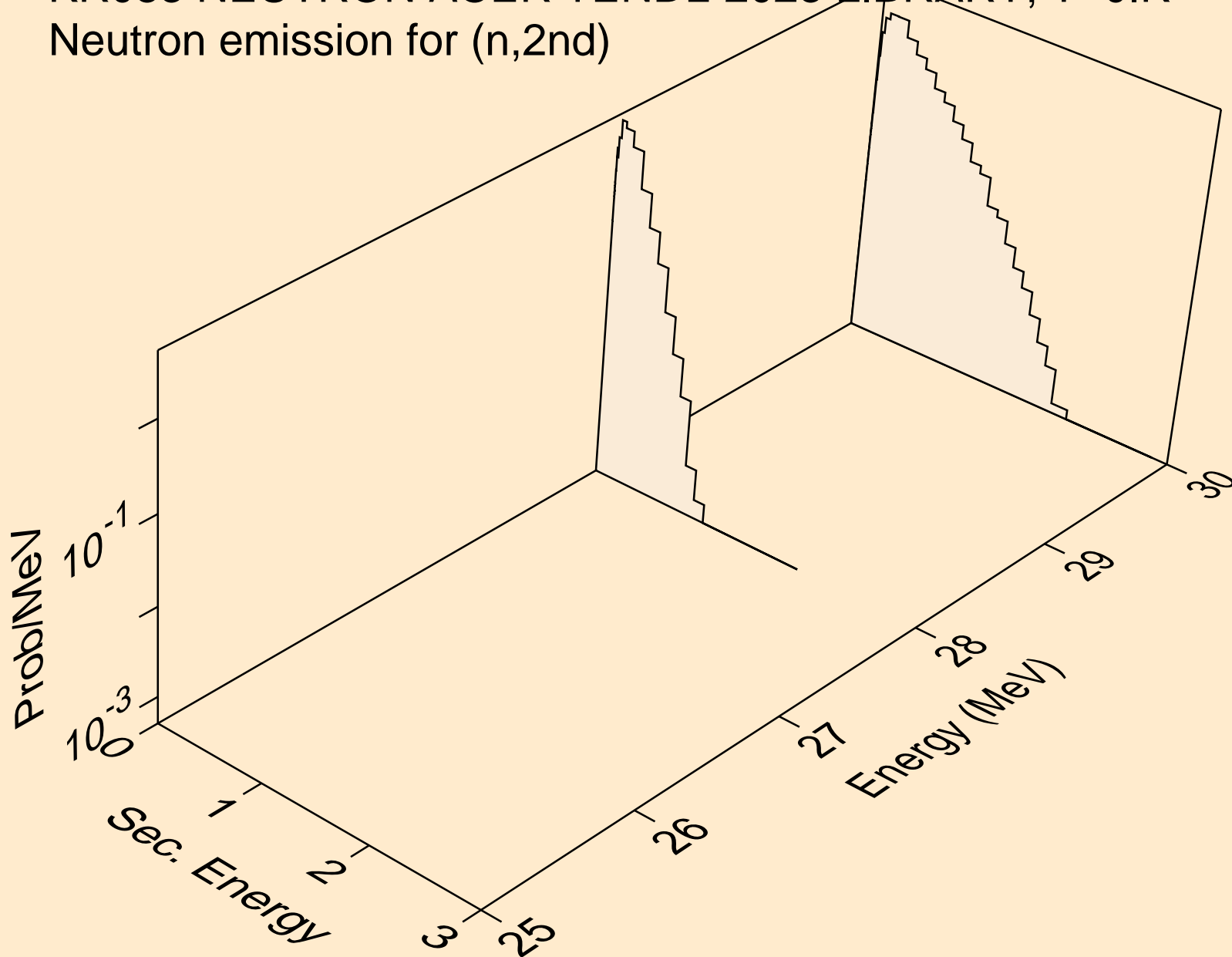

KR083 NEUTRON ACER TENDL-2023 LIBRARY; T=0.K  
Neutron emission for (n,2n)

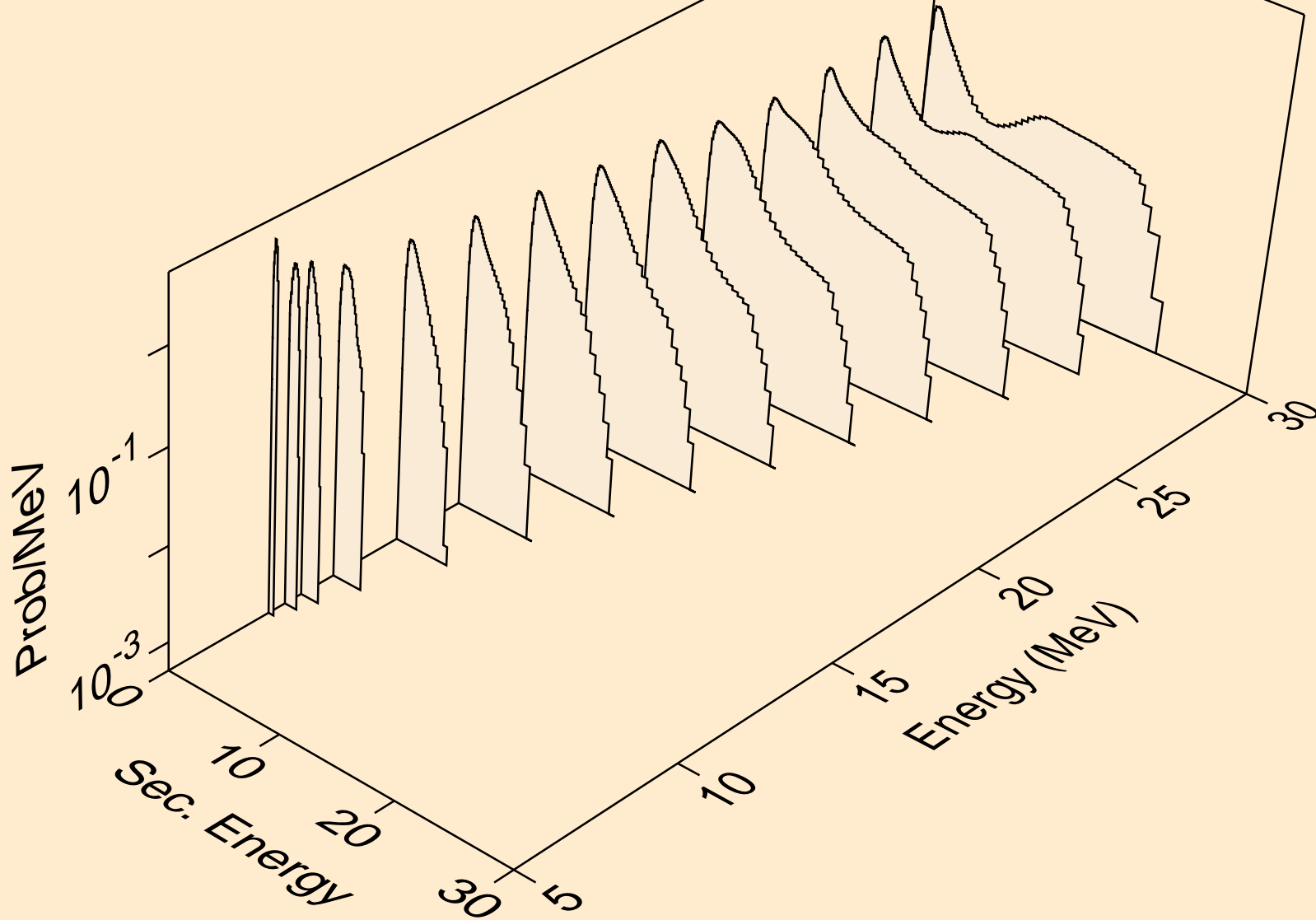



KR083 NEUTRON ACER TENDL-2023 LIBRARY; T=0.K  
Neutron emission for (n,3n)

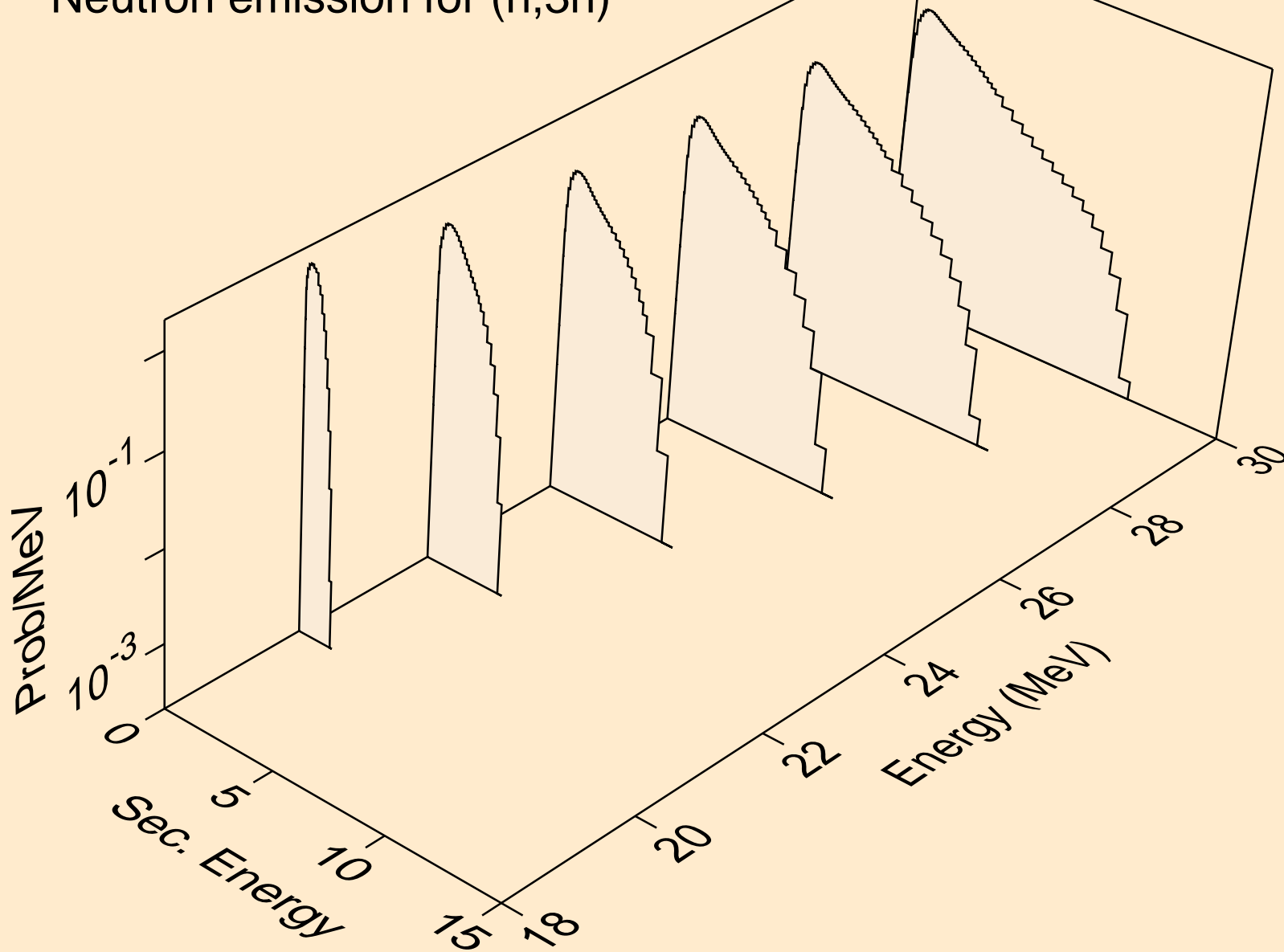

KR083 NEUTRON ACER TENDL-2023 LIBRARY; T=0.K  
Neutron emission for (n,n\*)a

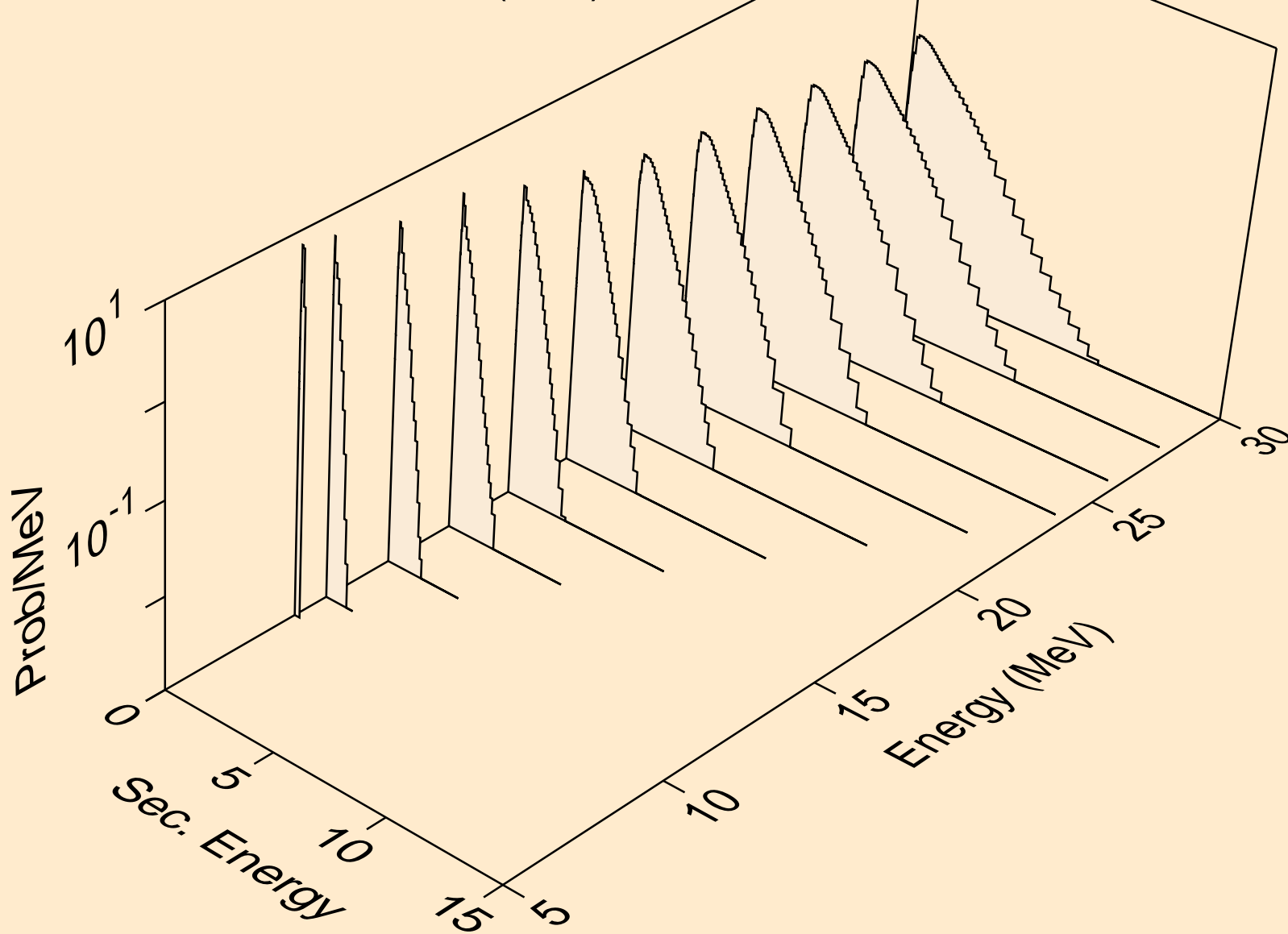

KR083 NEUTRON ACER TENDL-2023 LIBRARY; T=0.K  
Neutron emission for (n,2n)a

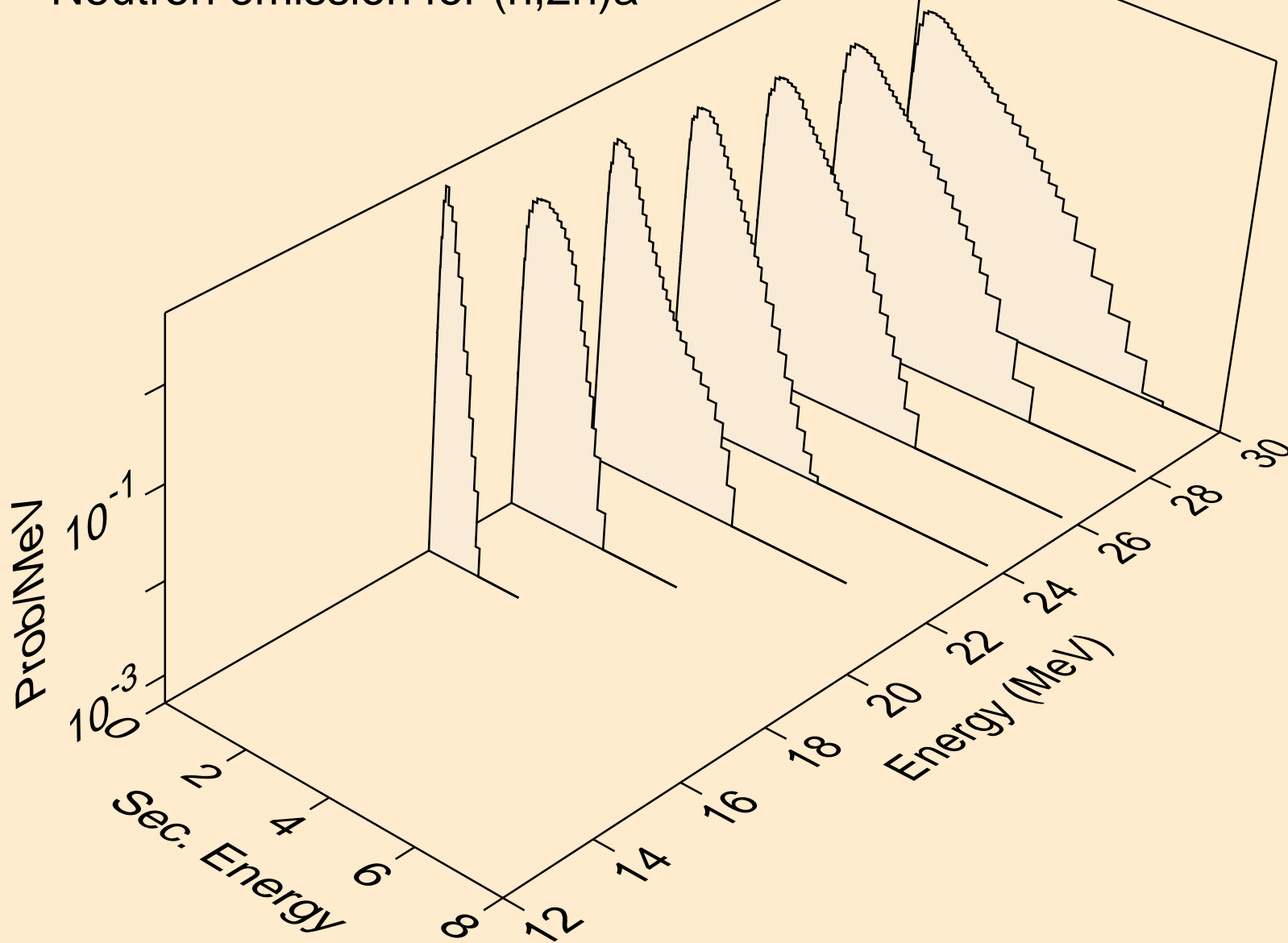

KR083 NEUTRON ACER TENDL-2023 LIBRARY; T=0.K  
Neutron emission for (n,n\*)p

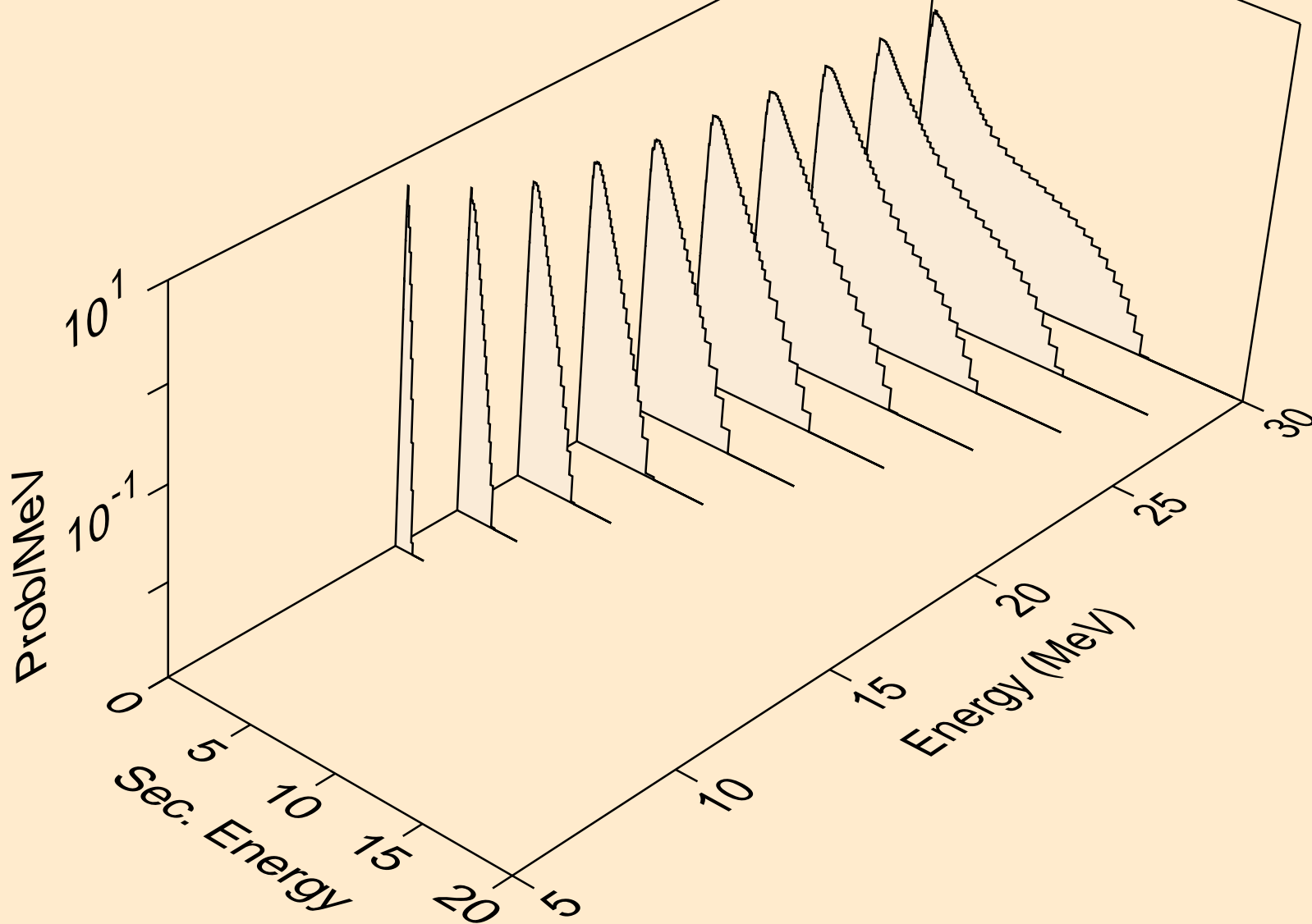

KR083 NEUTRON ACER TENDL-2023 LIBRARY; T=0.K  
Neutron emission for (n,n\*)2a

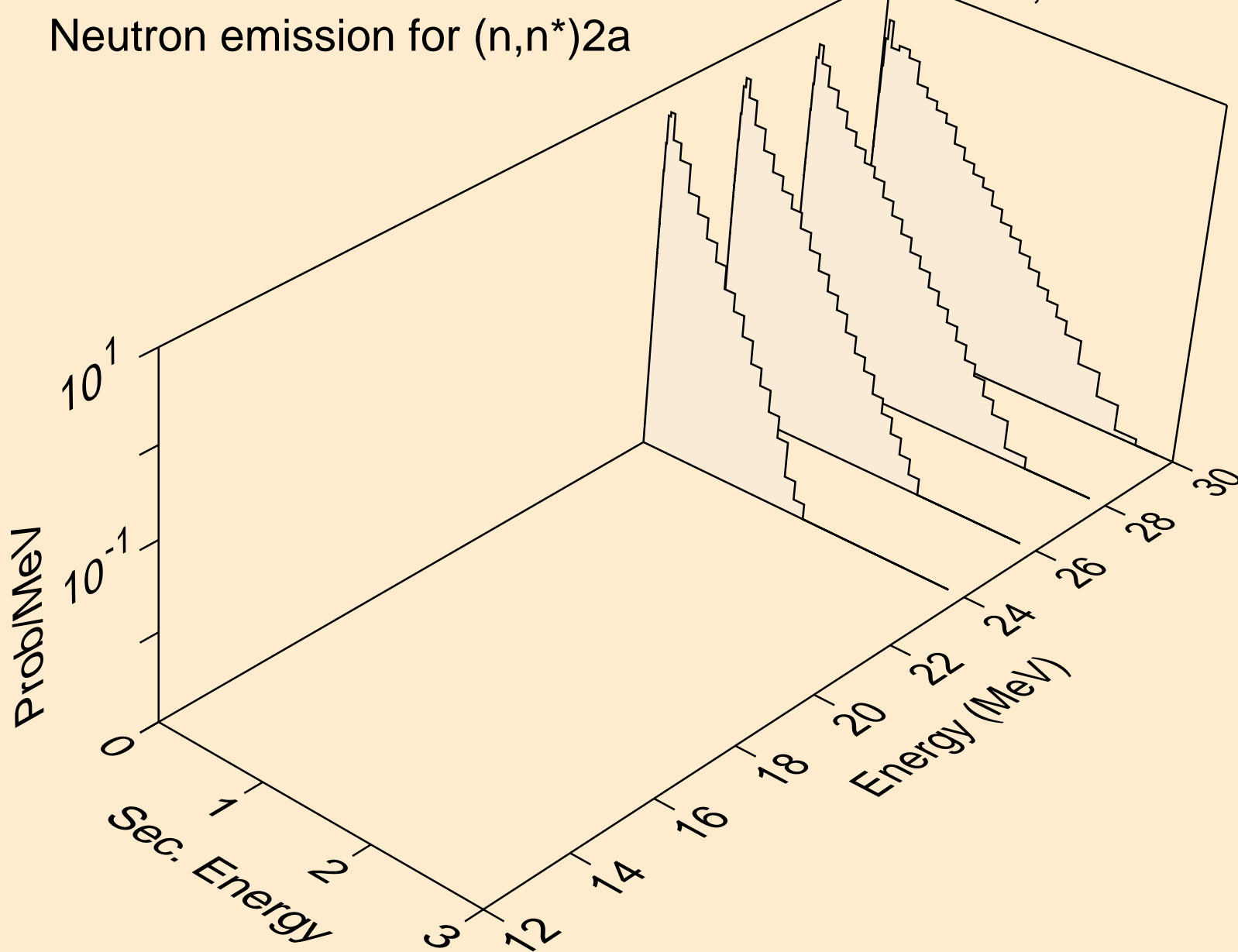

KR083 NEUTRON ACER TENDL-2023 LIBRARY; T=0.K  
Neutron emission for (n,n\*)d

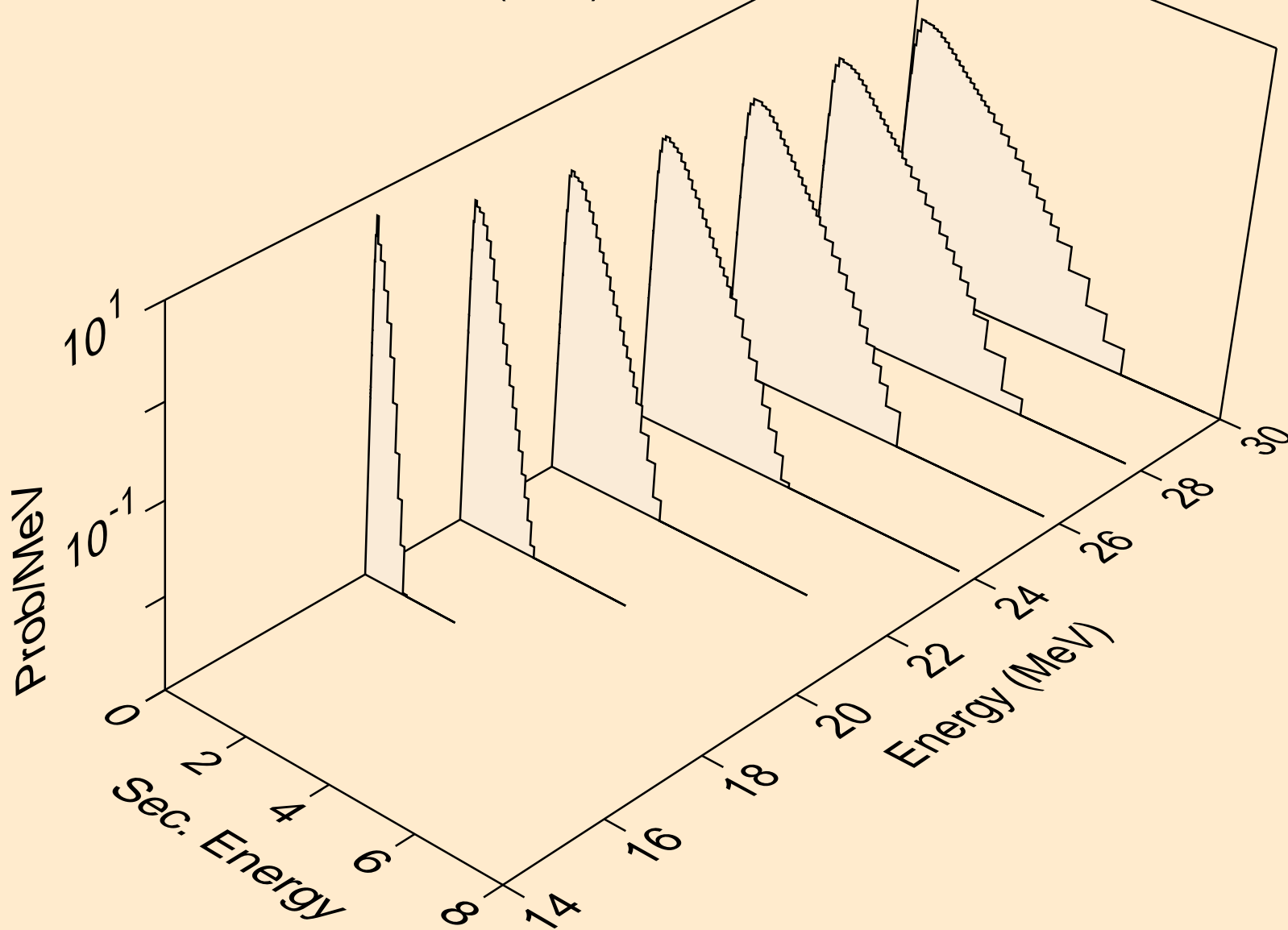

KR083 NEUTRON ACER TENDL-2023 LIBRARY; T=0.K  
Neutron emission for (n,n\*)t

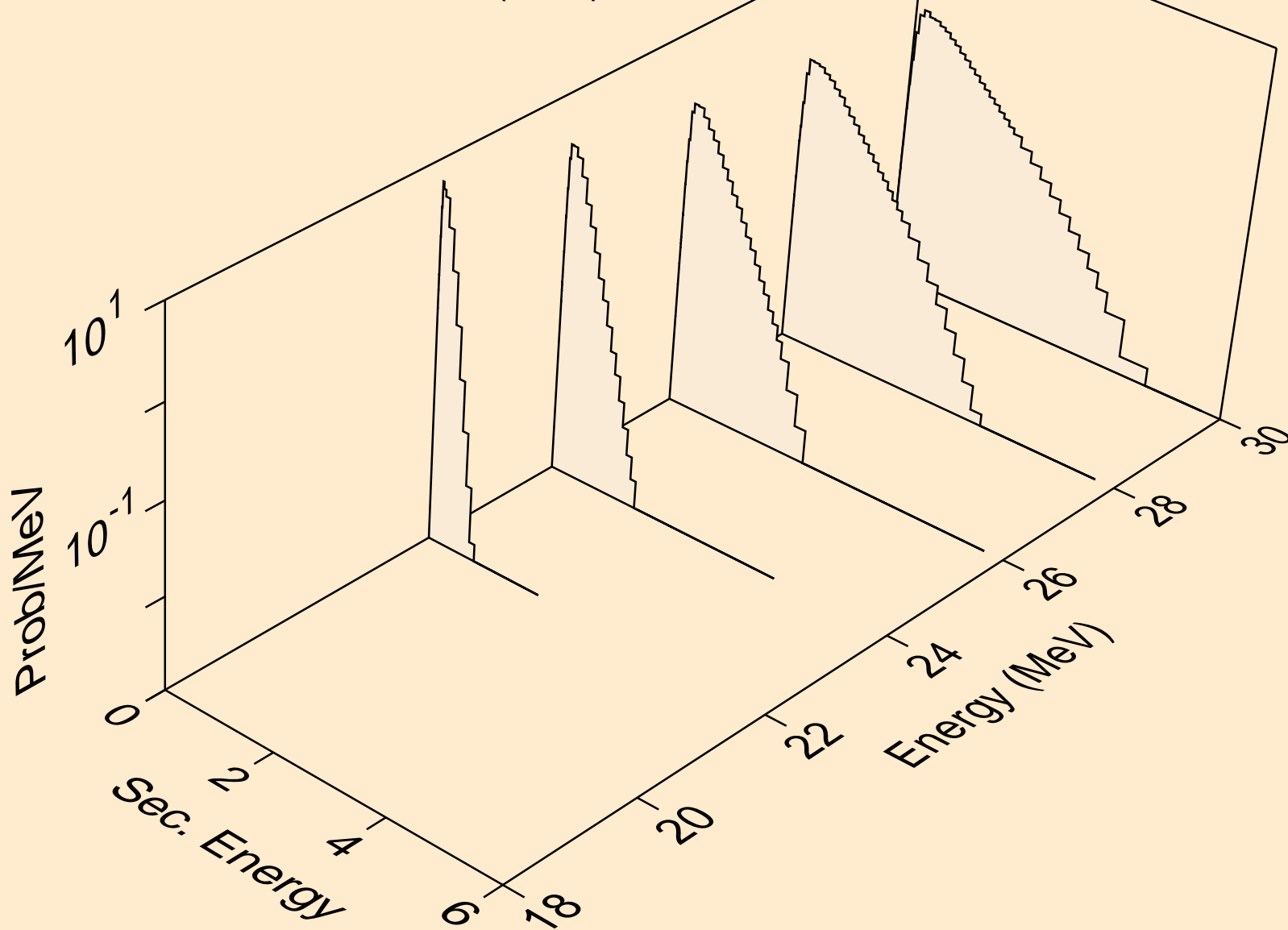

KR083 NEUTRON ACER TENDL-2023 LIBRARY; T=0.K  
Neutron emission for (n,n\*)he3

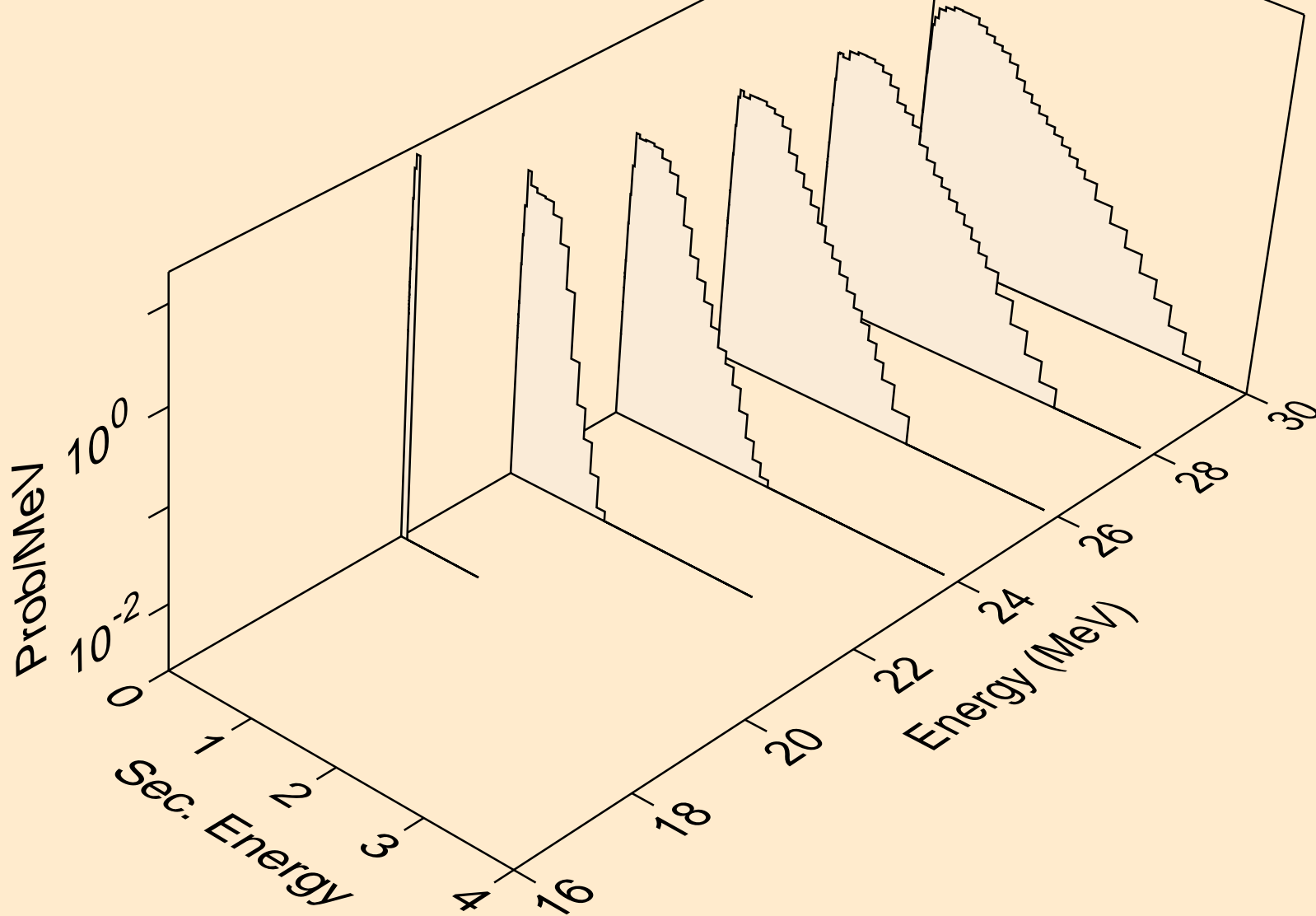



KR083 NEUTRON ACER TENDL-2023 LIBRARY; T=0.K  
Neutron emission for (n,4n)

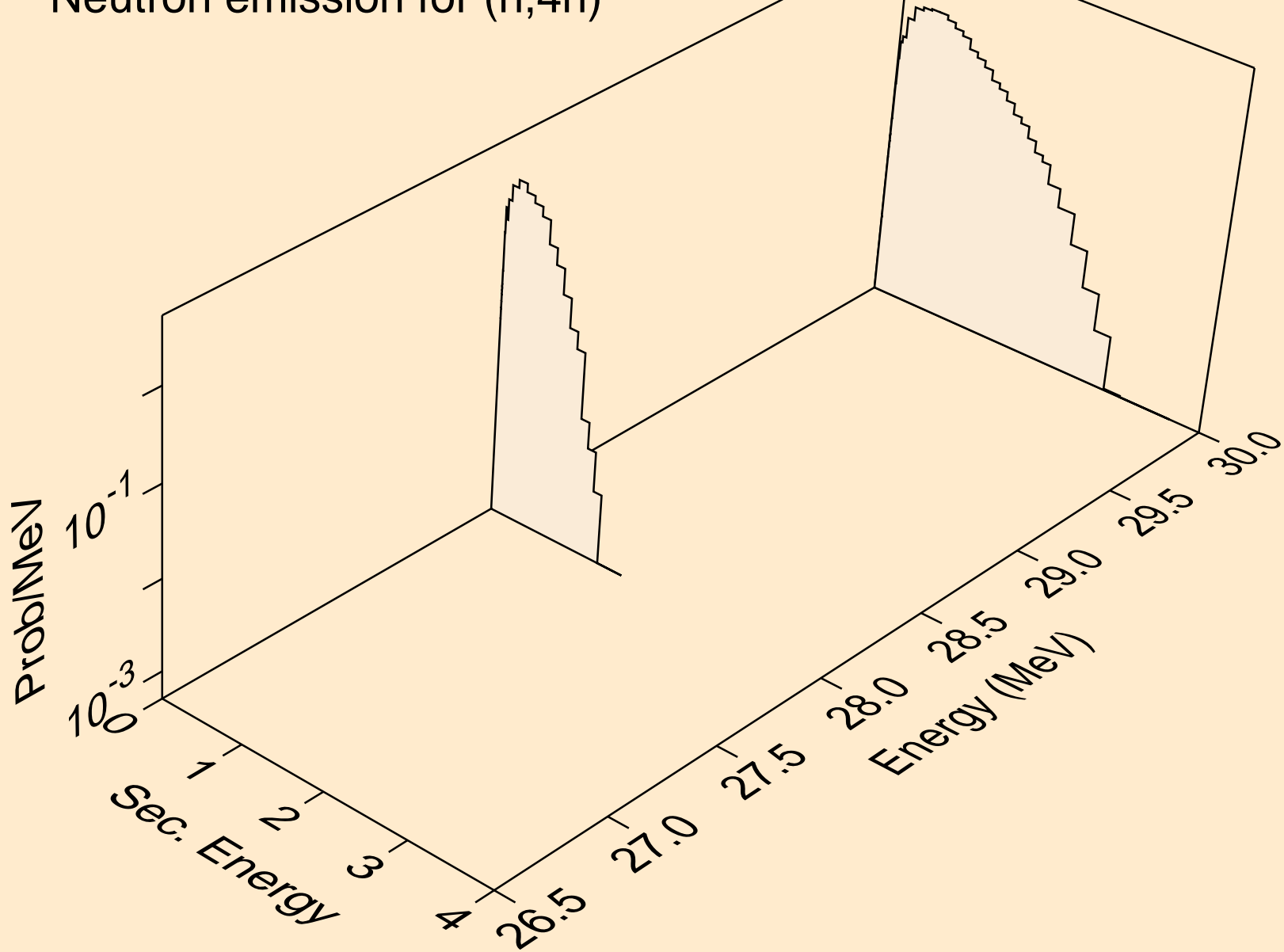

KR083 NEUTRON ACER TENDL-2023 LIBRARY; T=0.K  
Neutron emission for (n,2np)

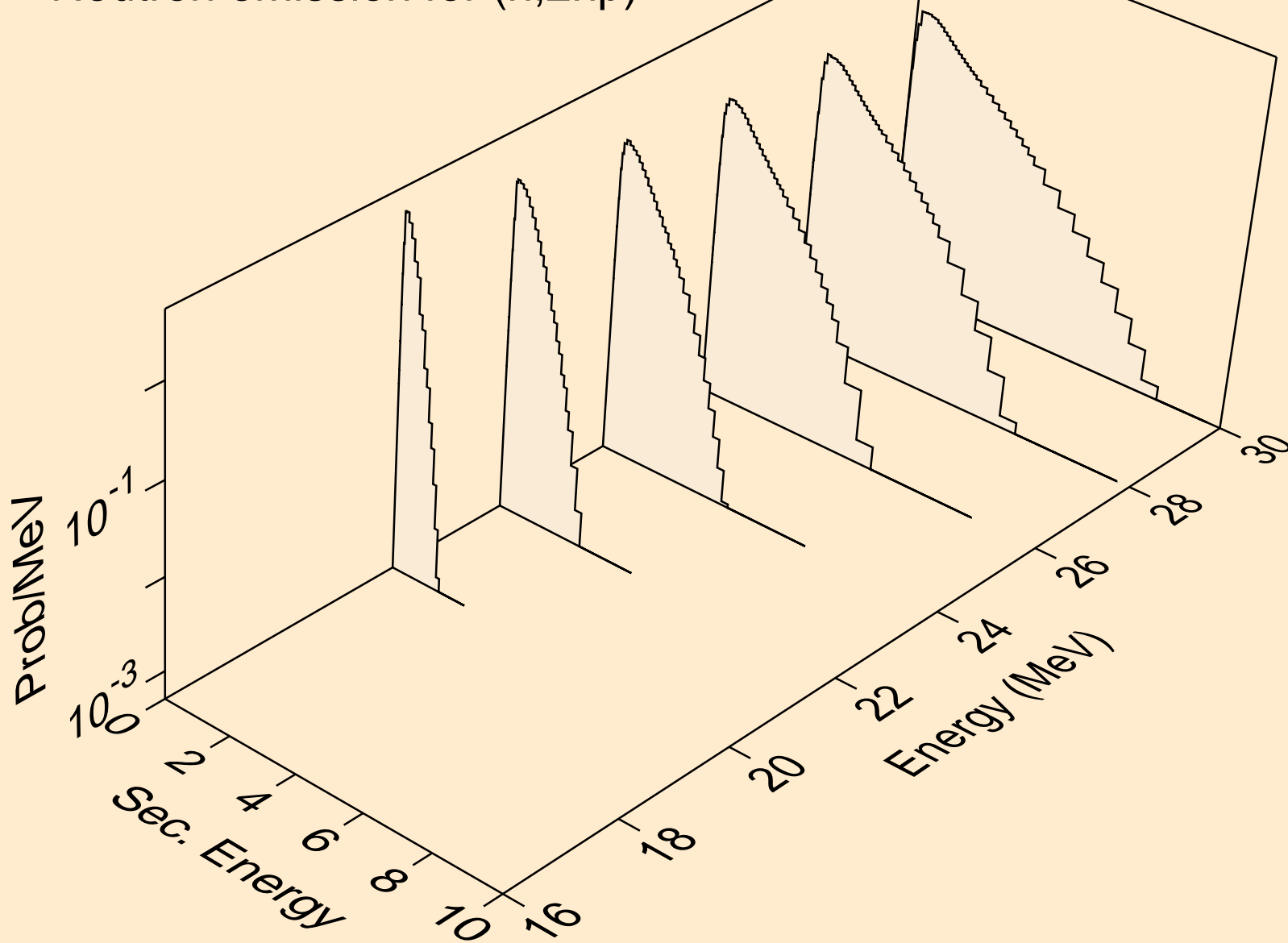

KR083 NEUTRON ACER TENDL-2023 LIBRARY; T=0.K  
Neutron emission for (n,n2p)

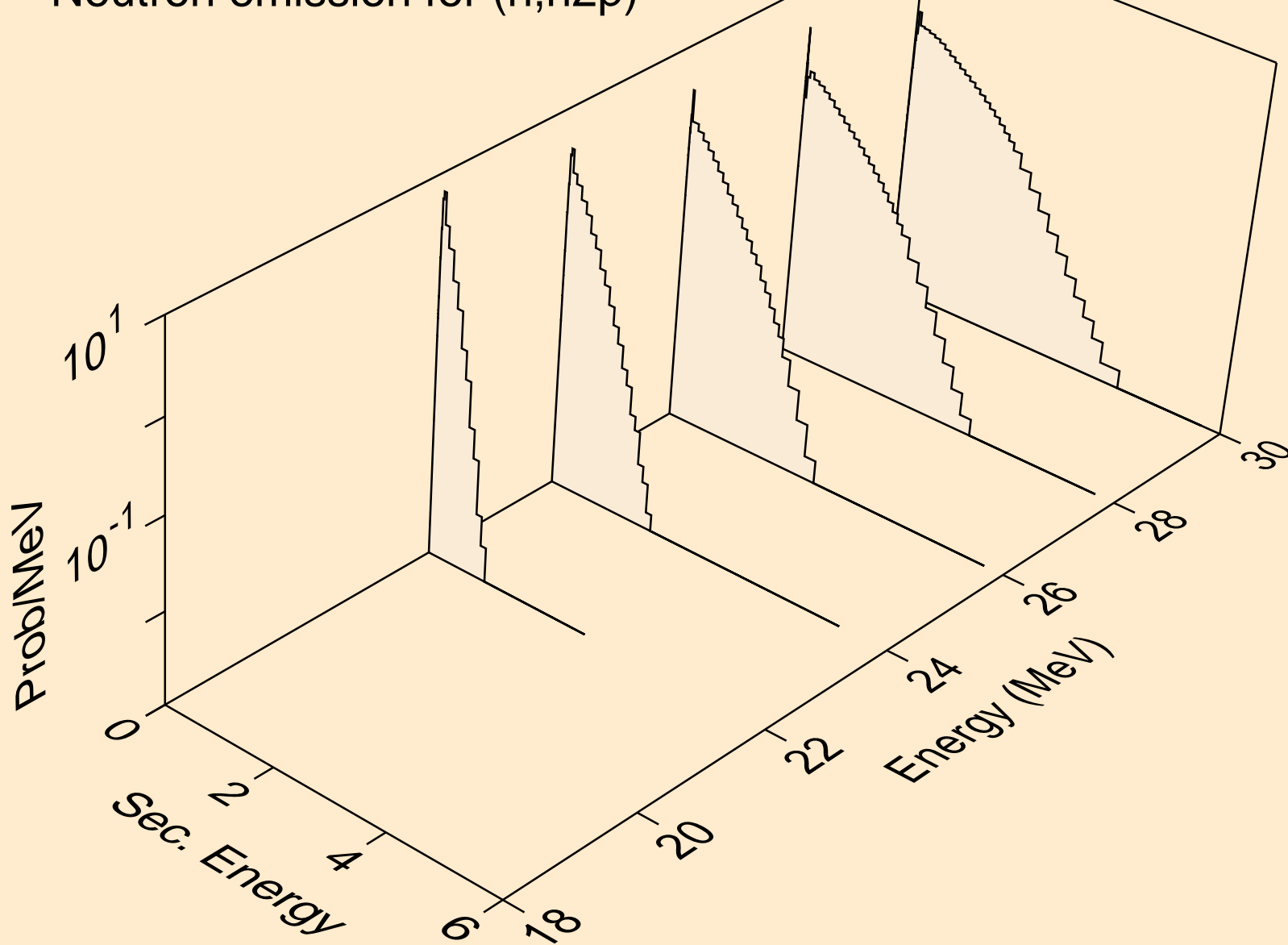

KR083 NEUTRON ACER TENDL-2023 LIBRARY; T=0.K  
Neutron emission for (n,npa)

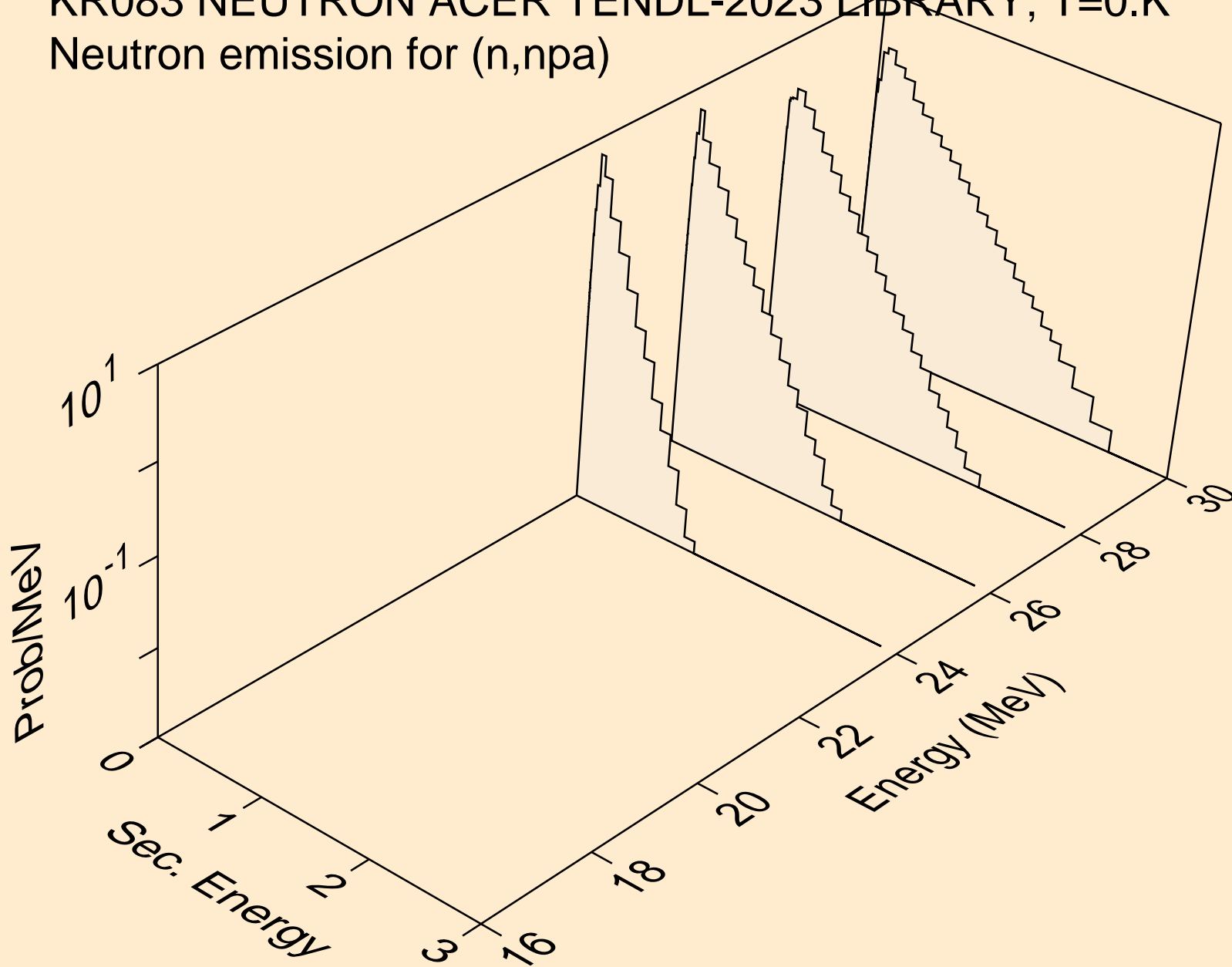

KR083 NEUTRON ACER TENDL-2023 LIBRARY; T=0.K  
Neutron emission for (n,n\*c)

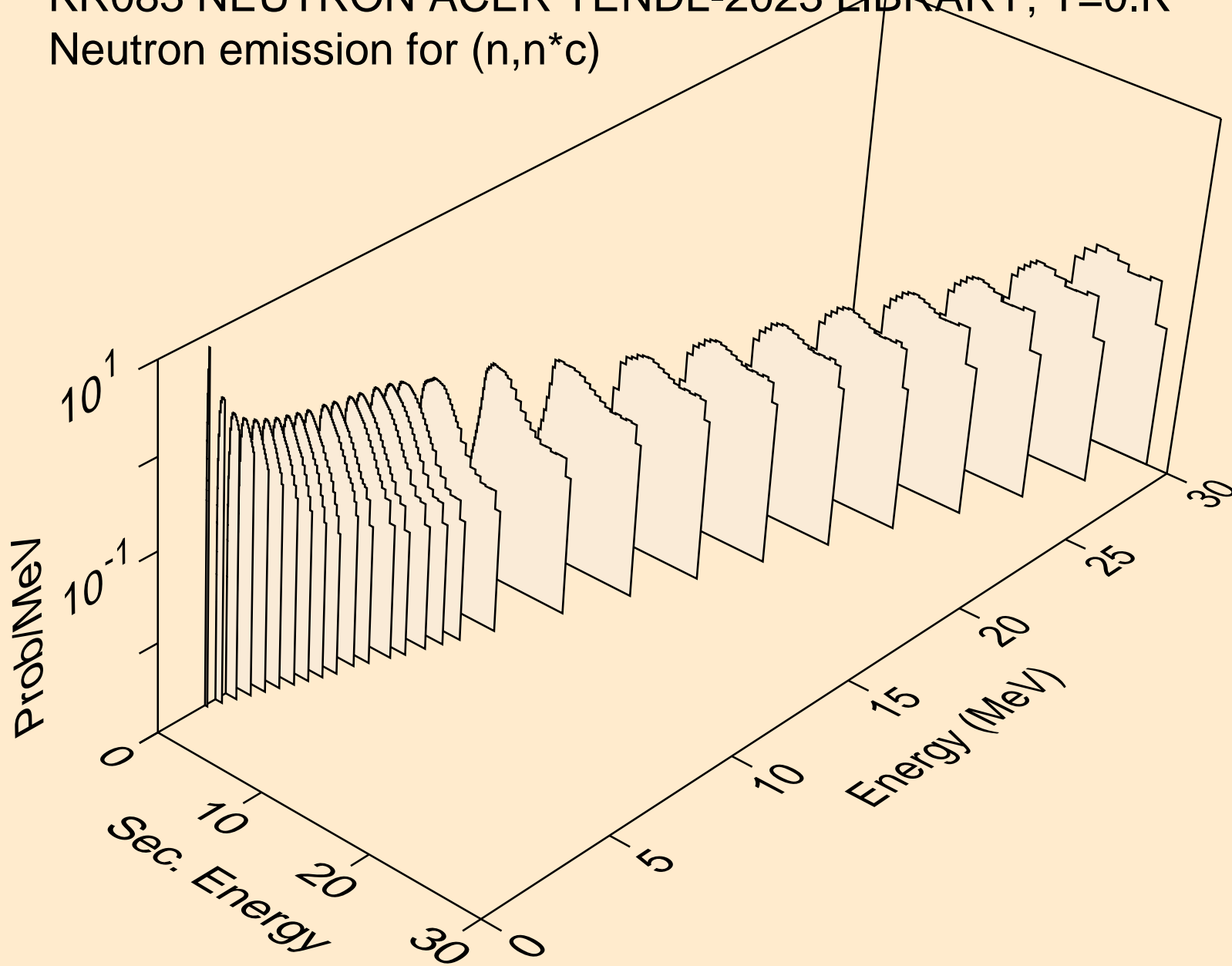

KR083 NEUTRON ACER TENDL-2023 LIBRARY; T=0.K  
Photon emission for (n,x)

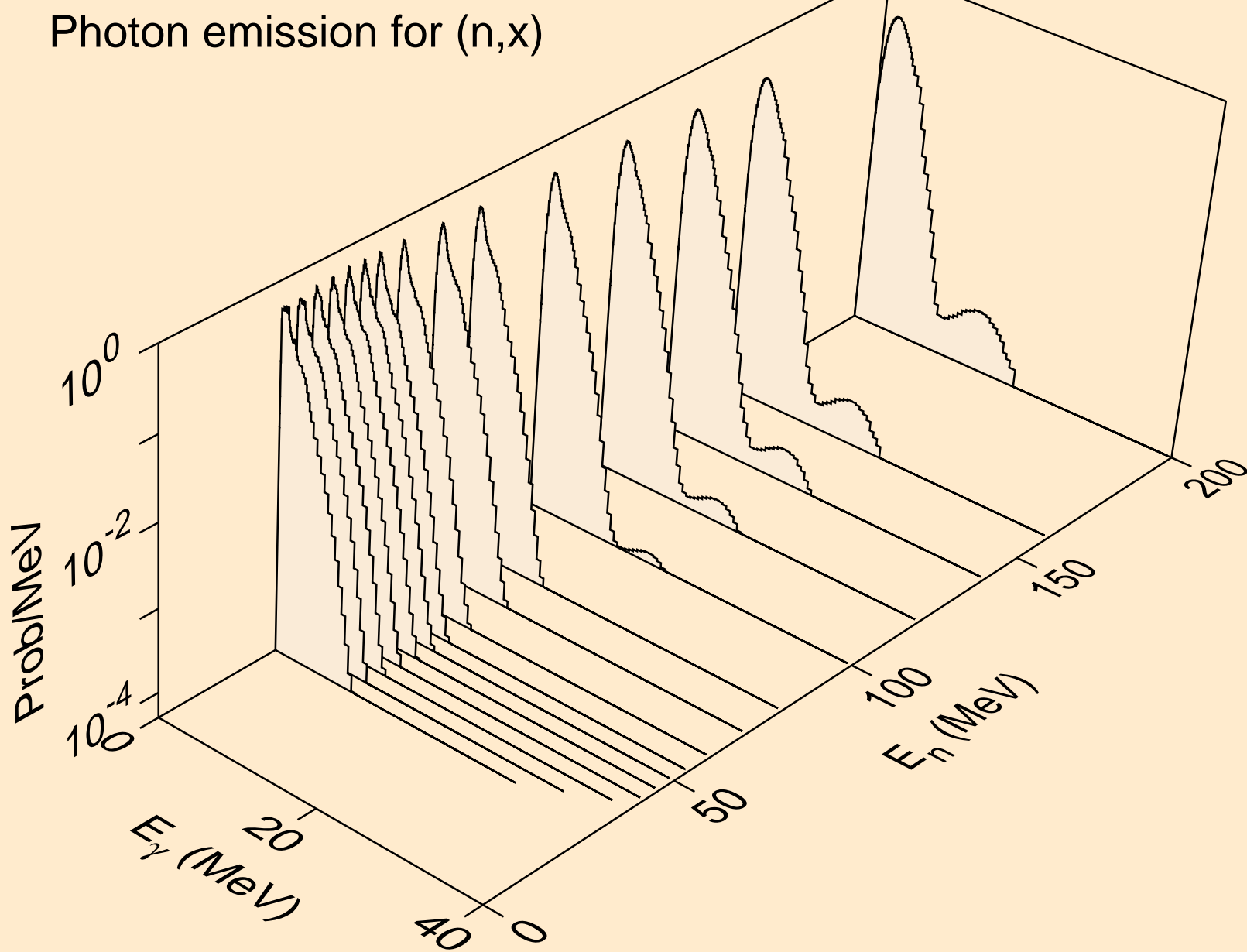

KR083 NEUTRON ACER TENDL-2023 LIBRARY; T=0.K  
Photon emission for (n,2nd)

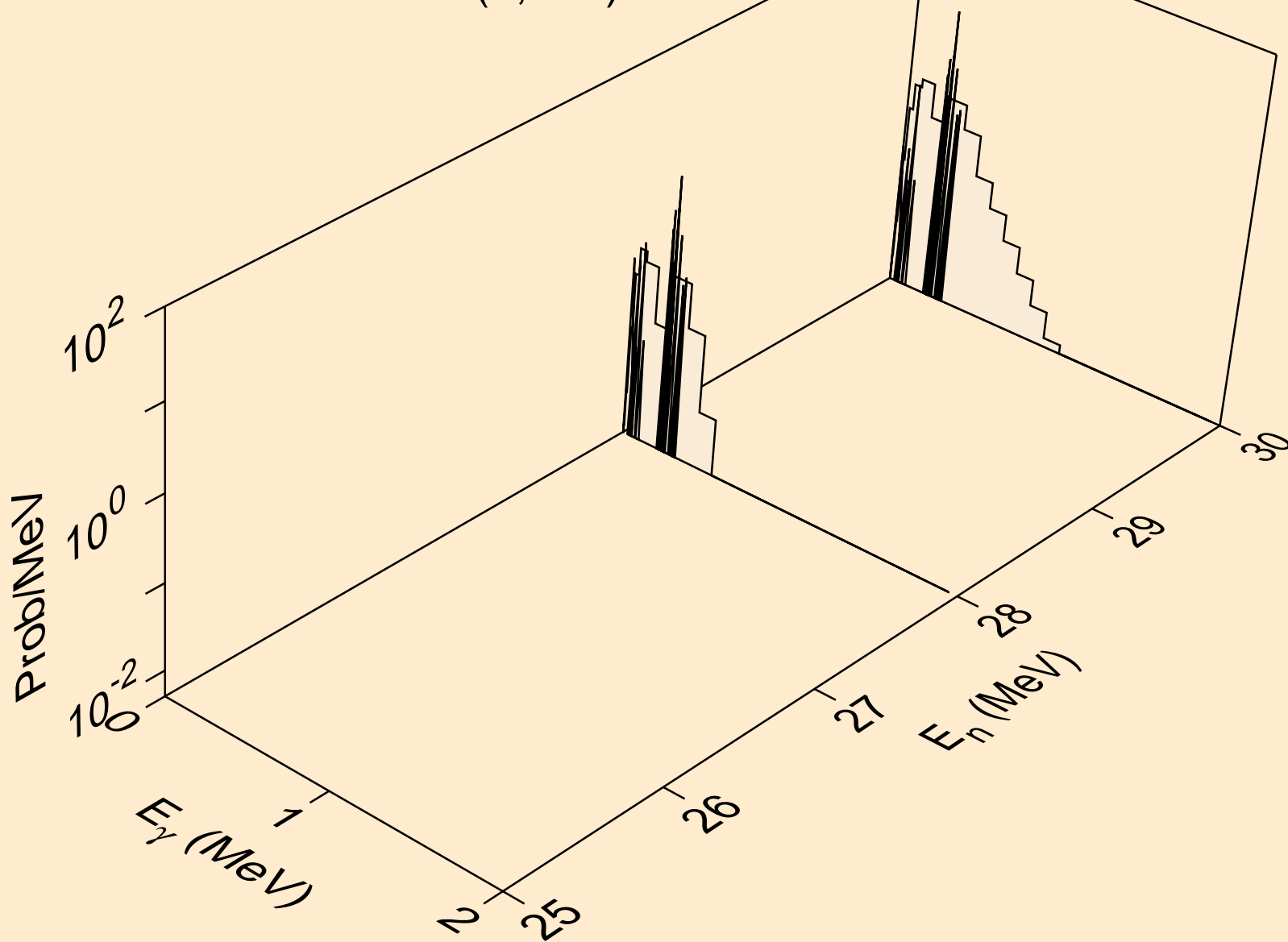

KR083 NEUTRON ACER TENDL-2023 LIBRARY; T=0.K  
Photon emission for (n,2n)

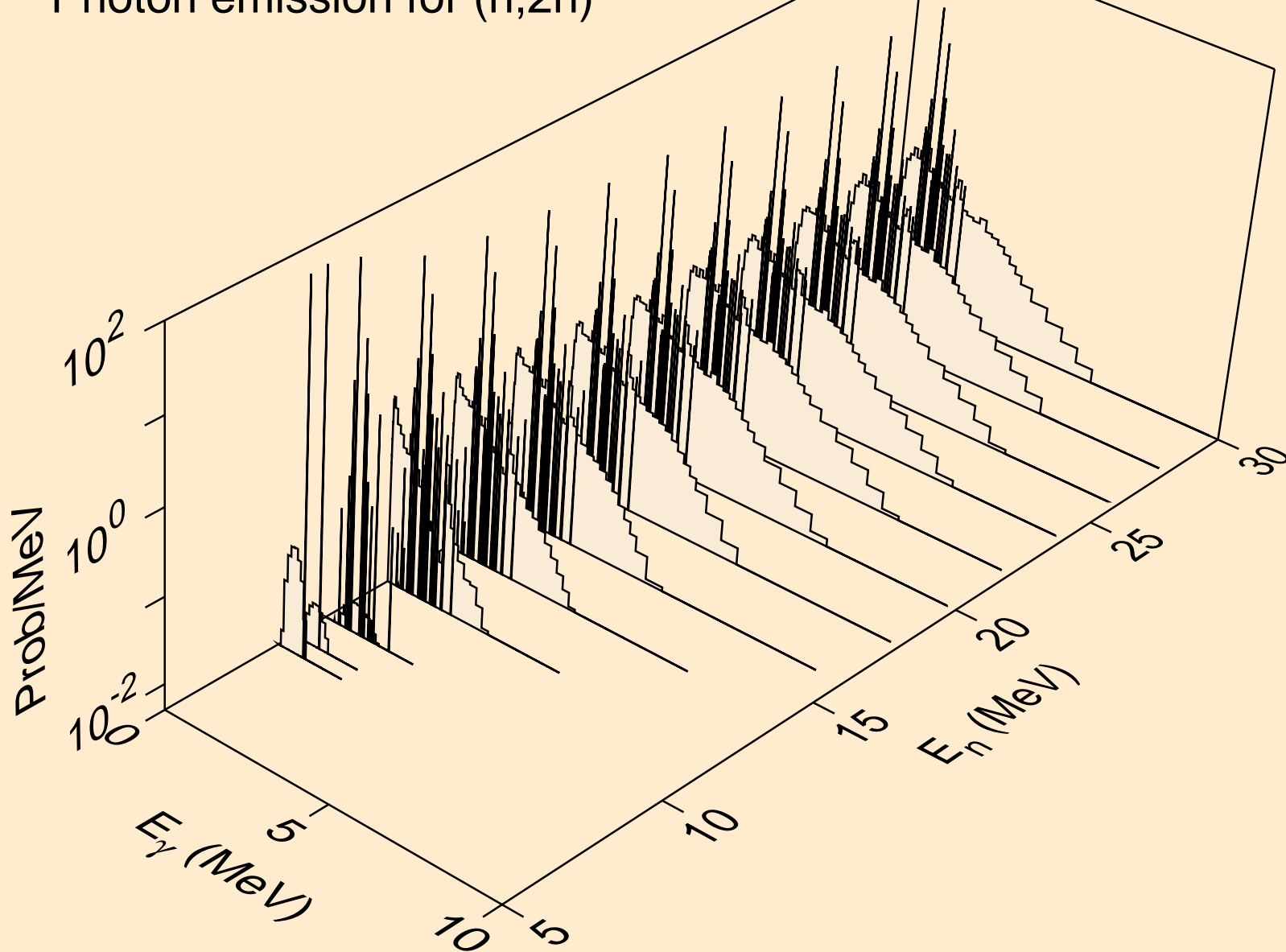



KR083 NEUTRON ACER TENDL-2023 LIBRARY; T=0.K  
Photon emission for (n,3n)

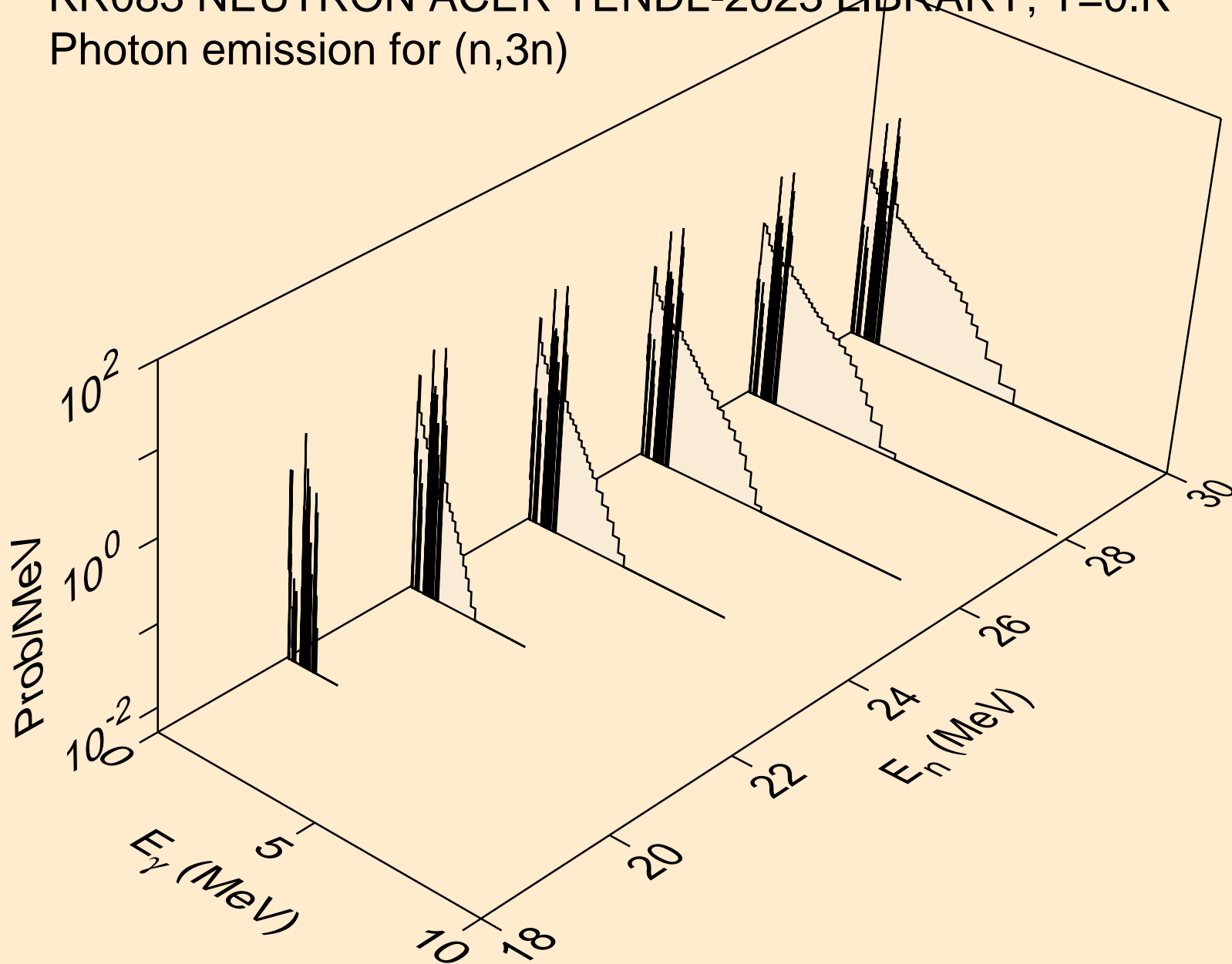

KR083 NEUTRON ACER TENDL-2023 LIBRARY; T=0.K  
Photon emission for (n,n\*)a

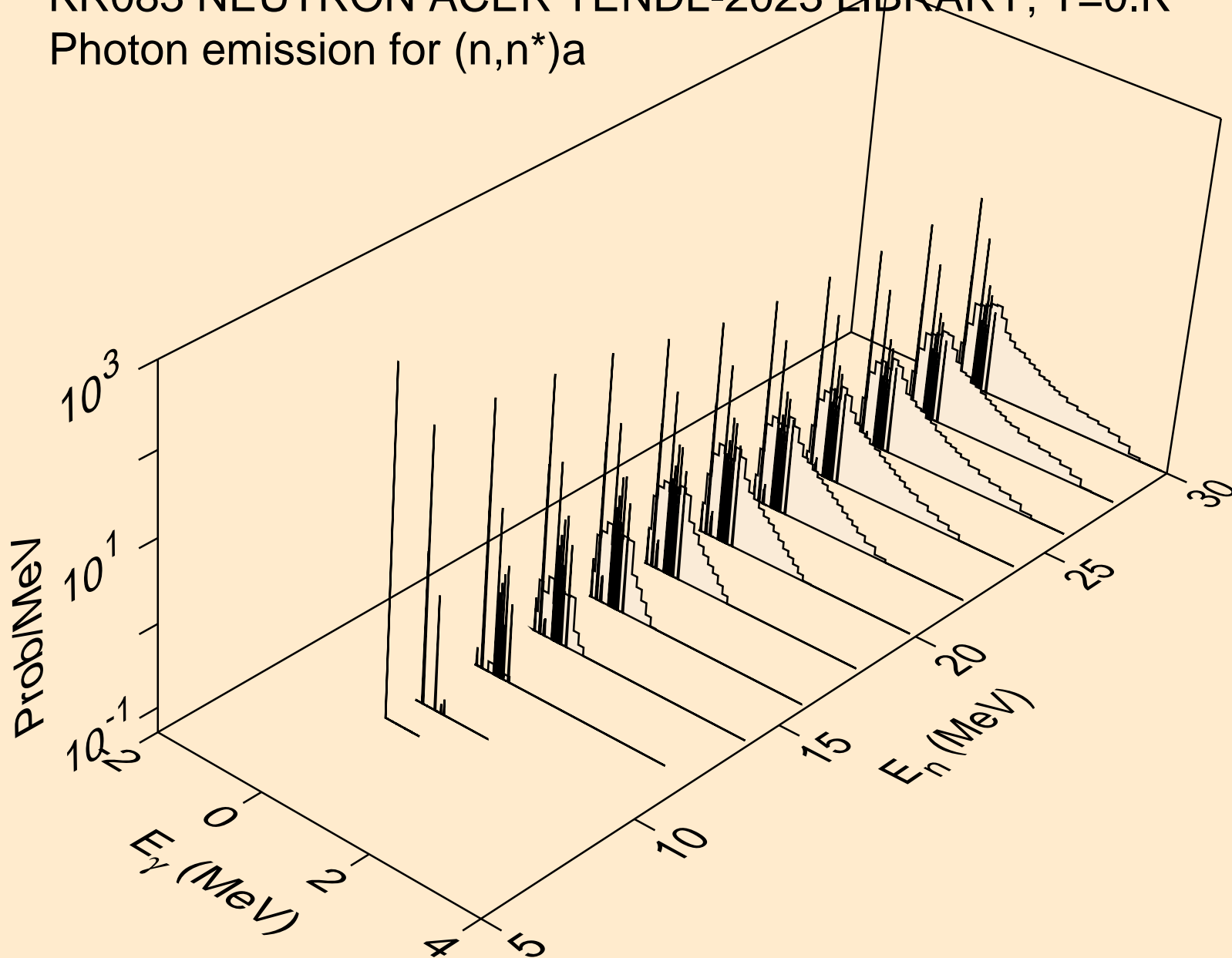

KR083 NEUTRON ACER TENDL-2023 LIBRARY; T=0.K  
Photon emission for (n,2n)a

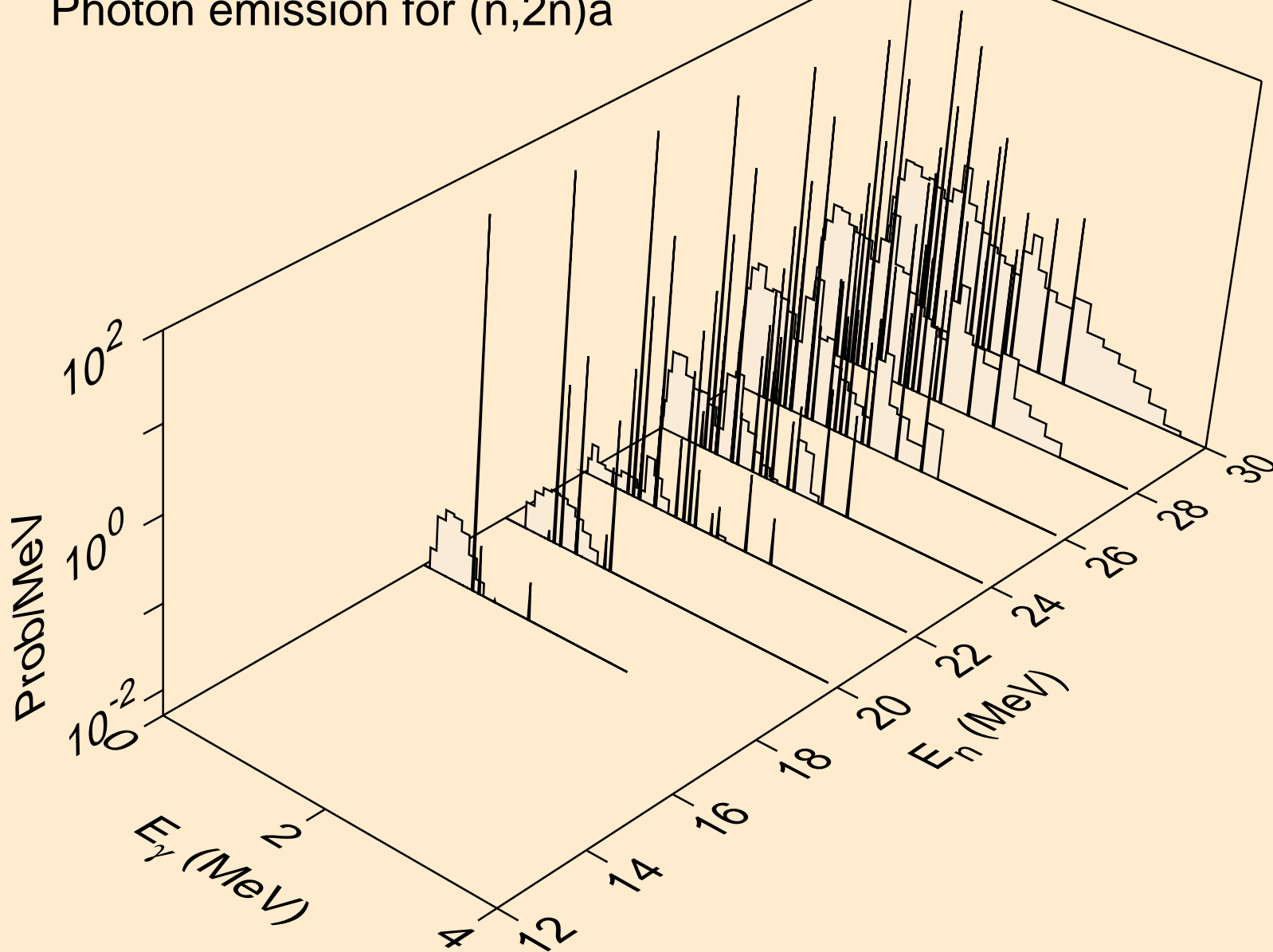

KR083 NEUTRON ACER TENDL-2023 LIBRARY; T=0.K  
Photon emission for (n,n\*)p

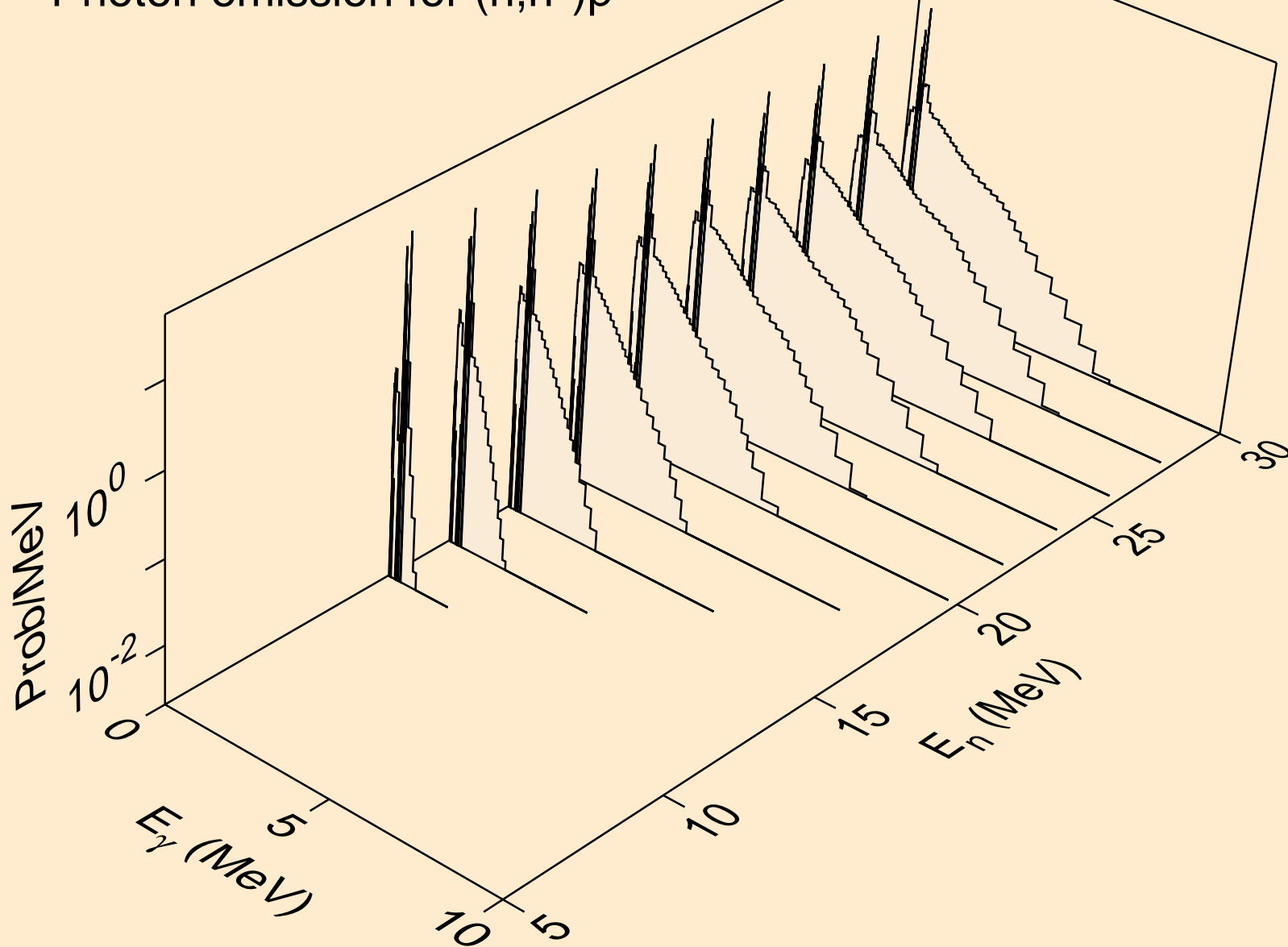

KR083 NEUTRON ACER TENDL-2023 LIBRARY; T=0.K  
Photon emission for (n,n\*)2a

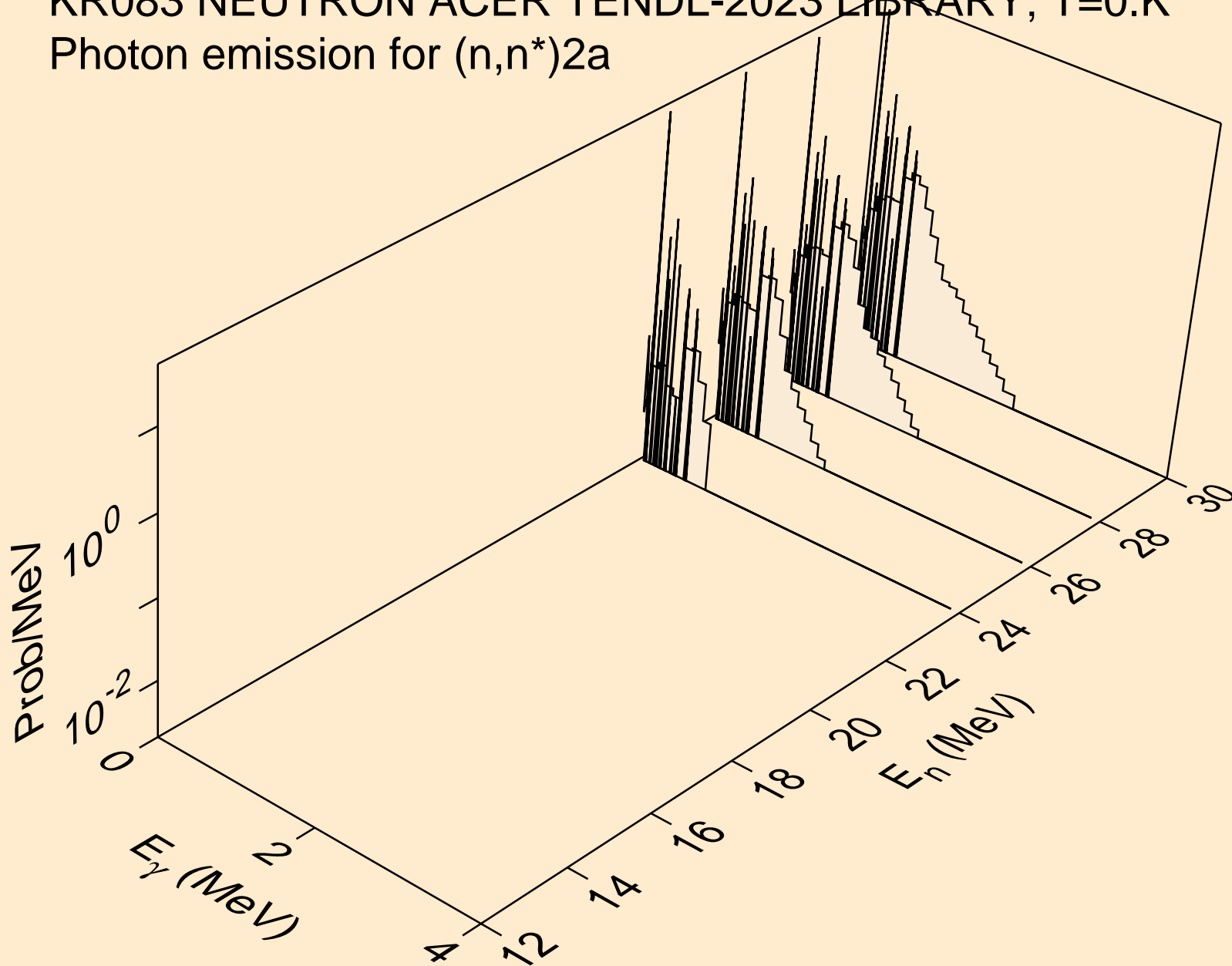

KR083 NEUTRON ACER TENDL-2023 LIBRARY; T=0.K  
Photon emission for (n,n\*)d

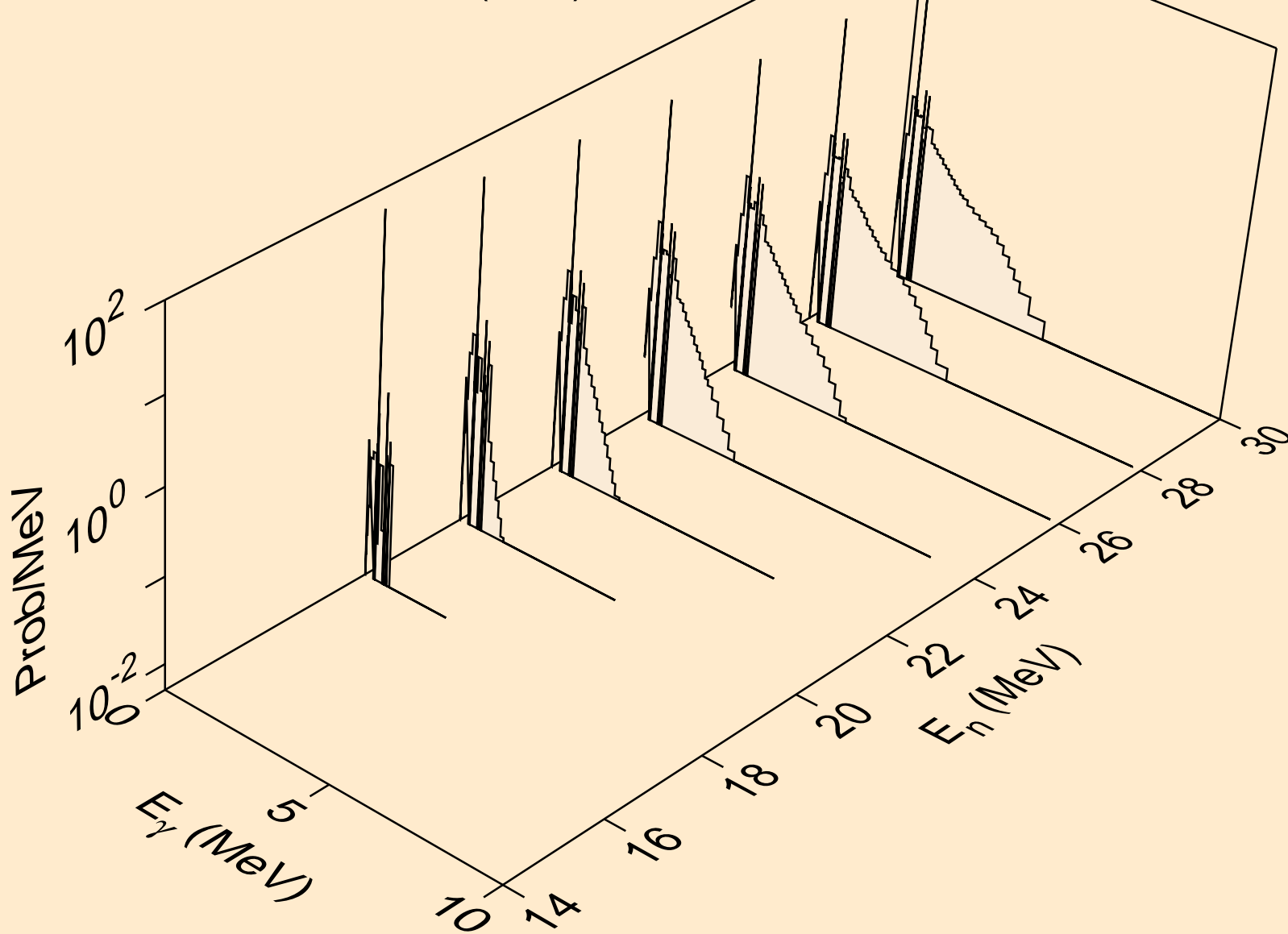

KR083 NEUTRON ACER TENDL-2023 LIBRARY; T=0.K  
Photon emission for (n,n\*)t

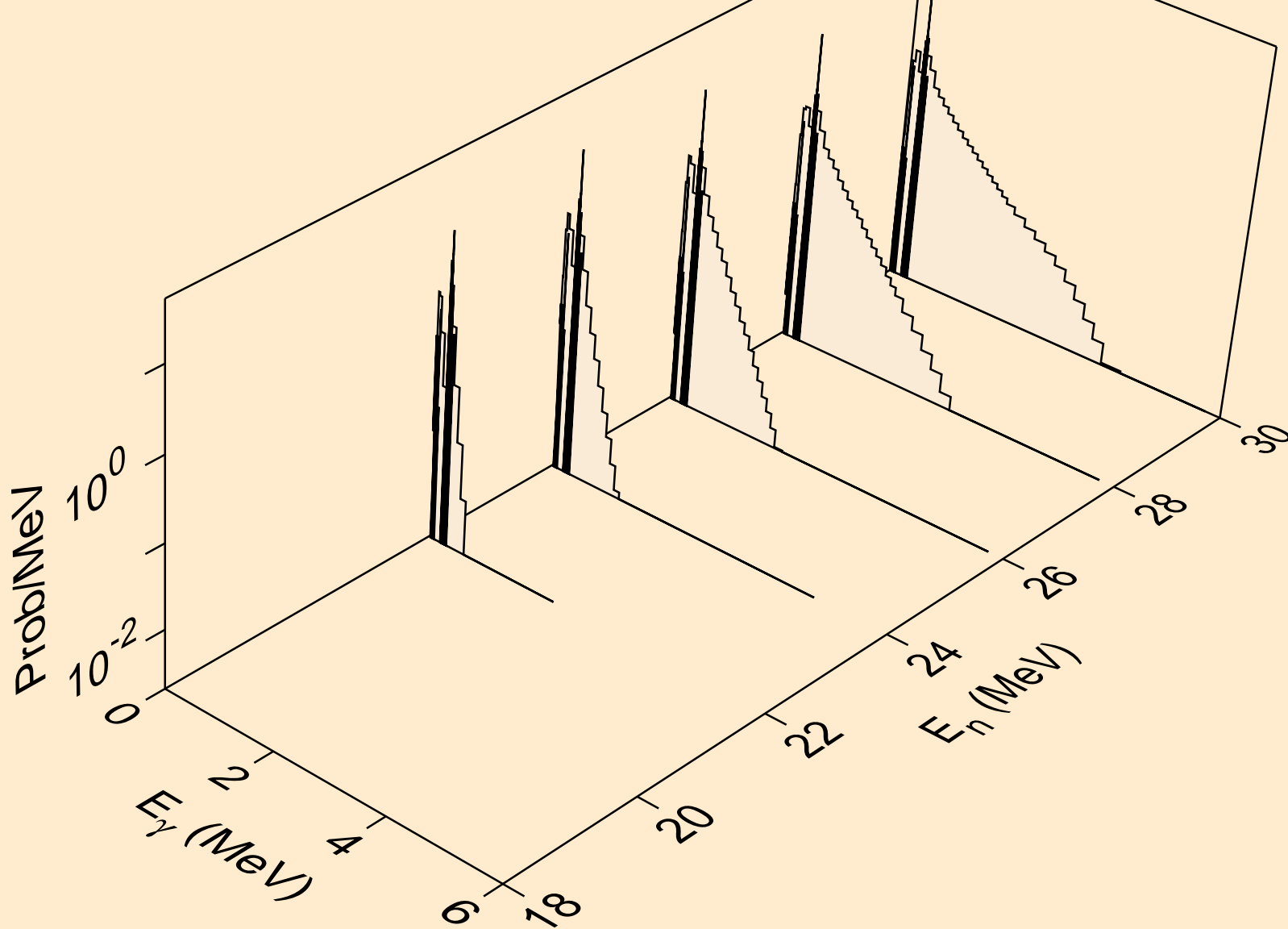

KR083 NEUTRON ACER TENDL-2023 LIBRARY; T=0.K  
Photon emission for (n,n\*)he3

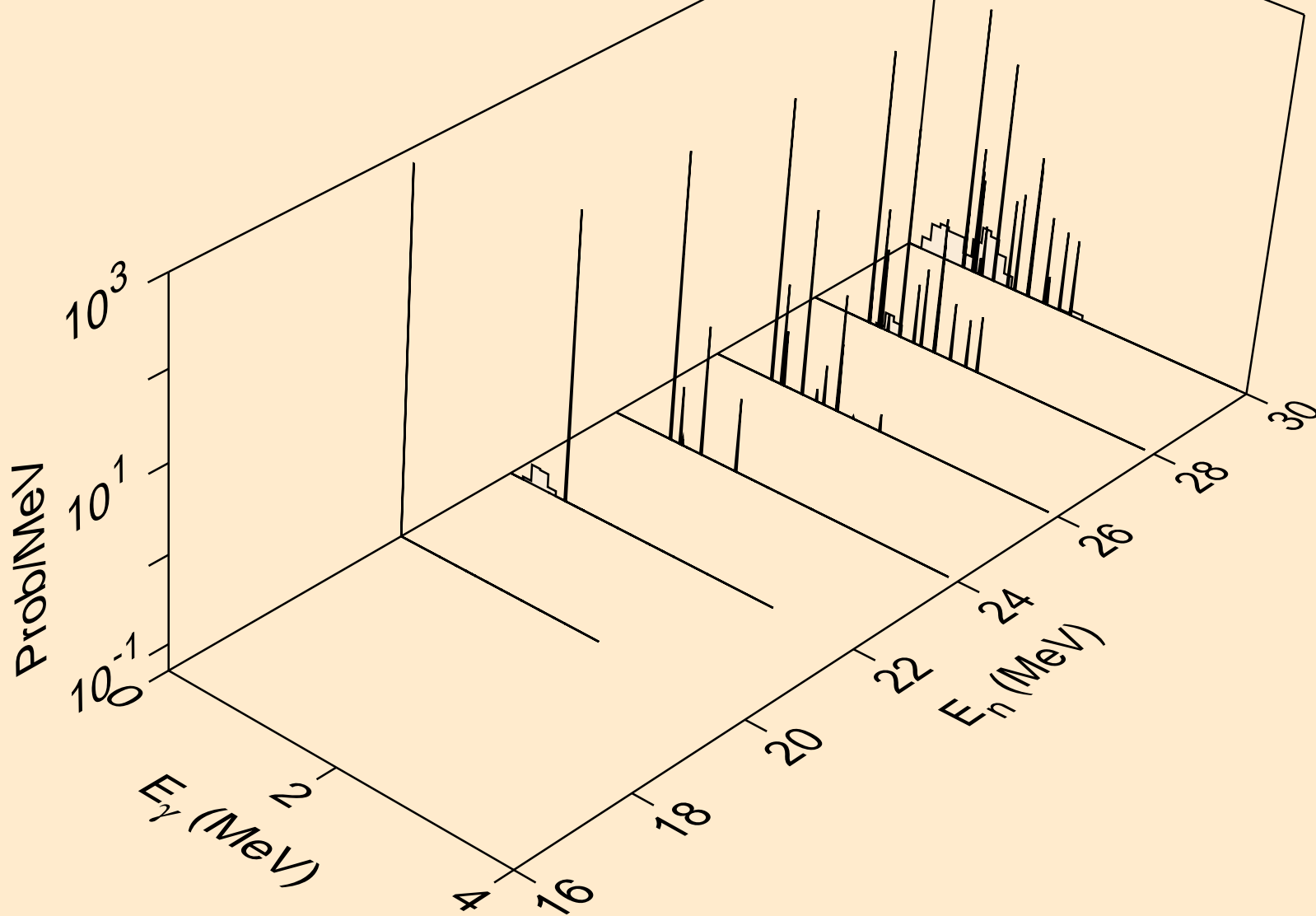



KR083 NEUTRON ACER TENDL-2023 LIBRARY; T=0.K  
Photon emission for (n,4n)

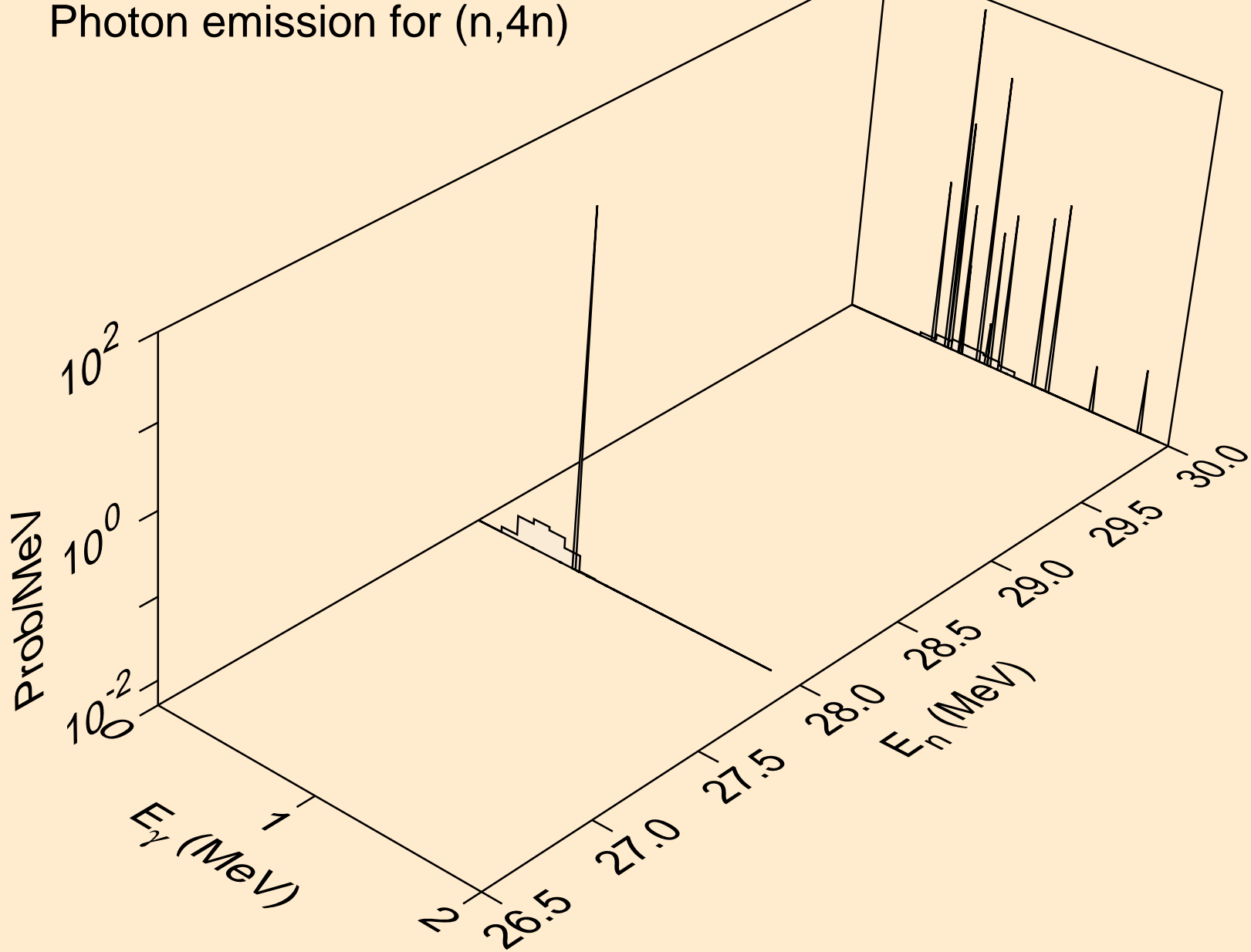

KR083 NEUTRON ACER TENDL-2023 LIBRARY; T=0.K  
Photon emission for (n,2np)

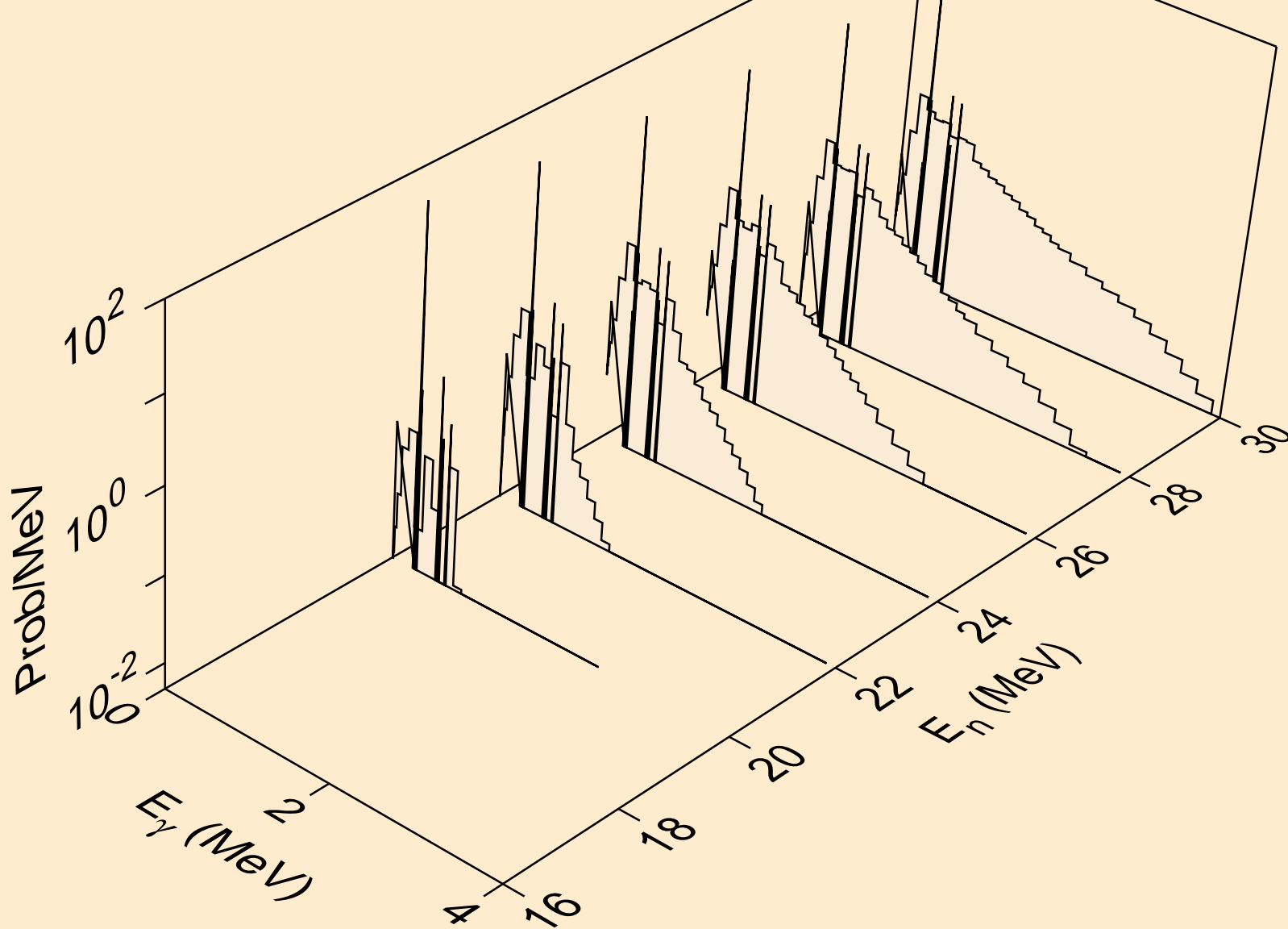

KR083 NEUTRON ACER TENDL-2023 LIBRARY; T=0.K  
Photon emission for (n,n2p)

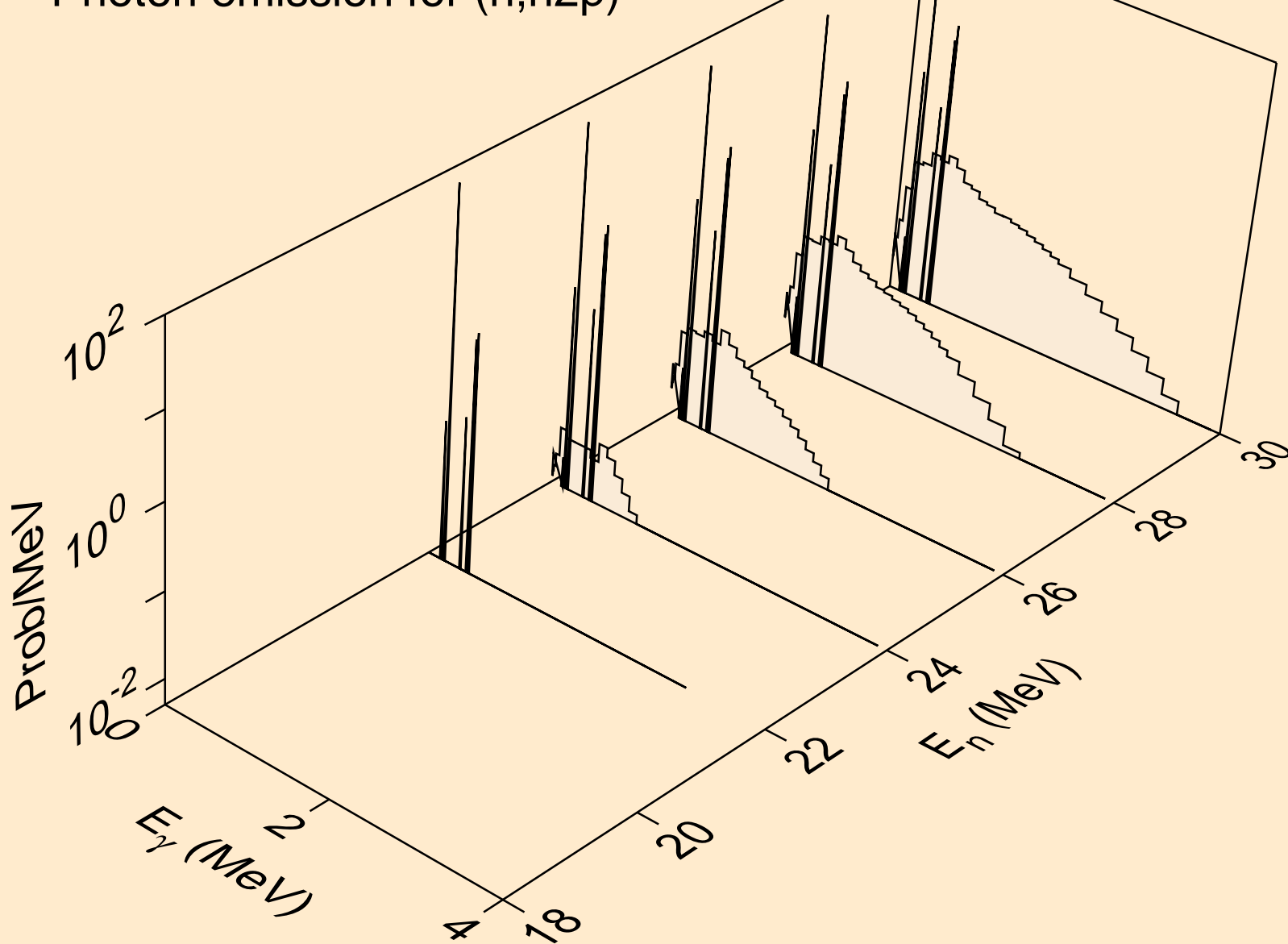

KR083 NEUTRON ACER TENDL-2023 LIBRARY; T=0.K  
Photon emission for (n,npa)

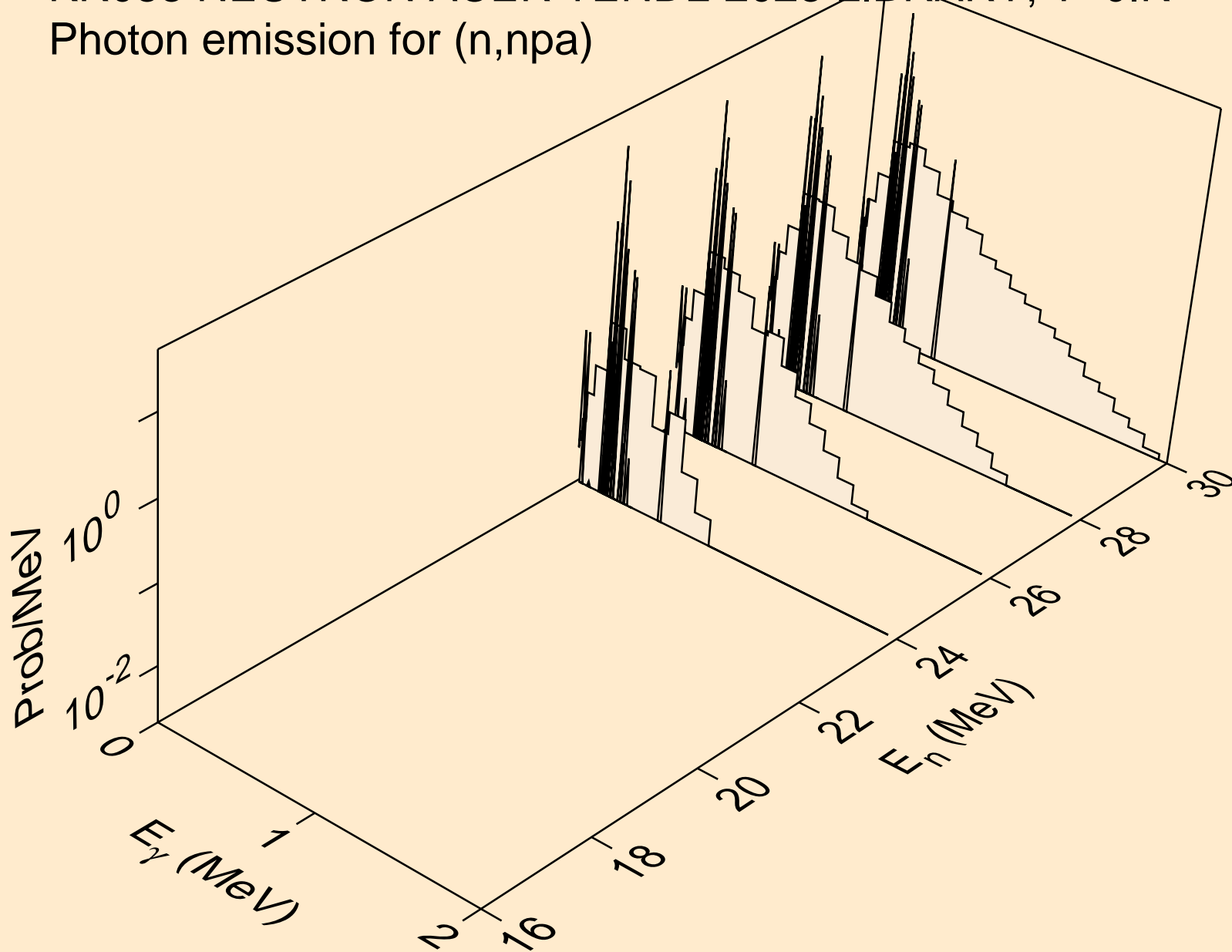

KR083 NEUTRON ACER TENDL-2023 LIBRARY; T=0.K  
Photon emission for (n,n\*c)

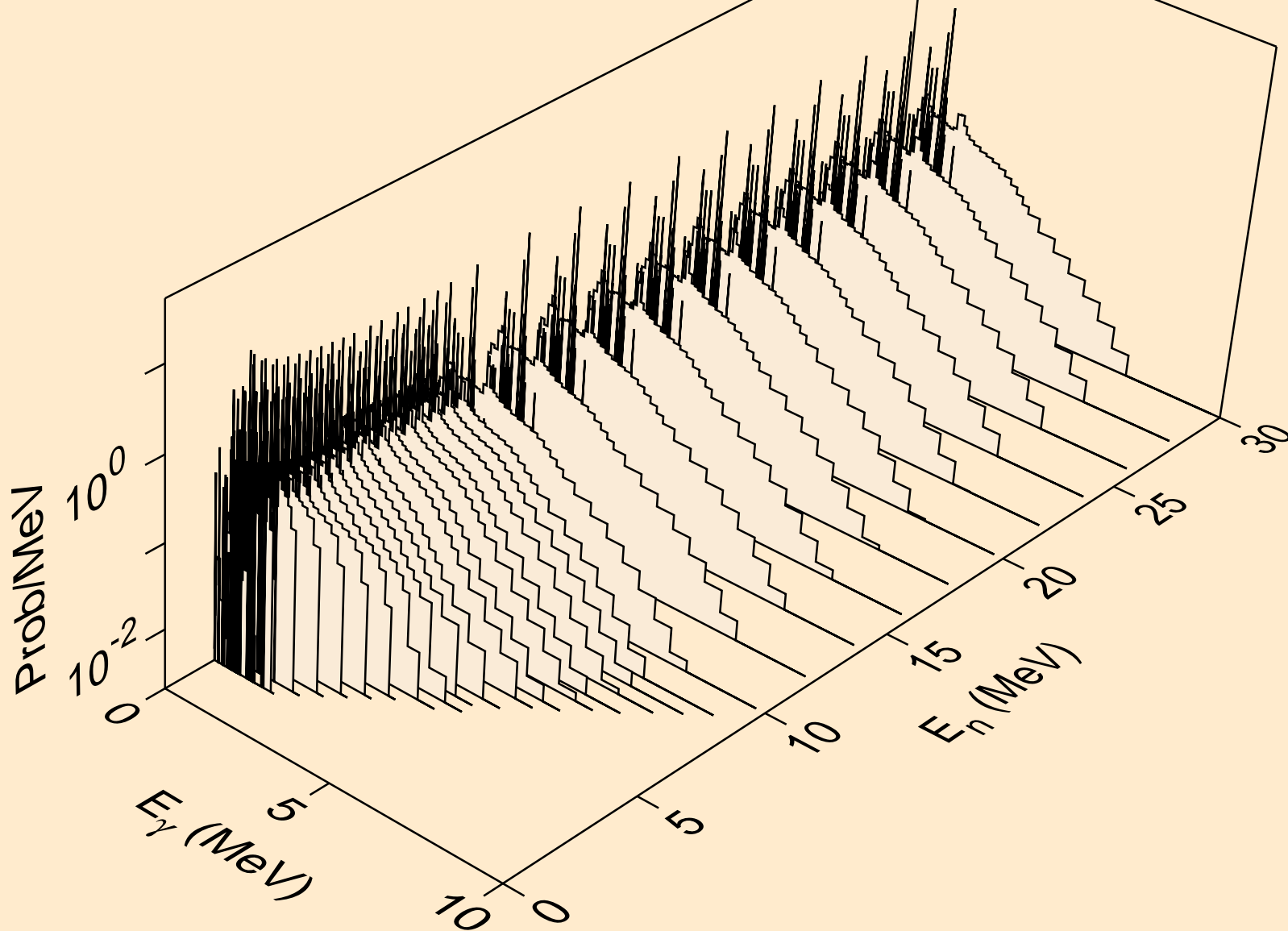

KR083 NEUTRON ACER TENDL-2023 LIBRARY; T=0.K  
Photon emission for (n,gma)

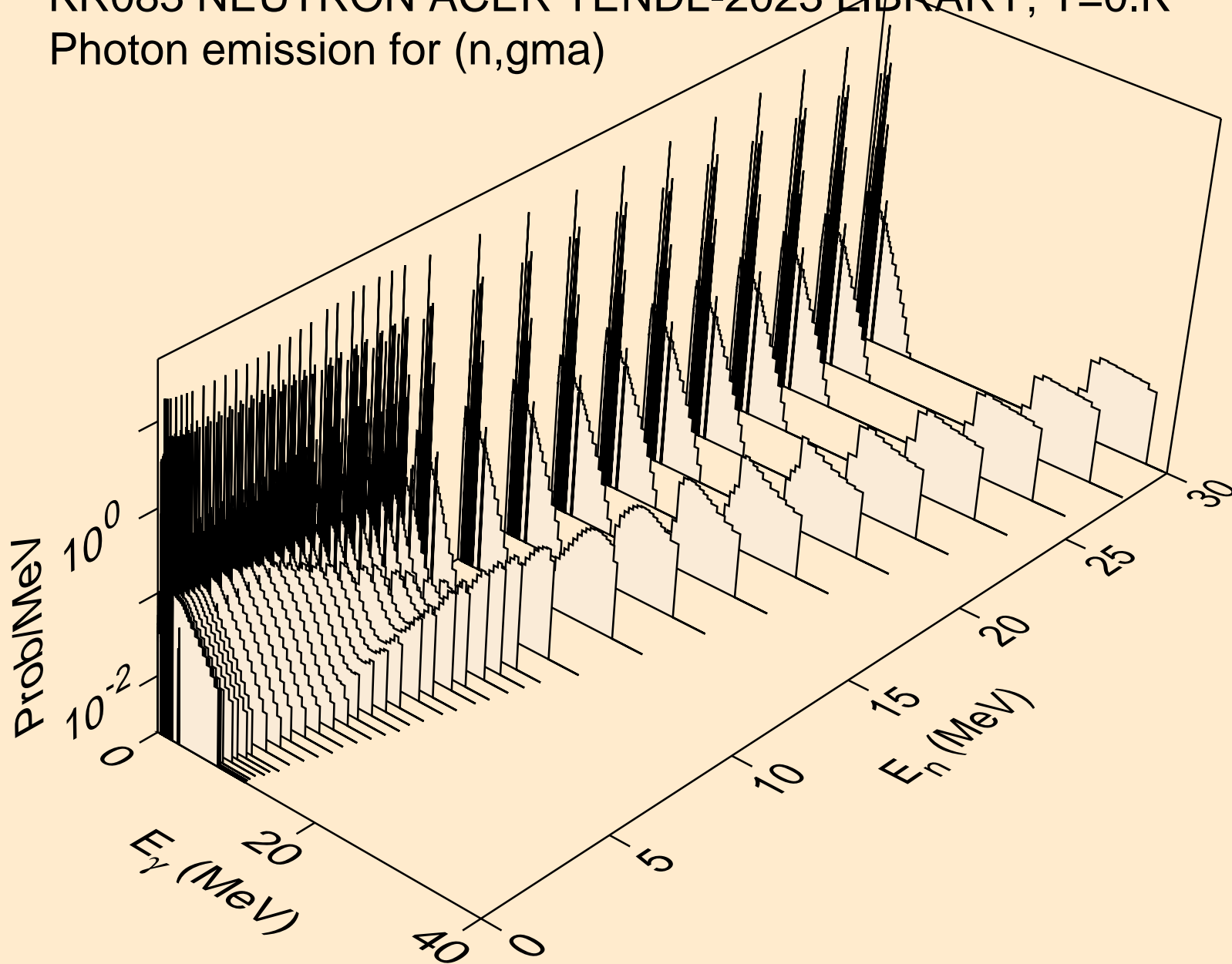

KR083 NEUTRON ACER TENDL-2023 LIBRARY; T=0.K  
Photon emission for (n,p)

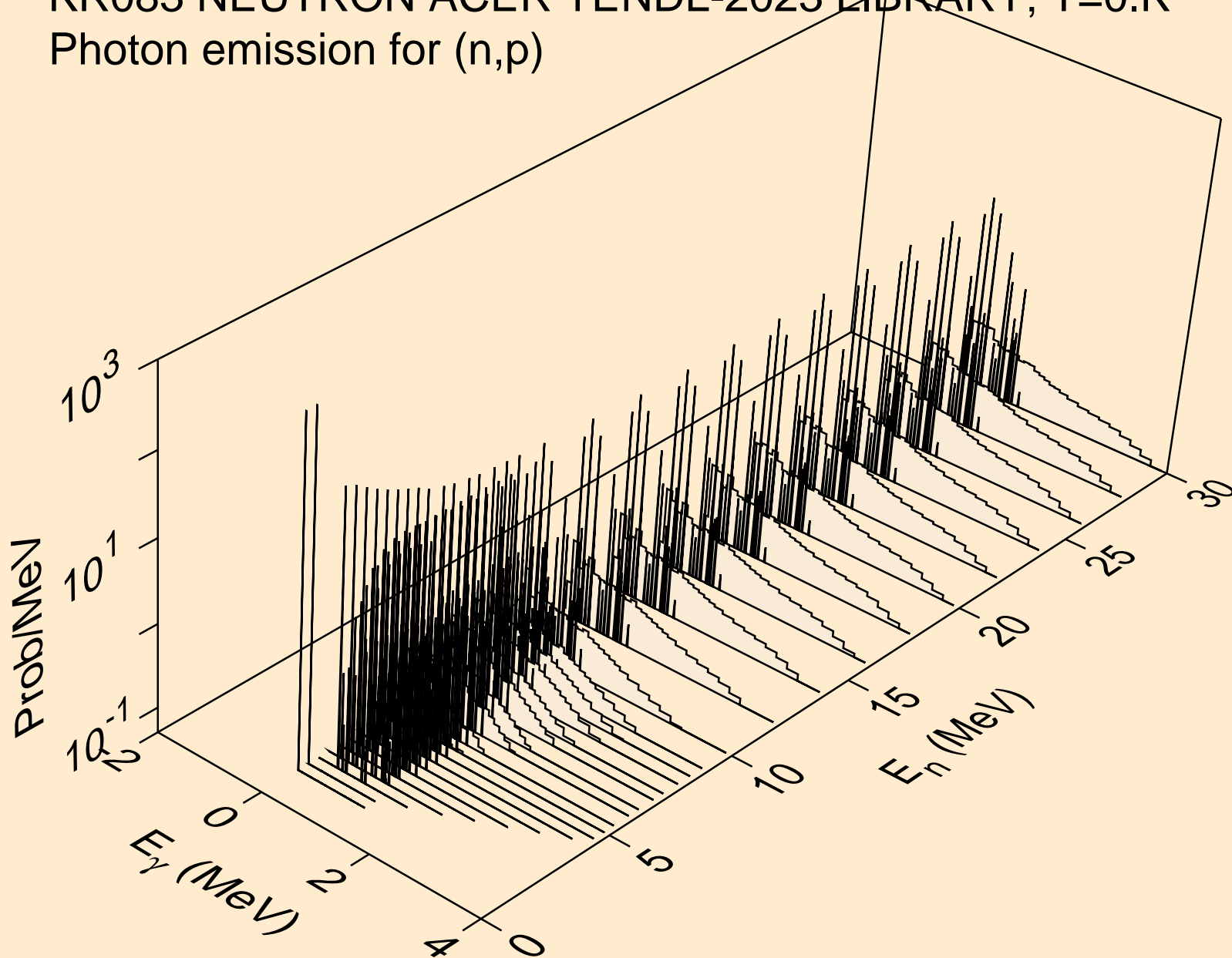

KR083 NEUTRON ACER TENDL-2023 LIBRARY; T=0.K  
Photon emission for (n,d)

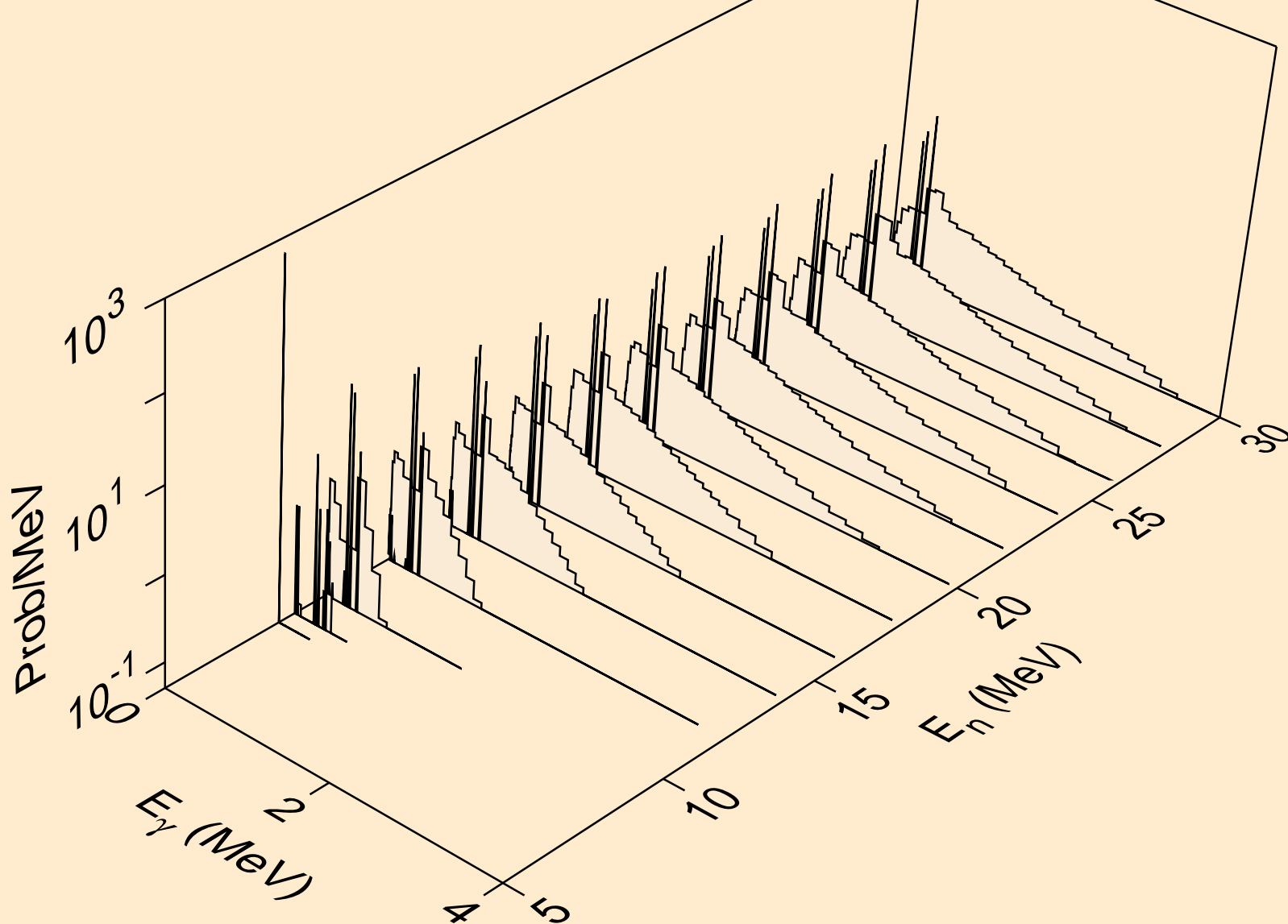



KR083 NEUTRON ACER TENDL-2023 LIBRARY; T=0.K  
Photon emission for (n,t)

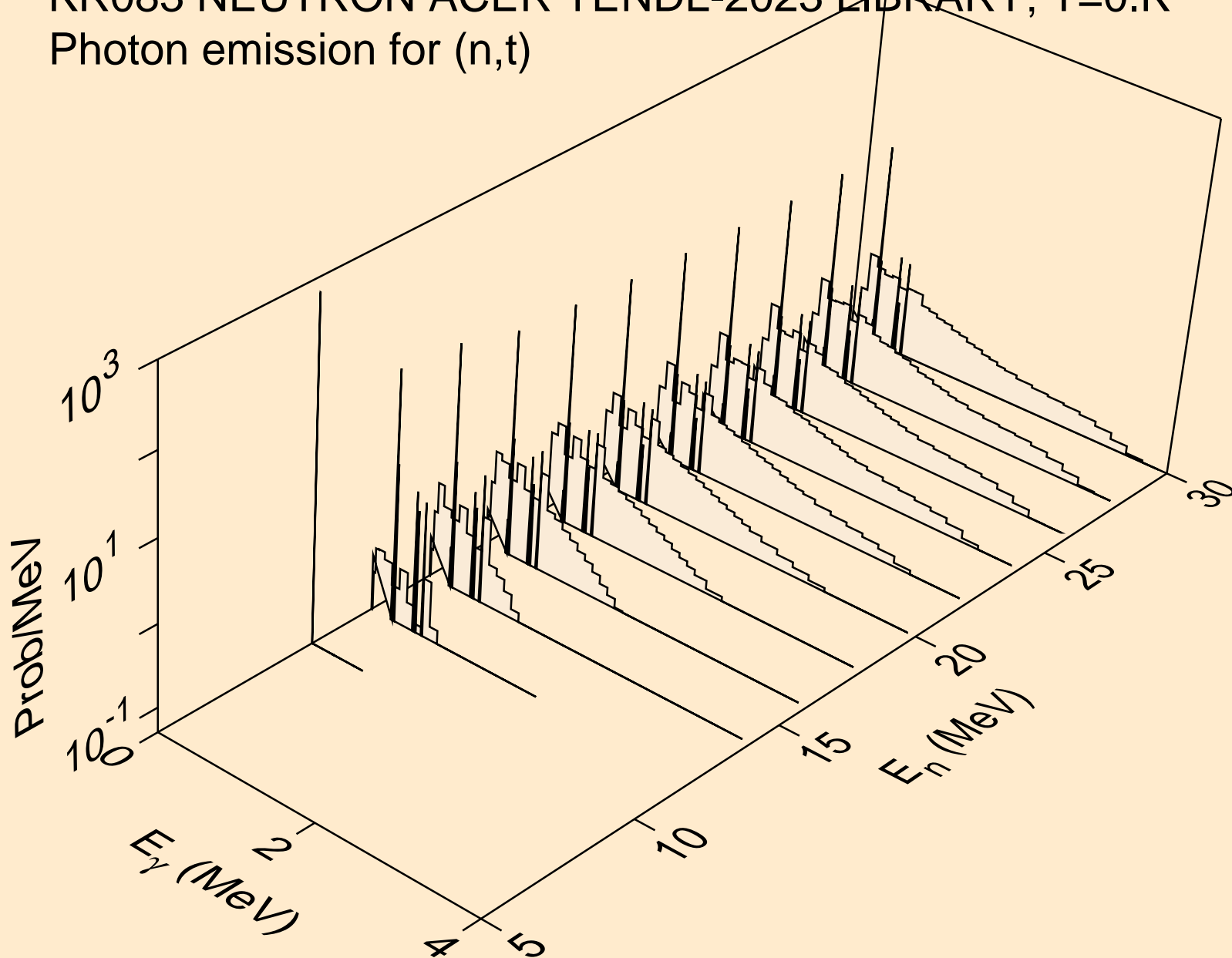

KR083 NEUTRON ACER TENDL-2023 LIBRARY; T=0.K  
Photon emission for (n,he3)

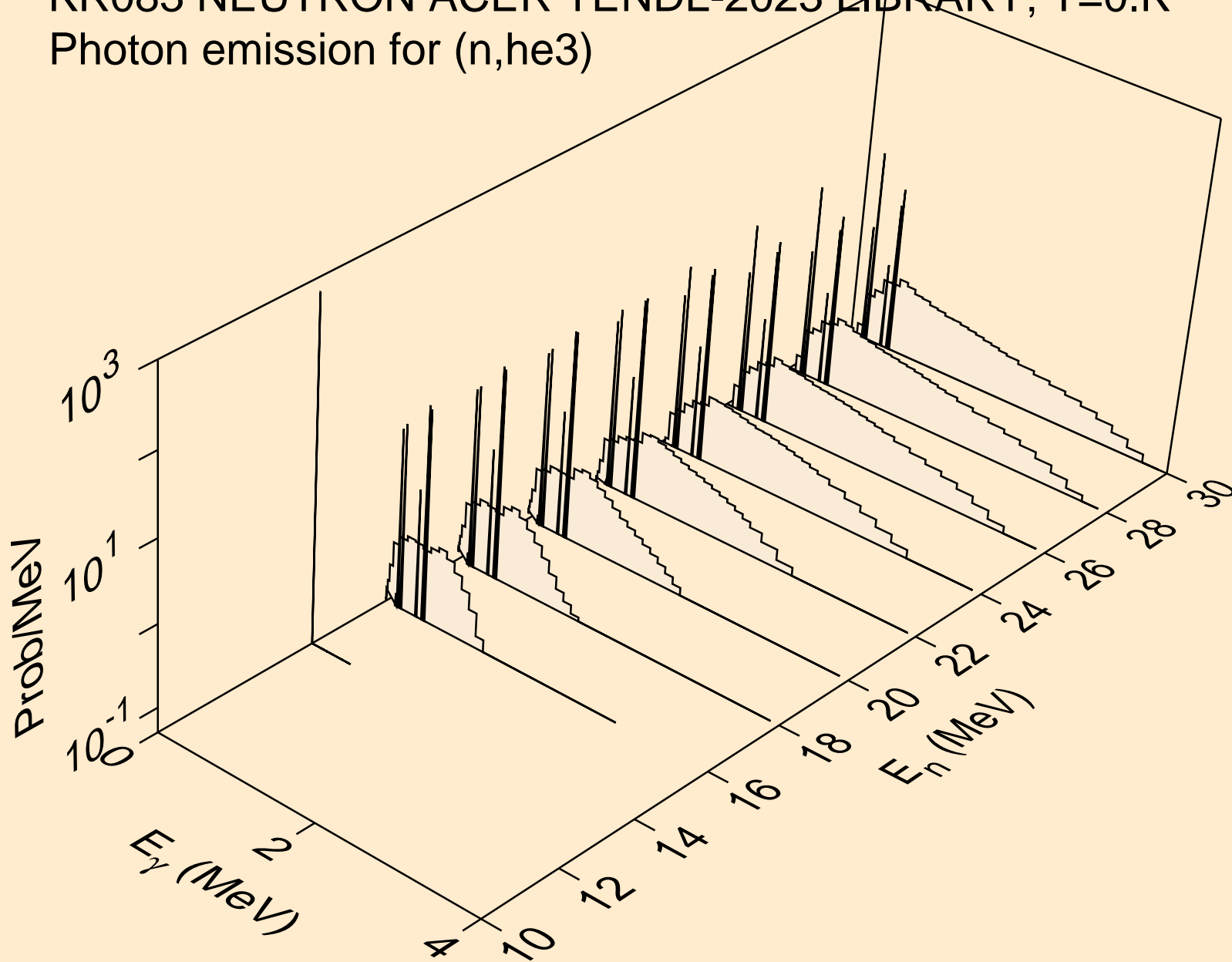

KR083 NEUTRON ACER TENDL-2023 LIBRARY; T=0.K  
Photon emission for (n,a)

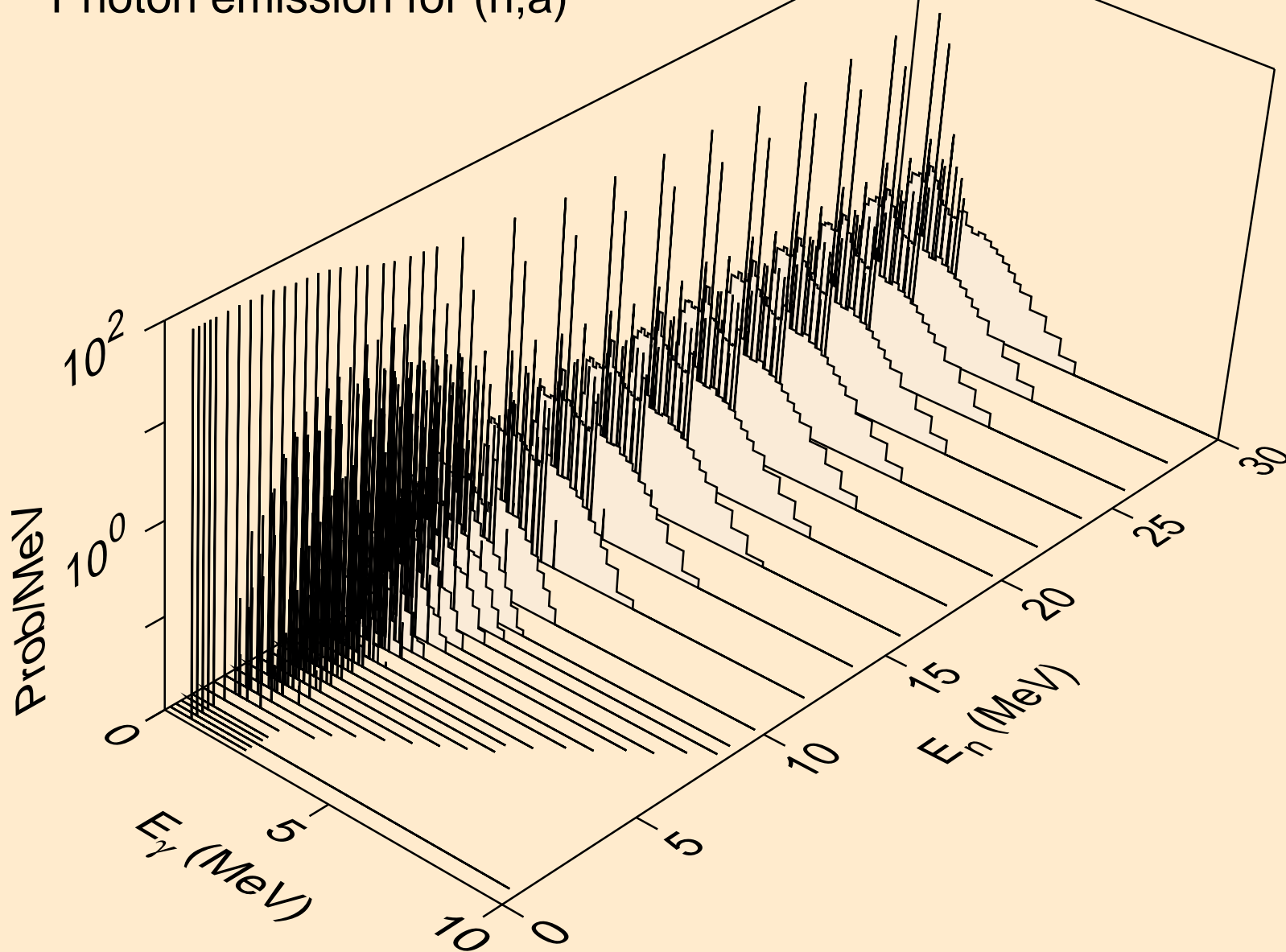

KR083 NEUTRON ACER TENDL-2023 LIBRARY; T=0.K  
Photon emission for (n,2a)

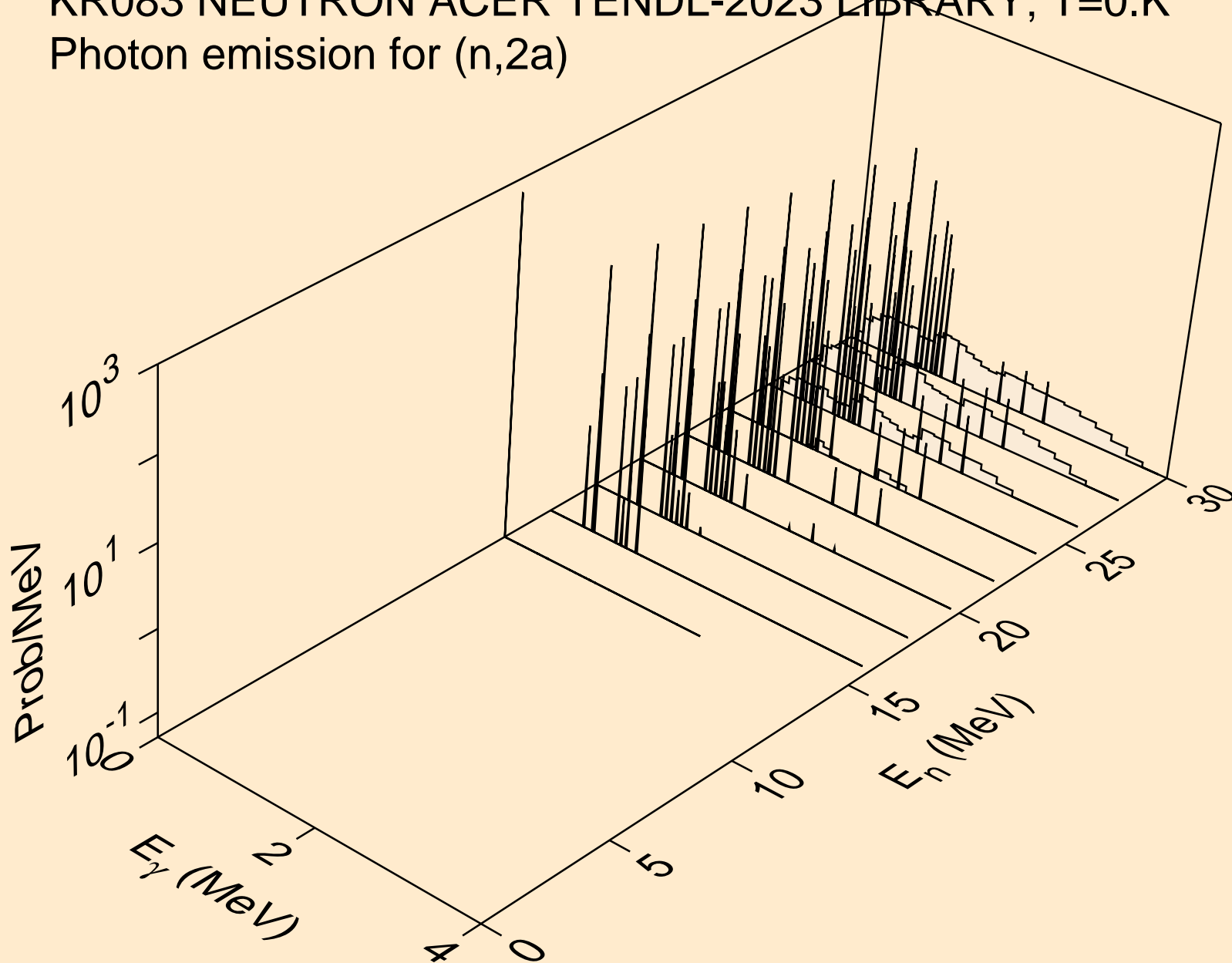

KR083 NEUTRON ACER TENDL-2023 LIBRARY; T=0.K  
Photon emission for (n,2p)

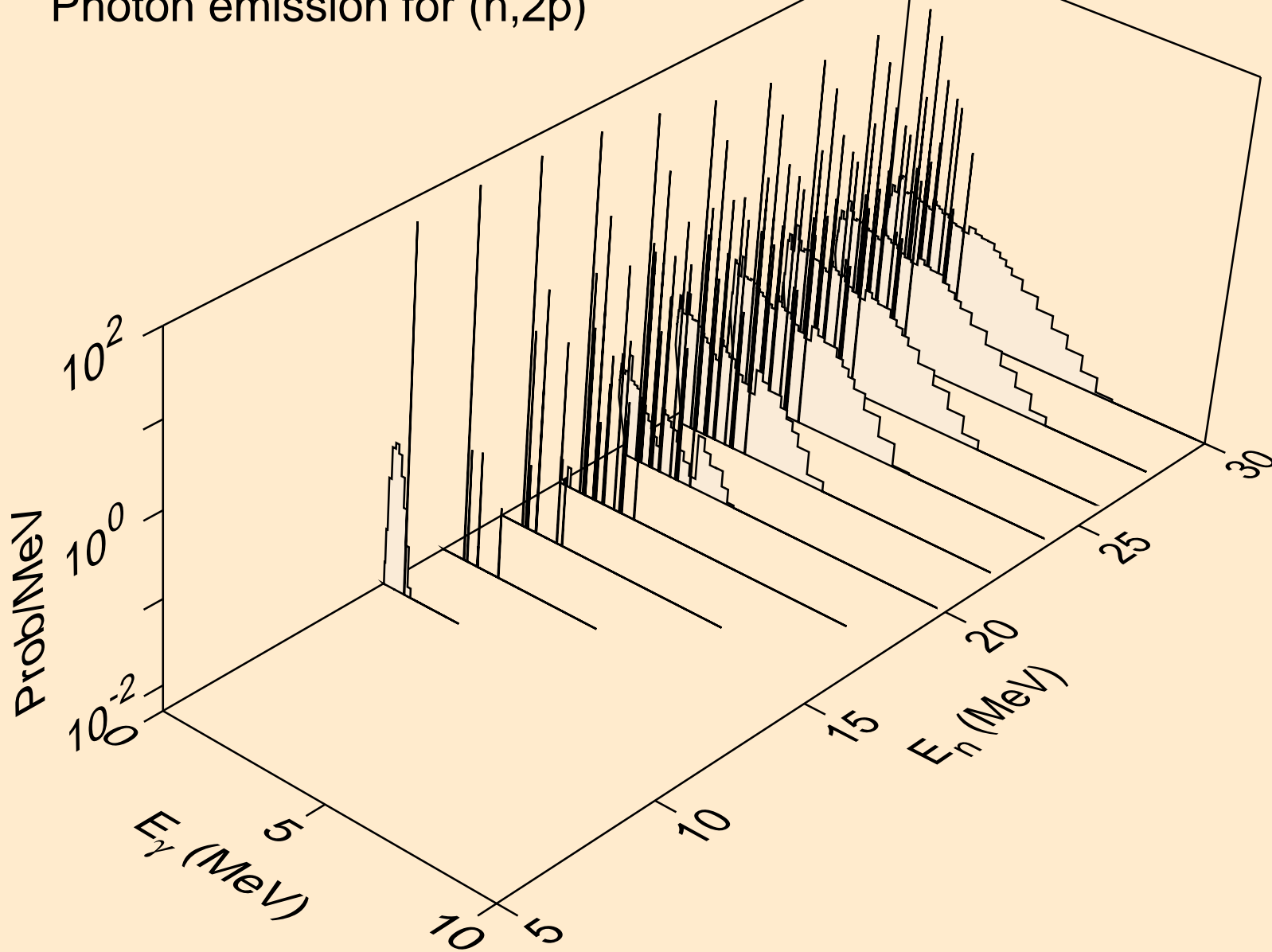

KR083 NEUTRON ACER TENDL-2023 LIBRARY; T=0.K  
Photon emission for (n,p $\alpha$ )

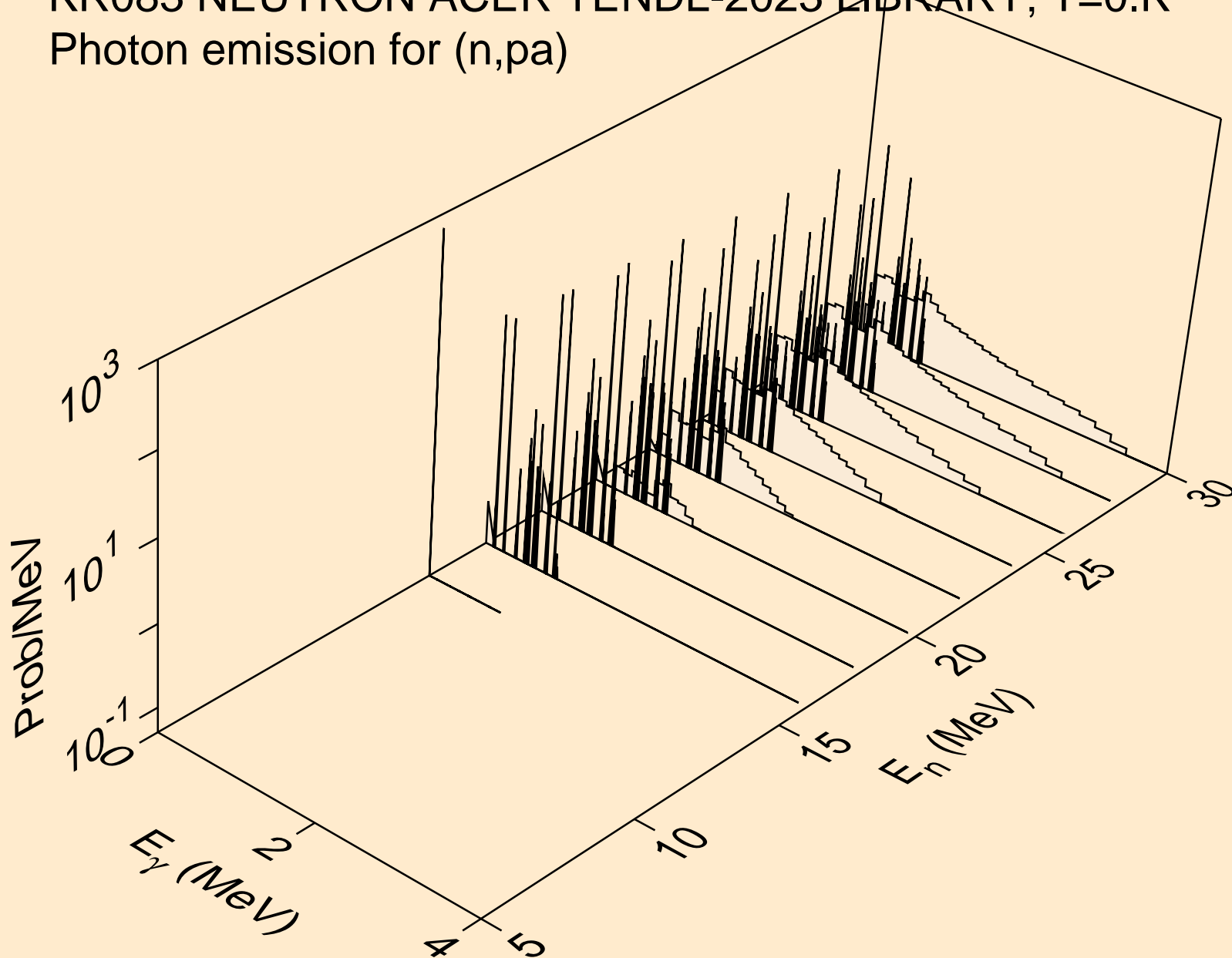

KR083 NEUTRON ACER TENDL-2023 LIBRARY; T=0.K  
Photon emission for (n,pd)

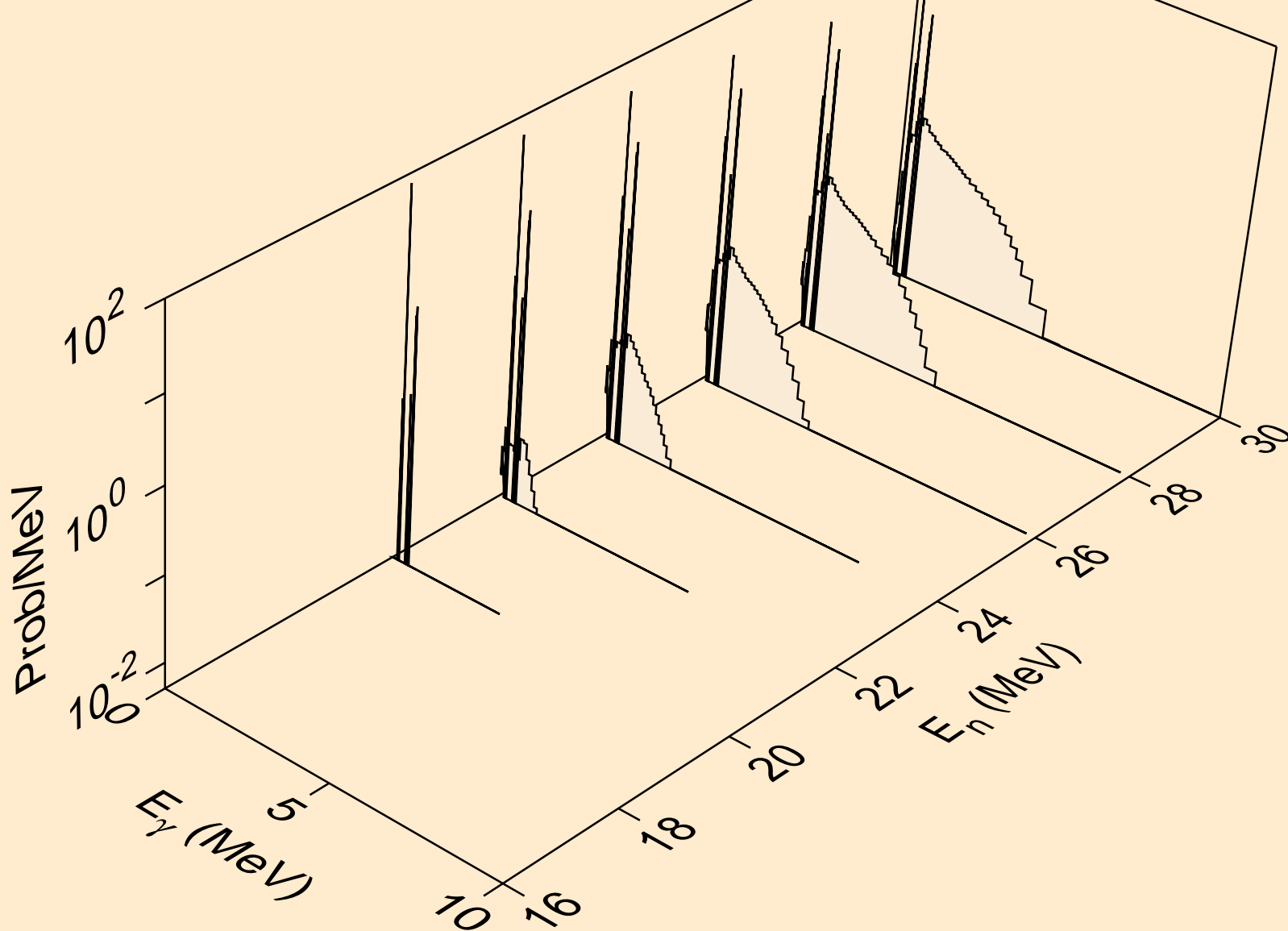

KR083 NEUTRON ACER TENDL-2023 LIBRARY; T=0.K  
Photon emission for (n,pt)

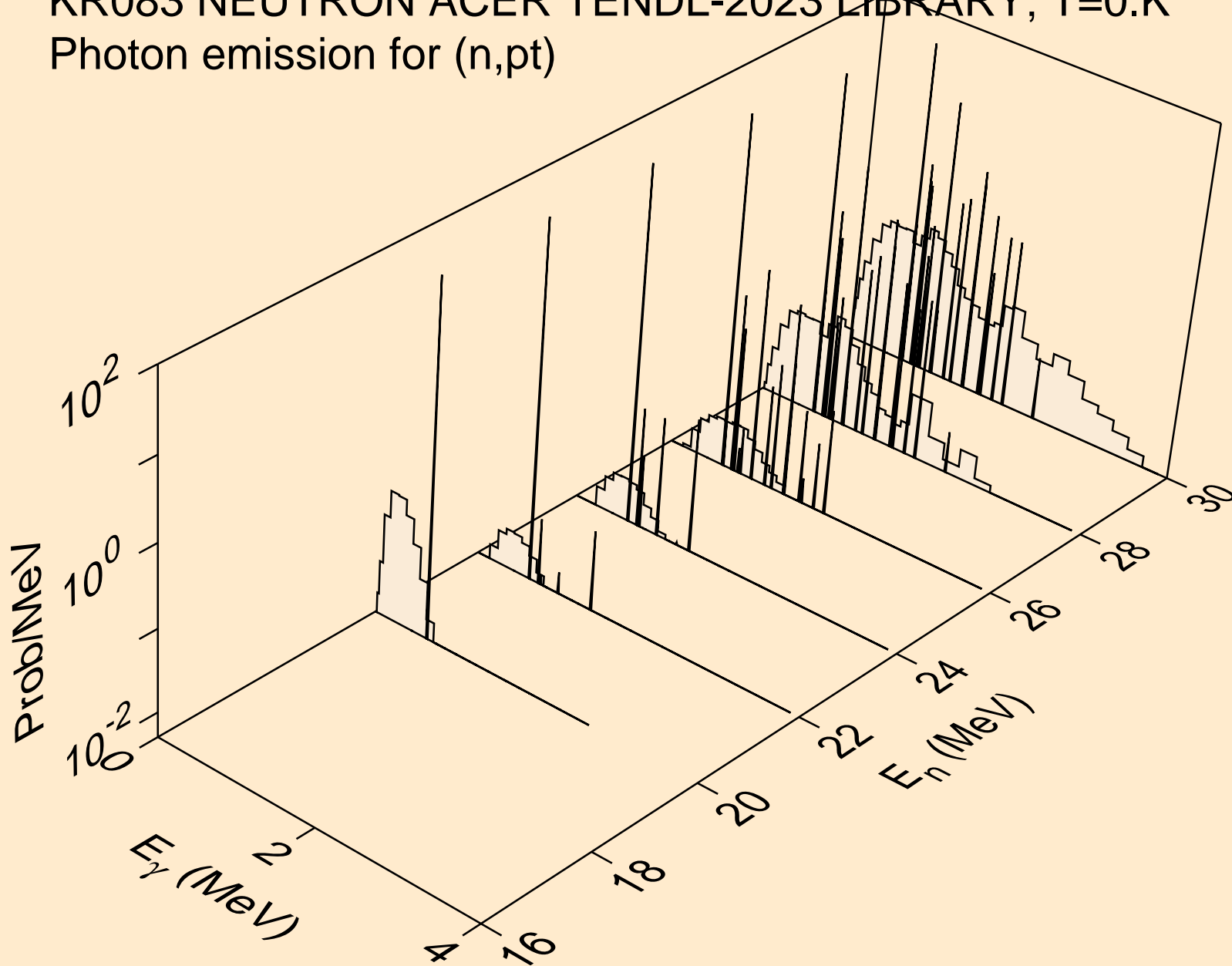



KR083 NEUTRON ACER TENDL-2023 LIBRARY; T=0.K  
Photon emission for (n,da)

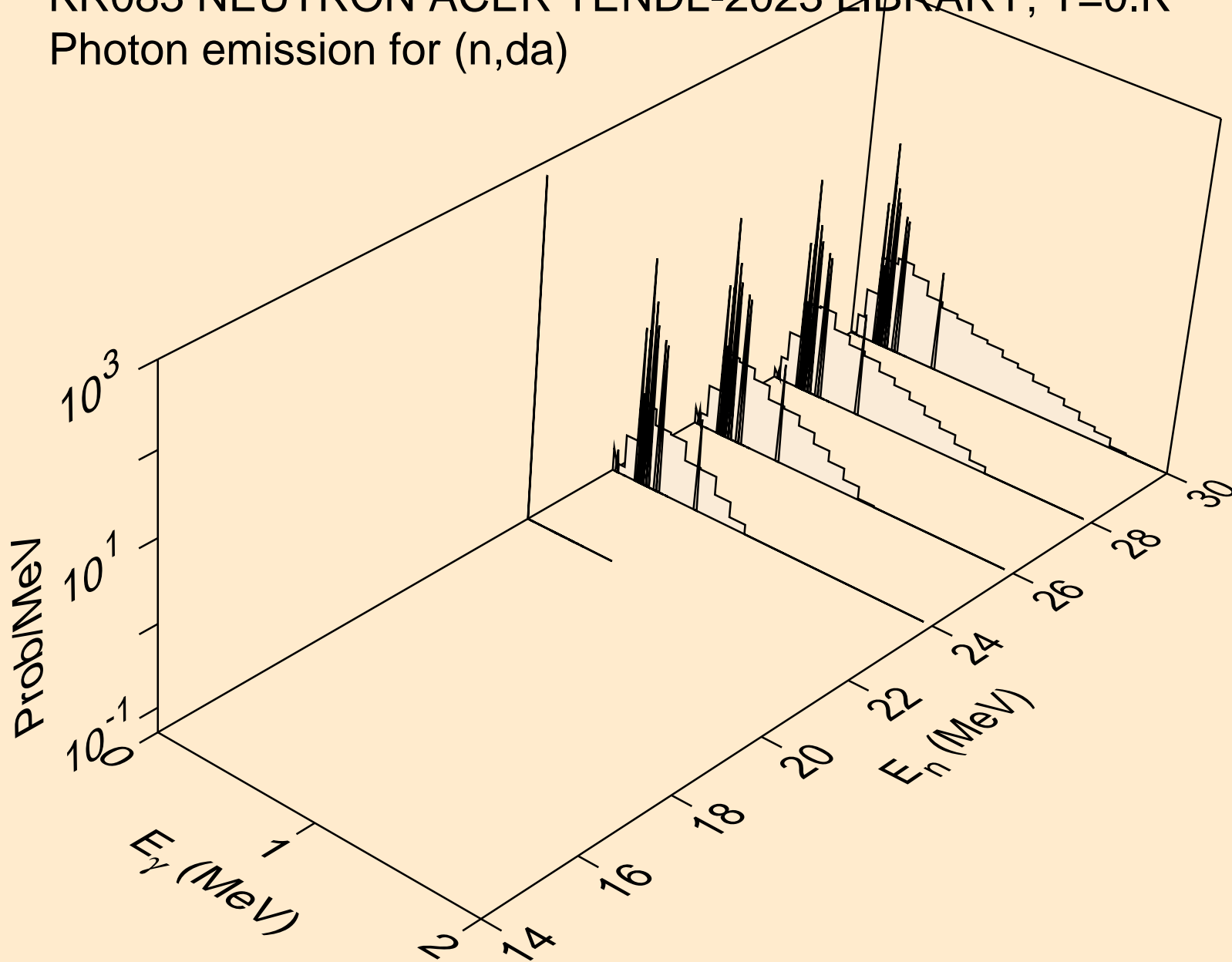

KR083 NEUTRON ACER TENDL-2023 LIBRARY; T=0.K  
thermal capture photon spectrum

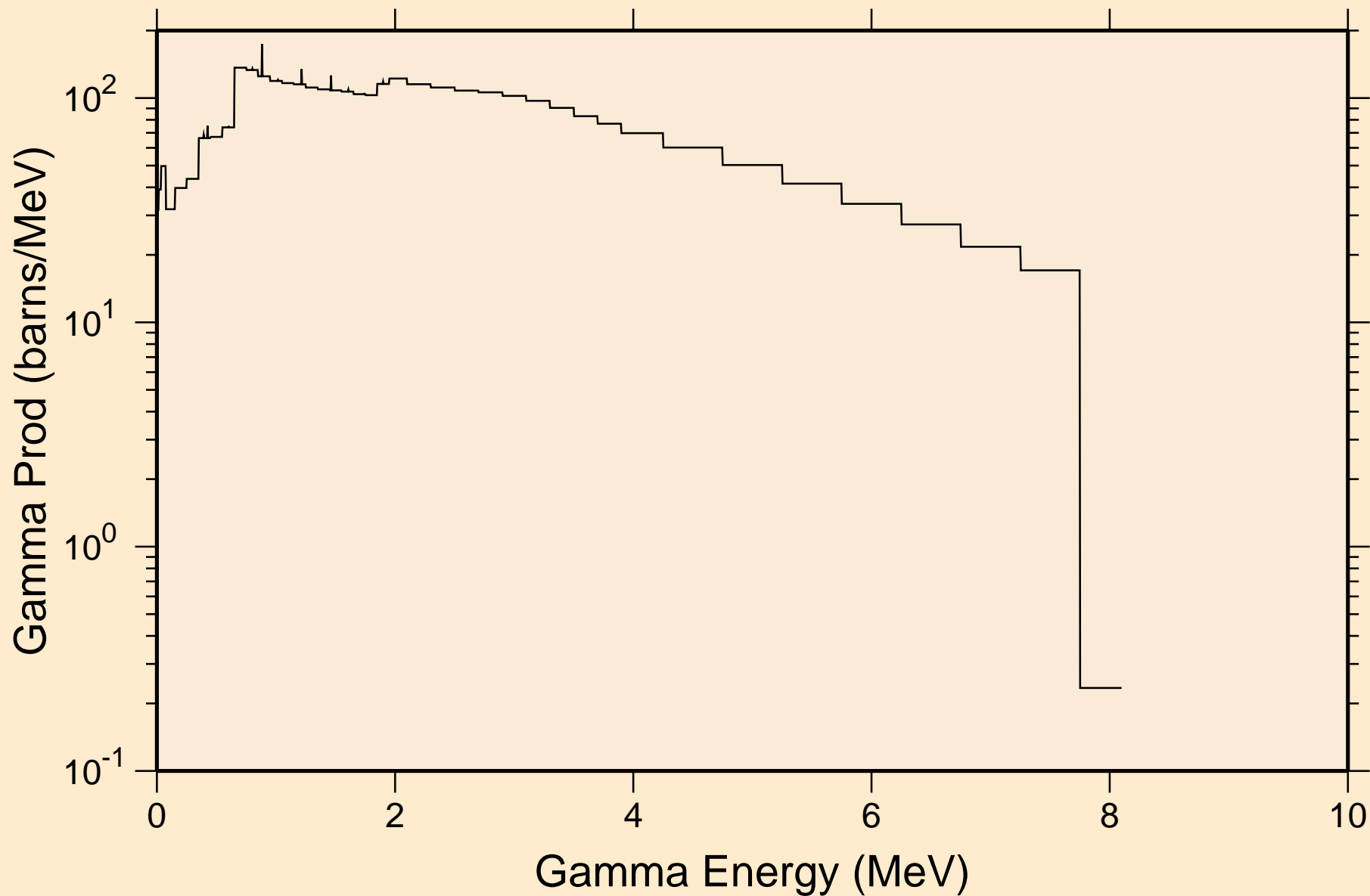

KR083 NEUTRON ACER TENDL-2023 LIBRARY; T=0.K  
14 MeV photon spectrum

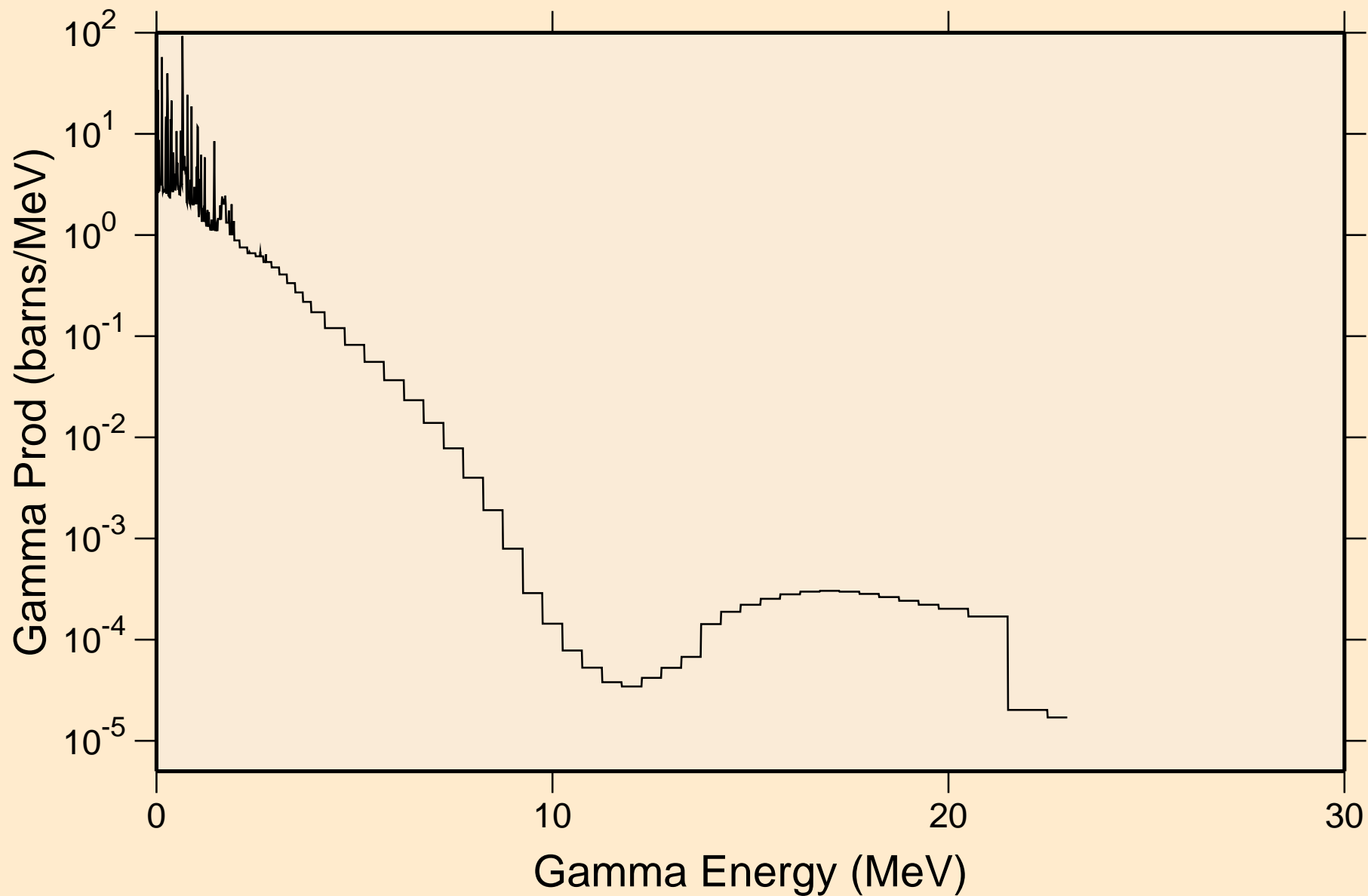

# KR083 NEUTRON ACER TENDL-2023 LIBRARY; T=0.K

## Particle heating contributions

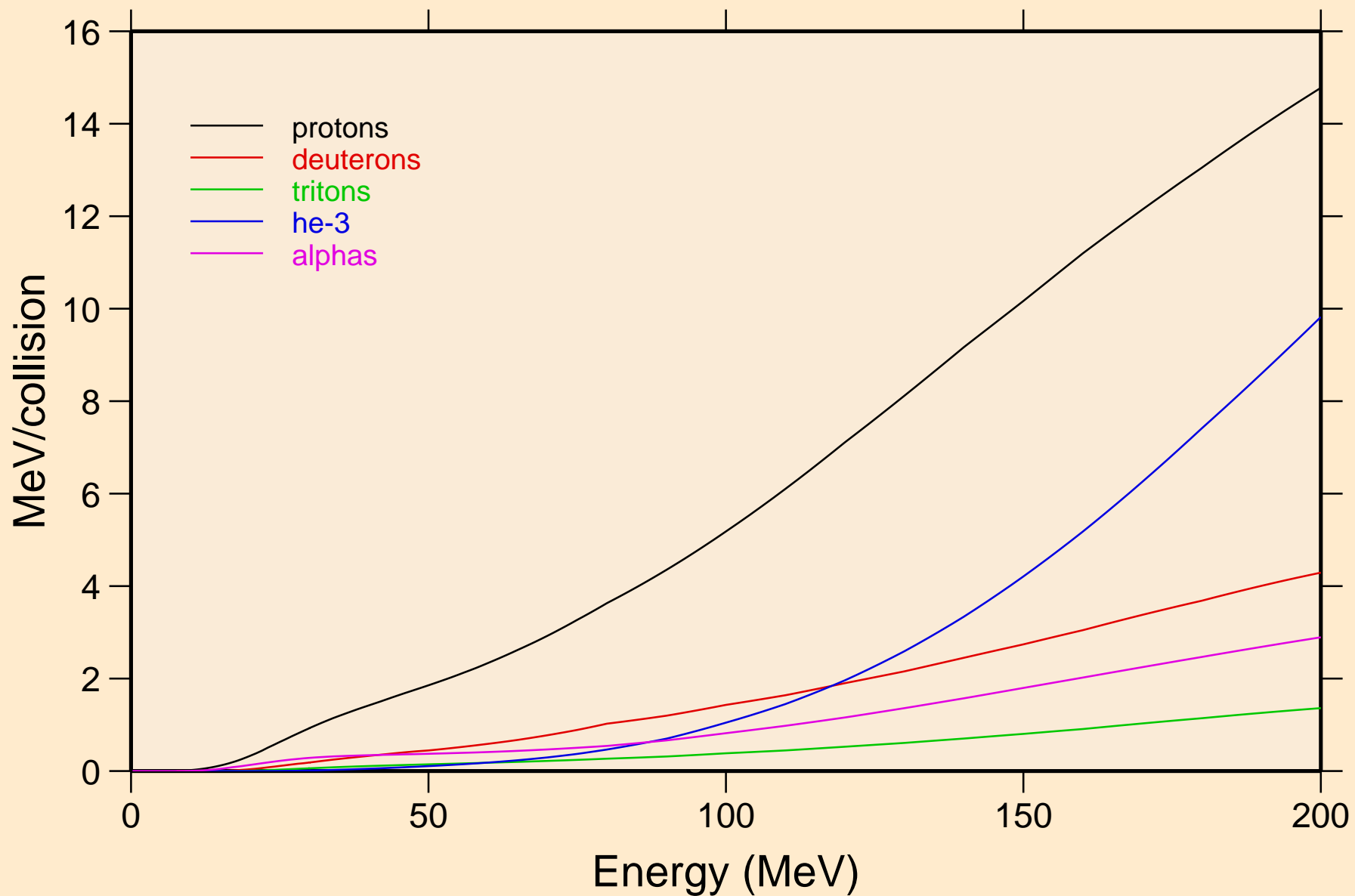

KR083 NEUTRON ACER TENDL-2023 LIBRARY; T=0.K  
Recoil Heating

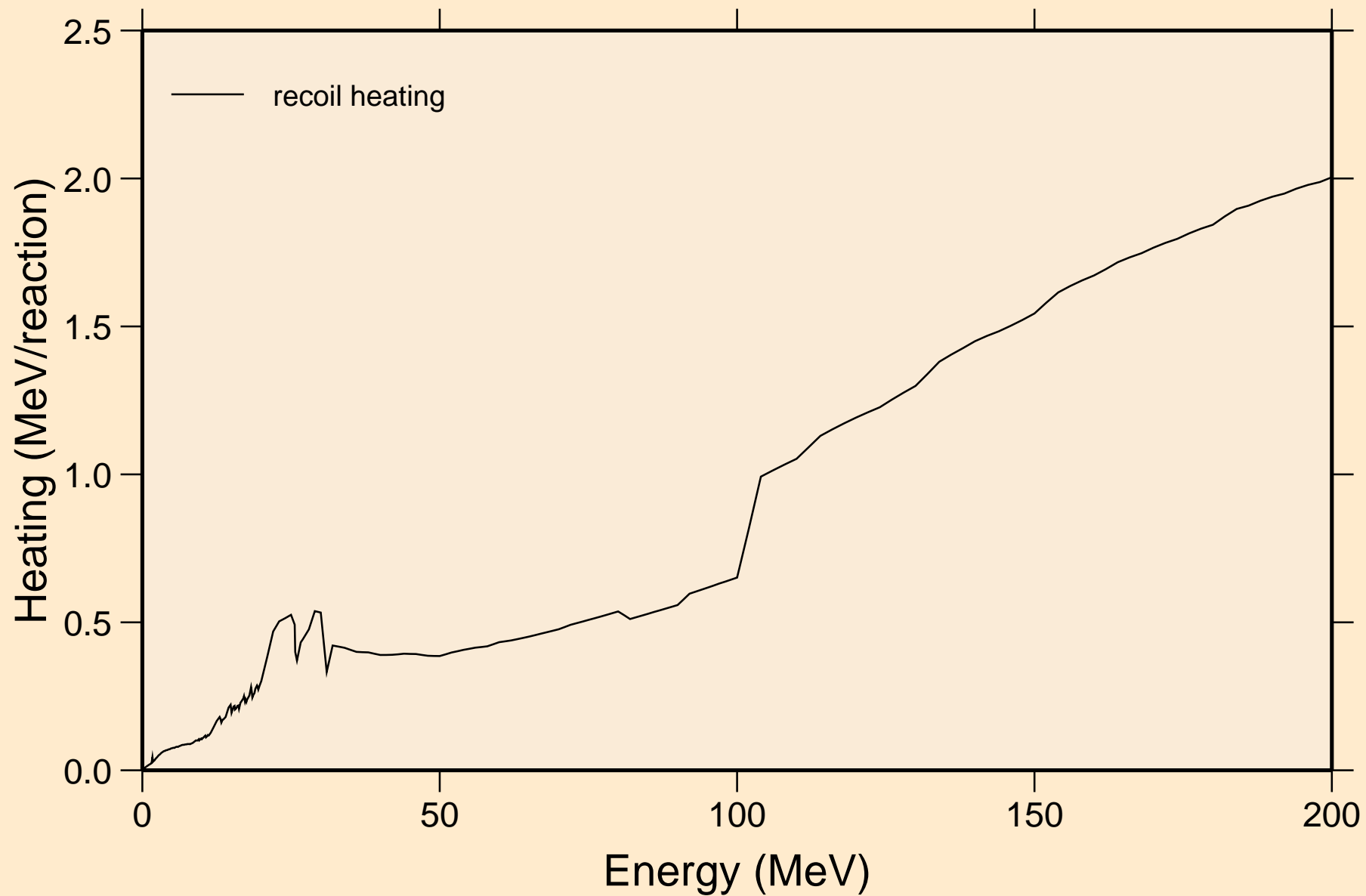

KR083 NEUTRON ACER TENDL-2023 LIBRARY; T=0.K  
Particle production cross sections

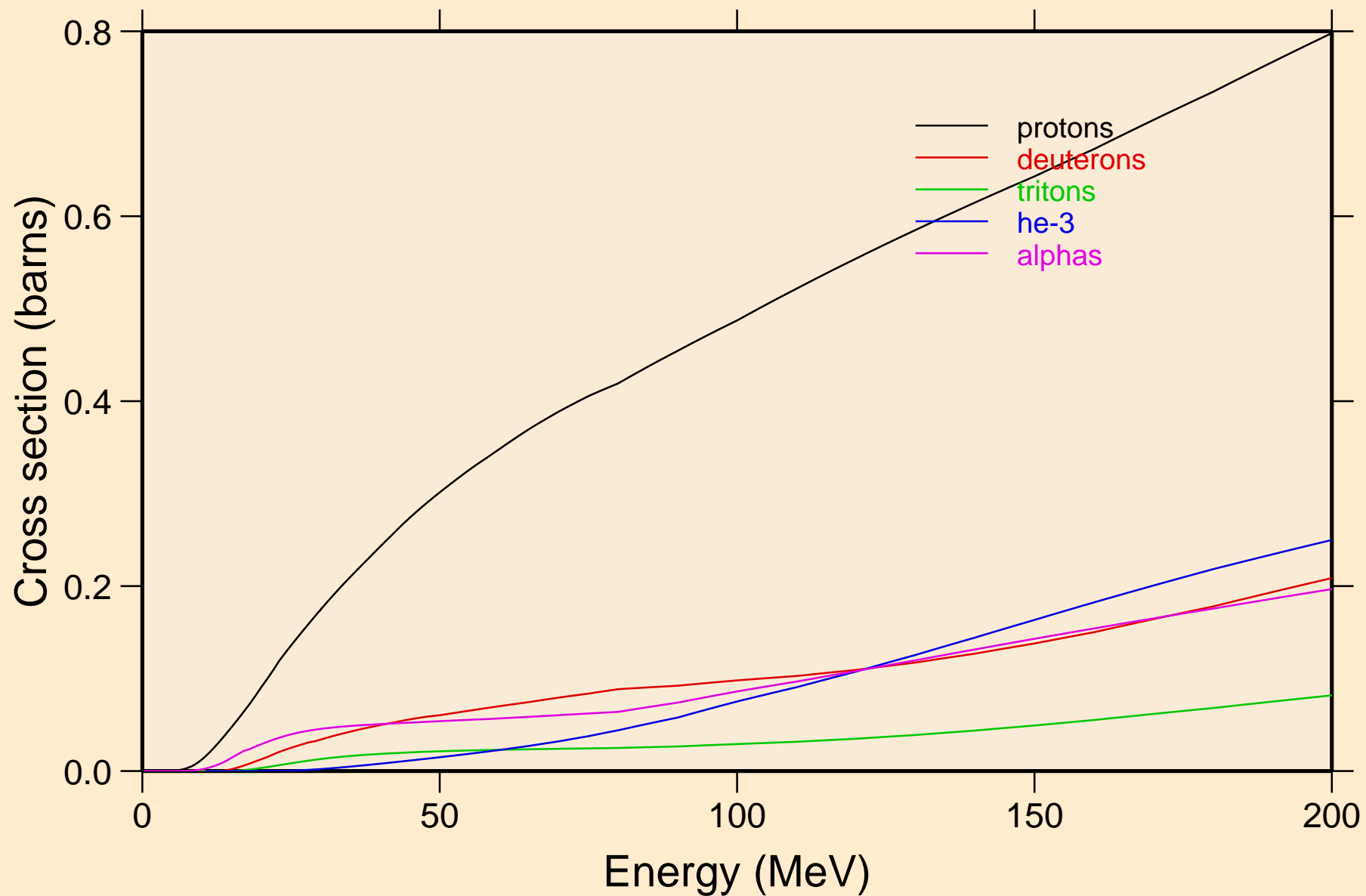

KR083 NEUTRON ACER TENDL-2023 LIBRARY; T=0.K  
protons from (n,x)

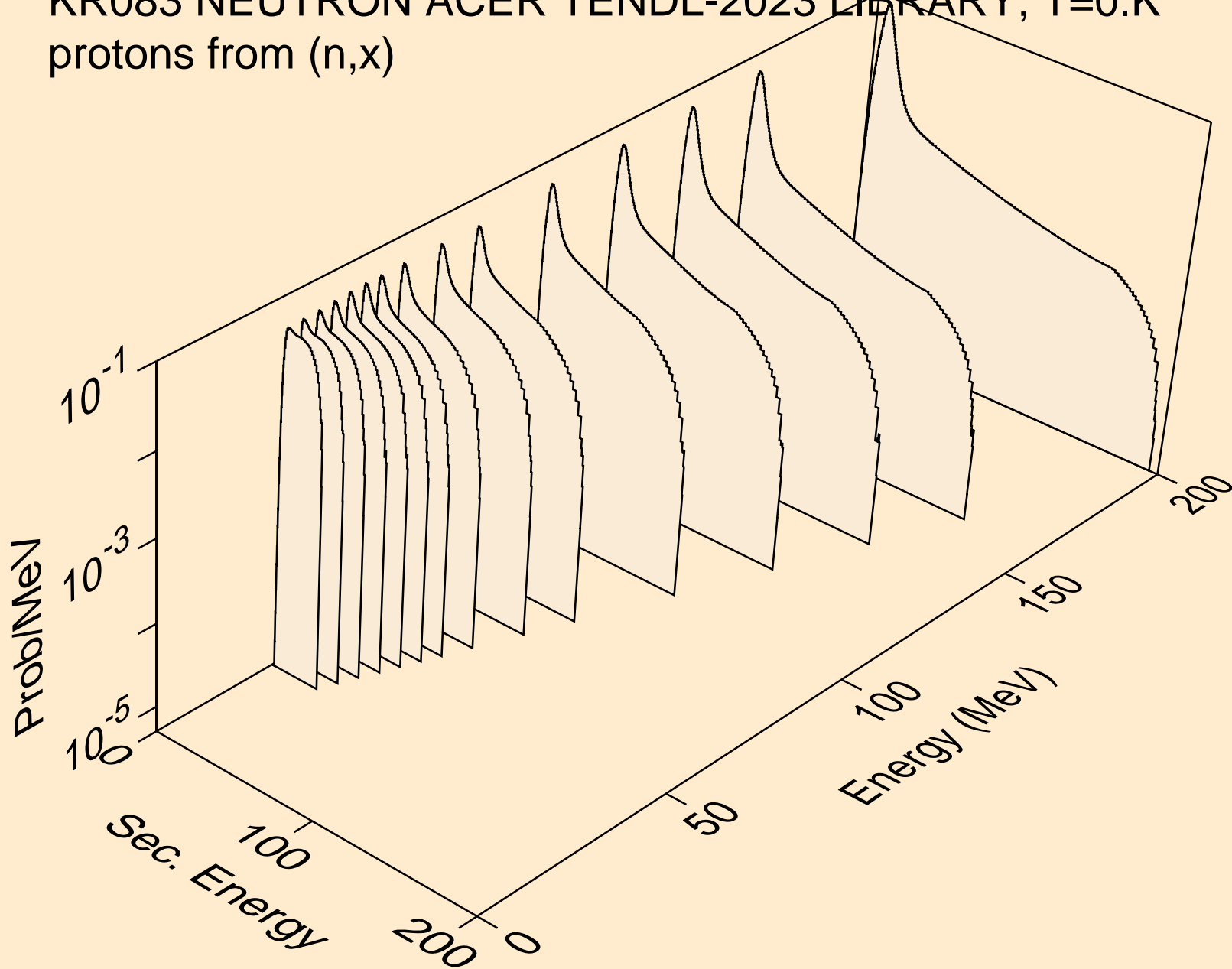

KR083 NEUTRON ACER TENDL-2023 LIBRARY; T=0.K  
protons from (n,n\*)p

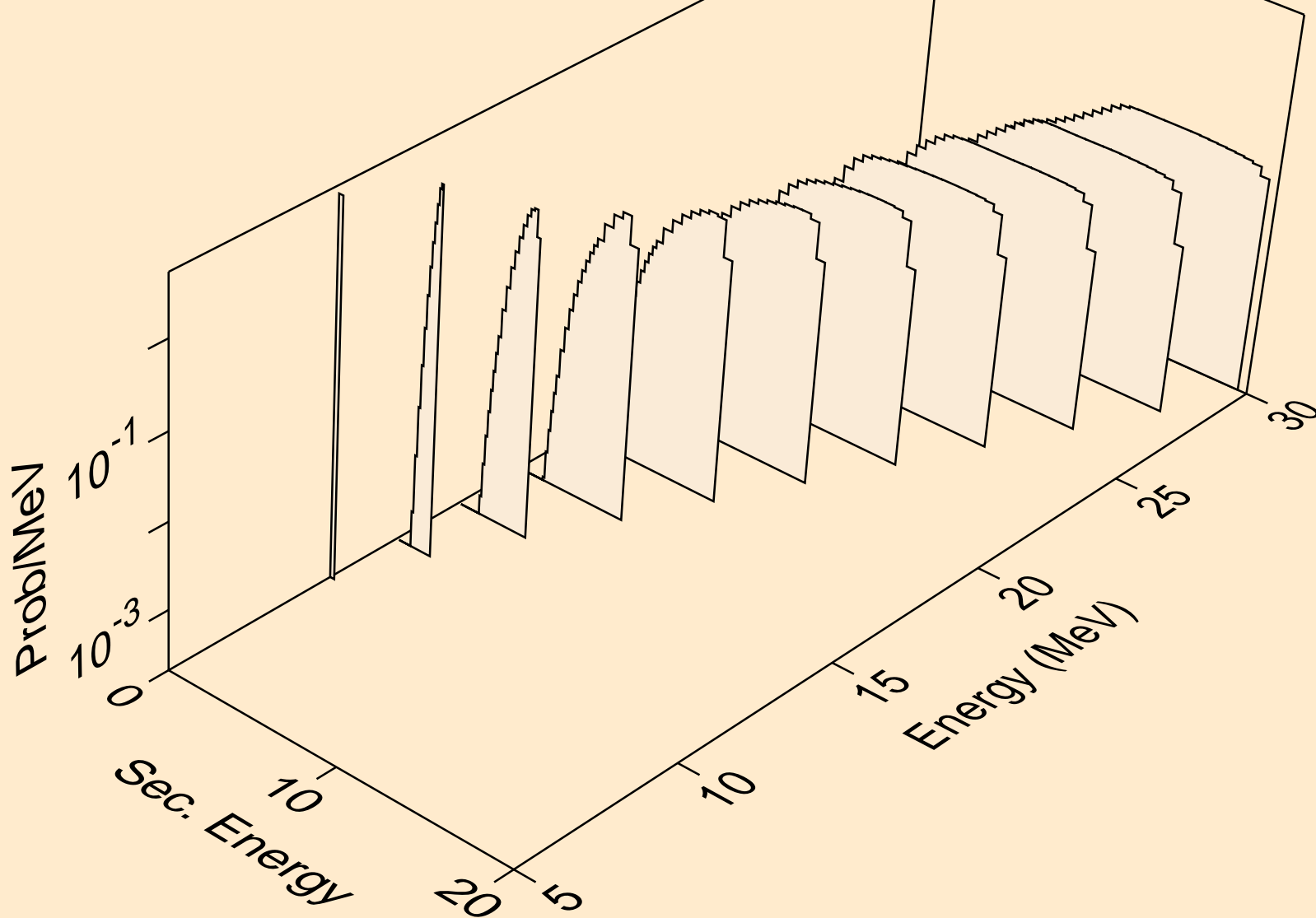



KR083 NEUTRON ACER TENDL-2023 LIBRARY; T=0.K  
protons from (n,2np)

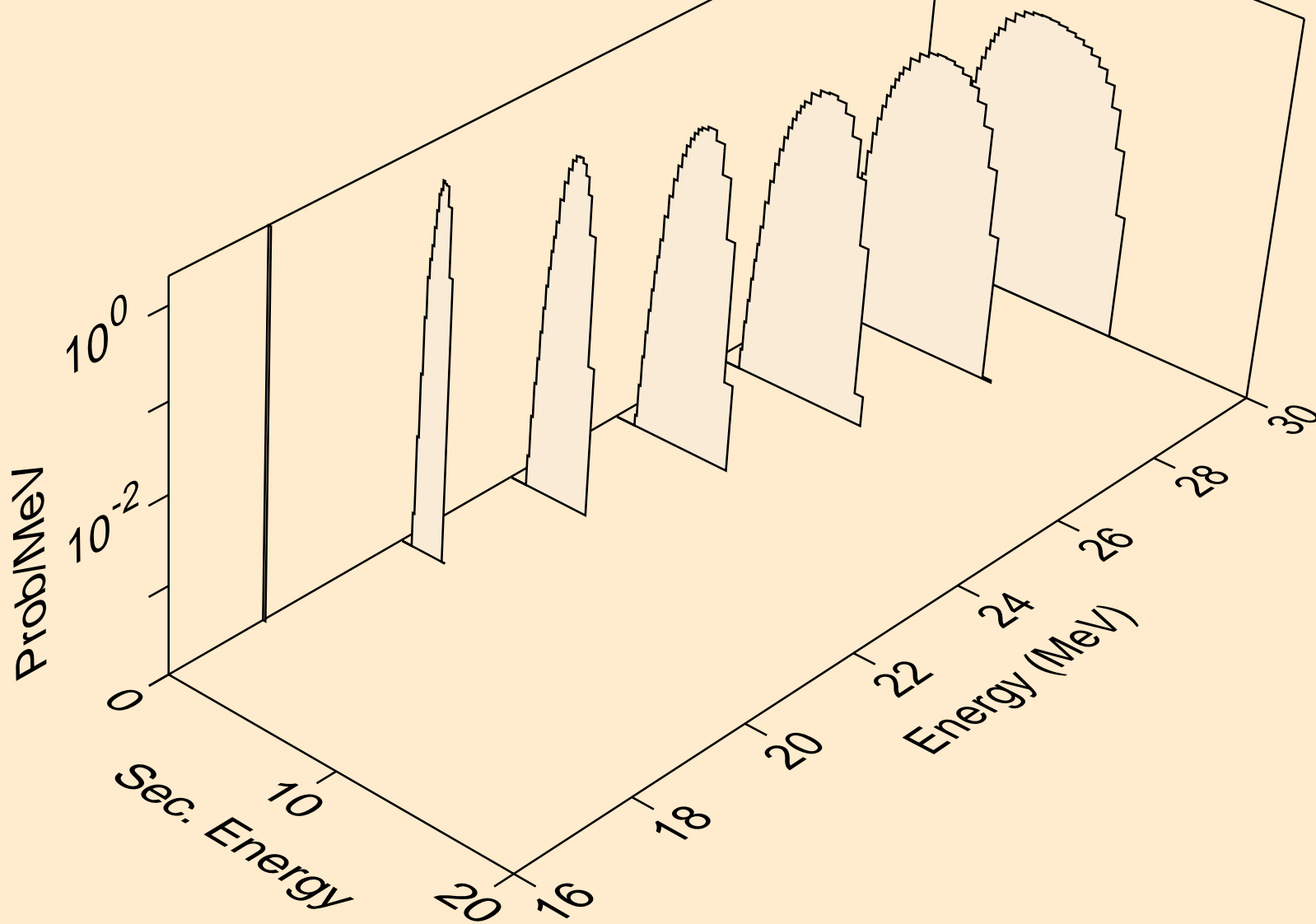

KR083 NEUTRON ACER TENDL-2023 LIBRARY; T=0.K  
protons from (n,n2p)

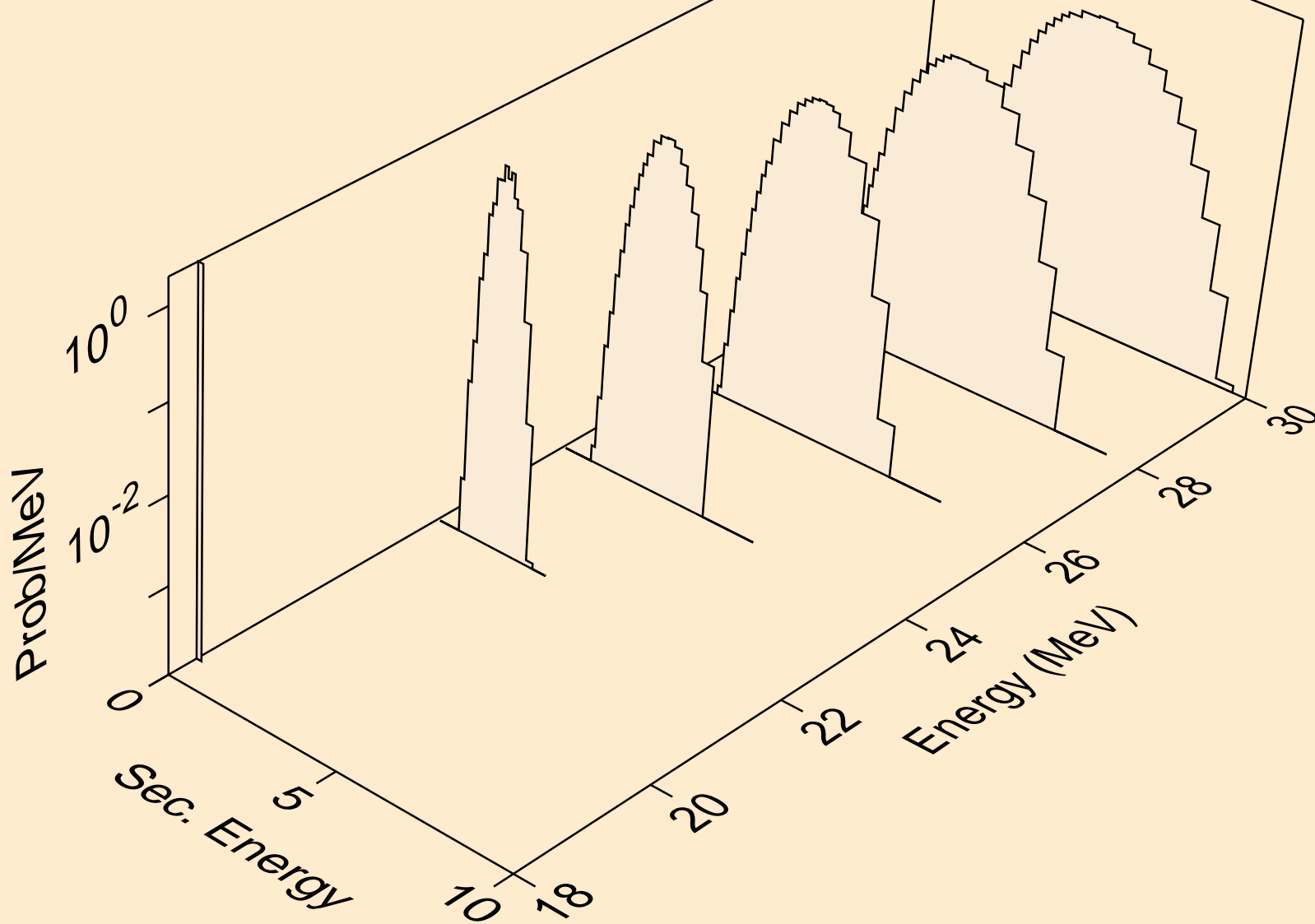

KR083 NEUTRON ACER TENDL-2023 LIBRARY; T=0.K  
protons from (n,npa)

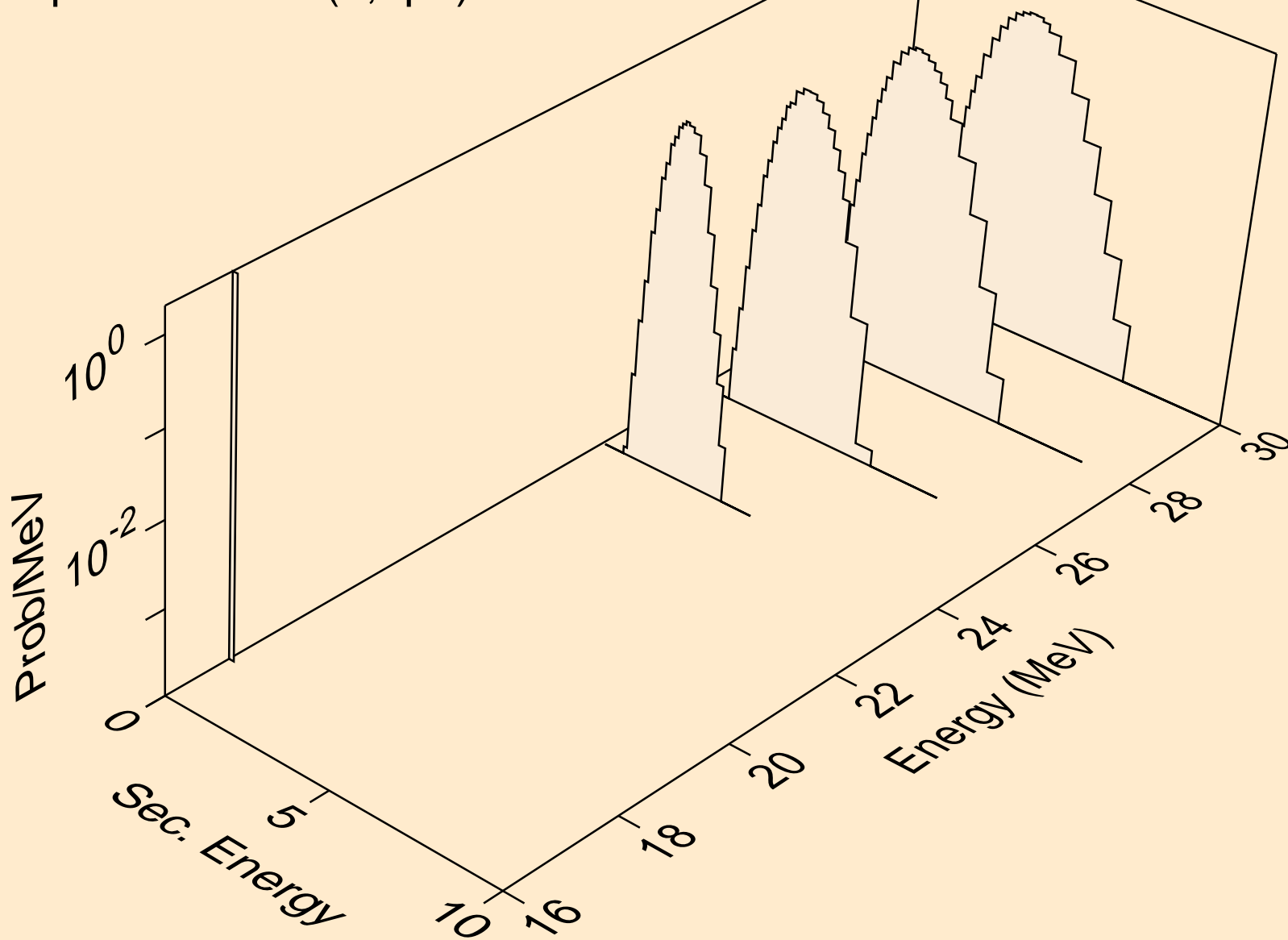

KR083 NEUTRON ACER TENDL-2023 LIBRARY; T=0.K  
protons from (n,p)

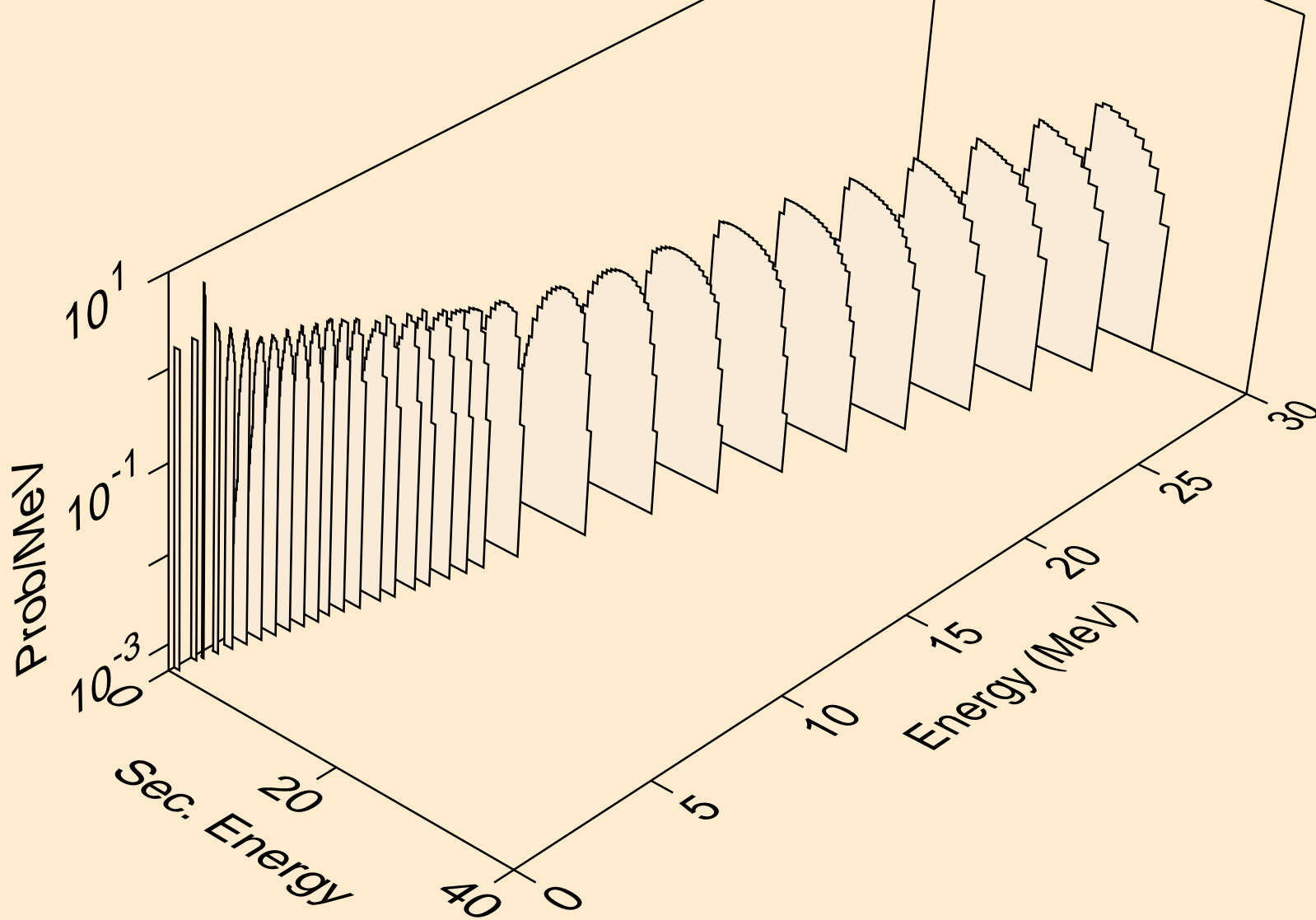

KR083 NEUTRON ACER TENDL-2023 LIBRARY; T=0.K  
protons from (n,2p)

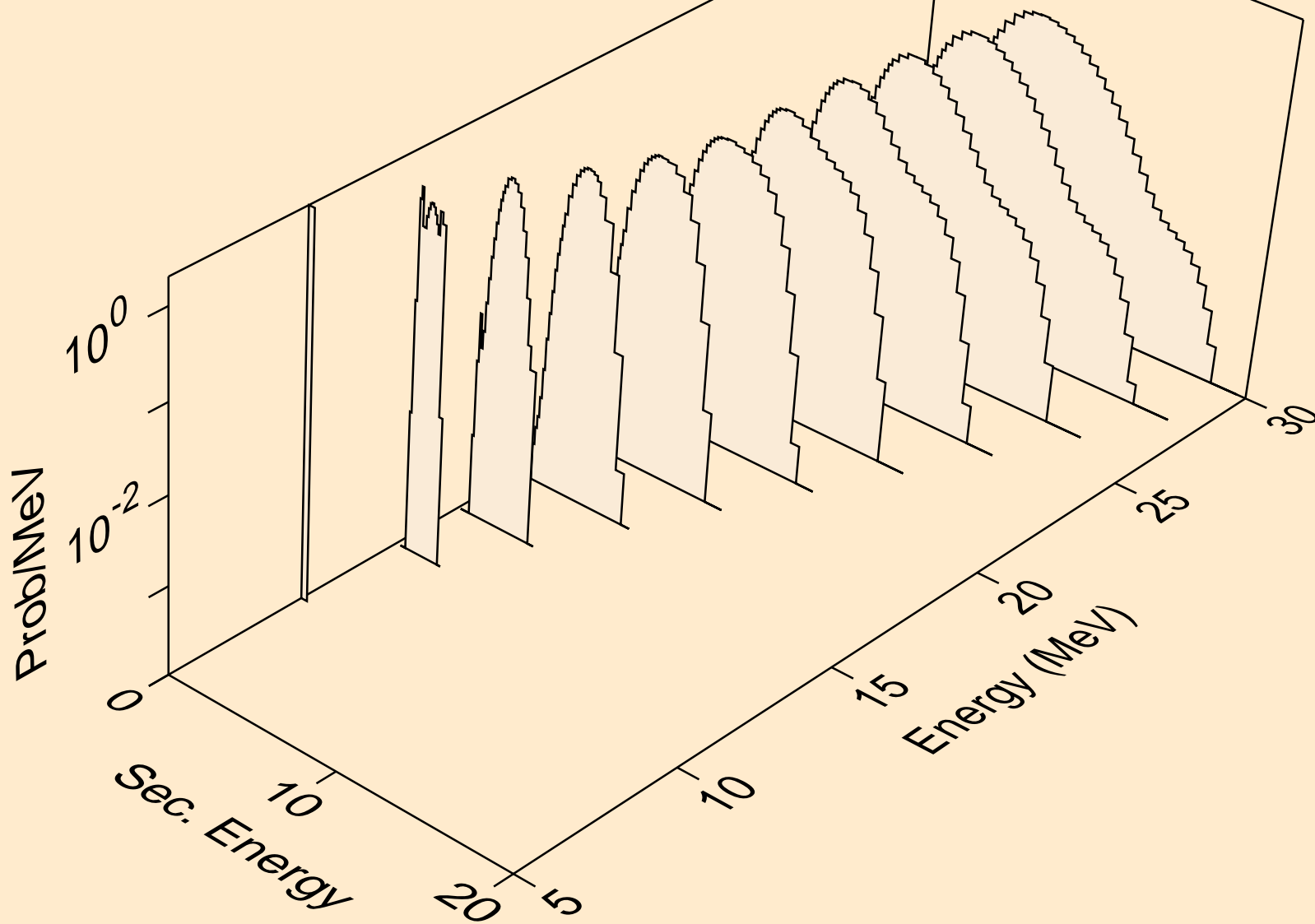

KR083 NEUTRON ACER TENDL-2023 LIBRARY; T=0.K  
protons from (n,p)

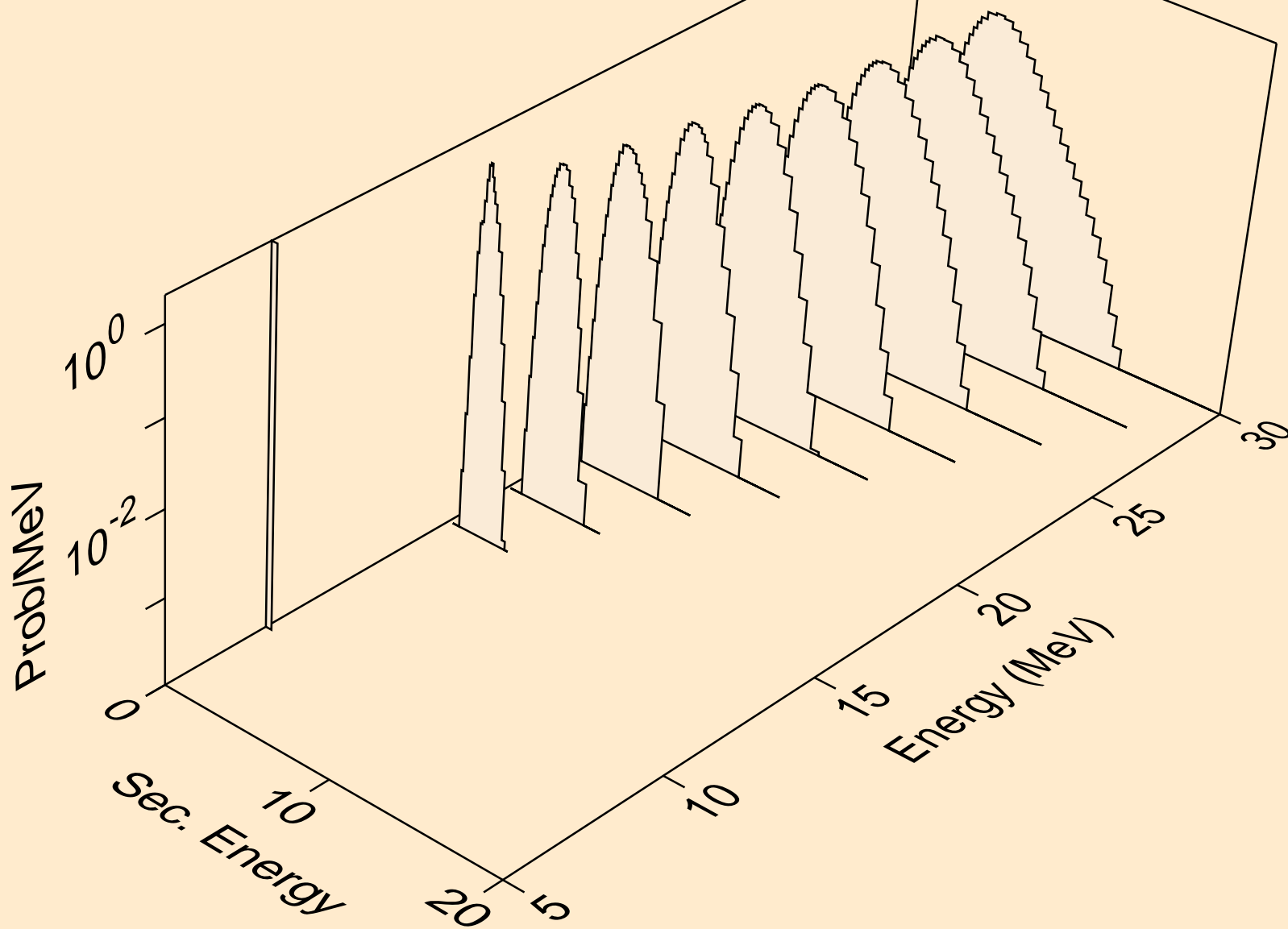

KR083 NEUTRON ACER TENDL-2023 LIBRARY; T=0.K  
protons from (n,pd)

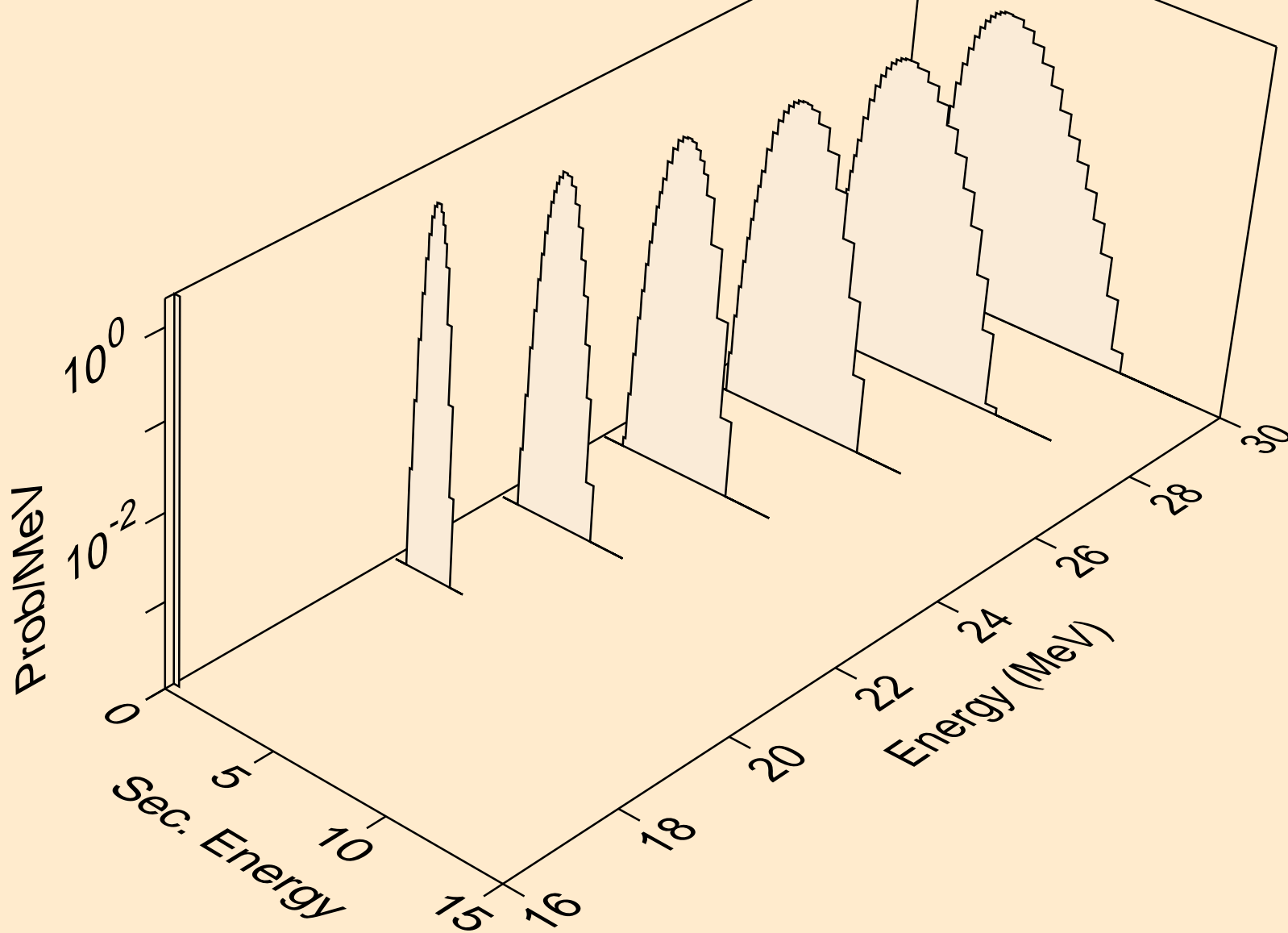

KR083 NEUTRON ACER TENDL-2023 LIBRARY; T=0.K  
protons from (n,pt)

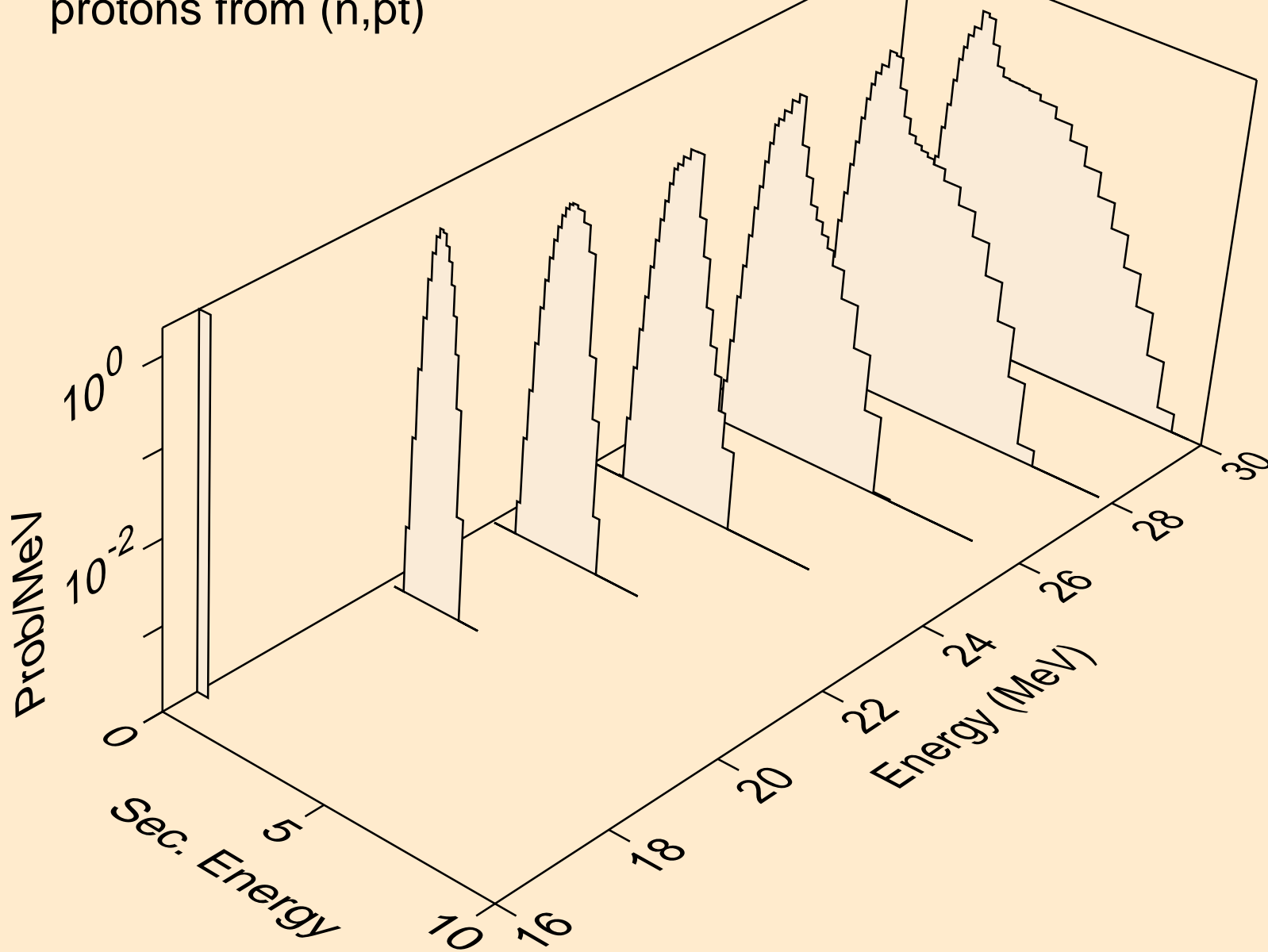



KR083 NEUTRON ACER TENDL-2023 LIBRARY; T=0.K  
deuterons from (n,x)

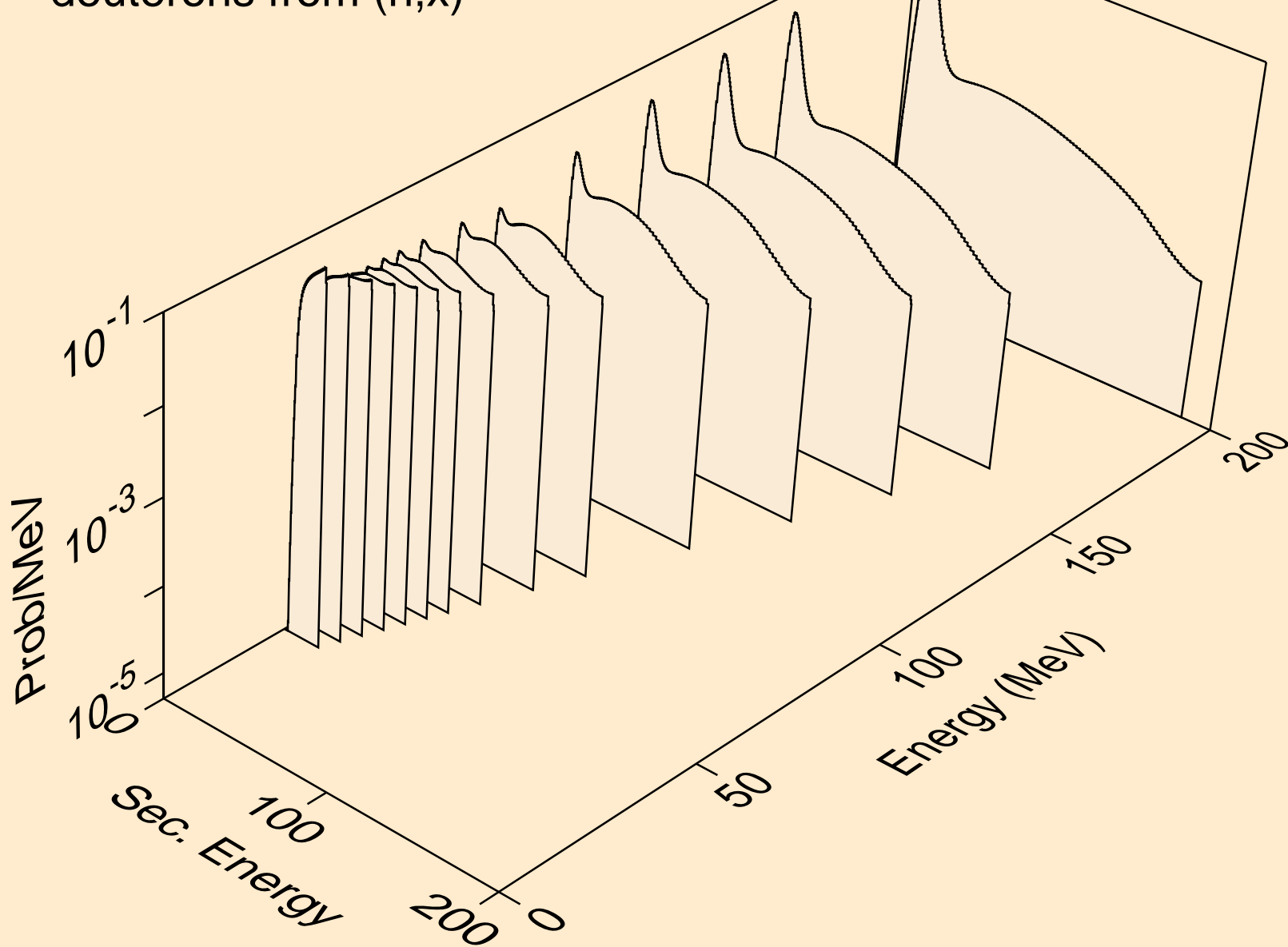

KR083 NEUTRON ACER TENDL-2023 LIBRARY; T=0.K  
deuterons from (n,2nd)

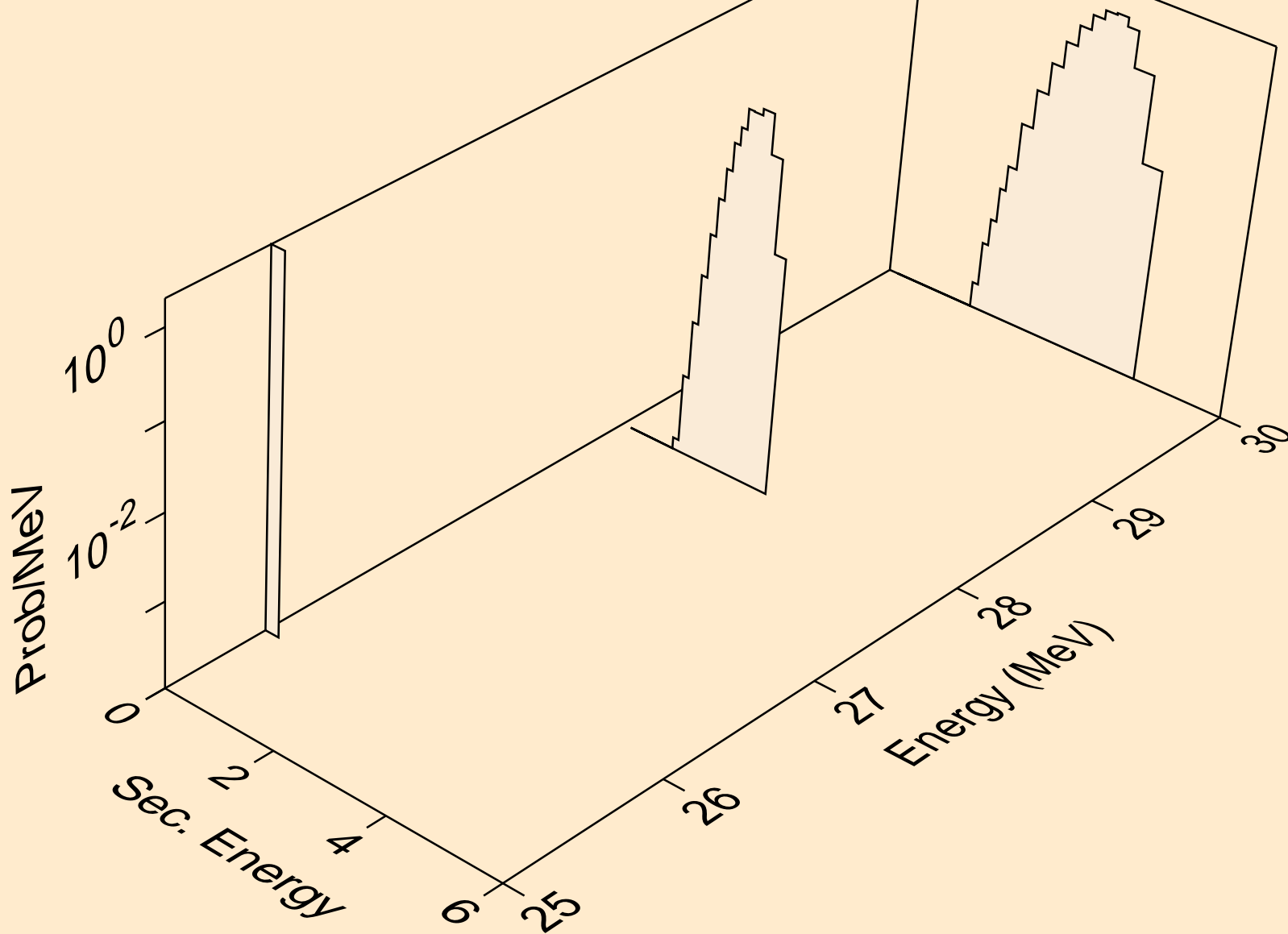

KR083 NEUTRON ACER TENDL-2023 LIBRARY; T=0.K  
deuterons from (n,n\*)d

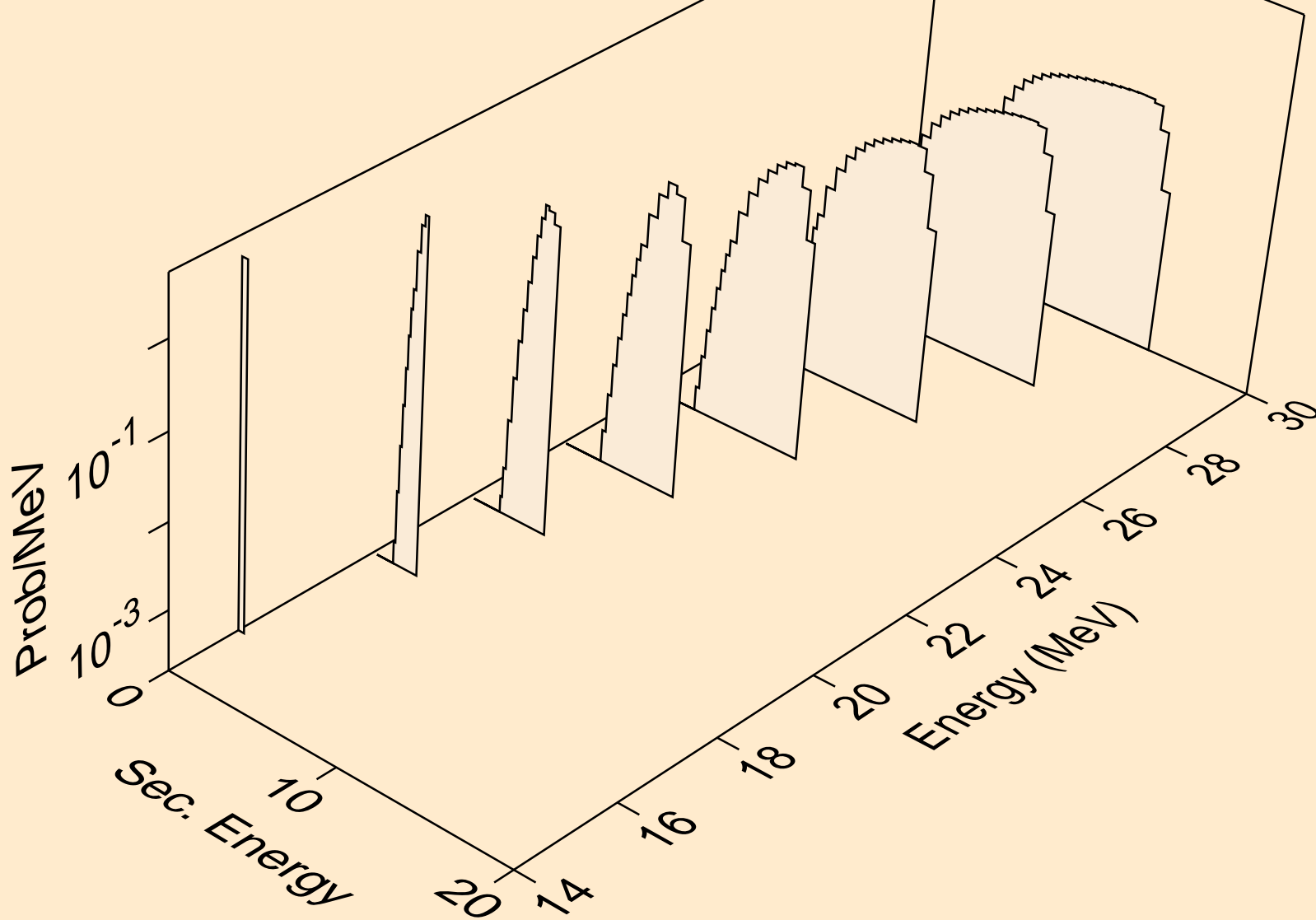

KR083 NEUTRON ACER TENDL-2023 LIBRARY; T=0.K  
deuterons from (n,d)

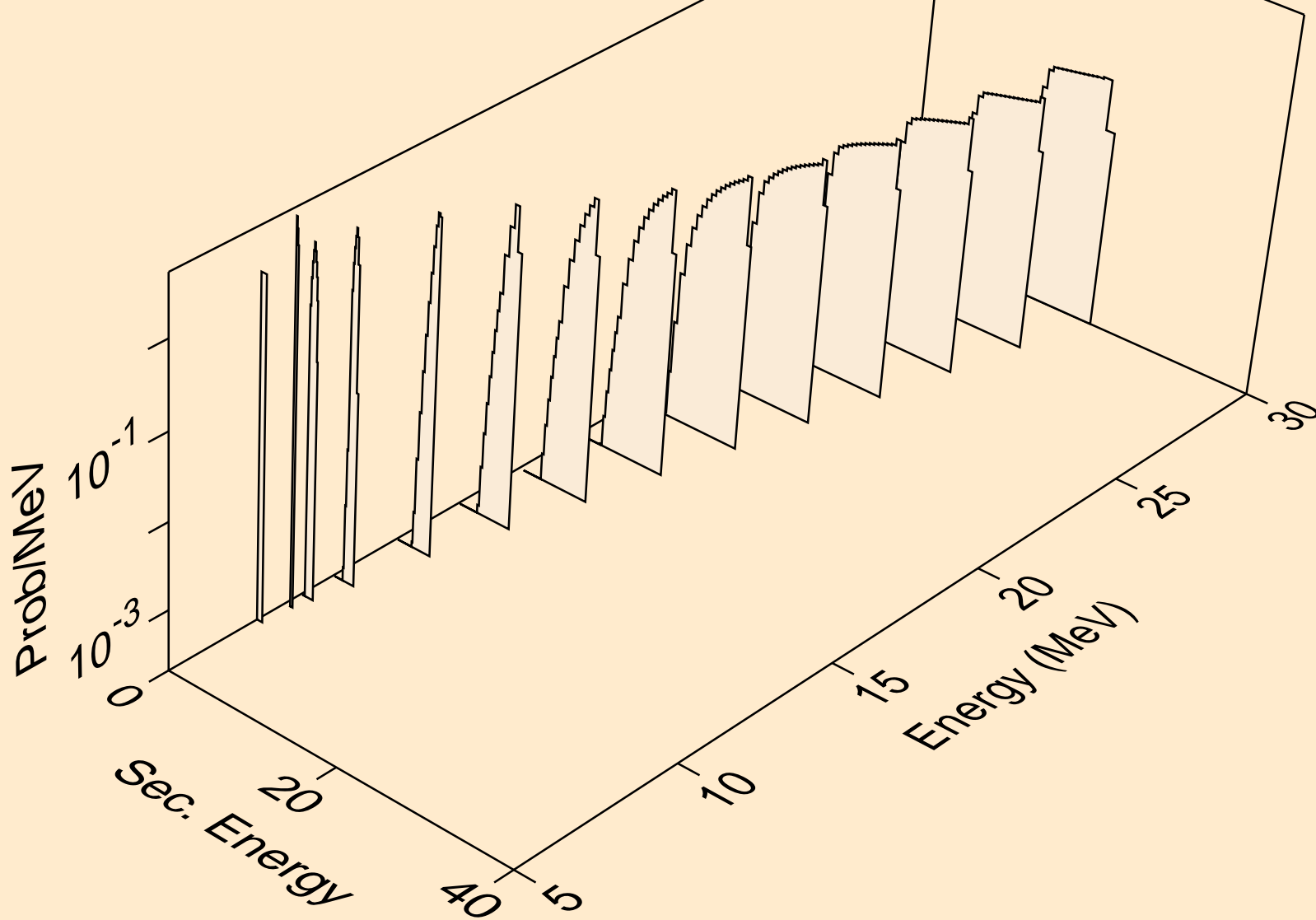

KR083 NEUTRON ACER TENDL-2023 LIBRARY; T=0.K  
deuterons from (n,pd)

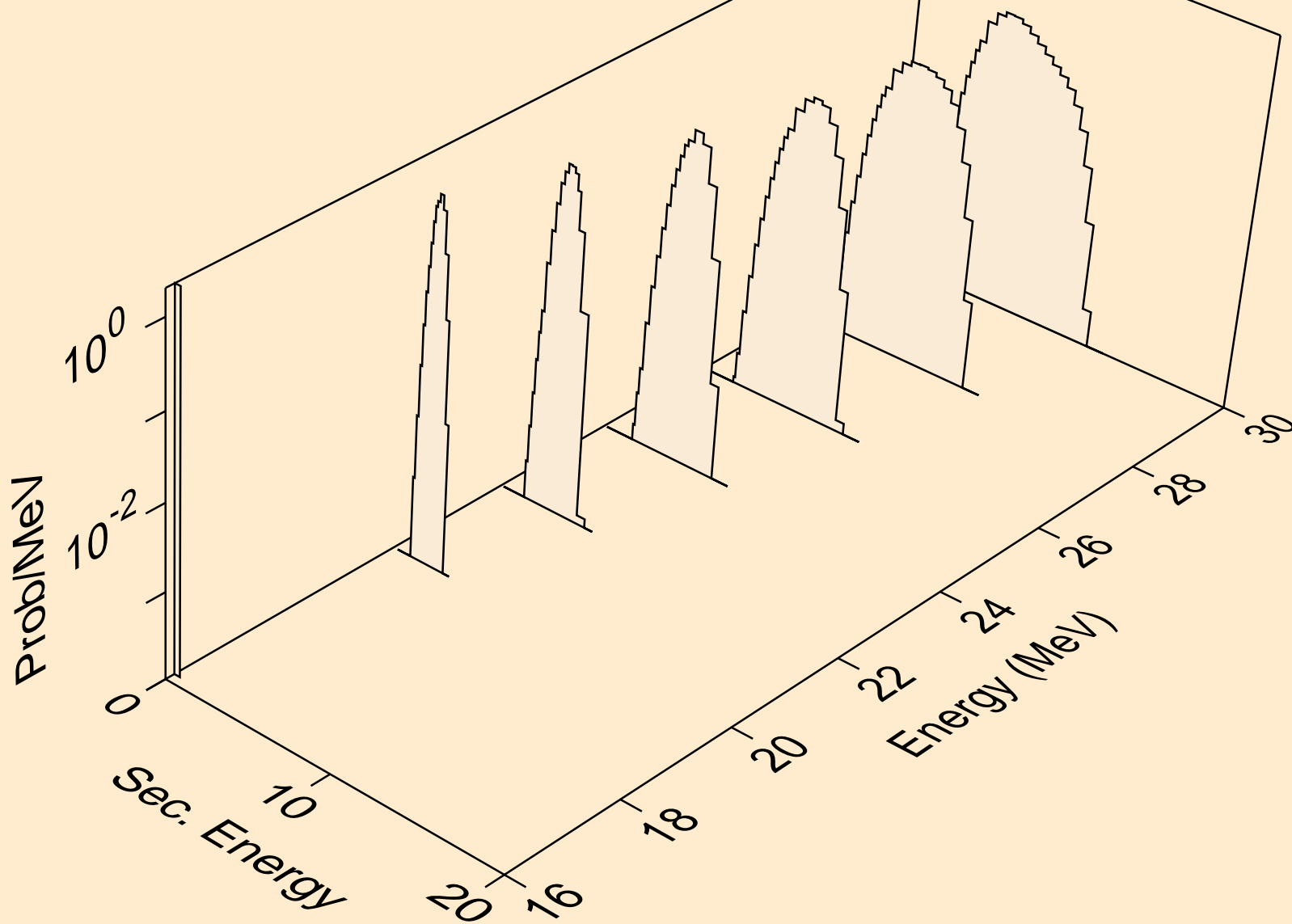

KR083 NEUTRON ACER TENDL-2023 LIBRARY; T=0.K  
deuterons from (n,da)

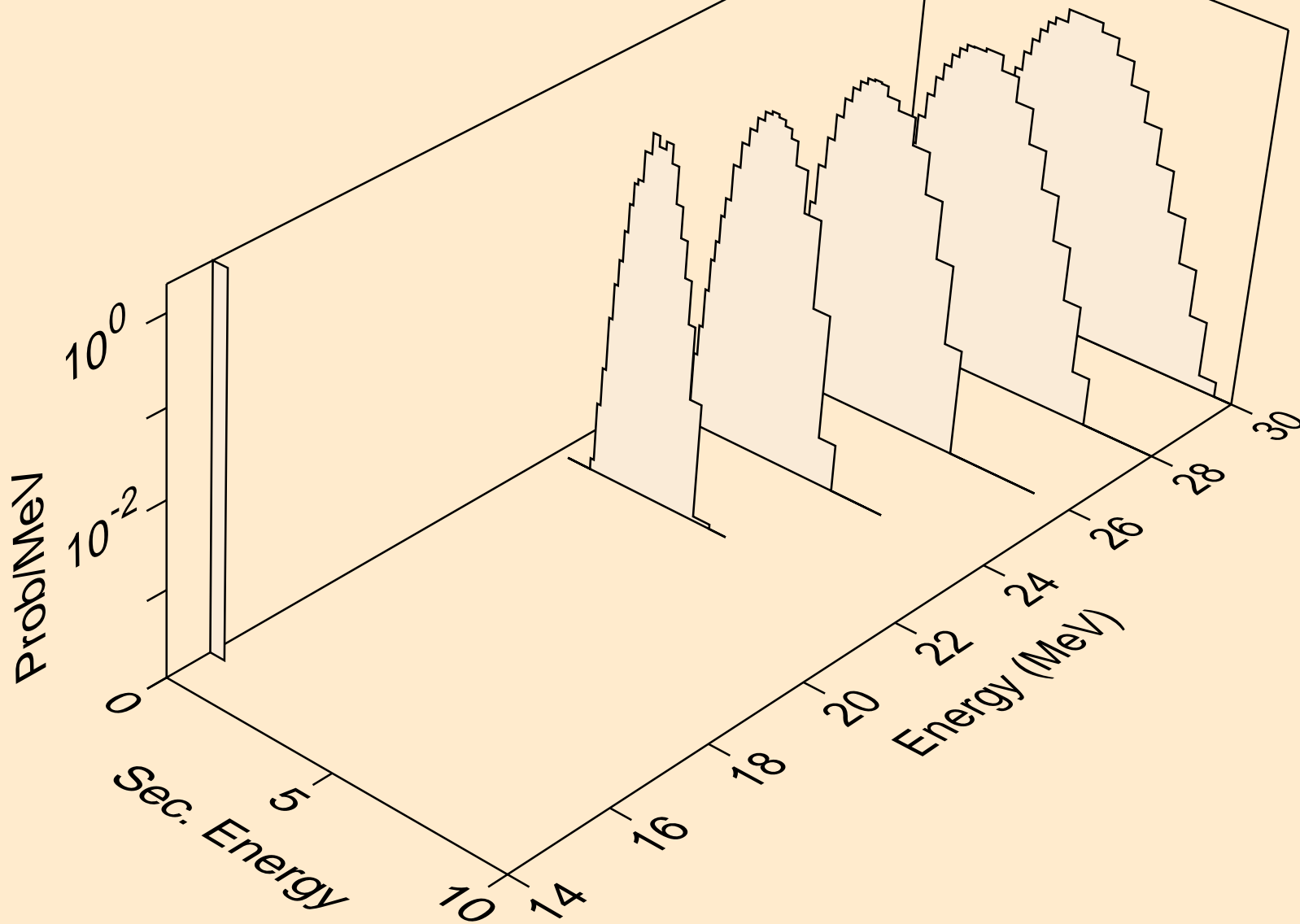

KR083 NEUTRON ACER TENDL-2023 LIBRARY; T=0.K  
tritons from (n,x)

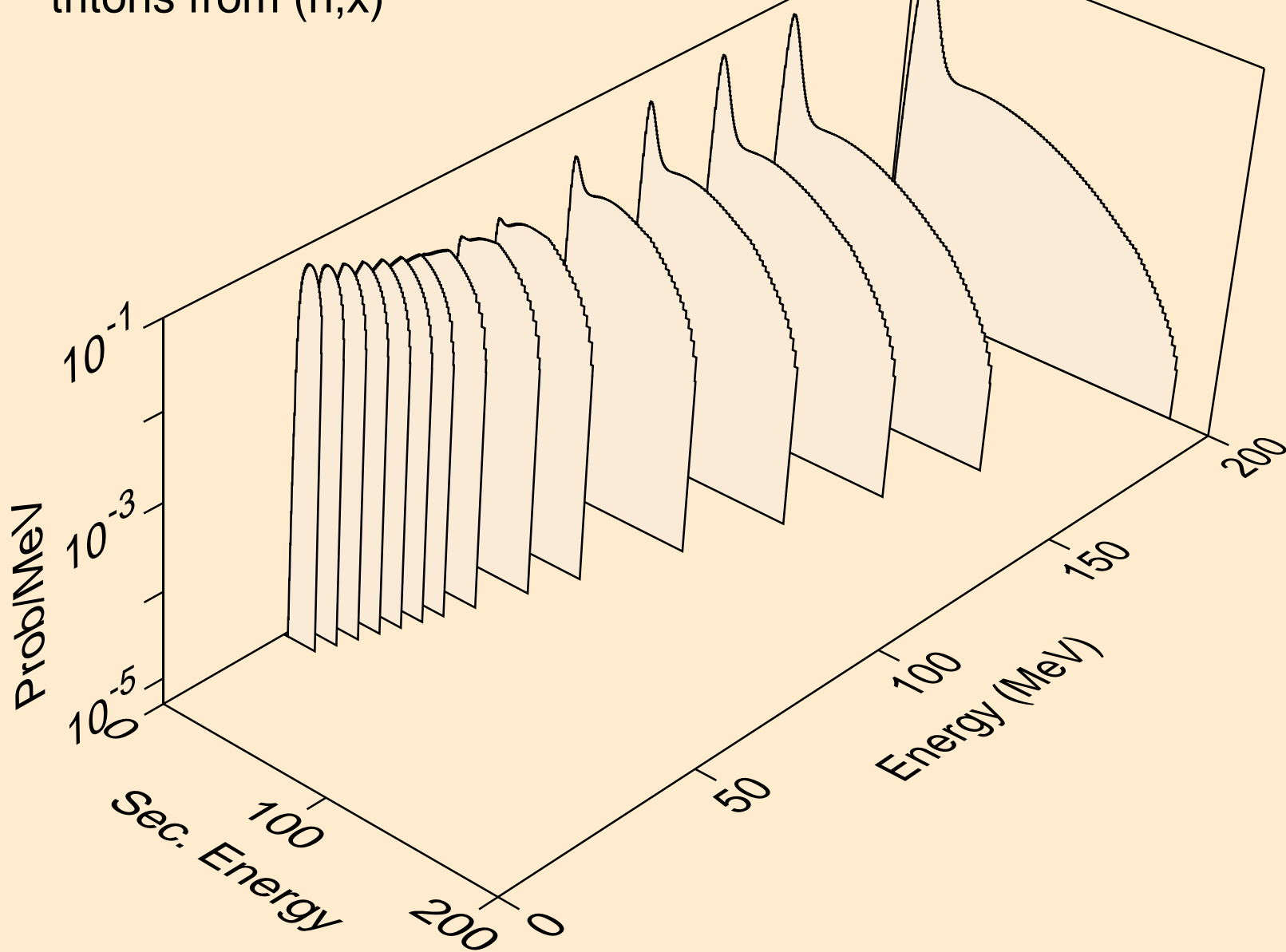

KR083 NEUTRON ACER TENDL-2023 LIBRARY; T=0.K  
tritons from (n,n\*)t

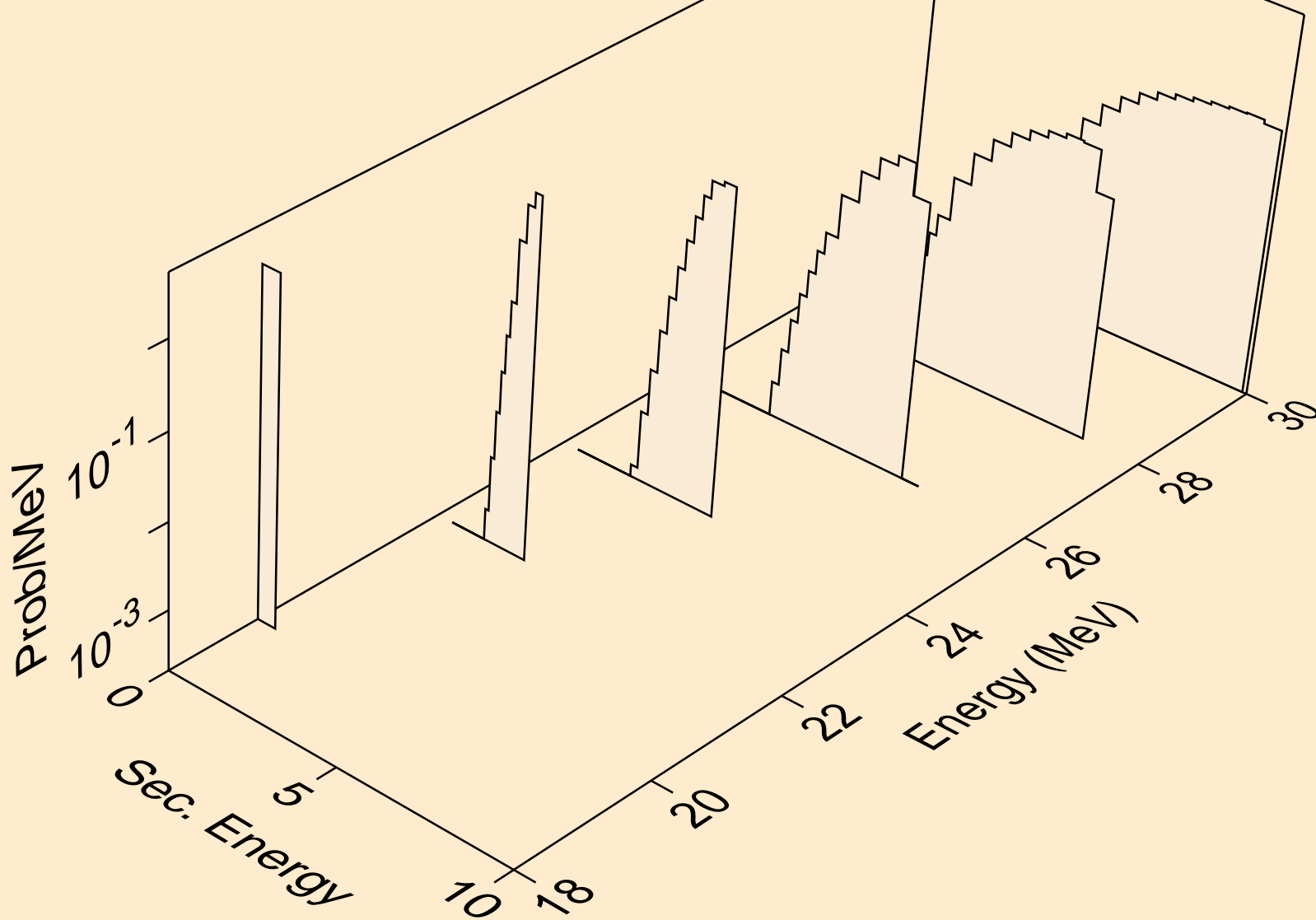



KR083 NEUTRON ACER TENDL-2023 LIBRARY; T=0.K  
tritons from (n,t)

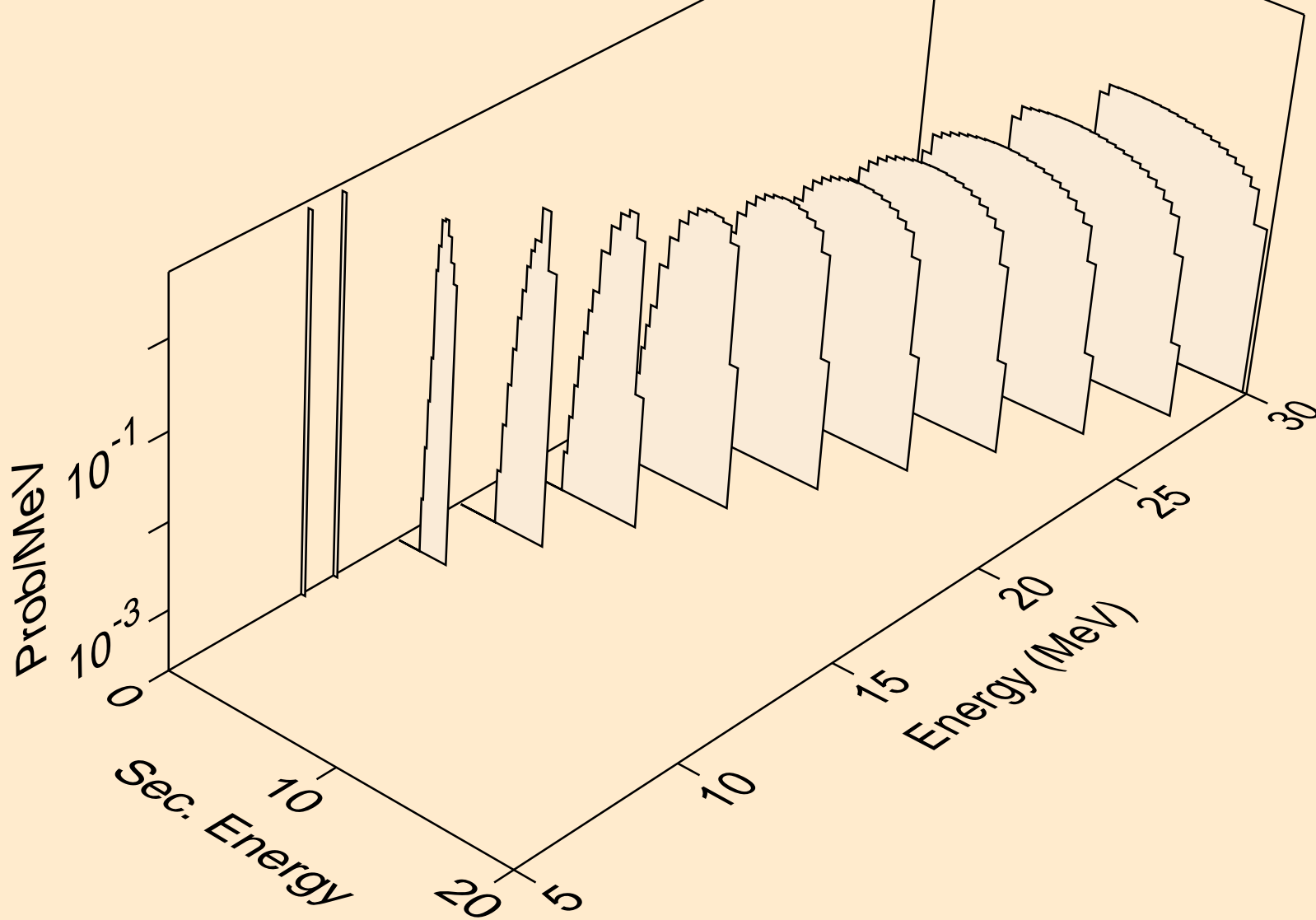

KR083 NEUTRON ACER TENDL-2023 LIBRARY; T=0.K  
tritons from (n,pt)

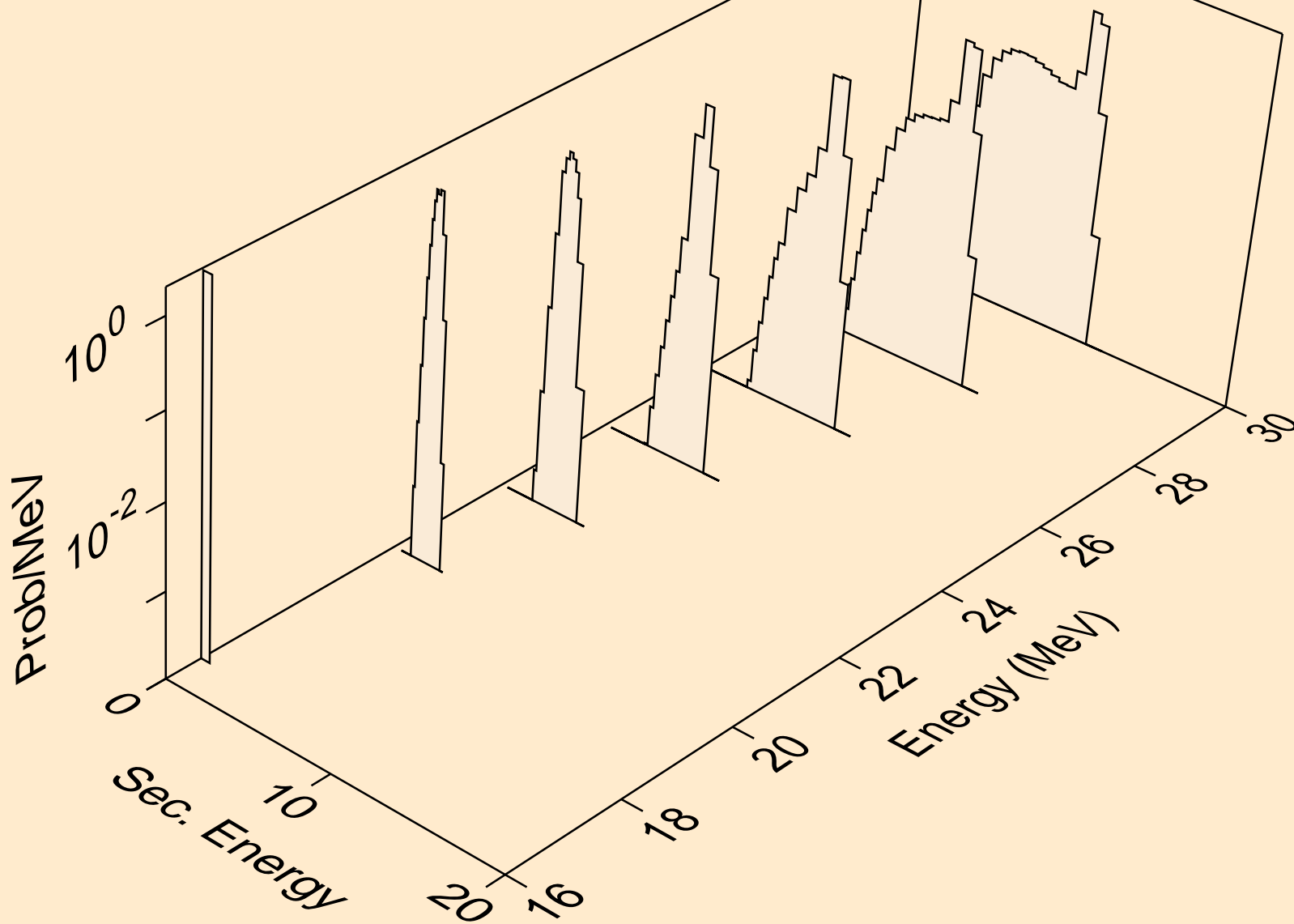

KR083 NEUTRON ACER TENDL-2023 LIBRARY; T=0.K  
he3s from (n,x)

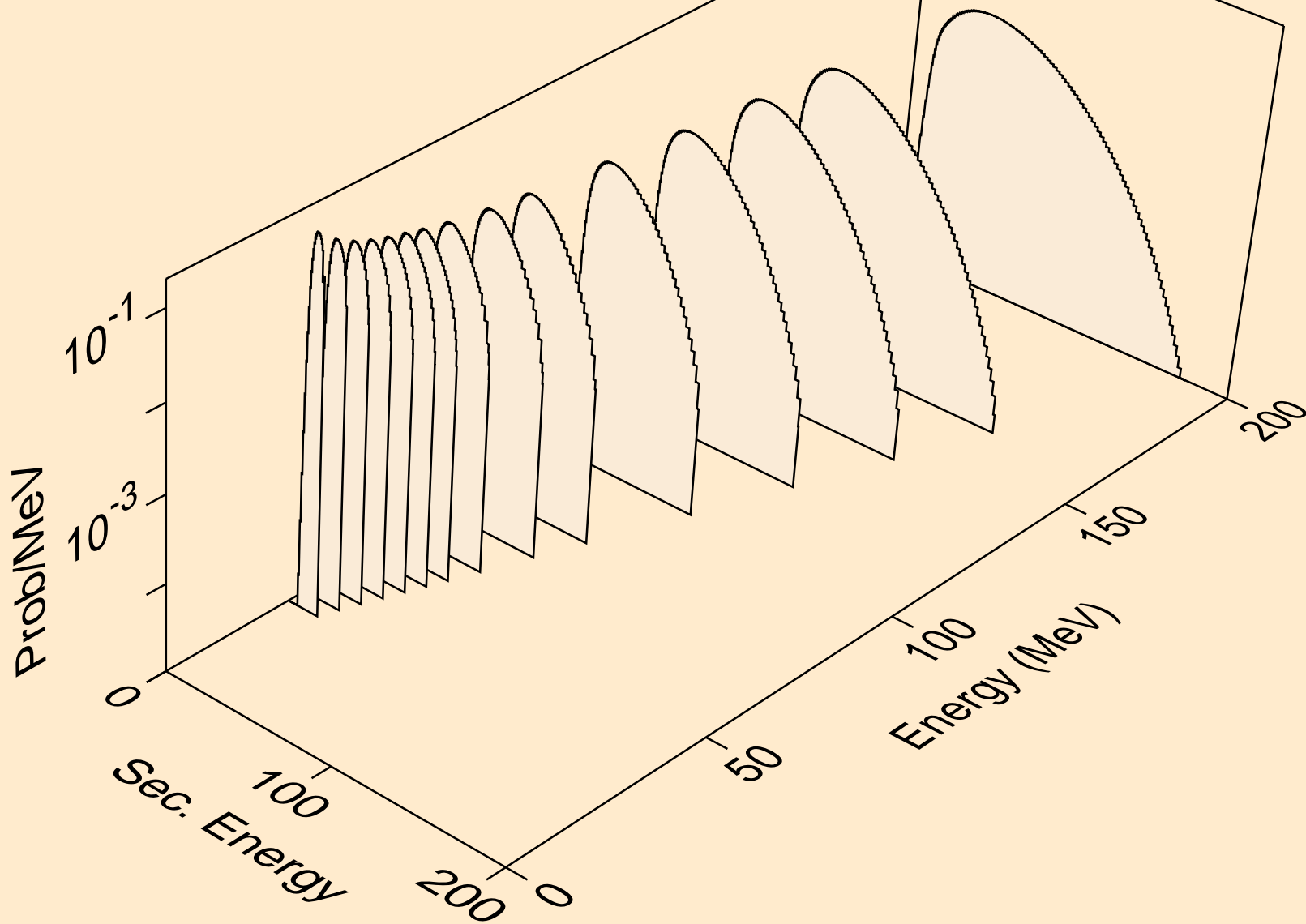

KR083 NEUTRON ACER TENDL-2023 LIBRARY; T=0.K  
he3s from (n,n\*)he3

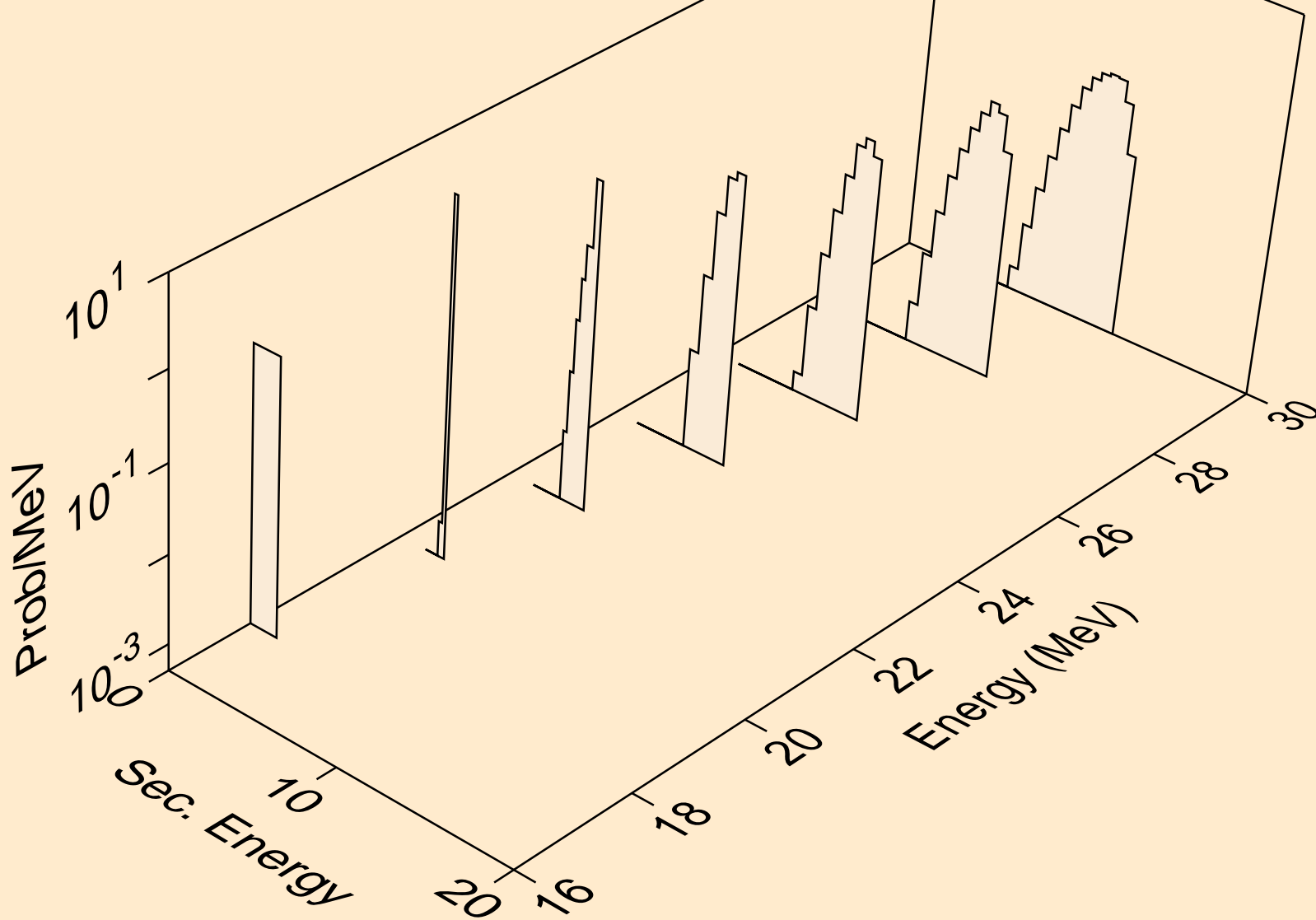

KR083 NEUTRON ACER TENDL-2023 LIBRARY; T=0.K  
he3s from (n,he3)

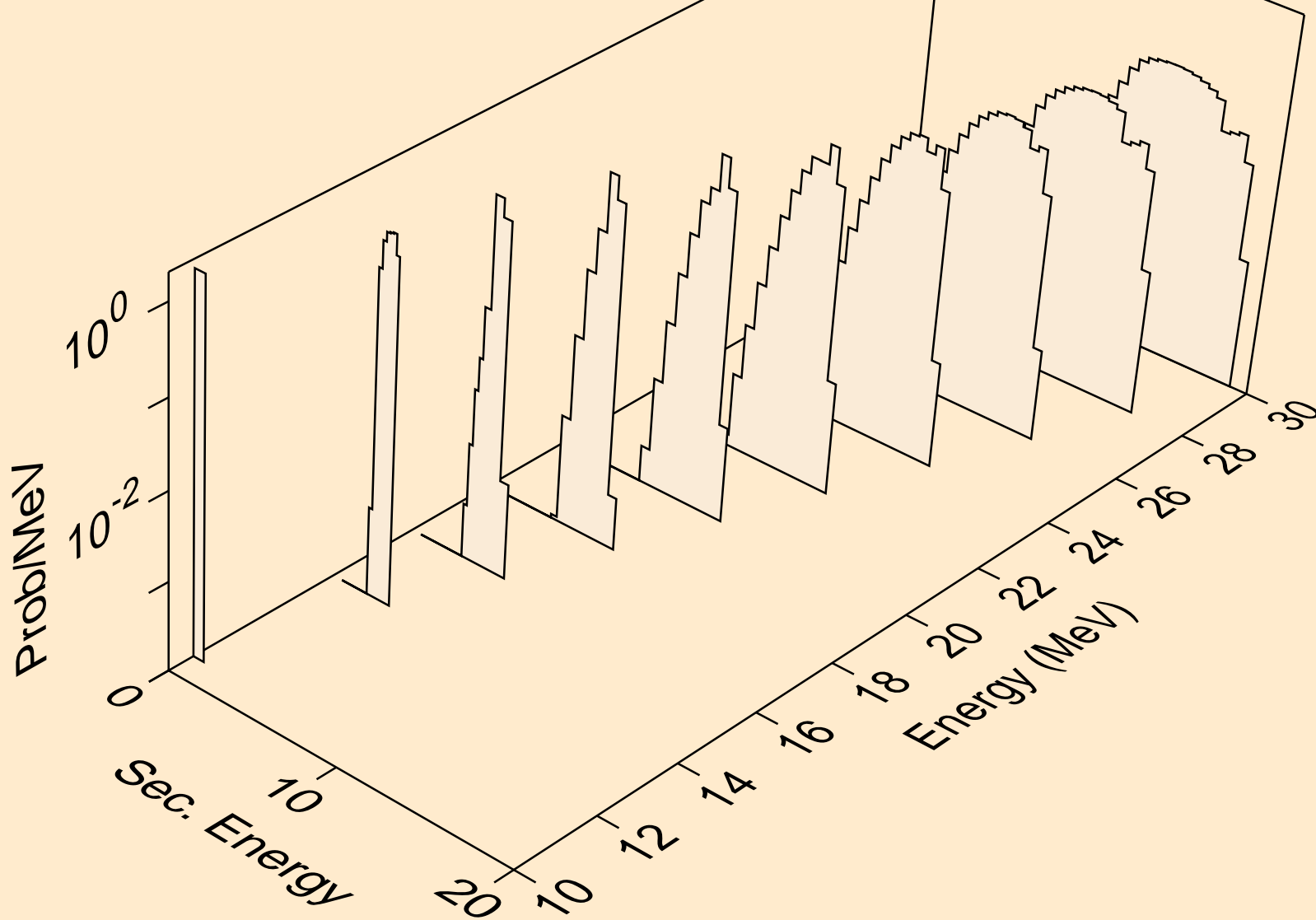

KR083 NEUTRON ACER TENDL-2023 LIBRARY; T=0.K  
alphas from (n,x)

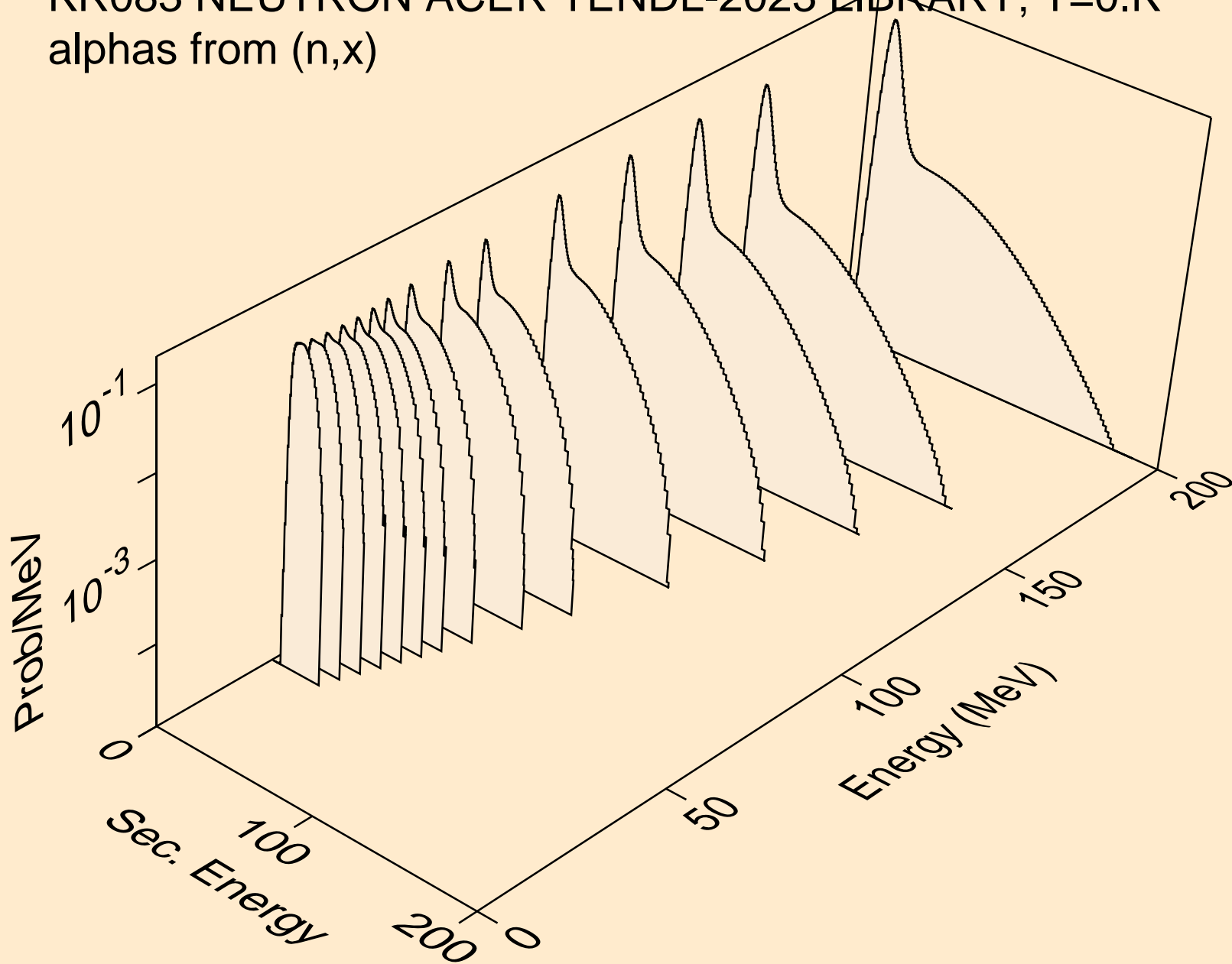

KR083 NEUTRON ACER TENDL-2023 LIBRARY; T=0.K  
alphas from (n,n\*)a

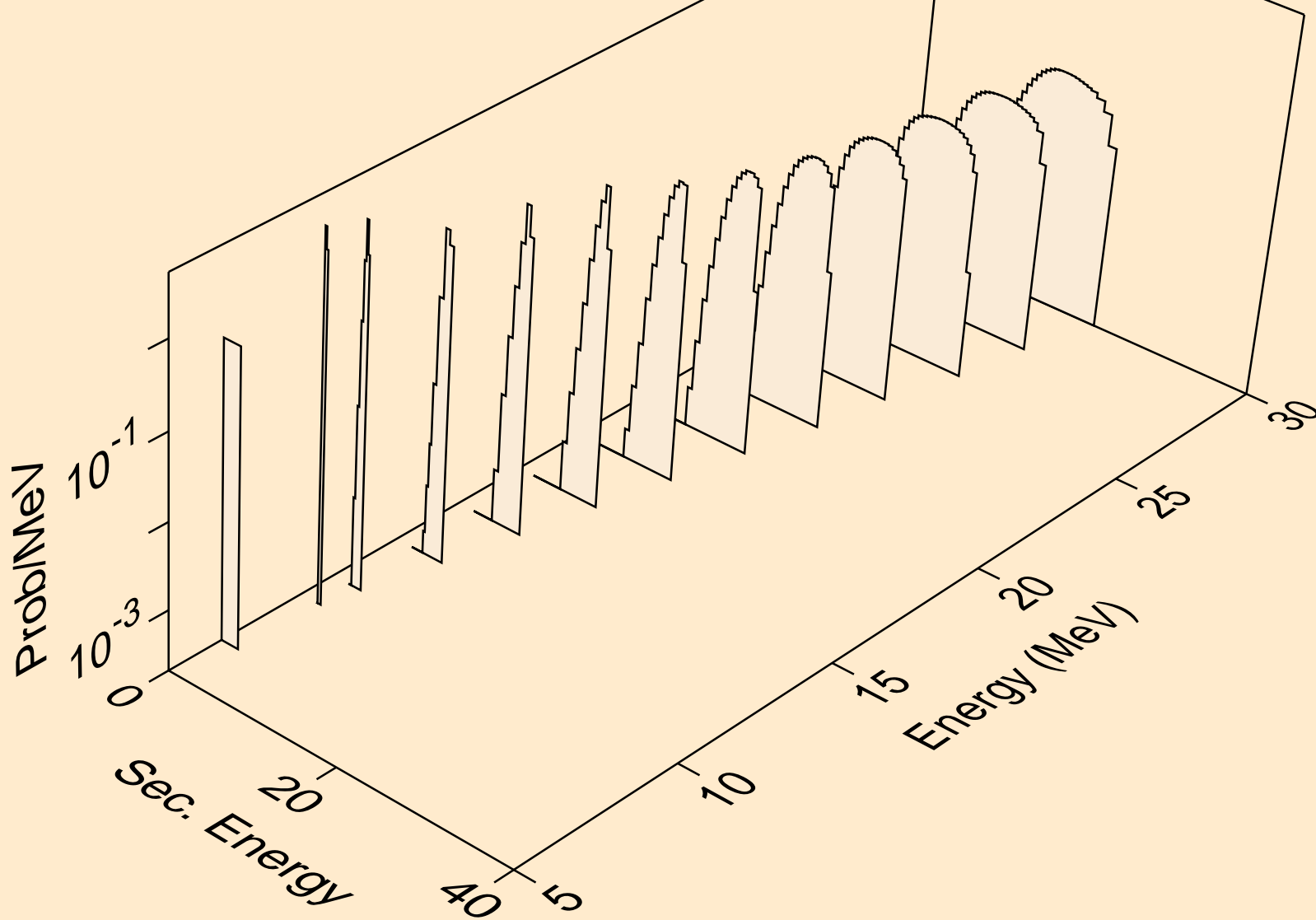

KR083 NEUTRON ACER TENDL-2023 LIBRARY; T=0.K  
alphas from (n,2n)a

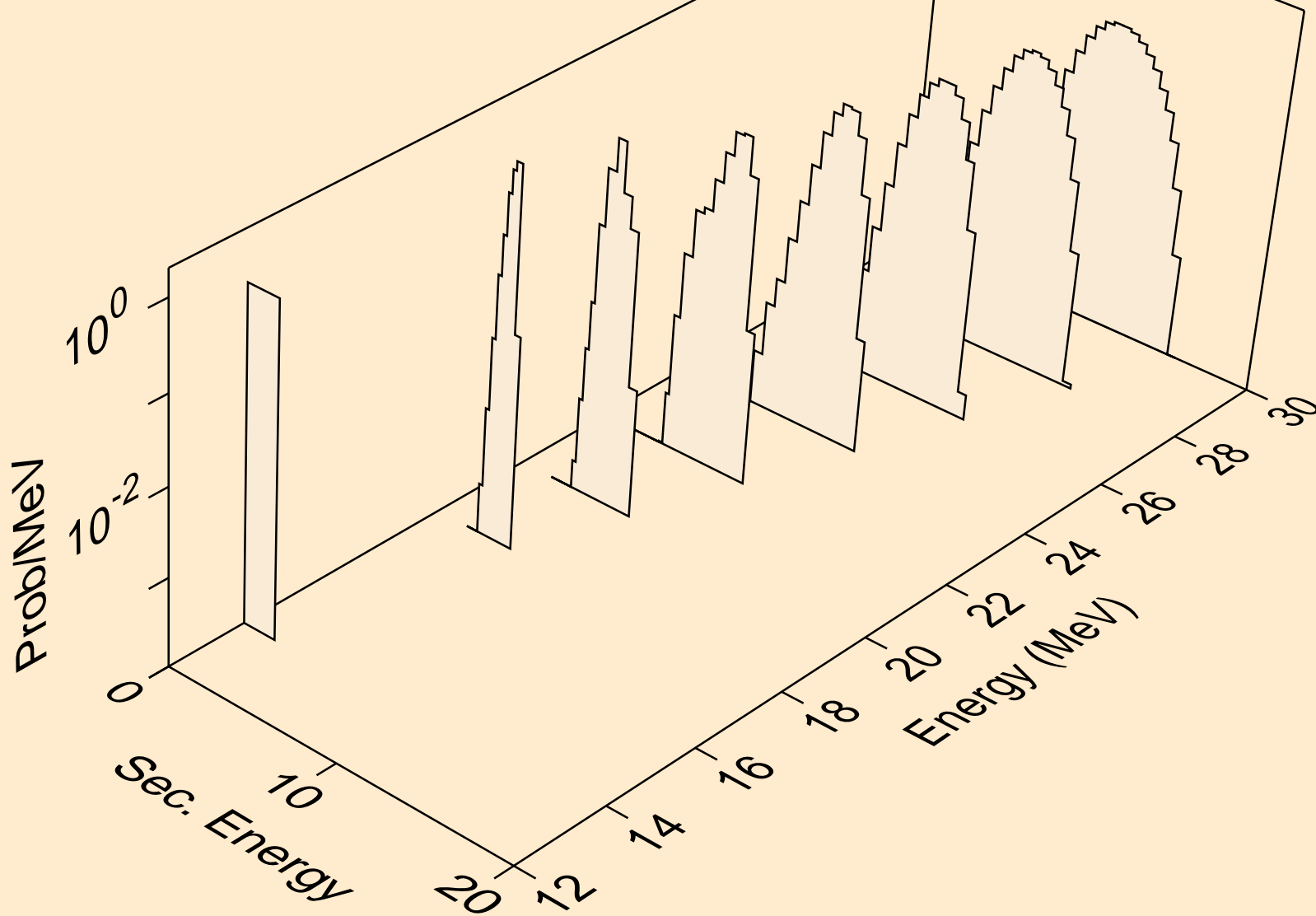



KR083 NEUTRON ACER TENDL-2023 LIBRARY; T=0.K  
alphas from (n,n\*)2a

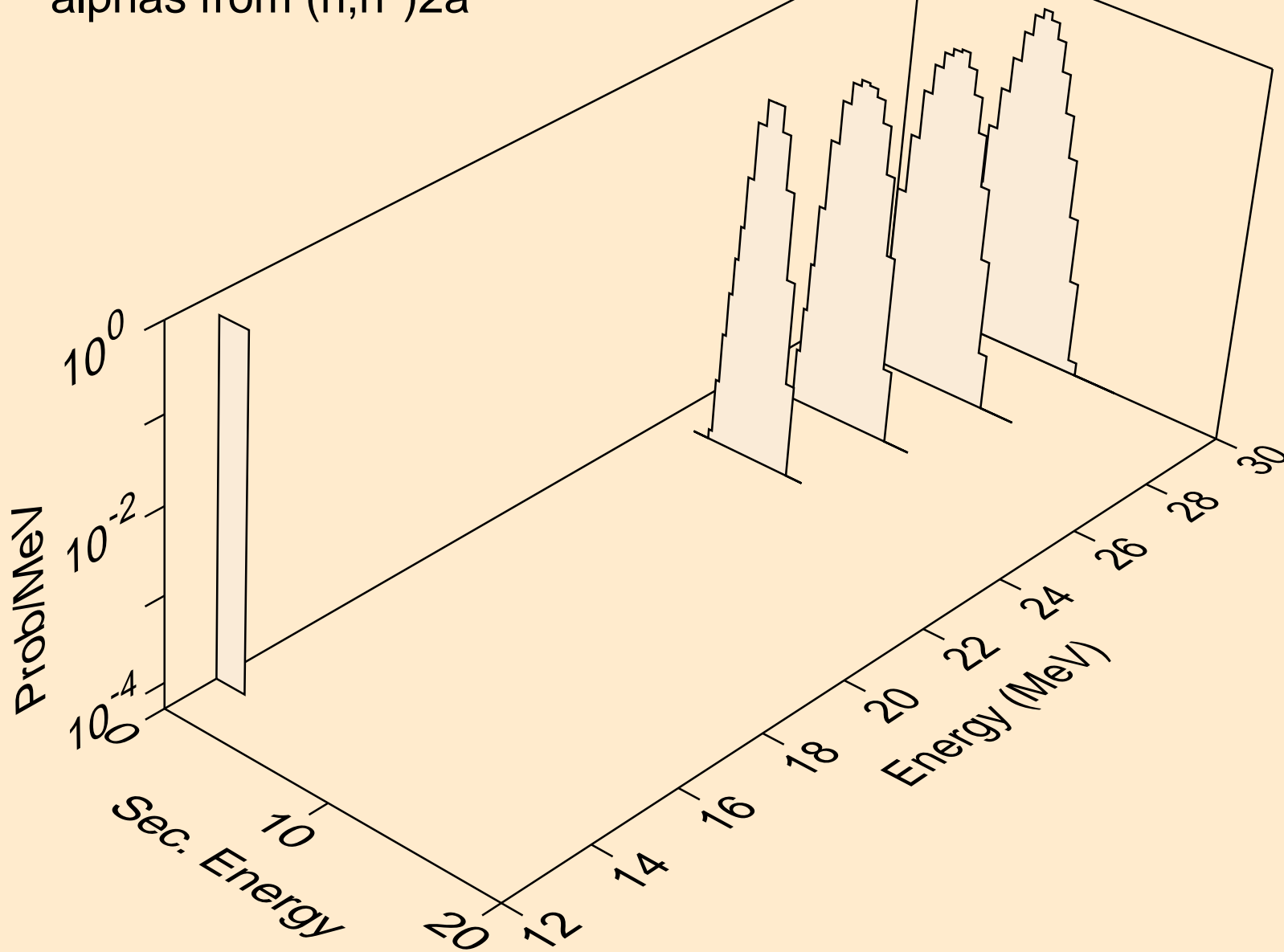

KR083 NEUTRON ACER TENDL-2023 LIBRARY; T=0.K  
alphas from (n,npa)

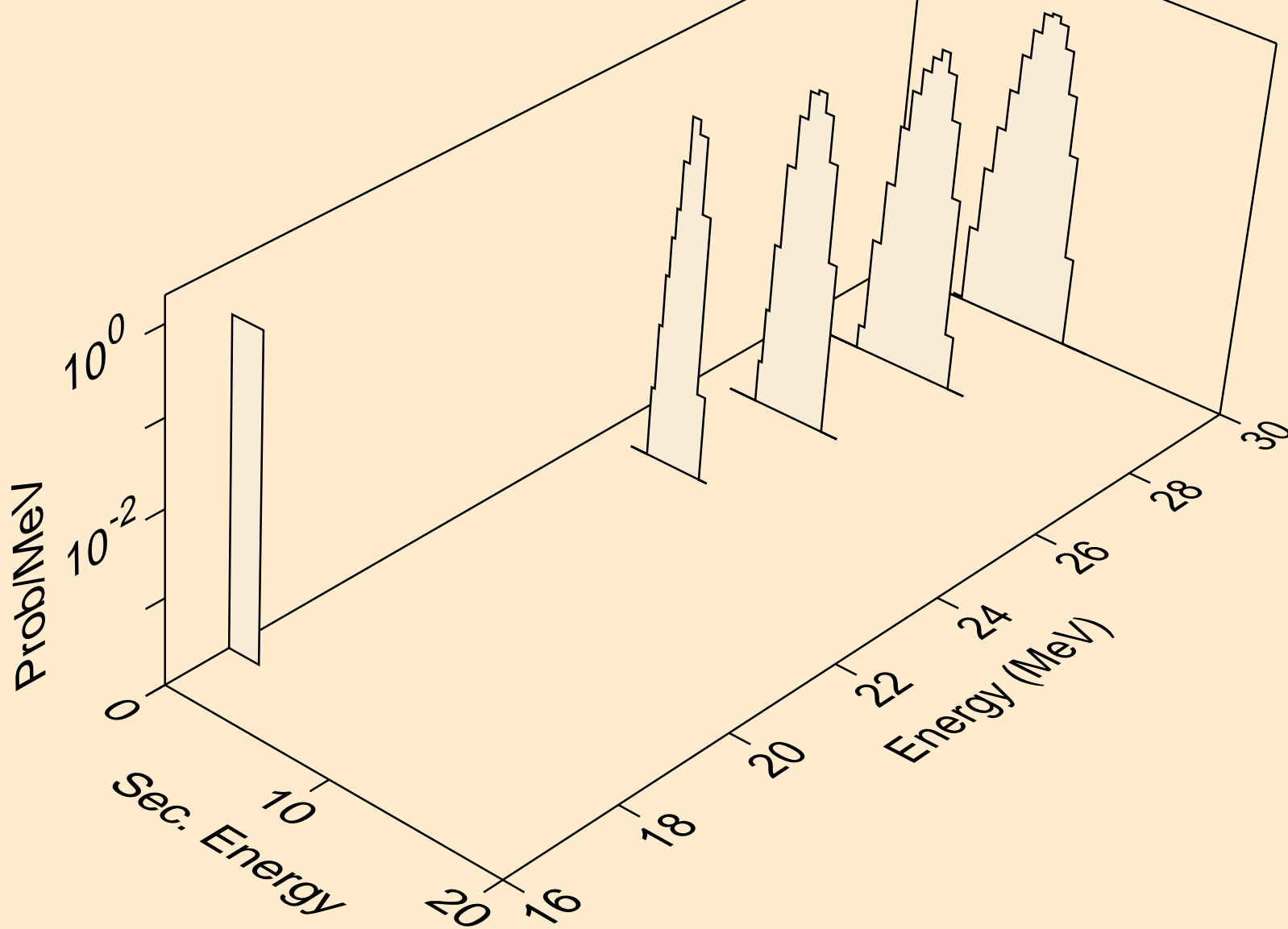

KR083 NEUTRON ACER TENDL-2023 LIBRARY; T=0.K  
alphas from (n,a)

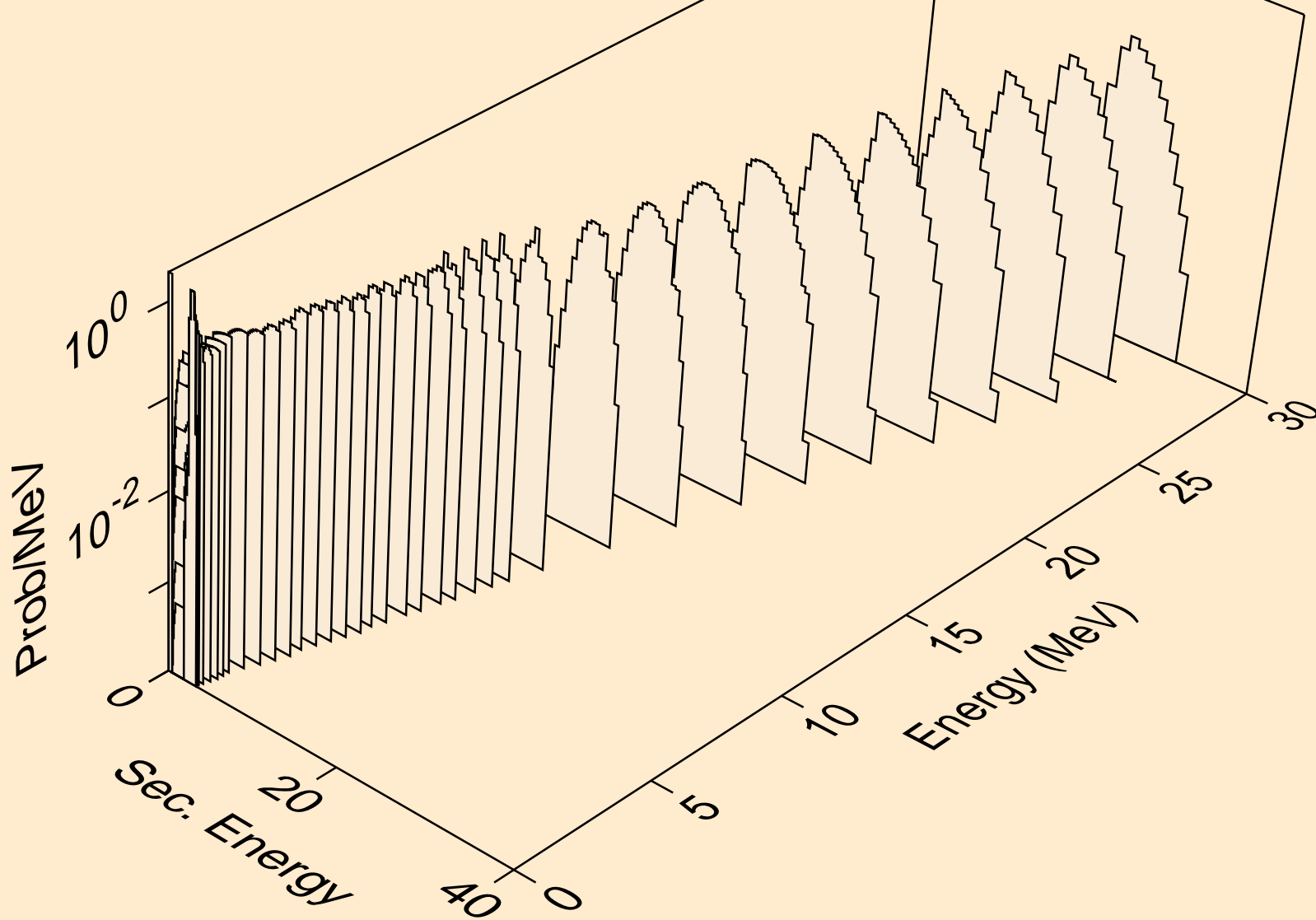

KR083 NEUTRON ACER TENDL-2023 LIBRARY; T=0.K  
alphas from (n,2a)

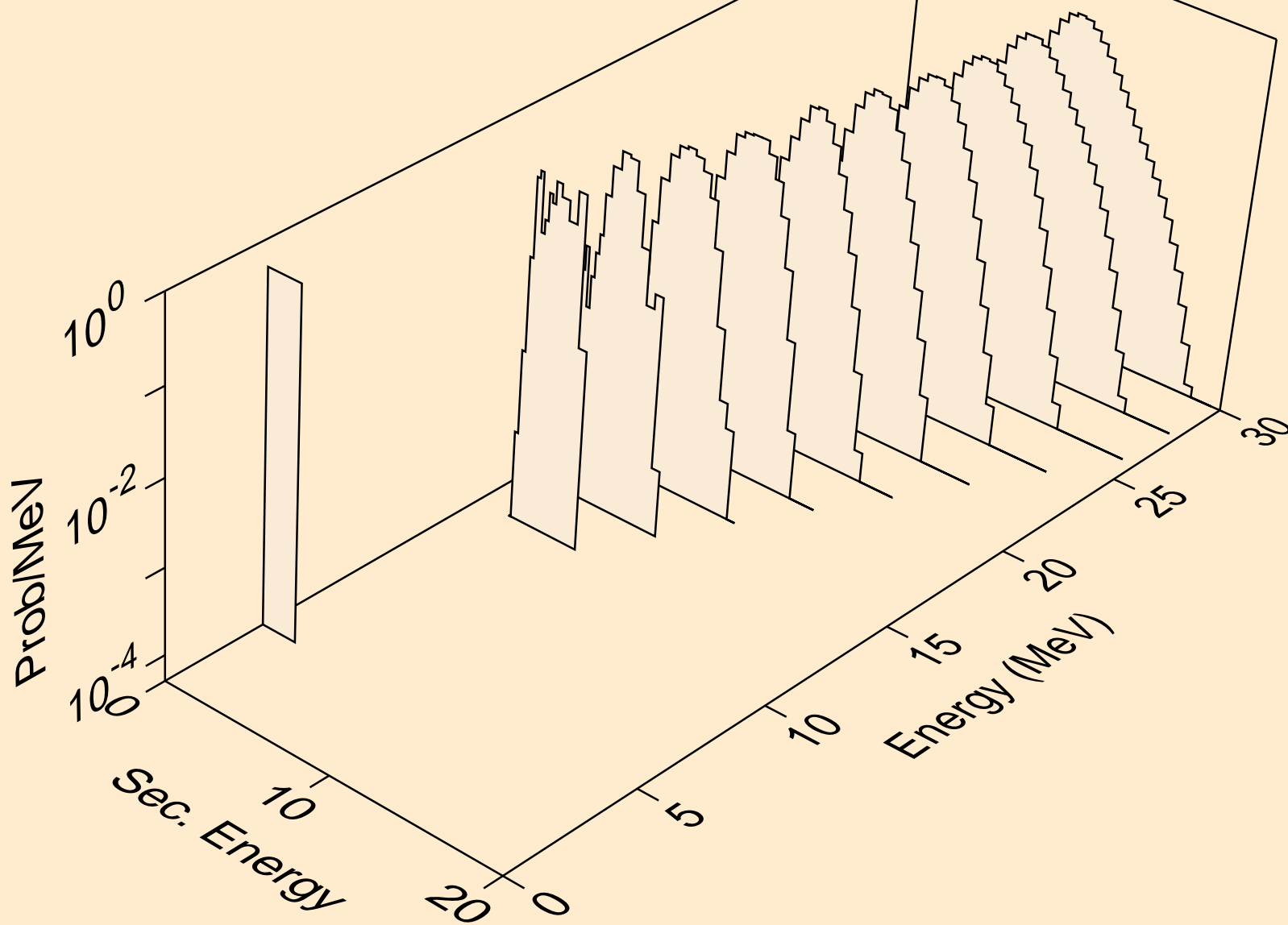

KR083 NEUTRON ACER TENDL-2023 LIBRARY; T=0.K  
alphas from (n,pa)

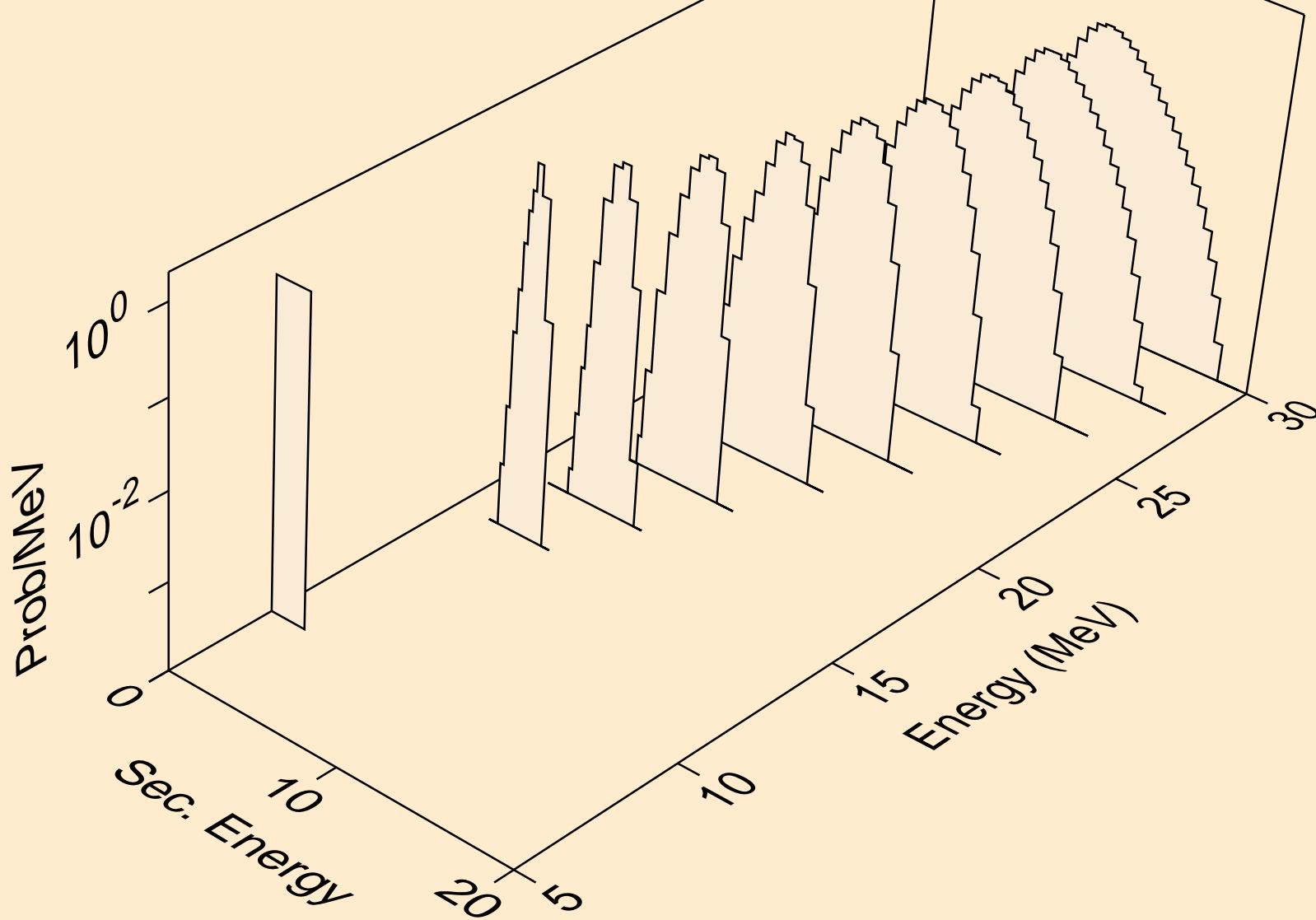

KR083 NEUTRON ACER TENDL-2023 LIBRARY; T=0.K  
alphas from (n,da)

