

LA121 NEUTRON ACER TENDL-2023 LIBRARY; T=0.K
Principal cross sections

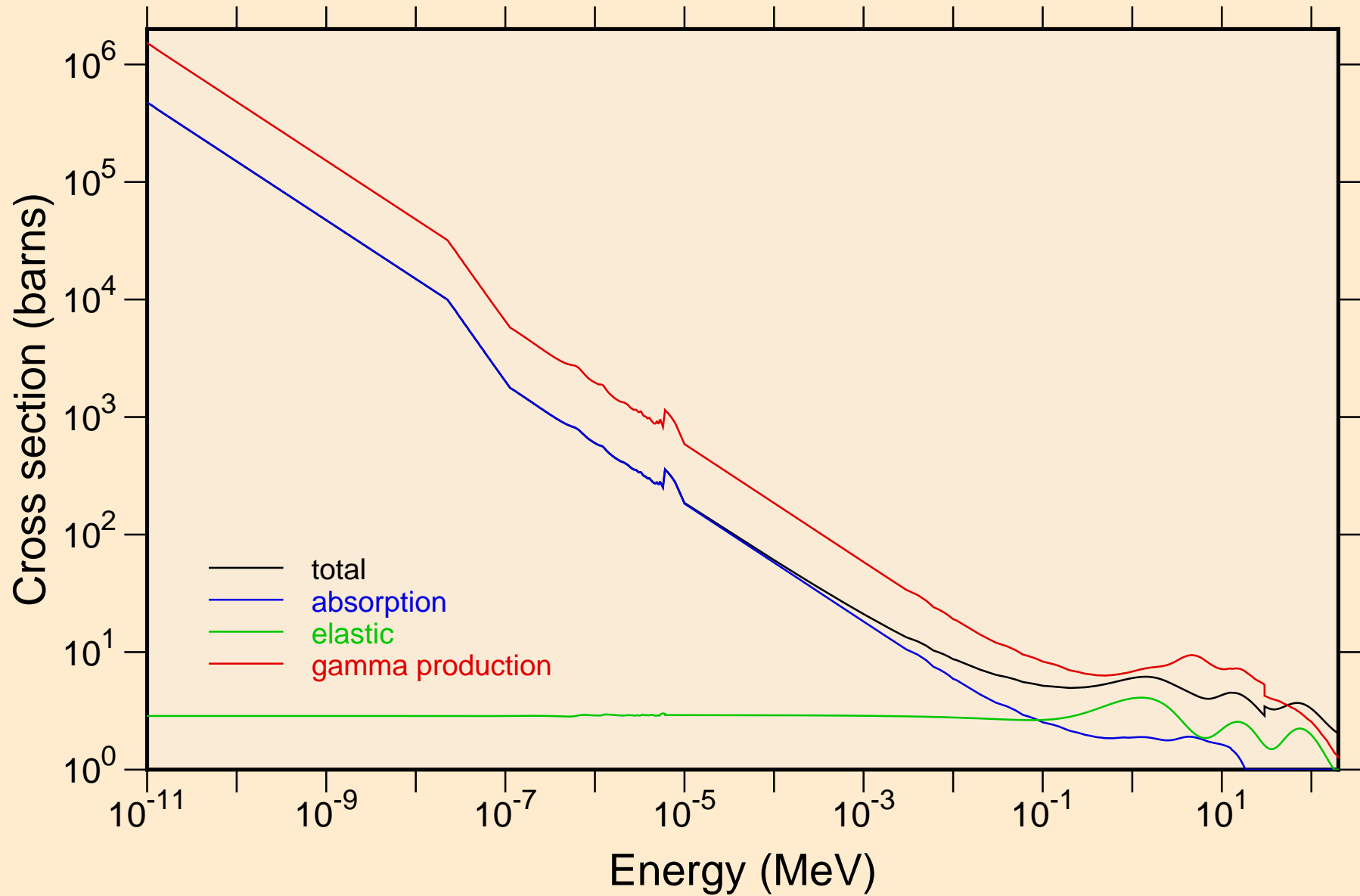

LA121 NEUTRON ACER TENDL-2023 LIBRARY; T=0.K

Heating

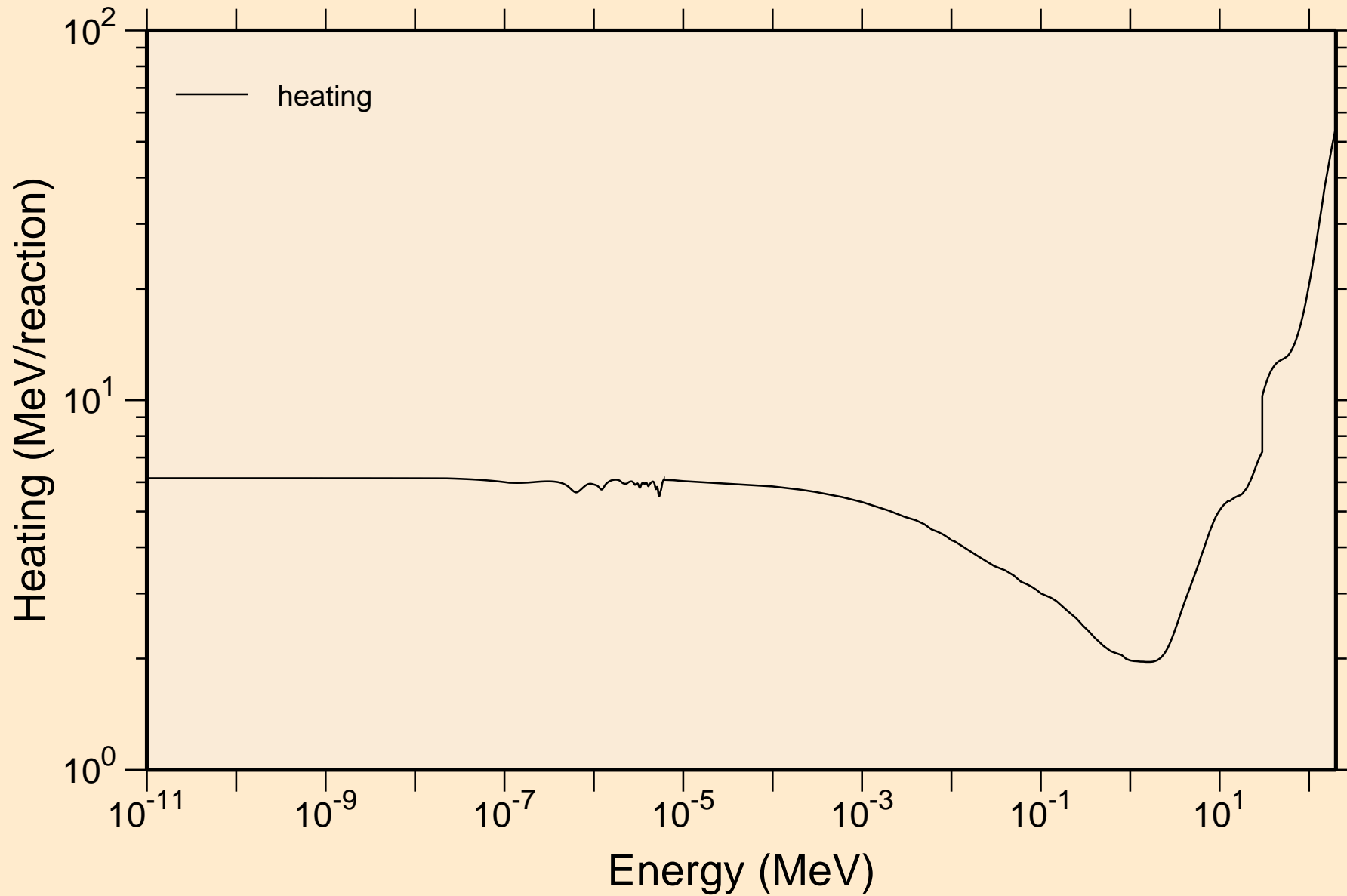

LA121 NEUTRON ACER TENDL-2023 LIBRARY; T=0.K
Damage

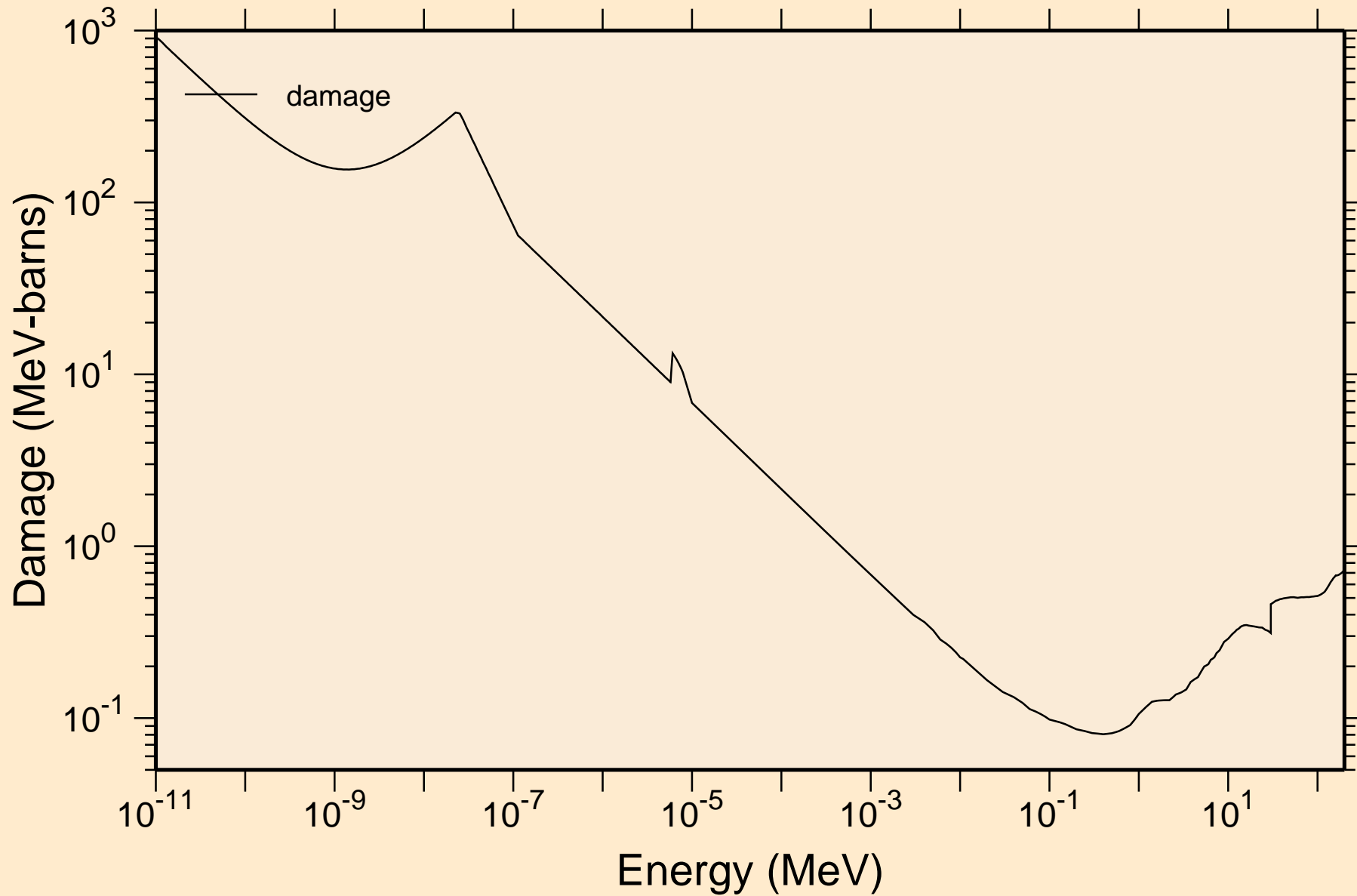

LA121 NEUTRON ACER TENDL-2023 LIBRARY; T=0.K
Non-threshold reactions

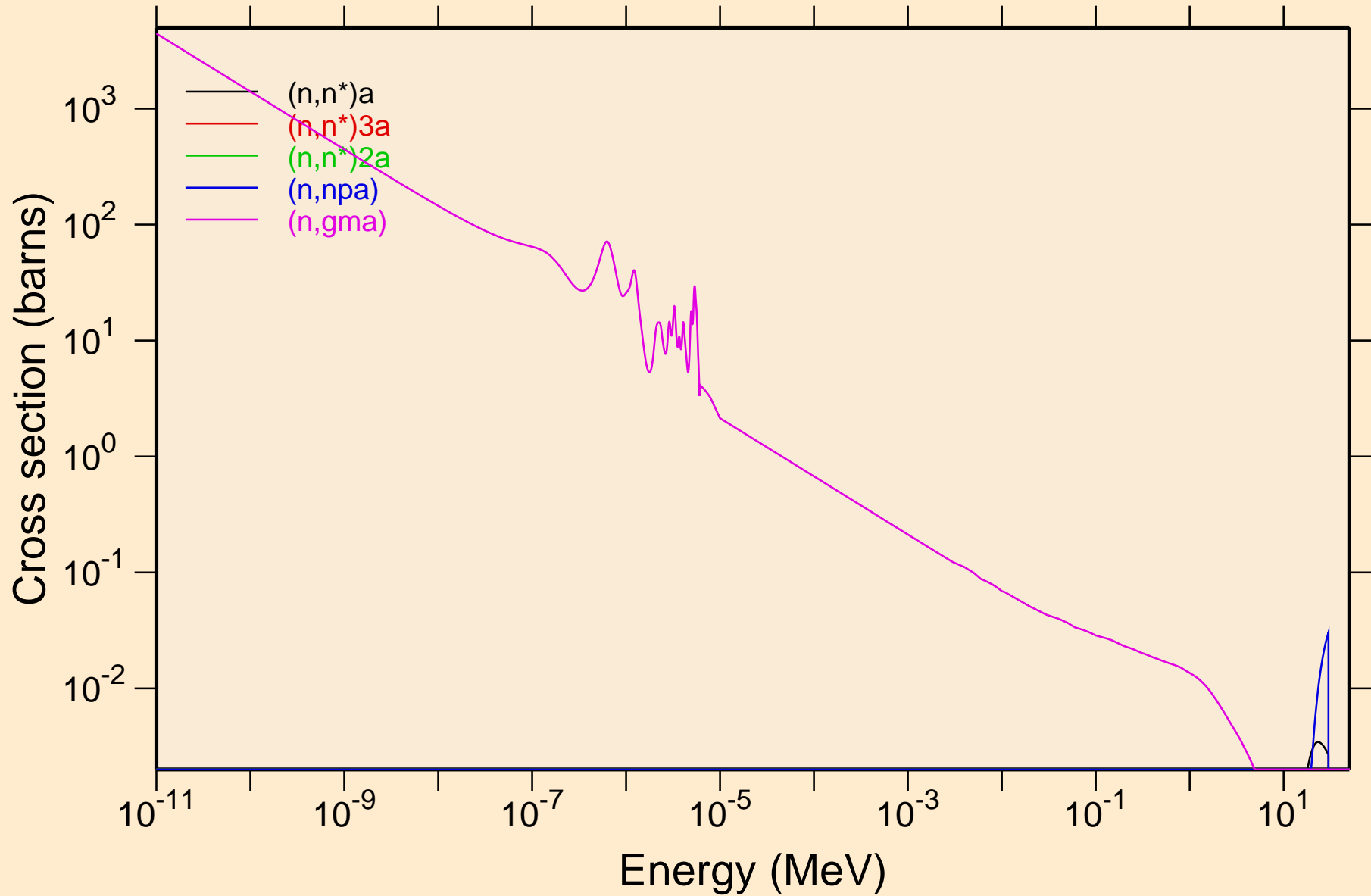

LA121 NEUTRON ACER TENDL-2023 LIBRARY; T=0.K
Non-threshold reactions

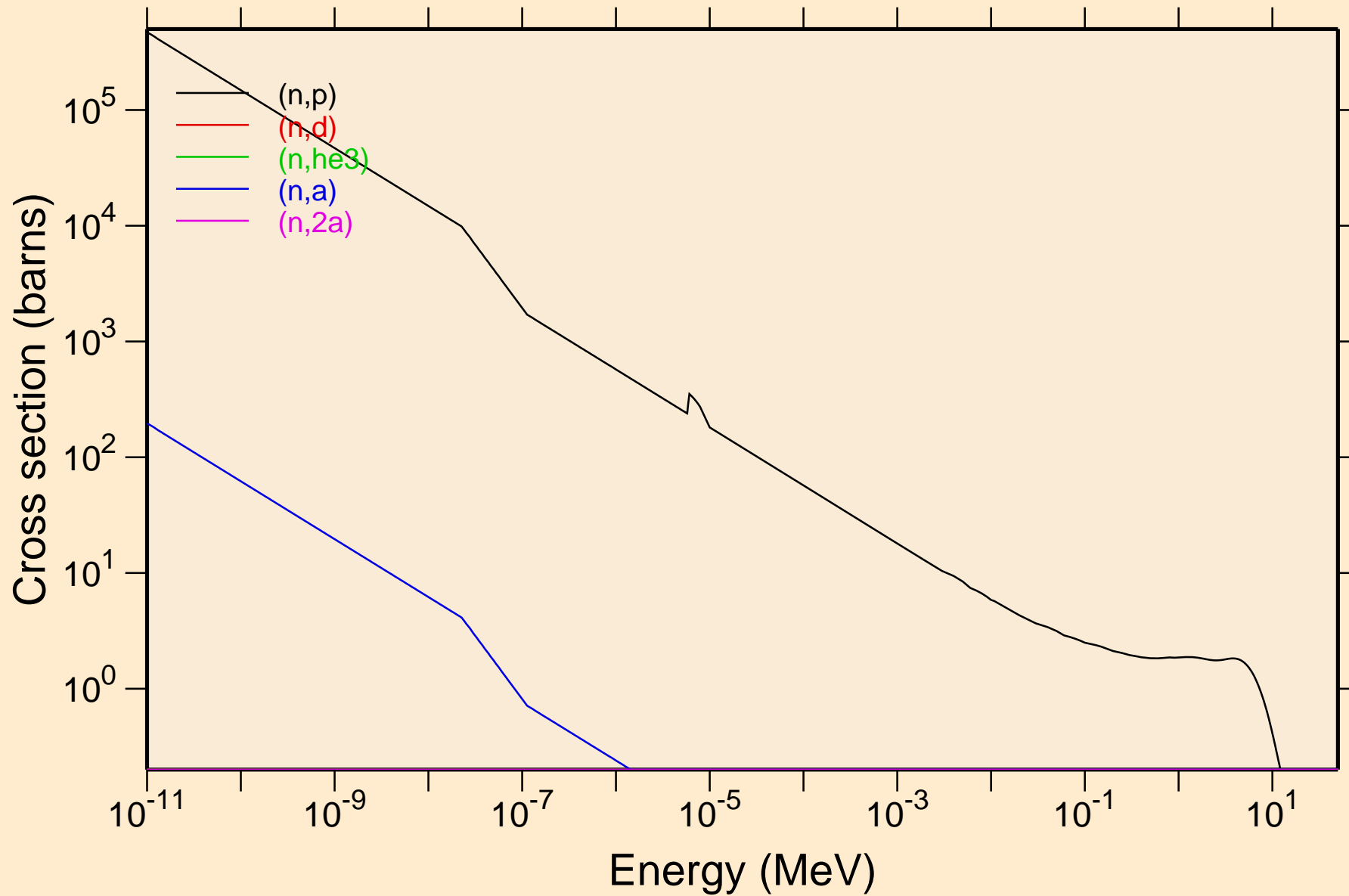

LA121 NEUTRON ACER TENDL-2023 LIBRARY; T=0.K
Non-threshold reactions

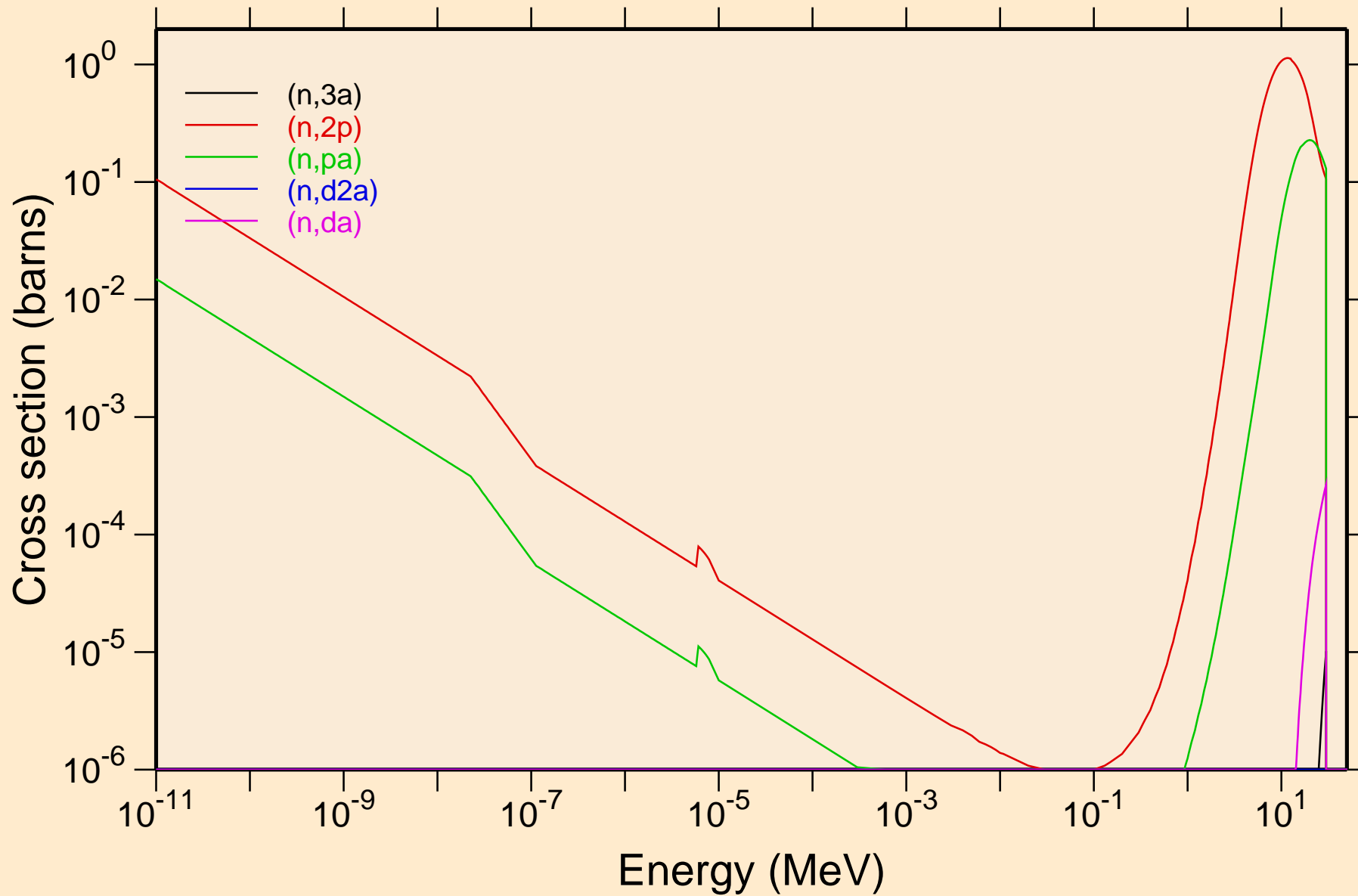

LA121 NEUTRON ACER TENDL-2023 LIBRARY; T=0.K
Non-threshold reactions

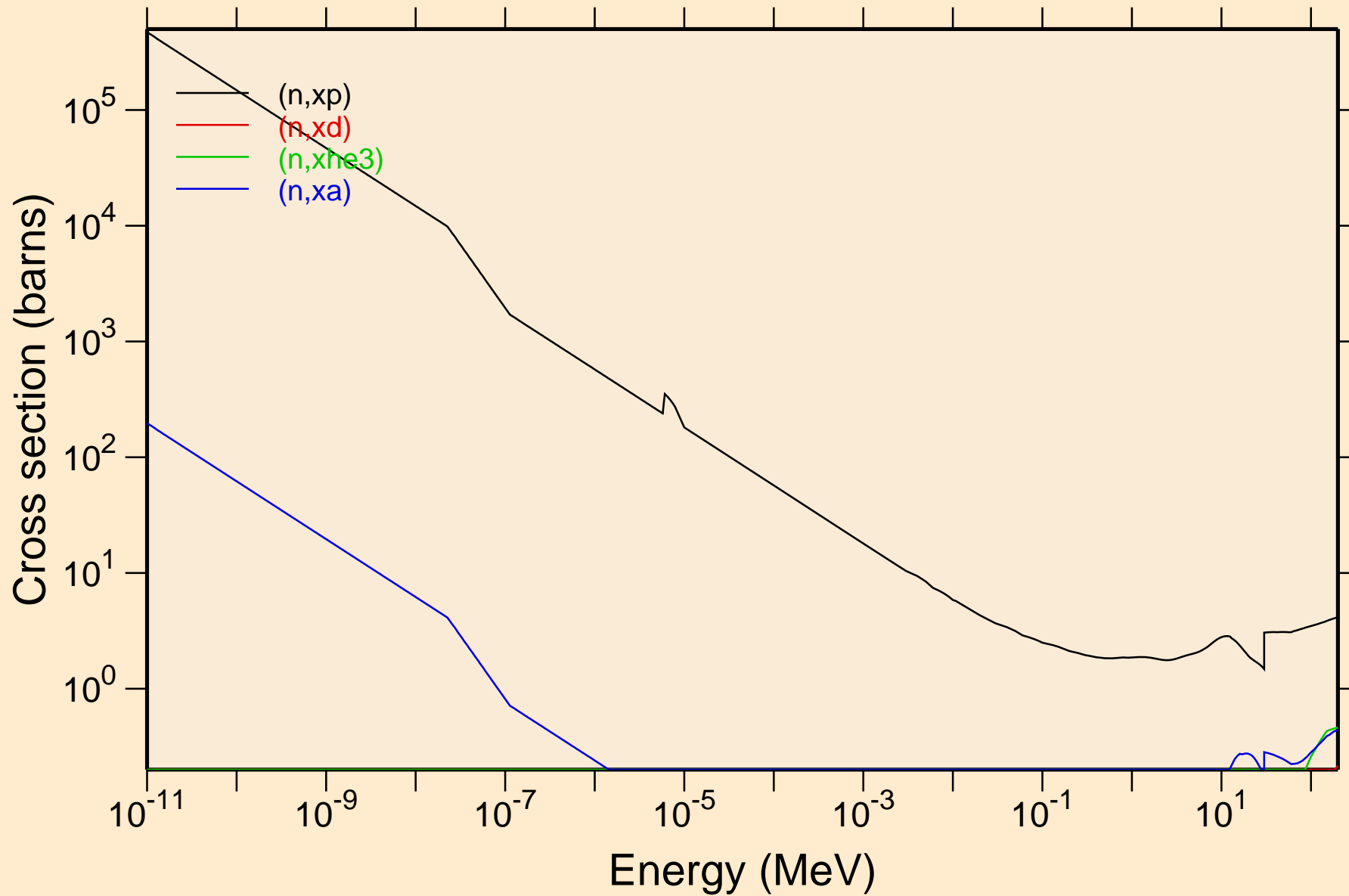

LA121 NEUTRON ACER TENDL-2023 LIBRARY; T=0.K

Principal cross sections

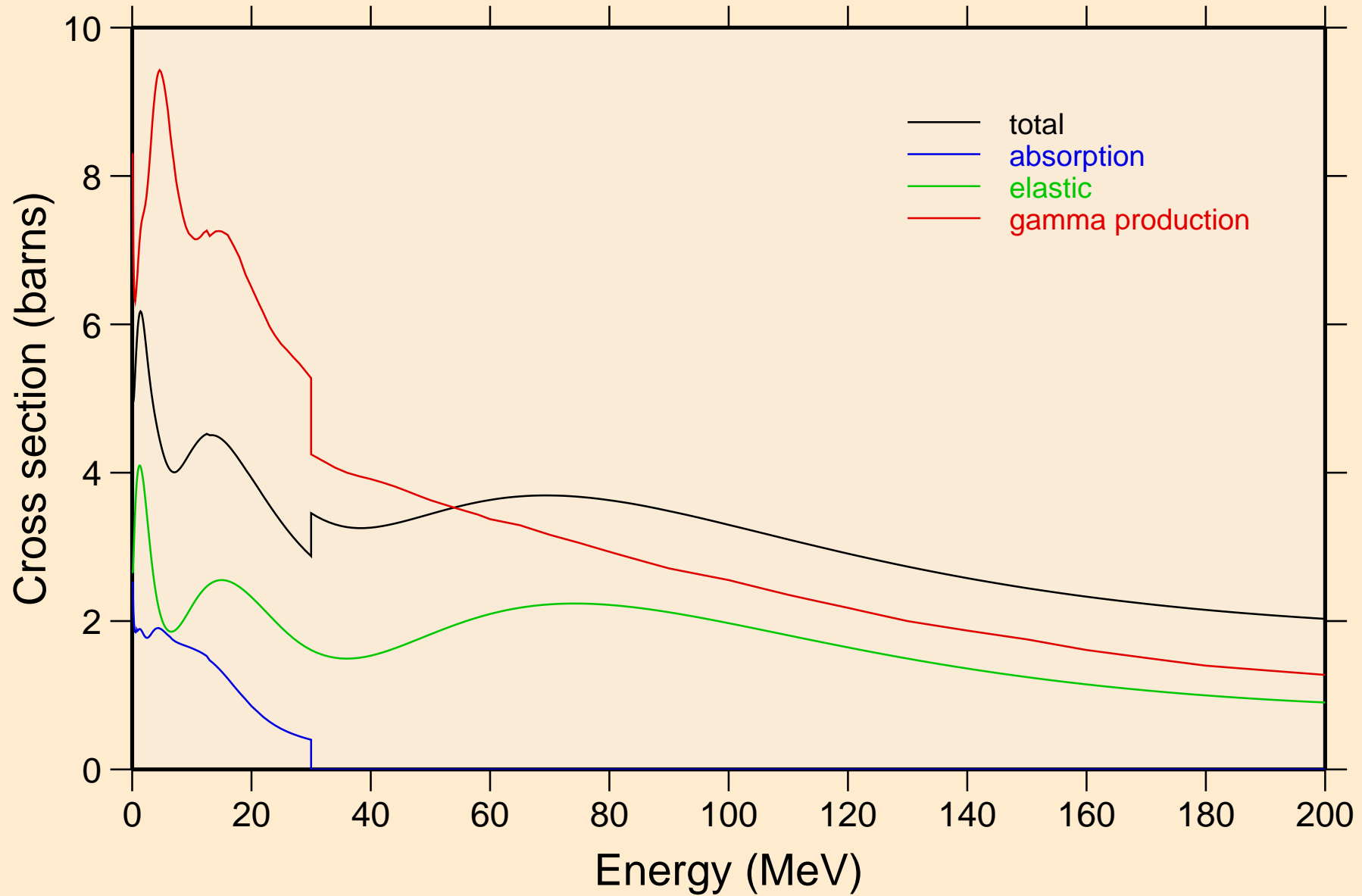

LA121 NEUTRON ACER TENDL-2023 LIBRARY; T=0.K

Heating

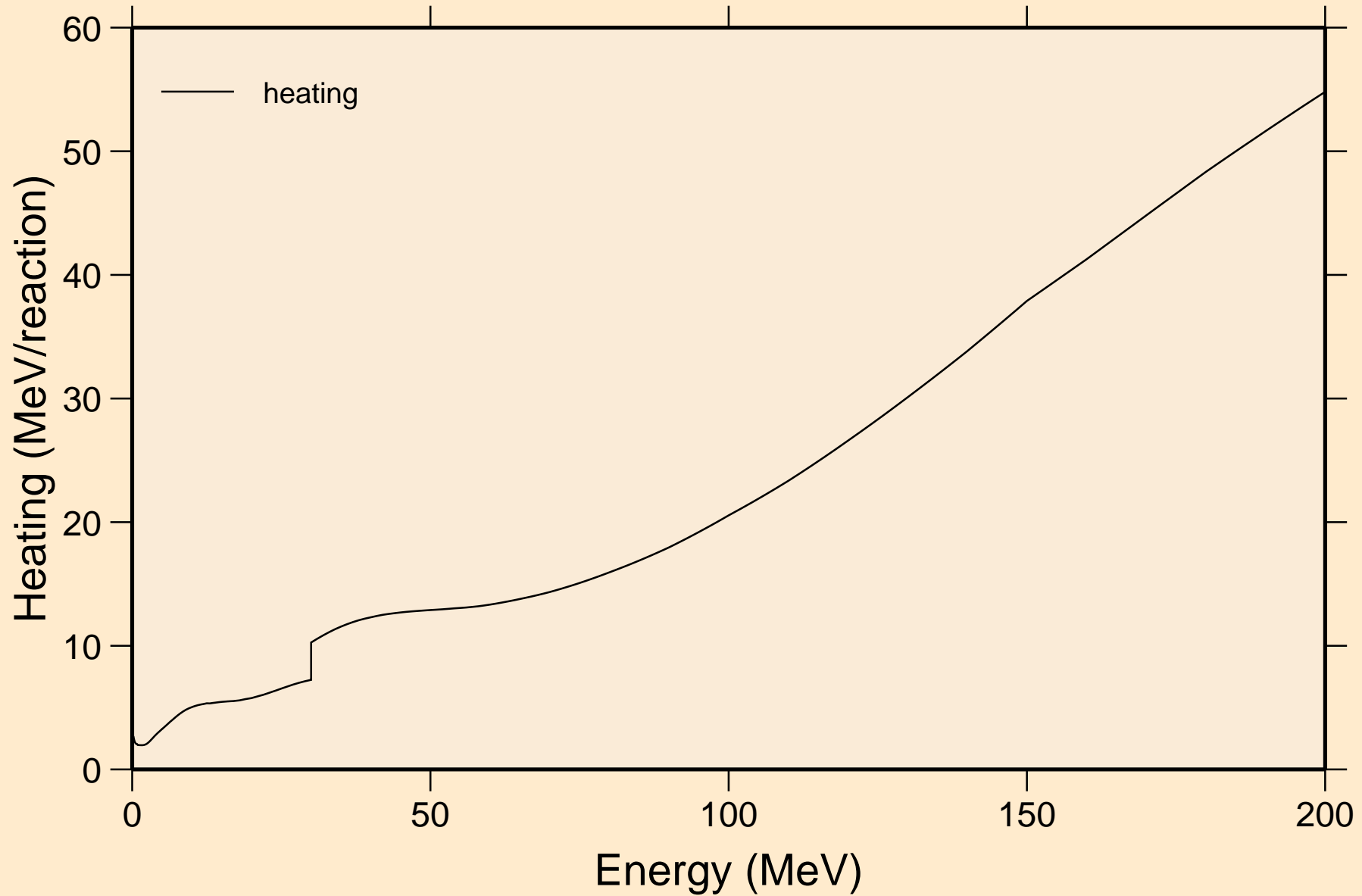

LA121 NEUTRON ACER TENDL-2023 LIBRARY; T=0.K
Damage

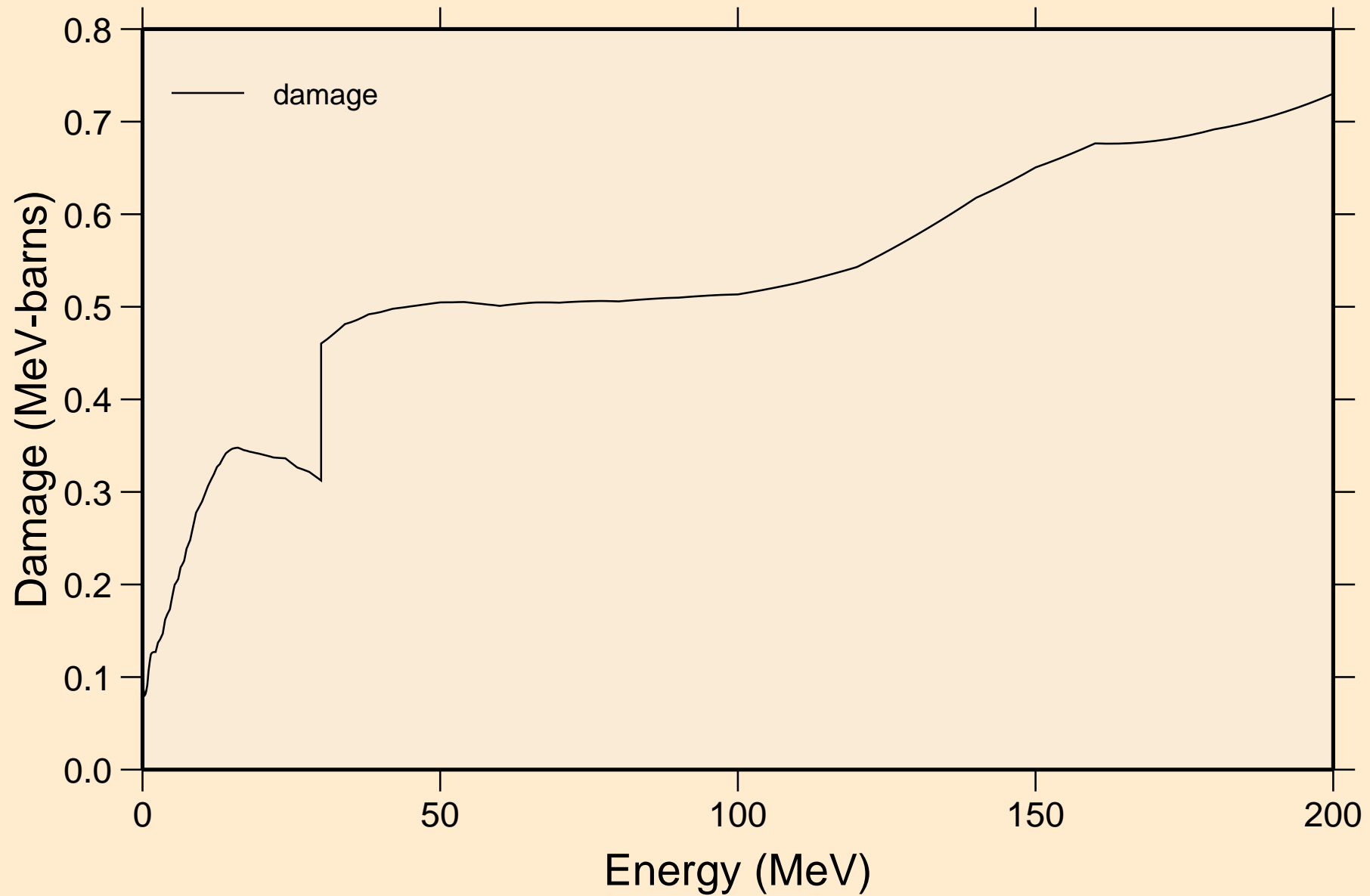

LA121 NEUTRON ACER TENDL-2023 LIBRARY; T=0.K
Non-threshold reactions

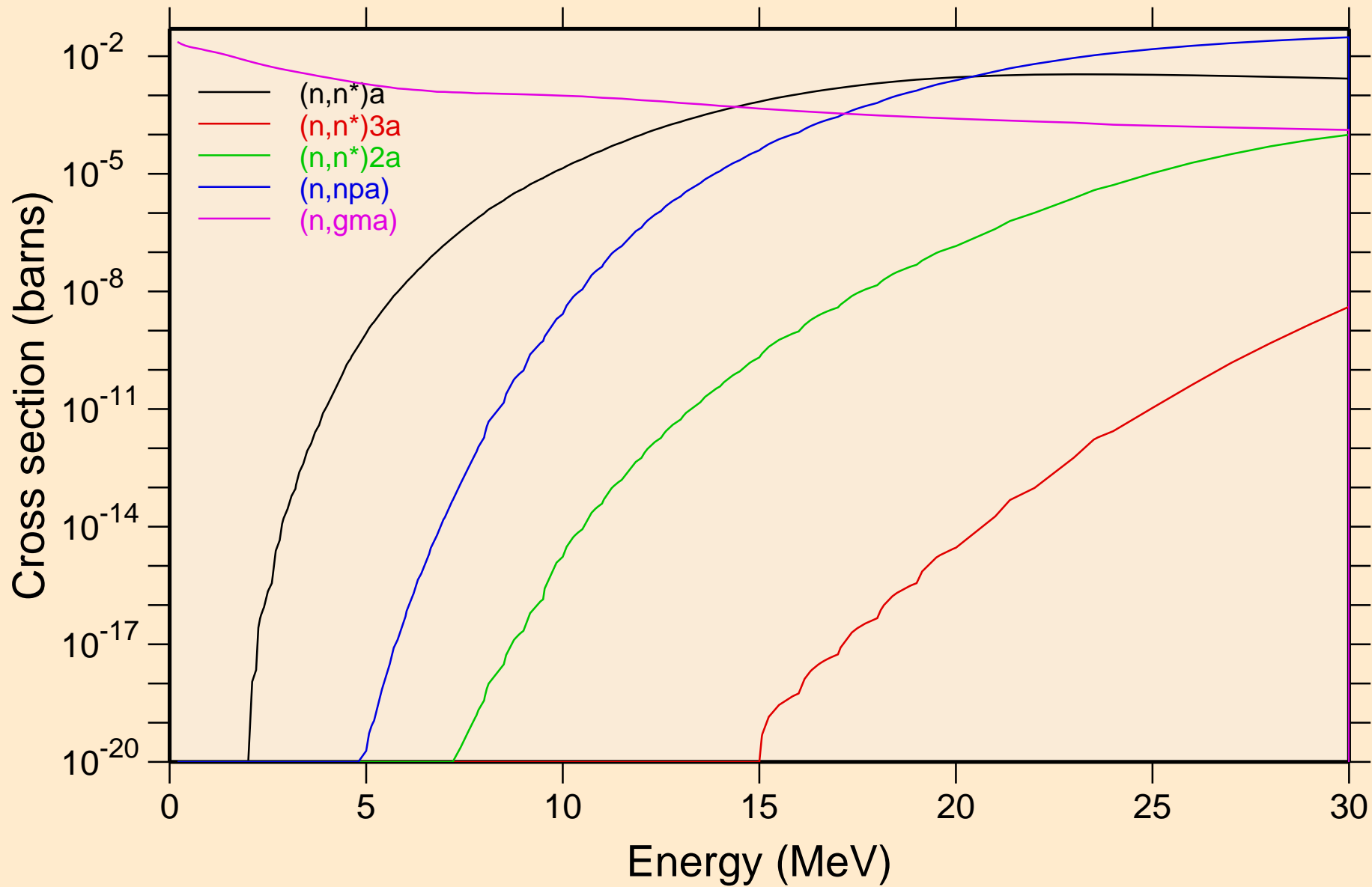

LA121 NEUTRON ACER TENDL-2023 LIBRARY; T=0.K
Non-threshold reactions

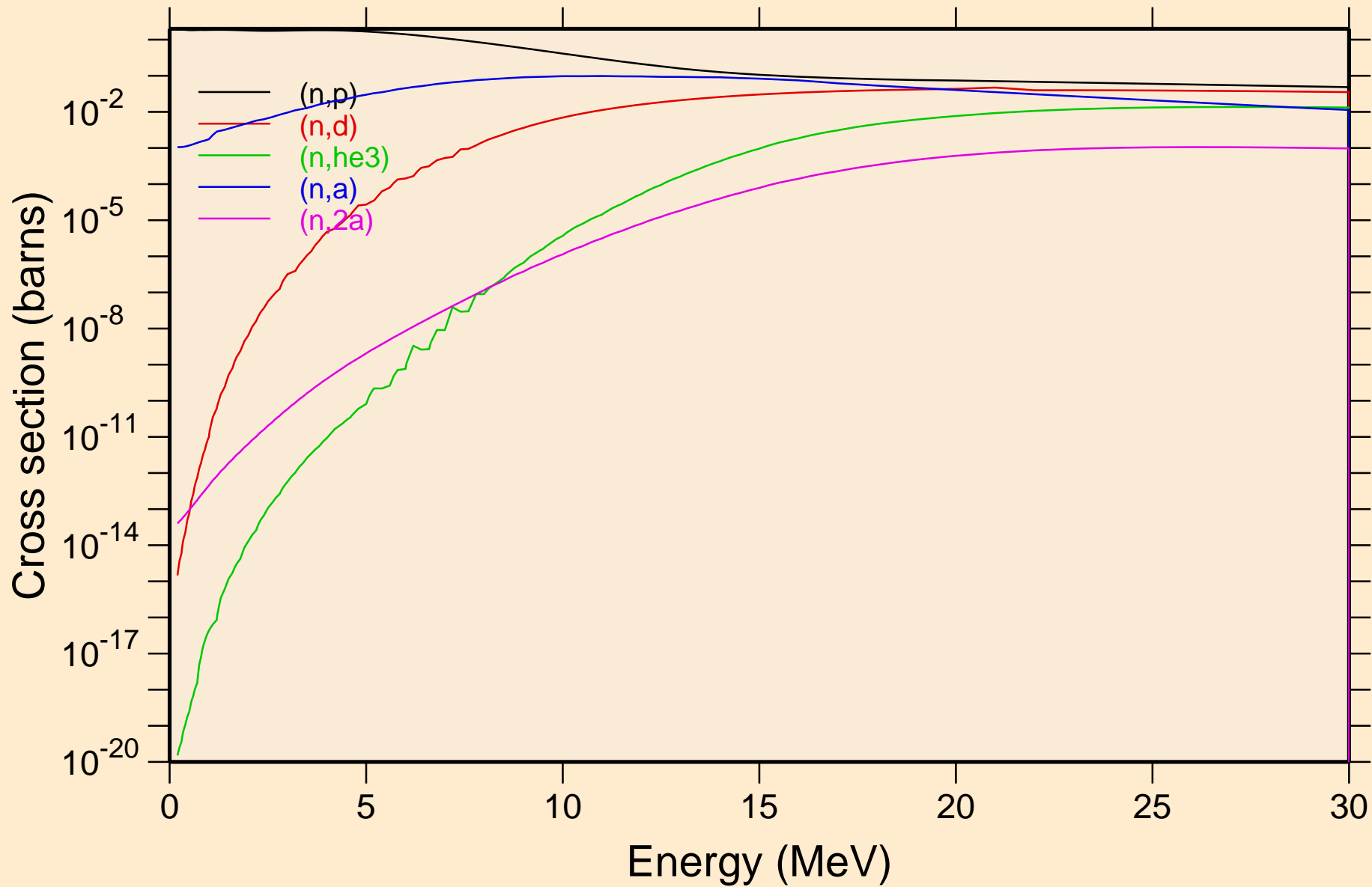

LA121 NEUTRON ACER TENDL-2023 LIBRARY; T=0.K
Non-threshold reactions

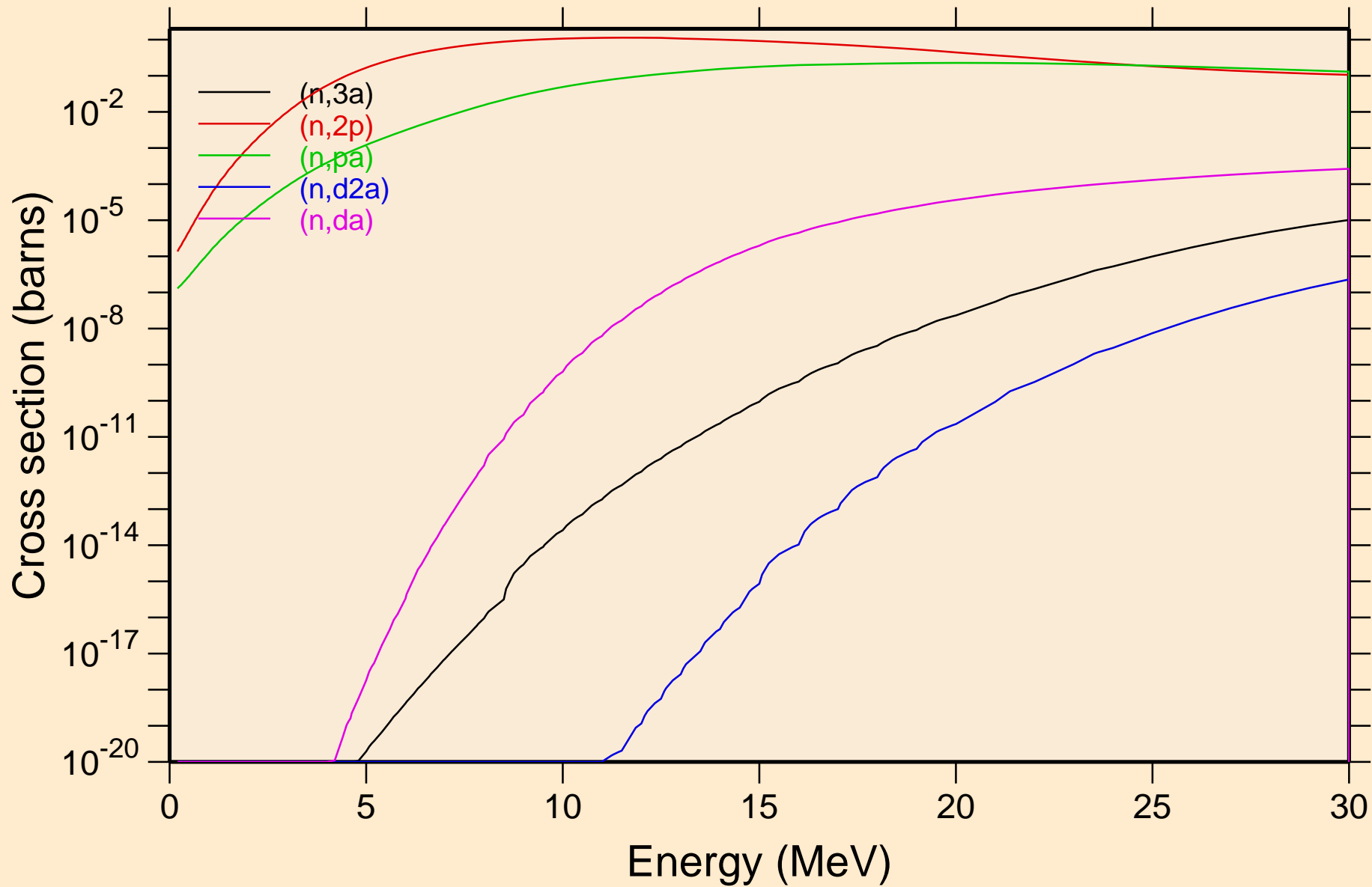

LA121 NEUTRON ACER TENDL-2023 LIBRARY; T=0.K
Non-threshold reactions

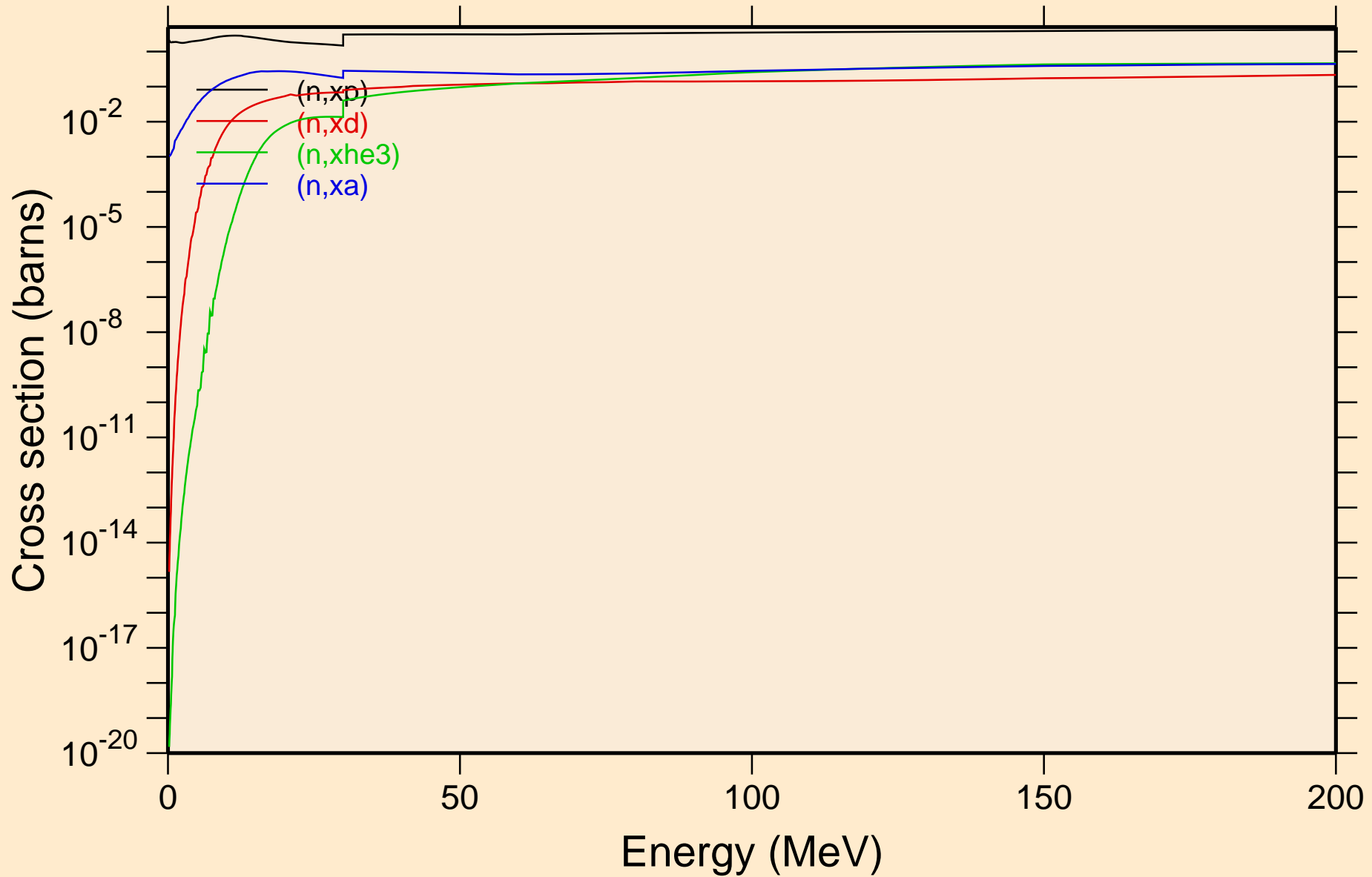

LA121 NEUTRON ACER TENDL-2023 LIBRARY; T=0.K
Inelastic levels

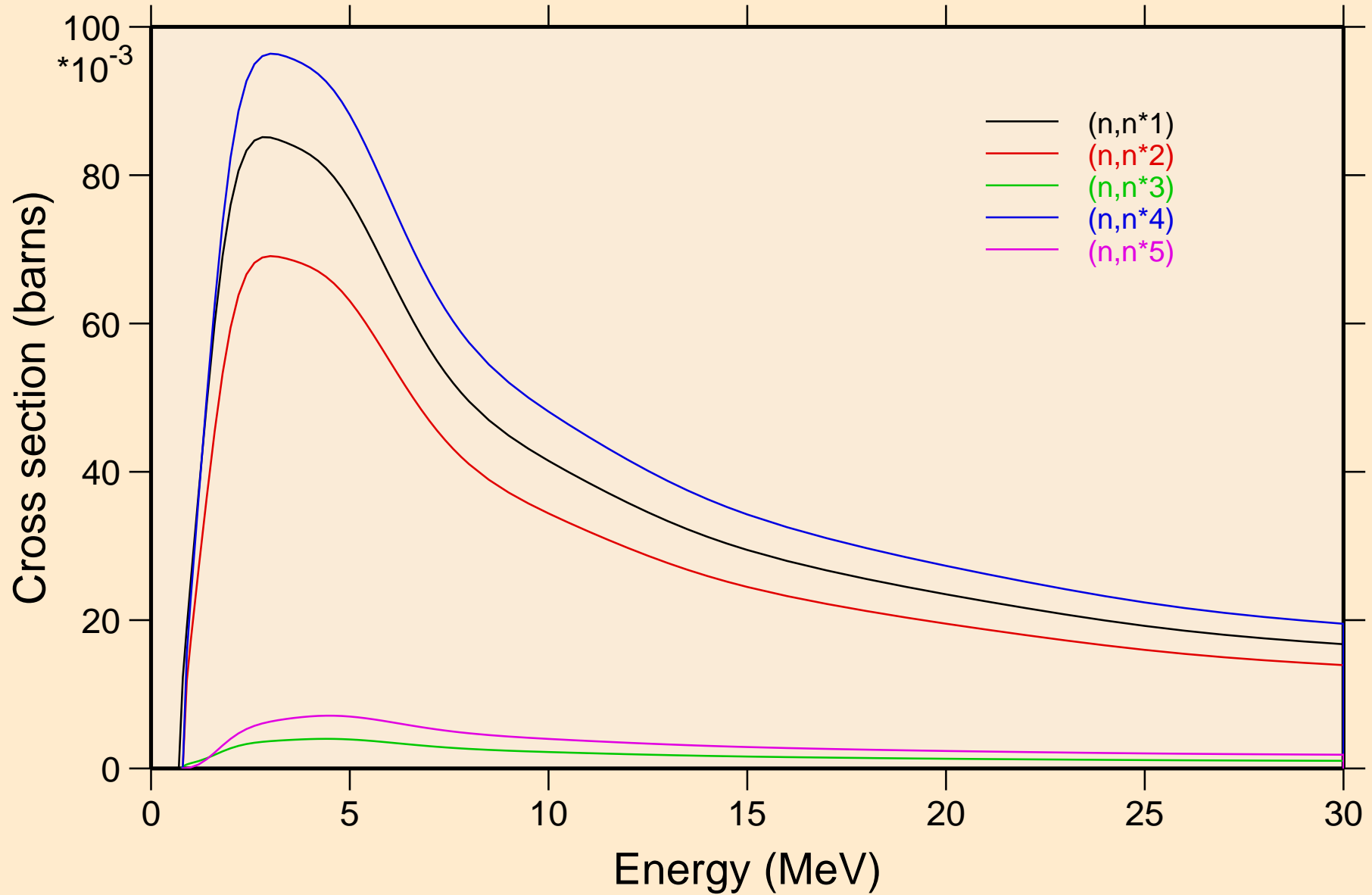

LA121 NEUTRON ACER TENDL-2023 LIBRARY; T=0.K
Inelastic levels

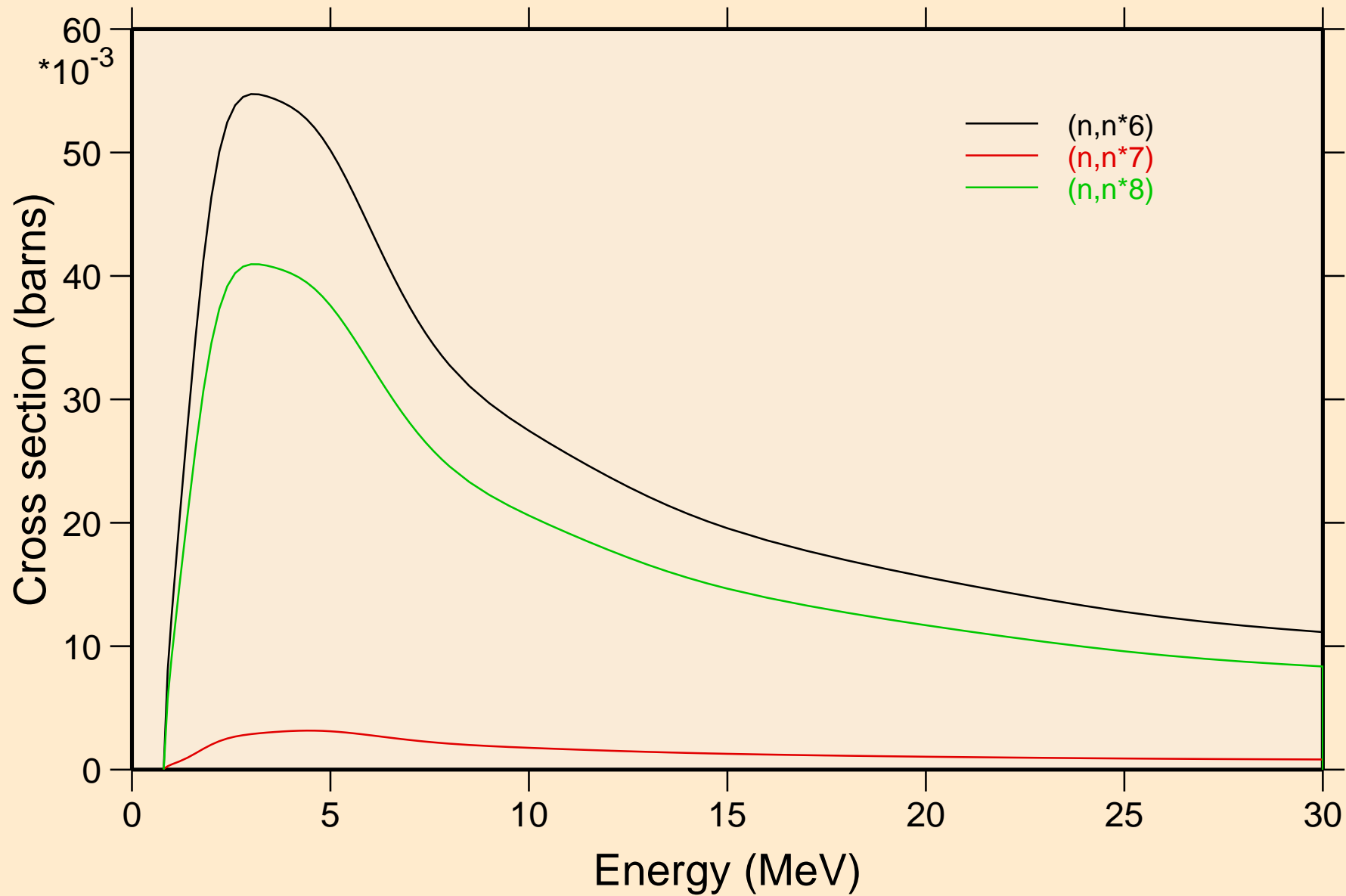

LA121 NEUTRON ACER TENDL-2023 LIBRARY; T=0.K

Threshold reactions

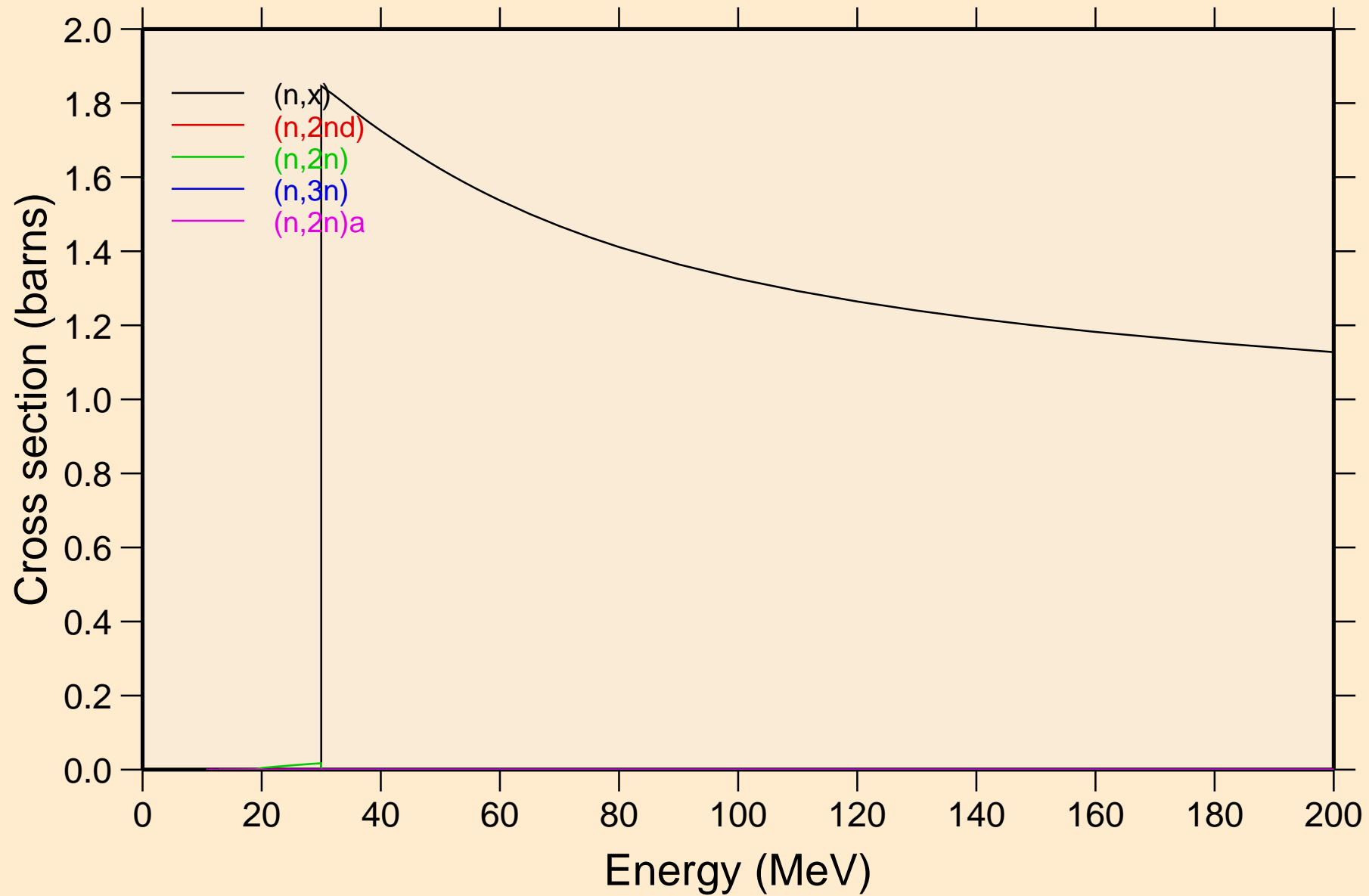

LA121 NEUTRON ACER TENDL-2023 LIBRARY; T=0.K
Threshold reactions

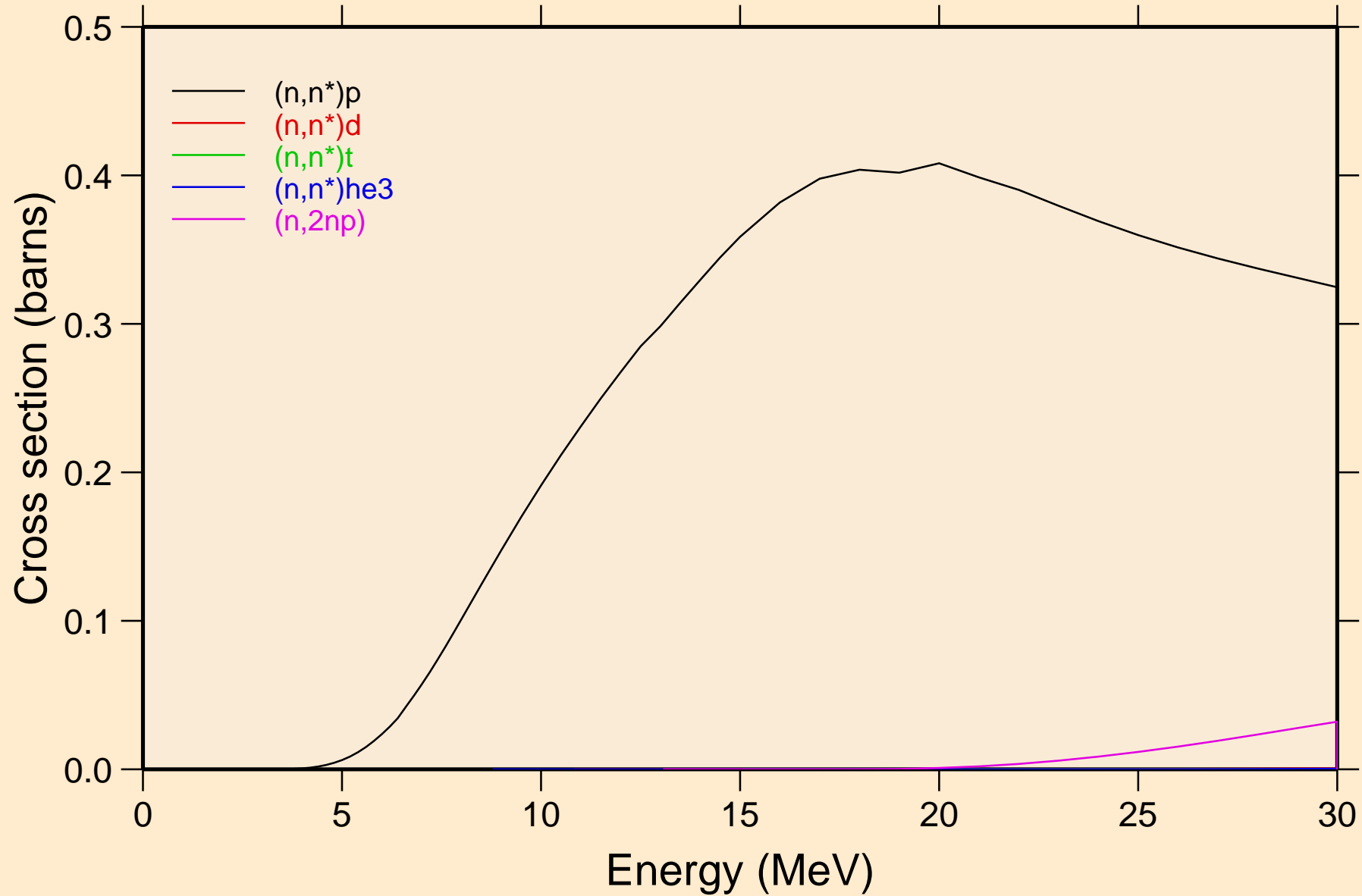

LA121 NEUTRON ACER TENDL-2023 LIBRARY; T=0.K
Threshold reactions

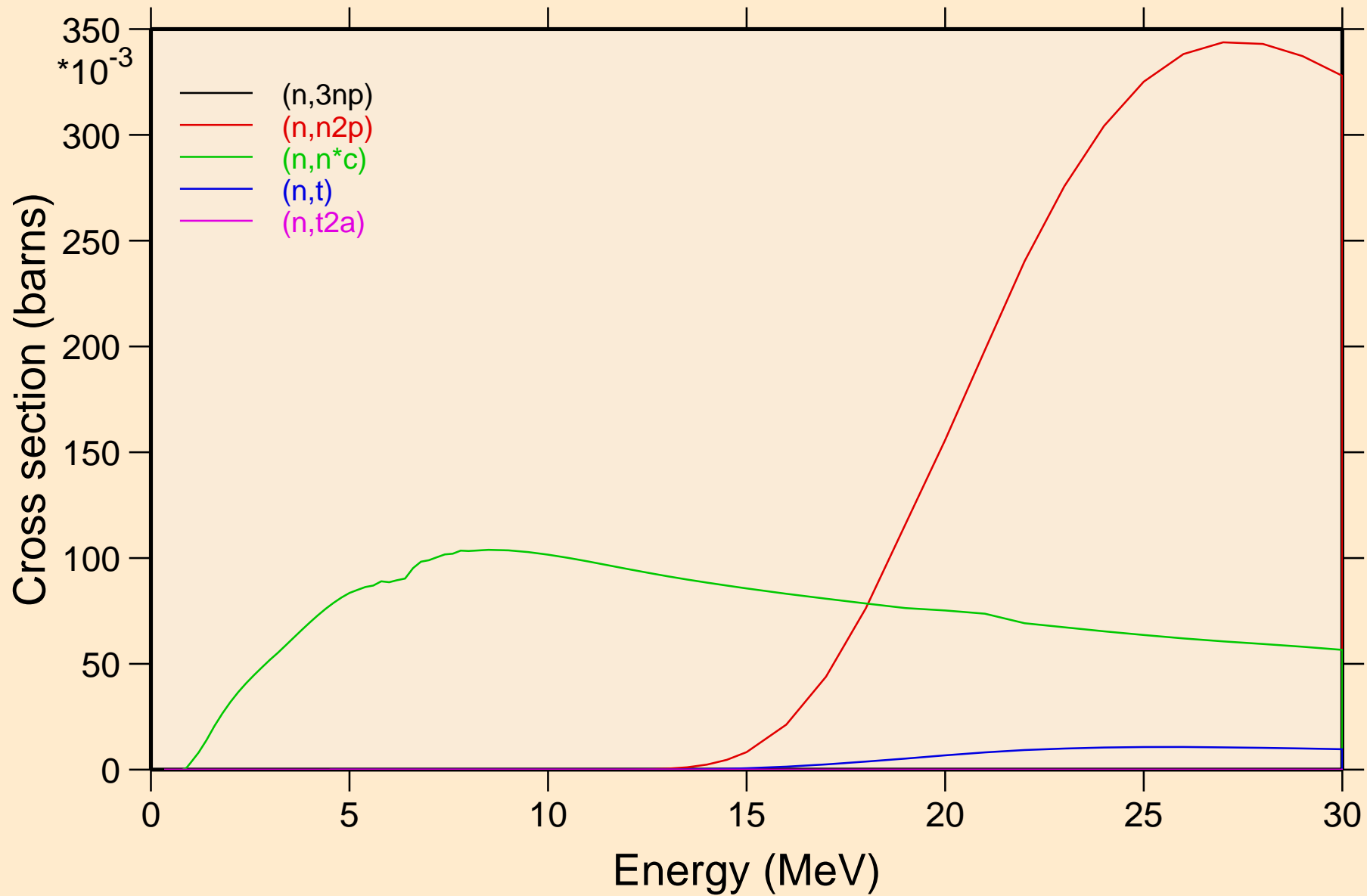

LA121 NEUTRON ACER TENDL-2023 LIBRARY; T=0.K
Threshold reactions

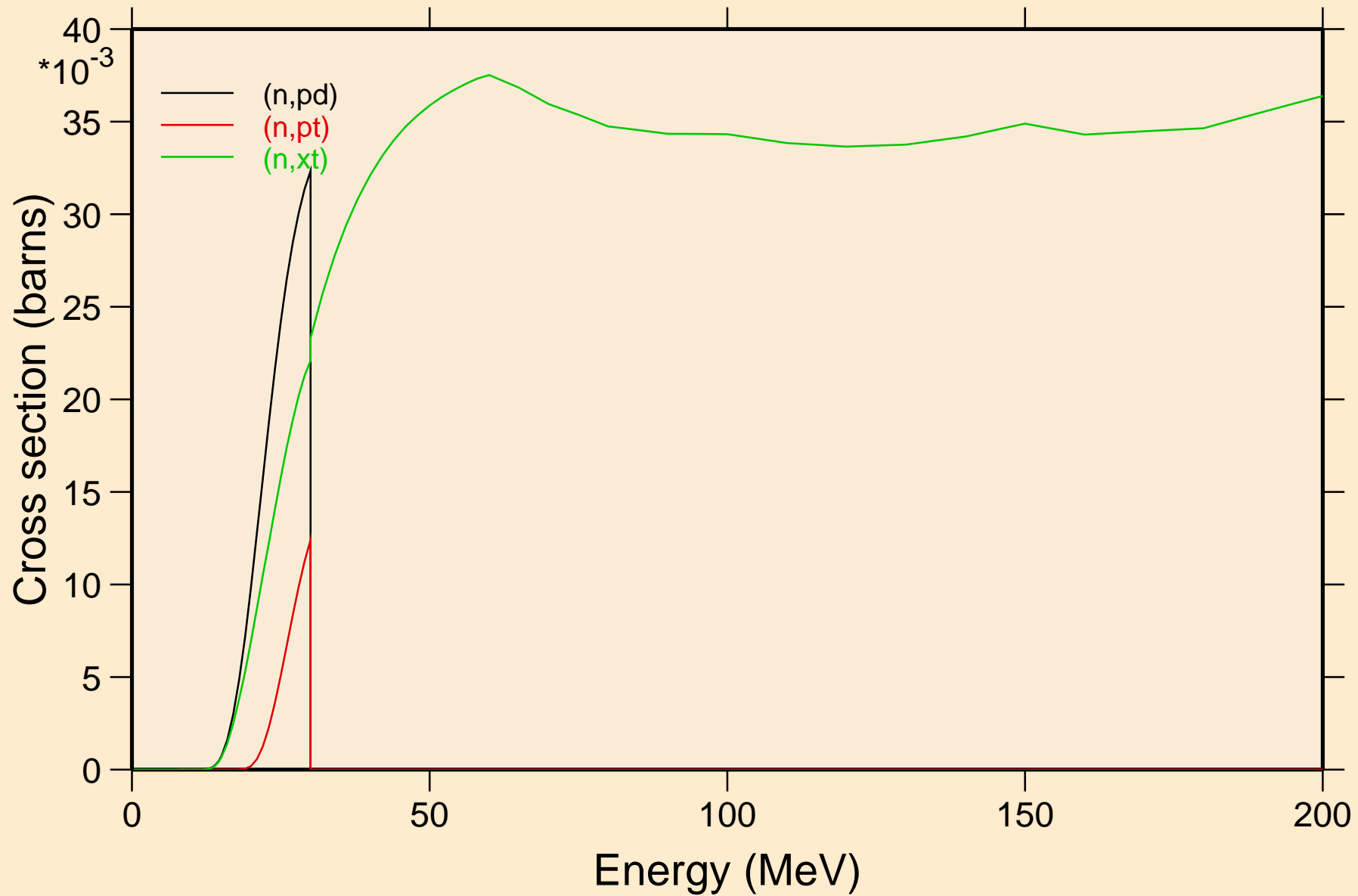

LA121 NEUTRON ACER TENDL-2023 LIBRARY; T=0.K
angular distribution for elastic

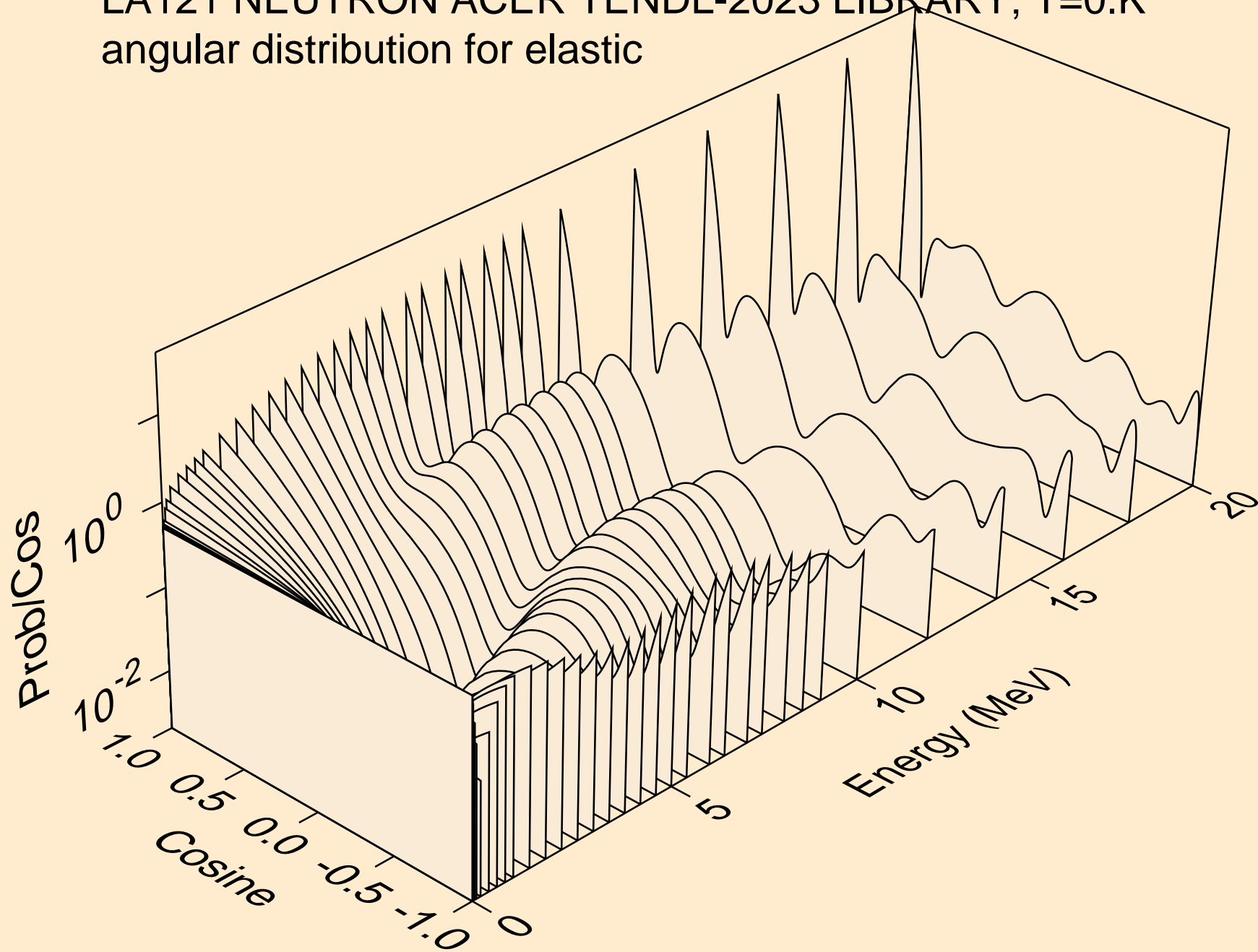

LA121 NEUTRON ACER TENDL-2023 LIBRARY; T=0.K
angular distribution for elastic

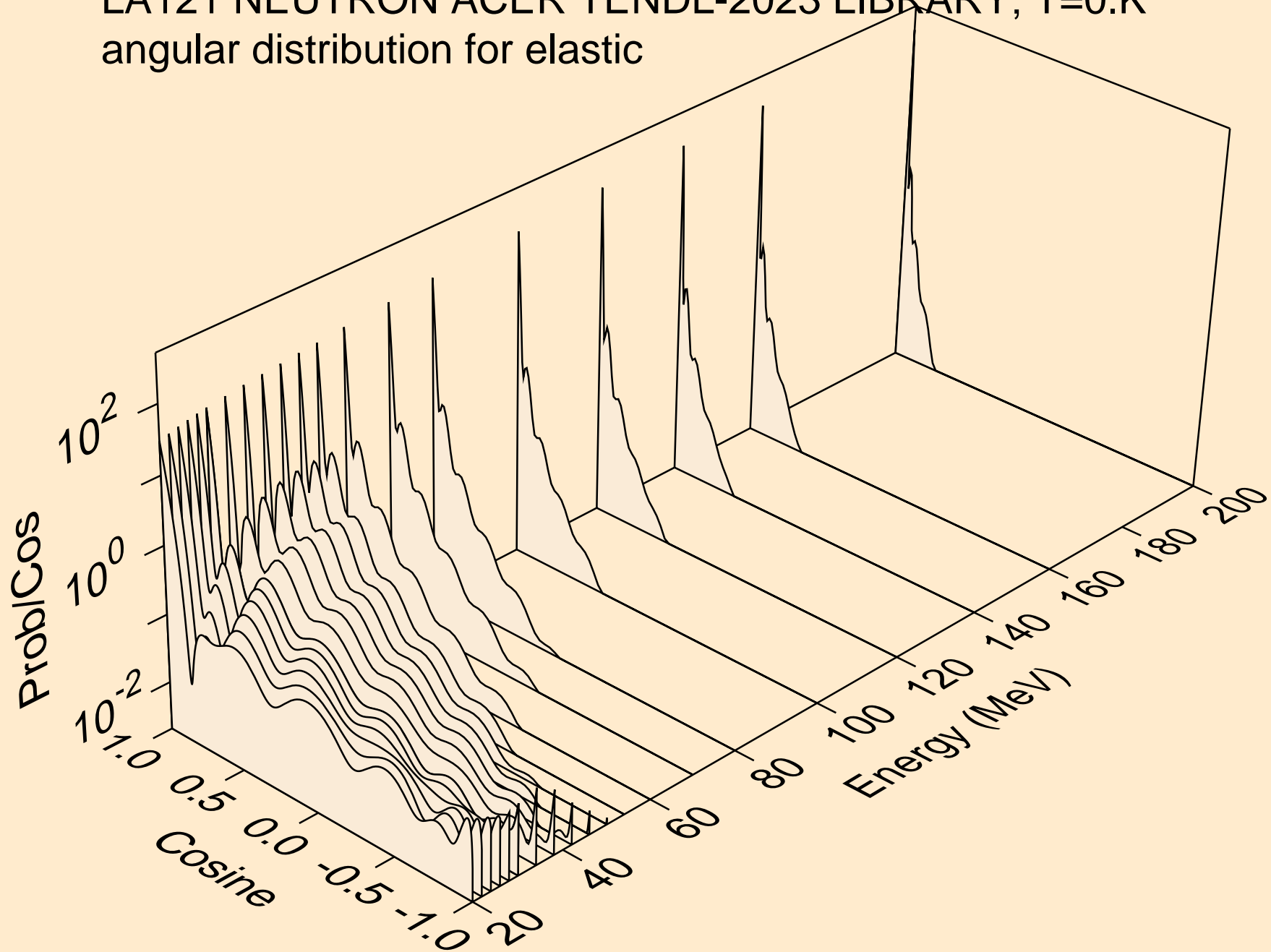

LA121 NEUTRON ACER TENDL-2023 LIBRARY; T=0.K
angular distribution for (n,n*1)

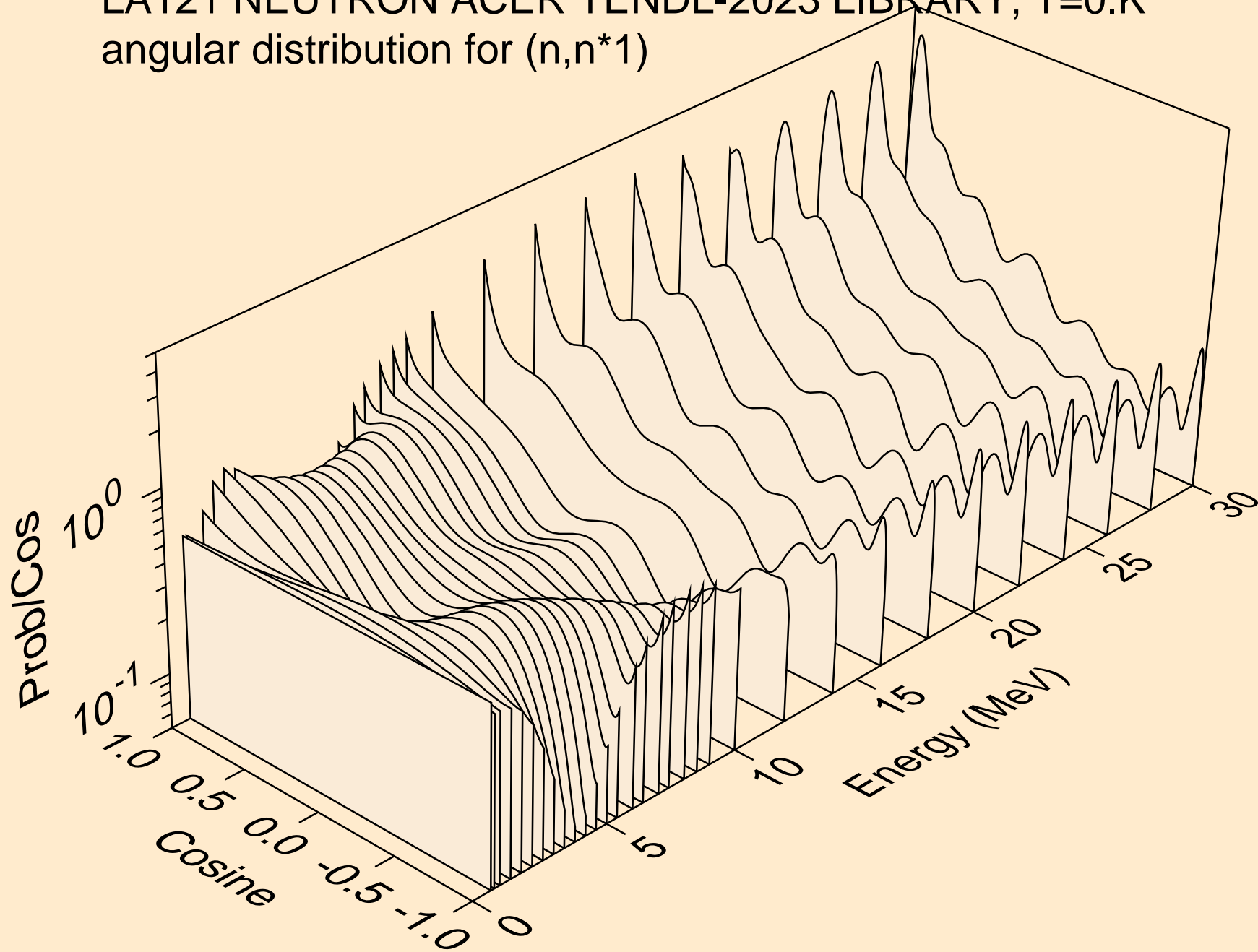

LA121 NEUTRON ACER TENDL-2023 LIBRARY; T=0.K
angular distribution for (n,n*2)

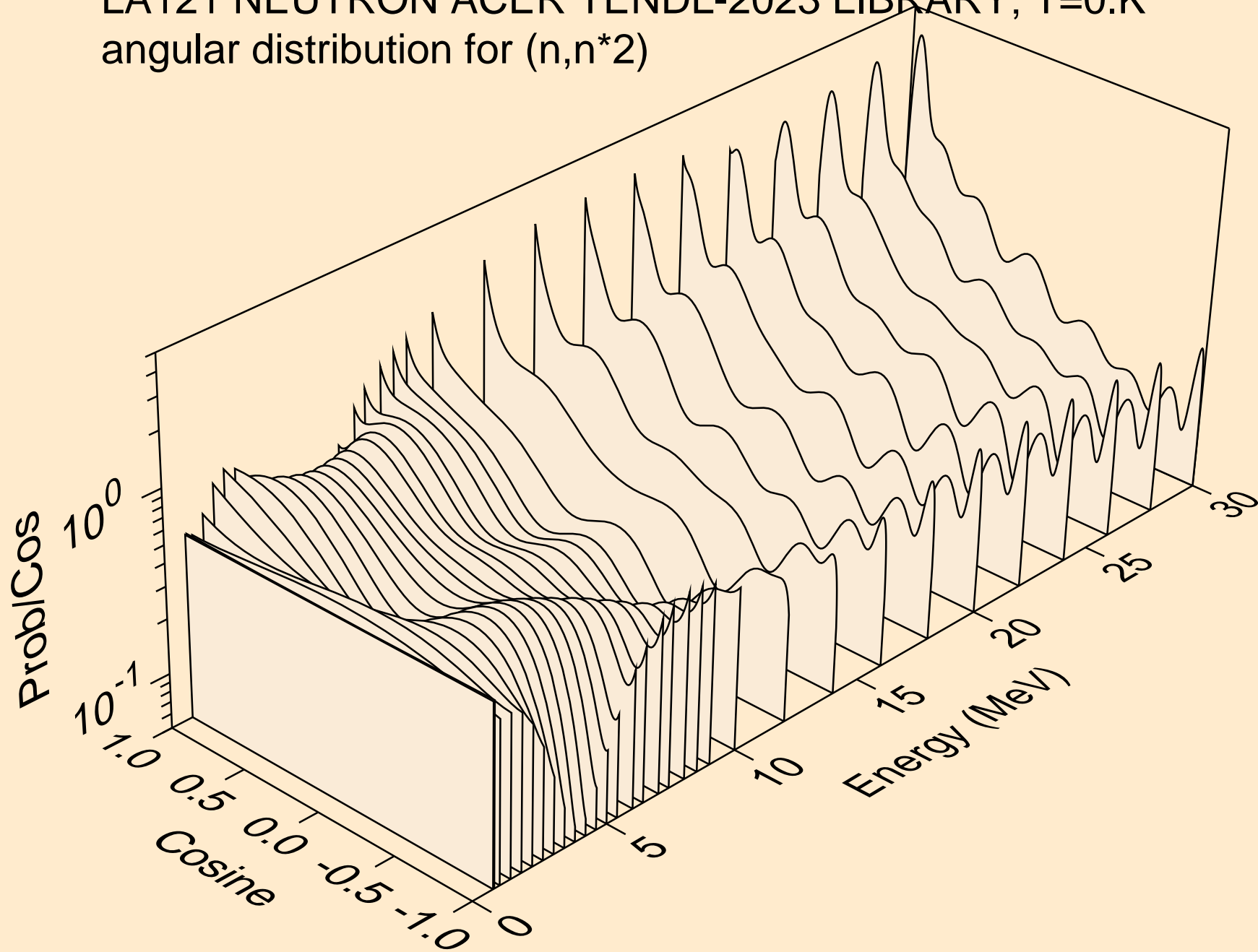

LA121 NEUTRON ACER TENDL-2023 LIBRARY; T=0.K
angular distribution for (n,n*3)

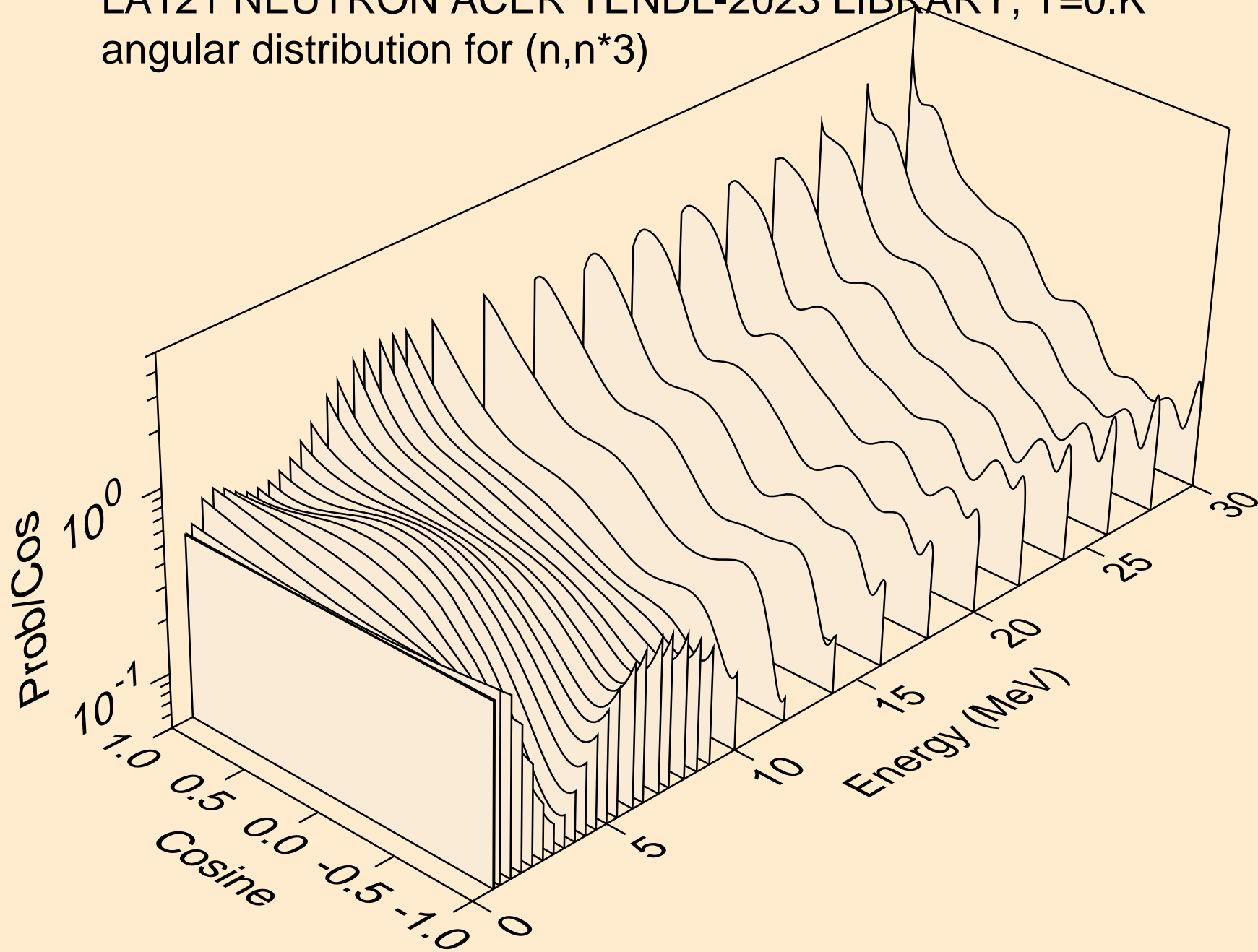

LA121 NEUTRON ACER TENDL-2023 LIBRARY; T=0.K
angular distribution for (n,n*4)

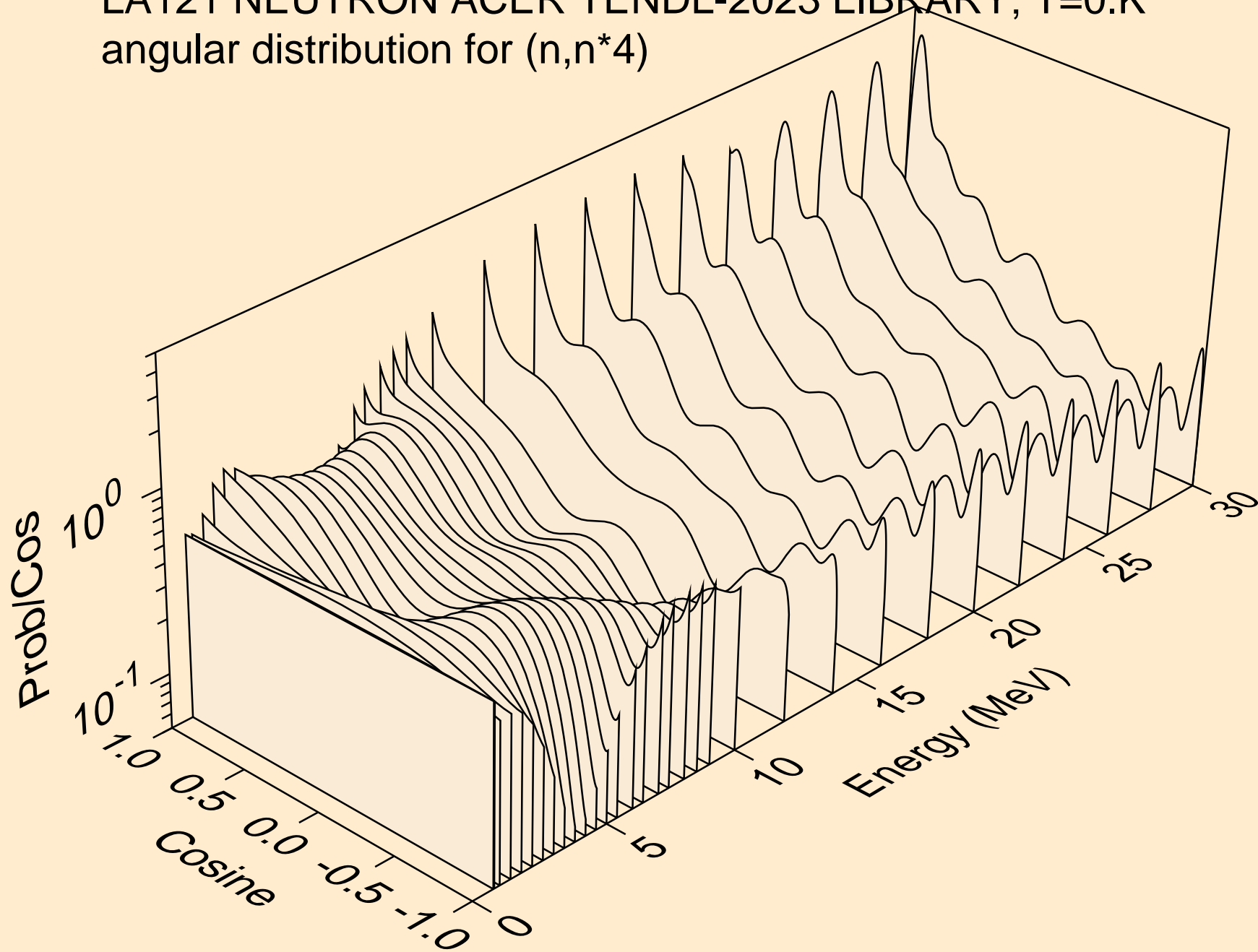

LA121 NEUTRON ACER TENDL-2023 LIBRARY; T=0.K
angular distribution for (n,n*5)

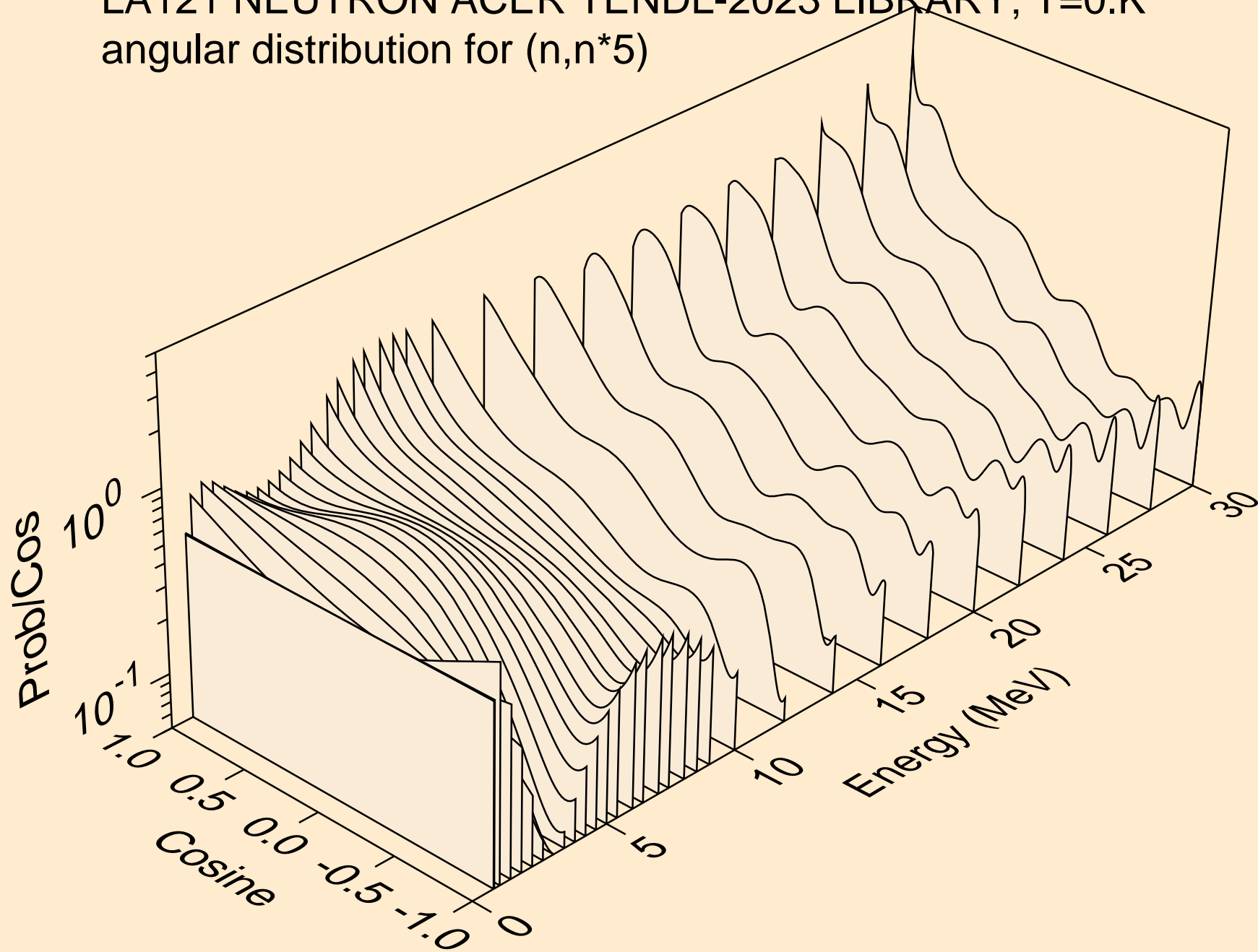

LA121 NEUTRON ACER TENDL-2023 LIBRARY; T=0.K
angular distribution for (n,n*6)

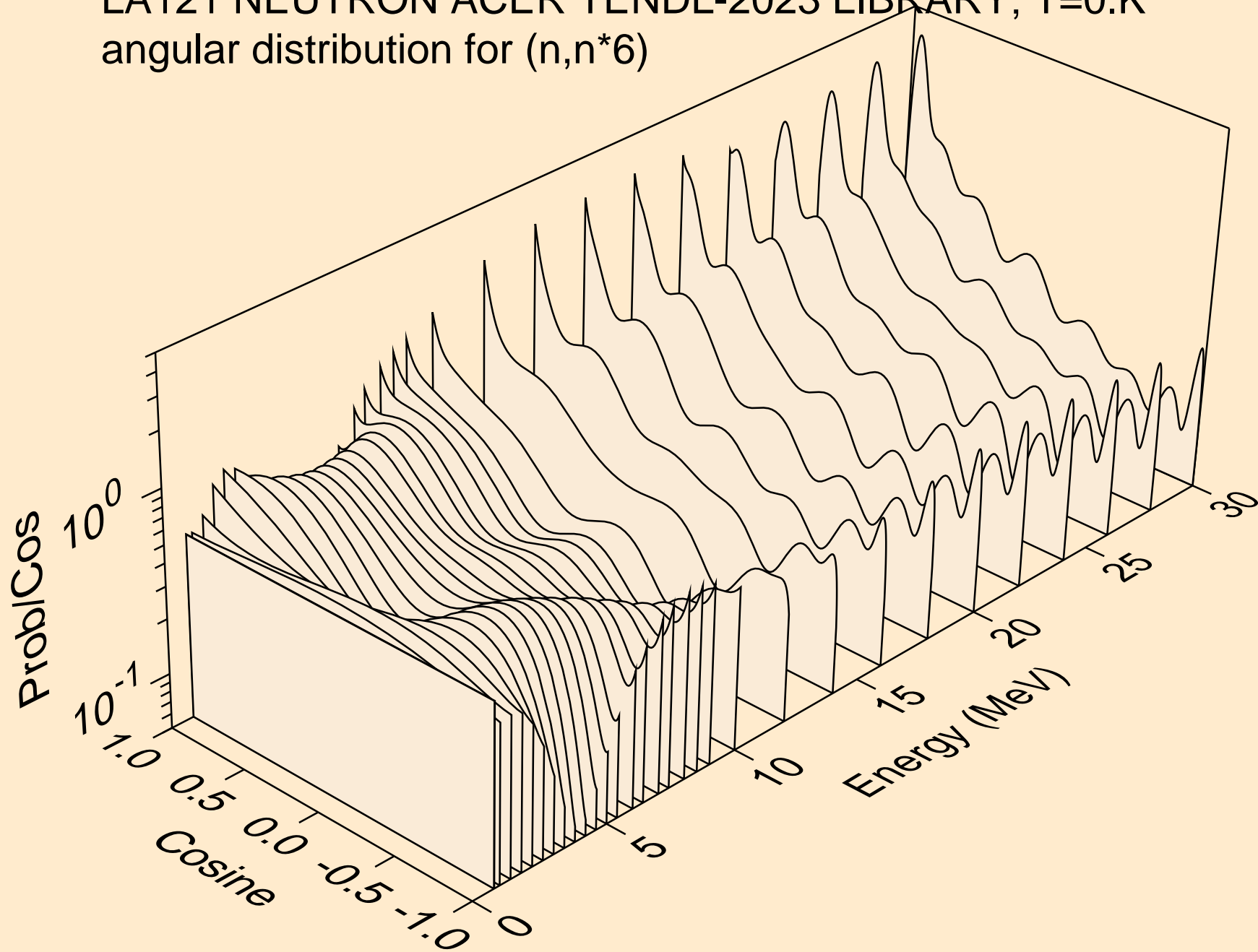

LA121 NEUTRON ACER TENDL-2023 LIBRARY; T=0.K
angular distribution for (n,n*7)

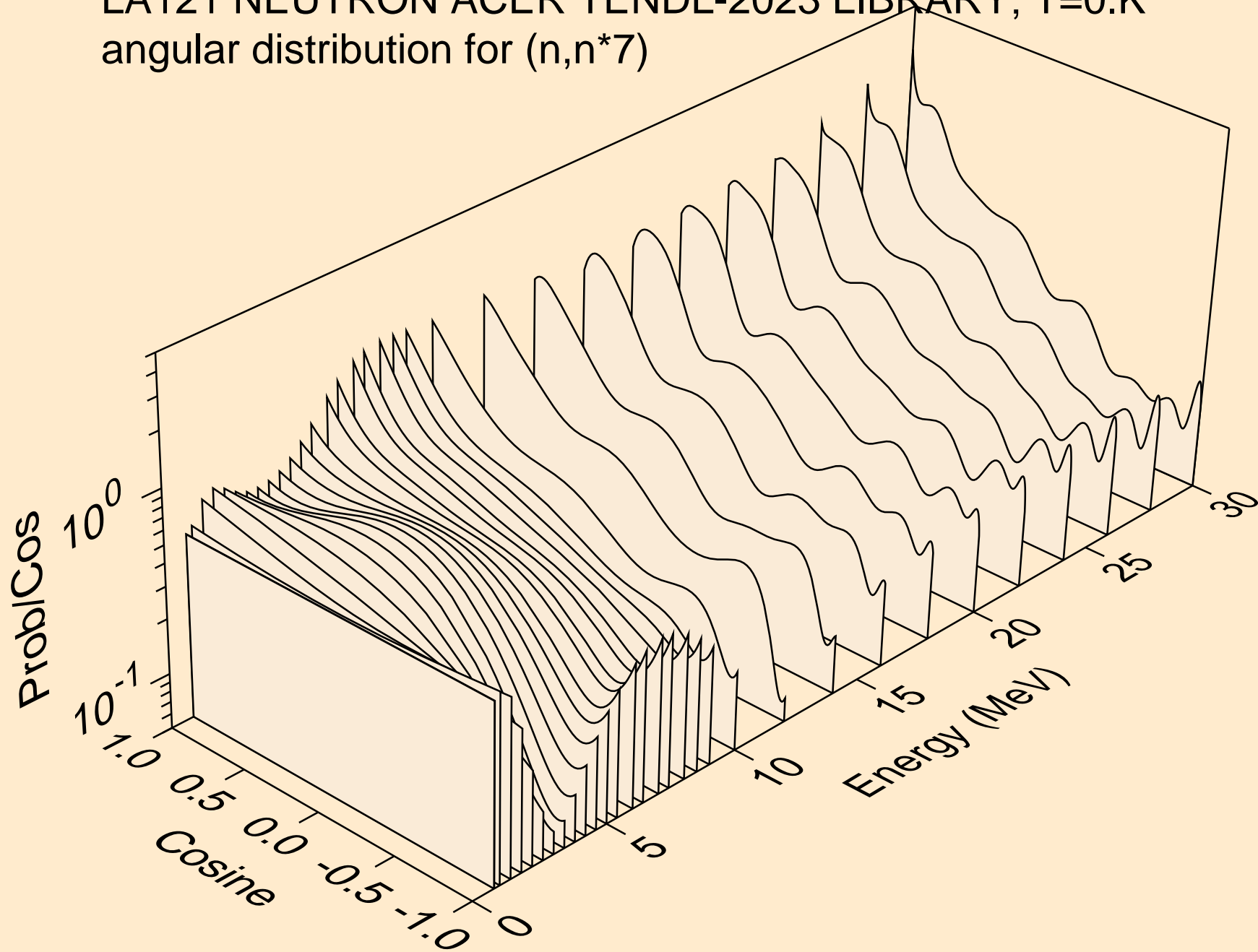

LA121 NEUTRON ACER TENDL-2023 LIBRARY; T=0.K
angular distribution for (n,n*8)

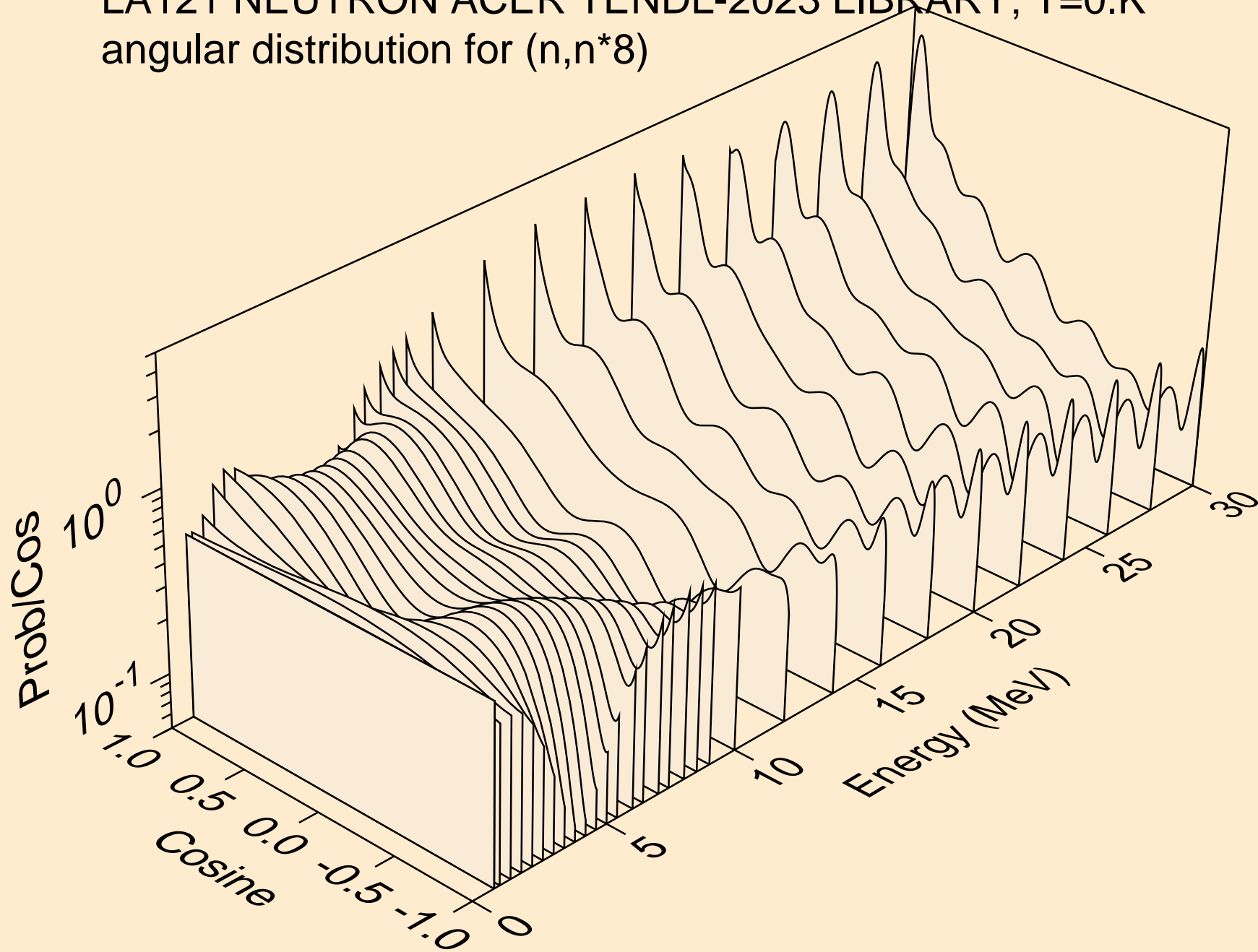

LA121 NEUTRON ACER TENDL-2023 LIBRARY; T=0.K
Neutron emission for (n,x)

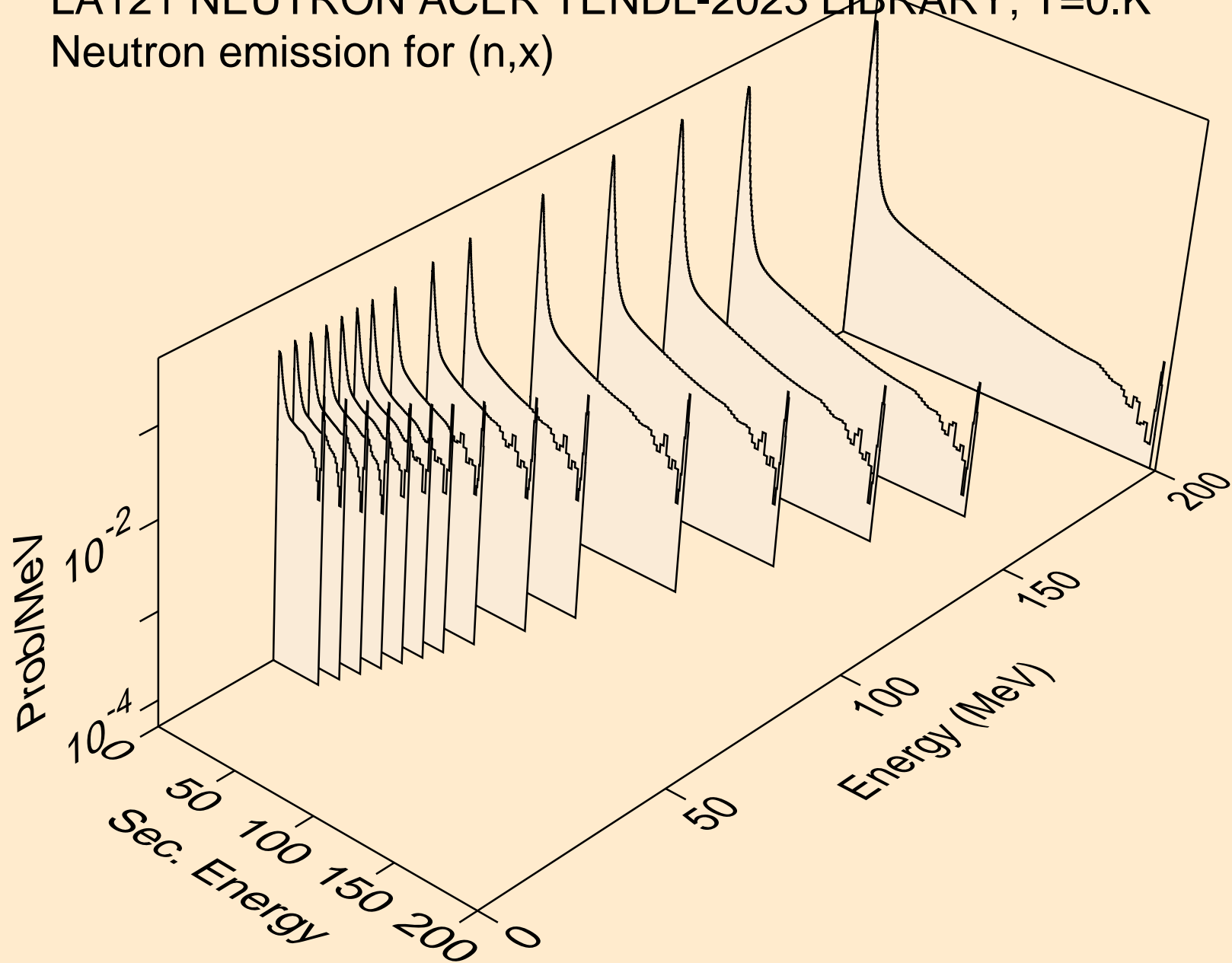

LA121 NEUTRON ACER TENDL-2023 LIBRARY; T=0.K
Neutron emission for (n,2nd)

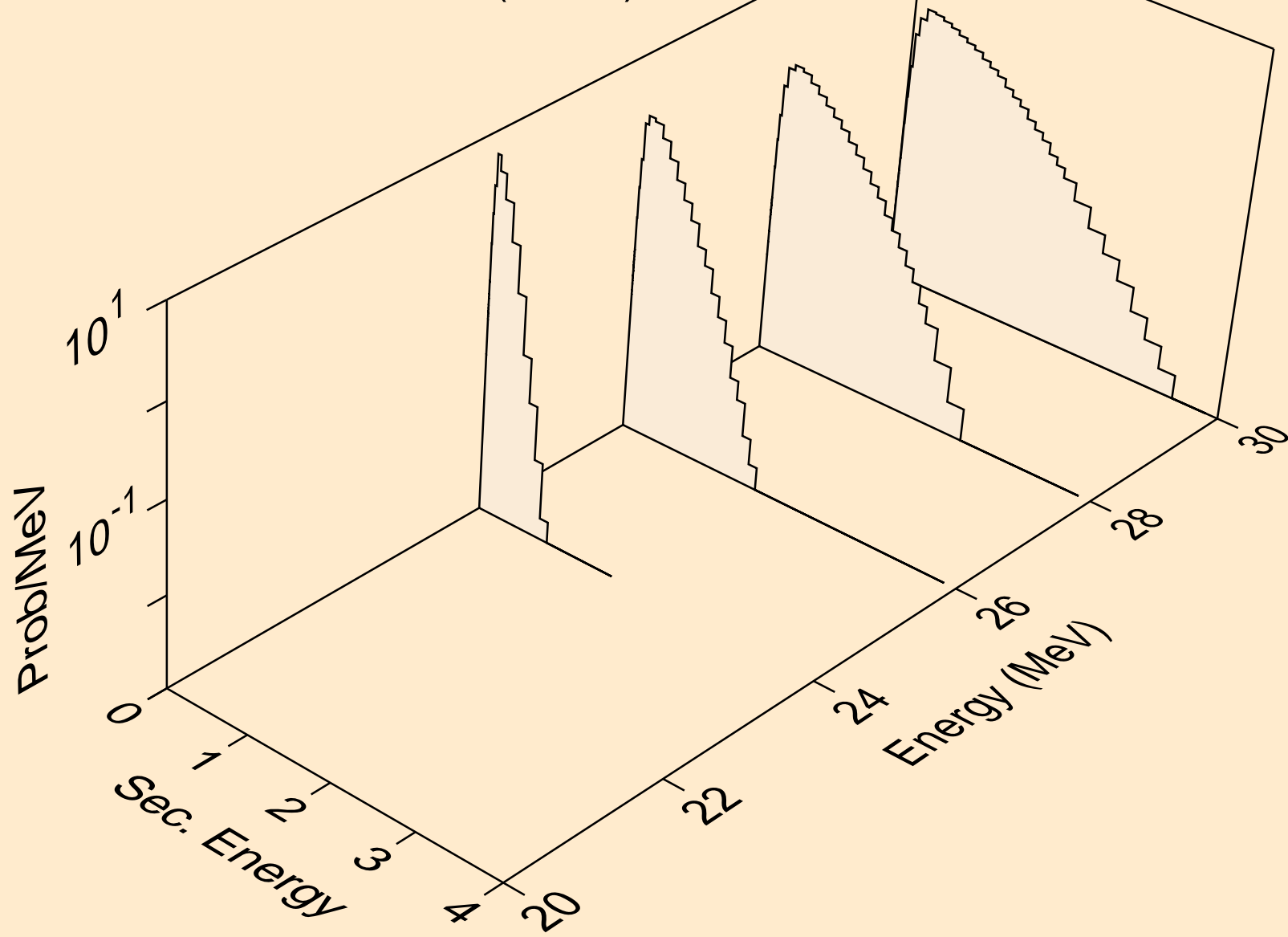

LA121 NEUTRON ACER TENDL-2023 LIBRARY; T=0.K
Neutron emission for (n,2n)

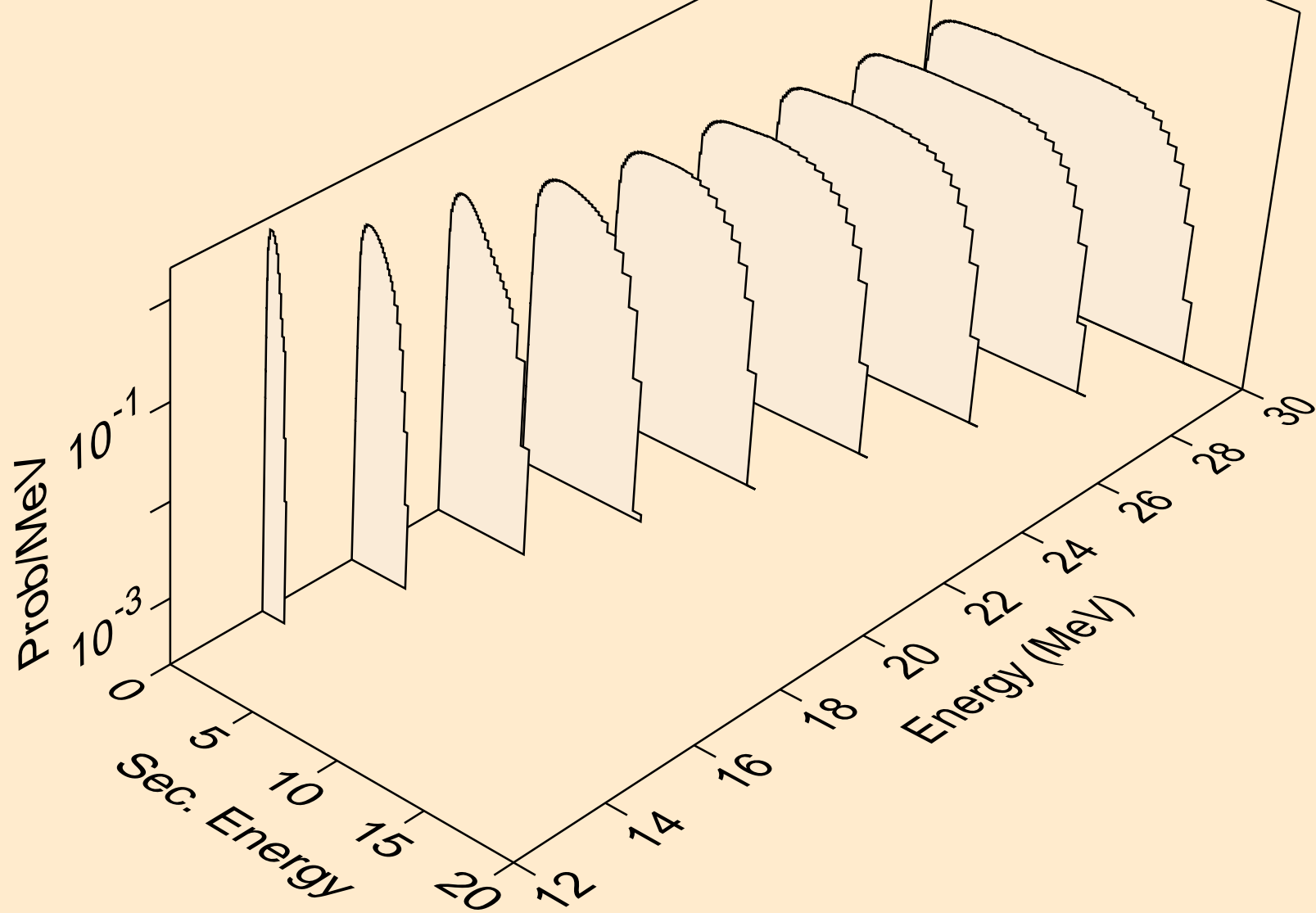

LA121 NEUTRON ACER TENDL-2023 LIBRARY; T=0.K
Neutron emission for (n,3n)

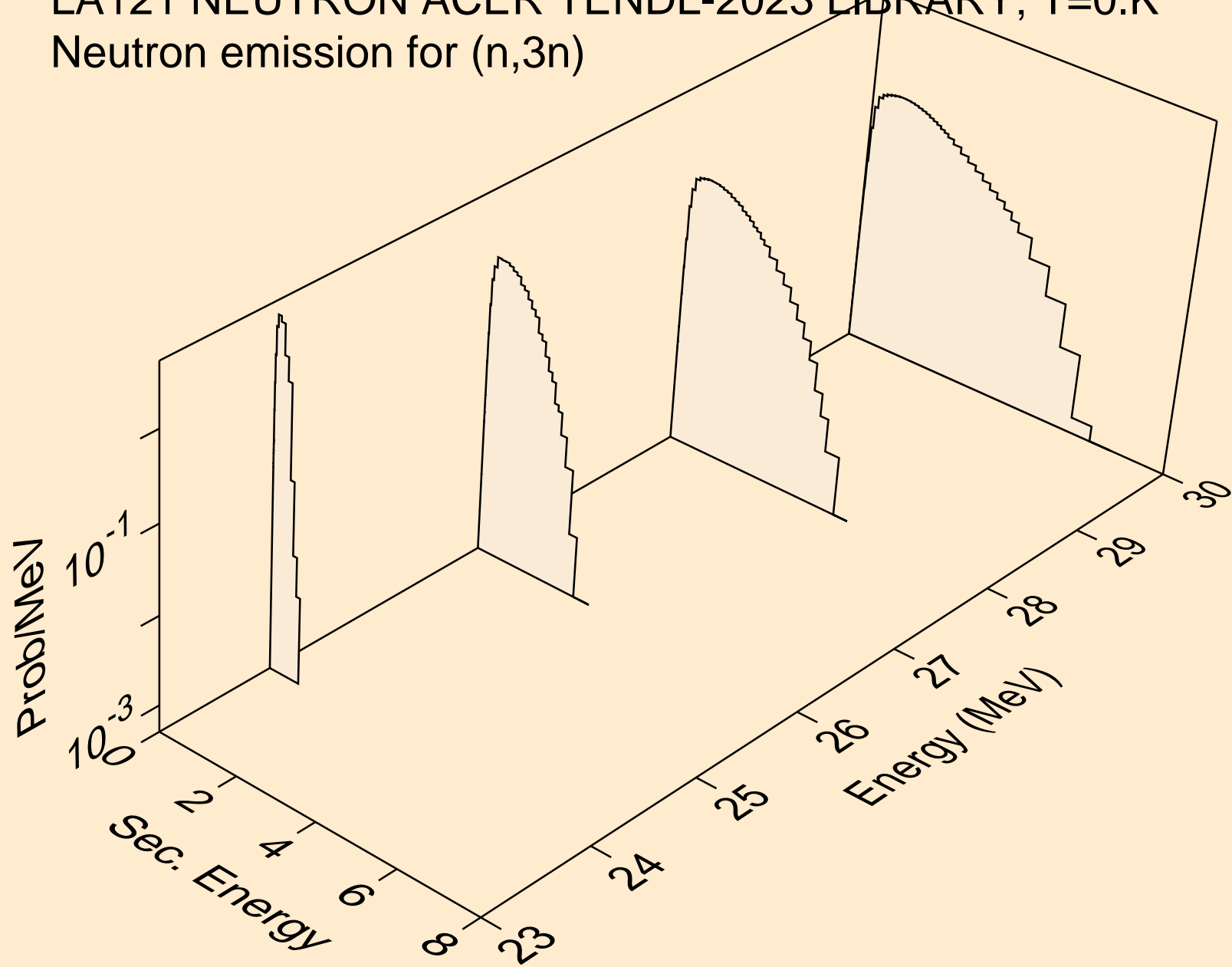

LA121 NEUTRON ACER TENDL-2023 LIBRARY; T=0.K
Neutron emission for (n,n*)a

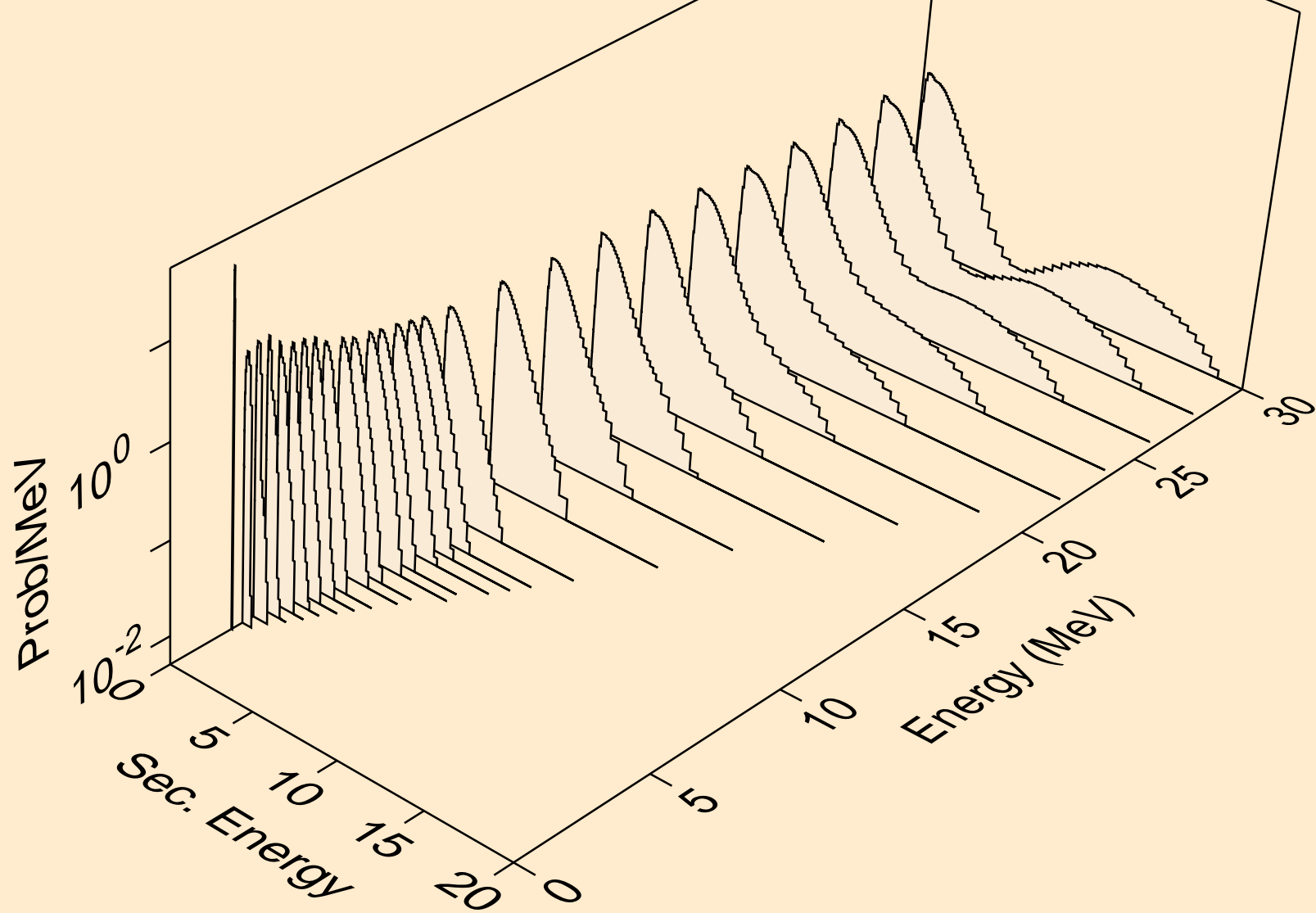

LA121 NEUTRON ACER TENDL-2023 LIBRARY; T=0.K
Neutron emission for (n,n*)3a

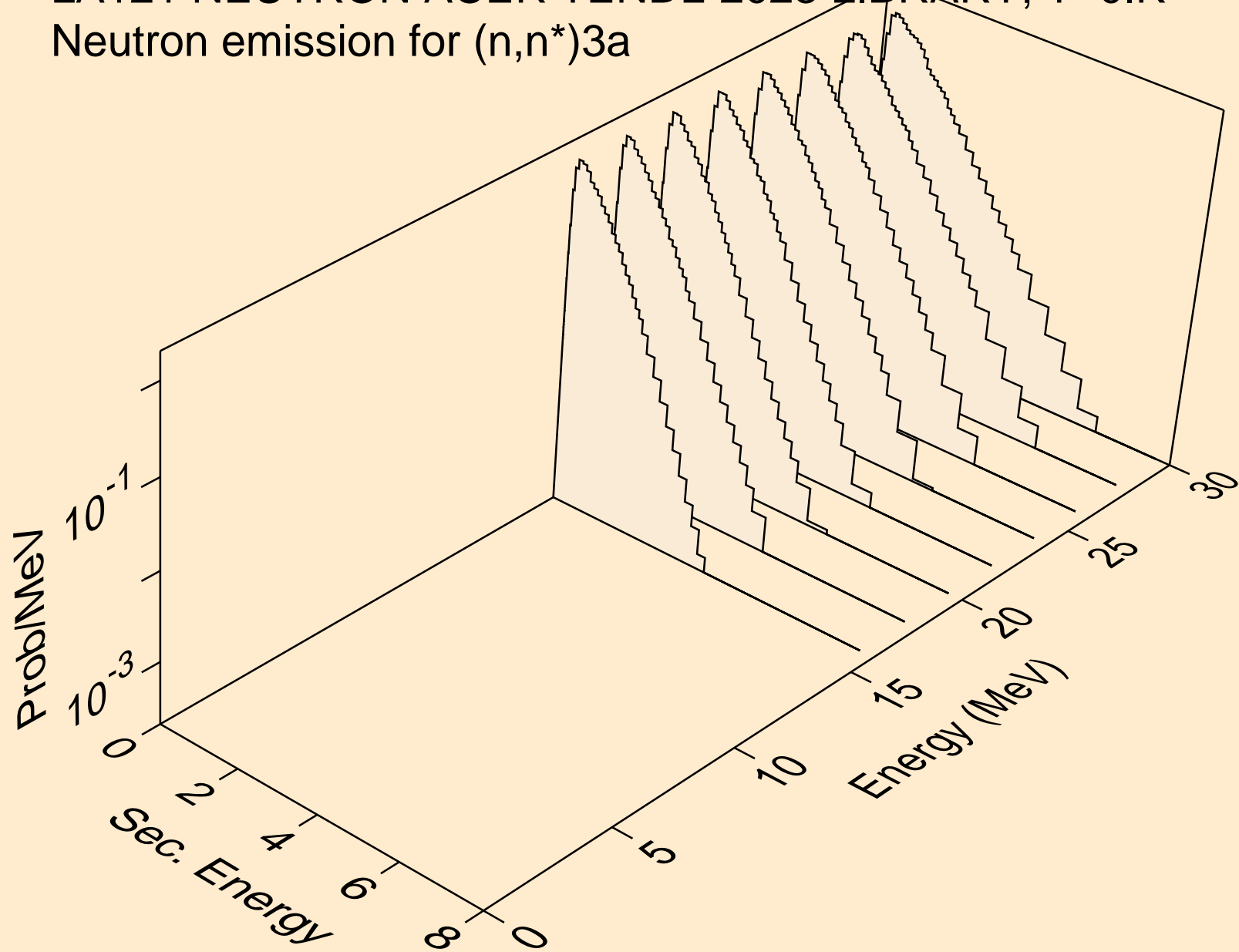

LA121 NEUTRON ACER TENDL-2023 LIBRARY; T=0.K
Neutron emission for (n,2n)a

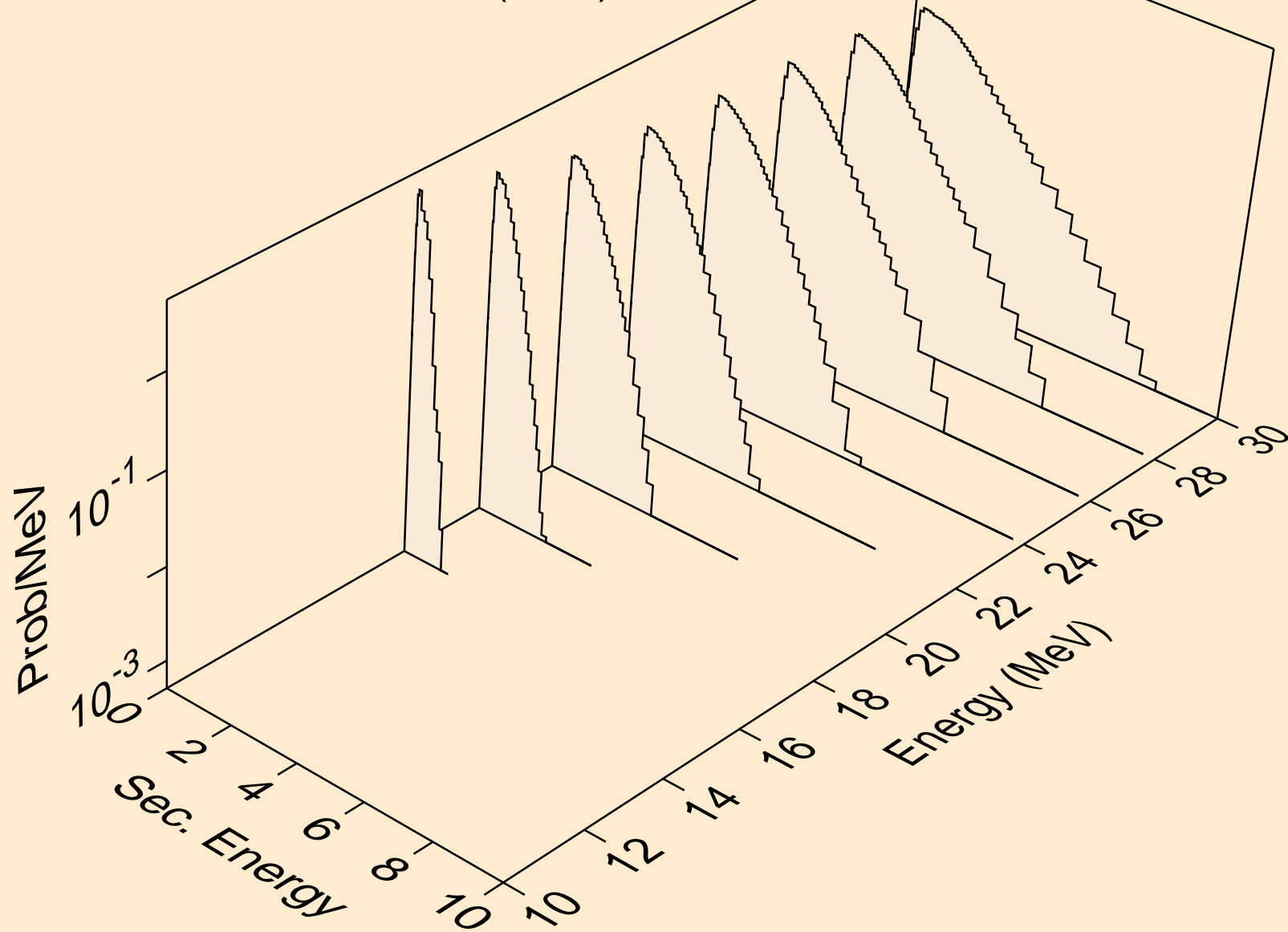

LA121 NEUTRON ACER TENDL-2023 LIBRARY; T=0.K
Neutron emission for (n,n*)p

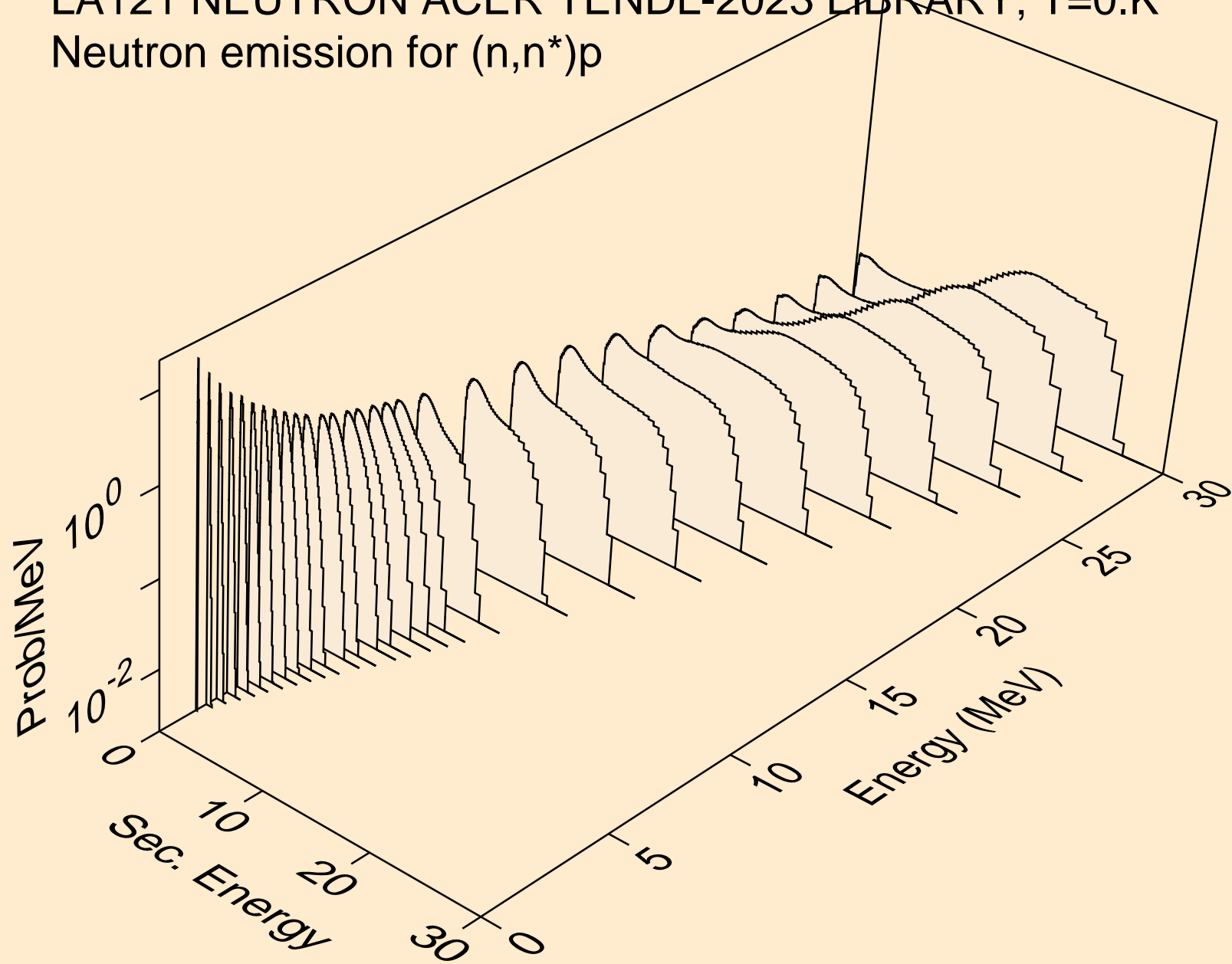

LA121 NEUTRON ACER TENDL-2023 LIBRARY; T=0.K
Neutron emission for (n,n*)2a

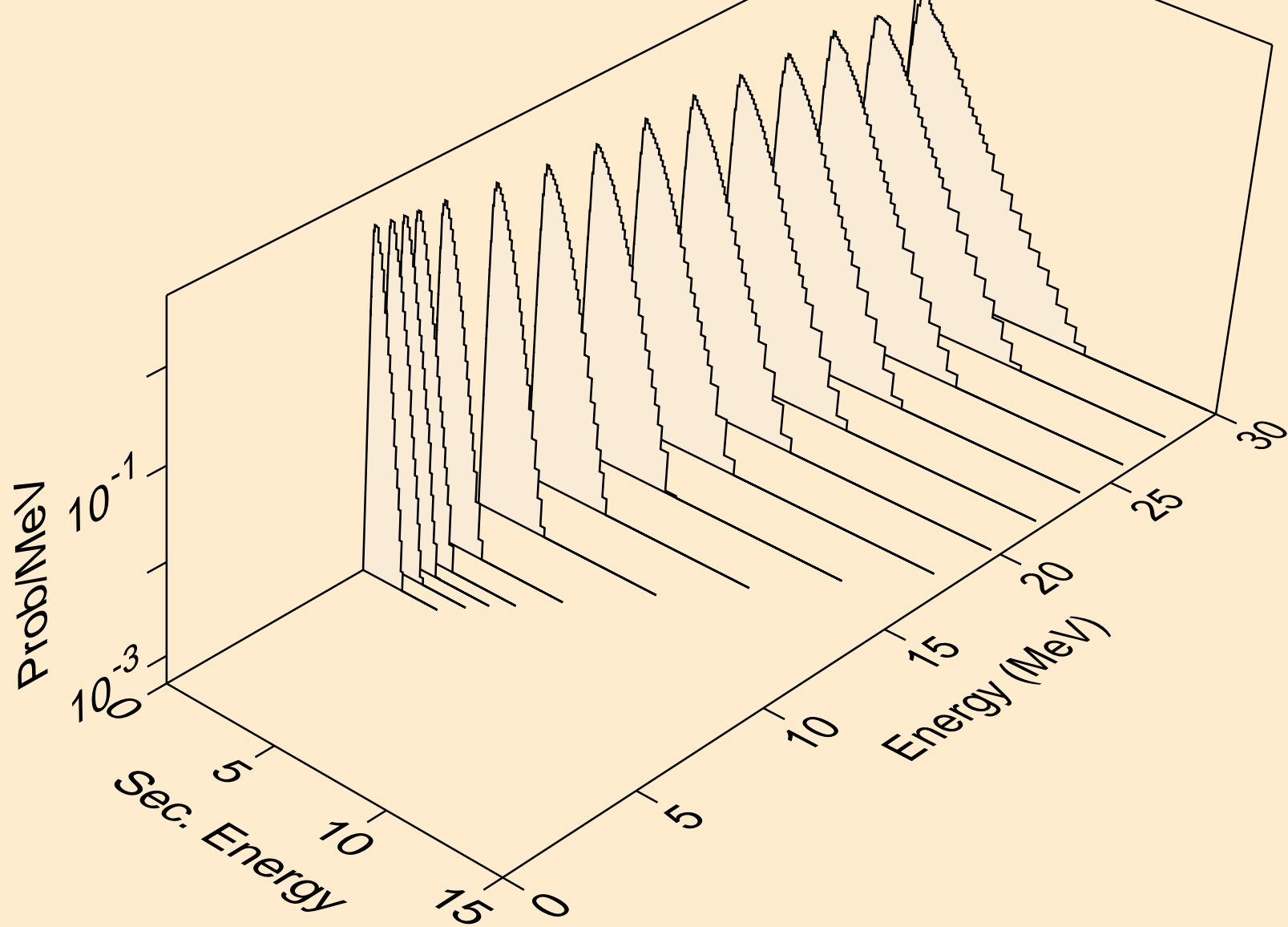

LA121 NEUTRON ACER TENDL-2023 LIBRARY; T=0.K
Neutron emission for (n,n*)d

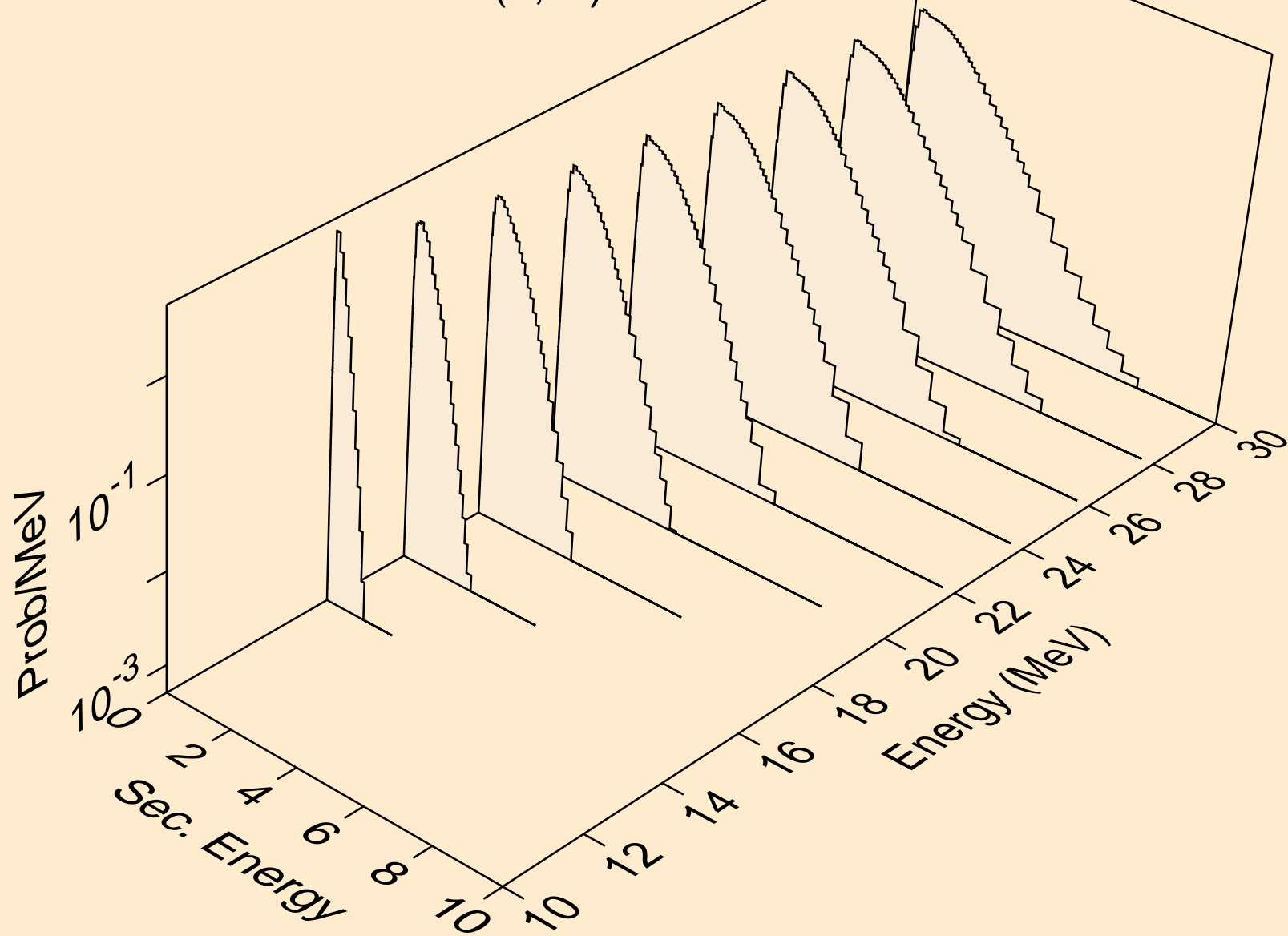

LA121 NEUTRON ACER TENDL-2023 LIBRARY; T=0.K
Neutron emission for (n,n*)t

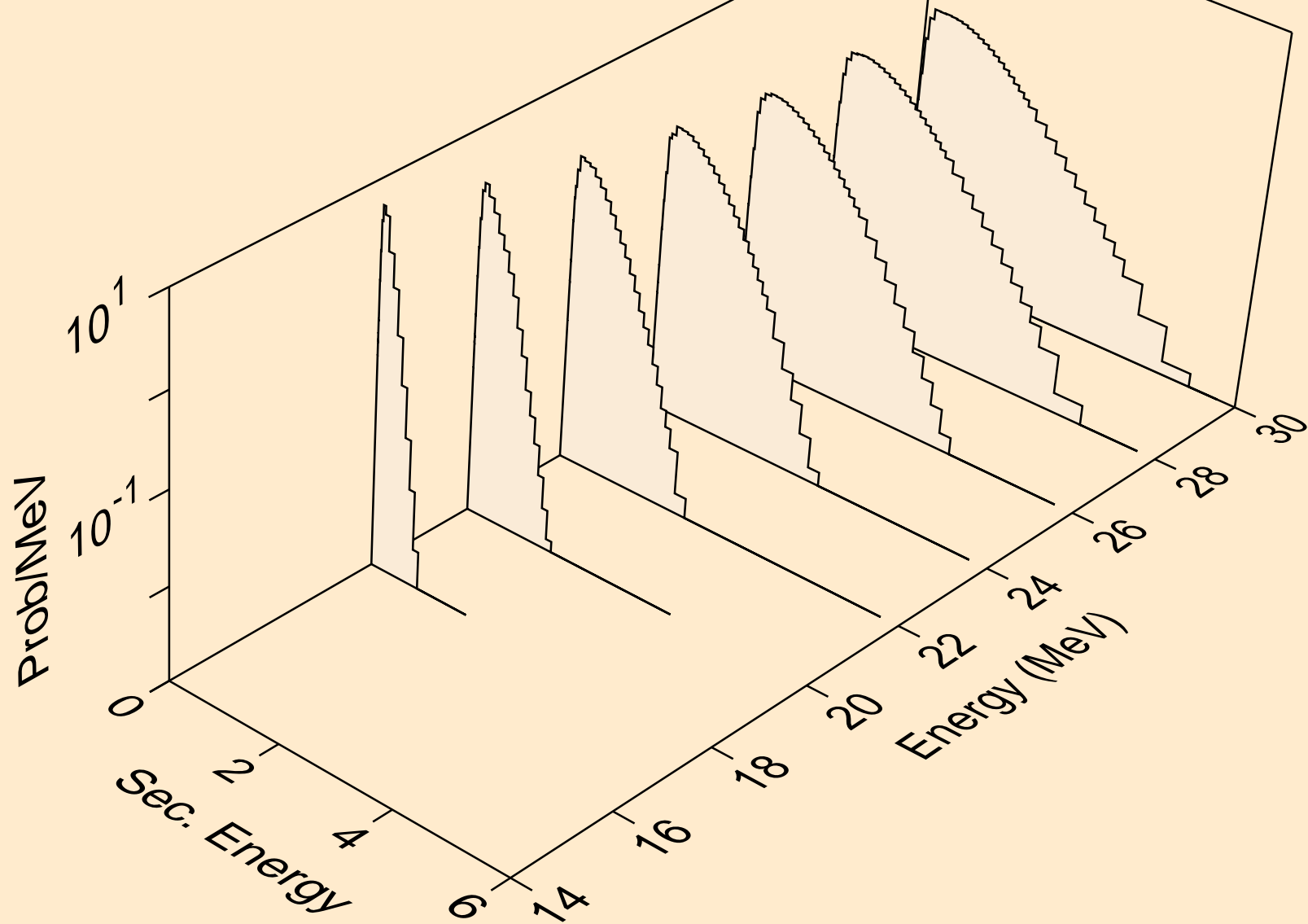

LA121 NEUTRON ACER TENDL-2023 LIBRARY; T=0.K
Neutron emission for (n,n*)he3

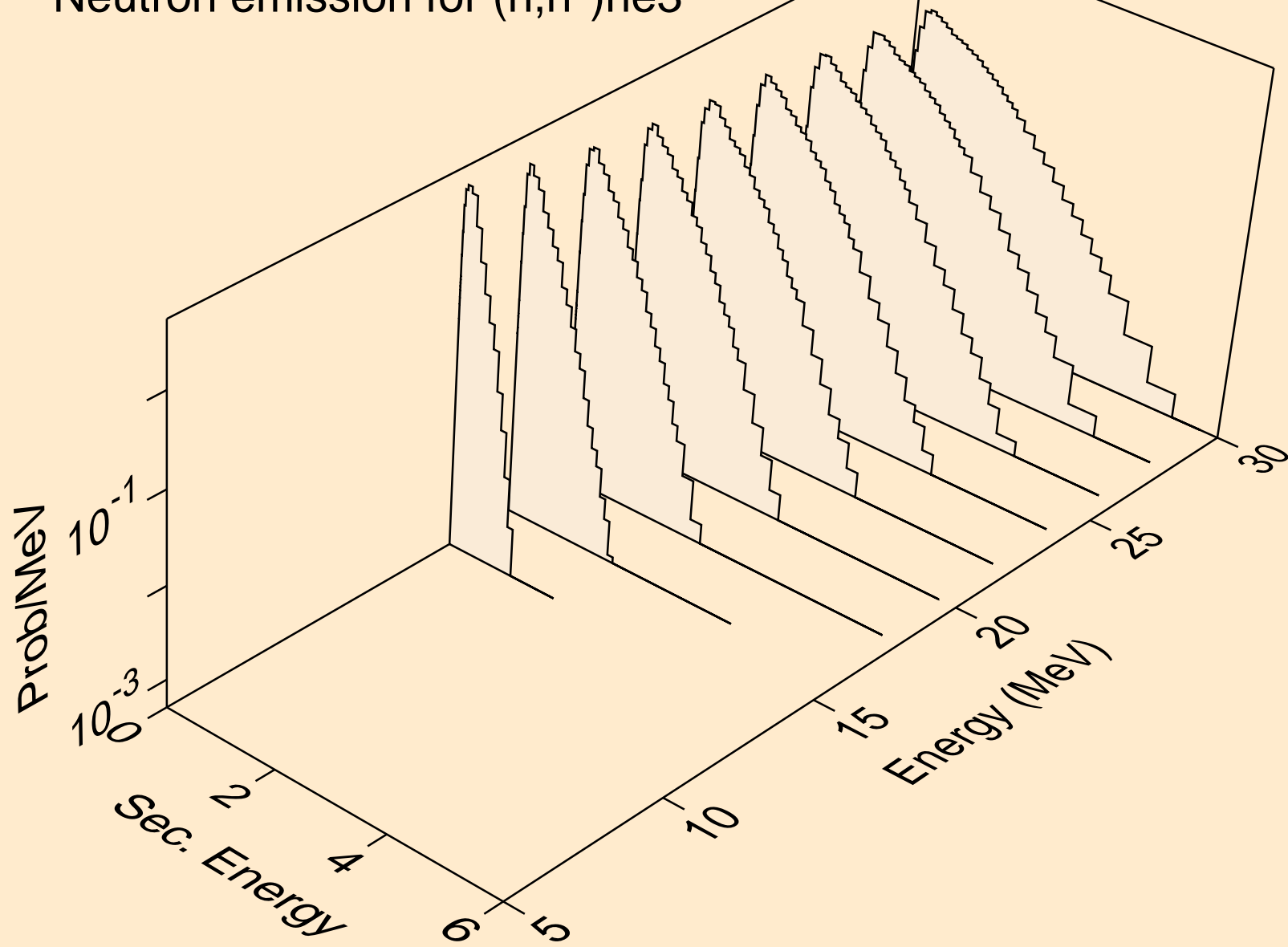

LA121 NEUTRON ACER TENDL-2023 LIBRARY; T=0.K
Neutron emission for (n,2np)

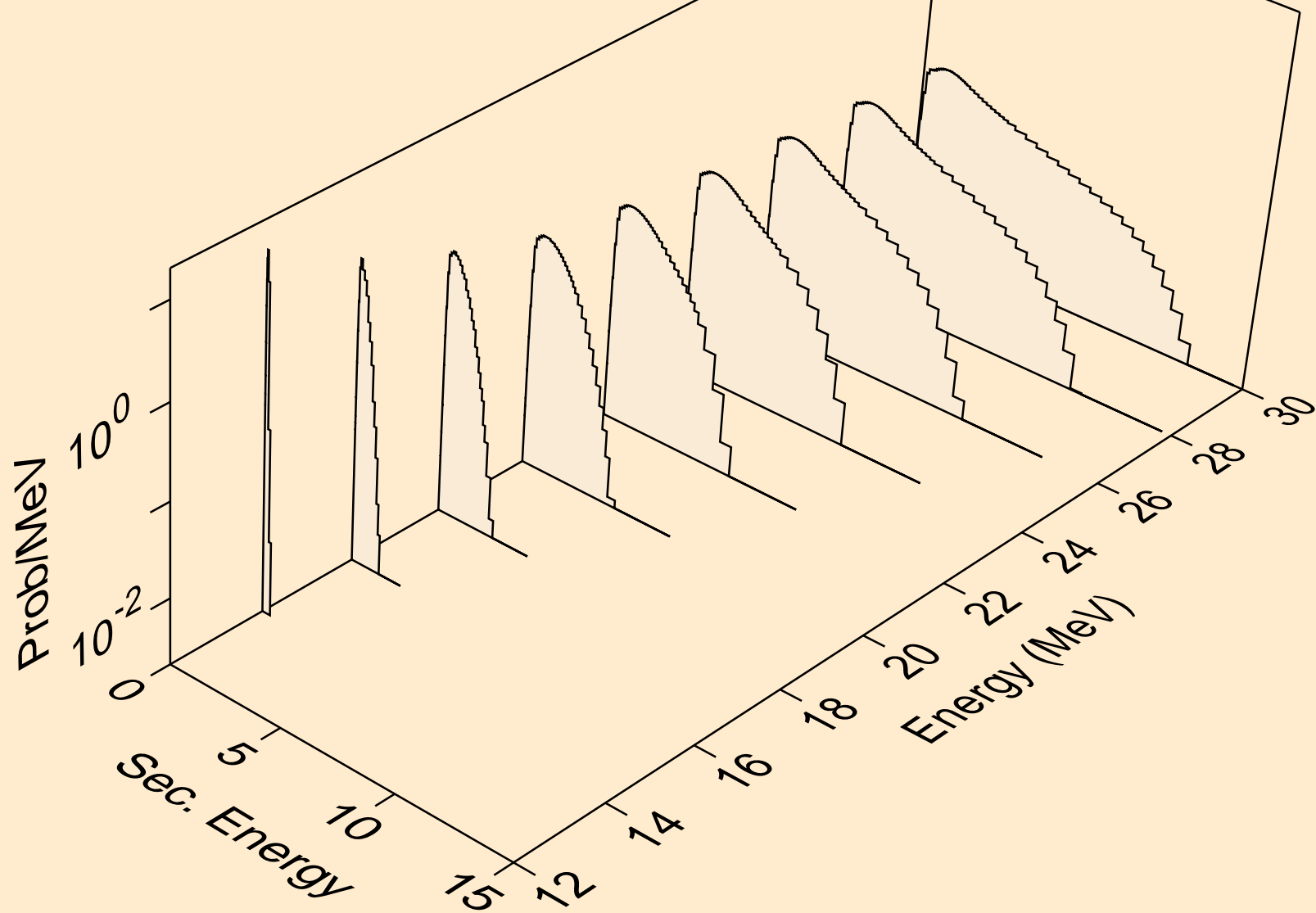

LA121 NEUTRON ACER TENDL-2023 LIBRARY; T=0.K
Neutron emission for (n,3np)

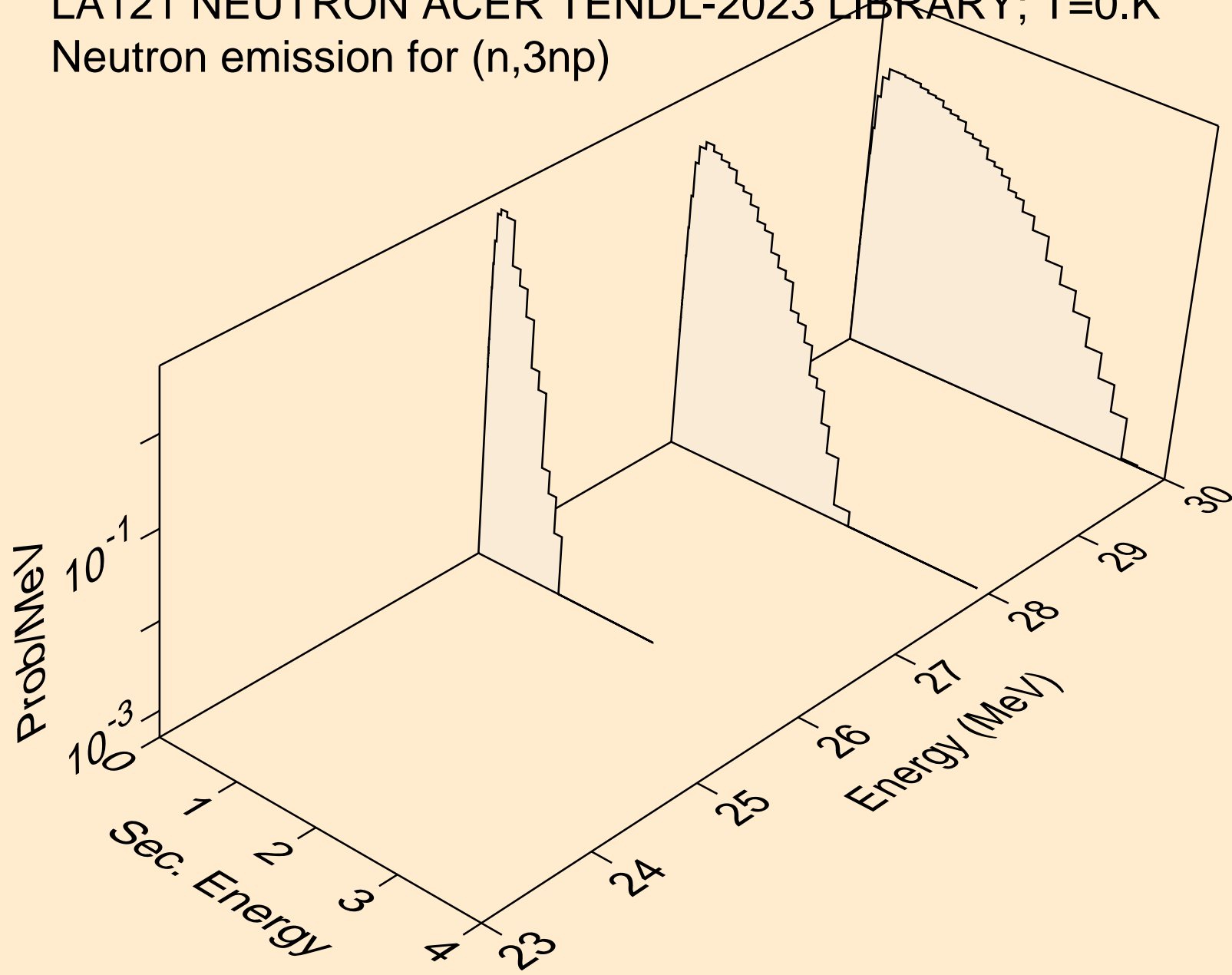

LA121 NEUTRON ACER TENDL-2023 LIBRARY; T=0.K
Neutron emission for (n,n2p)

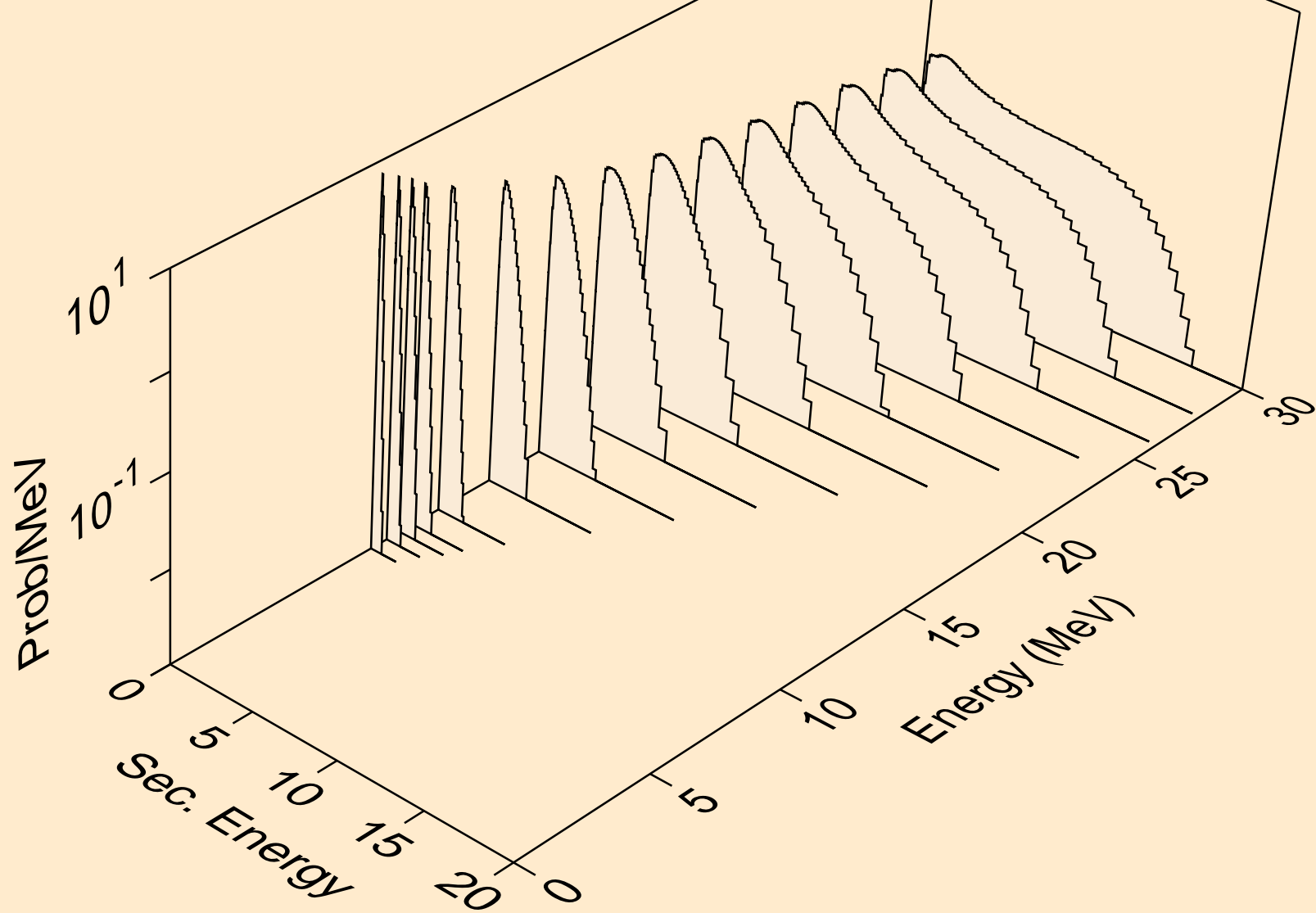

LA121 NEUTRON ACER TENDL-2023 LIBRARY; T=0.K
Neutron emission for (n,npa)

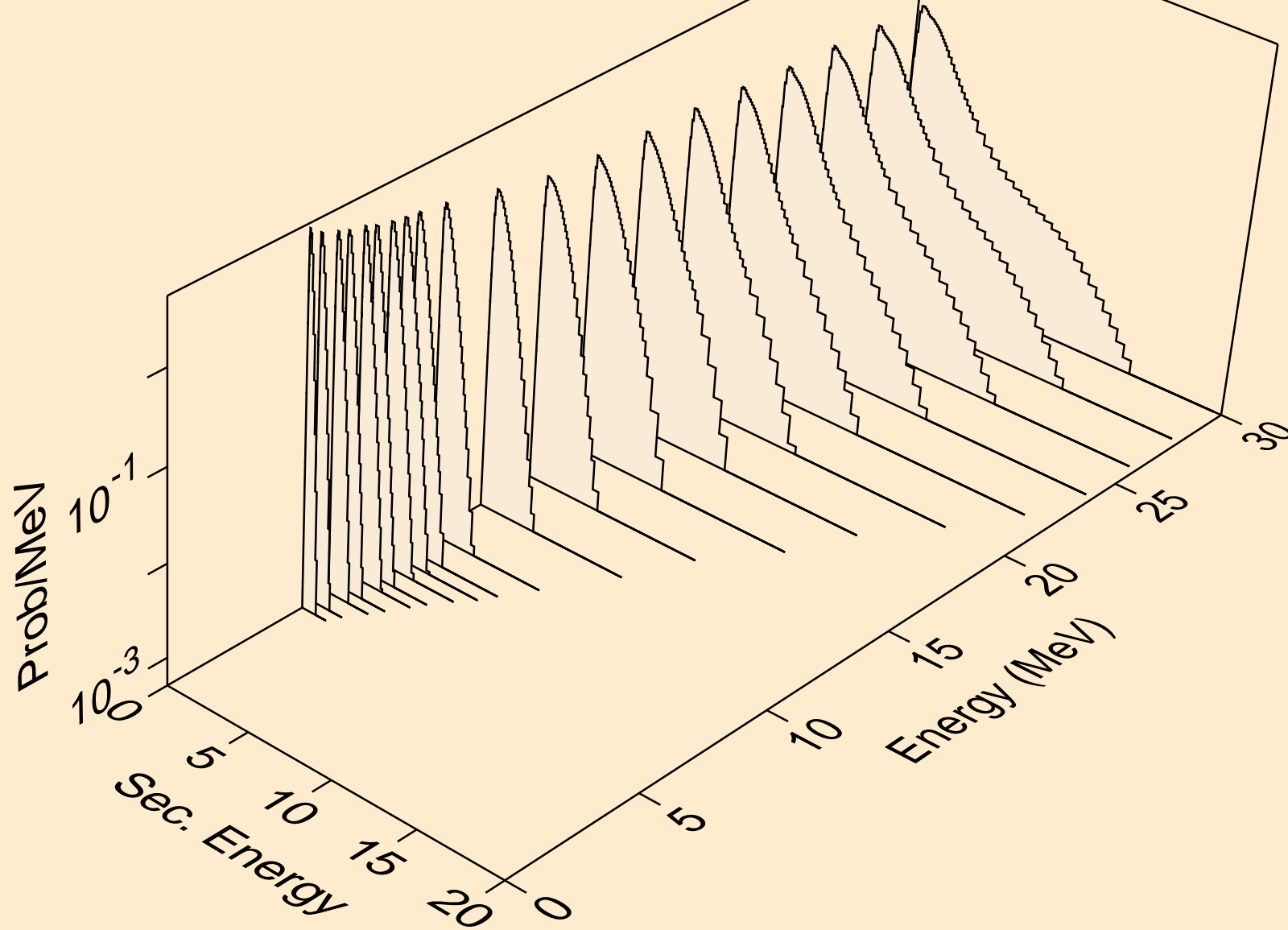

LA121 NEUTRON ACER TENDL-2023 LIBRARY; T=0.K
Neutron emission for (n,n*c)

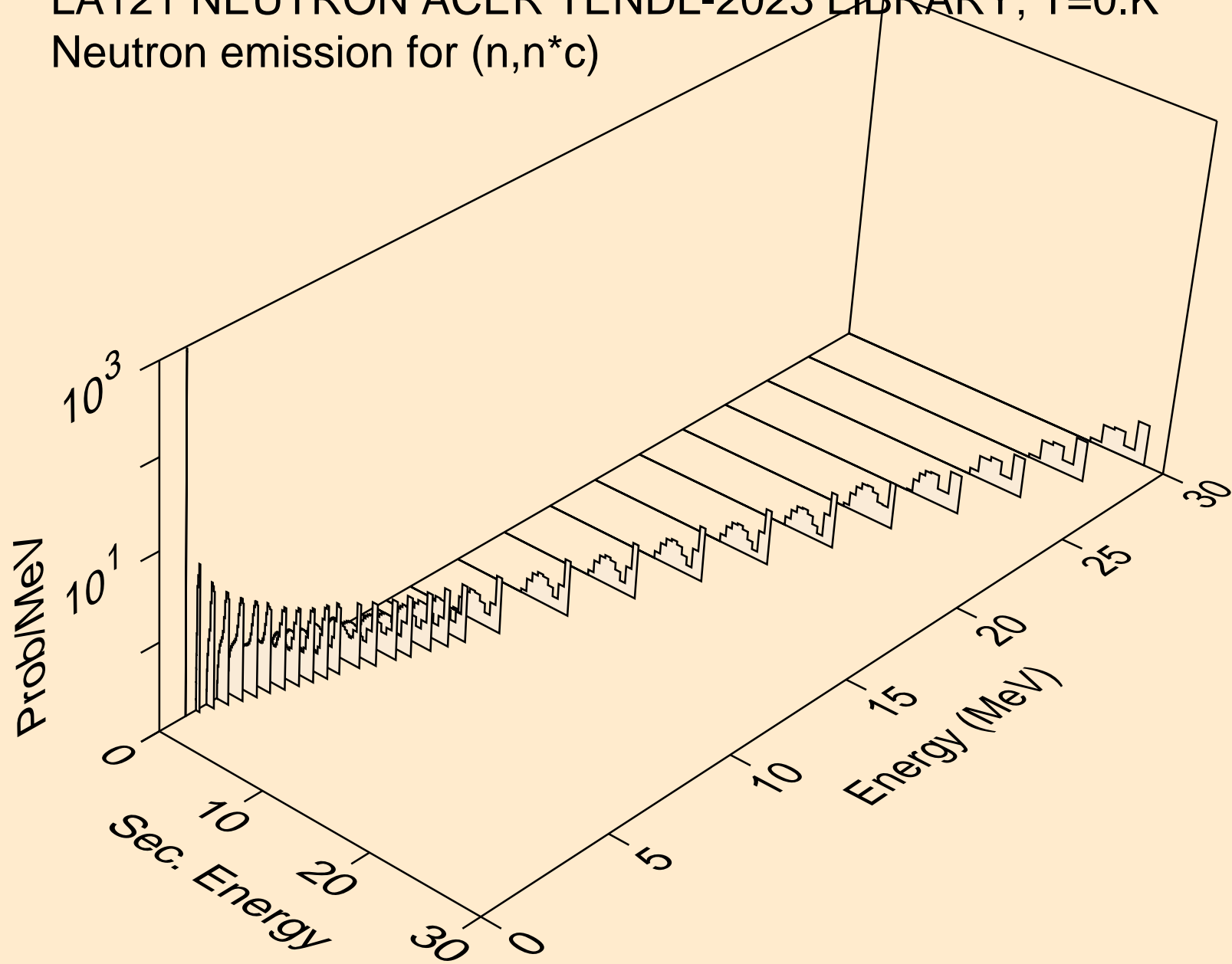

LA121 NEUTRON ACER TENDL-2023 LIBRARY; T=0.K
Photon emission for (n,x)

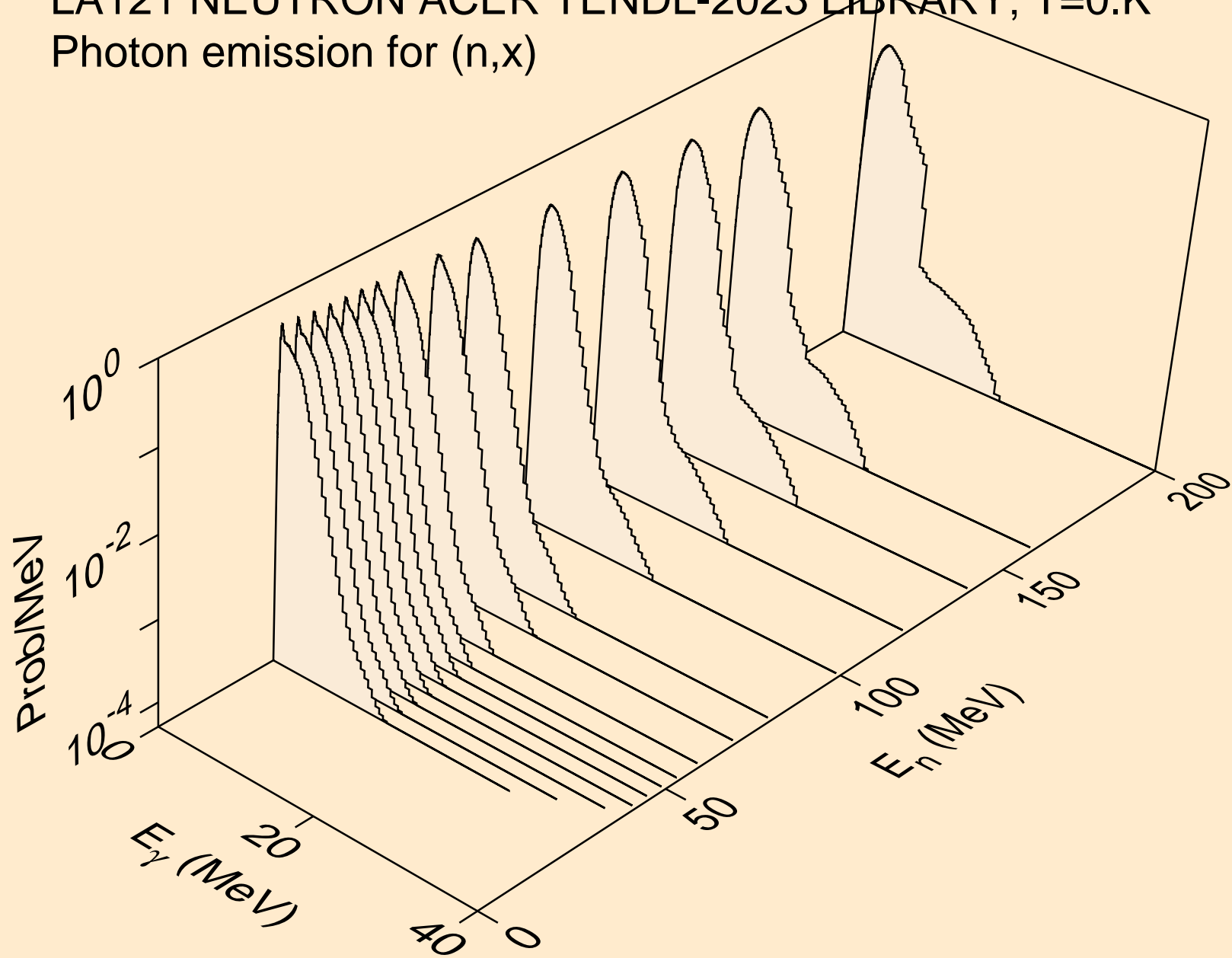

LA121 NEUTRON ACER TENDL-2023 LIBRARY; T=0.K
Photon emission for (n,2nd)

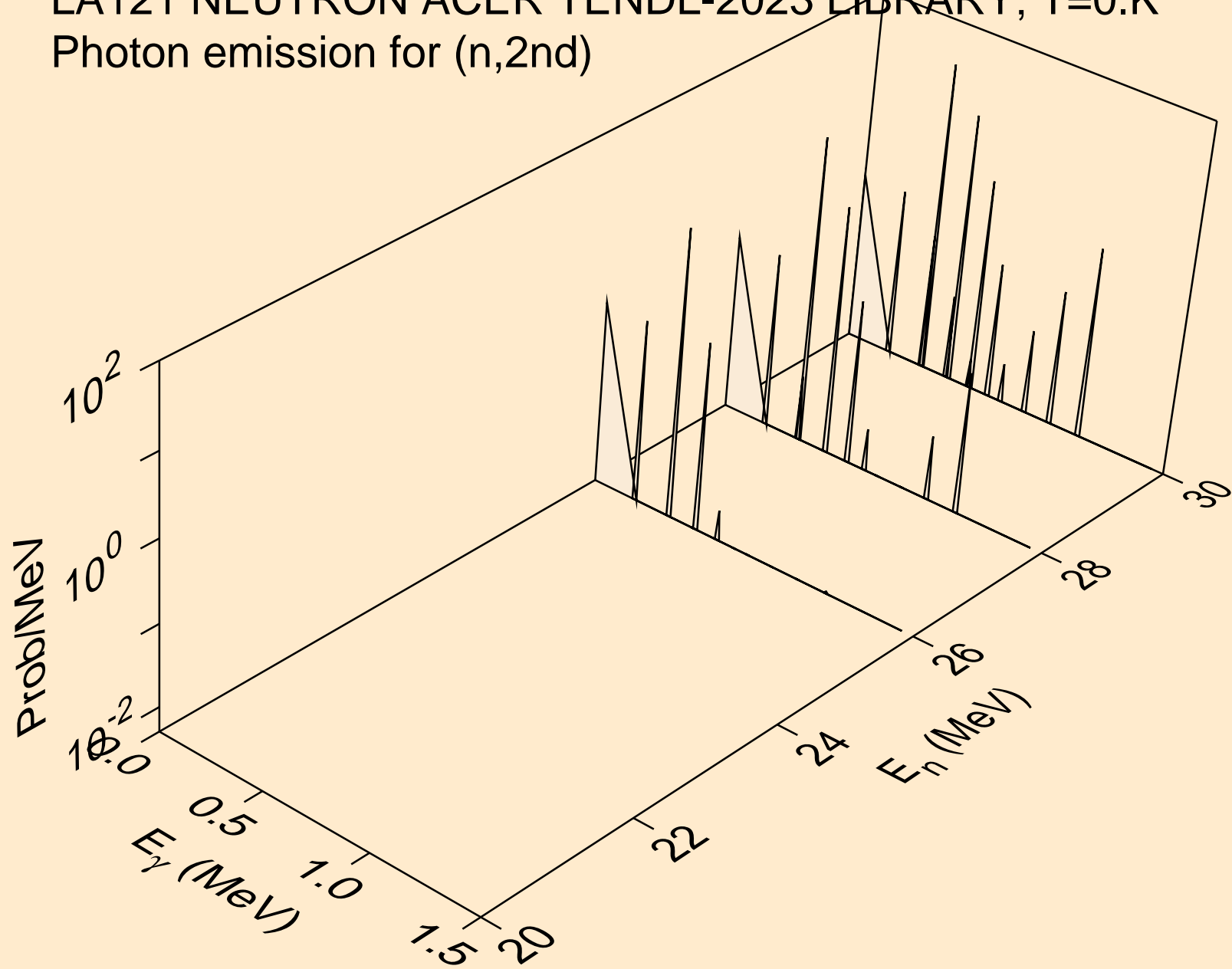

LA121 NEUTRON ACER TENDL-2023 LIBRARY; T=0.K
Photon emission for (n,2n)

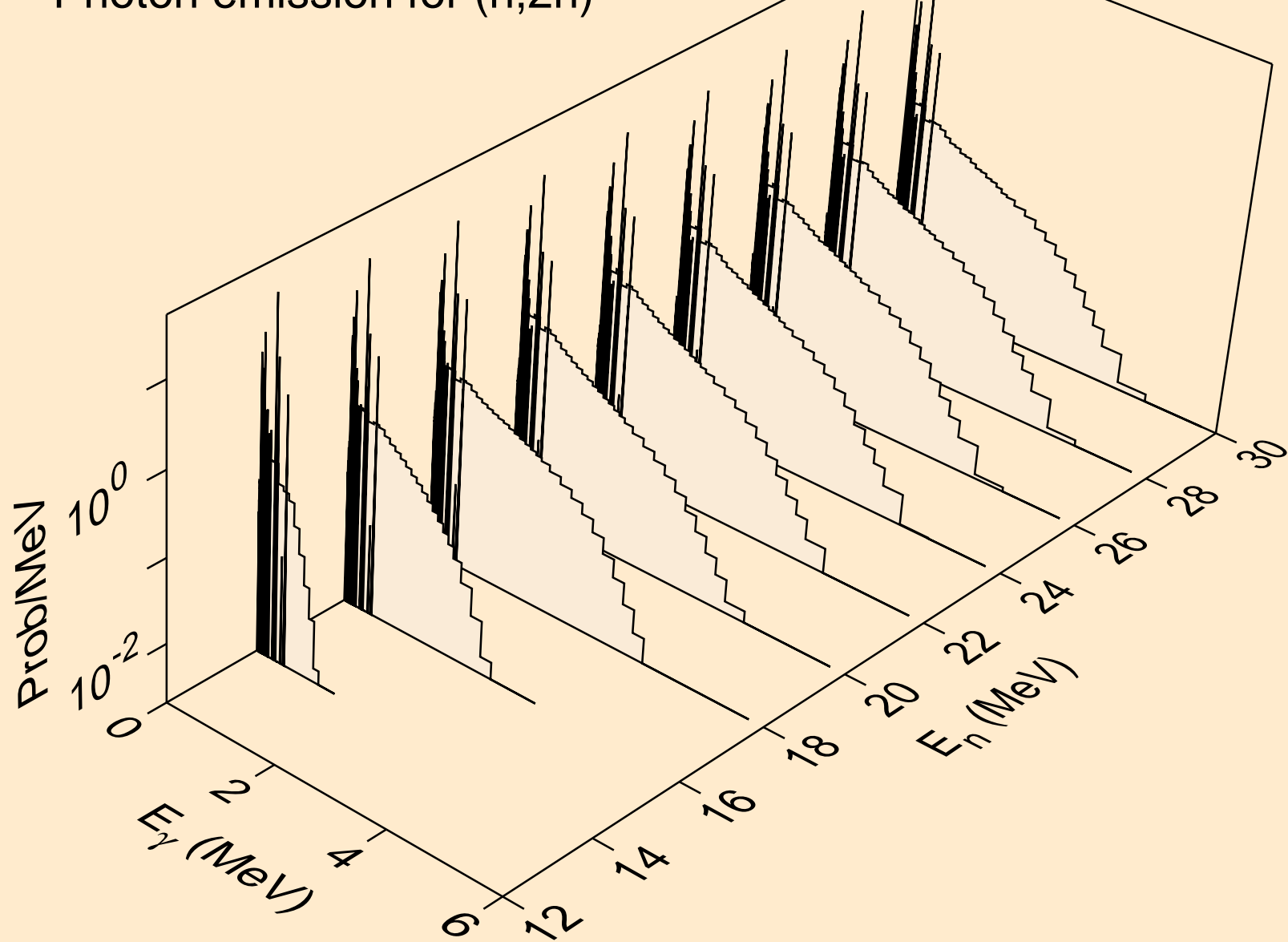

LA121 NEUTRON ACER TENDL-2023 LIBRARY; T=0.K
Photon emission for (n,3n)

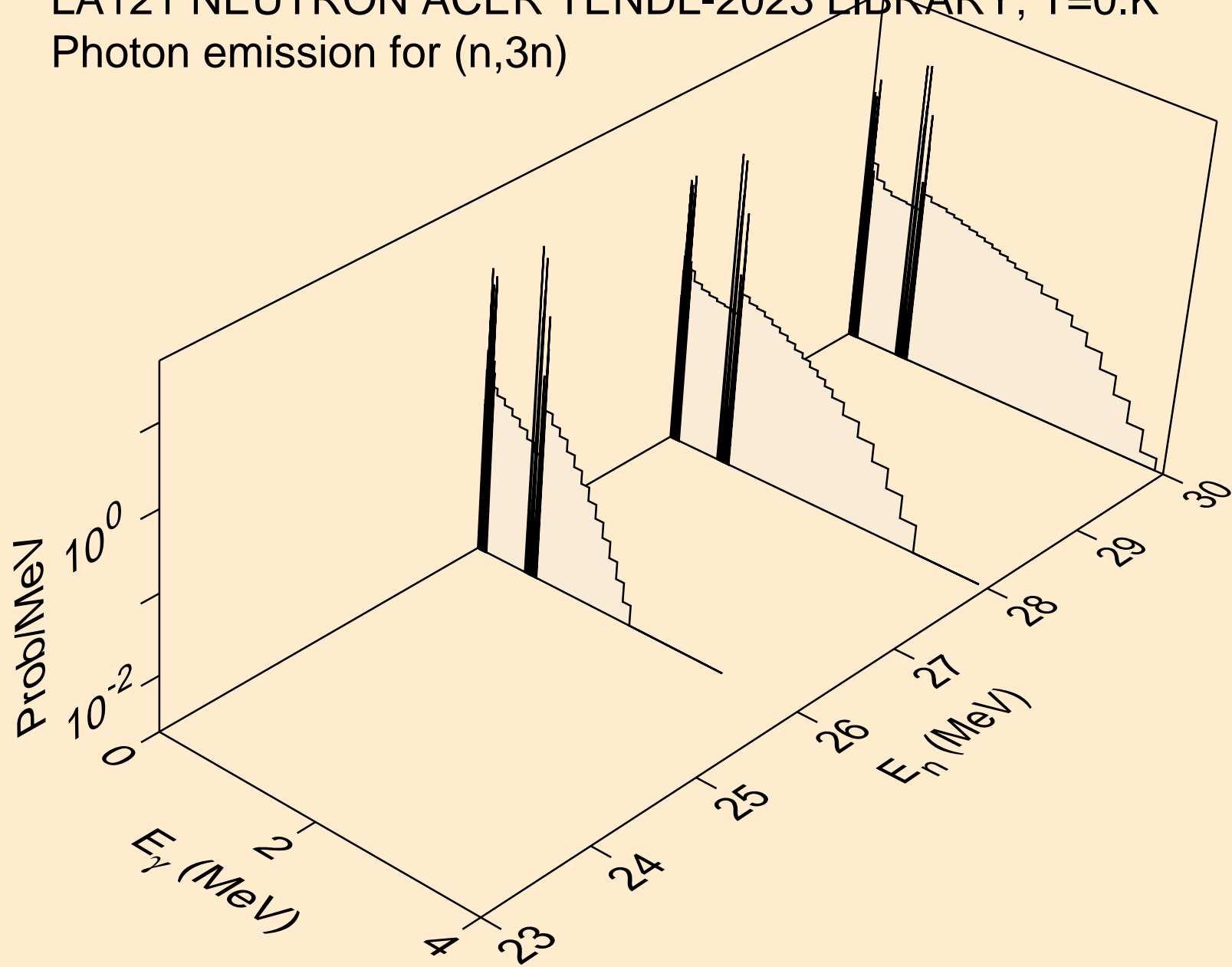

LA121 NEUTRON ACER TENDL-2023 LIBRARY; T=0.K
Photon emission for (n,n*)a

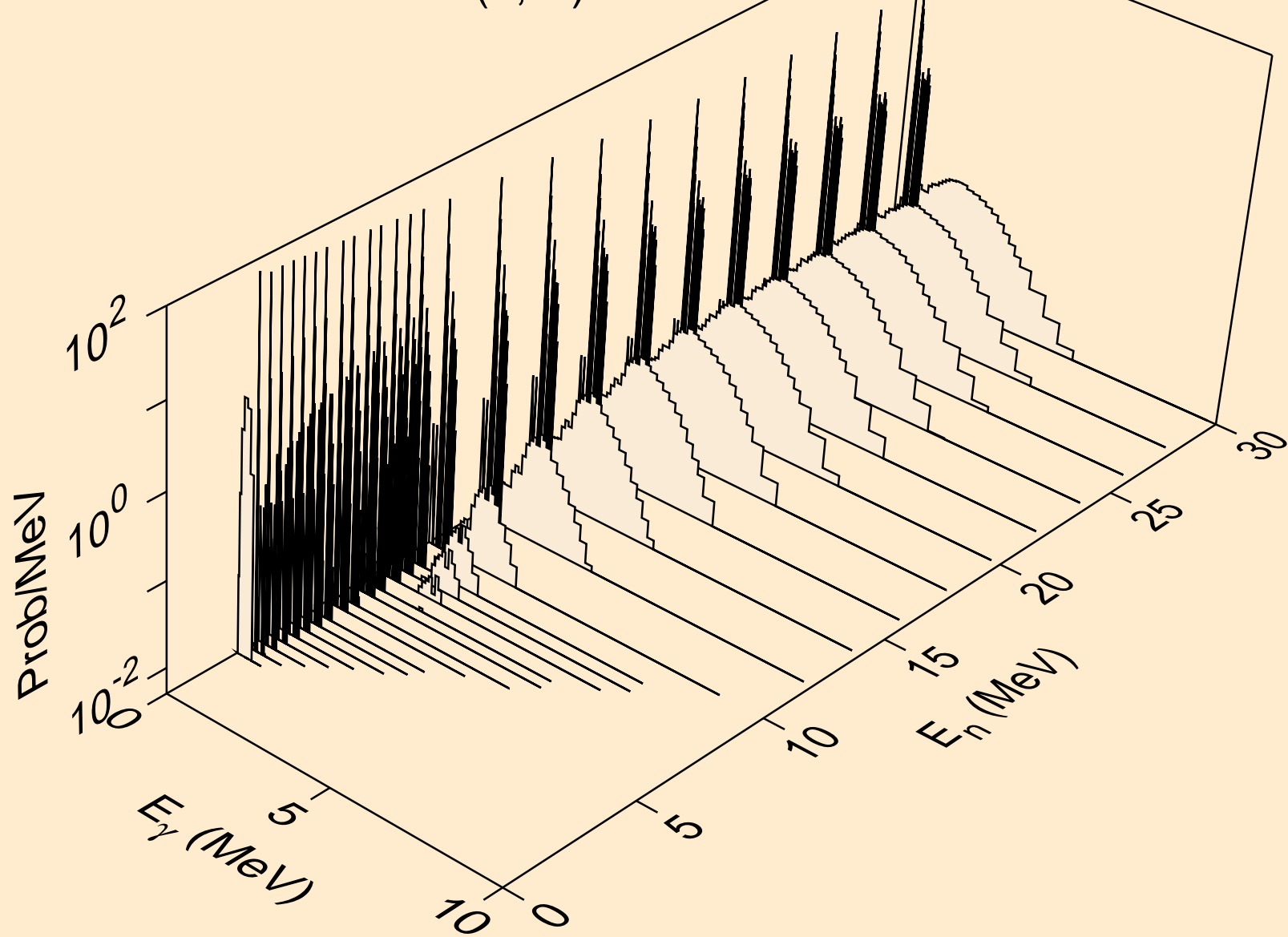

LA121 NEUTRON ACER TENDL-2023 LIBRARY; T=0.K
Photon emission for (n,n*)3a

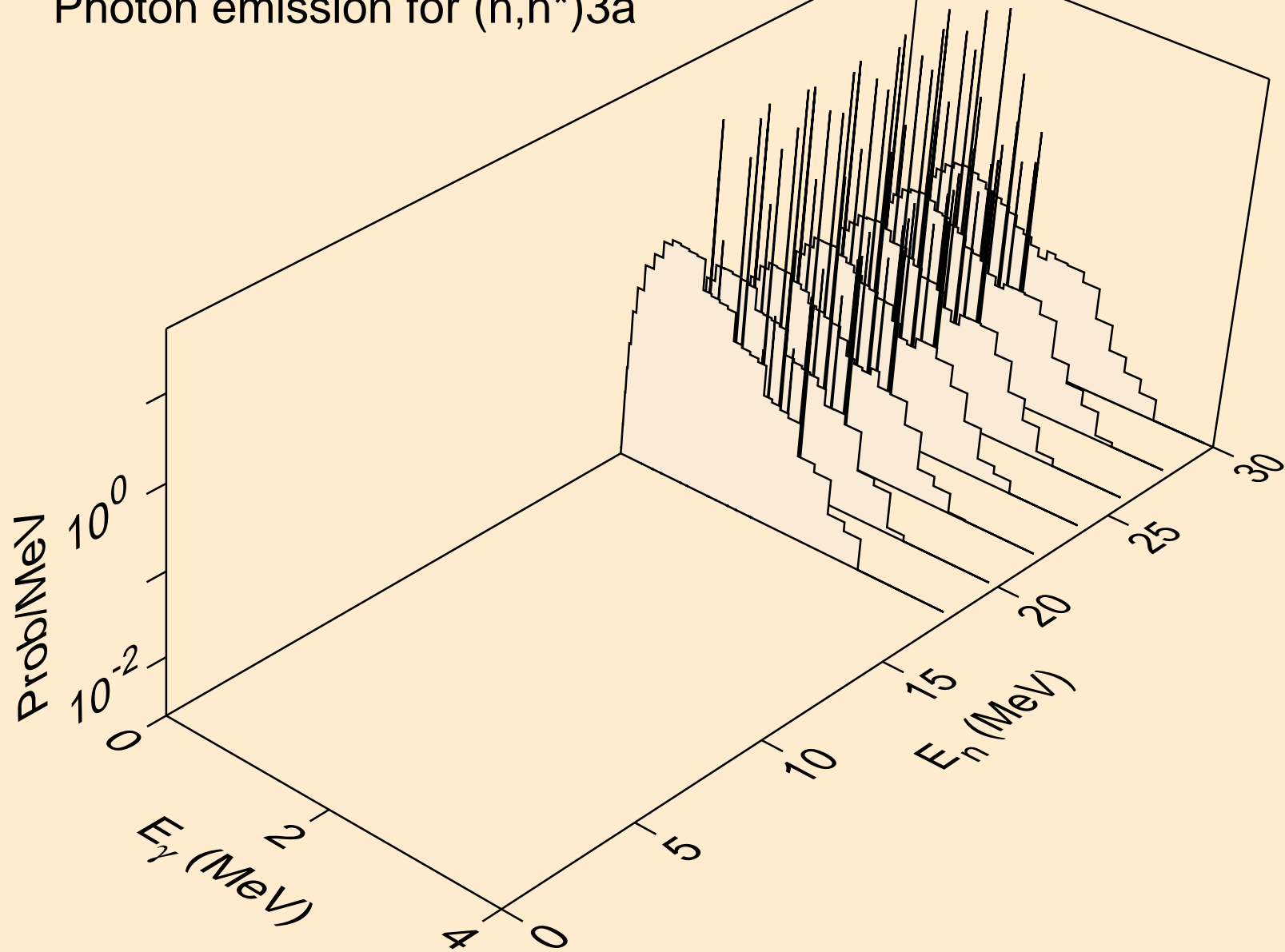

LA121 NEUTRON ACER TENDL-2023 LIBRARY; T=0.K
Photon emission for (n,2n)a

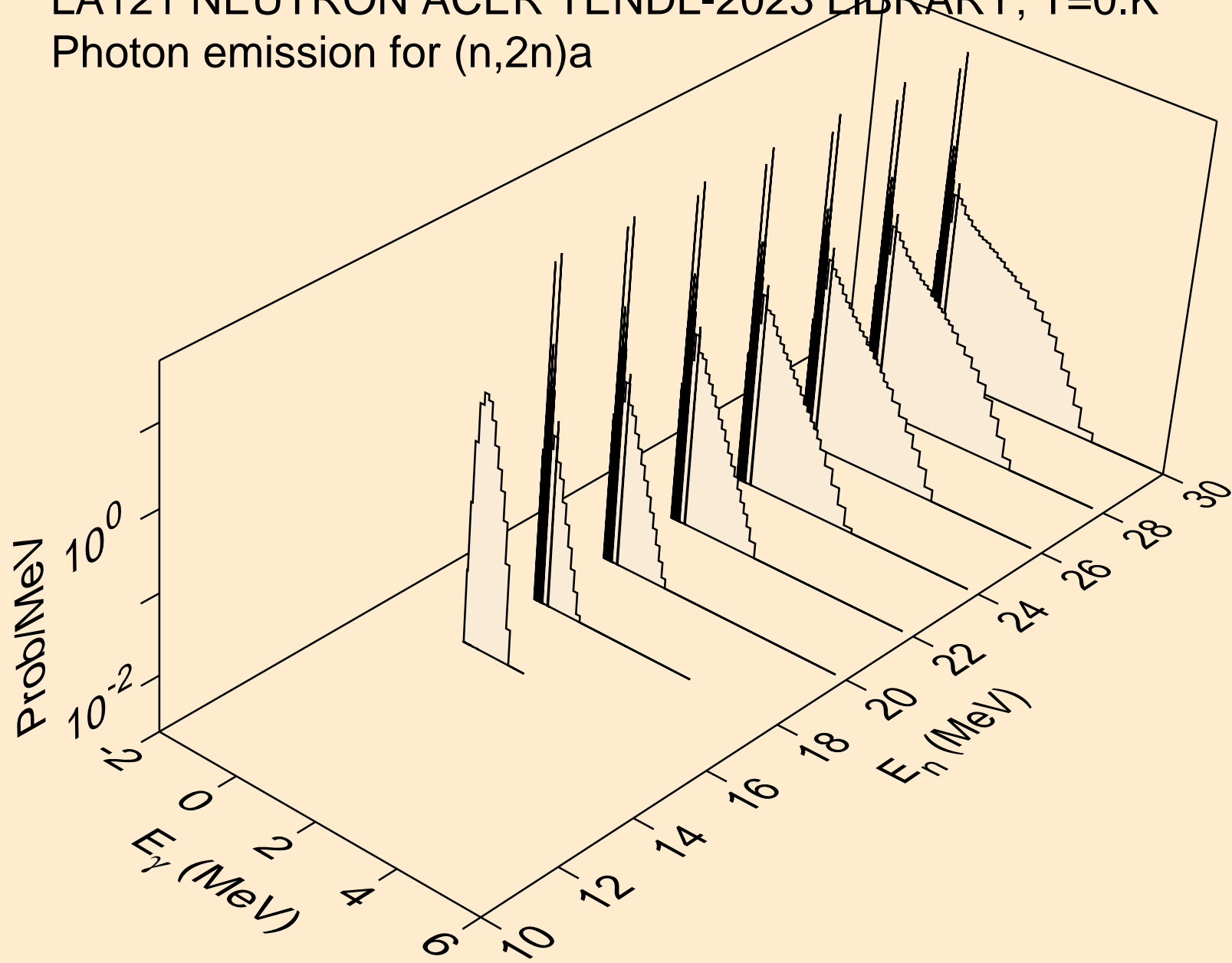

LA121 NEUTRON ACER TENDL-2023 LIBRARY; T=0.K
Photon emission for (n,n*)p

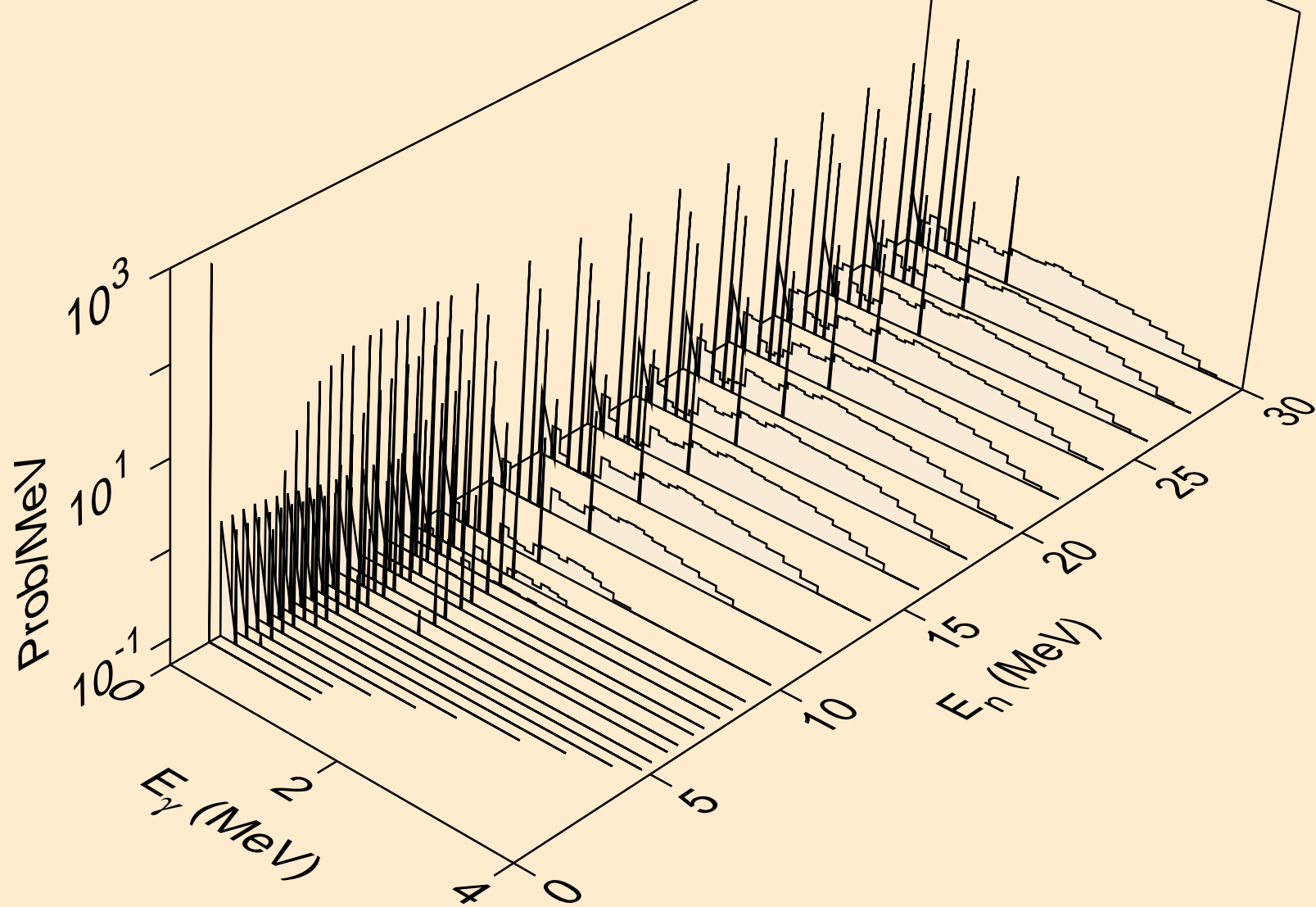

LA121 NEUTRON ACER TENDL-2023 LIBRARY; T=0.K
Photon emission for (n,n*)2a

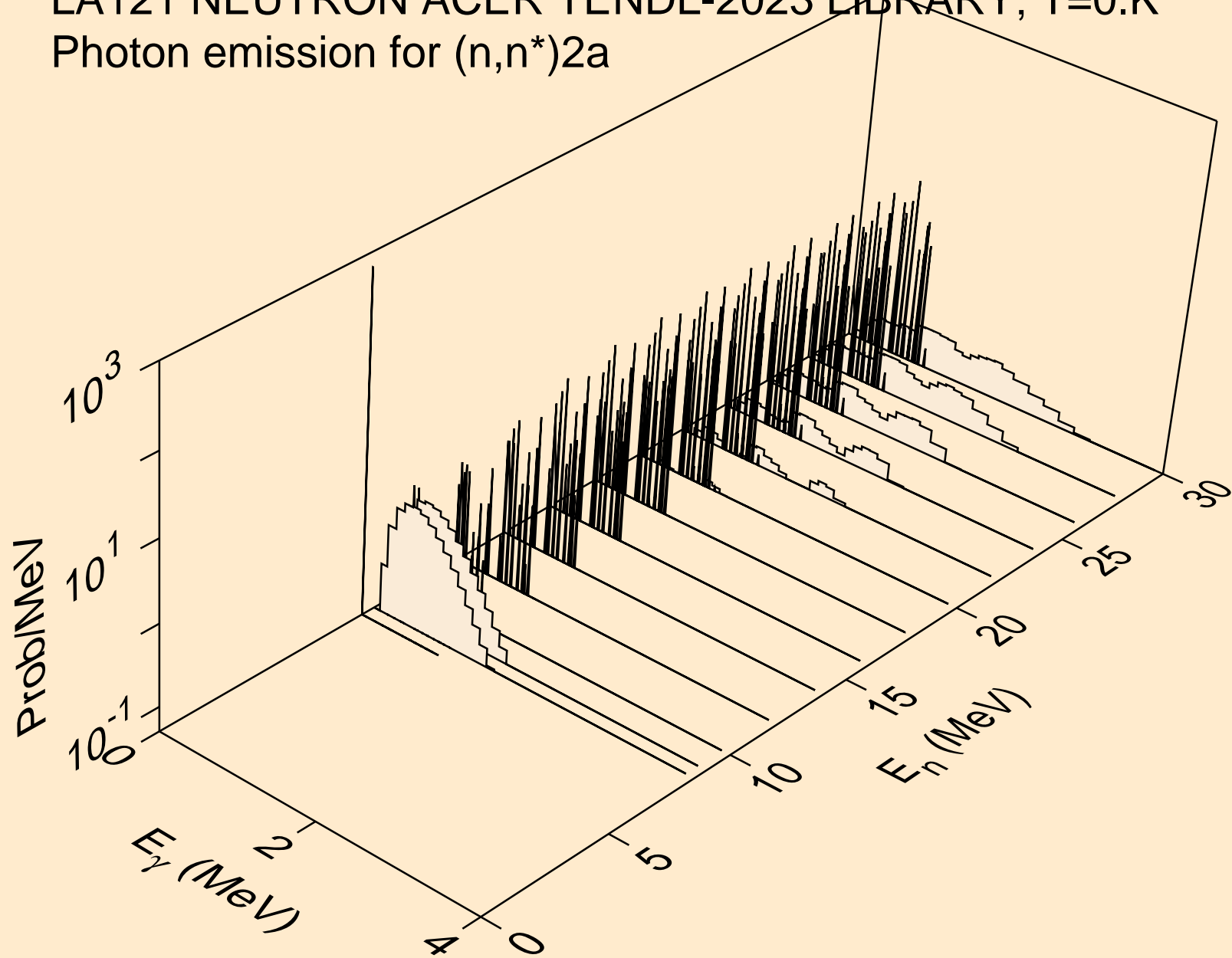

LA121 NEUTRON ACER TENDL-2023 LIBRARY; T=0.K
Photon emission for (n,n*)d

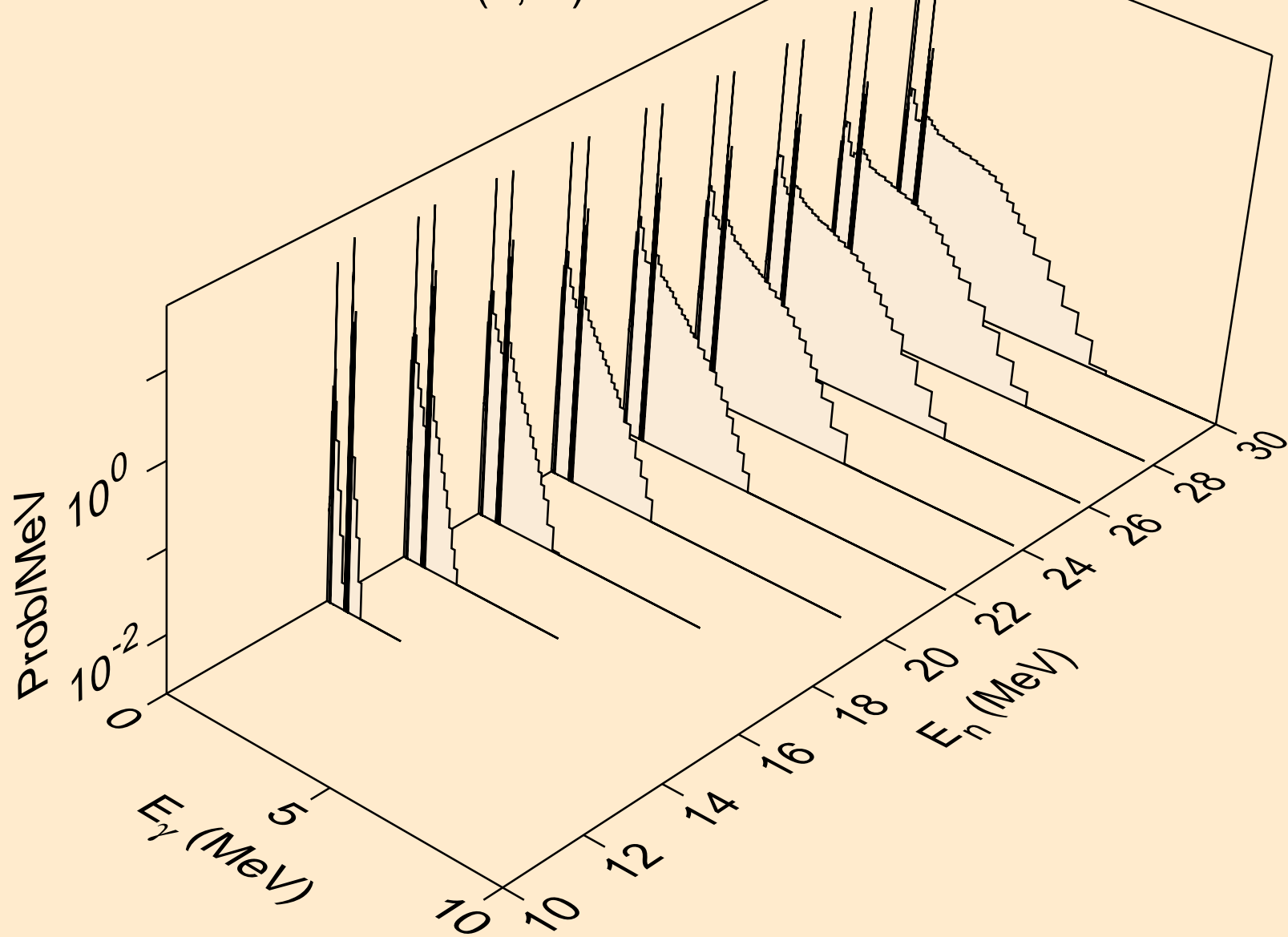

LA121 NEUTRON ACER TENDL-2023 LIBRARY; T=0.K
Photon emission for (n,n*)t

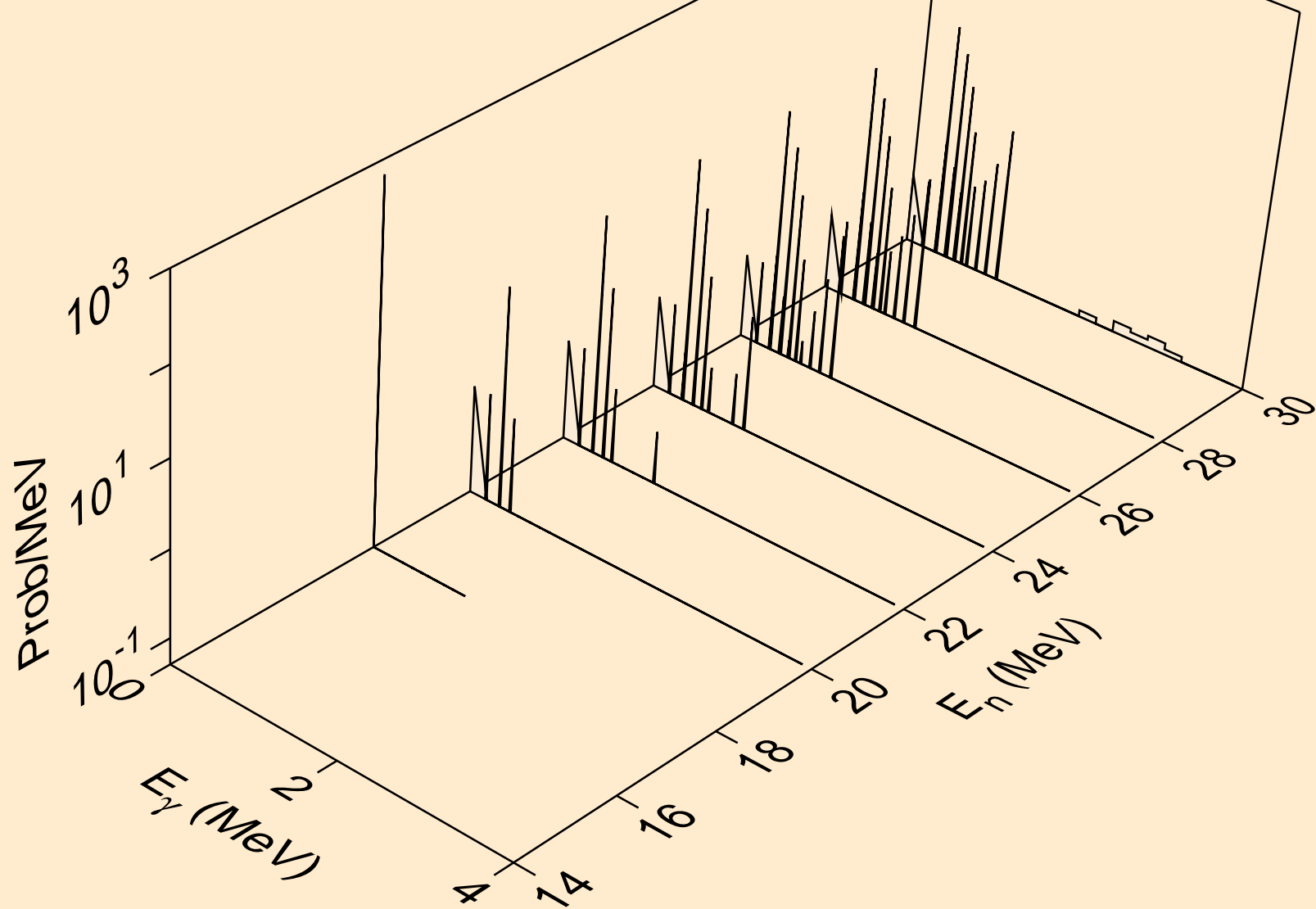

LA121 NEUTRON ACER TENDL-2023 LIBRARY; T=0.K
Photon emission for (n,n*)he3

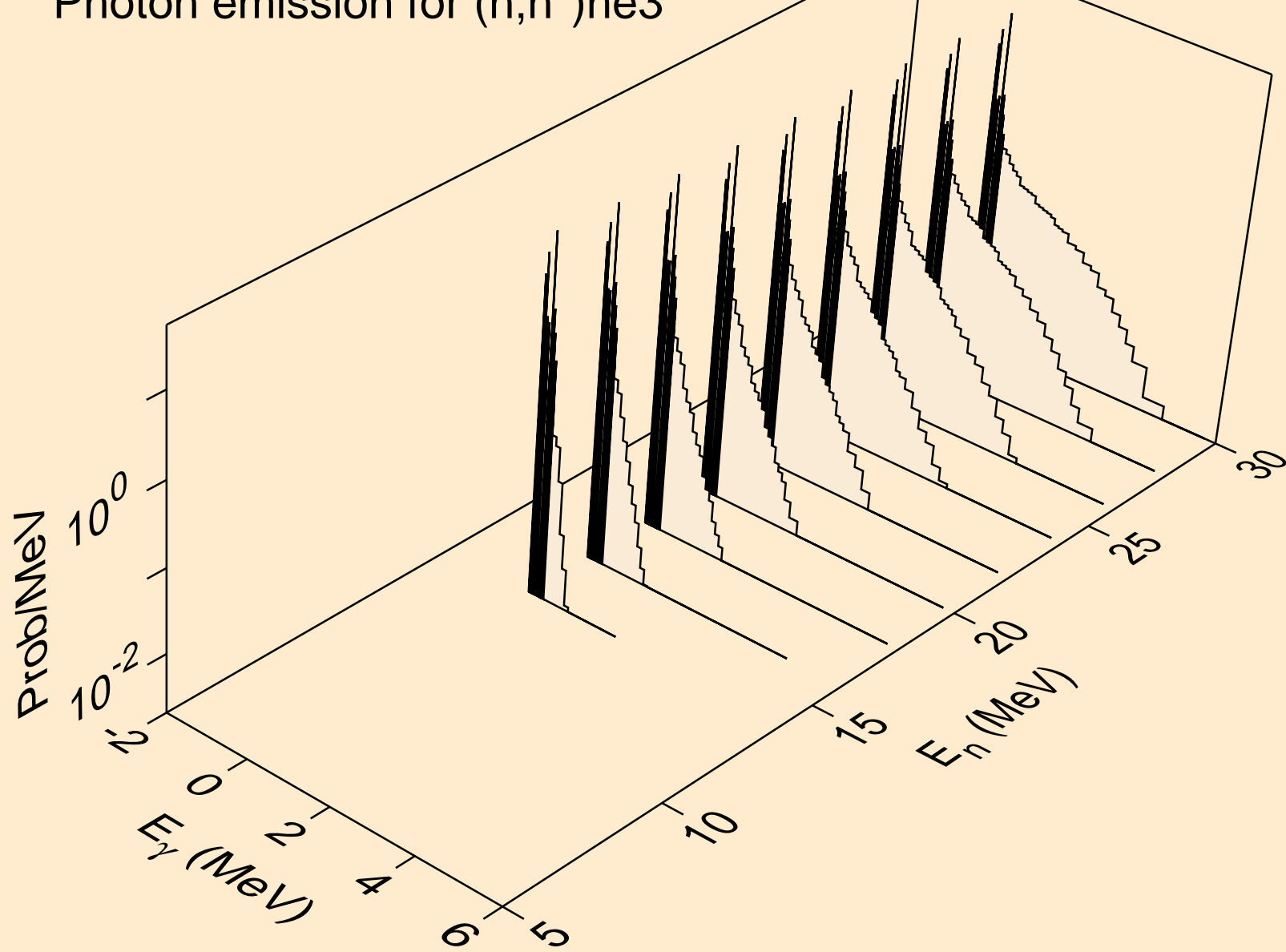

LA121 NEUTRON ACER TENDL-2023 LIBRARY; T=0.K
Photon emission for (n,2np)

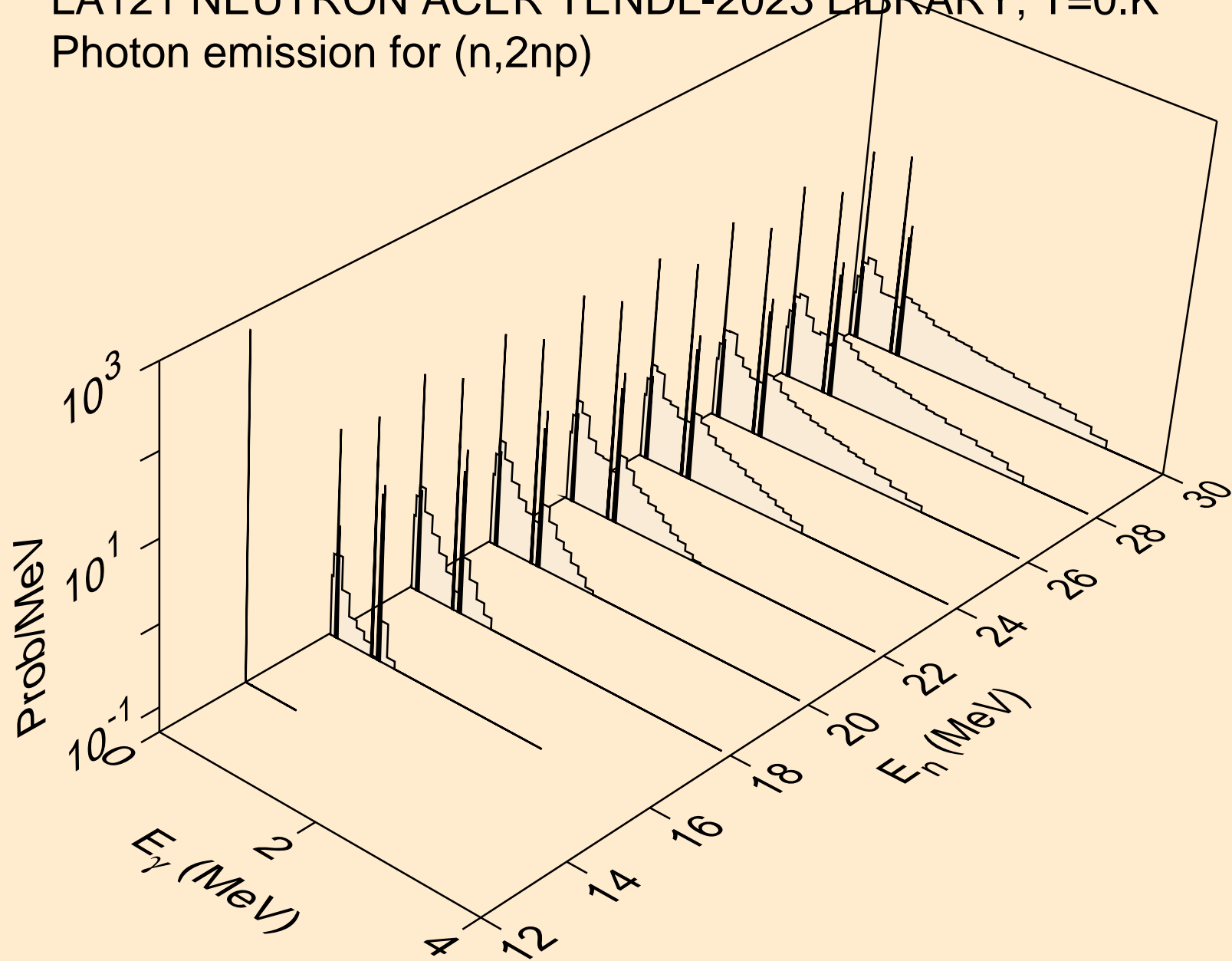

LA121 NEUTRON ACER TENDL-2023 LIBRARY; T=0.K
Photon emission for (n,3np)

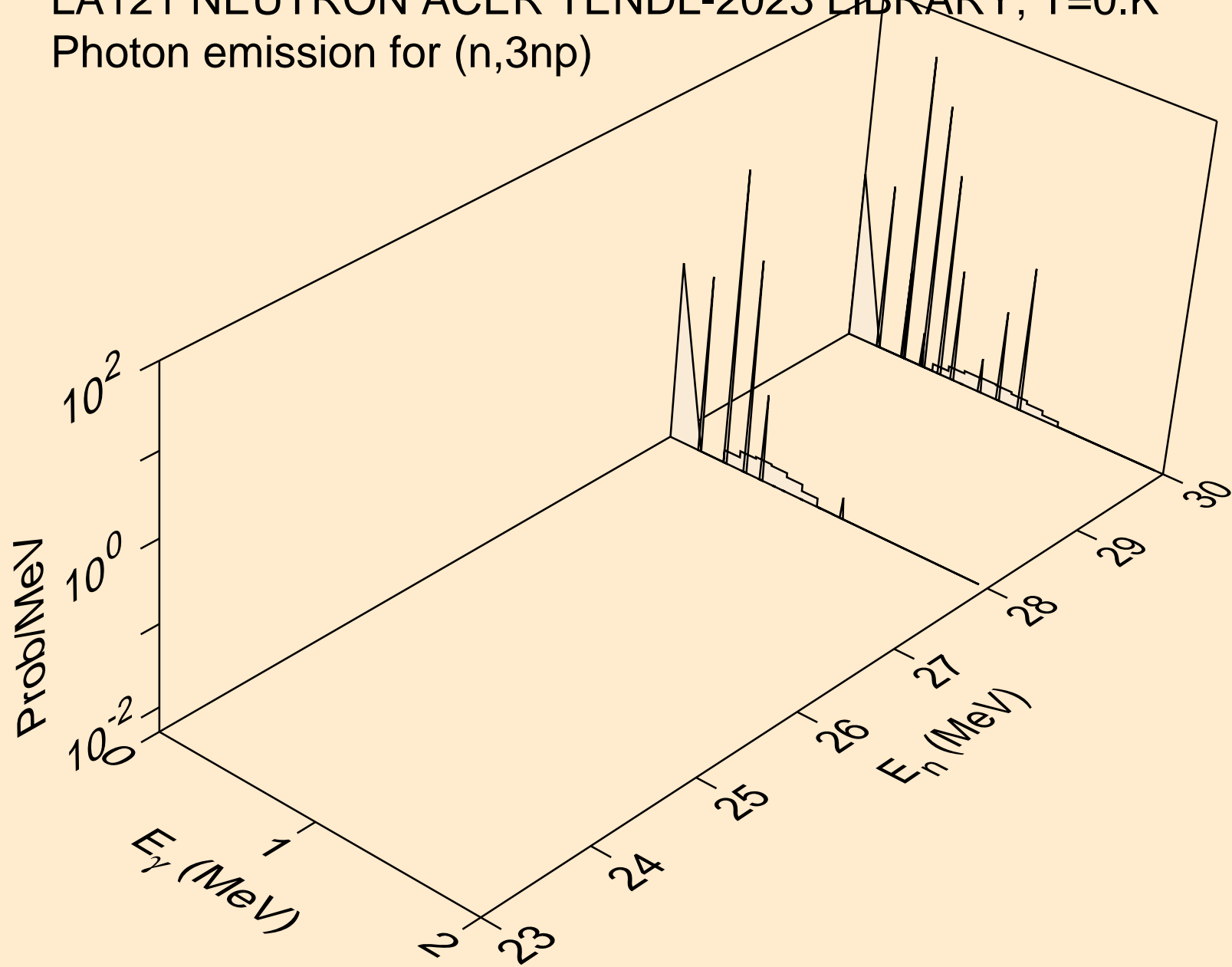

LA121 NEUTRON ACER TENDL-2023 LIBRARY; T=0.K
Photon emission for (n,n2p)

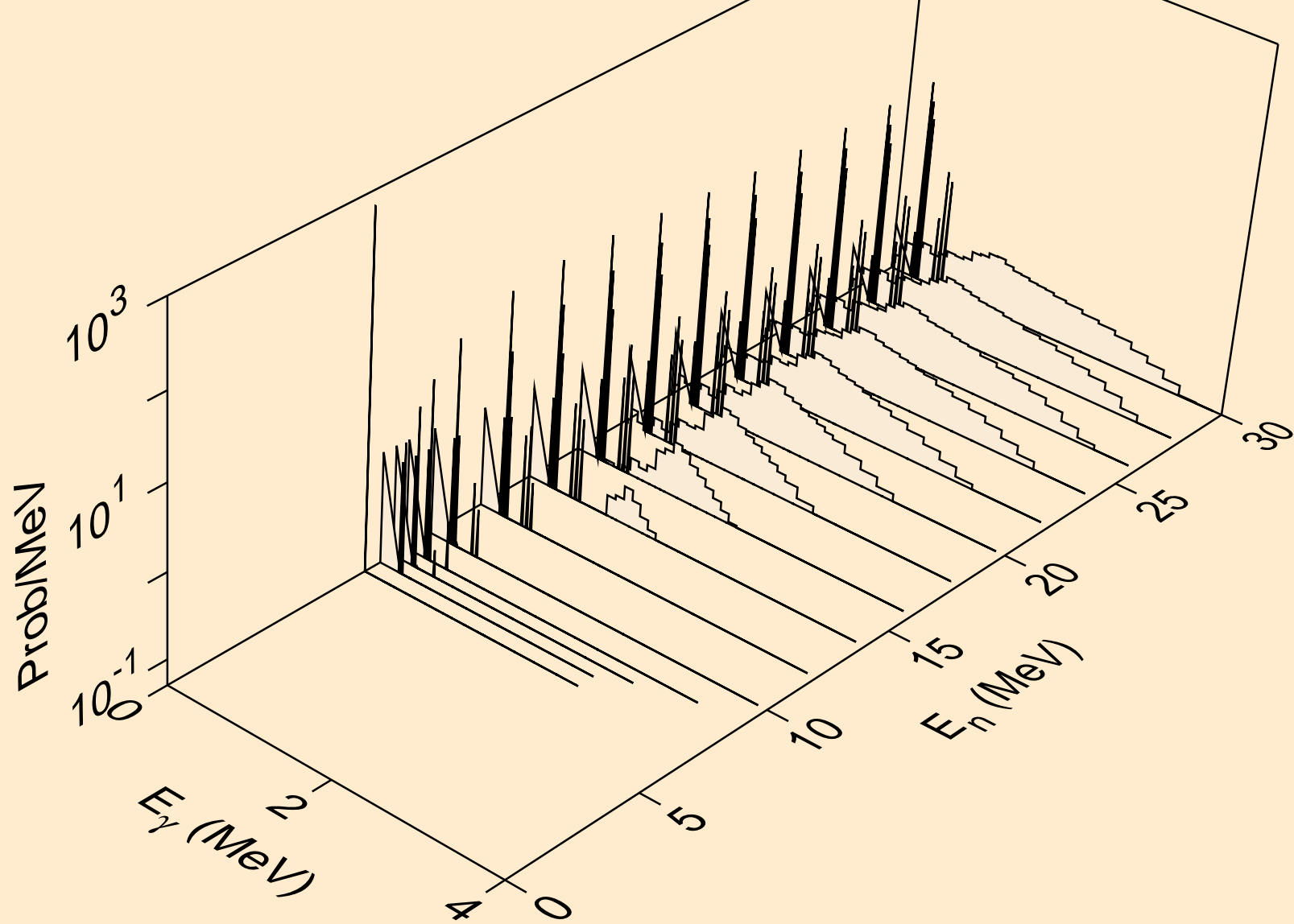

LA121 NEUTRON ACER TENDL-2023 LIBRARY; T=0.K
Photon emission for (n,npa)

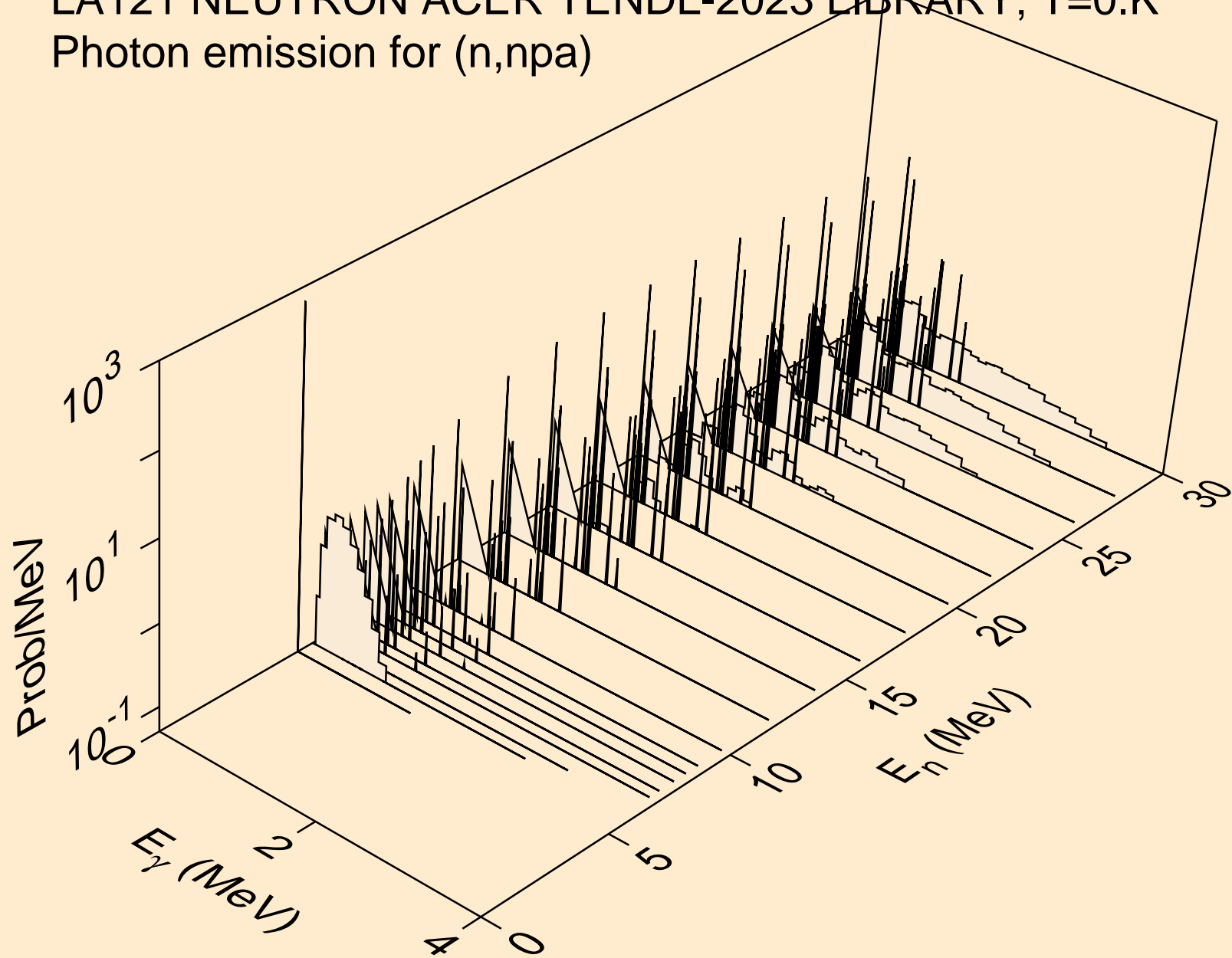

LA121 NEUTRON ACER TENDL-2023 LIBRARY; T=0.K
Photon emission for (n,n*c)

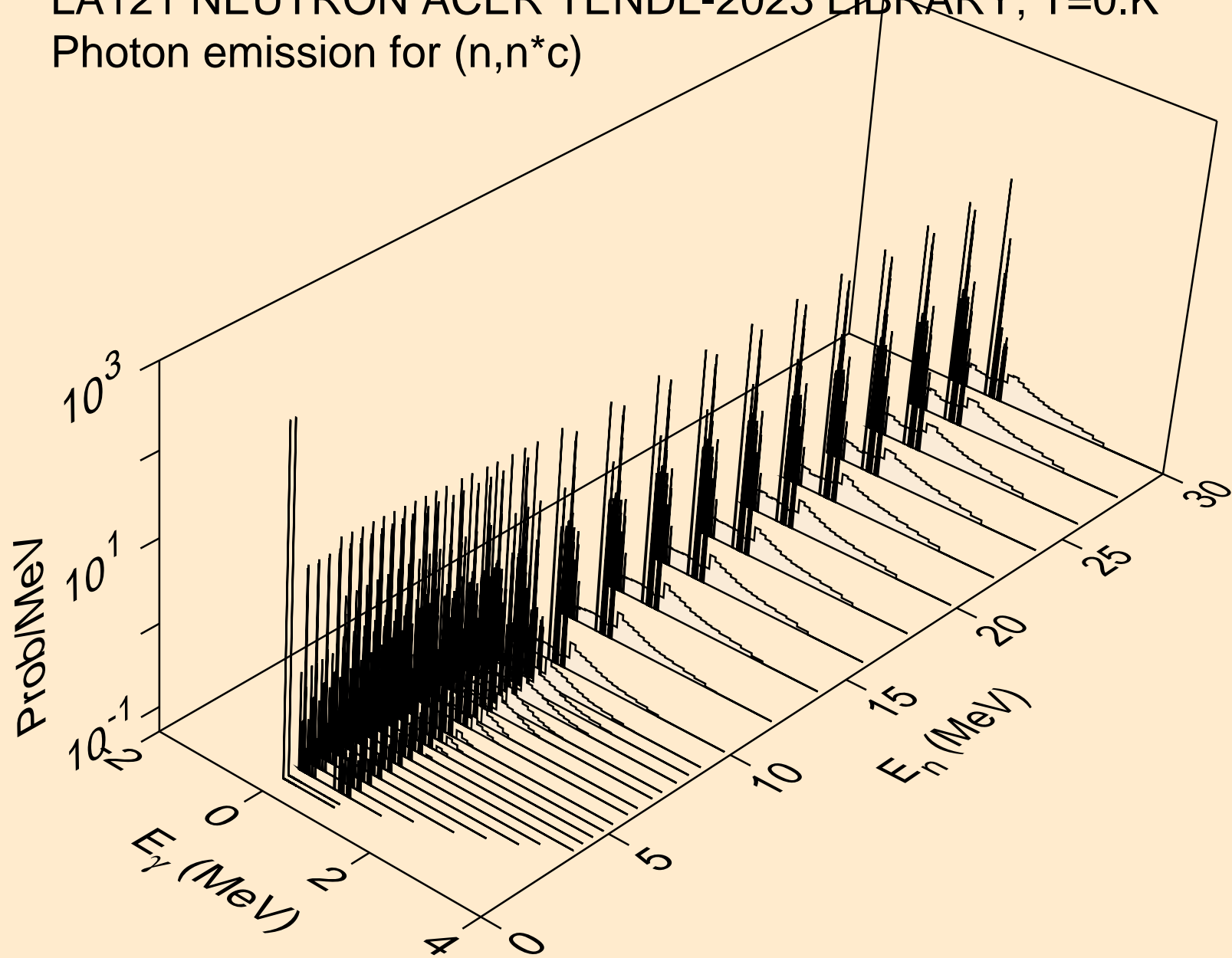

LA121 NEUTRON ACER TENDL-2023 LIBRARY; T=0.K
Photon emission for (n,gma)

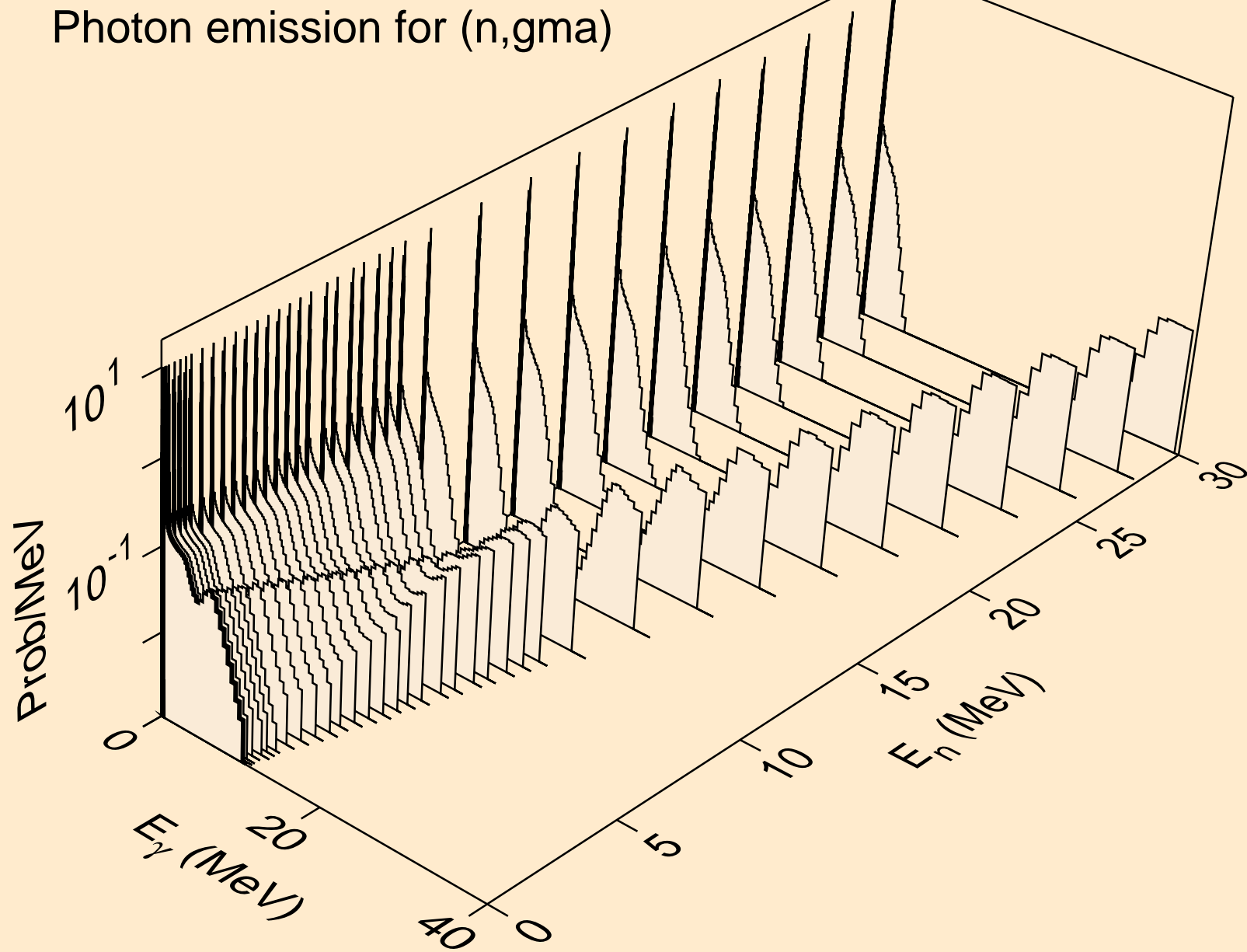

LA121 NEUTRON ACER TENDL-2023 LIBRARY; T=0.K
Photon emission for (n,p)

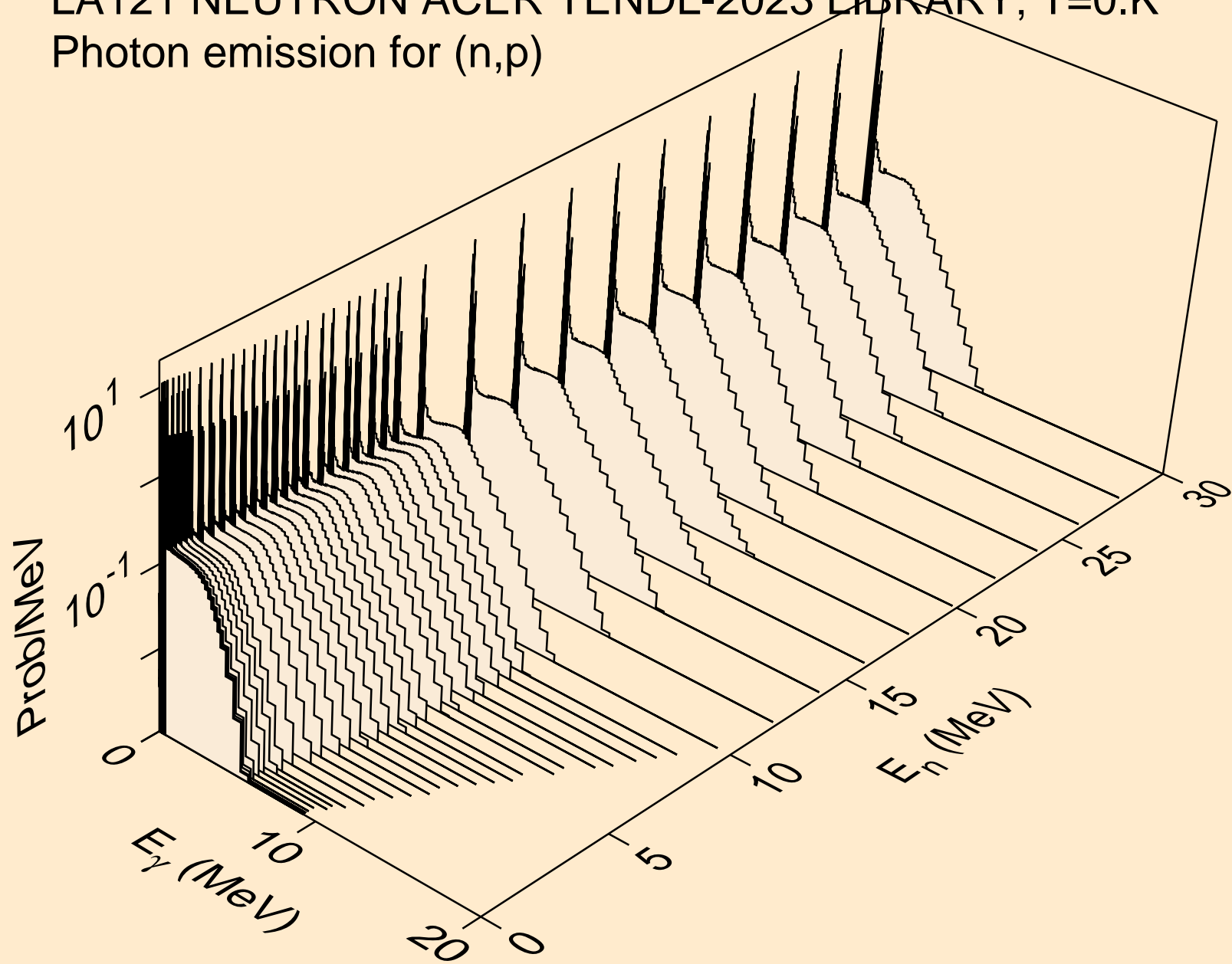

LA121 NEUTRON ACER TENDL-2023 LIBRARY; T=0.K
Photon emission for (n,d)

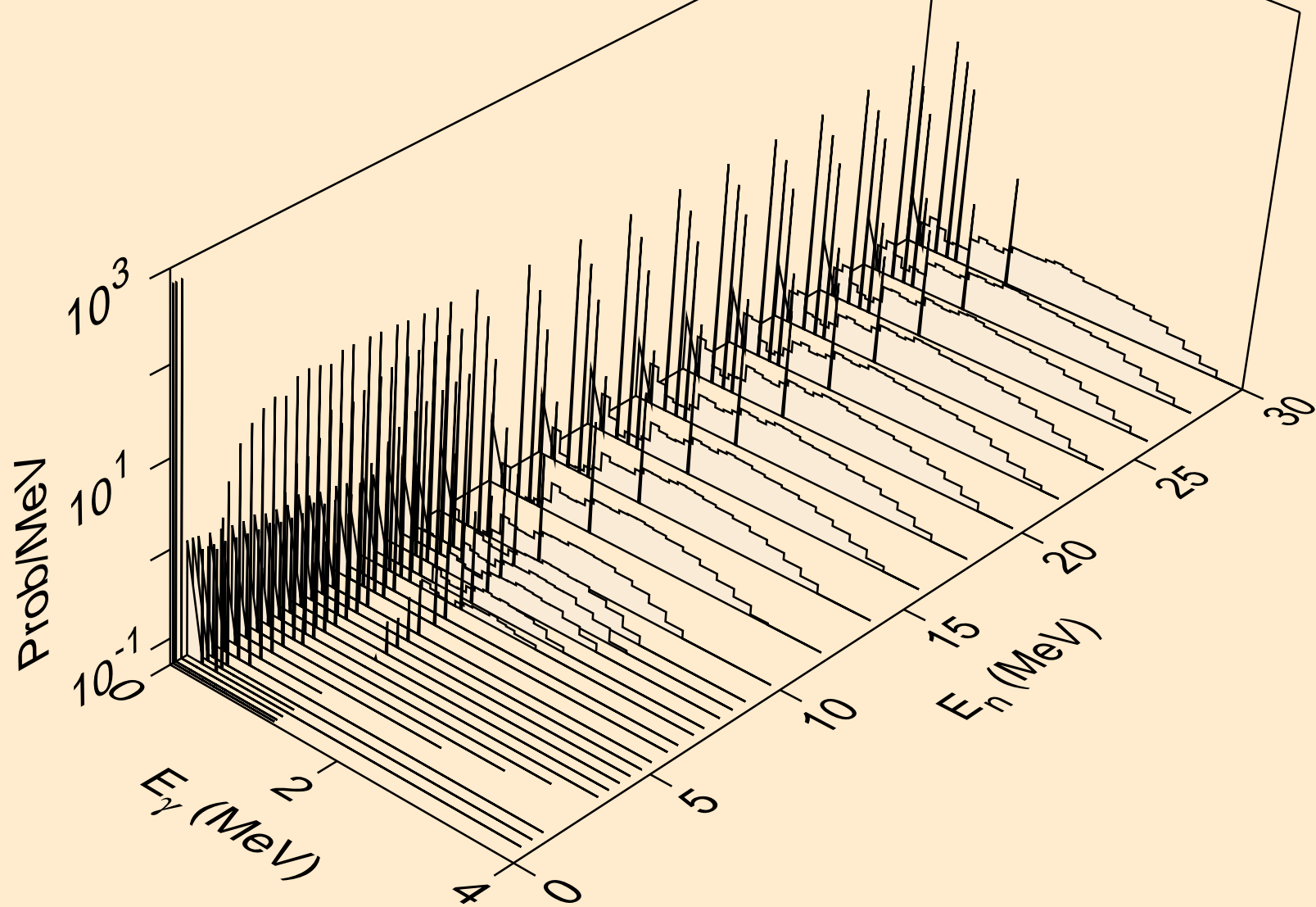

LA121 NEUTRON ACER TENDL-2023 LIBRARY; T=0.K
Photon emission for (n,t)

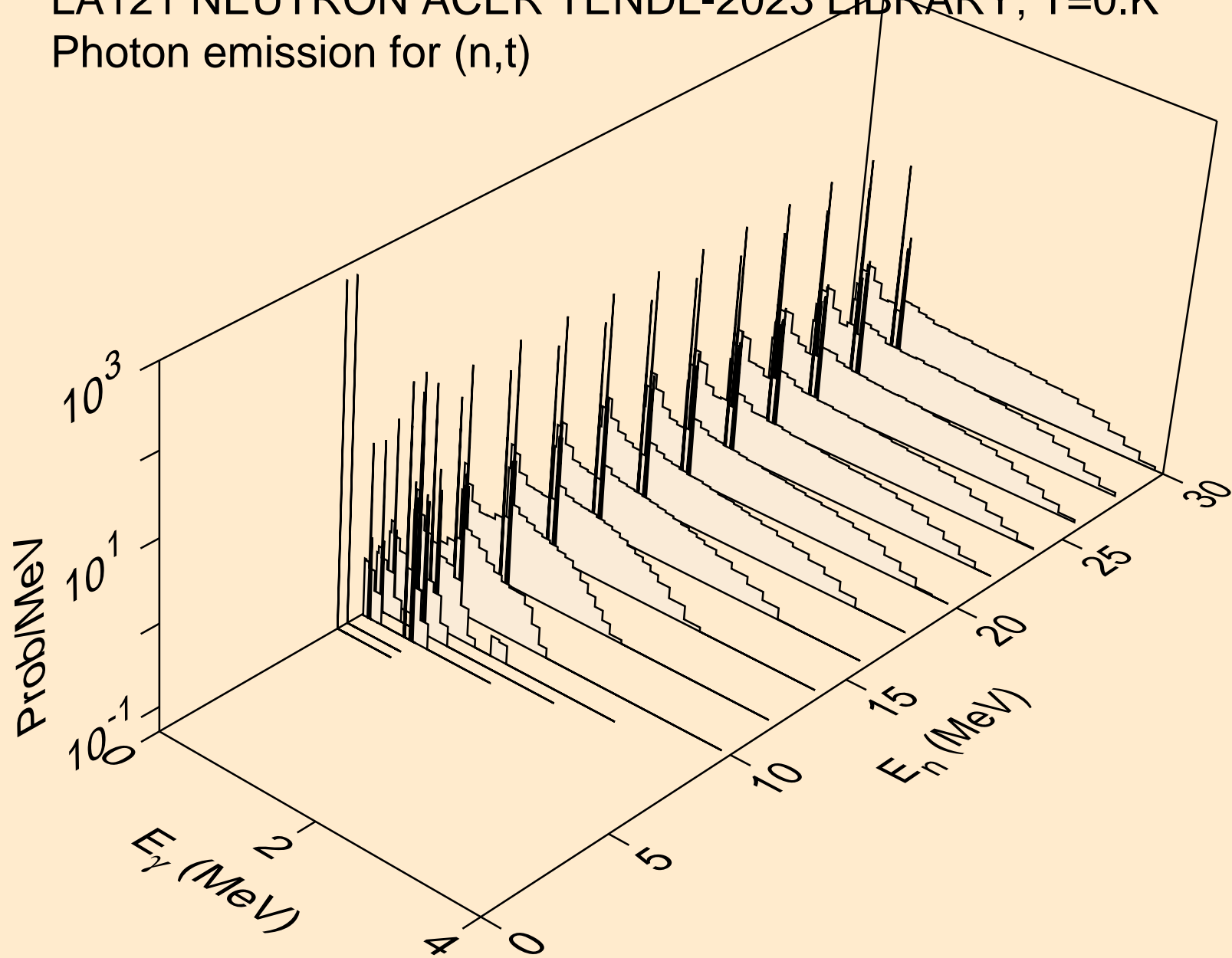

LA121 NEUTRON ACER TENDL-2023 LIBRARY; T=0.K
Photon emission for (n,he3)

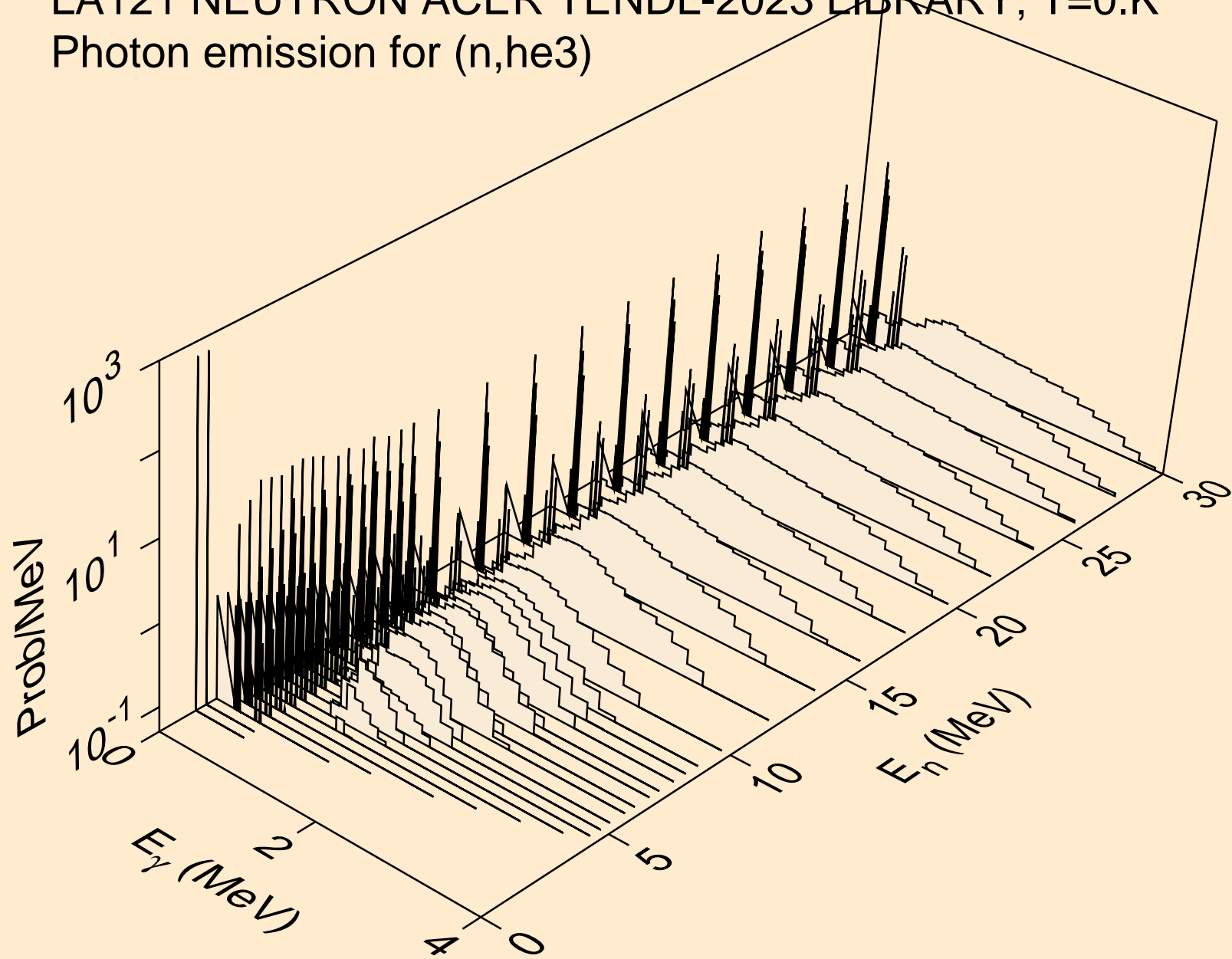

LA121 NEUTRON ACER TENDL-2023 LIBRARY; T=0.K
Photon emission for (n,a)

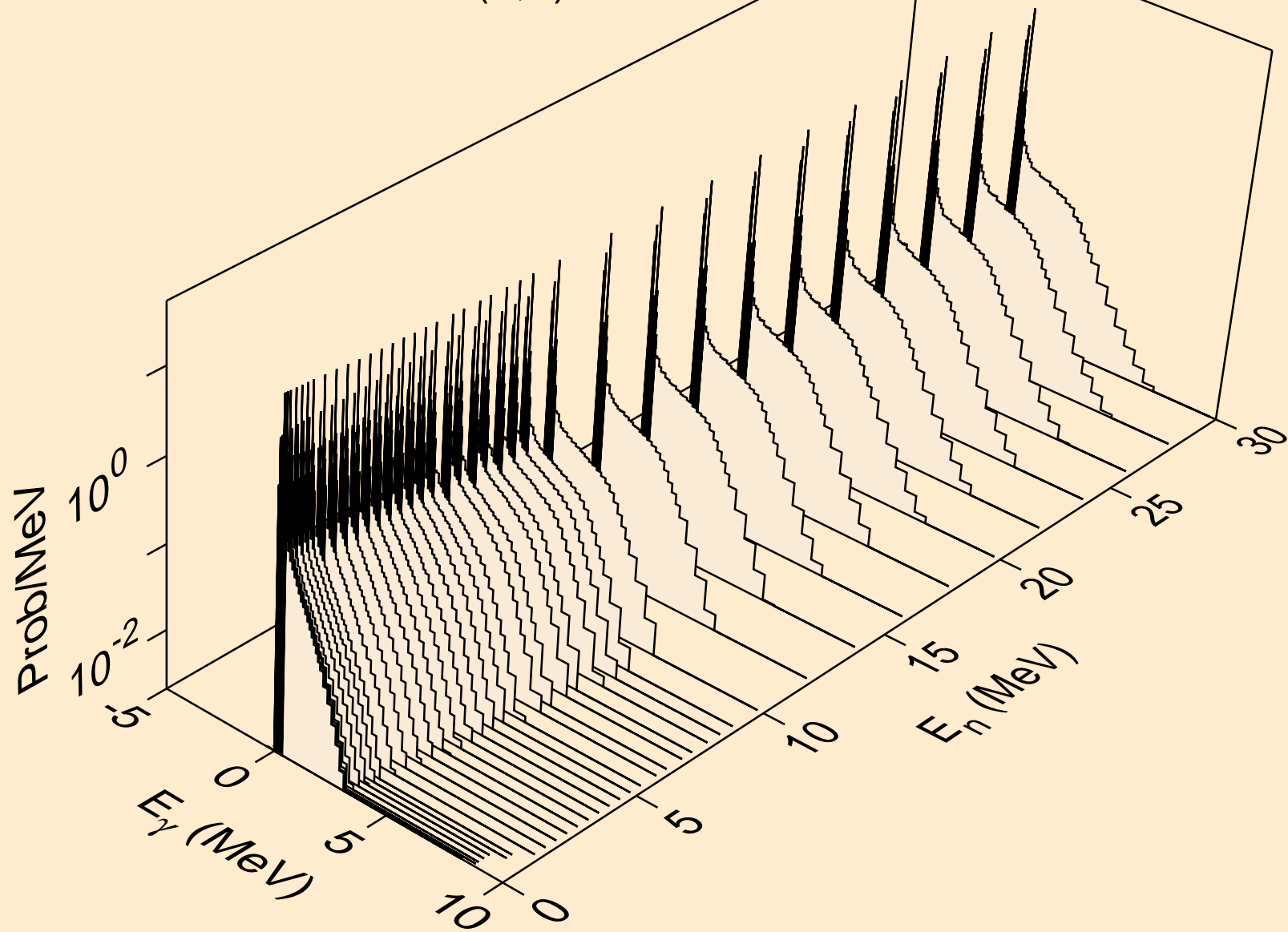

LA121 NEUTRON ACER TENDL-2023 LIBRARY; T=0.K
Photon emission for (n,2a)

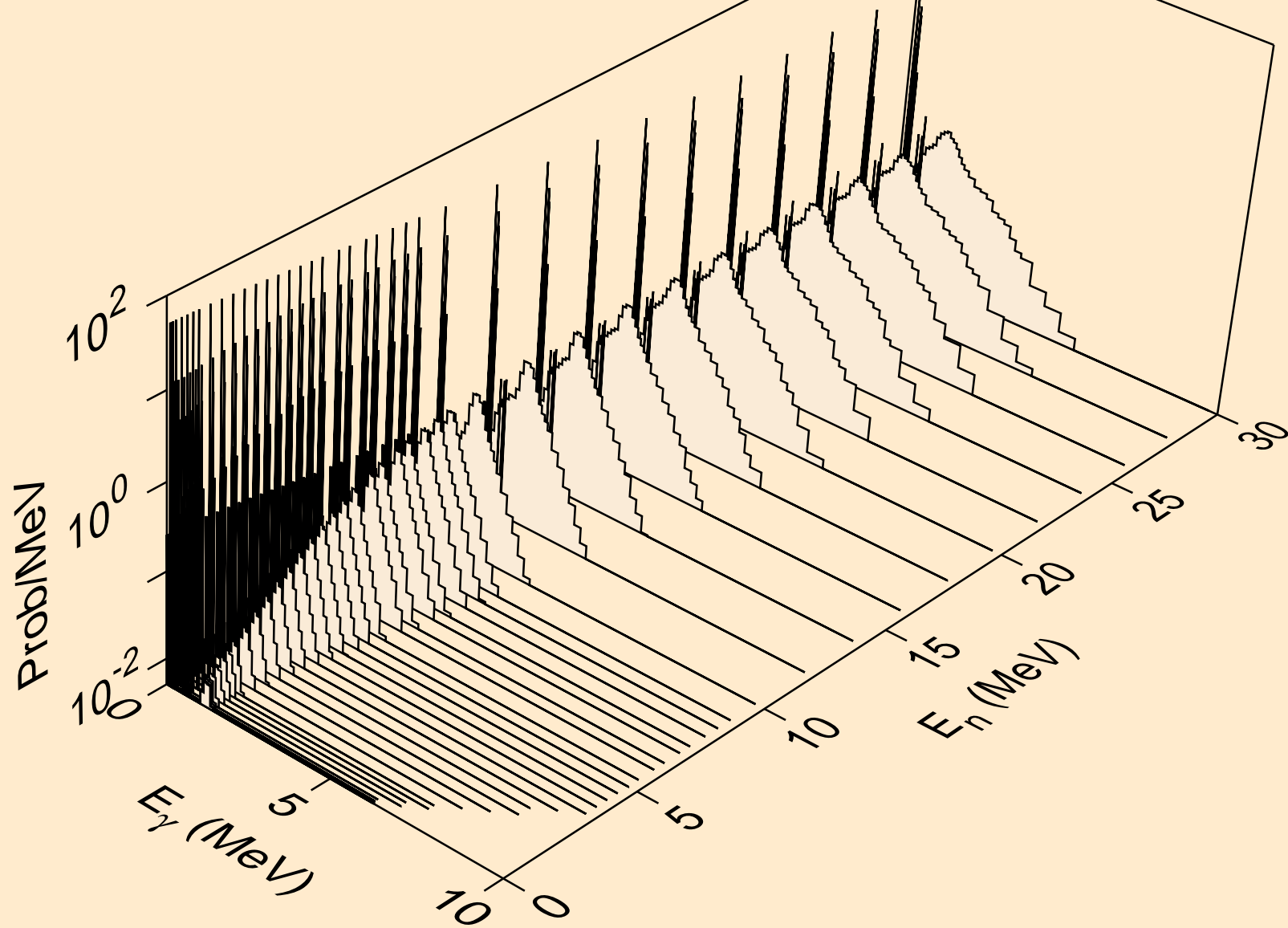

LA121 NEUTRON ACER TENDL-2023 LIBRARY; T=0.K
Photon emission for (n,3a)

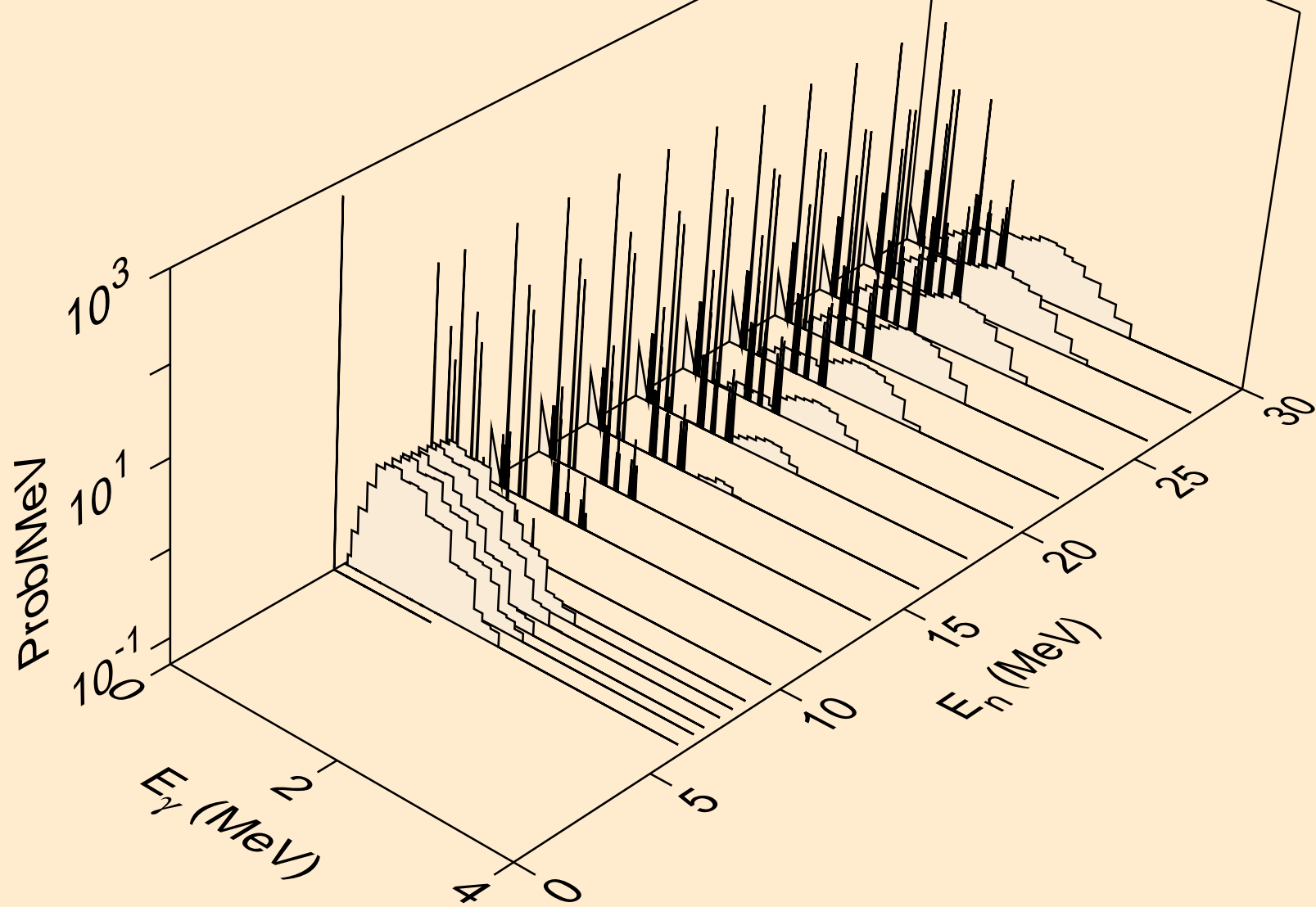

LA121 NEUTRON ACER TENDL-2023 LIBRARY; T=0.K
Photon emission for (n,2p)

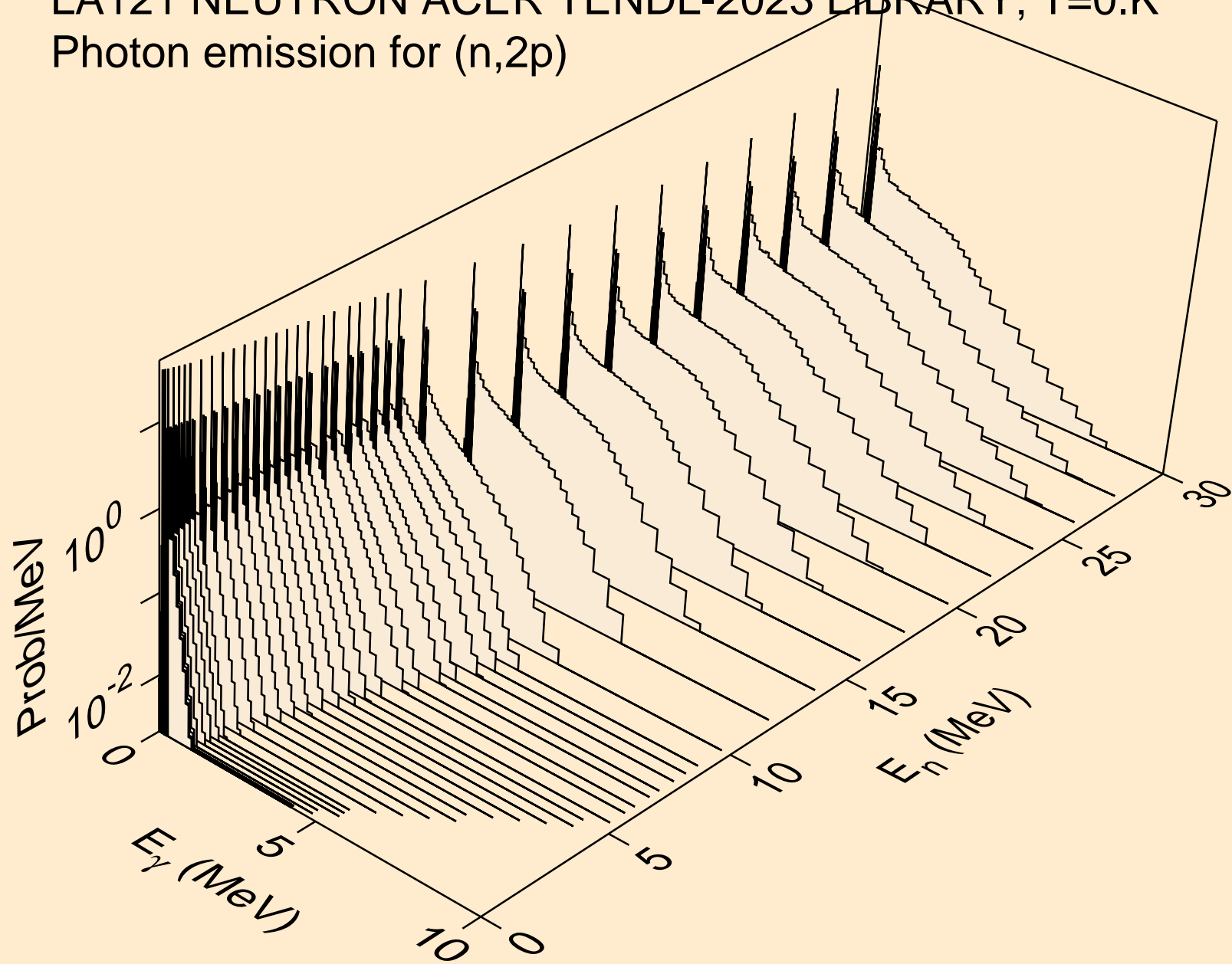

LA121 NEUTRON ACER TENDL-2023 LIBRARY; T=0.K
Photon emission for (n,p α)

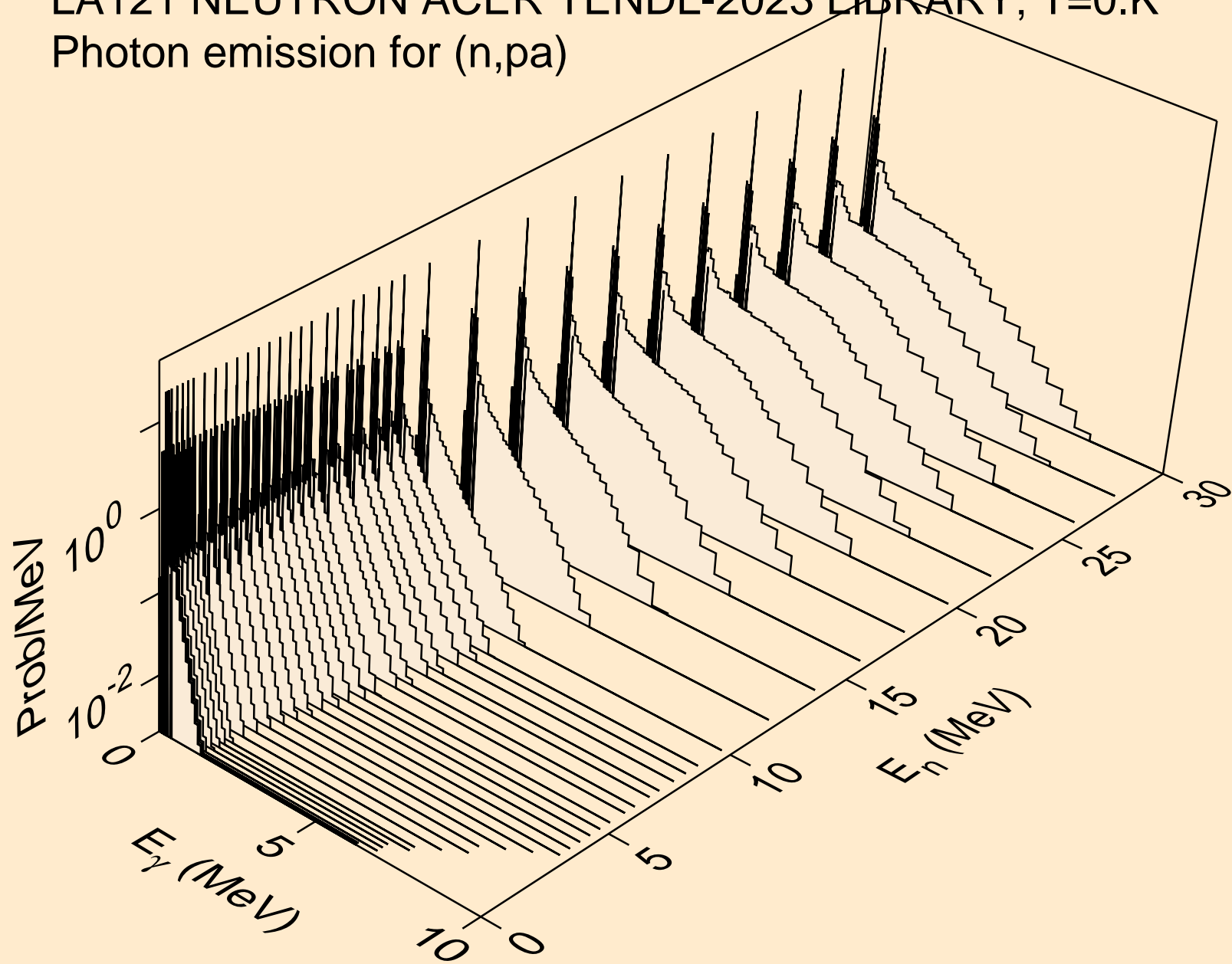

LA121 NEUTRON ACER TENDL-2023 LIBRARY; T=0.K
Photon emission for (n,t2a)

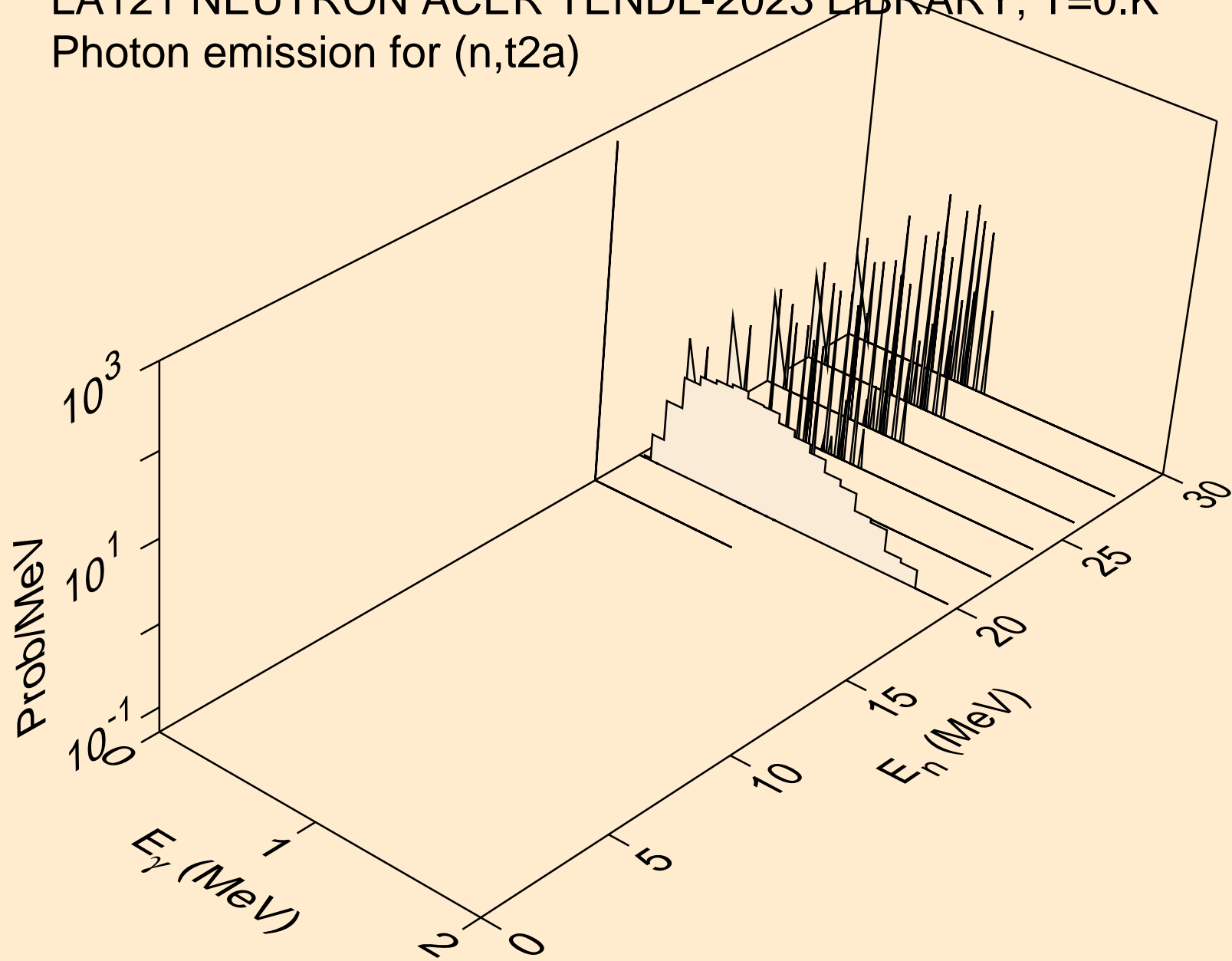

LA121 NEUTRON ACER TENDL-2023 LIBRARY; T=0.K
Photon emission for (n,d2a)

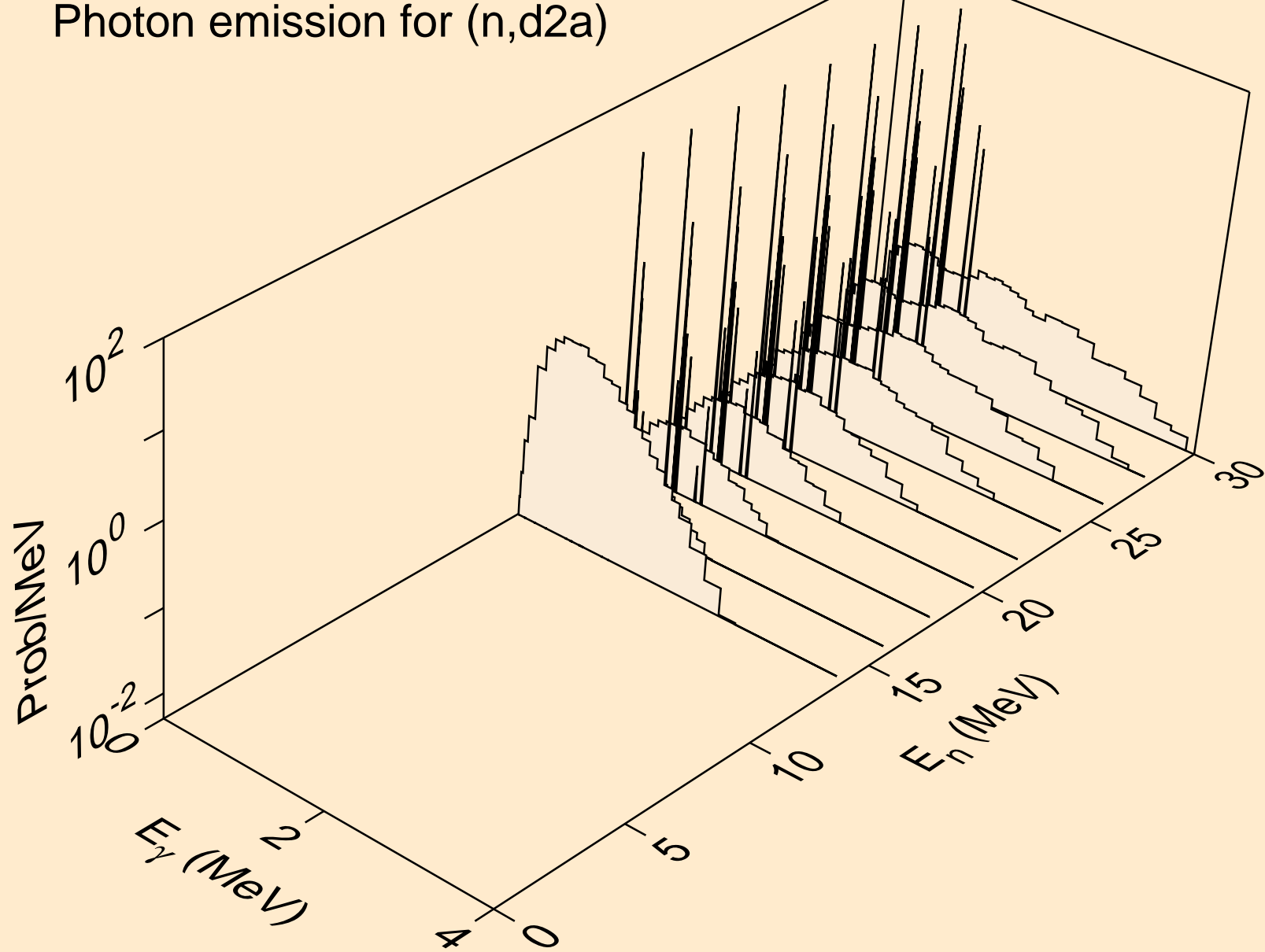

LA121 NEUTRON ACER TENDL-2023 LIBRARY; T=0.K
Photon emission for (n,pd)

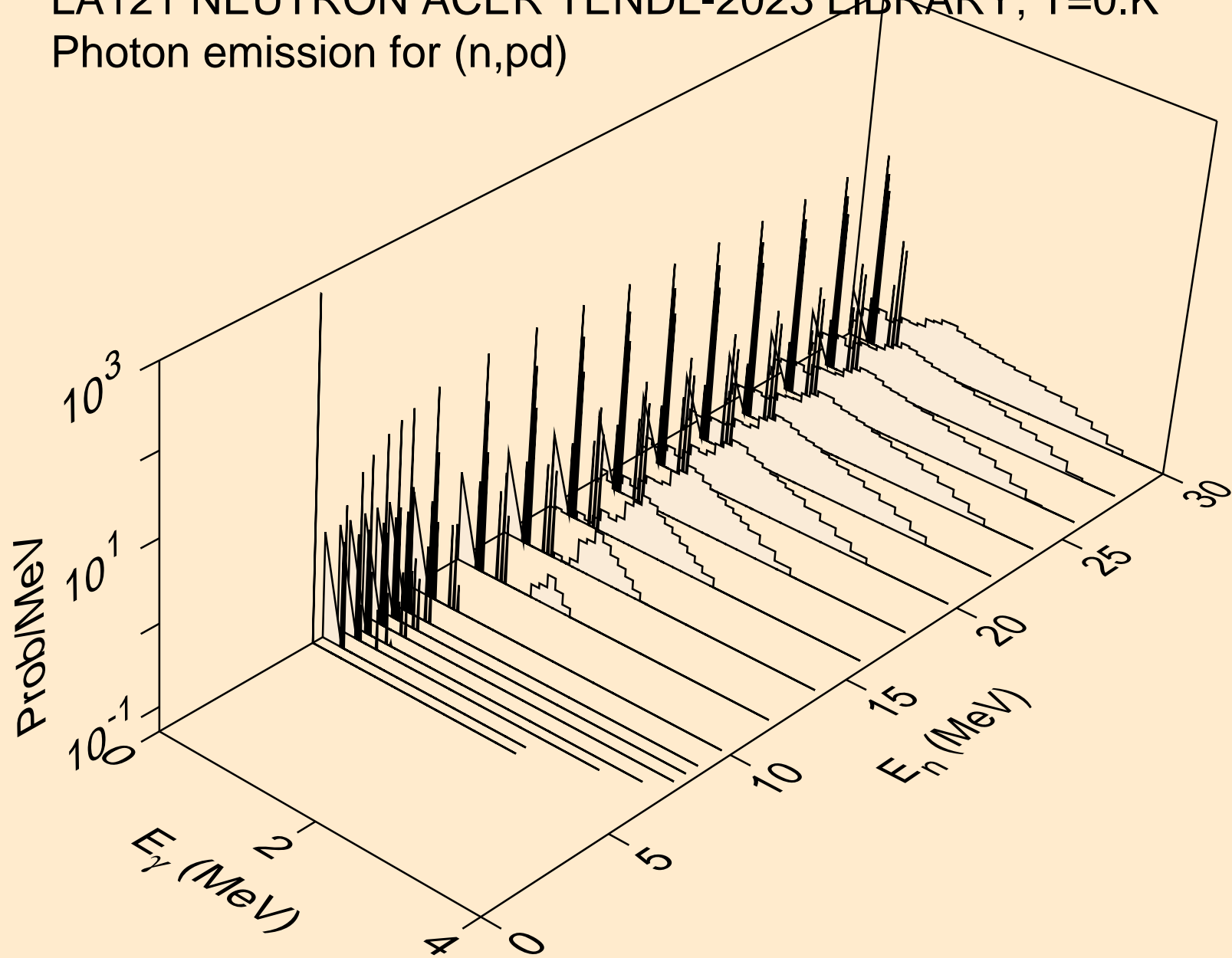

LA121 NEUTRON ACER TENDL-2023 LIBRARY; T=0.K
Photon emission for (n,pt)

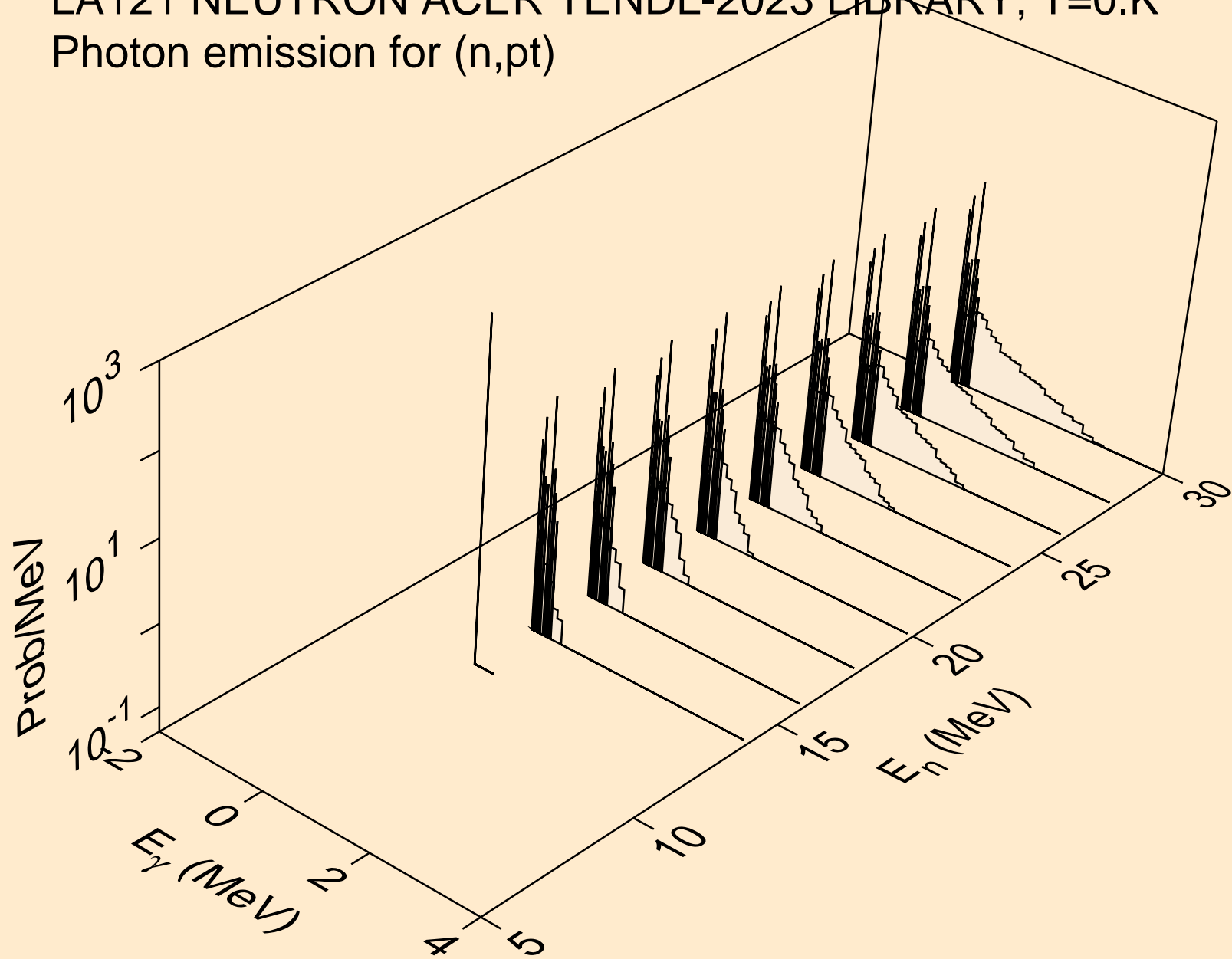

LA121 NEUTRON ACER TENDL-2023 LIBRARY; T=0.K
Photon emission for (n,da)

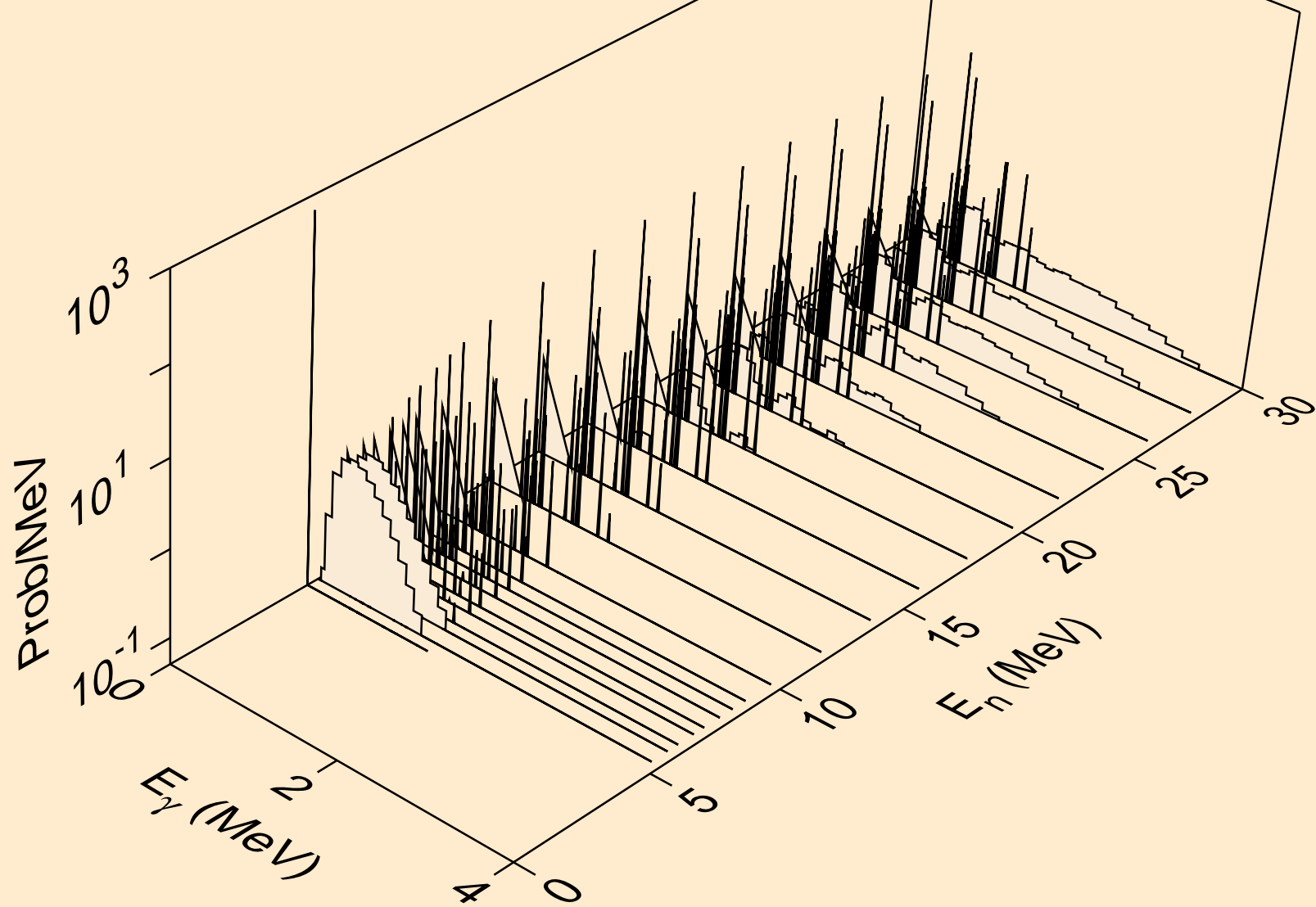

LA121 NEUTRON ACER TENDL-2023 LIBRARY; T=0.K
thermal capture photon spectrum

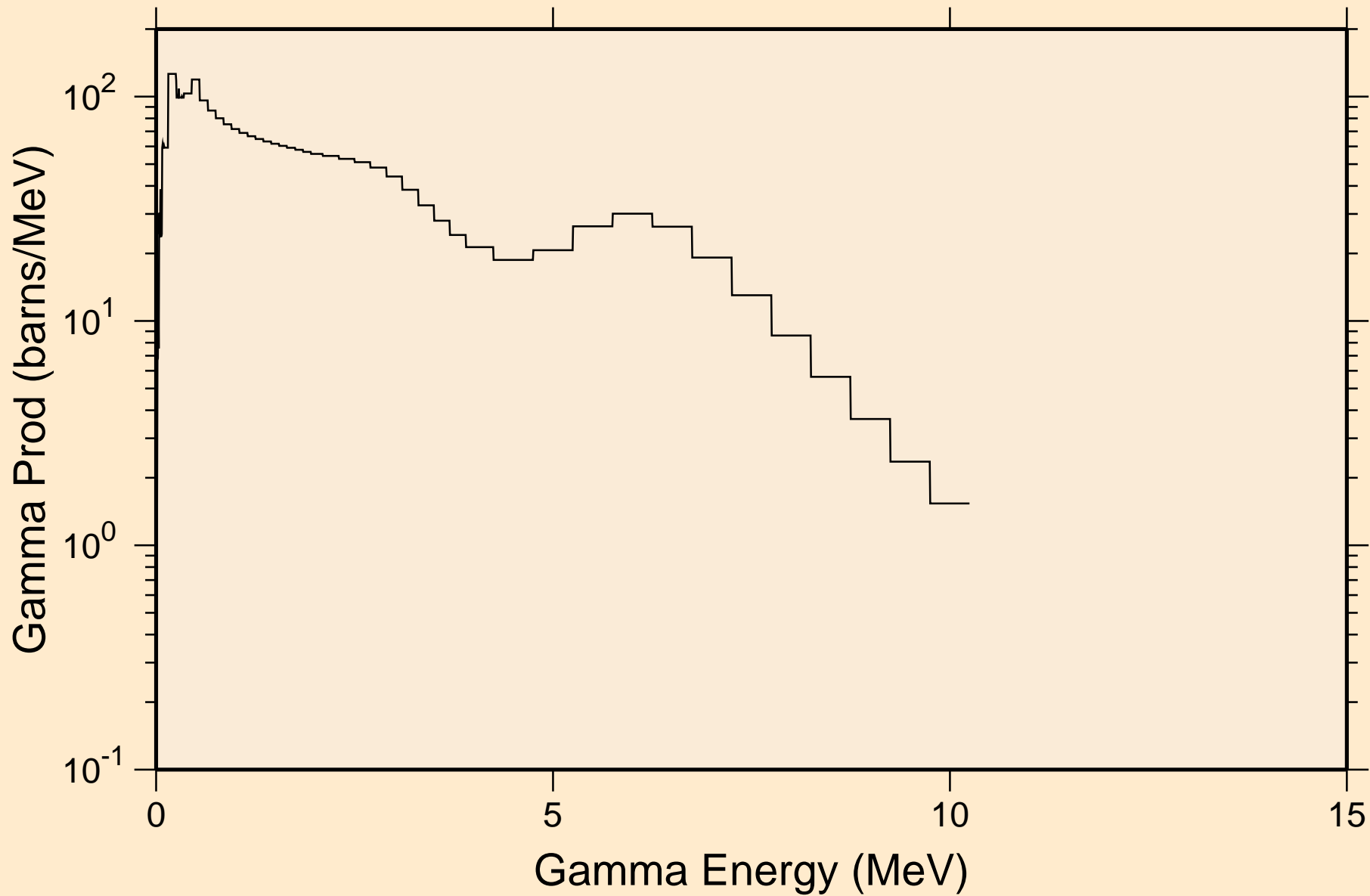

LA121 NEUTRON ACER TENDL-2023 LIBRARY; T=0.K
14 MeV photon spectrum

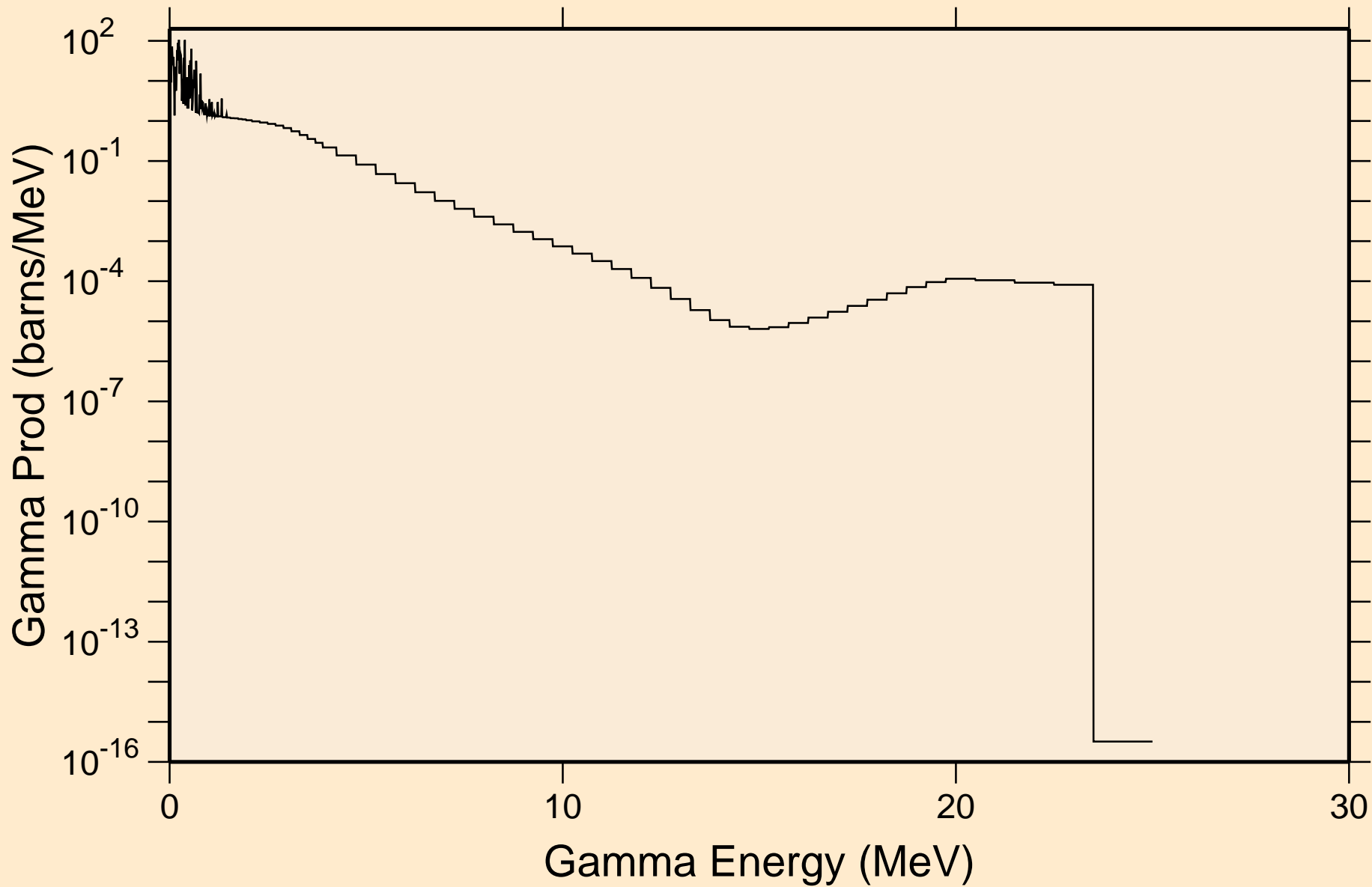

LA121 NEUTRON ACER TENDL-2023 LIBRARY; T=0.K
Particle heating contributions

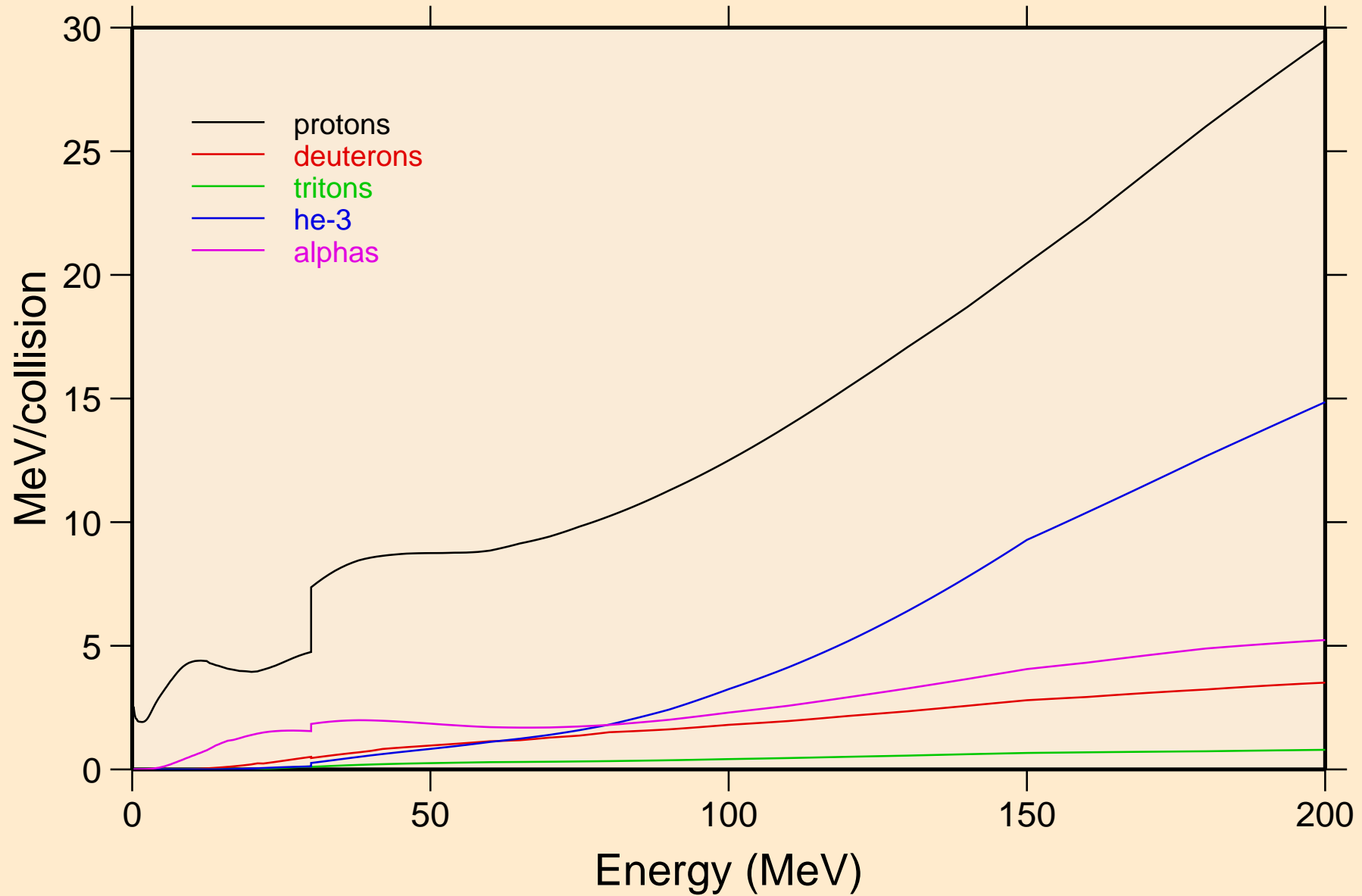

LA121 NEUTRON ACER TENDL-2023 LIBRARY; T=0.K
Recoil Heating

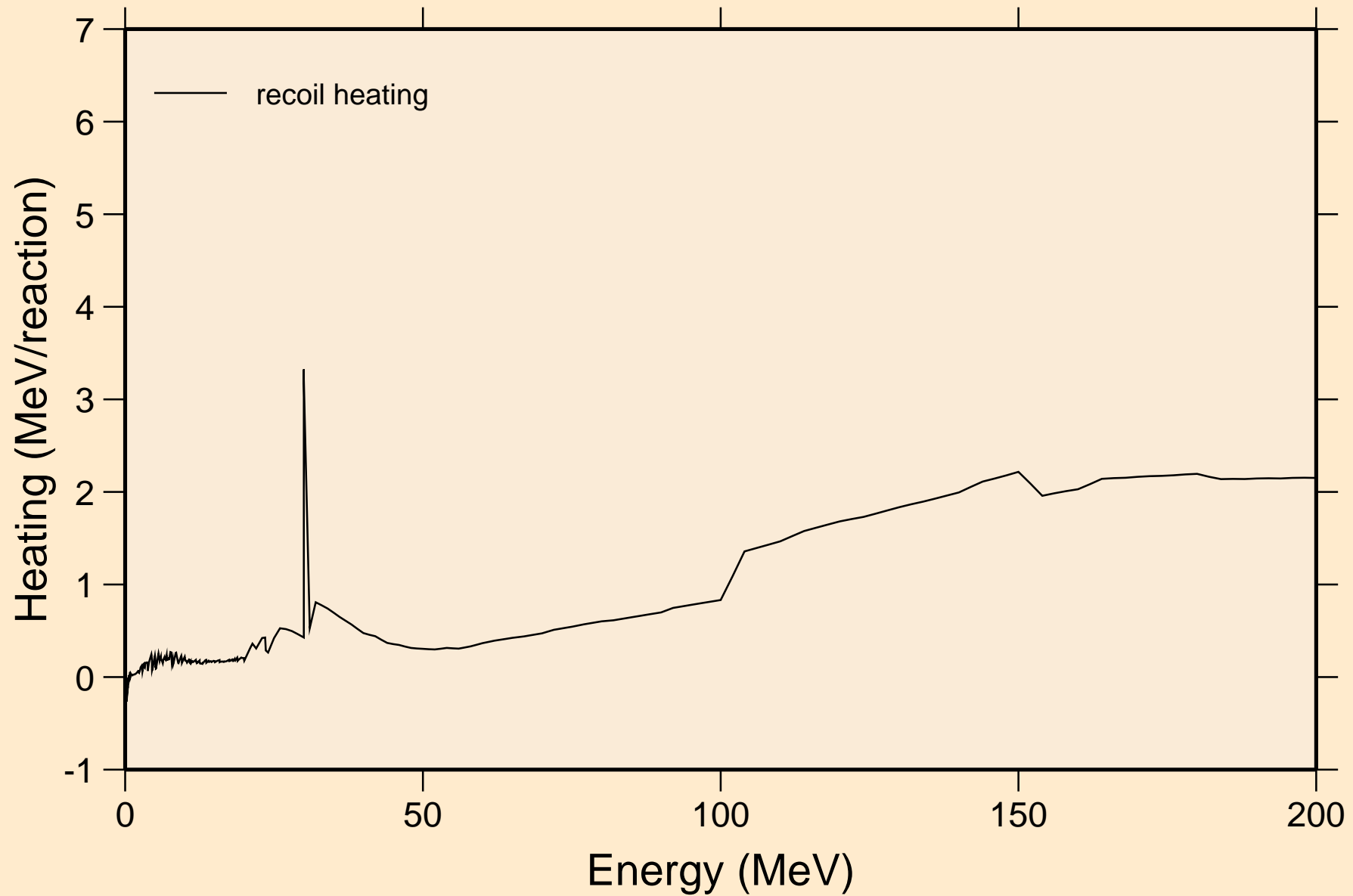

LA121 NEUTRON ACER TENDL-2023 LIBRARY; T=0.K
Particle production cross sections

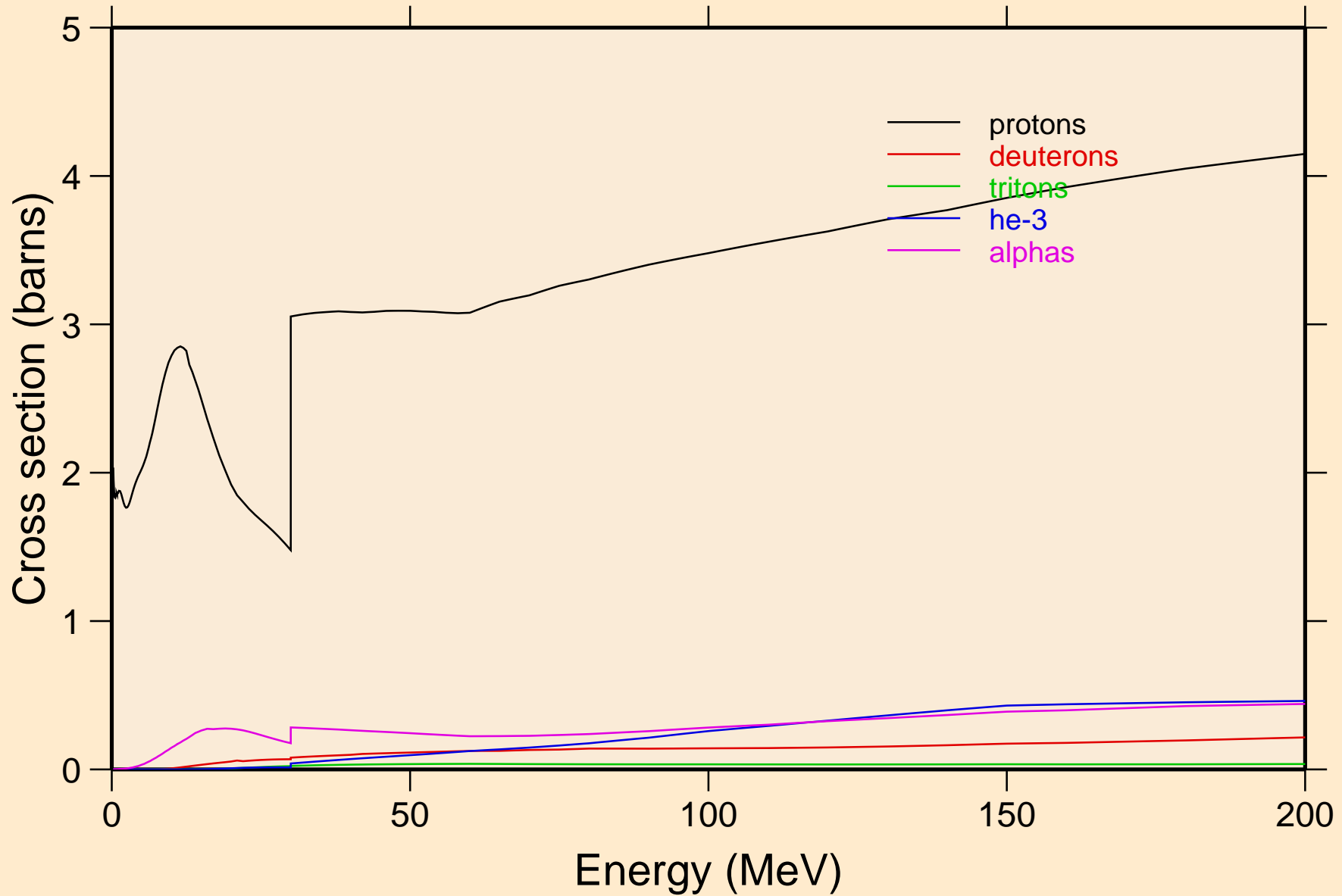

LA121 NEUTRON ACER TENDL-2023 LIBRARY; T=0.K
protons from (n,x)

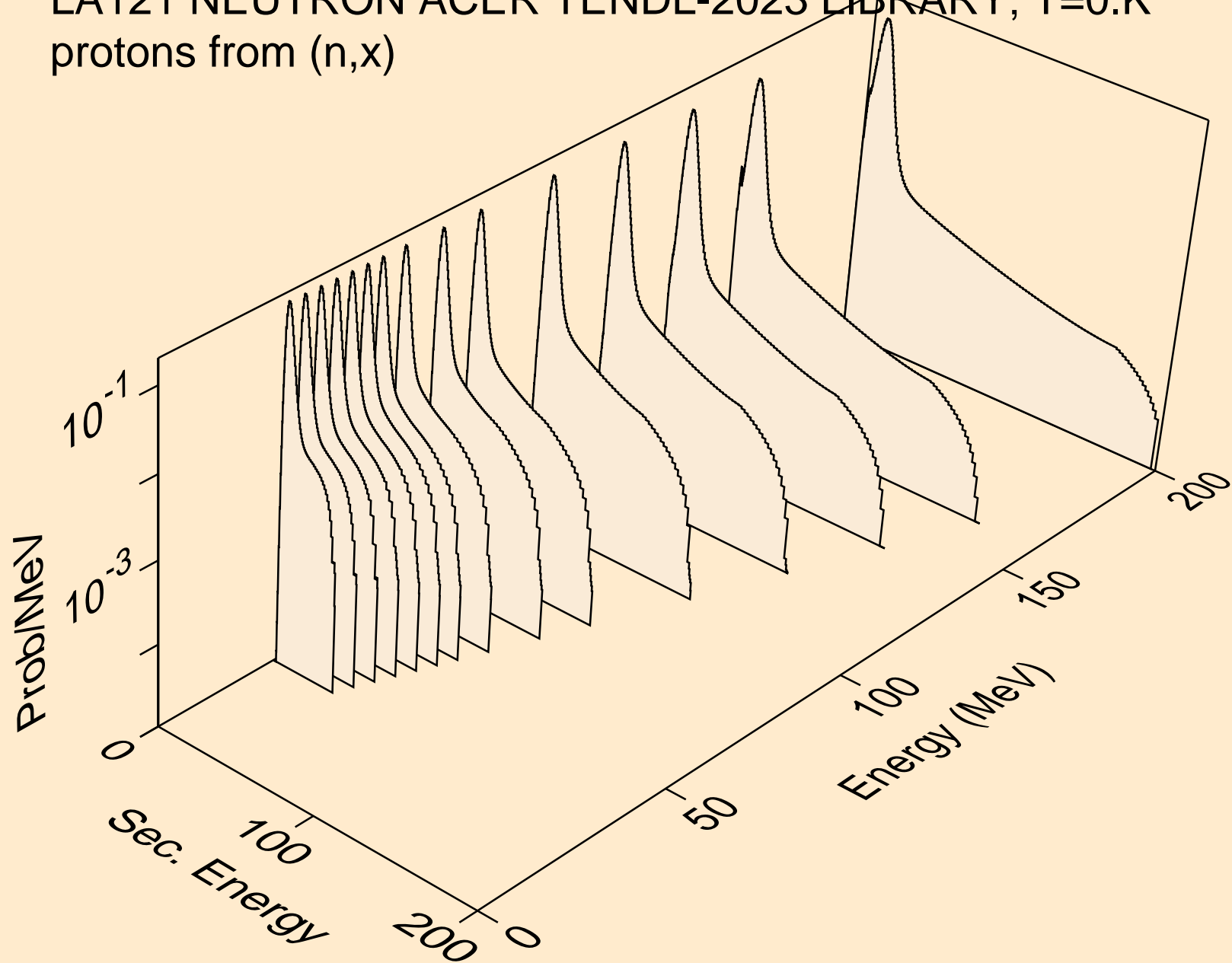

LA121 NEUTRON ACER TENDL-2023 LIBRARY; T=0.K
protons from (n,n*)p

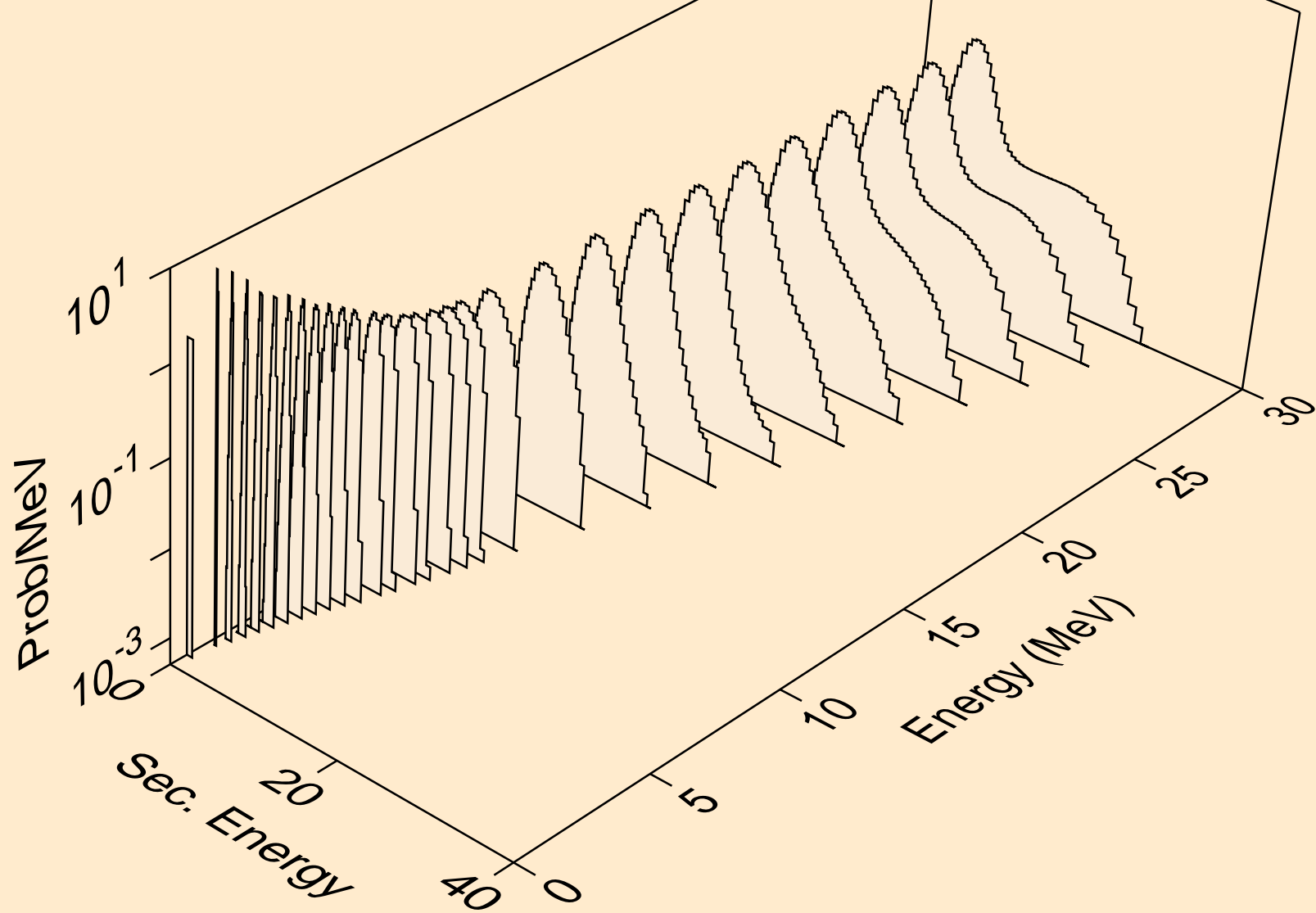

LA121 NEUTRON ACER TENDL-2023 LIBRARY; T=0.K
protons from (n,2np)

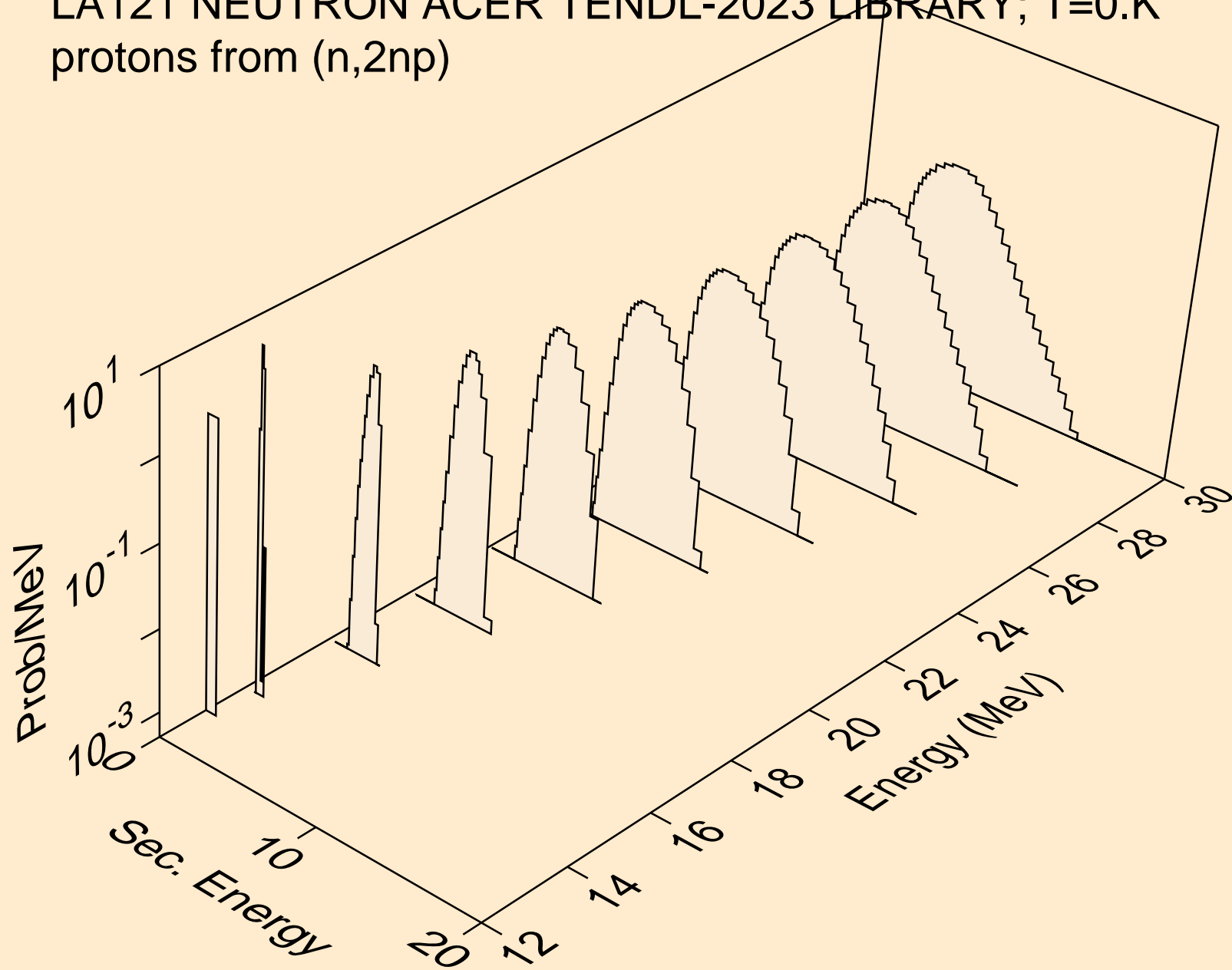

LA121 NEUTRON ACER TENDL-2023 LIBRARY; T=0.K
protons from (n,3np)

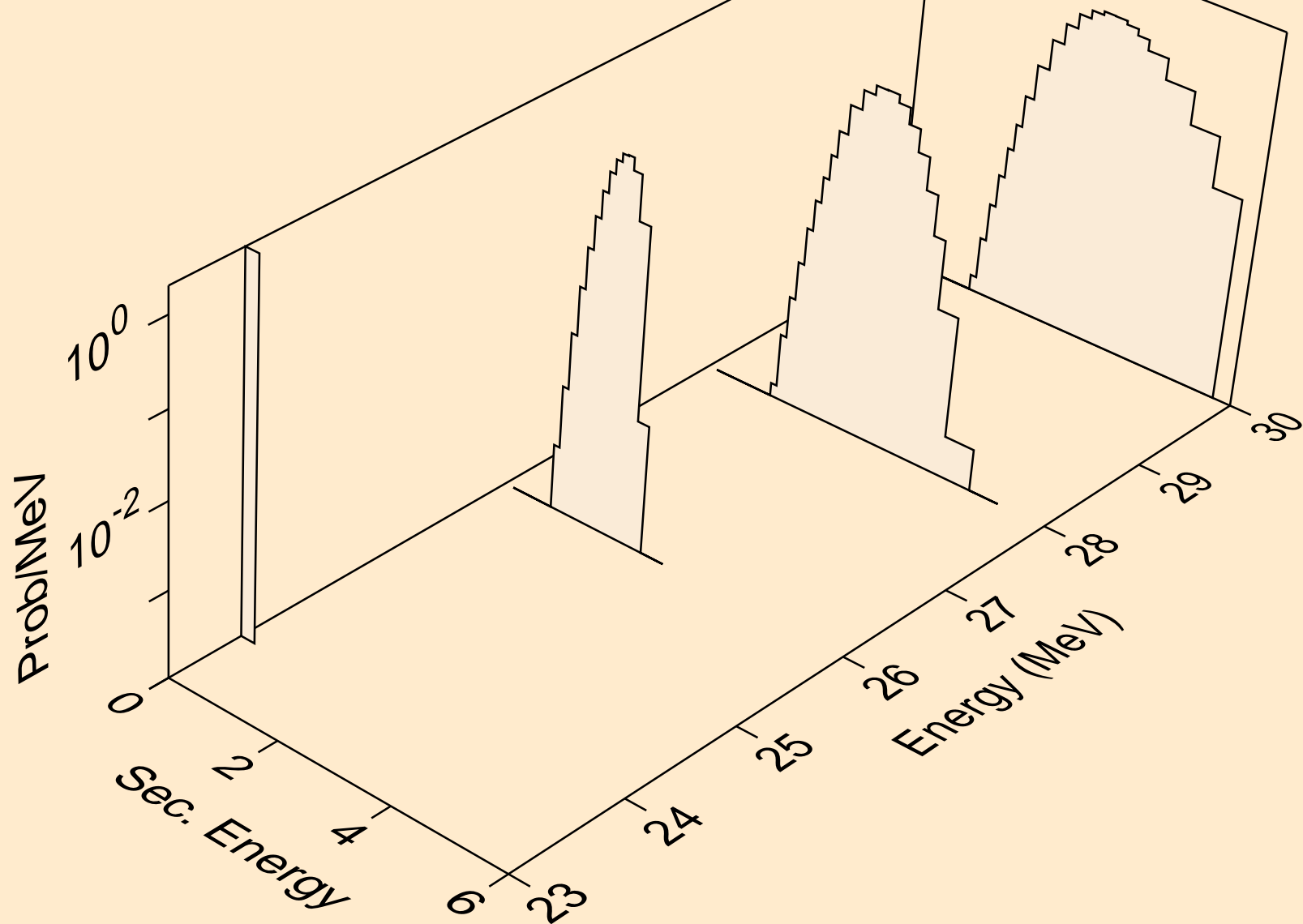

LA121 NEUTRON ACER TENDL-2023 LIBRARY; T=0.K
protons from (n,n2p)

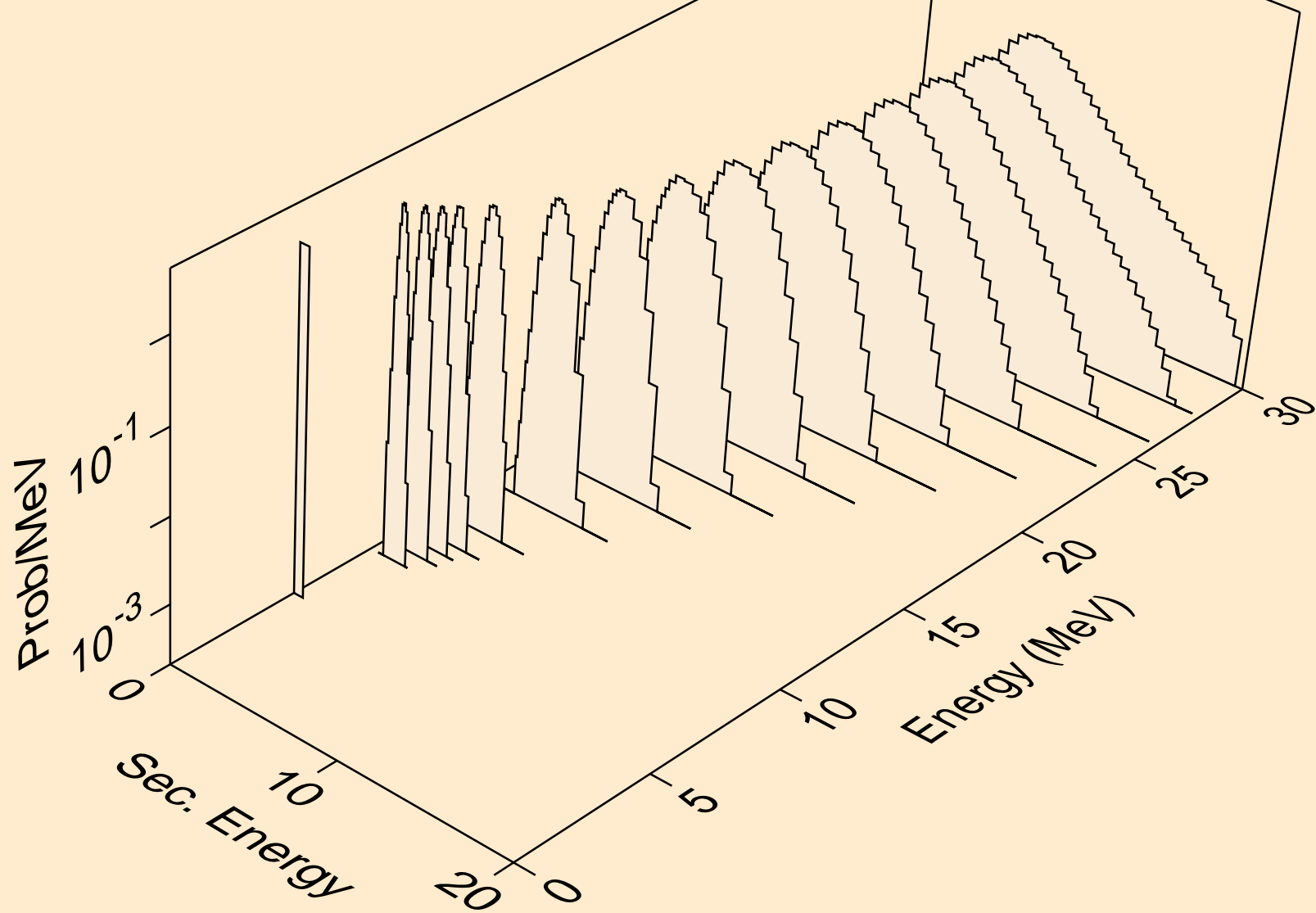

LA121 NEUTRON ACER TENDL-2023 LIBRARY; T=0.K
protons from (n,npa)

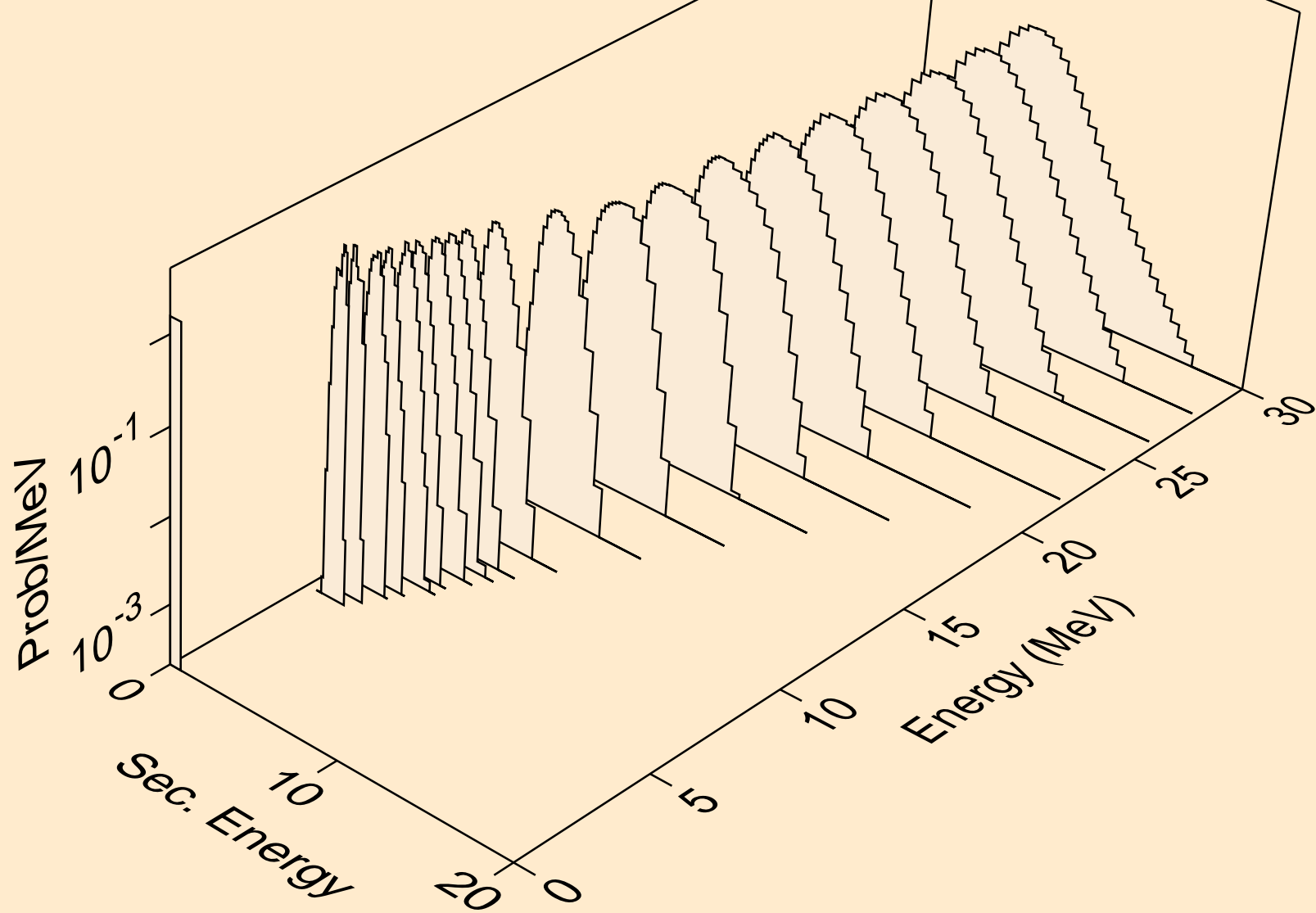

LA121 NEUTRON ACER TENDL-2023 LIBRARY; T=0.K
protons from (n,p)

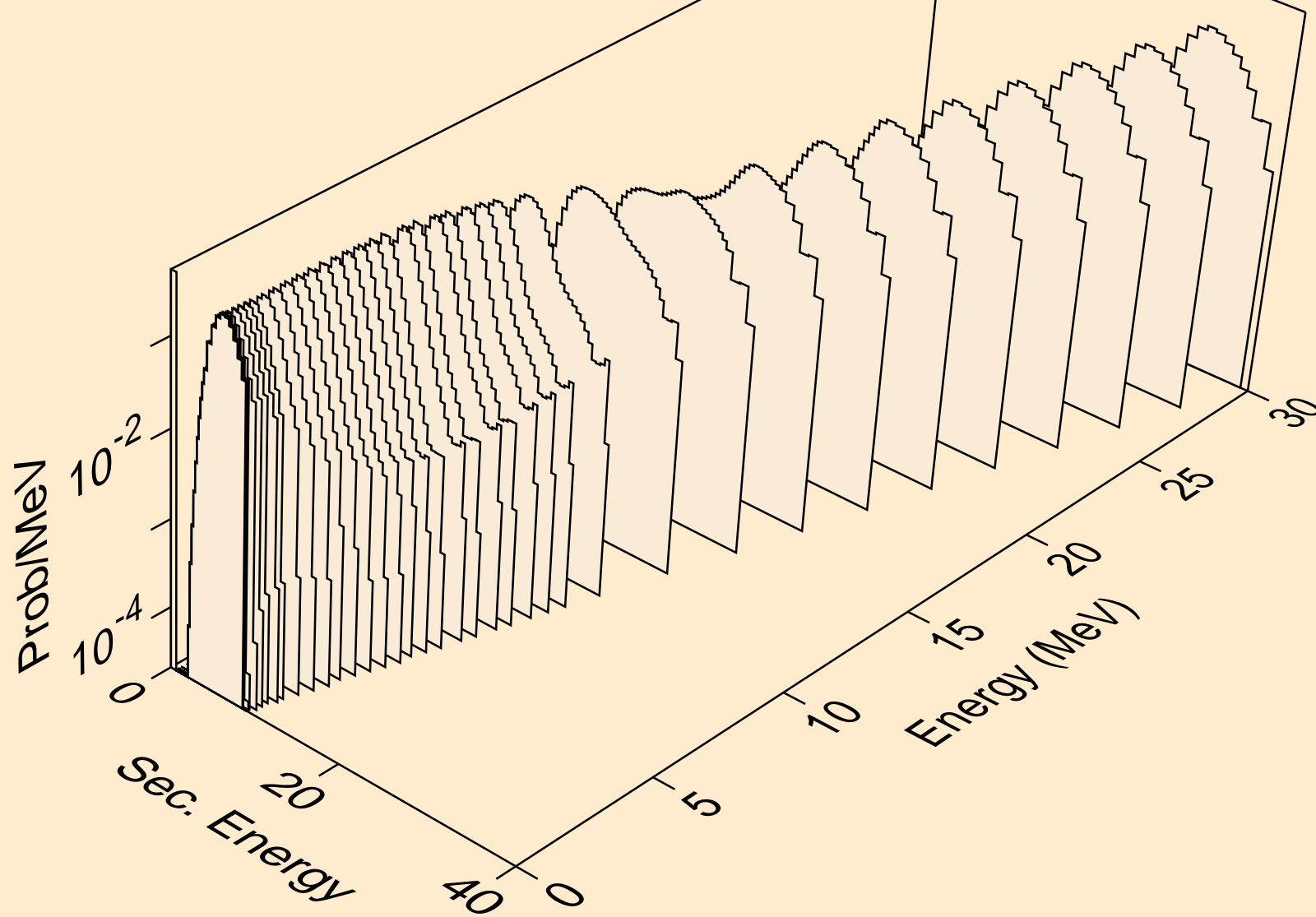

LA121 NEUTRON ACER TENDL-2023 LIBRARY; T=0.K
protons from (n,2p)

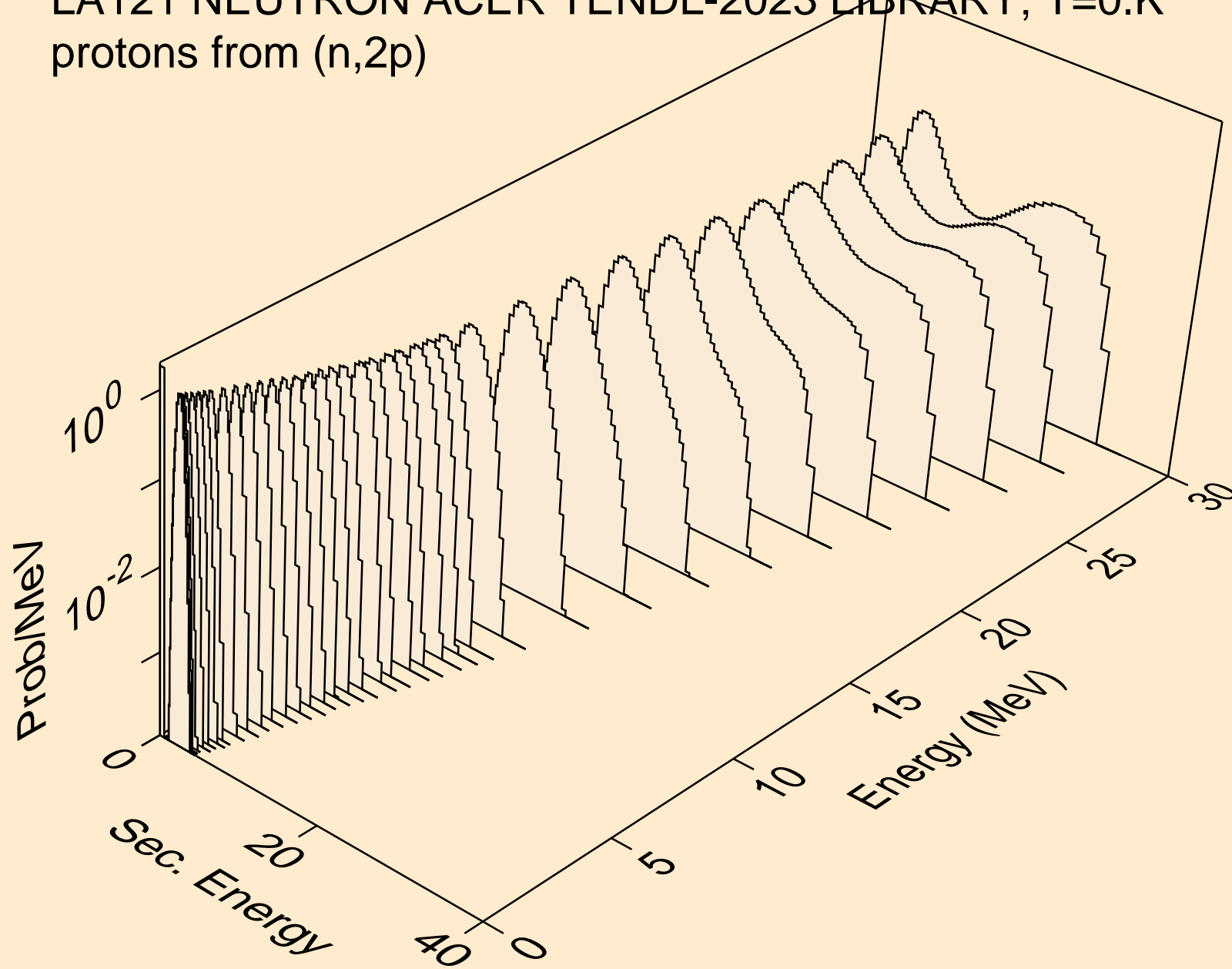

LA121 NEUTRON ACER TENDL-2023 LIBRARY; T=0.K
protons from (n,p)

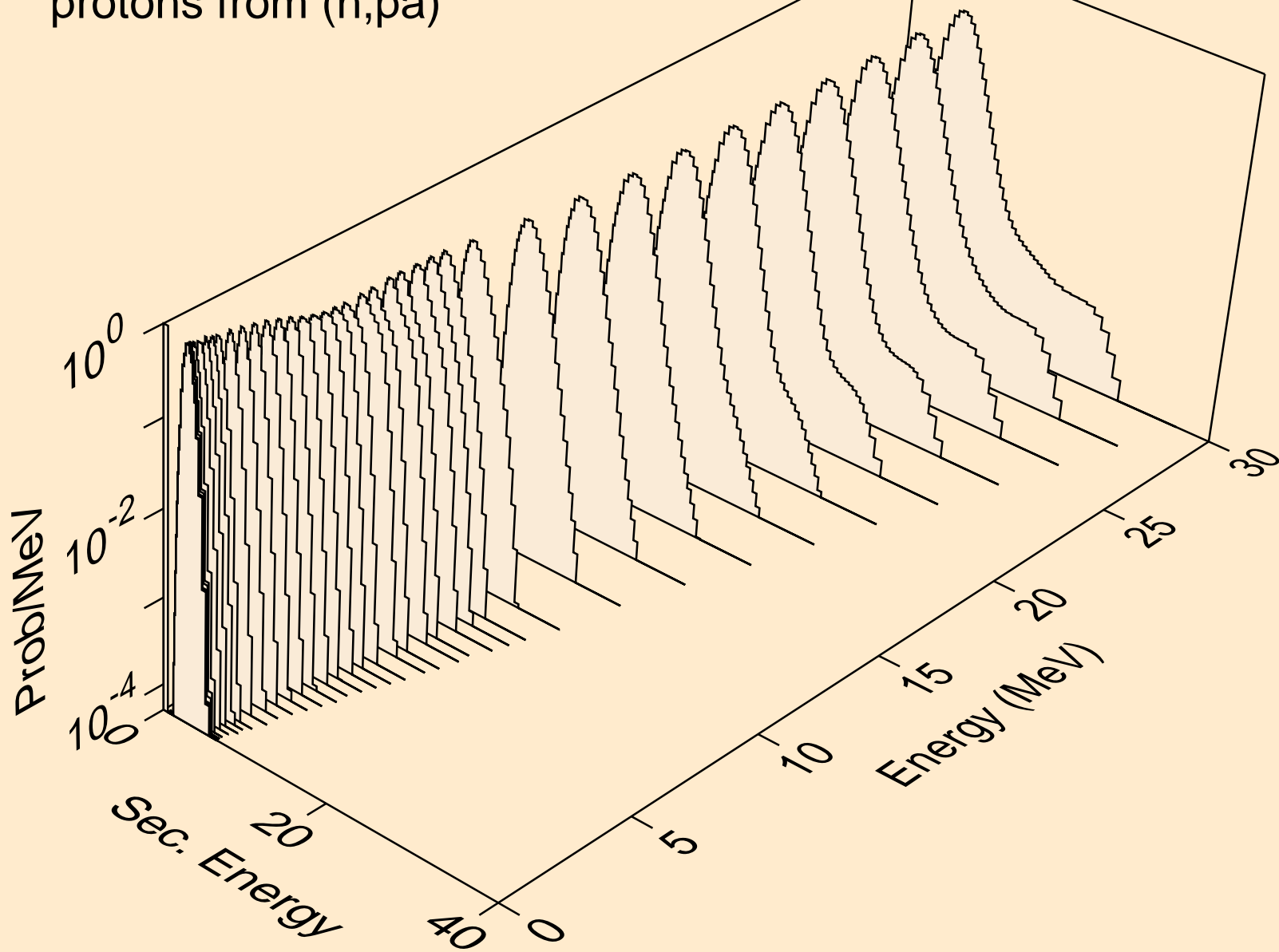

LA121 NEUTRON ACER TENDL-2023 LIBRARY; T=0.K
protons from (n,pd)

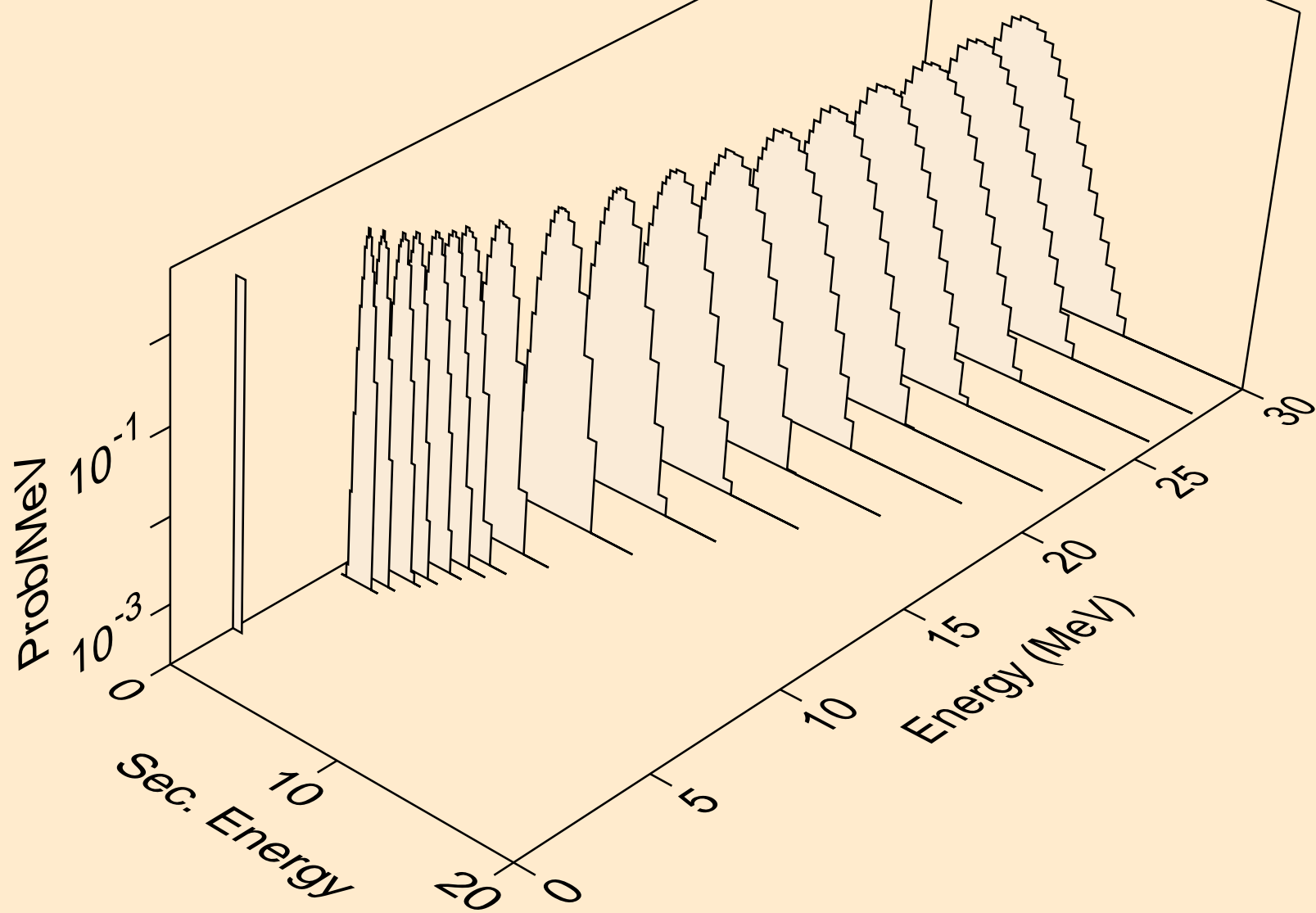

LA121 NEUTRON ACER TENDL-2023 LIBRARY; T=0.K
protons from (n,pt)

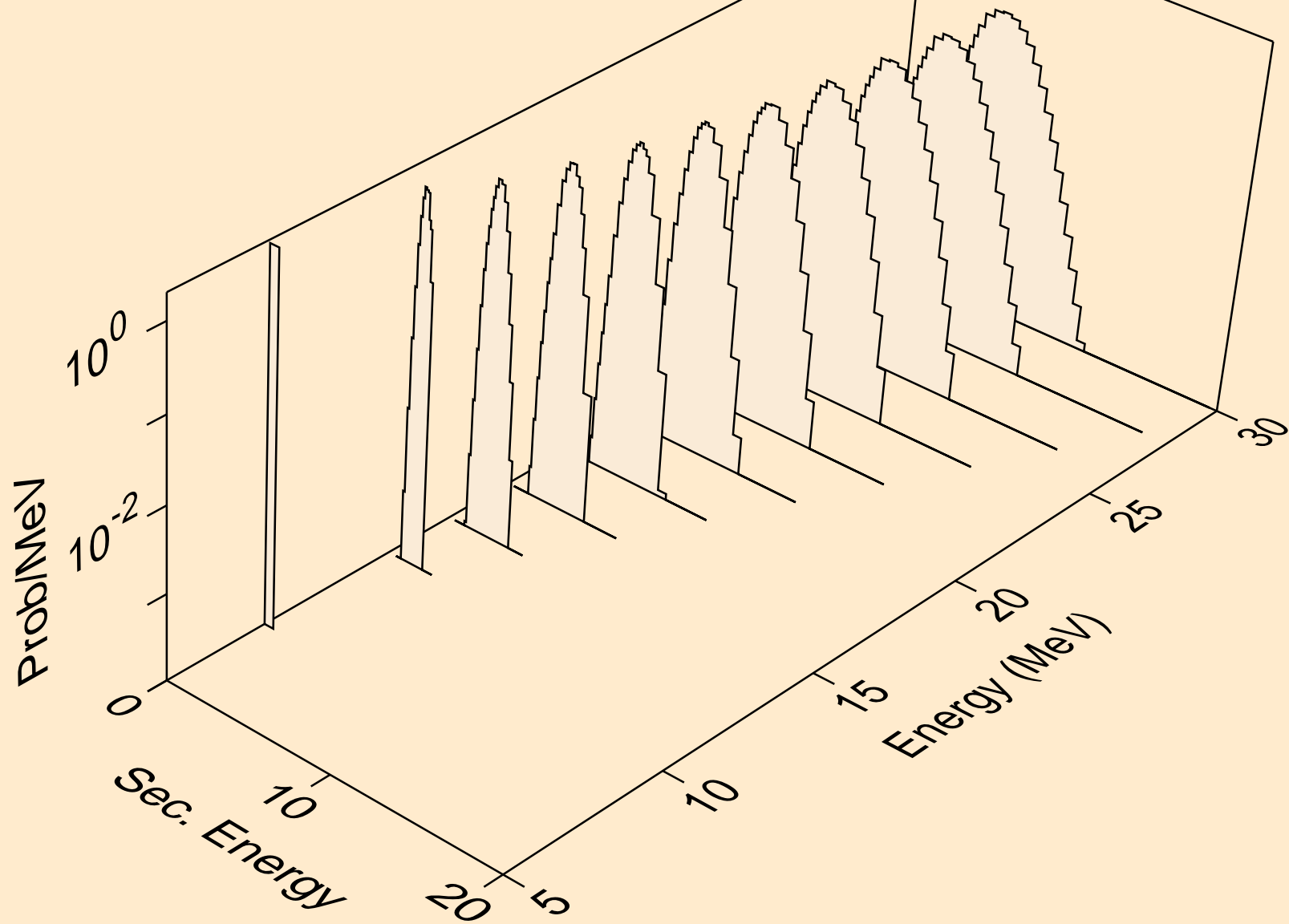

LA121 NEUTRON ACER TENDL-2023 LIBRARY; T=0.K
deuterons from (n,x)

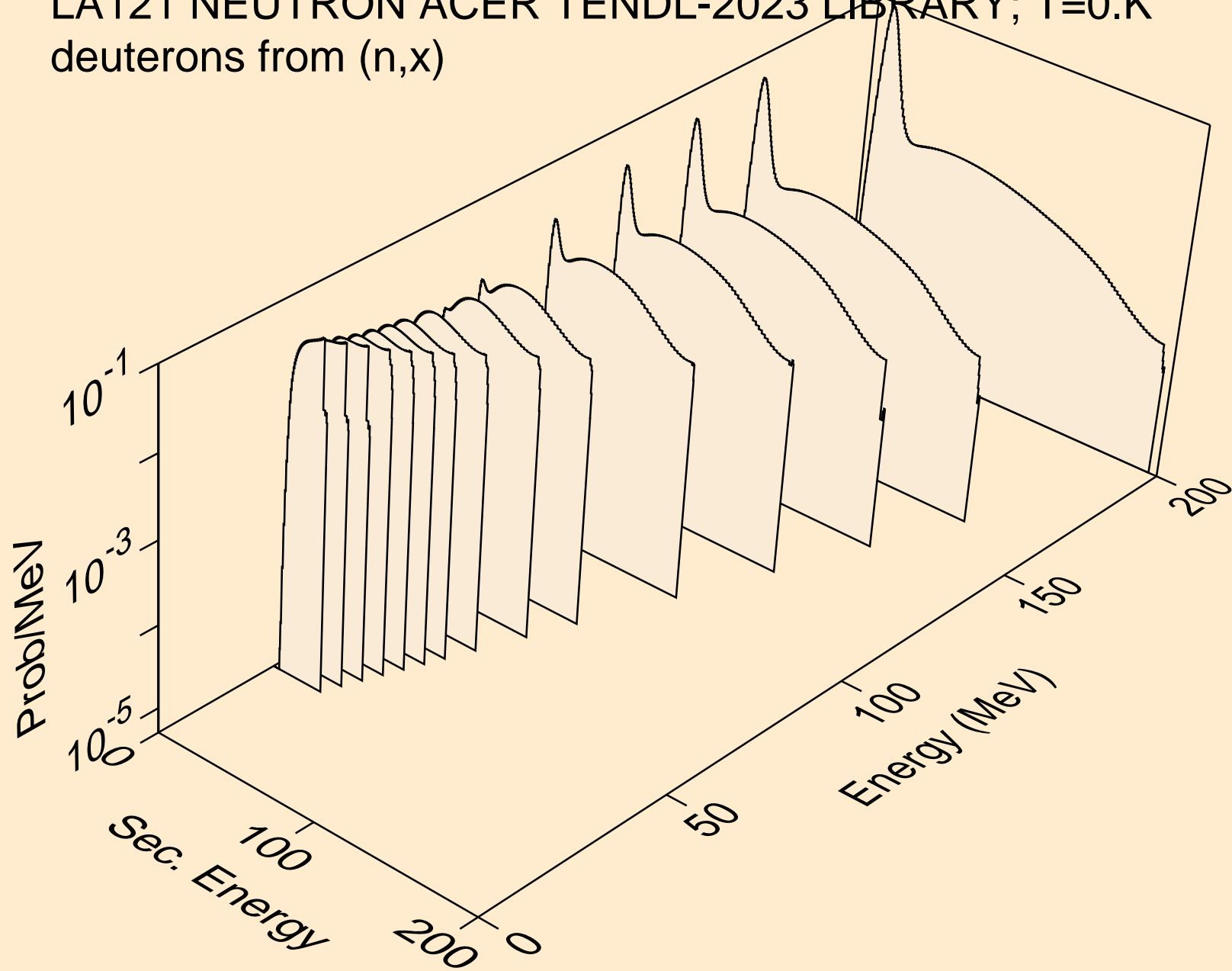

LA121 NEUTRON ACER TENDL-2023 LIBRARY; T=0.K
deuterons from (n,2nd)

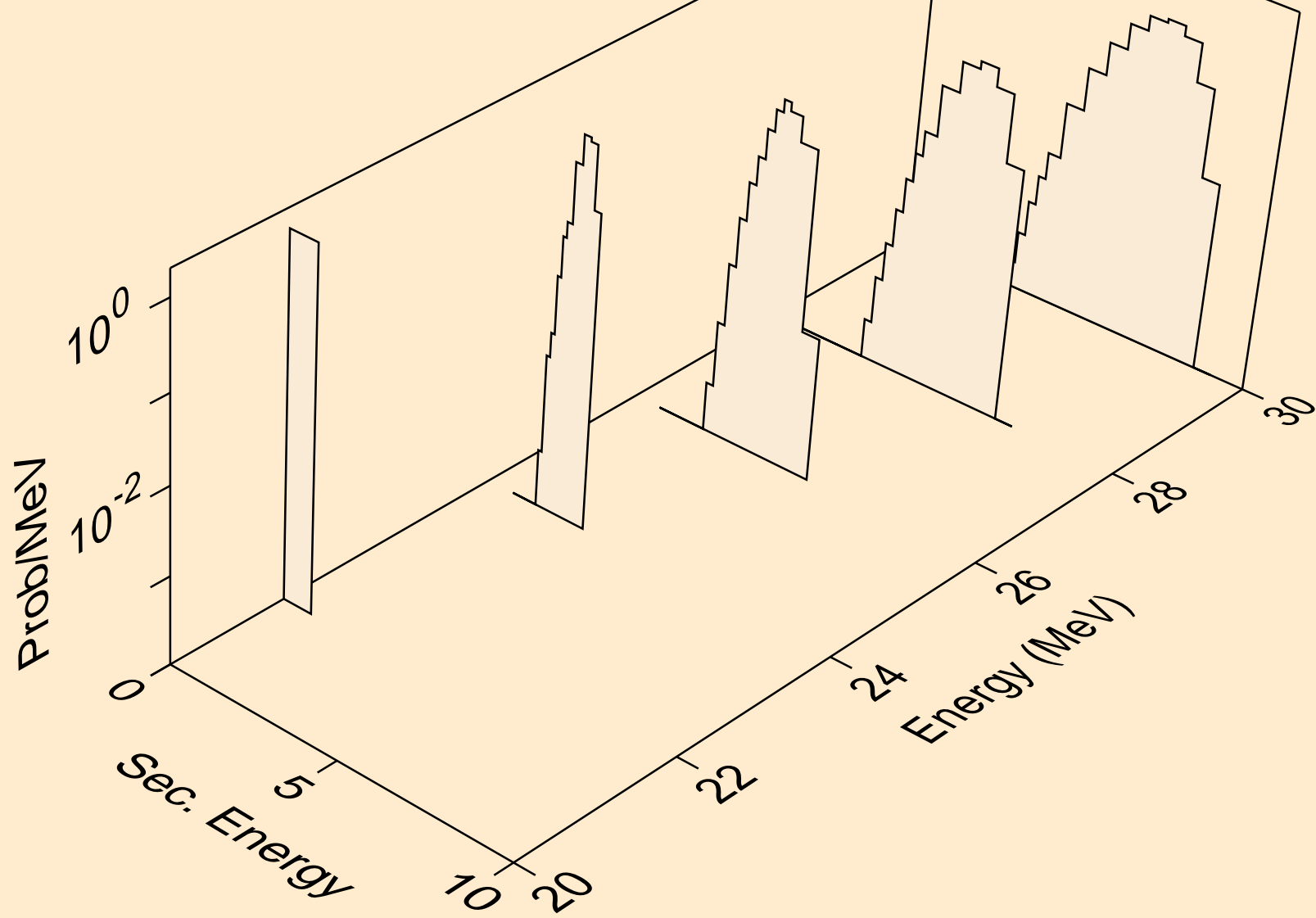

LA121 NEUTRON ACER TENDL-2023 LIBRARY; T=0.K
deuterons from (n,n*)d

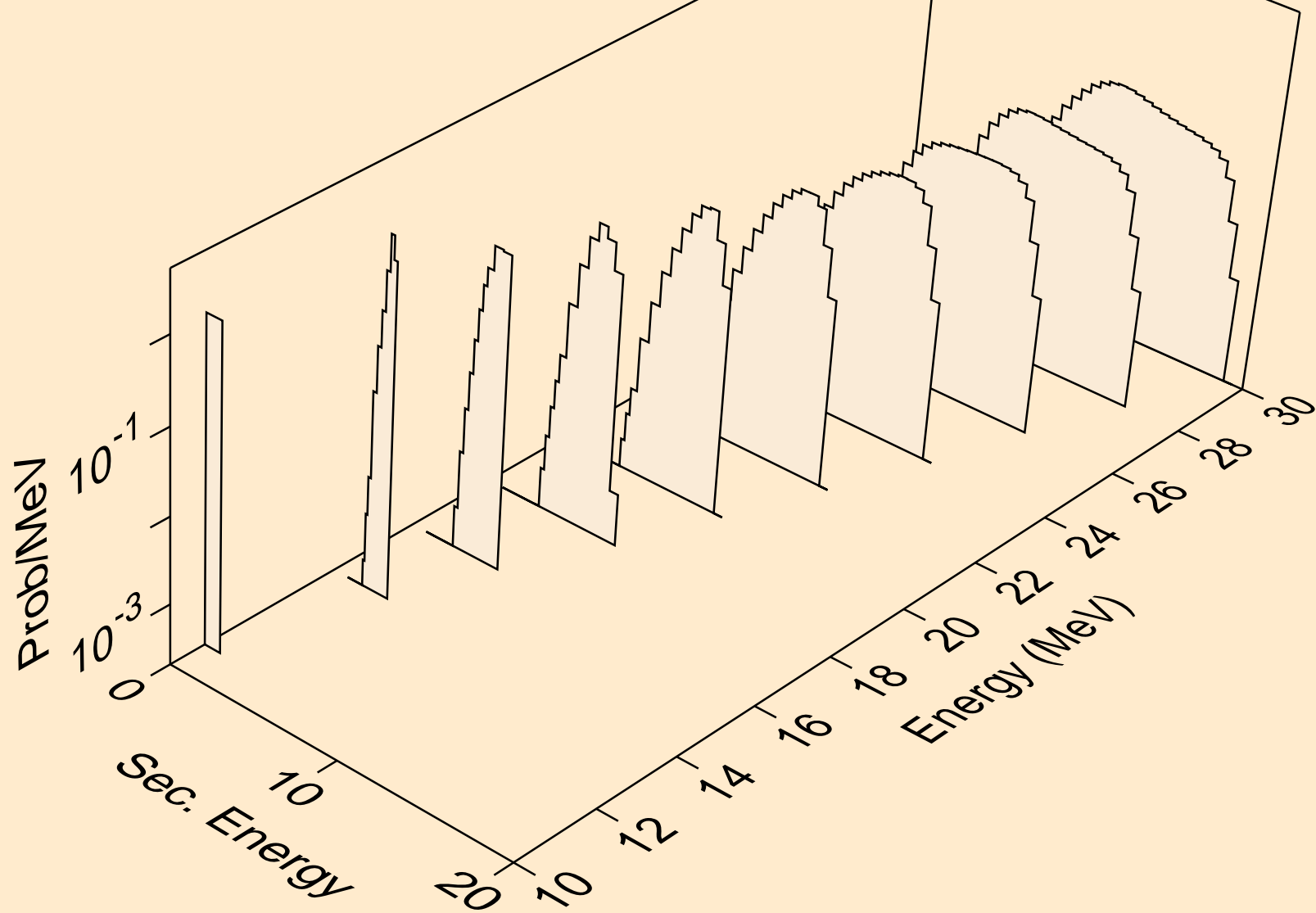

LA121 NEUTRON ACER TENDL-2023 LIBRARY; T=0.K
deuterons from (n,d)

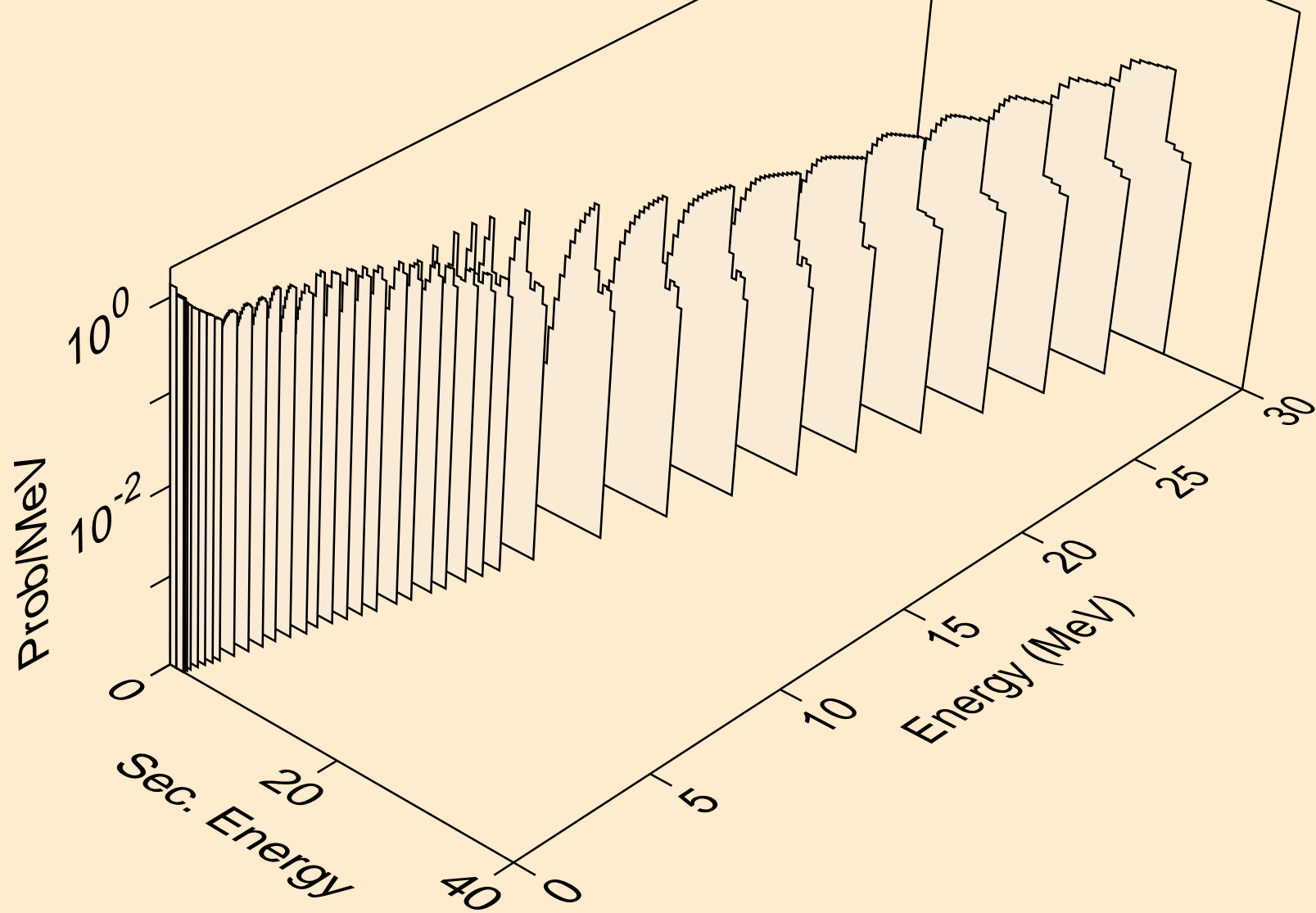

LA121 NEUTRON ACER TENDL-2023 LIBRARY; T=0.K
deuterons from (n,d2a)

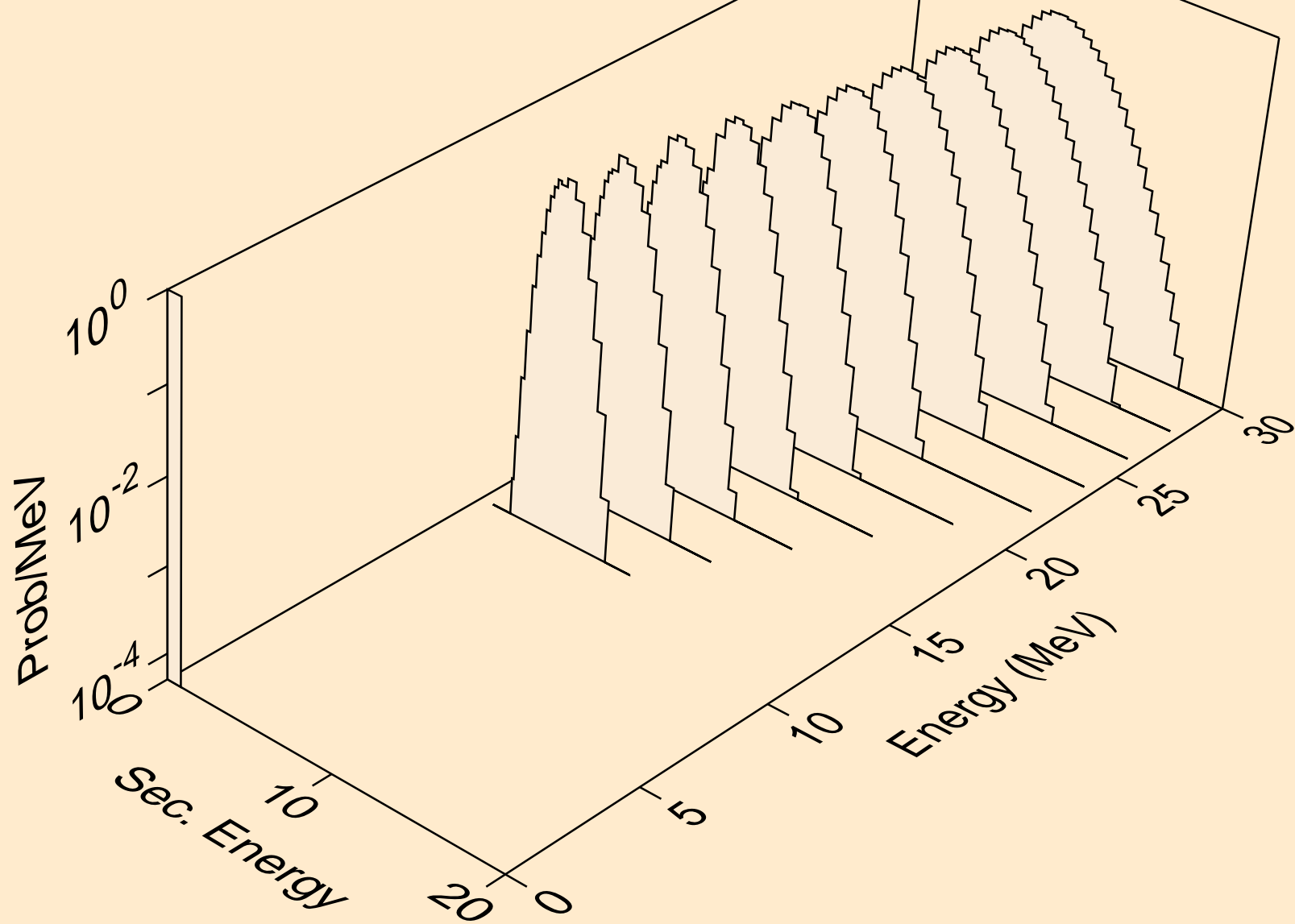

LA121 NEUTRON ACER TENDL-2023 LIBRARY; T=0.K
deuterons from (n,pd)

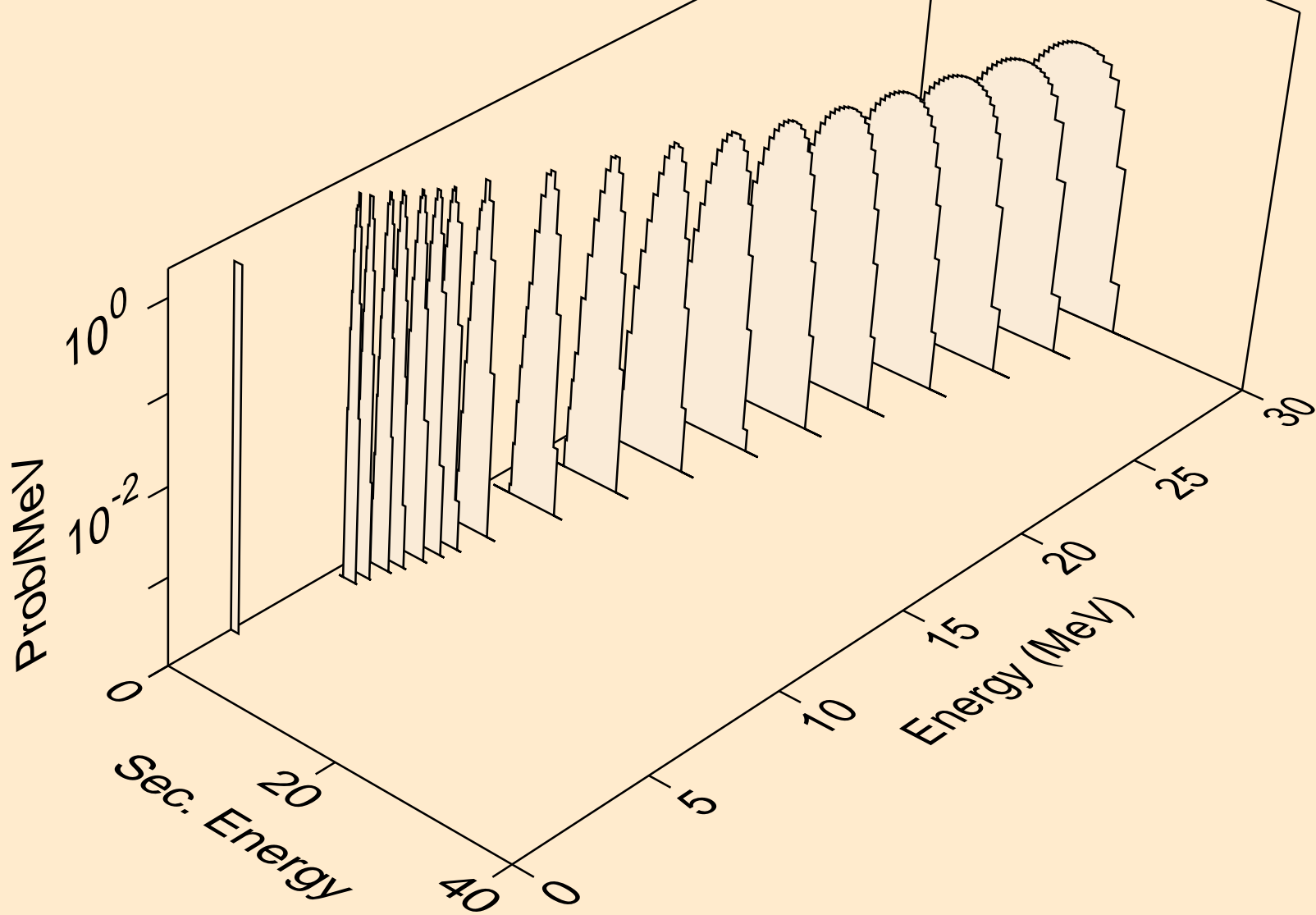

LA121 NEUTRON ACER TENDL-2023 LIBRARY; T=0.K
deuterons from (n,da)

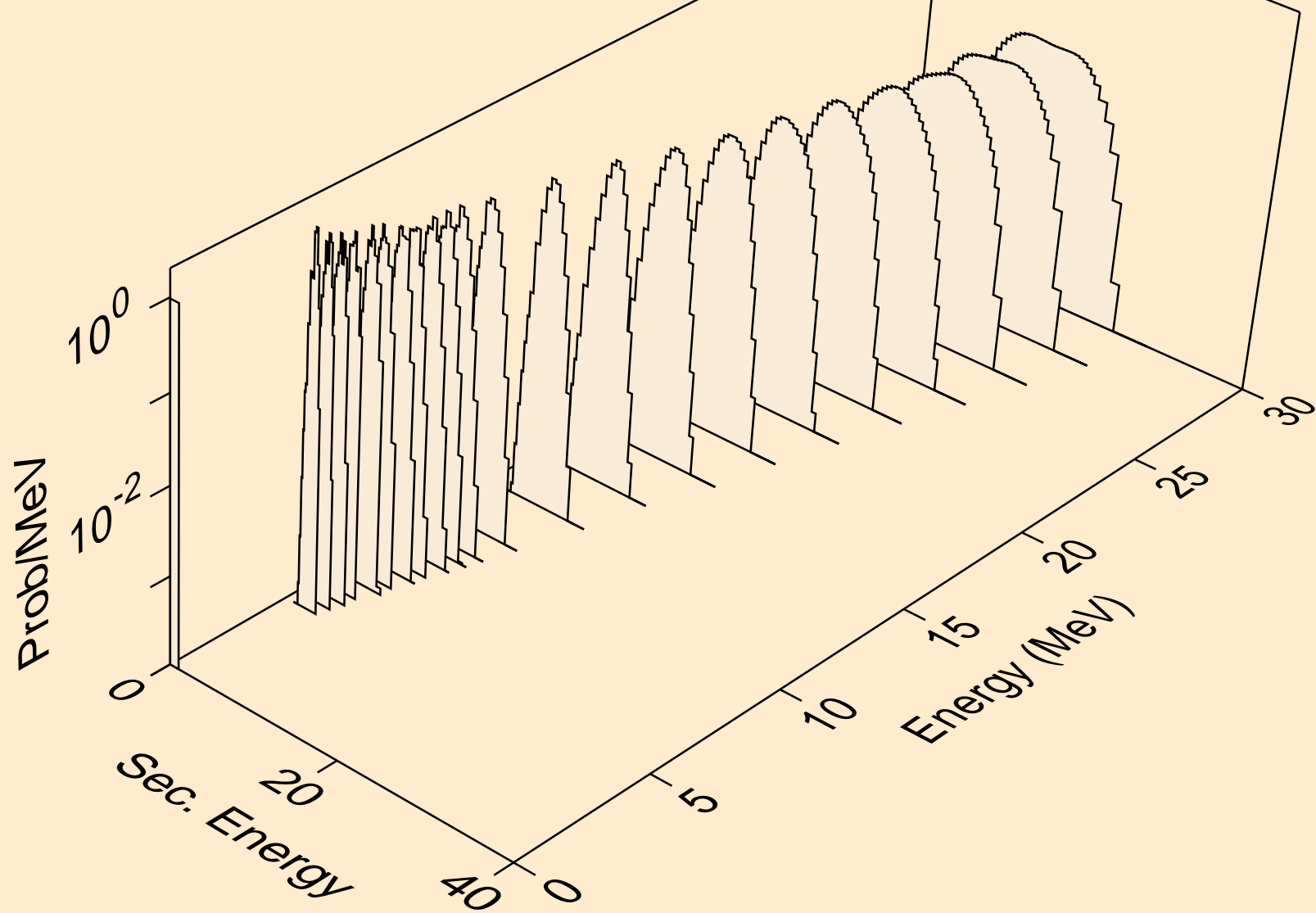

LA121 NEUTRON ACER TENDL-2023 LIBRARY; T=0.K
tritons from (n,x)

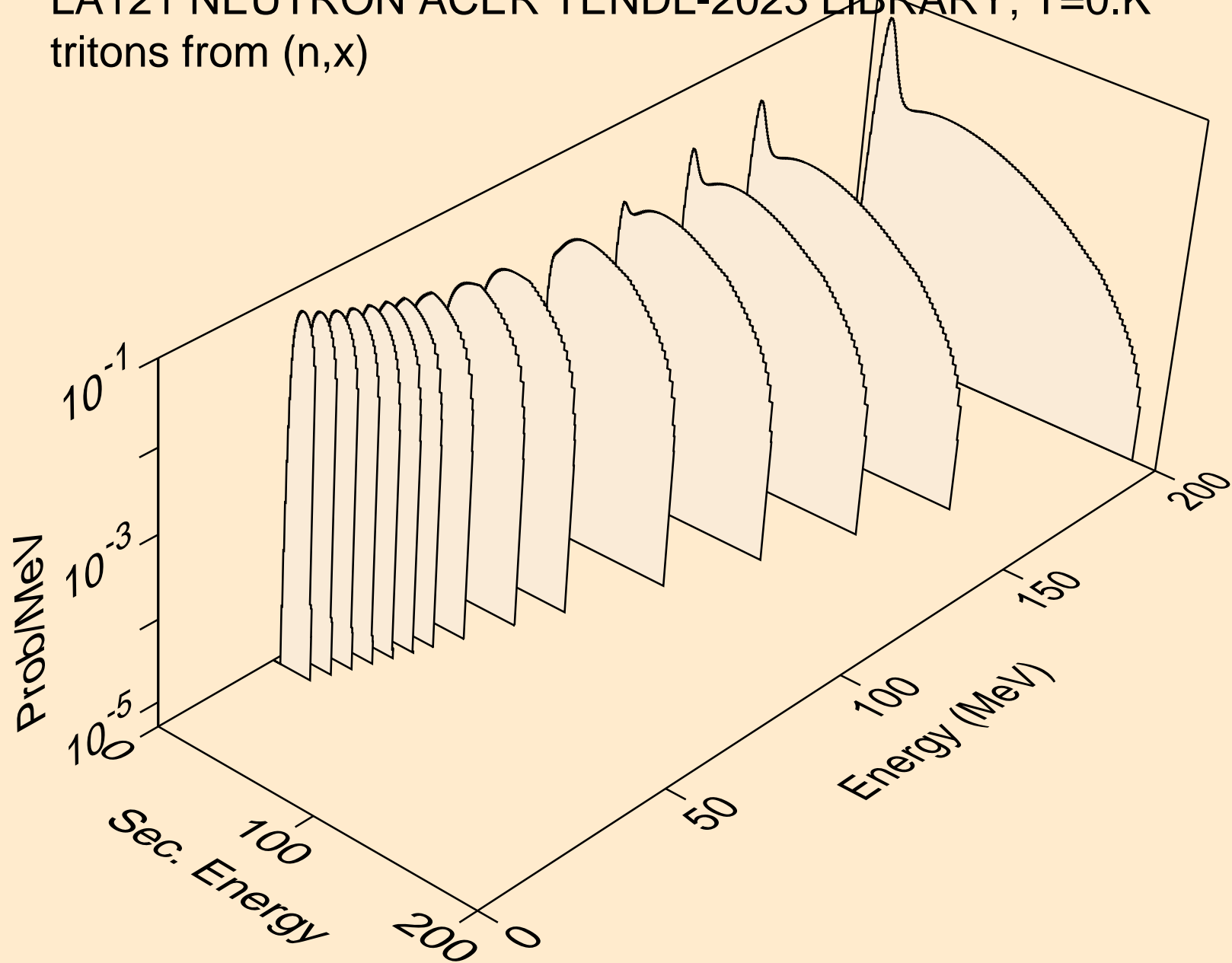

LA121 NEUTRON ACER TENDL-2023 LIBRARY; T=0.K
tritons from (n,n*)t

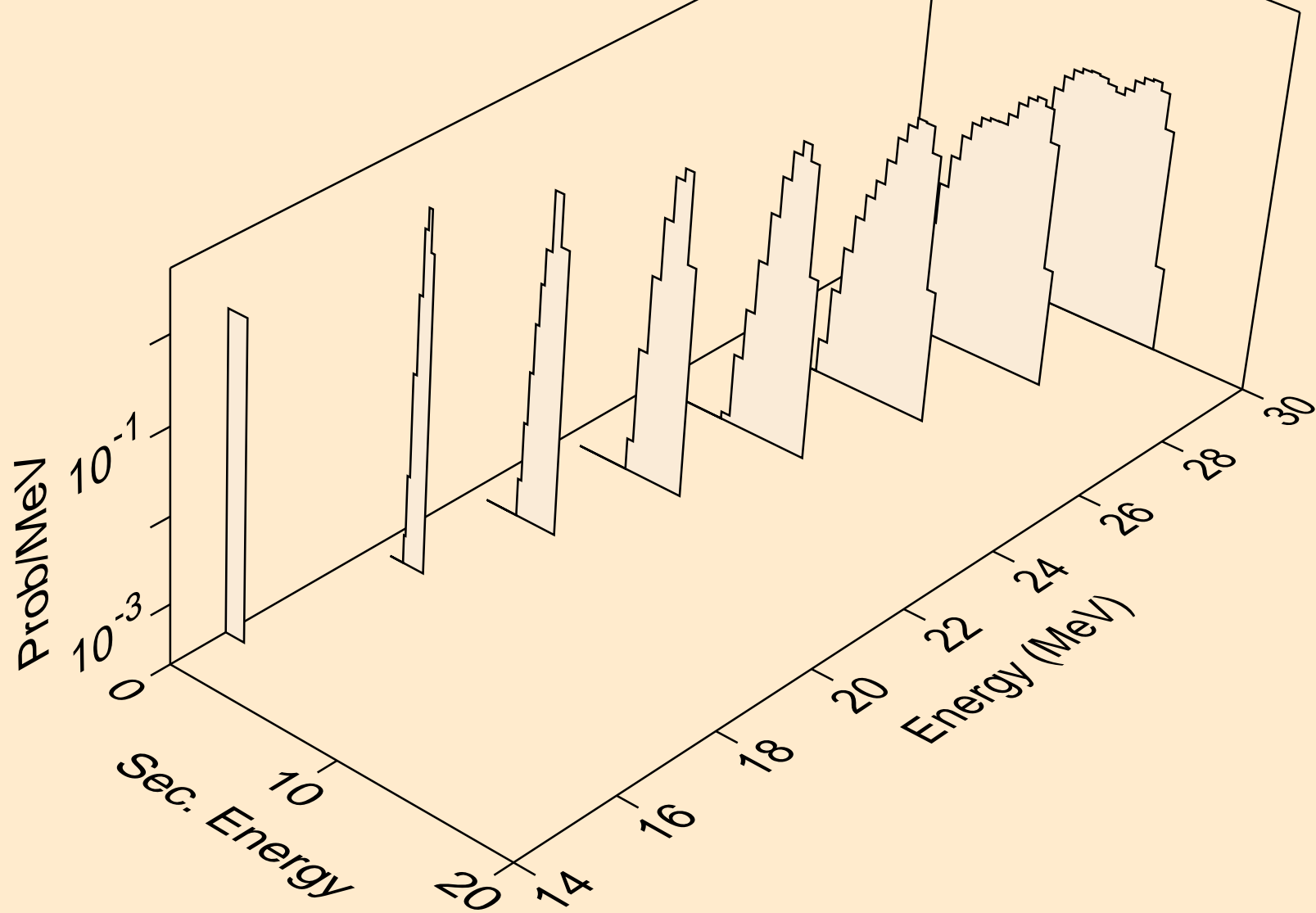

LA121 NEUTRON ACER TENDL-2023 LIBRARY; T=0.K
tritons from (n,t)

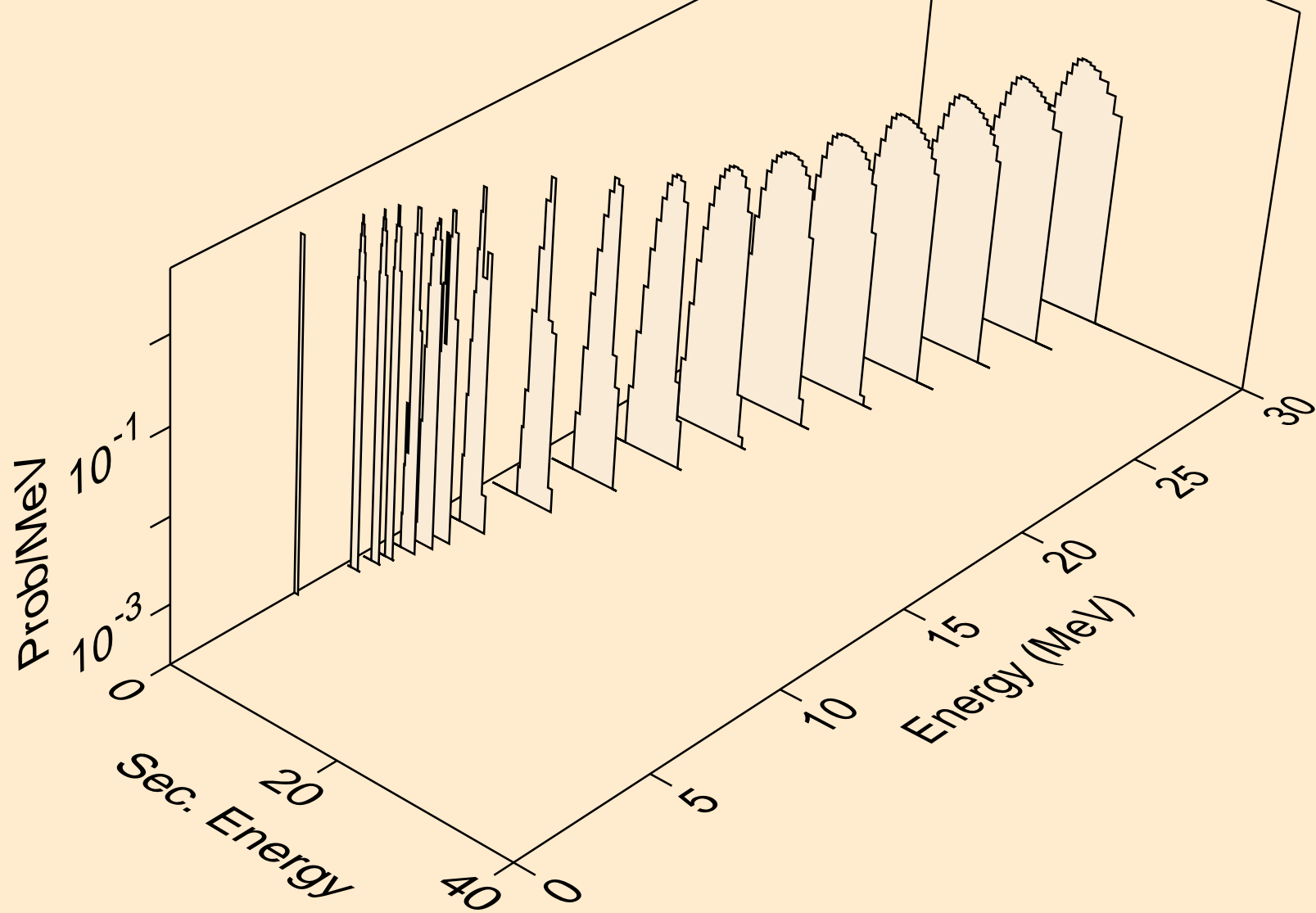

LA121 NEUTRON ACER TENDL-2023 LIBRARY; T=0.K
tritons from (n,t2a)

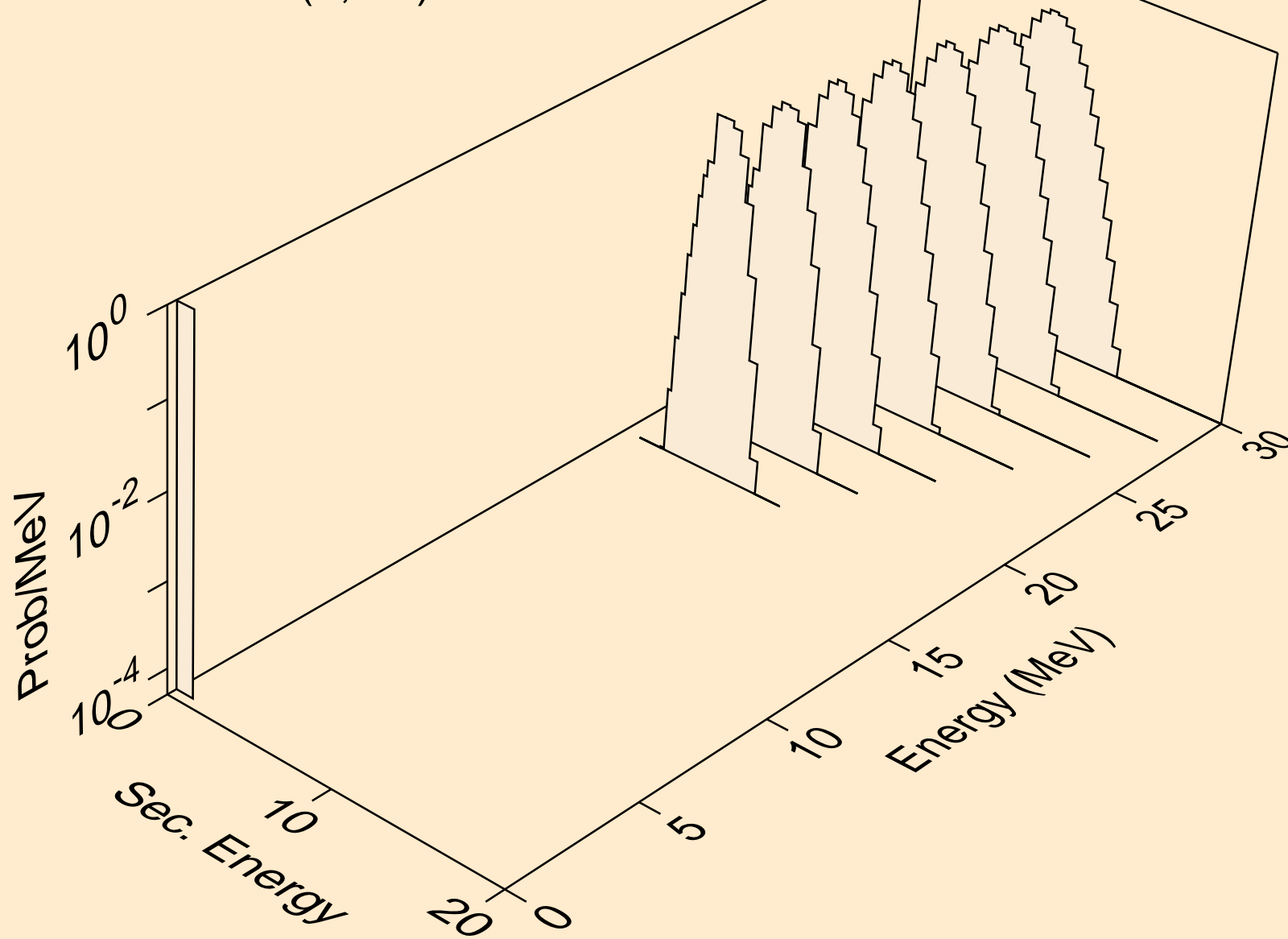

LA121 NEUTRON ACER TENDL-2023 LIBRARY; T=0.K
tritons from (n,pt)

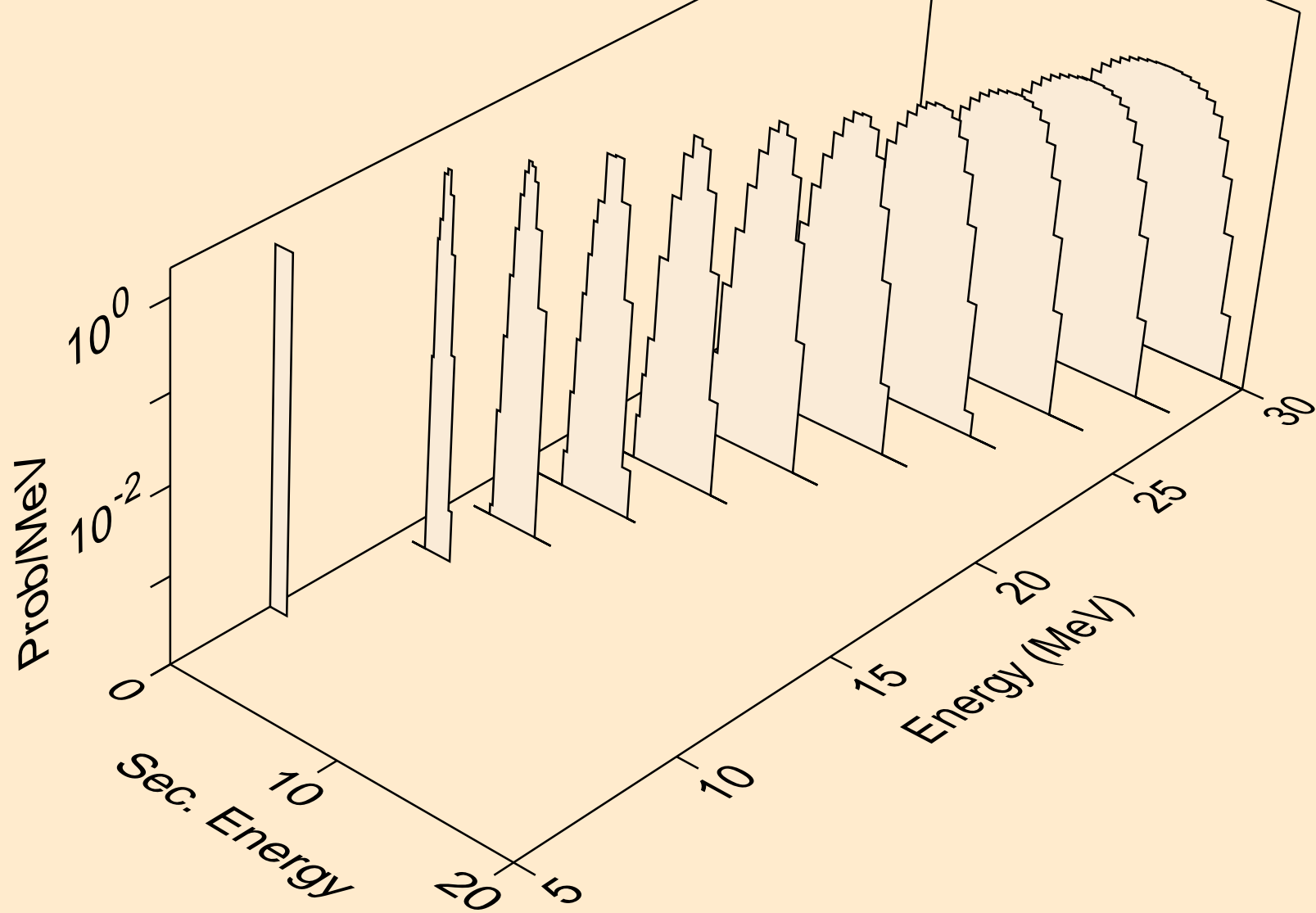

LA121 NEUTRON ACER TENDL-2023 LIBRARY; T=0.K
he3s from (n,x)

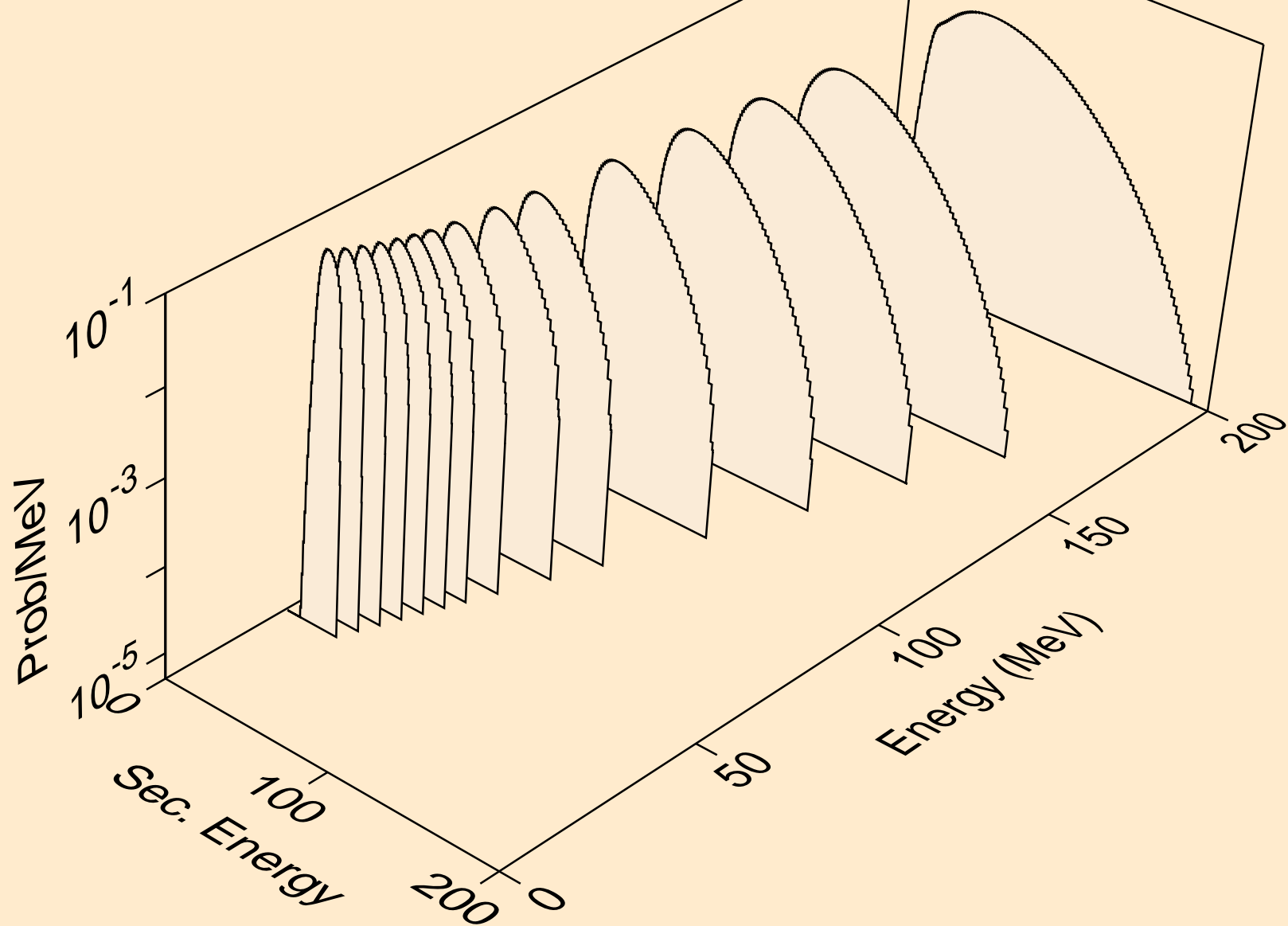

LA121 NEUTRON ACER TENDL-2023 LIBRARY; T=0.K
he3s from (n,n*)he3

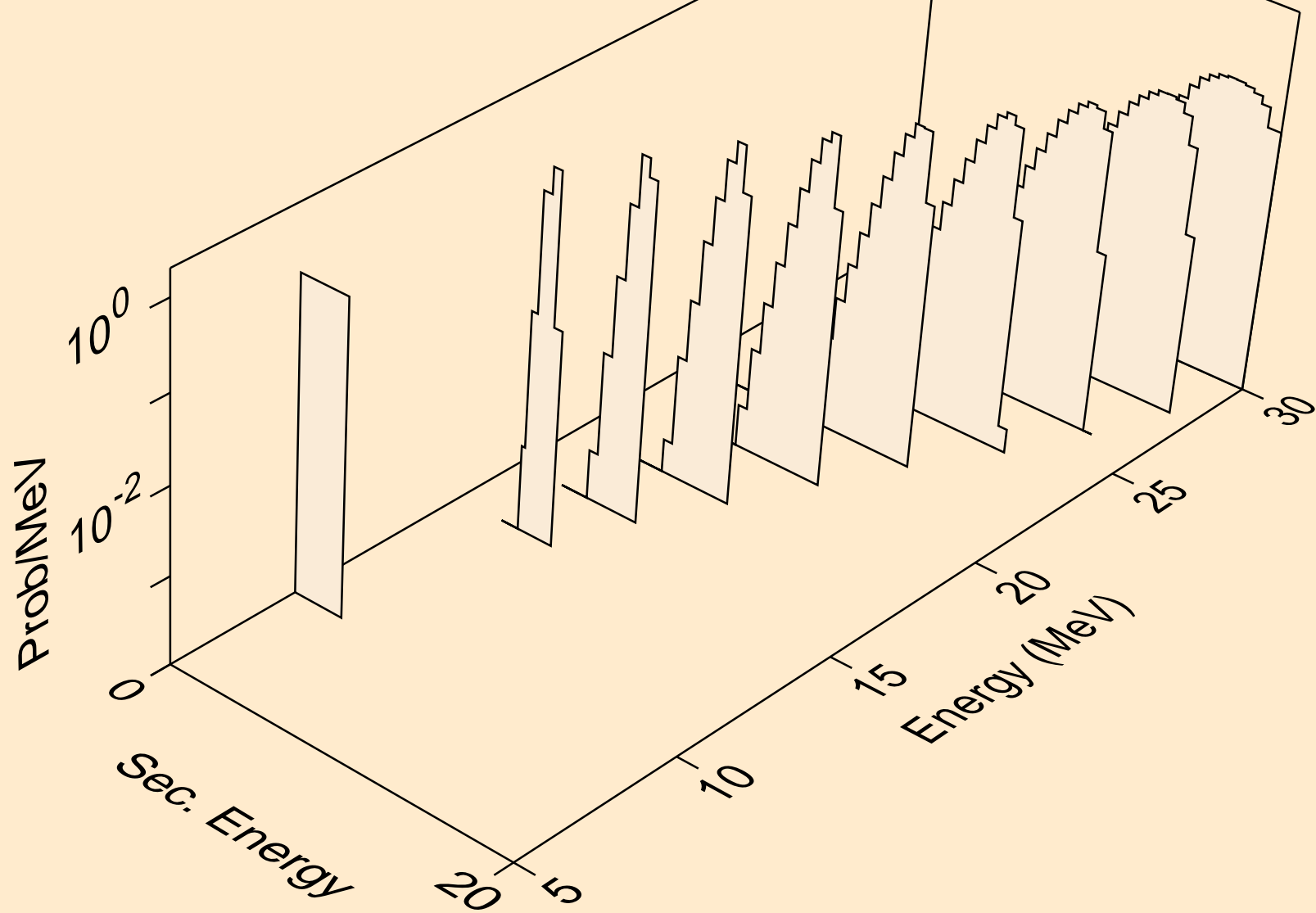

LA121 NEUTRON ACER TENDL-2023 LIBRARY; T=0.K
he3s from (n,he3)

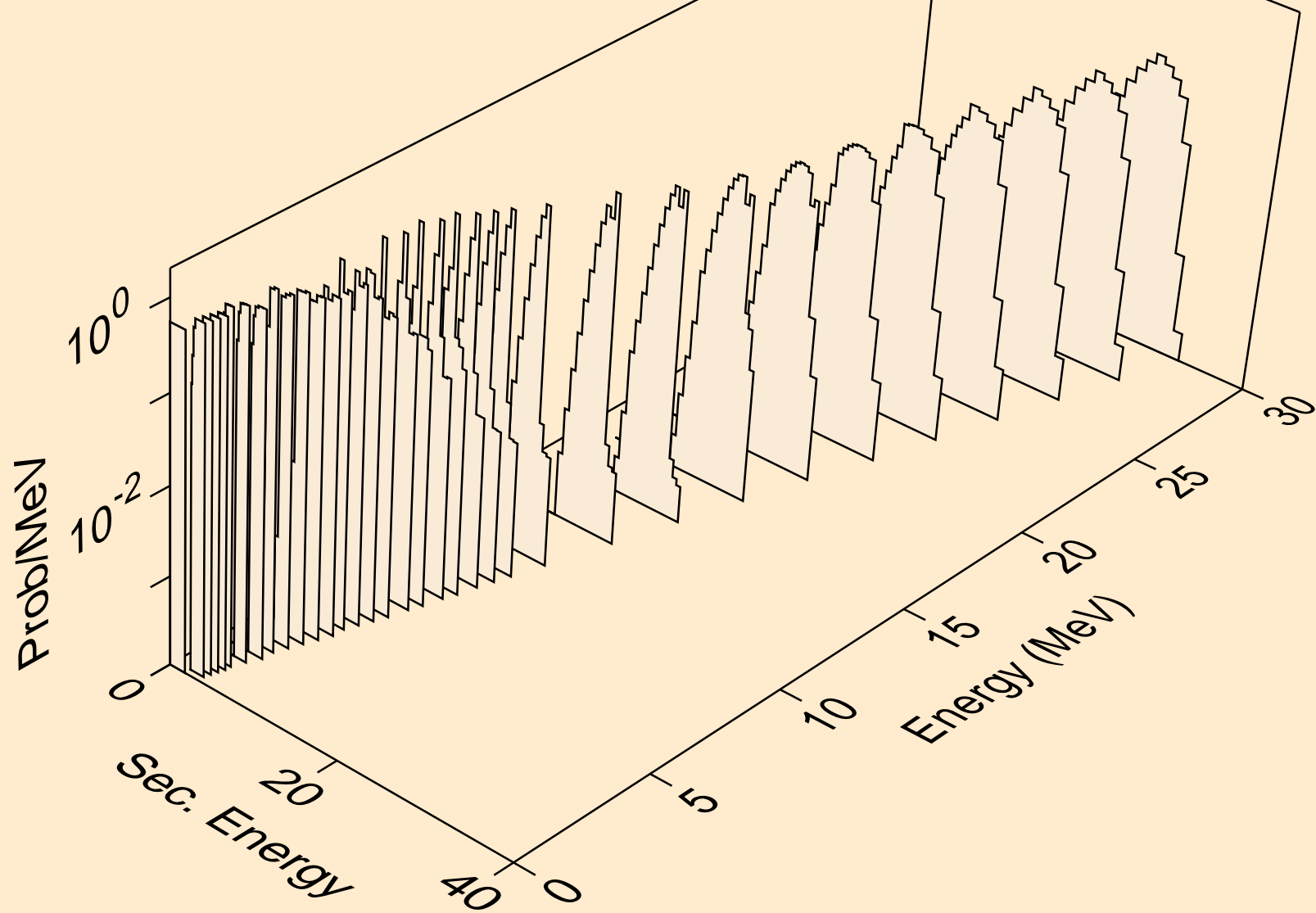

LA121 NEUTRON ACER TENDL-2023 LIBRARY; T=0.K
alphas from (n,x)

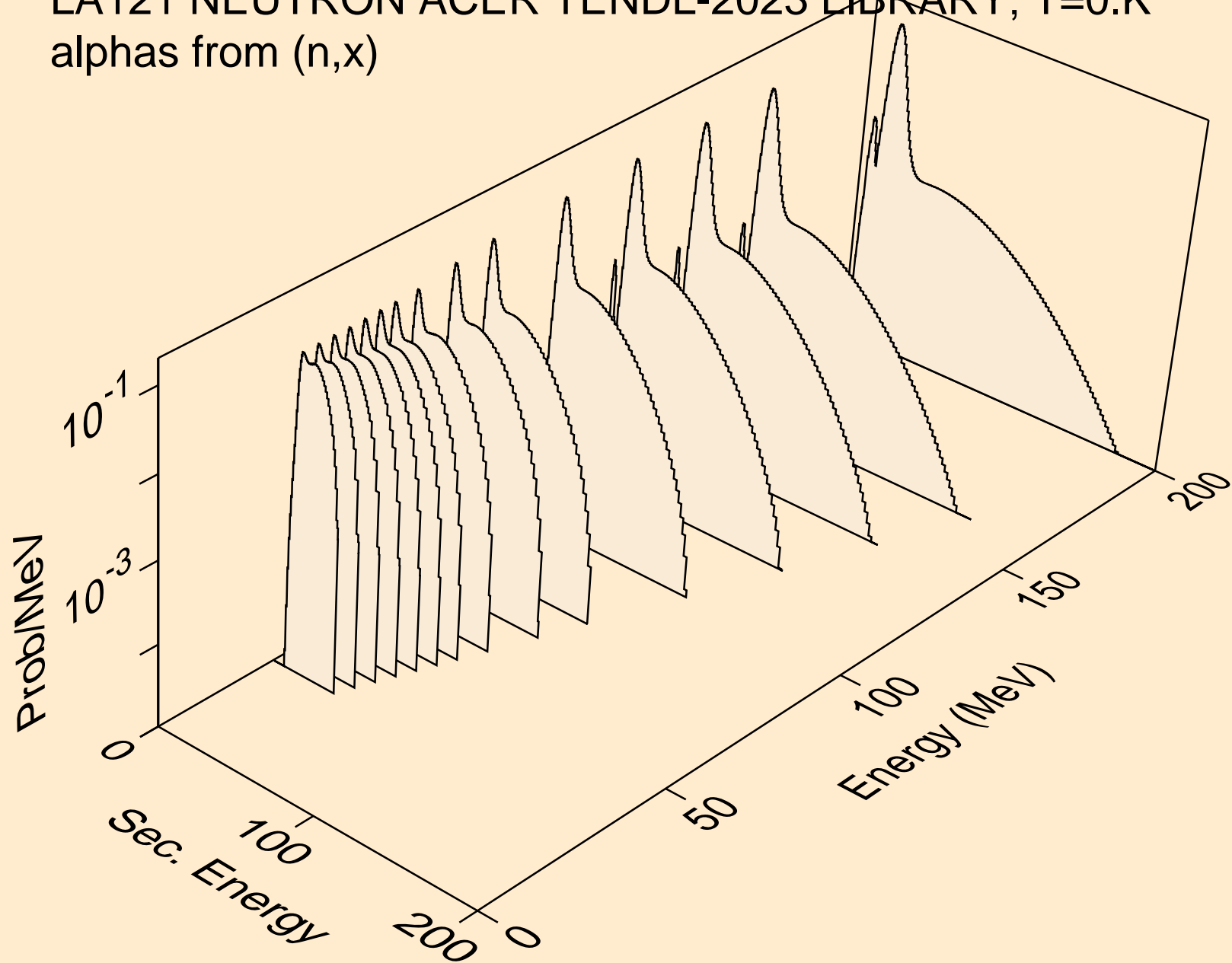

LA121 NEUTRON ACER TENDL-2023 LIBRARY; T=0.K
alphas from (n,n*)a

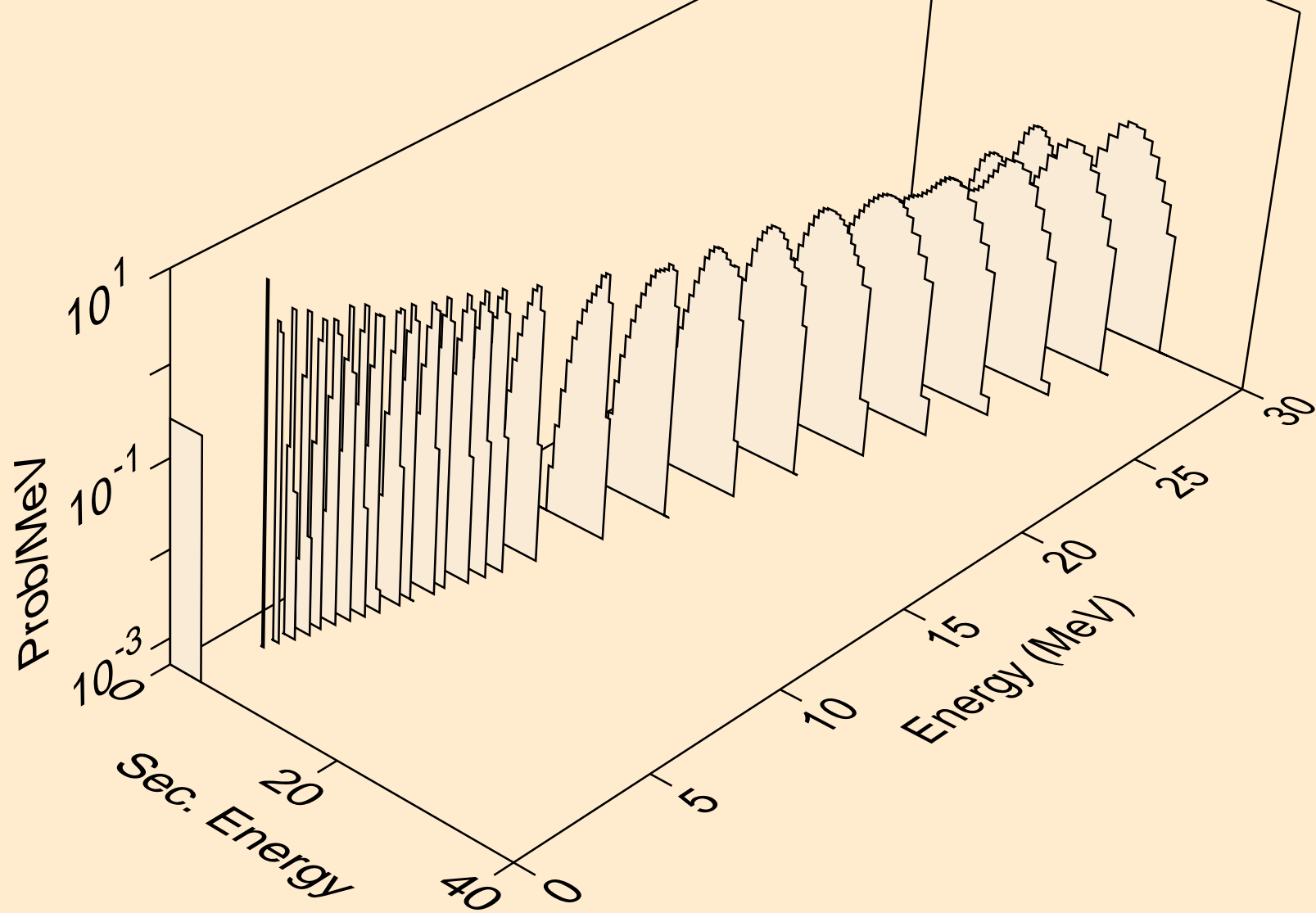

LA121 NEUTRON ACER TENDL-2023 LIBRARY; T=0.K
alphas from (n,n*)3a

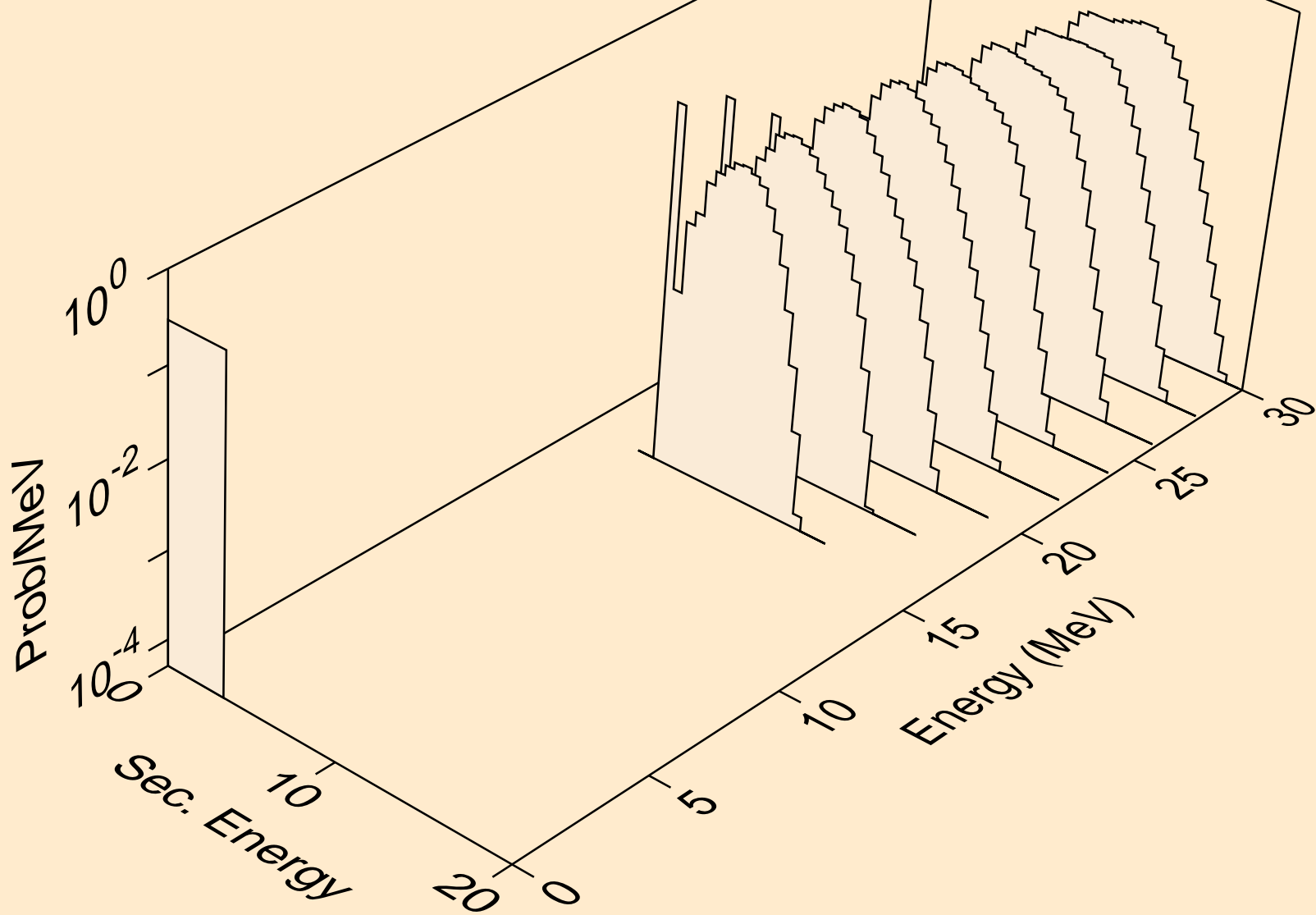

LA121 NEUTRON ACER TENDL-2023 LIBRARY; T=0.K
alphas from (n,2n)a

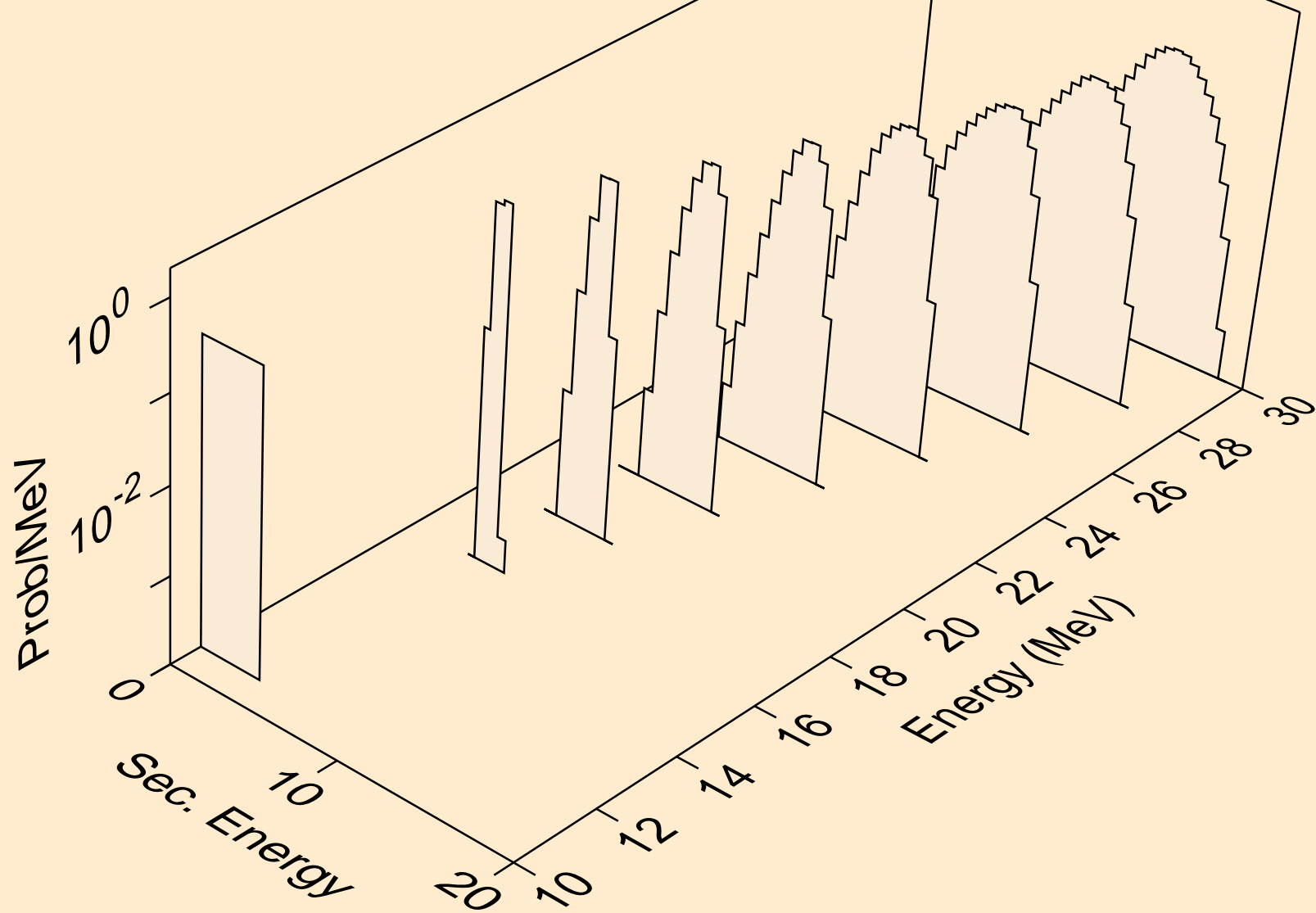

LA121 NEUTRON ACER TENDL-2023 LIBRARY; T=0.K
alphas from (n,n*)2a

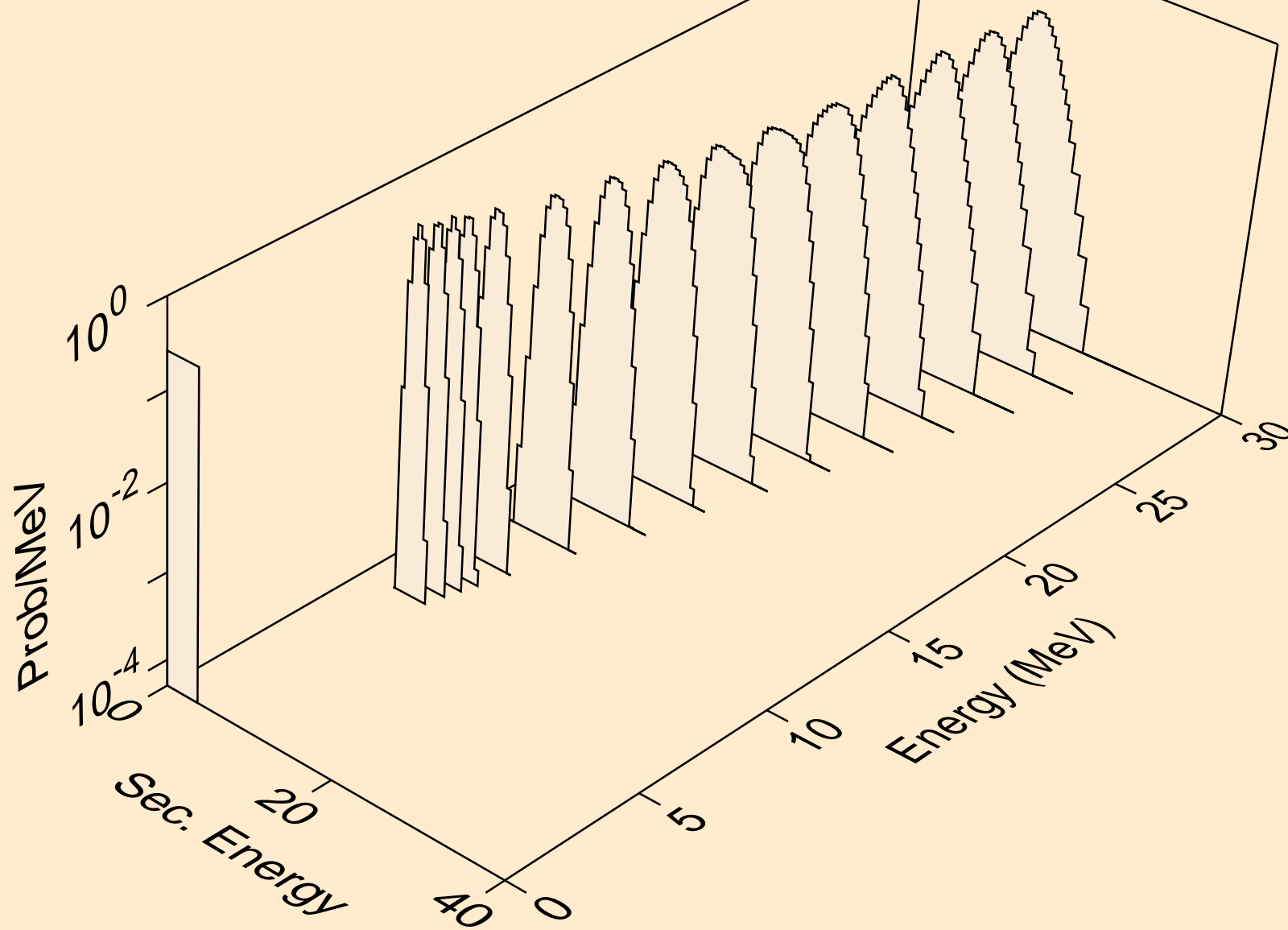

LA121 NEUTRON ACER TENDL-2023 LIBRARY; T=0.K
alphas from (n,npa)

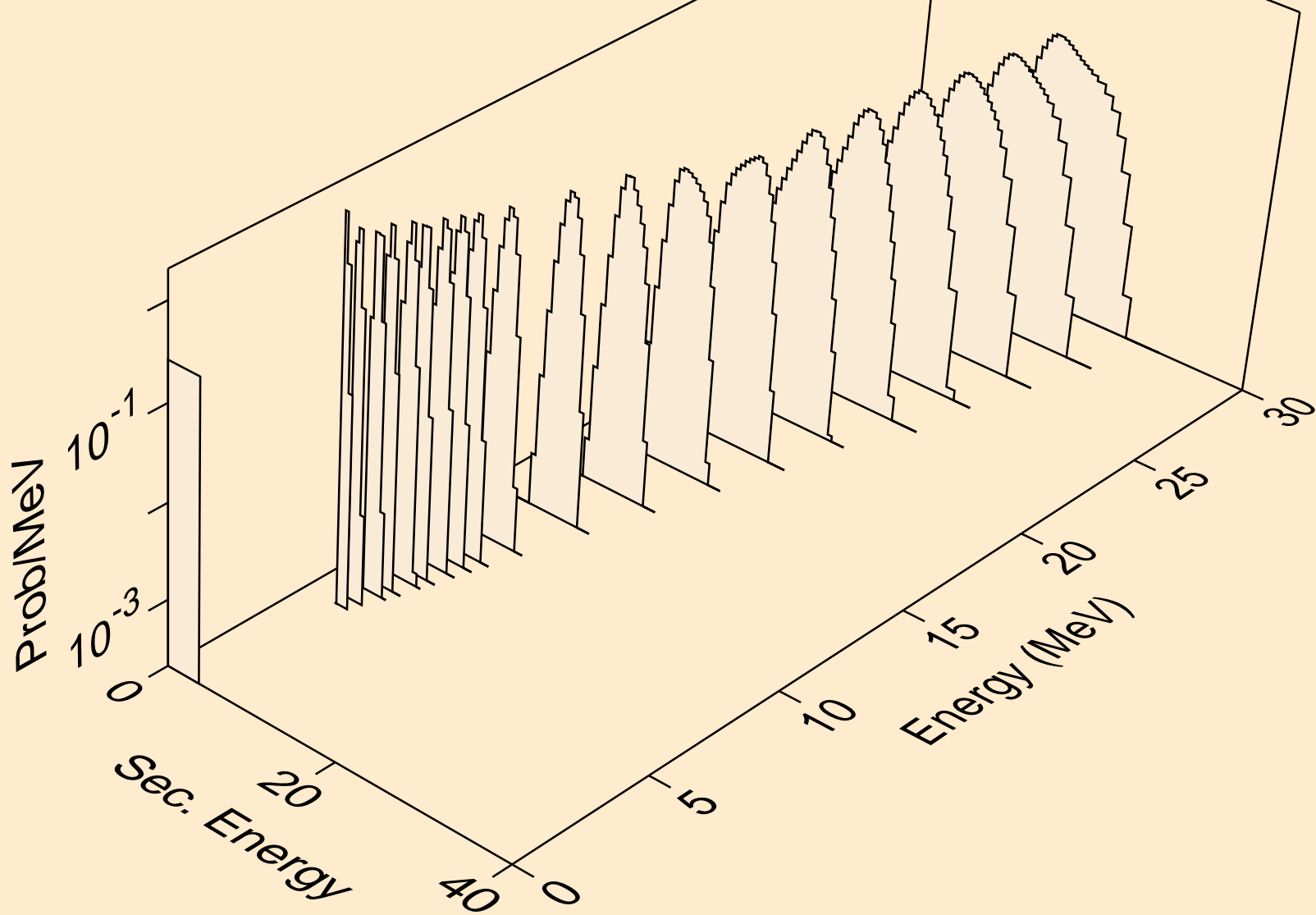

LA121 NEUTRON ACER TENDL-2023 LIBRARY; T=0.K
alphas from (n,a)

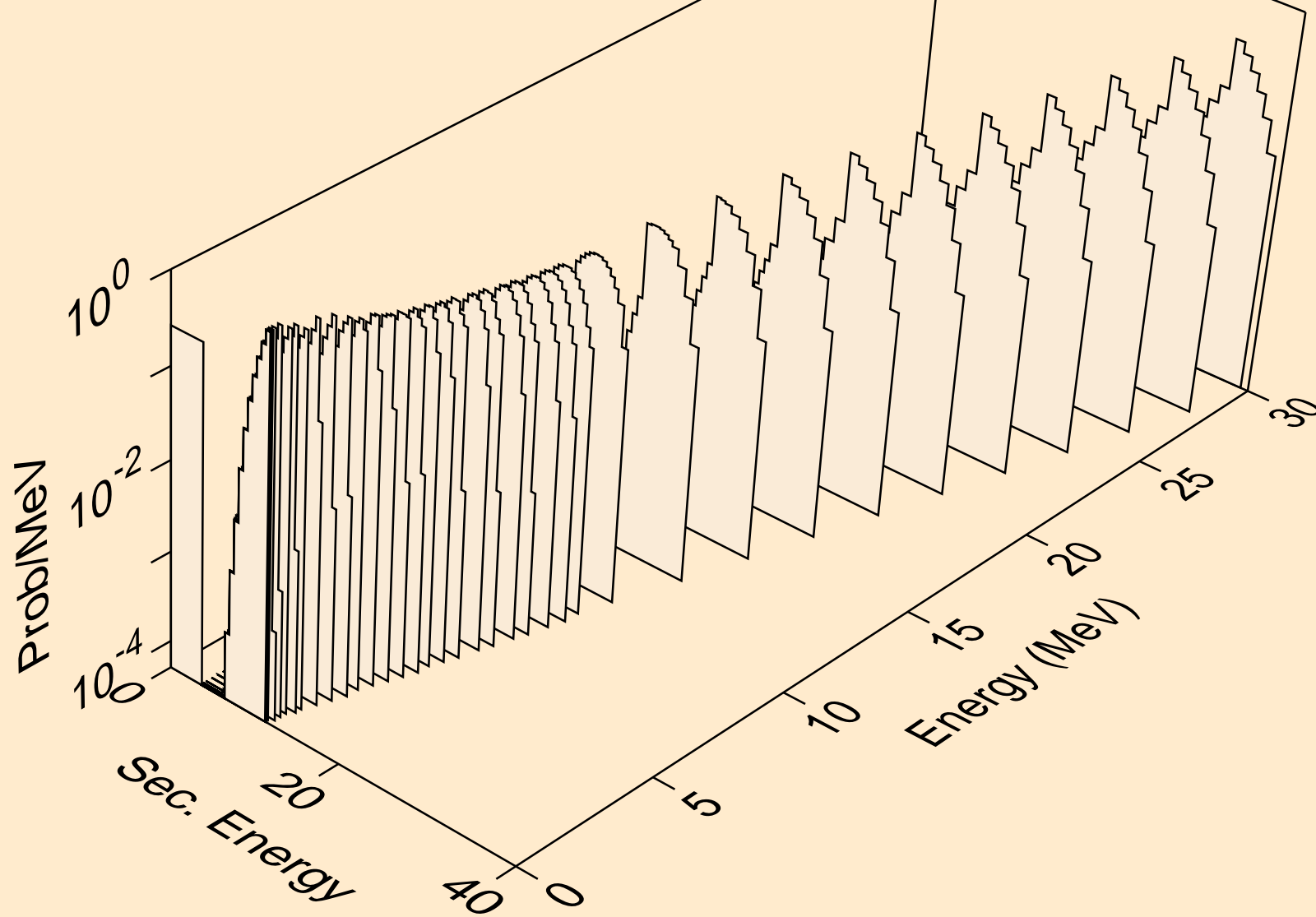

LA121 NEUTRON ACER TENDL-2023 LIBRARY; T=0.K
alphas from (n,2a)

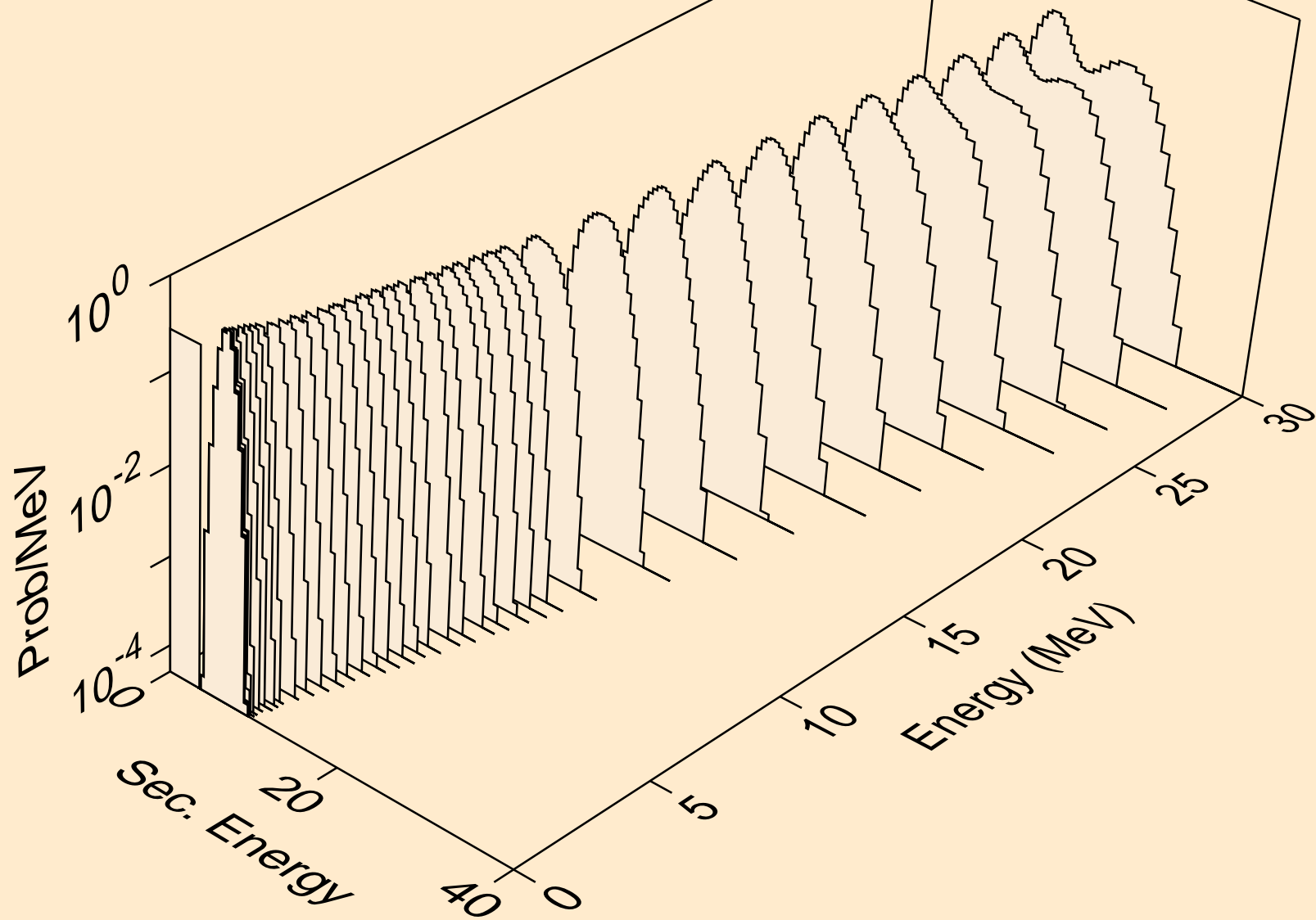

LA121 NEUTRON ACER TENDL-2023 LIBRARY; T=0.K
alphas from (n,3a)

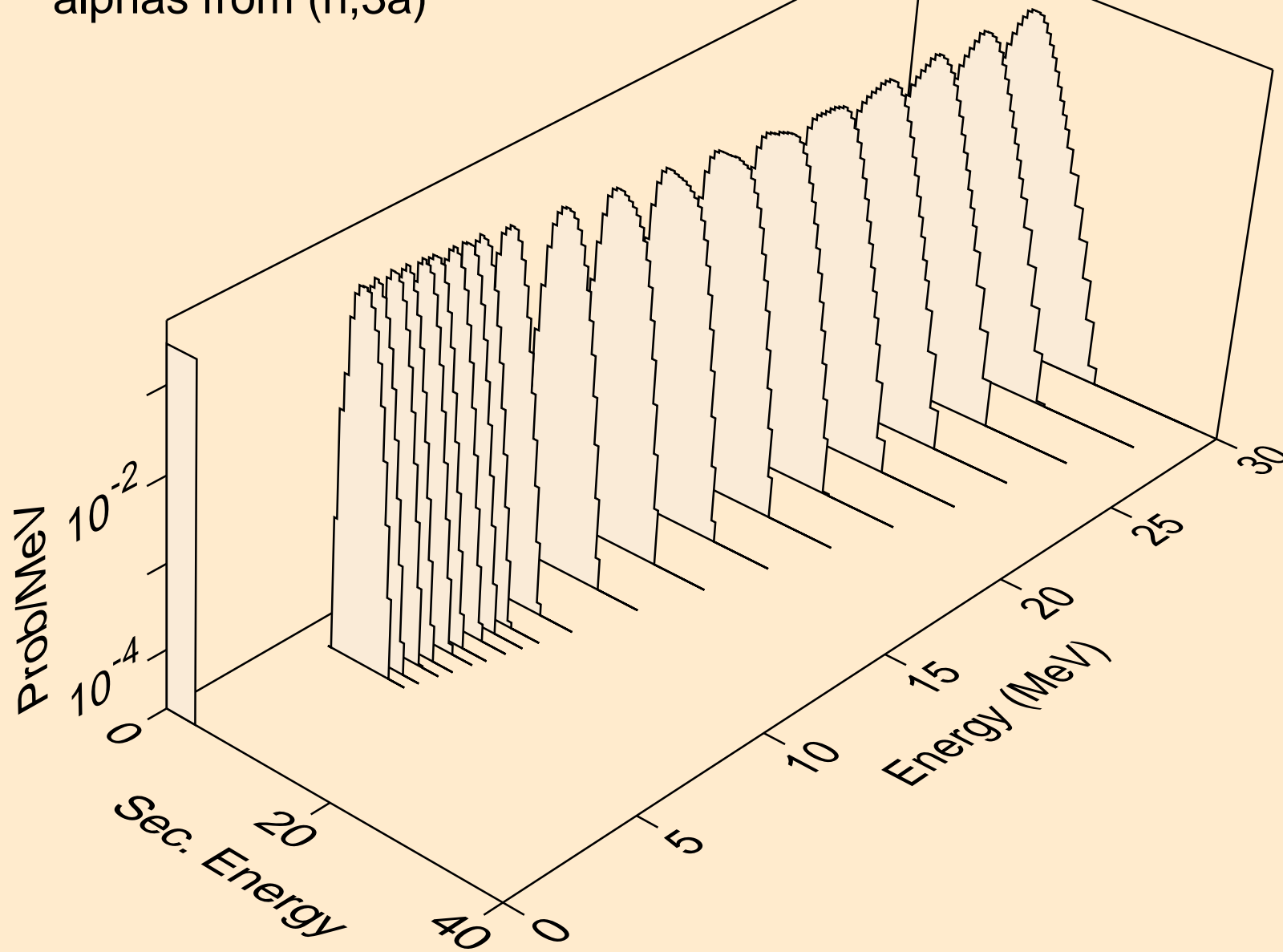

LA121 NEUTRON ACER TENDL-2023 LIBRARY; T=0.K
alphas from (n,pa)

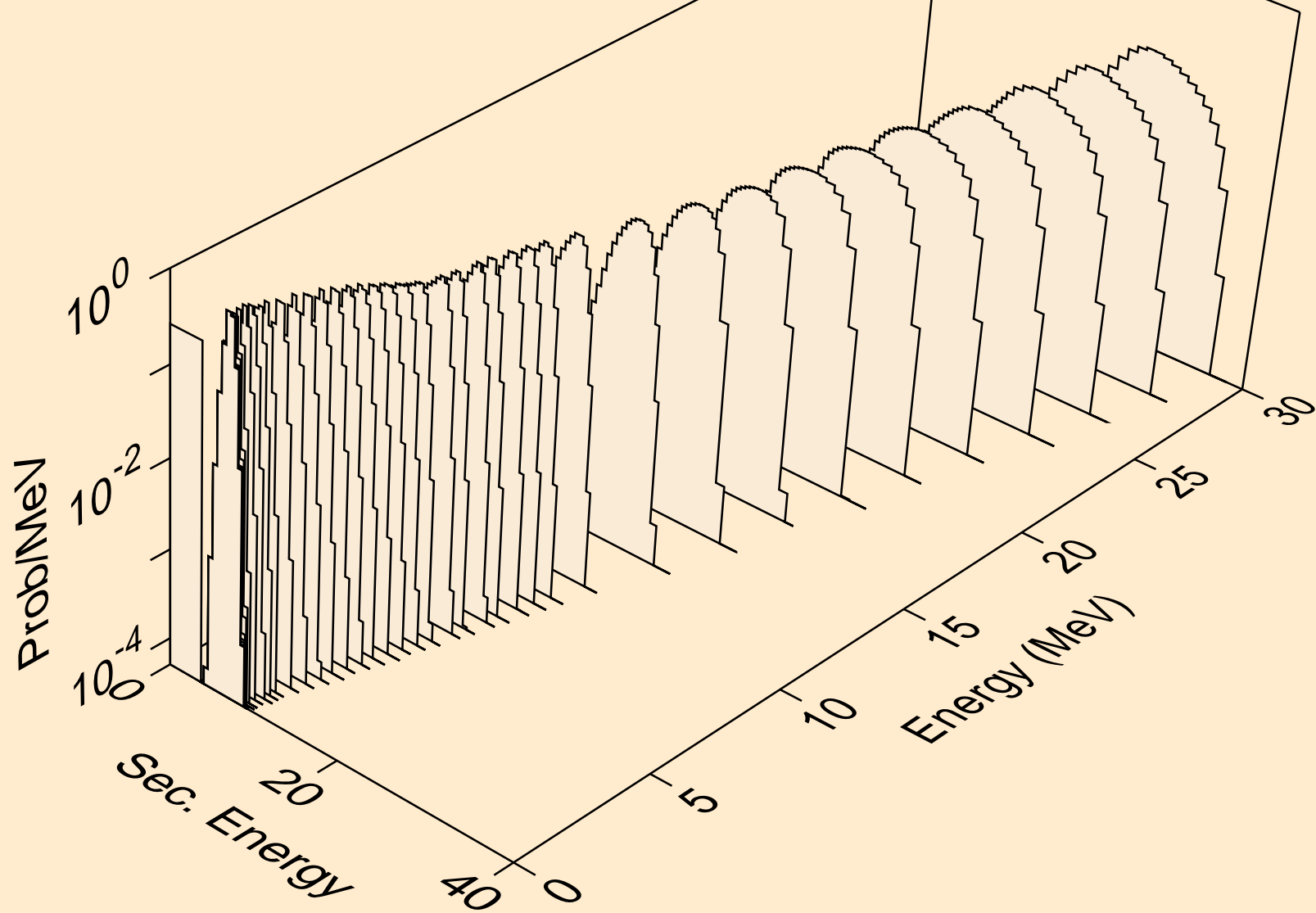

LA121 NEUTRON ACER TENDL-2023 LIBRARY; T=0.K
alphas from (n,t2a)

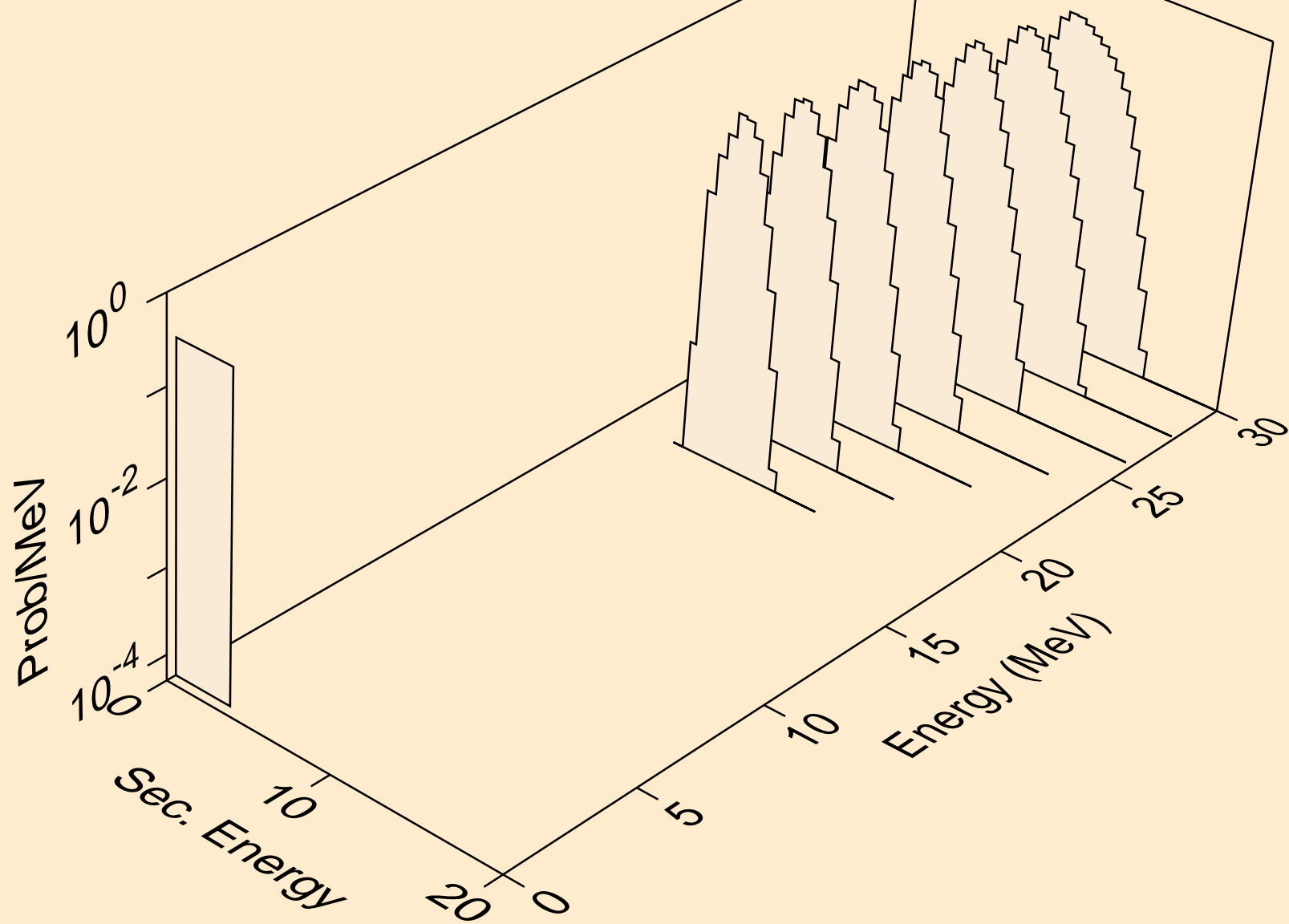

LA121 NEUTRON ACER TENDL-2023 LIBRARY; T=0.K
alphas from (n,d2a)

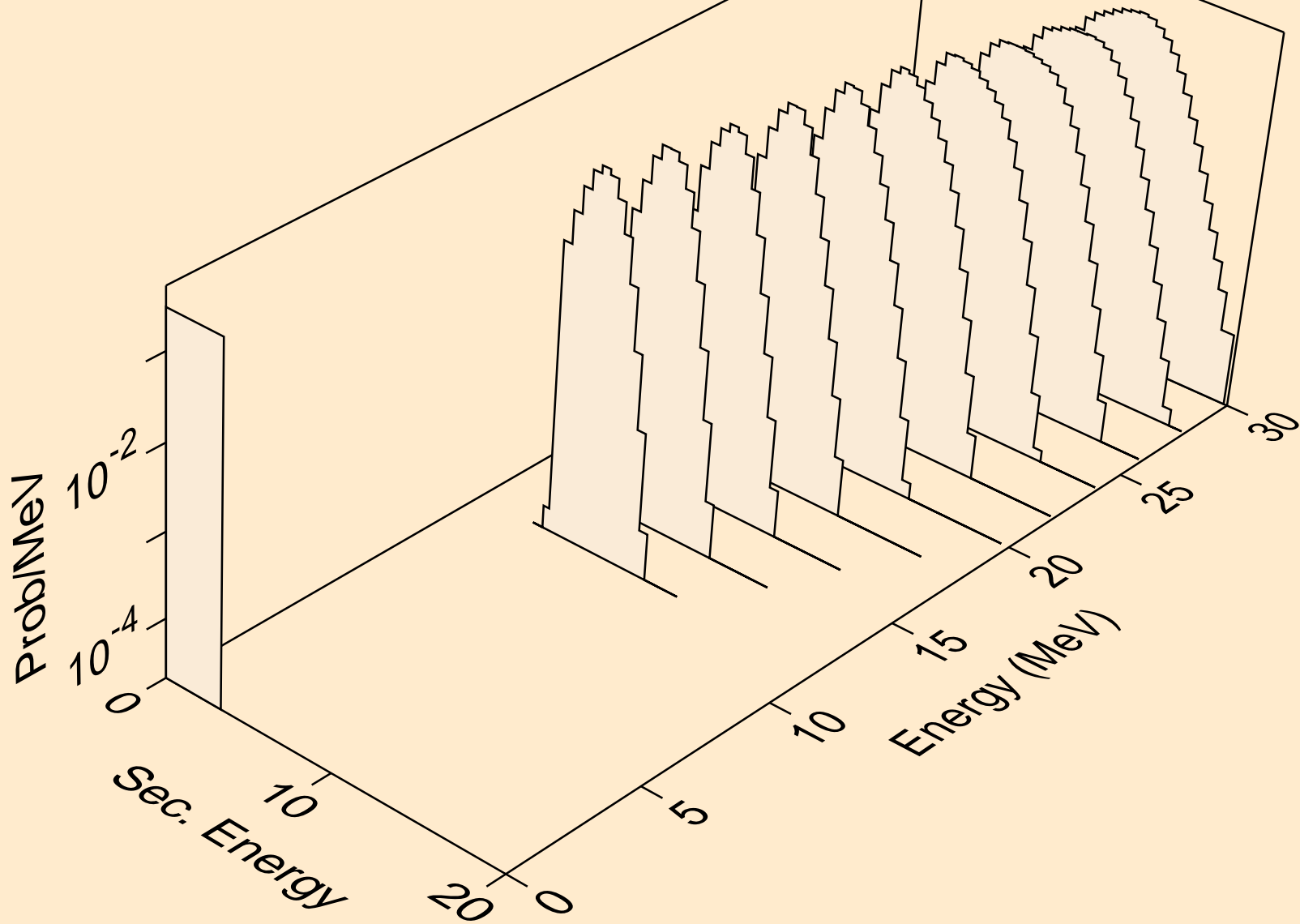

LA121 NEUTRON ACER TENDL-2023 LIBRARY; T=0.K
alphas from (n,da)

