

Program EVALPLOT
(Version 2021-1)

by

Dermott E. Cullen
(Present Contact Information)

Dermott E. Cullen
1466 Hudson Way
Livermore, CA 94550
U.S.A.

Tele: 925-443-1911

E.Mail:redcullen1@comcast.net

Web:redcullen1.net/HOMEPAGE.NEW

Press Mouse Button to Start

MAT 5734

Neutron Major
293 Kelvin Cross Sections

57-La-141

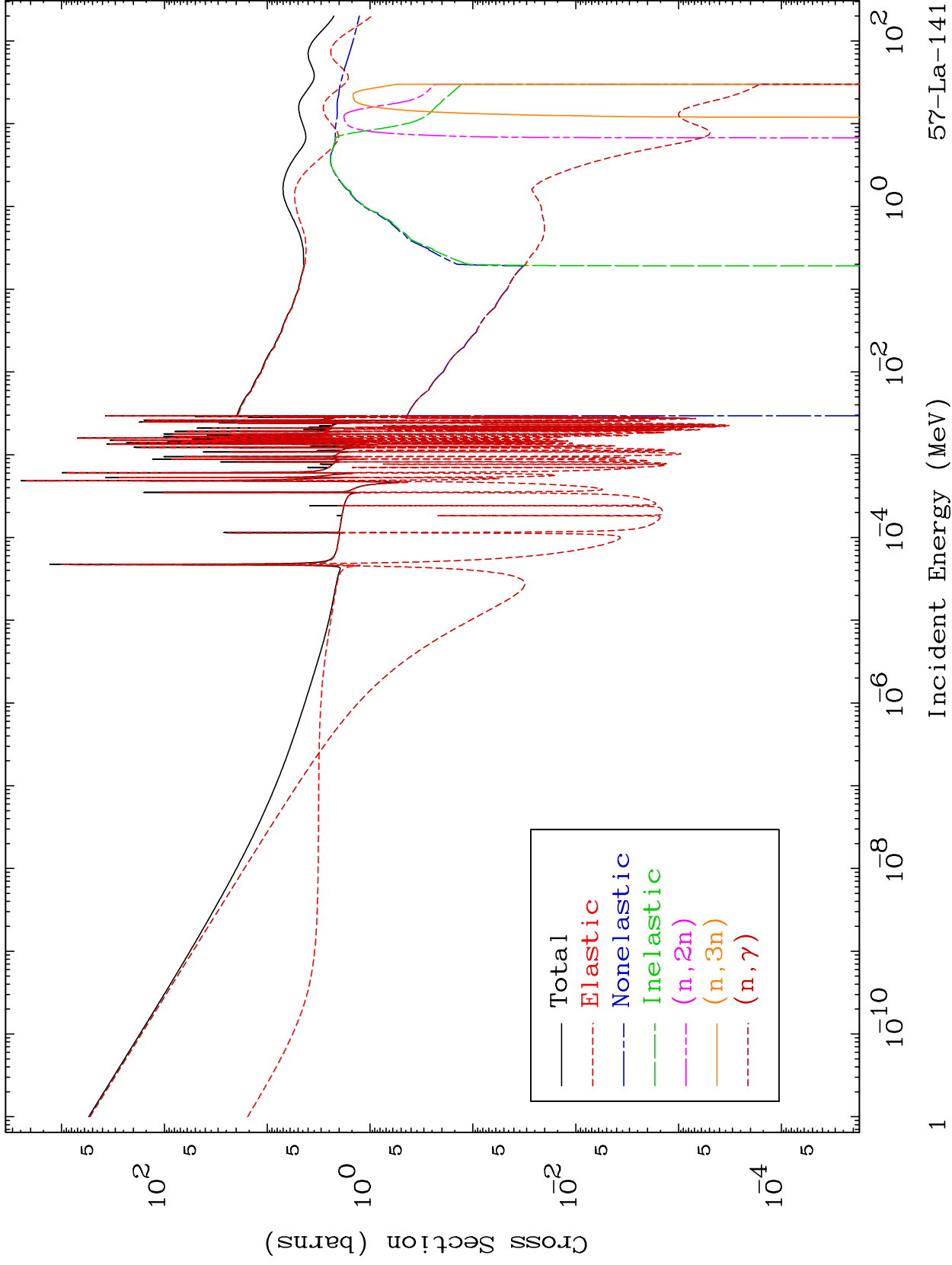

57-La-141

MAT 5734

Neutron Absorption
293 Kelvin Cross Sections

57-La-141

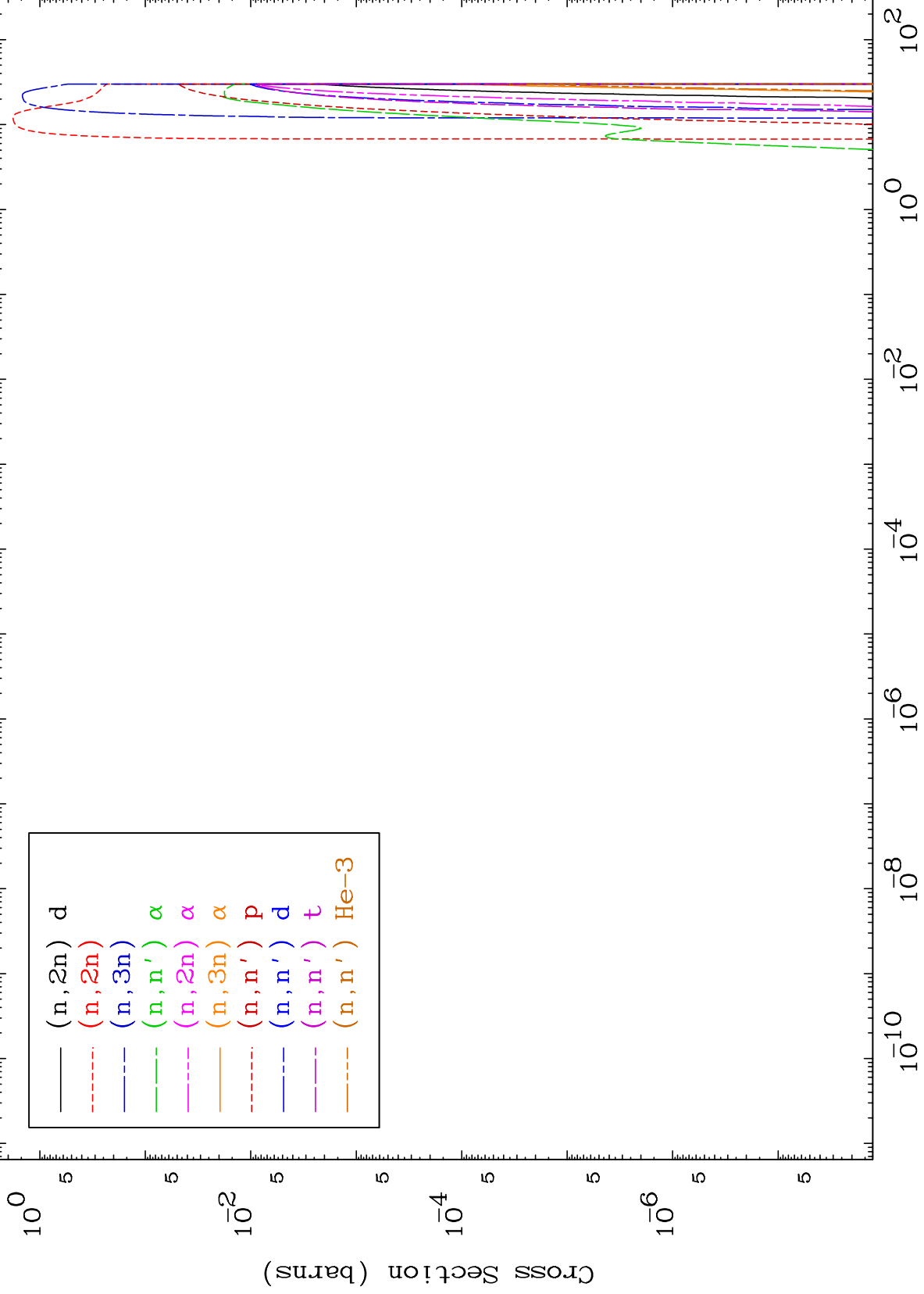

57-La-141

Incident Energy (MeV)

MAT 5734

Neutron Absorption
293 Kelvin Cross Sections

57-La-141

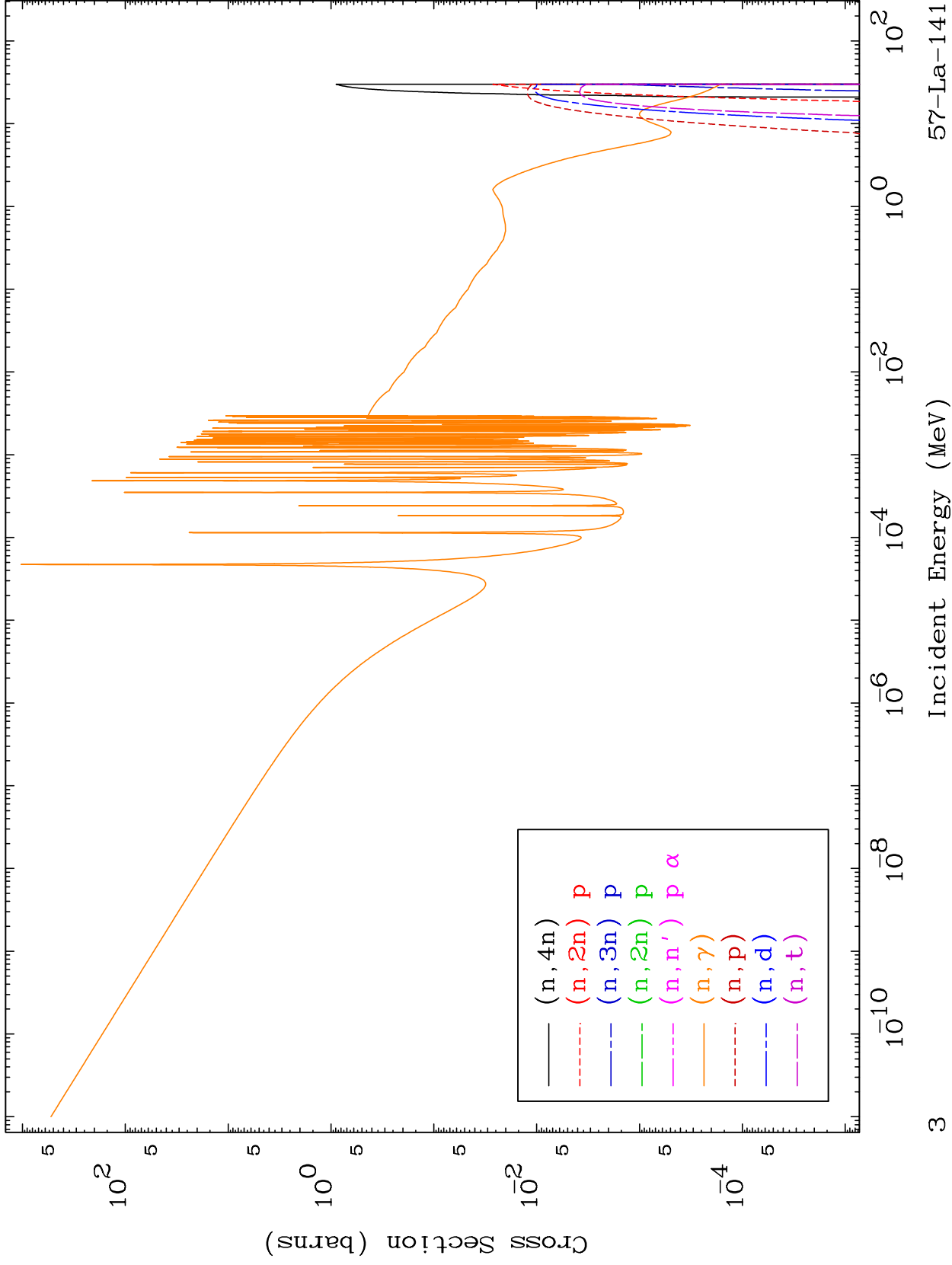

MAT 5734

Neutron Absorption
293 Kelvin Cross Sections

57-La-141

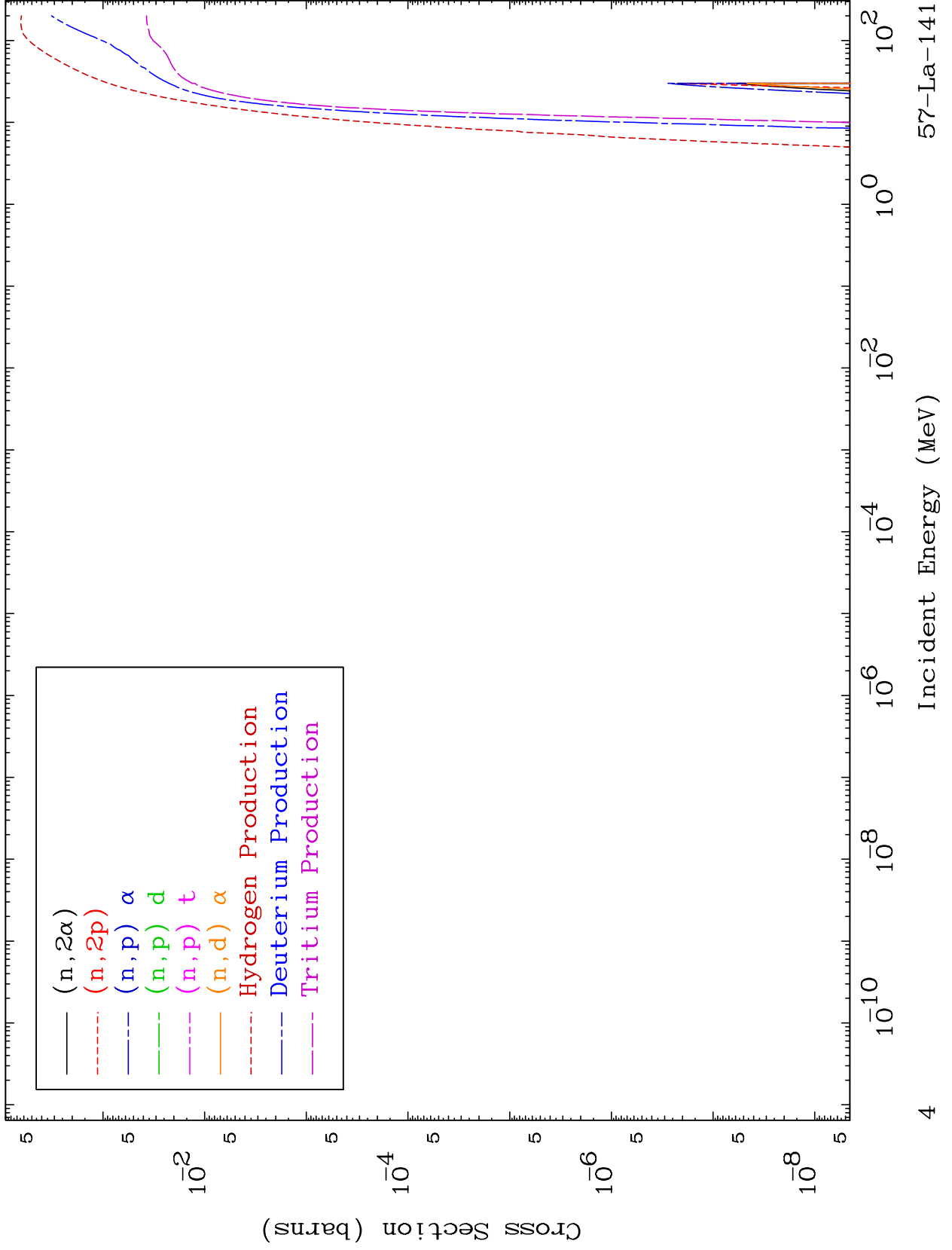

MAT 5734

Charged Particle
293 Kelvin Cross Sections

57-La-141

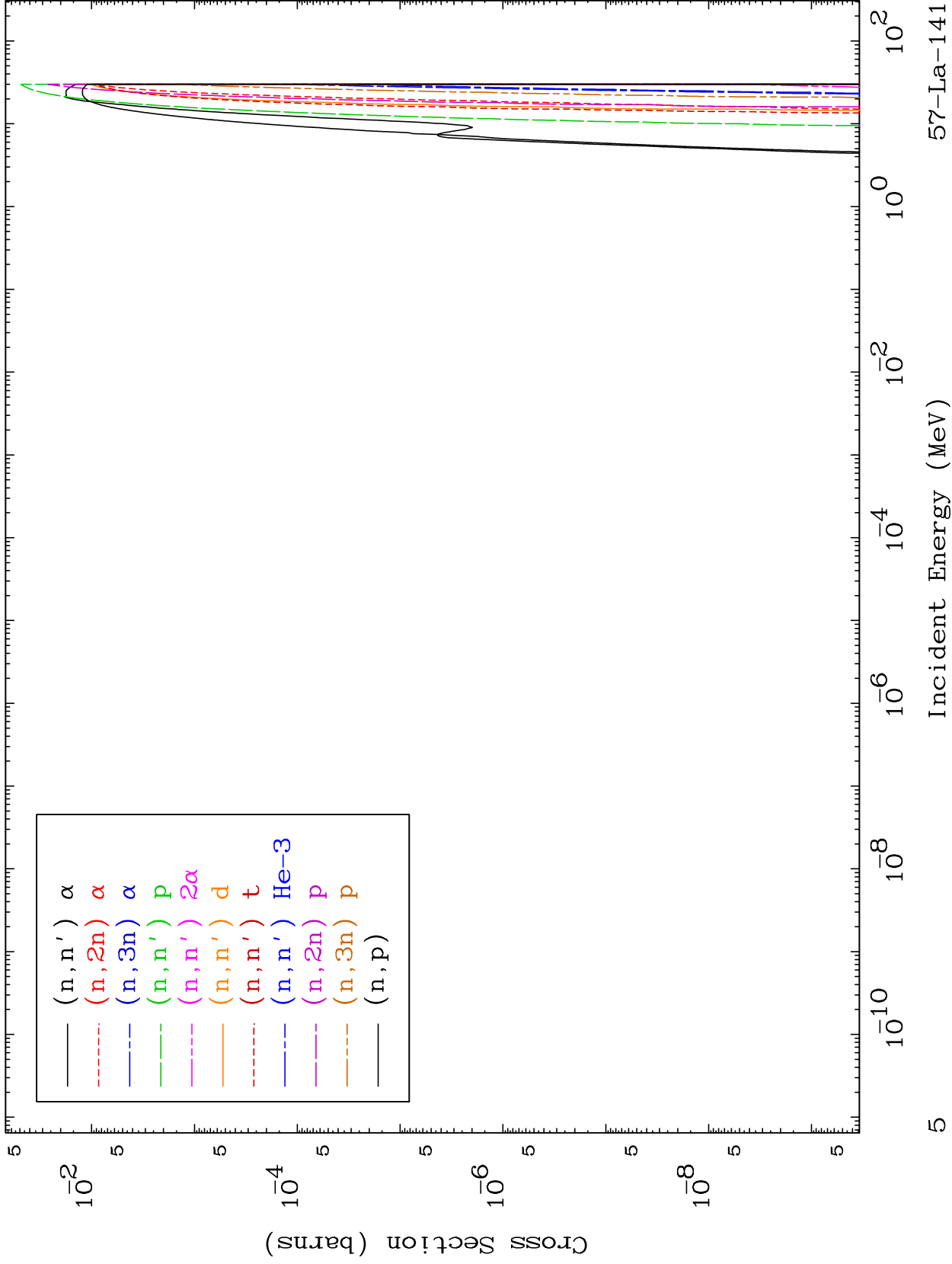

5

Incident Energy (MeV)

57-La-141

MAT 5734

Charged Particle
293 Kelvin Cross Sections

57-La-141

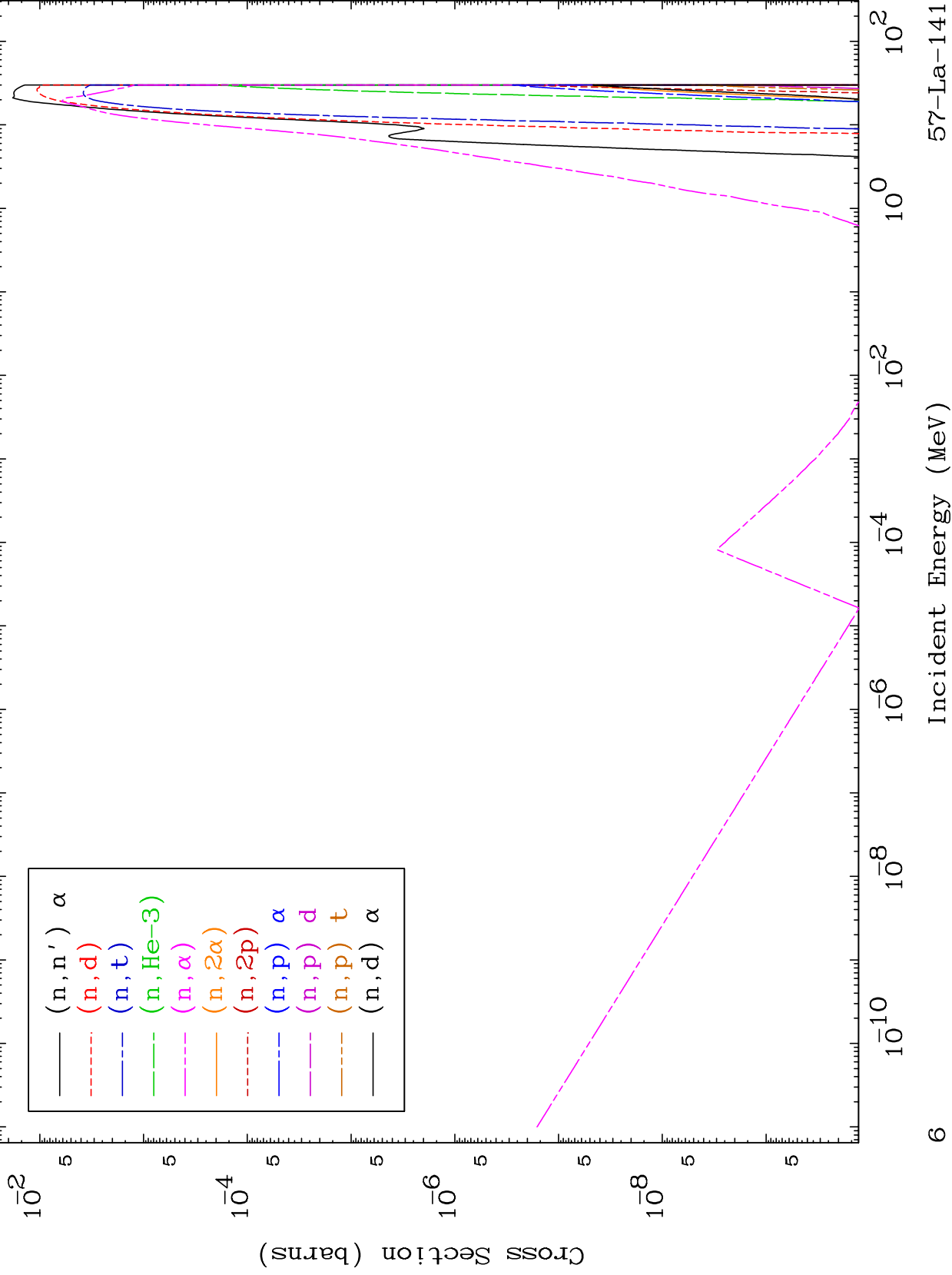

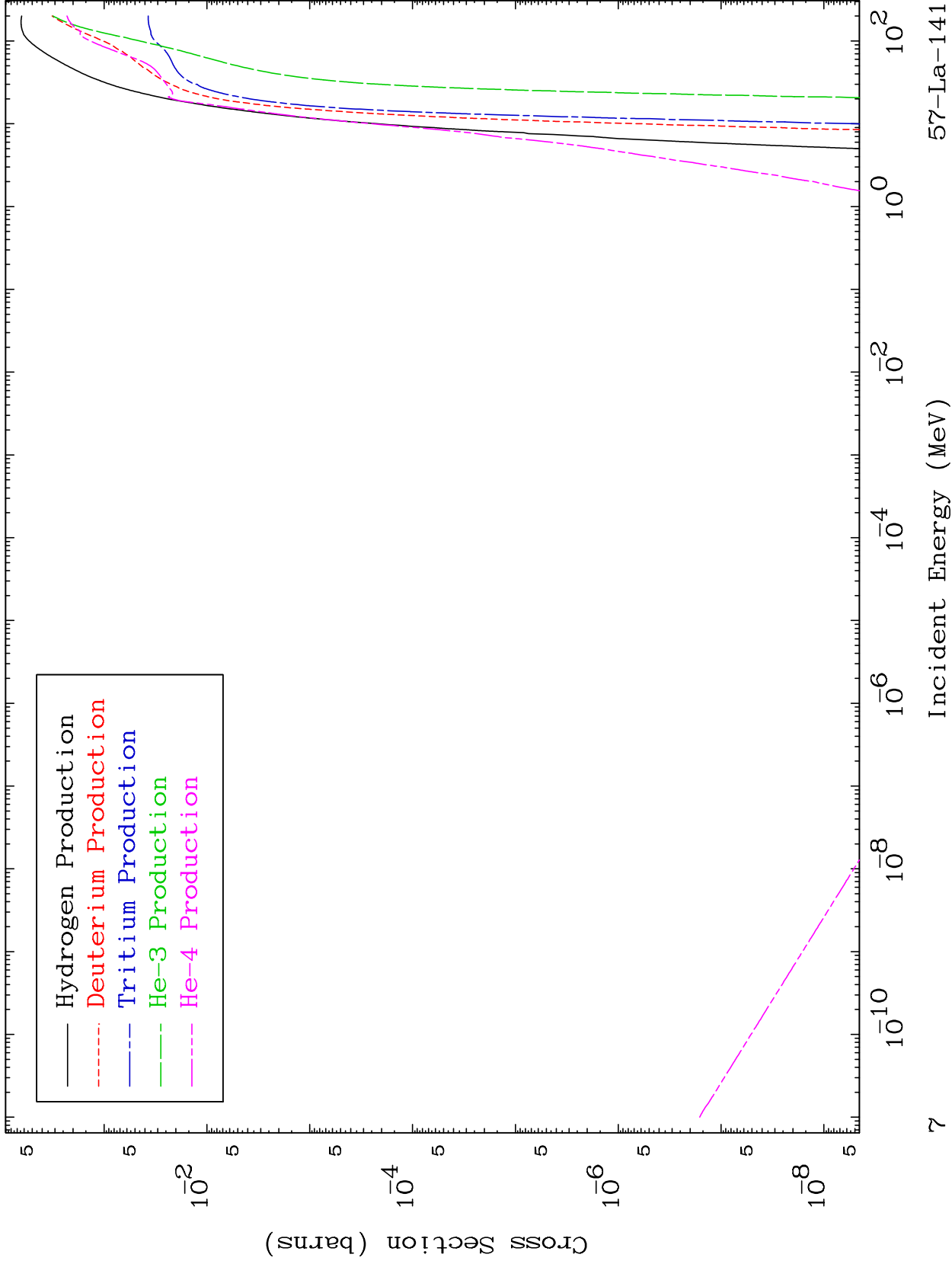

MAT 5734

(n,n') Levels

57-La-141

293 Kelvin Cross Sections

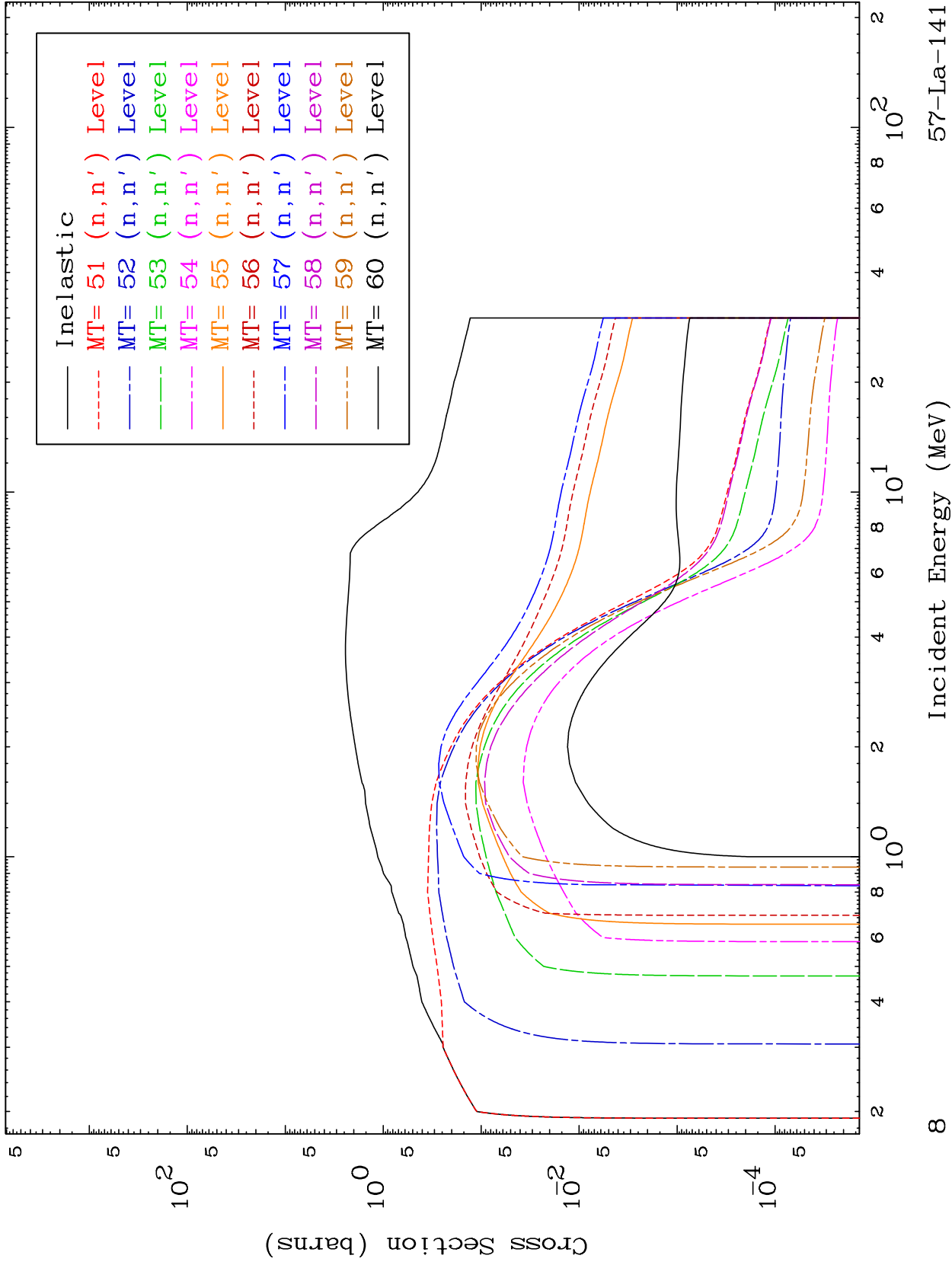

8

Incident Energy (MeV)

57-La-141

293 Kelvin Cross Sections

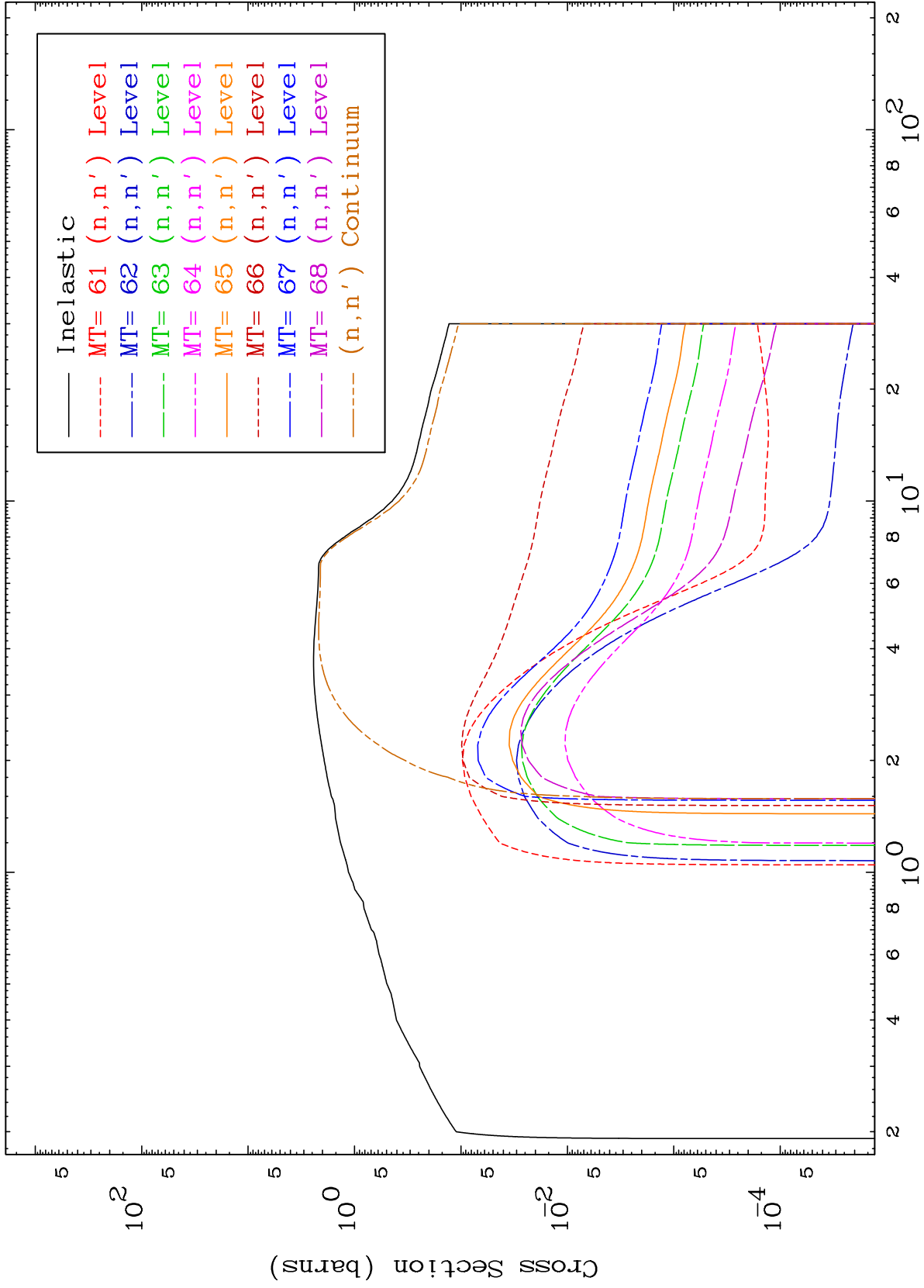

MAT 5734

(n,p) Levels
293 Kelvin Cross Sections

57-La-141

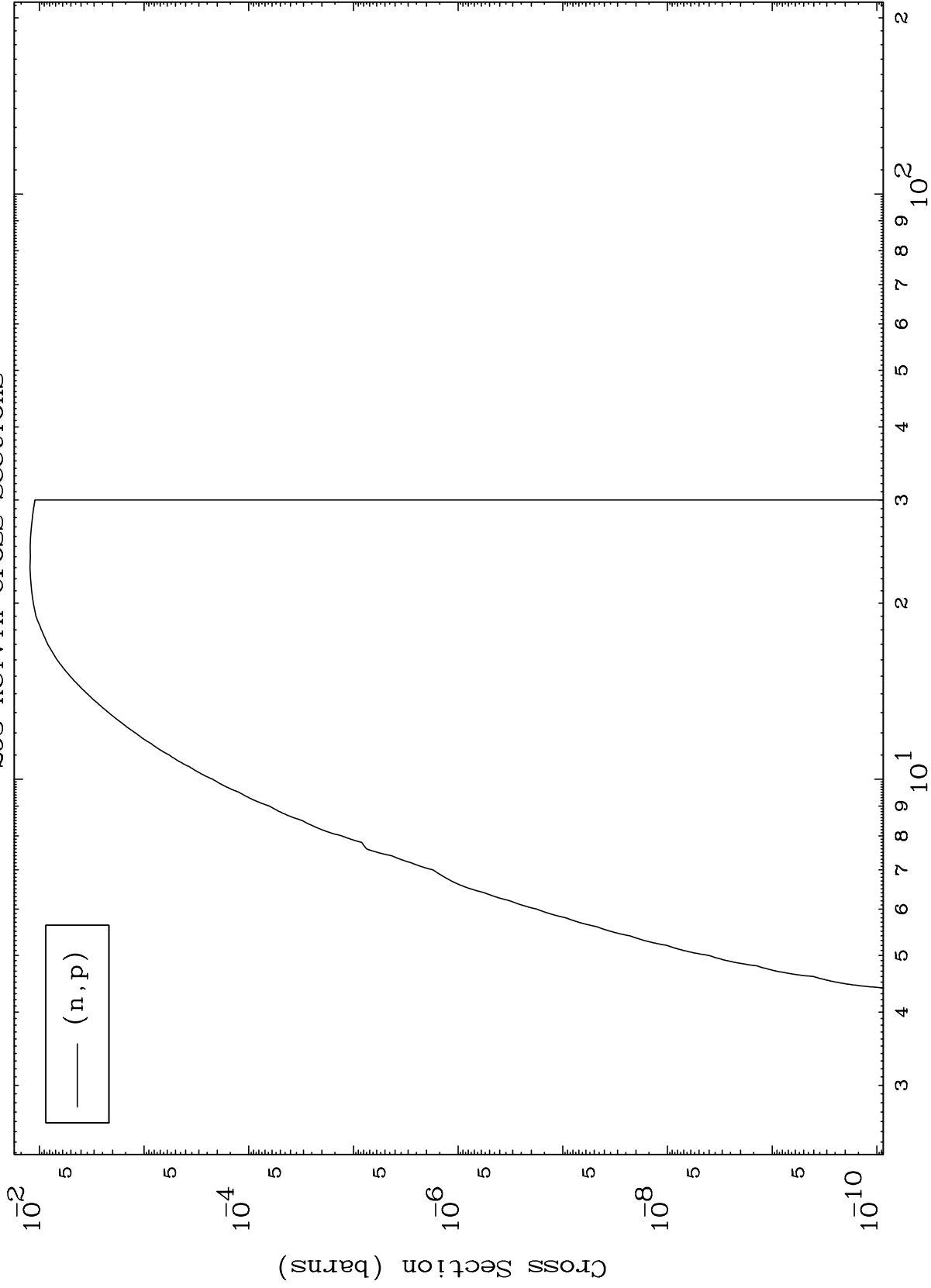

10

Incident Energy (MeV)

57-La-141

MAT 5734

(n,d) Levels
293 Kelvin Cross Sections

57-La-141

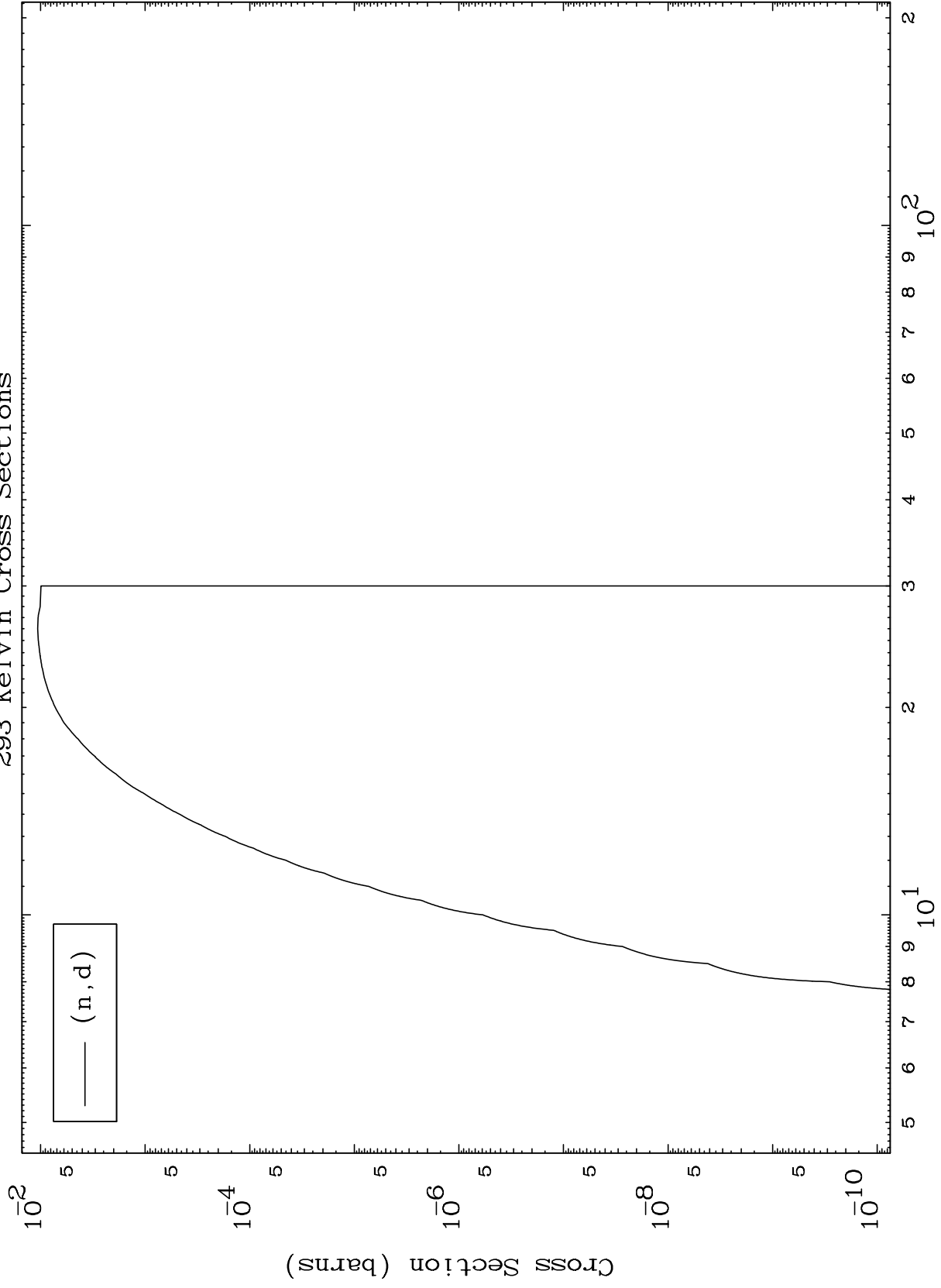

11

Incident Energy (MeV)

57-La-141

MAT 5734

(n,t) Levels
293 Kelvin Cross Sections

57-La-141

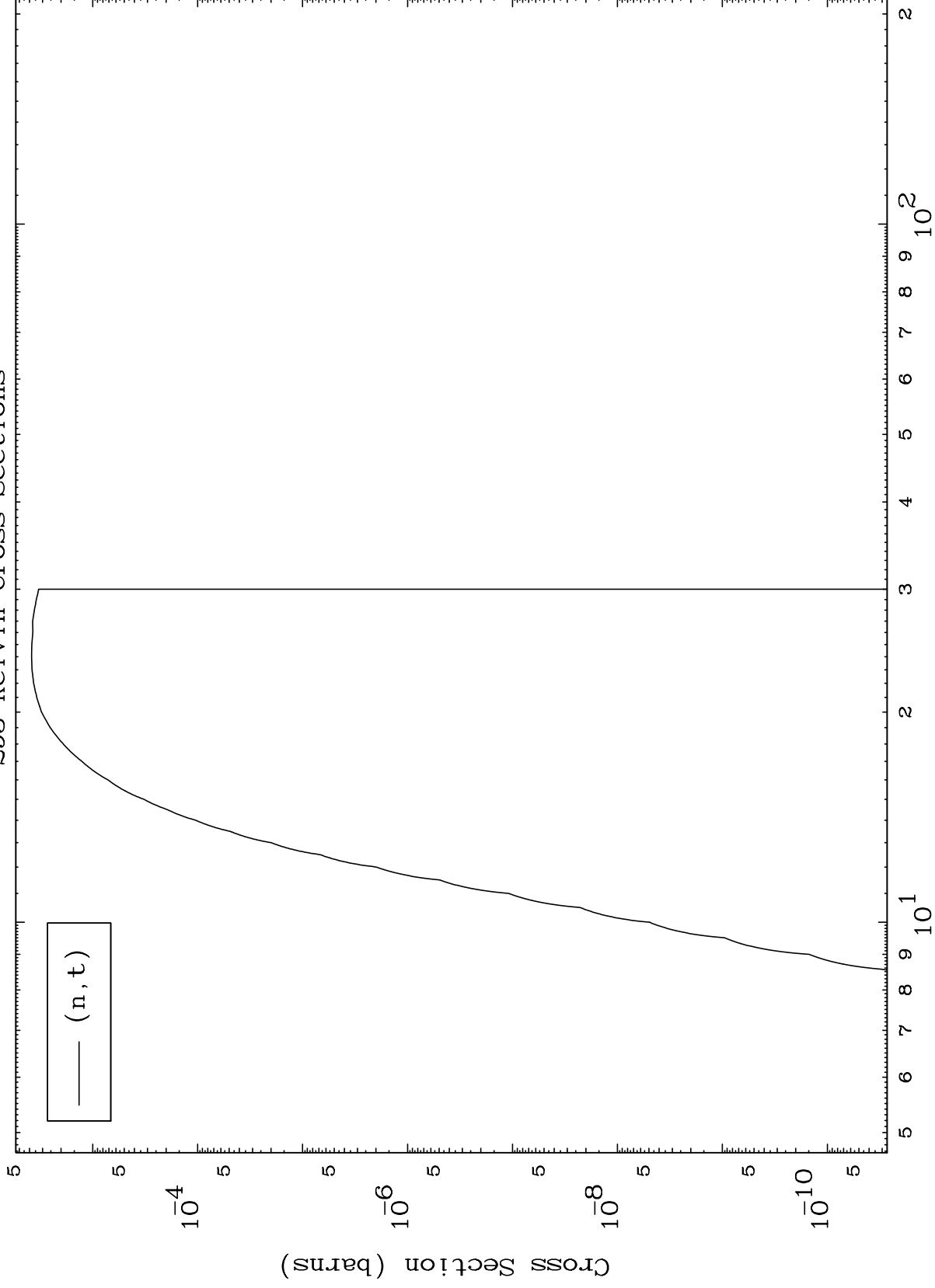

12

Incident Energy (MeV)

57-La-141

MAT 5734

(n,He3) Levels
293 Kelvin Cross Sections

57-La-141

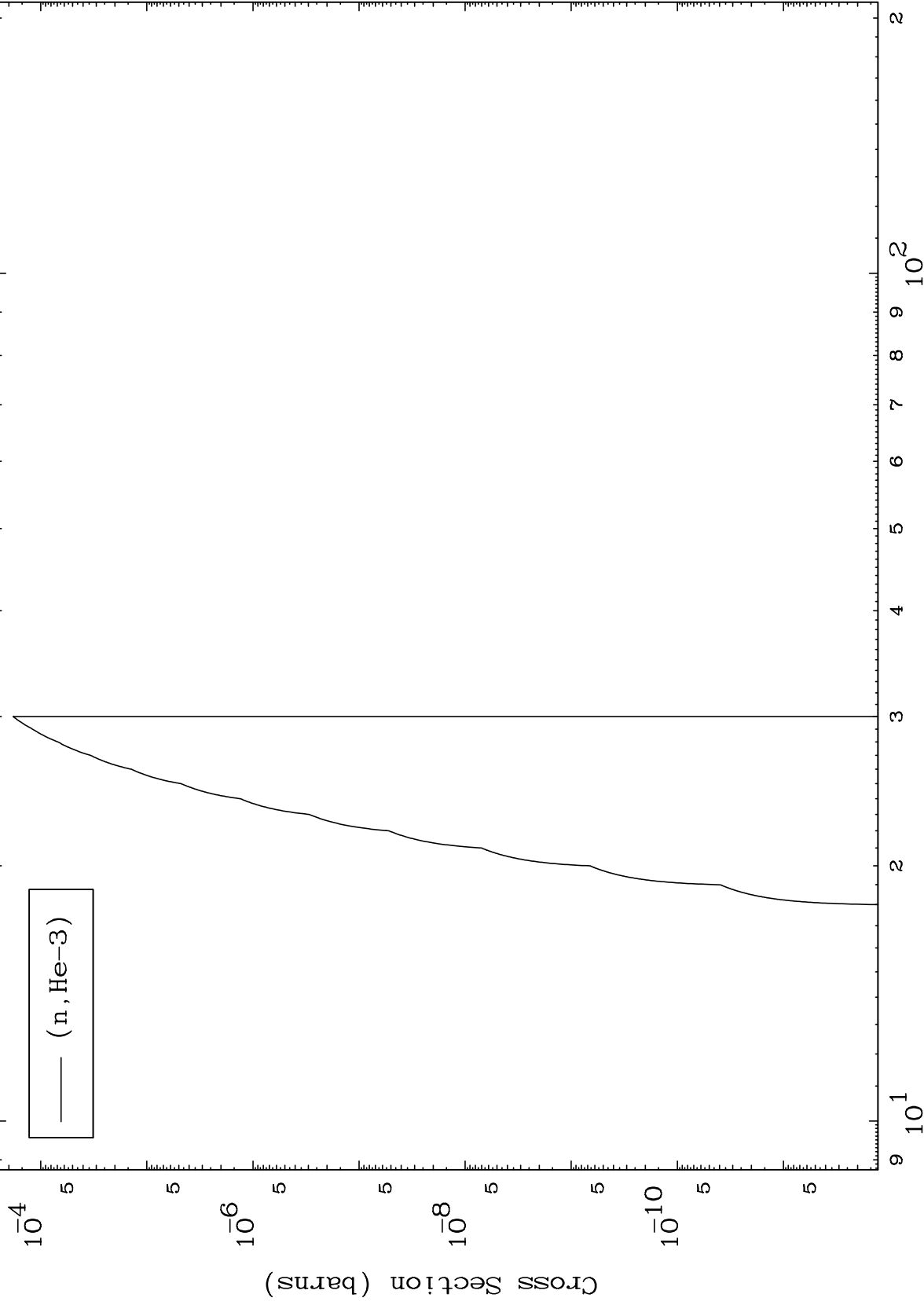

13

Incident Energy (MeV)

57-La-141

MAT 5734

(n, α) Levels
293 Kelvin Cross Sections

57-La-141

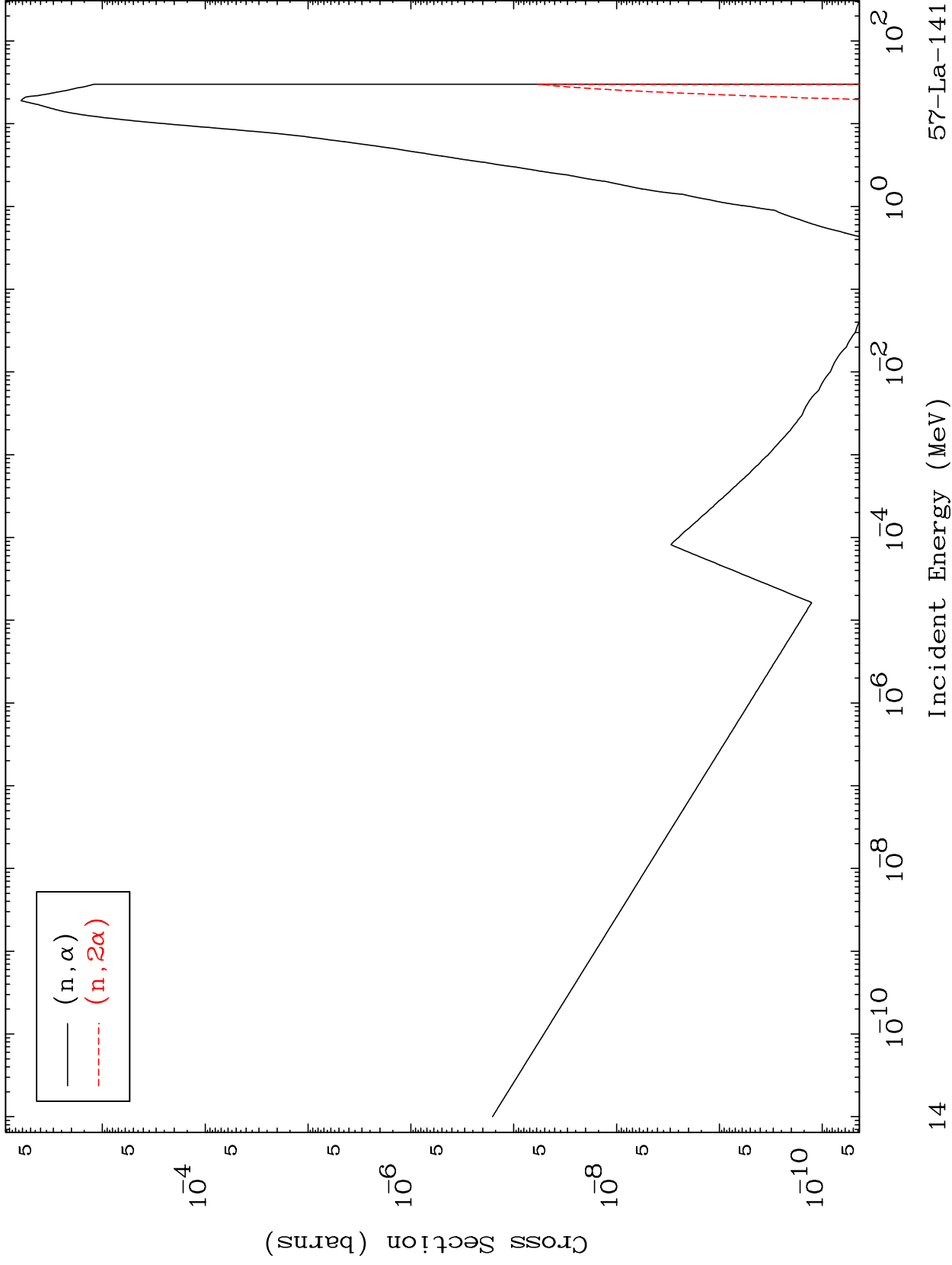

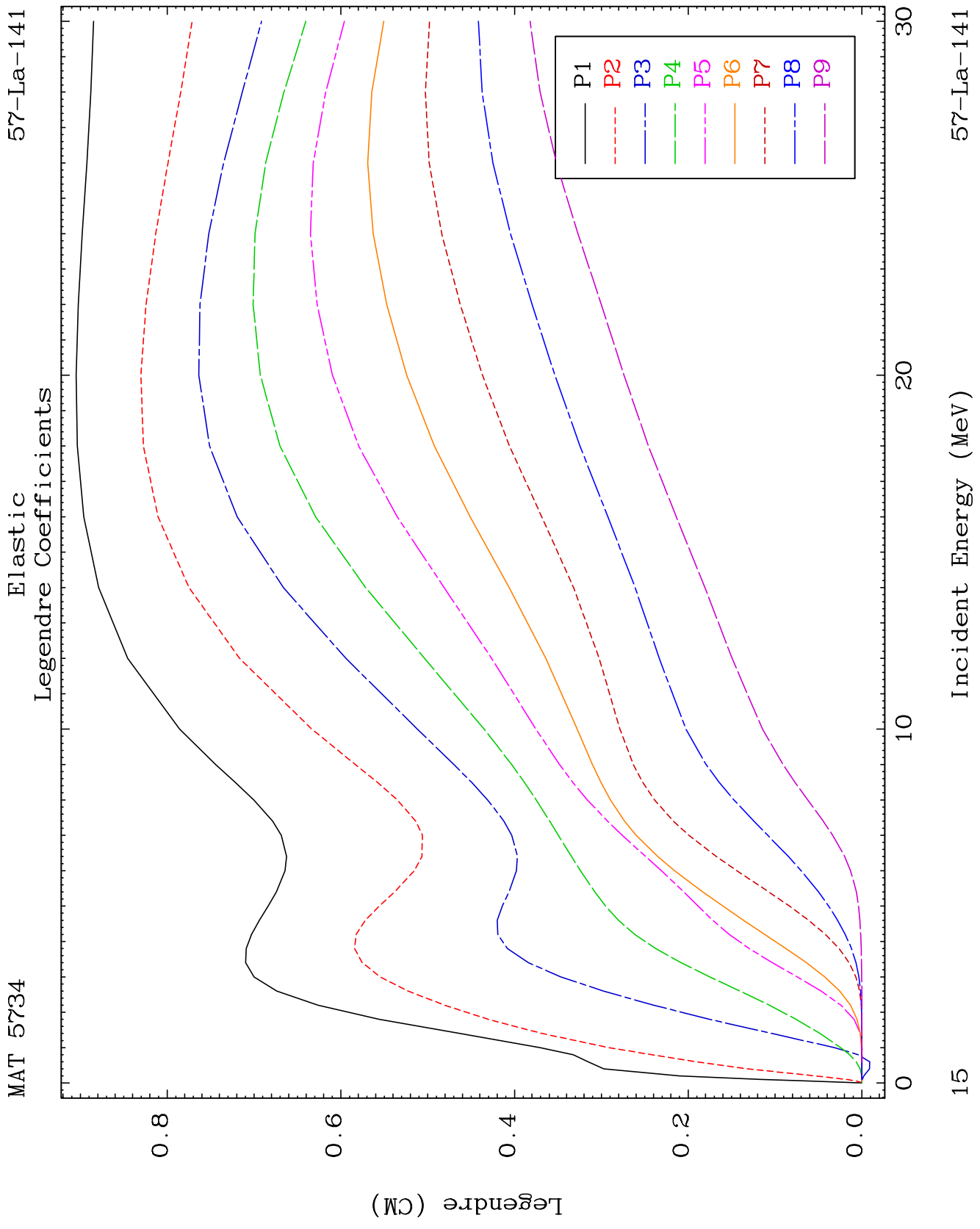

MAT 5734

Elastic Legendre Coefficients

⁵⁷La-141

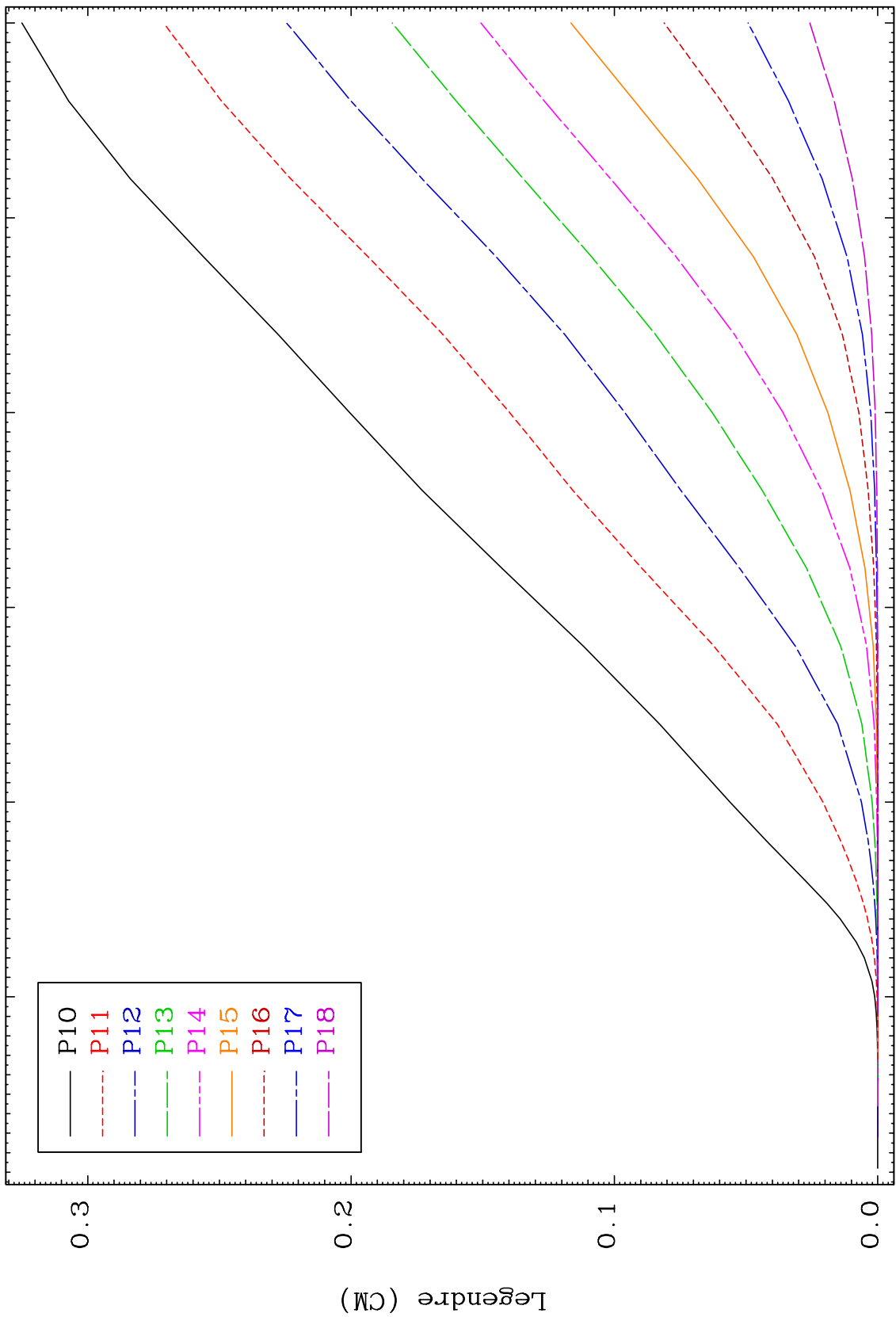

16

Incident Energy (MeV)

⁵⁷La-141

MAT 5734

Elastic Legendre Coefficients

57-La-141

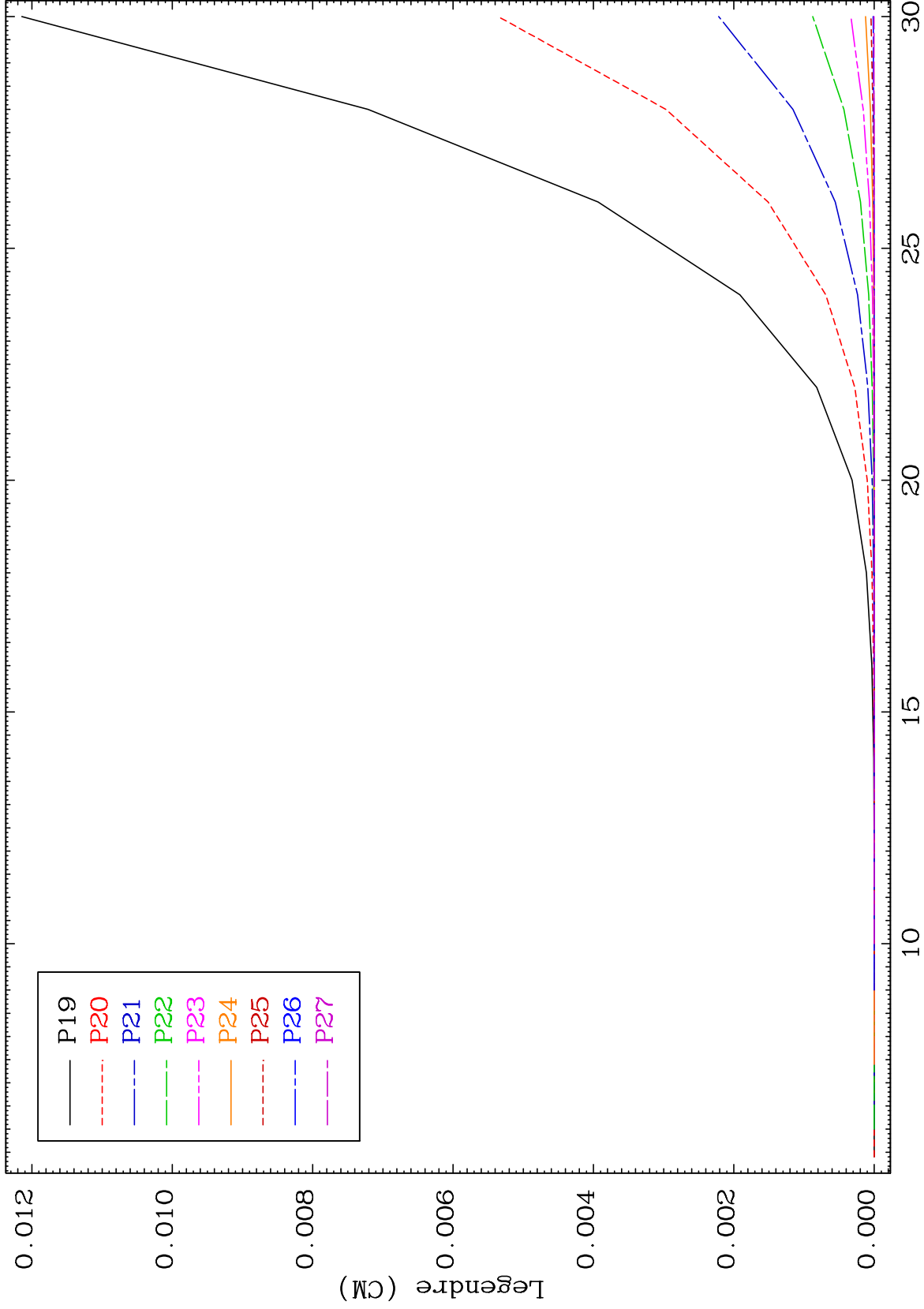

17

Incident Energy (MeV)

57-La-141

MAT 5734

Elastic Legendre Coefficients

57-La-141

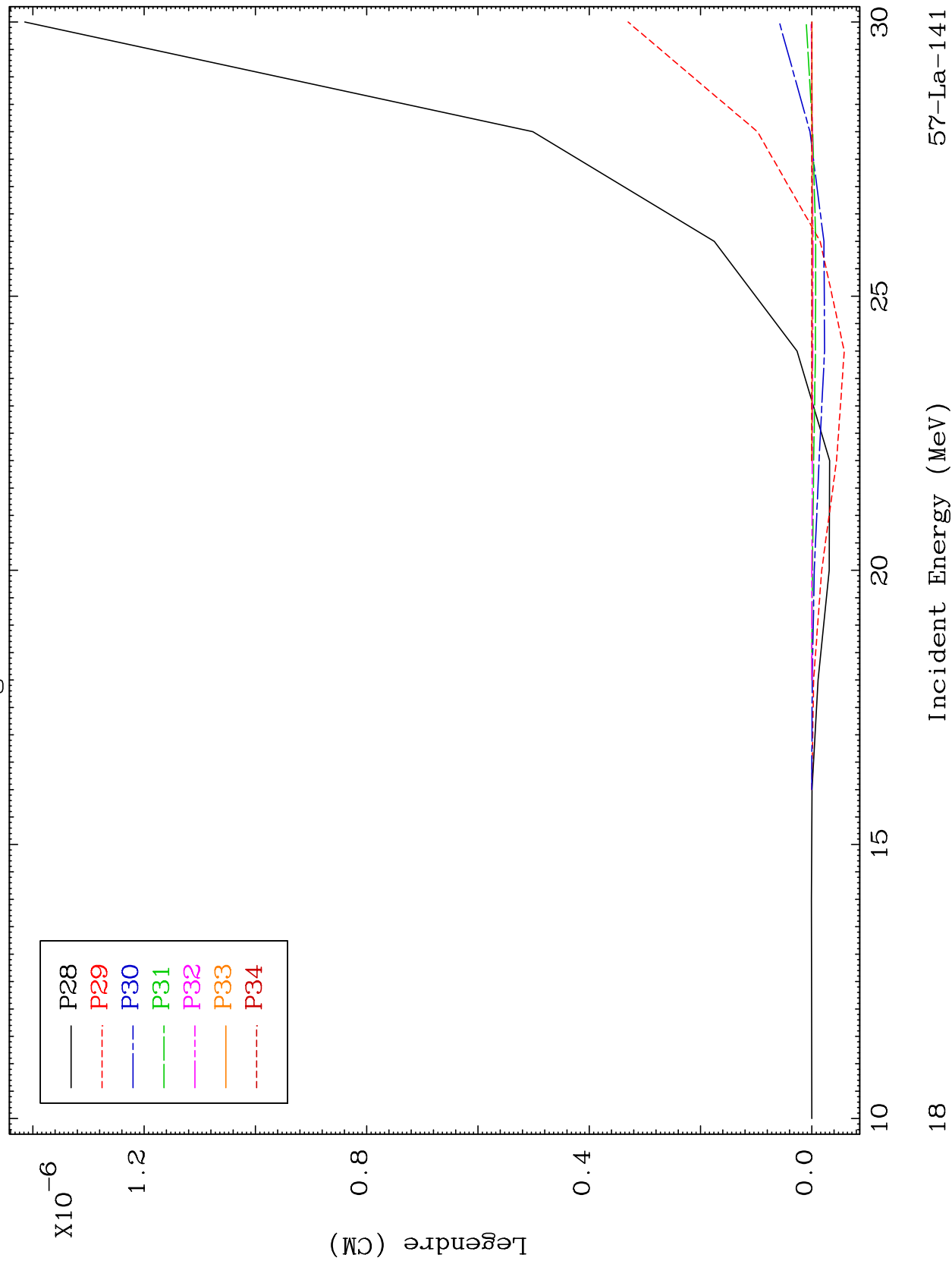

57-La-141

Incident Energy (MeV)

MAT 5734

MT= 51 (n,n') Level
Legendre Coefficients

57-La-141

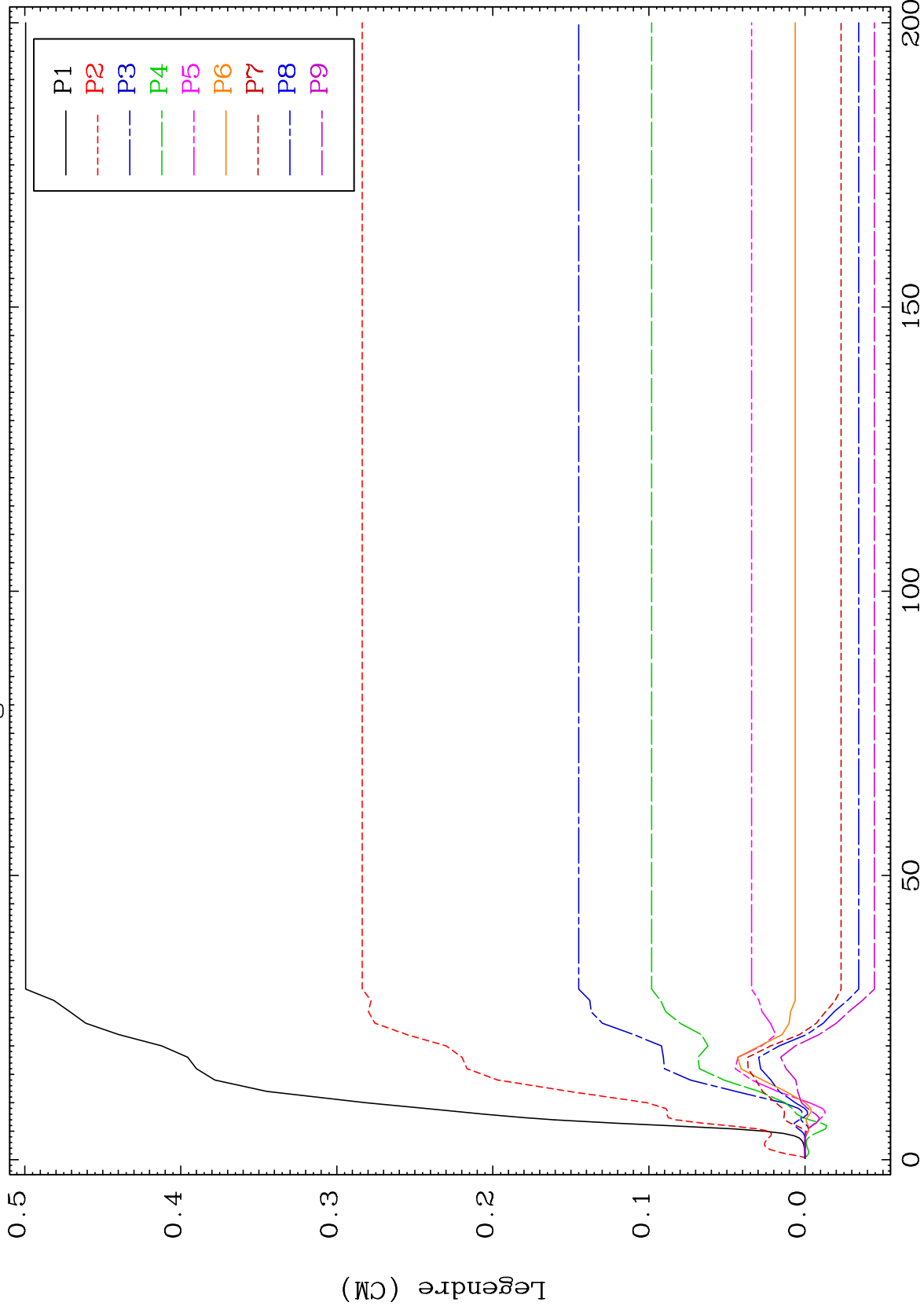

57-La-141

Incident Energy (MeV)

19

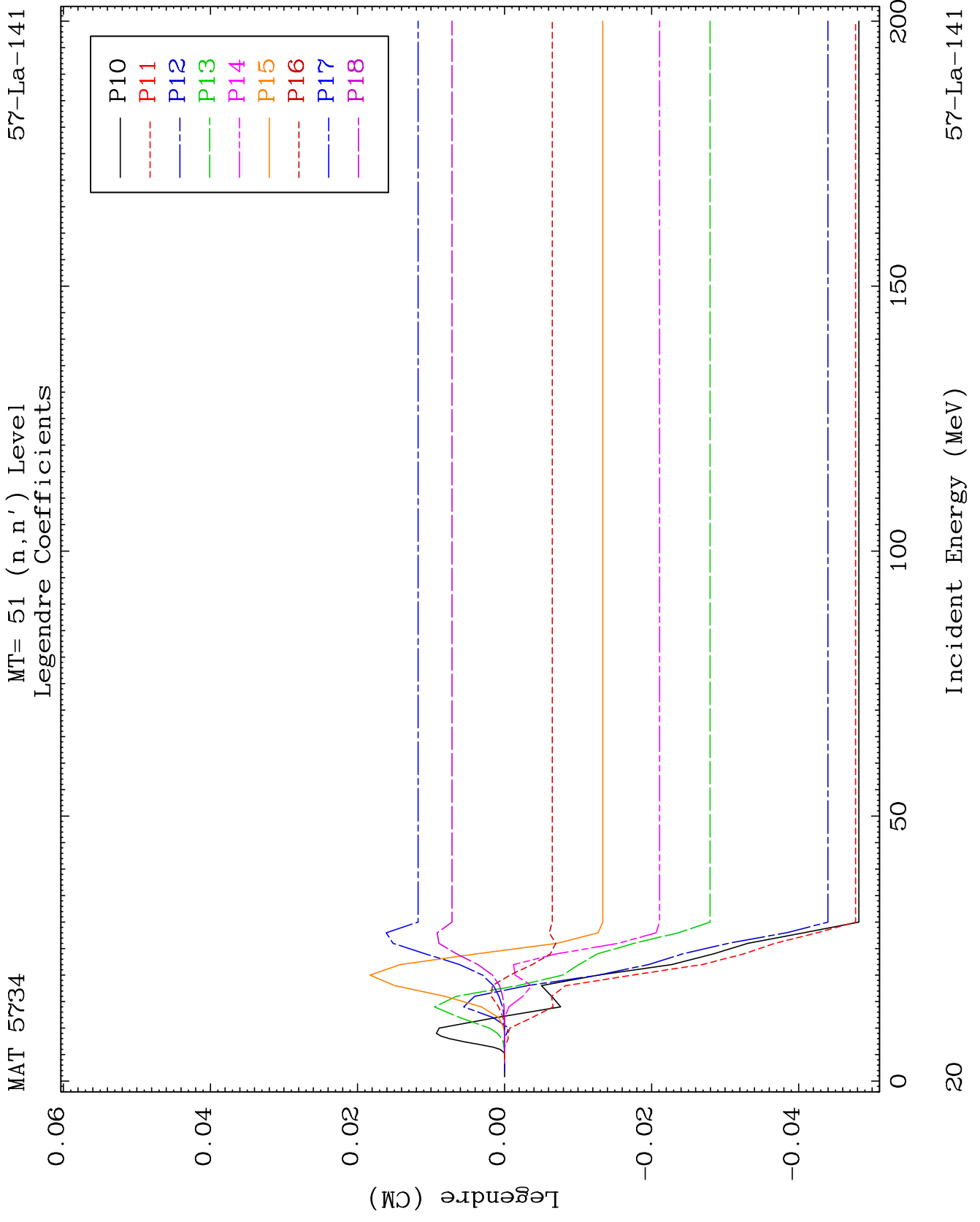

MAT 5734

MT= 51 (n,n') Level
Legendre Coefficients

57-La-141

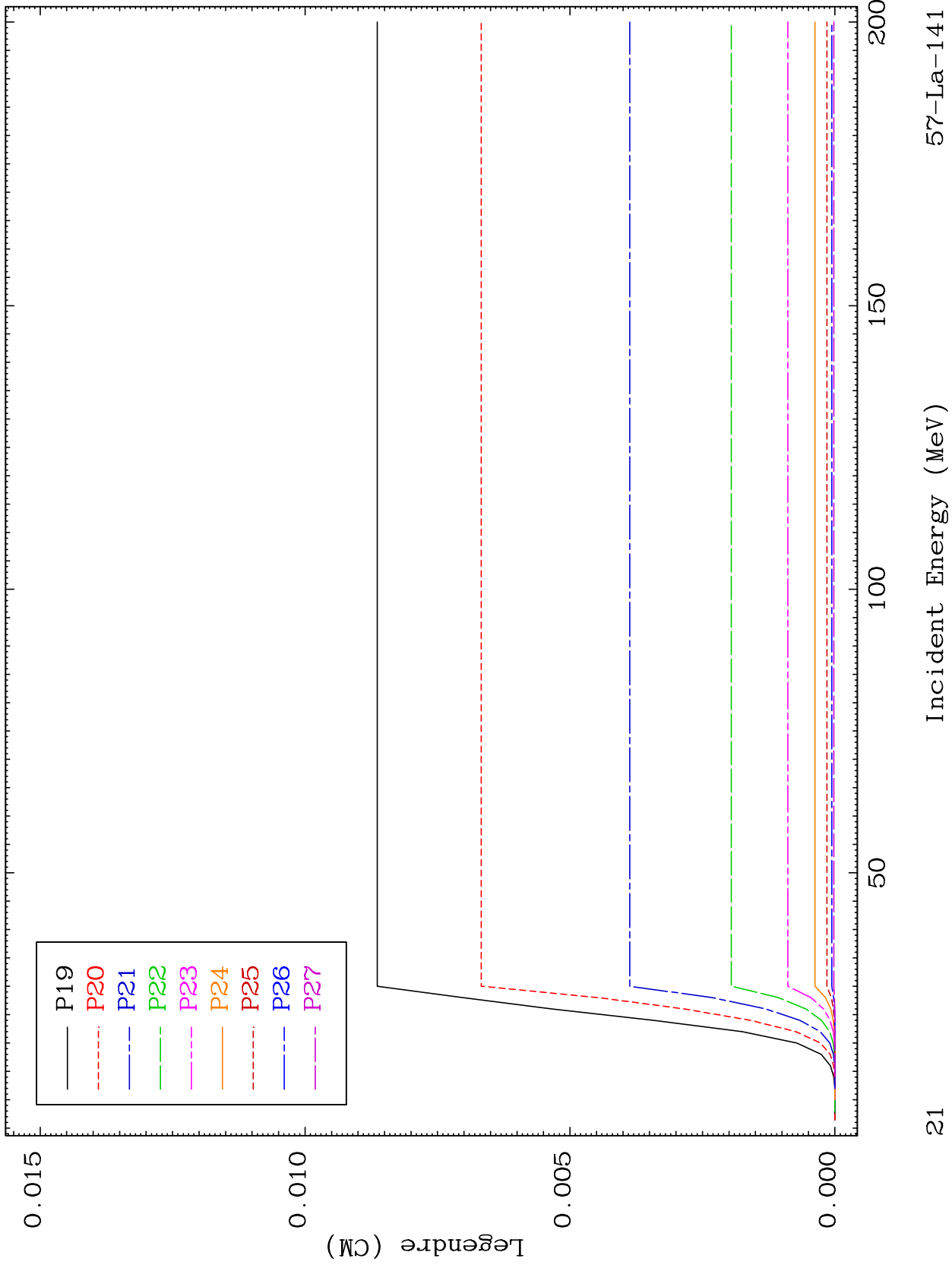

21

57-La-141

MAT 5734

MT= 51 (n,n') Level
Legendre Coefficients

57-La-141

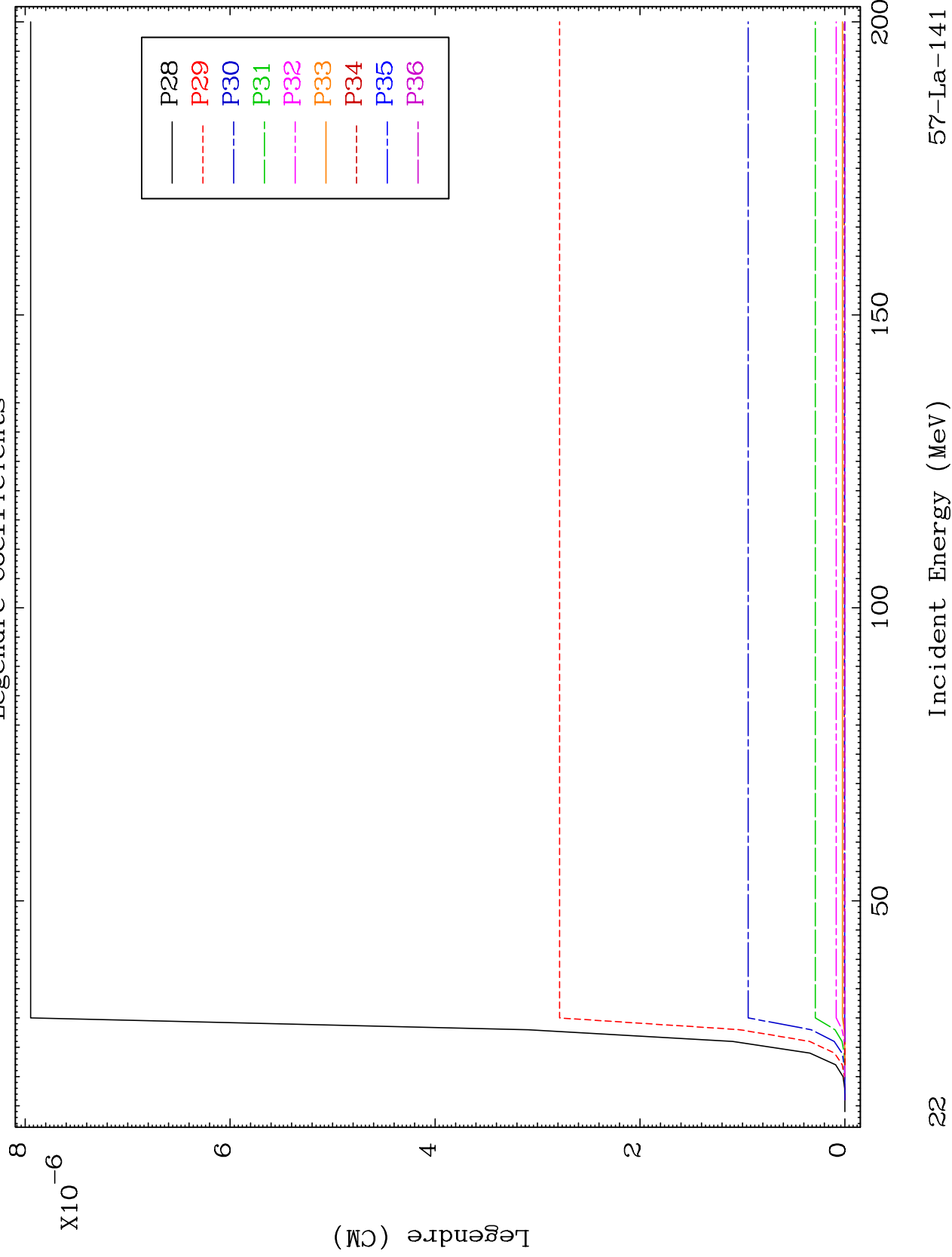

22

Incident Energy (MeV)

57-La-141

MAT 5734

MT= 52 (n,n') Level
Legendre Coefficients

57-La-141

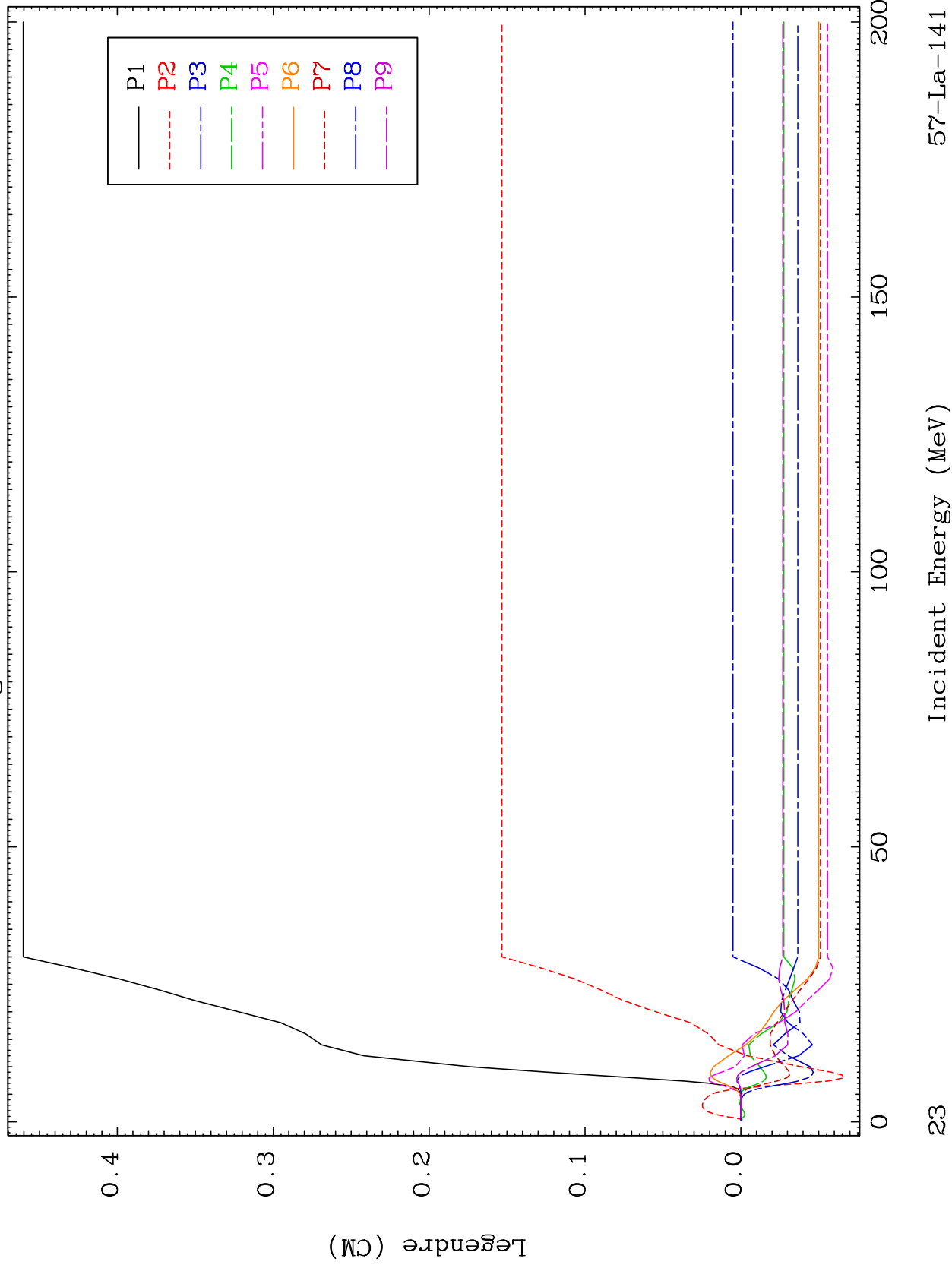

57-La-141

MAT 5734

MT= 52 (n,n') Level
Legendre Coefficients

57-La-141

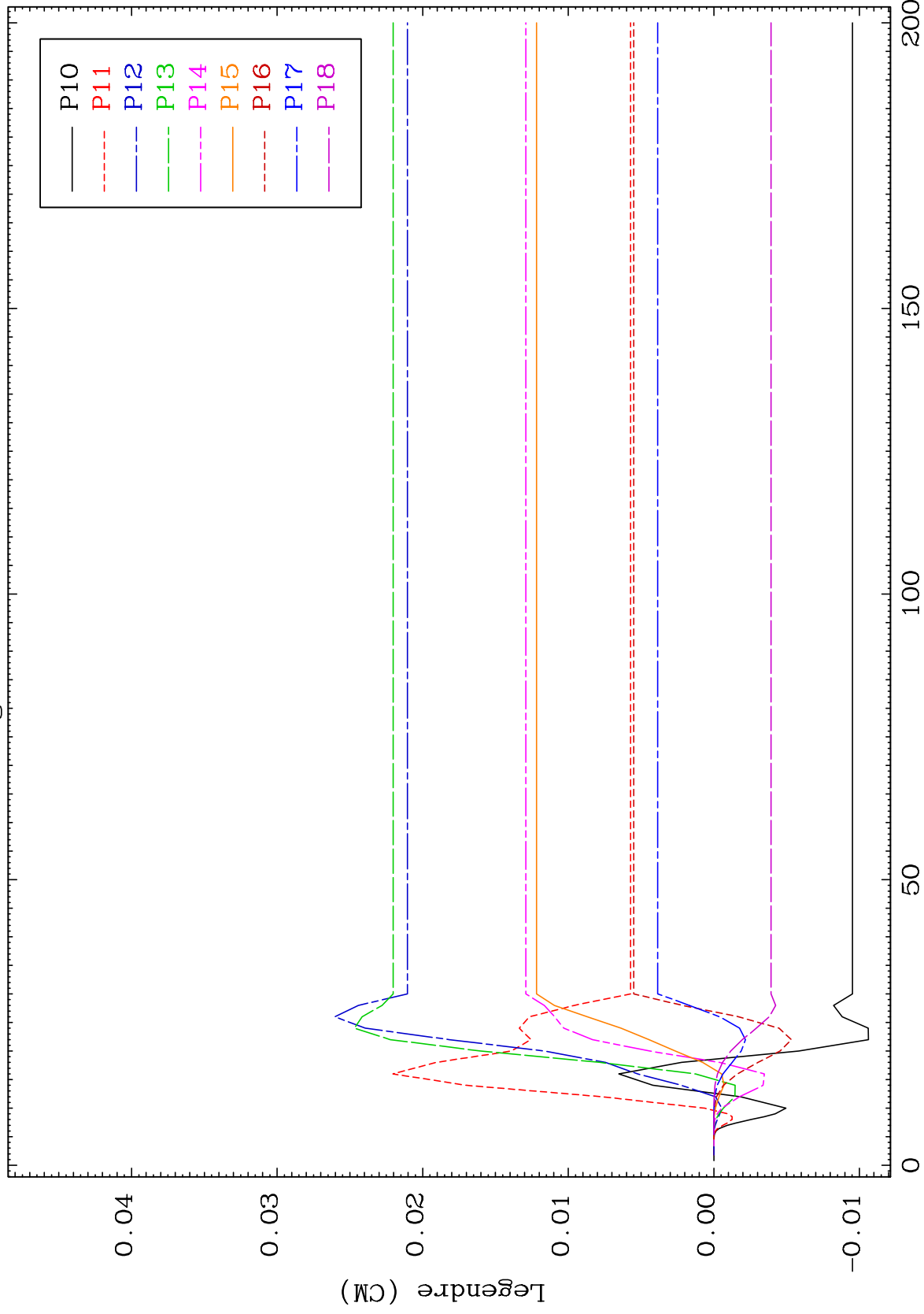

24

57-La-141

MAT 5734

MT= 52 (n,n') Level
Legendre Coefficients

57-La-141

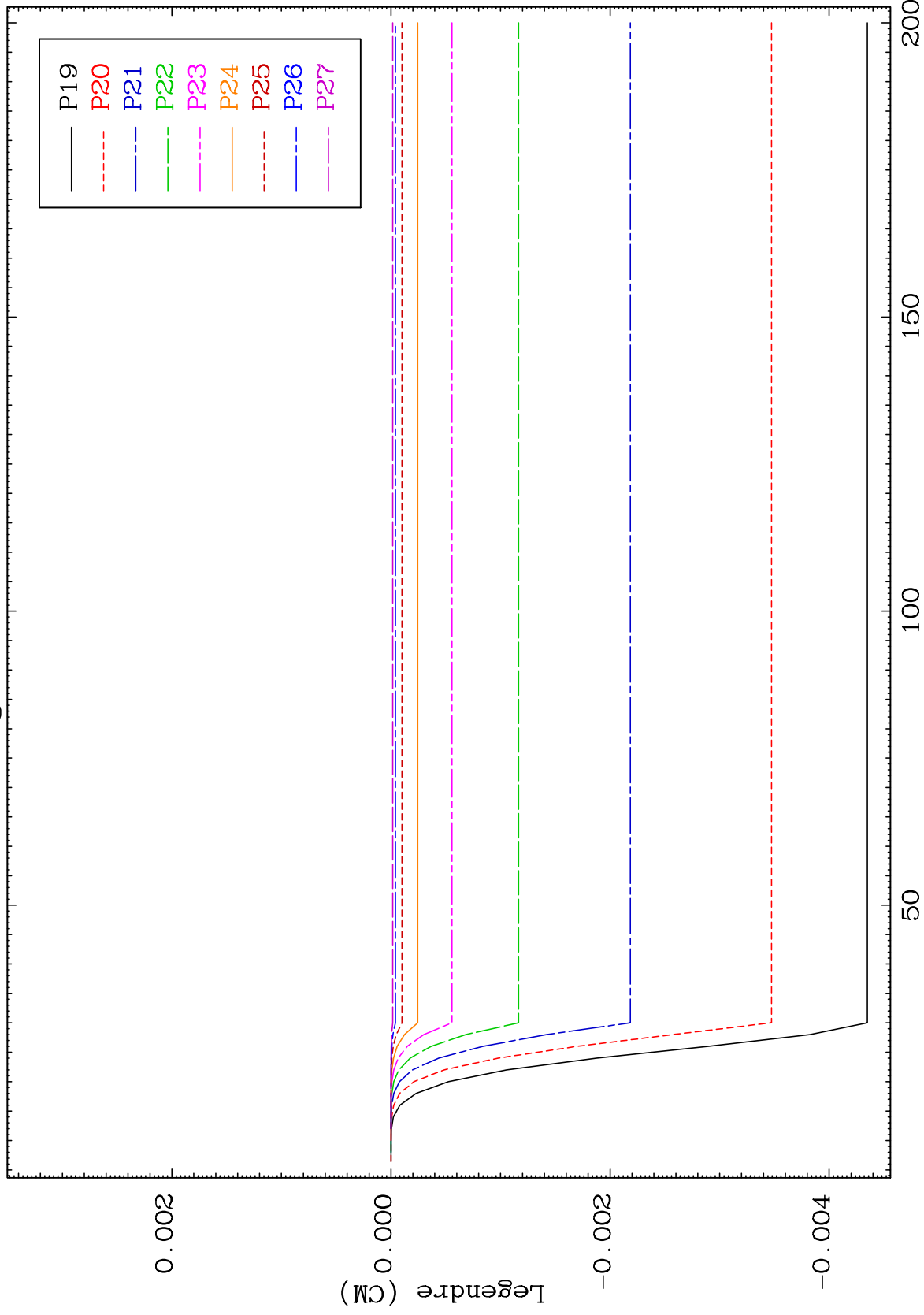

25

Incident Energy (MeV)

57-La-141

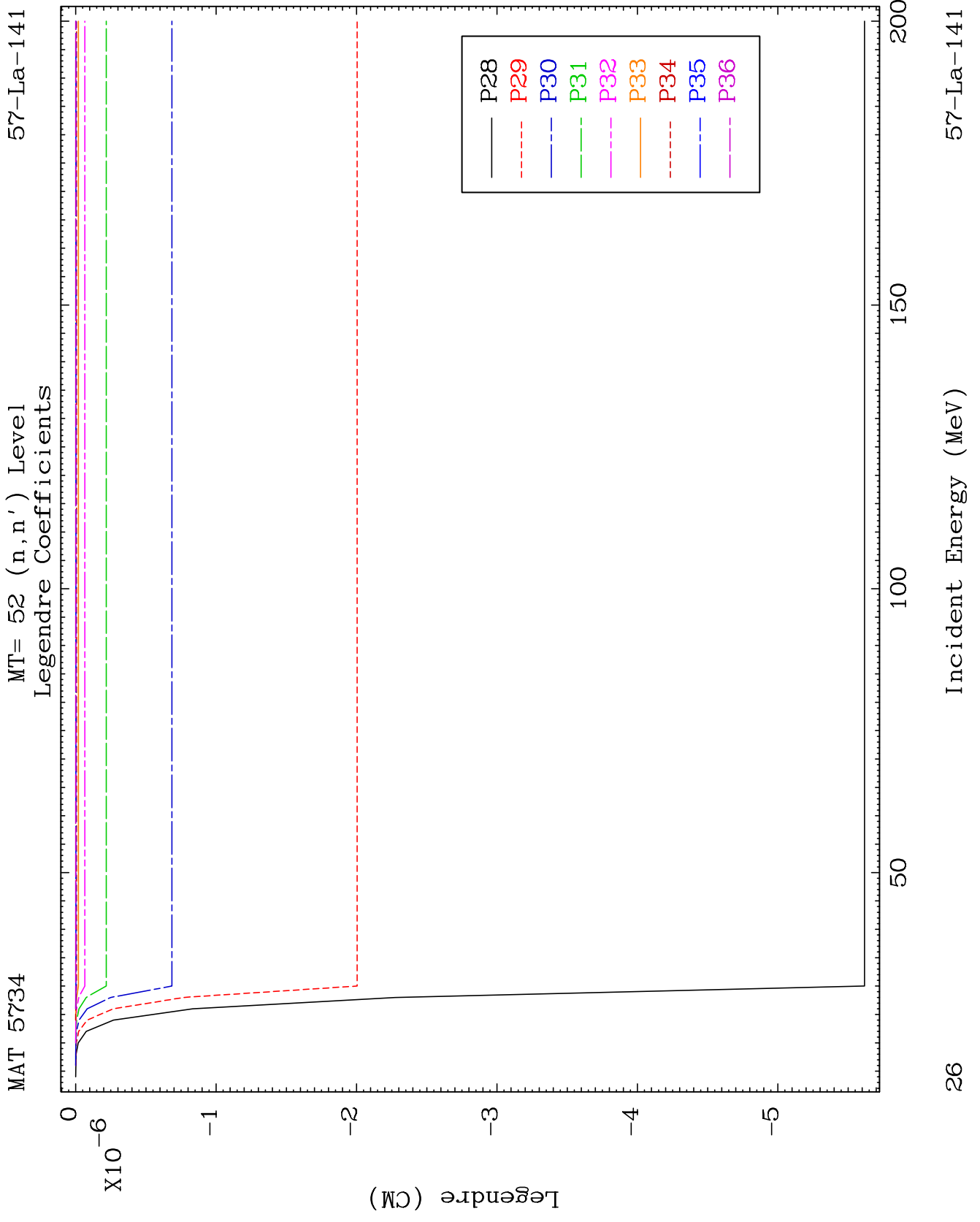

MAT 5734

MT= 53 (n,n') Level
Legendre Coefficients

57-La-141

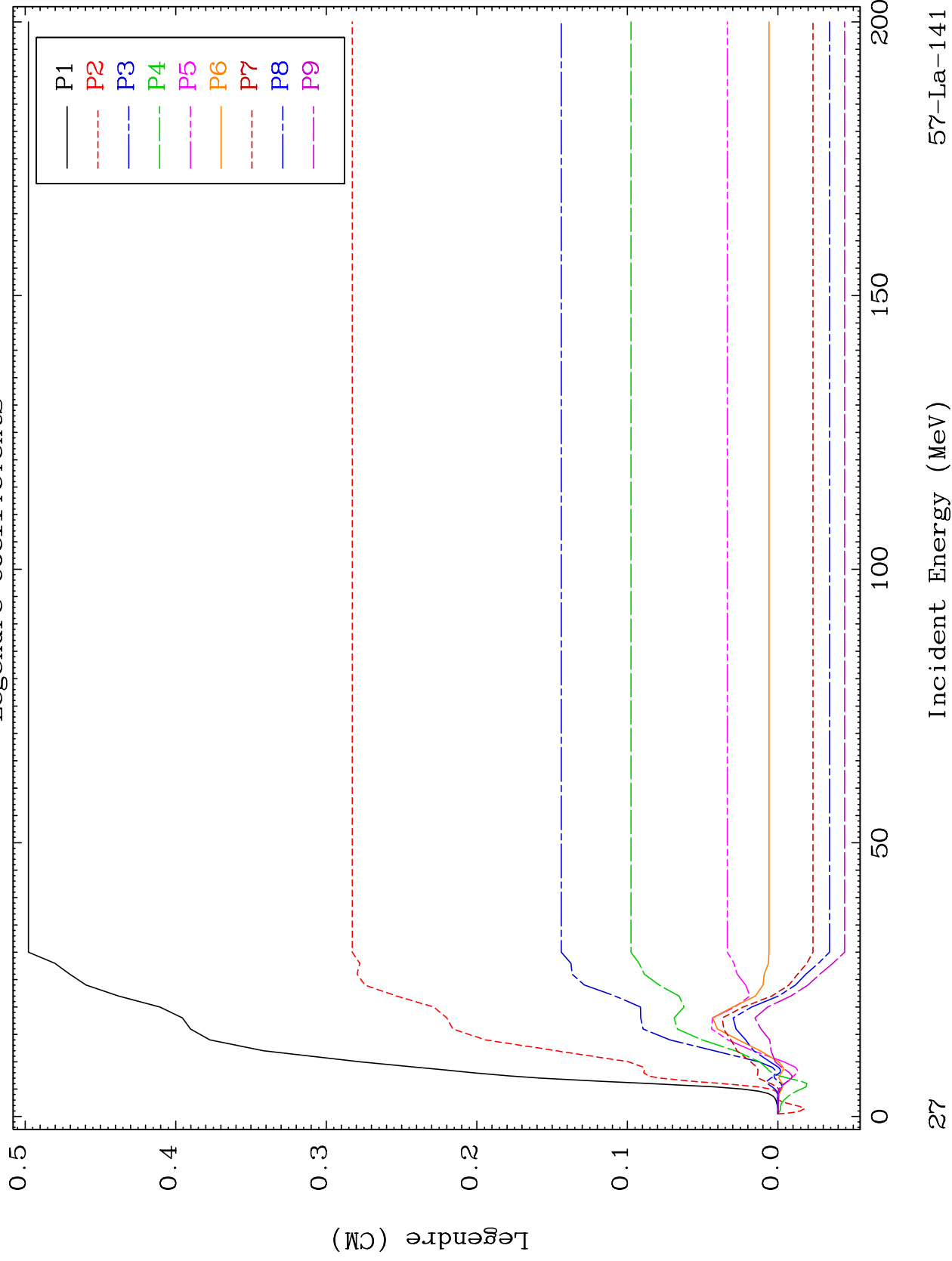

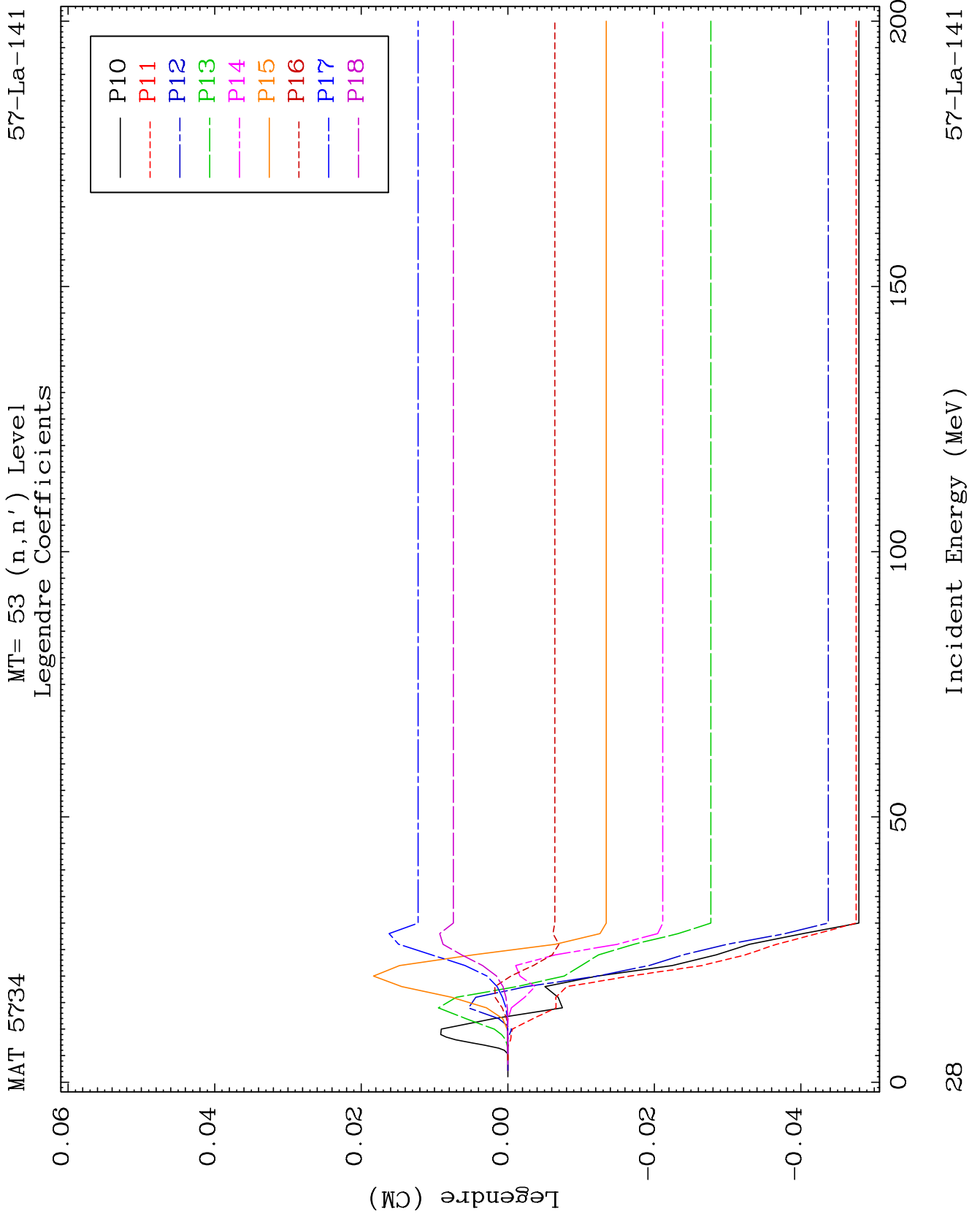

MAT 5734

MT= 53 (n,n') Level
Legendre Coefficients

57-La-141

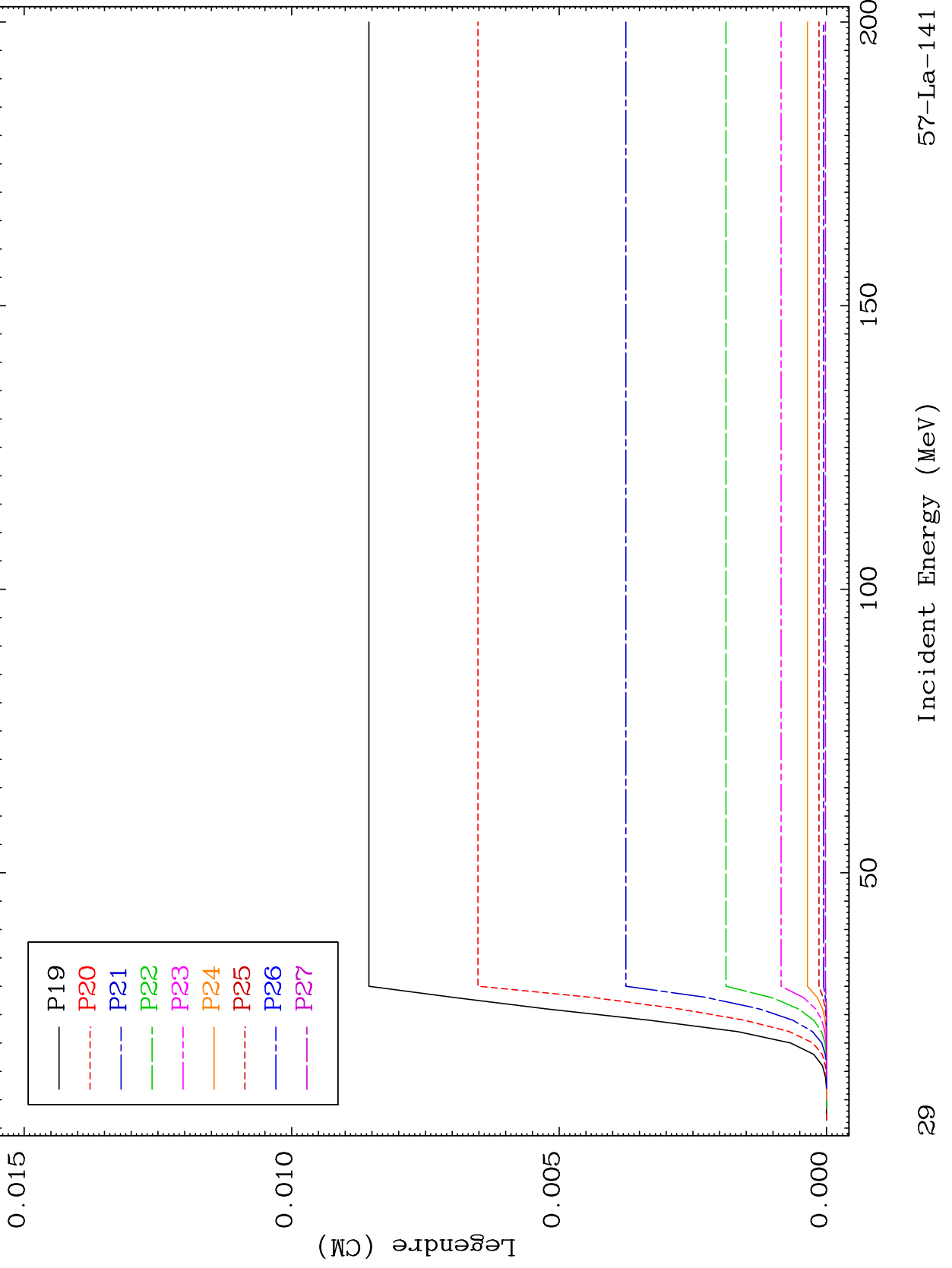

29

57-La-141

MAT 5734

MT= 53 (n,n') Level
Legendre Coefficients

57-La-141

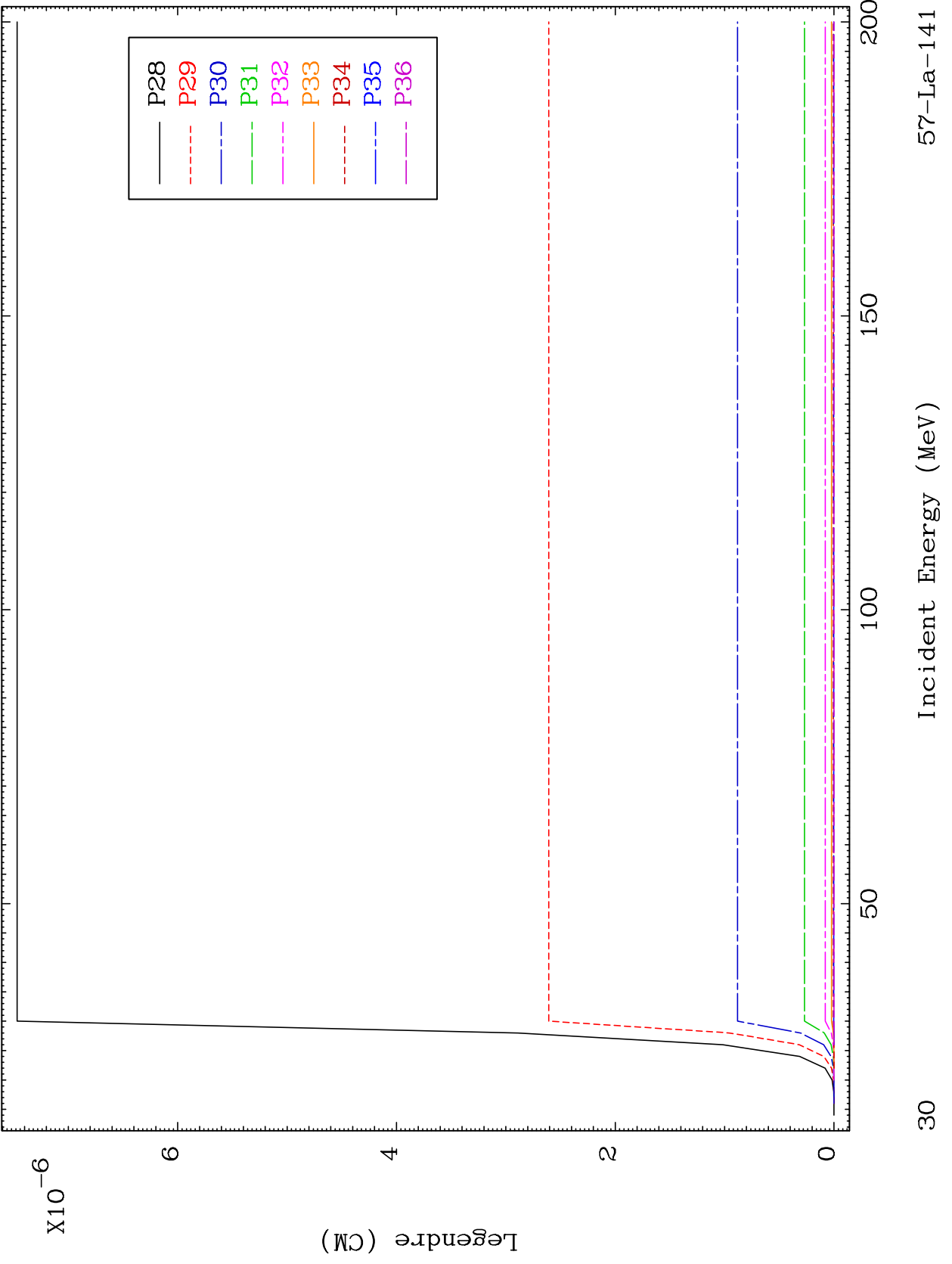

57-La-141

Incident Energy (MeV)

30

MAT 5734

MT= 54 (n,n') Level
Legendre Coefficients

57-La-141

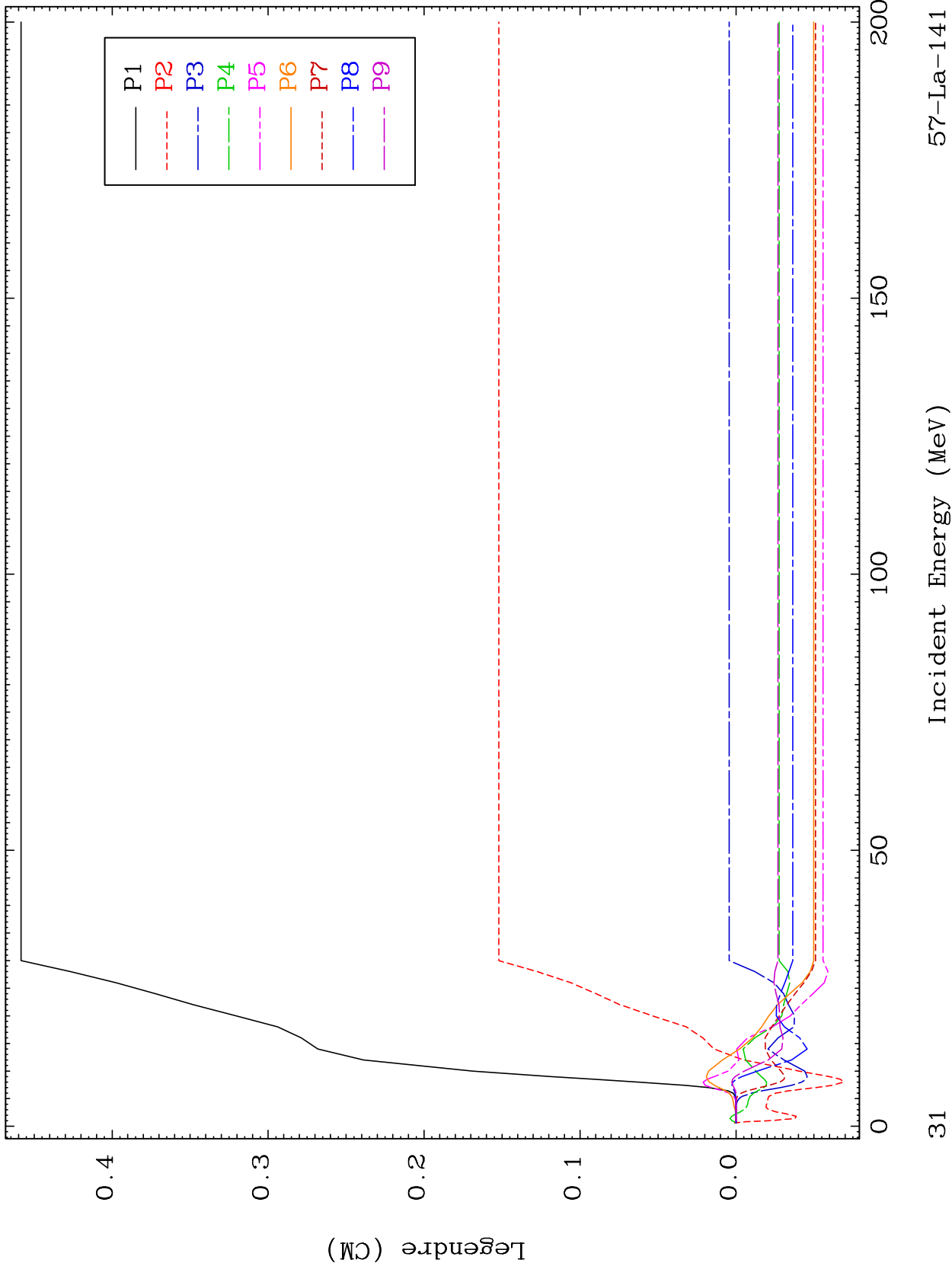

31

57-La-141

MAT 5734

MT= 54 (n,n') Level
Legendre Coefficients

57-La-141

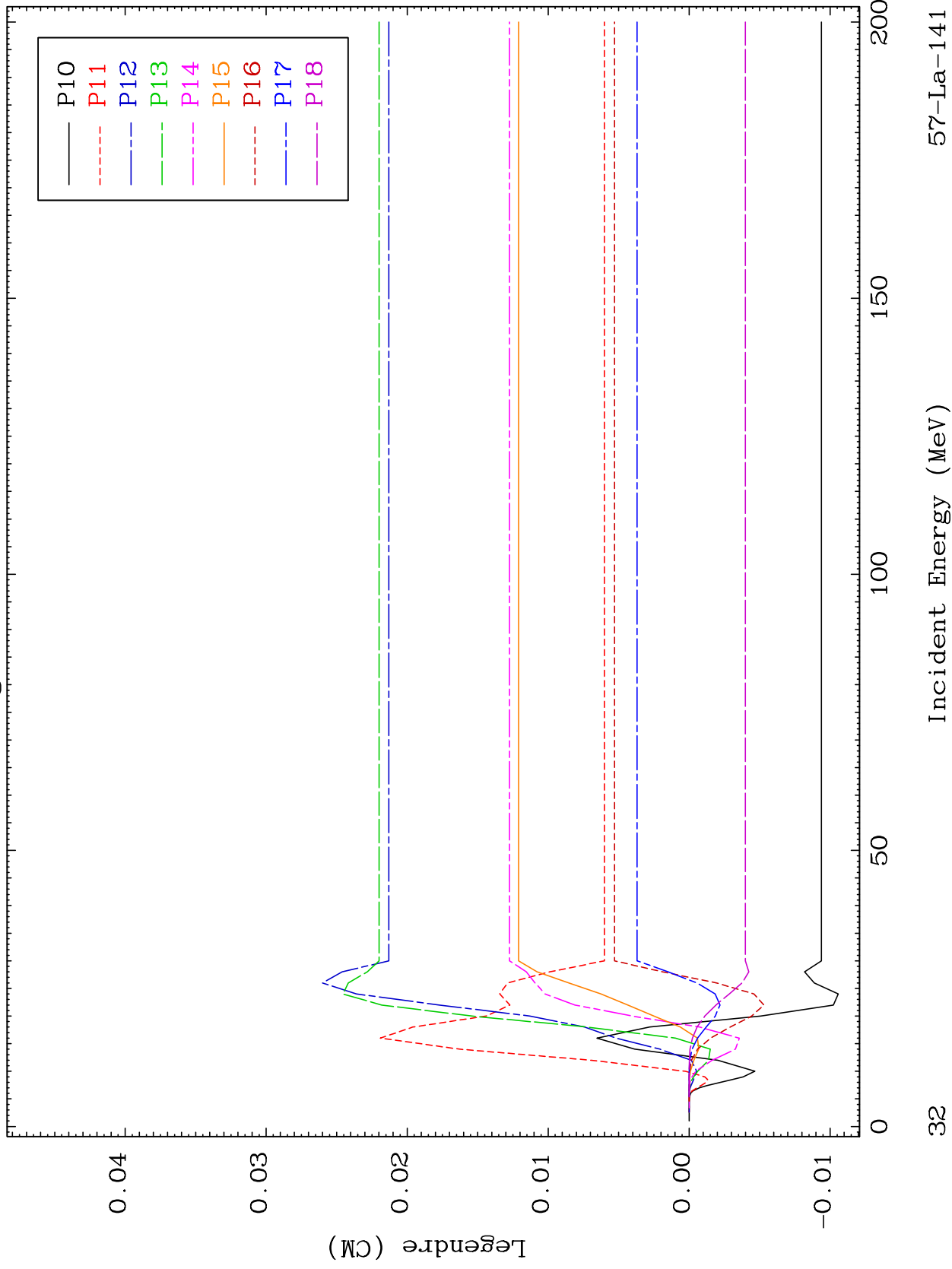

57-La-141

Incident Energy (MeV)

32

MAT 5734

MT= 54 (n,n') Level
Legendre Coefficients

57-La-141

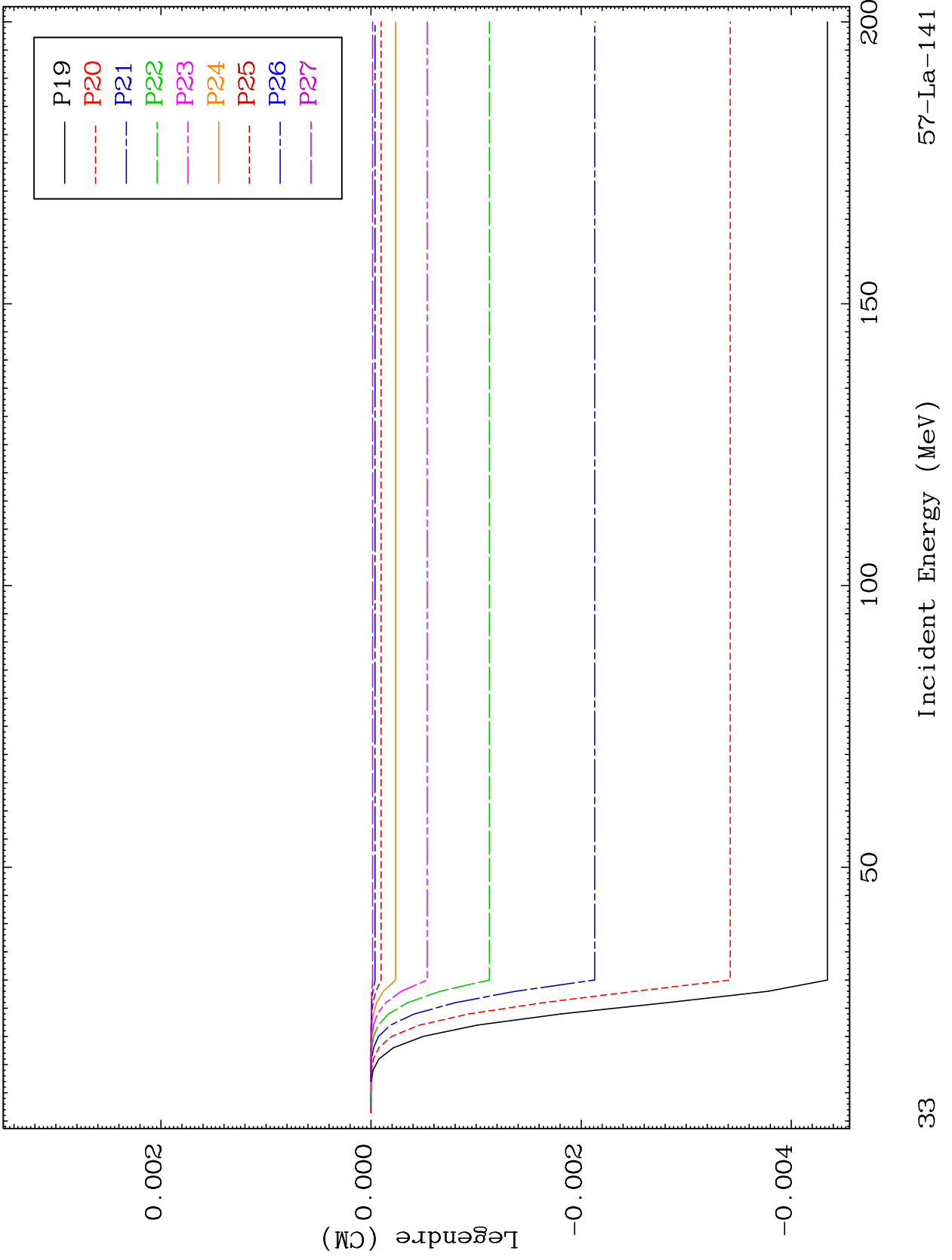

33

Incident Energy (MeV)

57-La-141

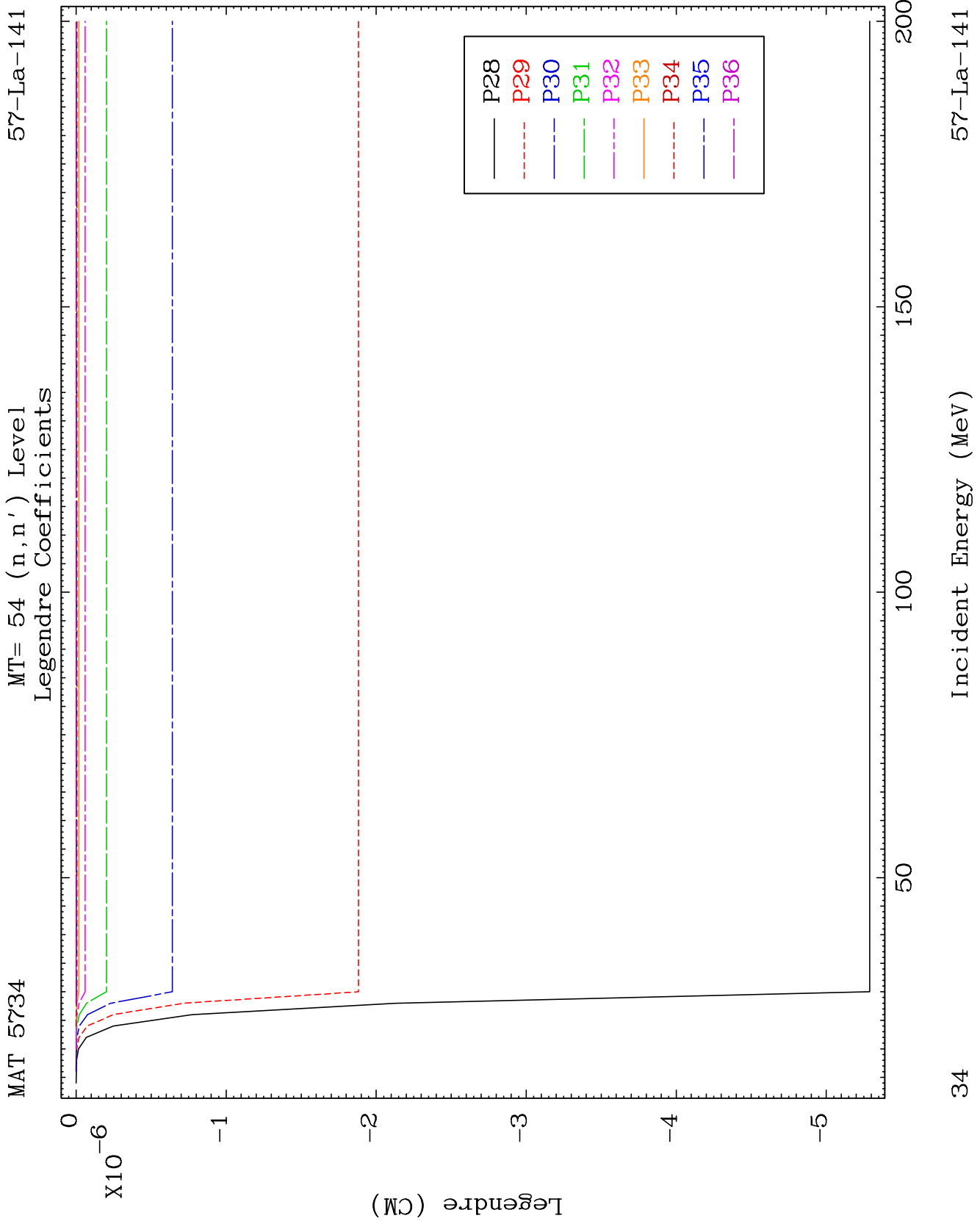

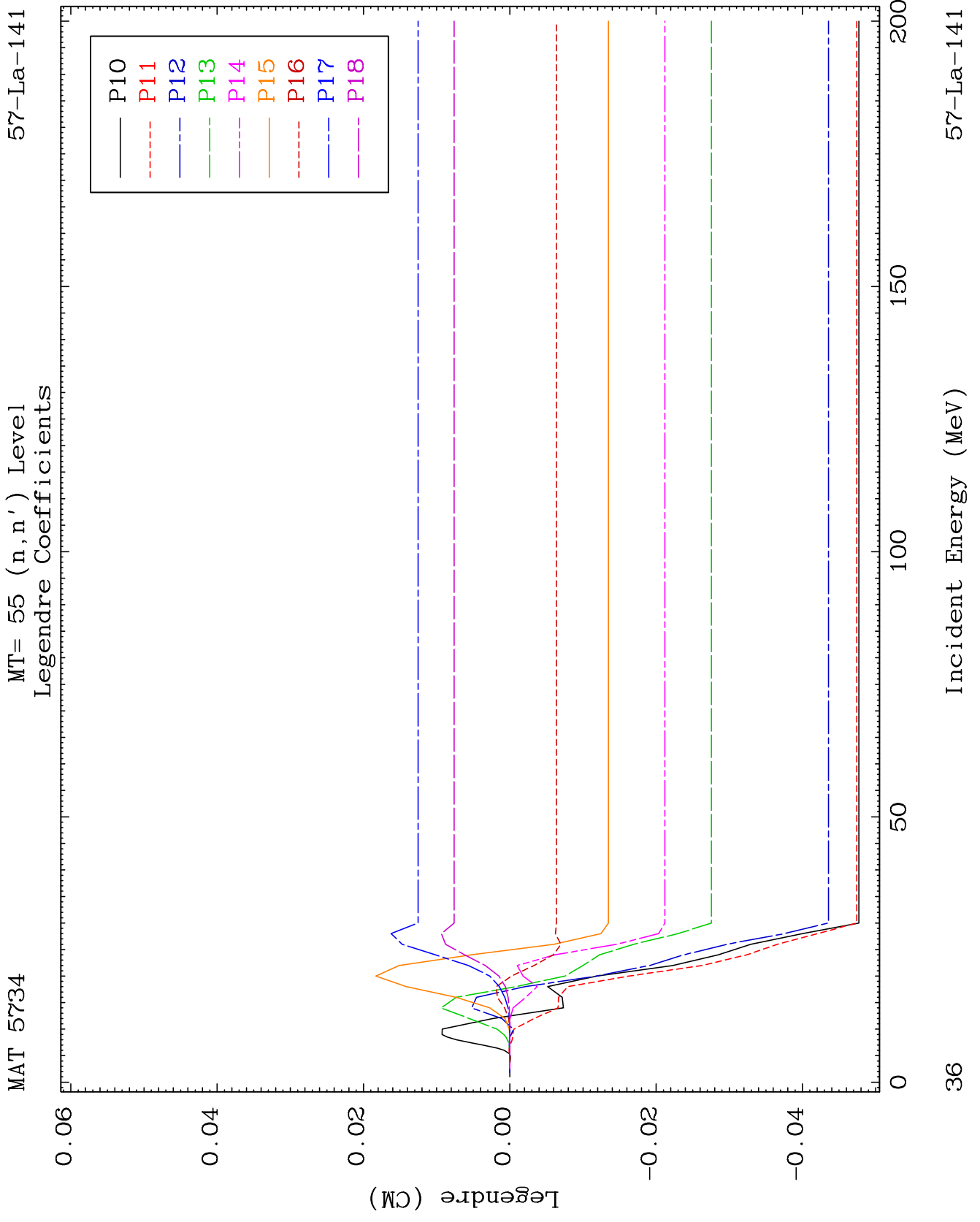

MAT 5734

MT= 55 (n,n') Level
Legendre Coefficients

57-La-141

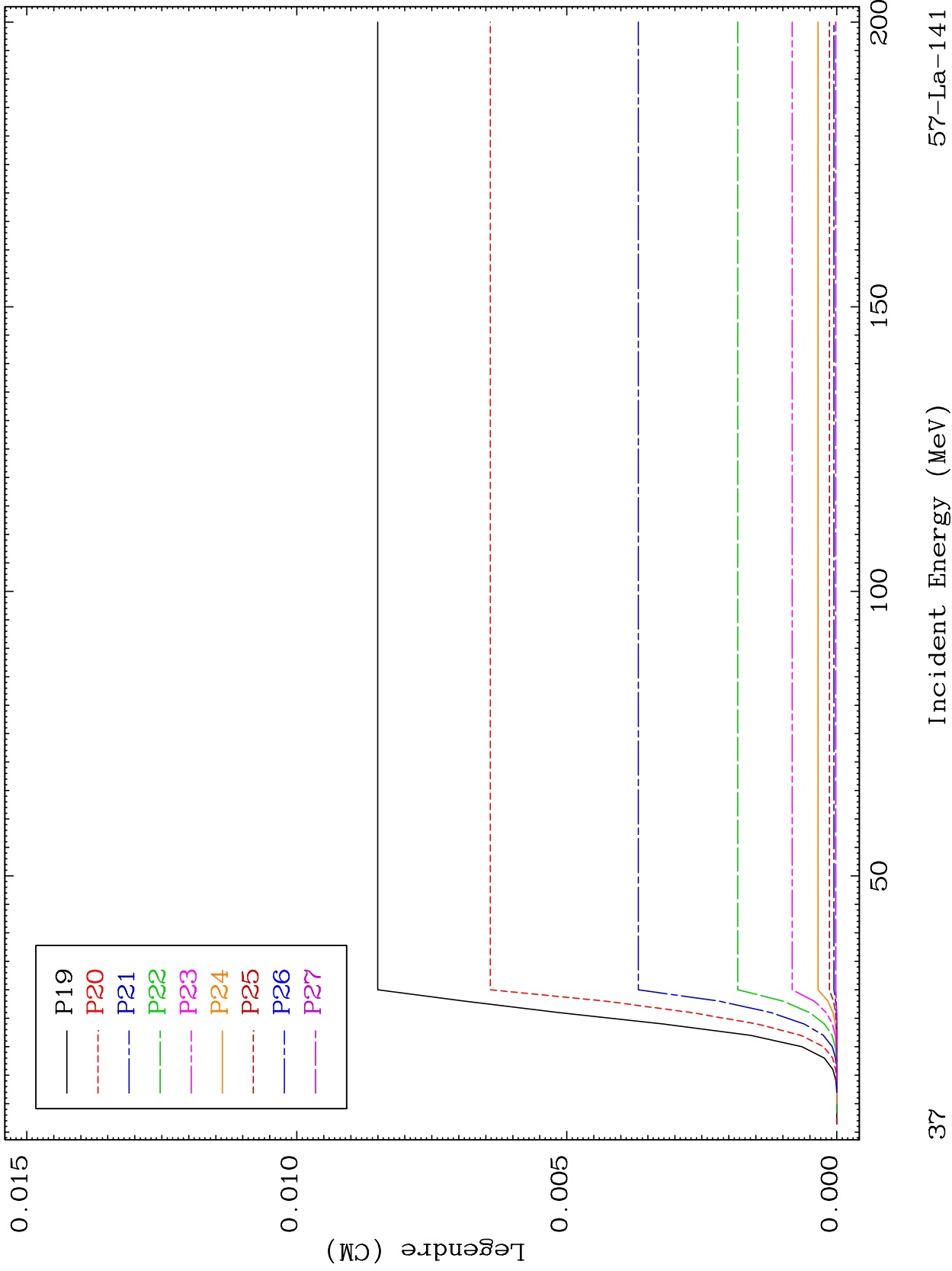

37

Incident Energy (MeV)

57-La-141

MAT 5734

MT= 55 (n,n') Level
Legendre Coefficients

57-La-141

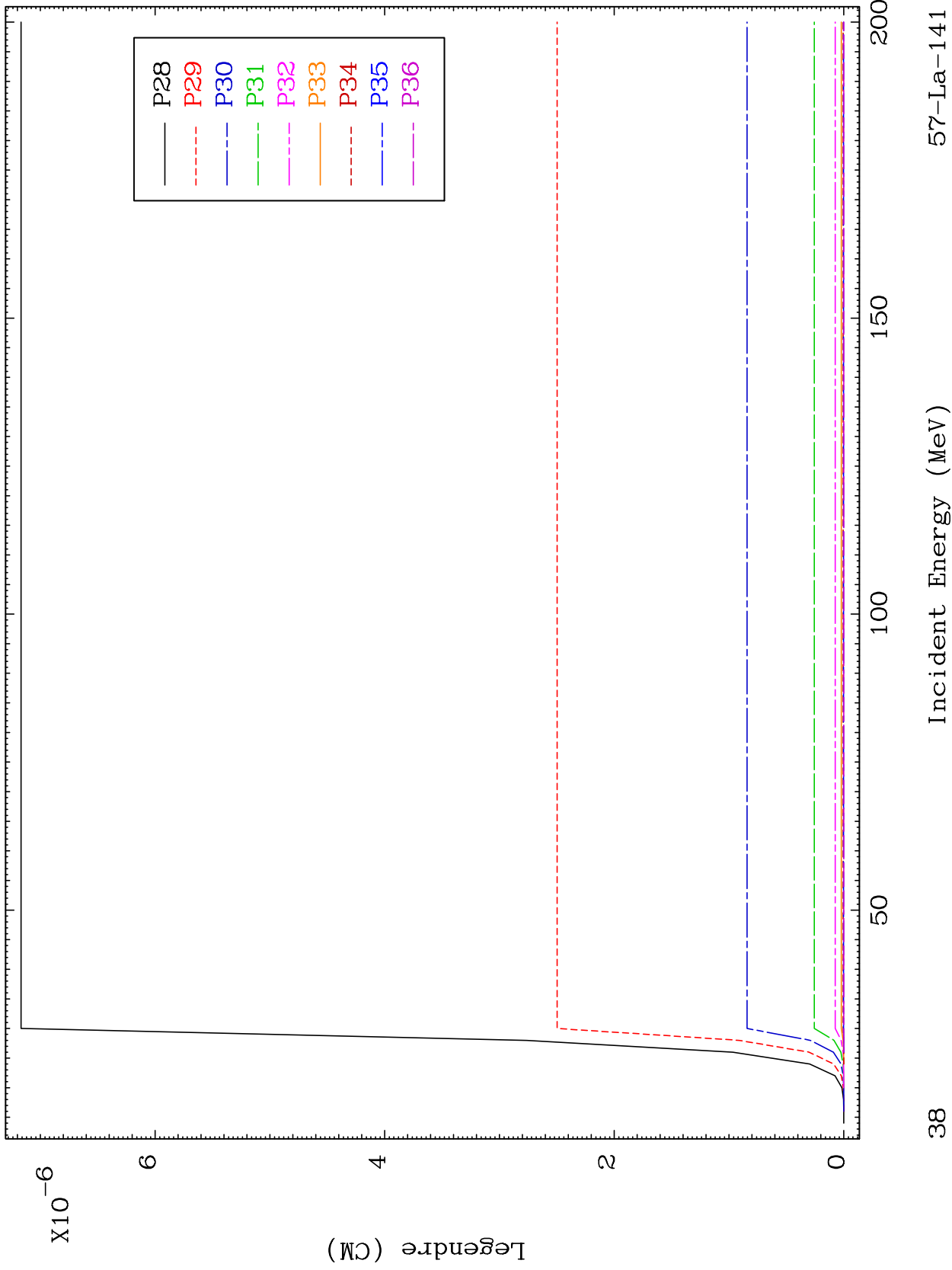

38

57-La-141

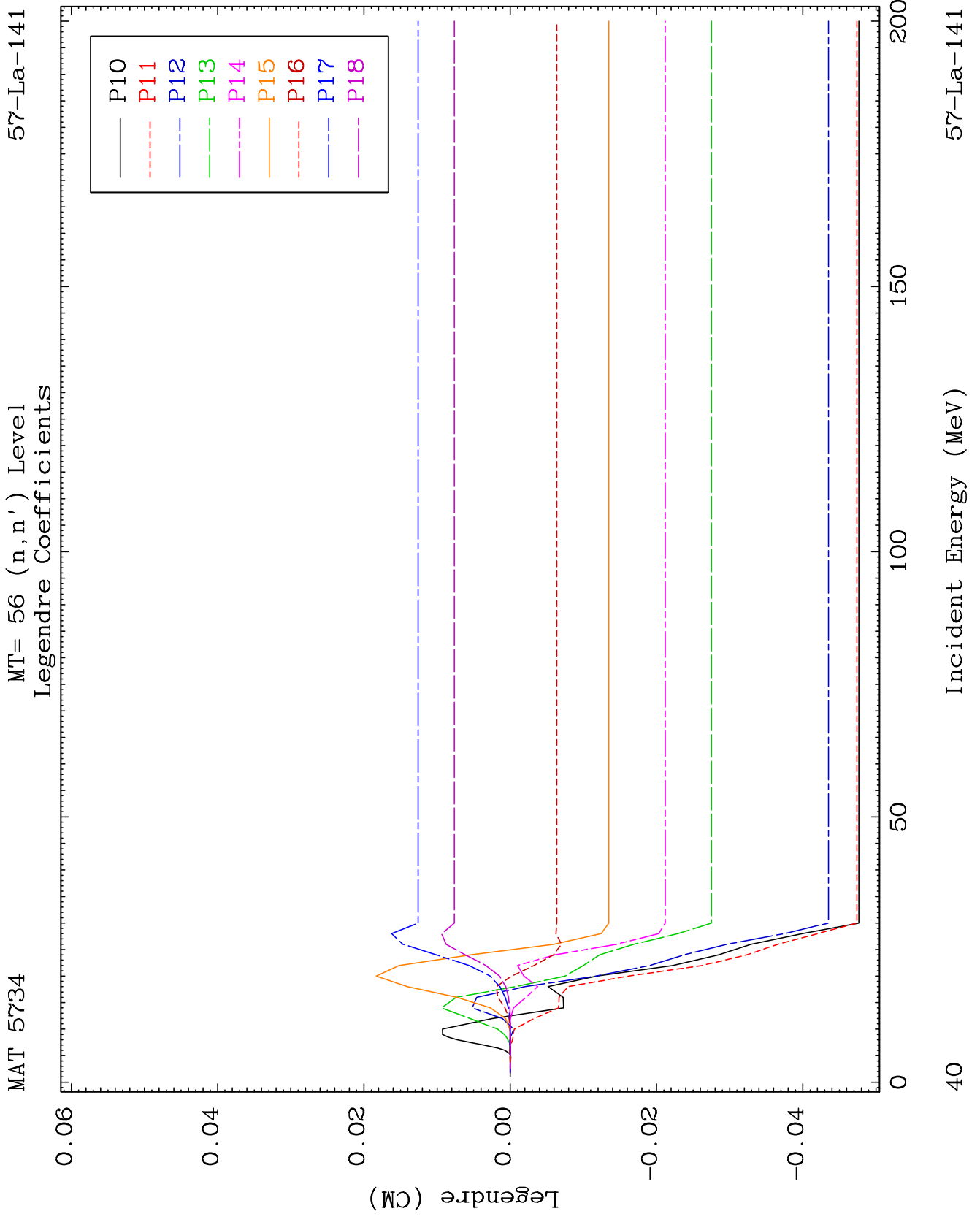

MAT 5734

MT= 56 (n,n') Level
Legendre Coefficients

57-La-141

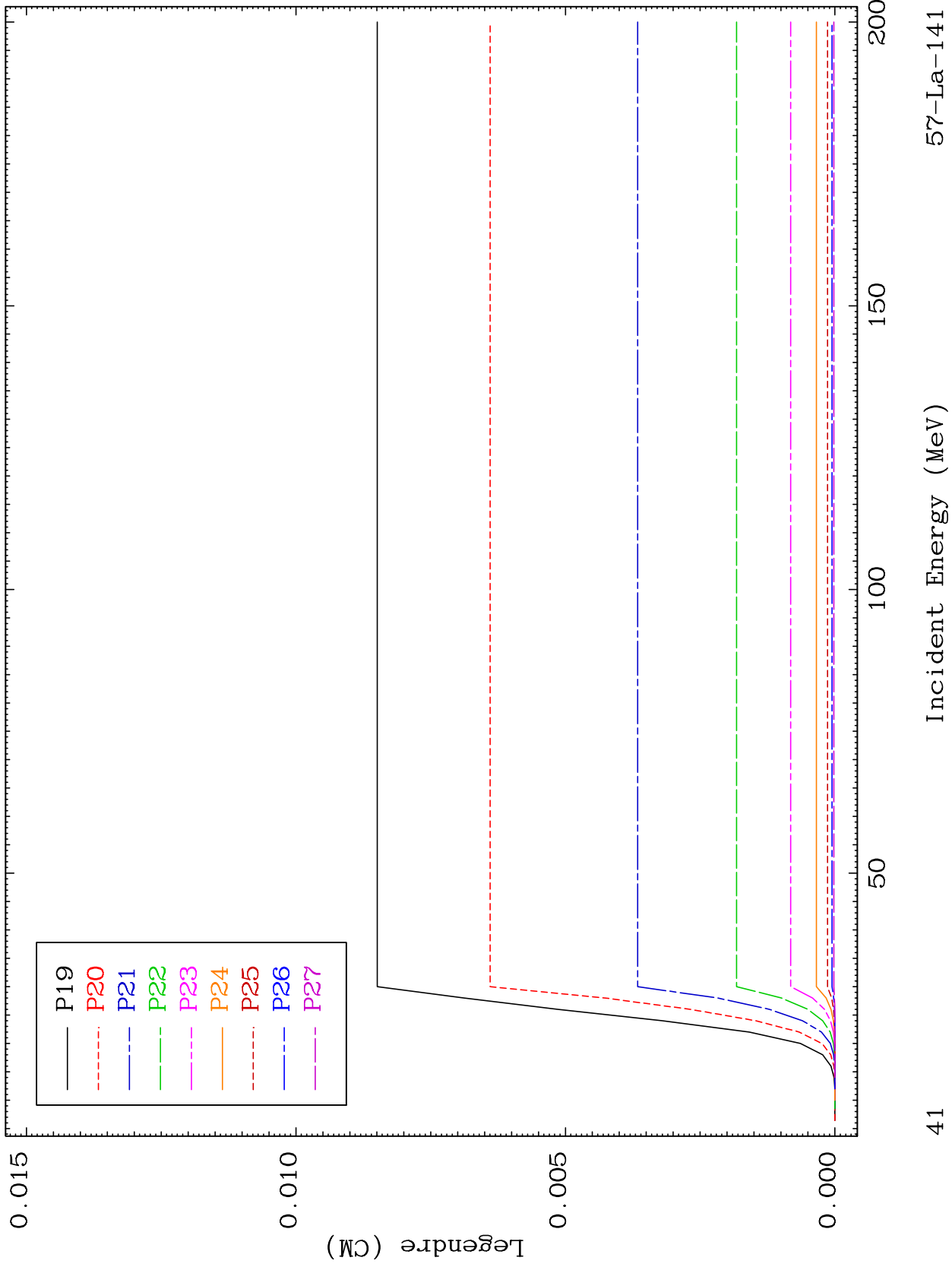

41

57-La-141

MAT 5734

MT= 56 (n,n') Level
Legendre Coefficients

57-La-141

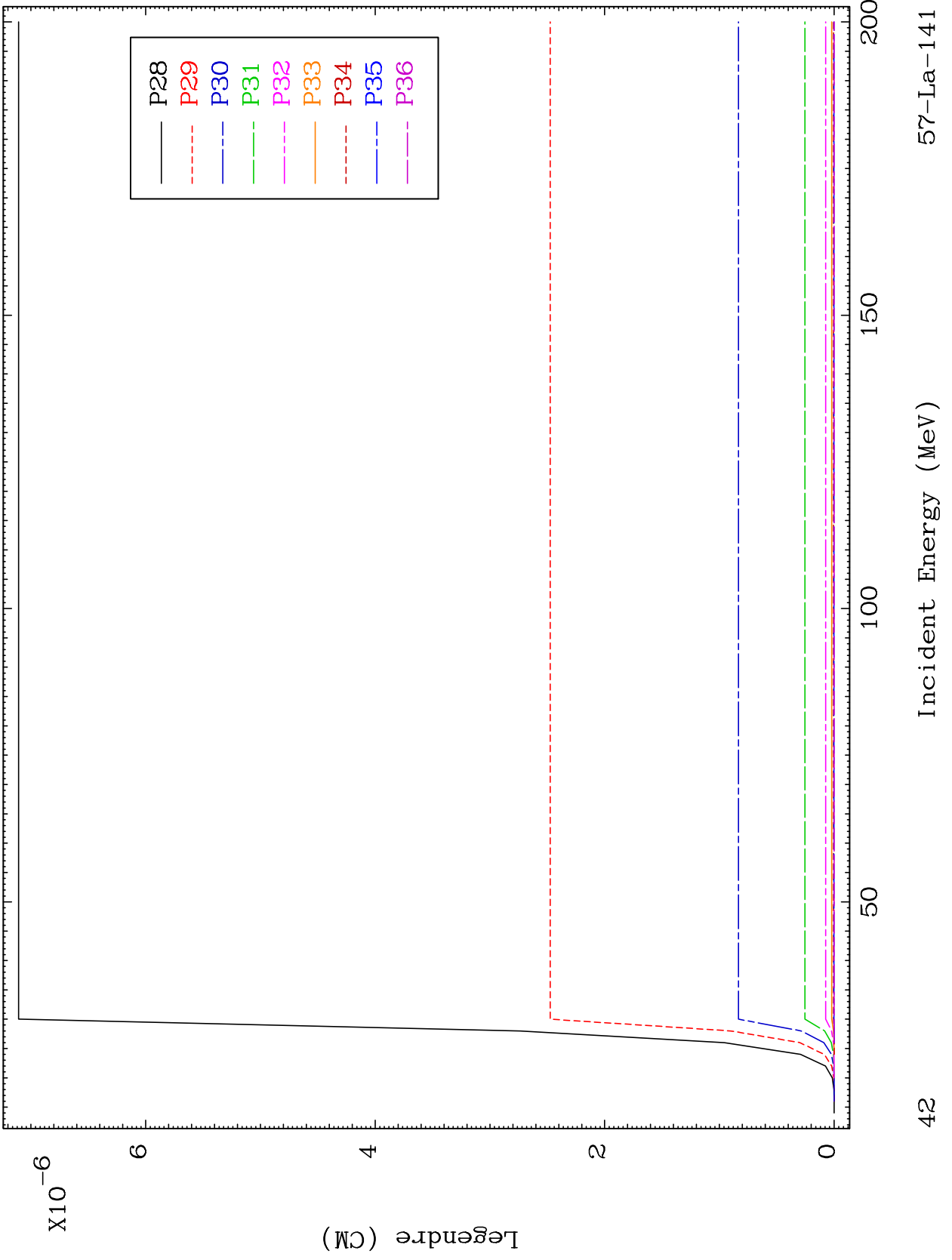

42

Incident Energy (MeV)

57-La-141

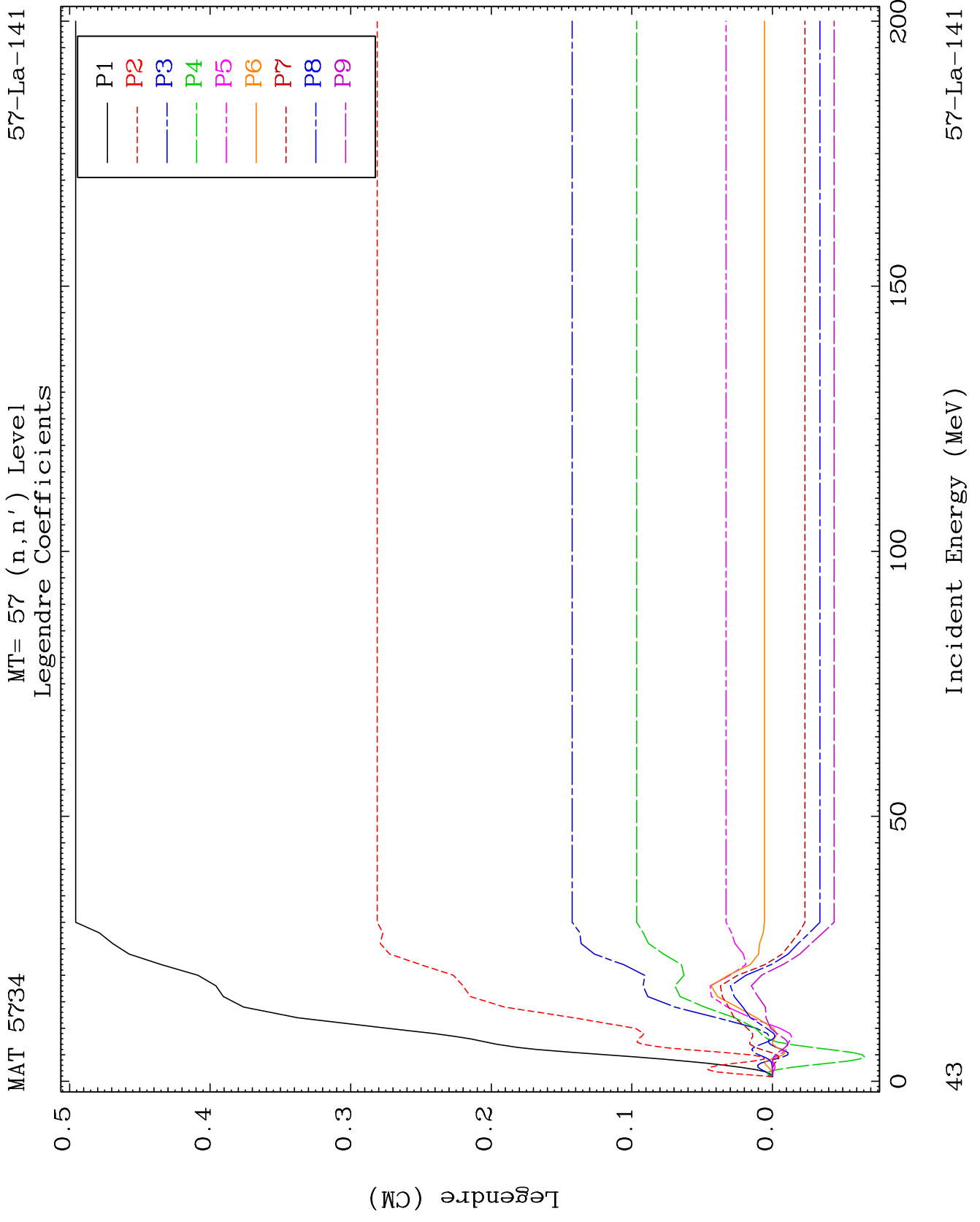

MAT 5734

MT= 57 (n,n') Level
Legendre Coefficients

57-La-141

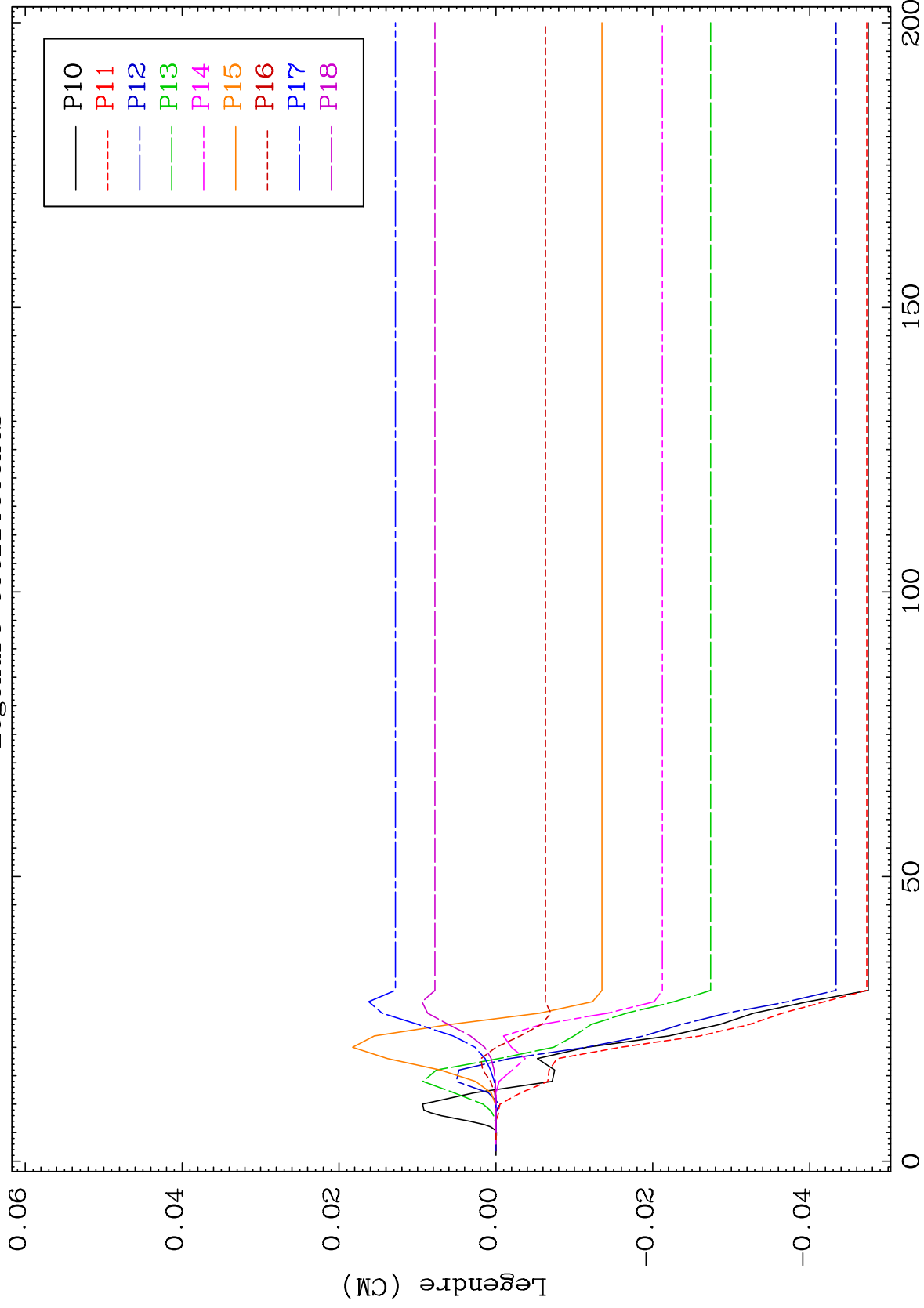

44

Incident Energy (MeV)

57-La-141

MAT 5734

MT= 57 (n,n') Level
Legendre Coefficients

57-La-141

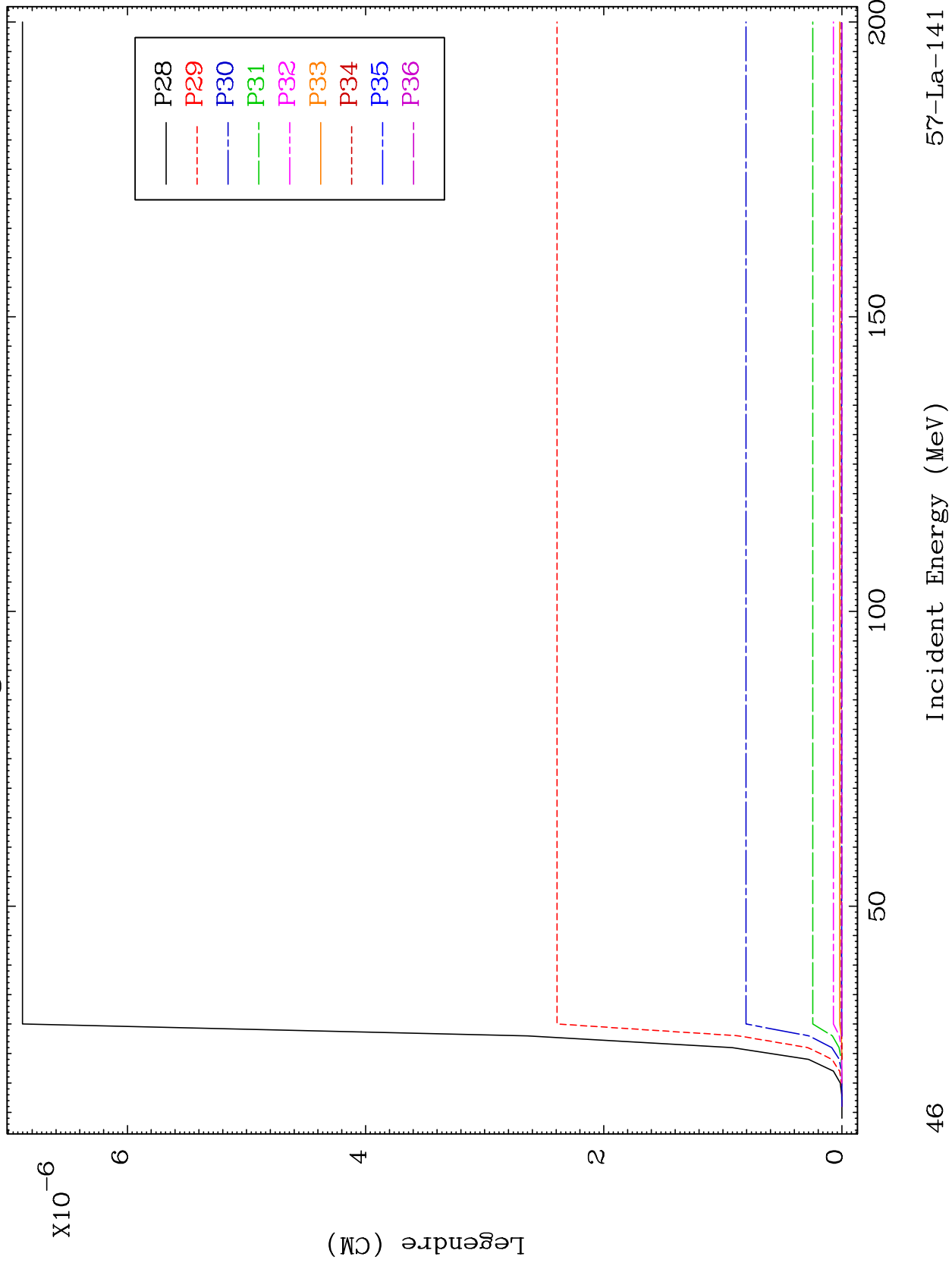

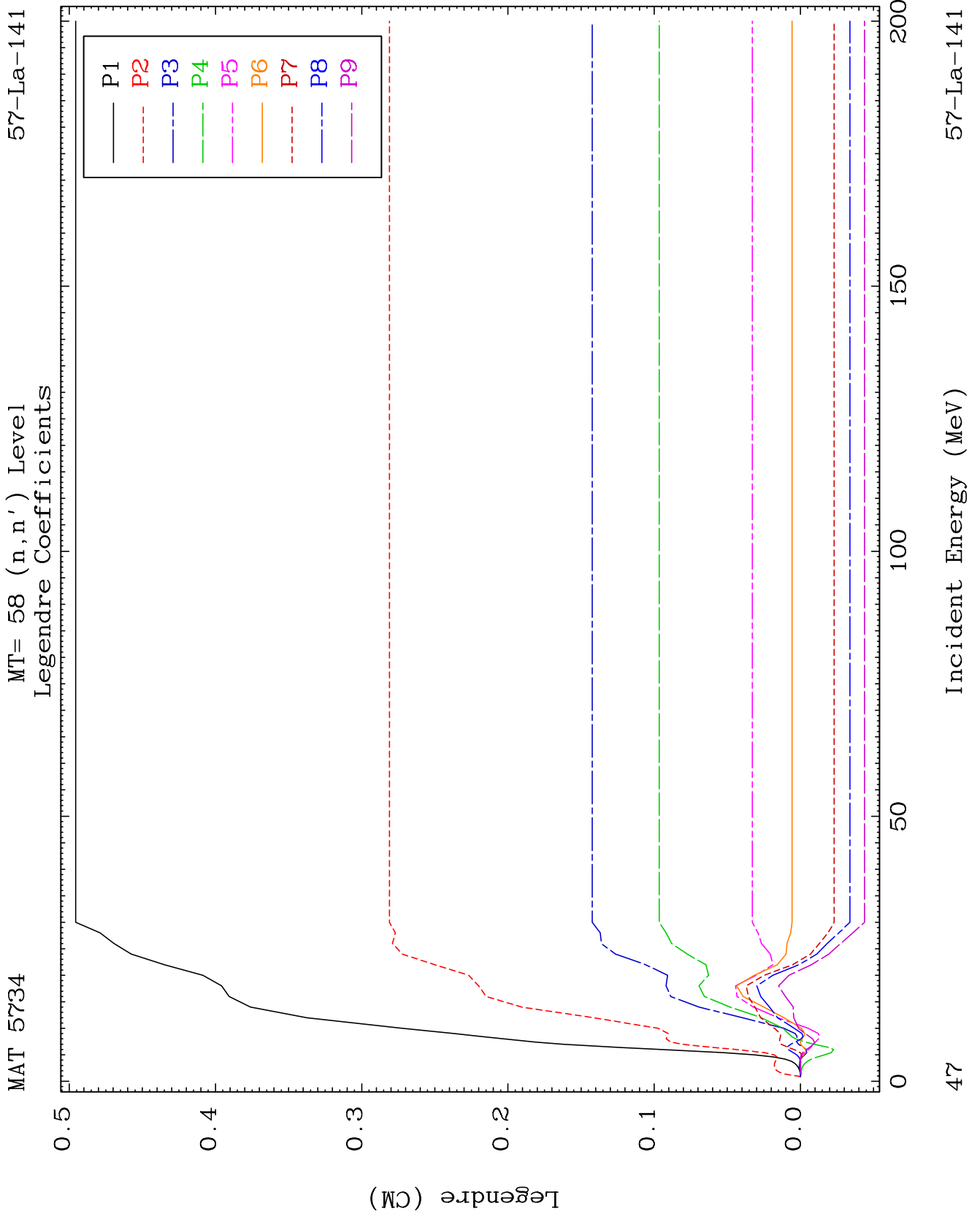

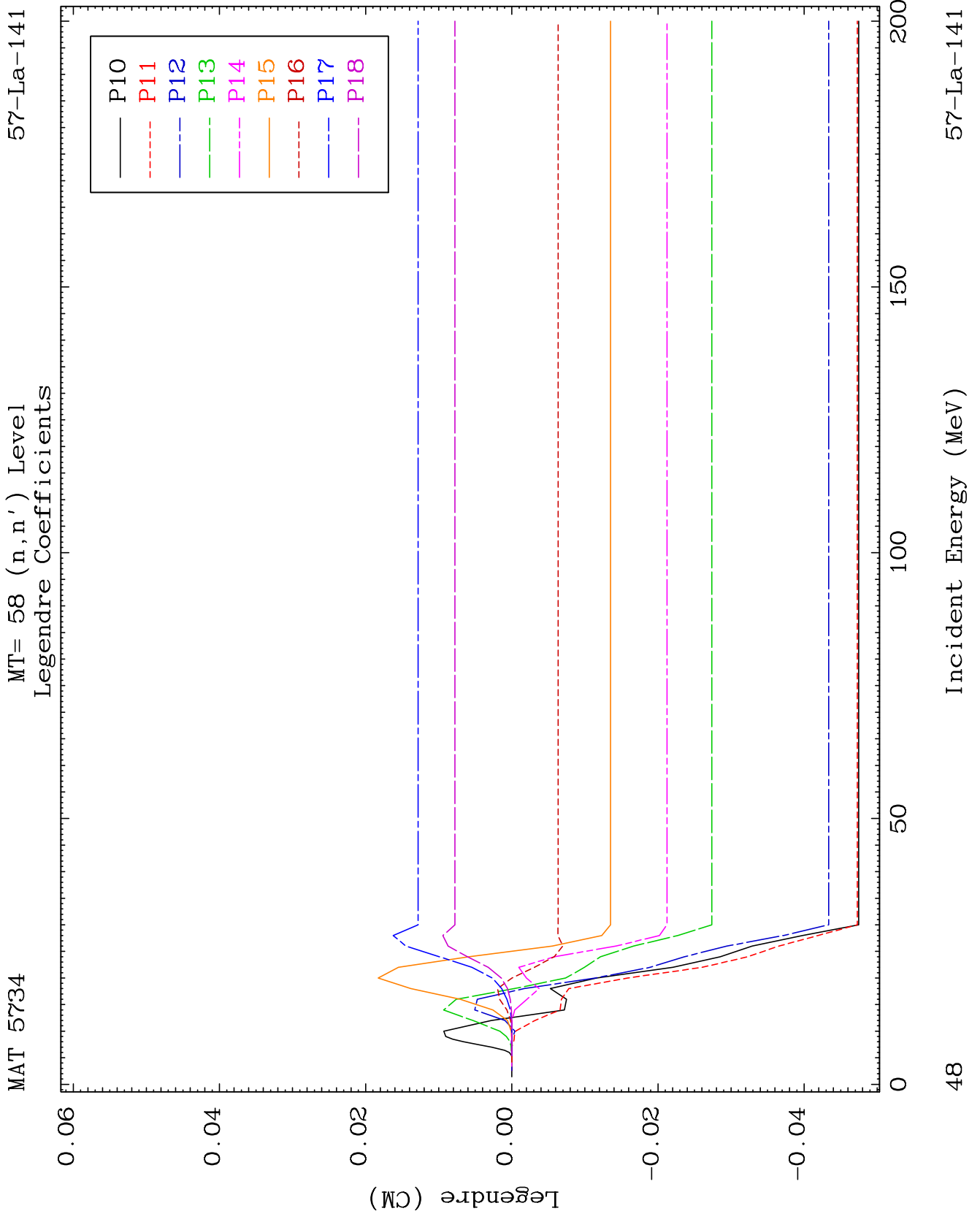

MAT 5734

MT= 58 (n,n') Level
Legendre Coefficients

57-La-141

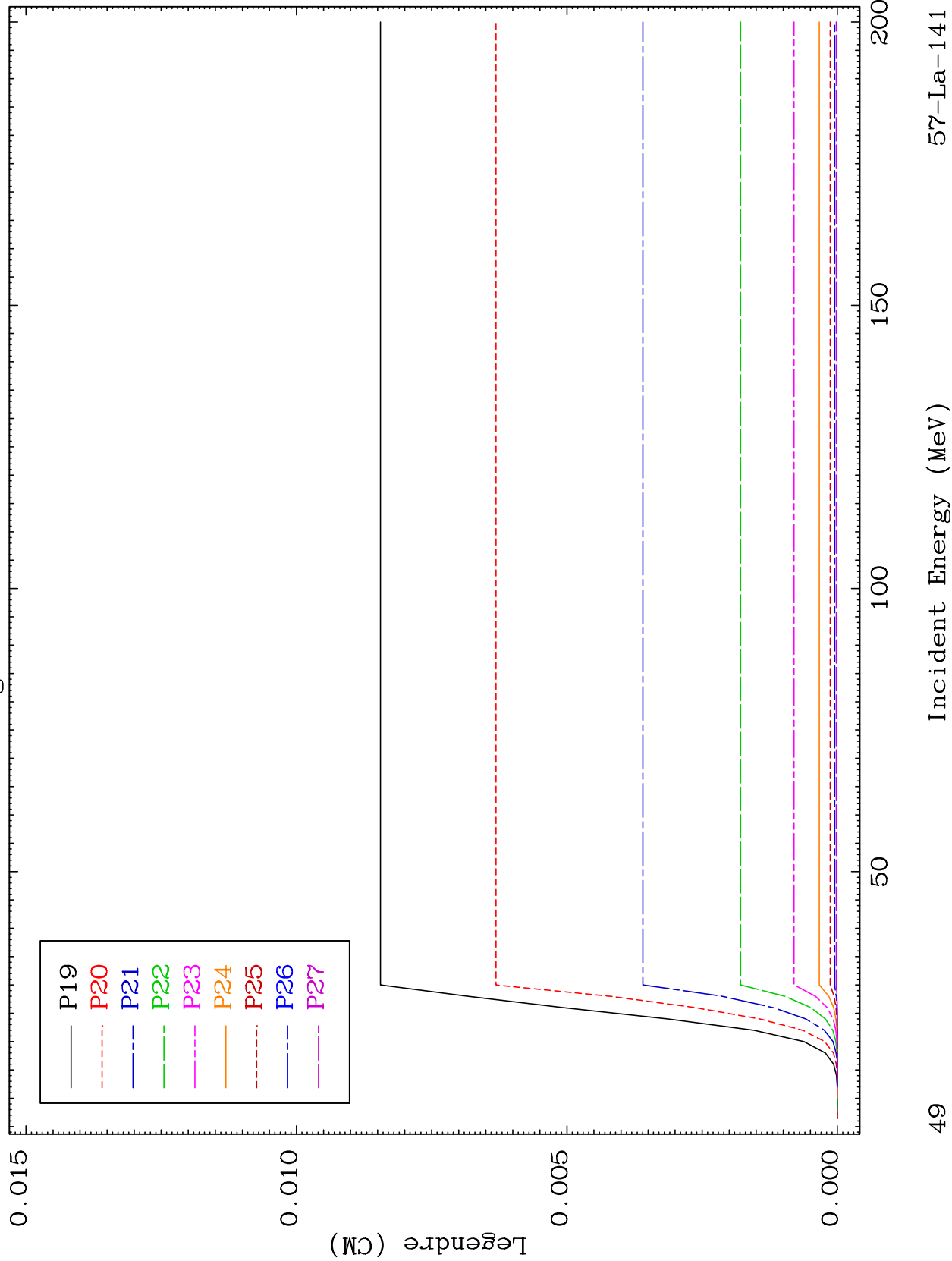

49

Incident Energy (MeV)

57-La-141

MAT 5734

MT= 58 (n,n') Level
Legendre Coefficients

57-La-141

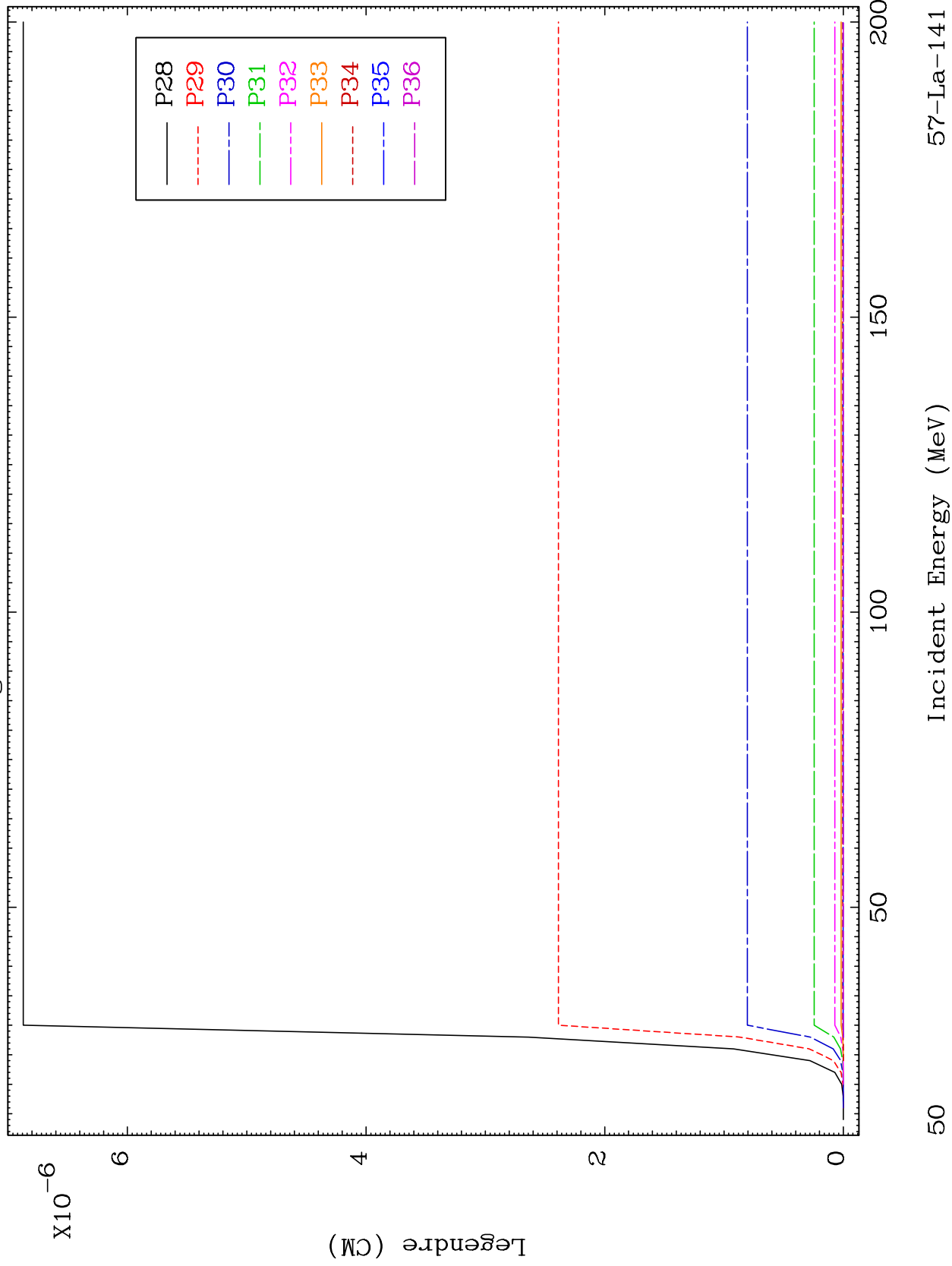

MAT 5734

MT= 59 (n,n') Level
Legendre Coefficients

57-La-141

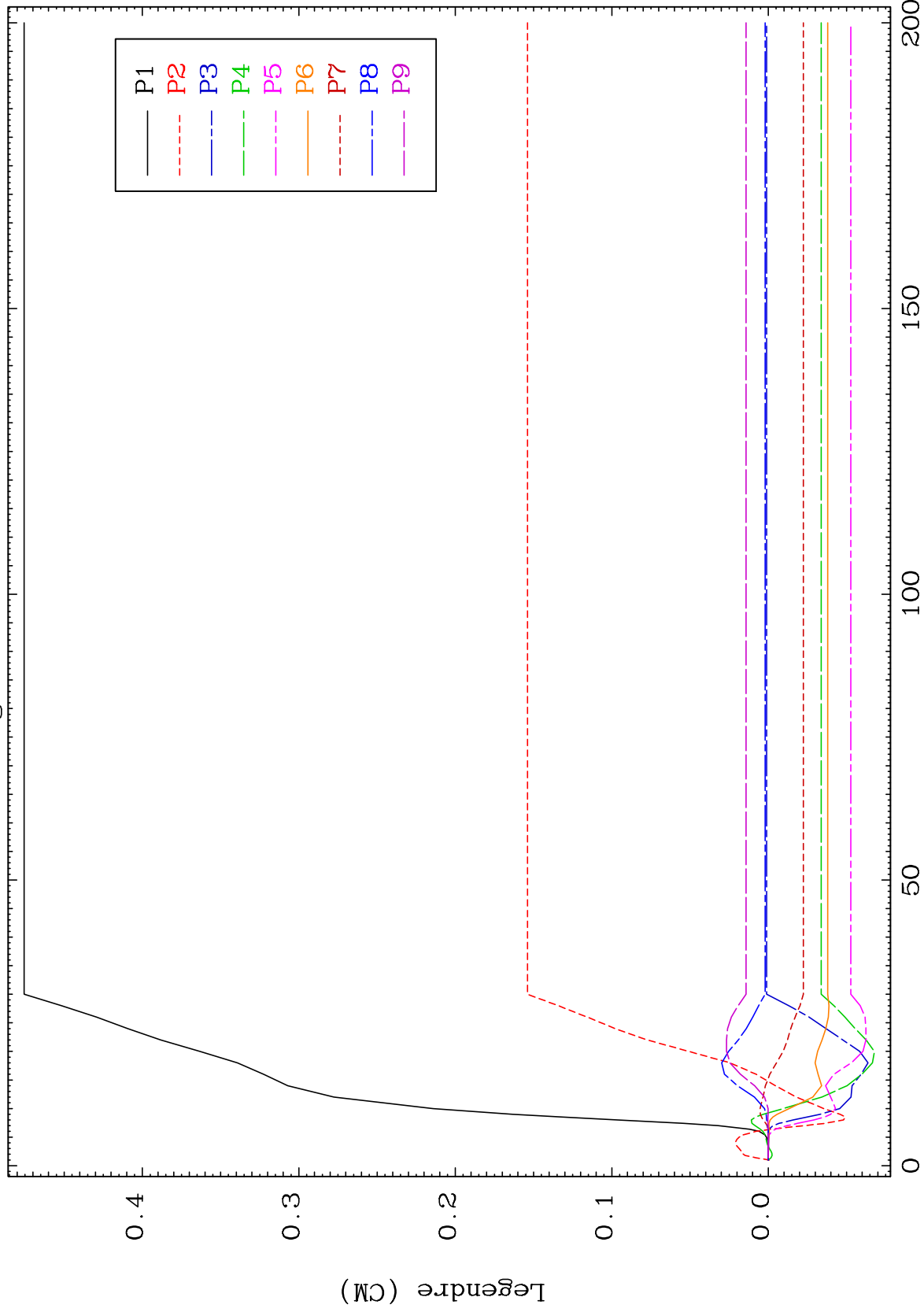

51

Incident Energy (MeV)

57-La-141

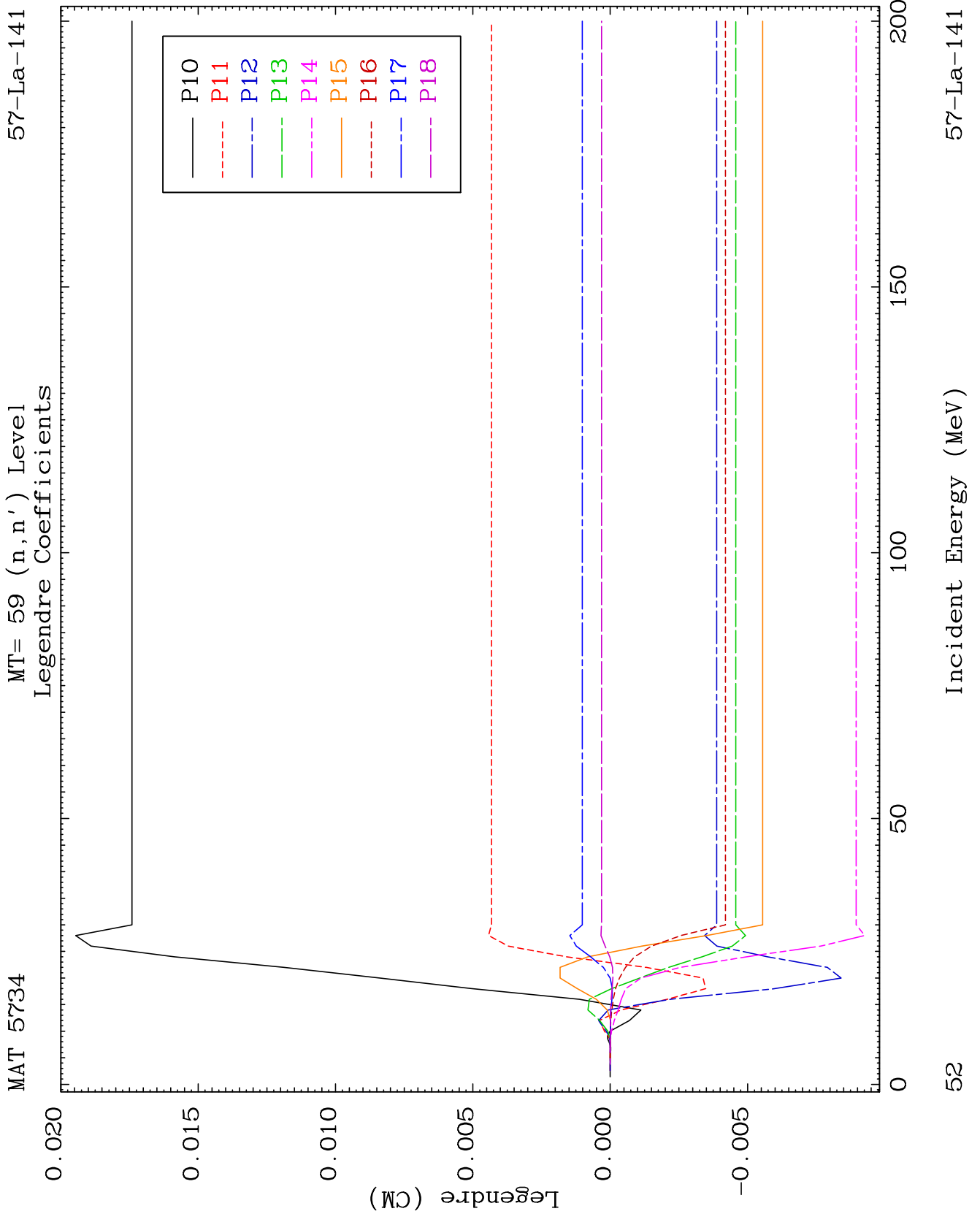

MAT 5734

MT= 59 (n,n') Level
Legendre Coefficients

57-La-141

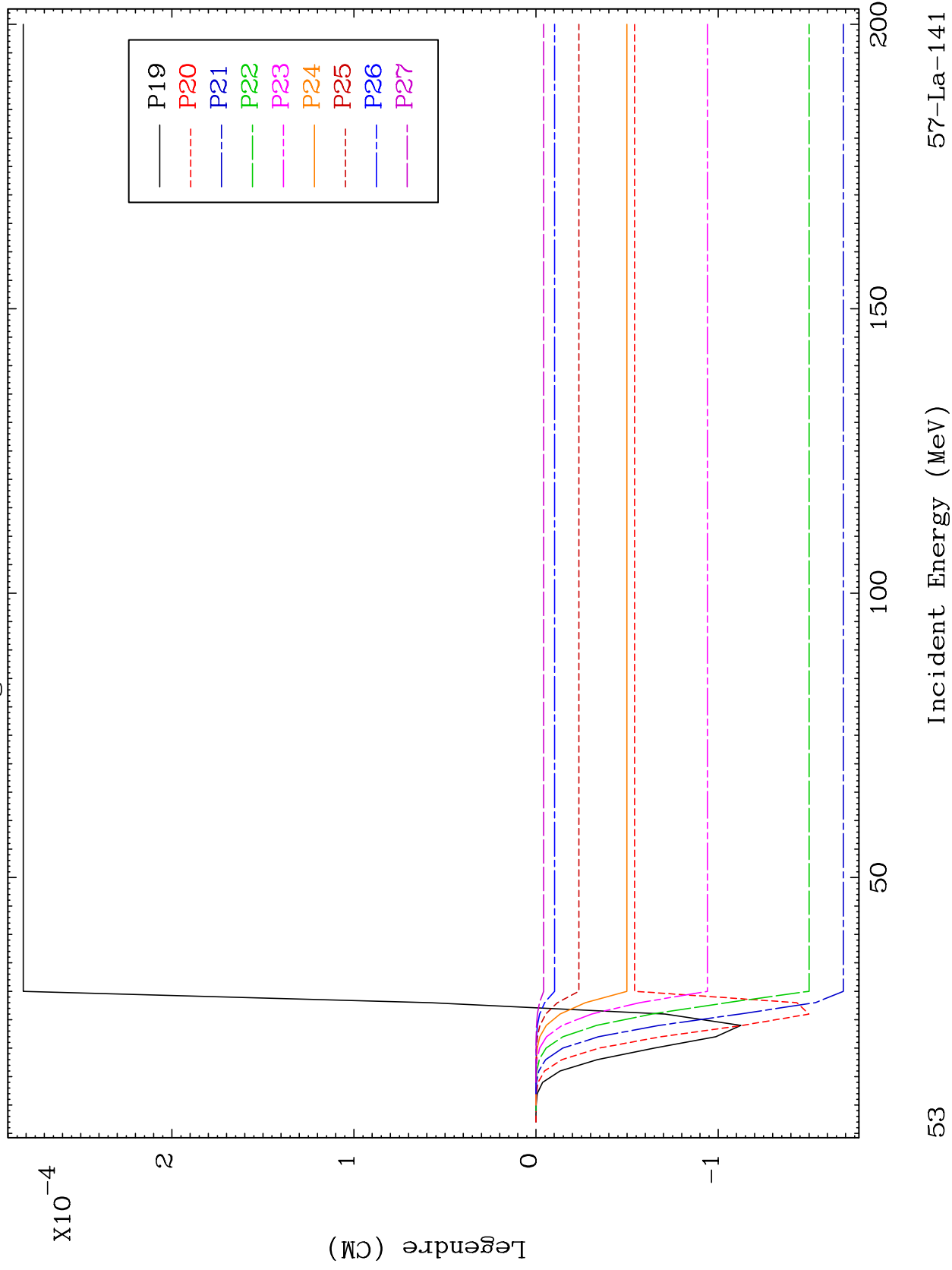

53

57-La-141

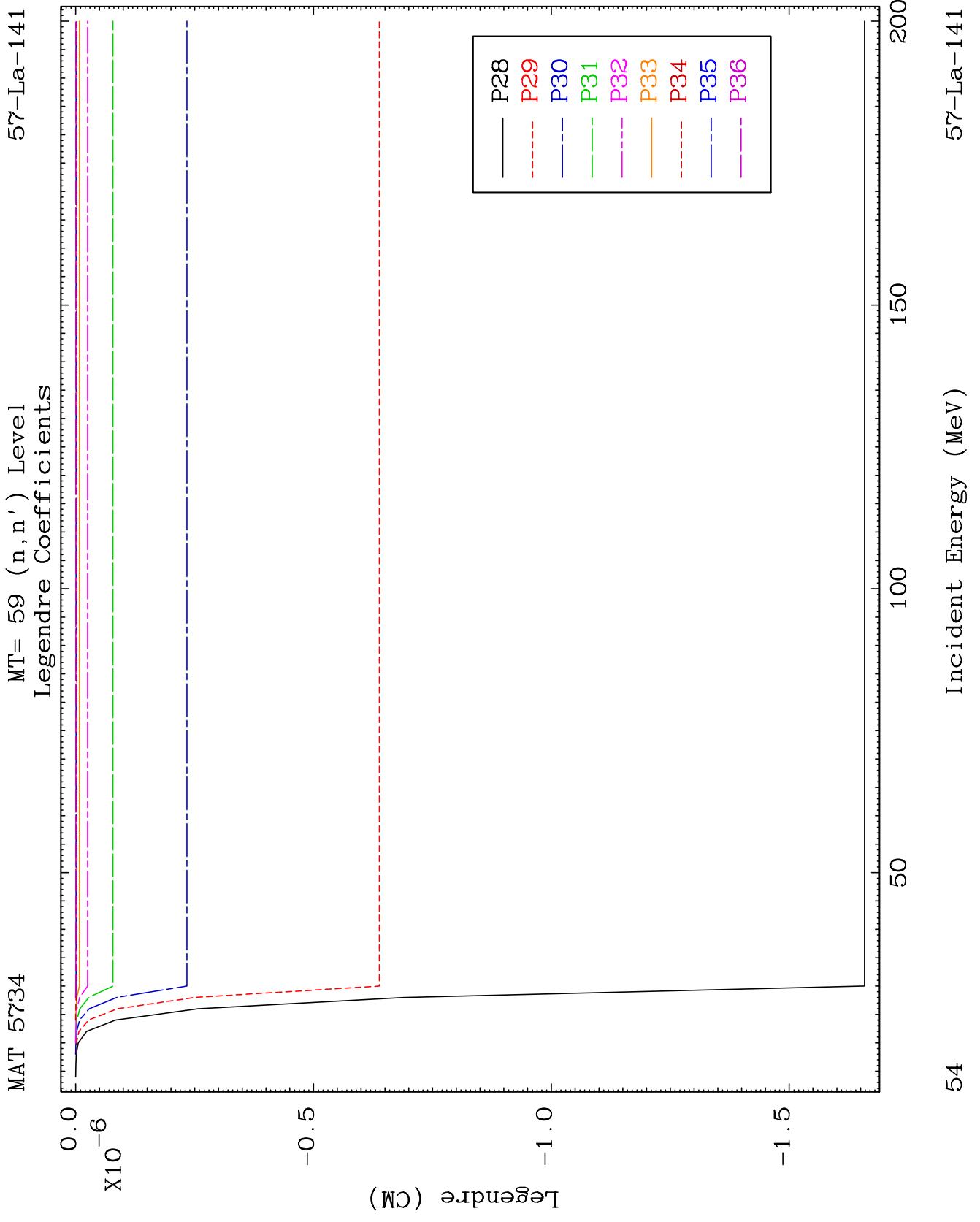

MAT 5734

MT= 60 (n,n') Level
Legendre Coefficients

57-La-141

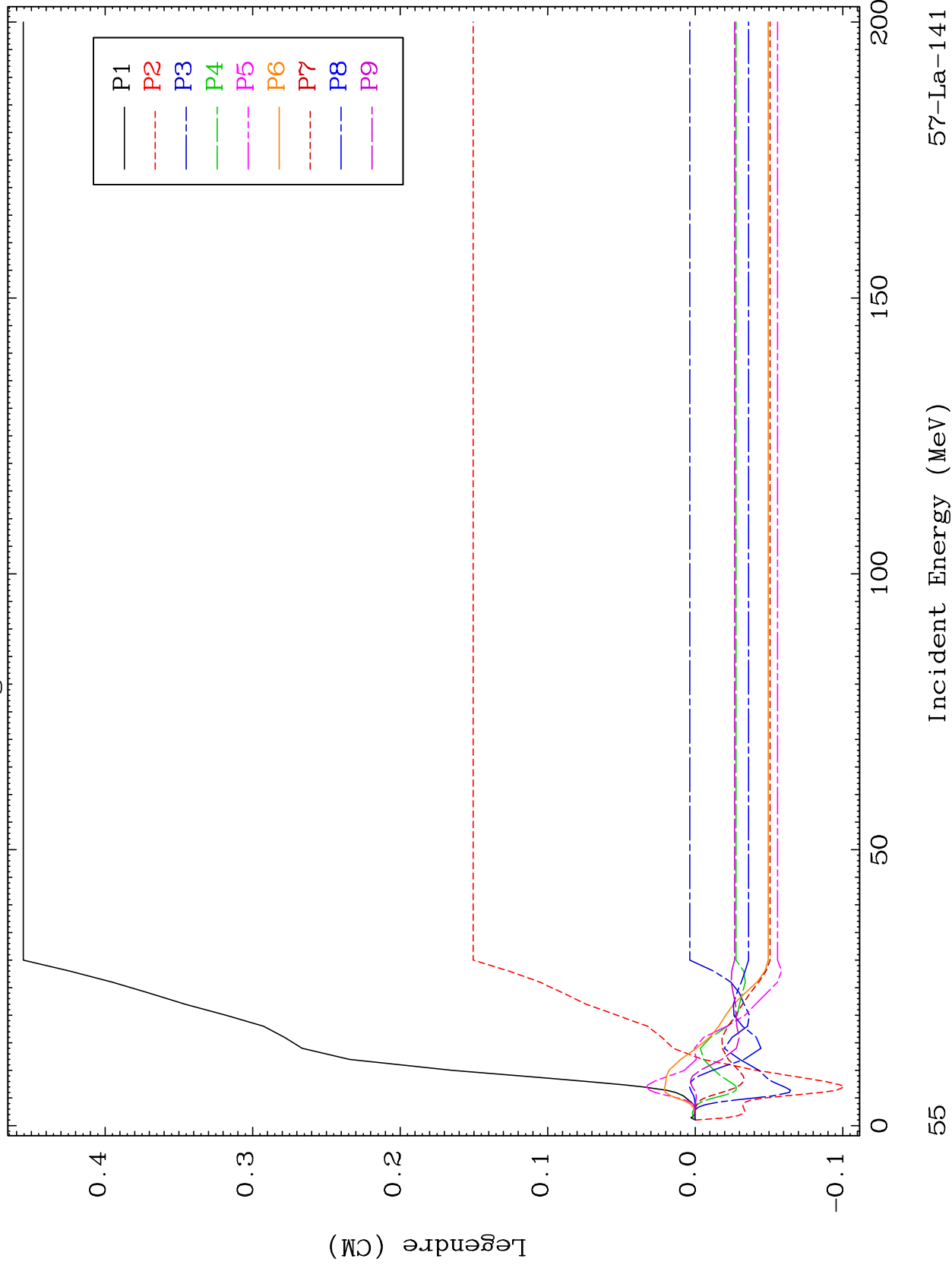

57-La-141

Incident Energy (MeV)

55

MAT 5734

MT= 60 (n,n') Level
Legendre Coefficients

57-La-141

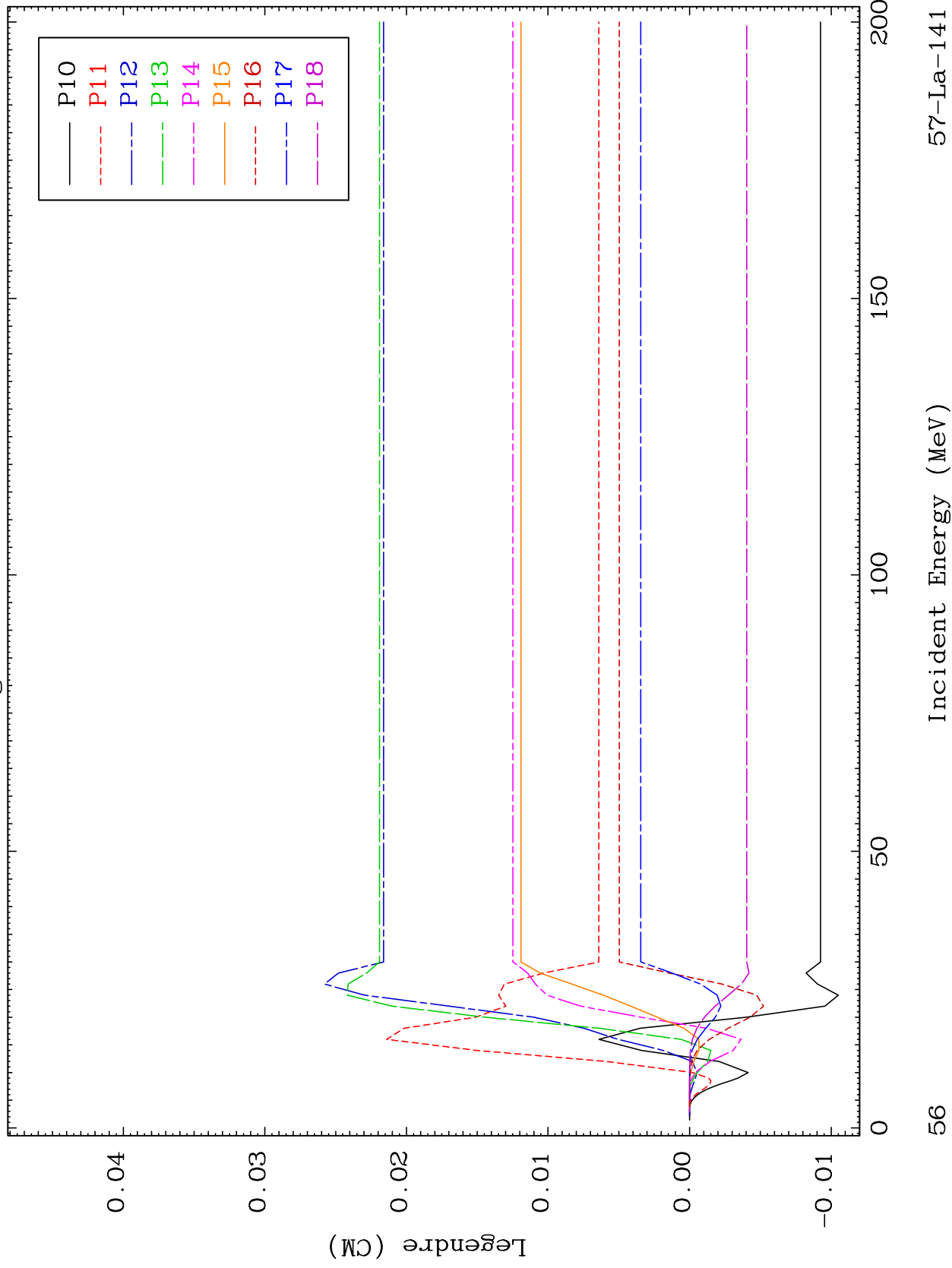

MAT 5734

MT= 60 (n,n') Level
Legendre Coefficients

57-La-141

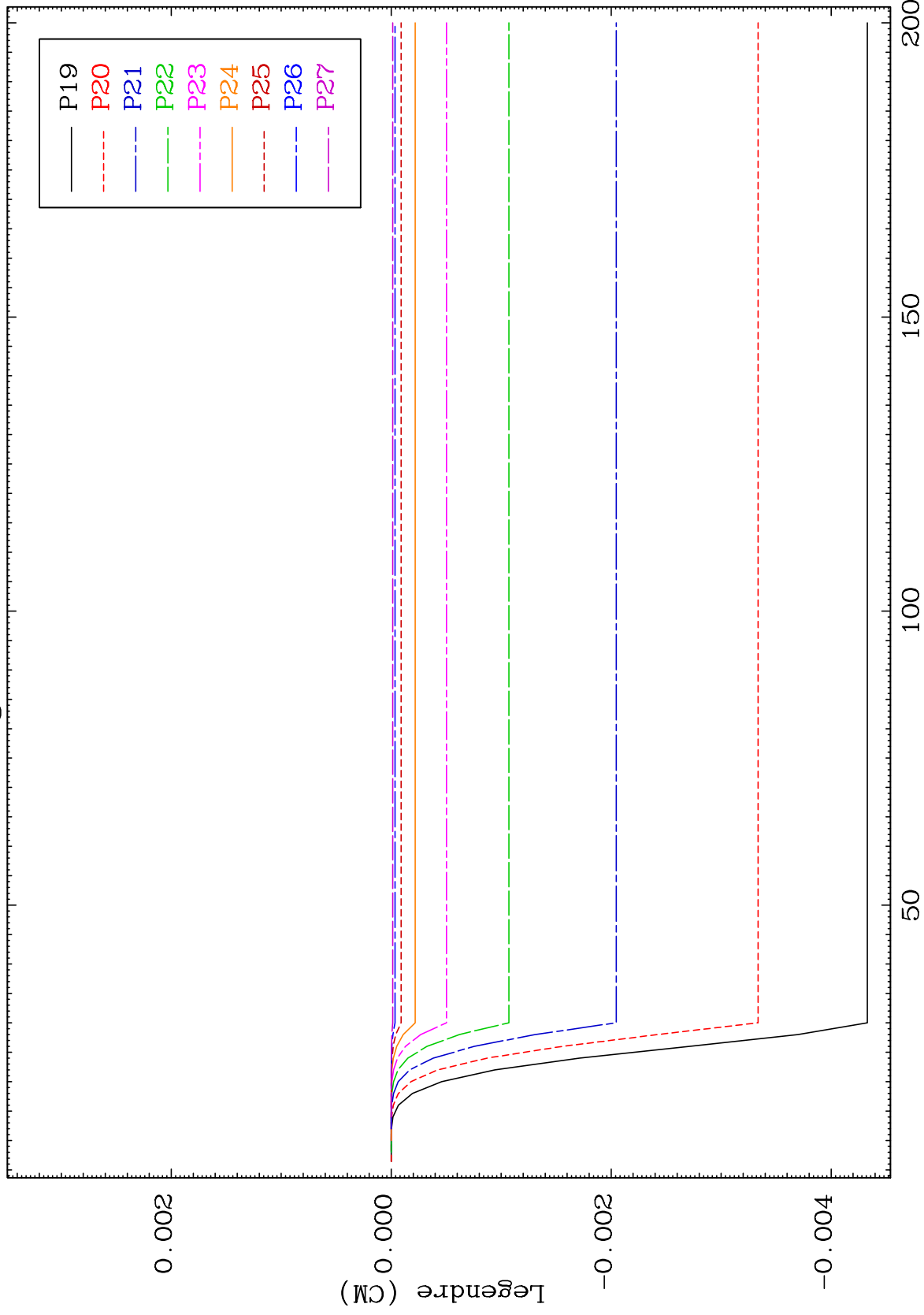

57

Incident Energy (MeV)

57-La-141

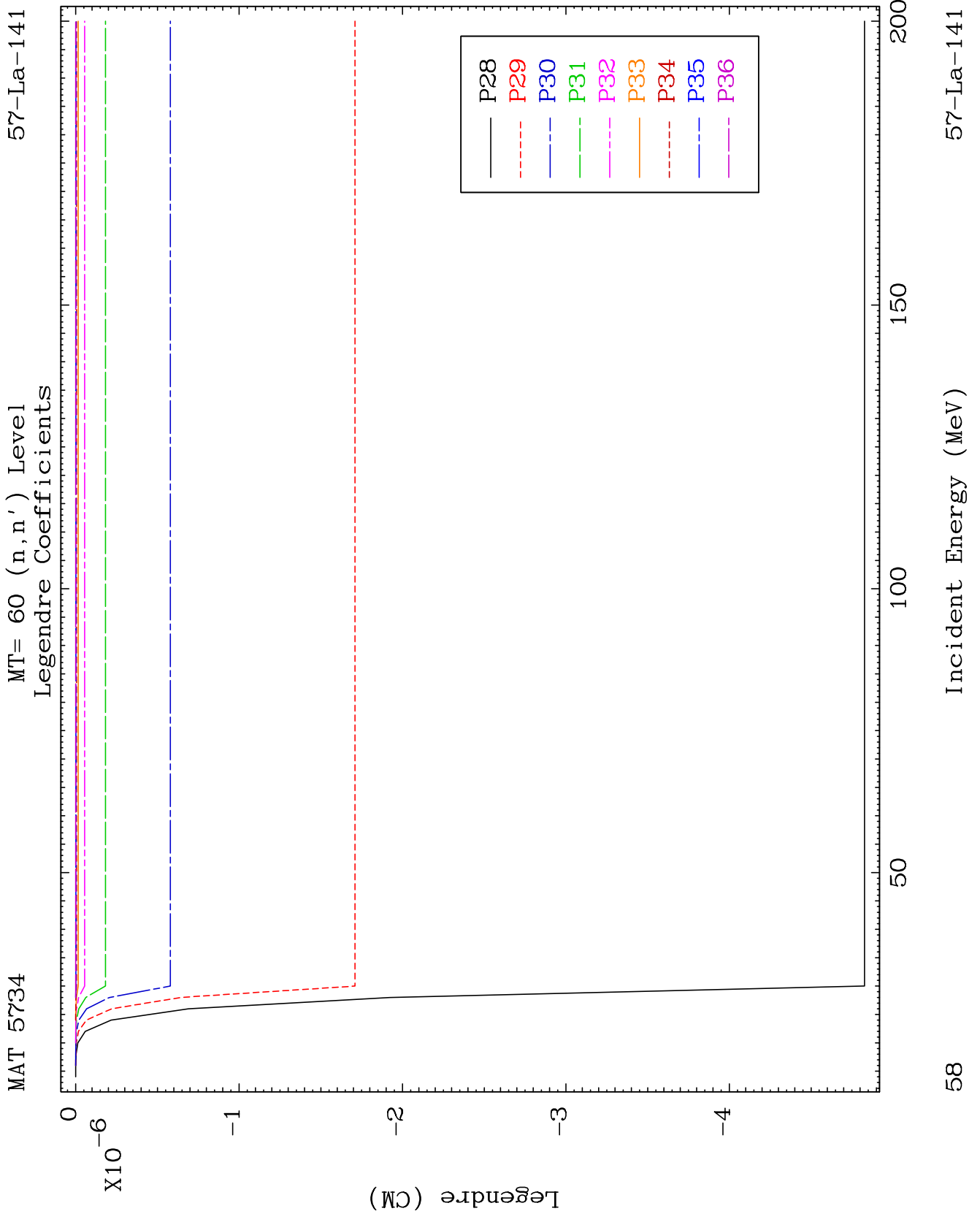

MAT 5734

MT= 61 (n,n') Level
Legendre Coefficients

57-La-141

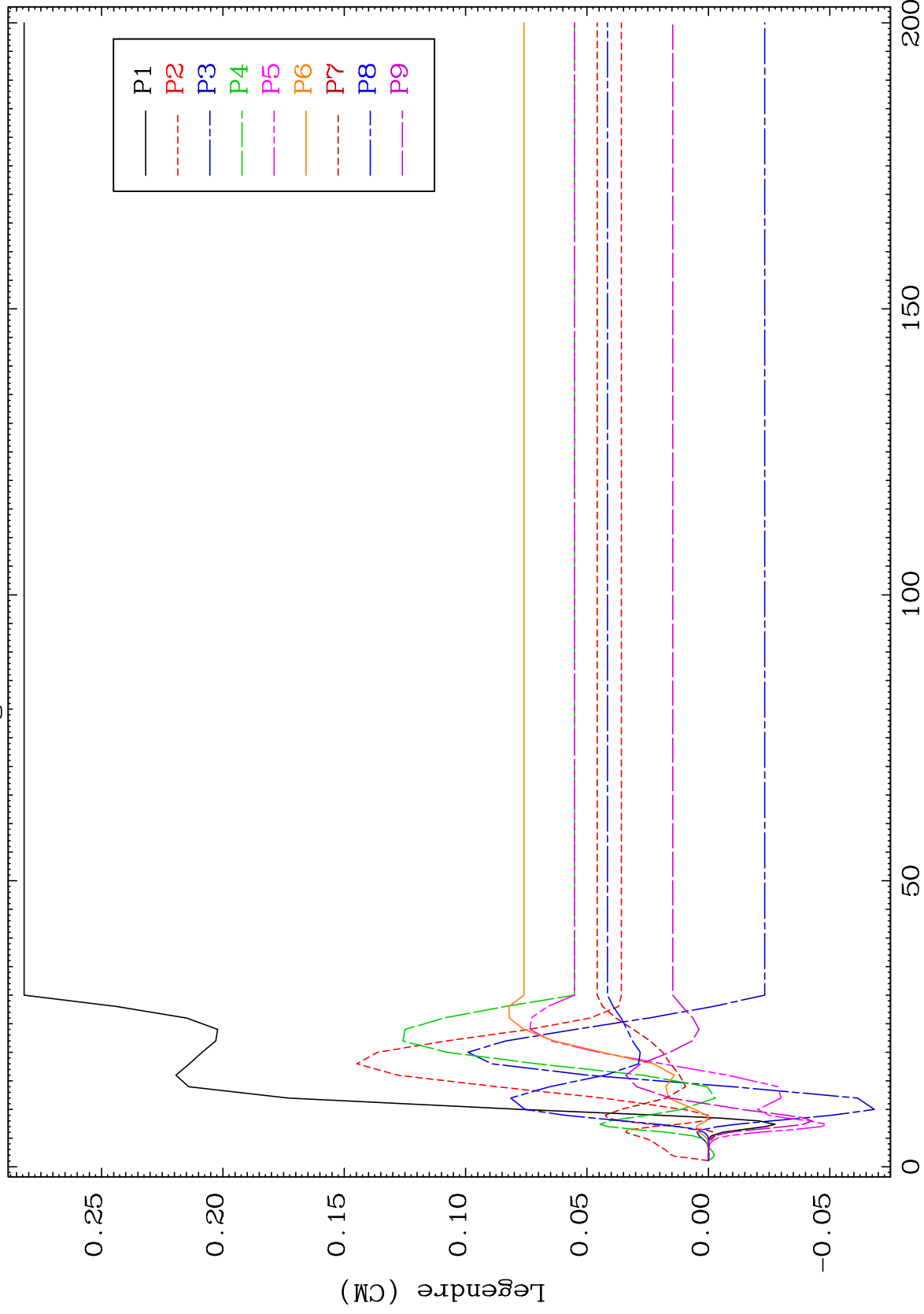

57-La-141

Incident Energy (MeV)

59

MAT 5734

MT= 61 (n,n') Level
Legendre Coefficients

57-La-141

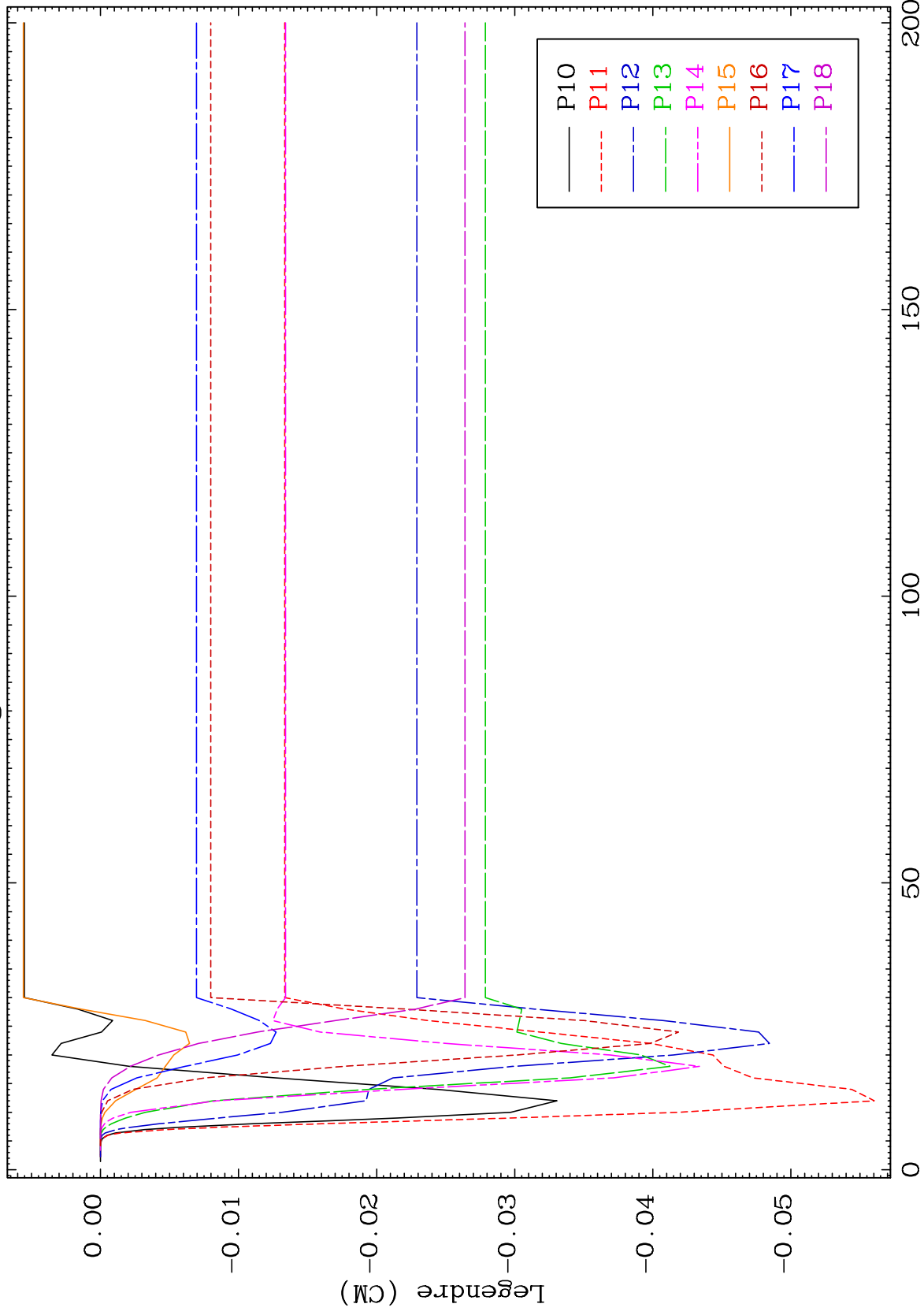

57-La-141

Incident Energy (MeV)

60

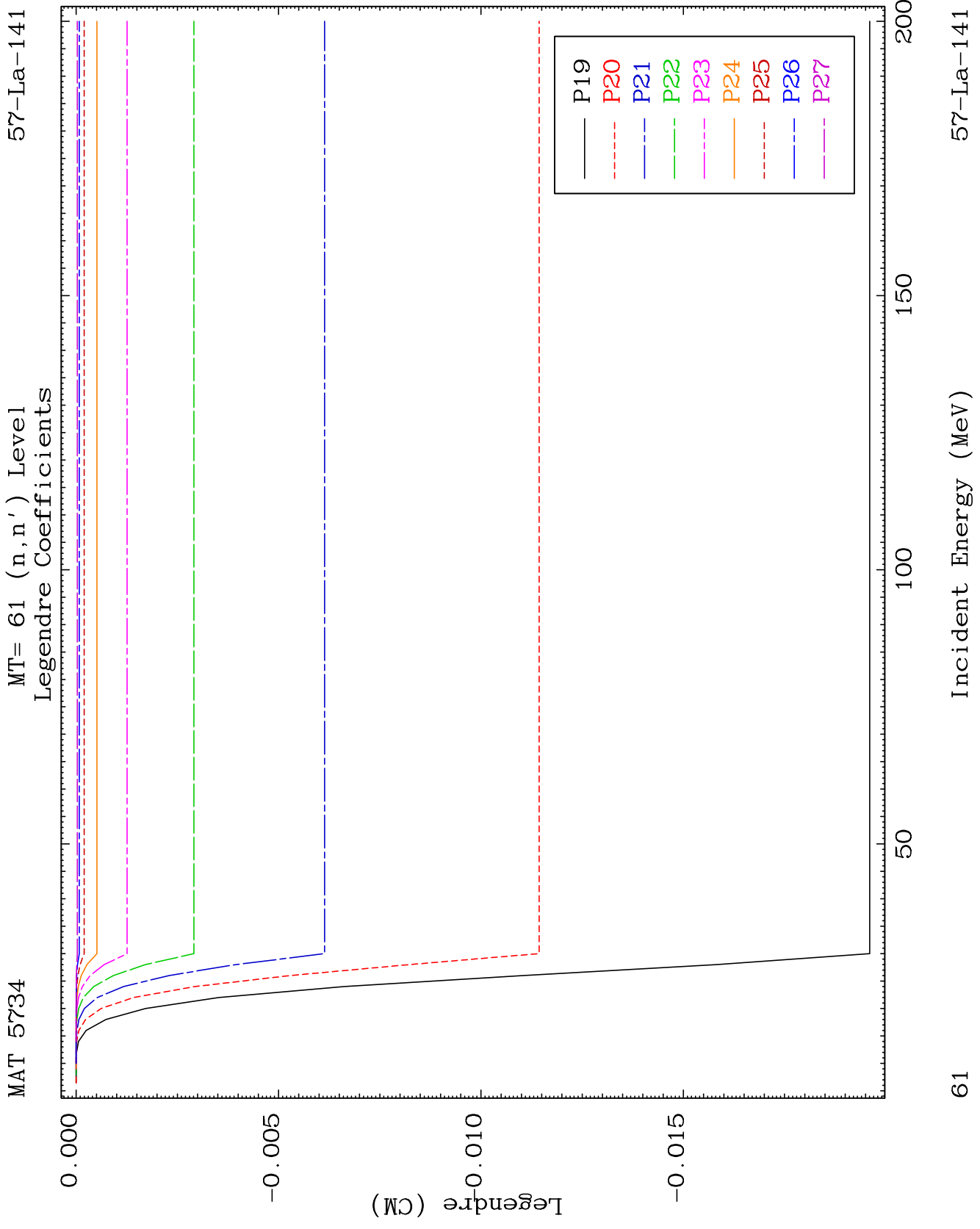

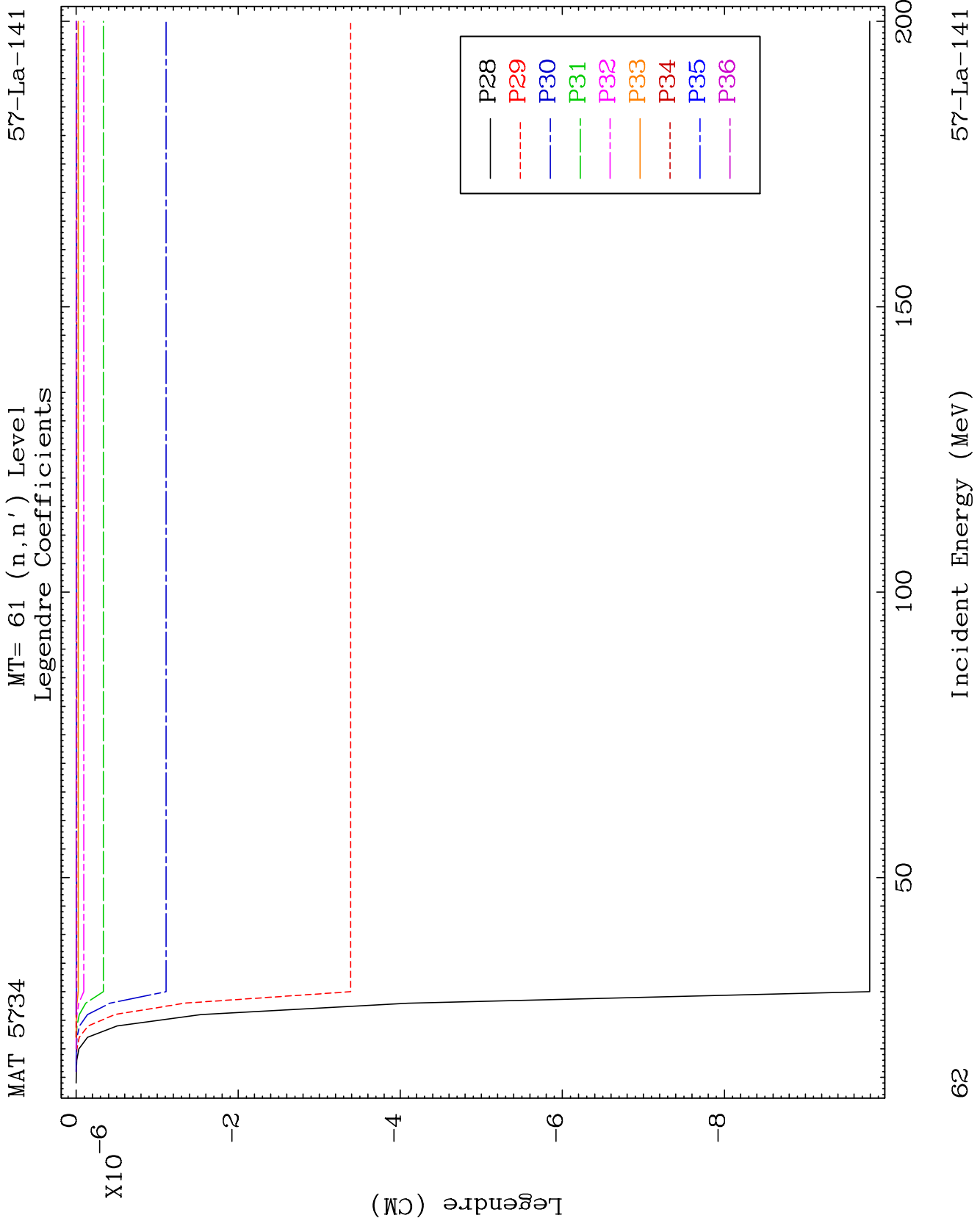

MAT 5734

MT= 62 (n,n') Level

57-La-141

Legendre Coefficients

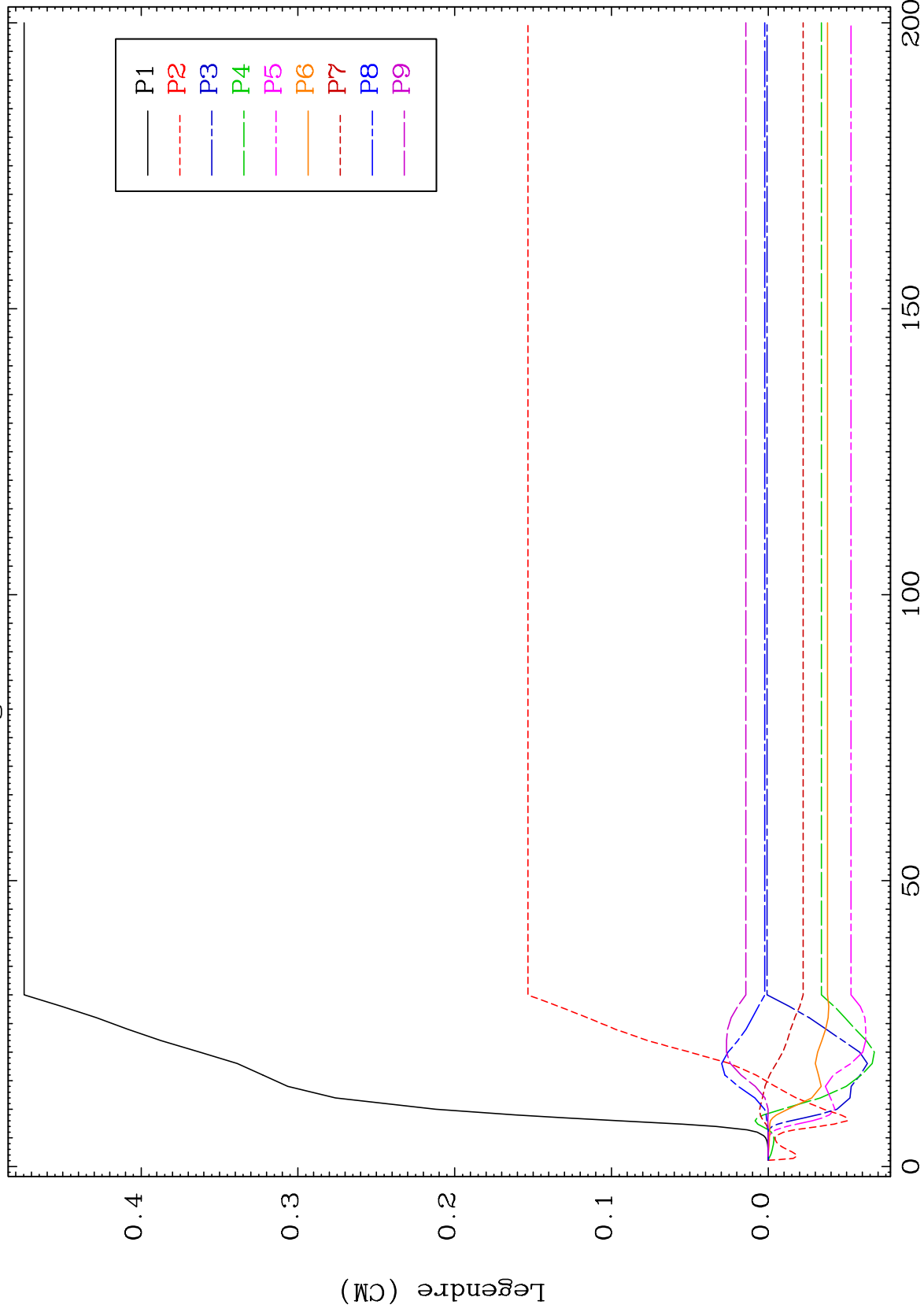

63

Incident Energy (MeV)

57-La-141

MAT 5734

MT= 62 (n,n') Level
Legendre Coefficients

57-La-141

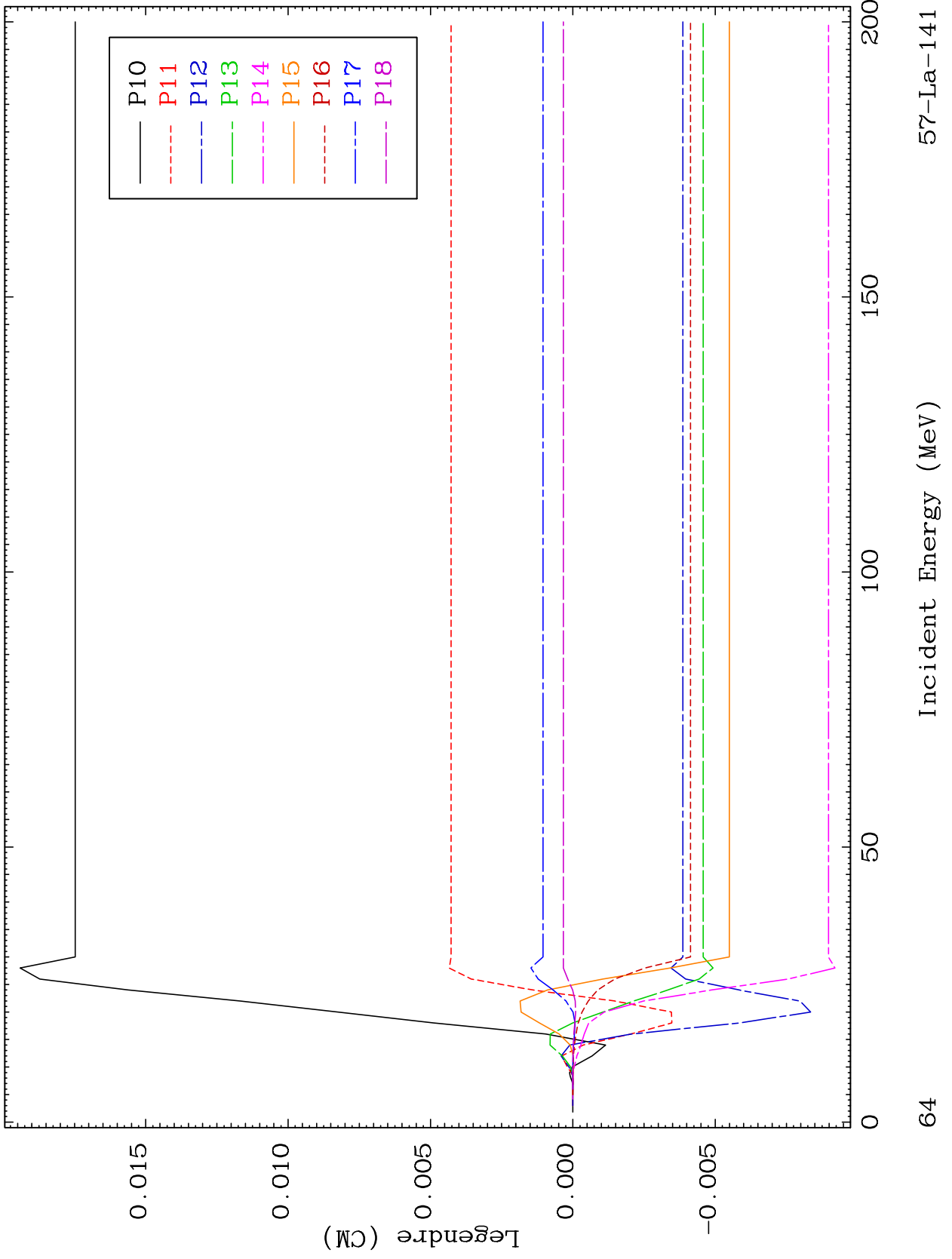

64

Incident Energy (MeV)

57-La-141

MAT 5734

MT= 62 (n,n') Level
Legendre Coefficients

57-La-141

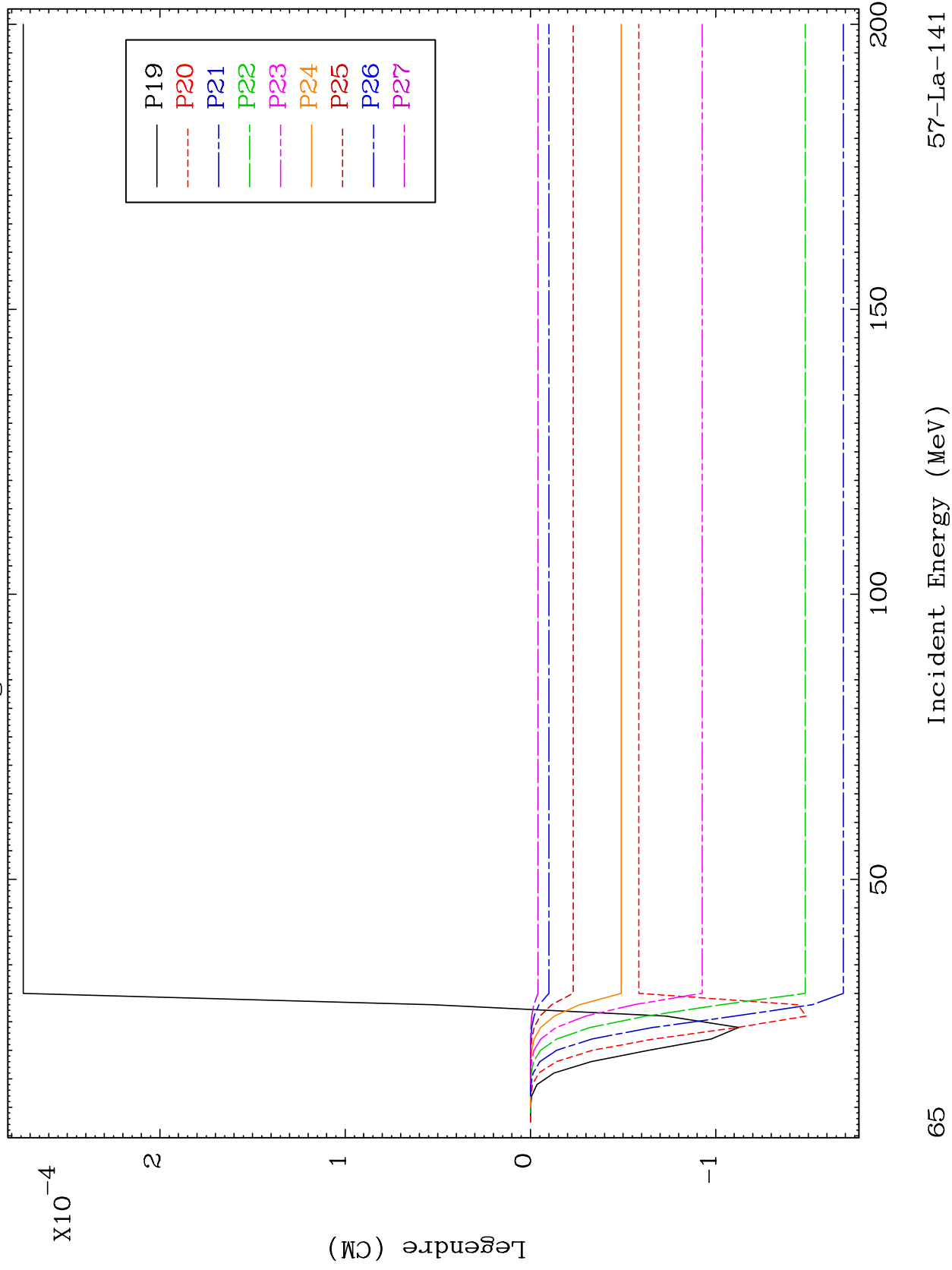

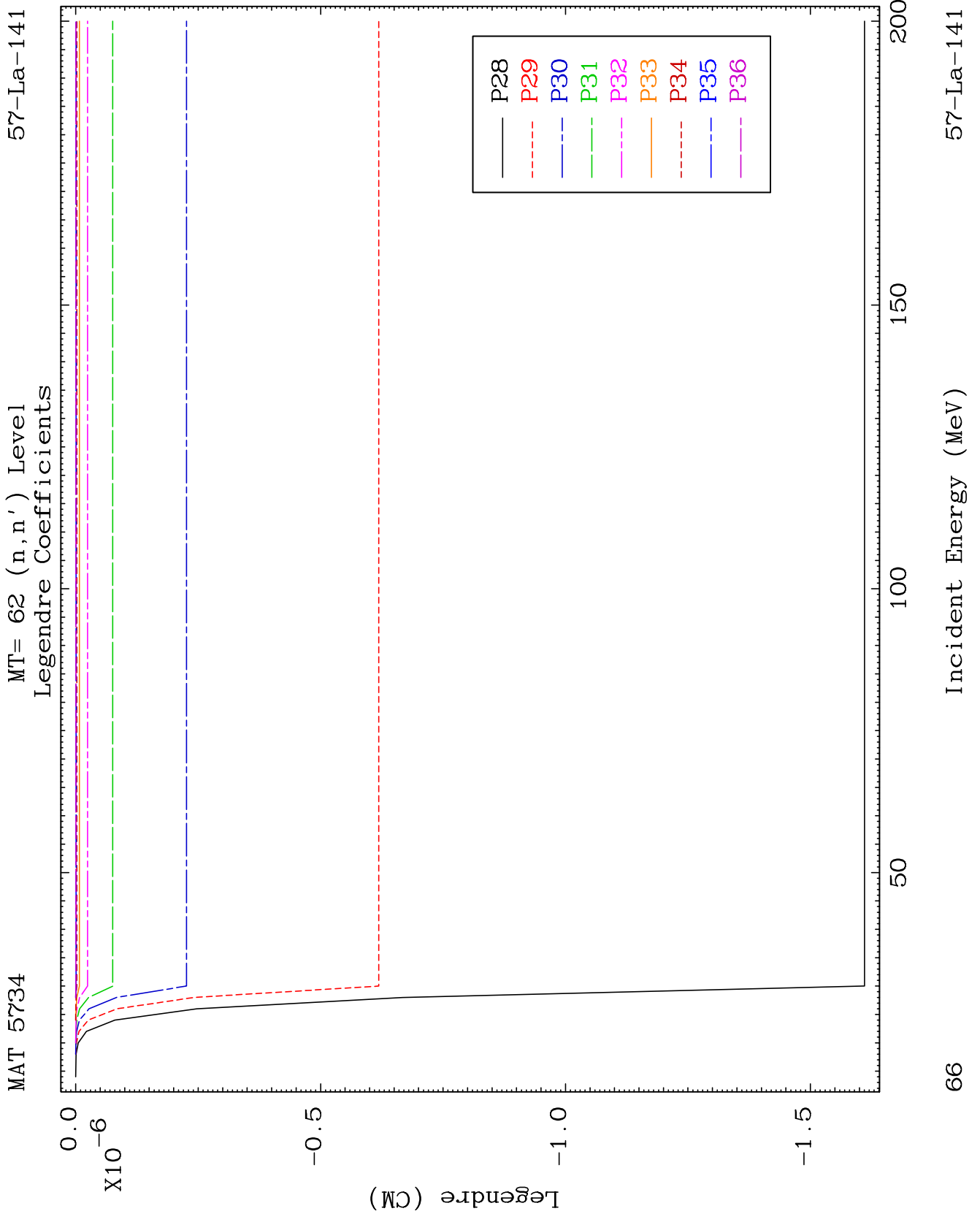

MAT 5734

MT= 63 (n,n') Level
Legendre Coefficients

57-La-141

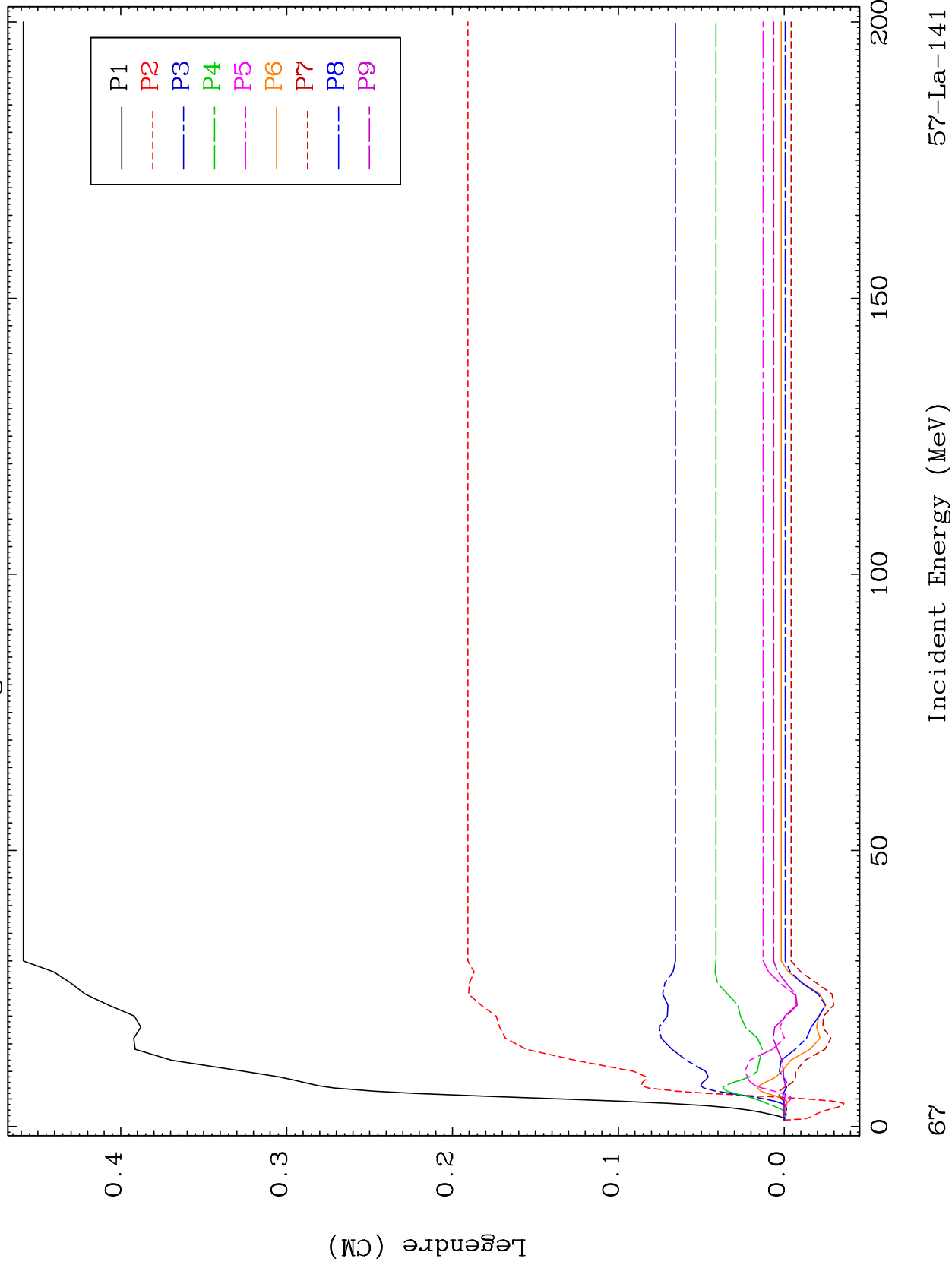

57-La-141

Incident Energy (MeV)

67

MAT 5734

MT= 63 (n,n') Level
Legendre Coefficients

57-La-141

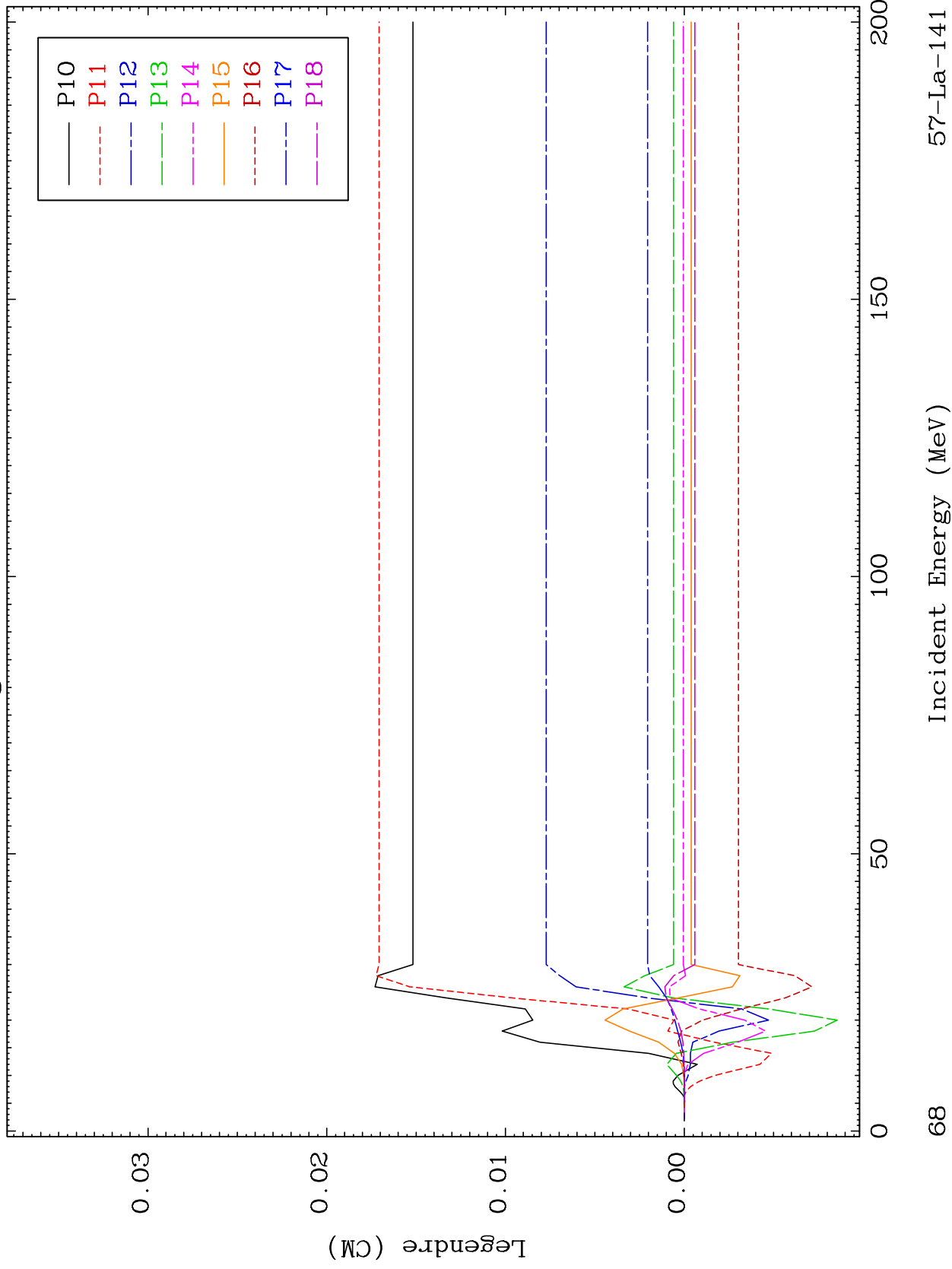

57-La-141

Incident Energy (MeV)

68

MAT 5734

MT= 63 (n,n') Level
Legendre Coefficients

57-La-141

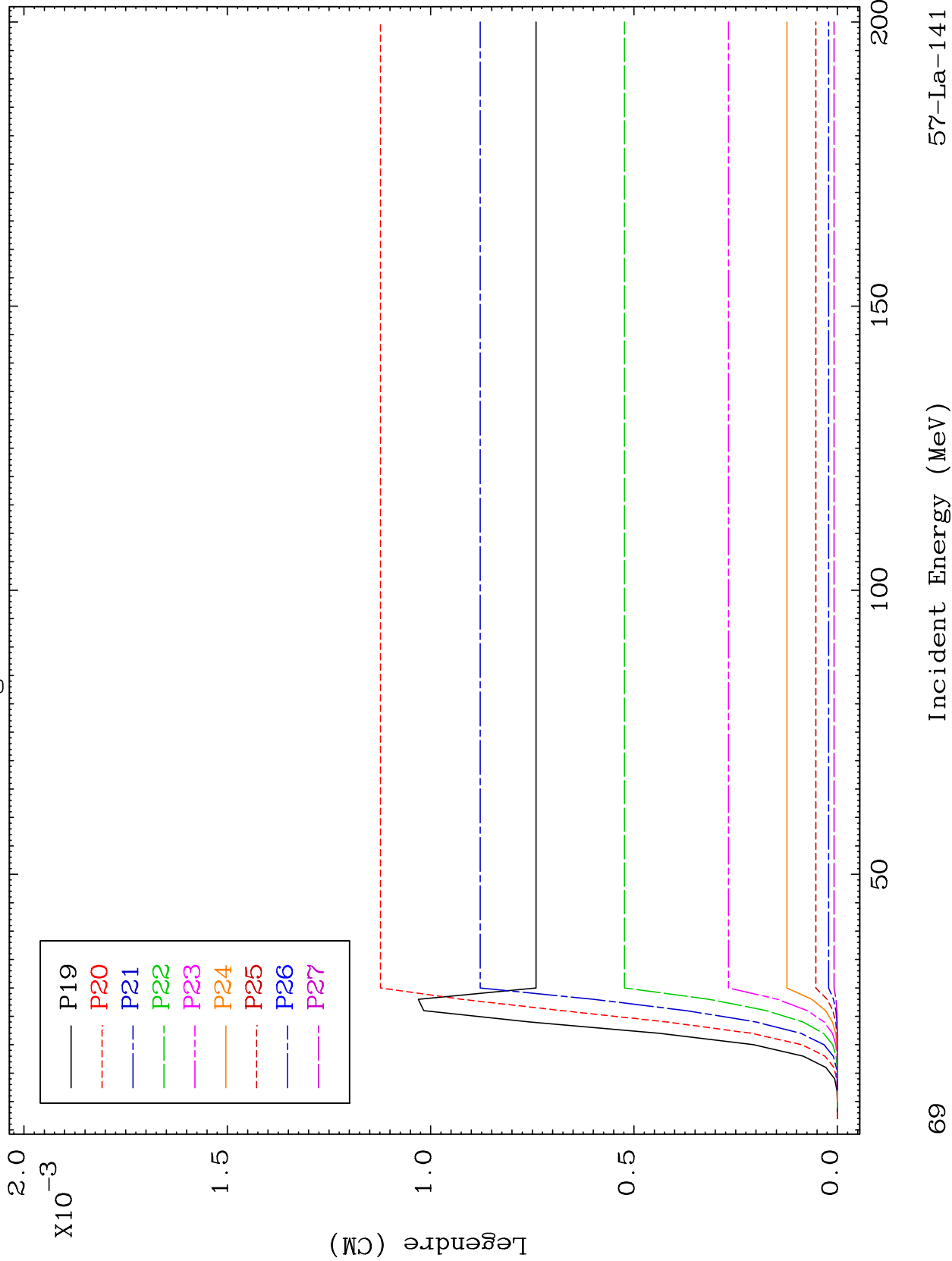

MAT 5734

MT= 63 (n,n') Level
Legendre Coefficients

57-La-141

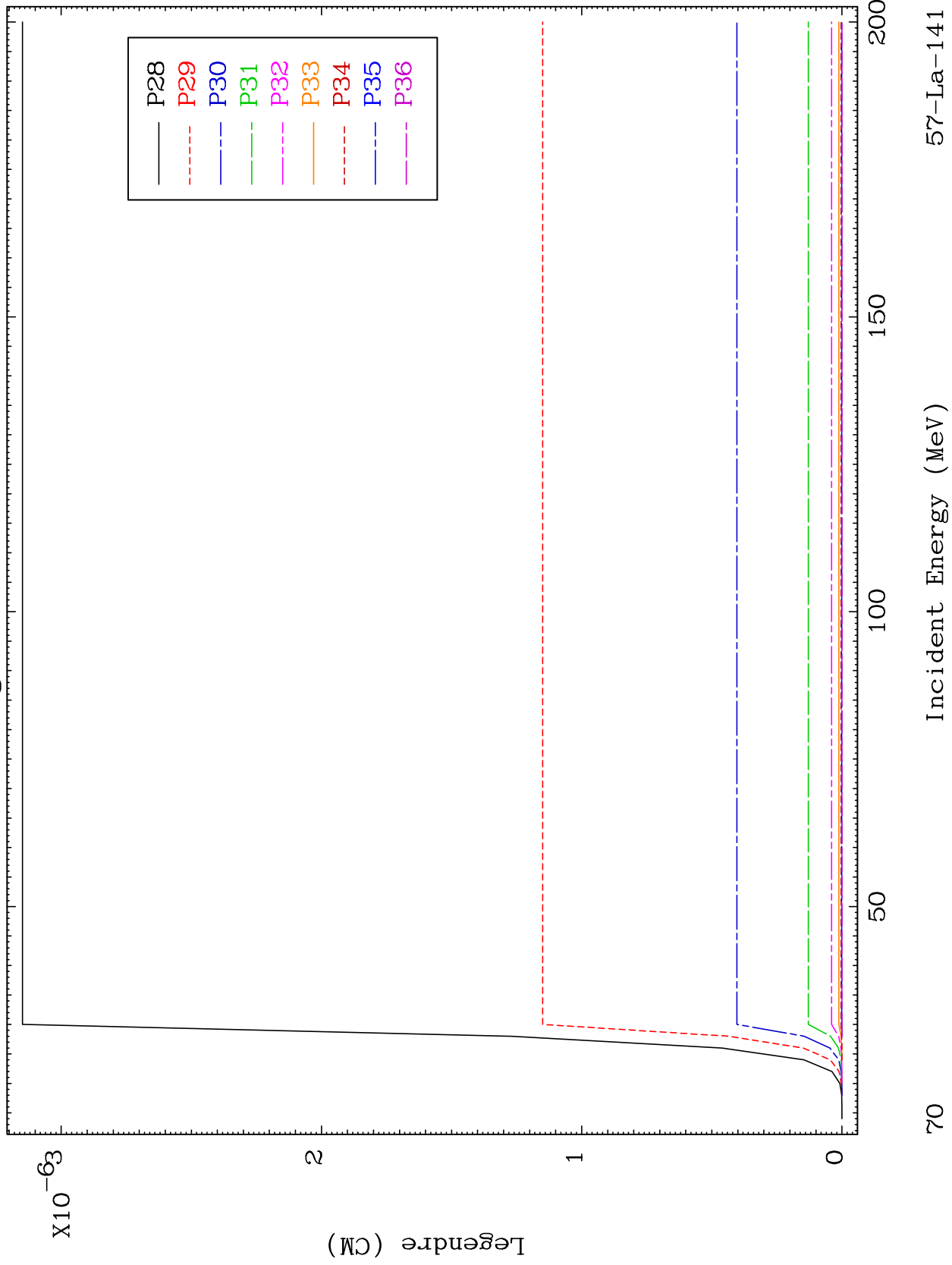

MAT 5734

MT= 64 (n,n') Level
Legendre Coefficients

57-La-141

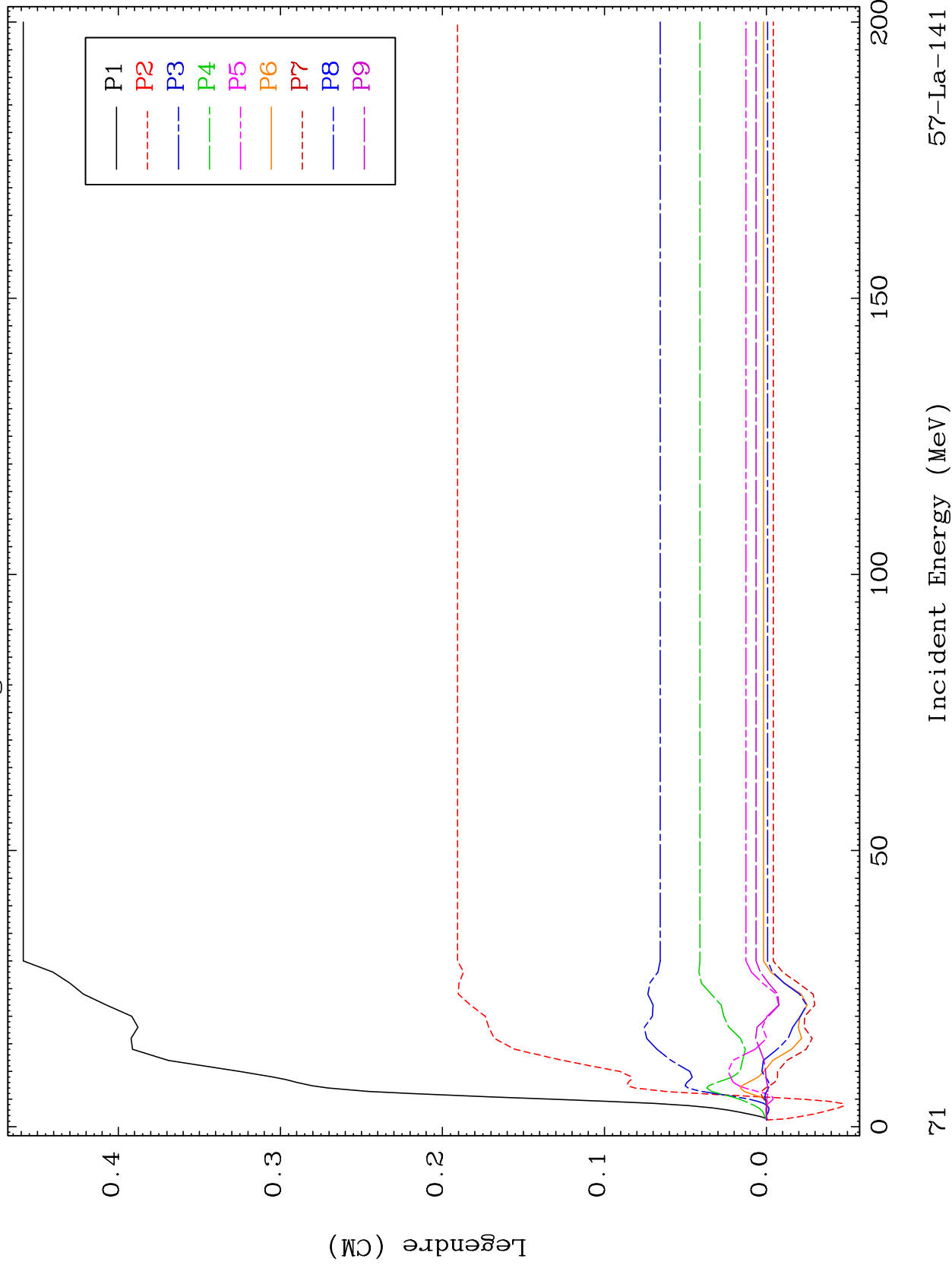

57-La-141

Incident Energy (MeV)

71

MAT 5734

MT= 64 (n,n') Level
Legendre Coefficients

57-La-141

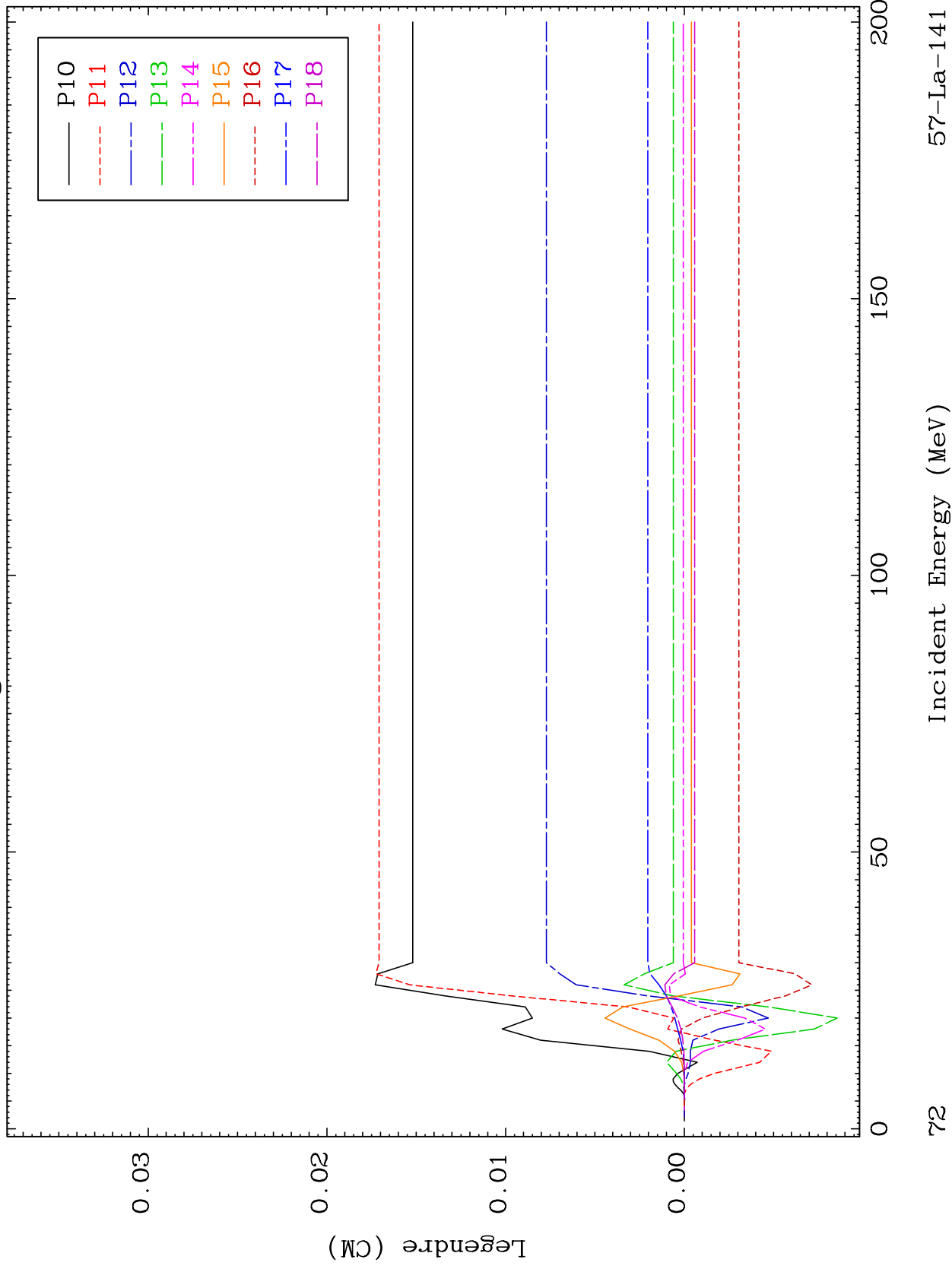

57-La-141

Incident Energy (MeV)

72

MAT 5734

MT= 64 (n,n') Level
Legendre Coefficients

57-La-141

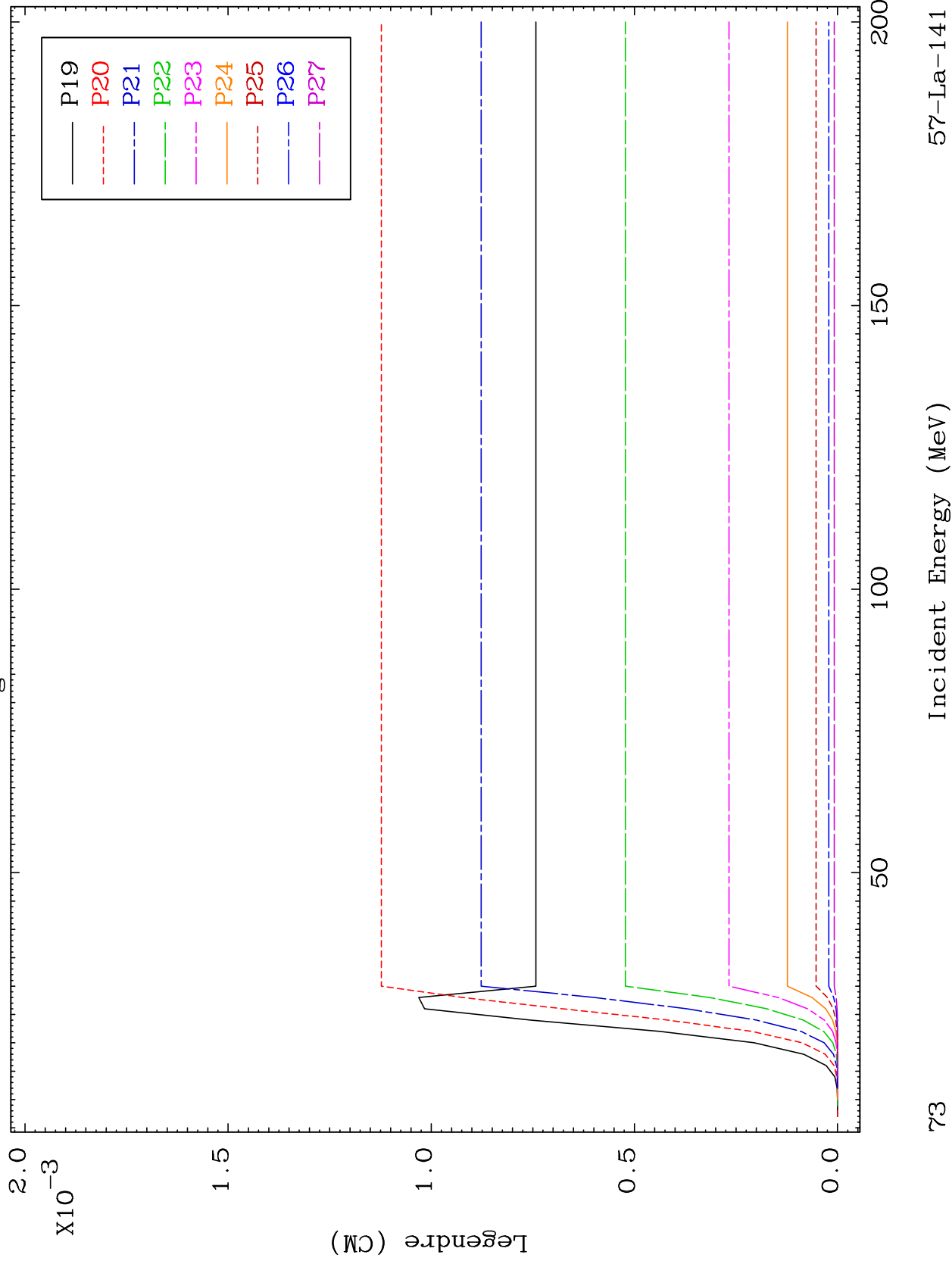

73

Incident Energy (MeV)

57-La-141

MAT 5734

MT= 64 (n,n') Level
Legendre Coefficients

57-La-141

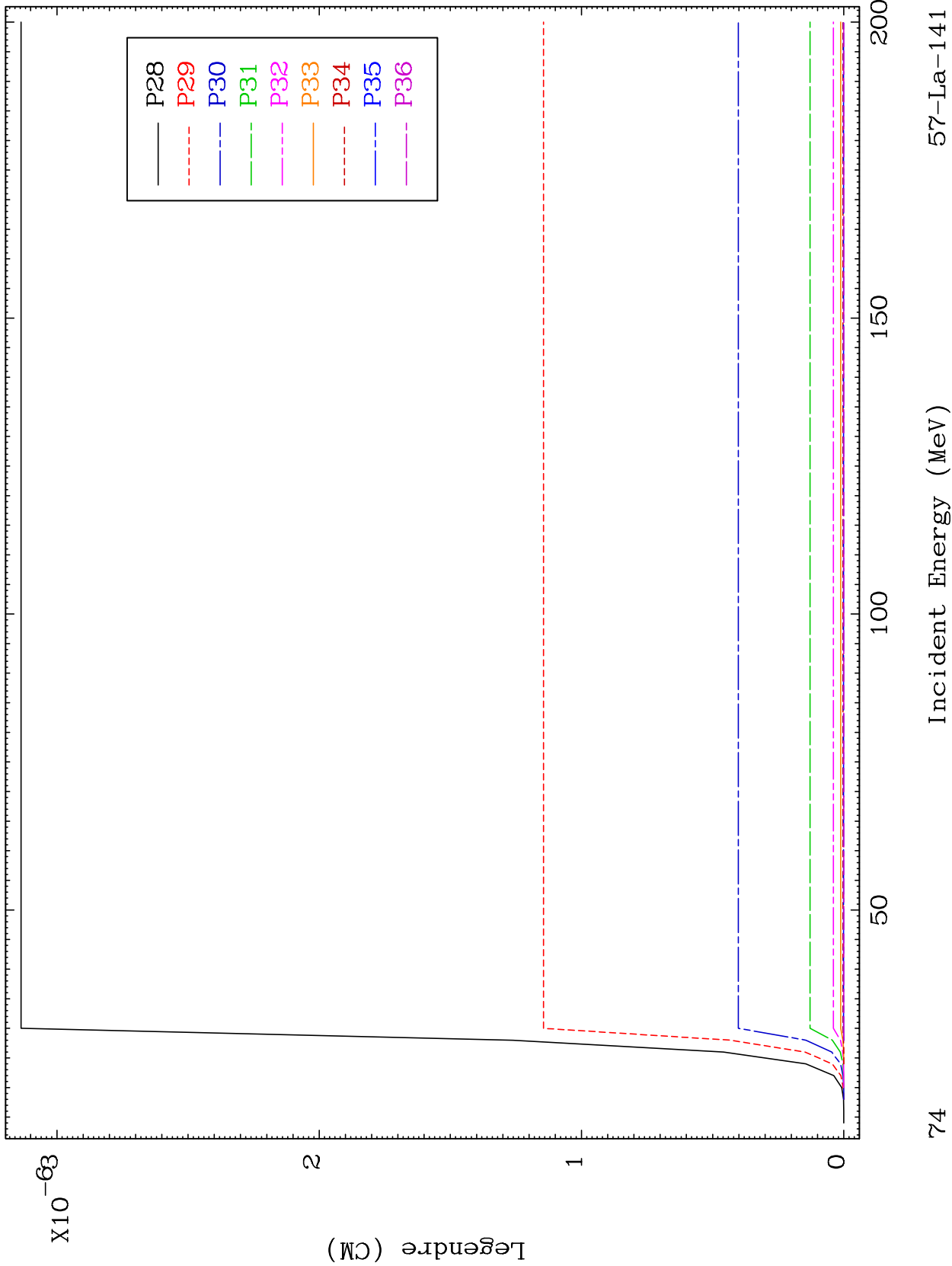

74

Incident Energy (MeV)

57-La-141

MAT 5734

MT= 65 (n,n') Level
Legendre Coefficients

57-La-141

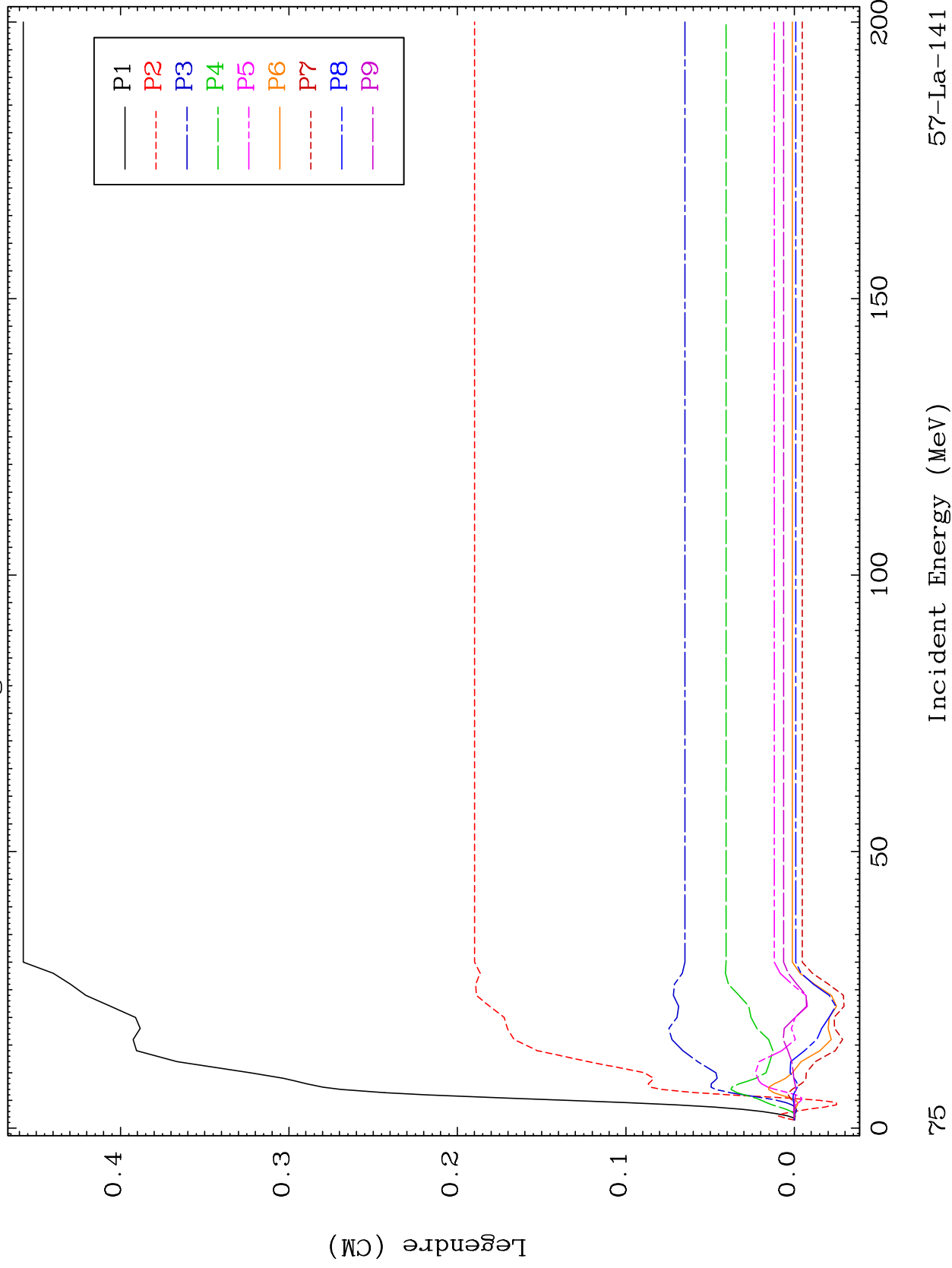

57-La-141

Incident Energy (MeV)

75

MAT 5734

MT= 65 (n,n') Level
Legendre Coefficients

57-La-141

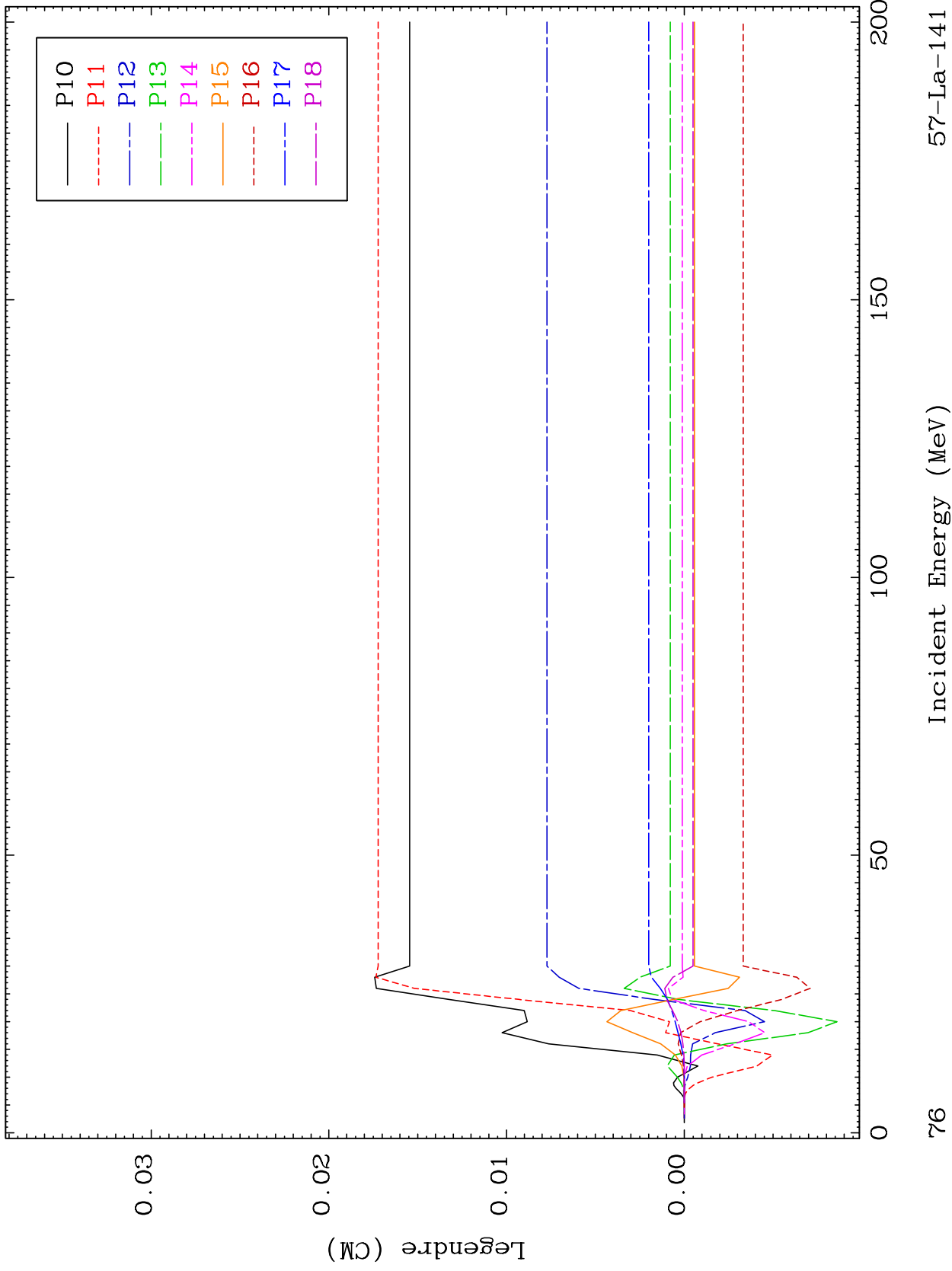

57-La-141

Incident Energy (MeV)

76

MAT 5734

MT= 65 (n,n') Level
Legendre Coefficients

57-La-141

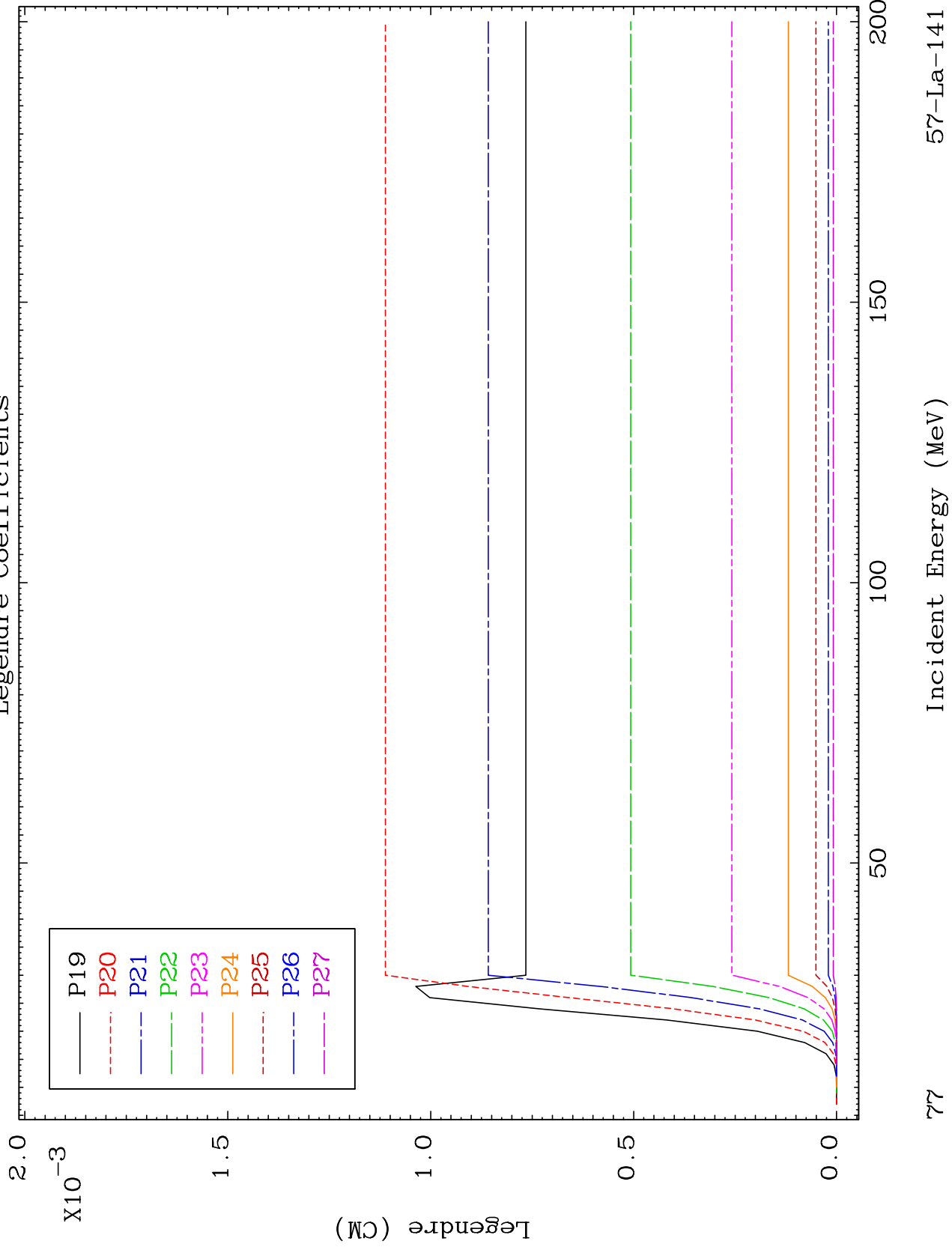

77

57-La-141

MAT 5734

MT= 65 (n,n') Level
Legendre Coefficients

57-La-141

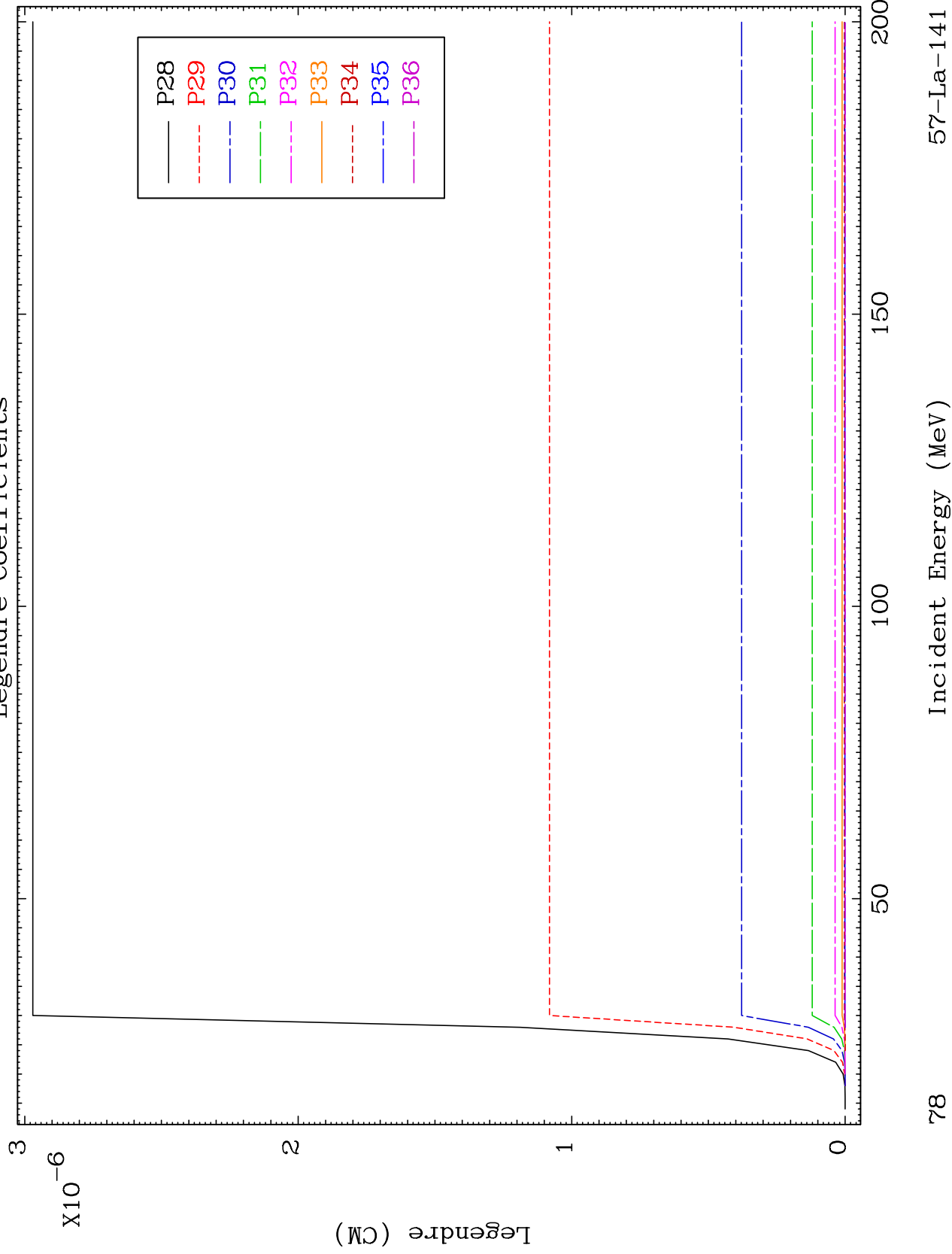

78

Incident Energy (MeV)

57-La-141

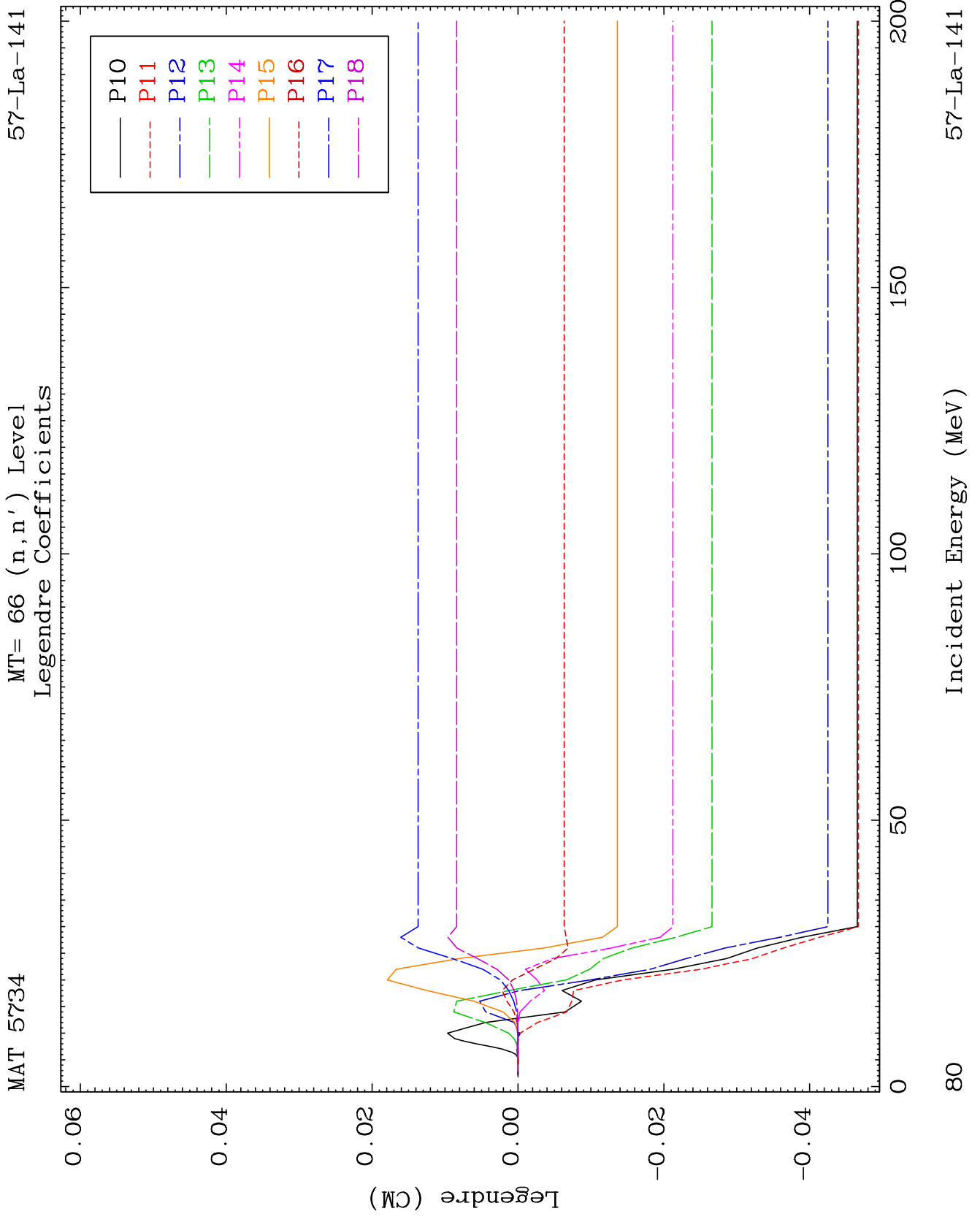

MAT 5734

MT= 66 (n,n') Level
Legendre Coefficients

57-La-141

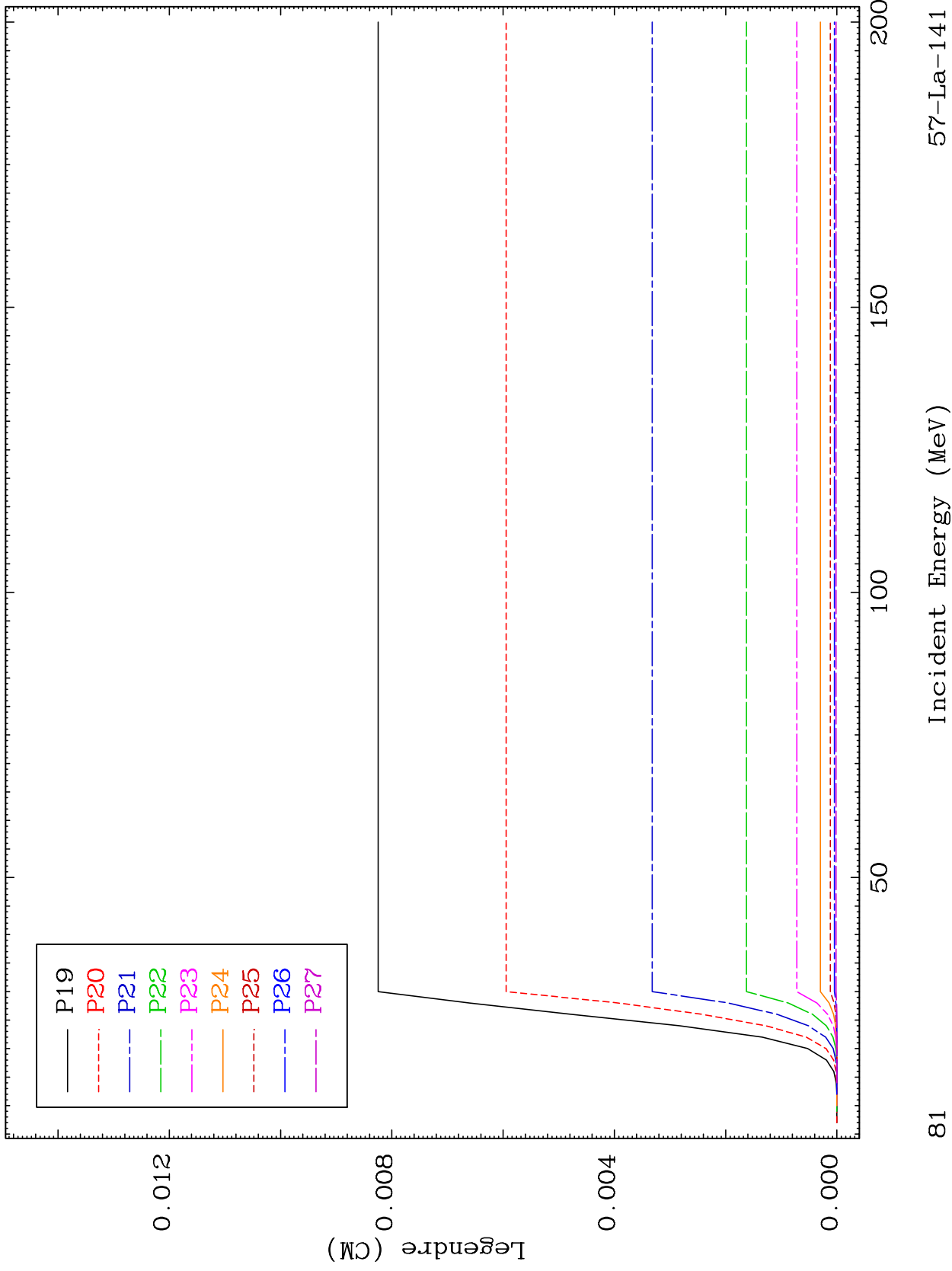

81

57-La-141

MAT 5734

MT= 66 (n,n') Level
Legendre Coefficients

57-La-141

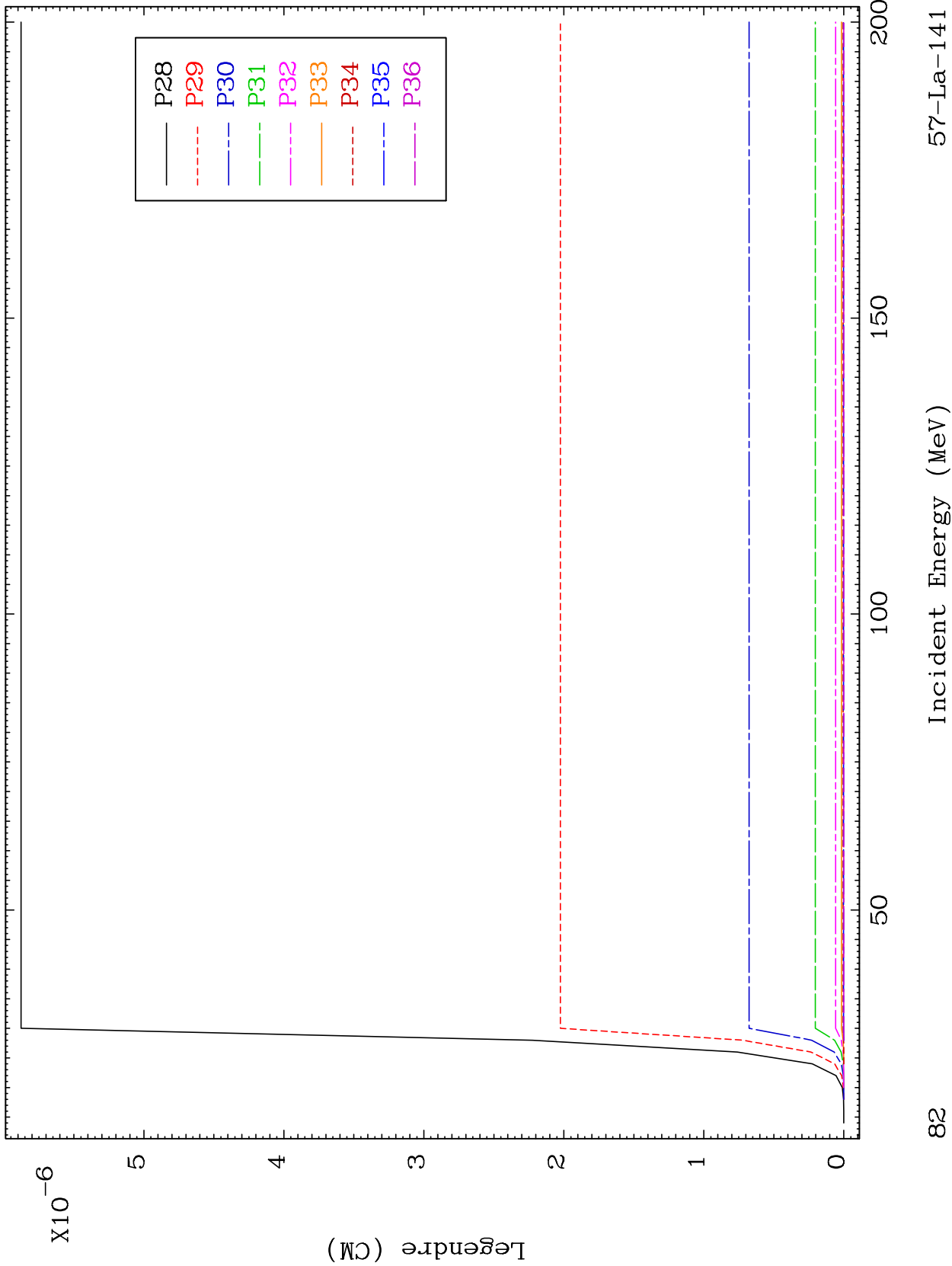

82

57-La-141

MAT 5734

MT= 67 (n,n') Level
Legendre Coefficients

57-La-141

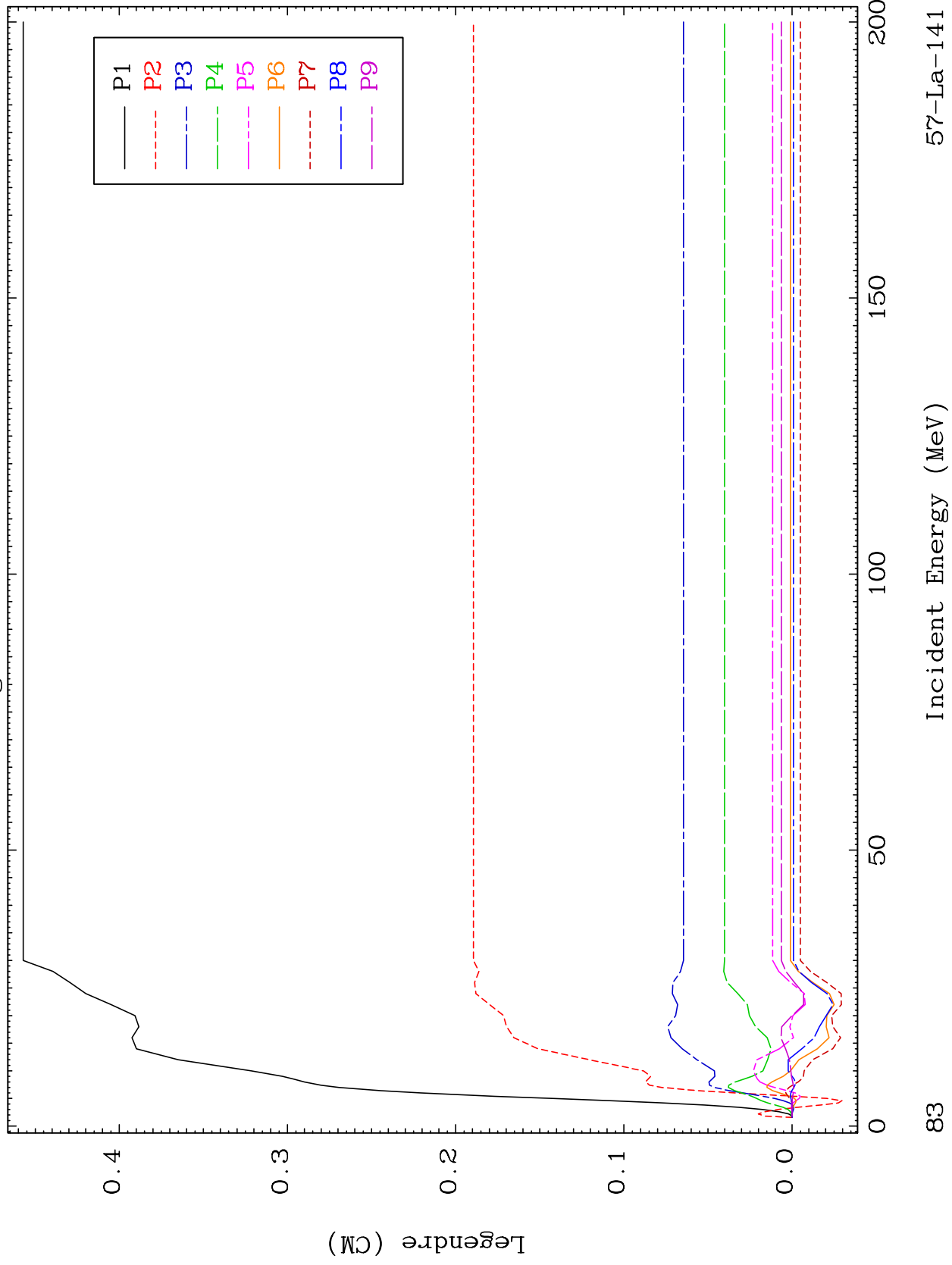

57-La-141

Incident Energy (MeV)

83

MAT 5734

MT= 67 (n,n') Level
Legendre Coefficients

57-La-141

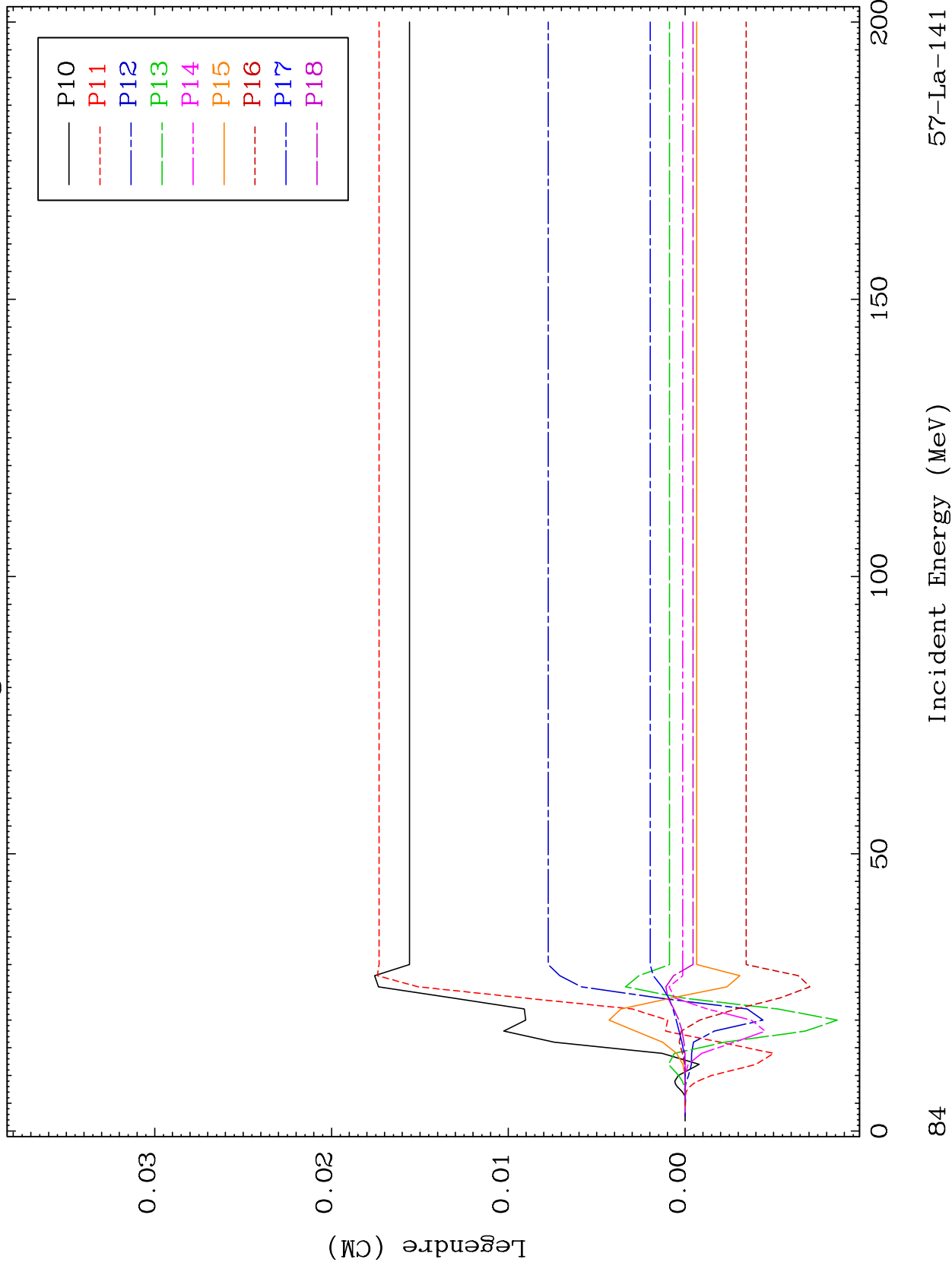

84

Incident Energy (MeV)

57-La-141

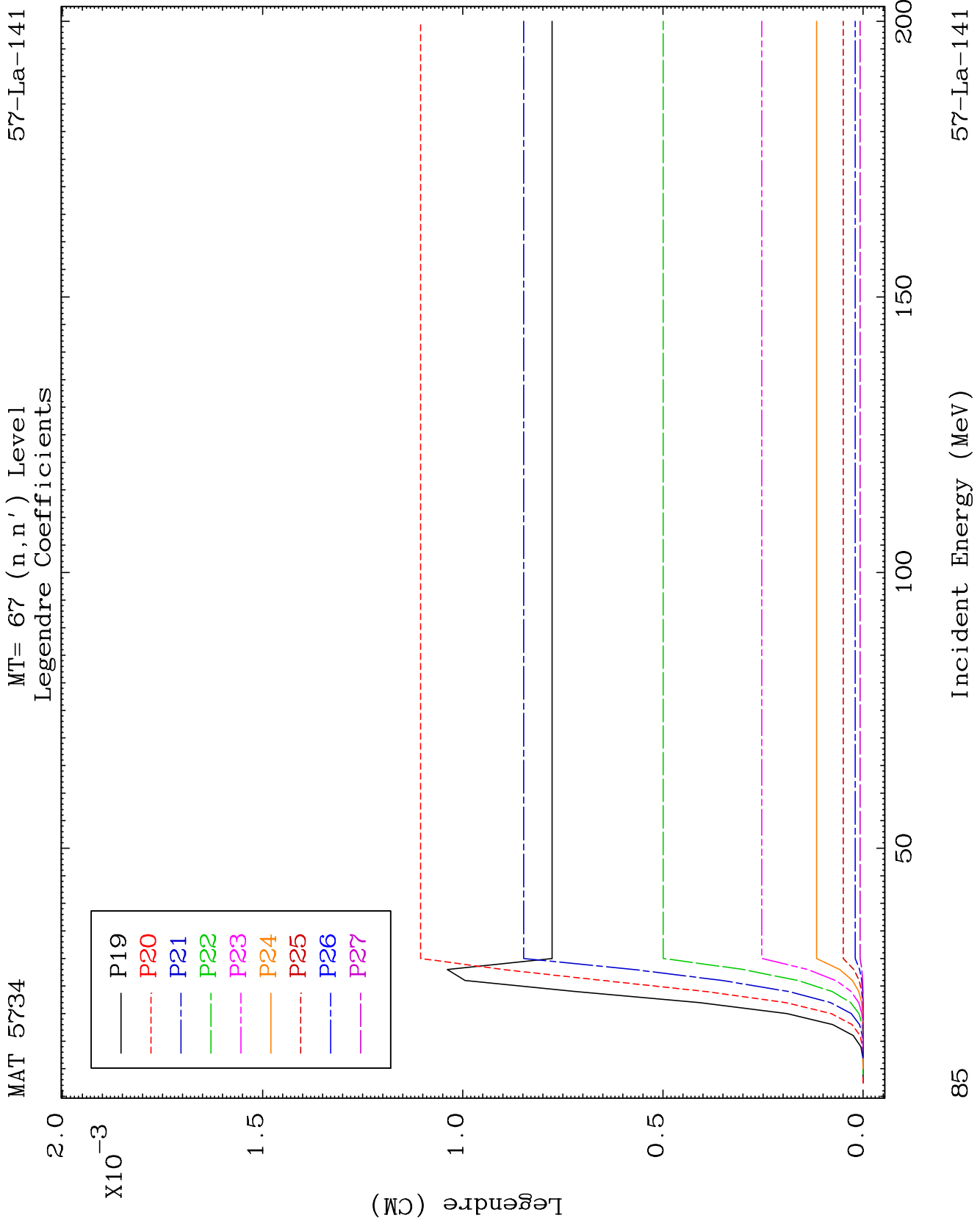

MAT 5734

MT= 67 (n,n') Level
Legendre Coefficients

57-La-141

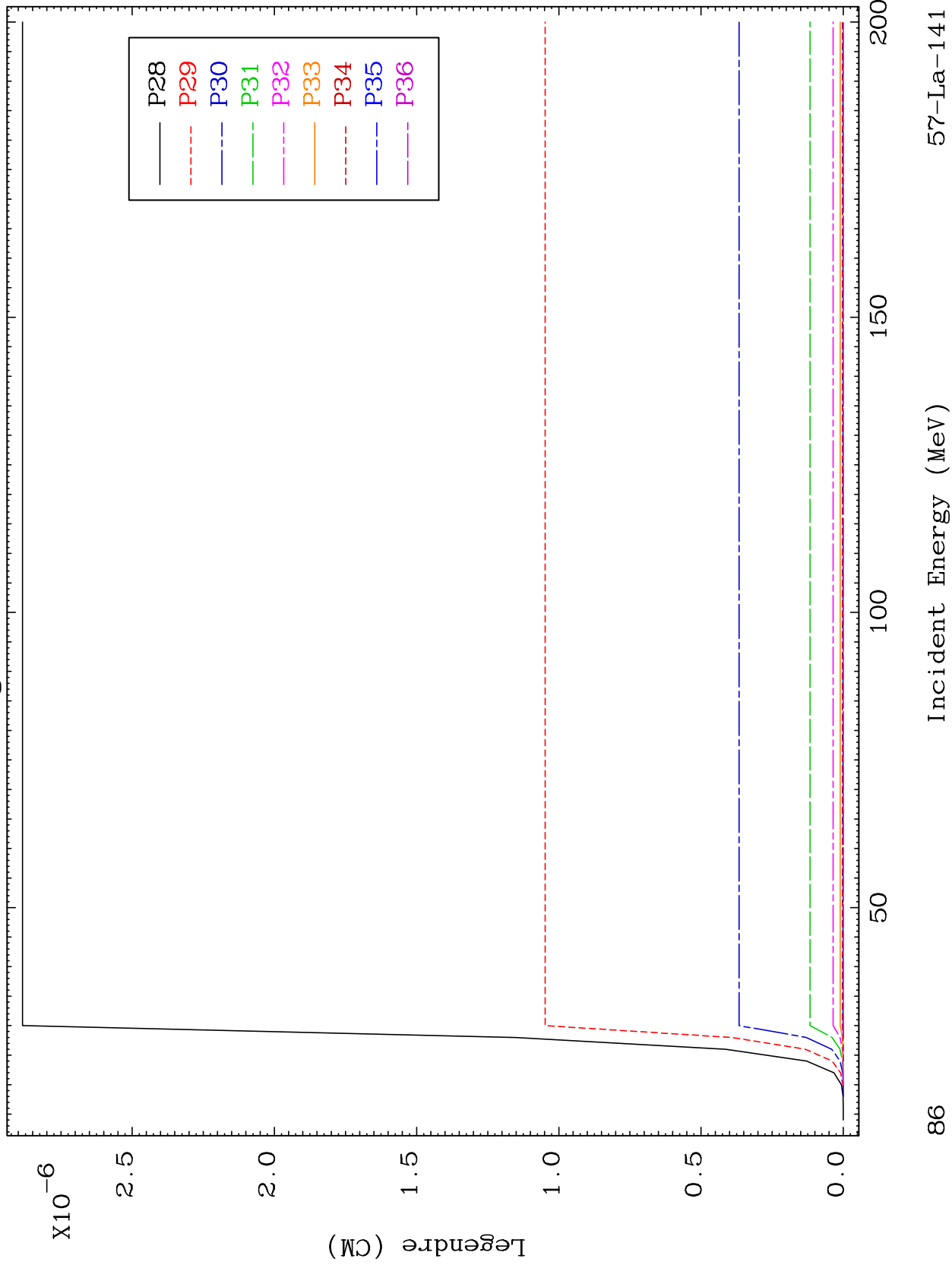

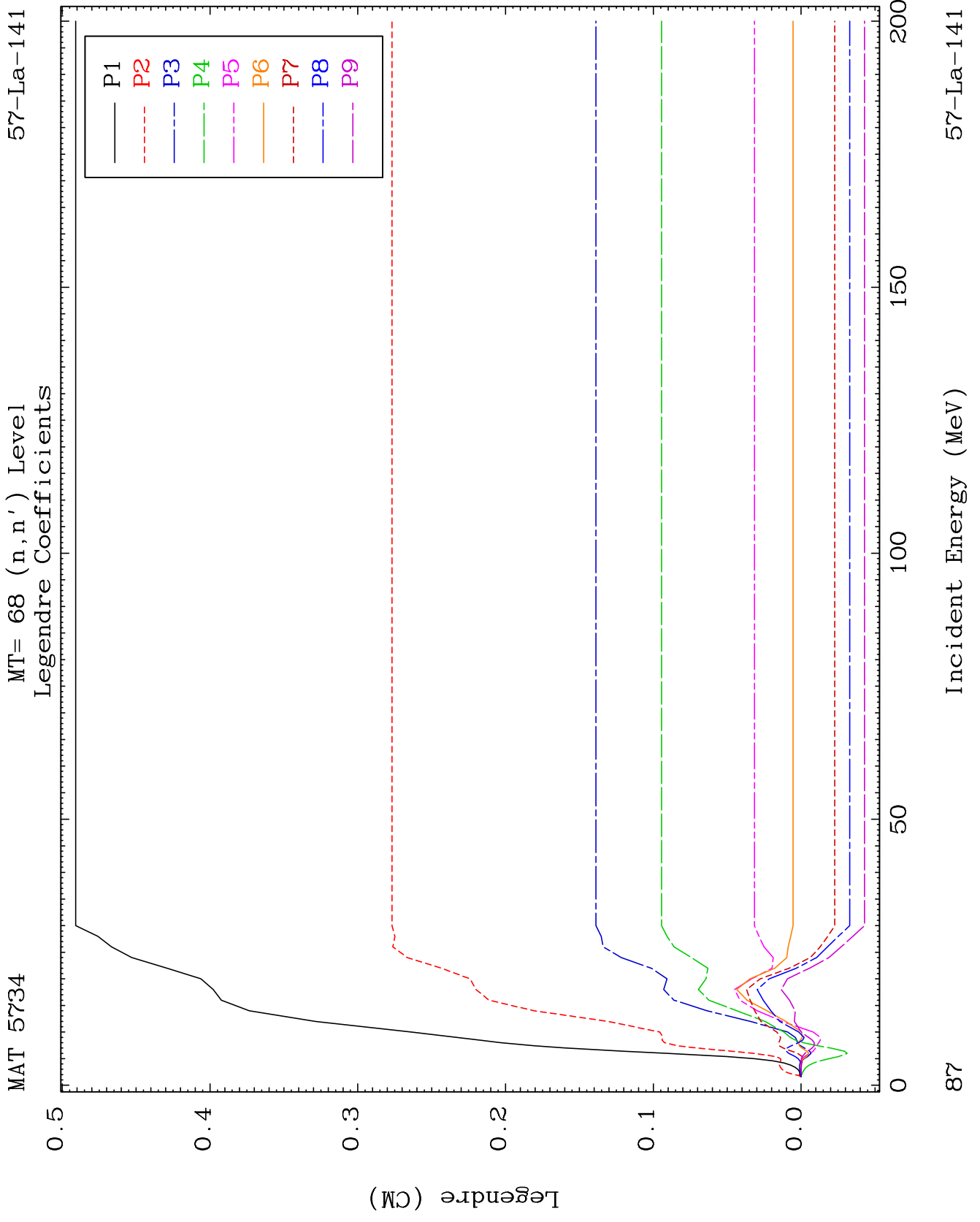

MAT 5734

MT= 68 (n,n') Level
Legendre Coefficients

57-La-141

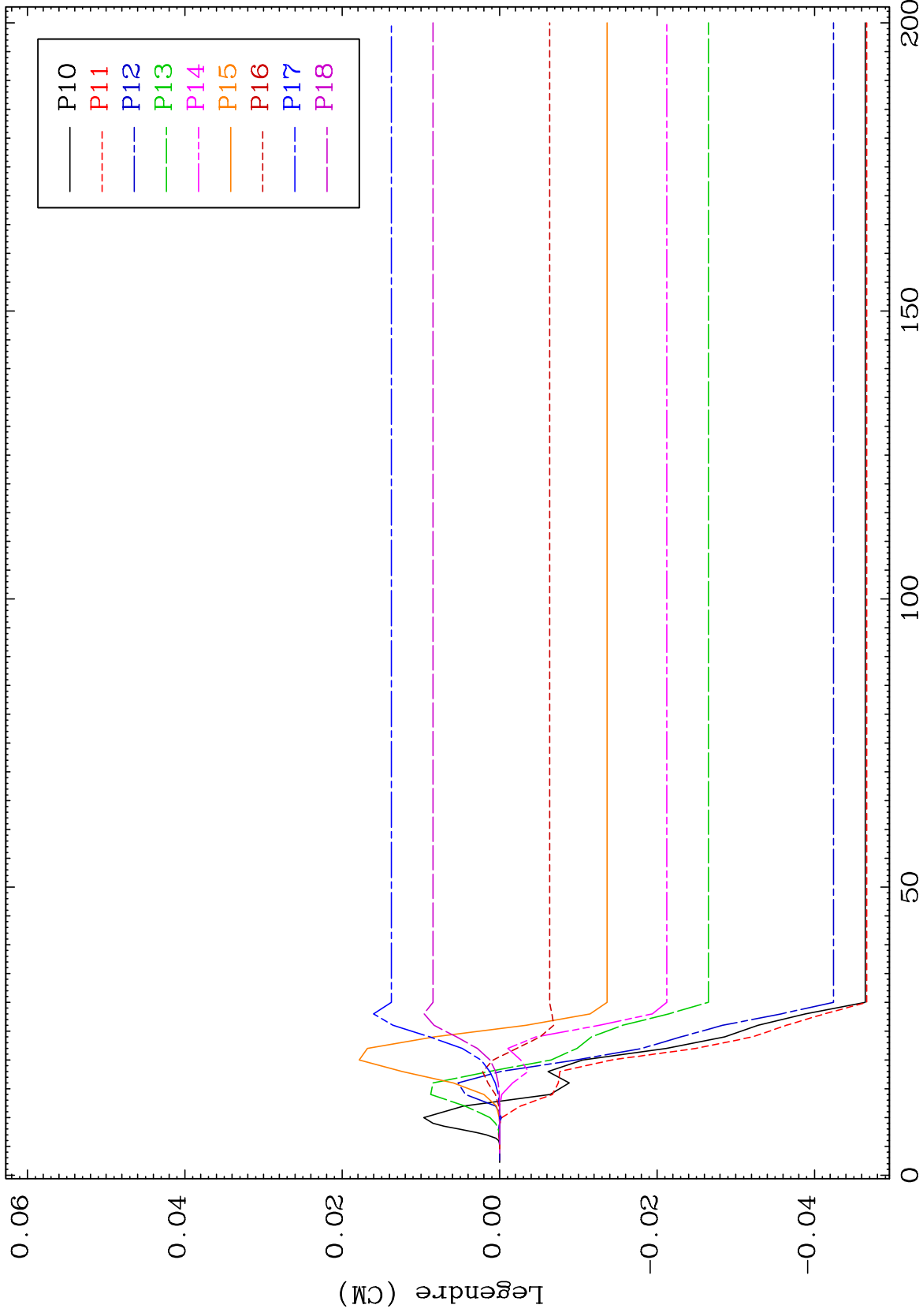

88

Incident Energy (MeV)

57-La-141

MAT 5734

MT= 68 (n,n') Level
Legendre Coefficients

57-La-141

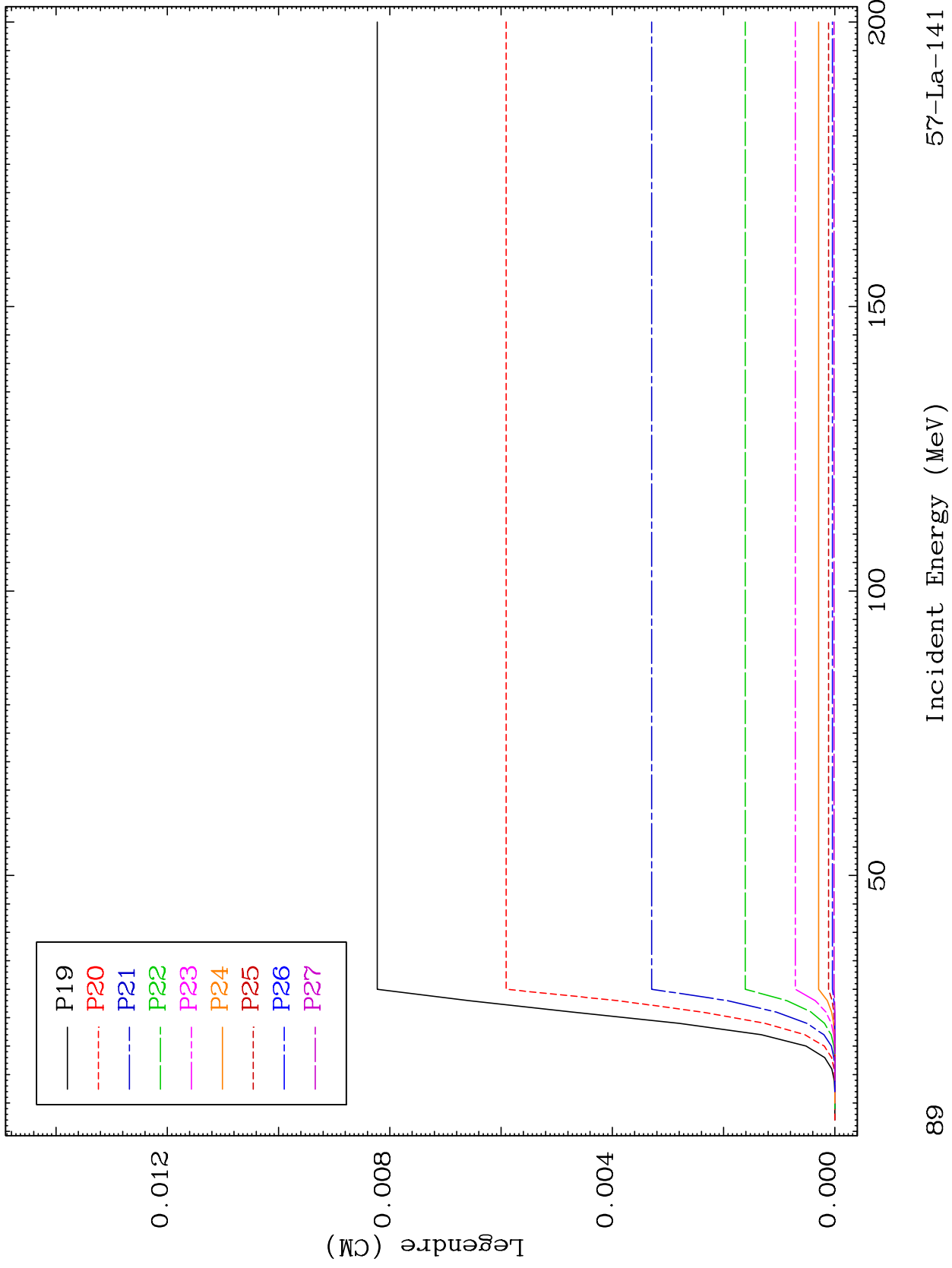

89

57-La-141

MAT 5734

MT= 68 (n,n') Level
Legendre Coefficients

57-La-141

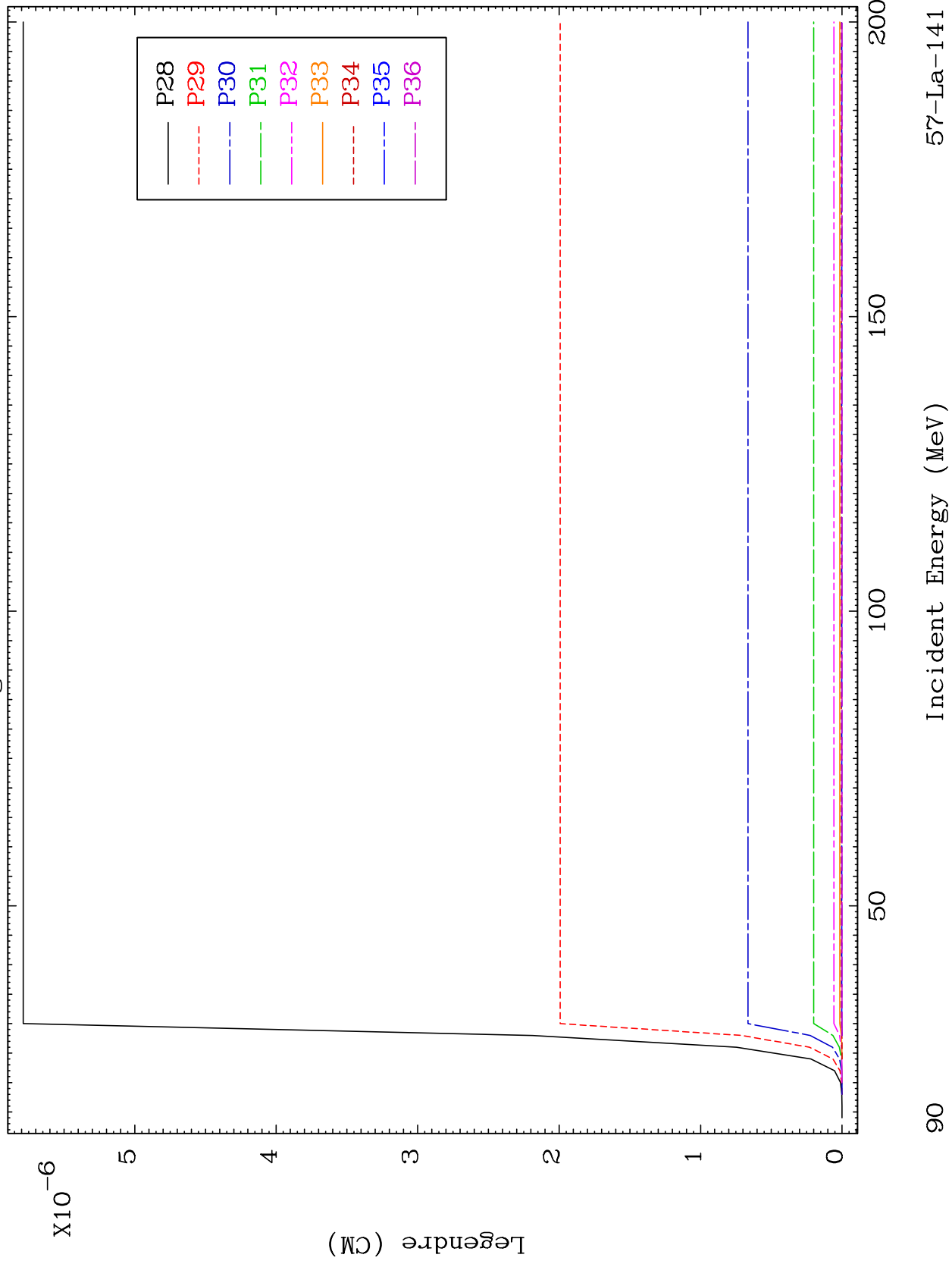

MAT 5734

57-La-141

(n,2n) α

Radionuclide Production Cross Section

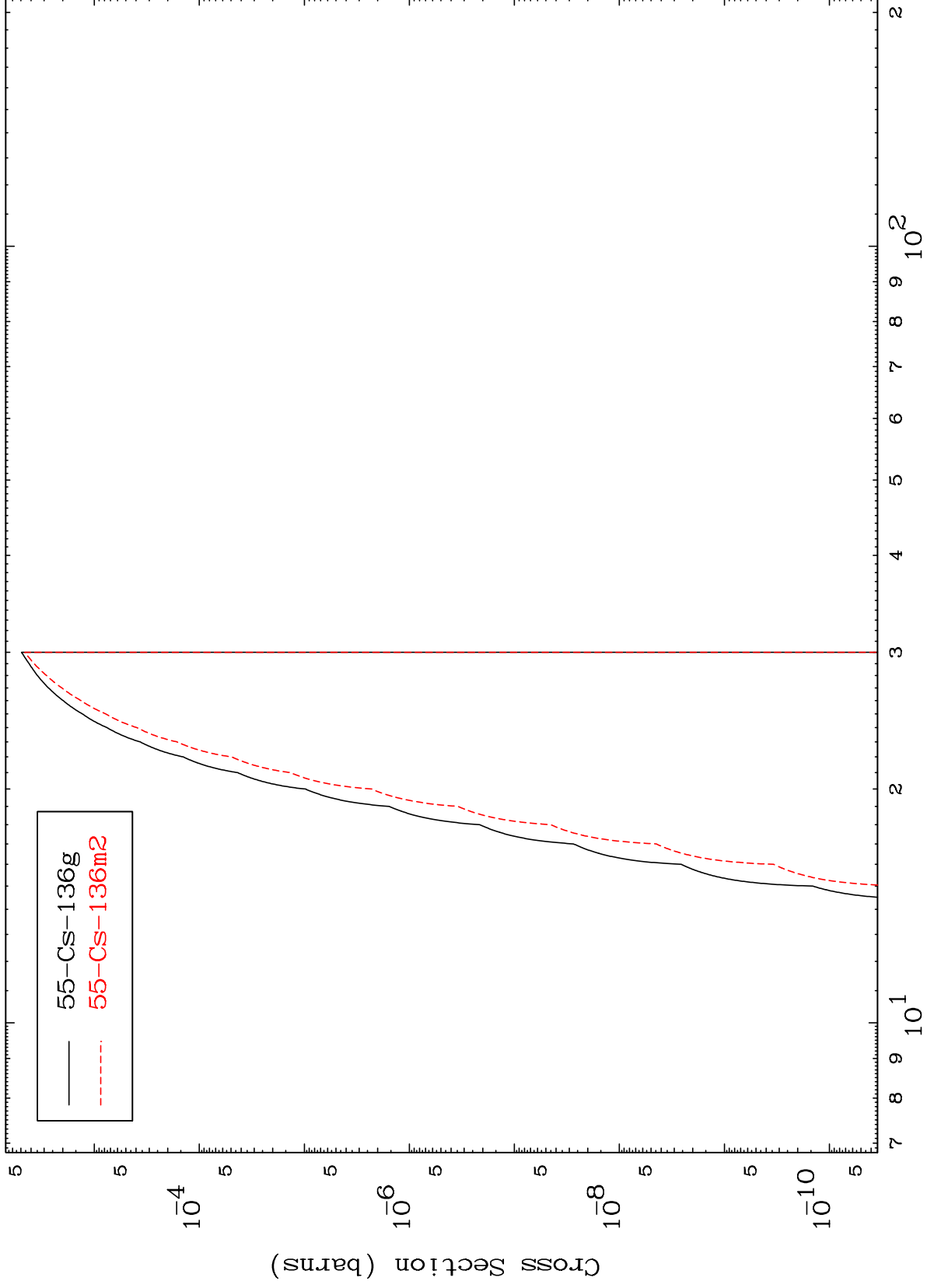

91

Incident Energy (MeV)

57-La-141

MAT 5734

(n,3n) α

57-La-141

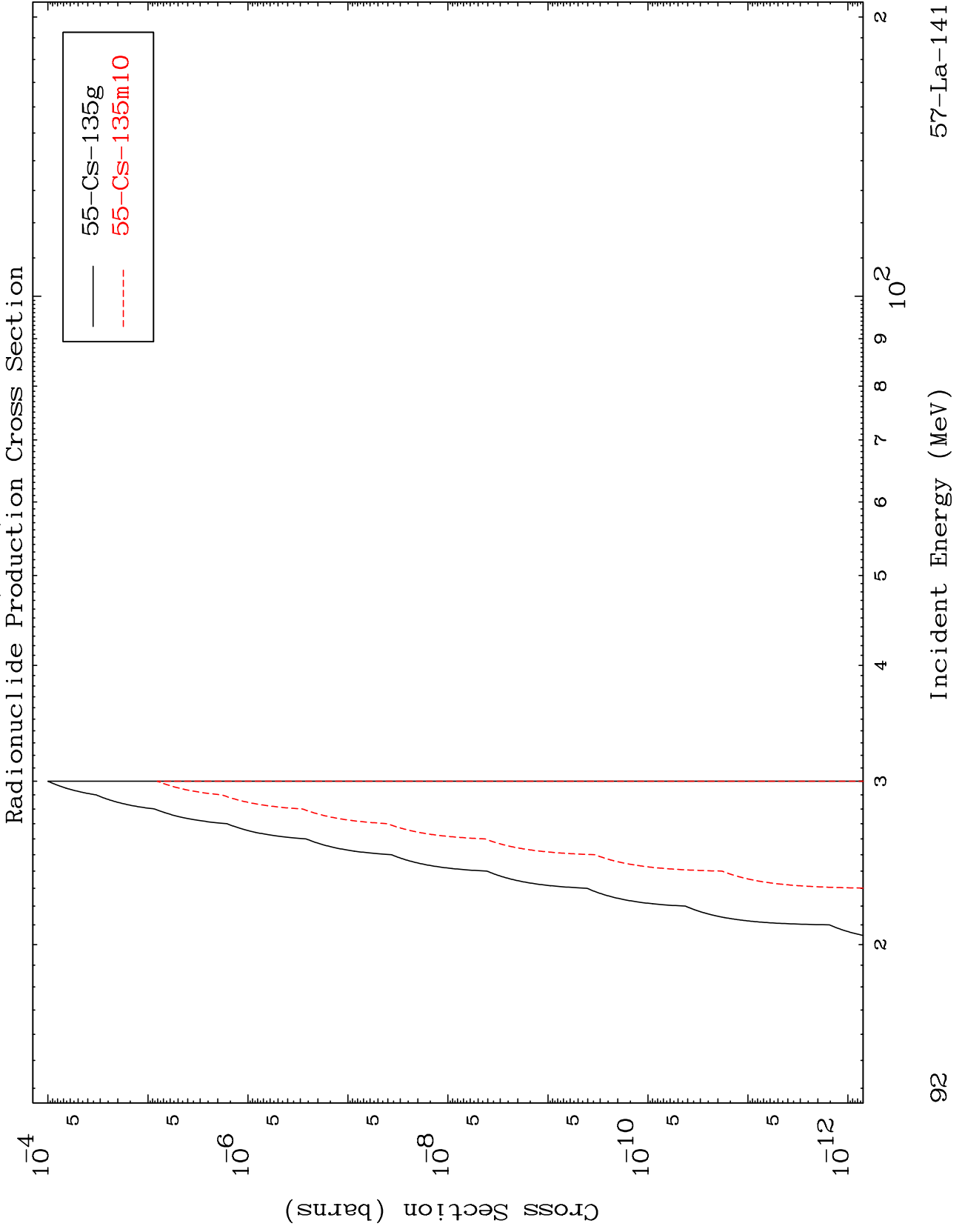

92

57-La-141

MAT 5734

(n,n') 2α

57-La-141

Radionuclide Production Cross Section

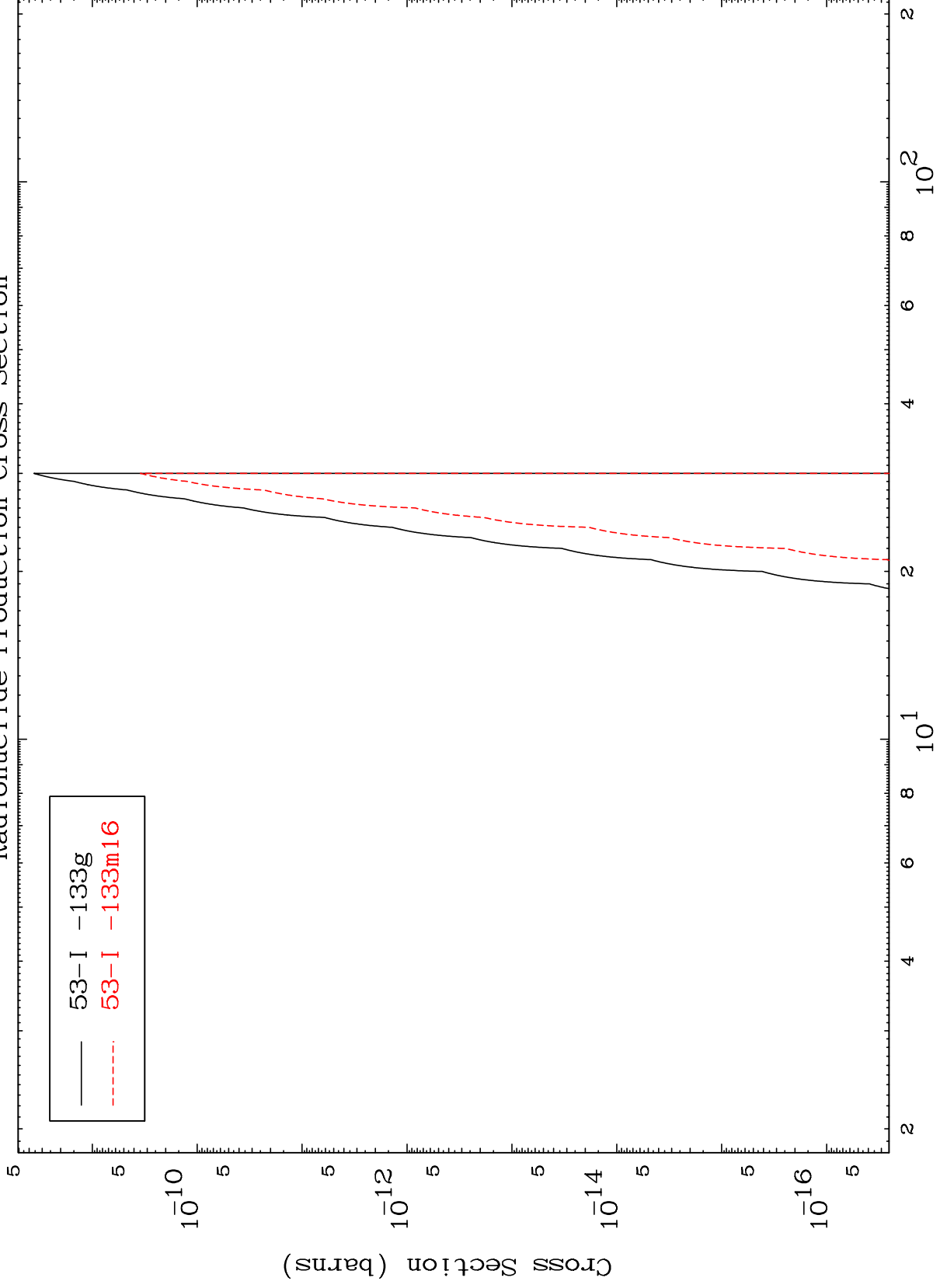

53-I -133g
53-I -133m16

93

Incident Energy (MeV)

57-La-141

MAT 5734

(n,n') He-3

57-La-141

Radionuclide Production Cross Section

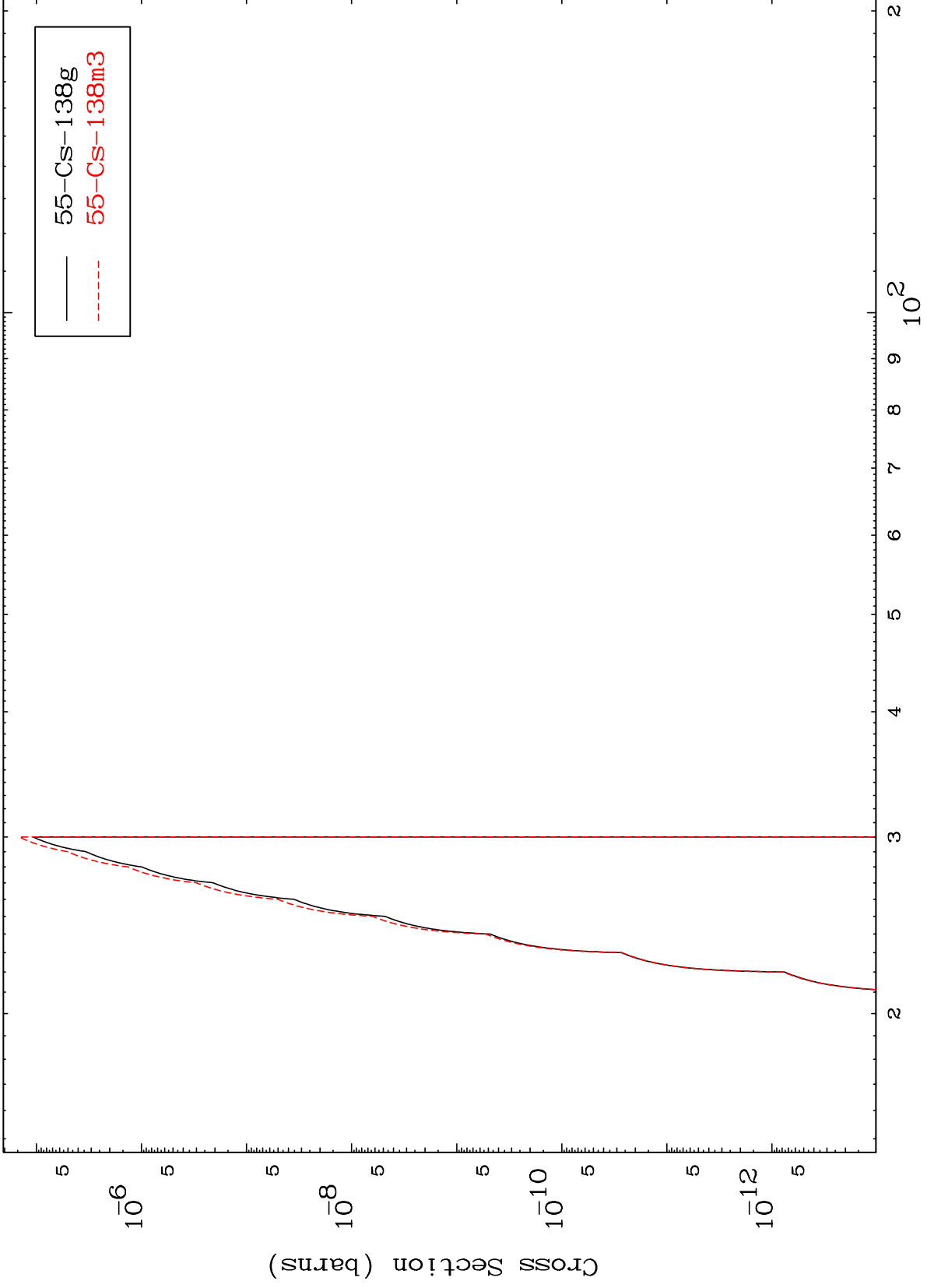

94

Incident Energy (MeV)

57-La-141

MAT 5734

57-La-141

Radionuclide Production Cross Section

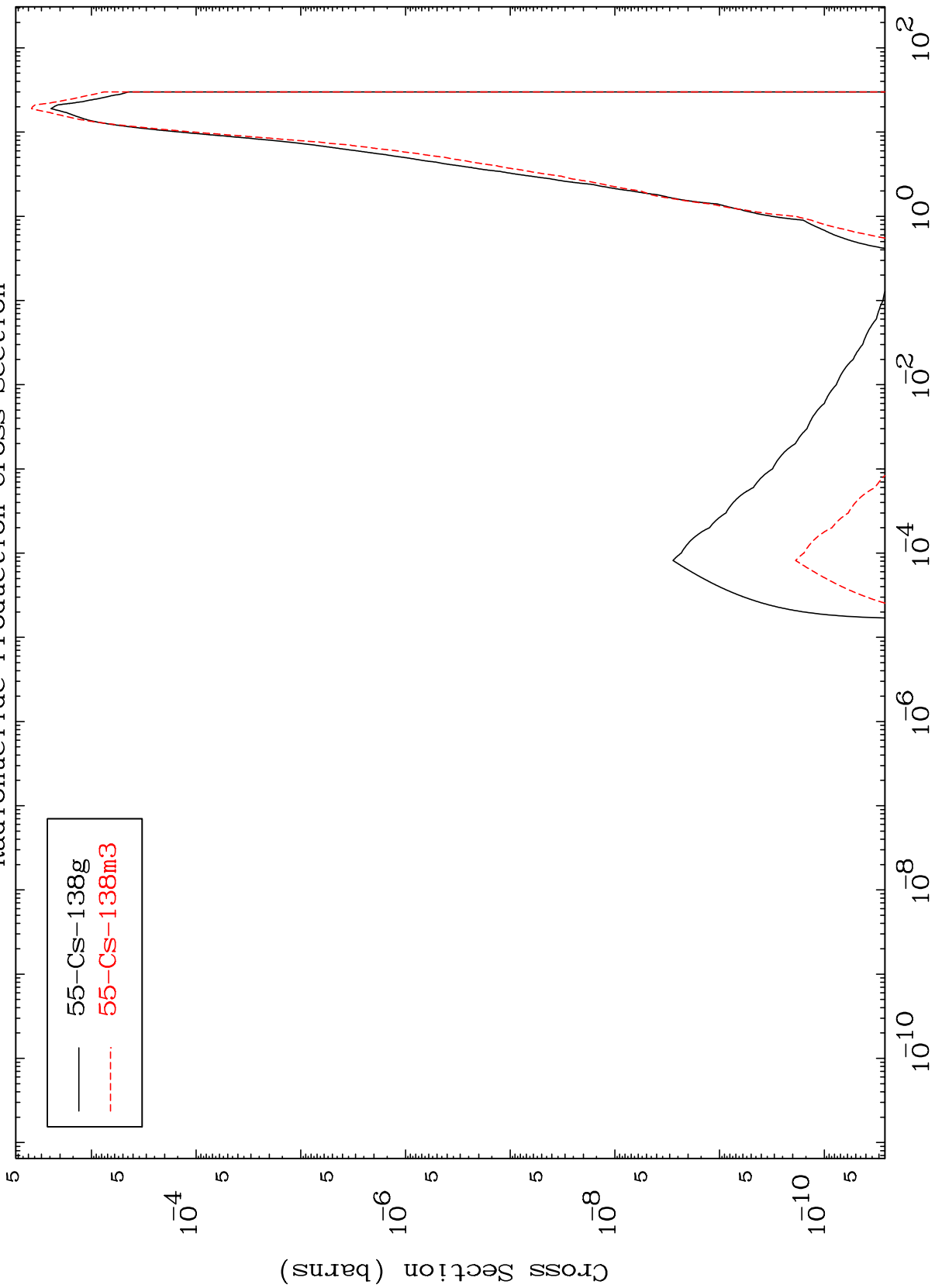

95

57-La-141

MAT 5734

(n,2α)

57-La-141

Radionuclide Production Cross Section

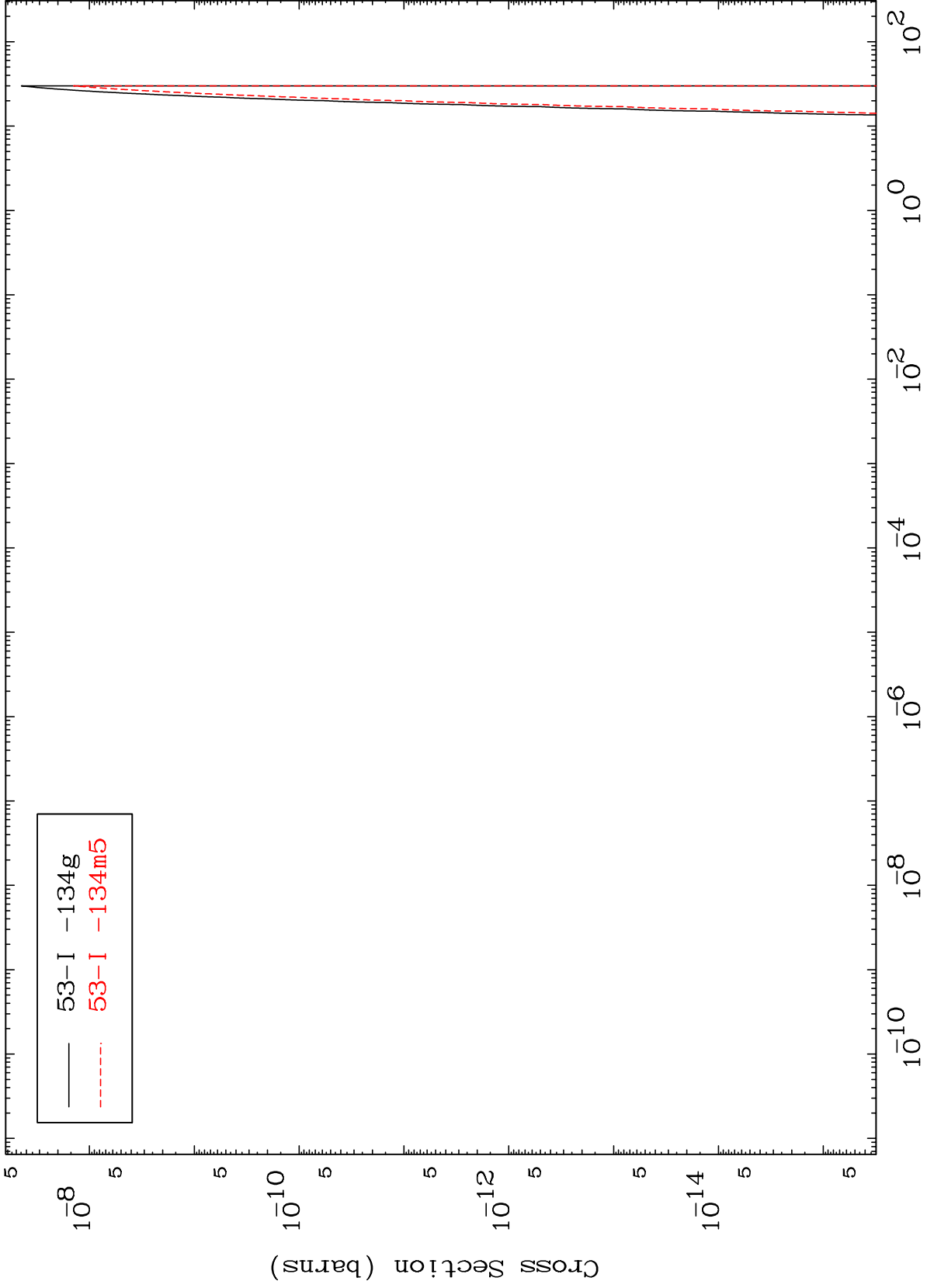

53-I-134g
53-I-134m5

MAT 5734

(n,p) t

57-La-141

Radionuclide Production Cross Section

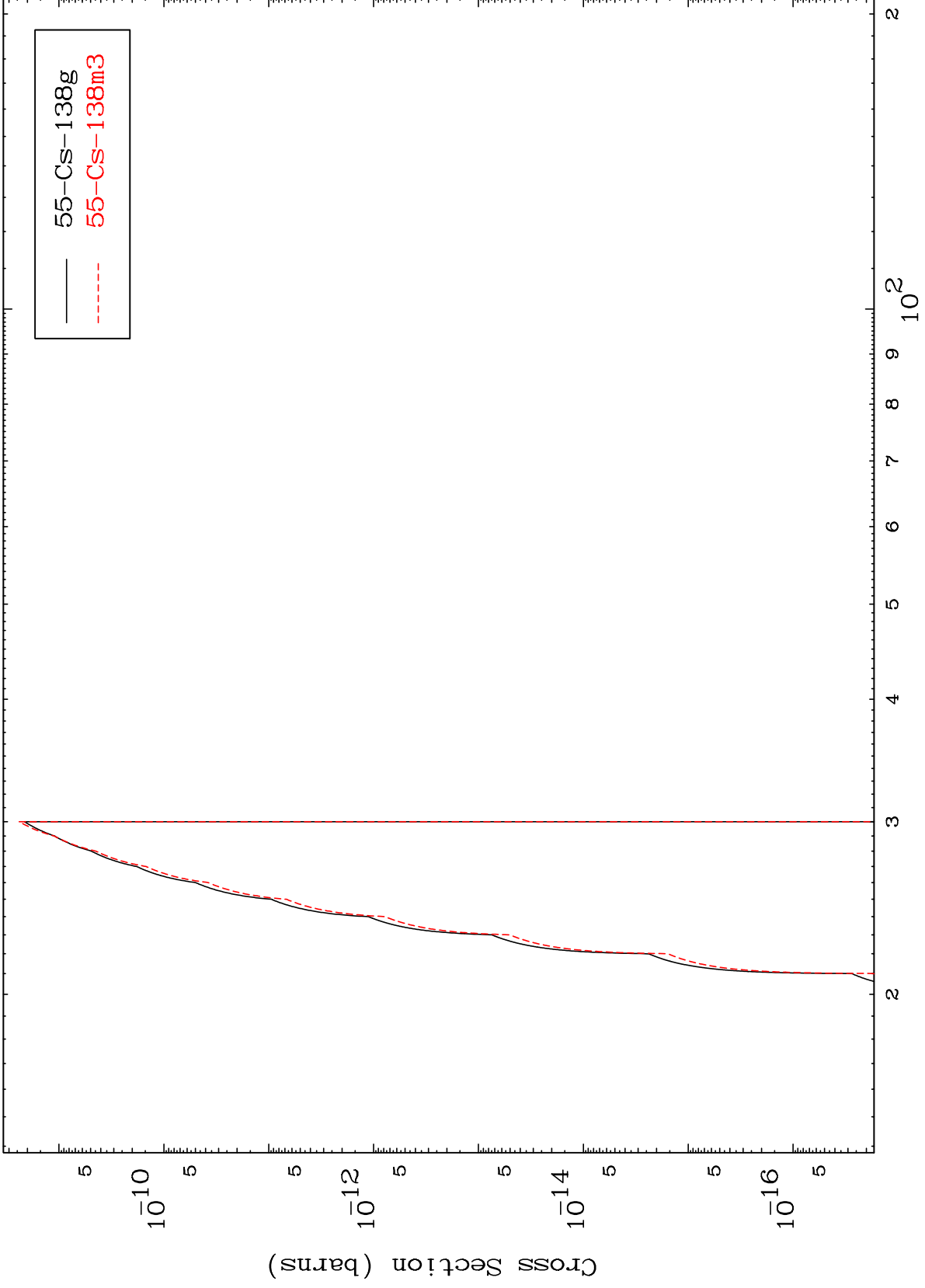

97

Incident Energy (MeV)

57-La-141