

LU154 NEUTRON ACER TENDL-2023 LIBRARY; T=0.K
Principal cross sections

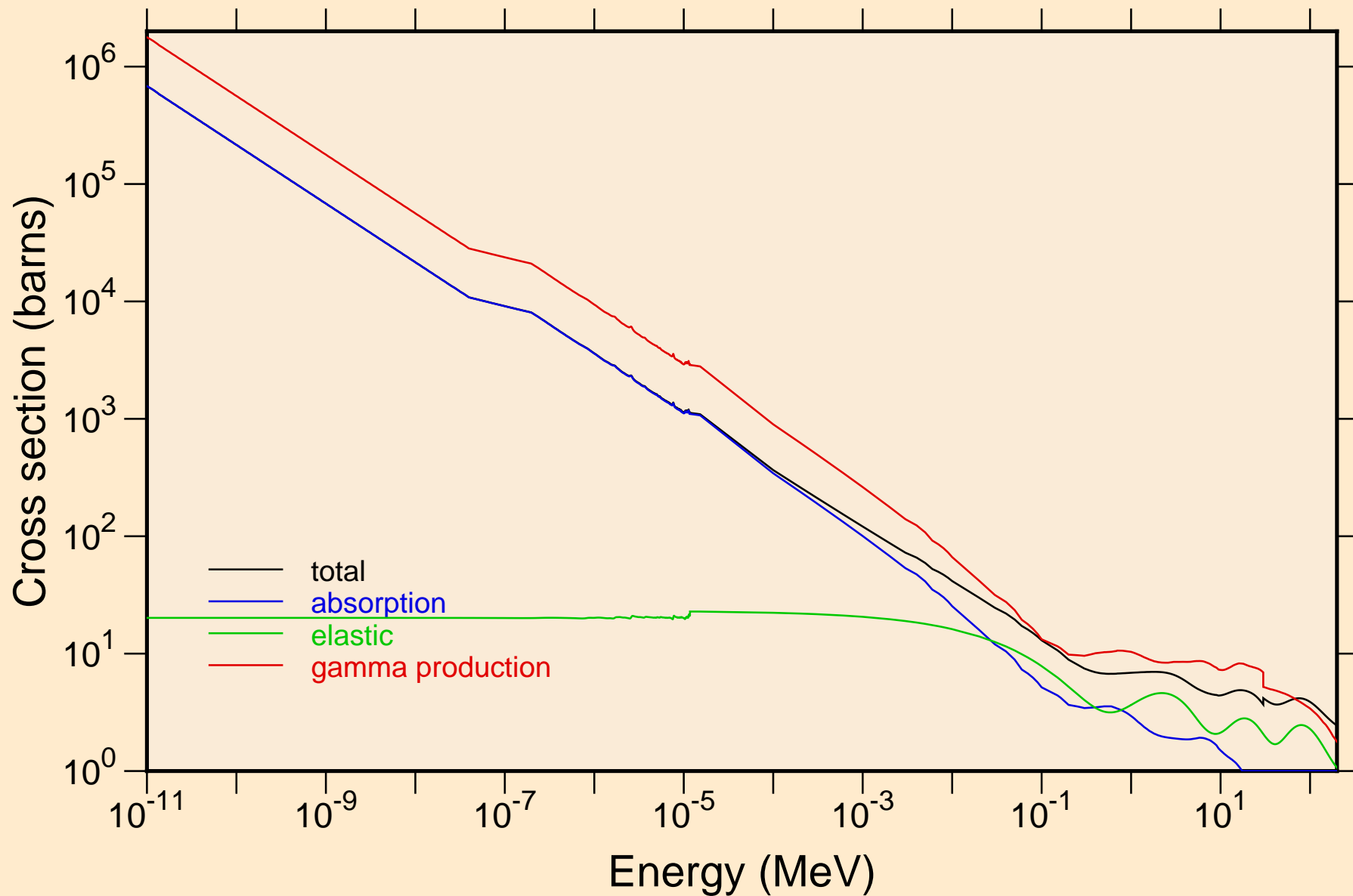

LU154 NEUTRON ACER TENDL-2023 LIBRARY; T=0.K
resonance total cross section

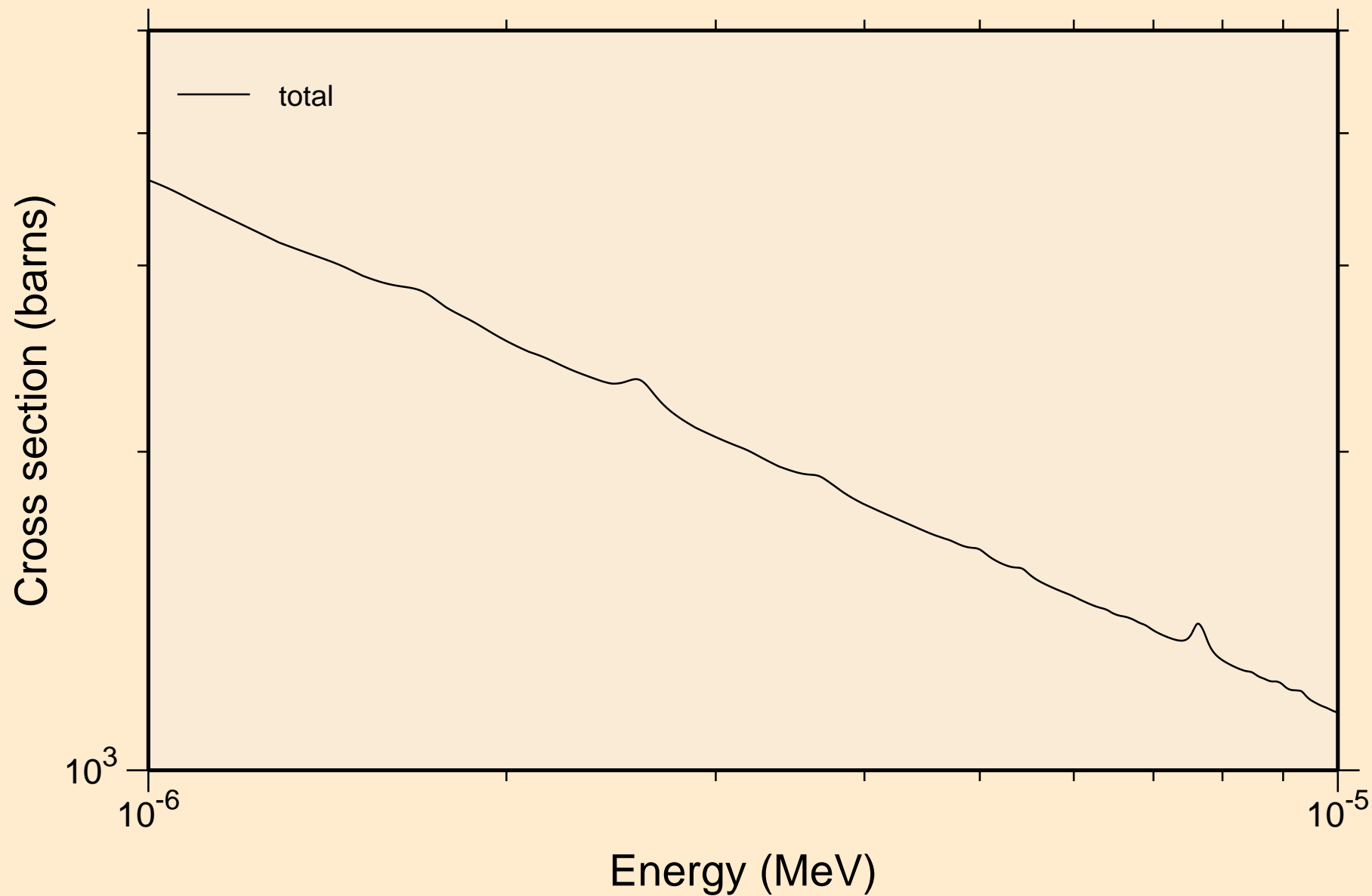

LU154 NEUTRON ACER TENDL-2023 LIBRARY; T=0.K
resonance total cross section

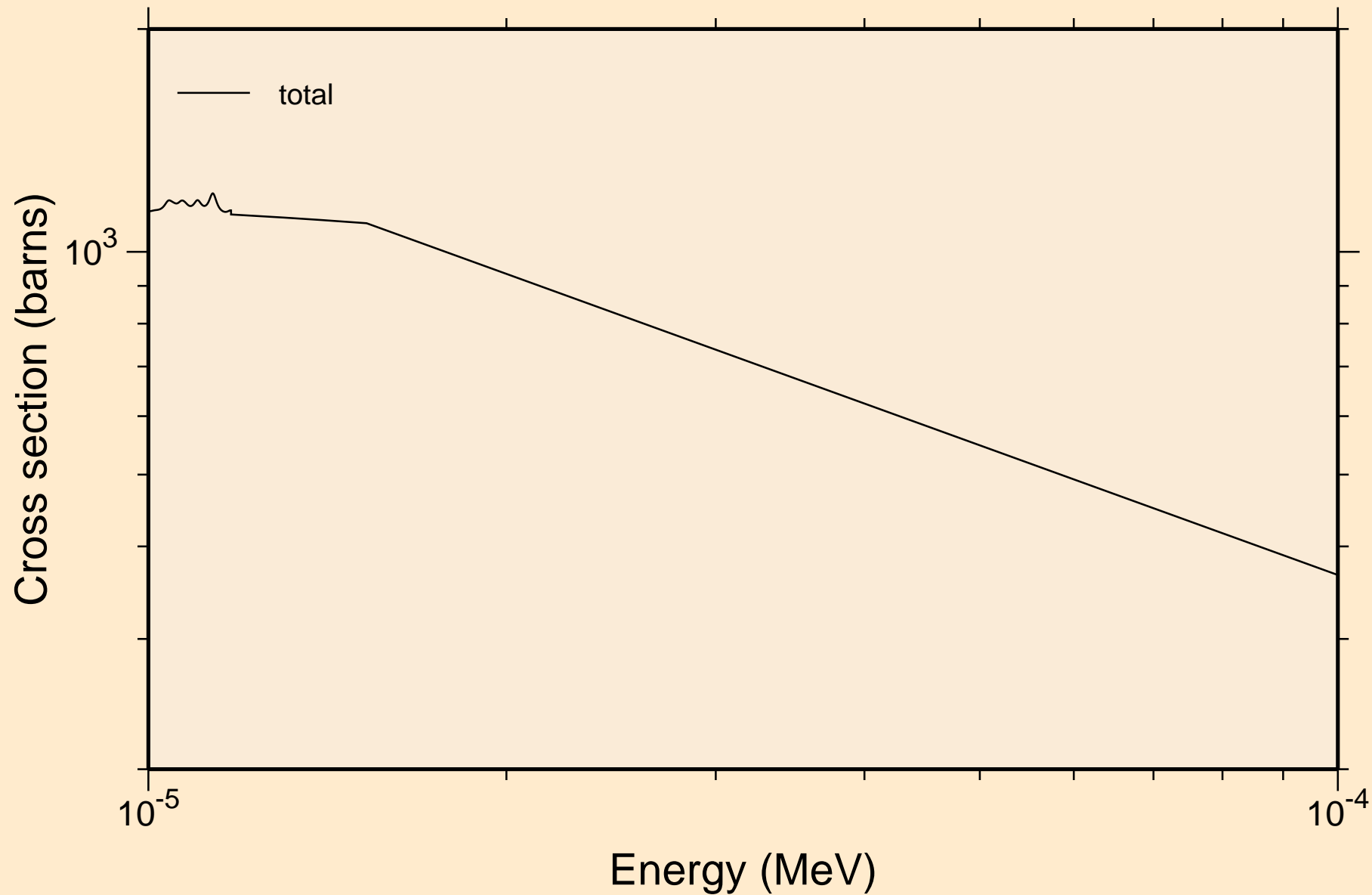

L \bar{U} 154 NEUTRON ACER TENDL-2023 LIBRARY; T=0.K
resonance total cross section

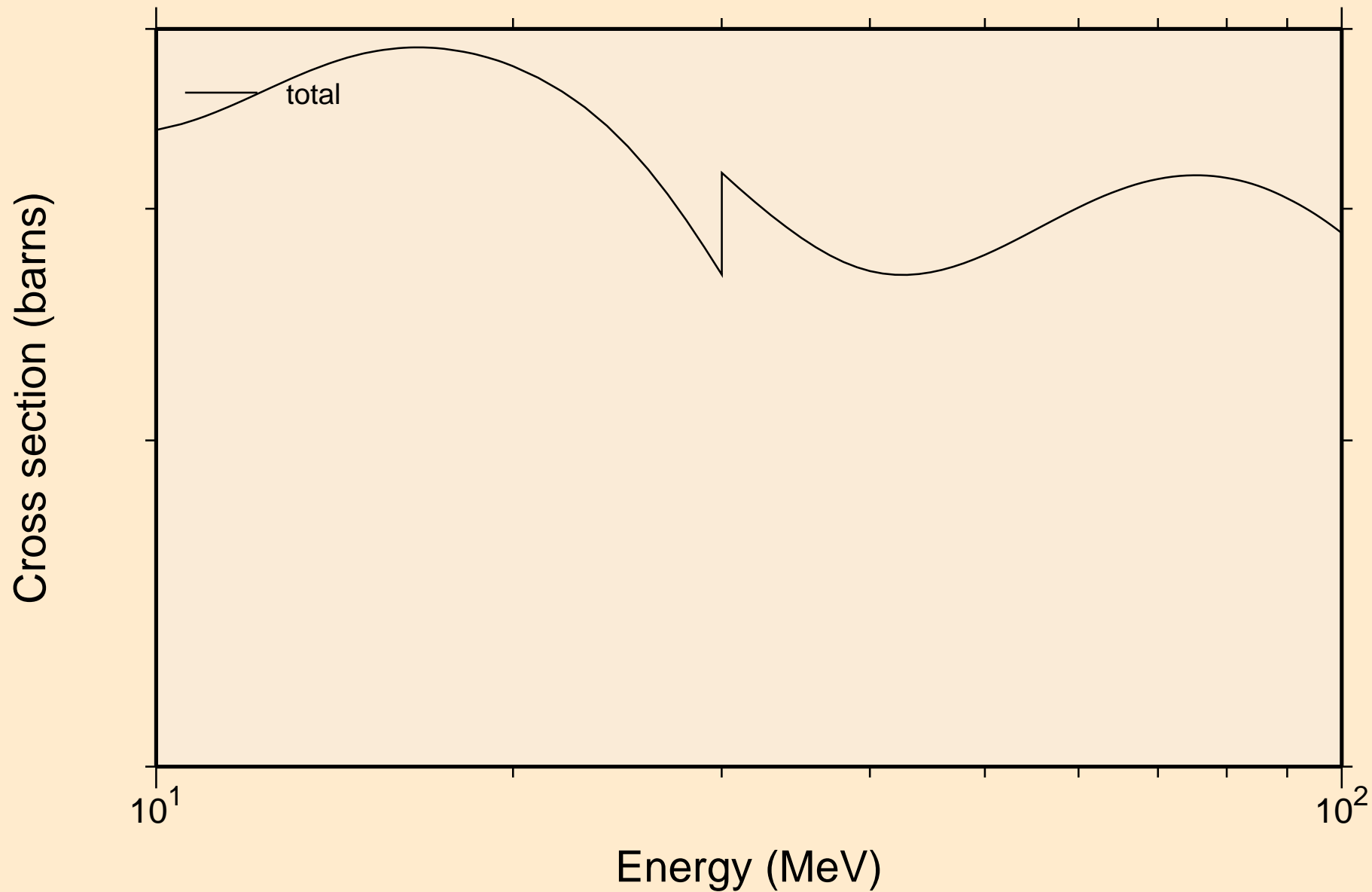

LU154 NEUTRON ACER TENDL-2023 LIBRARY; T=0.K
resonance absorption cross sections

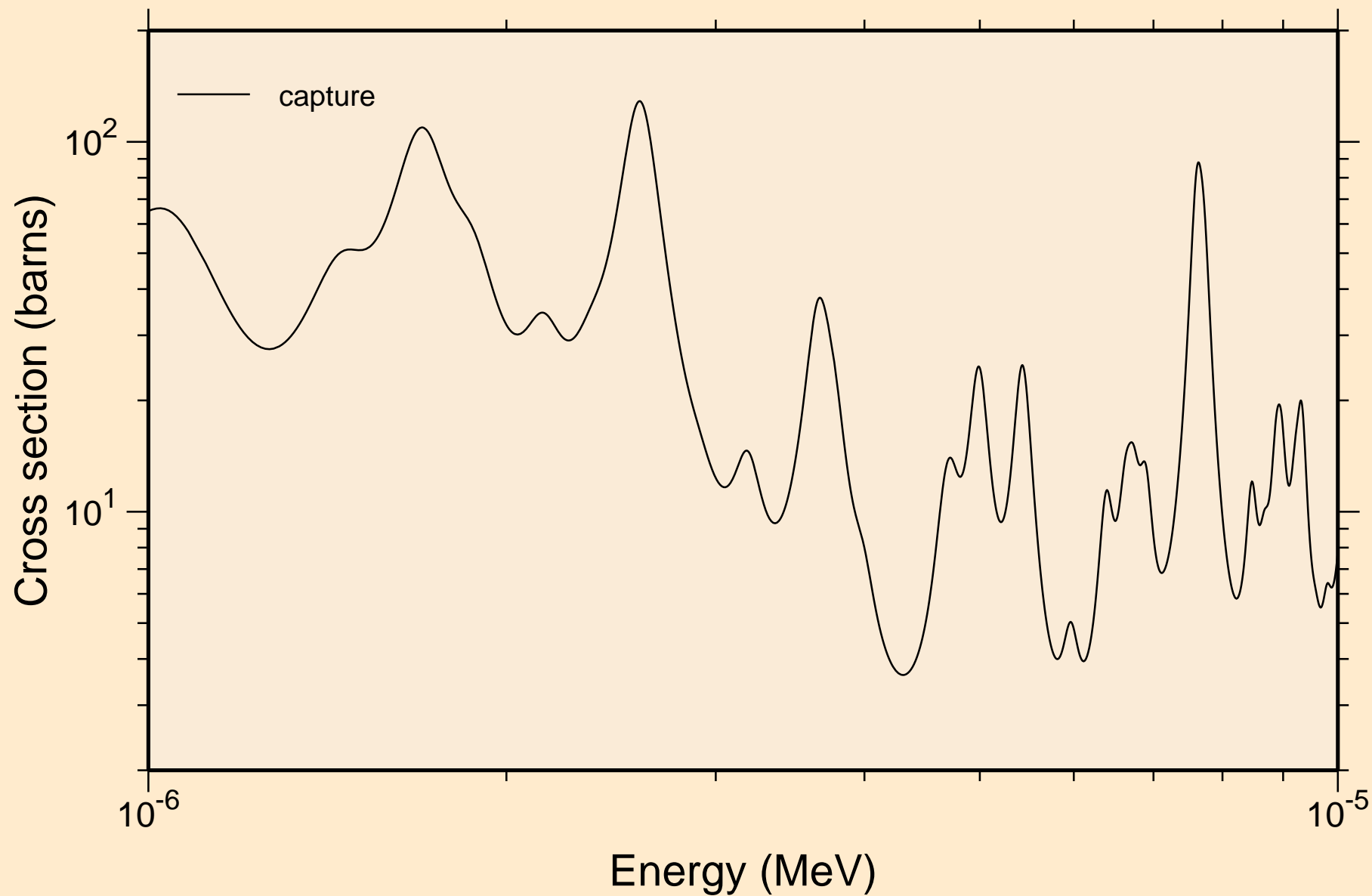

LU154 NEUTRON ACER TENDL-2023 LIBRARY; T=0.K
resonance absorption cross sections

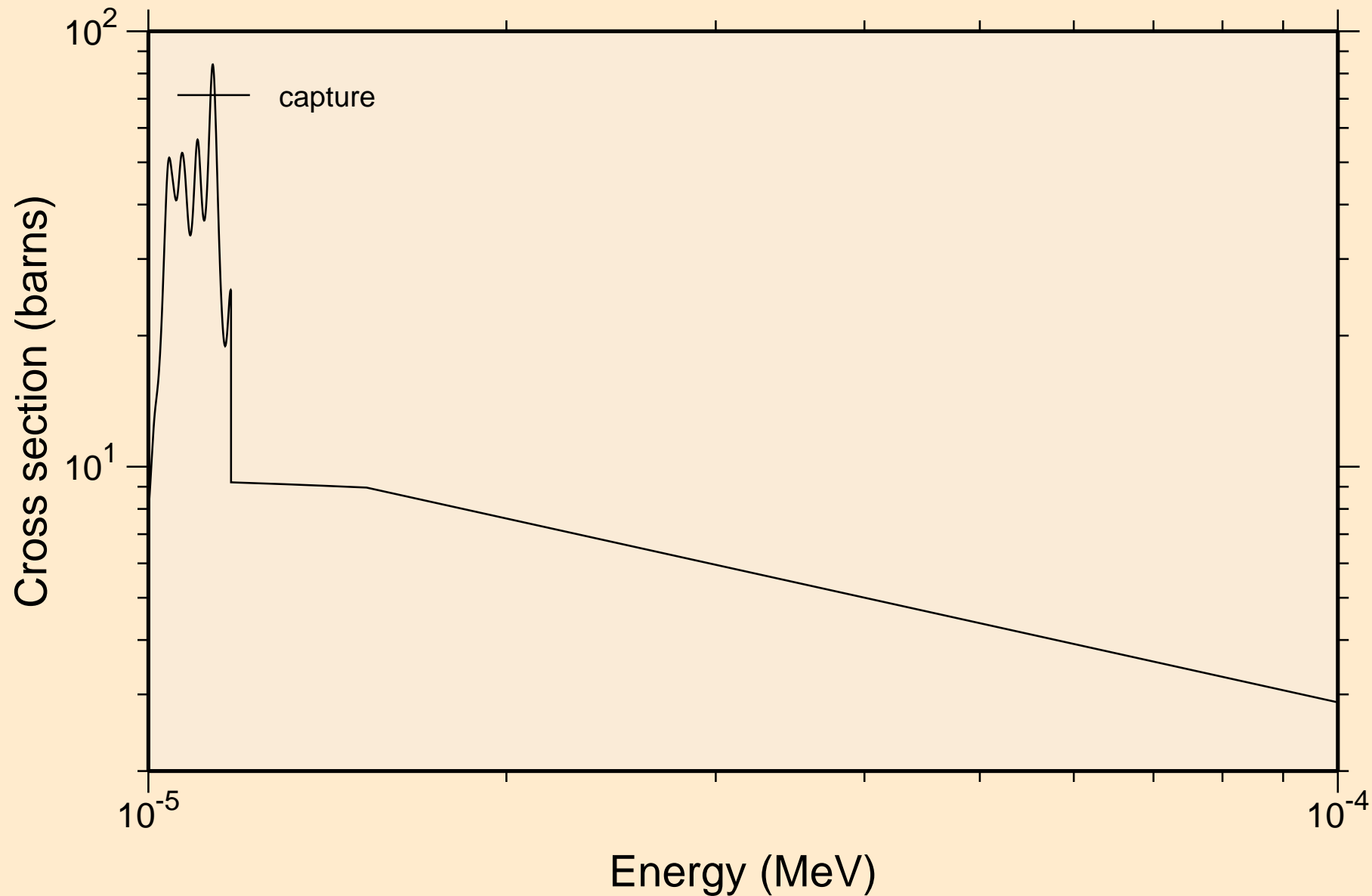

LU154 NEUTRON ACER TENDL-2023 LIBRARY; T=0.K
resonance absorption cross sections

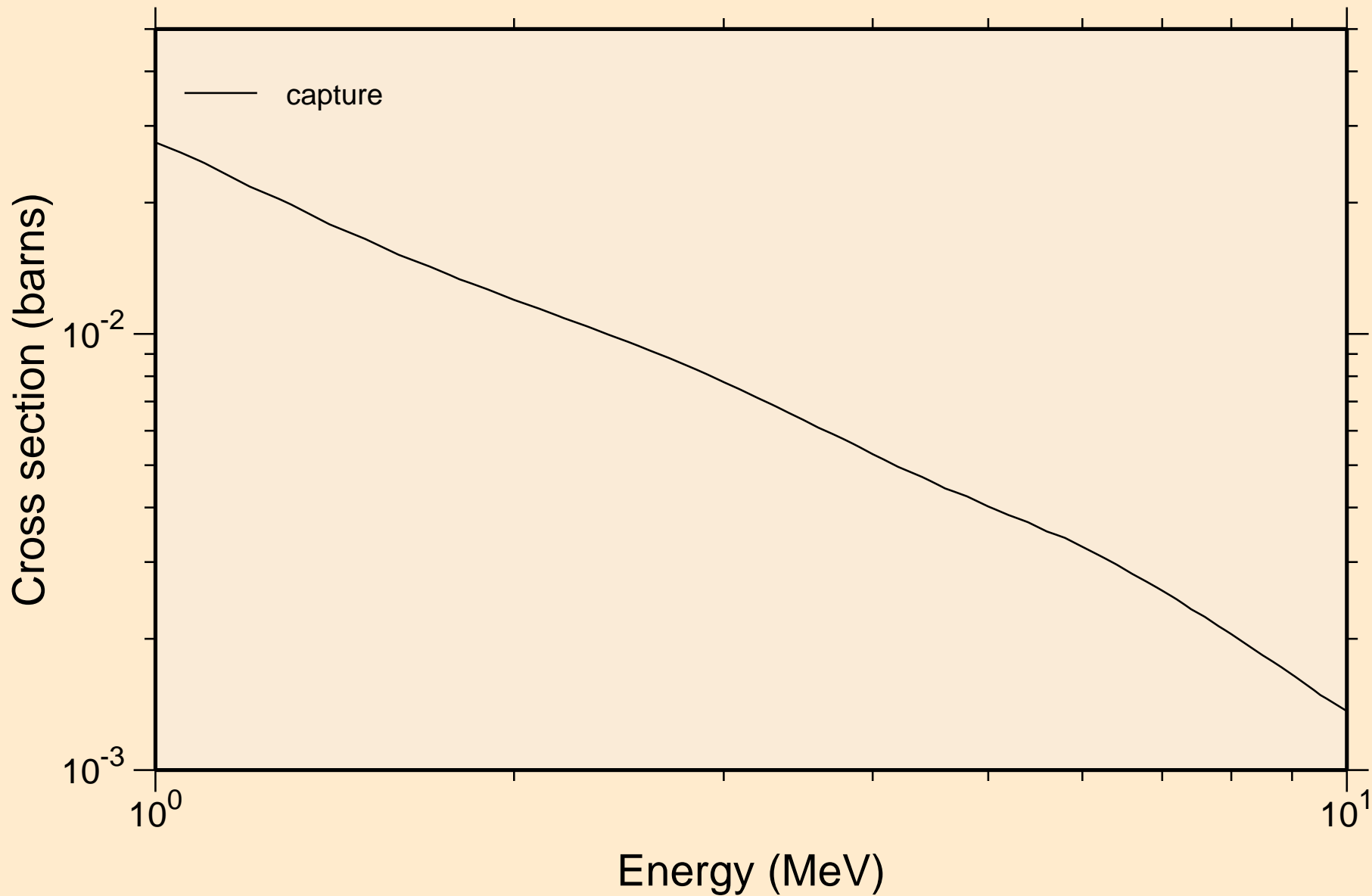

LU154 NEUTRON ACER TENDL-2023 LIBRARY; T=0.K
Heating

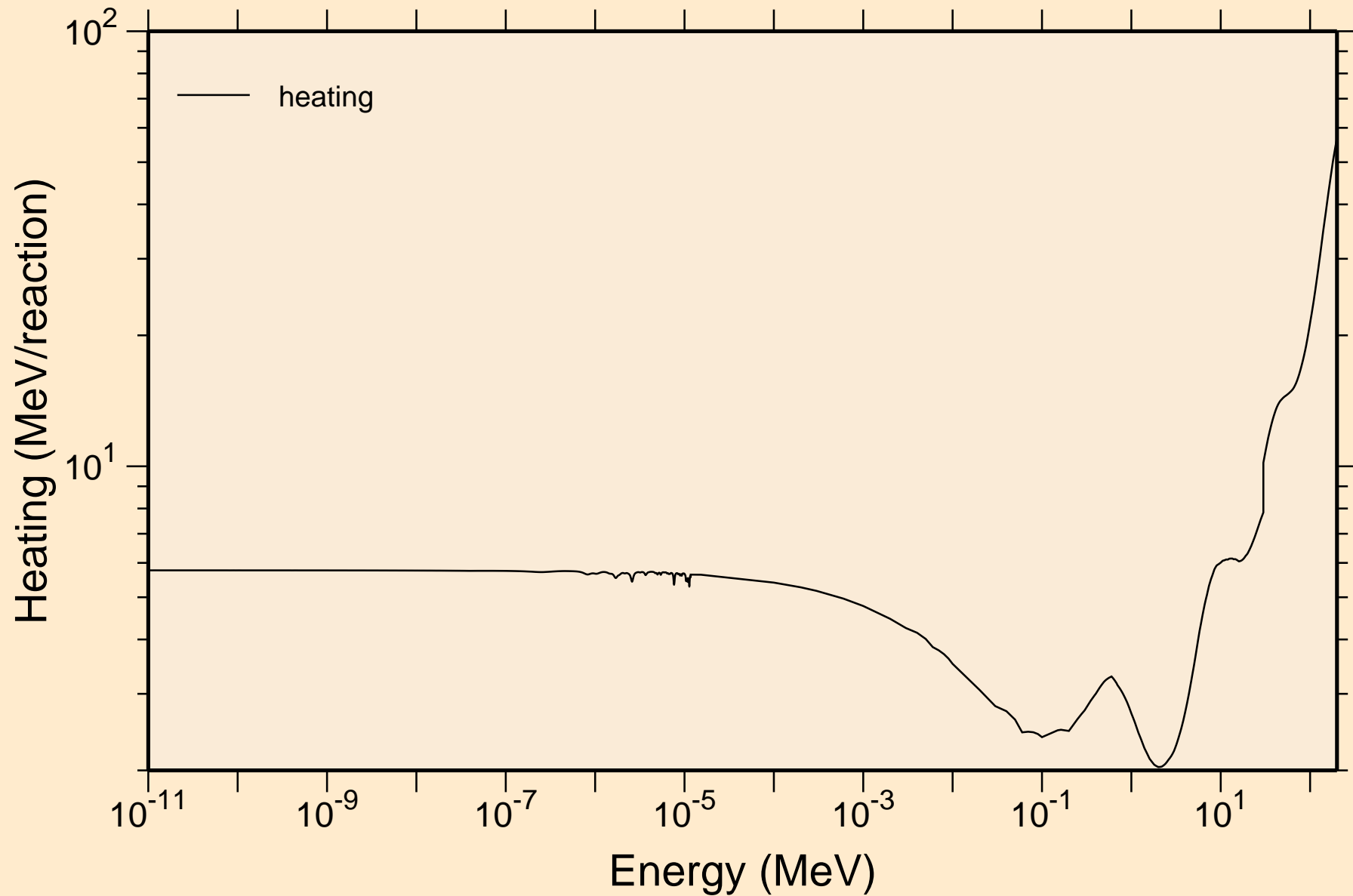

LU154 NEUTRON ACER TENDL-2023 LIBRARY; T=0.K

Damage

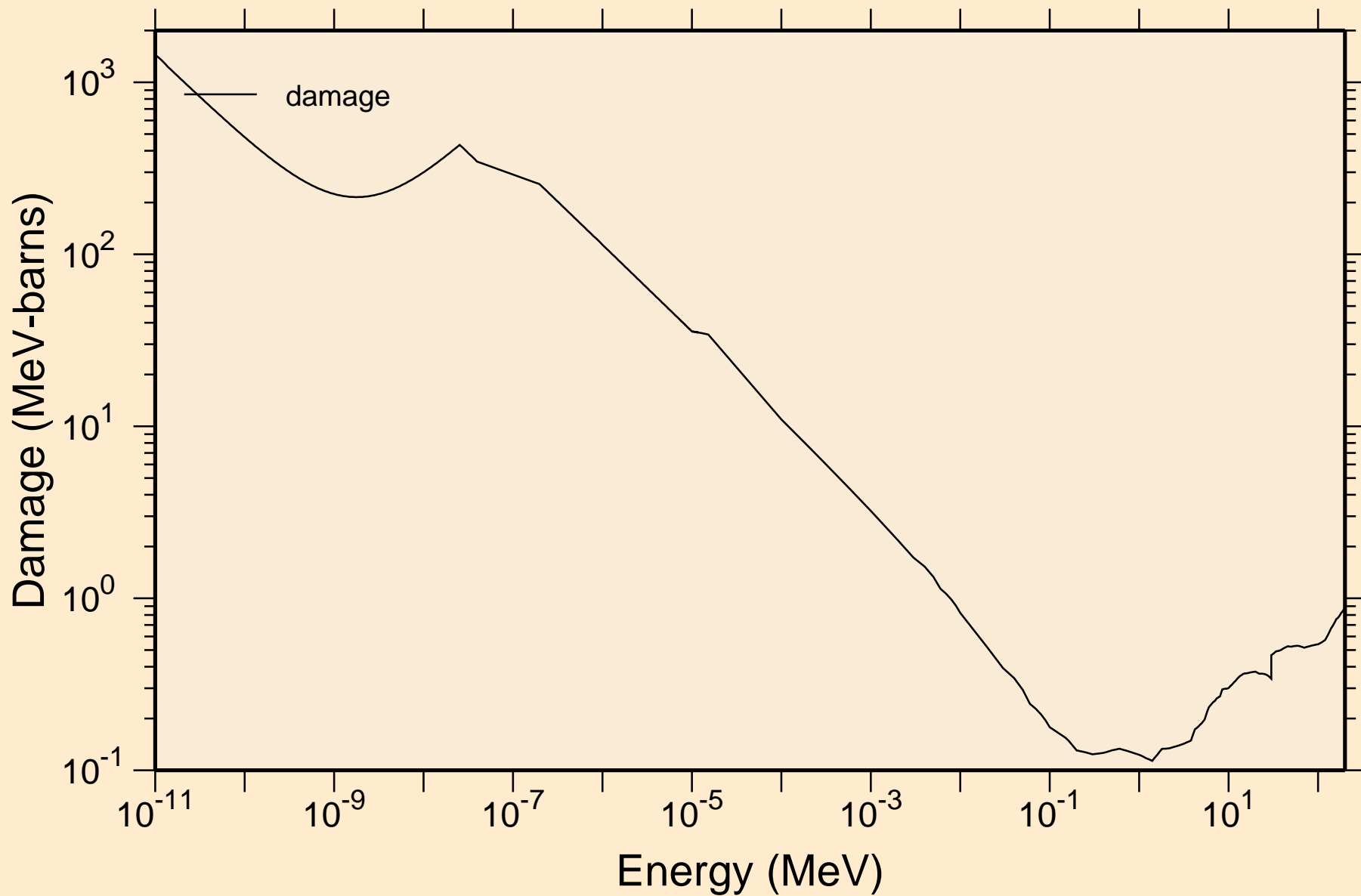

LU154 NEUTRON ACER TENDL-2023 LIBRARY; T=0.K
Non-threshold reactions

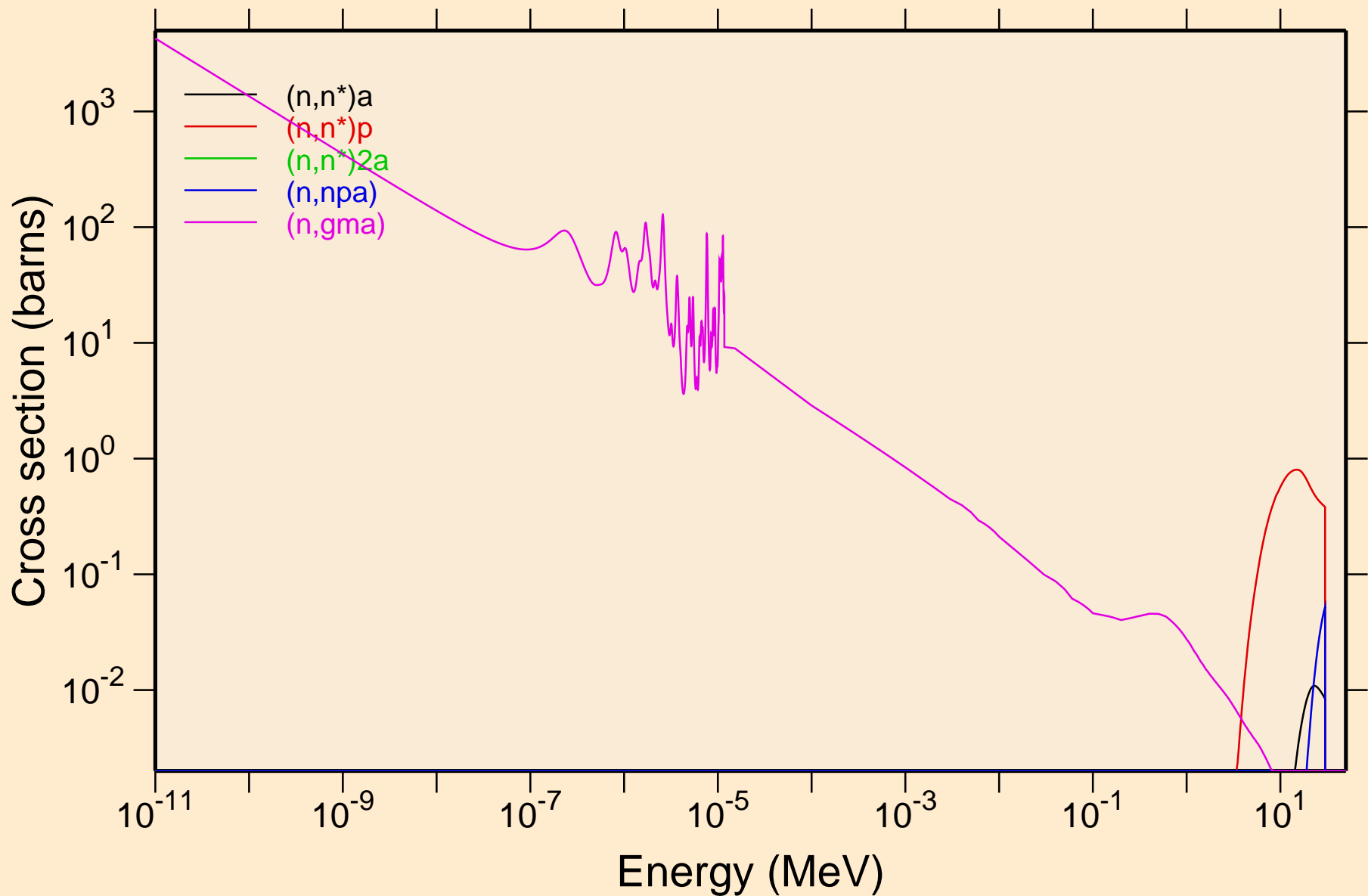

LU154 NEUTRON ACER TENDL-2023 LIBRARY; T=0.K
Non-threshold reactions

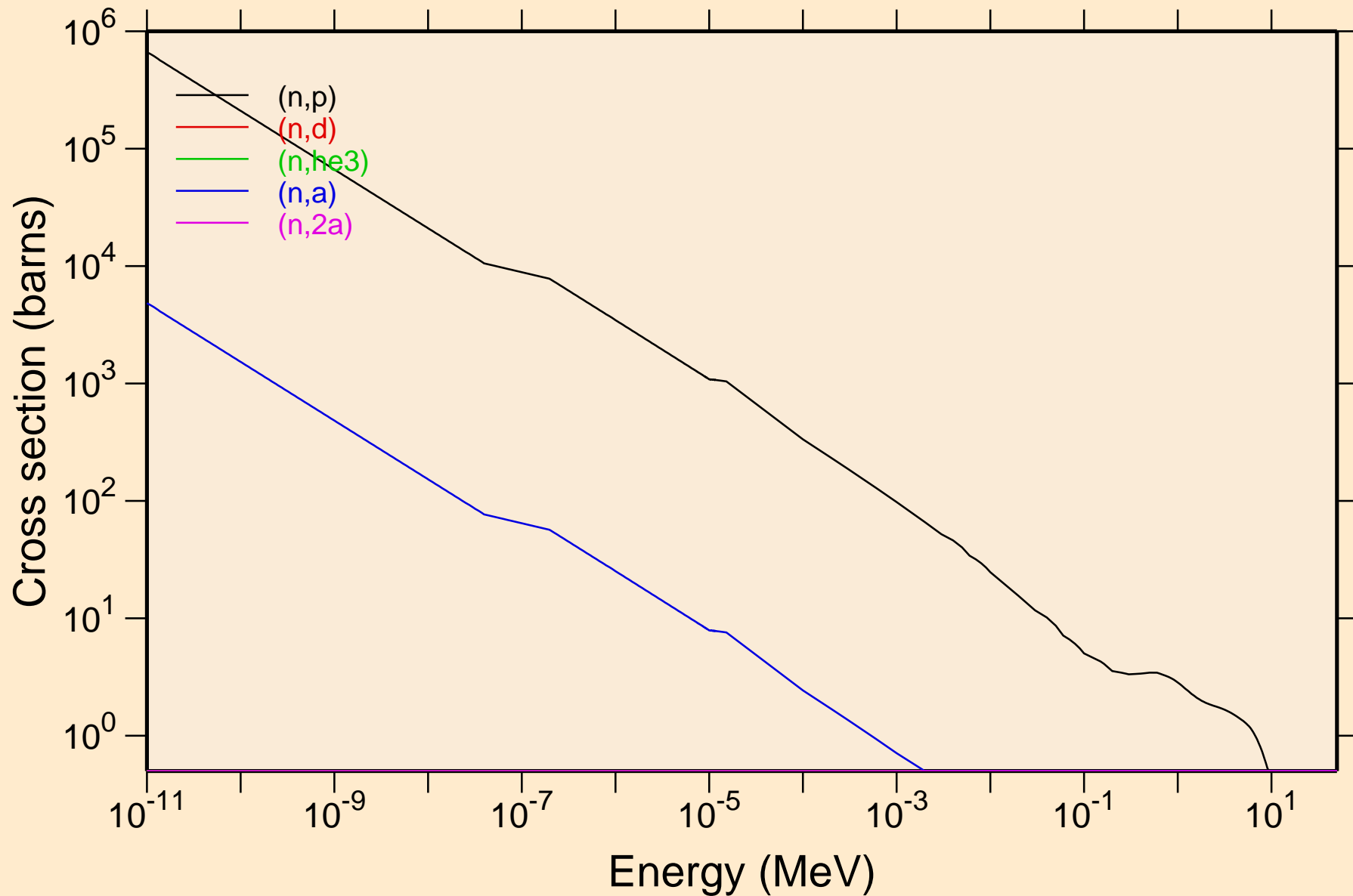

LU154 NEUTRON ACER TENDL-2023 LIBRARY; T=0.K
Non-threshold reactions

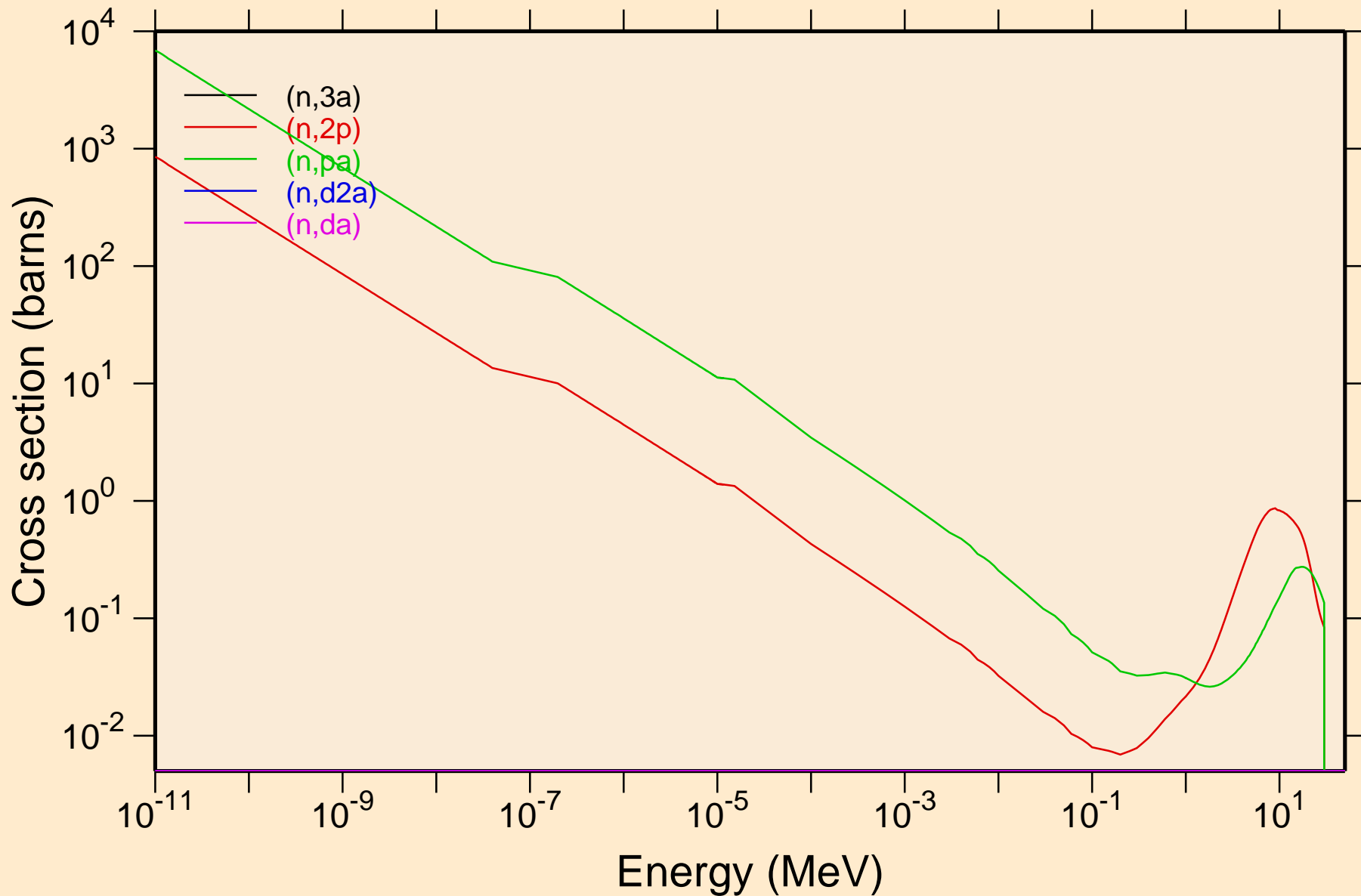

LU154 NEUTRON ACER TENDL-2023 LIBRARY; T=0.K
Non-threshold reactions

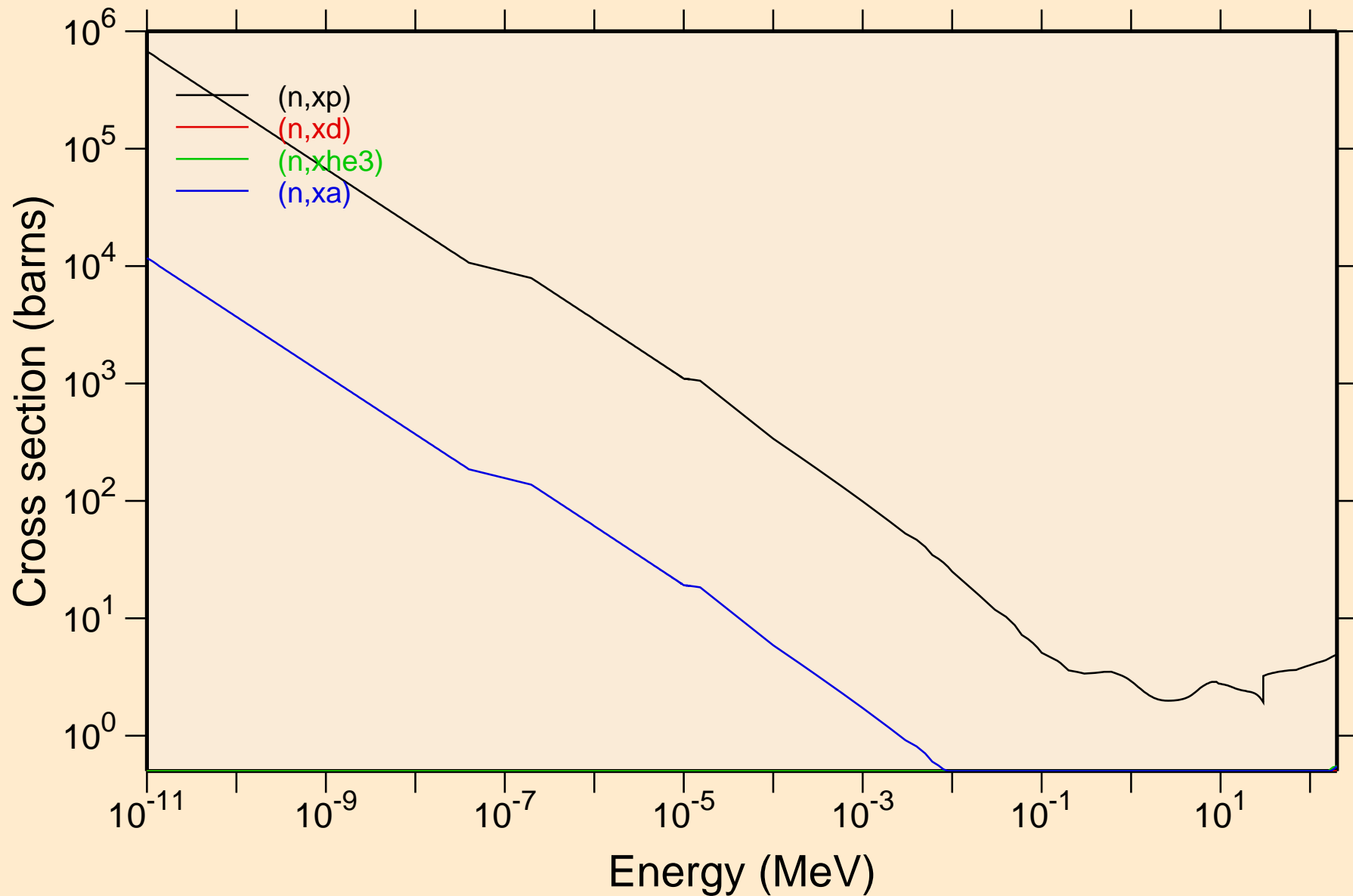

LU154 NEUTRON ACER TENDL-2023 LIBRARY; T=0.K
Principal cross sections

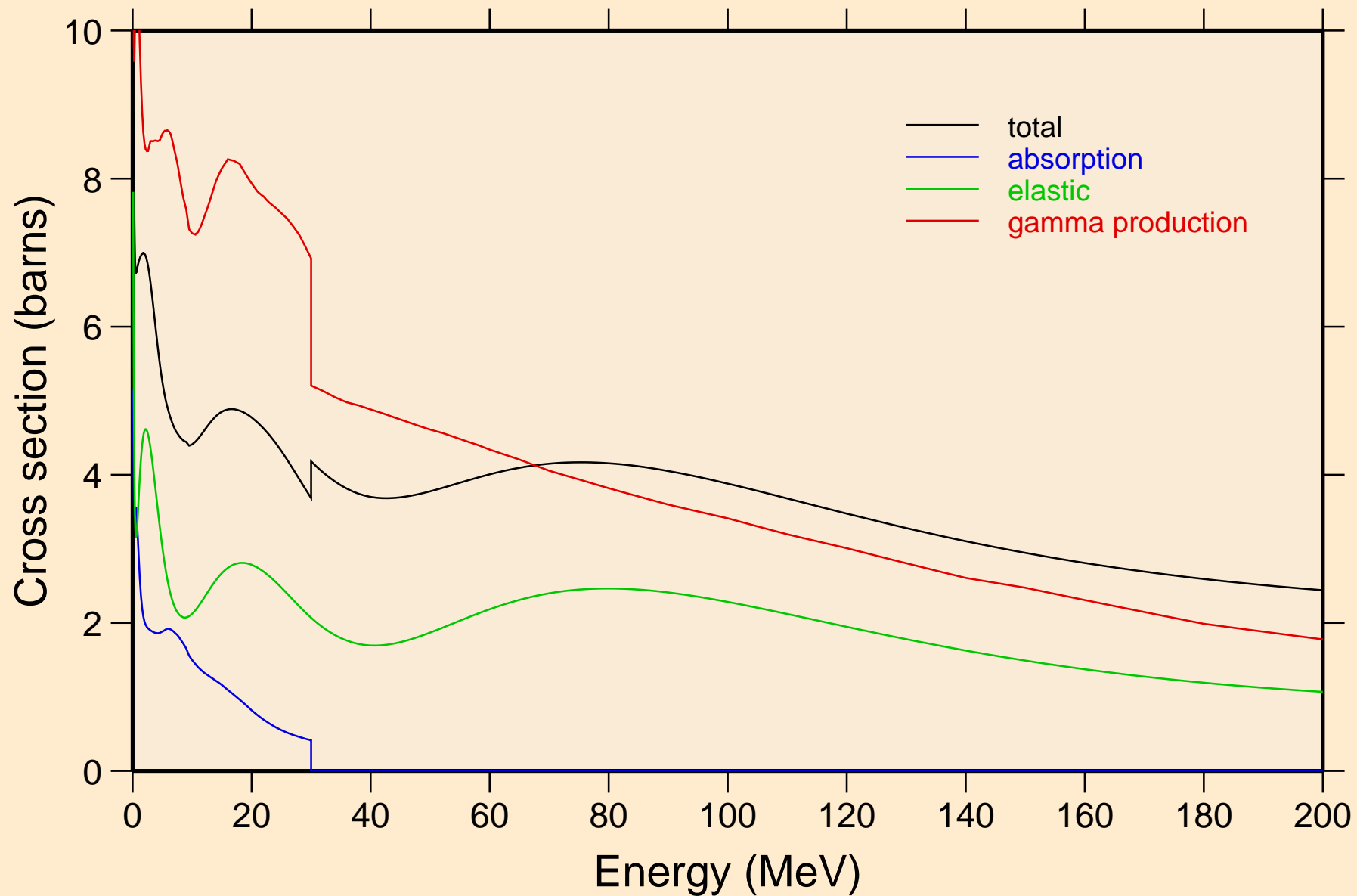

LU154 NEUTRON ACER TENDL-2023 LIBRARY; T=0.K

Heating

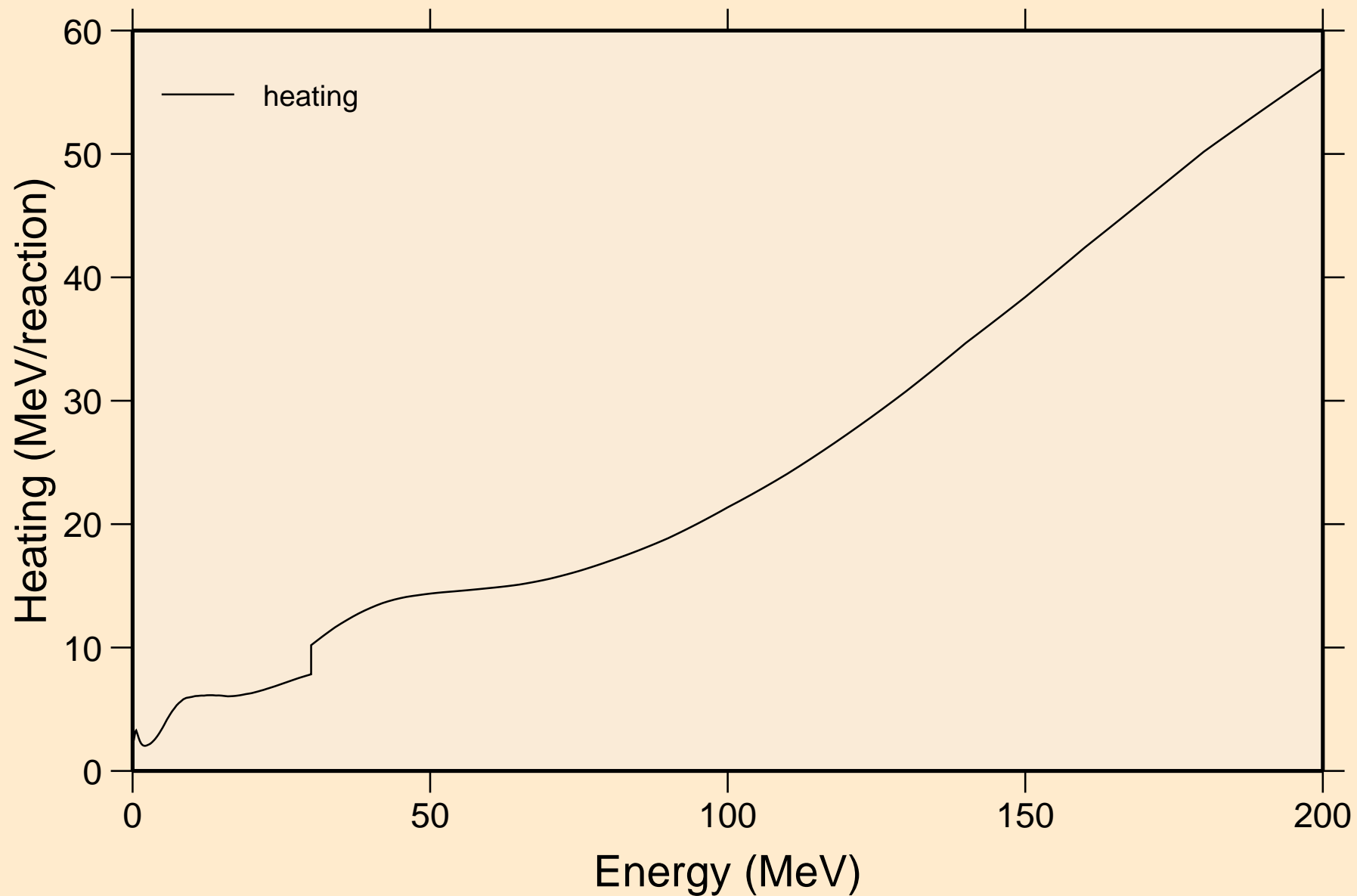

LU154 NEUTRON ACER TENDL-2023 LIBRARY; T=0.K

Damage

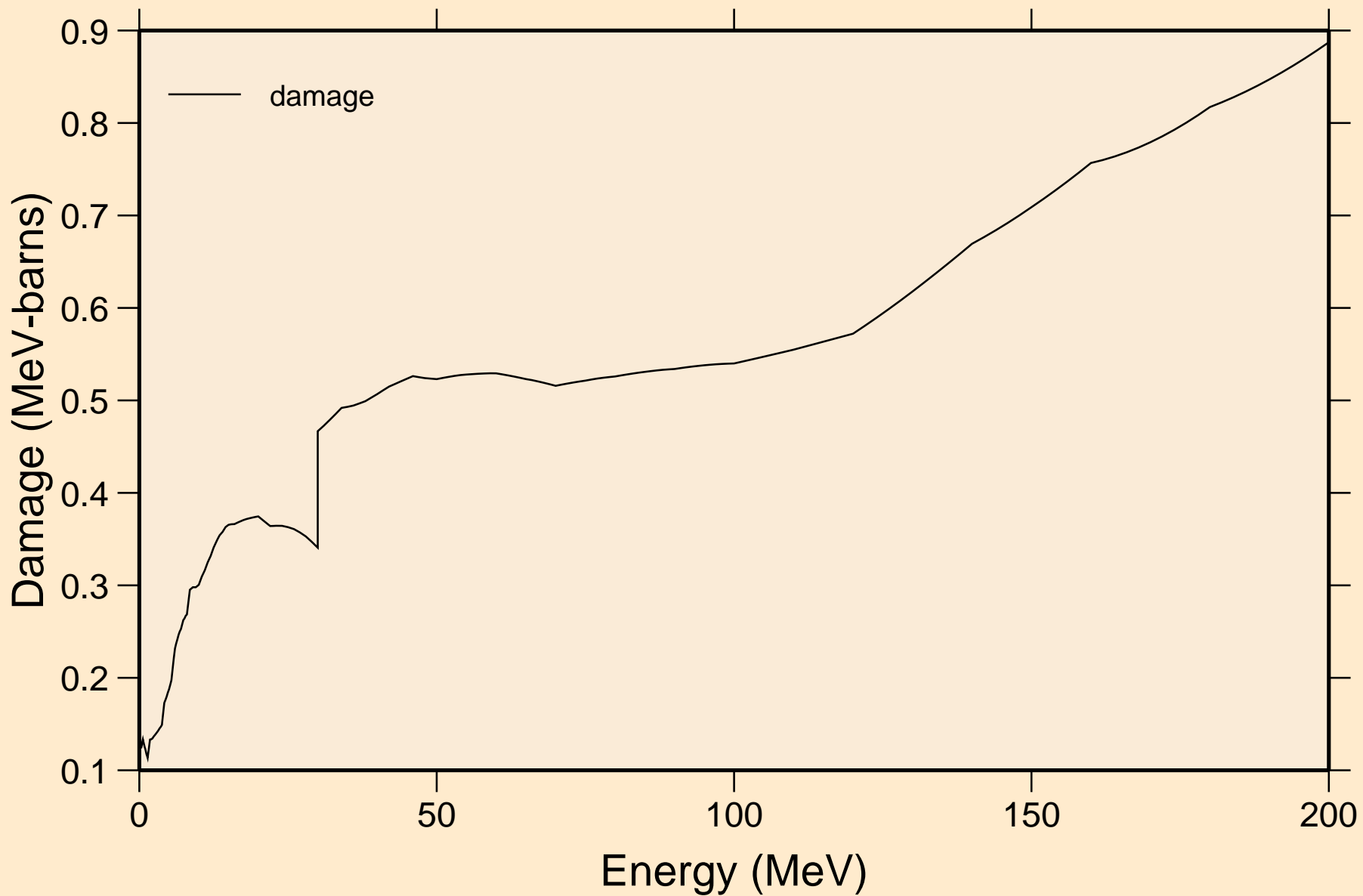

LU154 NEUTRON ACER TENDL-2023 LIBRARY; T=0.K
Non-threshold reactions

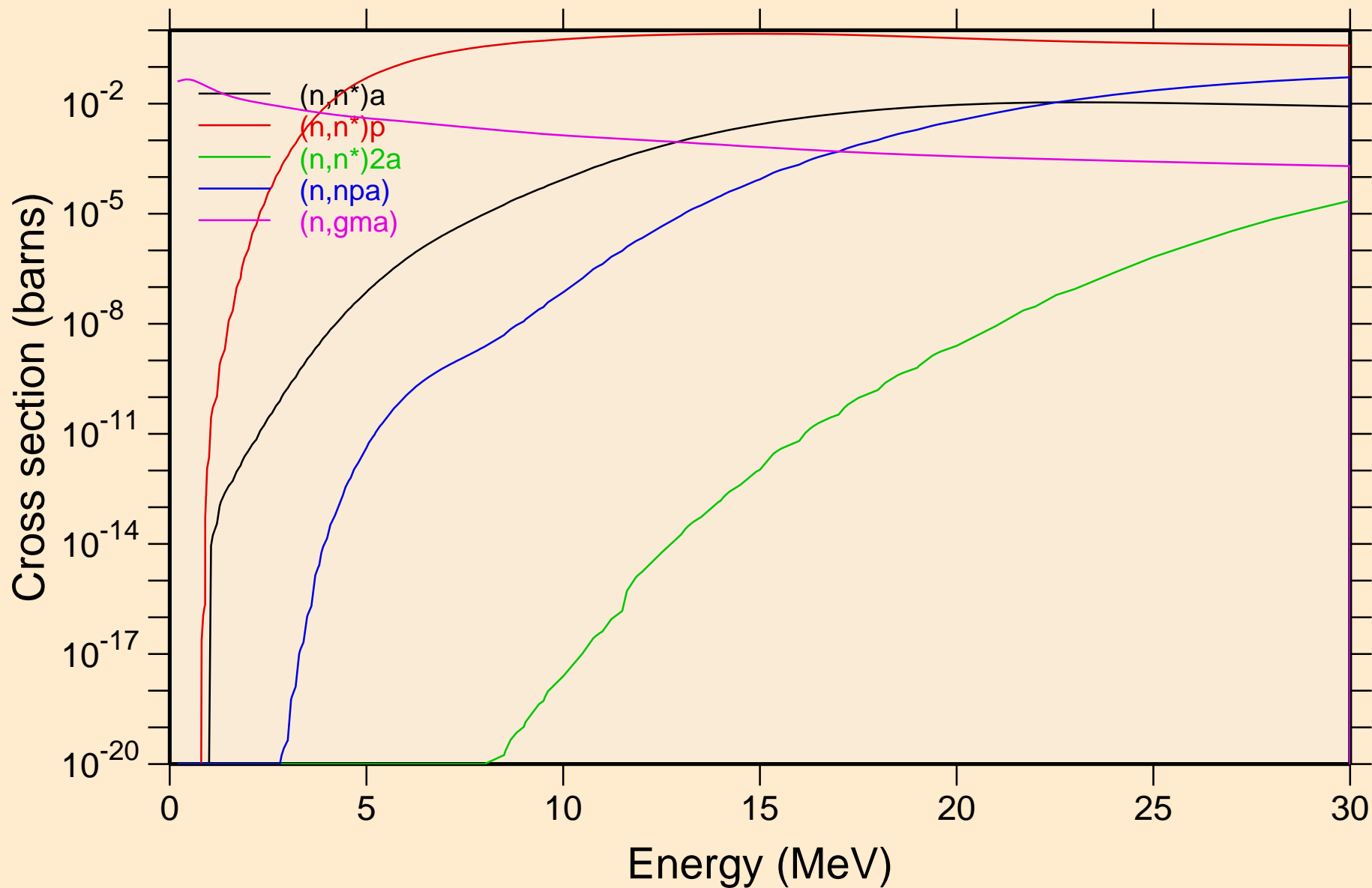

LU154 NEUTRON ACER TENDL-2023 LIBRARY; T=0.K
Non-threshold reactions

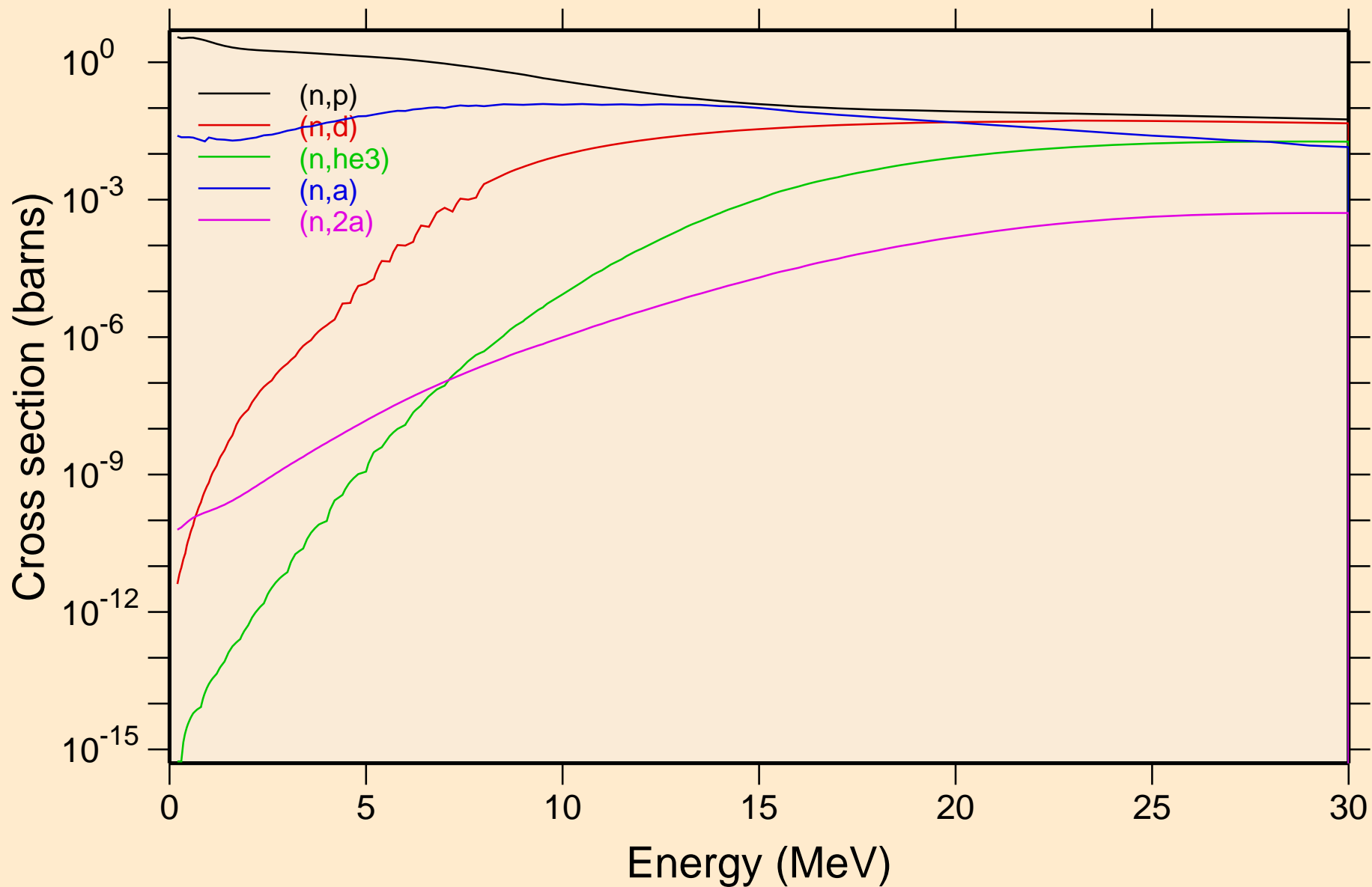

LU154 NEUTRON ACER TENDL-2023 LIBRARY; T=0.K
Non-threshold reactions

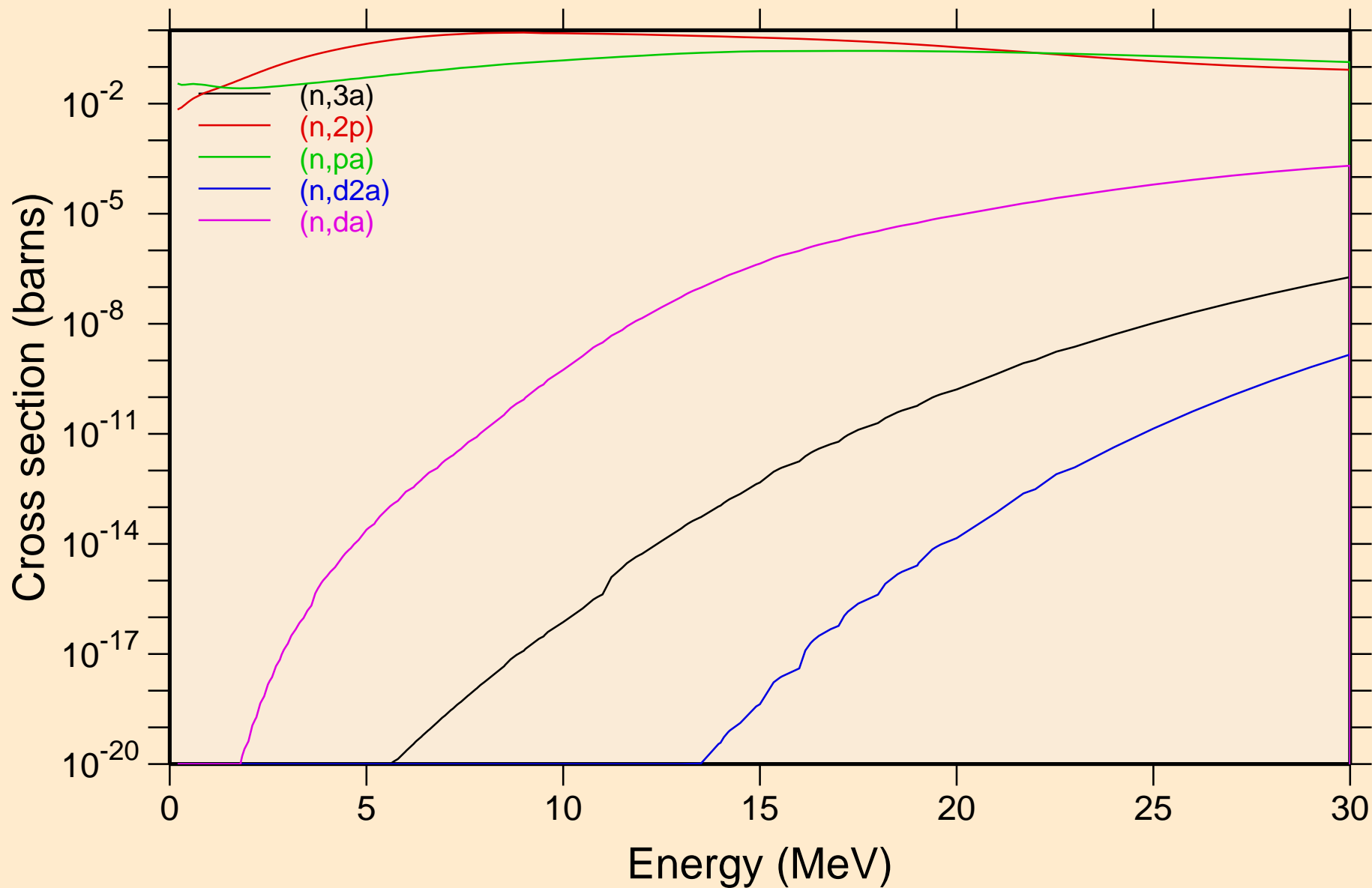

LU154 NEUTRON ACER TENDL-2023 LIBRARY; T=0.K
Non-threshold reactions

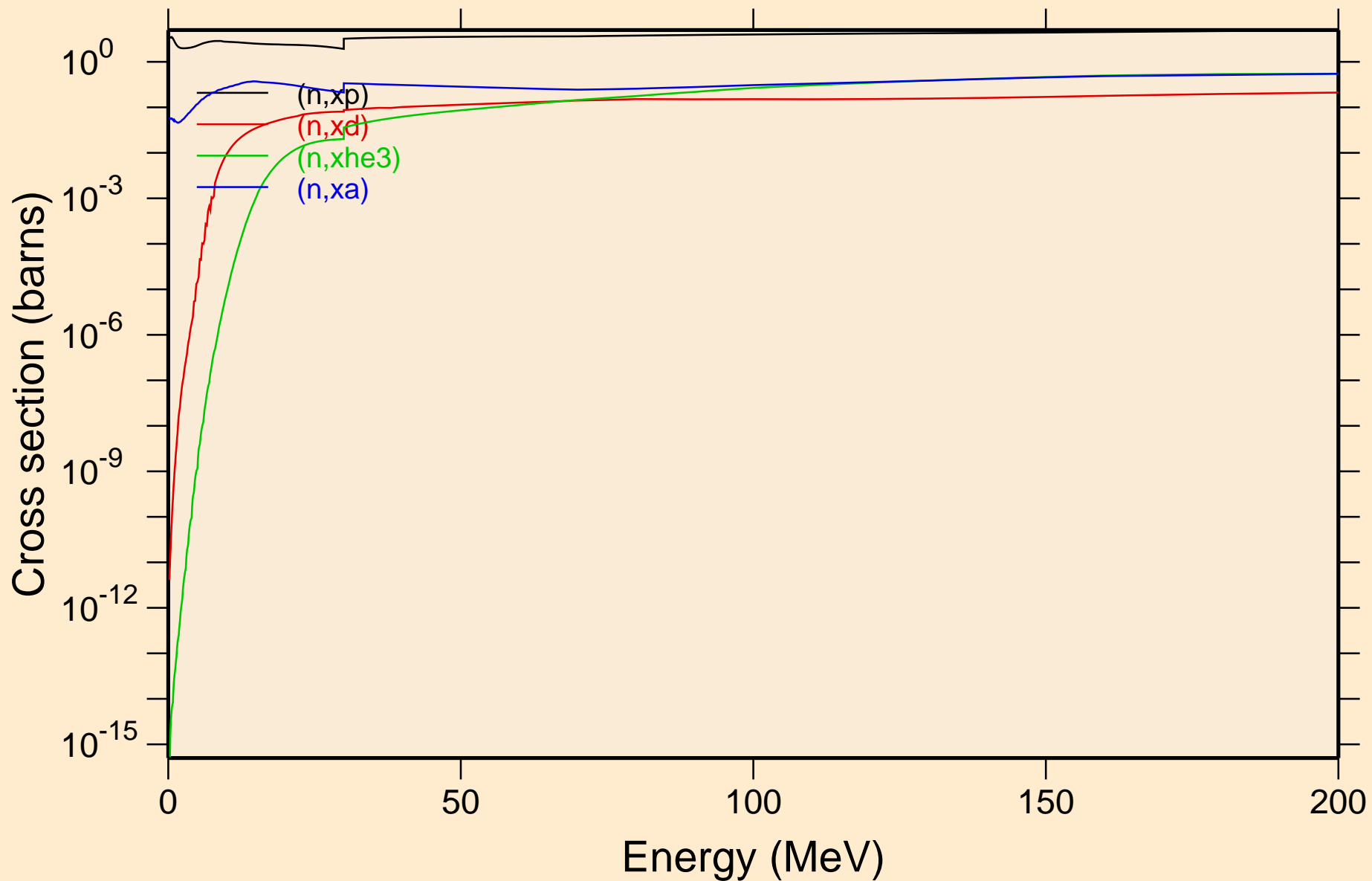

LU154 NEUTRON ACER TENDL-2023 LIBRARY; T=0.K
Inelastic levels

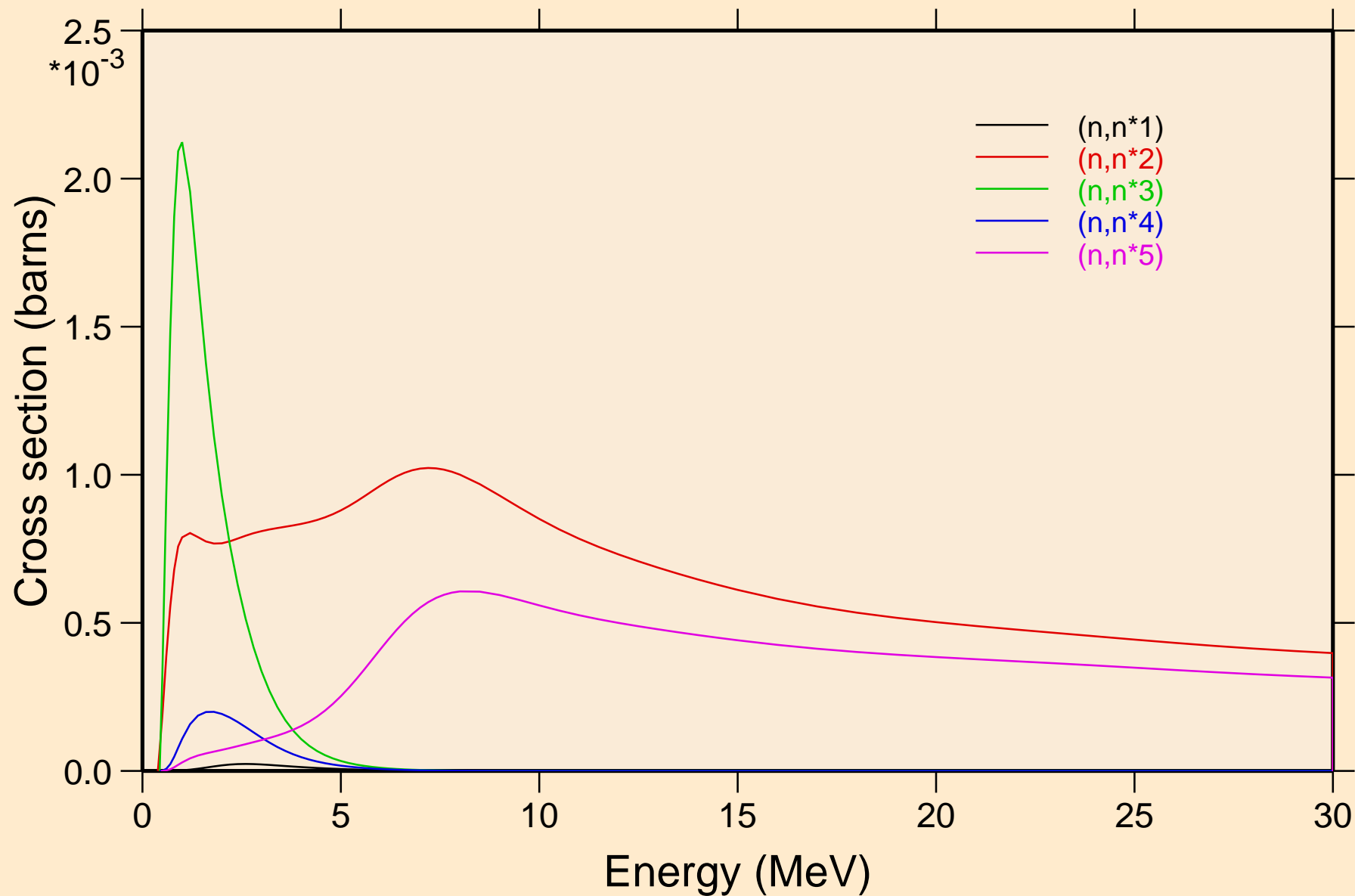

LU154 NEUTRON ACER TENDL-2023 LIBRARY; T=0.K
Inelastic levels

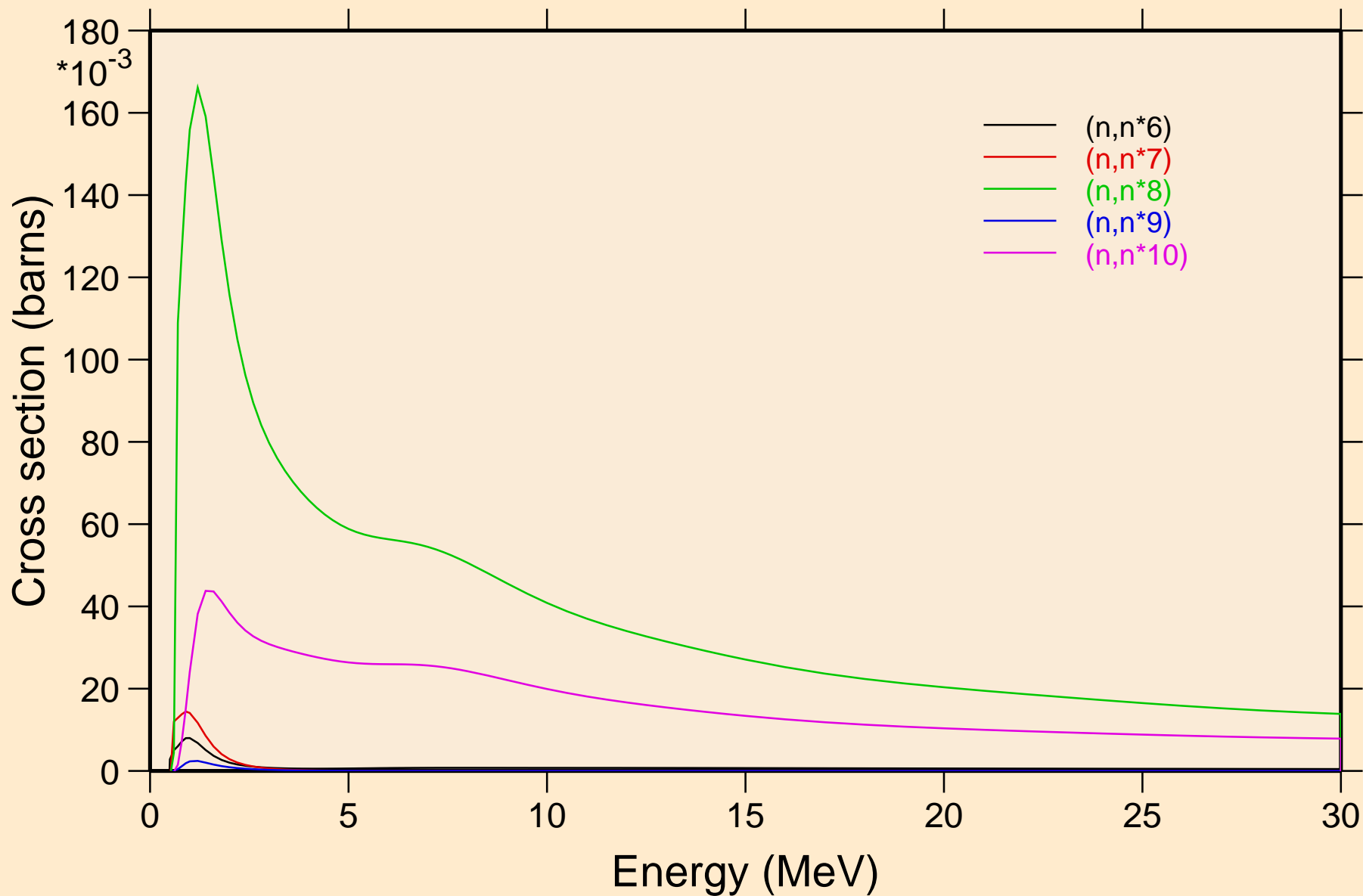

LU154 NEUTRON ACER TENDL-2023 LIBRARY; T=0.K
Inelastic levels

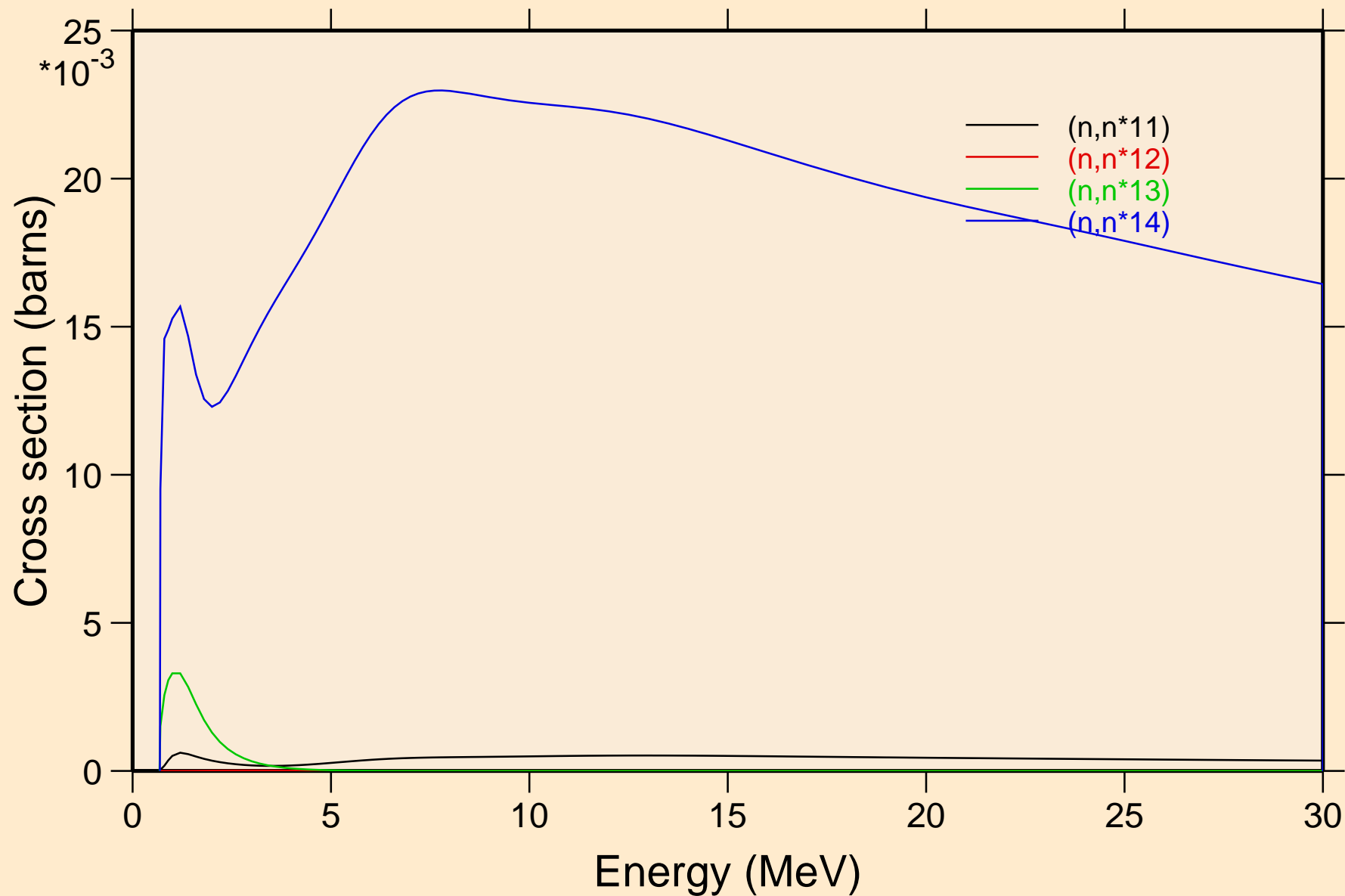

LU154 NEUTRON ACER TENDL-2023 LIBRARY; T=0.K

Threshold reactions

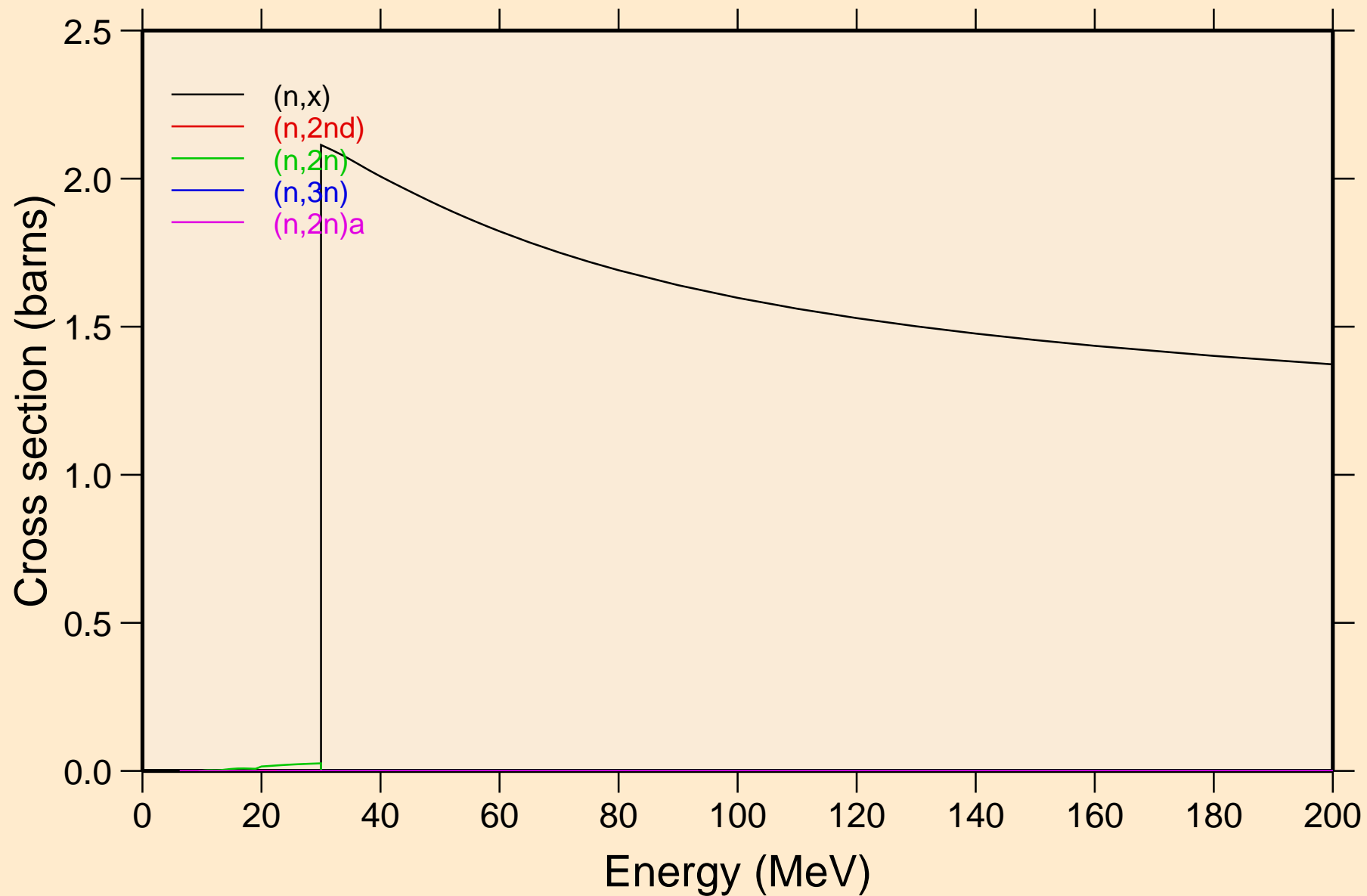

LU154 NEUTRON ACER TENDL-2023 LIBRARY; T=0.K

Threshold reactions

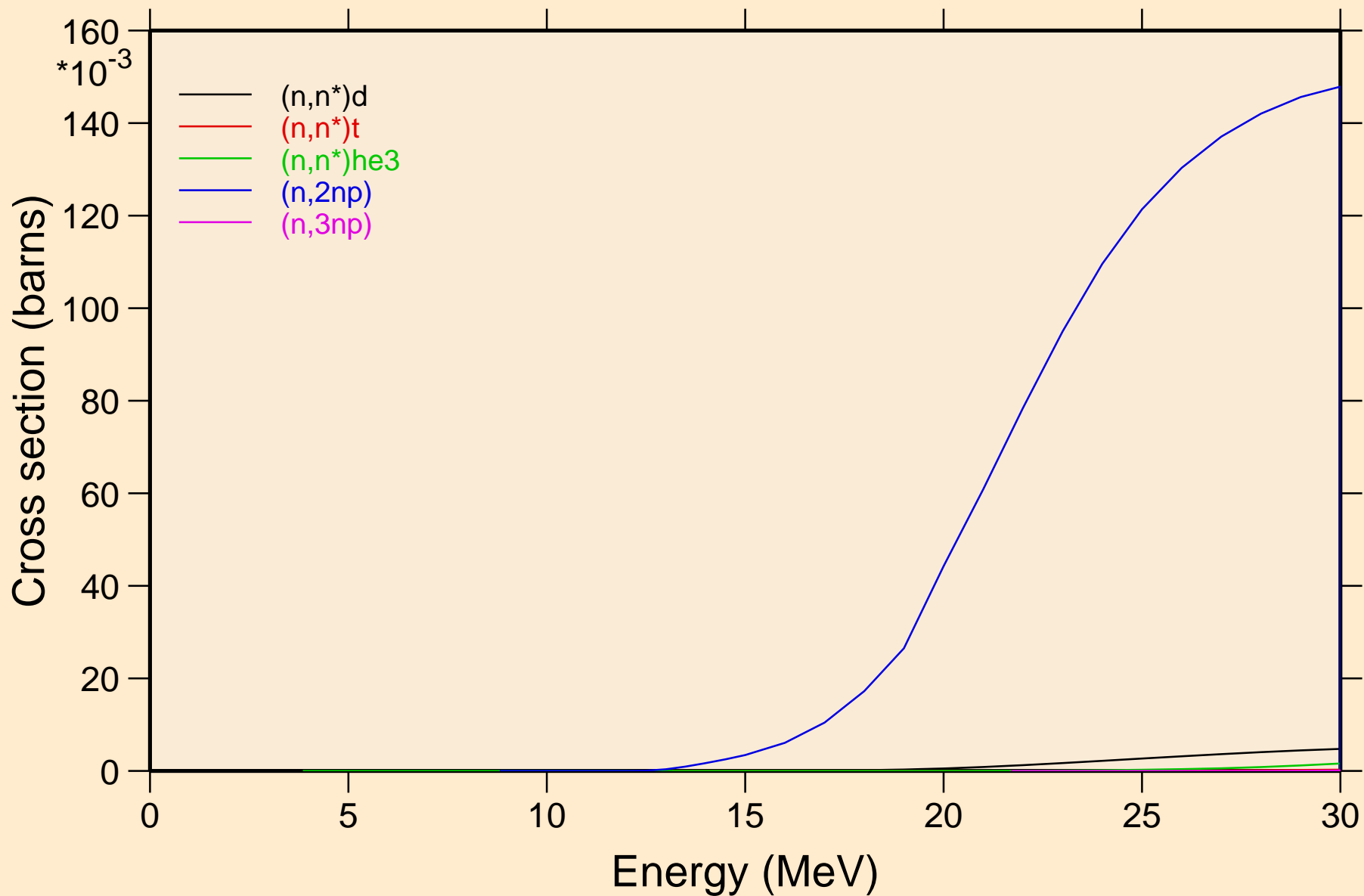

LU154 NEUTRON ACER TENDL-2023 LIBRARY; T=0.K
Threshold reactions

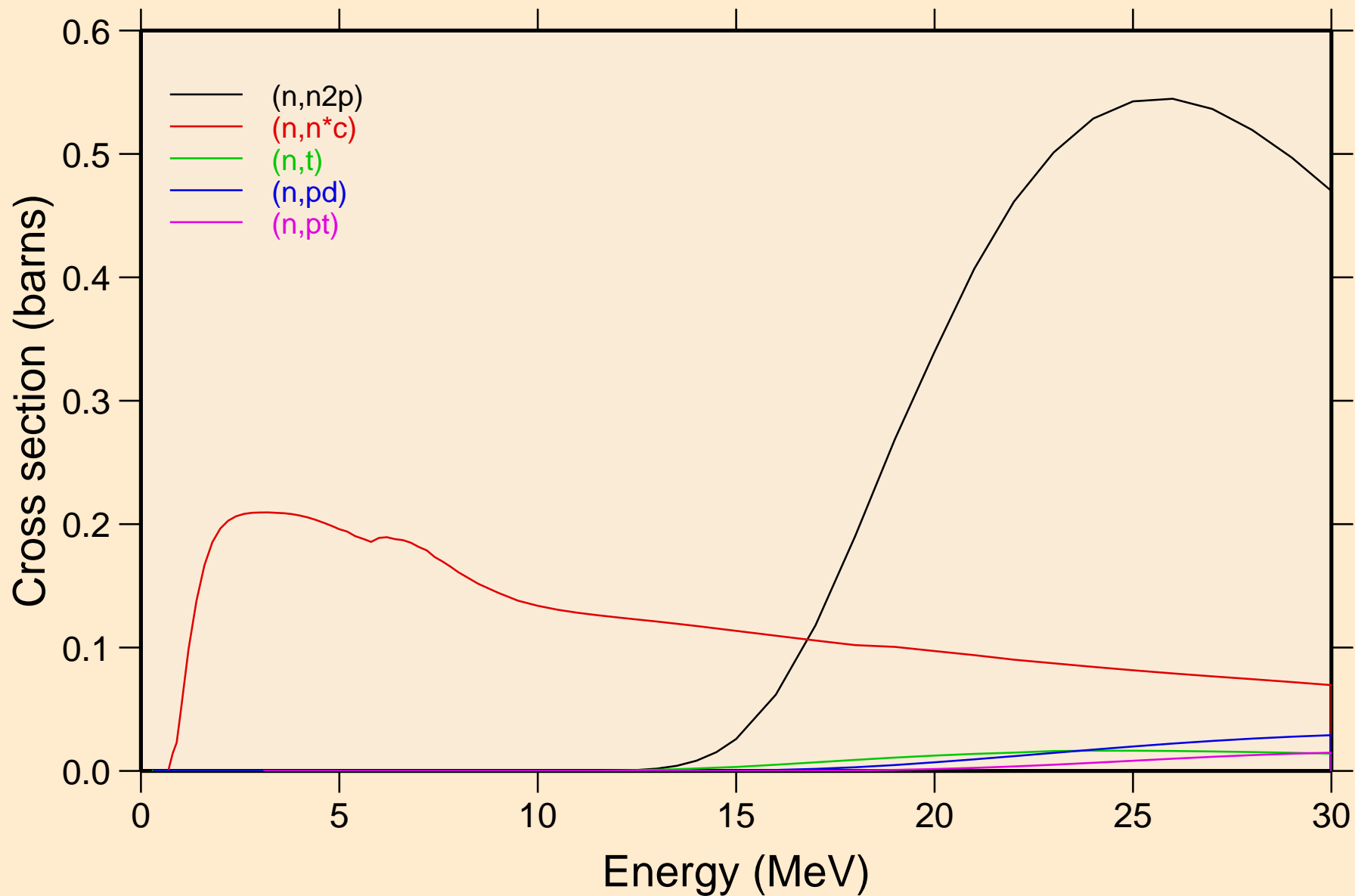

LU154 NEUTRON ACER TENDL-2023 LIBRARY; T=0.K
Threshold reactions

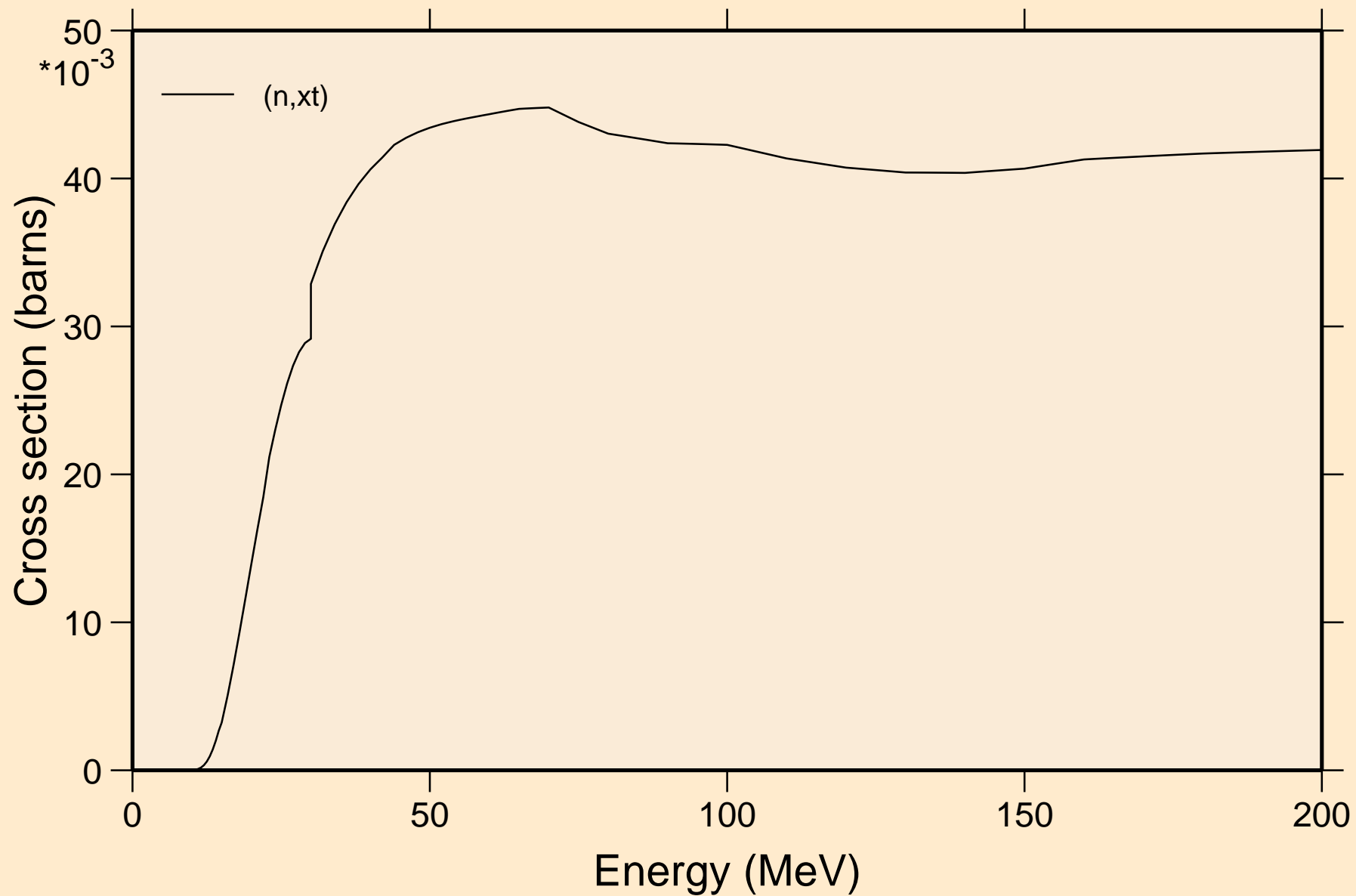

LU154 NEUTRON ACER TENDL-2023 LIBRARY; T=0.K
angular distribution for elastic

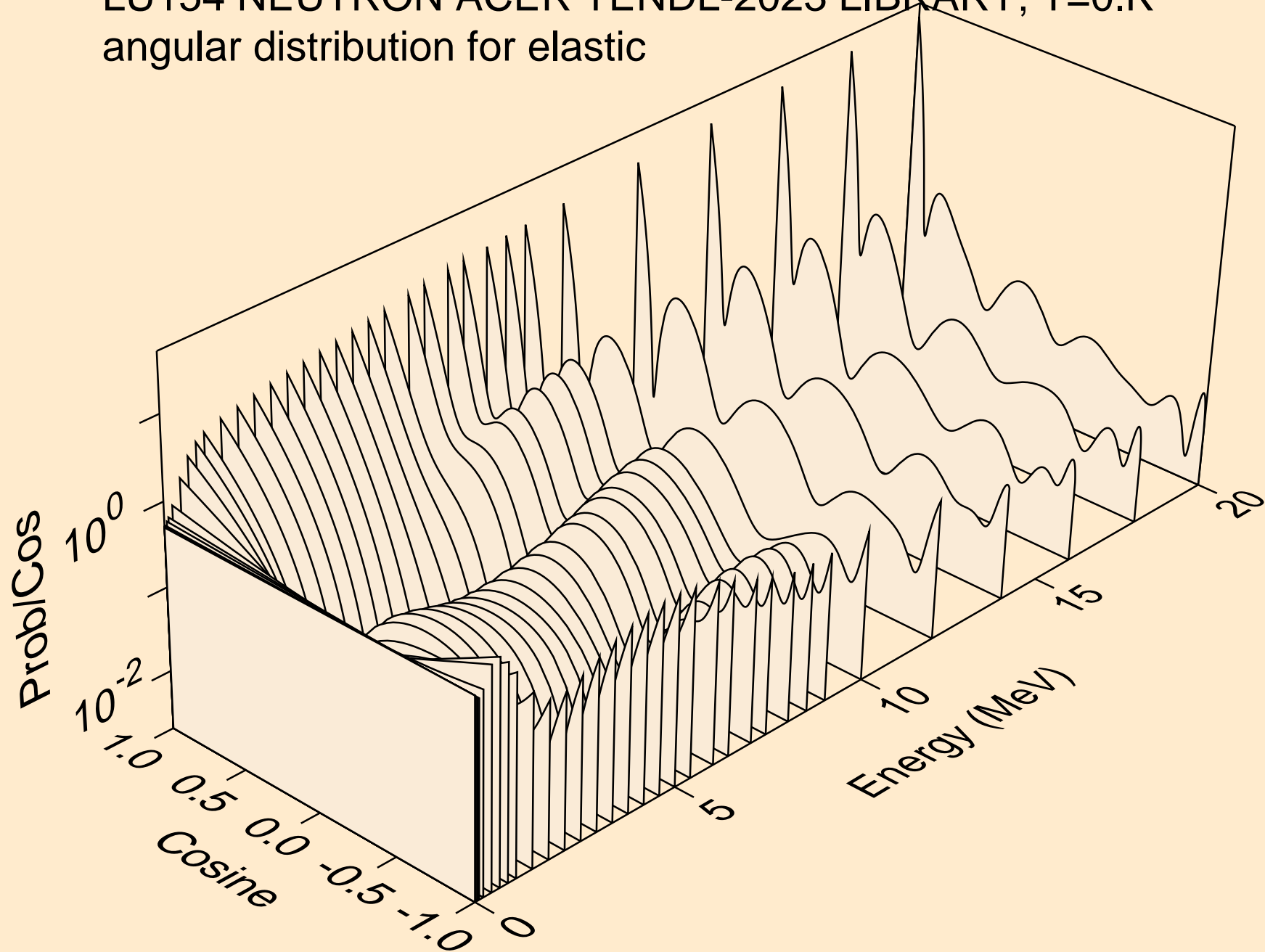

LU154 NEUTRON ACER TENDL-2023 LIBRARY; T=0.K
angular distribution for elastic

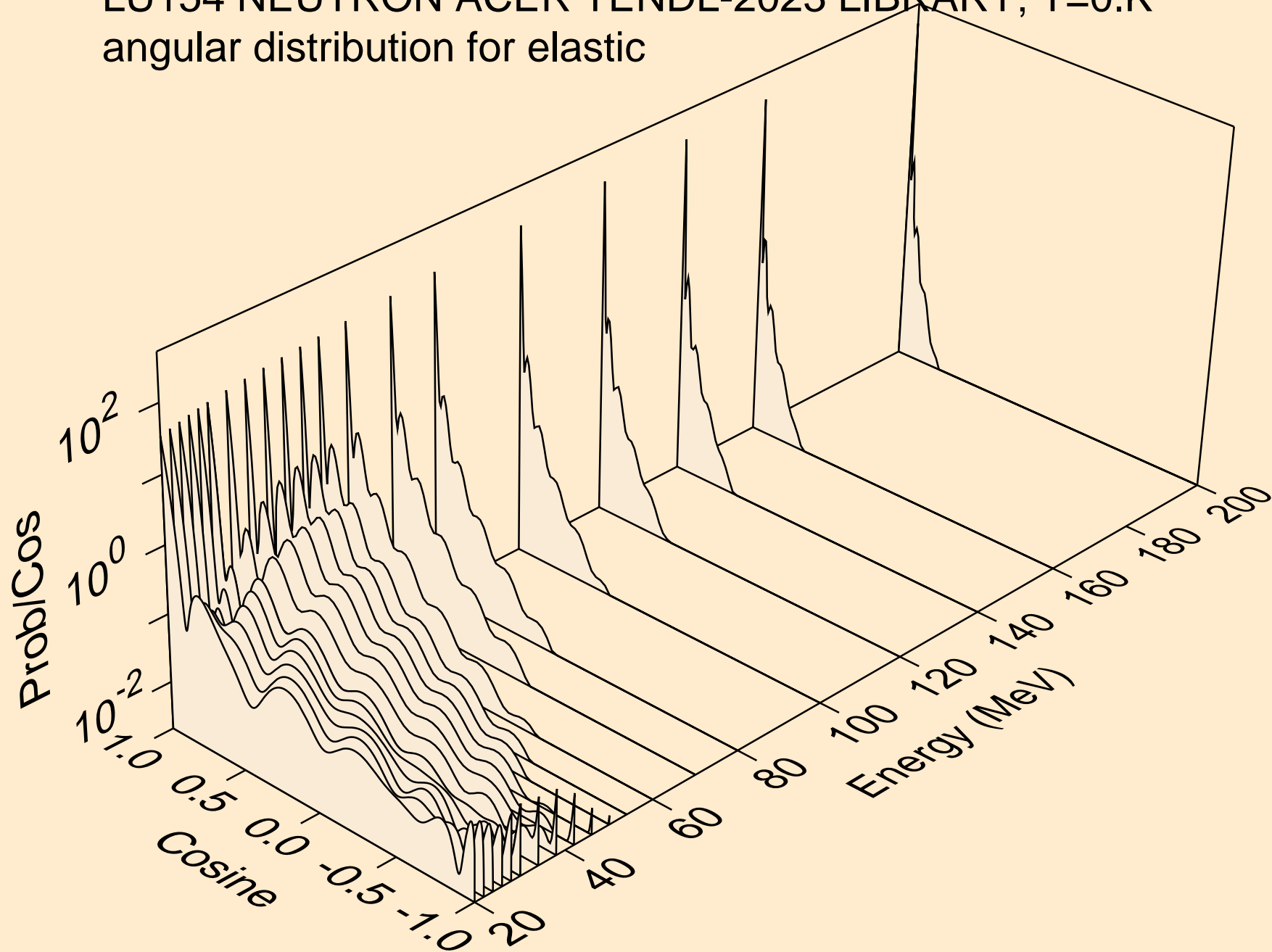

LU154 NEUTRON ACER TENDL-2023 LIBRARY; T=0.K
angular distribution for (n,n*1)

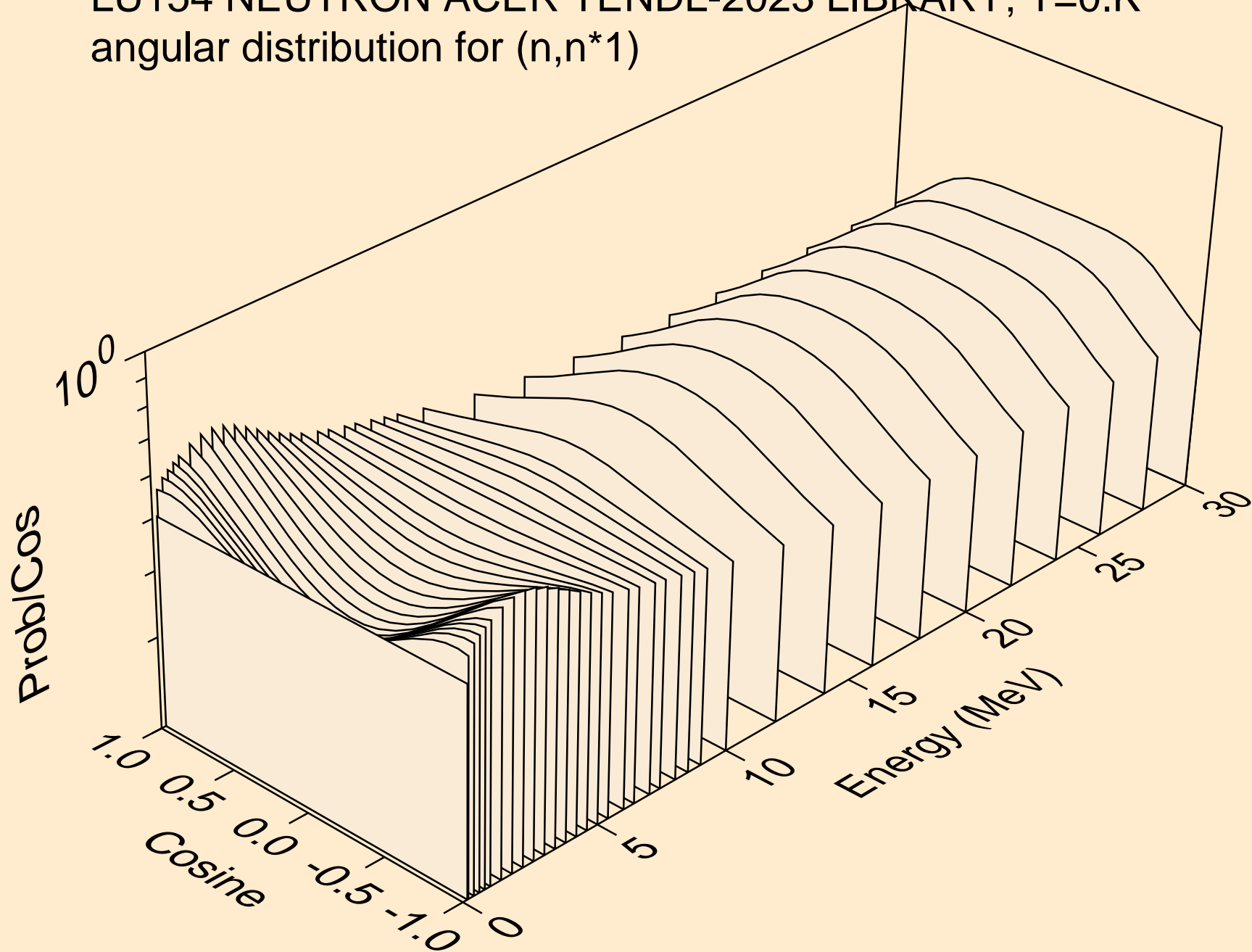

LU154 NEUTRON ACER TENDL-2023 LIBRARY; T=0.K
angular distribution for (n,n*2)

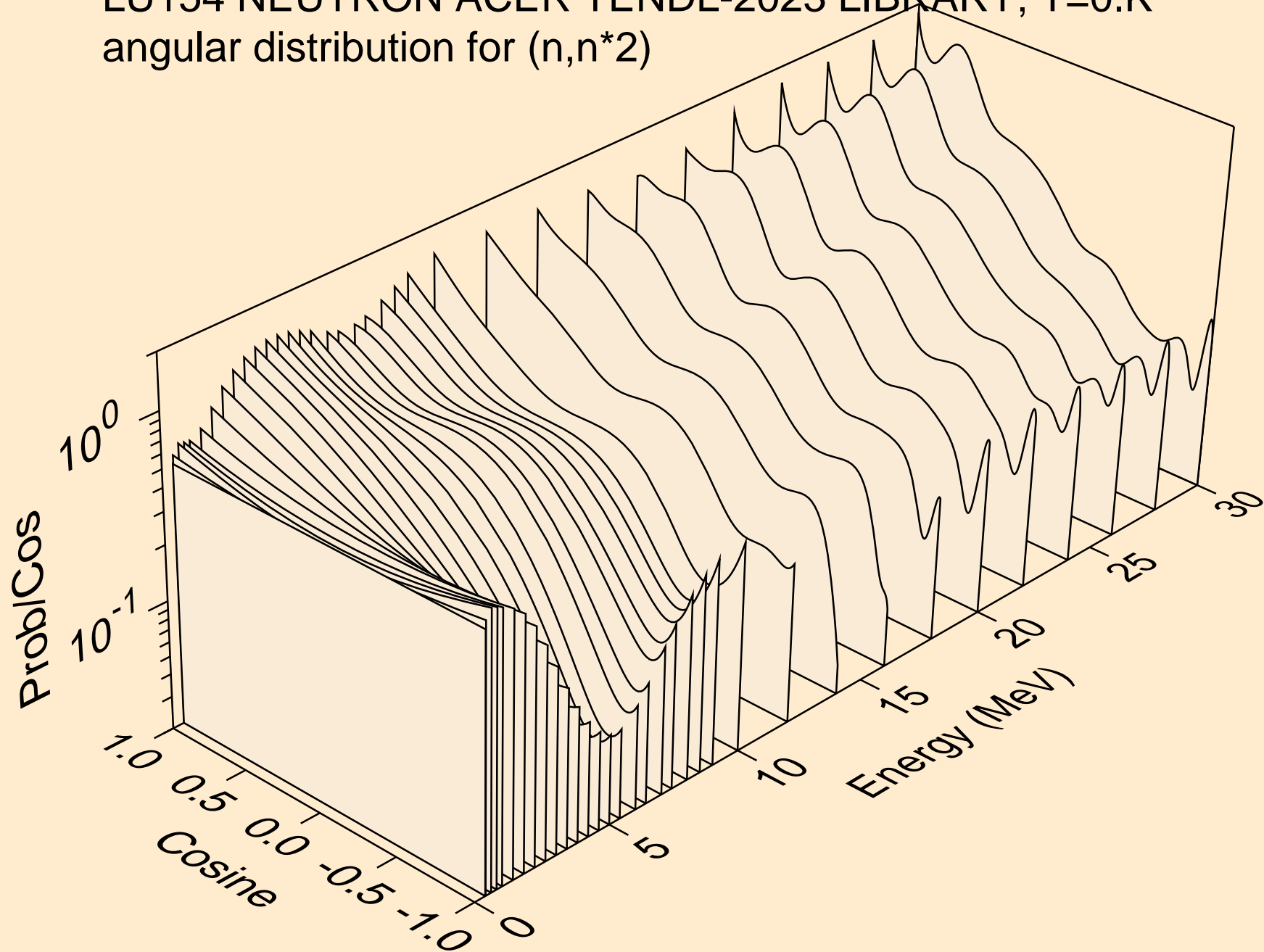

LU154 NEUTRON ACER TENDL-2023 LIBRARY; T=0.K
angular distribution for (n,n*3)

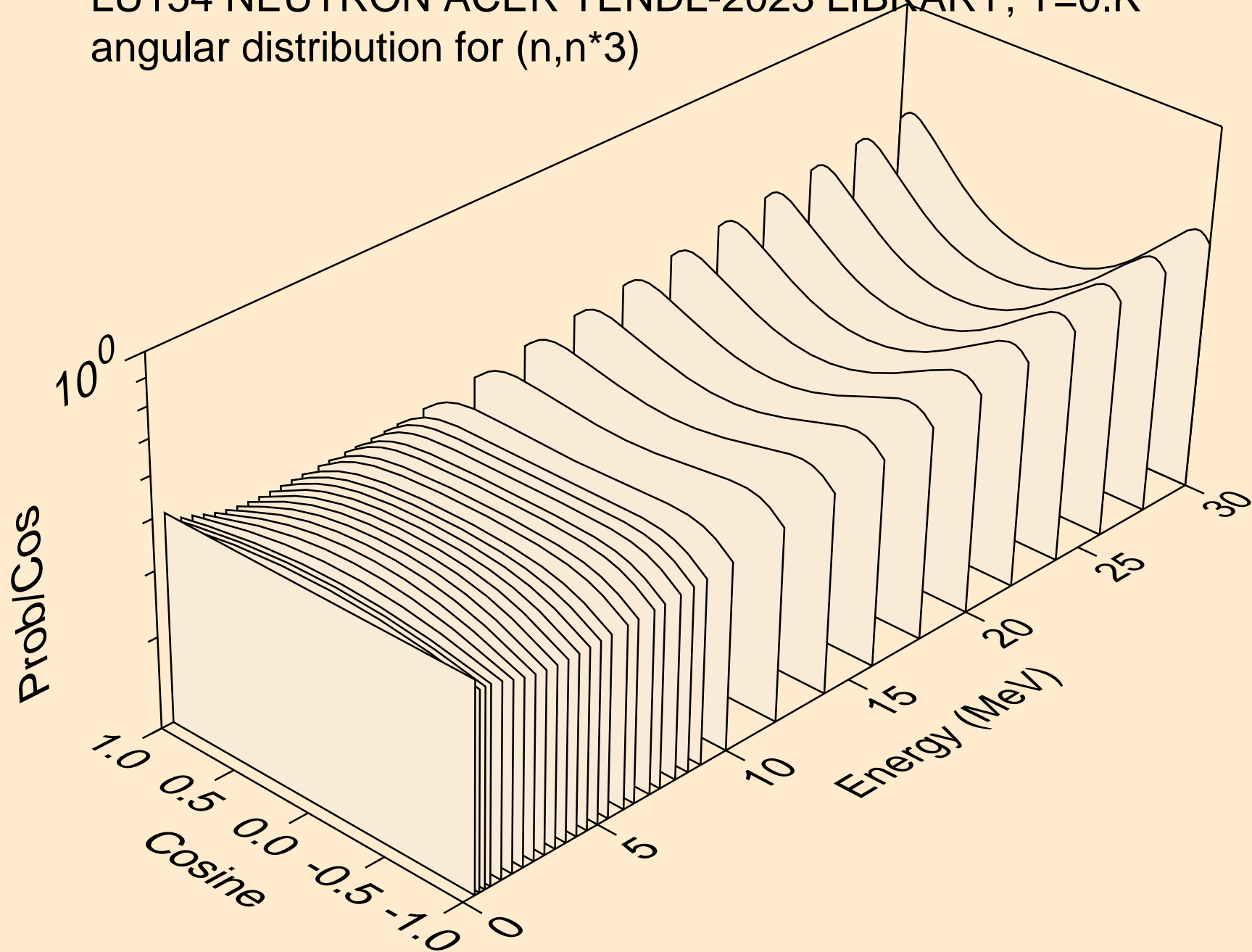

LU154 NEUTRON ACER TENDL-2023 LIBRARY; T=0.K
angular distribution for (n,n*4)

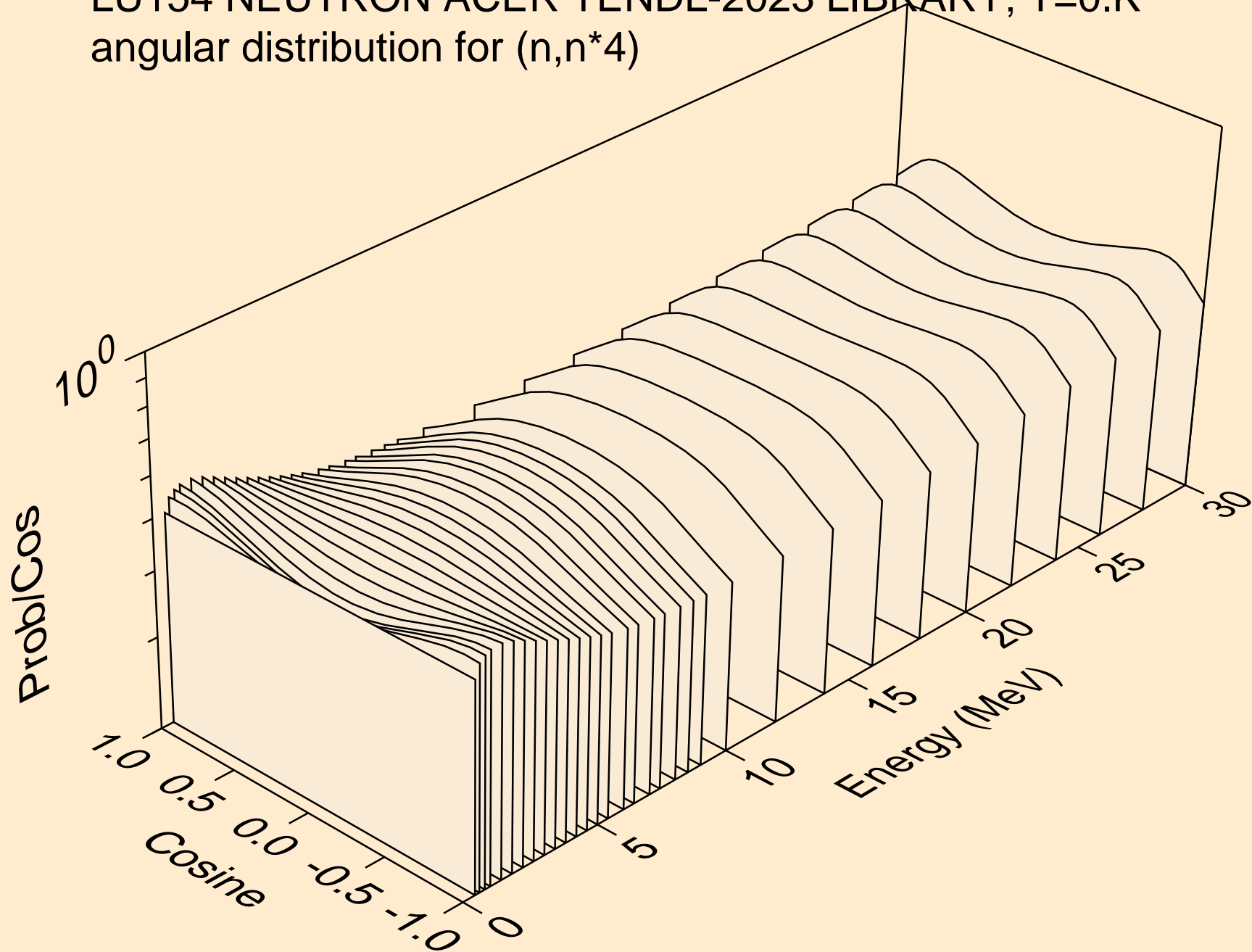

LU154 NEUTRON ACER TENDL-2023 LIBRARY; T=0.K
angular distribution for (n,n*5)

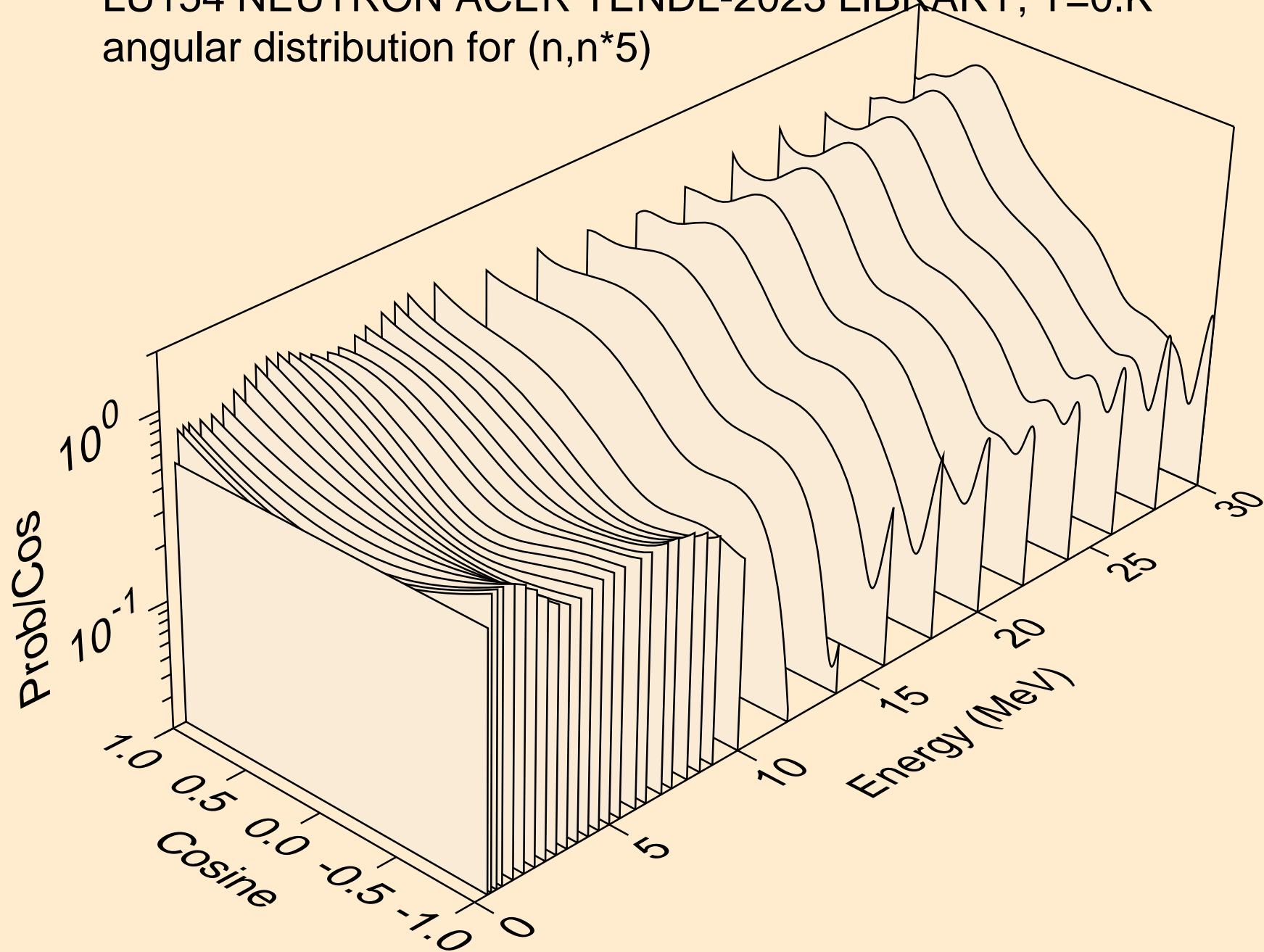

LU154 NEUTRON ACER TENDL-2023 LIBRARY; T=0.K
angular distribution for (n,n*6)

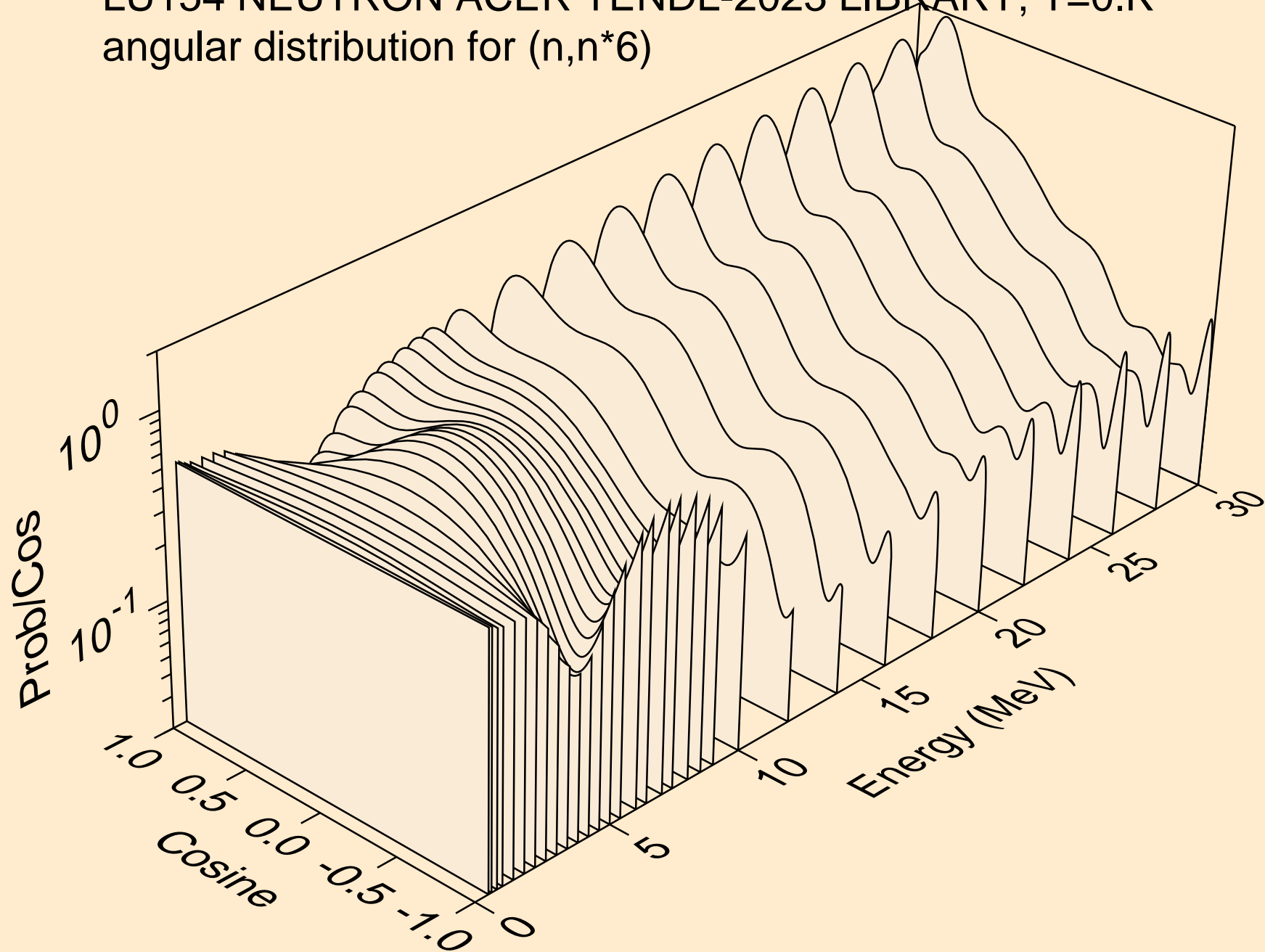

LU154 NEUTRON ACER TENDL-2023 LIBRARY; T=0.K
angular distribution for (n,n*7)

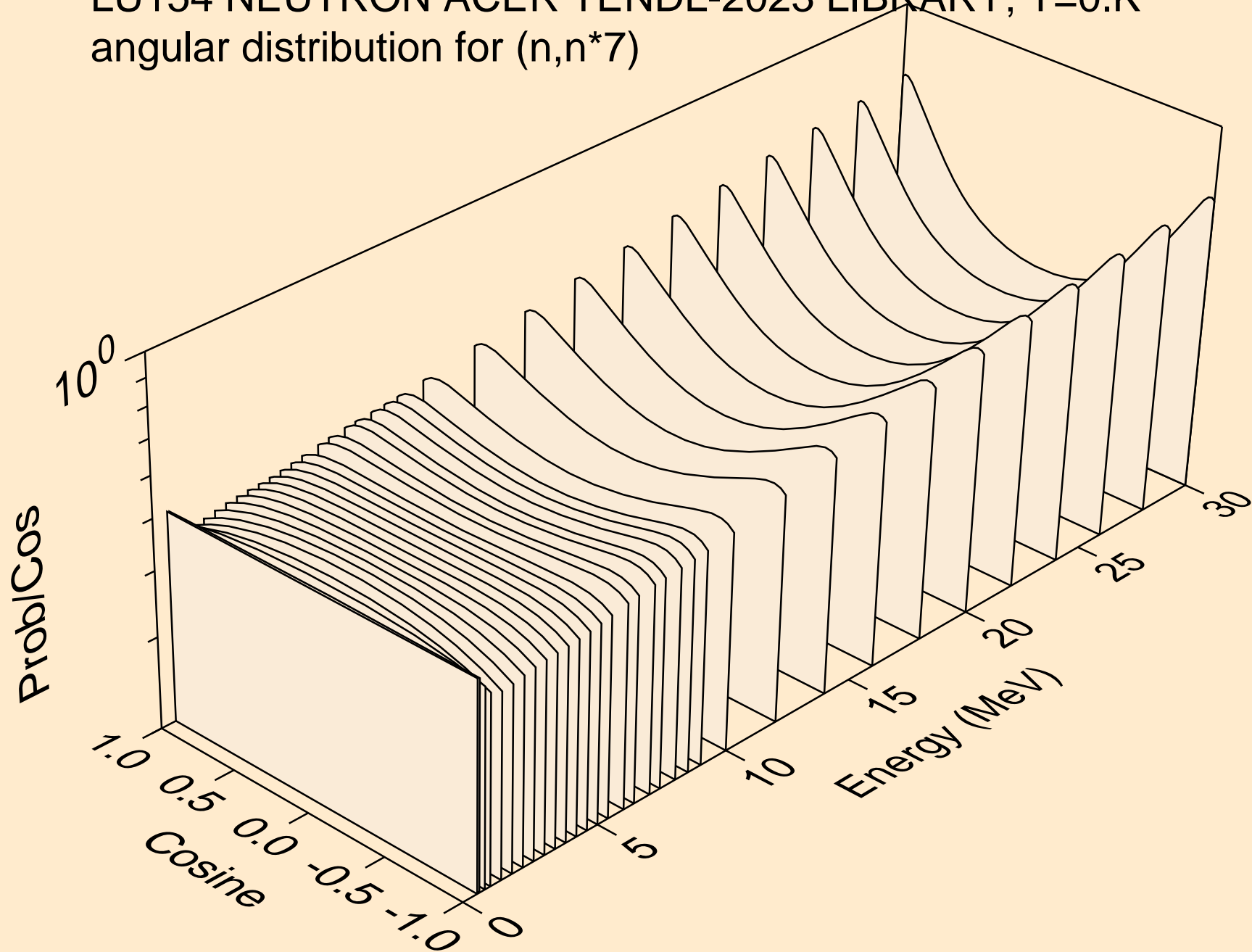

LU154 NEUTRON ACER TENDL-2023 LIBRARY; T=0.K
angular distribution for (n,n*8)

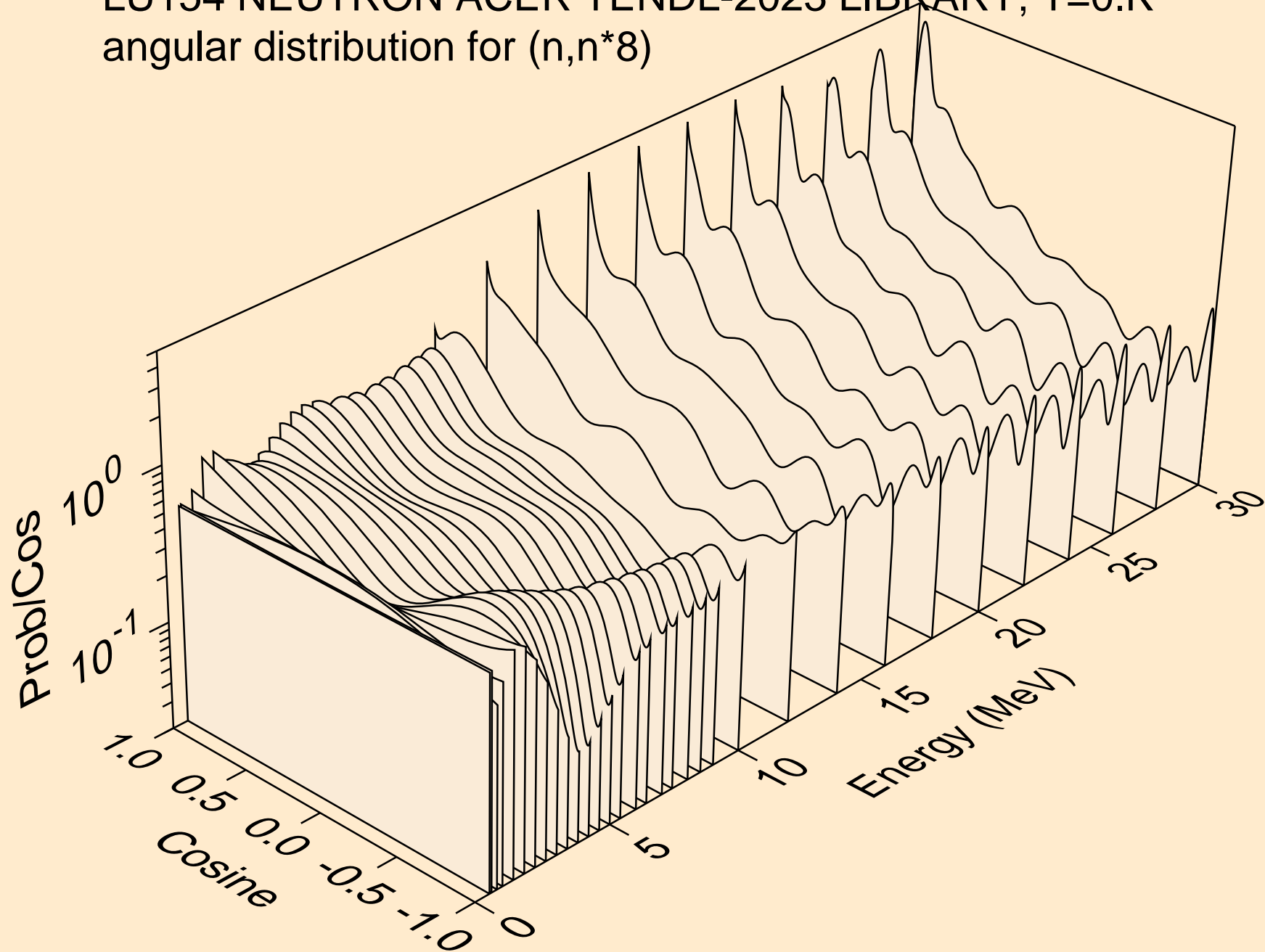

LU154 NEUTRON ACER TENDL-2023 LIBRARY; T=0.K
angular distribution for (n,n*9)

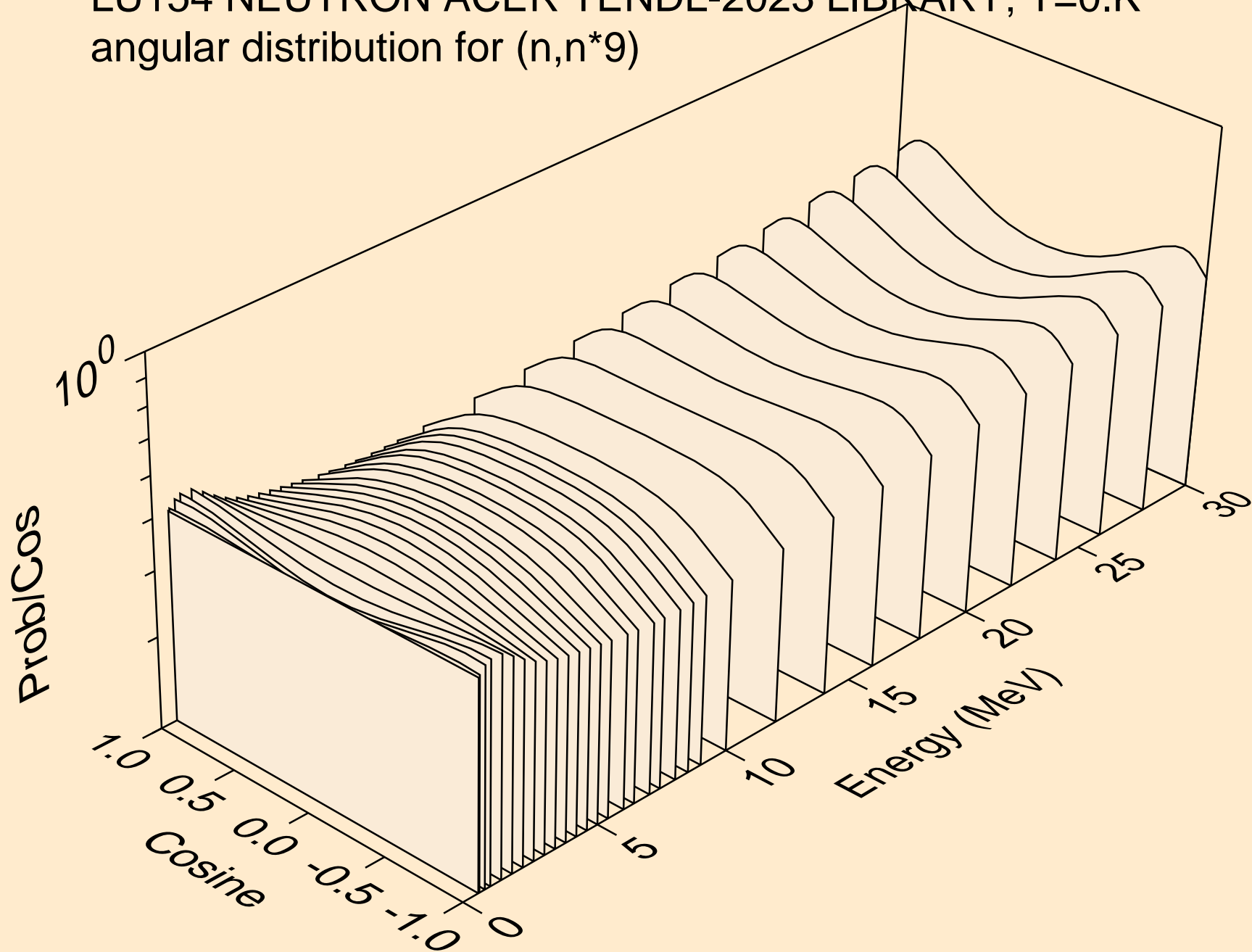

LU154 NEUTRON ACER TENDL-2023 LIBRARY; T=0.K
angular distribution for (n,n*10)

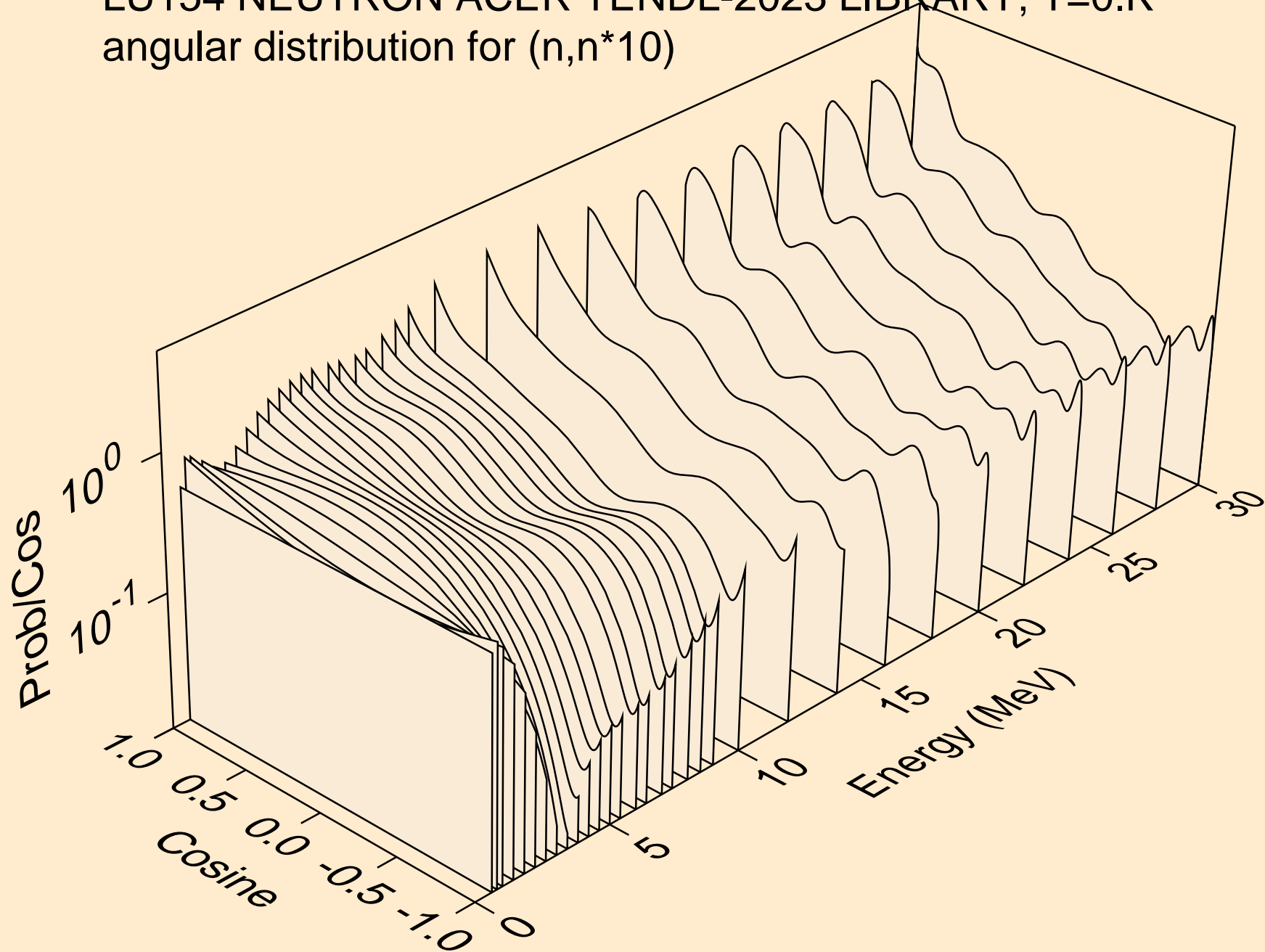

LU154 NEUTRON ACER TENDL-2023 LIBRARY; T=0.K
angular distribution for (n,n*11)

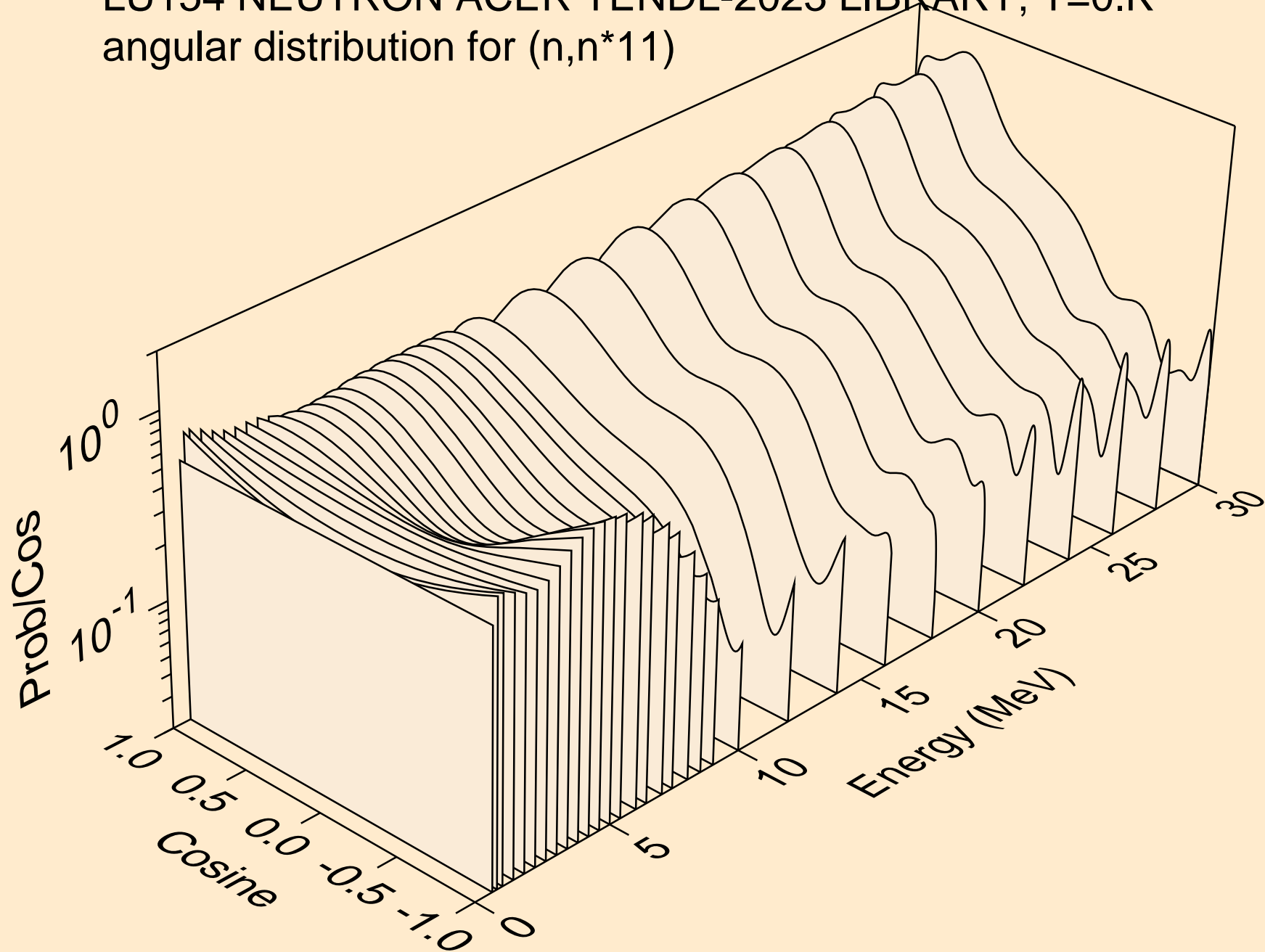

LU154 NEUTRON ACER TENDL-2023 LIBRARY; T=0.K
angular distribution for (n,n*12)

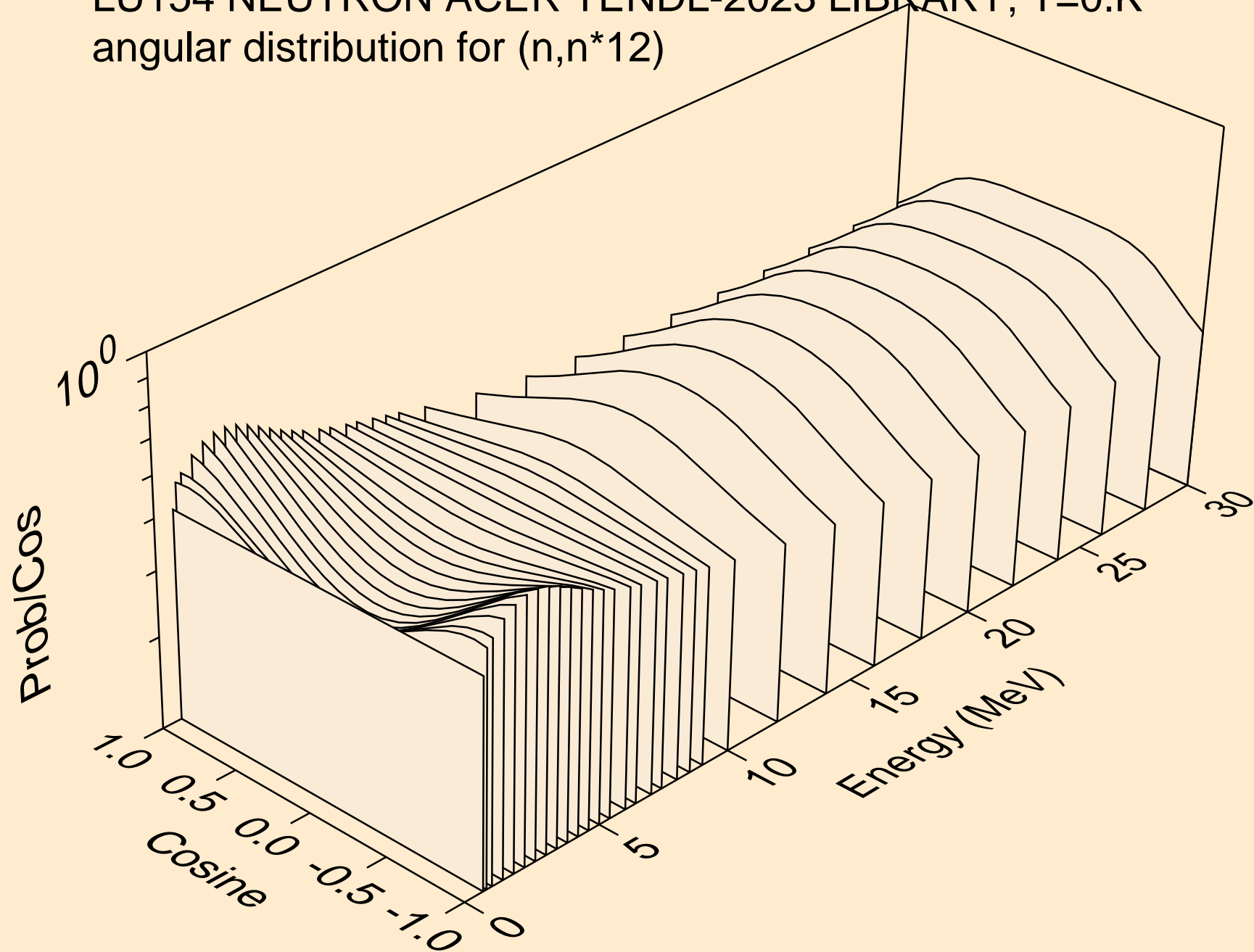

LU154 NEUTRON ACER TENDL-2023 LIBRARY; T=0.K
angular distribution for (n,n*13)

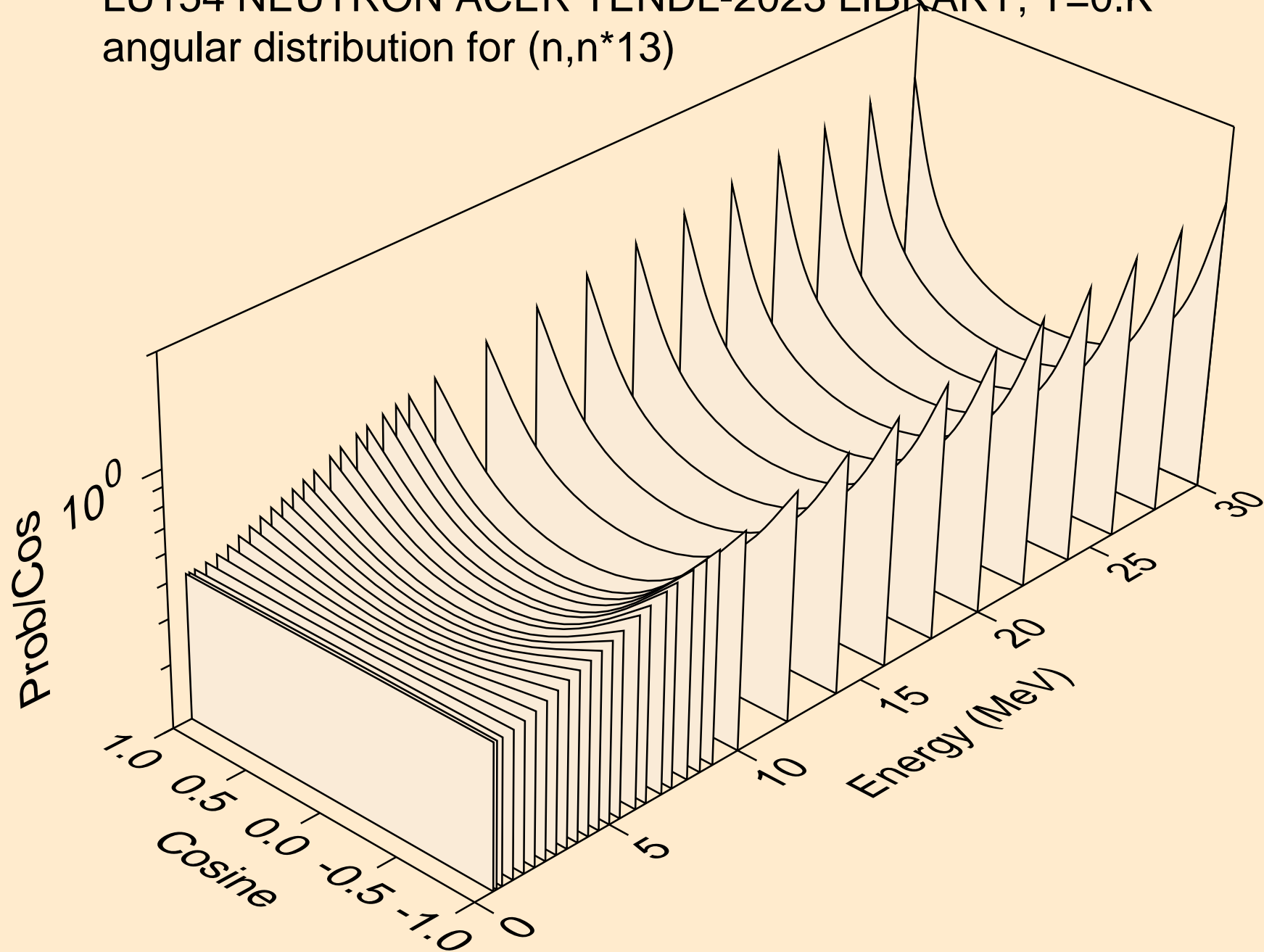

LU154 NEUTRON ACER TENDL-2023 LIBRARY; T=0.K
angular distribution for (n,n*14)

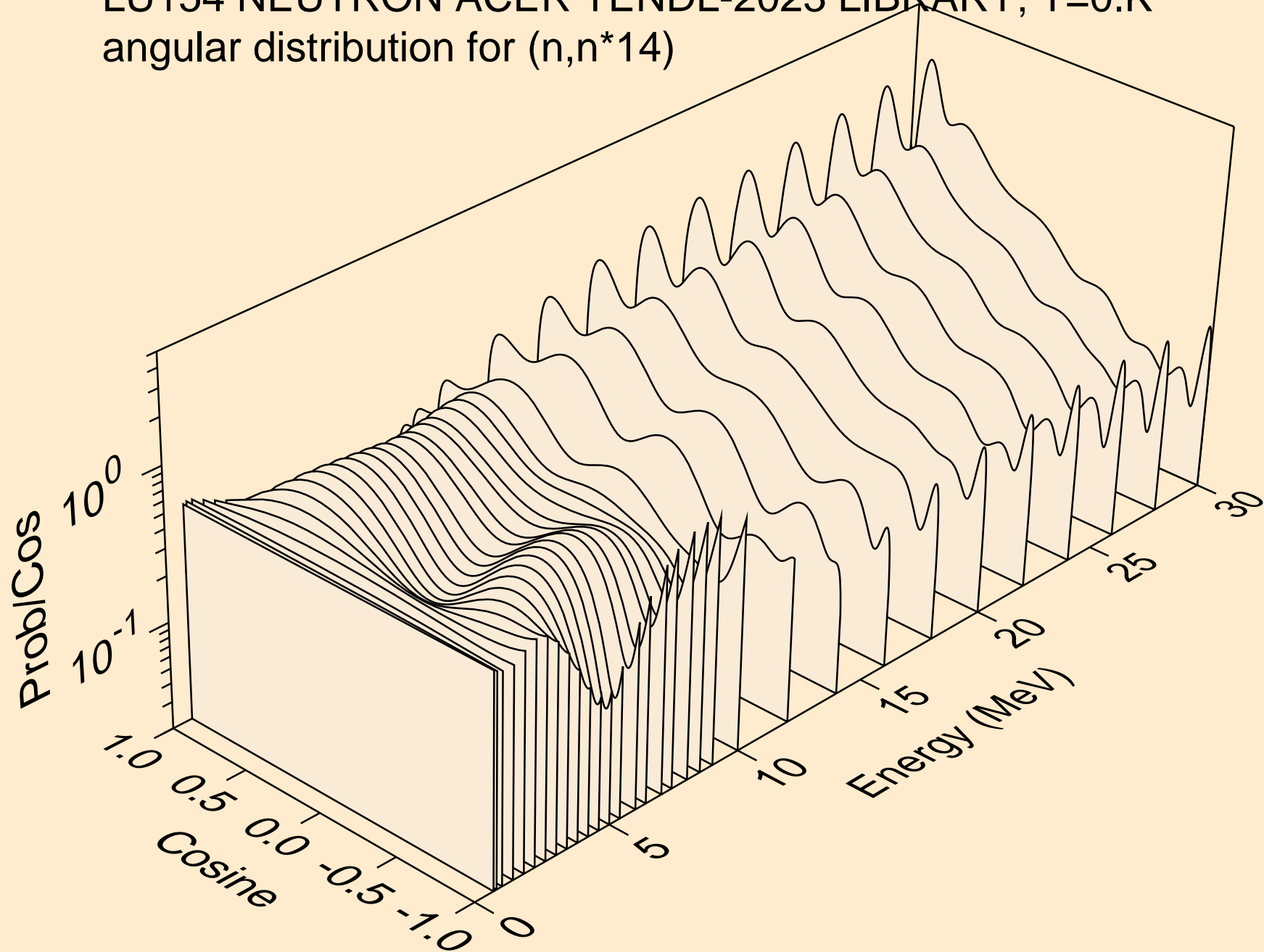

LU154 NEUTRON ACER TENDL-2023 LIBRARY; T=0.K
Neutron emission for (n,x)

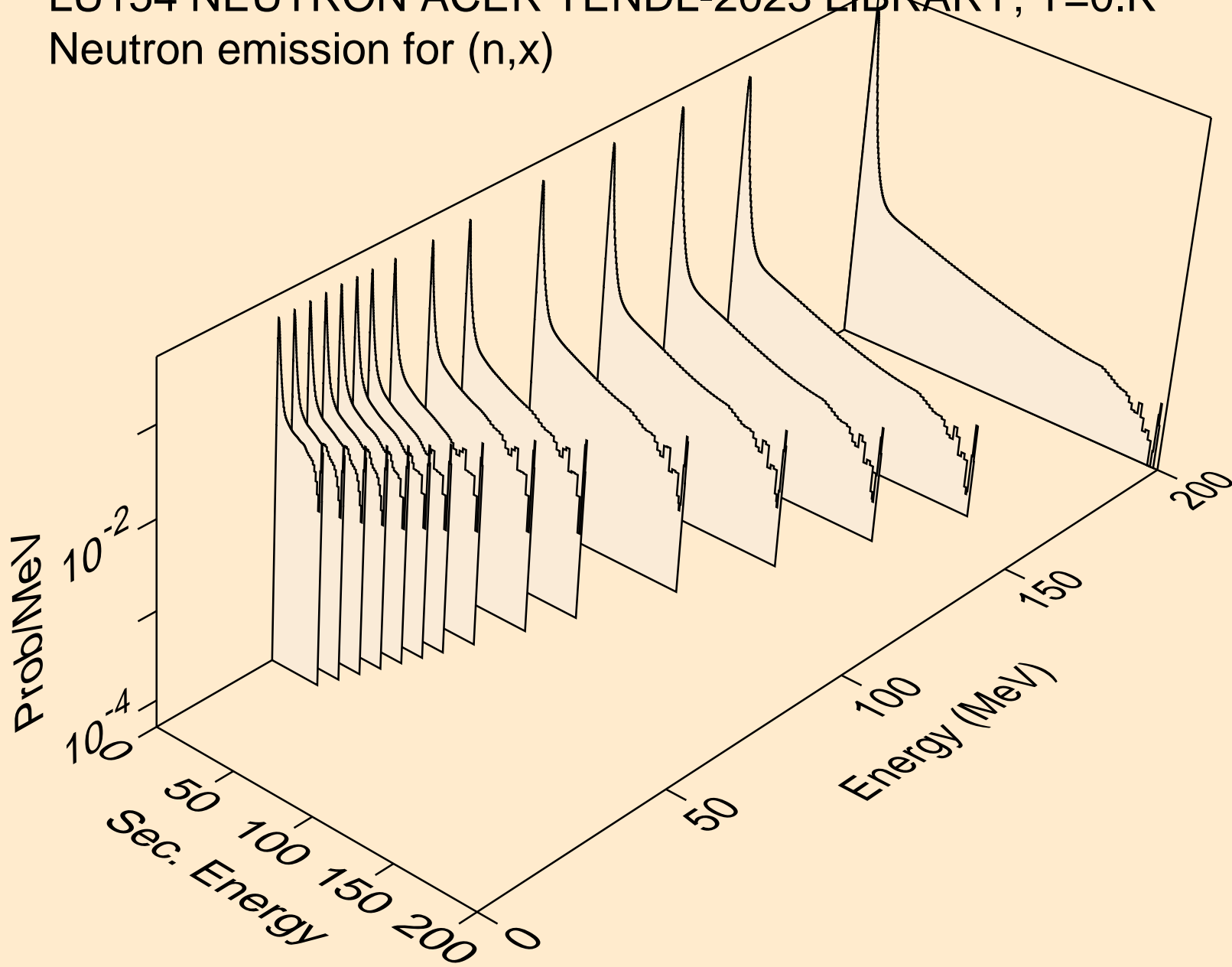

LU154 NEUTRON ACER TENDL-2023 LIBRARY; T=0.K
Neutron emission for (n,2nd)

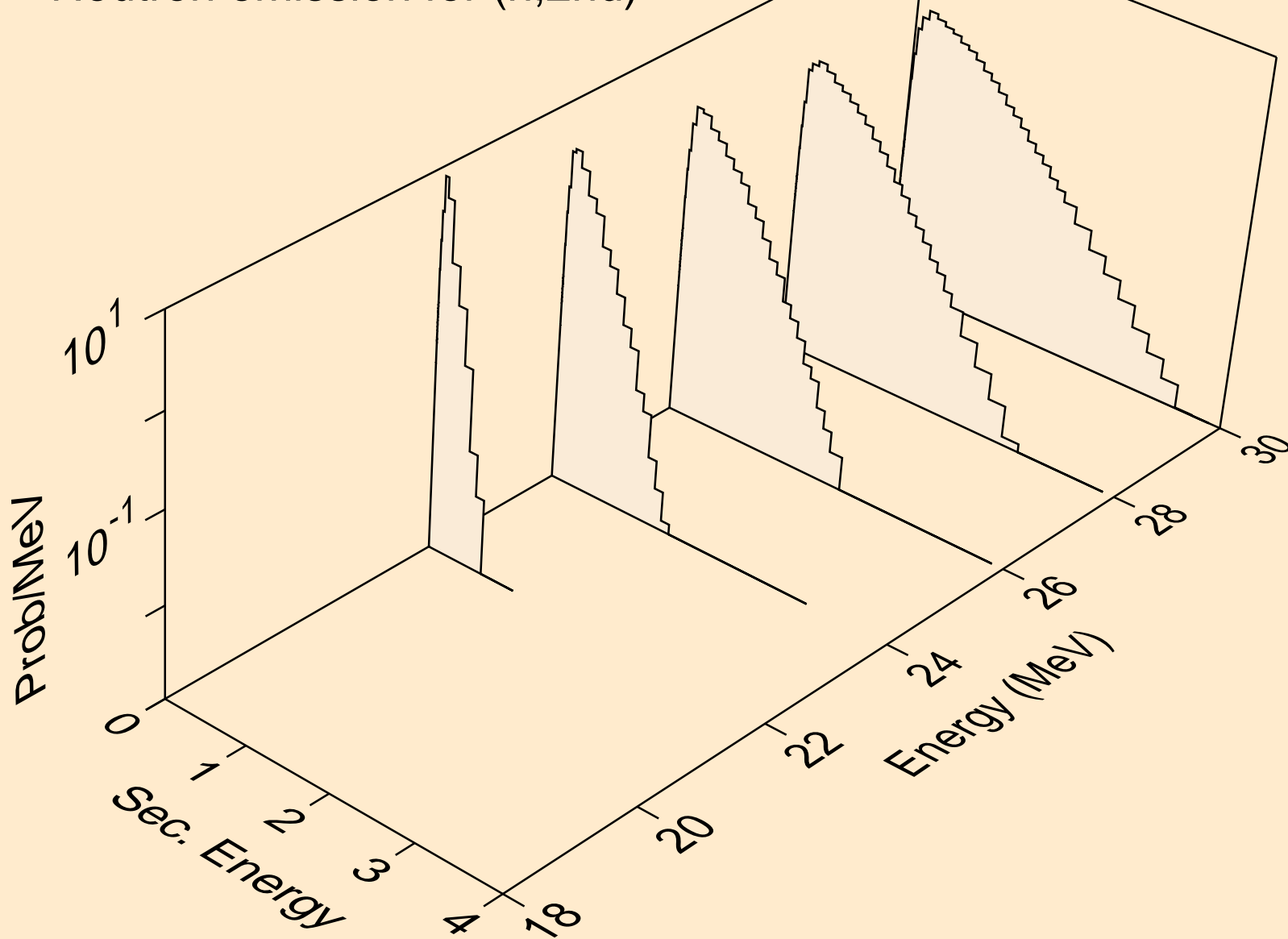

LU154 NEUTRON ACER TENDL-2023 LIBRARY; T=0.K
Neutron emission for (n,2n)

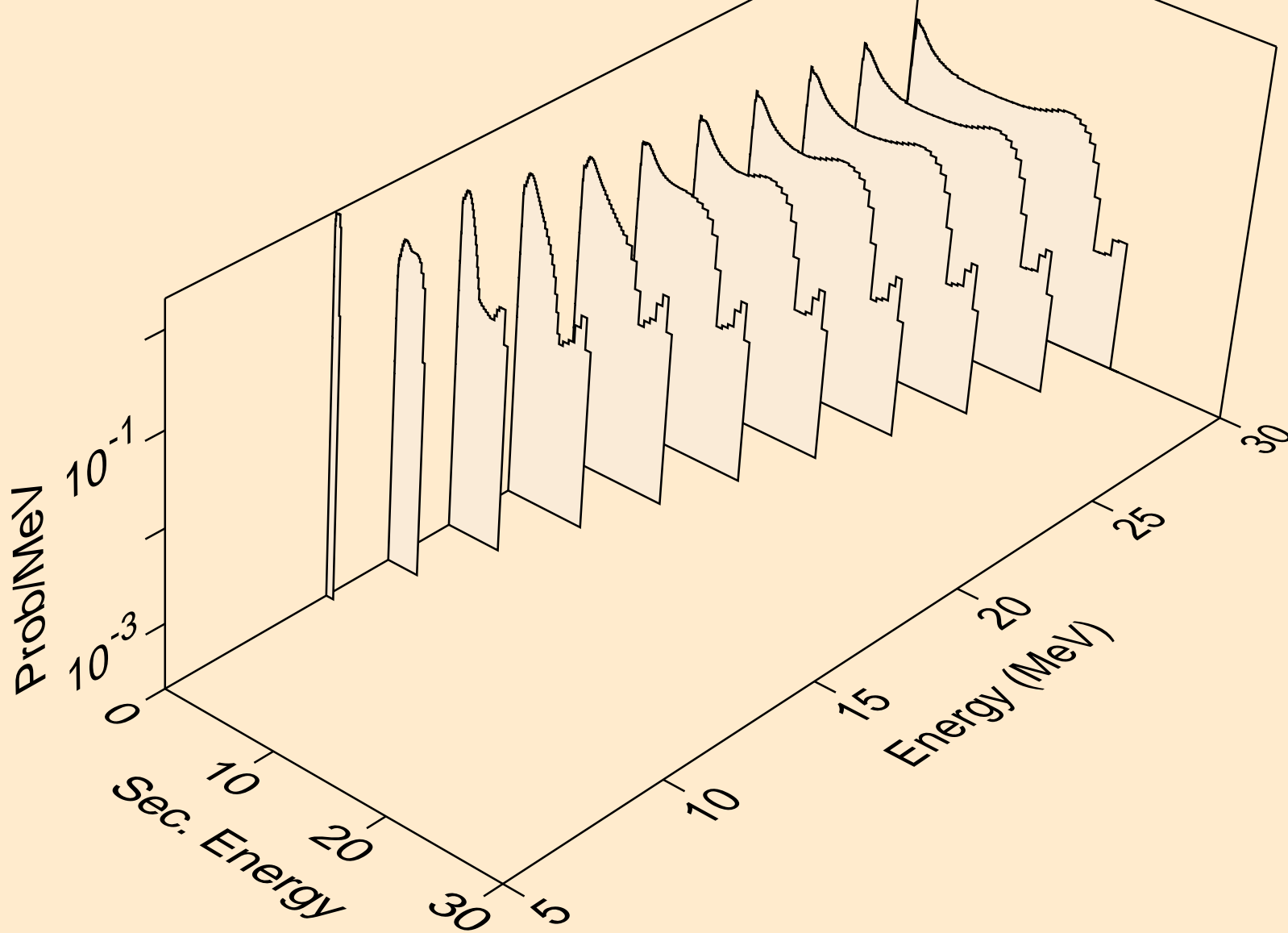

LU154 NEUTRON ACER TENDL-2023 LIBRARY; T=0.K
Neutron emission for (n,3n)

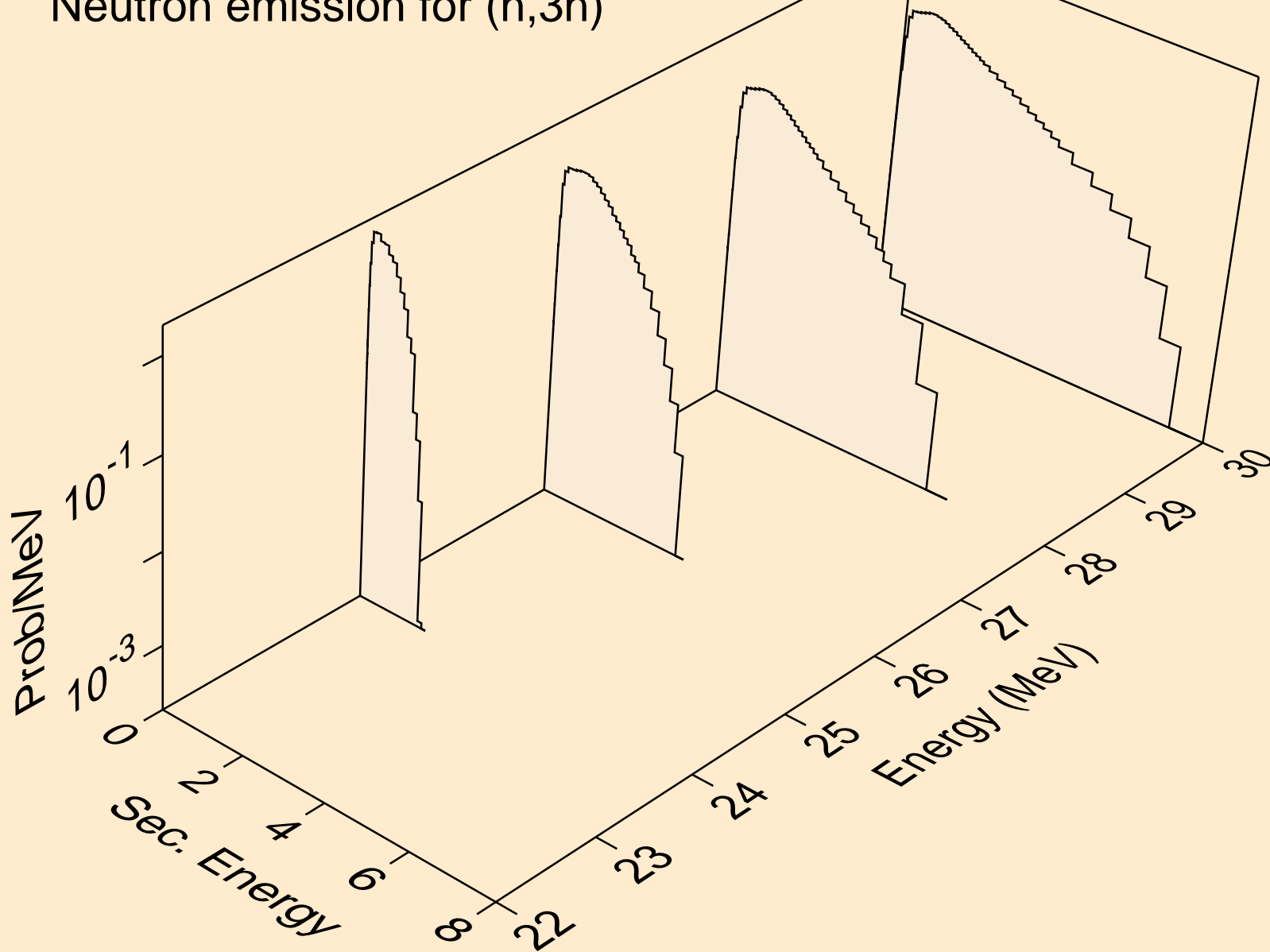

LU154 NEUTRON ACER TENDL-2023 LIBRARY; T=0.K
Neutron emission for (n,n*)a

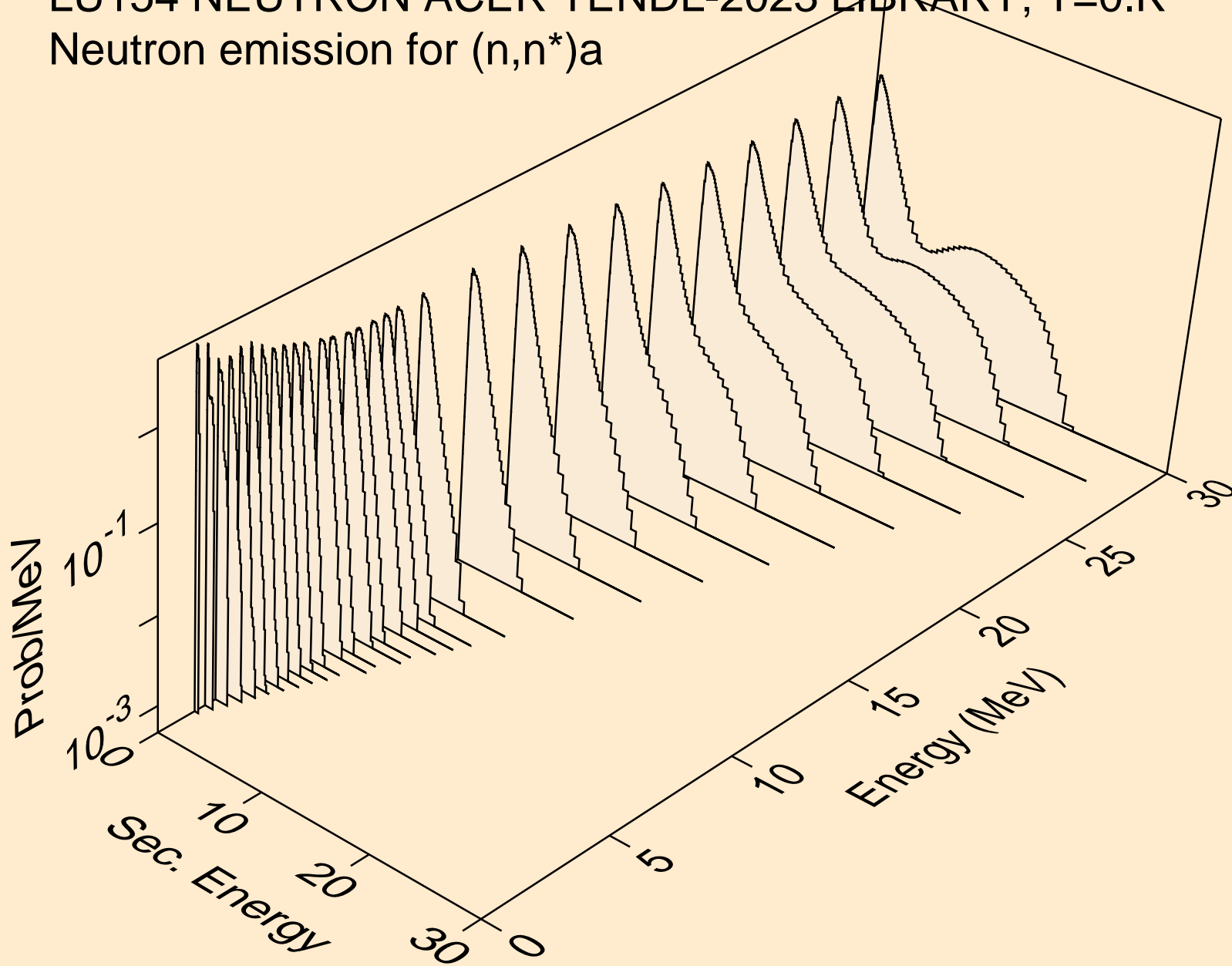

LU154 NEUTRON ACER TENDL-2023 LIBRARY; T=0.K
Neutron emission for (n,2n)a

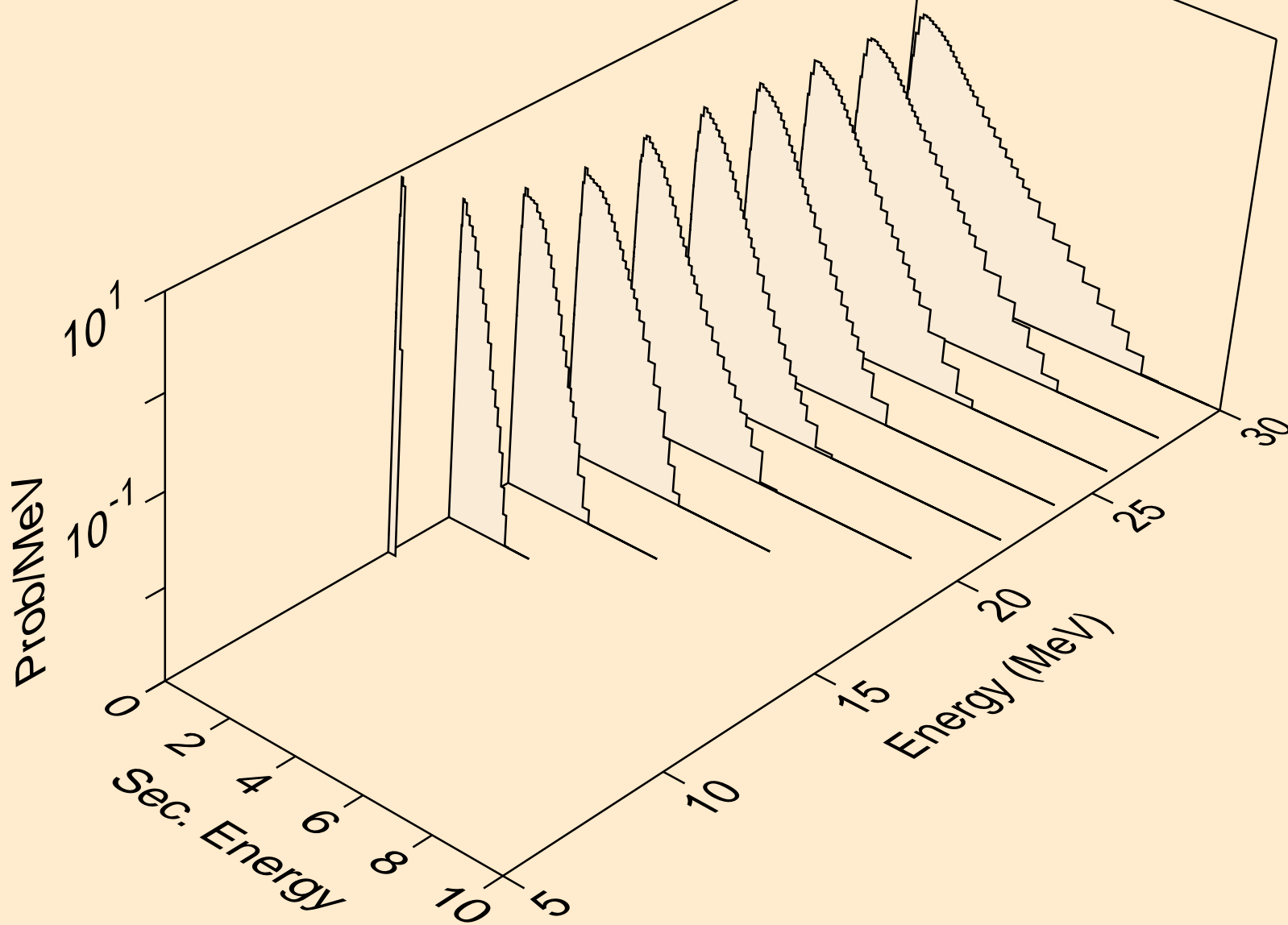

LU154 NEUTRON ACER TENDL-2023 LIBRARY; T=0.K
Neutron emission for (n,n*)p

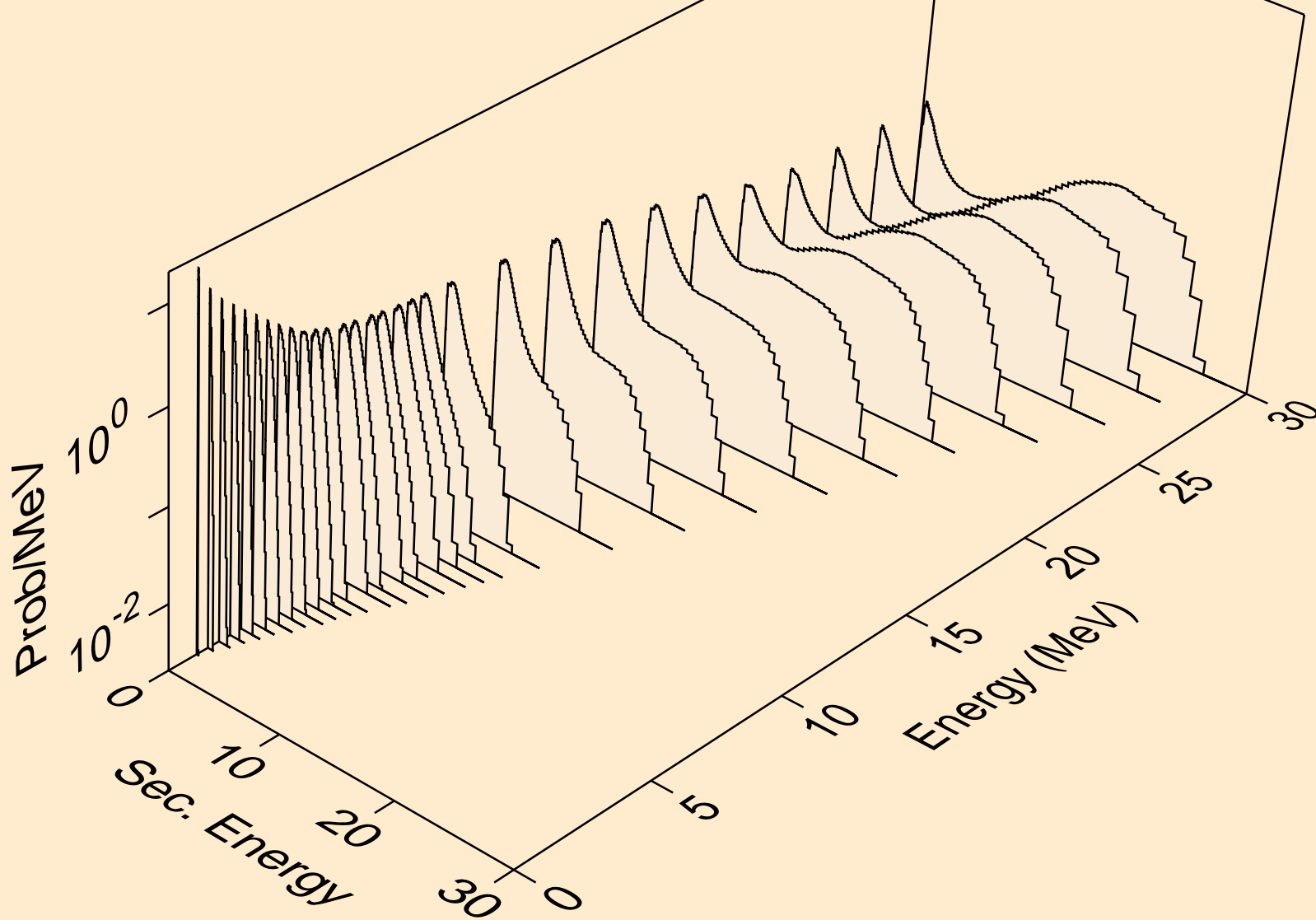

LU154 NEUTRON ACER TENDL-2023 LIBRARY; T=0.K
Neutron emission for (n,n*)2a

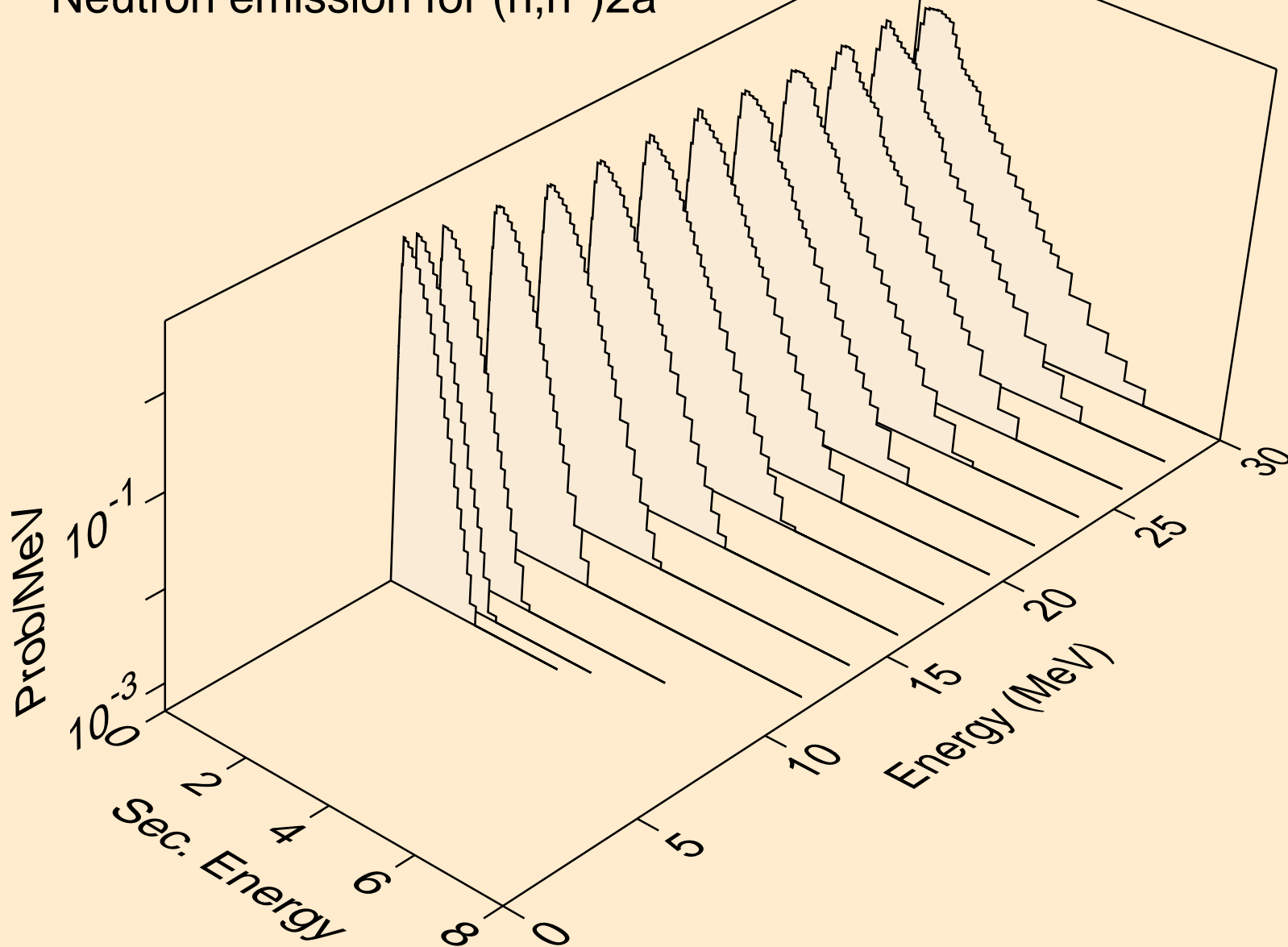

LU154 NEUTRON ACER TENDL-2023 LIBRARY; T=0.K
Neutron emission for (n,n*)d

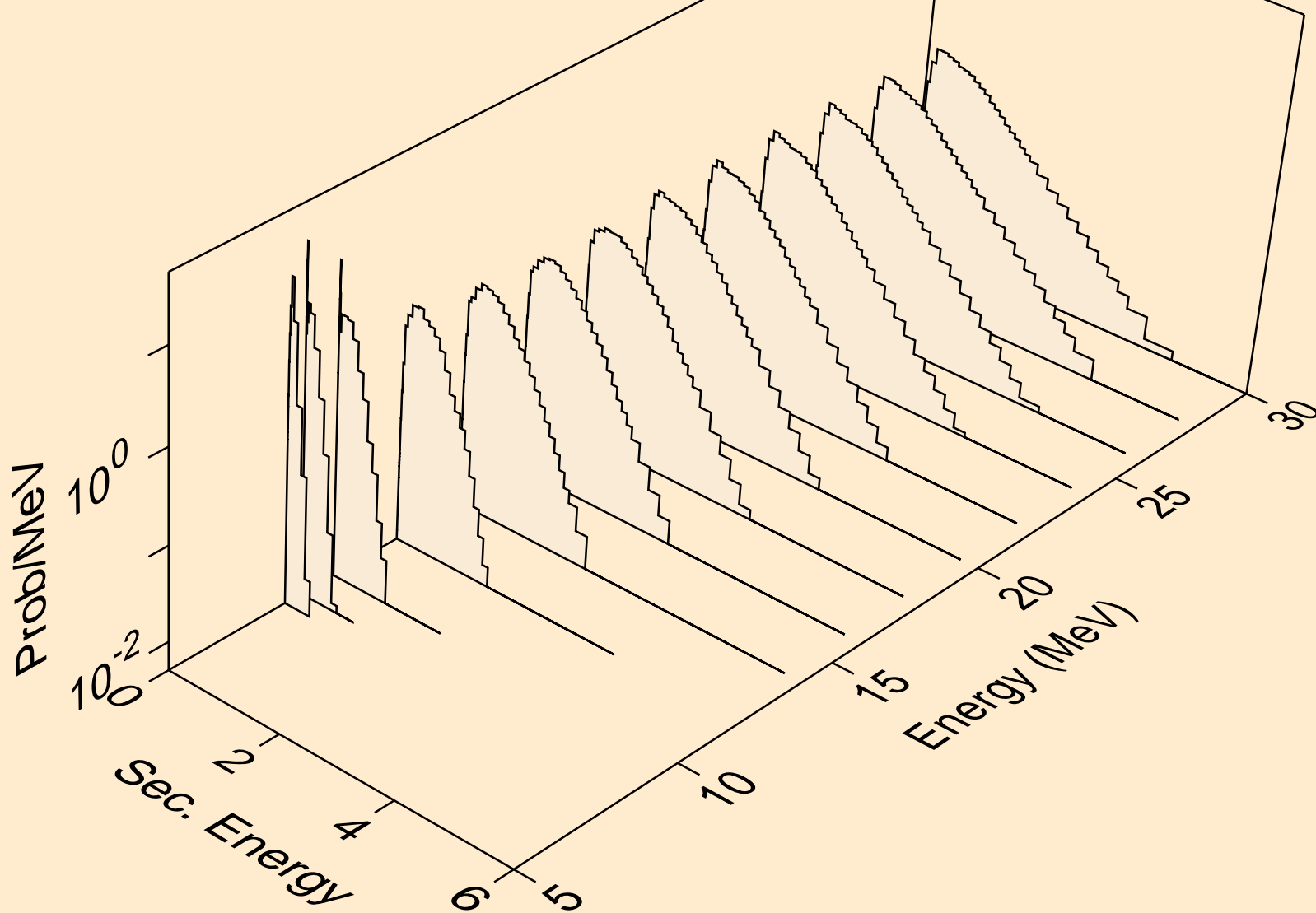

LU154 NEUTRON ACER TENDL-2023 LIBRARY; T=0.K
Neutron emission for (n,n*)t

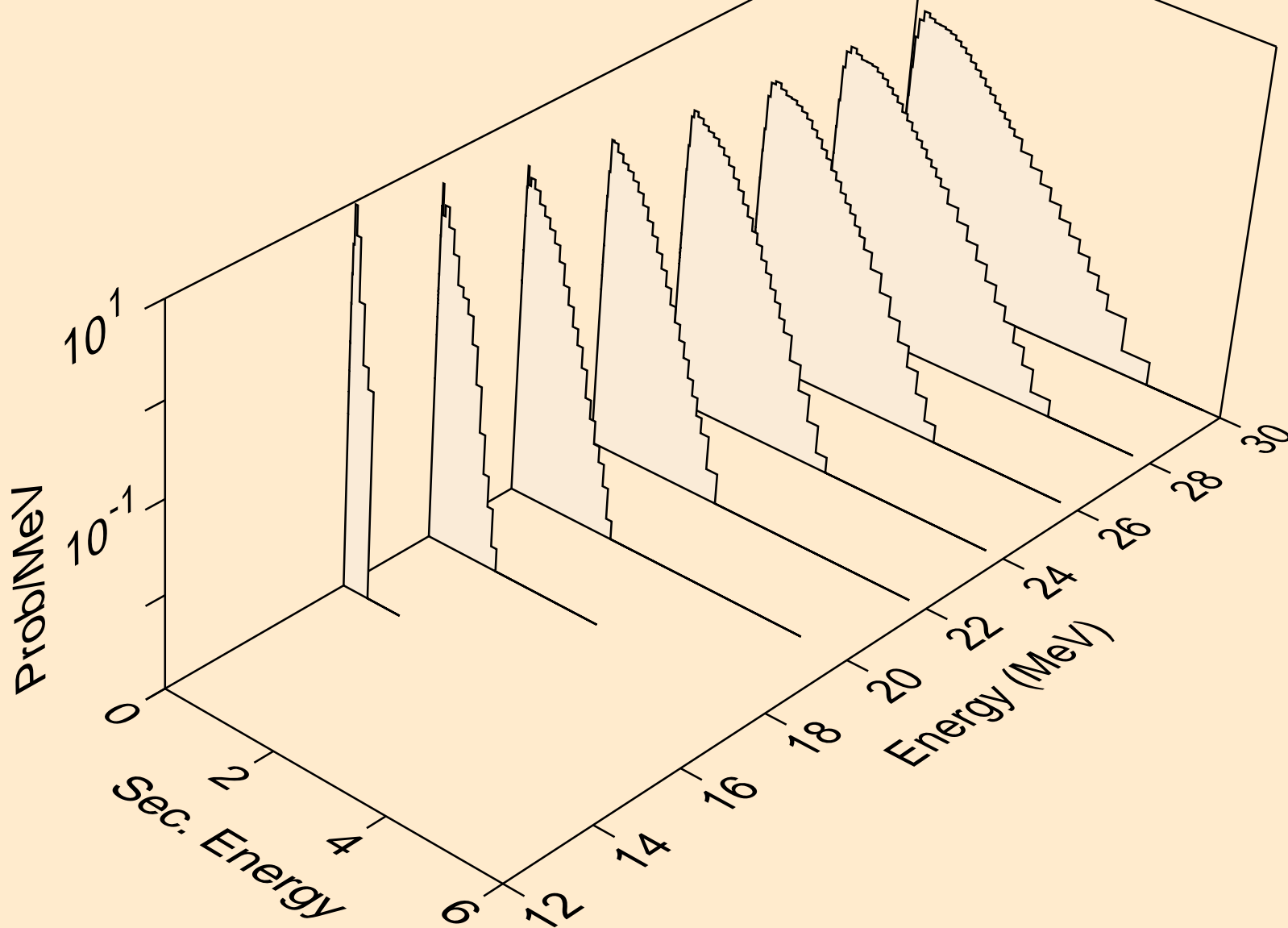

LU154 NEUTRON ACER TENDL-2023 LIBRARY; T=0.K
Neutron emission for (n,n*)he3

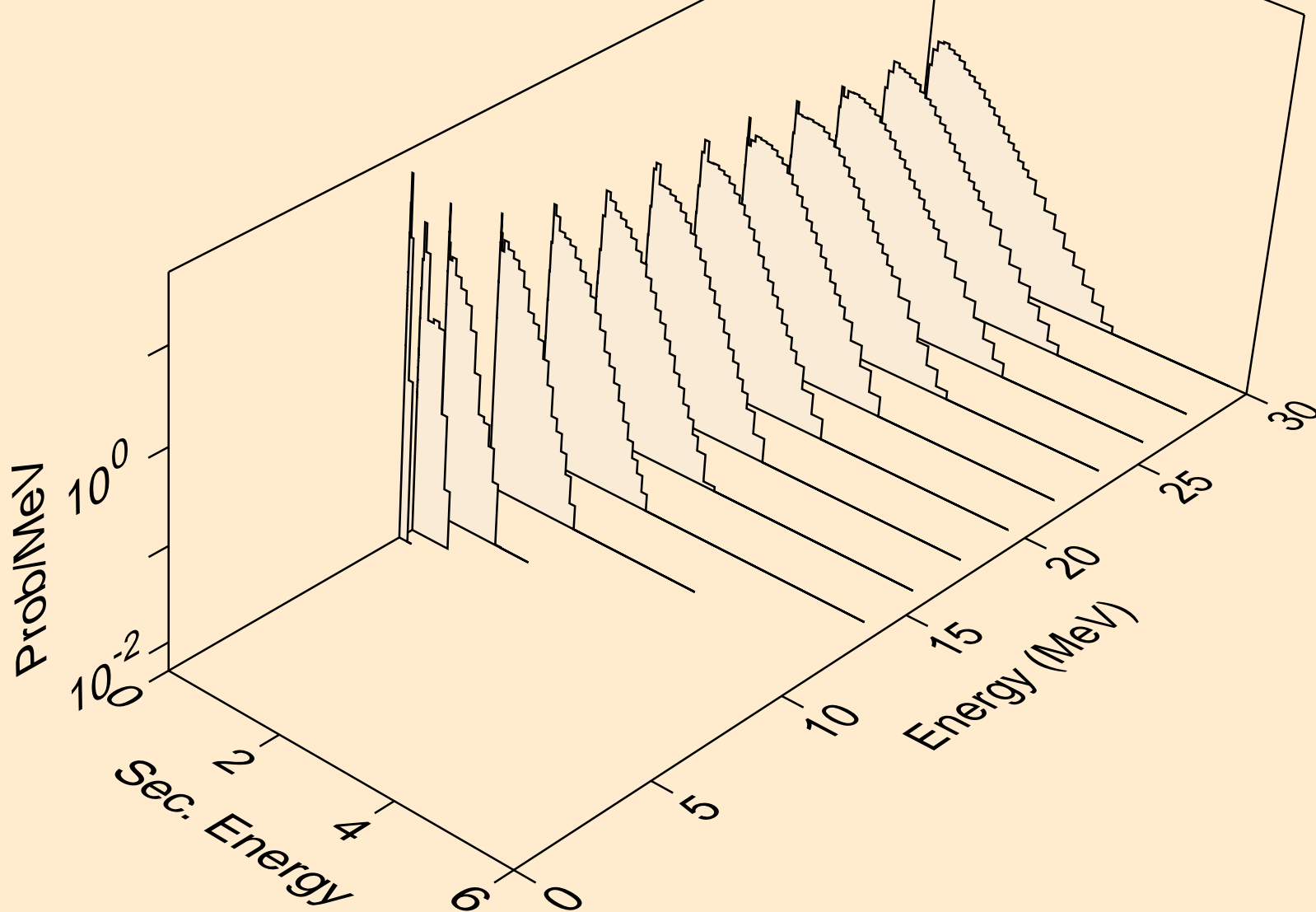

LU154 NEUTRON ACER TENDL-2023 LIBRARY; T=0.K
Neutron emission for (n,2np)

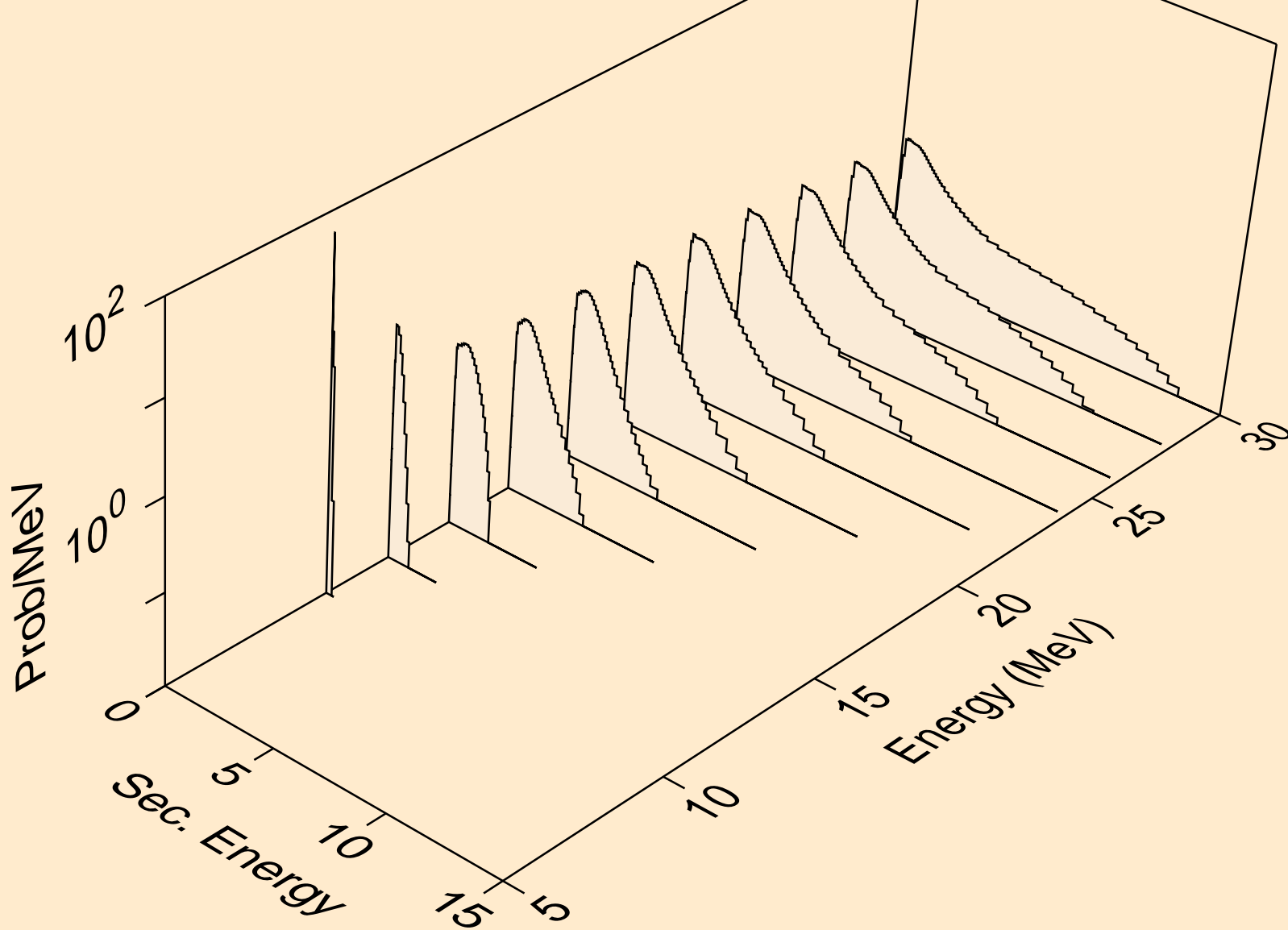

LU154 NEUTRON ACER TENDL-2023 LIBRARY; T=0.K
Neutron emission for (n,3np)

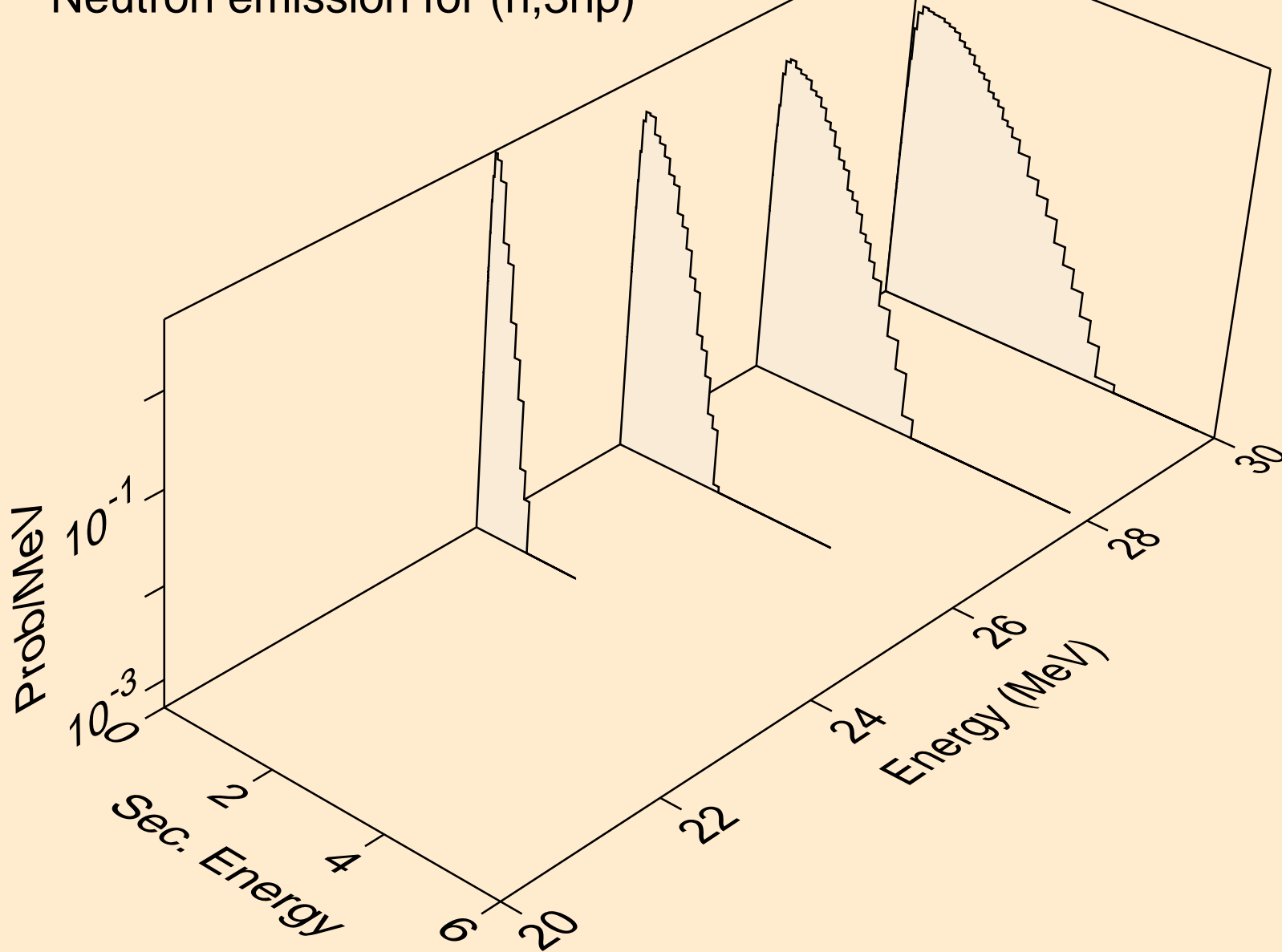

LU154 NEUTRON ACER TENDL-2023 LIBRARY; T=0.K
Neutron emission for (n,n2p)

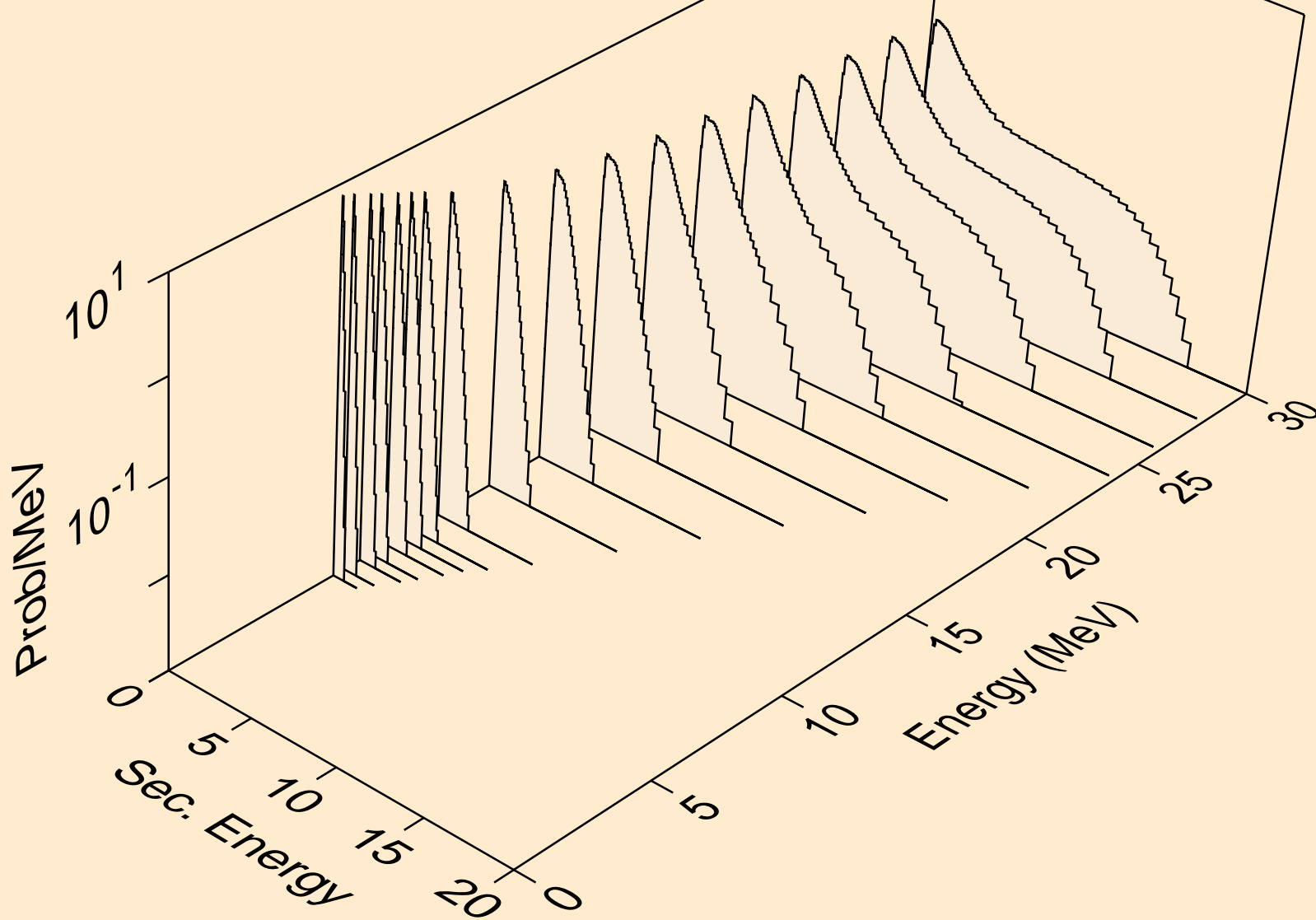

LU154 NEUTRON ACER TENDL-2023 LIBRARY; T=0.K
Neutron emission for (n,npa)

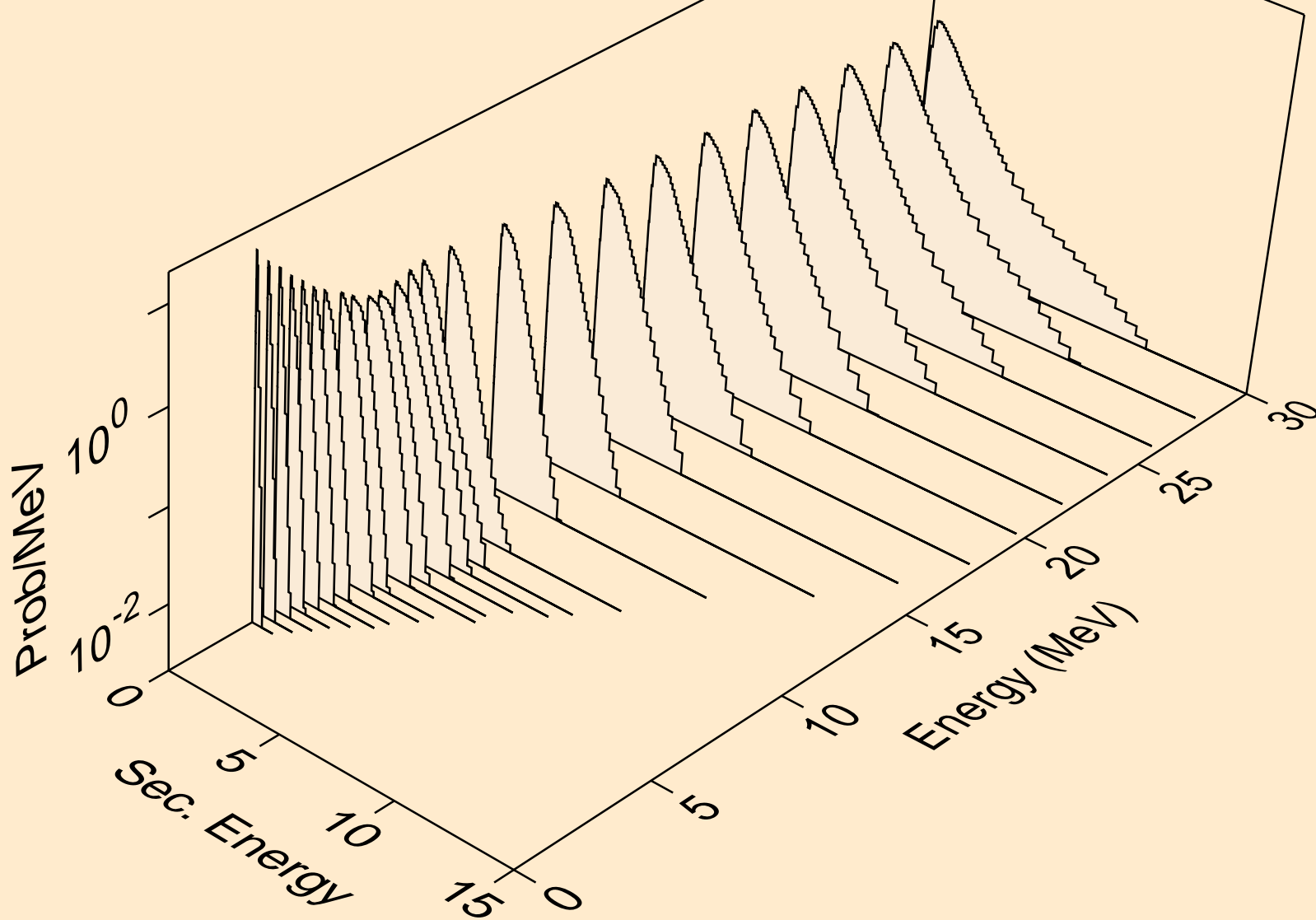

LU154 NEUTRON ACER TENDL-2023 LIBRARY; T=0.K
Neutron emission for (n,n*c)

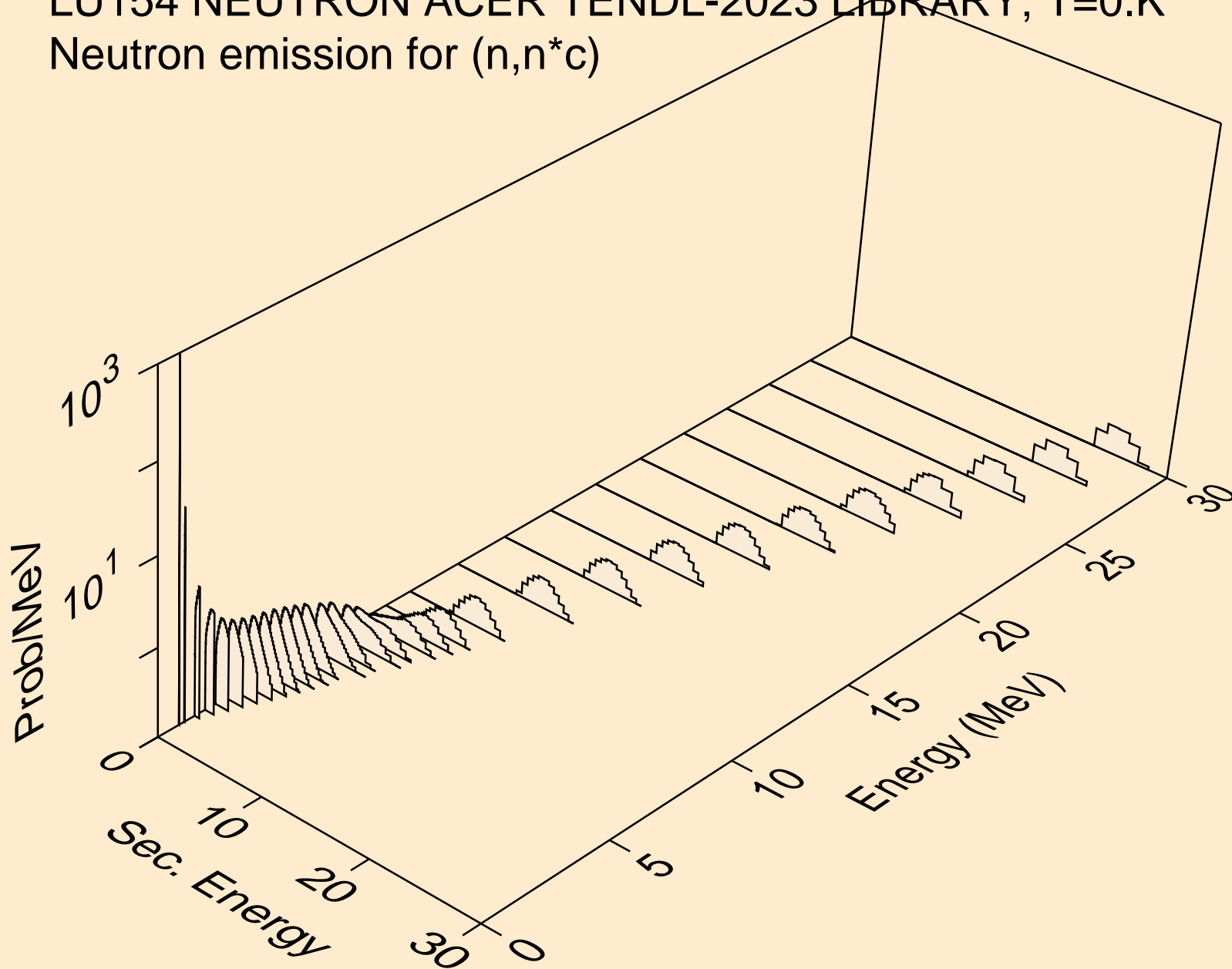

LU154 NEUTRON ACER TENDL-2023 LIBRARY; T=0.K
Photon emission for (n,x)

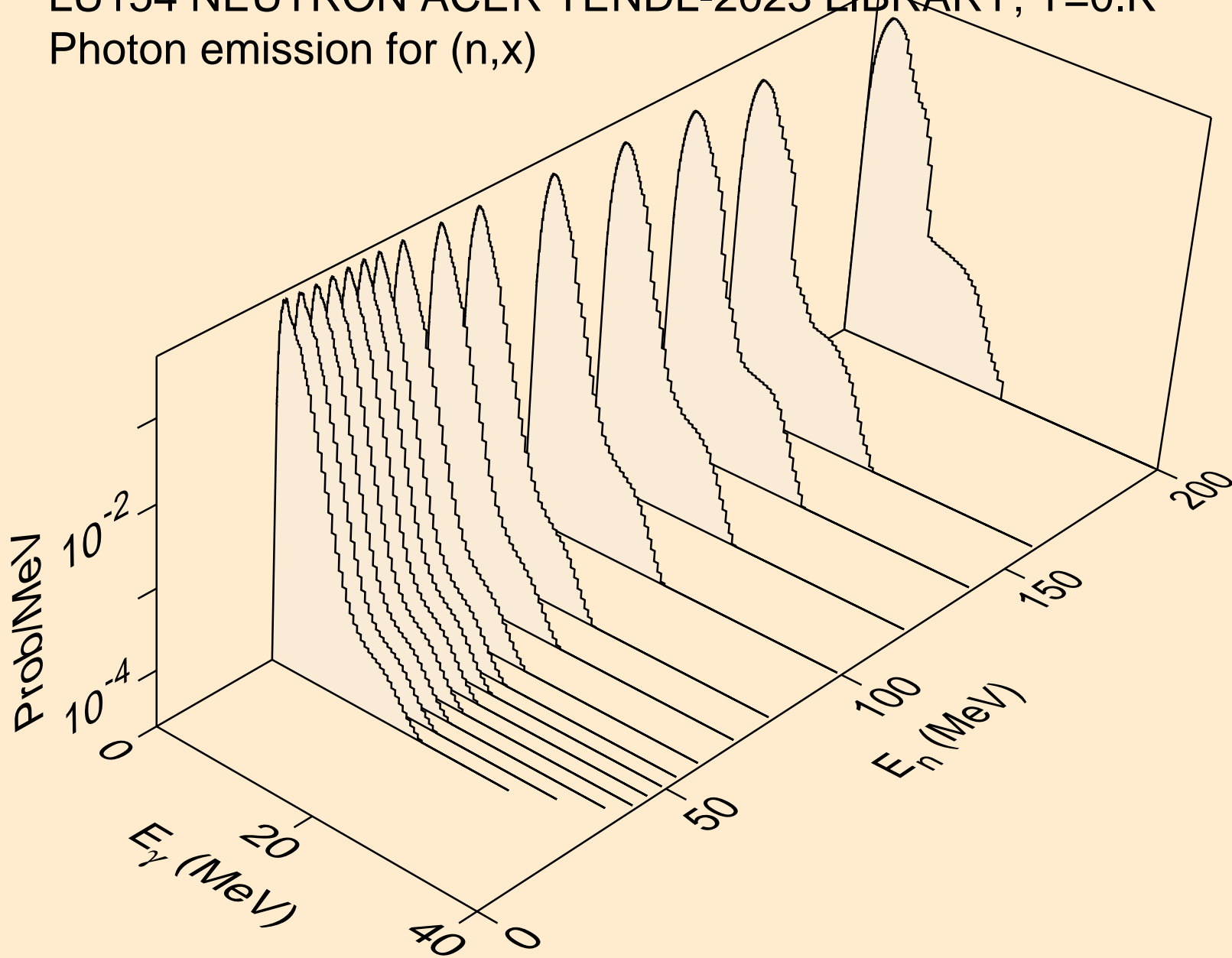

LU154 NEUTRON ACER TENDL-2023 LIBRARY; T=0.K
Photon emission for (n,2nd)

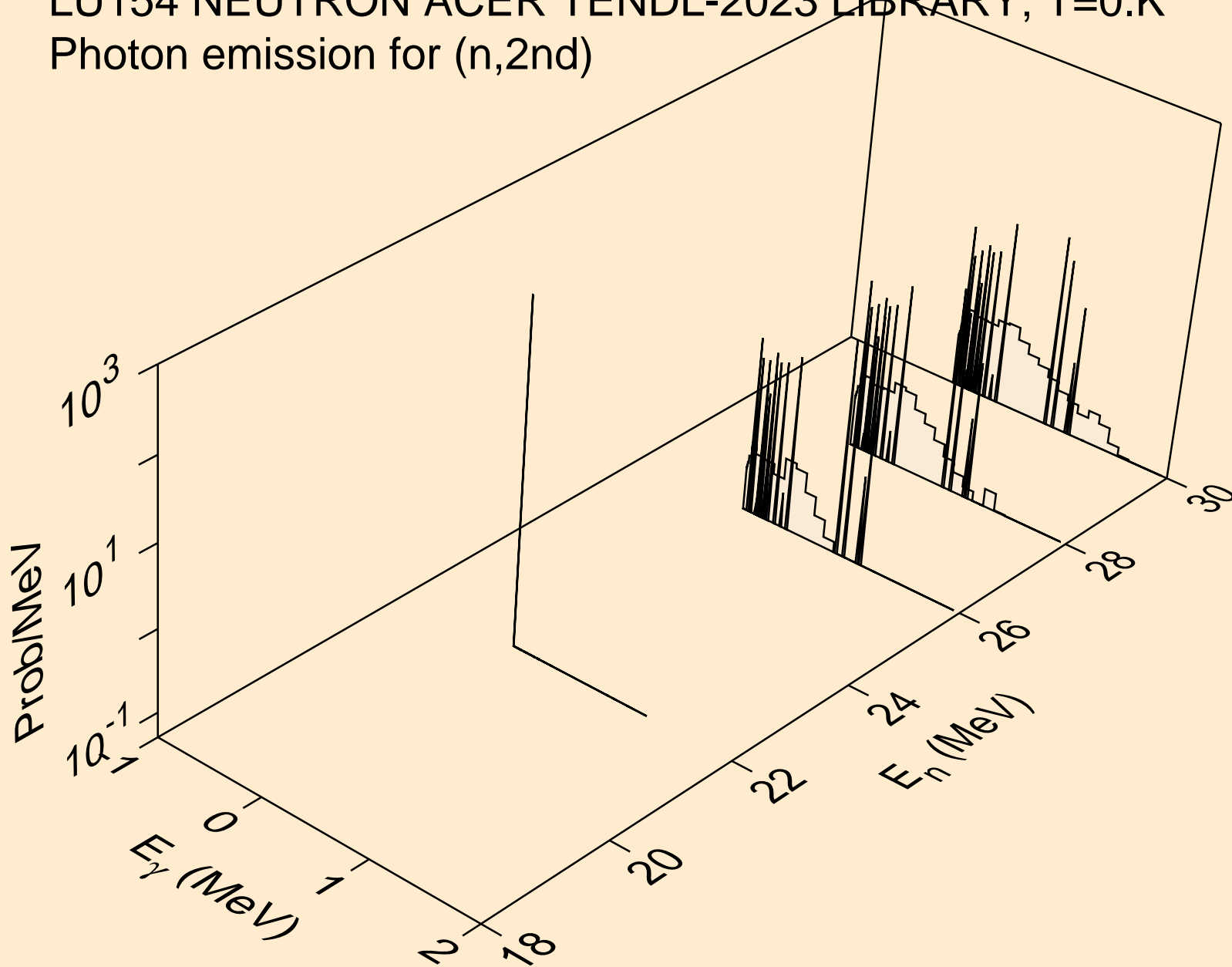

LU154 NEUTRON ACER TENDL-2023 LIBRARY; T=0.K
Photon emission for (n,2n)

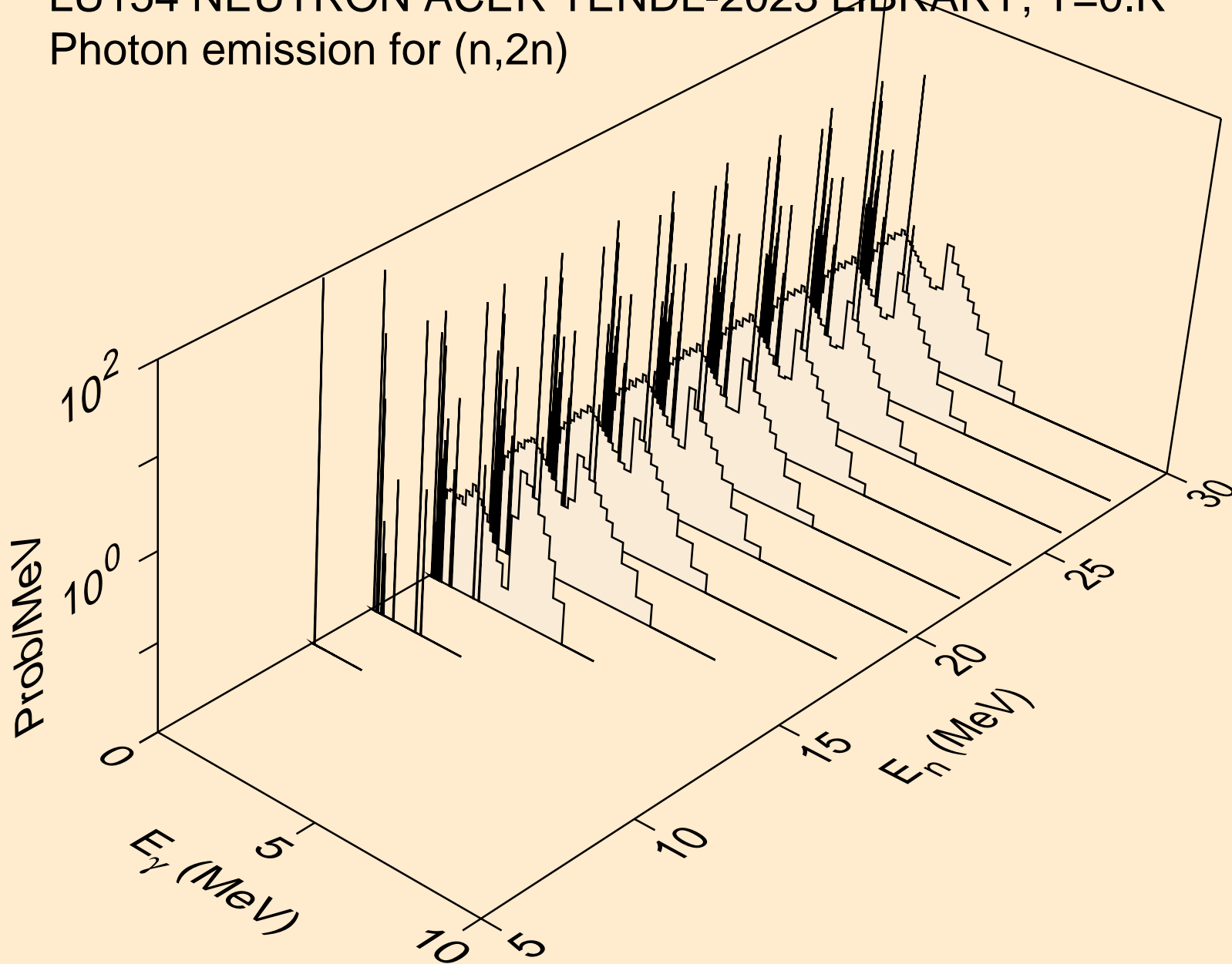

LU154 NEUTRON ACER TENDL-2023 LIBRARY; T=0.K
Photon emission for (n,3n)

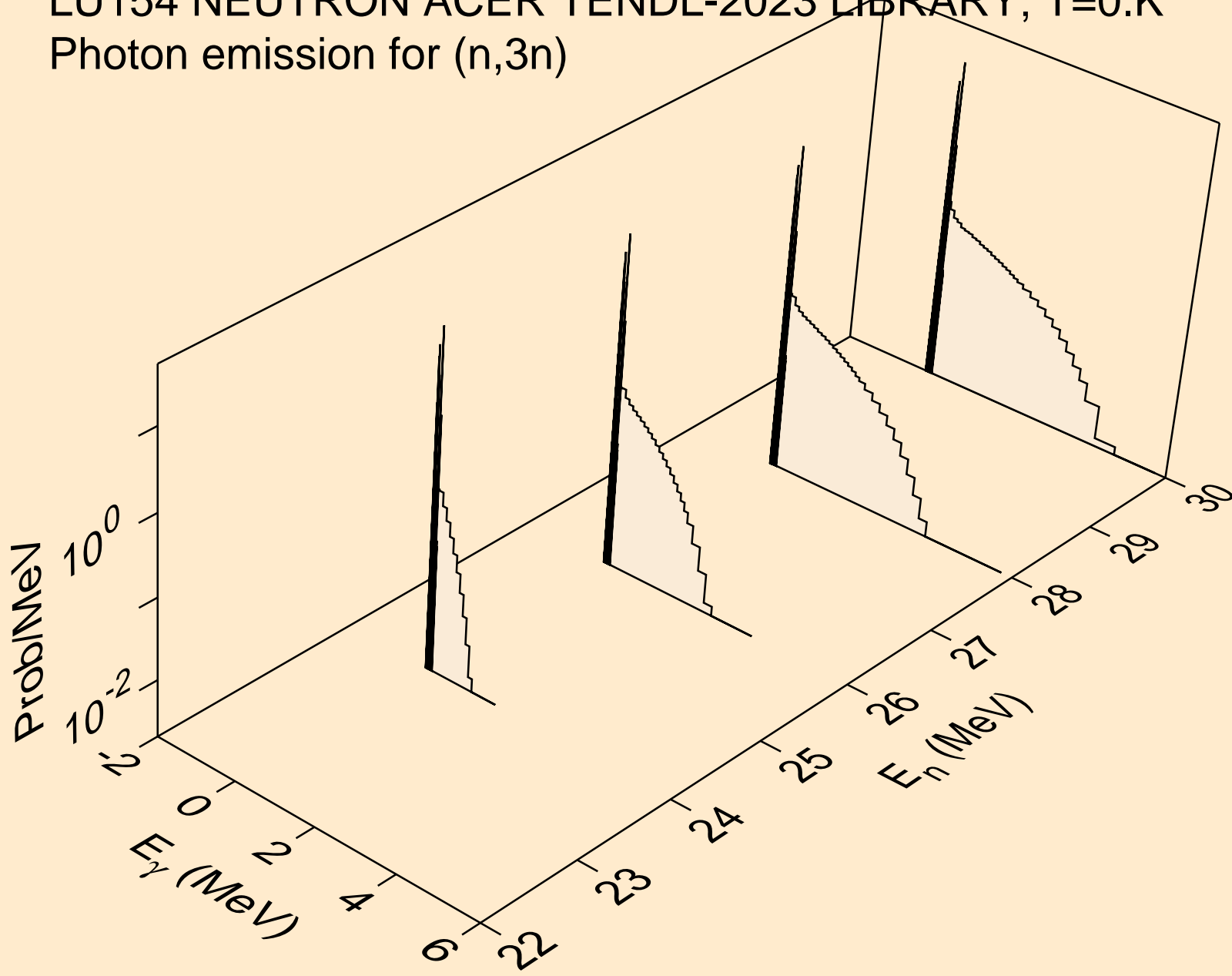

LU154 NEUTRON ACER TENDL-2023 LIBRARY; T=0.K
Photon emission for (n,n*)a

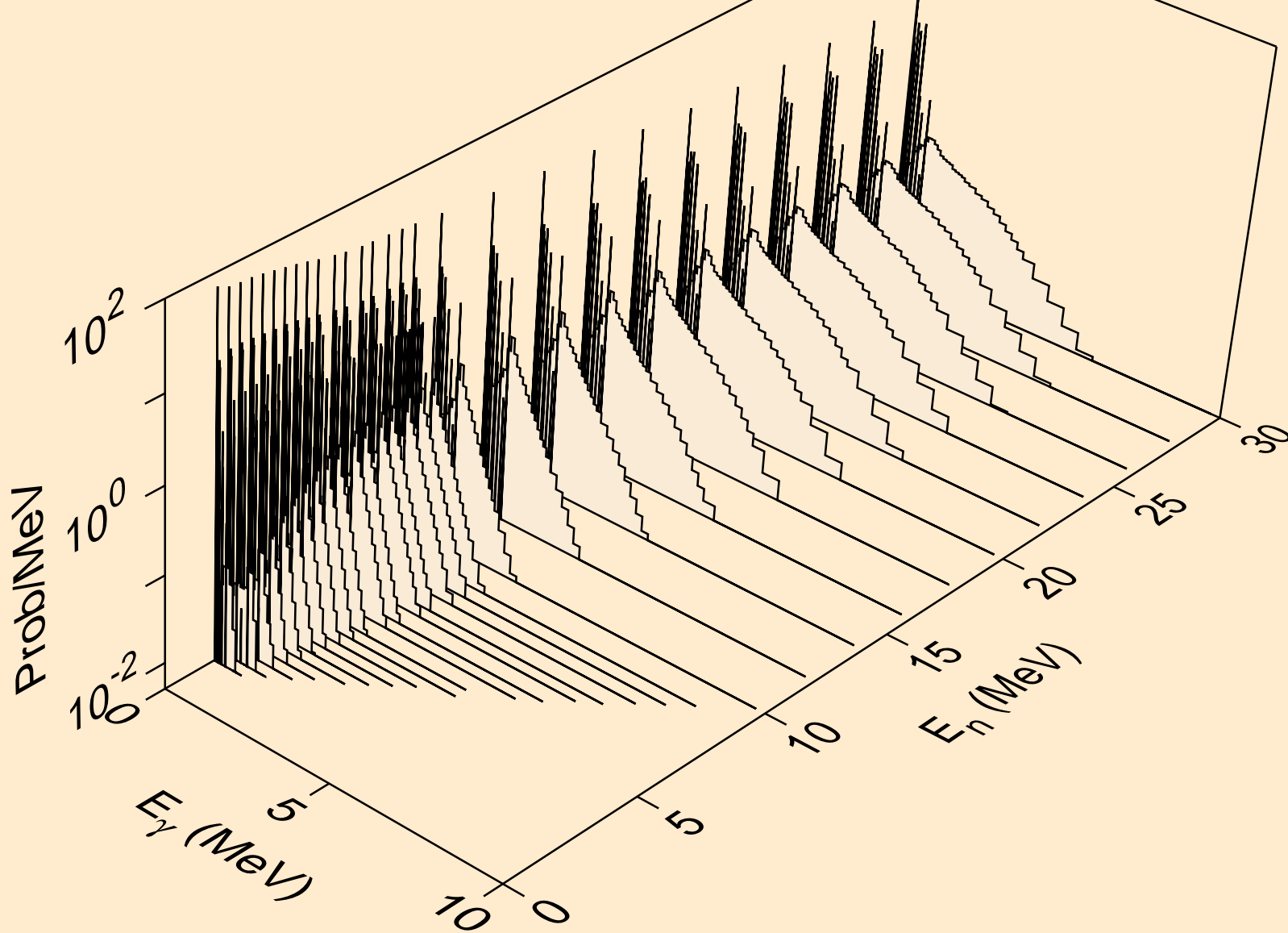

LU154 NEUTRON ACER TENDL-2023 LIBRARY; T=0.K
Photon emission for (n,2n)a

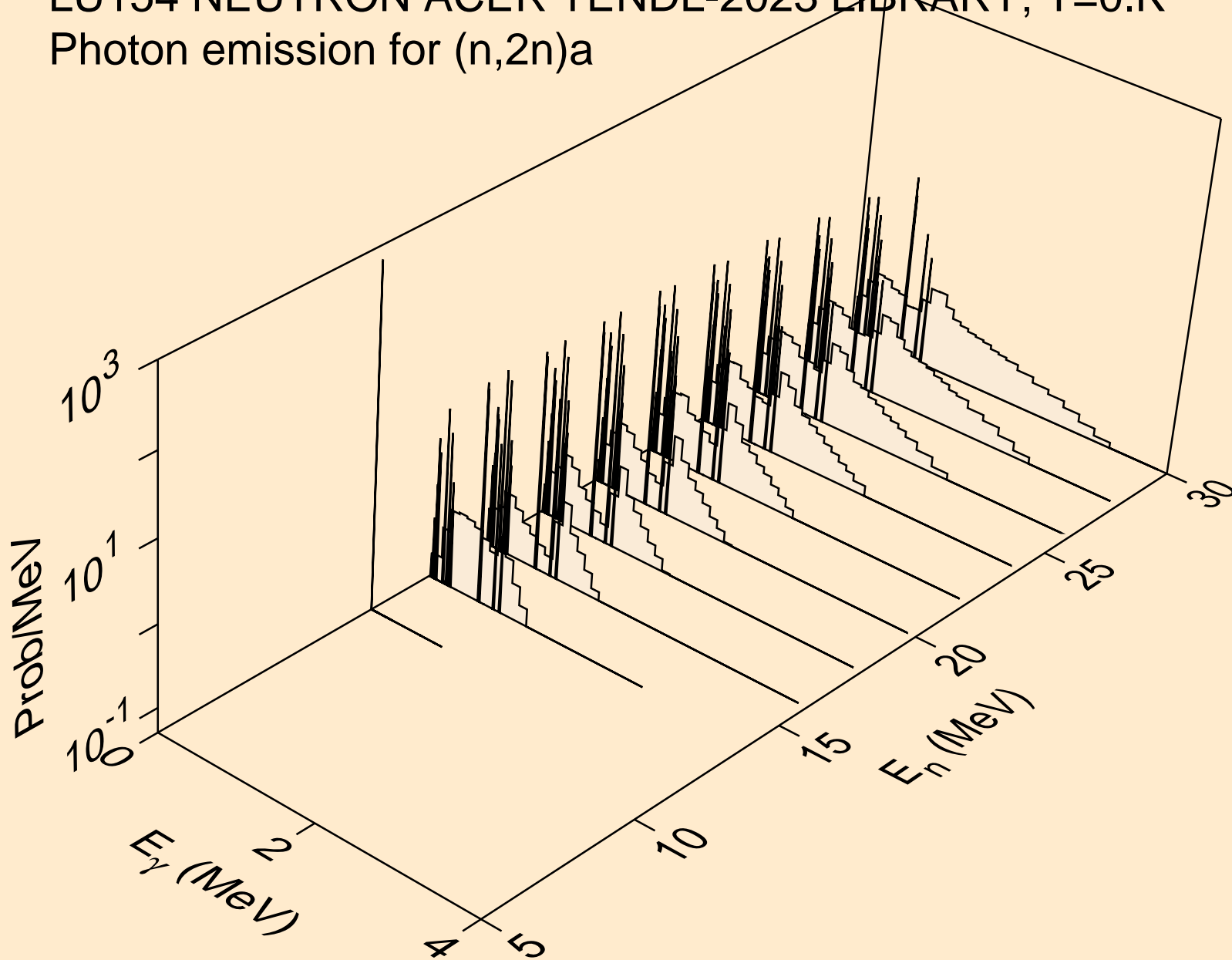

LU154 NEUTRON ACER TENDL-2023 LIBRARY; T=0.K
Photon emission for (n,n*)p

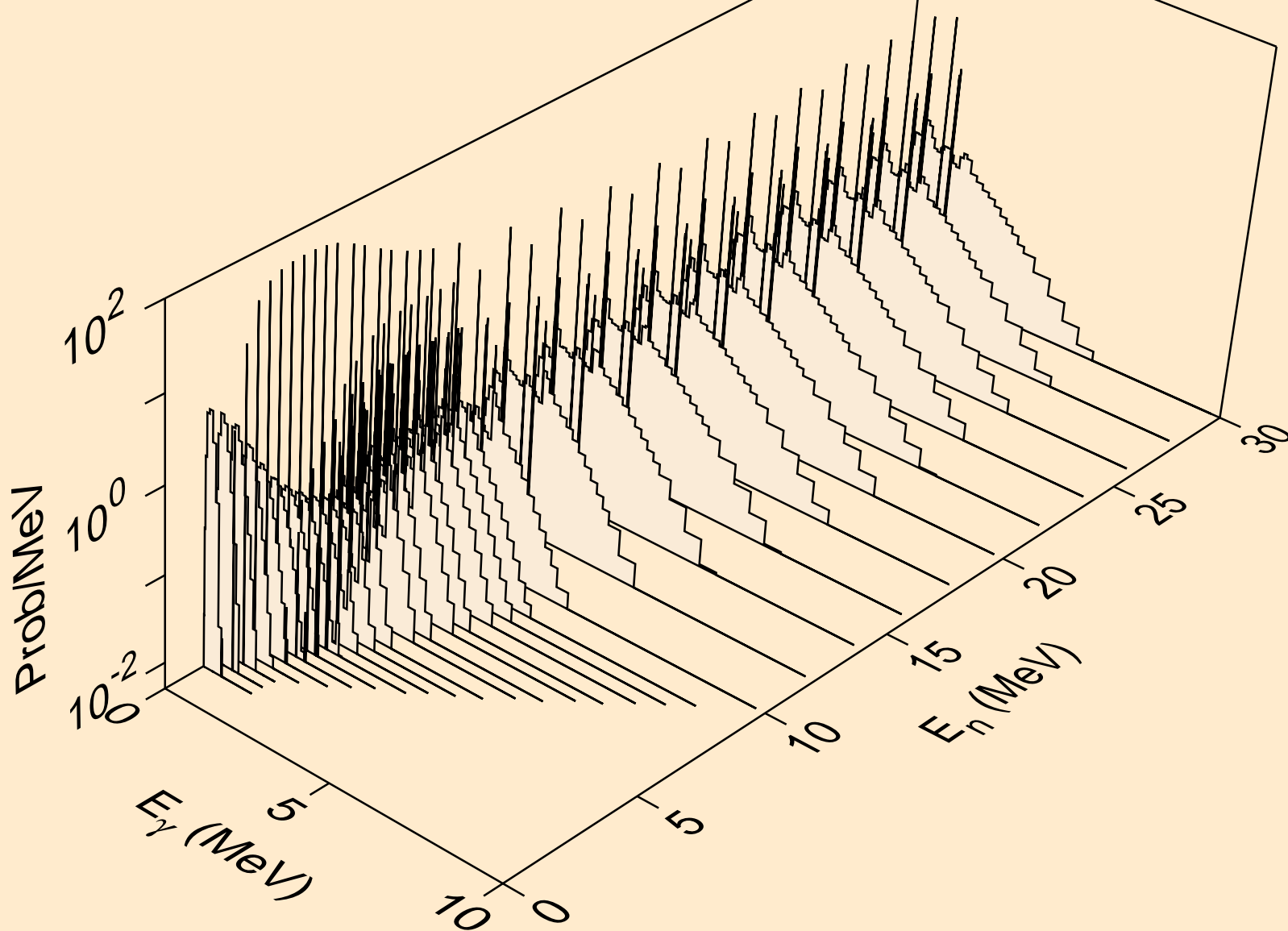

LU154 NEUTRON ACER TENDL-2023 LIBRARY; T=0.K
Photon emission for (n,n*)2a

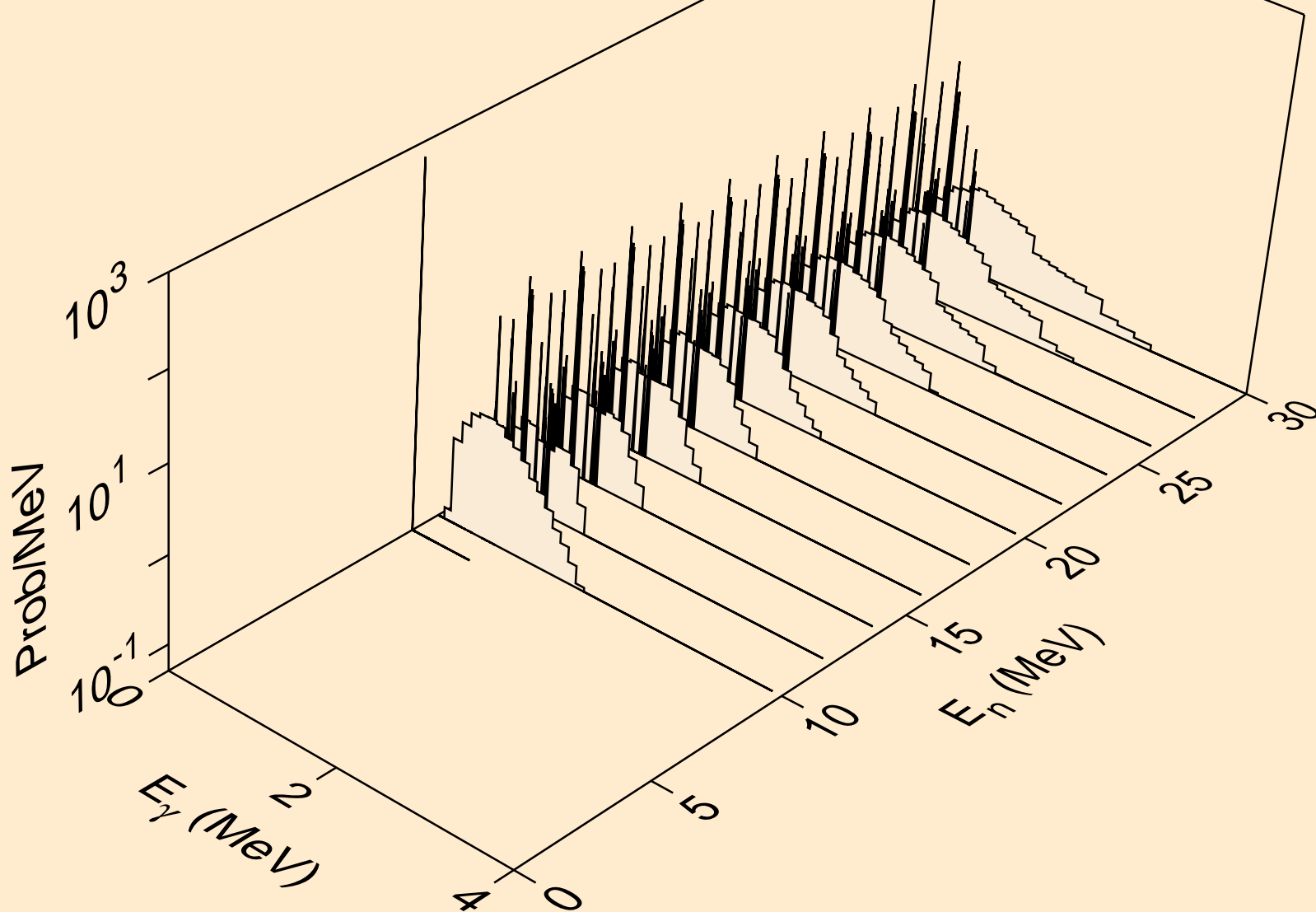

LU154 NEUTRON ACER TENDL-2023 LIBRARY; T=0.K
Photon emission for (n,n*)d

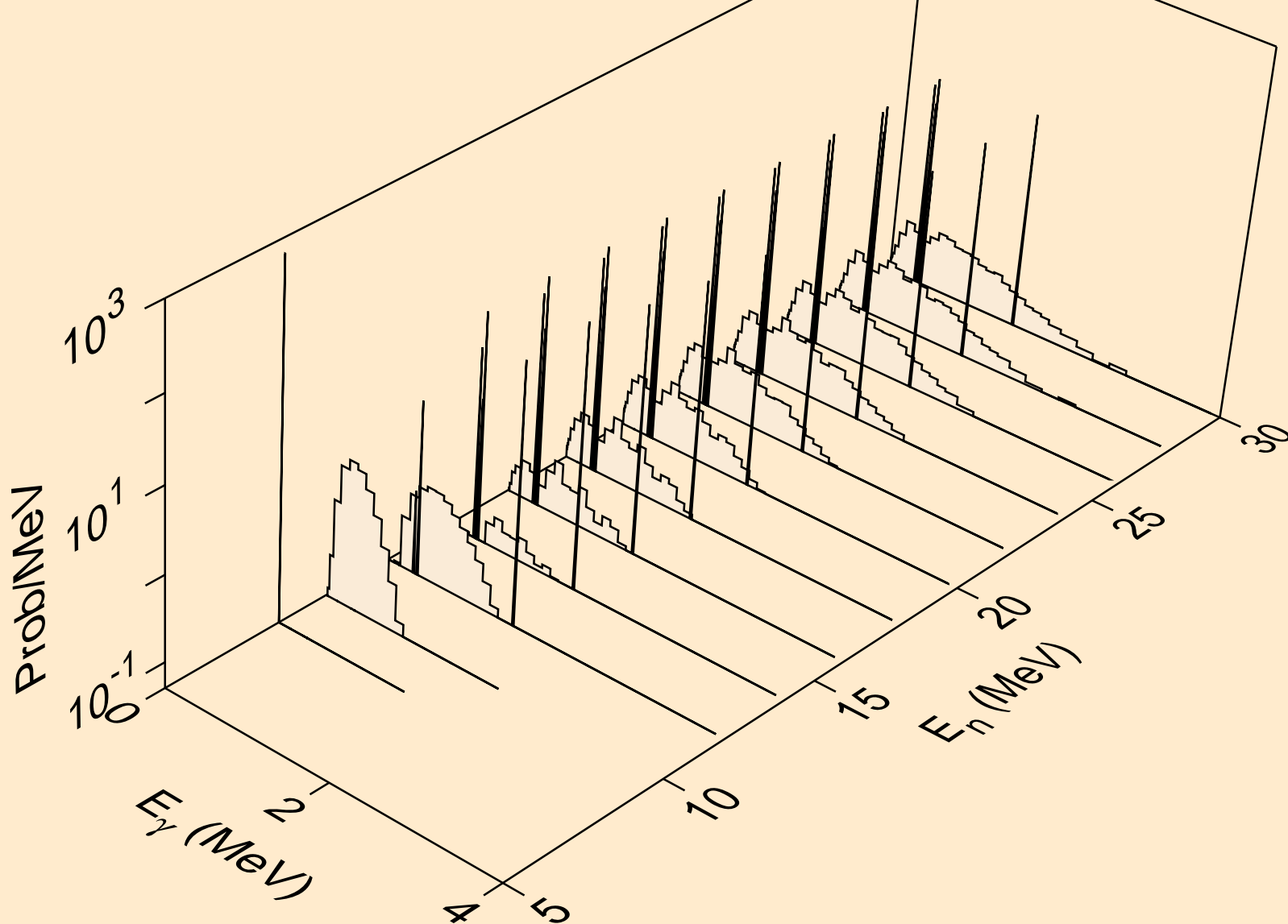

LU154 NEUTRON ACER TENDL-2023 LIBRARY; T=0.K
Photon emission for (n,n*)t

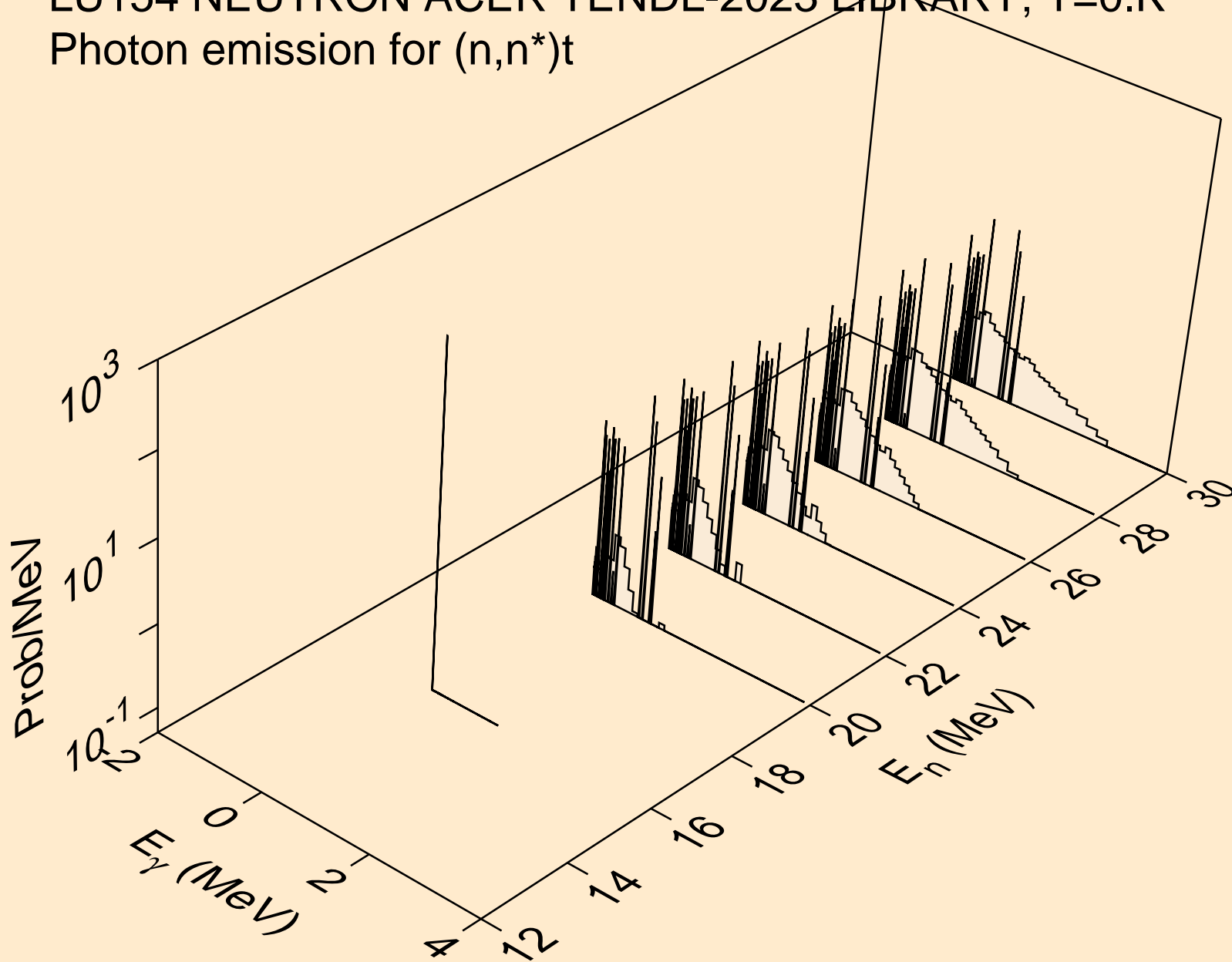

LU154 NEUTRON ACER TENDL-2023 LIBRARY; T=0.K
Photon emission for (n,n*)he3

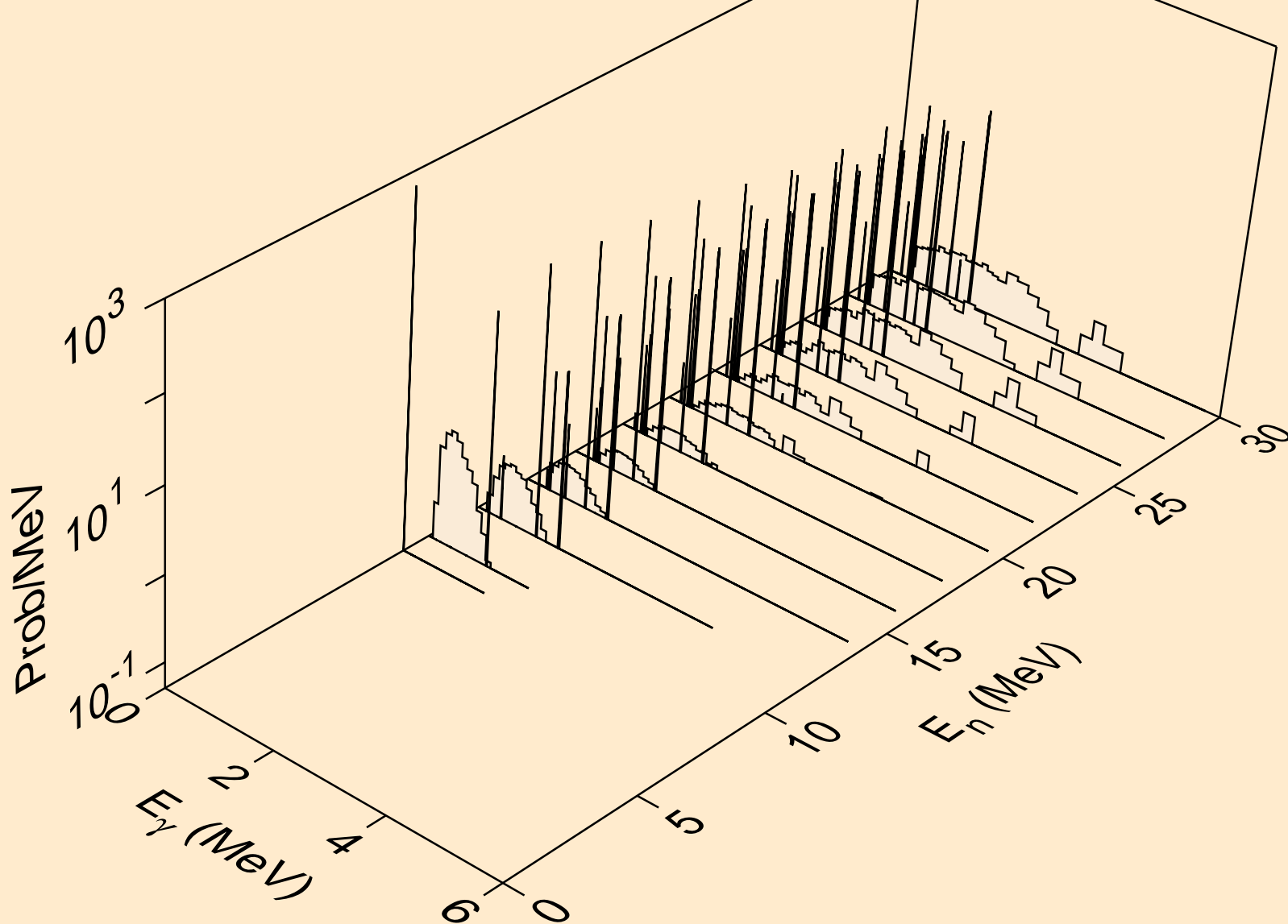

LU154 NEUTRON ACER TENDL-2023 LIBRARY; T=0.K
Photon emission for (n,2np)

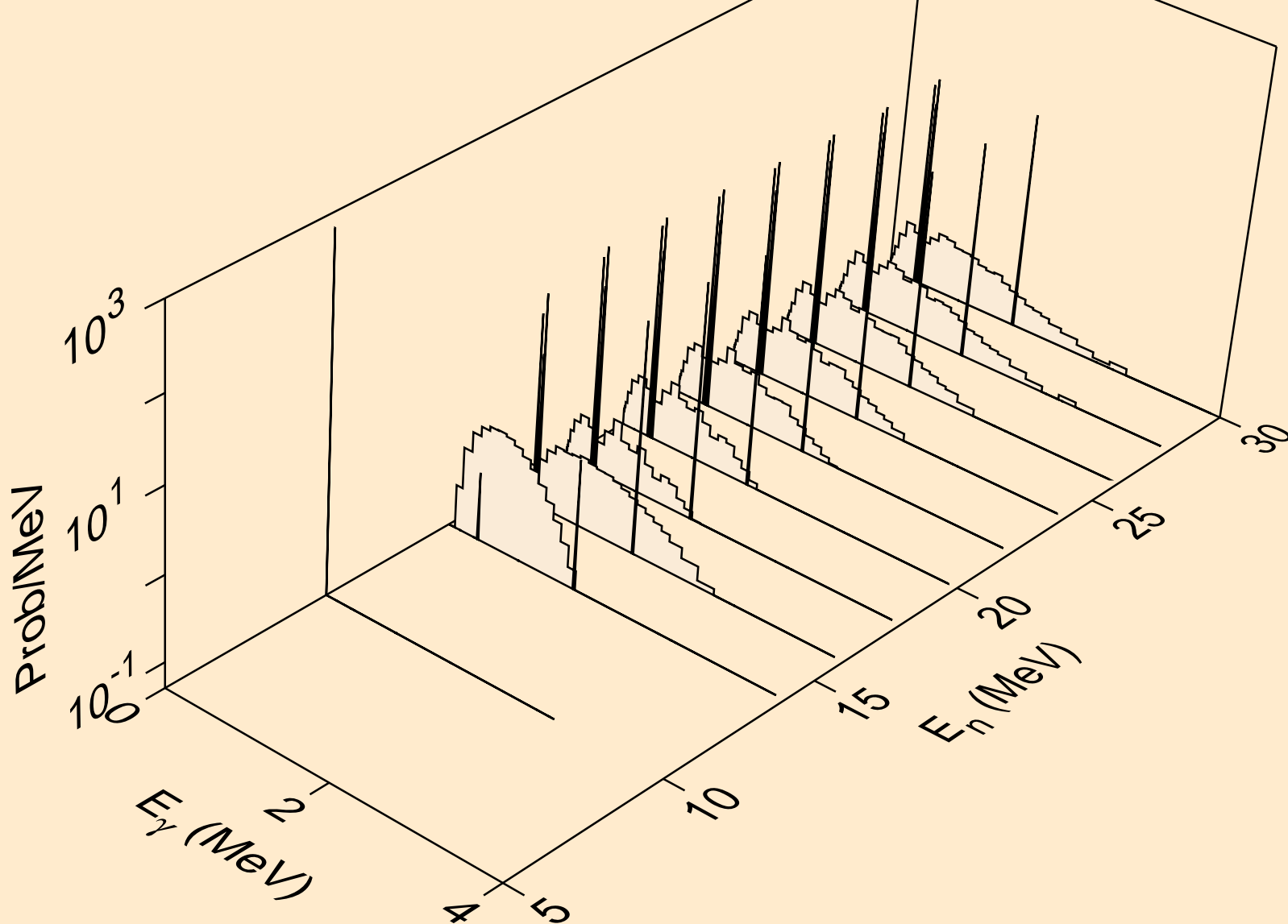

LU154 NEUTRON ACER TENDL-2023 LIBRARY; T=0.K
Photon emission for (n,3np)

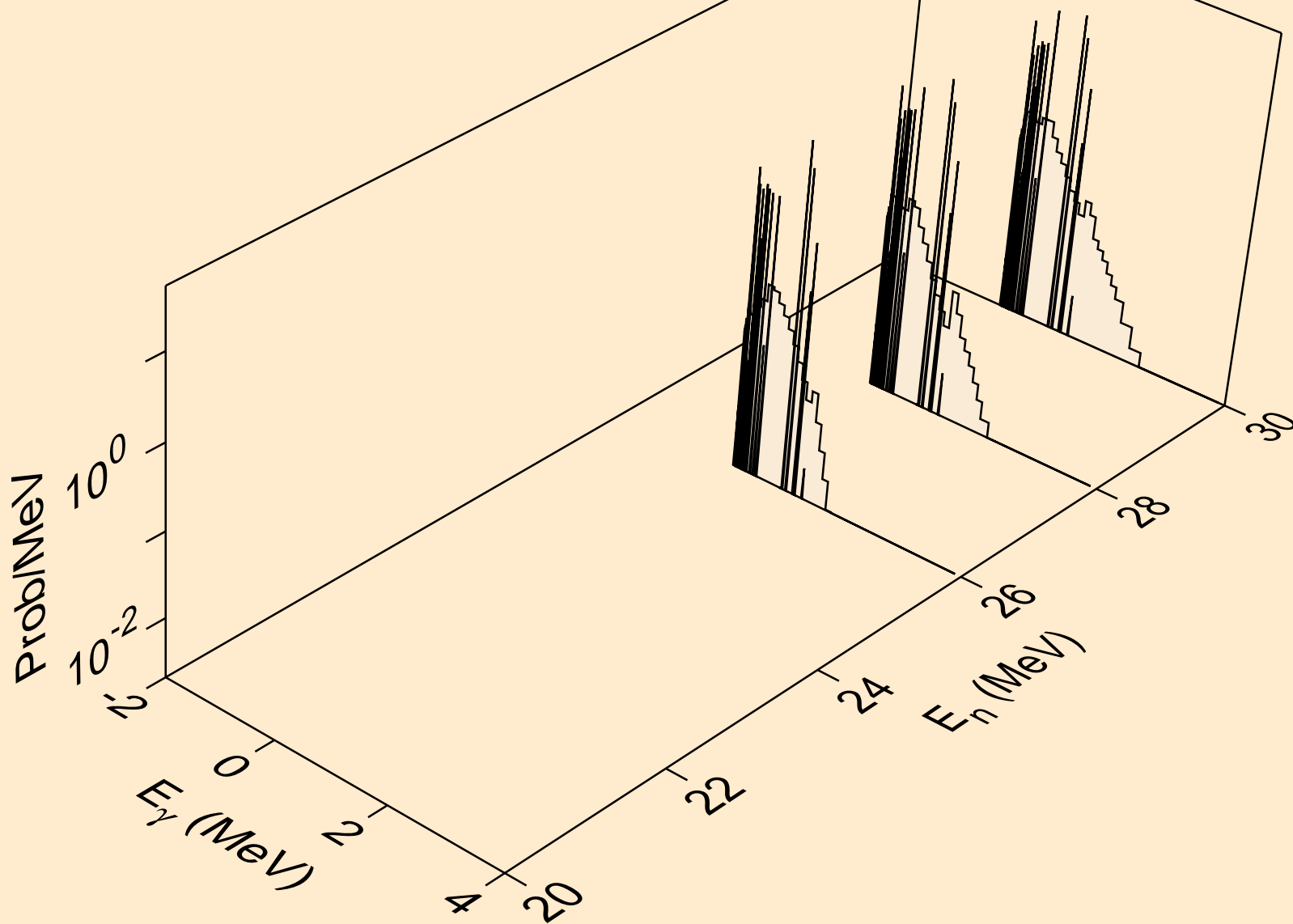

LU154 NEUTRON ACER TENDL-2023 LIBRARY; T=0.K
Photon emission for (n,n2p)

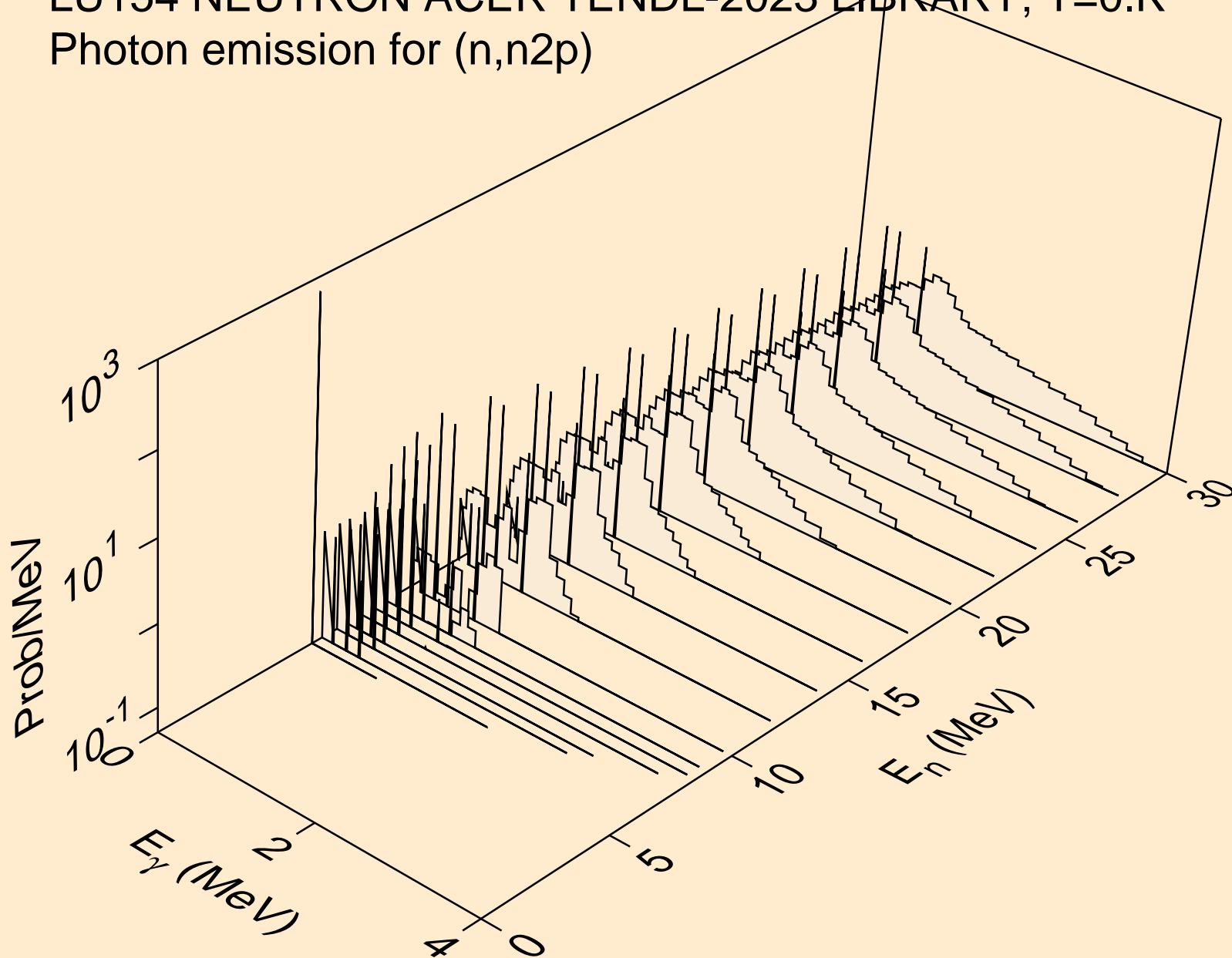

LU154 NEUTRON ACER TENDL-2023 LIBRARY; T=0.K
Photon emission for (n,npa)

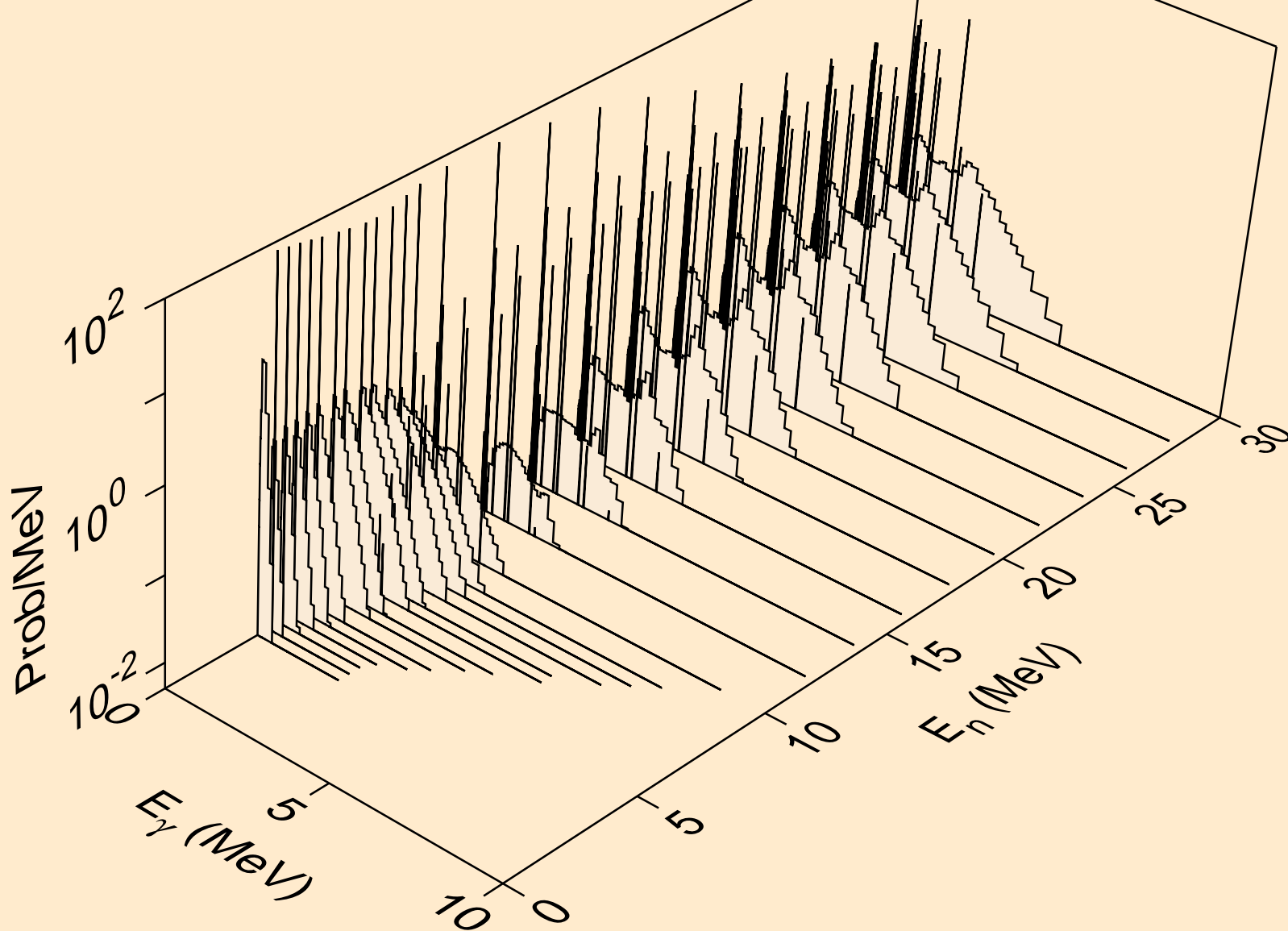

LU154 NEUTRON ACER TENDL-2023 LIBRARY; T=0.K
Photon emission for (n,n*c)

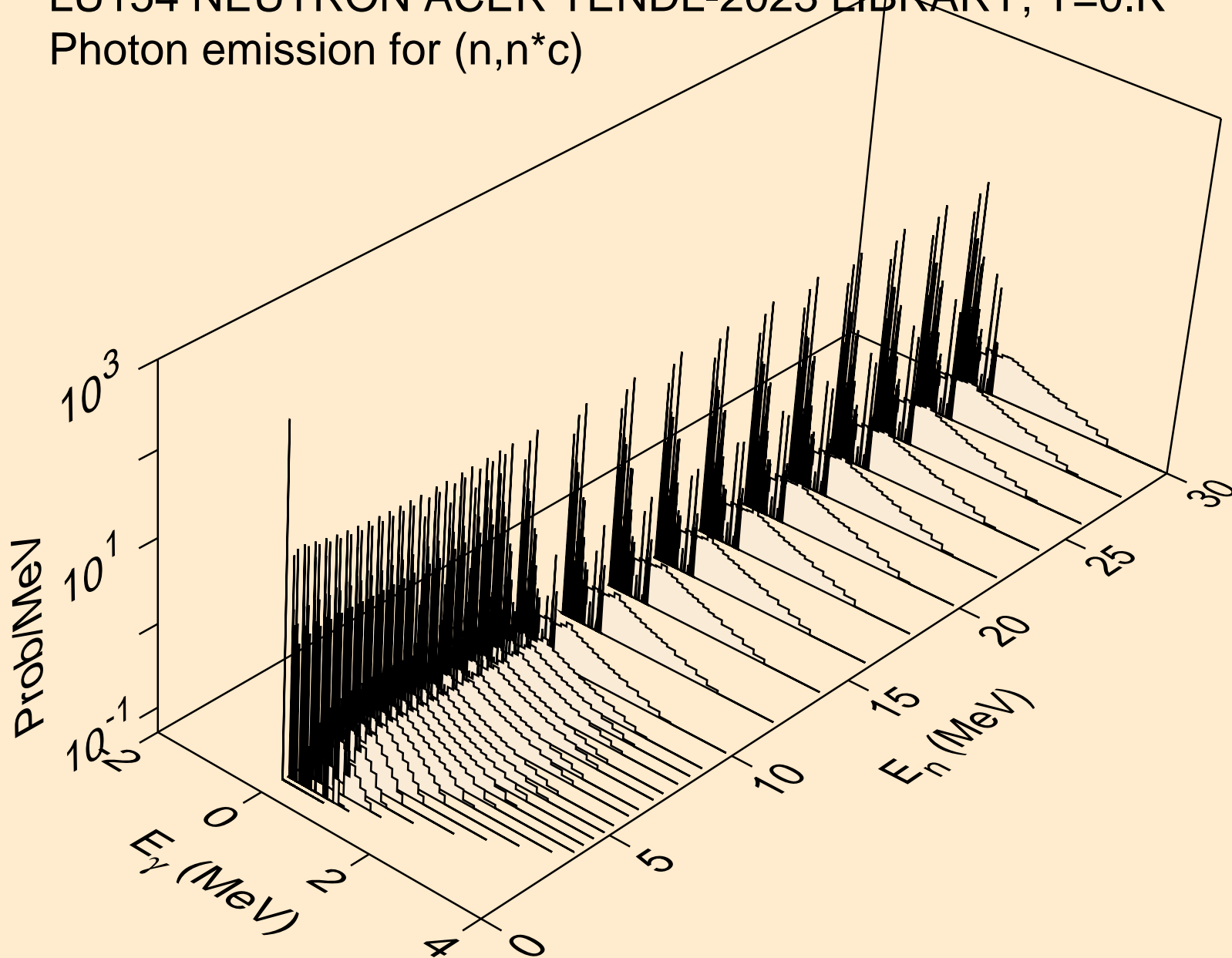

LU154 NEUTRON ACER TENDL-2023 LIBRARY; T=0.K
Photon emission for (n,gma)

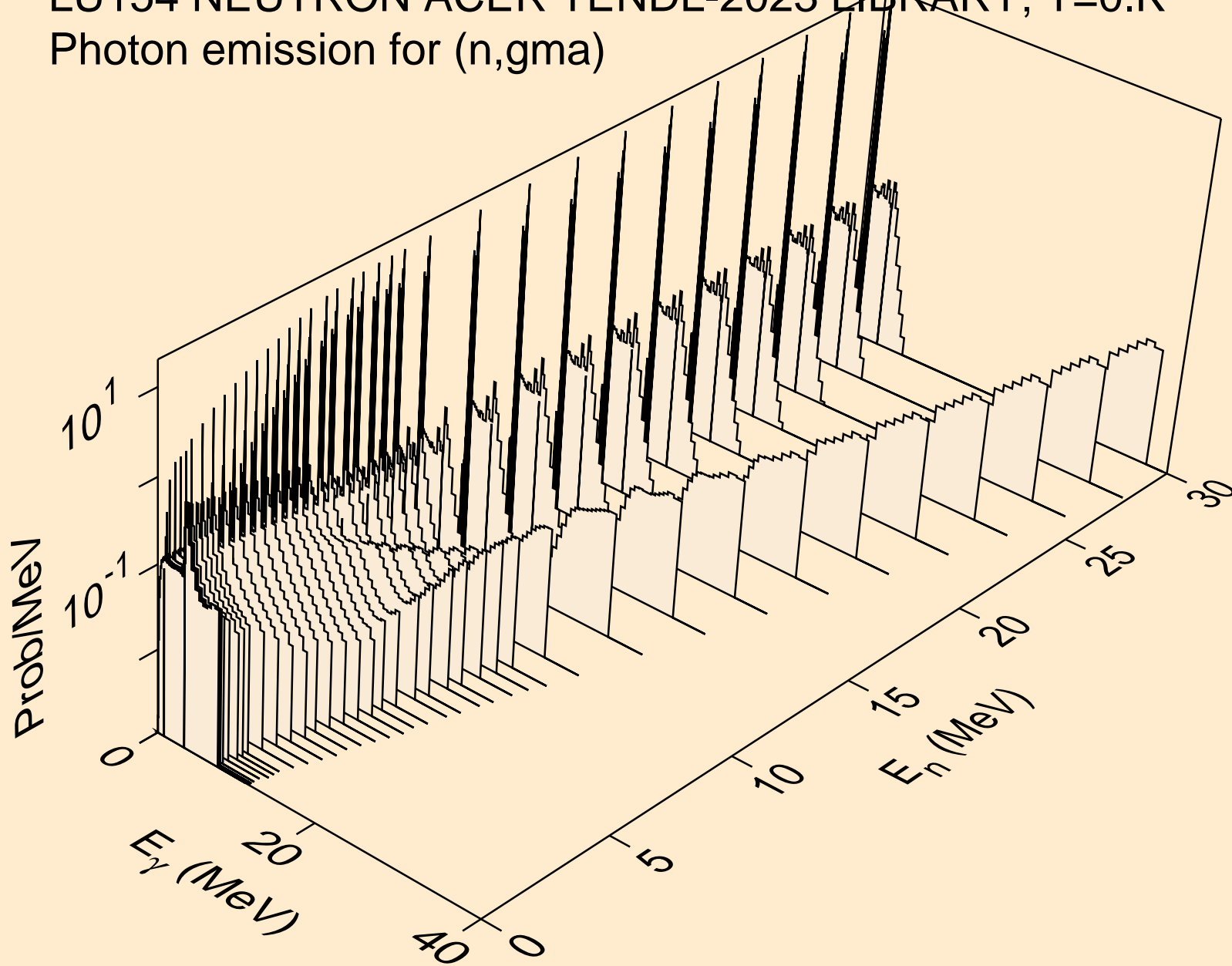

LU154 NEUTRON ACER TENDL-2023 LIBRARY; T=0.K
Photon emission for (n,p)

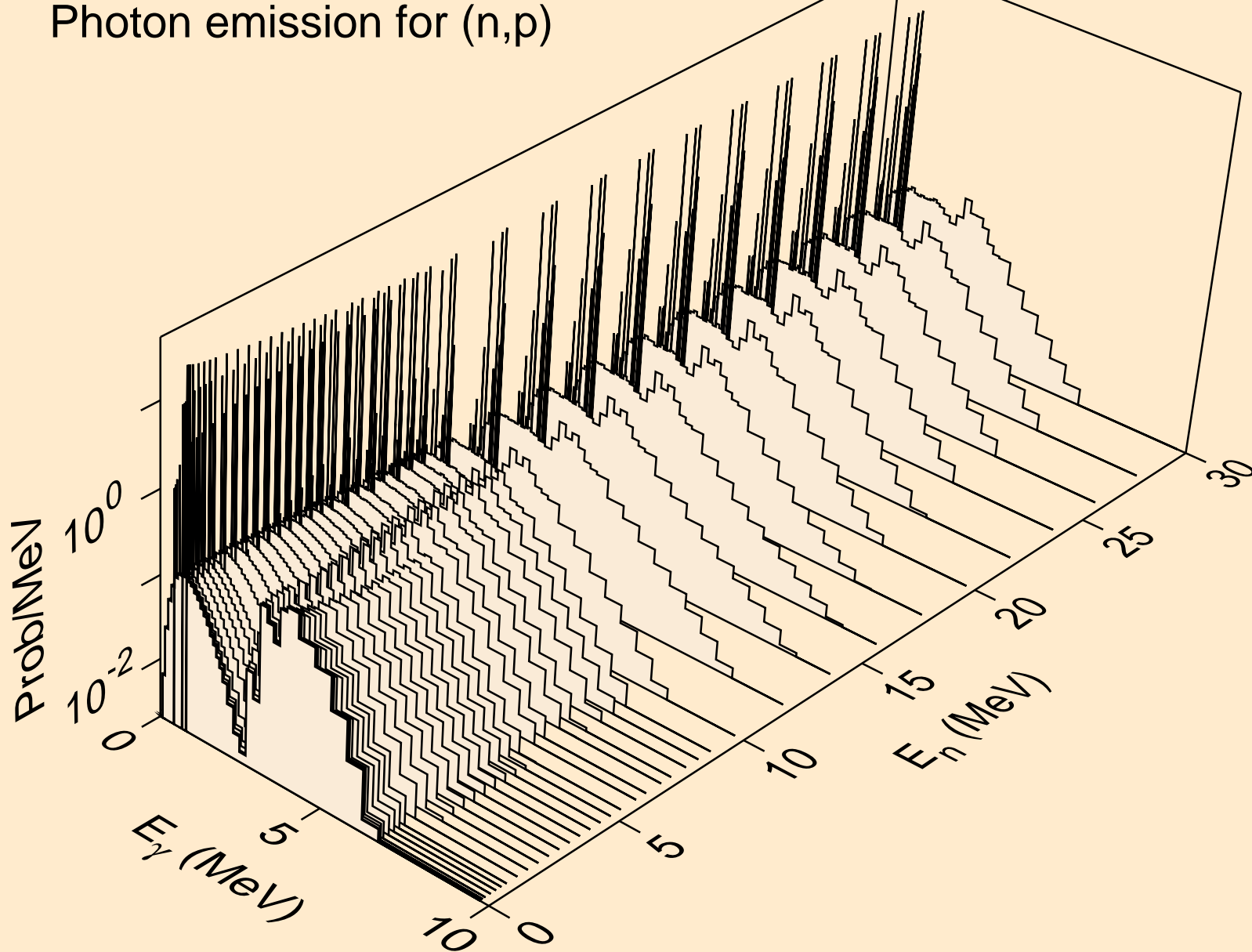

LU154 NEUTRON ACER TENDL-2023 LIBRARY; T=0.K
Photon emission for (n,d)

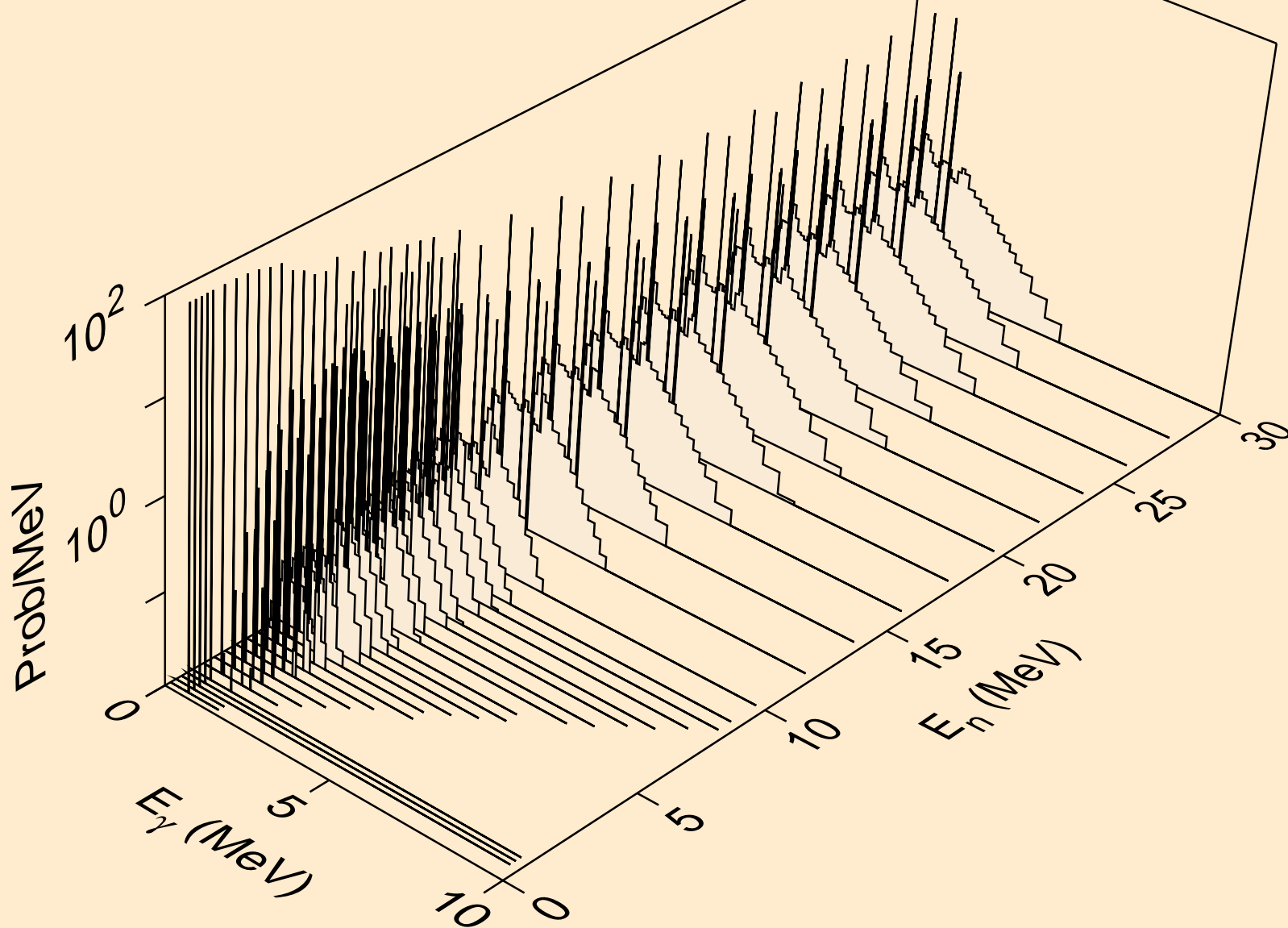

LU154 NEUTRON ACER TENDL-2023 LIBRARY; T=0.K
Photon emission for (n,t)

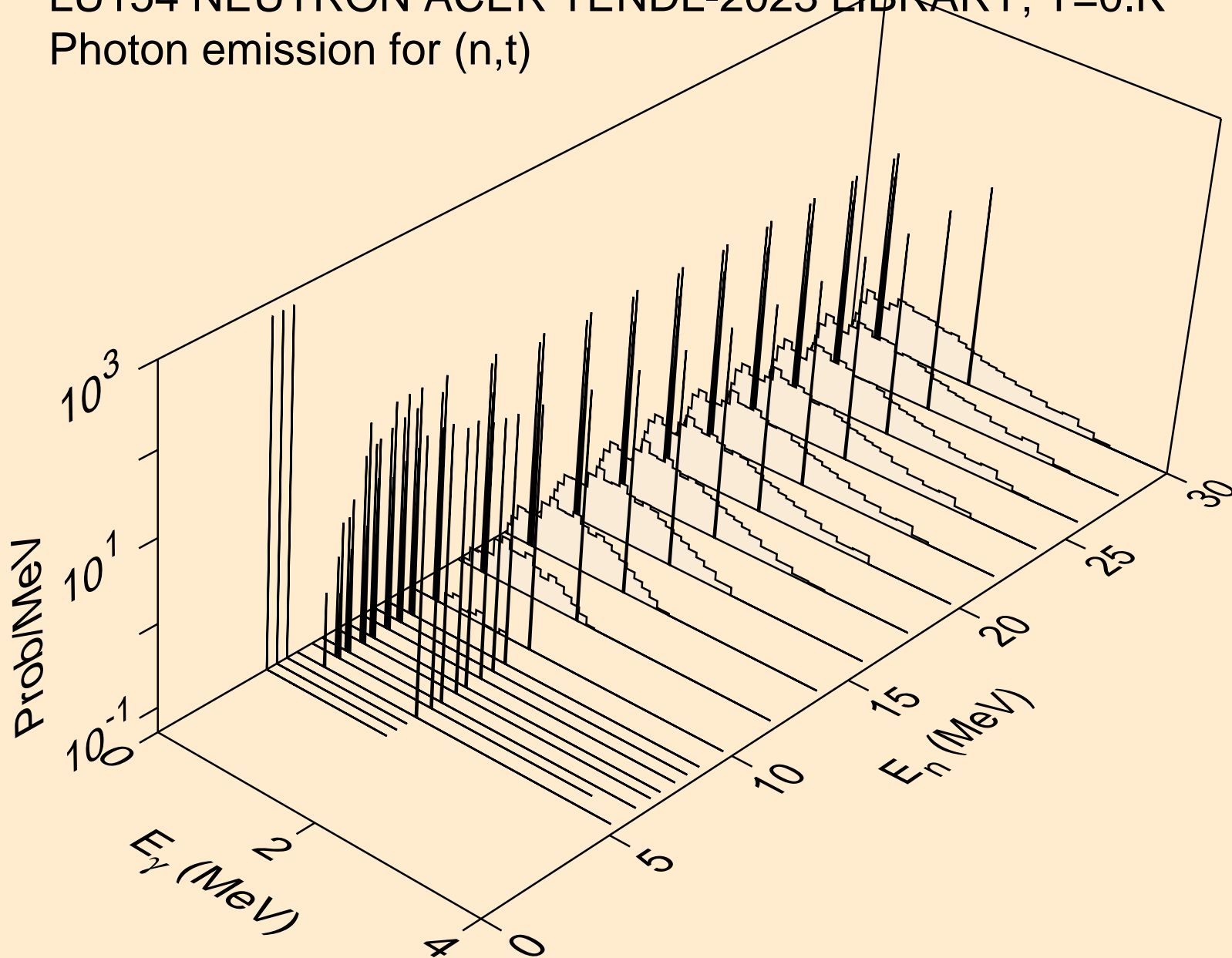

LU154 NEUTRON ACER TENDL-2023 LIBRARY; T=0.K
Photon emission for (n,he3)

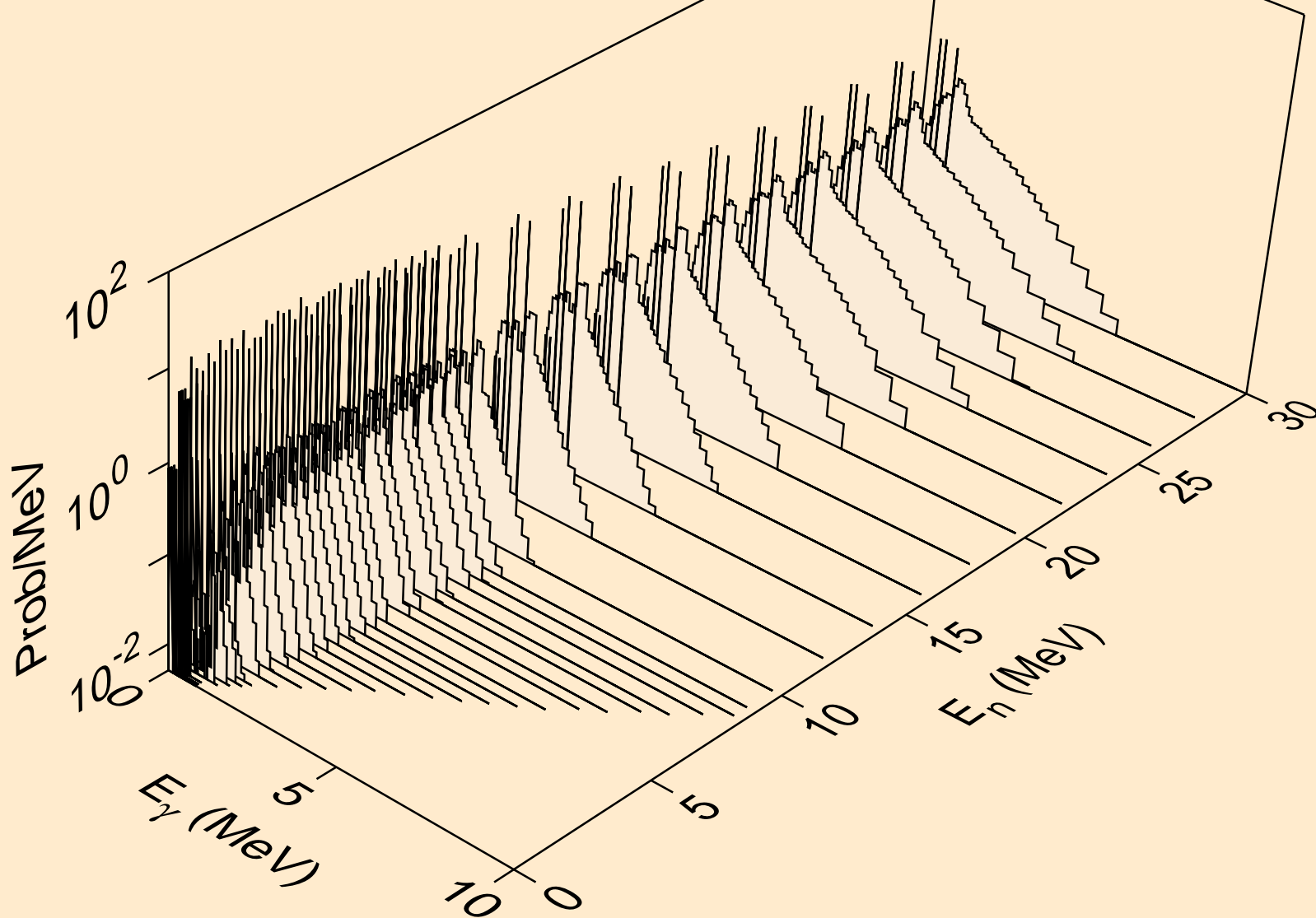

LU154 NEUTRON ACER TENDL-2023 LIBRARY; T=0.K
Photon emission for (n,a)

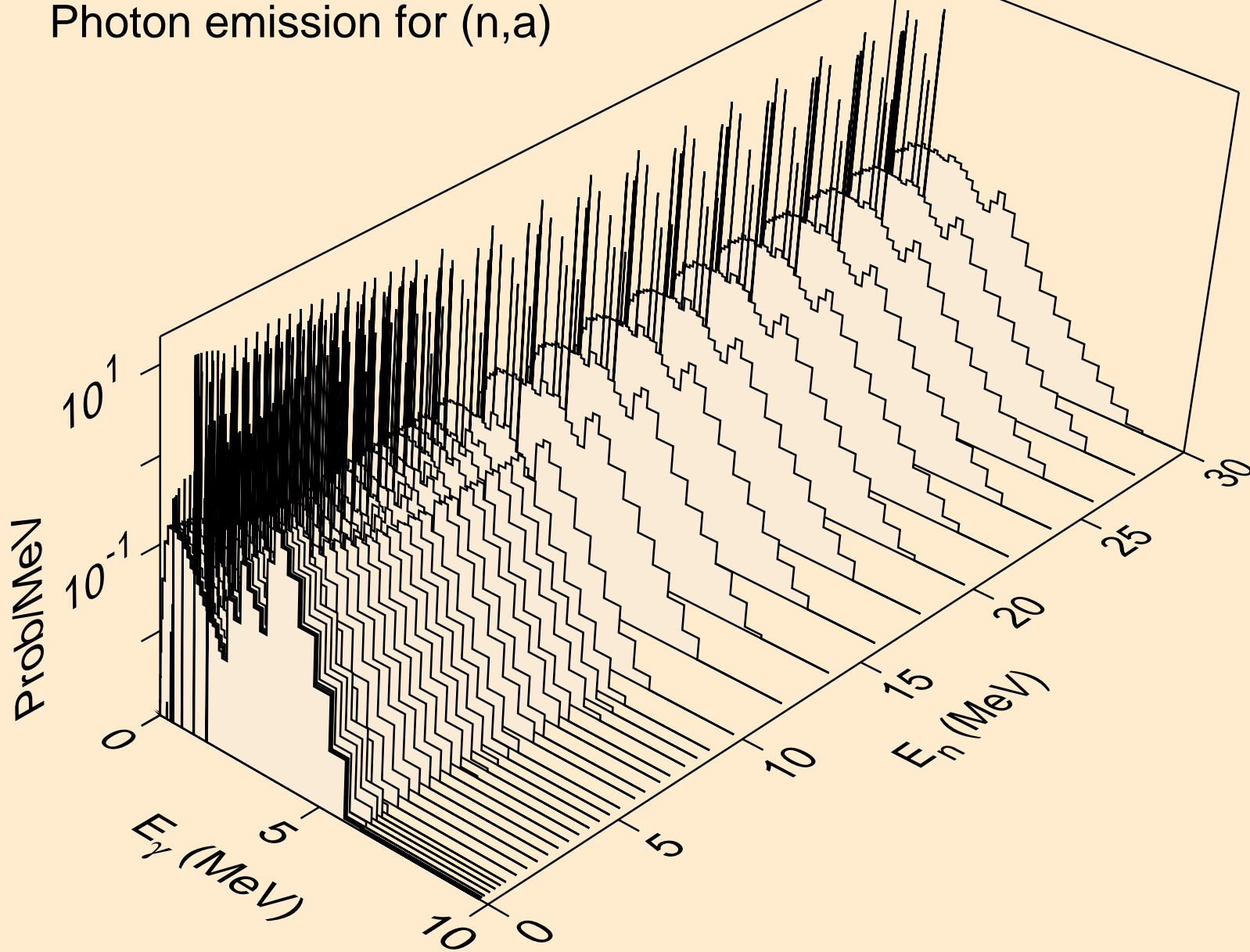

LU154 NEUTRON ACER TENDL-2023 LIBRARY; T=0.K
Photon emission for (n,2a)

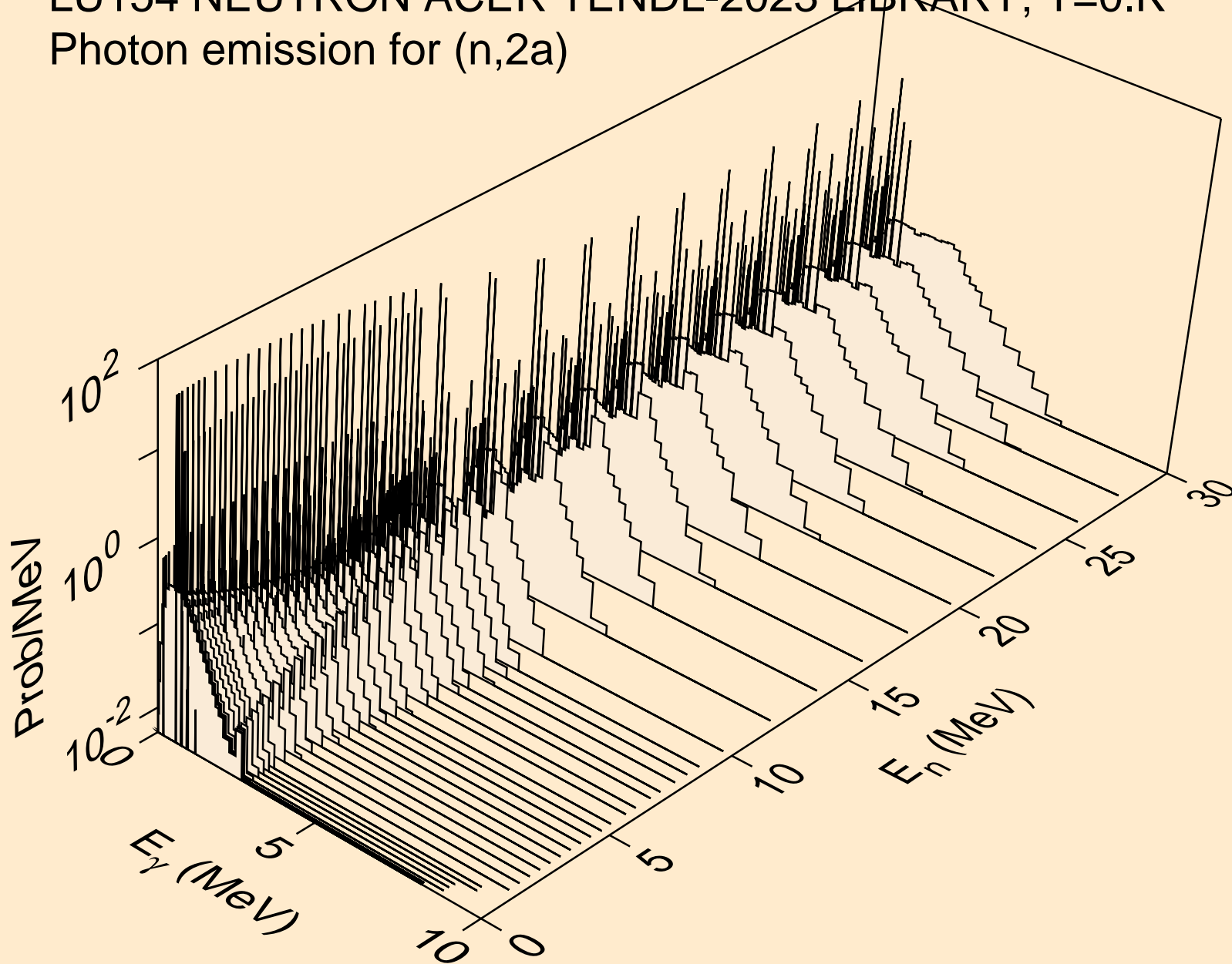

LU154 NEUTRON ACER TENDL-2023 LIBRARY; T=0.K
Photon emission for (n,3a)

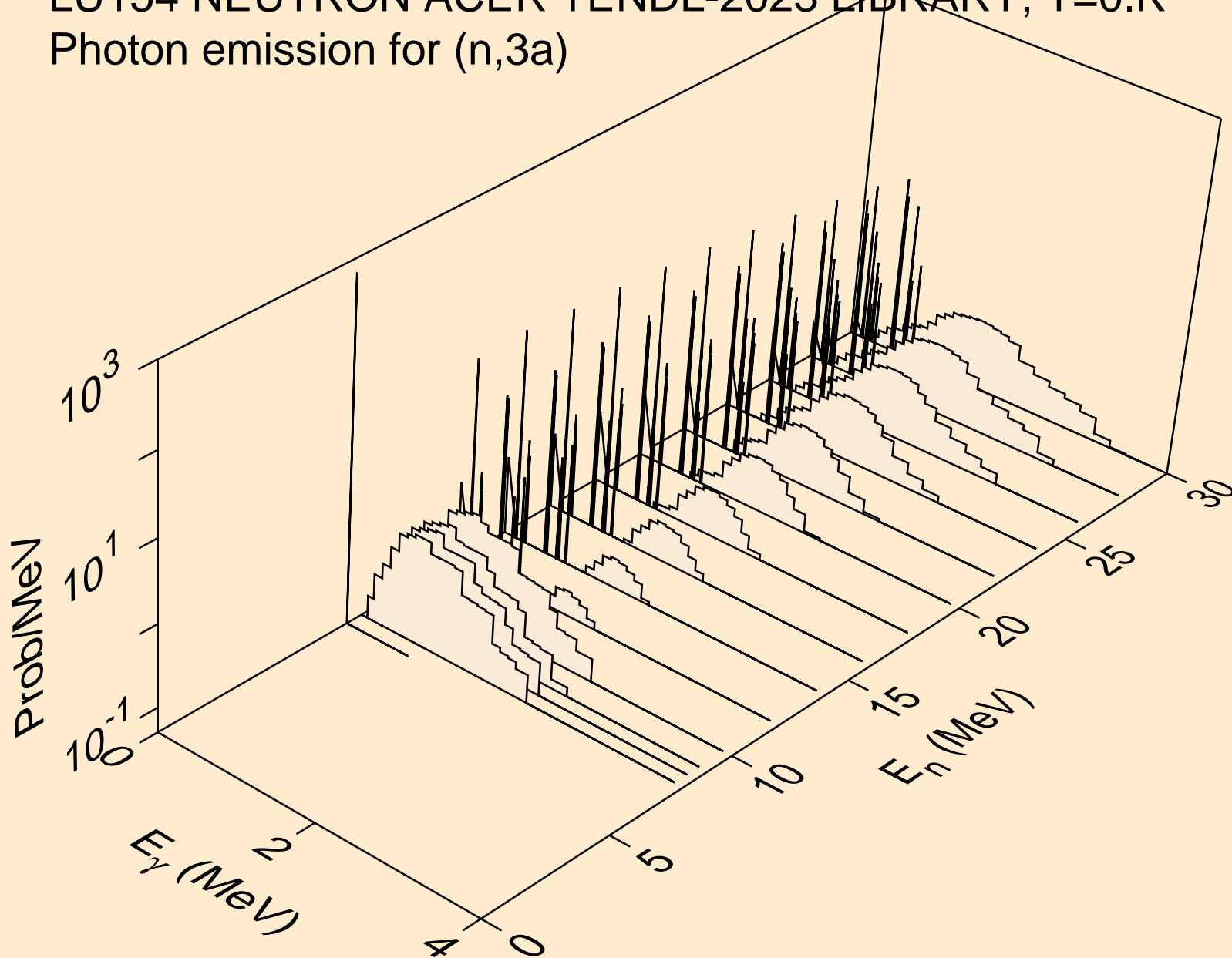

LU154 NEUTRON ACER TENDL-2023 LIBRARY; T=0.K
Photon emission for (n,2p)

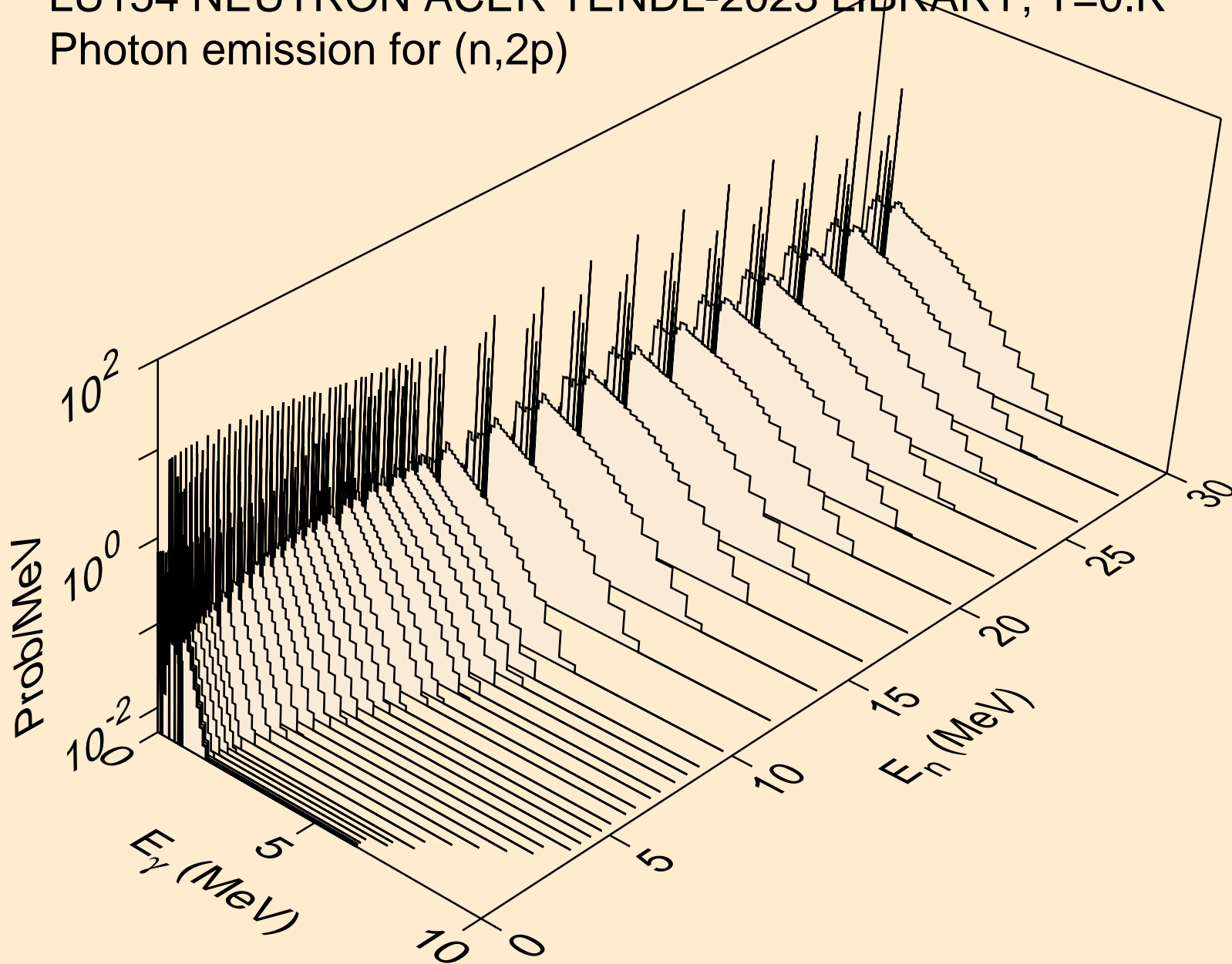

LU154 NEUTRON ACER TENDL-2023 LIBRARY; T=0.K
Photon emission for (n,p α)

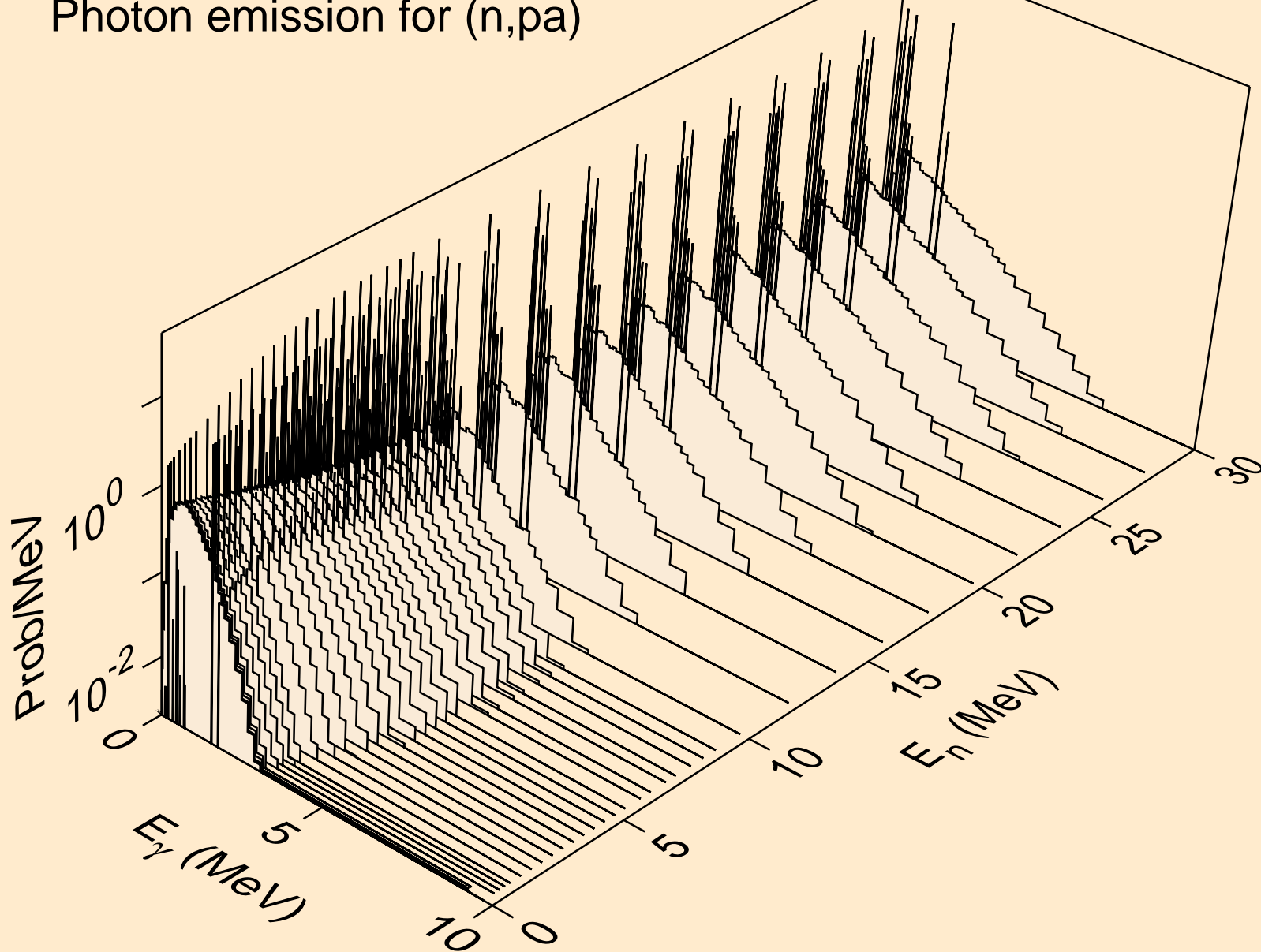

LU154 NEUTRON ACER TENDL-2023 LIBRARY; T=0.K
Photon emission for (n,d2a)

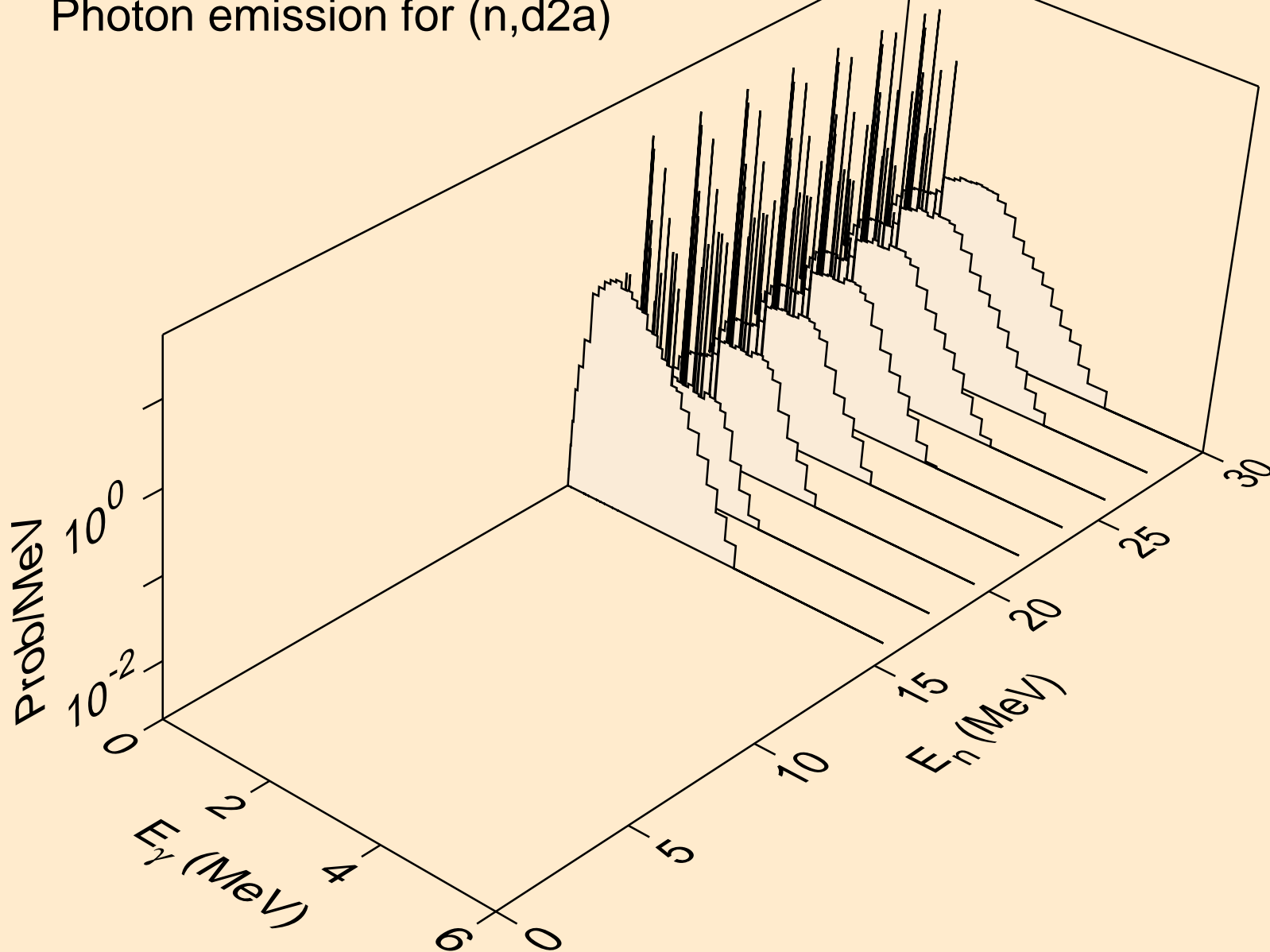

LU154 NEUTRON ACER TENDL-2023 LIBRARY; T=0.K
Photon emission for (n,pd)

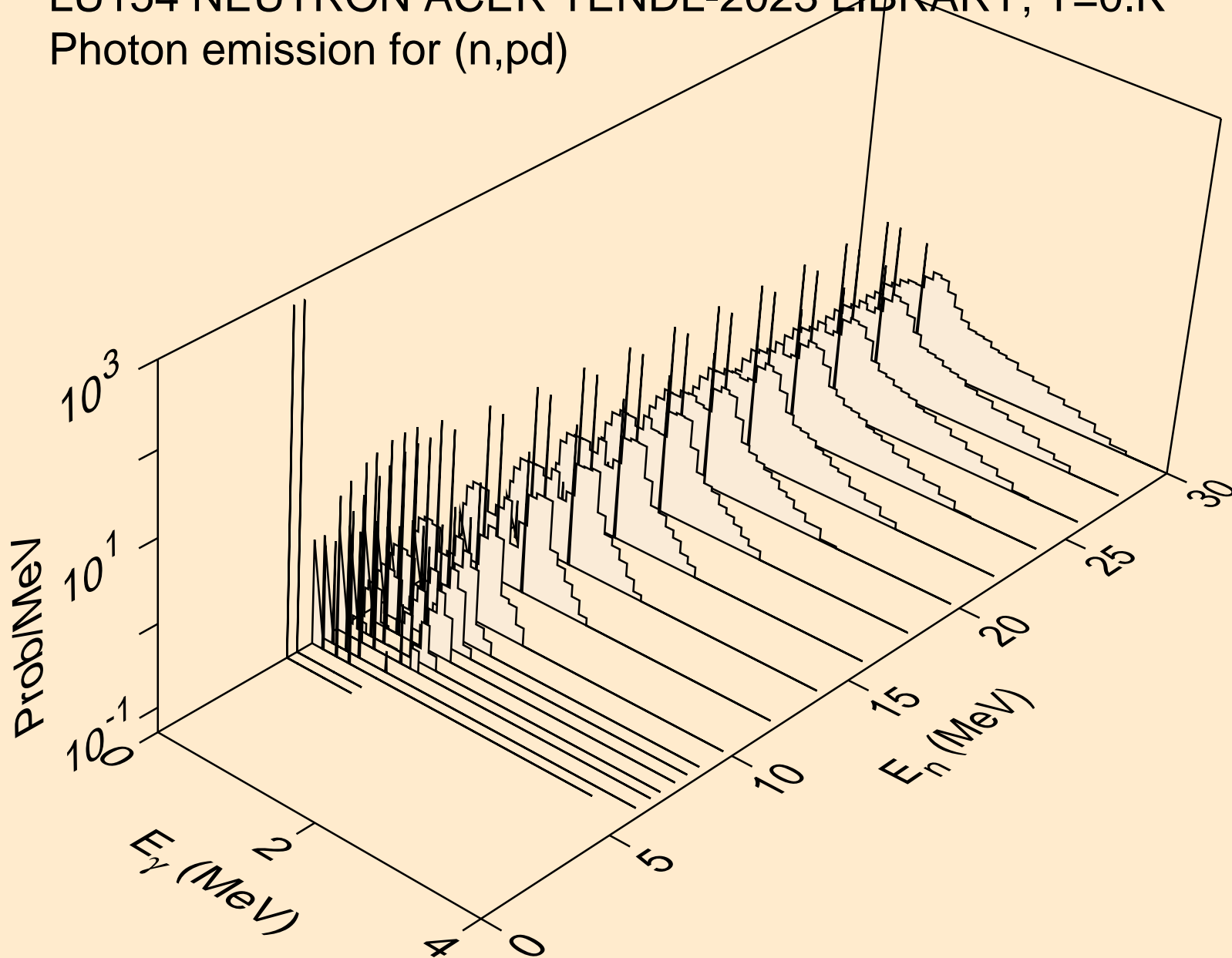

LU154 NEUTRON ACER TENDL-2023 LIBRARY; T=0.K
Photon emission for (n,pt)

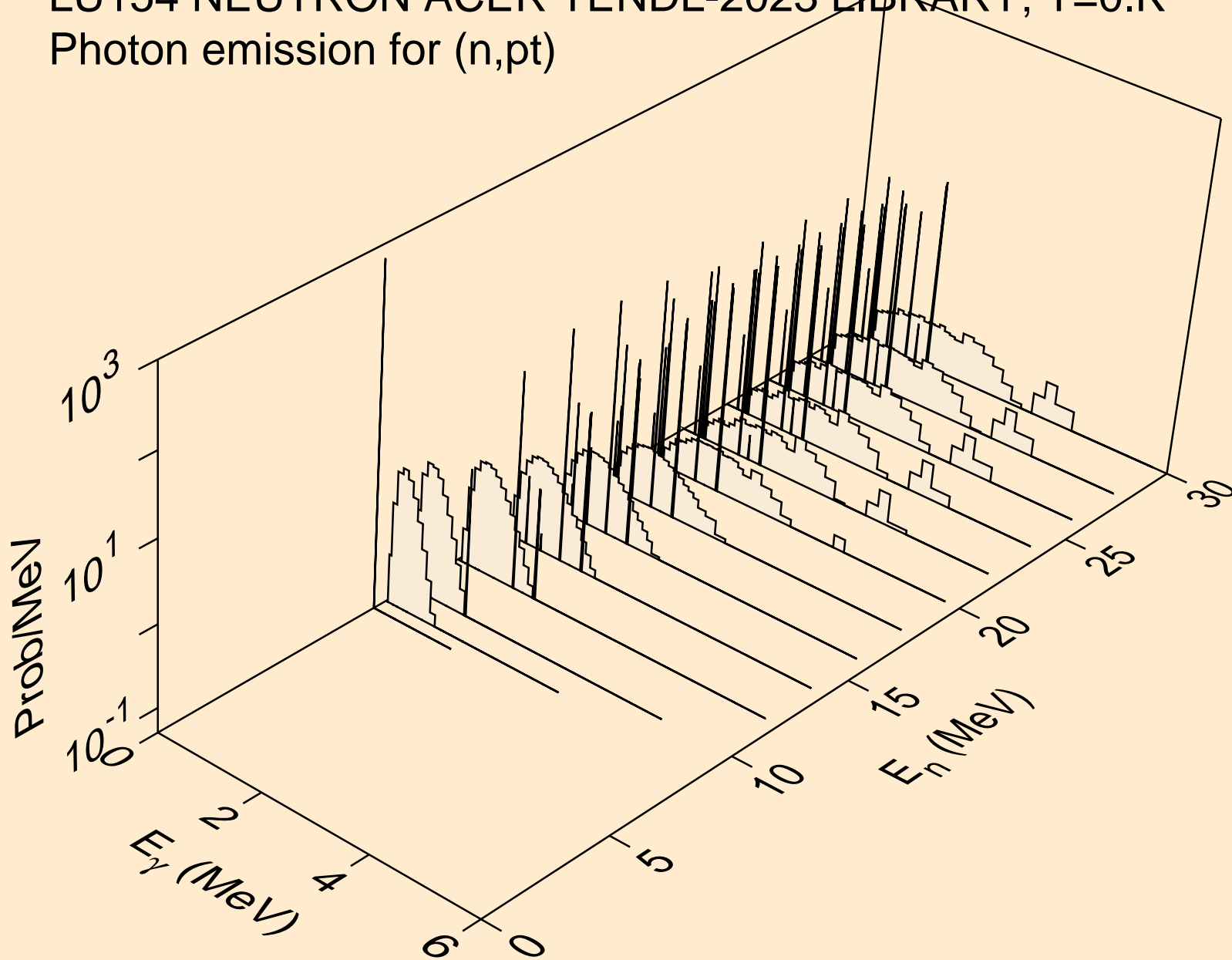

LU154 NEUTRON ACER TENDL-2023 LIBRARY; T=0.K
Photon emission for (n,da)

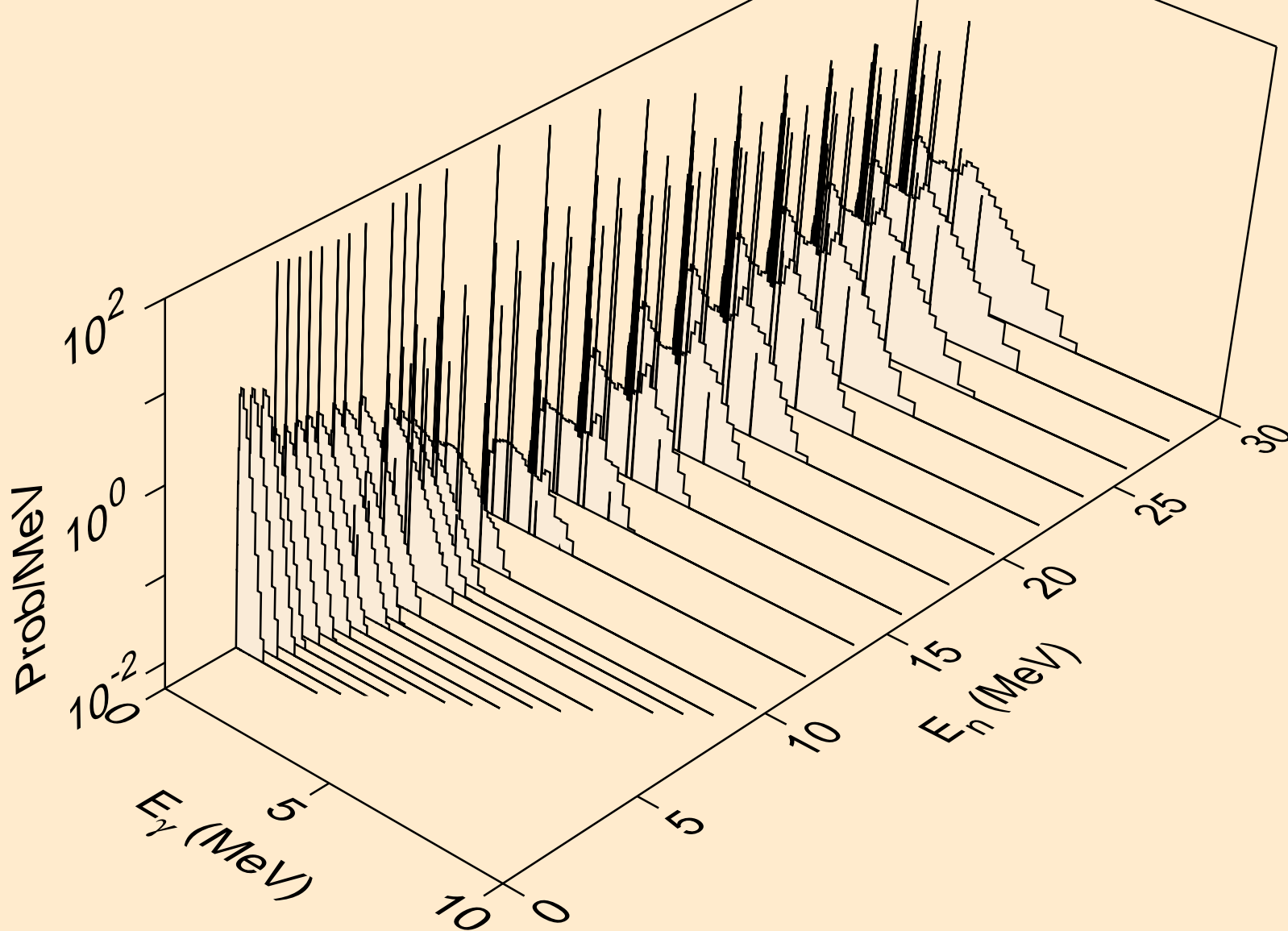

LU154 NEUTRON ACER TENDL-2023 LIBRARY; T=0.K
thermal capture photon spectrum

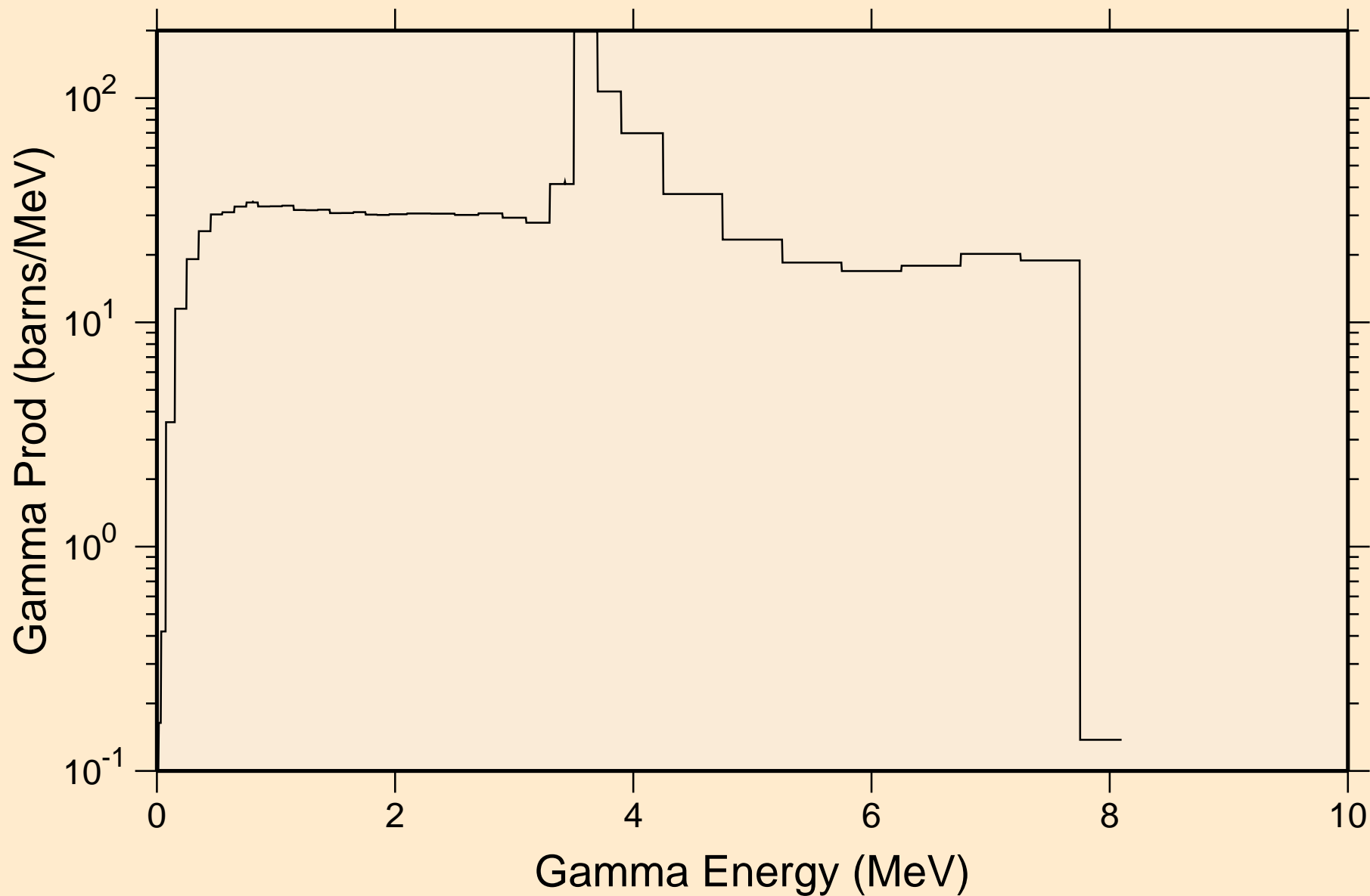

LU154 NEUTRON ACER TENDL-2023 LIBRARY; T=0.K
14 MeV photon spectrum

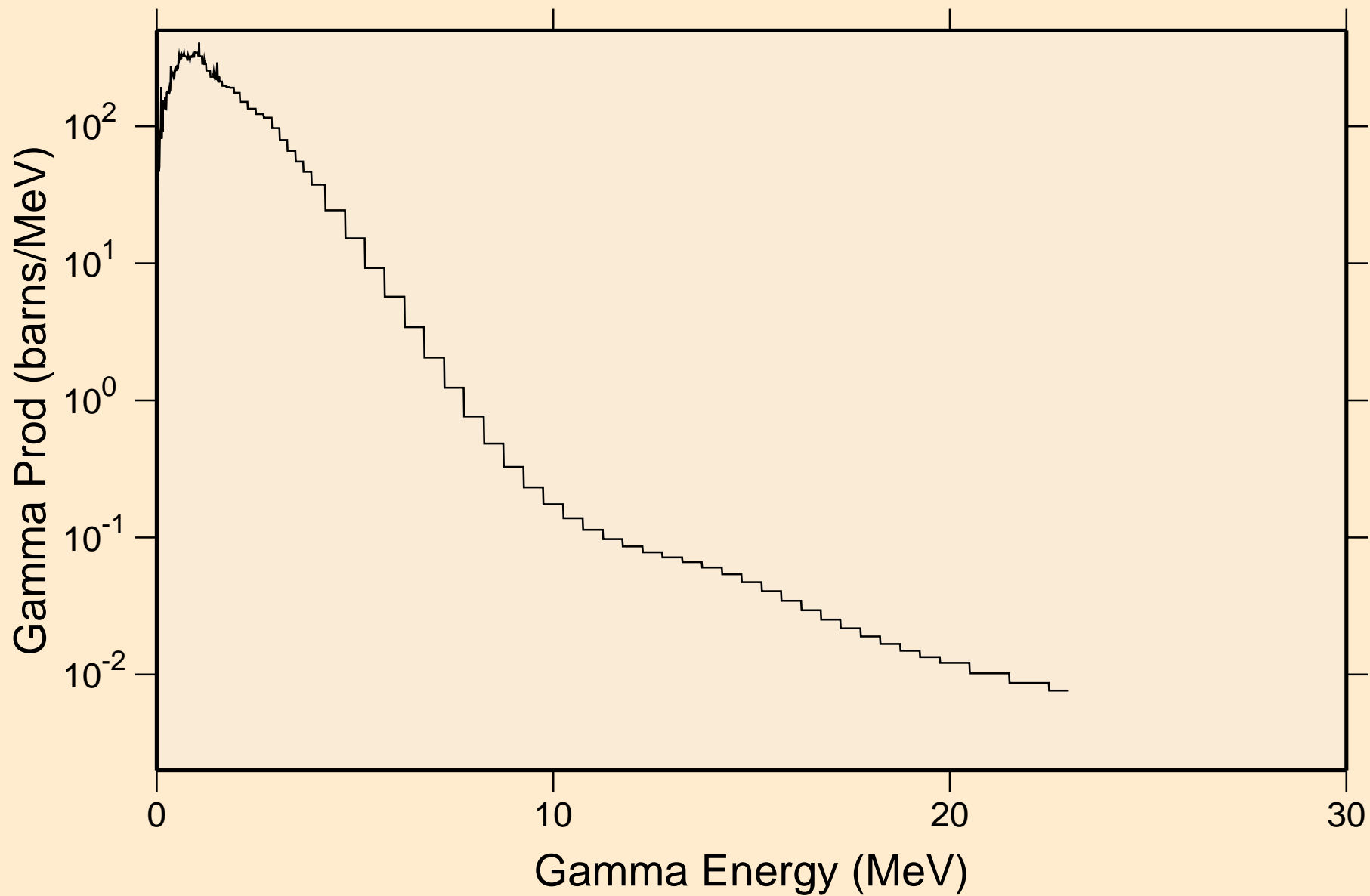

LU154 NEUTRON ACER TENDL-2023 LIBRARY; T=0.K

Particle heating contributions

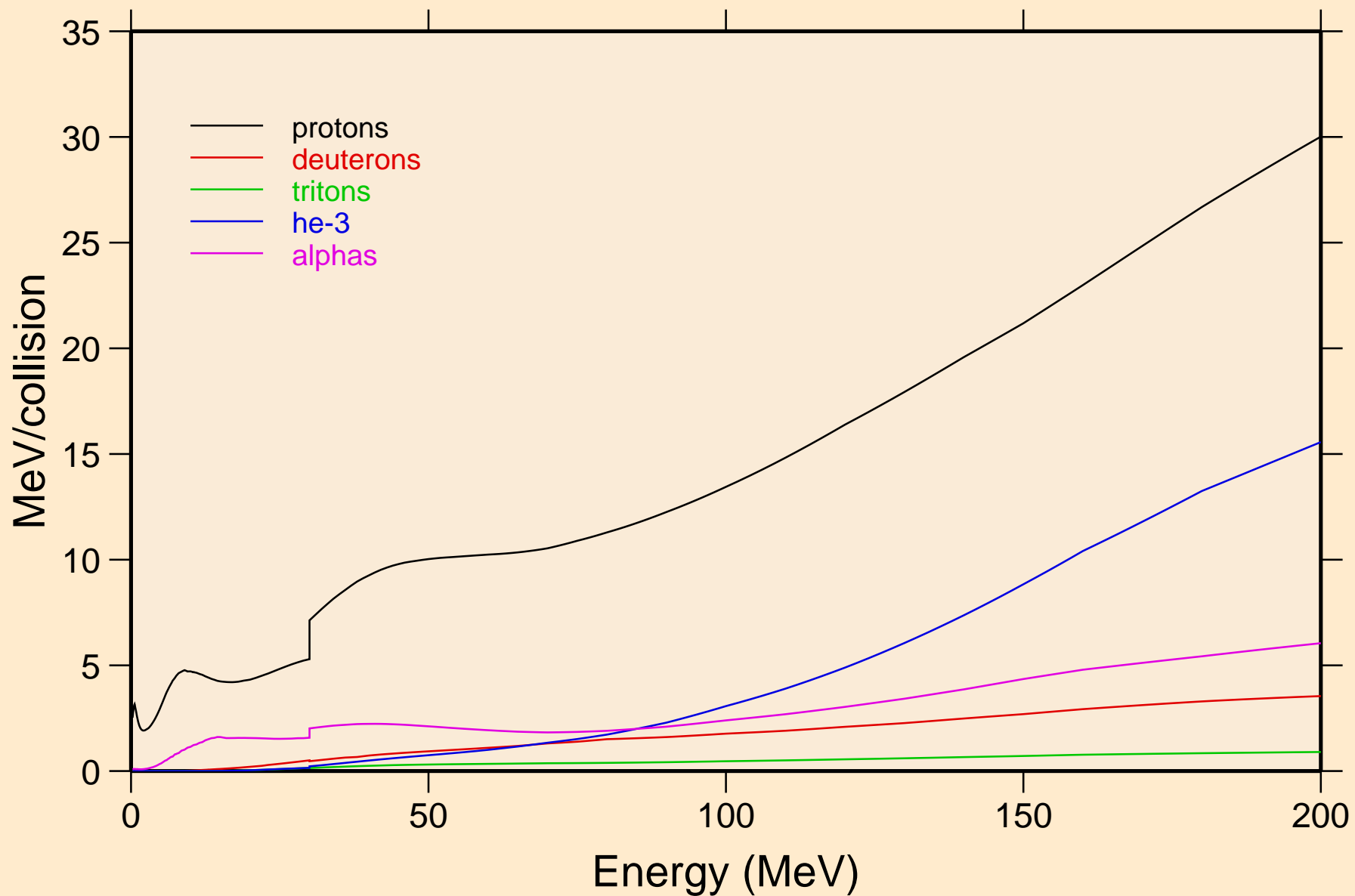

LU154 NEUTRON ACER TENDL-2023 LIBRARY; T=0.K
Recoil Heating

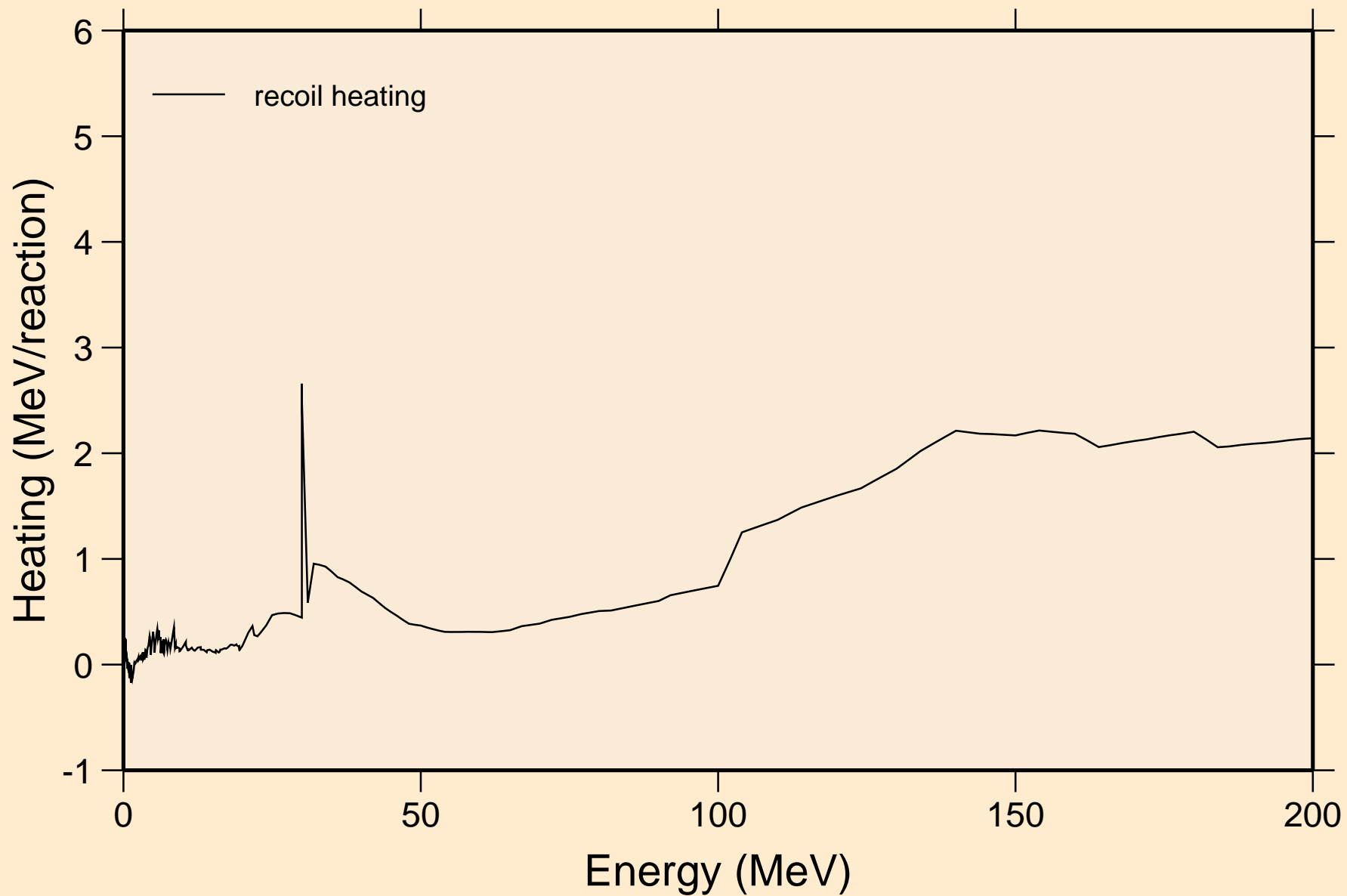

LU154 NEUTRON ACER TENDL-2023 LIBRARY; T=0.K
Particle production cross sections

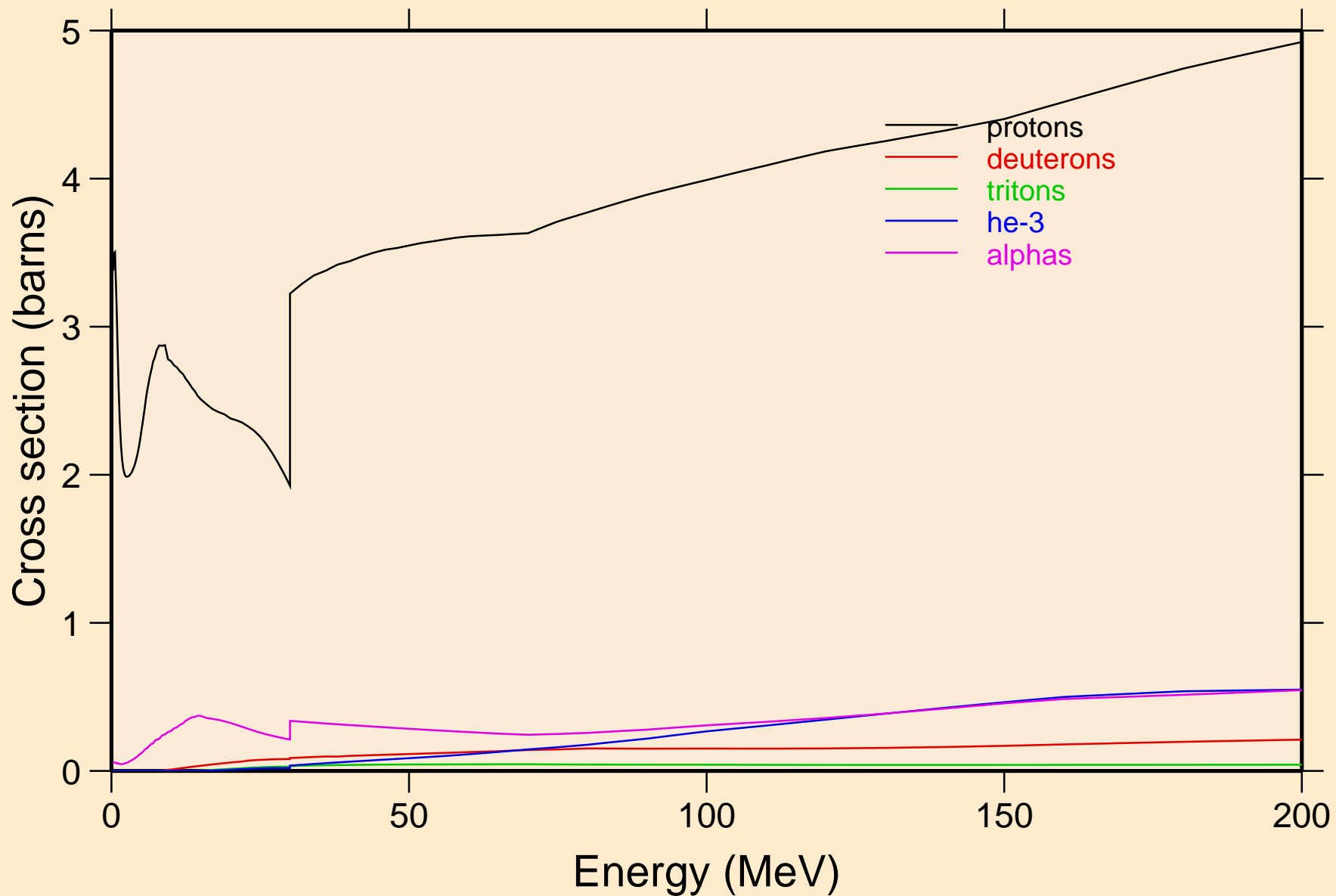

LU154 NEUTRON ACER TENDL-2023 LIBRARY; T=0.K
protons from (n,x)

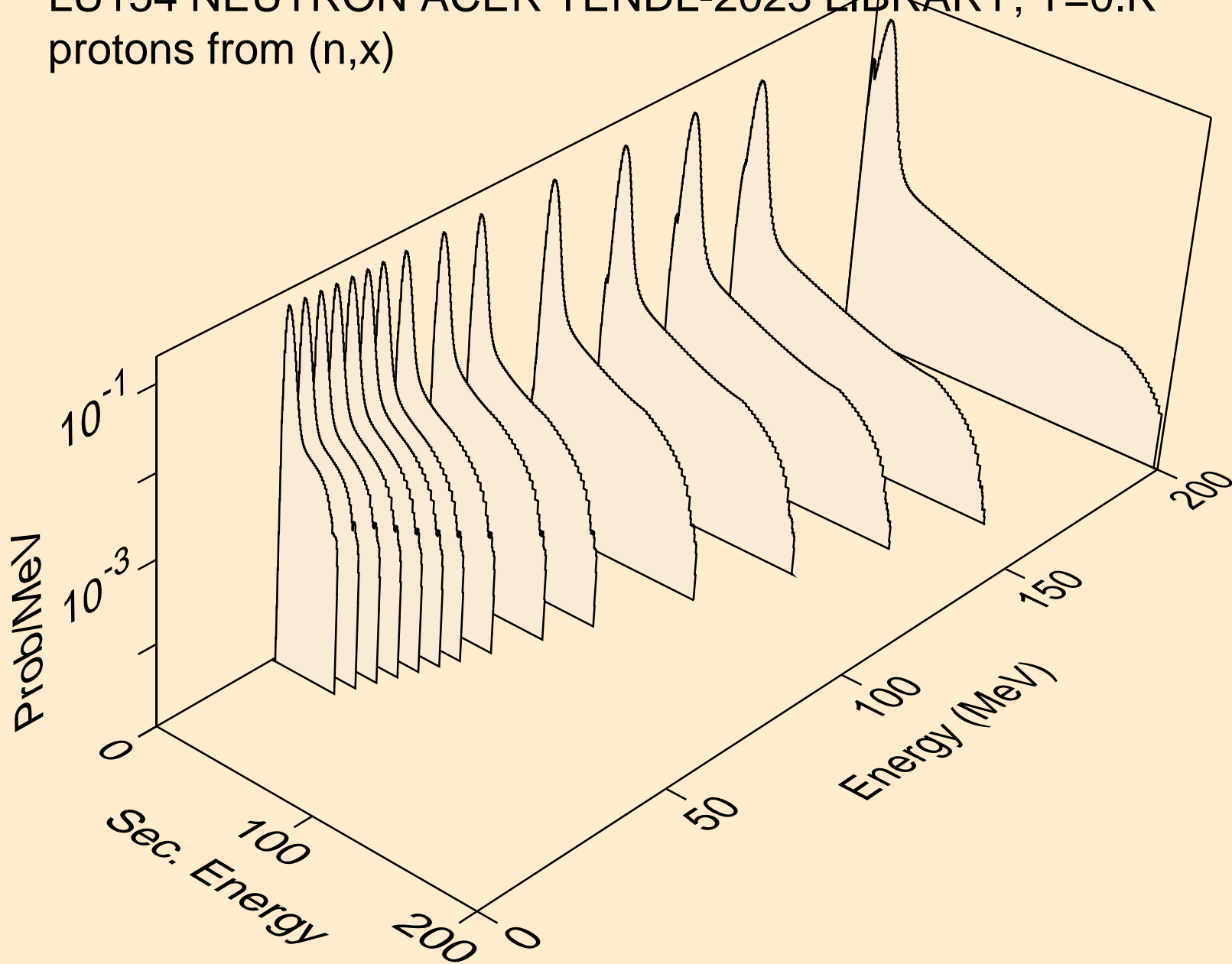

LU154 NEUTRON ACER TENDL-2023 LIBRARY; T=0.K
protons from (n,n*)p

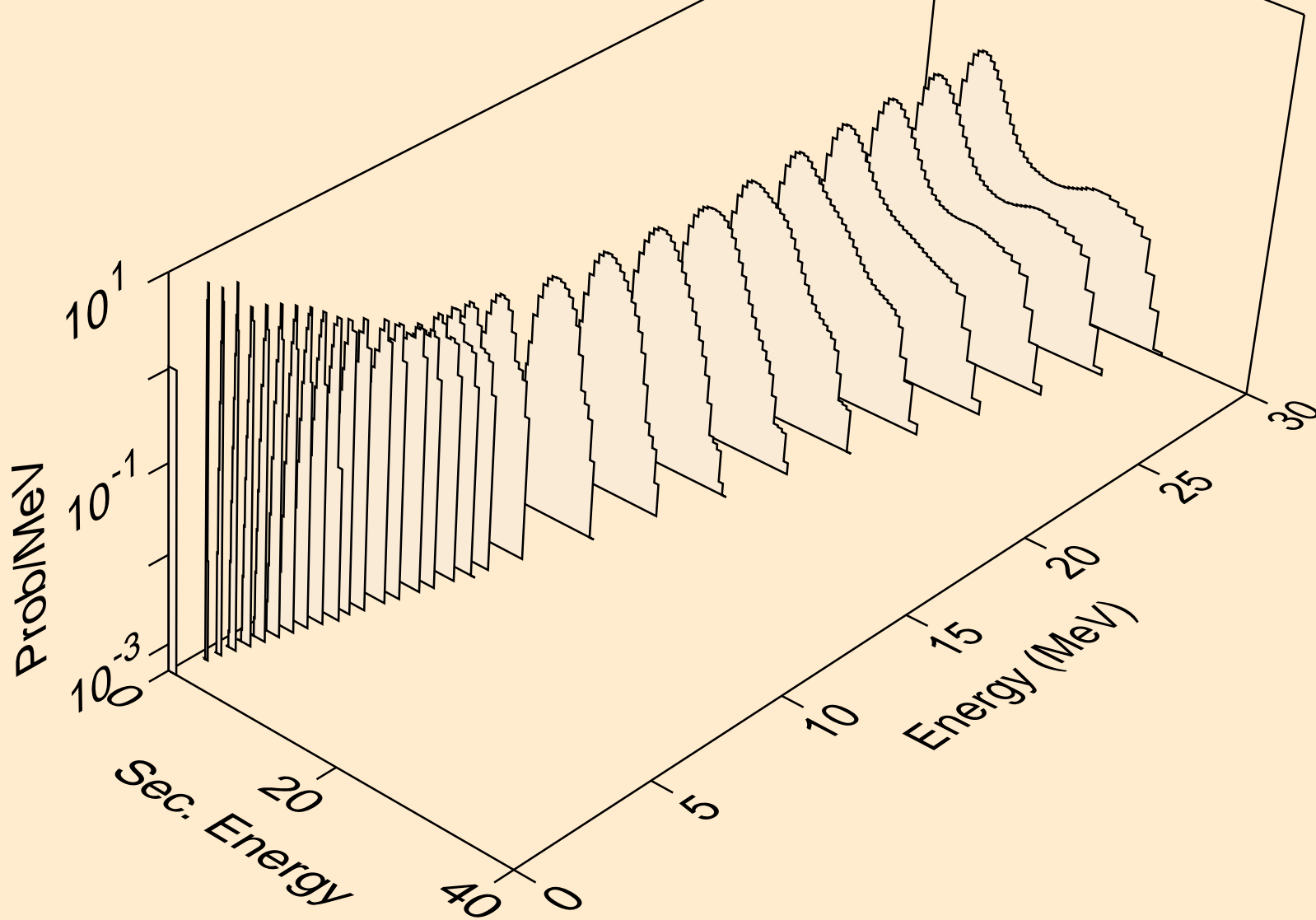

LU154 NEUTRON ACER TENDL-2023 LIBRARY; T=0.K
protons from (n,2np)

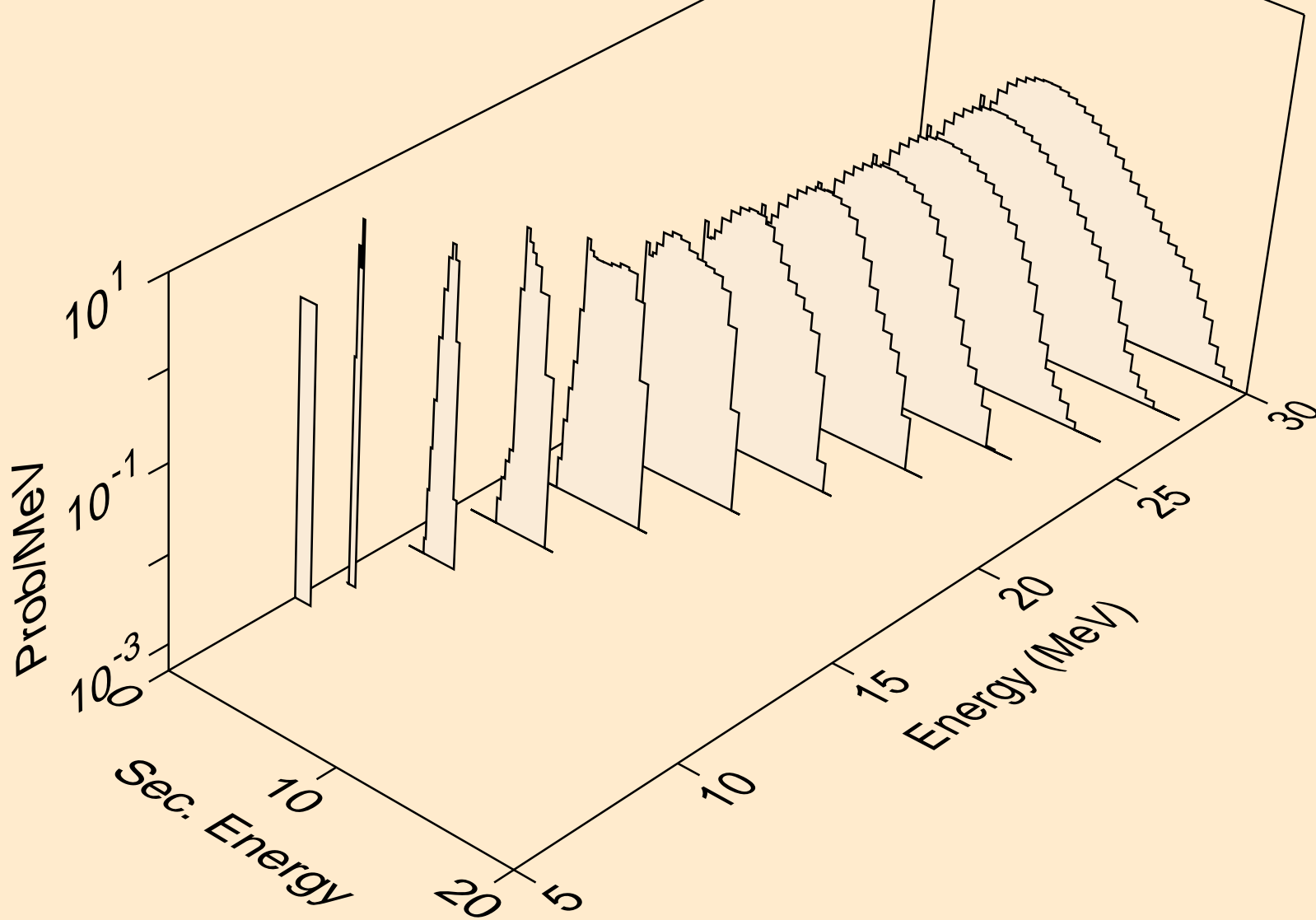

LU154 NEUTRON ACER TENDL-2023 LIBRARY; T=0.K
protons from (n,3np)

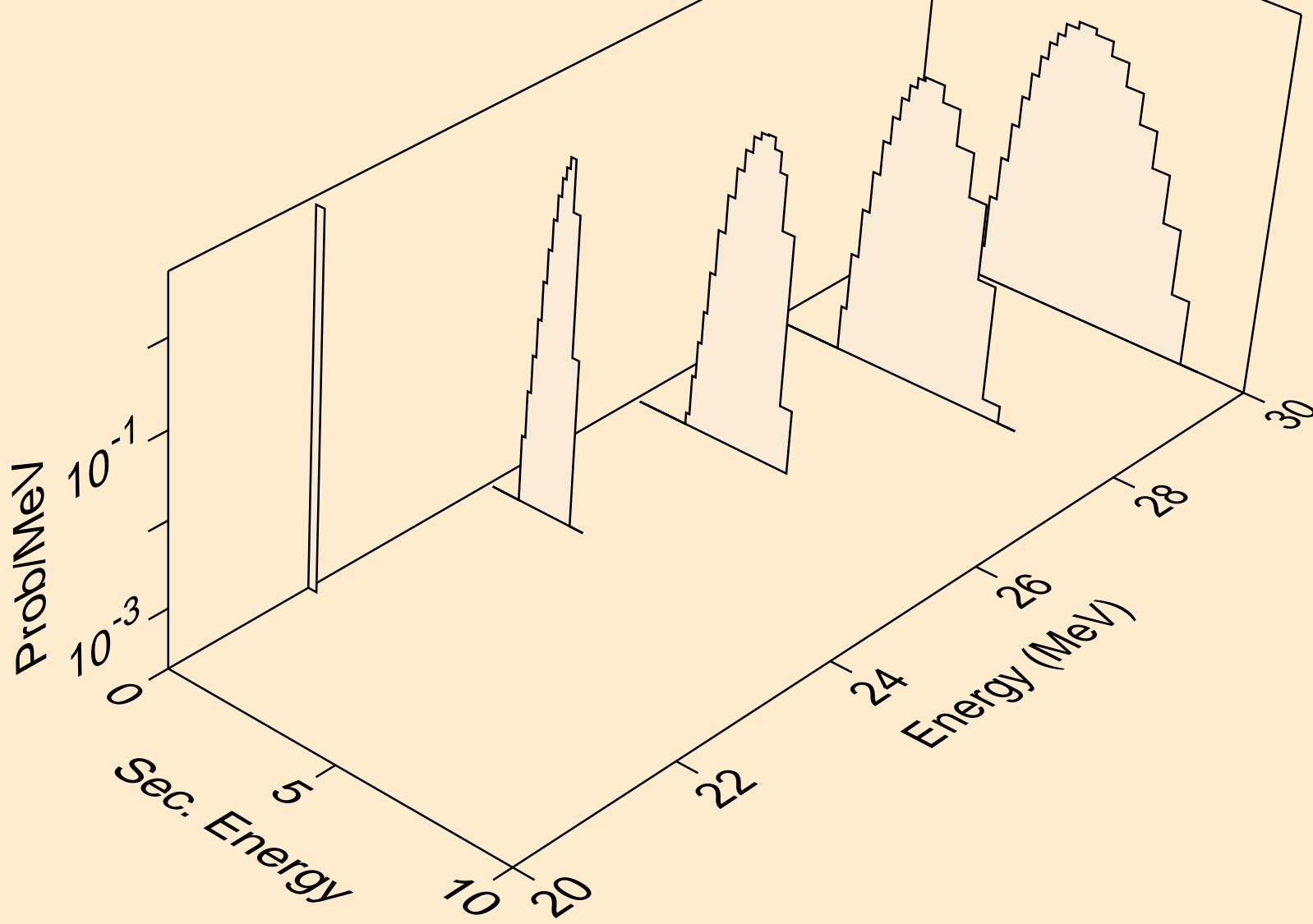

LU154 NEUTRON ACER TENDL-2023 LIBRARY; T=0.K
protons from (n,n2p)

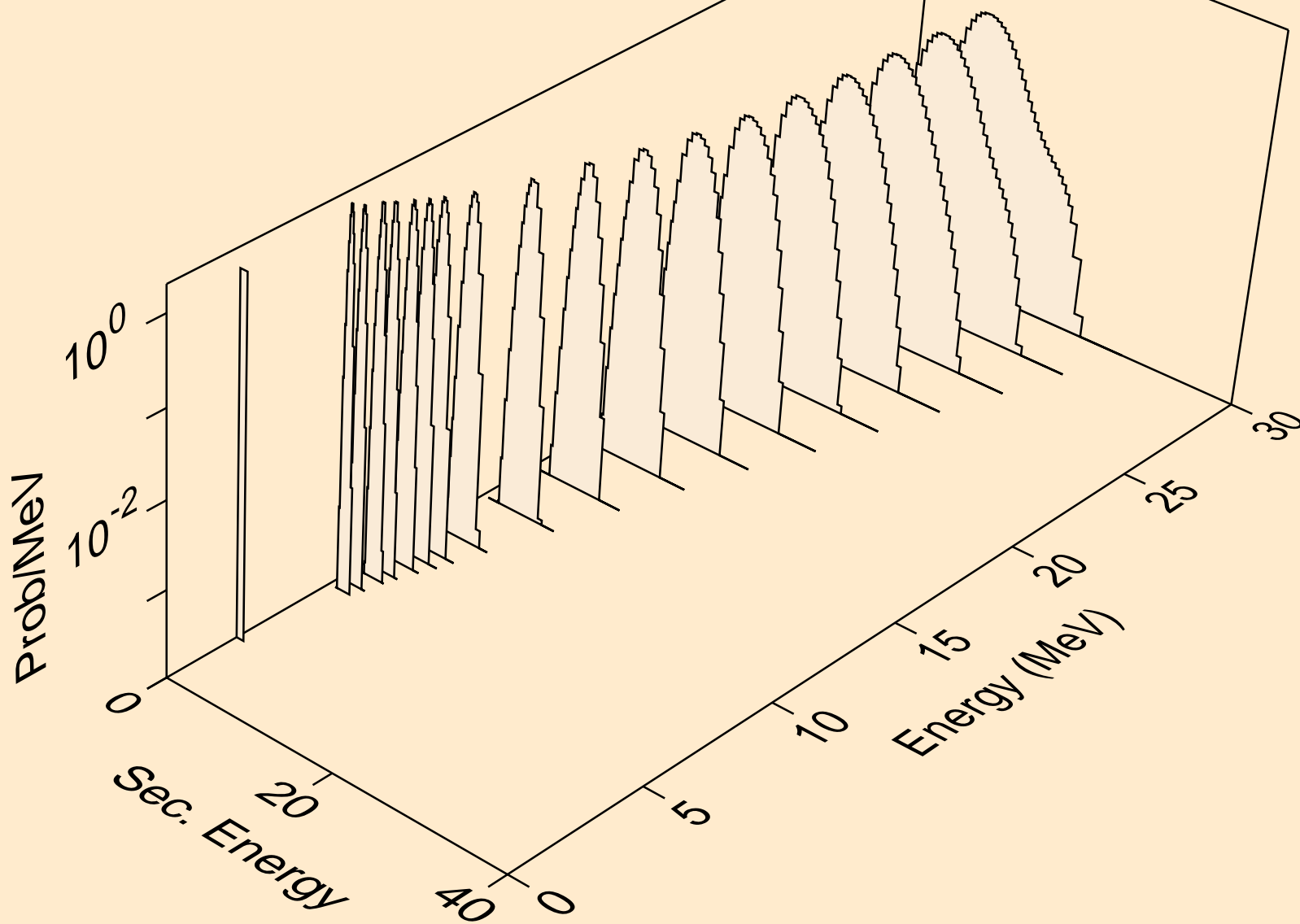

LU154 NEUTRON ACER TENDL-2023 LIBRARY; T=0.K
protons from (n,npa)

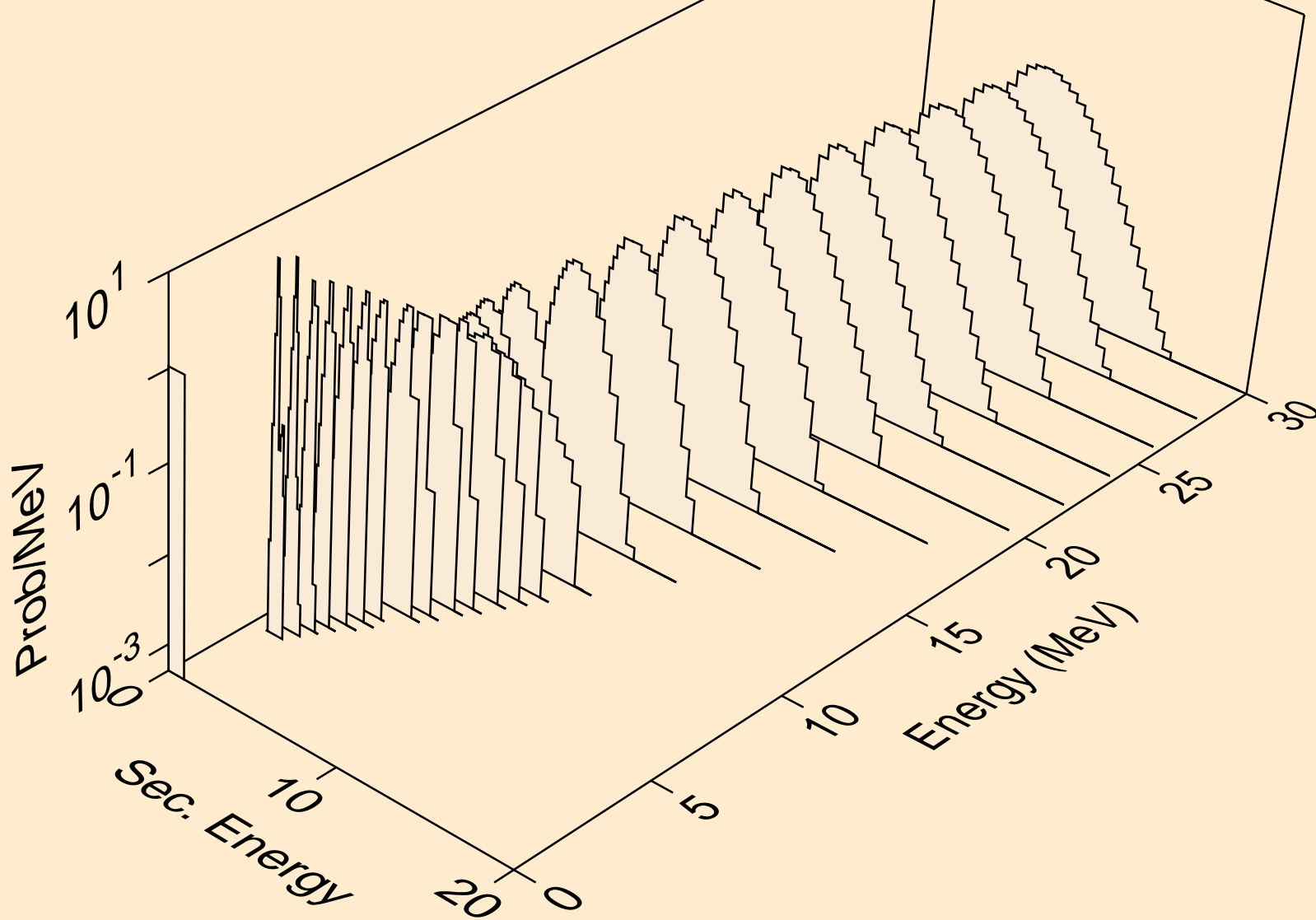

LU154 NEUTRON ACER TENDL-2023 LIBRARY; T=0.K
protons from (n,p)

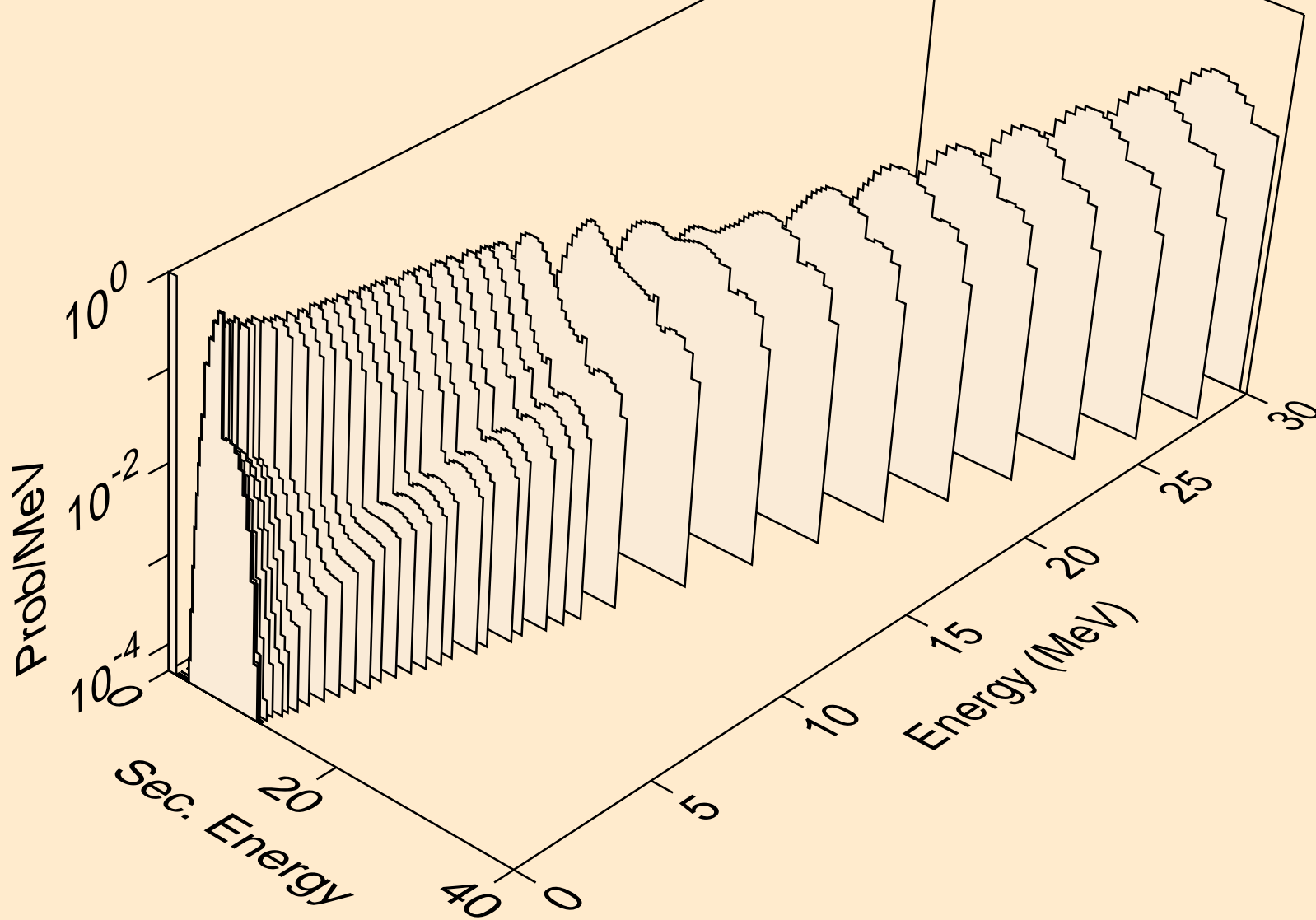

LU154 NEUTRON ACER TENDL-2023 LIBRARY; T=0.K
protons from (n,2p)

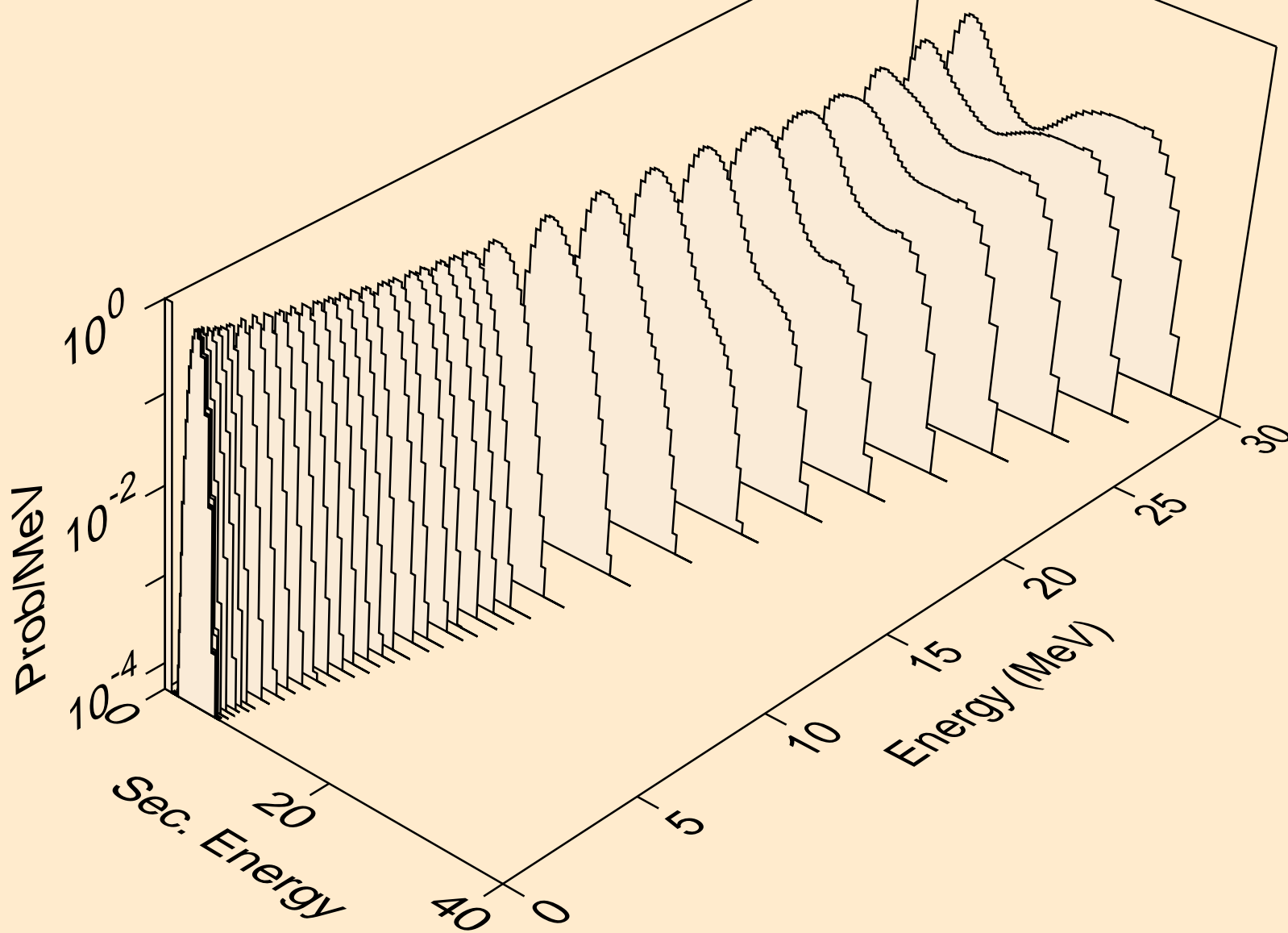

LU154 NEUTRON ACER TENDL-2023 LIBRARY; T=0.K
protons from (n,p)

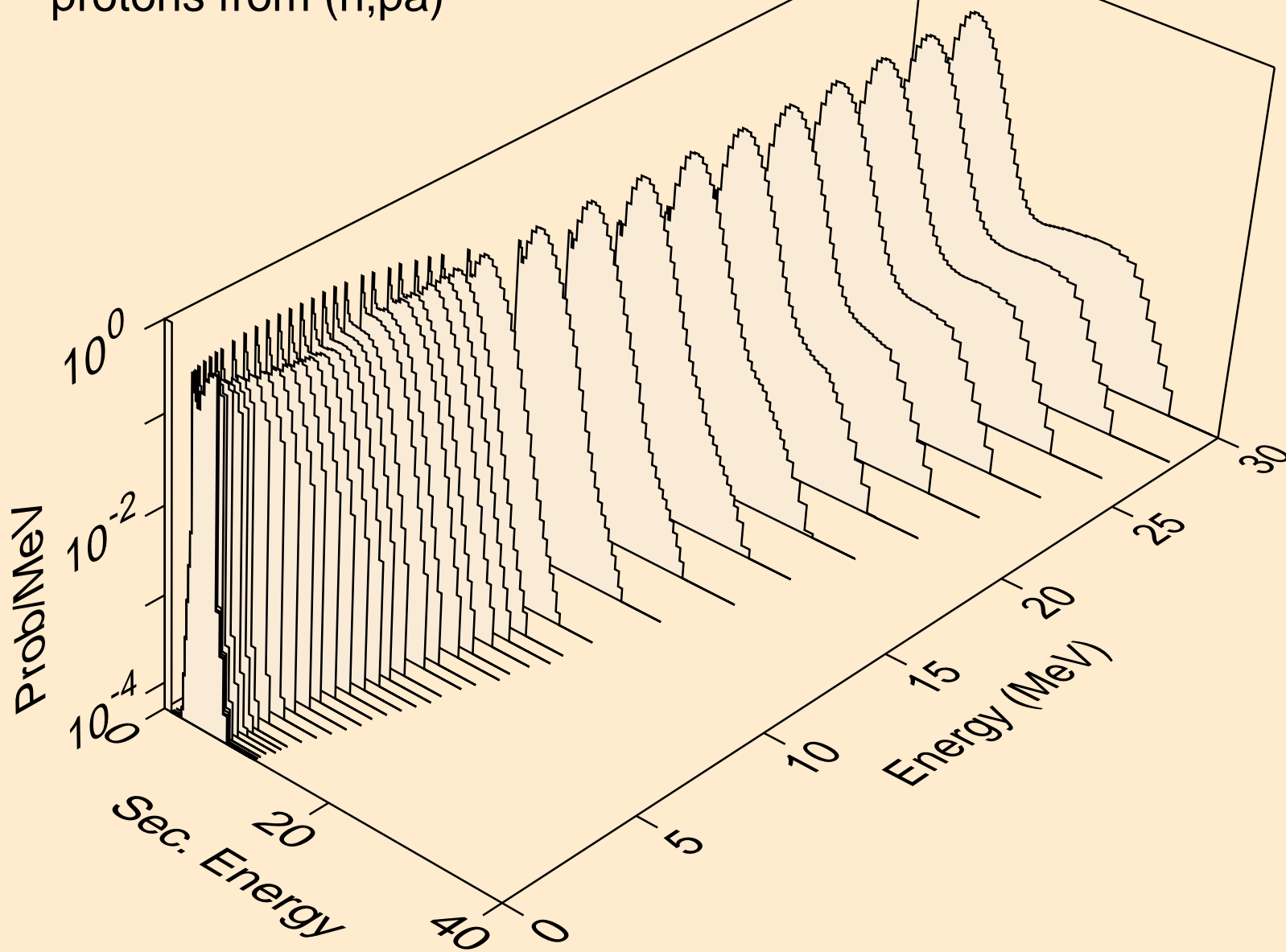

LU154 NEUTRON ACER TENDL-2023 LIBRARY; T=0.K
protons from (n,pd)

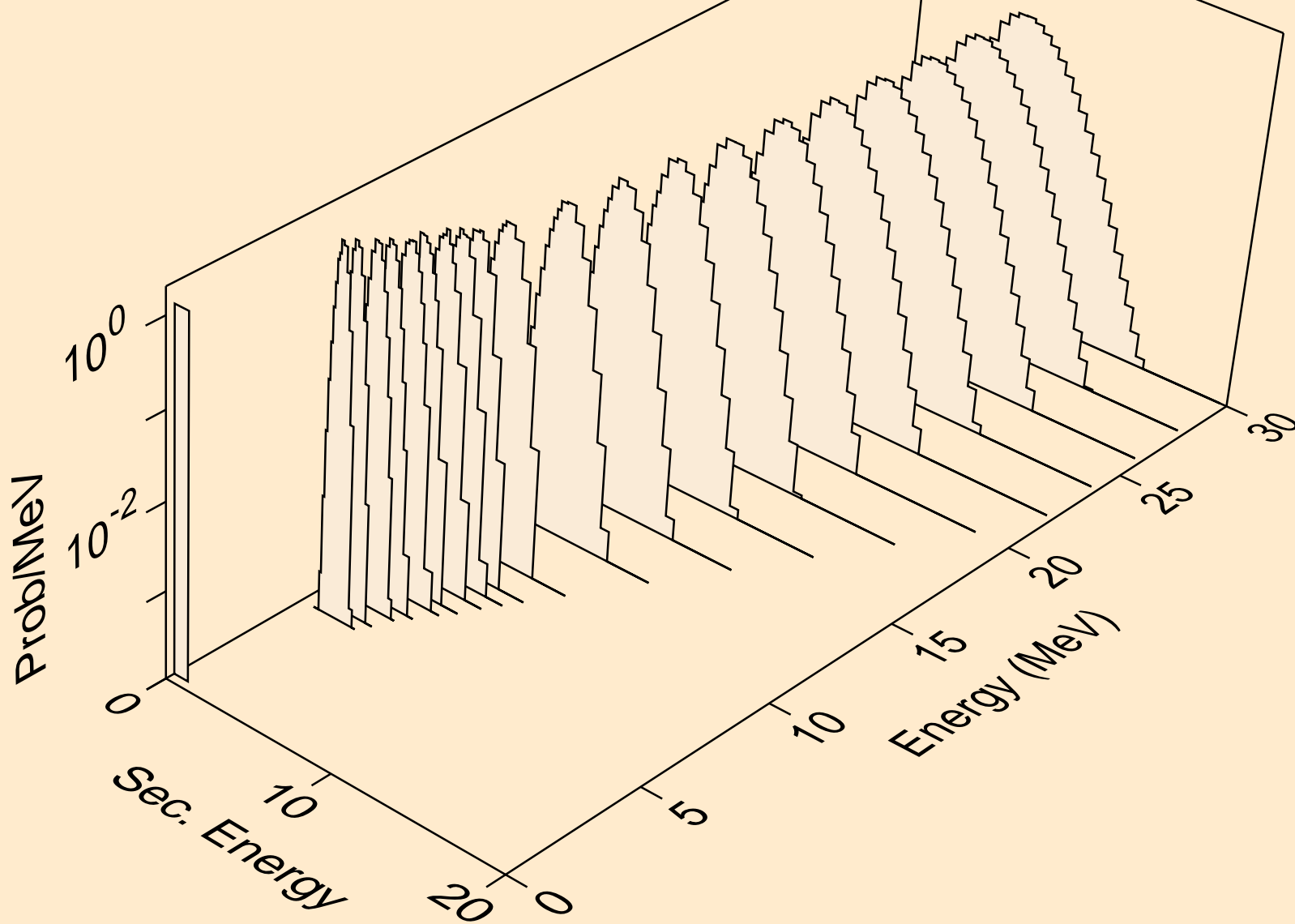

LU154 NEUTRON ACER TENDL-2023 LIBRARY; T=0.K
protons from (n,pt)

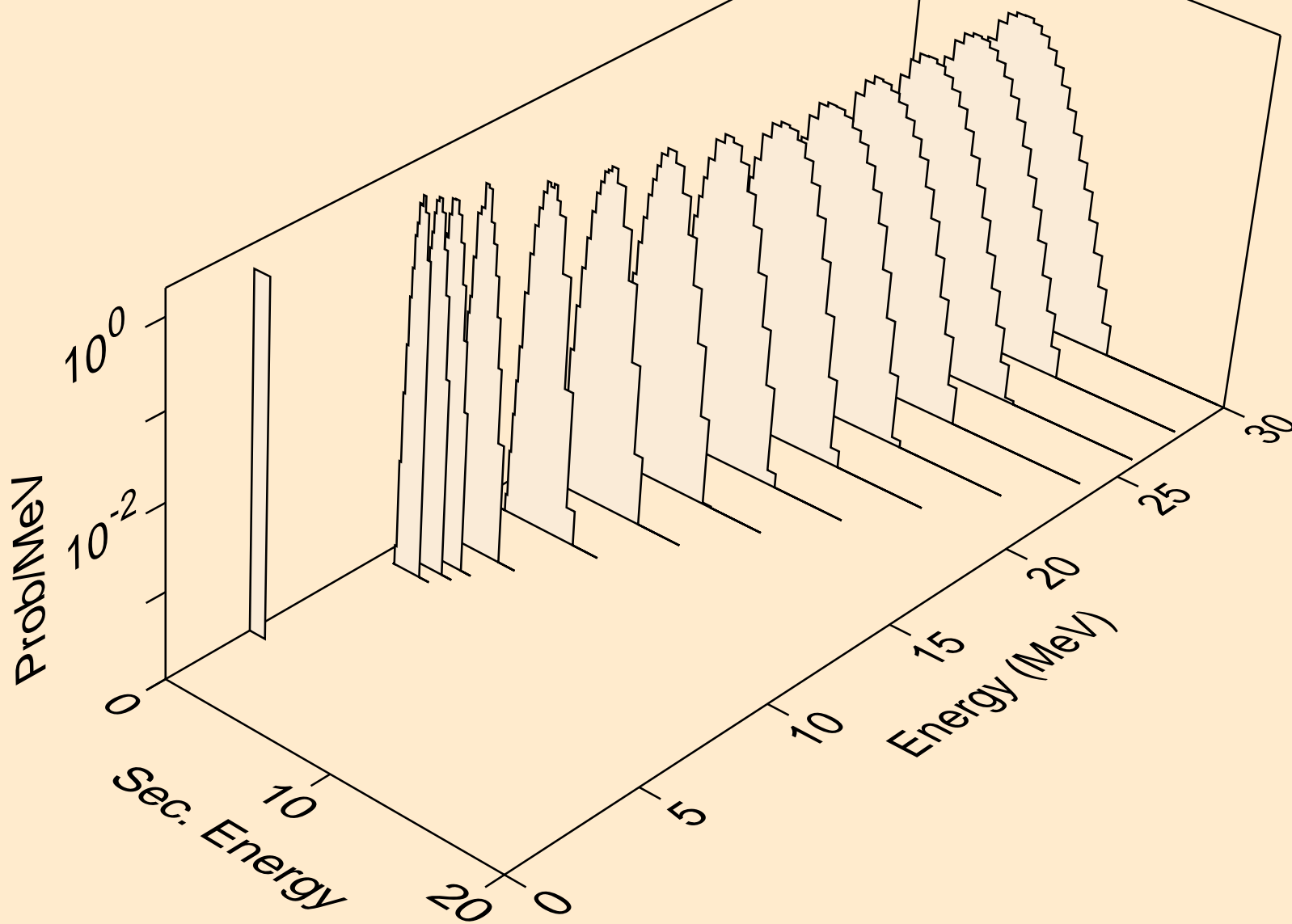

LU154 NEUTRON ACER TENDL-2023 LIBRARY; T=0.K
deuterons from (n,x)

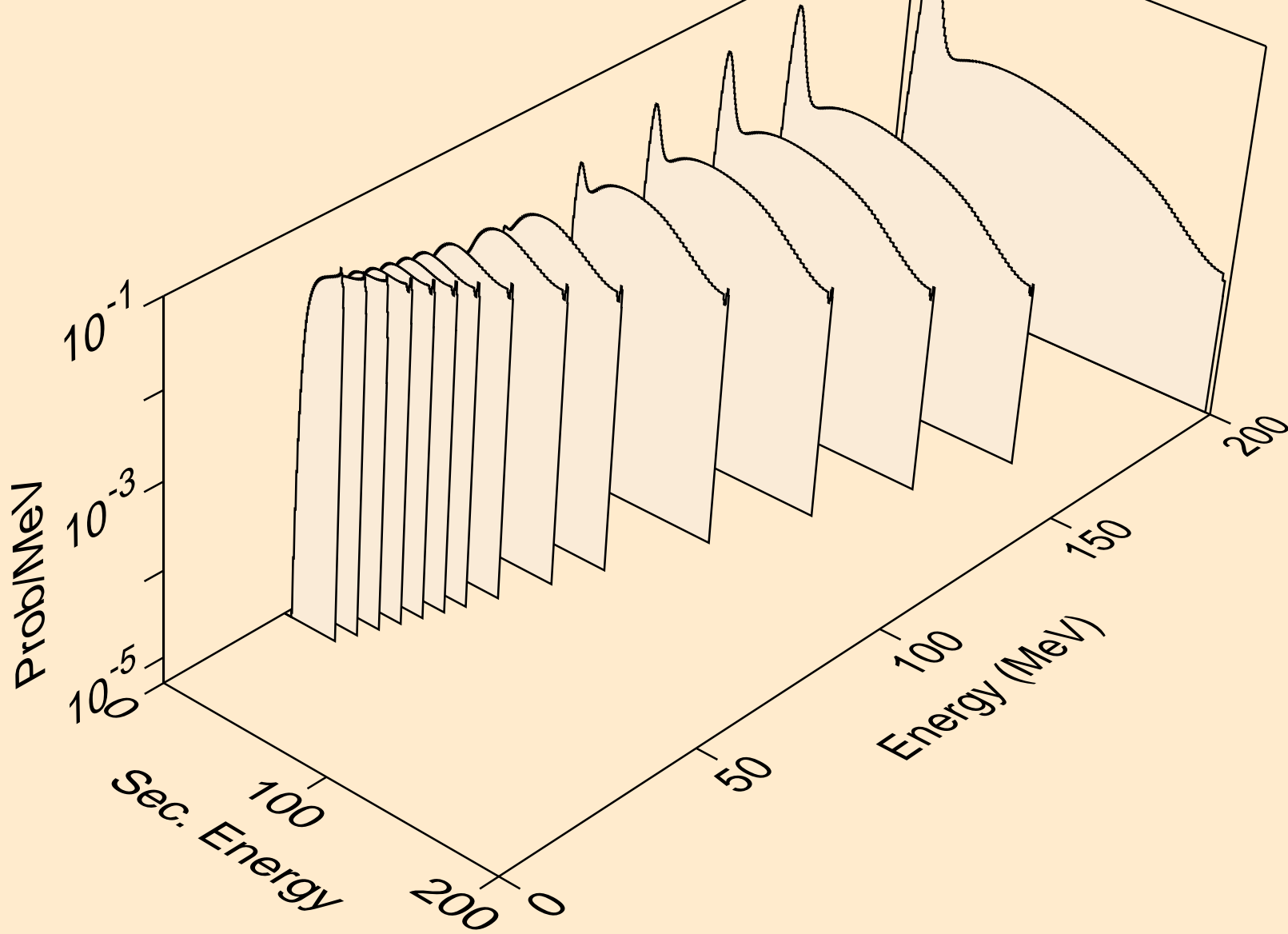

LU154 NEUTRON ACER TENDL-2023 LIBRARY; T=0.K
deuterons from (n,2nd)

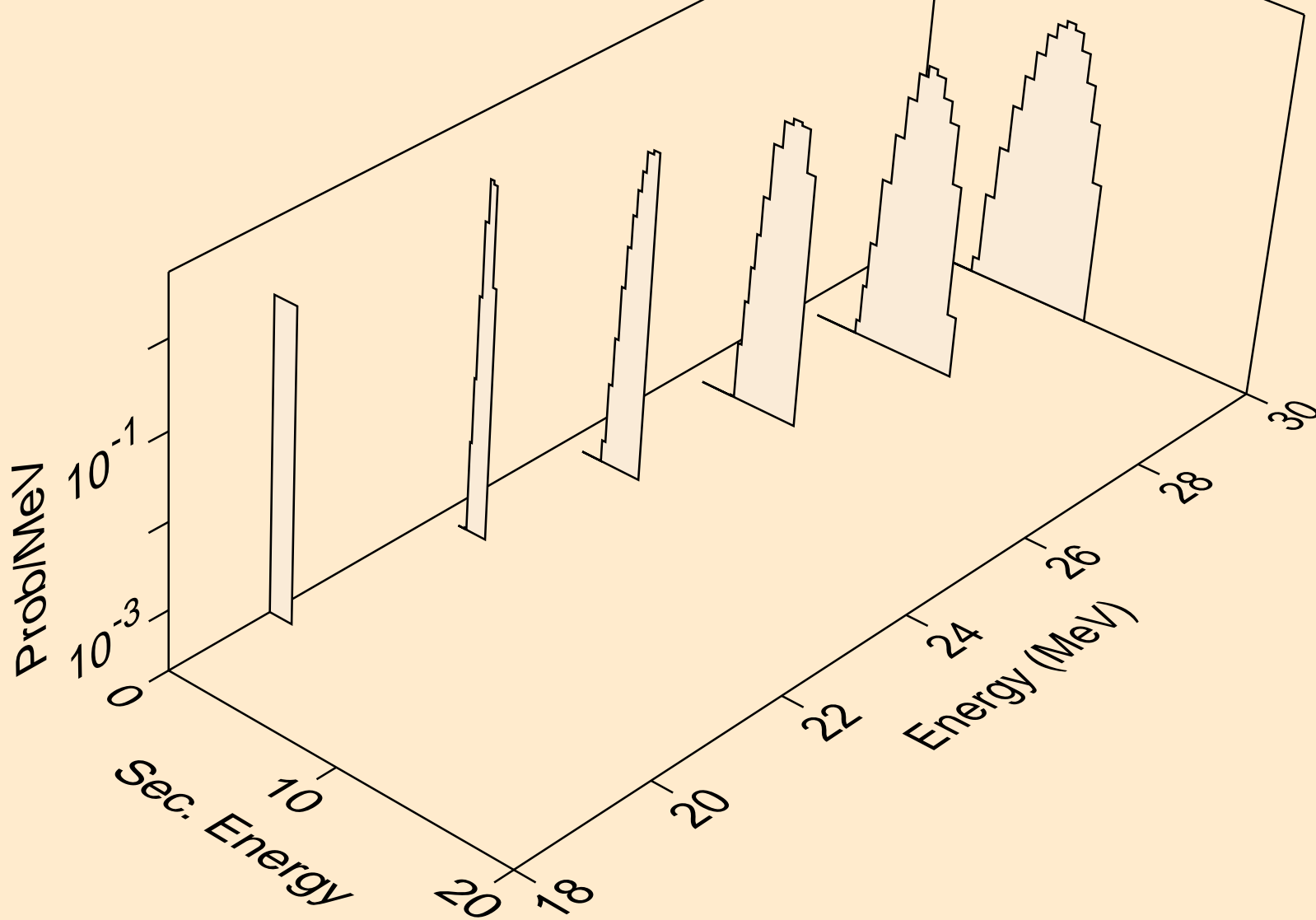

LU154 NEUTRON ACER TENDL-2023 LIBRARY; T=0.K
deuterons from (n,n*)d

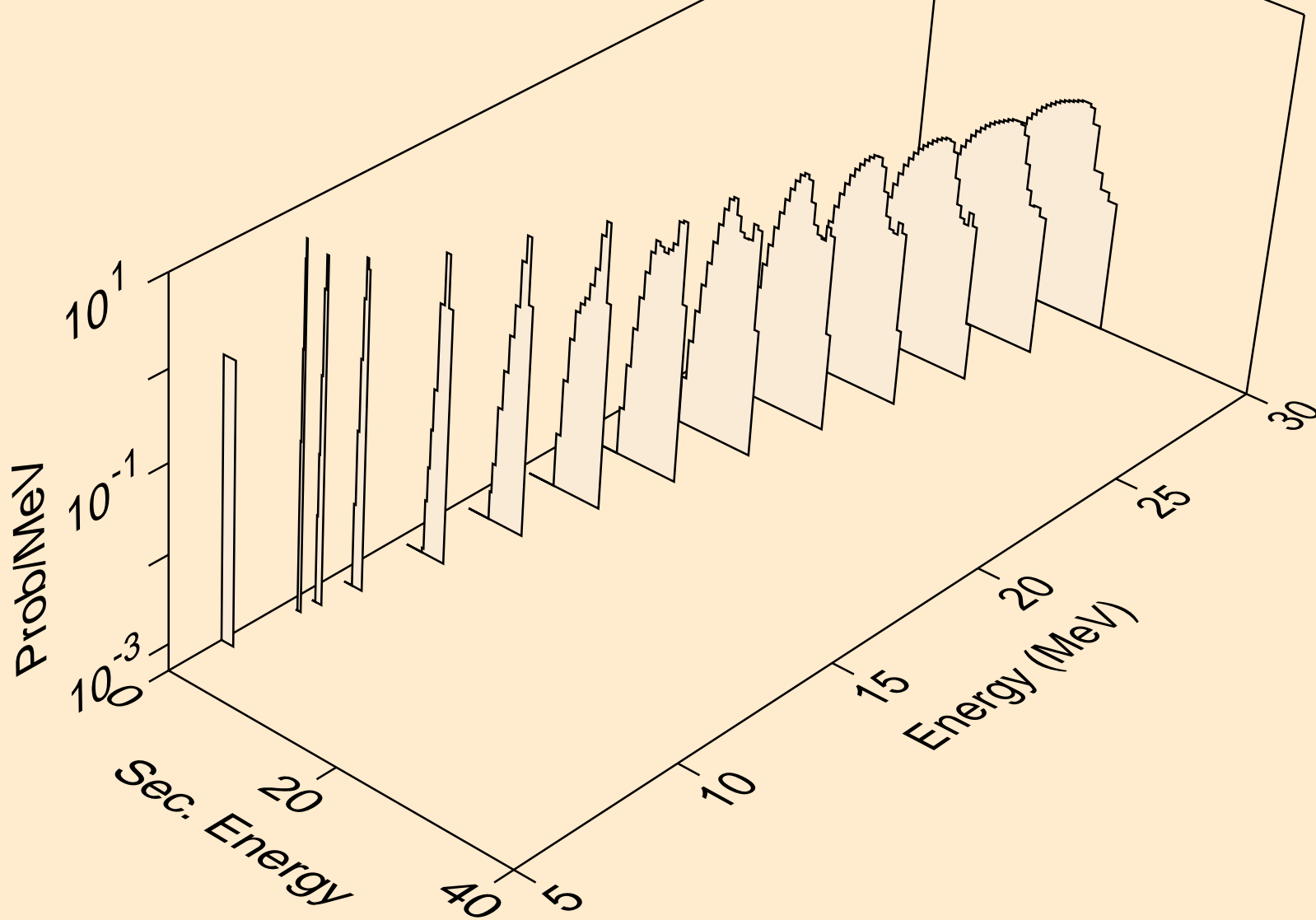

LU154 NEUTRON ACER TENDL-2023 LIBRARY; T=0.K
deuterons from (n,d)

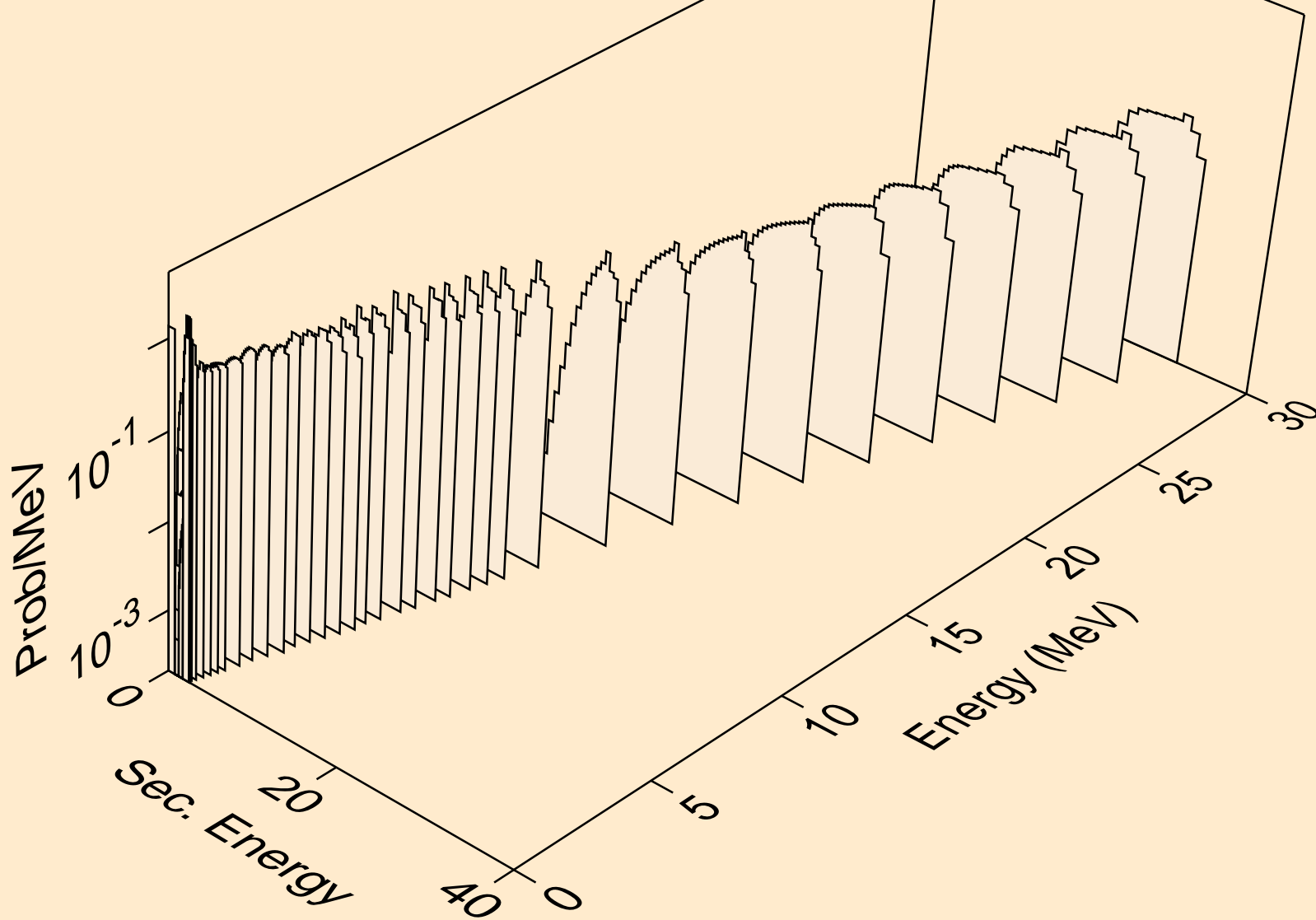

LU154 NEUTRON ACER TENDL-2023 LIBRARY; T=0.K
deuterons from (n,d2a)

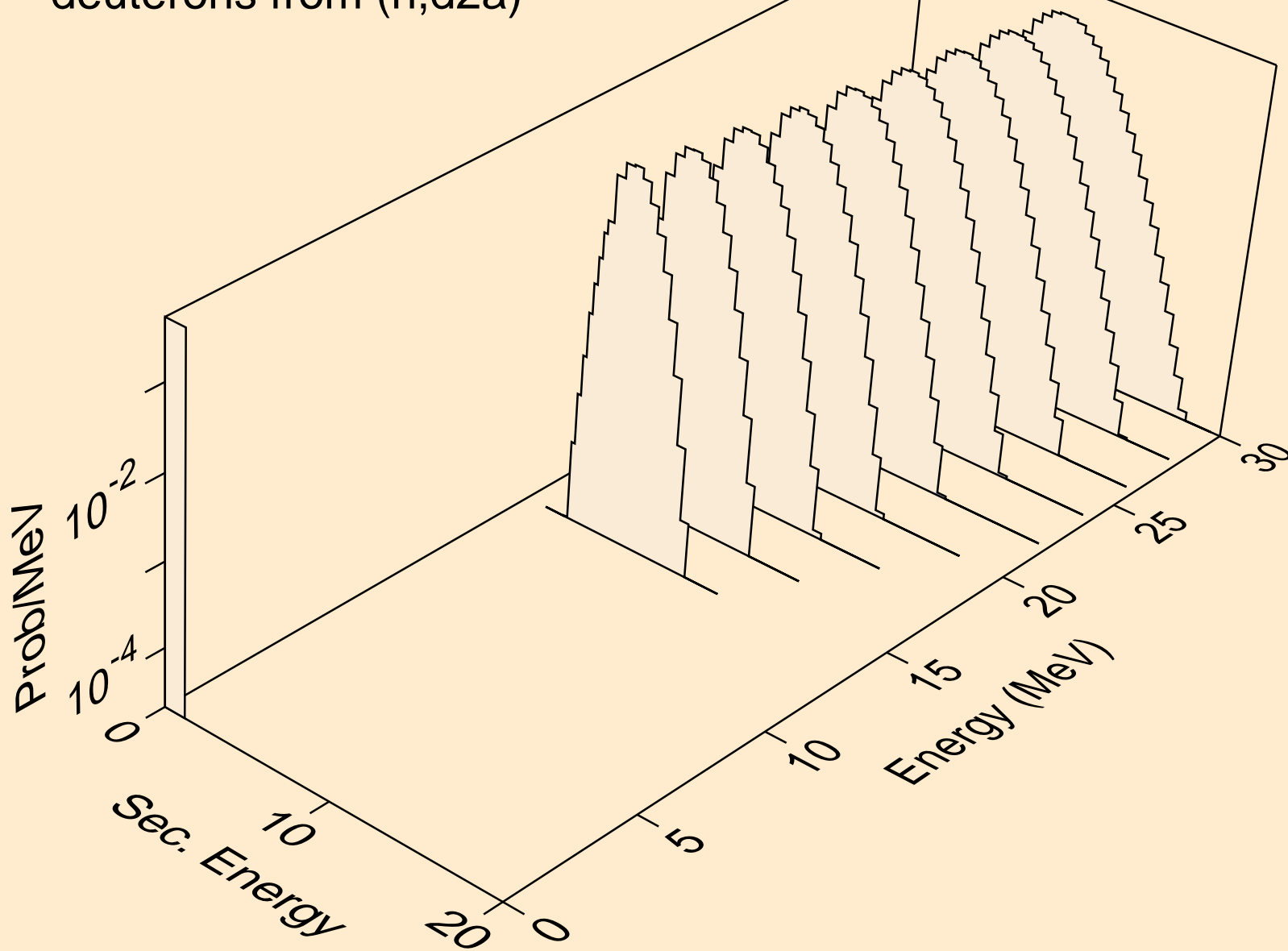

LU154 NEUTRON ACER TENDL-2023 LIBRARY; T=0.K
deuterons from (n,pd)

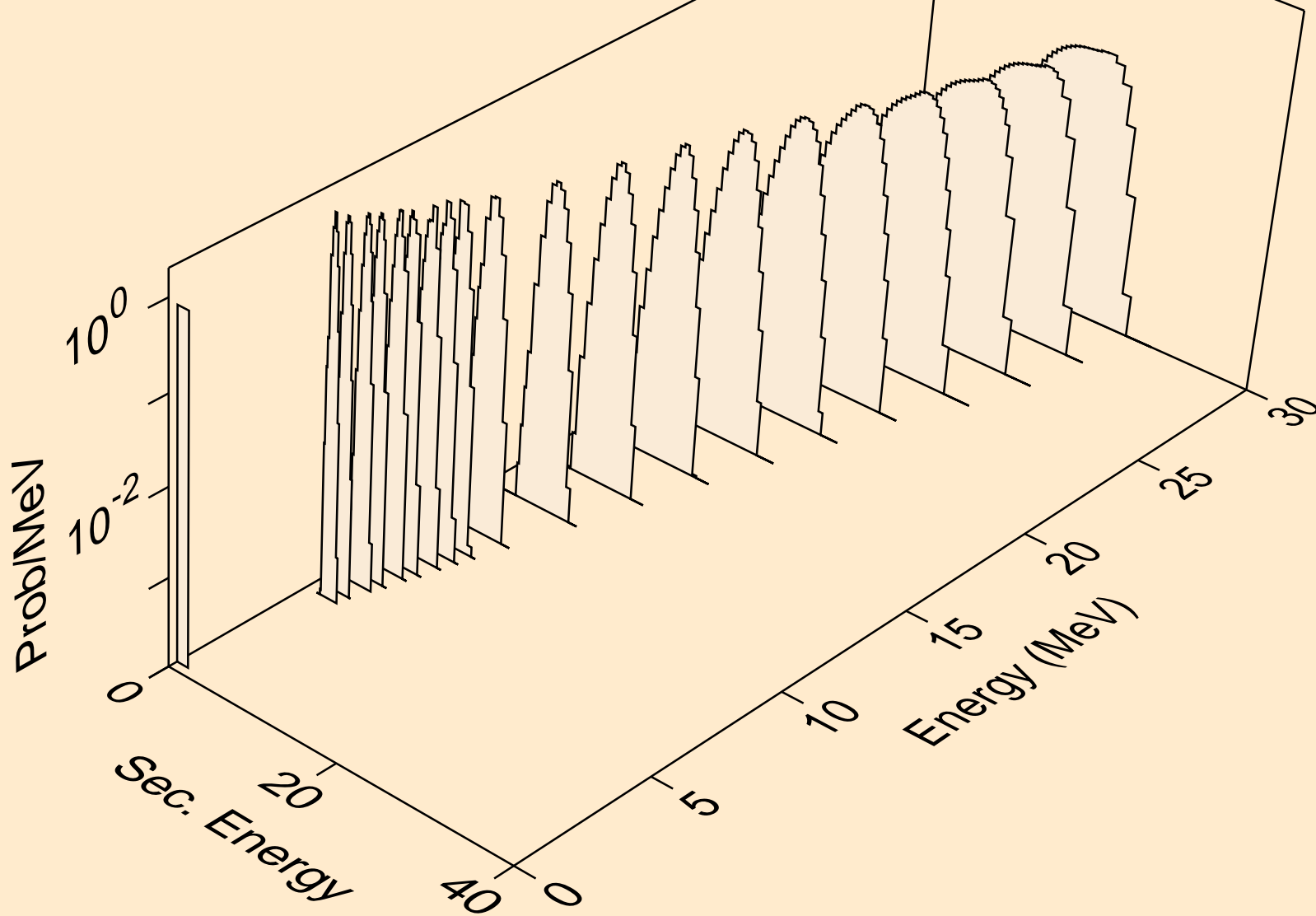

LU154 NEUTRON ACER TENDL-2023 LIBRARY; T=0.K
deuterons from (n,da)

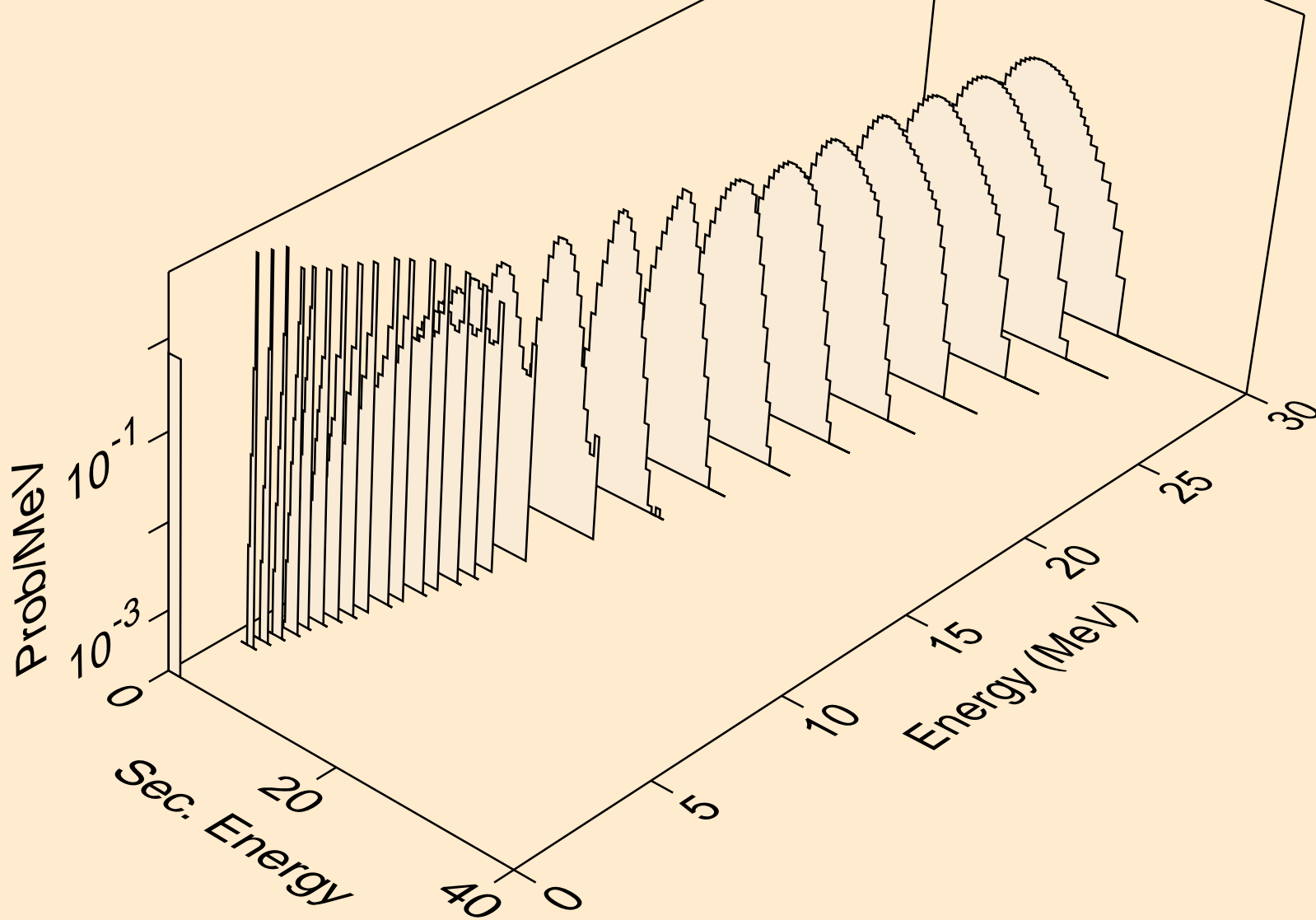

LU154 NEUTRON ACER TENDL-2023 LIBRARY; T=0.K
tritons from (n,x)

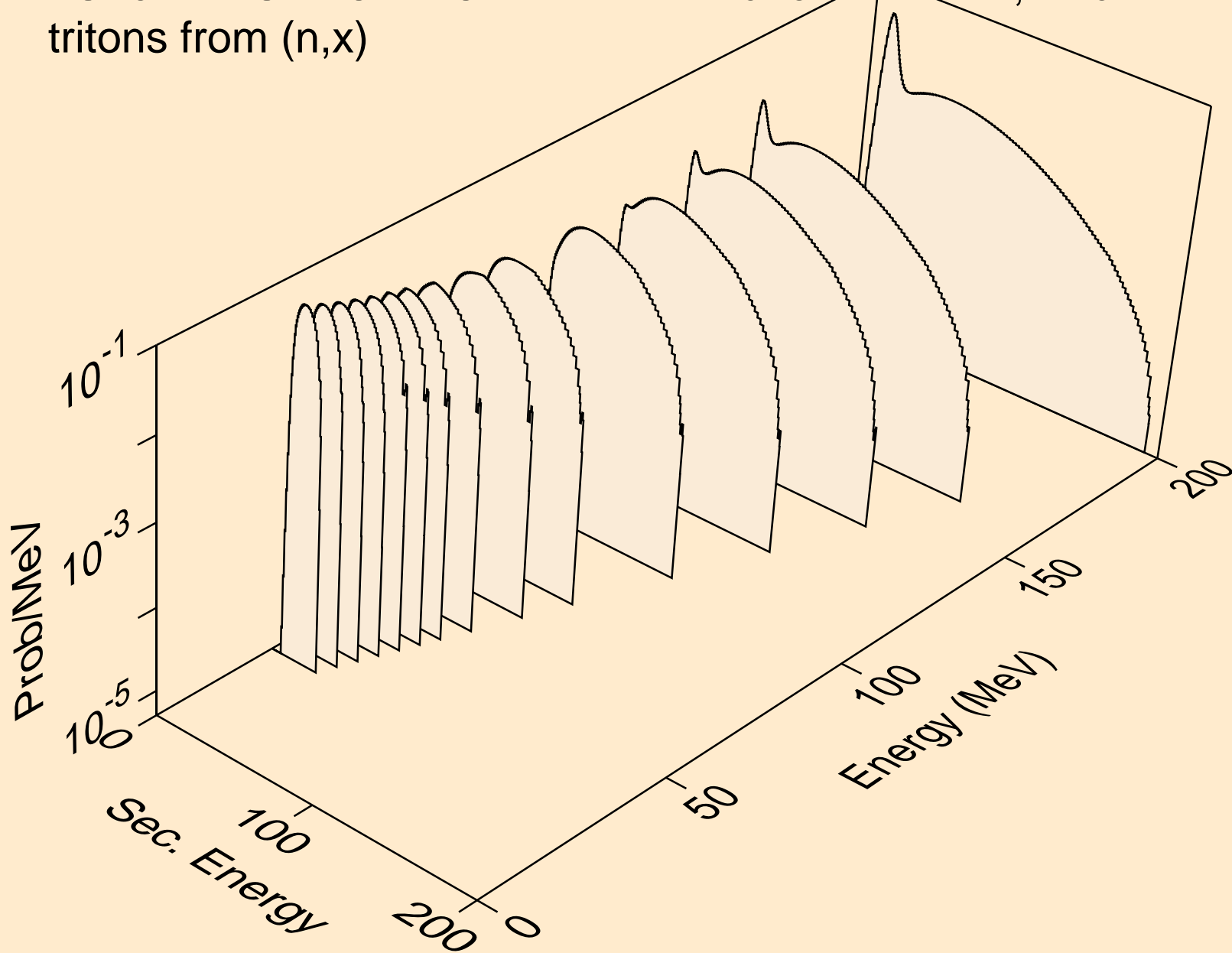

LU154 NEUTRON ACER TENDL-2023 LIBRARY; T=0.K
tritons from (n,n*)t

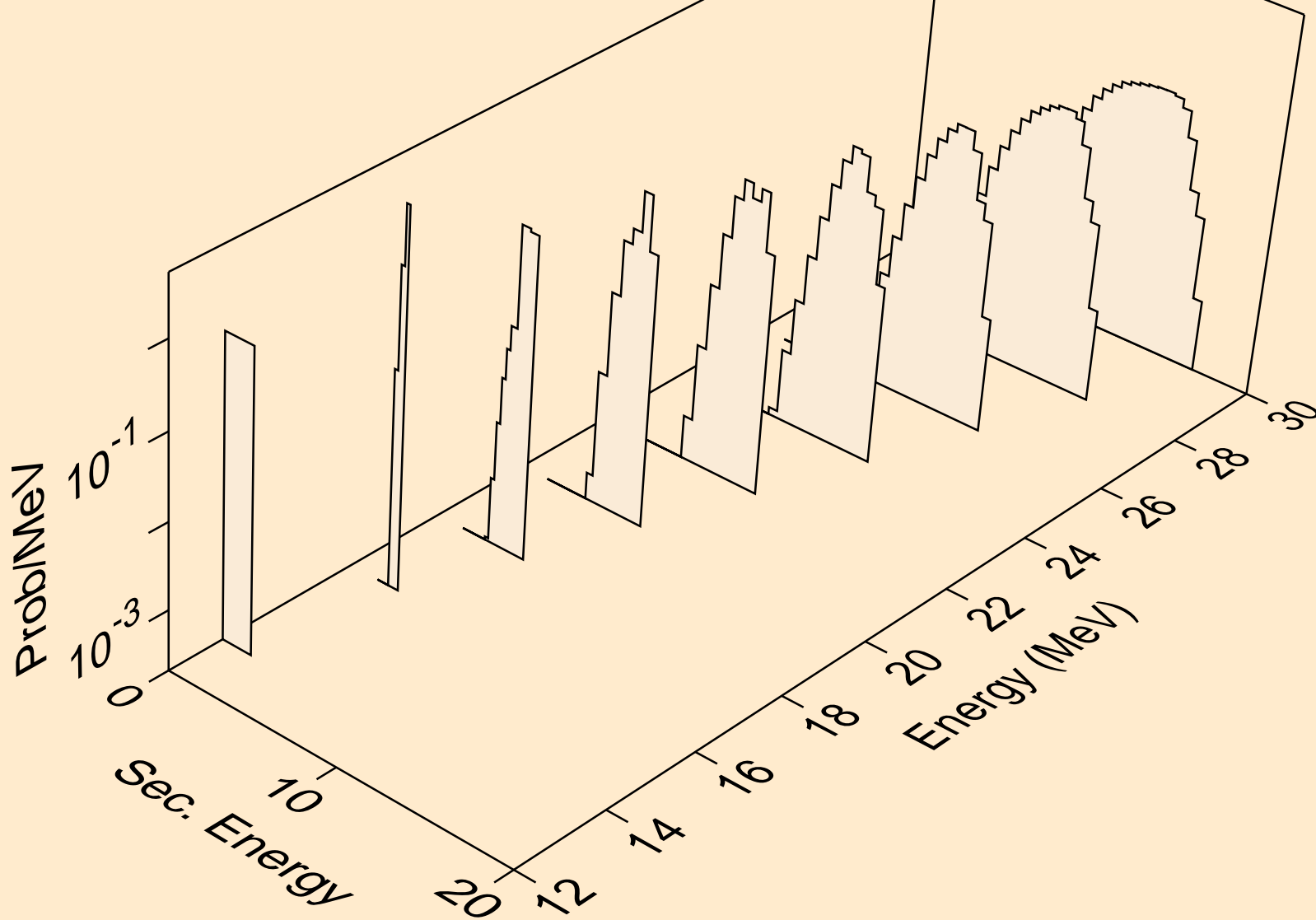

LU154 NEUTRON ACER TENDL-2023 LIBRARY; T=0.K
tritons from (n,t)

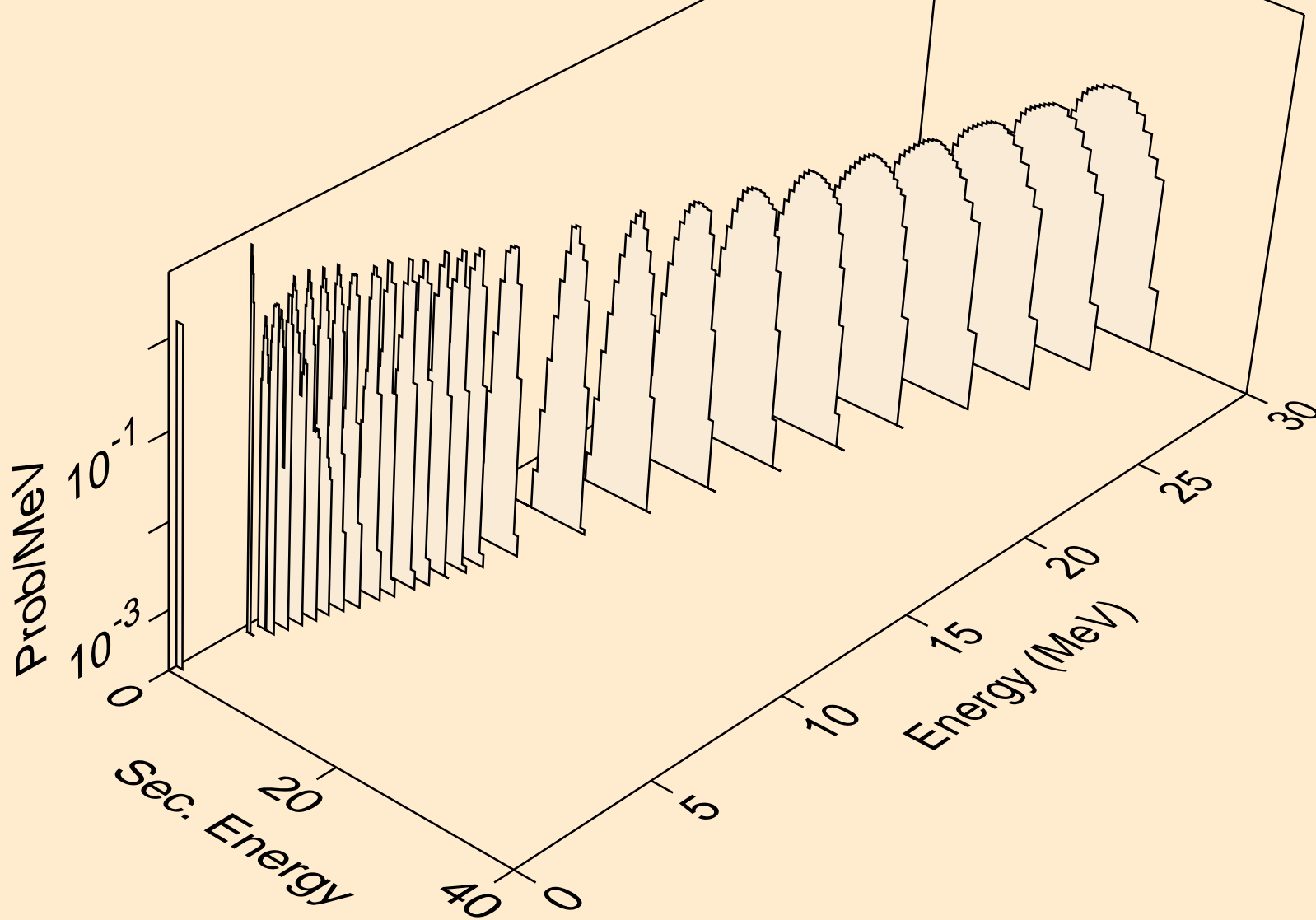

LU154 NEUTRON ACER TENDL-2023 LIBRARY; T=0.K
tritons from (n,pt)

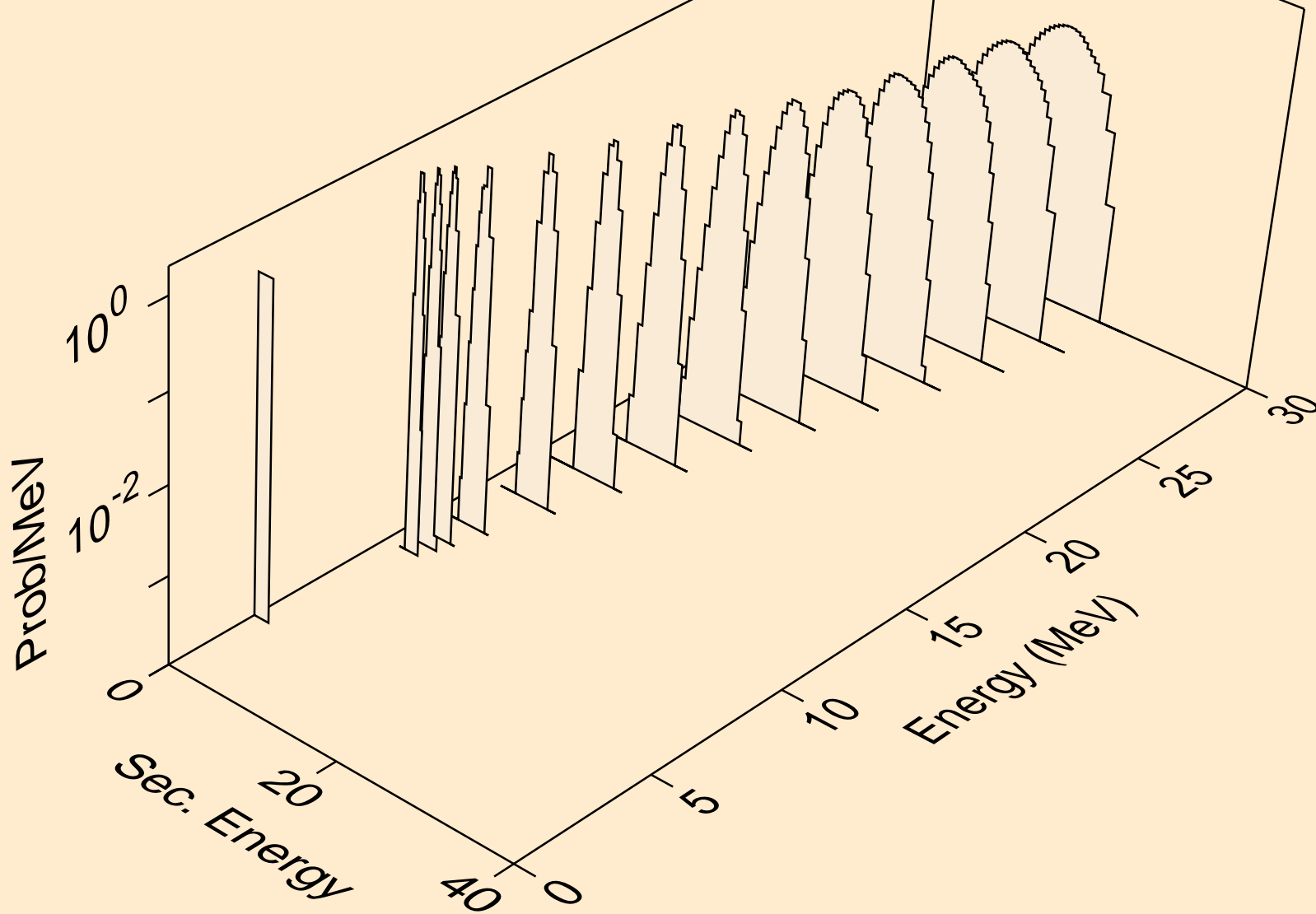

LU154 NEUTRON ACER TENDL-2023 LIBRARY; T=0.K
he3s from (n,x)

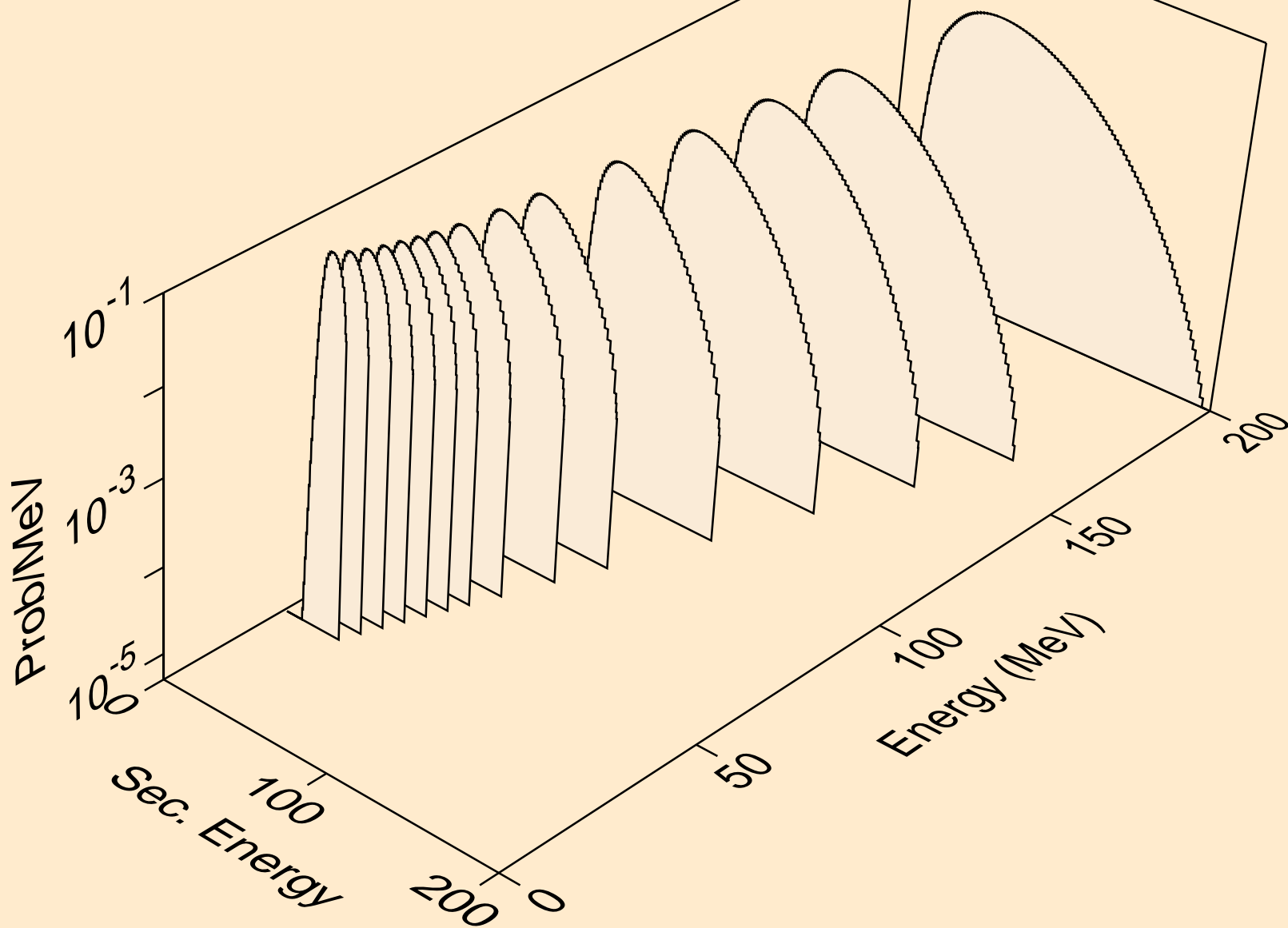

LU154 NEUTRON ACER TENDL-2023 LIBRARY; T=0.K
he3s from (n,n*)he3

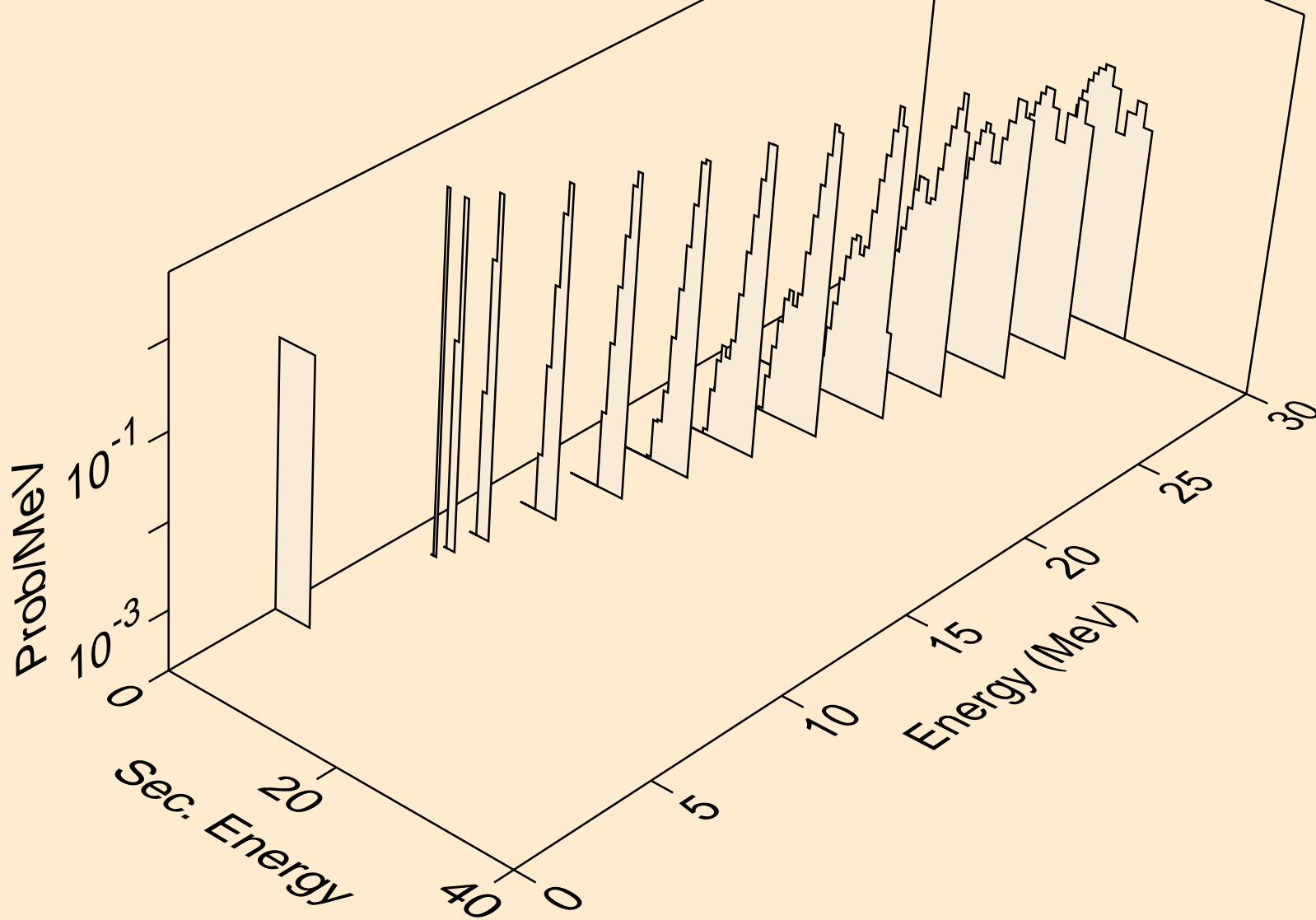

LU154 NEUTRON ACER TENDL-2023 LIBRARY; T=0.K
he3s from (n,he3)

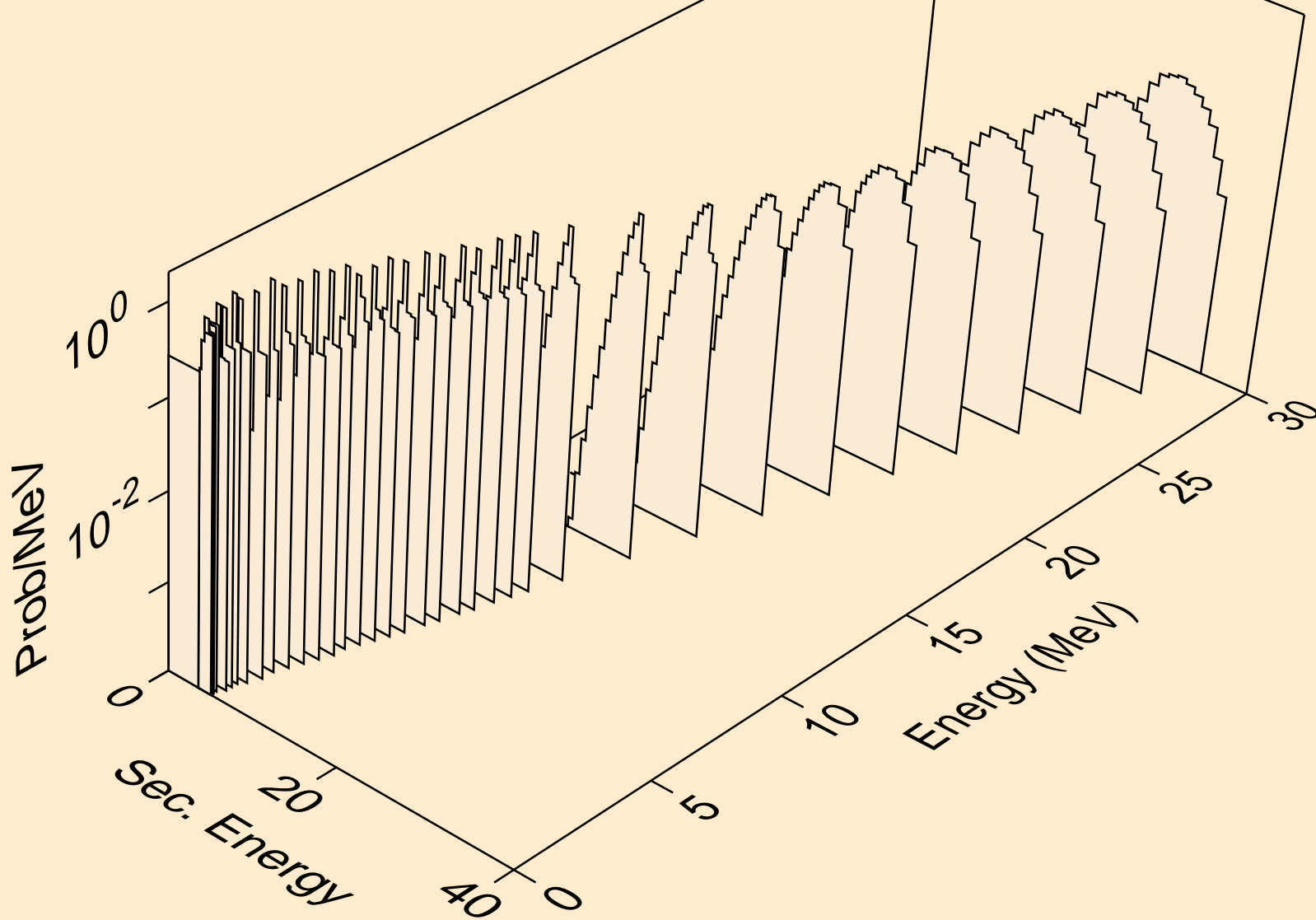

LU154 NEUTRON ACER TENDL-2023 LIBRARY; T=0.K
alphas from (n,x)

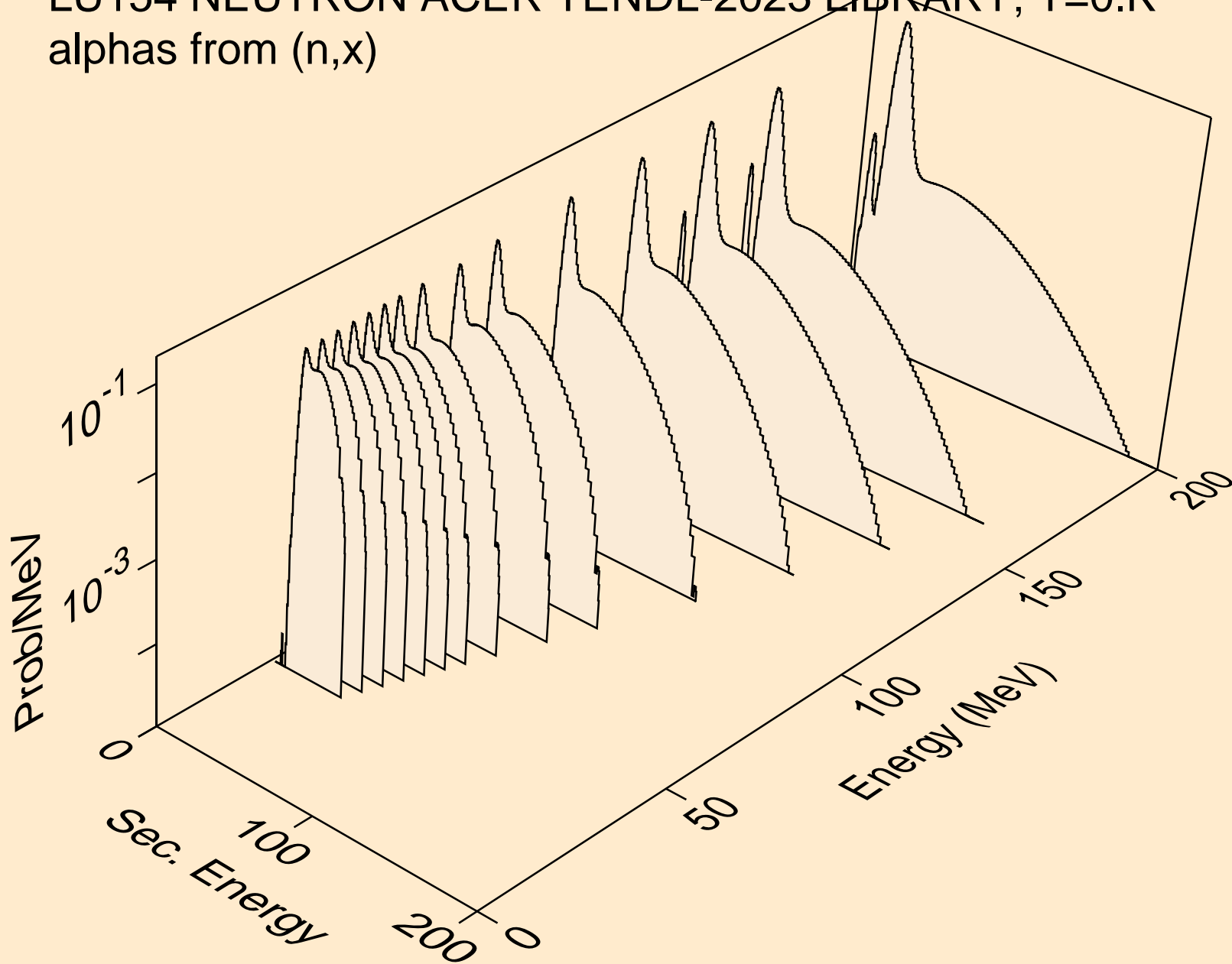

LU154 NEUTRON ACER TENDL-2023 LIBRARY; T=0.K
alphas from (n,n*)a

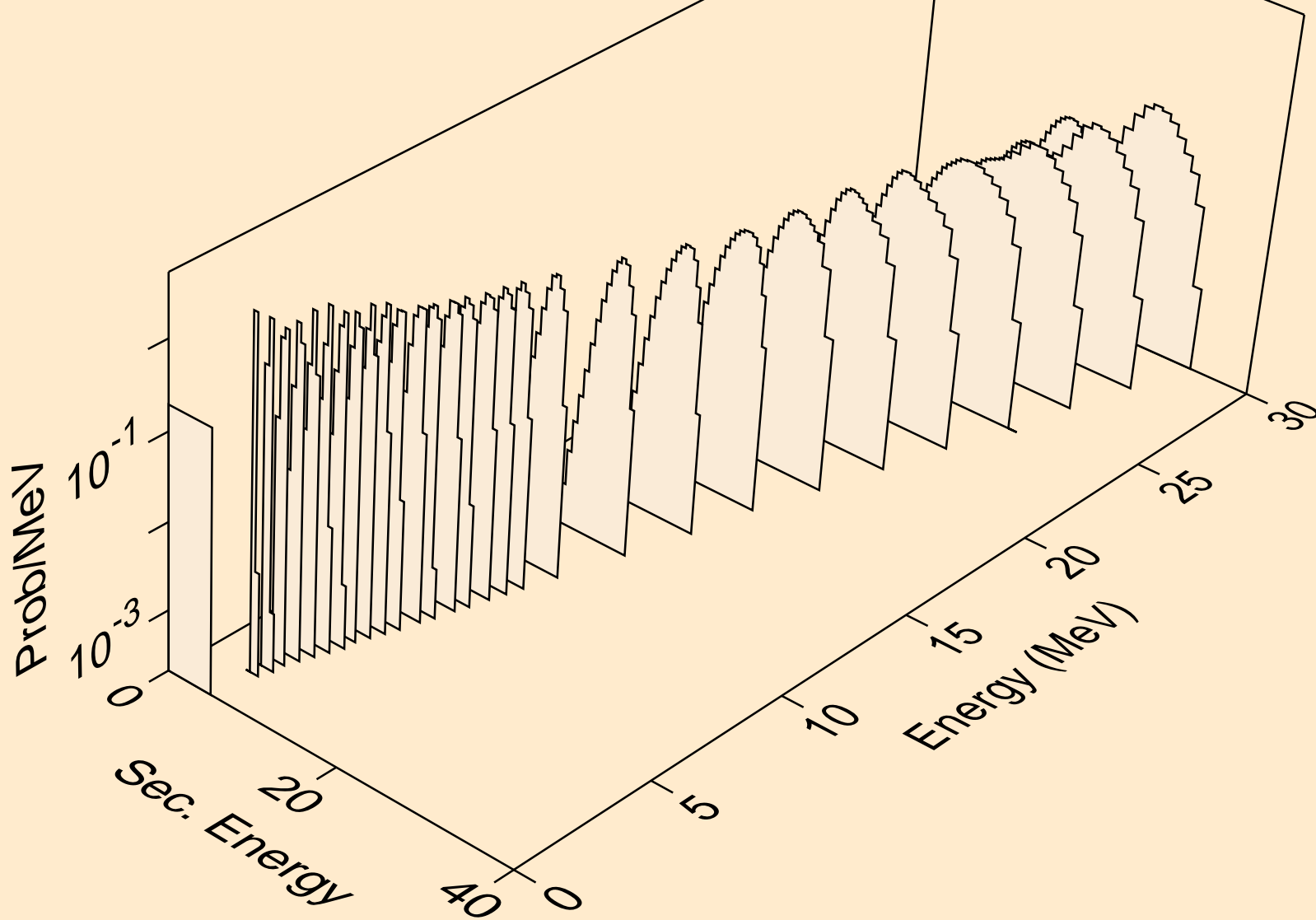

LU154 NEUTRON ACER TENDL-2023 LIBRARY; T=0.K
alphas from (n,2n)a

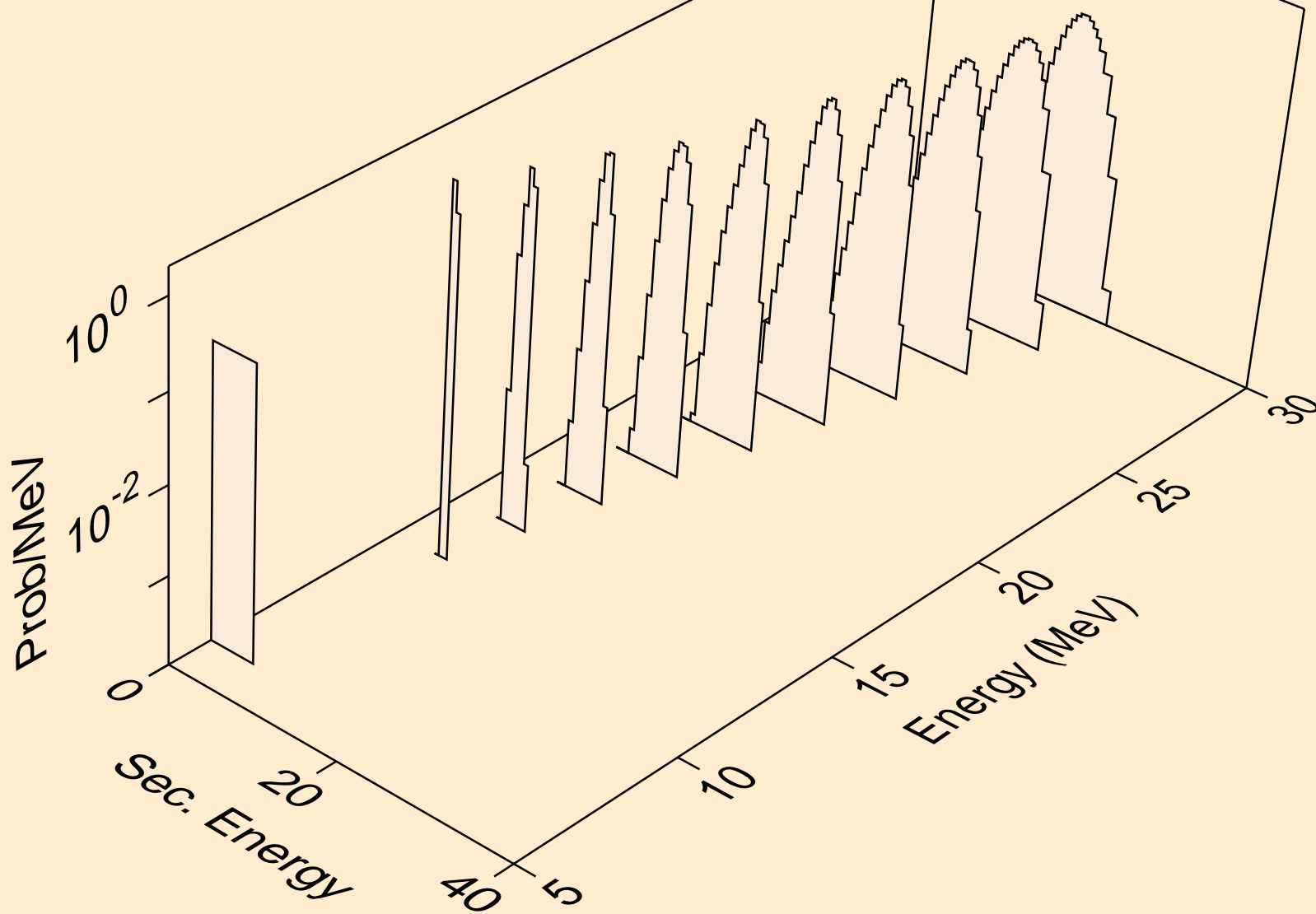

LU154 NEUTRON ACER TENDL-2023 LIBRARY; T=0.K
alphas from (n,n*)2a

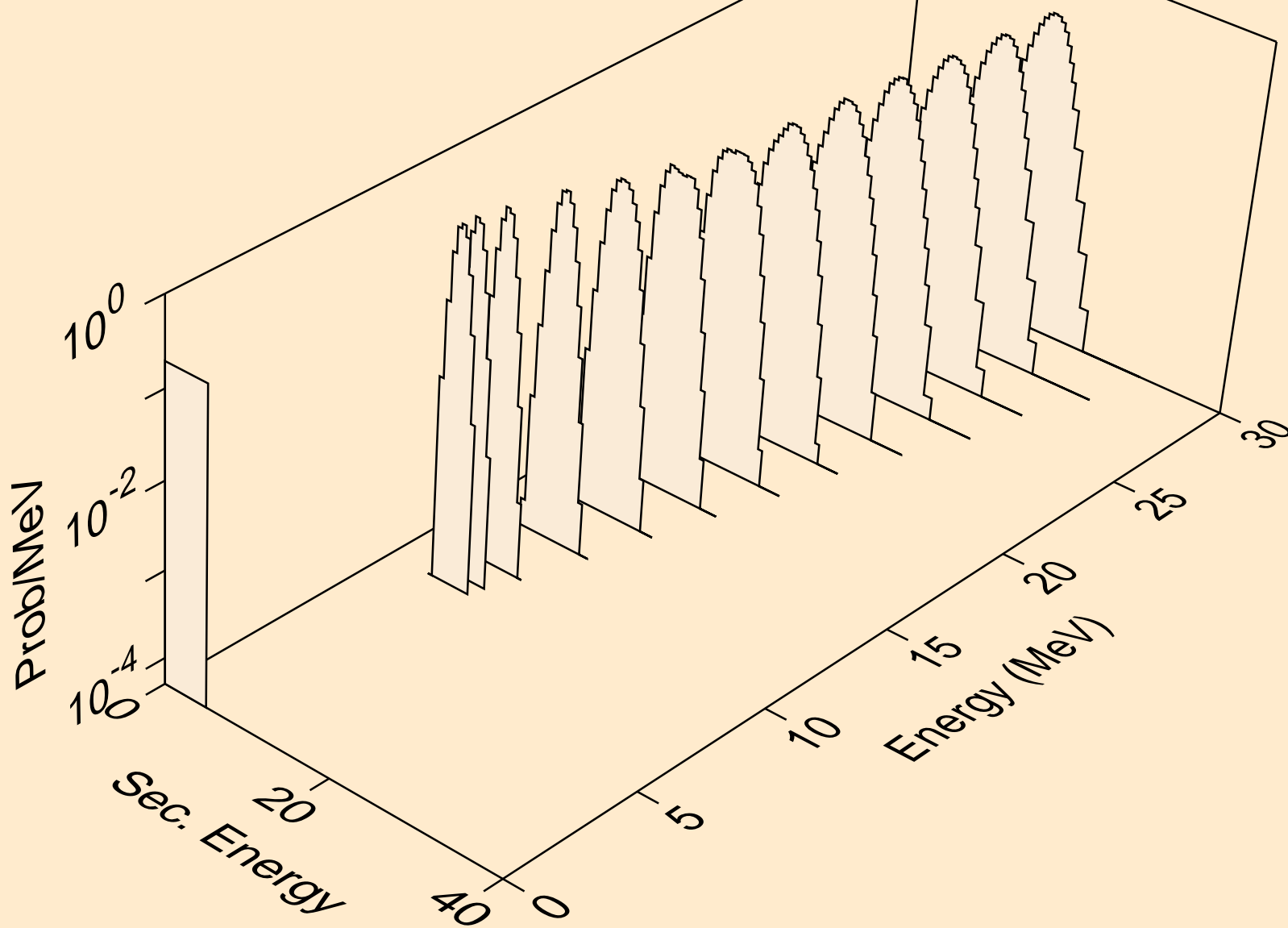

LU154 NEUTRON ACER TENDL-2023 LIBRARY; T=0.K
alphas from (n,npa)

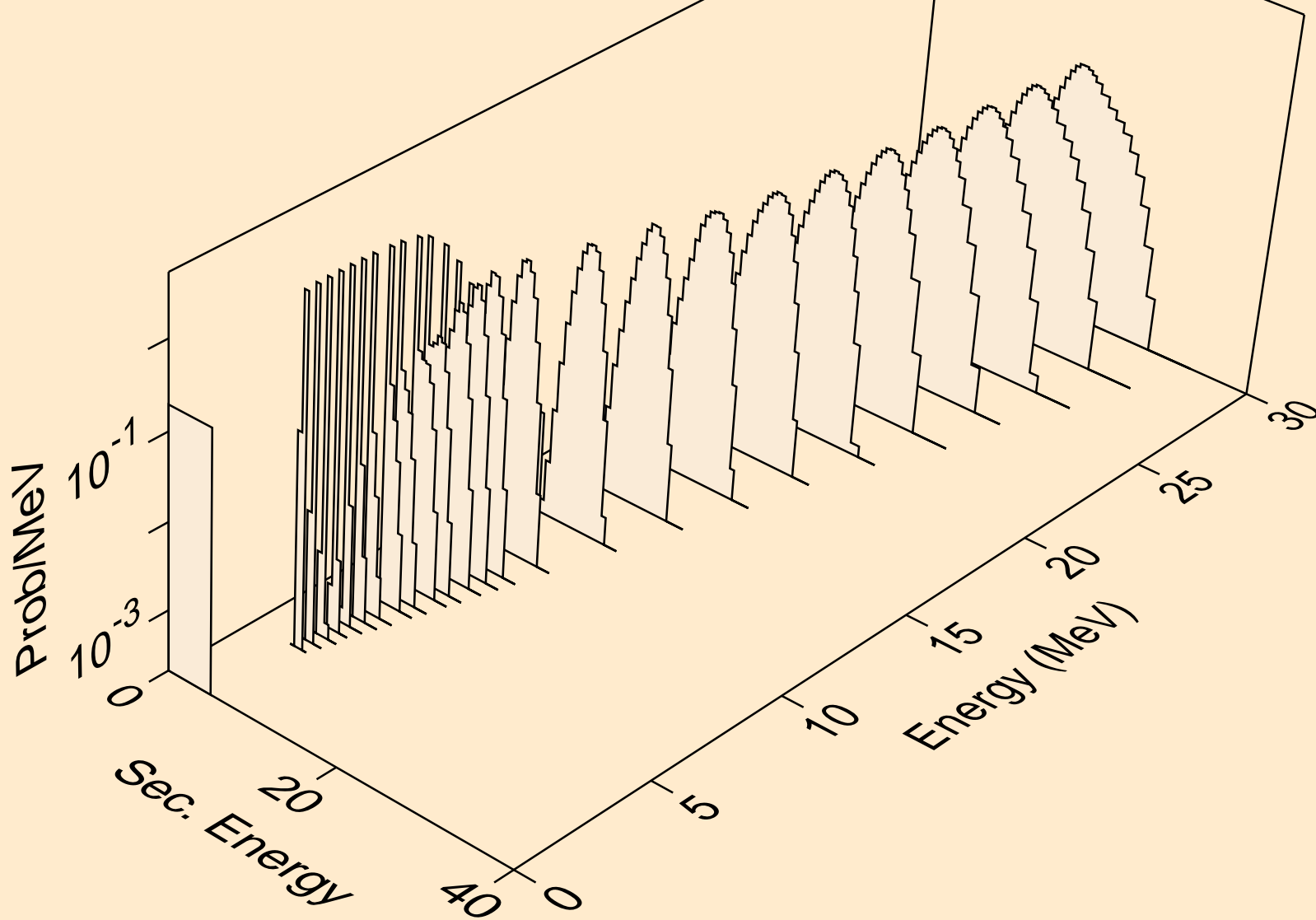

LU154 NEUTRON ACER TENDL-2023 LIBRARY; T=0.K
alphas from (n,a)

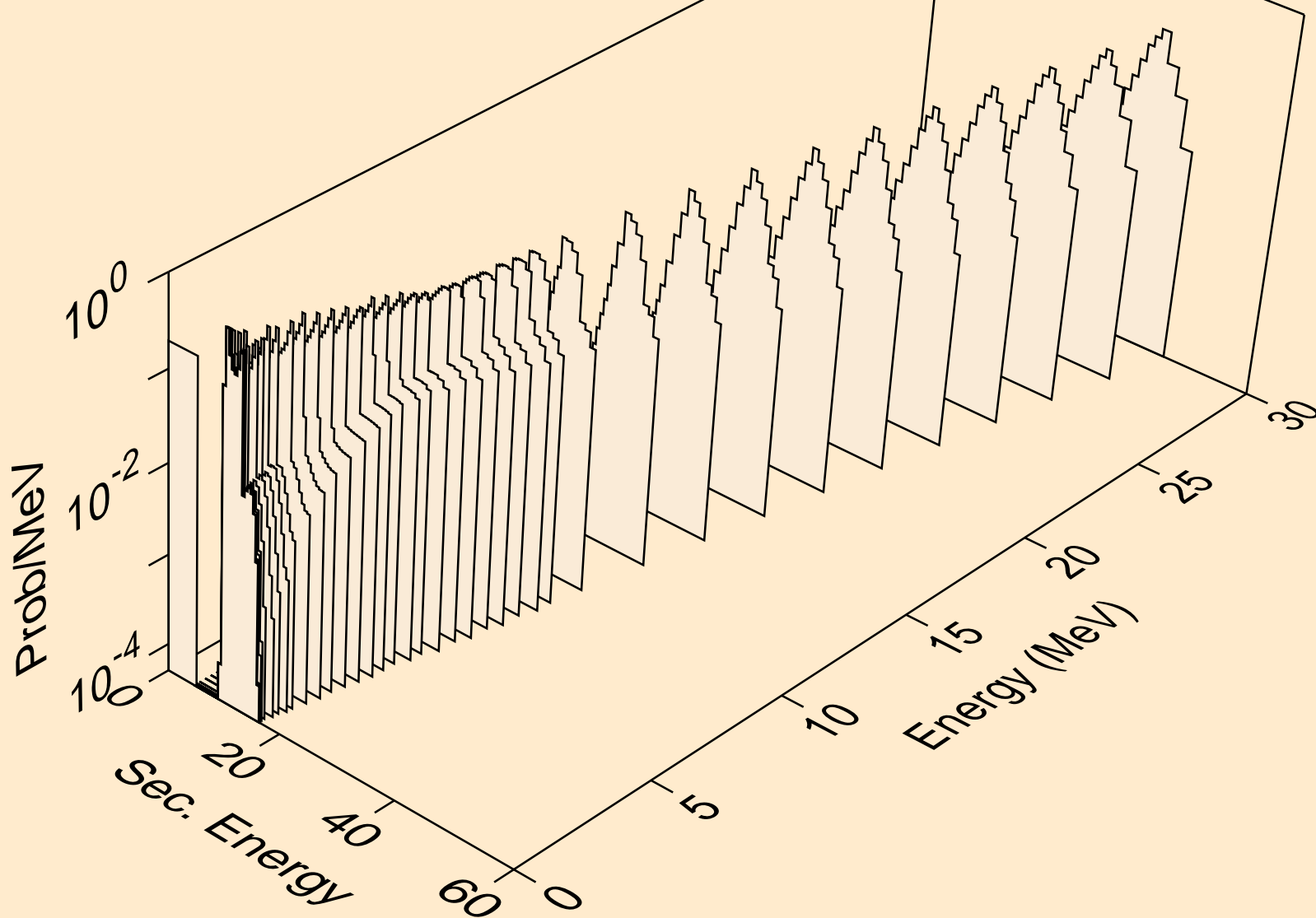

LU154 NEUTRON ACER TENDL-2023 LIBRARY; T=0.K
alphas from (n,2a)

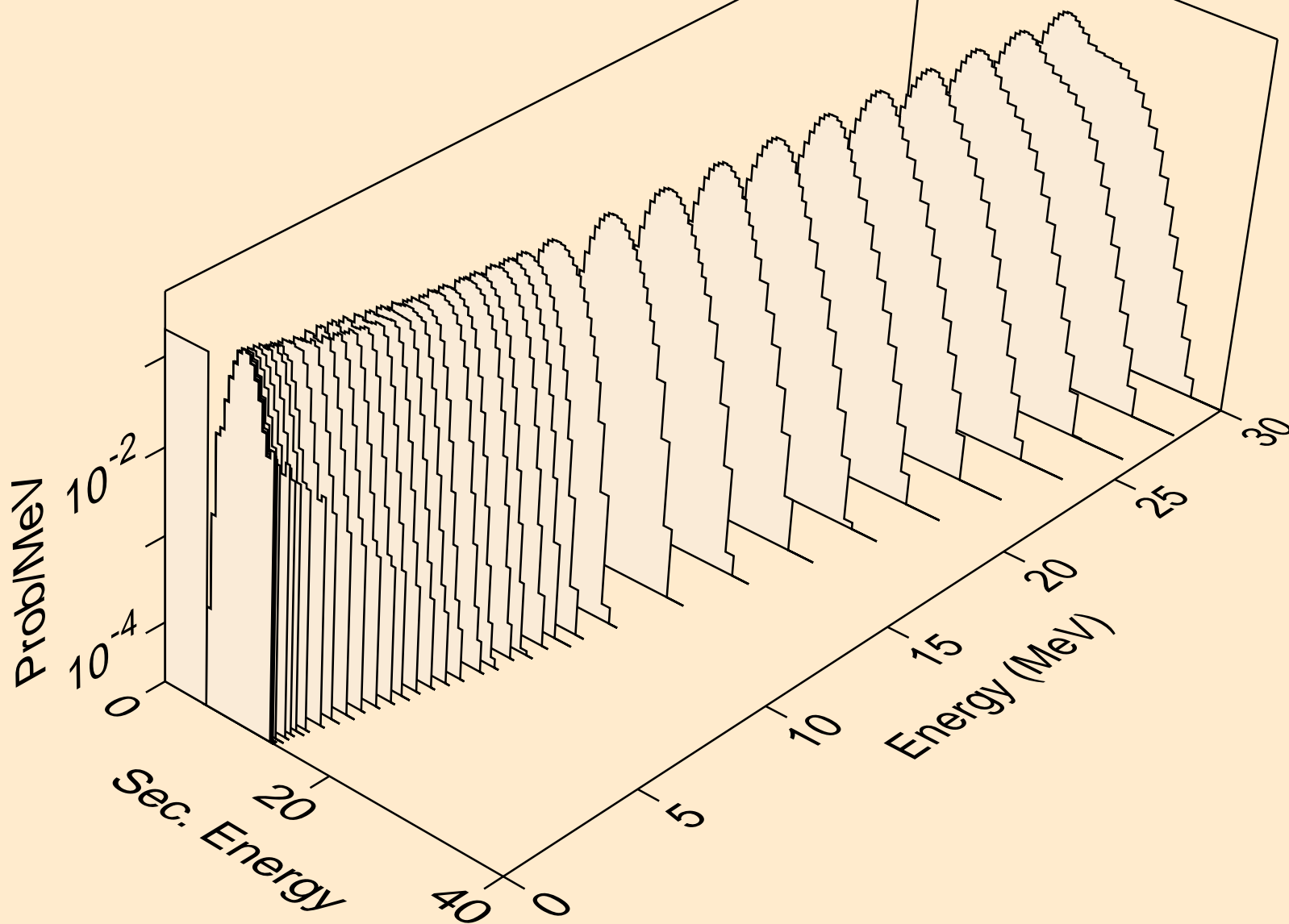

LU154 NEUTRON ACER TENDL-2023 LIBRARY; T=0.K
alphas from (n,3a)

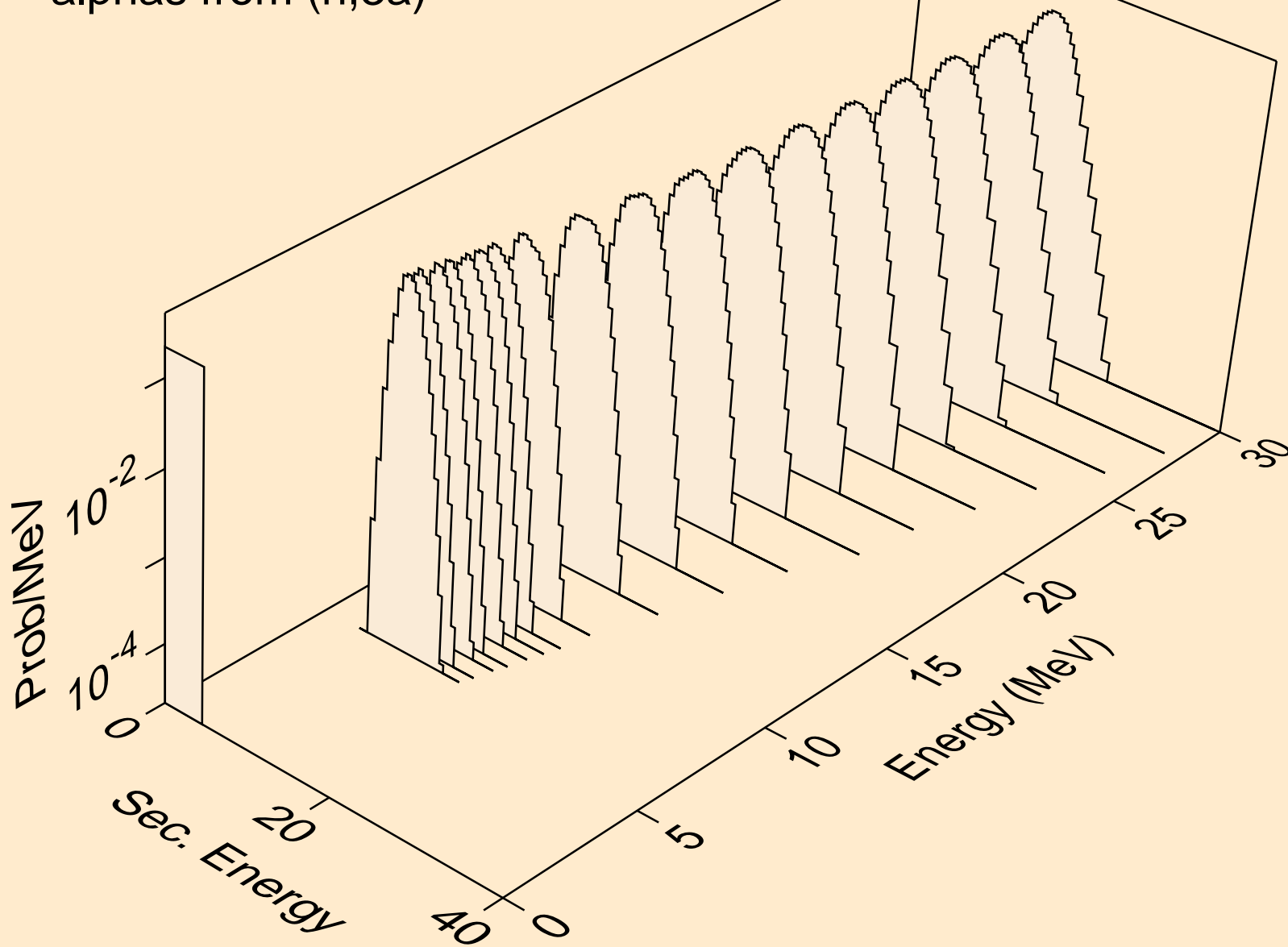

LU154 NEUTRON ACER TENDL-2023 LIBRARY; T=0.K
alphas from (n,pa)

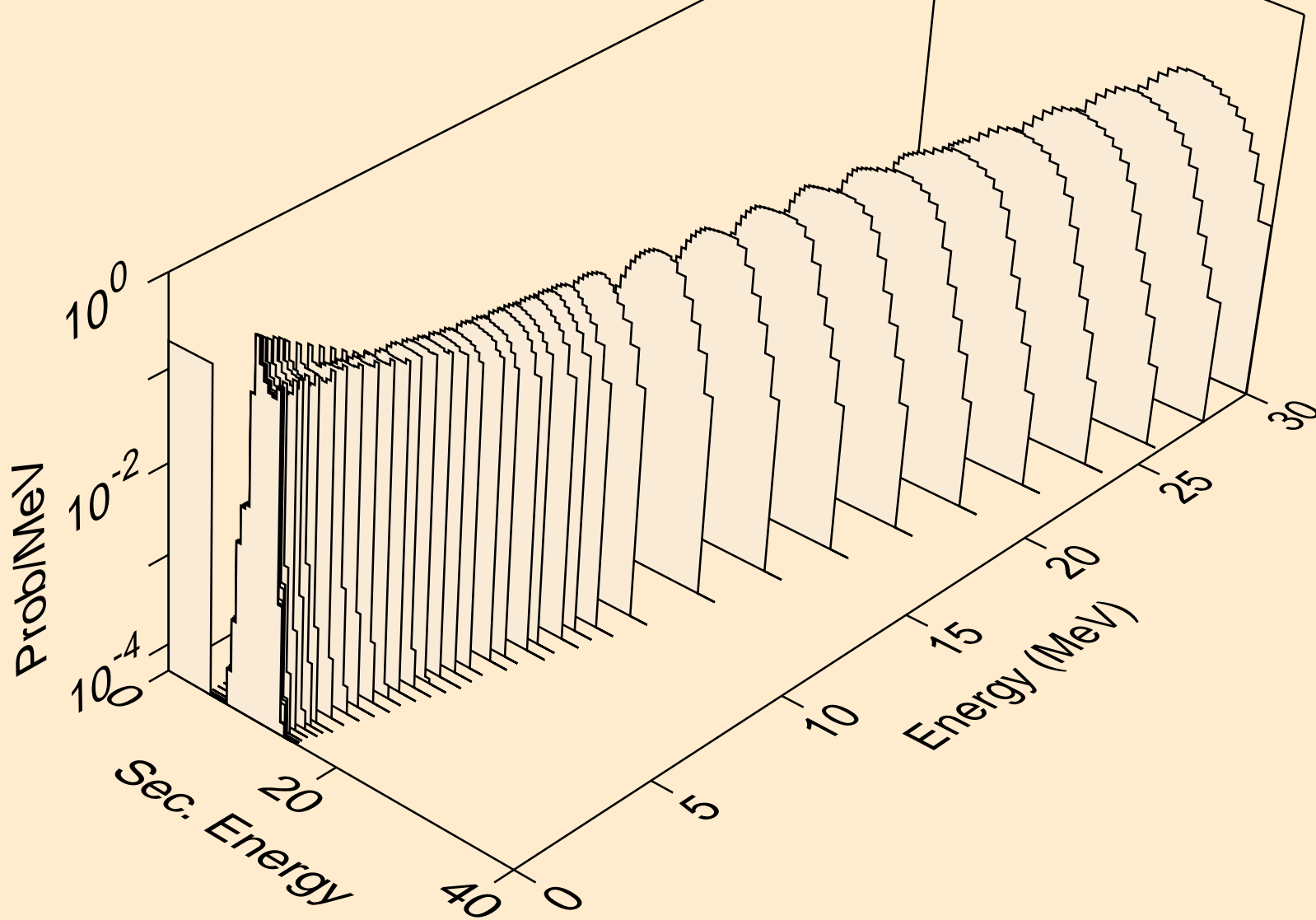

LU154 NEUTRON ACER TENDL-2023 LIBRARY; T=0.K
alphas from (n,d2a)

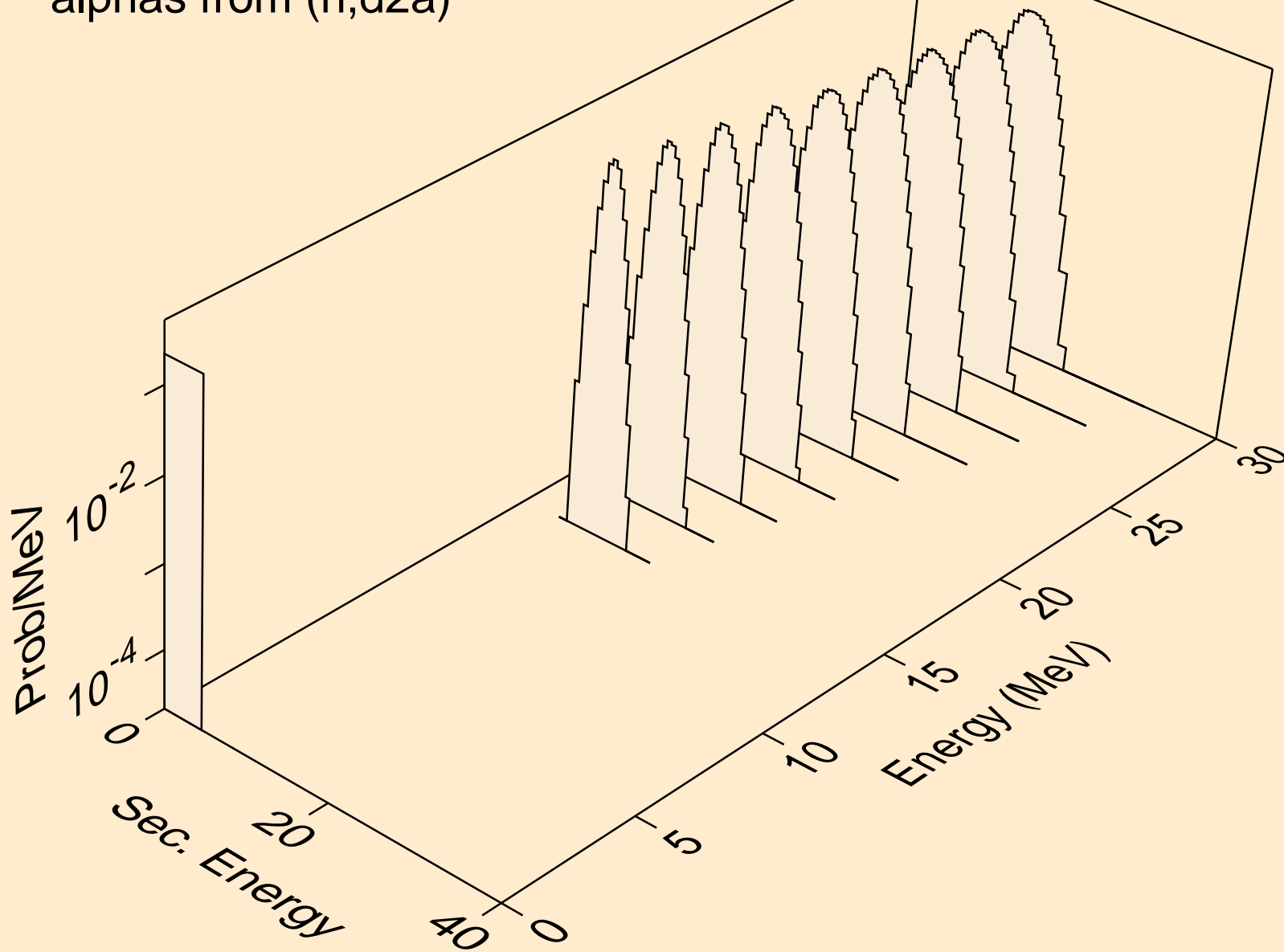

LU154 NEUTRON ACER TENDL-2023 LIBRARY; T=0.K
alphas from (n,da)

