

LU176M NEUTRON ACER TENDL-2023 LIBRARY; T=0.K

Principal cross sections

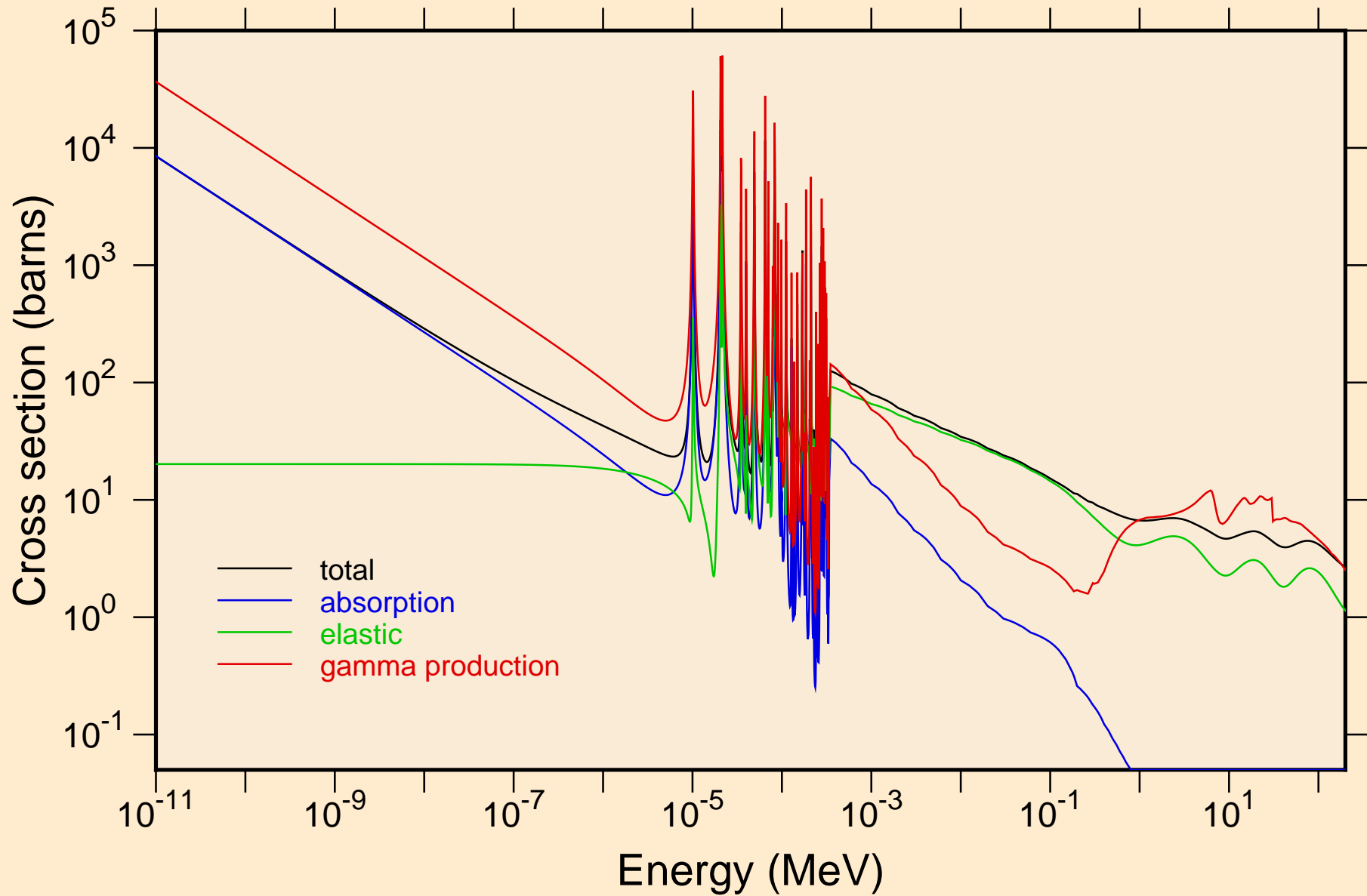

LU176M NEUTRON ACER TENDL-2023 LIBRARY; T=0.K
resonance total cross section

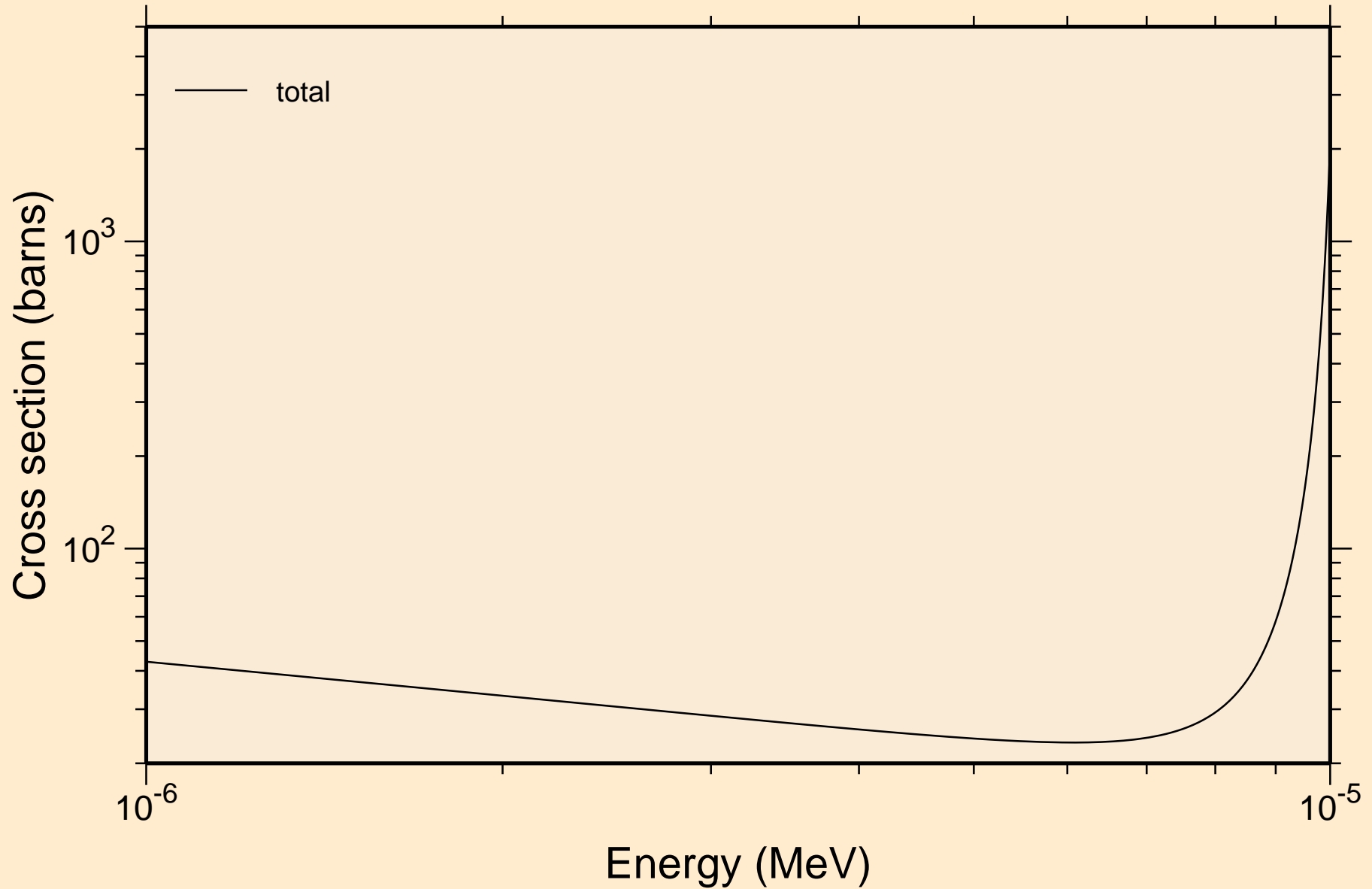

LU176M NEUTRON ACER TENDL-2023 LIBRARY; T=0.K
resonance total cross section

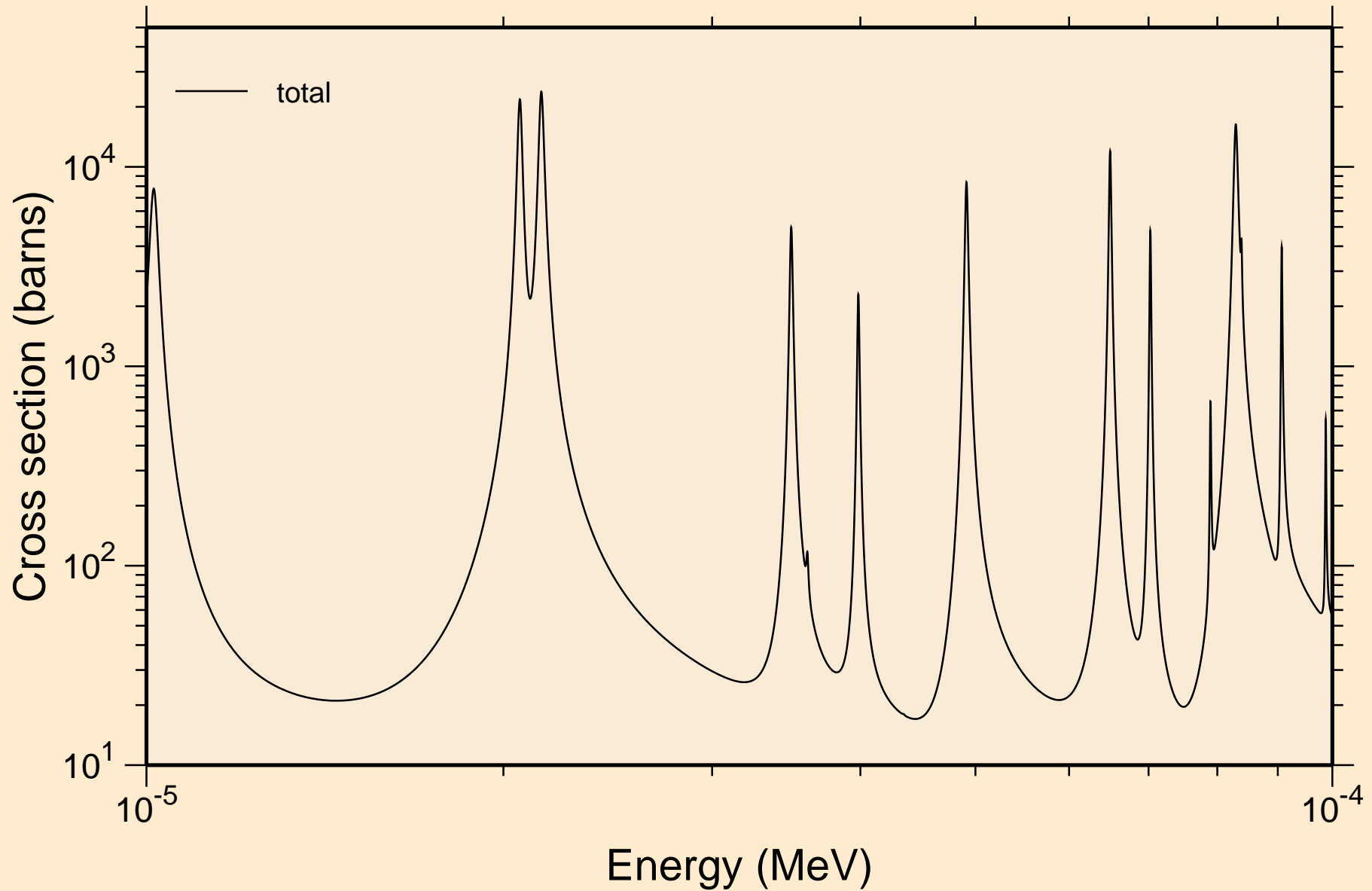

LU176M NEUTRON ACER TENDL-2023 LIBRARY; T=0.K
resonance total cross section

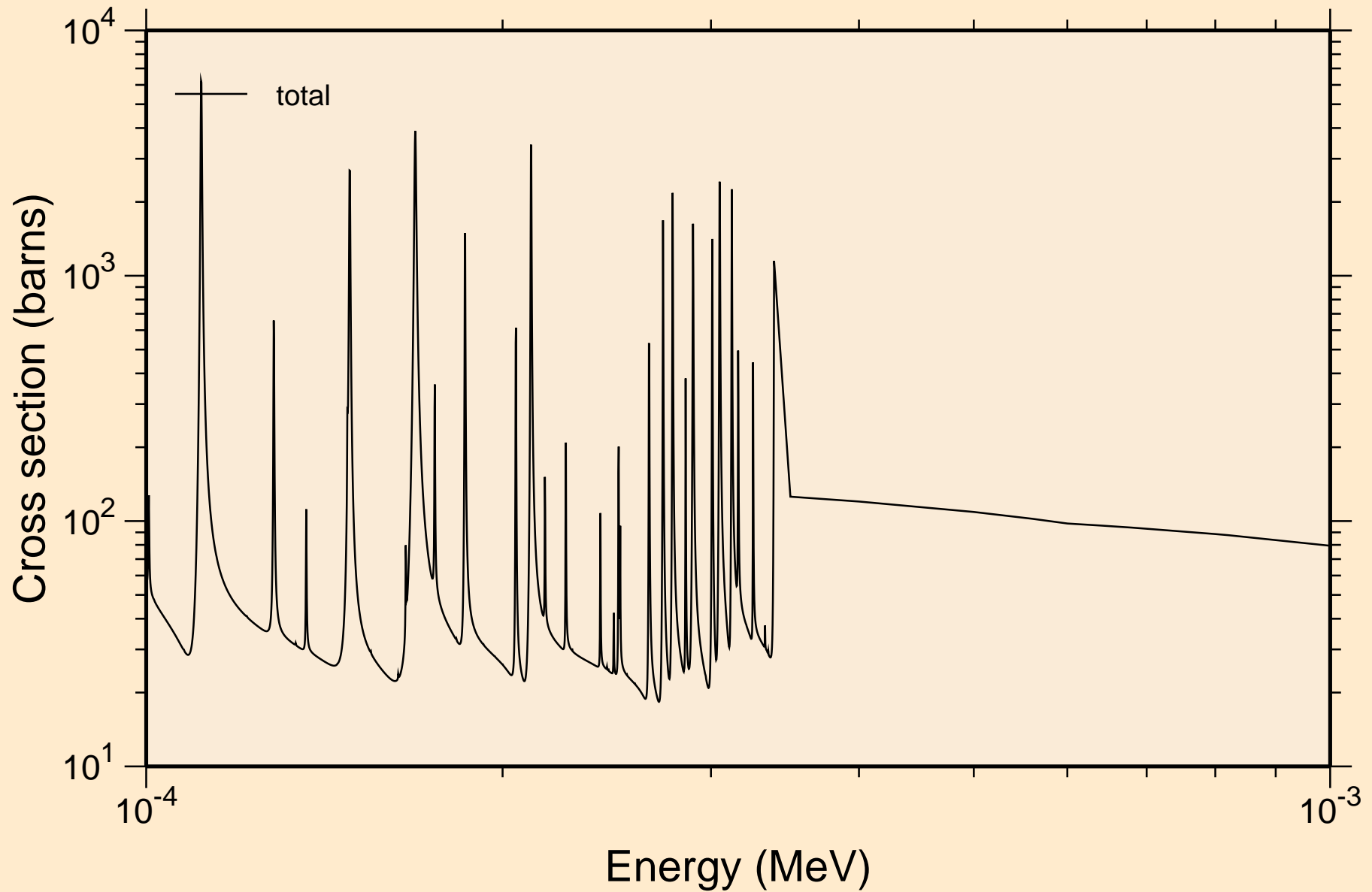

LU176M NEUTRON ACER TENDL-2023 LIBRARY; T=0.K
resonance total cross section

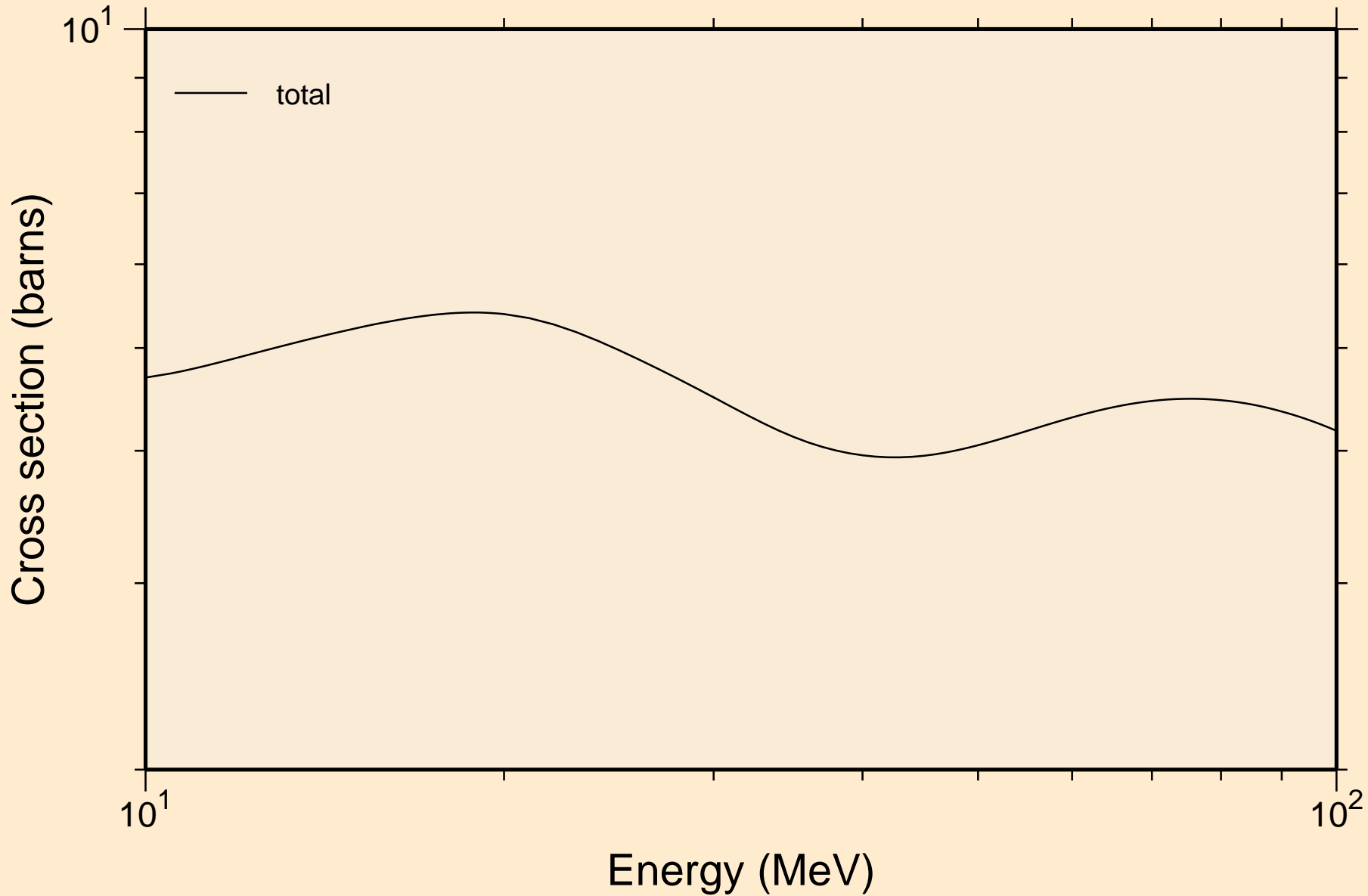

LU176M NEUTRON ACER TENDL-2023 LIBRARY; T=0.K
resonance absorption cross sections

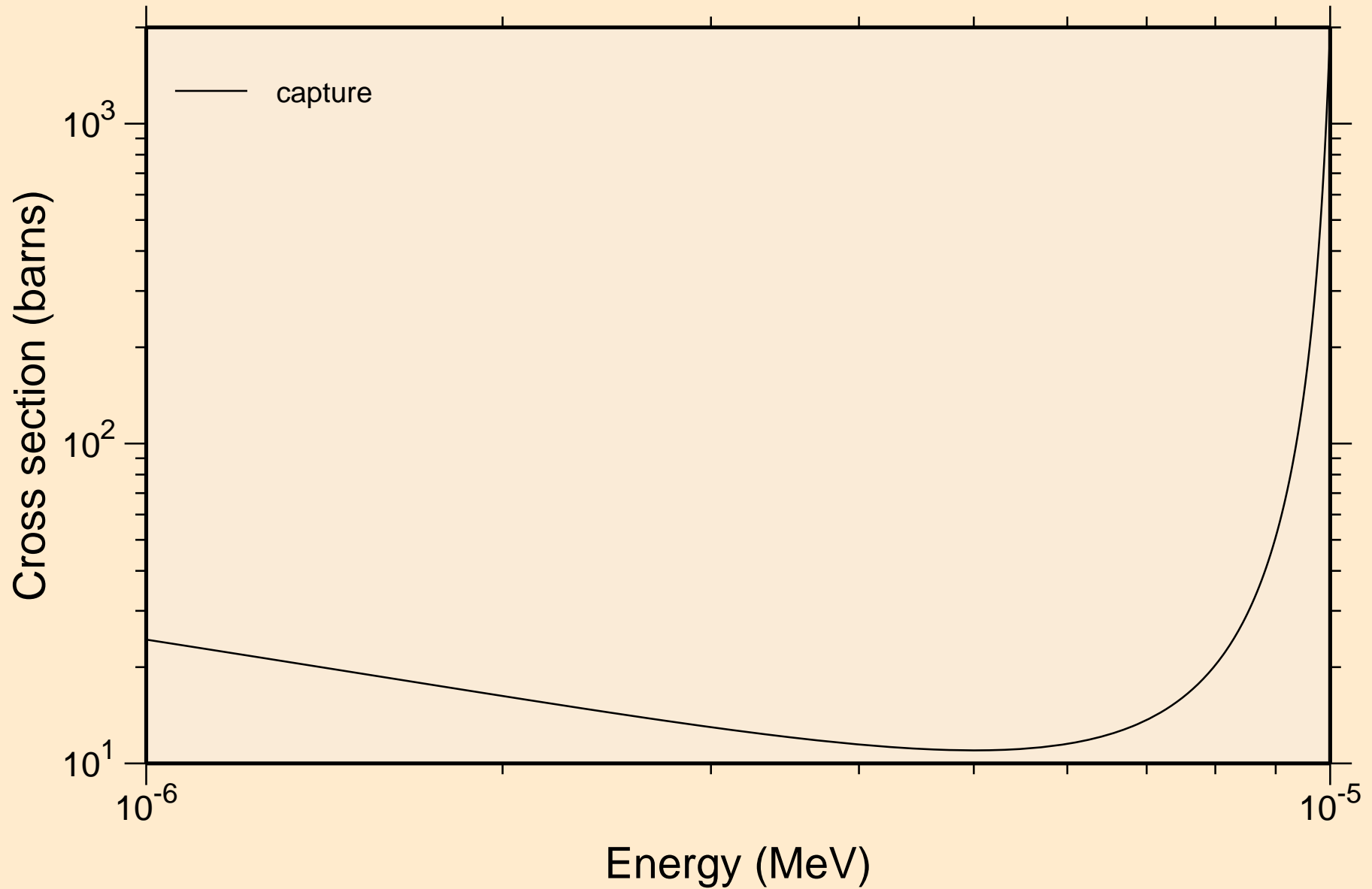

LU176M NEUTRON ACER TENDL-2023 LIBRARY; T=0.K
resonance absorption cross sections

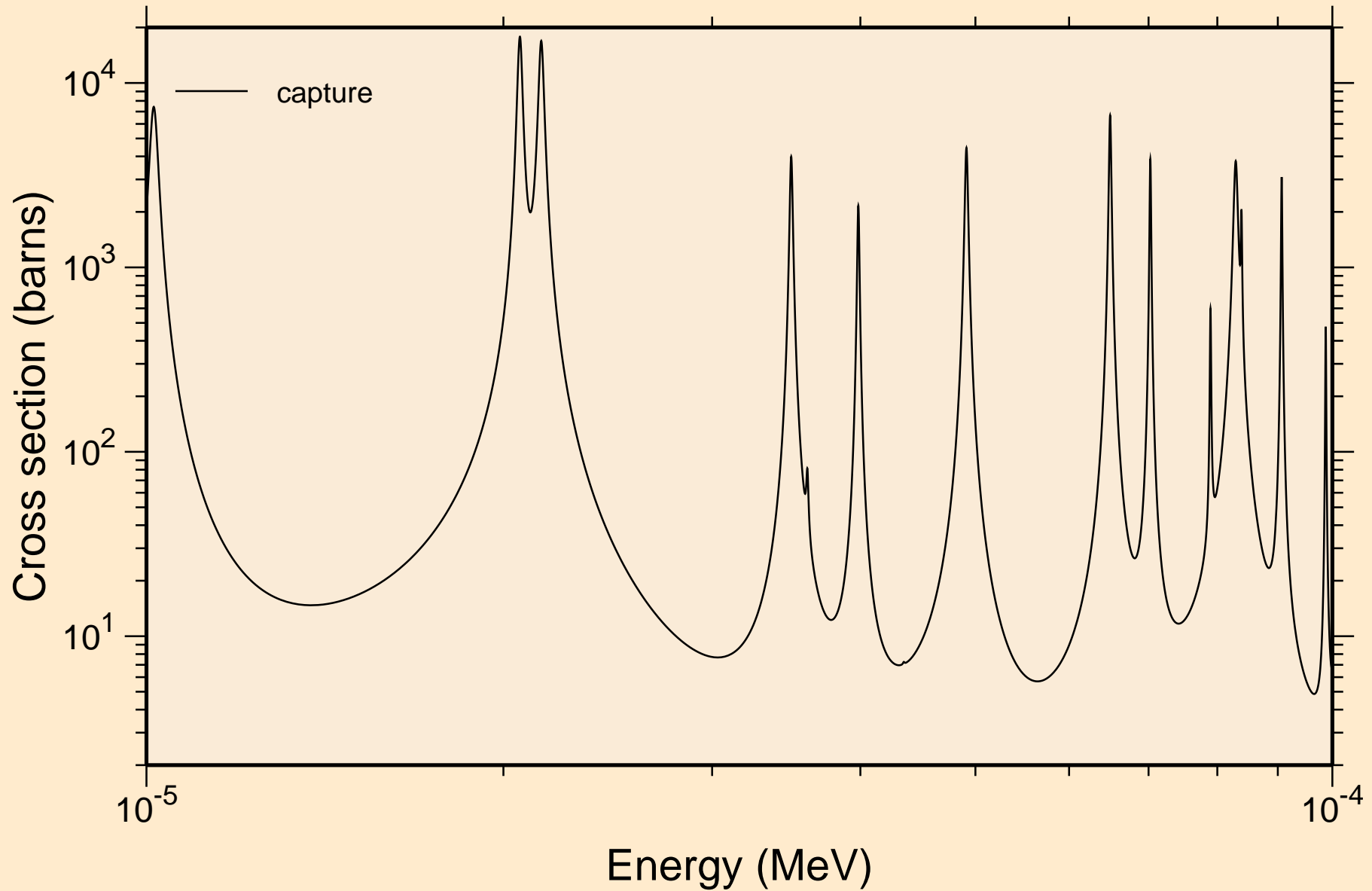

LU176M NEUTRON ACER TENDL-2023 LIBRARY; T=0.K
resonance absorption cross sections

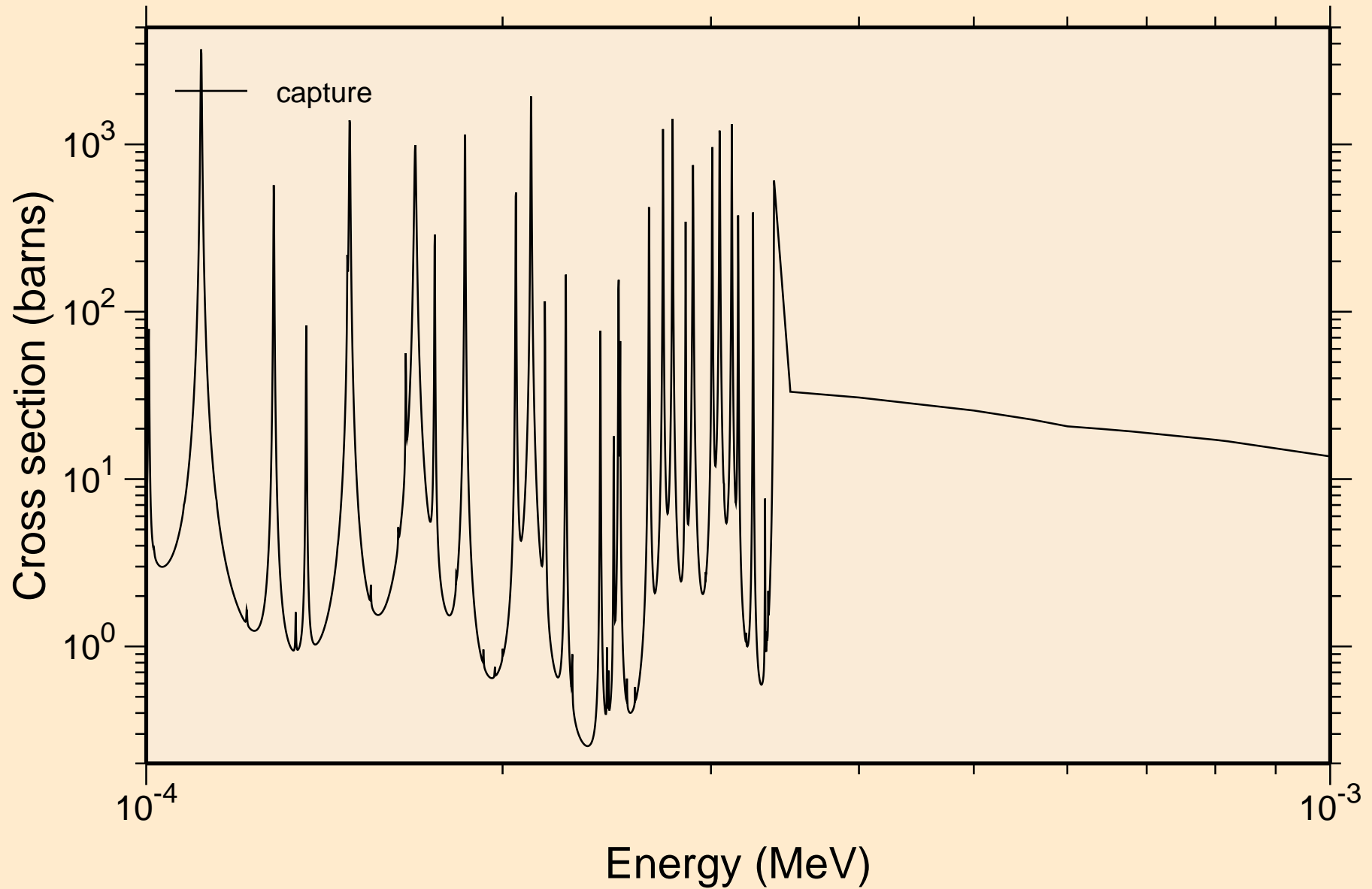

LU176M NEUTRON ACER TENDL-2023 LIBRARY; T=0.K
resonance absorption cross sections

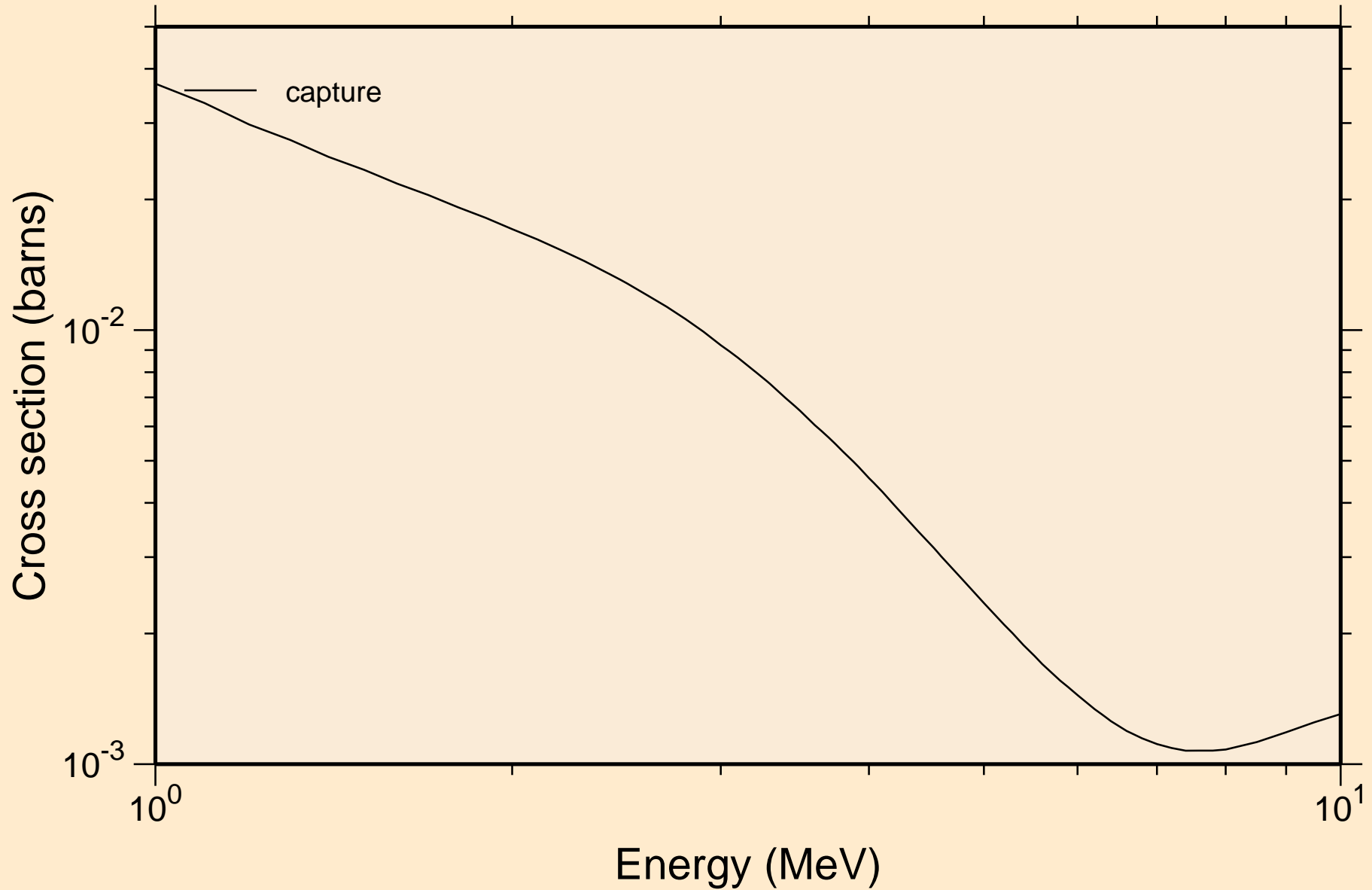

LU176M NEUTRON ACER TENDL-2023 LIBRARY; T=0.K
Heating

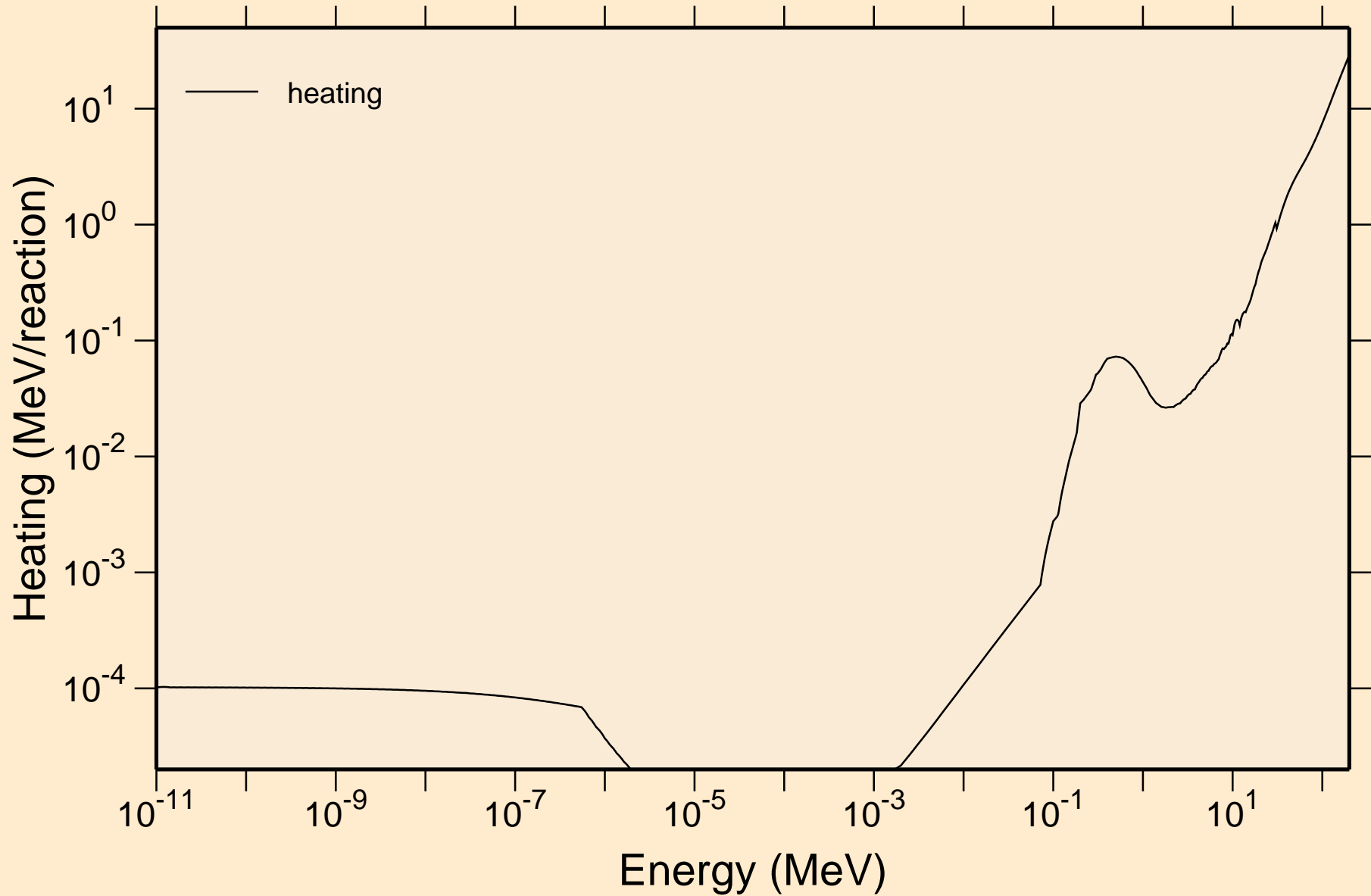

LU176M NEUTRON ACER TENDL-2023 LIBRARY; T=0.K
Damage

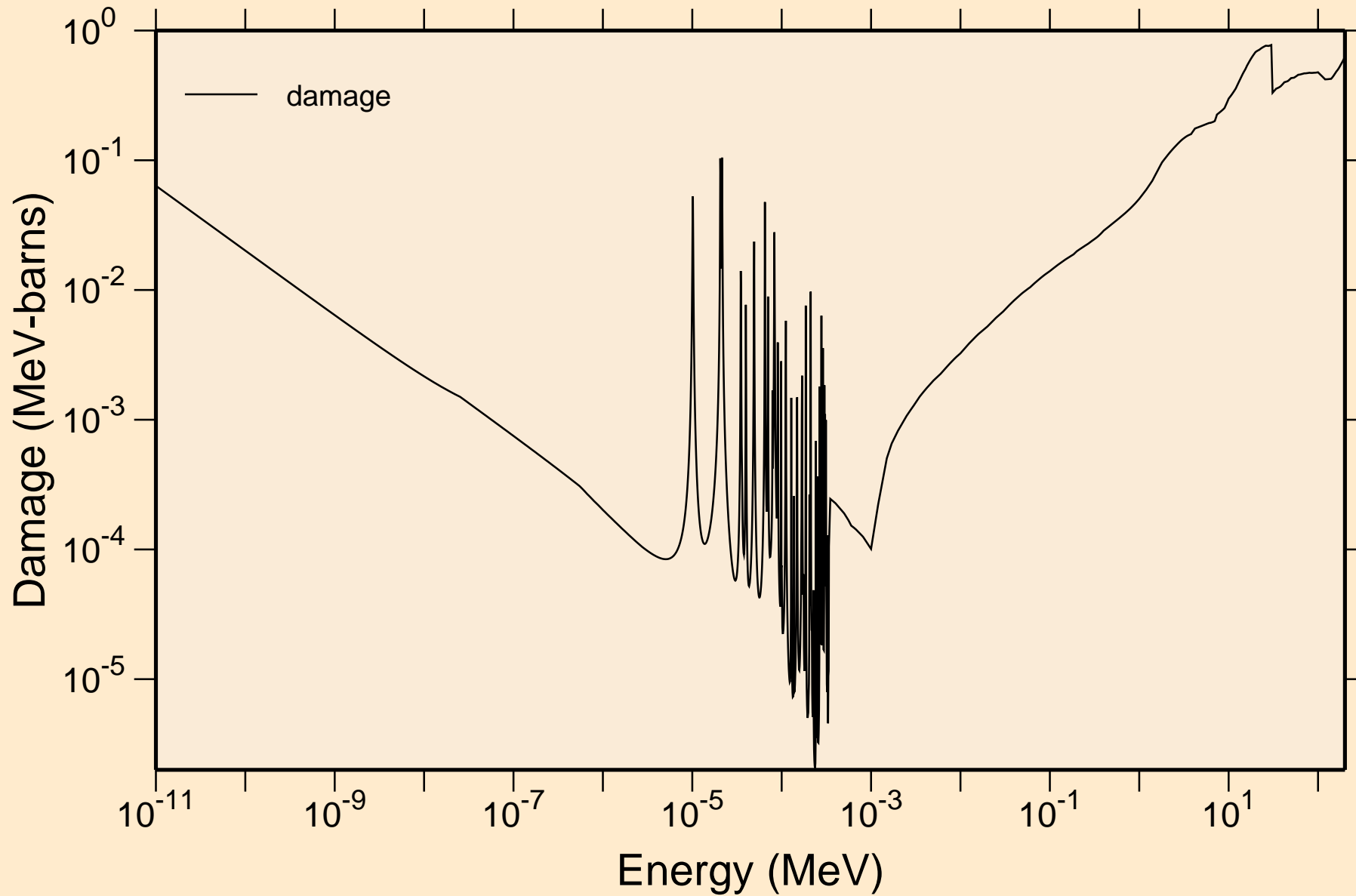

LU176M NEUTRON ACER TENDL-2023 LIBRARY; T=0.K
Non-threshold reactions

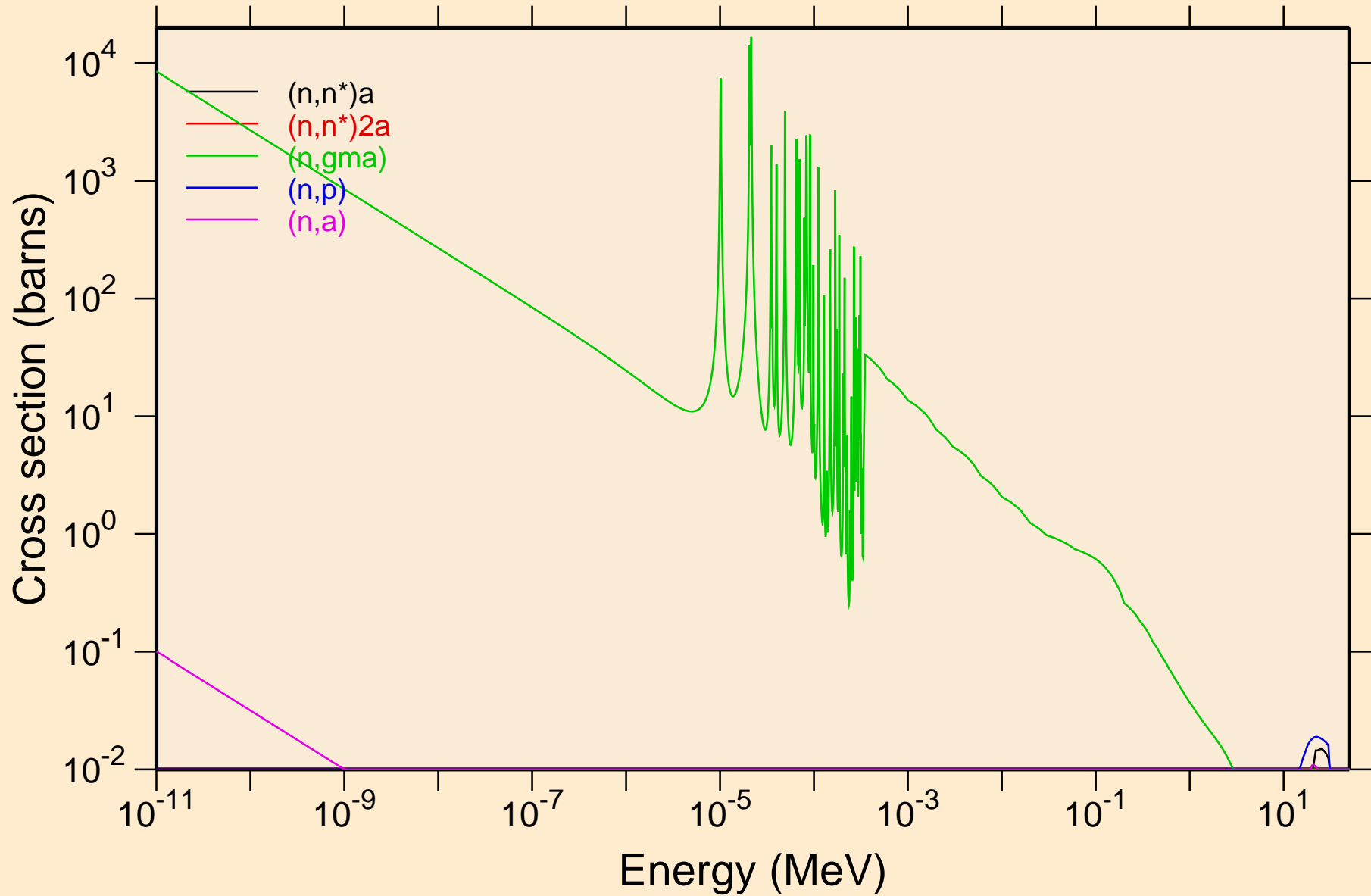

LU176M NEUTRON ACER TENDL-2023 LIBRARY; T=0.K
Non-threshold reactions

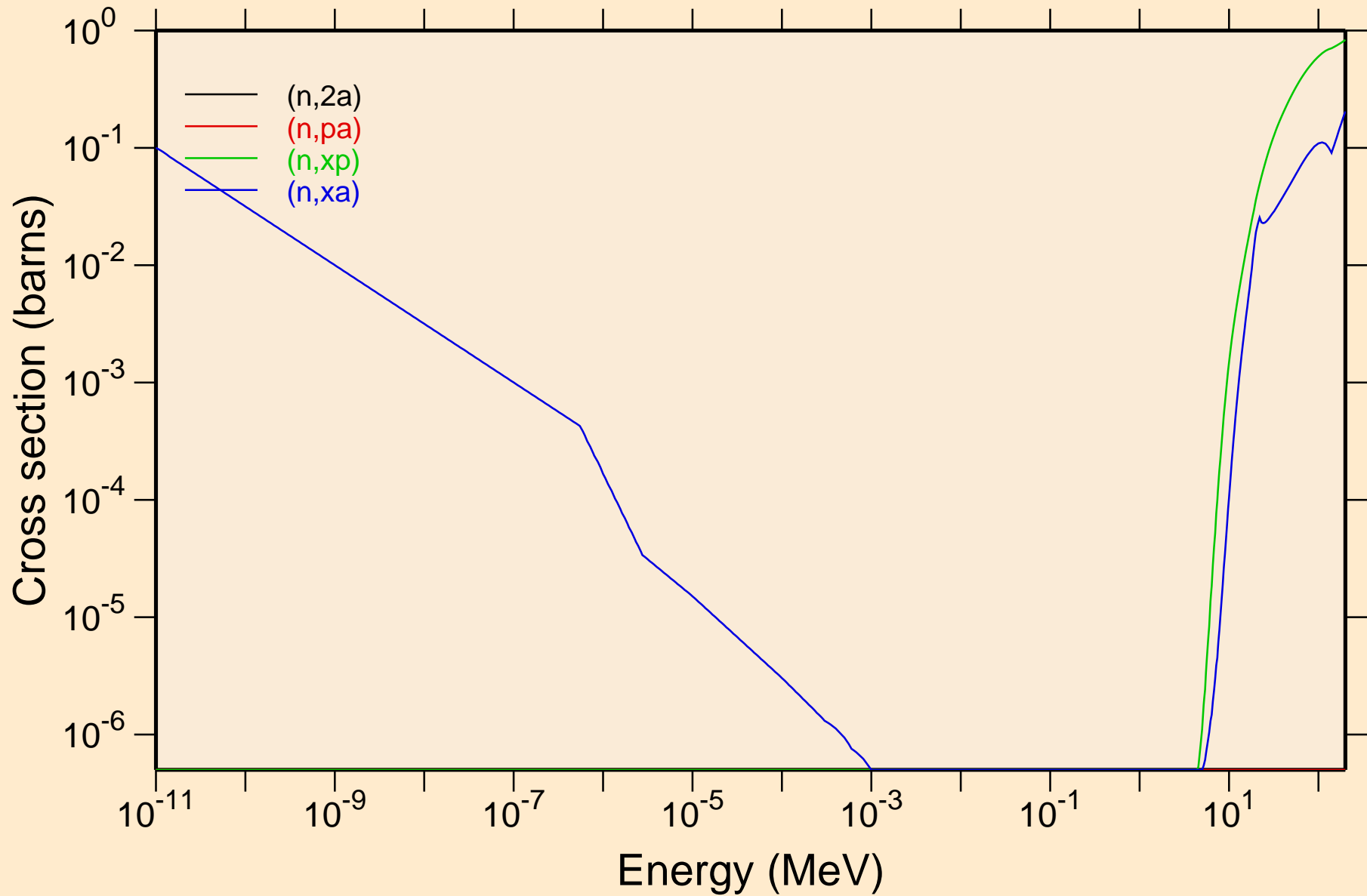

LU176M NEUTRON ACER TENDL-2023 LIBRARY; T=0.K

Principal cross sections

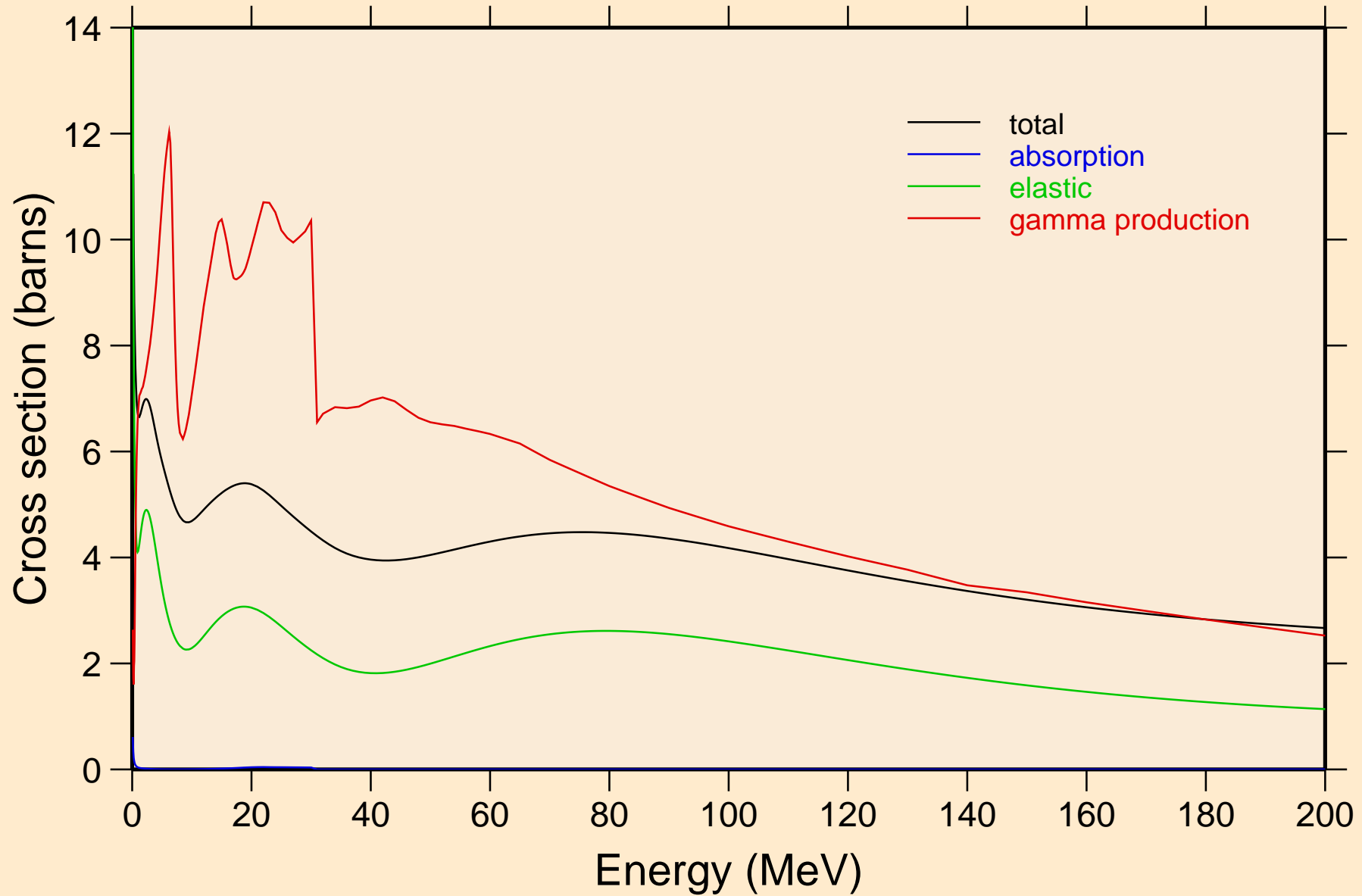

LU176M NEUTRON ACER TENDL-2023 LIBRARY; T=0.K

Heating

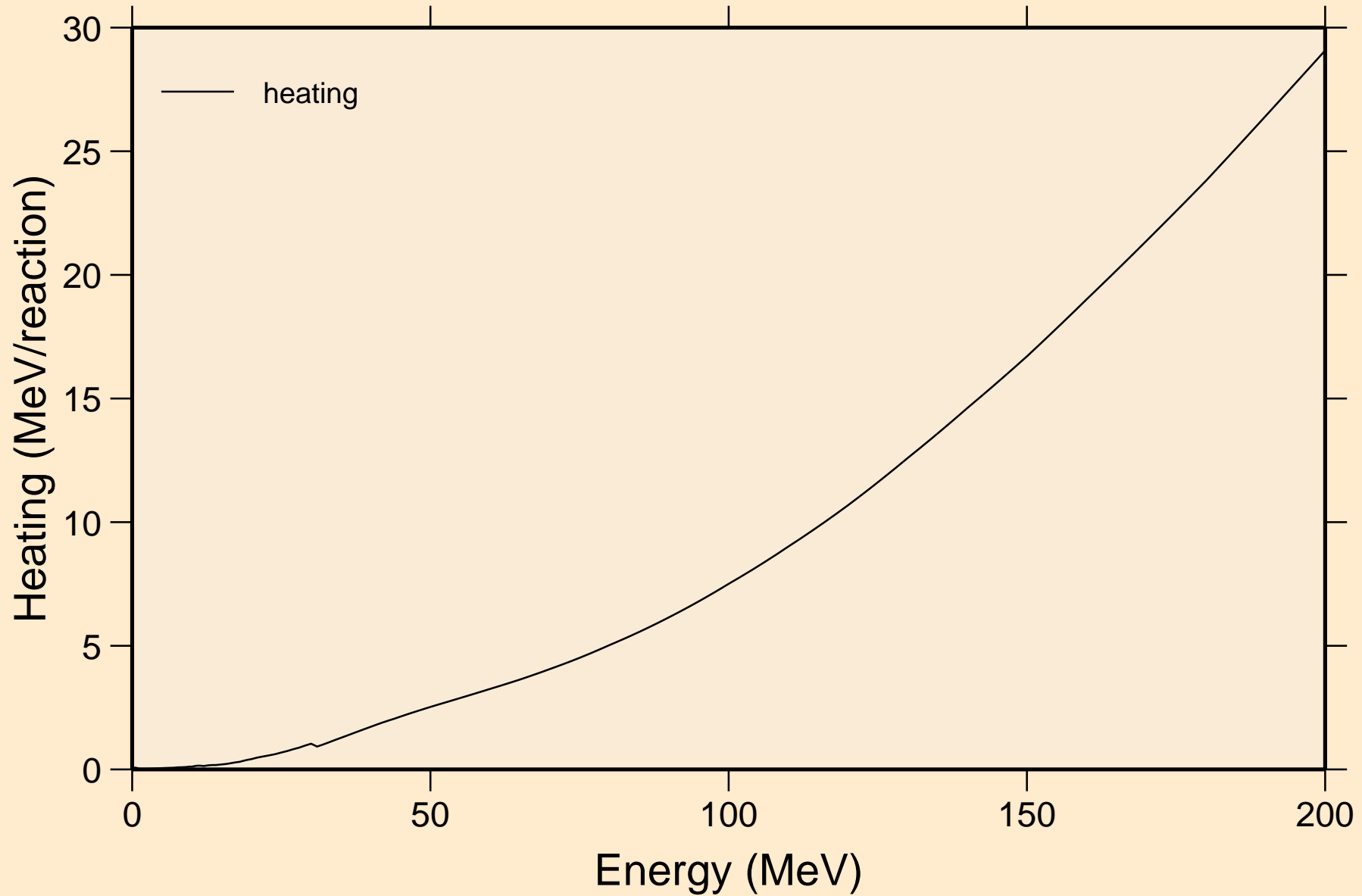

LU176M NEUTRON ACER TENDL-2023 LIBRARY; T=0.K
Damage

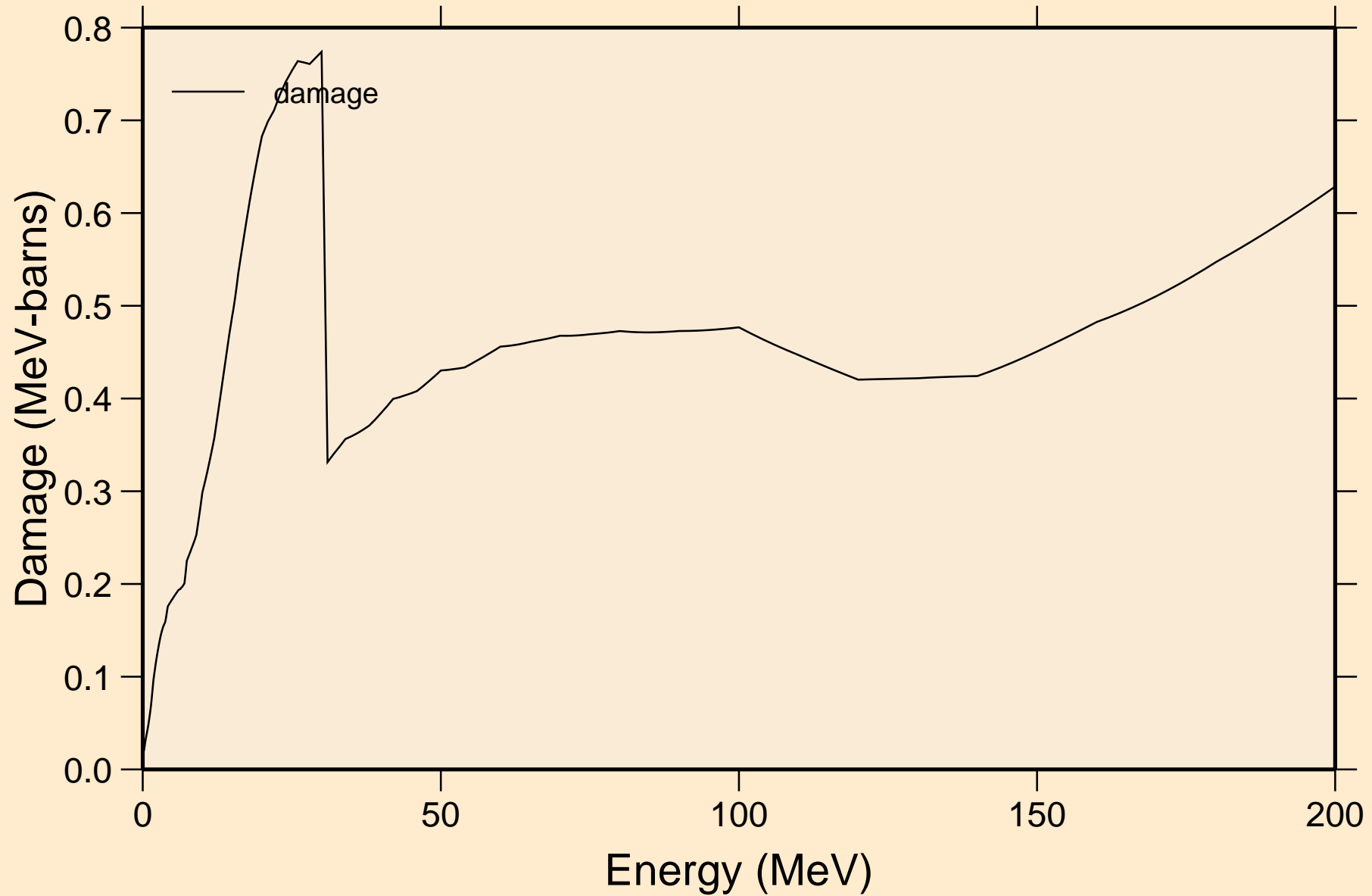

LU176M NEUTRON ACER TENDL-2023 LIBRARY; T=0.K
Non-threshold reactions

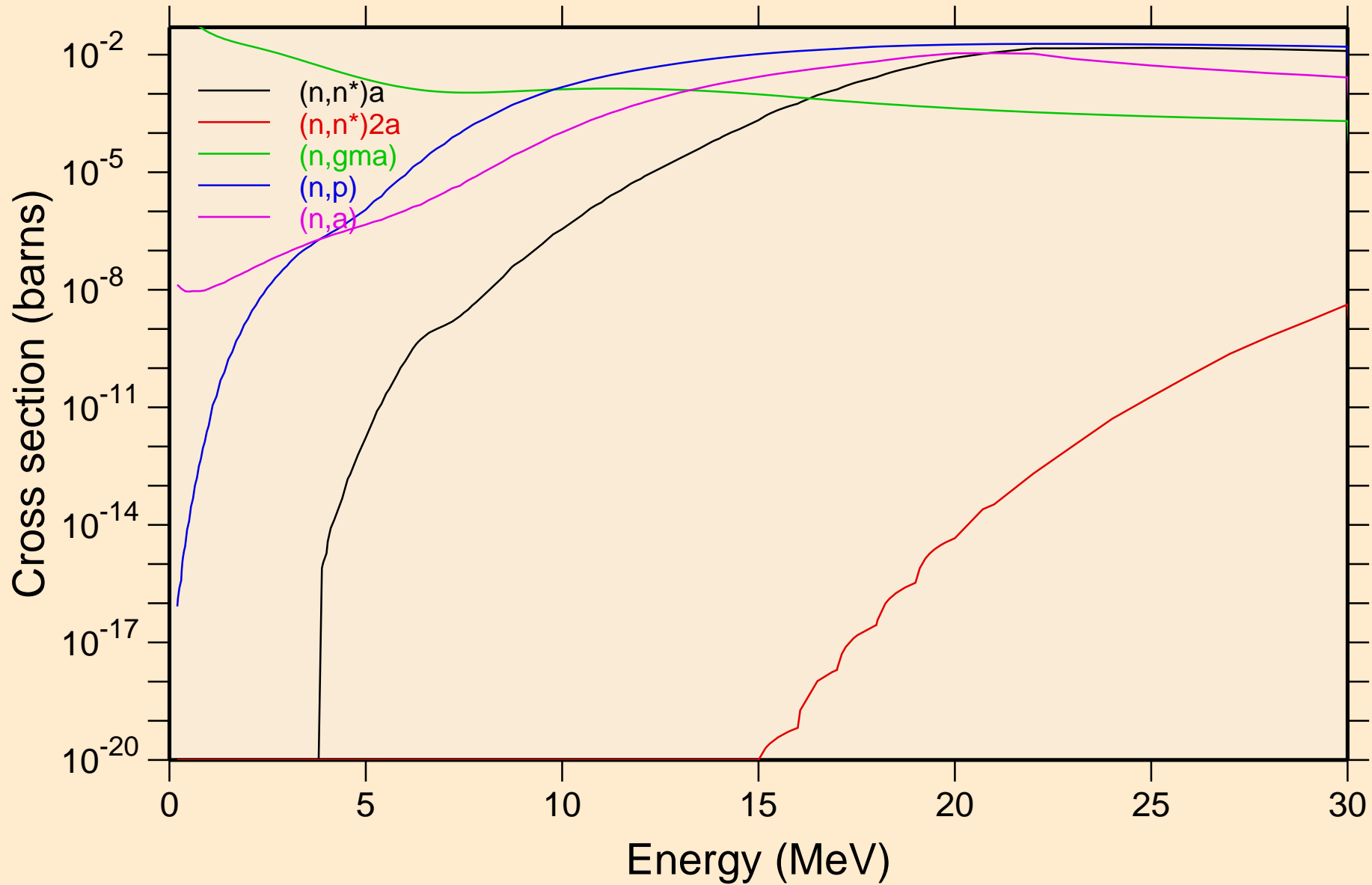

LU176M NEUTRON ACER TENDL-2023 LIBRARY; T=0.K
Non-threshold reactions

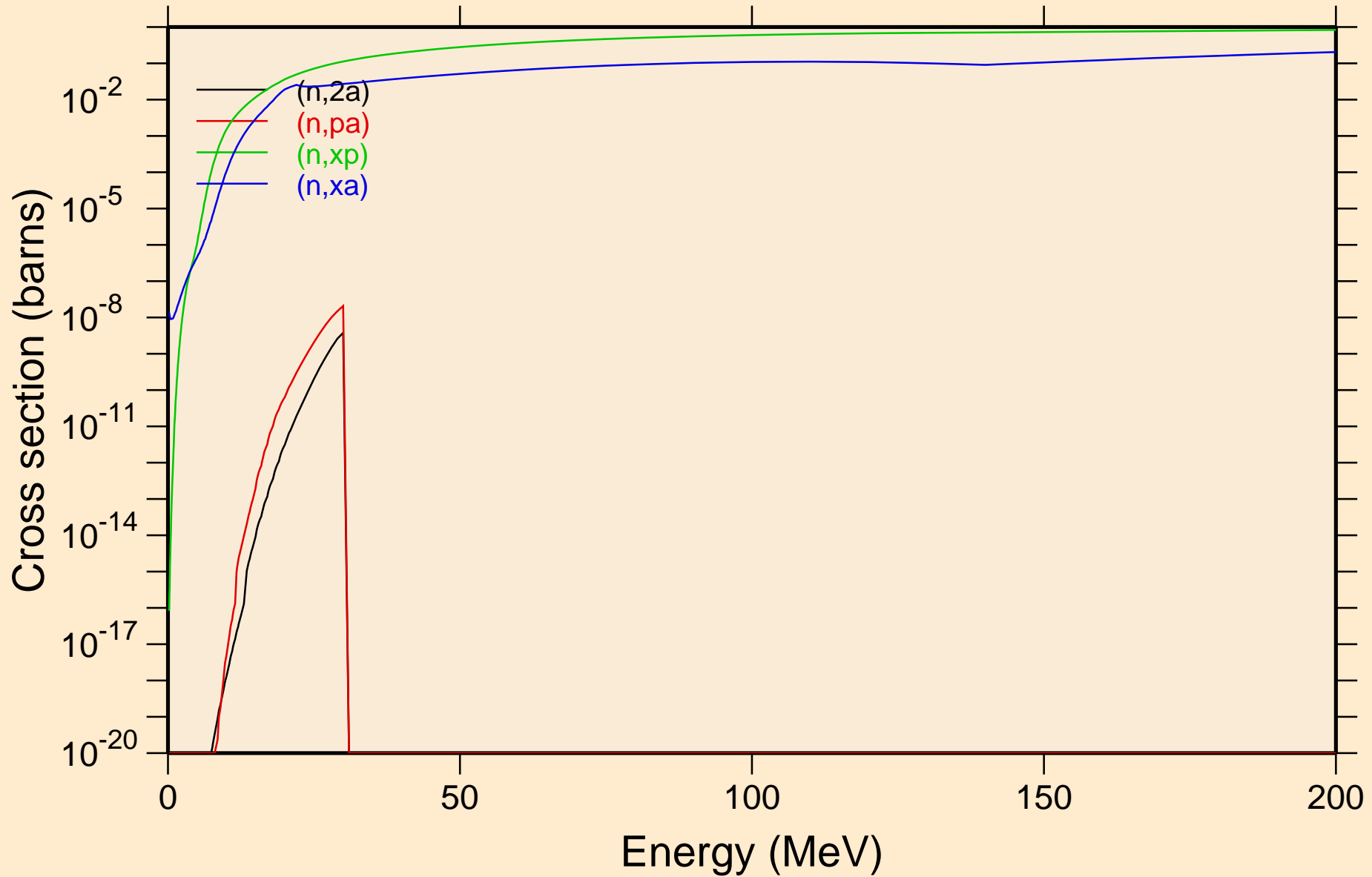

LU176M NEUTRON ACER TENDL-2023 LIBRARY; T=0.K
Inelastic levels

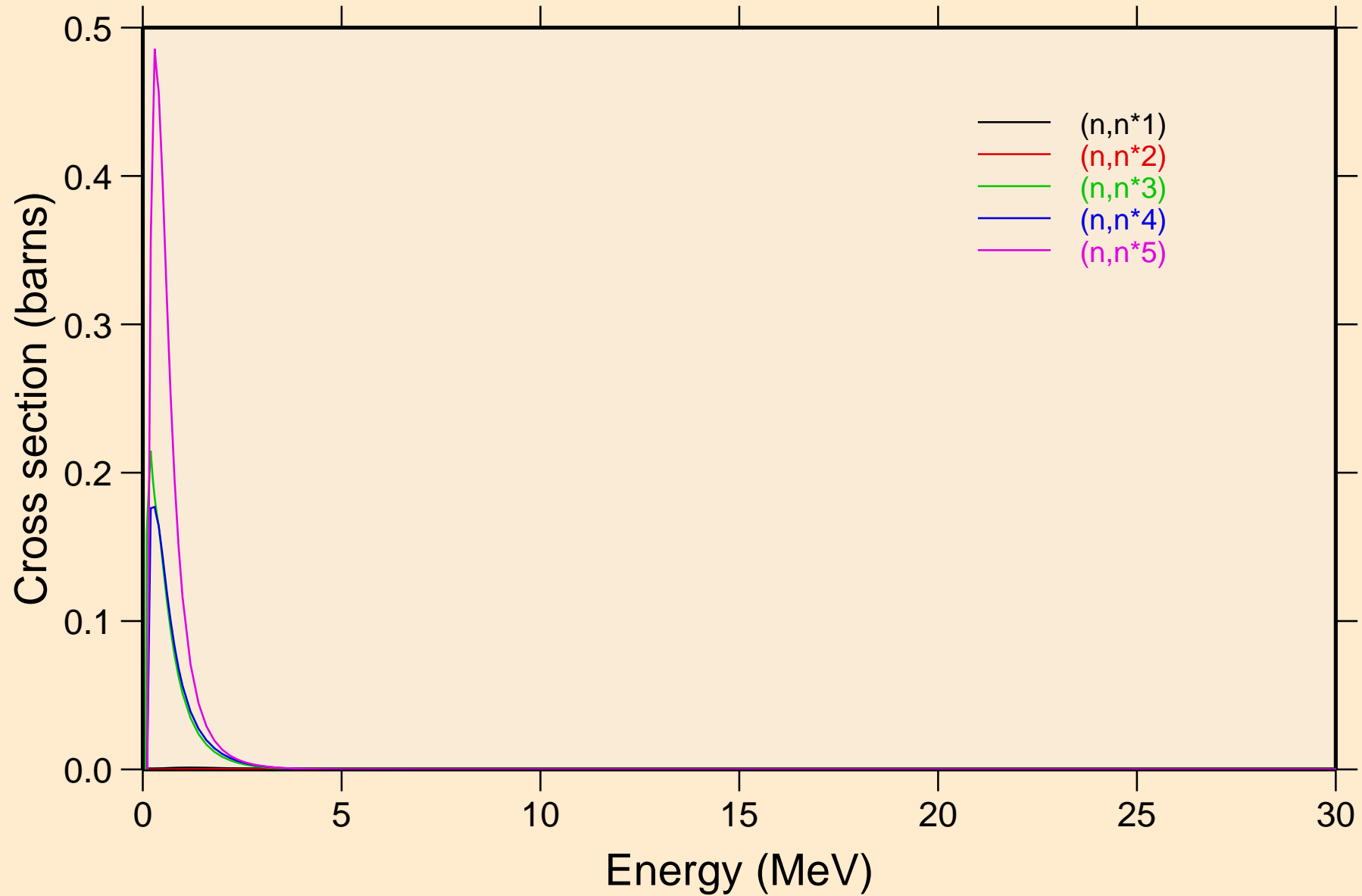

LU176M NEUTRON ACER TENDL-2023 LIBRARY; T=0.K
Inelastic levels

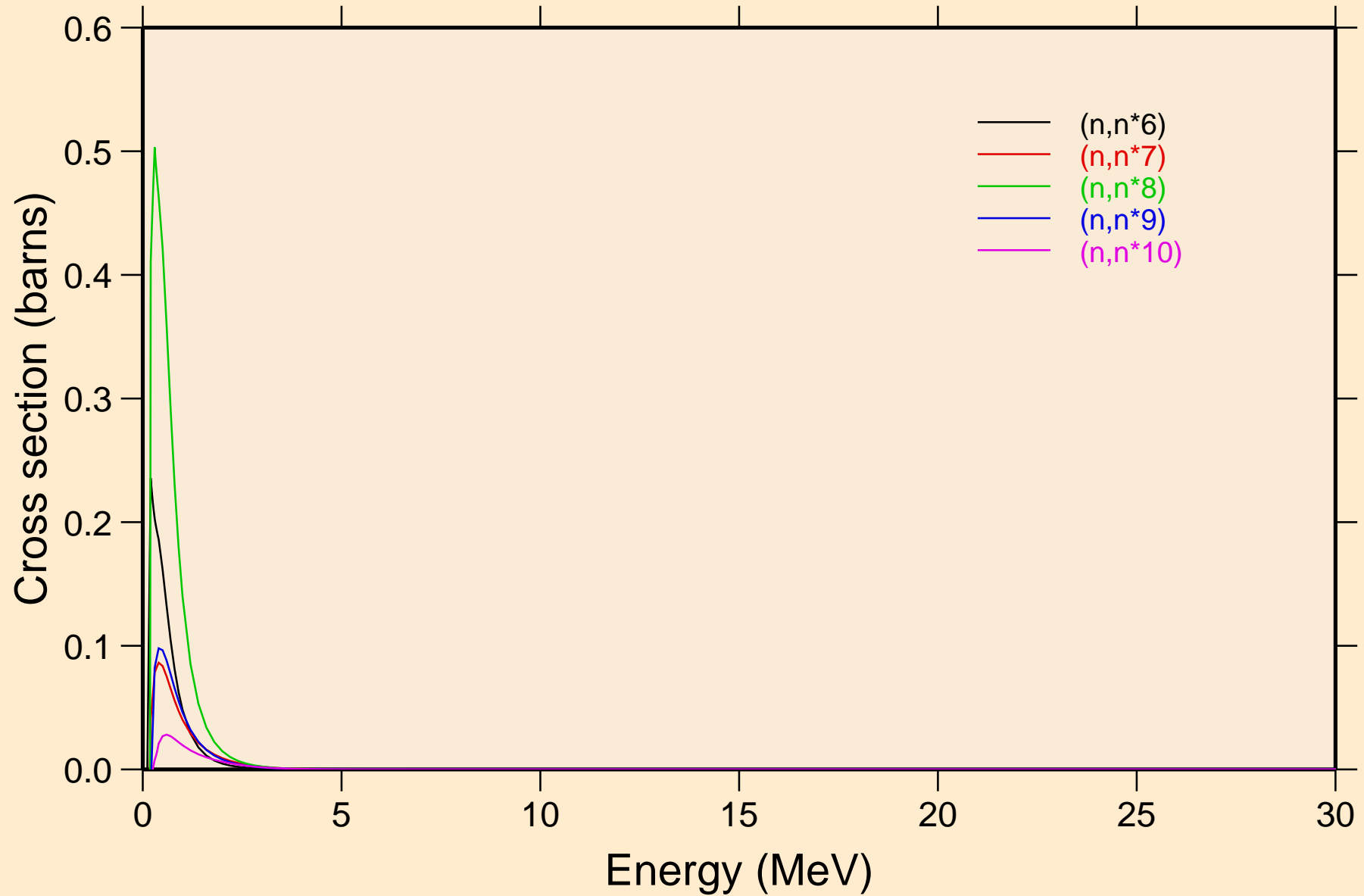

LU176M NEUTRON ACER TENDL-2023 LIBRARY; T=0.K
Inelastic levels

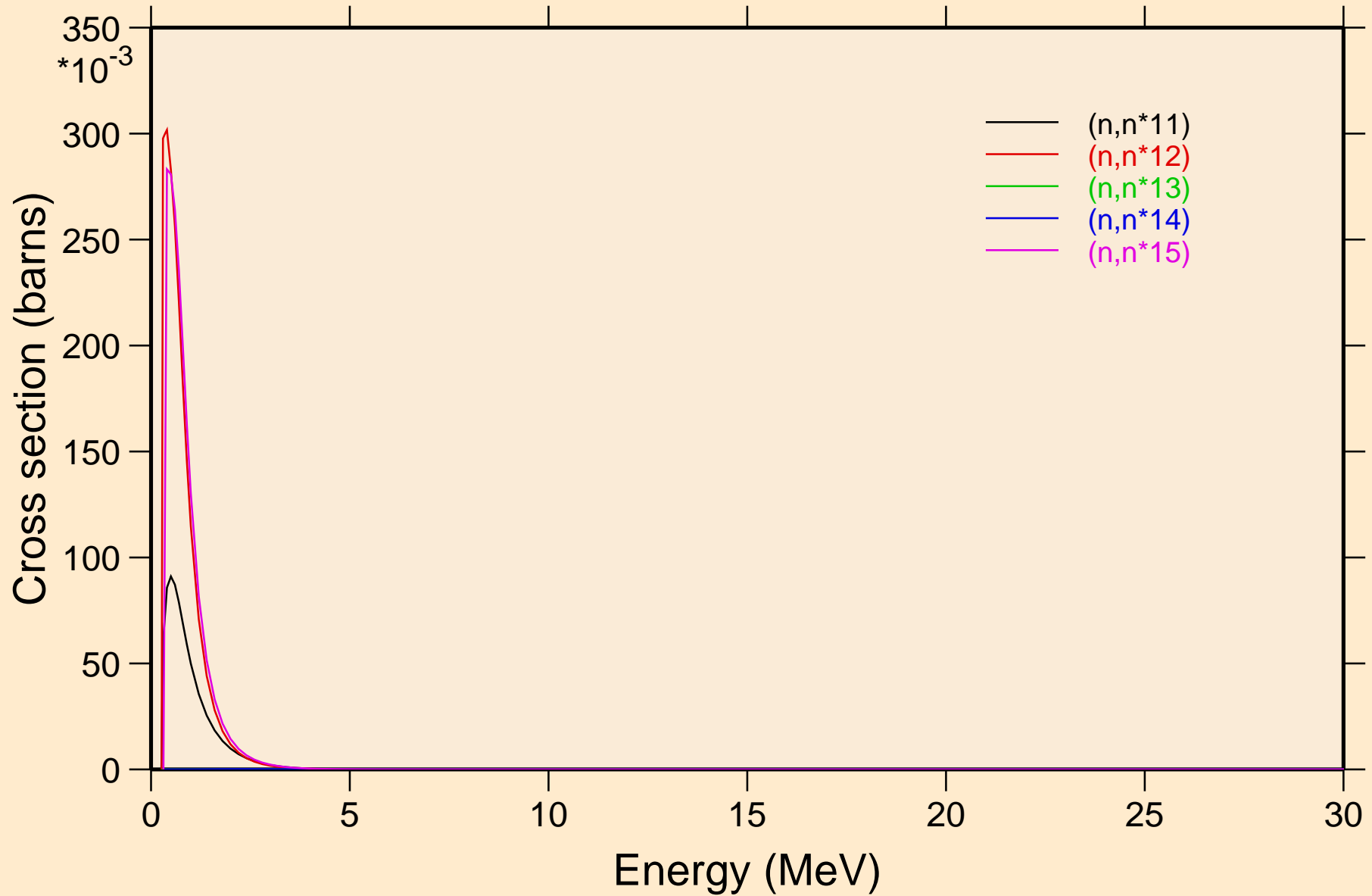

LU176M NEUTRON ACER TENDL-2023 LIBRARY; T=0.K
Inelastic levels

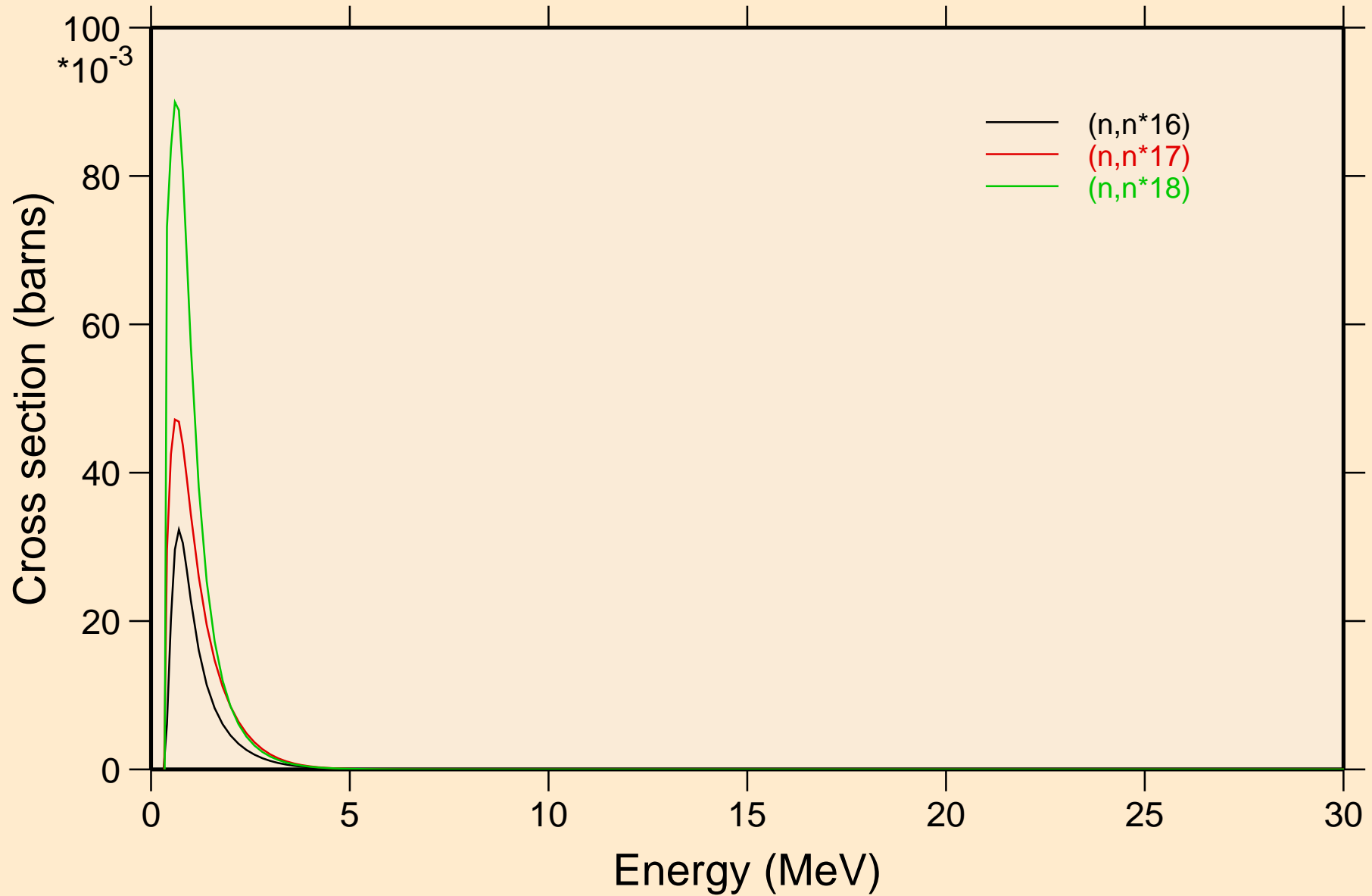

LU176M NEUTRON ACER TENDL-2023 LIBRARY; T=0.K
Threshold reactions

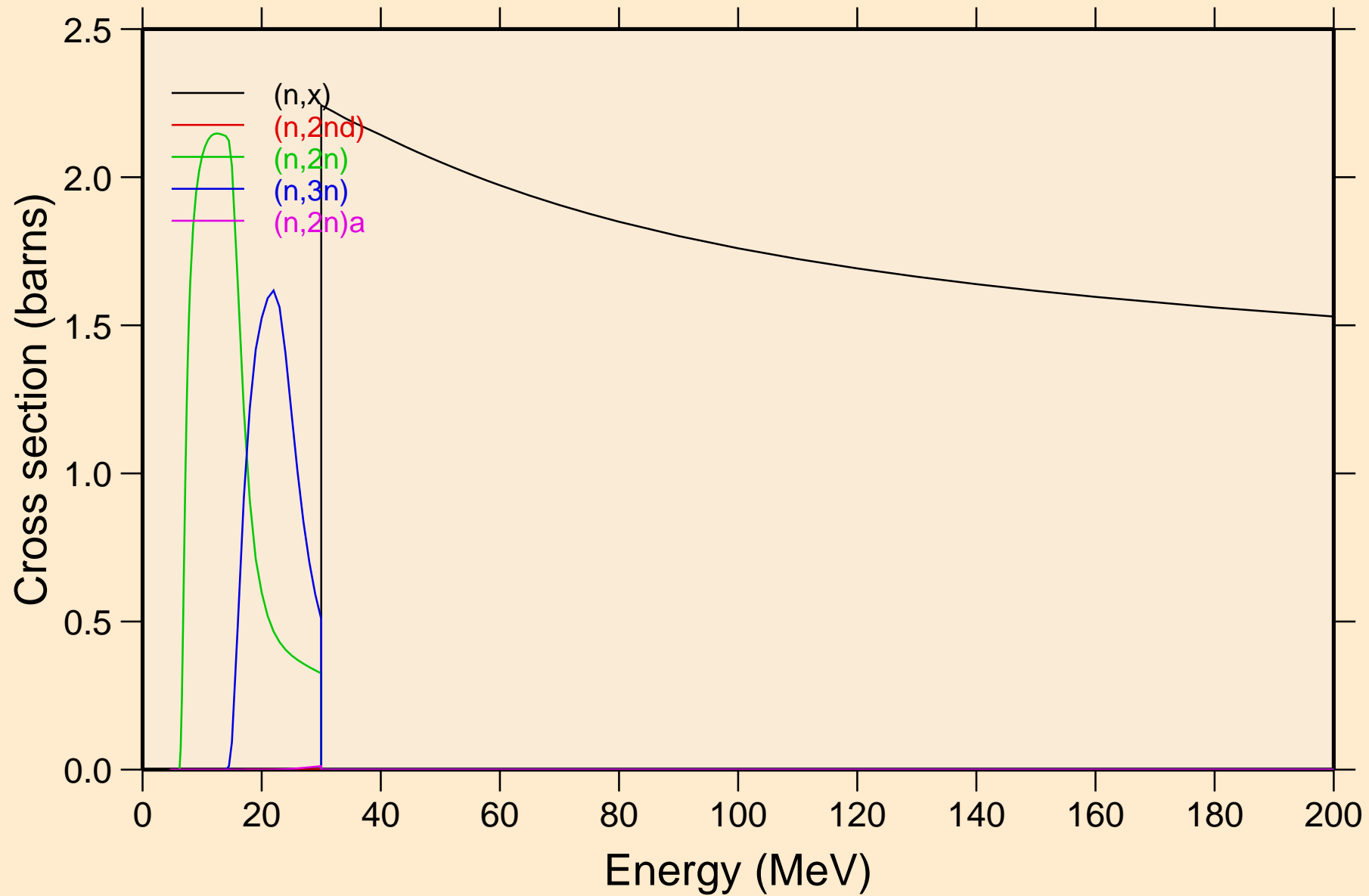

LU176M NEUTRON ACER TENDL-2023 LIBRARY; T=0.K
Threshold reactions

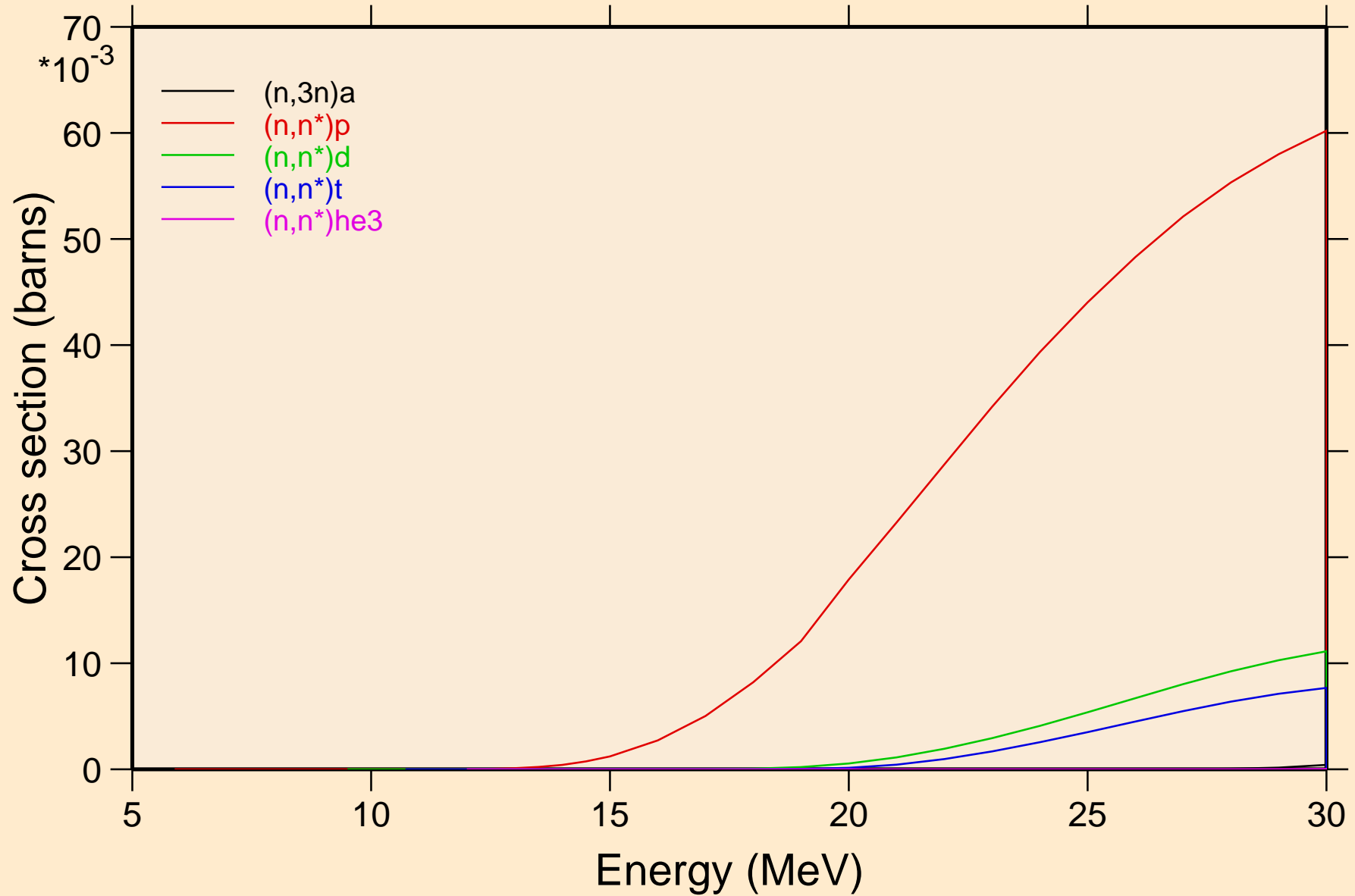

LU176M NEUTRON ACER TENDL-2023 LIBRARY; T=0.K
Threshold reactions

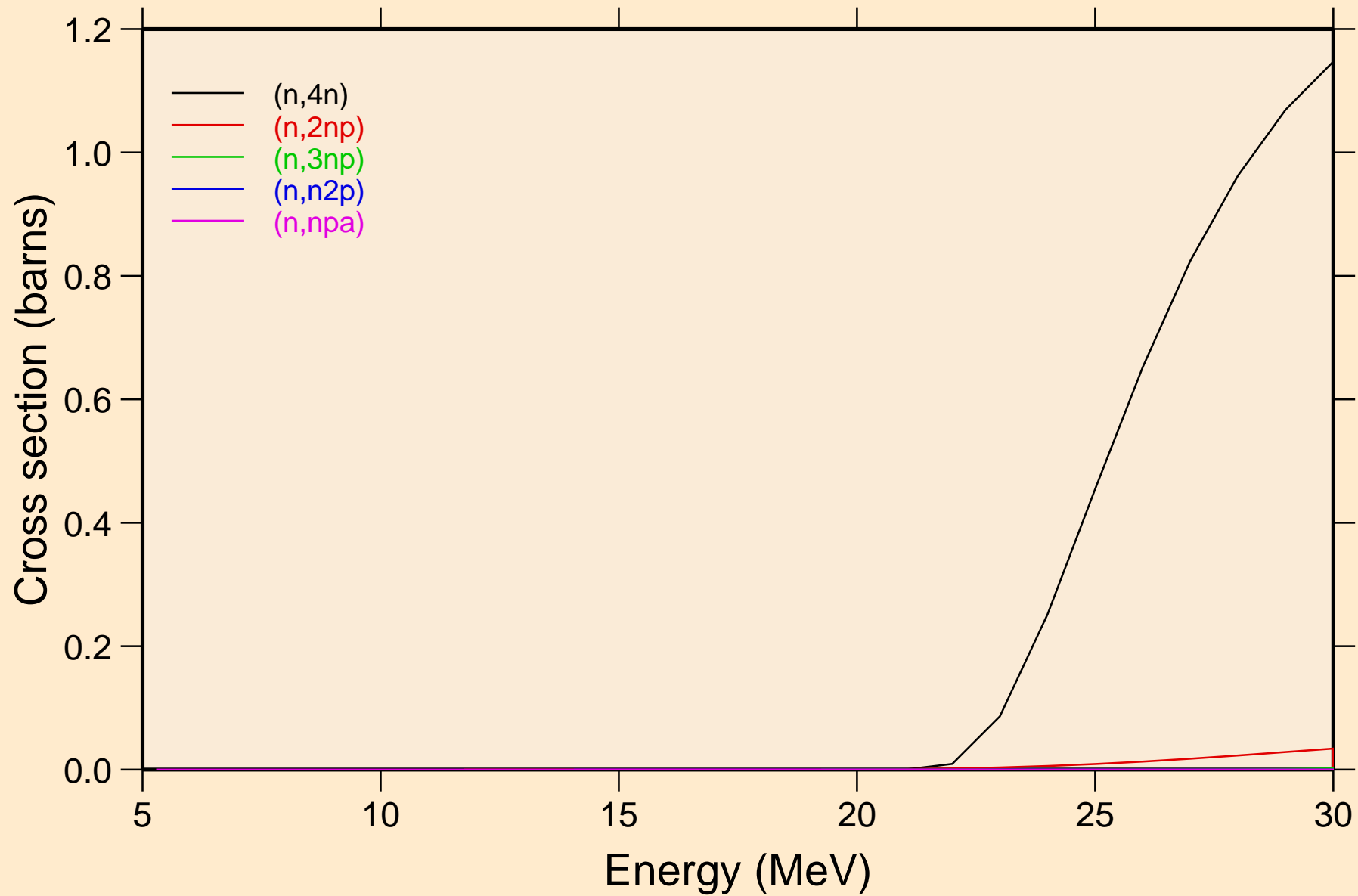

LU176M NEUTRON ACER TENDL-2023 LIBRARY; T=0.K
Threshold reactions

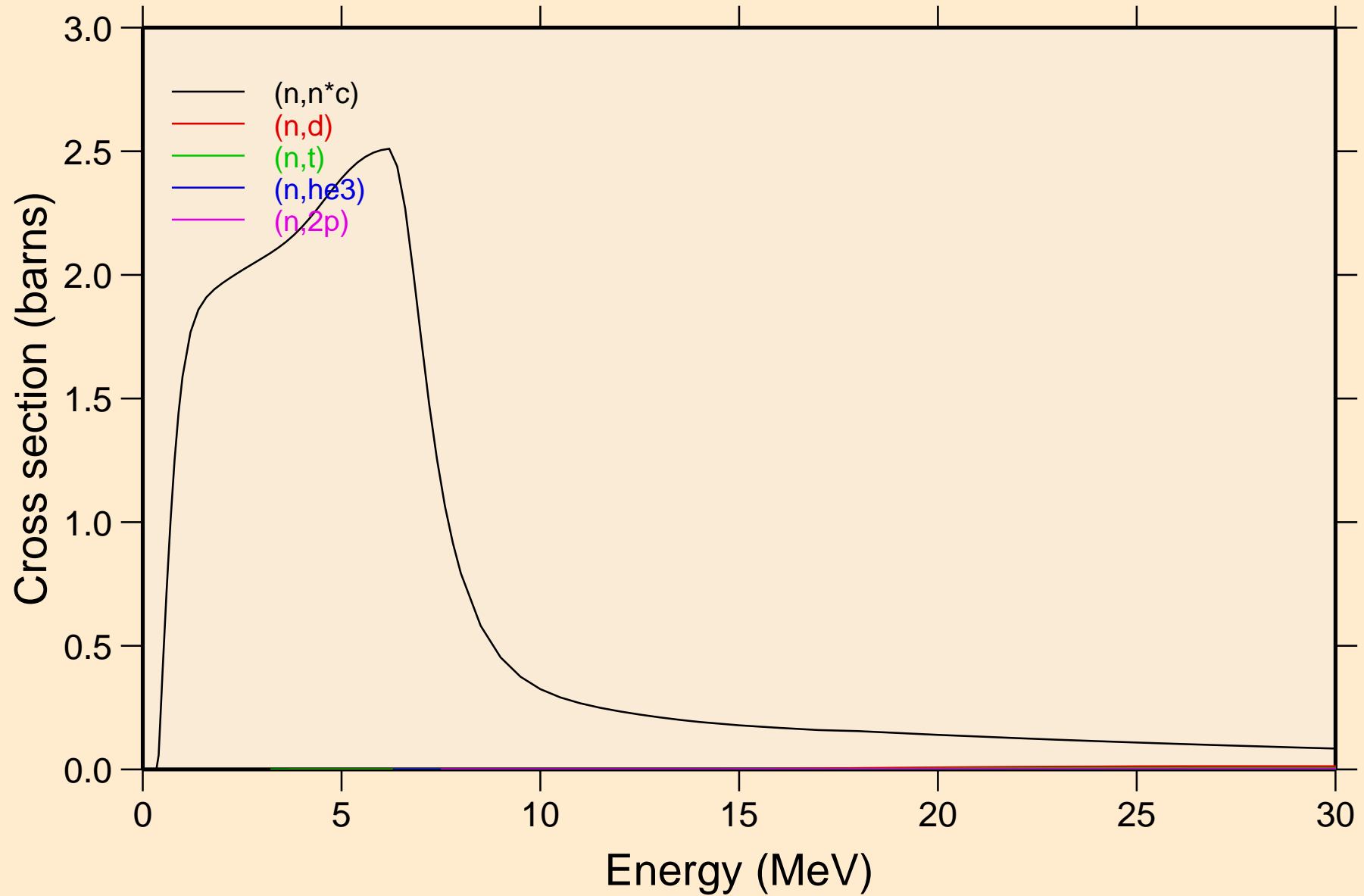

LU176M NEUTRON ACER TENDL-2023 LIBRARY; T=0.K
Threshold reactions

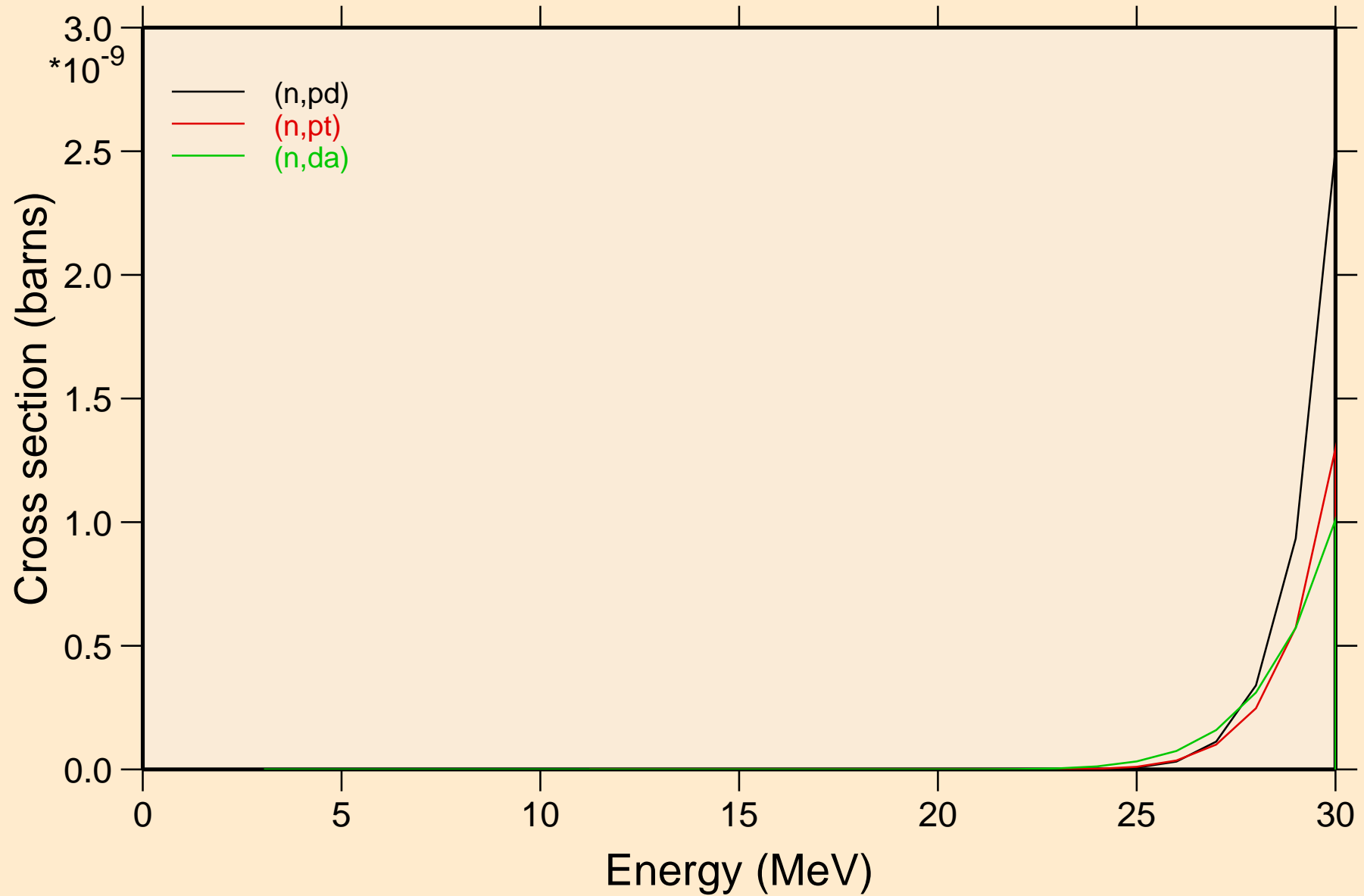

LU176M NEUTRON ACER TENDL-2023 LIBRARY; T=0.K
Threshold reactions

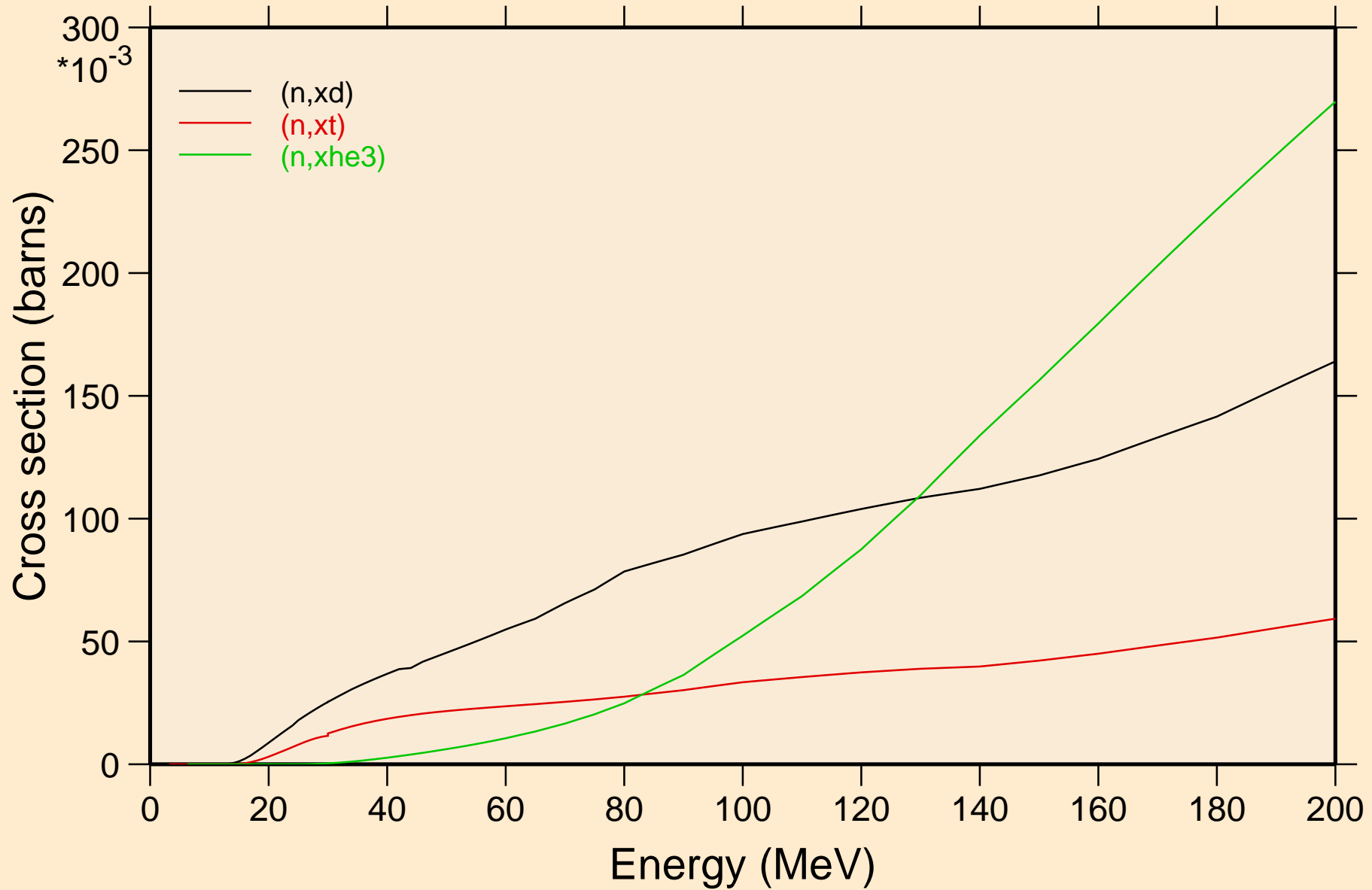

LU176M NEUTRON ACER TENDL-2023 LIBRARY; T=0.K
angular distribution for elastic

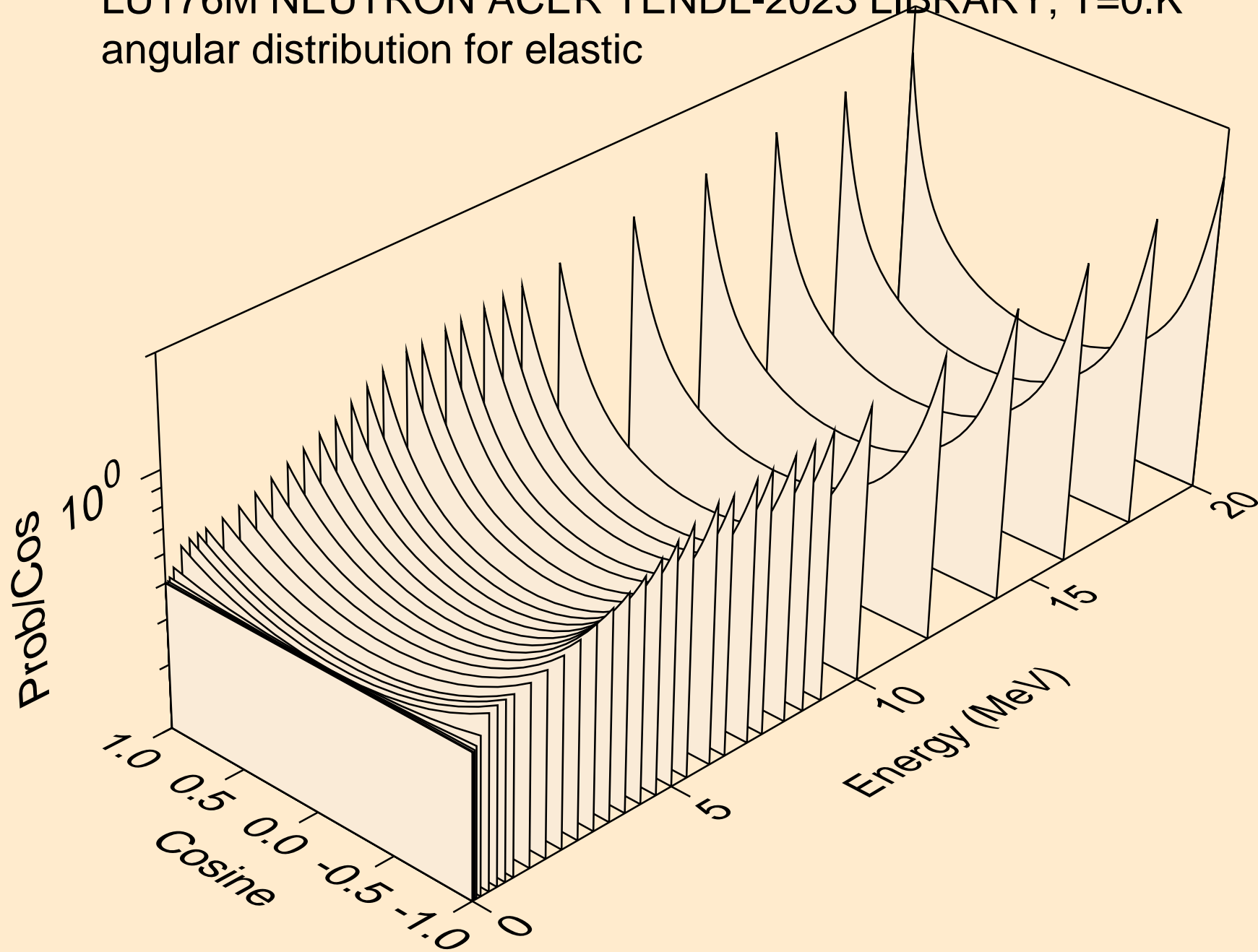

LU176M NEUTRON ACER TENDL-2023 LIBRARY; T=0.K
angular distribution for elastic

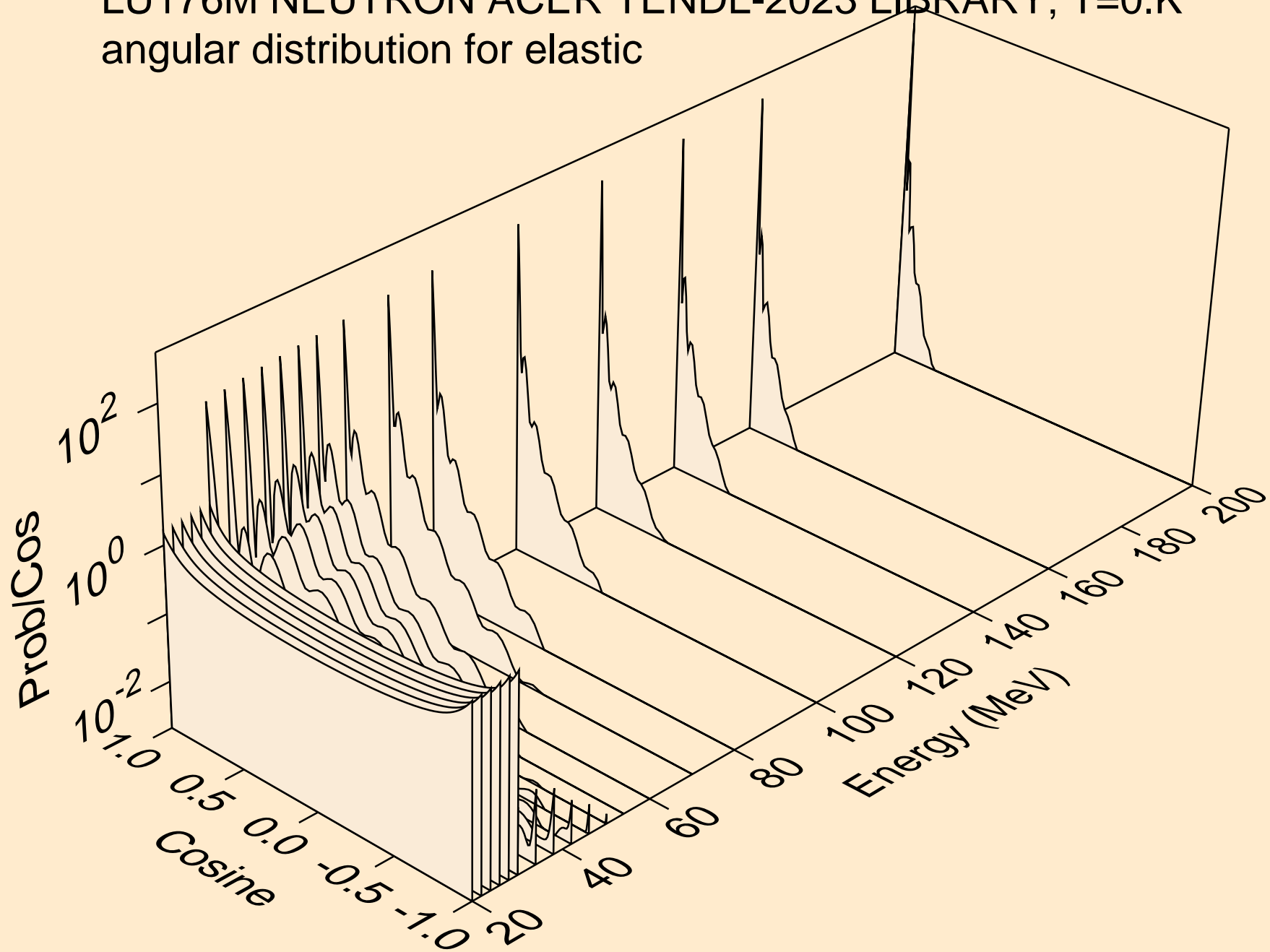

LU176M NEUTRON ACER TENDL-2023 LIBRARY; T=0.K
angular distribution for (n,n*1)

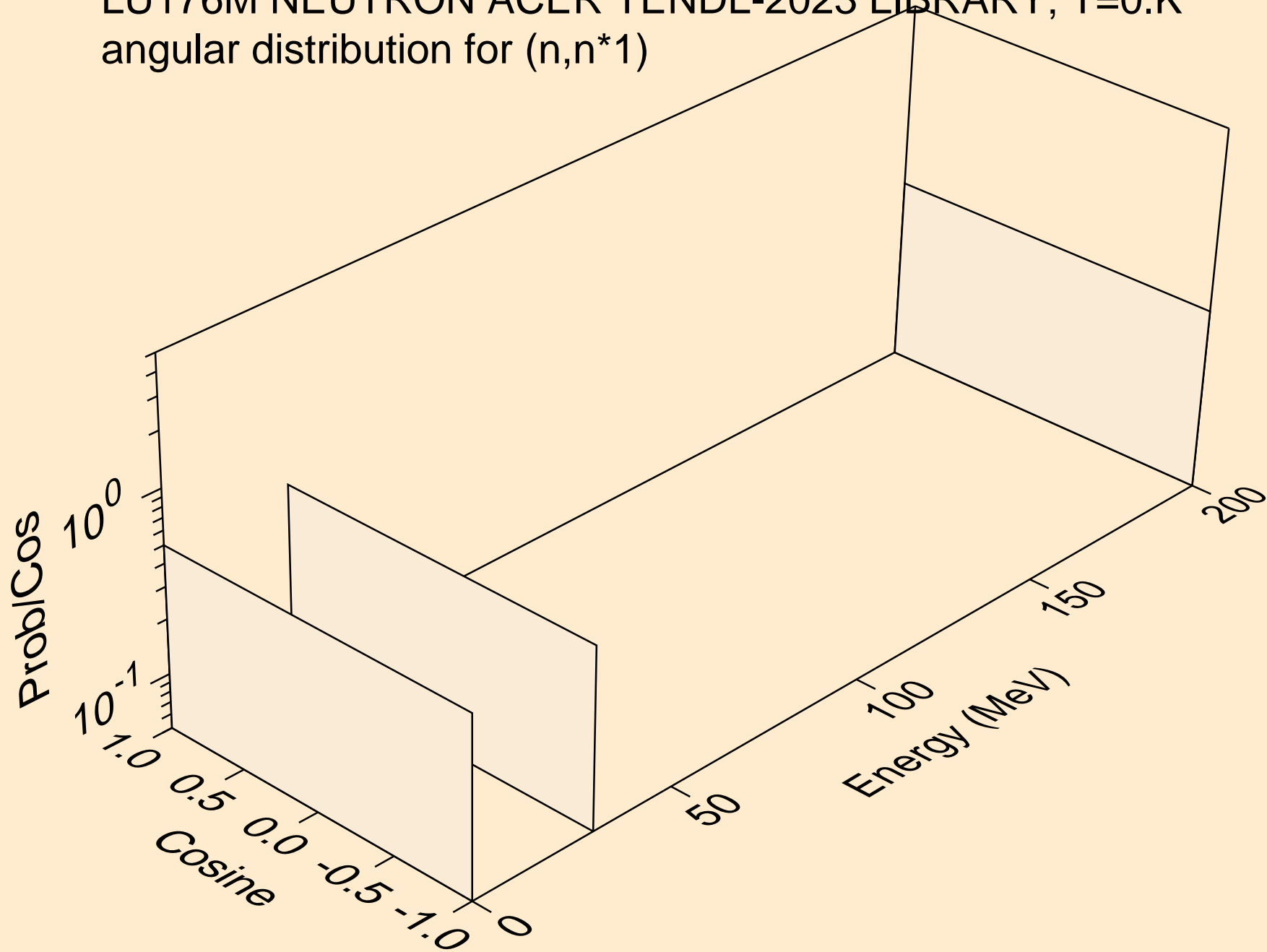

LU176M NEUTRON ACER TENDL-2023 LIBRARY; T=0.K
angular distribution for (n,n*2)

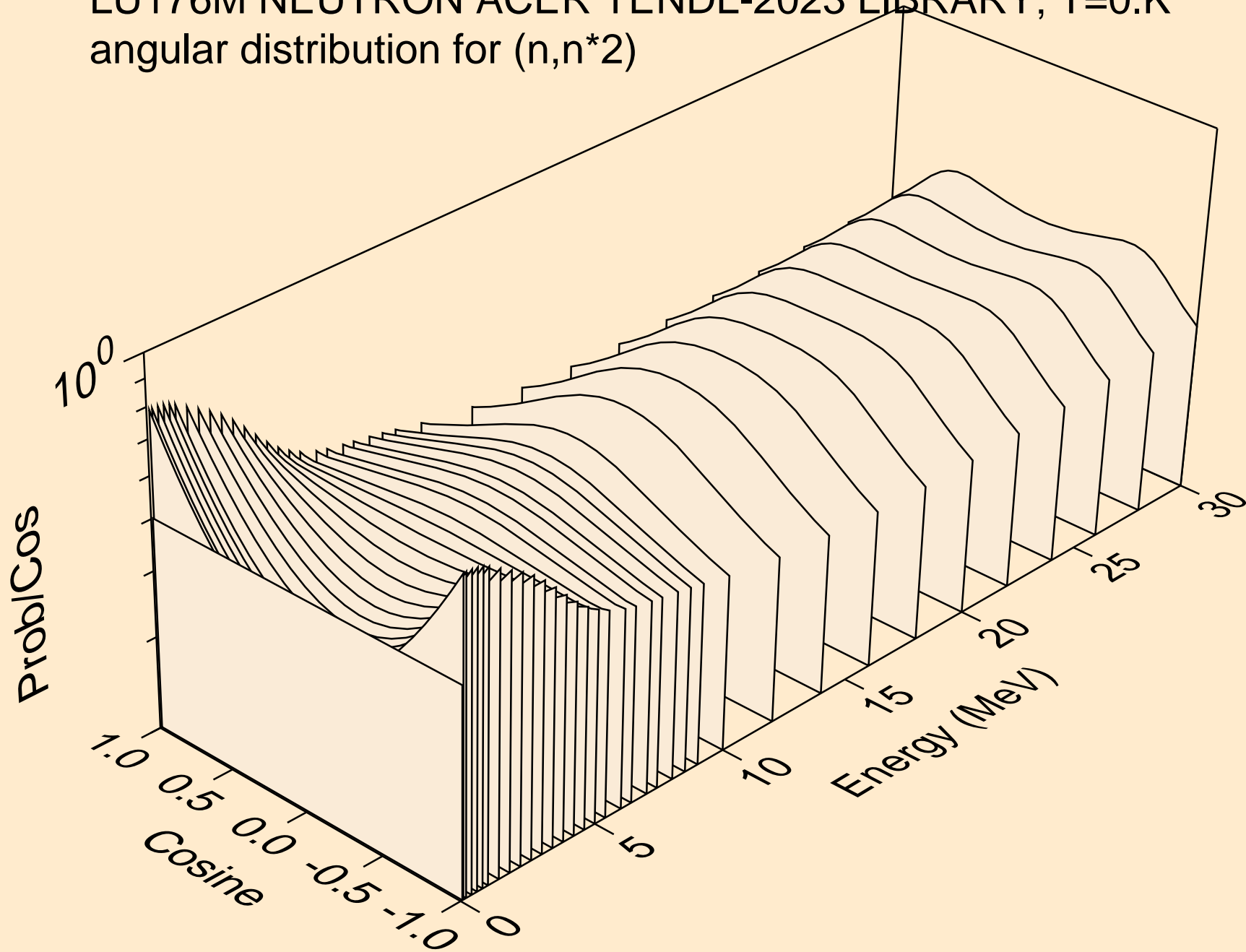

LU176M NEUTRON ACER TENDL-2023 LIBRARY; T=0.K
angular distribution for (n,n*3)

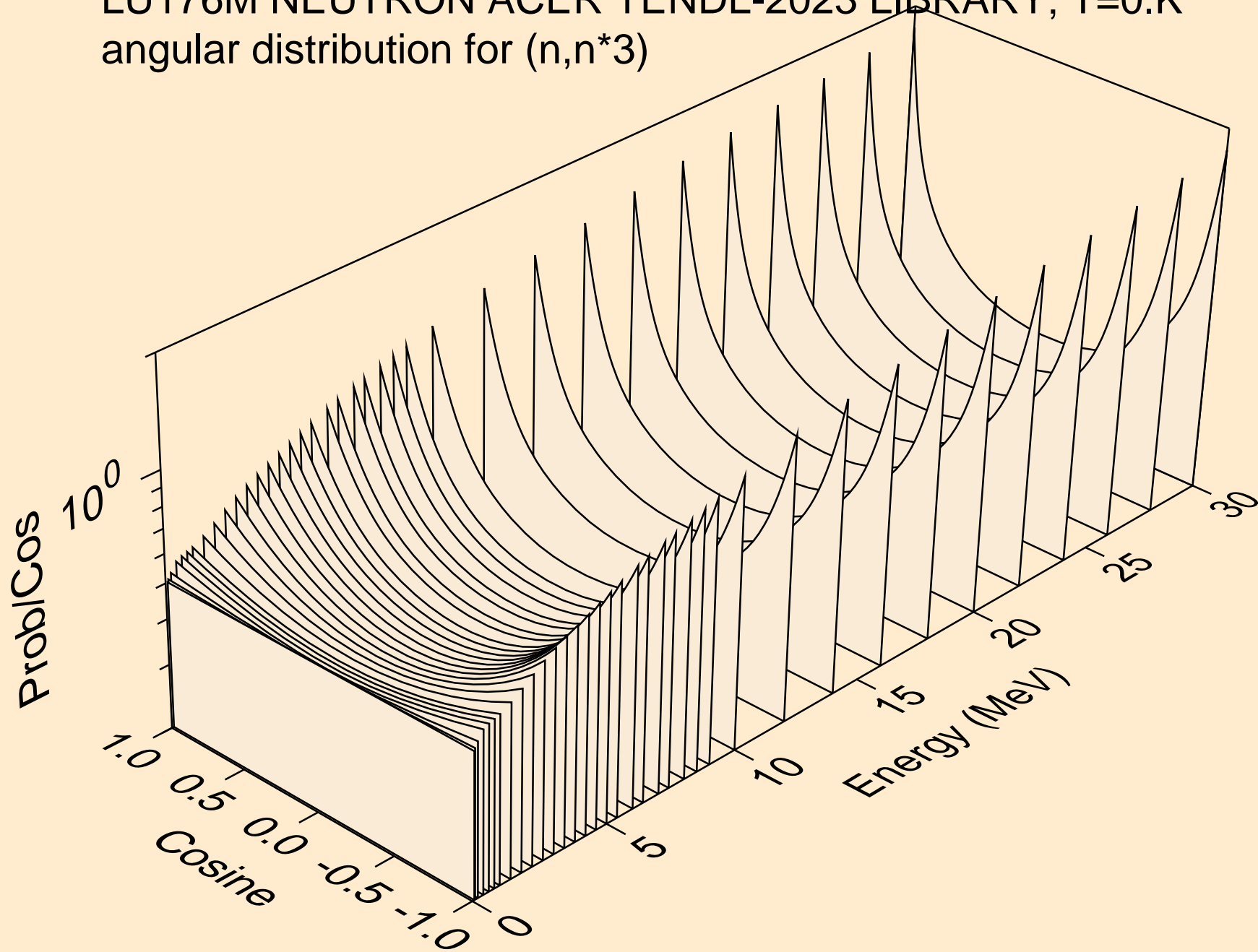

LU176M NEUTRON ACER TENDL-2023 LIBRARY; T=0.K
angular distribution for (n,n*4)

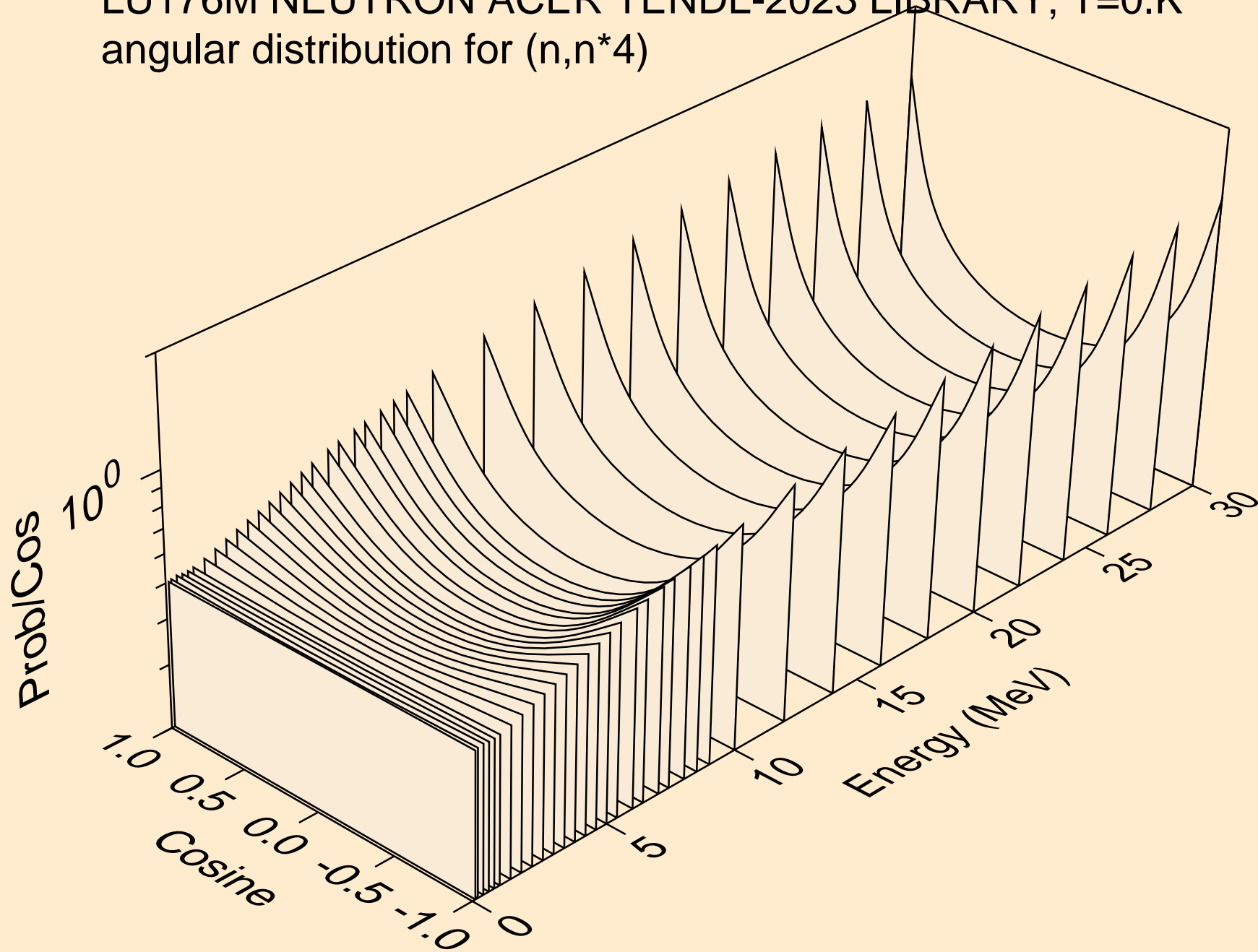

LU176M NEUTRON ACER TENDL-2023 LIBRARY; T=0.K
angular distribution for (n,n*5)

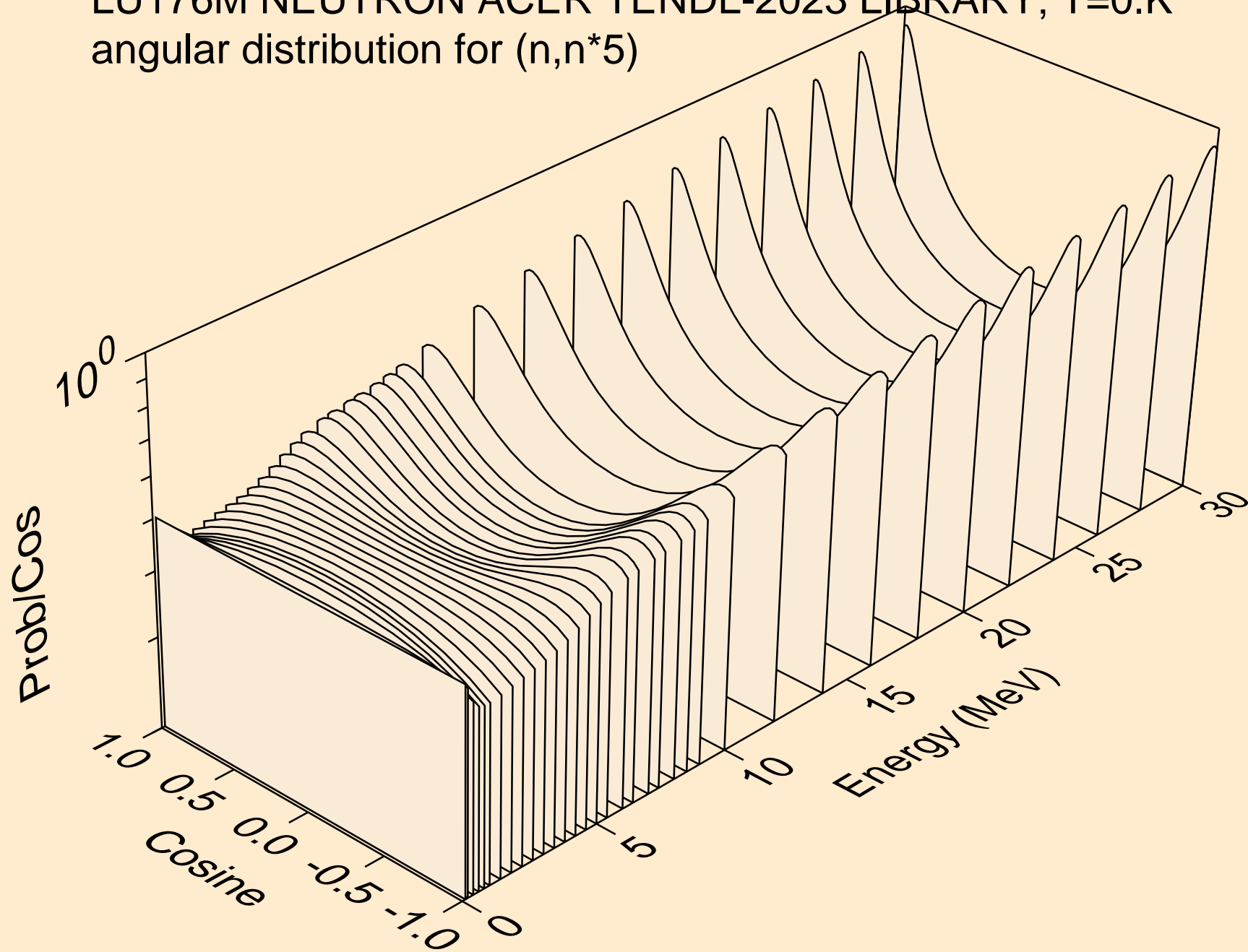

LU176M NEUTRON ACER TENDL-2023 LIBRARY; T=0.K
angular distribution for (n,n*6)

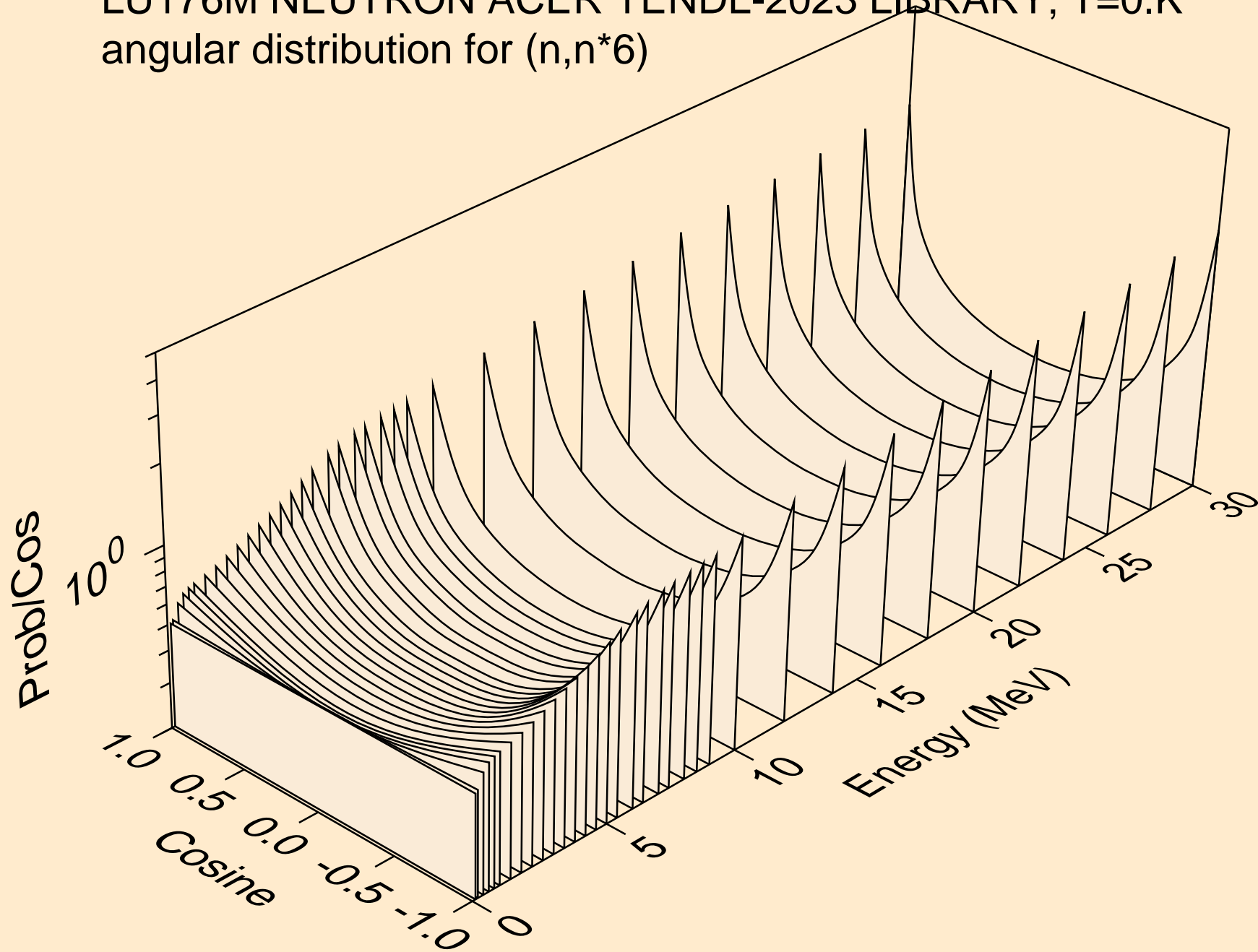

LU176M NEUTRON ACER TENDL-2023 LIBRARY; T=0.K
angular distribution for (n,n*7)

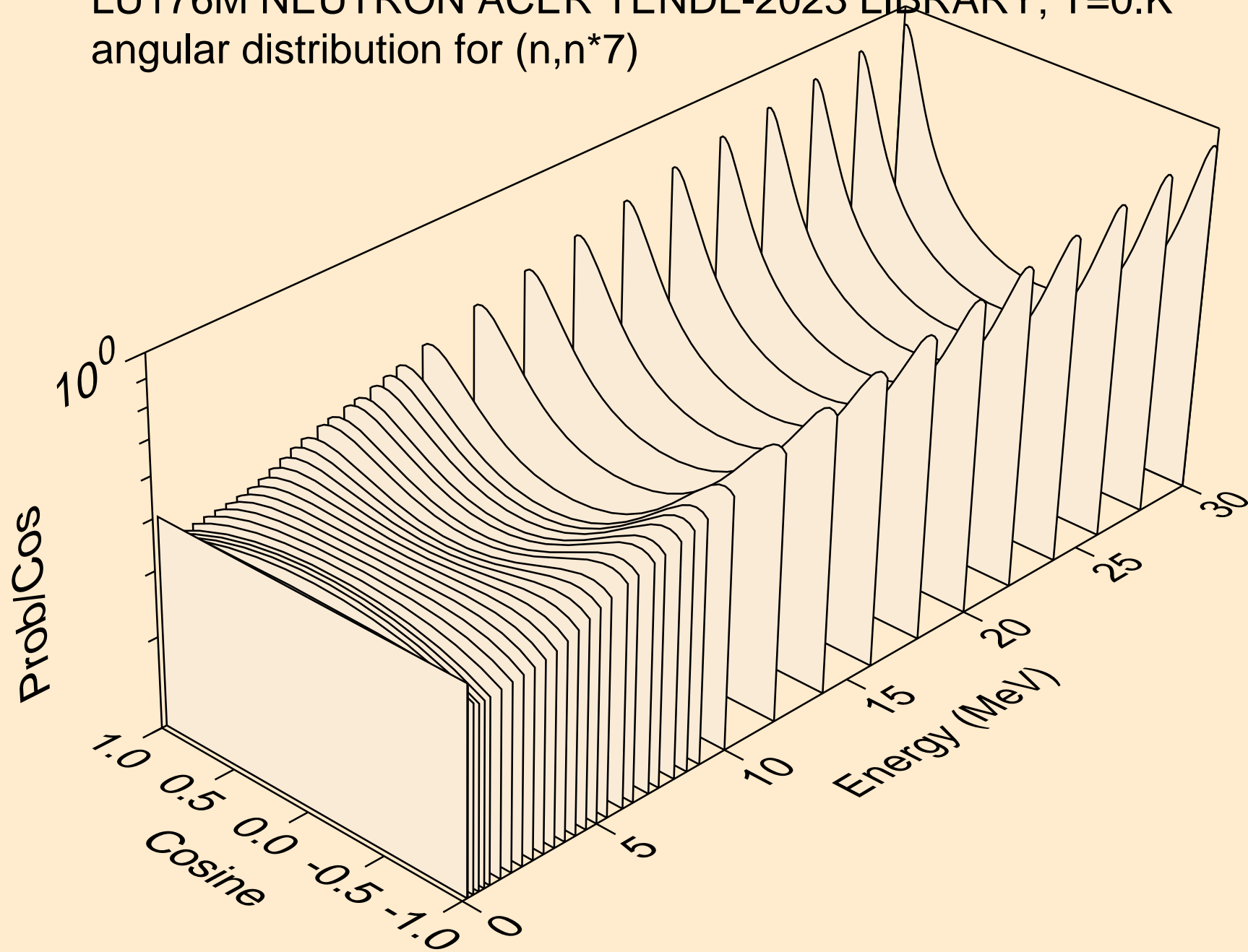

LU176M NEUTRON ACER TENDL-2023 LIBRARY; T=0.K
angular distribution for (n,n*8)

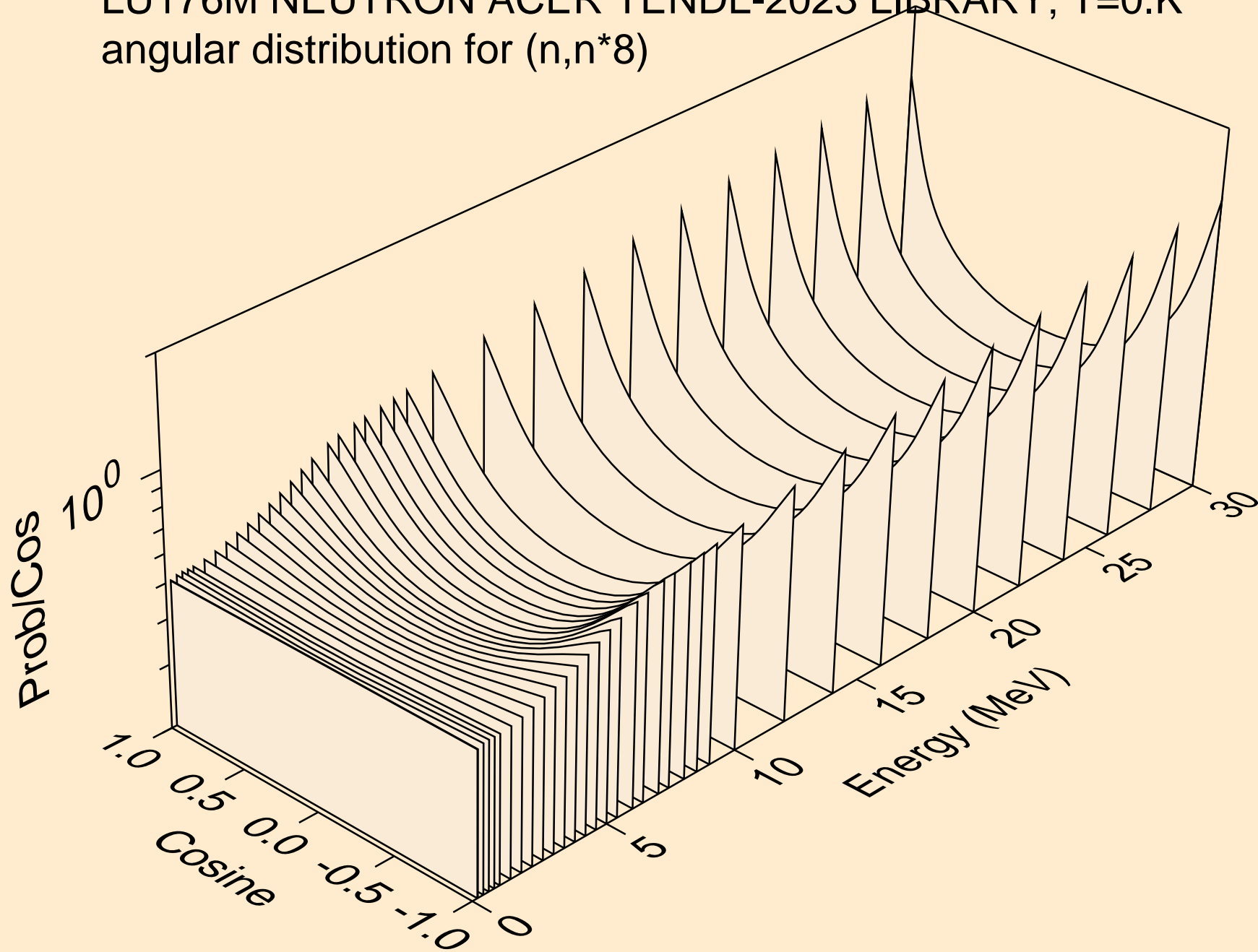

LU176M NEUTRON ACER TENDL-2023 LIBRARY; T=0.K
angular distribution for (n,n*9)

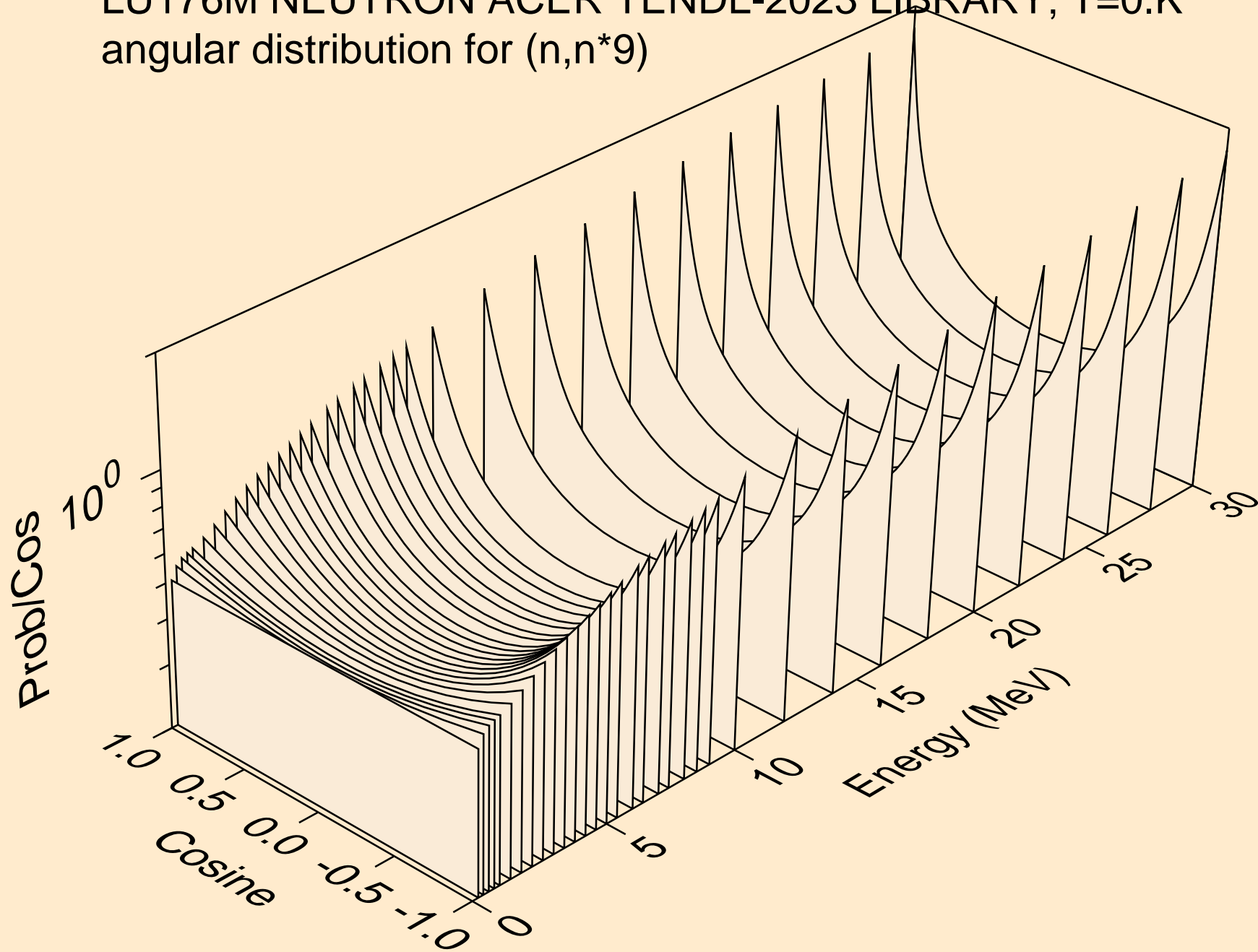

LU176M NEUTRON ACER TENDL-2023 LIBRARY; T=0.K
angular distribution for (n,n*10)

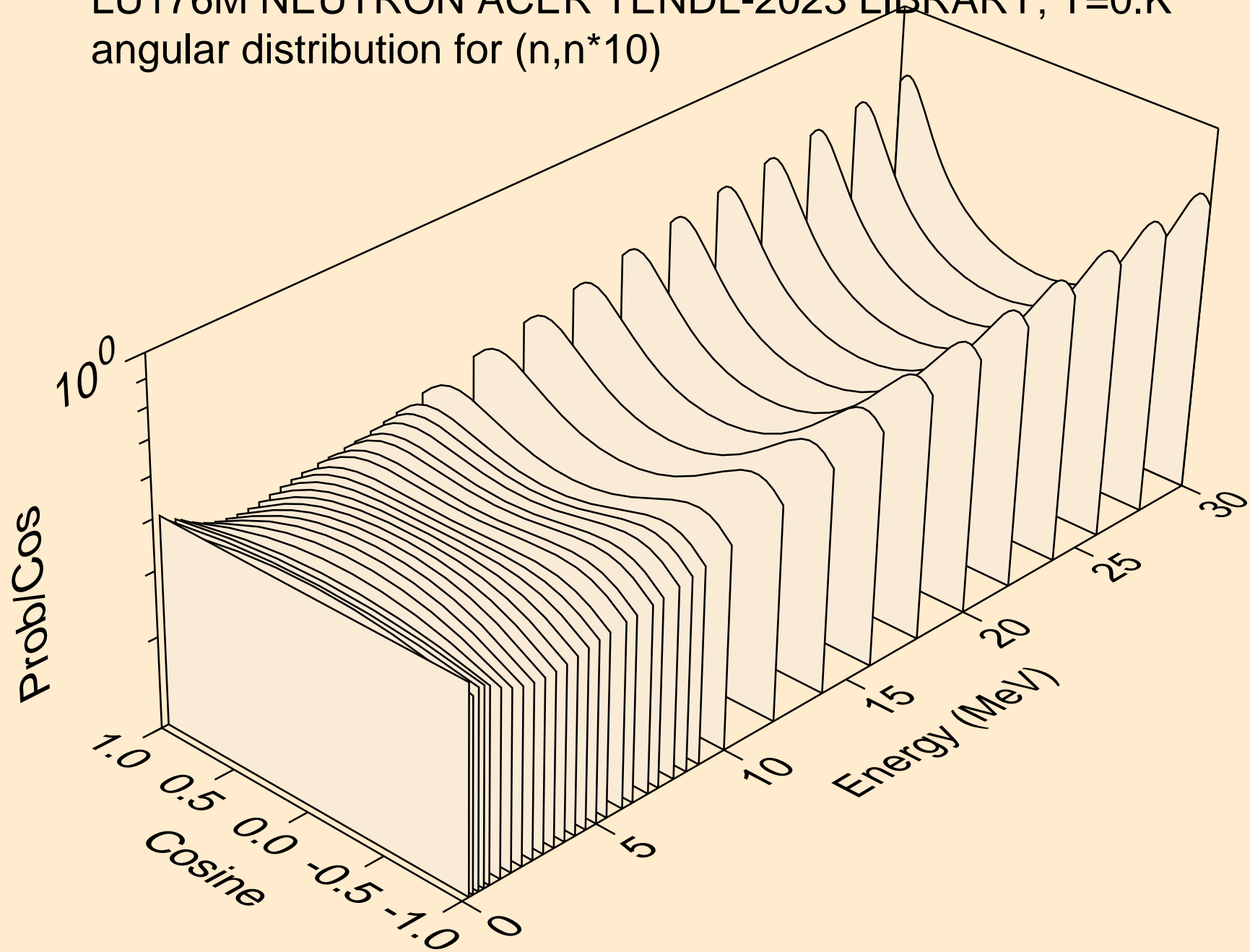

LU176M NEUTRON ACER TENDL-2023 LIBRARY; T=0.K
angular distribution for (n,n*11)

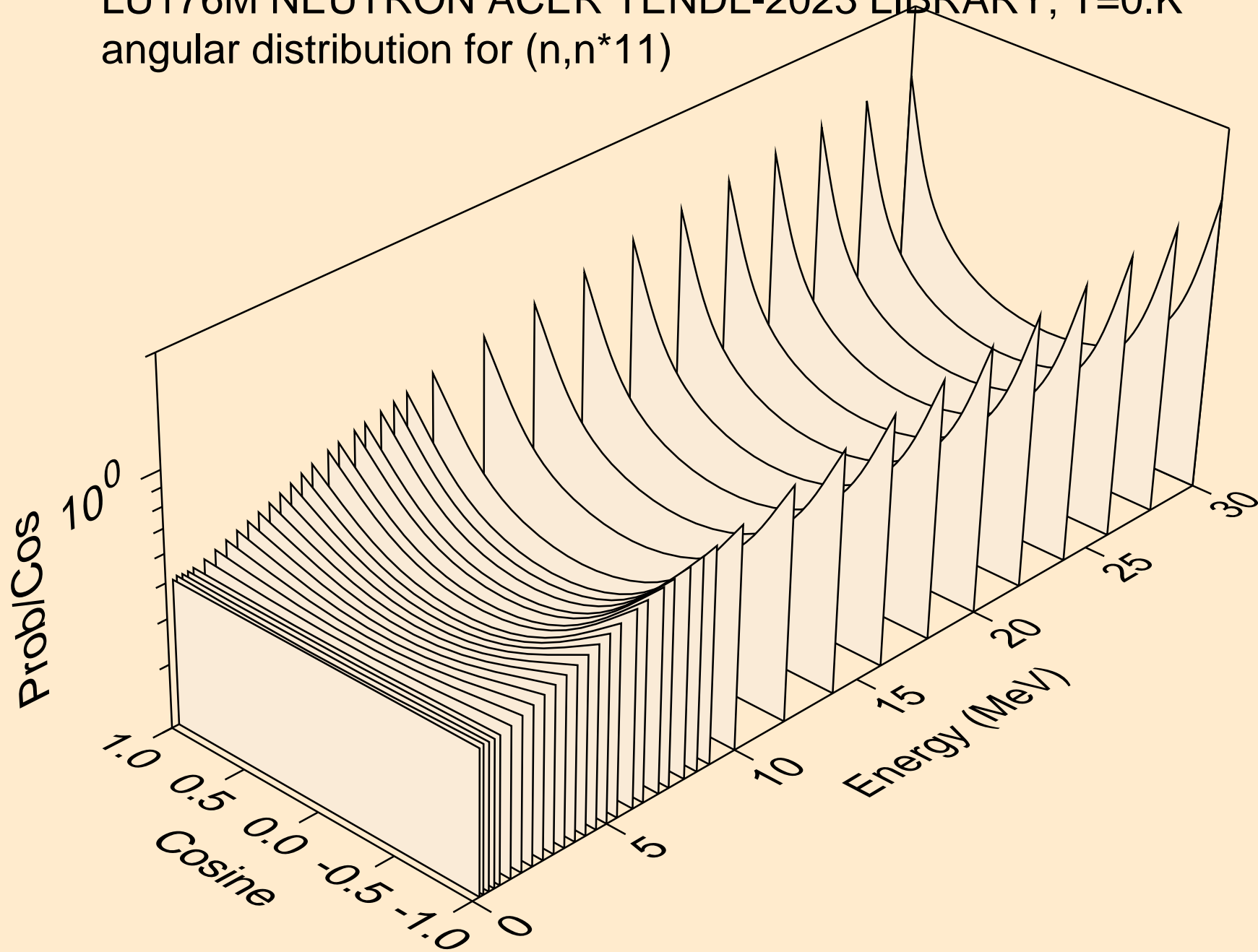

LU176M NEUTRON ACER TENDL-2023 LIBRARY; T=0.K
angular distribution for (n,n*12)

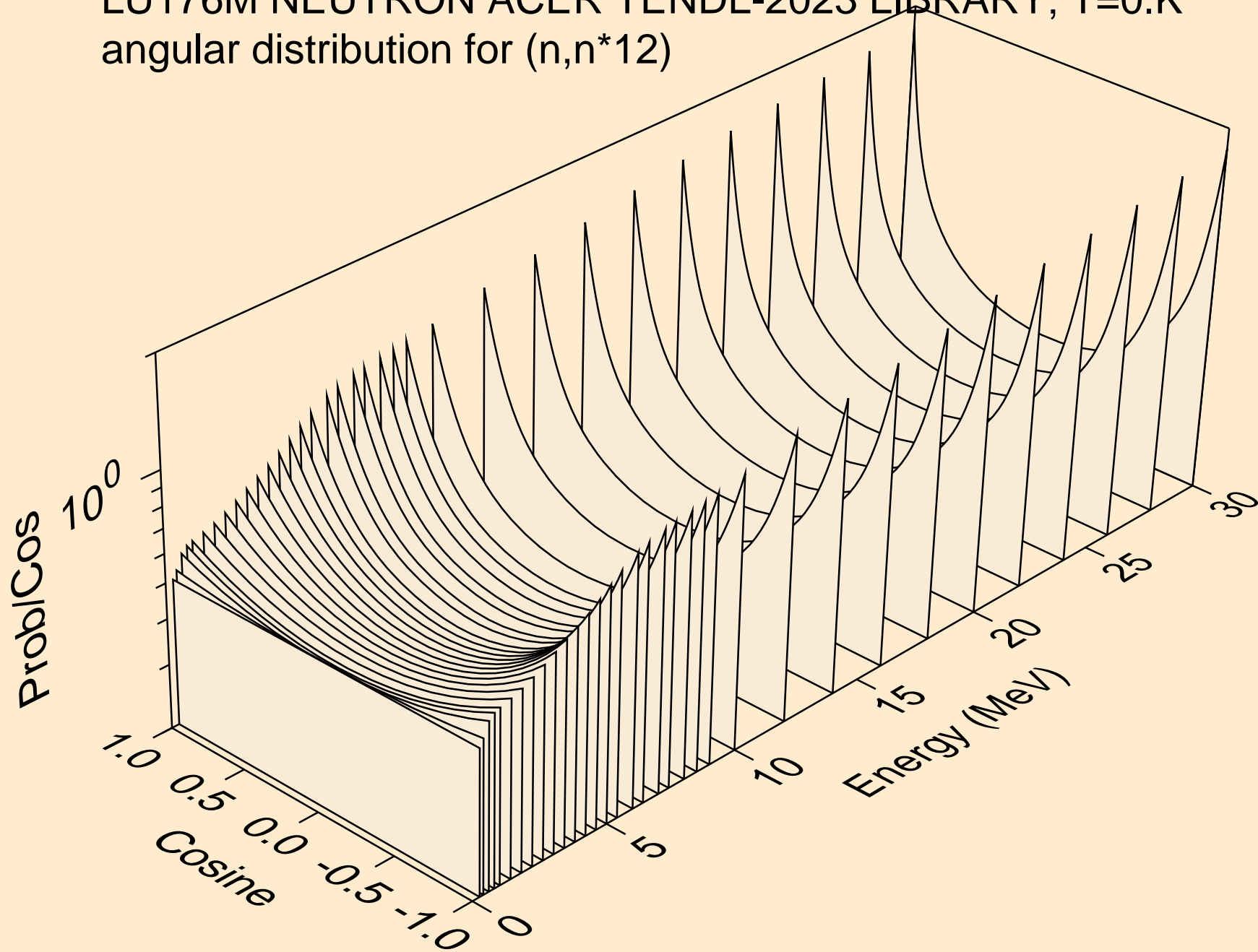

LU176M NEUTRON ACER TENDL-2023 LIBRARY; T=0.K
angular distribution for (n,n*13)

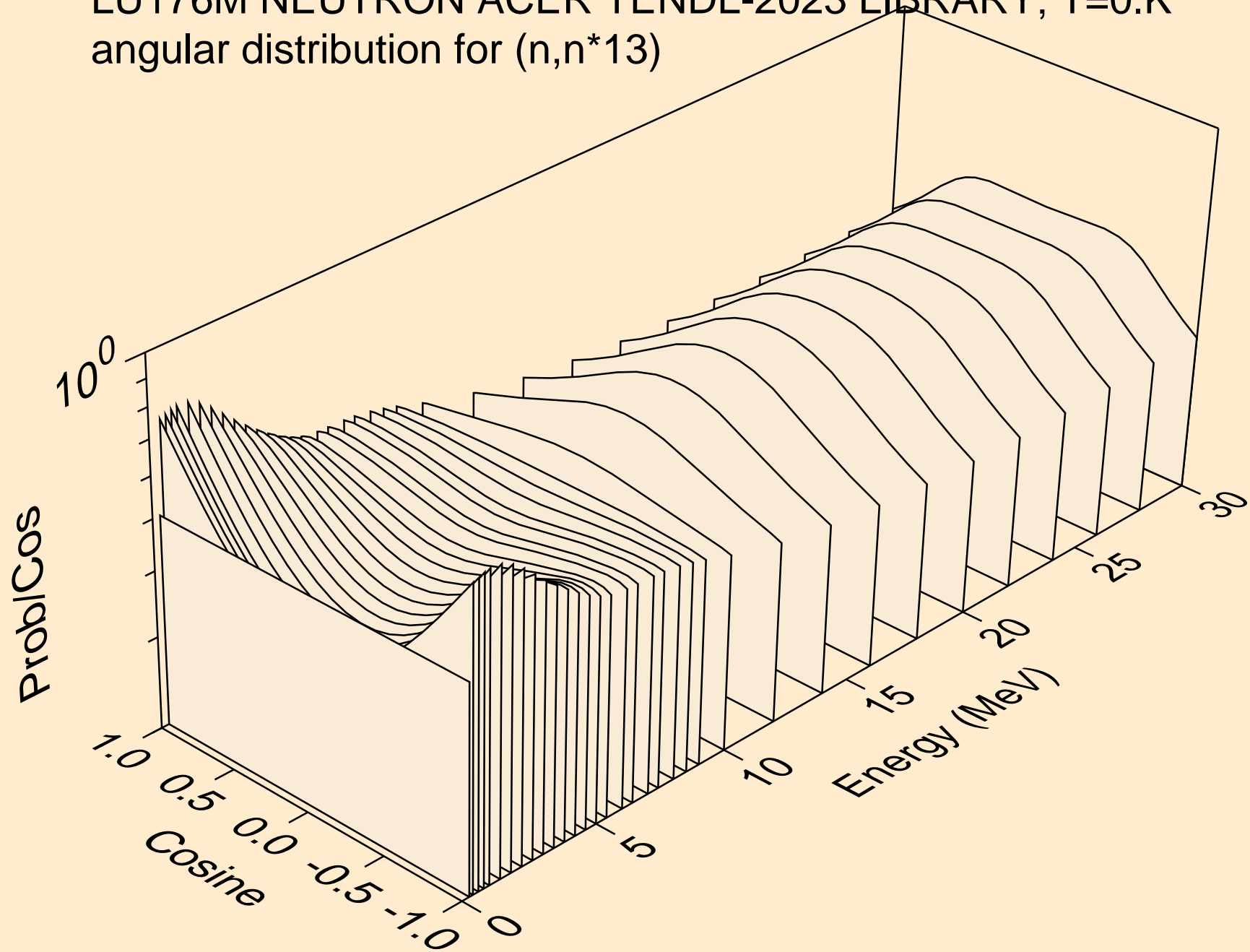

LU176M NEUTRON ACER TENDL-2023 LIBRARY; T=0.K
angular distribution for (n,n*14)

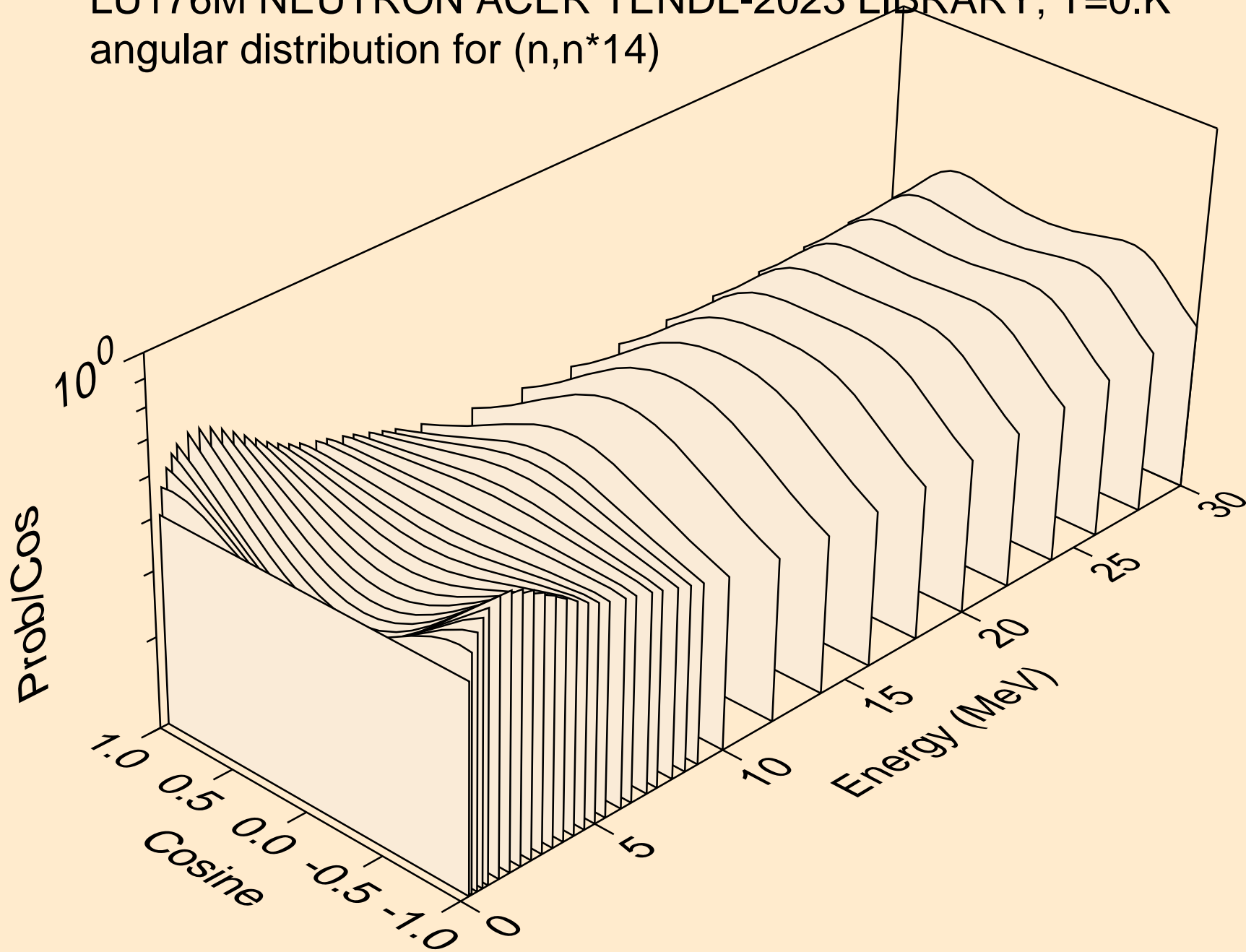

LU176M NEUTRON ACER TENDL-2023 LIBRARY; T=0.K
angular distribution for (n,n*15)

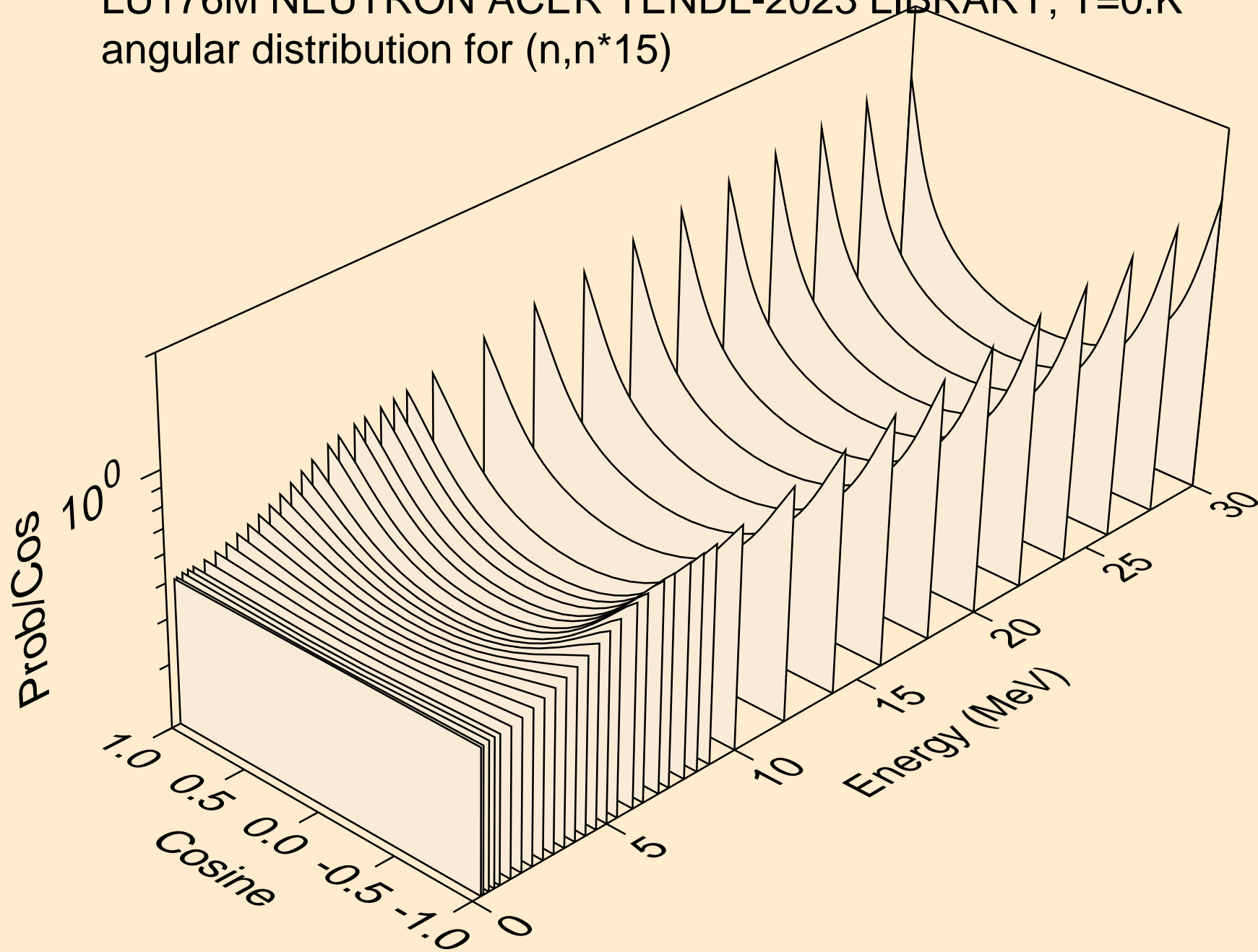

LU176M NEUTRON ACER TENDL-2023 LIBRARY; T=0.K
angular distribution for (n,n*16)

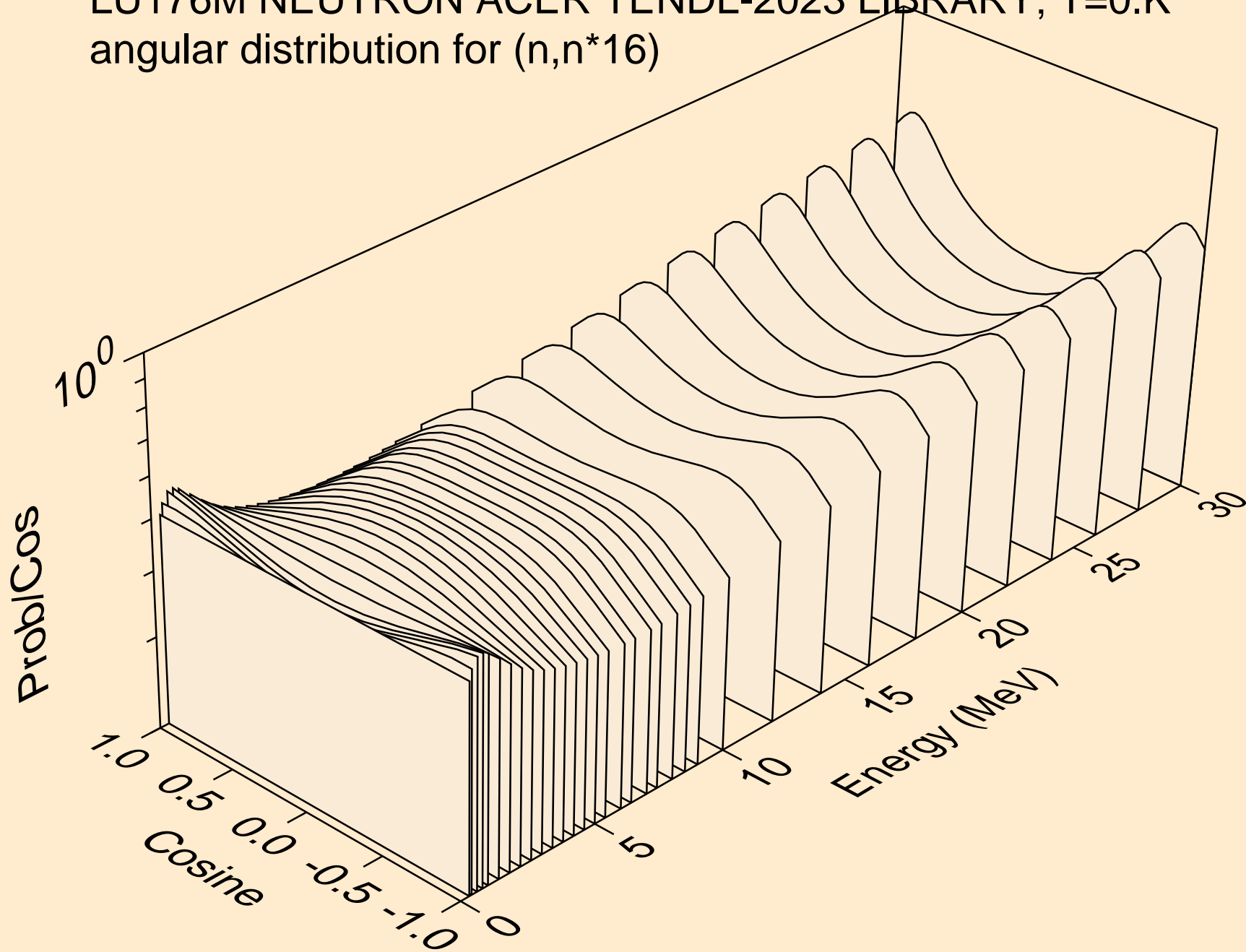

LU176M NEUTRON ACER TENDL-2023 LIBRARY; T=0.K
angular distribution for (n,n*17)

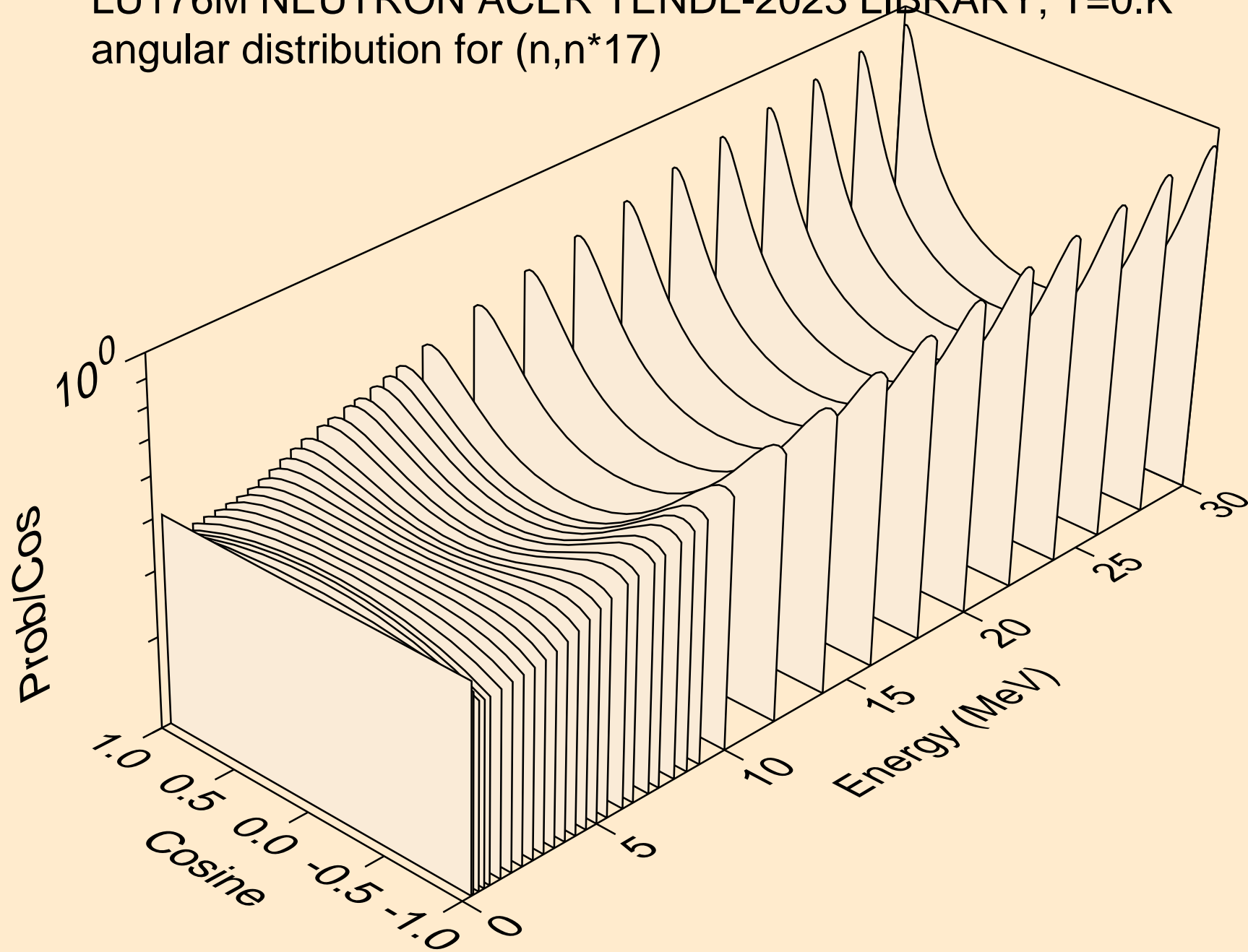

LU176M NEUTRON ACER TENDL-2023 LIBRARY; T=0.K
angular distribution for (n,n*18)

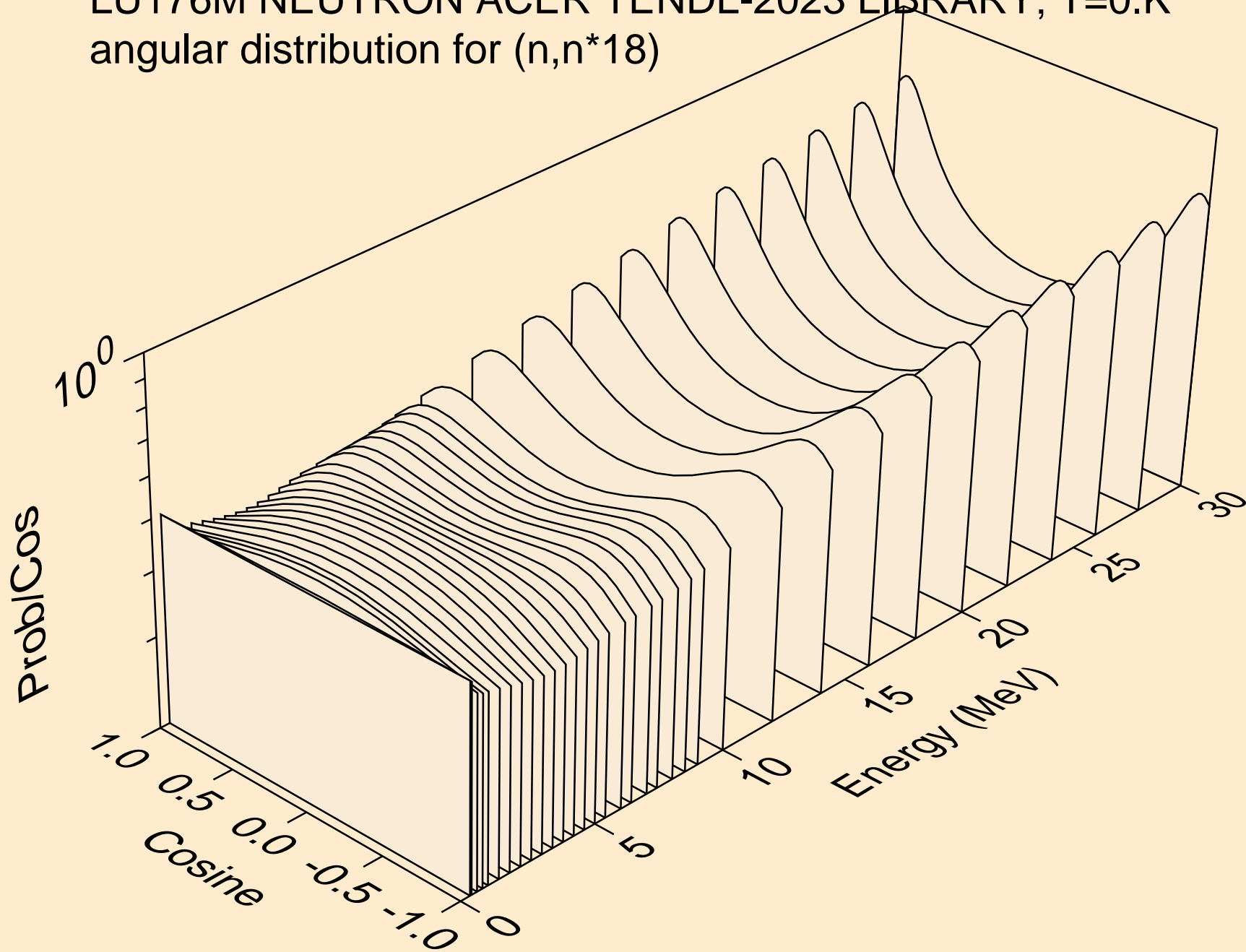

LU176M NEUTRON ACER TENDL-2023 LIBRARY; T=0.K
Neutron emission for (n,x)

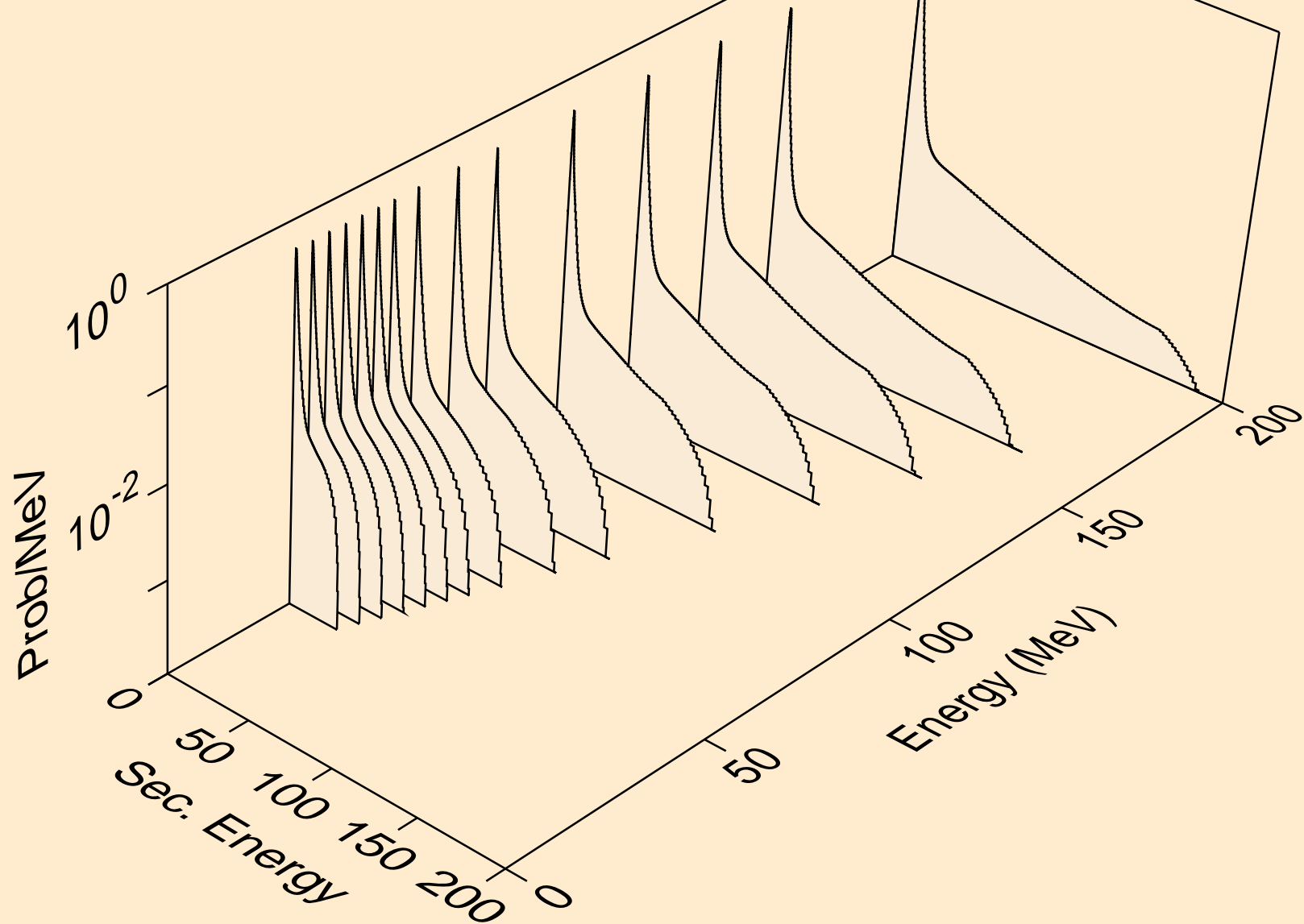

LU176M NEUTRON ACER TENDL-2023 LIBRARY; T=0.K
Neutron emission for (n,2nd)

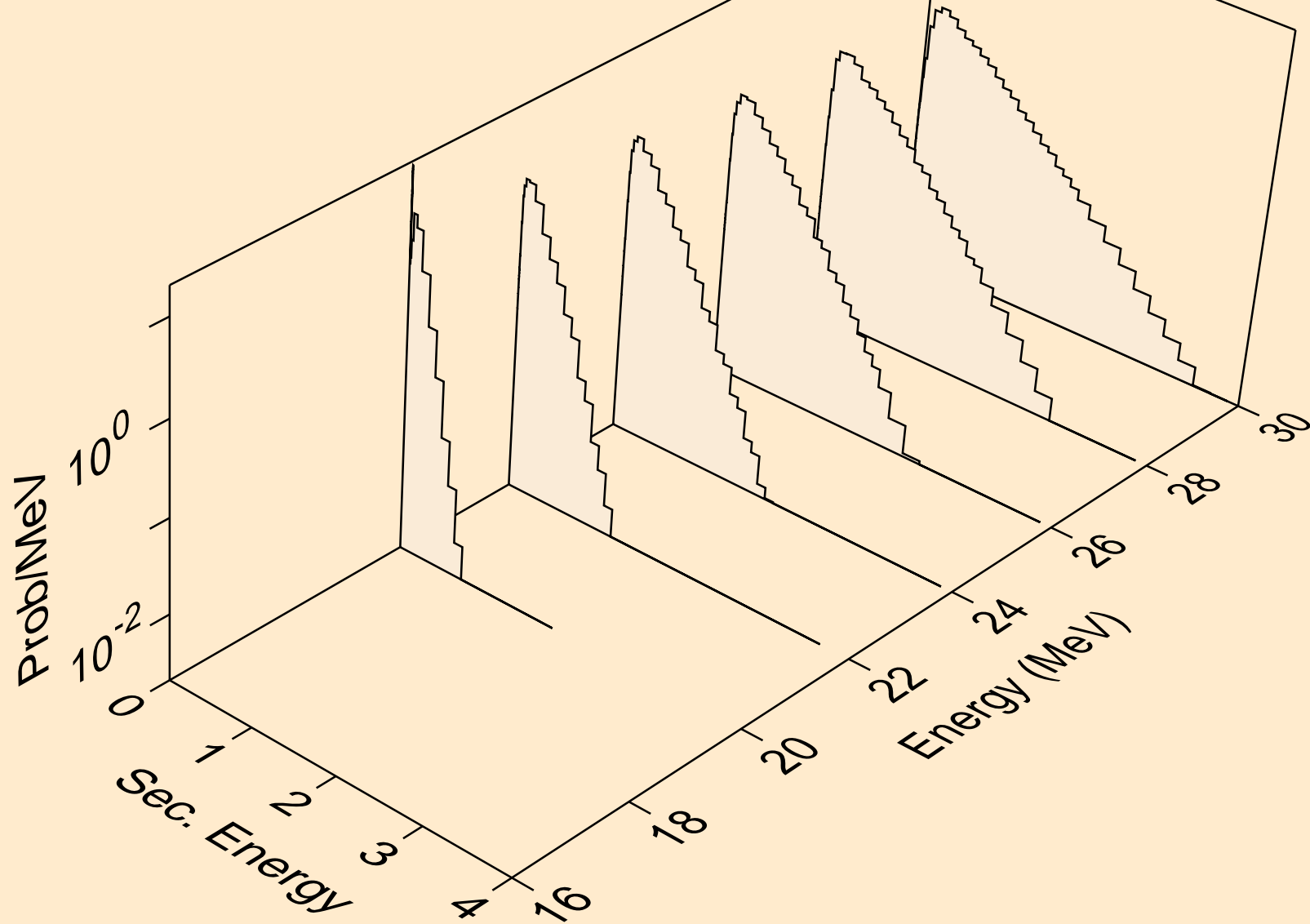

LU176M NEUTRON ACER TENDL-2023 LIBRARY; T=0.K
Neutron emission for (n,2n)

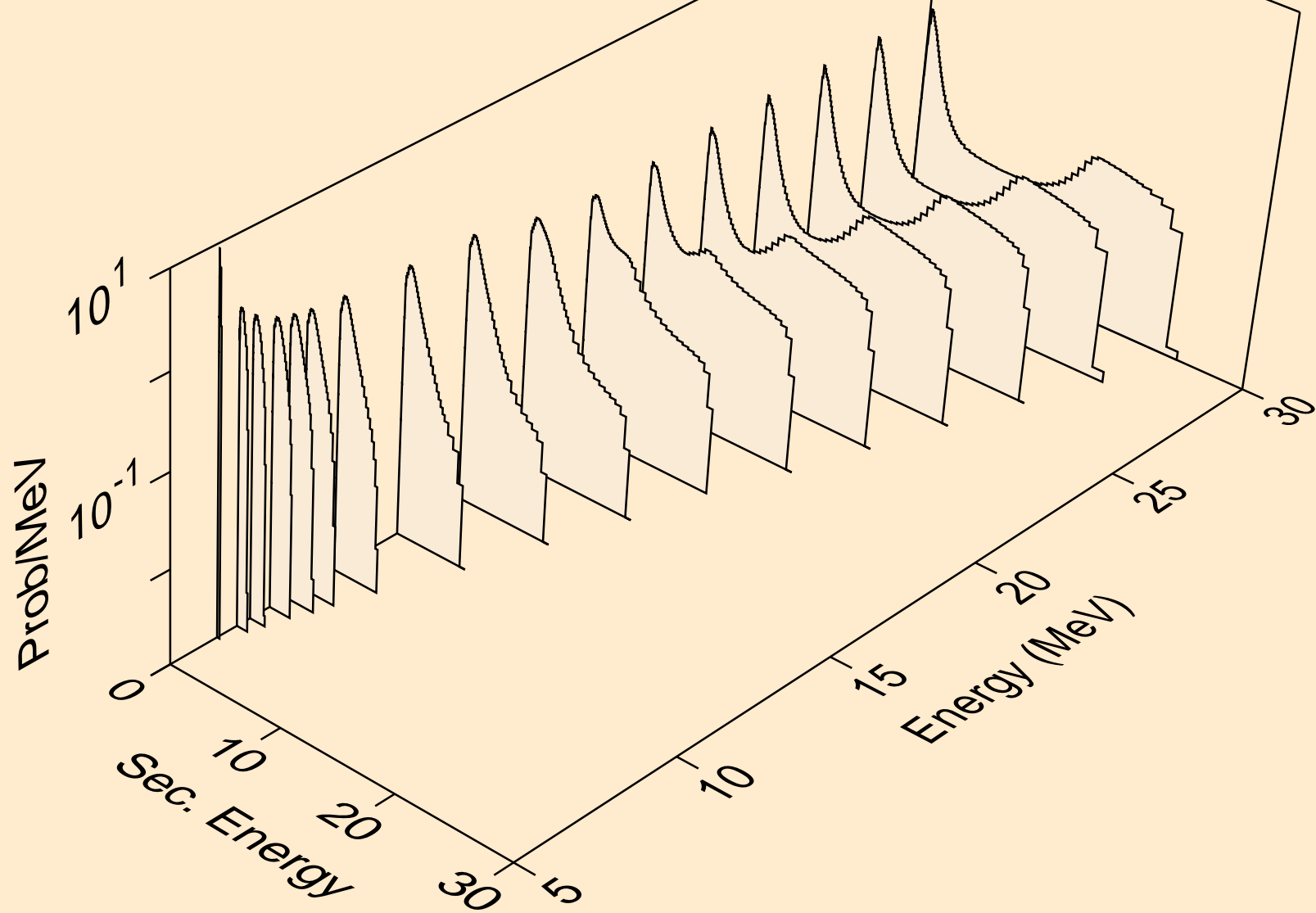

LU176M NEUTRON ACER TENDL-2023 LIBRARY; T=0.K
Neutron emission for (n,3n)

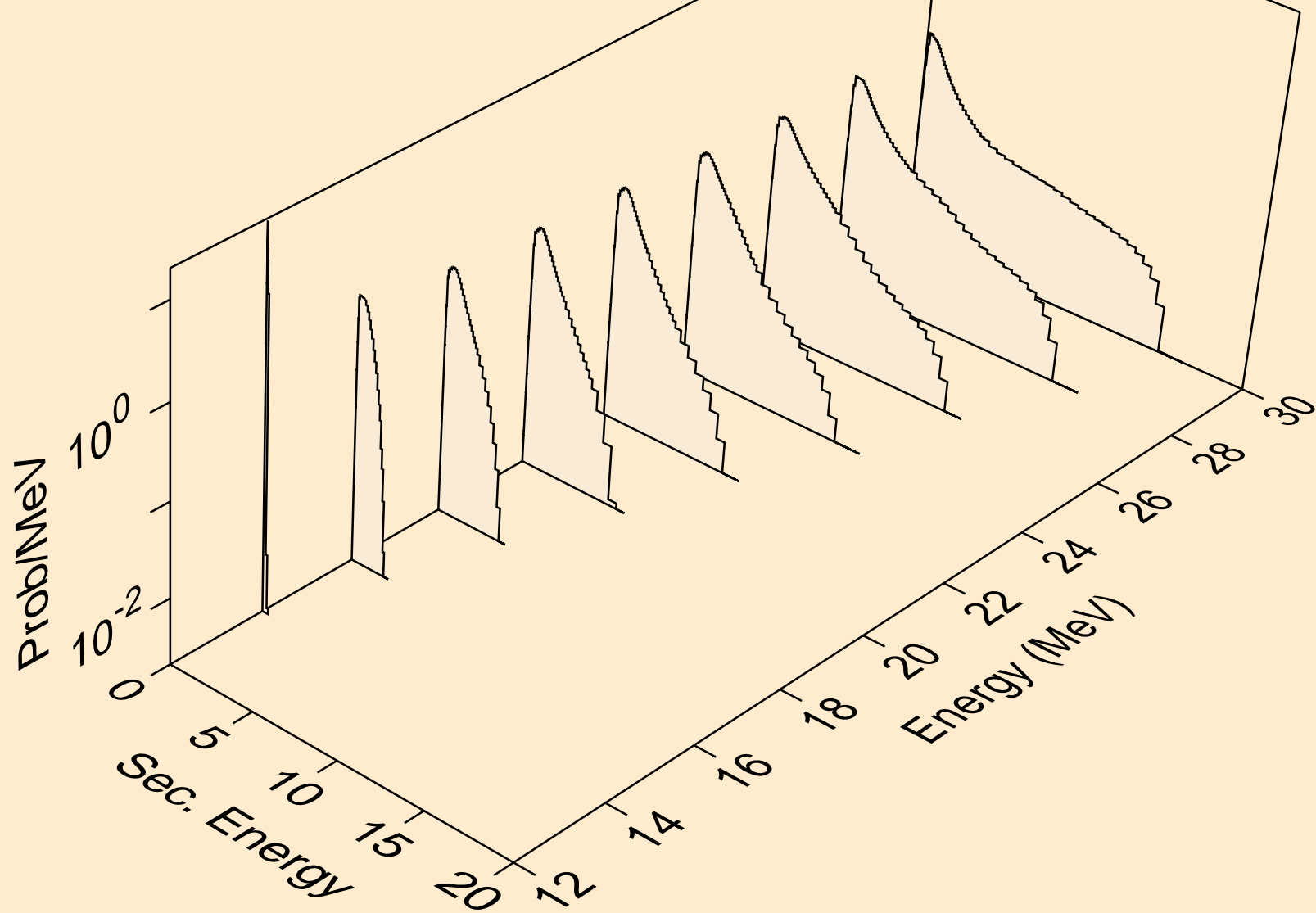

LU176M NEUTRON ACER TENDL-2023 LIBRARY; T=0.K
Neutron emission for (n,n*)a

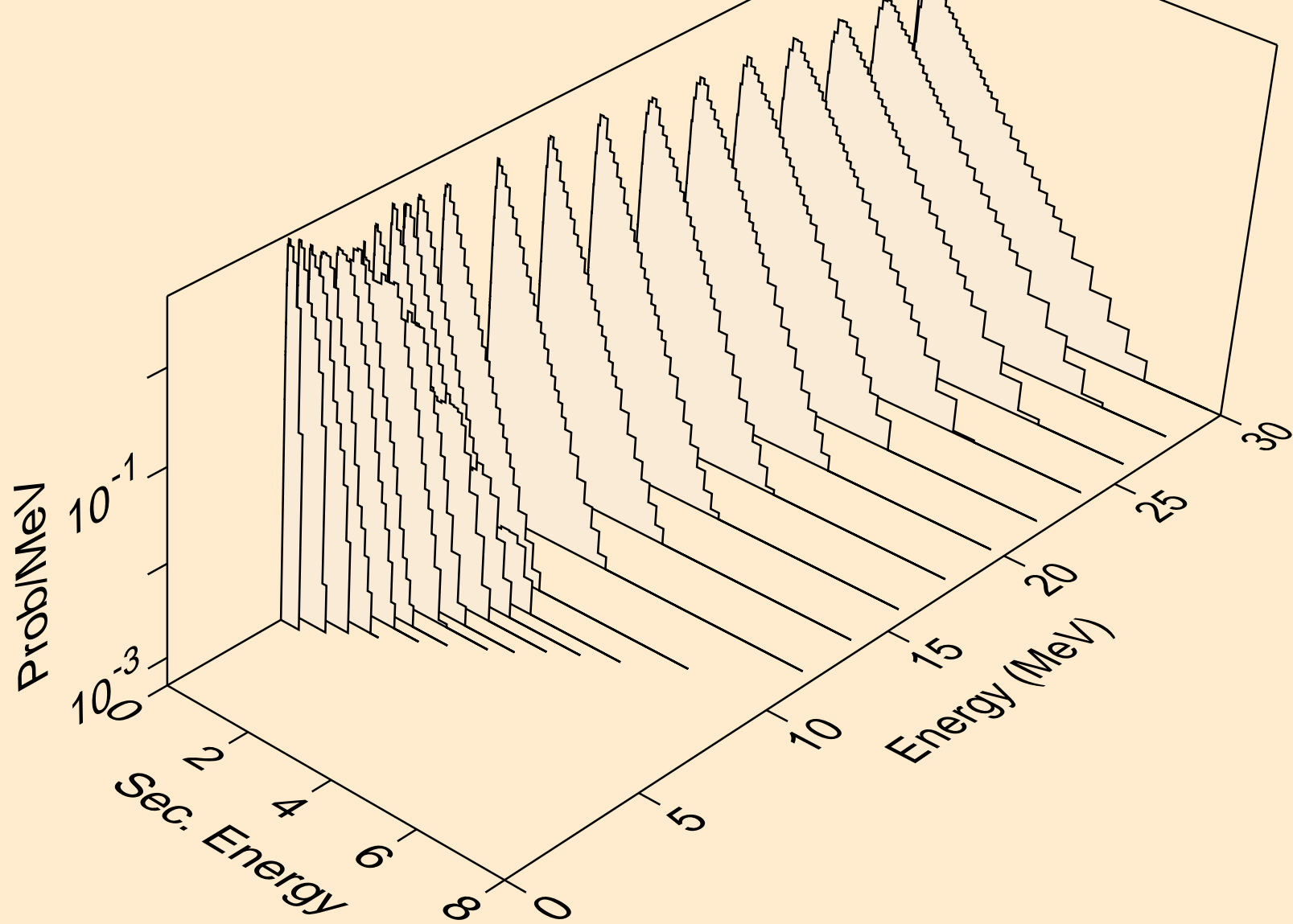

LU176M NEUTRON ACER TENDL-2023 LIBRARY; T=0.K
Neutron emission for (n,2n)a

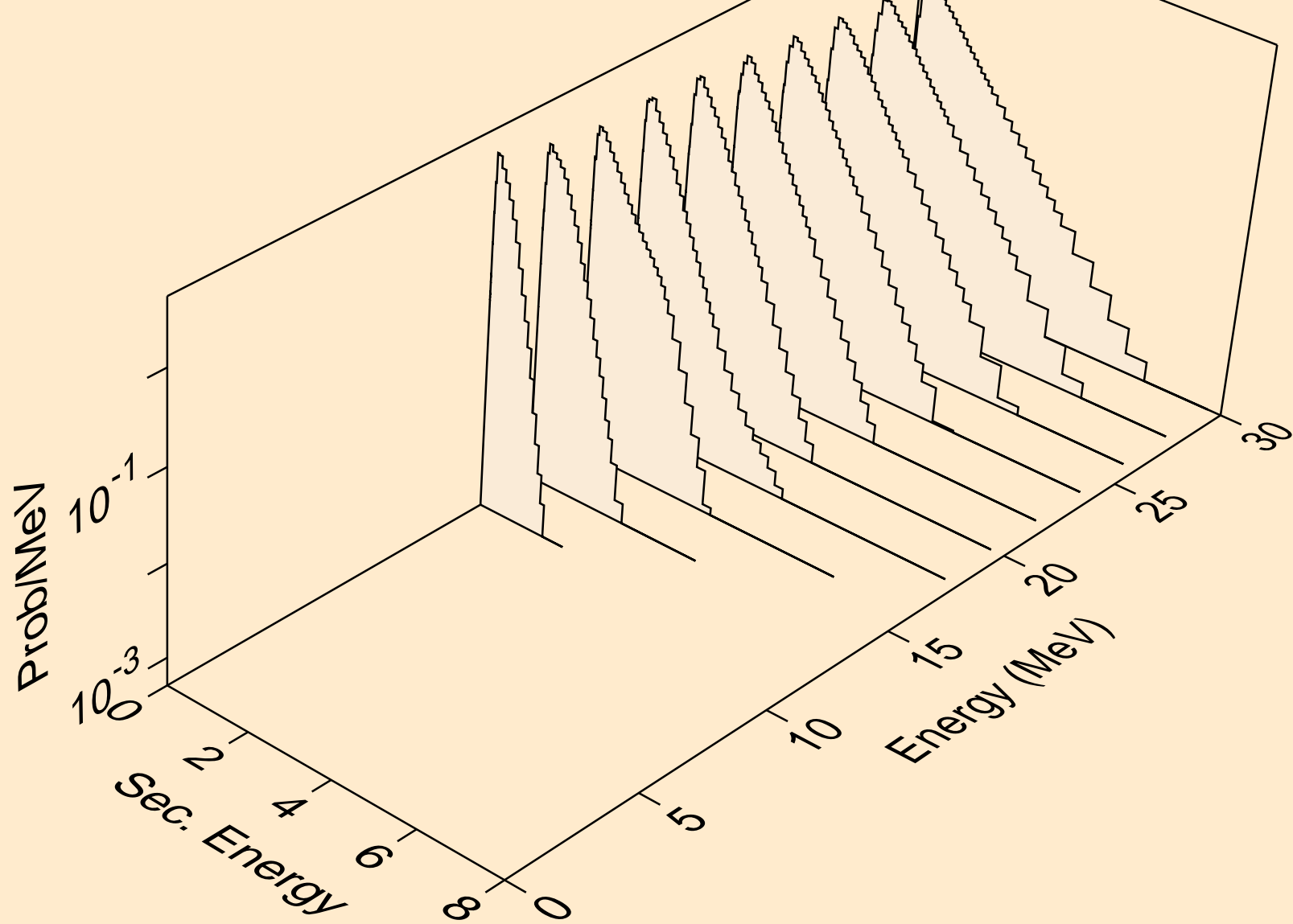

LU176M NEUTRON ACER TENDL-2023 LIBRARY; T=0.K
Neutron emission for (n,3n)a

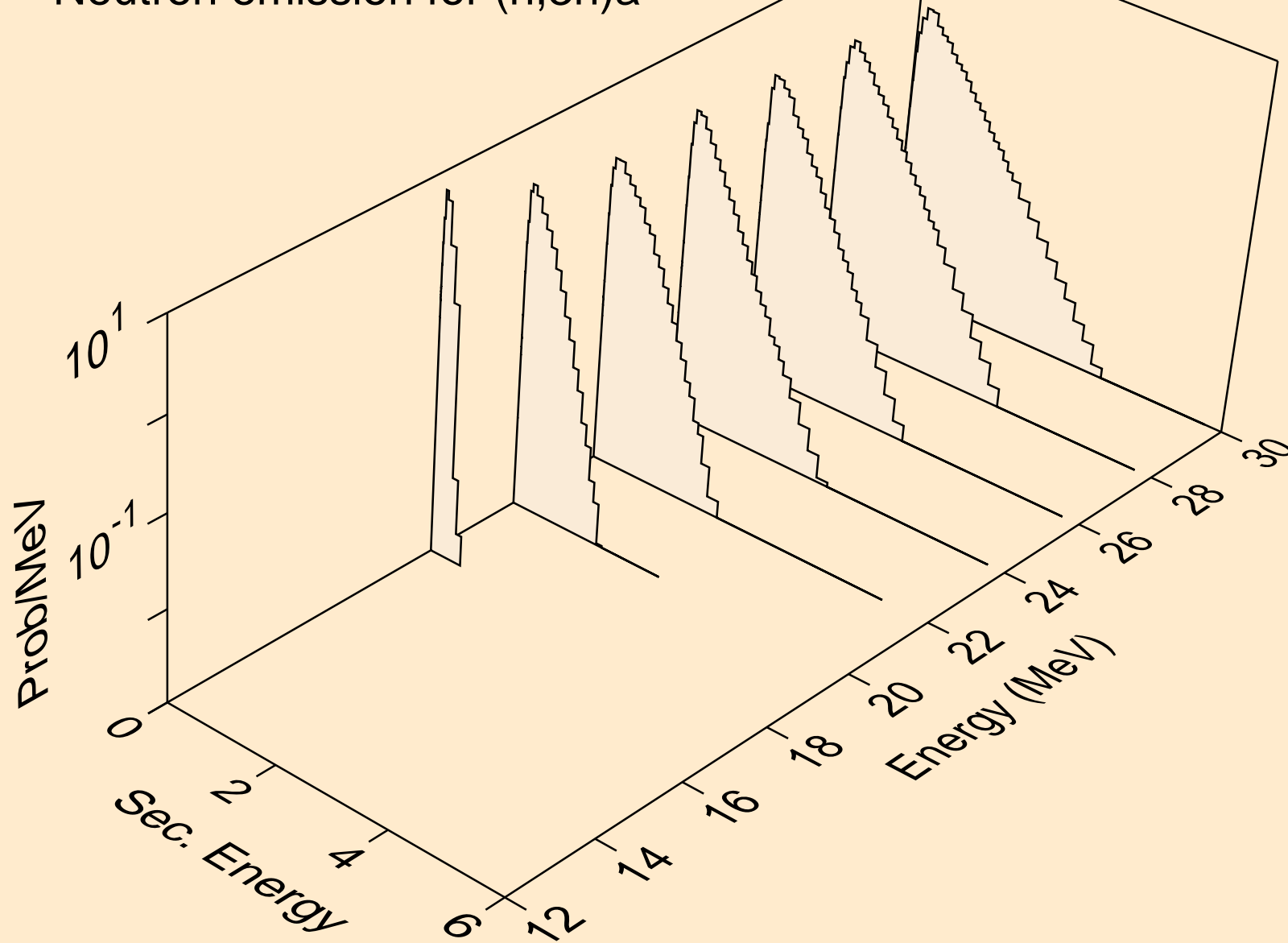

LU176M NEUTRON ACER TENDL-2023 LIBRARY; T=0.K
Neutron emission for (n,n*)p

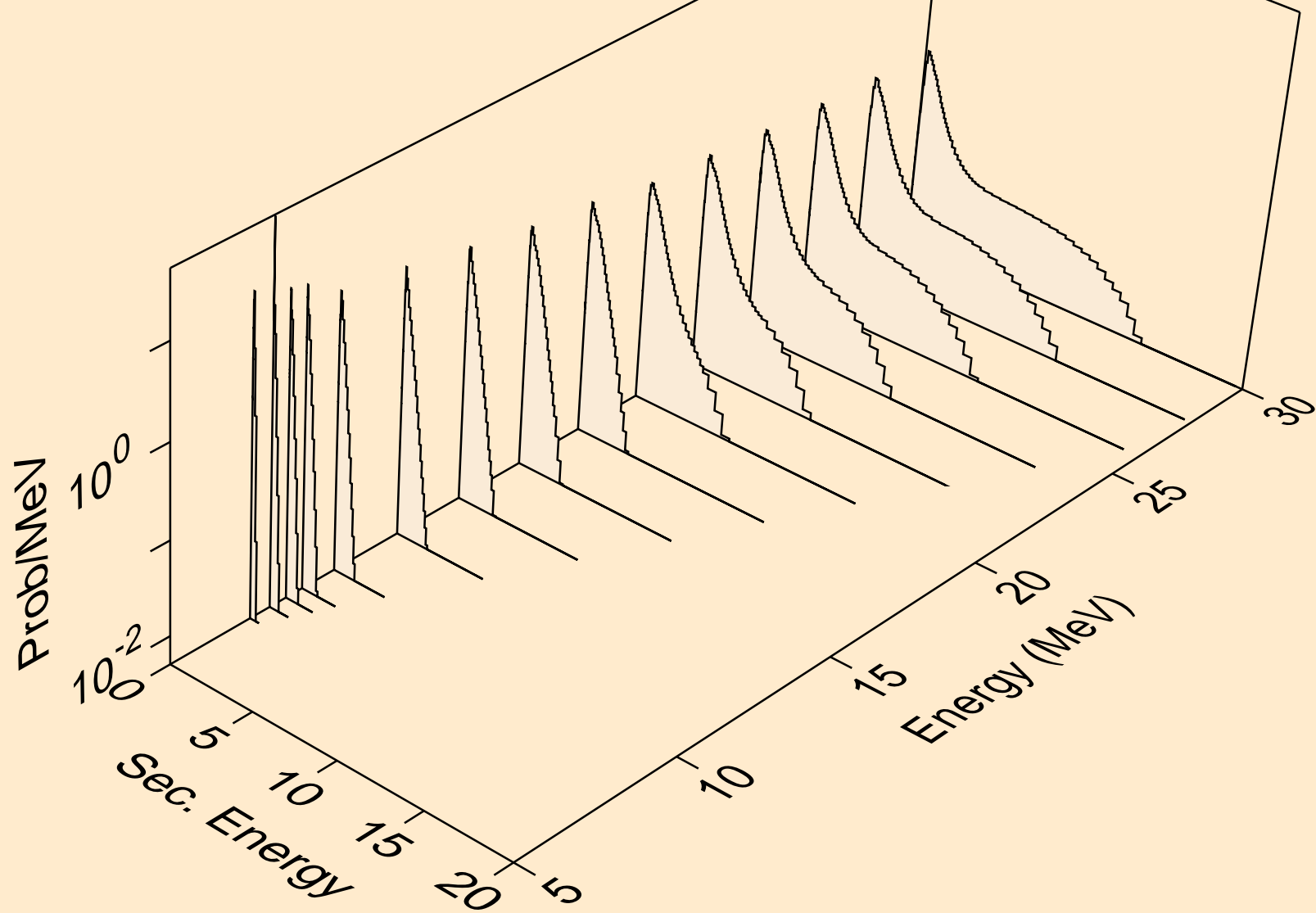

LU176M NEUTRON ACER TENDL-2023 LIBRARY; T=0.K
Neutron emission for (n,n*)2a

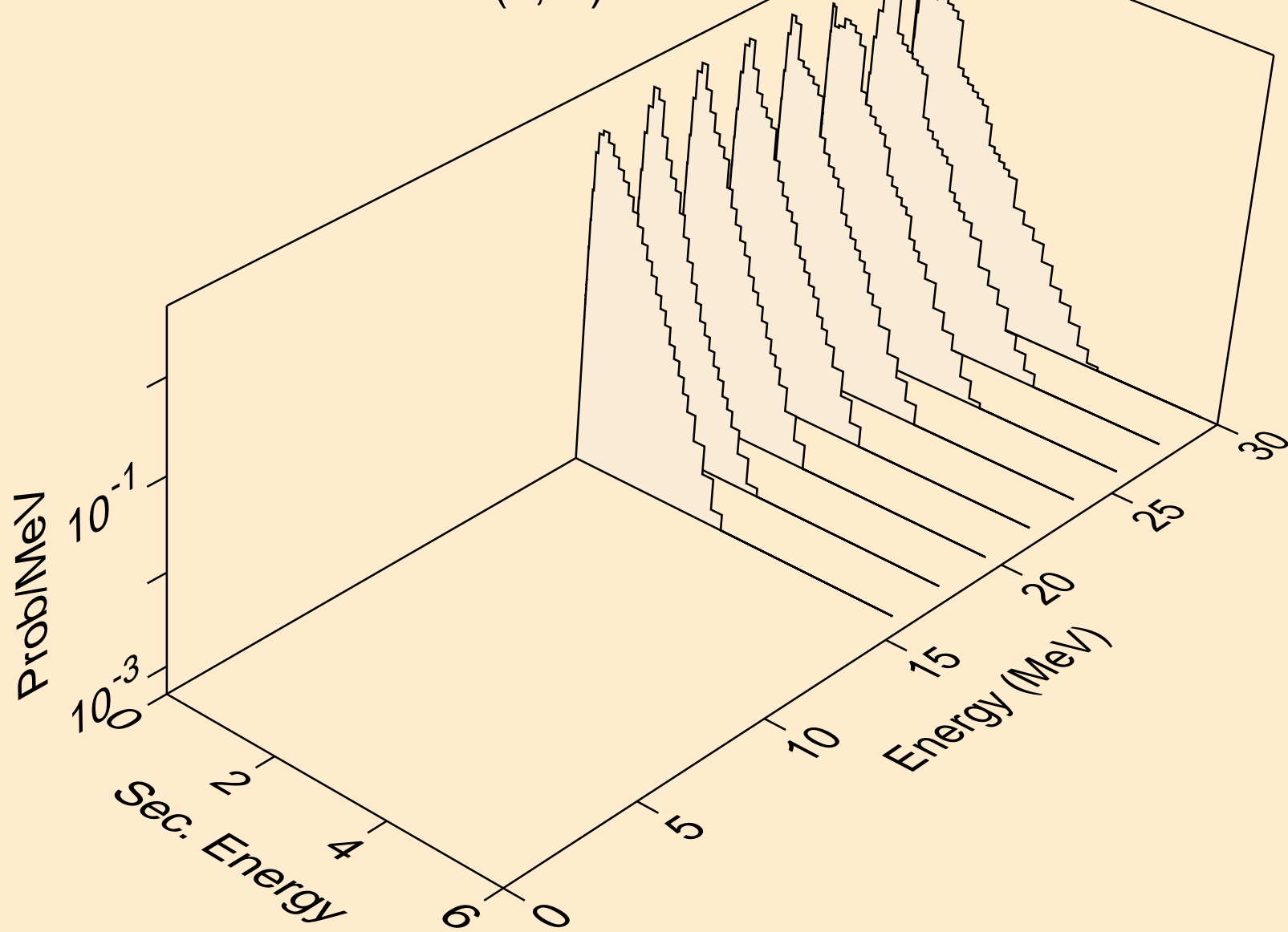

LU176M NEUTRON ACER TENDL-2023 LIBRARY; T=0.K
Neutron emission for (n,n*)d

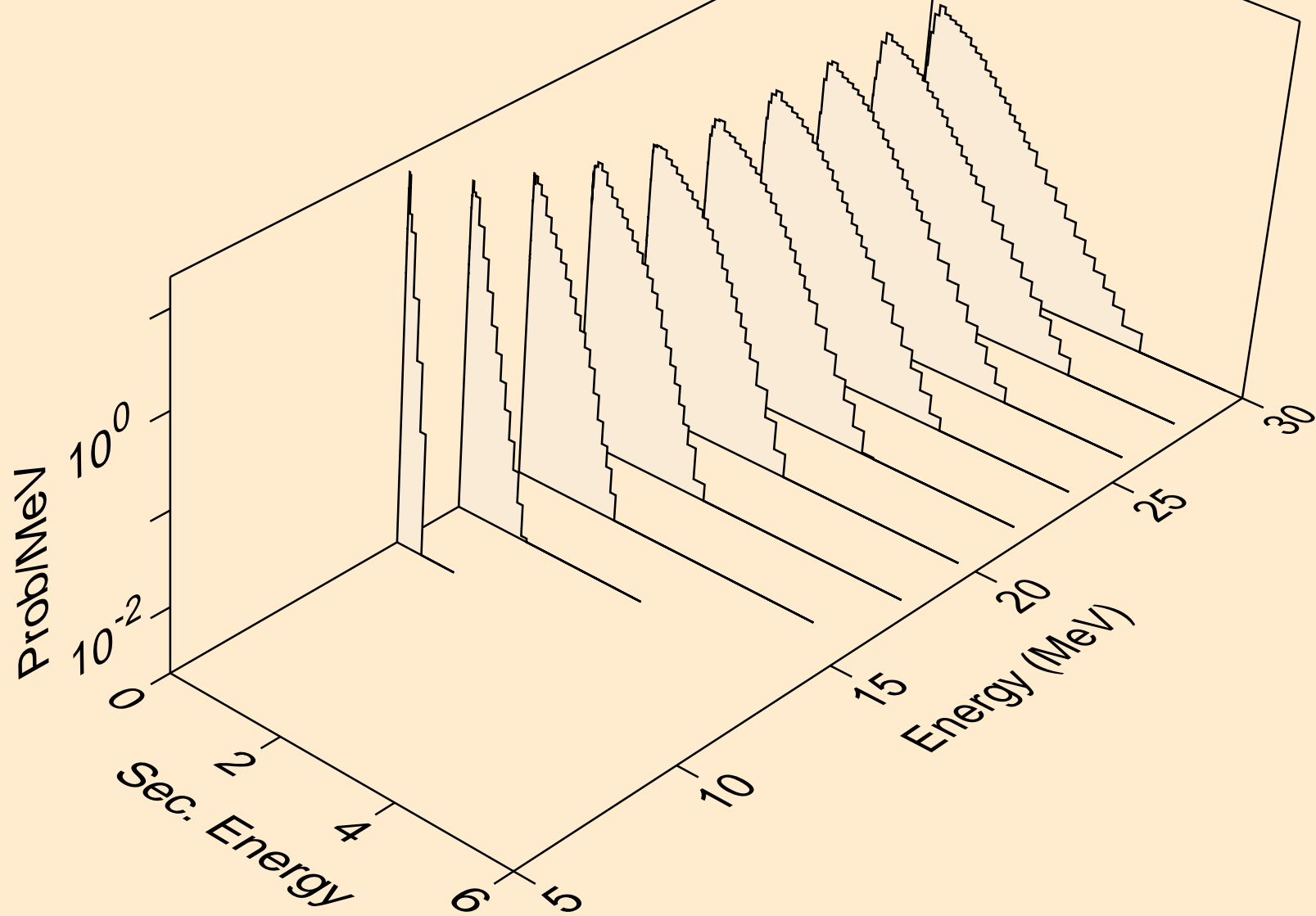

LU176M NEUTRON ACER TENDL-2023 LIBRARY; T=0.K
Neutron emission for (n,n*)t

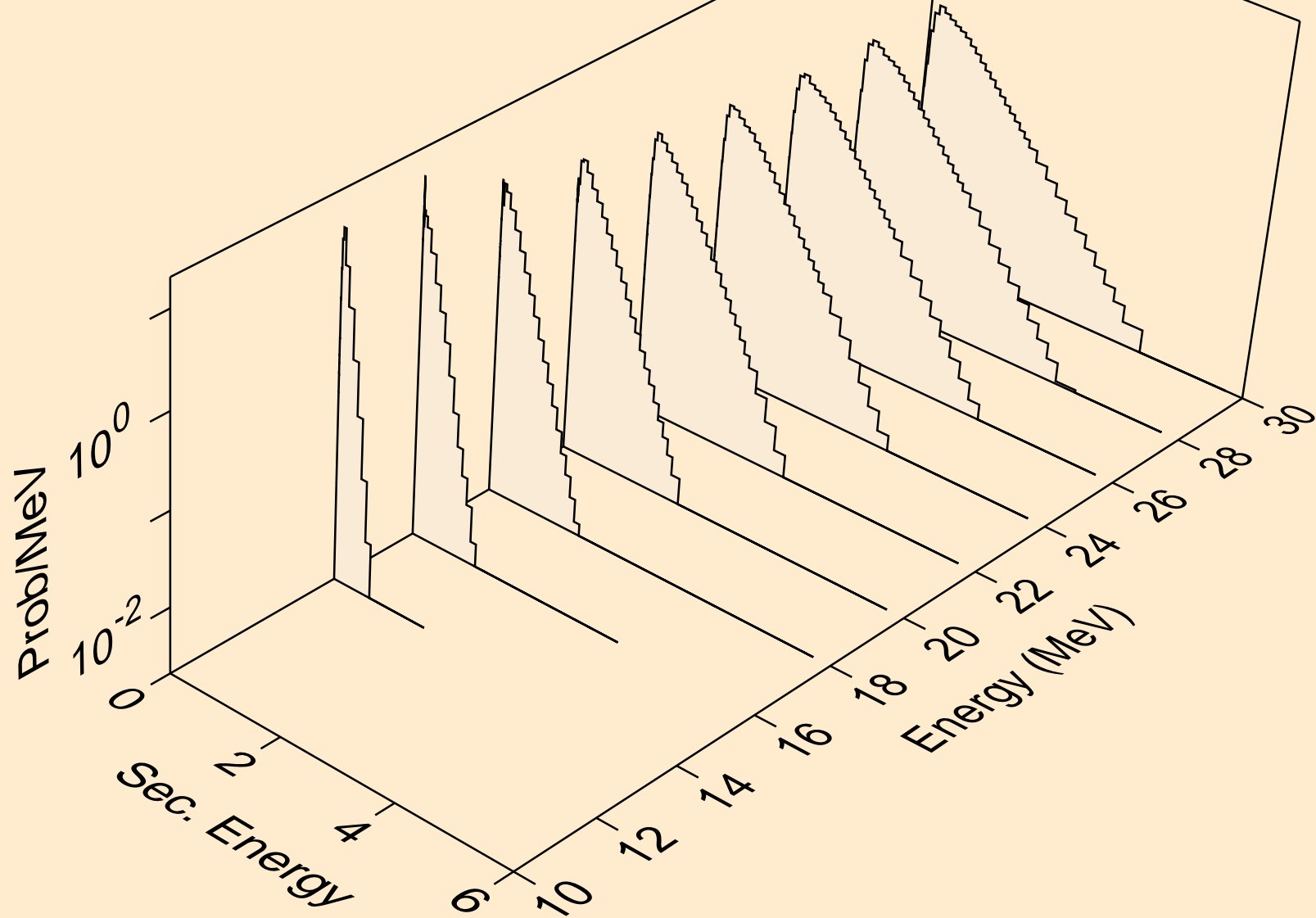

LU176M NEUTRON ACER TENDL-2023 LIBRARY; T=0.K
Neutron emission for (n,n*)he3

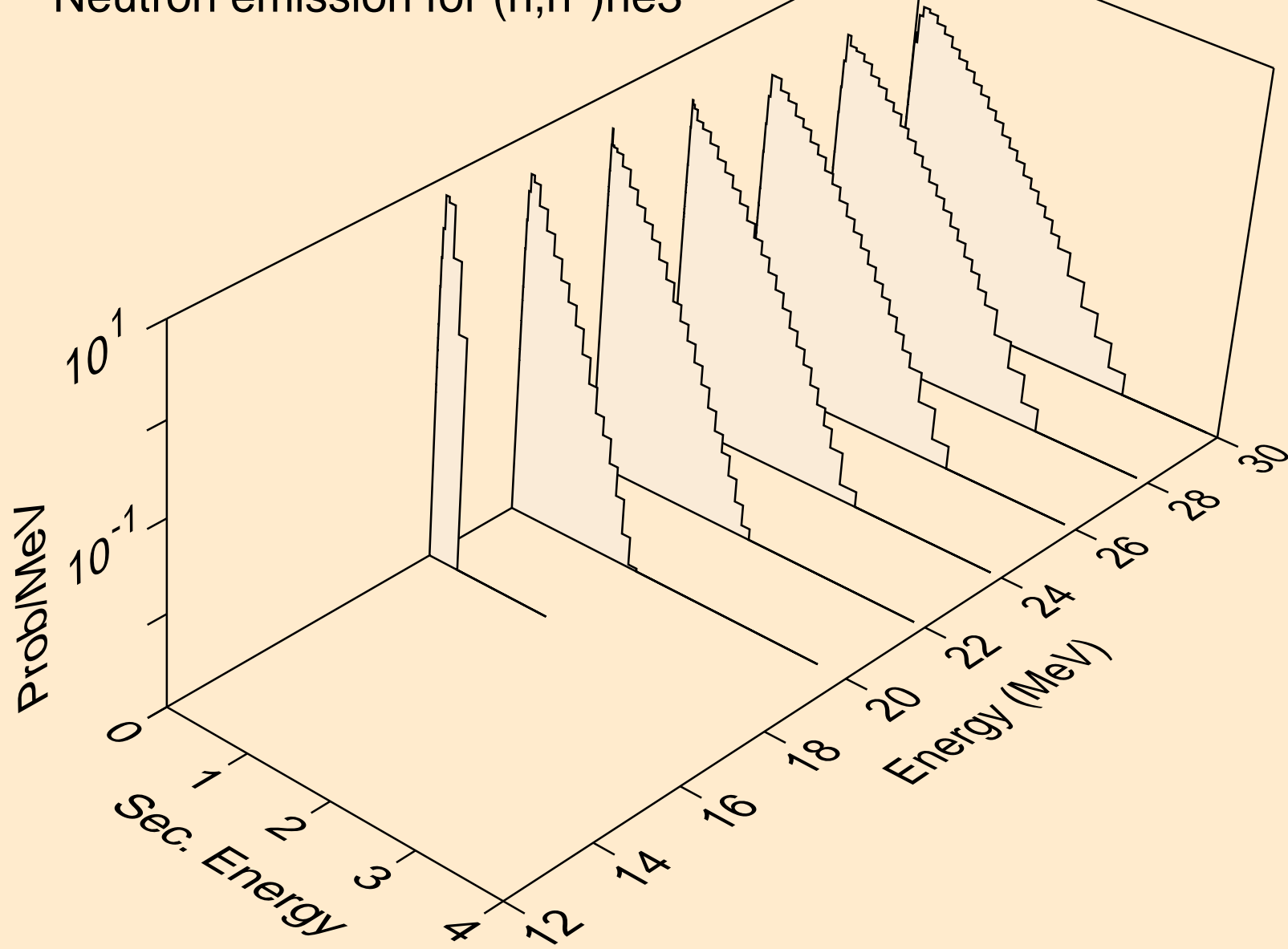

LU176M NEUTRON ACER TENDL-2023 LIBRARY; T=0.K
Neutron emission for (n,4n)

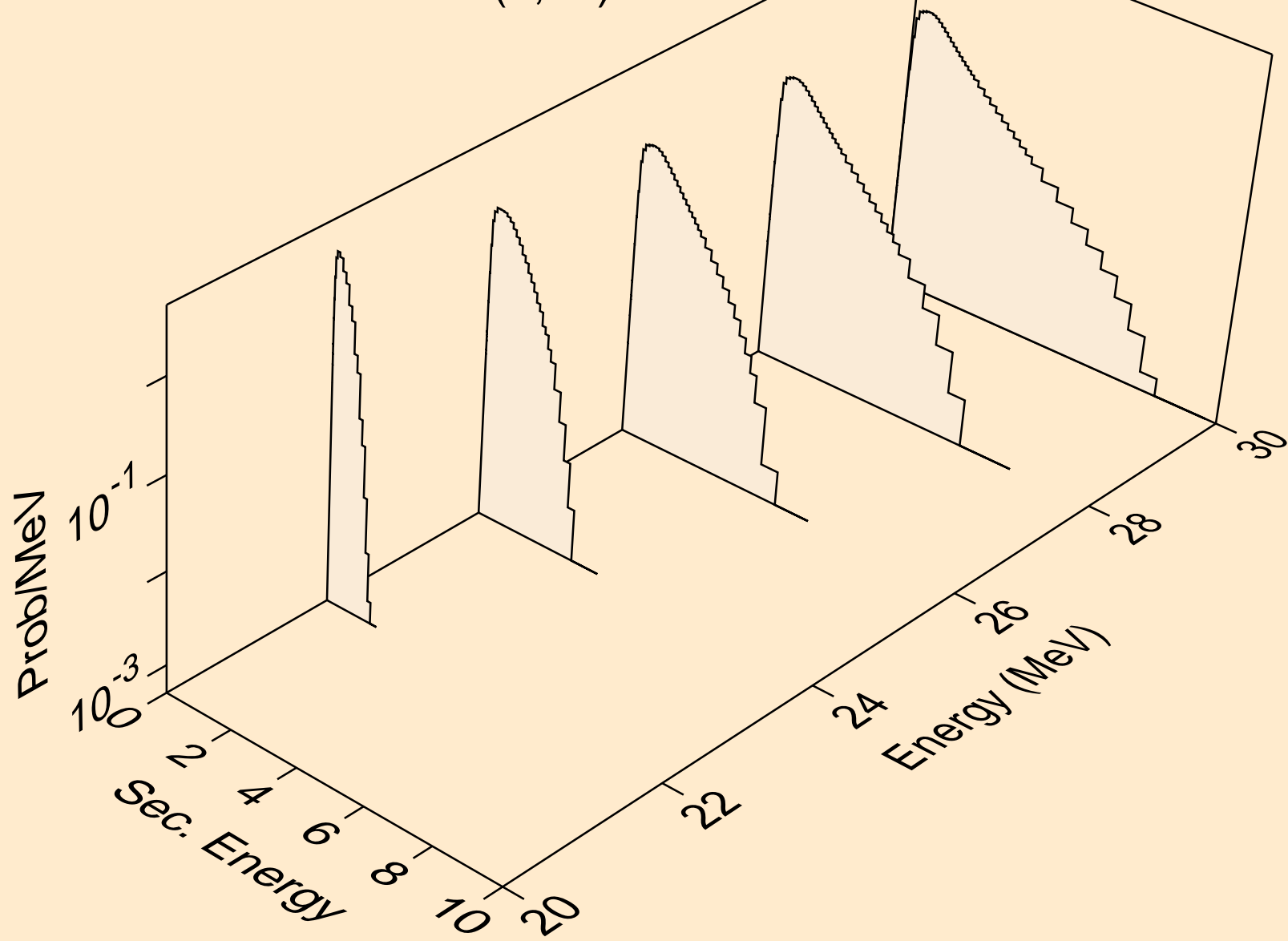

LU176M NEUTRON ACER TENDL-2023 LIBRARY; T=0.K
Neutron emission for (n,2np)

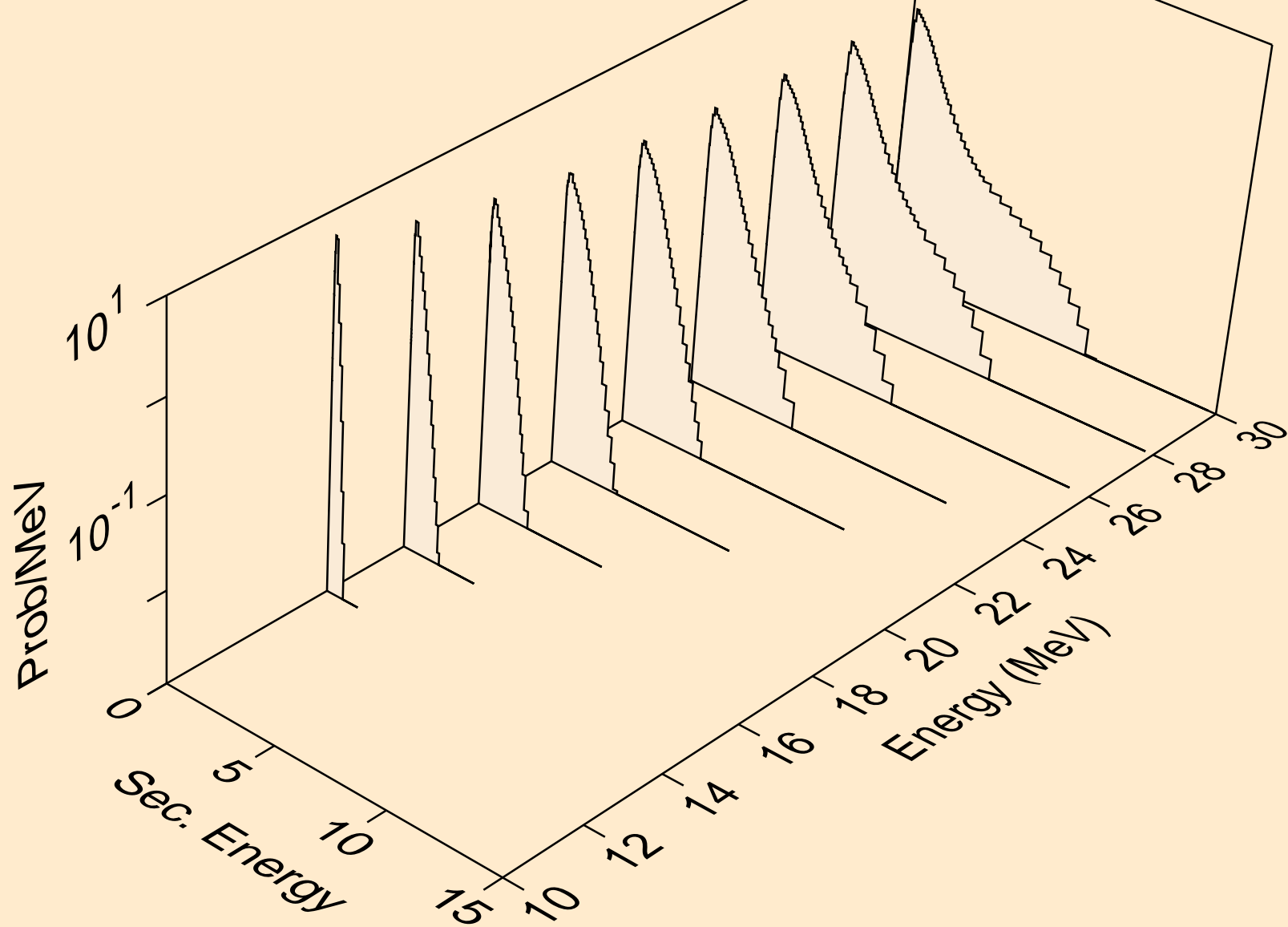

LU176M NEUTRON ACER TENDL-2023 LIBRARY; T=0.K
Neutron emission for (n,3np)

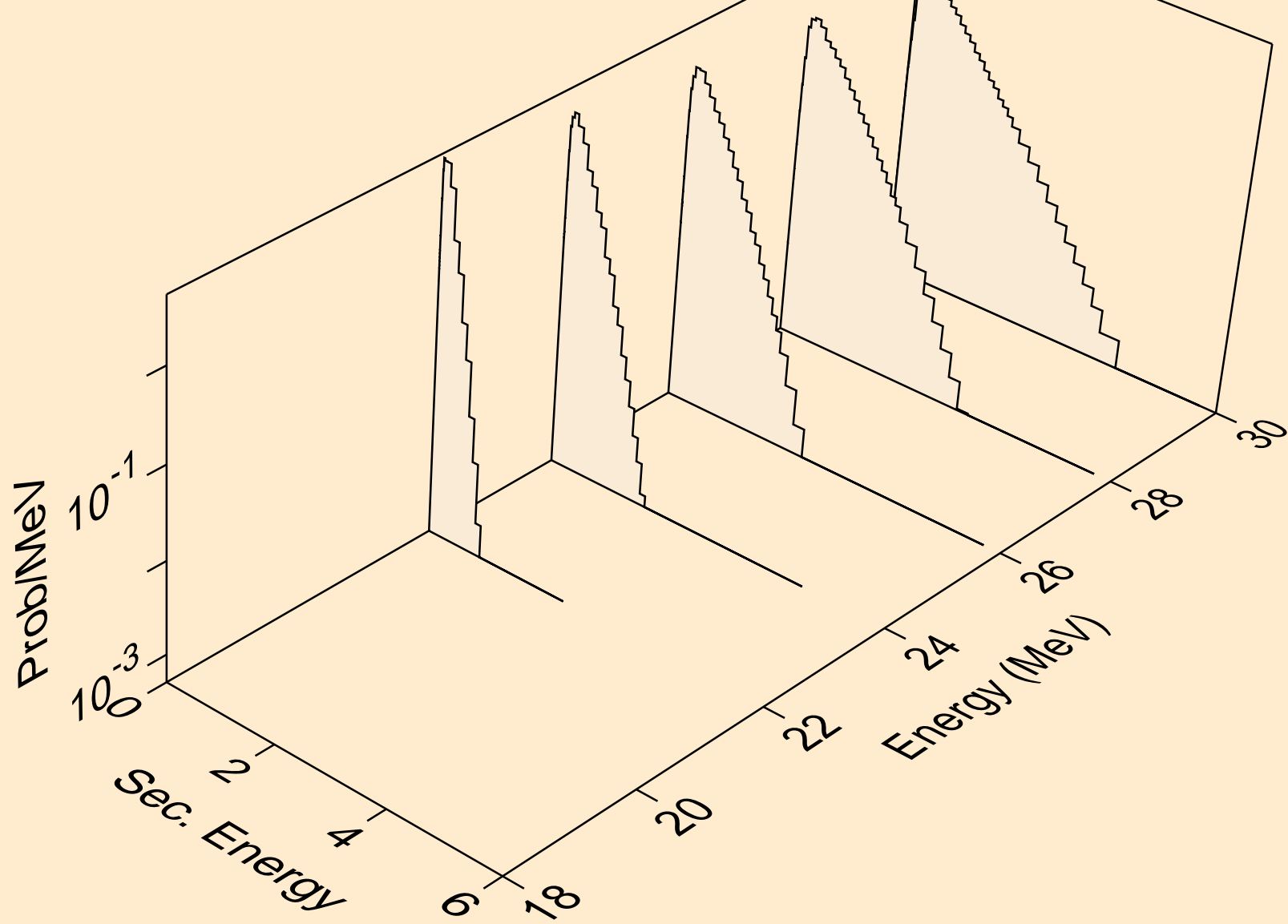

LU176M NEUTRON ACER TENDL-2023 LIBRARY; T=0.K
Neutron emission for (n,n2p)

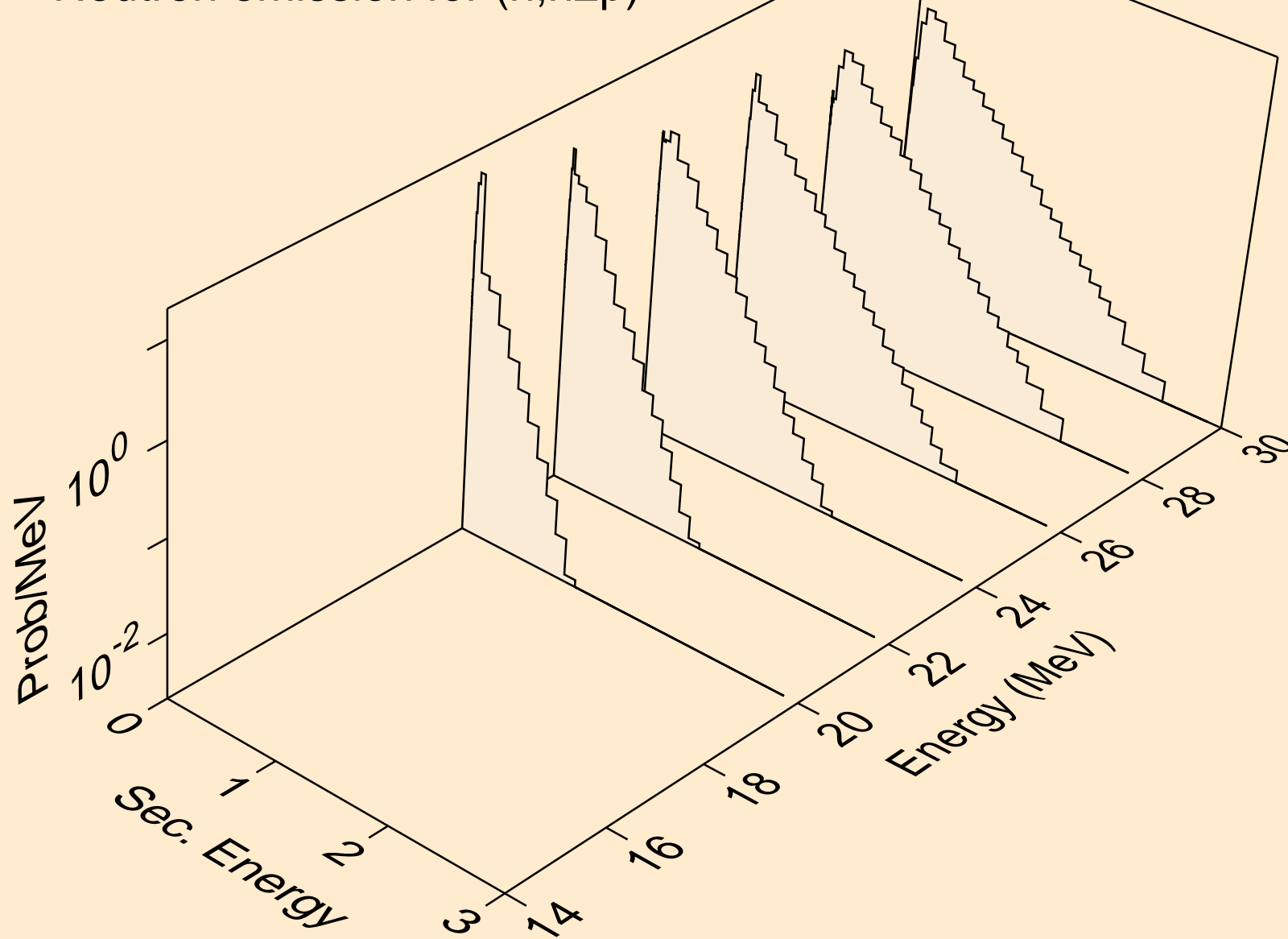

LU176M NEUTRON ACER TENDL-2023 LIBRARY; T=0.K
Neutron emission for (n,npa)

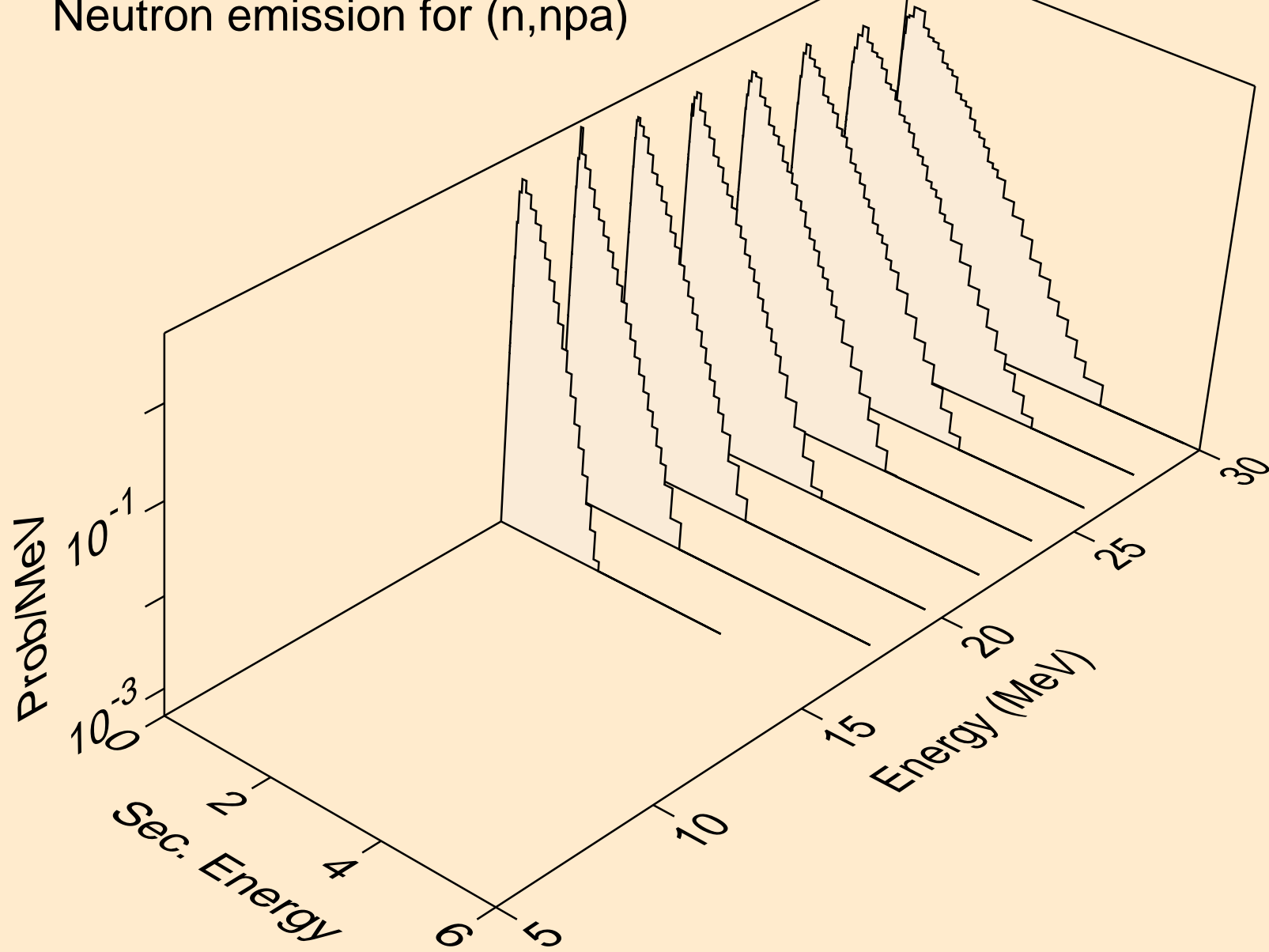

LU176M NEUTRON ACER TENDL-2023 LIBRARY; T=0.K
Neutron emission for (n,n*c)

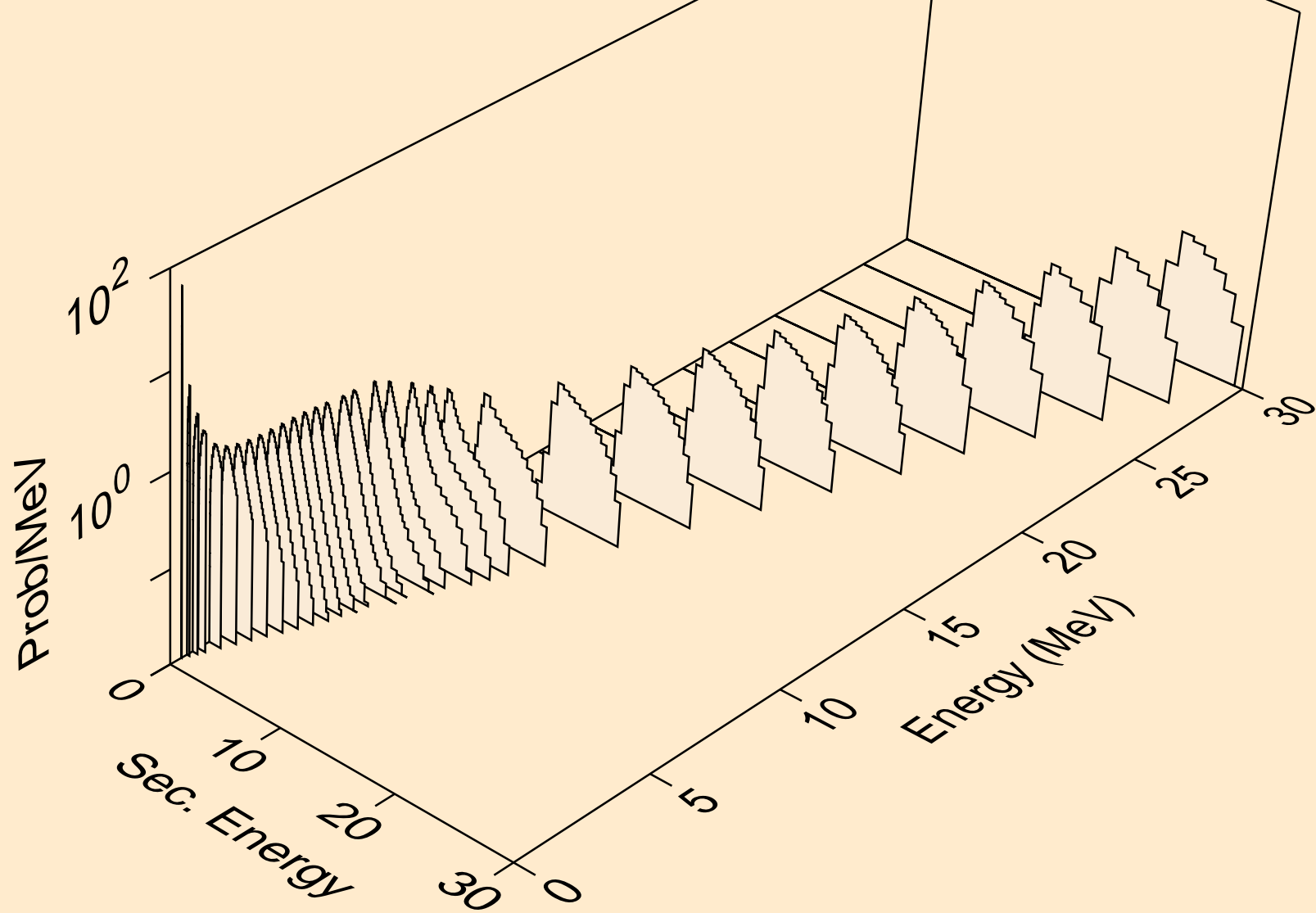

LU176M NEUTRON ACER TENDL-2023 LIBRARY; T=0.K
Photon emission for (n,x)

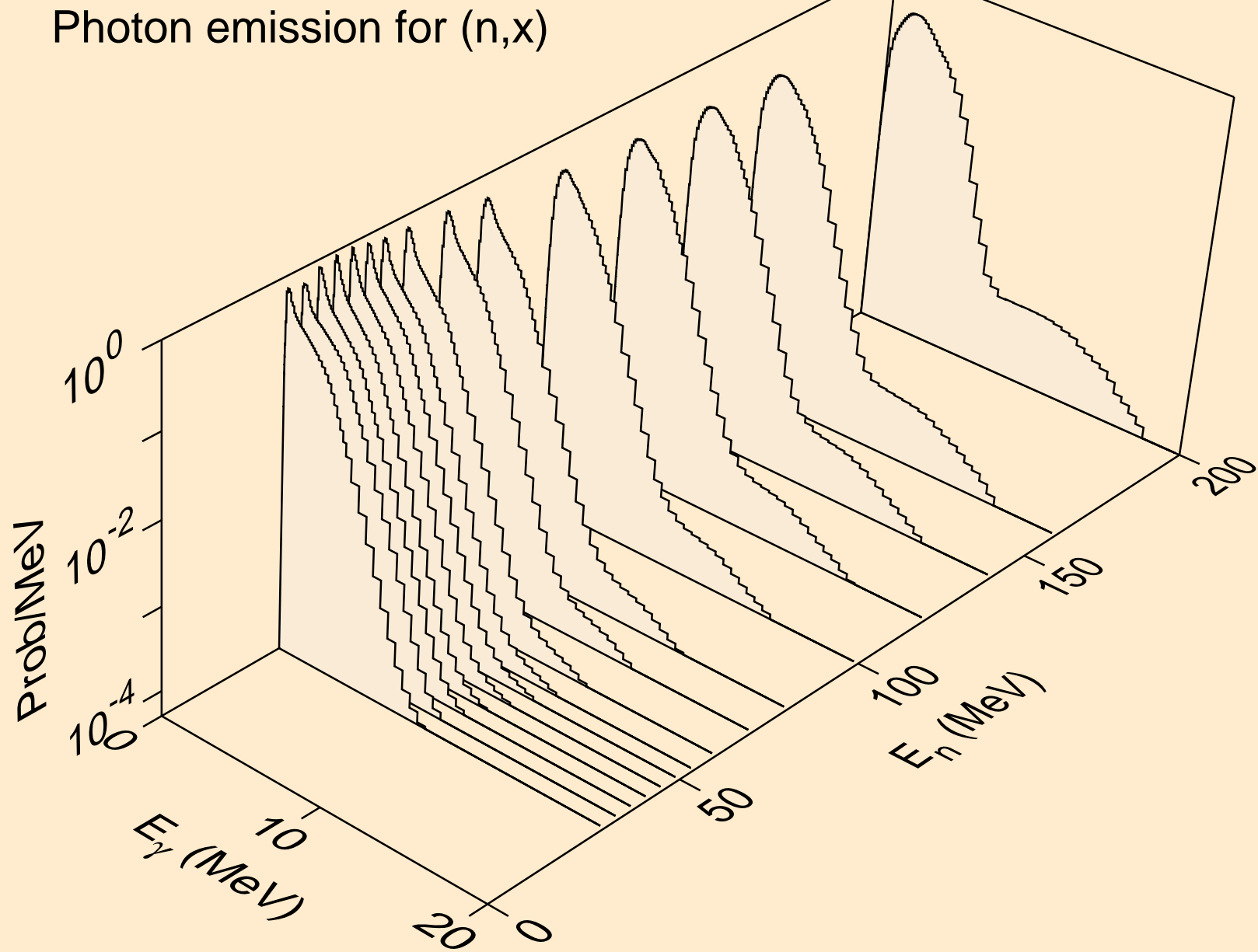

LU176M NEUTRON ACER TENDL-2023 LIBRARY; T=0.K
Photon emission for (n,2nd)

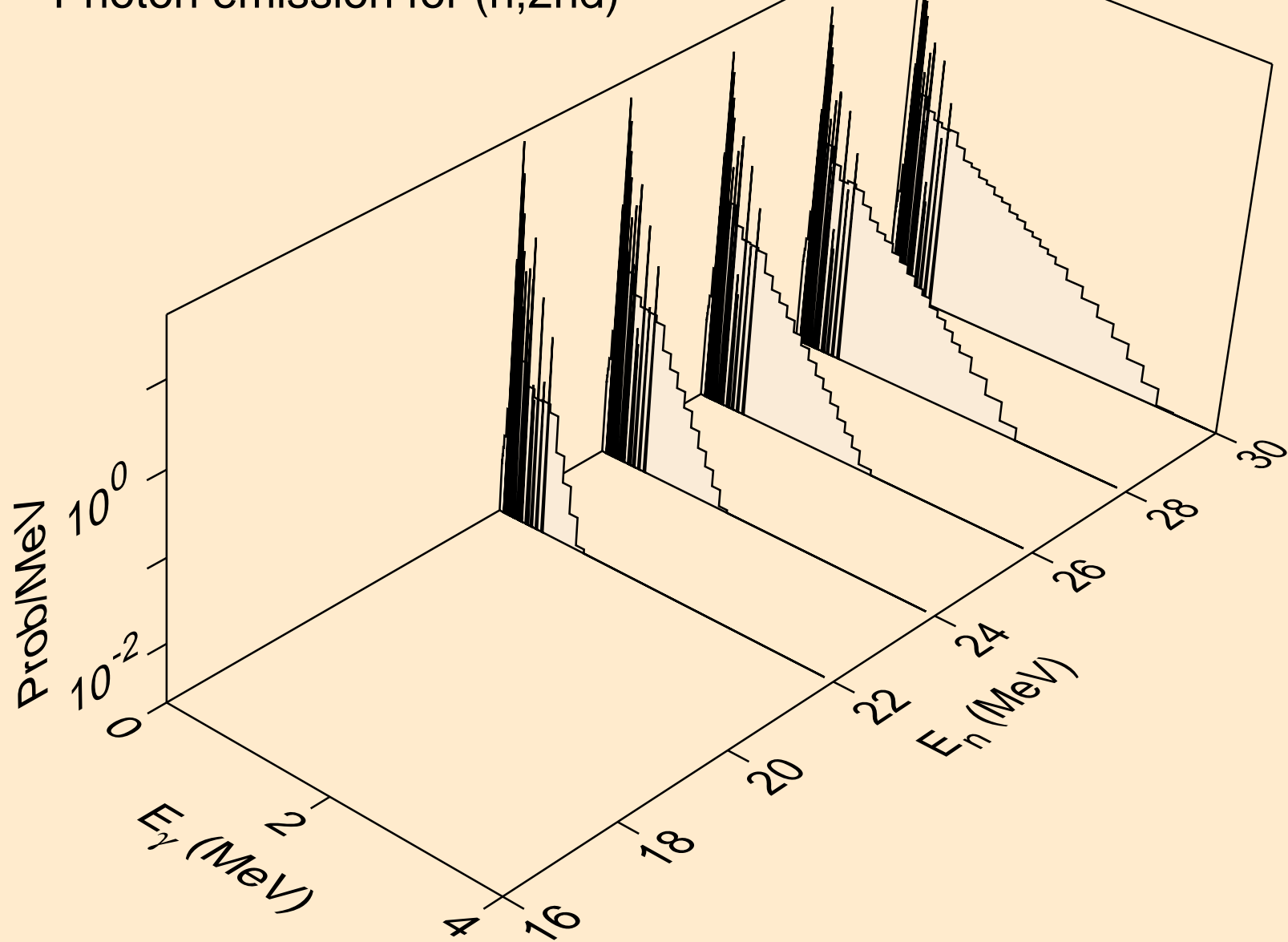

LU176M NEUTRON ACER TENDL-2023 LIBRARY; T=0.K
Photon emission for (n,2n)

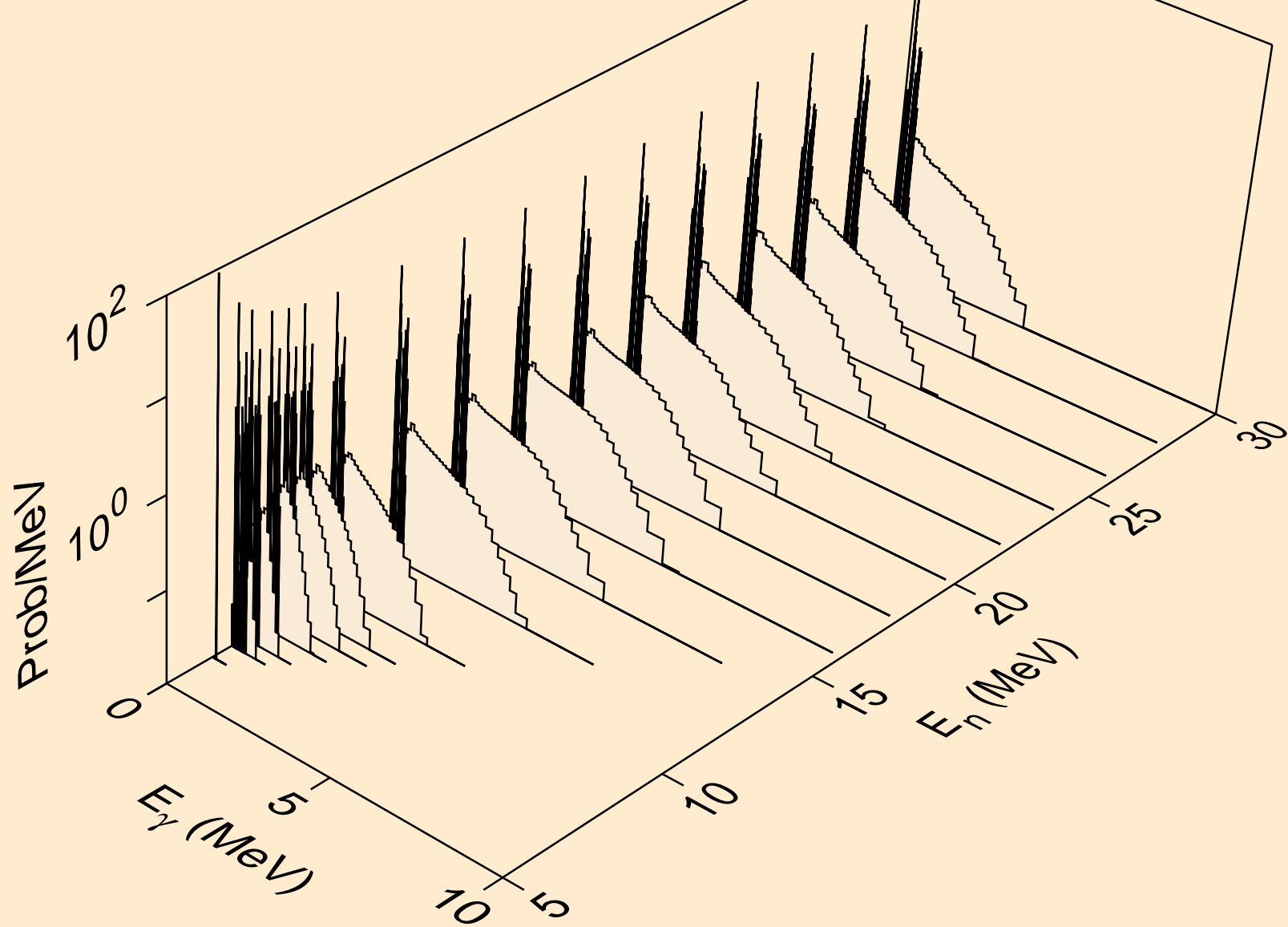

LU176M NEUTRON ACER TENDL-2023 LIBRARY; T=0.K
Photon emission for (n,3n)

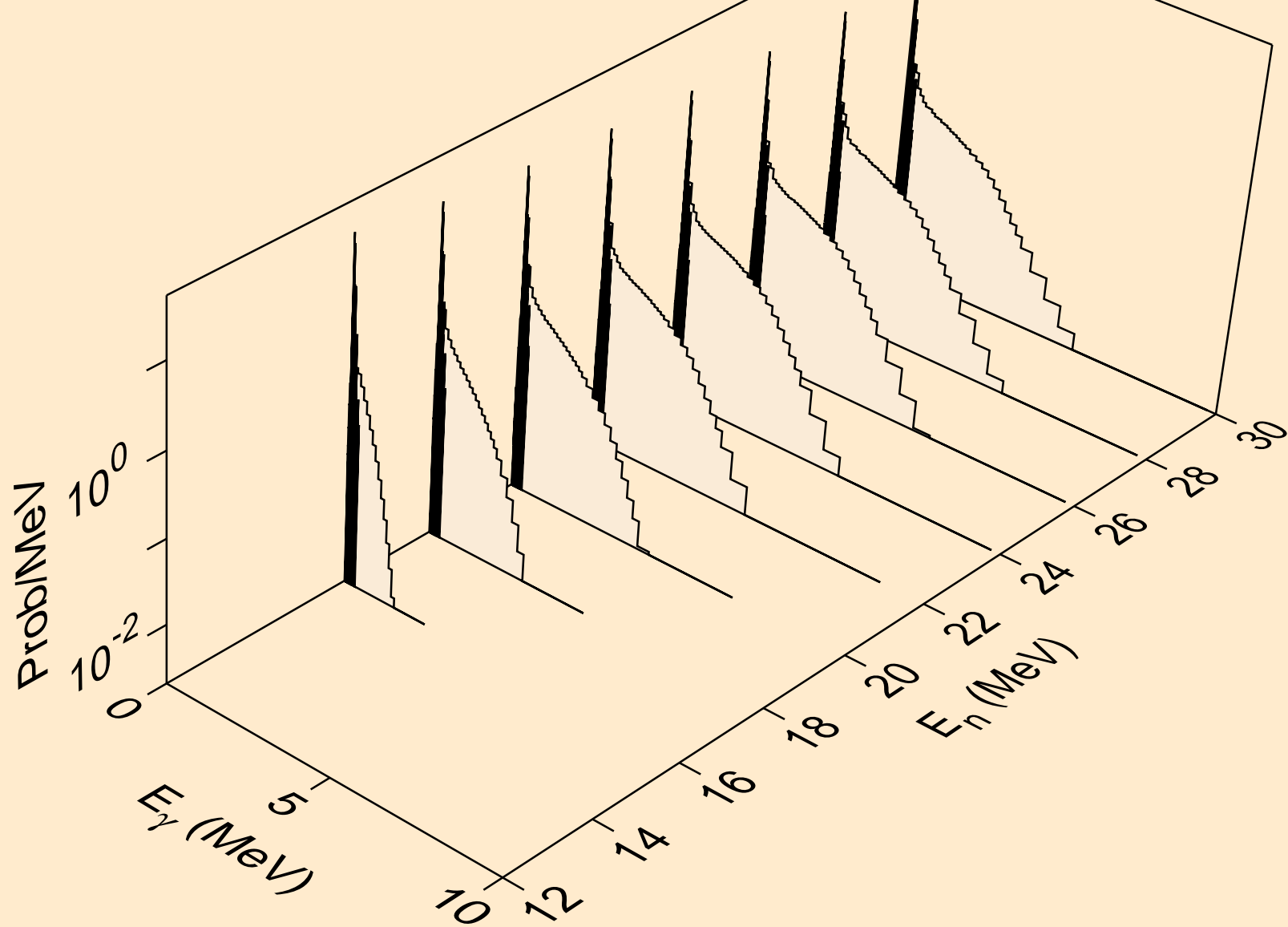

LU176M NEUTRON ACER TENDL-2023 LIBRARY; T=0.K
Photon emission for (n,n*)a

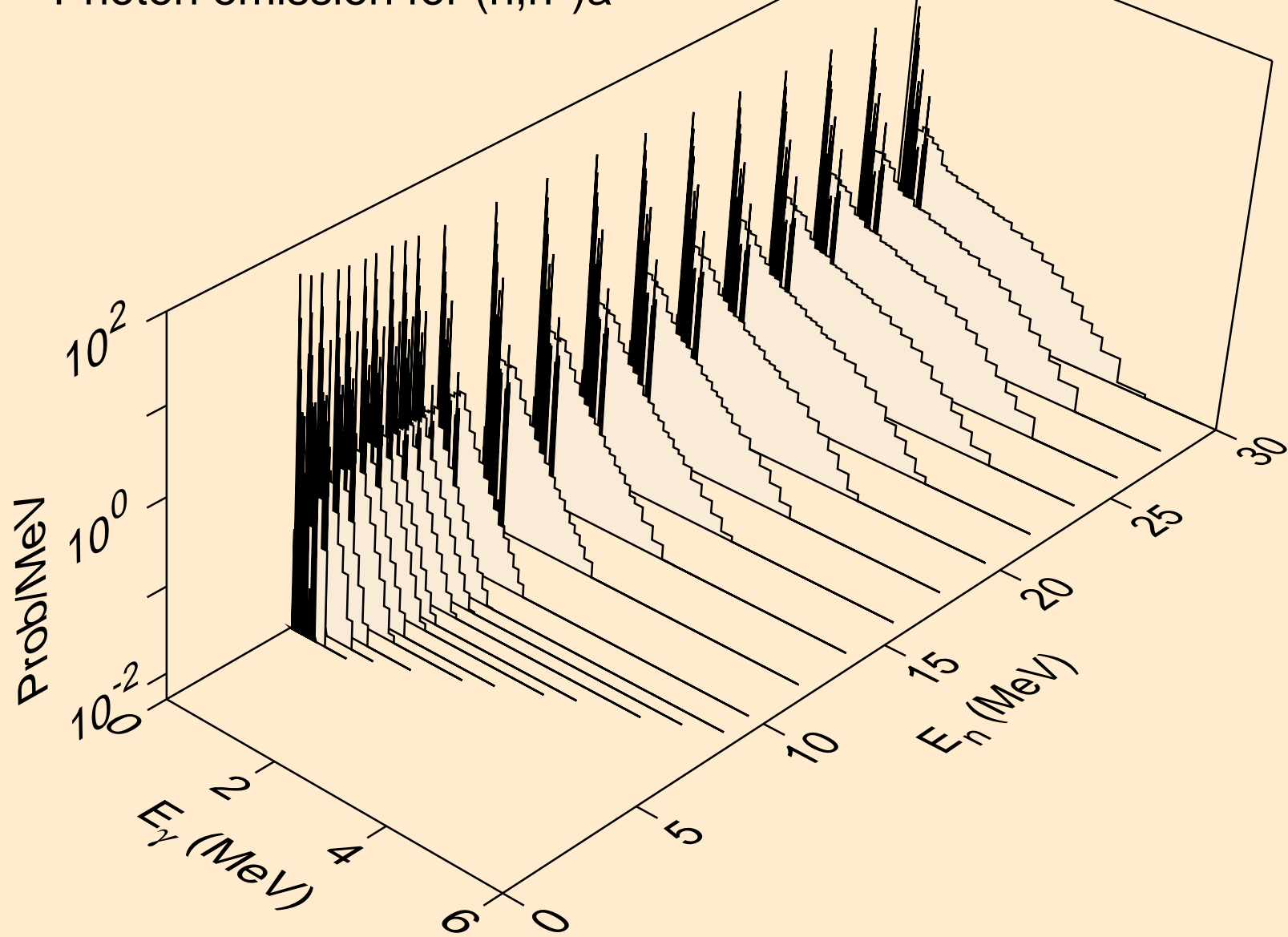

LU176M NEUTRON ACER TENDL-2023 LIBRARY; T=0.K
Photon emission for (n,2n)a

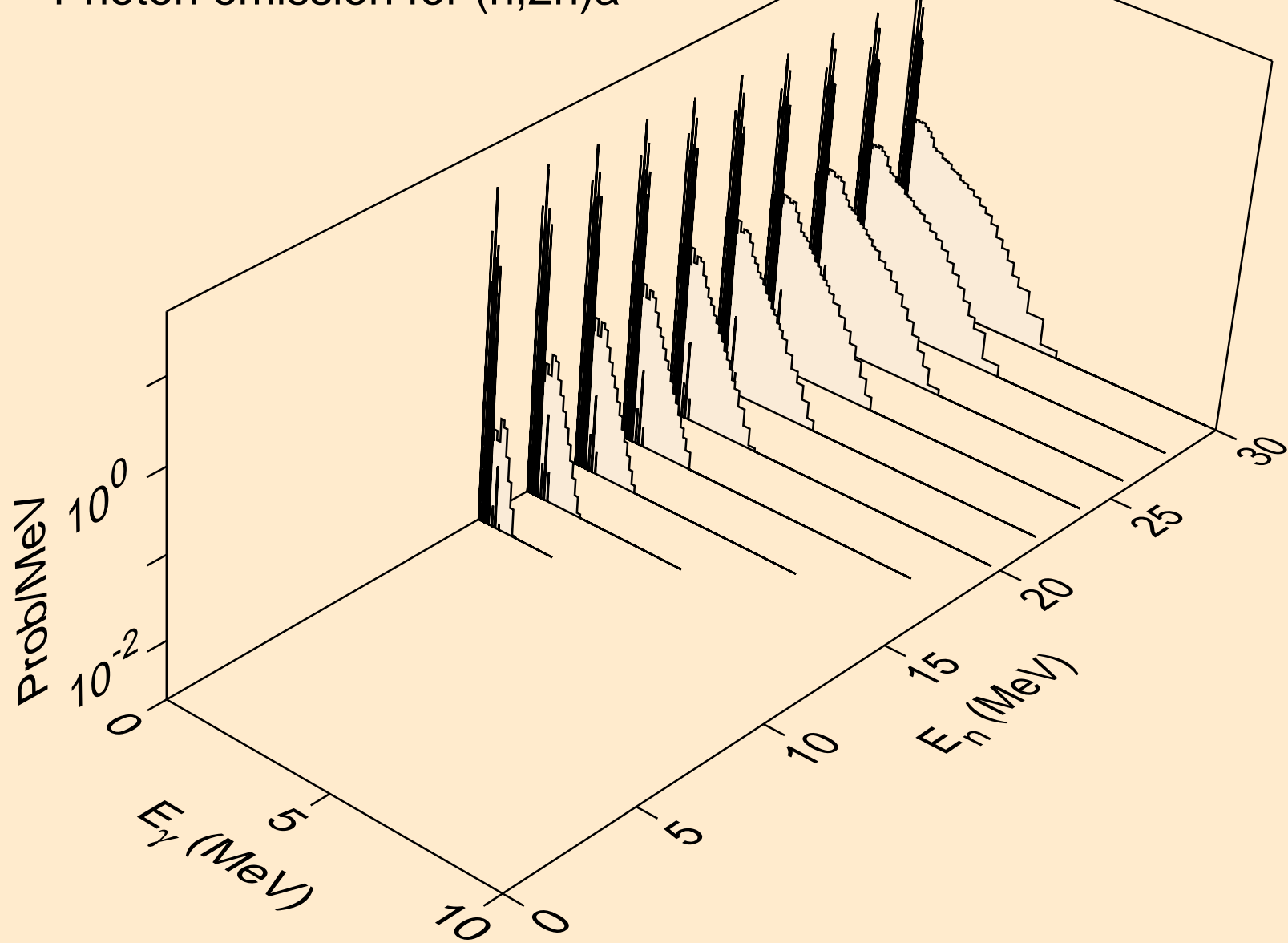

LU176M NEUTRON ACER TENDL-2023 LIBRARY; T=0.K
Photon emission for (n,3n)a

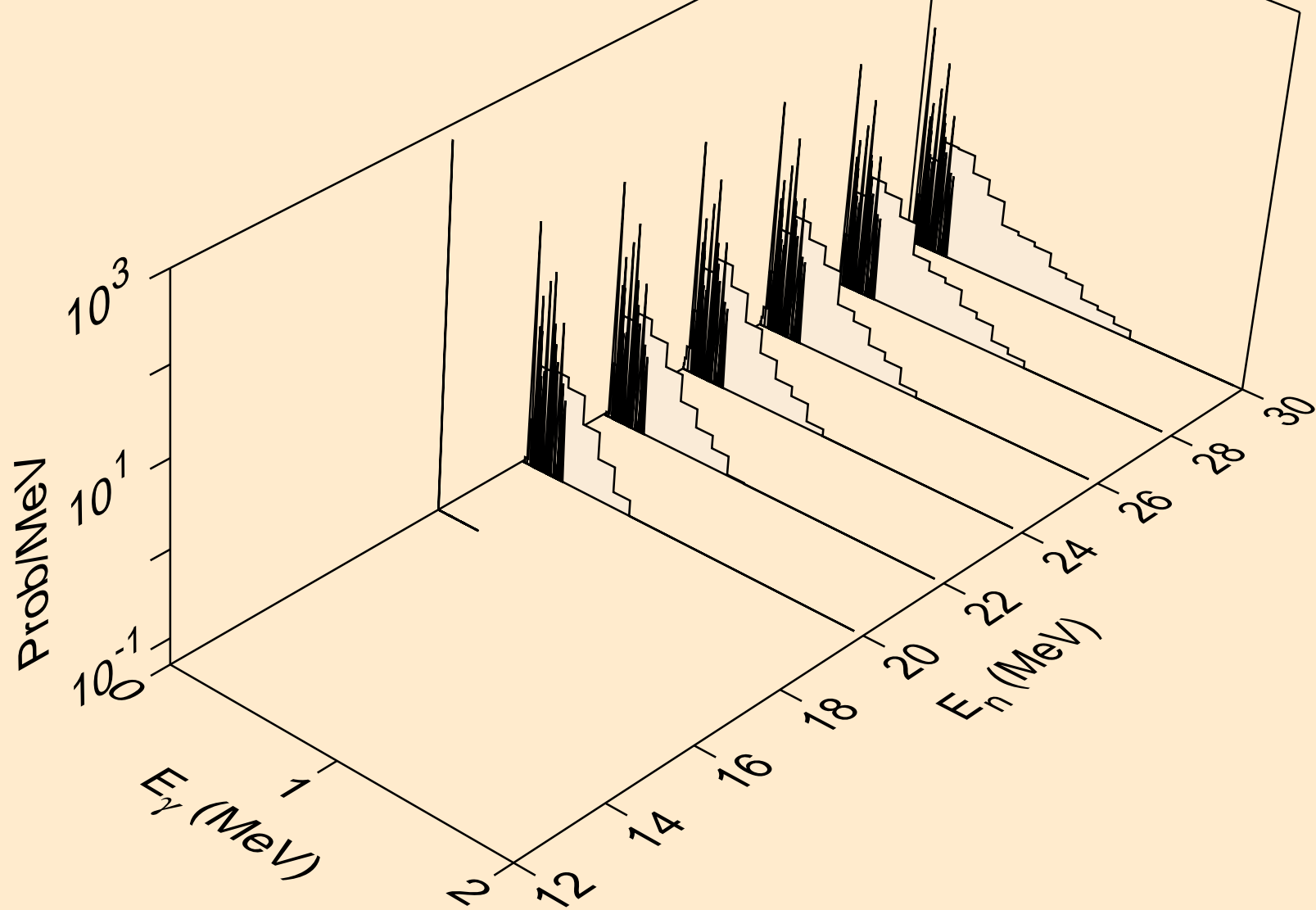

LU176M NEUTRON ACER TENDL-2023 LIBRARY; T=0.K
Photon emission for (n,n*)p

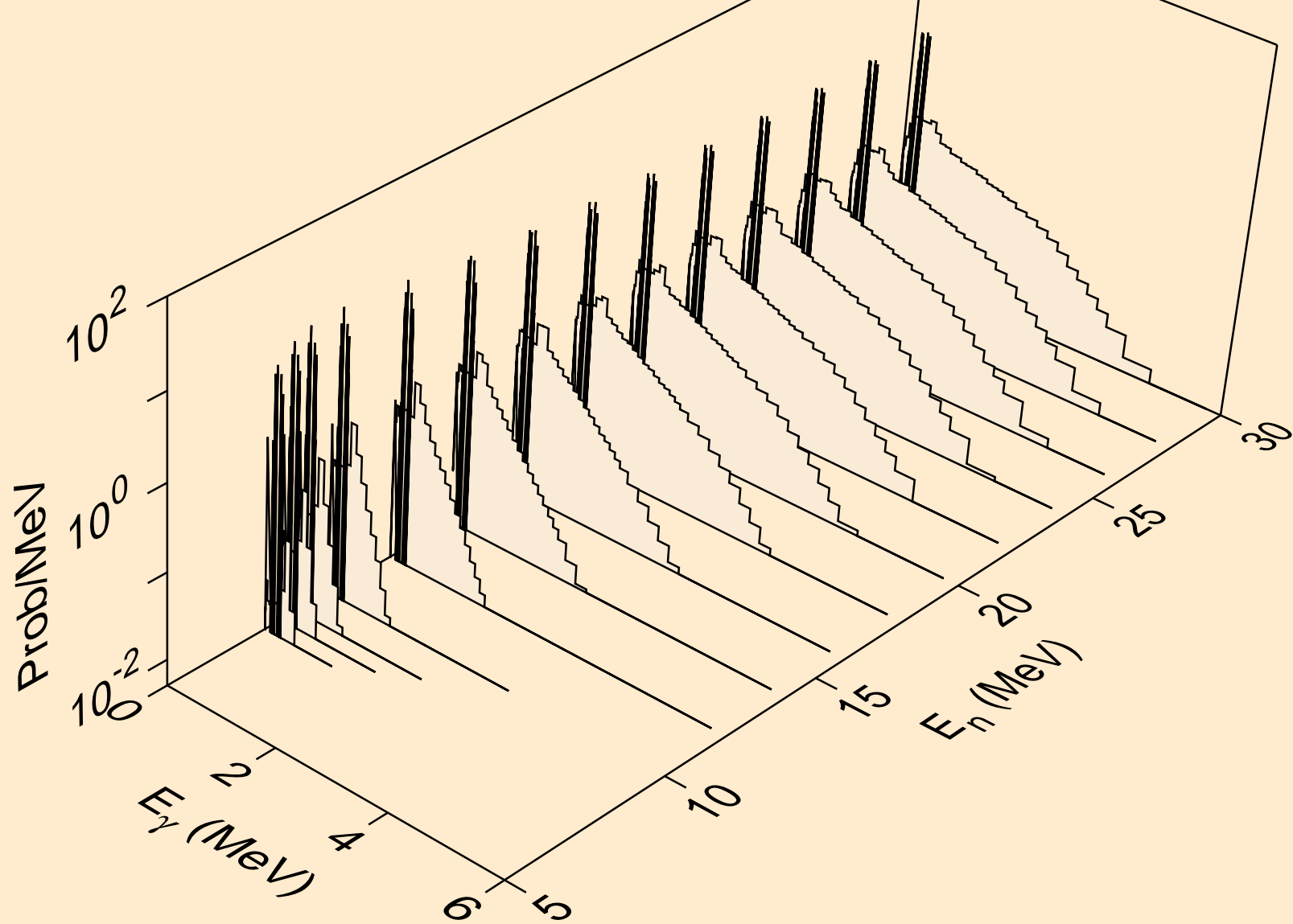

LU176M NEUTRON ACER TENDL-2023 LIBRARY; T=0.K
Photon emission for (n,n*)2a

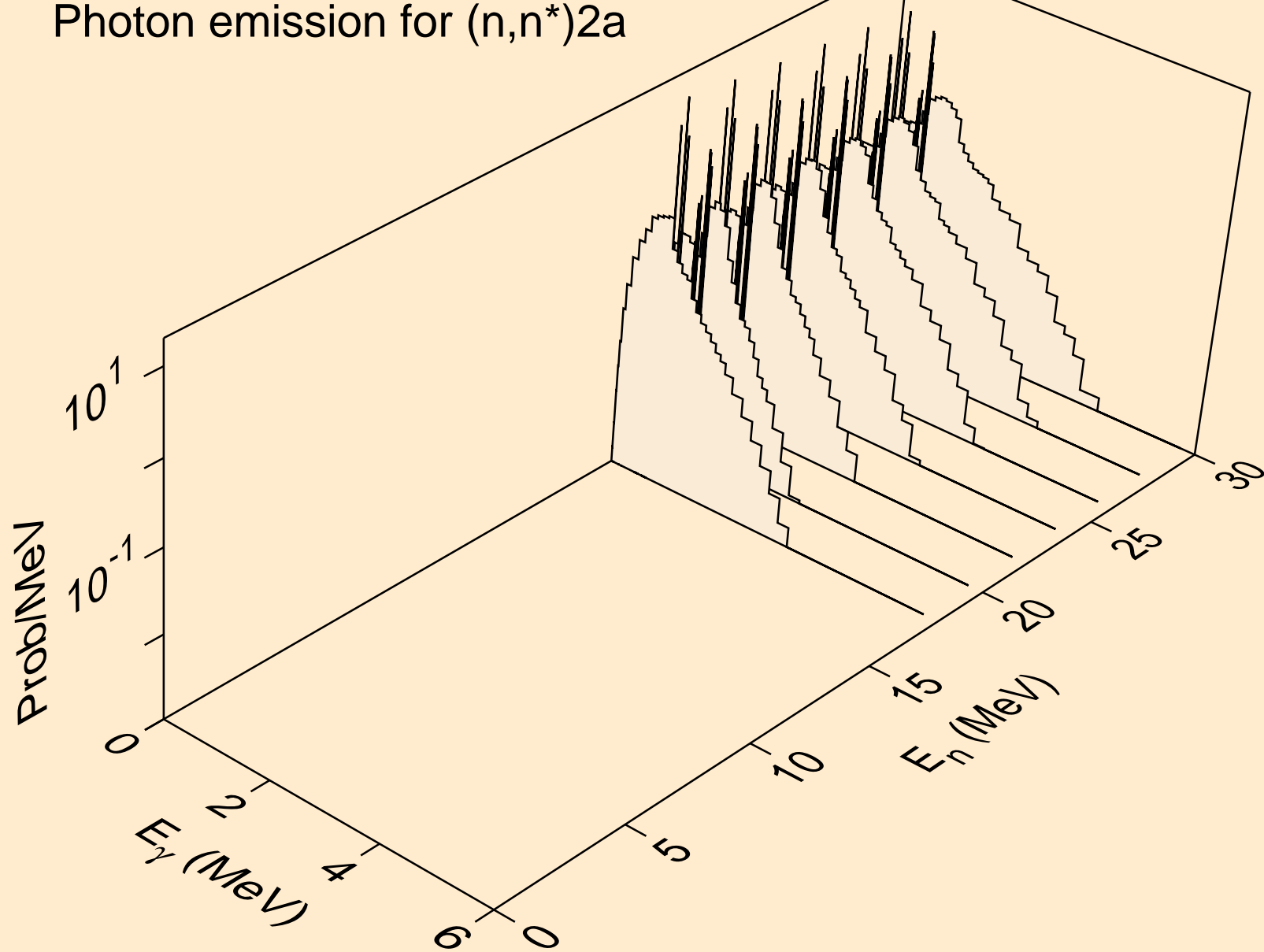

LU176M NEUTRON ACER TENDL-2023 LIBRARY; T=0.K
Photon emission for (n,n*)d

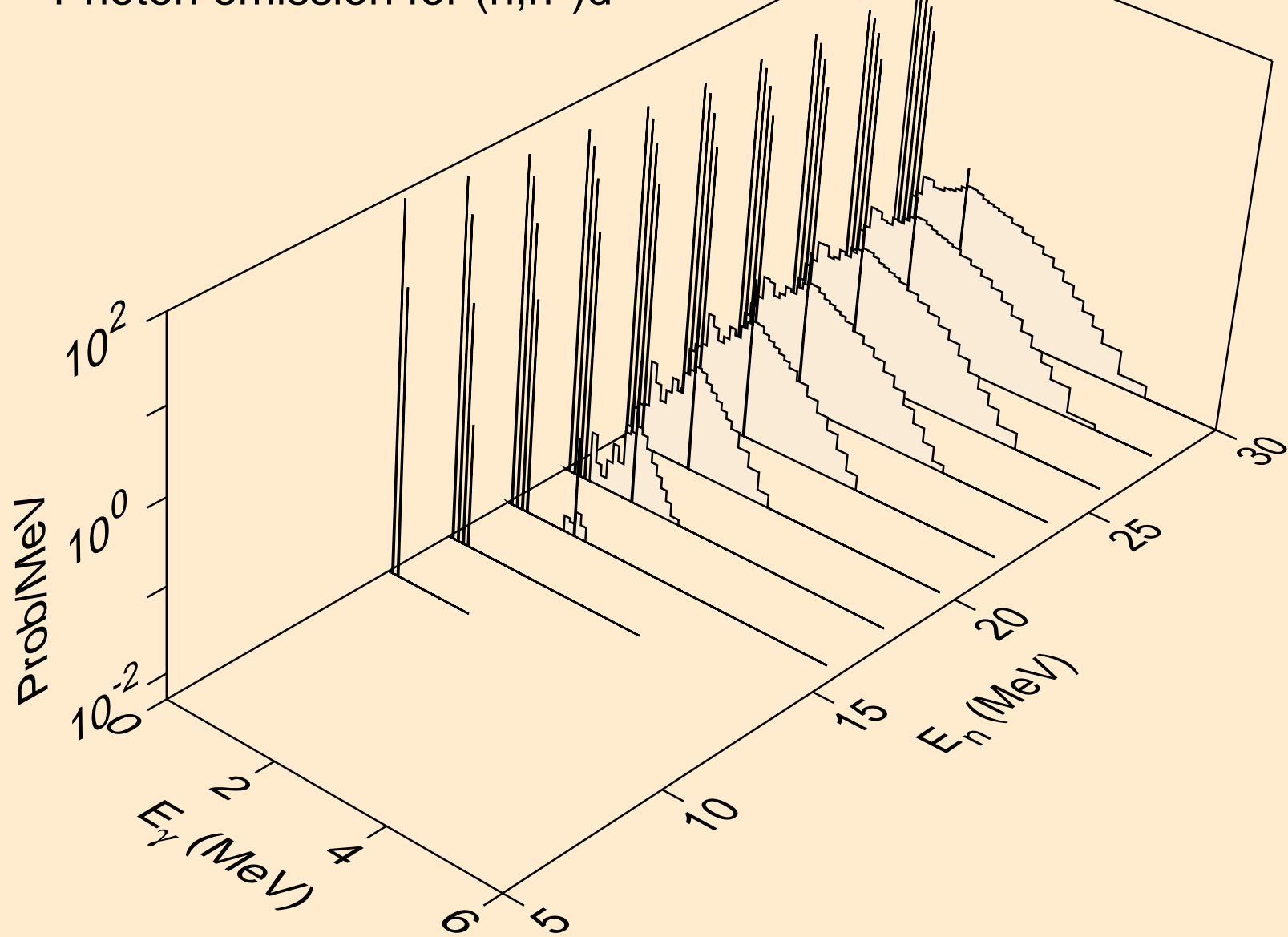

LU176M NEUTRON ACER TENDL-2023 LIBRARY; T=0.K
Photon emission for (n,n*)t

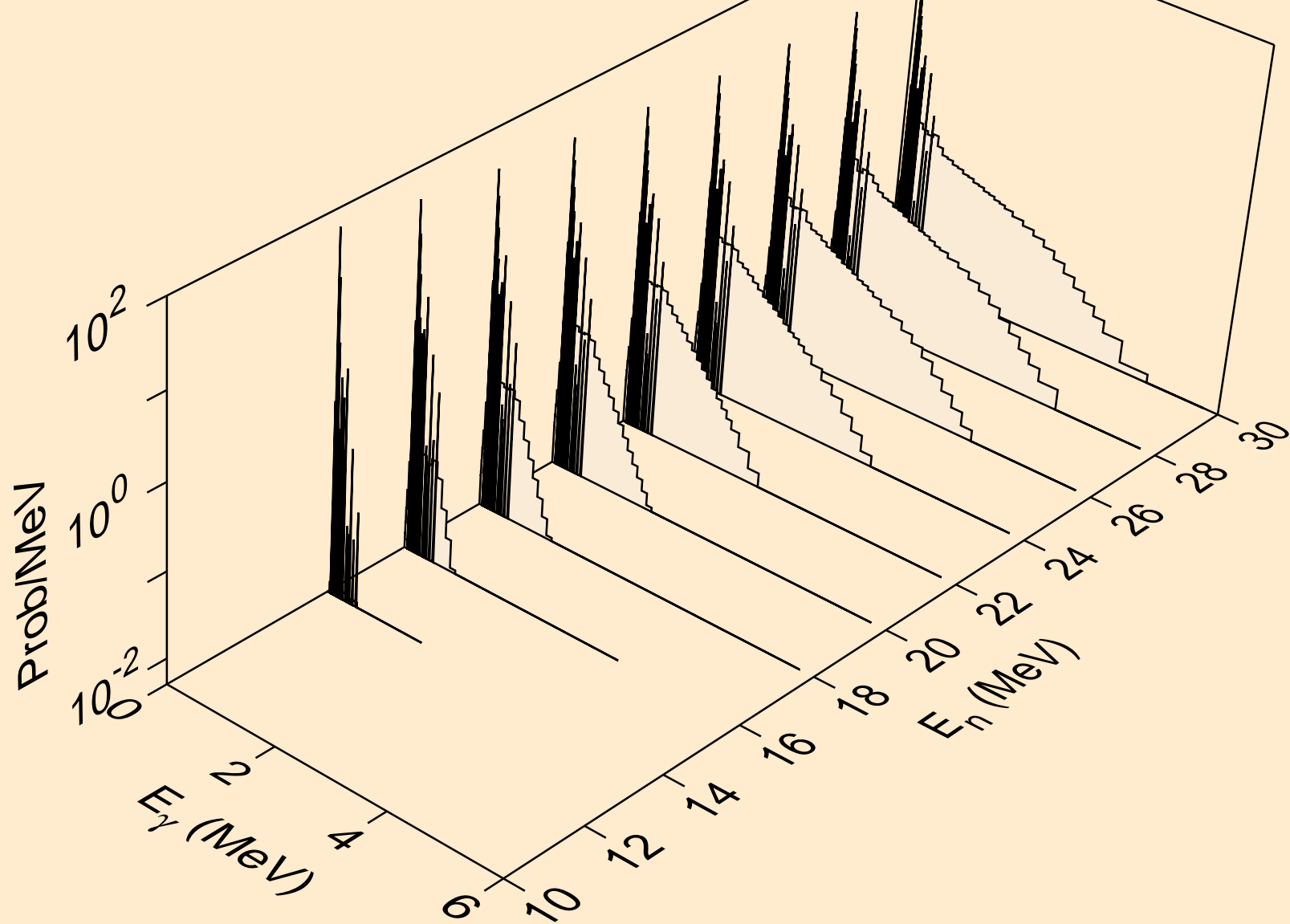

LU176M NEUTRON ACER TENDL-2023 LIBRARY; T=0.K
Photon emission for (n,n*)he3

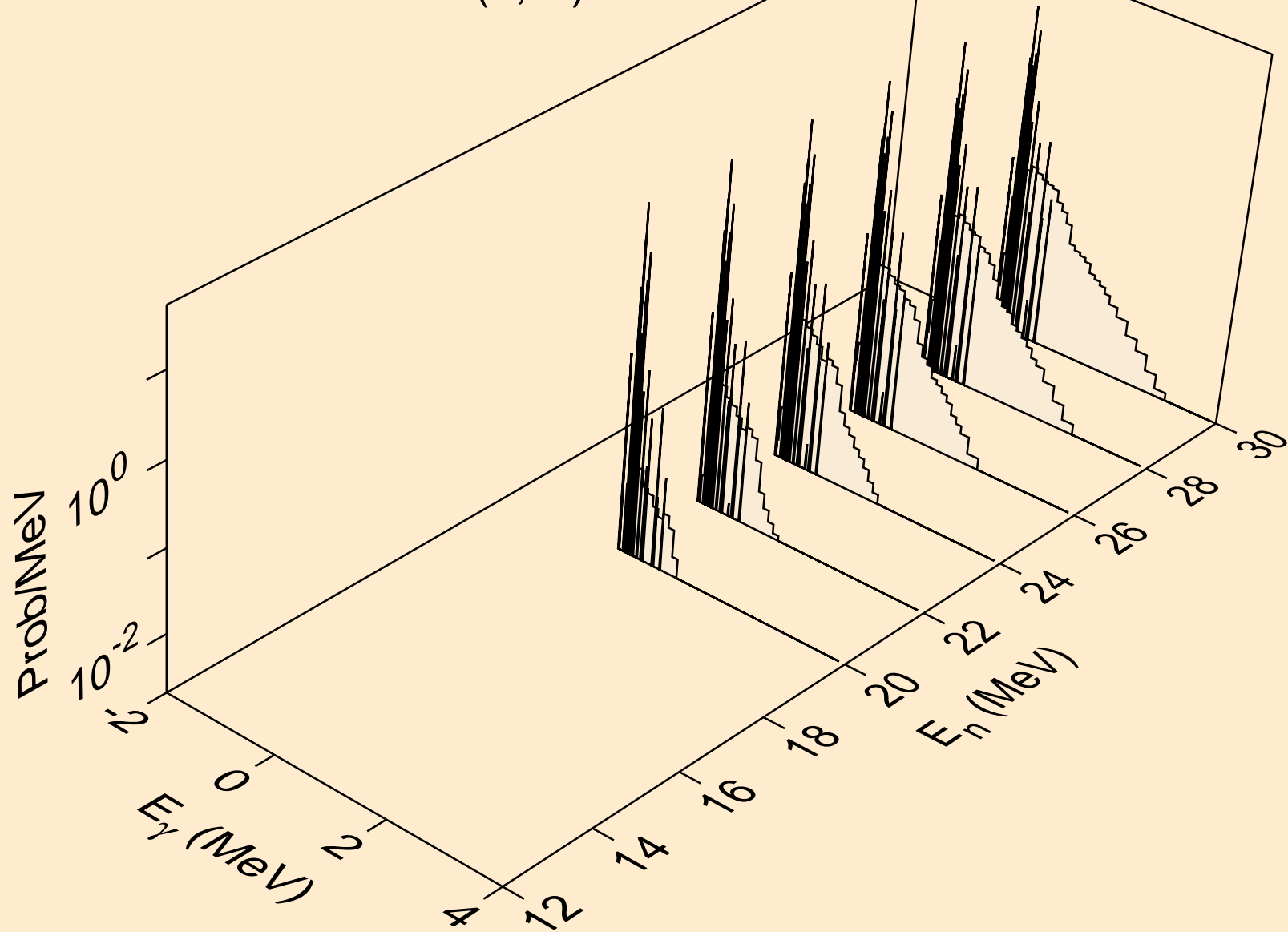

LU176M NEUTRON ACER TENDL-2023 LIBRARY; T=0.K
Photon emission for (n,4n)

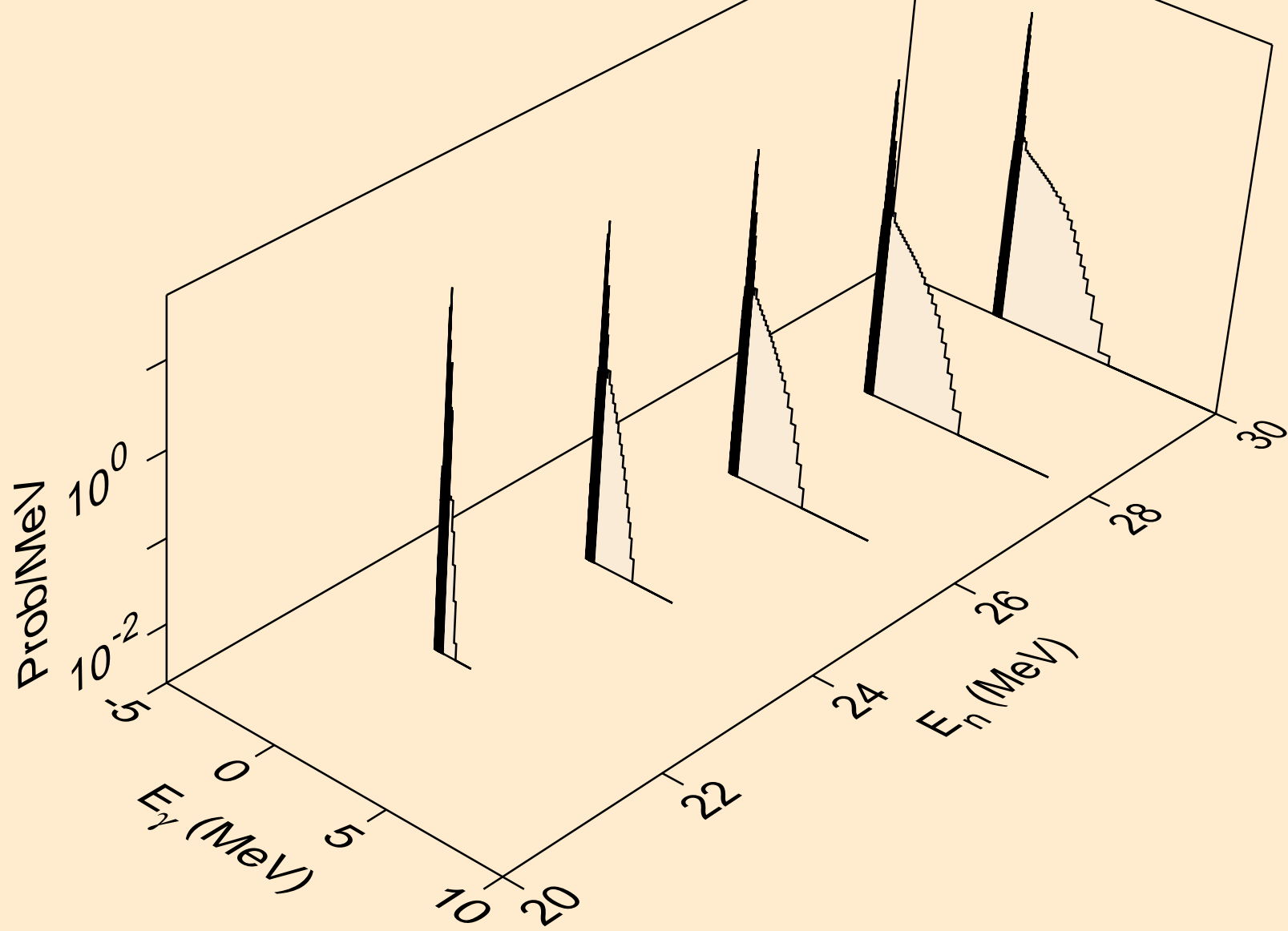

LU176M NEUTRON ACER TENDL-2023 LIBRARY; T=0.K
Photon emission for (n,2np)

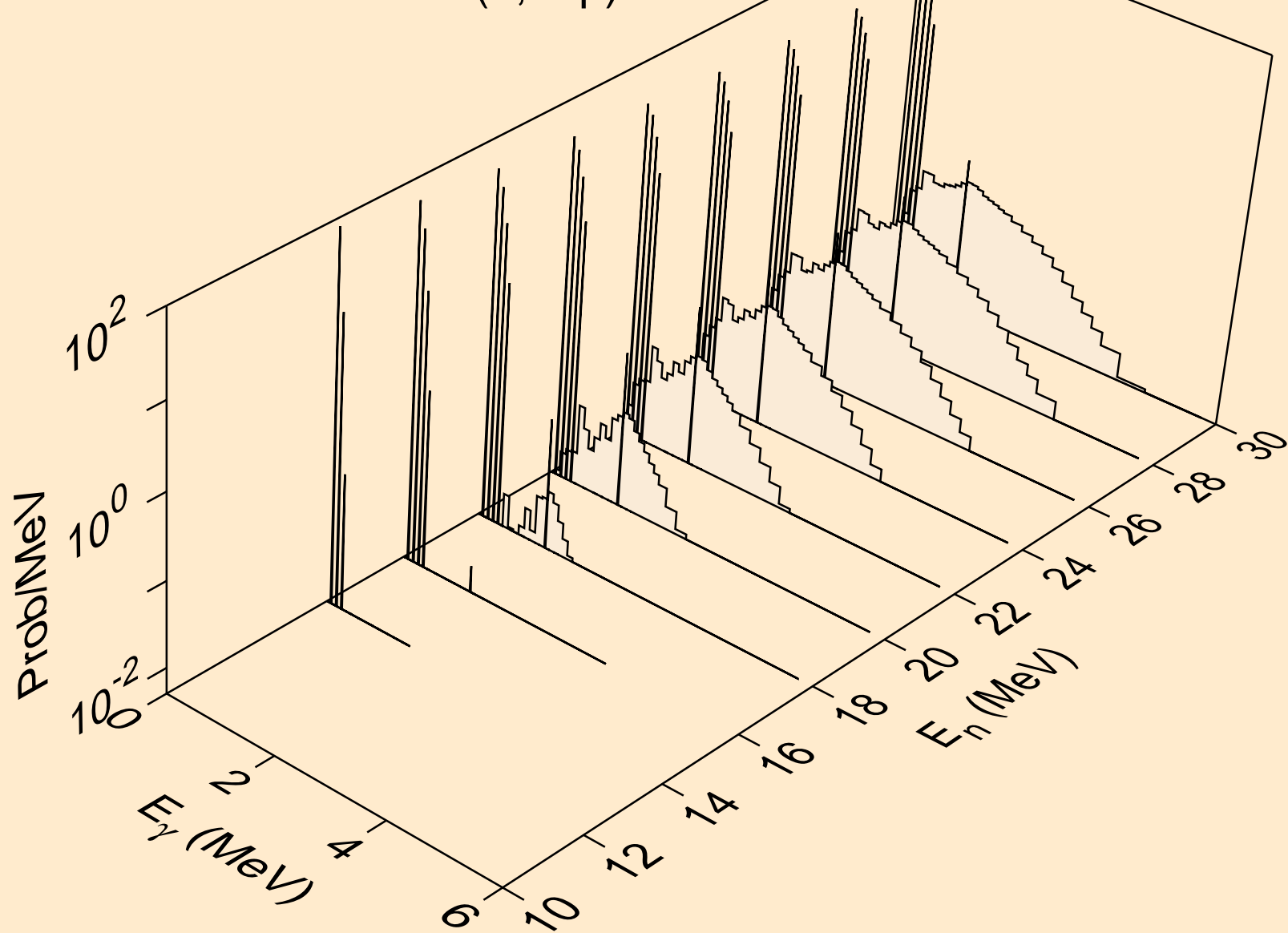

LU176M NEUTRON ACER TENDL-2023 LIBRARY; T=0.K
Photon emission for (n,3np)

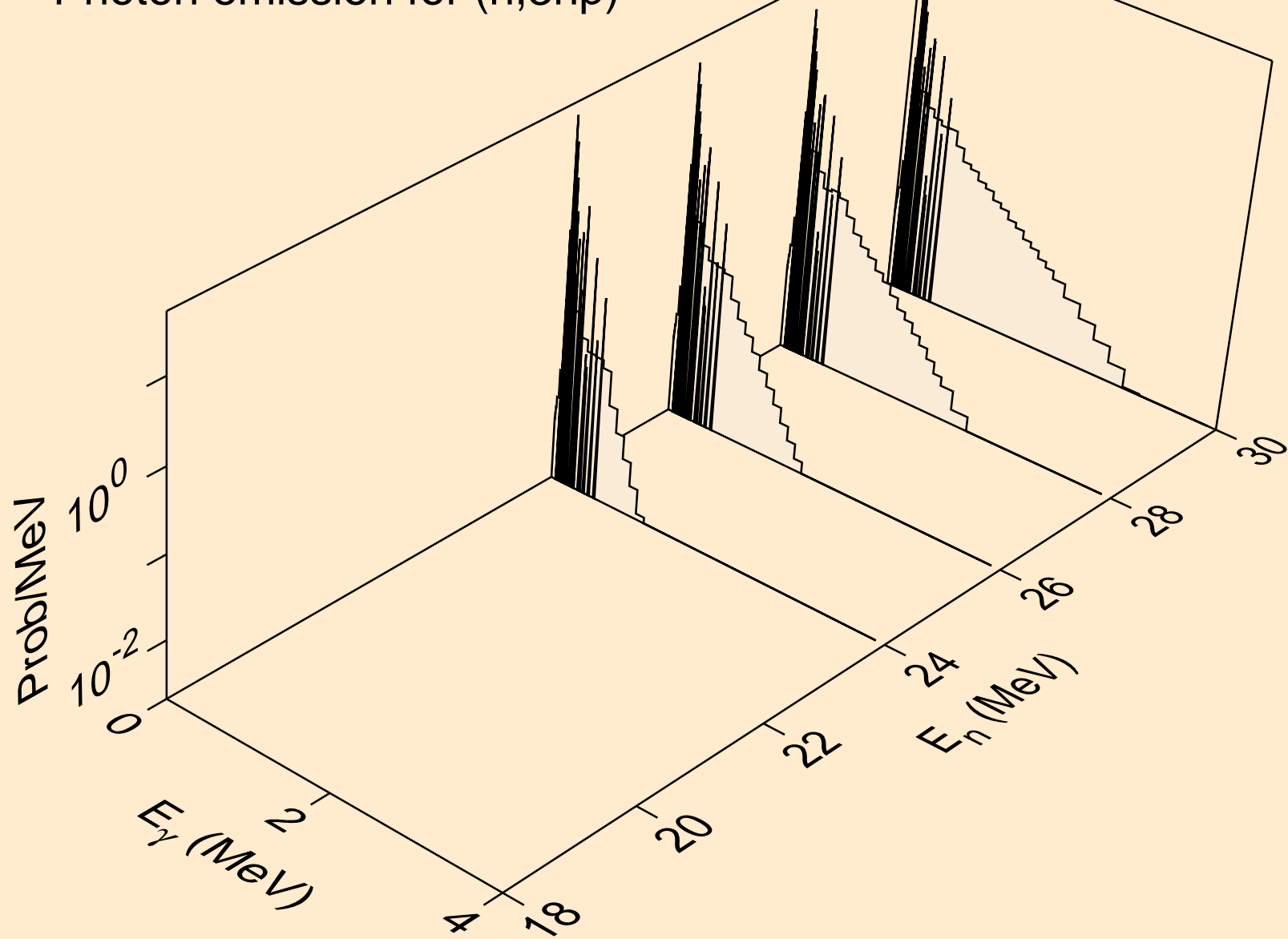

LU176M NEUTRON ACER TENDL-2023 LIBRARY; T=0.K
Photon emission for (n,n2p)

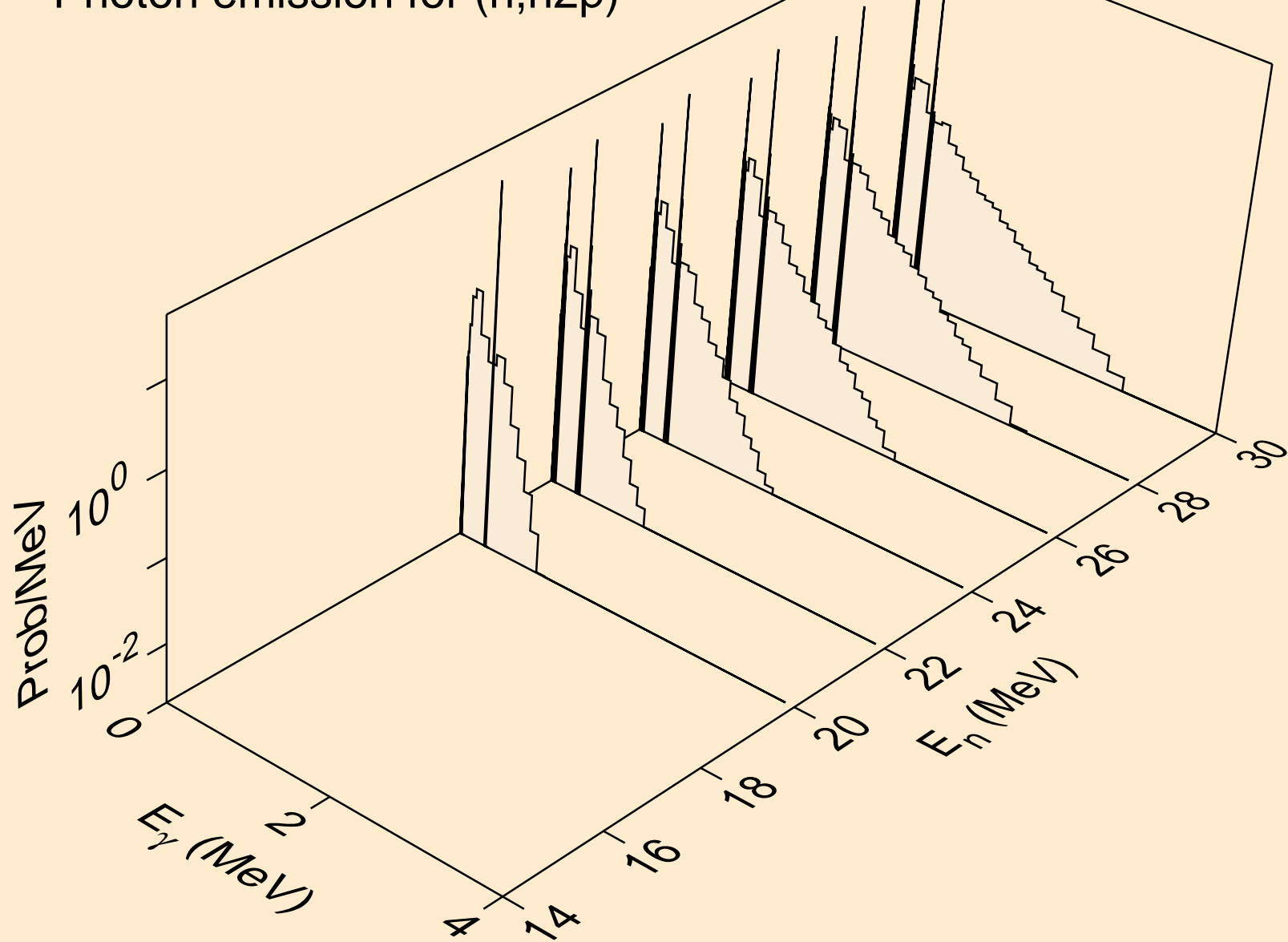

LU176M NEUTRON ACER TENDL-2023 LIBRARY; T=0.K
Photon emission for (n,npa)

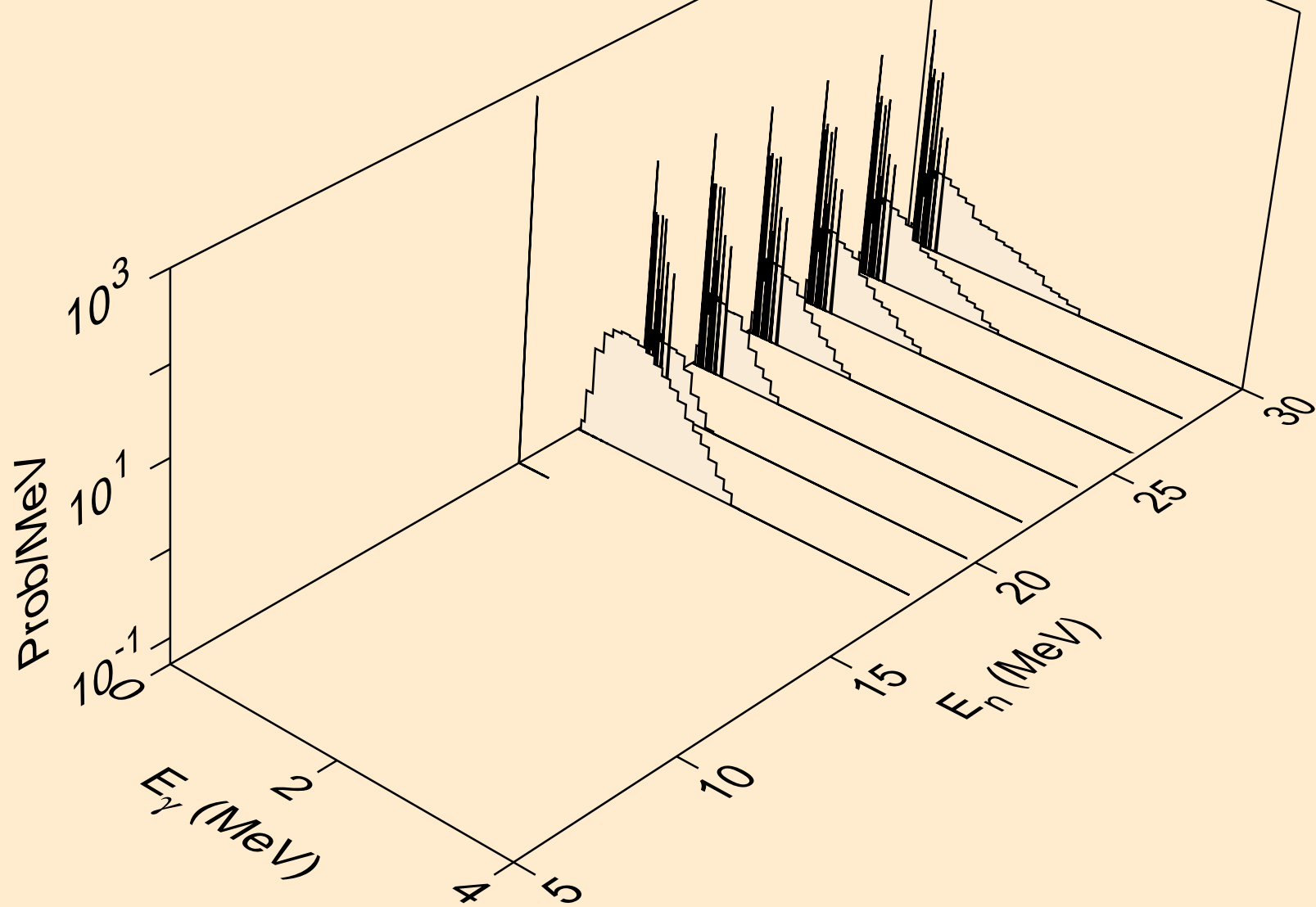

LU176M NEUTRON ACER TENDL-2023 LIBRARY; T=0.K
Photon emission for (n,n*2)

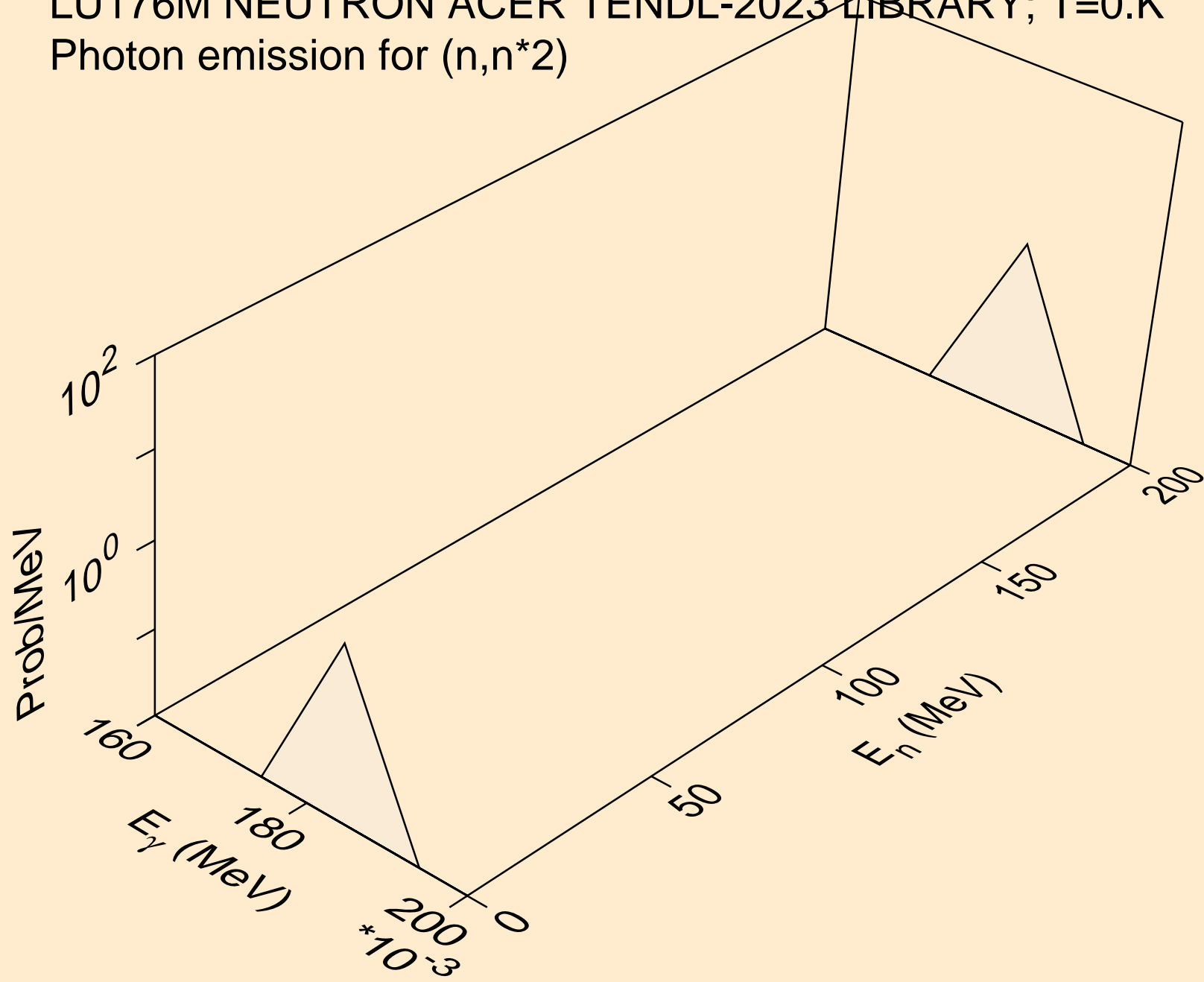

LU176M NEUTRON ACER TENDL-2023 LIBRARY; T=0.K
Photon emission for (n,n*3)

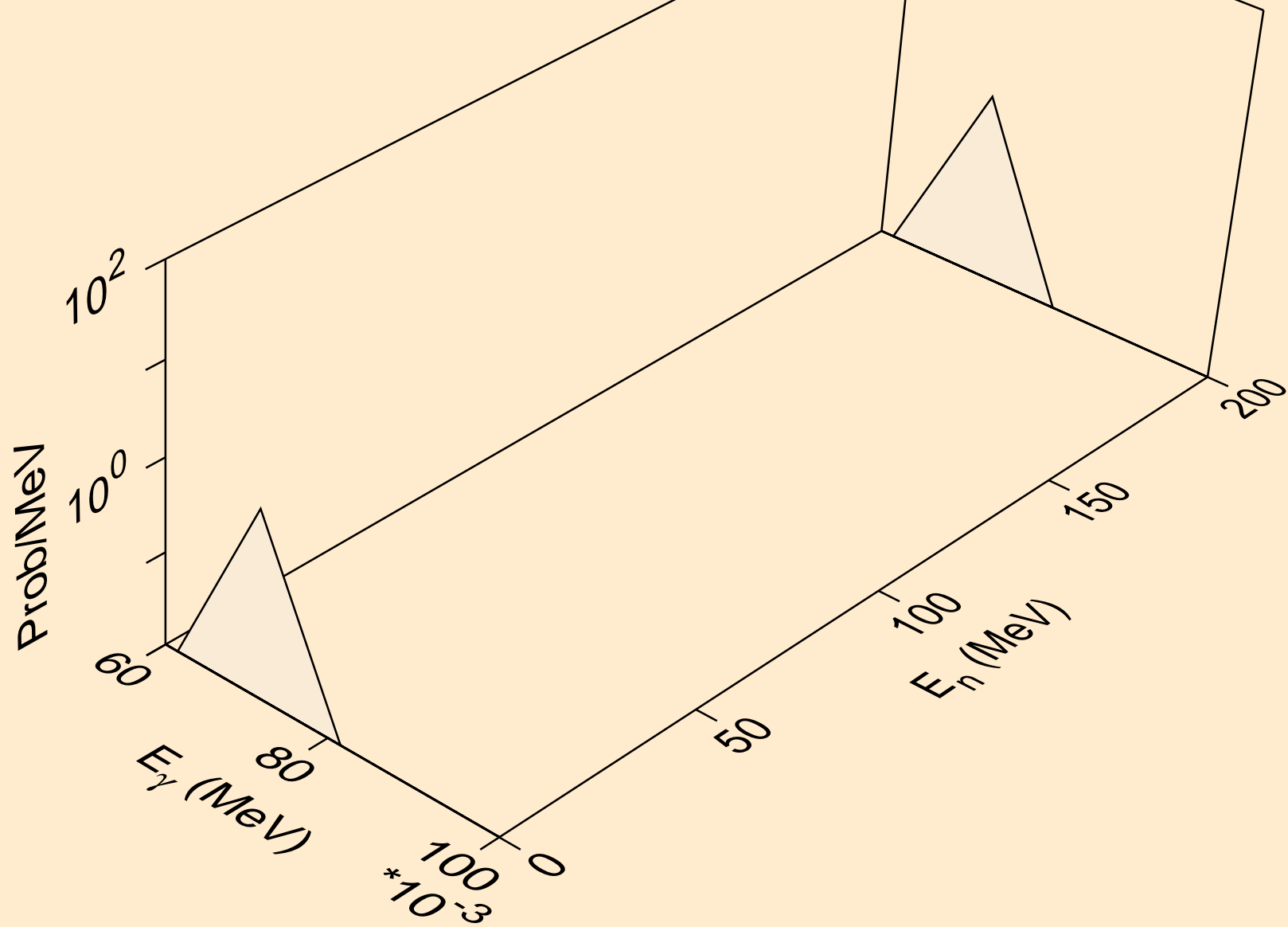

LU176M NEUTRON ACER TENDL-2023 LIBRARY; T=0.K
Photon emission for (n,n*4)

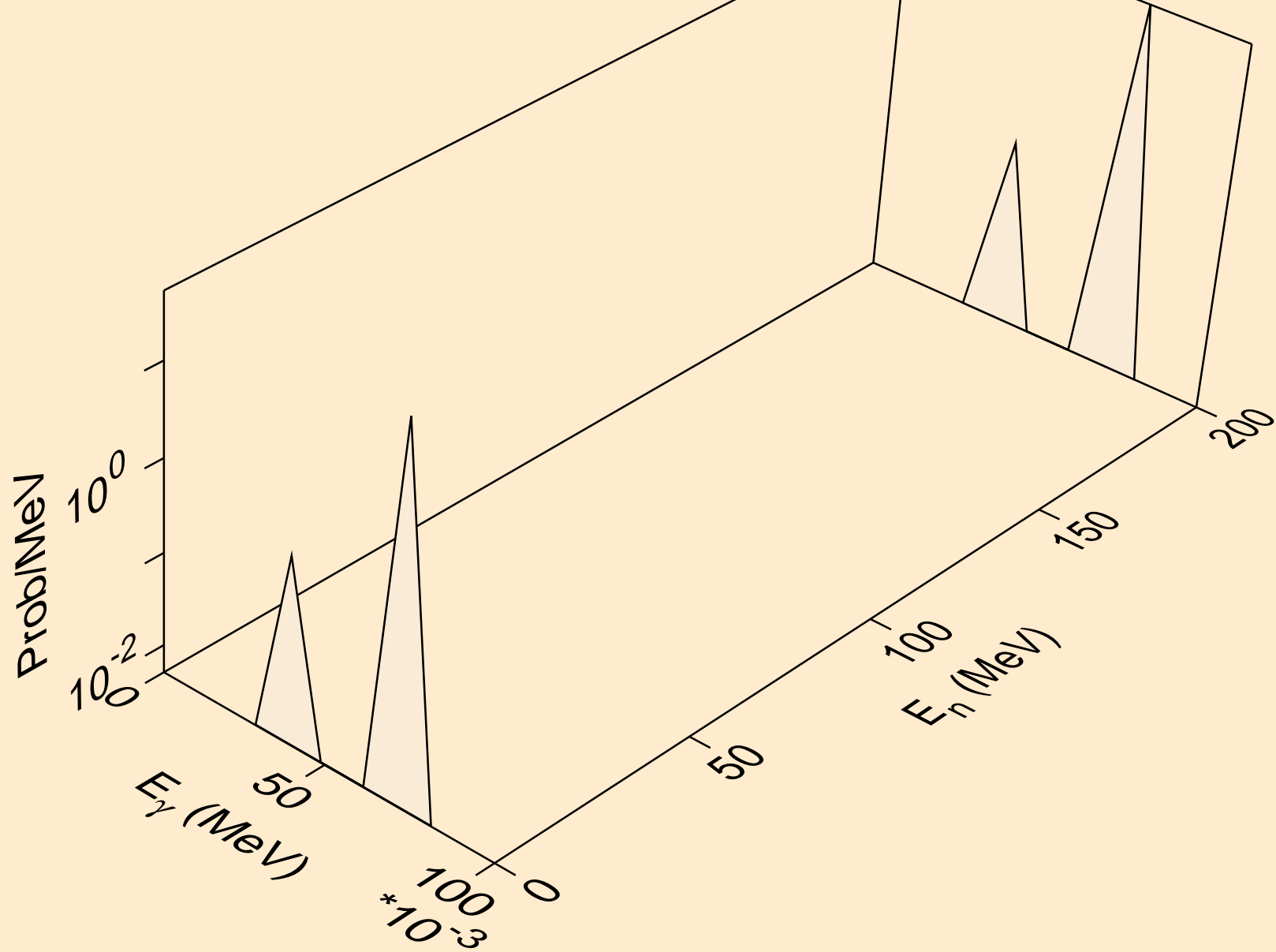

LU176M NEUTRON ACER TENDL-2023 LIBRARY; T=0.K
Photon emission for (n,n*5)

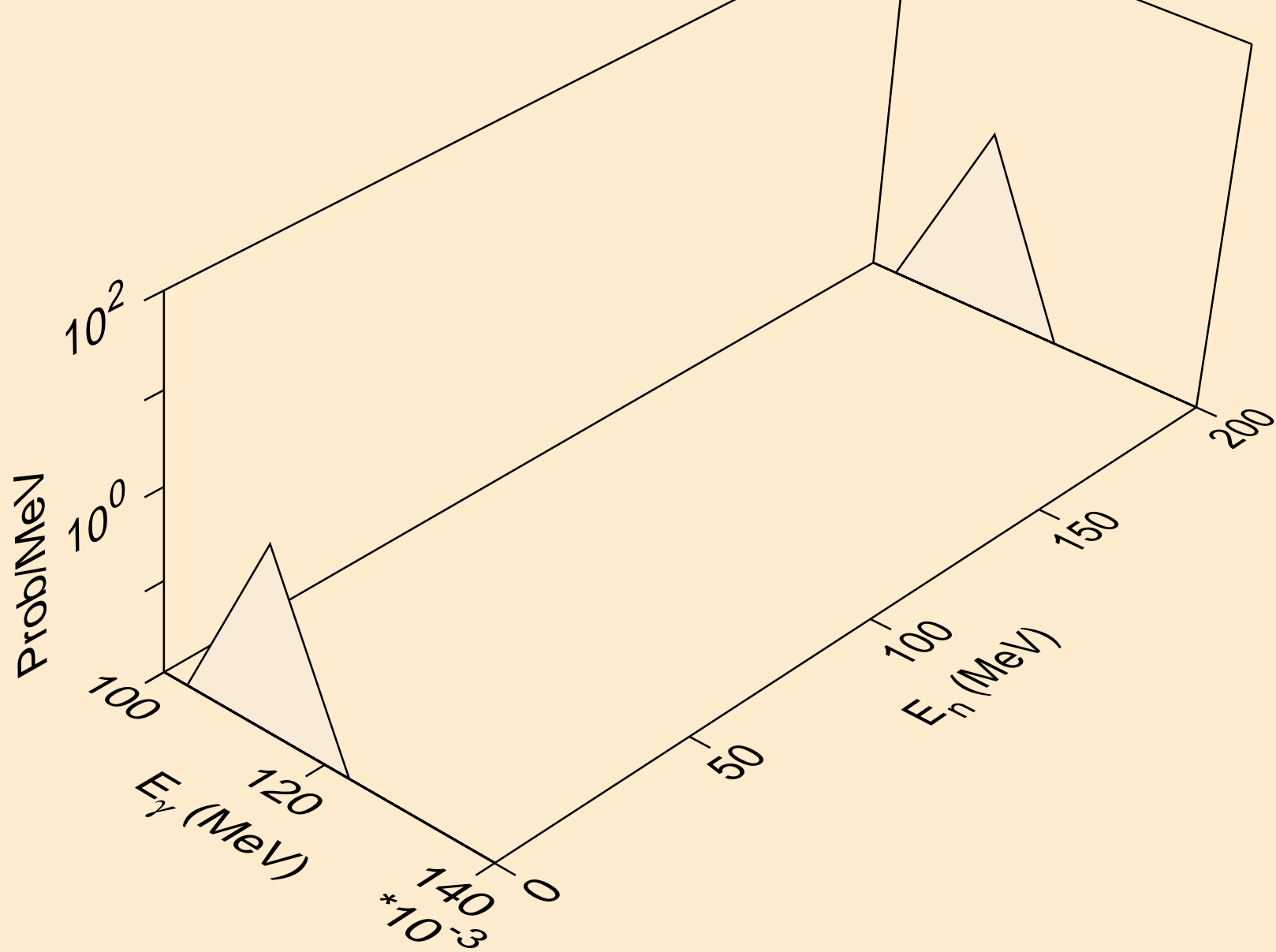

LU176M NEUTRON ACER TENDL-2023 LIBRARY; T=0.K
Photon emission for (n,n*6)

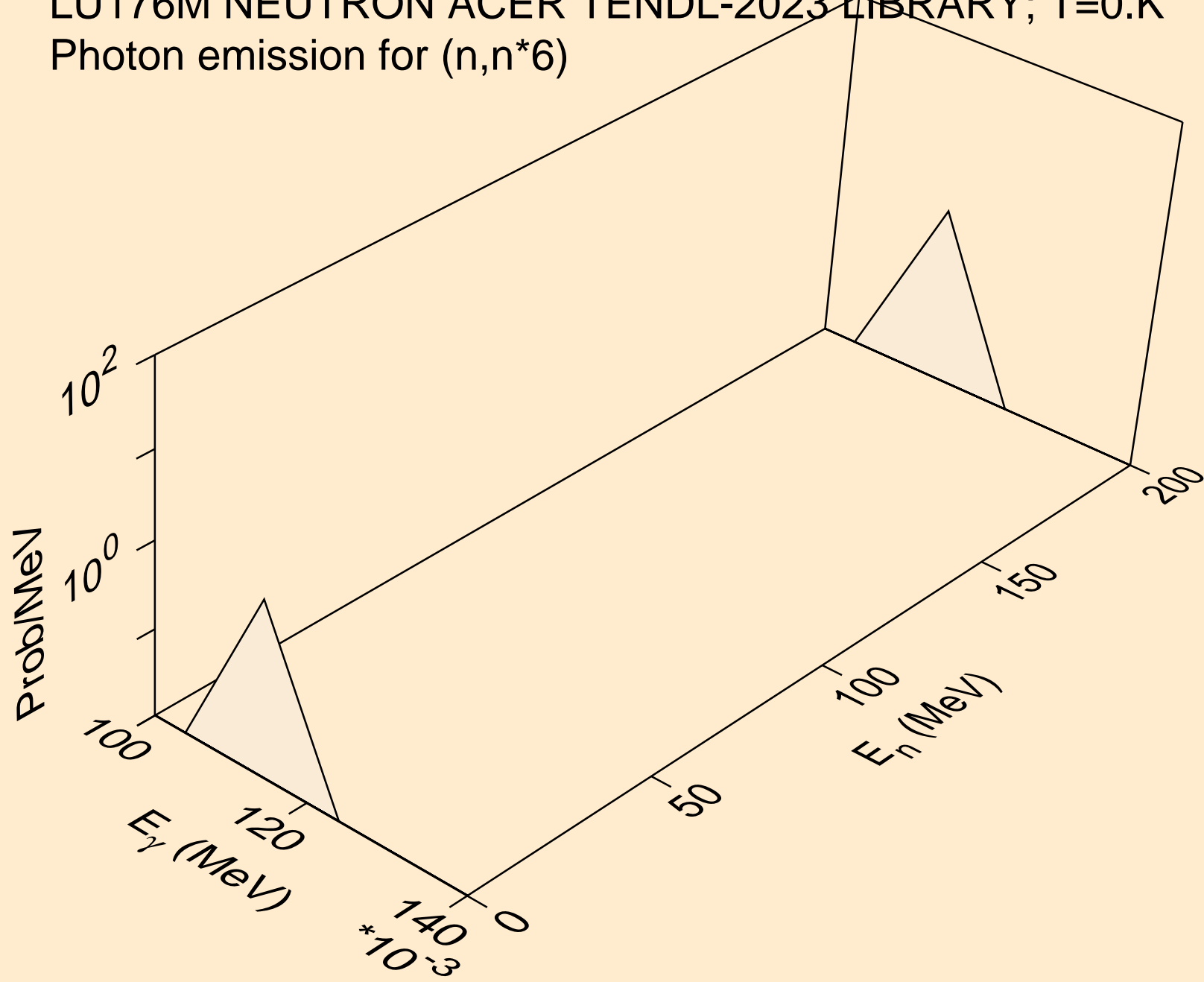

LU176M NEUTRON ACER TENDL-2023 LIBRARY; T=0.K
Photon emission for (n,n*7)

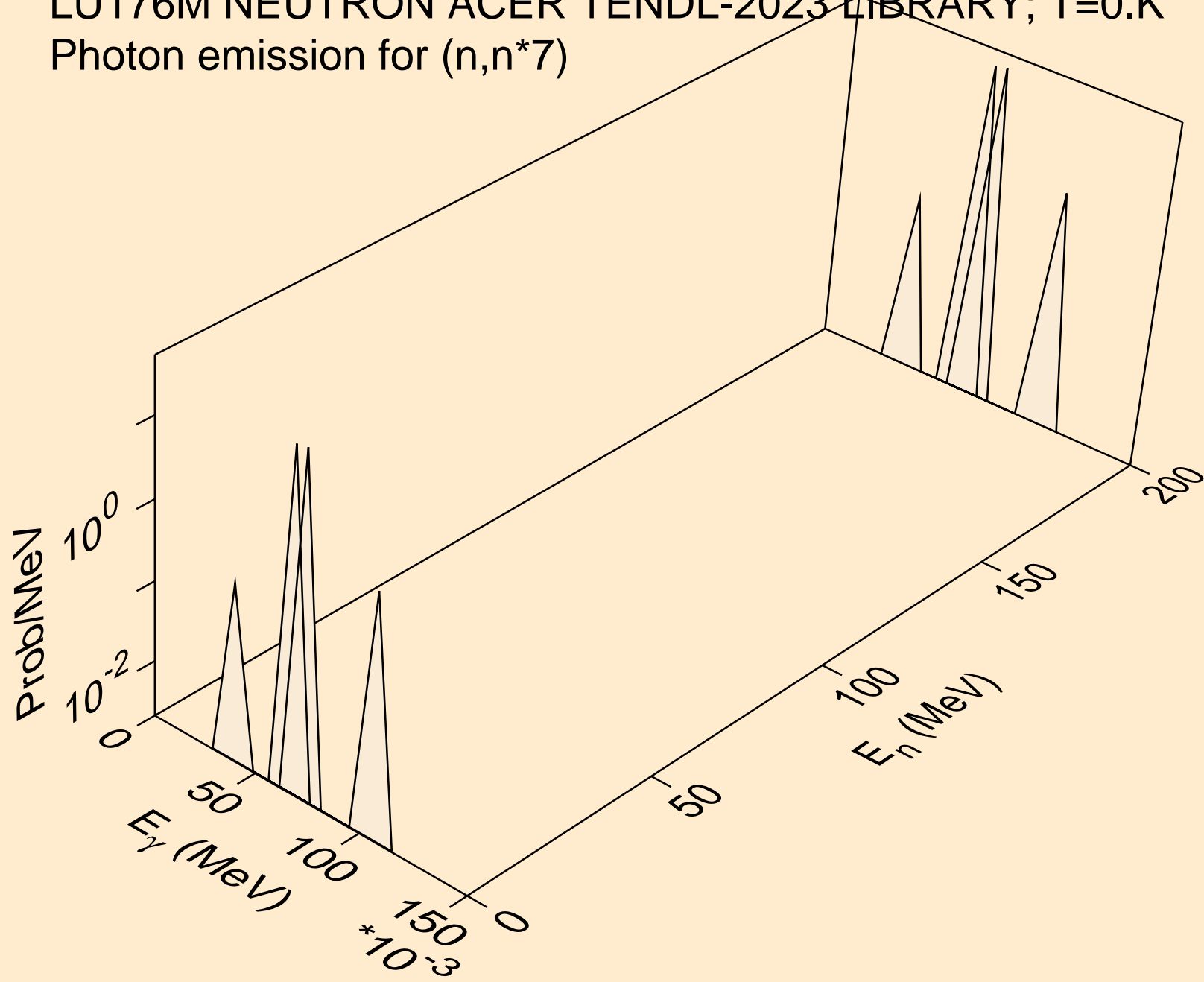

LU176M NEUTRON ACER TENDL-2023 LIBRARY; T=0.K
Photon emission for (n,n*8)

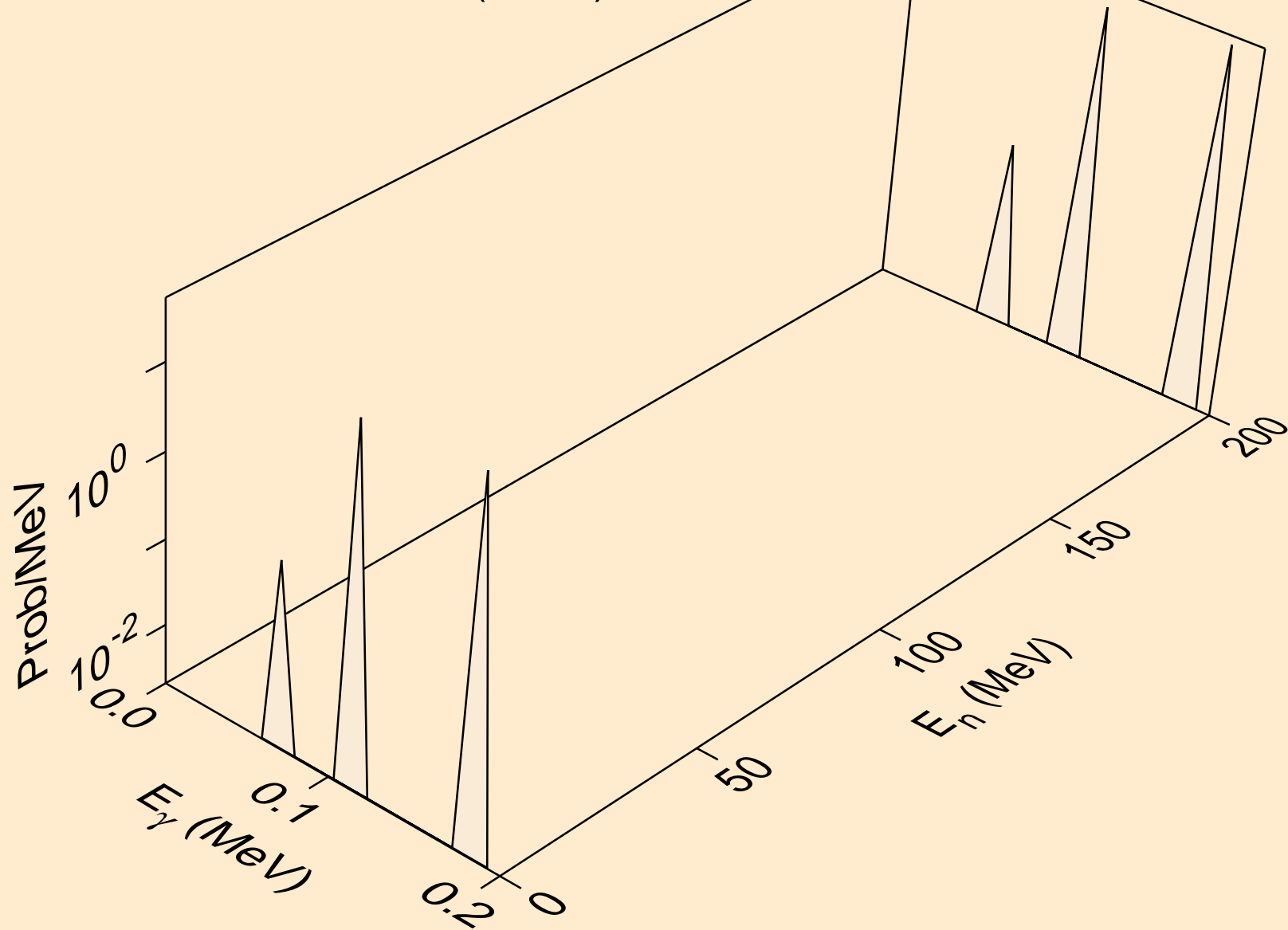

LU176M NEUTRON ACER TENDL-2023 LIBRARY; T=0.K
Photon emission for (n,n*9)

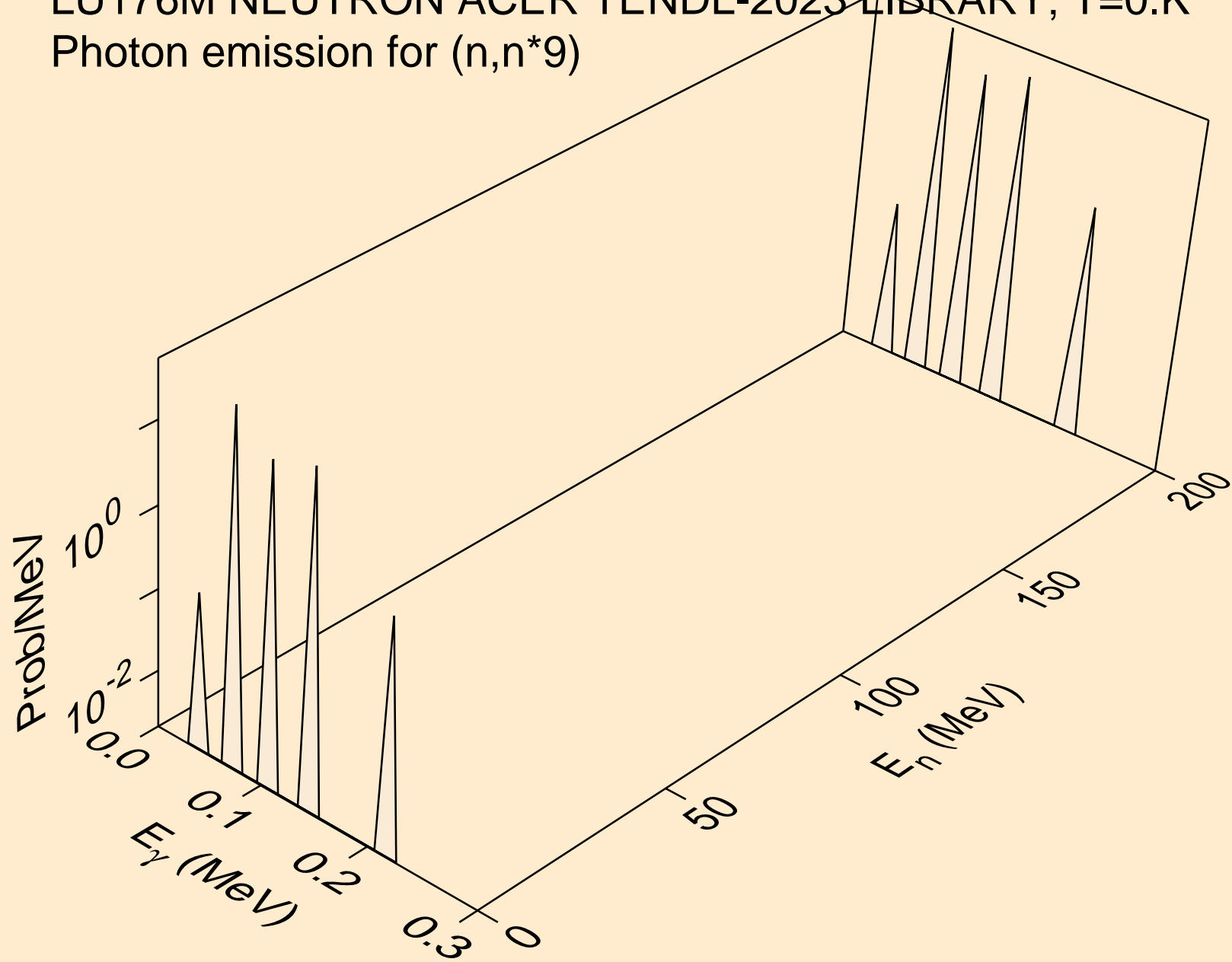

LU176M NEUTRON ACER TENDL-2023 LIBRARY; T=0.K
Photon emission for (n,n*10)

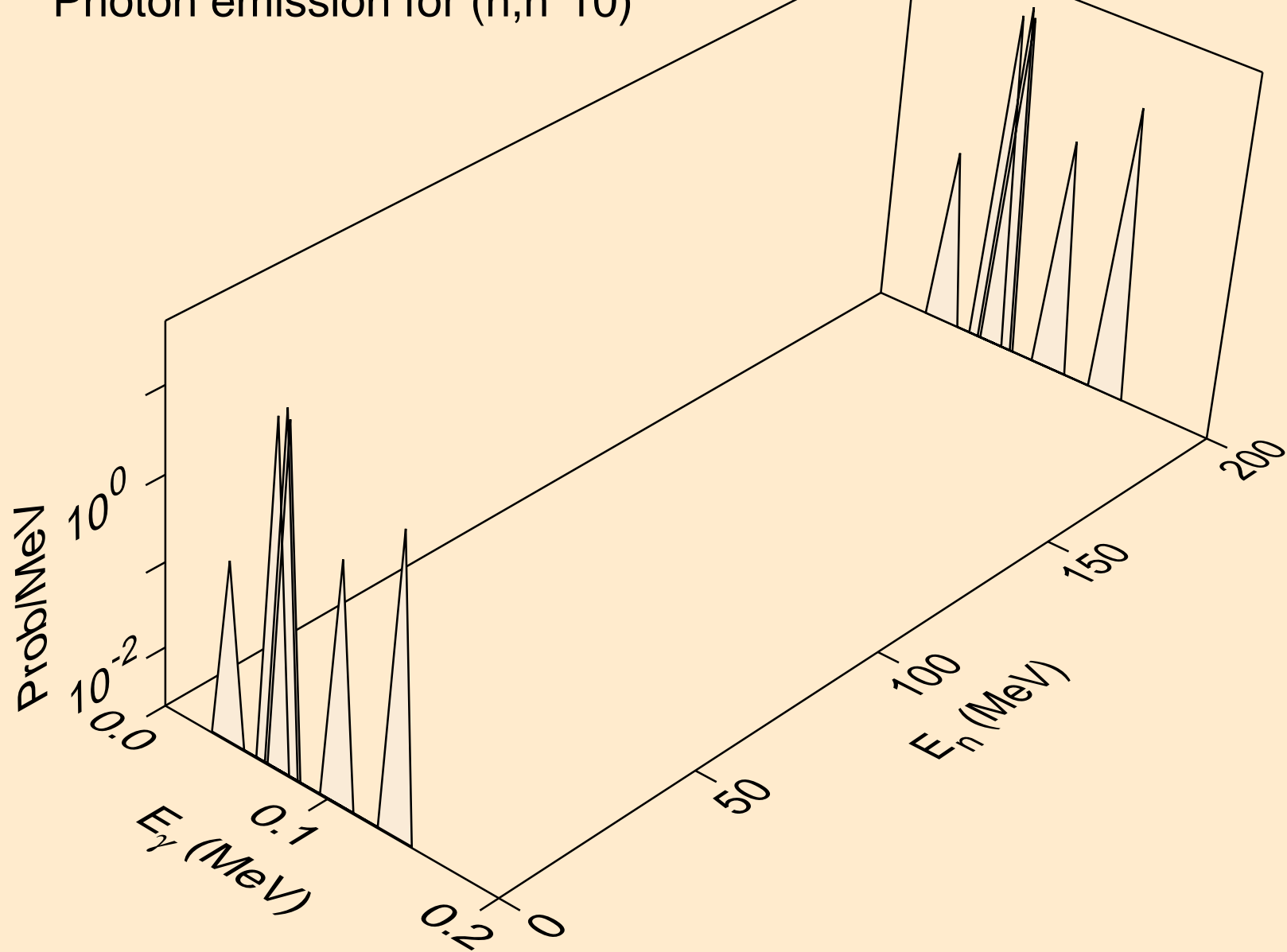

LU176M NEUTRON ACER TENDL-2023 LIBRARY; T=0.K
Photon emission for (n,n*11)

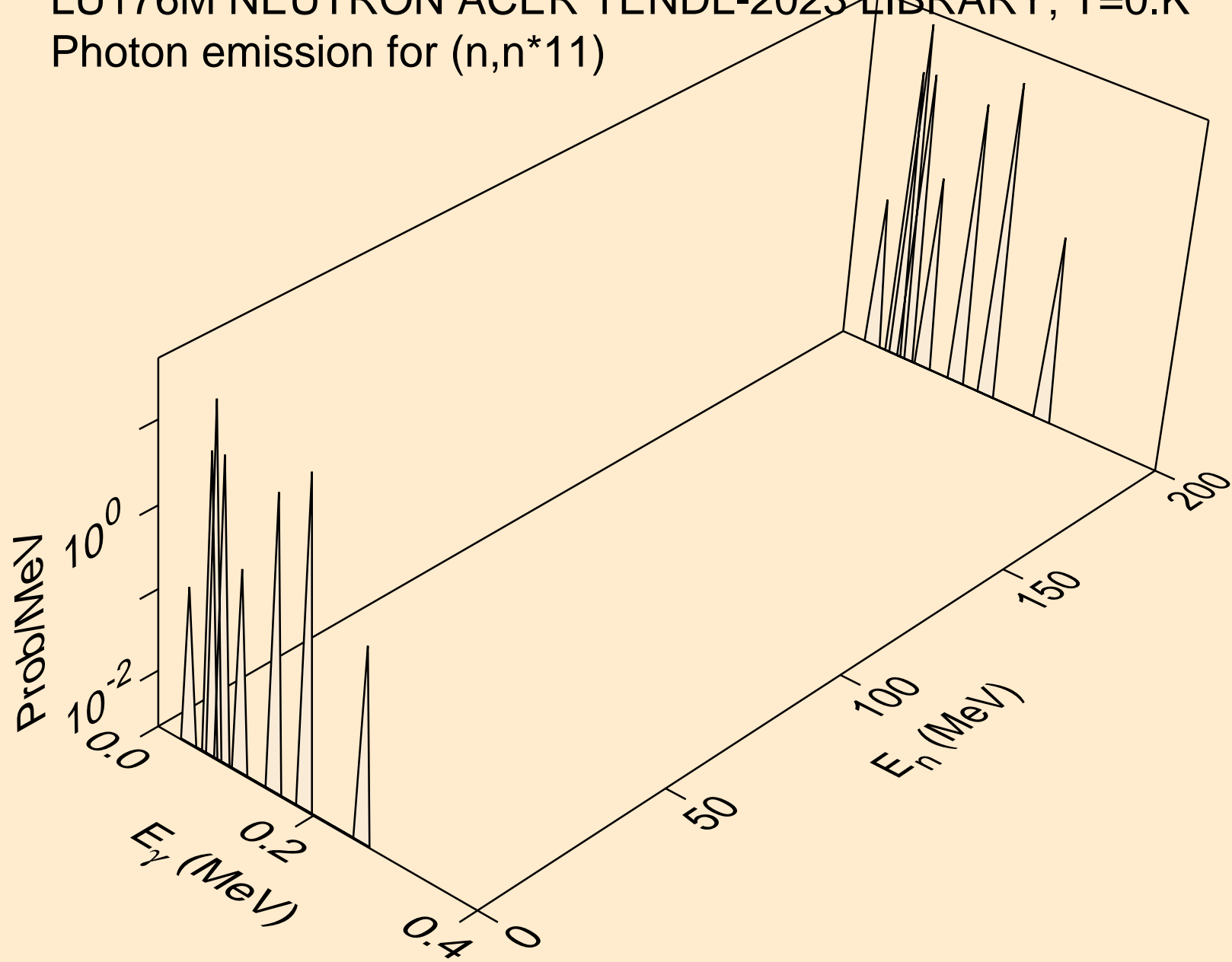

LU176M NEUTRON ACER TENDL-2023 LIBRARY; T=0.K
Photon emission for (n,n*12)

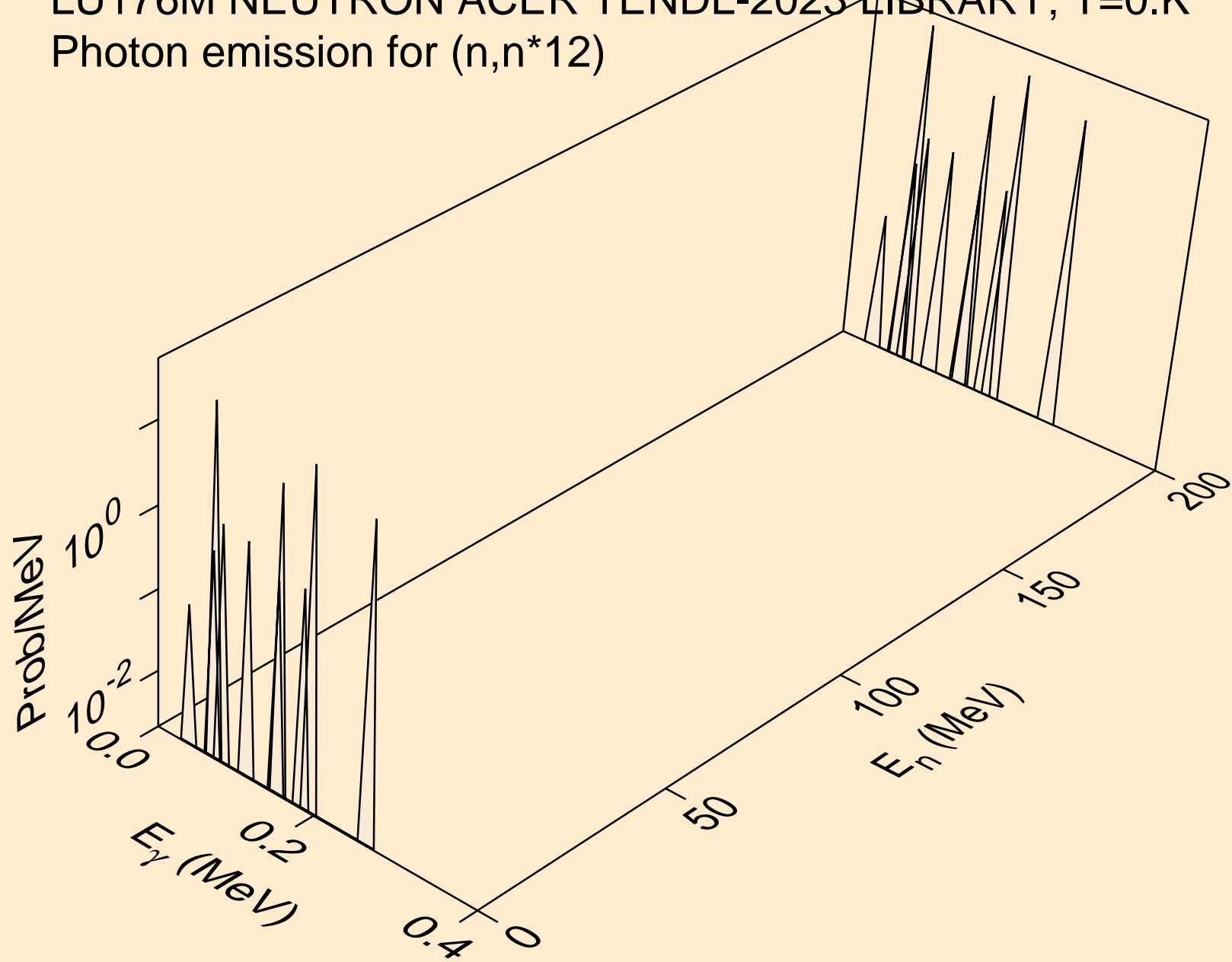

LU176M NEUTRON ACER TENDL-2023 LIBRARY; T=0.K
Photon emission for (n,n*13)

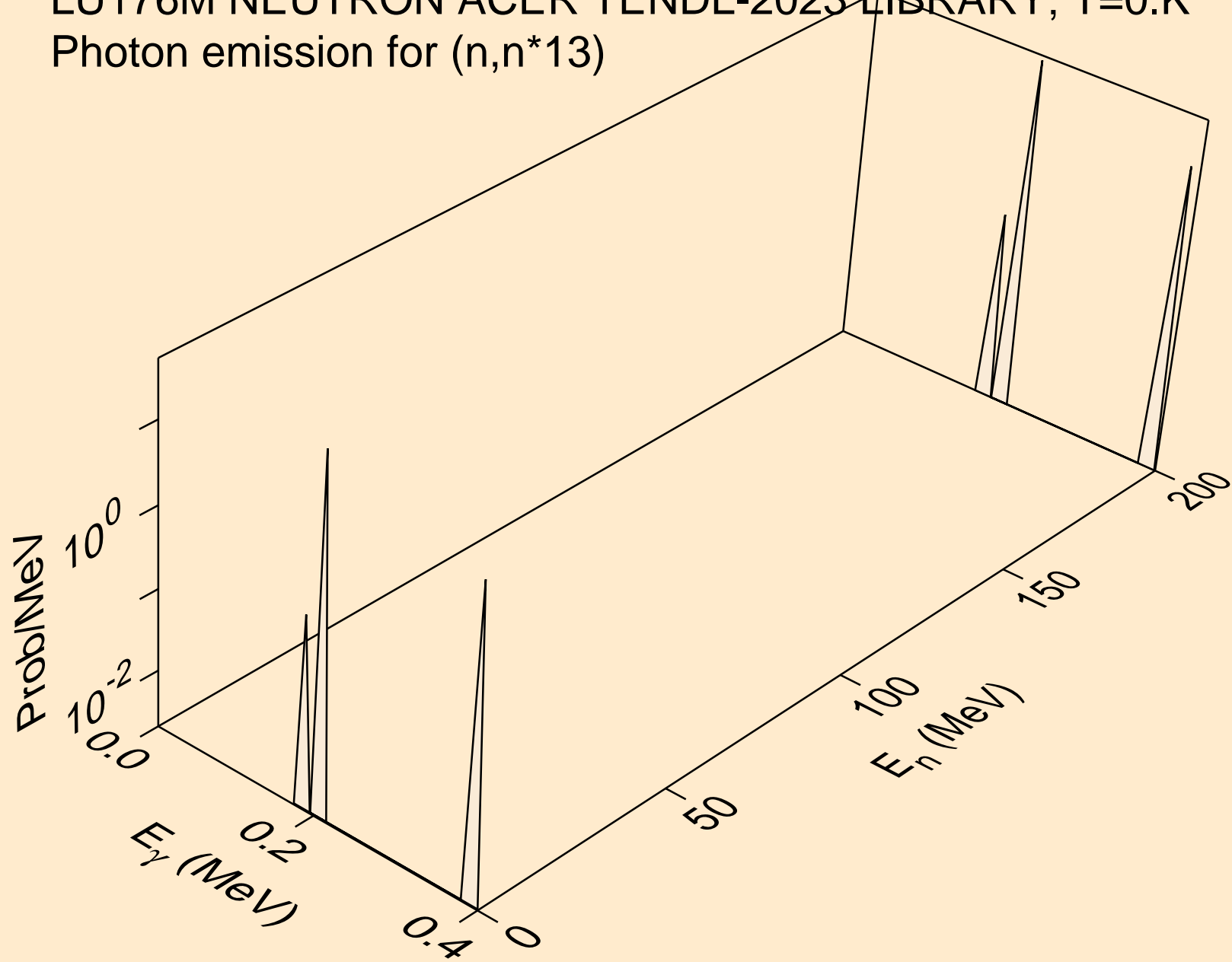

LU176M NEUTRON ACER TENDL-2023 LIBRARY; T=0.K
Photon emission for (n,n*14)

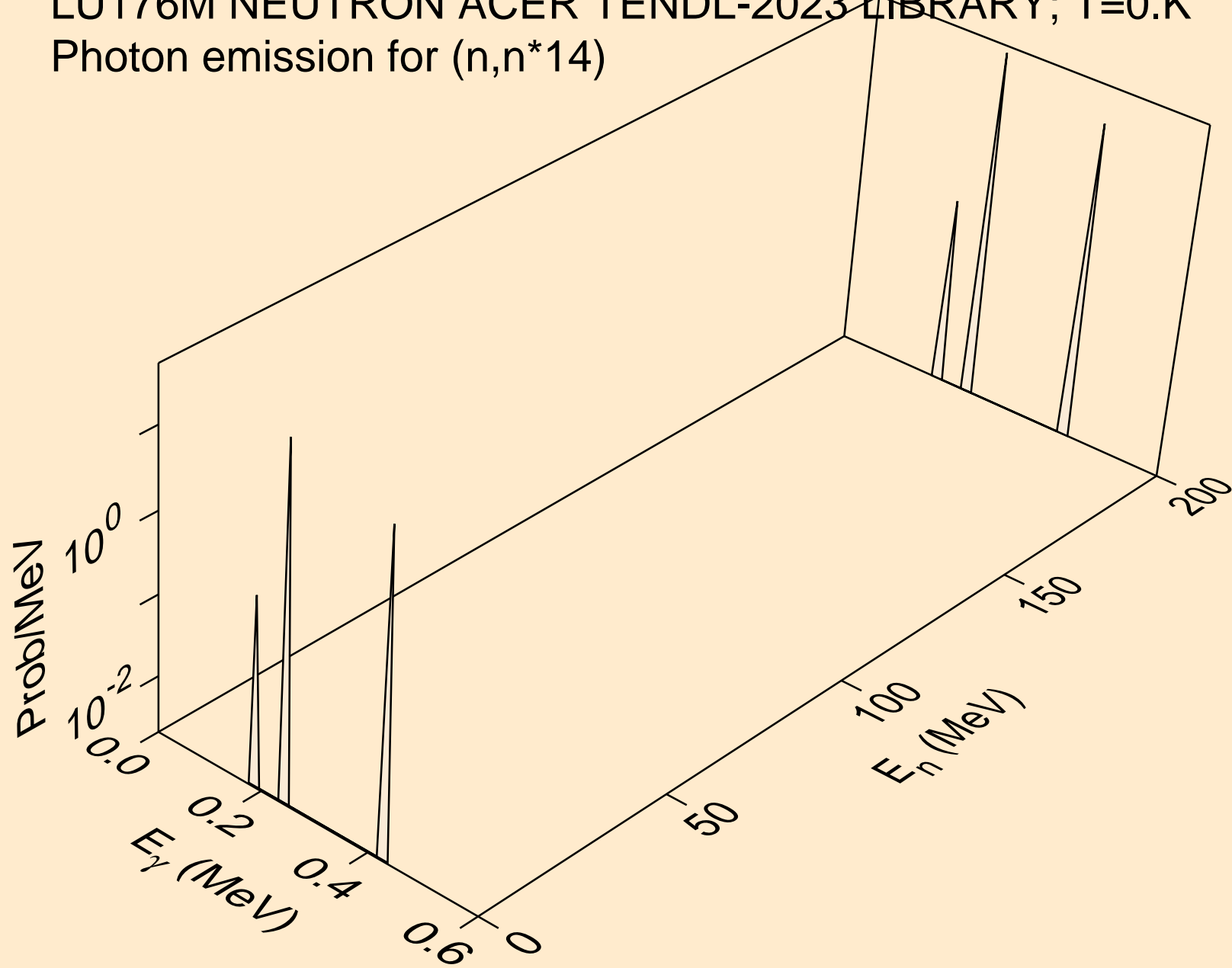

LU176M NEUTRON ACER TENDL-2023 LIBRARY; T=0.K
Photon emission for (n,n*15)

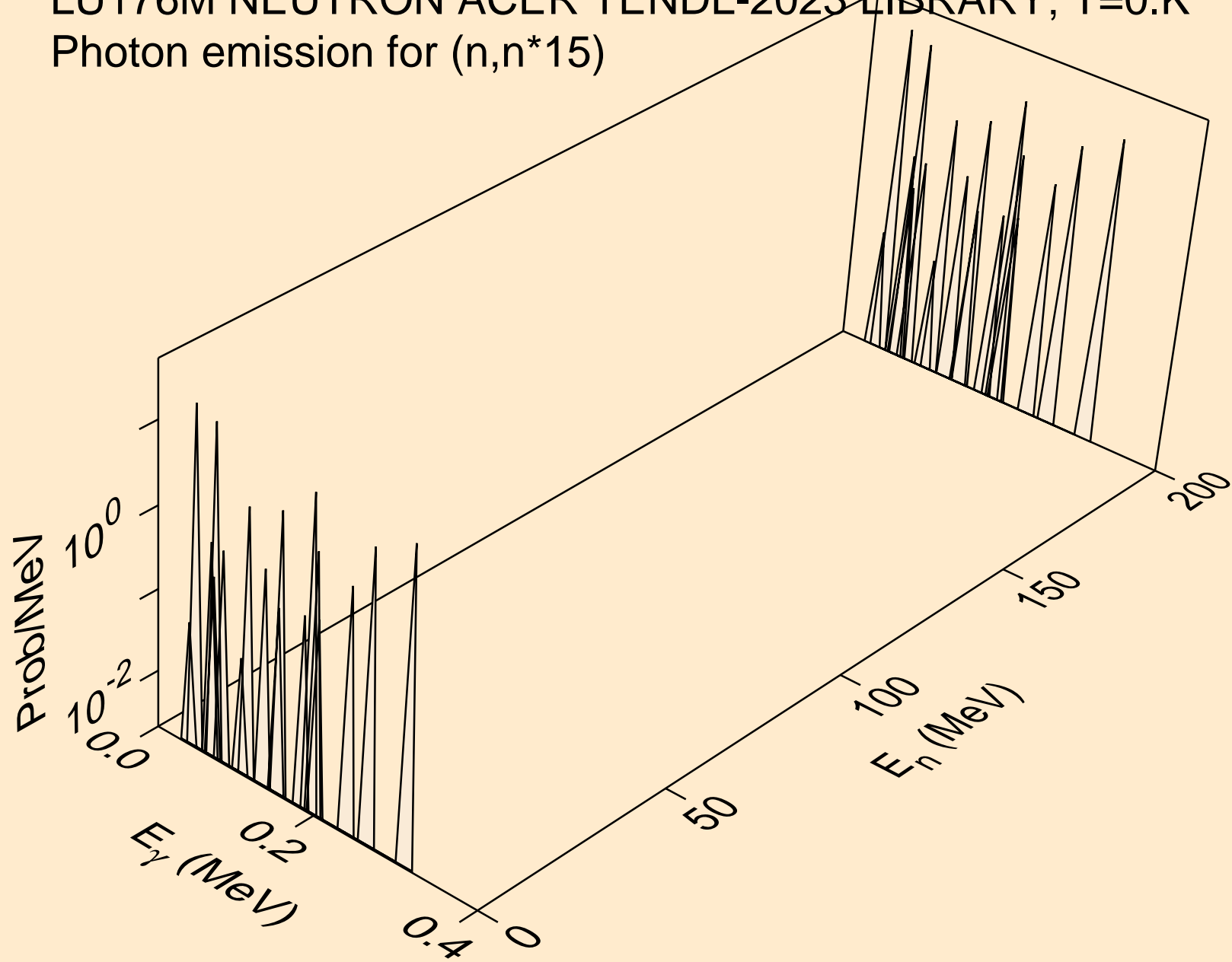

LU176M NEUTRON ACER TENDL-2023 LIBRARY; T=0.K
Photon emission for (n,n*16)

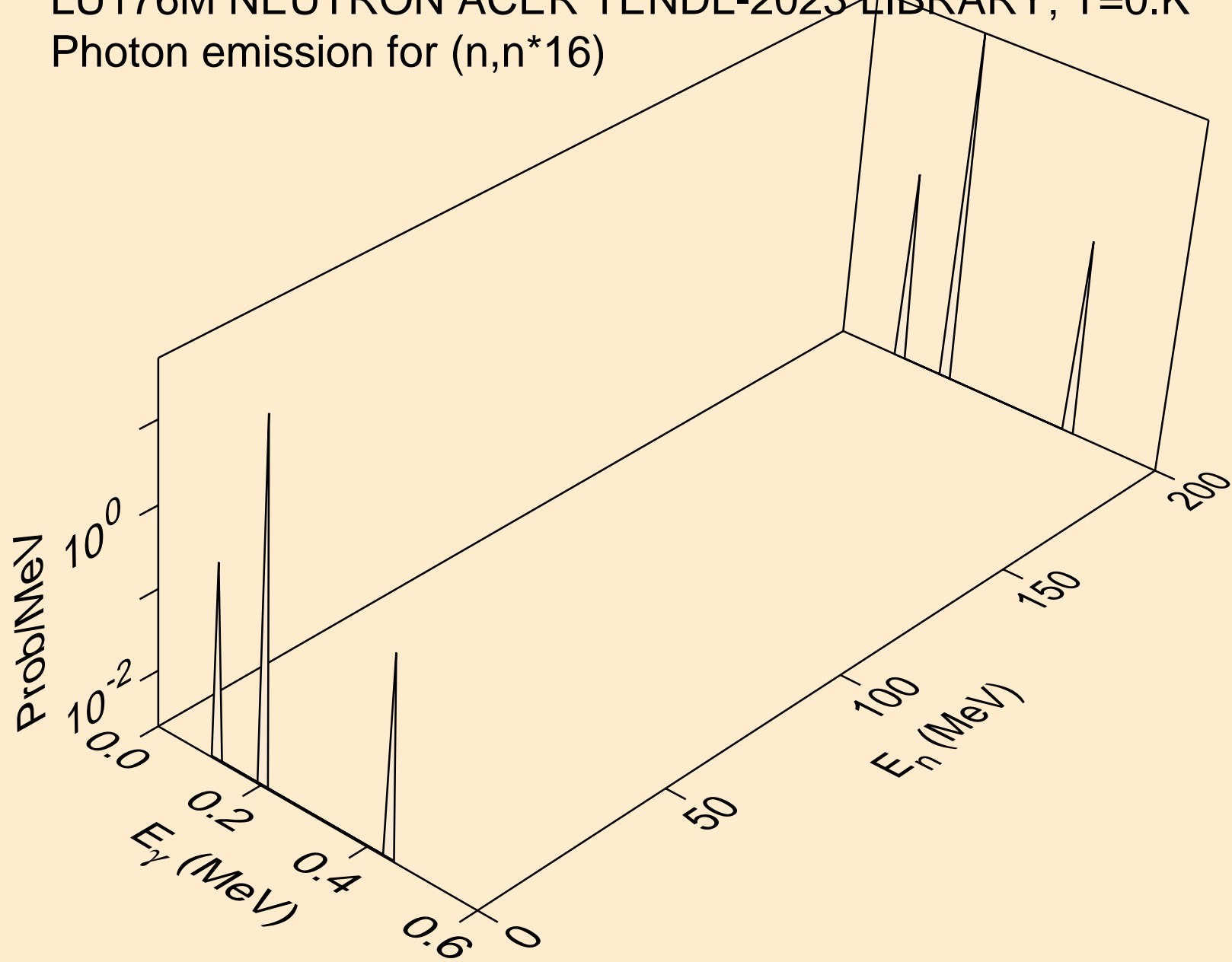

LU176M NEUTRON ACER TENDL-2023 LIBRARY; T=0.K
Photon emission for (n,n*17)

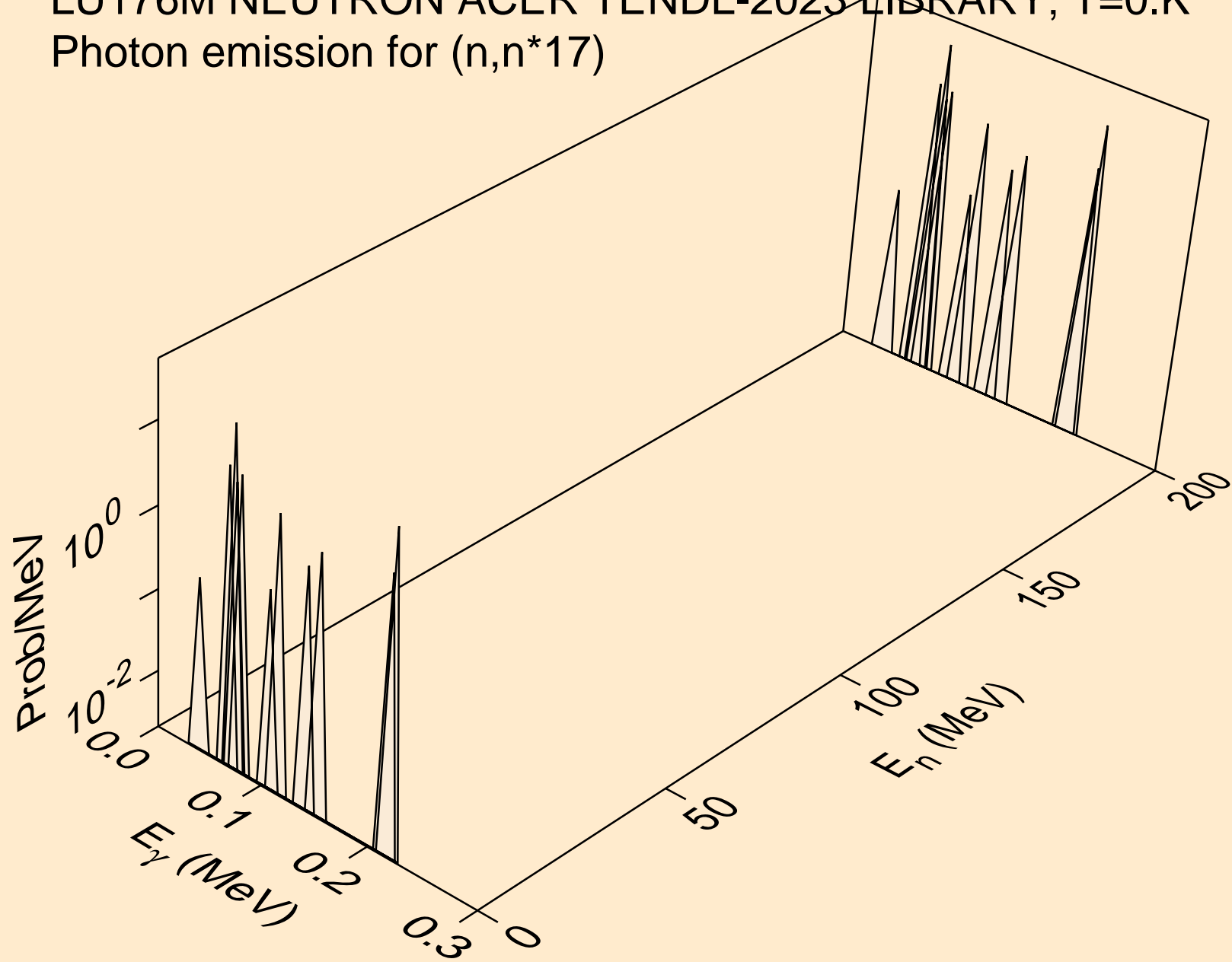

LU176M NEUTRON ACER TENDL-2023 LIBRARY; T=0.K
Photon emission for (n,n*18)

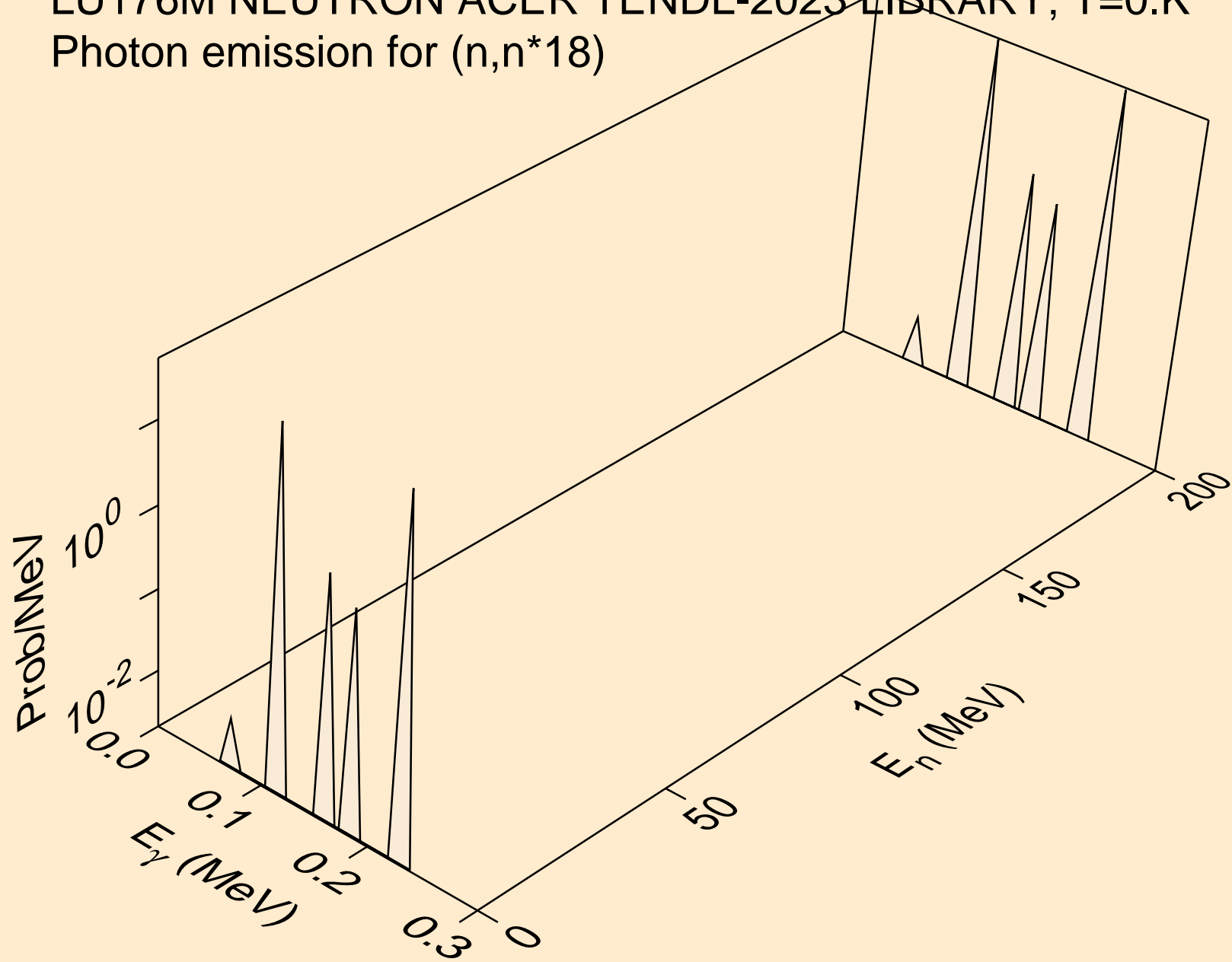

LU176M NEUTRON ACER TENDL-2023 LIBRARY; T=0.K
Photon emission for (n,n*c)

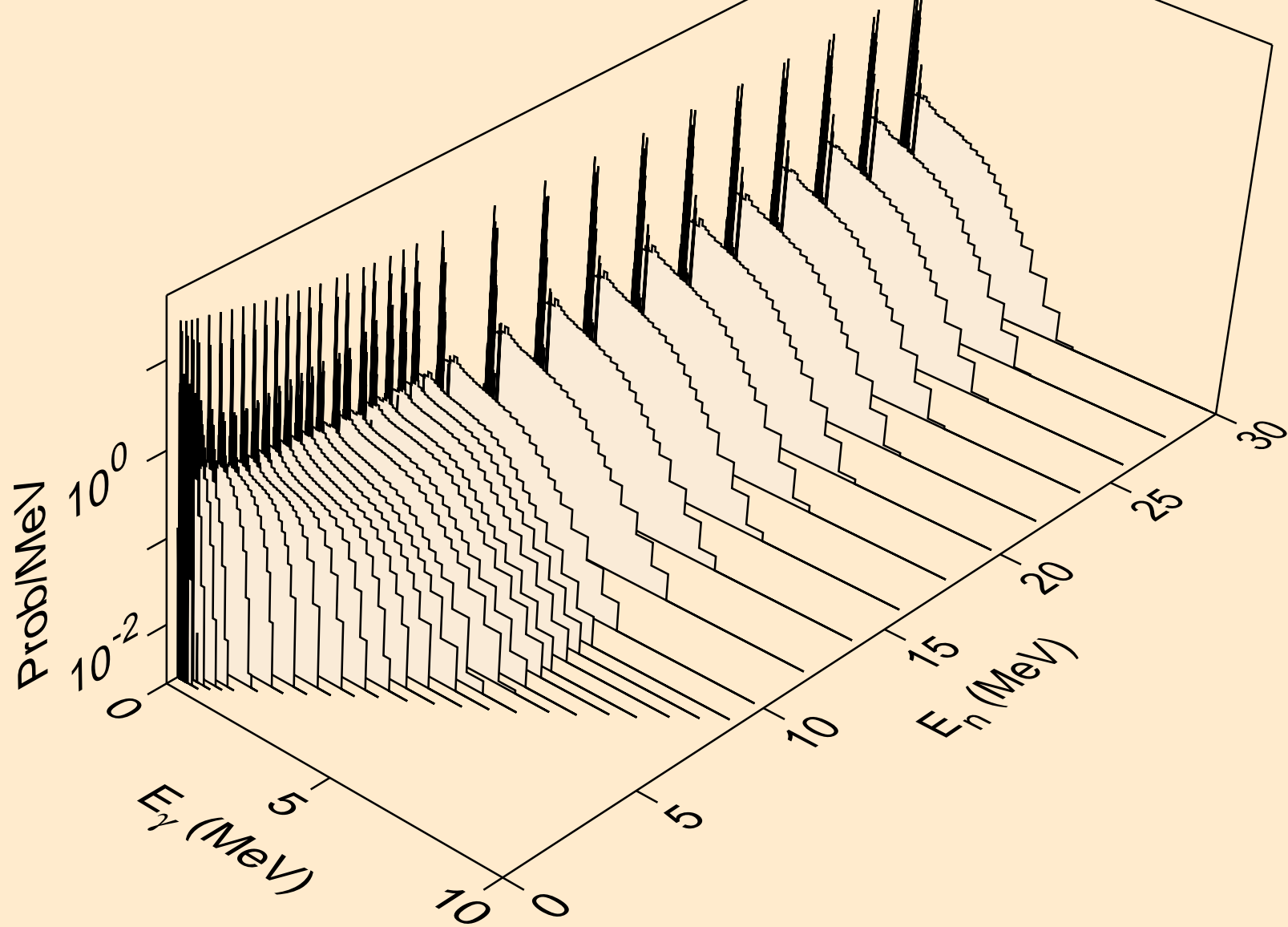

LU176M NEUTRON ACER TENDL-2023 LIBRARY; T=0.K
Photon emission for (n,gma)

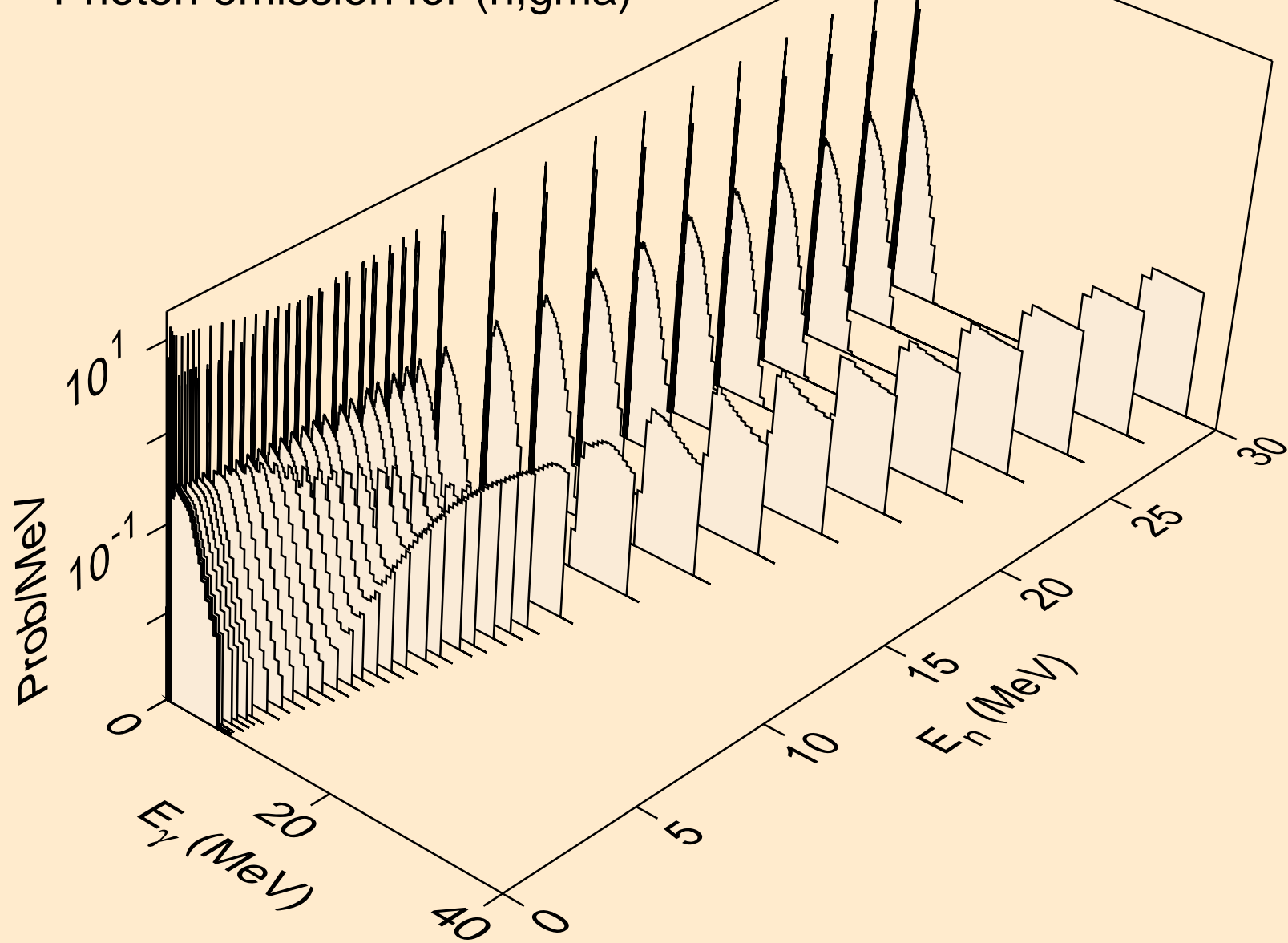

LU176M NEUTRON ACER TENDL-2023 LIBRARY; T=0.K
Photon emission for (n,p)

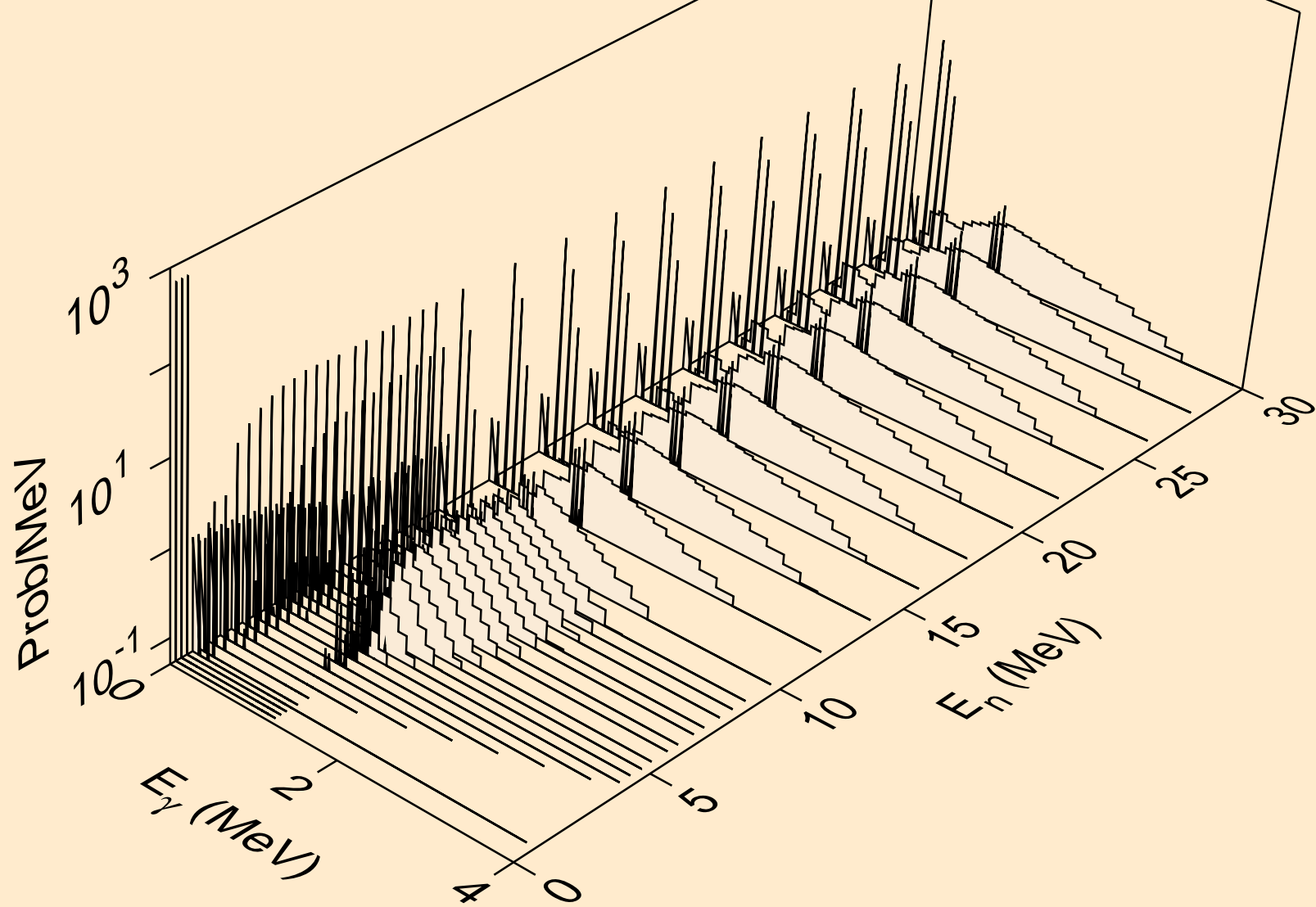

LU176M NEUTRON ACER TENDL-2023 LIBRARY; T=0.K
Photon emission for (n,d)

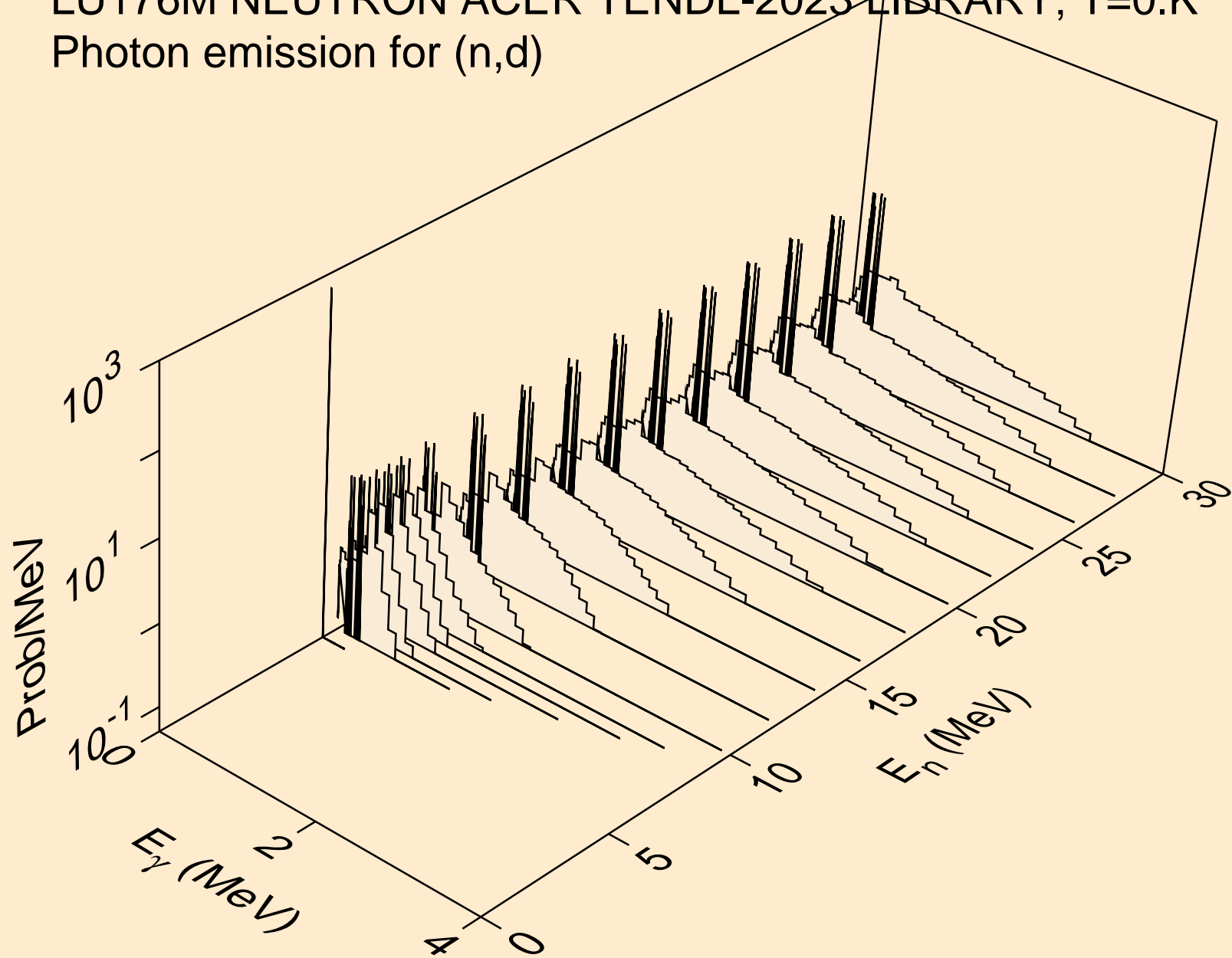

LU176M NEUTRON ACER TENDL-2023 LIBRARY; T=0.K
Photon emission for (n,t)

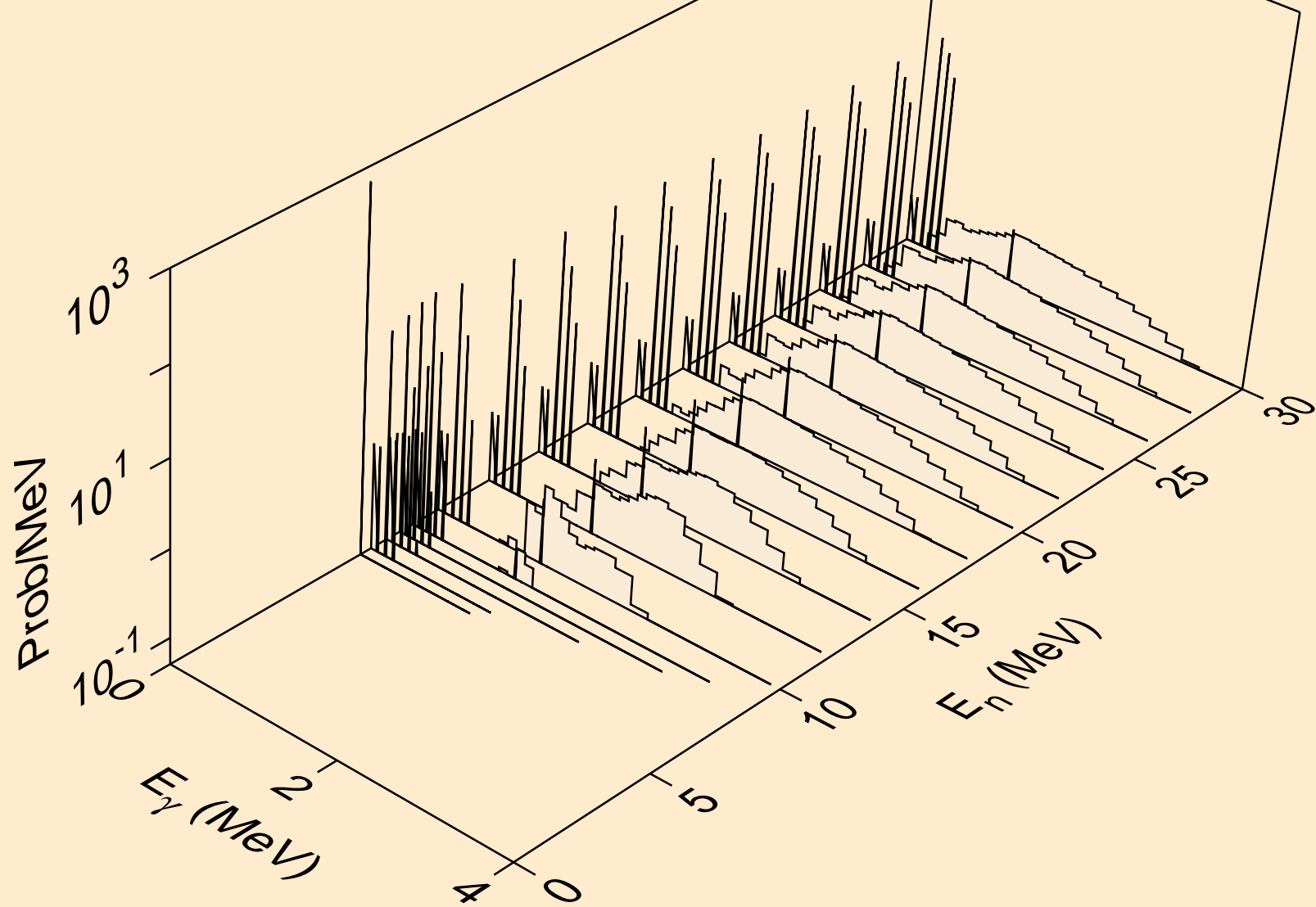

LU176M NEUTRON ACER TENDL-2023 LIBRARY; T=0.K
Photon emission for (n,he3)

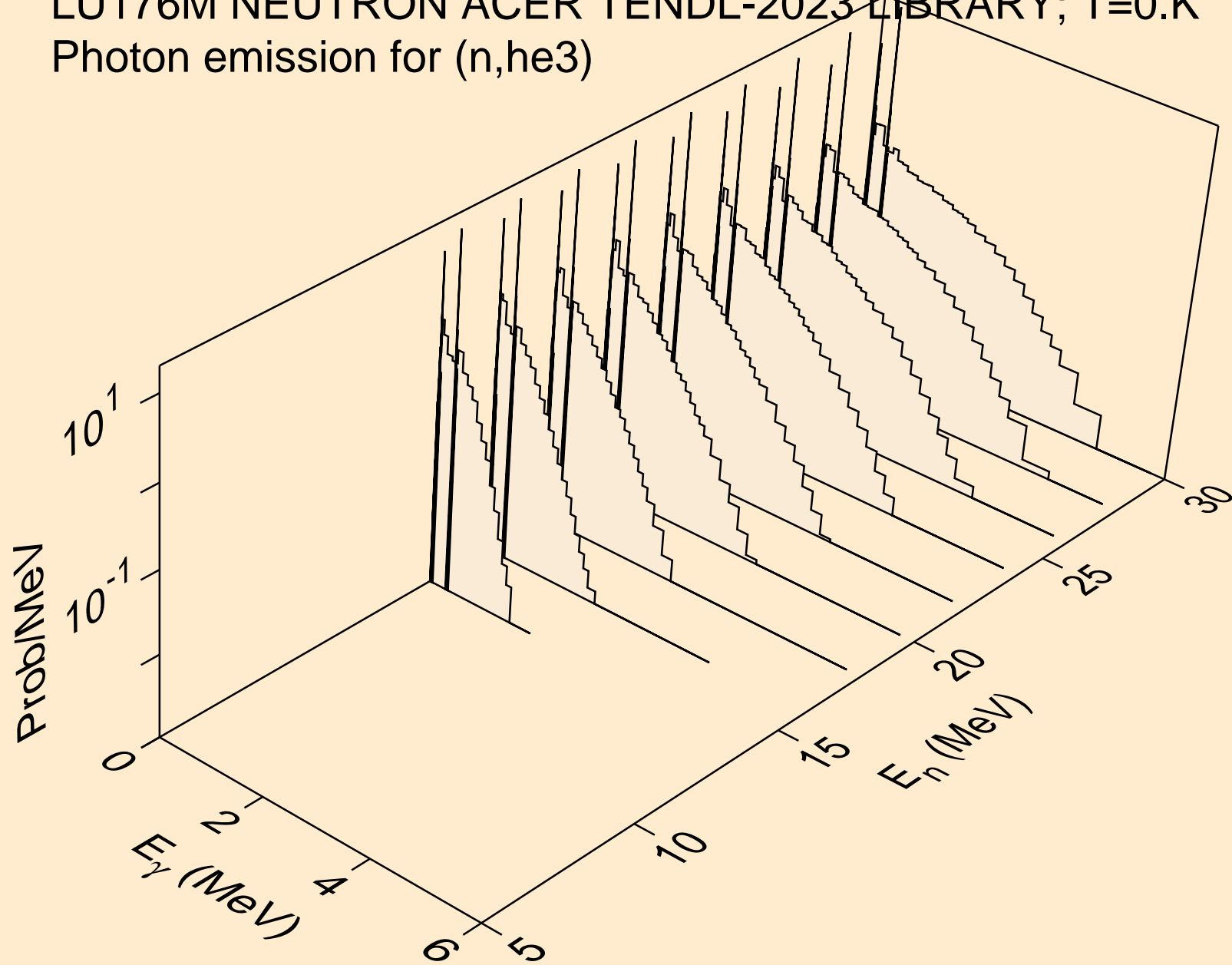

LU176M NEUTRON ACER TENDL-2023 LIBRARY; T=0.K
Photon emission for (n,a)

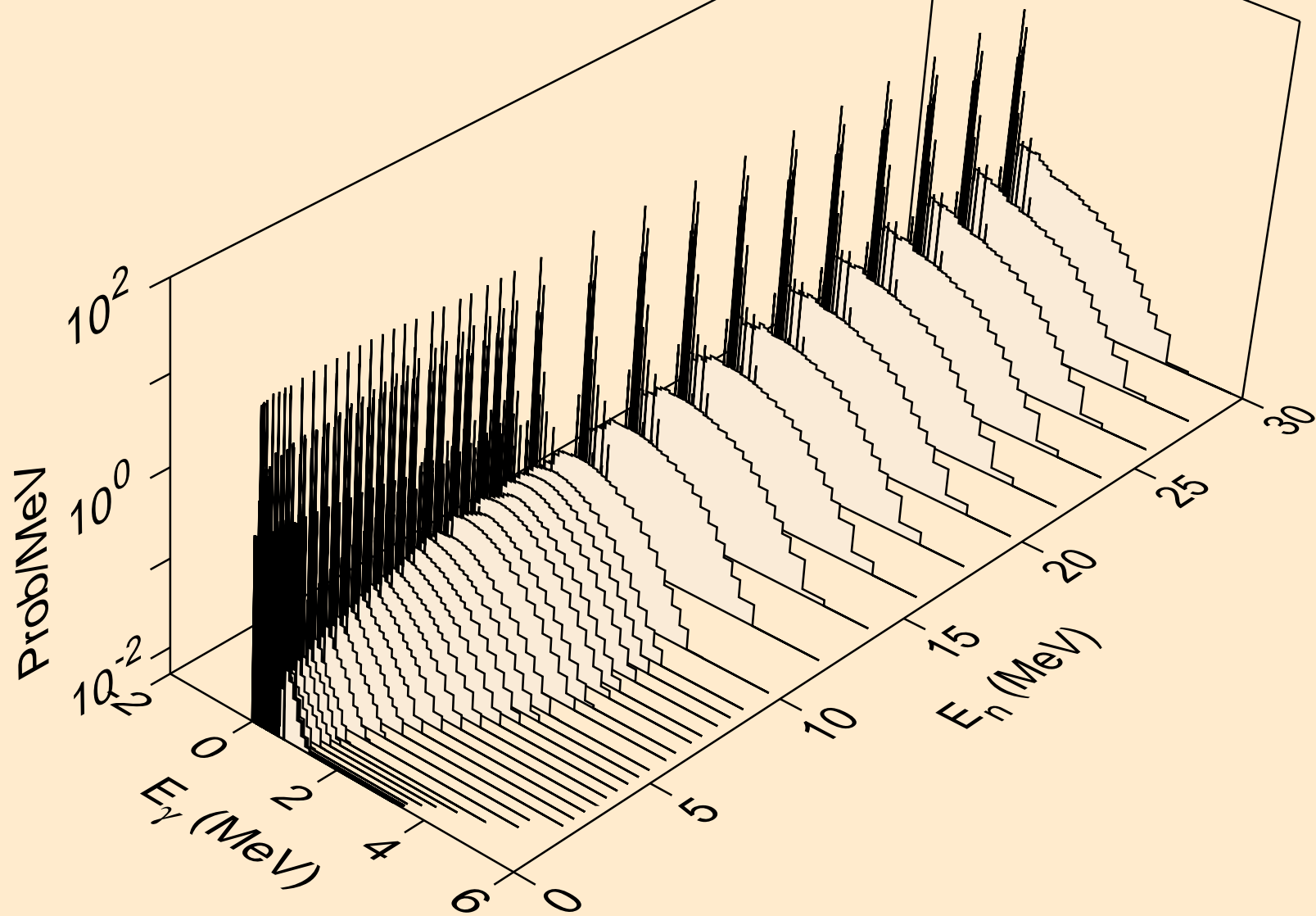

LU176M NEUTRON ACER TENDL-2023 LIBRARY; T=0.K
Photon emission for (n,2a)

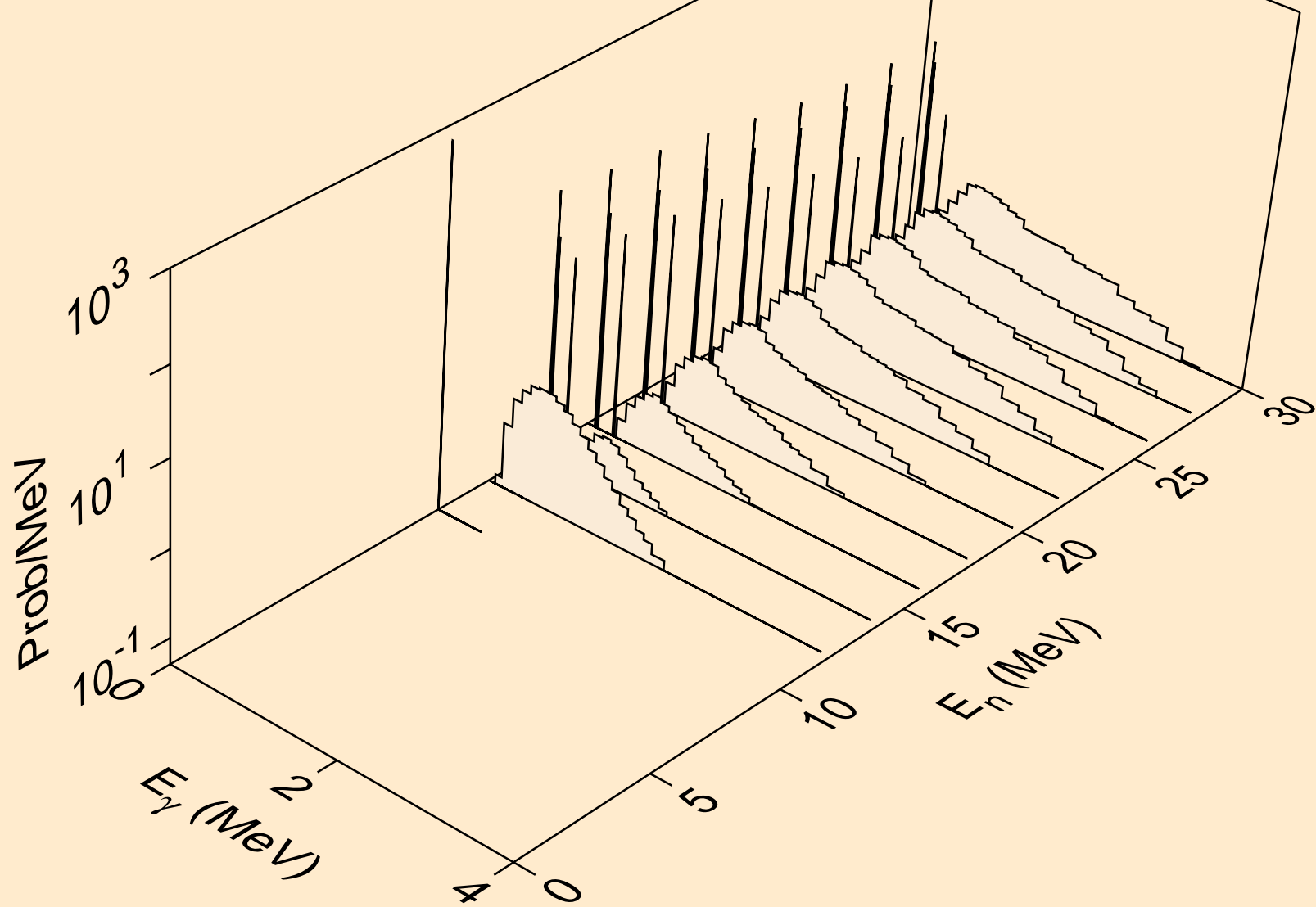

LU176M NEUTRON ACER TENDL-2023 LIBRARY; T=0.K
Photon emission for (n,2p)

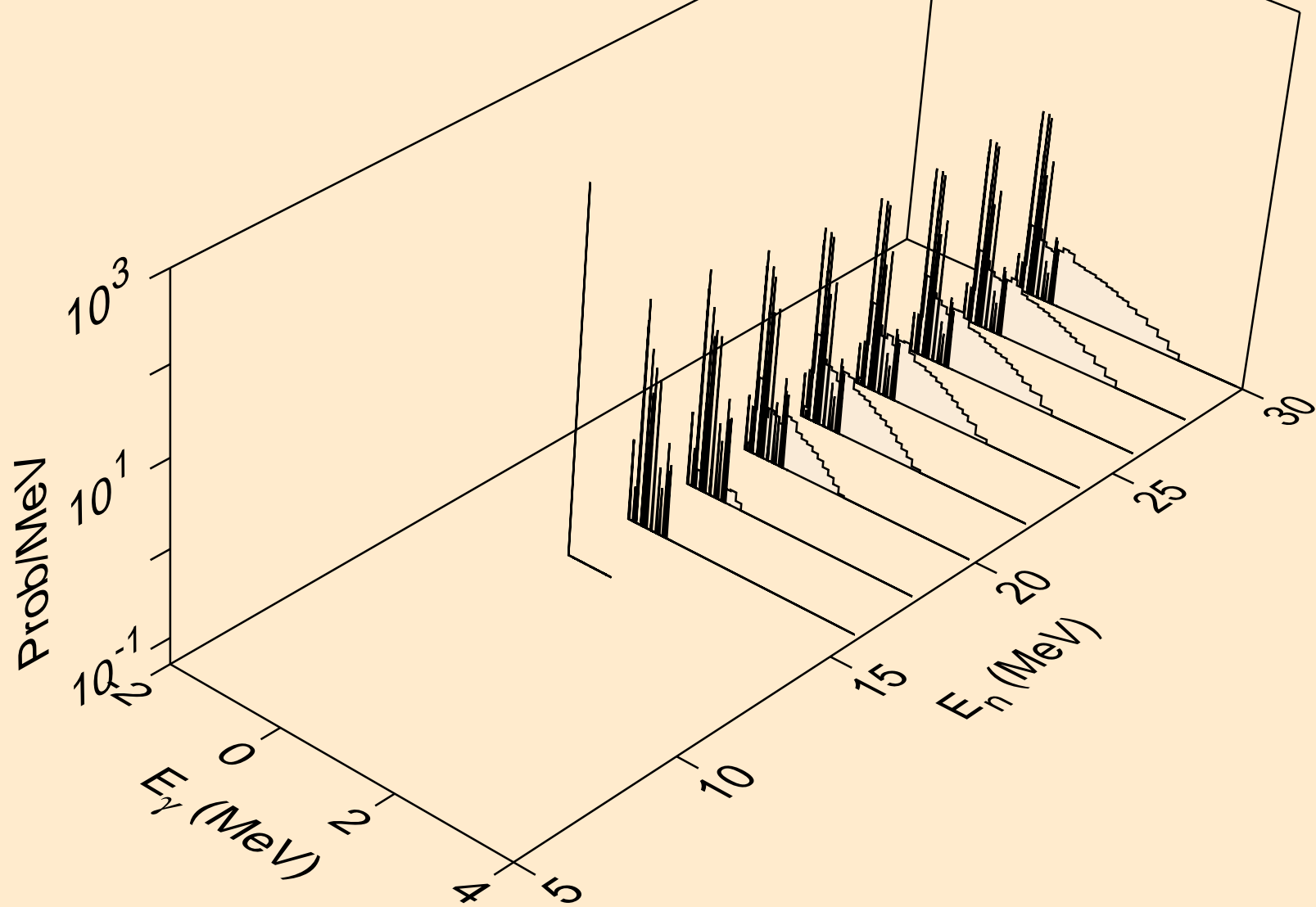

LU176M NEUTRON ACER TENDL-2023 LIBRARY; T=0.K
Photon emission for (n,p)

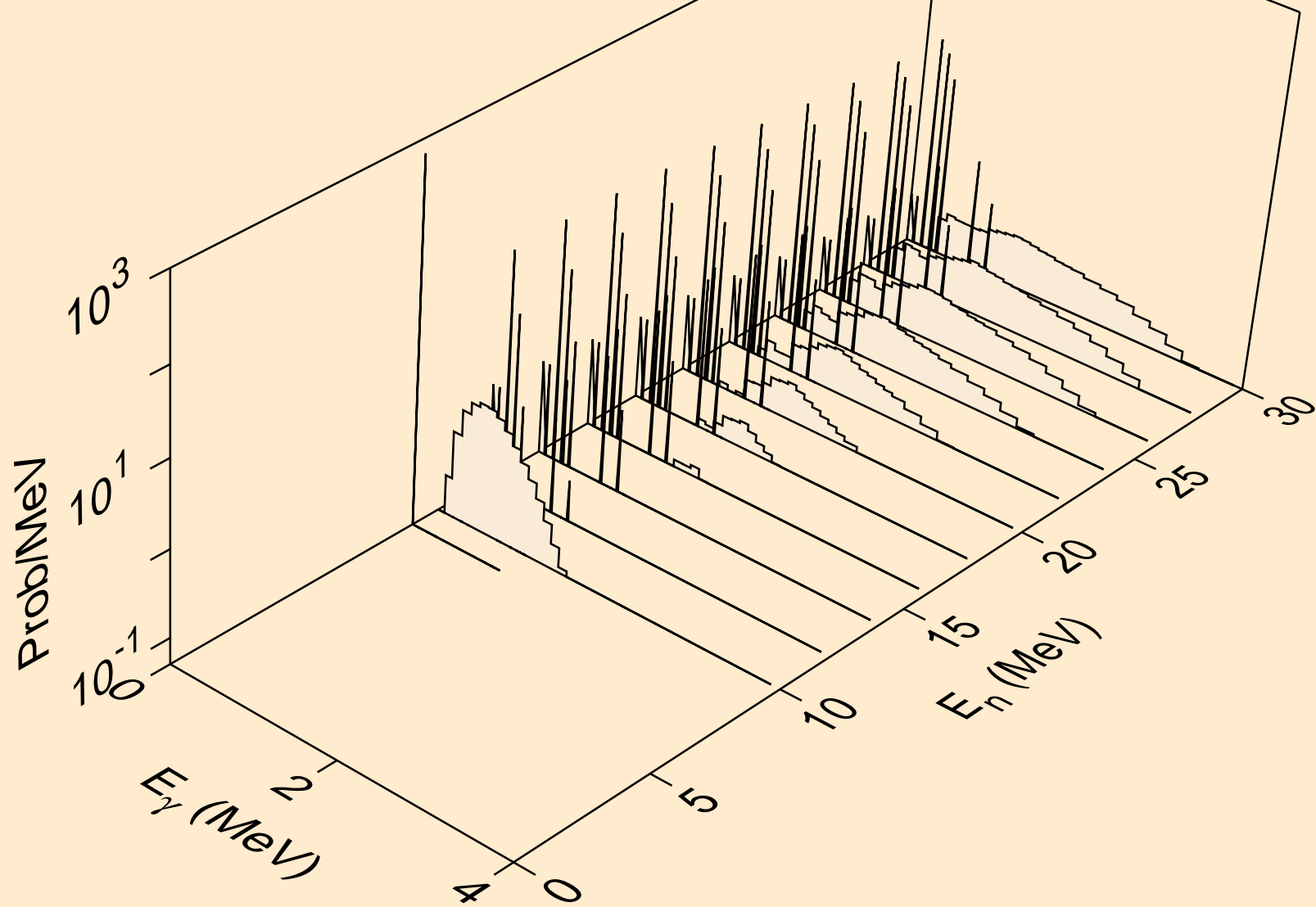

LU176M NEUTRON ACER TENDL-2023 LIBRARY; T=0.K
Photon emission for (n,pd)

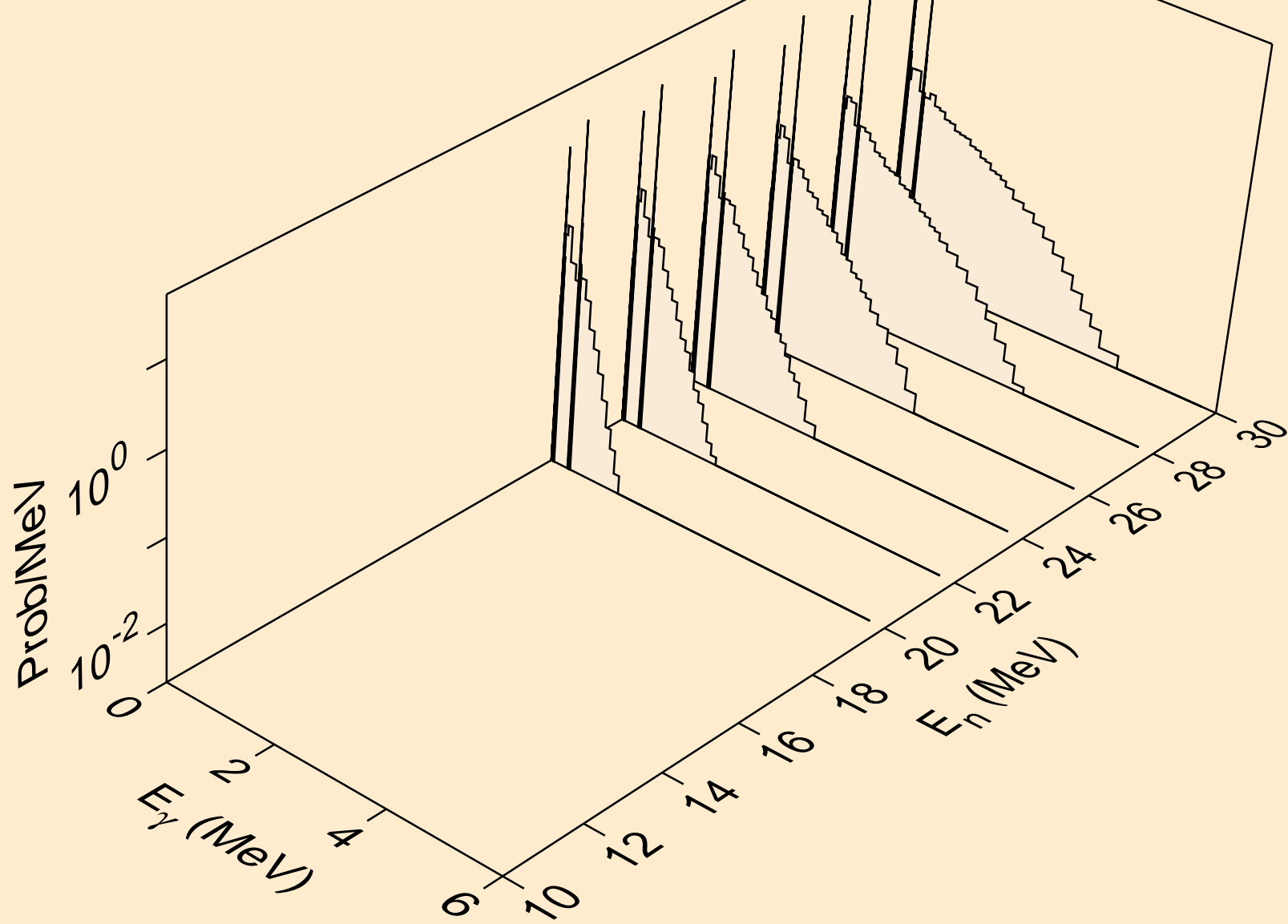

LU176M NEUTRON ACER TENDL-2023 LIBRARY; T=0.K
Photon emission for (n,pt)

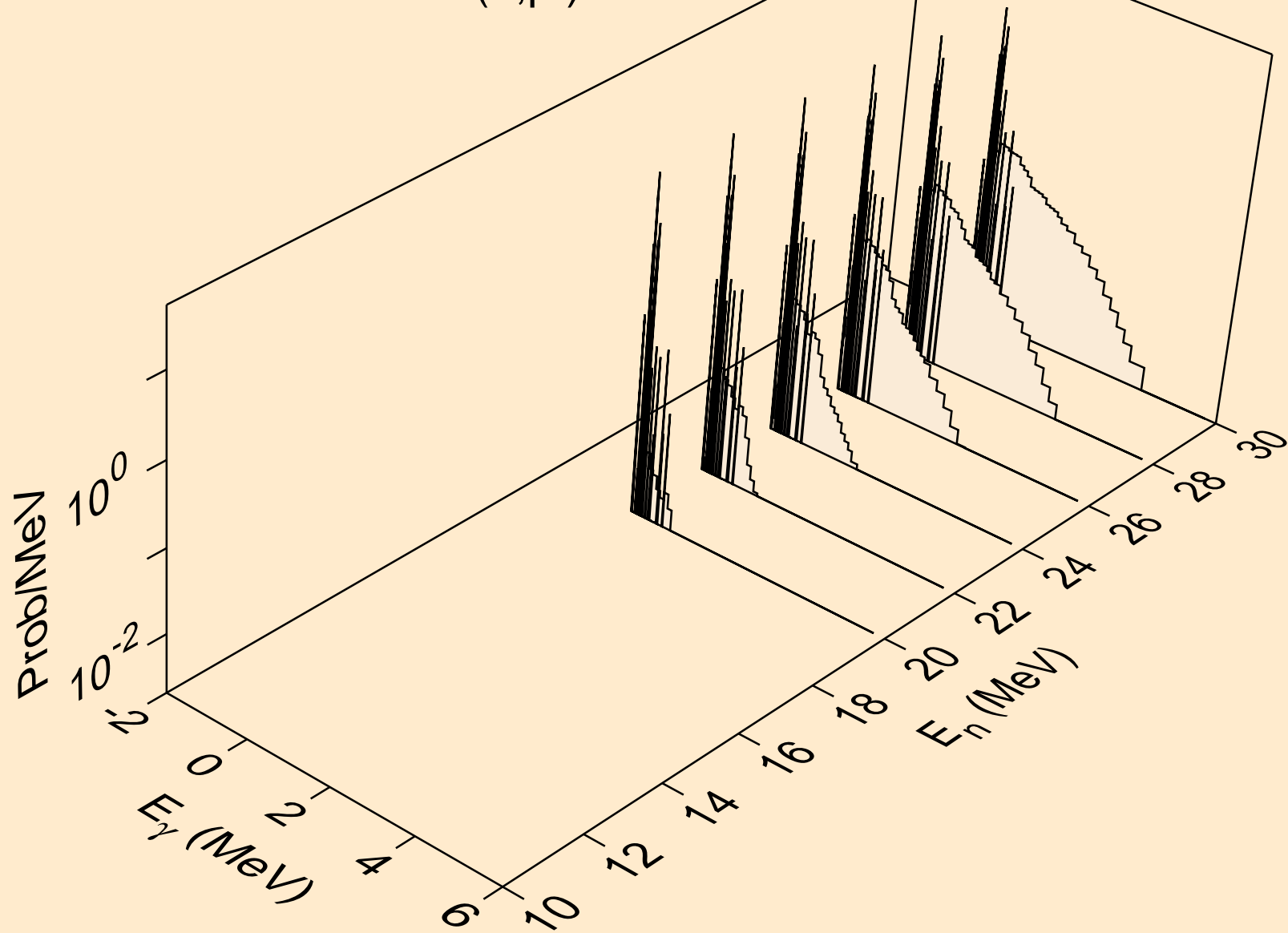

LU176M NEUTRON ACER TENDL-2023 LIBRARY; T=0.K
Photon emission for (n,da)

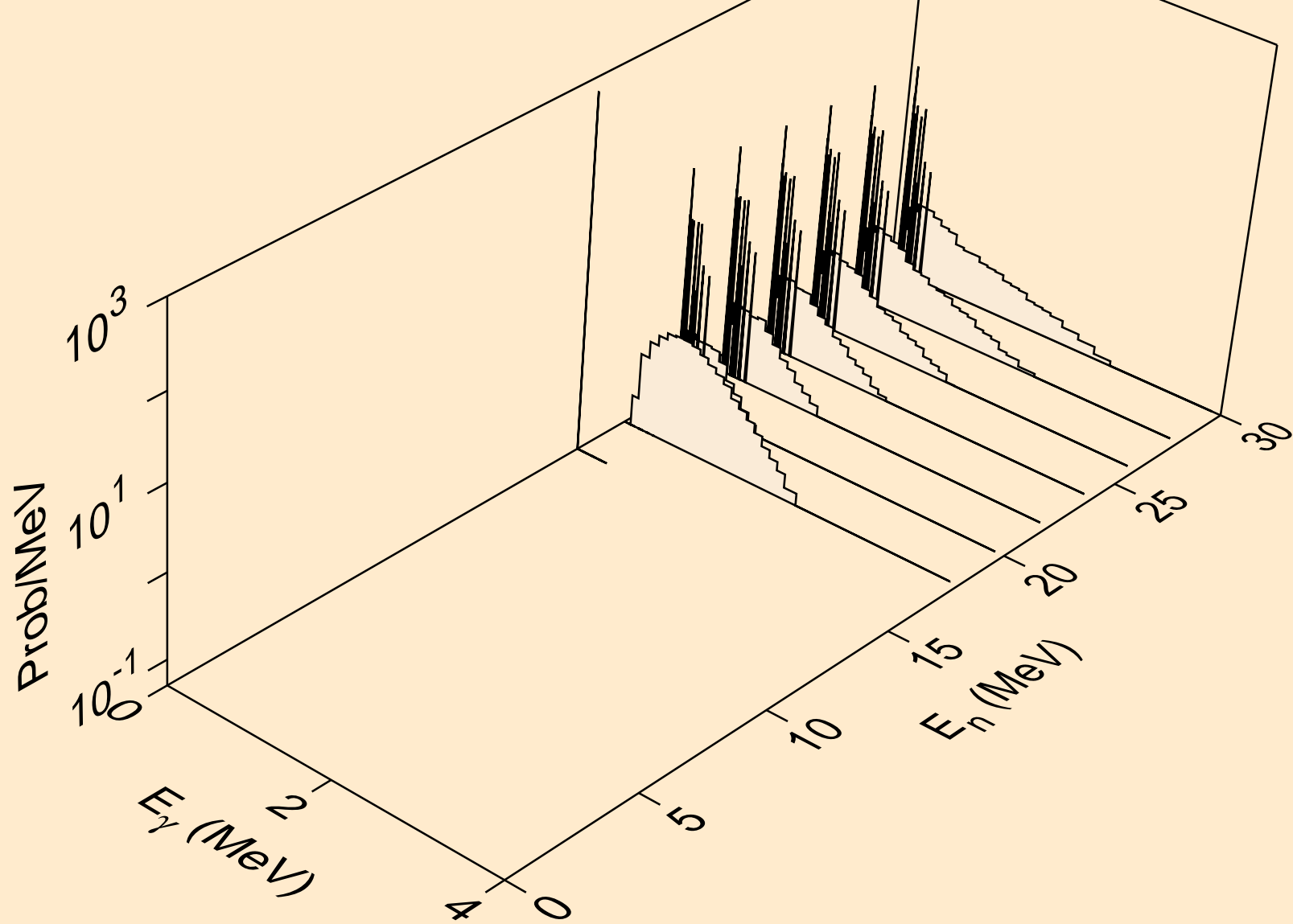

LU176M NEUTRON ACER TENDL-2023 LIBRARY; T=0.K
thermal capture photon spectrum

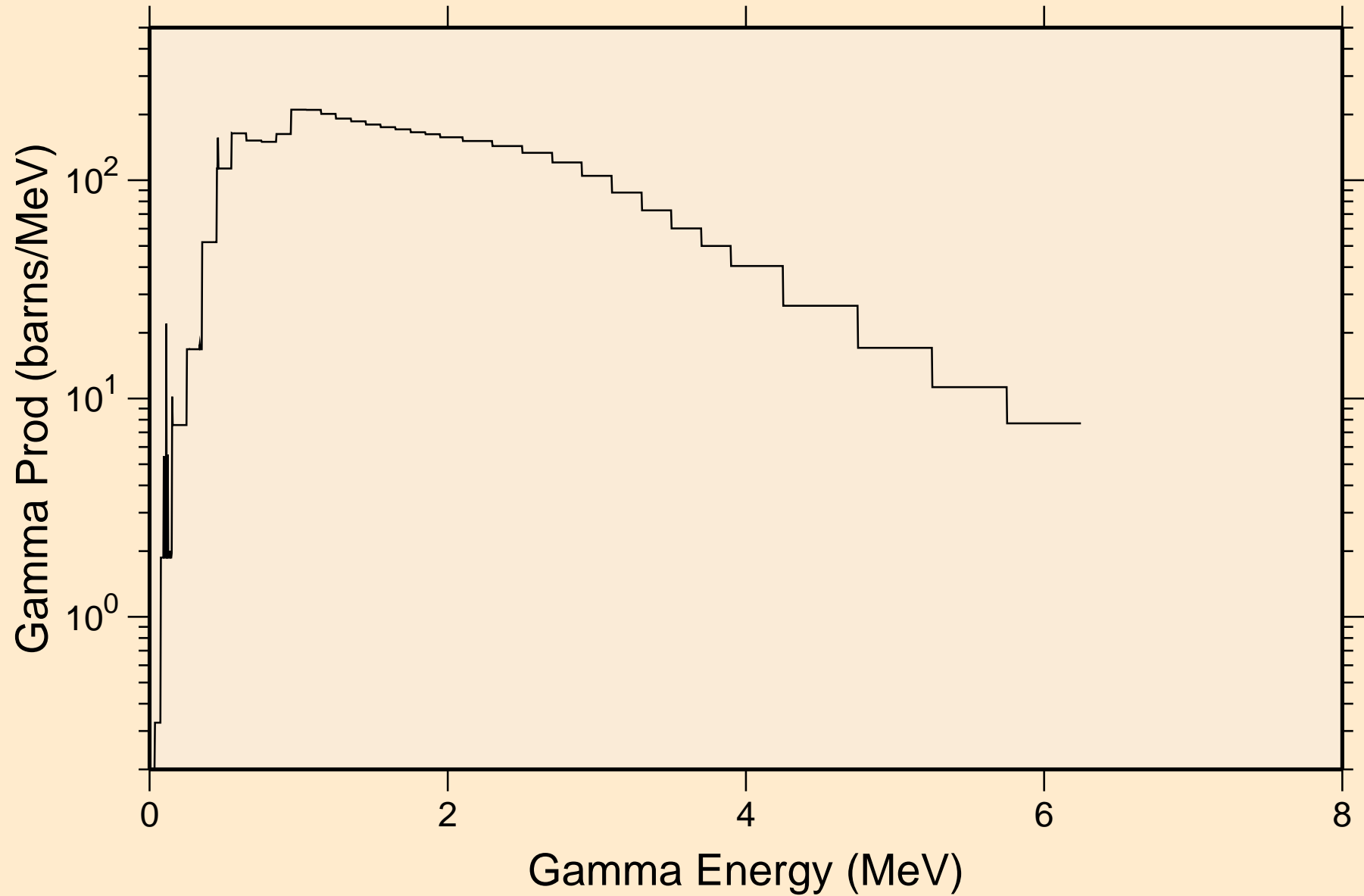

LU176M NEUTRON ACER TENDL-2023 LIBRARY; T=0.K
14 MeV photon spectrum

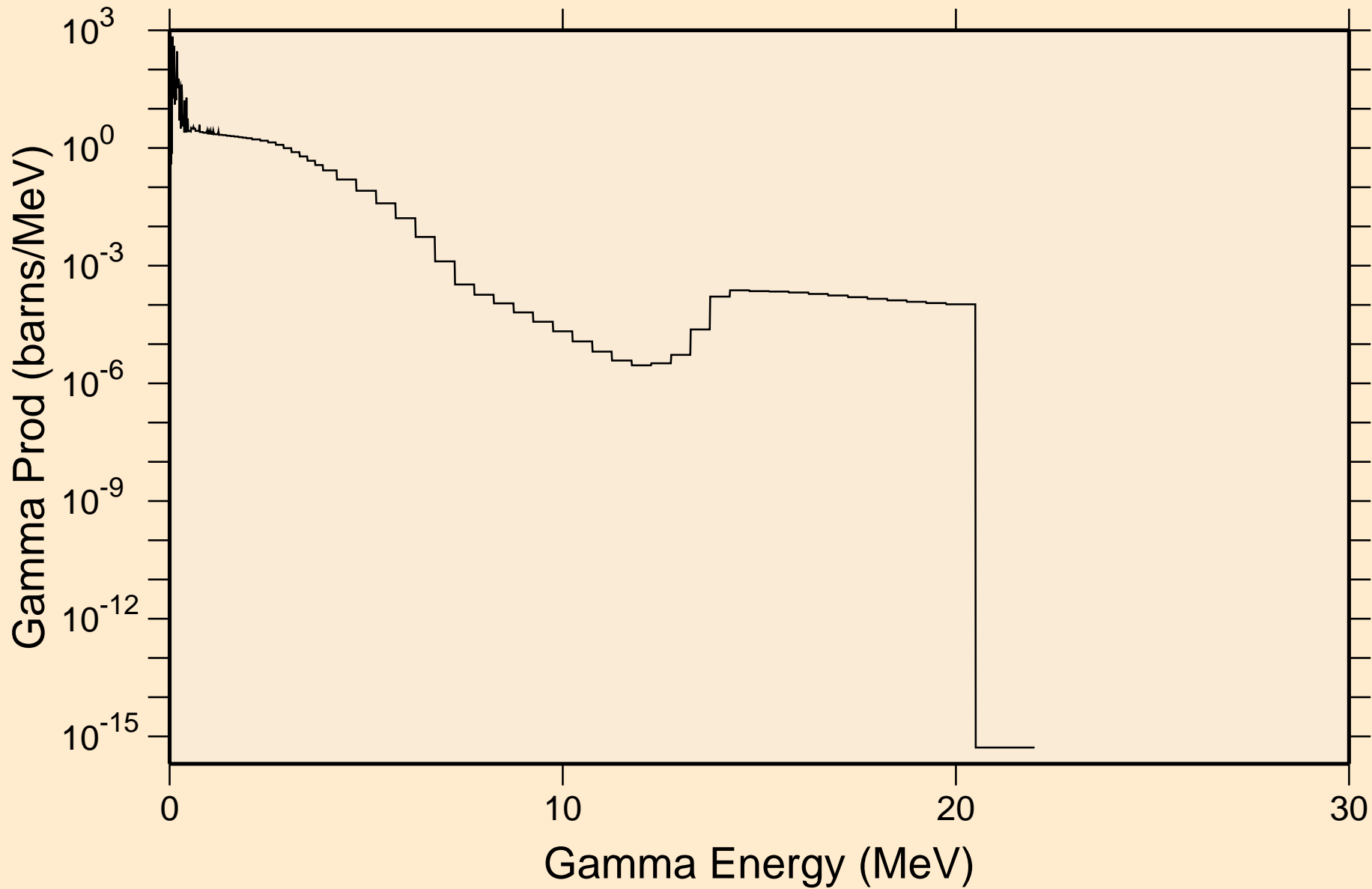

LU176M NEUTRON ACER TENDL-2023 LIBRARY; T=0.K
Particle heating contributions

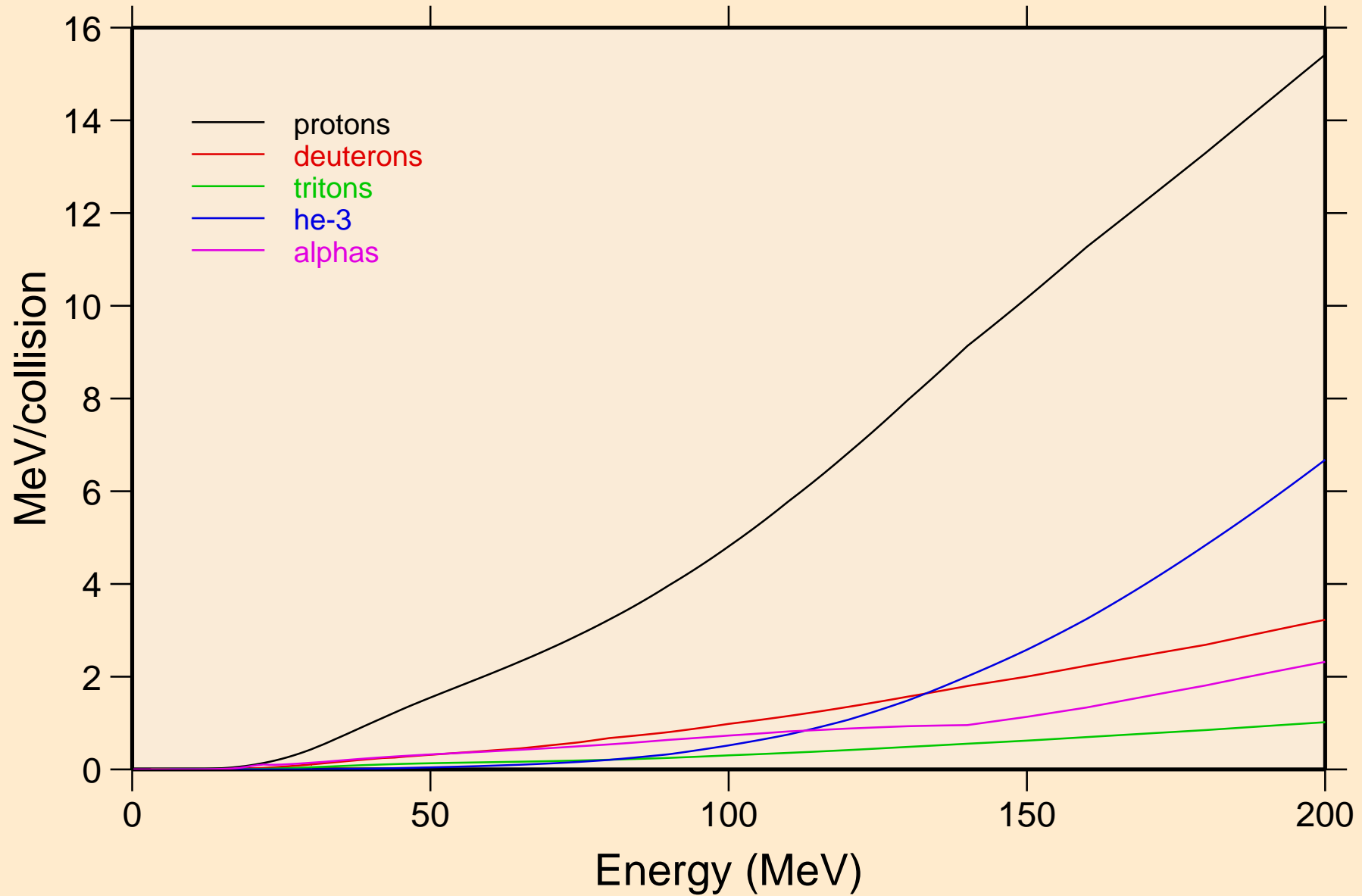

LU176M NEUTRON ACER TENDL-2023 LIBRARY; T=0.K
Recoil Heating

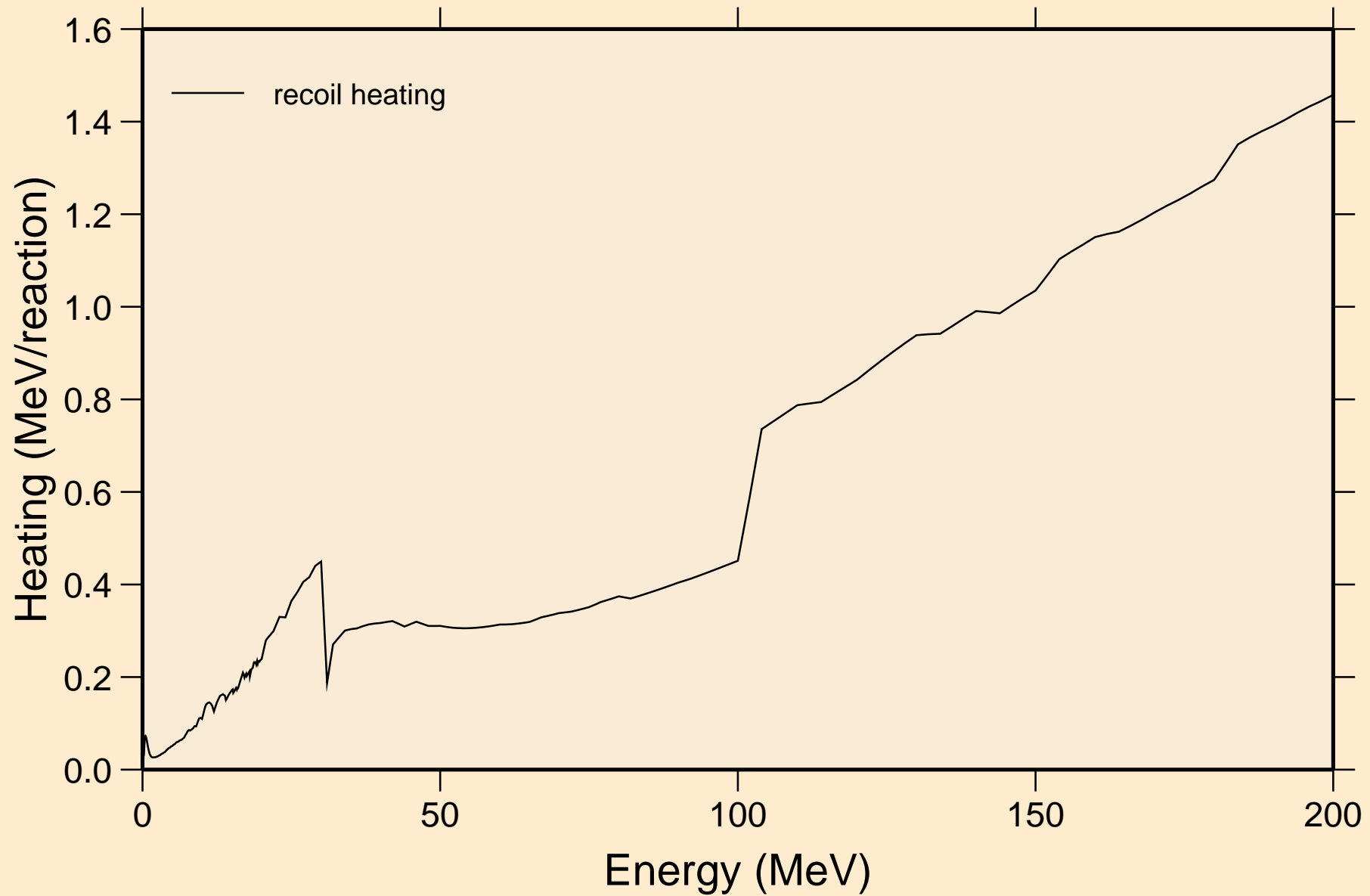

LU176M NEUTRON ACER TENDL-2023 LIBRARY; T=0.K
Particle production cross sections

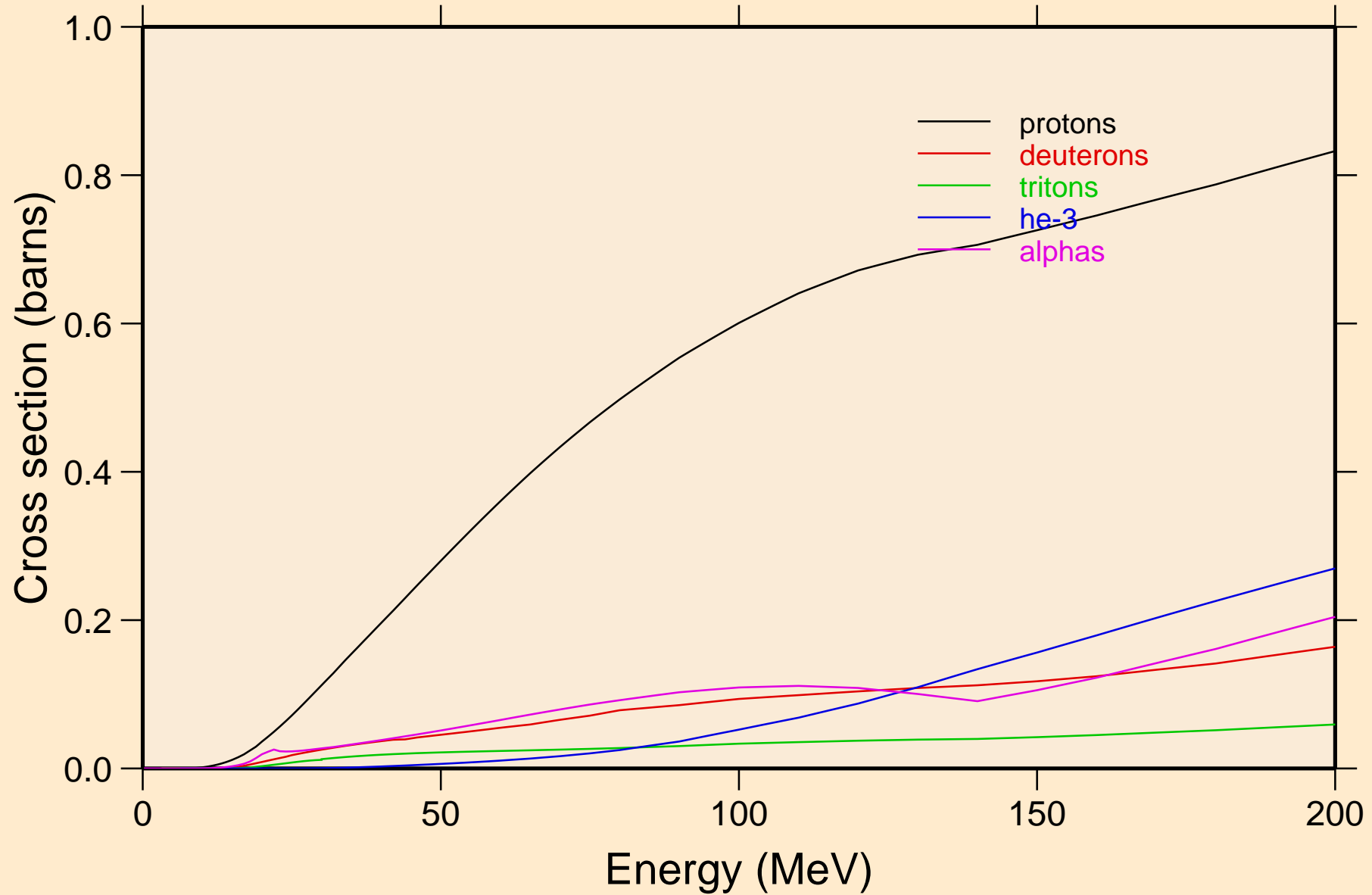

LU176M NEUTRON ACER TENDL-2023 LIBRARY; T=0.K
protons from (n,x)

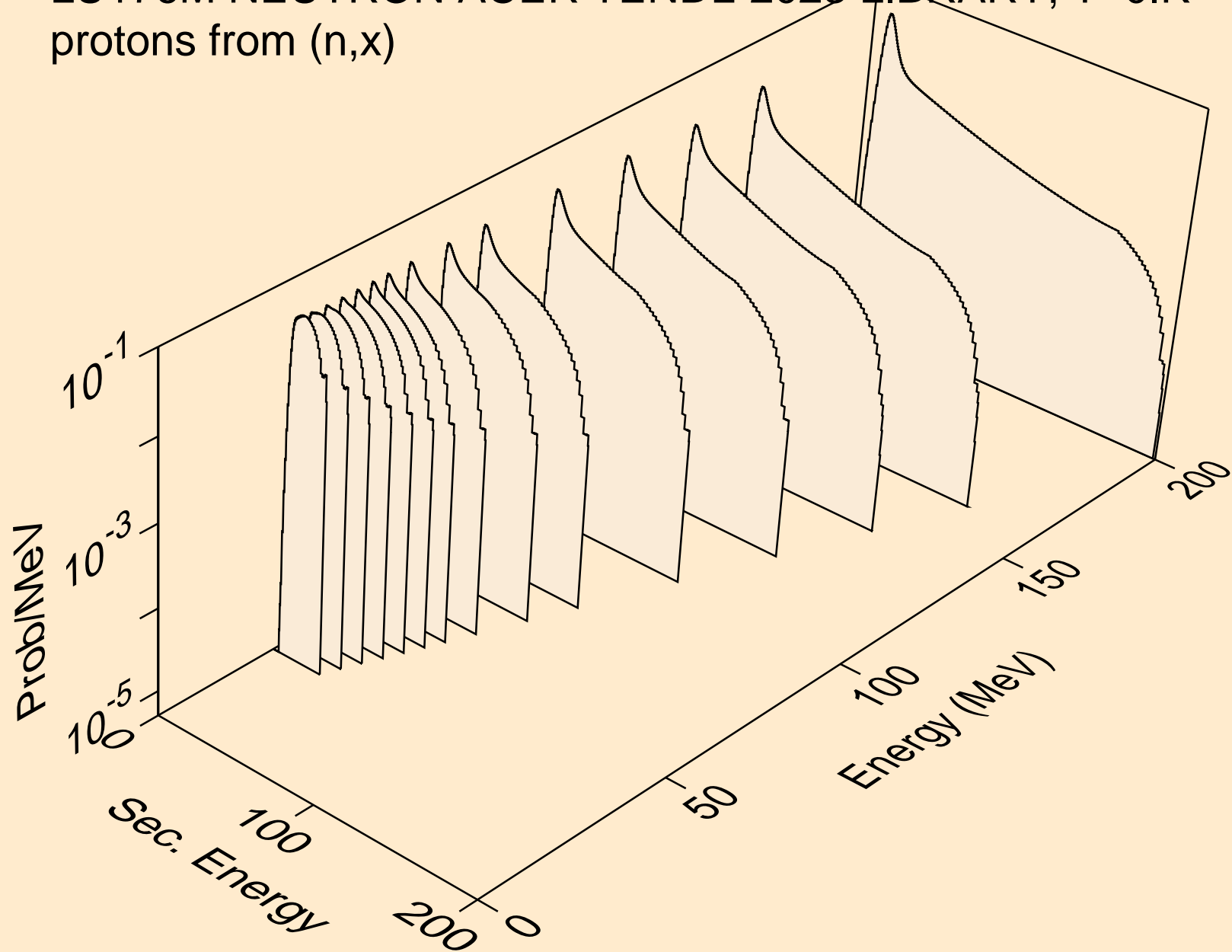

LU176M NEUTRON ACER TENDL-2023 LIBRARY; T=0.K
protons from (n,n*)p

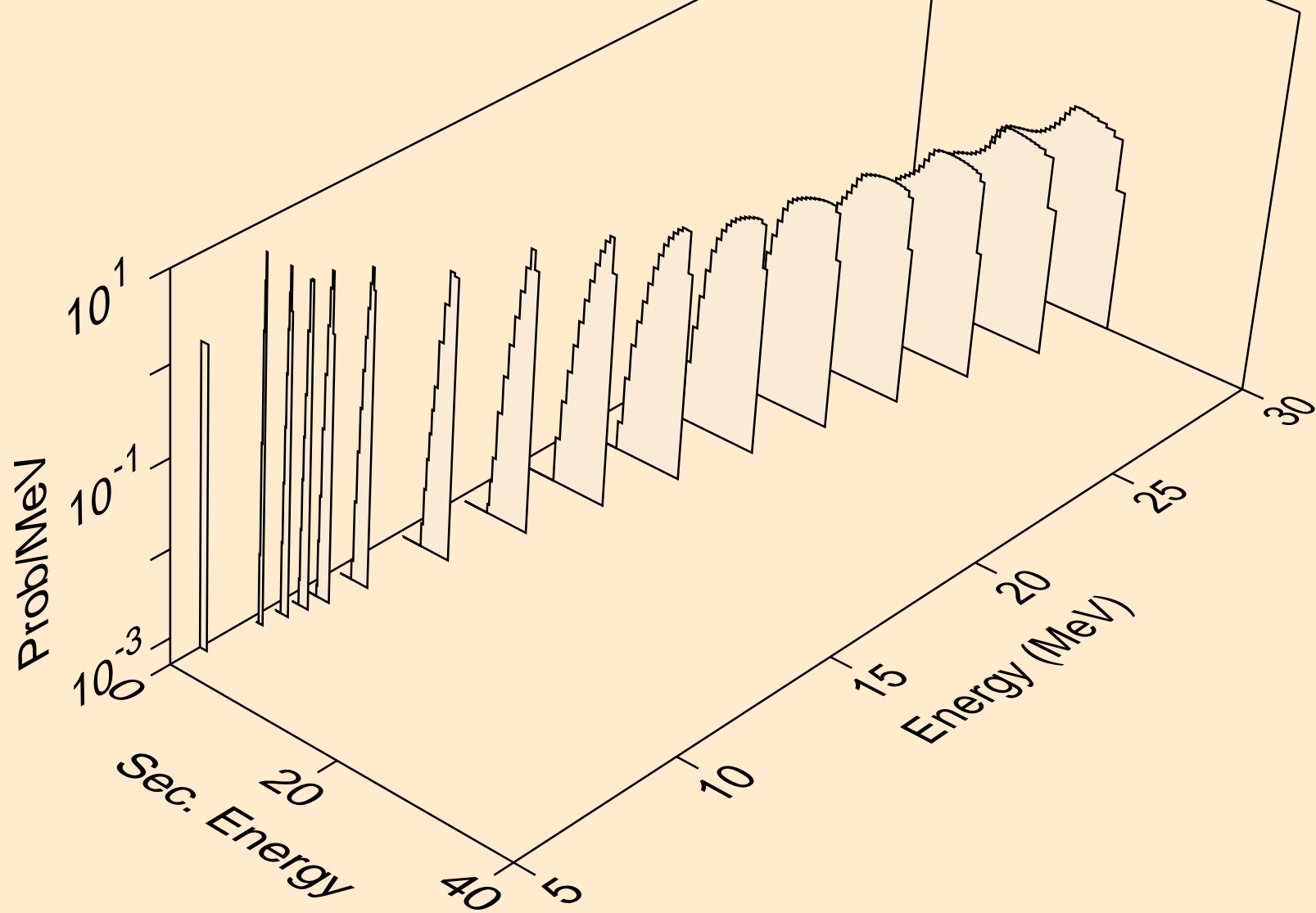

LU176M NEUTRON ACER TENDL-2023 LIBRARY; T=0.K
protons from (n,2np)

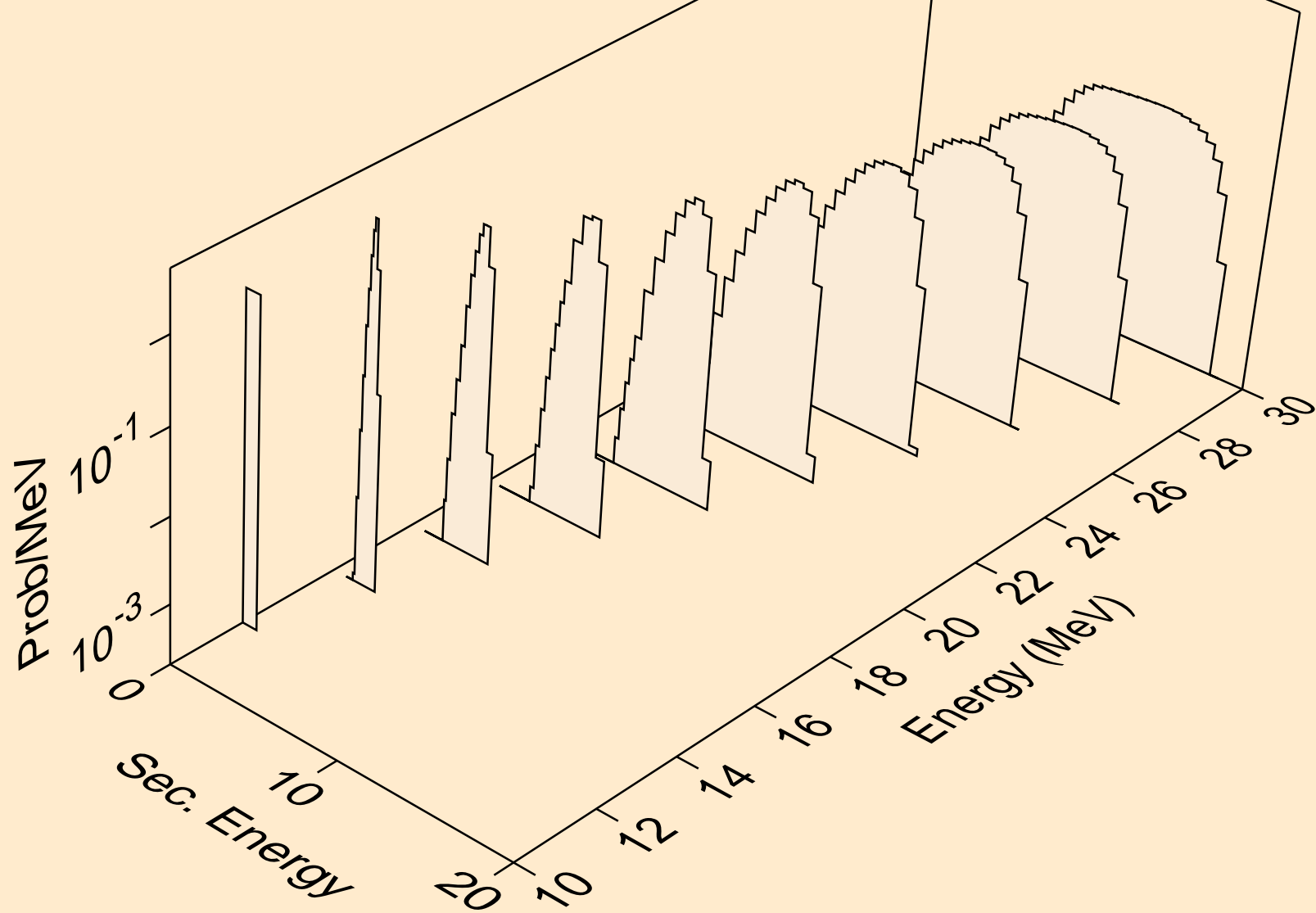

LU176M NEUTRON ACER TENDL-2023 LIBRARY; T=0.K
protons from (n,3np)

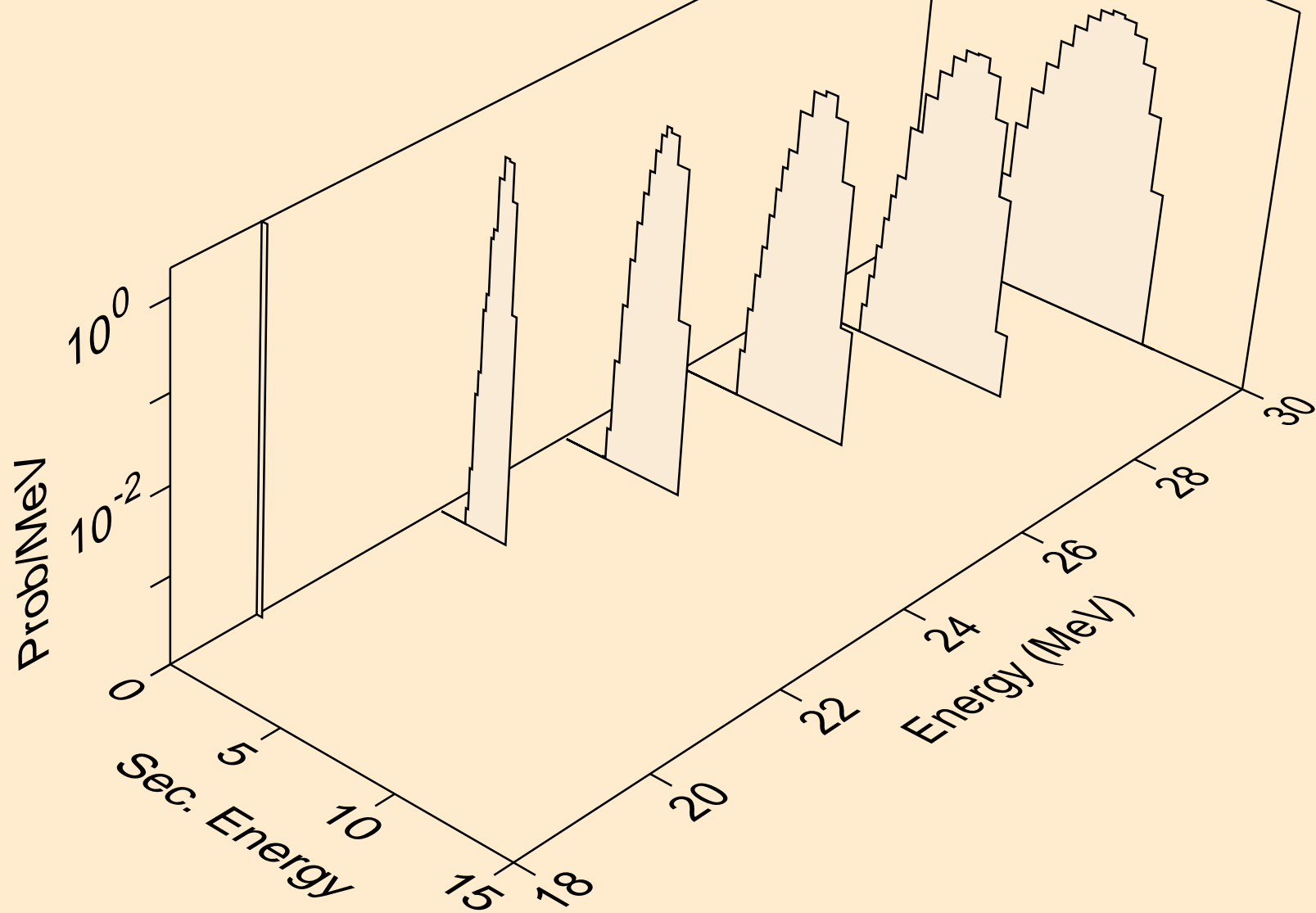

LU176M NEUTRON ACER TENDL-2023 LIBRARY; T=0.K
protons from (n,n2p)

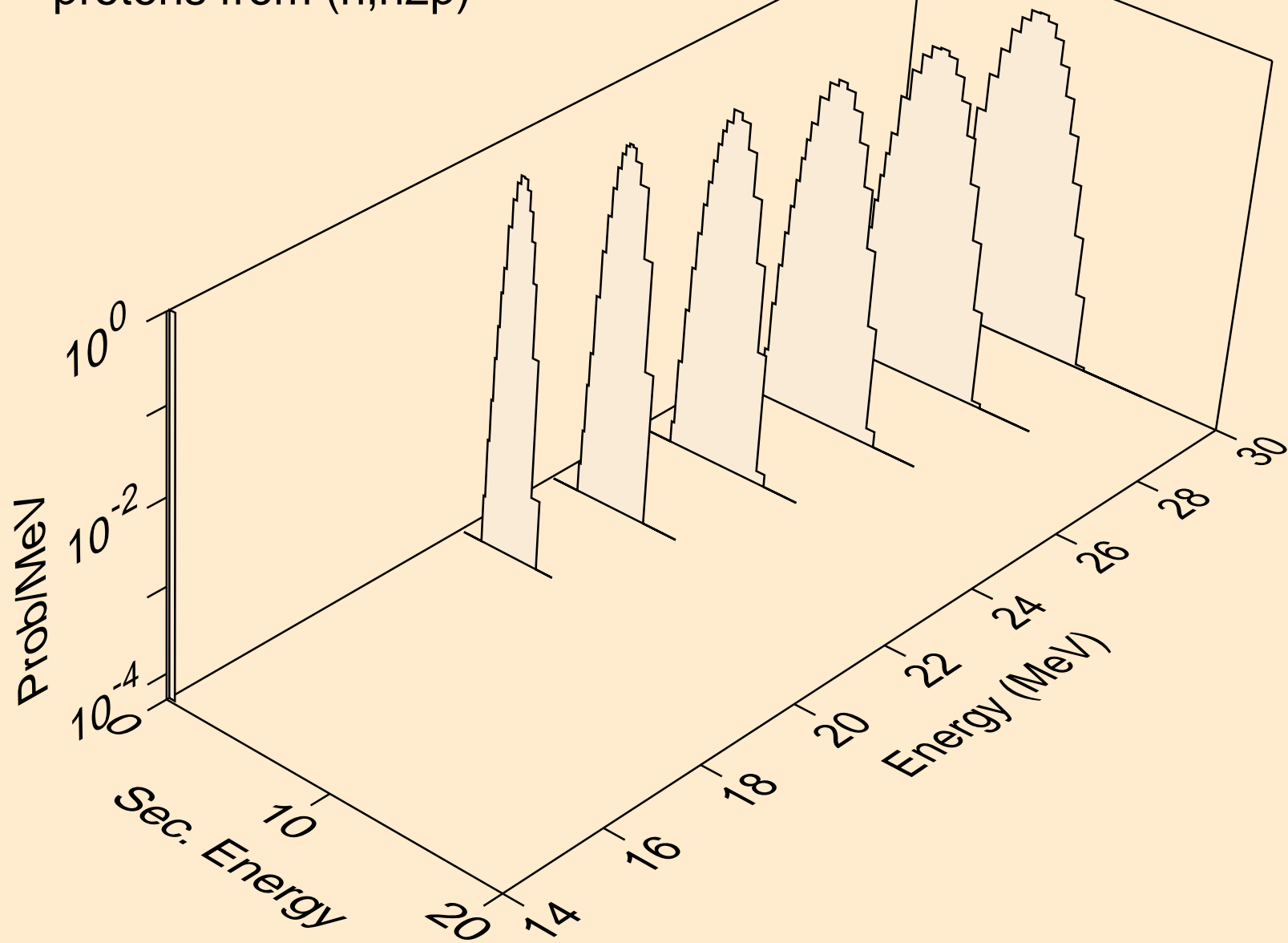

LU176M NEUTRON ACER TENDL-2023 LIBRARY; T=0.K
protons from (n,npa)

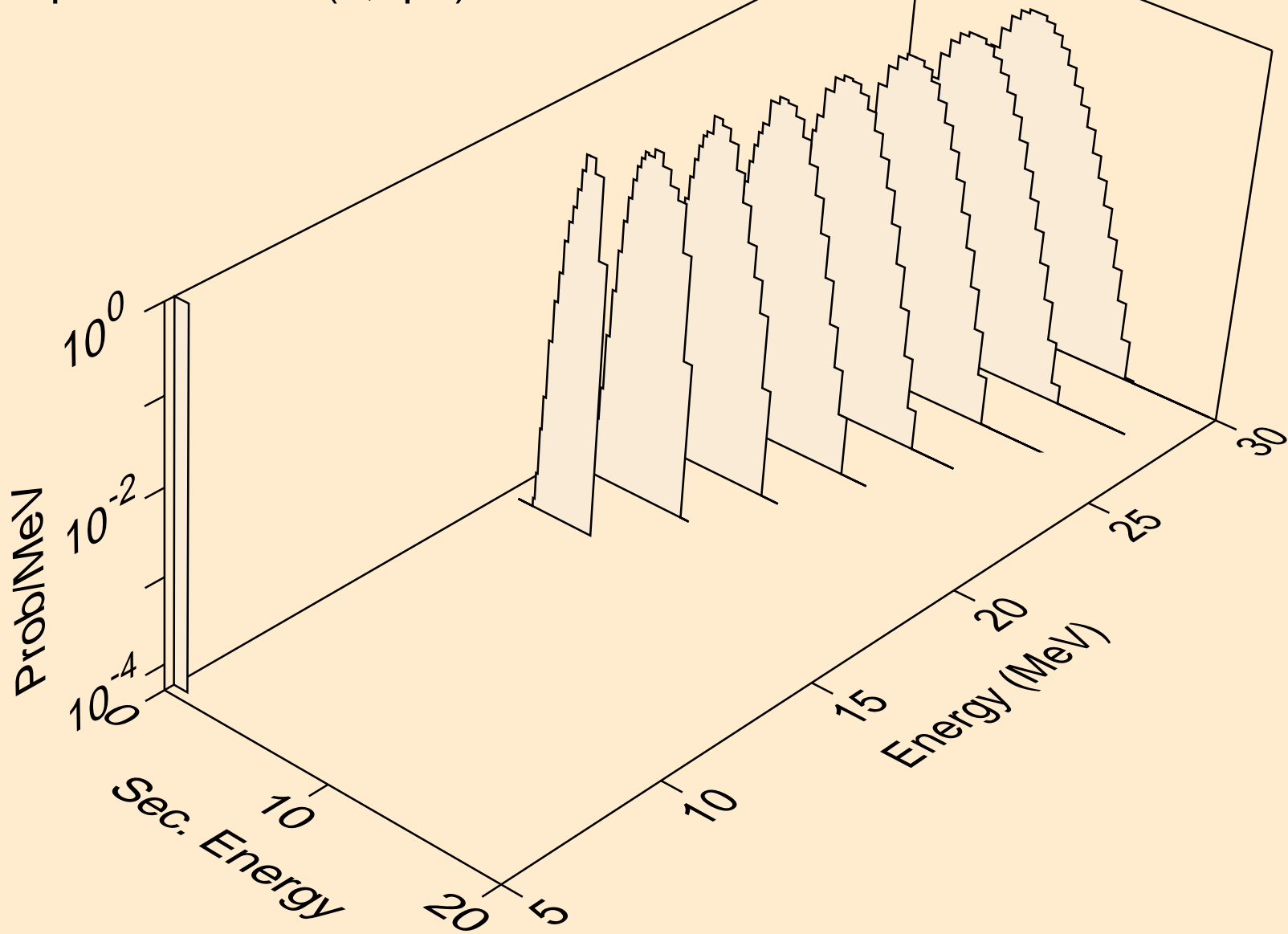

LU176M NEUTRON ACER TENDL-2023 LIBRARY; T=0.K
protons from (n,p)

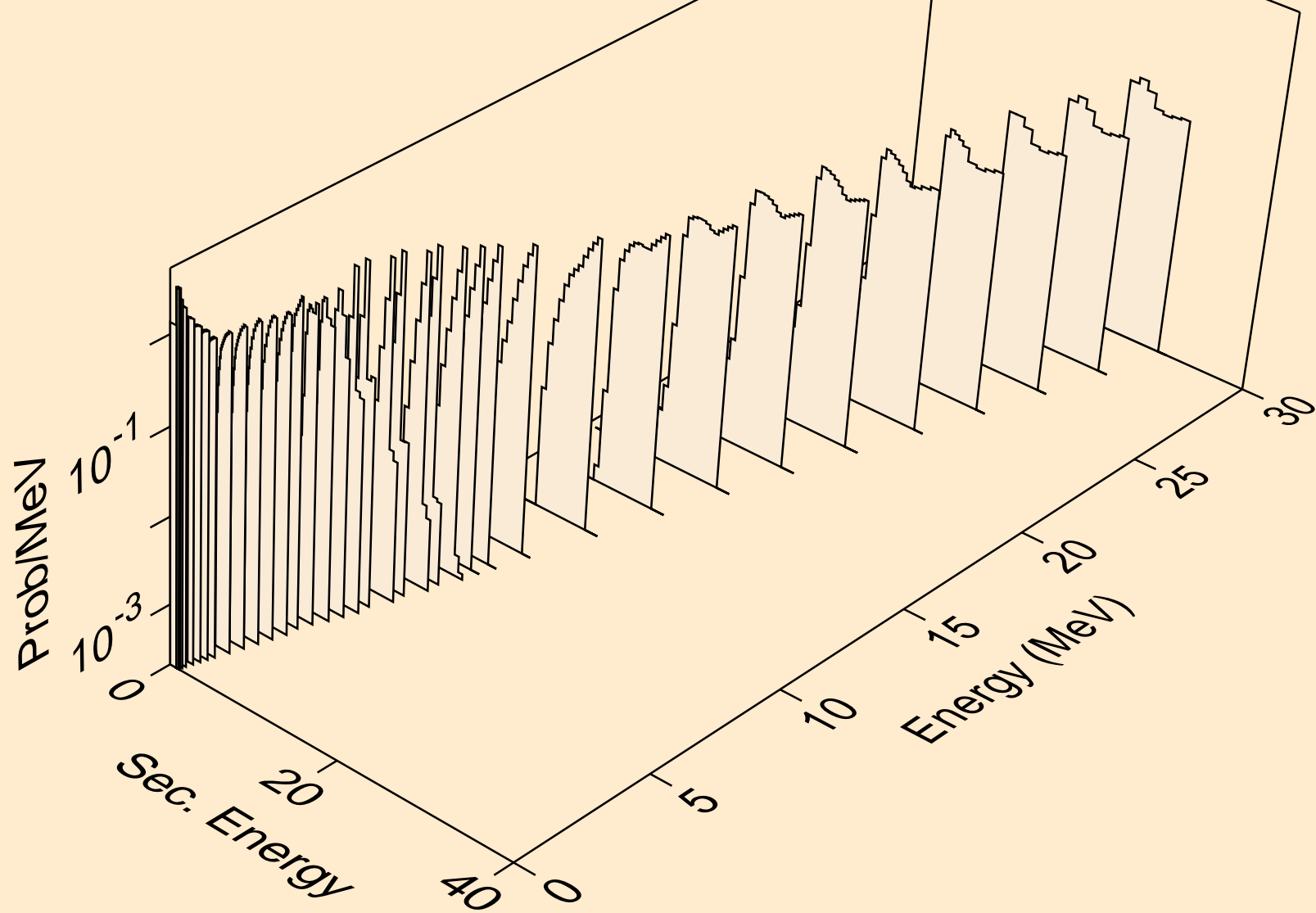

LU176M NEUTRON ACER TENDL-2023 LIBRARY; T=0.K
protons from (n,2p)

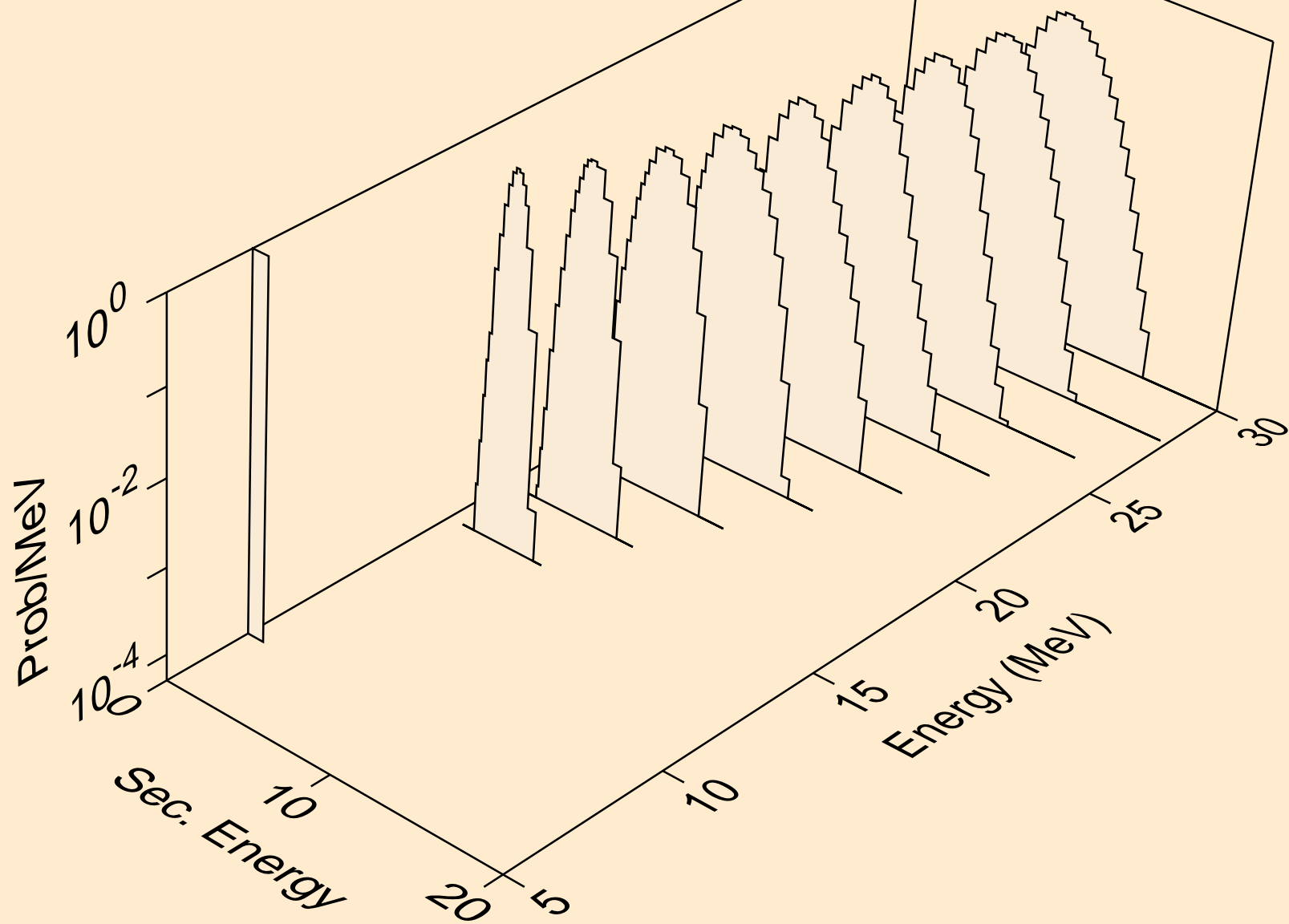

LU176M NEUTRON ACER TENDL-2023 LIBRARY; T=0.K
protons from (n,p)

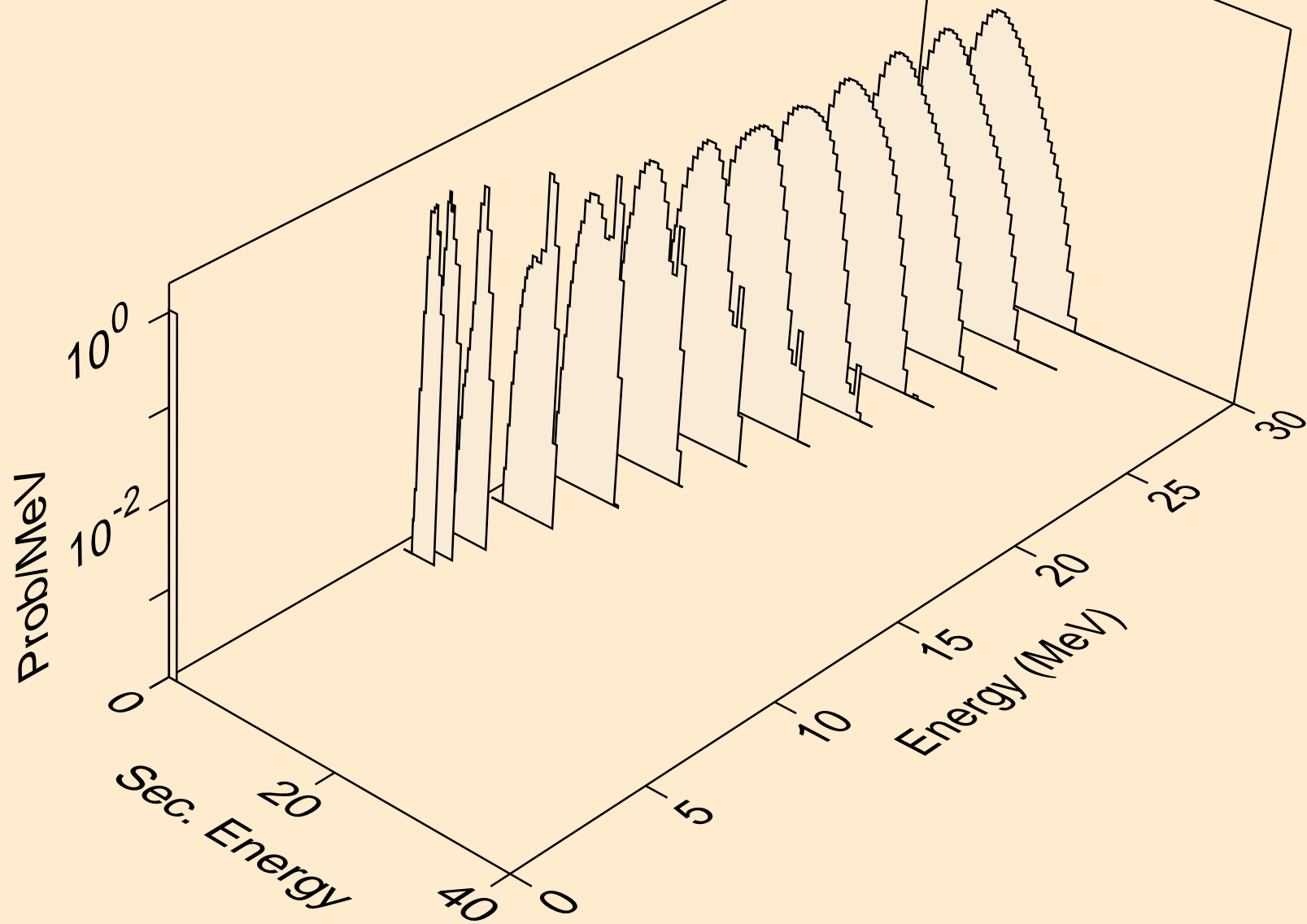

LU176M NEUTRON ACER TENDL-2023 LIBRARY; T=0.K
protons from (n,pd)

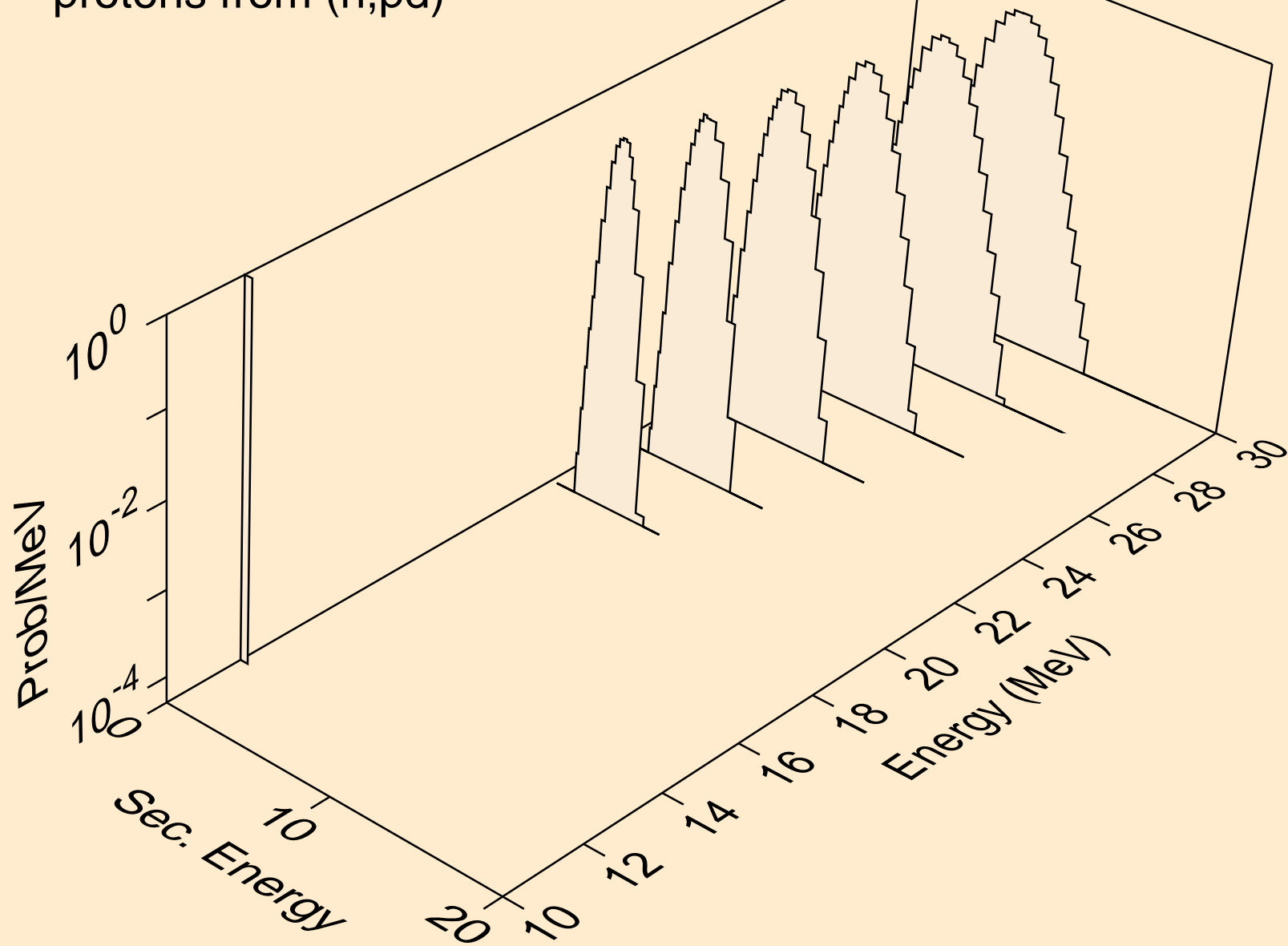

LU176M NEUTRON ACER TENDL-2023 LIBRARY; T=0.K
protons from (n,pt)

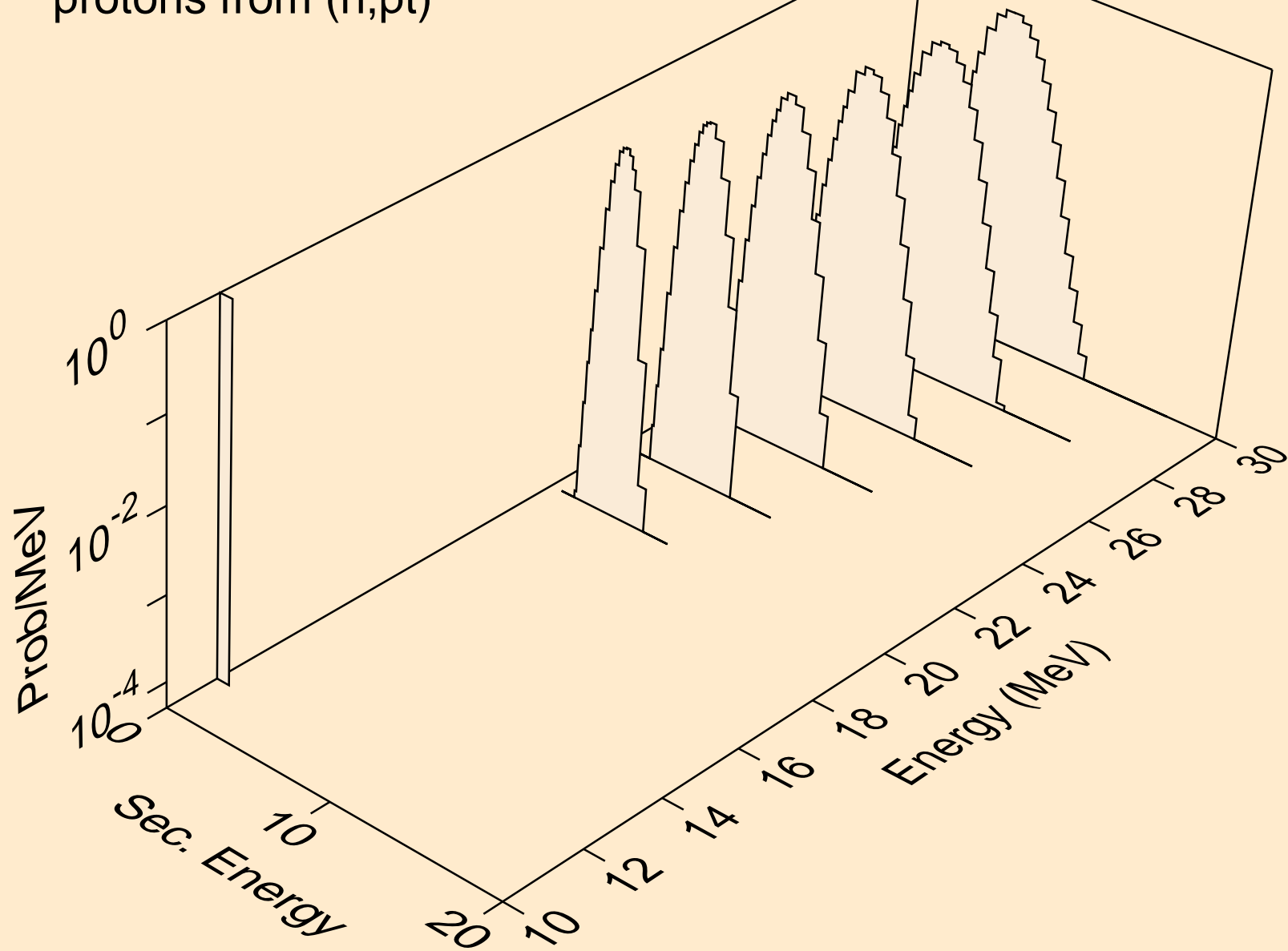

LU176M NEUTRON ACER TENDL-2023 LIBRARY; T=0.K
deuterons from (n,x)

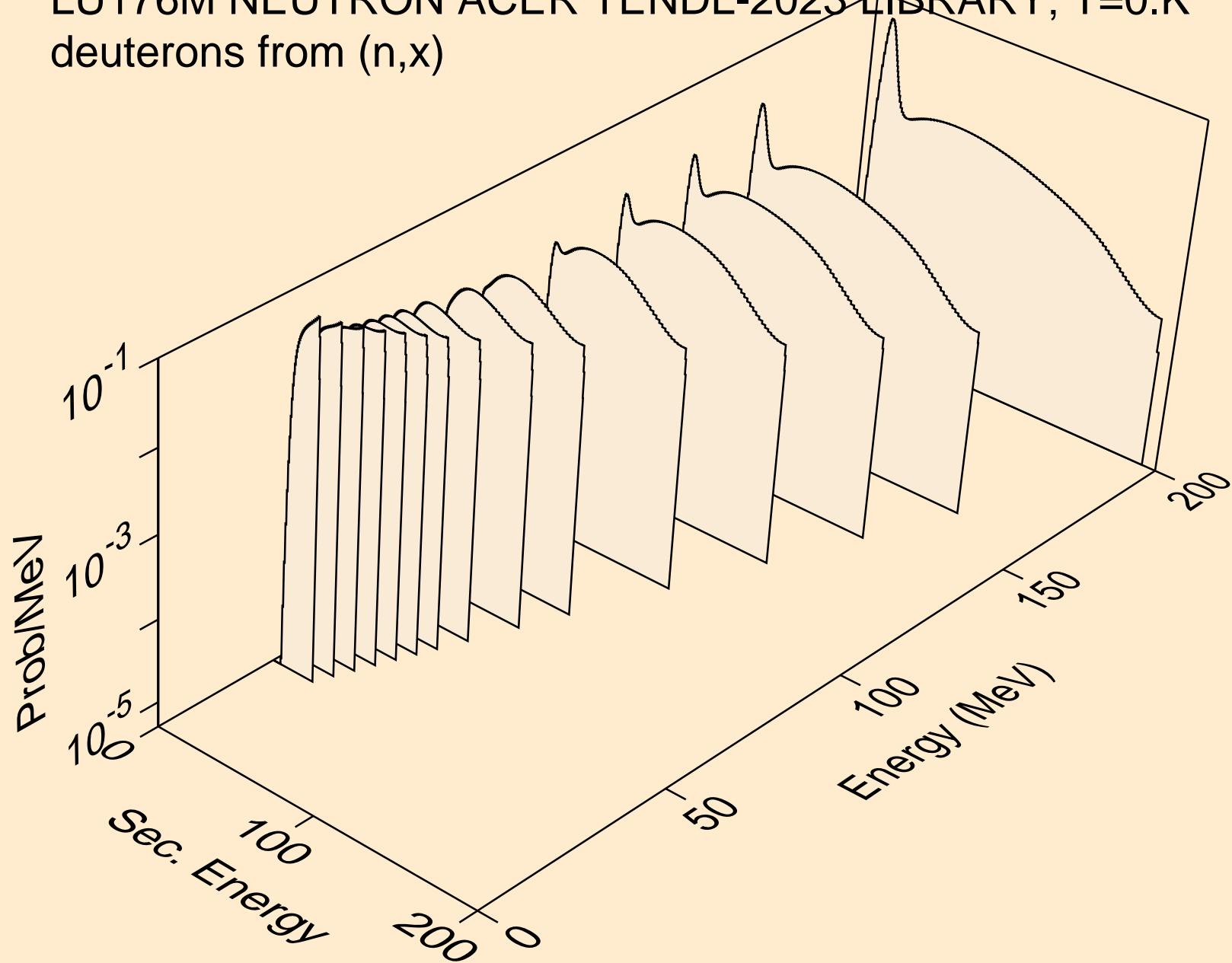

LU176M NEUTRON ACER TENDL-2023 LIBRARY; T=0.K
deuterons from (n,2nd)

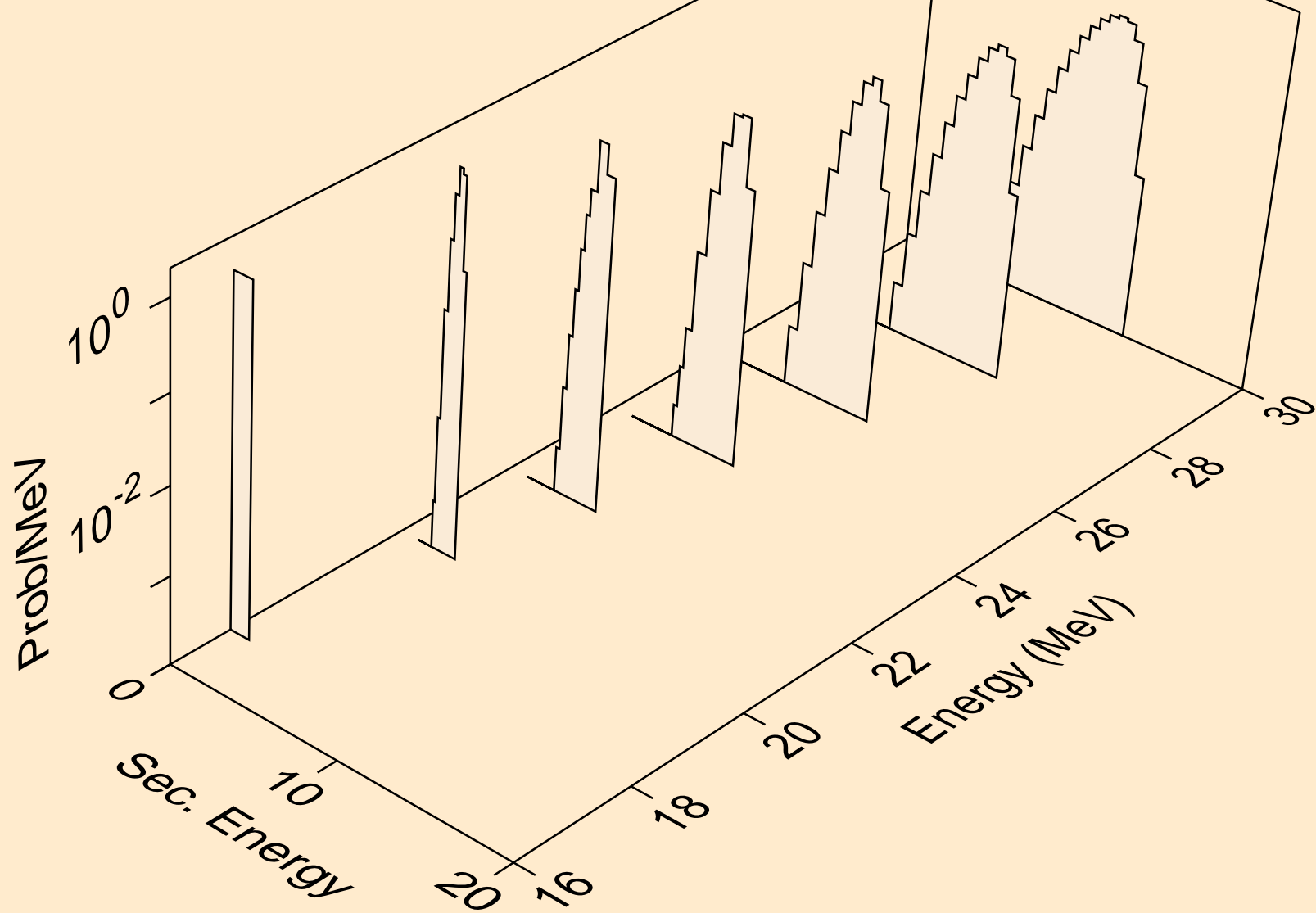

LU176M NEUTRON ACER TENDL-2023 LIBRARY; T=0.K
deuterons from (n,n*)d

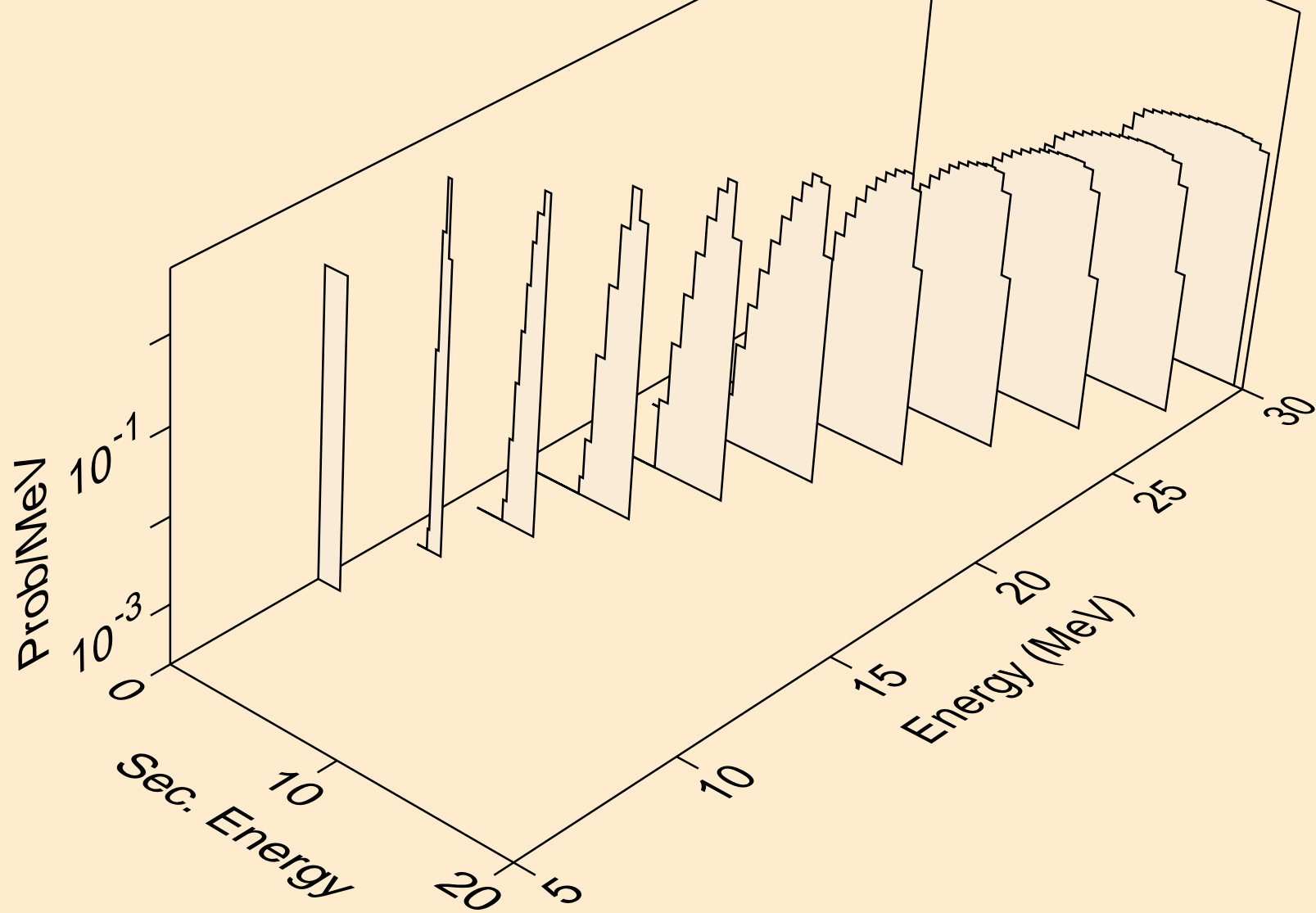

LU176M NEUTRON ACER TENDL-2023 LIBRARY; T=0.K
deuterons from (n,d)

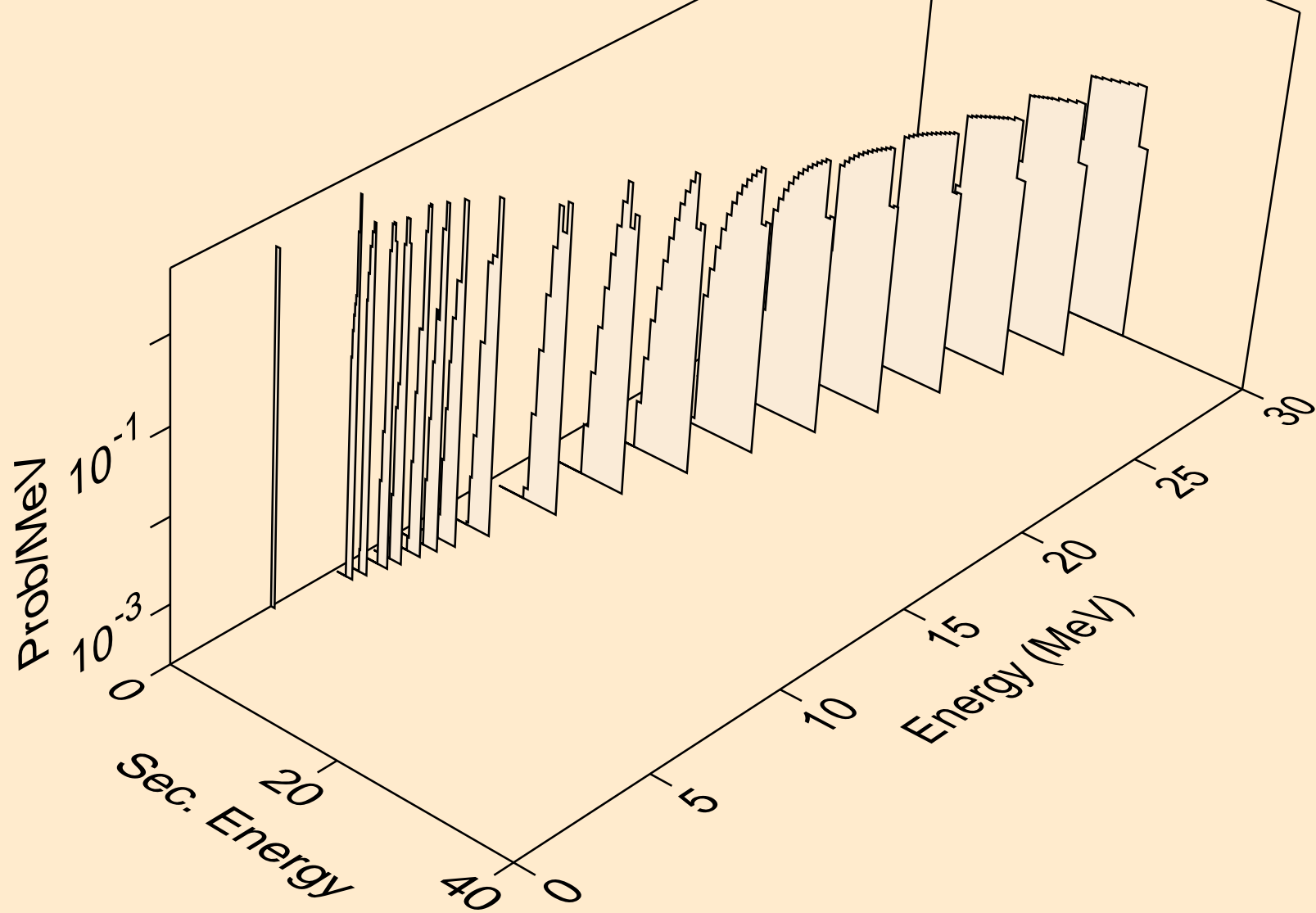

LU176M NEUTRON ACER TENDL-2023 LIBRARY; T=0.K
deuterons from (n,pd)

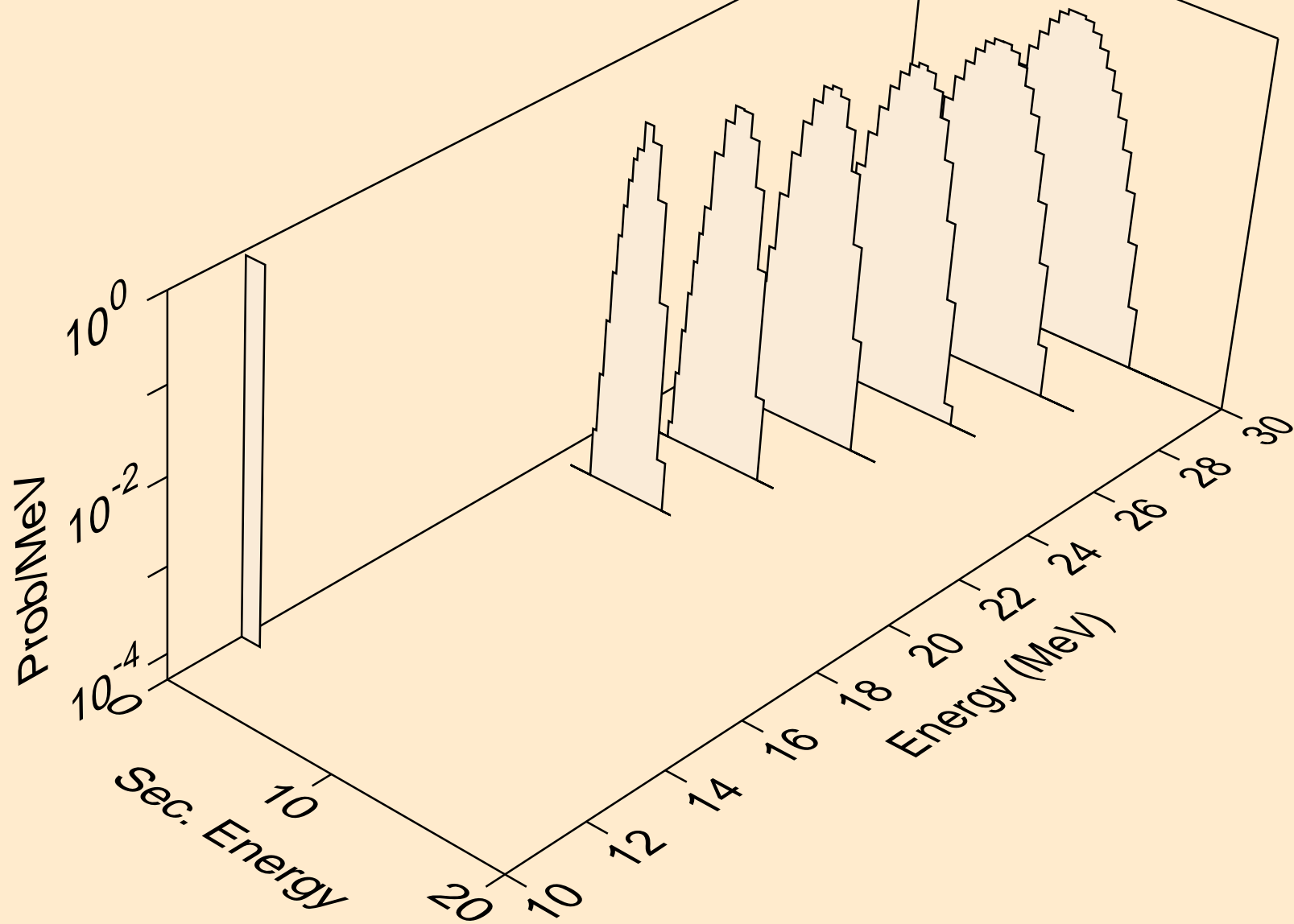

LU176M NEUTRON ACER TENDL-2023 LIBRARY; T=0.K
deuterons from (n,da)

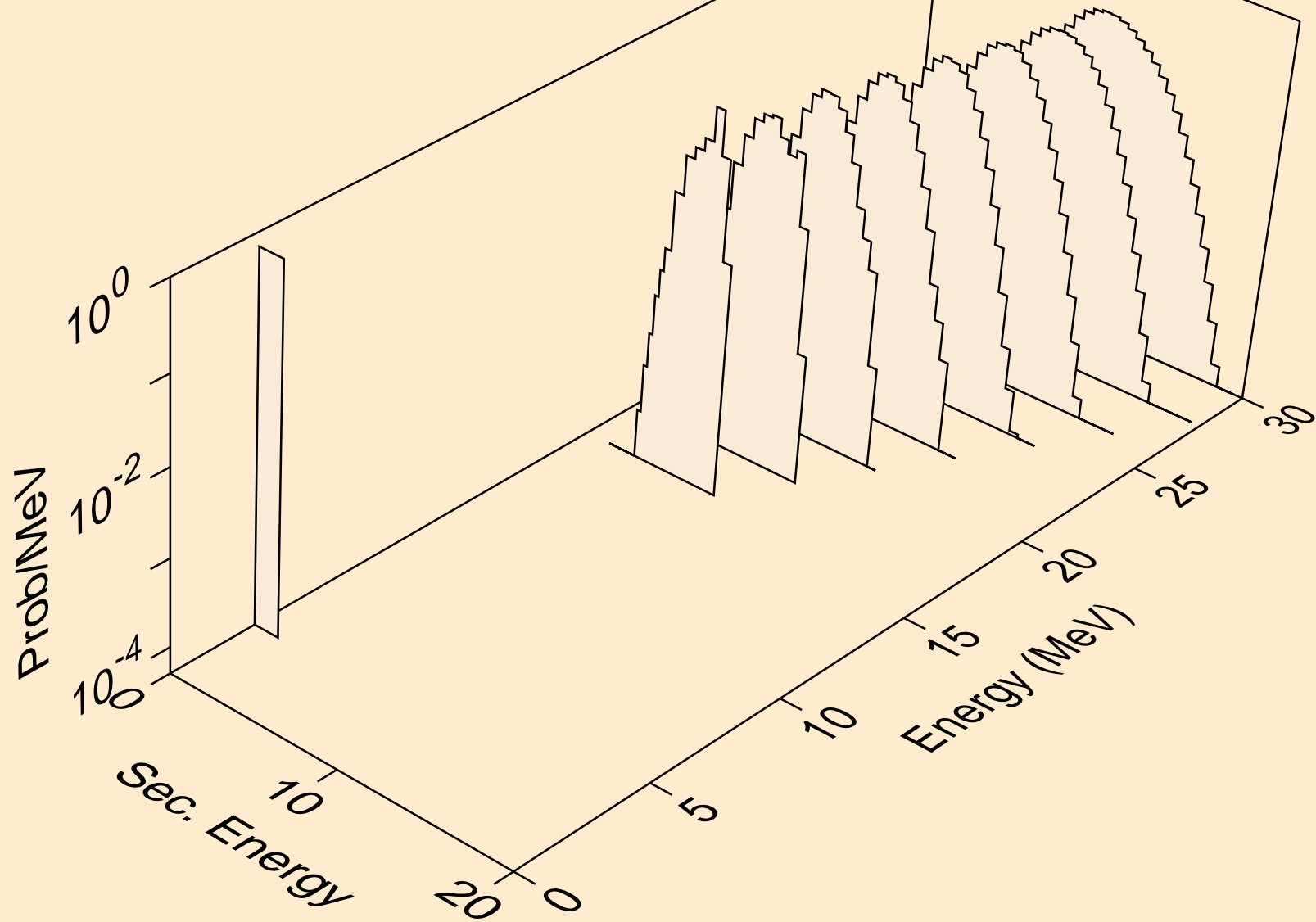

LU176M NEUTRON ACER TENDL-2023 LIBRARY; T=0.K
tritons from (n,x)

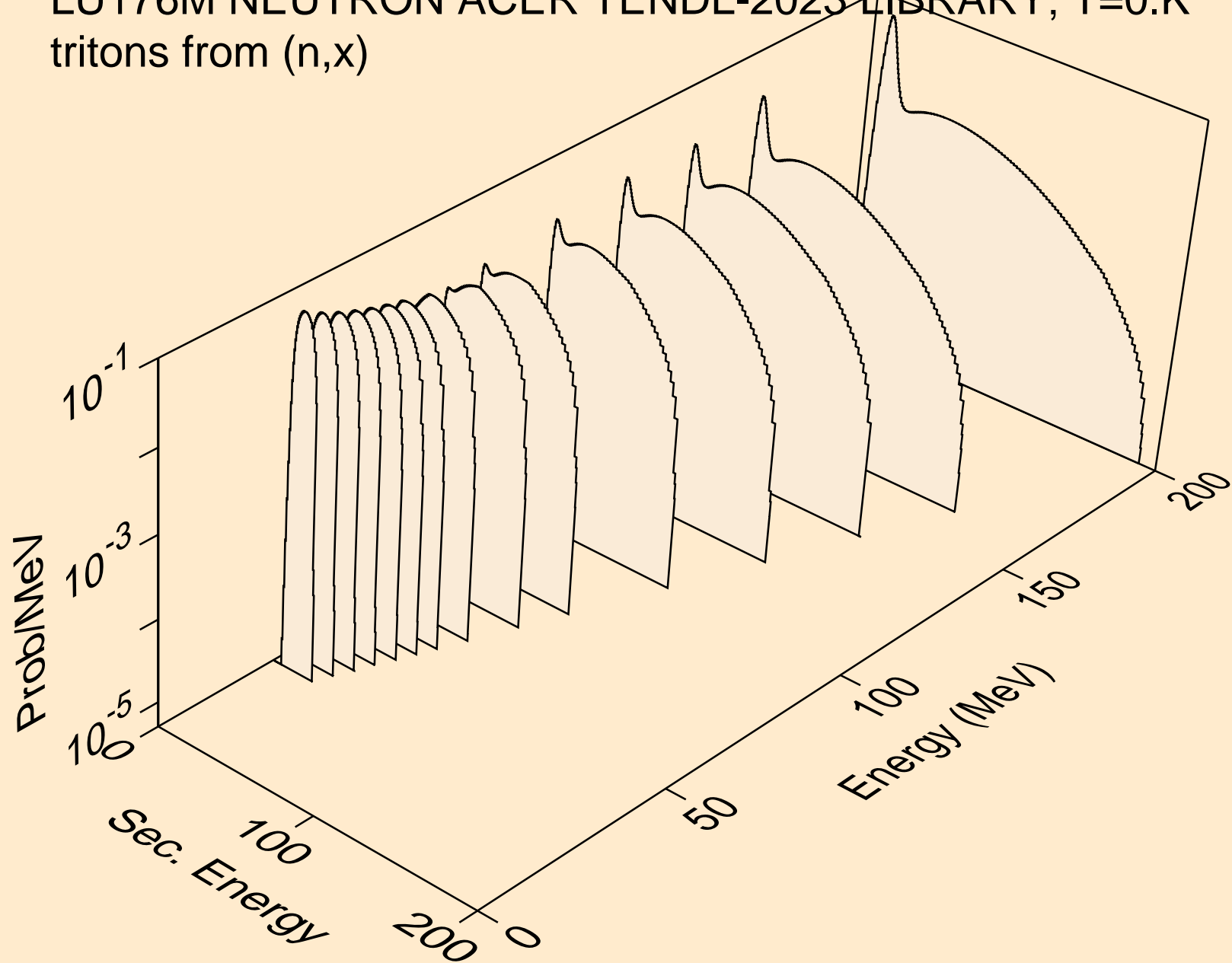

LU176M NEUTRON ACER TENDL-2023 LIBRARY; T=0.K
tritons from (n,n*)t

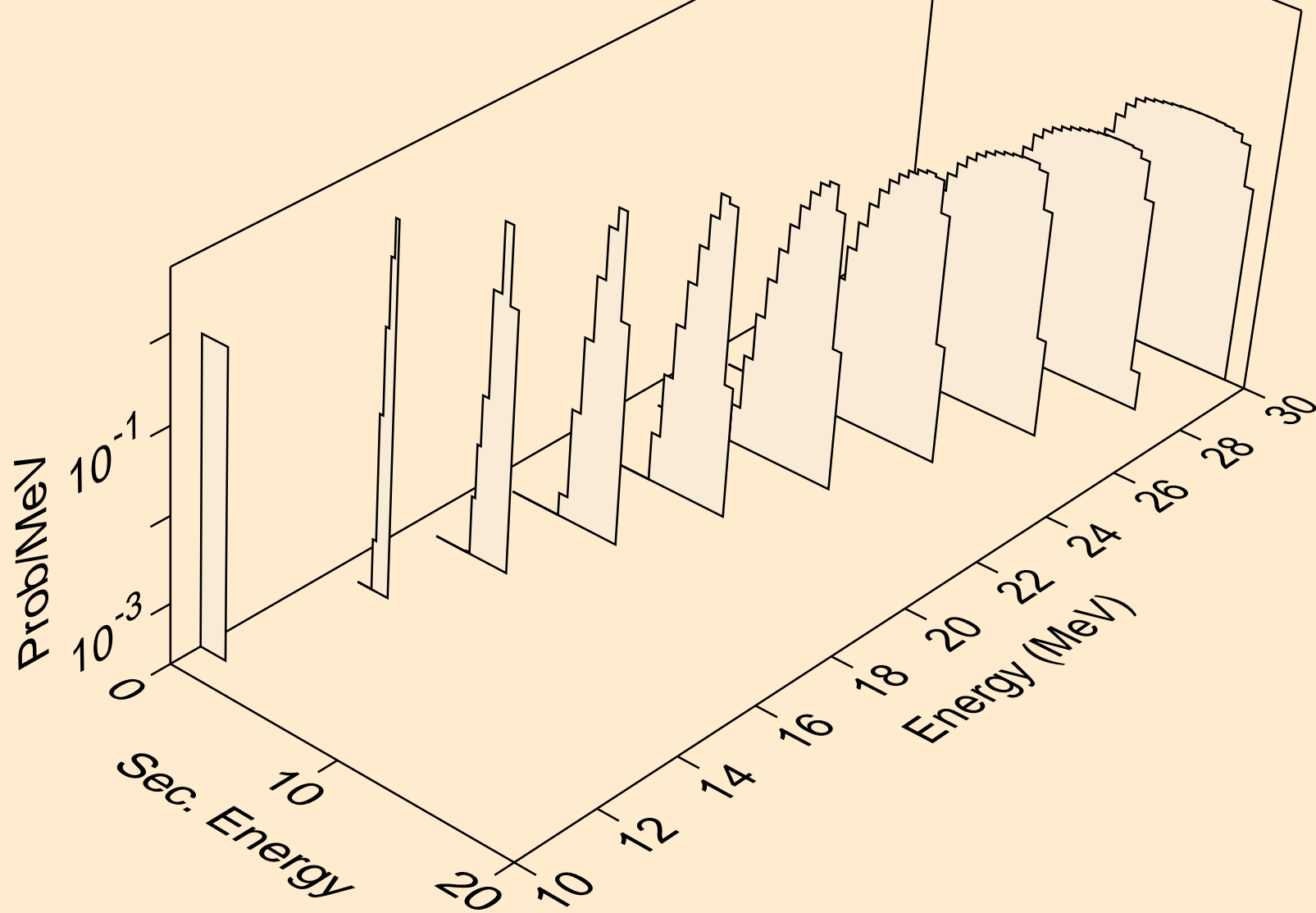

LU176M NEUTRON ACER TENDL-2023 LIBRARY; T=0.K
tritons from (n,t)

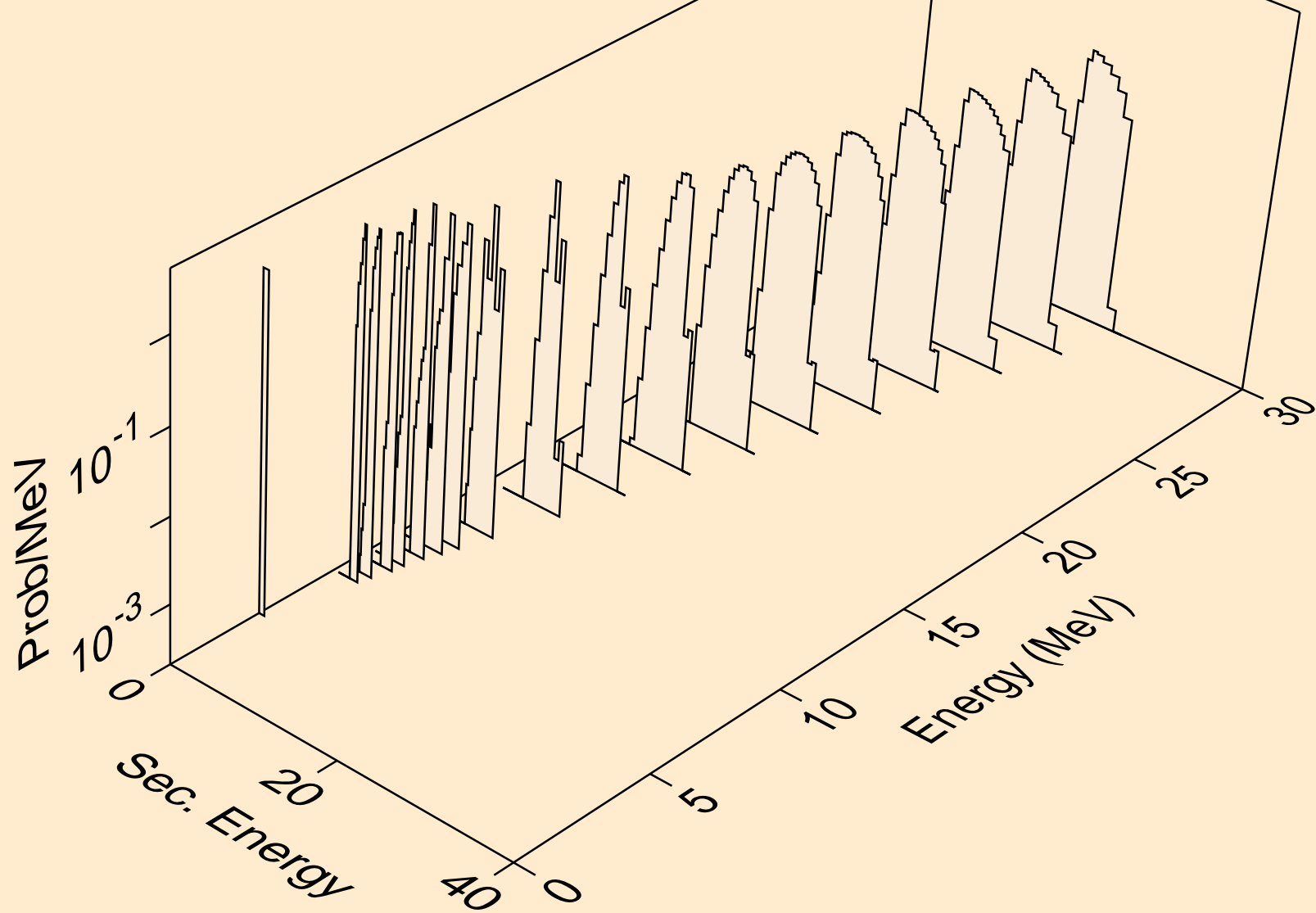

LU176M NEUTRON ACER TENDL-2023 LIBRARY; T=0.K
tritons from (n,pt)

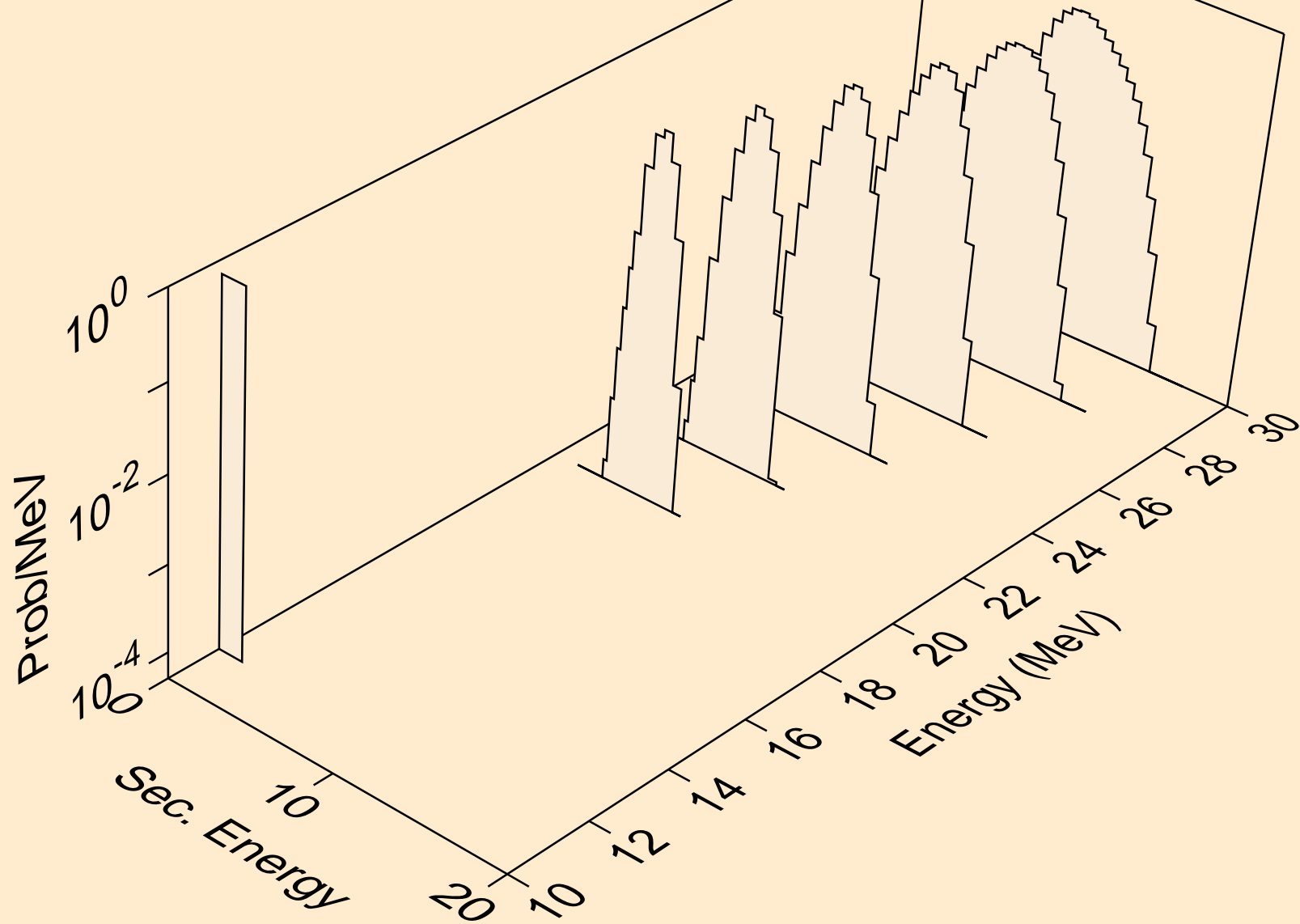

LU176M NEUTRON ACER TENDL-2023 LIBRARY; T=0.K
he3s from (n,x)

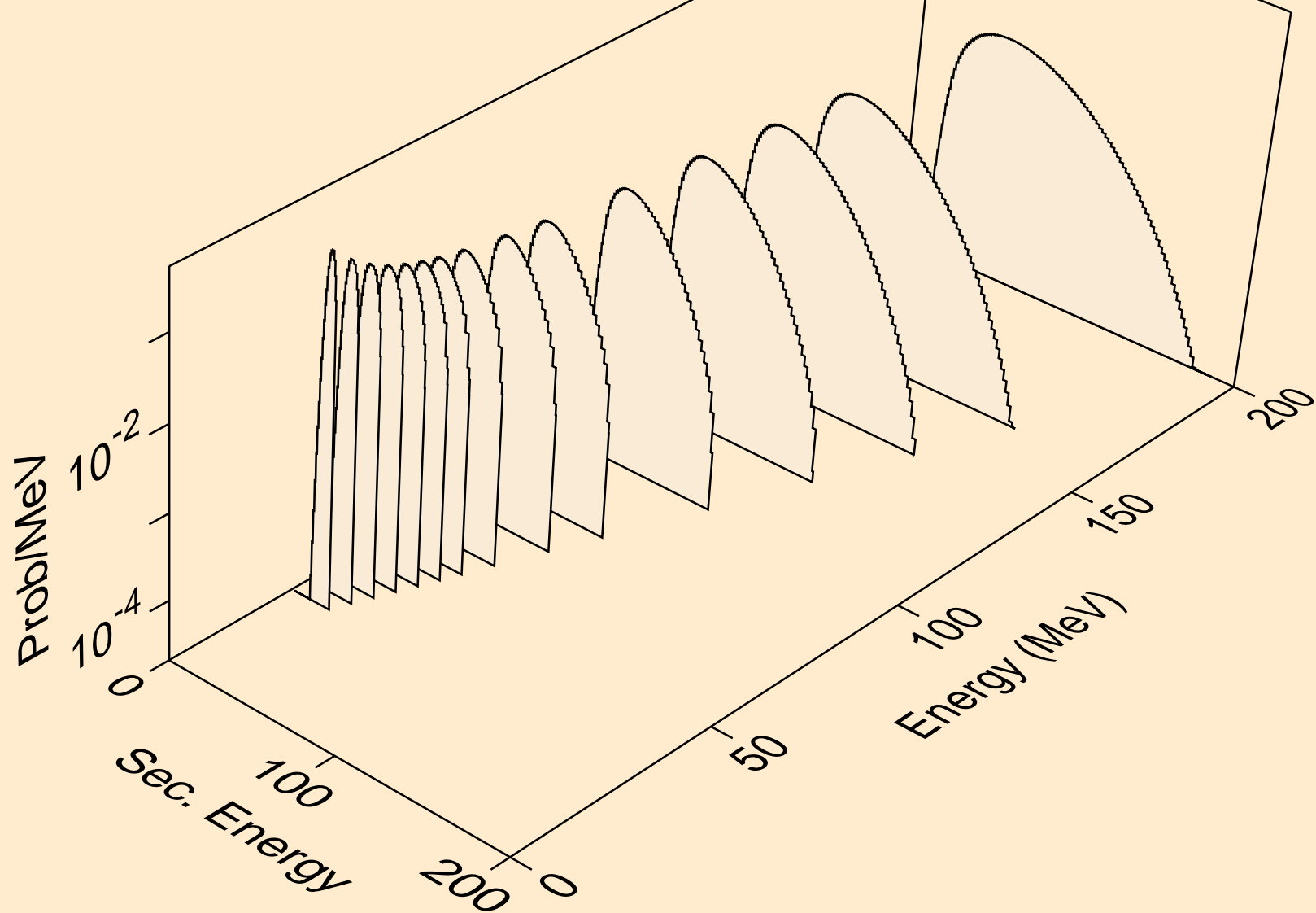

LU176M NEUTRON ACER TENDL-2023 LIBRARY; T=0.K
he3s from (n,n*)he3

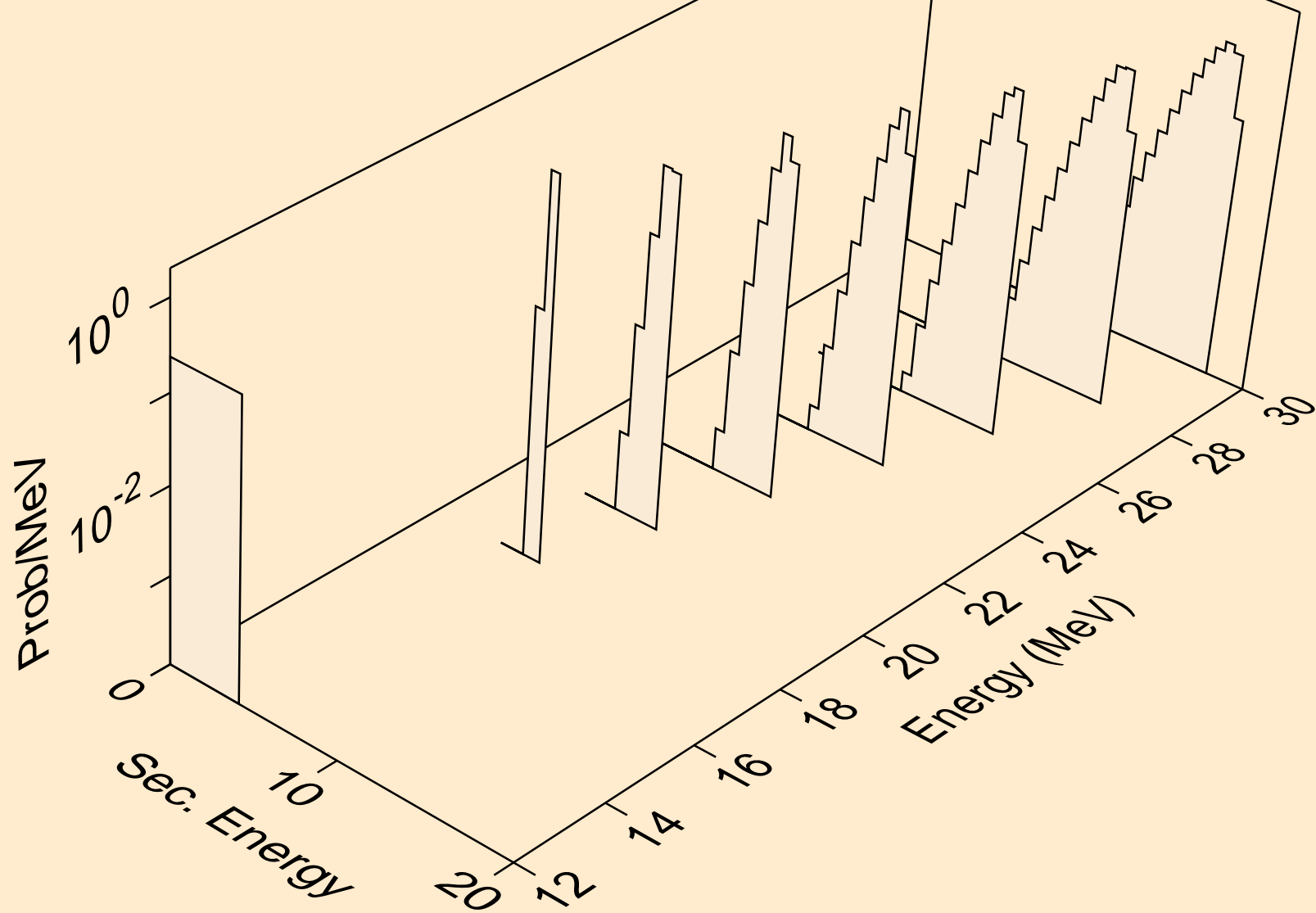

LU176M NEUTRON ACER TENDL-2023 LIBRARY; T=0.K
he3s from (n,he3)

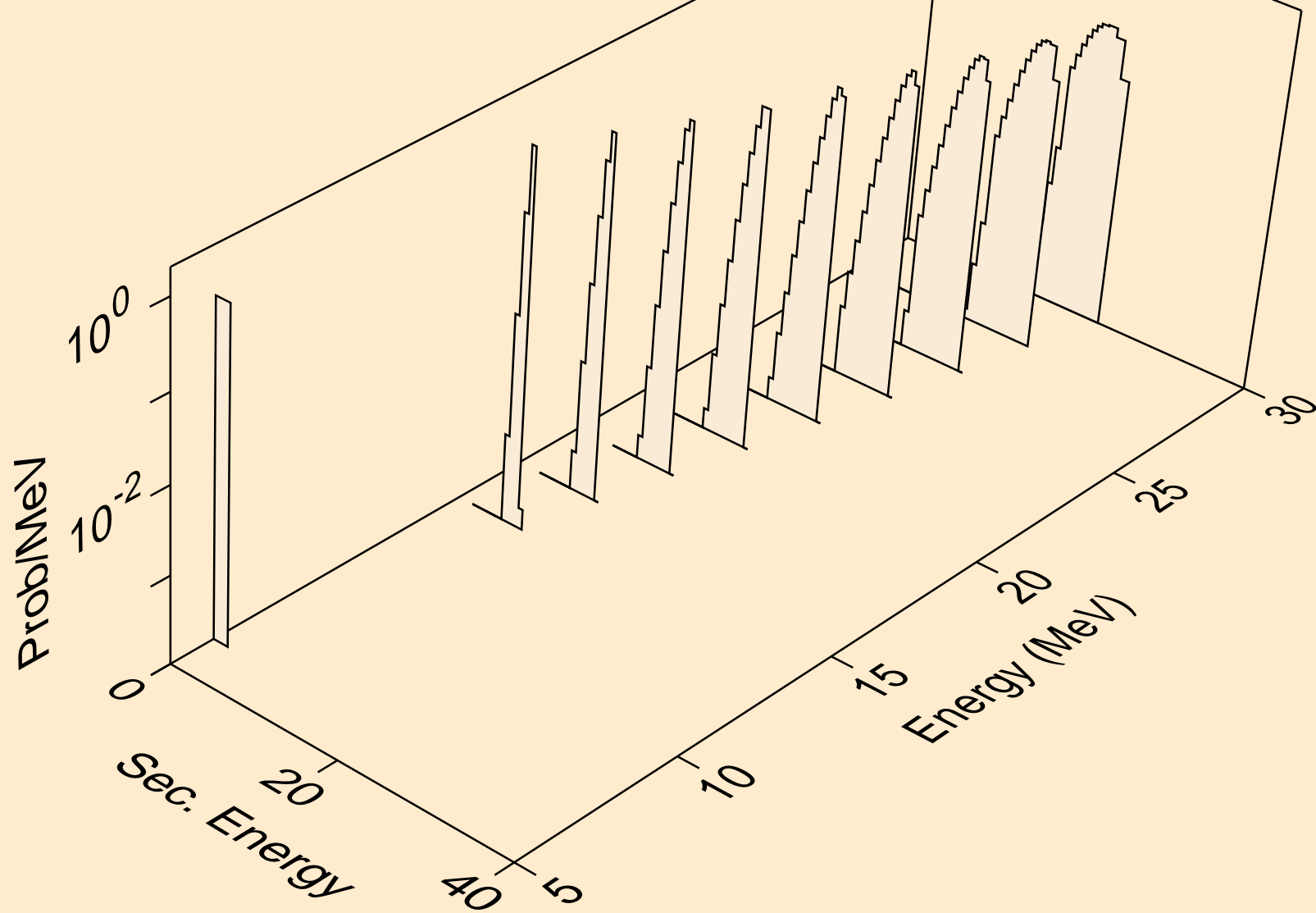

LU176M NEUTRON ACER TENDL-2023 LIBRARY; T=0.K
alphas from (n,x)

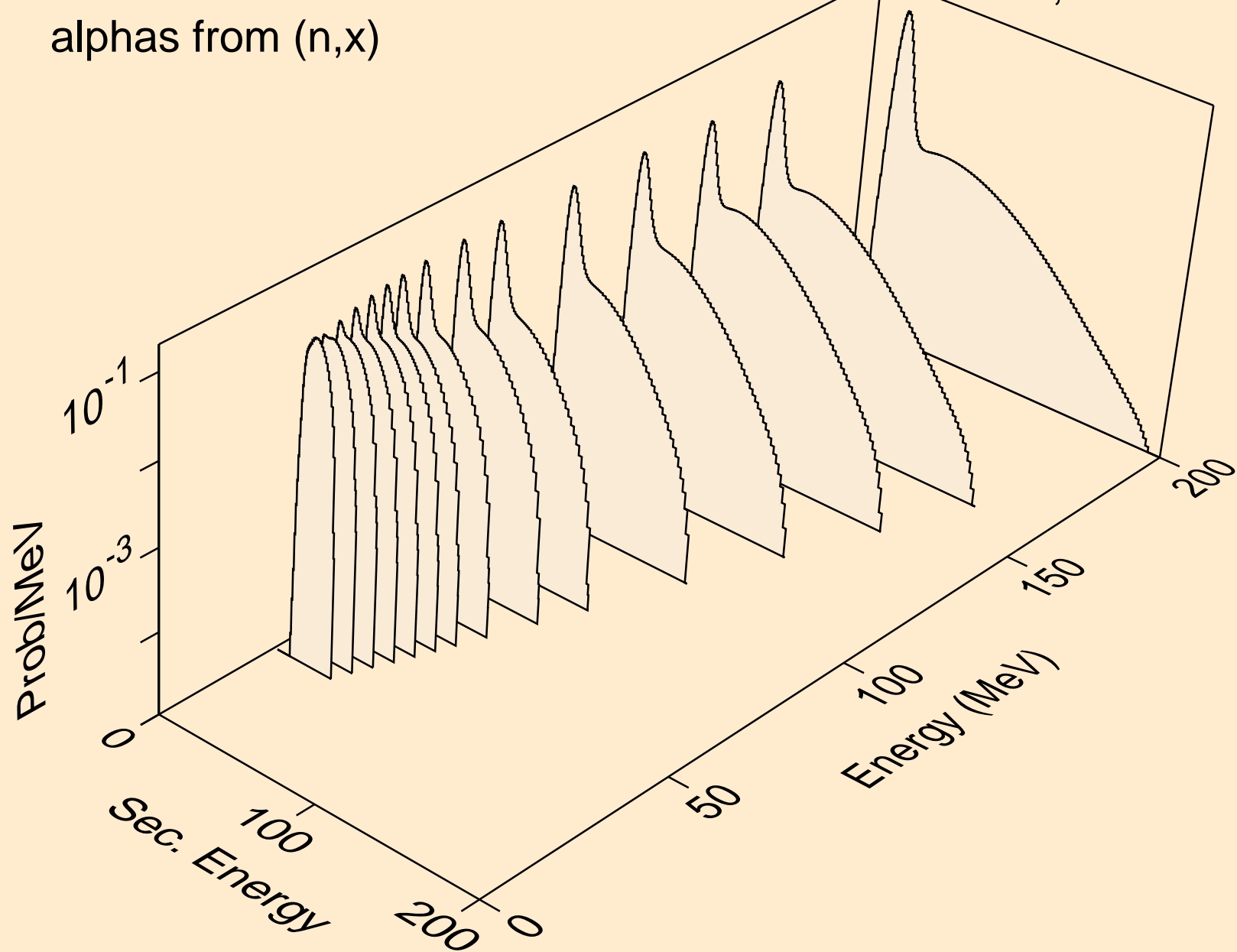

LU176M NEUTRON ACER TENDL-2023 LIBRARY; T=0.K
alphas from (n,n*)a

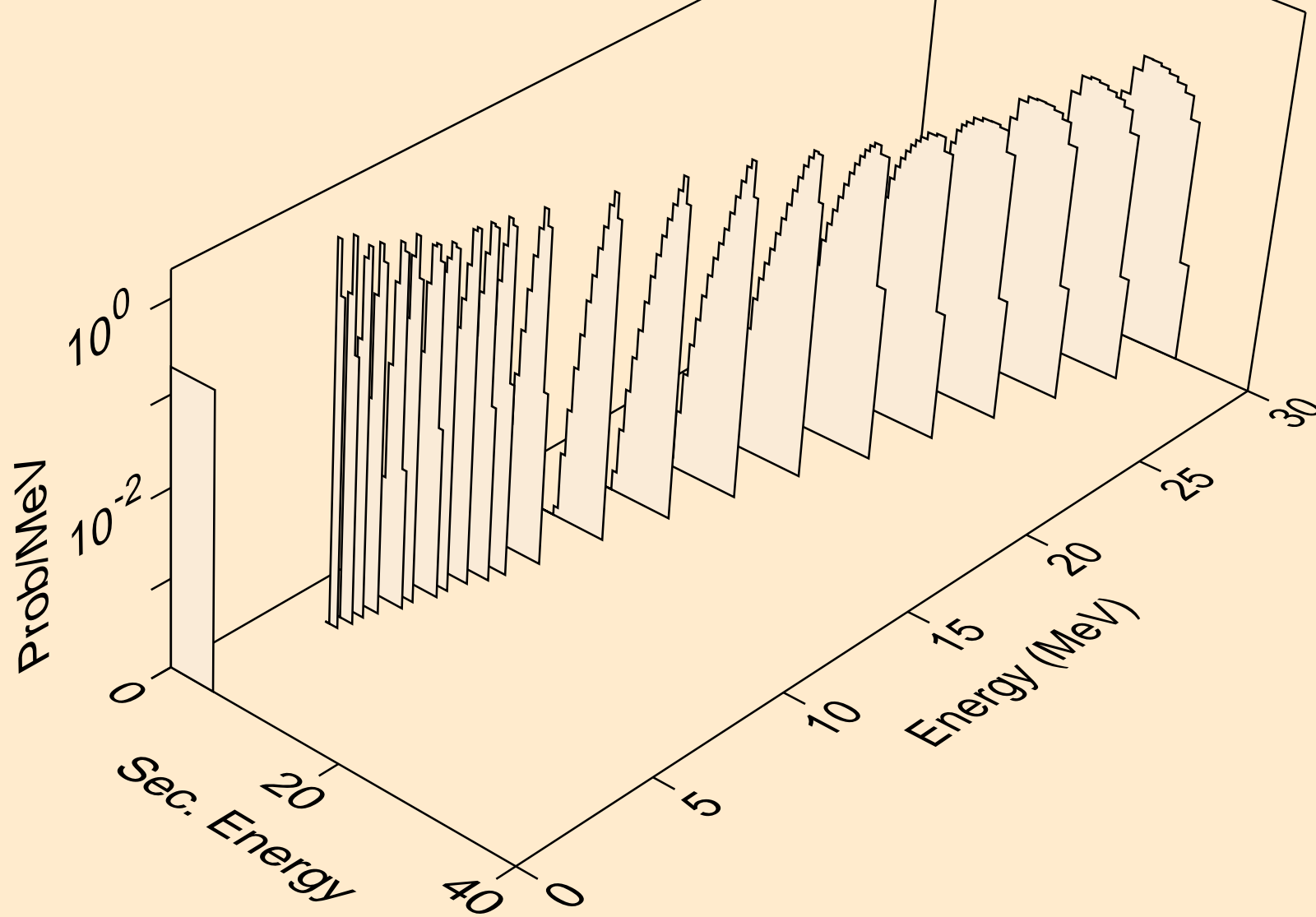

LU176M NEUTRON ACER TENDL-2023 LIBRARY; T=0.K
alphas from (n,2n)a

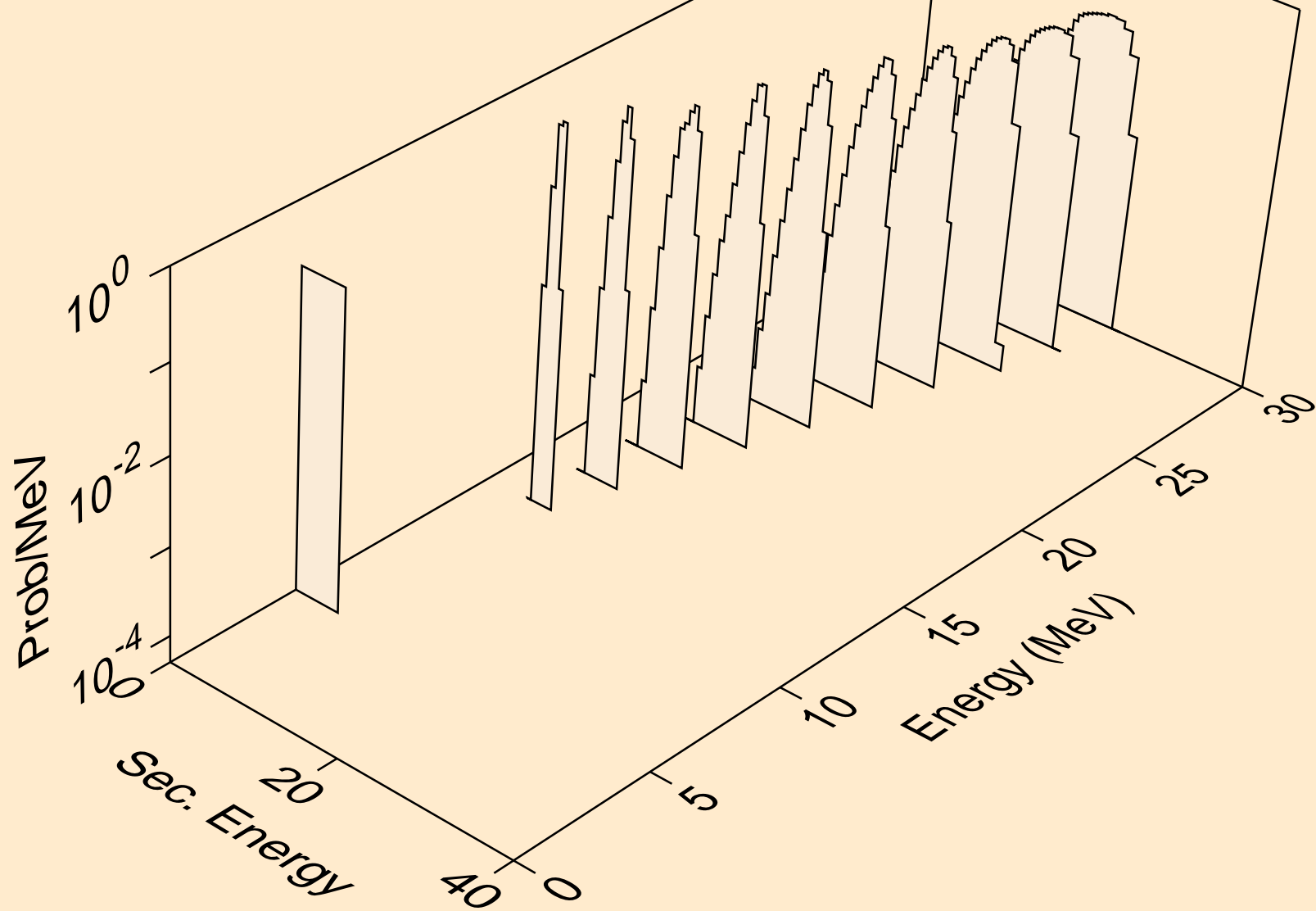

LU176M NEUTRON ACER TENDL-2023 LIBRARY; T=0.K
alphas from (n,3n)a

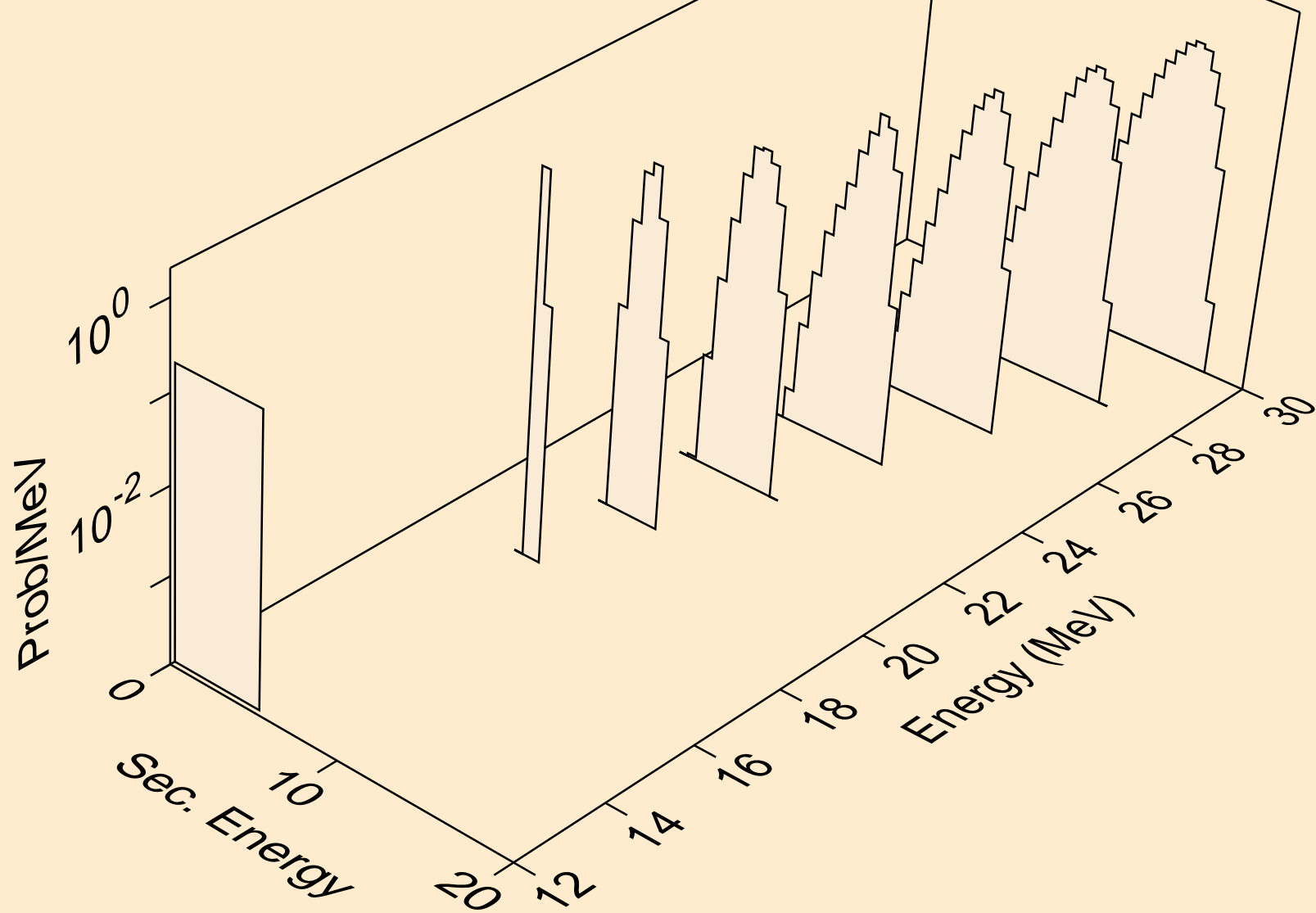

LU176M NEUTRON ACER TENDL-2023 LIBRARY; T=0.K
alphas from (n,n*)2a

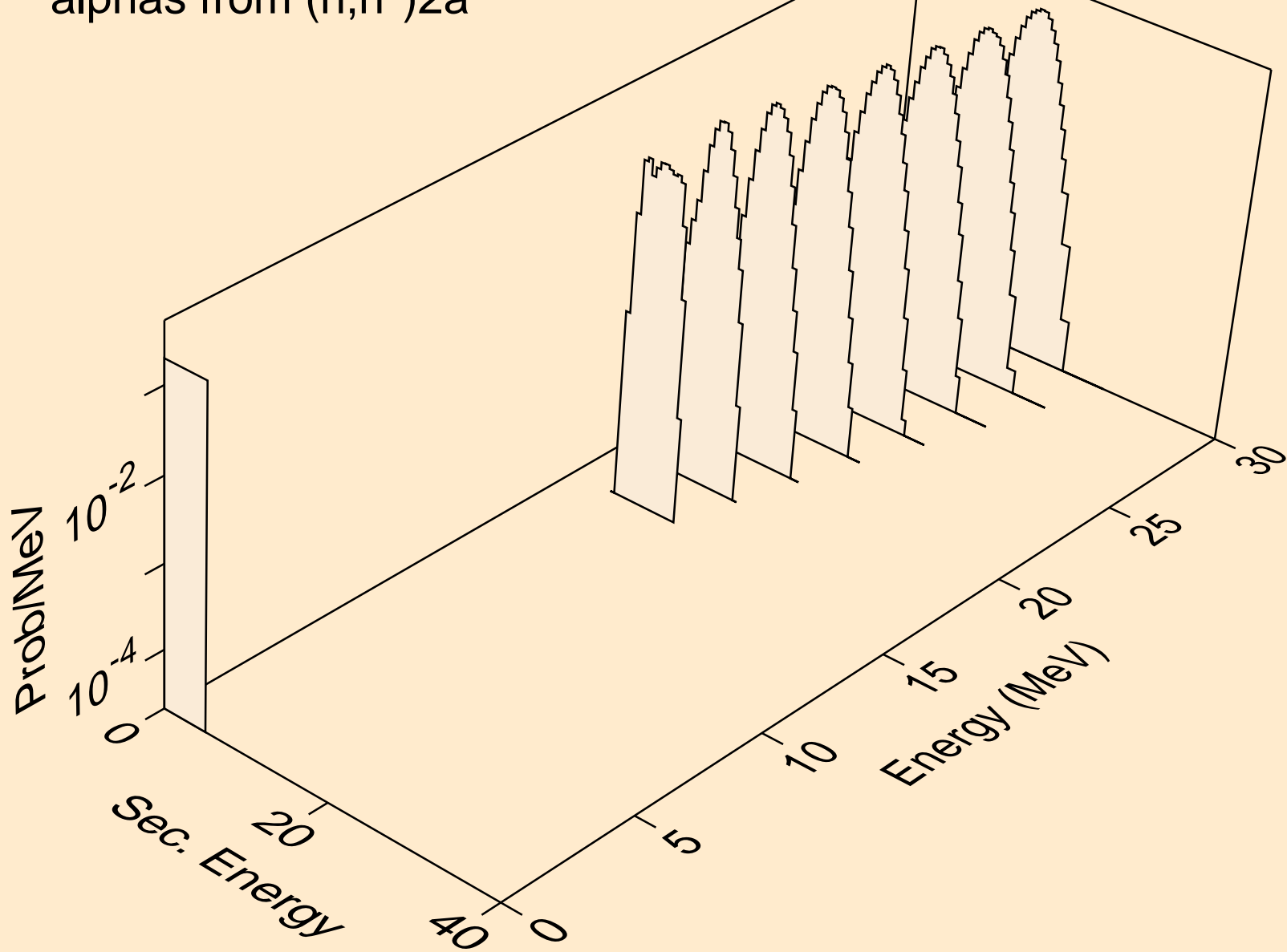

LU176M NEUTRON ACER TENDL-2023 LIBRARY; T=0.K
alphas from (n,npa)

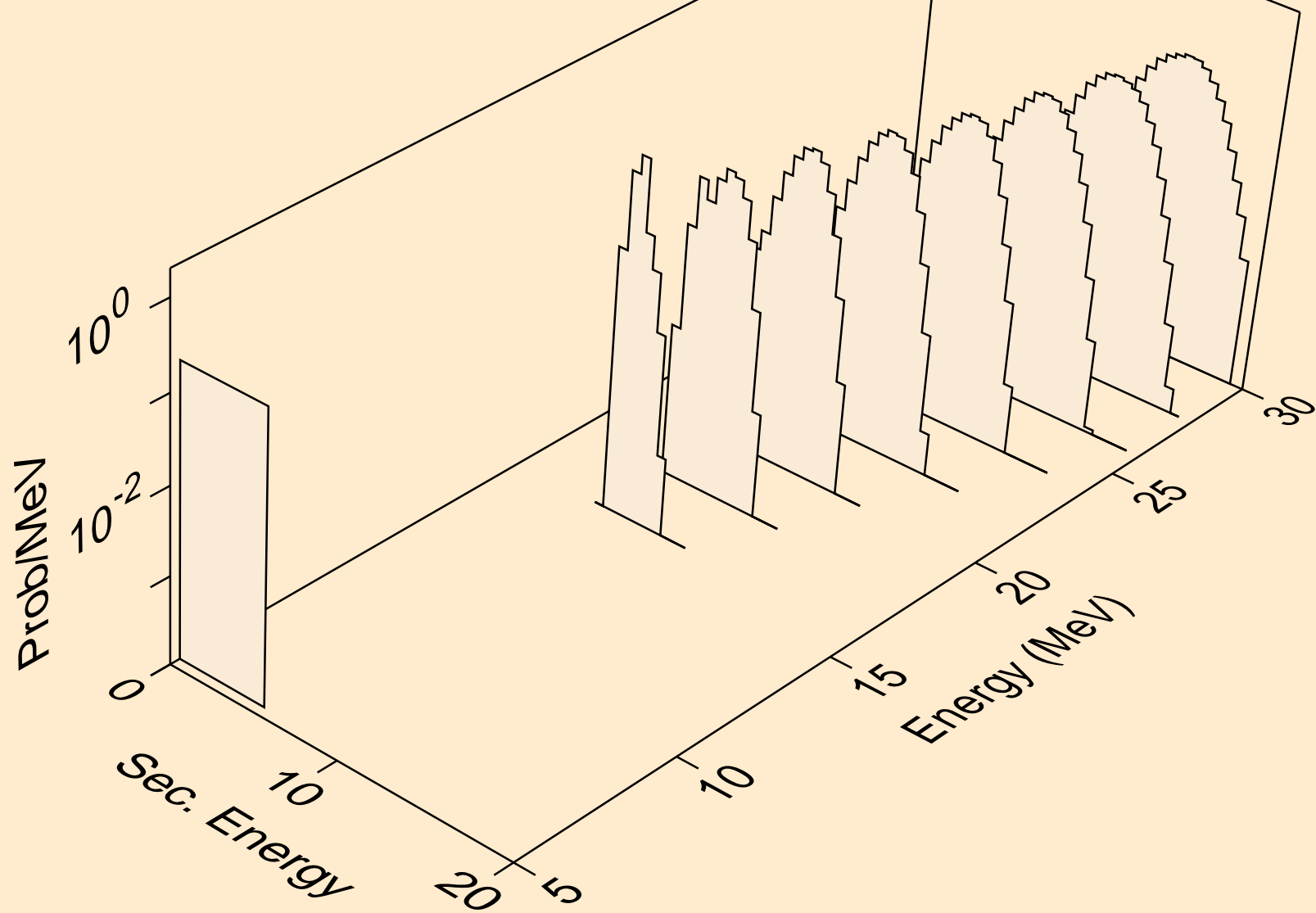

LU176M NEUTRON ACER TENDL-2023 LIBRARY; T=0.K
alphas from (n,a)

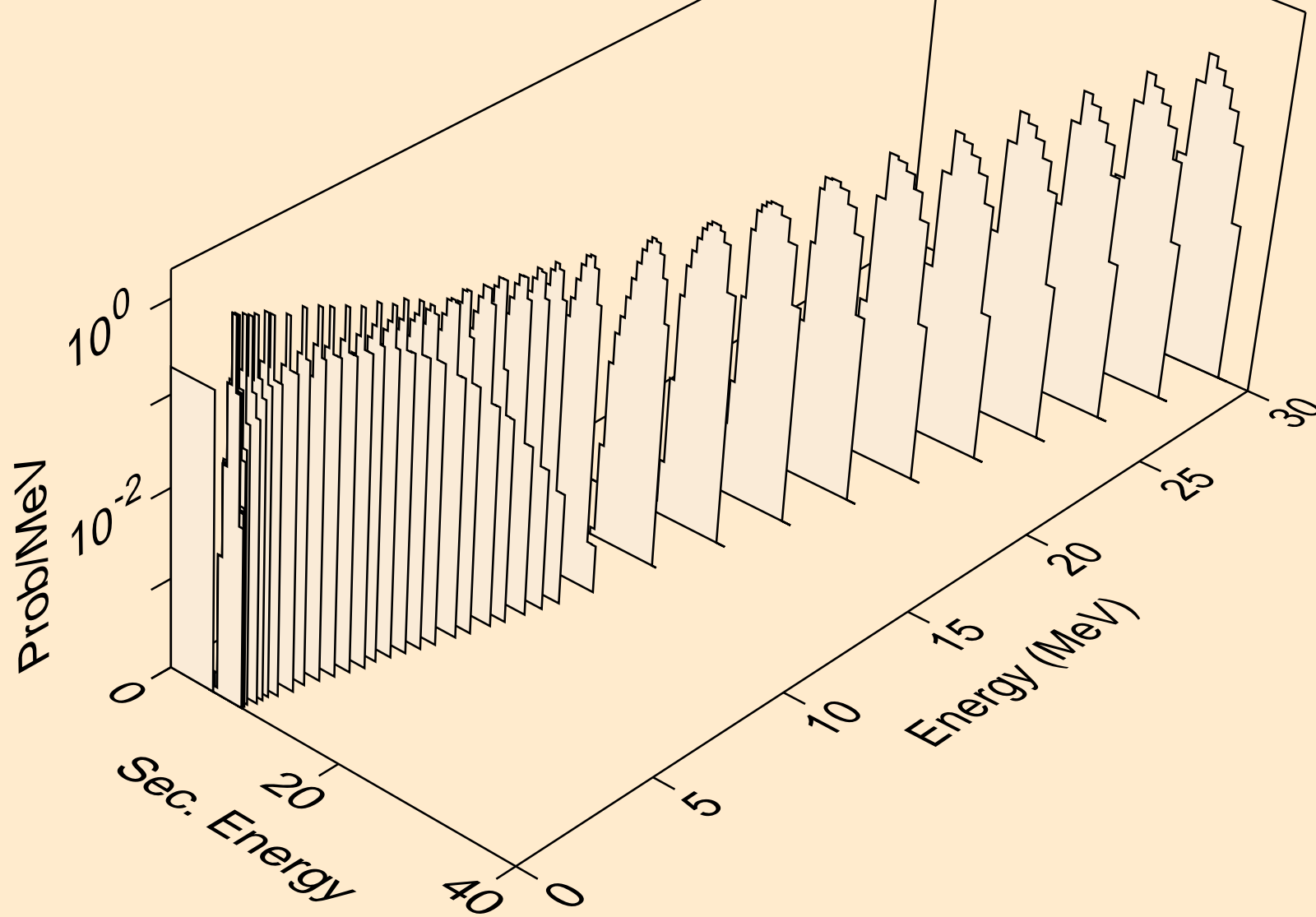

LU176M NEUTRON ACER TENDL-2023 LIBRARY; T=0.K
alphas from (n,2a)

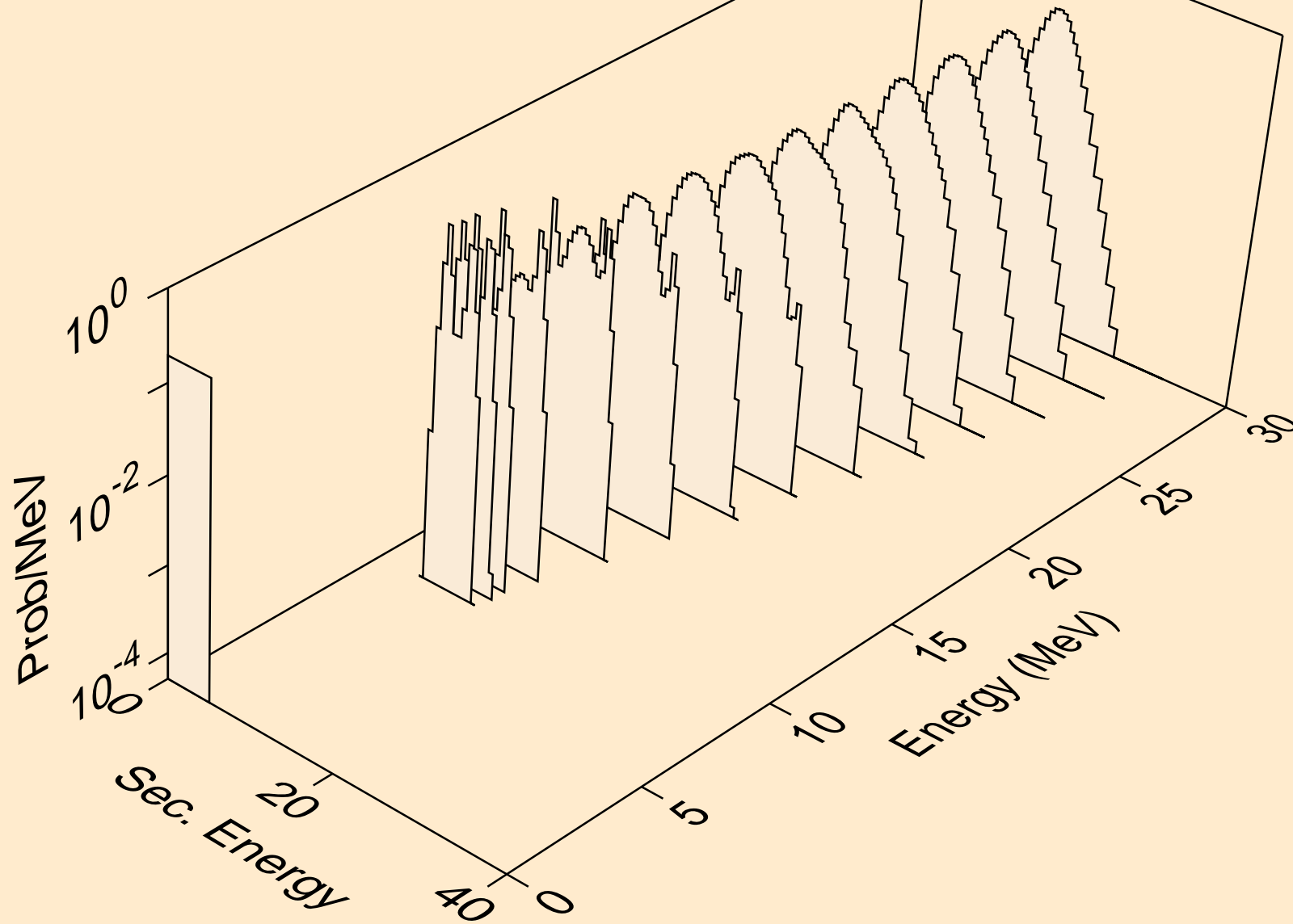

LU176M NEUTRON ACER TENDL-2023 LIBRARY; T=0.K
alphas from (n,pa)

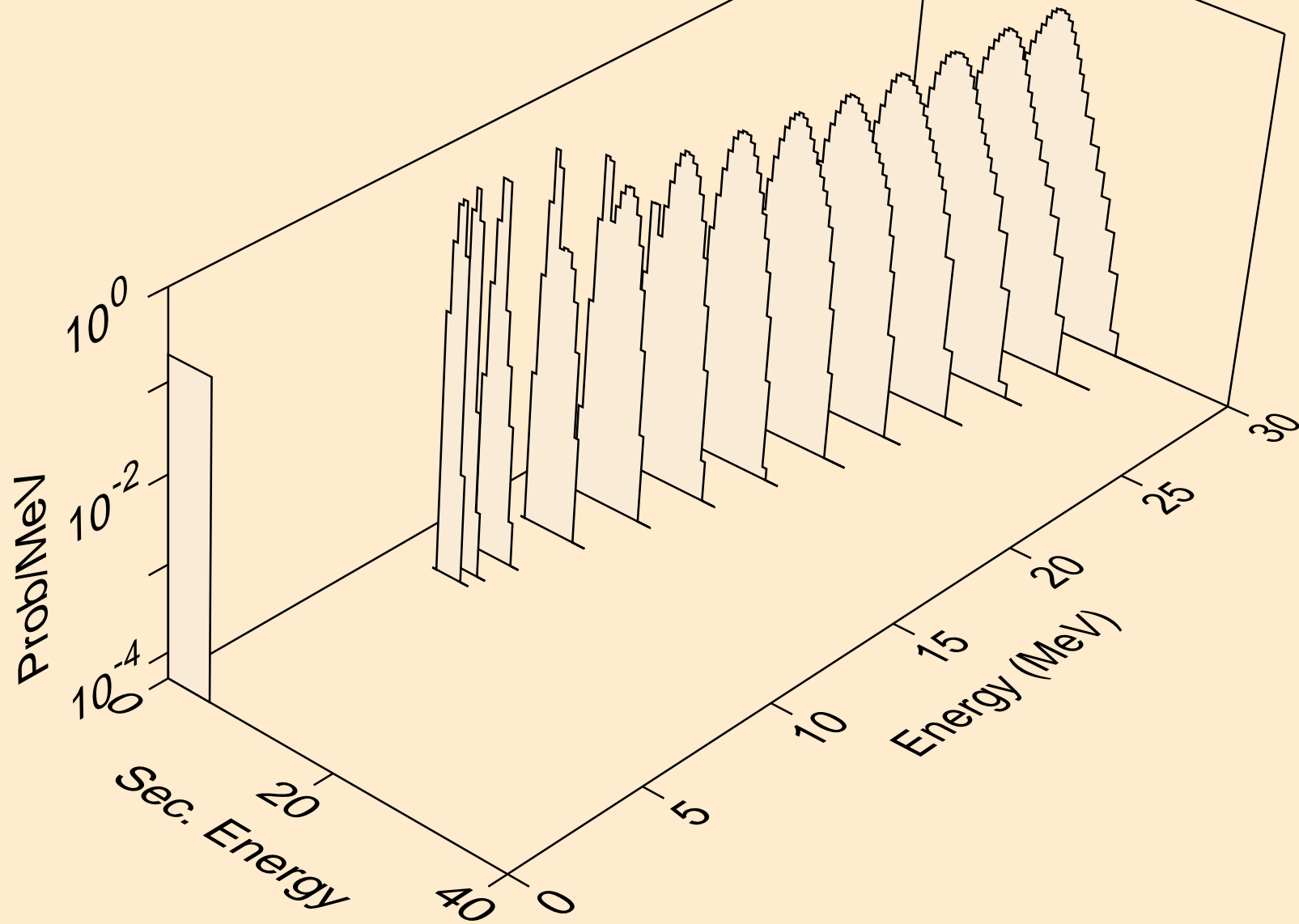

LU176M NEUTRON ACER TENDL-2023 LIBRARY; T=0.K
alphas from (n,da)

