

# LU188 NEUTRON ACER TENDL-2023 LIBRARY; T=0.K

## Principal cross sections

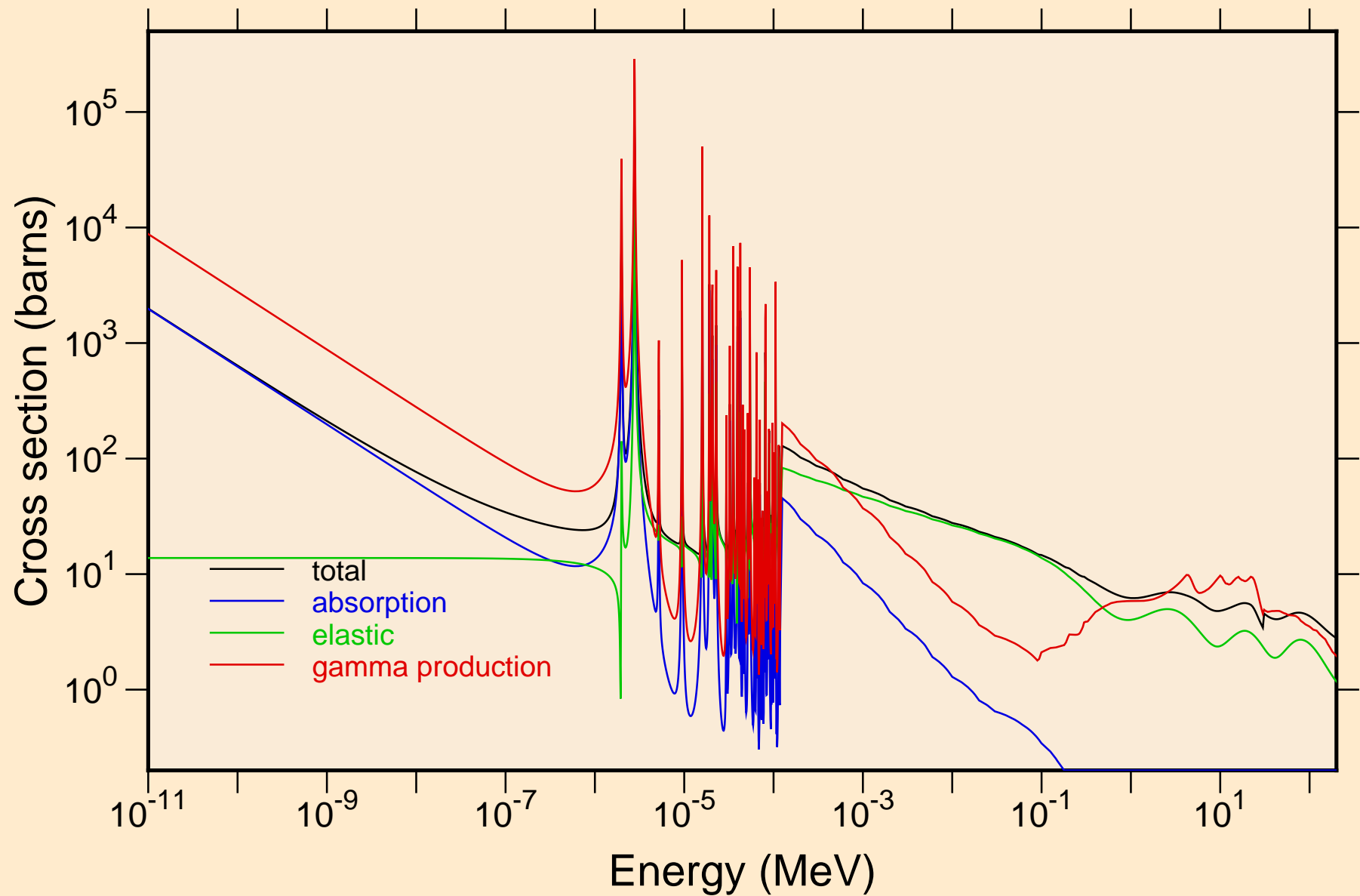

LU188 NEUTRON ACER TENDL-2023 LIBRARY; T=0.K  
resonance total cross section

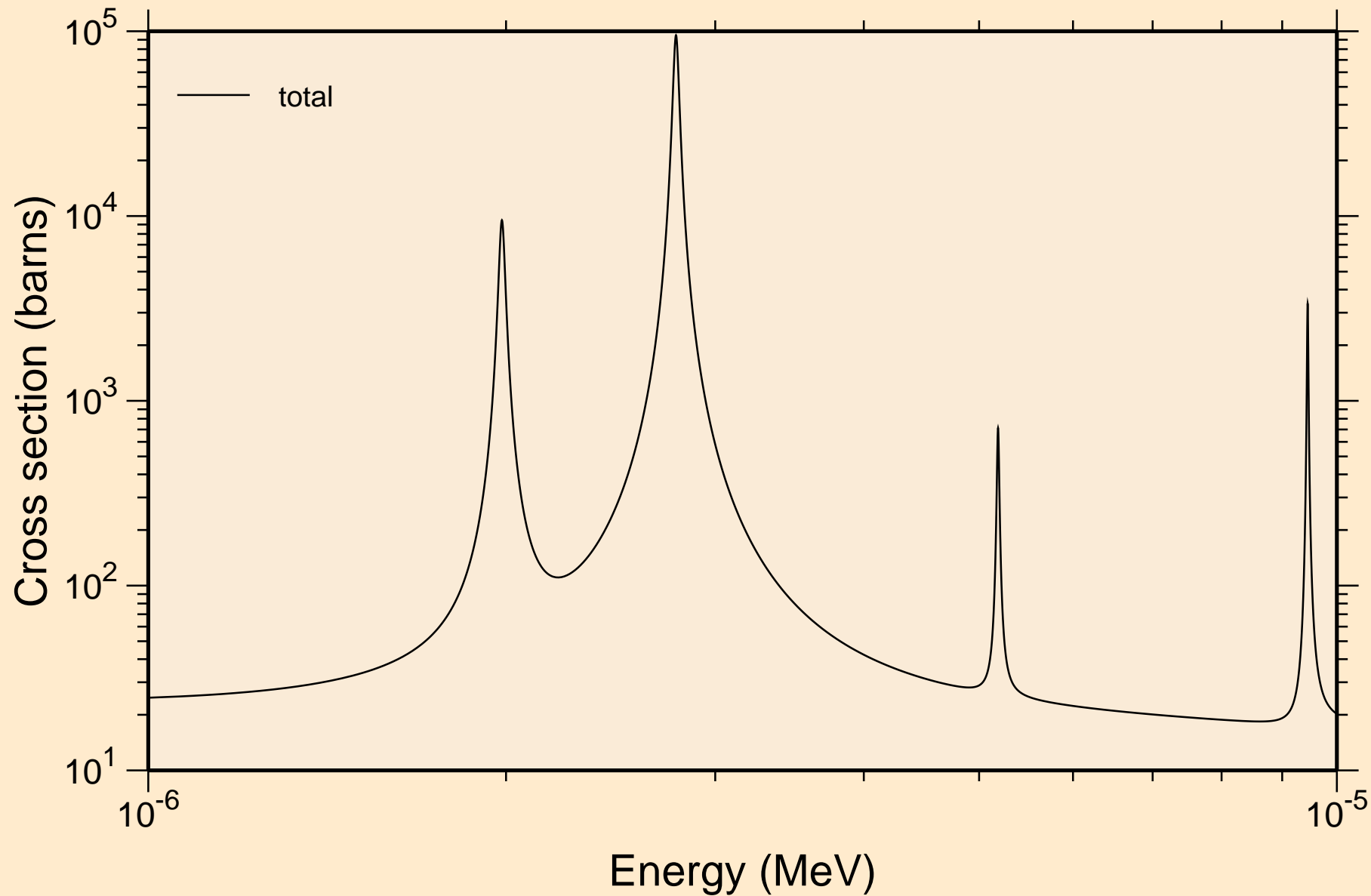

LU188 NEUTRON ACER TENDL-2023 LIBRARY; T=0.K  
resonance total cross section

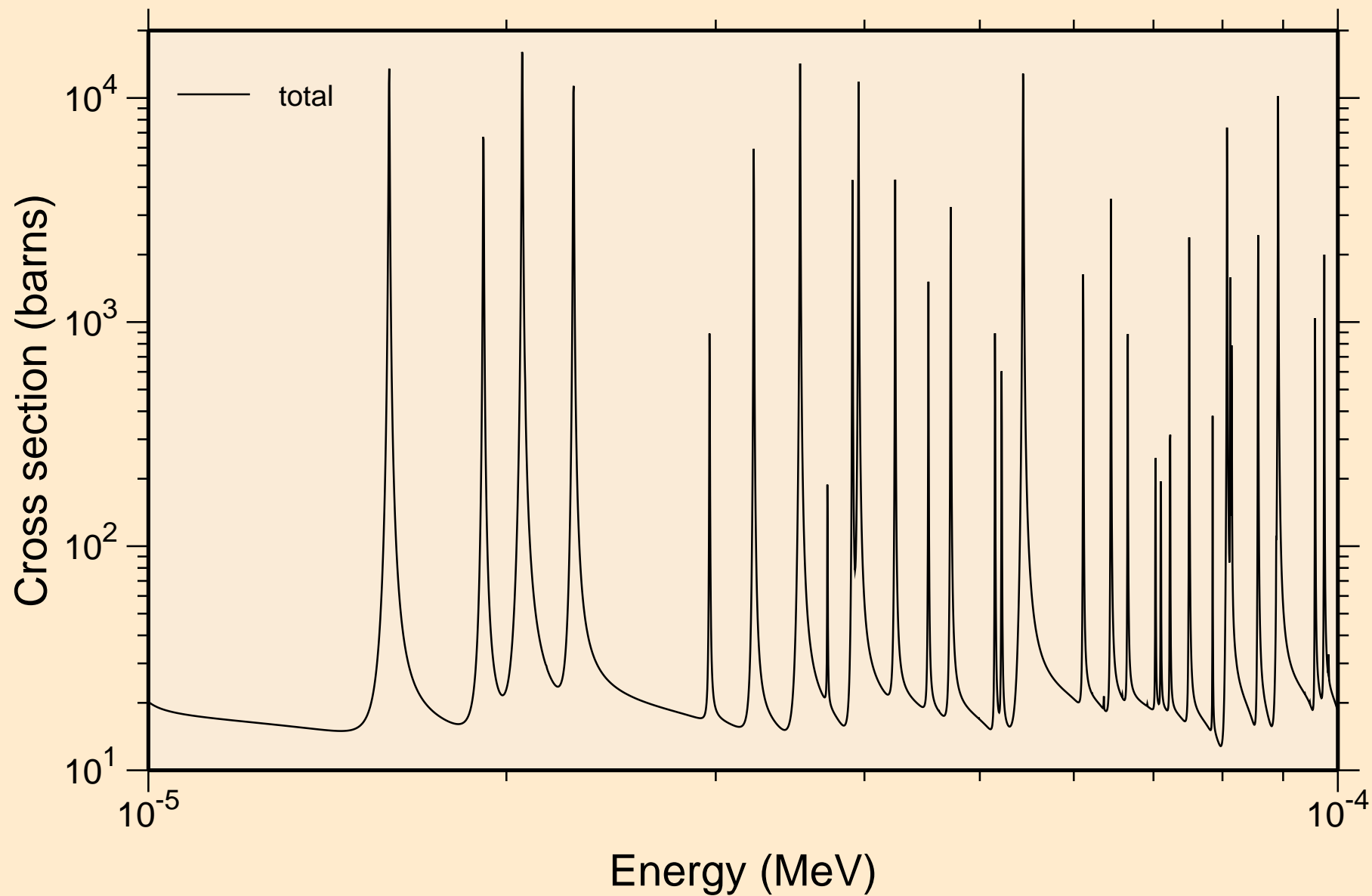

LU188 NEUTRON ACER TENDL-2023 LIBRARY; T=0.K  
resonance total cross section

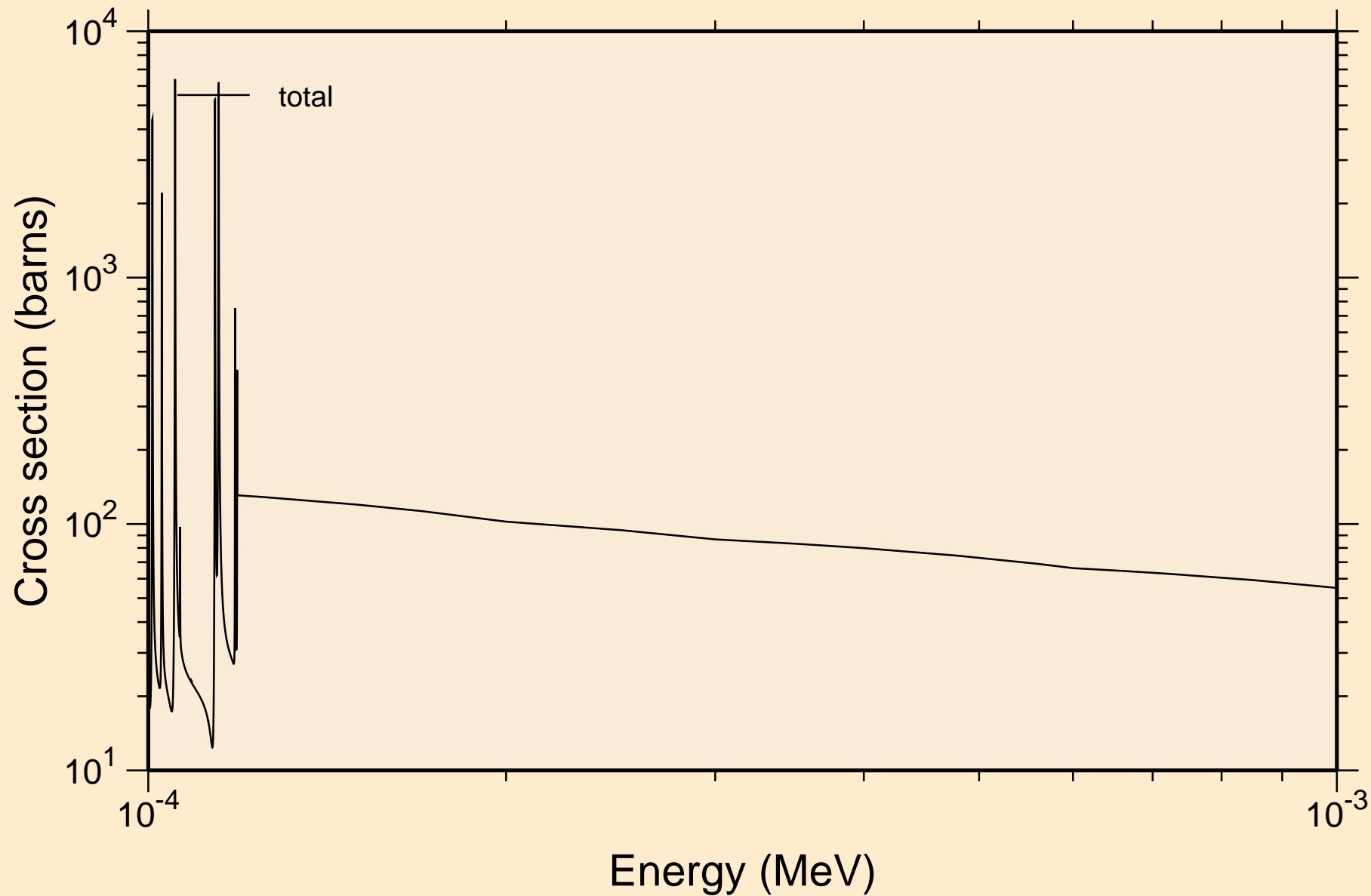

LU188 NEUTRON ACER TENDL-2023 LIBRARY; T=0.K  
resonance total cross section

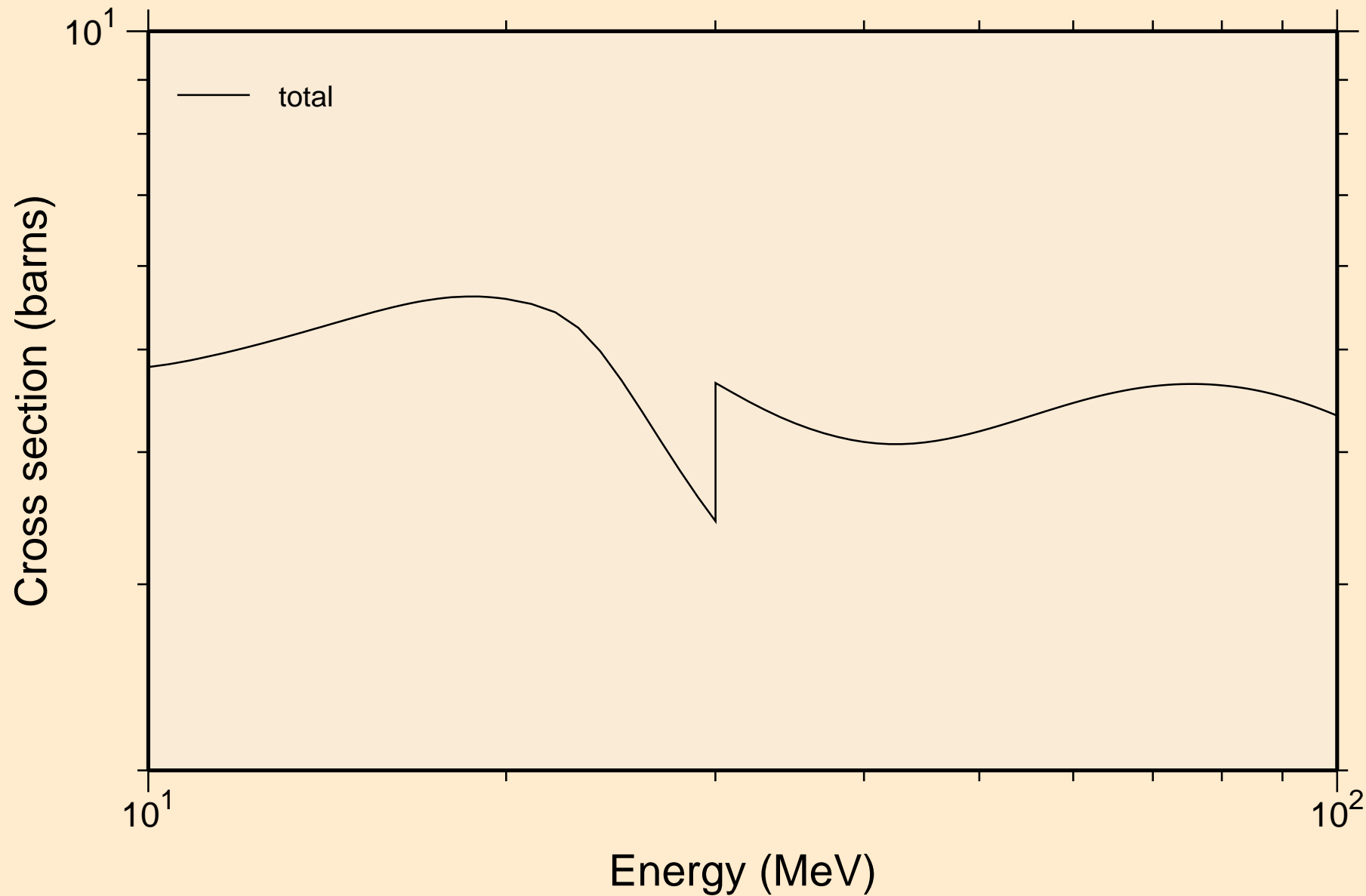

LU188 NEUTRON ACER TENDL-2023 LIBRARY; T=0.K  
resonance absorption cross sections

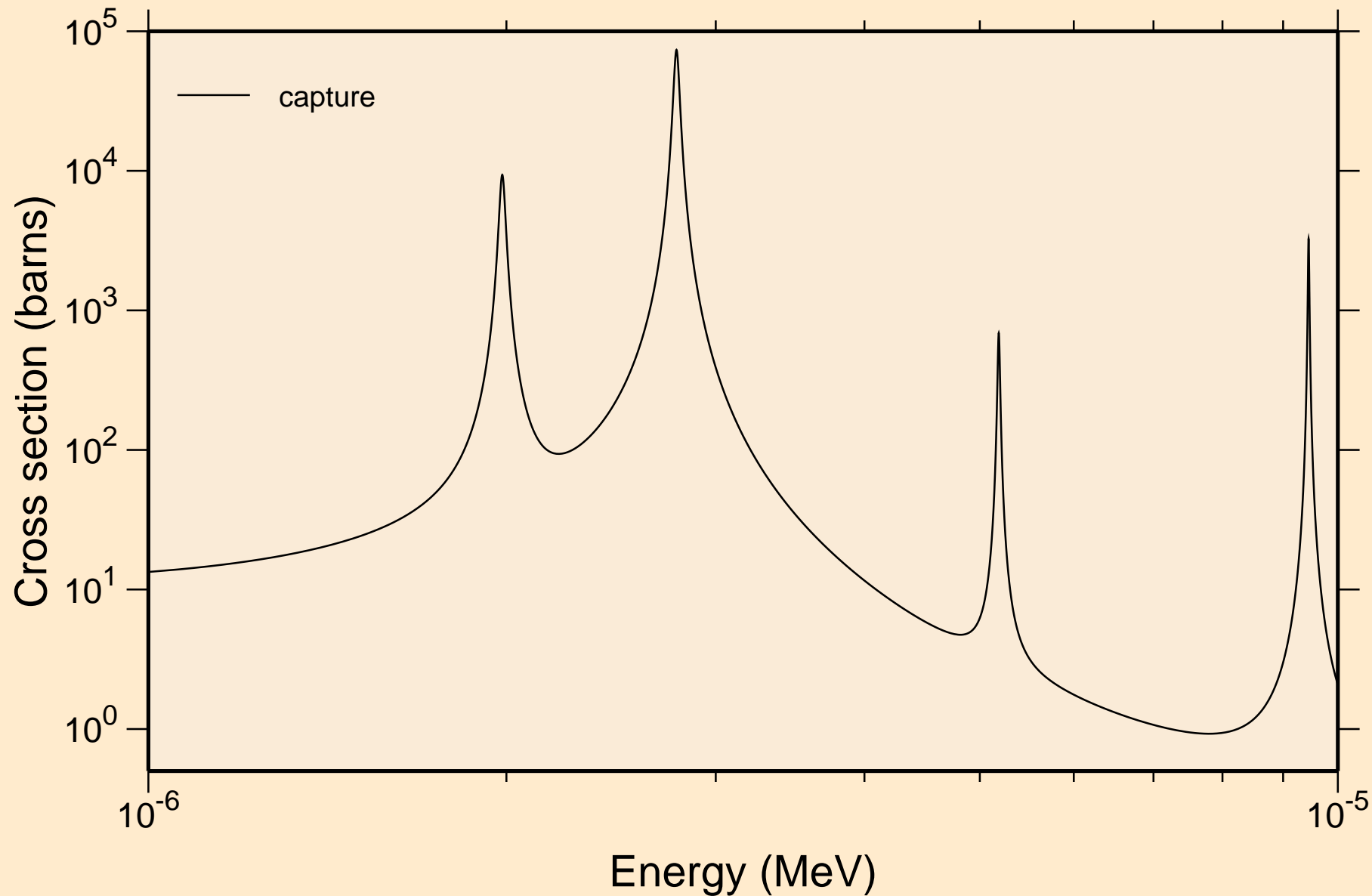

LU188 NEUTRON ACER TENDL-2023 LIBRARY; T=0.K  
resonance absorption cross sections

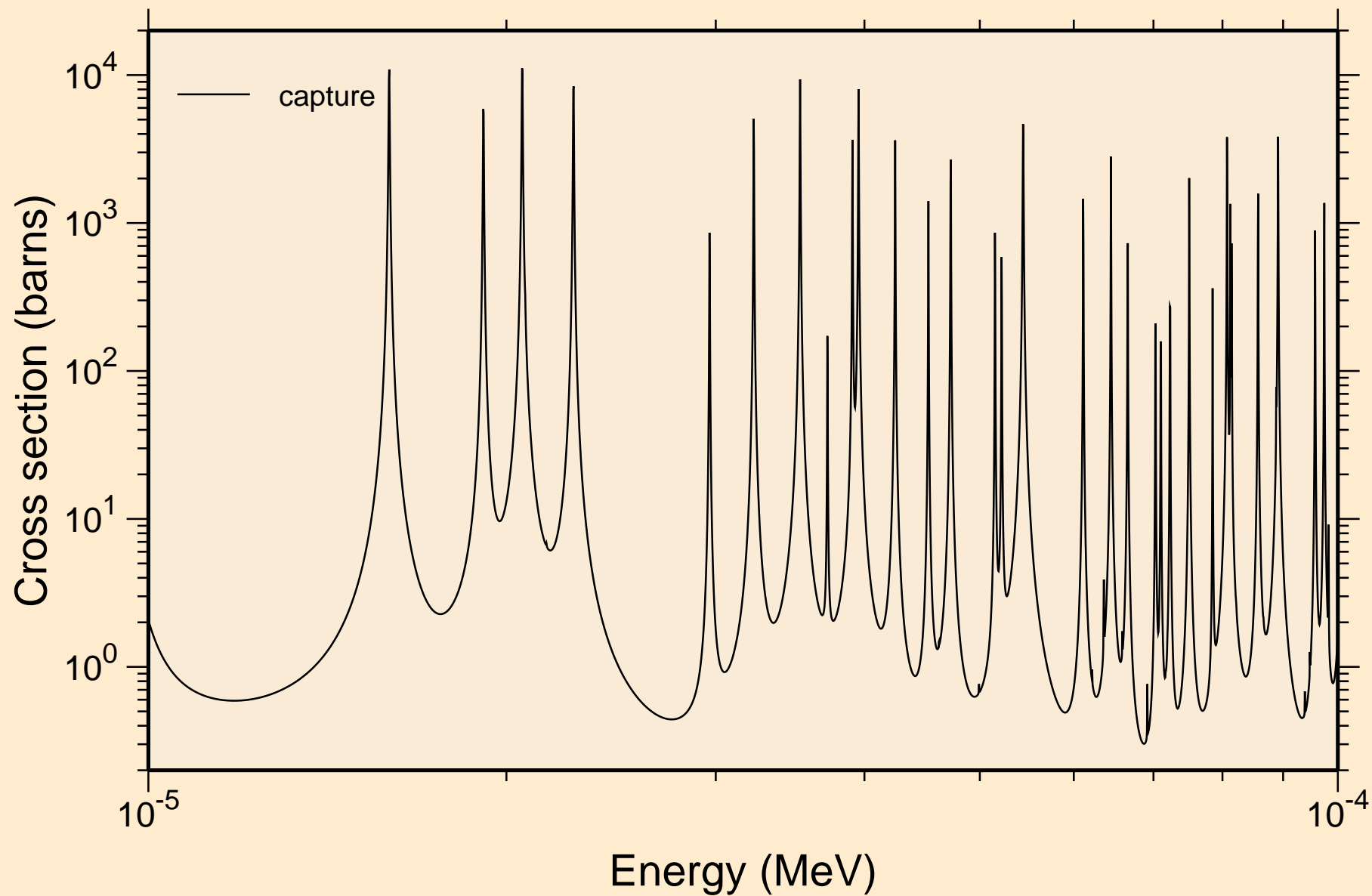

LU188 NEUTRON ACER TENDL-2023 LIBRARY; T=0.K  
resonance absorption cross sections

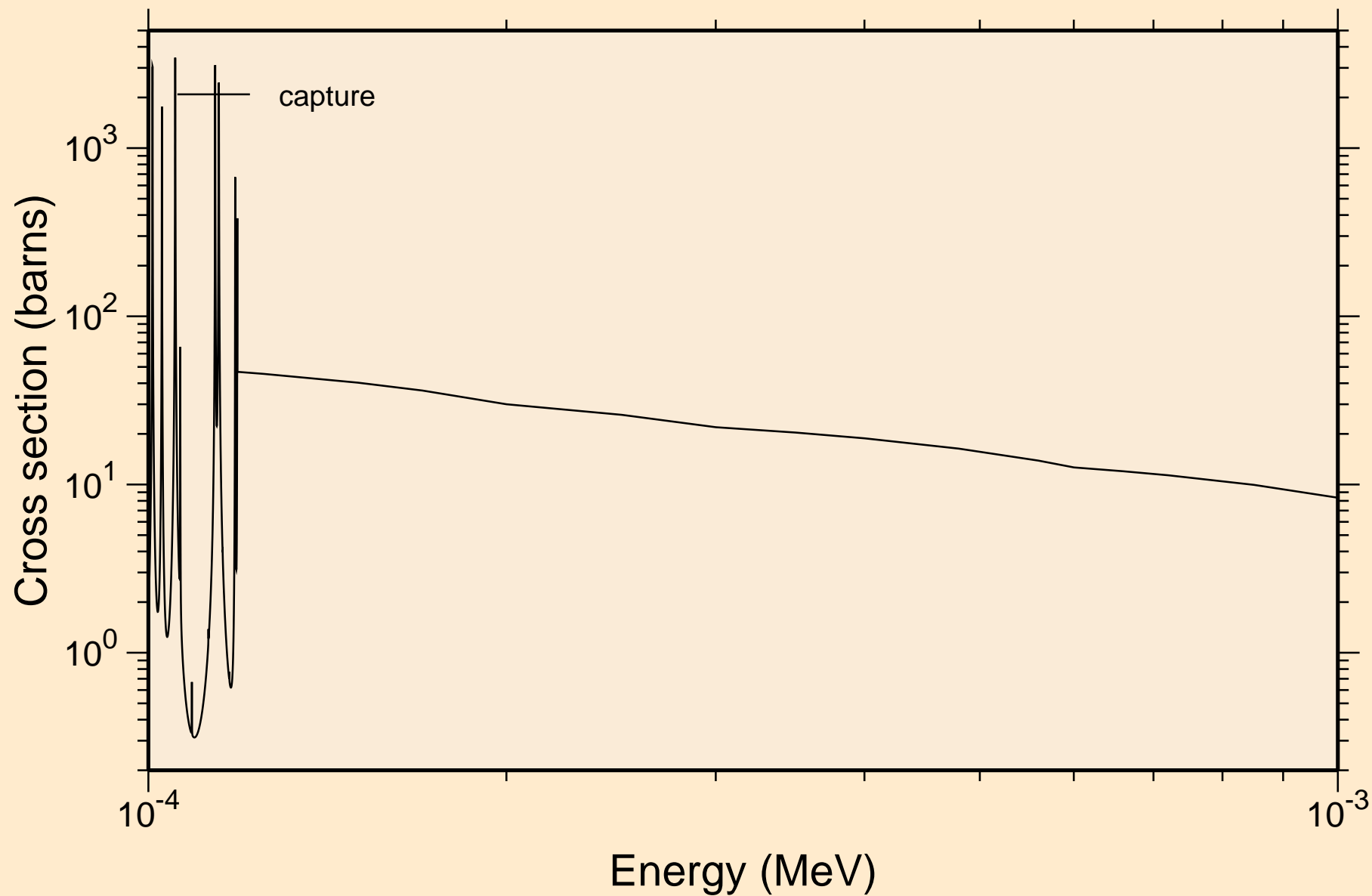



LU188 NEUTRON ACER TENDL-2023 LIBRARY; T=0.K  
resonance absorption cross sections

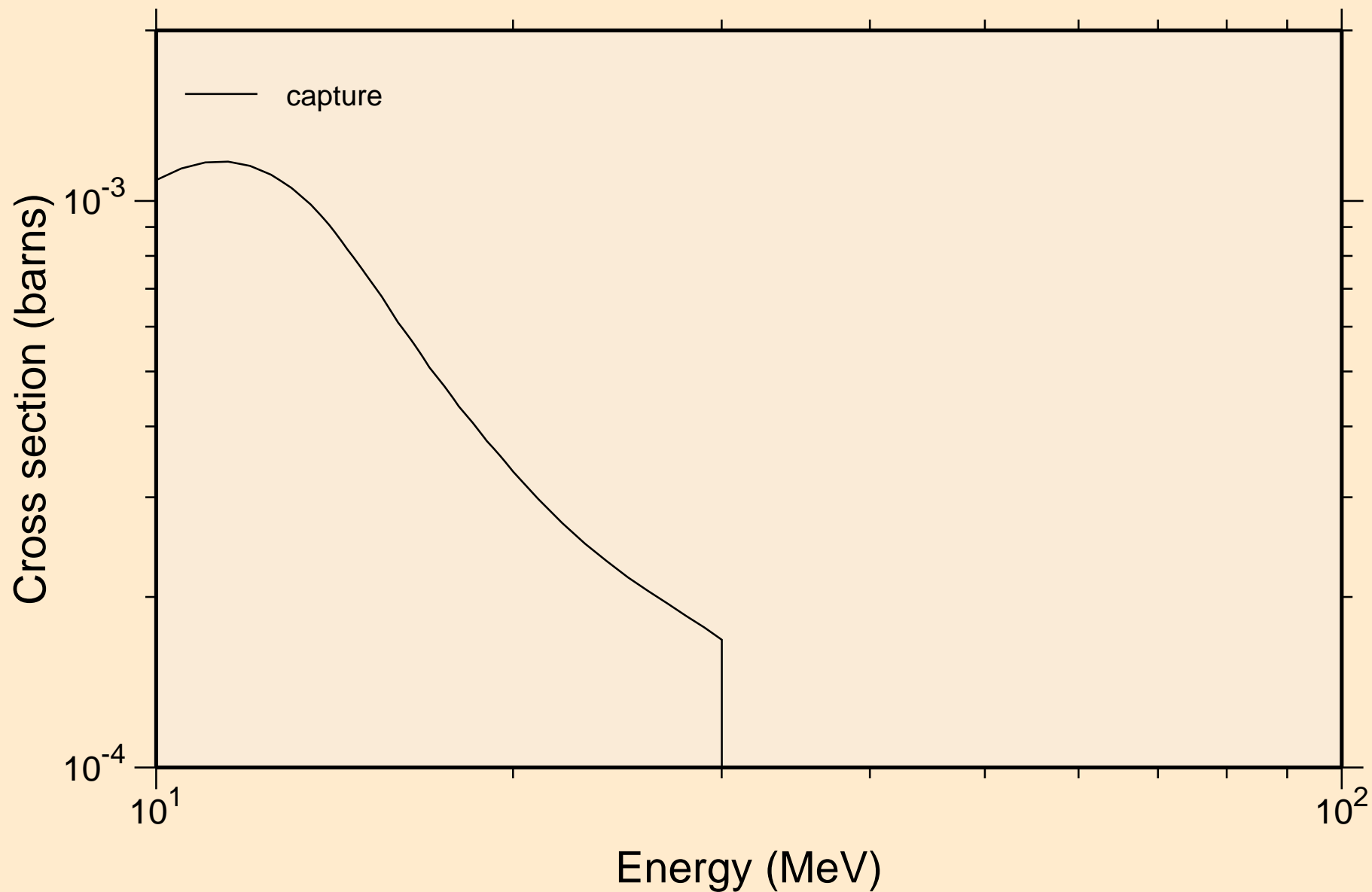

LU188 NEUTRON ACER TENDL-2023 LIBRARY; T=0.K  
Heating

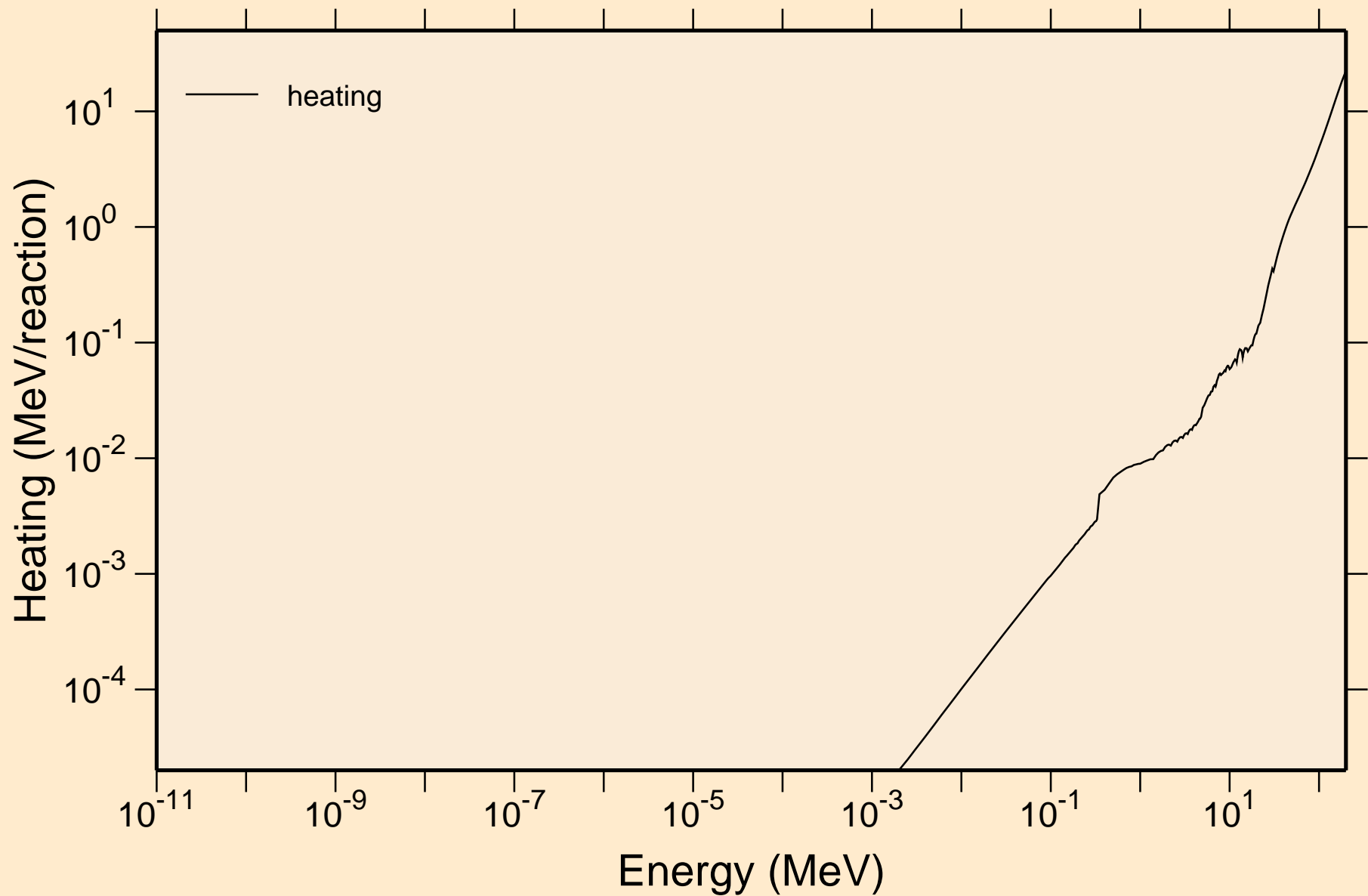

LU188 NEUTRON ACER TENDL-2023 LIBRARY; T=0.K  
Damage

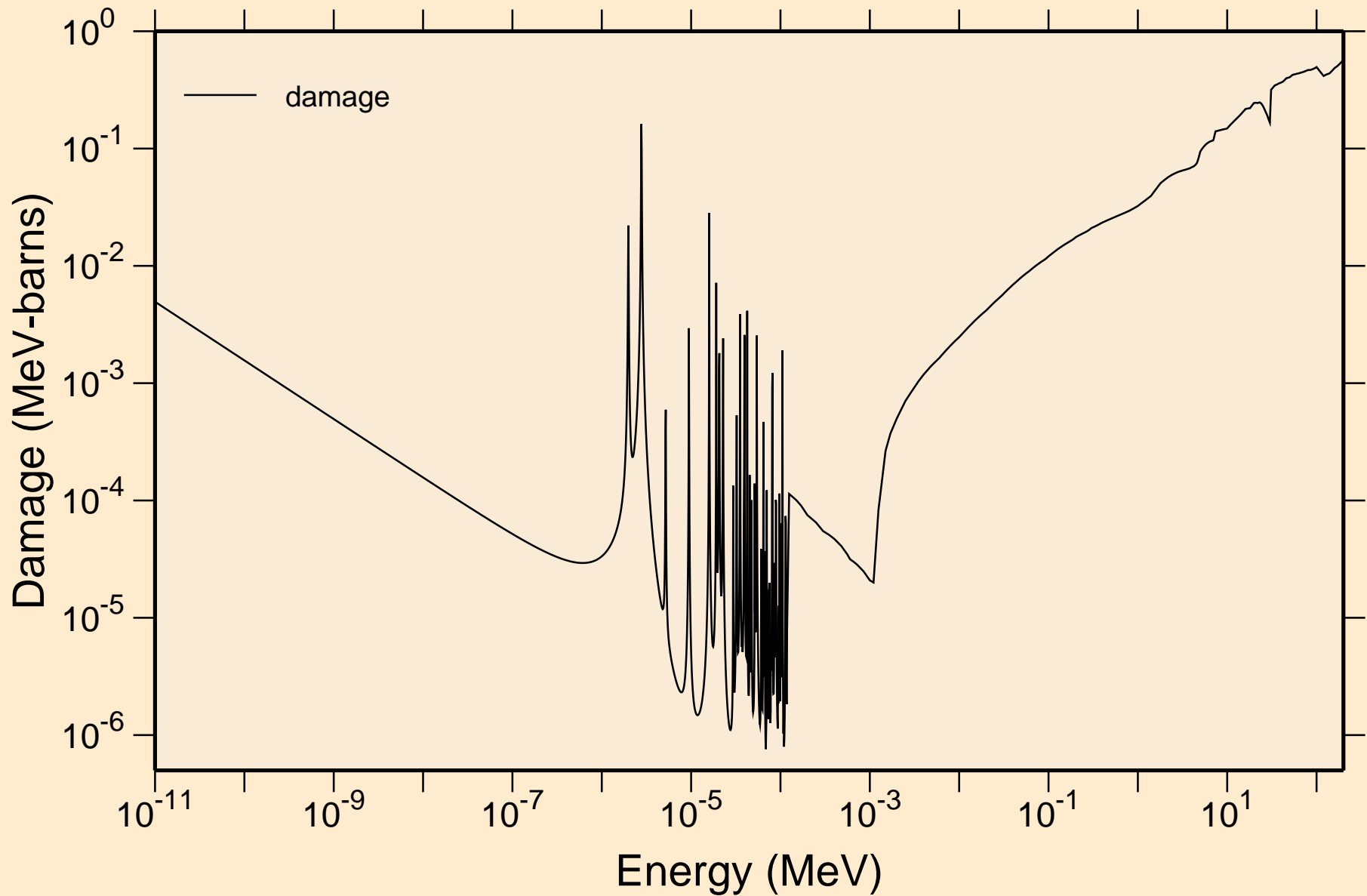

LU188 NEUTRON ACER TENDL-2023 LIBRARY; T=0.K  
Non-threshold reactions

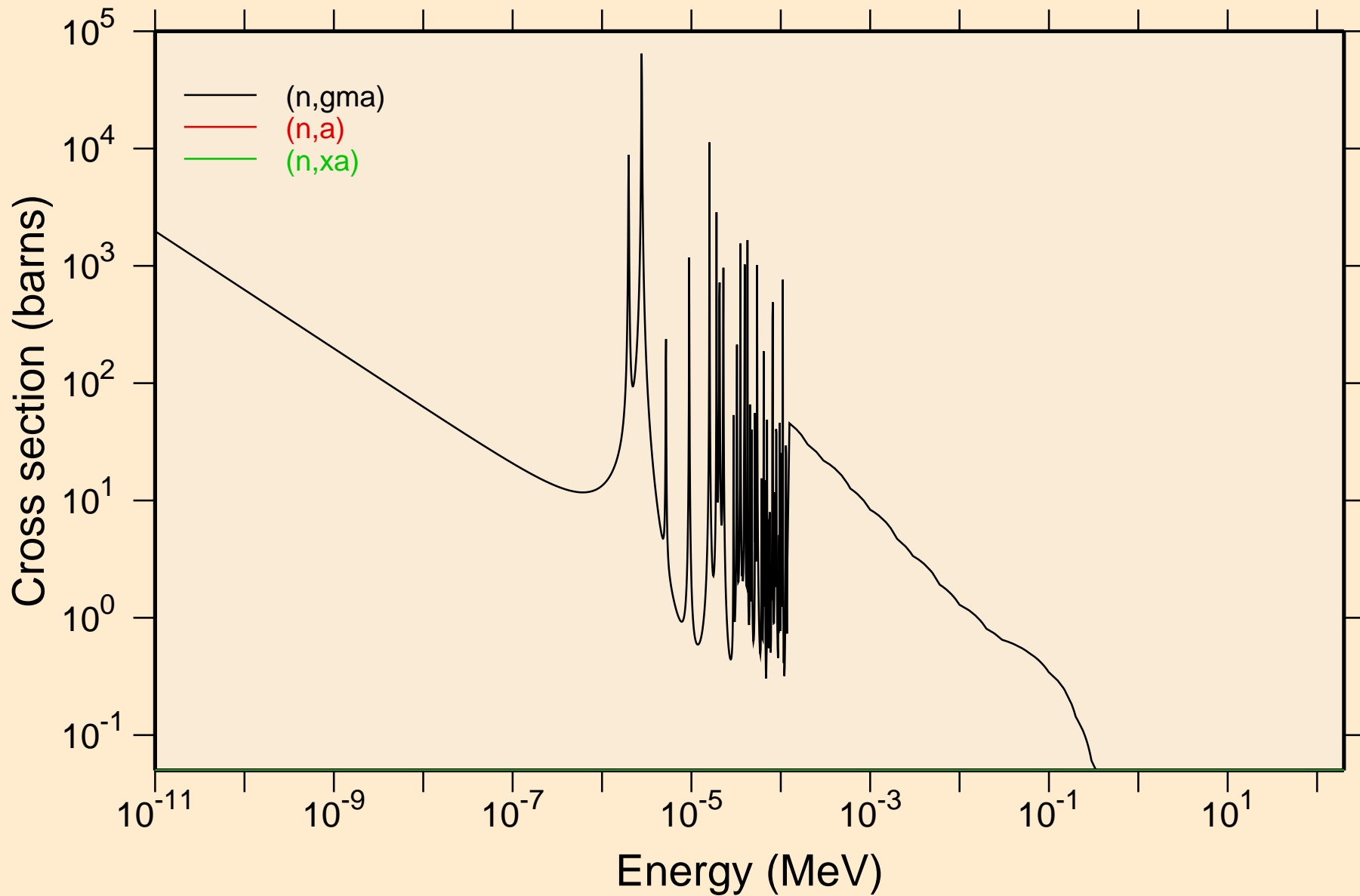

LU188 NEUTRON ACER TENDL-2023 LIBRARY; T=0.K  
Principal cross sections

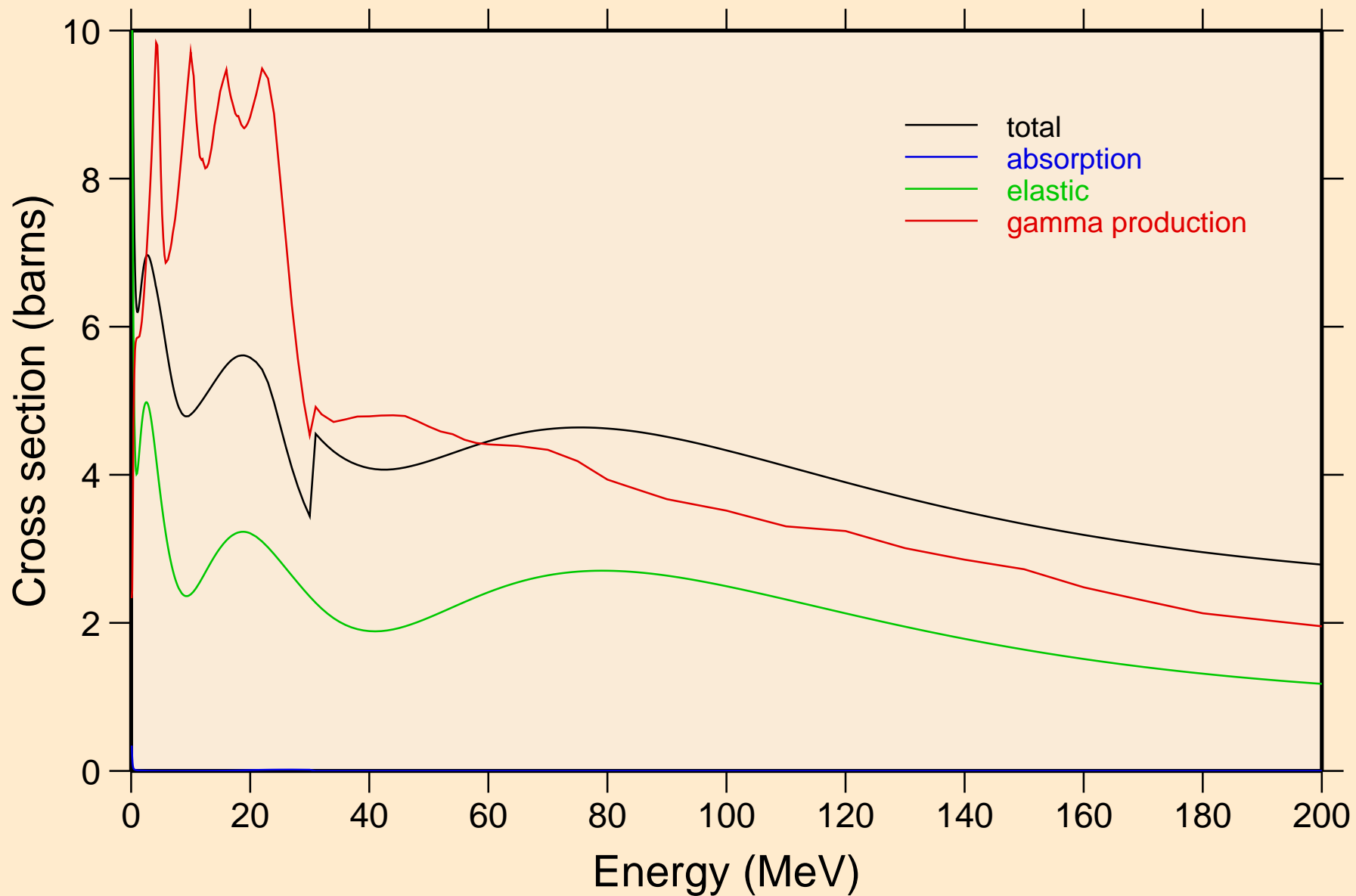

LU188 NEUTRON ACER TENDL-2023 LIBRARY; T=0.K  
Heating

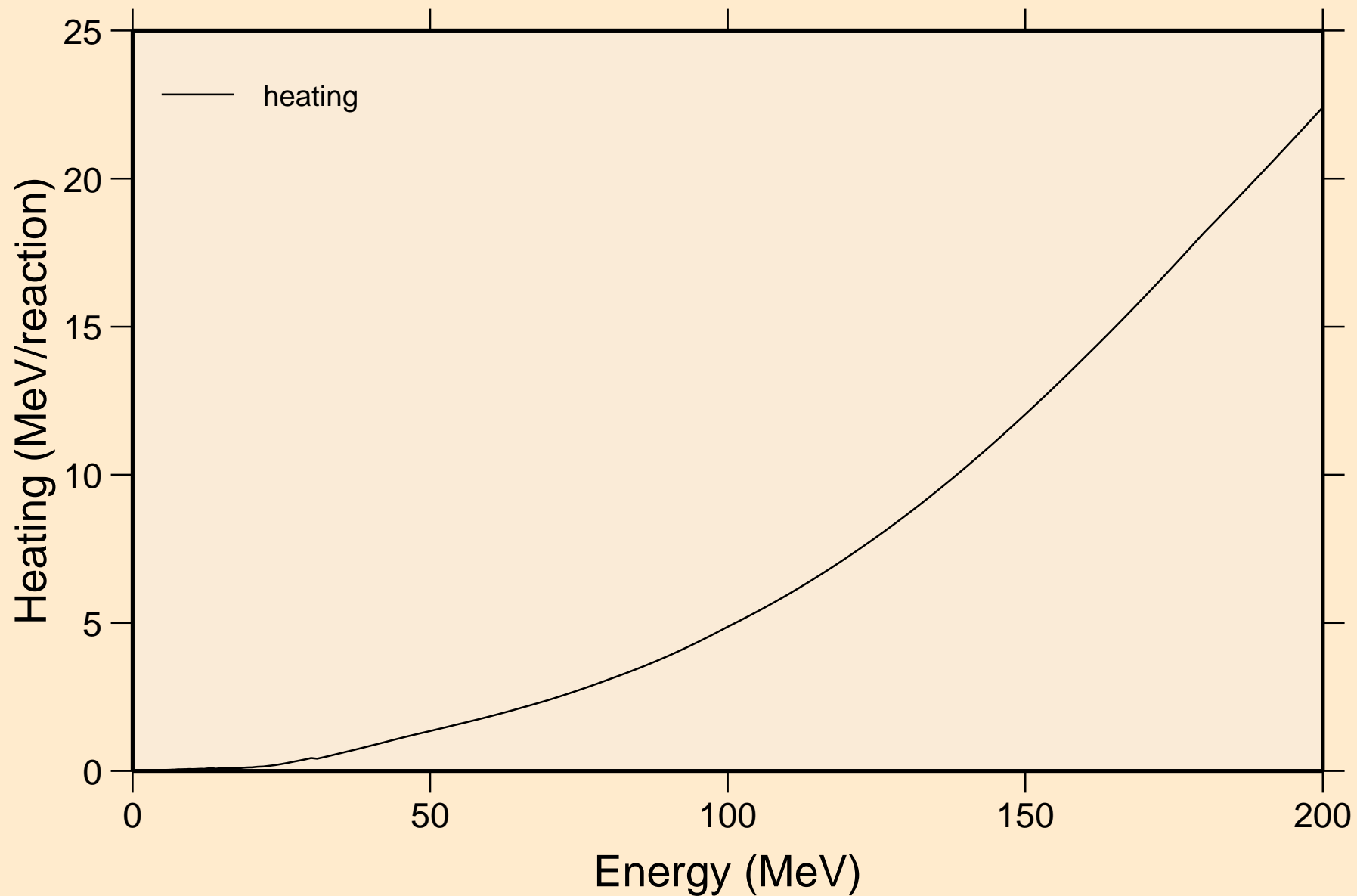

LU188 NEUTRON ACER TENDL-2023 LIBRARY; T=0.K  
Damage

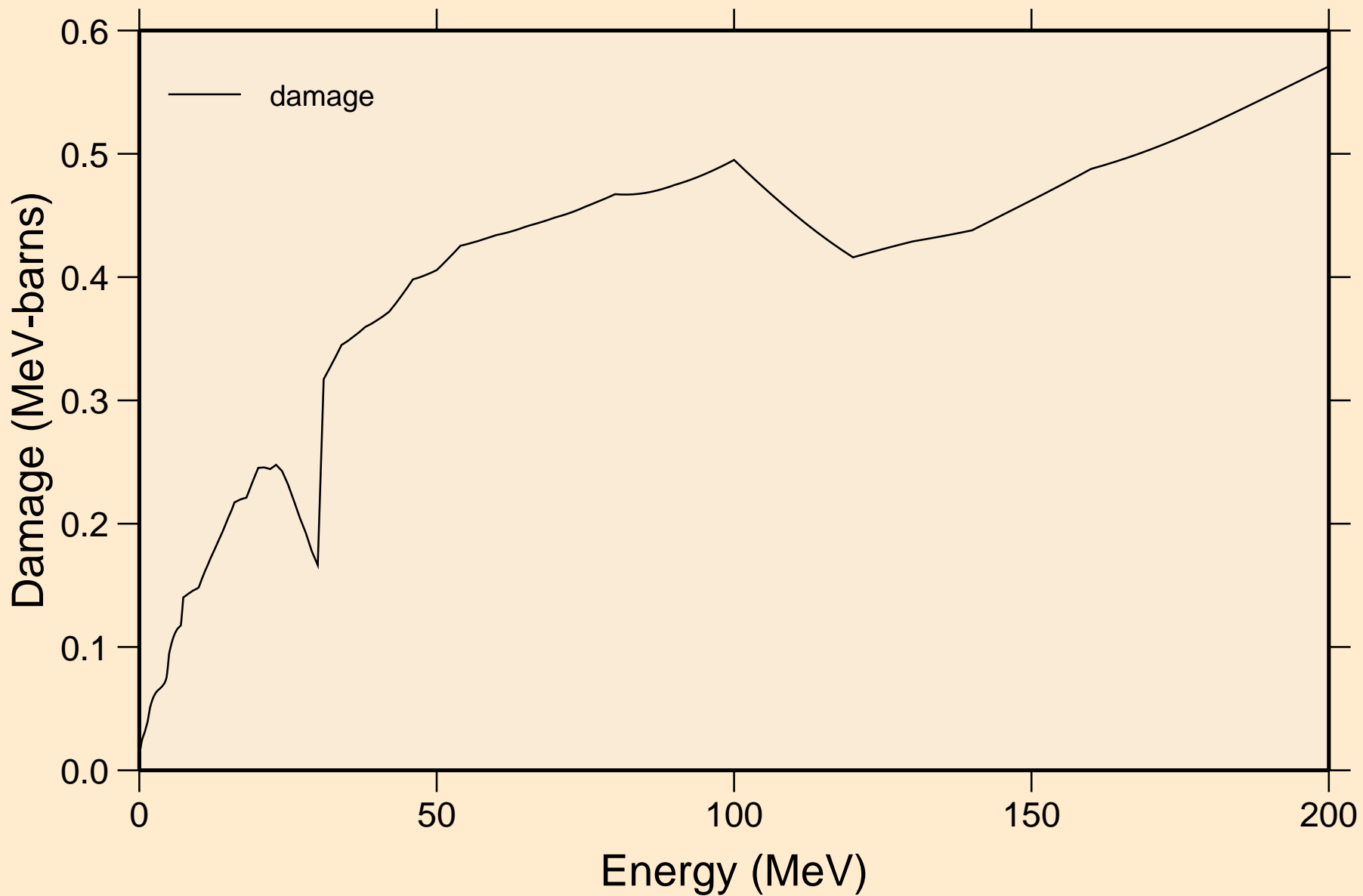

LU188 NEUTRON ACER TENDL-2023 LIBRARY; T=0.K  
Non-threshold reactions

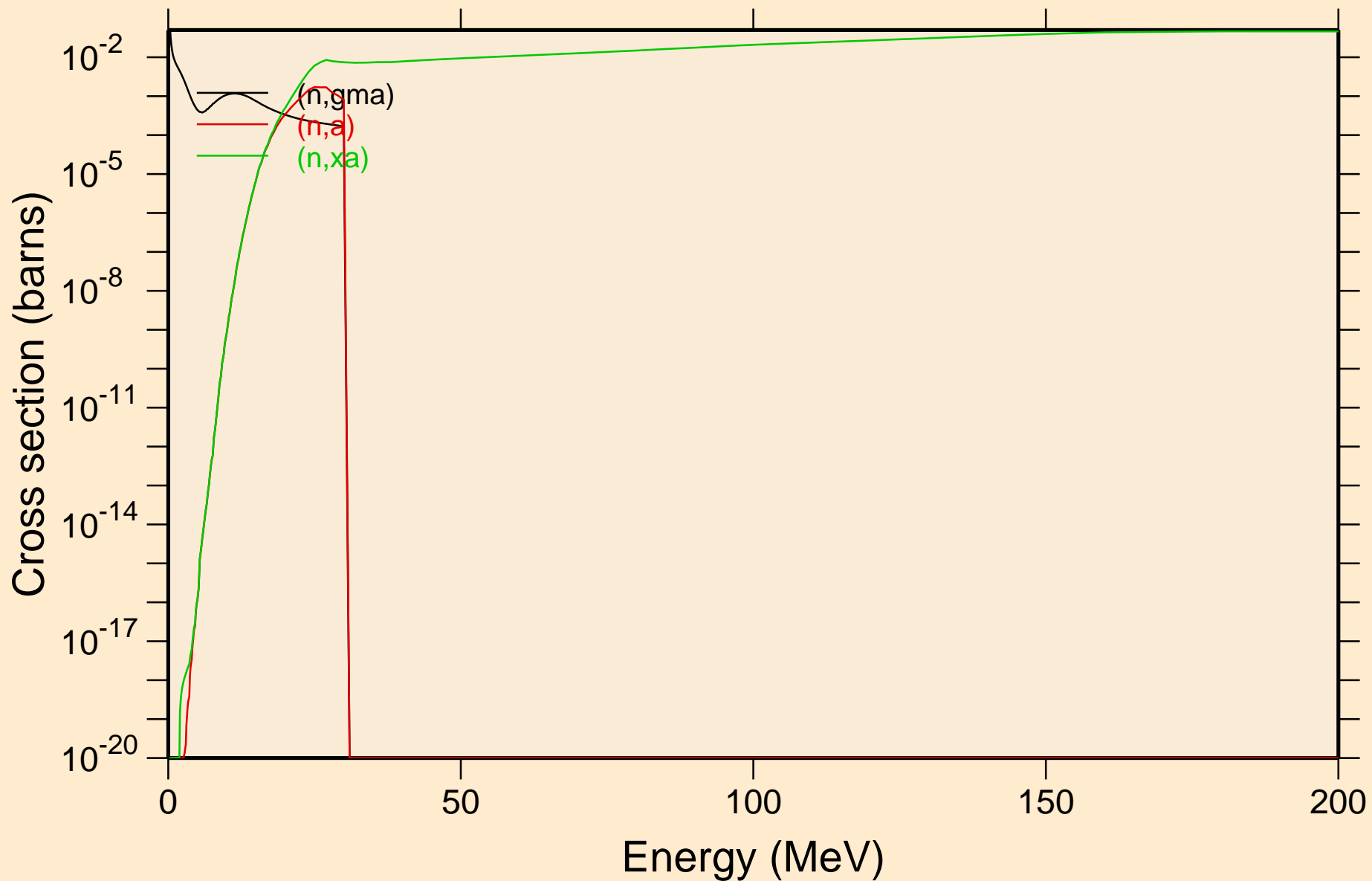



LU188 NEUTRON ACER TENDL-2023 LIBRARY; T=0.K  
Inelastic levels

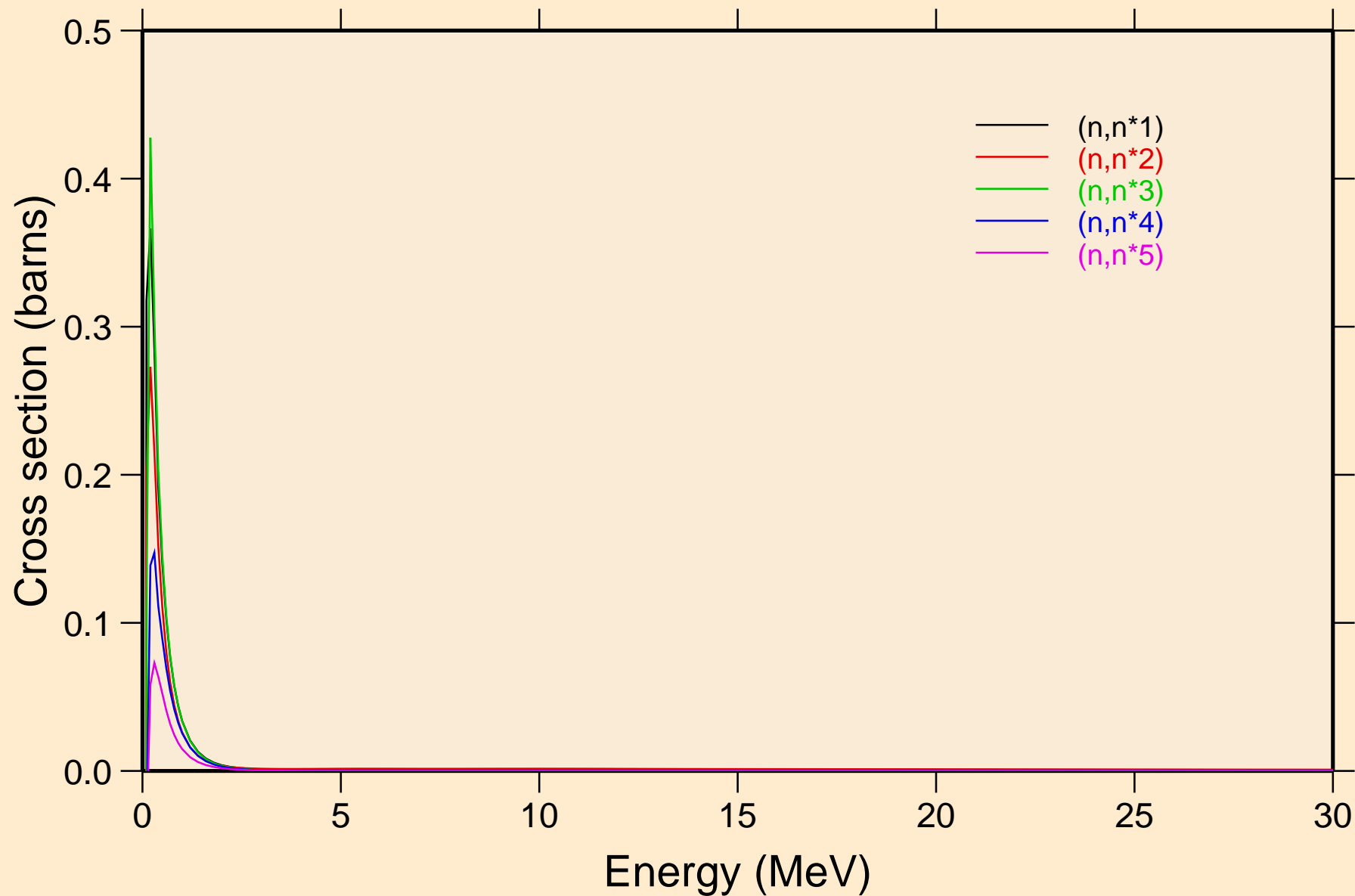

LU188 NEUTRON ACER TENDL-2023 LIBRARY; T=0.K  
Inelastic levels

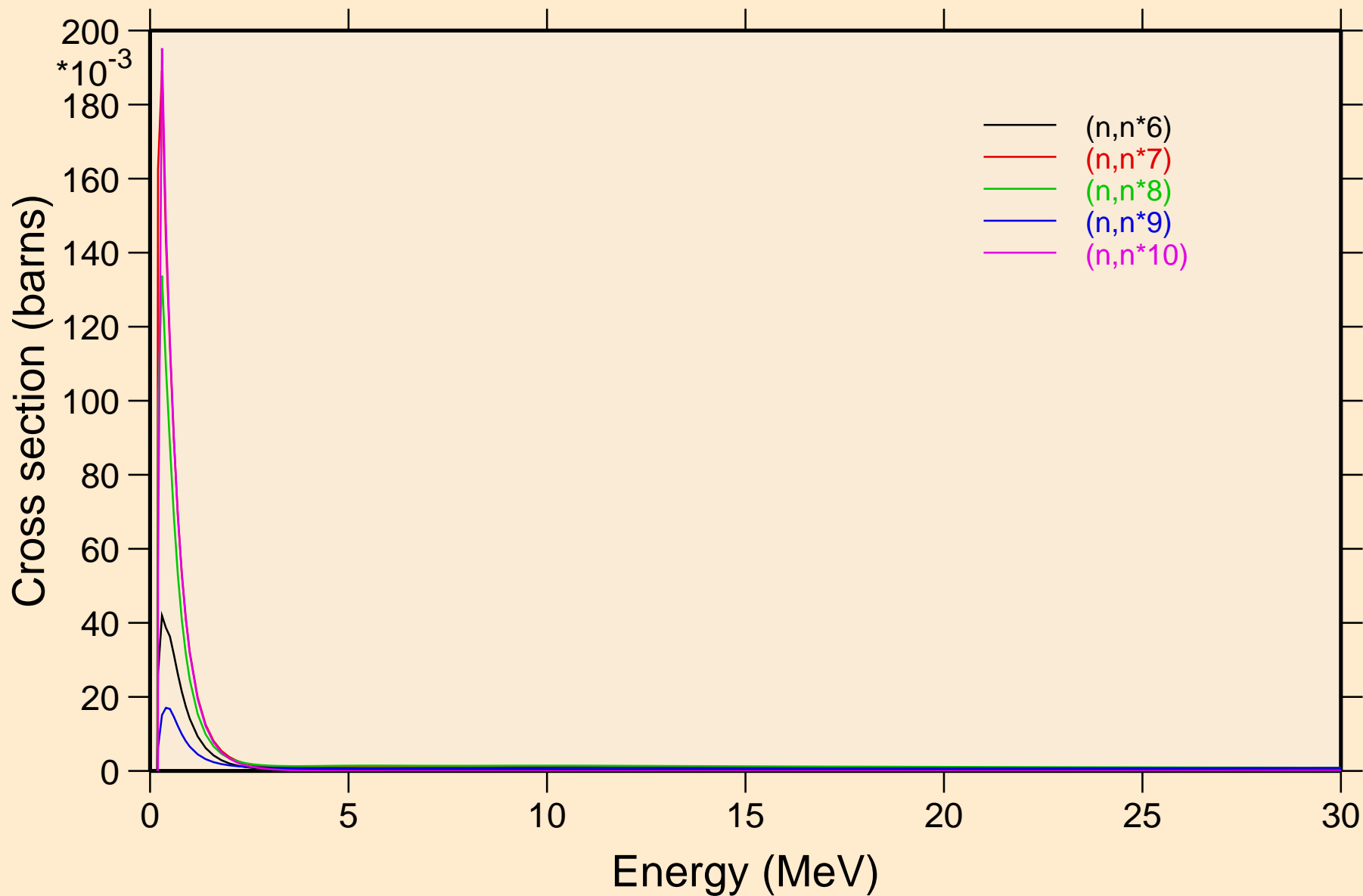

LU188 NEUTRON ACER TENDL-2023 LIBRARY; T=0.K  
Inelastic levels

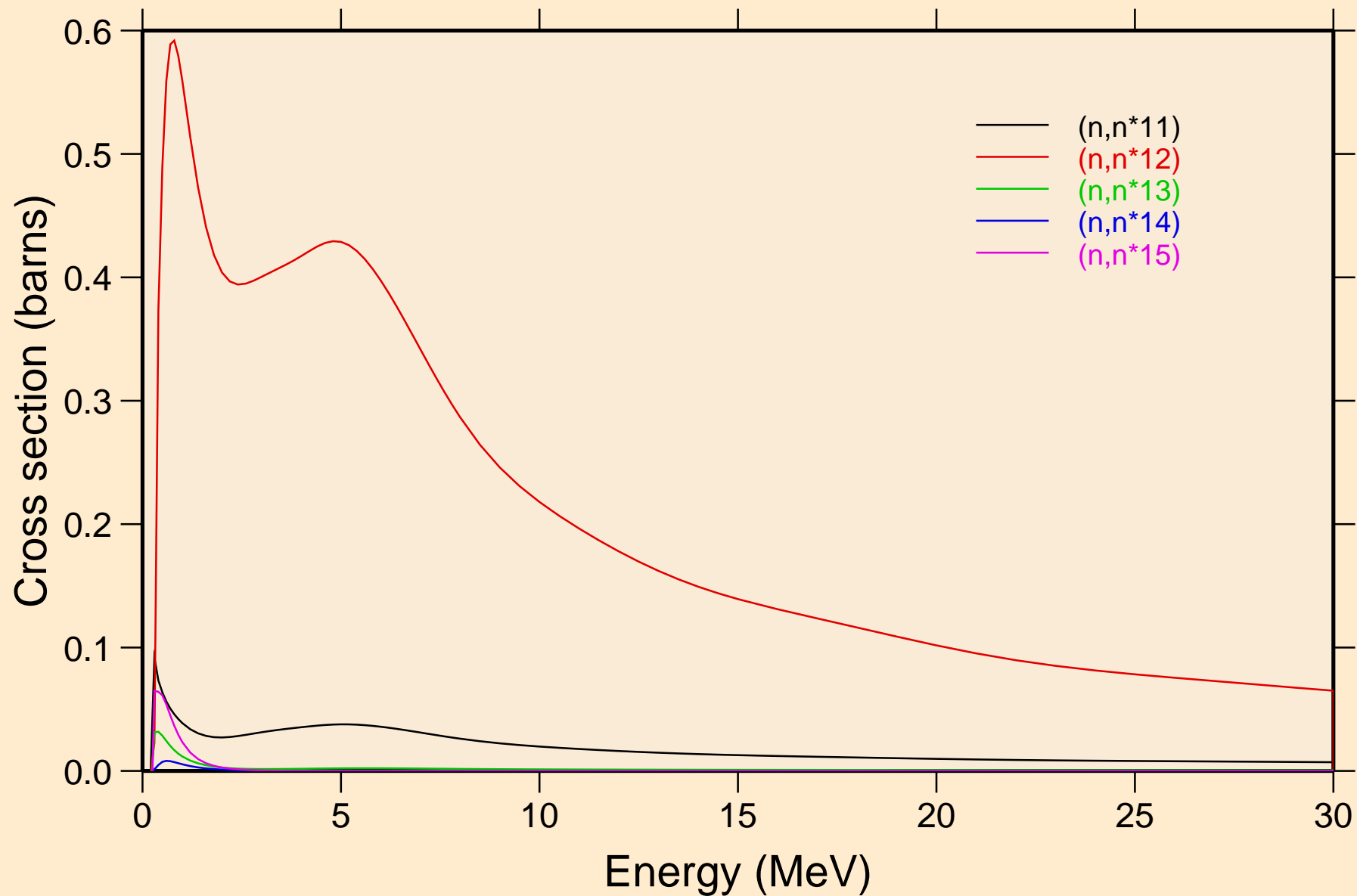

LU188 NEUTRON ACER TENDL-2023 LIBRARY; T=0.K  
Inelastic levels

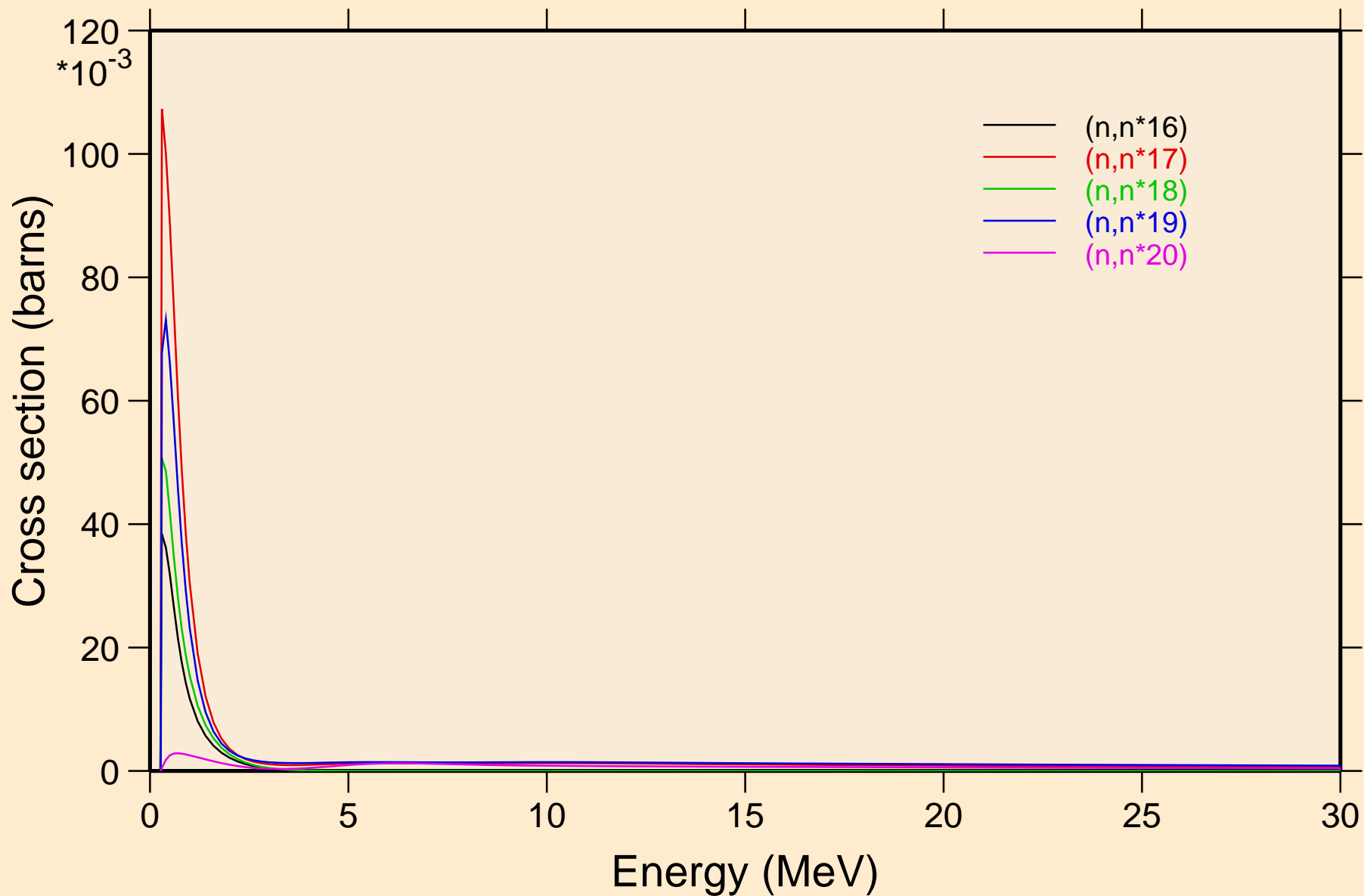

LU188 NEUTRON ACER TENDL-2023 LIBRARY; T=0.K  
Inelastic levels

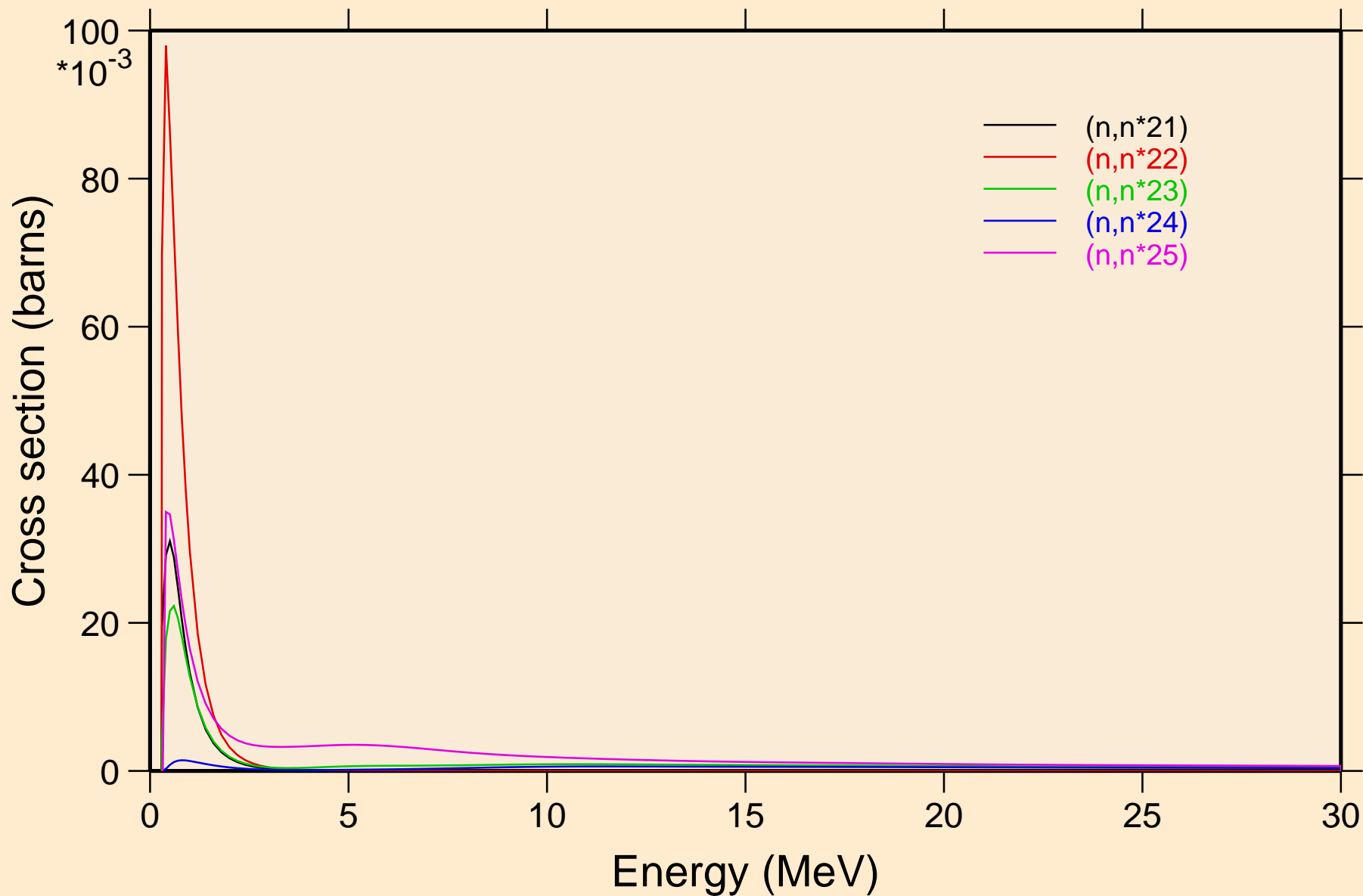

LU188 NEUTRON ACER TENDL-2023 LIBRARY; T=0.K  
Inelastic levels

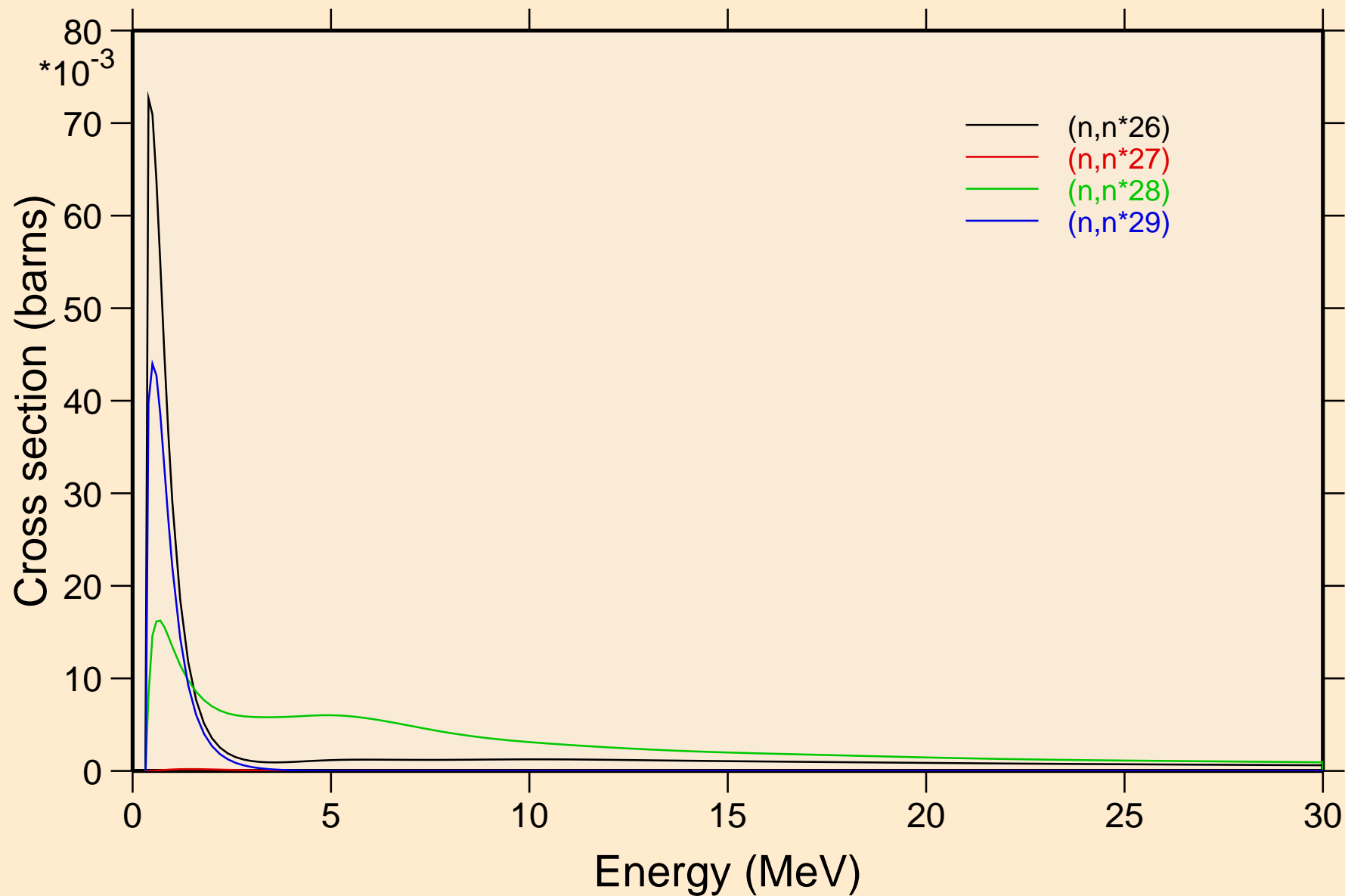

LU188 NEUTRON ACER TENDL-2023 LIBRARY; T=0.K  
Threshold reactions

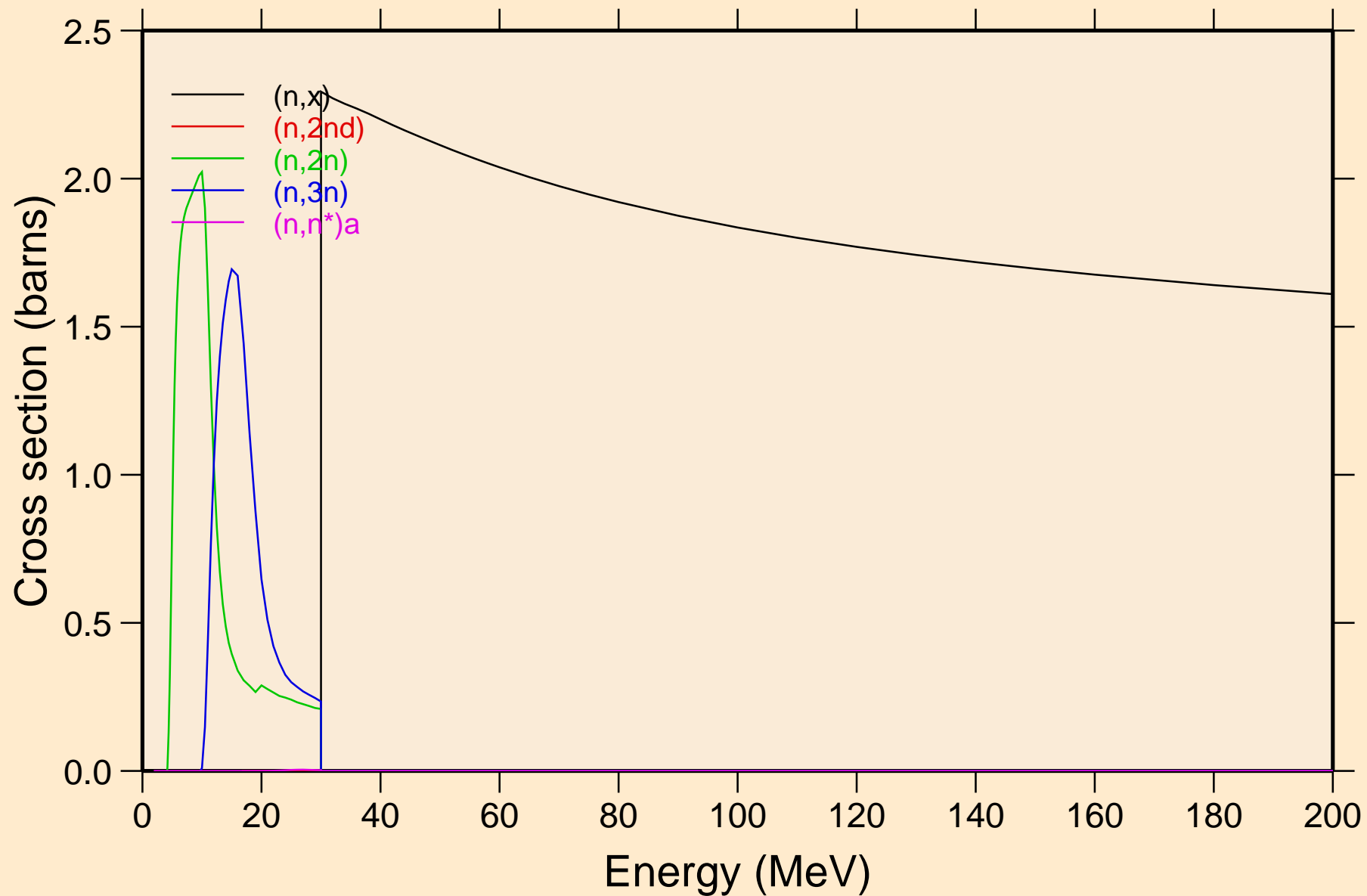

LU188 NEUTRON ACER TENDL-2023 LIBRARY; T=0.K  
Threshold reactions

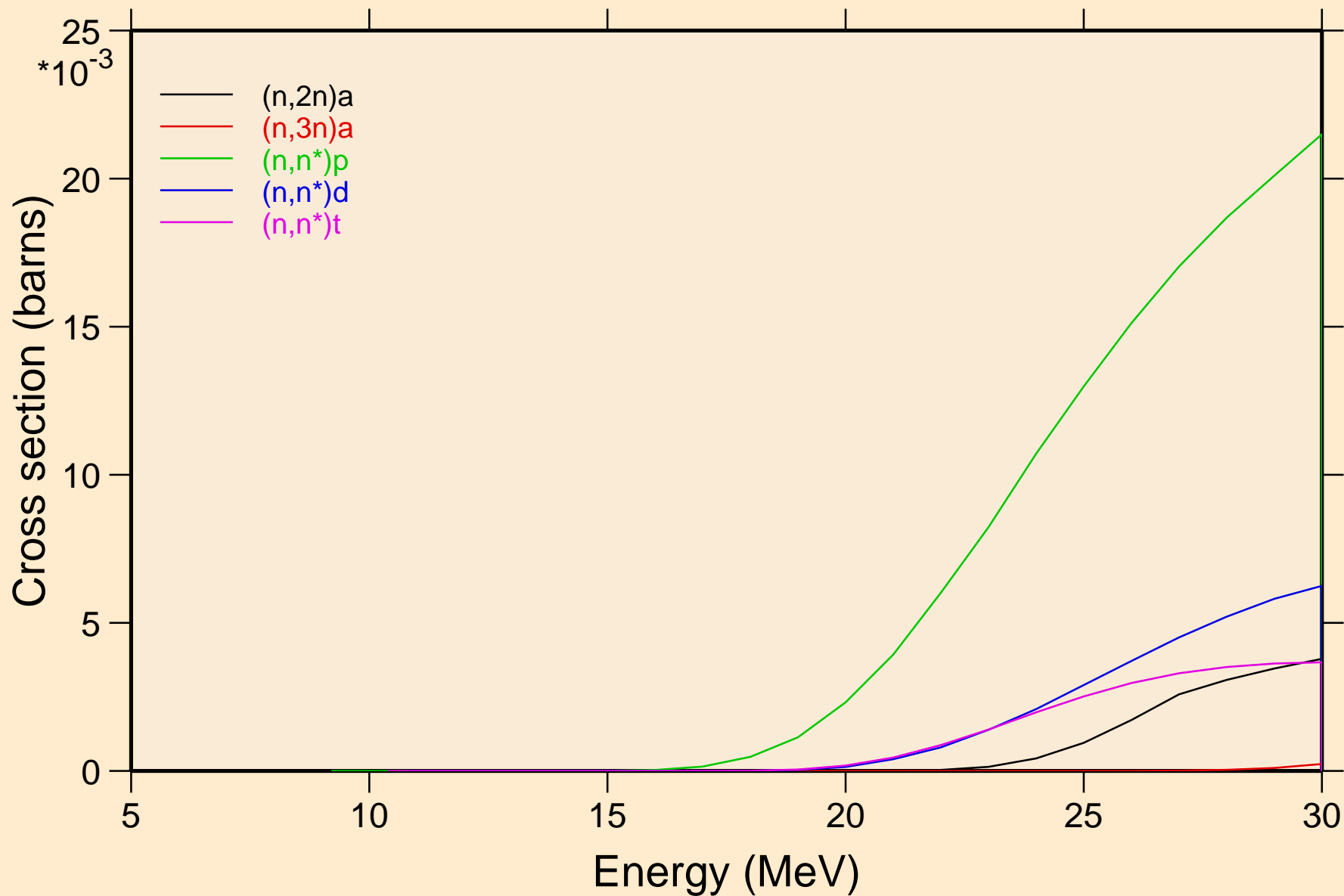



LU188 NEUTRON ACER TENDL-2023 LIBRARY; T=0.K  
Threshold reactions

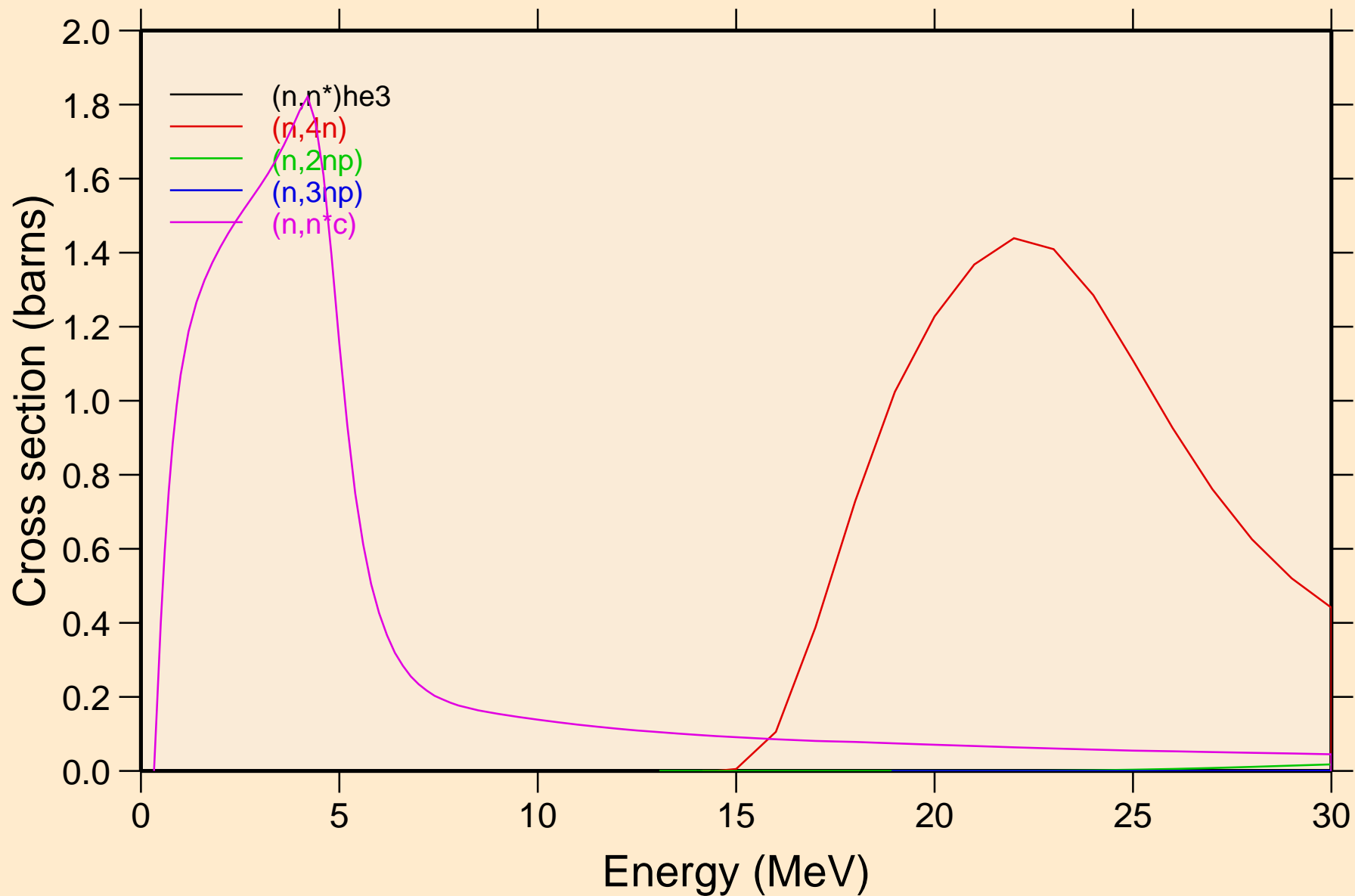

LU188 NEUTRON ACER TENDL-2023 LIBRARY; T=0.K  
Threshold reactions

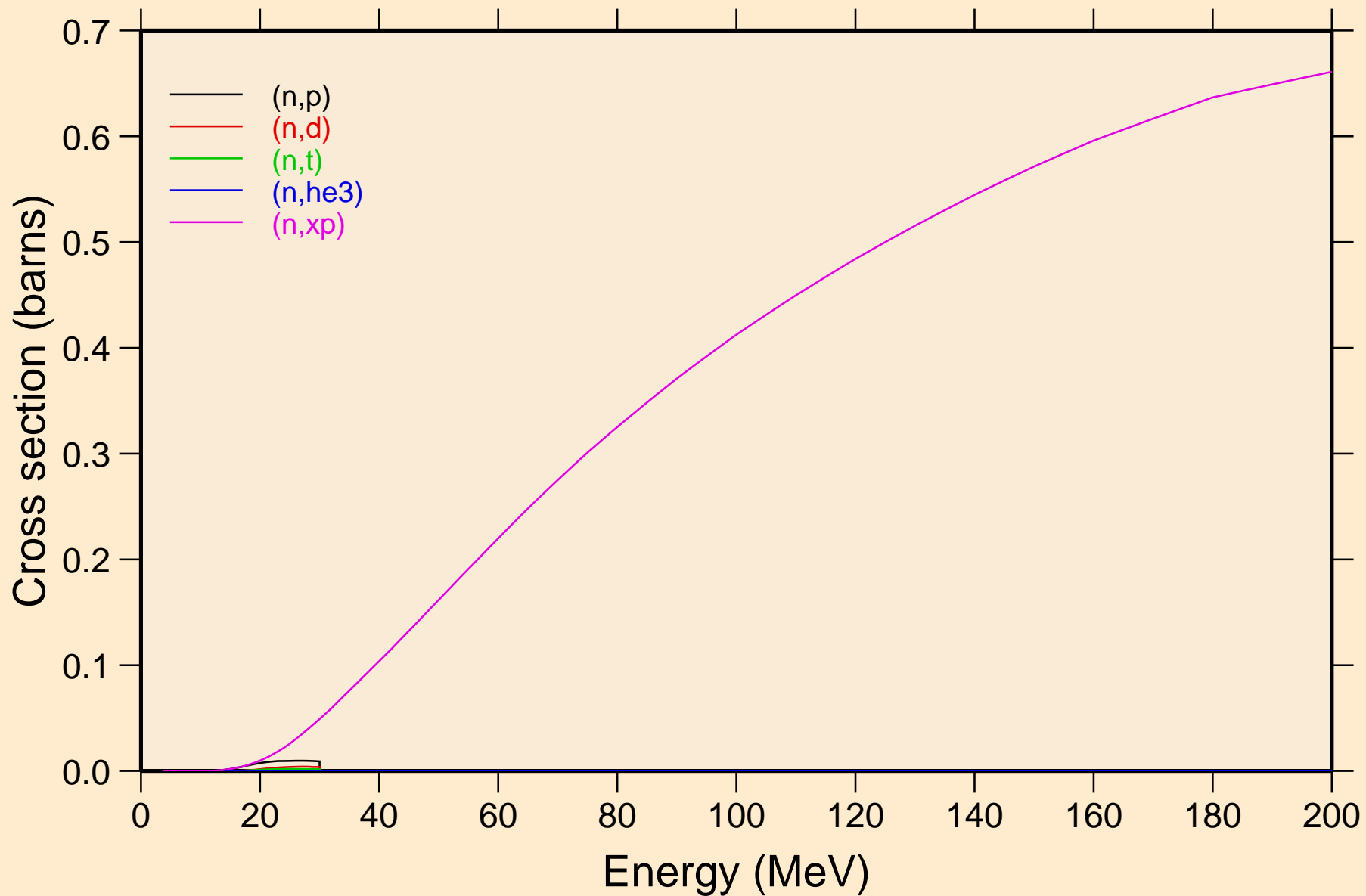

LU188 NEUTRON ACER TENDL-2023 LIBRARY; T=0.K  
Threshold reactions

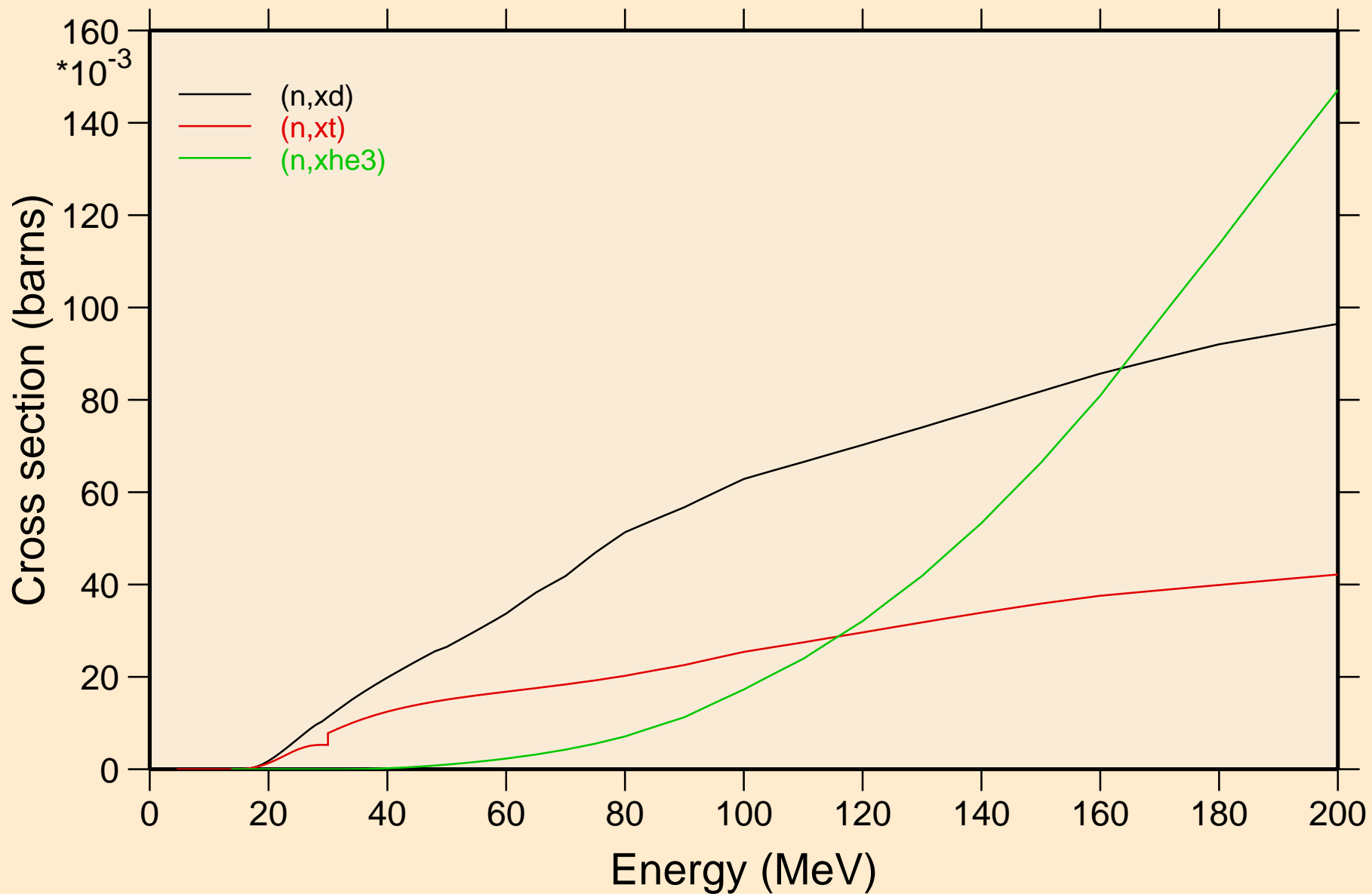

LU188 NEUTRON ACER TENDL-2023 LIBRARY; T=0.K  
angular distribution for elastic

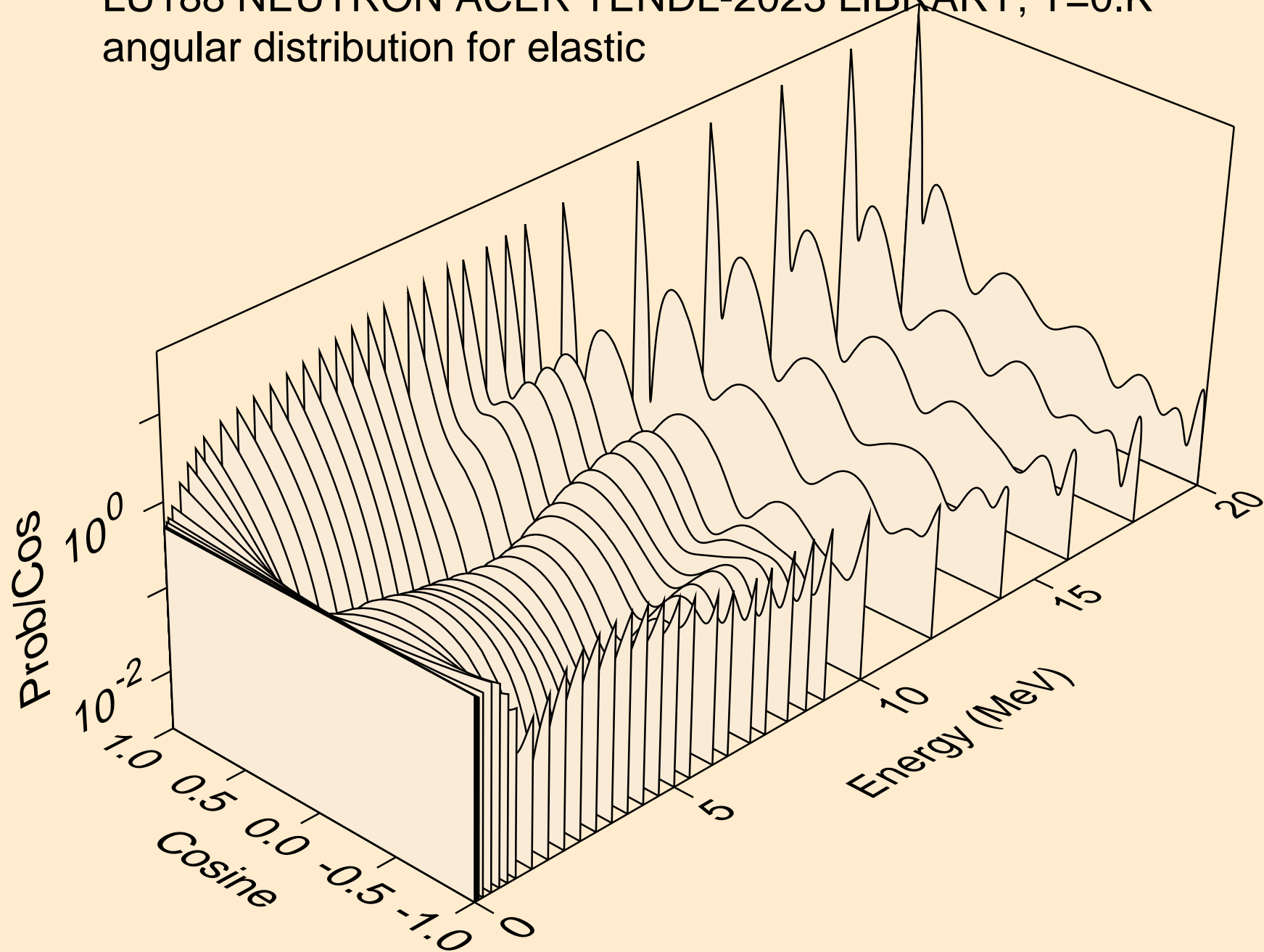

LU188 NEUTRON ACER TENDL-2023 LIBRARY; T=0.K  
angular distribution for elastic

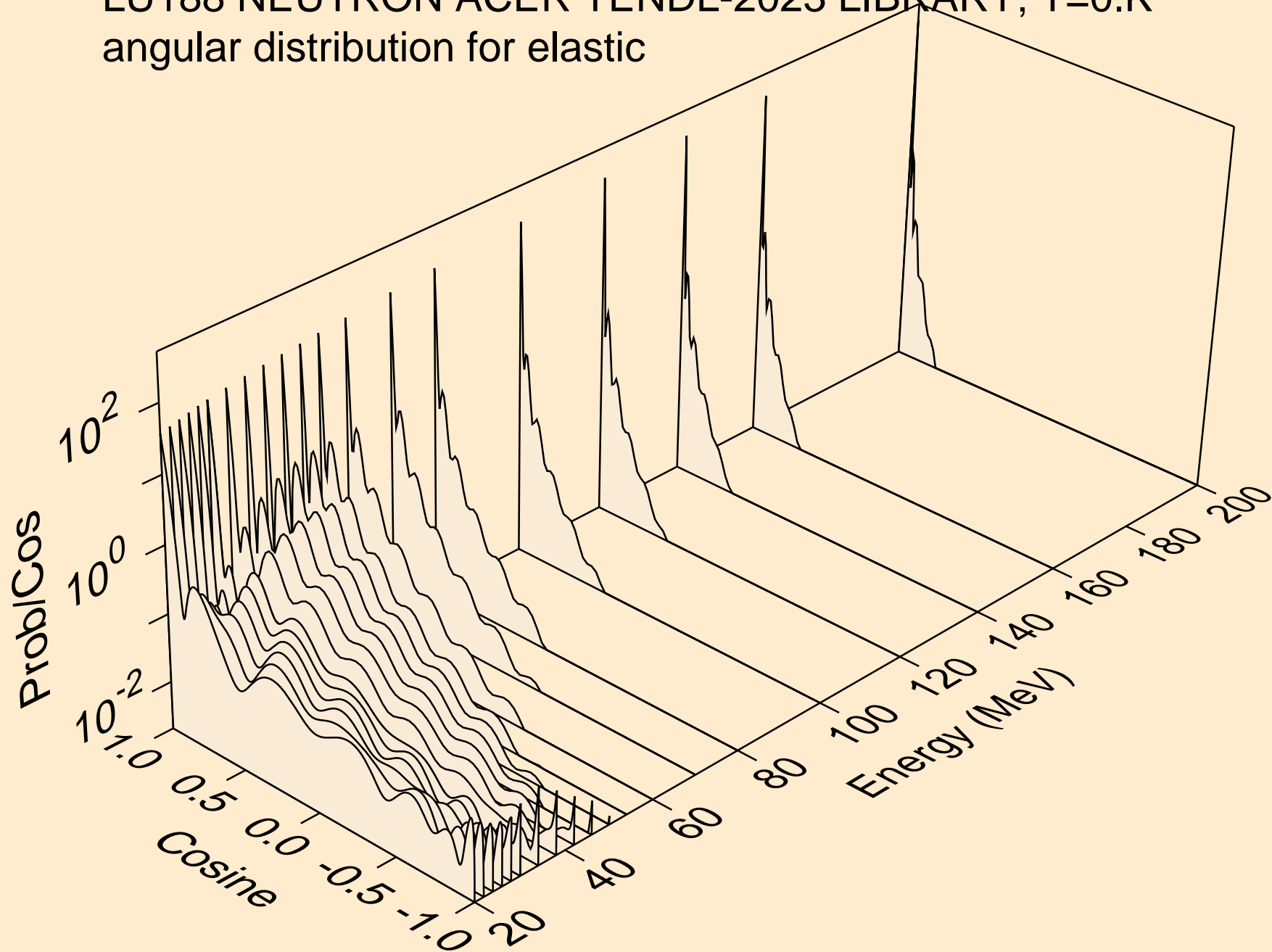

LU188 NEUTRON ACER TENDL-2023 LIBRARY; T=0.K  
angular distribution for (n,n\*1)

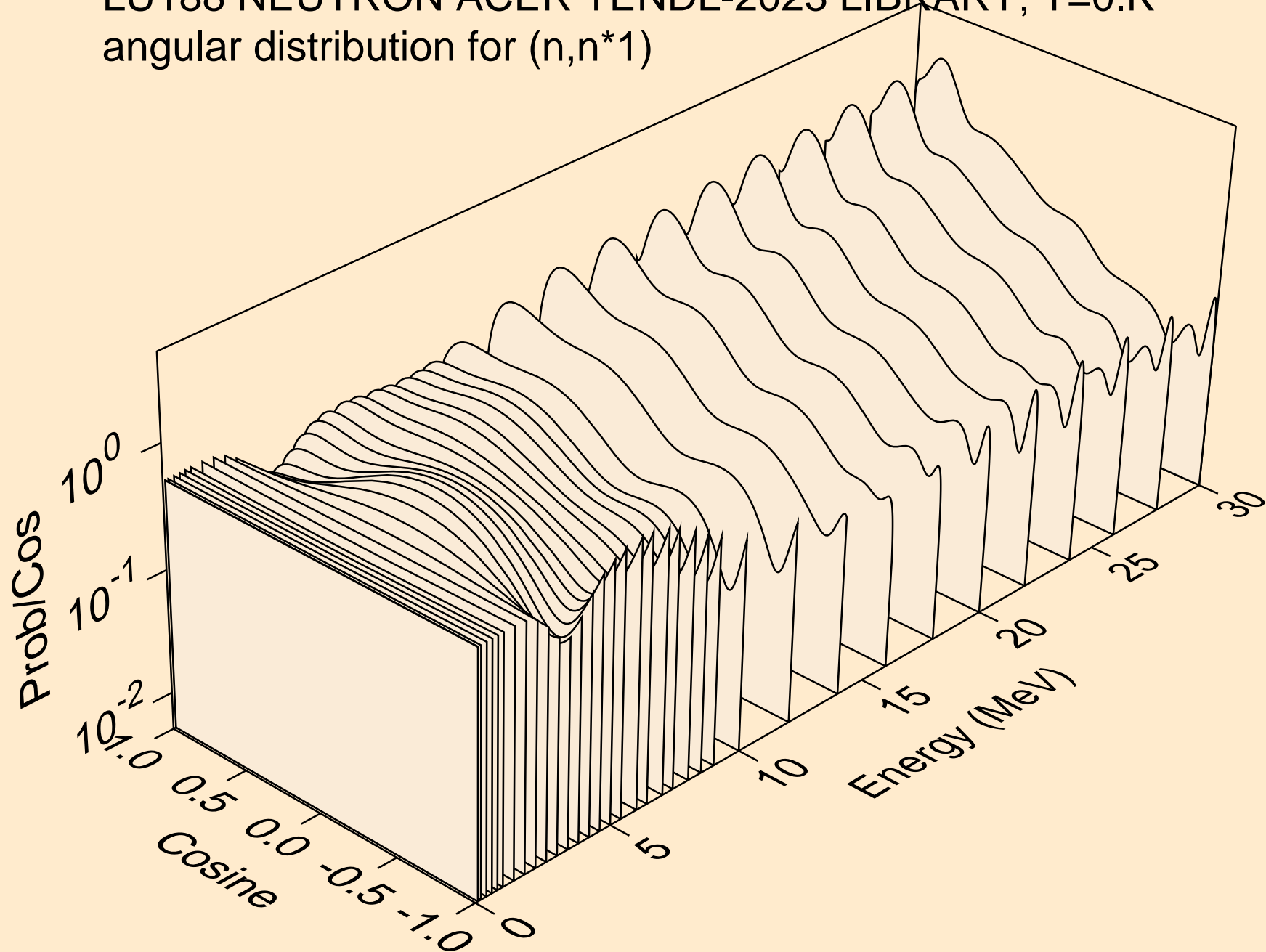

LU188 NEUTRON ACER TENDL-2023 LIBRARY; T=0.K  
angular distribution for (n,n\*2)

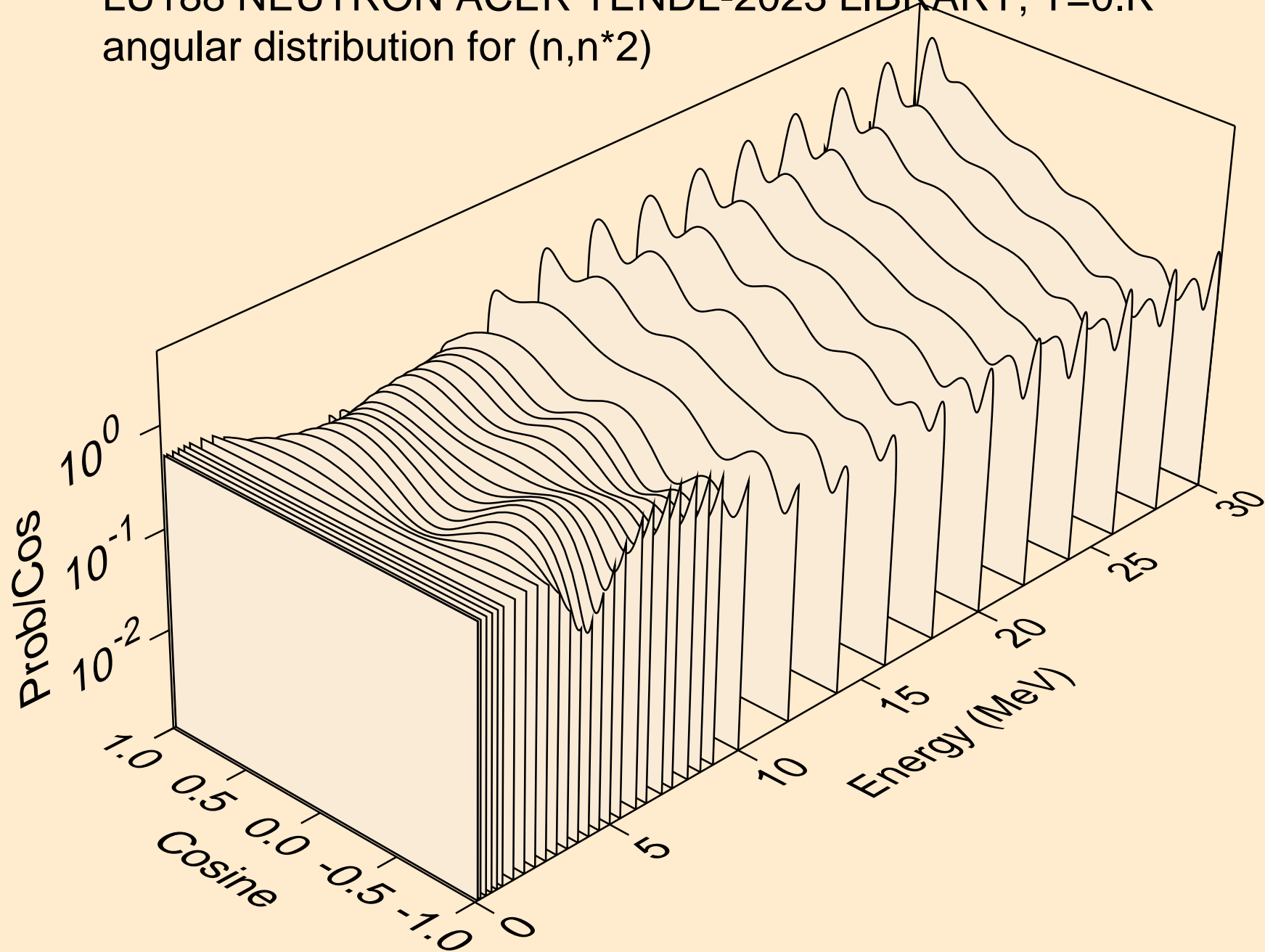

LU188 NEUTRON ACER TENDL-2023 LIBRARY; T=0.K  
angular distribution for (n,n\*3)

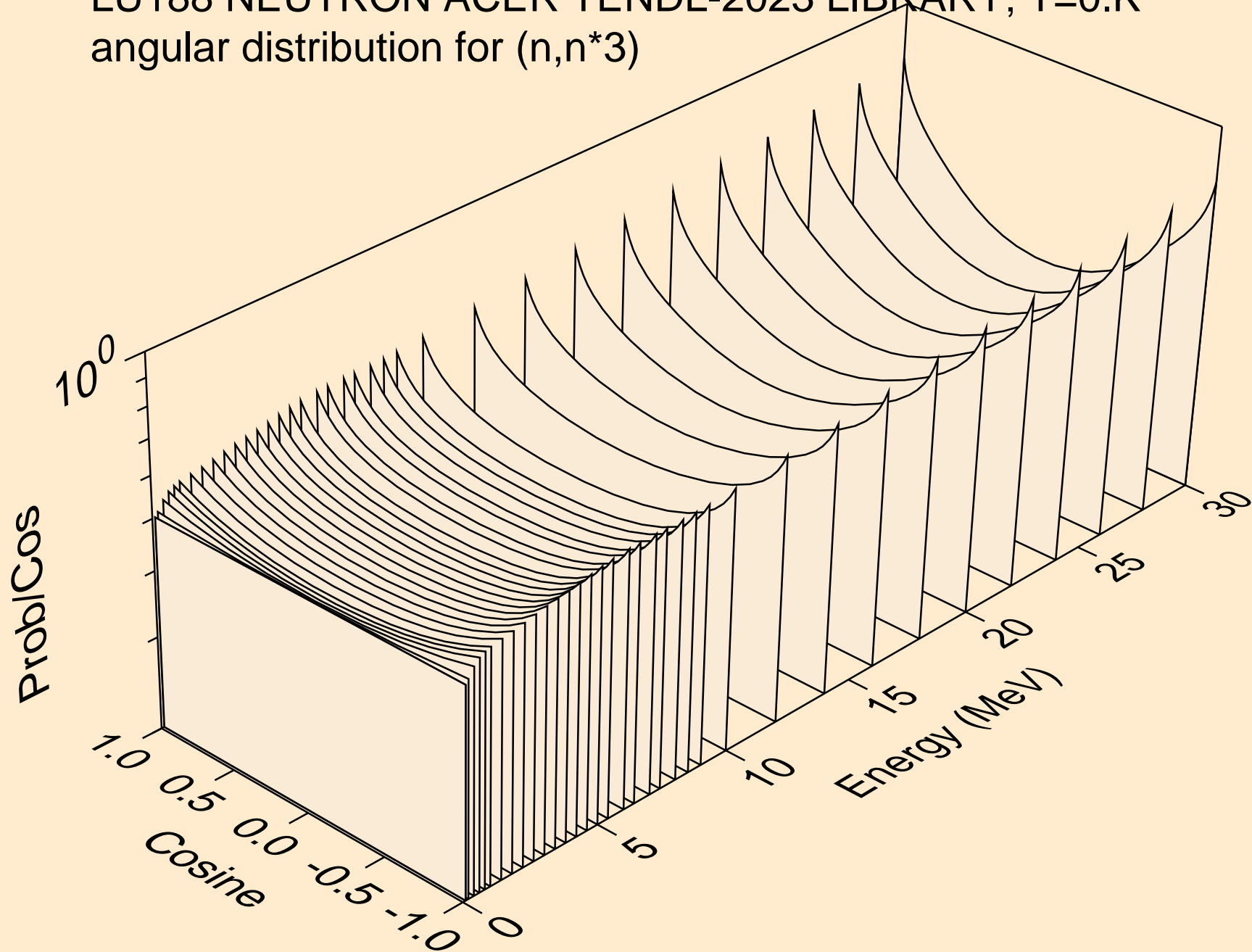



LU188 NEUTRON ACER TENDL-2023 LIBRARY; T=0.K  
angular distribution for (n,n\*4)

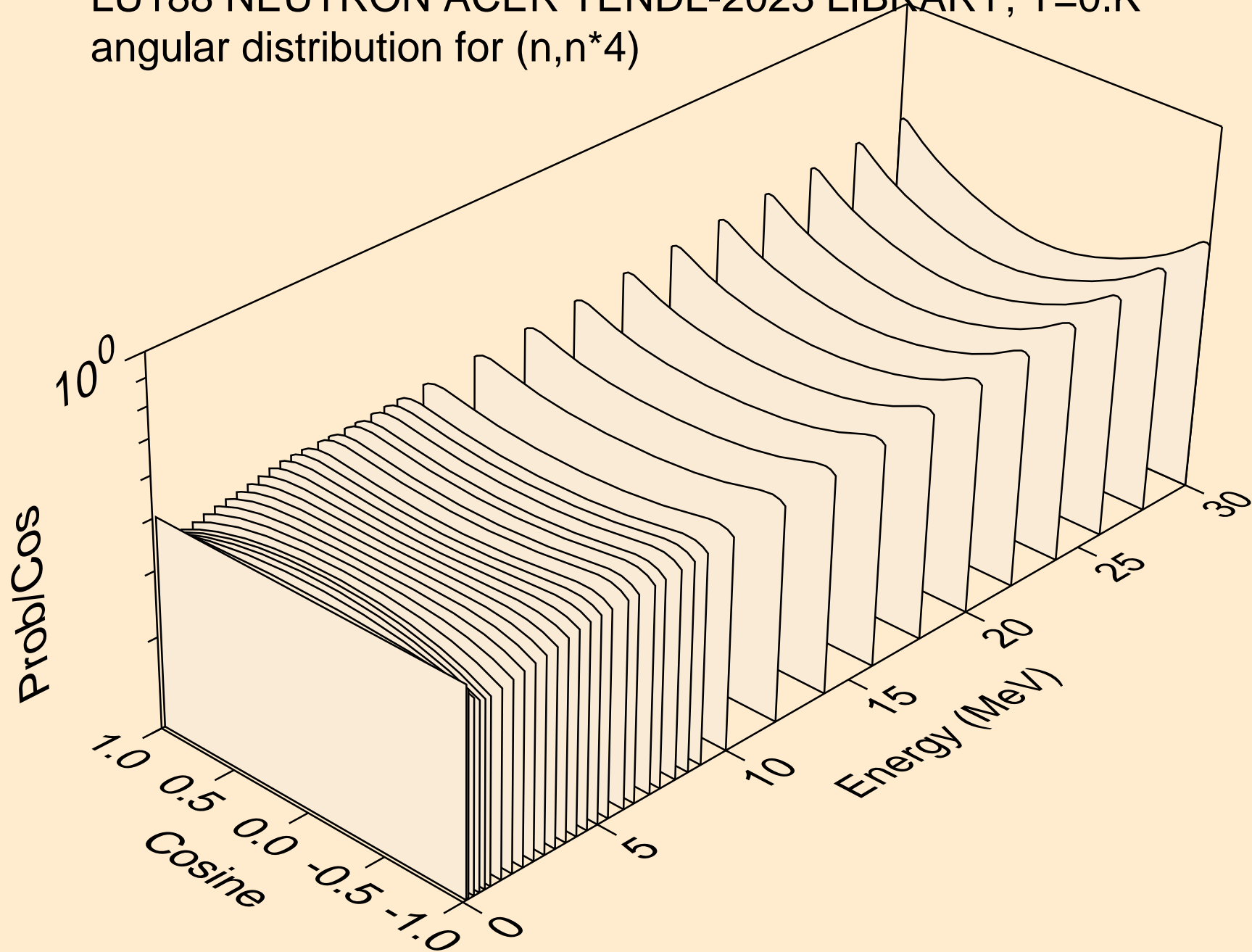

LU188 NEUTRON ACER TENDL-2023 LIBRARY; T=0.K  
angular distribution for (n,n\*5)

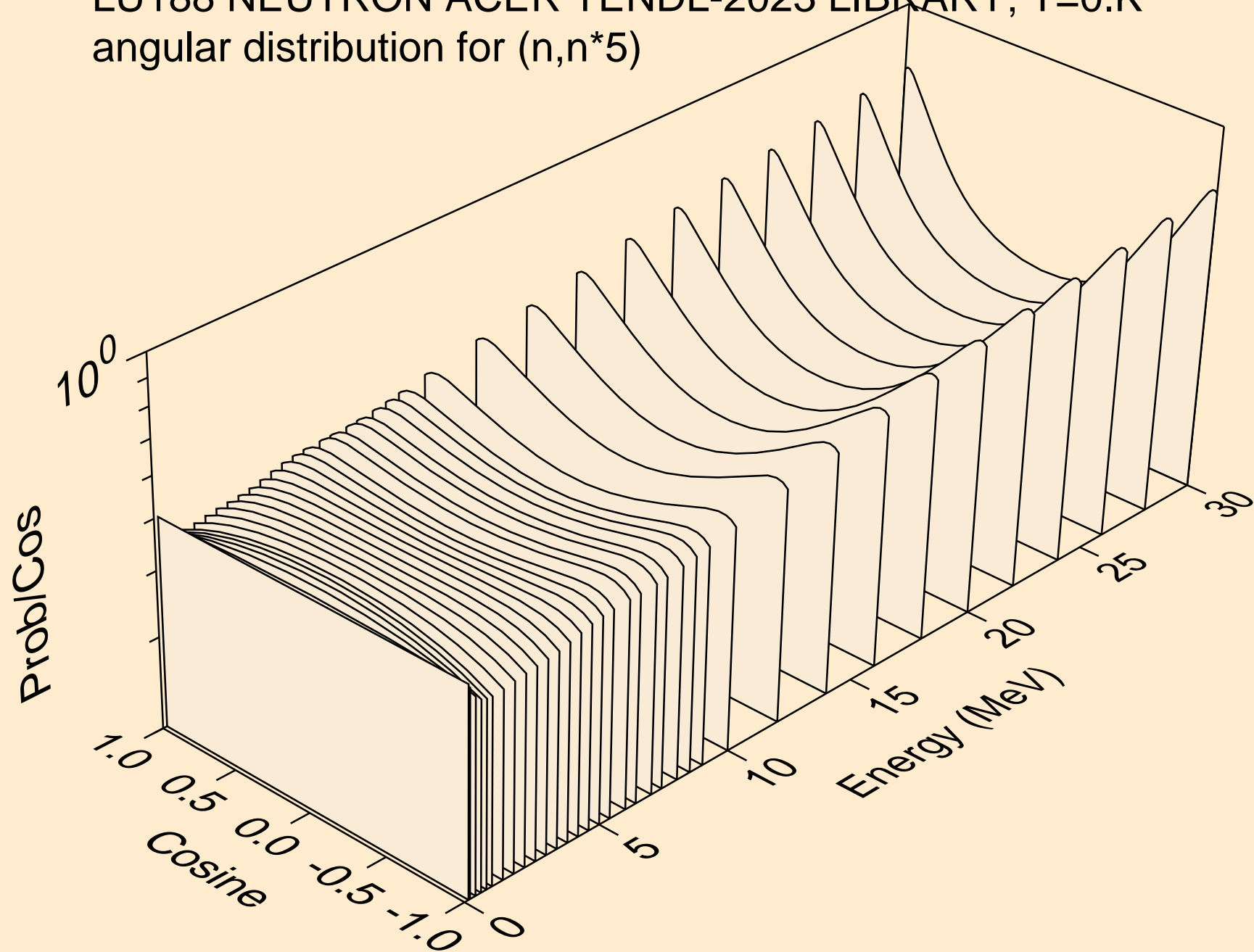

LU188 NEUTRON ACER TENDL-2023 LIBRARY; T=0.K  
angular distribution for (n,n\*6)

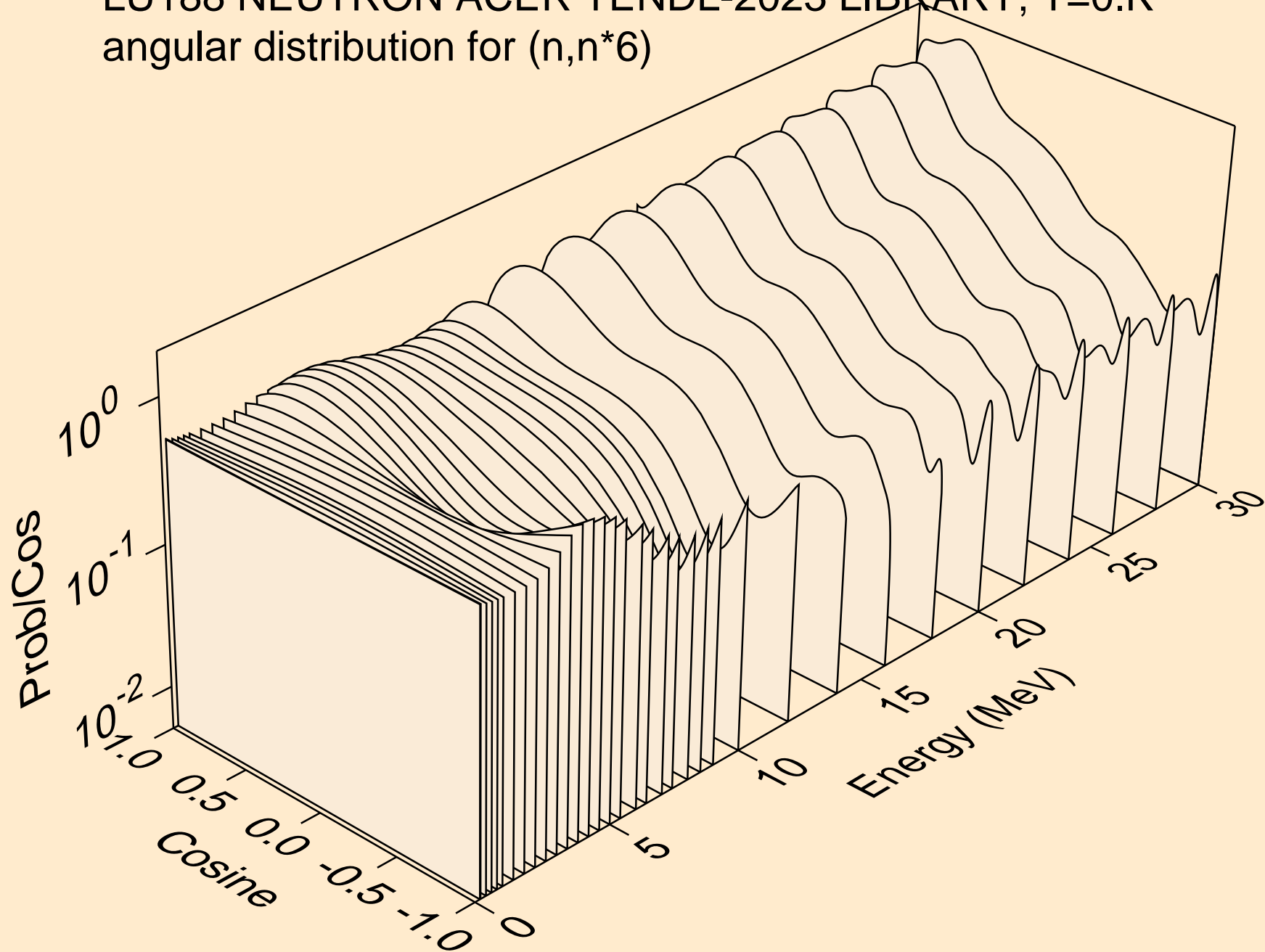

LU188 NEUTRON ACER TENDL-2023 LIBRARY; T=0.K  
angular distribution for (n,n\*7)

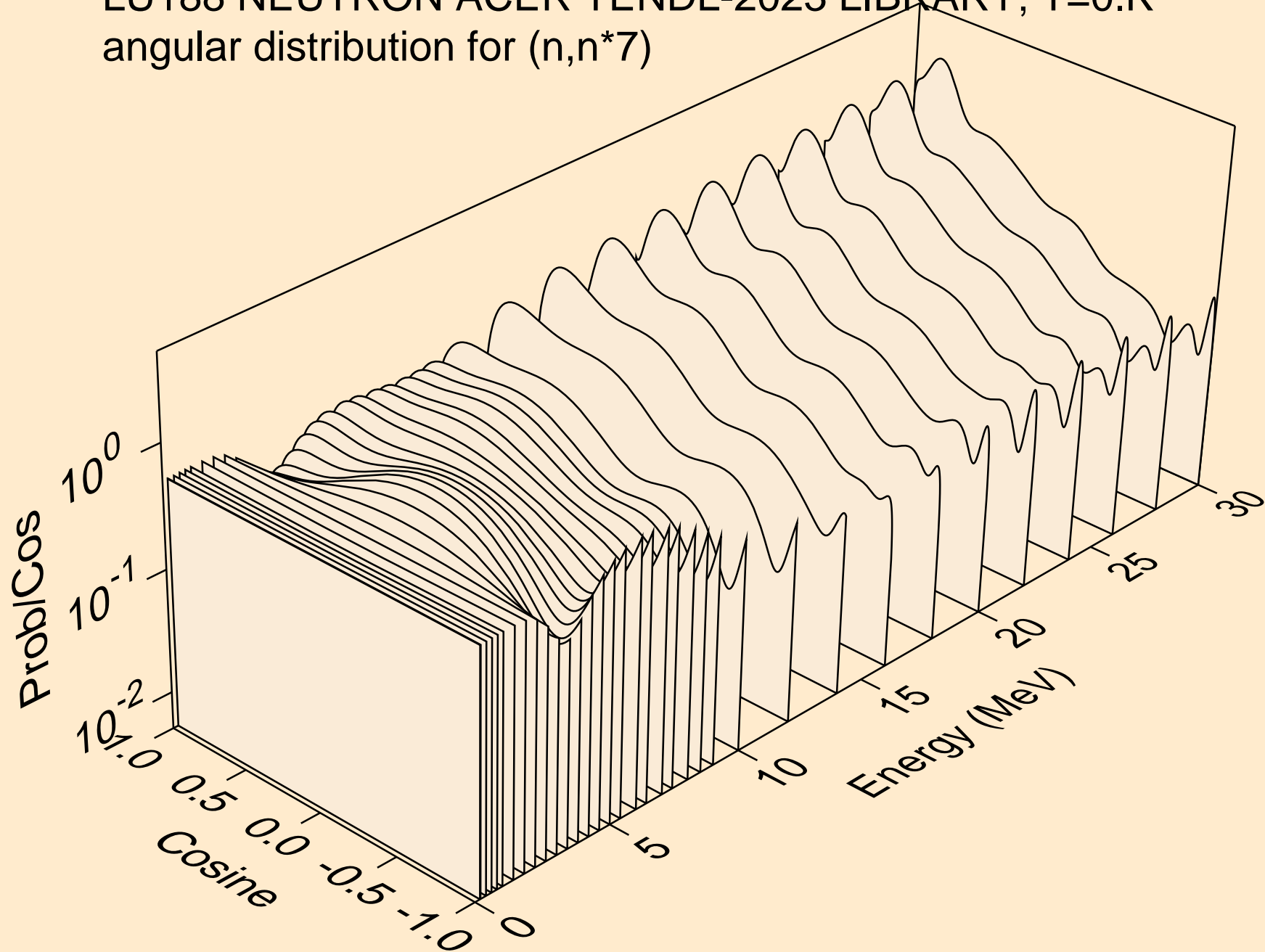

LU188 NEUTRON ACER TENDL-2023 LIBRARY; T=0.K  
angular distribution for (n,n\*8)

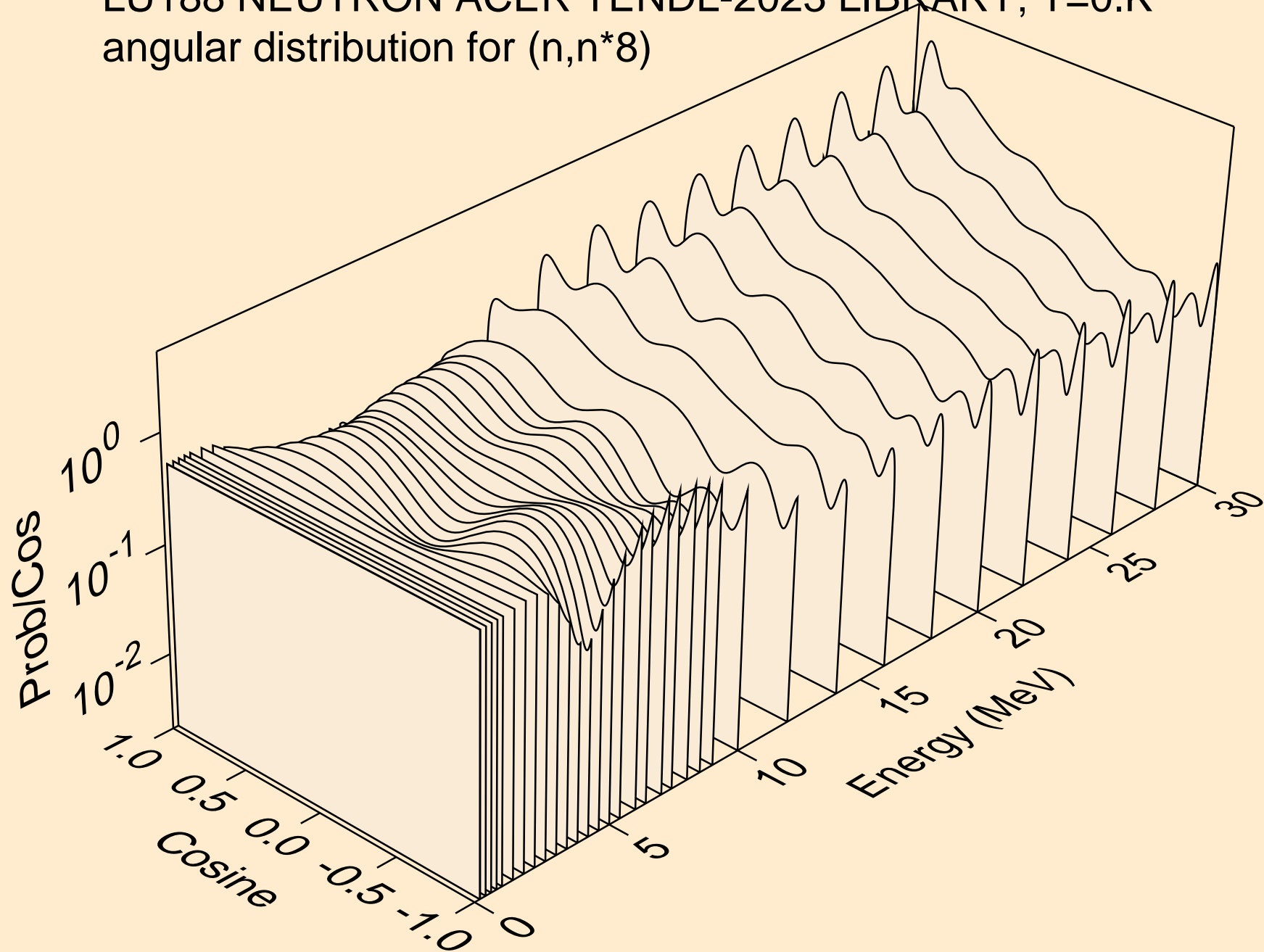

LU188 NEUTRON ACER TENDL-2023 LIBRARY; T=0.K  
angular distribution for (n,n\*9)

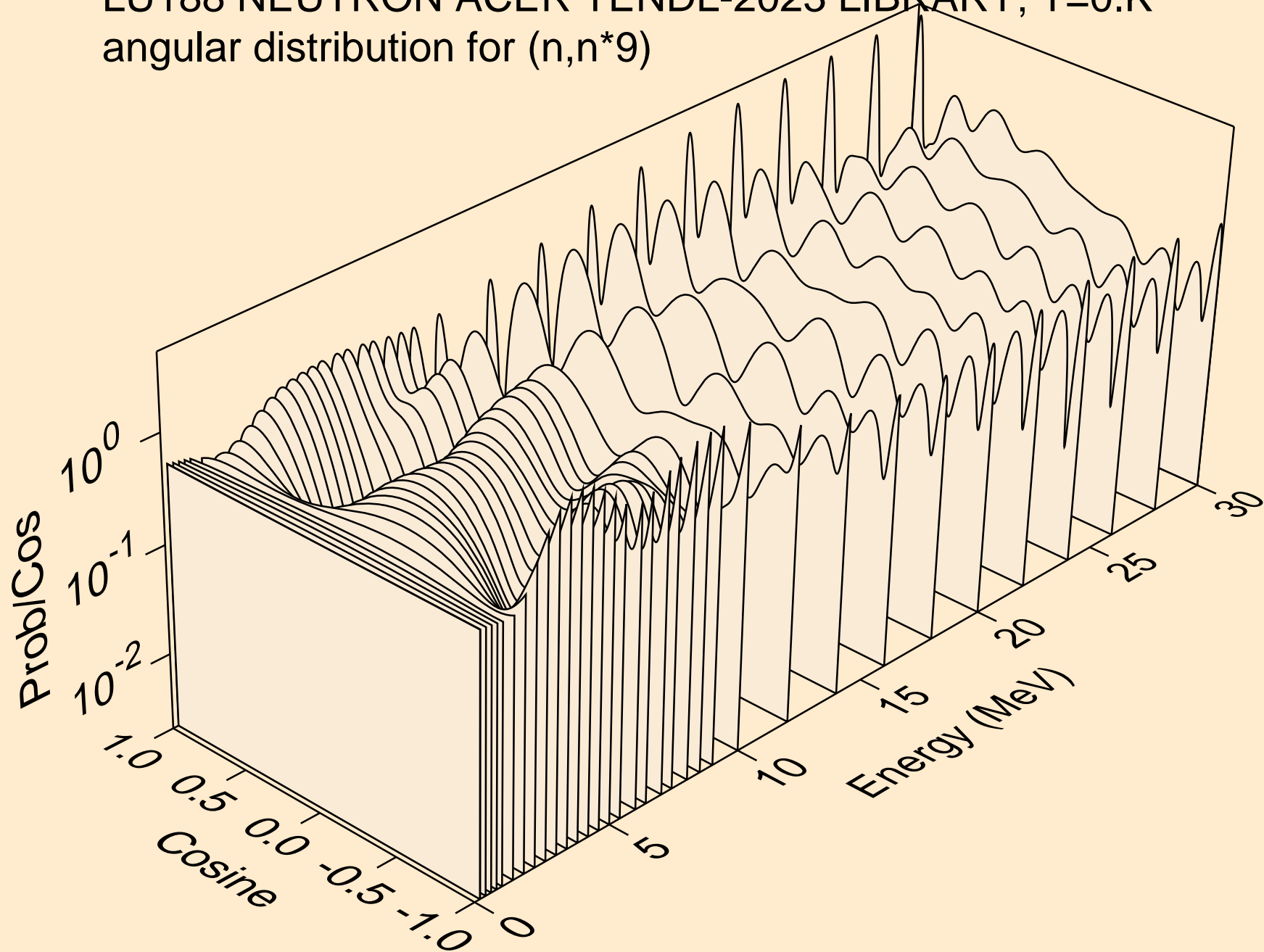

LU188 NEUTRON ACER TENDL-2023 LIBRARY; T=0.K  
angular distribution for (n,n\*10)

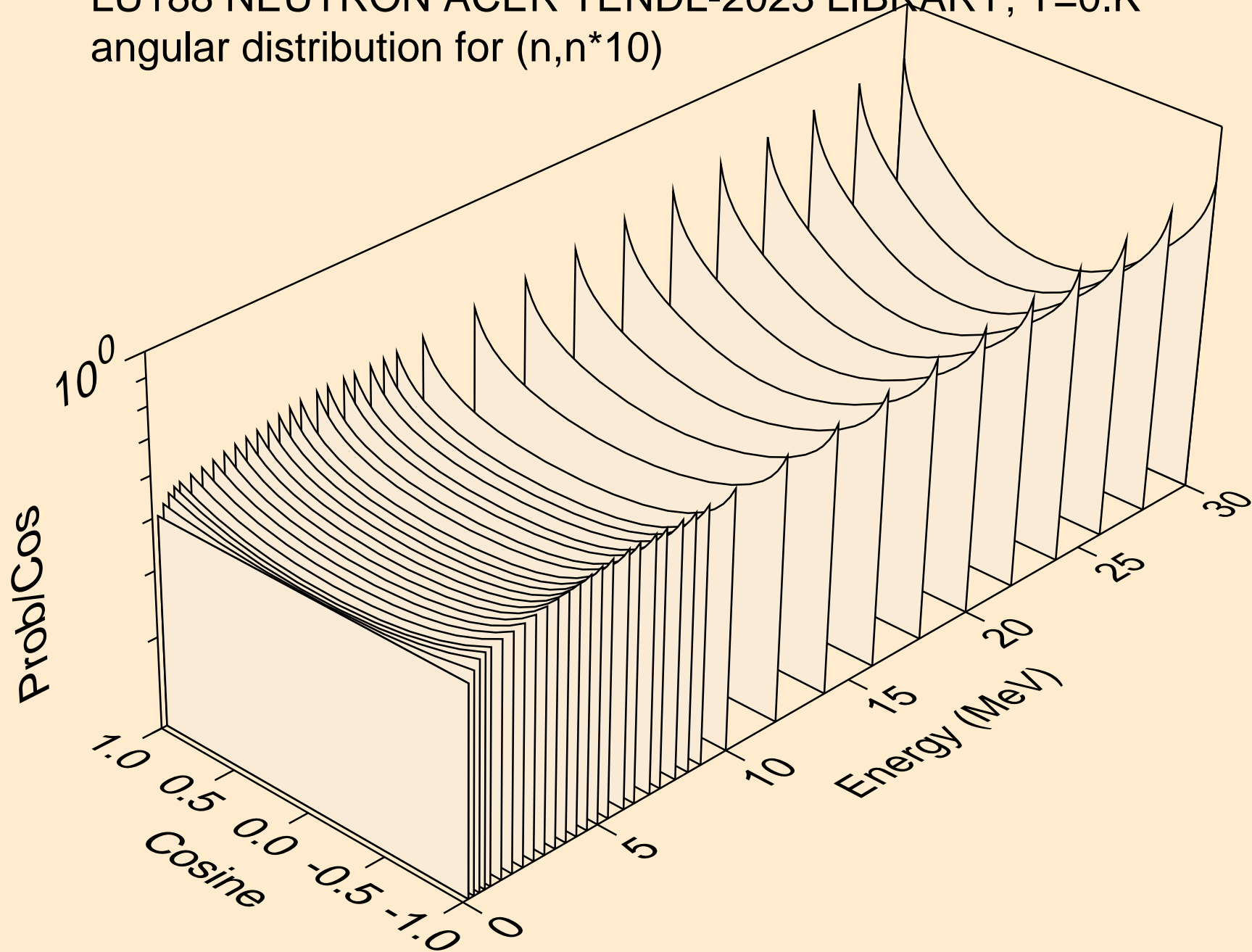

LU188 NEUTRON ACER TENDL-2023 LIBRARY; T=0.K  
angular distribution for (n,n\*11)

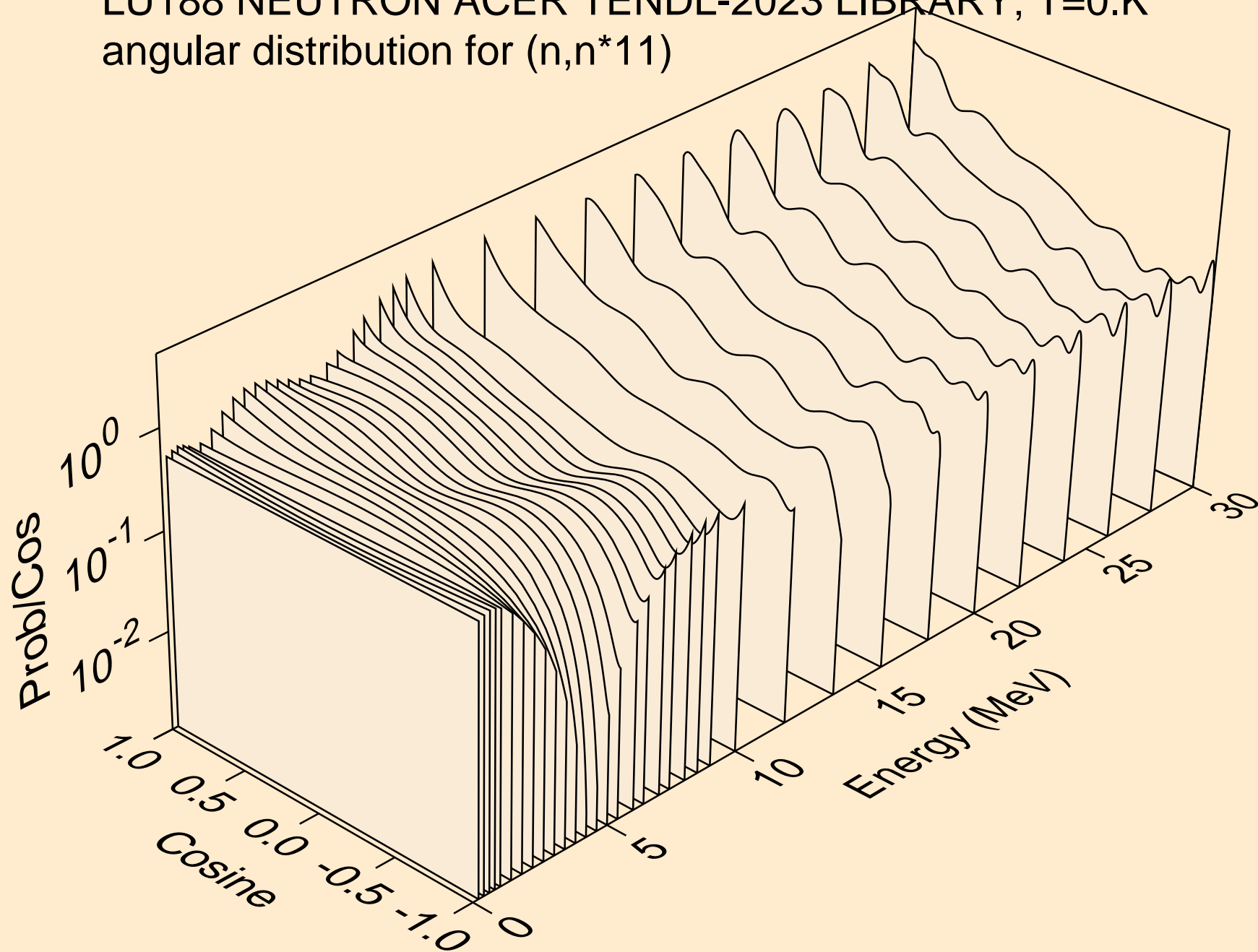



LU188 NEUTRON ACER TENDL-2023 LIBRARY; T=0.K  
angular distribution for (n,n\*12)

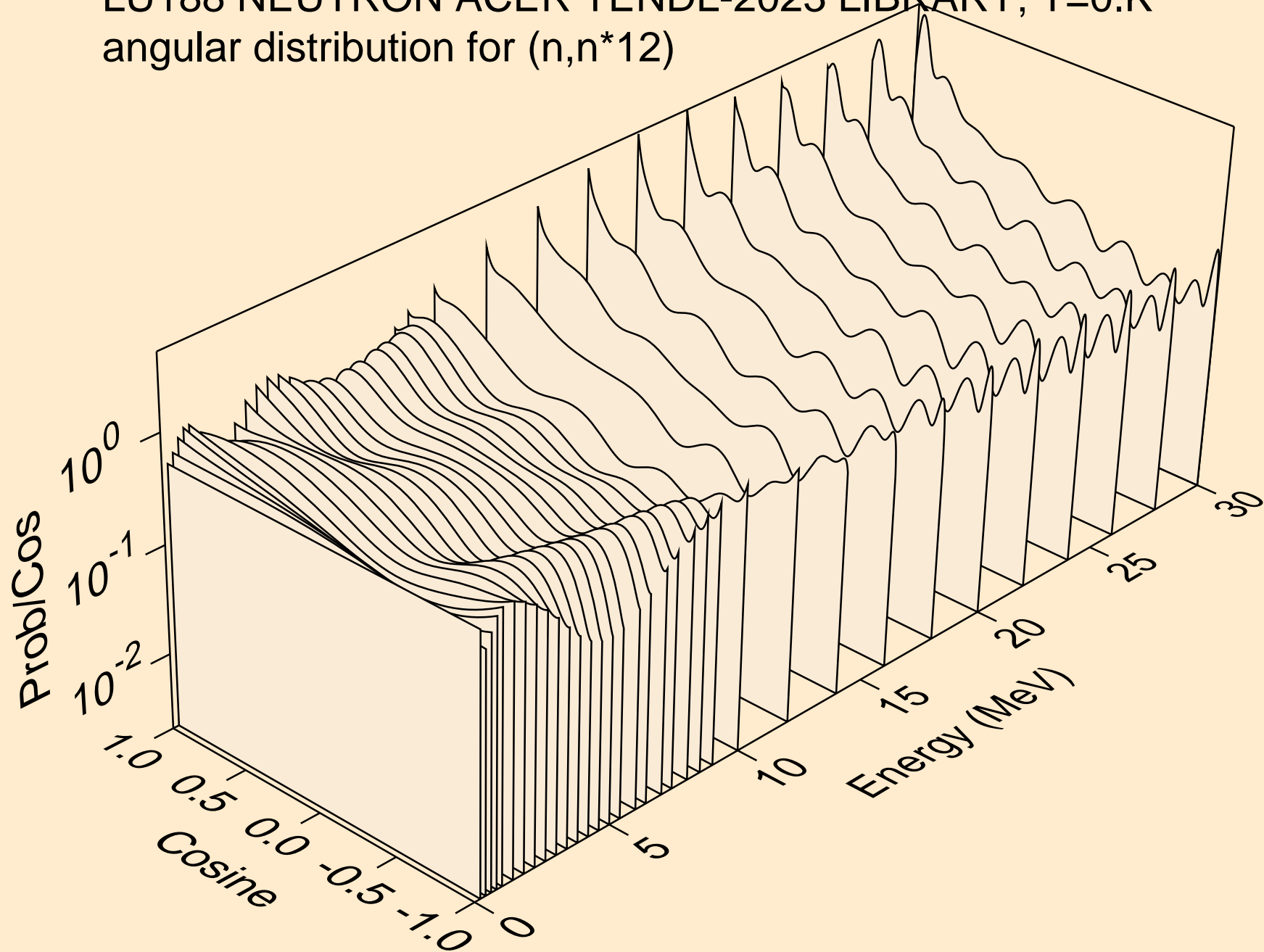

LU188 NEUTRON ACER TENDL-2023 LIBRARY; T=0.K  
angular distribution for (n,n\*13)

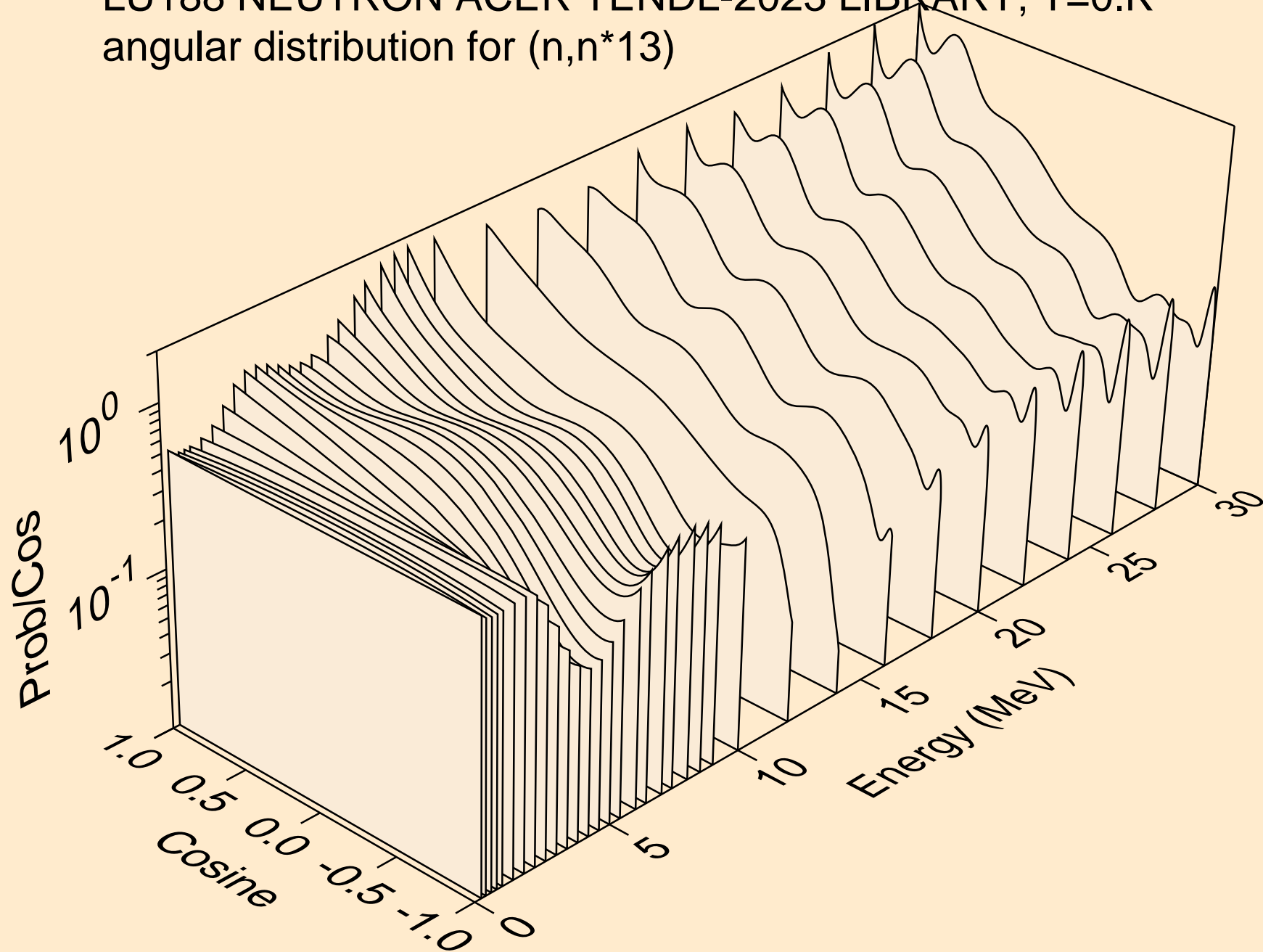

LU188 NEUTRON ACER TENDL-2023 LIBRARY; T=0.K  
angular distribution for (n,n\*14)

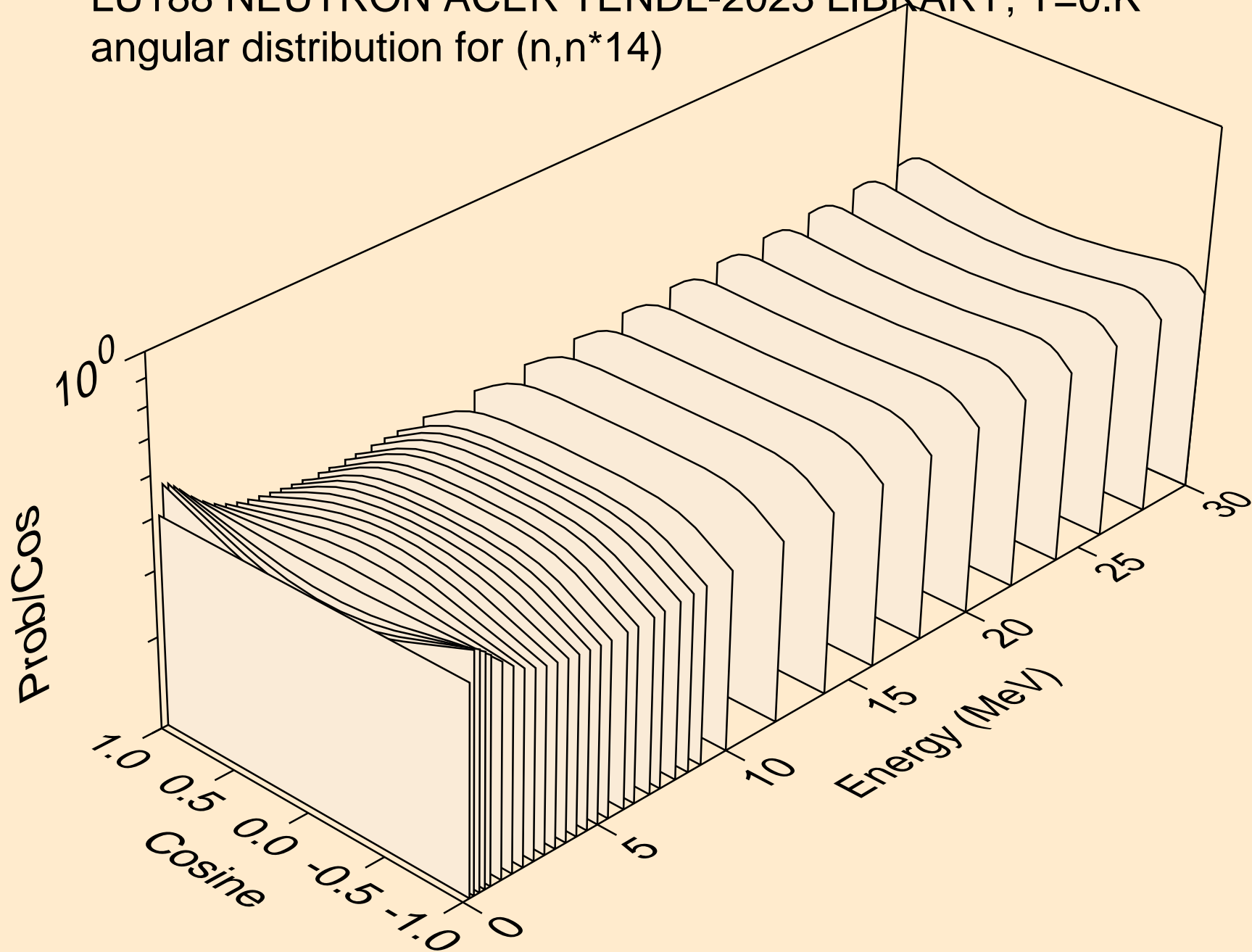

LU188 NEUTRON ACER TENDL-2023 LIBRARY; T=0.K  
angular distribution for (n,n\*15)

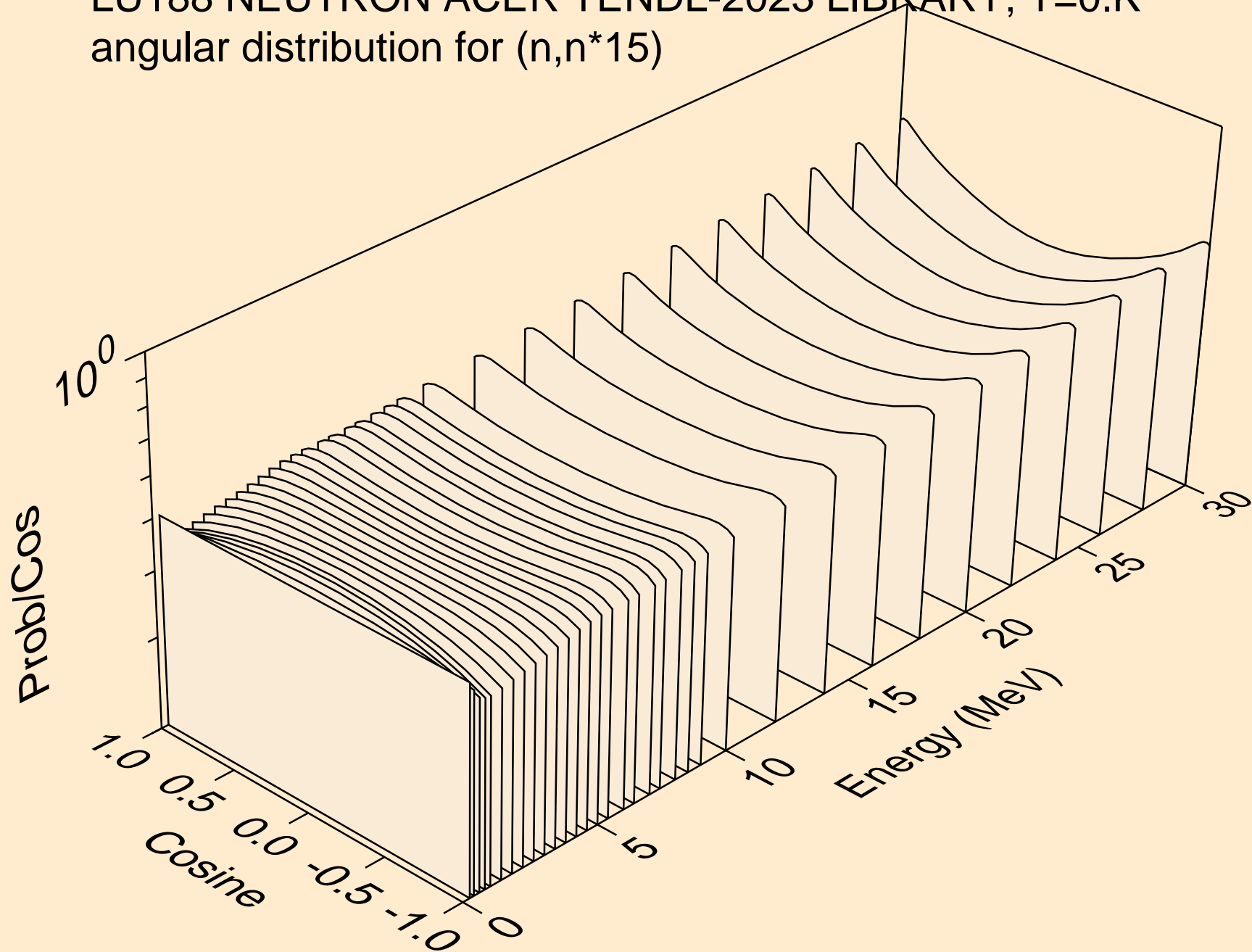

LU188 NEUTRON ACER TENDL-2023 LIBRARY; T=0.K  
angular distribution for (n,n\*16)

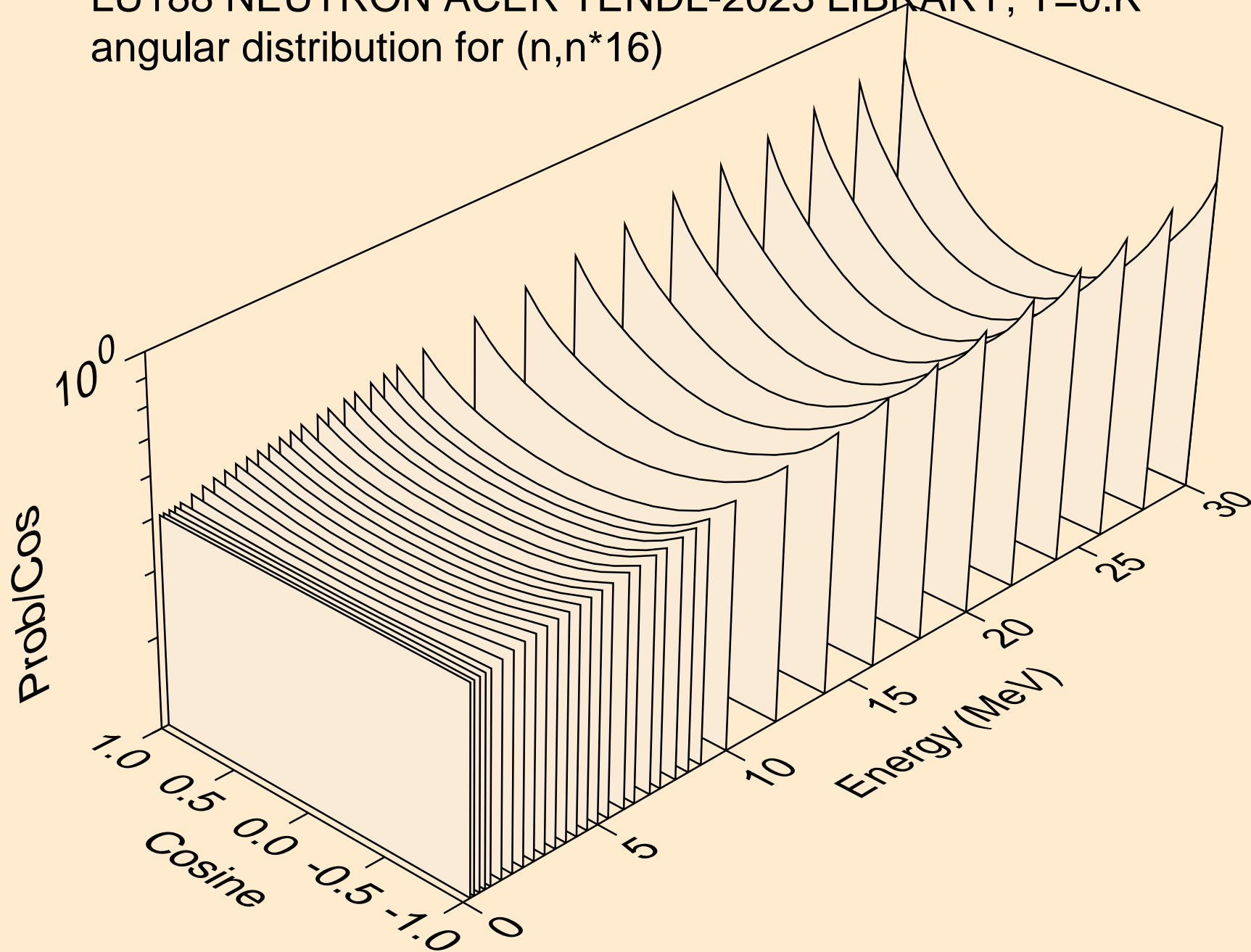

LU188 NEUTRON ACER TENDL-2023 LIBRARY; T=0.K  
angular distribution for (n,n\*17)

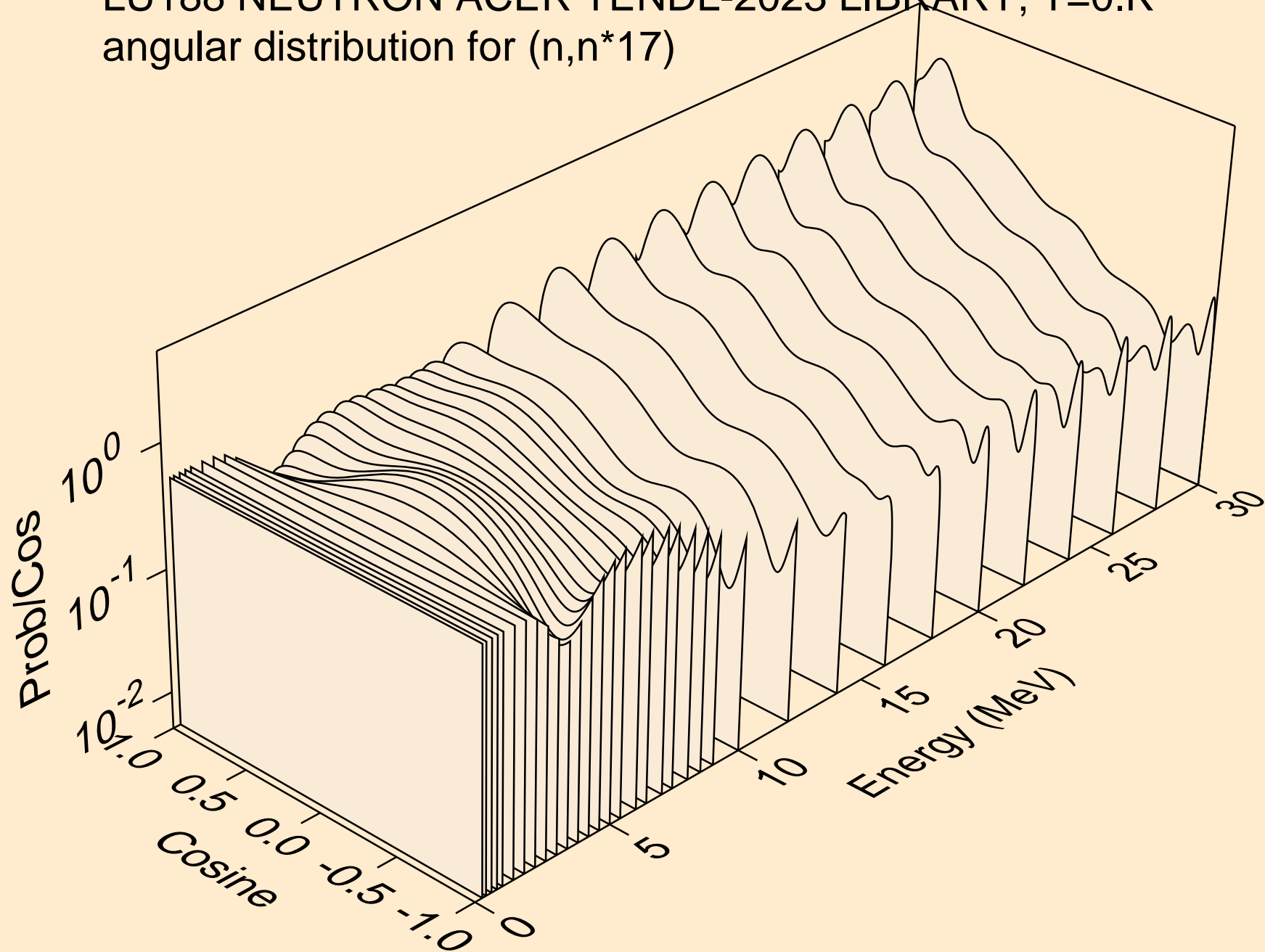

LU188 NEUTRON ACER TENDL-2023 LIBRARY; T=0.K  
angular distribution for (n,n\*18)

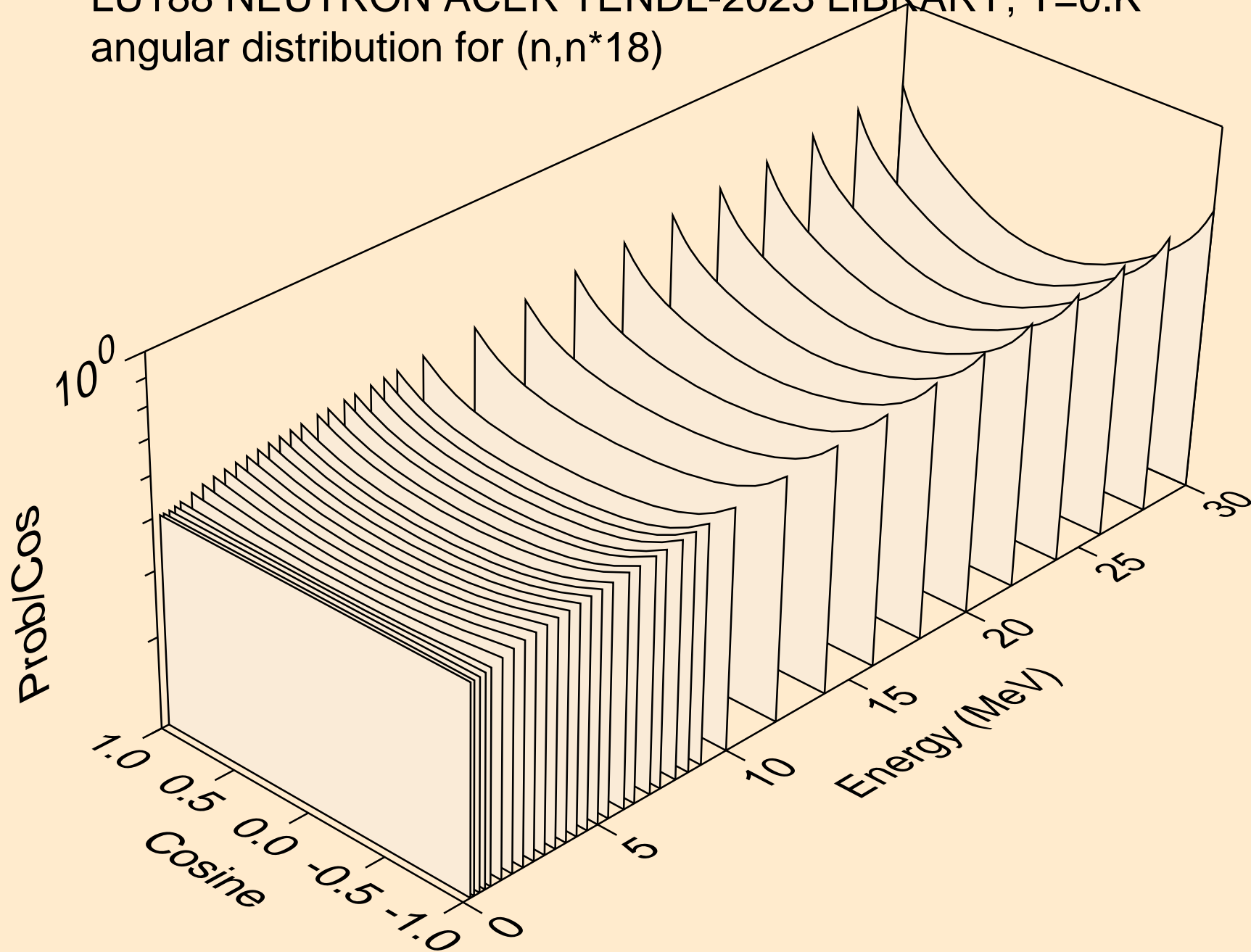

LU188 NEUTRON ACER TENDL-2023 LIBRARY; T=0.K  
angular distribution for (n,n\*19)

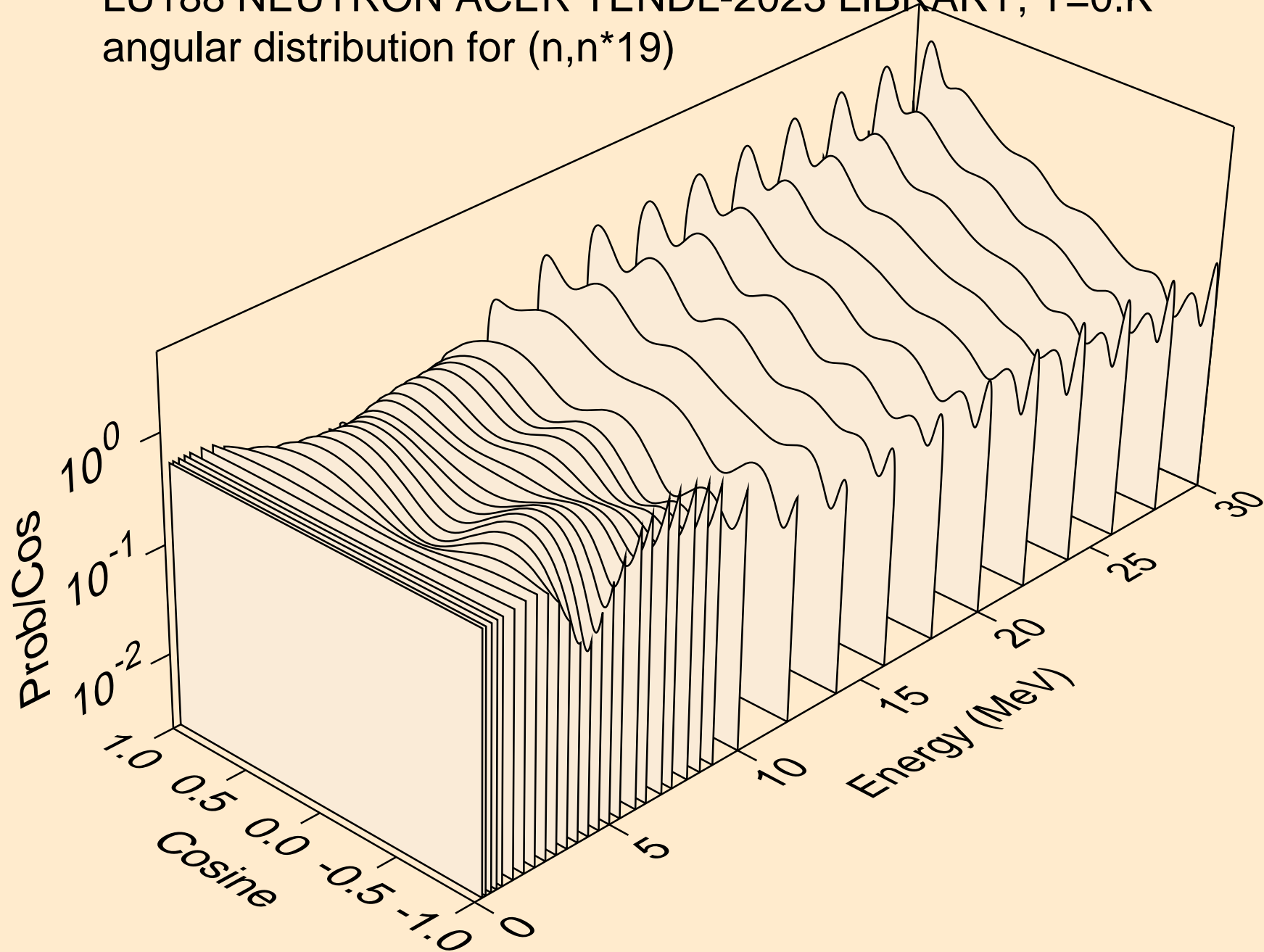



LU188 NEUTRON ACER TENDL-2023 LIBRARY; T=0.K  
angular distribution for (n,n\*20)

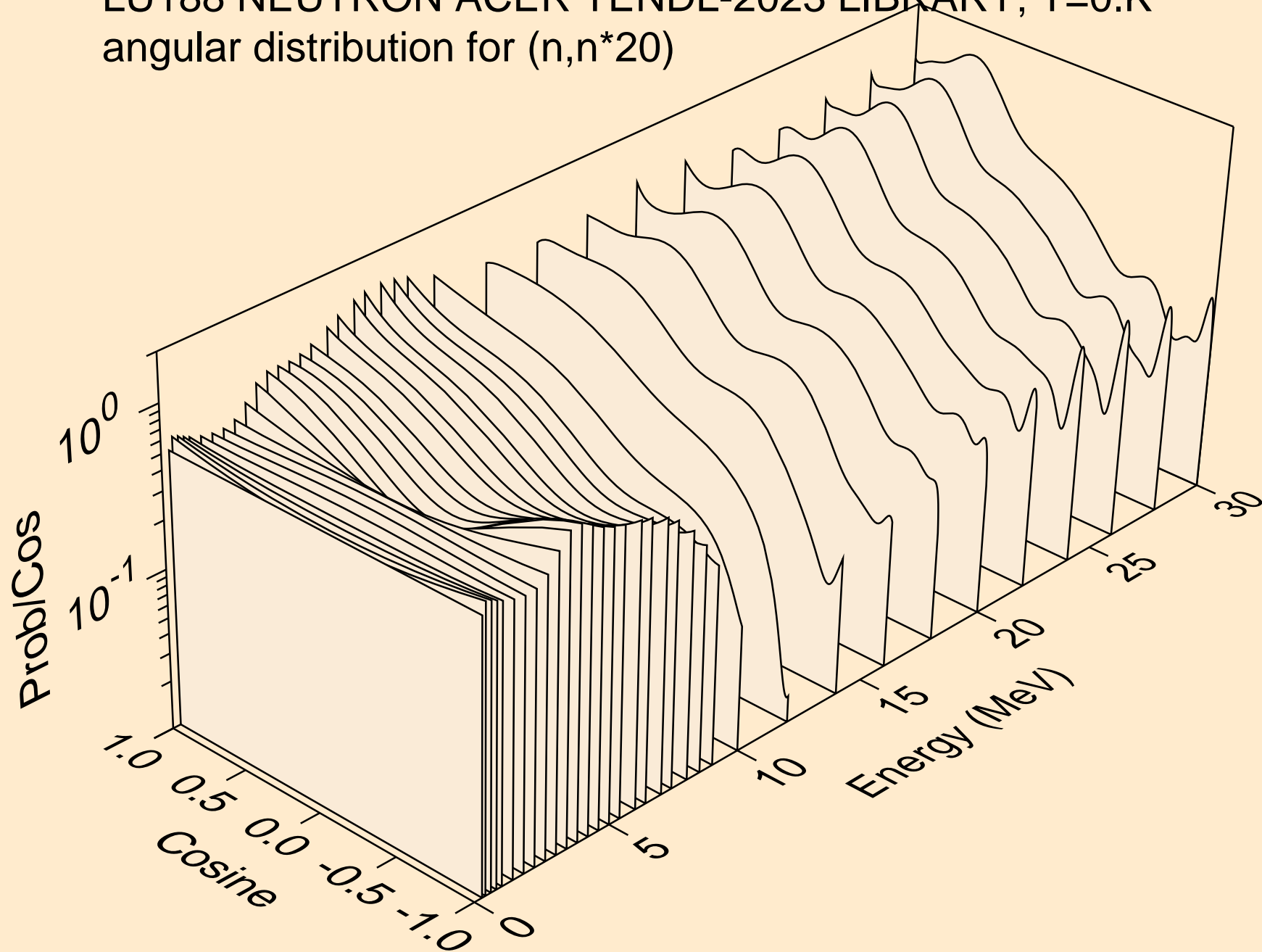

LU188 NEUTRON ACER TENDL-2023 LIBRARY; T=0.K  
angular distribution for (n,n\*21)

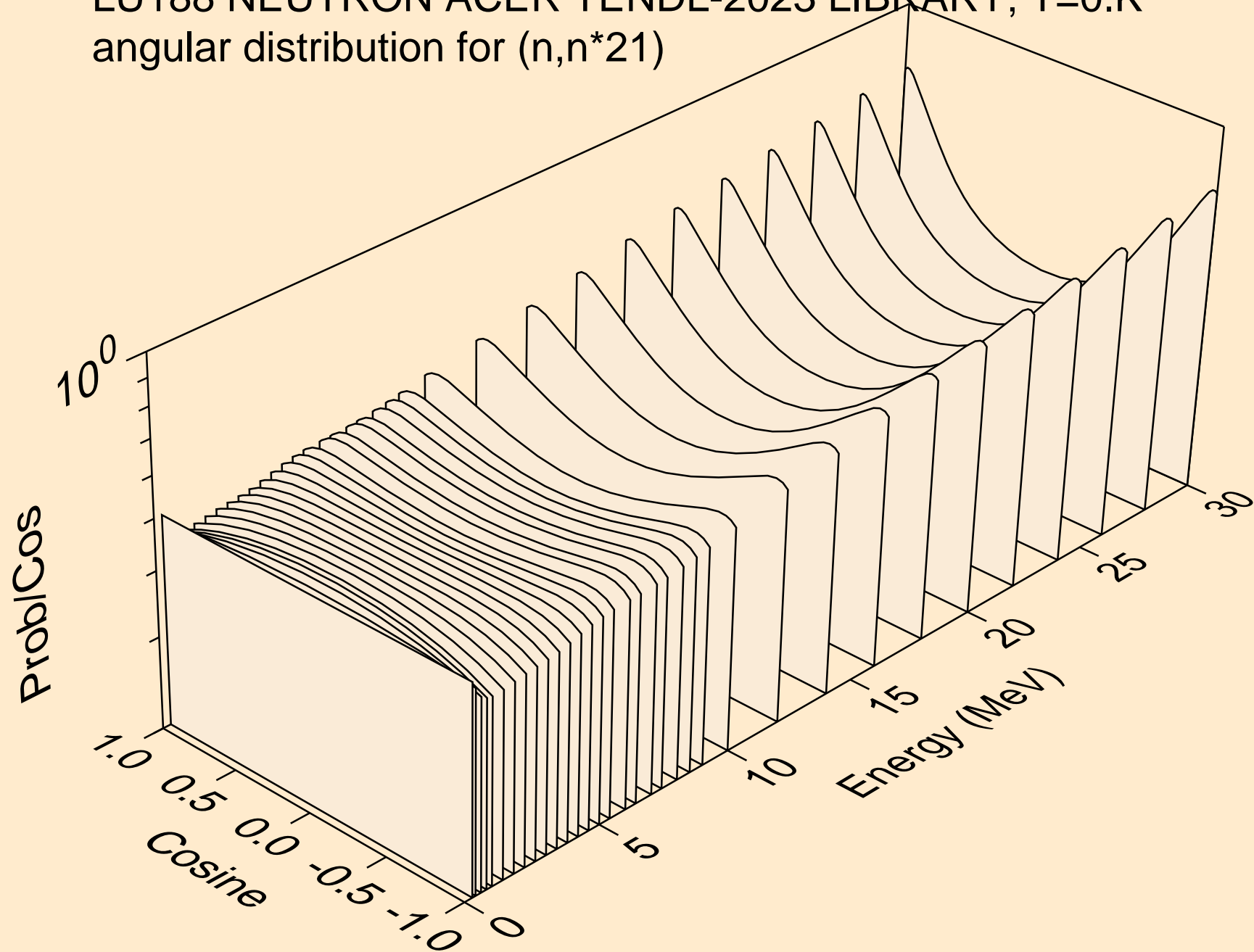

LU188 NEUTRON ACER TENDL-2023 LIBRARY; T=0.K  
angular distribution for (n,n\*22)

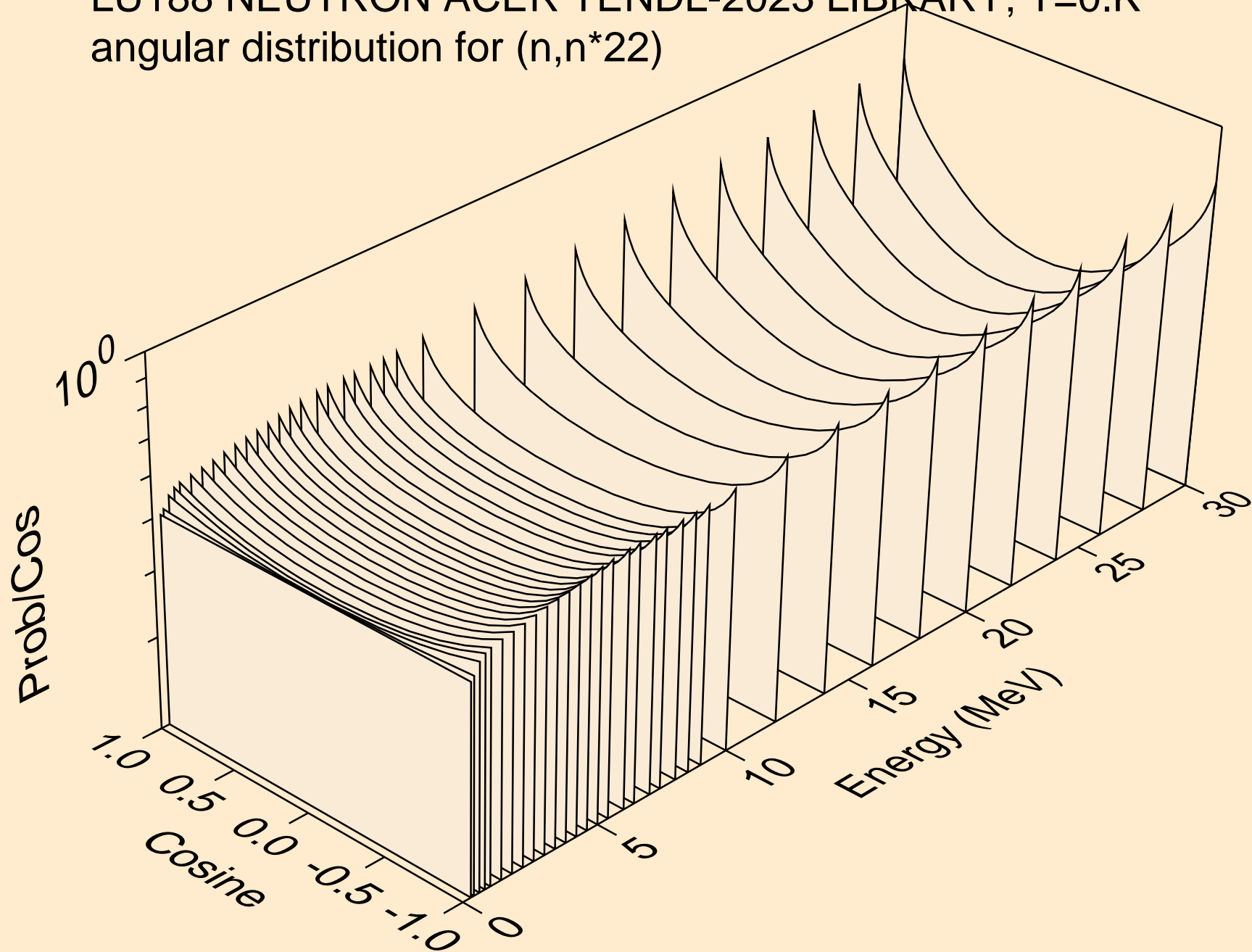

LU188 NEUTRON ACER TENDL-2023 LIBRARY; T=0.K  
angular distribution for (n,n\*23)

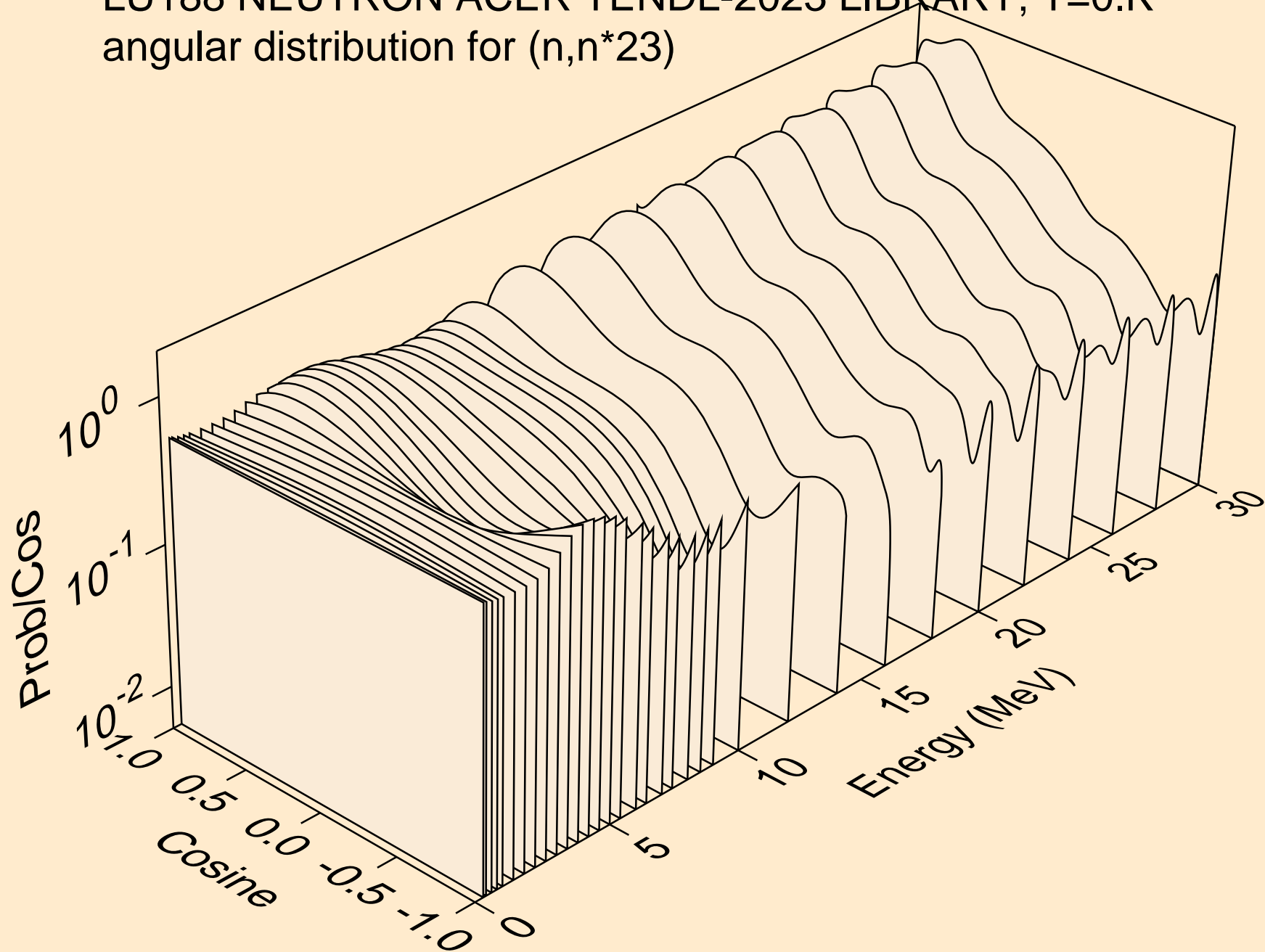

LU188 NEUTRON ACER TENDL-2023 LIBRARY; T=0.K  
angular distribution for (n,n\*24)

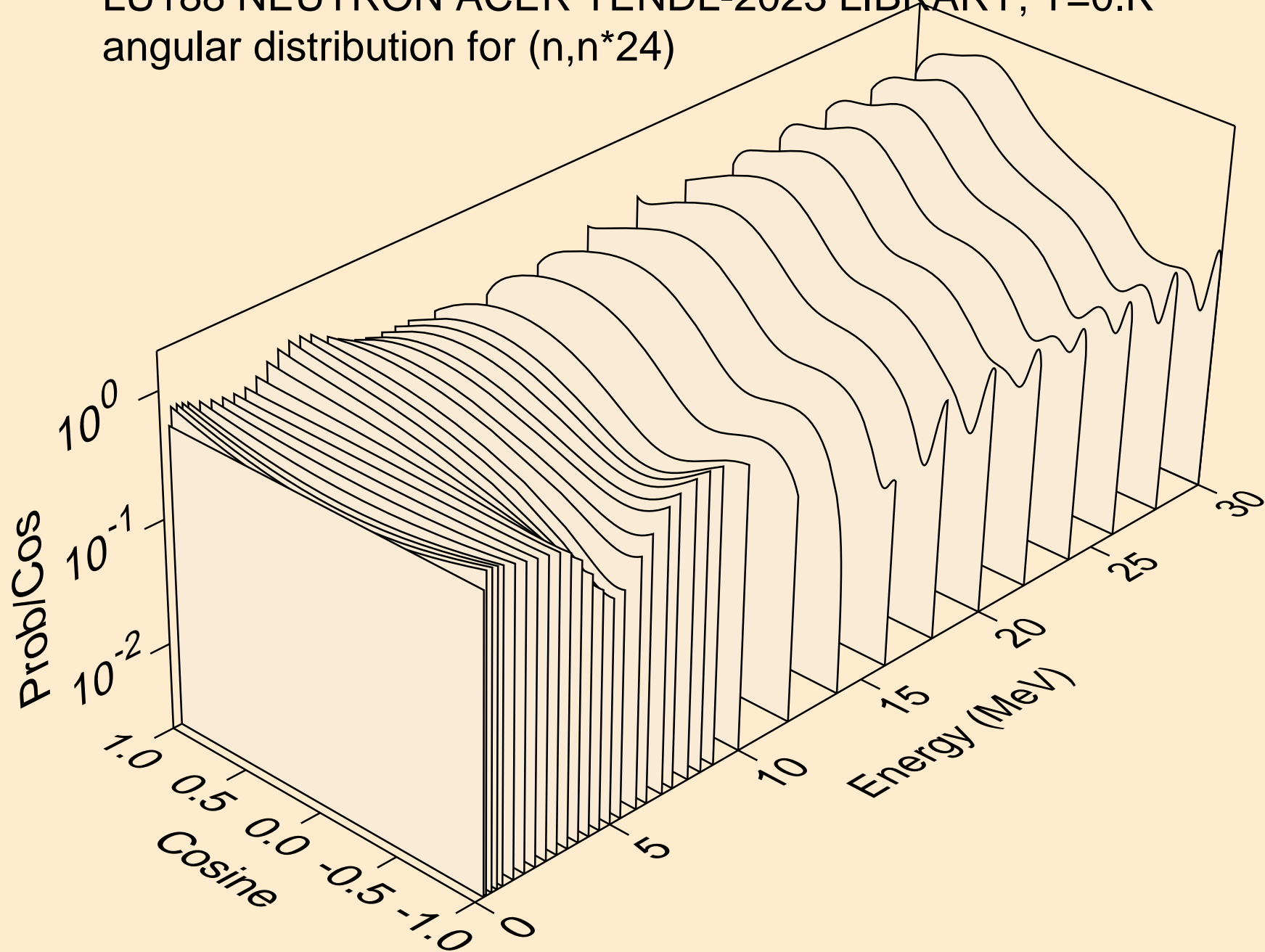

LU188 NEUTRON ACER TENDL-2023 LIBRARY; T=0.K  
angular distribution for (n,n\*25)

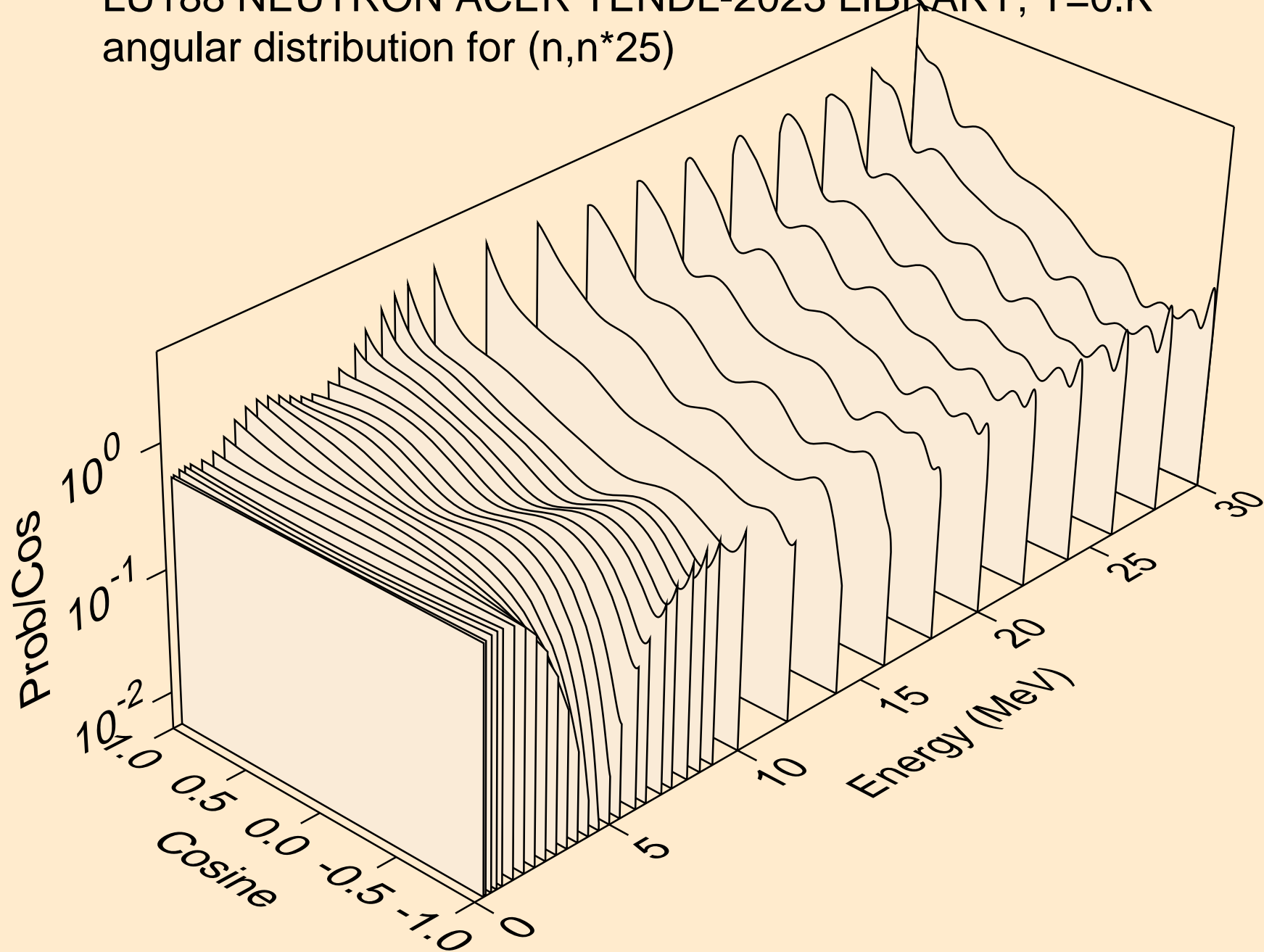

LU188 NEUTRON ACER TENDL-2023 LIBRARY; T=0.K  
angular distribution for (n,n\*26)

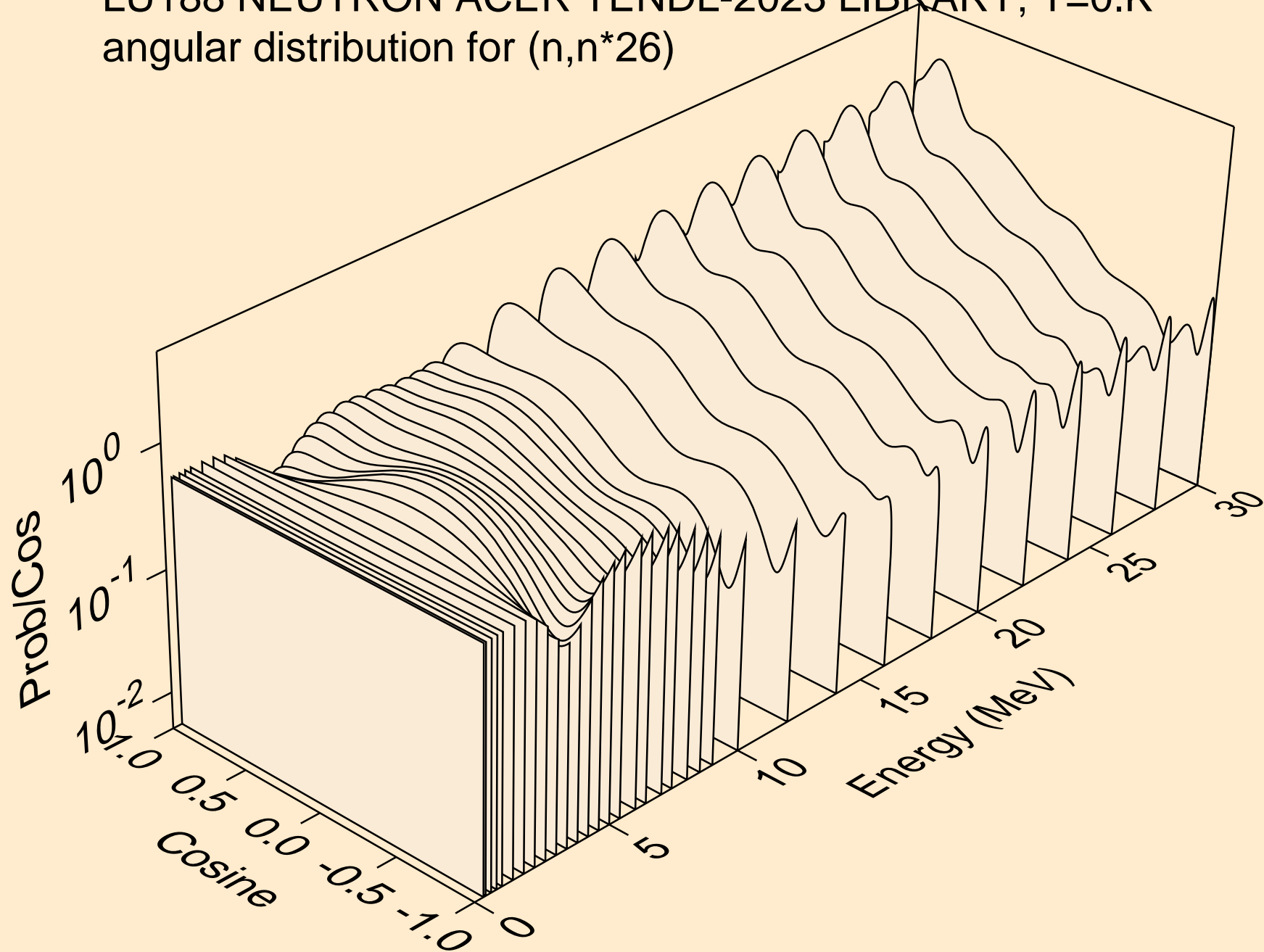

LU188 NEUTRON ACER TENDL-2023 LIBRARY; T=0.K  
angular distribution for (n,n\*27)

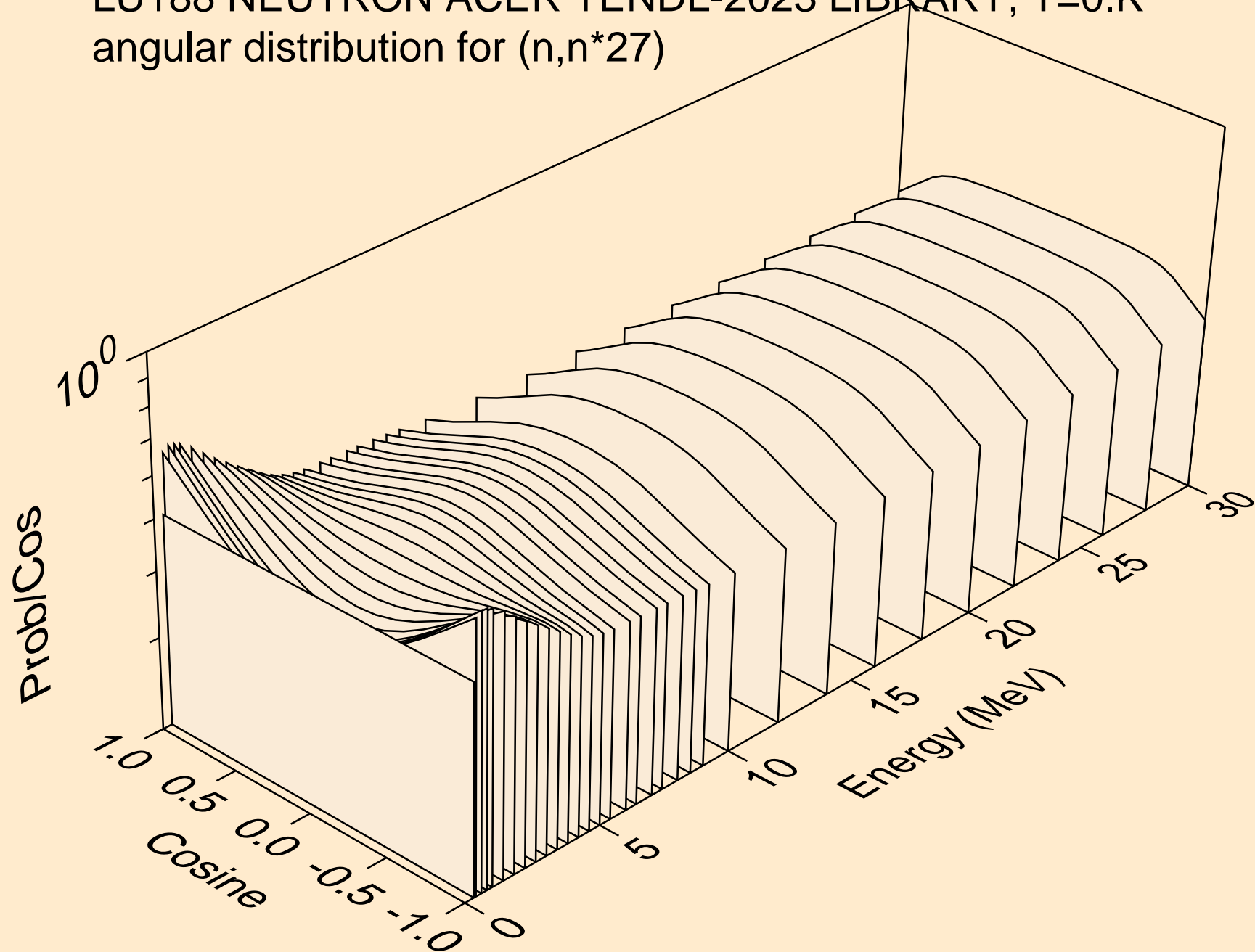



LU188 NEUTRON ACER TENDL-2023 LIBRARY; T=0.K  
angular distribution for (n,n\*28)

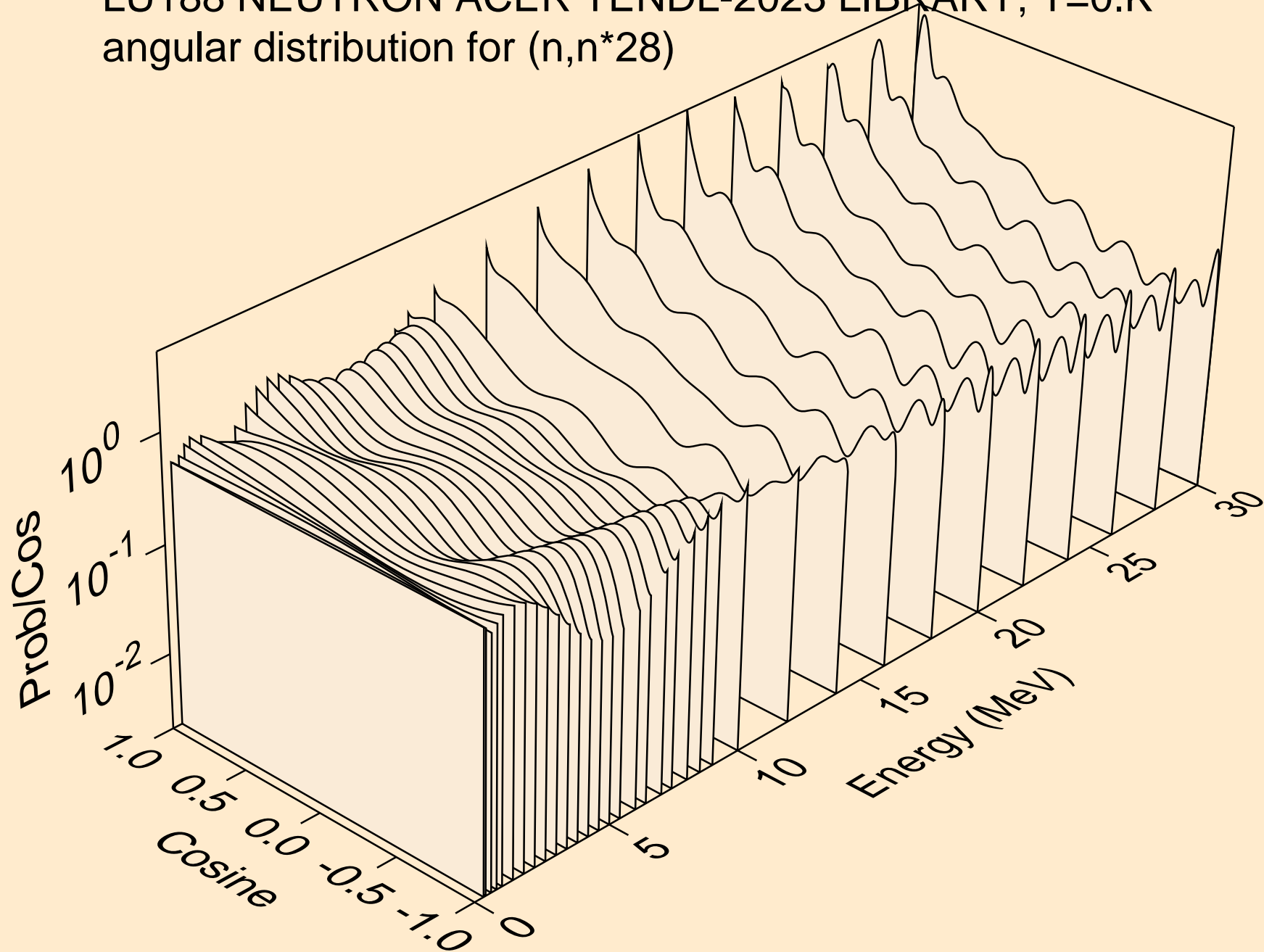

LU188 NEUTRON ACER TENDL-2023 LIBRARY; T=0.K  
angular distribution for (n,n\*29)

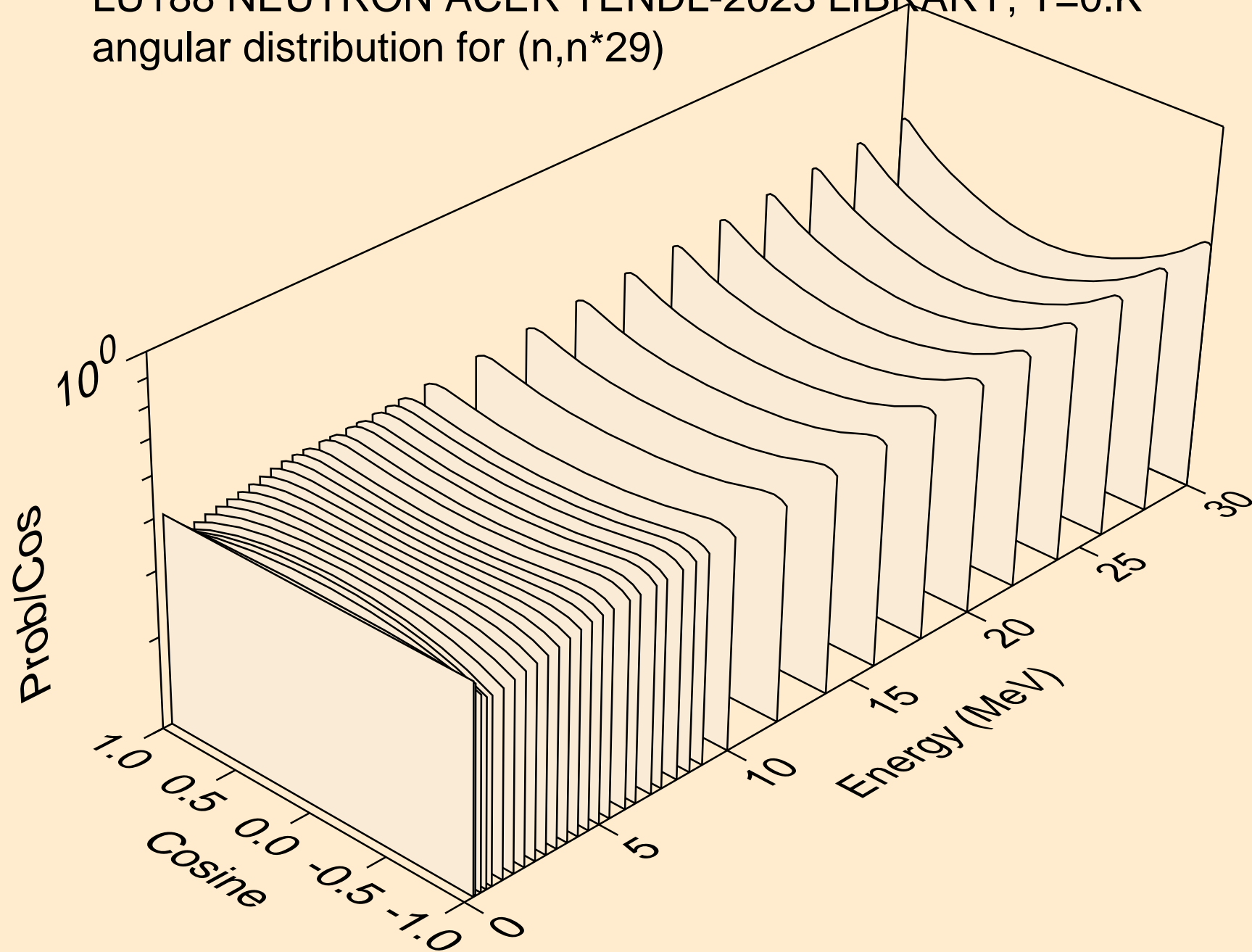

LU188 NEUTRON ACER TENDL-2023 LIBRARY; T=0.K  
Neutron emission for (n,x)

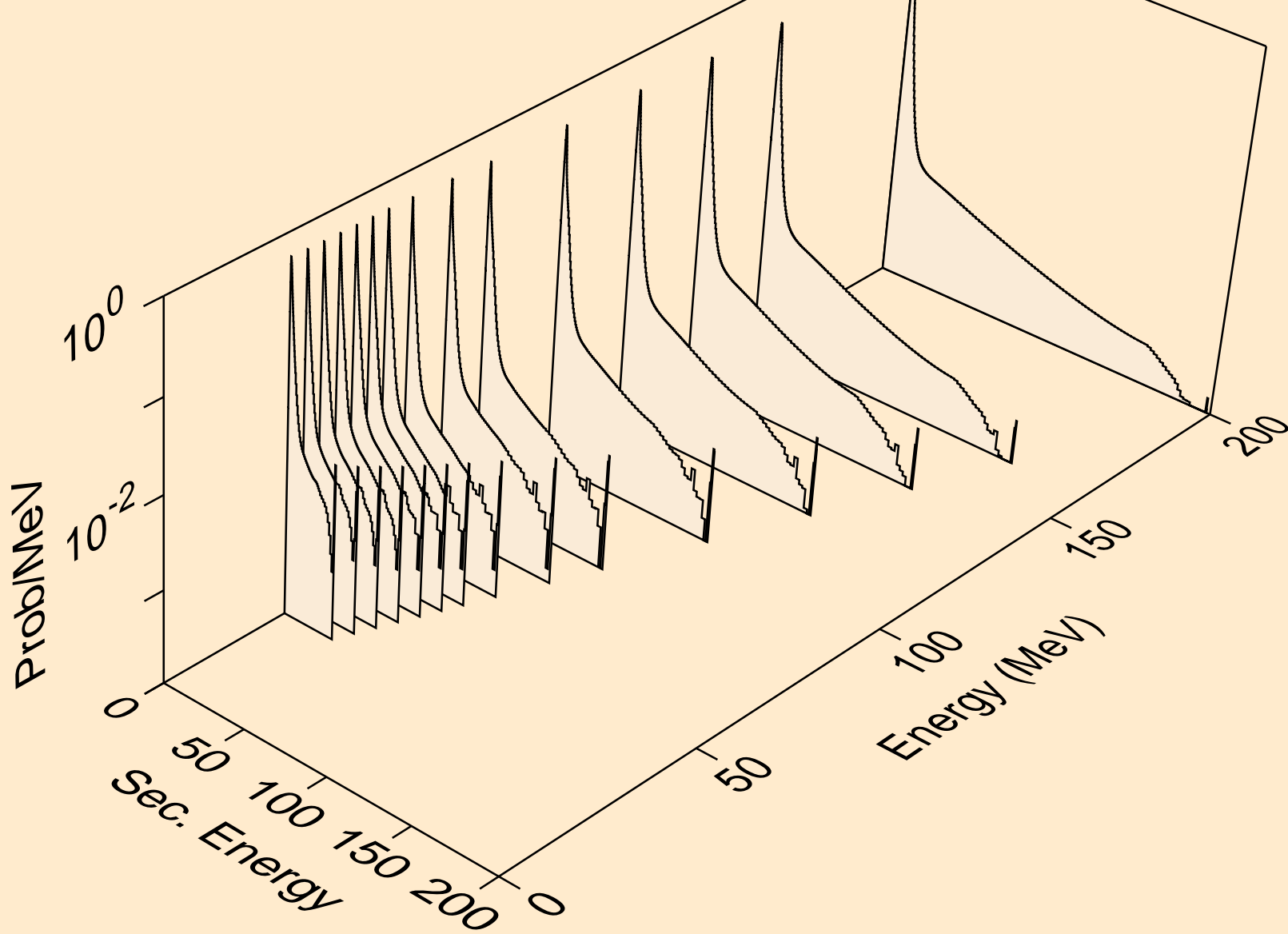

LU188 NEUTRON ACER TENDL-2023 LIBRARY; T=0.K  
Neutron emission for (n,2nd)

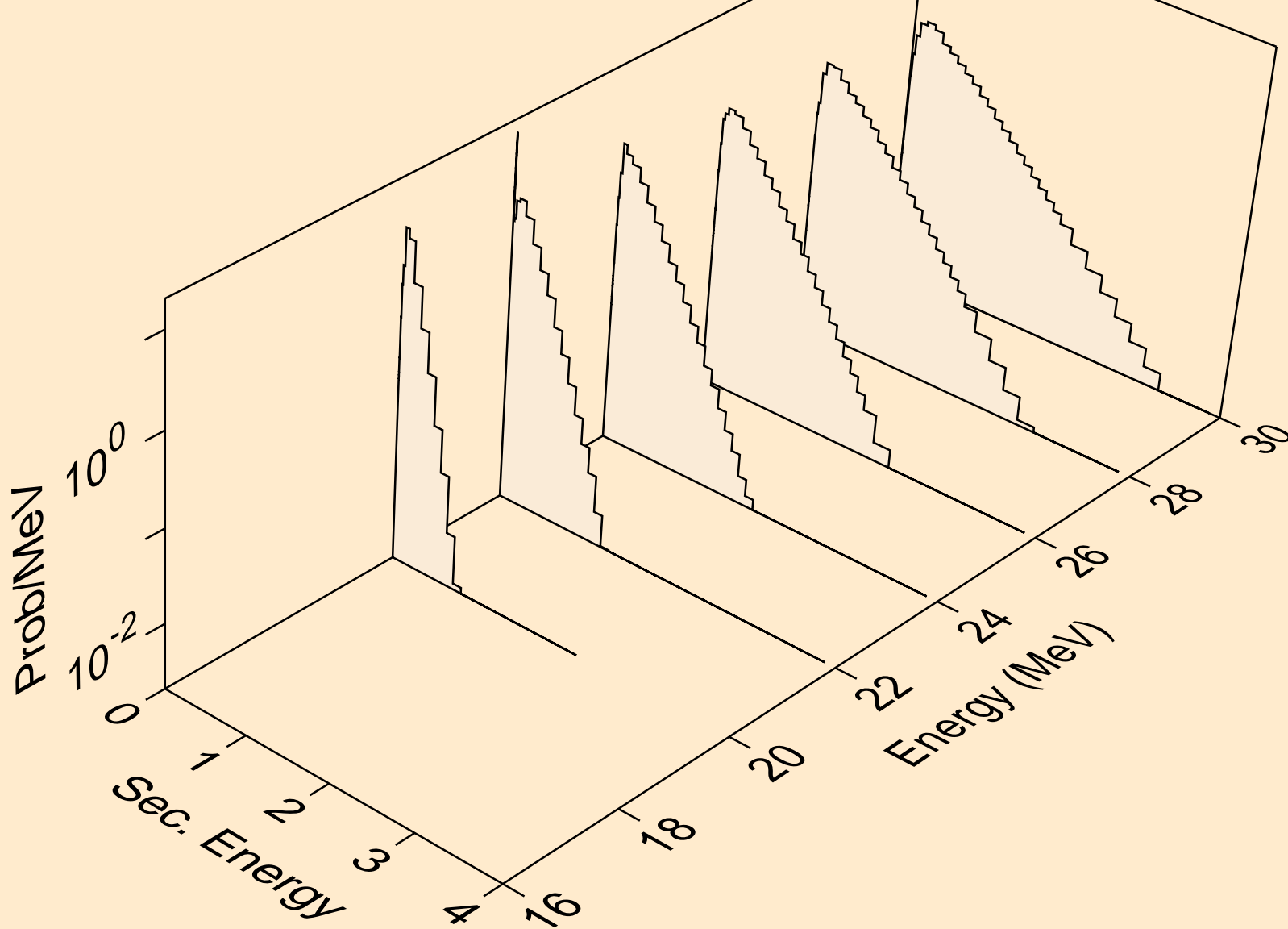

LU188 NEUTRON ACER TENDL-2023 LIBRARY; T=0.K  
Neutron emission for (n,2n)

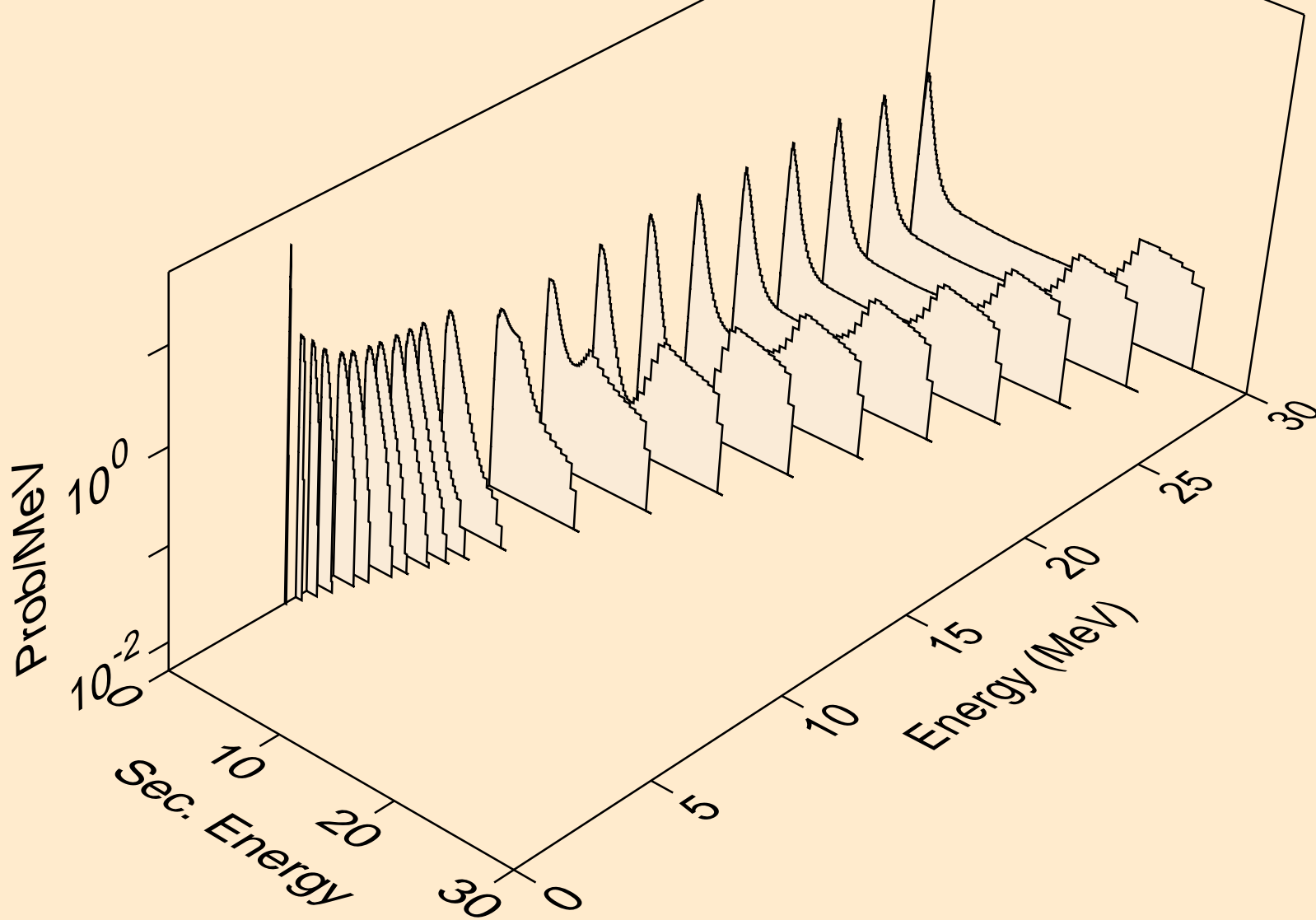

LU188 NEUTRON ACER TENDL-2023 LIBRARY; T=0.K  
Neutron emission for (n,3n)

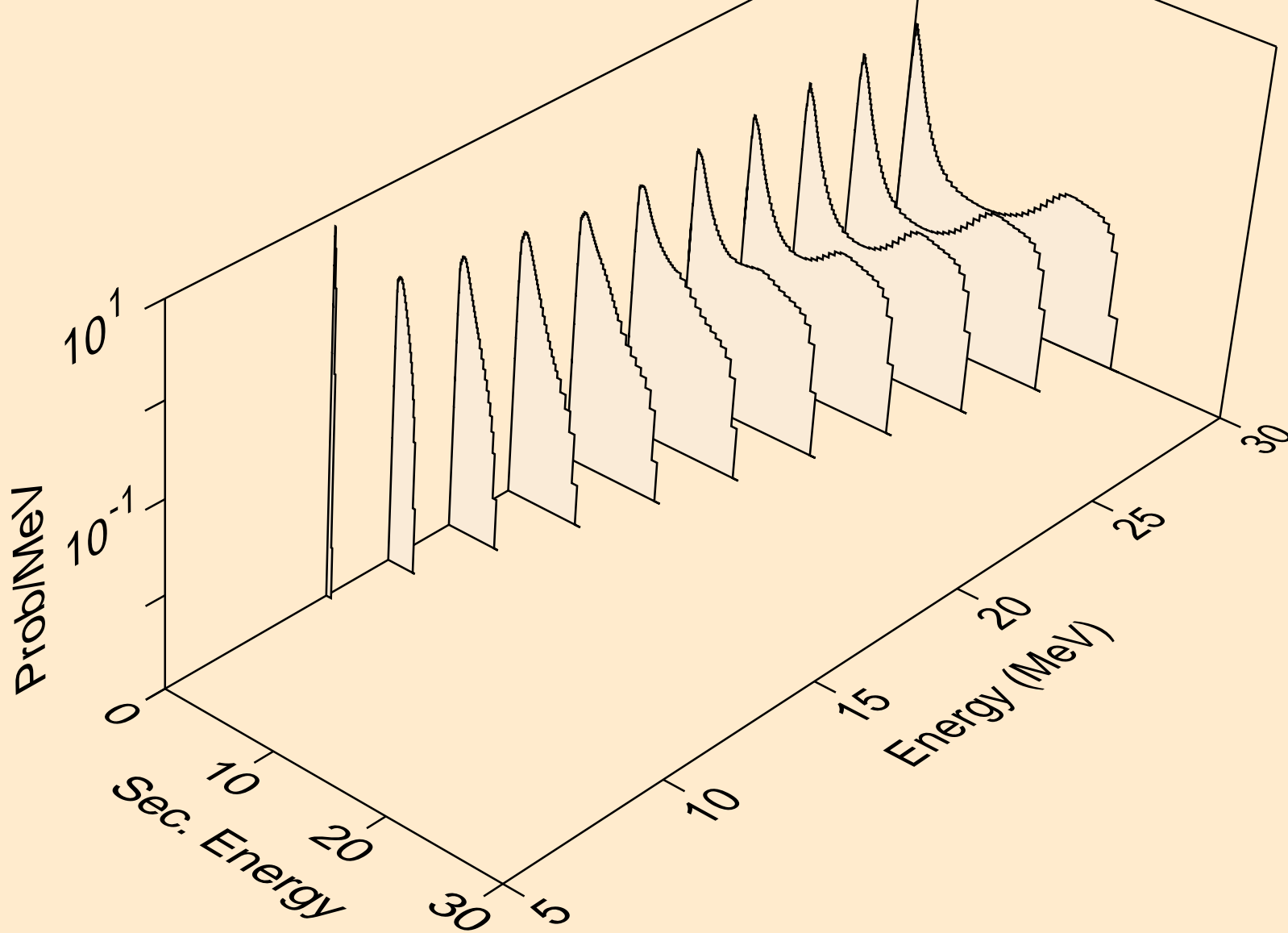

LU188 NEUTRON ACER TENDL-2023 LIBRARY; T=0.K  
Neutron emission for (n,n\*)a

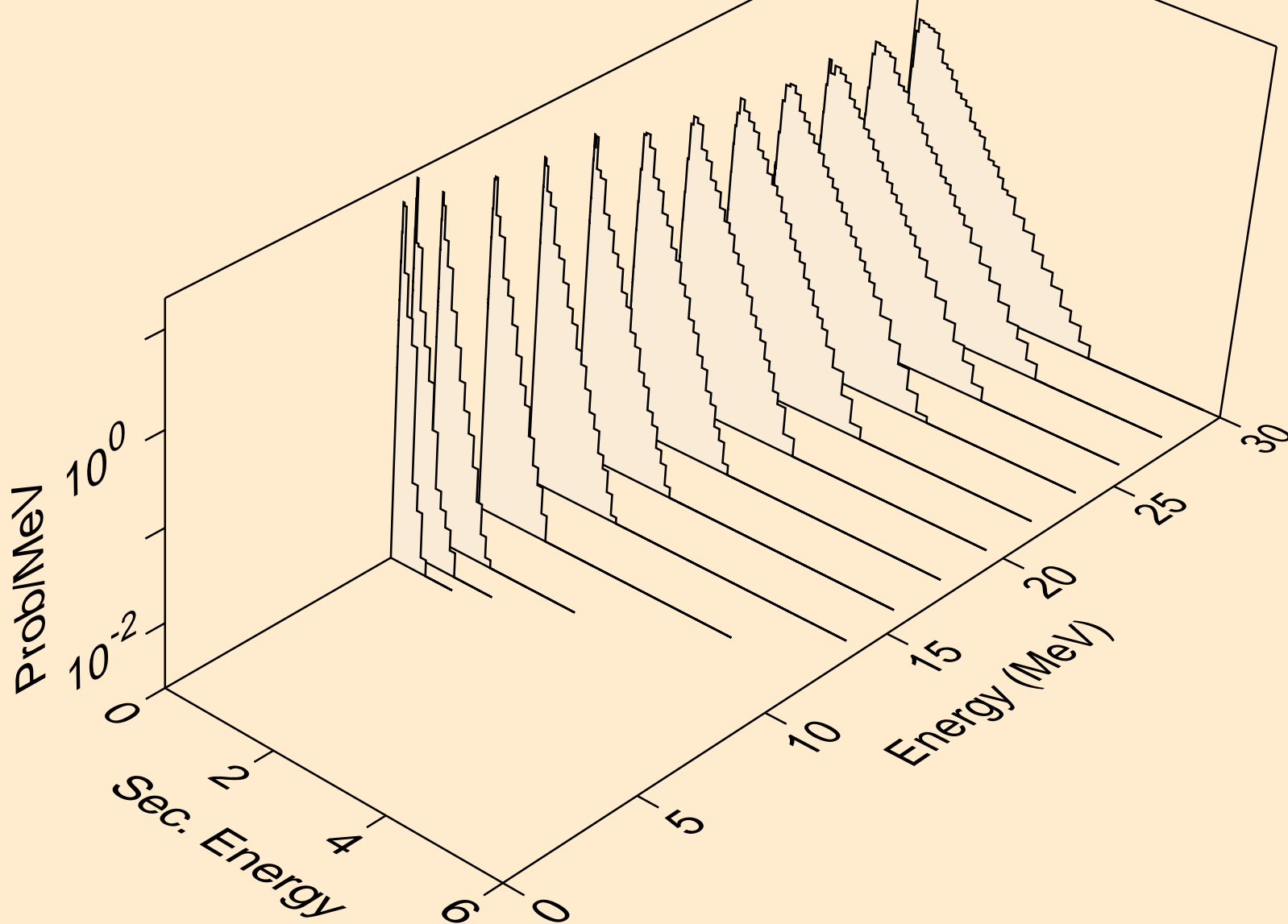

LU188 NEUTRON ACER TENDL-2023 LIBRARY; T=0.K  
Neutron emission for (n,2n)a

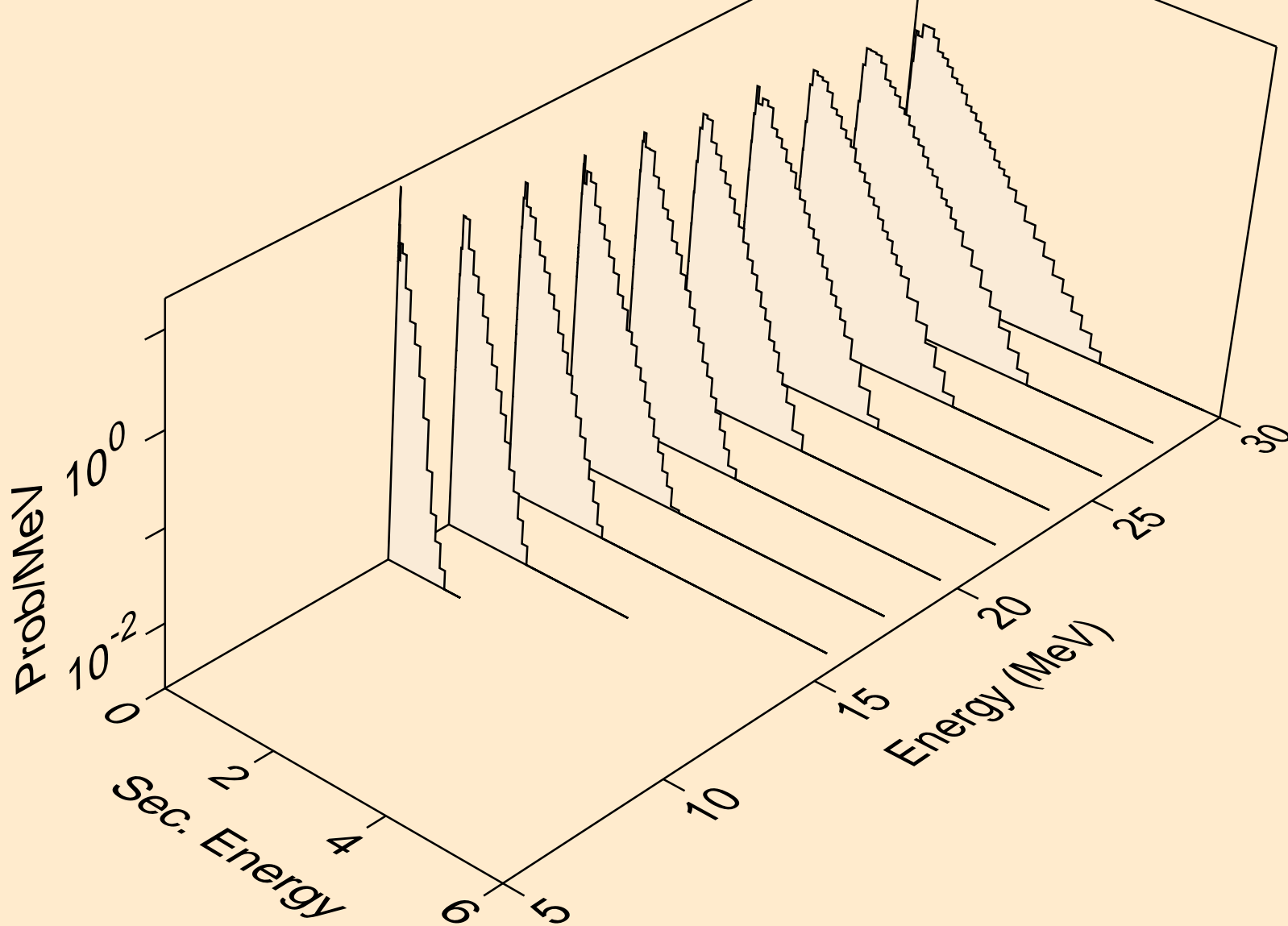



LU188 NEUTRON ACER TENDL-2023 LIBRARY; T=0.K  
Neutron emission for (n,3n)a

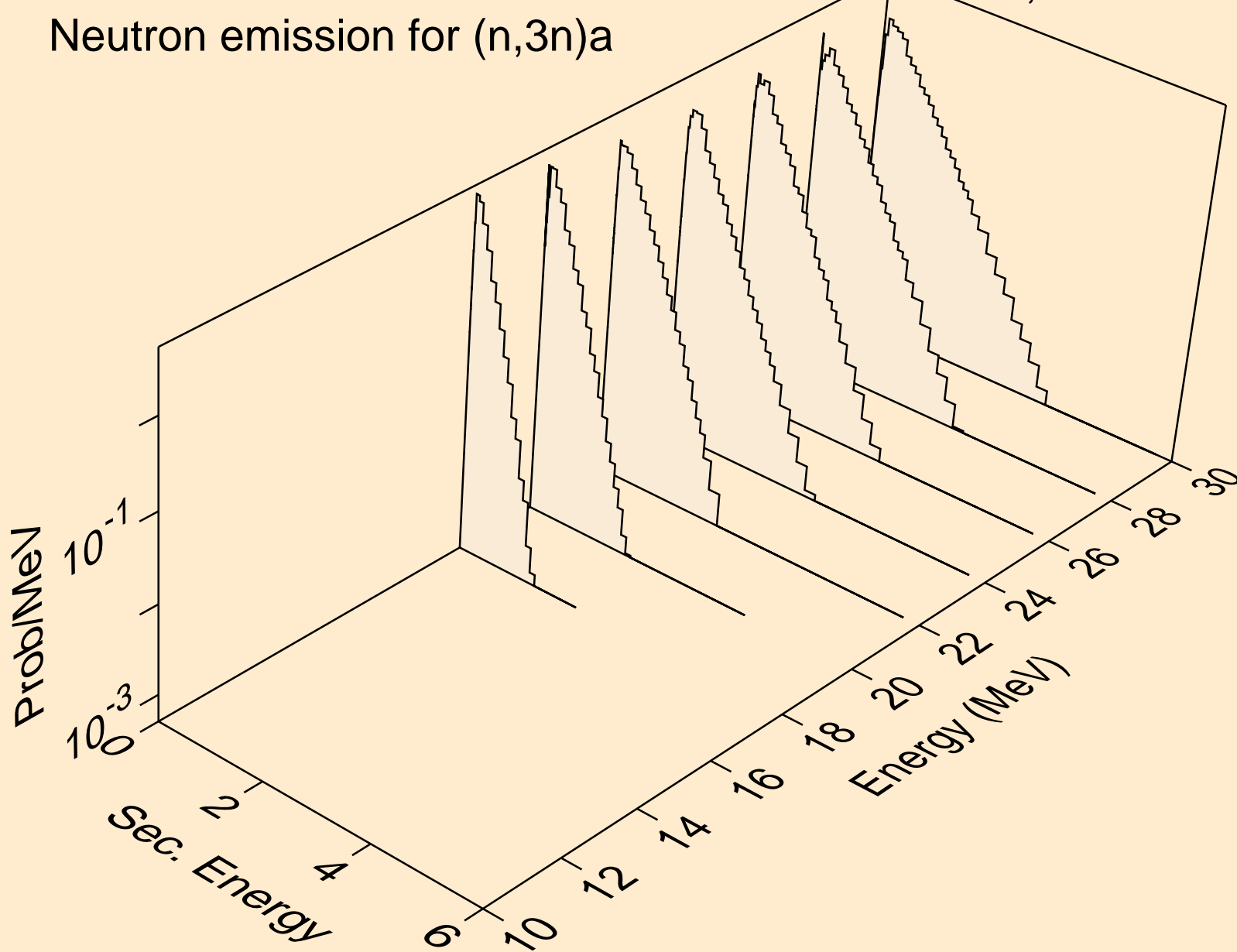

LU188 NEUTRON ACER TENDL-2023 LIBRARY; T=0.K  
Neutron emission for (n,n\*)p

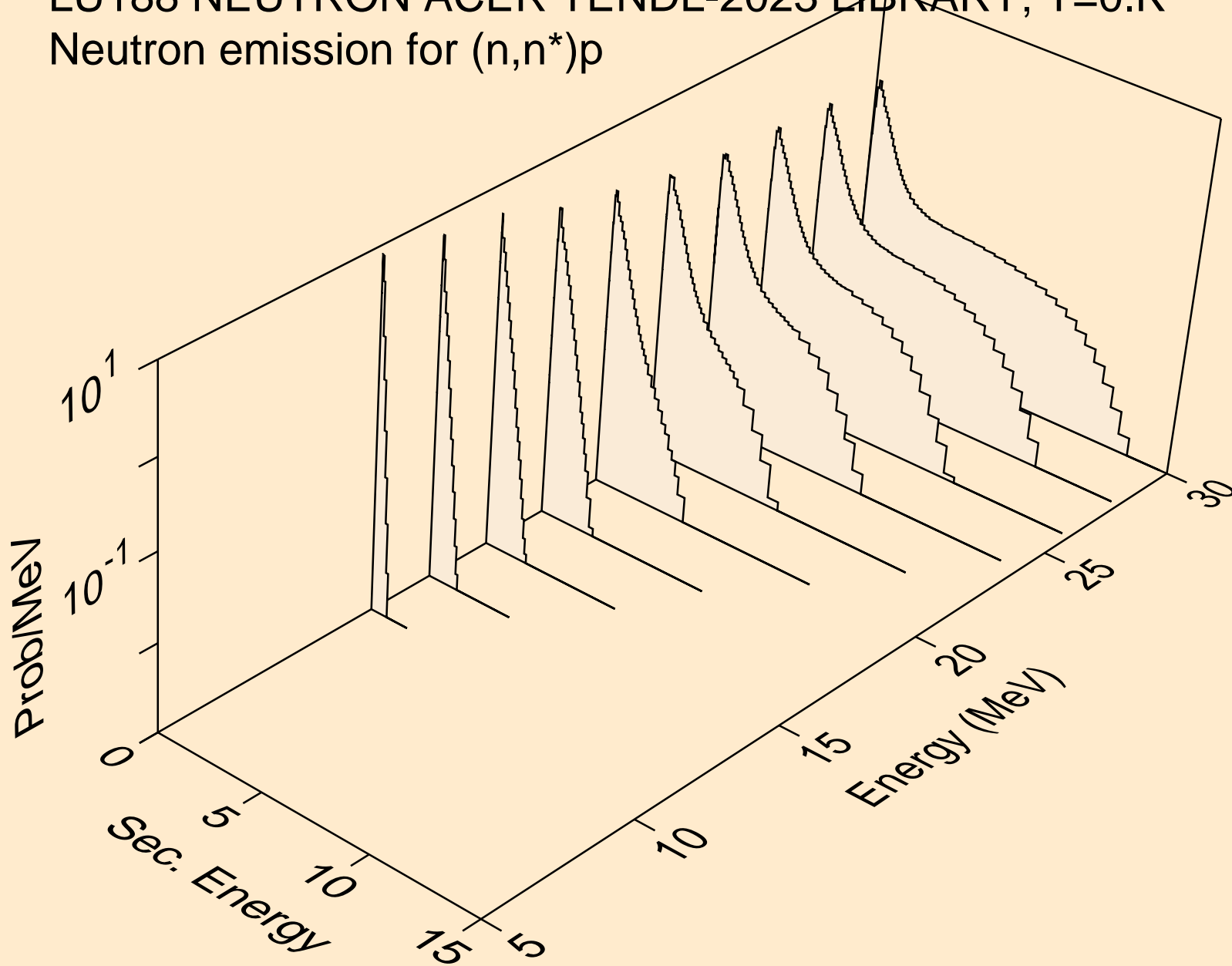

LU188 NEUTRON ACER TENDL-2023 LIBRARY; T=0.K  
Neutron emission for (n,n\*)d

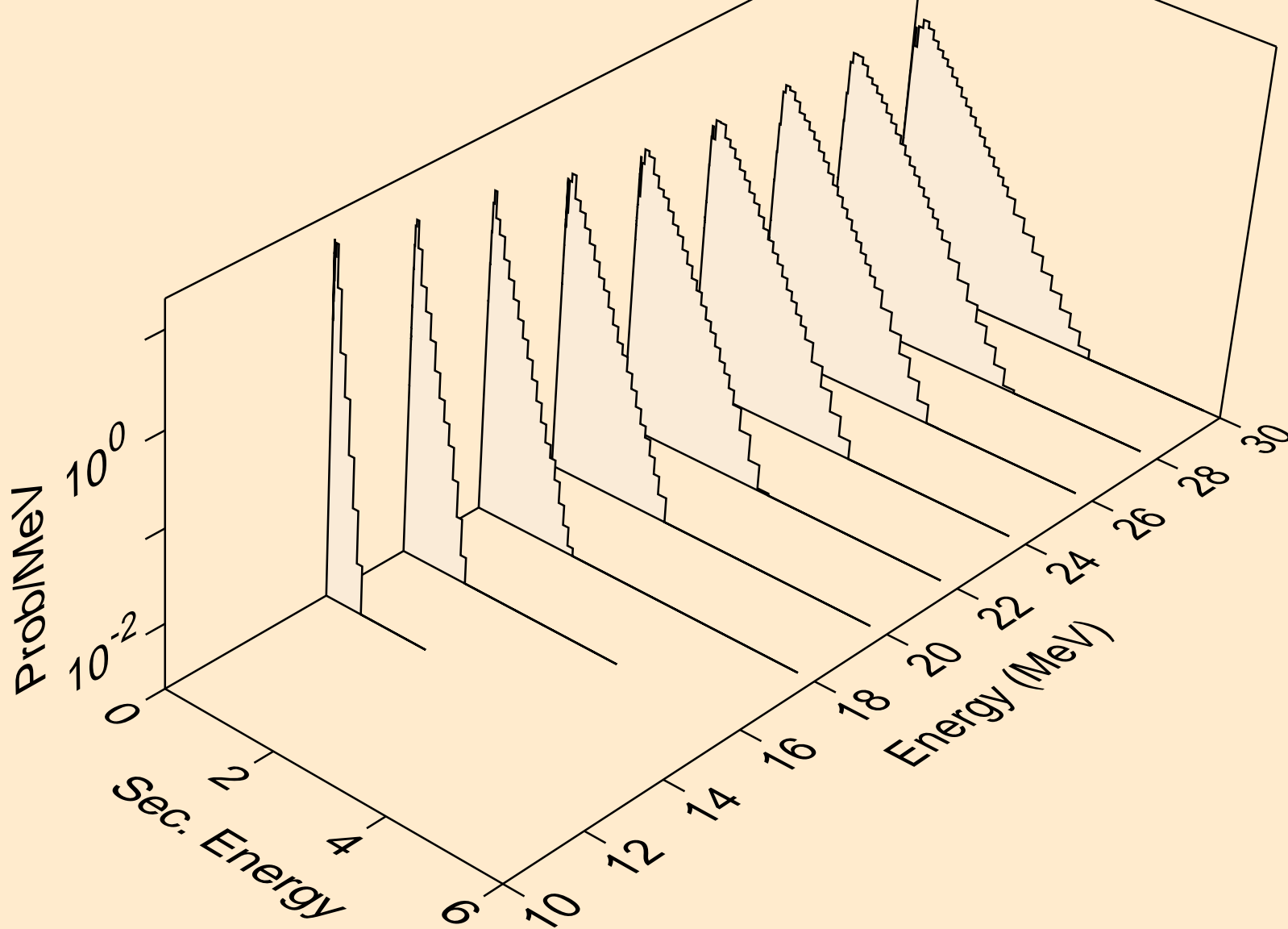

LU188 NEUTRON ACER TENDL-2023 LIBRARY; T=0.K  
Neutron emission for (n,n\*)t

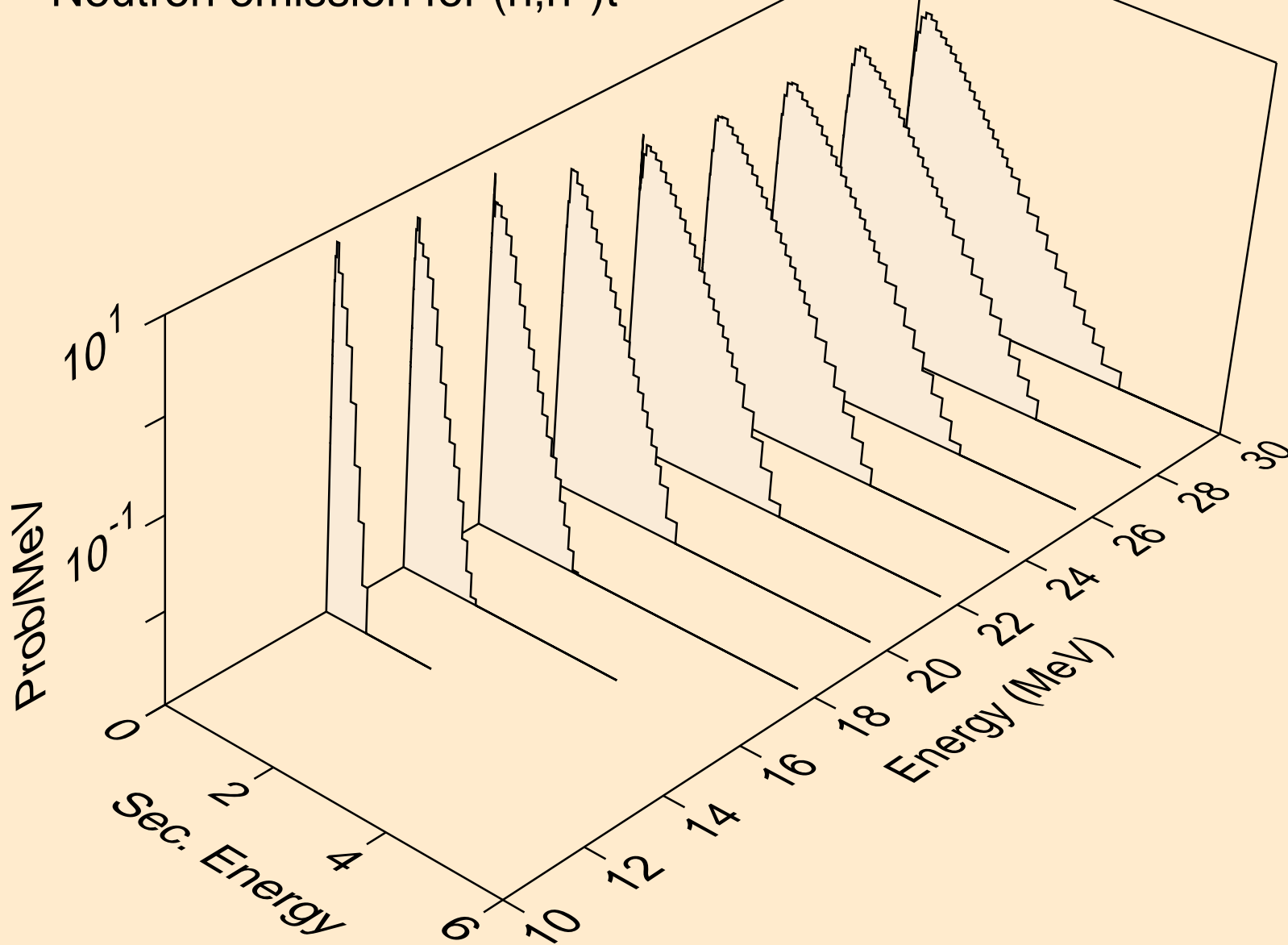

LU188 NEUTRON ACER TENDL-2023 LIBRARY; T=0.K  
Neutron emission for (n,n\*)he3

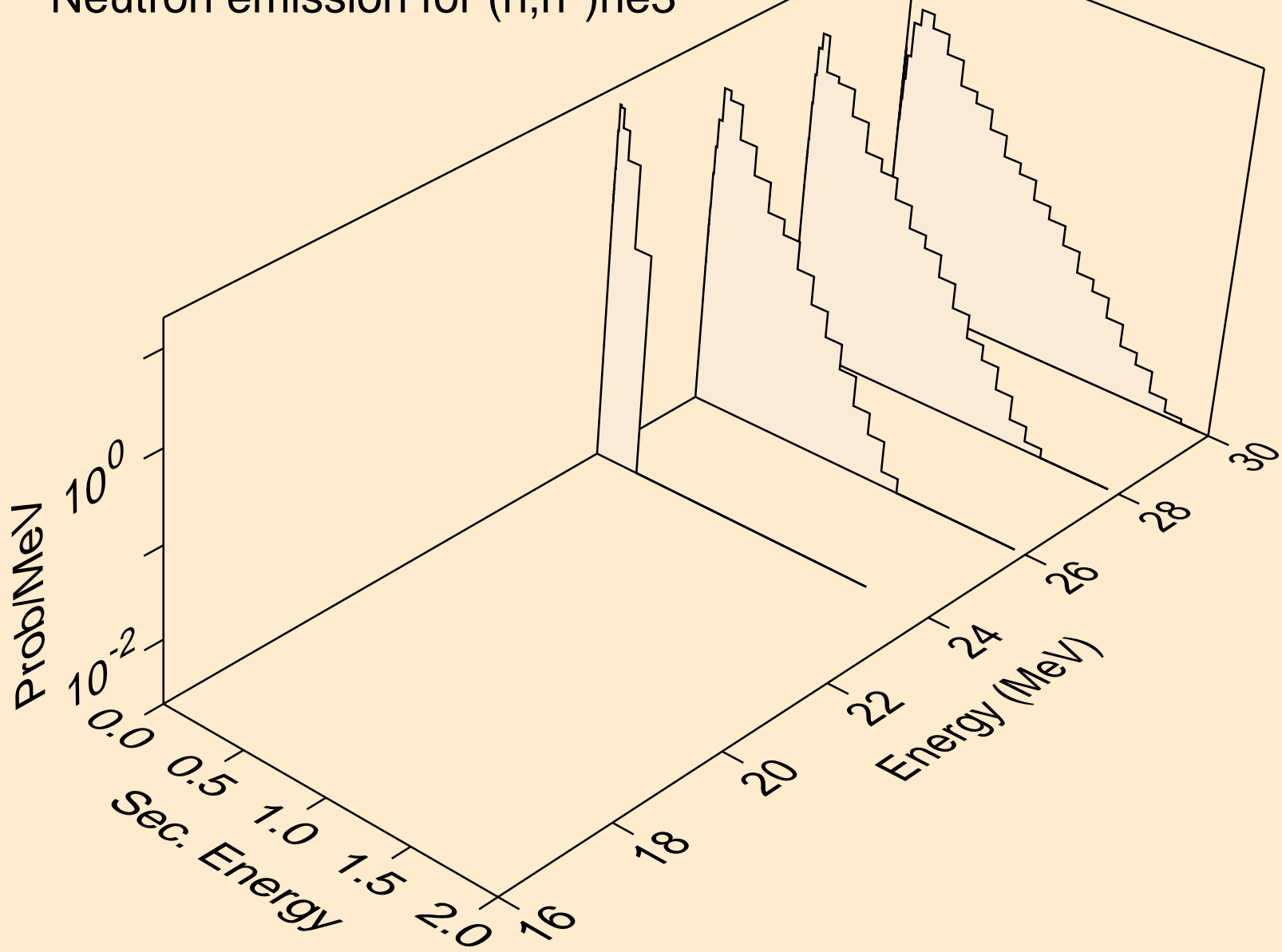

LU188 NEUTRON ACER TENDL-2023 LIBRARY; T=0.K  
Neutron emission for (n,4n)

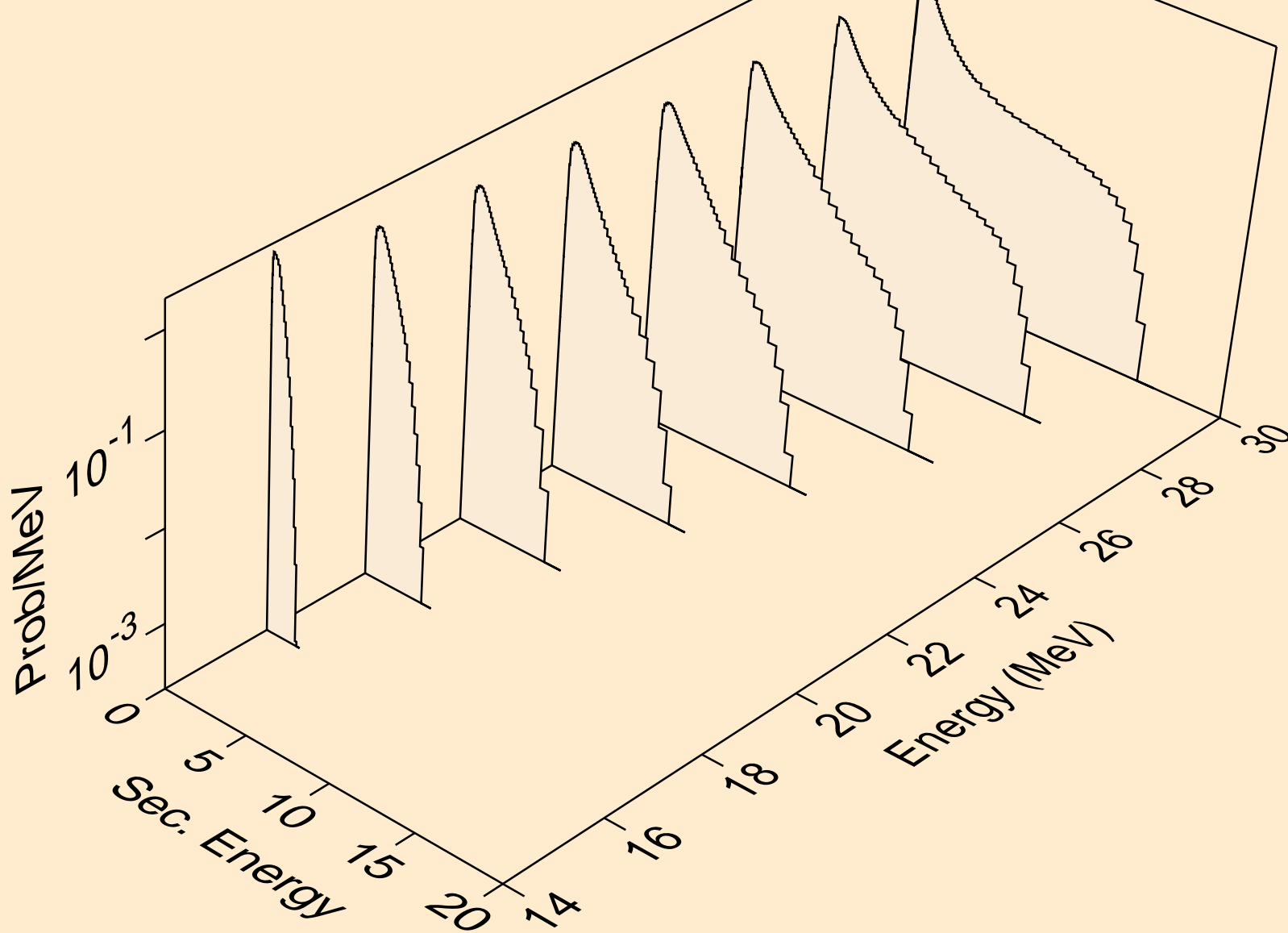

LU188 NEUTRON ACER TENDL-2023 LIBRARY; T=0.K  
Neutron emission for (n,2np)

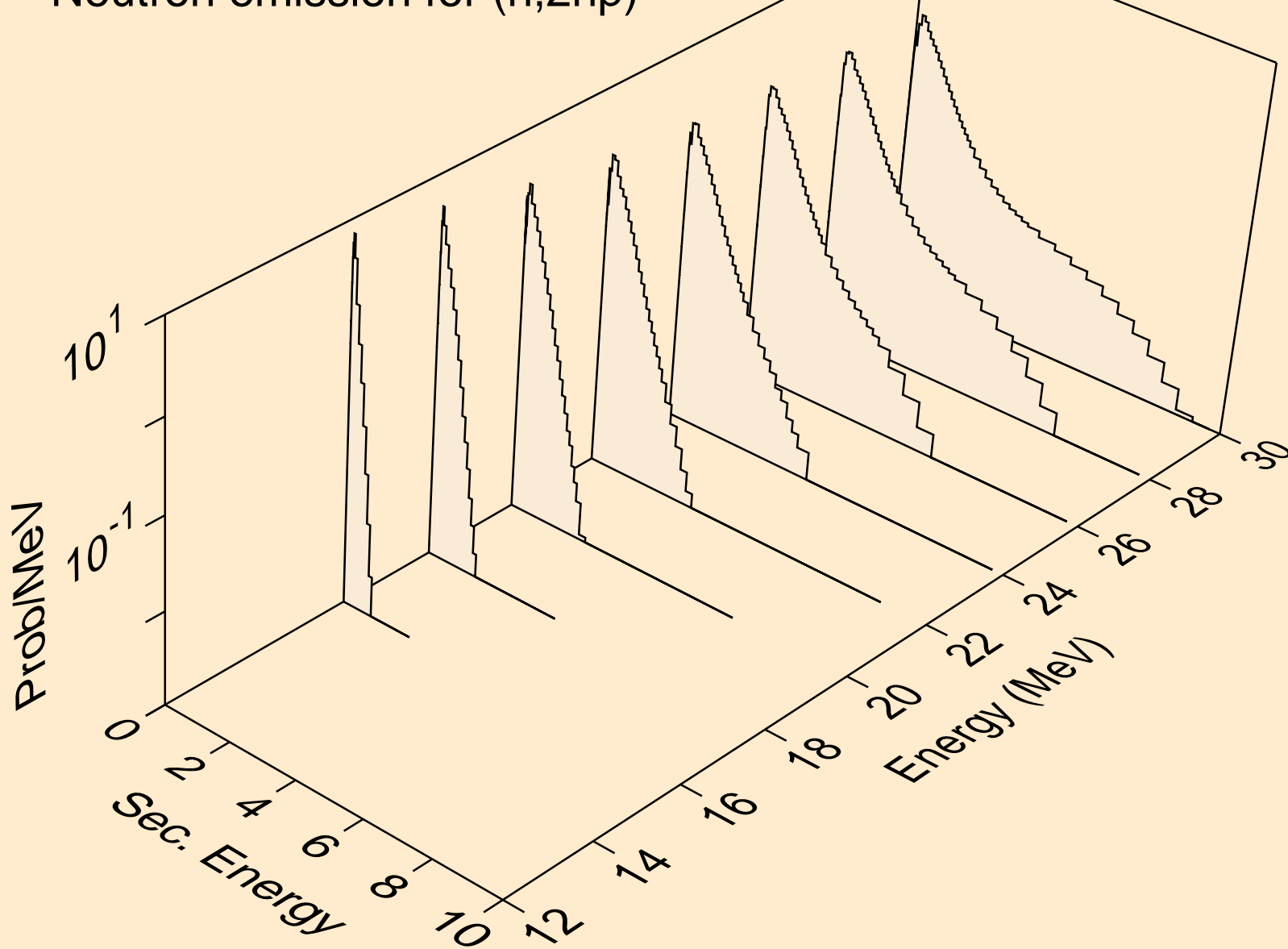

LU188 NEUTRON ACER TENDL-2023 LIBRARY; T=0.K  
Neutron emission for (n,3np)

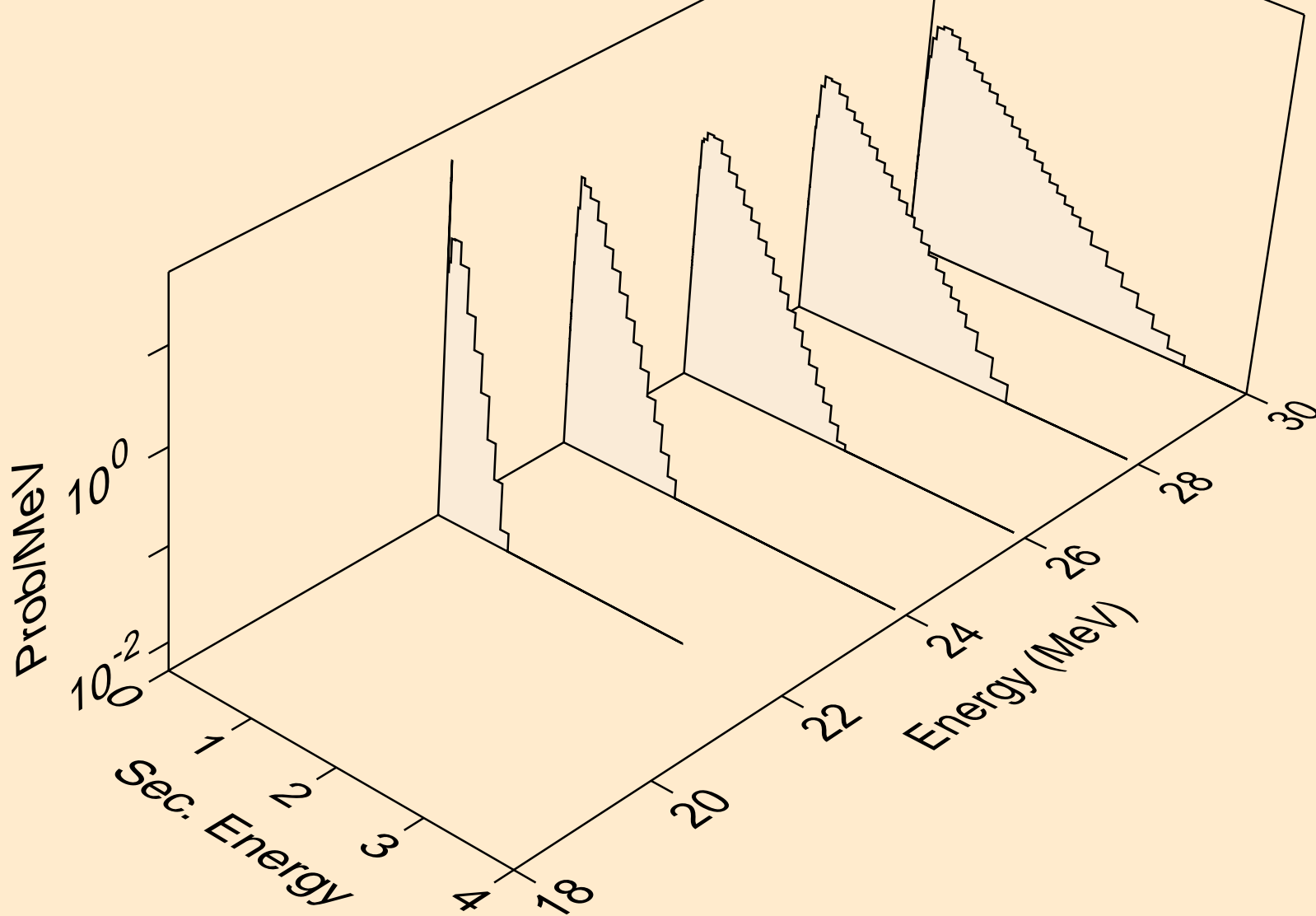



LU188 NEUTRON ACER TENDL-2023 LIBRARY; T=0.K  
Neutron emission for (n,n\*c)

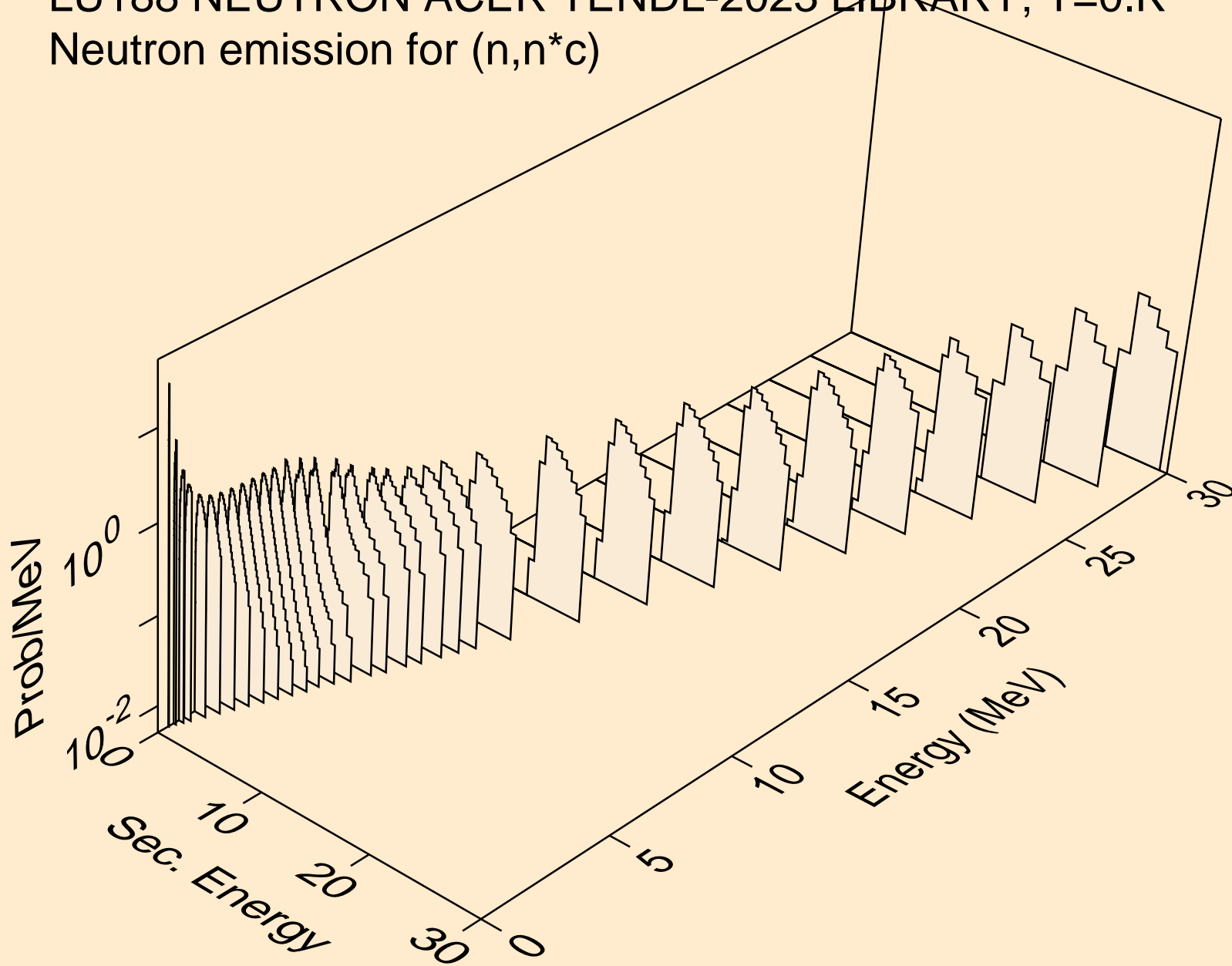

LU188 NEUTRON ACER TENDL-2023 LIBRARY; T=0.K  
Photon emission for (n,x)

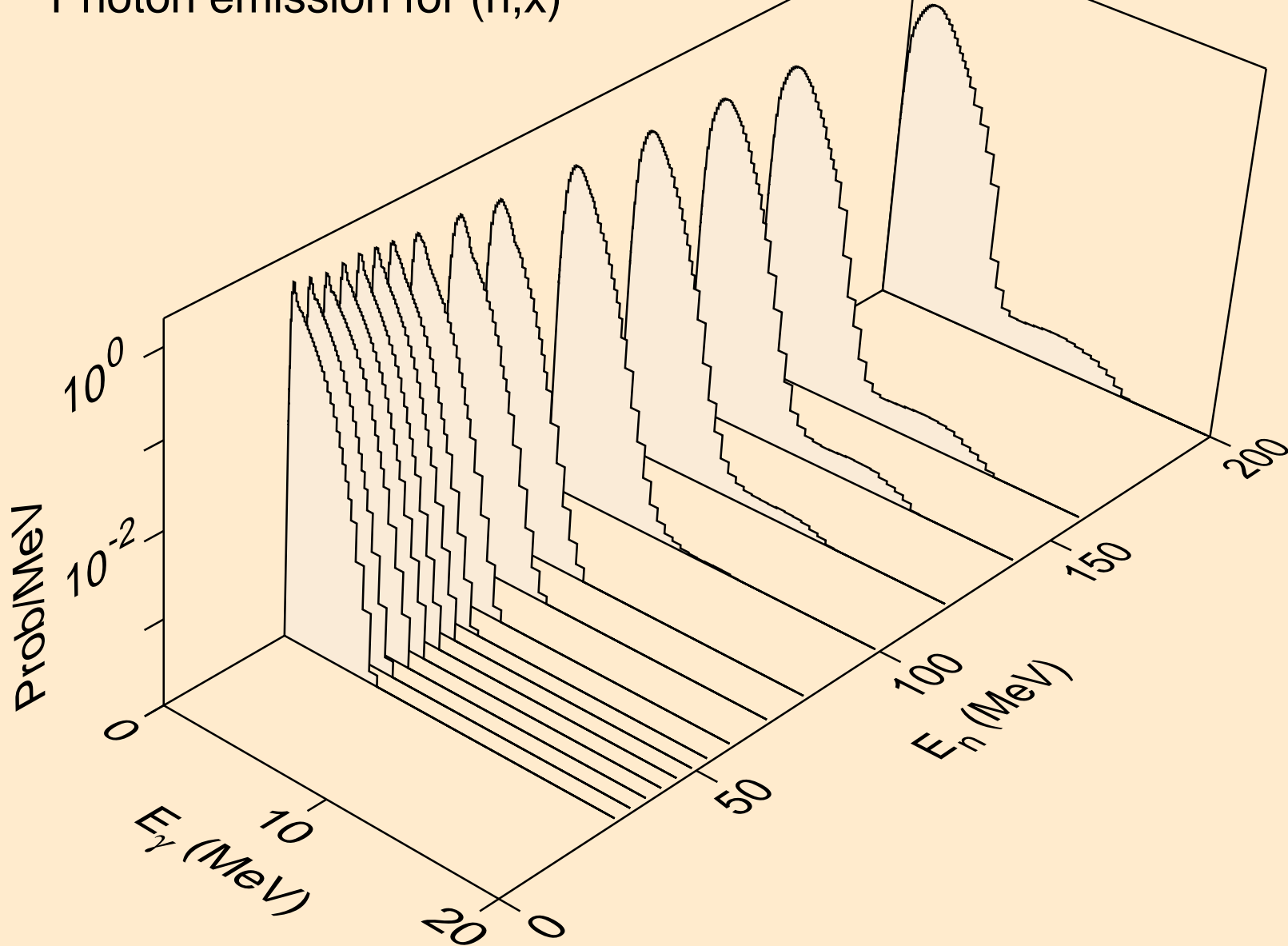

LU188 NEUTRON ACER TENDL-2023 LIBRARY; T=0.K  
Photon emission for (n,2nd)

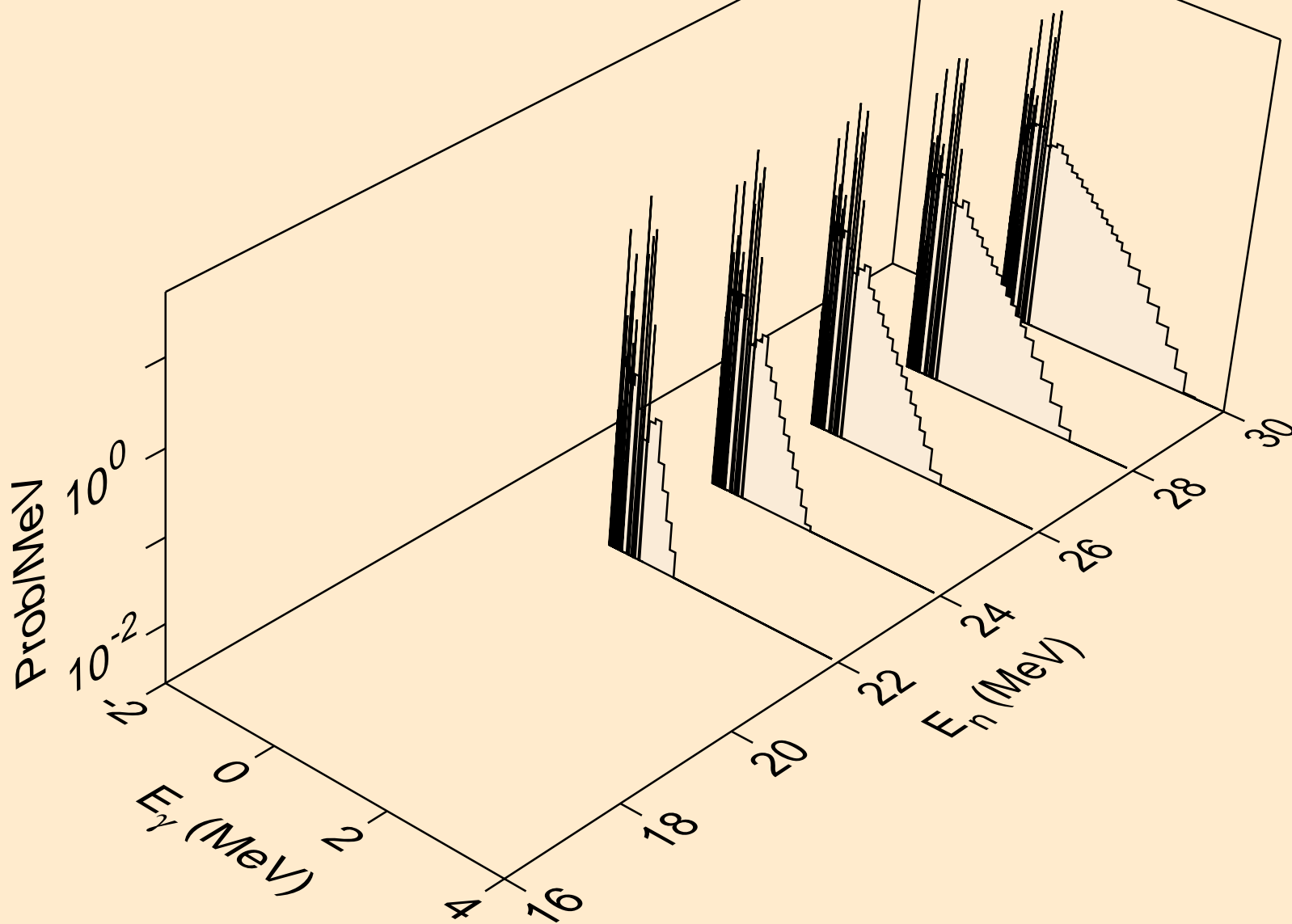

LU188 NEUTRON ACER TENDL-2023 LIBRARY; T=0.K  
Photon emission for (n,2n)

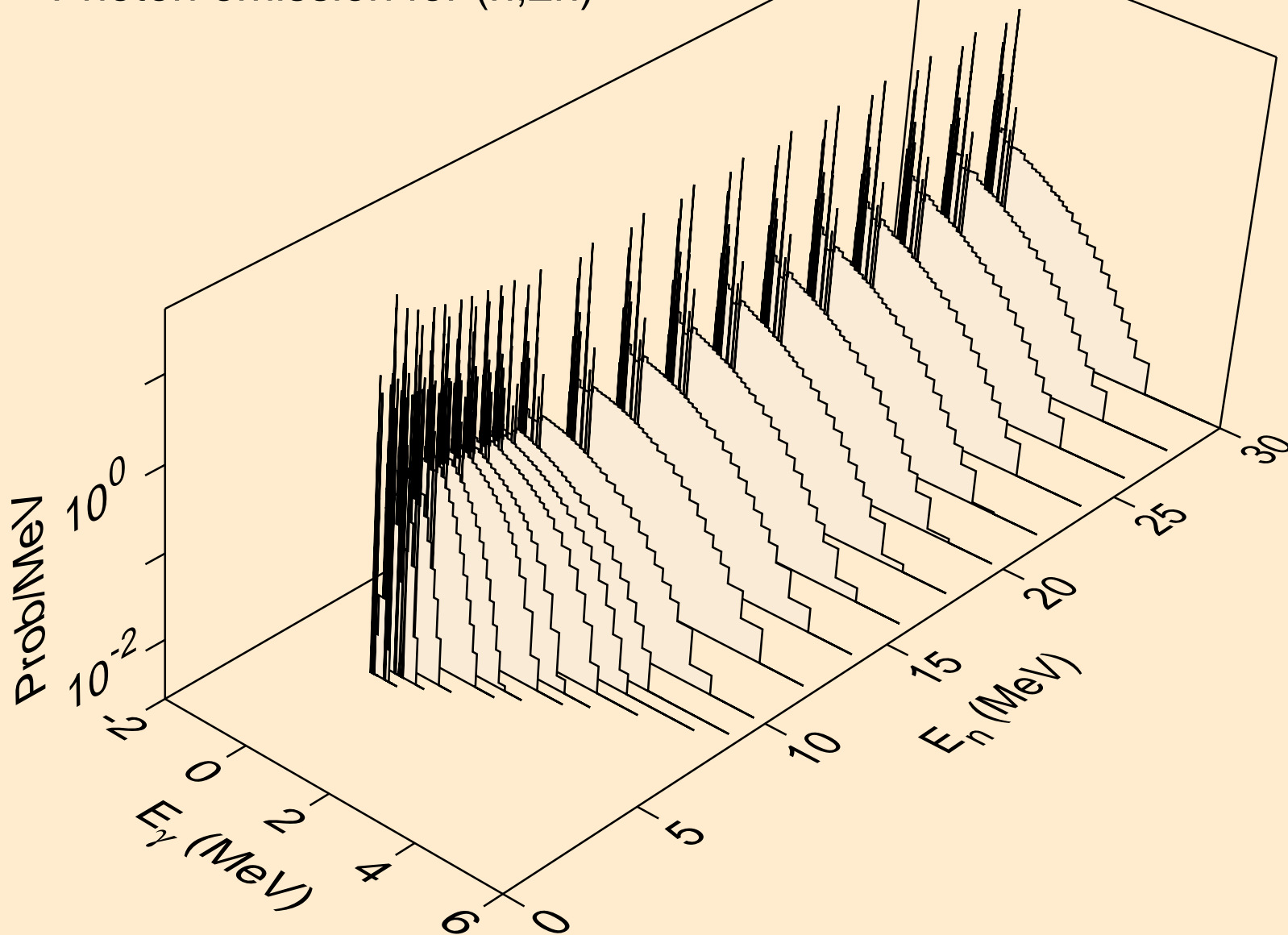

LU188 NEUTRON ACER TENDL-2023 LIBRARY; T=0.K  
Photon emission for (n,3n)

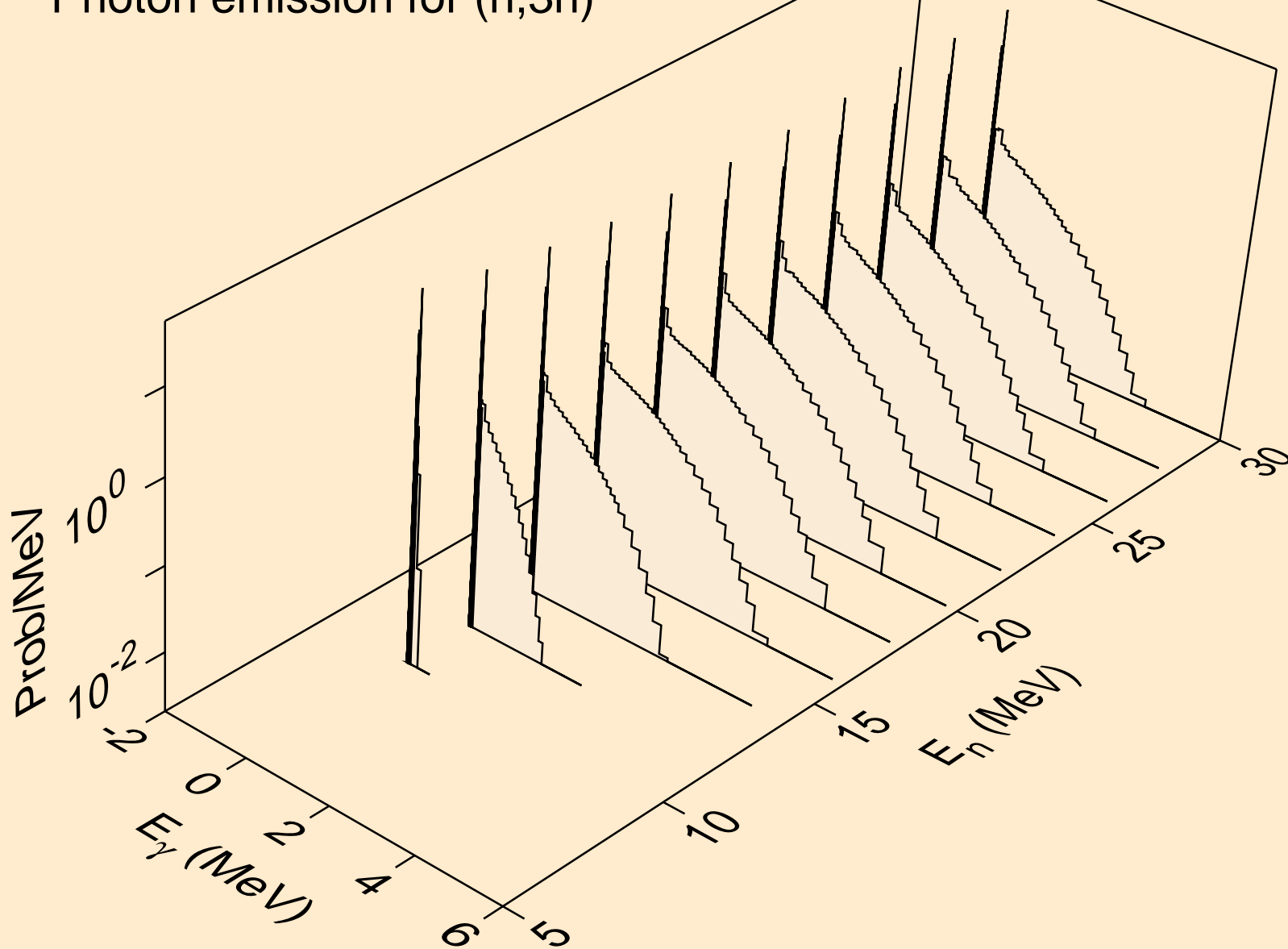

LU188 NEUTRON ACER TENDL-2023 LIBRARY; T=0.K  
Photon emission for (n,n\*)a

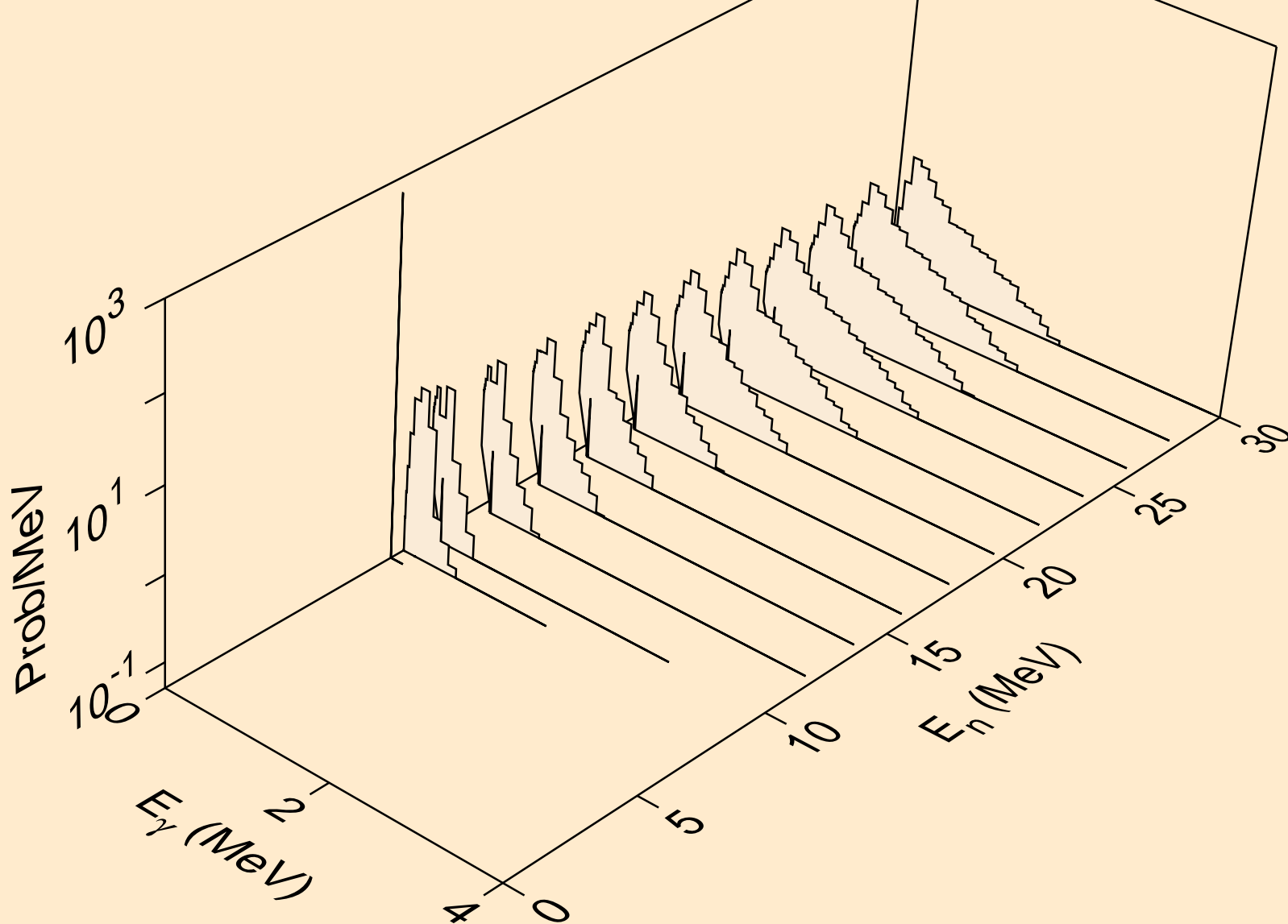

LU188 NEUTRON ACER TENDL-2023 LIBRARY; T=0.K  
Photon emission for (n,2n) $\alpha$

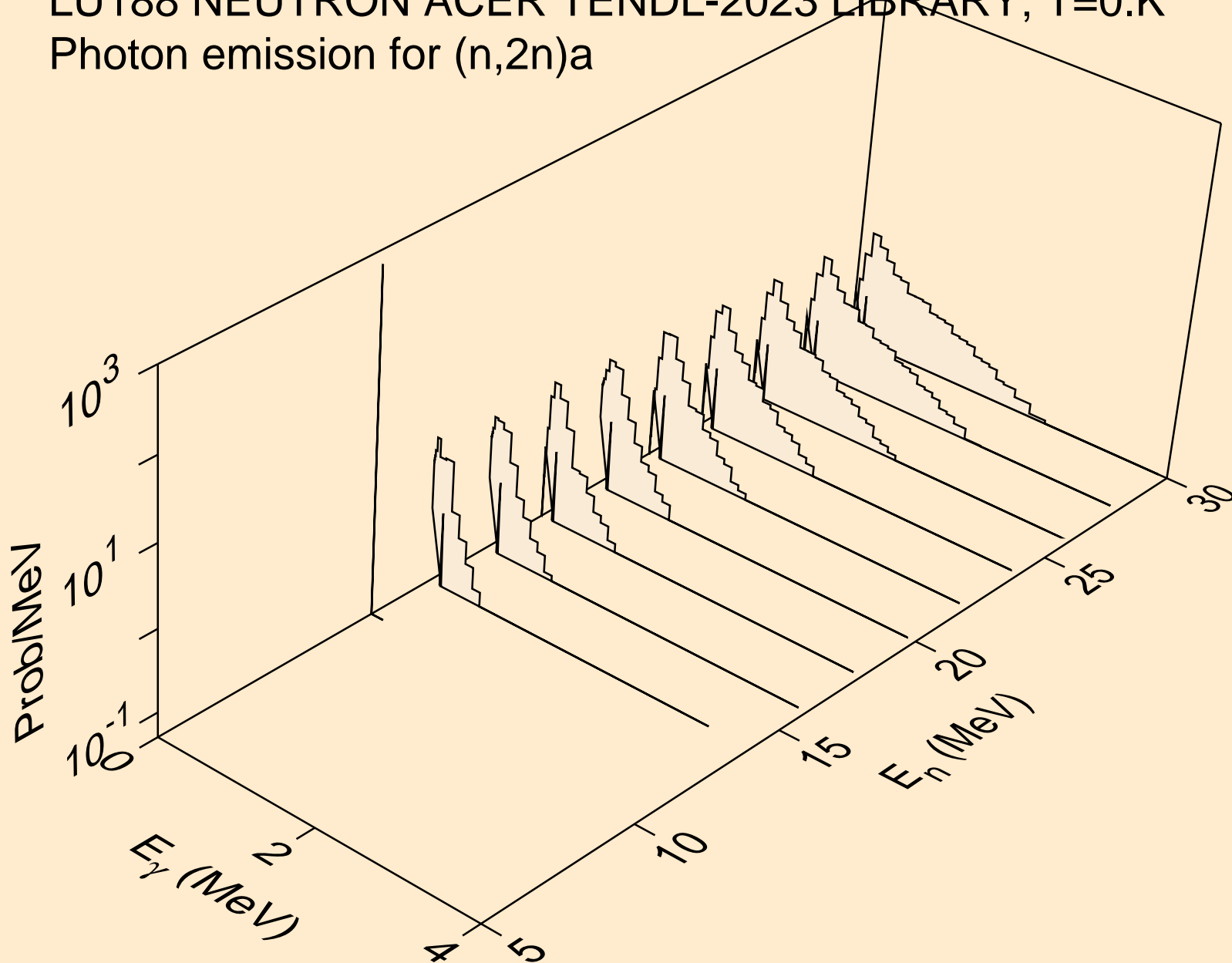

LU188 NEUTRON ACER TENDL-2023 LIBRARY; T=0.K  
Photon emission for (n,3n)a

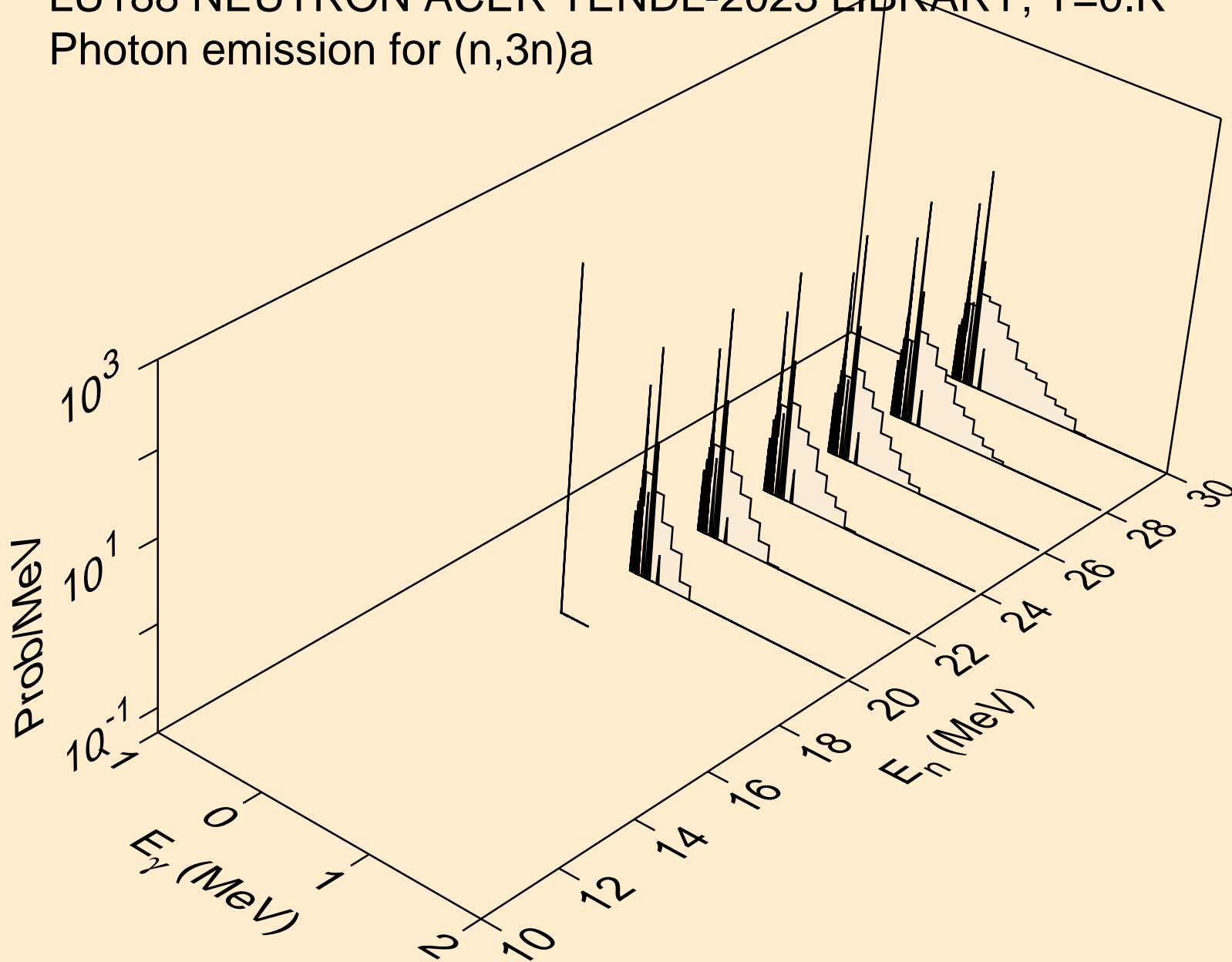



LU188 NEUTRON ACER TENDL-2023 LIBRARY; T=0.K  
Photon emission for (n,n\*)p

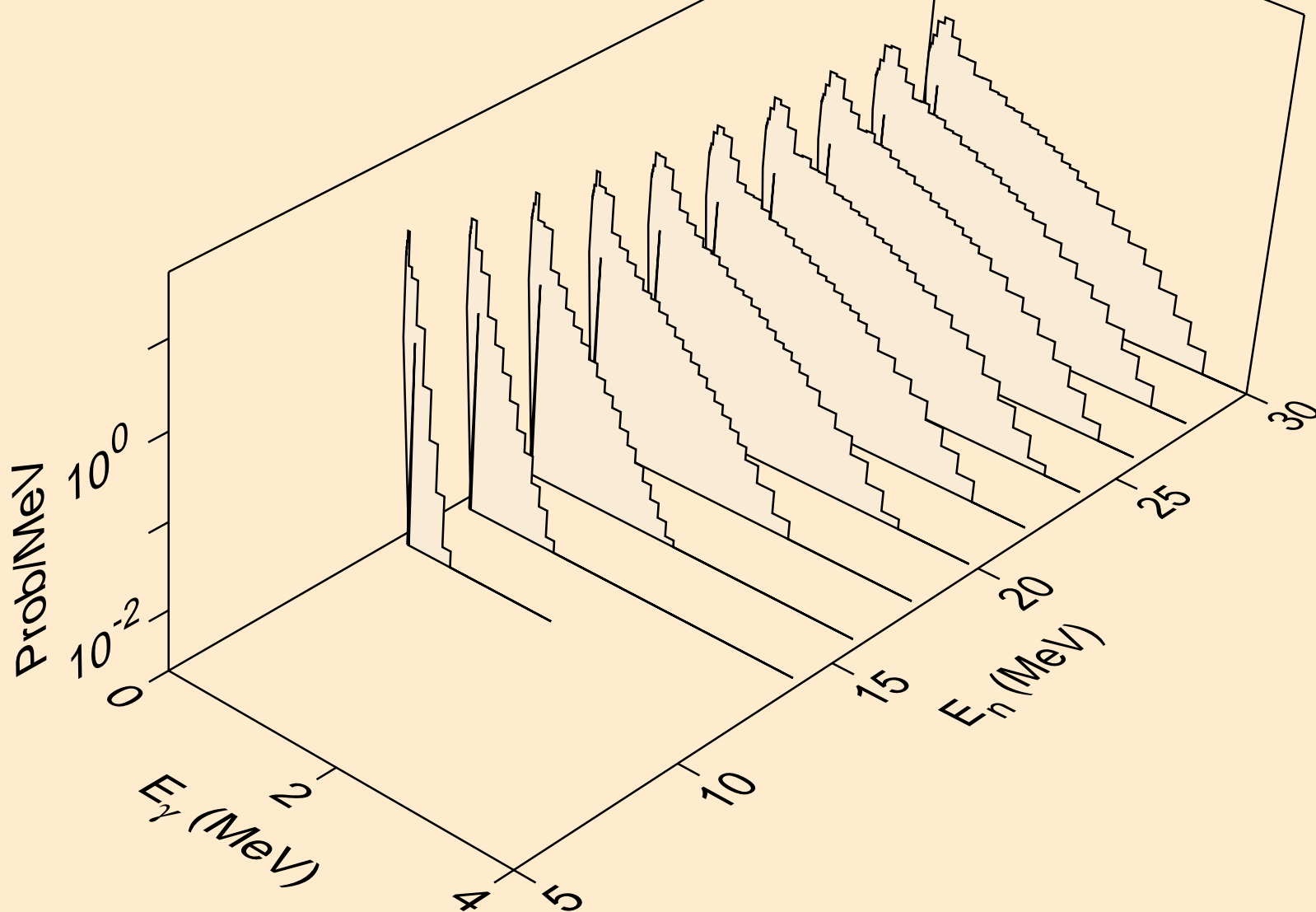

LU188 NEUTRON ACER TENDL-2023 LIBRARY; T=0.K  
Photon emission for (n,n\*)d

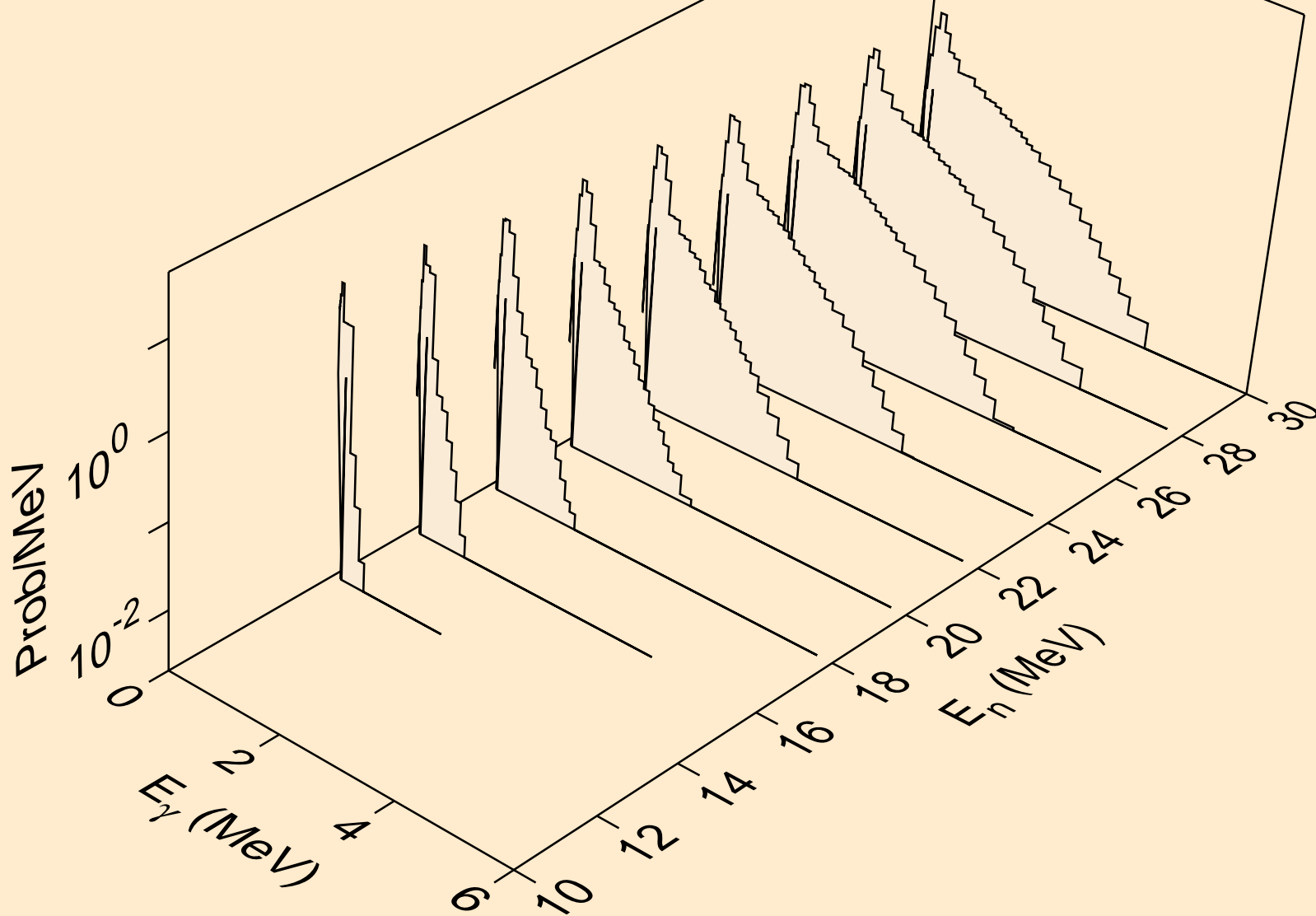

LU188 NEUTRON ACER TENDL-2023 LIBRARY; T=0.K  
Photon emission for (n,n\*)t

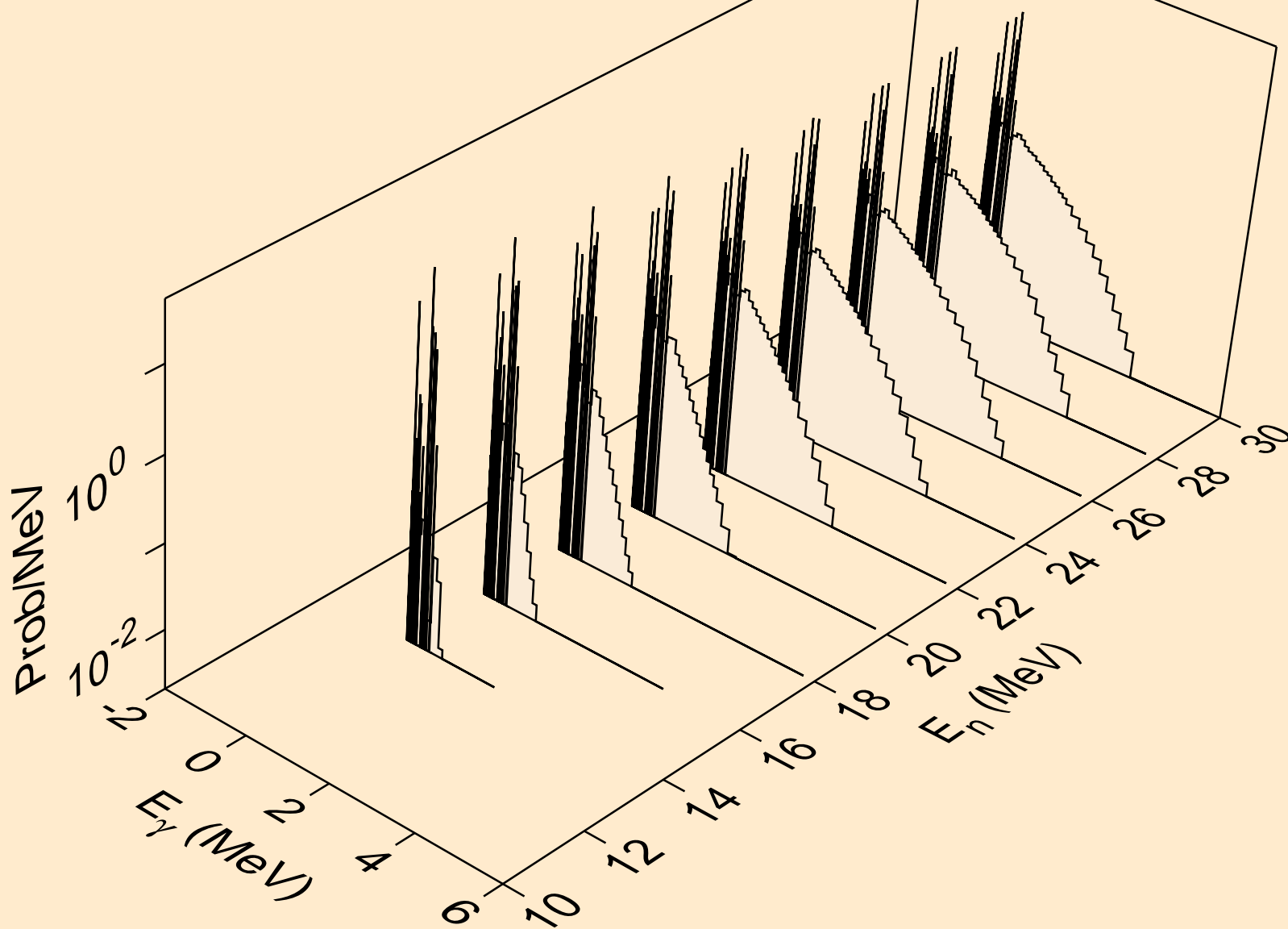

LU188 NEUTRON ACER TENDL-2023 LIBRARY; T=0.K  
Photon emission for (n,n\*)he3

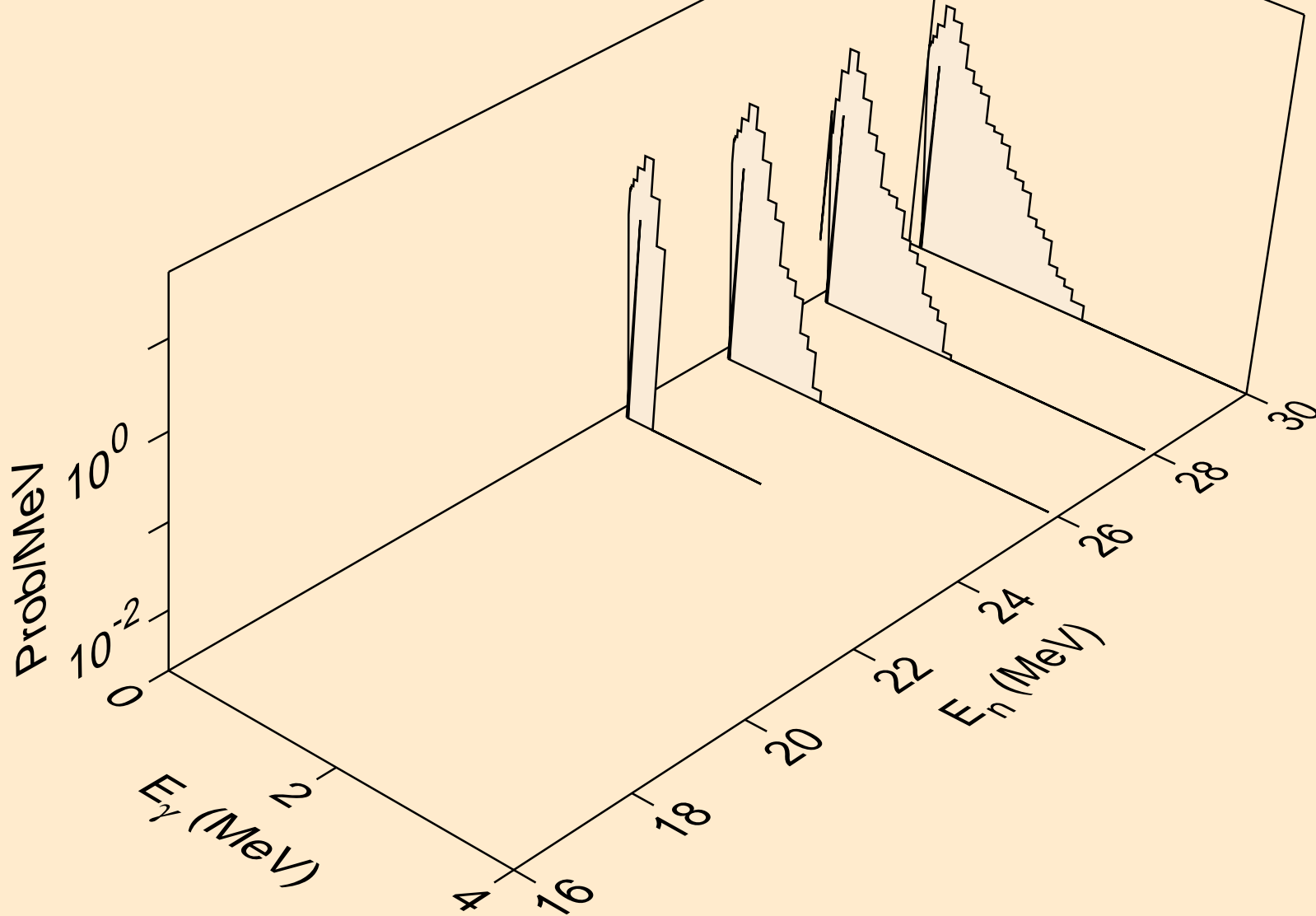

LU188 NEUTRON ACER TENDL-2023 LIBRARY; T=0.K  
Photon emission for (n,4n)

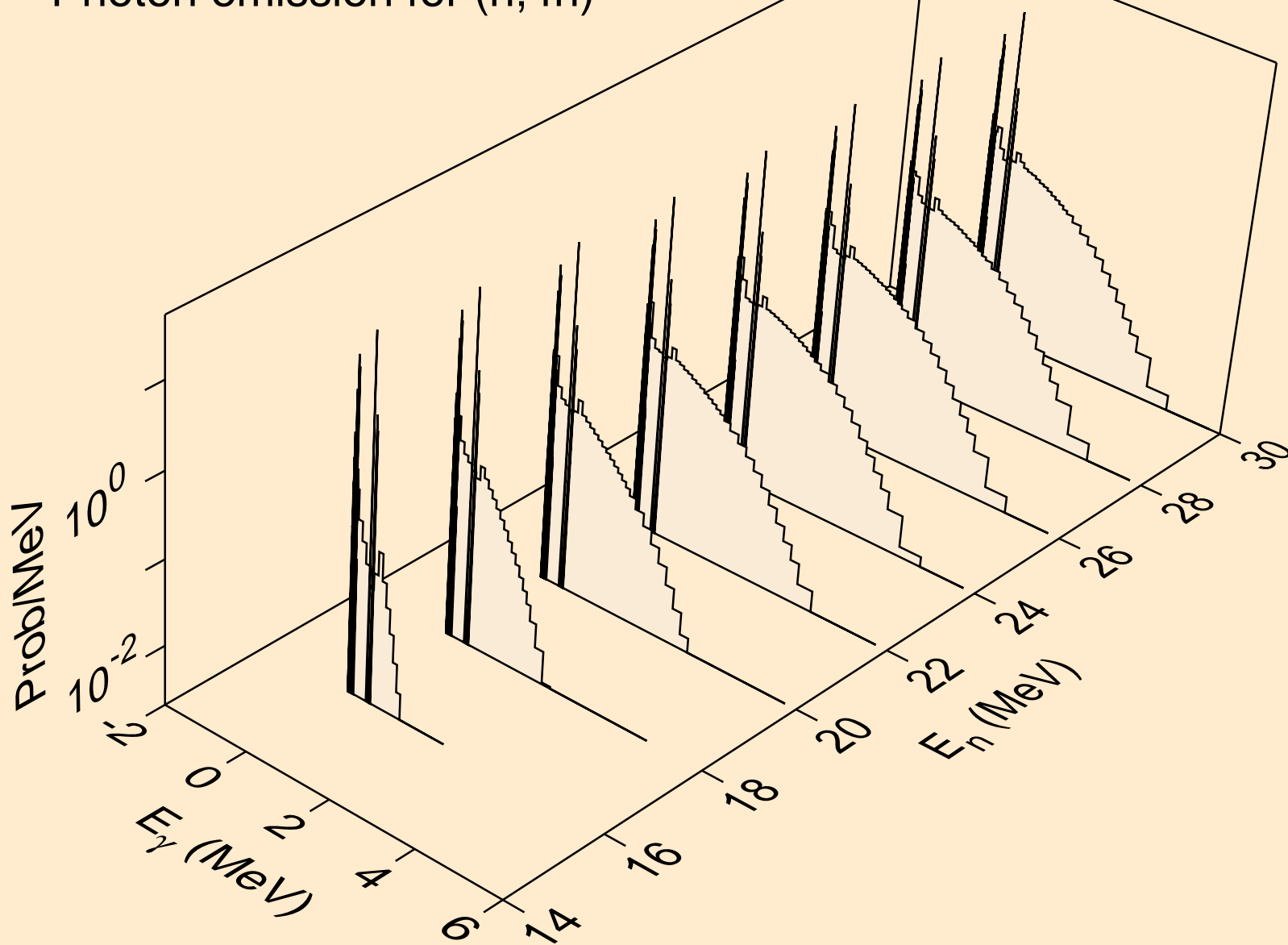

LU188 NEUTRON ACER TENDL-2023 LIBRARY; T=0.K  
Photon emission for (n,2np)

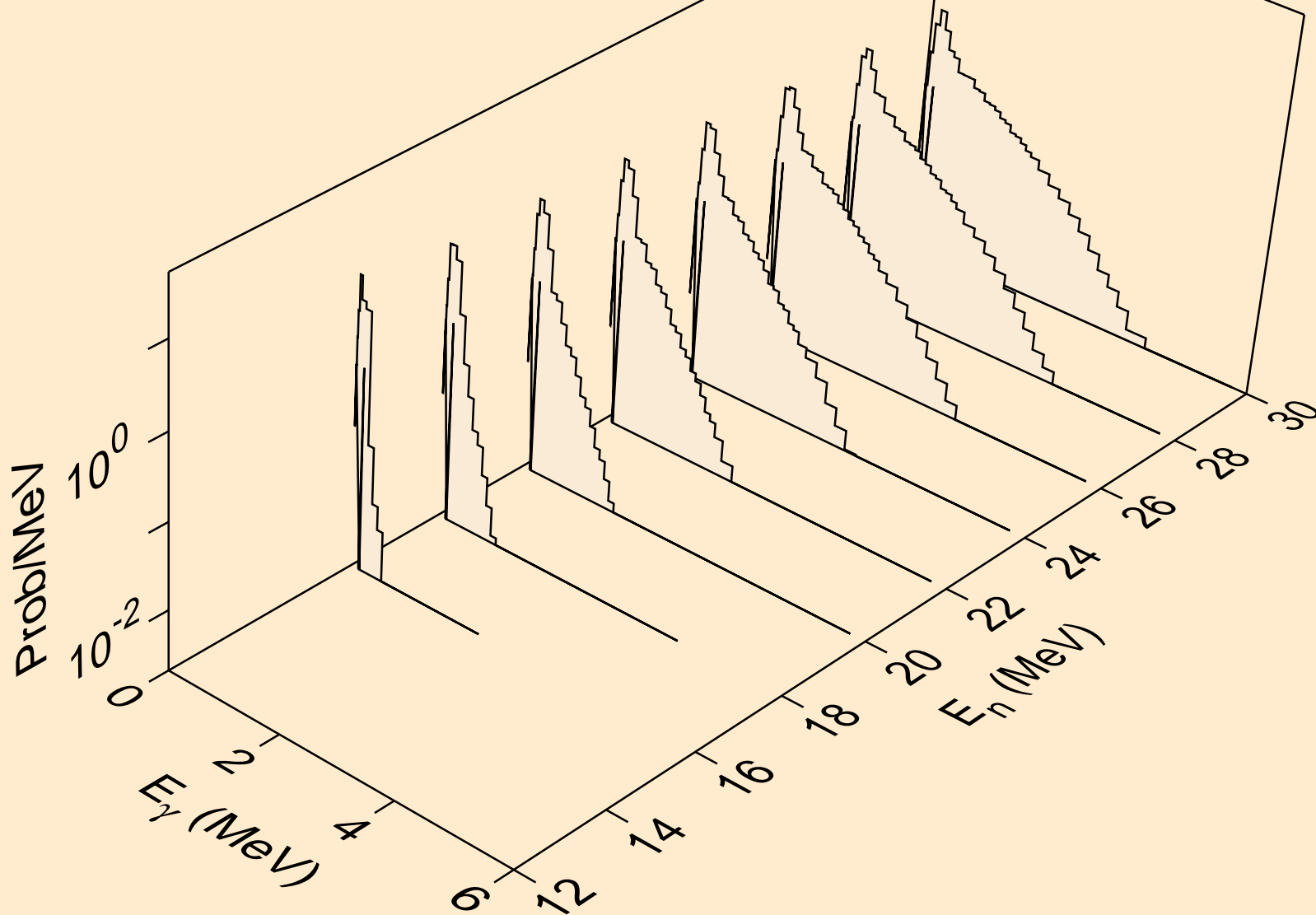

LU188 NEUTRON ACER TENDL-2023 LIBRARY; T=0.K  
Photon emission for (n,3np)

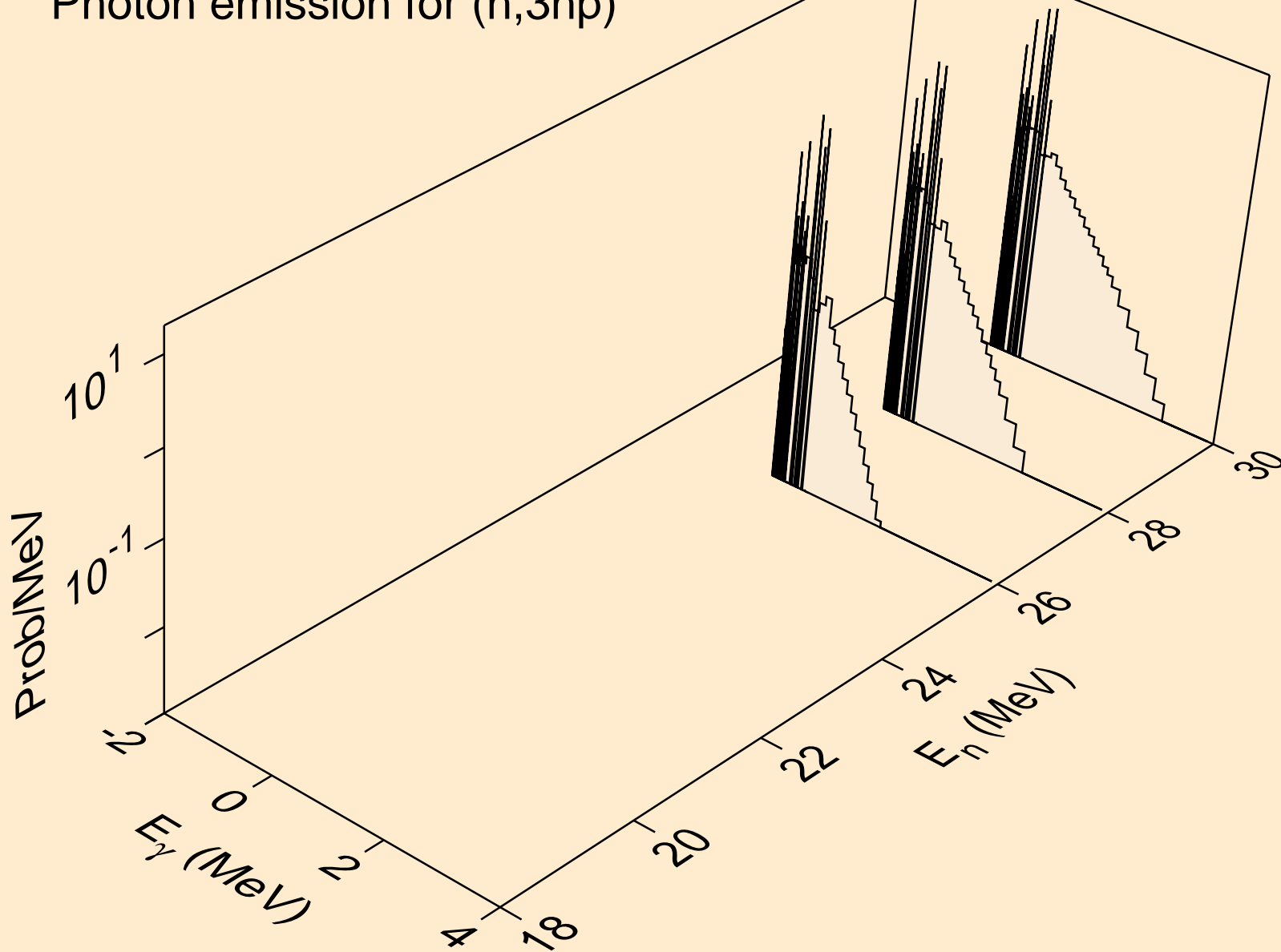

LU188 NEUTRON ACER TENDL-2023 LIBRARY; T=0.K  
Photon emission for (n,n\*c)

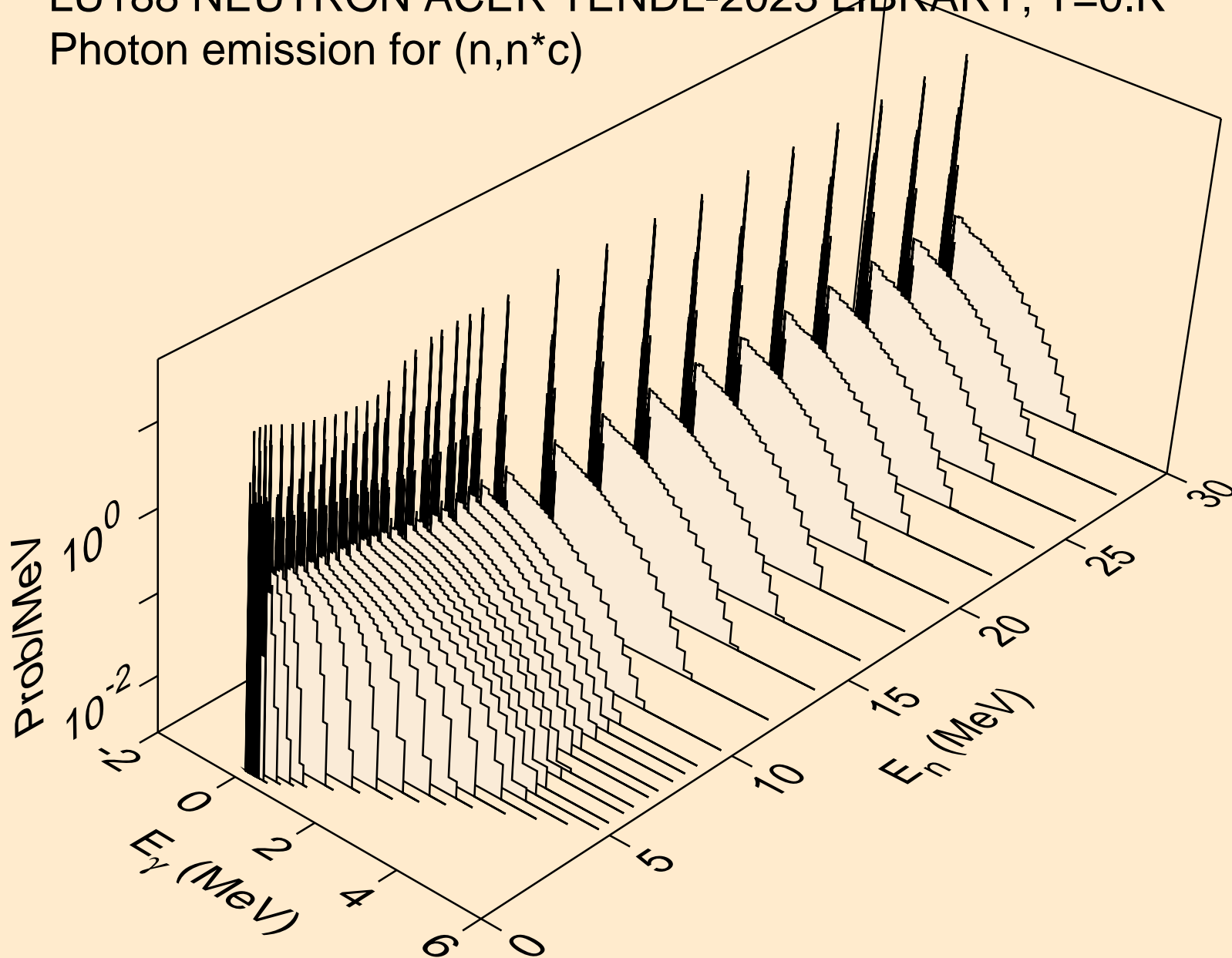



LU188 NEUTRON ACER TENDL-2023 LIBRARY; T=0.K  
Photon emission for (n,gma)

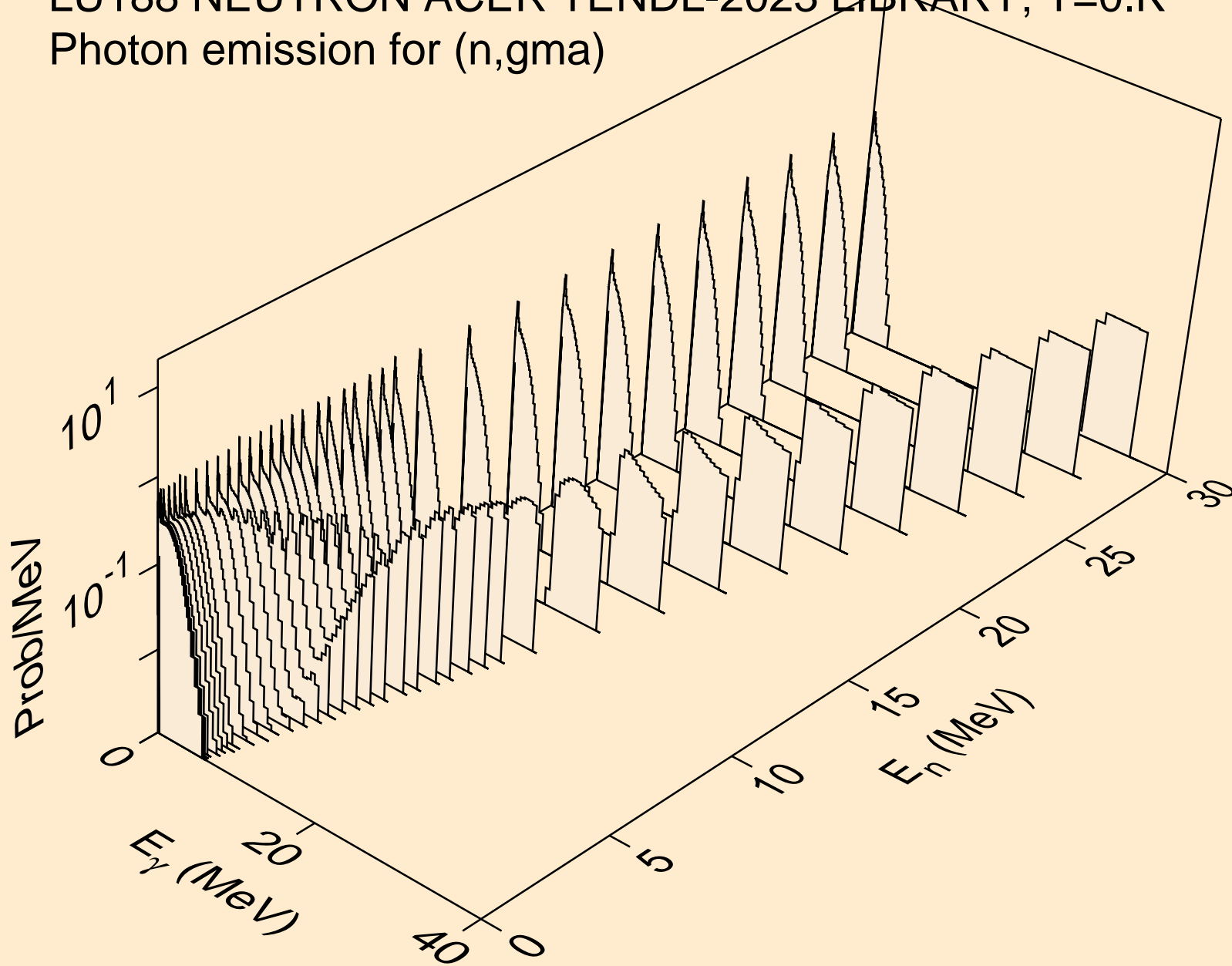

LU188 NEUTRON ACER TENDL-2023 LIBRARY; T=0.K  
Photon emission for (n,p)

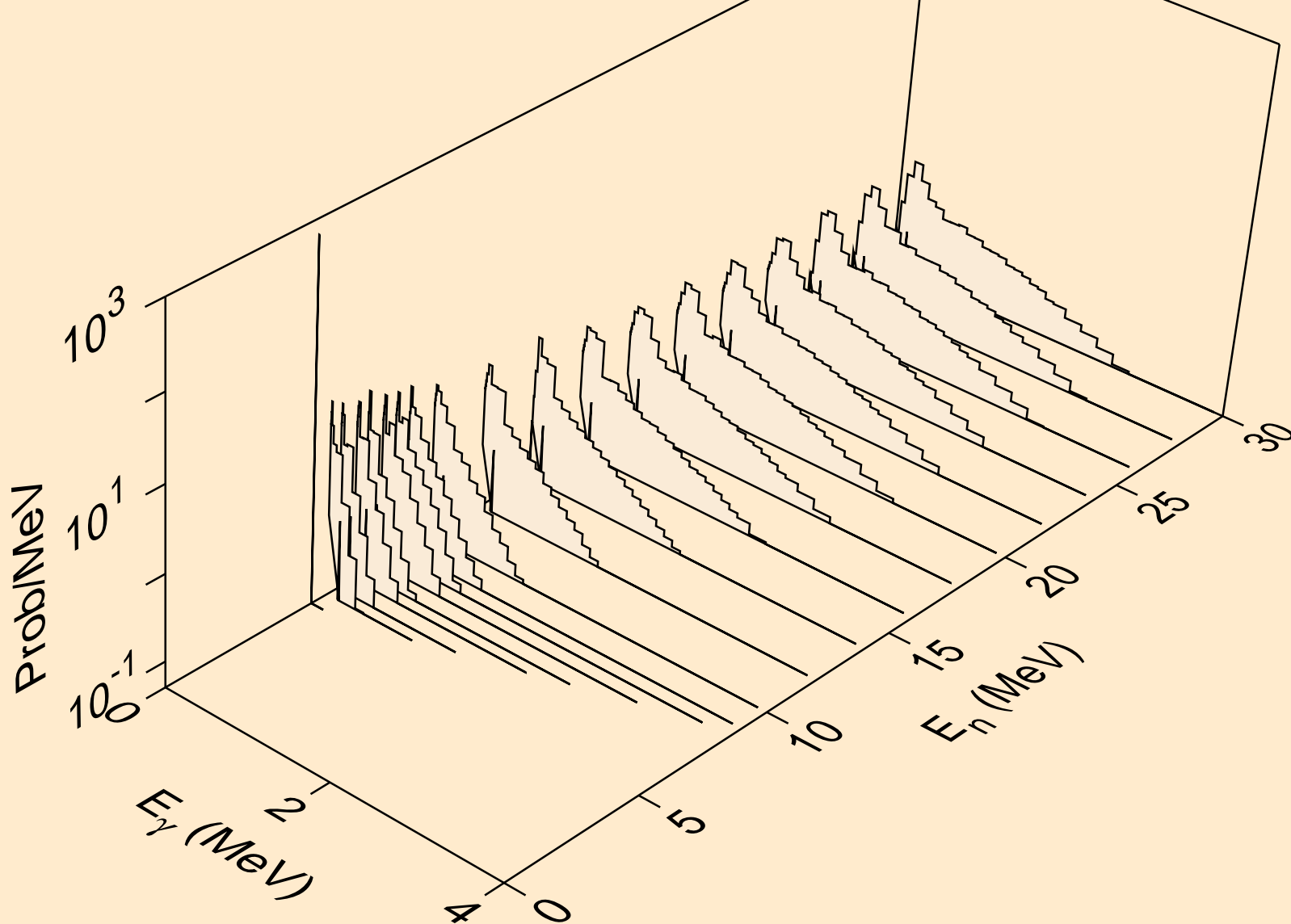

LU188 NEUTRON ACER TENDL-2023 LIBRARY; T=0.K  
Photon emission for (n,d)

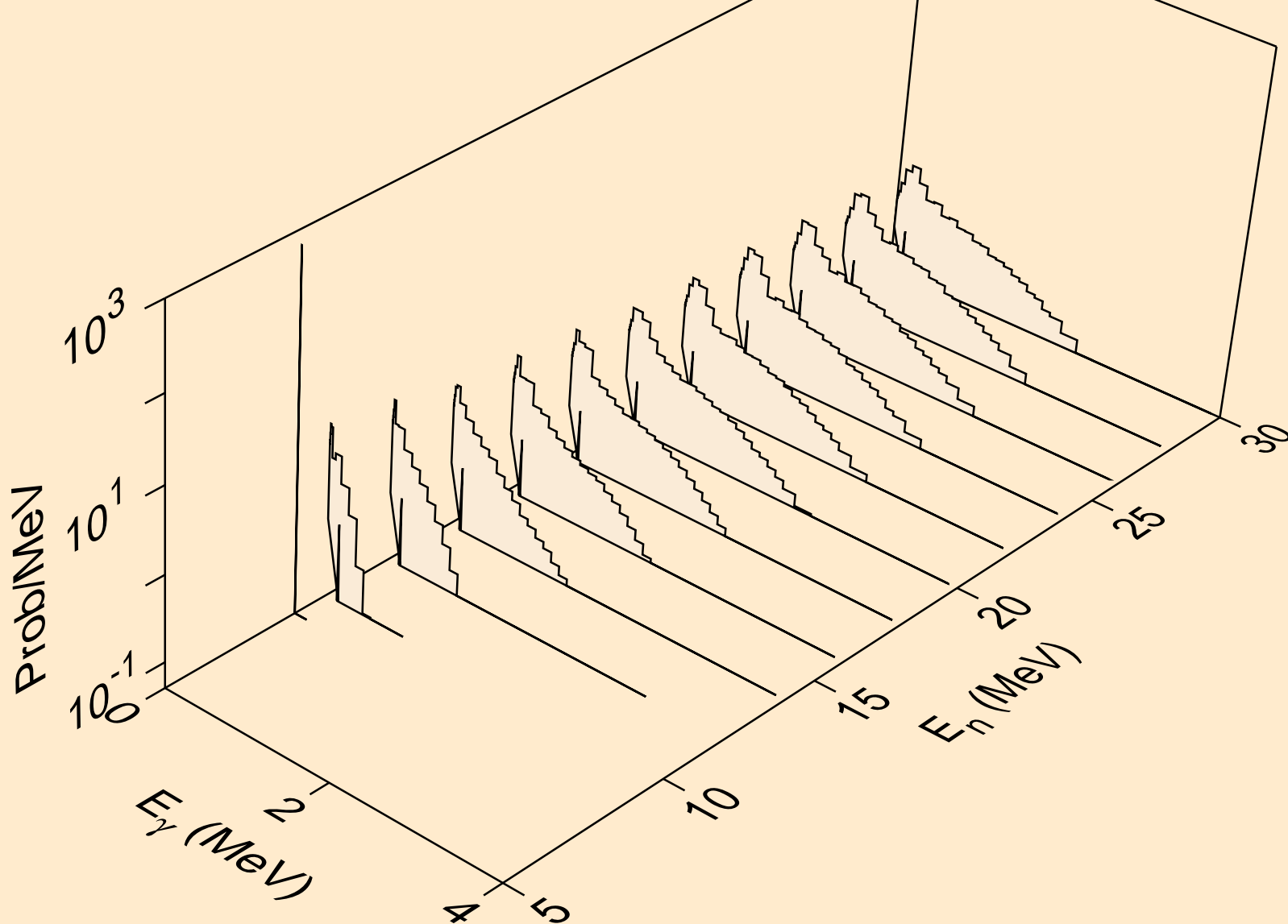

LU188 NEUTRON ACER TENDL-2023 LIBRARY; T=0.K  
Photon emission for (n,t)

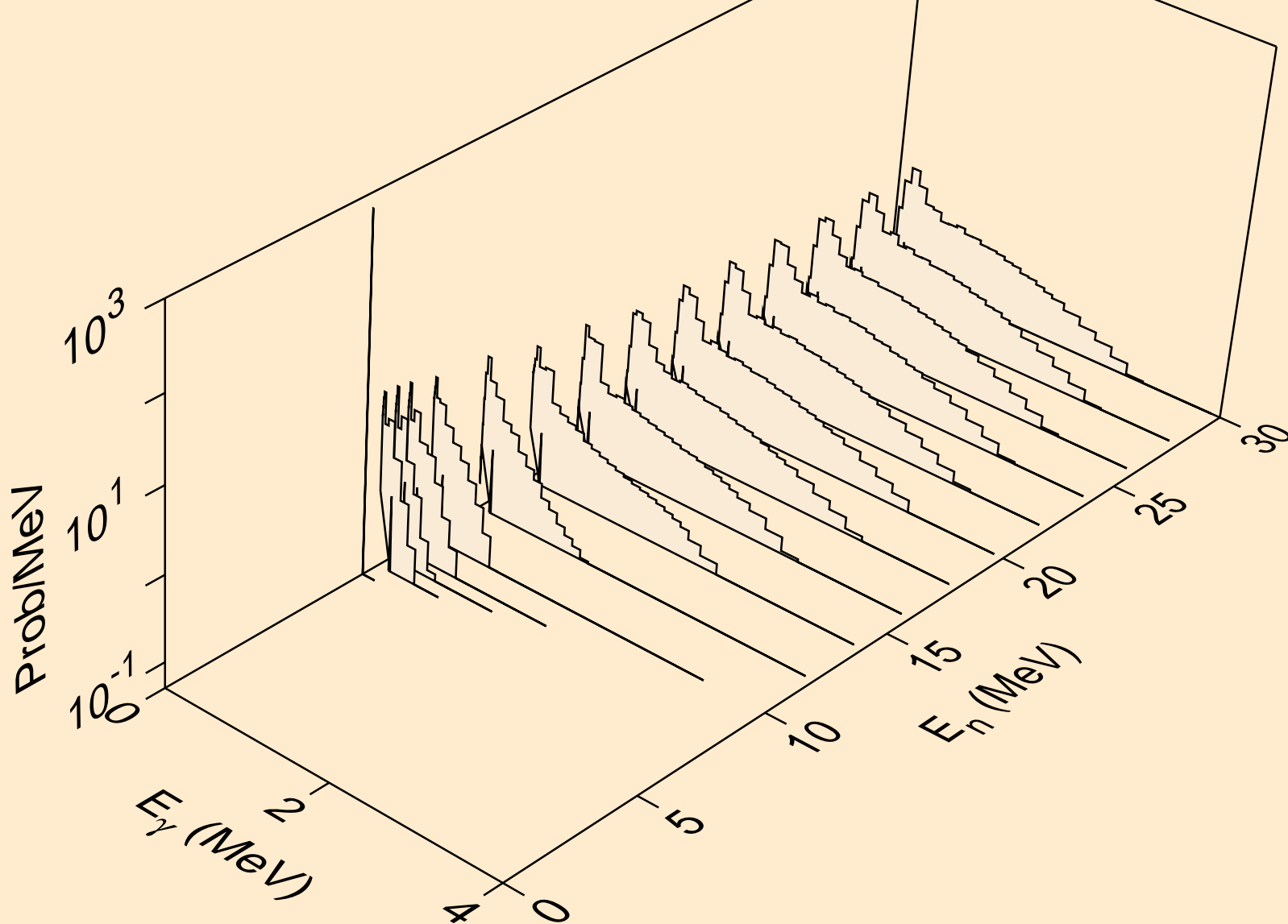

LU188 NEUTRON ACER TENDL-2023 LIBRARY; T=0.K  
Photon emission for (n,he3)

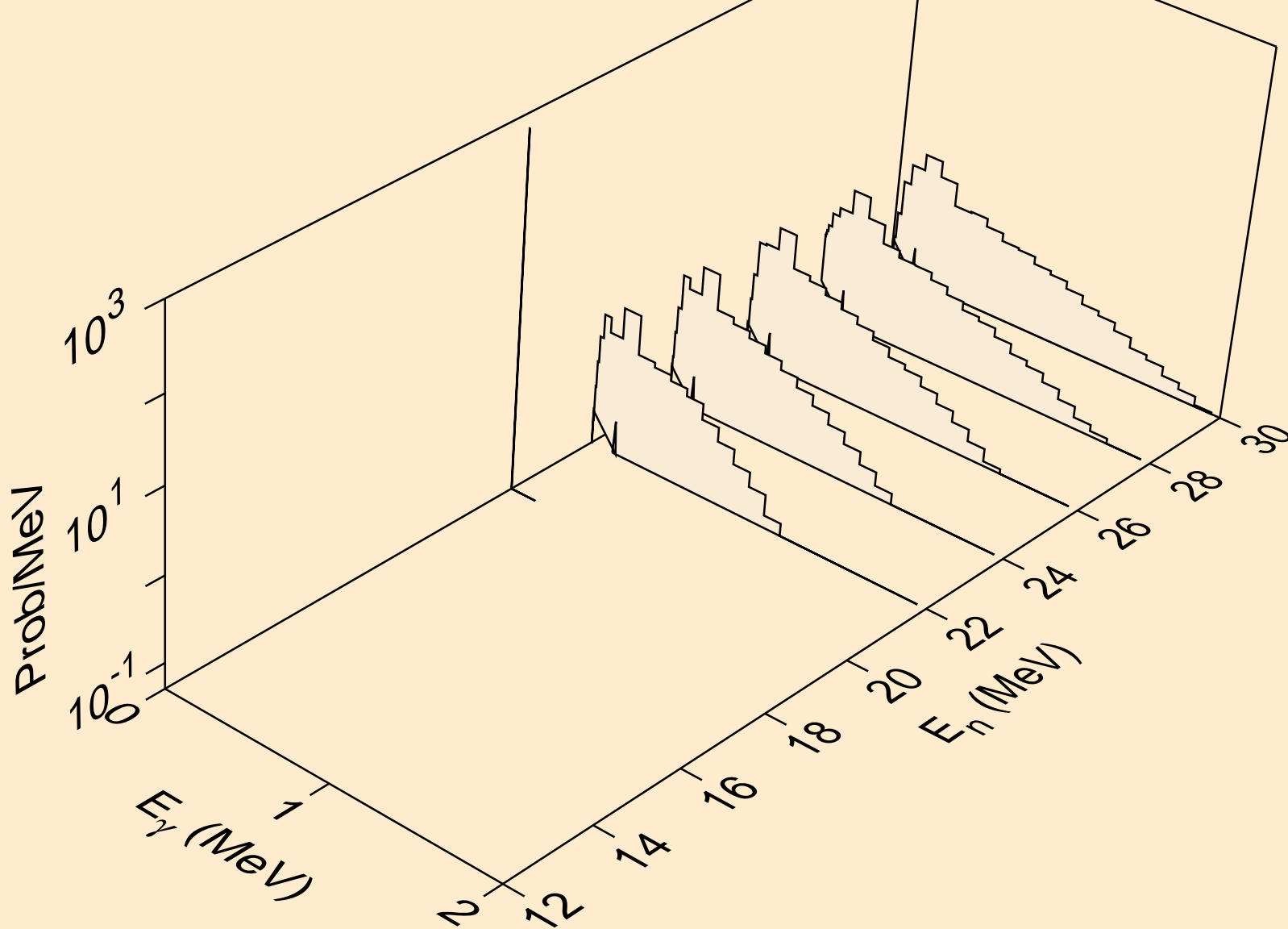

LU188 NEUTRON ACER TENDL-2023 LIBRARY; T=0.K  
Photon emission for (n,a)

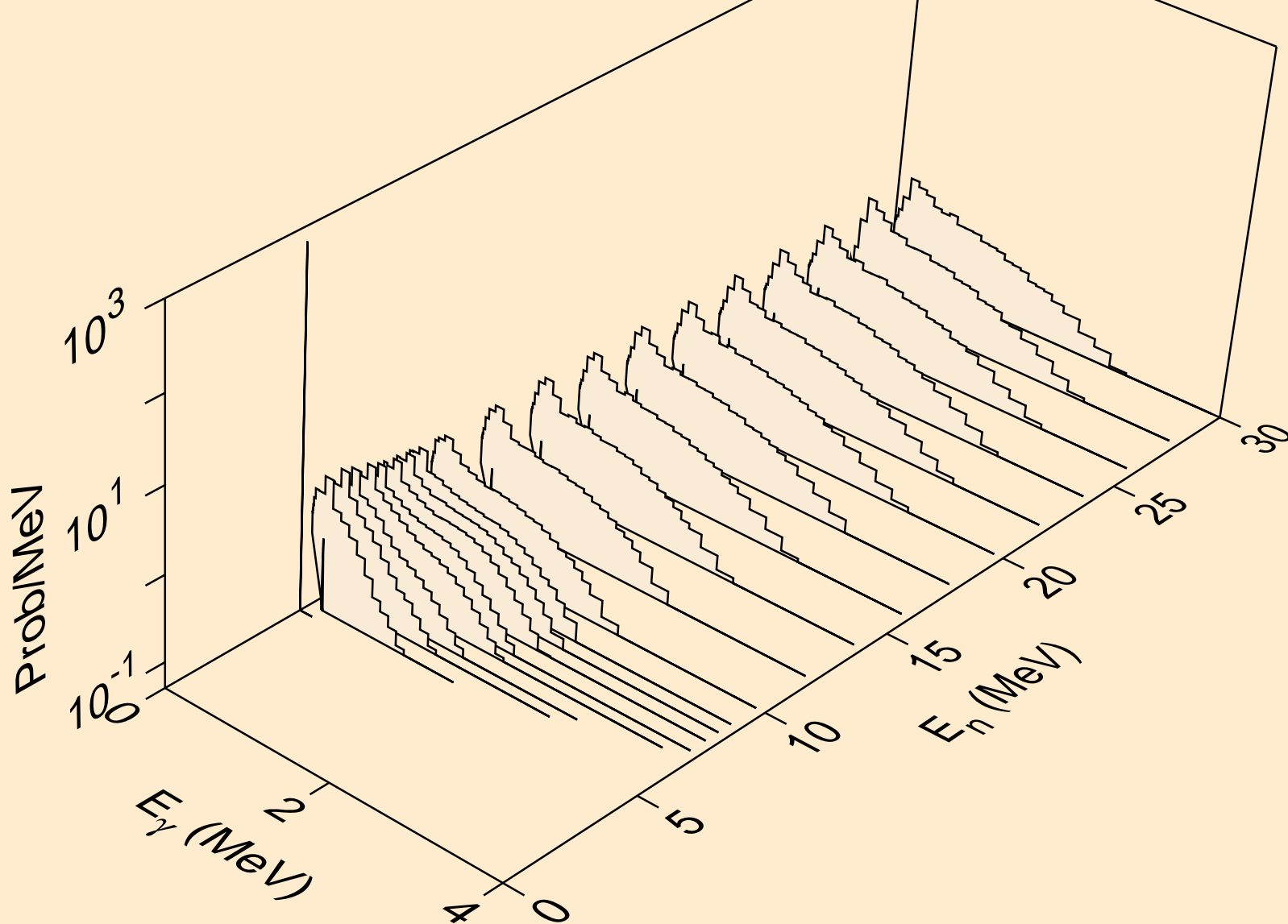

LU188 NEUTRON ACER TENDL-2023 LIBRARY; T=0.K  
thermal capture photon spectrum

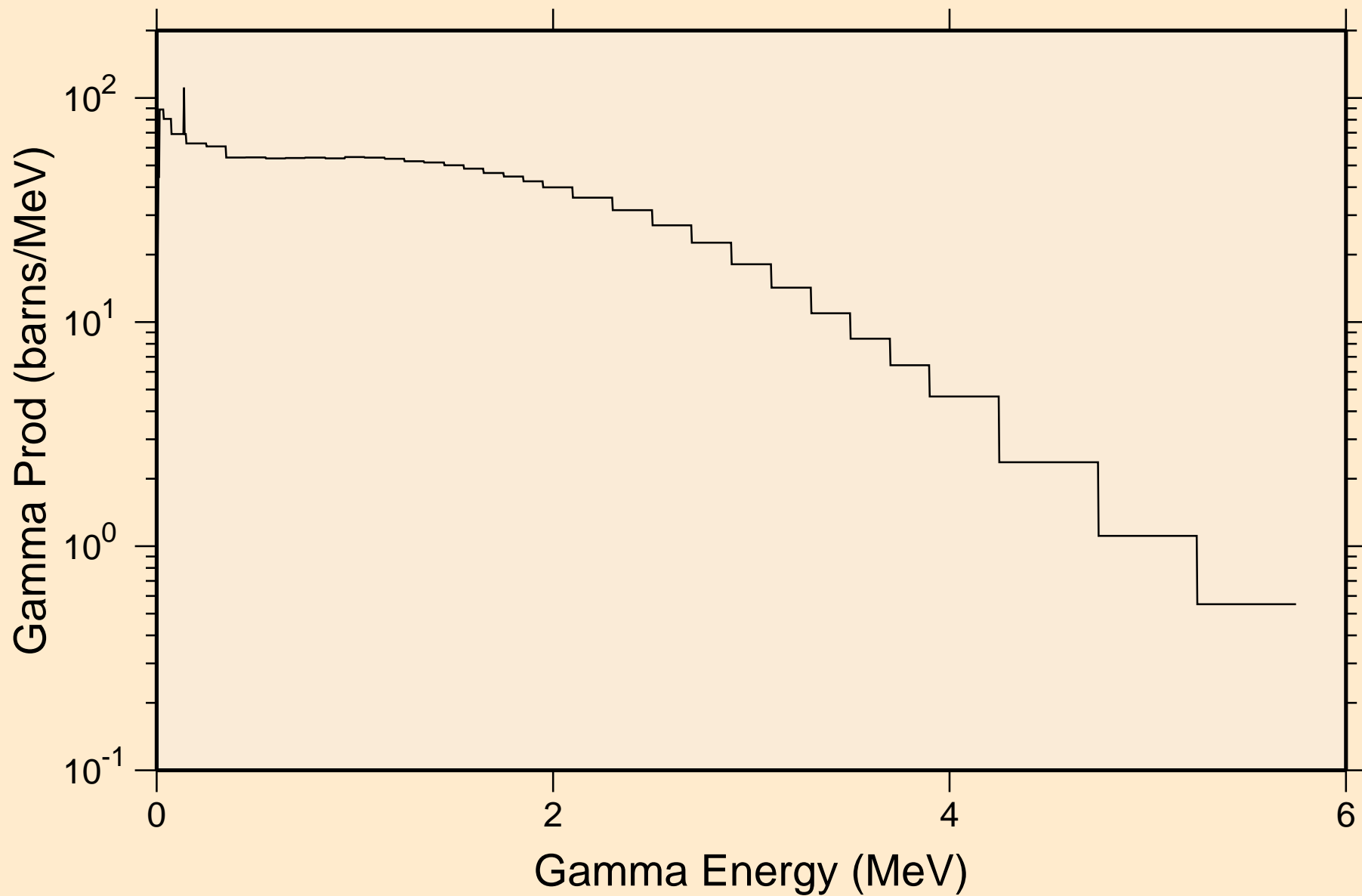

LU188 NEUTRON ACER TENDL-2023 LIBRARY; T=0.K  
14 MeV photon spectrum

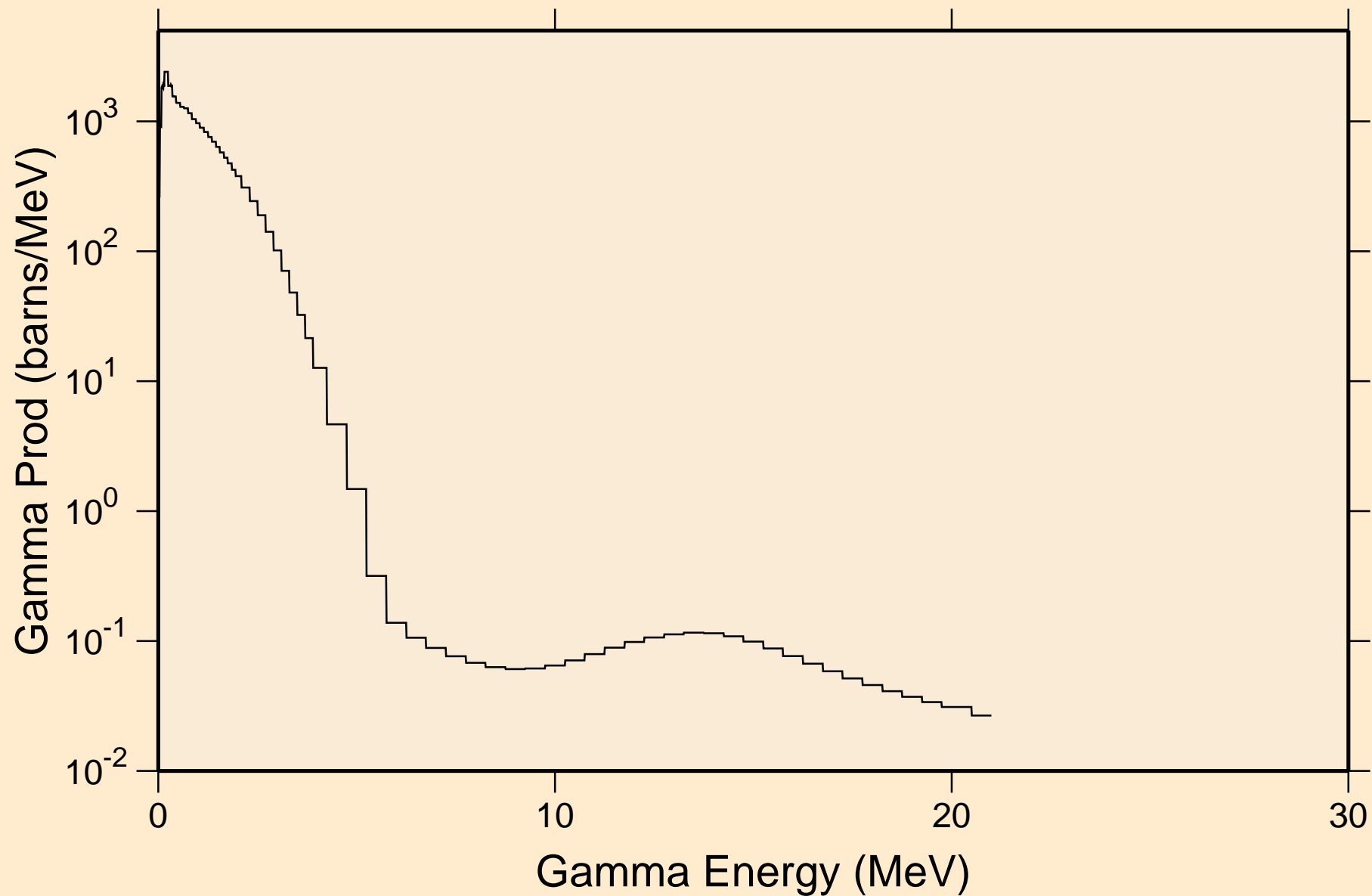



# LU188 NEUTRON ACER TENDL-2023 LIBRARY; T=0.K

## Particle heating contributions

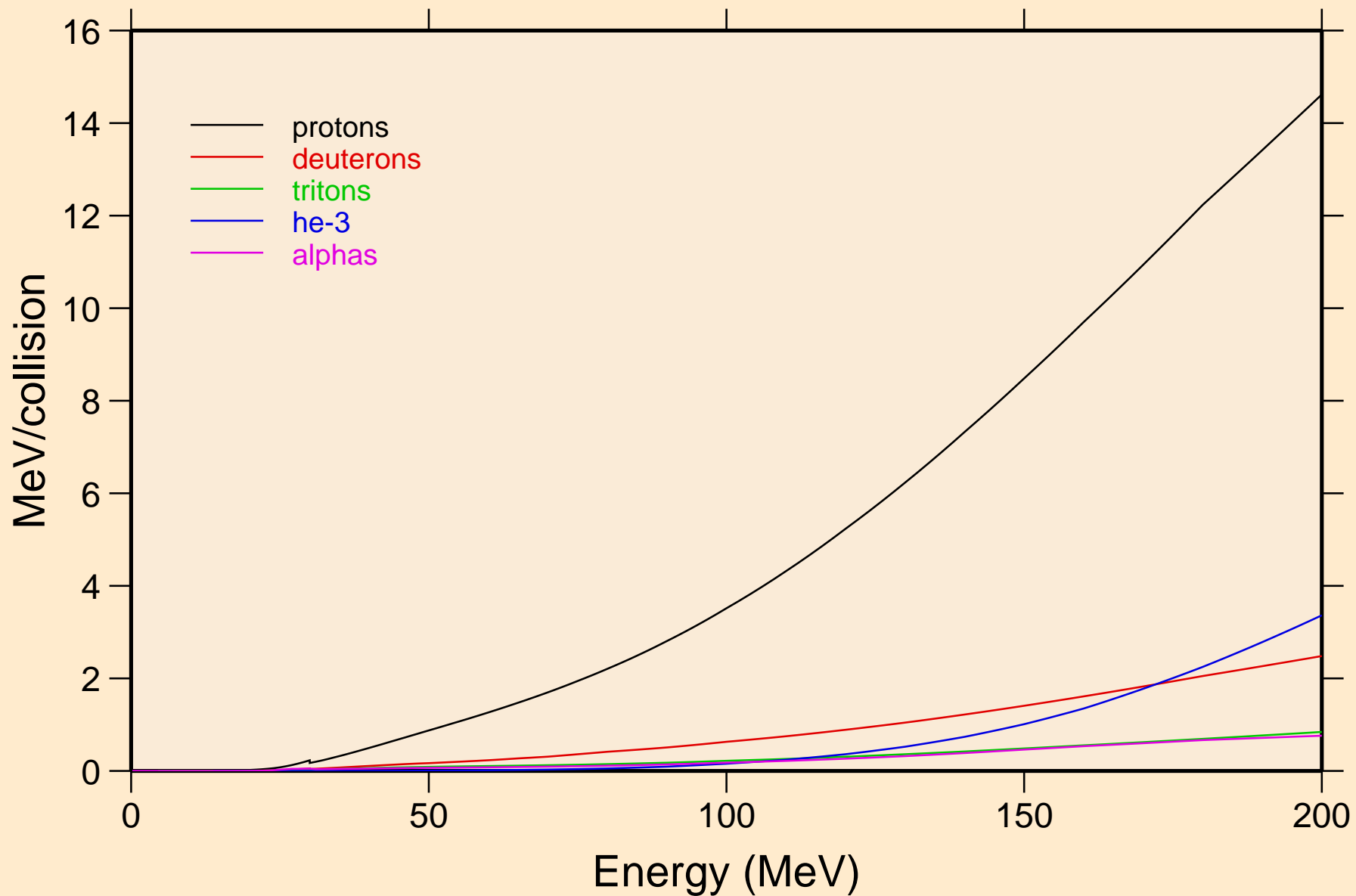

LU188 NEUTRON ACER TENDL-2023 LIBRARY; T=0.K  
Recoil Heating

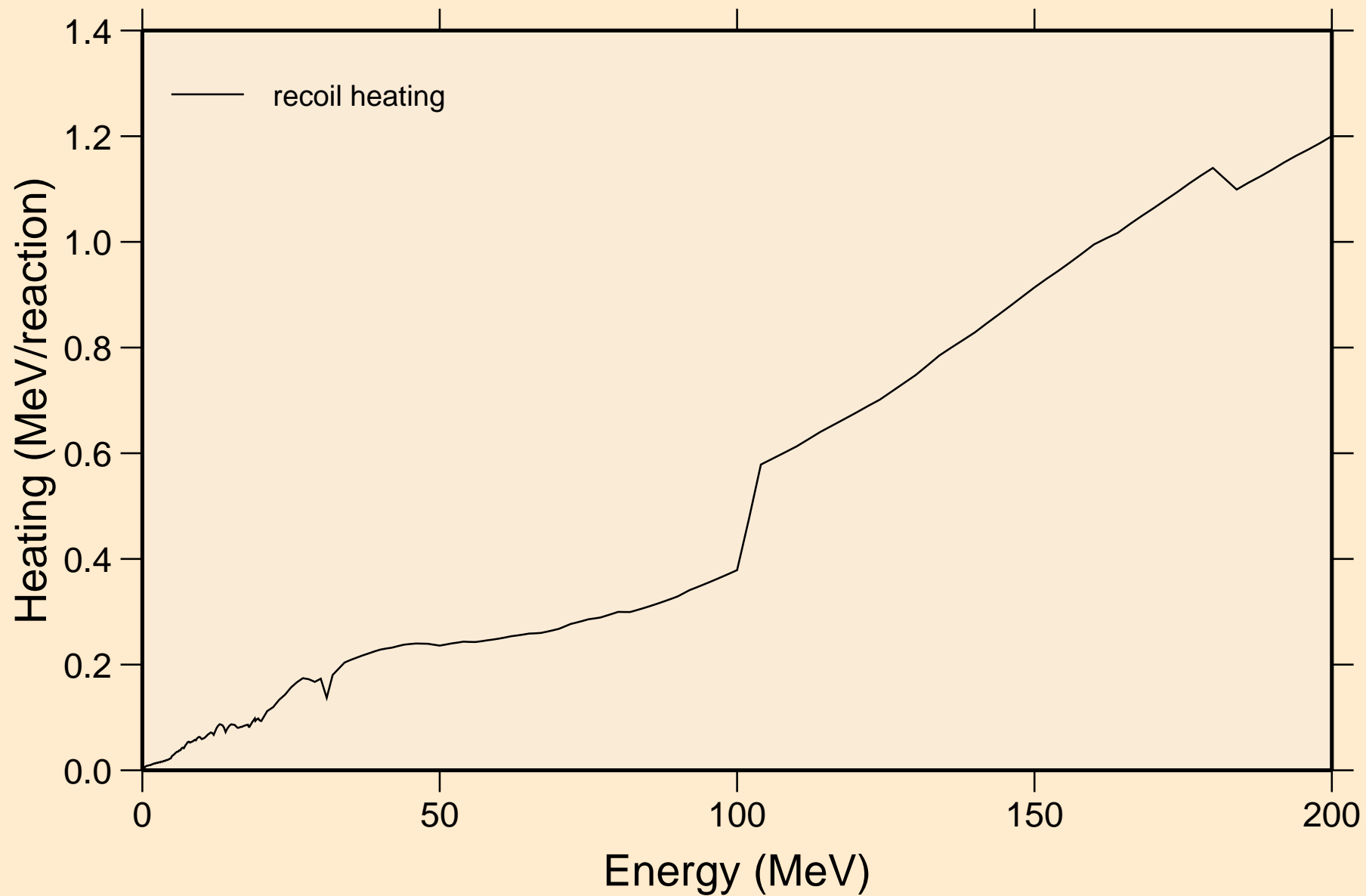

LU188 NEUTRON ACER TENDL-2023 LIBRARY; T=0.K  
Particle production cross sections

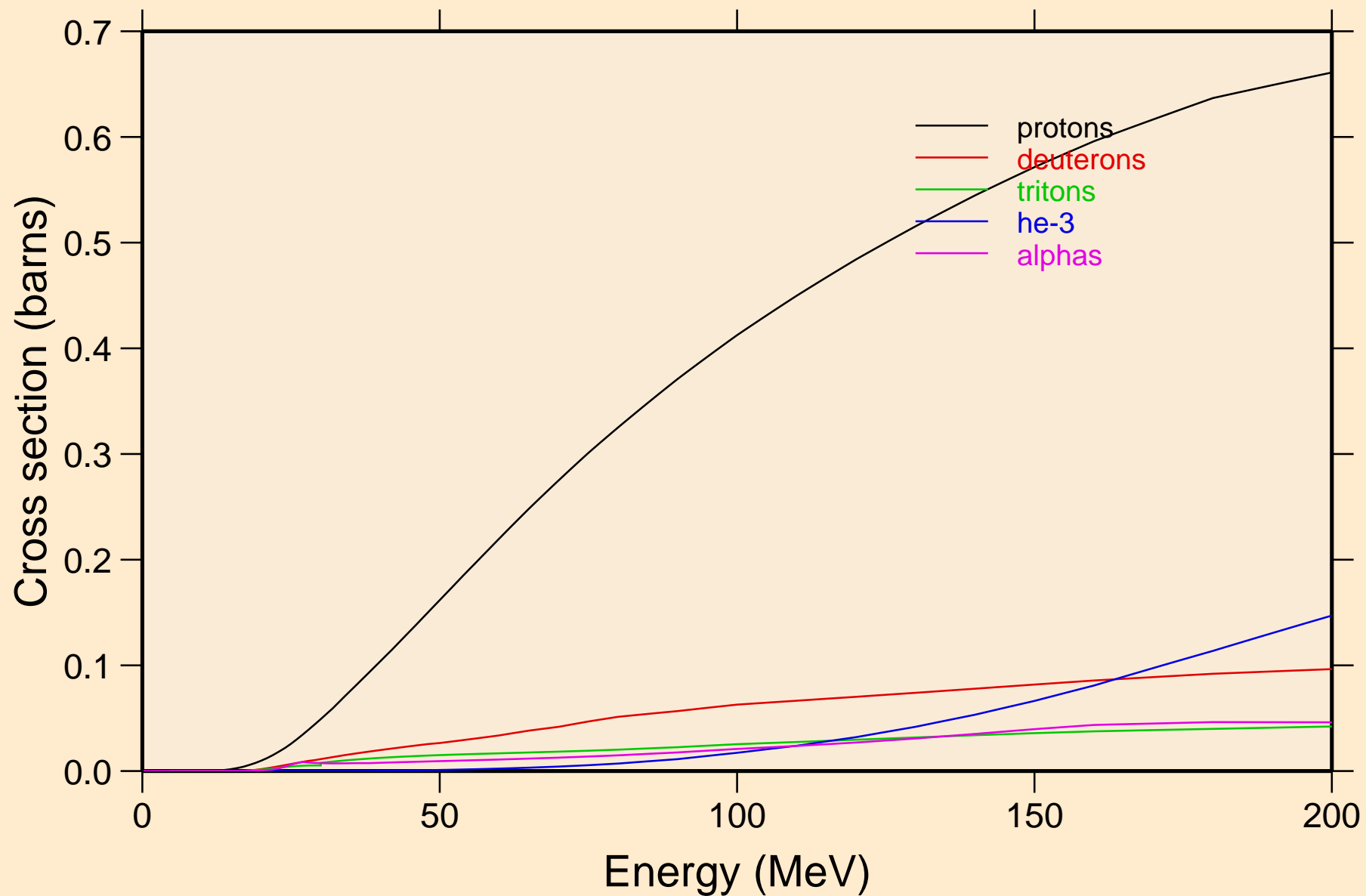

LU188 NEUTRON ACER TENDL-2023 LIBRARY; T=0.K  
protons from (n,x)

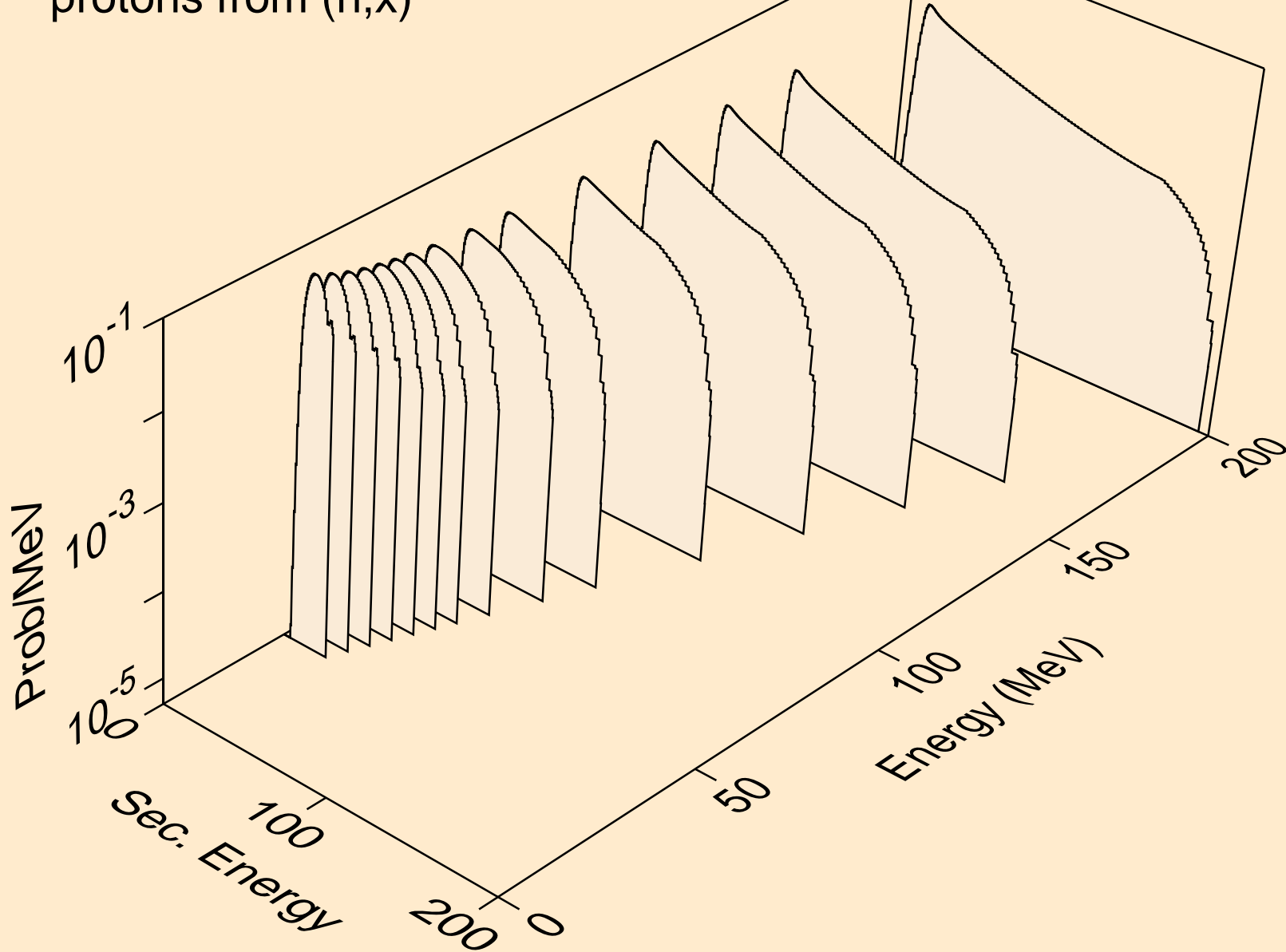

LU188 NEUTRON ACER TENDL-2023 LIBRARY; T=0.K  
protons from (n,n\*)p

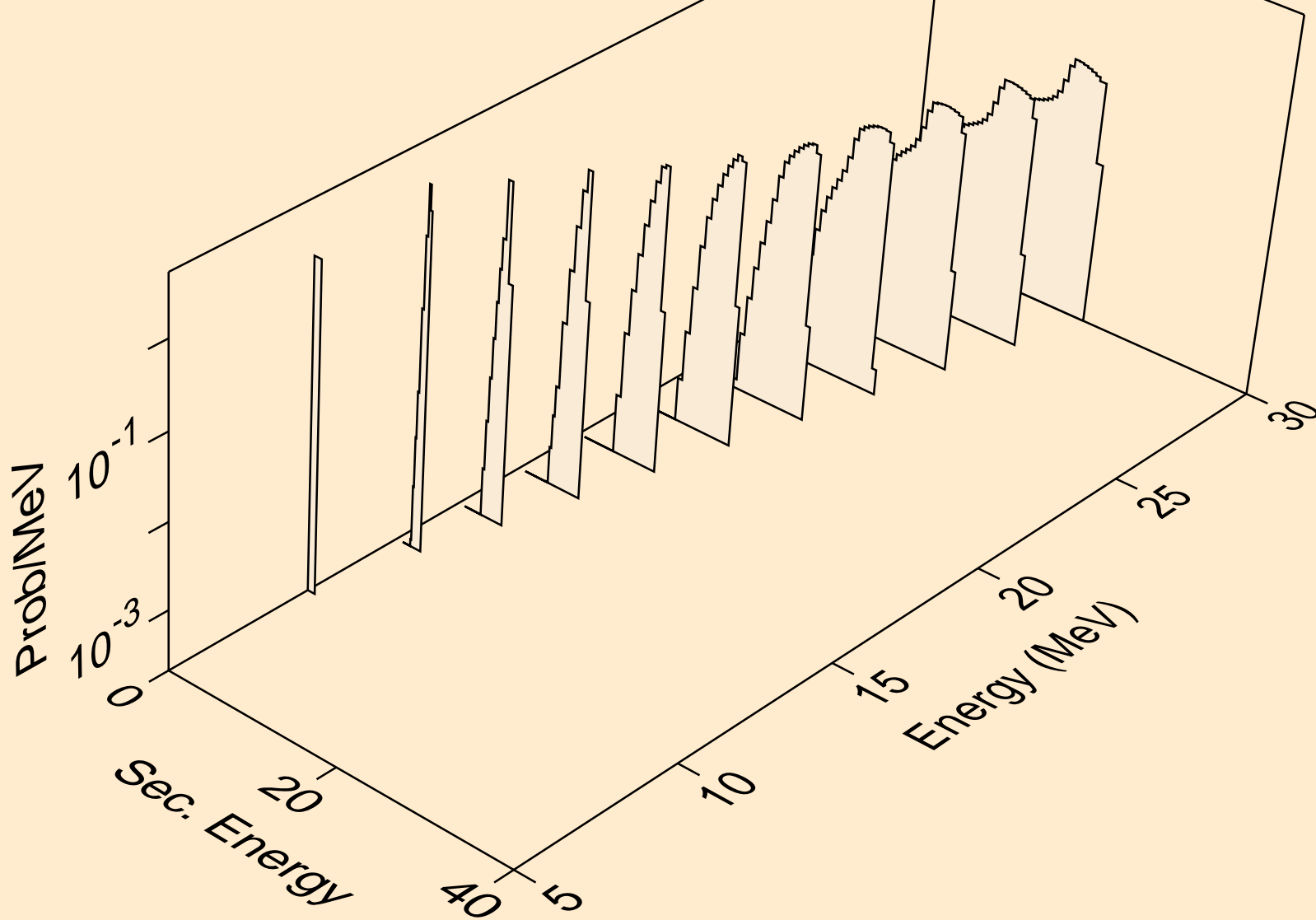

LU188 NEUTRON ACER TENDL-2023 LIBRARY; T=0.K  
protons from (n,2np)

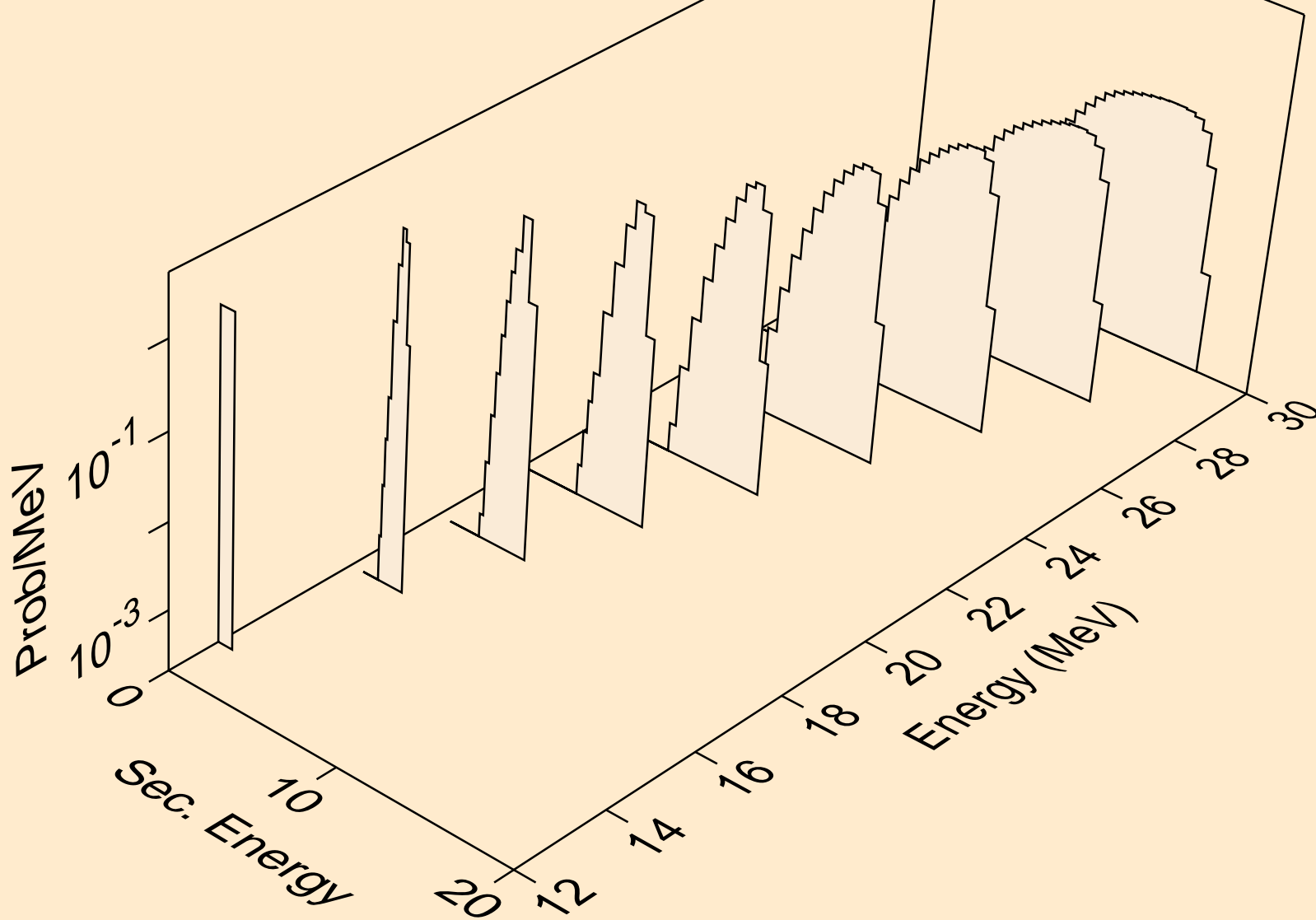

LU188 NEUTRON ACER TENDL-2023 LIBRARY; T=0.K  
protons from (n,3np)

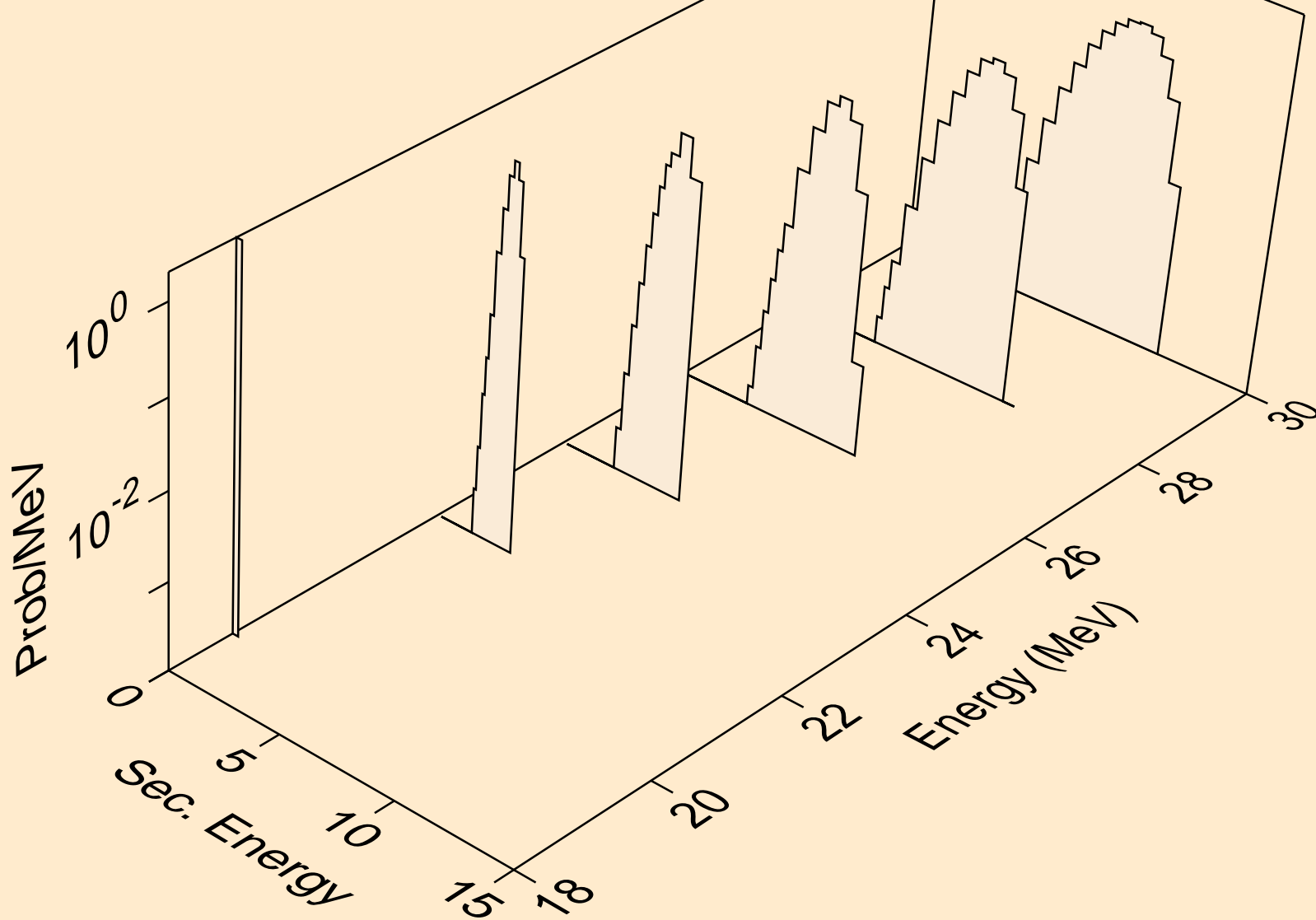

LU188 NEUTRON ACER TENDL-2023 LIBRARY; T=0.K  
protons from (n,p)

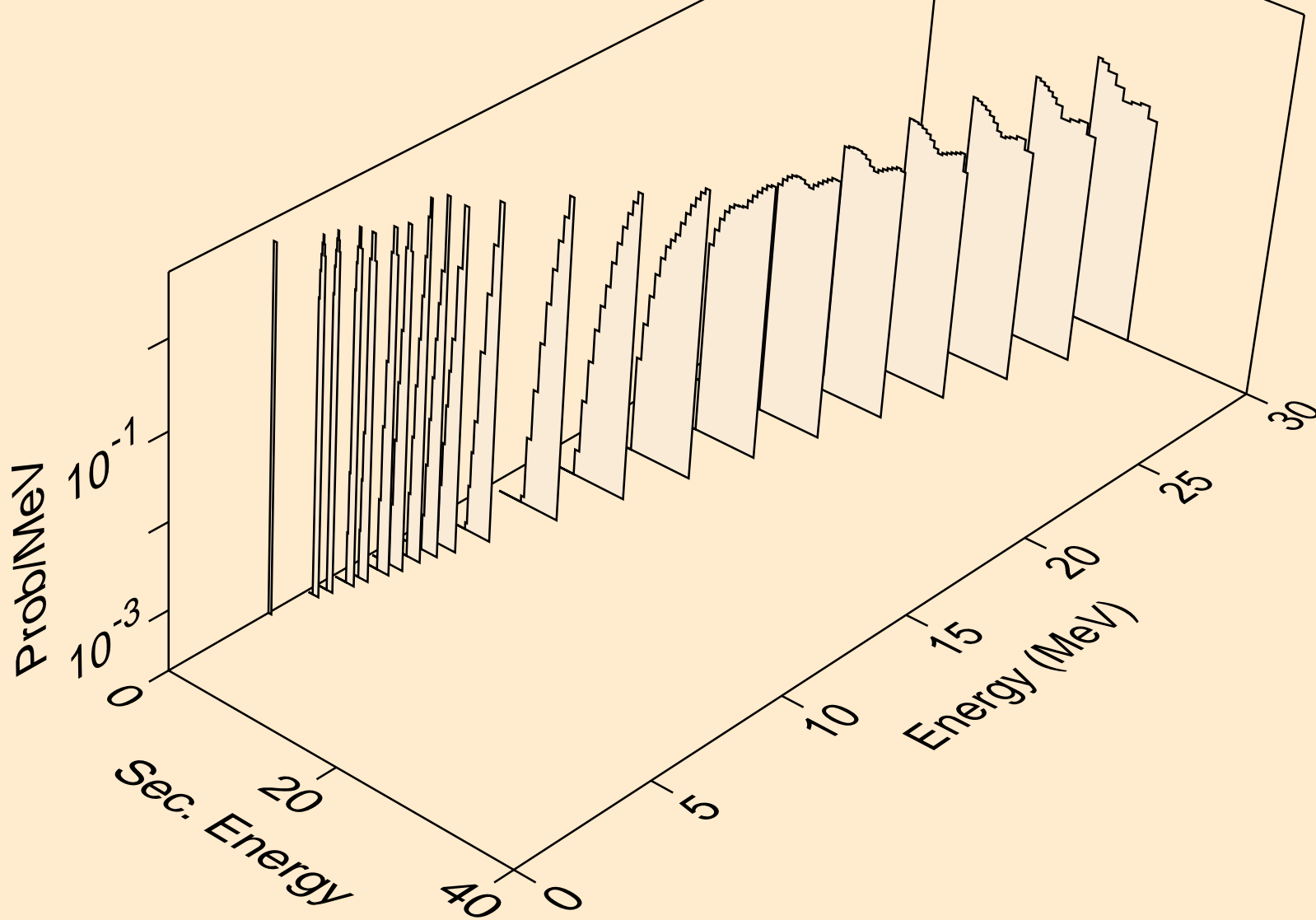



LU188 NEUTRON ACER TENDL-2023 LIBRARY; T=0.K  
deuterons from (n,x)

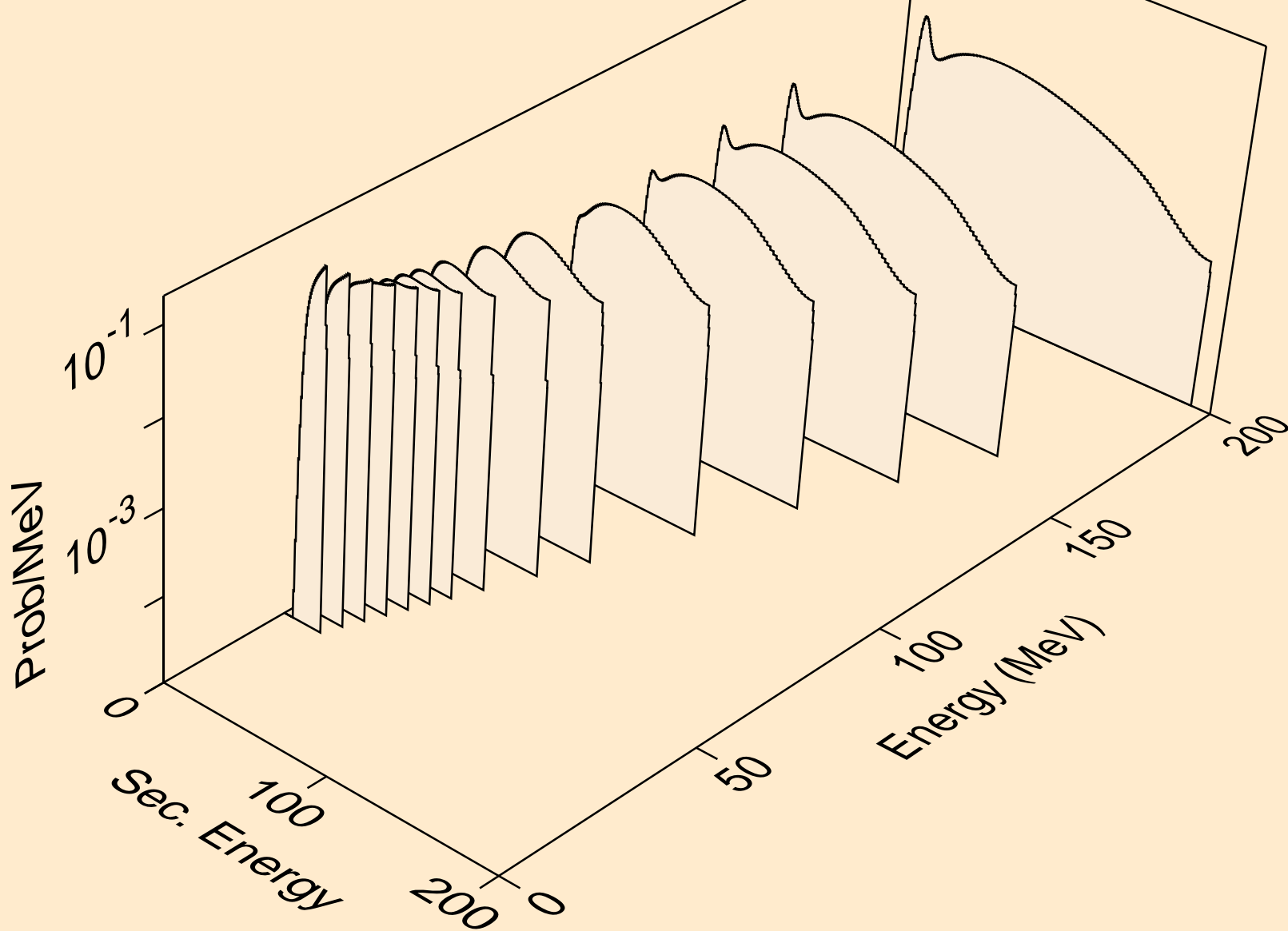

LU188 NEUTRON ACER TENDL-2023 LIBRARY; T=0.K  
deuterons from (n,2nd)

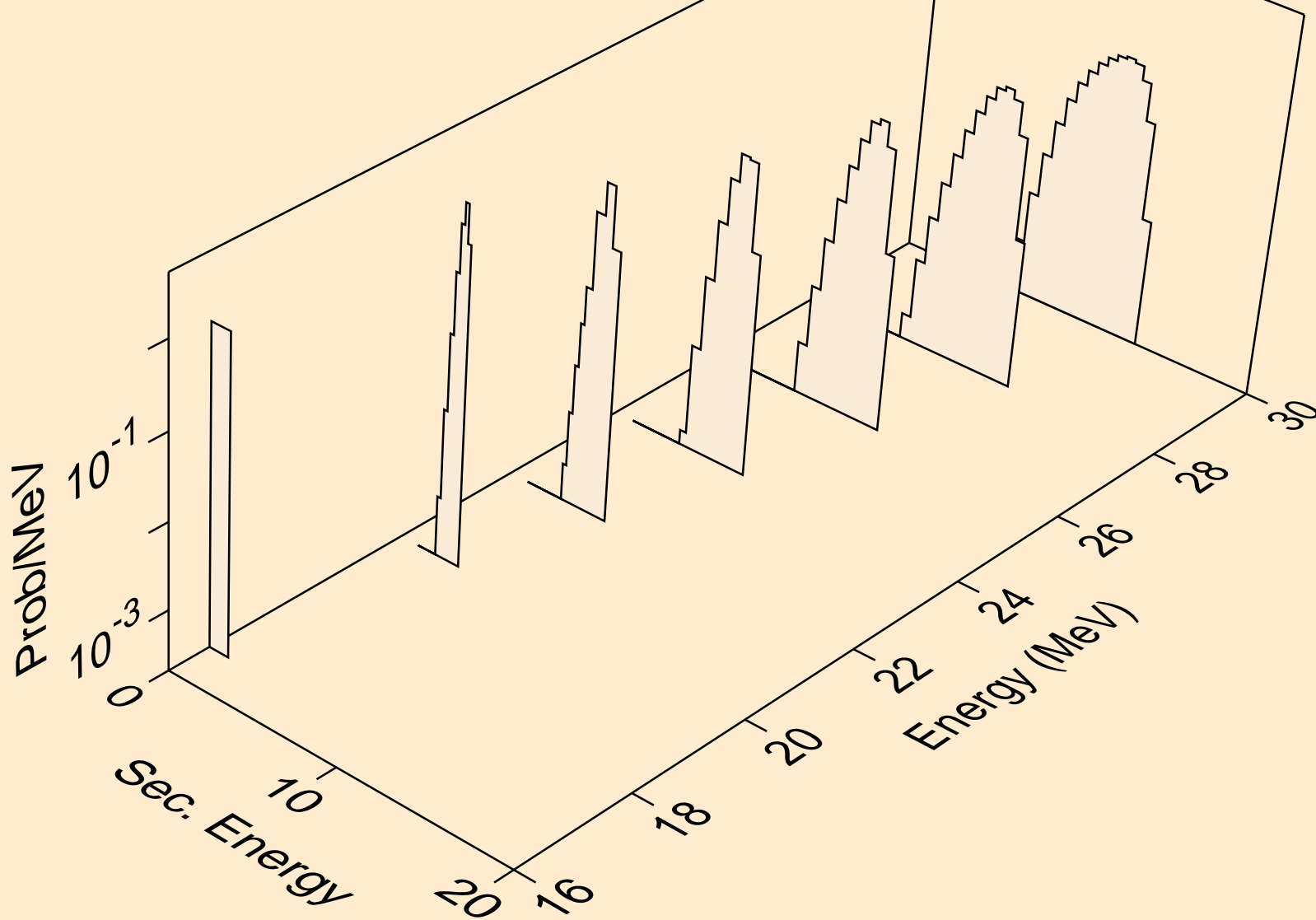

LU188 NEUTRON ACER TENDL-2023 LIBRARY; T=0.K  
deuterons from (n,n\*)d

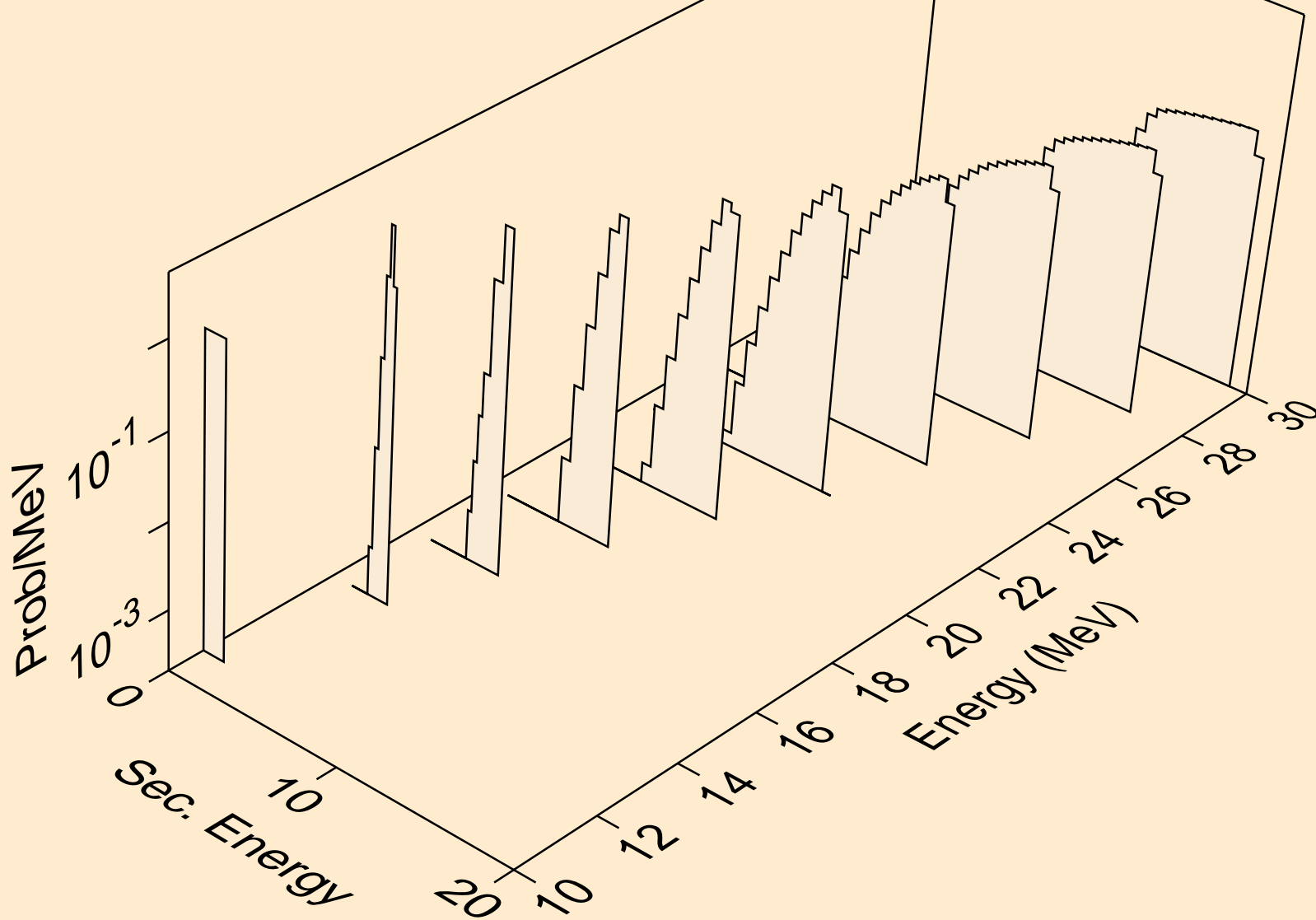

LU188 NEUTRON ACER TENDL-2023 LIBRARY; T=0.K  
deuterons from (n,d)

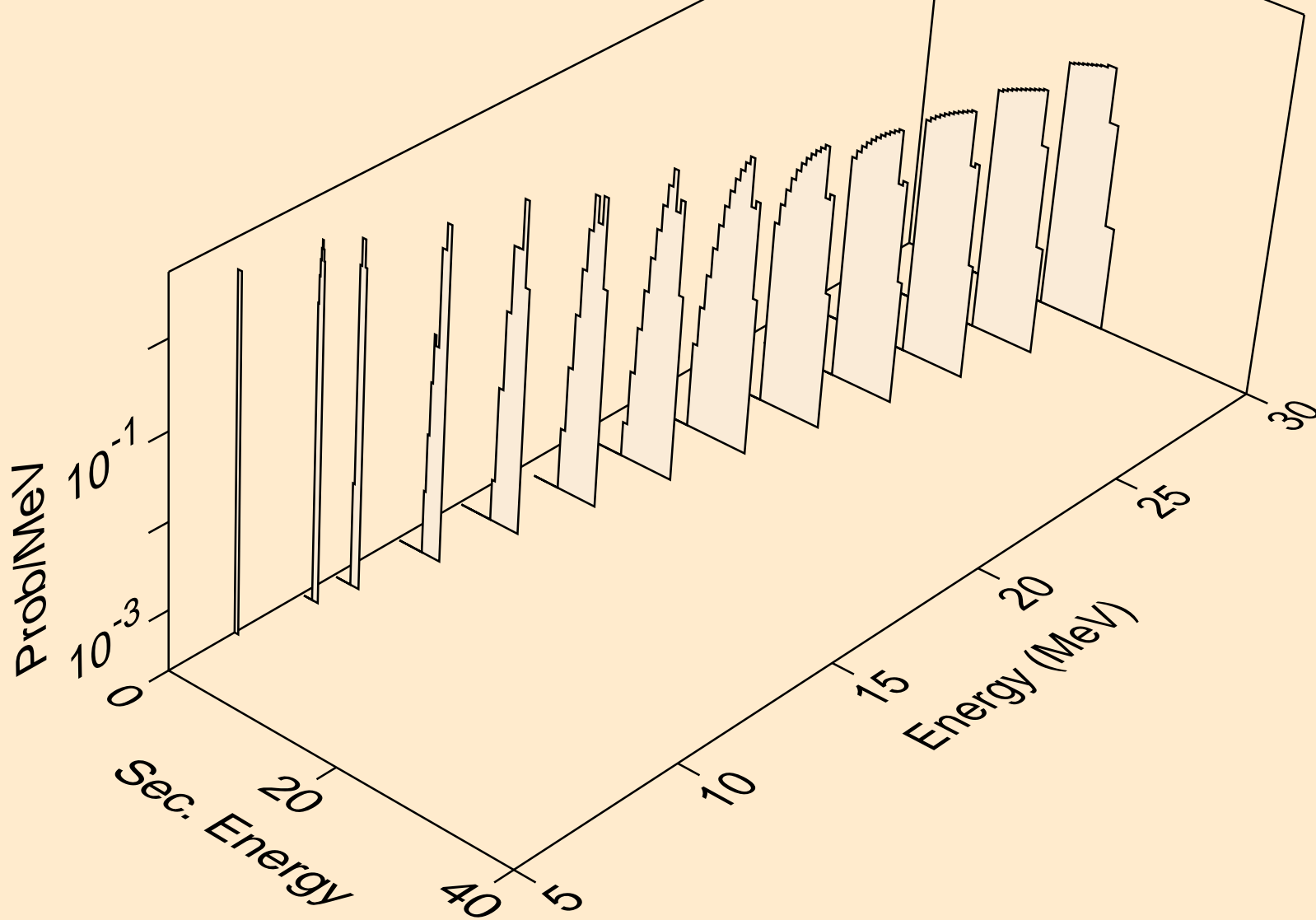

LU188 NEUTRON ACER TENDL-2023 LIBRARY; T=0.K  
tritons from (n,x)

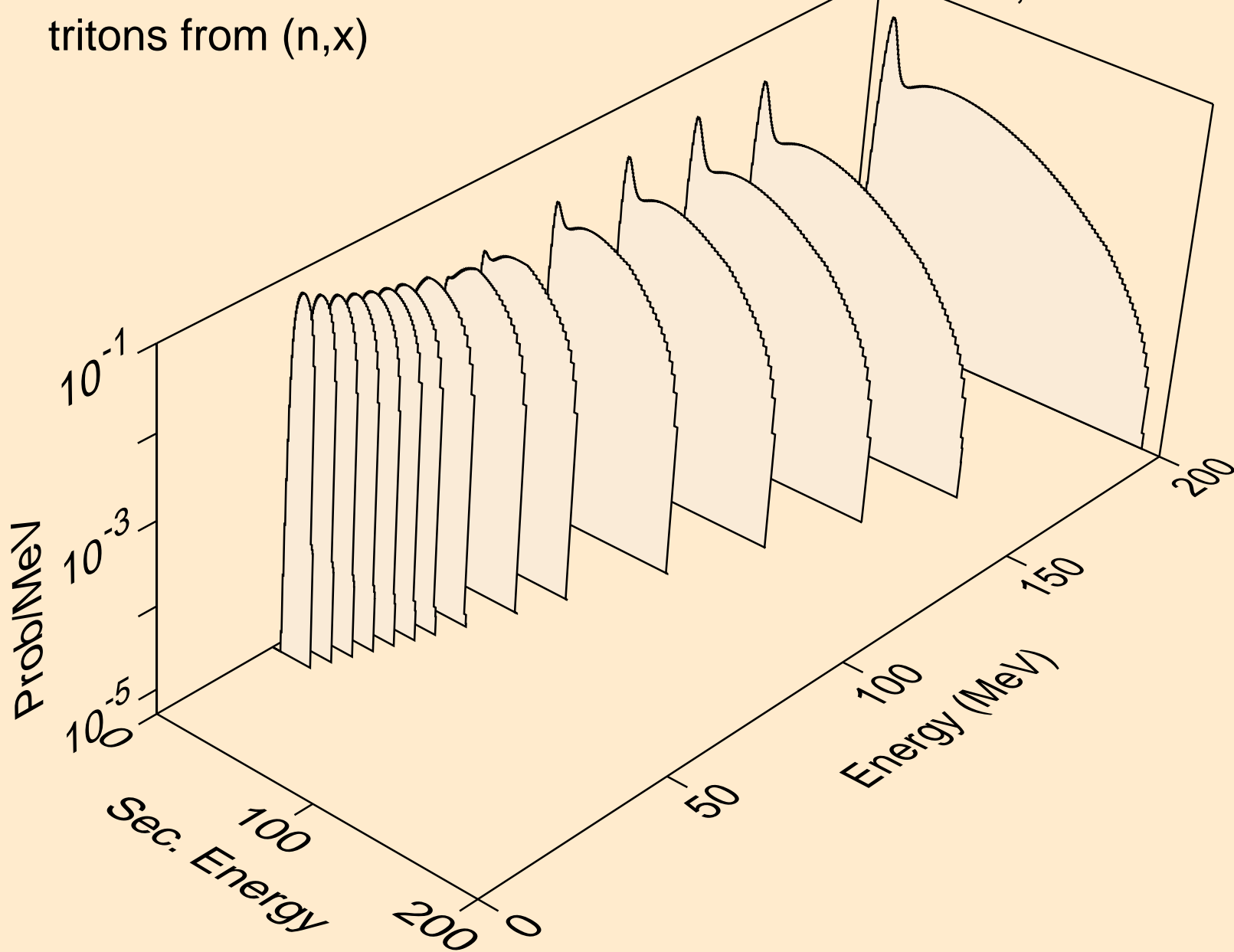

LU188 NEUTRON ACER TENDL-2023 LIBRARY; T=0.K  
tritons from (n,n\*)t

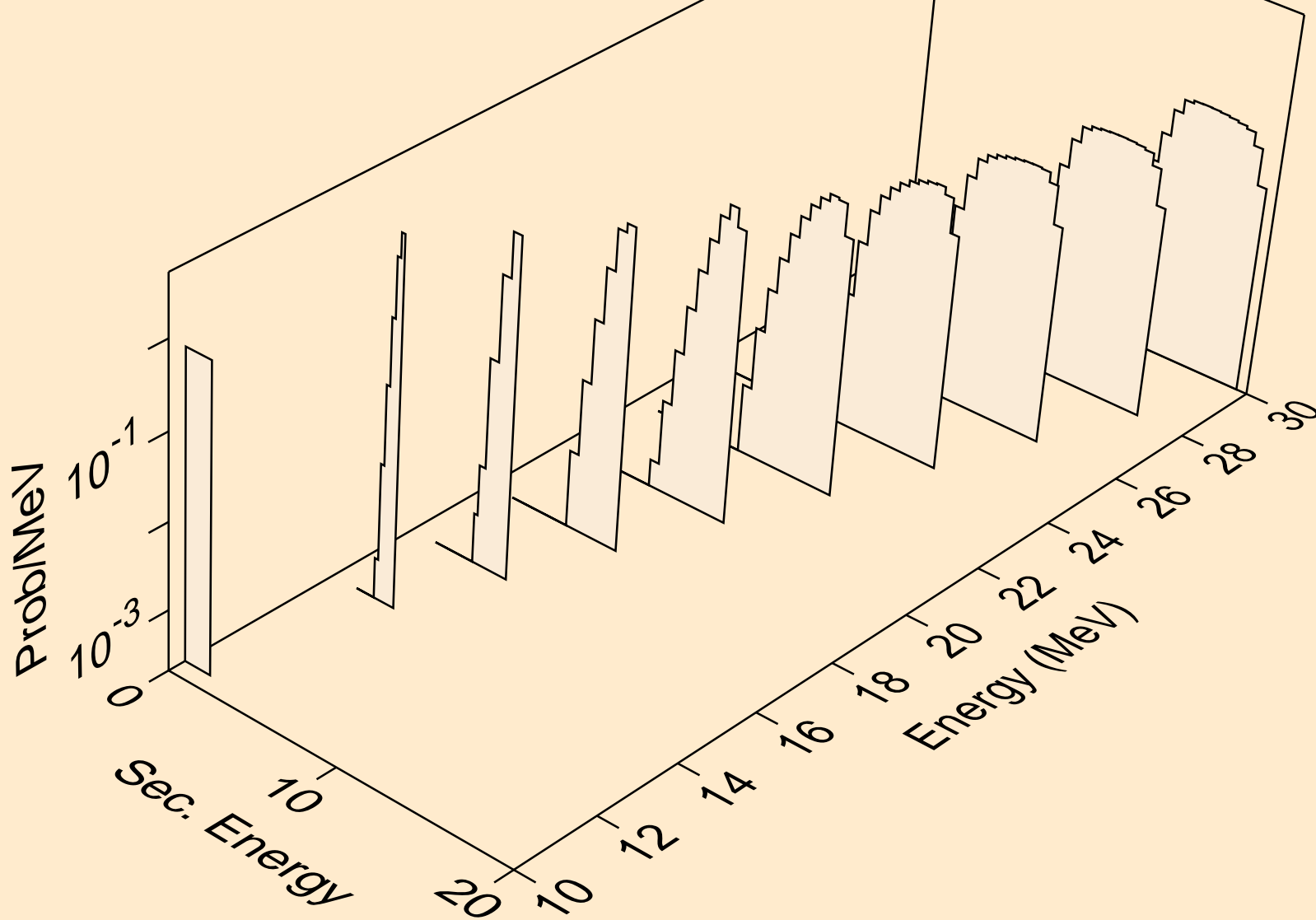

LU188 NEUTRON ACER TENDL-2023 LIBRARY; T=0.K  
tritons from (n,t)

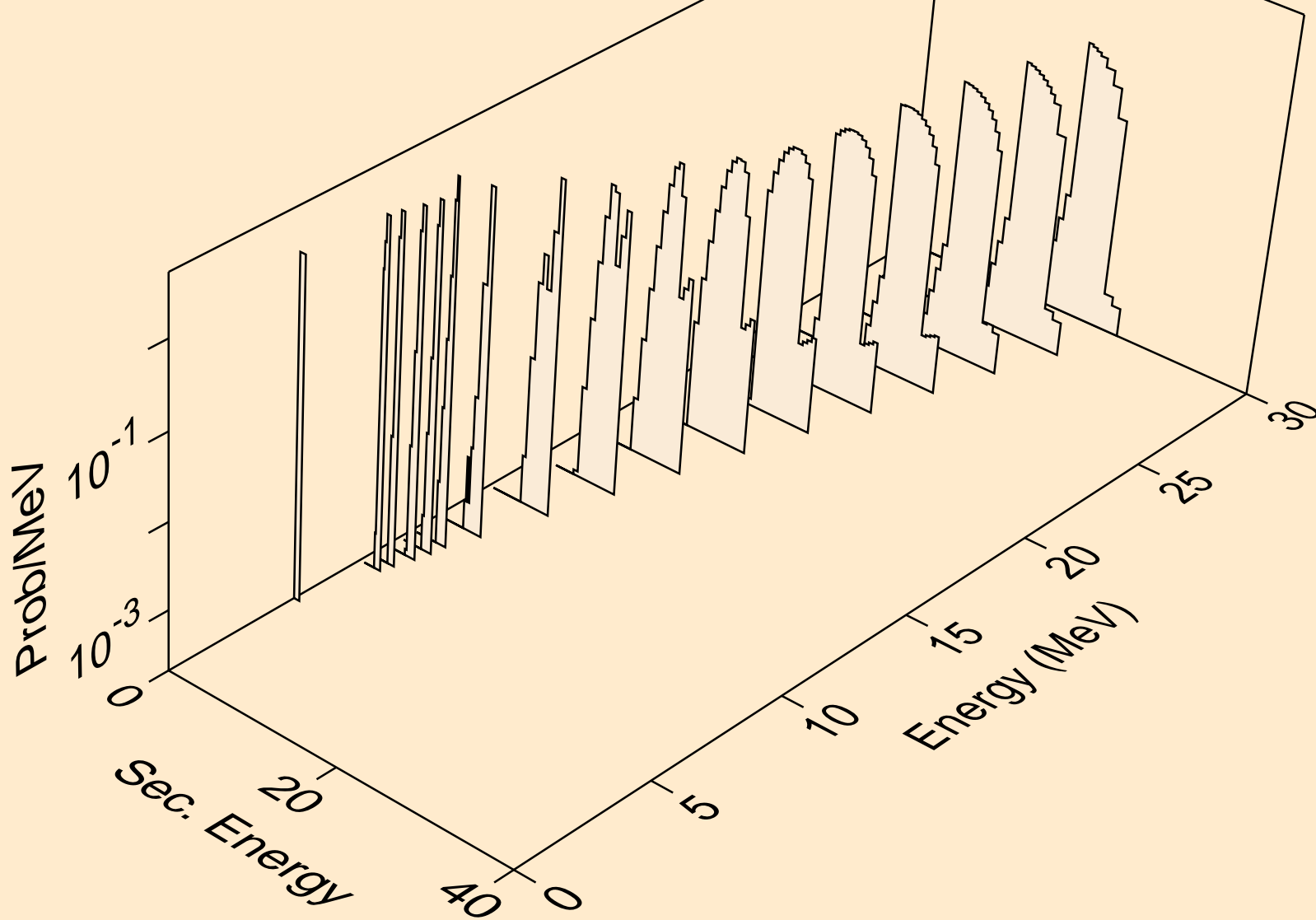

LU188 NEUTRON ACER TENDL-2023 LIBRARY; T=0.K  
he3s from (n,x)

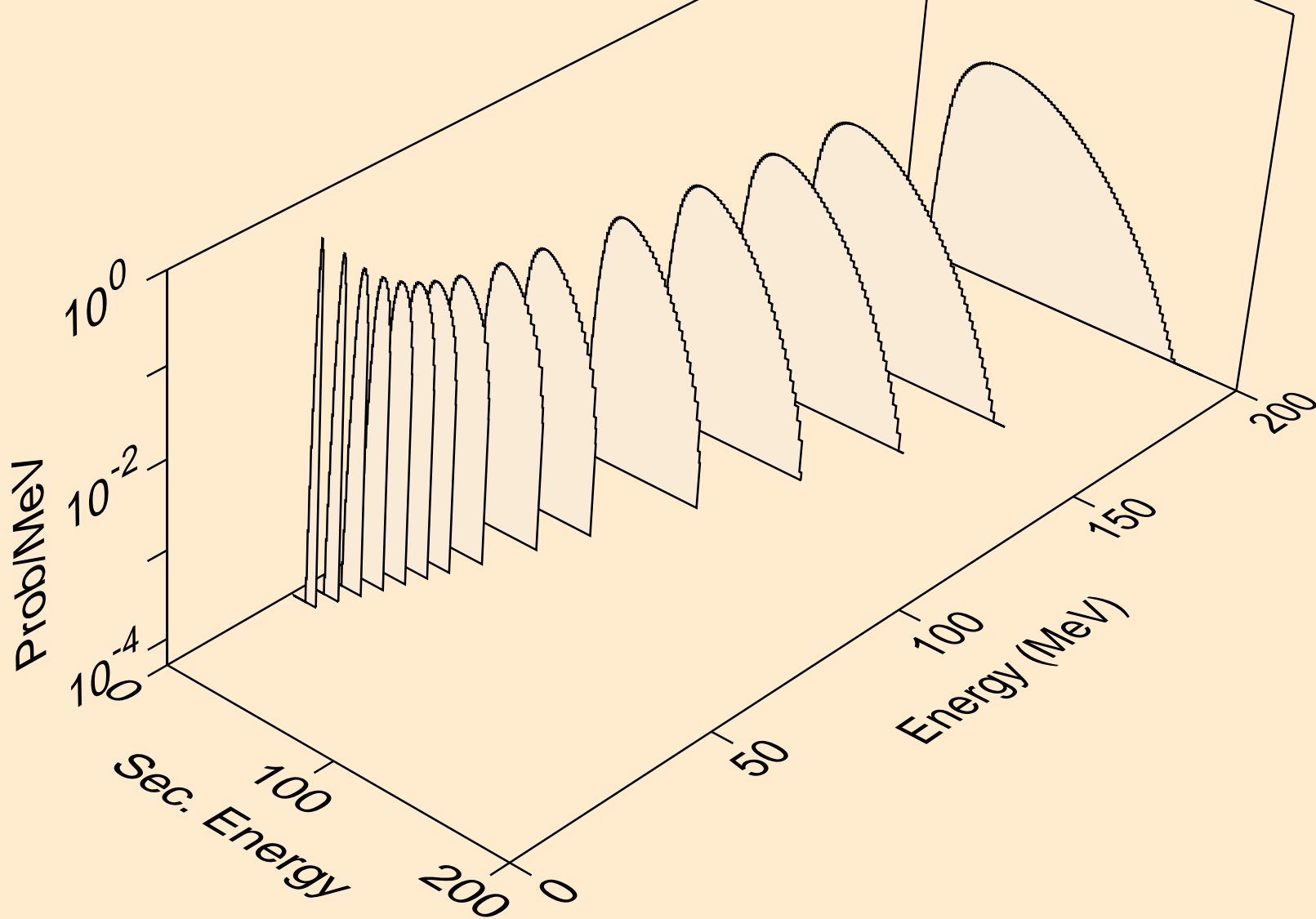



LU188 NEUTRON ACER TENDL-2023 LIBRARY; T=0.K  
he3s from (n,n\*)he3

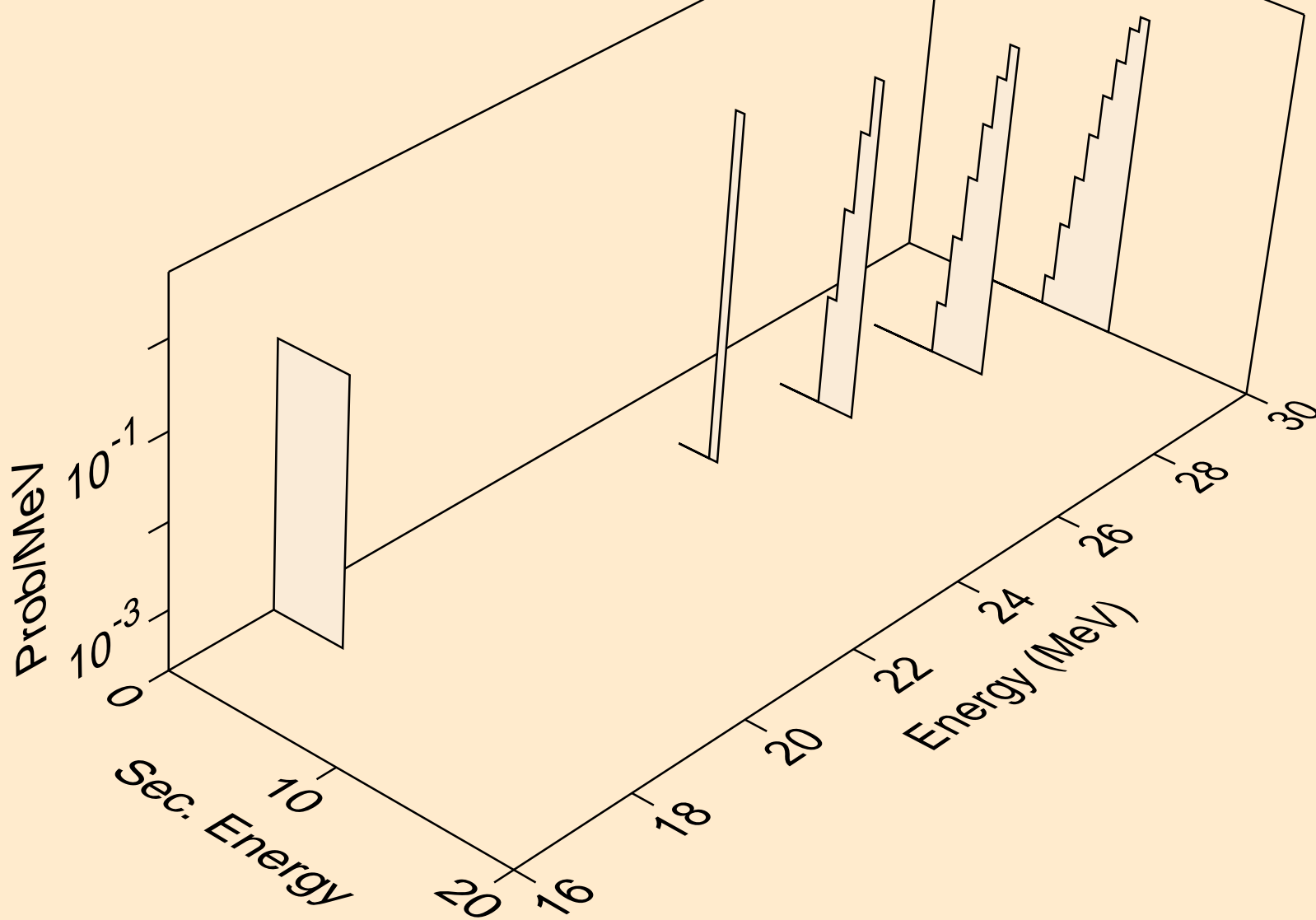

LU188 NEUTRON ACER TENDL-2023 LIBRARY; T=0.K  
he3s from (n,he3)

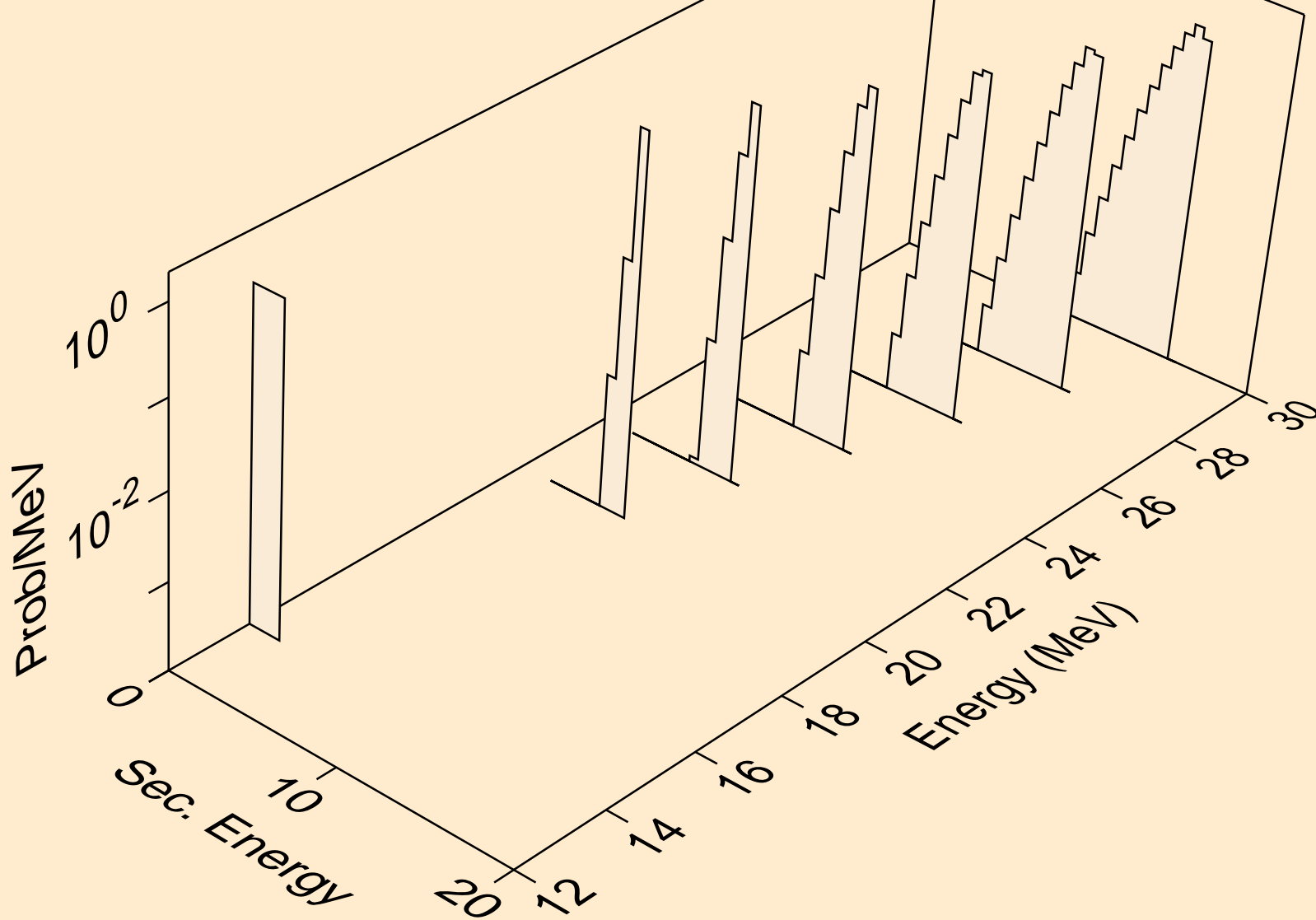

LU188 NEUTRON ACER TENDL-2023 LIBRARY; T=0.K  
alphas from (n,x)

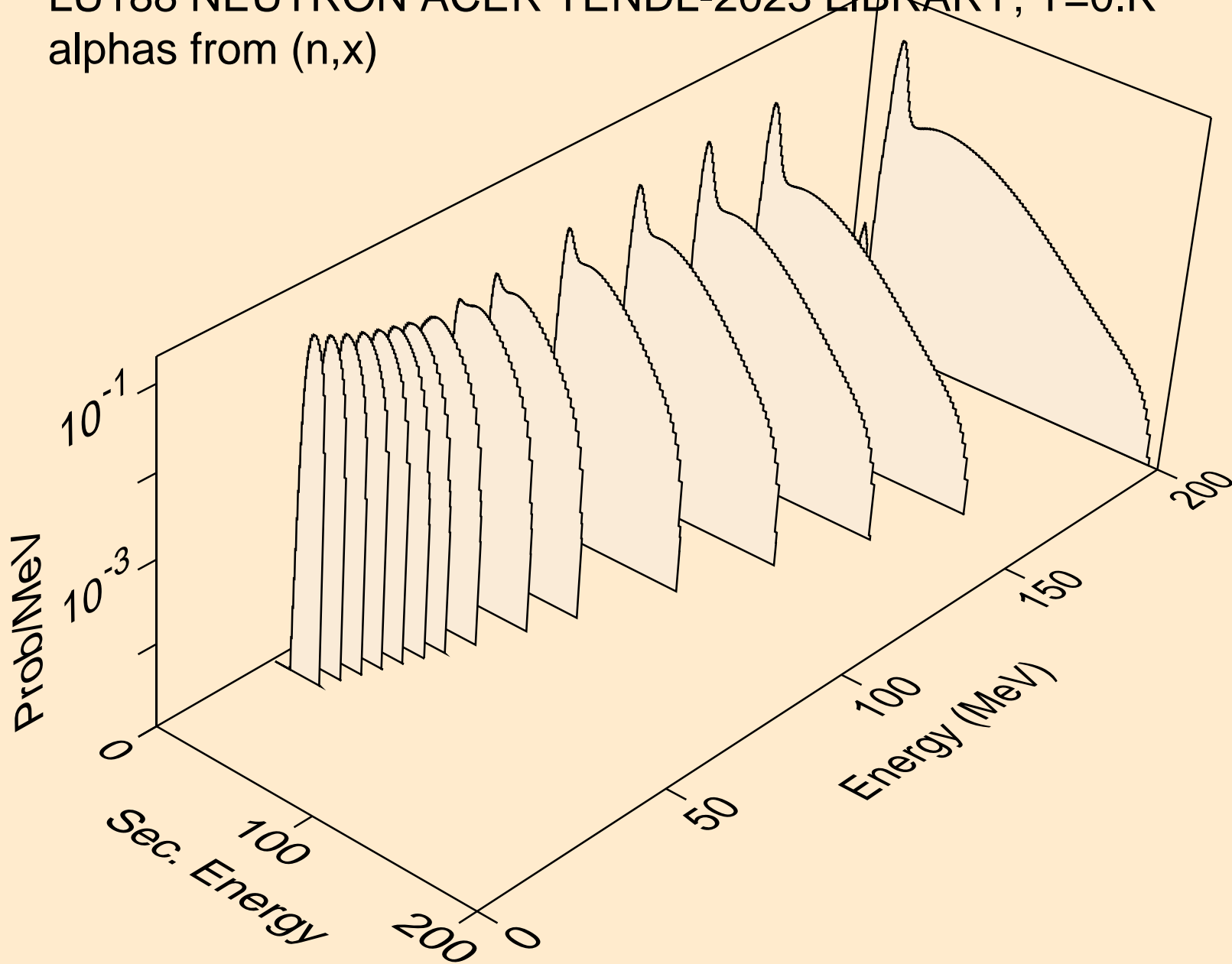

LU188 NEUTRON ACER TENDL-2023 LIBRARY; T=0.K  
alphas from (n,n\*)a

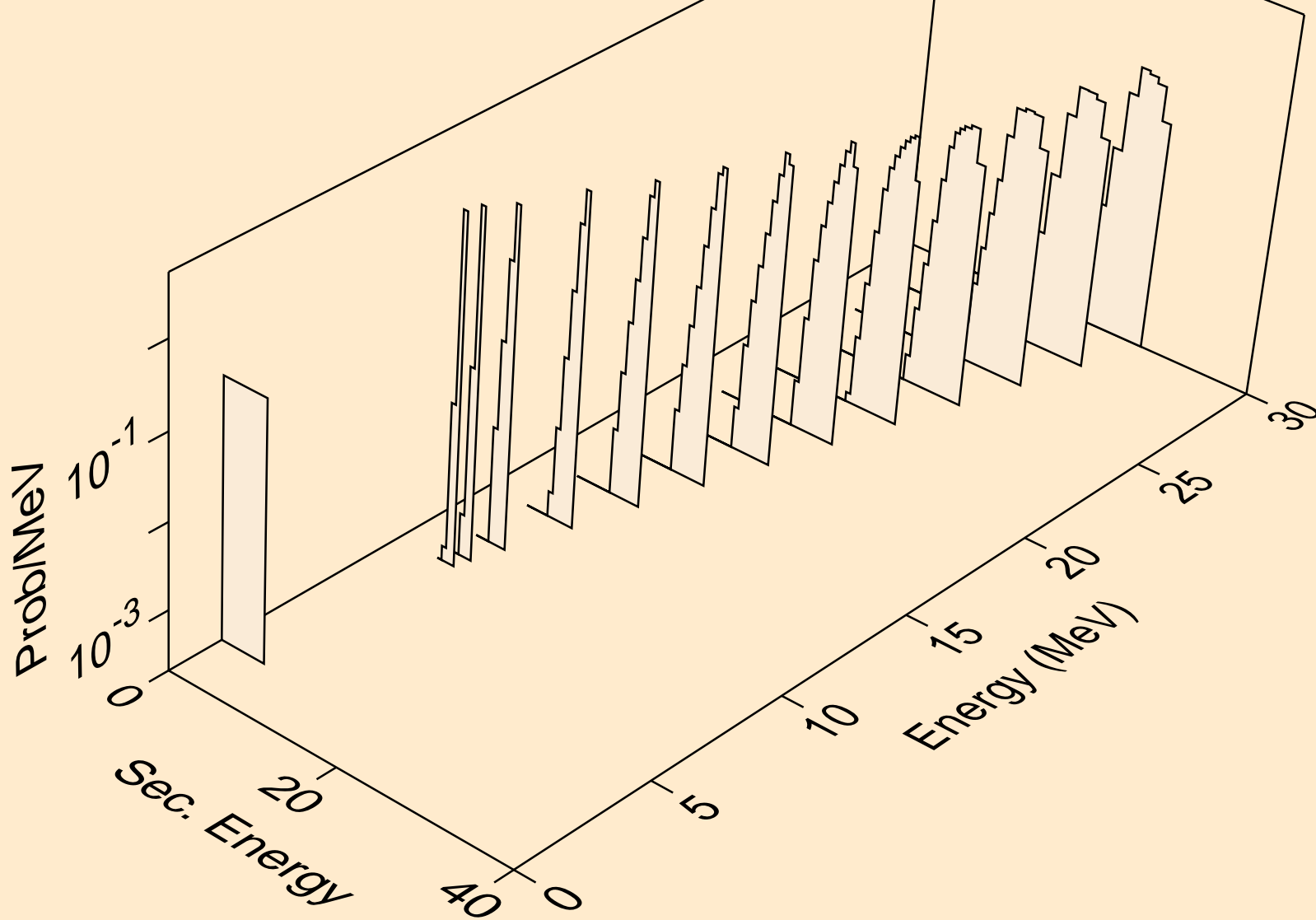

LU188 NEUTRON ACER TENDL-2023 LIBRARY; T=0.K  
alphas from (n,2n)a

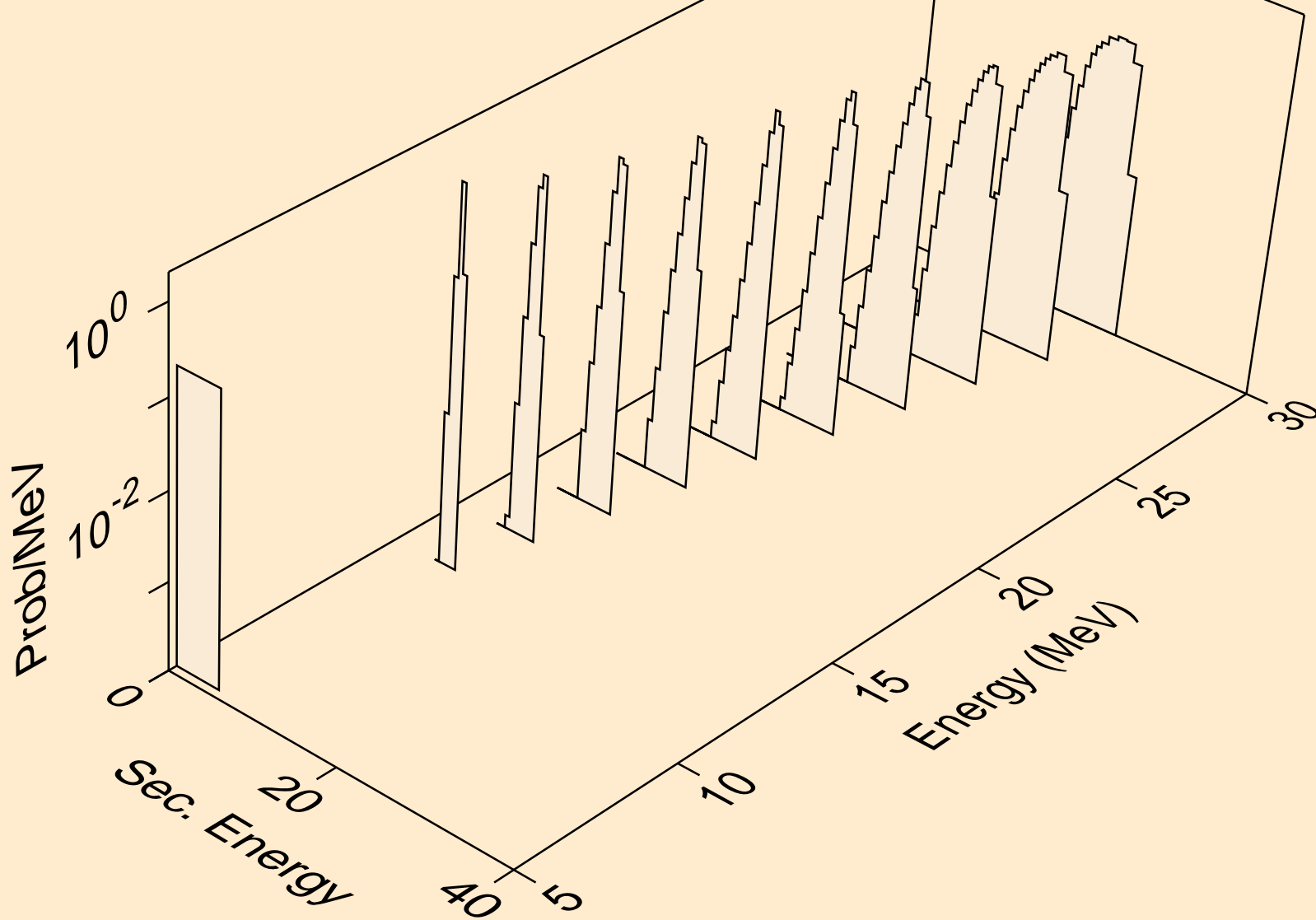

LU188 NEUTRON ACER TENDL-2023 LIBRARY; T=0.K  
alphas from (n,3n)a

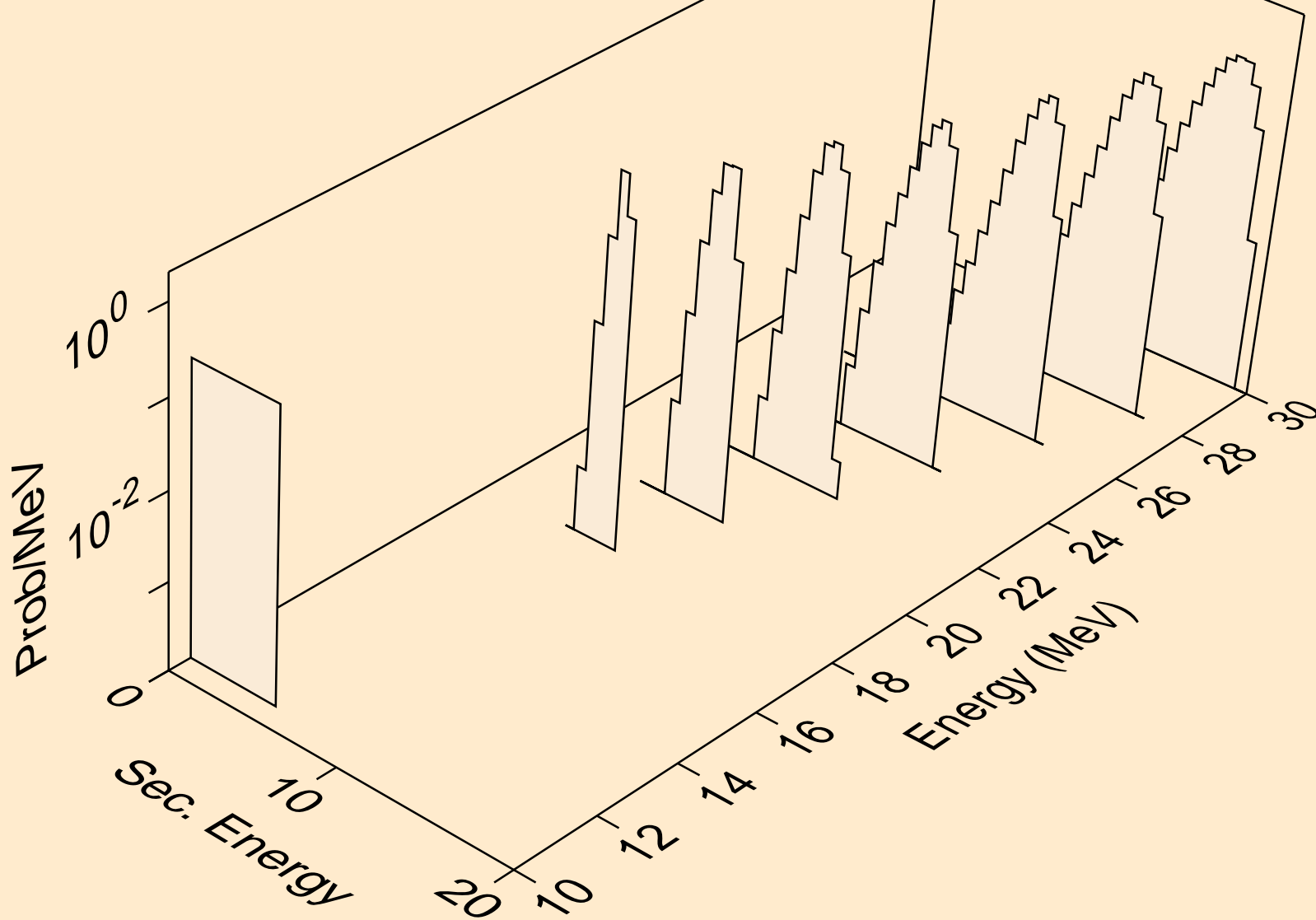

LU188 NEUTRON ACER TENDL-2023 LIBRARY; T=0.K  
alphas from (n,a)

