

MD260 NEUTRON ACER TENDL-2023 LIBRARY; T=0.K
Principal cross sections

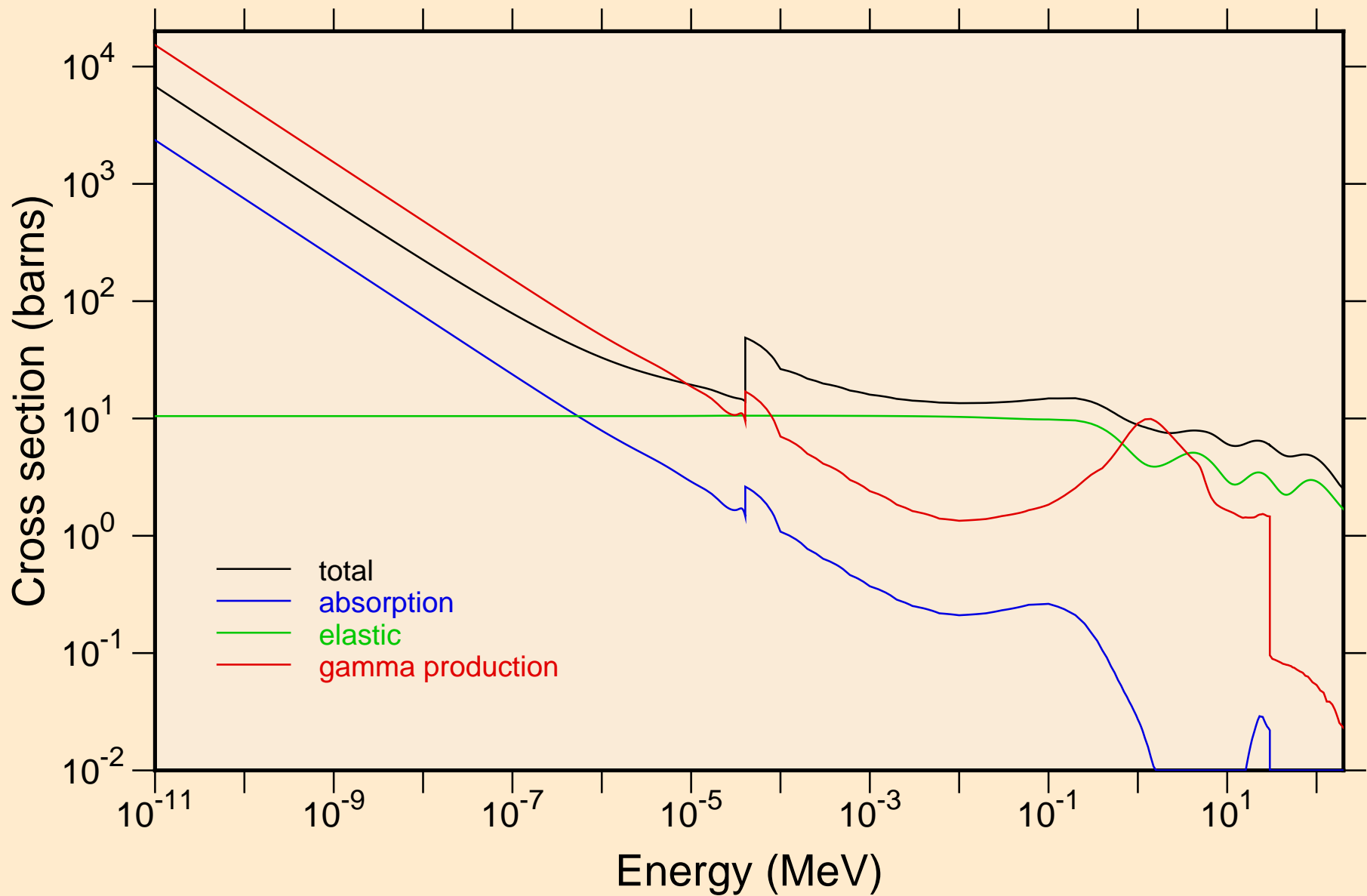

MD260 NEUTRON ACER TENDL-2023 LIBRARY; T=0.K
Heating

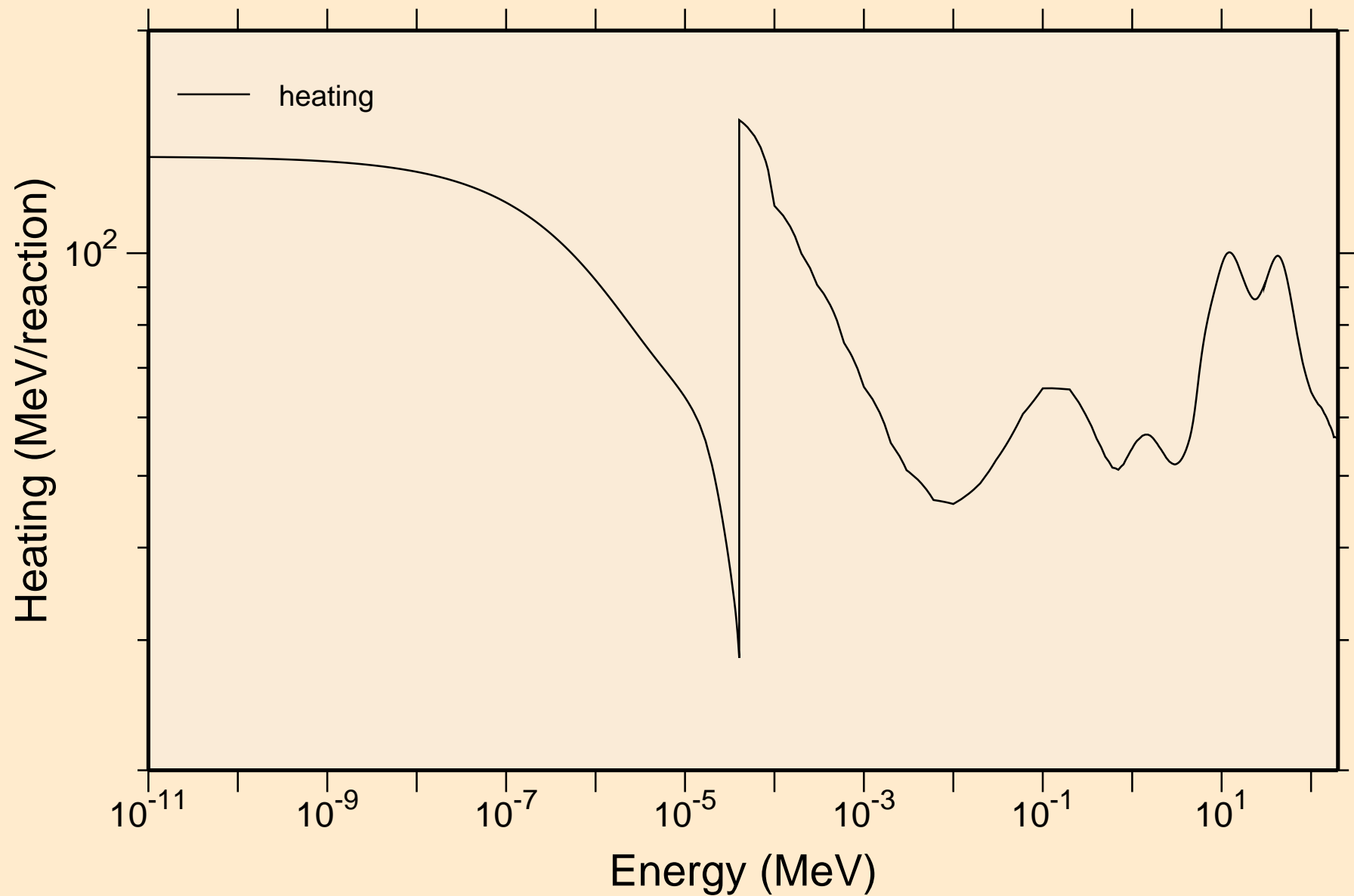

MD260 NEUTRON ACER TENDL-2023 LIBRARY; T=0.K
Damage

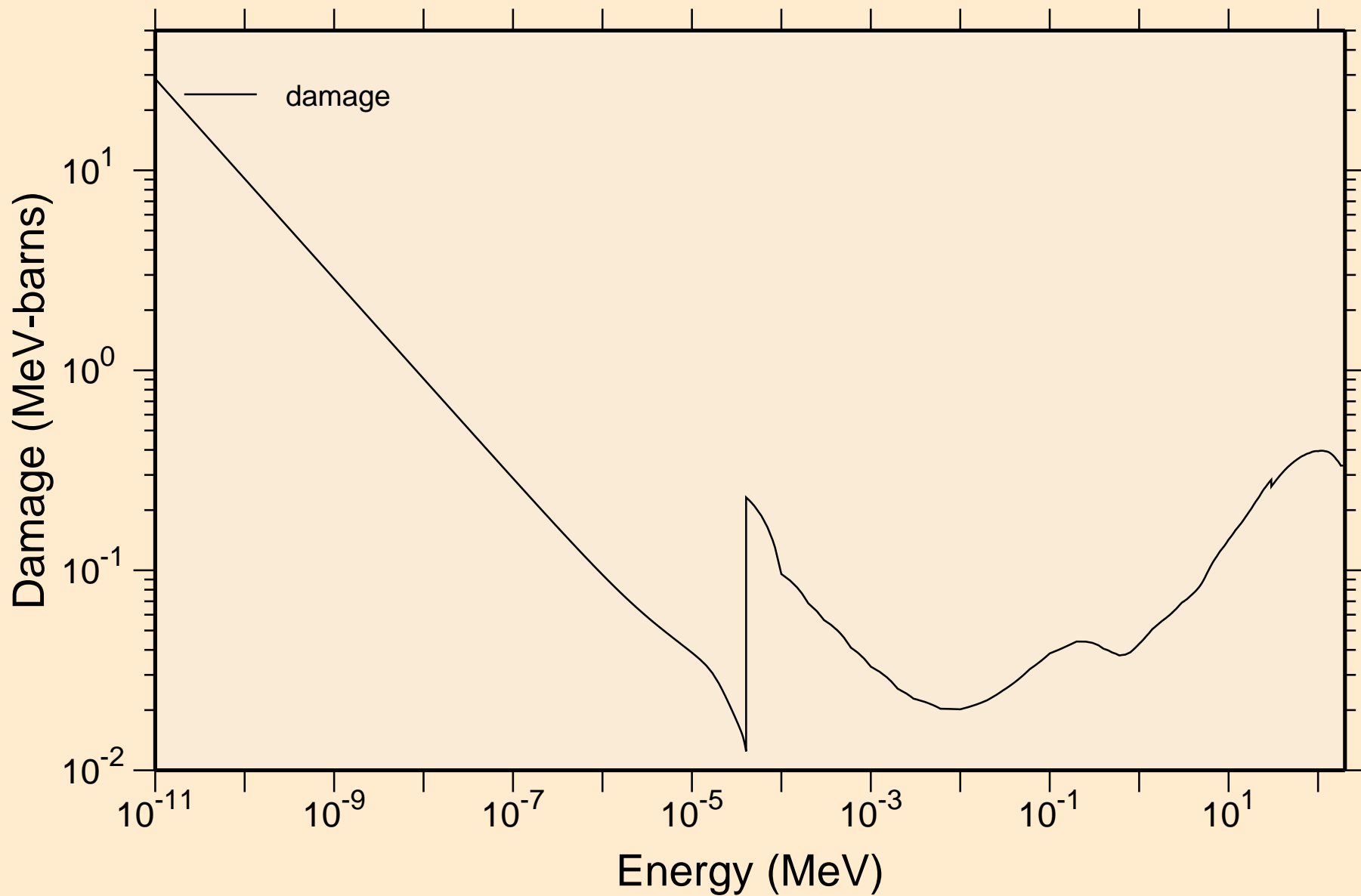

MD260 NEUTRON ACER TENDL-2023 LIBRARY; T=0.K
Non-threshold reactions

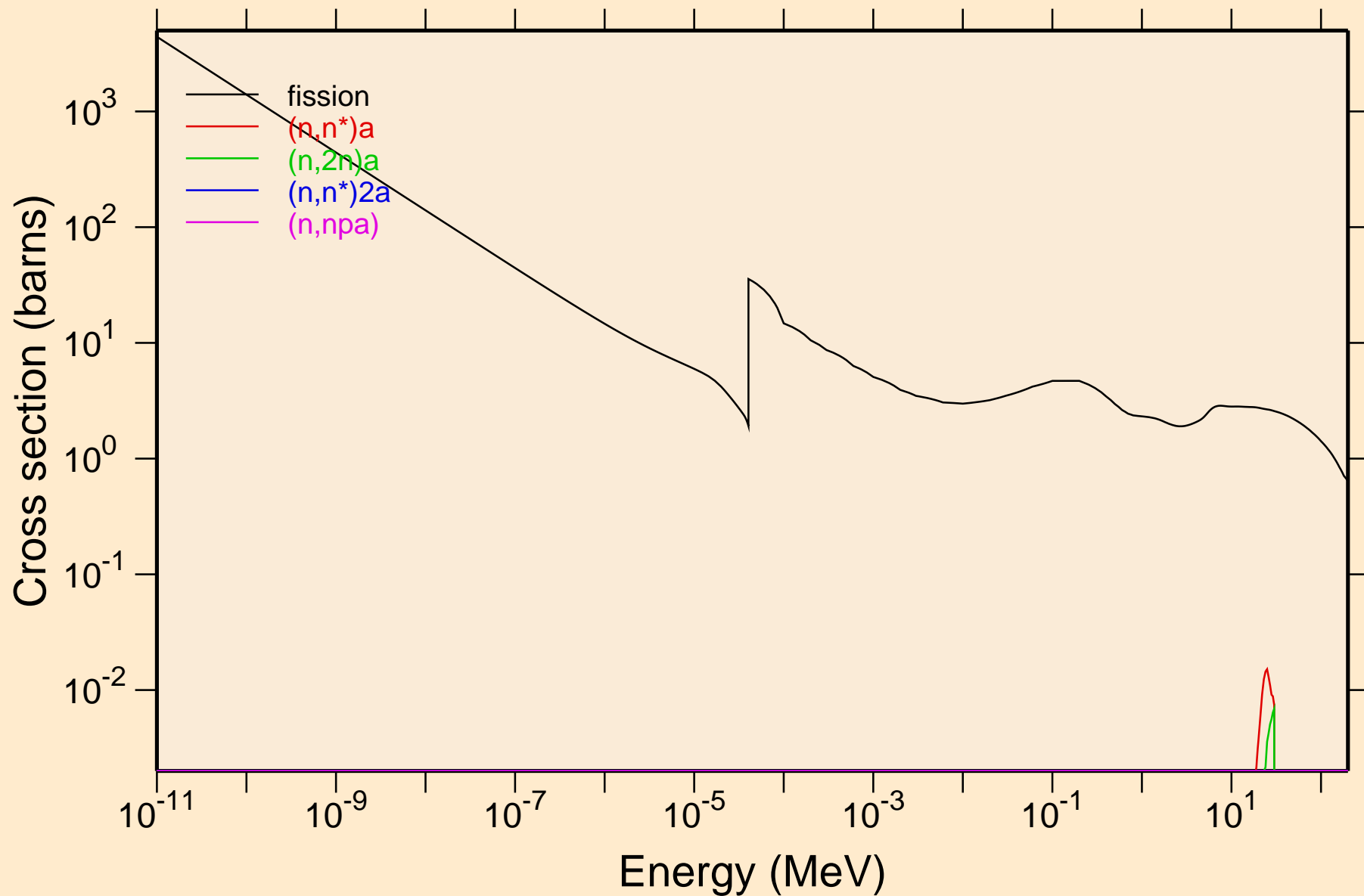

MD260 NEUTRON ACER TENDL-2023 LIBRARY; T=0.K
Non-threshold reactions

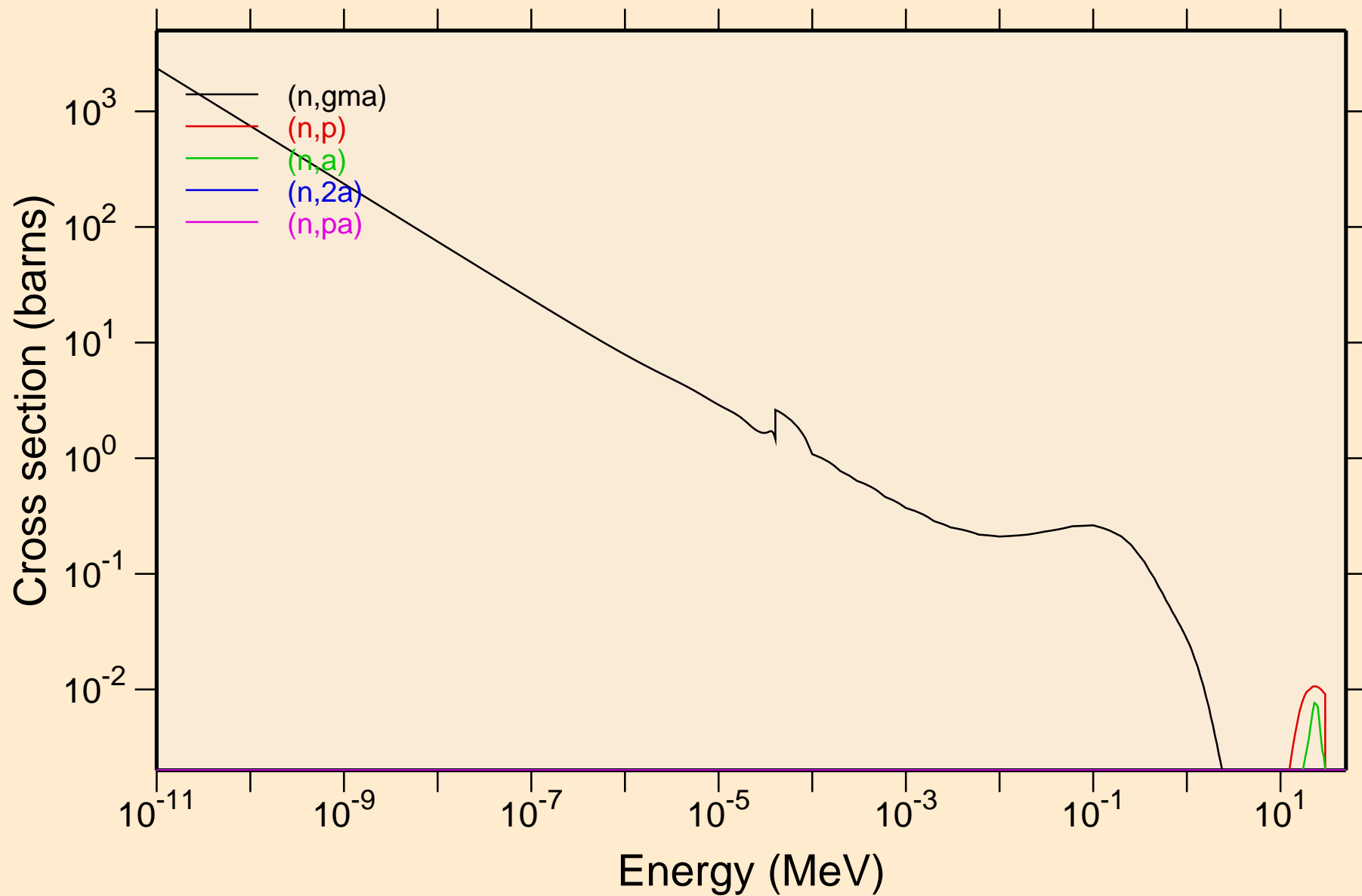

MD260 NEUTRON ACER TENDL-2023 LIBRARY; T=0.K
Non-threshold reactions

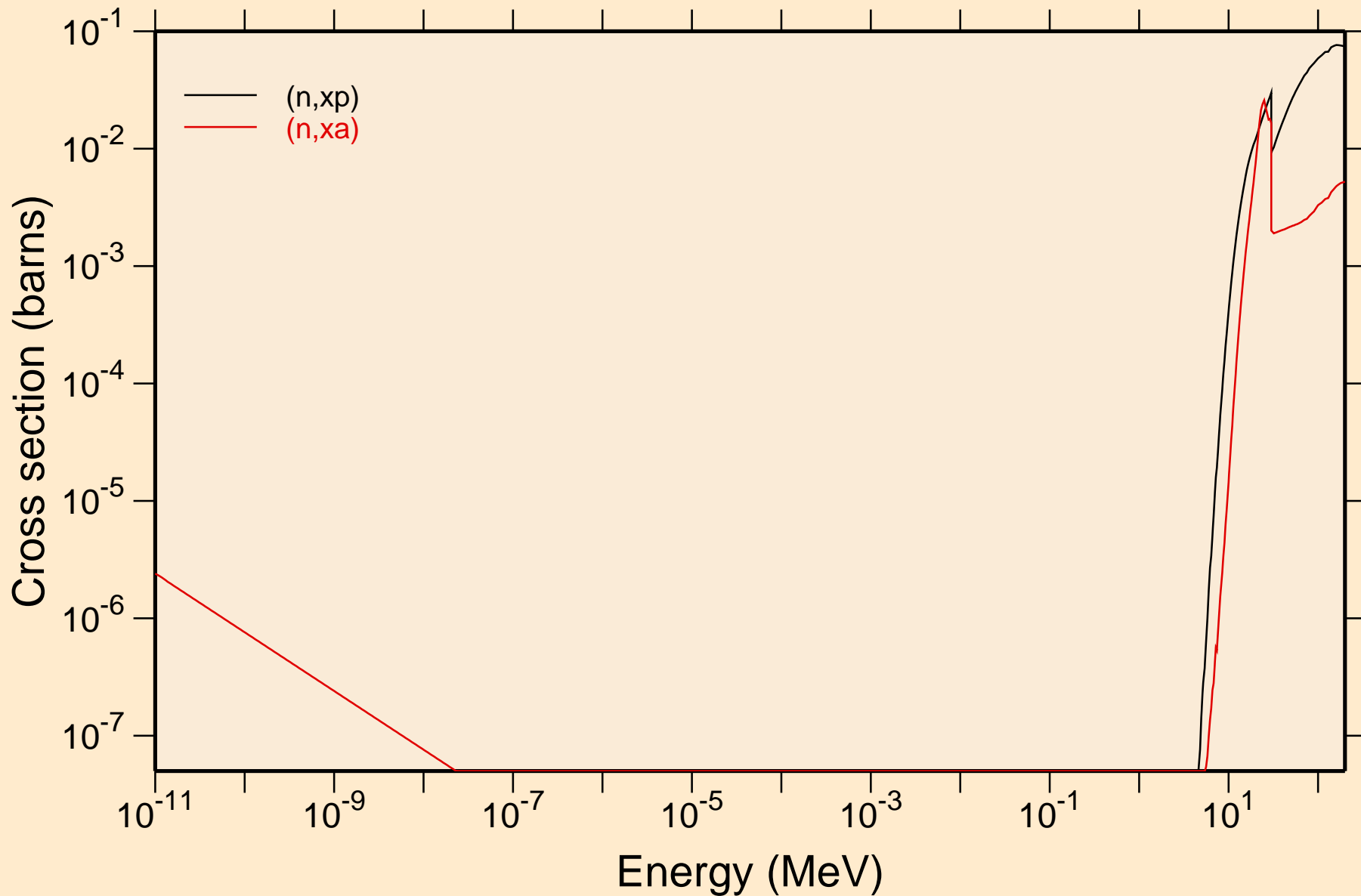

MD260 NEUTRON ACER TENDL-2023 LIBRARY; T=0.K

Principal cross sections

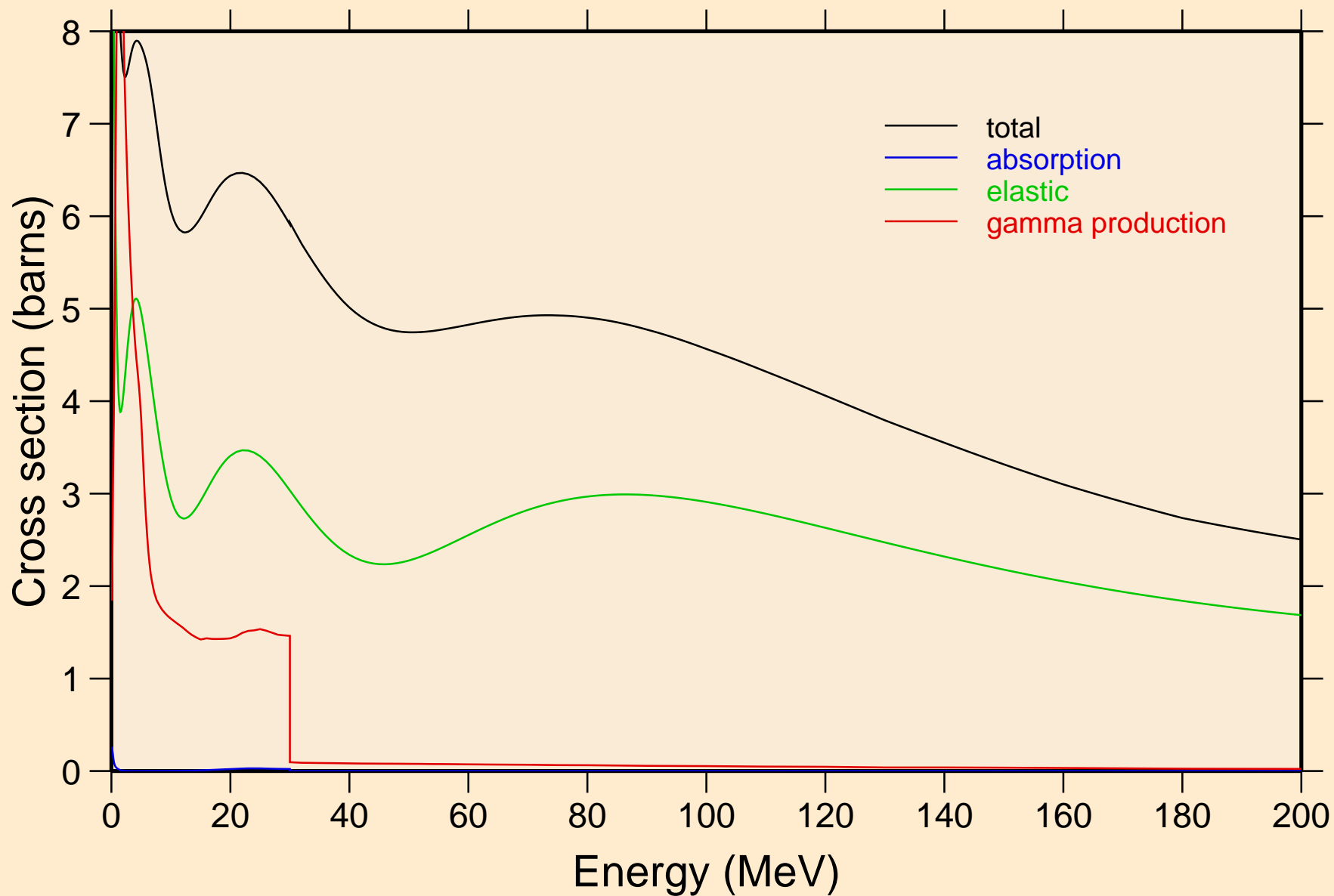

MD260 NEUTRON ACER TENDL-2023 LIBRARY; T=0.K
Heating

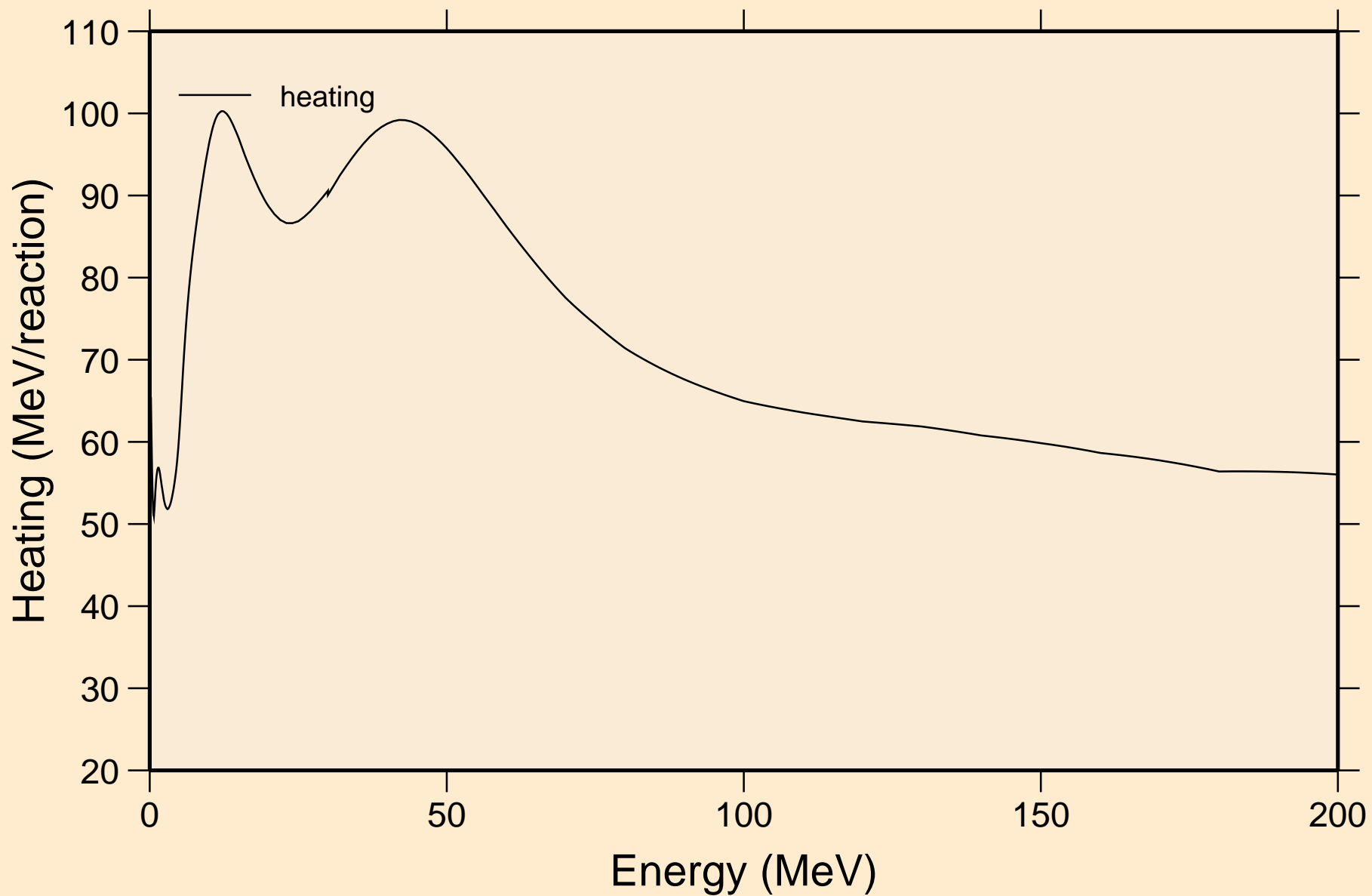

MD260 NEUTRON ACER TENDL-2023 LIBRARY; T=0.K
Damage

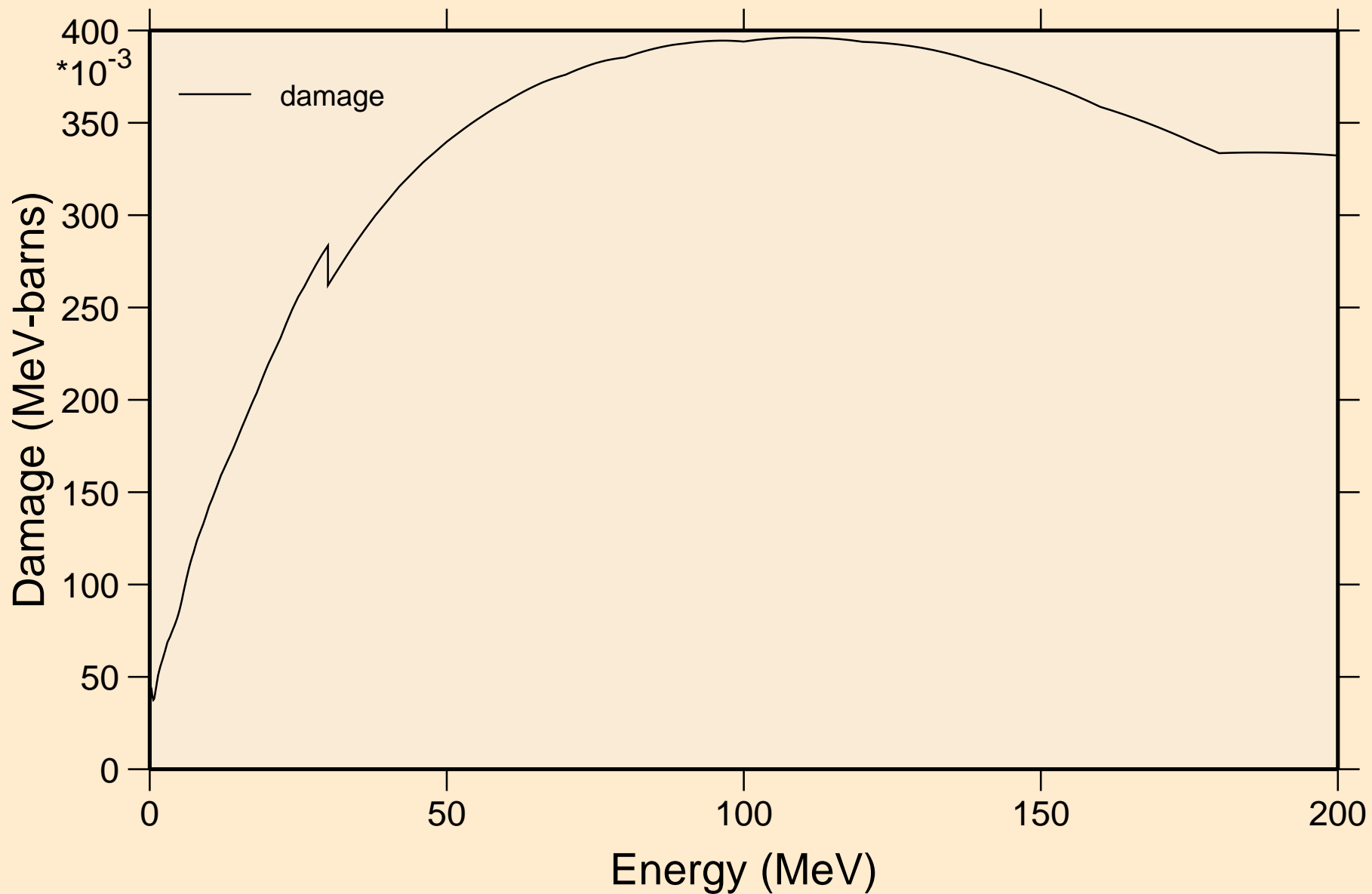

MD260 NEUTRON ACER TENDL-2023 LIBRARY; T=0.K
Non-threshold reactions

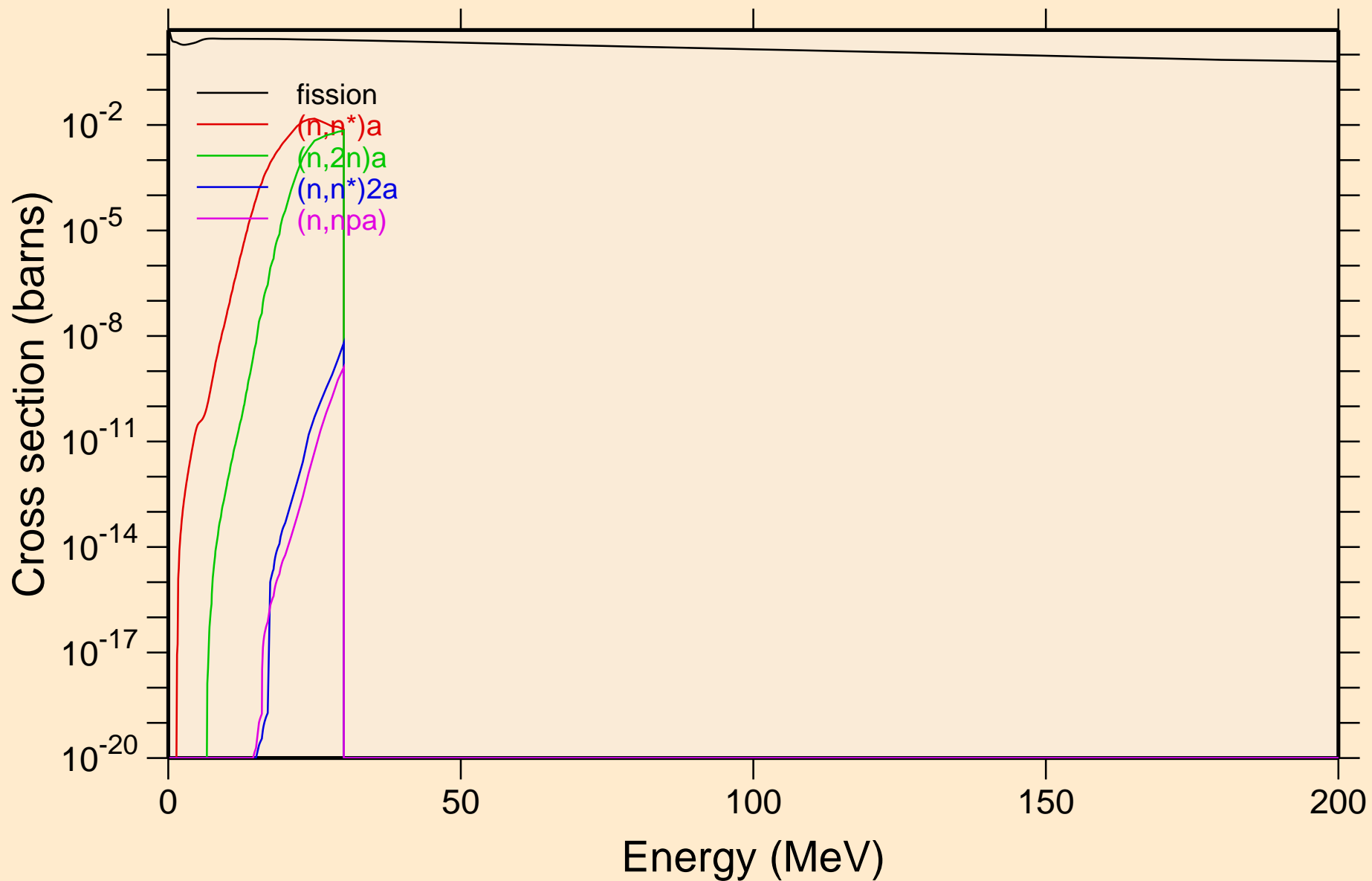

MD260 NEUTRON ACER TENDL-2023 LIBRARY; T=0.K
Non-threshold reactions

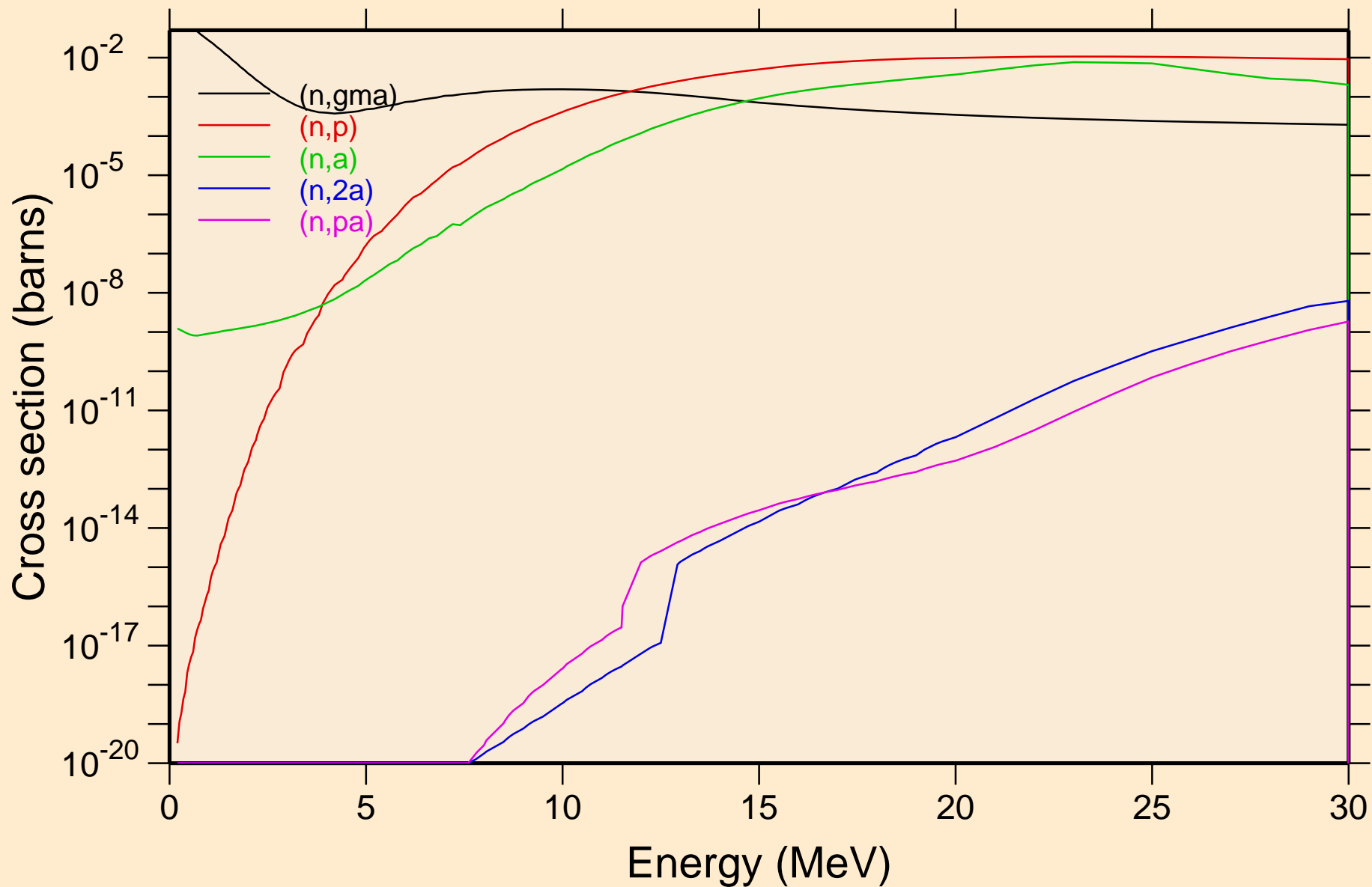

MD260 NEUTRON ACER TENDL-2023 LIBRARY; T=0.K
Non-threshold reactions

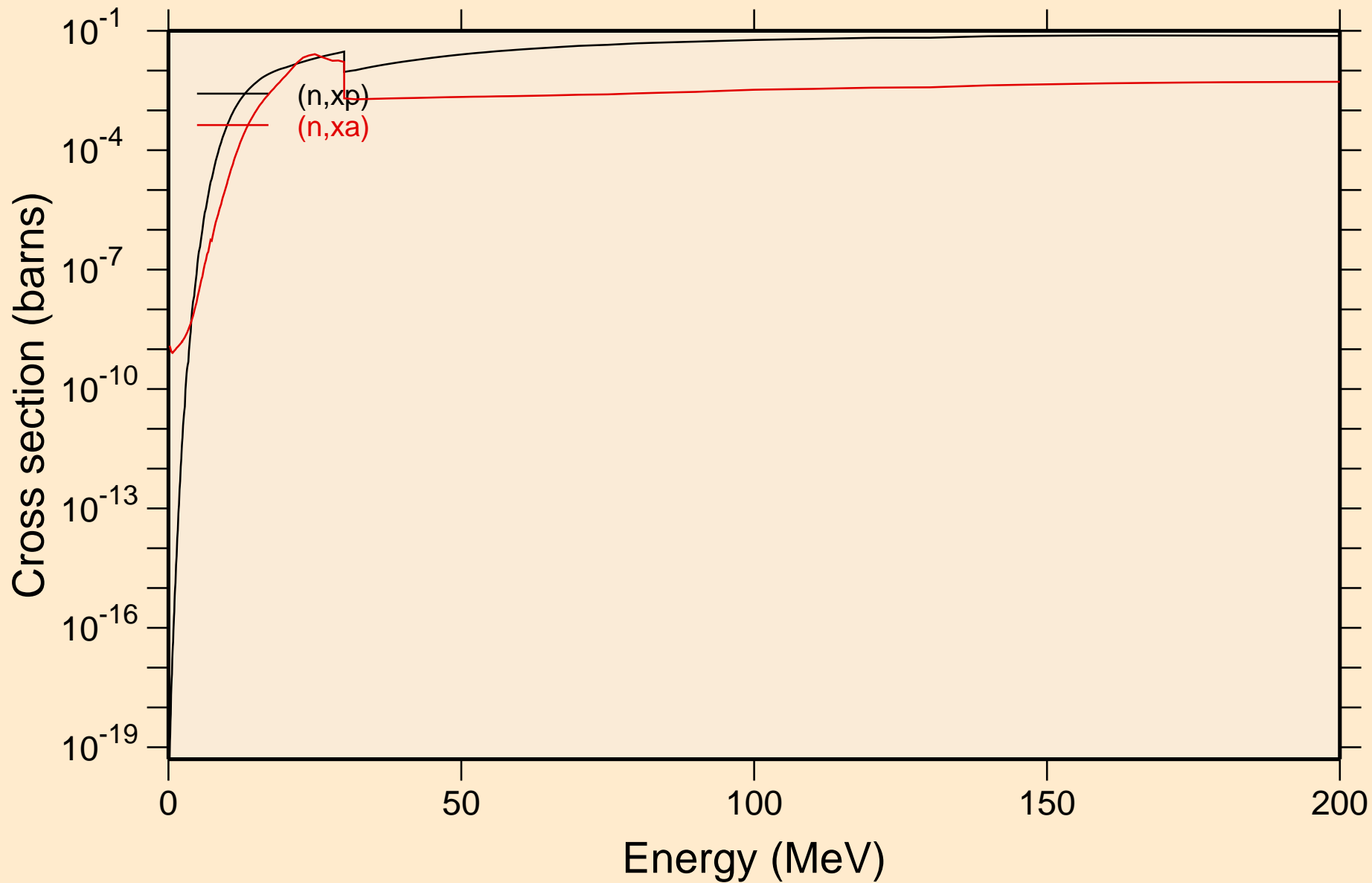

MD260 NEUTRON ACER TENDL-2023 LIBRARY; T=0.K
Inelastic levels

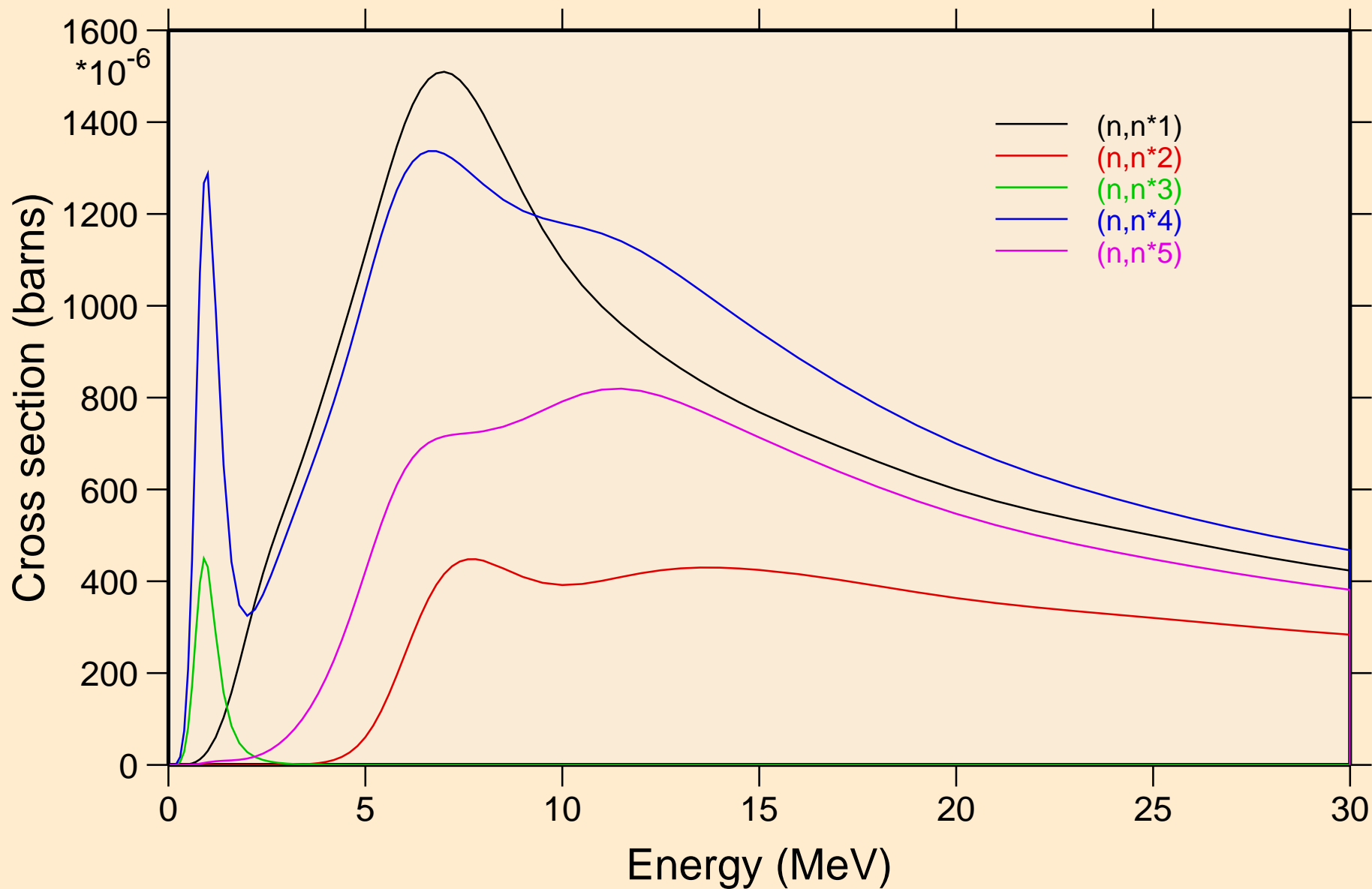

MD260 NEUTRON ACER TENDL-2023 LIBRARY; T=0.K
Inelastic levels

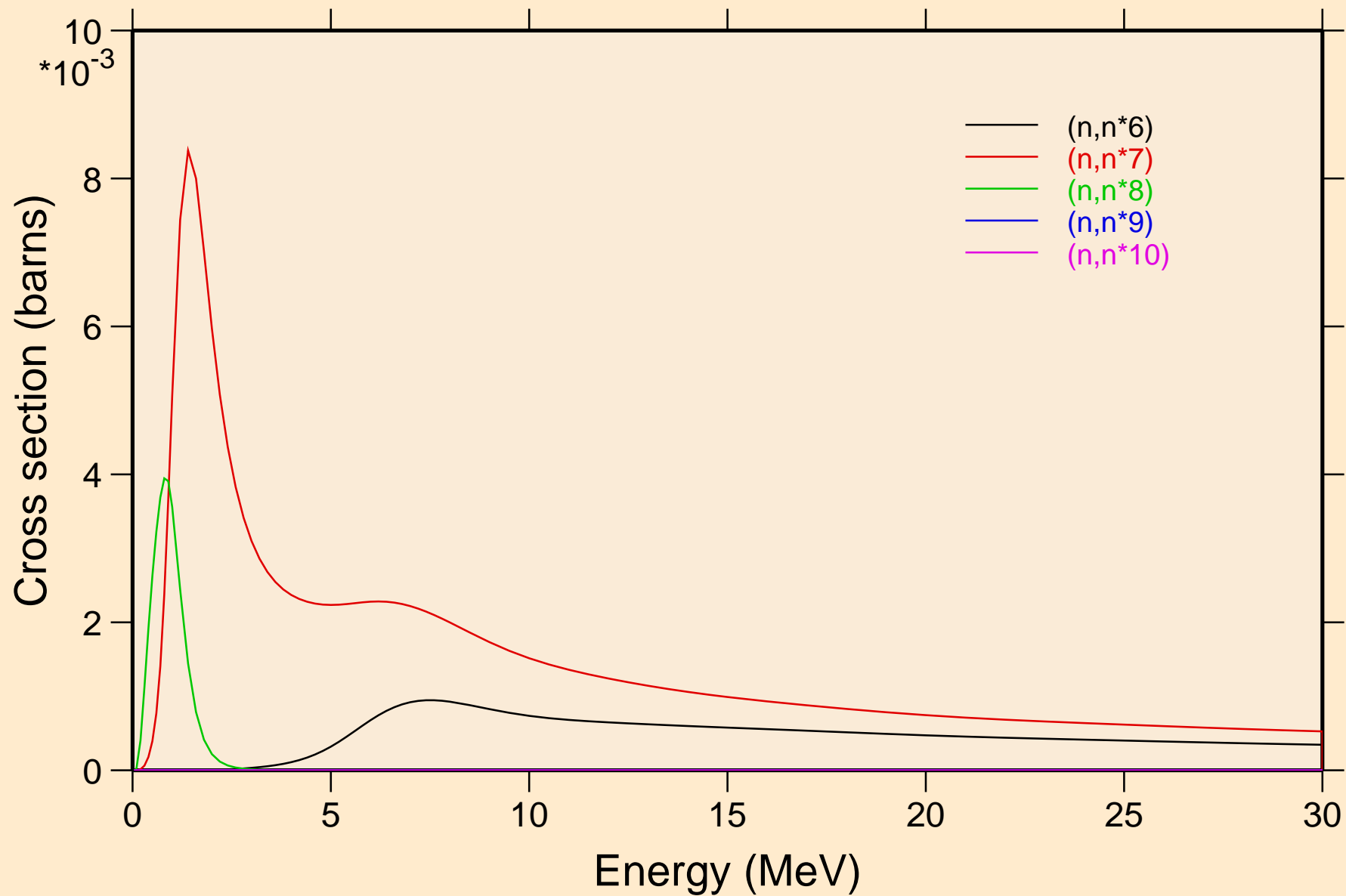

MD260 NEUTRON ACER TENDL-2023 LIBRARY; T=0.K
Inelastic levels

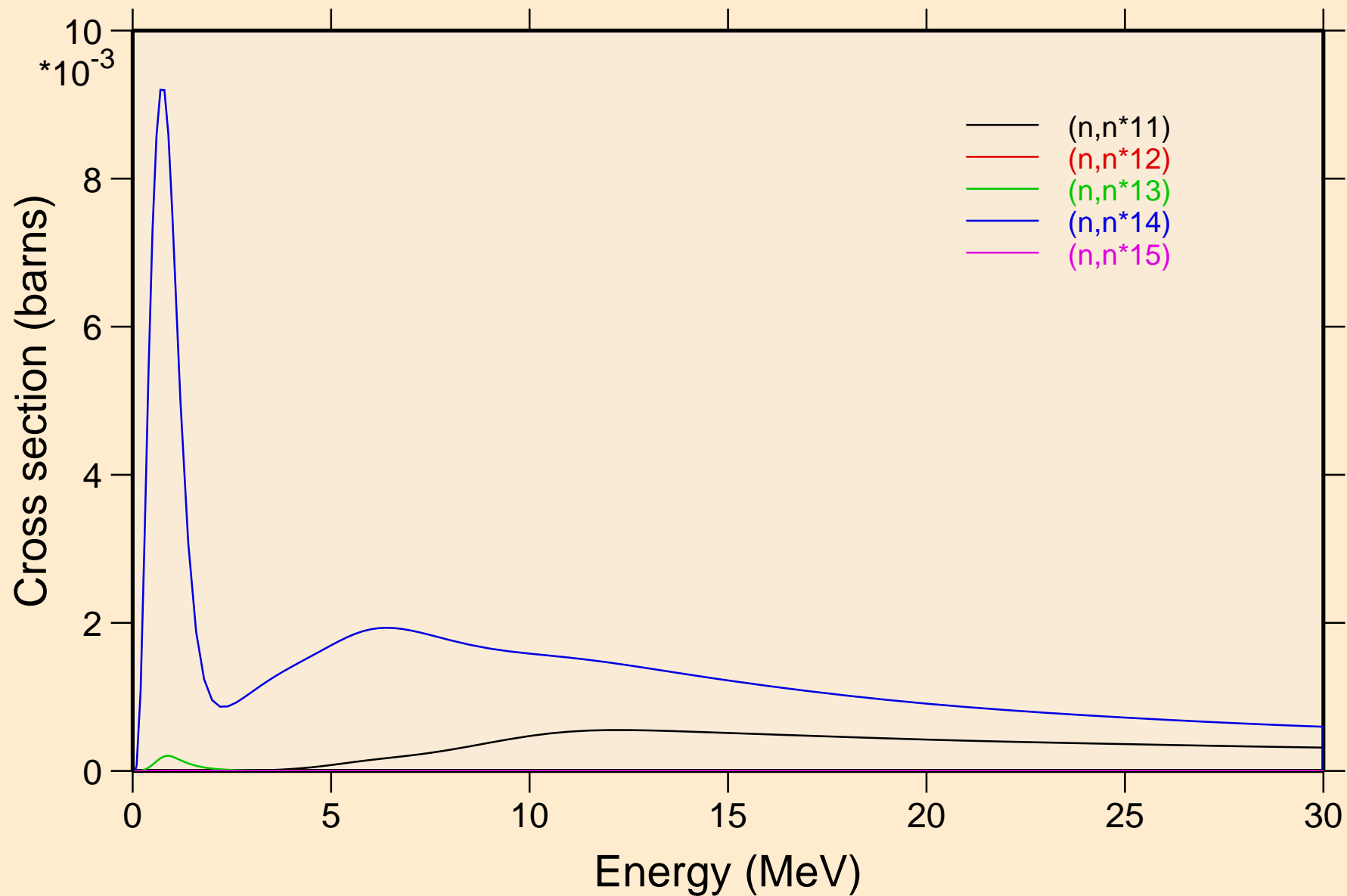

MD260 NEUTRON ACER TENDL-2023 LIBRARY; T=0.K
Inelastic levels

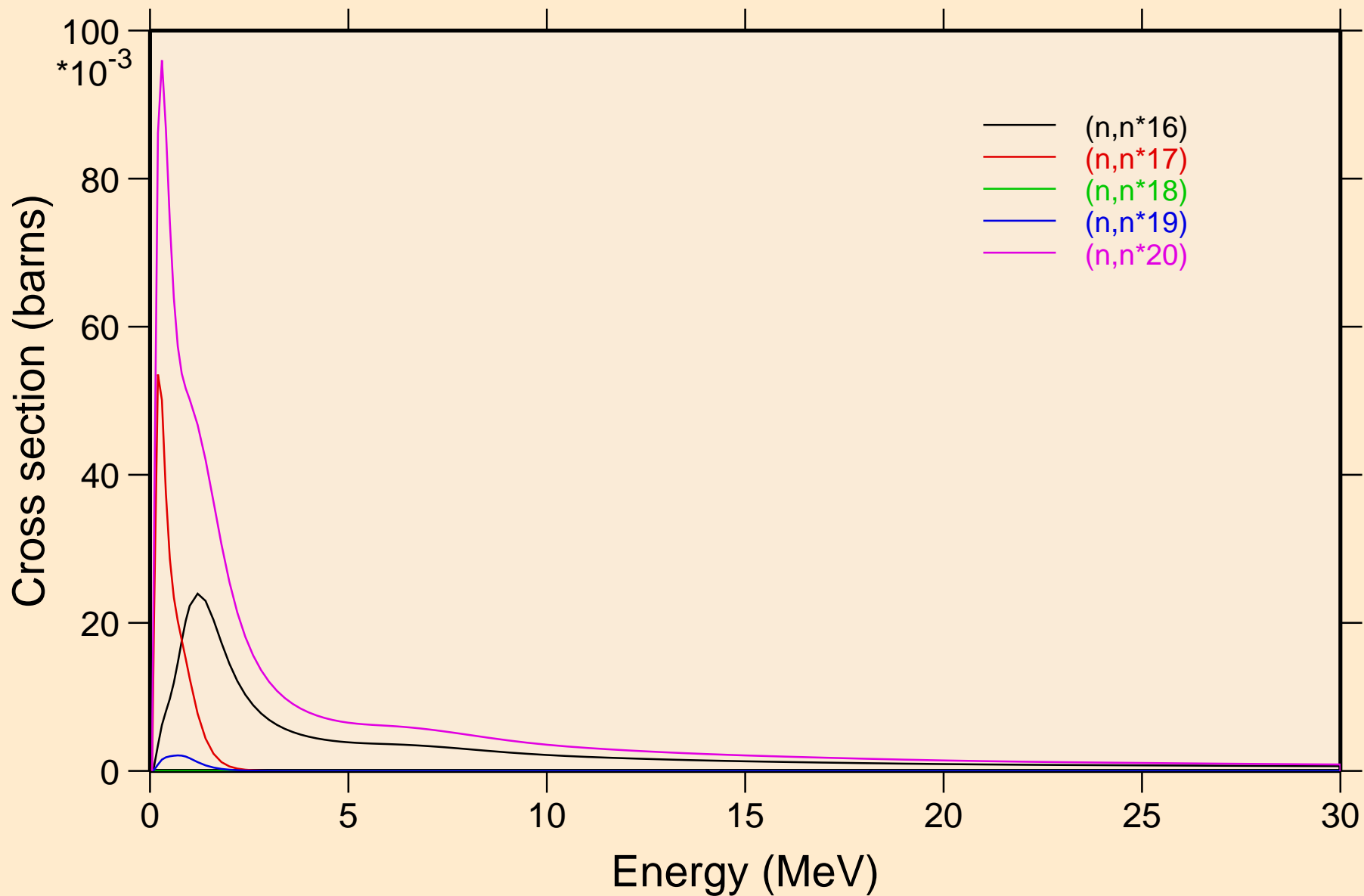

MD260 NEUTRON ACER TENDL-2023 LIBRARY; T=0.K

Threshold reactions

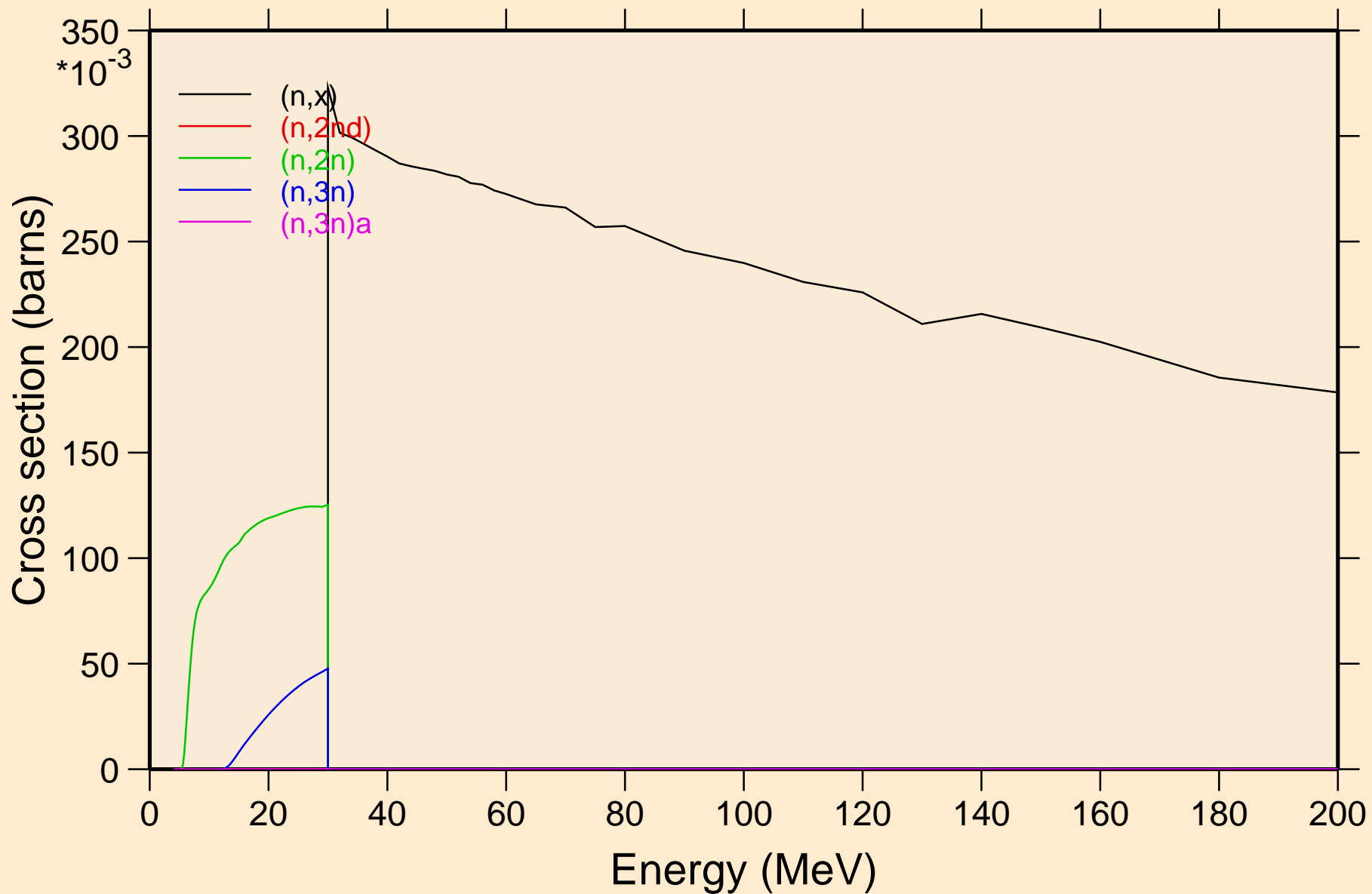

MD260 NEUTRON ACER TENDL-2023 LIBRARY; T=0.K
Threshold reactions

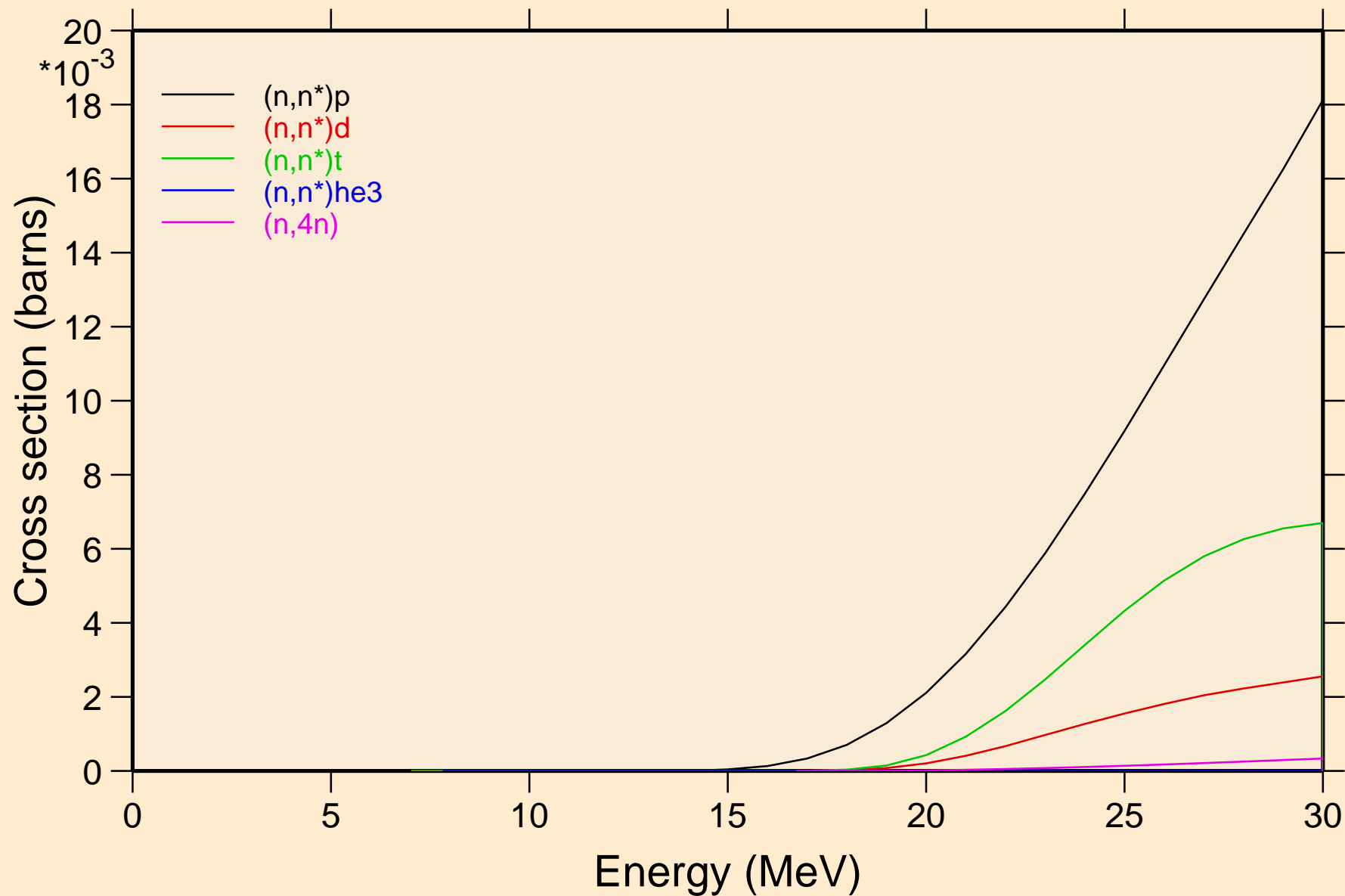

MD260 NEUTRON ACER TENDL-2023 LIBRARY; T=0.K
Threshold reactions

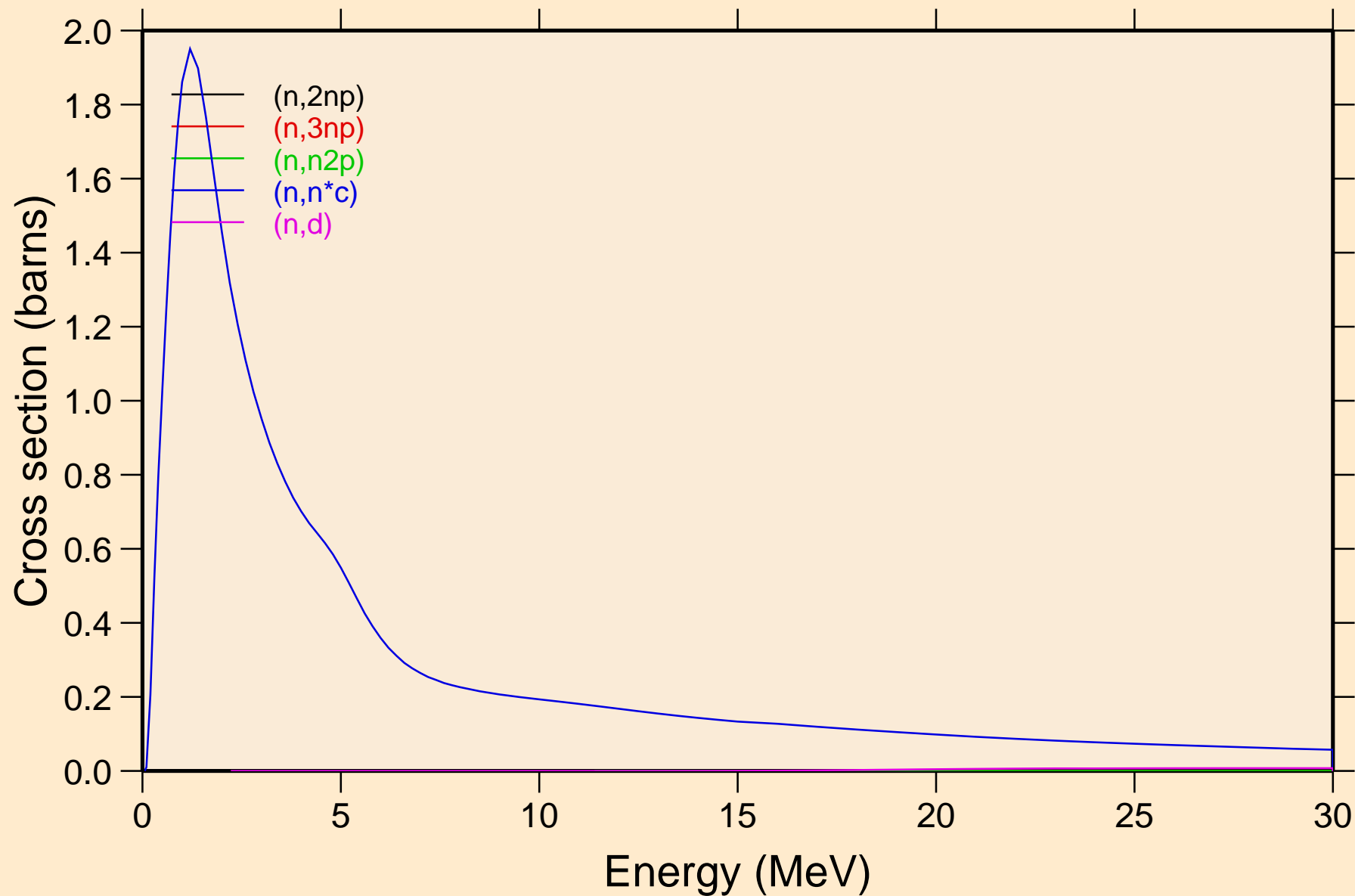

MD260 NEUTRON ACER TENDL-2023 LIBRARY; T=0.K
Threshold reactions

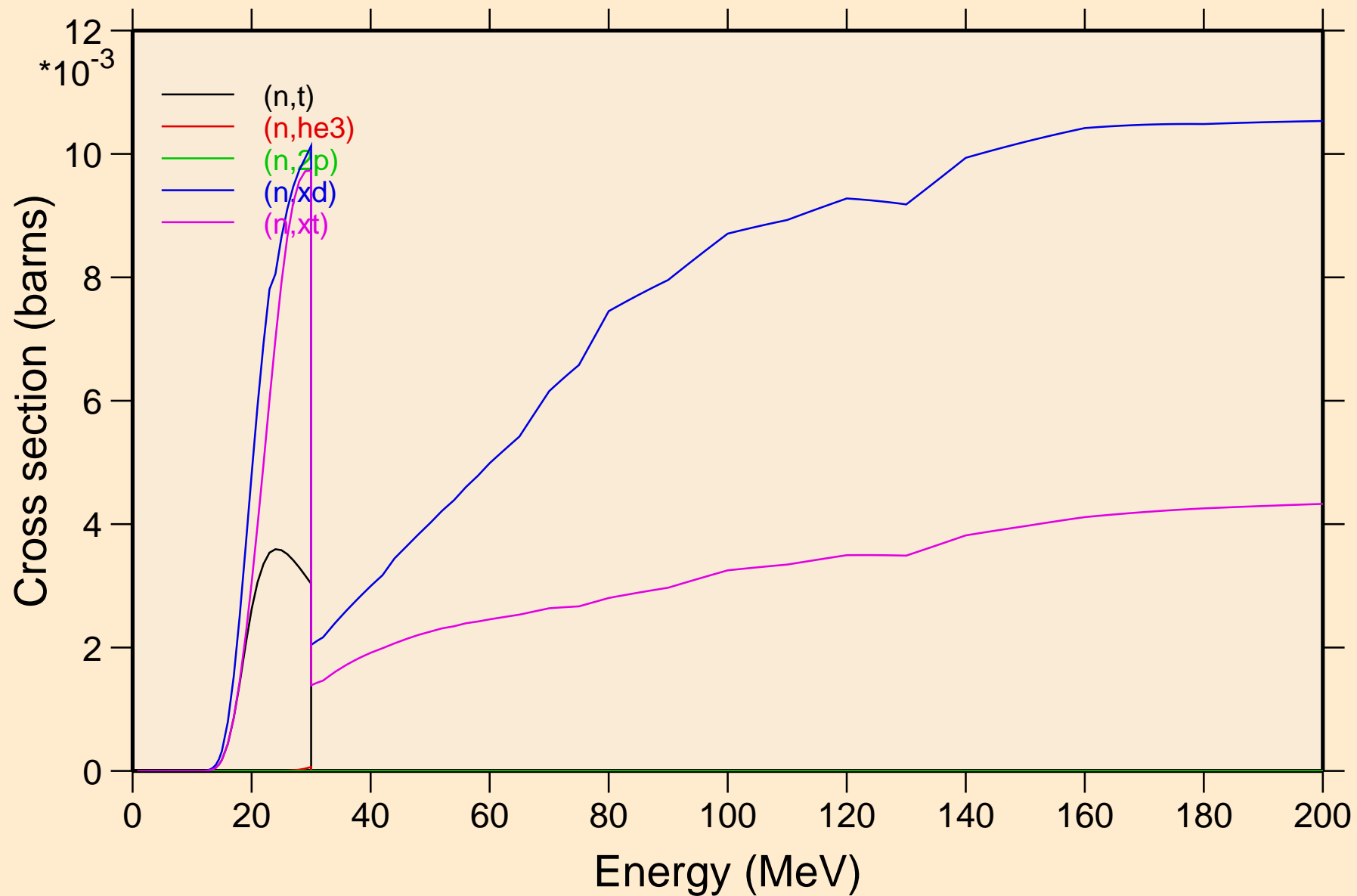

MD260 NEUTRON ACER TENDL-2023 LIBRARY; T=0.K
Threshold reactions

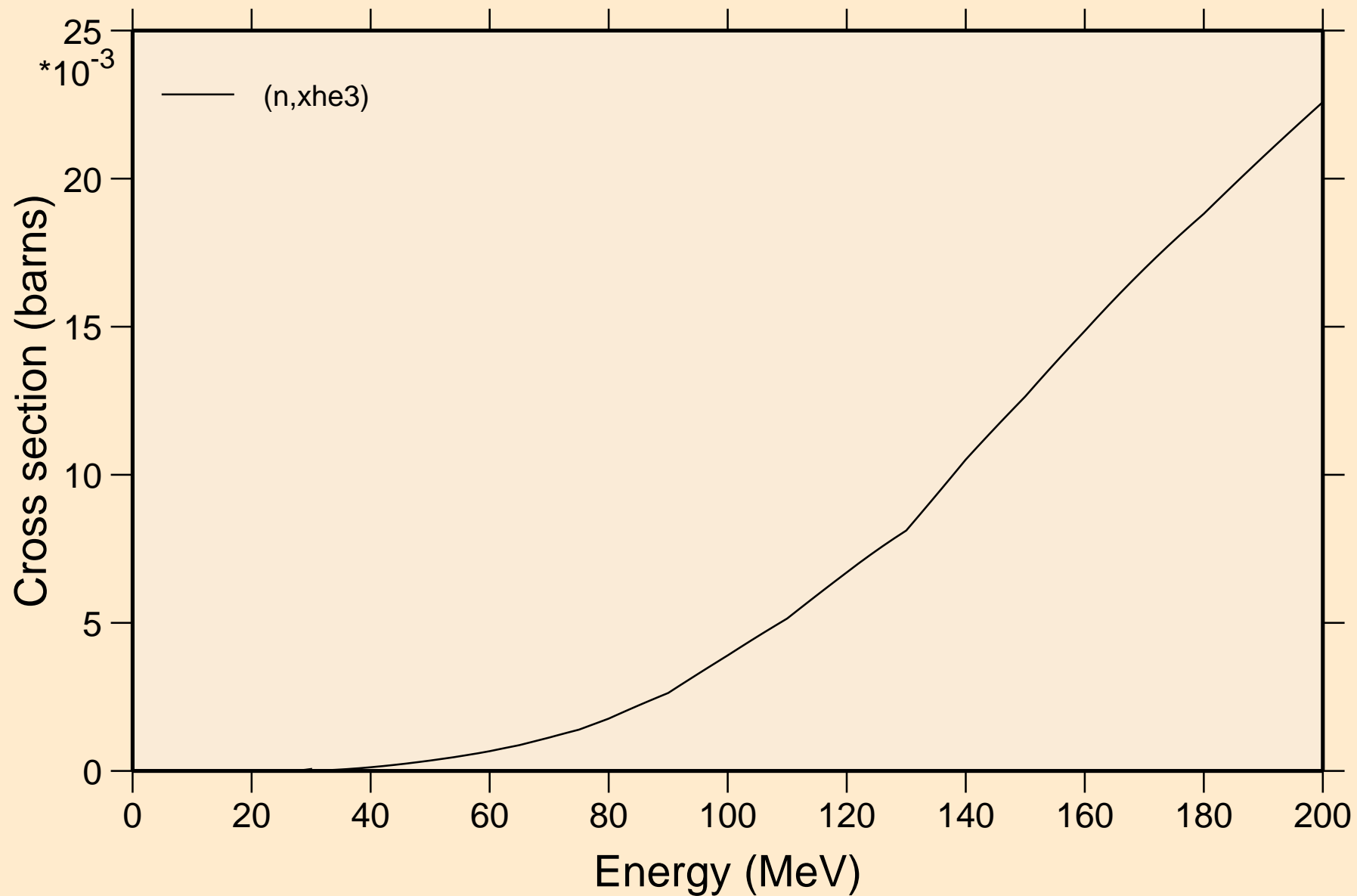

MD260 NEUTRON ACER TENDL-2023 LIBRARY; T=0.K
angular distribution for elastic

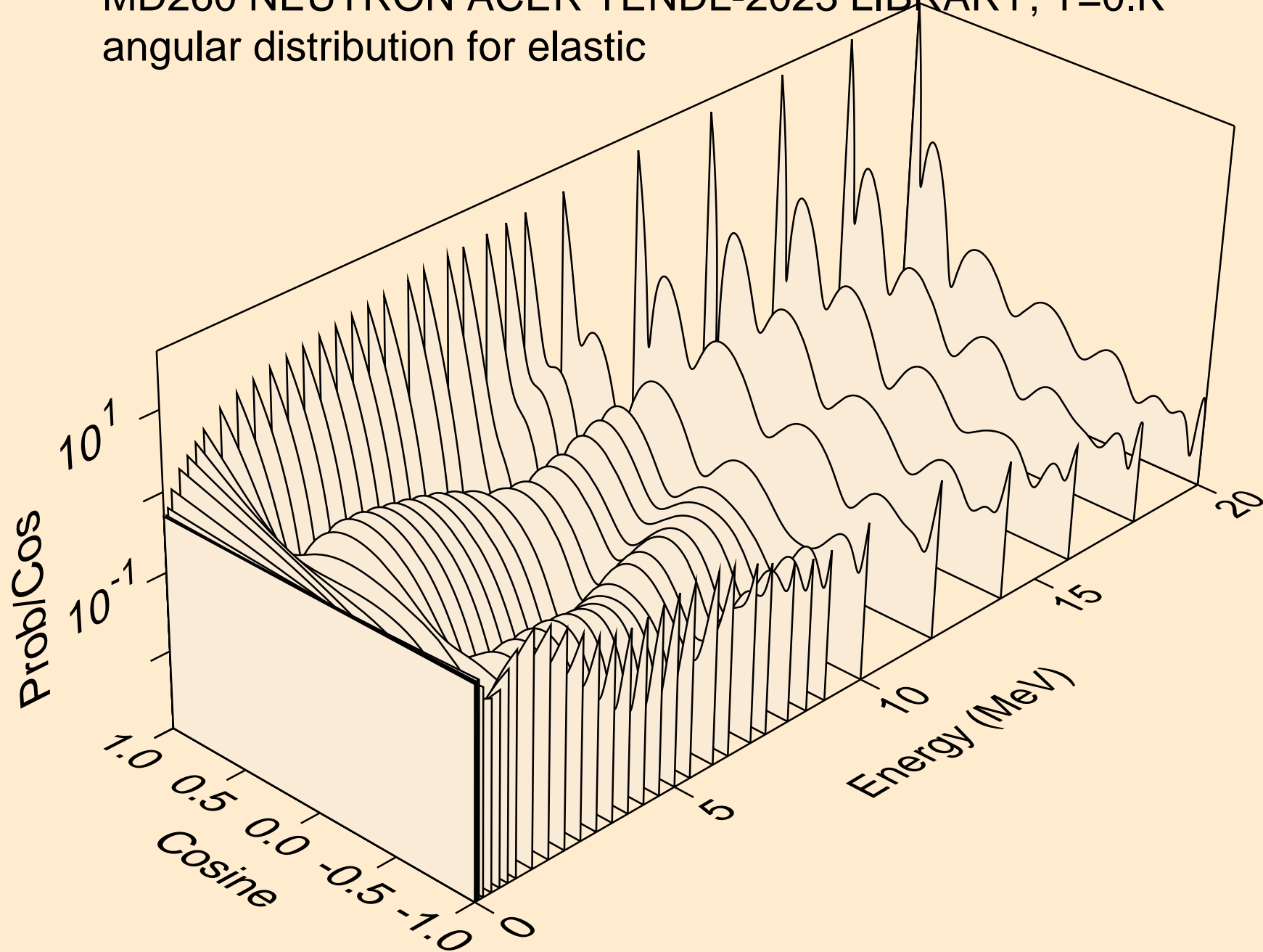

MD260 NEUTRON ACER TENDL-2023 LIBRARY; T=0.K
angular distribution for elastic

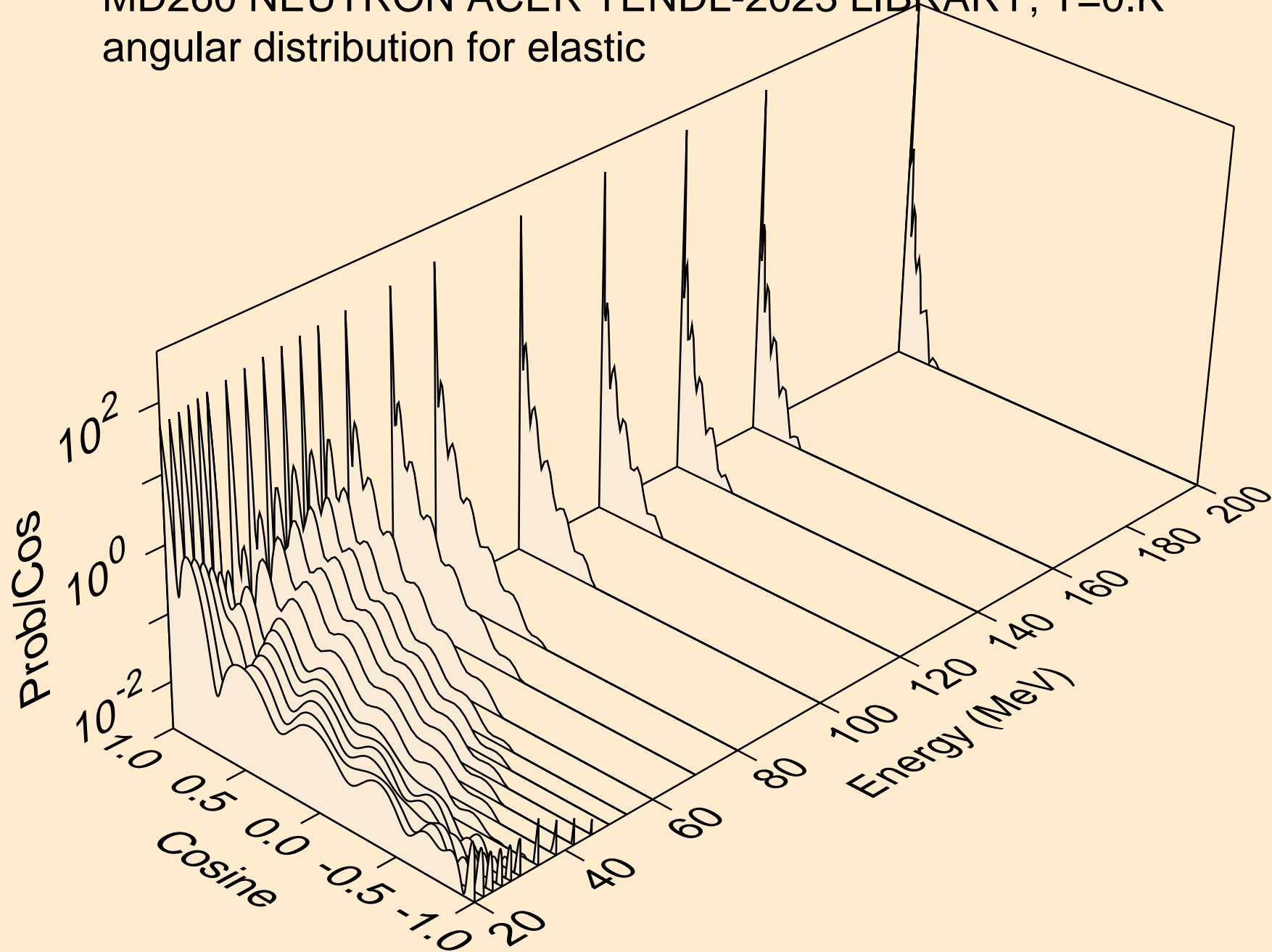

MD260 NEUTRON ACER TENDL-2023 LIBRARY; T=0.K
angular distribution for (n,n*1)

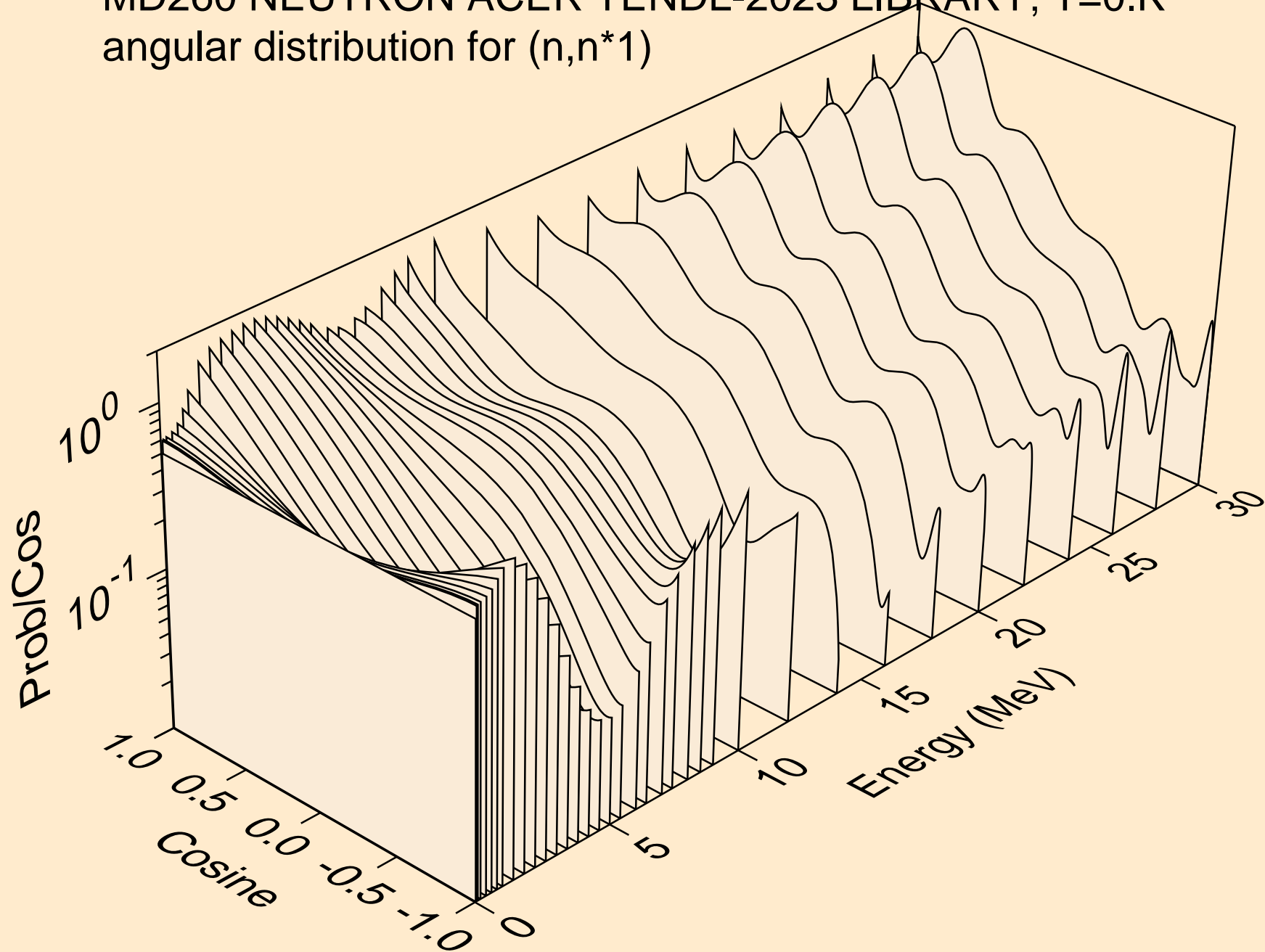

MD260 NEUTRON ACER TENDL-2023 LIBRARY; T=0.K
angular distribution for (n,n*2)

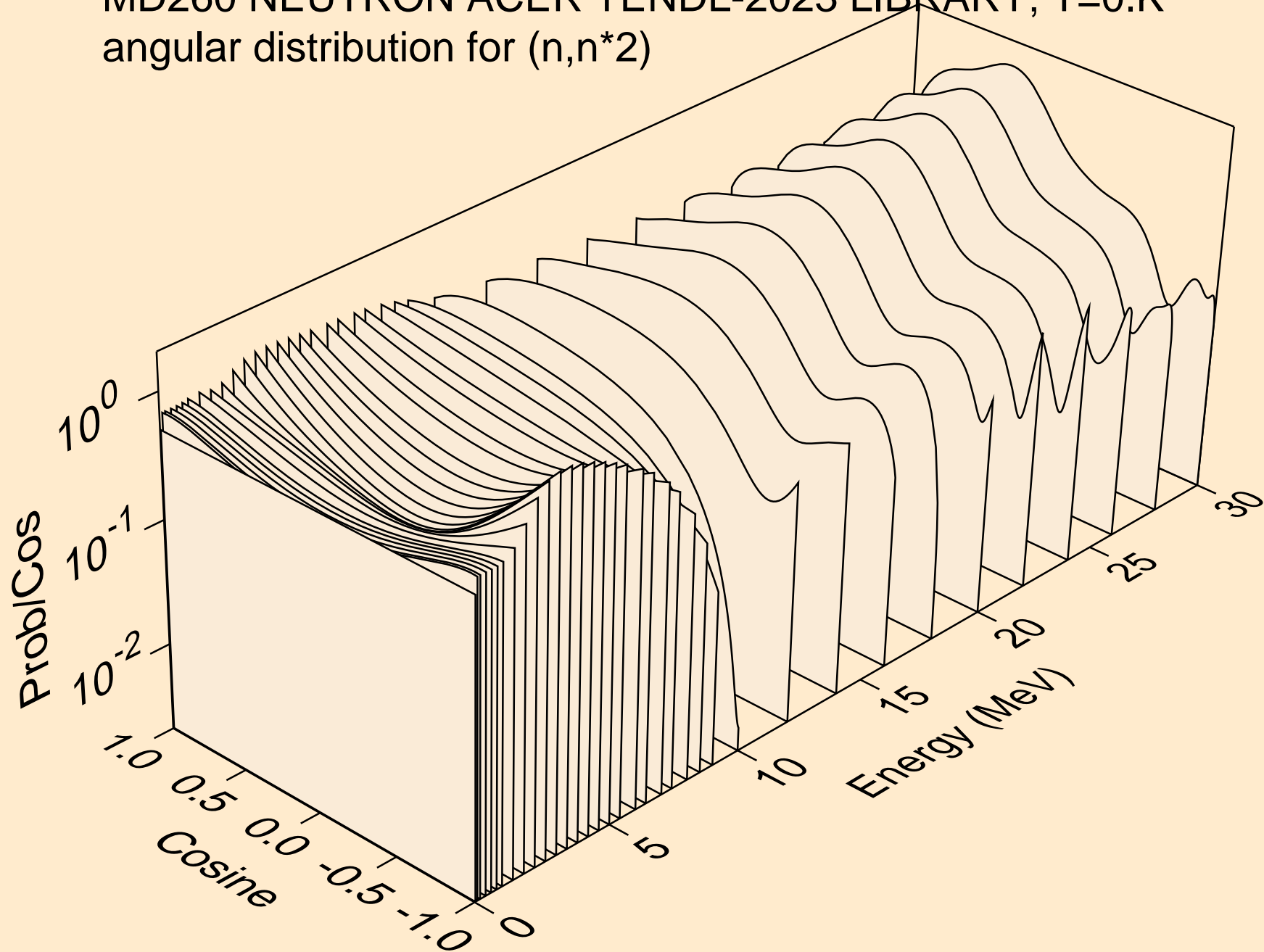

MD260 NEUTRON ACER TENDL-2023 LIBRARY; T=0.K
angular distribution for (n,n*3)

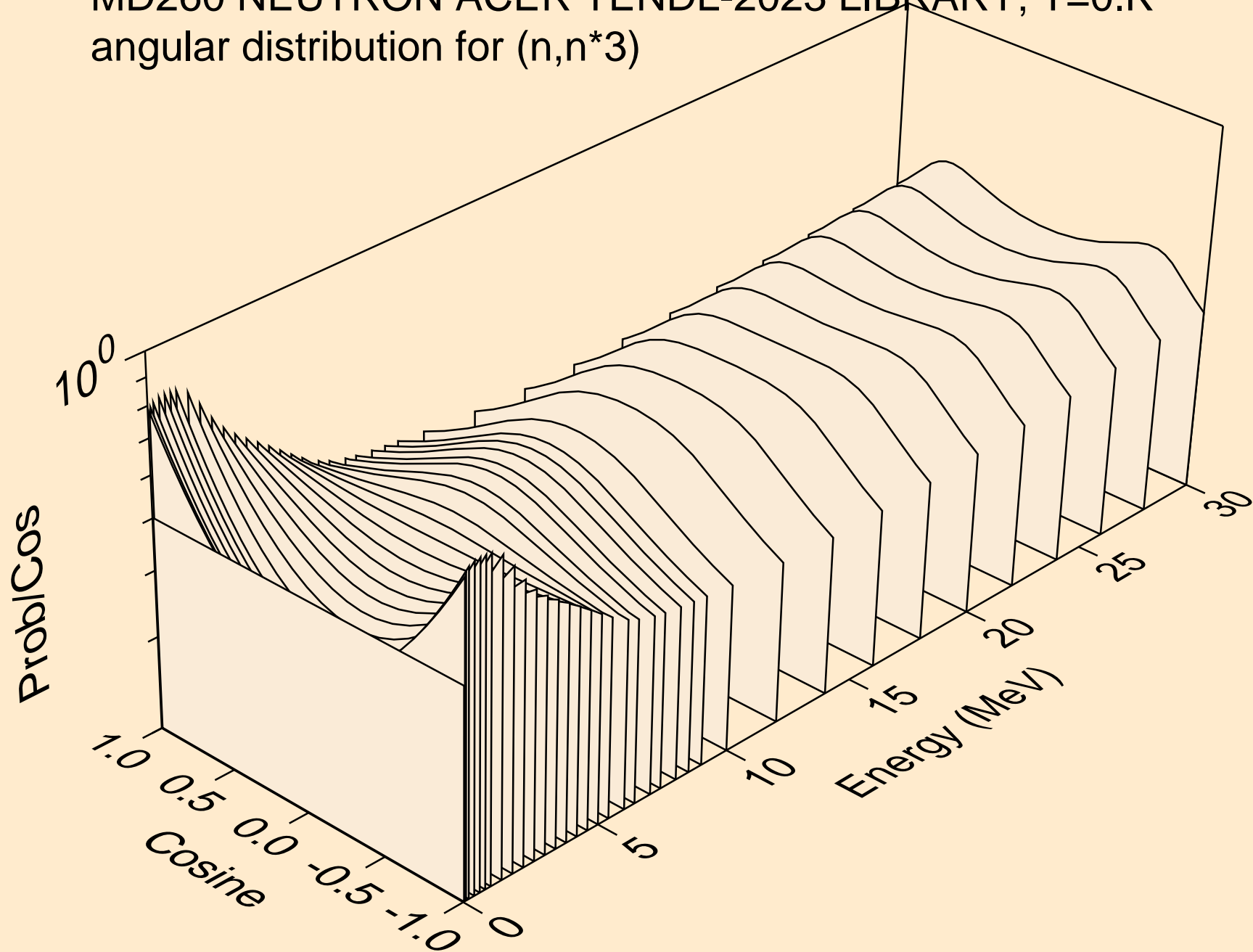

MD260 NEUTRON ACER TENDL-2023 LIBRARY; T=0.K
angular distribution for (n,n*4)

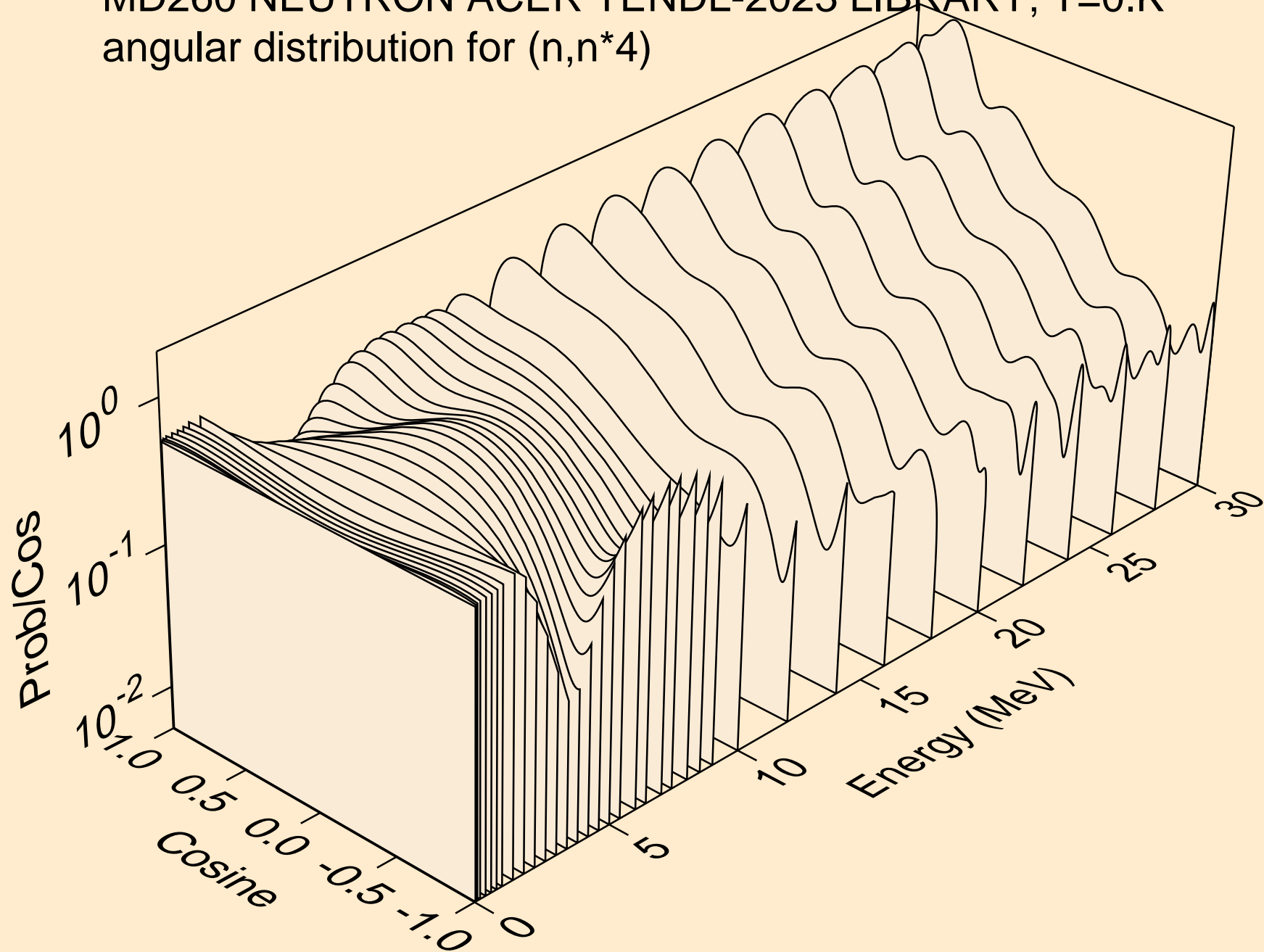

MD260 NEUTRON ACER TENDL-2023 LIBRARY; T=0.K
angular distribution for (n,n*5)

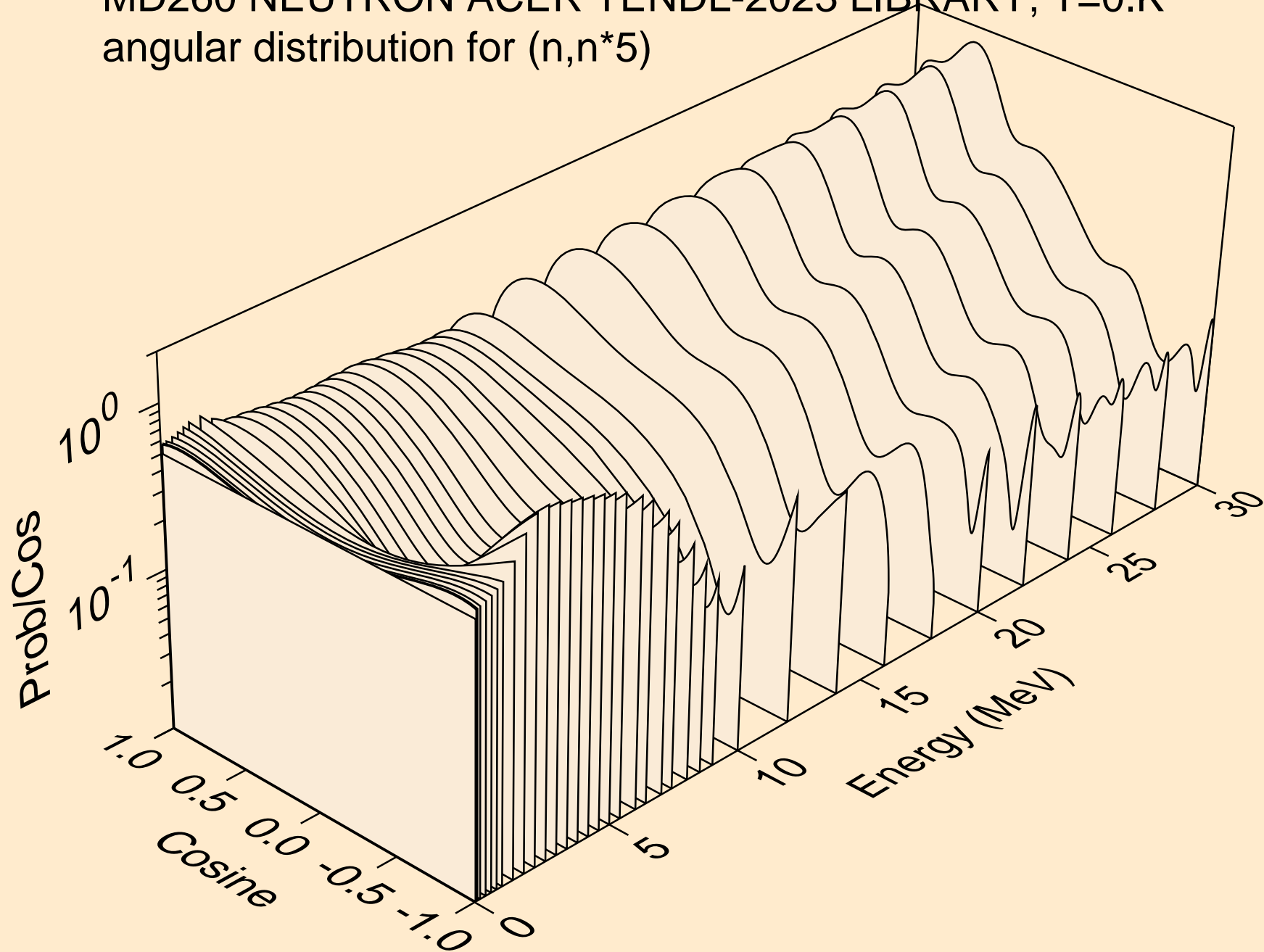

MD260 NEUTRON ACER TENDL-2023 LIBRARY; T=0.K
angular distribution for (n,n*6)

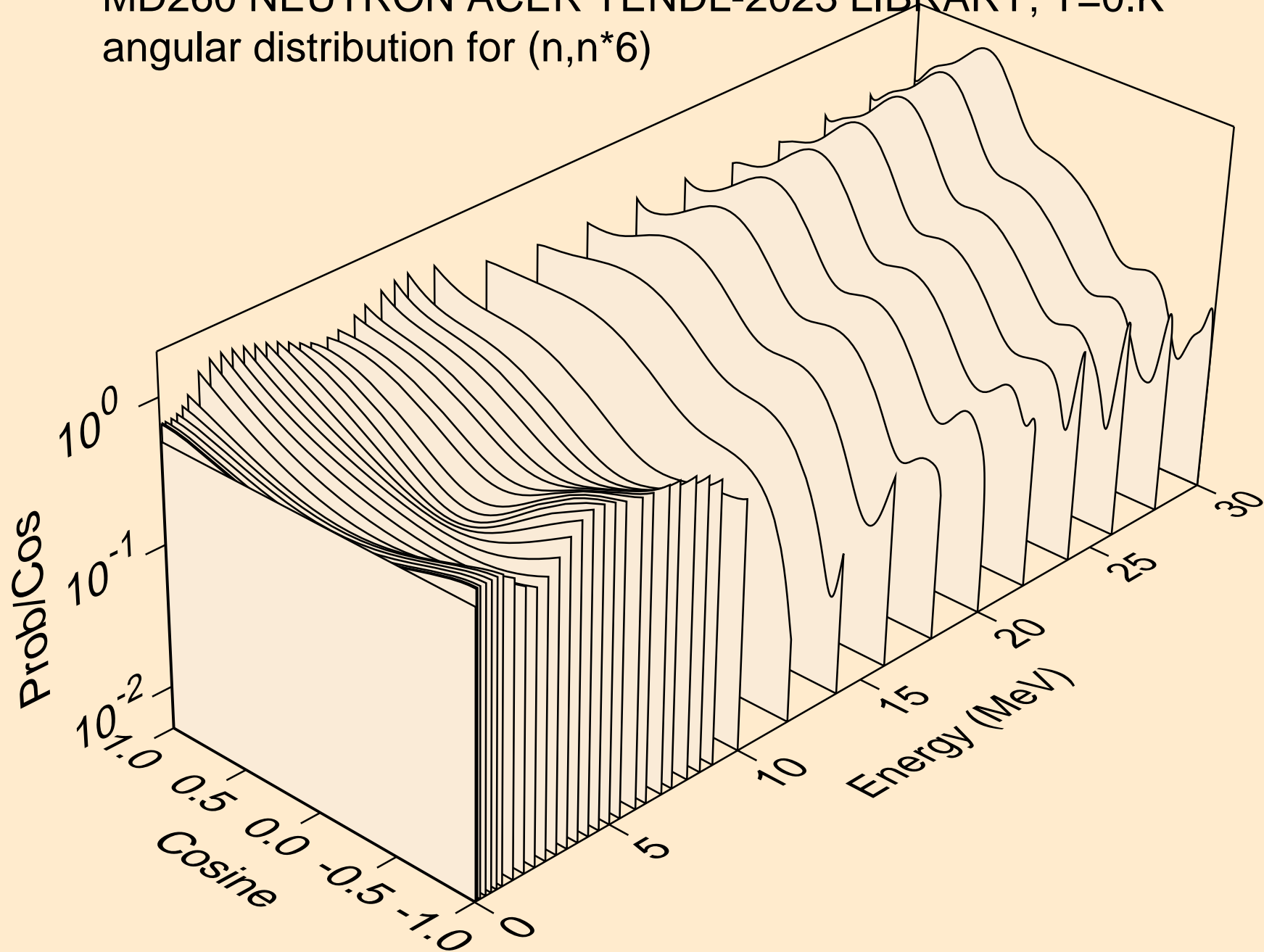

MD260 NEUTRON ACER TENDL-2023 LIBRARY; T=0.K
angular distribution for (n,n*7)

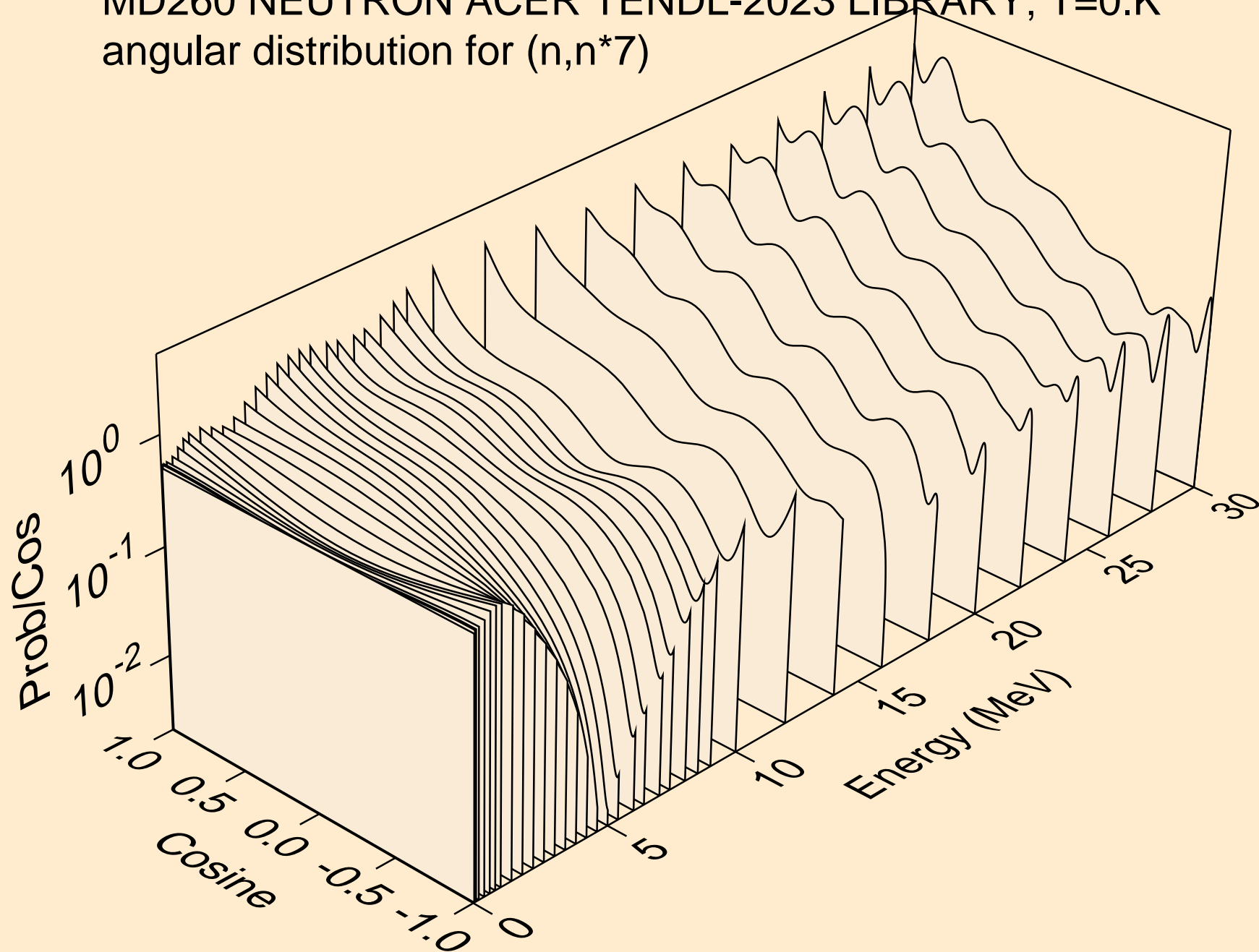

MD260 NEUTRON ACER TENDL-2023 LIBRARY; T=0.K
angular distribution for (n,n*8)

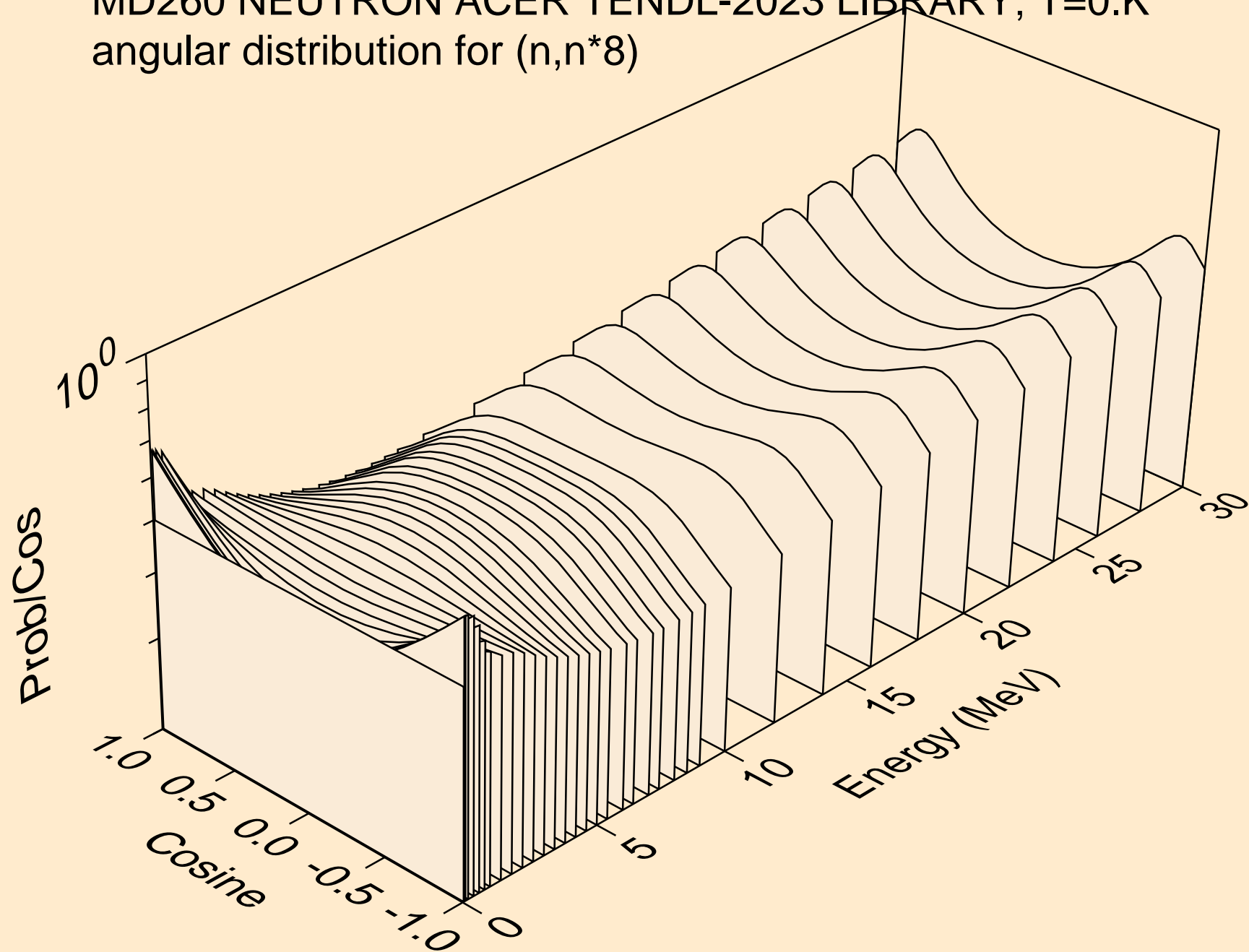

MD260 NEUTRON ACER TENDL-2023 LIBRARY; T=0.K
angular distribution for (n,n*9)

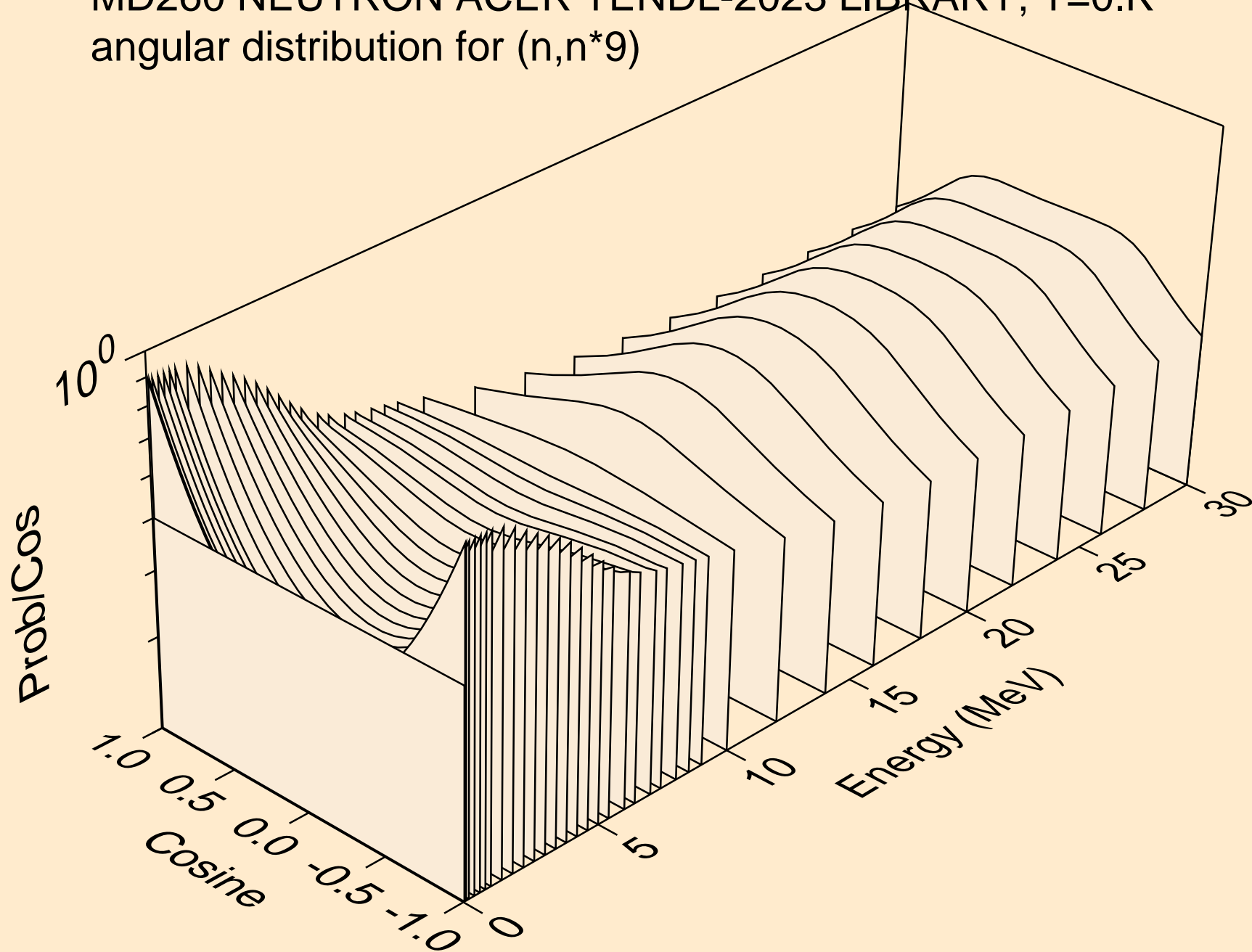

MD260 NEUTRON ACER TENDL-2023 LIBRARY; T=0.K
angular distribution for (n,n*10)

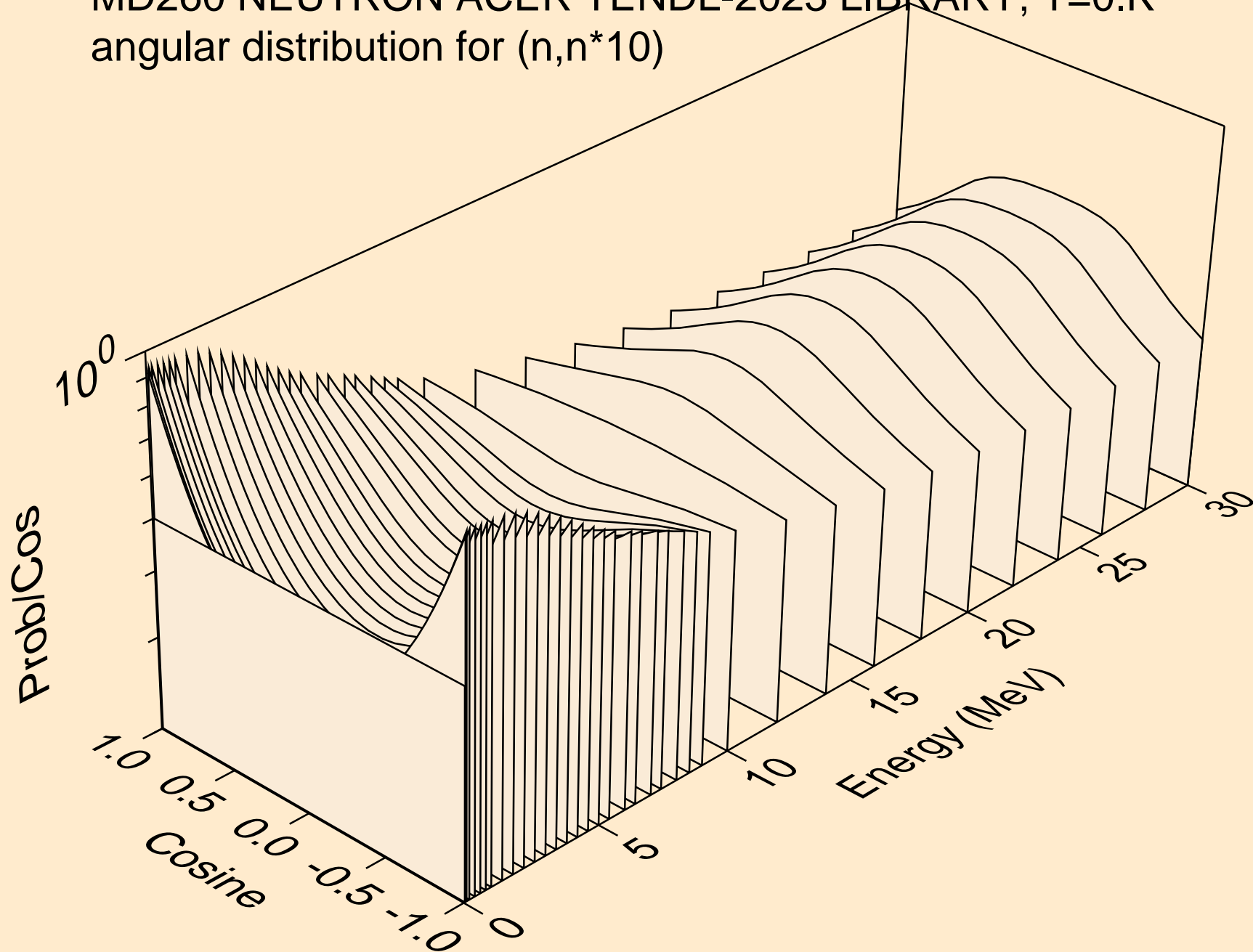

MD260 NEUTRON ACER TENDL-2023 LIBRARY; T=0.K
angular distribution for (n,n*11)

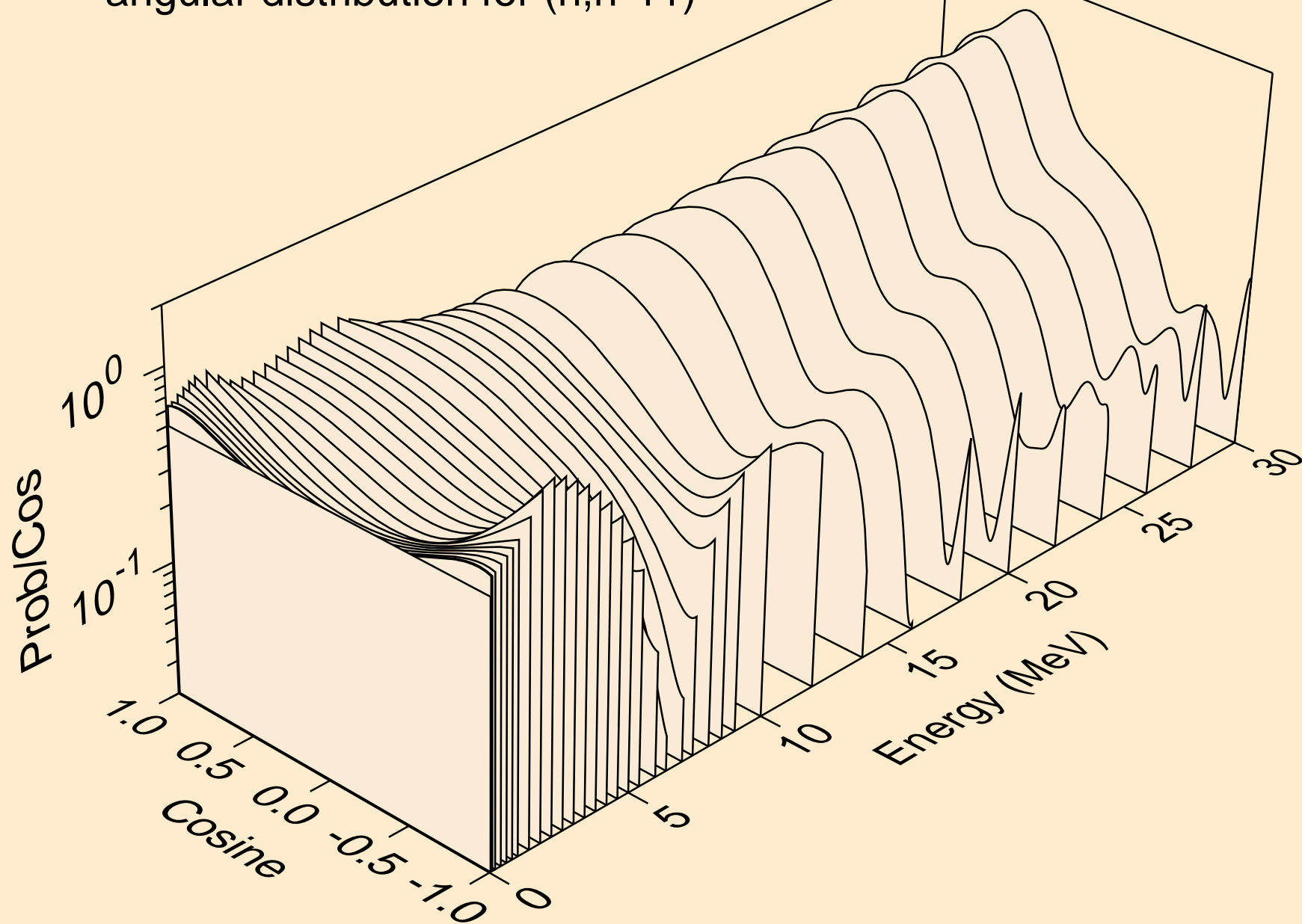

MD260 NEUTRON ACER TENDL-2023 LIBRARY; T=0.K
angular distribution for (n,n*12)

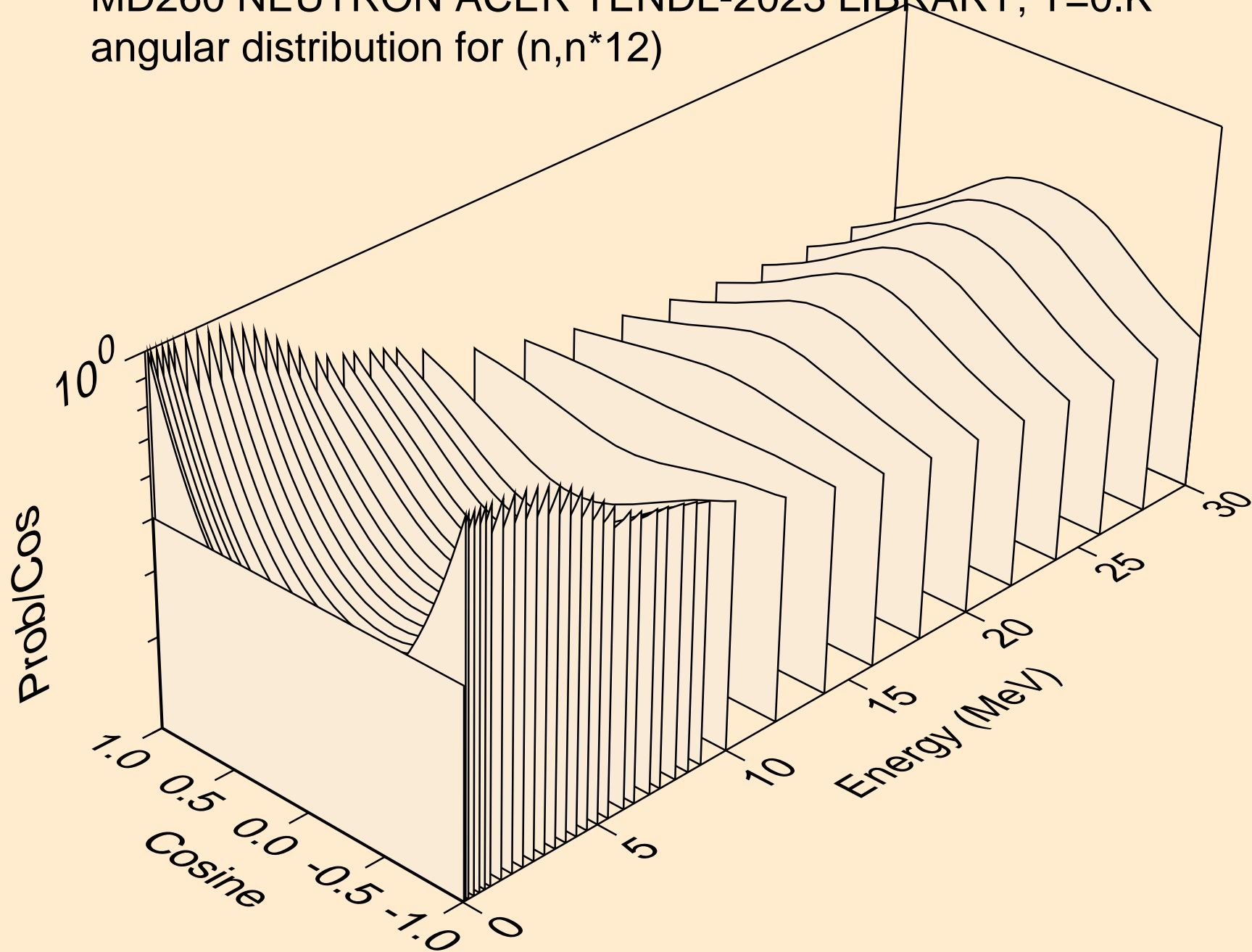

MD260 NEUTRON ACER TENDL-2023 LIBRARY; T=0.K
angular distribution for (n,n*13)

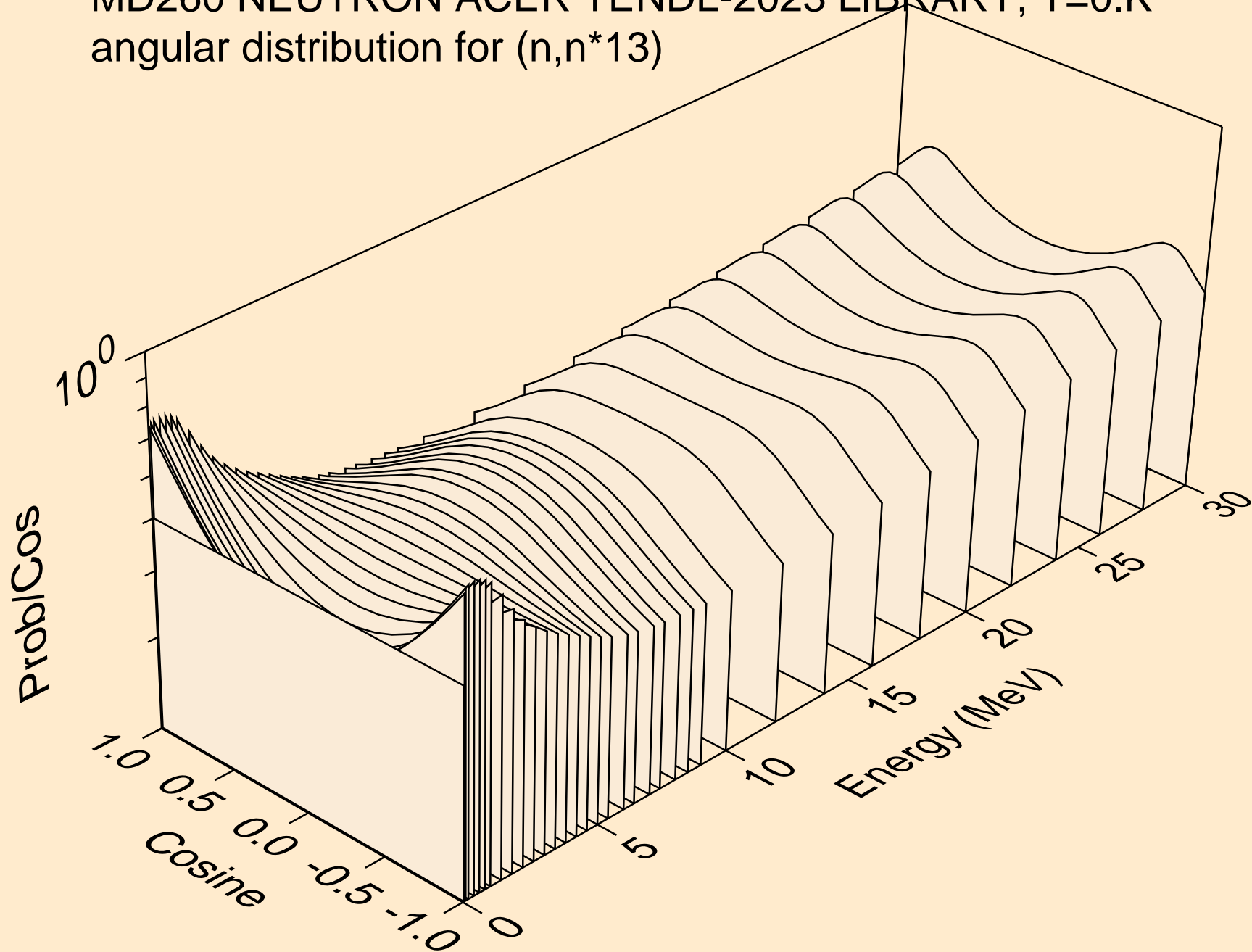

MD260 NEUTRON ACER TENDL-2023 LIBRARY; T=0.K
angular distribution for (n,n*14)

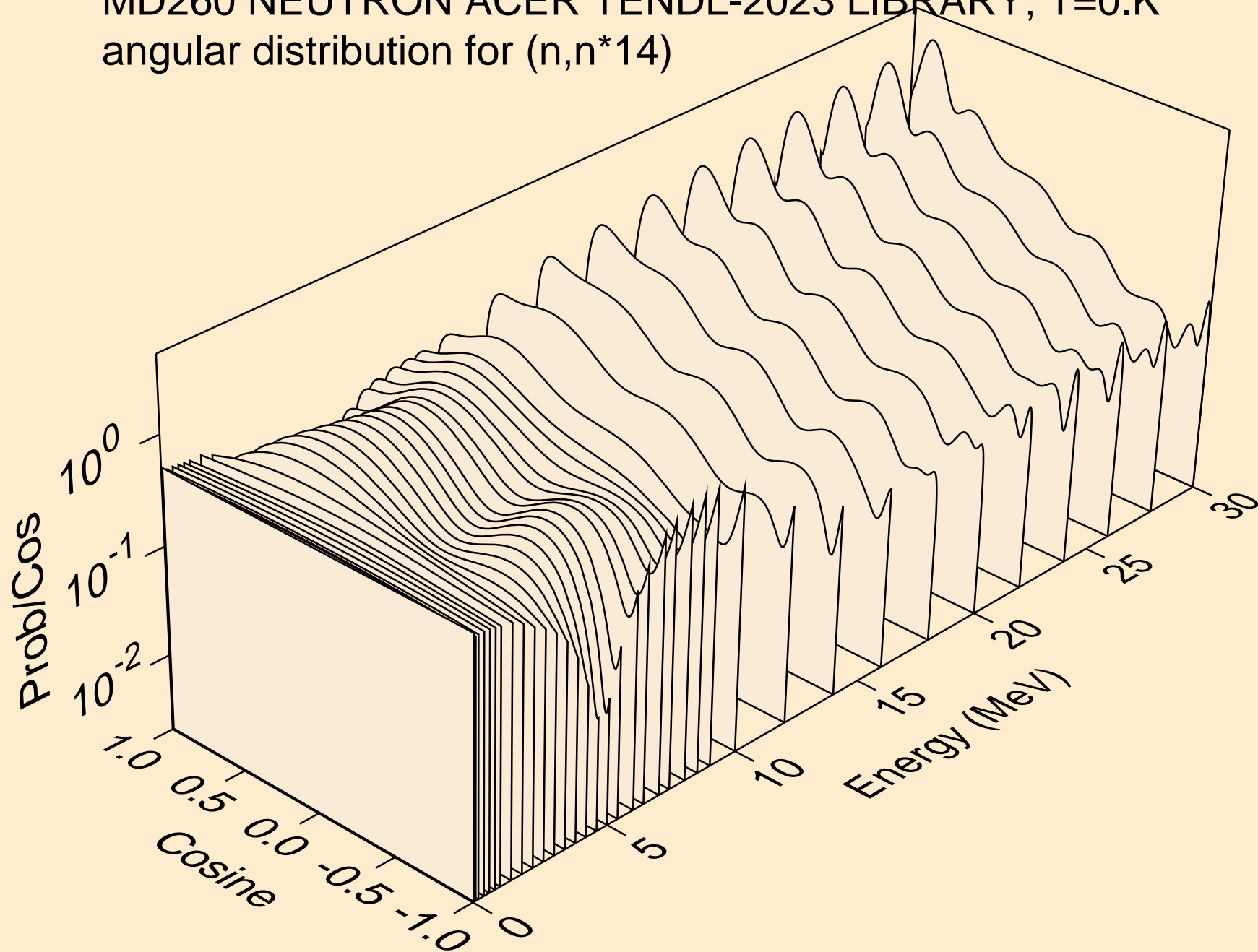

MD260 NEUTRON ACER TENDL-2023 LIBRARY; T=0.K
angular distribution for (n,n*15)

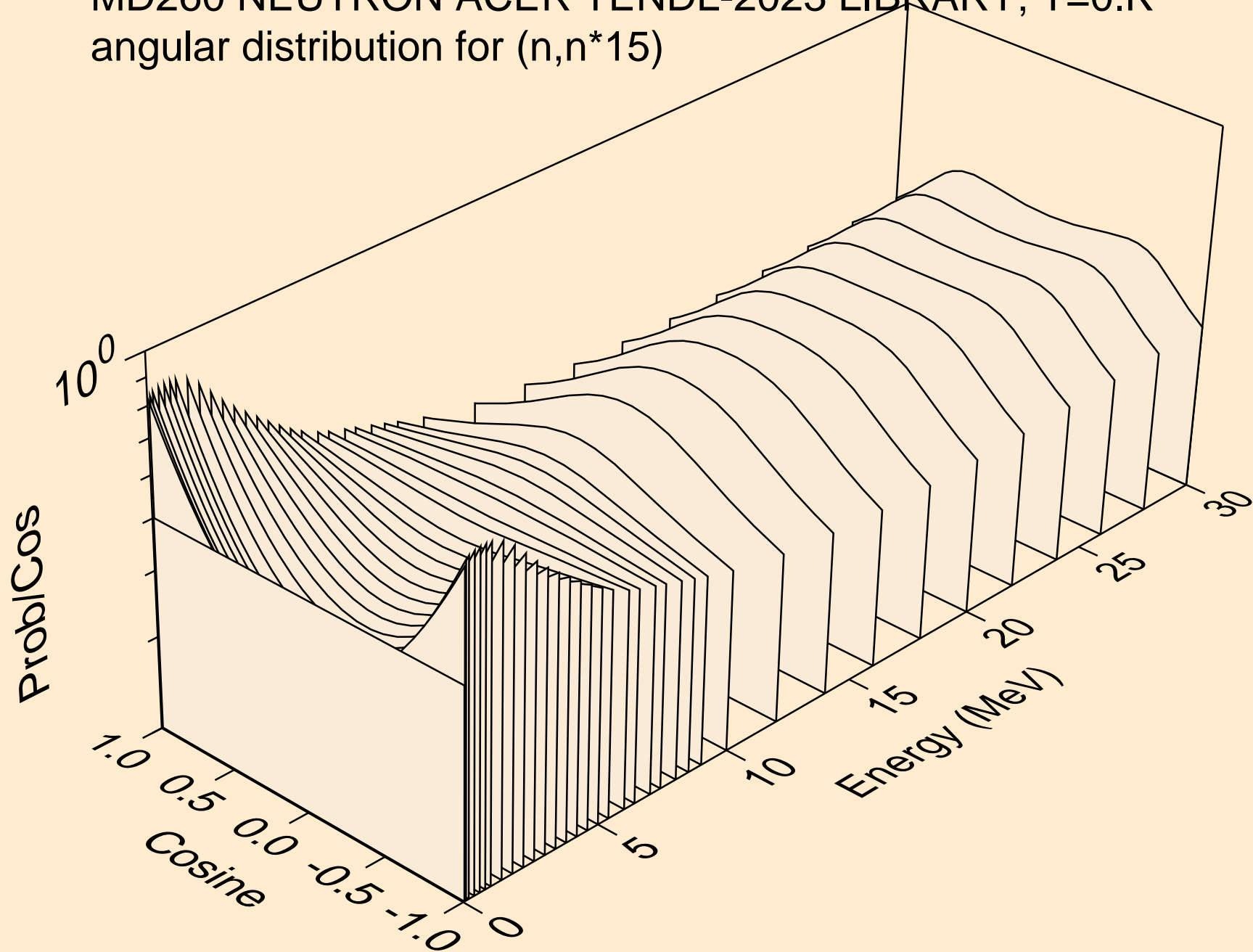

MD260 NEUTRON ACER TENDL-2023 LIBRARY; T=0.K
angular distribution for (n,n*16)

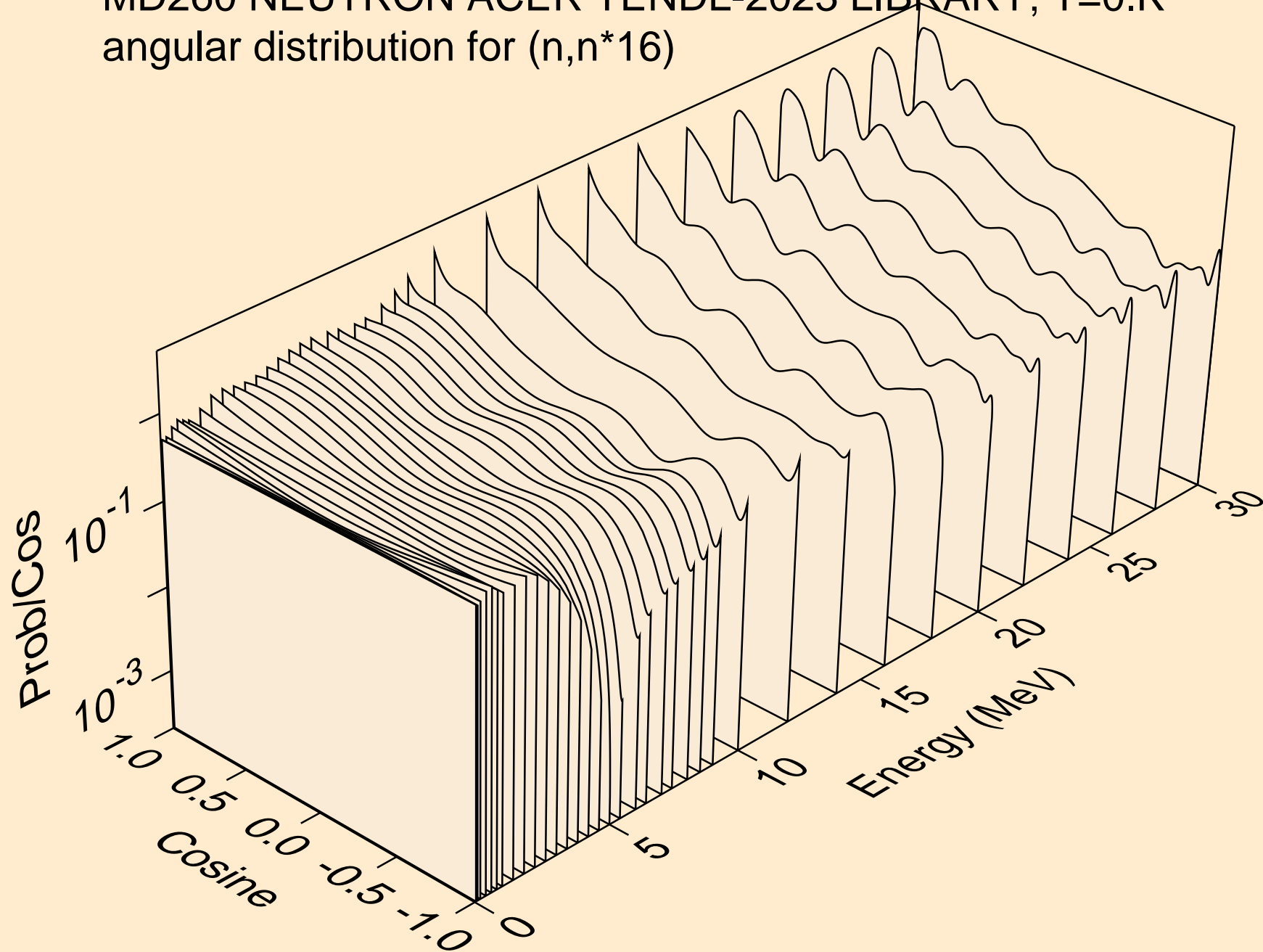

MD260 NEUTRON ACER TENDL-2023 LIBRARY; T=0.K
angular distribution for (n,n*17)

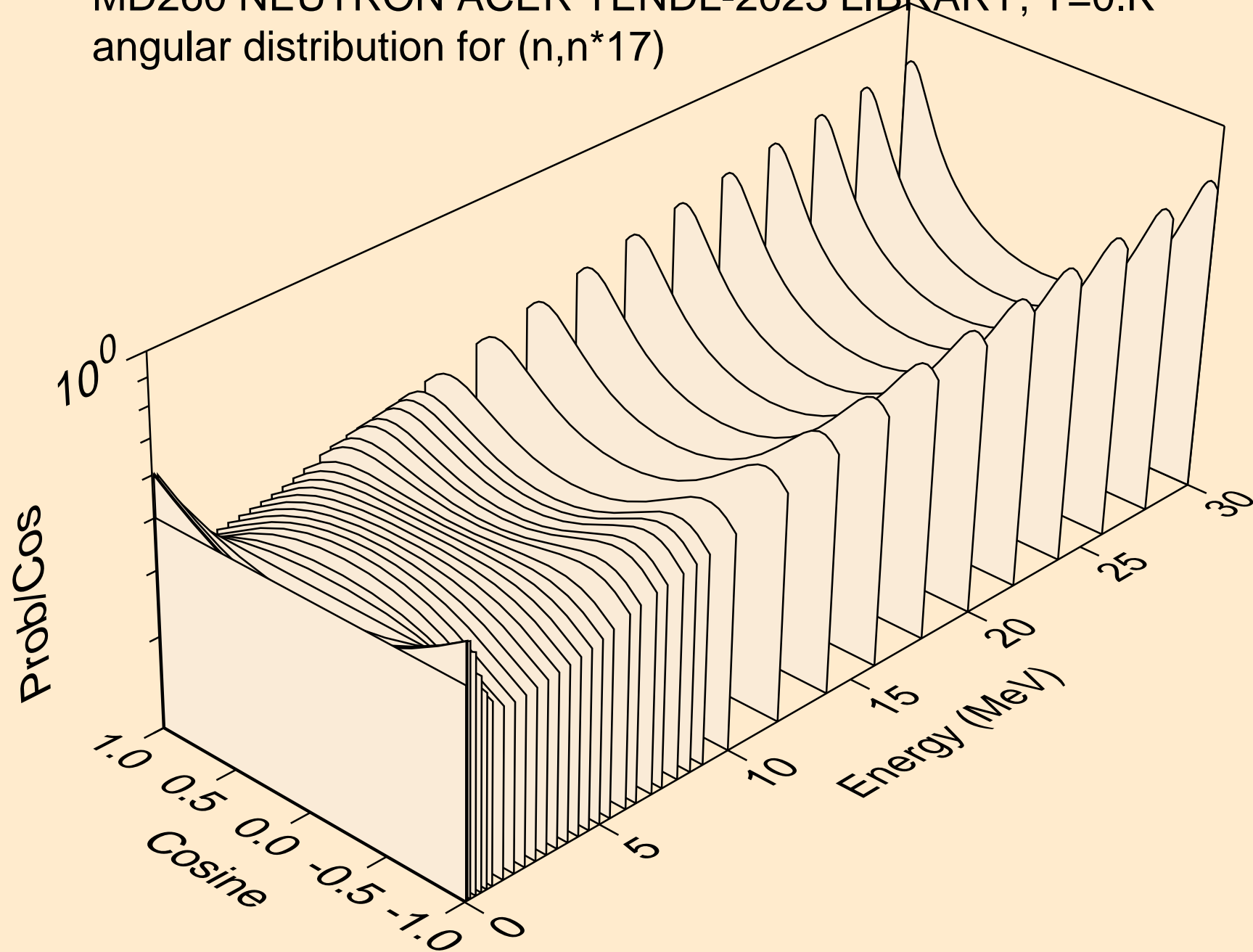

MD260 NEUTRON ACER TENDL-2023 LIBRARY; T=0.K
angular distribution for (n,n*18)

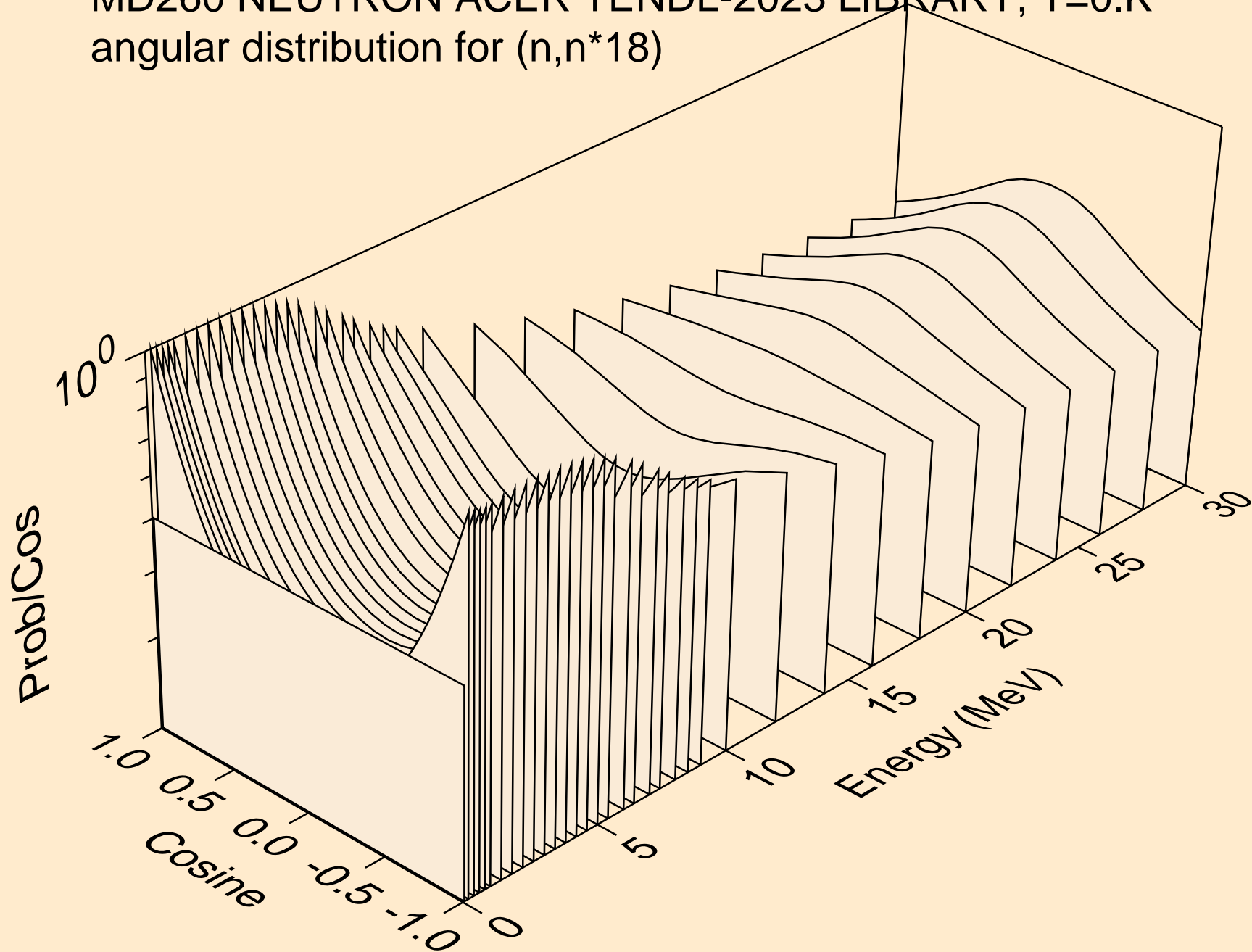

MD260 NEUTRON ACER TENDL-2023 LIBRARY; T=0.K
angular distribution for (n,n*19)

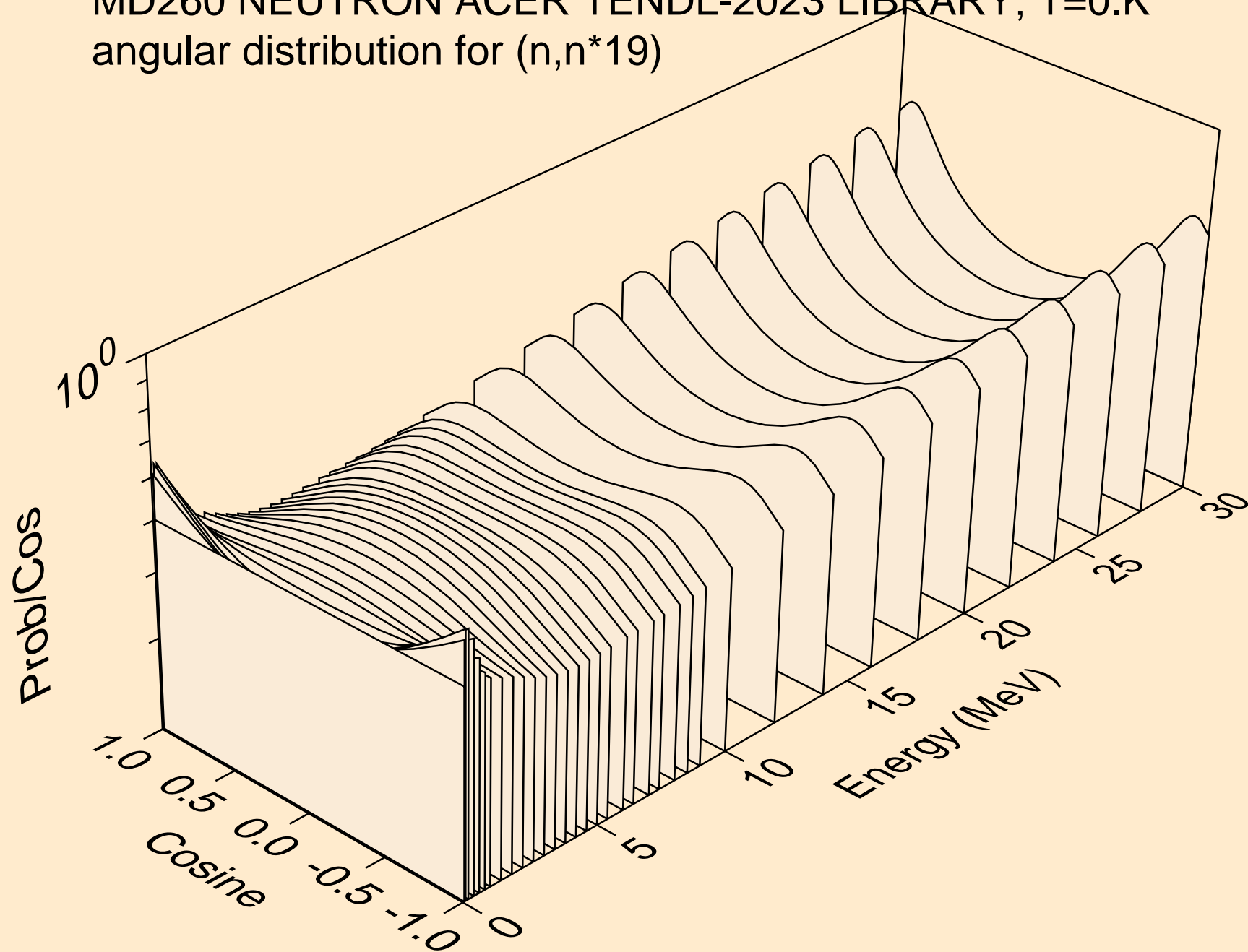

MD260 NEUTRON ACER TENDL-2023 LIBRARY; T=0.K
angular distribution for (n,n*20)

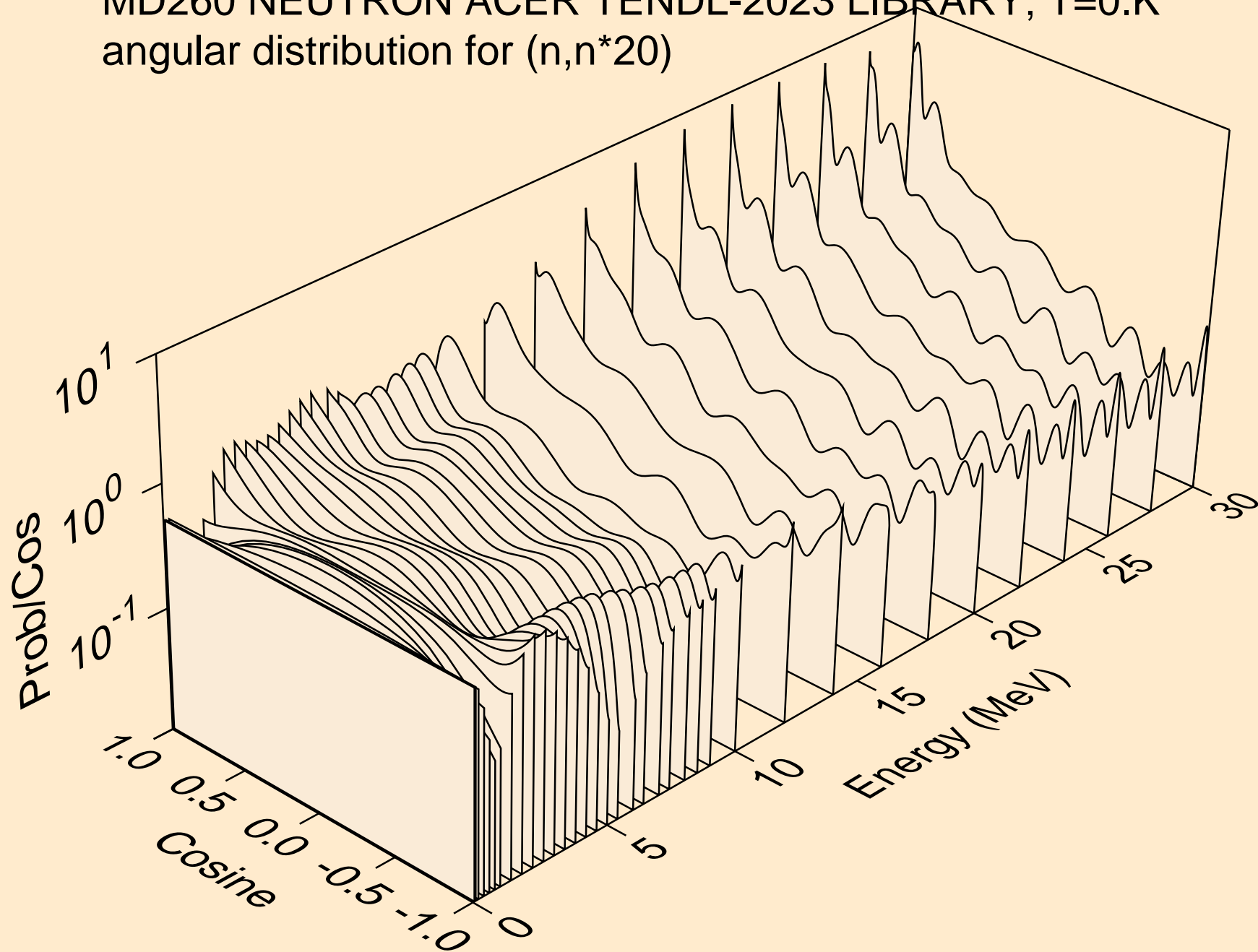

MD260 NEUTRON ACER TENDL-2023 LIBRARY; T=0.K

Total fission nuubar

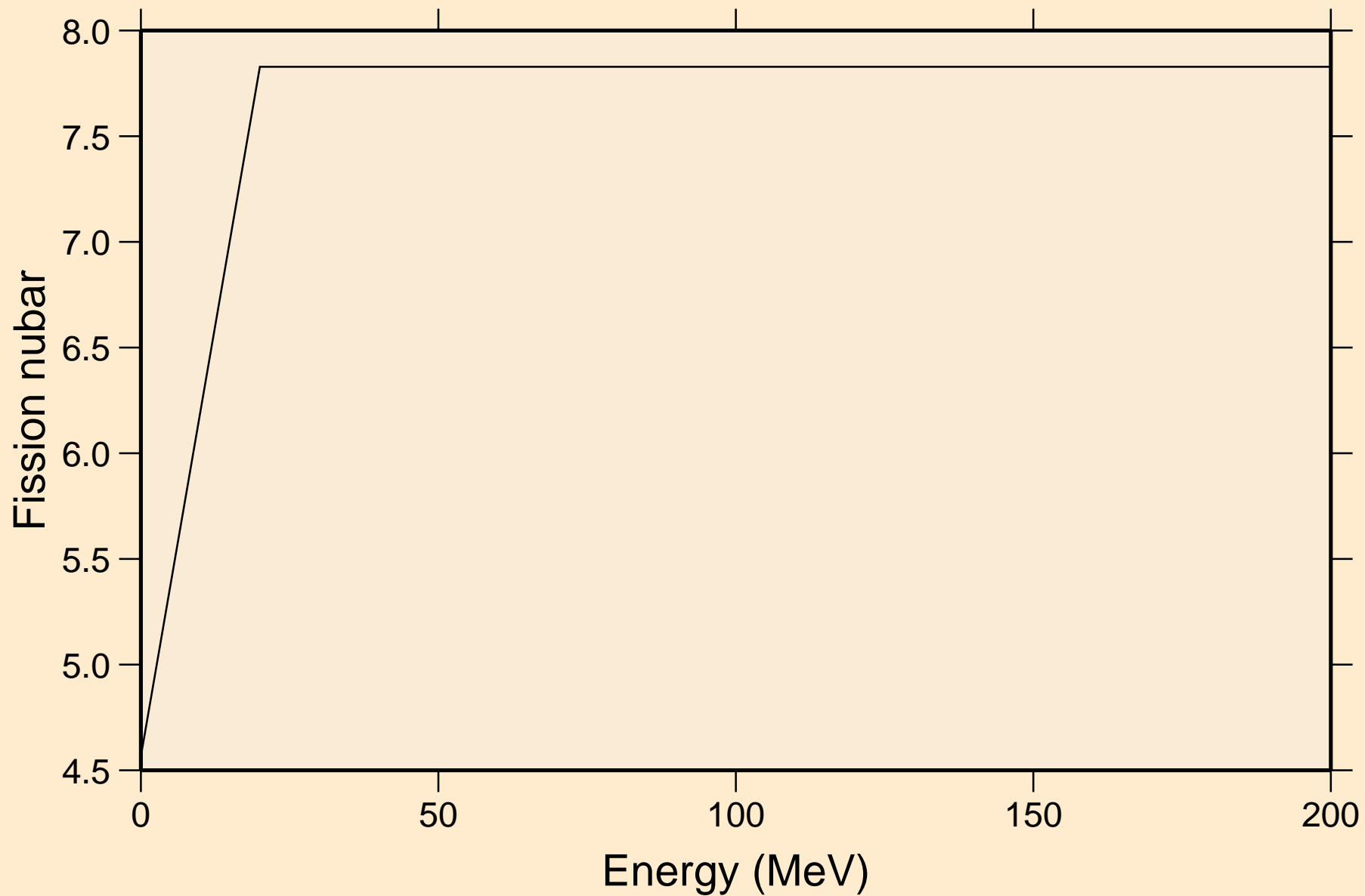

MD260 NEUTRON ACER TENDL-2023 LIBRARY; T=0.K
Neutron emission for (n,x)

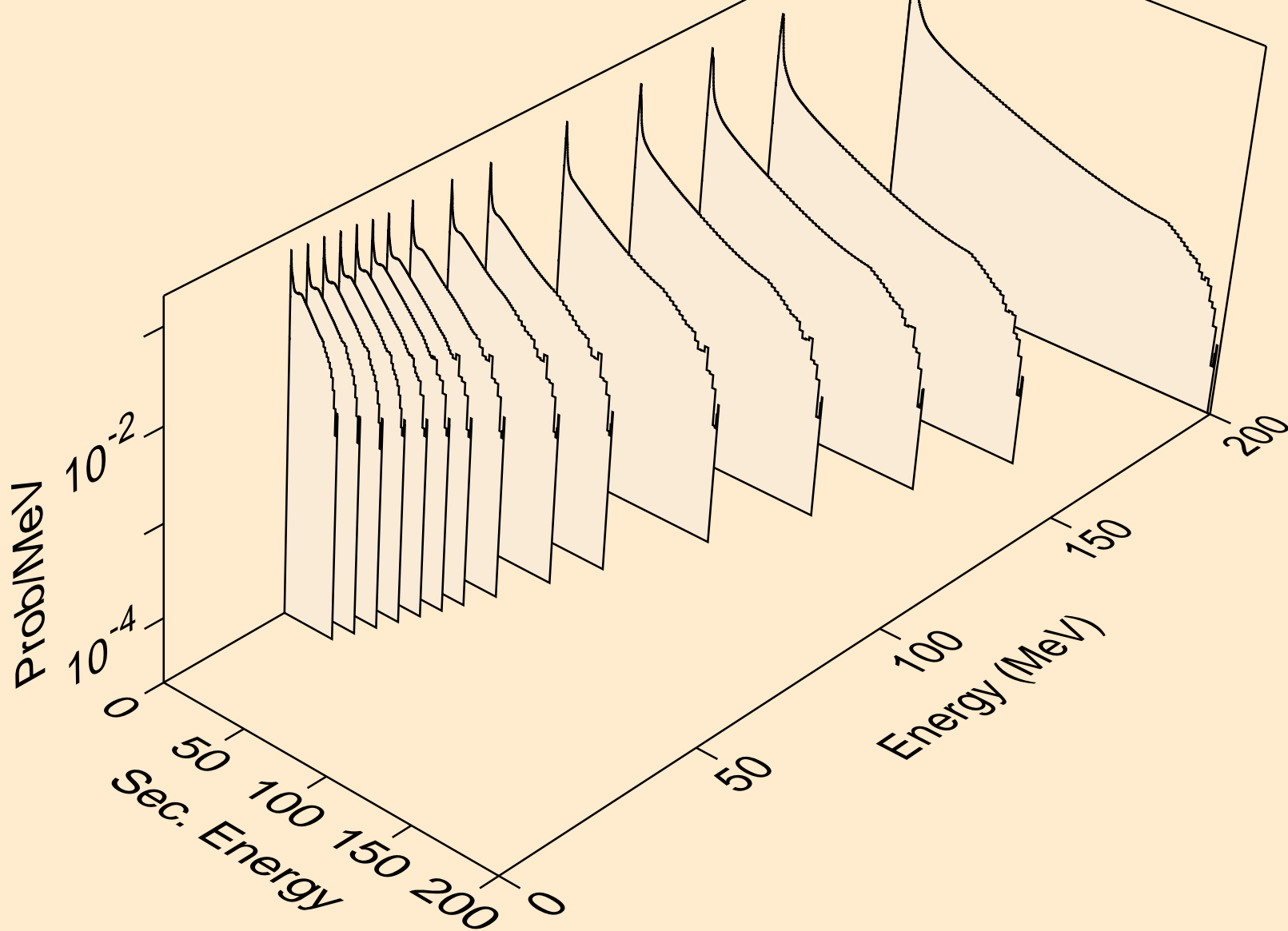

MD260 NEUTRON ACER TENDL-2023 LIBRARY; T=0.K
Neutron emission for (n,2nd)

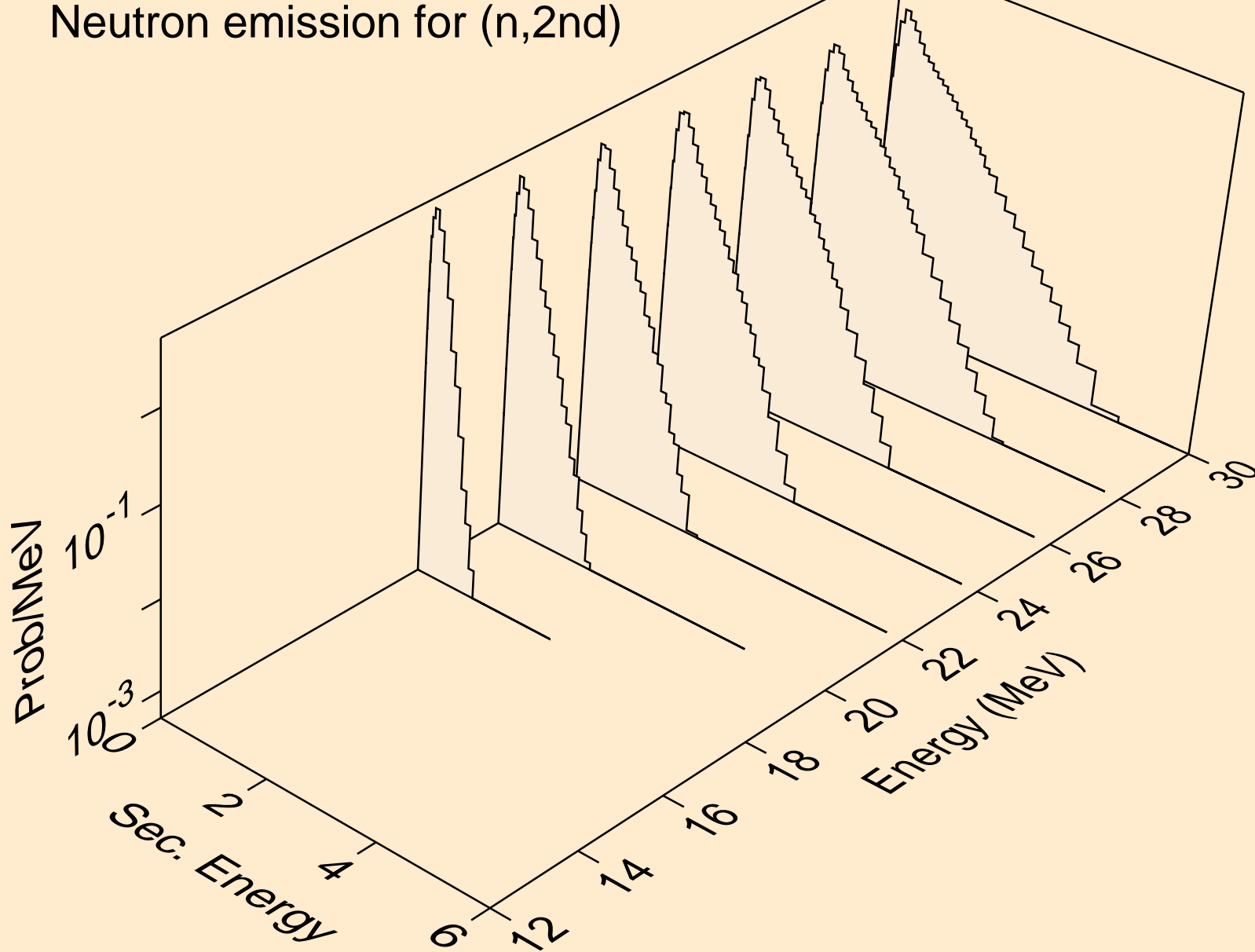

MD260 NEUTRON ACER TENDL-2023 LIBRARY; T=0.K
Neutron emission for (n,2n)

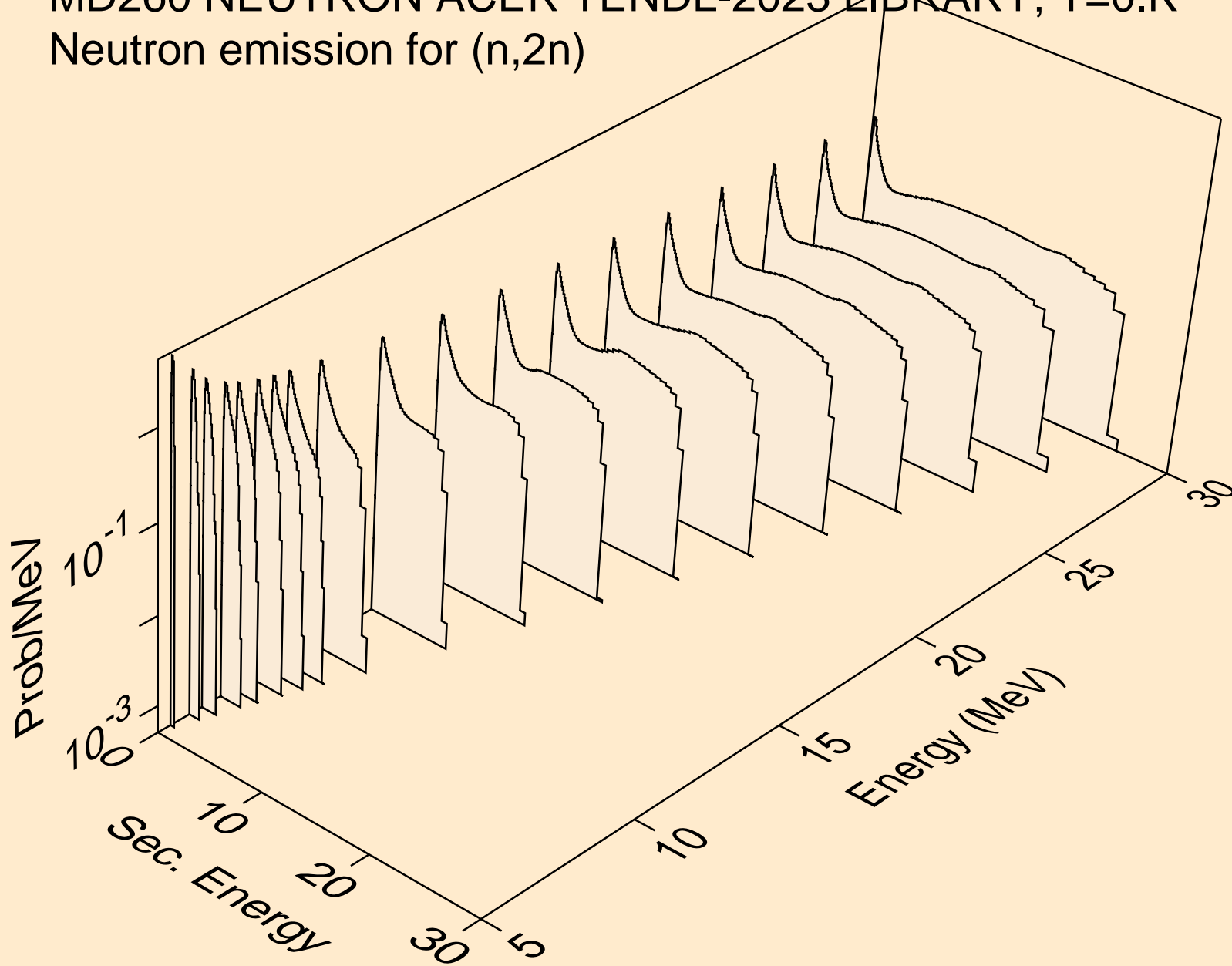

MD260 NEUTRON ACER TENDL-2023 LIBRARY; T=0.K
Neutron emission for (n,3n)

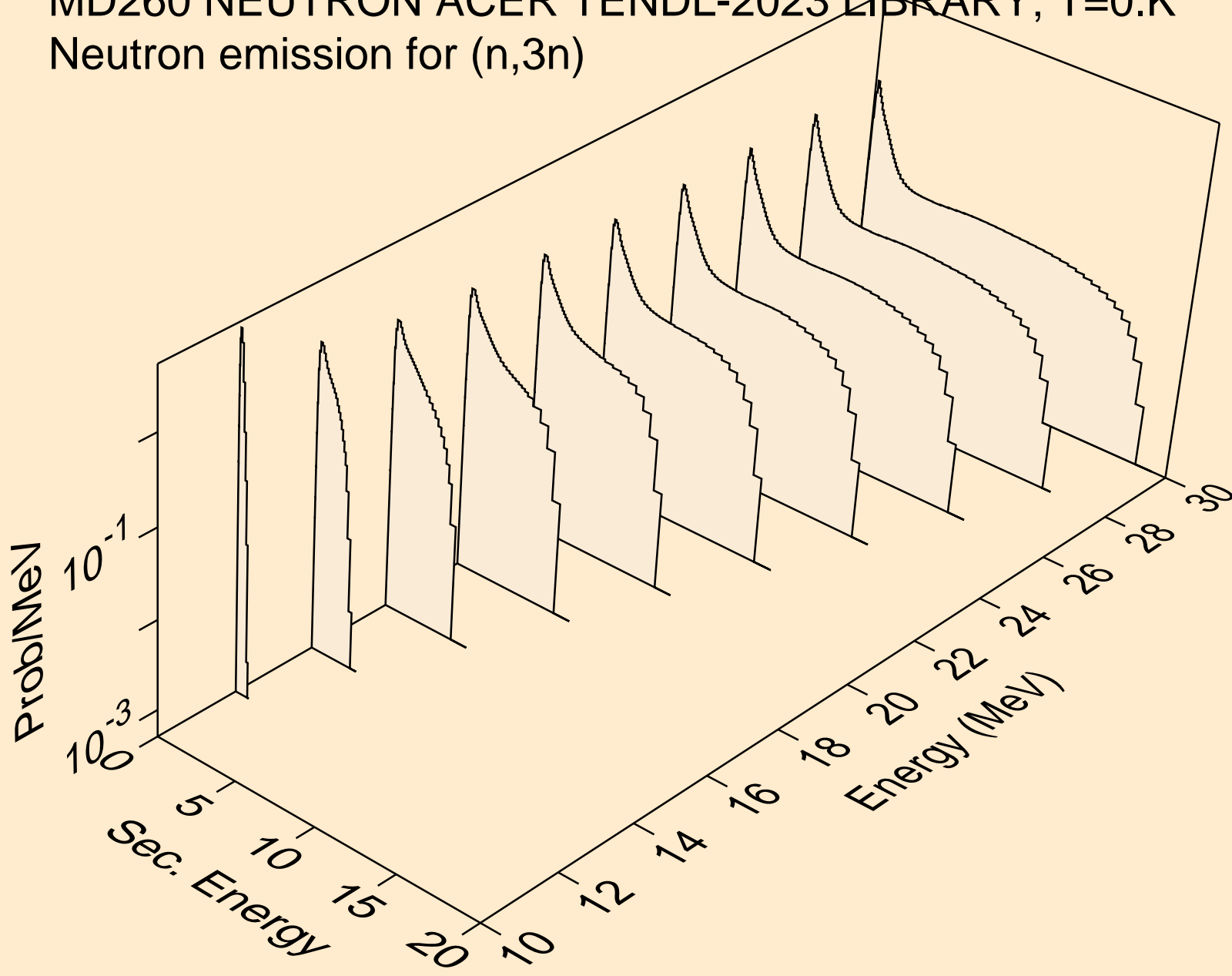

MD260 NEUTRON ACER TENDL-2023 LIBRARY; T=0.K
Neutron emission for fission

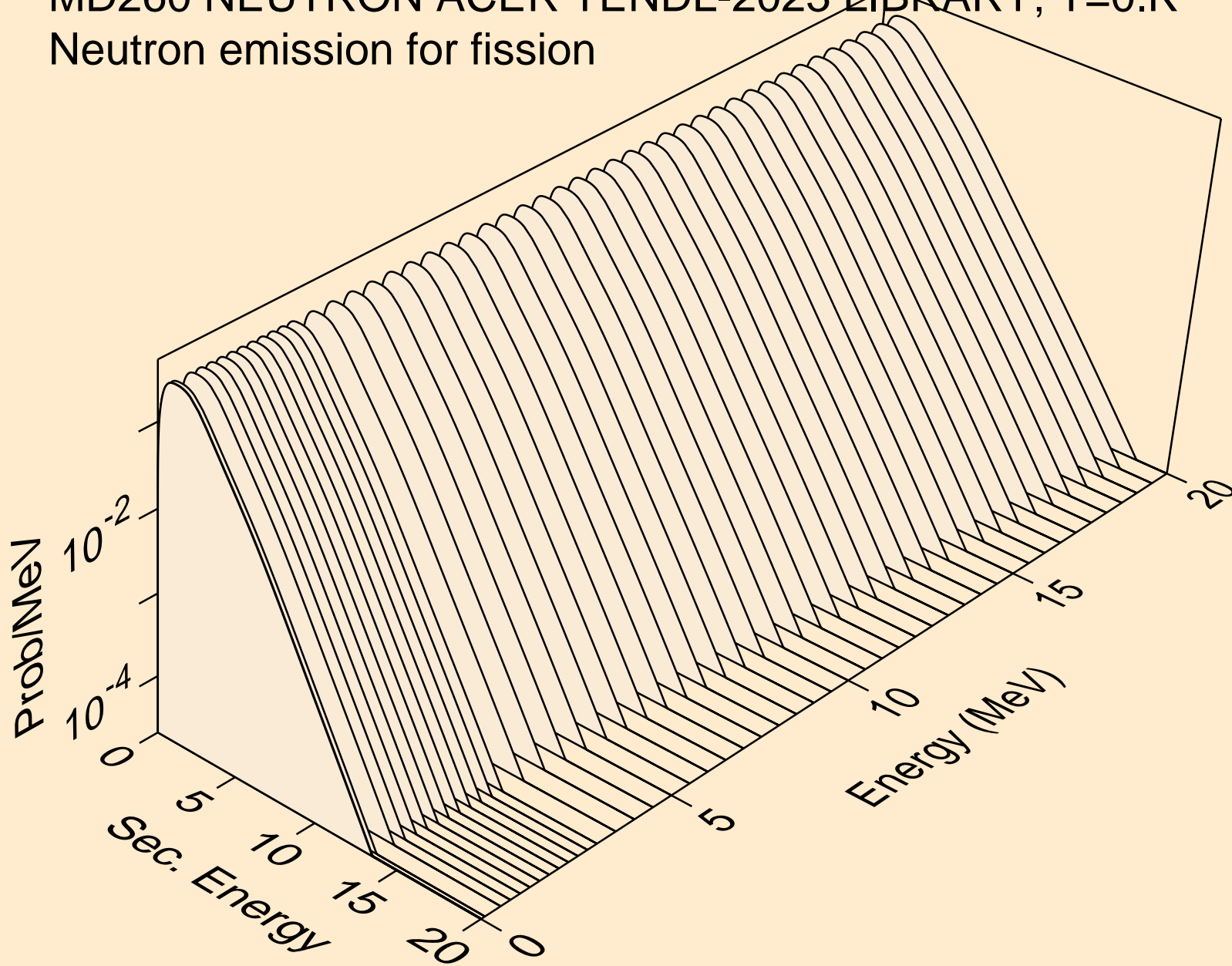

MD260 NEUTRON ACER TENDL-2023 LIBRARY; T=0.K
Neutron emission for (n,n*)a

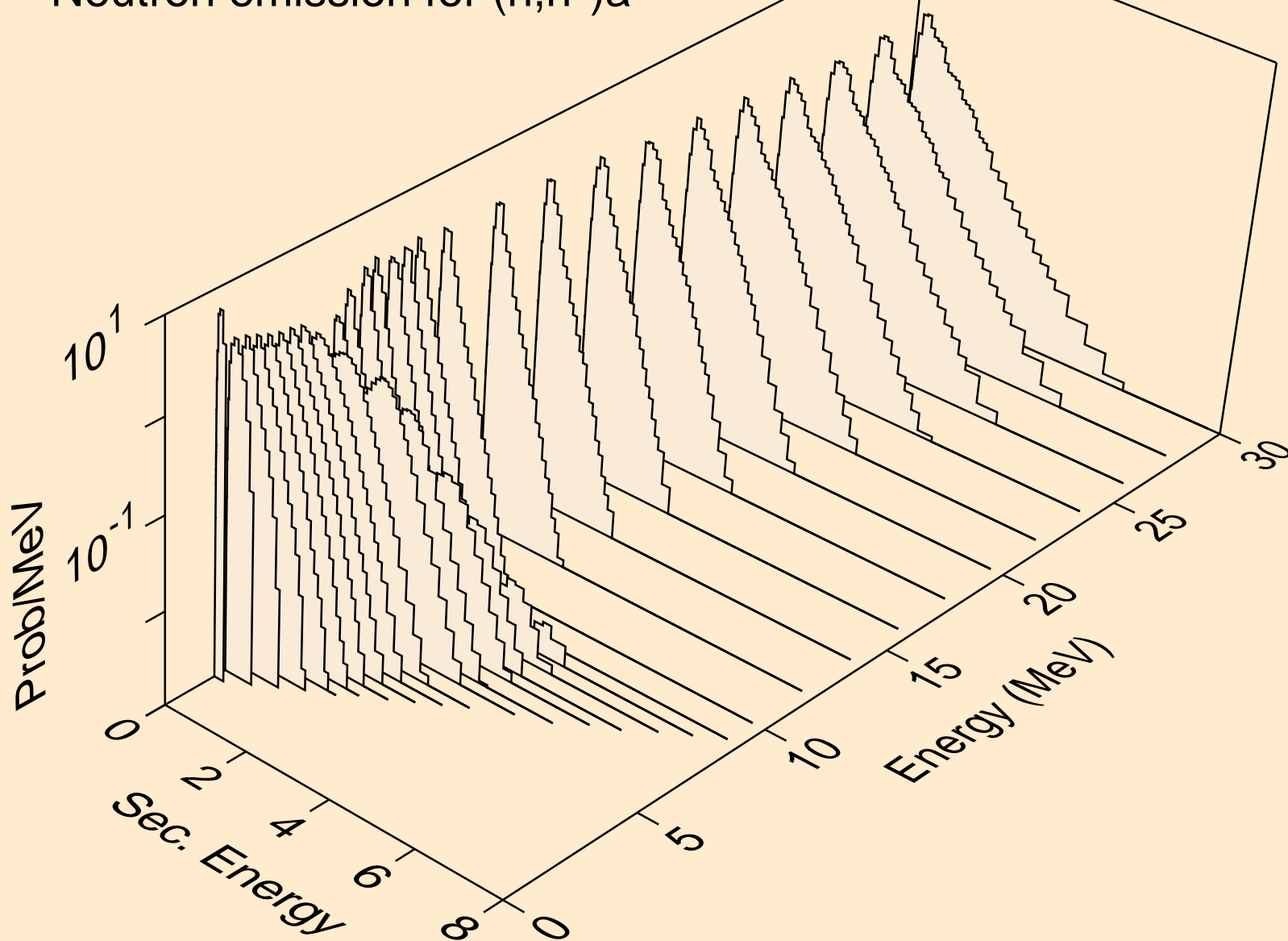

MD260 NEUTRON ACER TENDL-2023 LIBRARY; T=0.K
Neutron emission for (n,2n)a

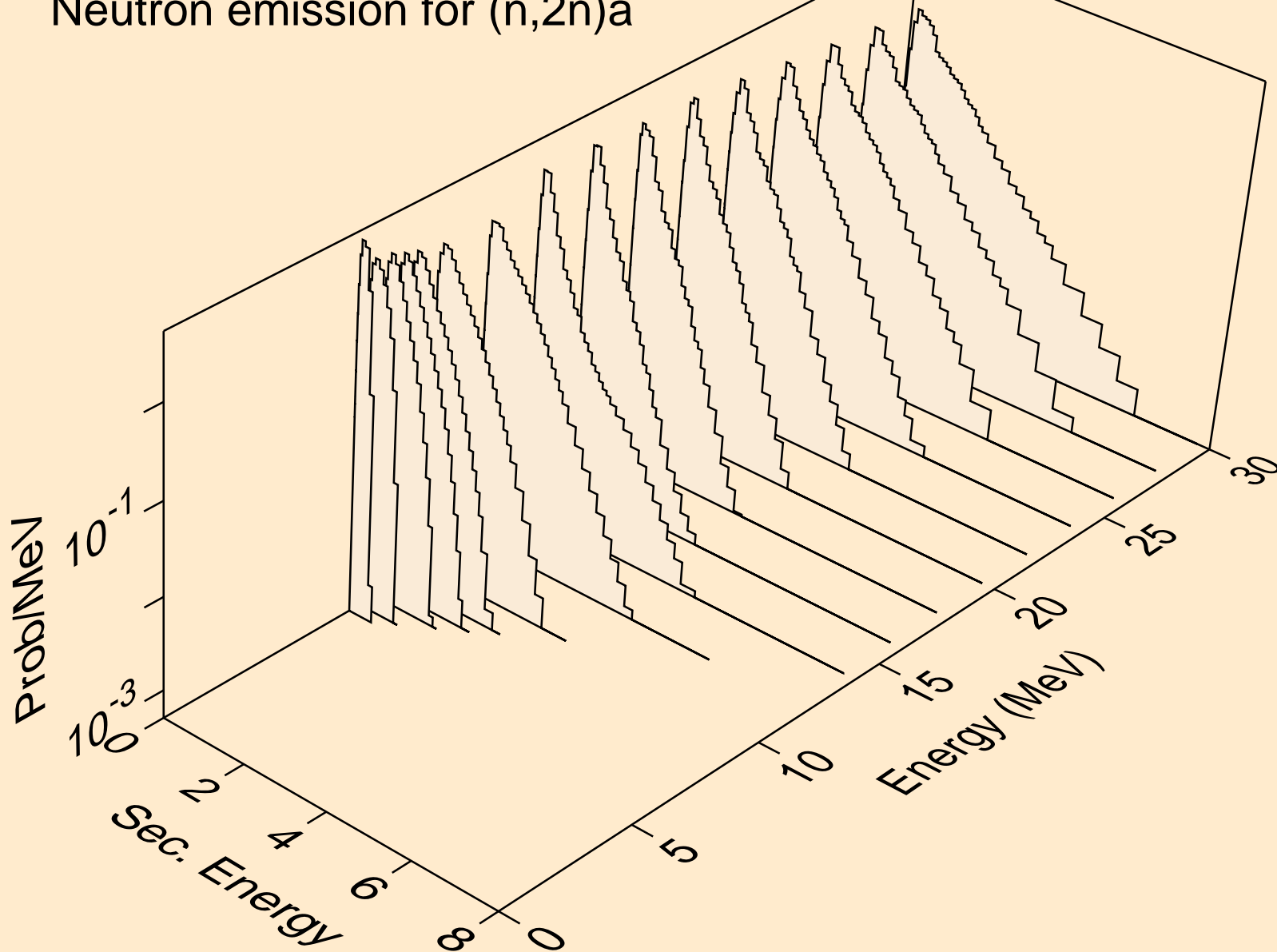

MD260 NEUTRON ACER TENDL-2023 LIBRARY; T=0.K
Neutron emission for (n,3n)a

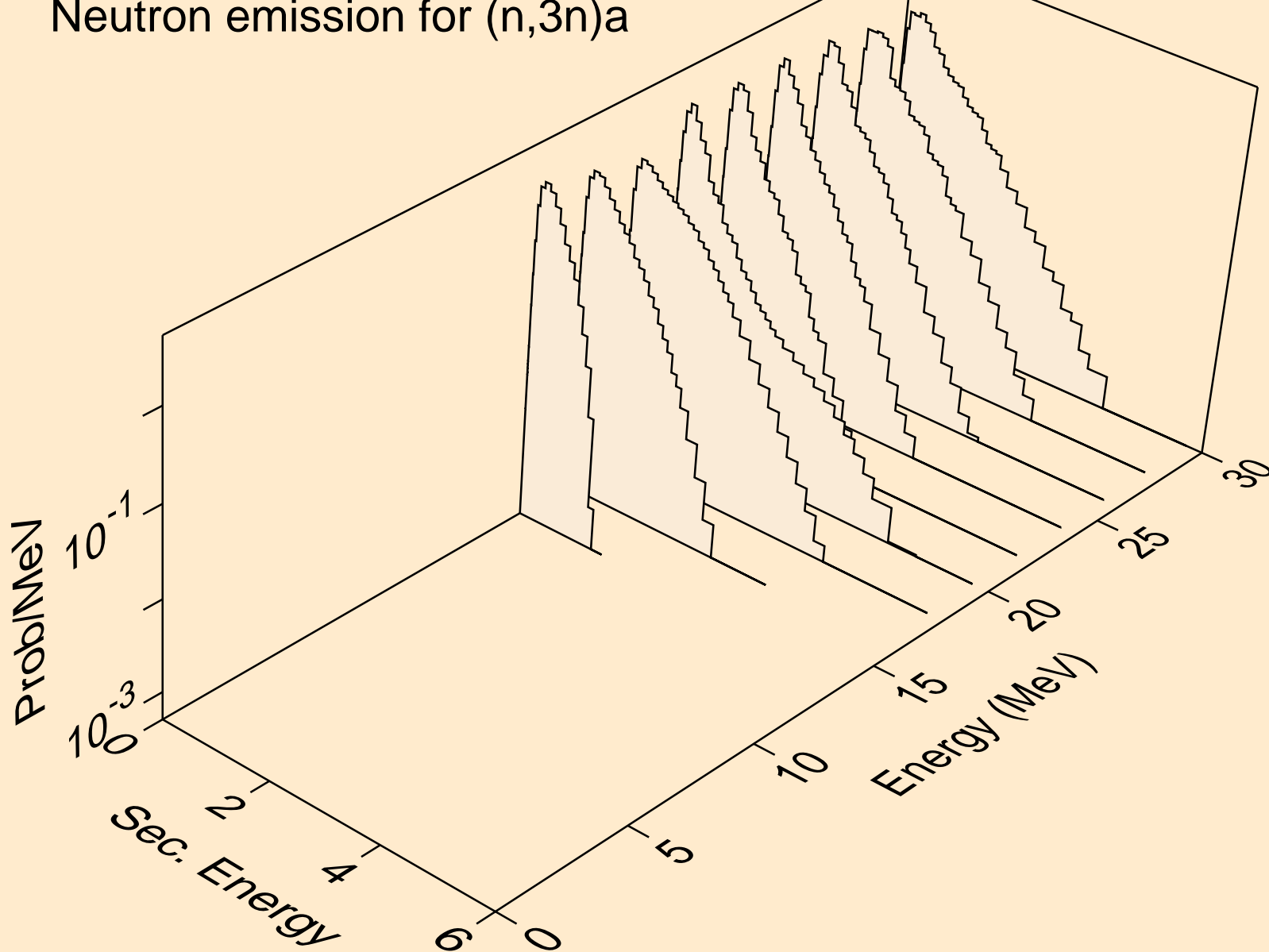

MD260 NEUTRON ACER TENDL-2023 LIBRARY; T=0.K
Neutron emission for (n,n*)p

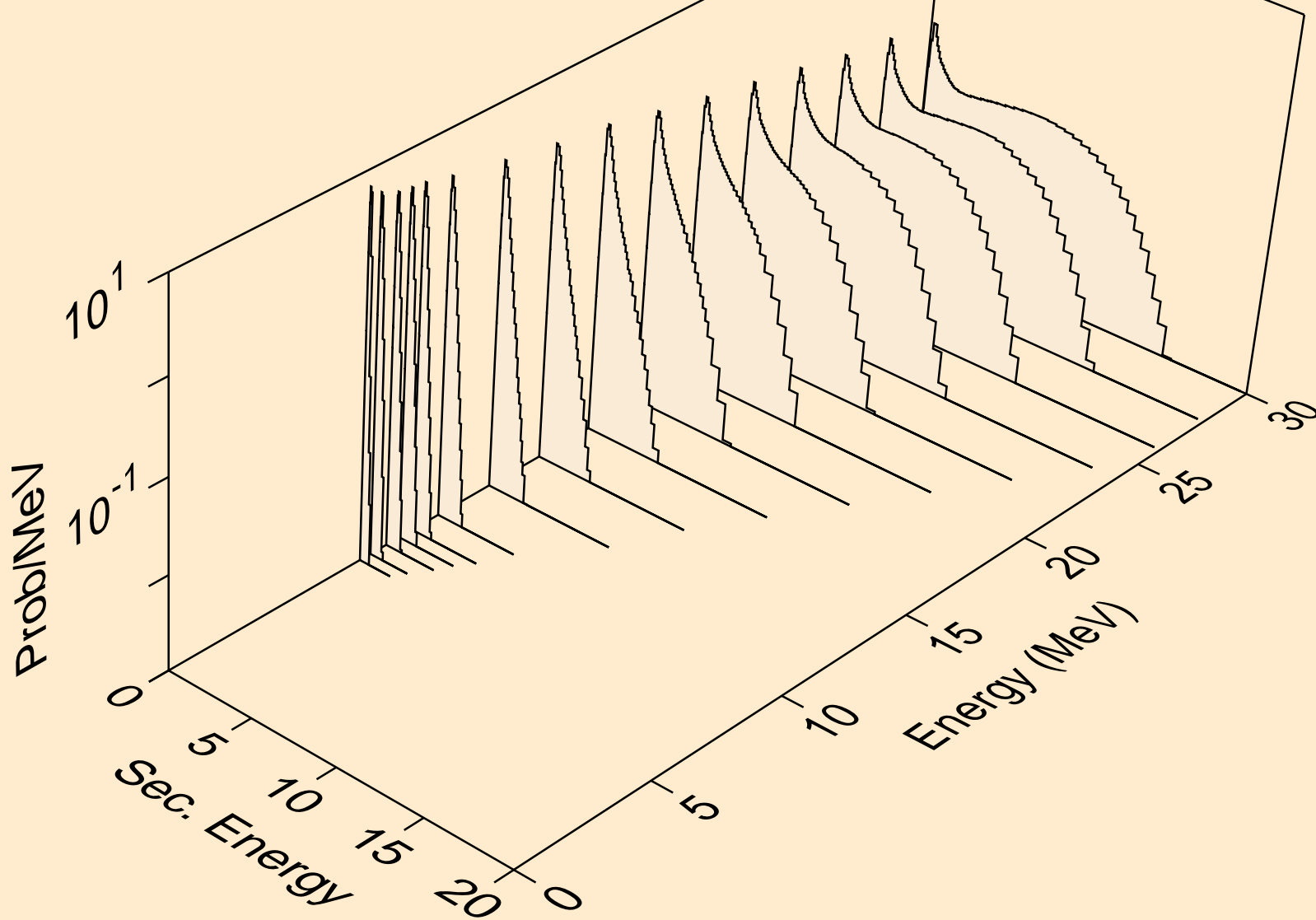

MD260 NEUTRON ACER TENDL-2023 LIBRARY; T=0.K
Neutron emission for (n,n*)2a

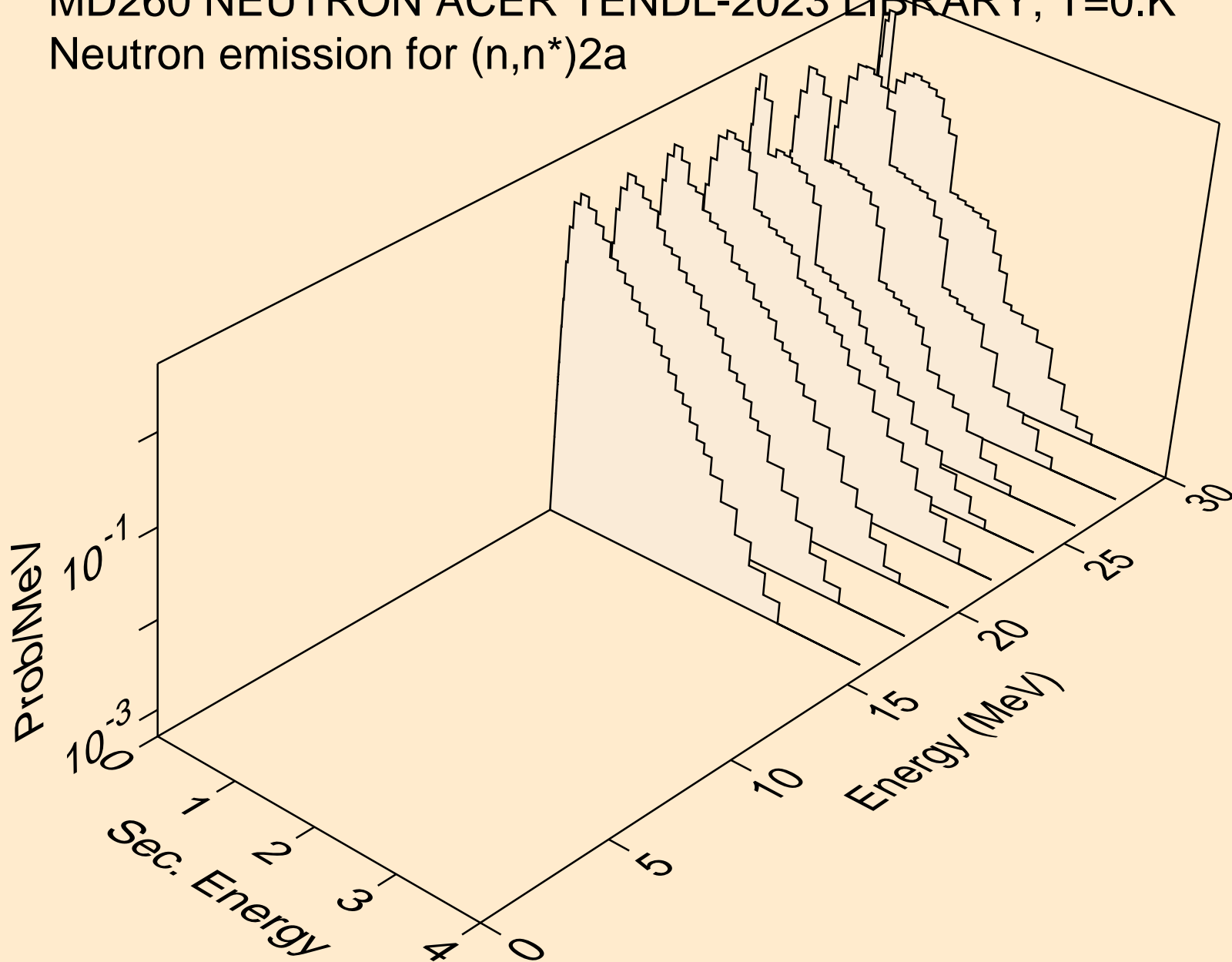

MD260 NEUTRON ACER TENDL-2023 LIBRARY; T=0.K
Neutron emission for (n,n*)d

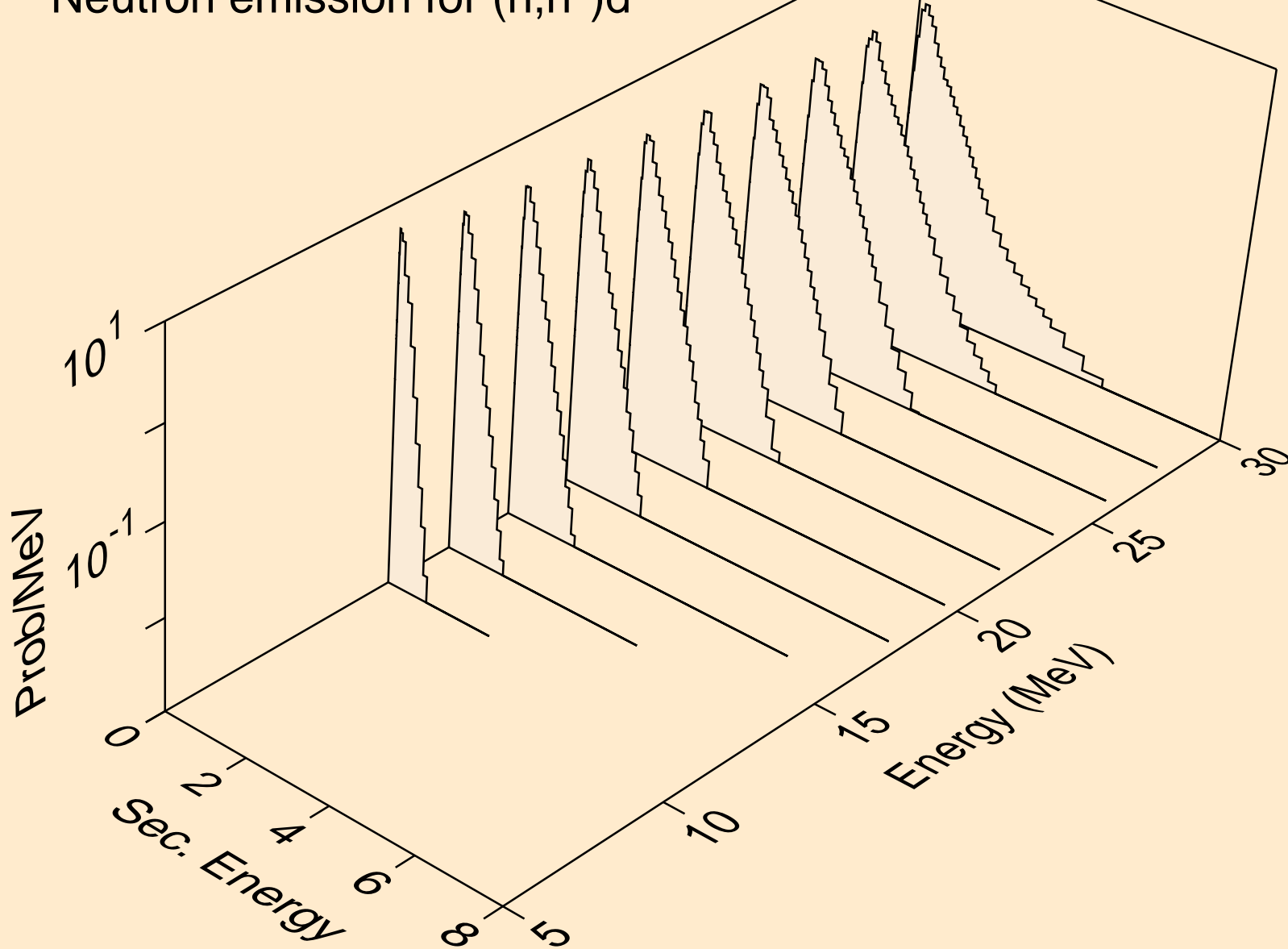

MD260 NEUTRON ACER TENDL-2023 LIBRARY; T=0.K
Neutron emission for (n,n*)t

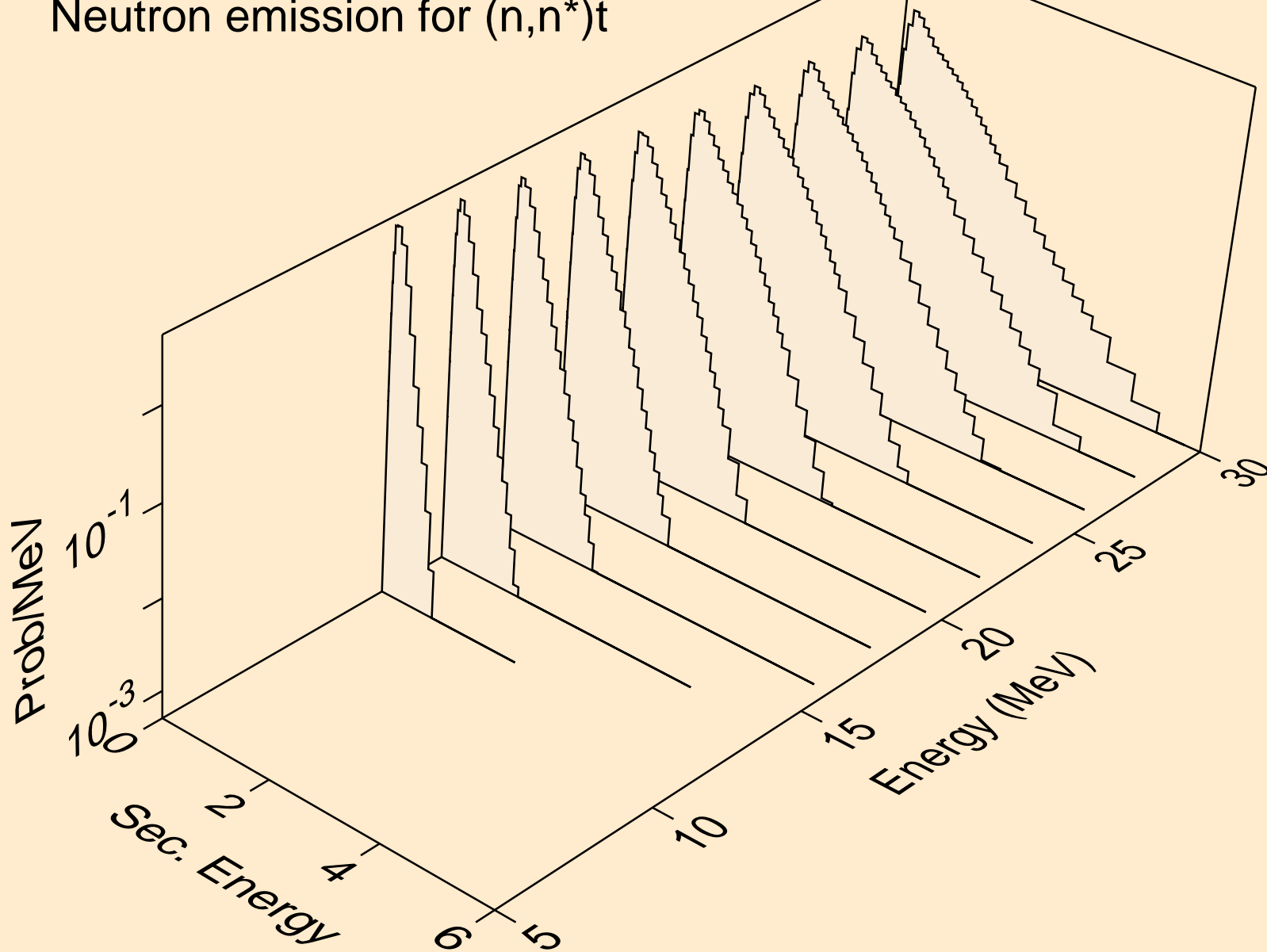

MD260 NEUTRON ACER TENDL-2023 LIBRARY; T=0.K
Neutron emission for (n,n*)he3

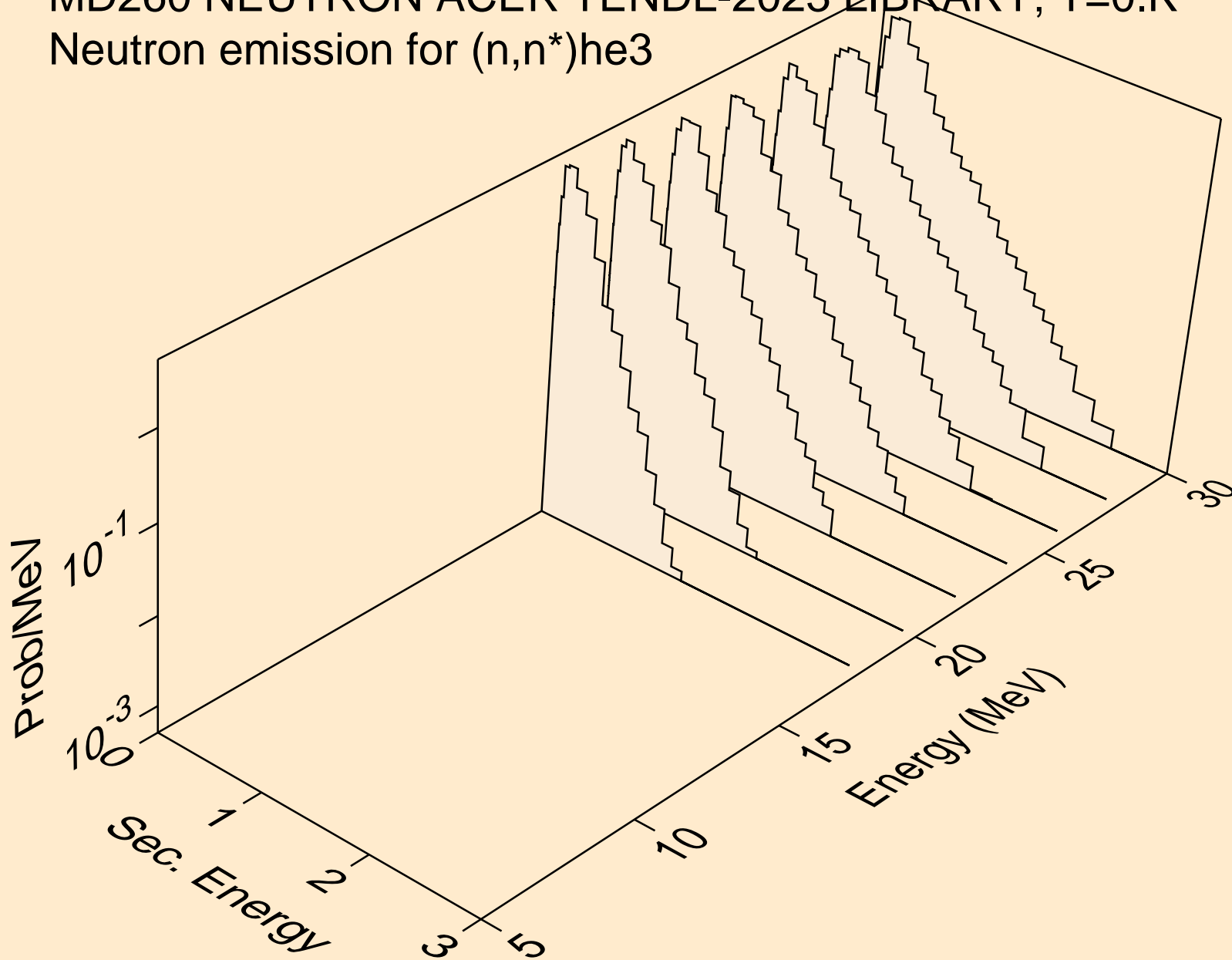

MD260 NEUTRON ACER TENDL-2023 LIBRARY; T=0.K
Neutron emission for (n,4n)

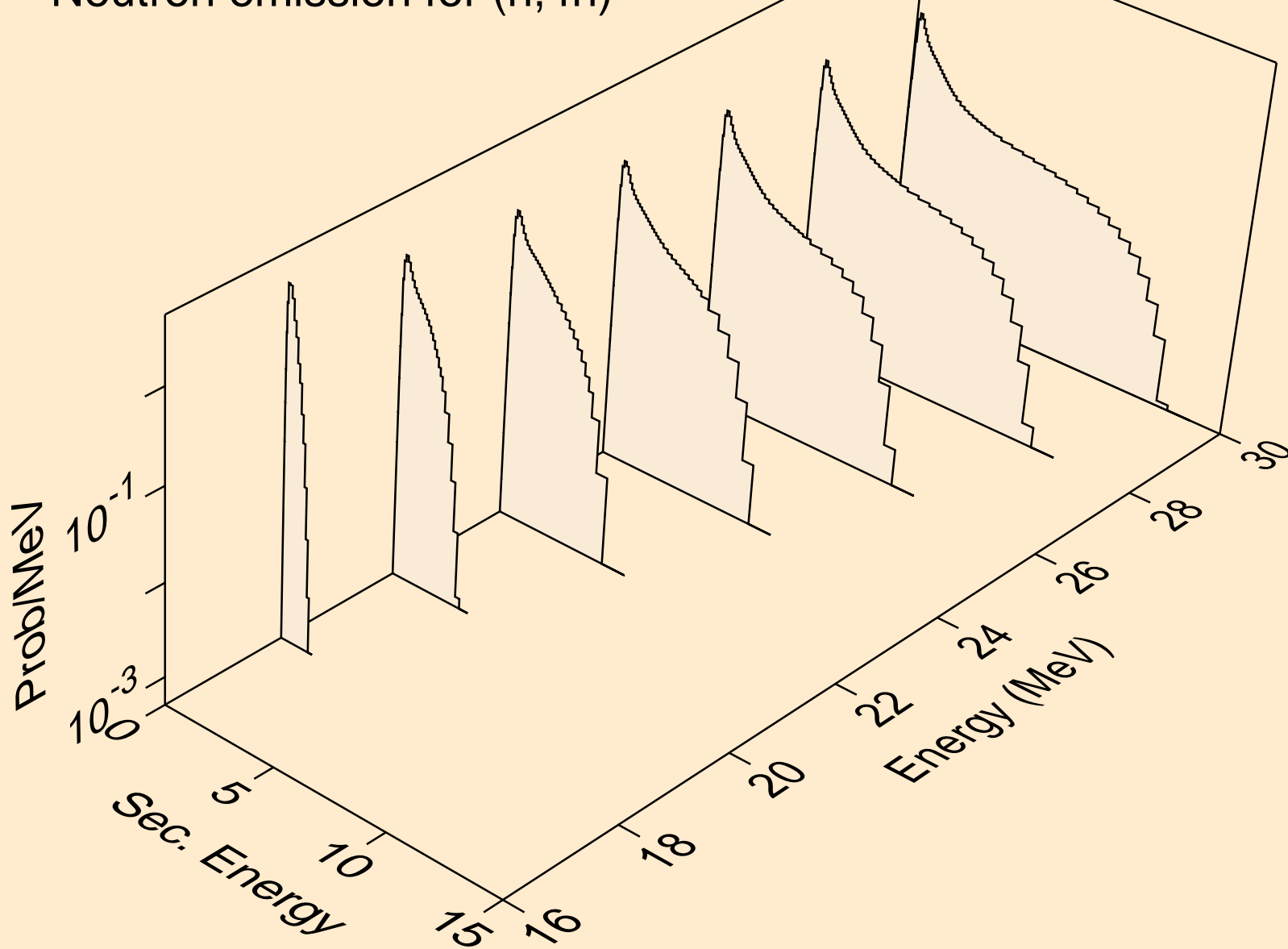

MD260 NEUTRON ACER TENDL-2023 LIBRARY; T=0.K
Neutron emission for (n,2np)

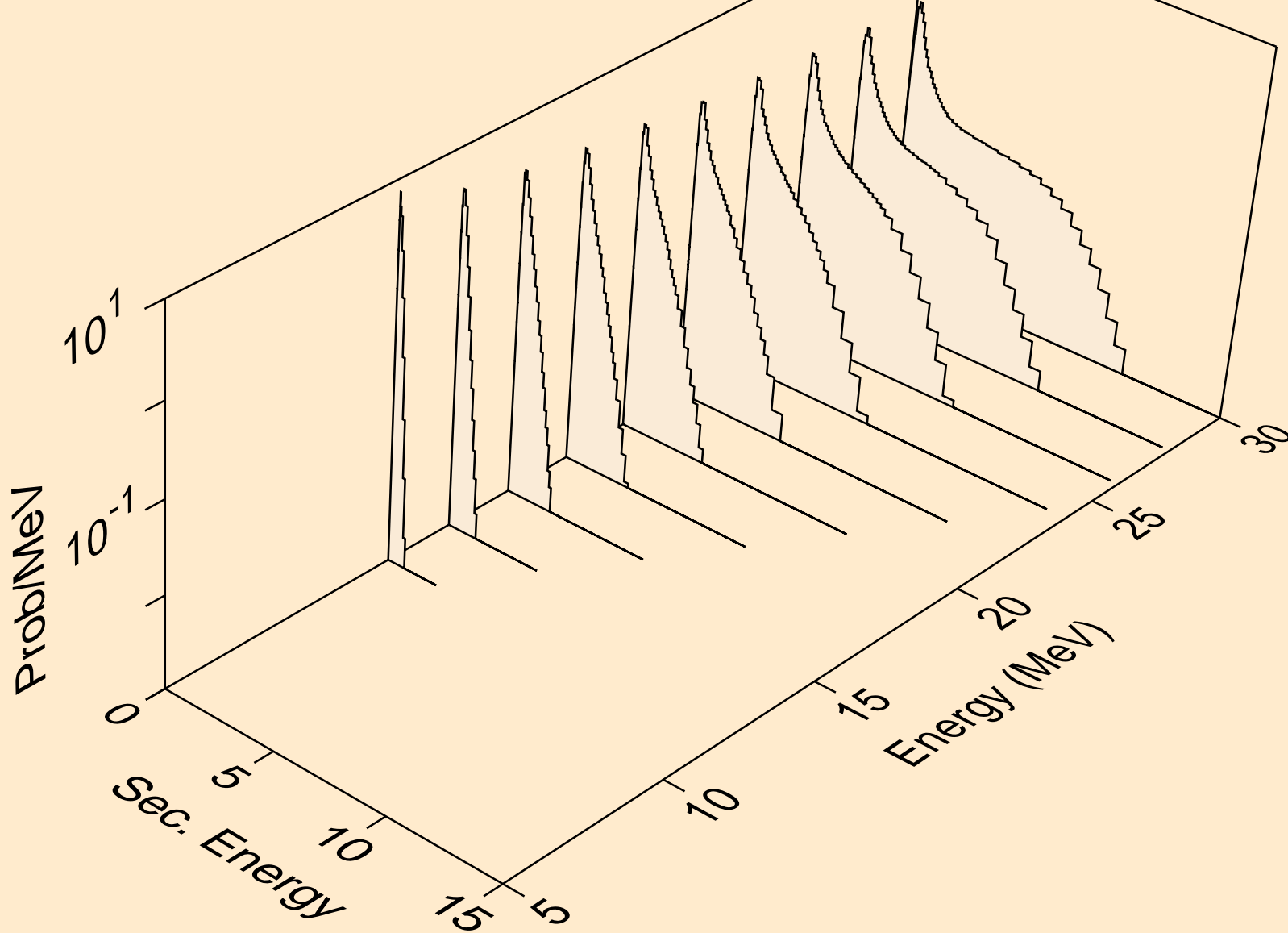

MD260 NEUTRON ACER TENDL-2023 LIBRARY; T=0.K
Neutron emission for (n,3np)

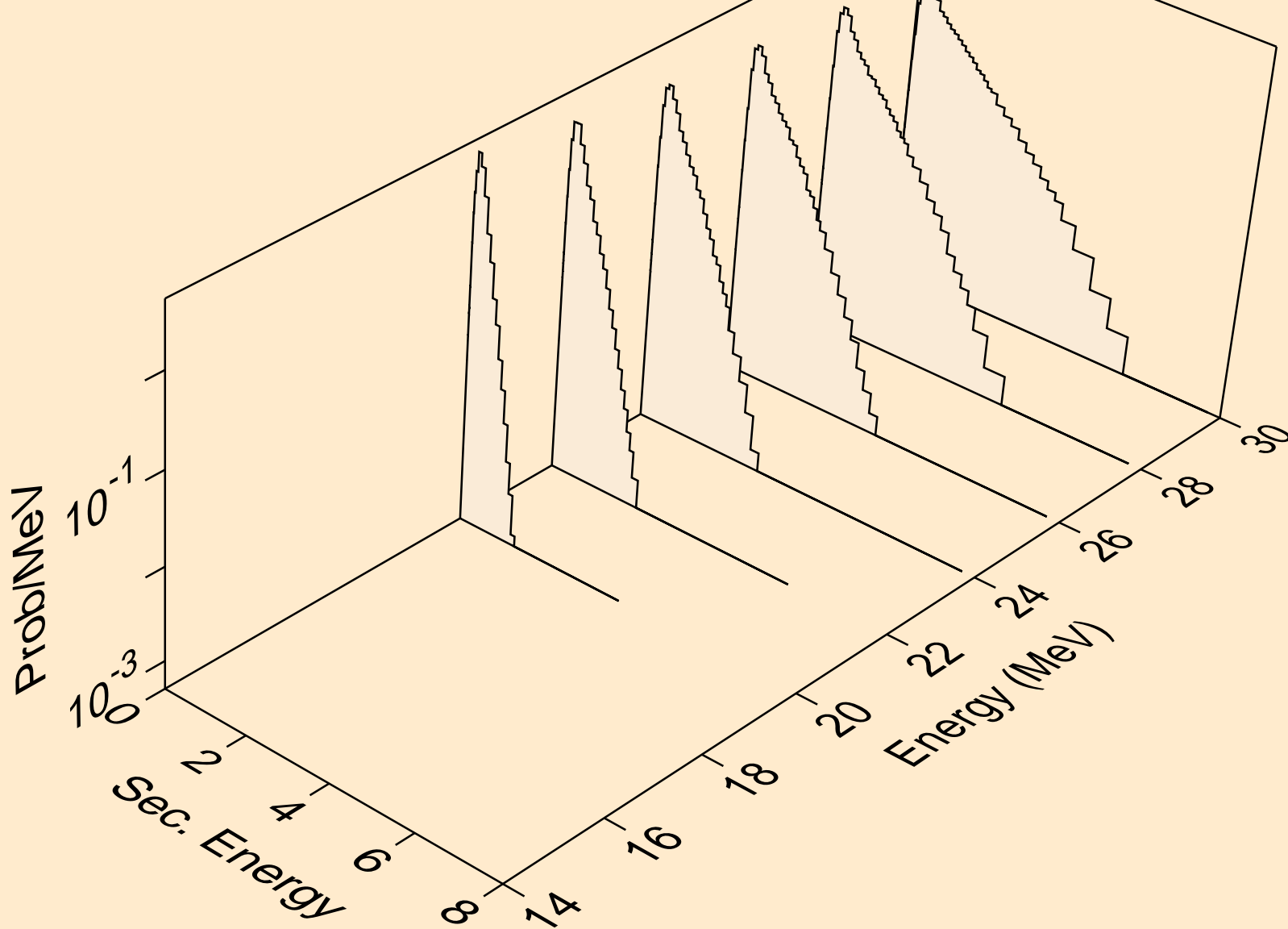

MD260 NEUTRON ACER TENDL-2023 LIBRARY; T=0.K
Neutron emission for (n,n2p)

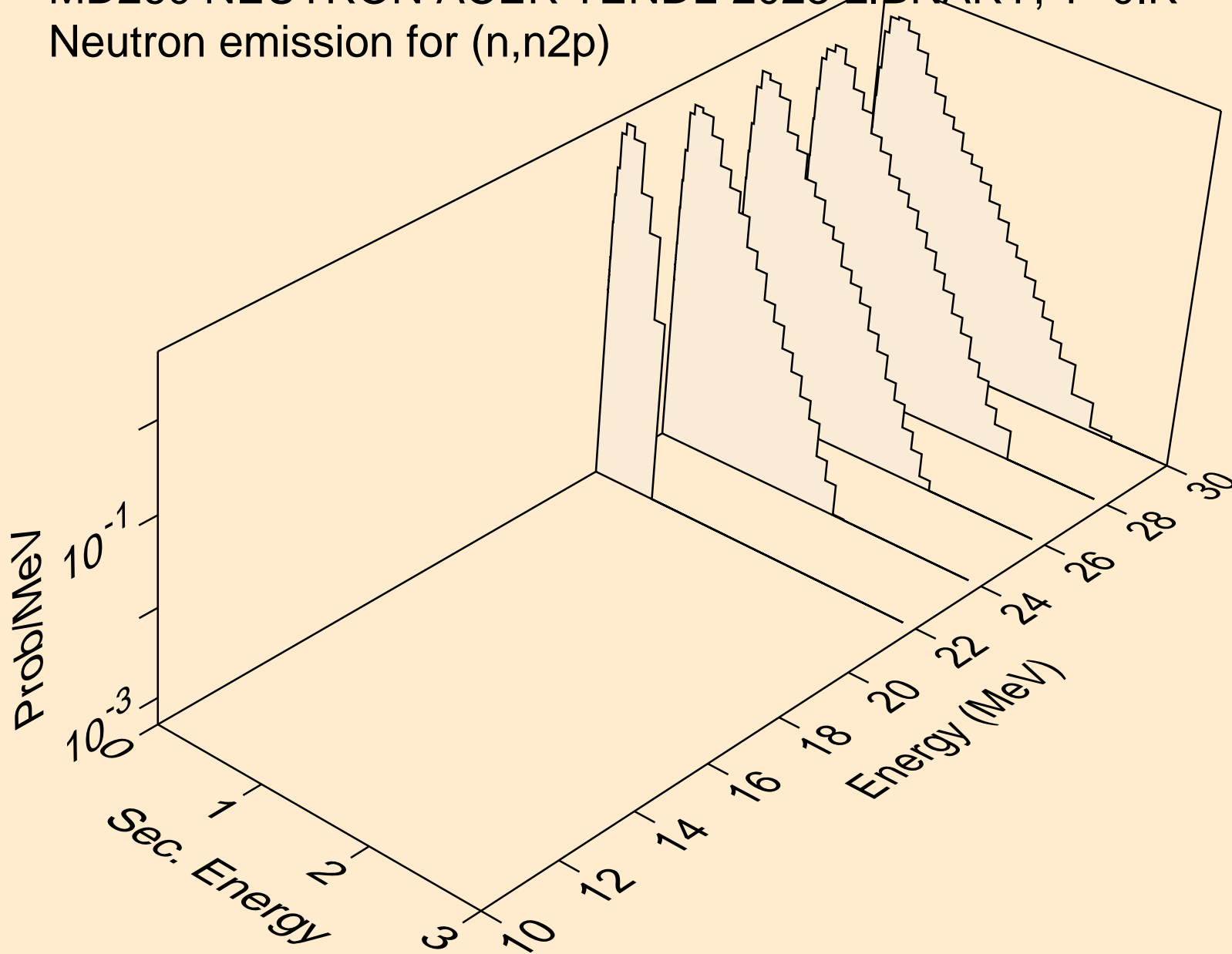

MD260 NEUTRON ACER TENDL-2023 LIBRARY; T=0.K
Neutron emission for (n,npa)

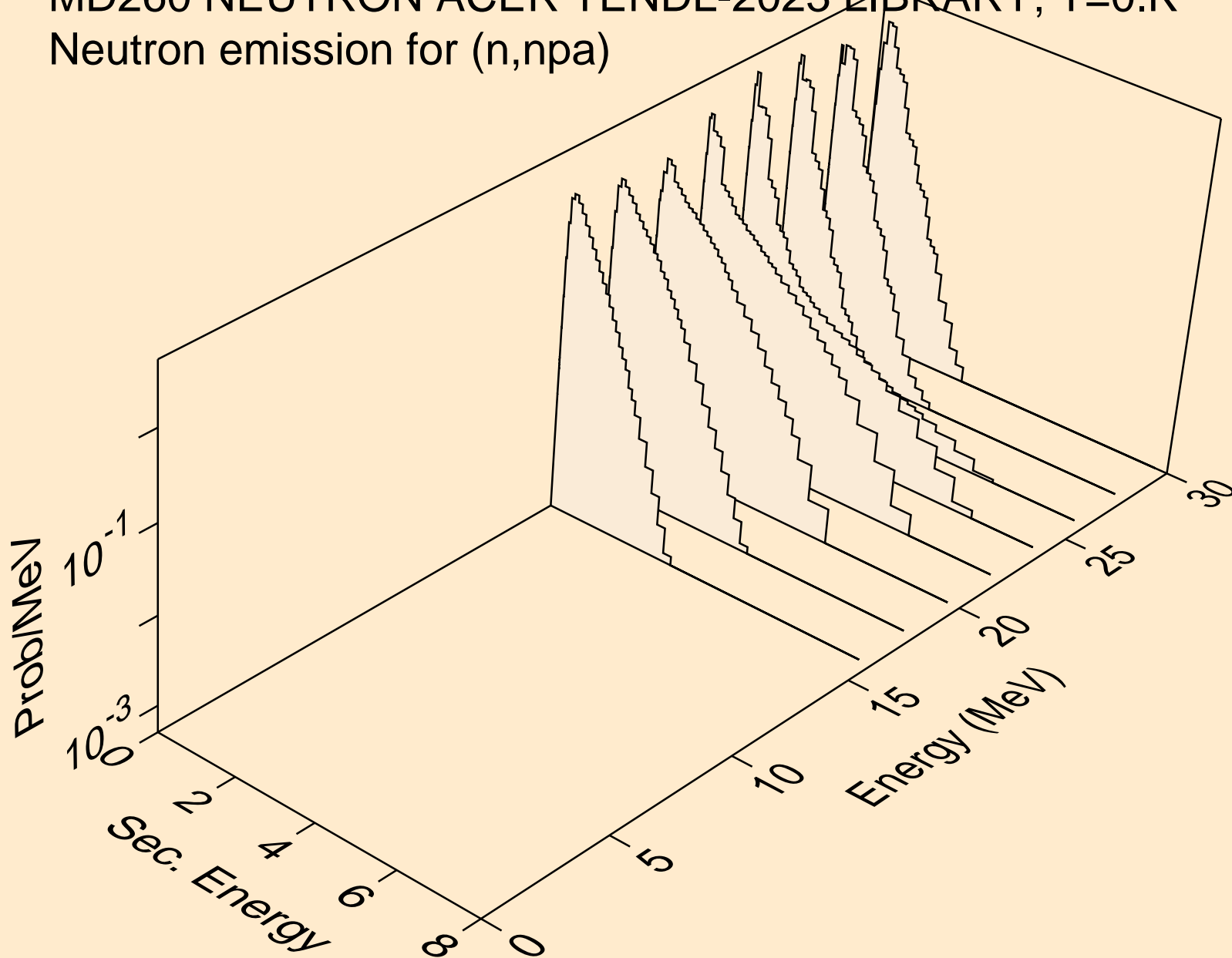

MD260 NEUTRON ACER TENDL-2023 LIBRARY; T=0.K
Neutron emission for (n,n*c)

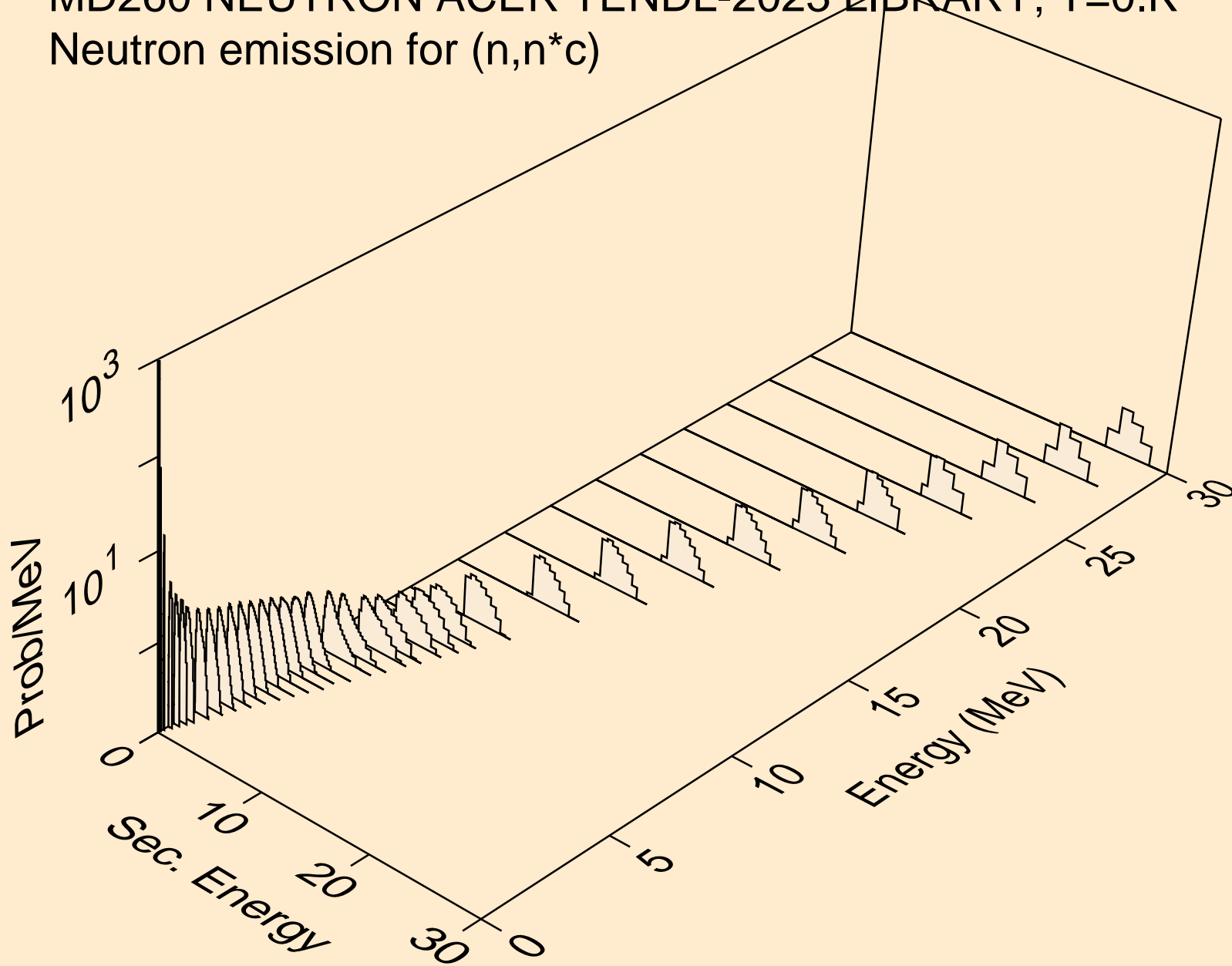

MD260 NEUTRON ACER TENDL-2023 LIBRARY; T=0.K

Delayed nubar

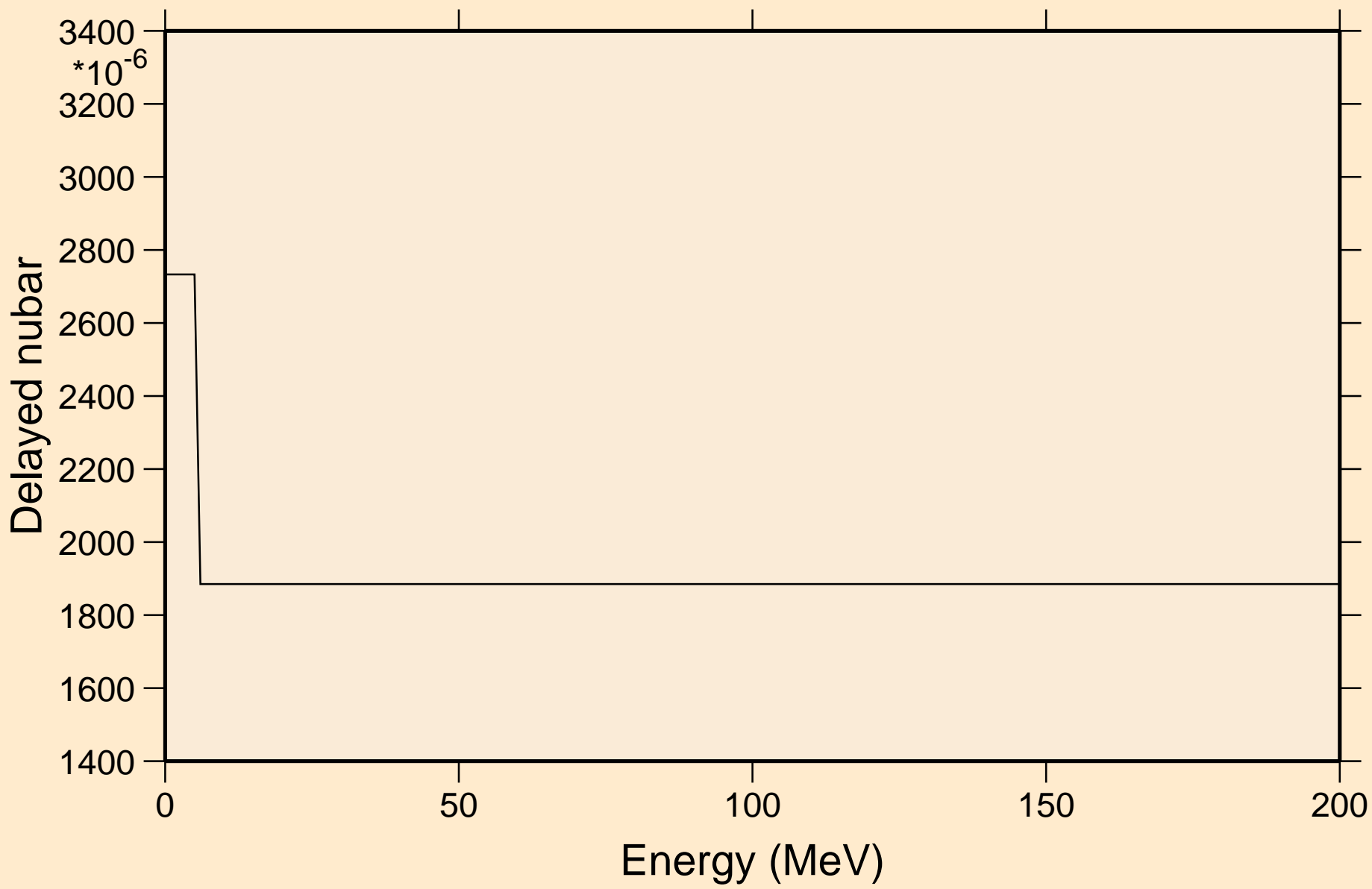

MD260 NEUTRON ACER TENDL-2023 LIBRARY; T=0.K

Delayed neutron spectra

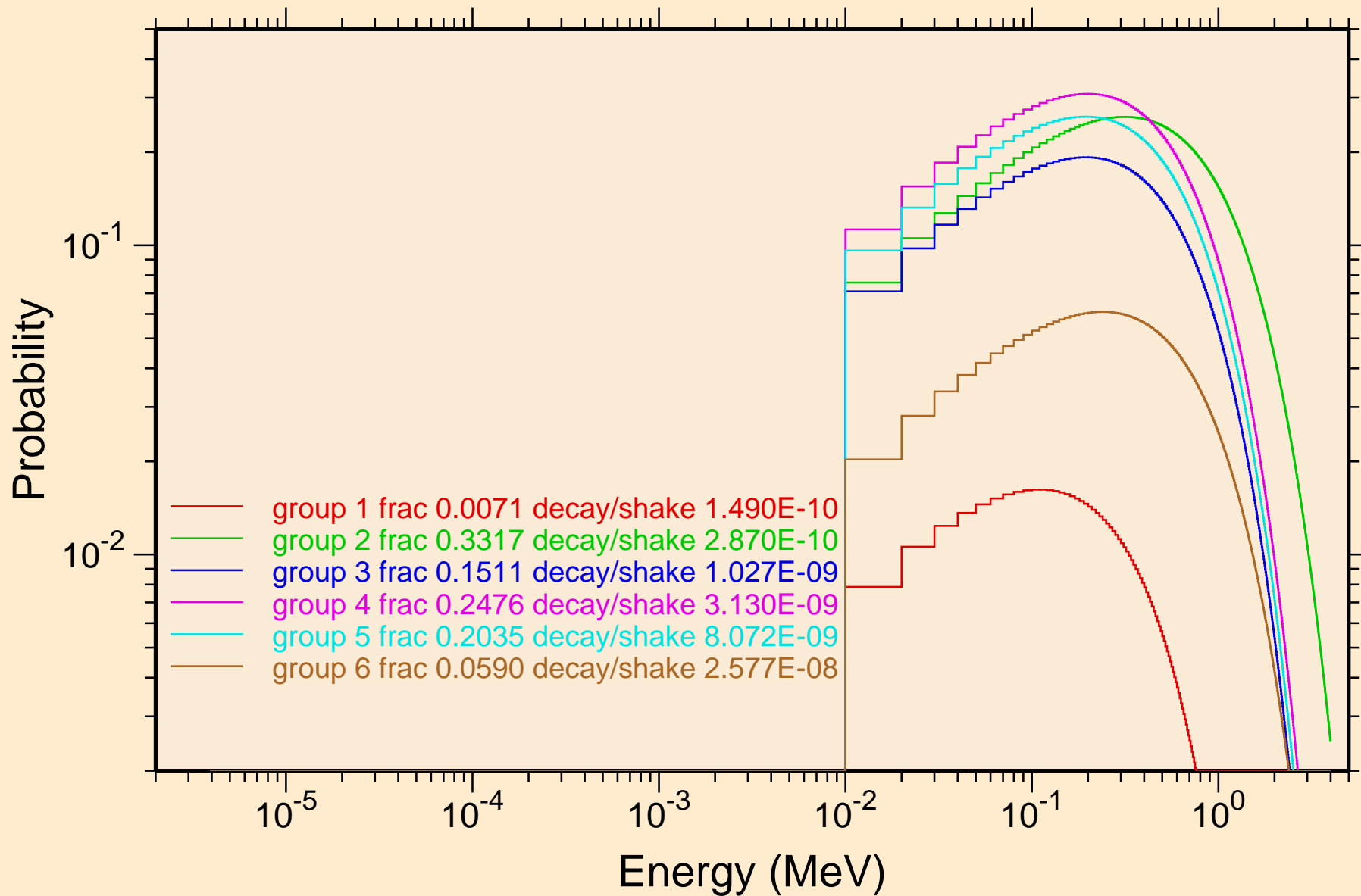

MD260 NEUTRON ACER TENDL-2023 LIBRARY; T=0.K
Photon emission for (n,x)

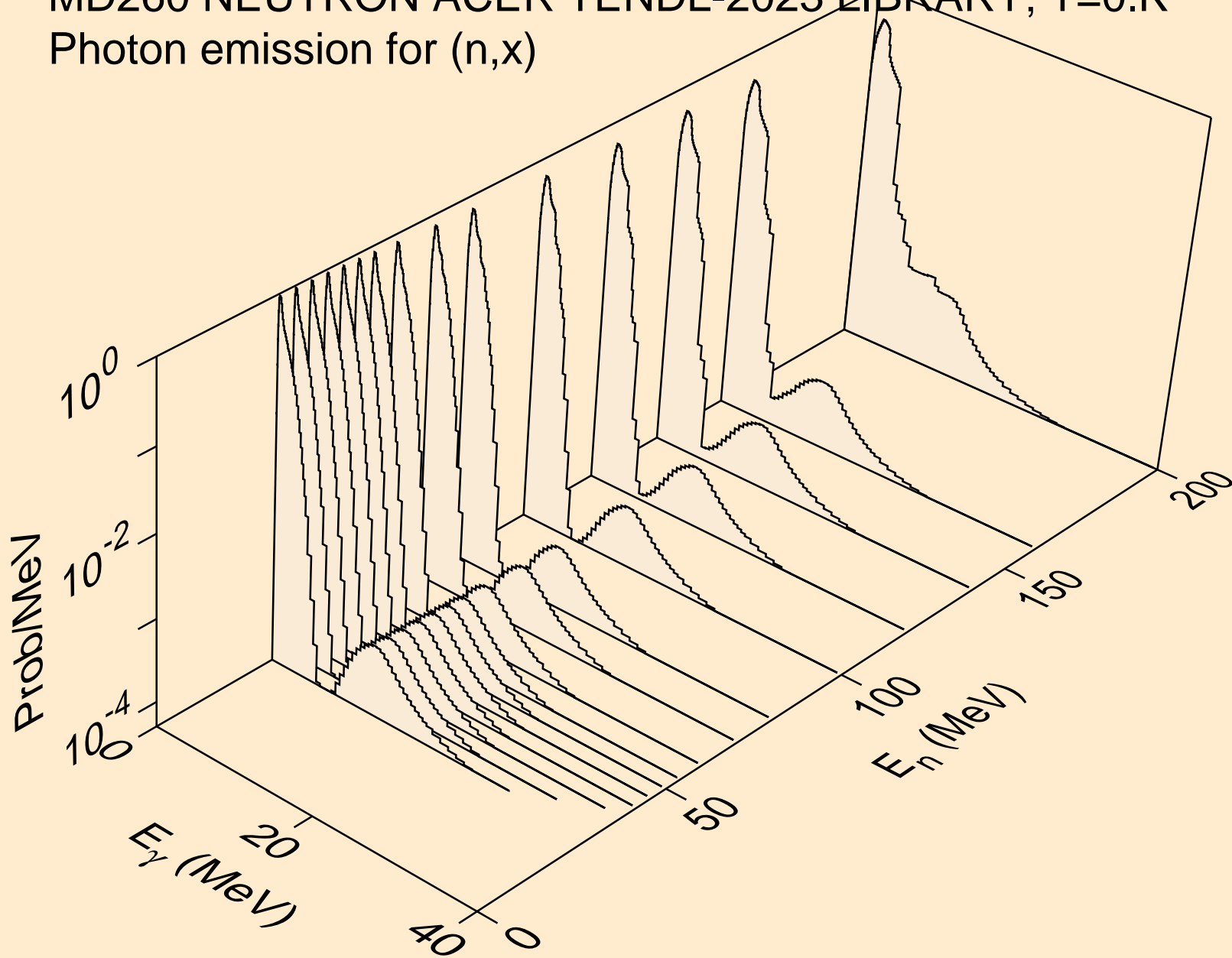

MD260 NEUTRON ACER TENDL-2023 LIBRARY; T=0.K
Photon emission for (n,2nd)

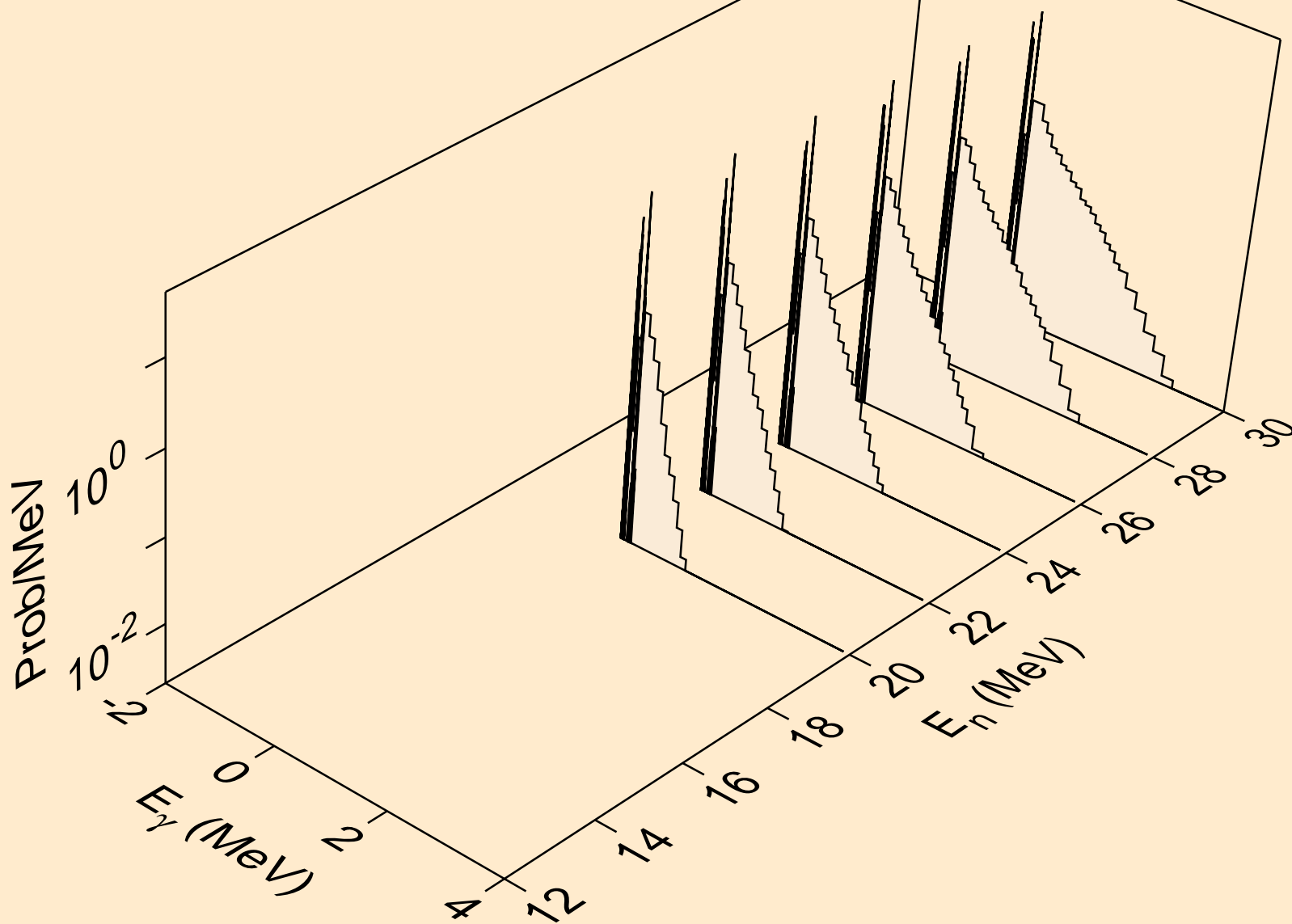

MD260 NEUTRON ACER TENDL-2023 LIBRARY; T=0.K
Photon emission for (n,2n)

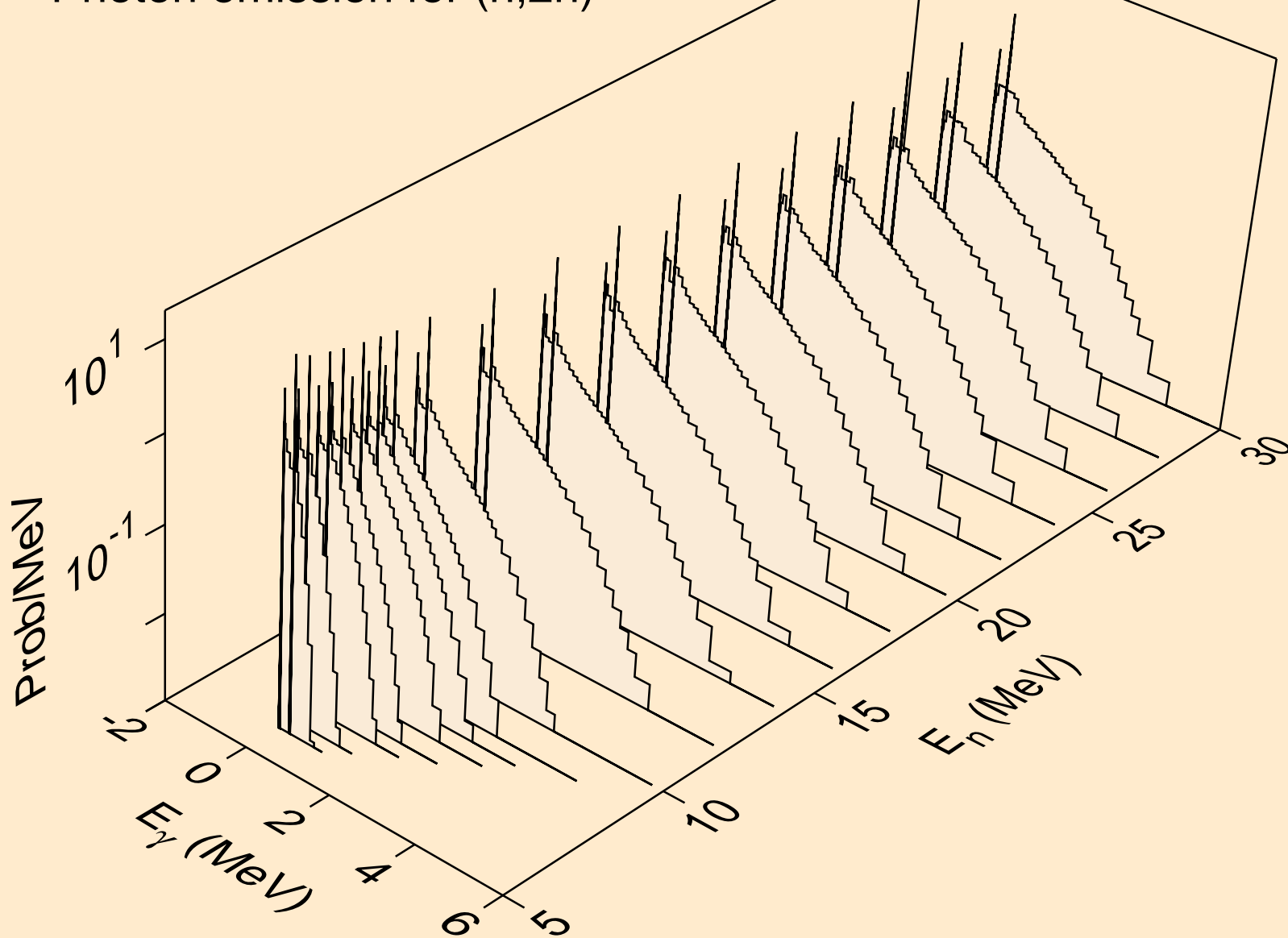

MD260 NEUTRON ACER TENDL-2023 LIBRARY; T=0.K
Photon emission for (n,3n)

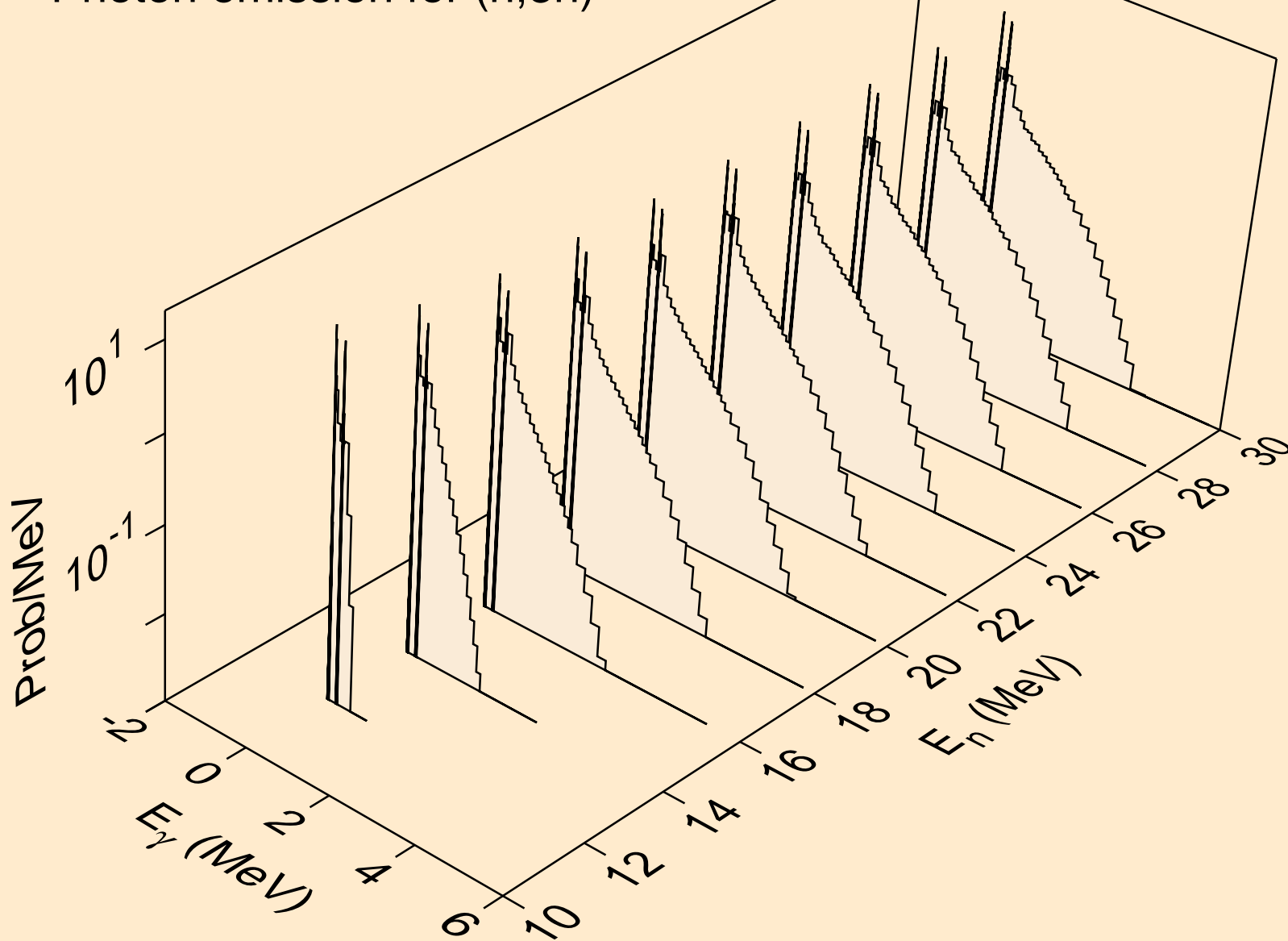

MD260 NEUTRON ACER TENDL-2023 LIBRARY; T=0.K
Photon emission for (n,n*)a

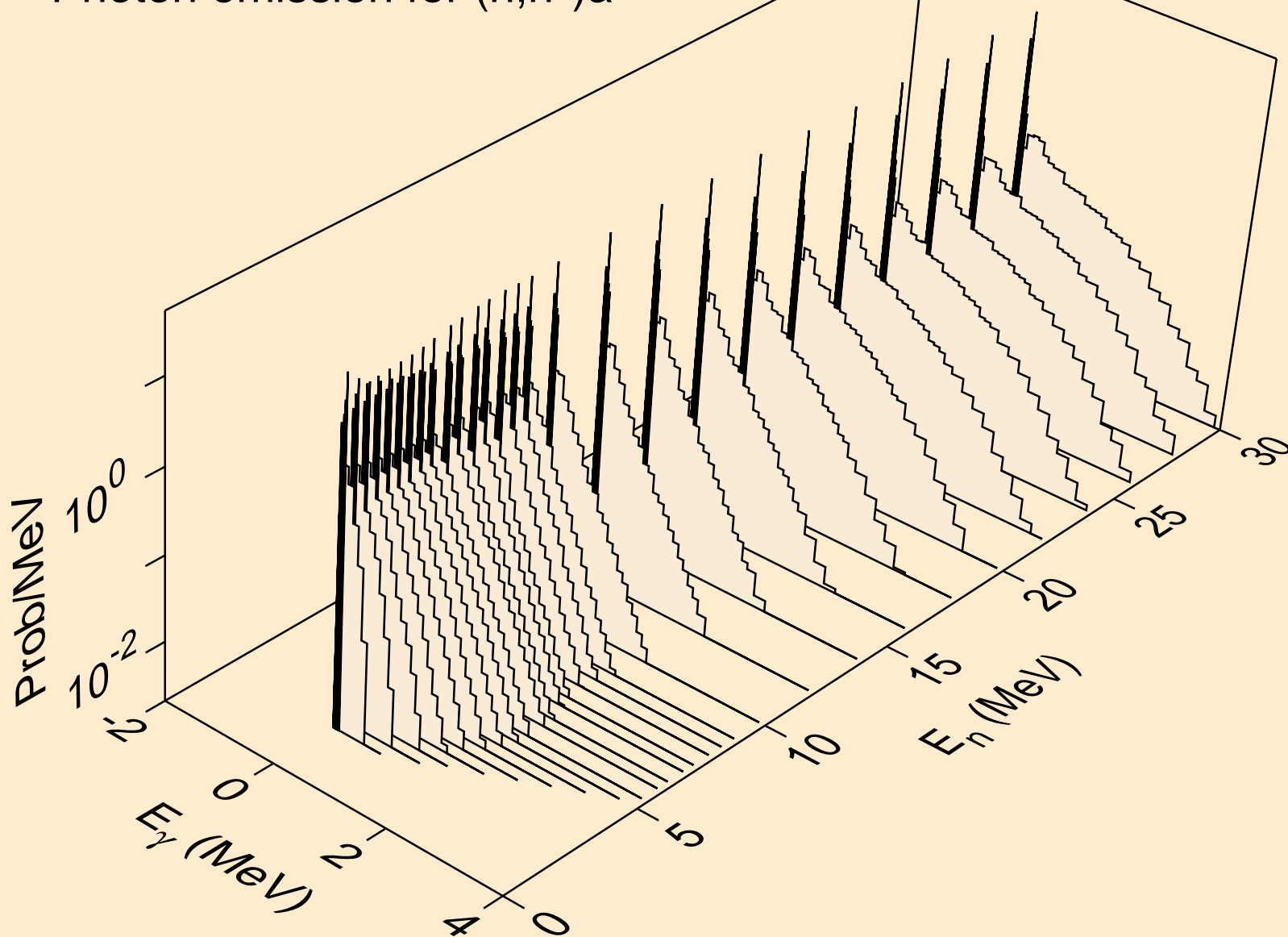

MD260 NEUTRON ACER TENDL-2023 LIBRARY; T=0.K
Photon emission for (n,2n)a

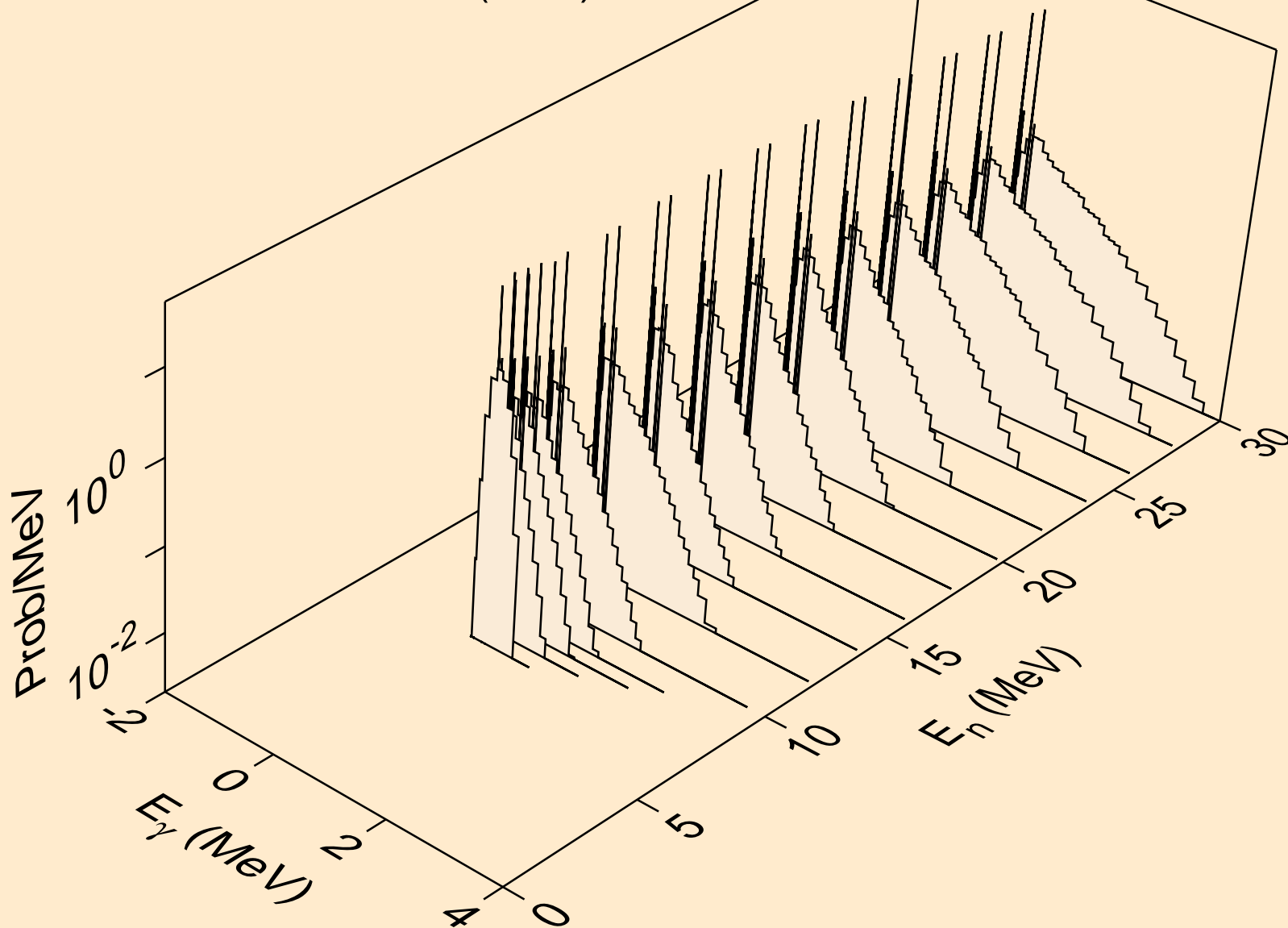

MD260 NEUTRON ACER TENDL-2023 LIBRARY; T=0.K
Photon emission for (n,3n)a

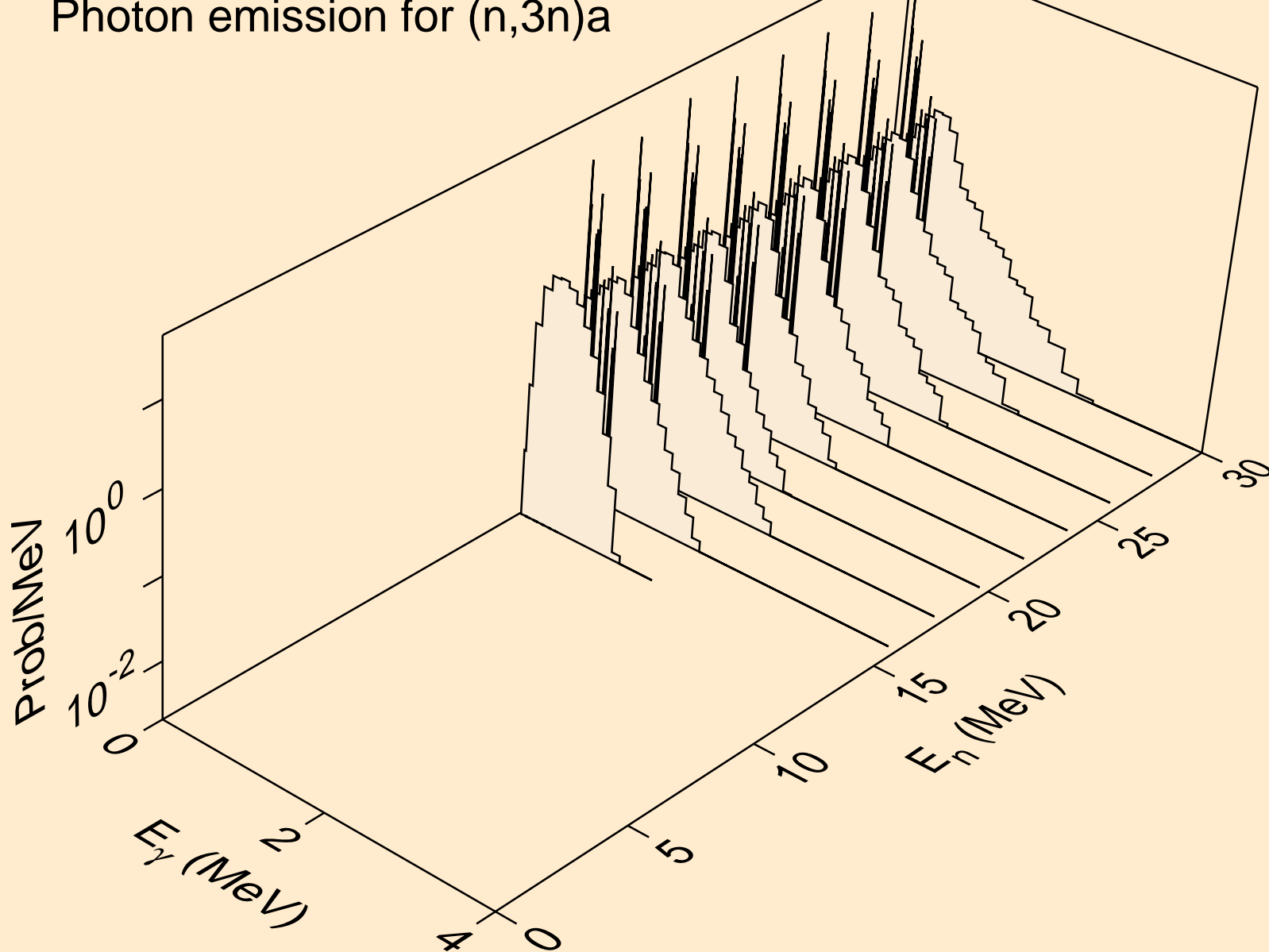

MD260 NEUTRON ACER TENDL-2023 LIBRARY; T=0.K
Photon emission for (n,n*)p

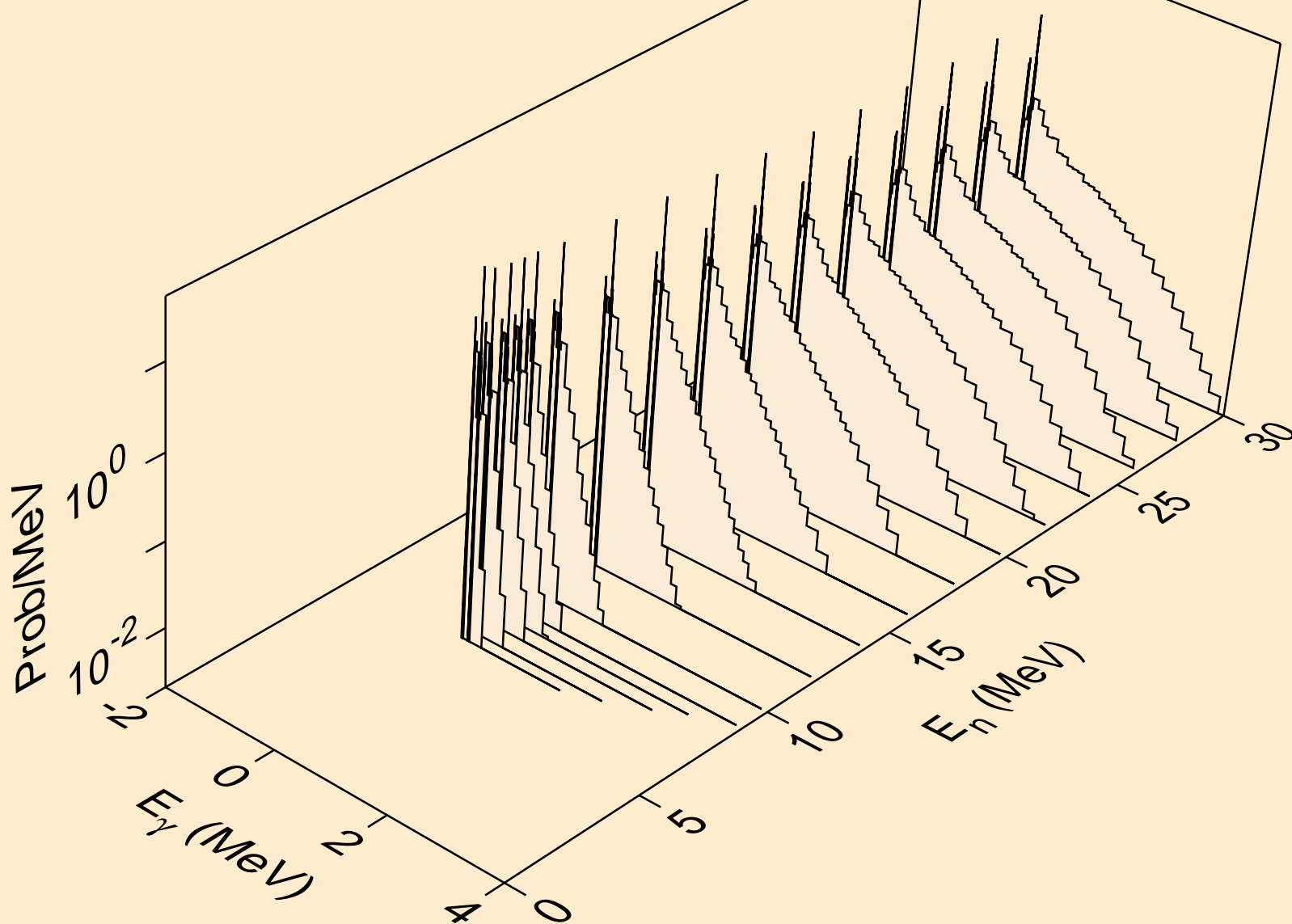

MD260 NEUTRON ACER TENDL-2023 LIBRARY; T=0.K
Photon emission for (n,n*)2a

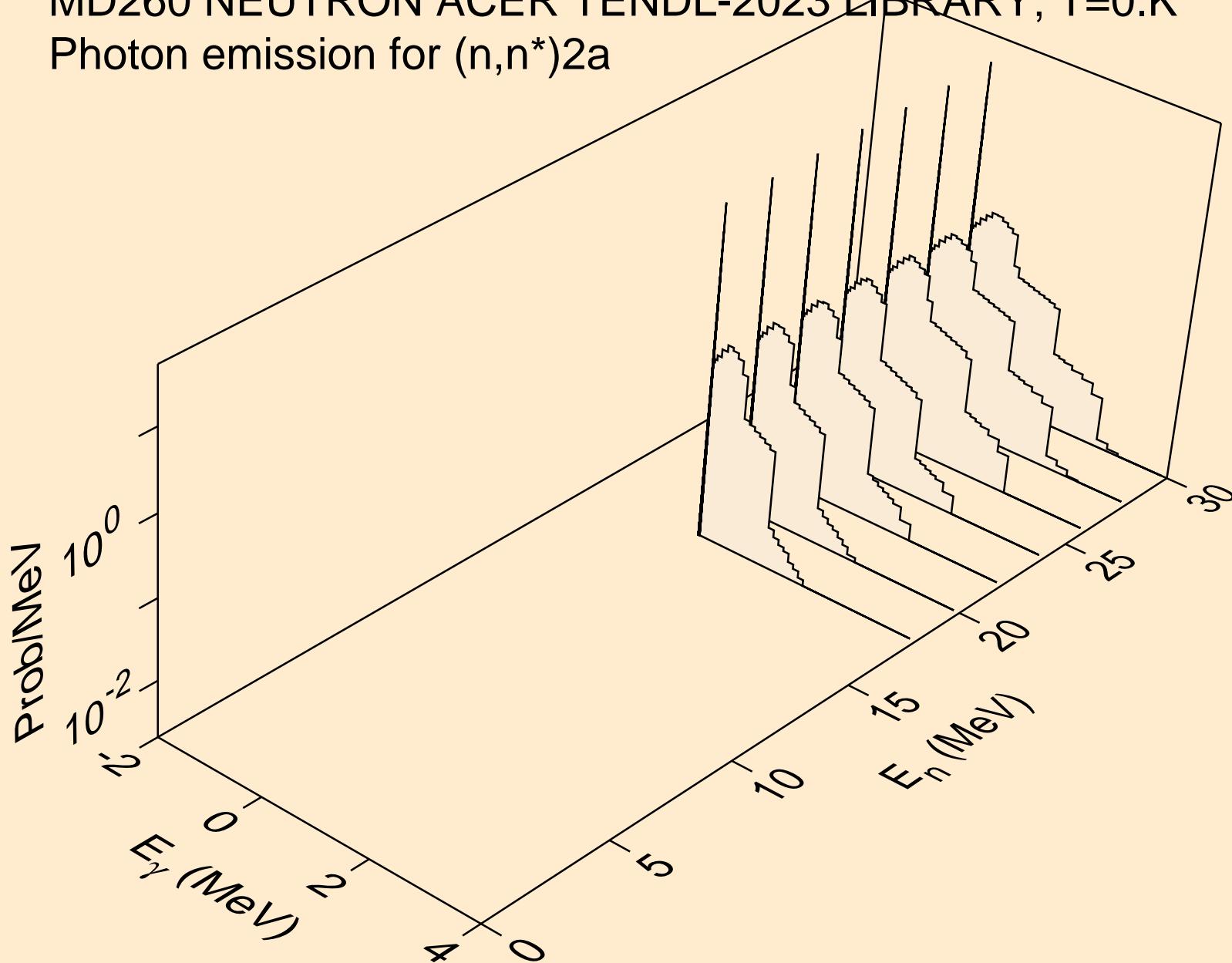

MD260 NEUTRON ACER TENDL-2023 LIBRARY; T=0.K
Photon emission for (n,n*)d

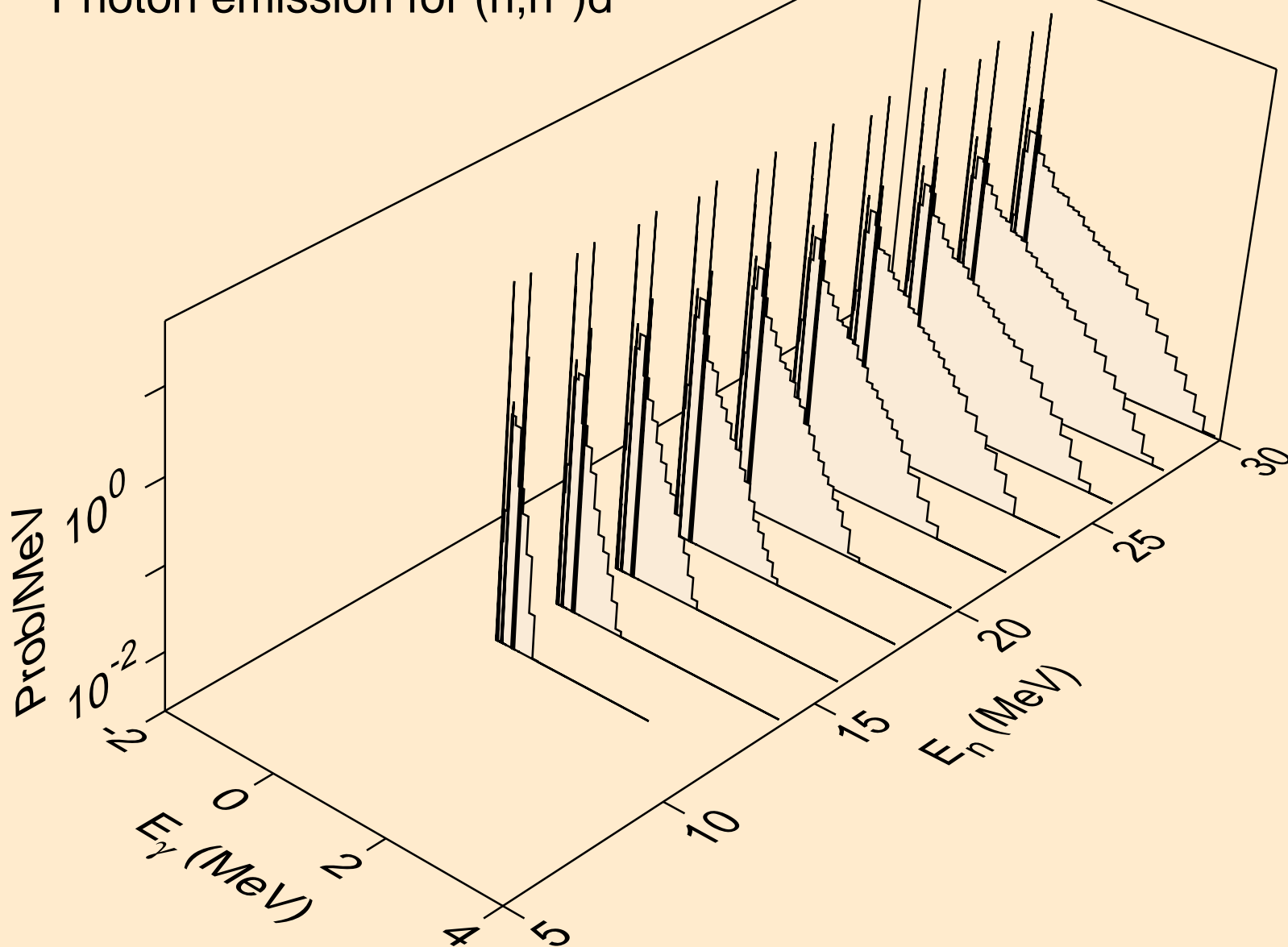

MD260 NEUTRON ACER TENDL-2023 LIBRARY; T=0.K
Photon emission for (n,n*)t

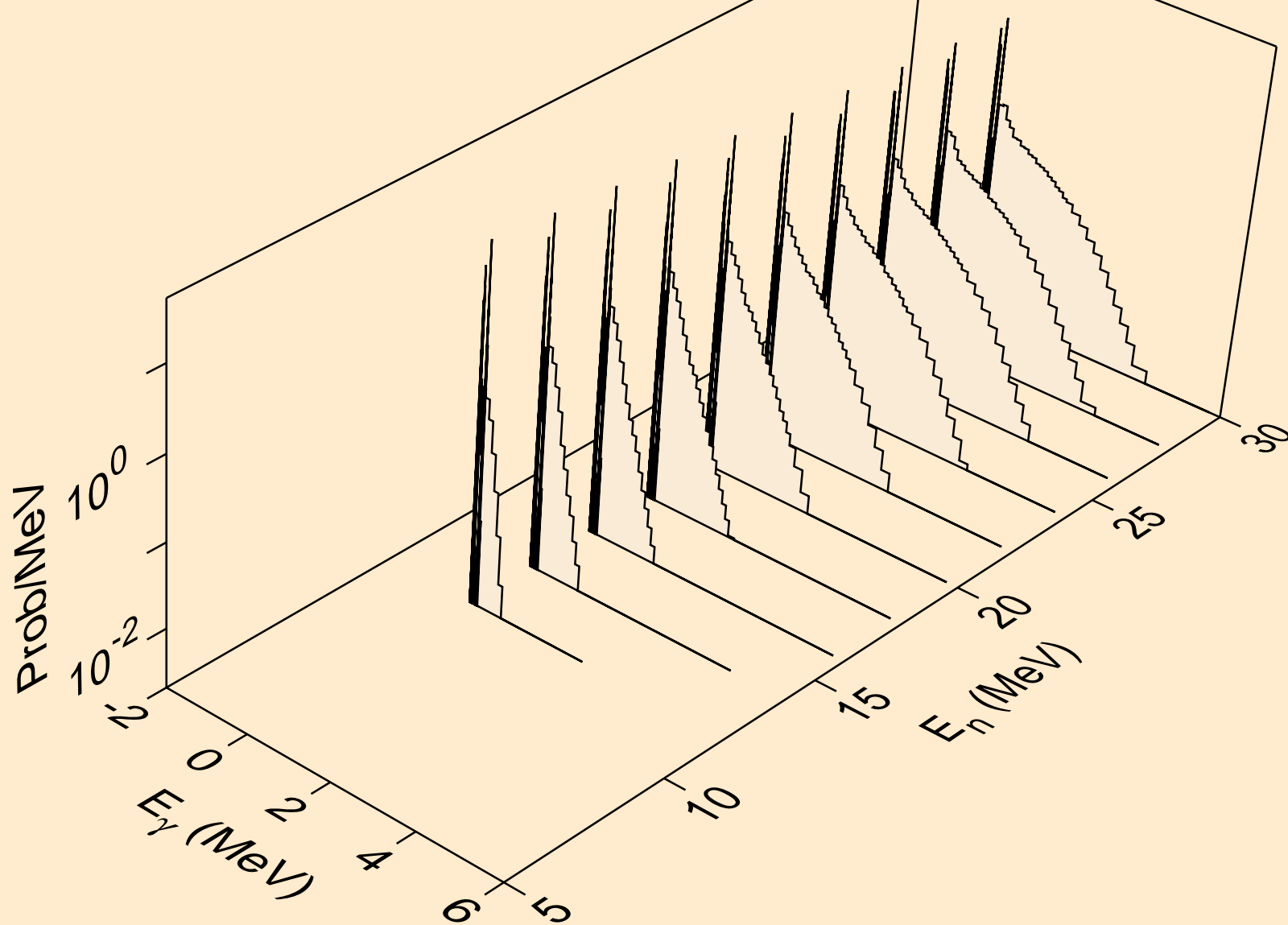

MD260 NEUTRON ACER TENDL-2023 LIBRARY; T=0.K
Photon emission for (n,n*)he3

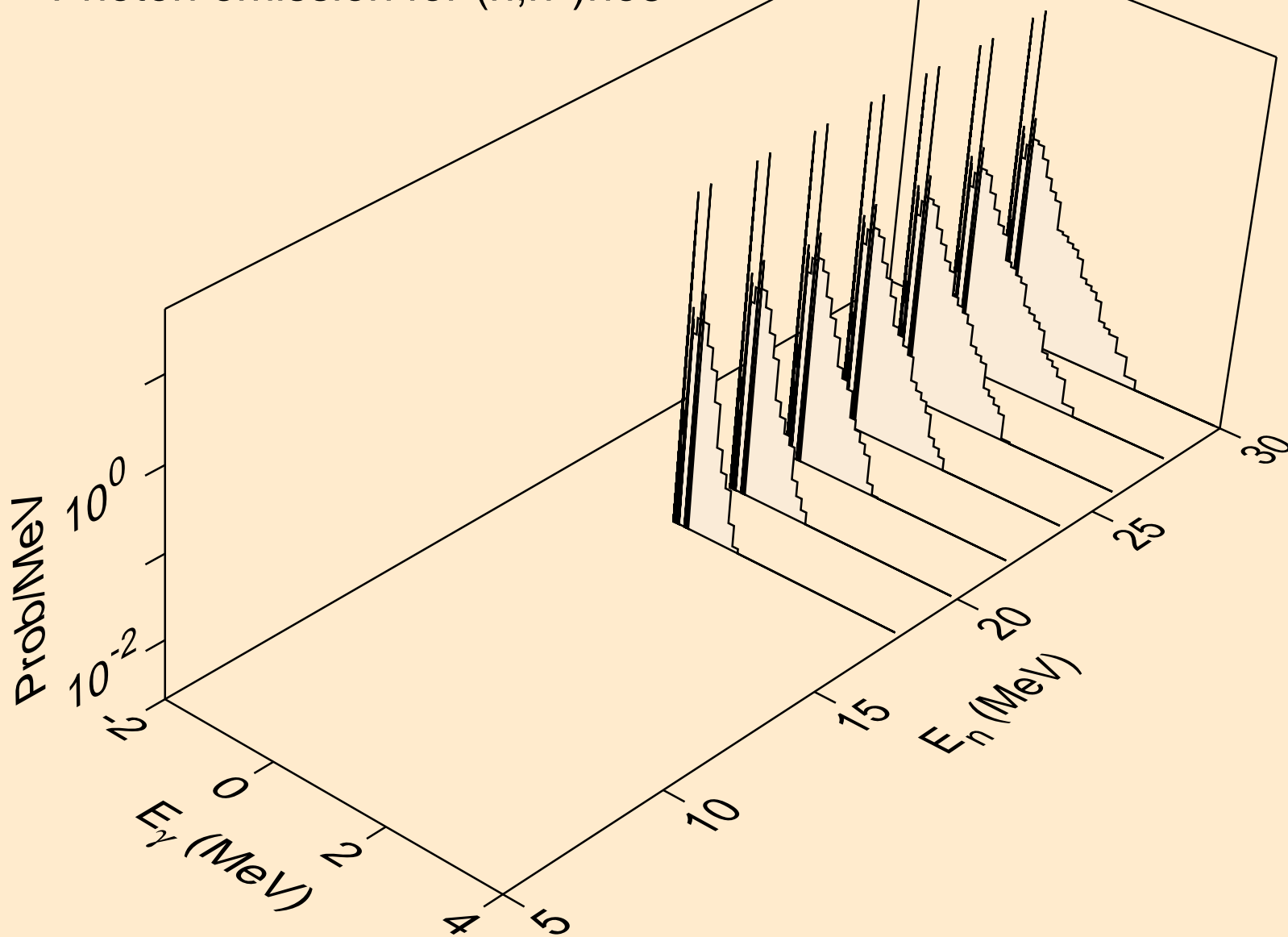

MD260 NEUTRON ACER TENDL-2023 LIBRARY; T=0.K
Photon emission for (n,4n)

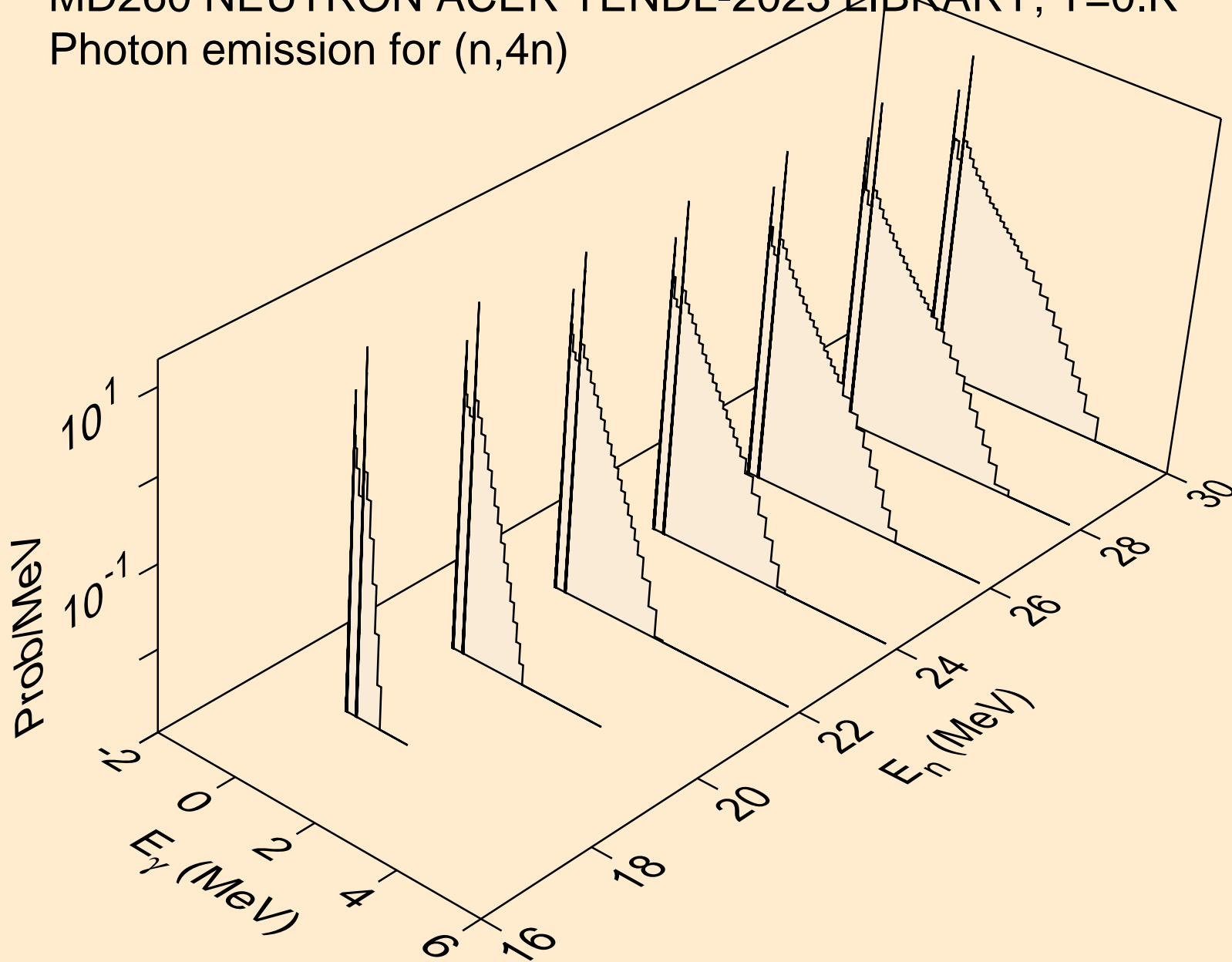

MD260 NEUTRON ACER TENDL-2023 LIBRARY; T=0.K
Photon emission for (n,2np)

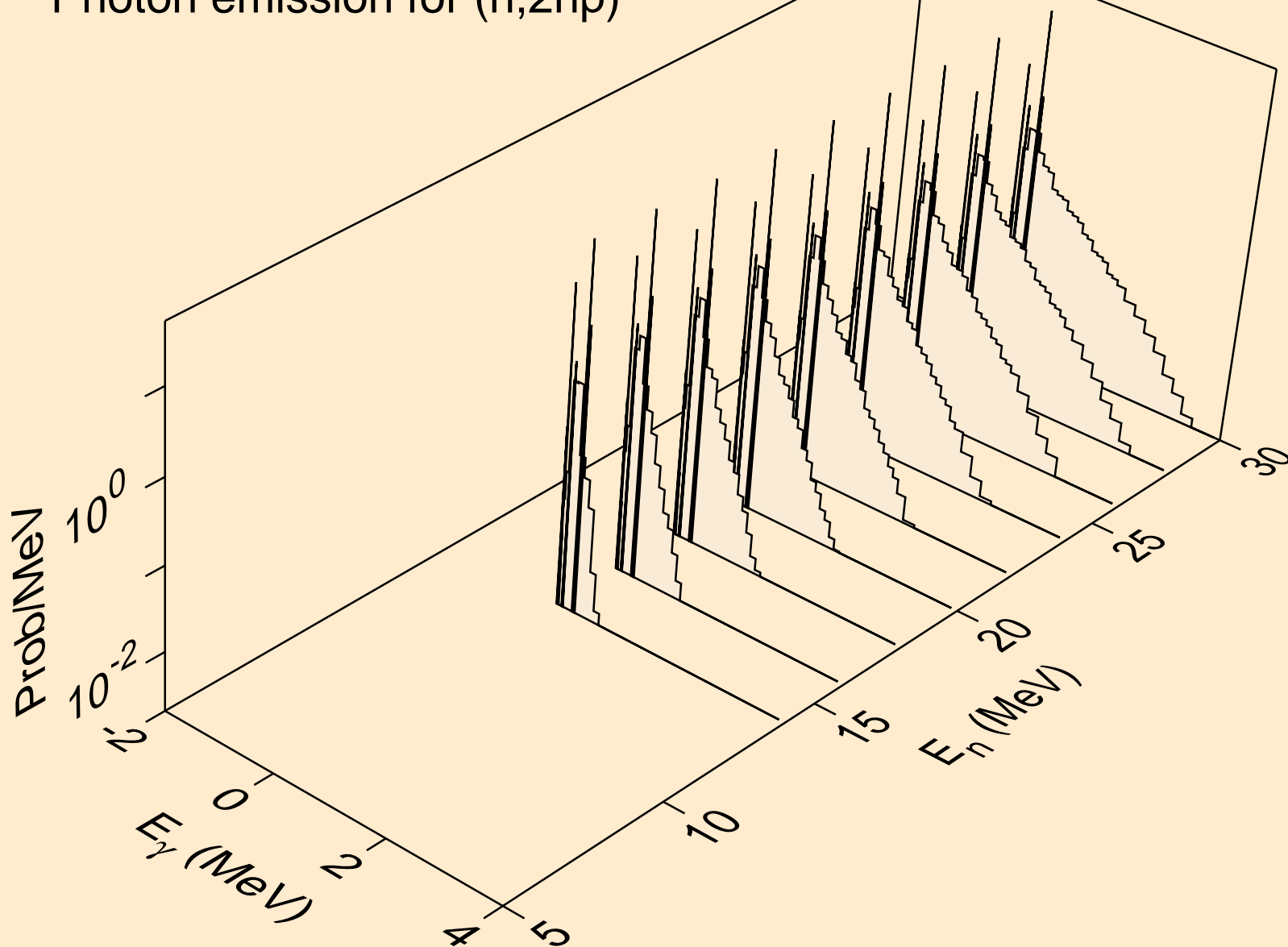

MD260 NEUTRON ACER TENDL-2023 LIBRARY; T=0.K
Photon emission for (n,3np)

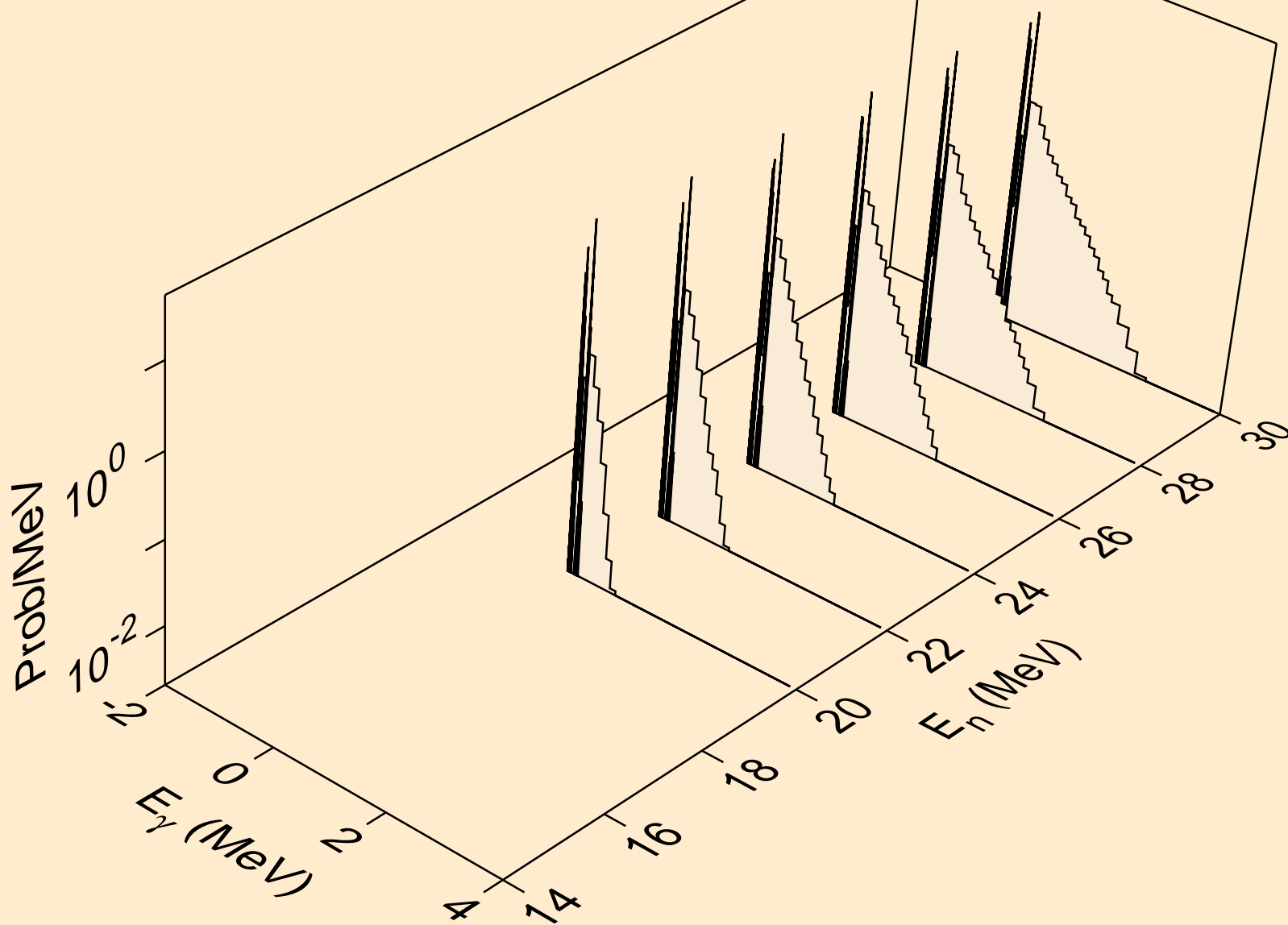

MD260 NEUTRON ACER TENDL-2023 LIBRARY; T=0.K
Photon emission for (n,n2p)

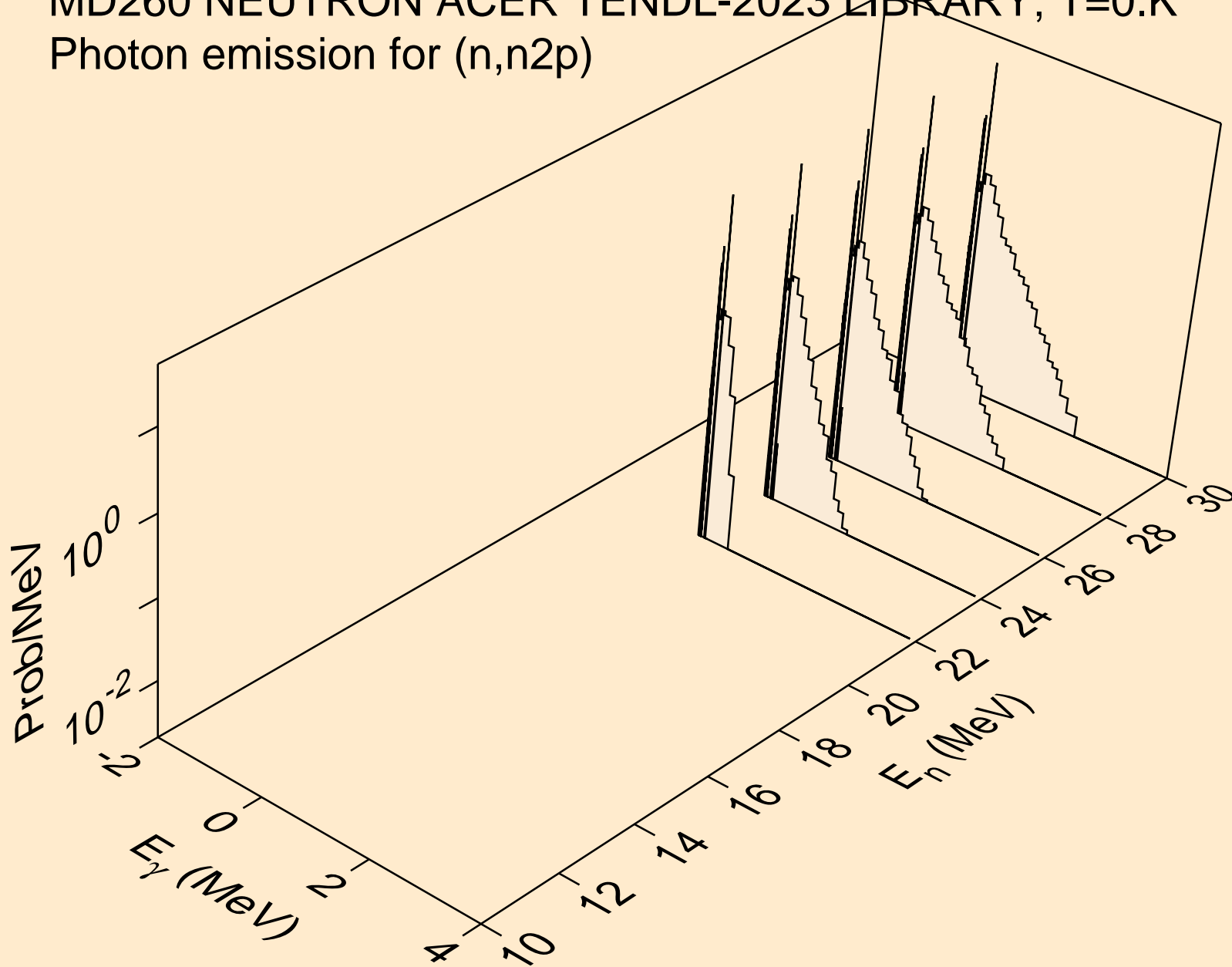

MD260 NEUTRON ACER TENDL-2023 LIBRARY; T=0.K
Photon emission for (n,npa)

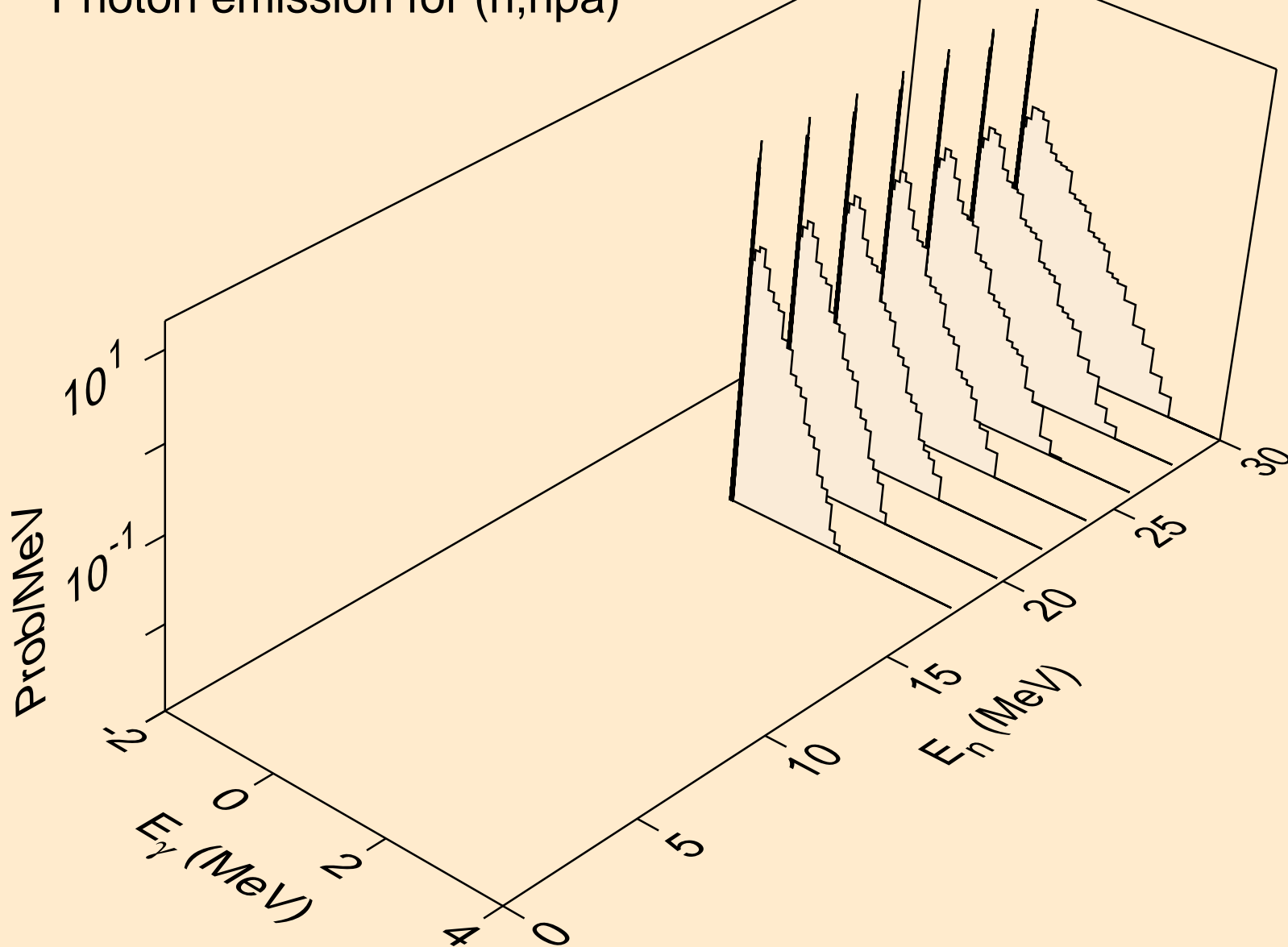

MD260 NEUTRON ACER TENDL-2023 LIBRARY; T=0.K
Photon emission for (n,n*c)

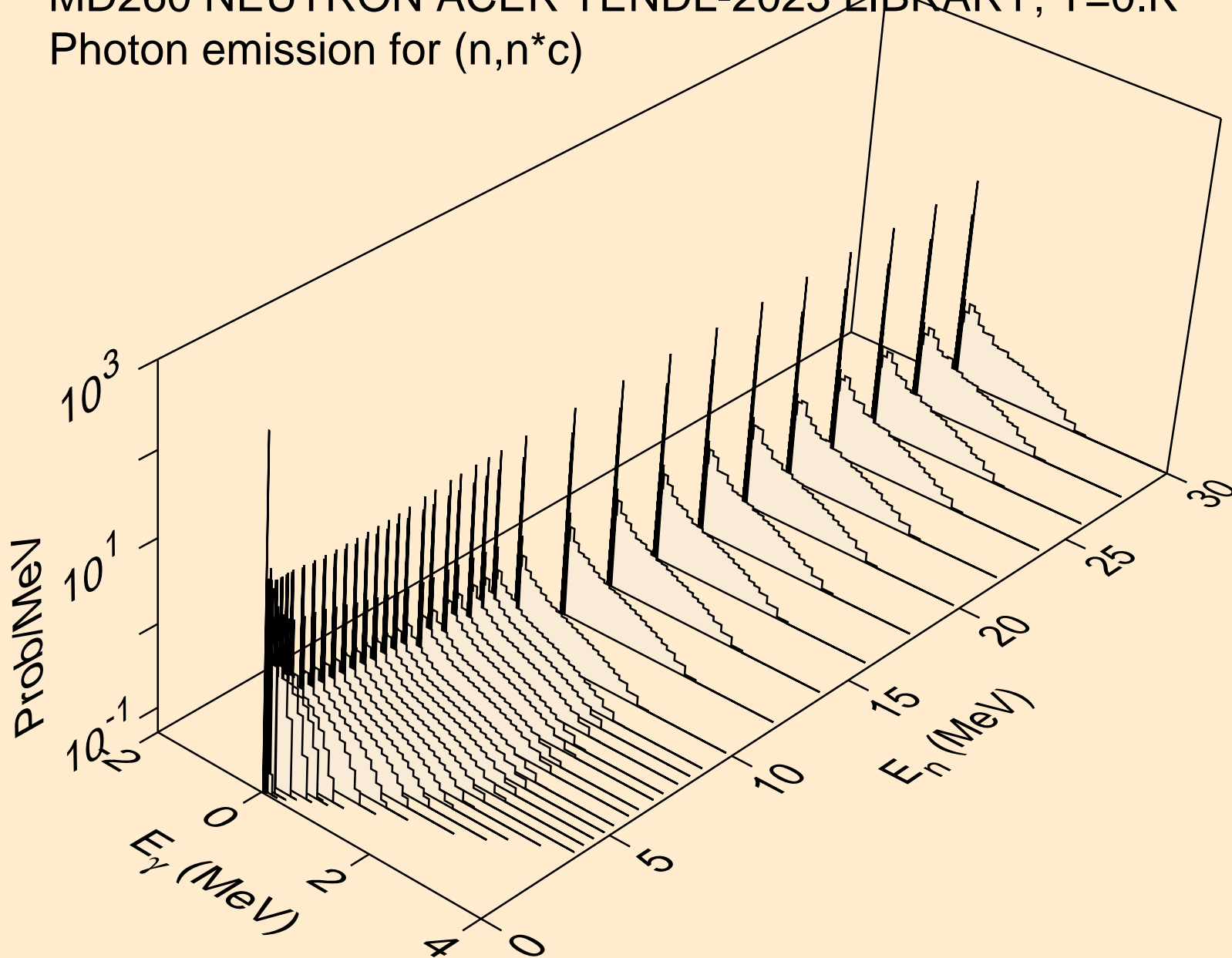

MD260 NEUTRON ACER TENDL-2023 LIBRARY; T=0.K
Photon emission for (n,gma)

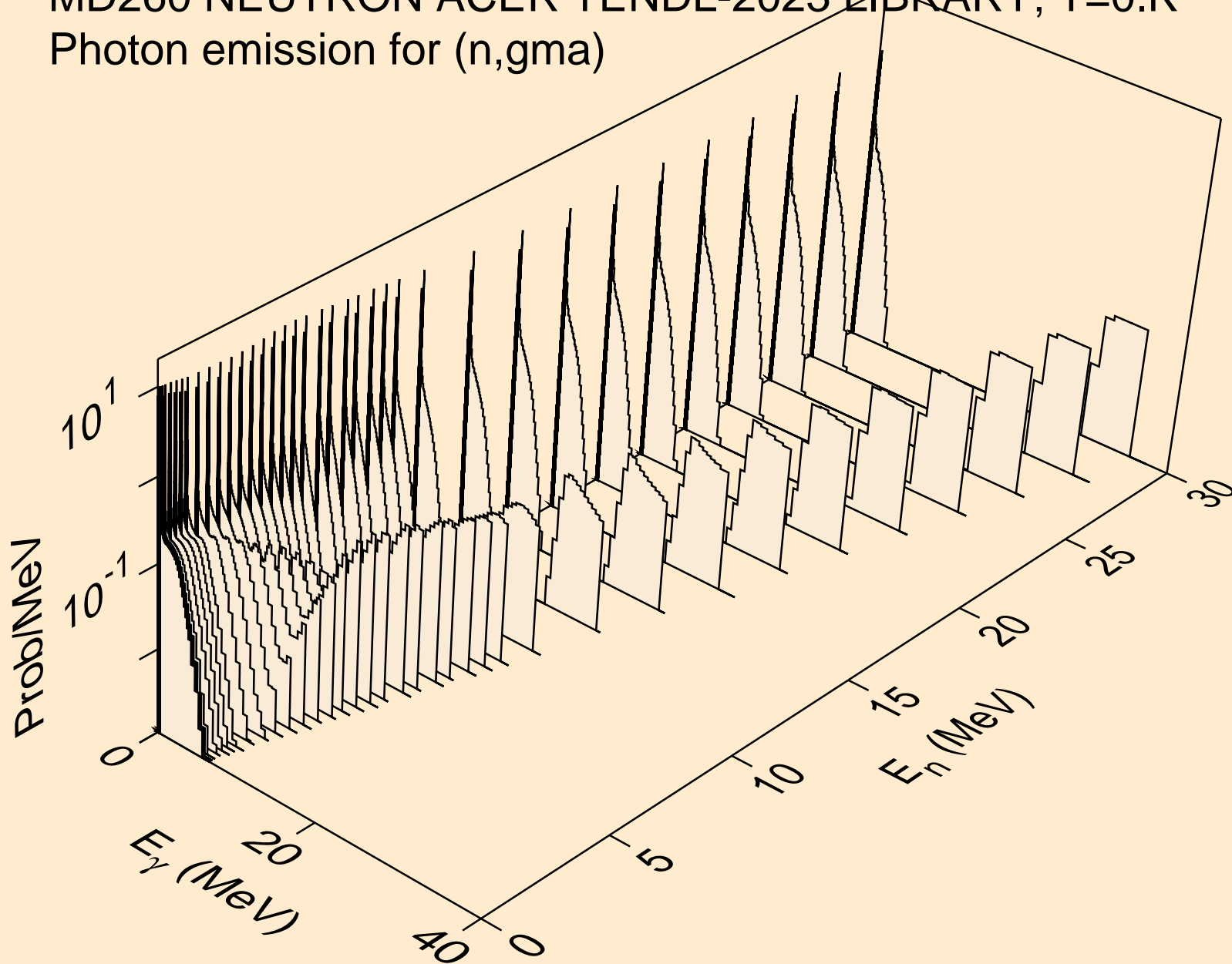

MD260 NEUTRON ACER TENDL-2023 LIBRARY; T=0.K
Photon emission for (n,p)

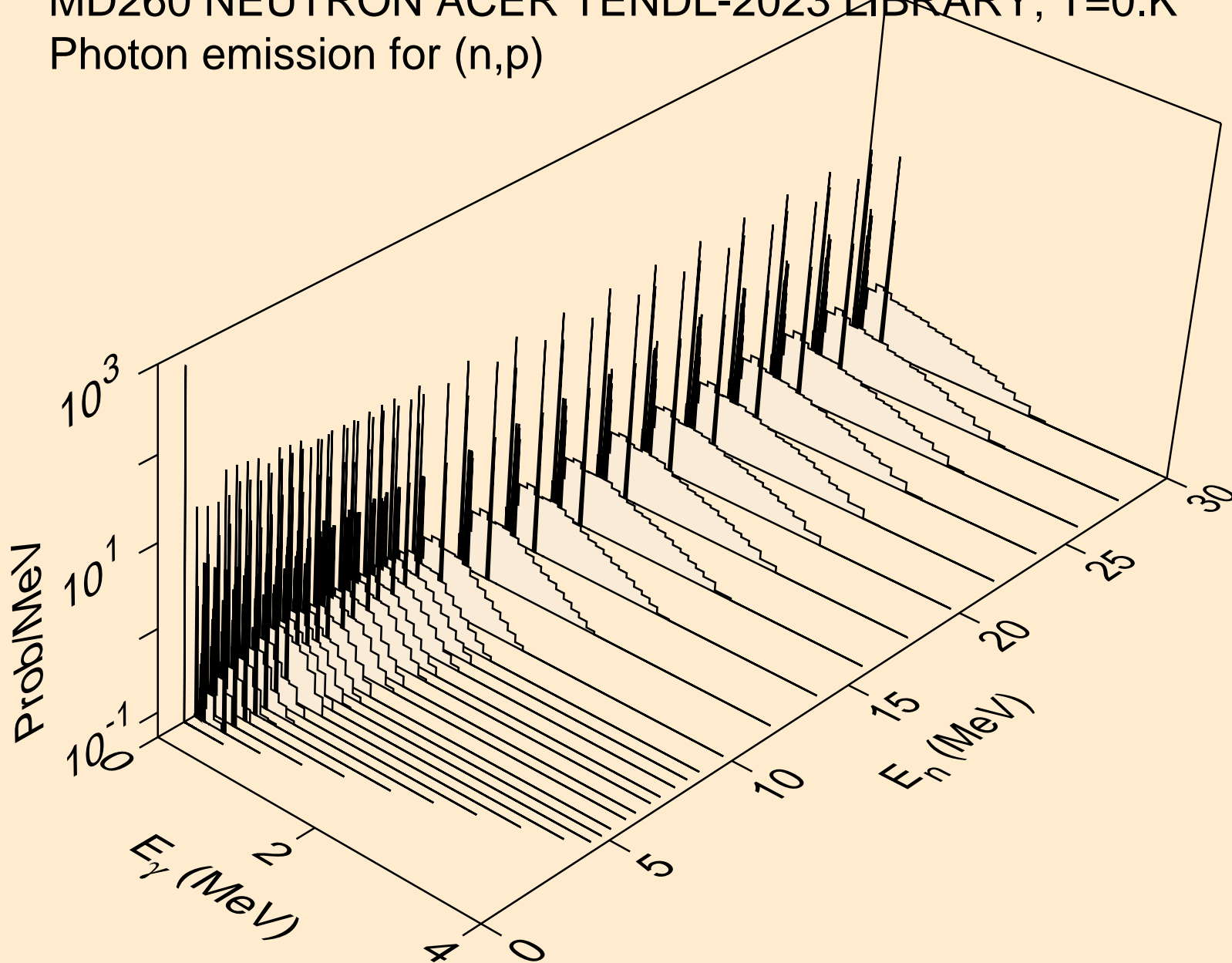

MD260 NEUTRON ACER TENDL-2023 LIBRARY; T=0.K
Photon emission for (n,d)

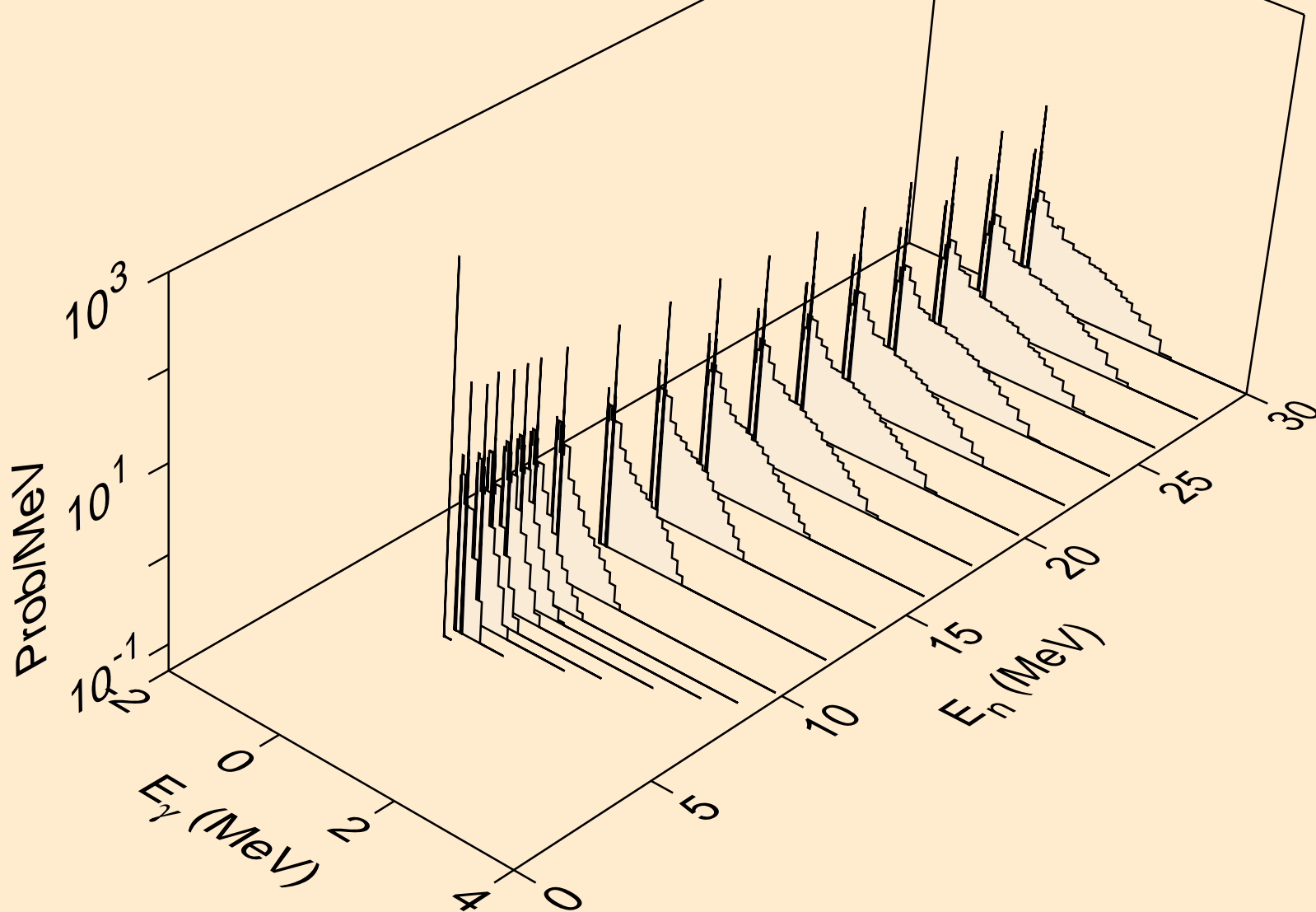

MD260 NEUTRON ACER TENDL-2023 LIBRARY; T=0.K
Photon emission for (n,t)

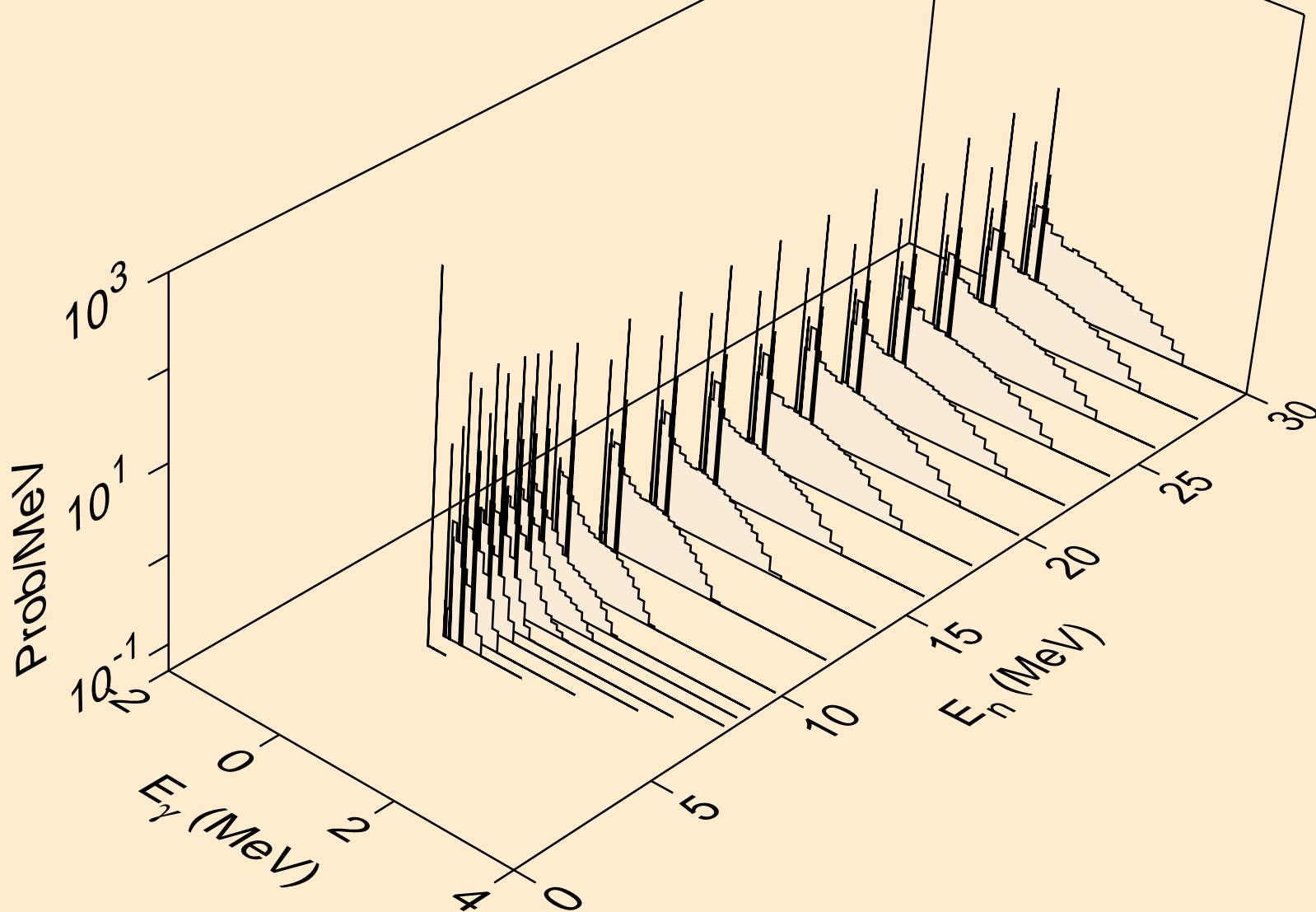

MD260 NEUTRON ACER TENDL-2023 LIBRARY; T=0.K
Photon emission for (n,he3)

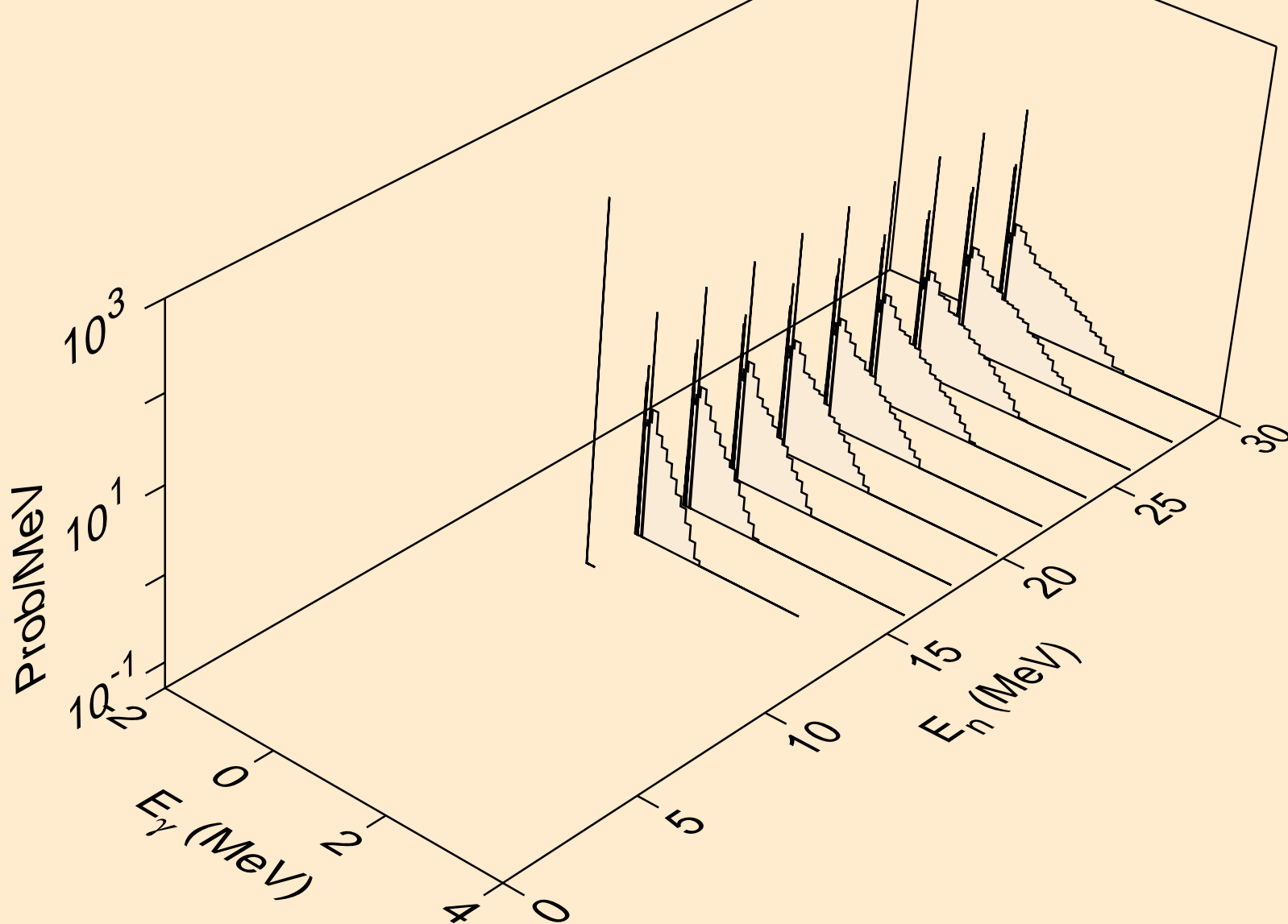

MD260 NEUTRON ACER TENDL-2023 LIBRARY; T=0.K
Photon emission for (n,a)

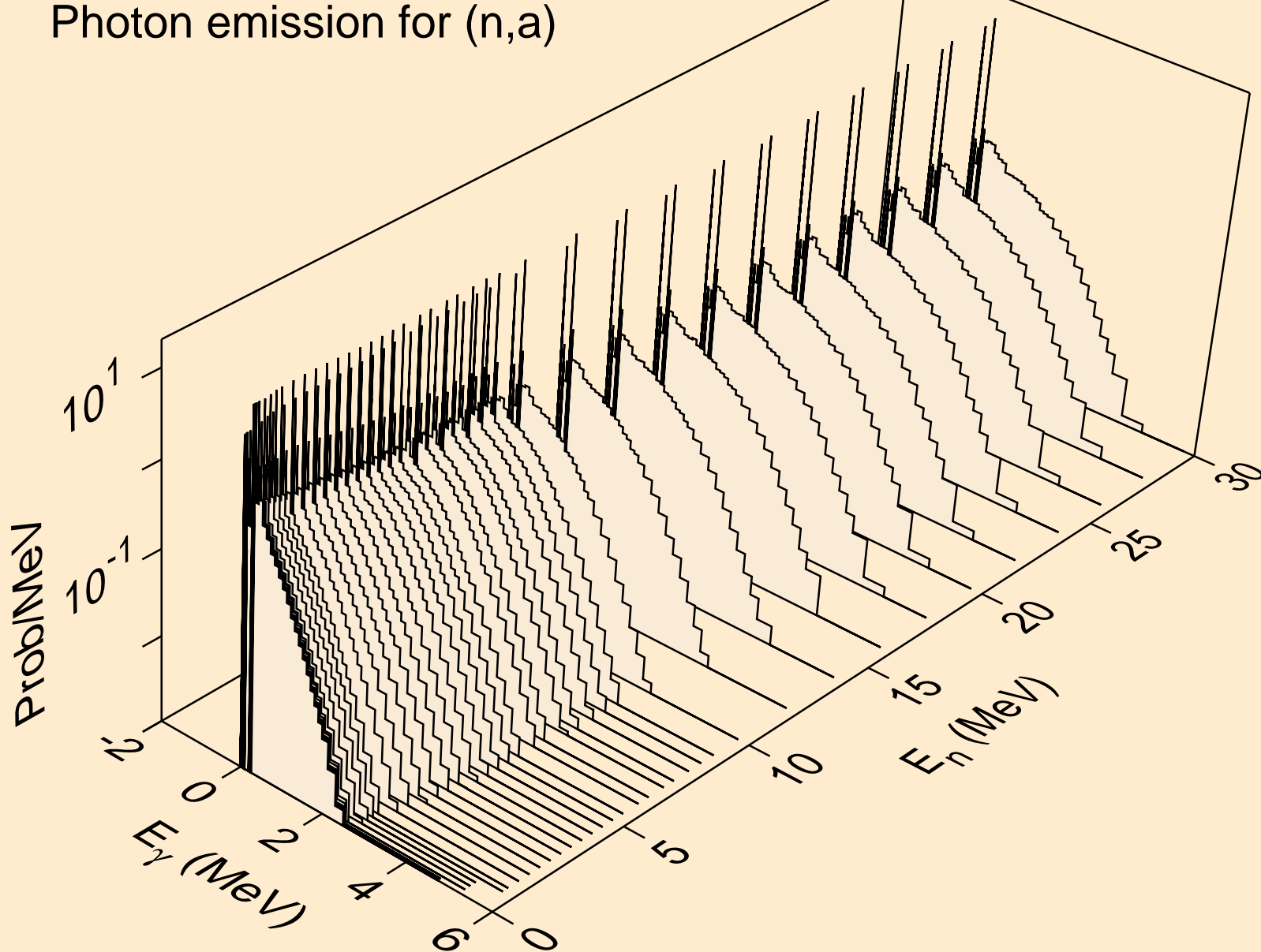

MD260 NEUTRON ACER TENDL-2023 LIBRARY; T=0.K
Photon emission for (n,2a)

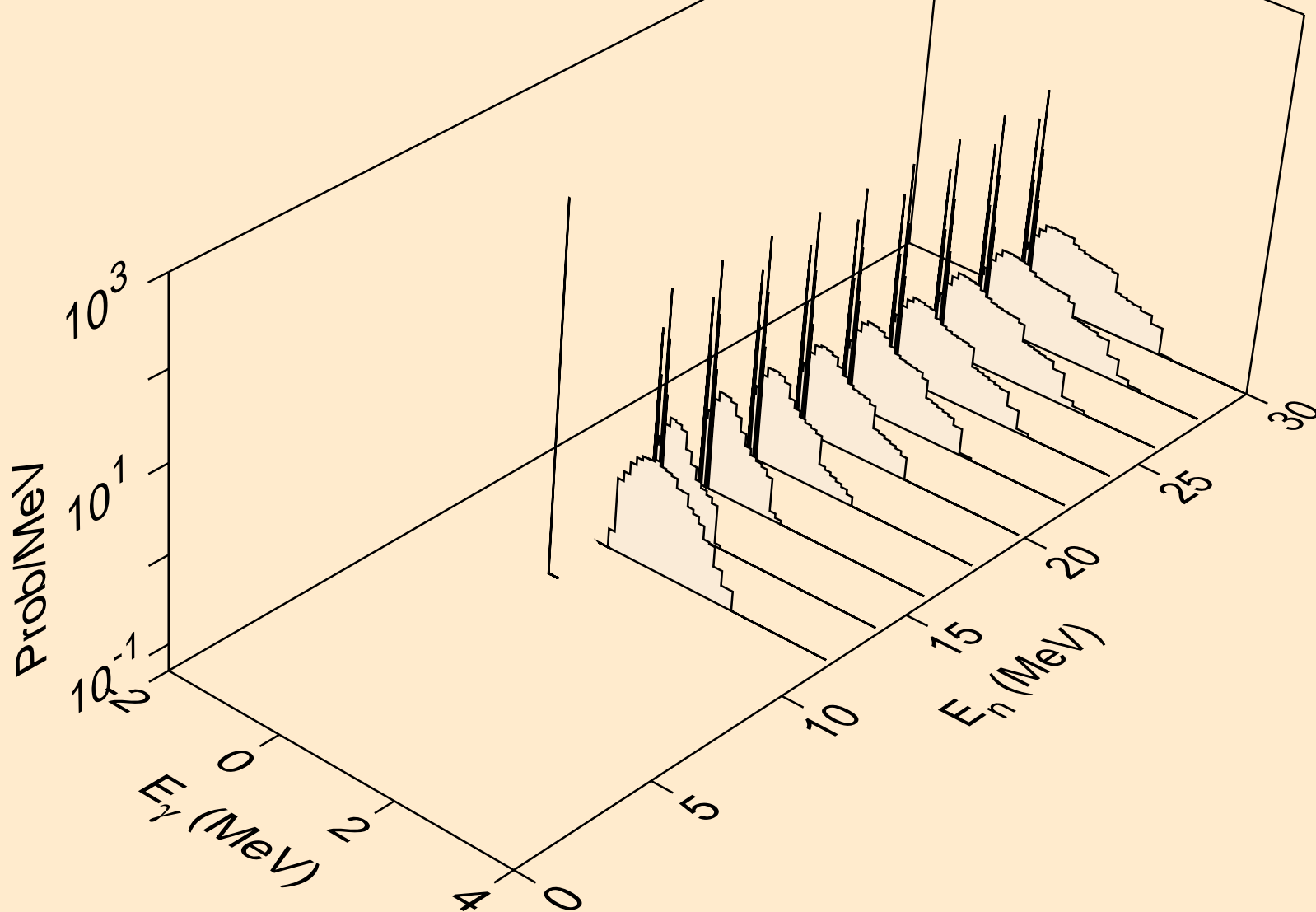

MD260 NEUTRON ACER TENDL-2023 LIBRARY; T=0.K
Photon emission for (n,2p)

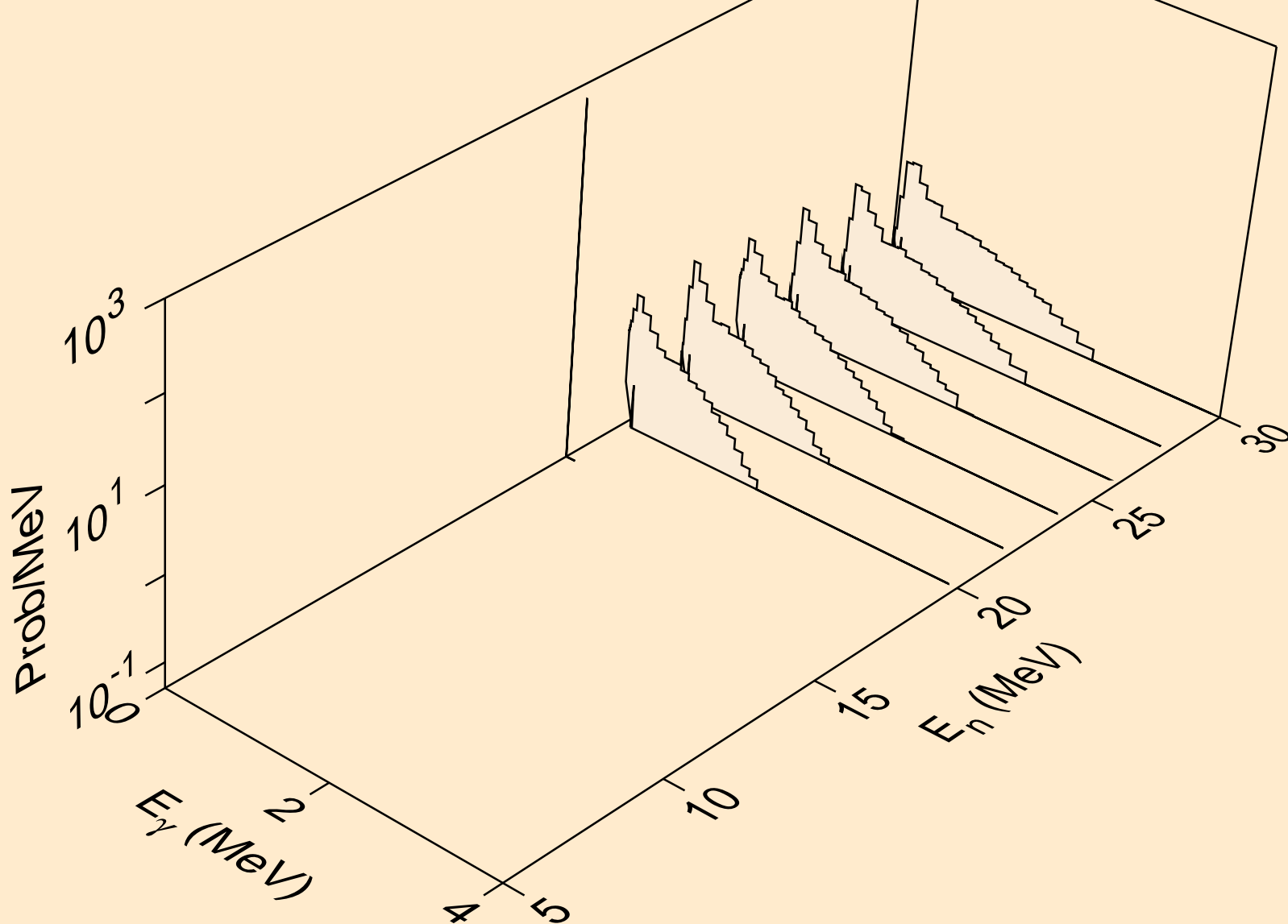

MD260 NEUTRON ACER TENDL-2023 LIBRARY; T=0.K
Photon emission for (n,pa)

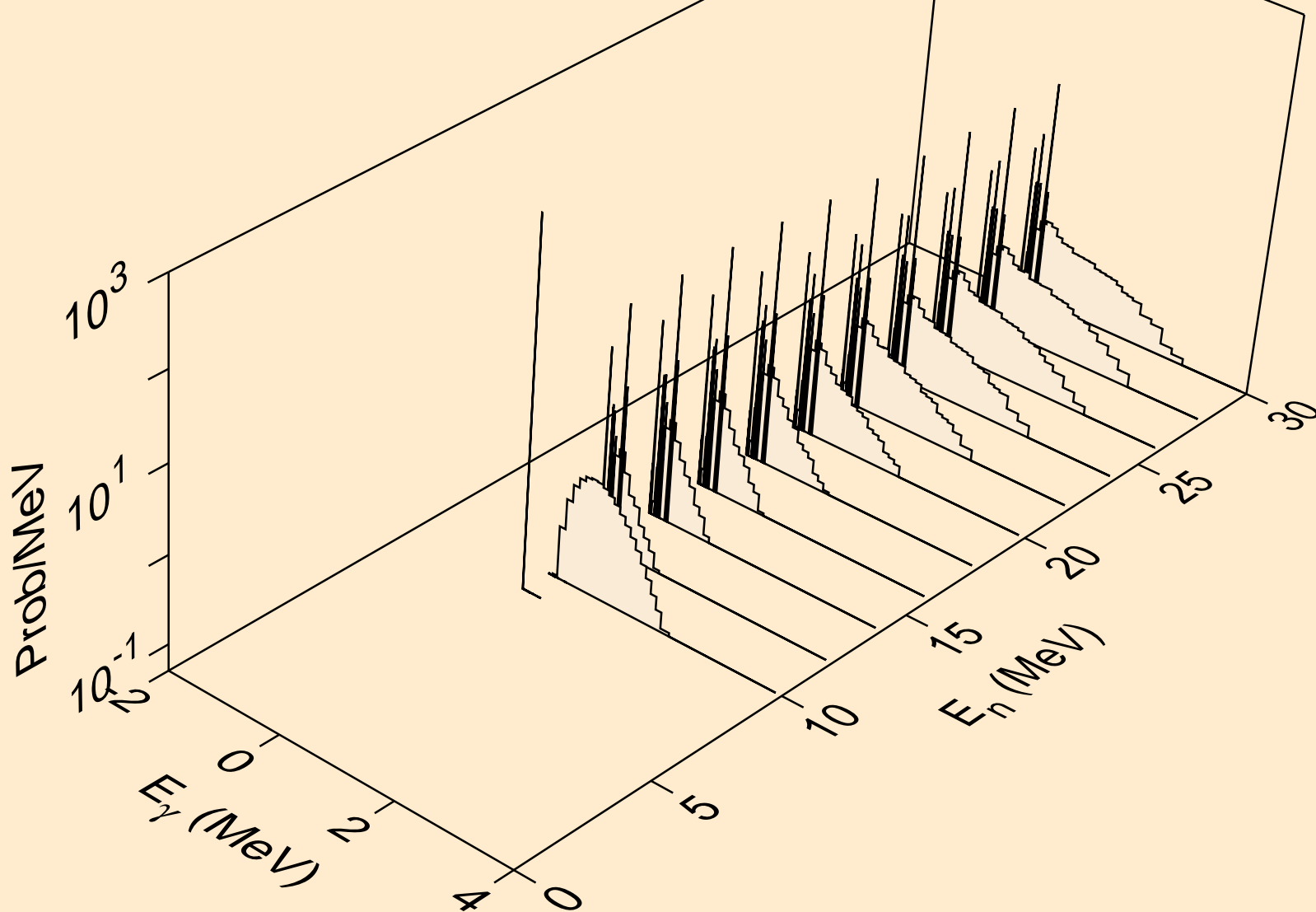

MD260 NEUTRON ACER TENDL-2023 LIBRARY; T=0.K
thermal capture photon spectrum

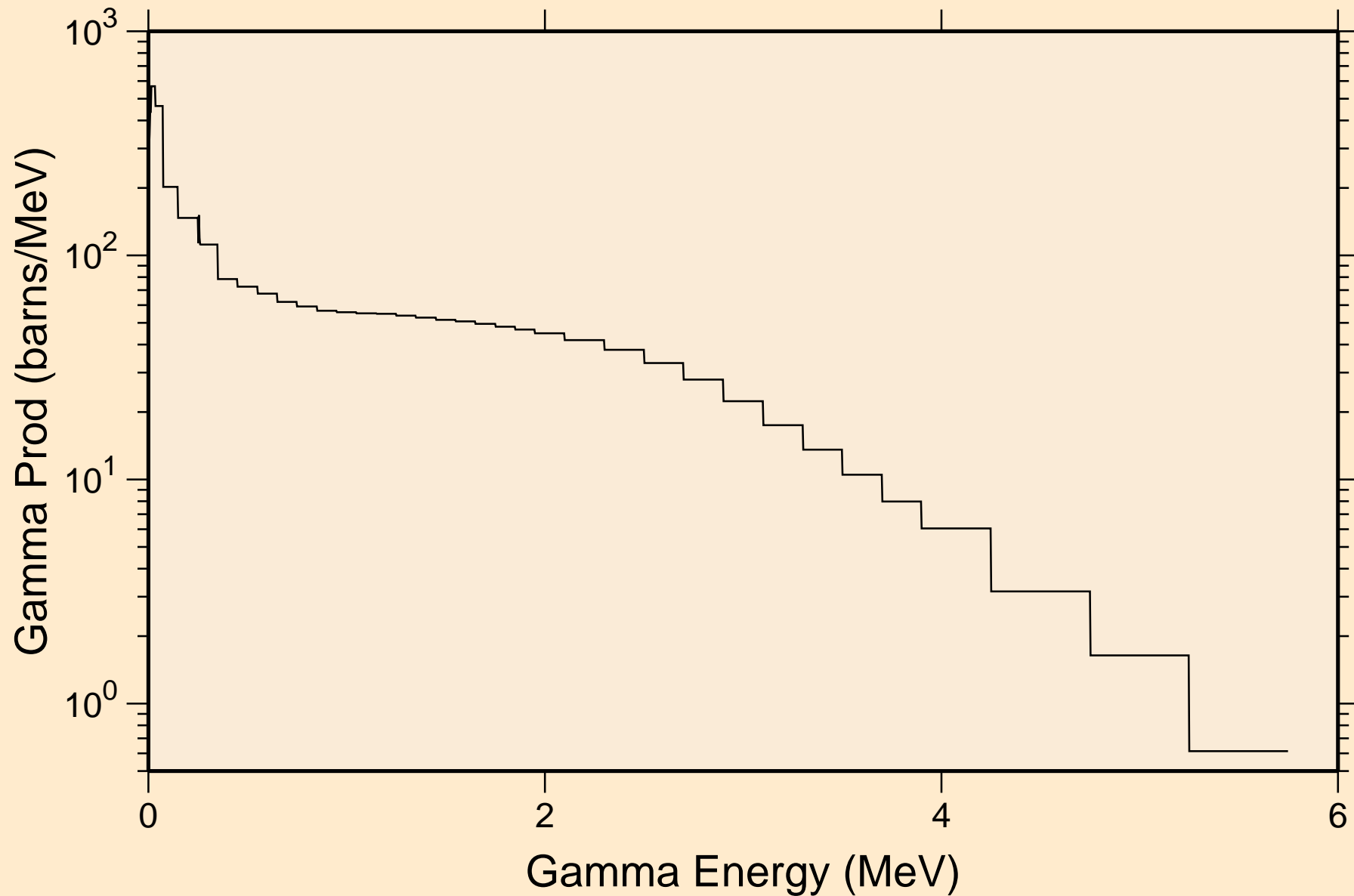

MD260 NEUTRON ACER TENDL-2023 LIBRARY; T=0.K
14 MeV photon spectrum

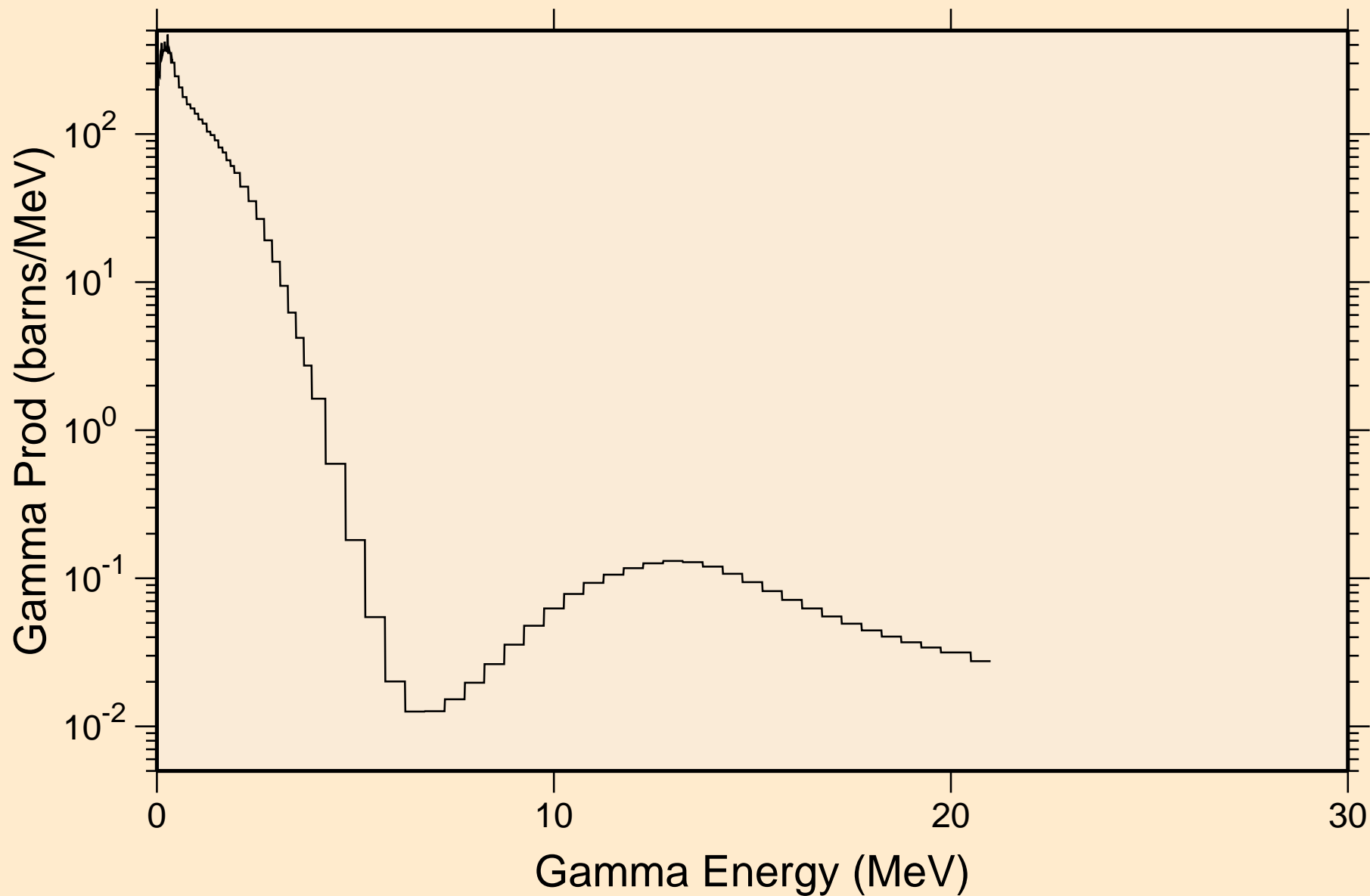

MD260 NEUTRON ACER TENDL-2023 LIBRARY; T=0.K

Particle heating contributions

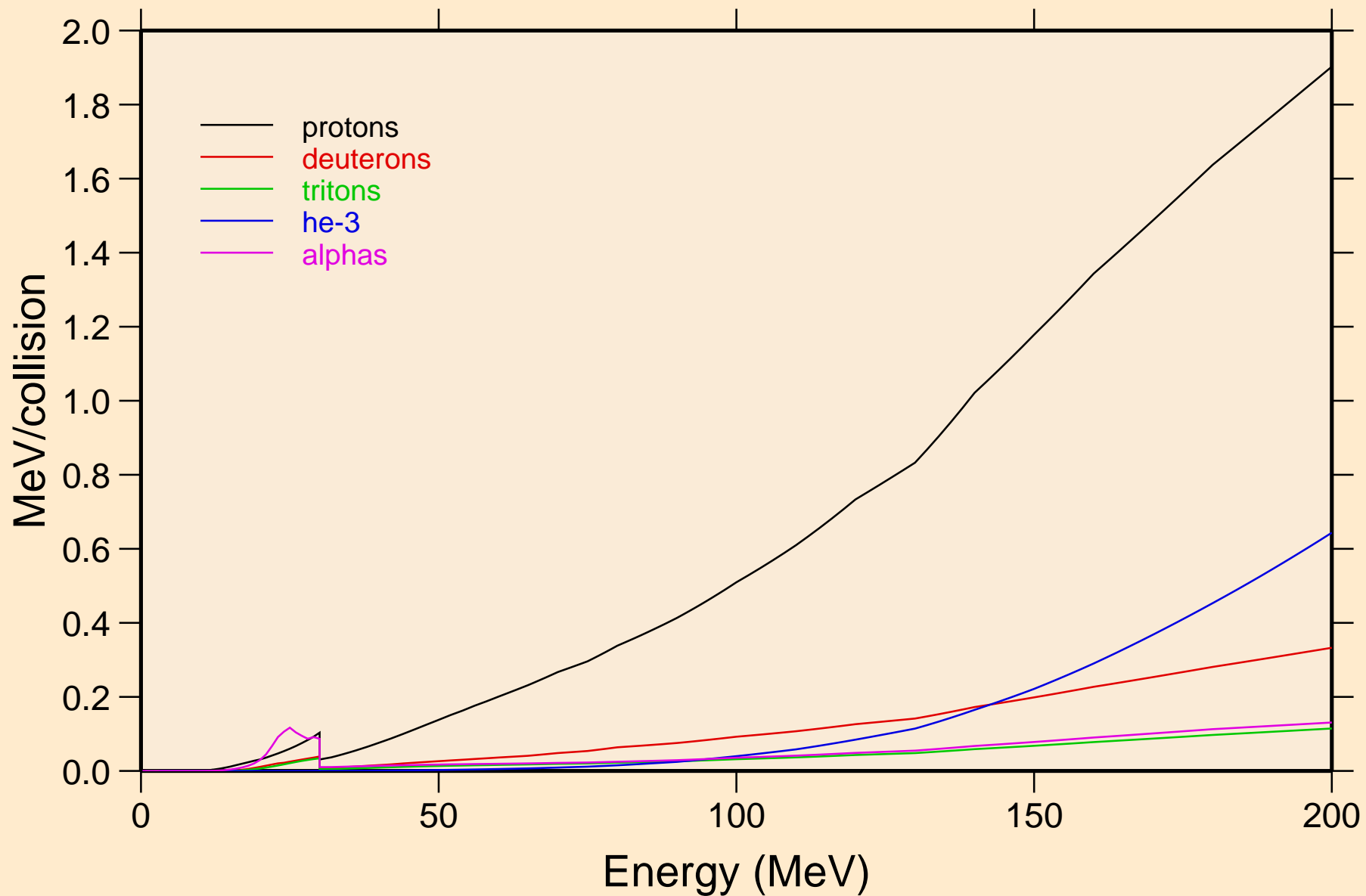

MD260 NEUTRON ACER TENDL-2023 LIBRARY; T=0.K
Recoil Heating

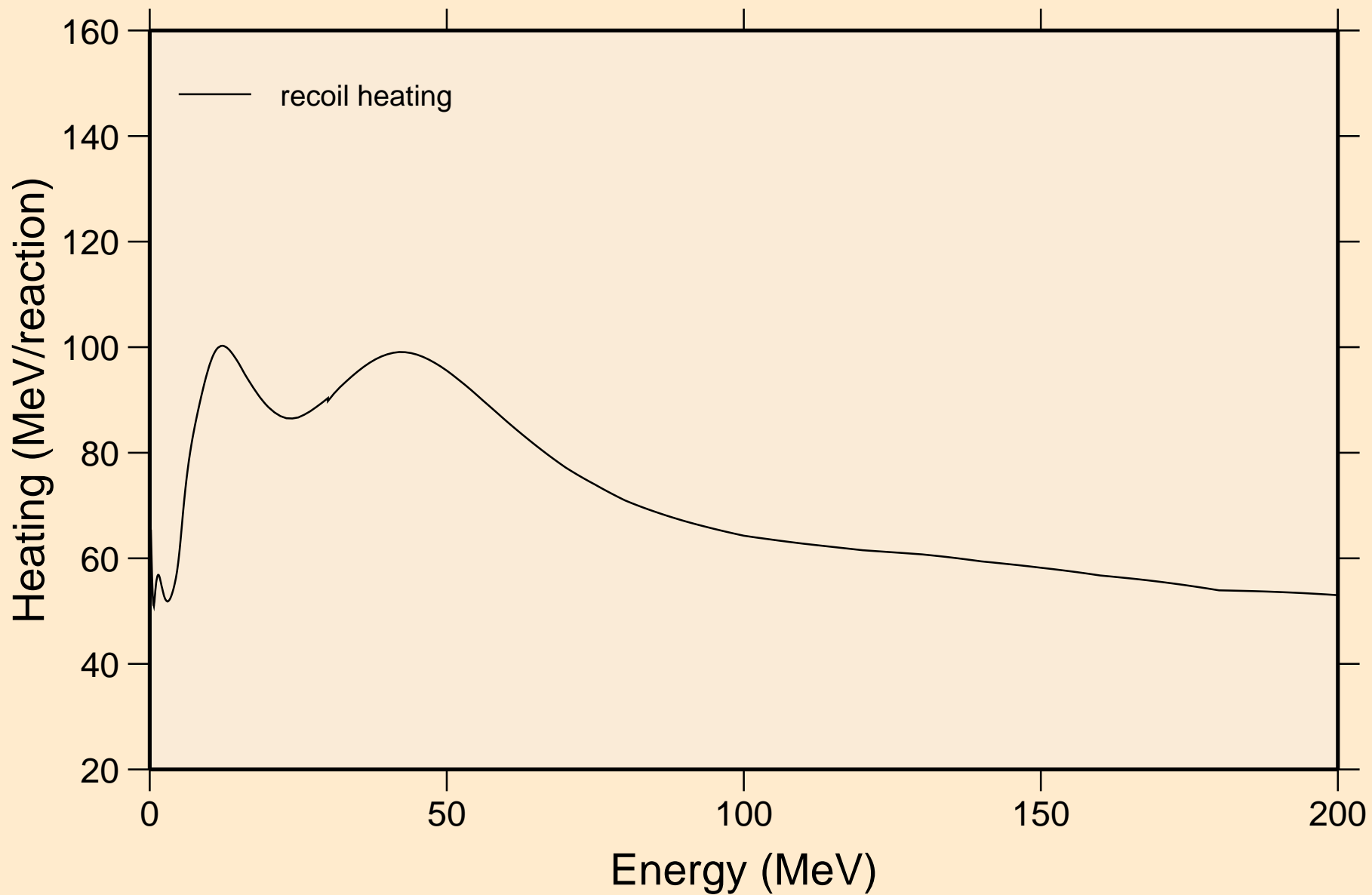

MD260 NEUTRON ACER TENDL-2023 LIBRARY; T=0.K

Particle production cross sections

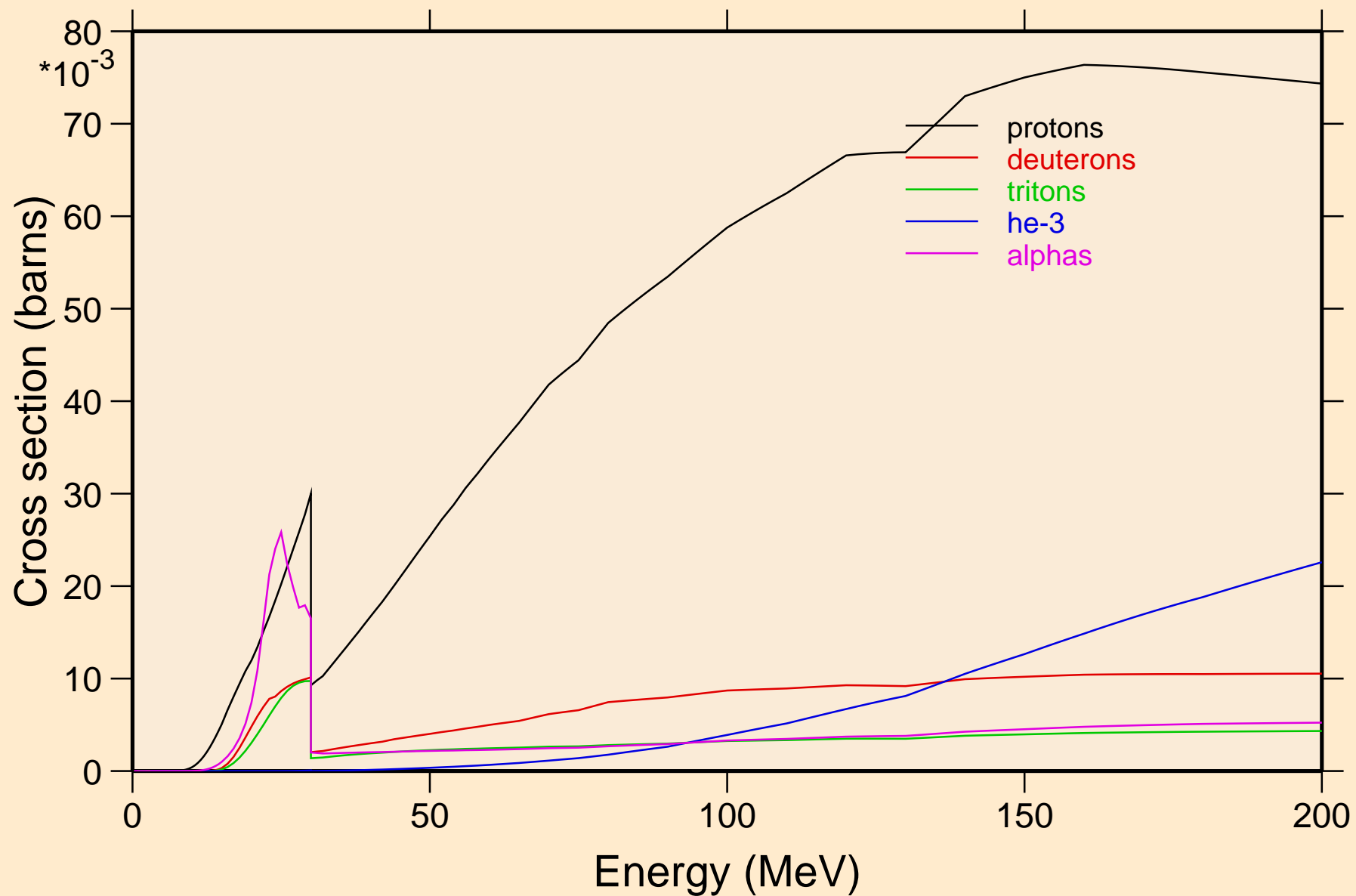

MD260 NEUTRON ACER TENDL-2023 LIBRARY; T=0.K
protons from (n,x)

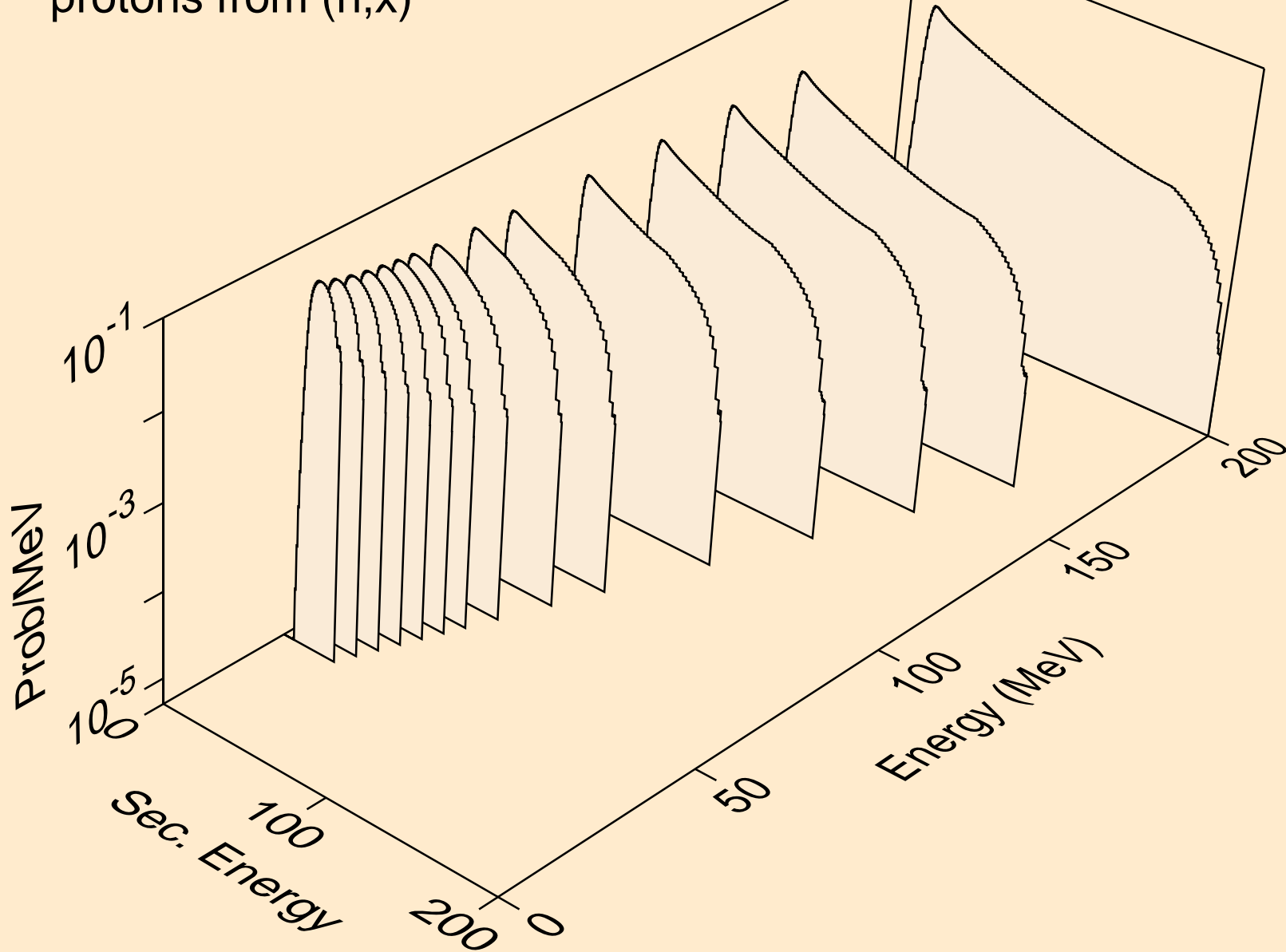

MD260 NEUTRON ACER TENDL-2023 LIBRARY; T=0.K
protons from (n,n*)p

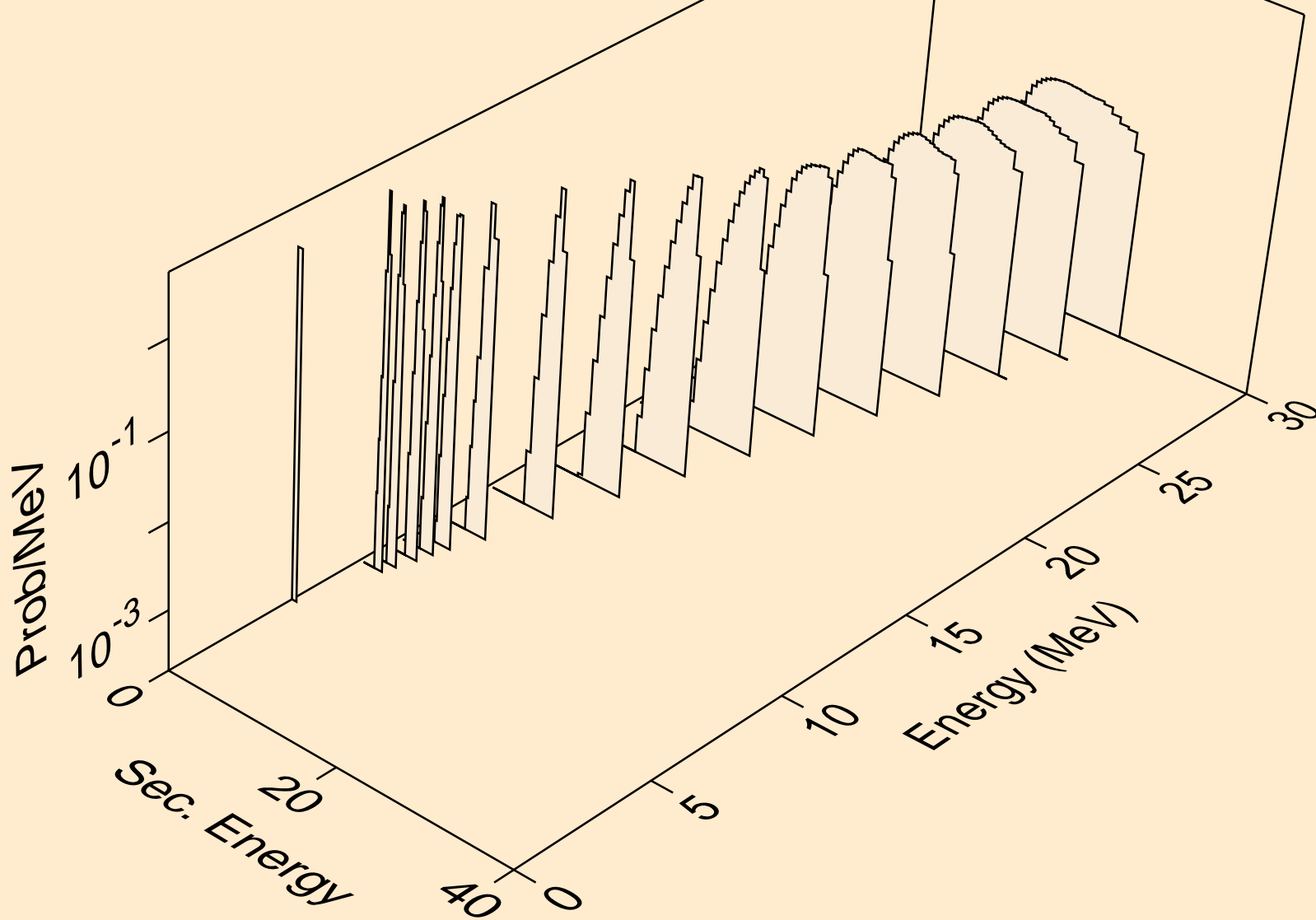

MD260 NEUTRON ACER TENDL-2023 LIBRARY; T=0.K
protons from (n,2np)

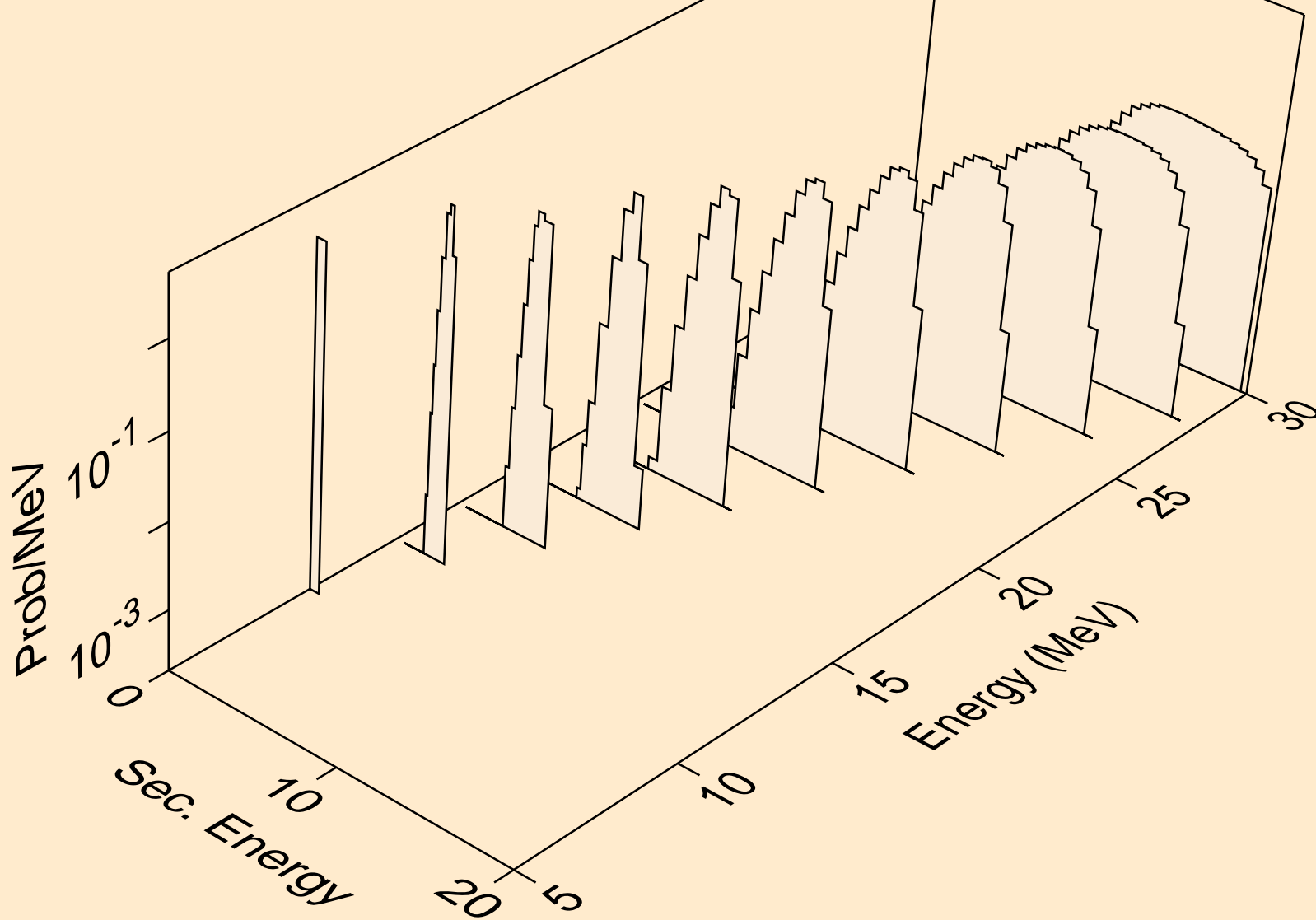

MD260 NEUTRON ACER TENDL-2023 LIBRARY; T=0.K
protons from (n,3np)

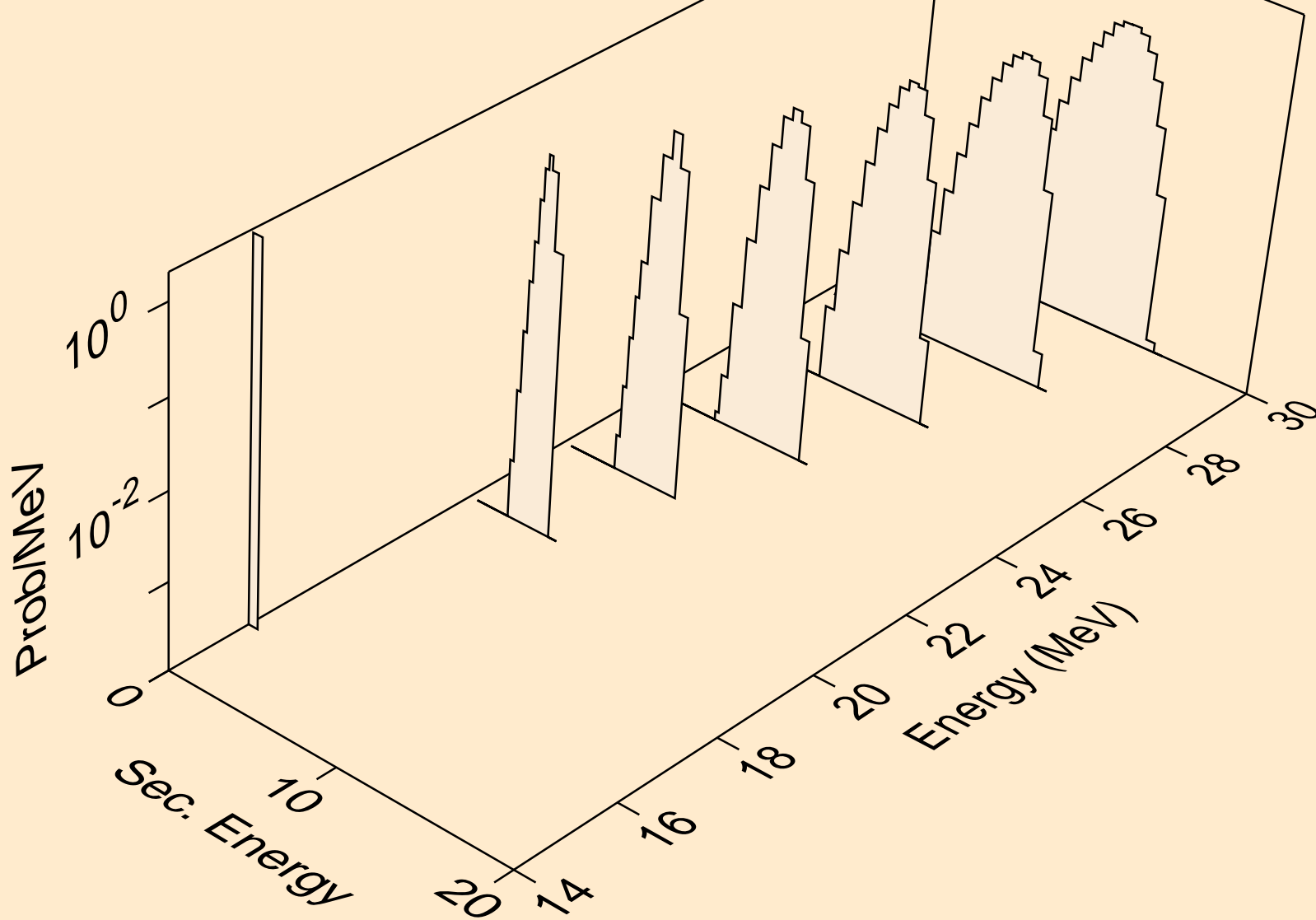

MD260 NEUTRON ACER TENDL-2023 LIBRARY; T=0.K
protons from (n,n2p)

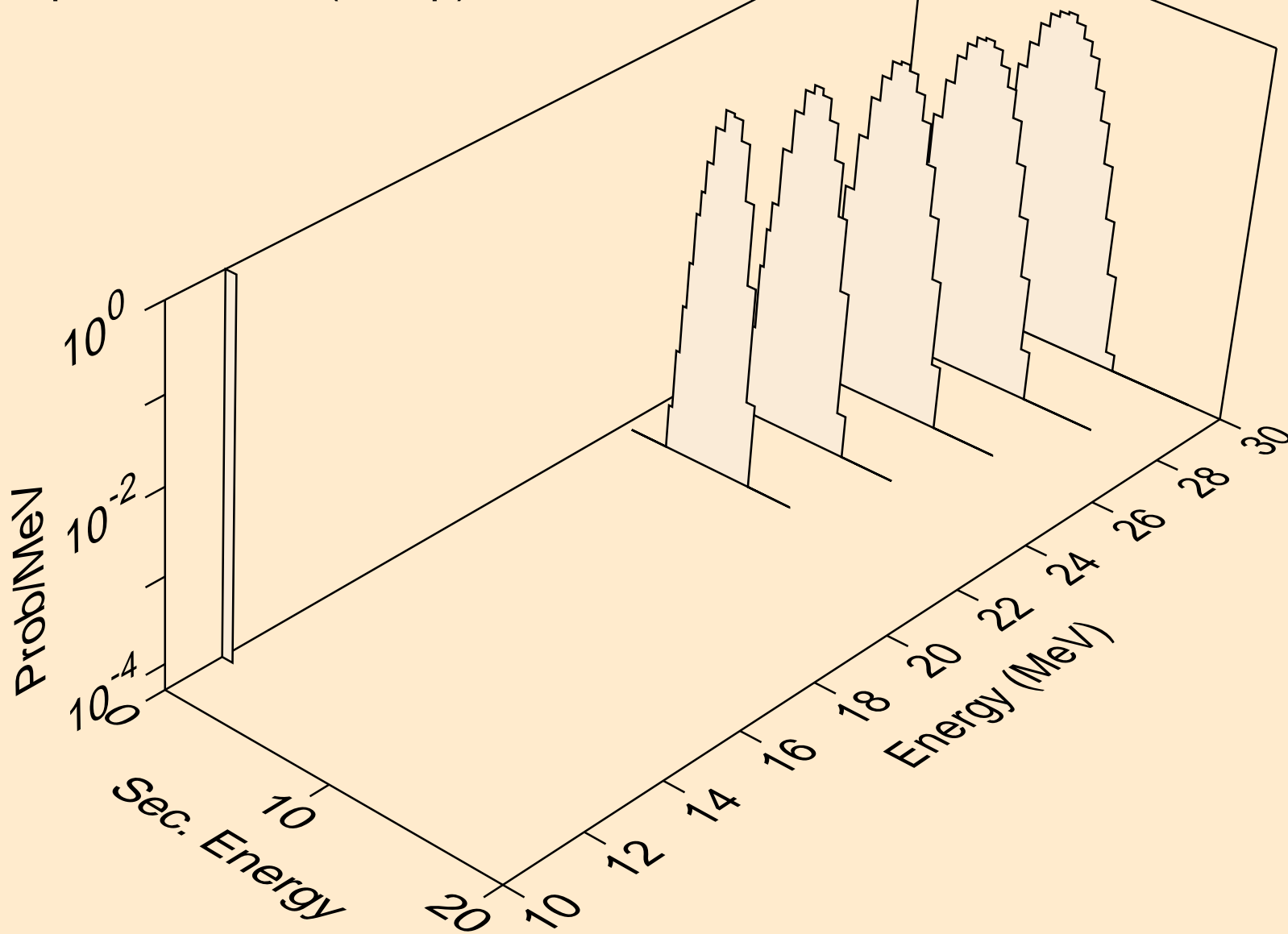

MD260 NEUTRON ACER TENDL-2023 LIBRARY; T=0.K
protons from (n,npa)

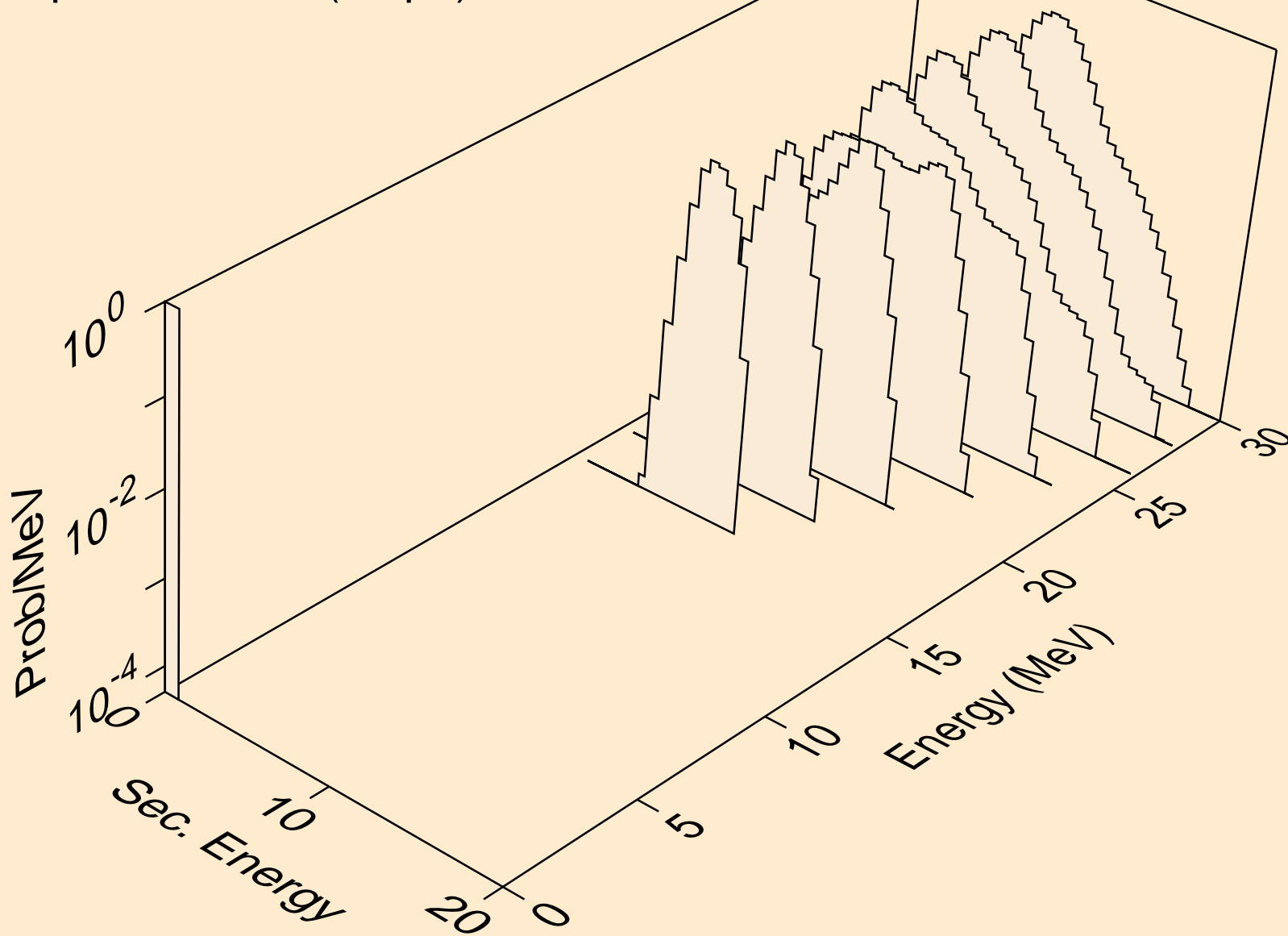

MD260 NEUTRON ACER TENDL-2023 LIBRARY; T=0.K
protons from (n,p)

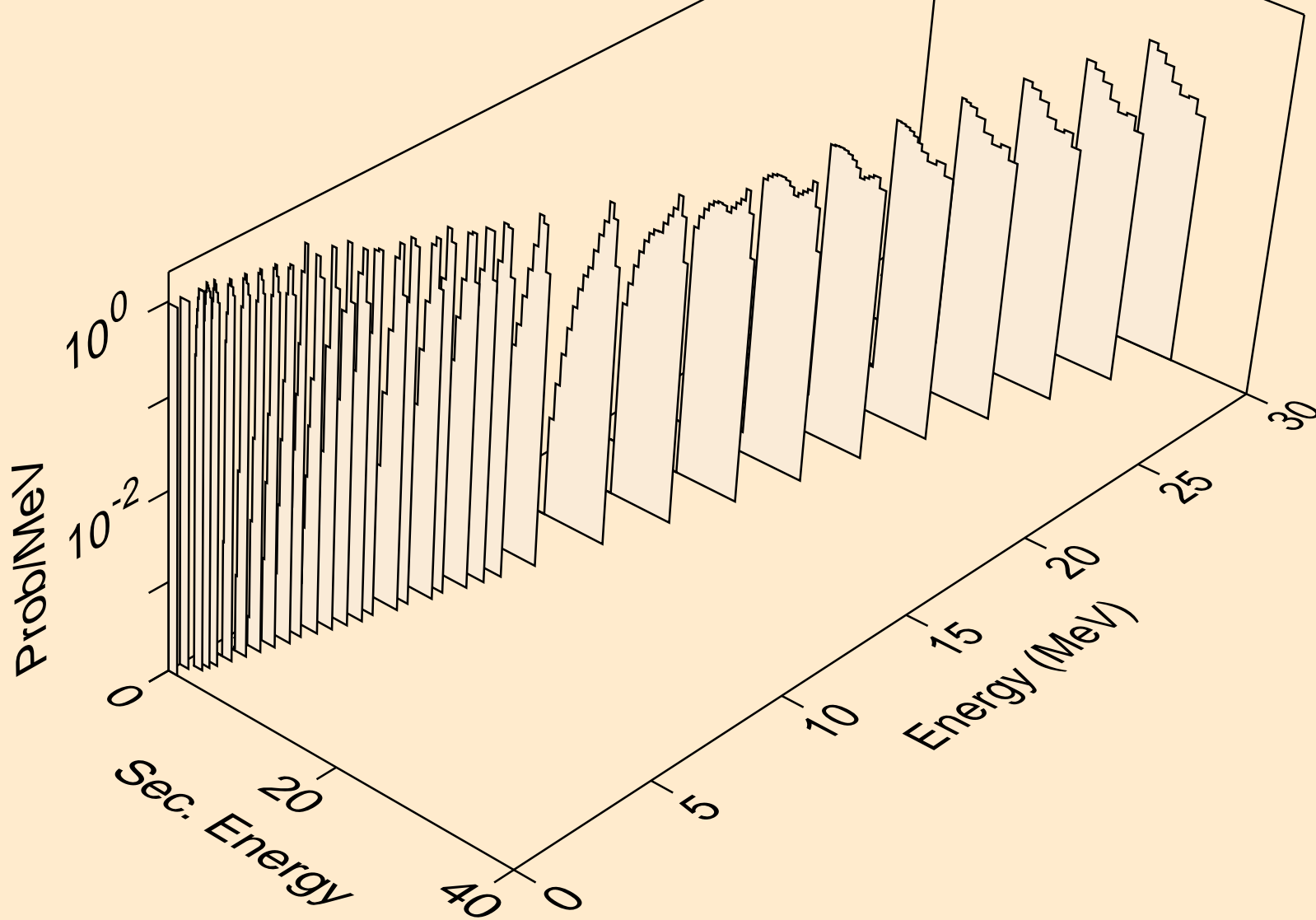

MD260 NEUTRON ACER TENDL-2023 LIBRARY; T=0.K
protons from (n,2p)

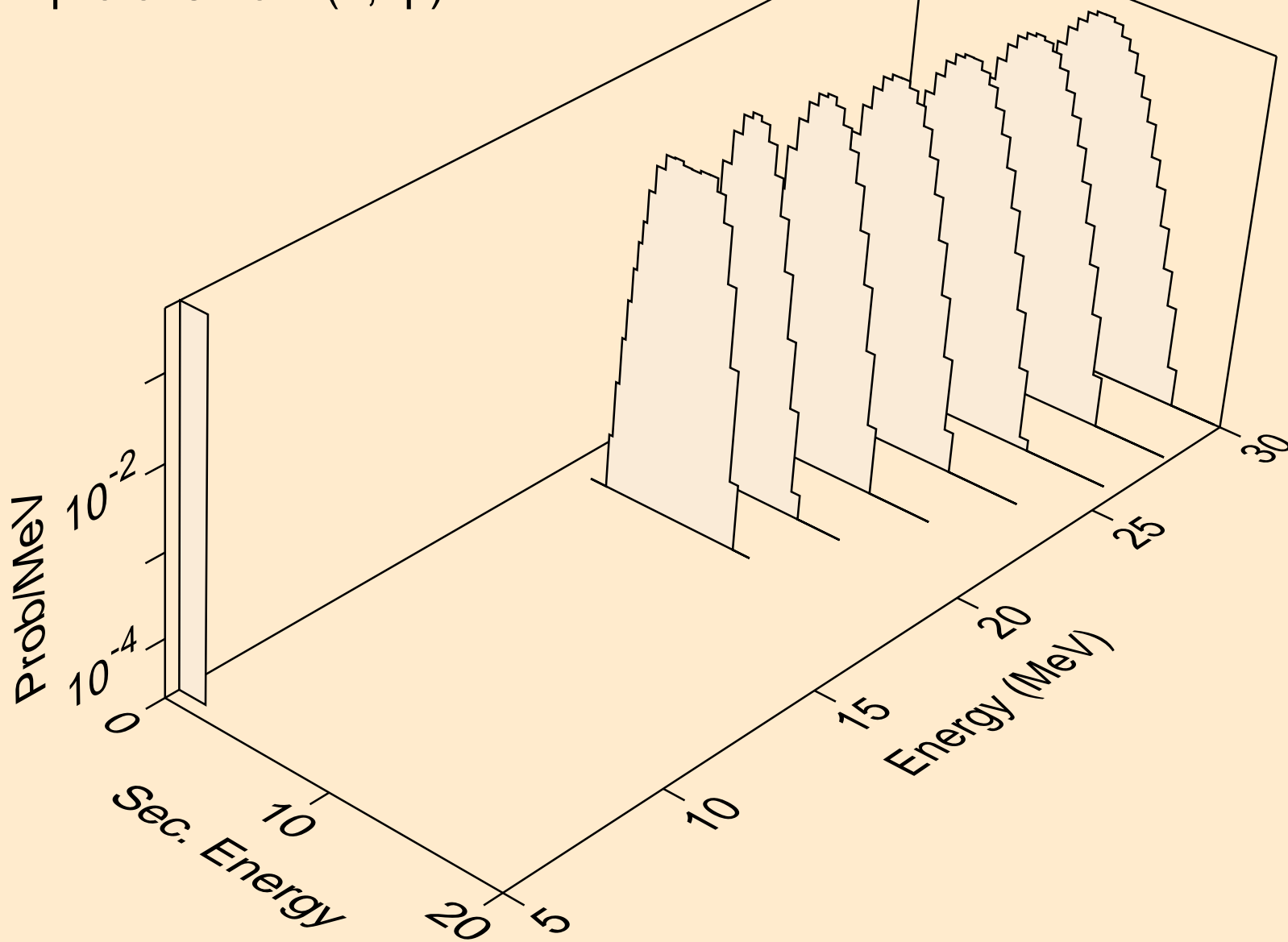

MD260 NEUTRON ACER TENDL-2023 LIBRARY; T=0.K
protons from (n,p)

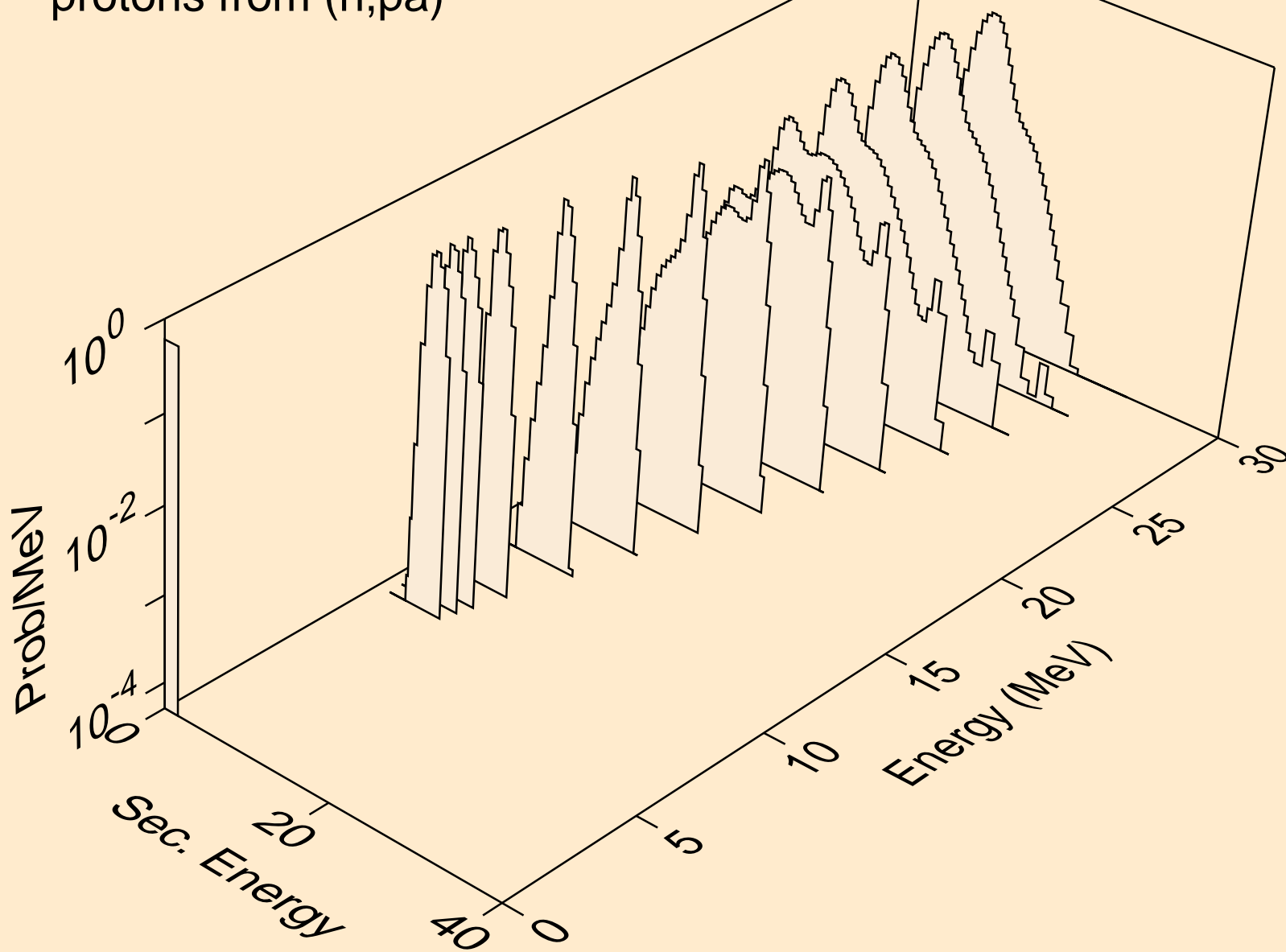

MD260 NEUTRON ACER TENDL-2023 LIBRARY; T=0.K
deuterons from (n,x)

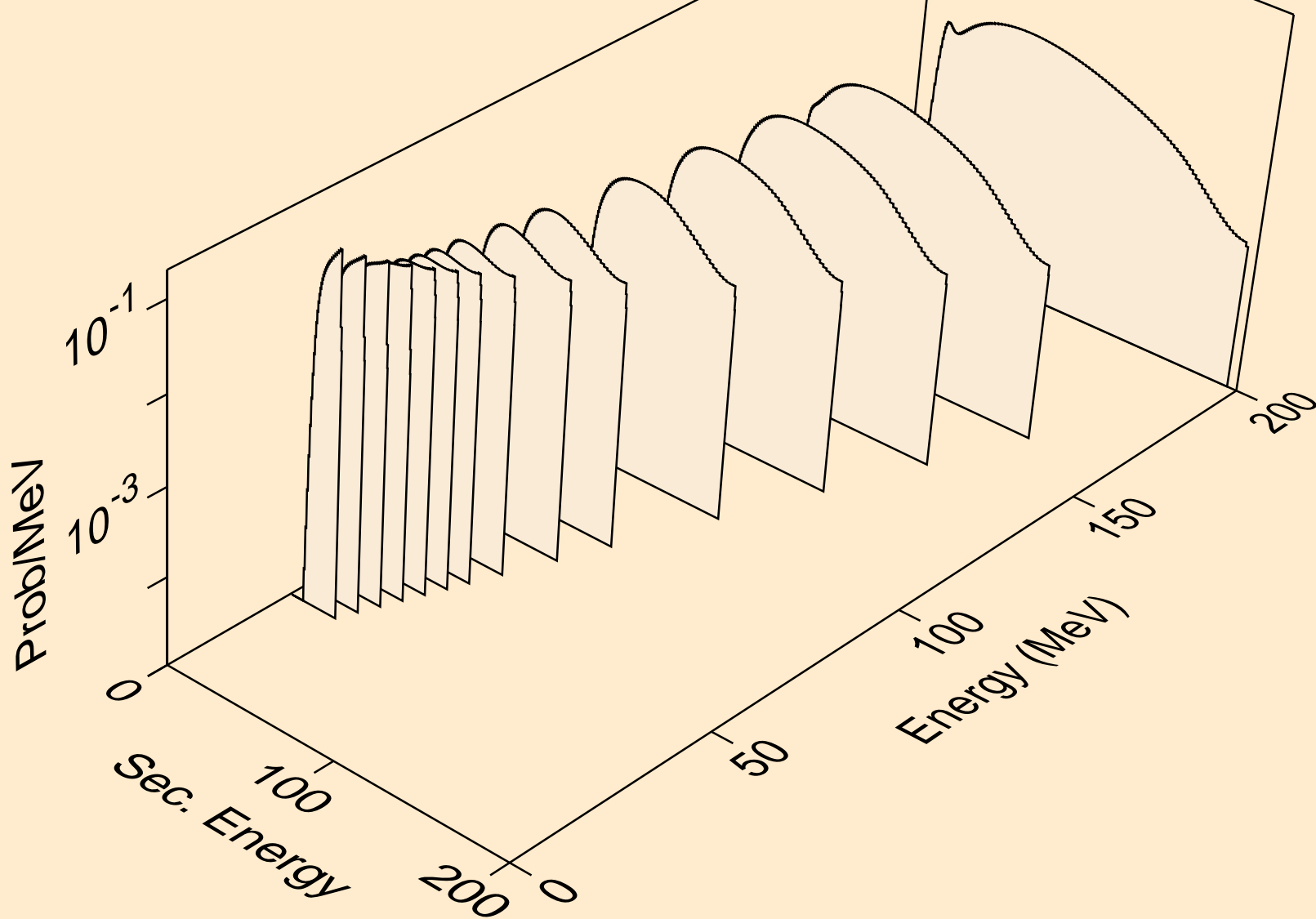

MD260 NEUTRON ACER TENDL-2023 LIBRARY; T=0.K
deuterons from (n,2nd)

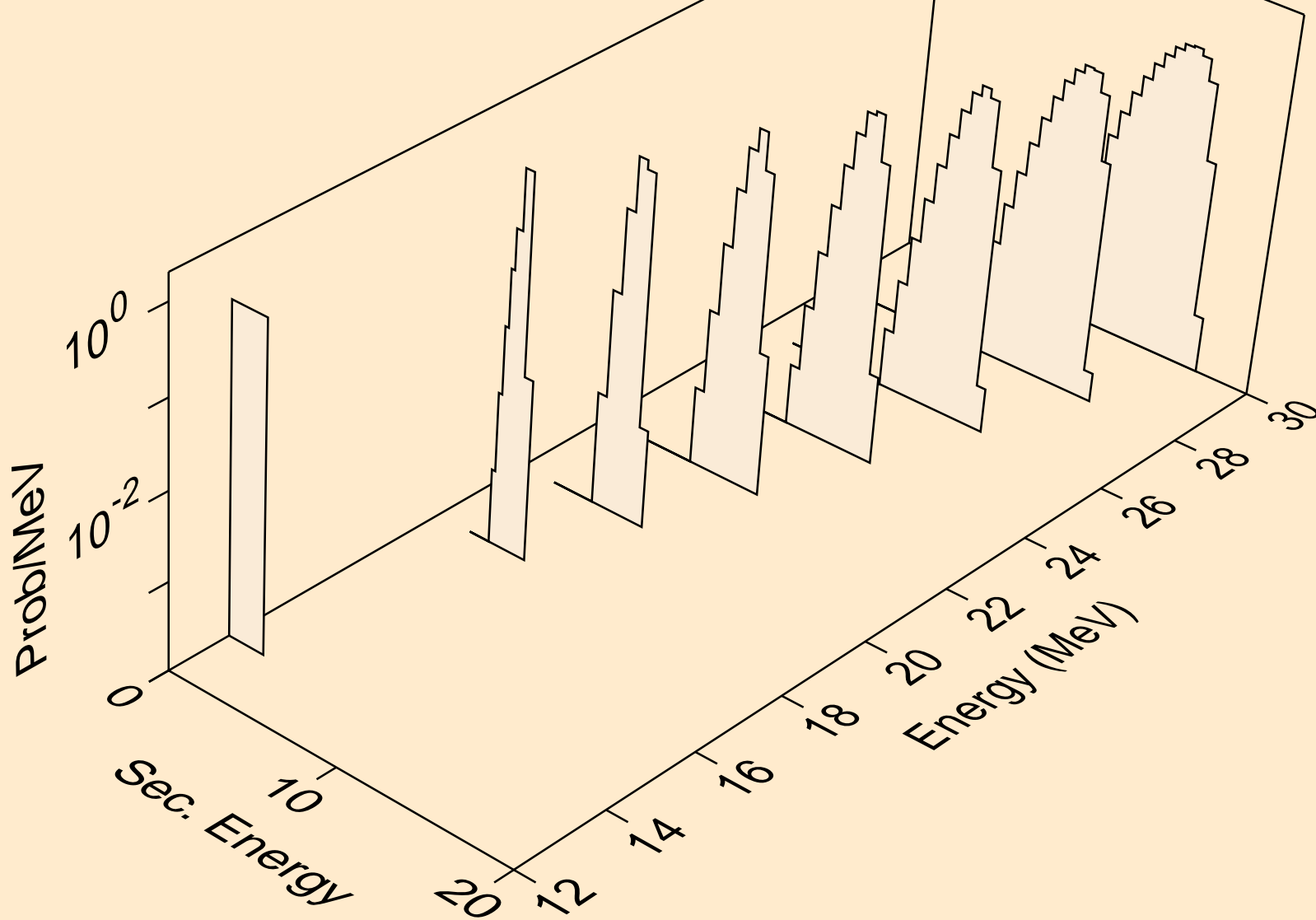

MD260 NEUTRON ACER TENDL-2023 LIBRARY; T=0.K
deuterons from (n,n*)d

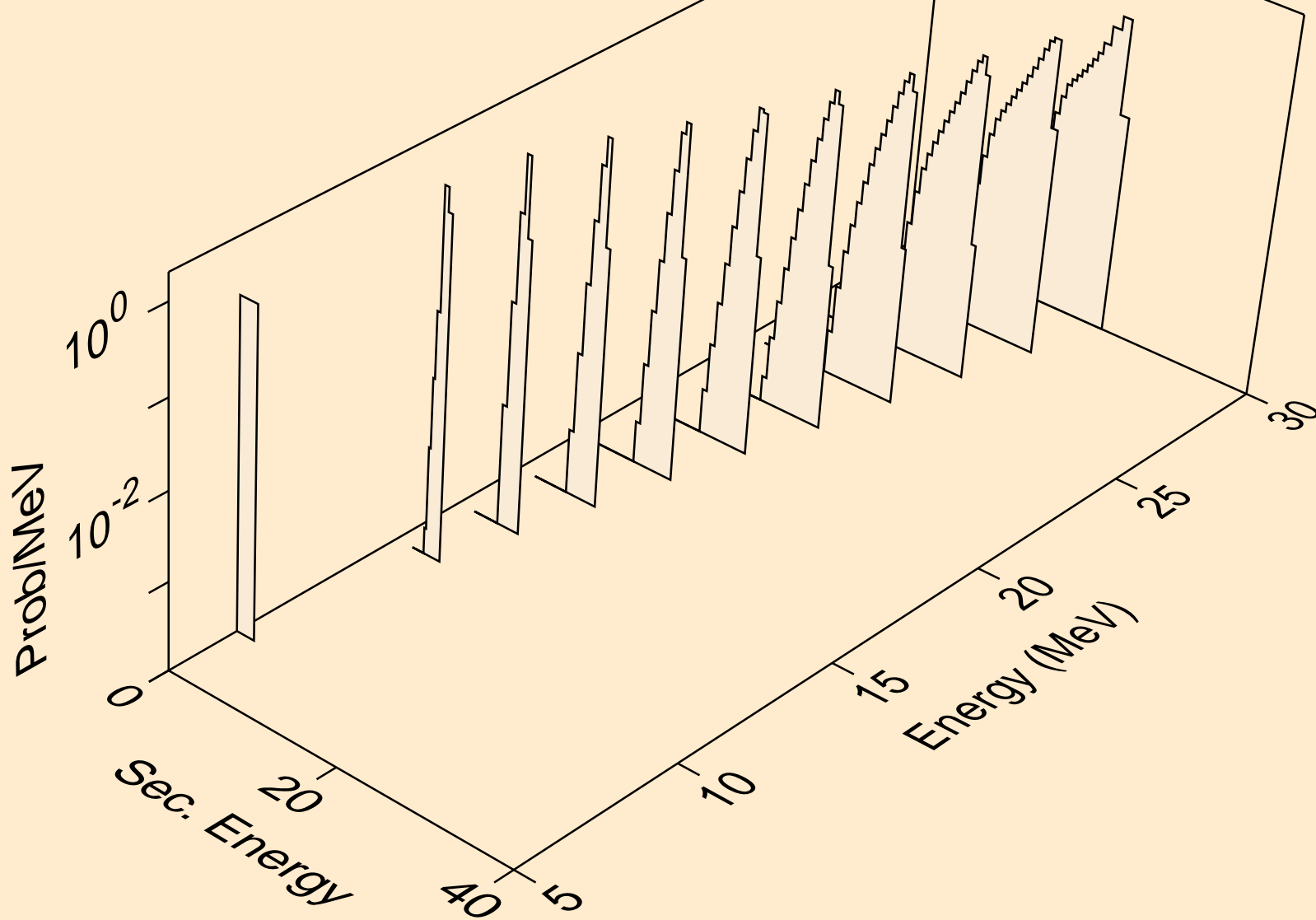

MD260 NEUTRON ACER TENDL-2023 LIBRARY; T=0.K
deuterons from (n,d)

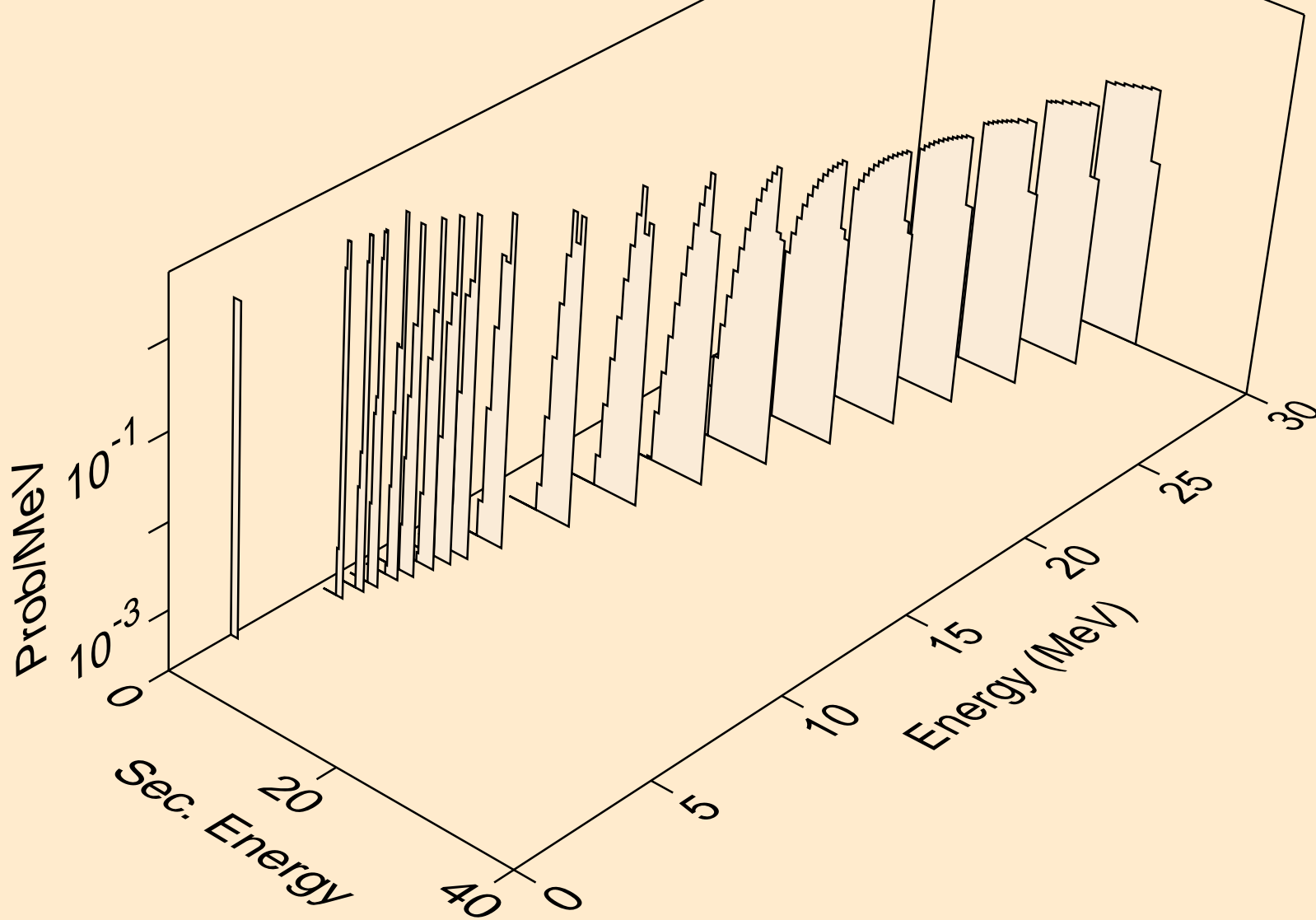

MD260 NEUTRON ACER TENDL-2023 LIBRARY; T=0.K
tritons from (n,x)

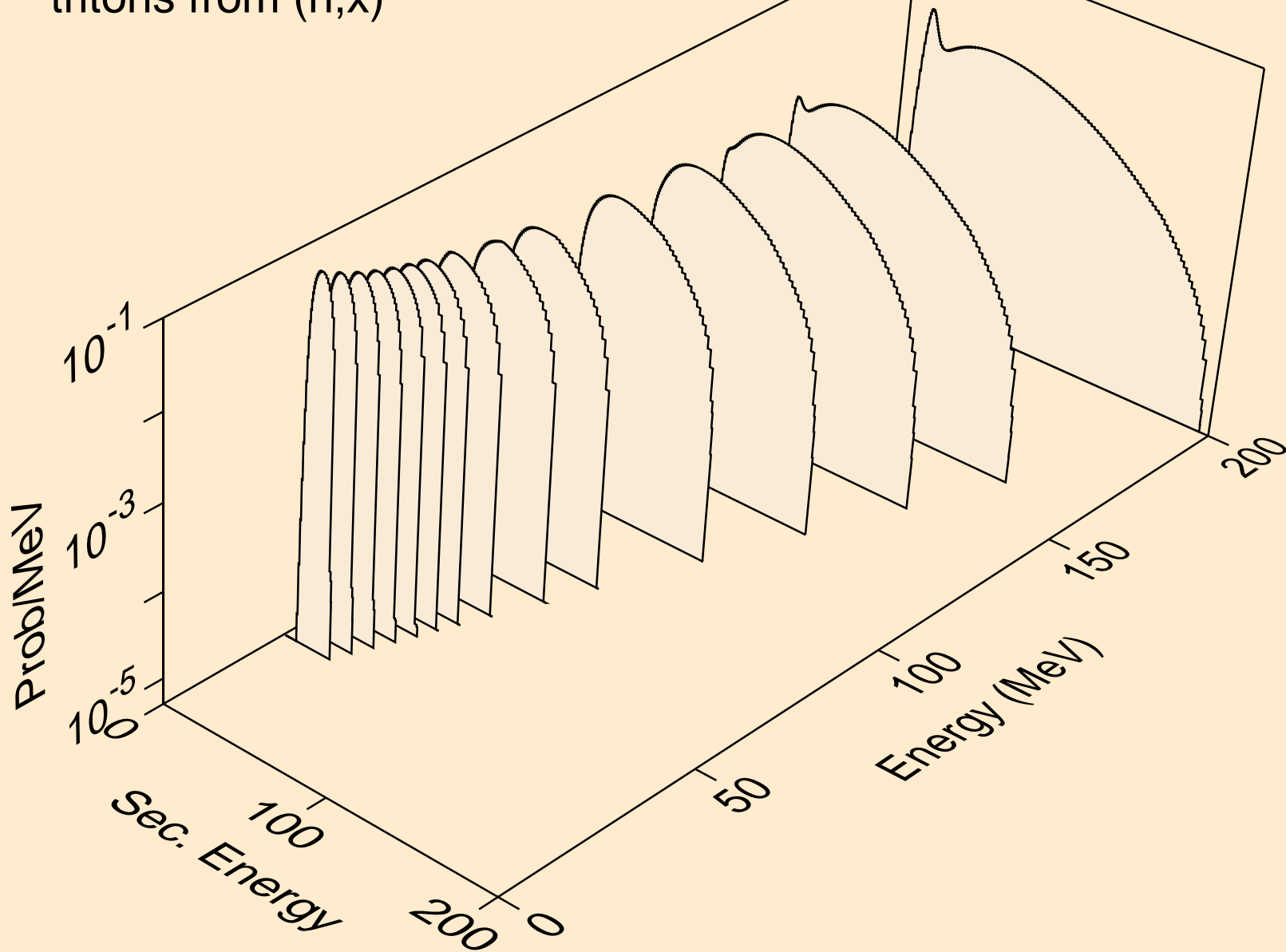

MD260 NEUTRON ACER TENDL-2023 LIBRARY; T=0.K
tritons from (n,n*)t

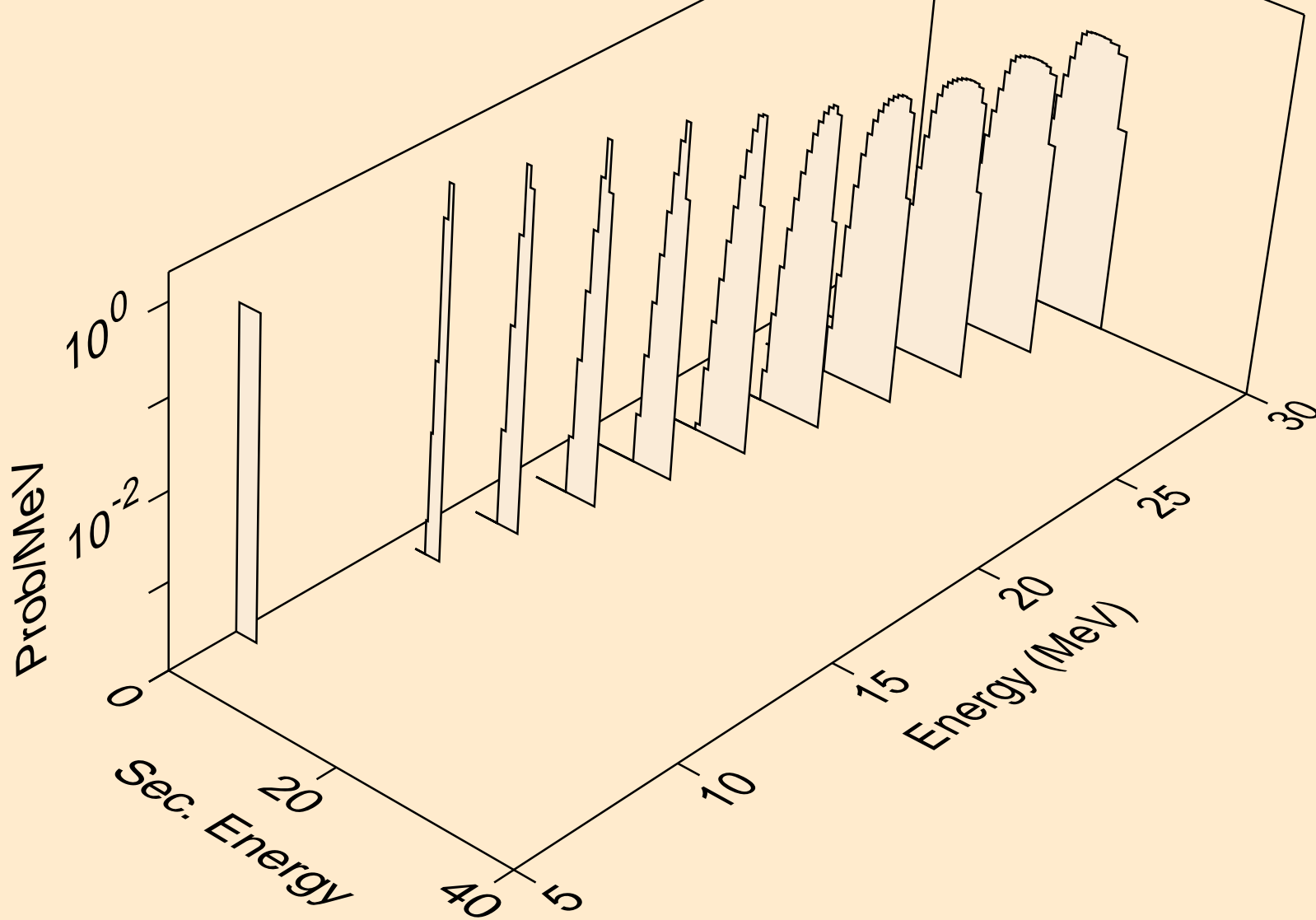

MD260 NEUTRON ACER TENDL-2023 LIBRARY; T=0.K
tritons from (n,t)

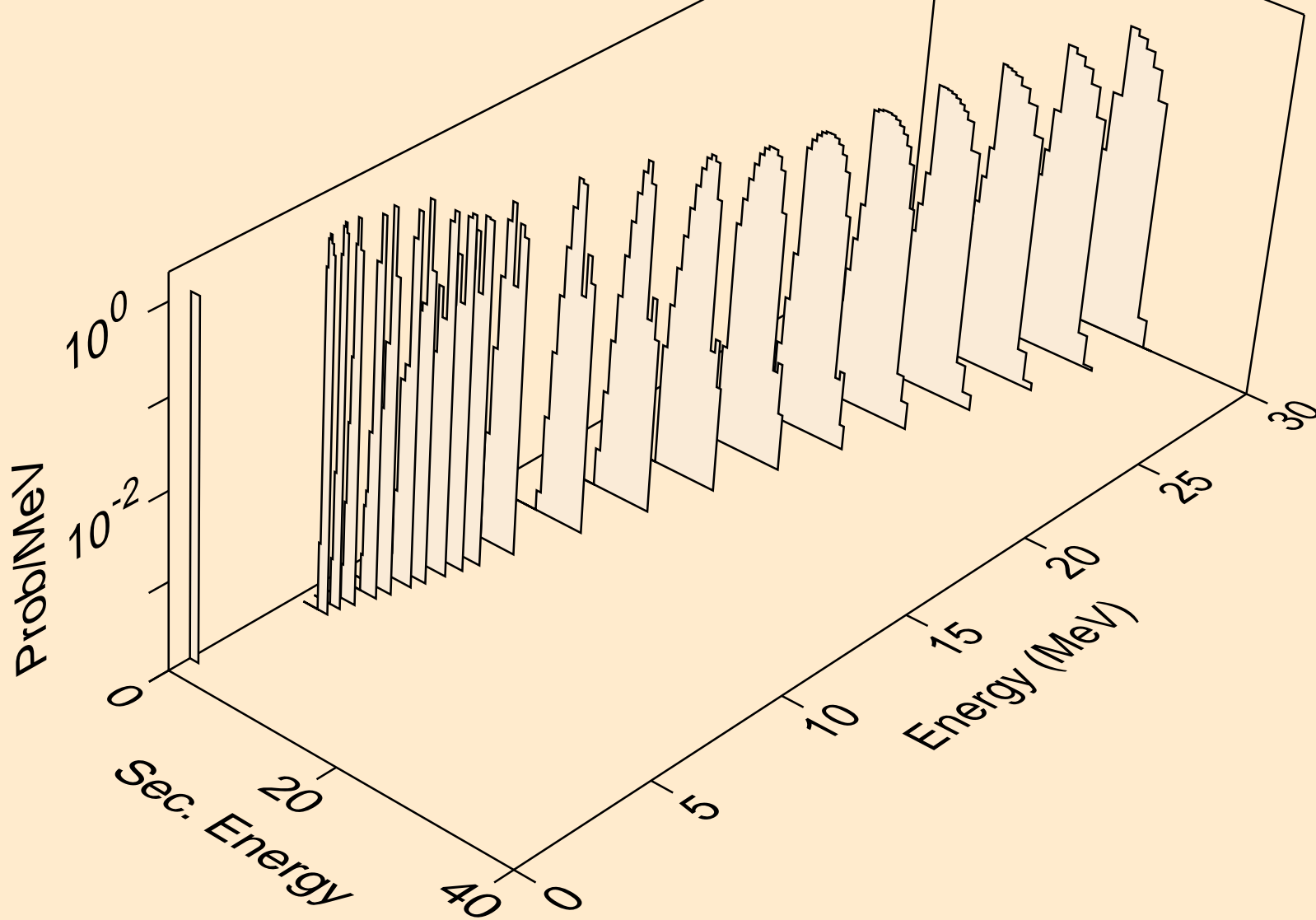

MD260 NEUTRON ACER TENDL-2023 LIBRARY; T=0.K
he3s from (n,x)

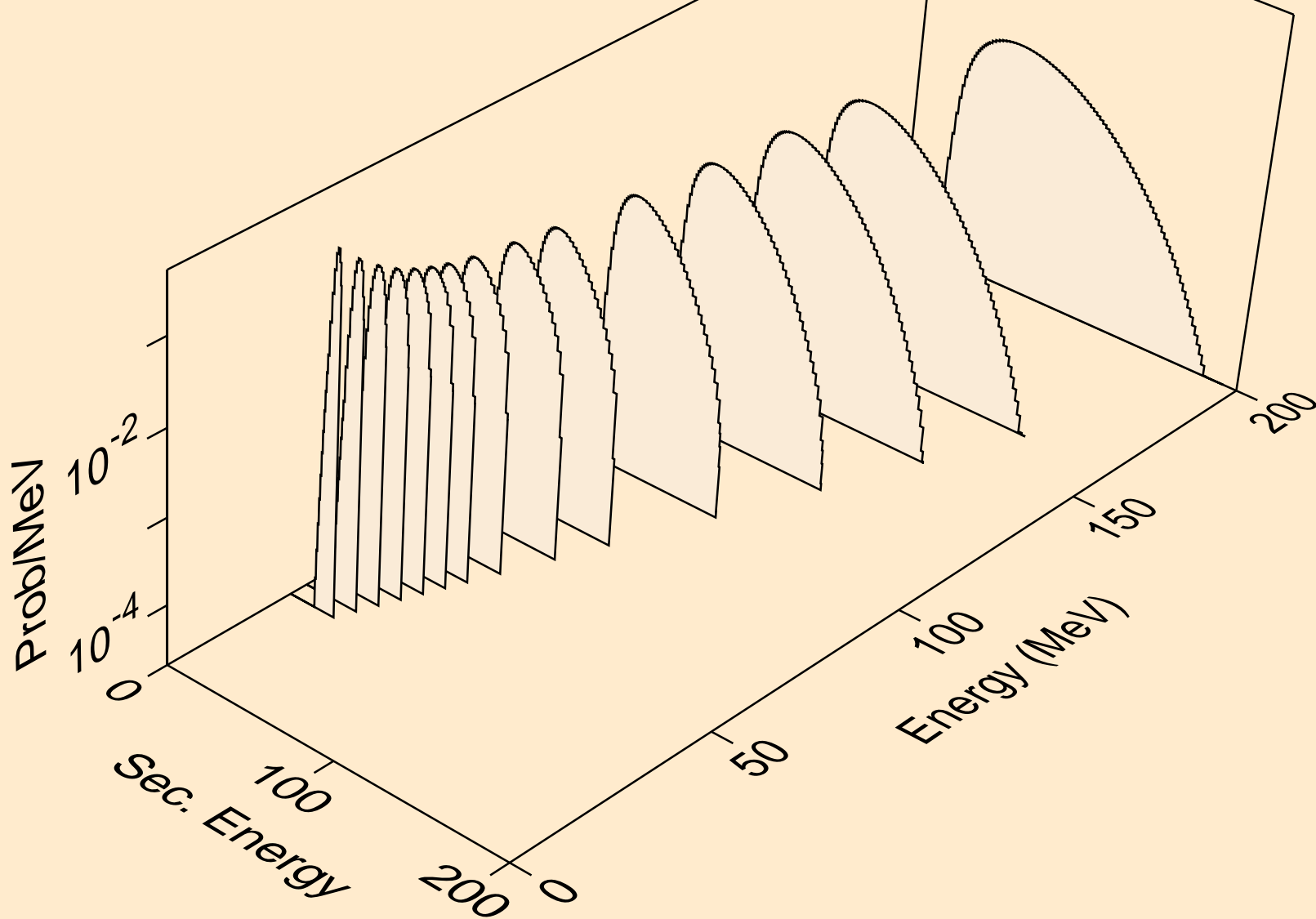

MD260 NEUTRON ACER TENDL-2023 LIBRARY; T=0.K
he3s from (n,n*)he3

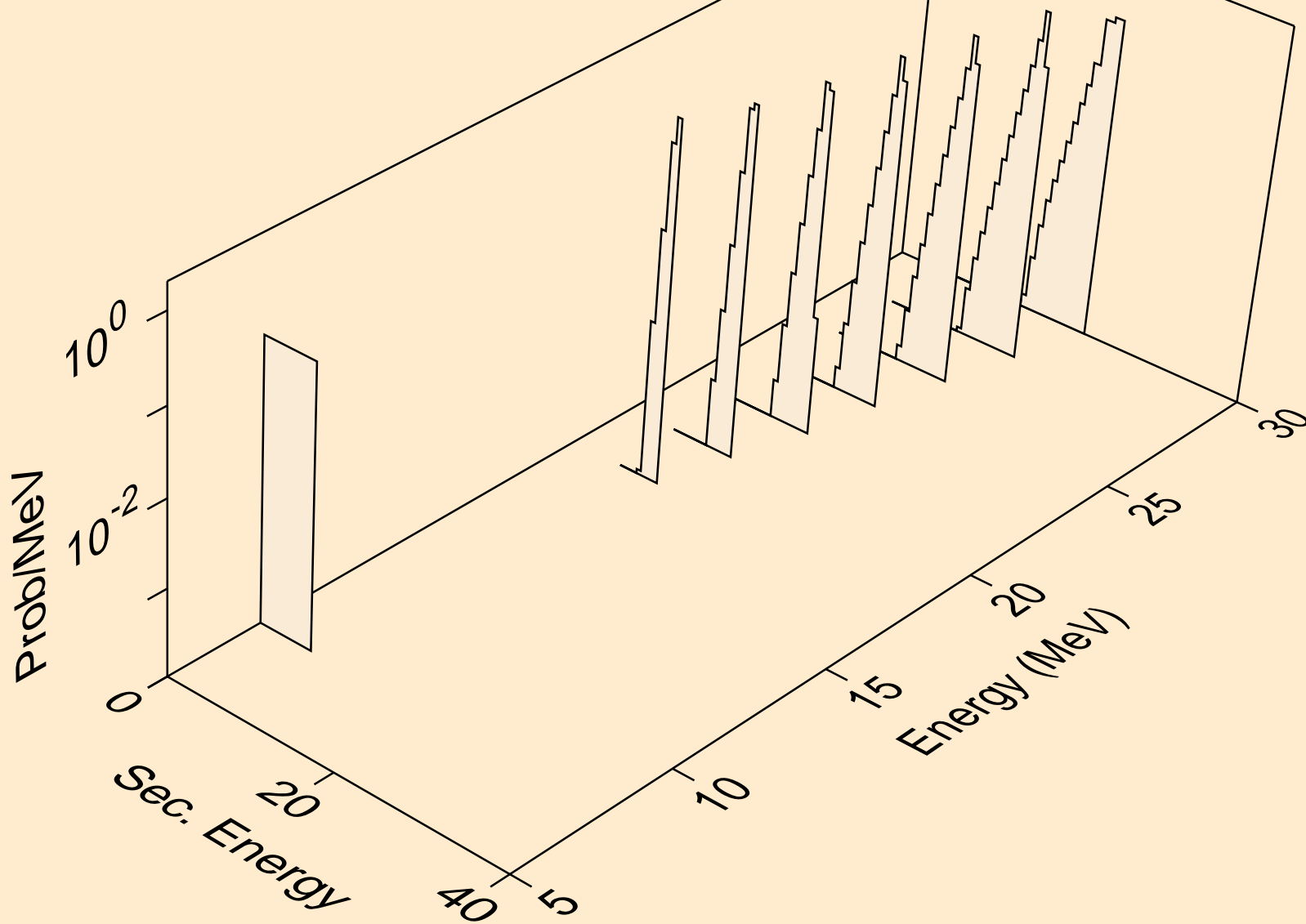

MD260 NEUTRON ACER TENDL-2023 LIBRARY; T=0.K
he3s from (n,he3)

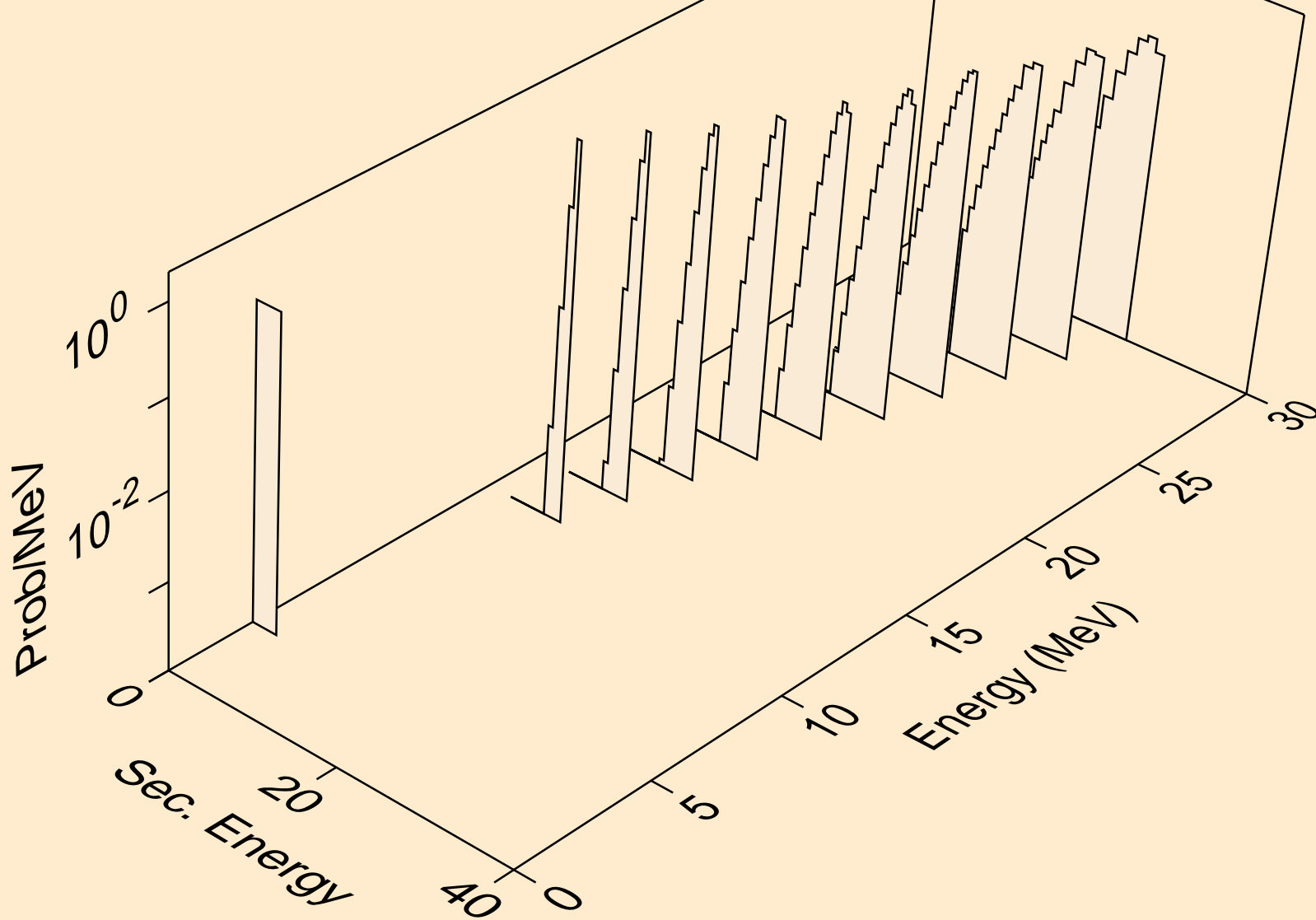

MD260 NEUTRON ACER TENDL-2023 LIBRARY; T=0.K
alphas from (n,x)

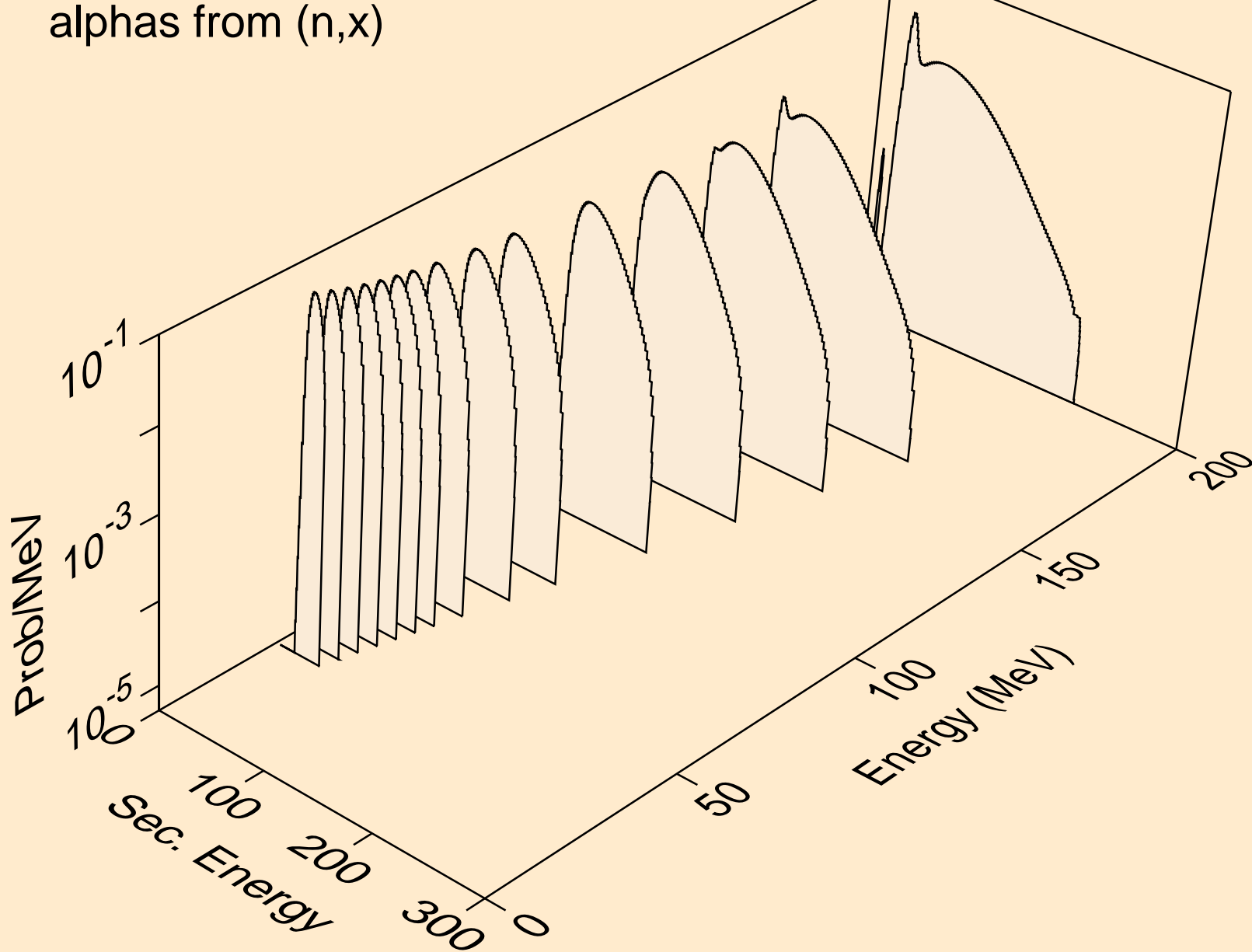

MD260 NEUTRON ACER TENDL-2023 LIBRARY; T=0.K
alphas from (n,n*)a

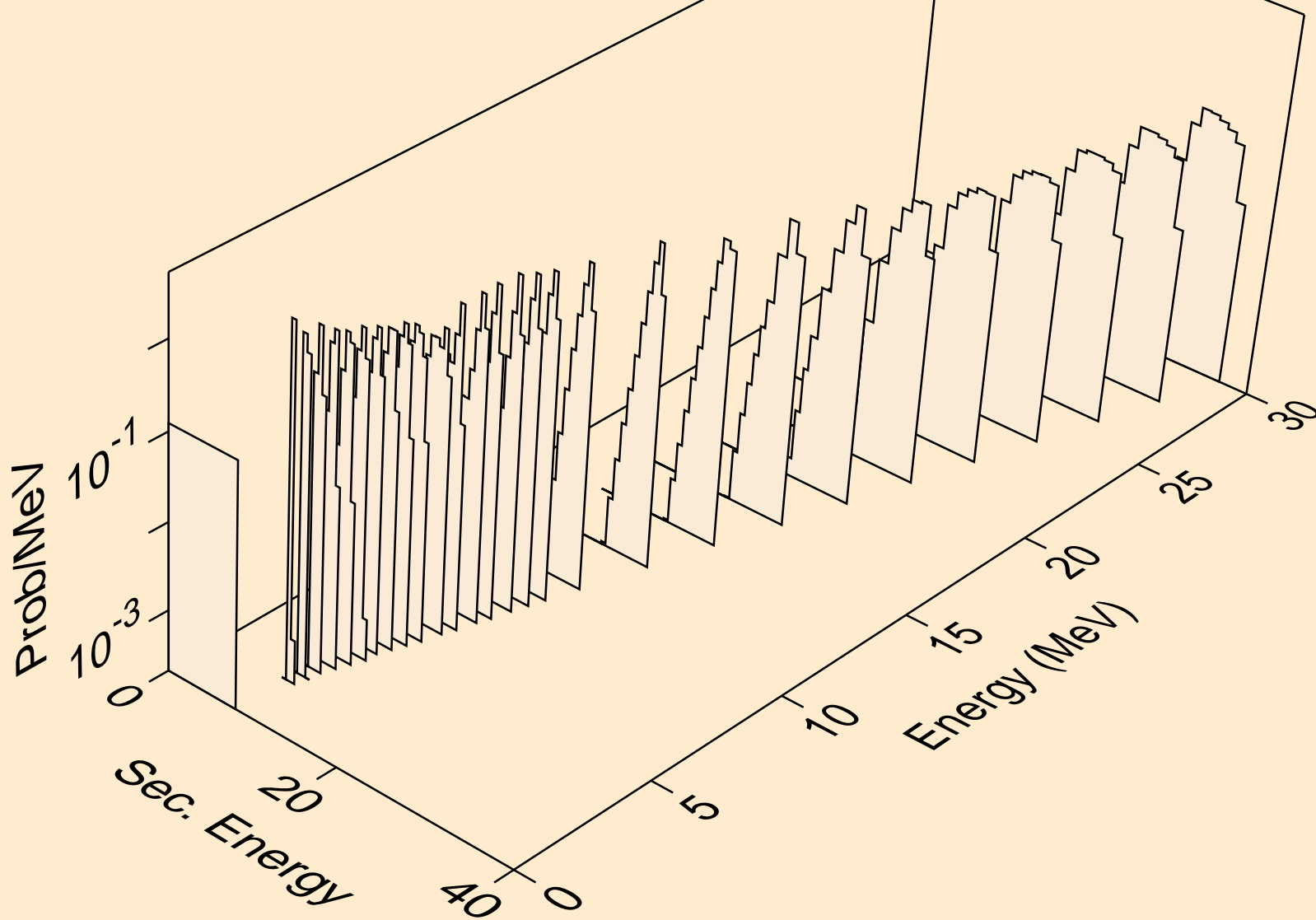

MD260 NEUTRON ACER TENDL-2023 LIBRARY; T=0.K
alphas from (n,2n)a

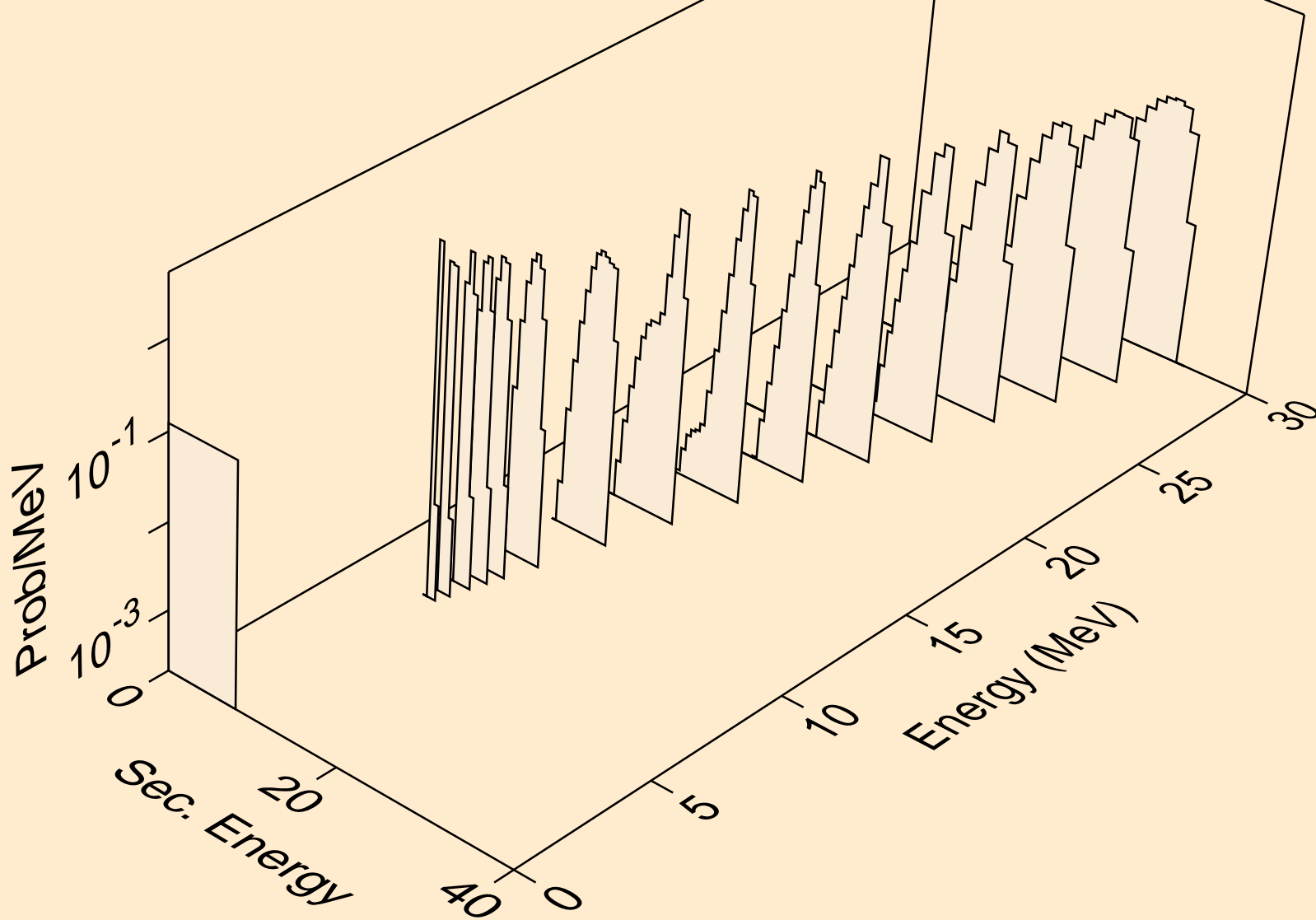

MD260 NEUTRON ACER TENDL-2023 LIBRARY; T=0.K
alphas from (n,3n)a

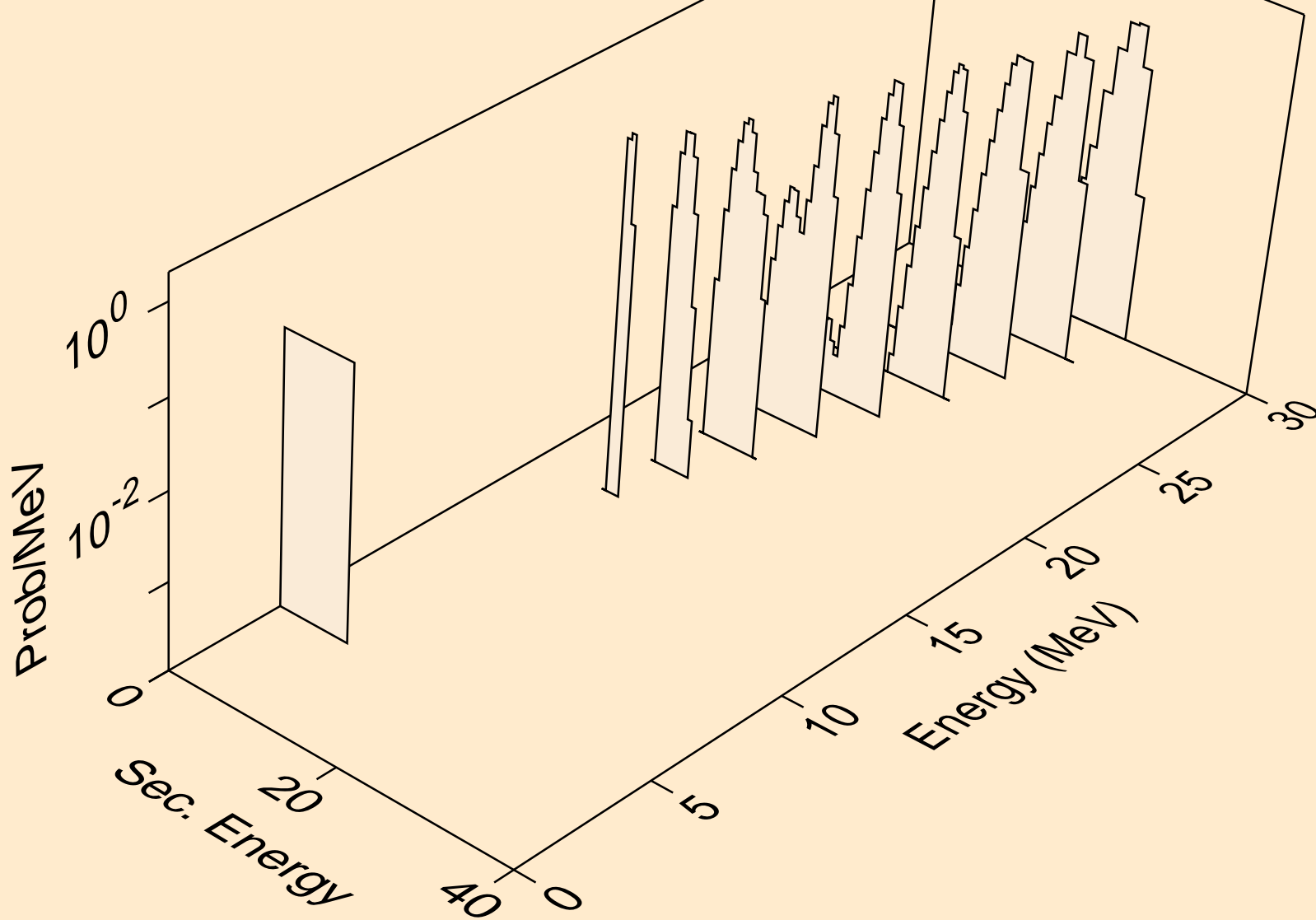

MD260 NEUTRON ACER TENDL-2023 LIBRARY; T=0.K
alphas from (n,n*)2a

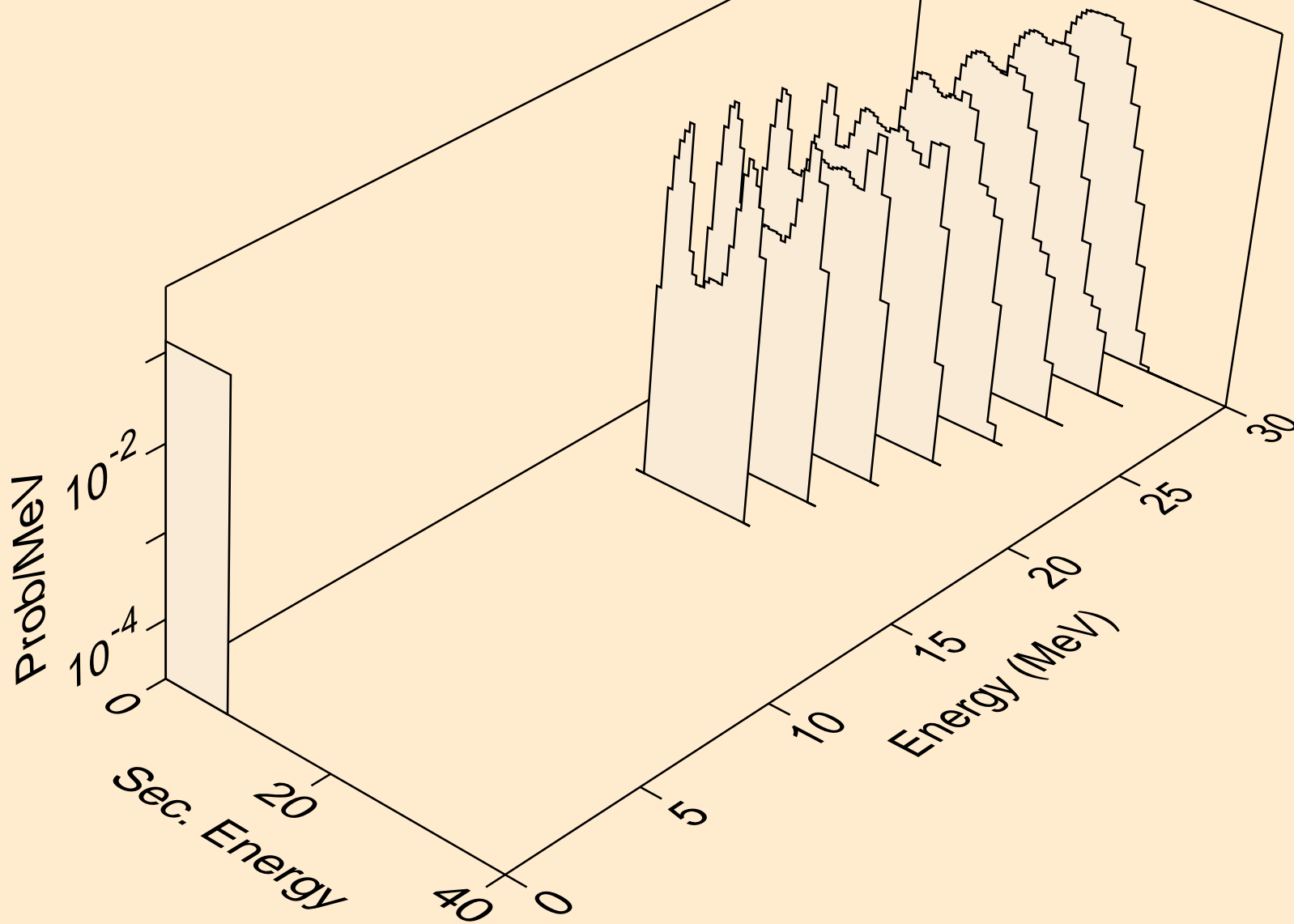

MD260 NEUTRON ACER TENDL-2023 LIBRARY; T=0.K
alphas from (n,npa)

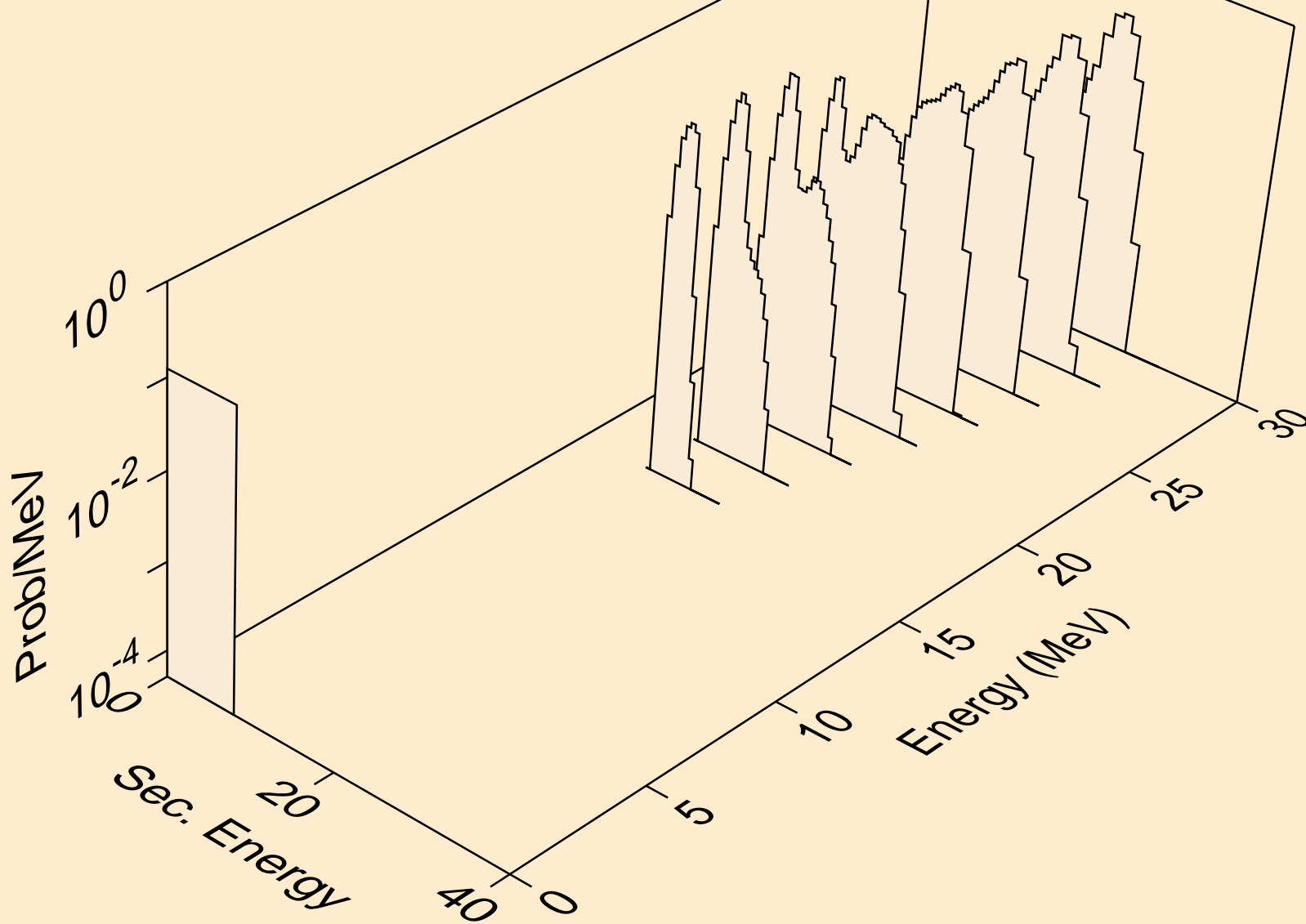

MD260 NEUTRON ACER TENDL-2023 LIBRARY; T=0.K
alphas from (n,a)

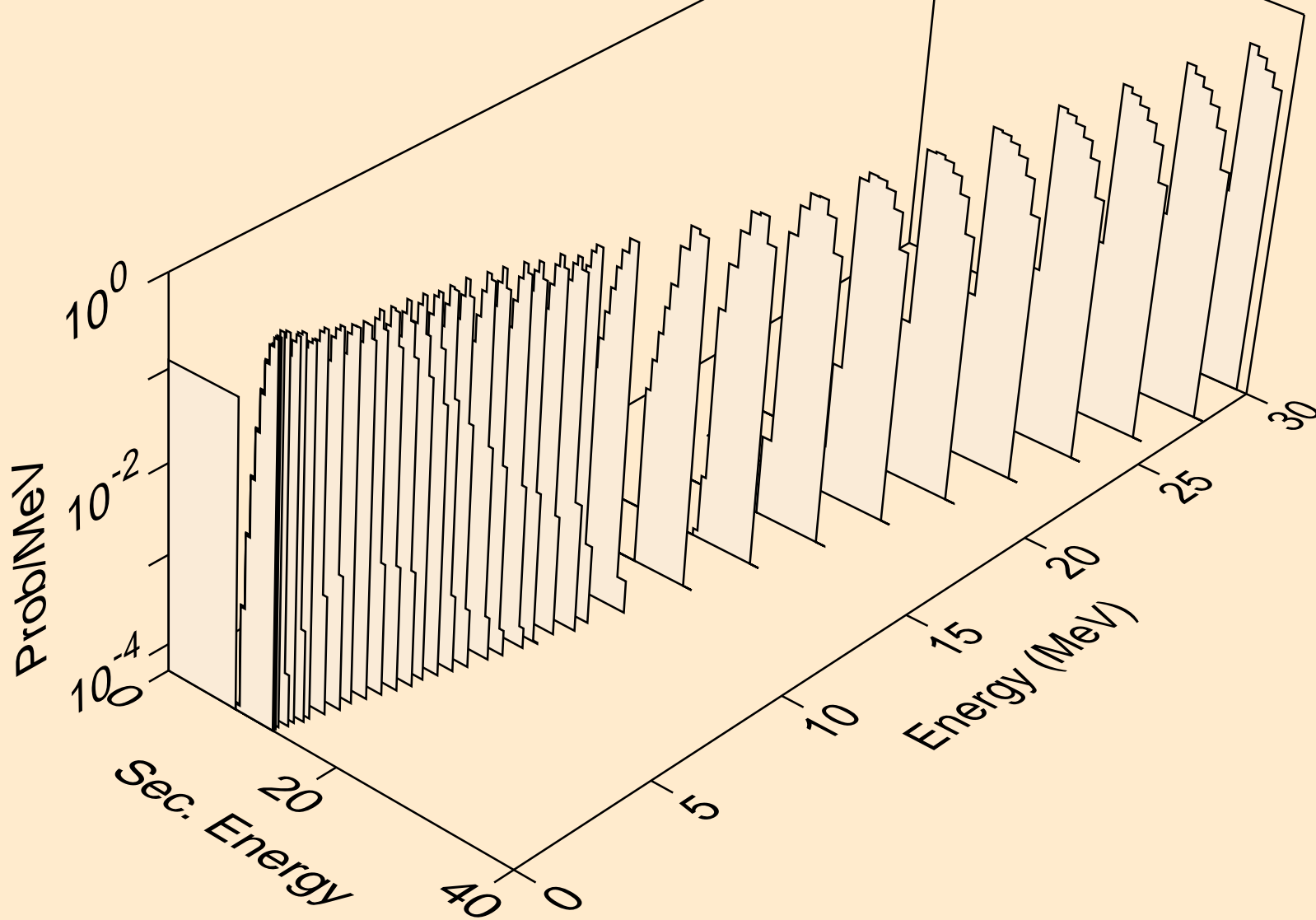

MD260 NEUTRON ACER TENDL-2023 LIBRARY; T=0.K
alphas from (n,2a)

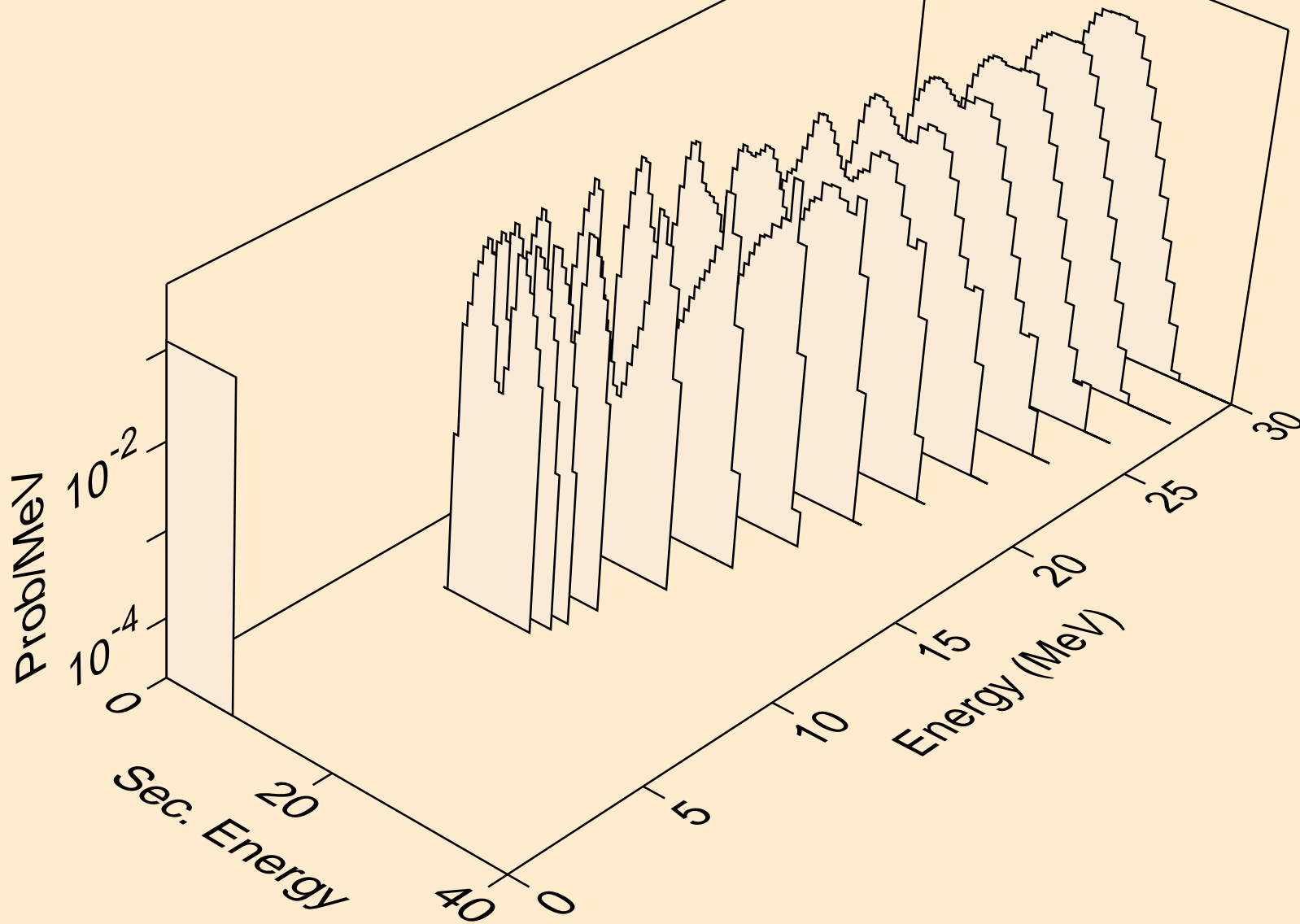

MD260 NEUTRON ACER TENDL-2023 LIBRARY; T=0.K
alphas from (n,pa)

