

# MG024 NEUTRON ACER TENDL-2023 LIBRARY; T=0.K

## Principal cross sections

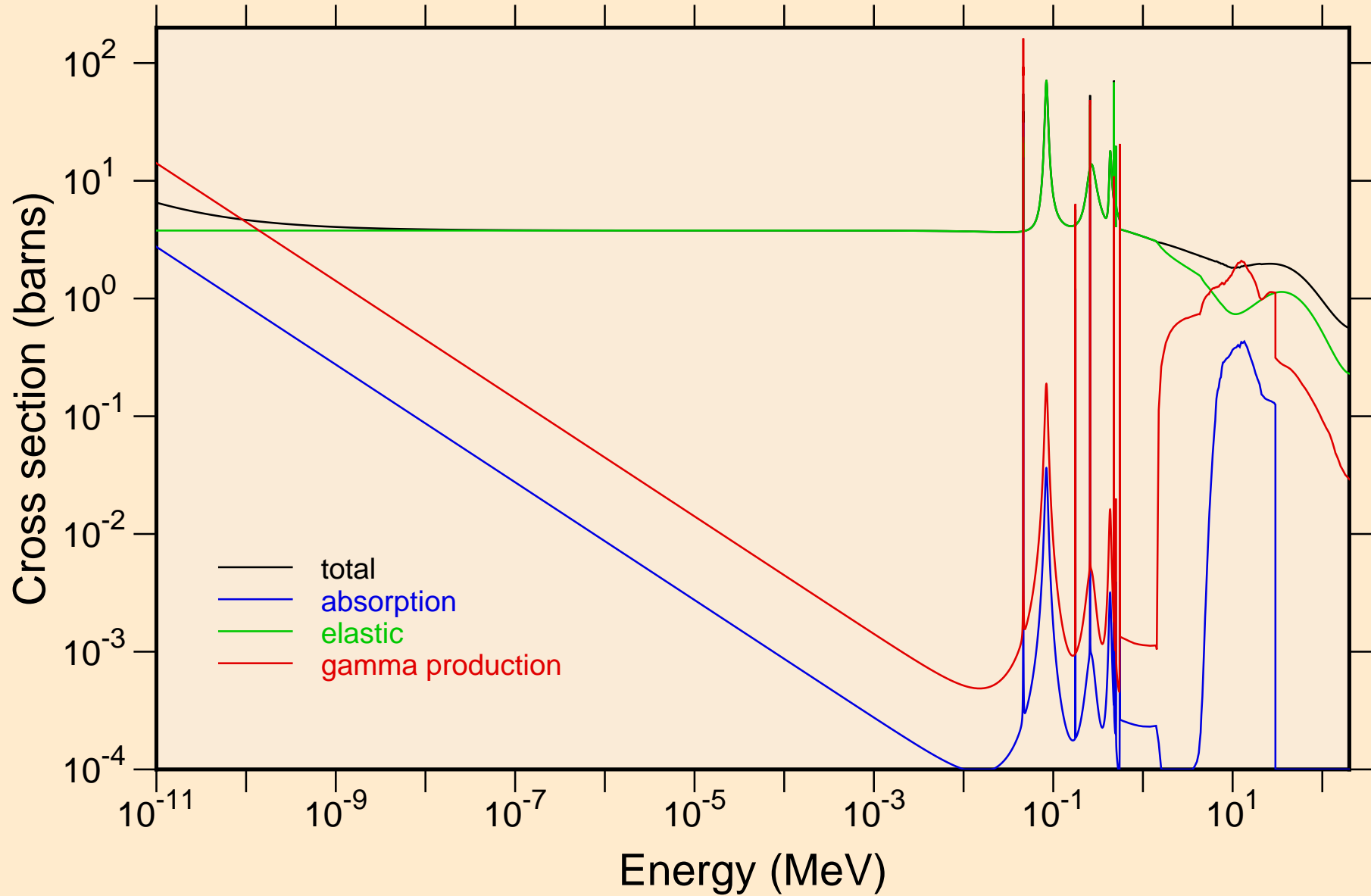

MG024 NEUTRON ACER TENDL-2023 LIBRARY; T=0.K  
resonance total cross section

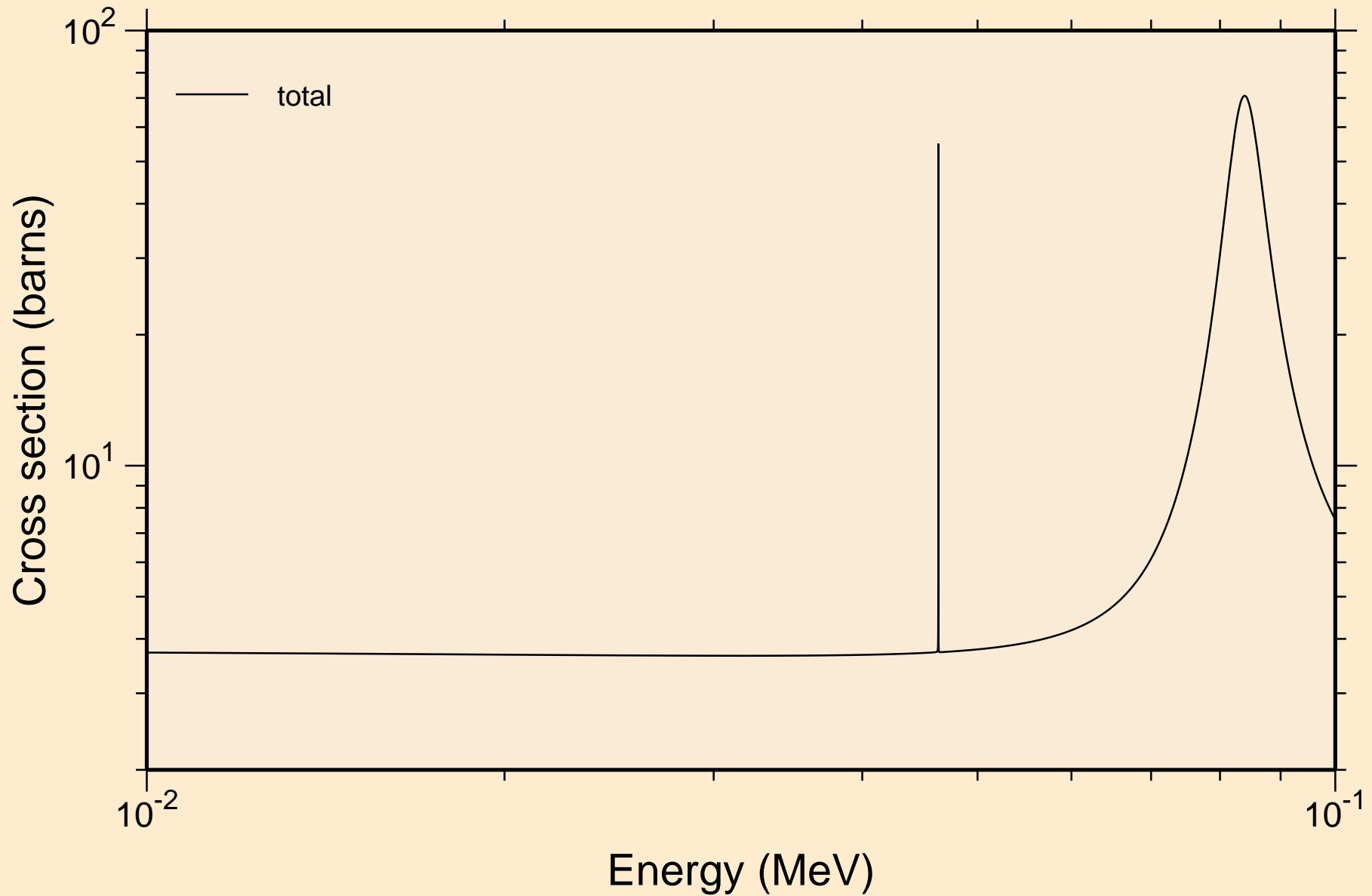

MG024 NEUTRON ACER TENDL-2023 LIBRARY; T=0.K  
resonance total cross section

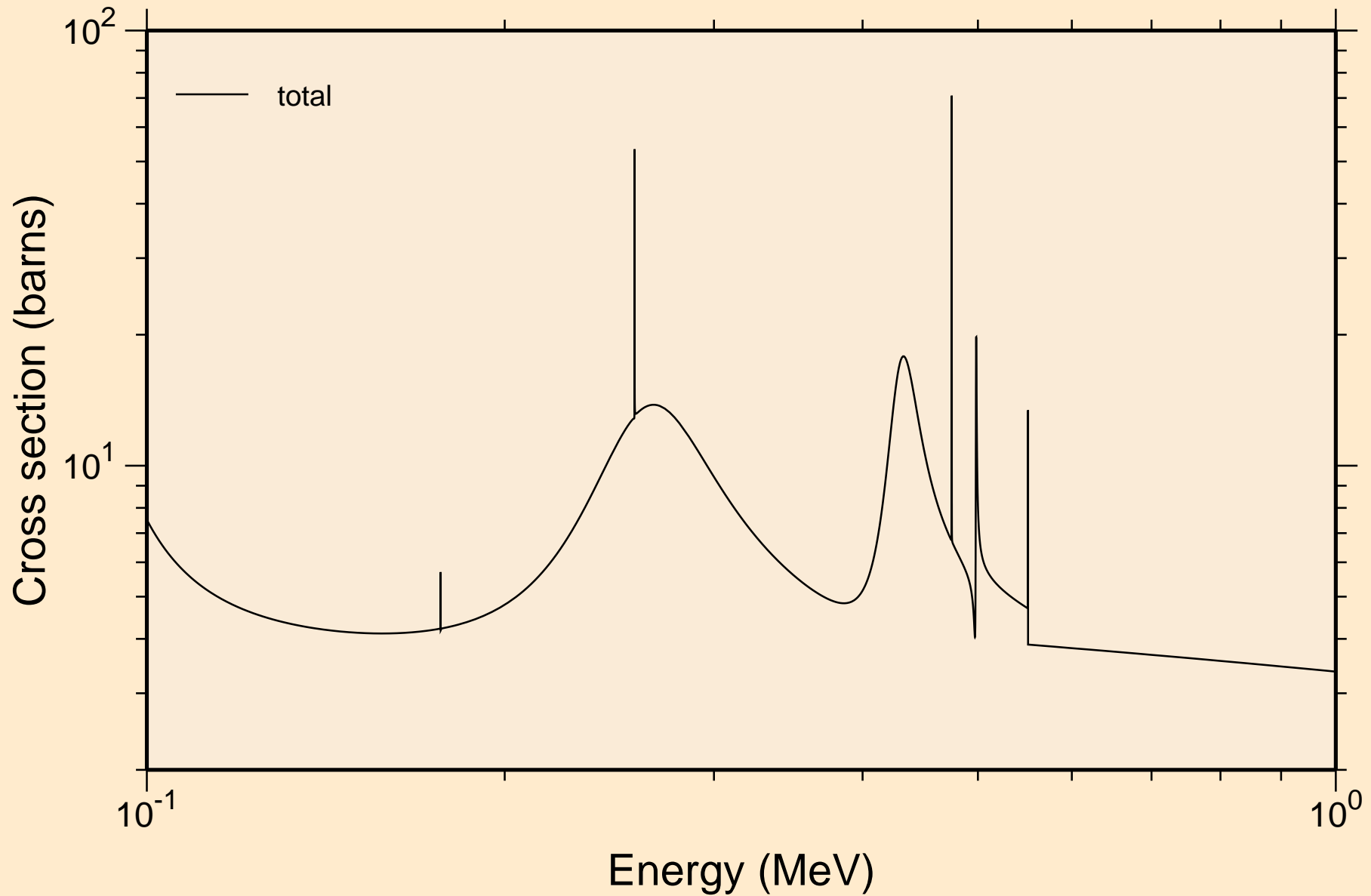

MG024 NEUTRON ACER TENDL-2023 LIBRARY; T=0.K  
resonance total cross section

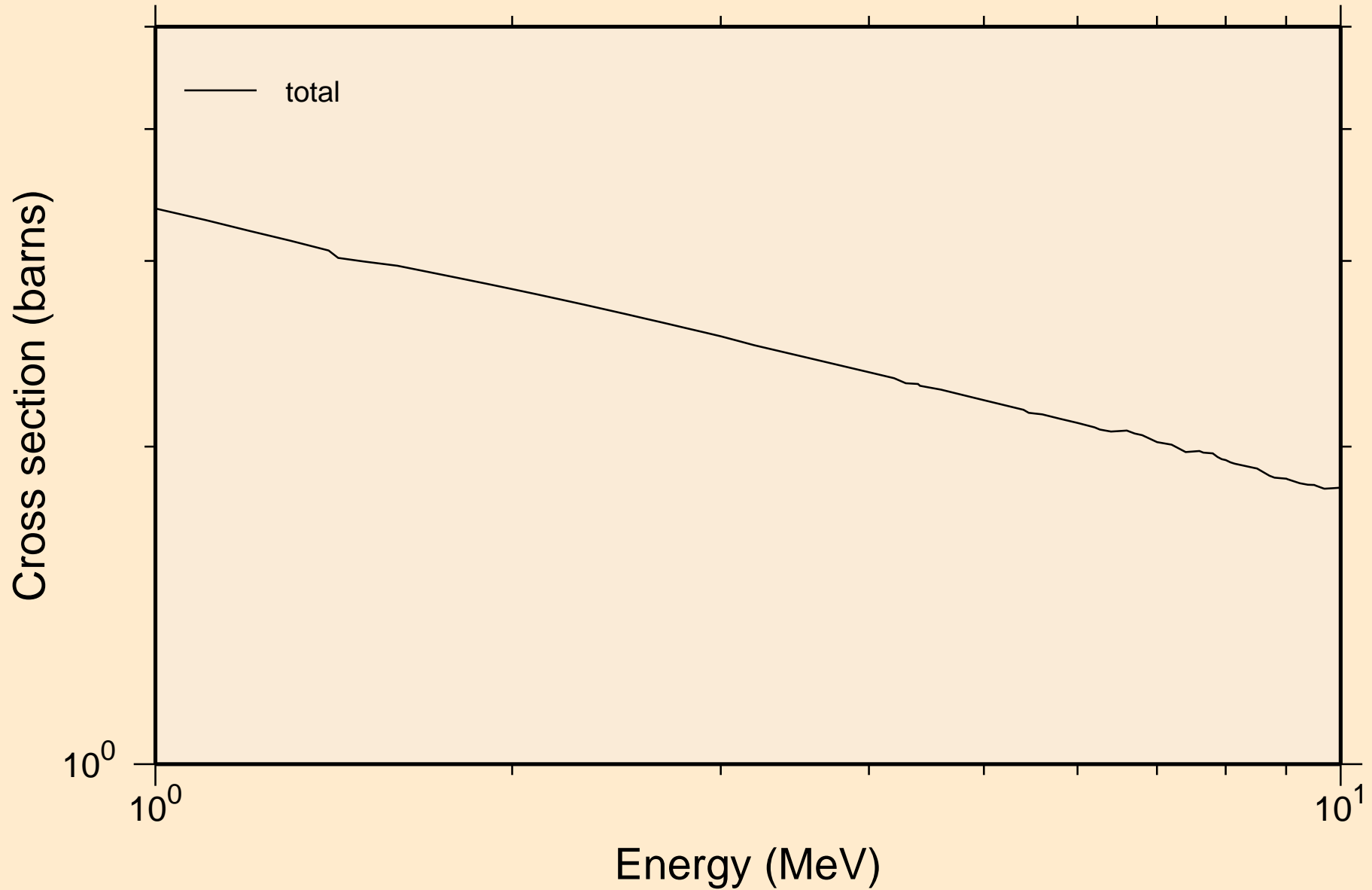

MG024 NEUTRON ACER TENDL-2023 LIBRARY; T=0.K  
resonance absorption cross sections

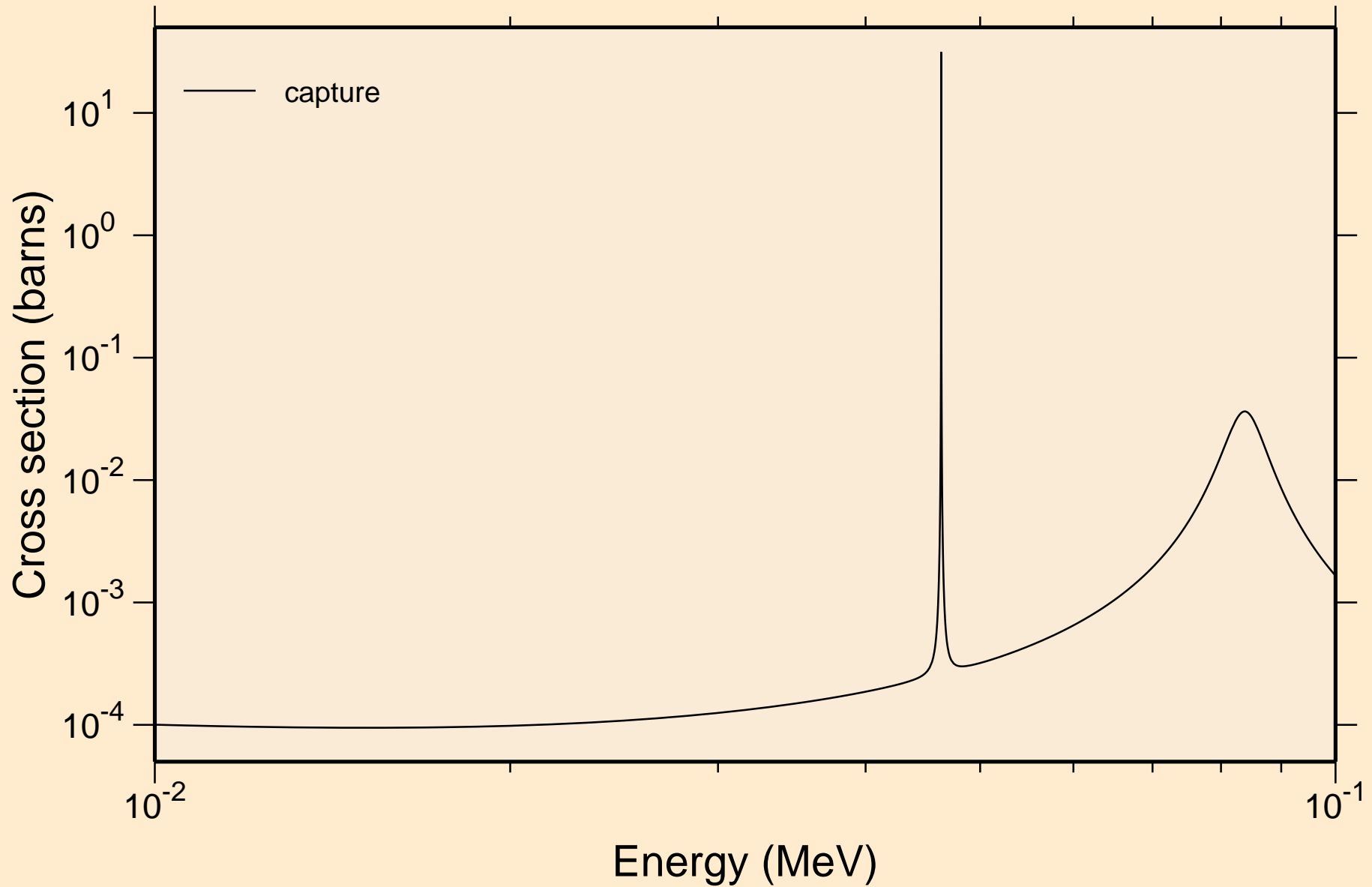

MG024 NEUTRON ACER TENDL-2023 LIBRARY; T=0.K  
resonance absorption cross sections

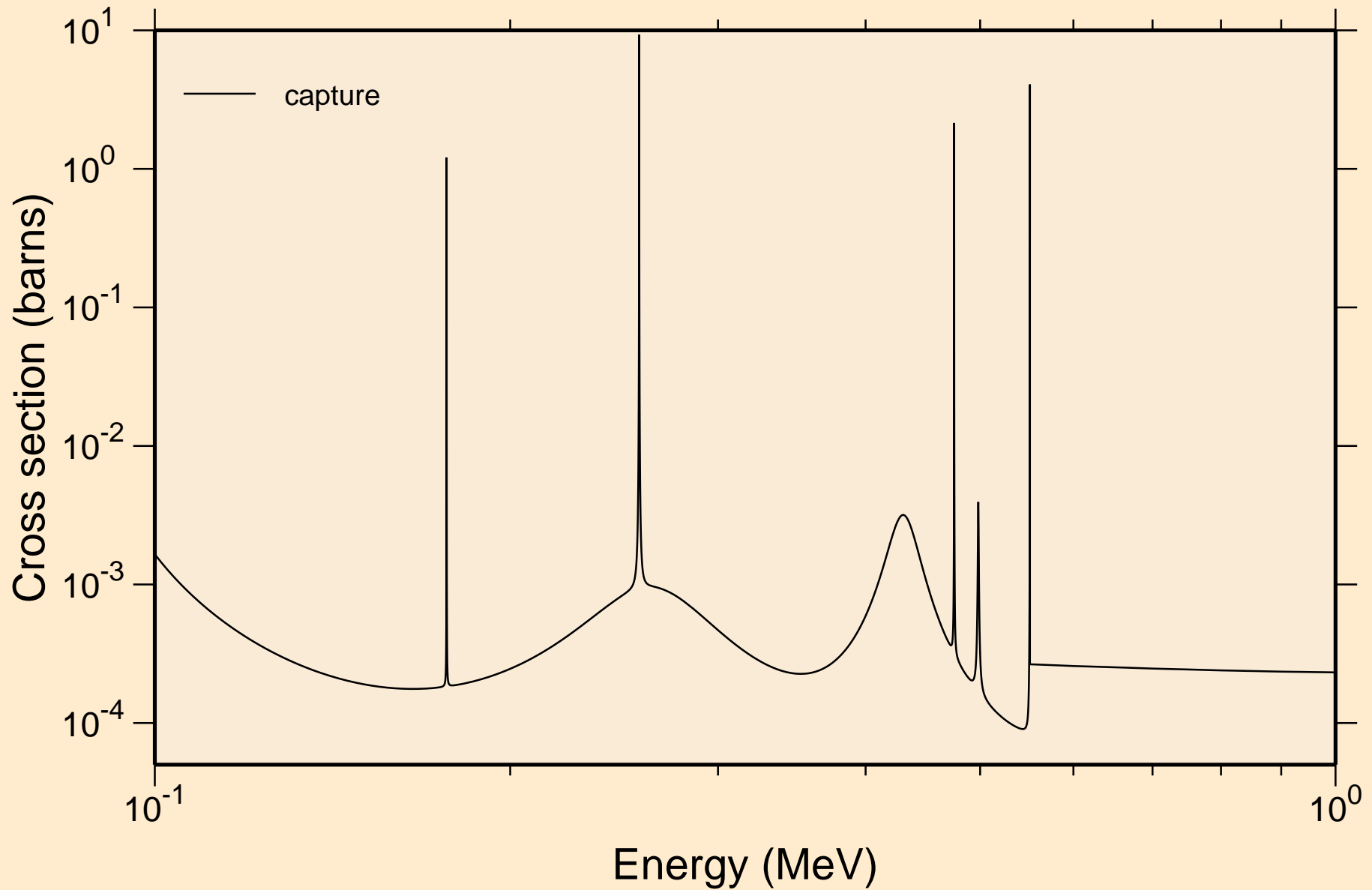

MG024 NEUTRON ACER TENDL-2023 LIBRARY; T=0.K  
resonance absorption cross sections

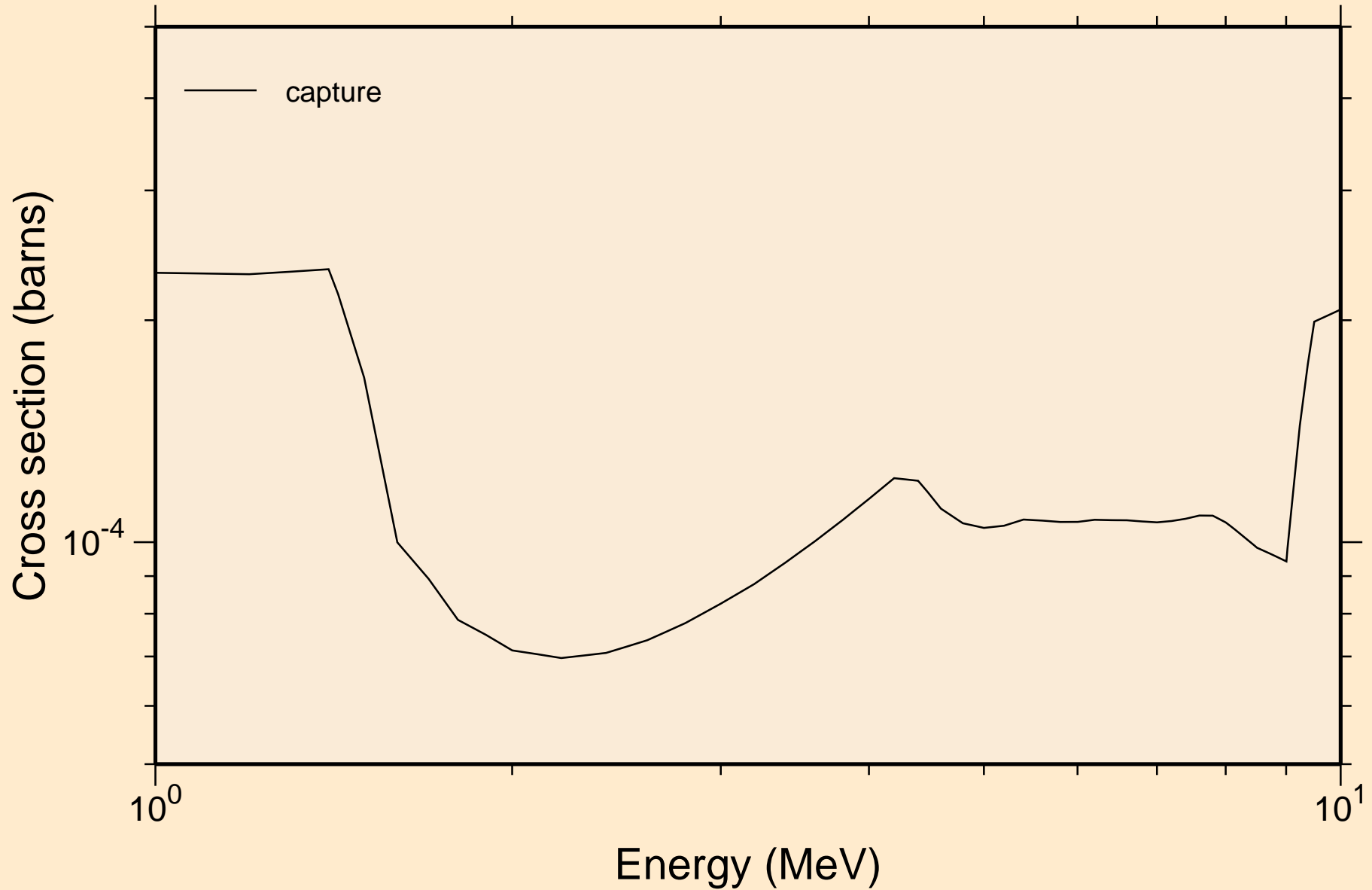

MG024 NEUTRON ACER TENDL-2023 LIBRARY; T=0.K  
Heating

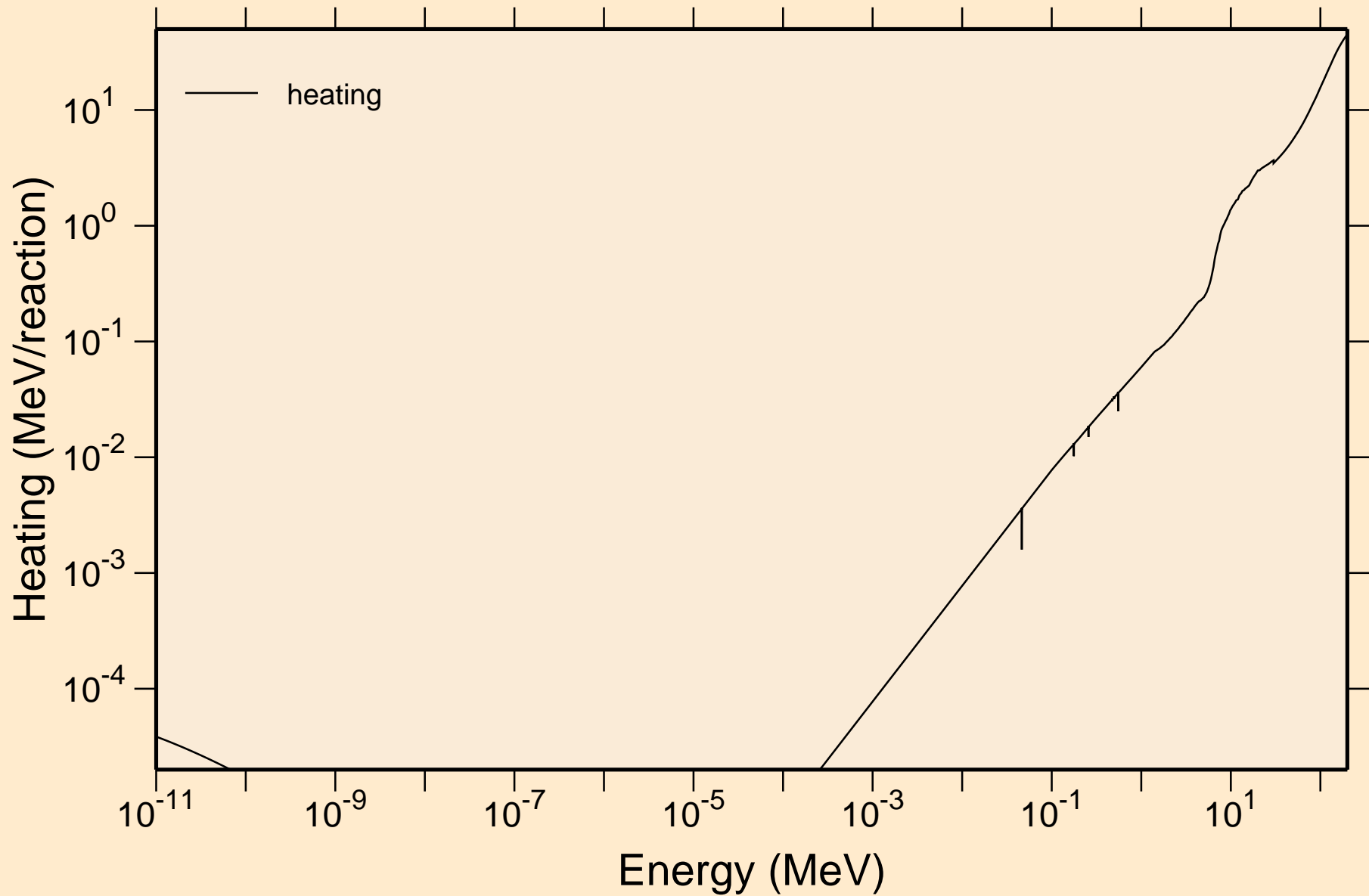



MG024 NEUTRON ACER TENDL-2023 LIBRARY; T=0.K  
Damage

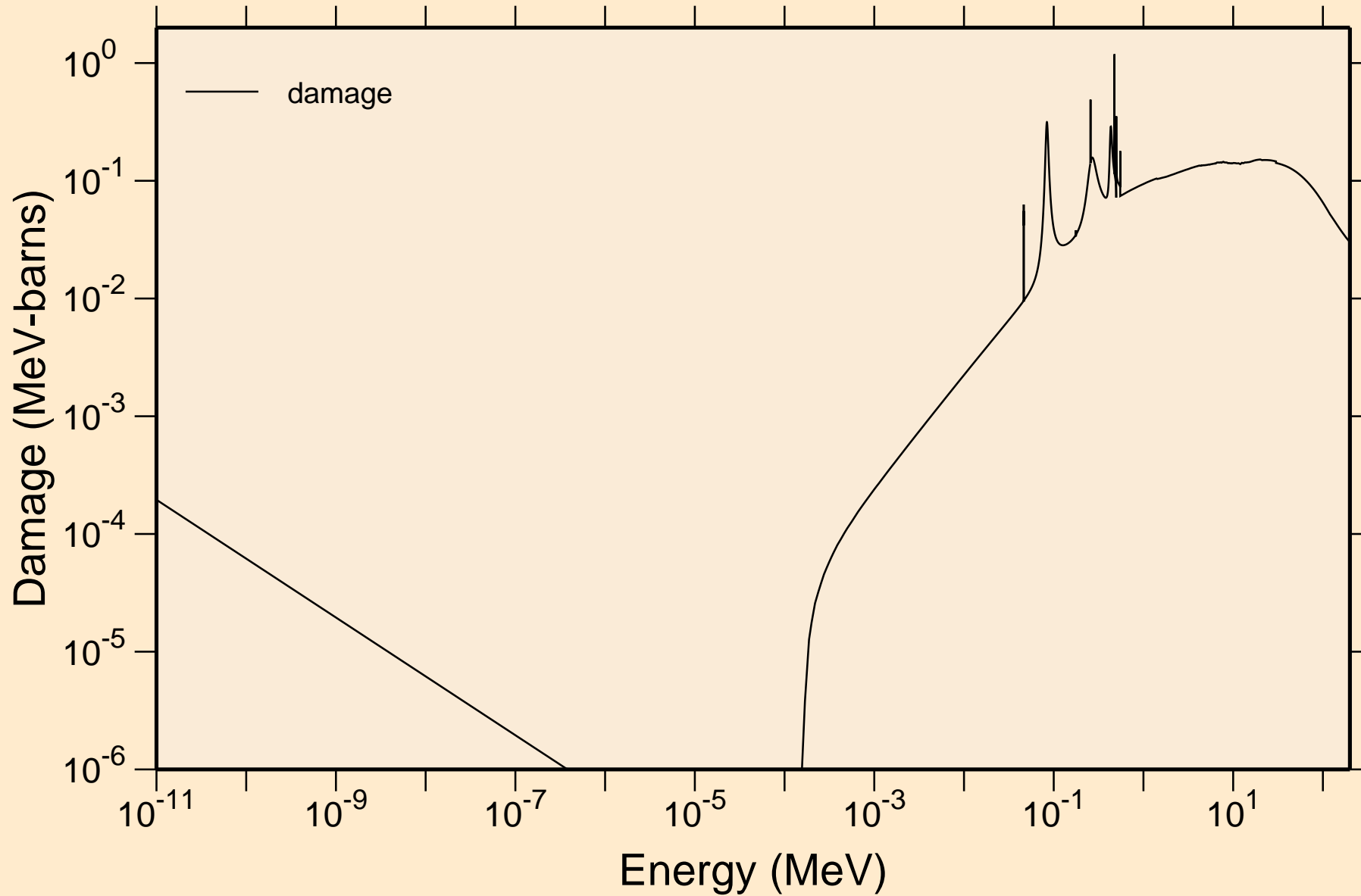

MG024 NEUTRON ACER TENDL-2023 LIBRARY; T=0.K  
Non-threshold reactions

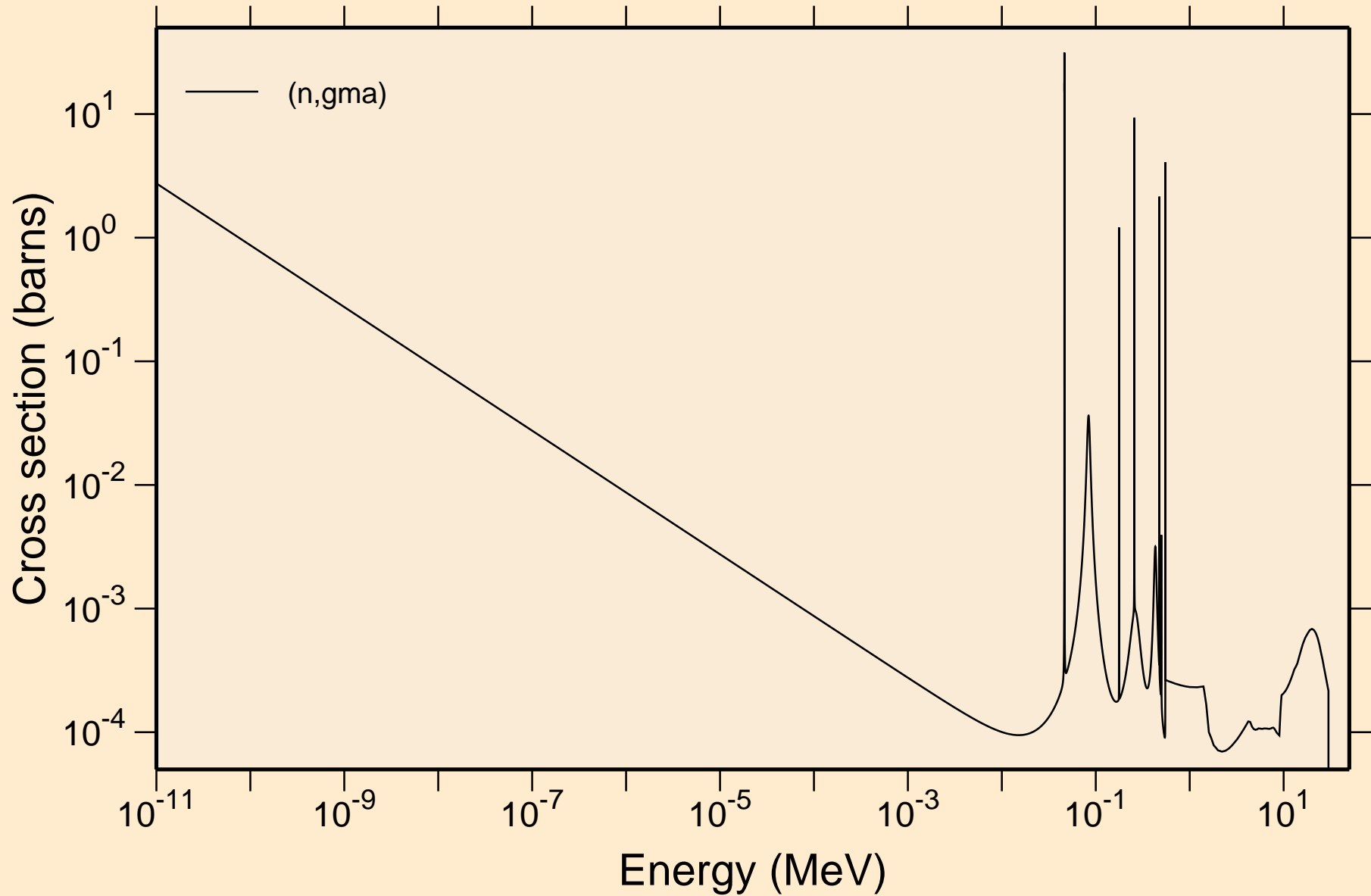

# MG024 NEUTRON ACER TENDL-2023 LIBRARY; T=0.K

## Principal cross sections

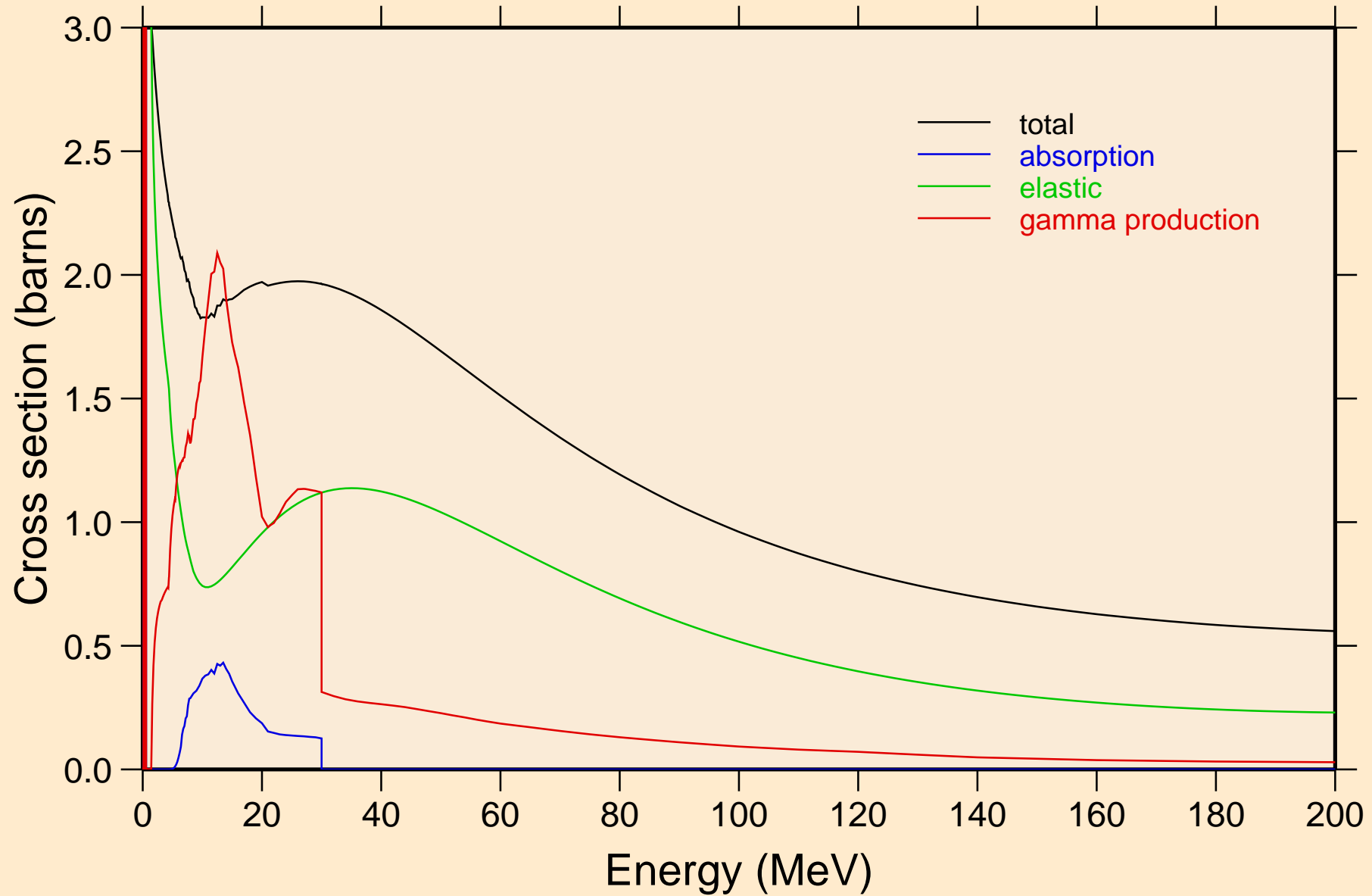

# MG024 NEUTRON ACER TENDL-2023 LIBRARY; T=0.K

## Heating

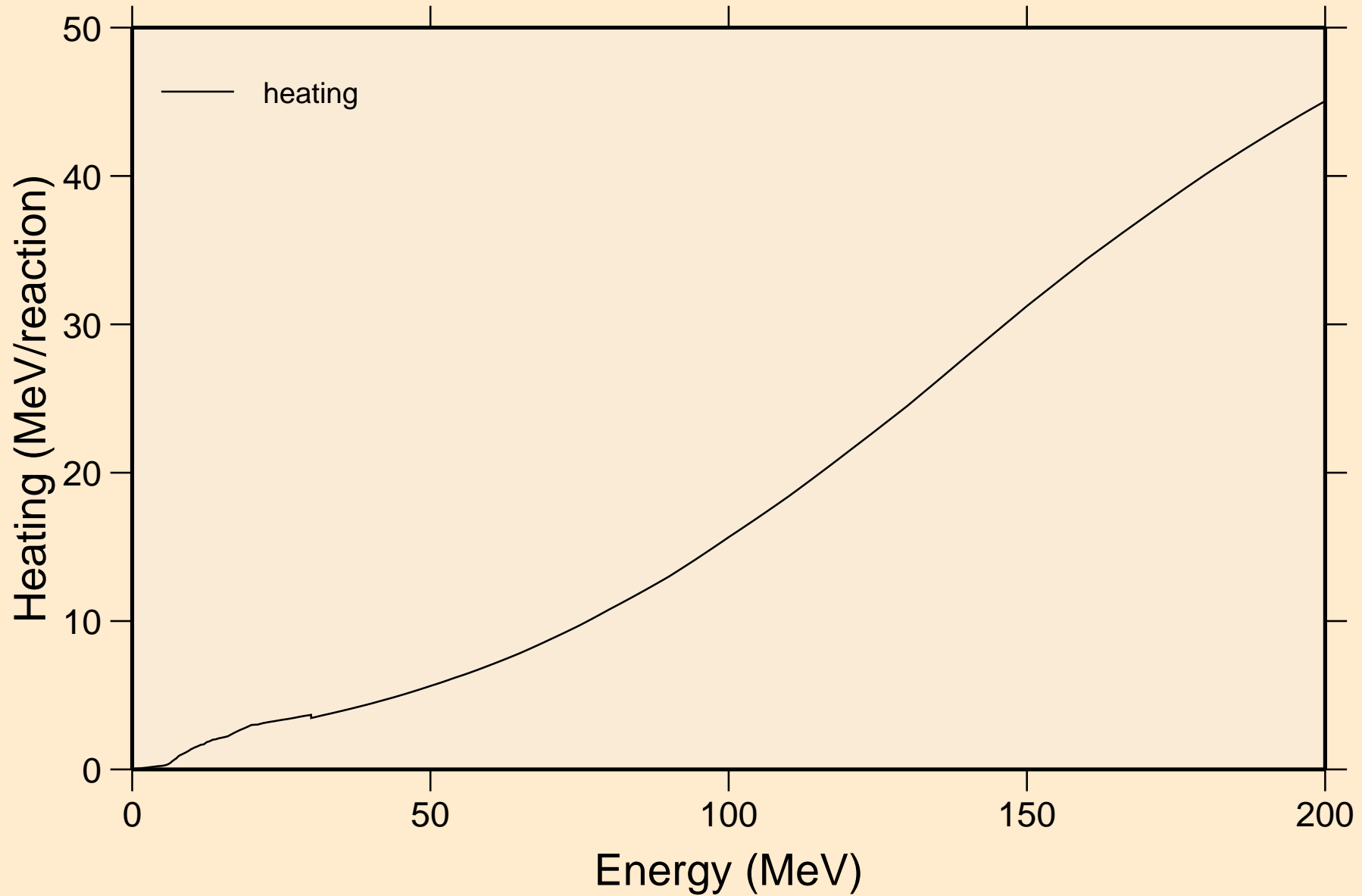

MG024 NEUTRON ACER TENDL-2023 LIBRARY; T=0.K  
Damage

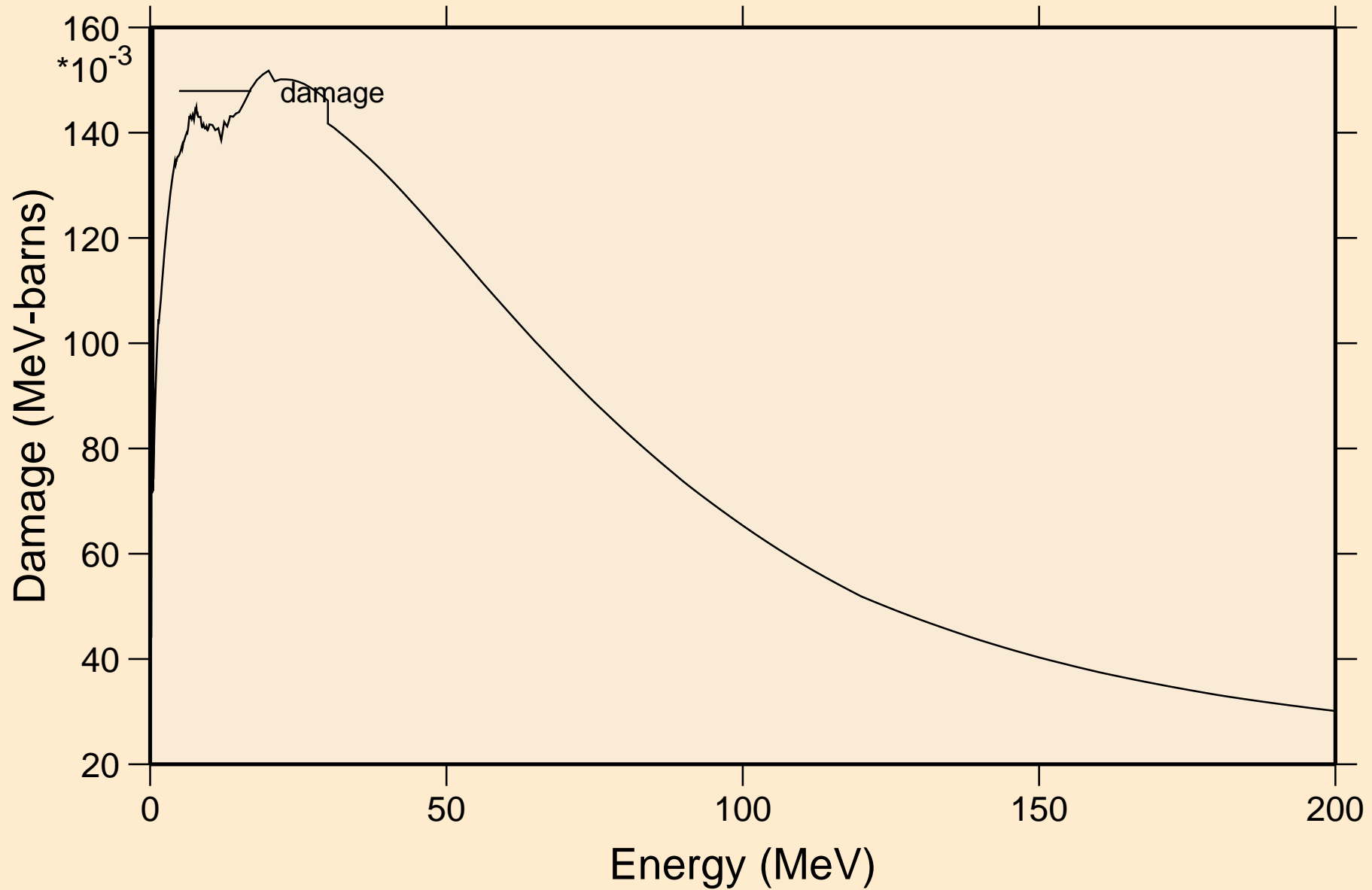

MG024 NEUTRON ACER TENDL-2023 LIBRARY; T=0.K  
Non-threshold reactions

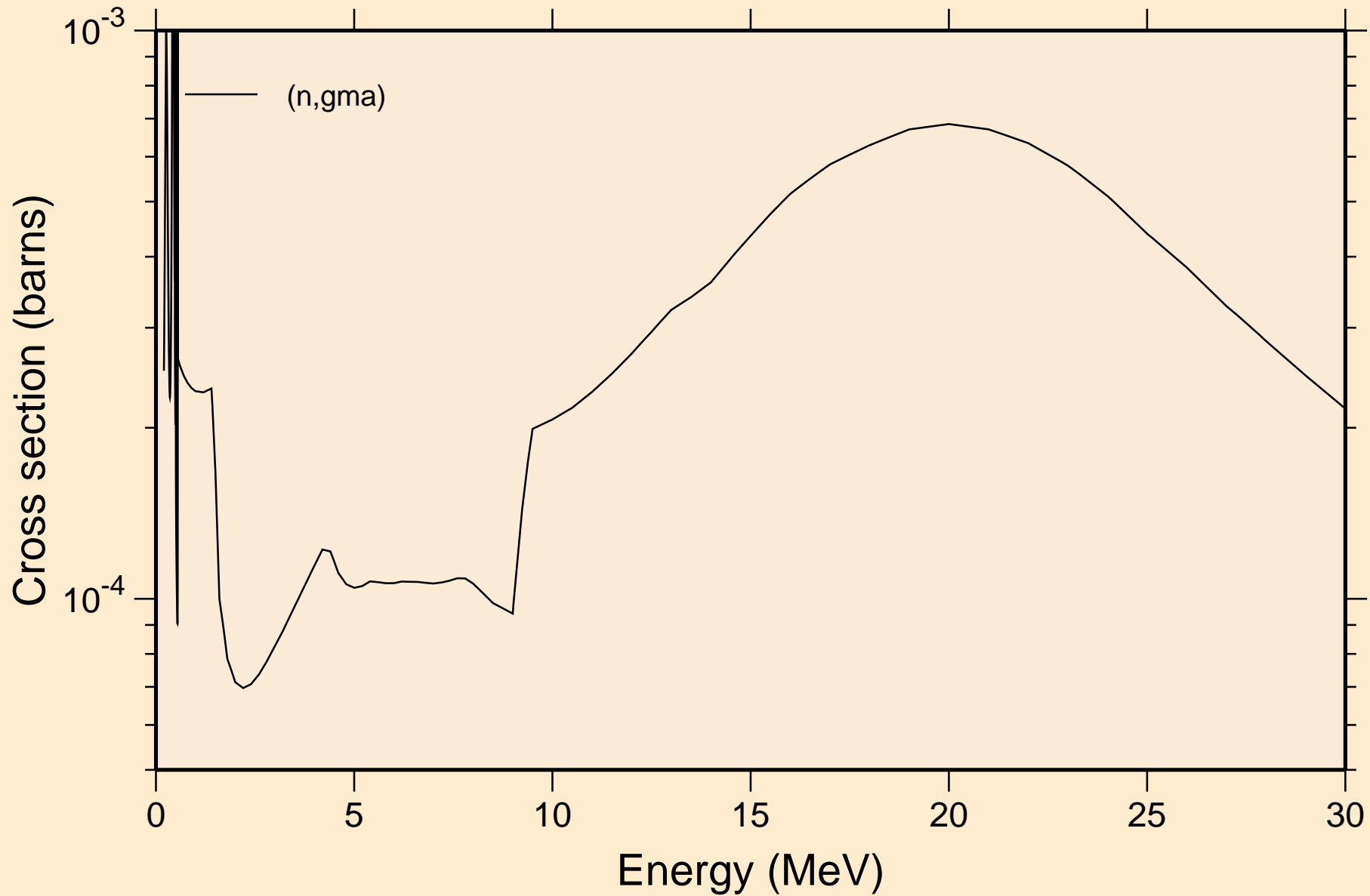

MG024 NEUTRON ACER TENDL-2023 LIBRARY; T=0.K  
Inelastic levels

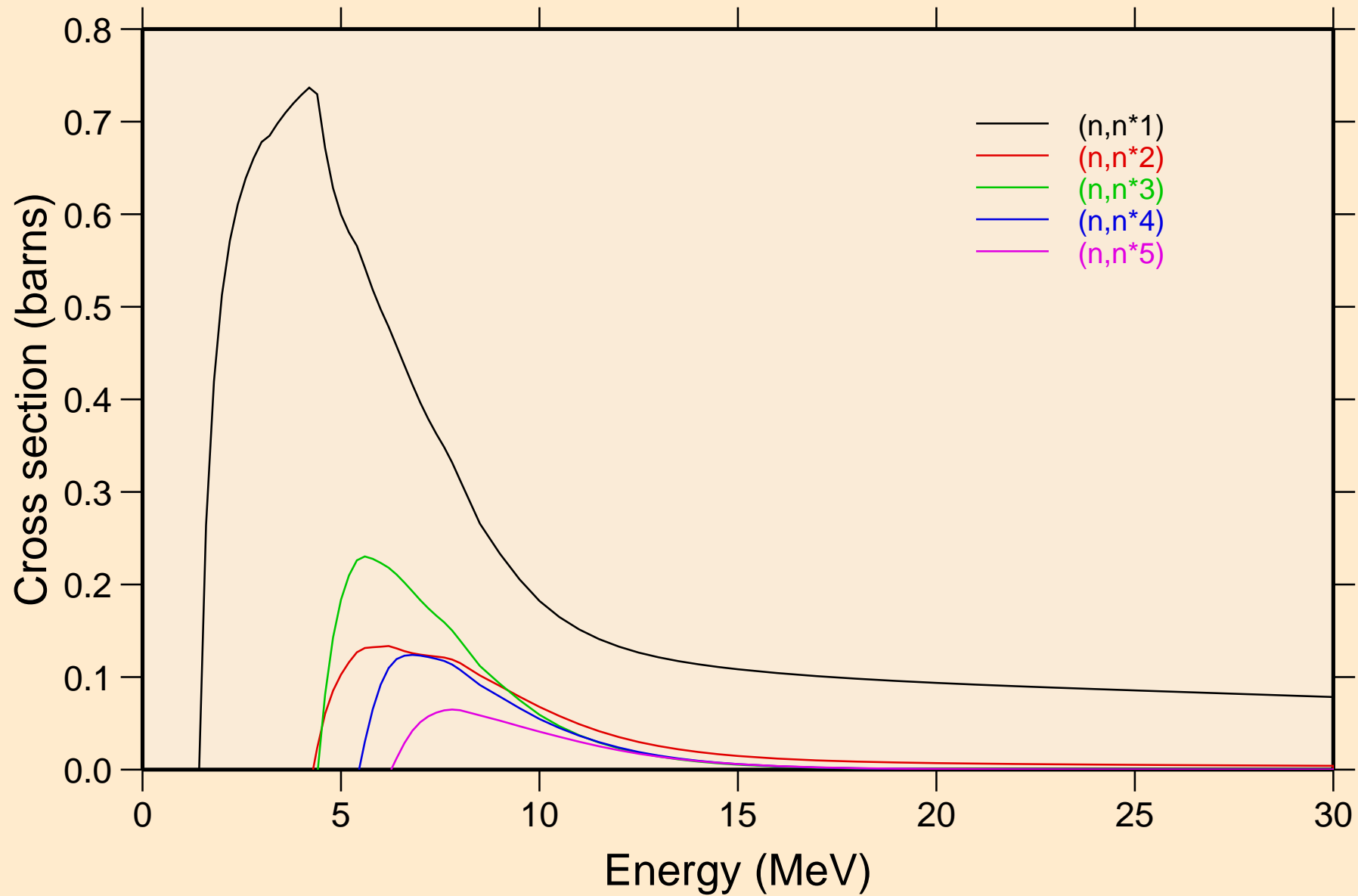

MG024 NEUTRON ACER TENDL-2023 LIBRARY; T=0.K  
Inelastic levels

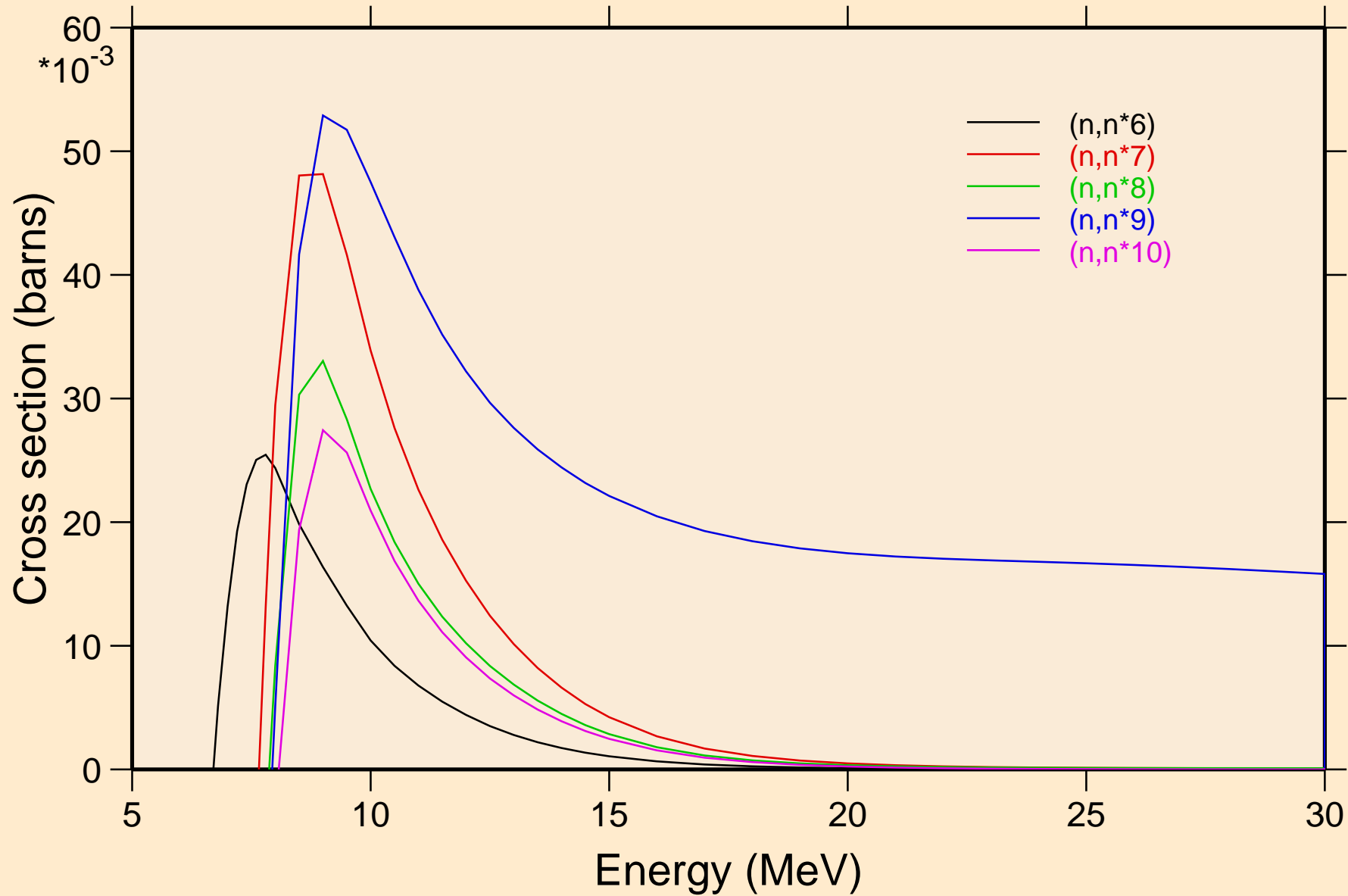



MG024 NEUTRON ACER TENDL-2023 LIBRARY; T=0.K  
Inelastic levels

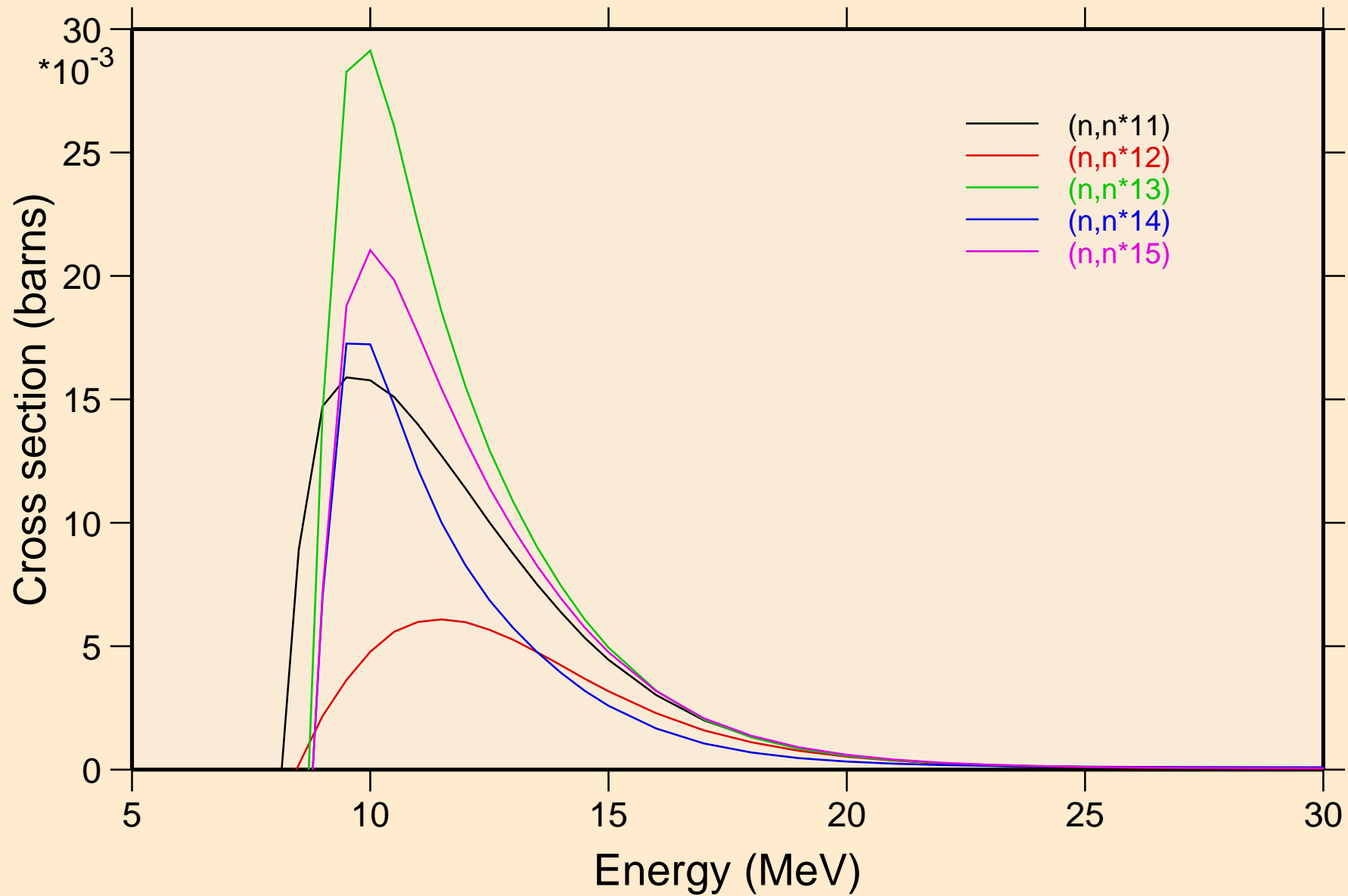

MG024 NEUTRON ACER TENDL-2023 LIBRARY; T=0.K  
Inelastic levels

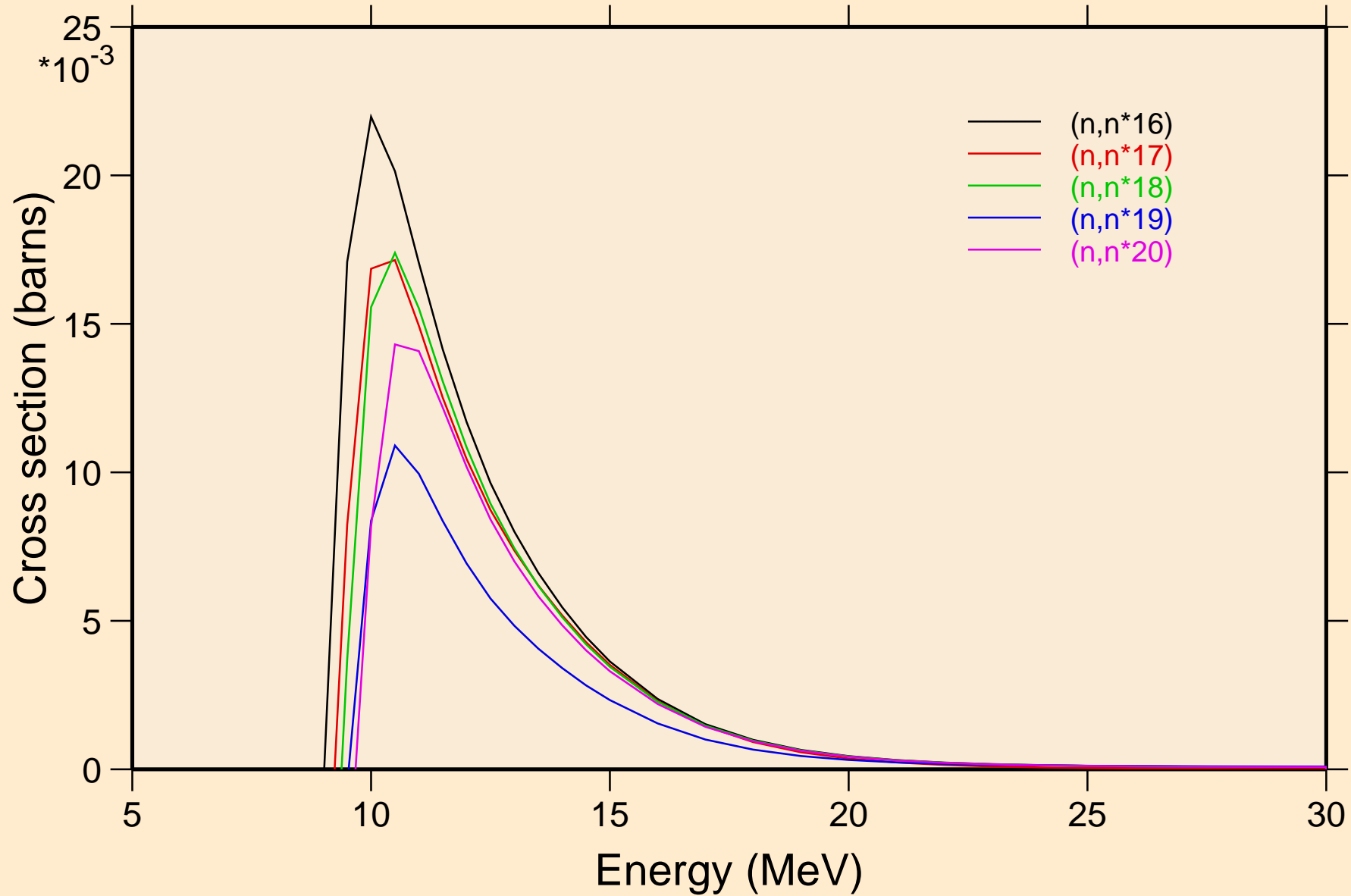

MG024 NEUTRON ACER TENDL-2023 LIBRARY; T=0.K  
Inelastic levels

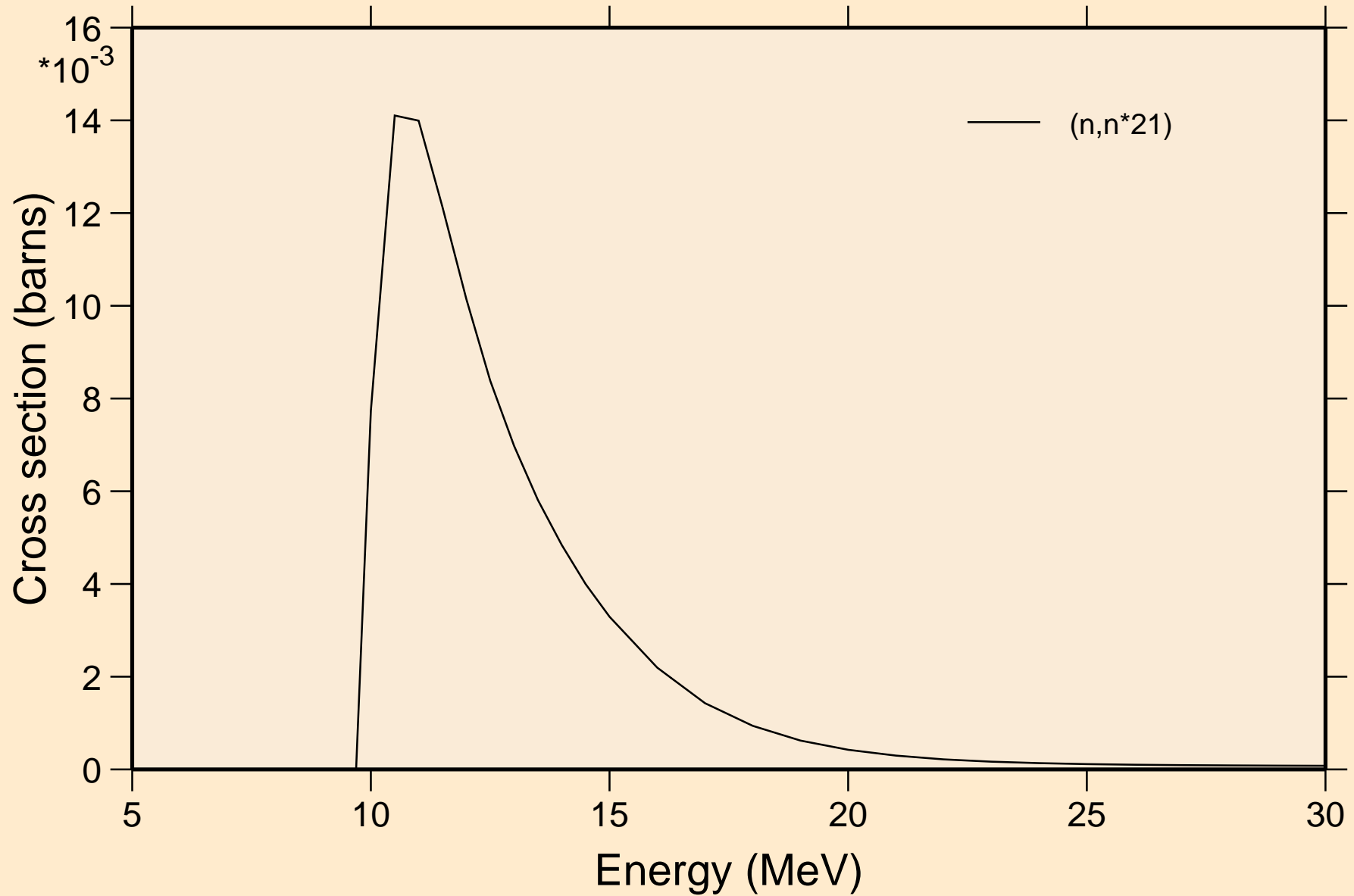

# MG024 NEUTRON ACER TENDL-2023 LIBRARY; T=0.K

## Threshold reactions

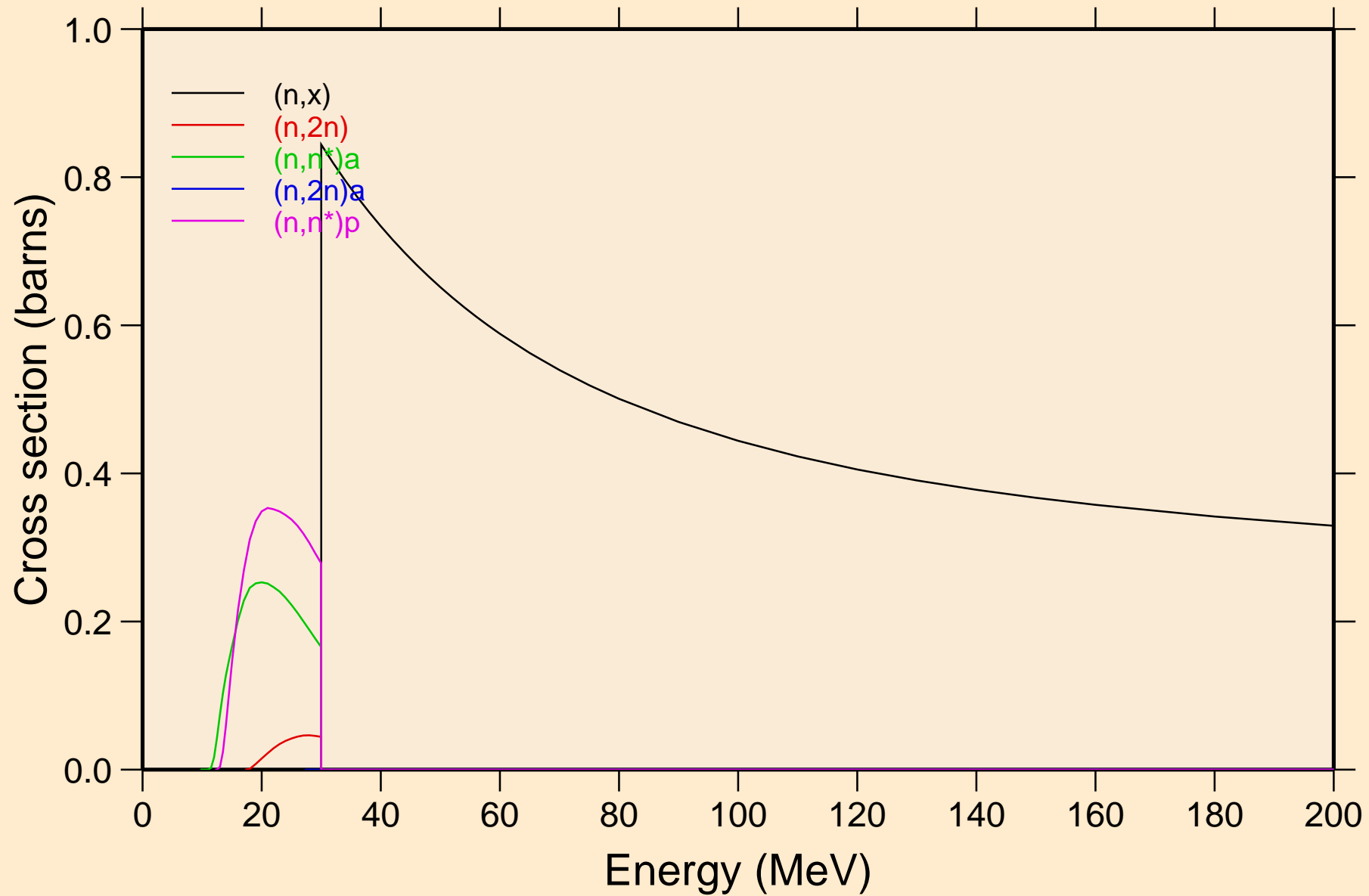

# MG024 NEUTRON ACER TENDL-2023 LIBRARY; T=0.K

## Threshold reactions

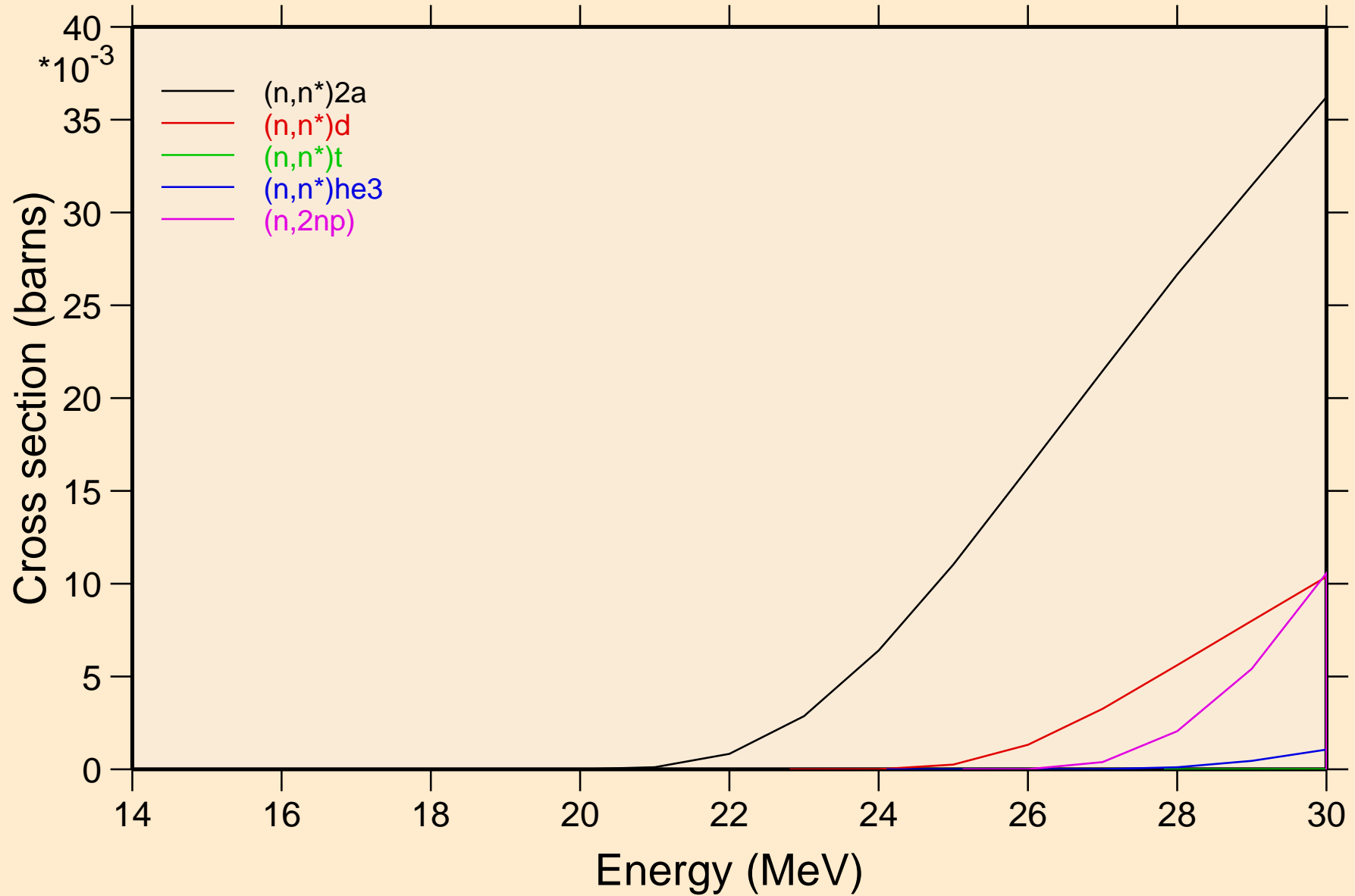

# MG024 NEUTRON ACER TENDL-2023 LIBRARY; T=0.K

## Threshold reactions

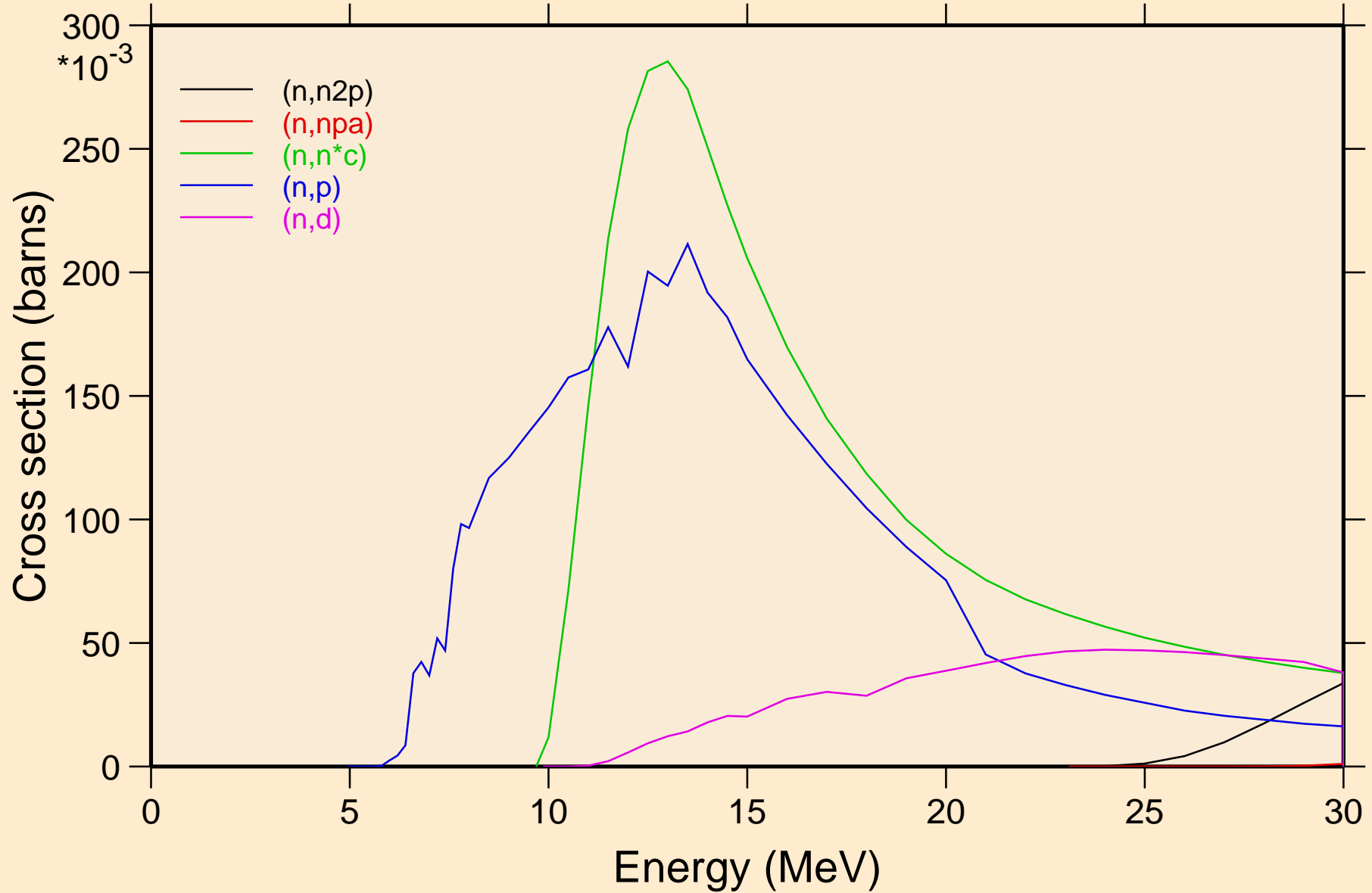

# MG024 NEUTRON ACER TENDL-2023 LIBRARY; T=0.K

## Threshold reactions

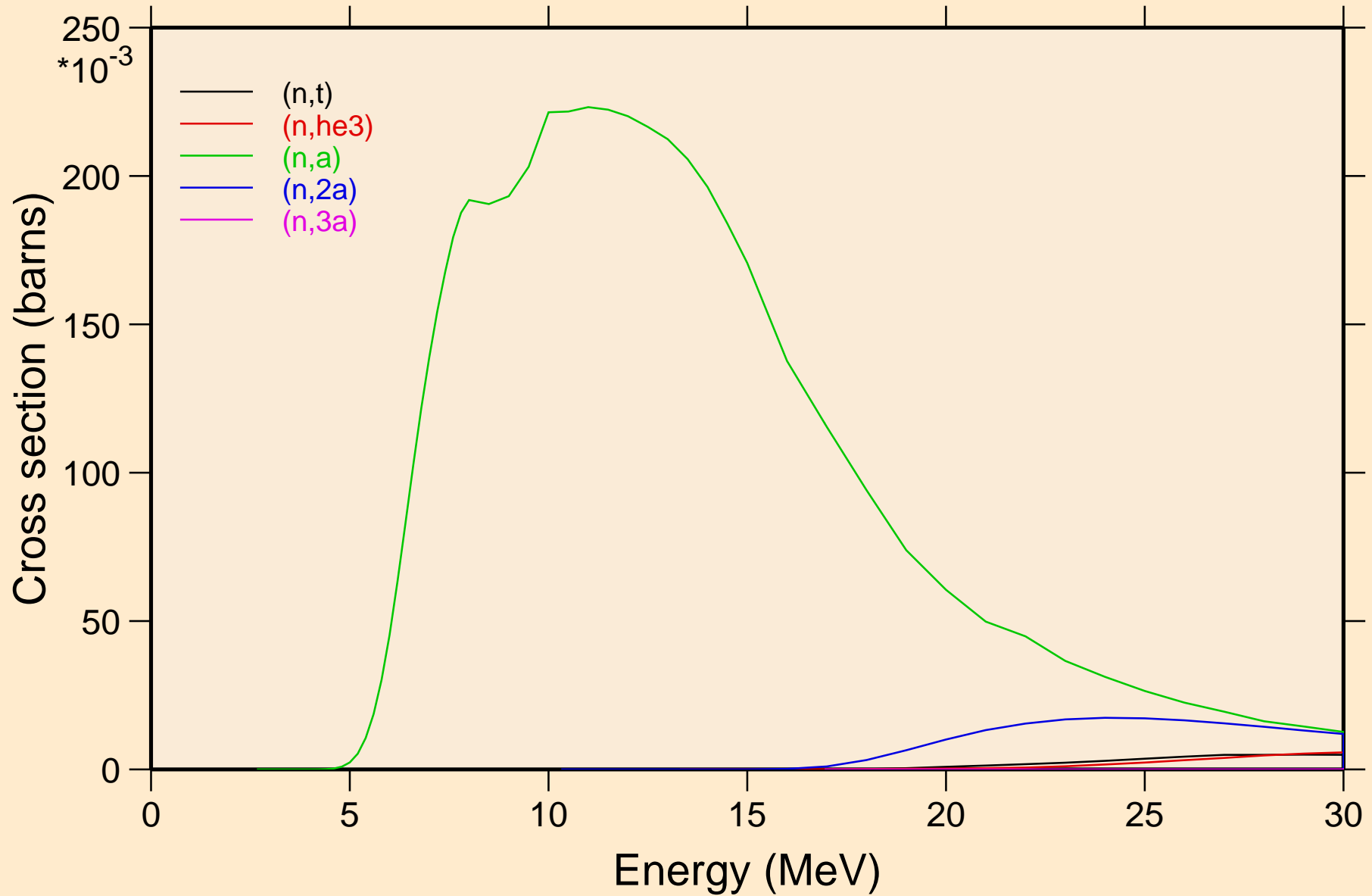

# MG024 NEUTRON ACER TENDL-2023 LIBRARY; T=0.K

## Threshold reactions

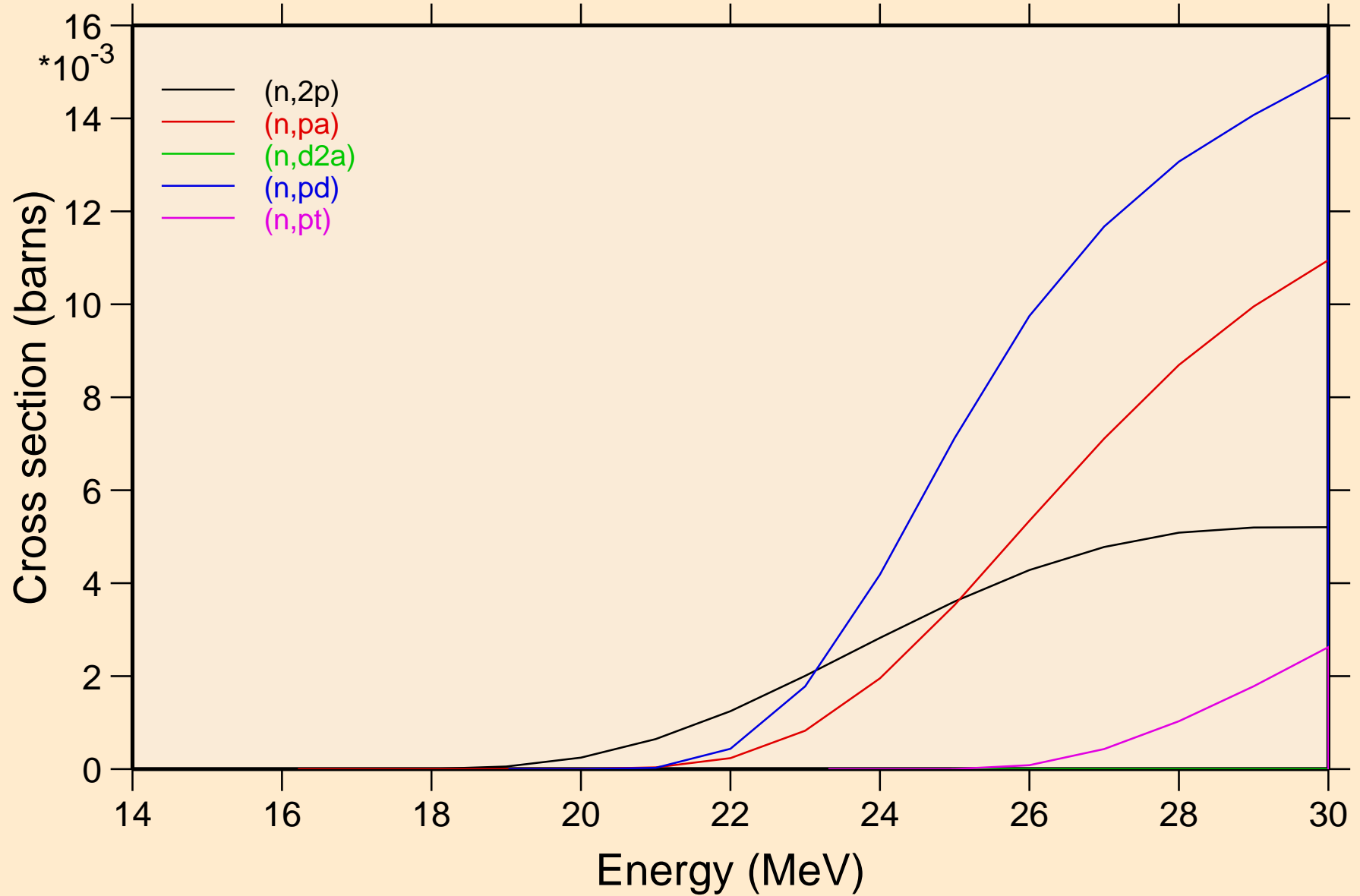



MG024 NEUTRON ACER TENDL-2023 LIBRARY; T=0.K  
Threshold reactions

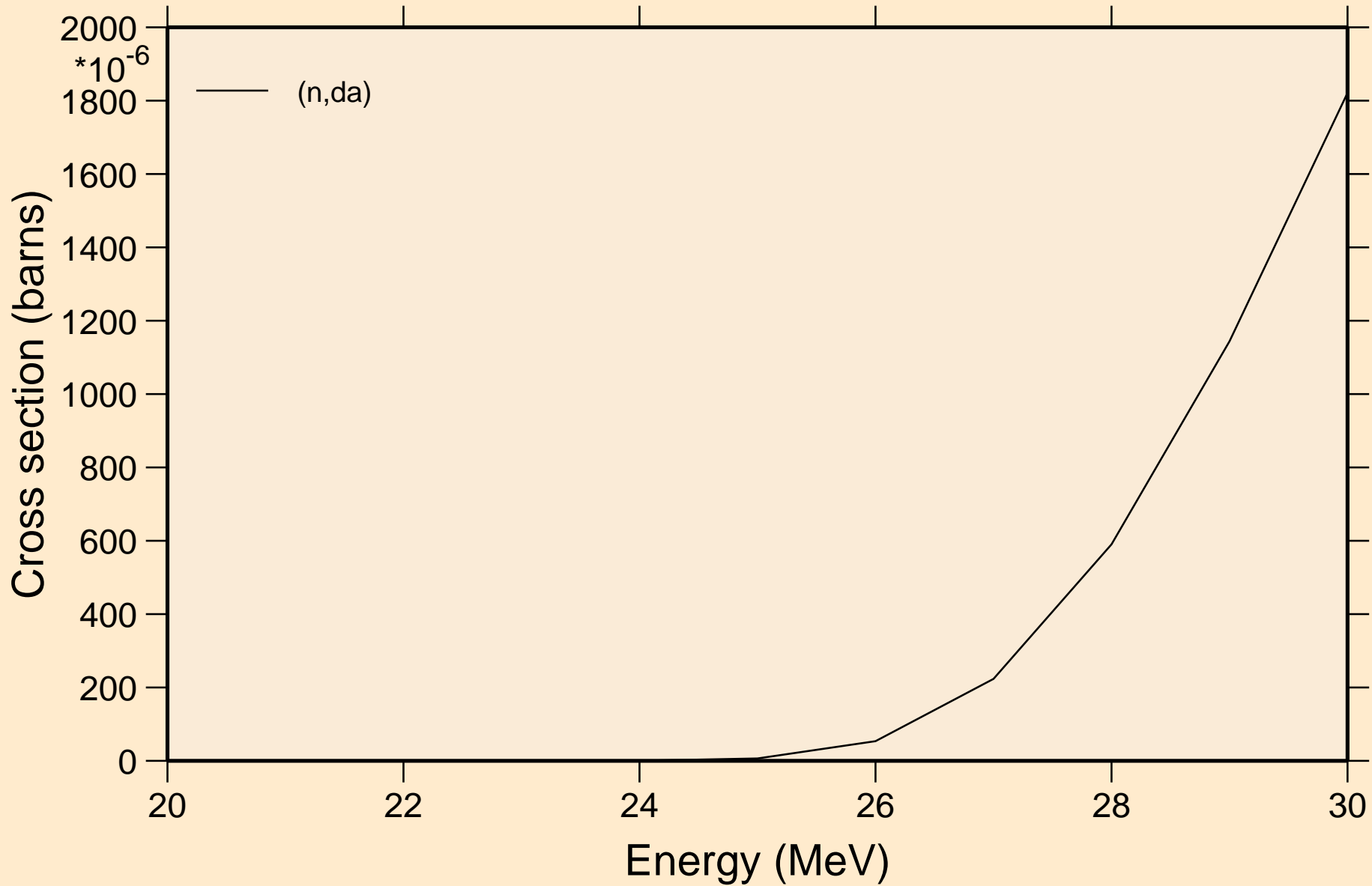

MG024 NEUTRON ACER TENDL-2023 LIBRARY; T=0.K  
Threshold reactions

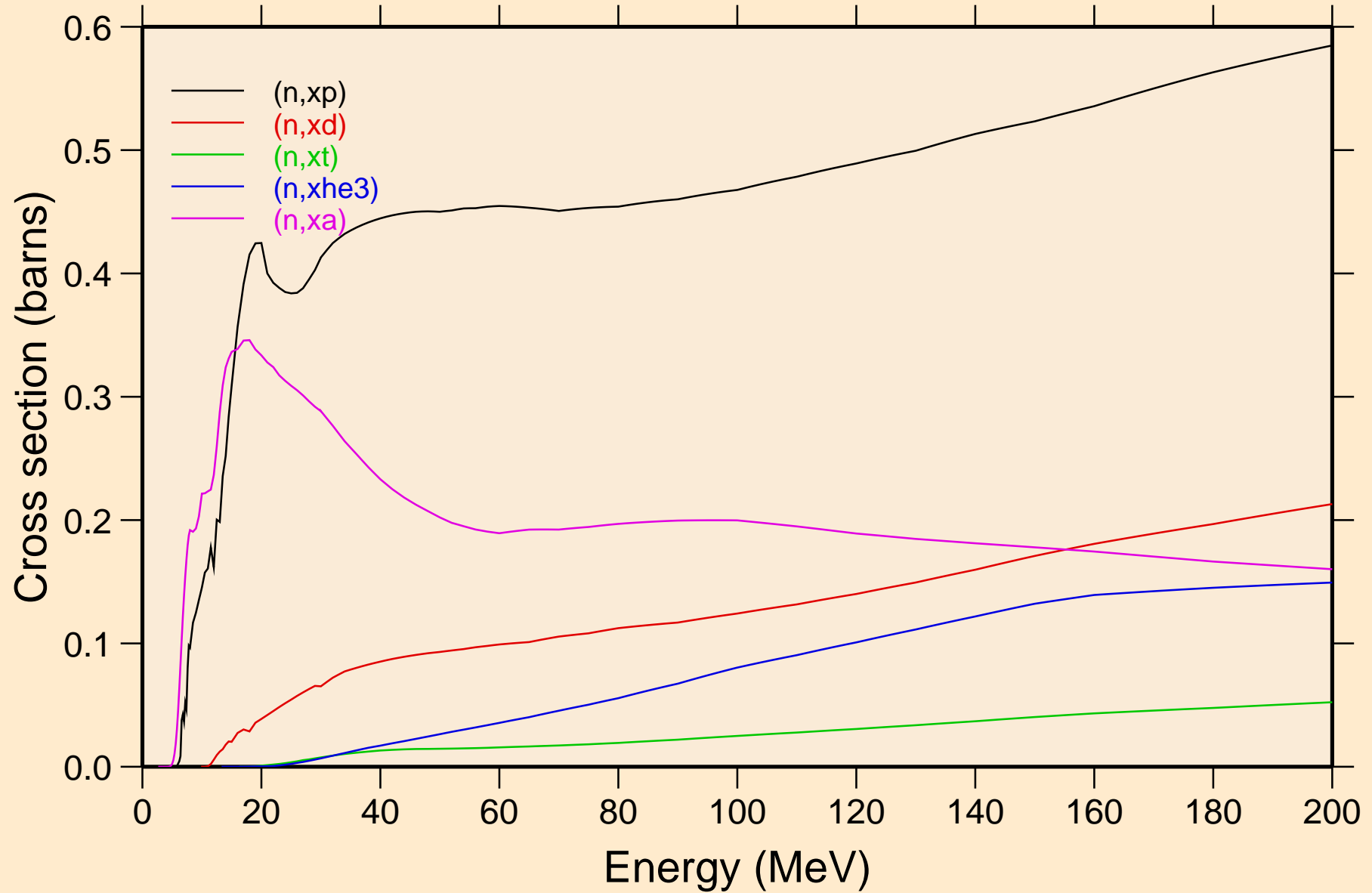

MG024 NEUTRON ACER TENDL-2023 LIBRARY; T=0.K  
angular distribution for elastic

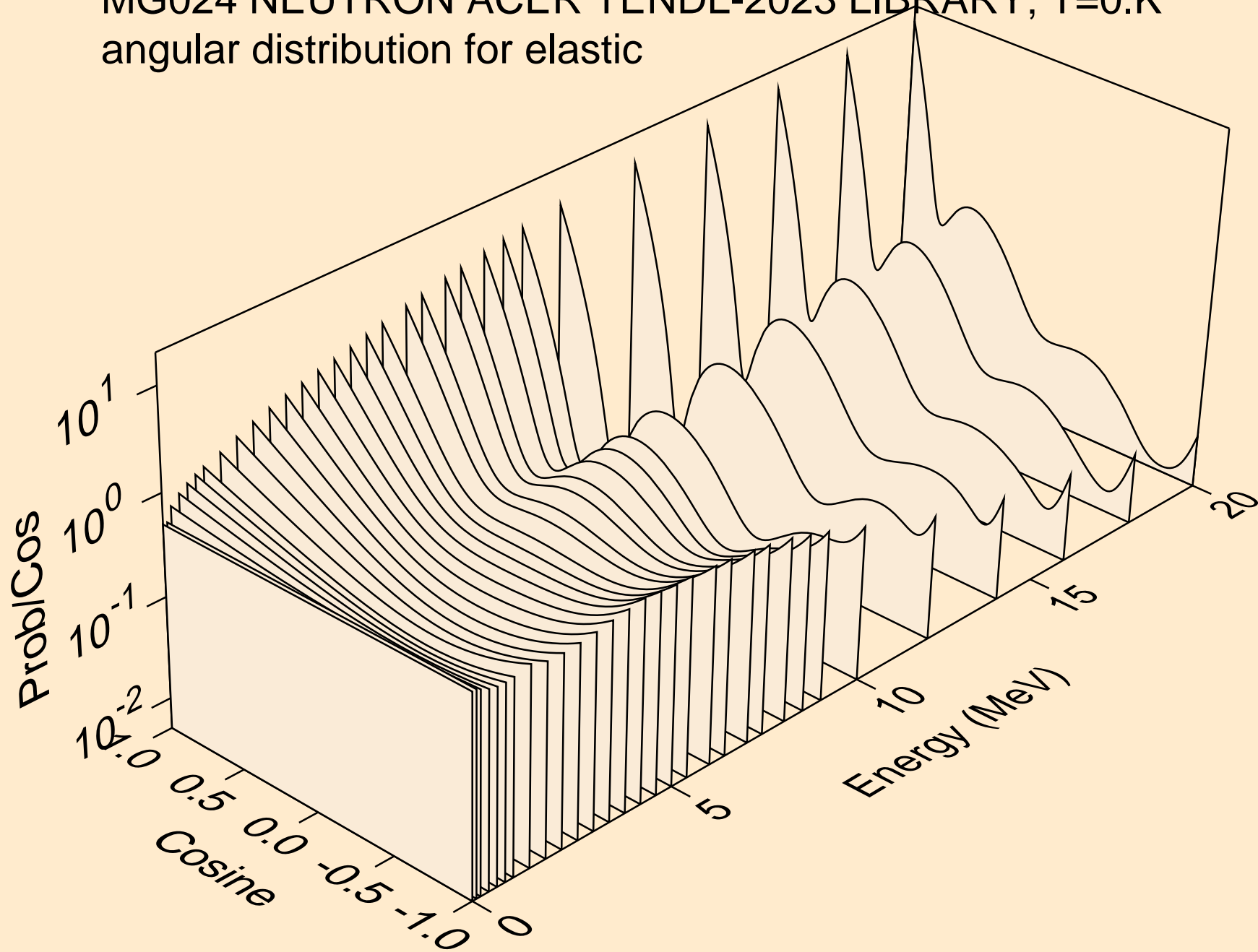

MG024 NEUTRON ACER TENDL-2023 LIBRARY; T=0.K  
angular distribution for elastic

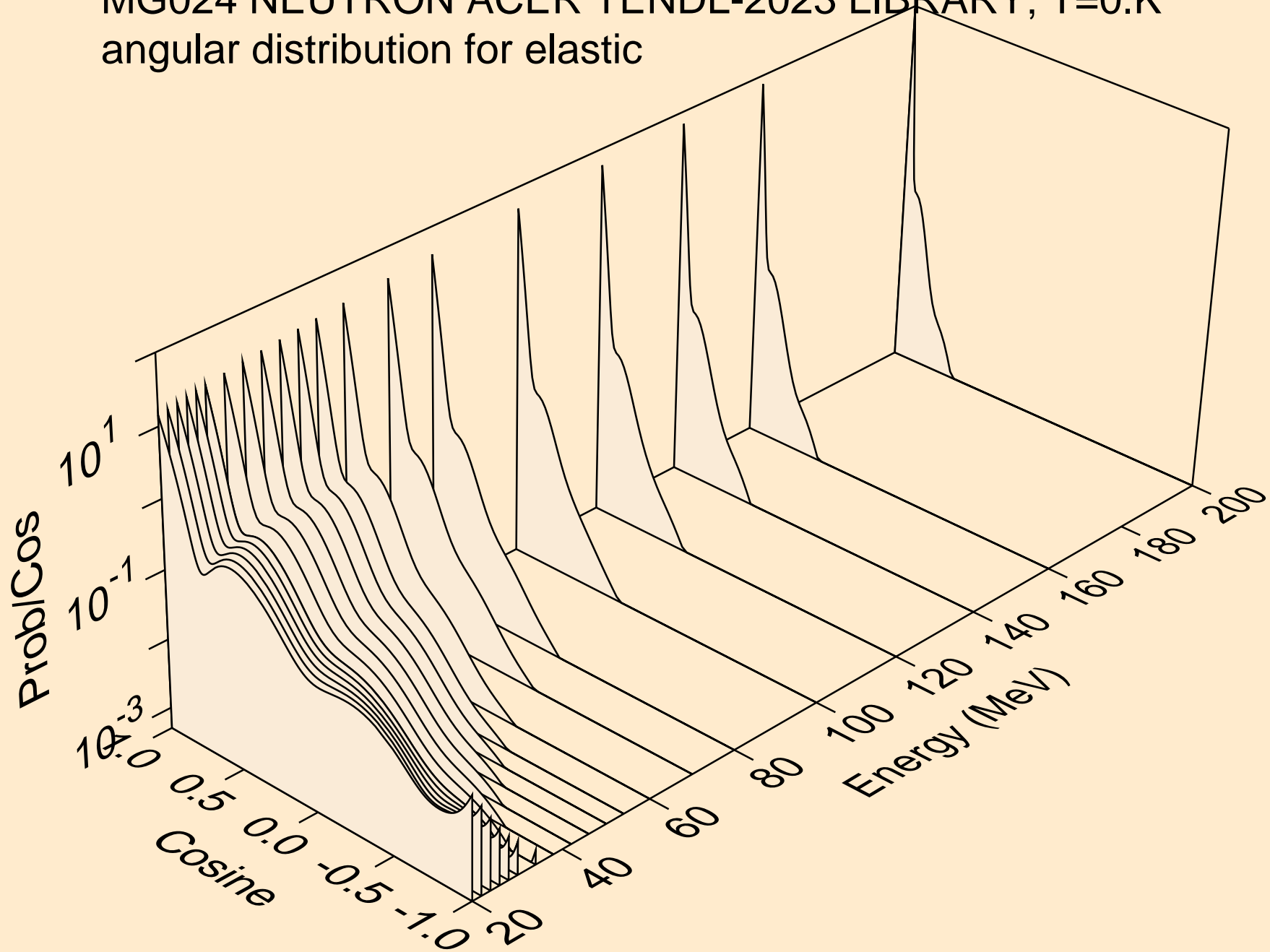

MG024 NEUTRON ACER TENDL-2023 LIBRARY; T=0.K  
angular distribution for (n,n\*1)

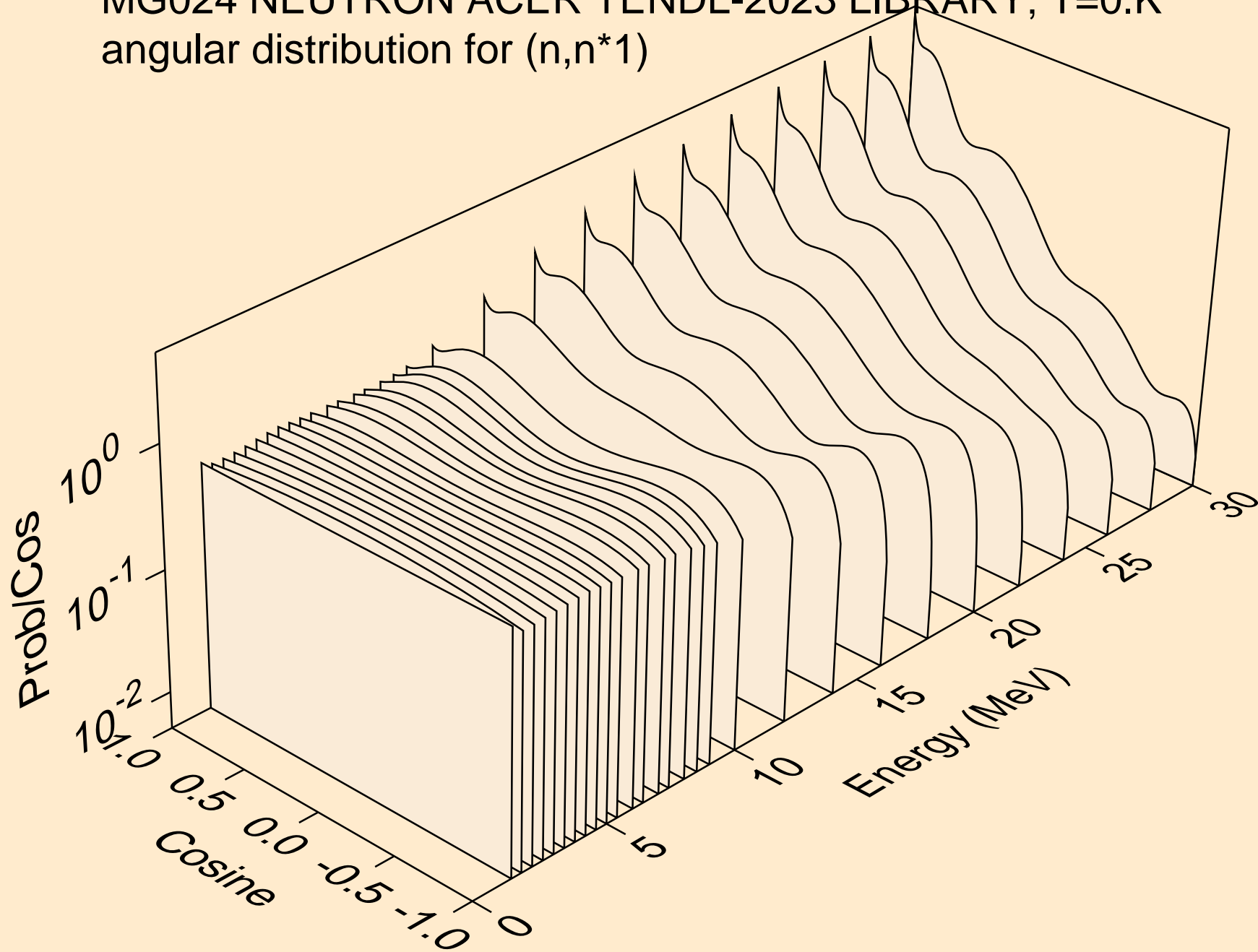

MG024 NEUTRON ACER TENDL-2023 LIBRARY; T=0.K  
angular distribution for (n,n\*2)

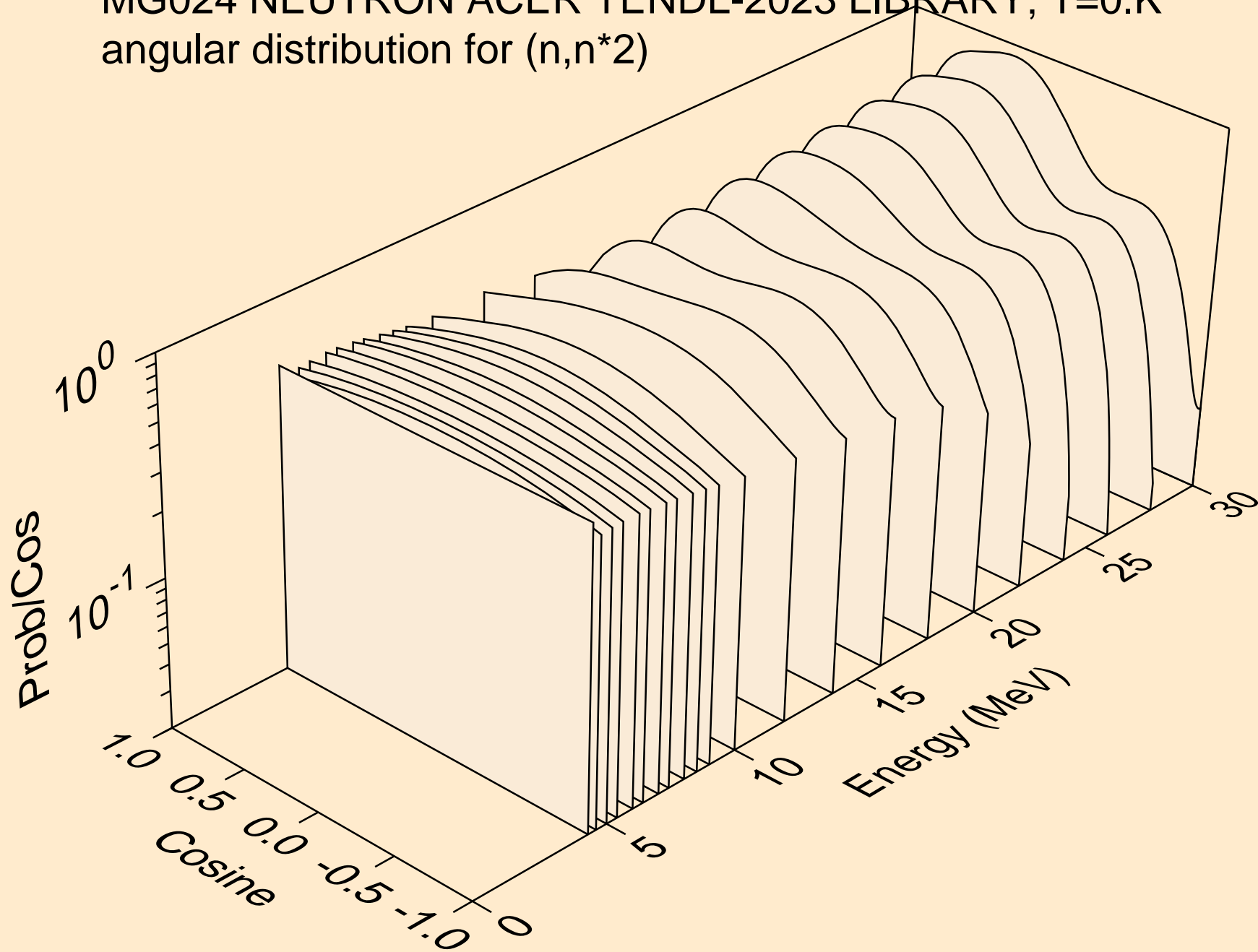

MG024 NEUTRON ACER TENDL-2023 LIBRARY; T=0.K  
angular distribution for (n,n\*3)

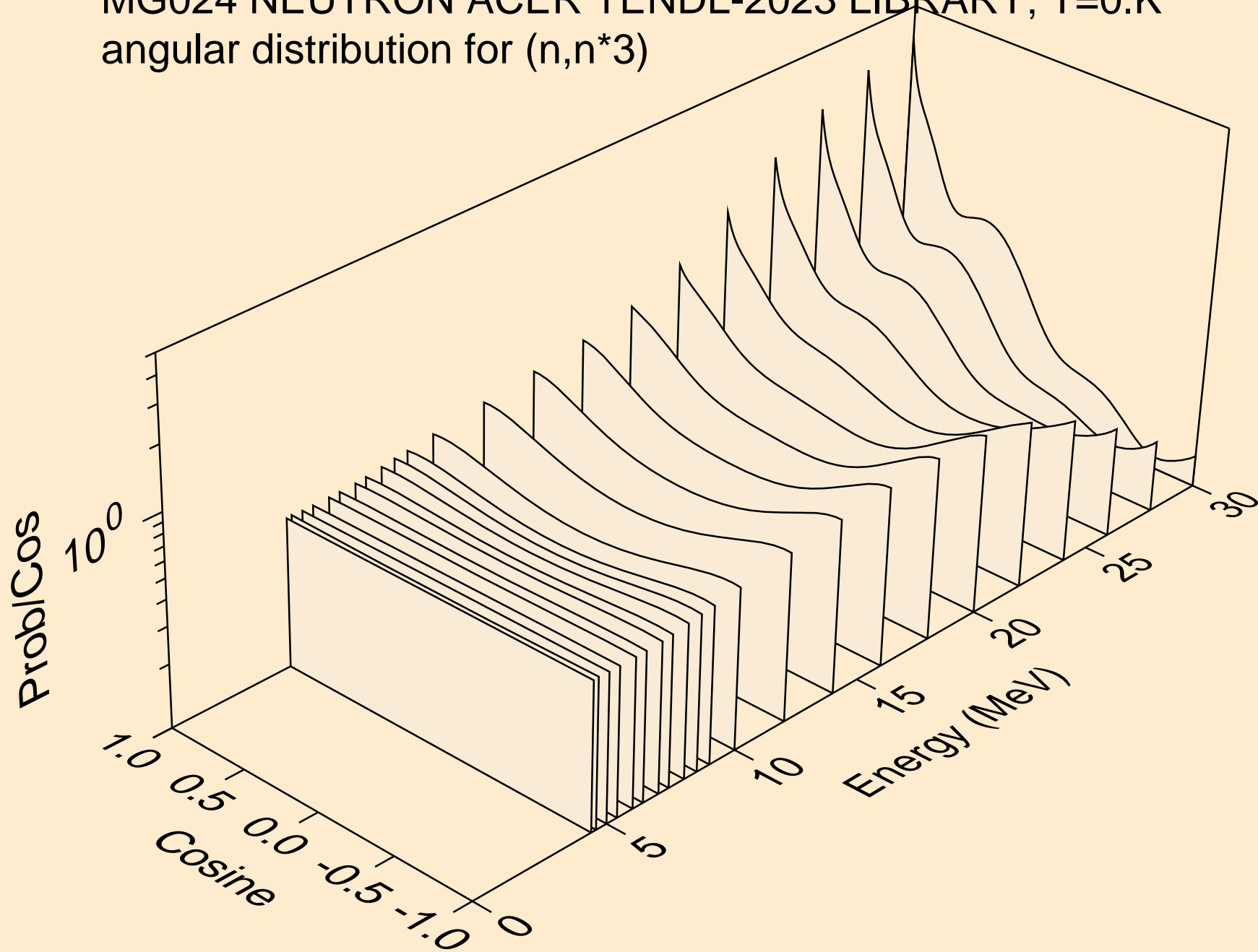

MG024 NEUTRON ACER TENDL-2023 LIBRARY; T=0.K  
angular distribution for (n,n\*4)

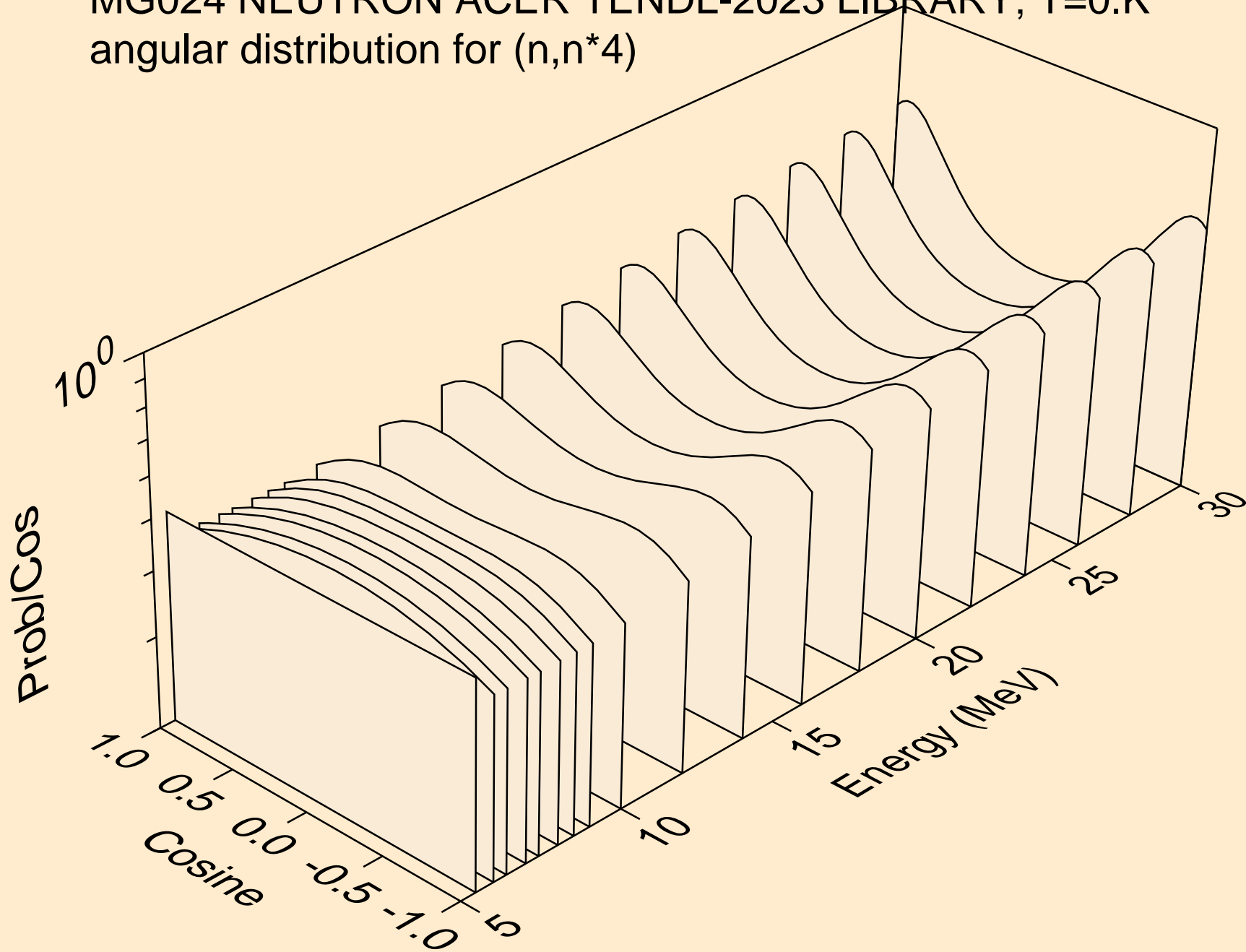



MG024 NEUTRON ACER TENDL-2023 LIBRARY; T=0.K  
angular distribution for (n,n\*5)

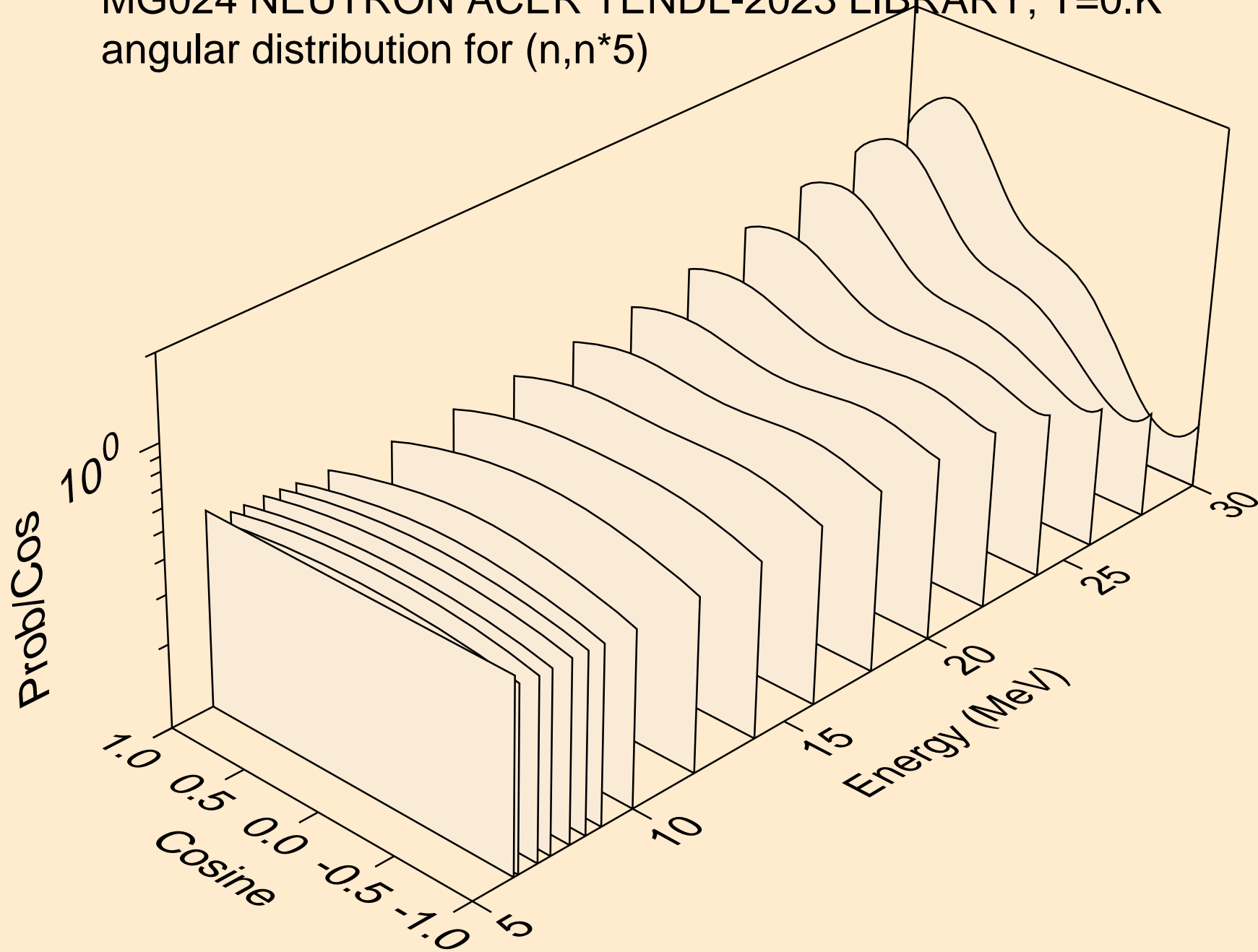

MG024 NEUTRON ACER TENDL-2023 LIBRARY; T=0.K  
angular distribution for (n,n\*6)

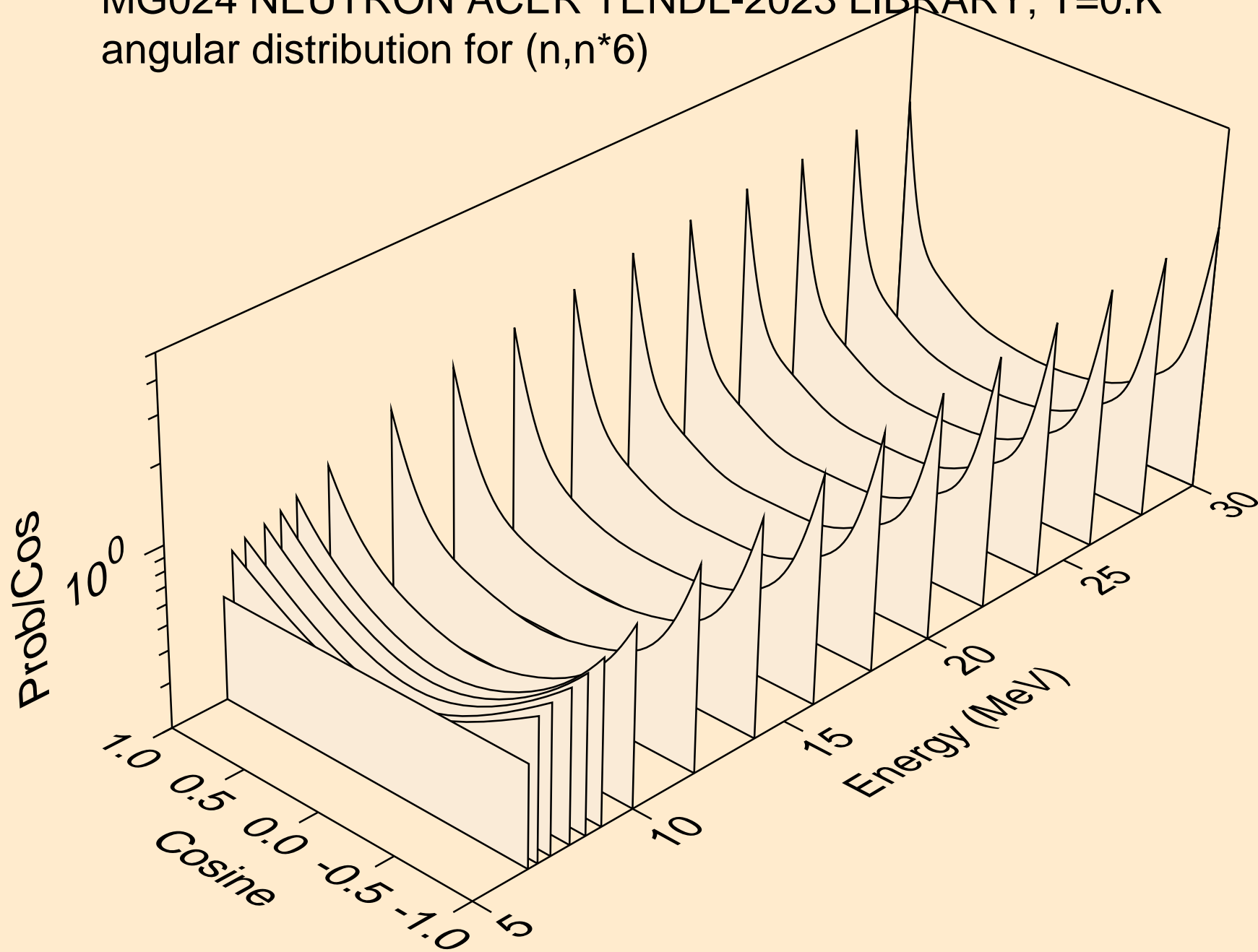

MG024 NEUTRON ACER TENDL-2023 LIBRARY; T=0.K  
angular distribution for (n,n\*7)

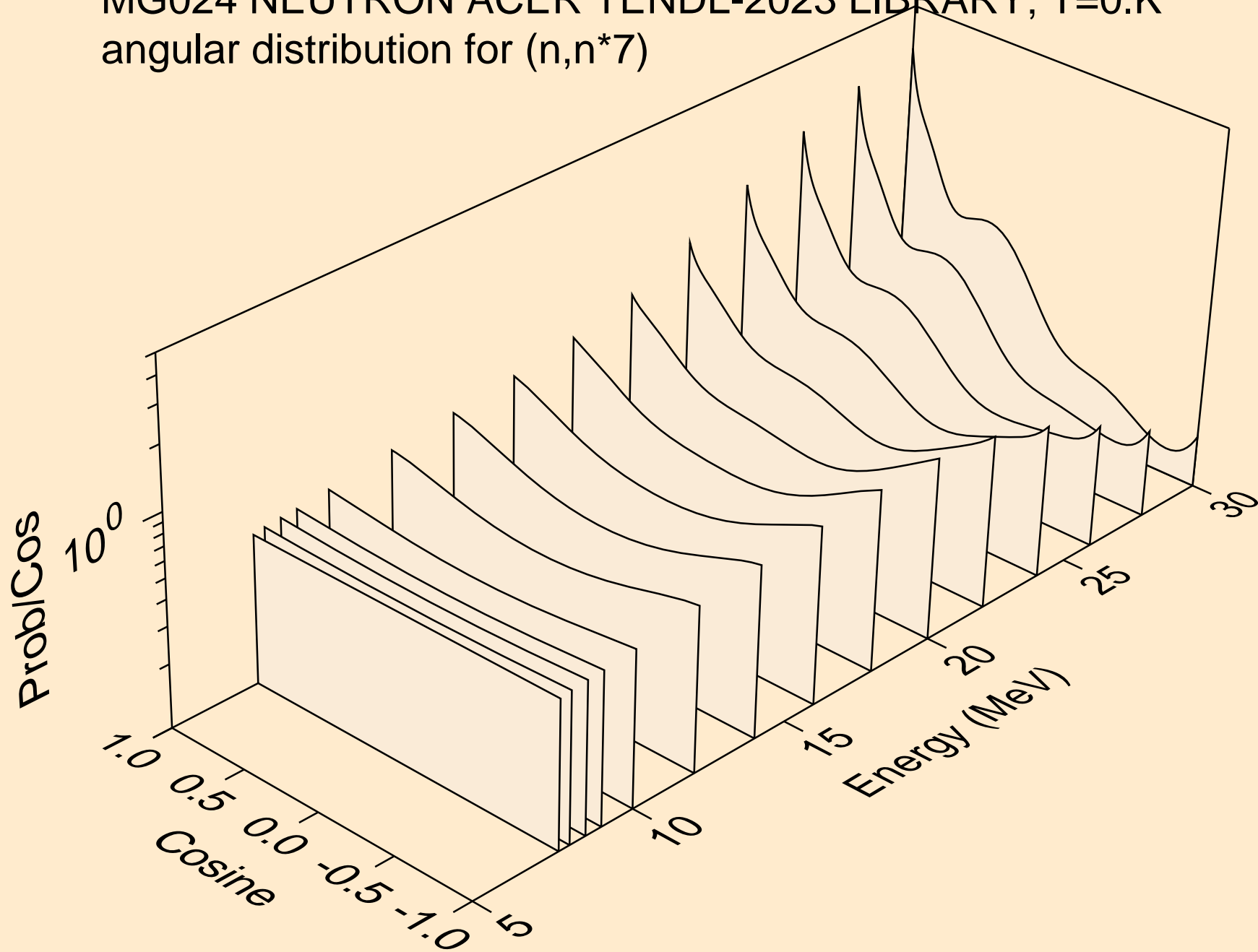

MG024 NEUTRON ACER TENDL-2023 LIBRARY; T=0.K  
angular distribution for (n,n\*8)

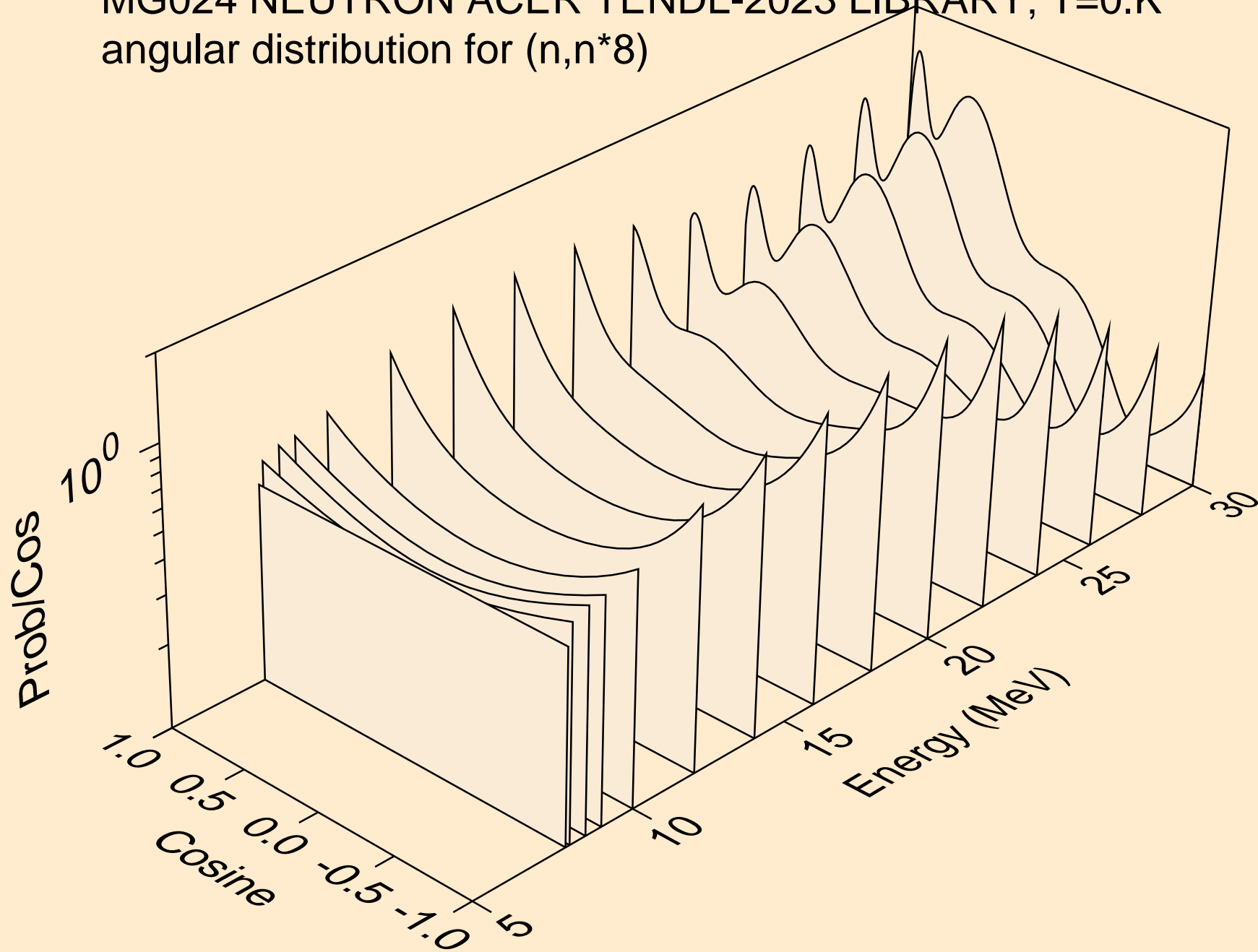

MG024 NEUTRON ACER TENDL-2023 LIBRARY; T=0.K  
angular distribution for (n,n\*9)

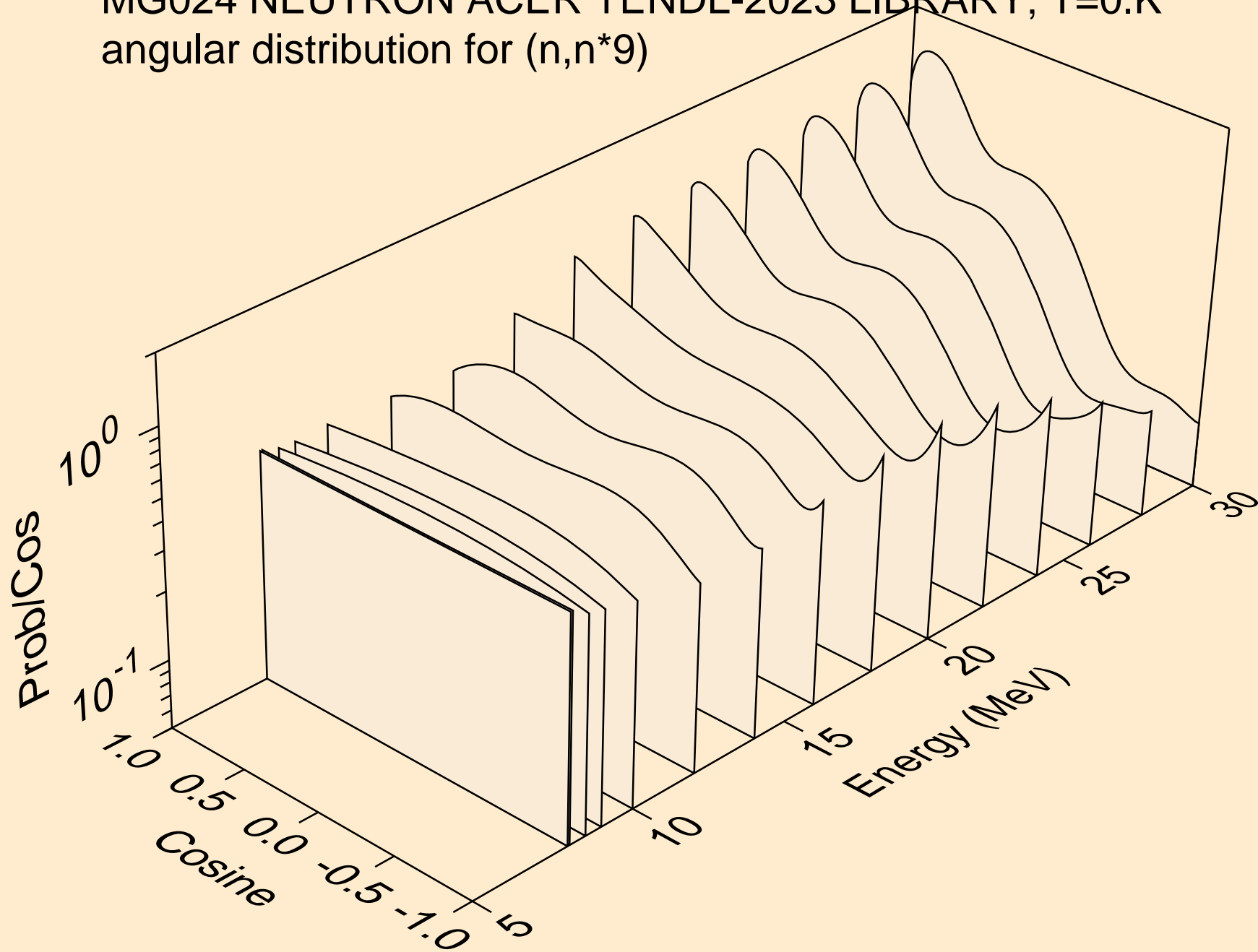

MG024 NEUTRON ACER TENDL-2023 LIBRARY; T=0.K  
angular distribution for (n,n\*10)

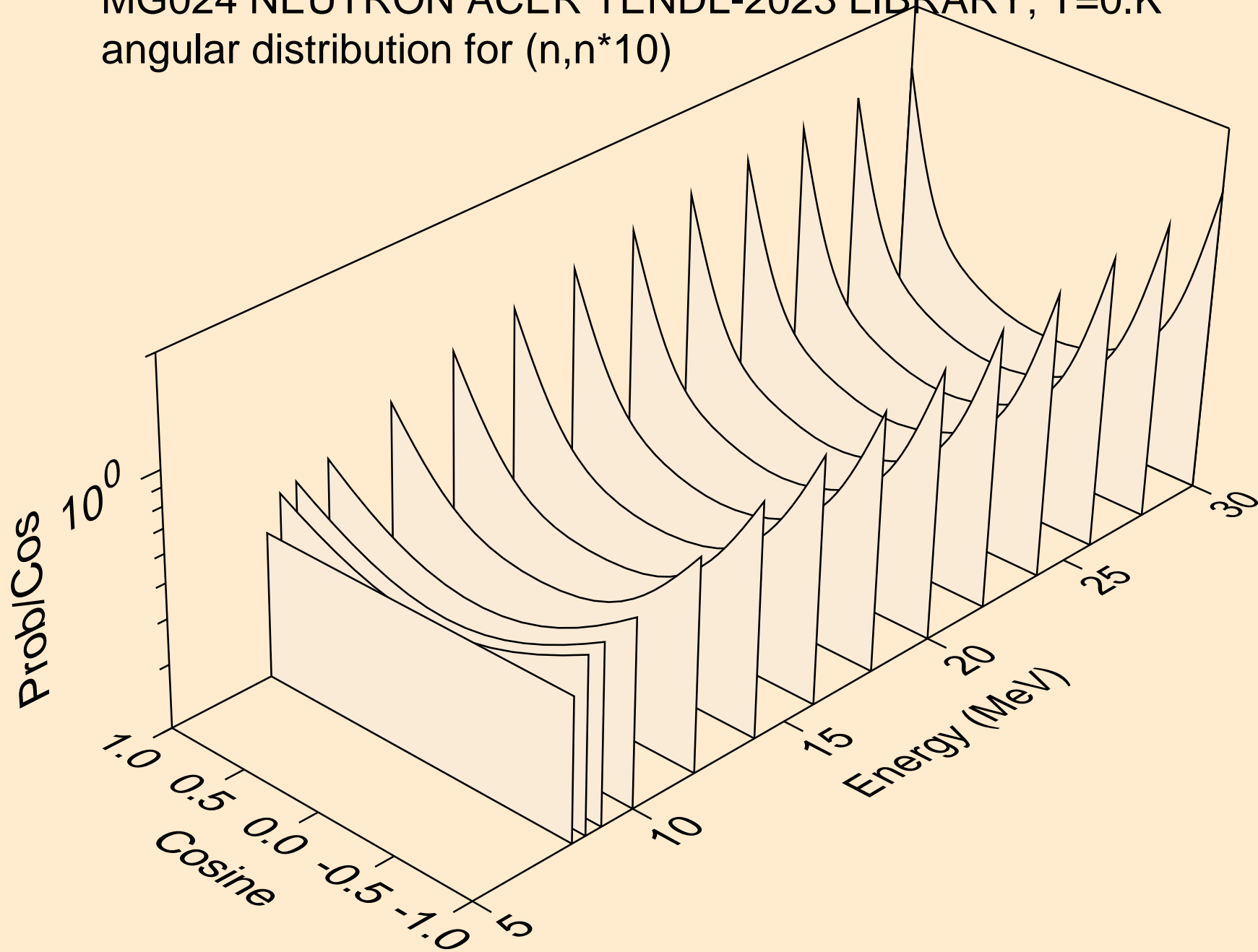

MG024 NEUTRON ACER TENDL-2023 LIBRARY; T=0.K  
angular distribution for (n,n\*11)

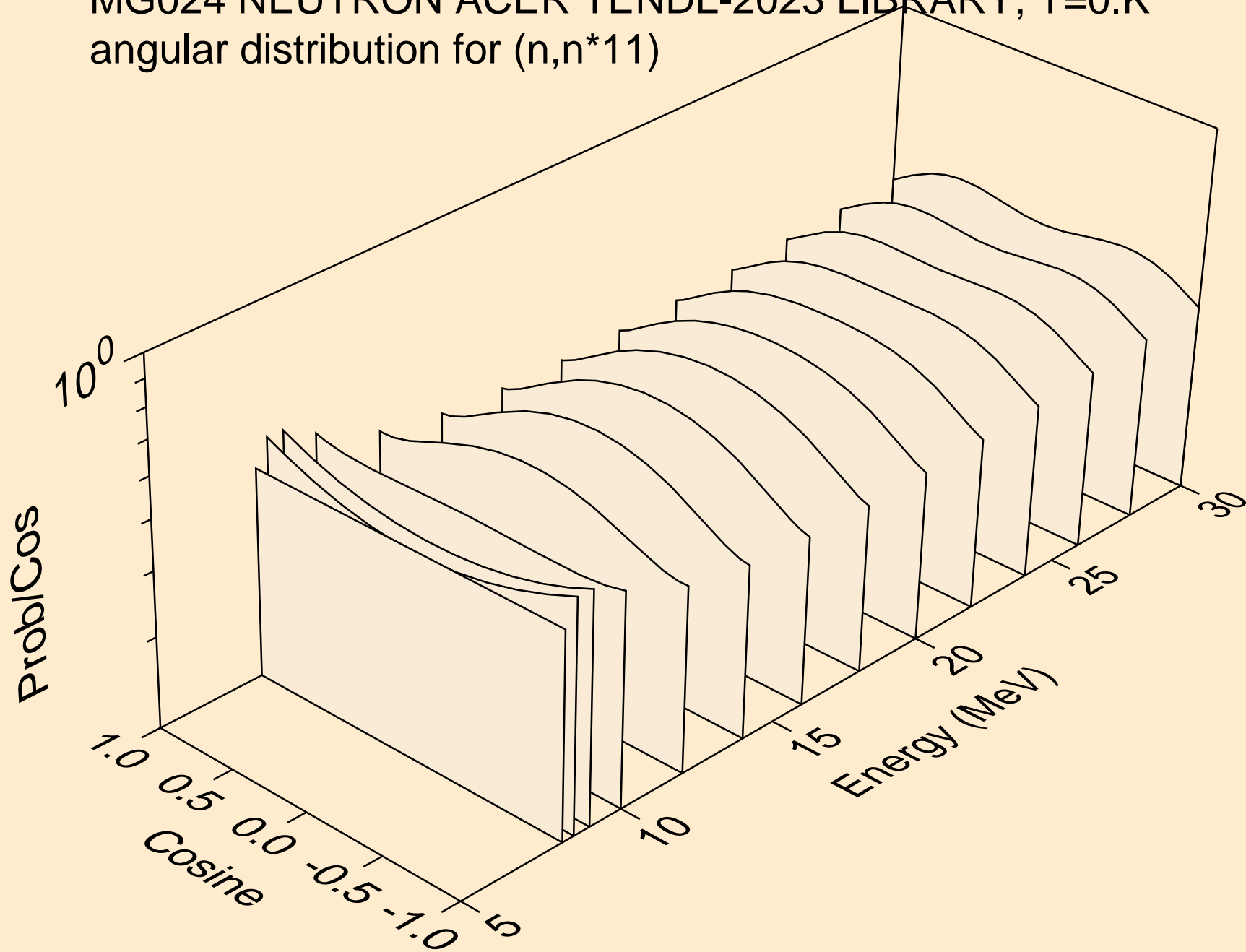

MG024 NEUTRON ACER TENDL-2023 LIBRARY; T=0.K  
angular distribution for (n,n\*12)

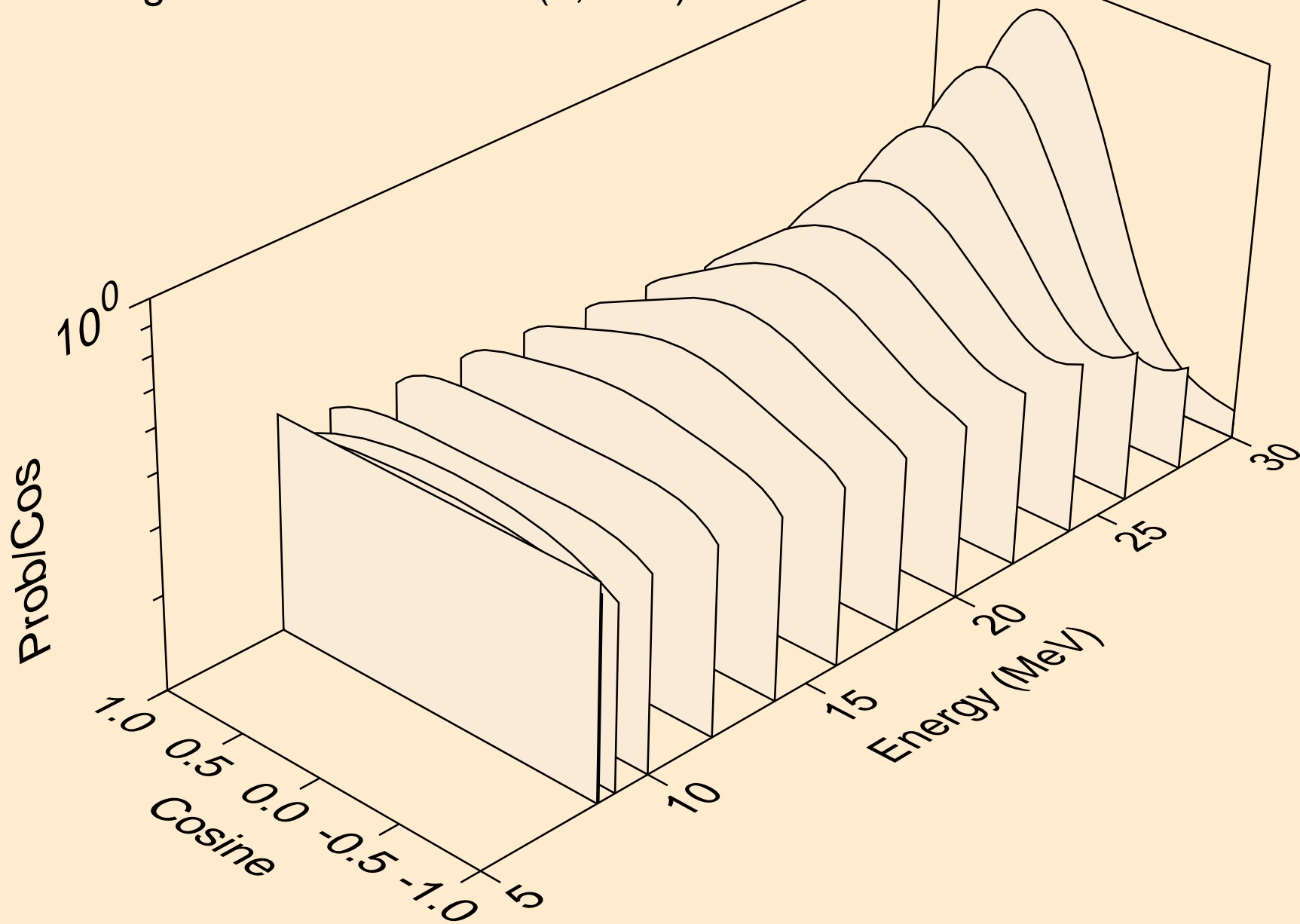



MG024 NEUTRON ACER TENDL-2023 LIBRARY; T=0.K  
angular distribution for (n,n\*13)

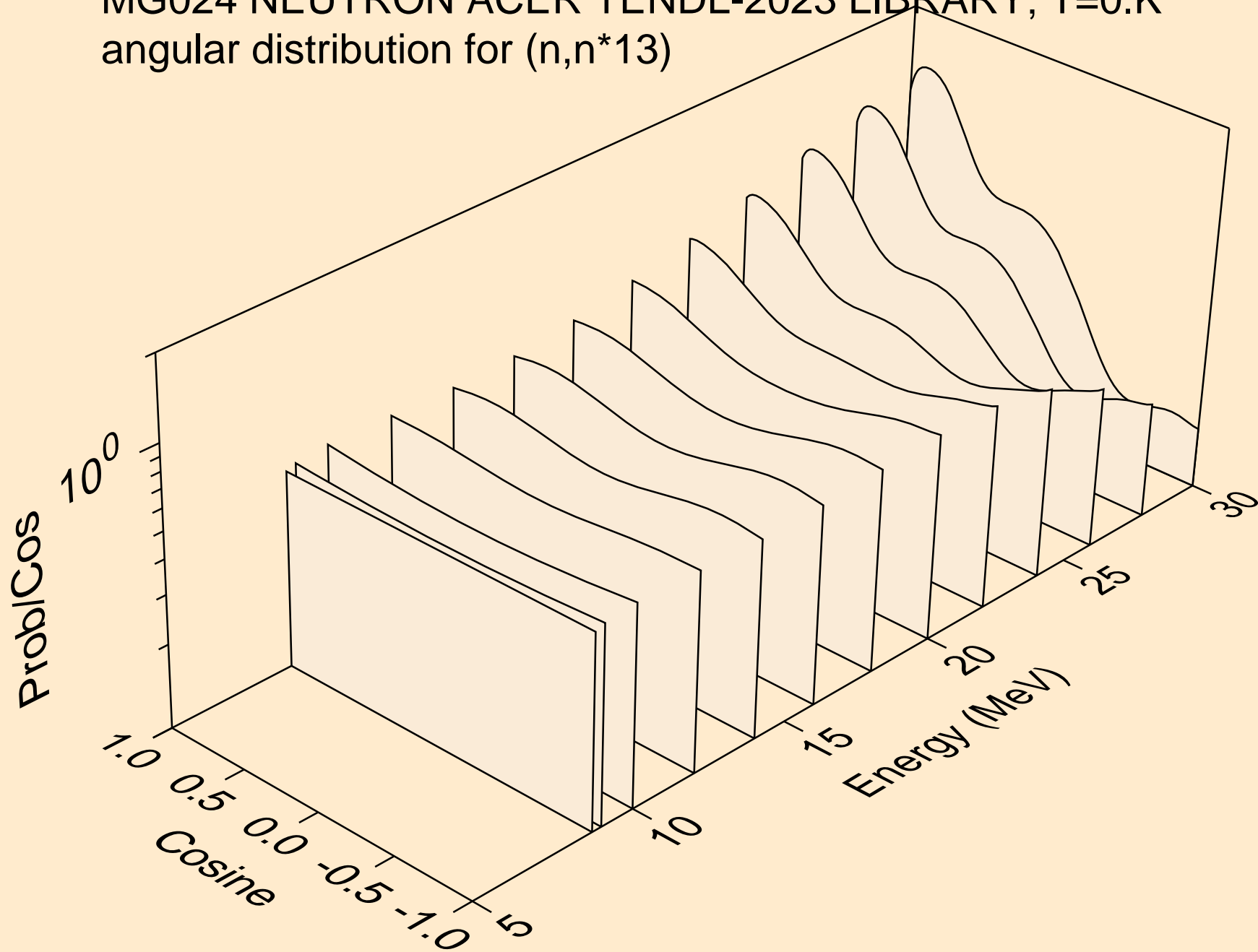

MG024 NEUTRON ACER TENDL-2023 LIBRARY; T=0.K  
angular distribution for (n,n\*14)

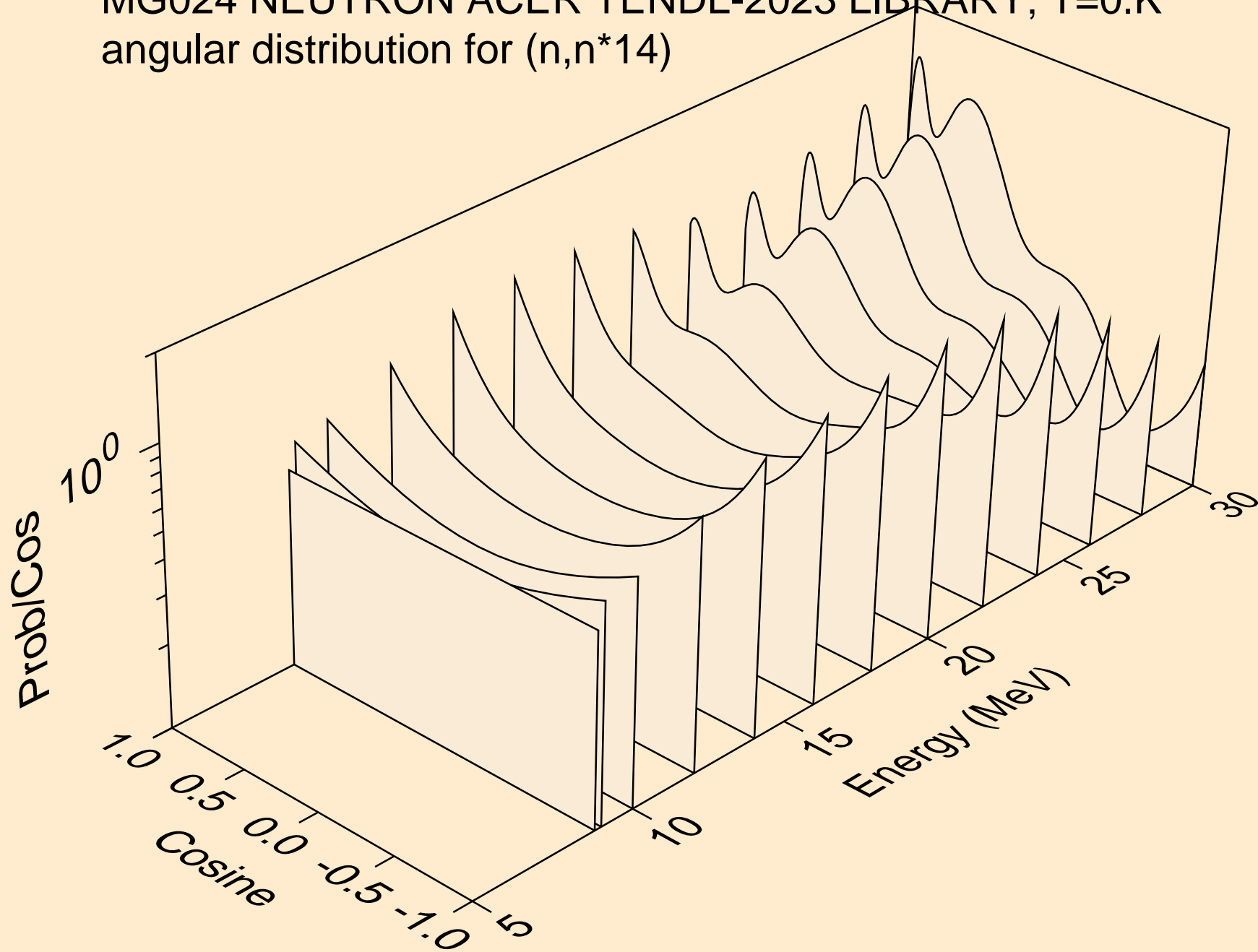

MG024 NEUTRON ACER TENDL-2023 LIBRARY; T=0.K  
angular distribution for (n,n\*15)

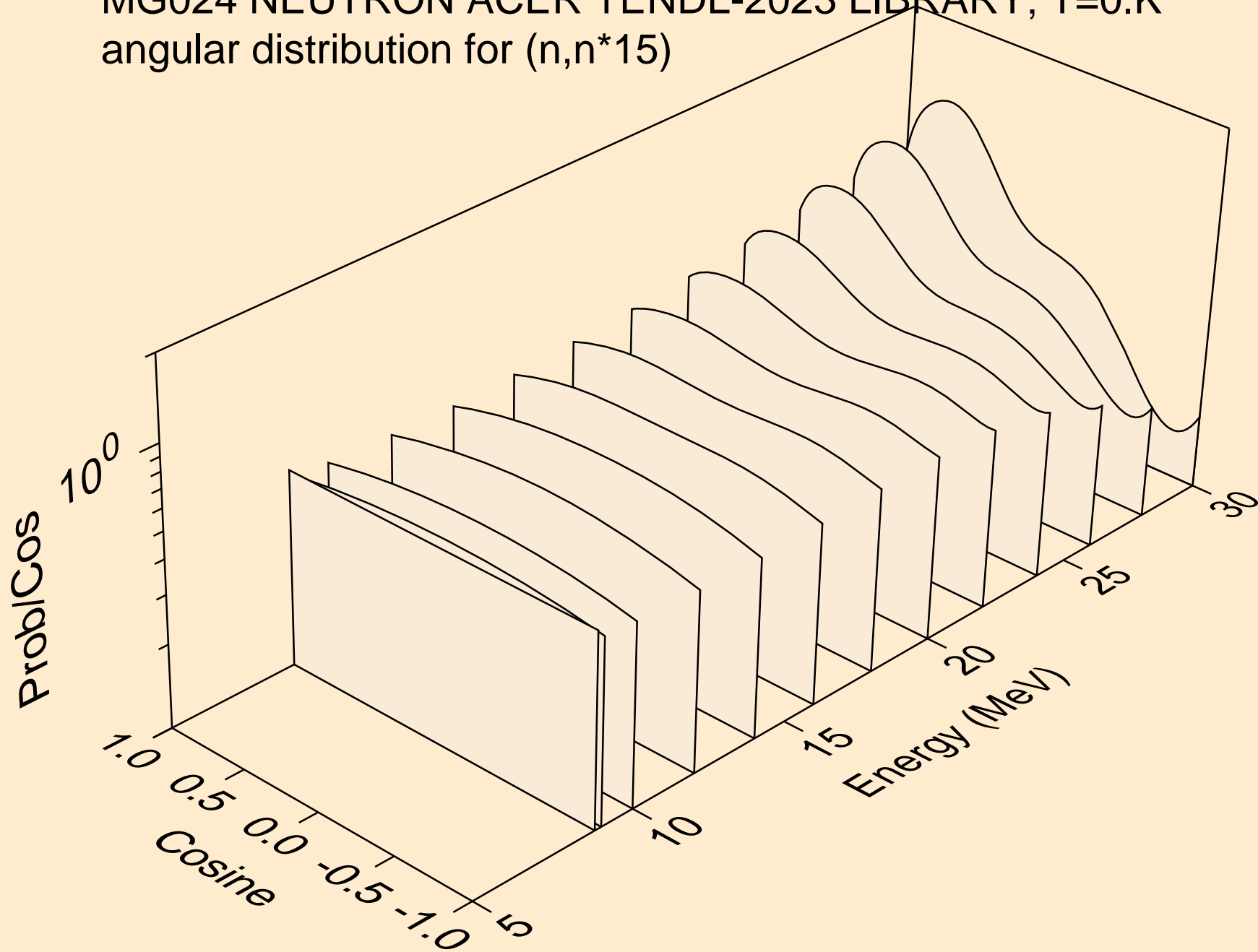

MG024 NEUTRON ACER TENDL-2023 LIBRARY; T=0.K  
angular distribution for (n,n\*16)

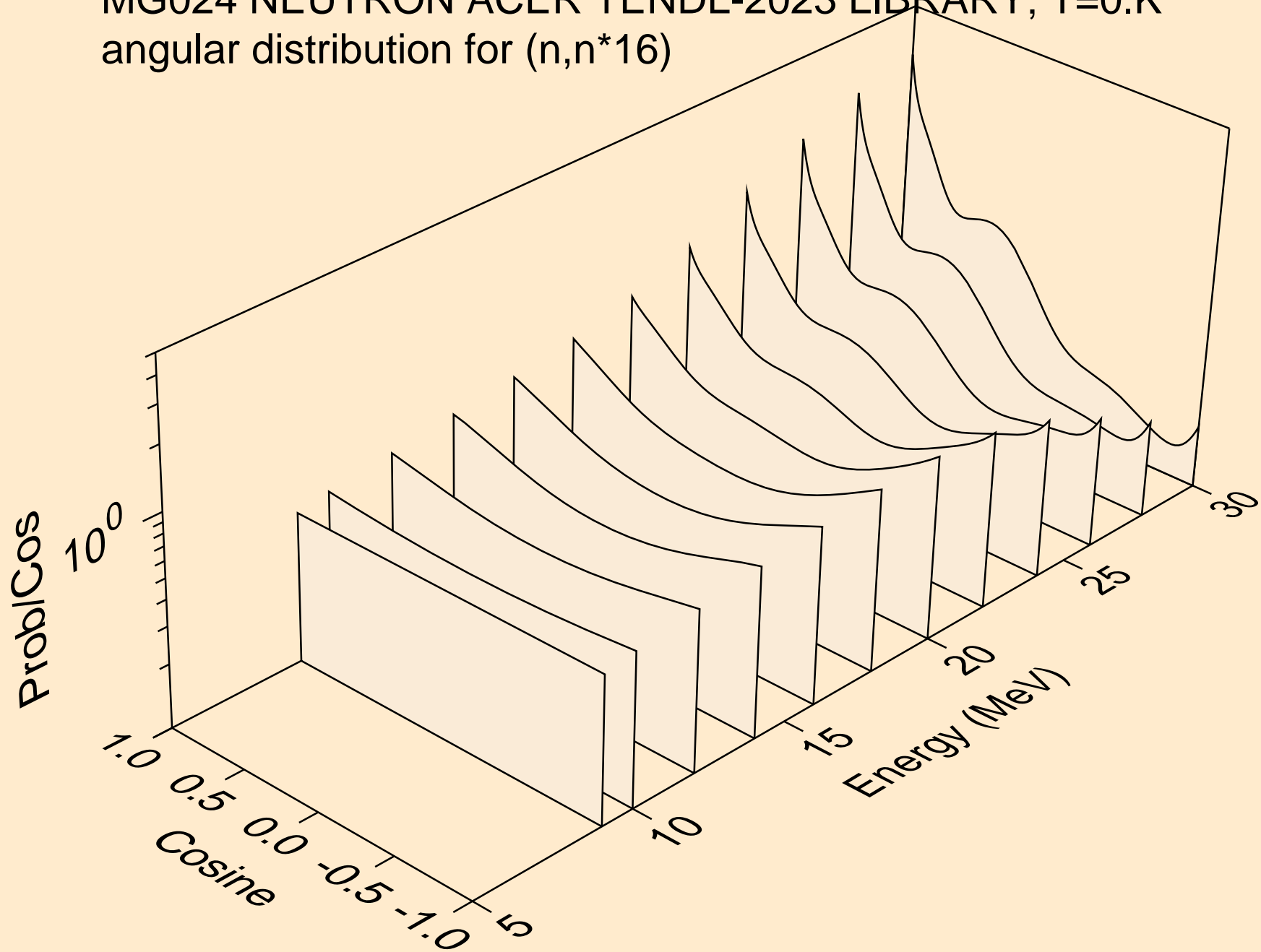

MG024 NEUTRON ACER TENDL-2023 LIBRARY; T=0.K  
angular distribution for (n,n\*17)

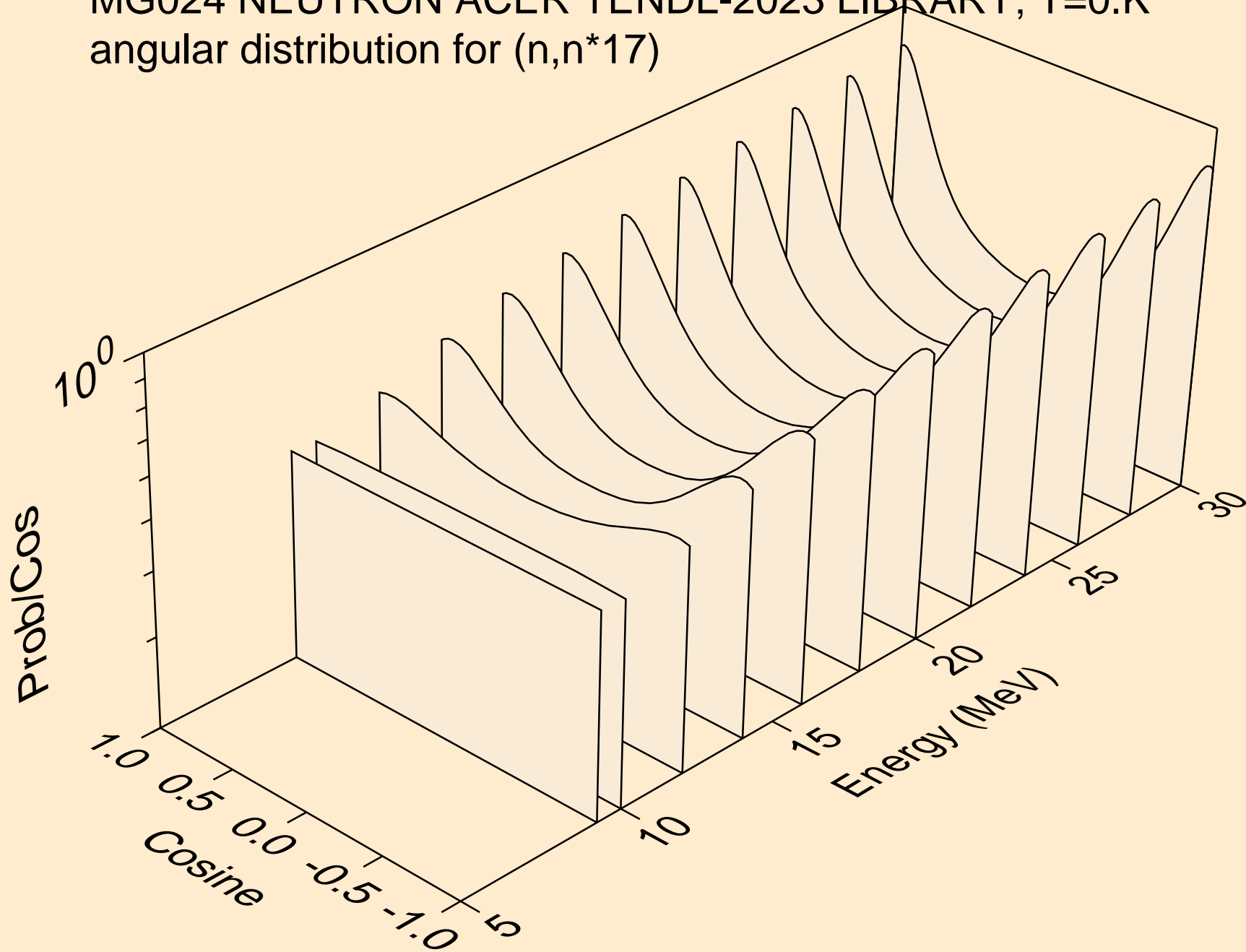

MG024 NEUTRON ACER TENDL-2023 LIBRARY; T=0.K  
angular distribution for (n,n\*18)

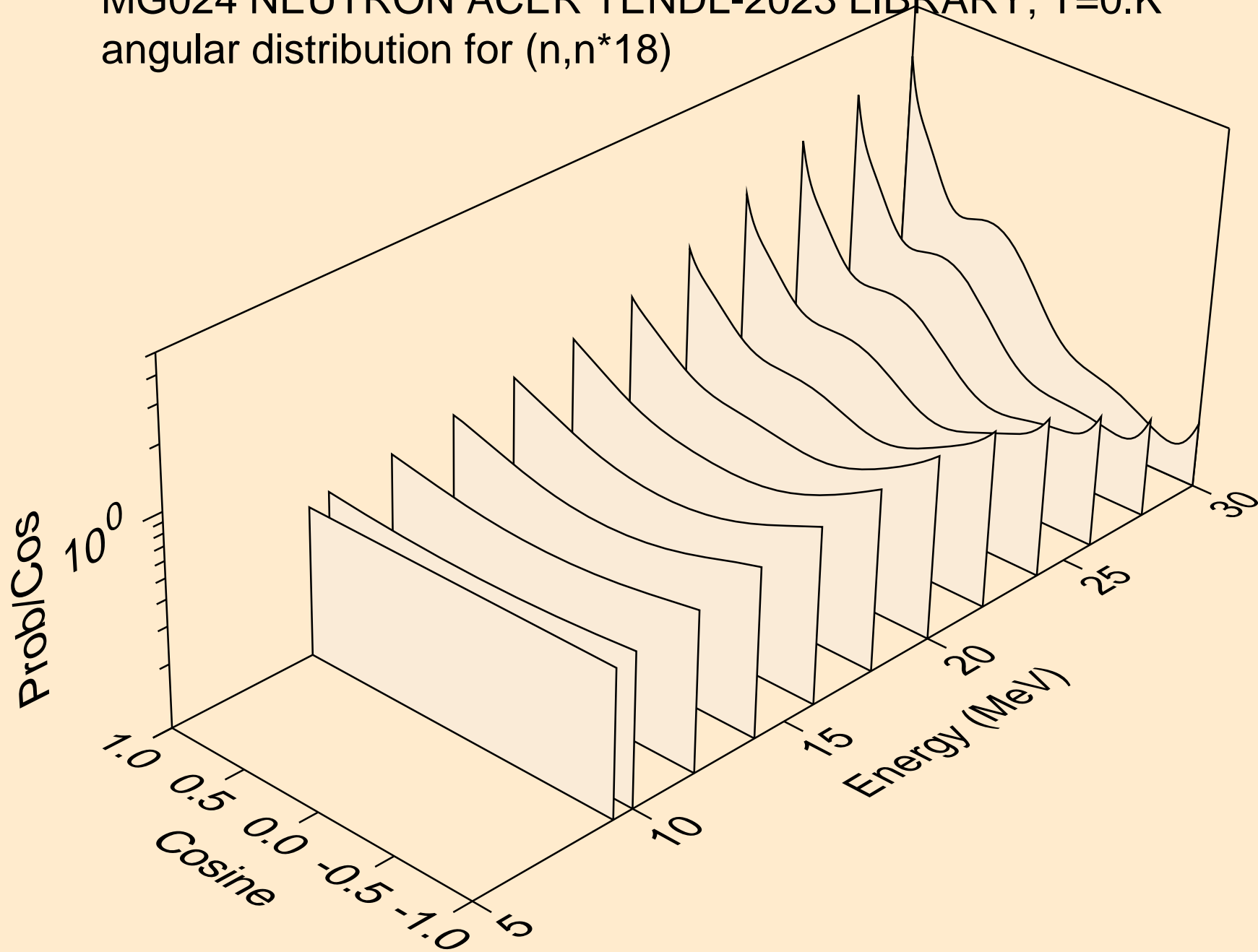

MG024 NEUTRON ACER TENDL-2023 LIBRARY; T=0.K  
angular distribution for (n,n\*19)

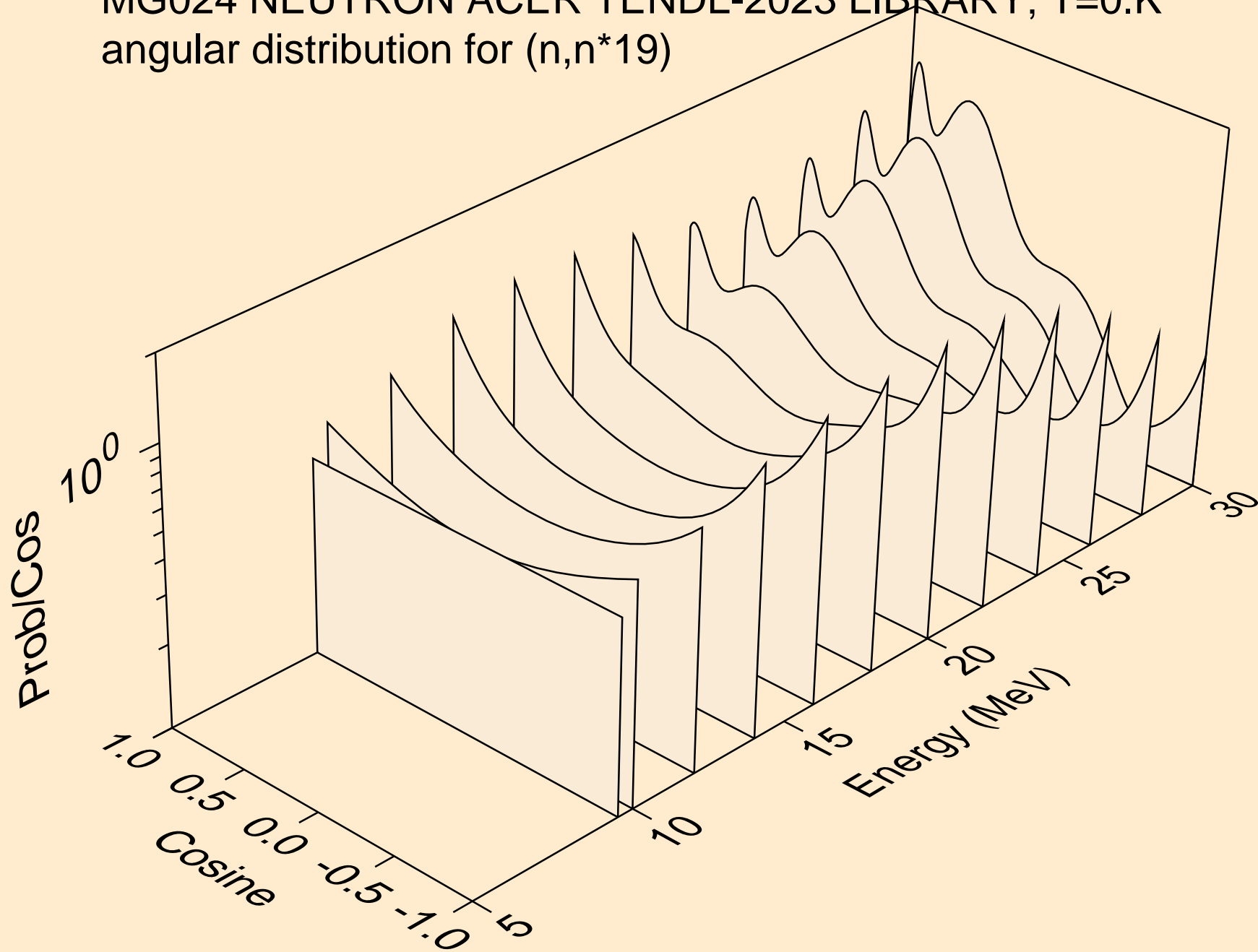

MG024 NEUTRON ACER TENDL-2023 LIBRARY; T=0.K  
angular distribution for (n,n\*20)

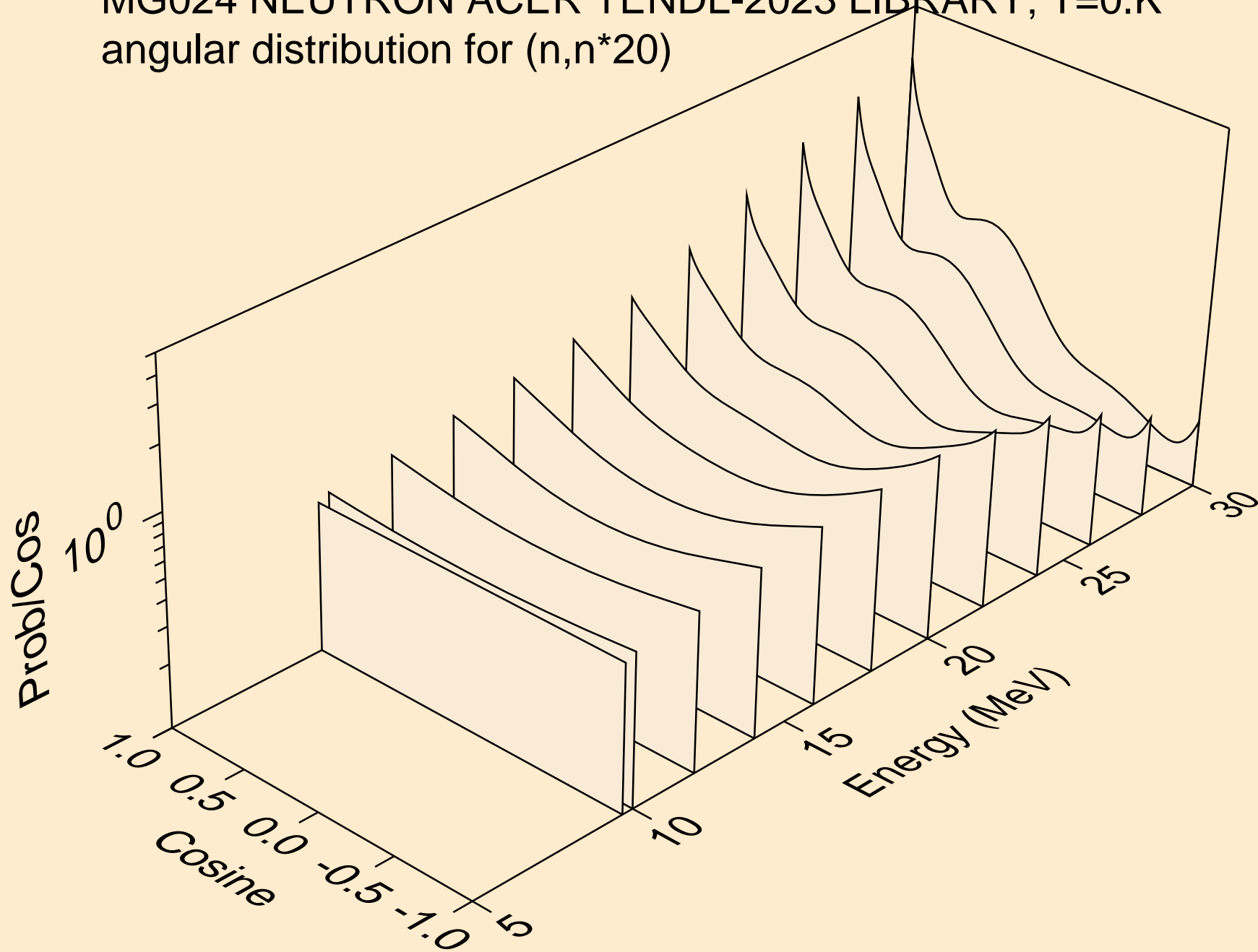



MG024 NEUTRON ACER TENDL-2023 LIBRARY; T=0.K  
angular distribution for (n,n\*21)

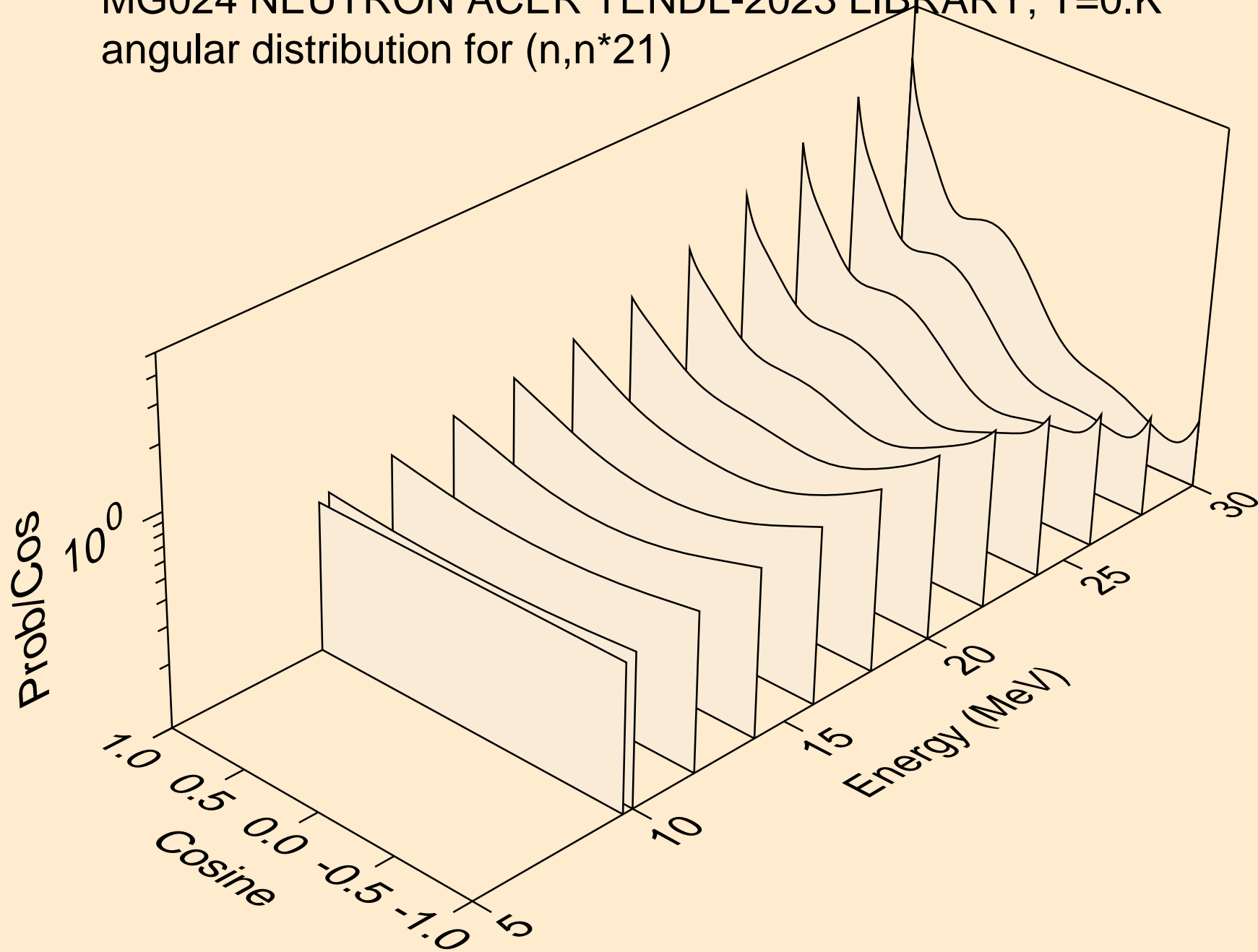

MG024 NEUTRON ACER TENDL-2023 LIBRARY; T=0.K  
Neutron emission for (n,x)

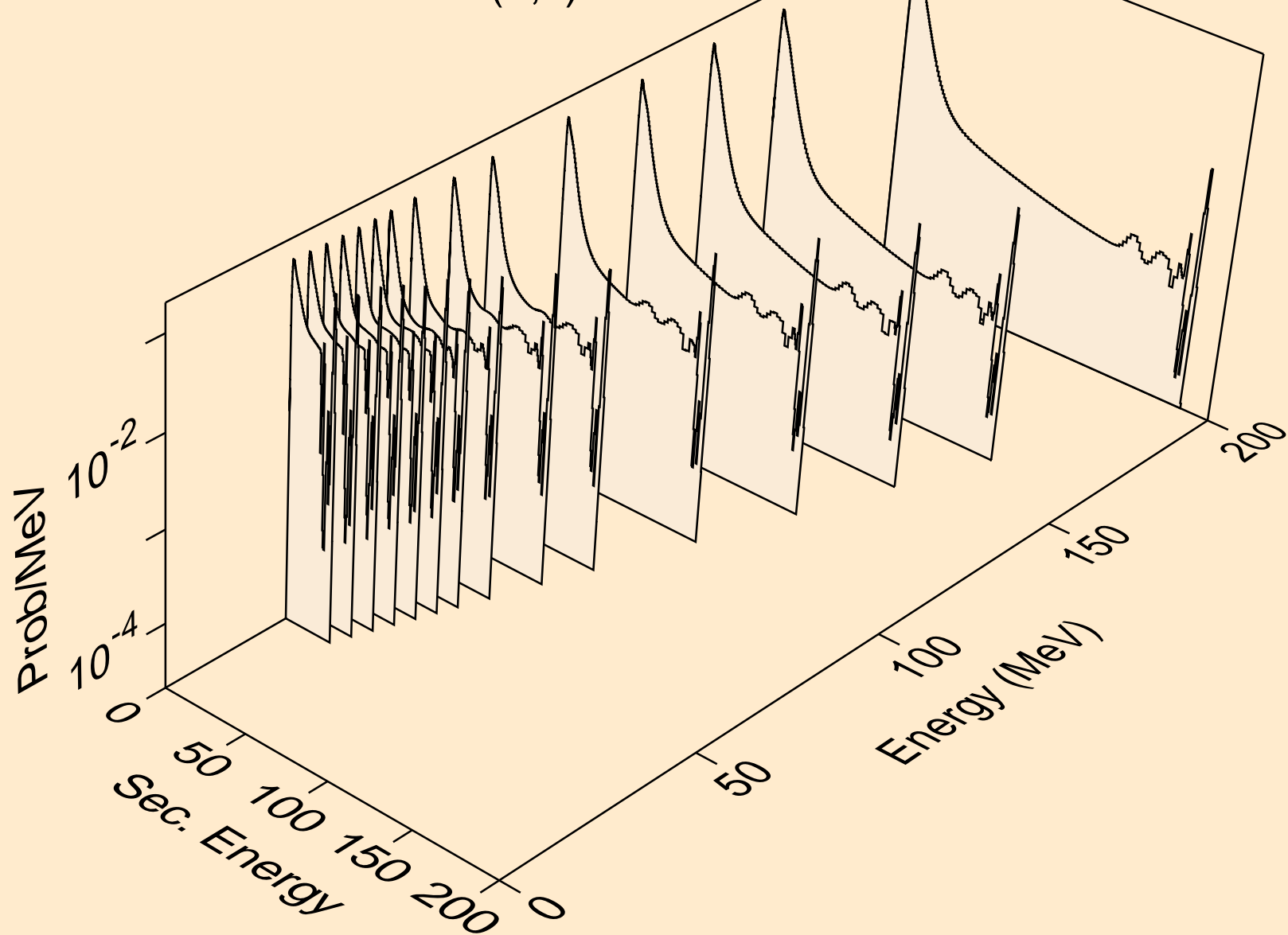

MG024 NEUTRON ACER TENDL-2023 LIBRARY; T=0.K  
Neutron emission for (n,2n)

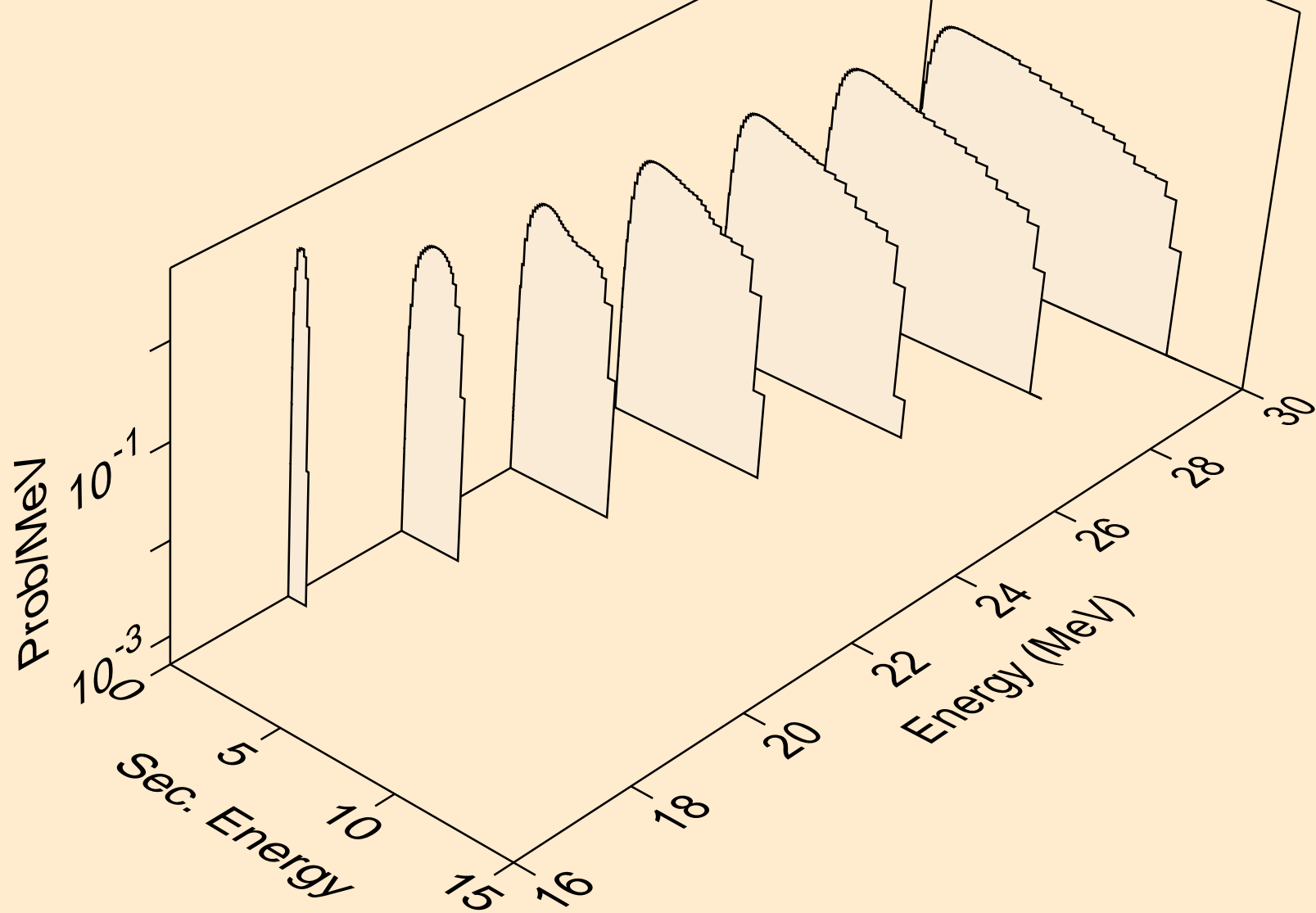

MG024 NEUTRON ACER TENDL-2023 LIBRARY; T=0.K  
Neutron emission for (n,n\*)a

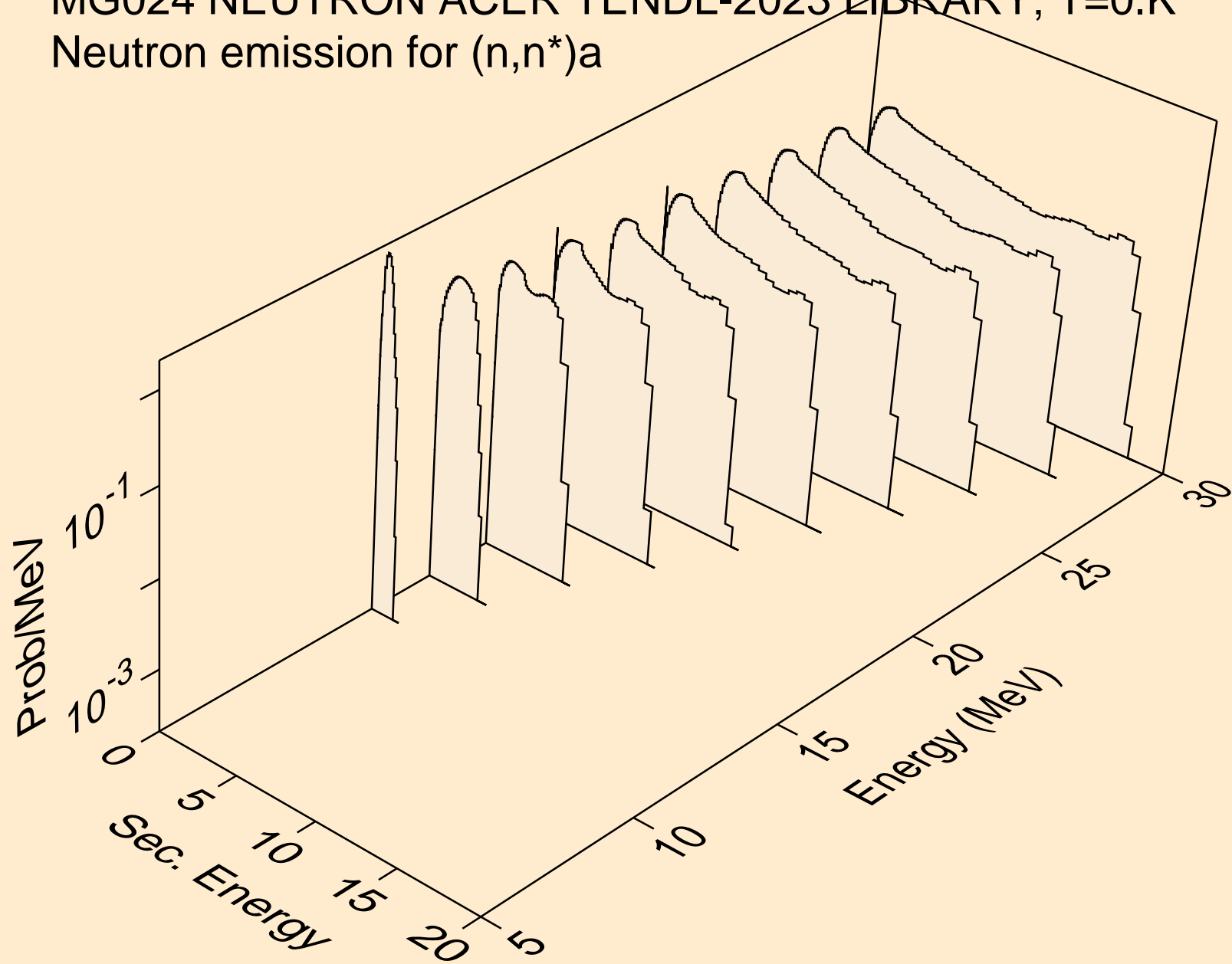

MG024 NEUTRON ACER TENDL-2023 LIBRARY; T=0.K  
Neutron emission for (n,2n)a

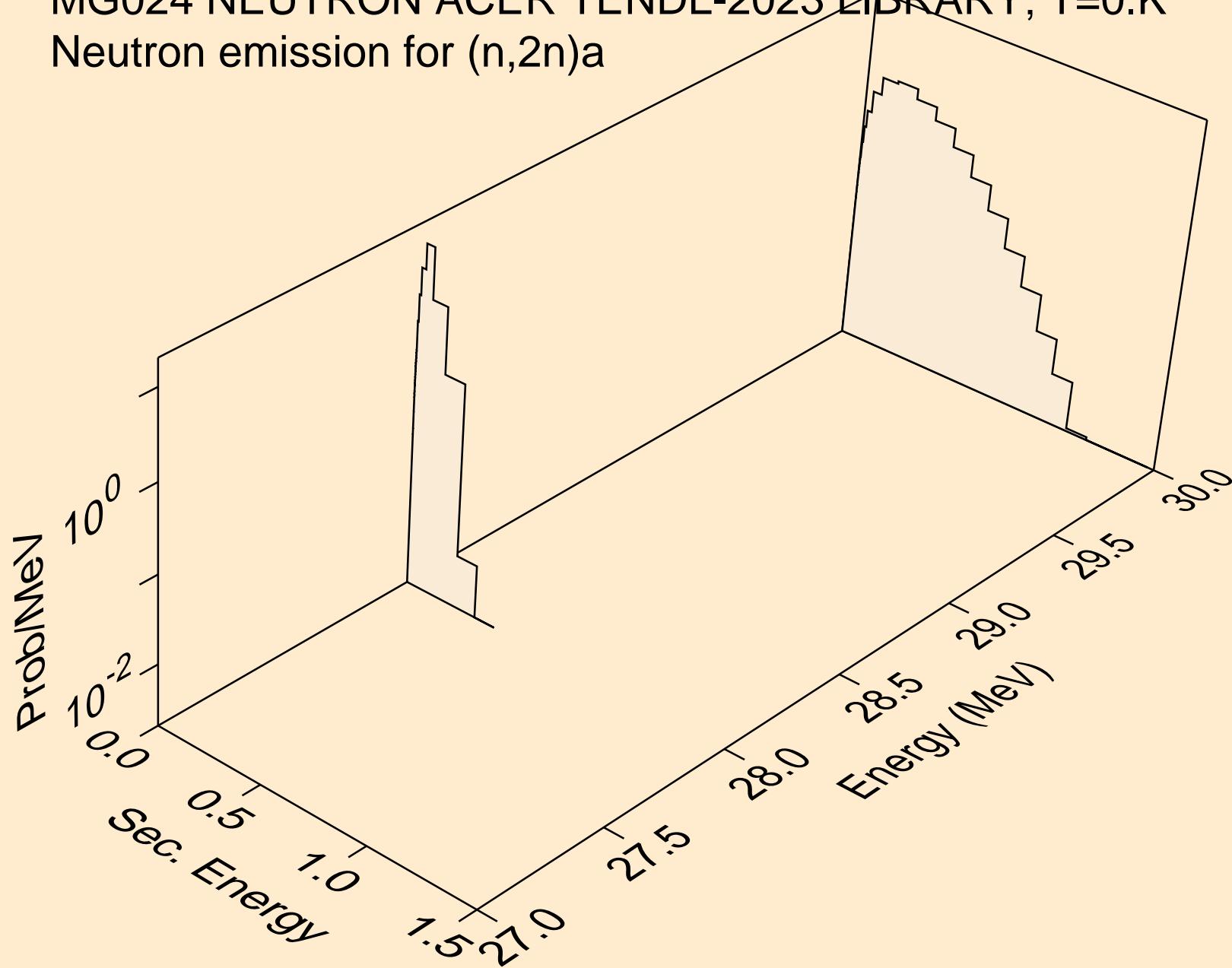

MG024 NEUTRON ACER TENDL-2023 LIBRARY; T=0.K  
Neutron emission for (n,n\*)p

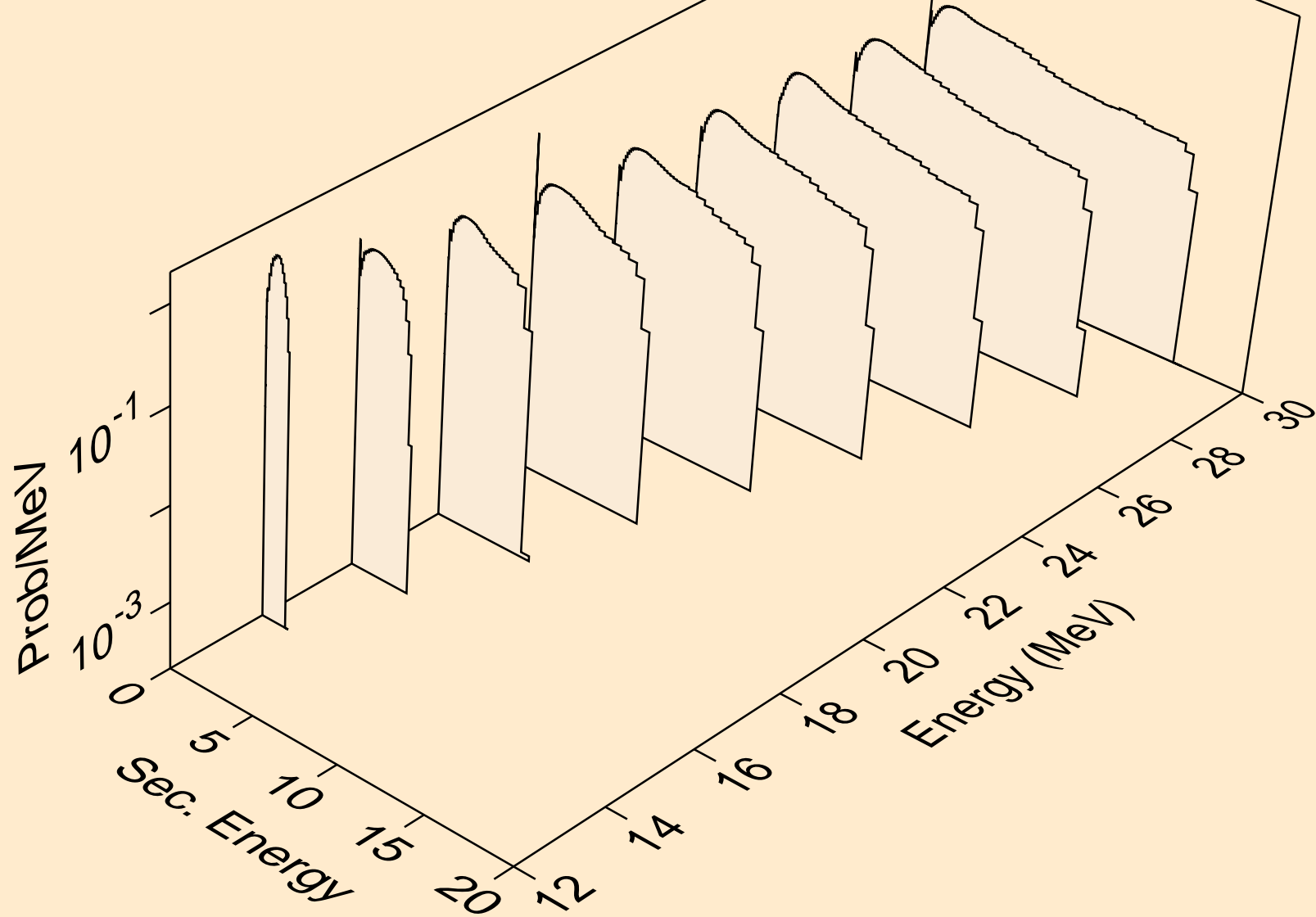

MG024 NEUTRON ACER TENDL-2023 LIBRARY; T=0.K  
Neutron emission for (n,n\*)2a

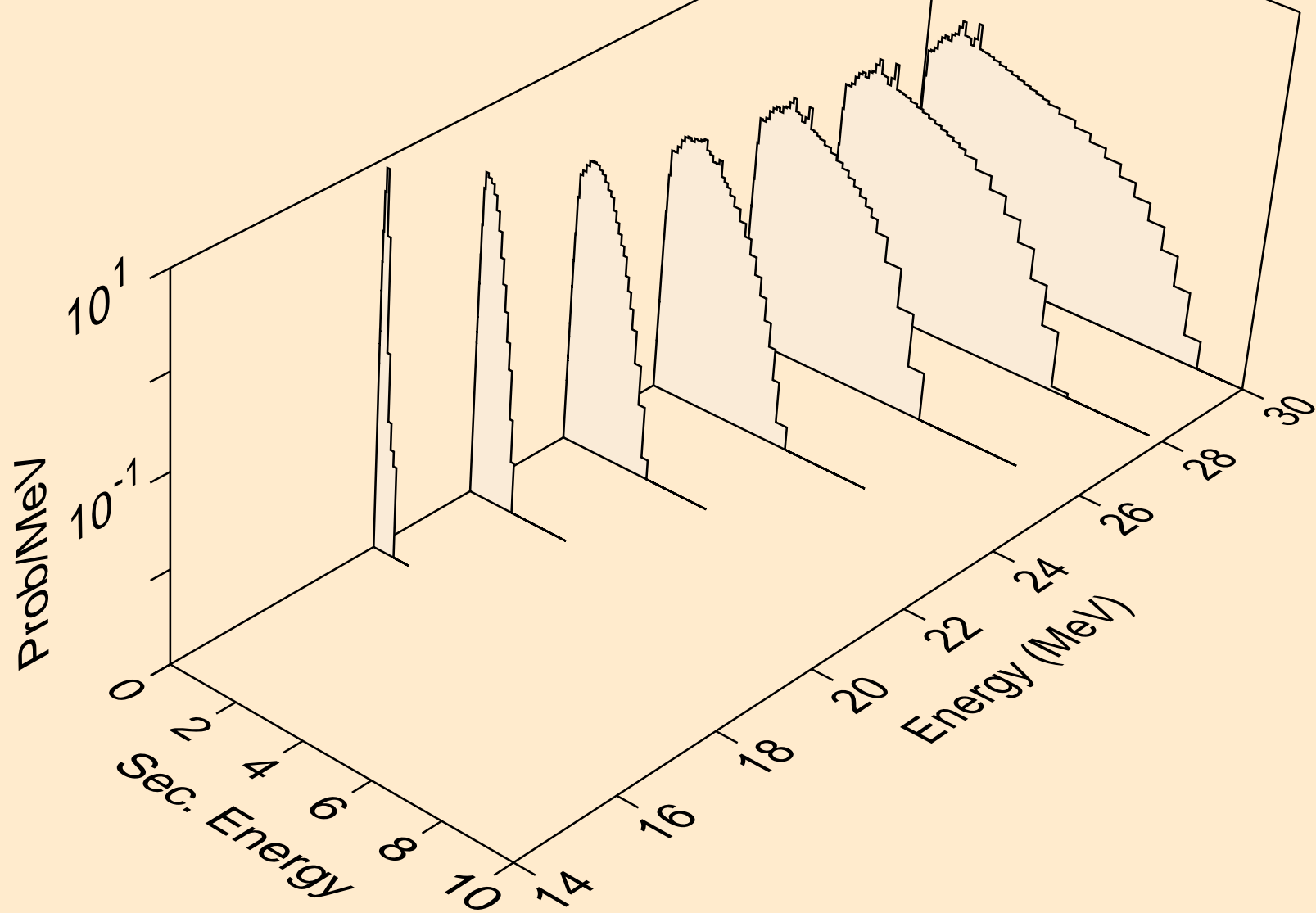

MG024 NEUTRON ACER TENDL-2023 LIBRARY; T=0.K  
Neutron emission for (n,n\*)d

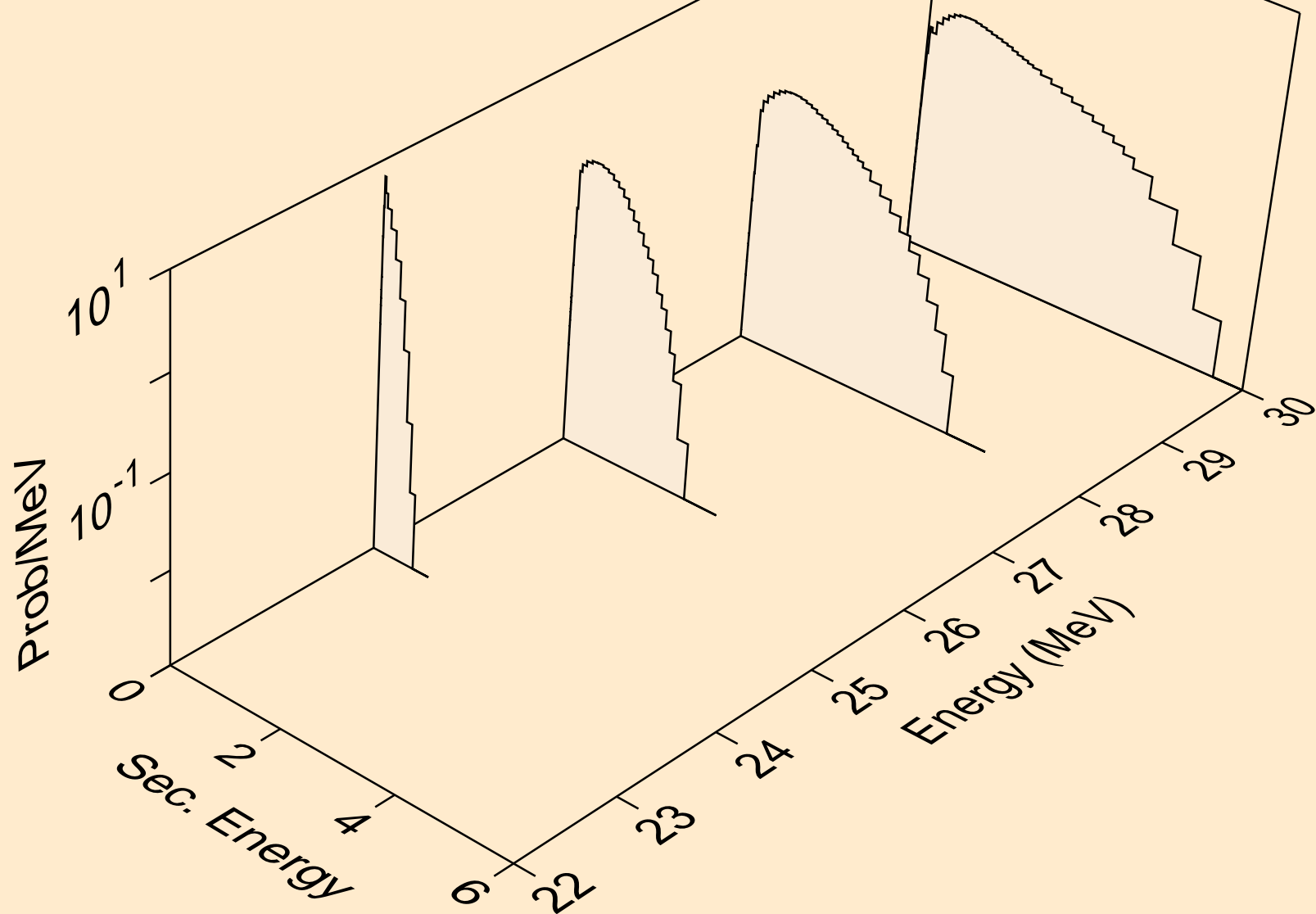



MG024 NEUTRON ACER TENDL-2023 LIBRARY; T=0.K  
Neutron emission for (n,n\*)t

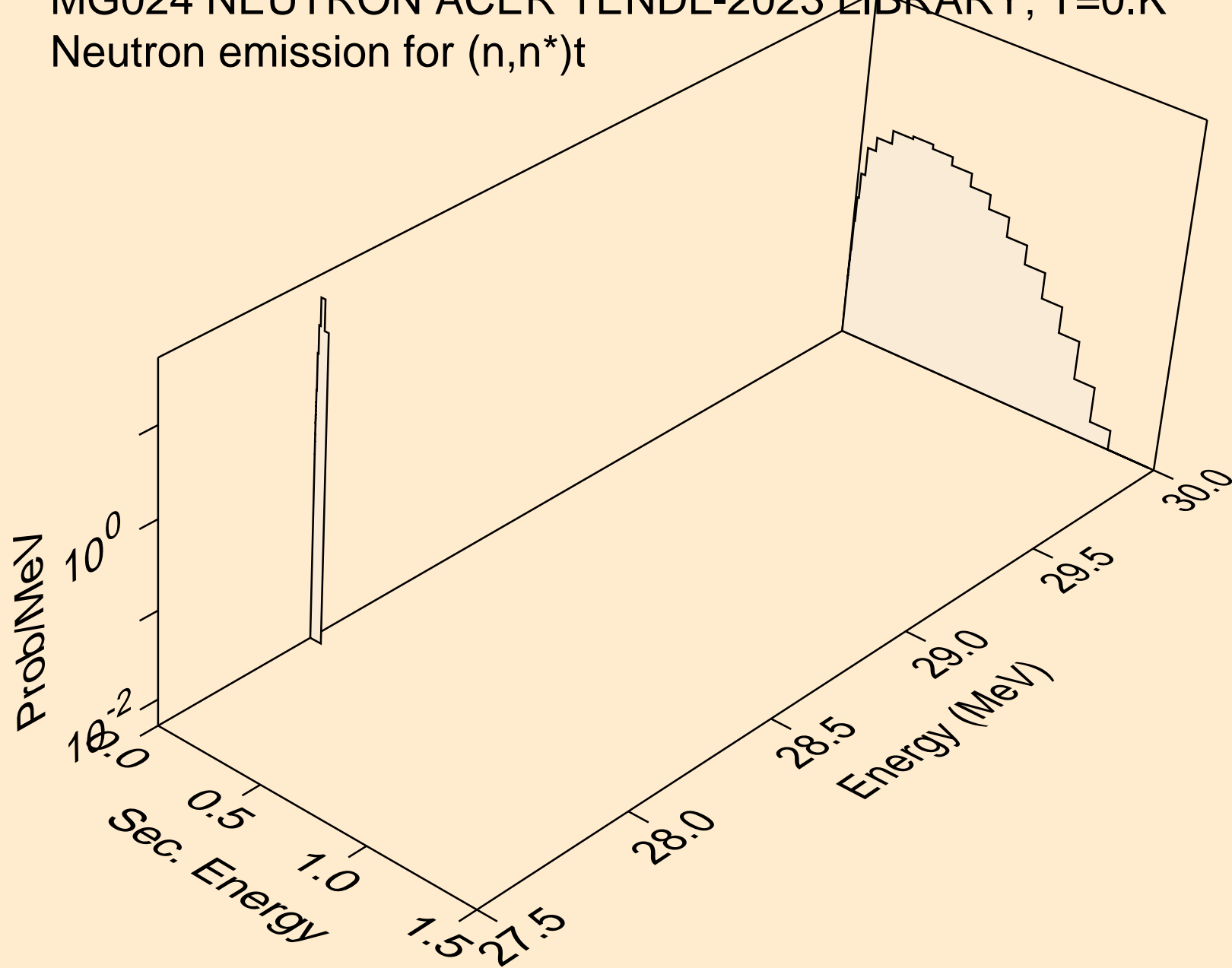

MG024 NEUTRON ACER TENDL-2023 LIBRARY; T=0.K  
Neutron emission for (n,n\*)he3

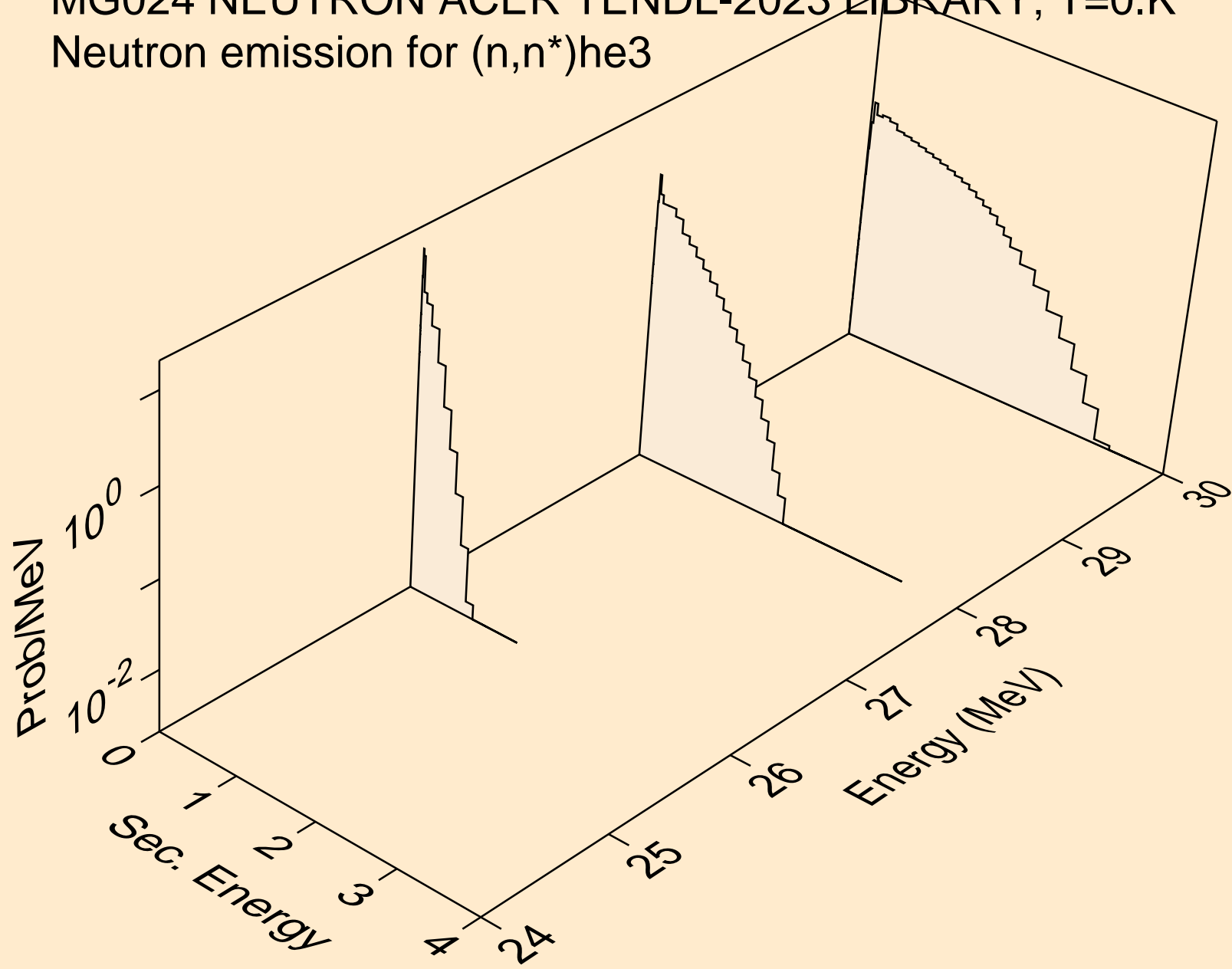

MG024 NEUTRON ACER TENDL-2023 LIBRARY; T=0.K  
Neutron emission for (n,2np)

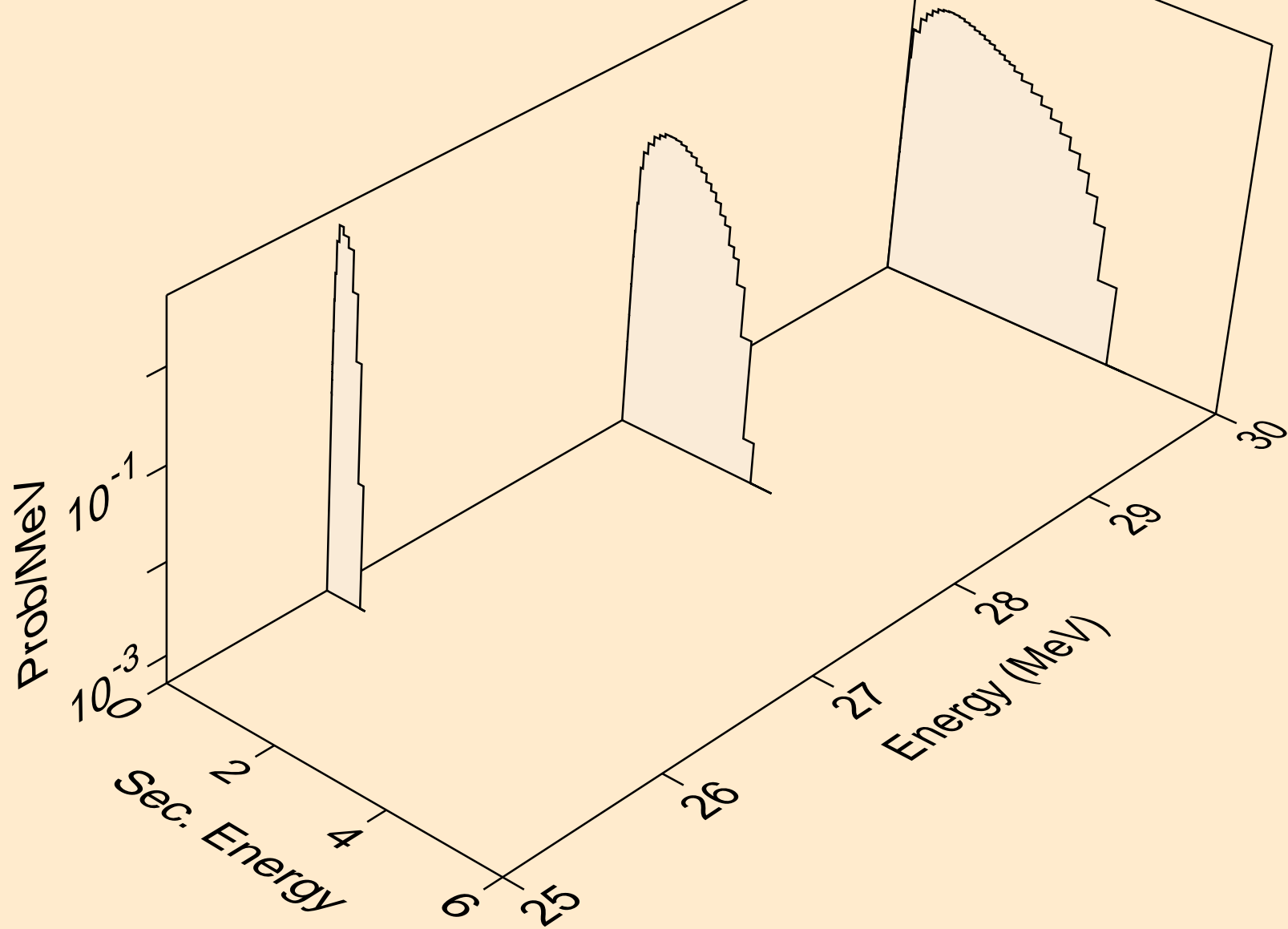

MG024 NEUTRON ACER TENDL-2023 LIBRARY; T=0.K  
Neutron emission for (n,n2p)

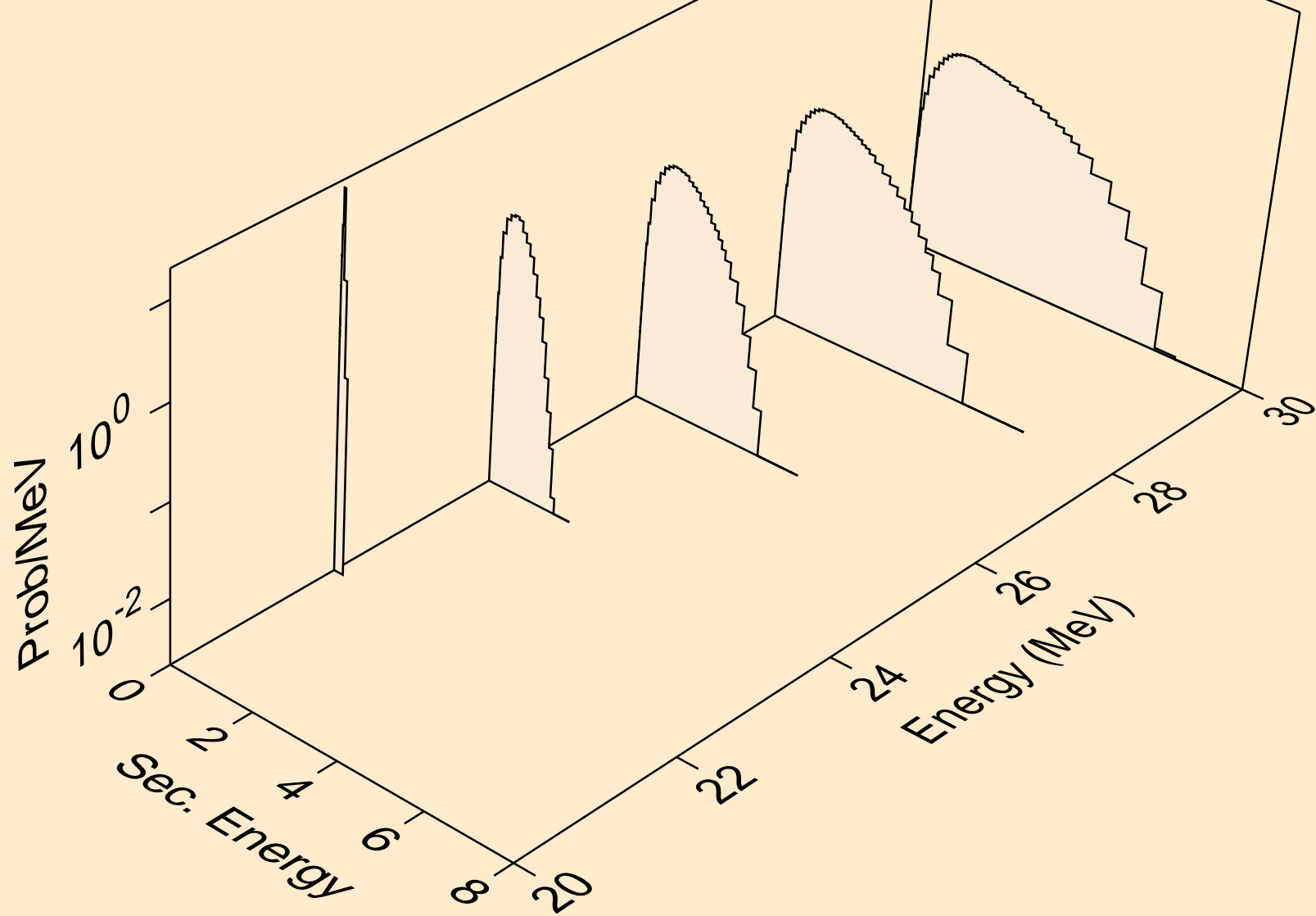

MG024 NEUTRON ACER TENDL-2023 LIBRARY; T=0.K  
Neutron emission for (n,npa)

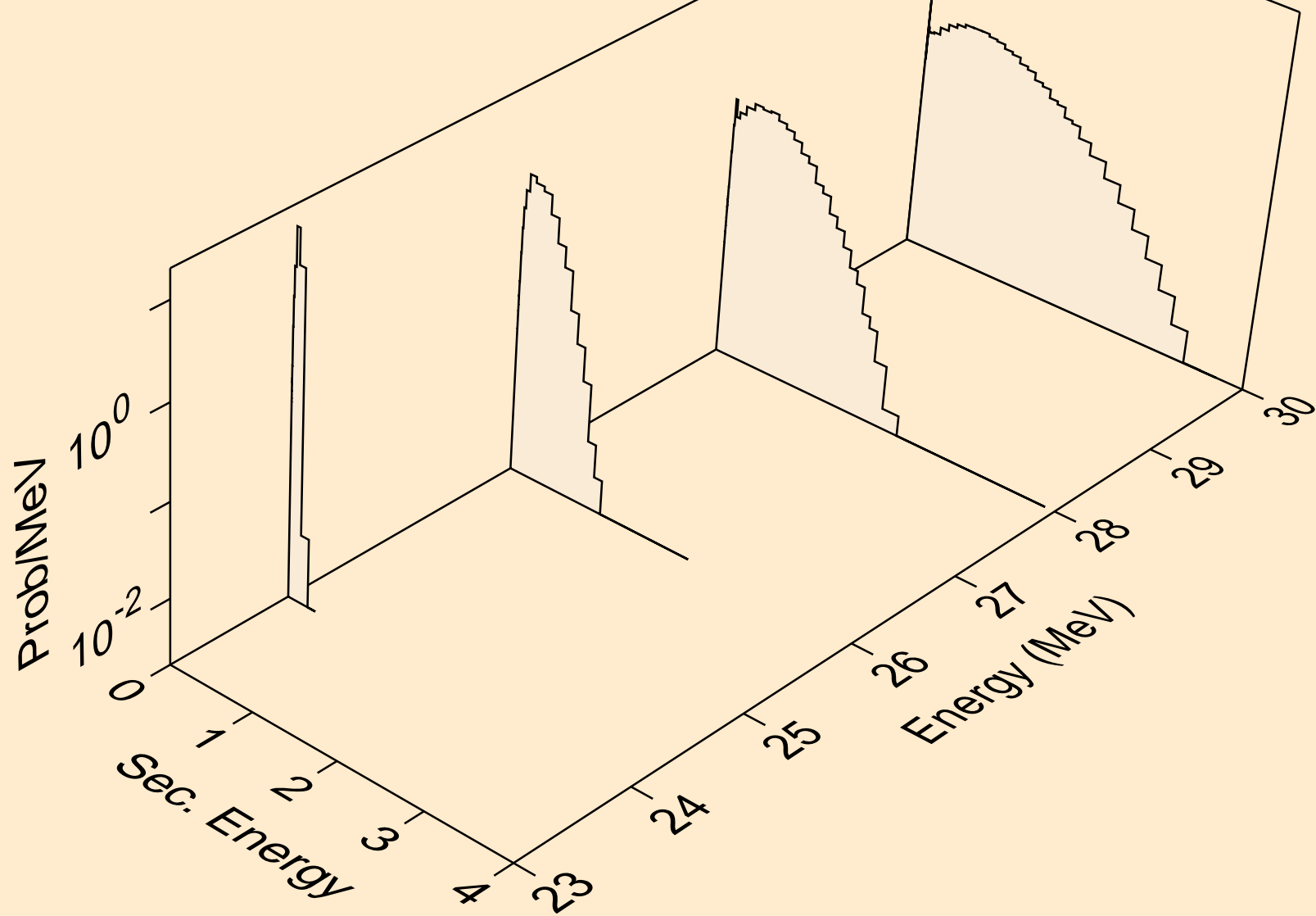

MG024 NEUTRON ACER TENDL-2023 LIBRARY; T=0.K  
Neutron emission for (n,n\*c)

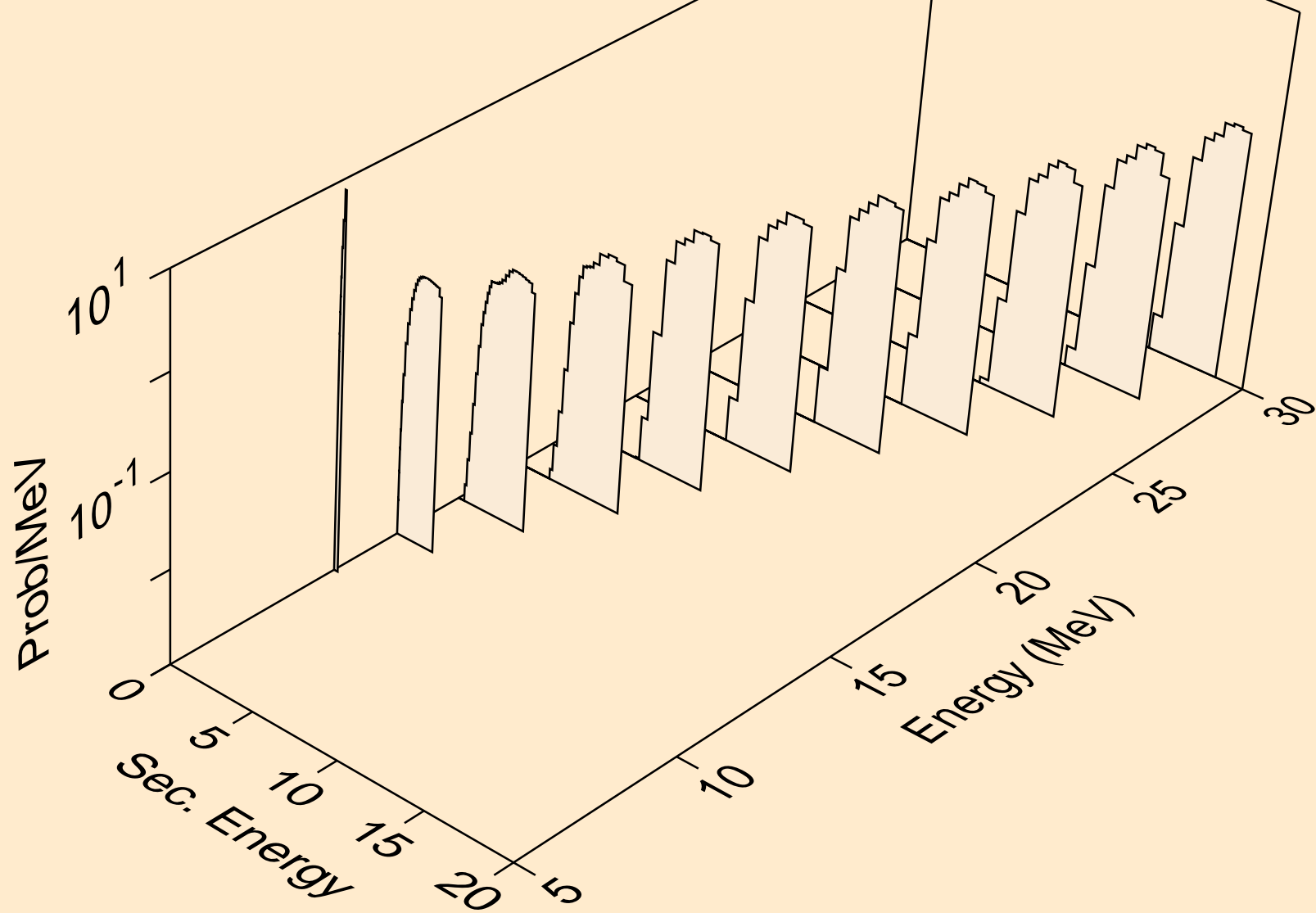

MG024 NEUTRON ACER TENDL-2023 LIBRARY; T=0.K  
Photon emission for (n,x)

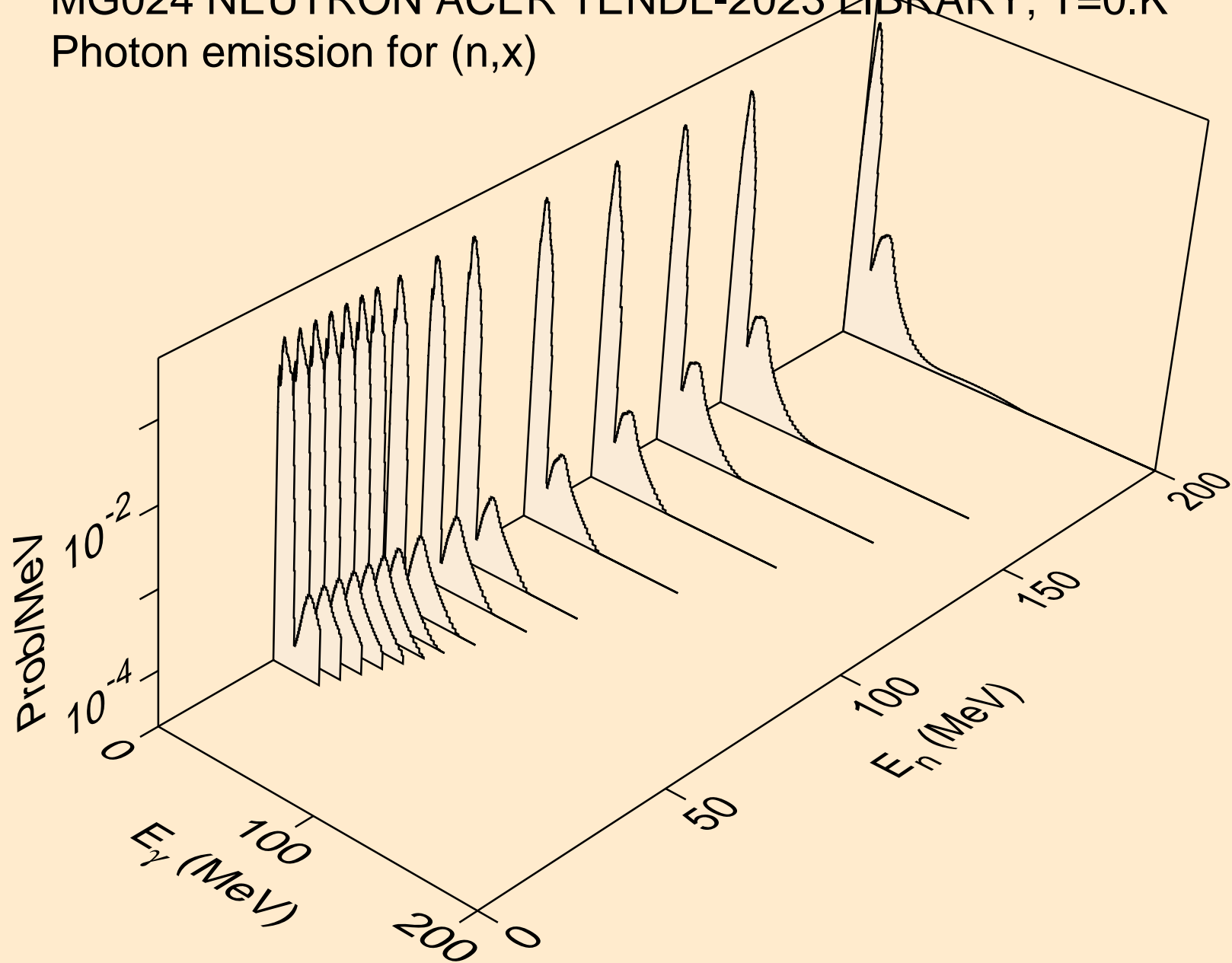

MG024 NEUTRON ACER TENDL-2023 LIBRARY; T=0.K  
Photon emission for (n,2n)

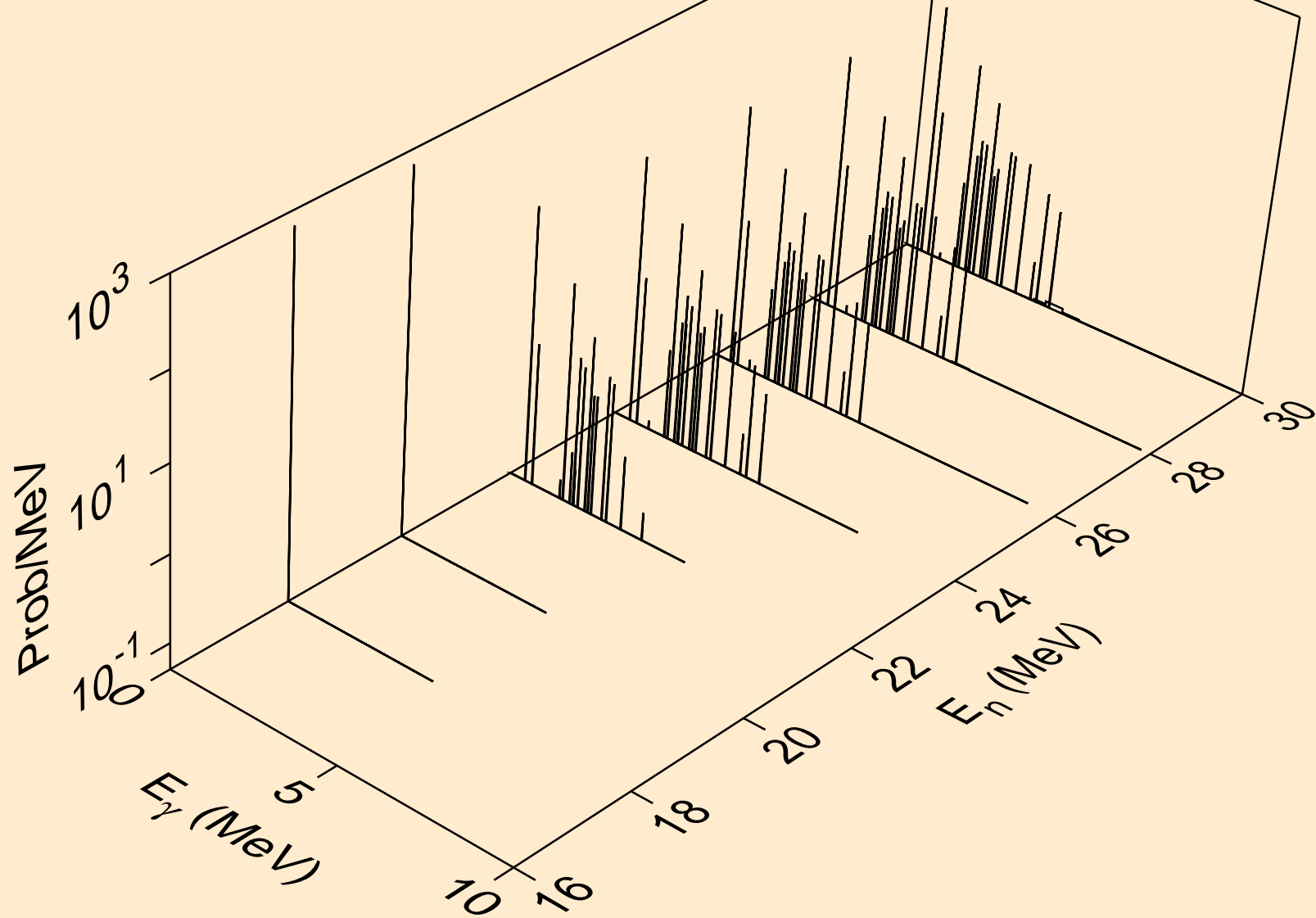



MG024 NEUTRON ACER TENDL-2023 LIBRARY; T=0.K  
Photon emission for (n,n\*)a

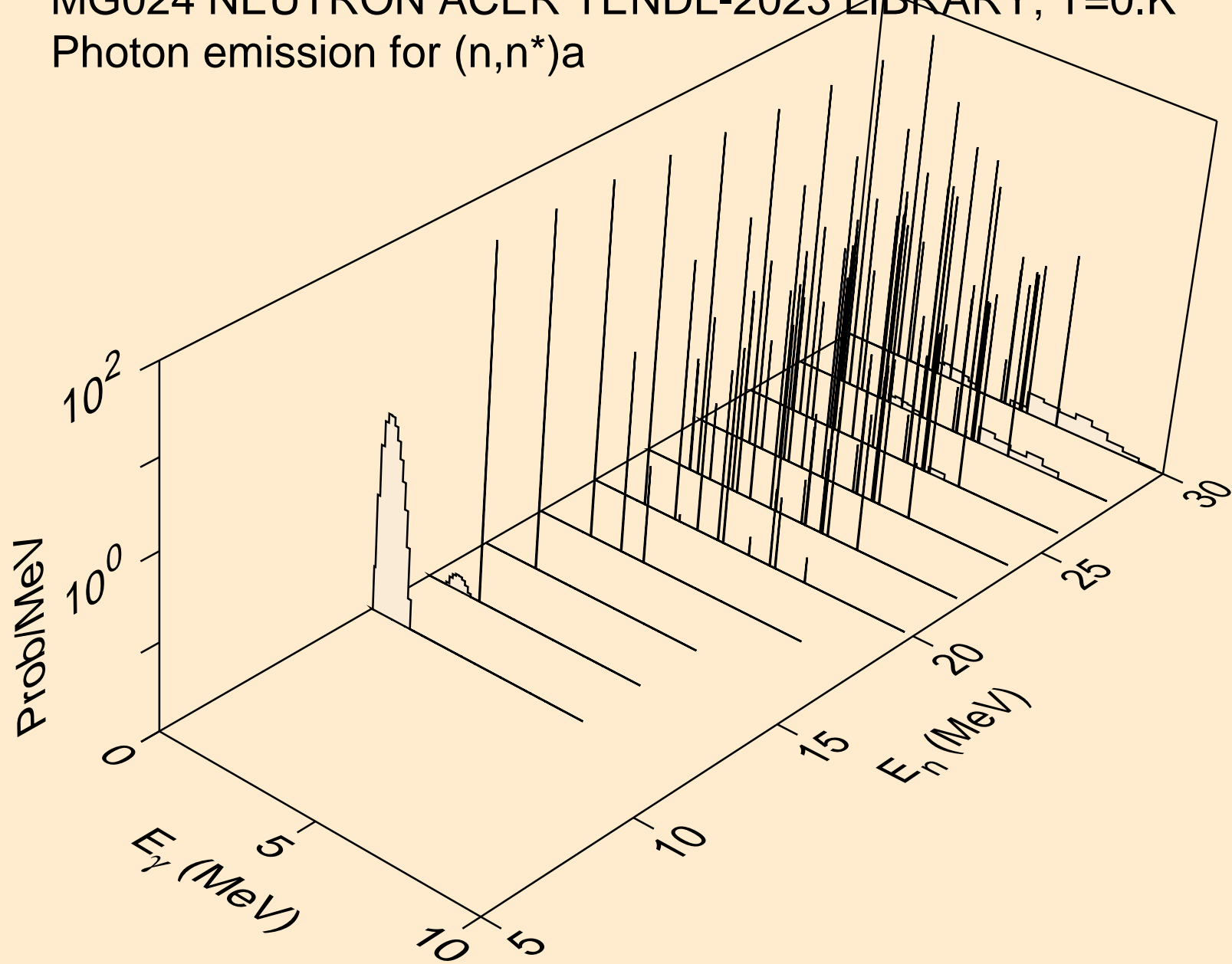

MG024 NEUTRON ACER TENDL-2023 LIBRARY; T=0.K  
Photon emission for (n,2n)a

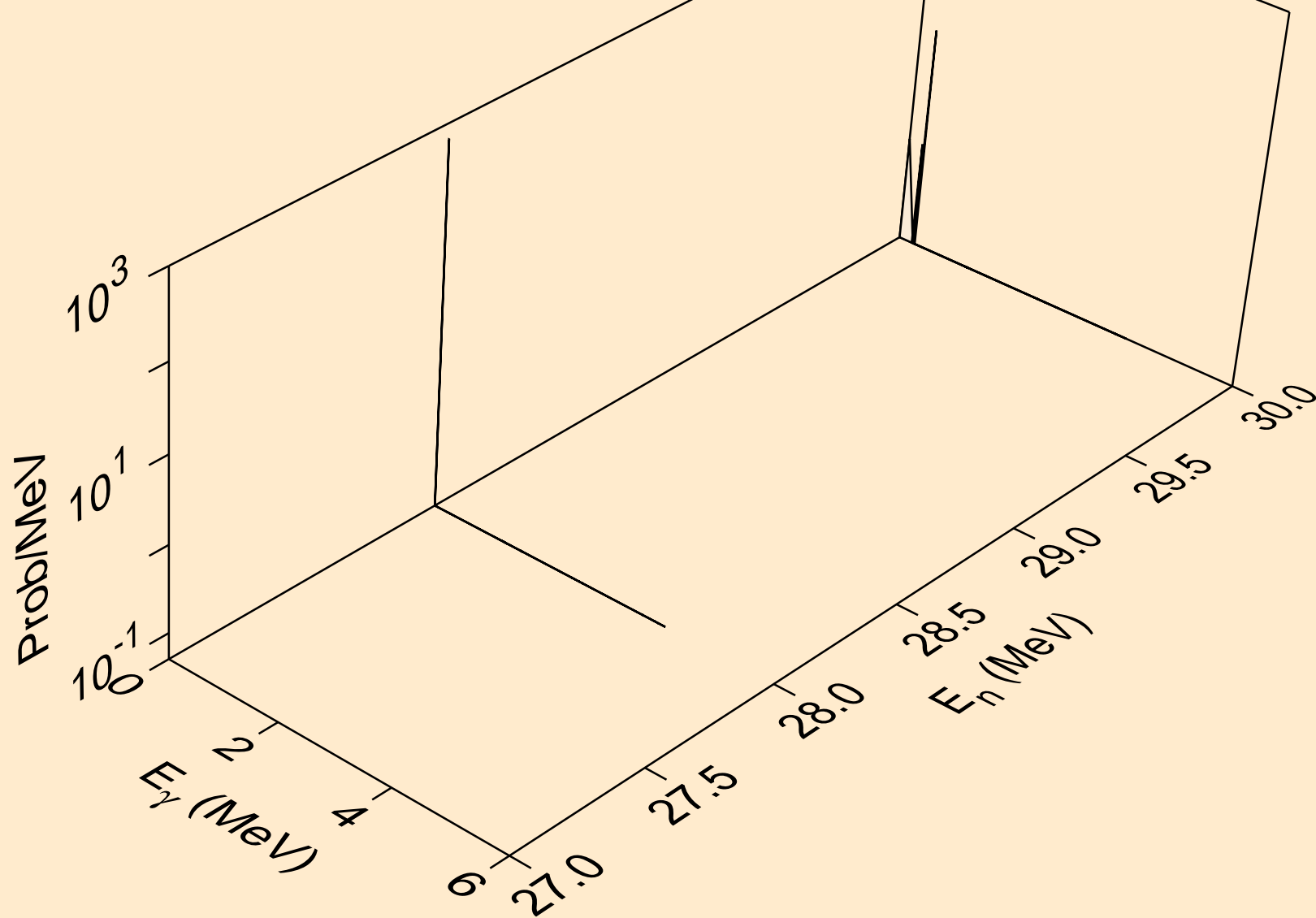

MG024 NEUTRON ACER TENDL-2023 LIBRARY; T=0.K  
Photon emission for (n,n\*)p

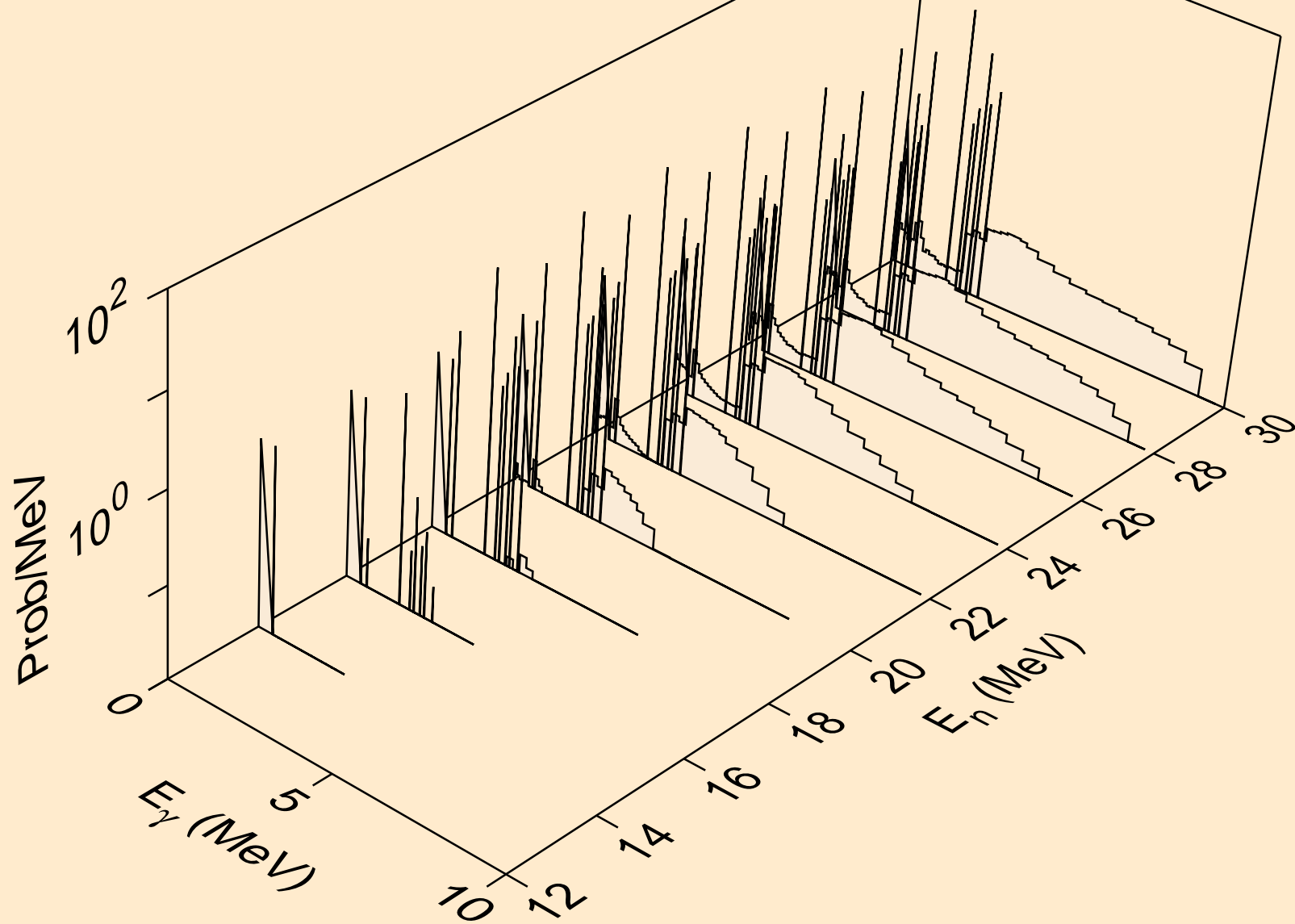

MG024 NEUTRON ACER TENDL-2023 LIBRARY; T=0.K  
Photon emission for (n,n\*)2a

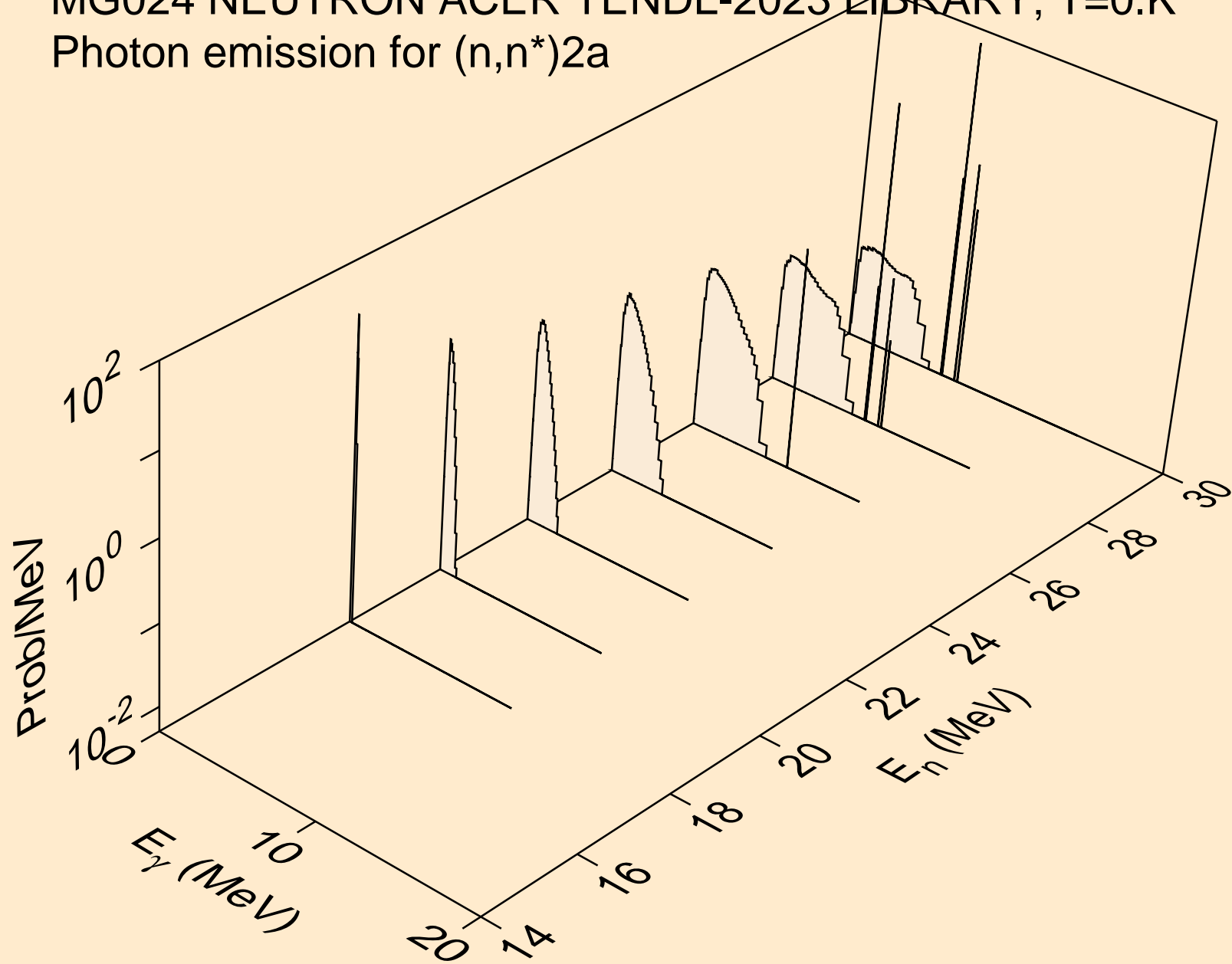

MG024 NEUTRON ACER TENDL-2023 LIBRARY; T=0.K  
Photon emission for (n,n\*)d

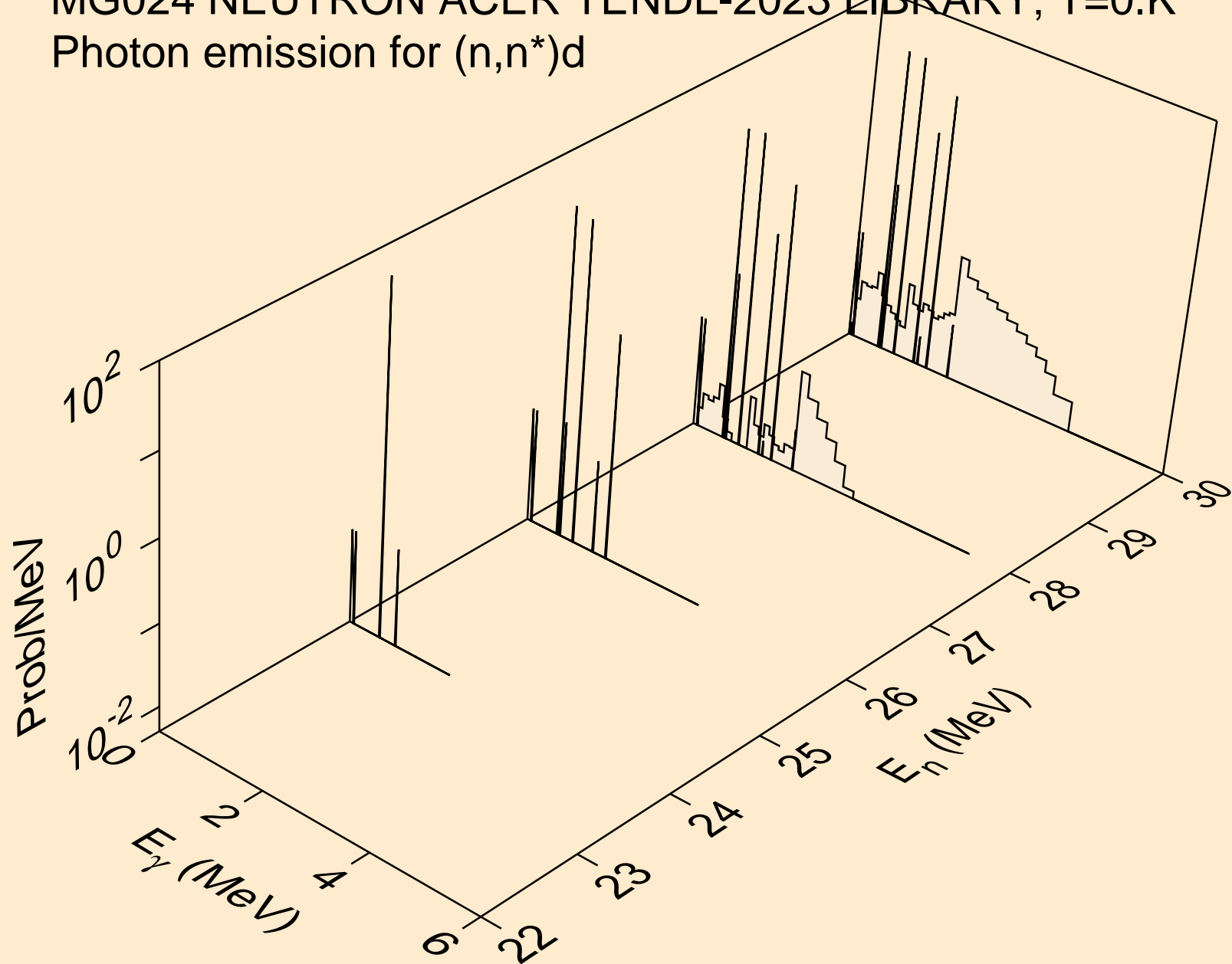

MG024 NEUTRON ACER TENDL-2023 LIBRARY; T=0.K  
Photon emission for (n,n\*)t

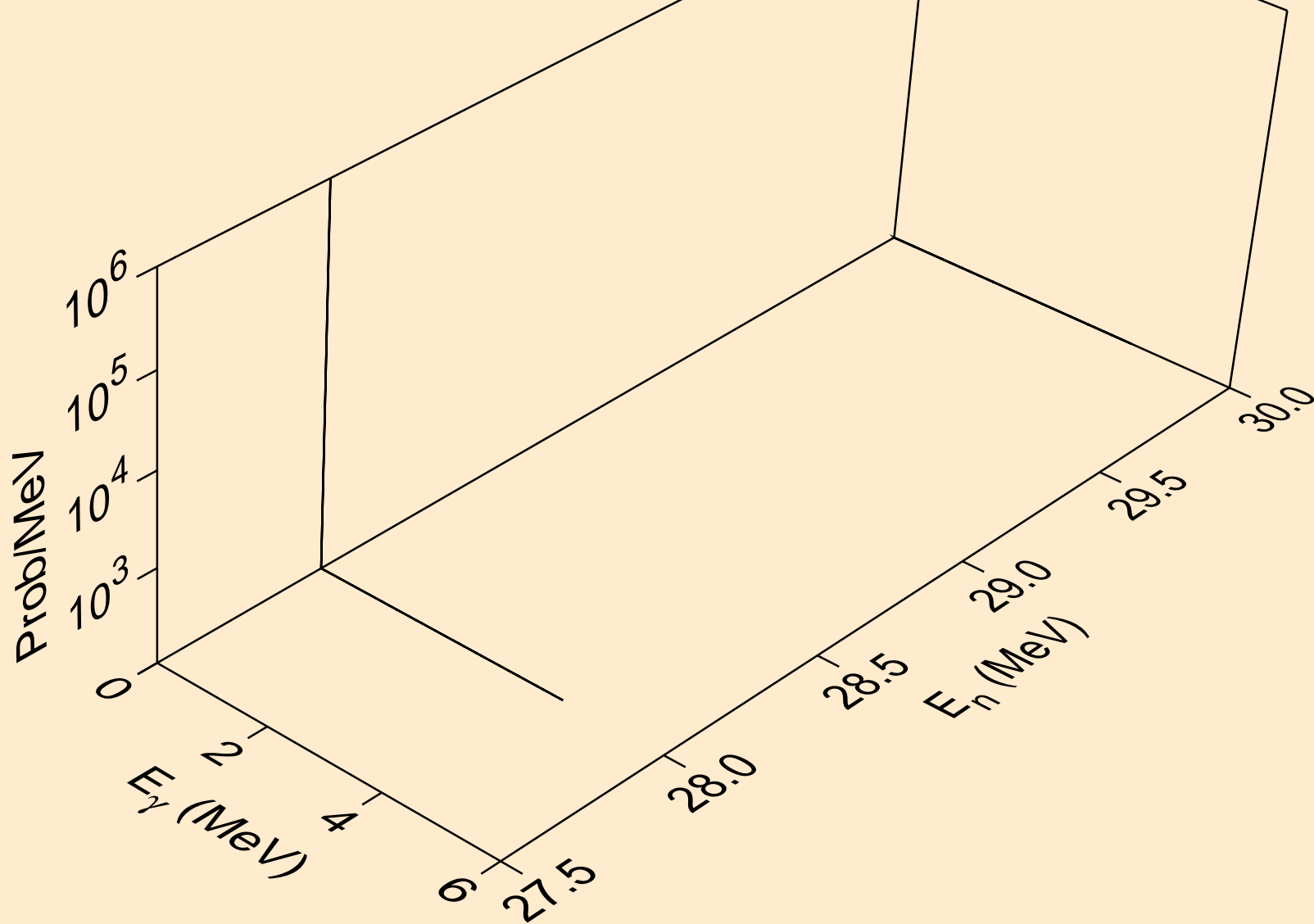

MG024 NEUTRON ACER TENDL-2023 LIBRARY; T=0.K  
Photon emission for (n,n\*)he3

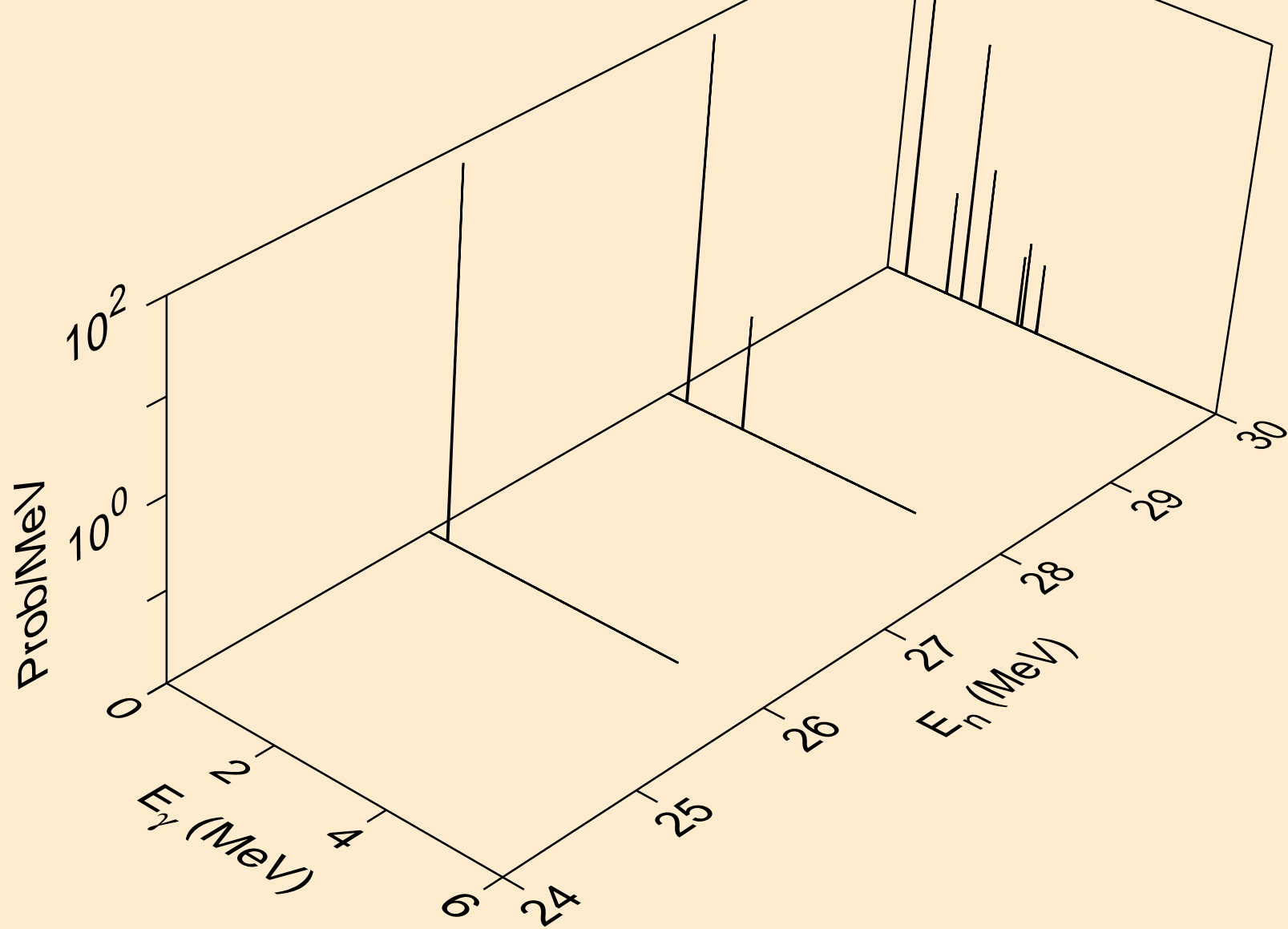

MG024 NEUTRON ACER TENDL-2023 LIBRARY; T=0.K  
Photon emission for (n,2np)

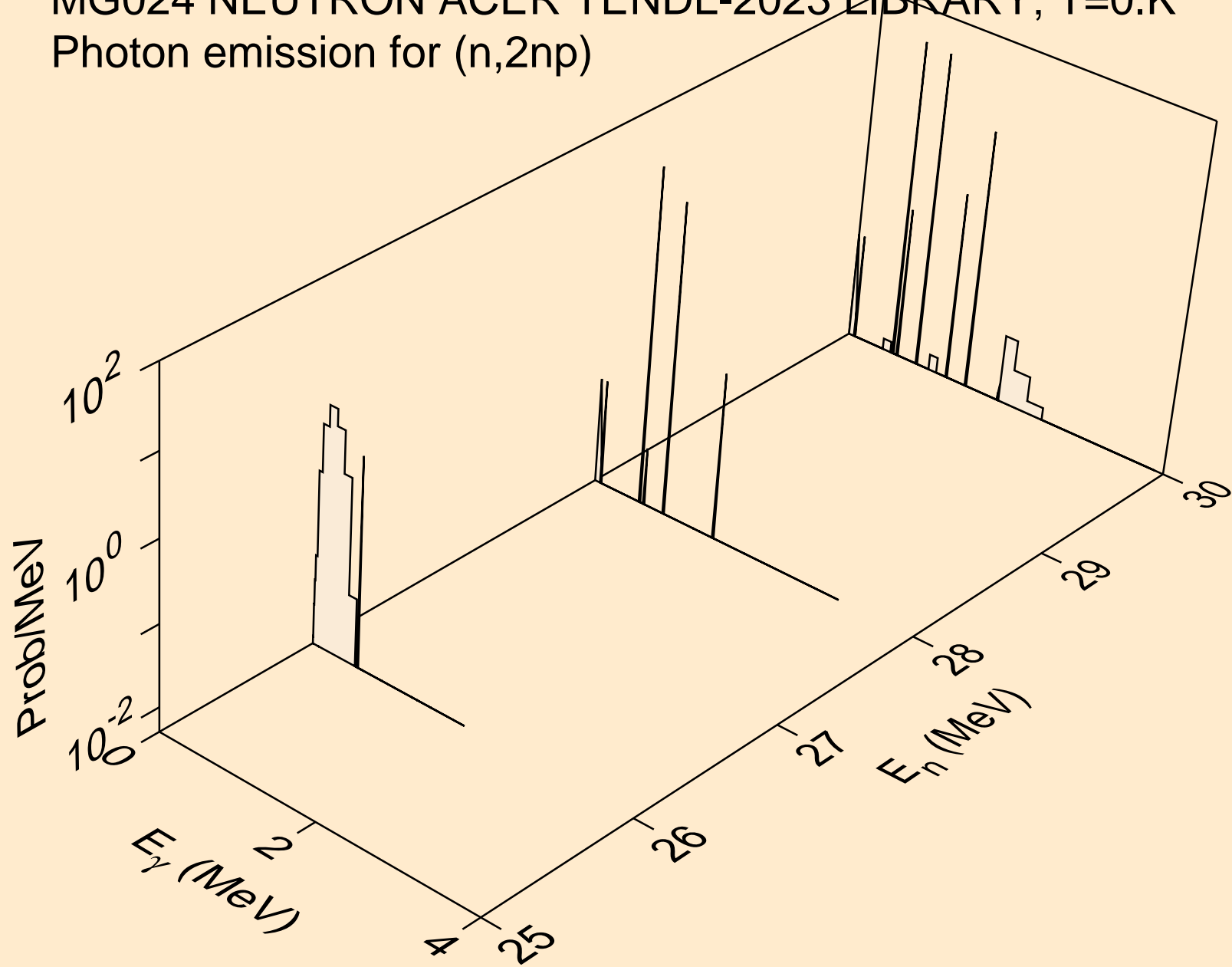



MG024 NEUTRON ACER TENDL-2023 LIBRARY; T=0.K  
Photon emission for (n,n2p)

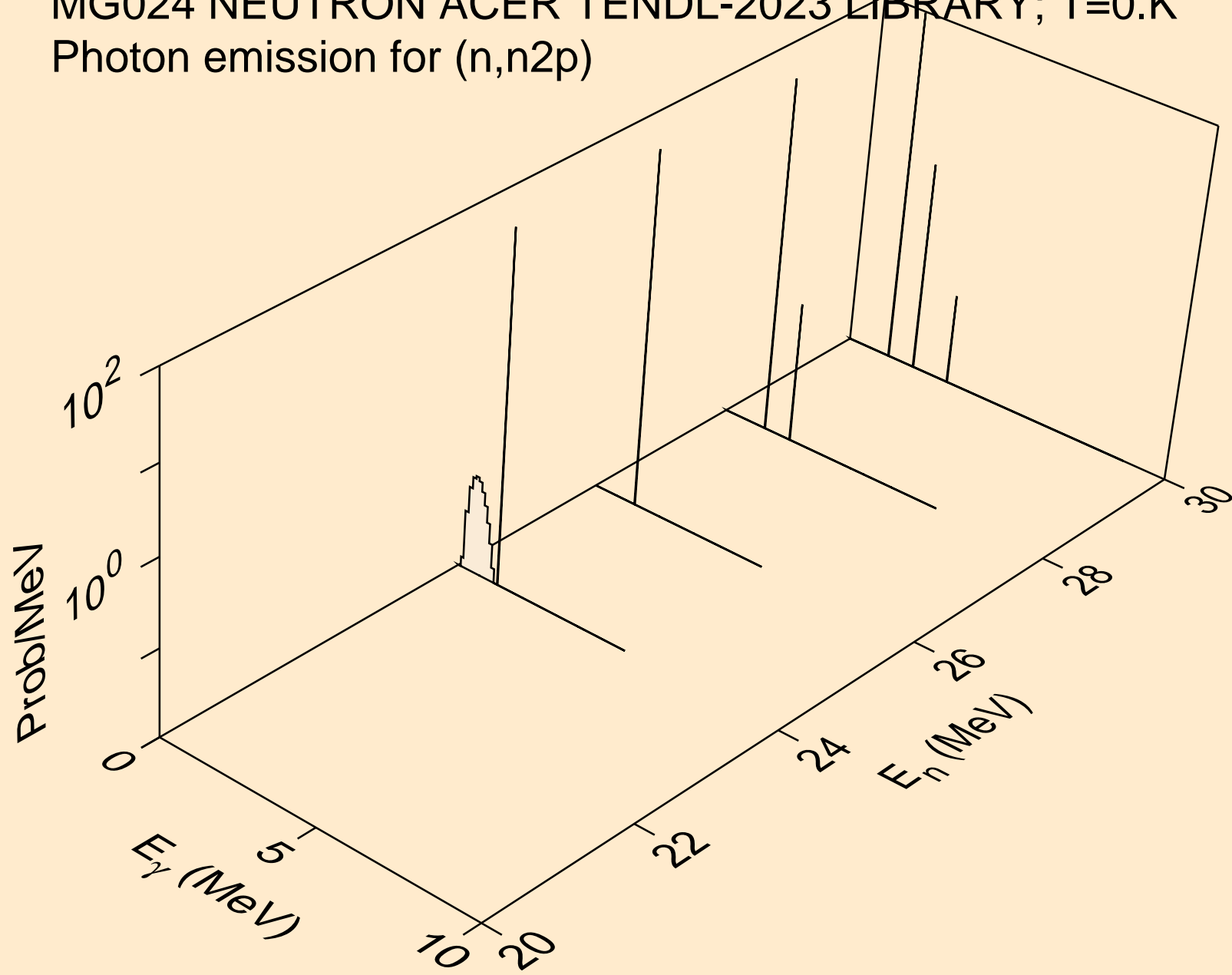

MG024 NEUTRON ACER TENDL-2023 LIBRARY; T=0.K  
Photon emission for (n,npa)

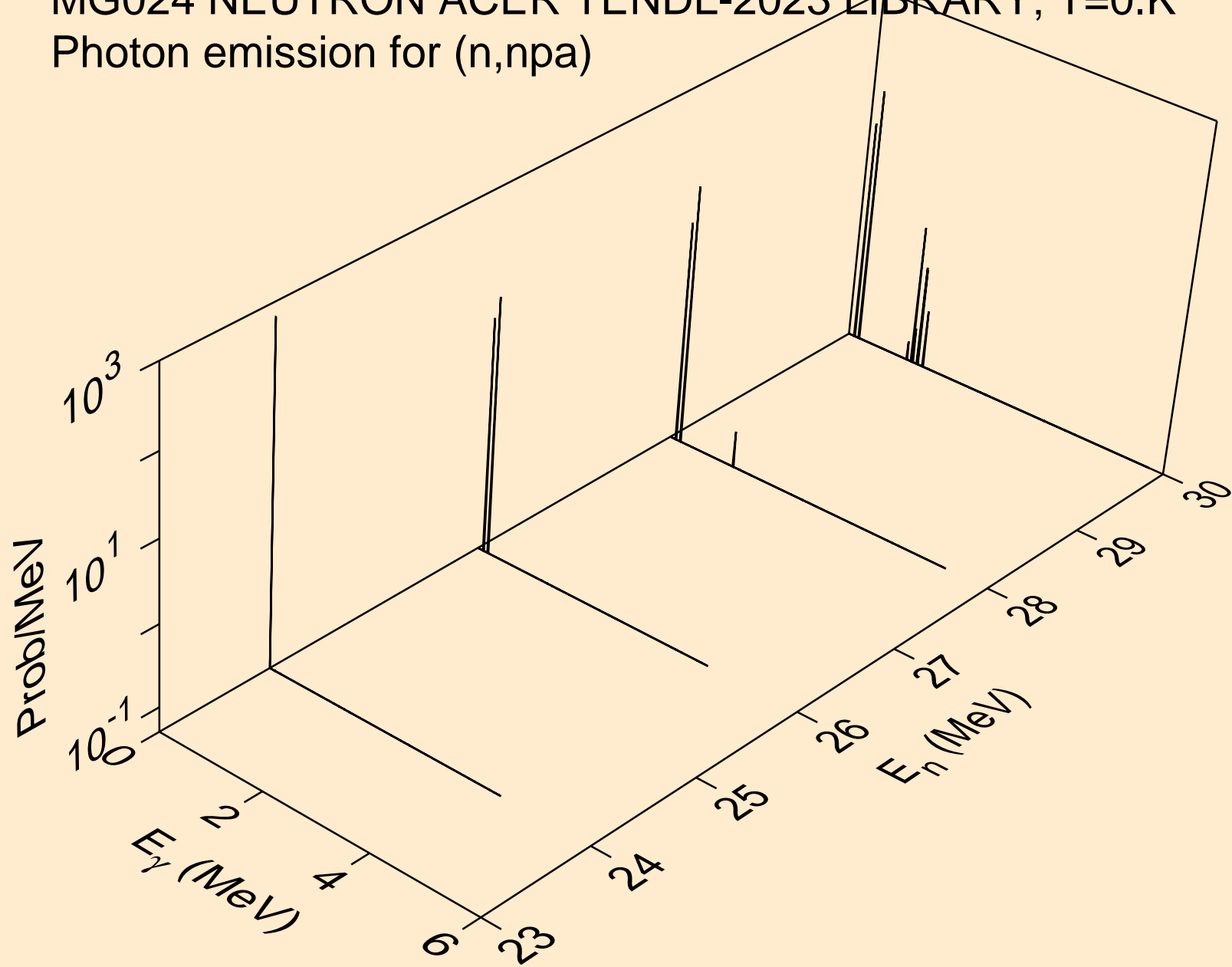

MG024 NEUTRON ACER TENDL-2023 LIBRARY; T=0.K  
Photon emission for (n,n\*c)

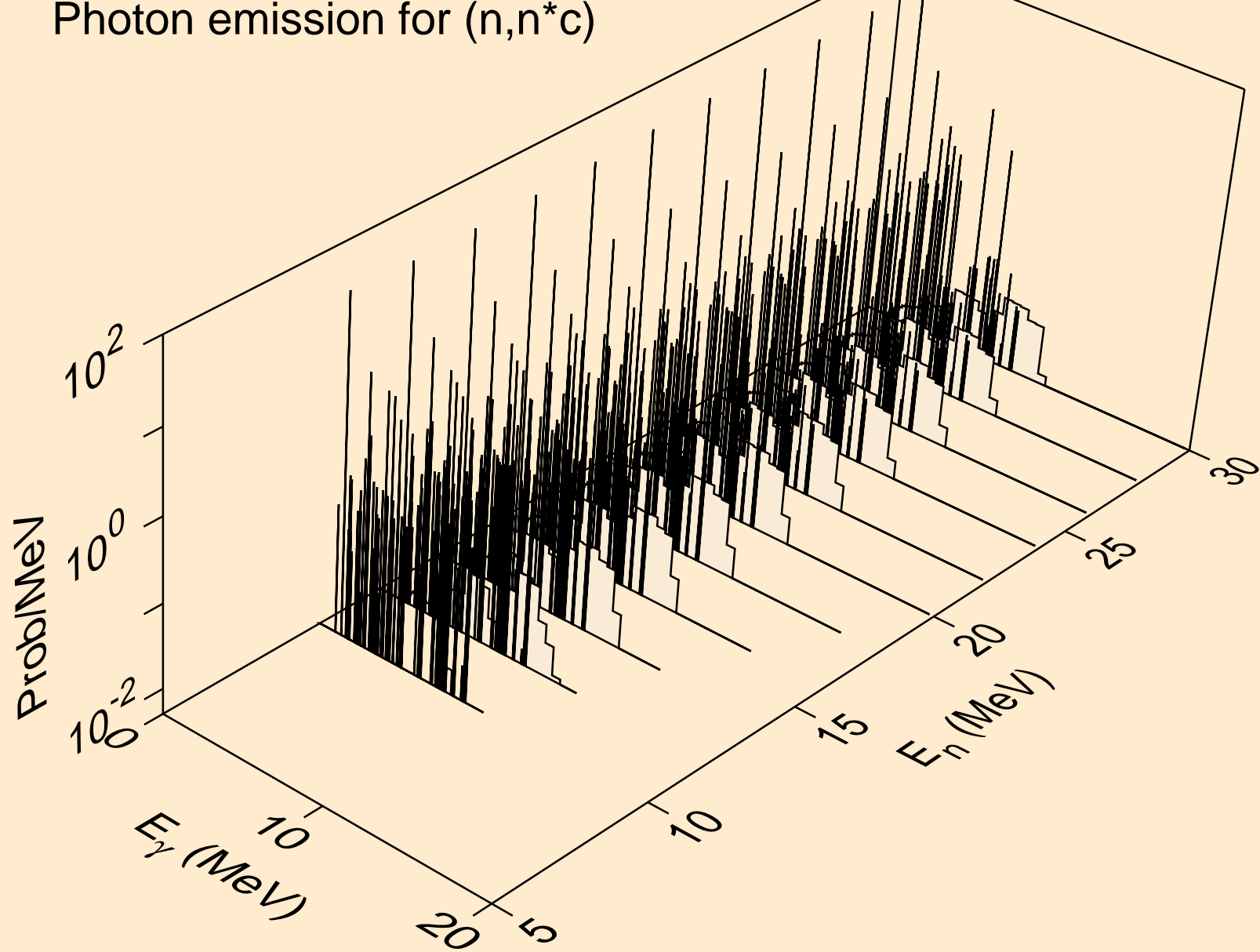

MG024 NEUTRON ACER TENDL-2023 LIBRARY; T=0.K  
Photon emission for (n,gma)

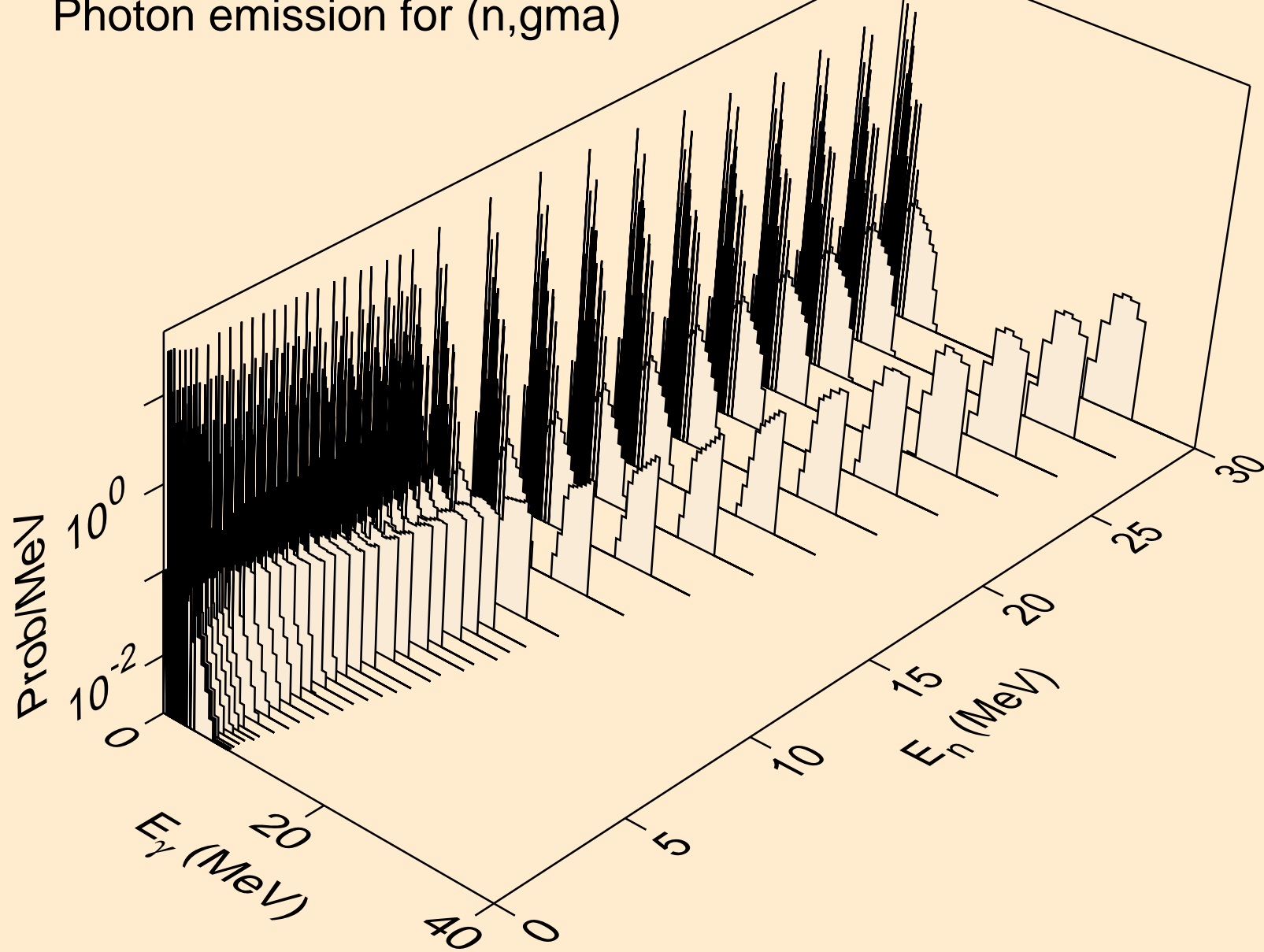

MG024 NEUTRON ACER TENDL-2023 LIBRARY; T=0.K  
Photon emission for (n,p)

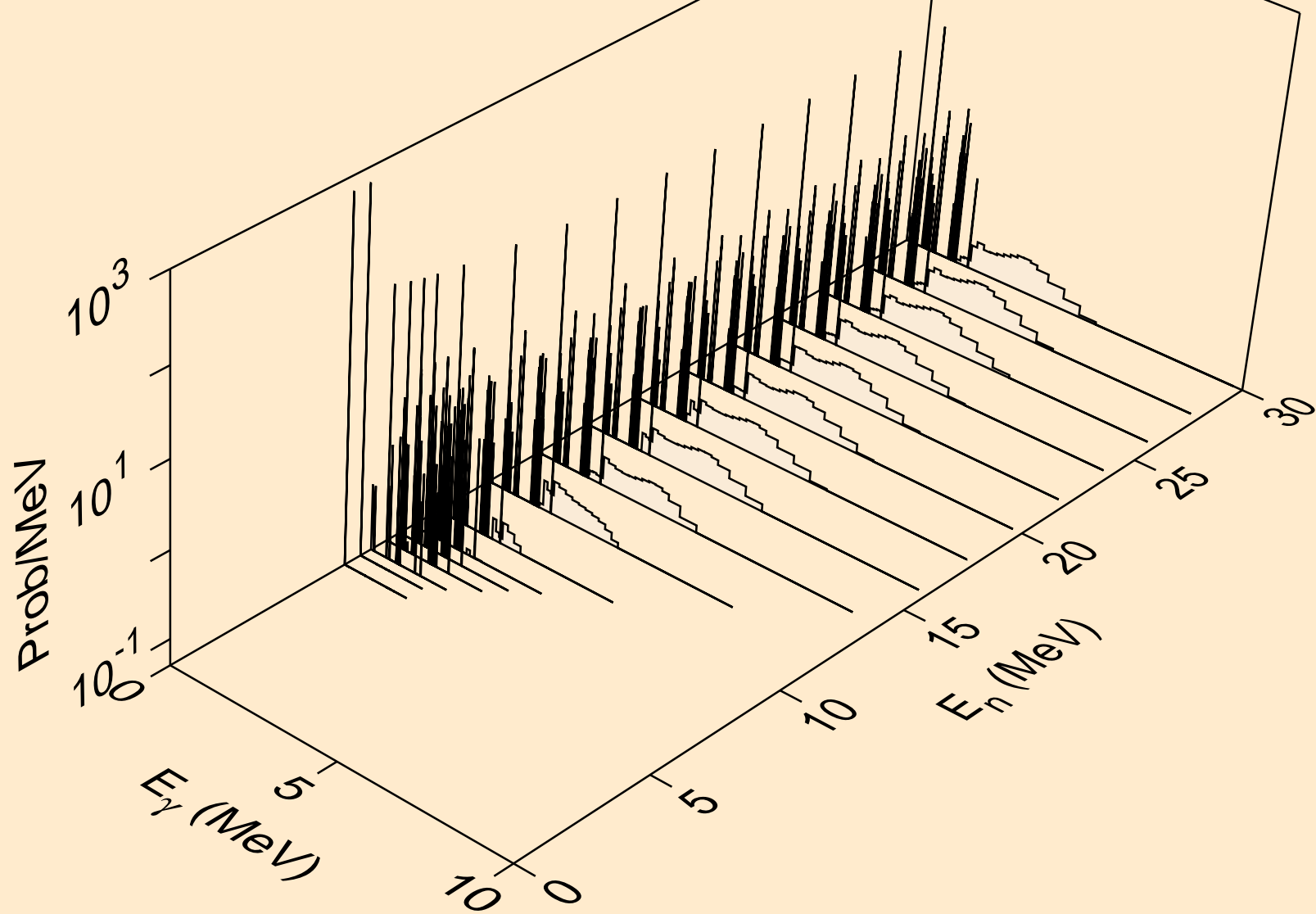

MG024 NEUTRON ACER TENDL-2023 LIBRARY; T=0.K  
Photon emission for (n,d)

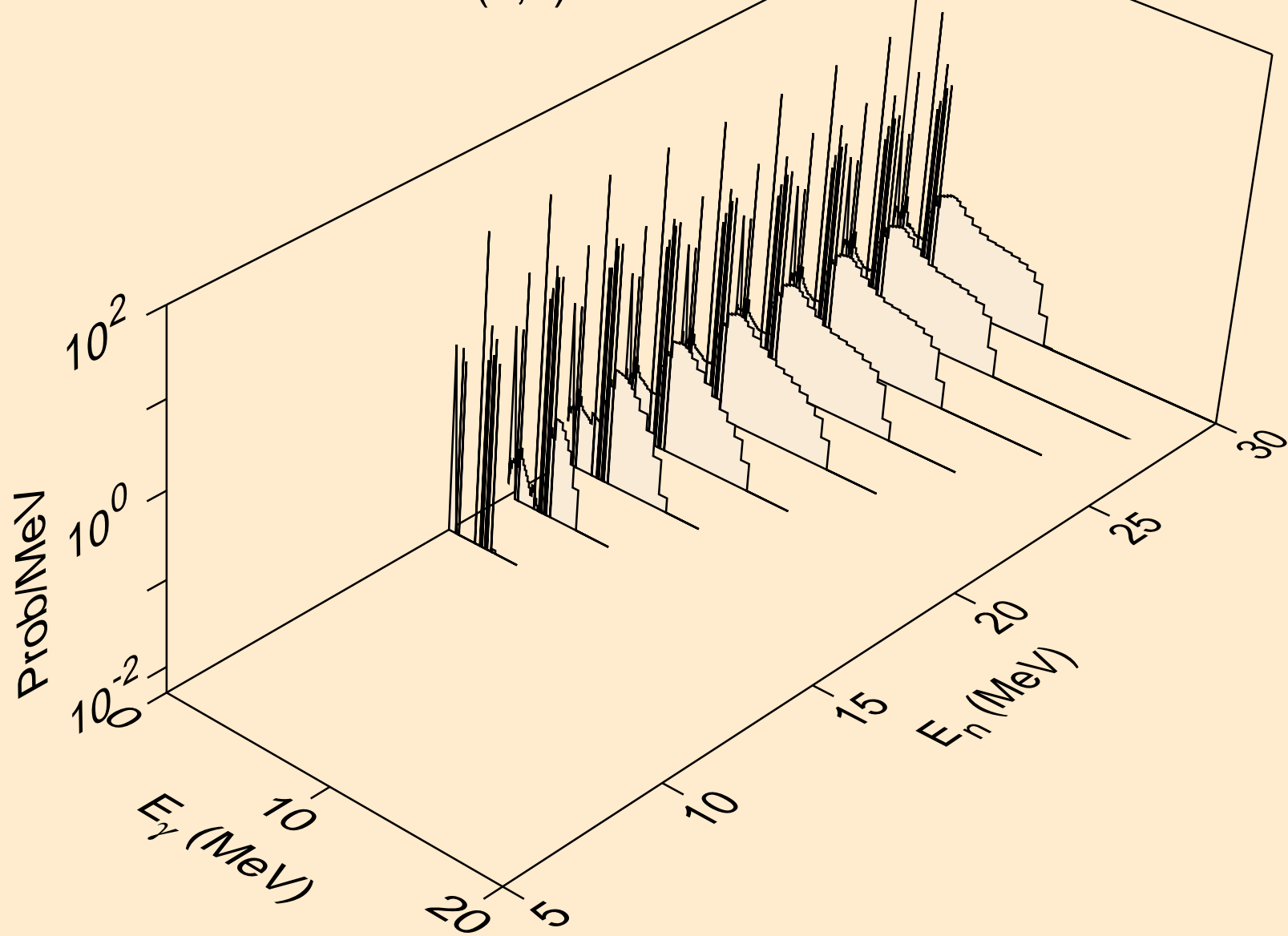

MG024 NEUTRON ACER TENDL-2023 LIBRARY; T=0.K  
Photon emission for (n,t)

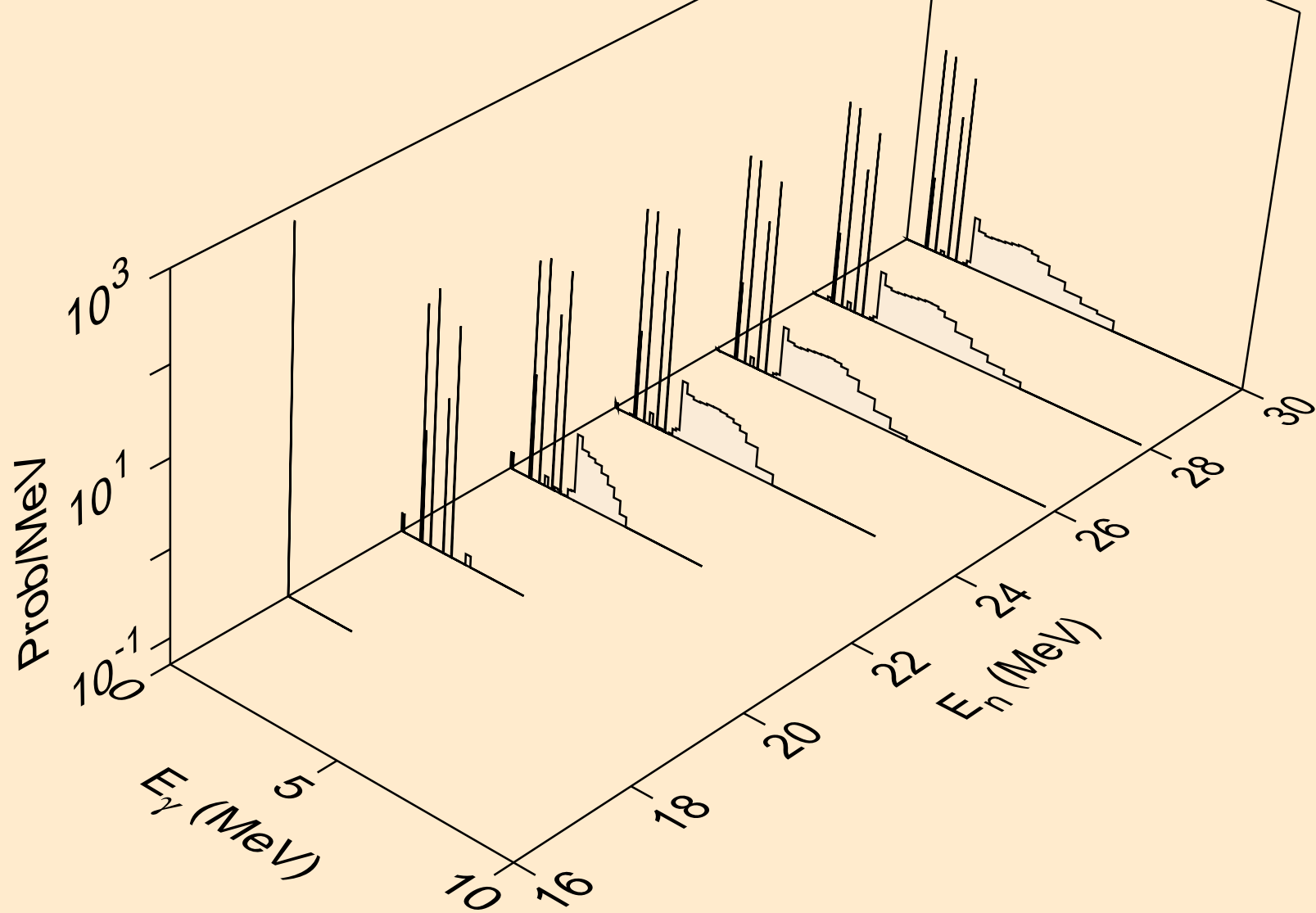

MG024 NEUTRON ACER TENDL-2023 LIBRARY; T=0.K  
Photon emission for (n,he3)

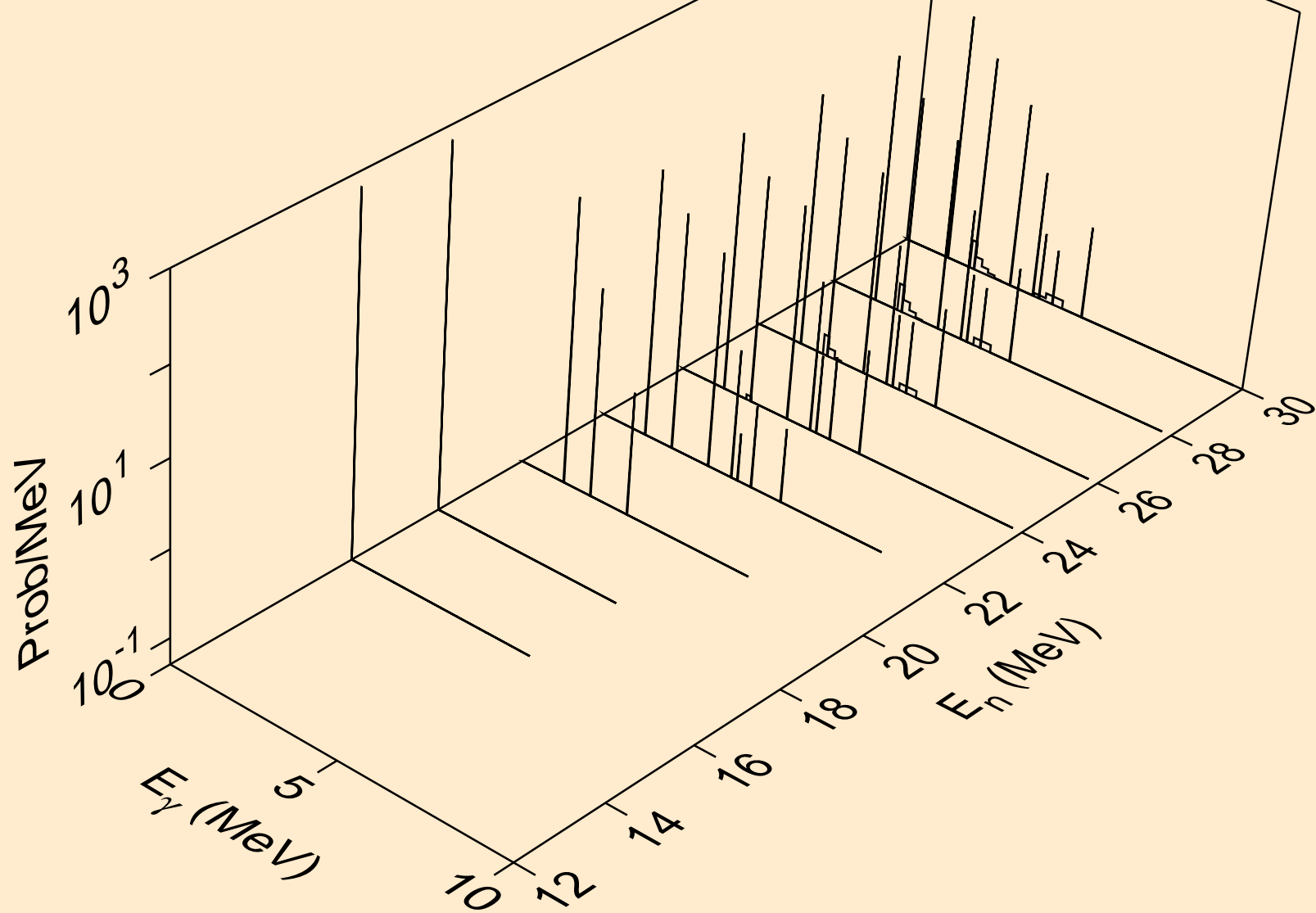



MG024 NEUTRON ACER TENDL-2023 LIBRARY; T=0.K  
Photon emission for (n,a)

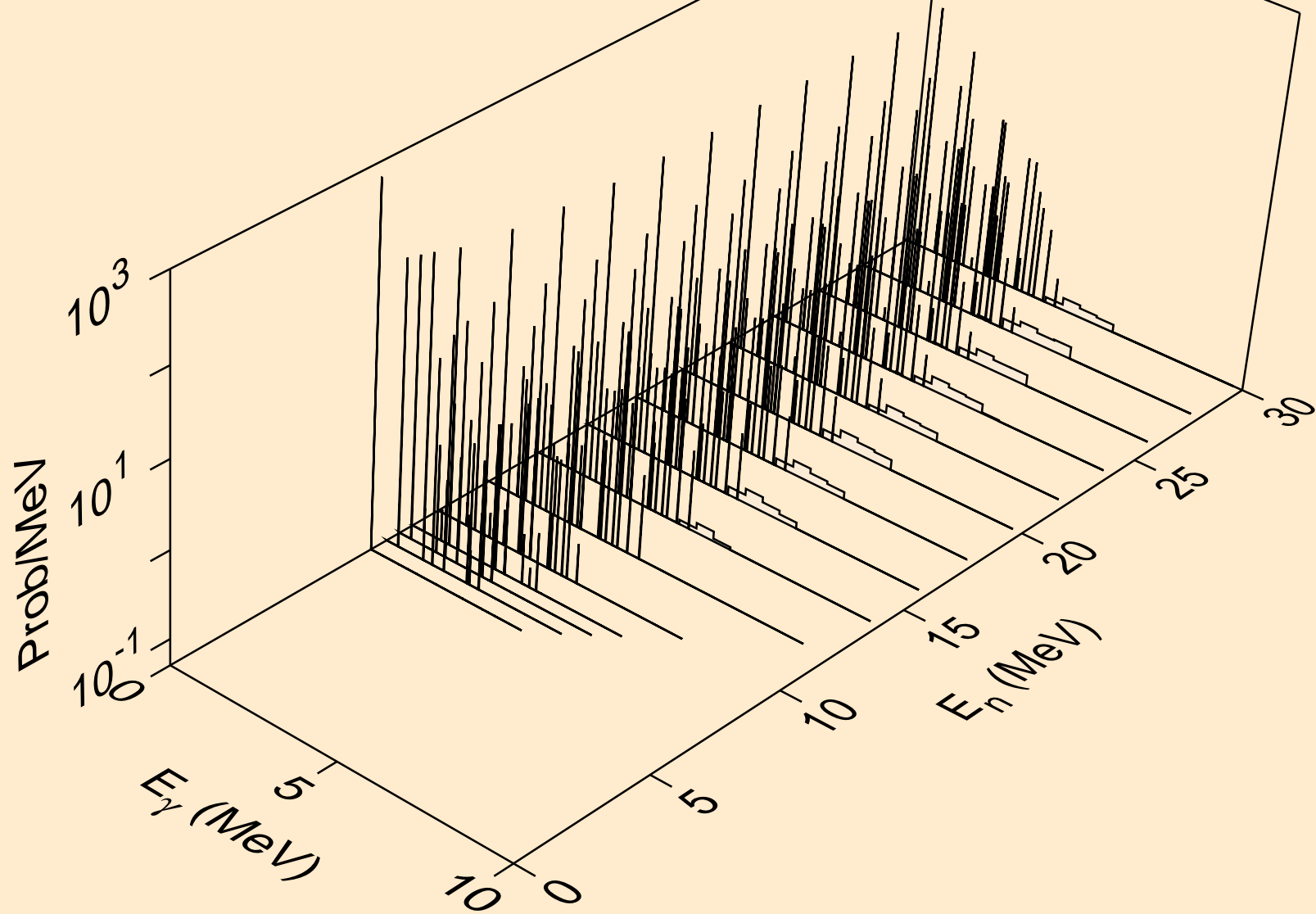

MG024 NEUTRON ACER TENDL-2023 LIBRARY; T=0.K  
Photon emission for (n,2a)

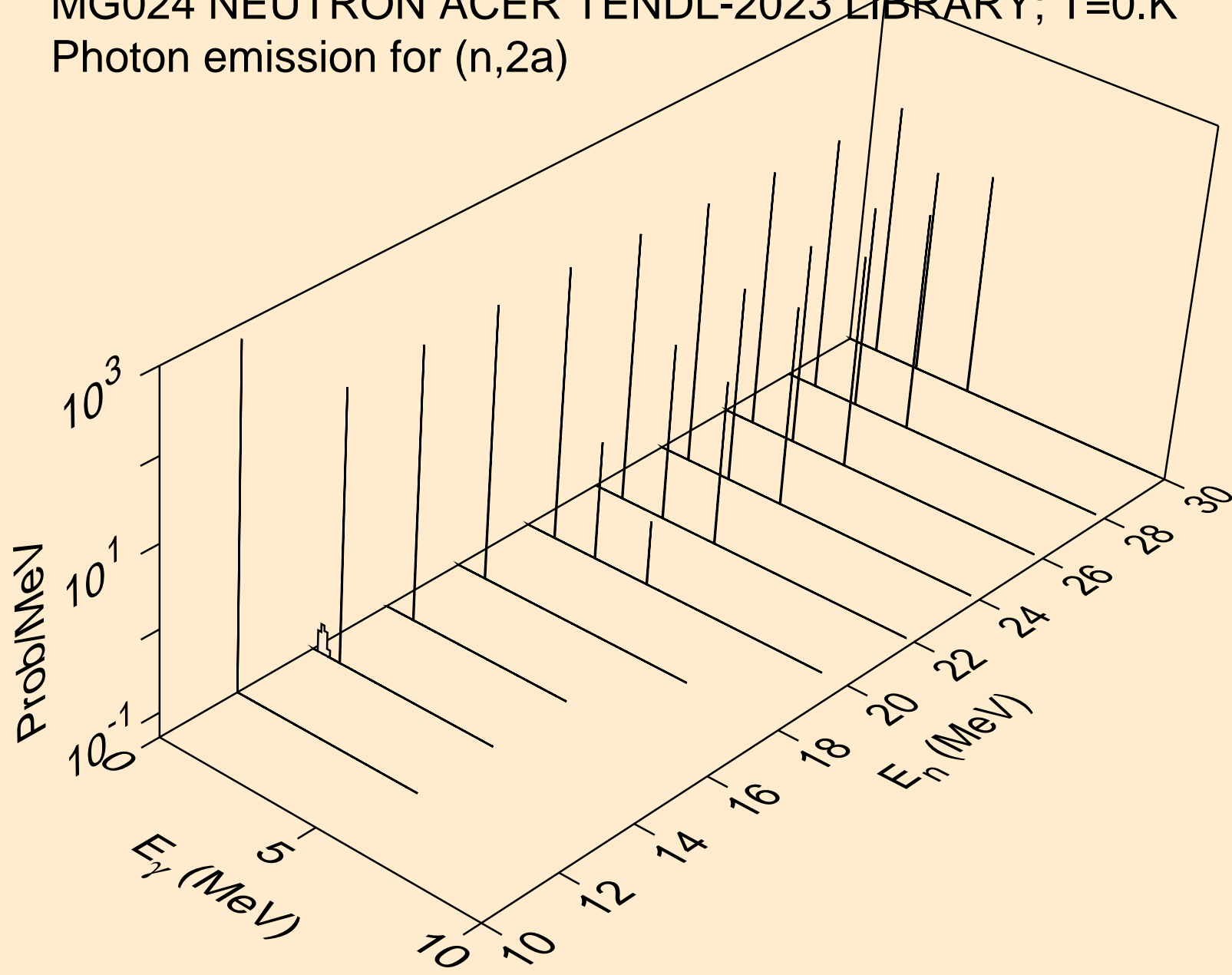

MG024 NEUTRON ACER TENDL-2023 LIBRARY; T=0.K  
Photon emission for (n,3a)

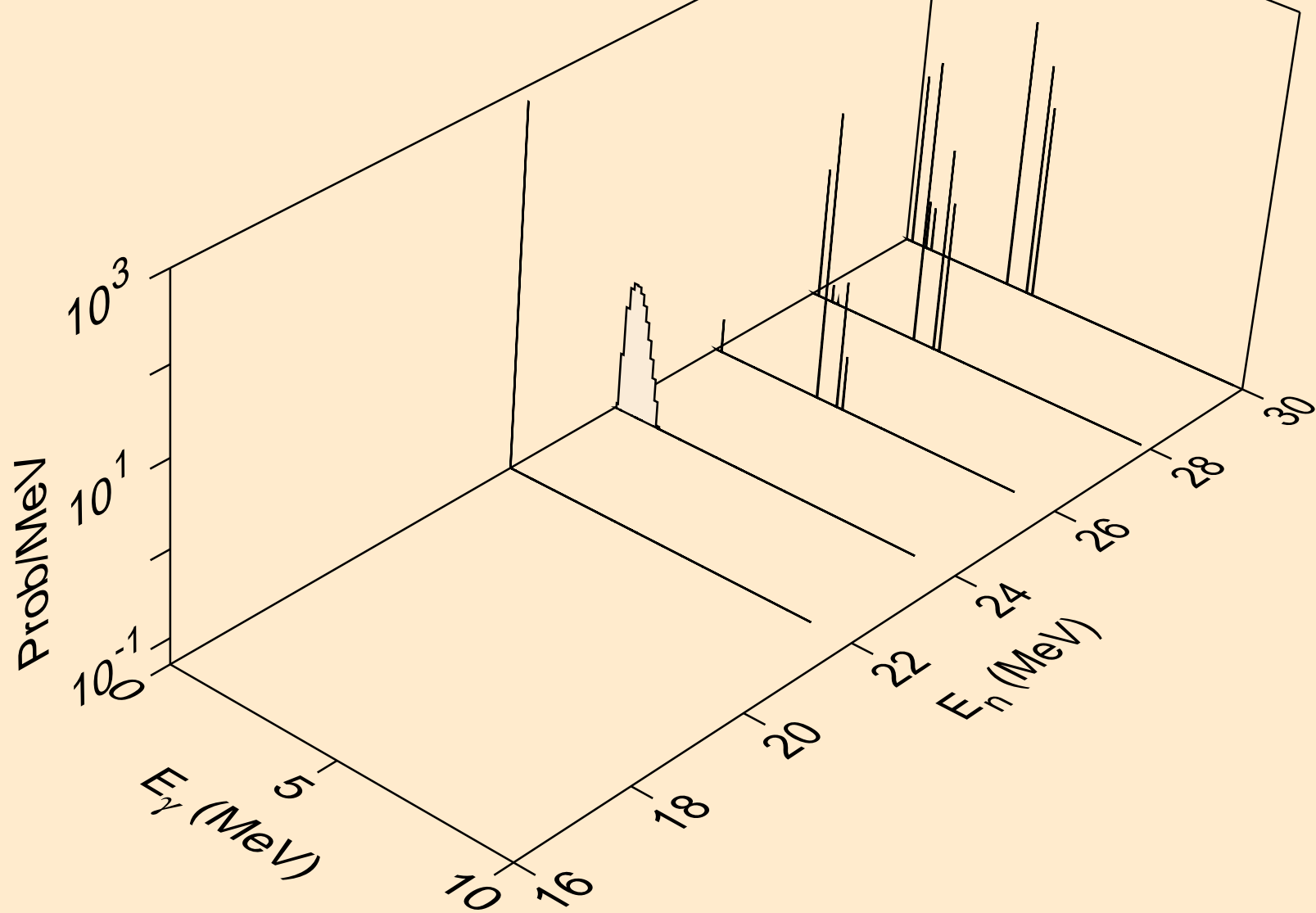

MG024 NEUTRON ACER TENDL-2023 LIBRARY; T=0.K  
Photon emission for (n,2p)

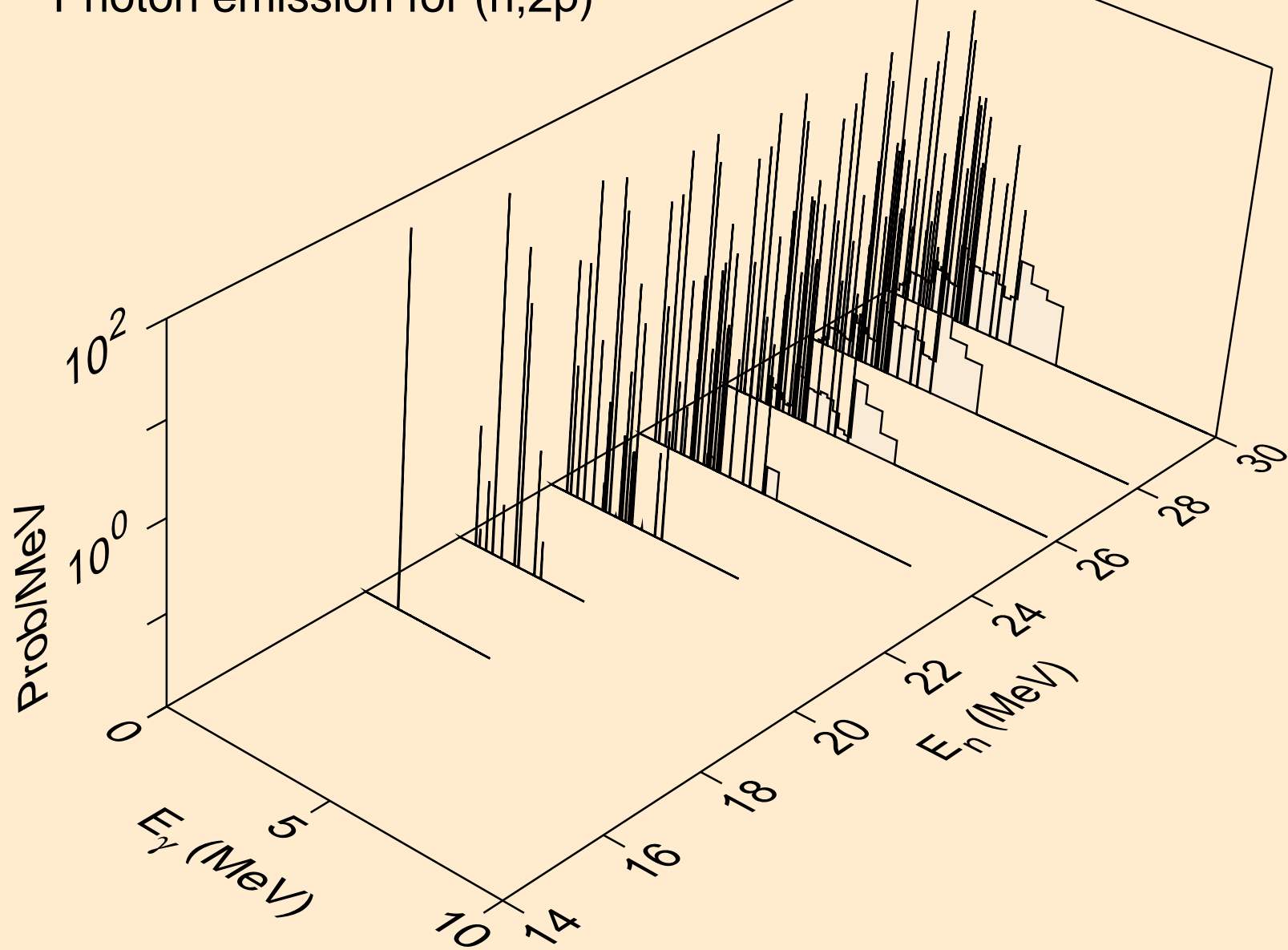

MG024 NEUTRON ACER TENDL-2023 LIBRARY; T=0.K  
Photon emission for (n,p $\alpha$ )

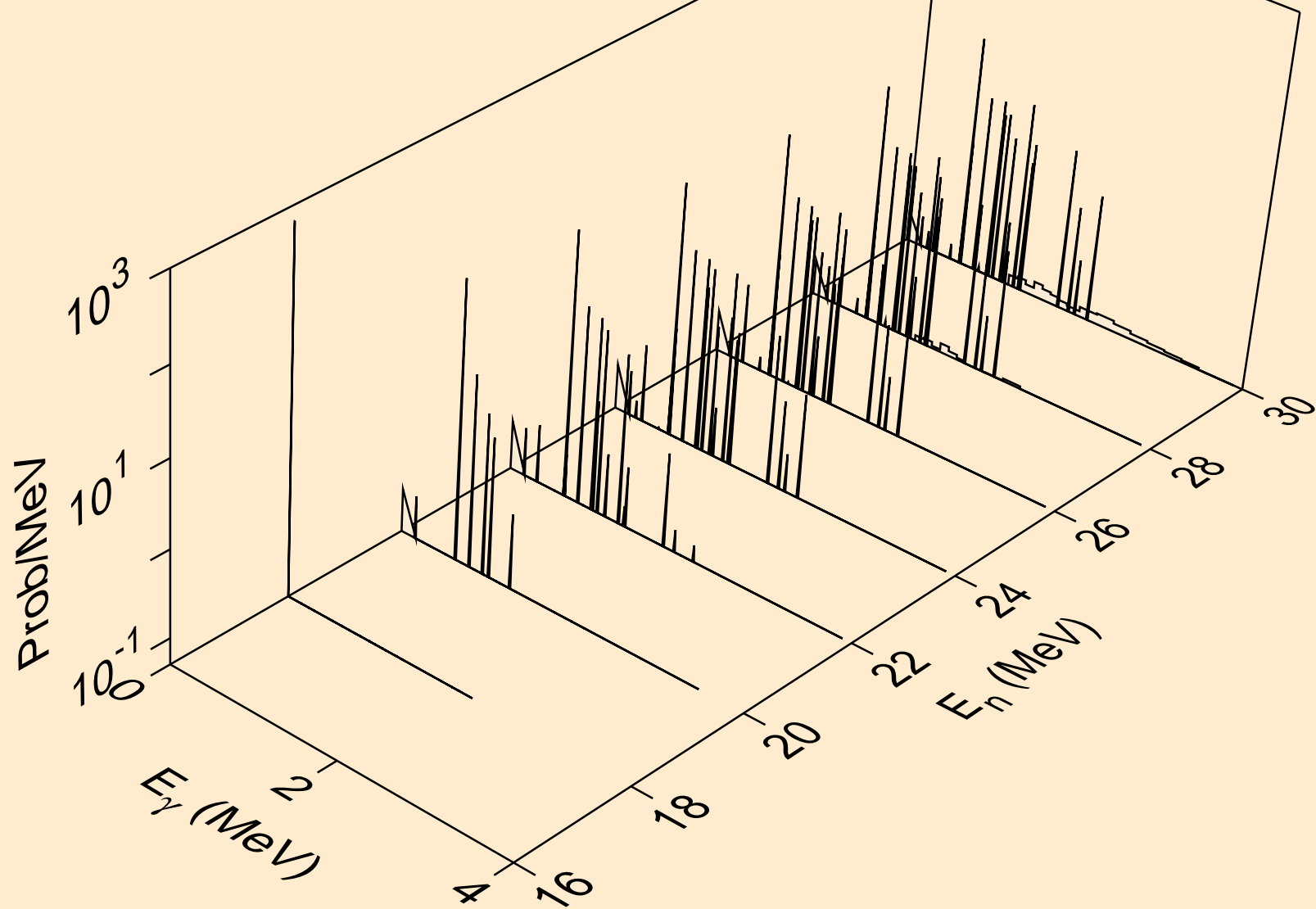

MG024 NEUTRON ACER TENDL-2023 LIBRARY; T=0.K  
Photon emission for (n,d2a)

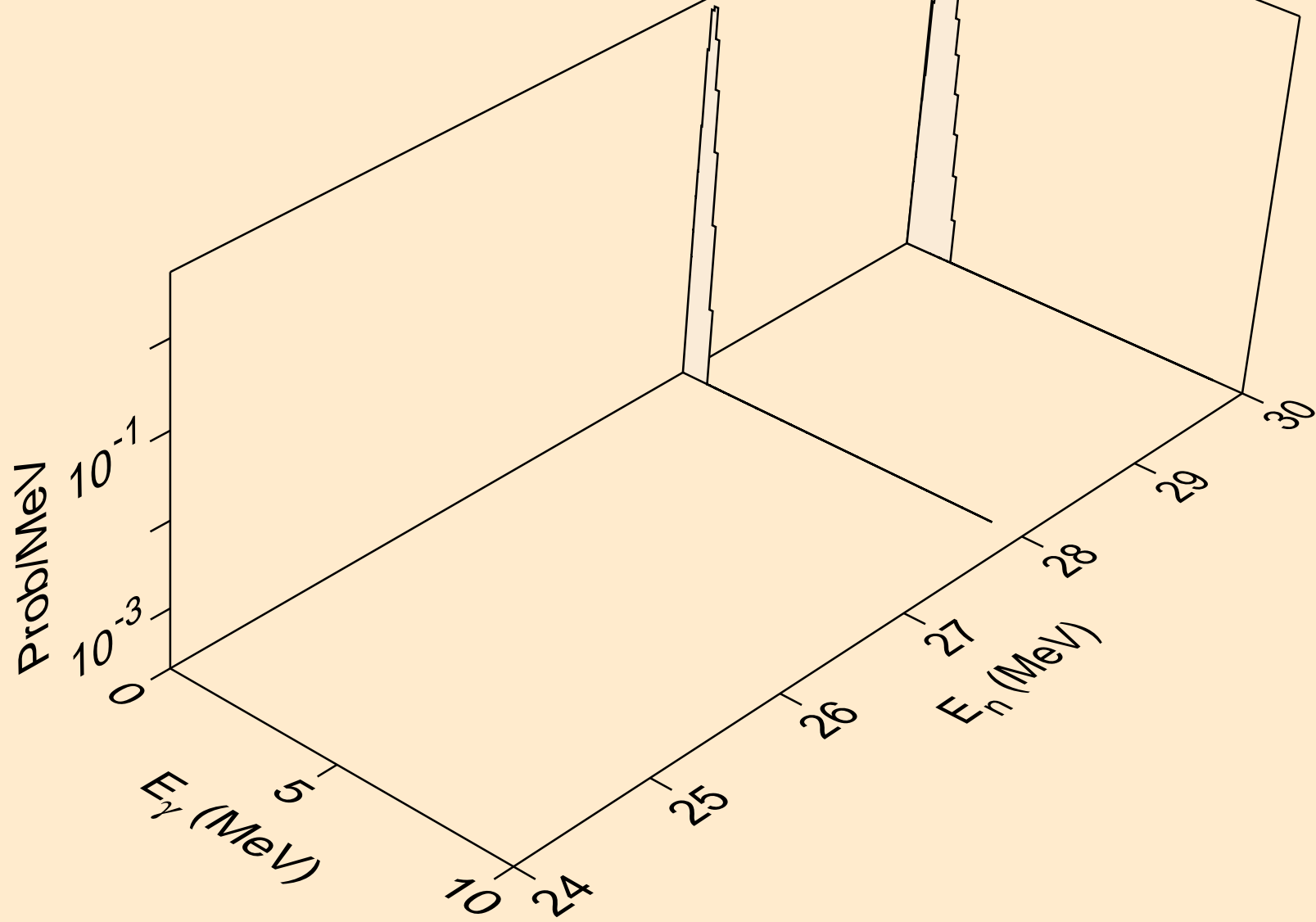

MG024 NEUTRON ACER TENDL-2023 LIBRARY; T=0.K  
Photon emission for (n,pd)

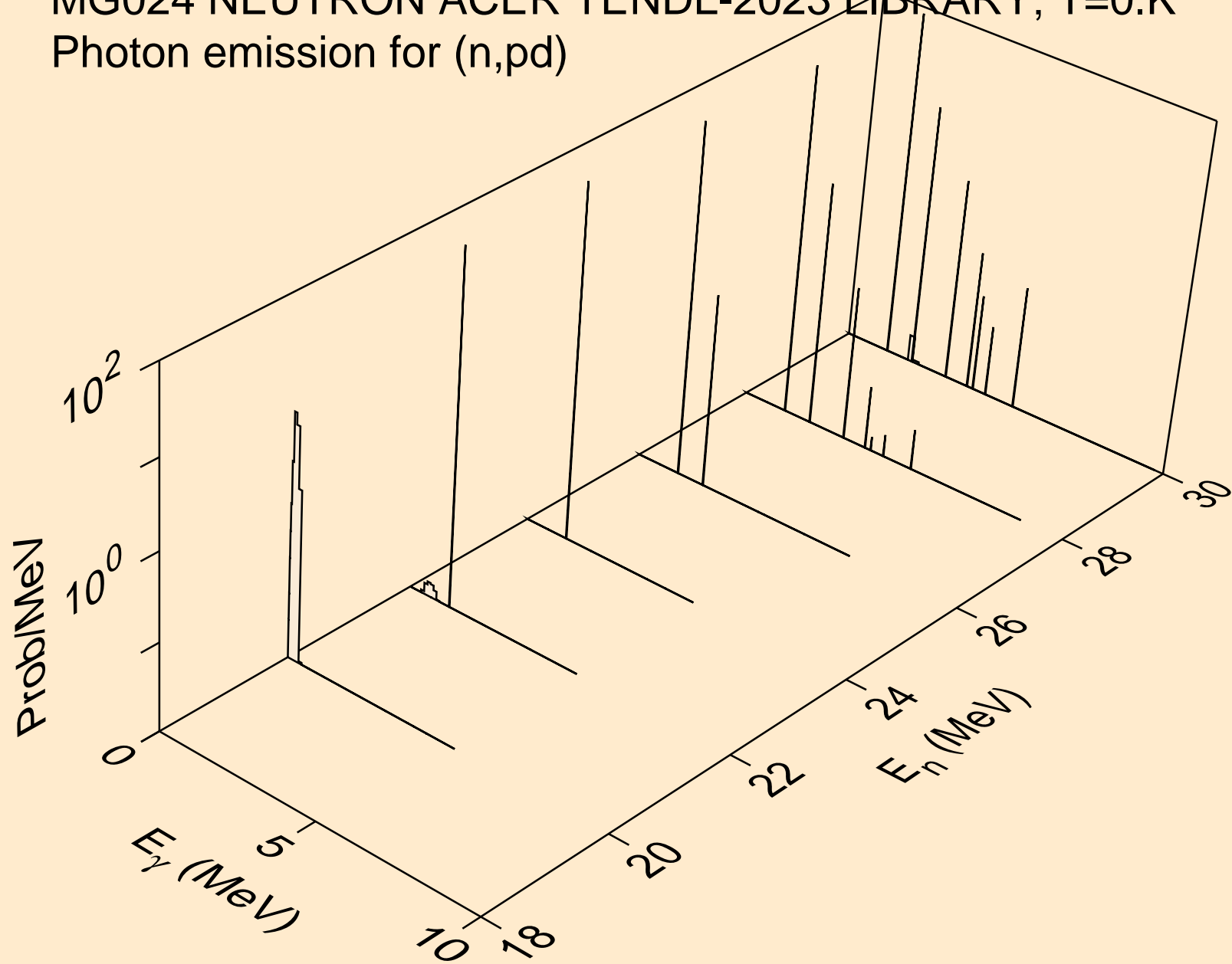

MG024 NEUTRON ACER TENDL-2023 LIBRARY; T=0.K  
Photon emission for (n,pt)

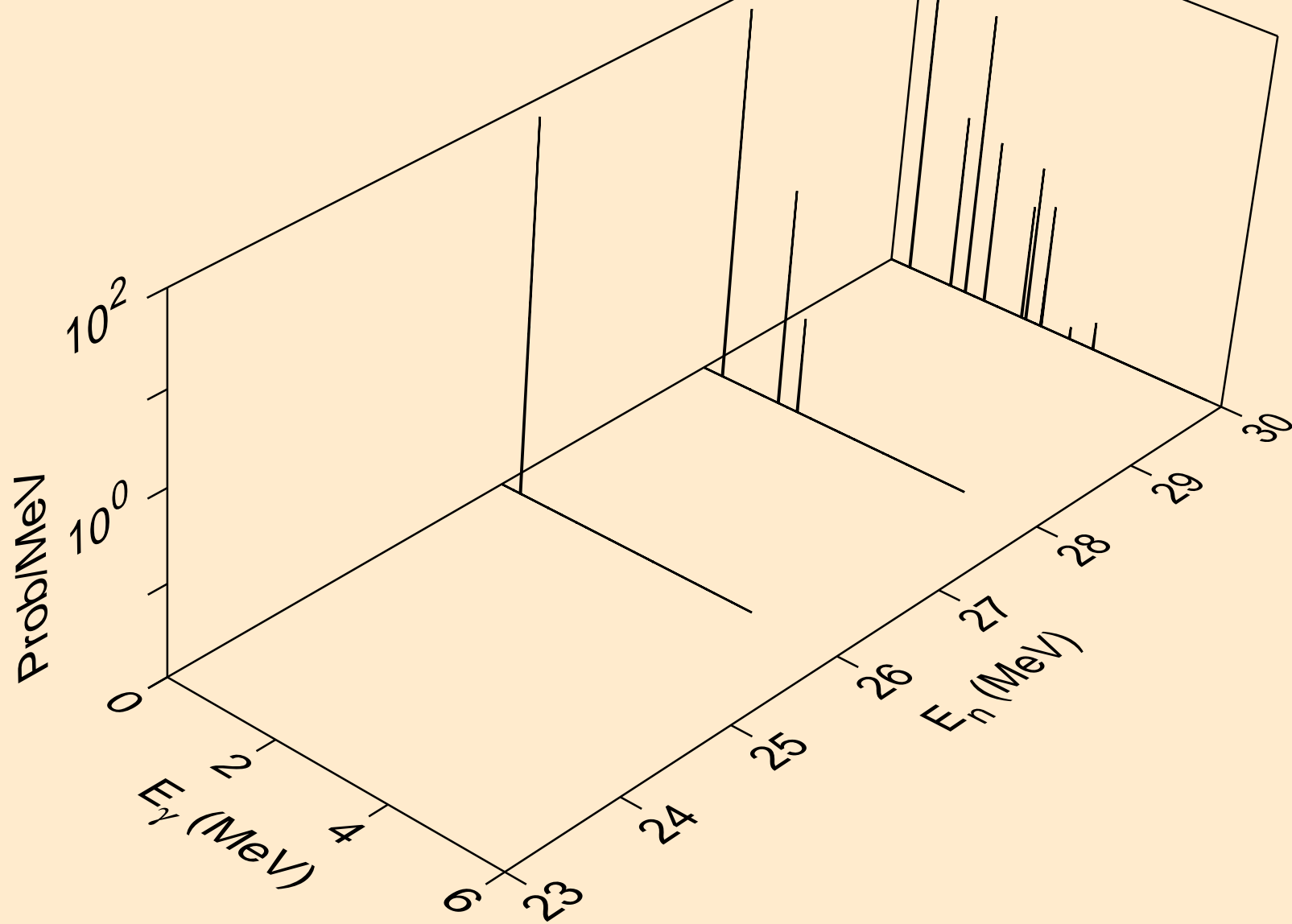



MG024 NEUTRON ACER TENDL-2023 LIBRARY; T=0.K  
Photon emission for (n,da)

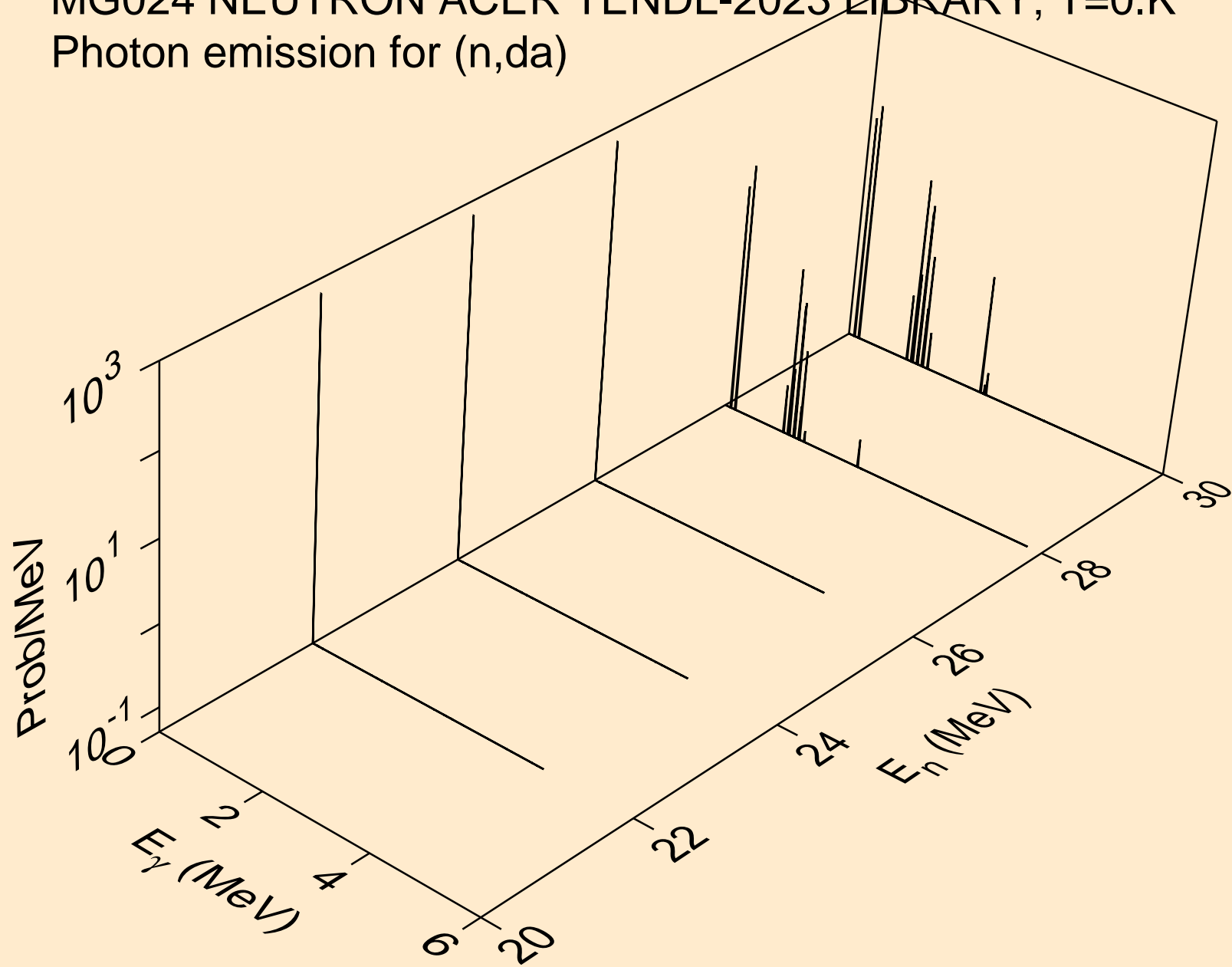

MG024 NEUTRON ACER TENDL-2023 LIBRARY; T=0.K  
thermal capture photon spectrum

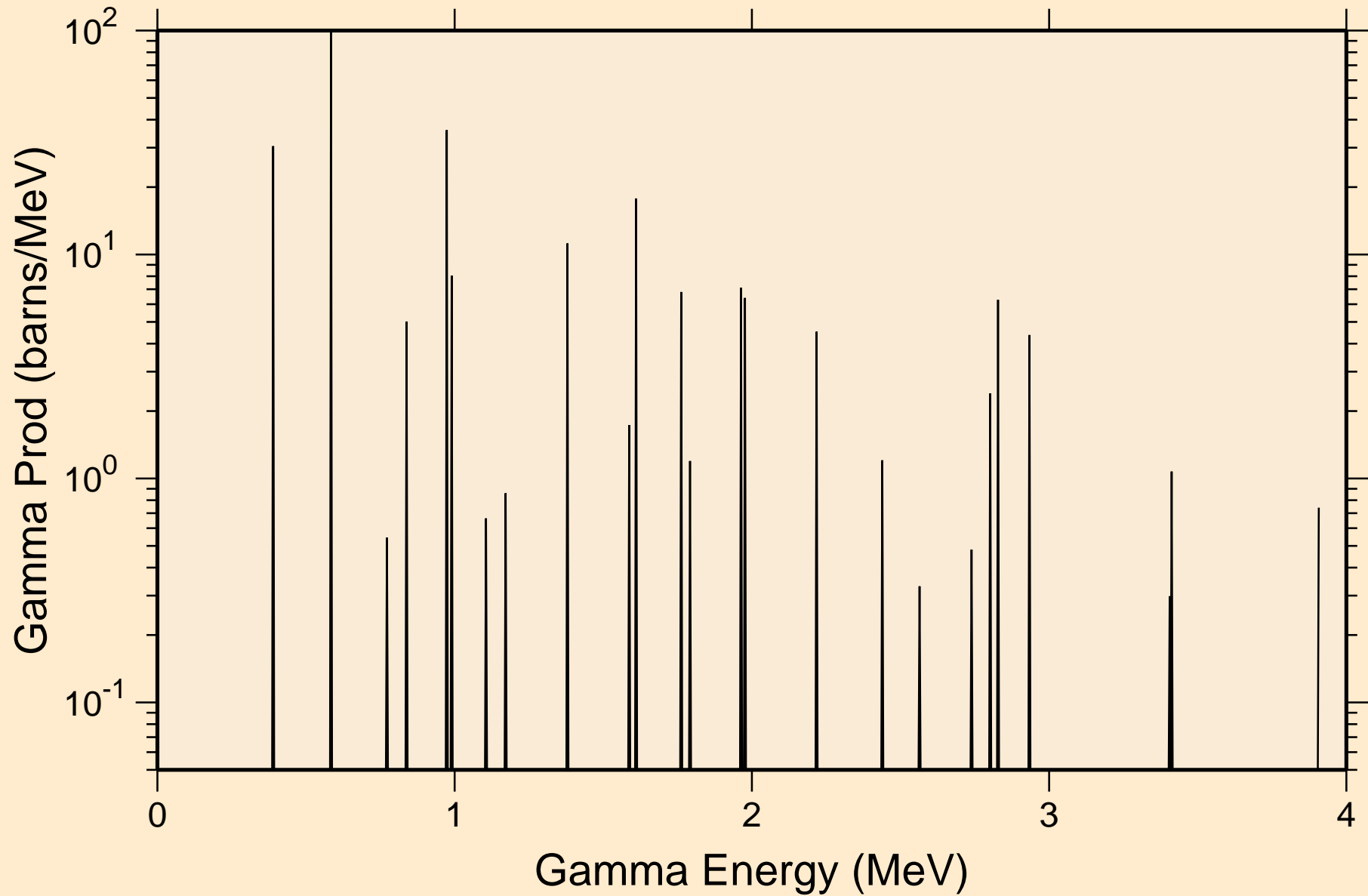

MG024 NEUTRON ACER TENDL-2023 LIBRARY; T=0.K  
14 MeV photon spectrum

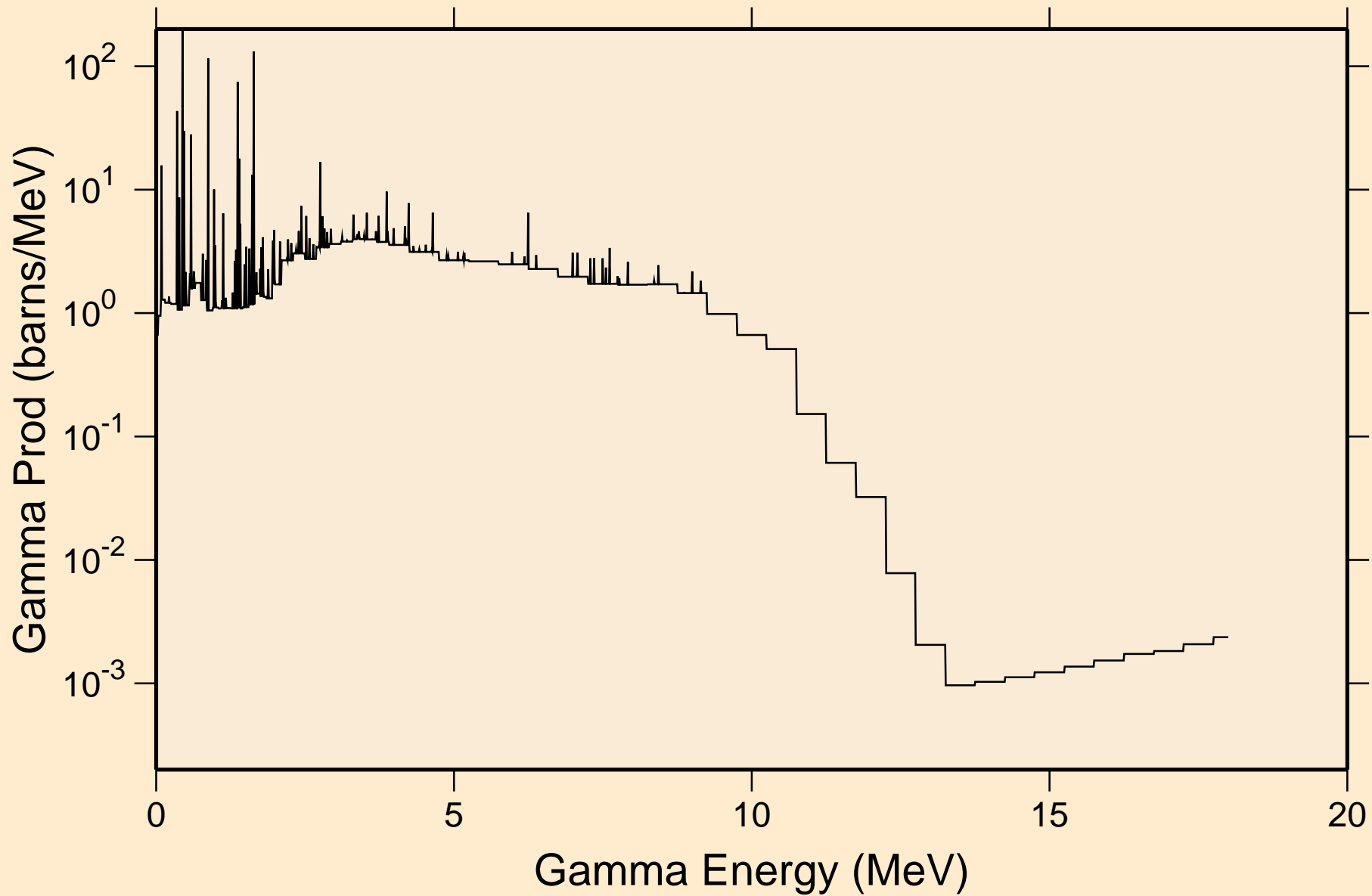

# MG024 NEUTRON ACER TENDL-2023 LIBRARY; T=0.K

## Particle heating contributions

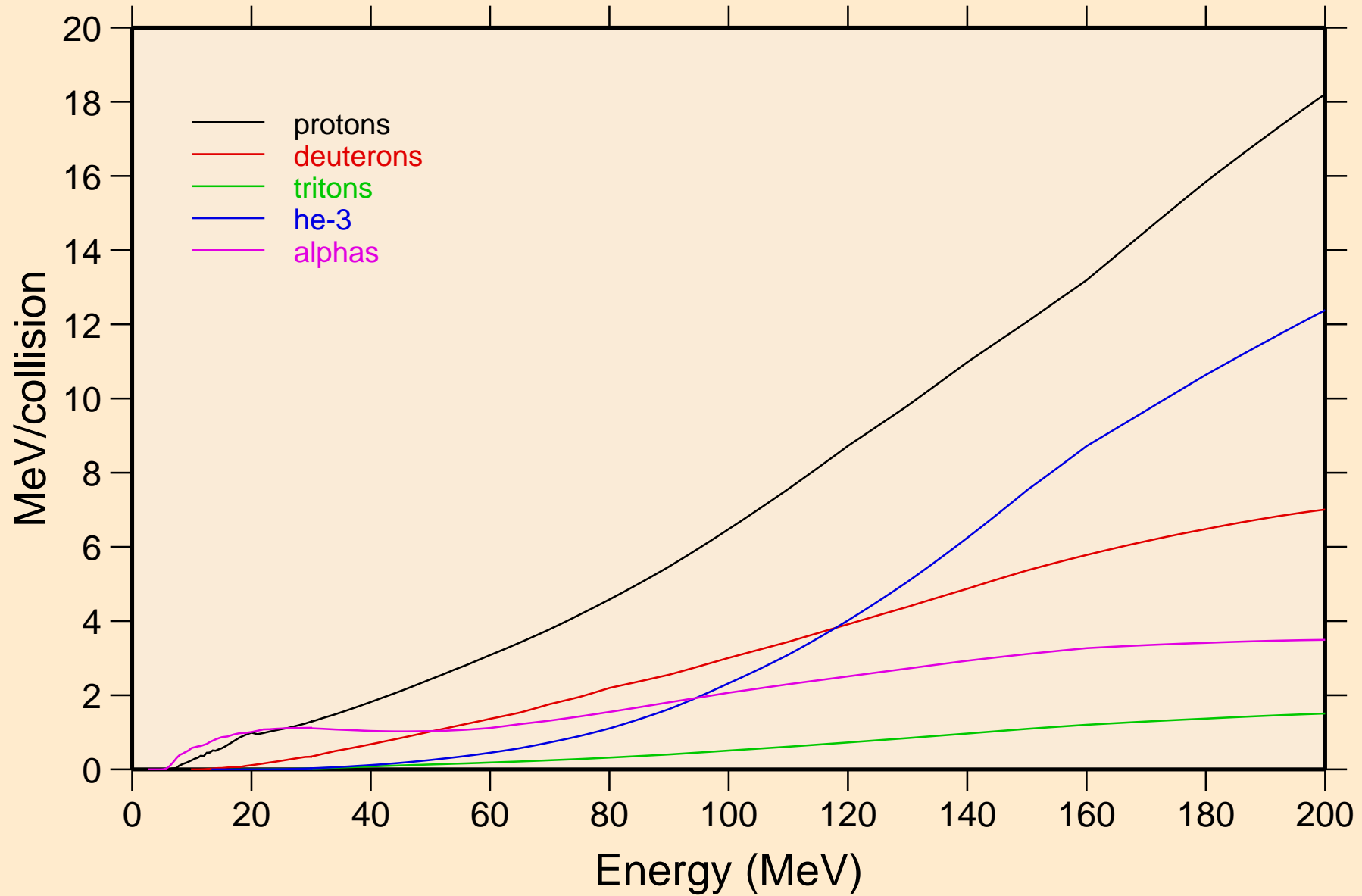

MG024 NEUTRON ACER TENDL-2023 LIBRARY; T=0.K  
Recoil Heating

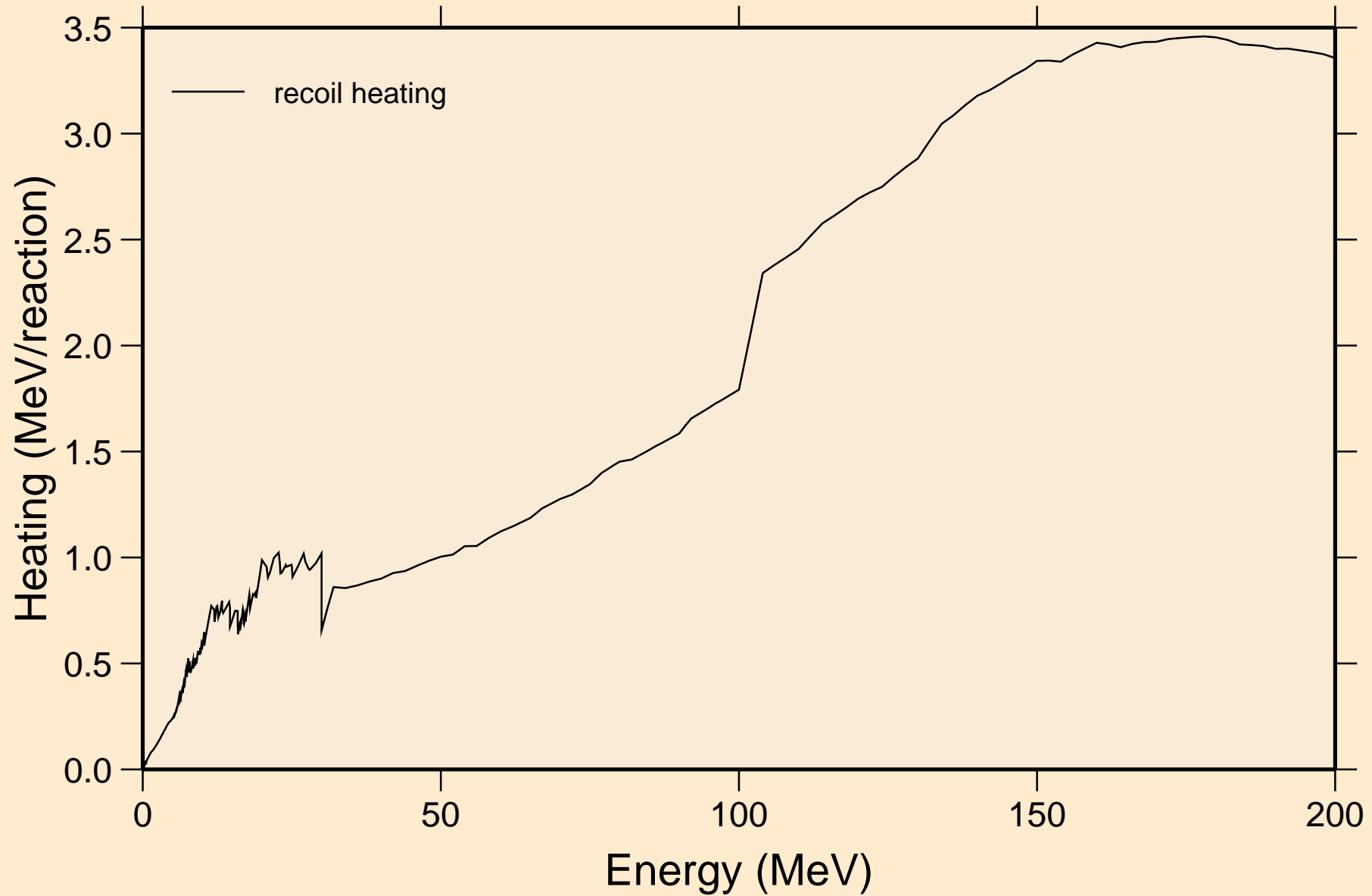

MG024 NEUTRON ACER TENDL-2023 LIBRARY; T=0.K  
Particle production cross sections

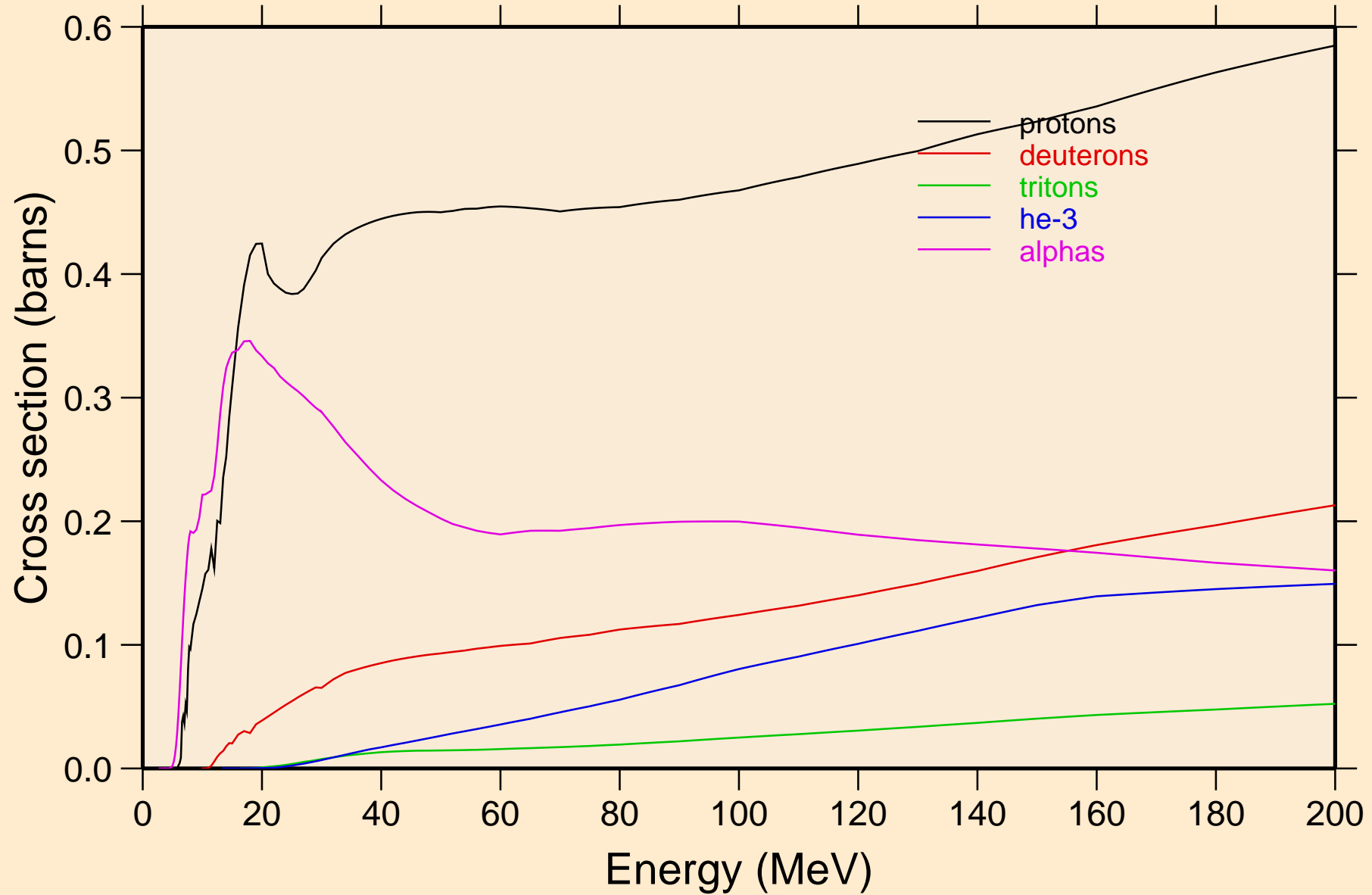

MG024 NEUTRON ACER TENDL-2023 LIBRARY; T=0.K  
protons from (n,x)

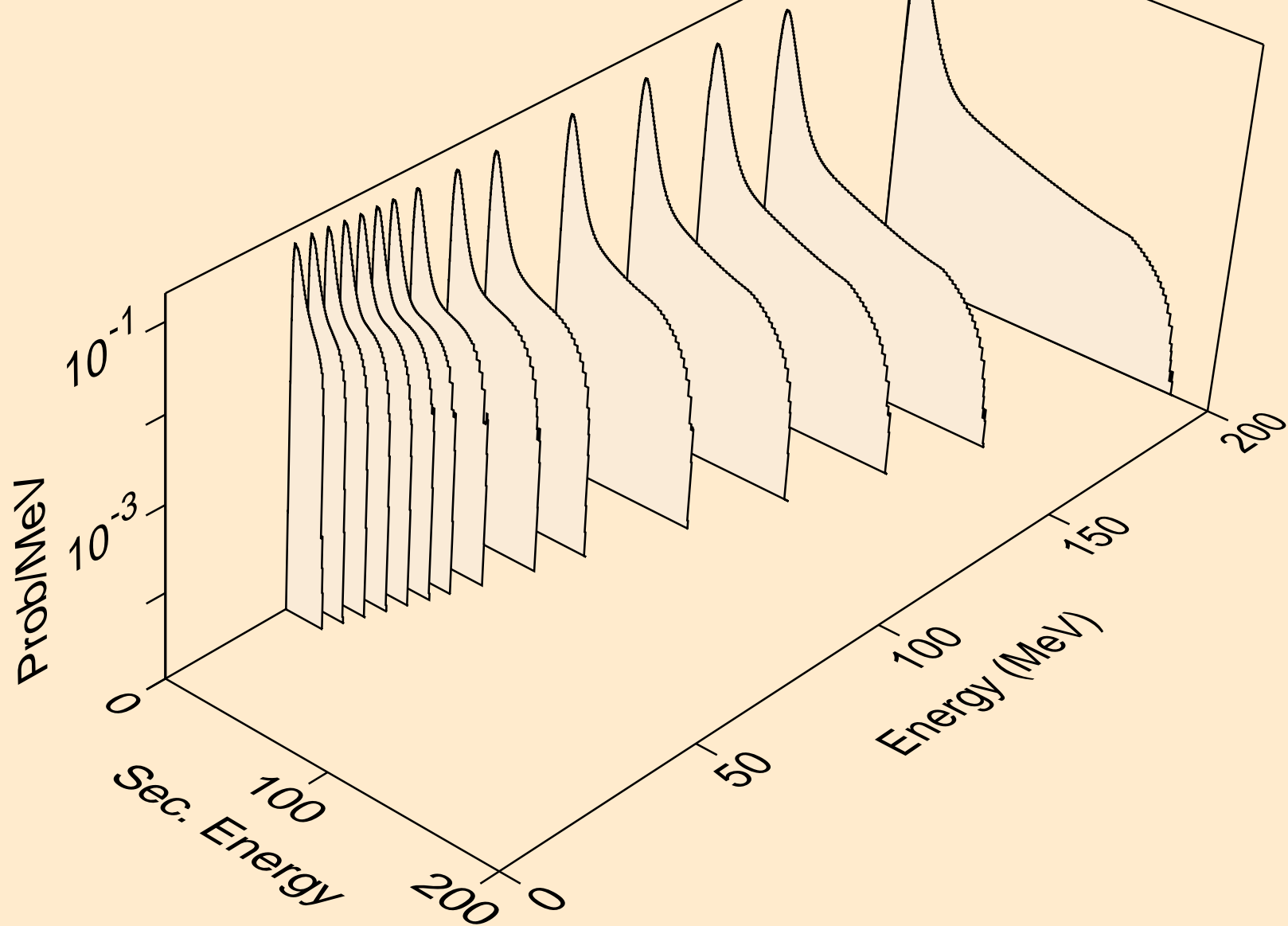

MG024 NEUTRON ACER TENDL-2023 LIBRARY; T=0.K  
protons from (n,n\*)p

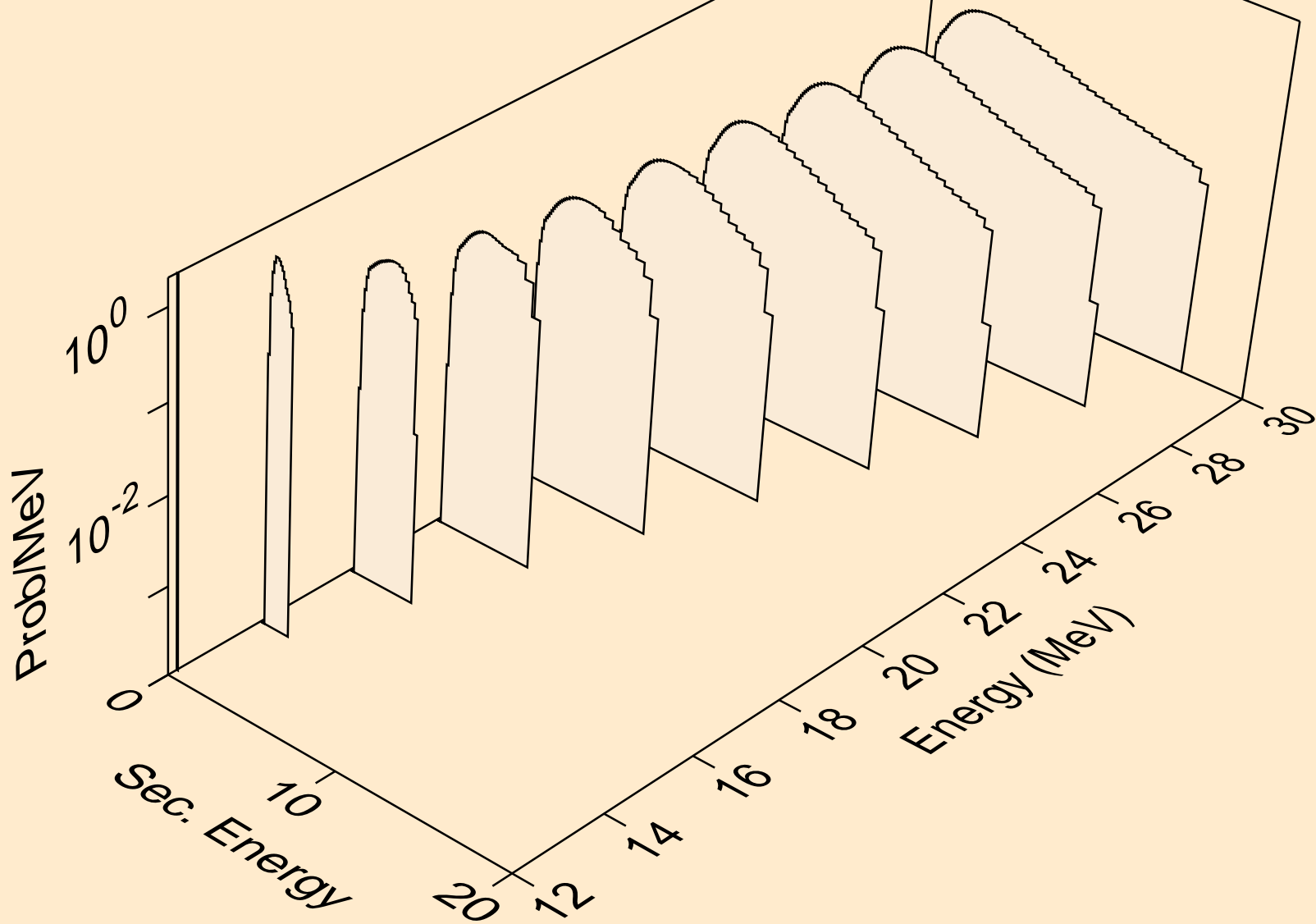



MG024 NEUTRON ACER TENDL-2023 LIBRARY; T=0.K  
protons from (n,2np)

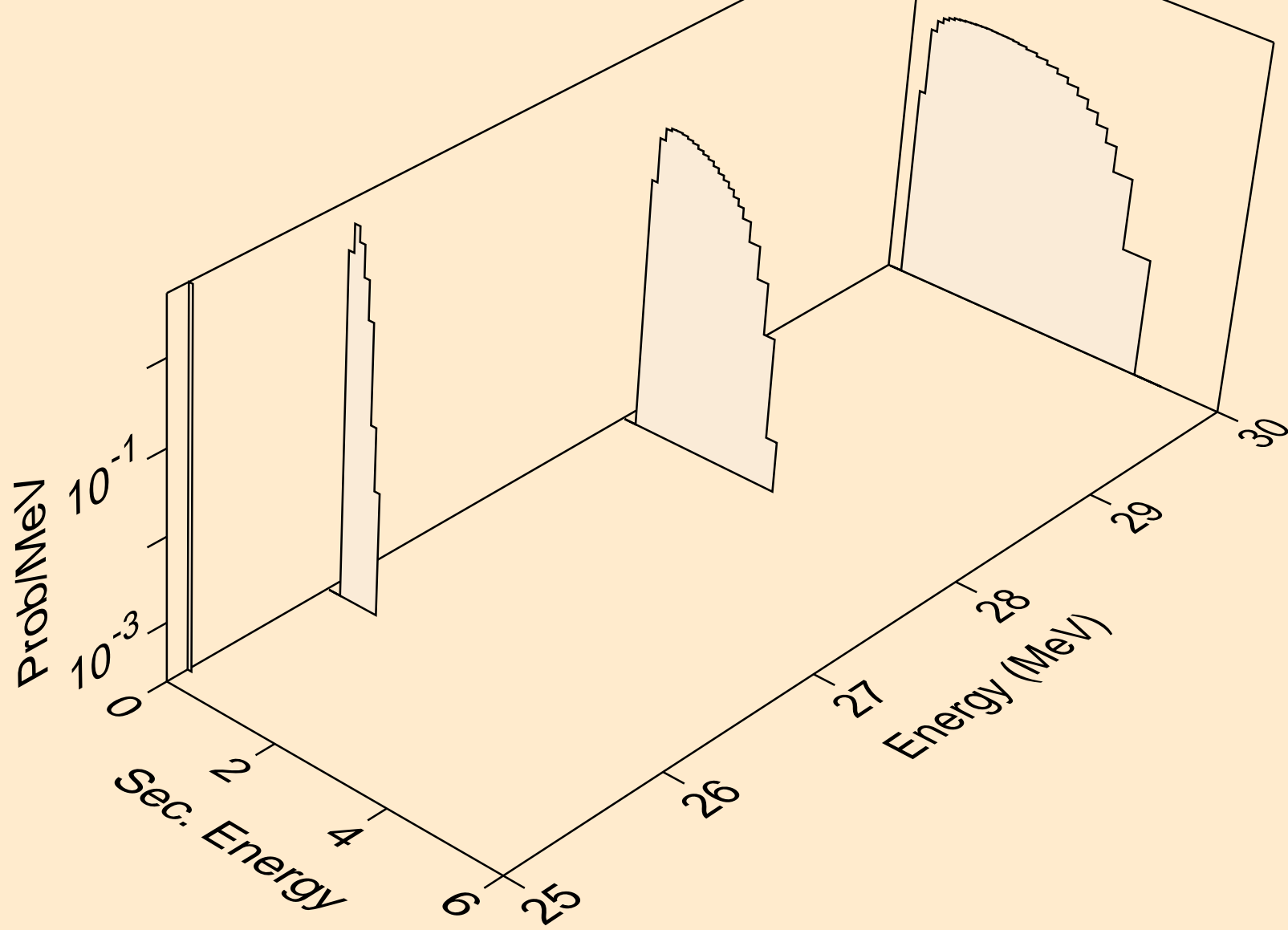

MG024 NEUTRON ACER TENDL-2023 LIBRARY; T=0.K  
protons from (n,n2p)

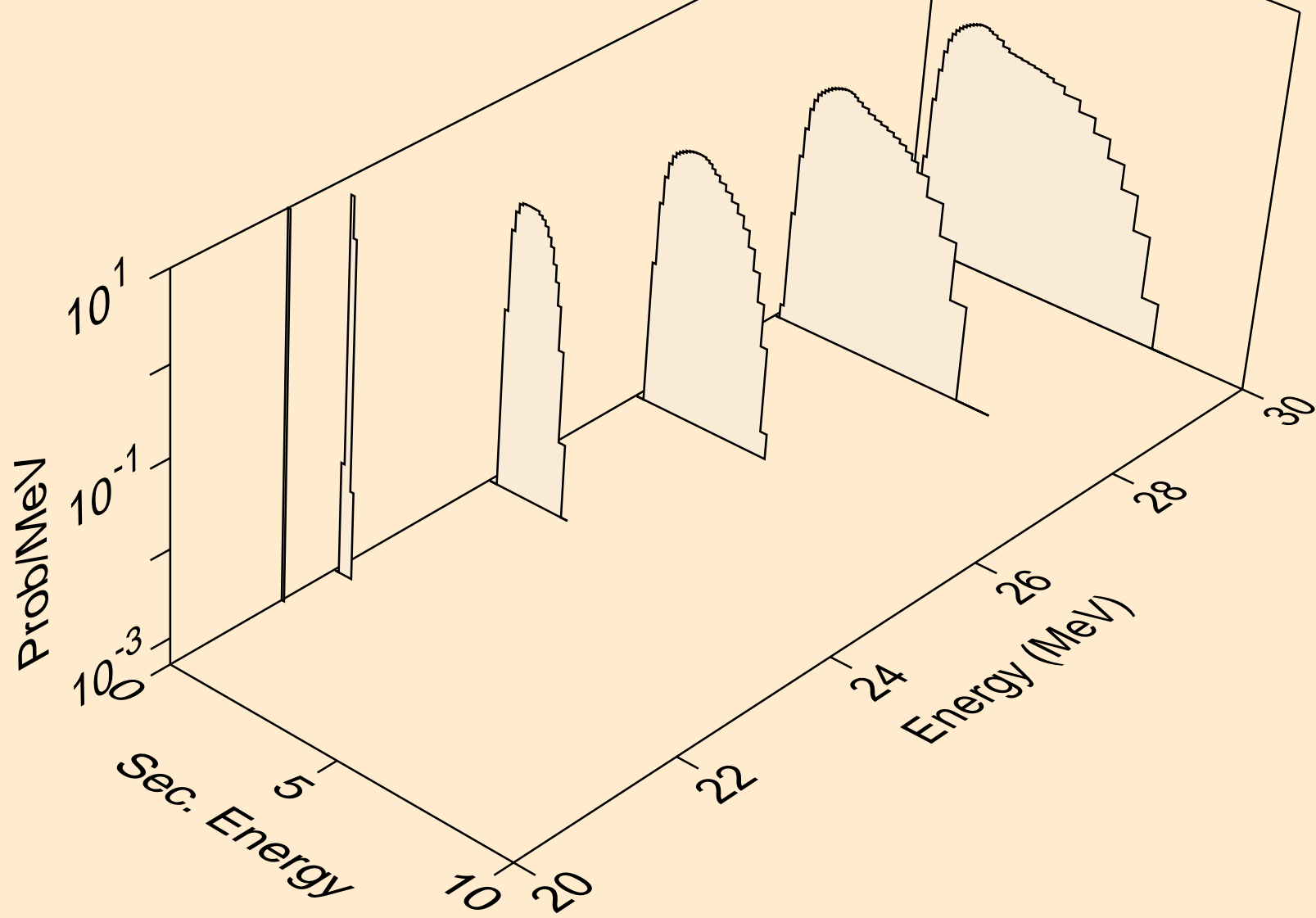

MG024 NEUTRON ACER TENDL-2023 LIBRARY; T=0.K  
protons from (n,npa)

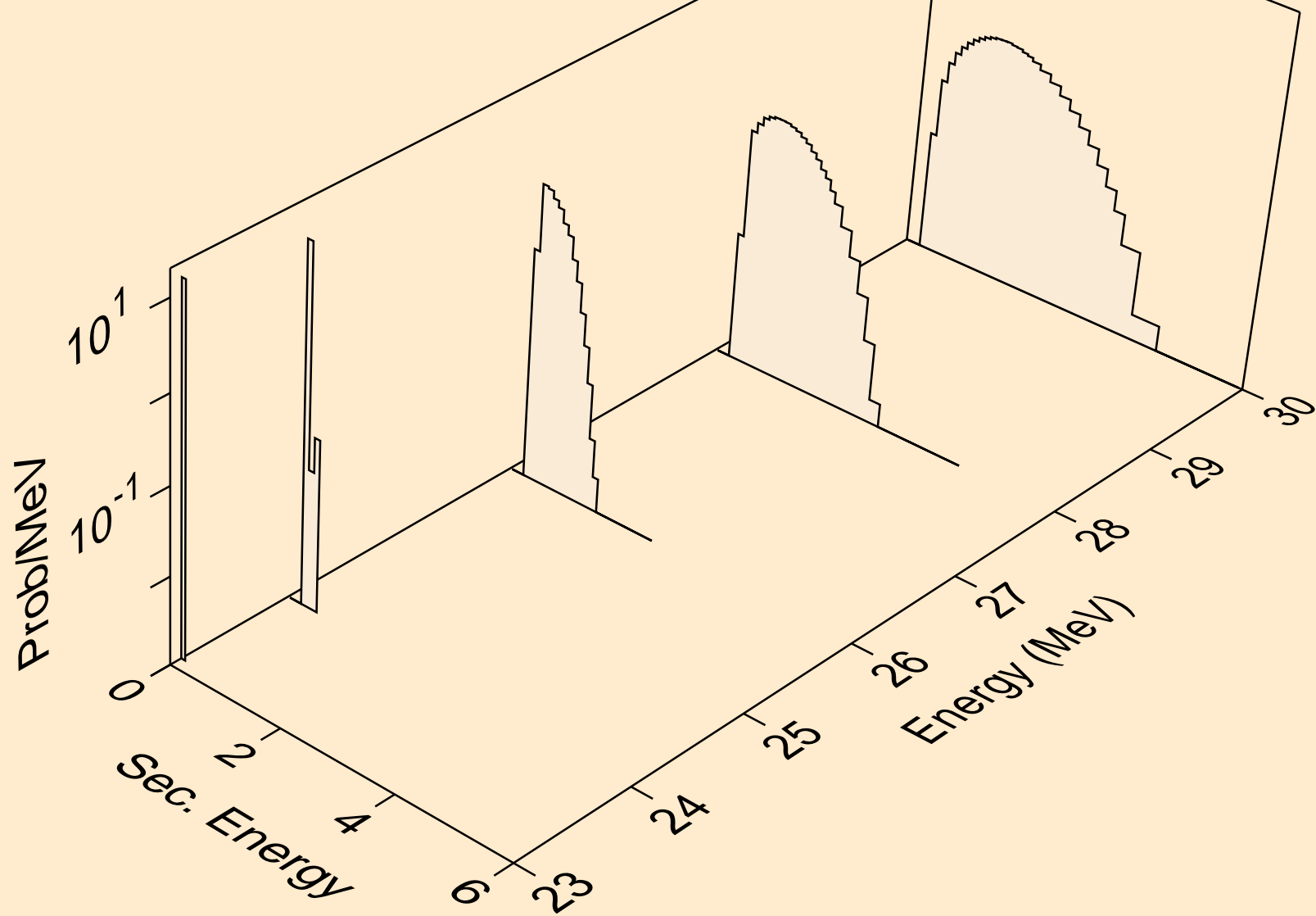

MG024 NEUTRON ACER TENDL-2023 LIBRARY; T=0.K  
protons from (n,p)

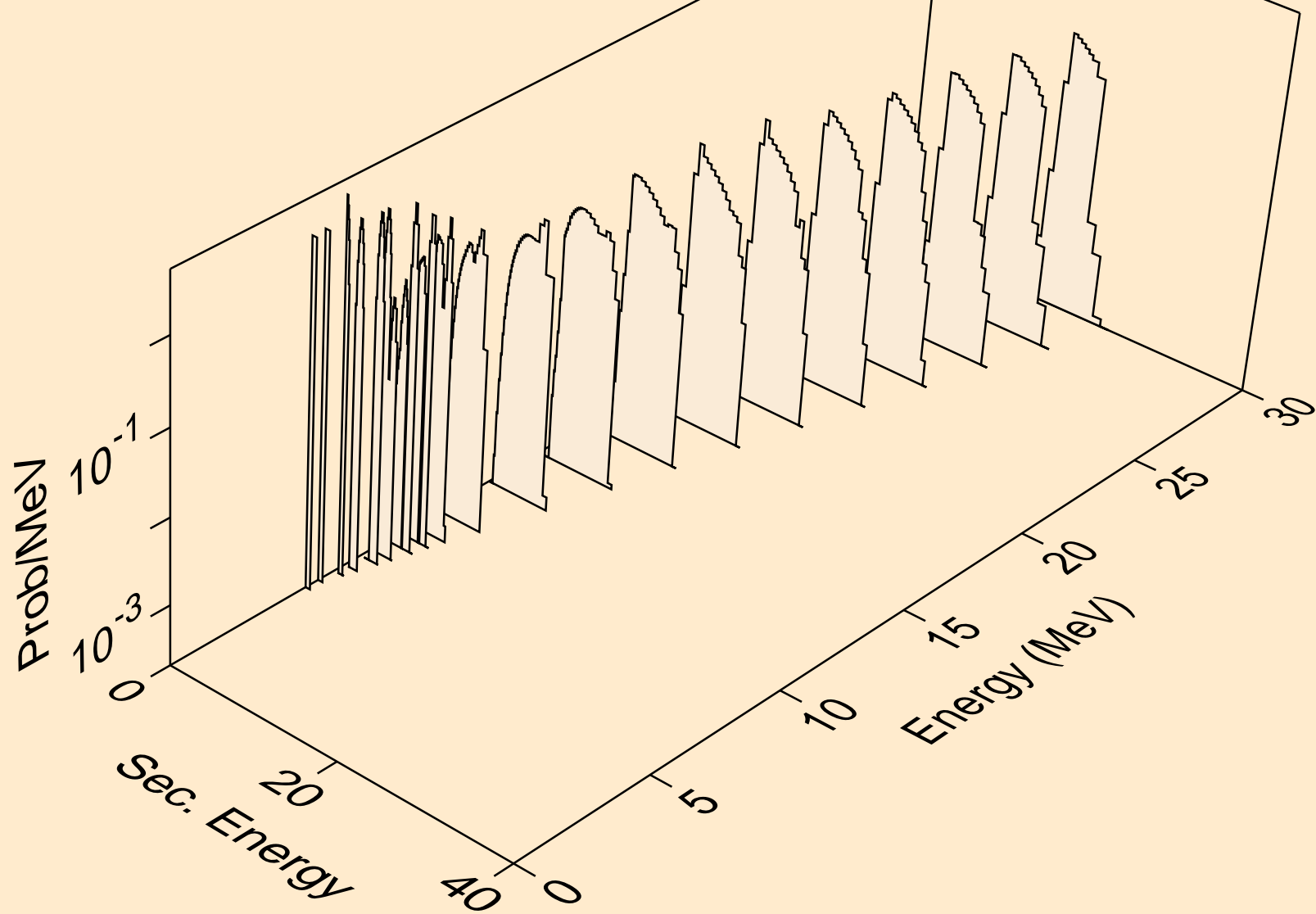

MG024 NEUTRON ACER TENDL-2023 LIBRARY; T=0.K  
protons from (n,2p)

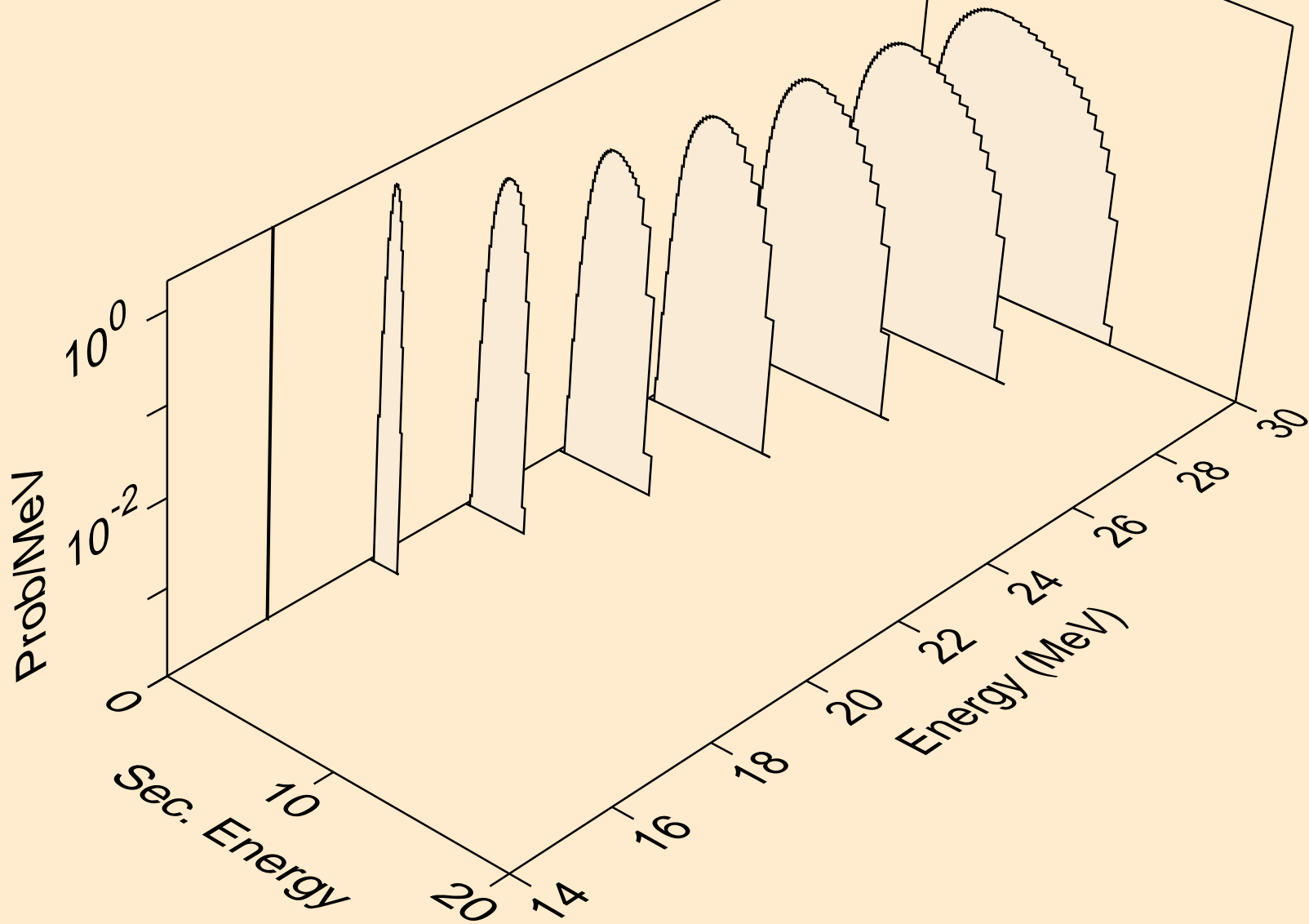

MG024 NEUTRON ACER TENDL-2023 LIBRARY; T=0.K  
protons from (n,p)

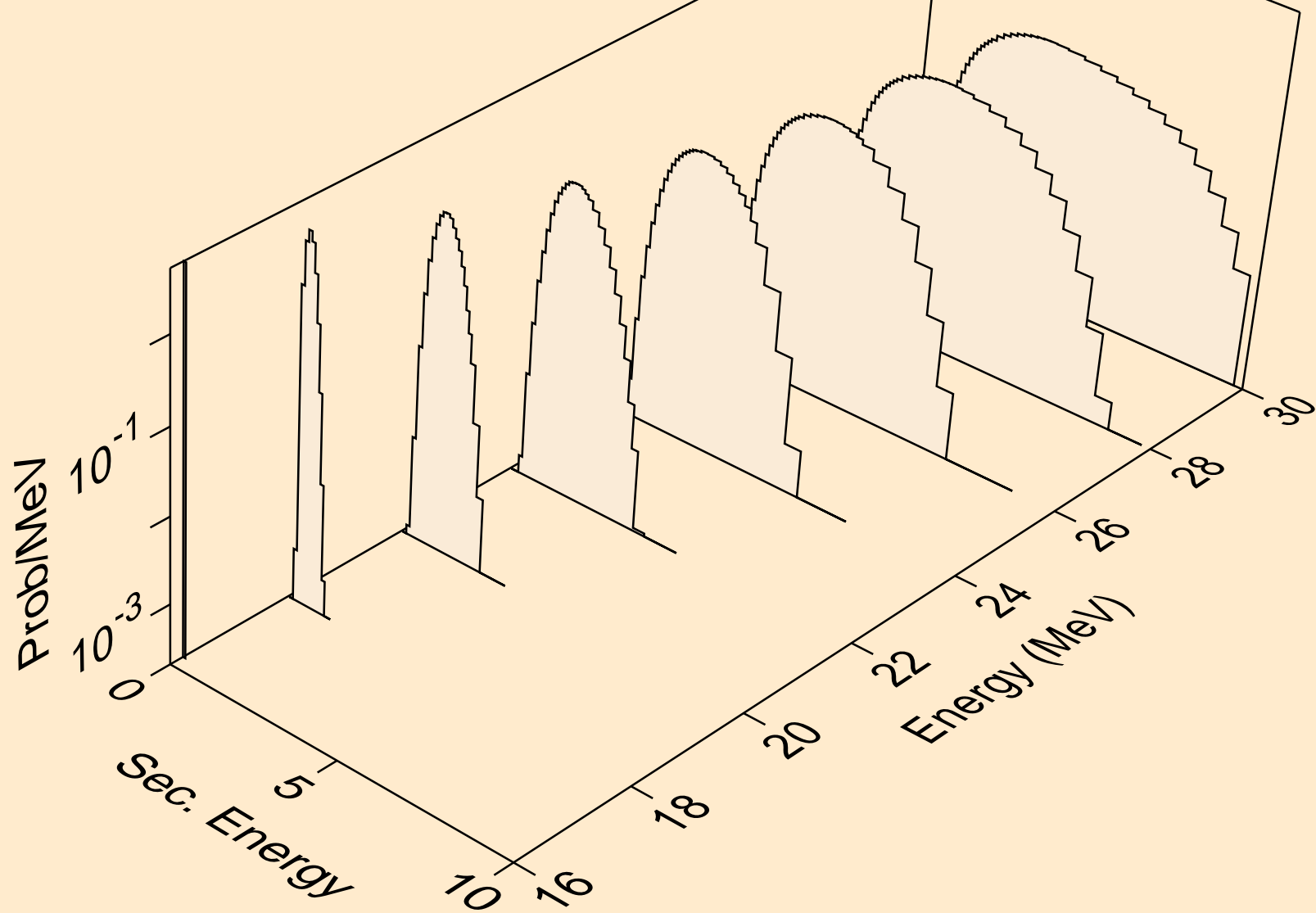

MG024 NEUTRON ACER TENDL-2023 LIBRARY; T=0.K  
protons from (n,pd)

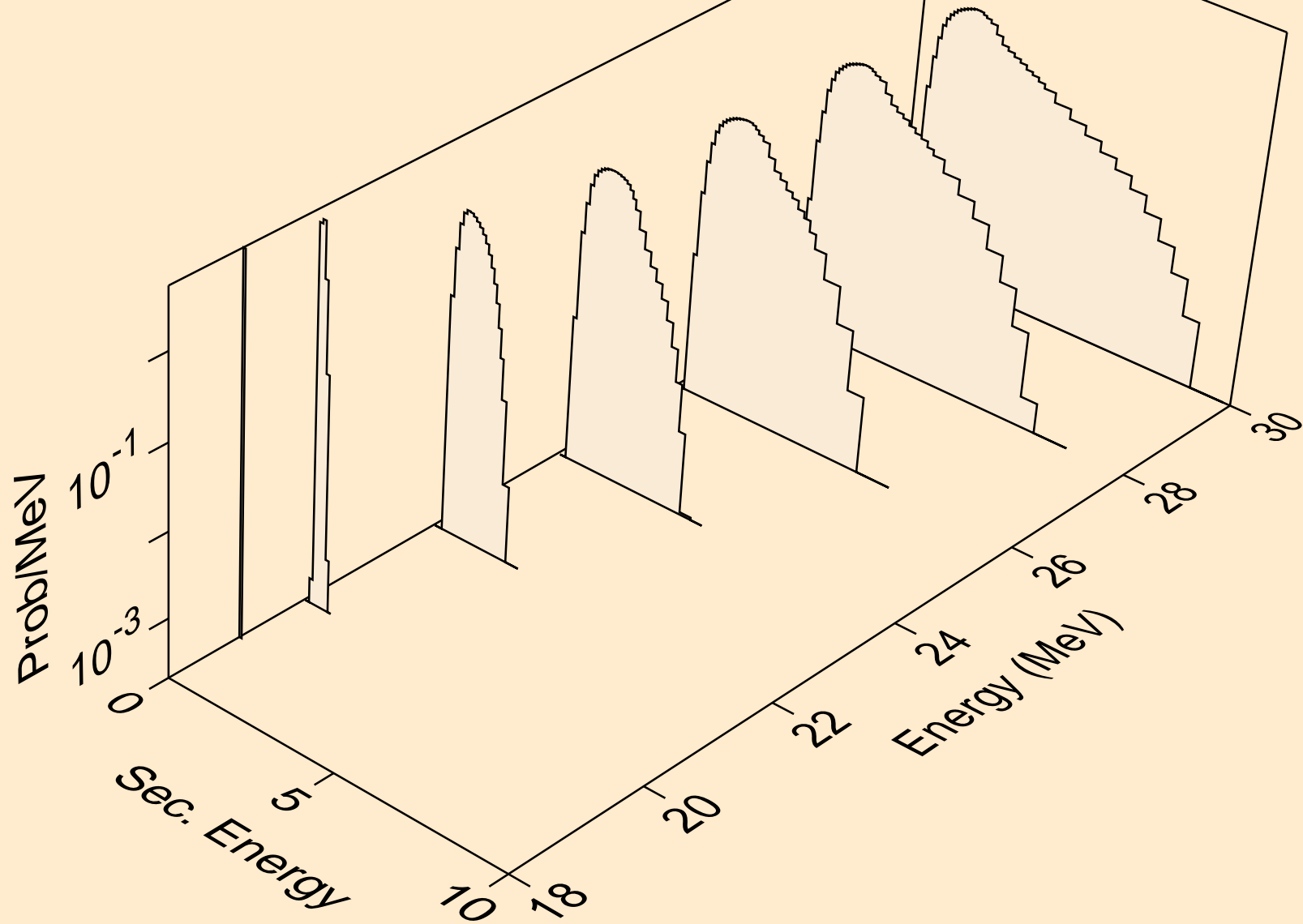

MG024 NEUTRON ACER TENDL-2023 LIBRARY; T=0.K  
protons from (n,pt)

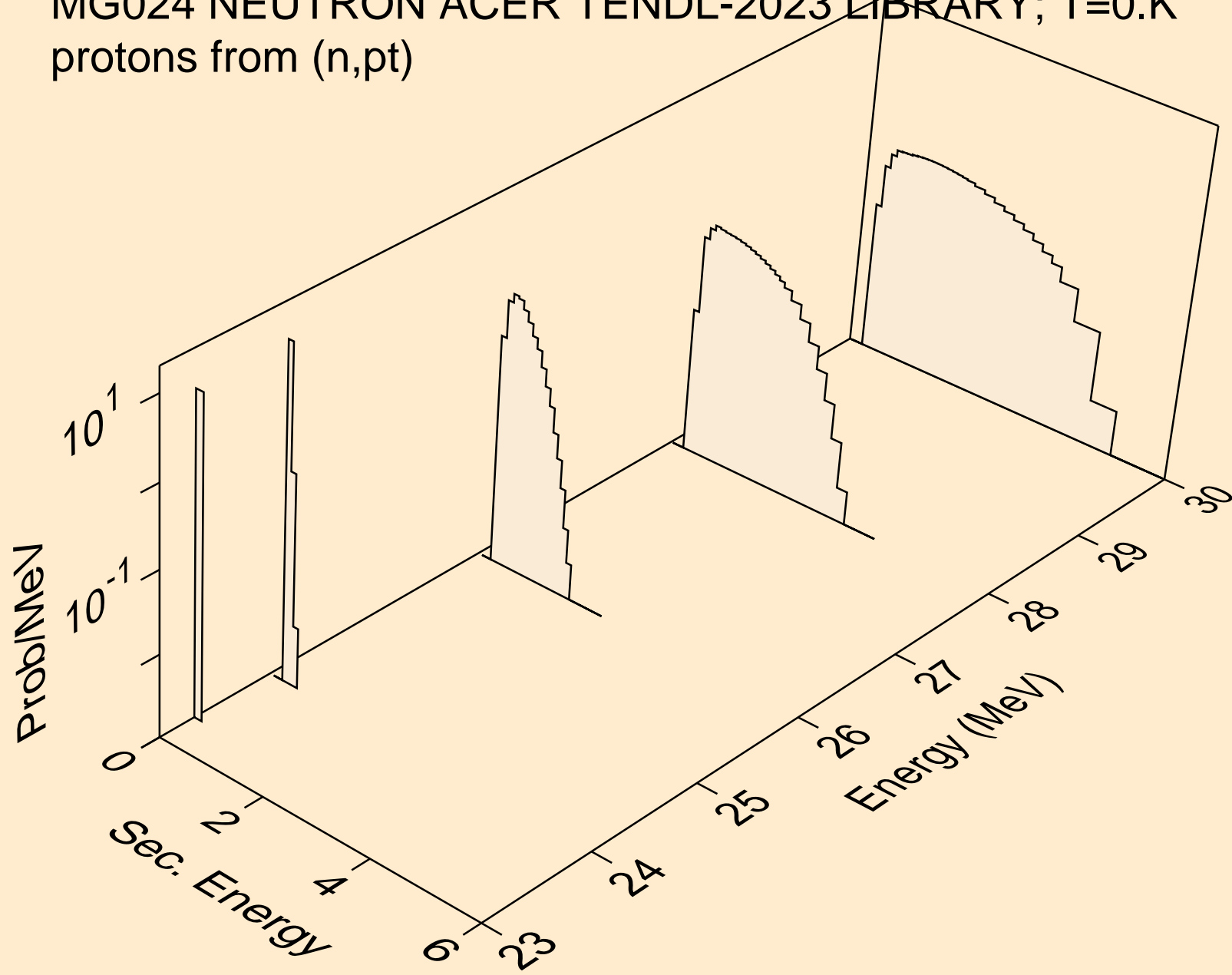



MG024 NEUTRON ACER TENDL-2023 LIBRARY; T=0.K  
deuterons from (n,x)

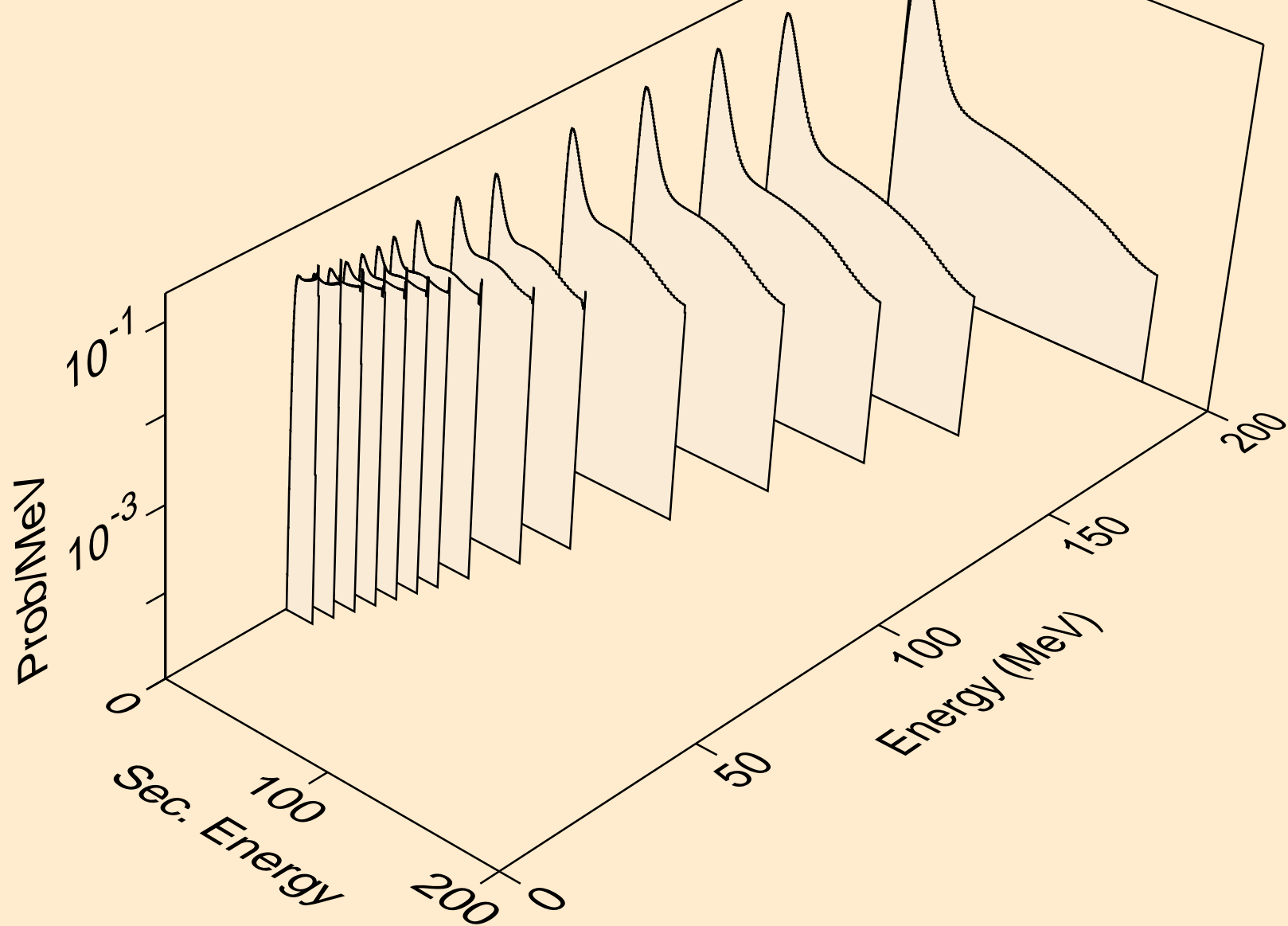

MG024 NEUTRON ACER TENDL-2023 LIBRARY; T=0.K  
deuterons from (n,n\*)d

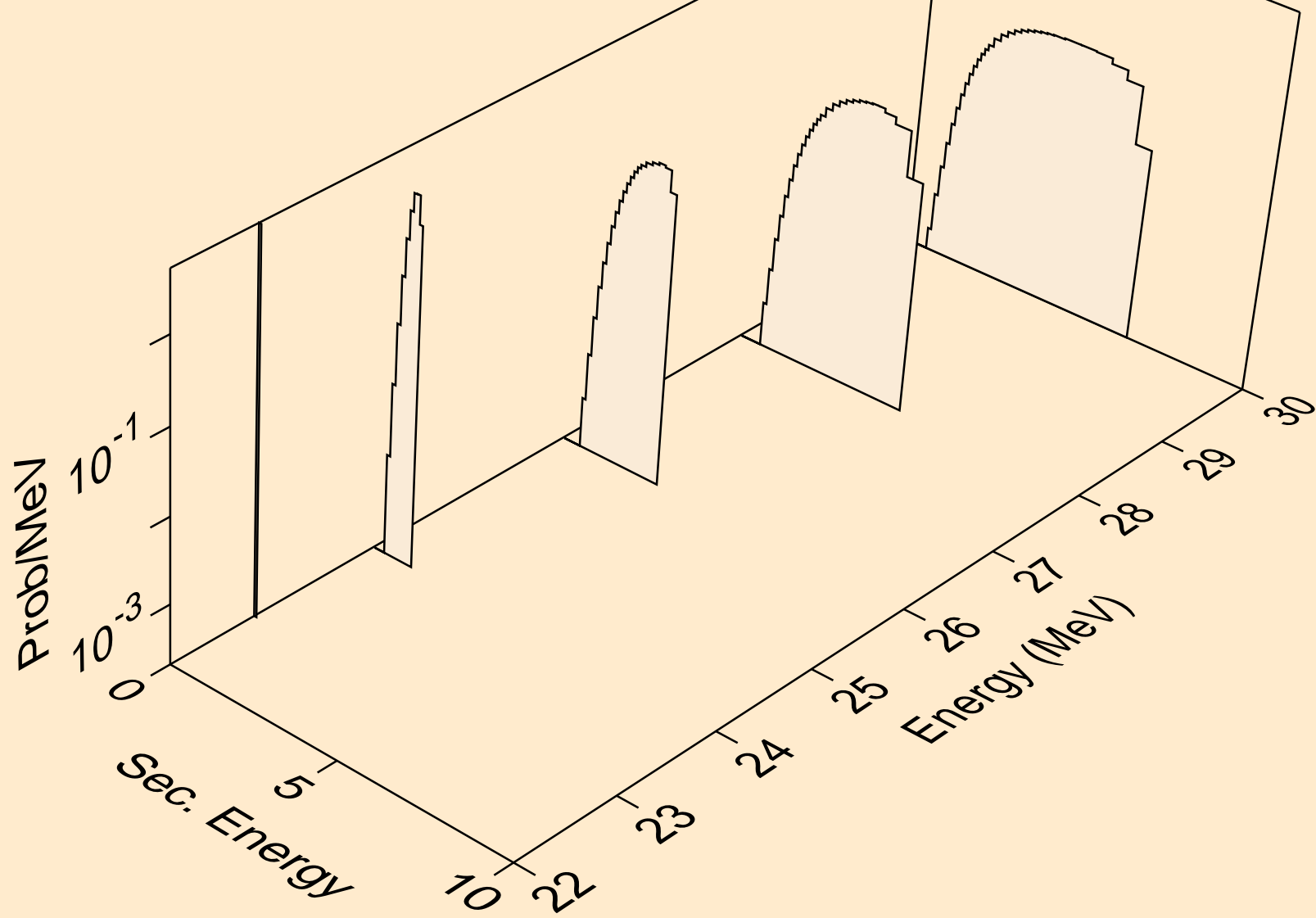

MG024 NEUTRON ACER TENDL-2023 LIBRARY; T=0.K  
deuterons from (n,d)

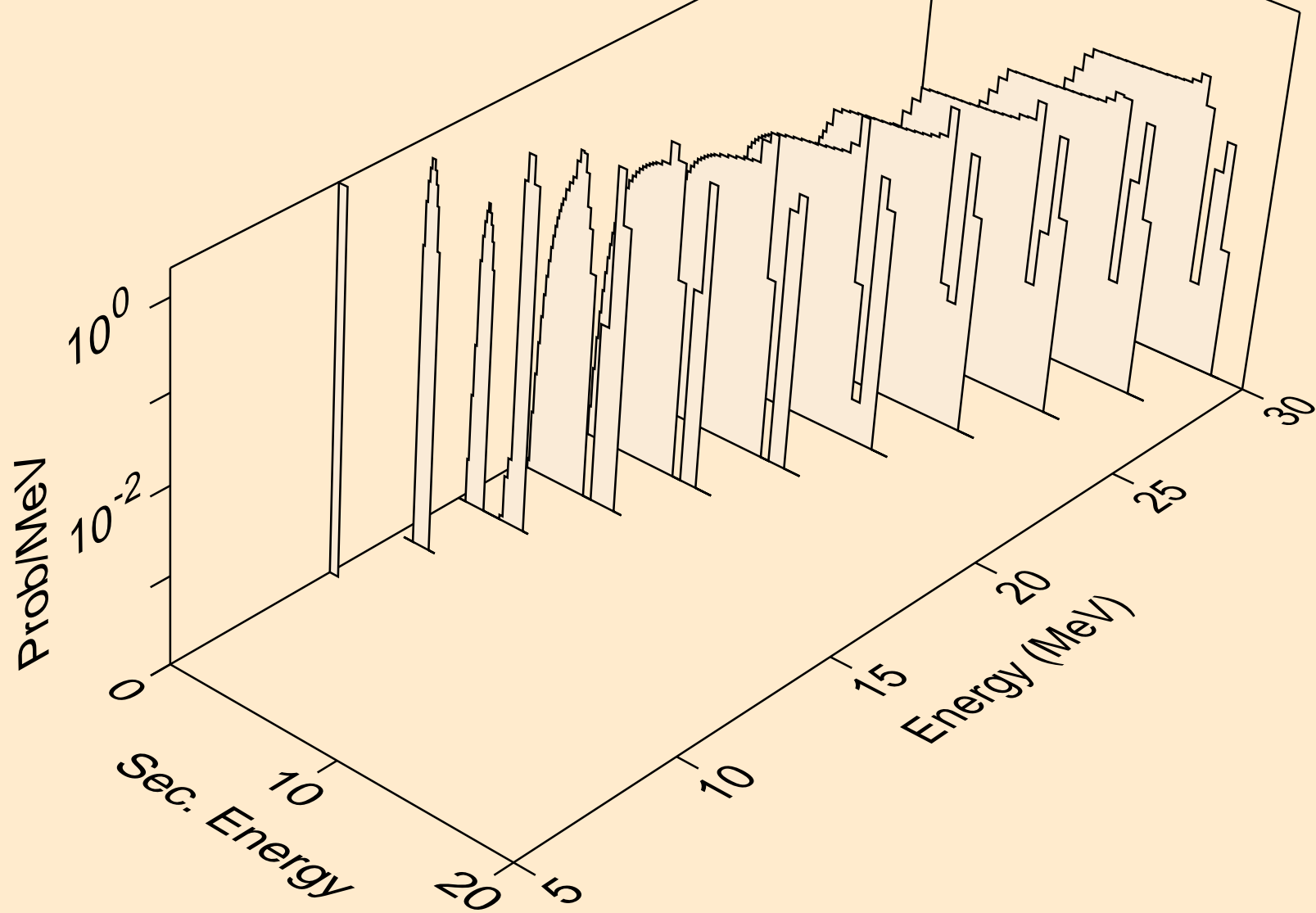

MG024 NEUTRON ACER TENDL-2023 LIBRARY; T=0.K  
deuterons from (n,d2a)

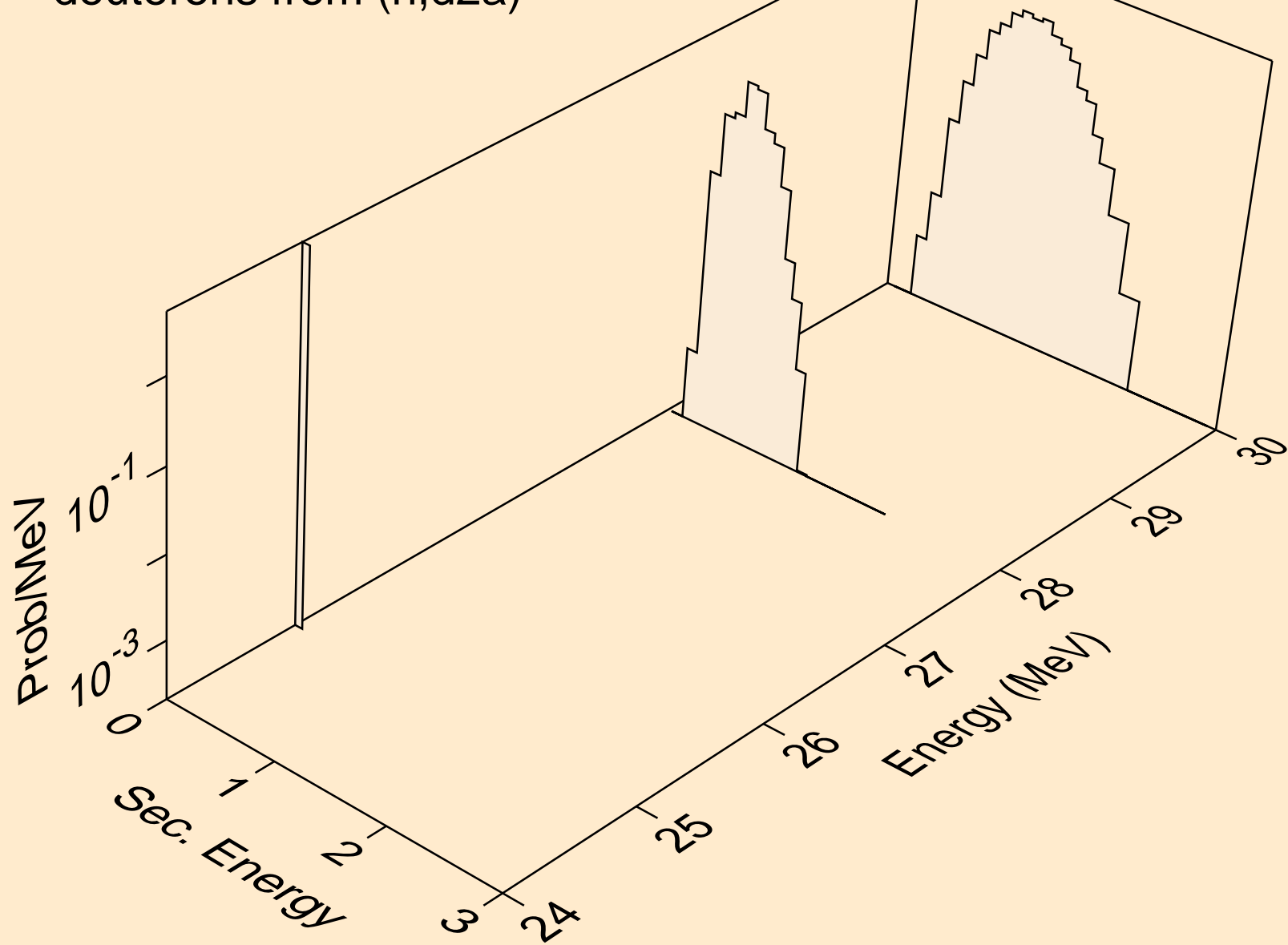

MG024 NEUTRON ACER TENDL-2023 LIBRARY; T=0.K  
deuterons from (n,pd)

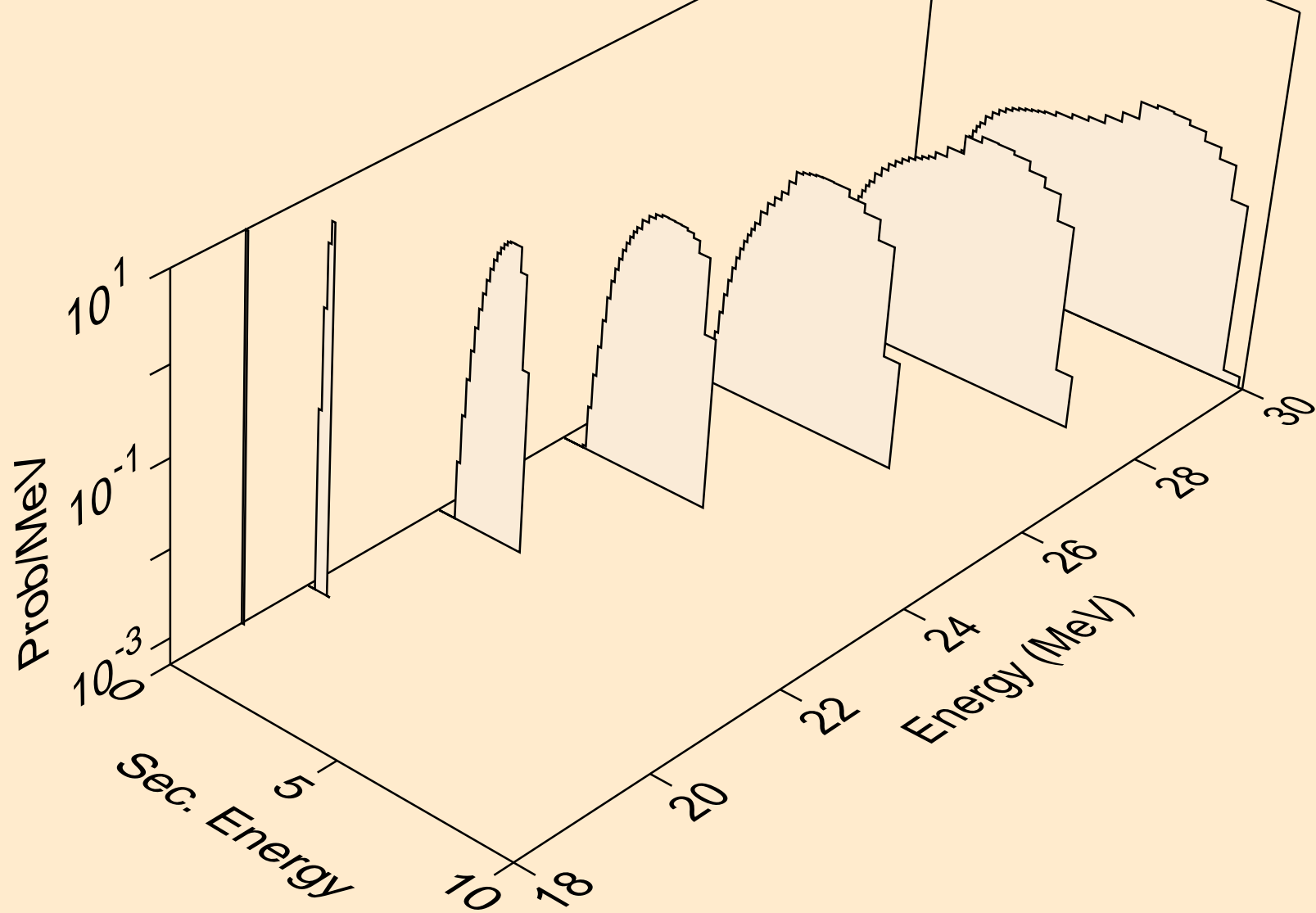

MG024 NEUTRON ACER TENDL-2023 LIBRARY; T=0.K  
deuterons from (n,da)

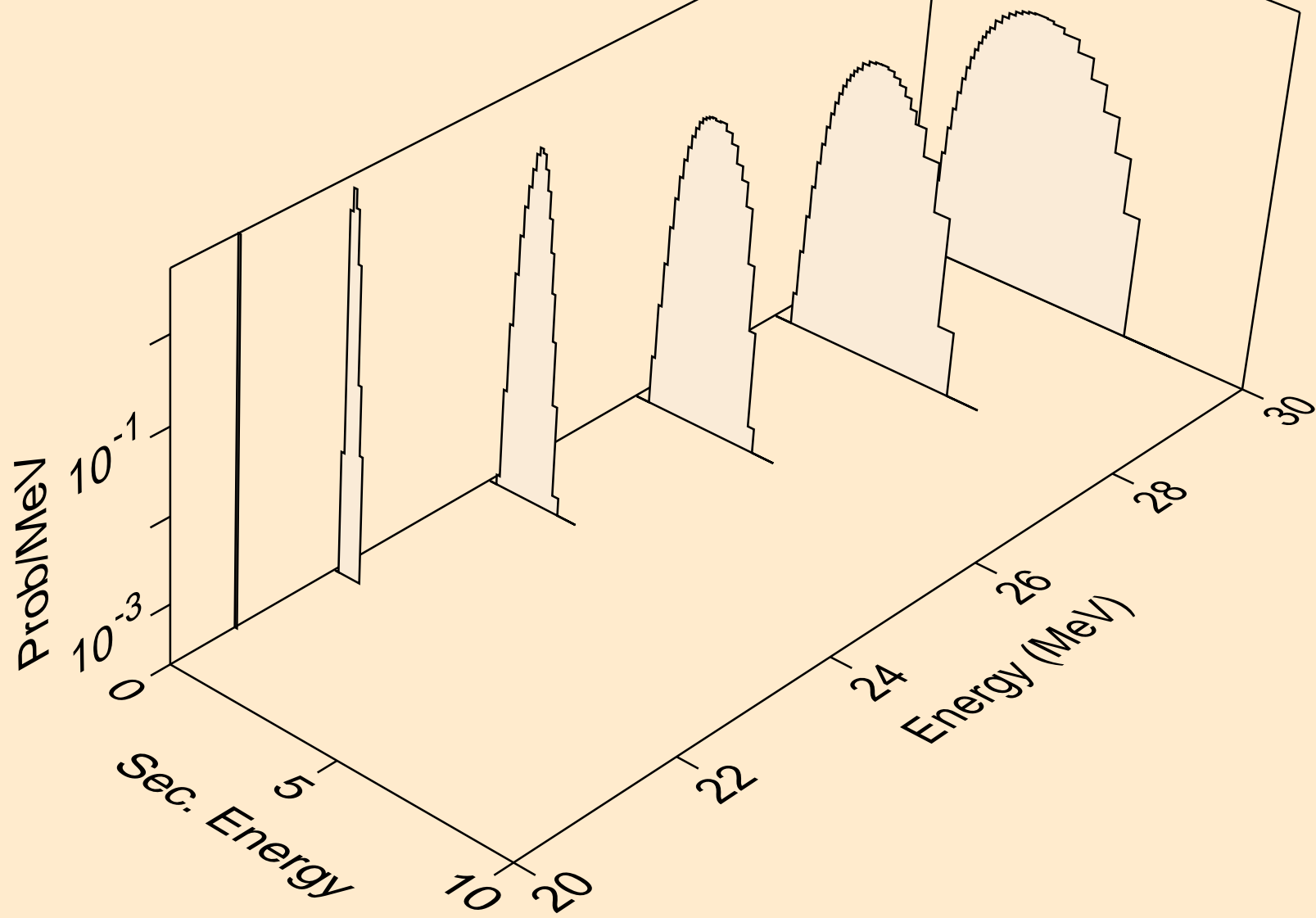

MG024 NEUTRON ACER TENDL-2023 LIBRARY; T=0.K  
tritons from (n,x)

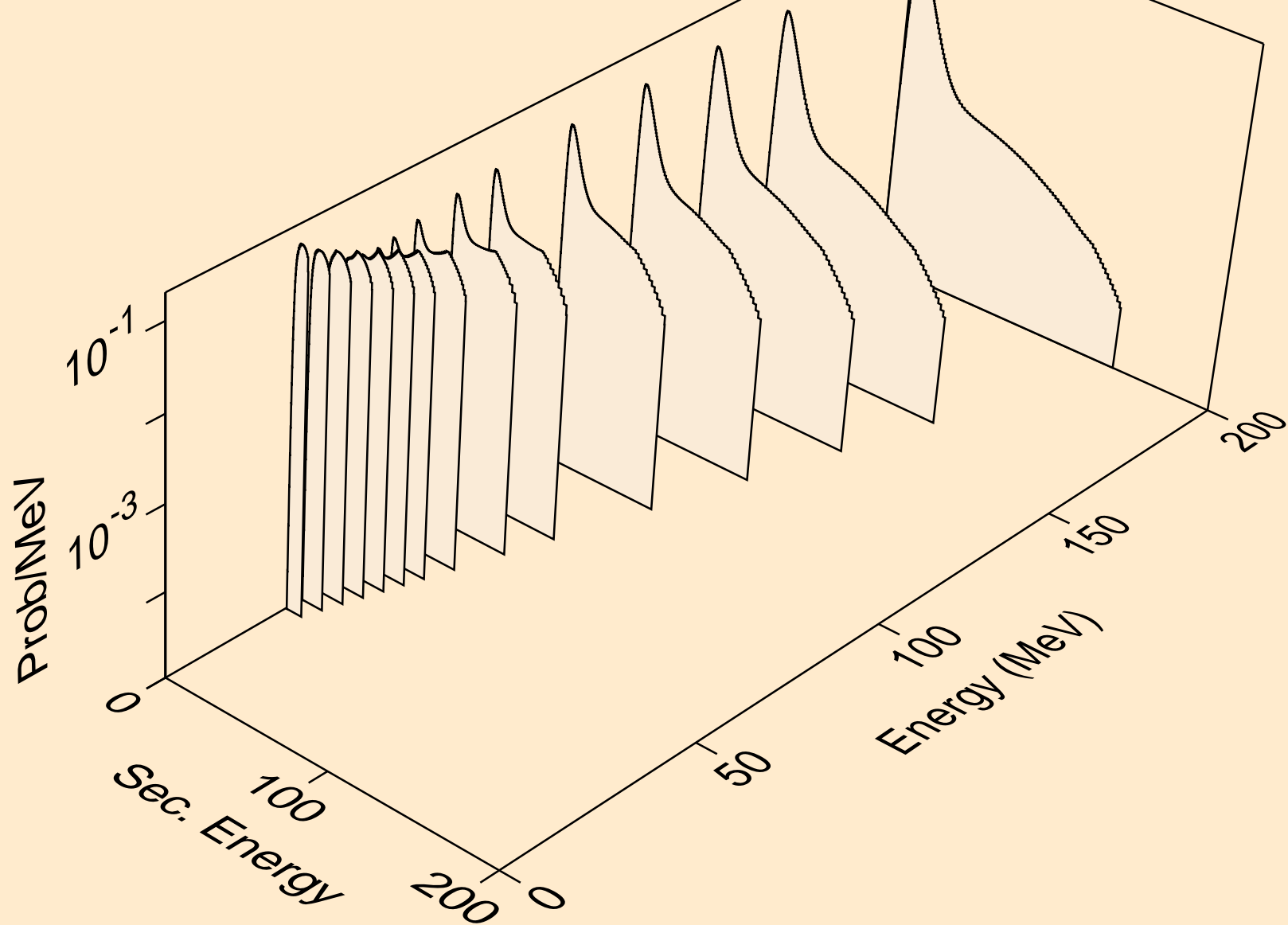

MG024 NEUTRON ACER TENDL-2023 LIBRARY; T=0.K  
tritons from (n,n\*)t

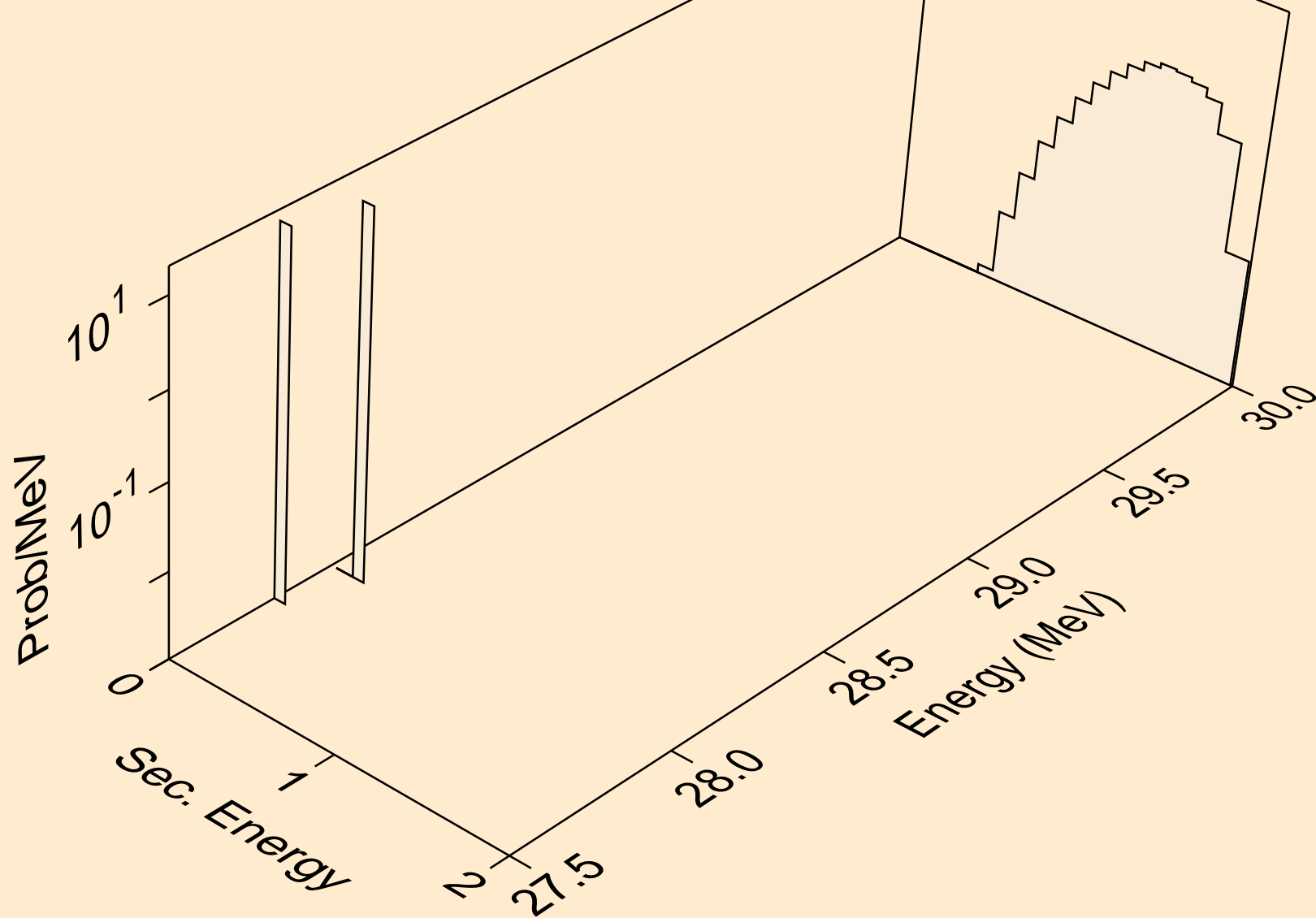



MG024 NEUTRON ACER TENDL-2023 LIBRARY; T=0.K  
tritons from (n,t)

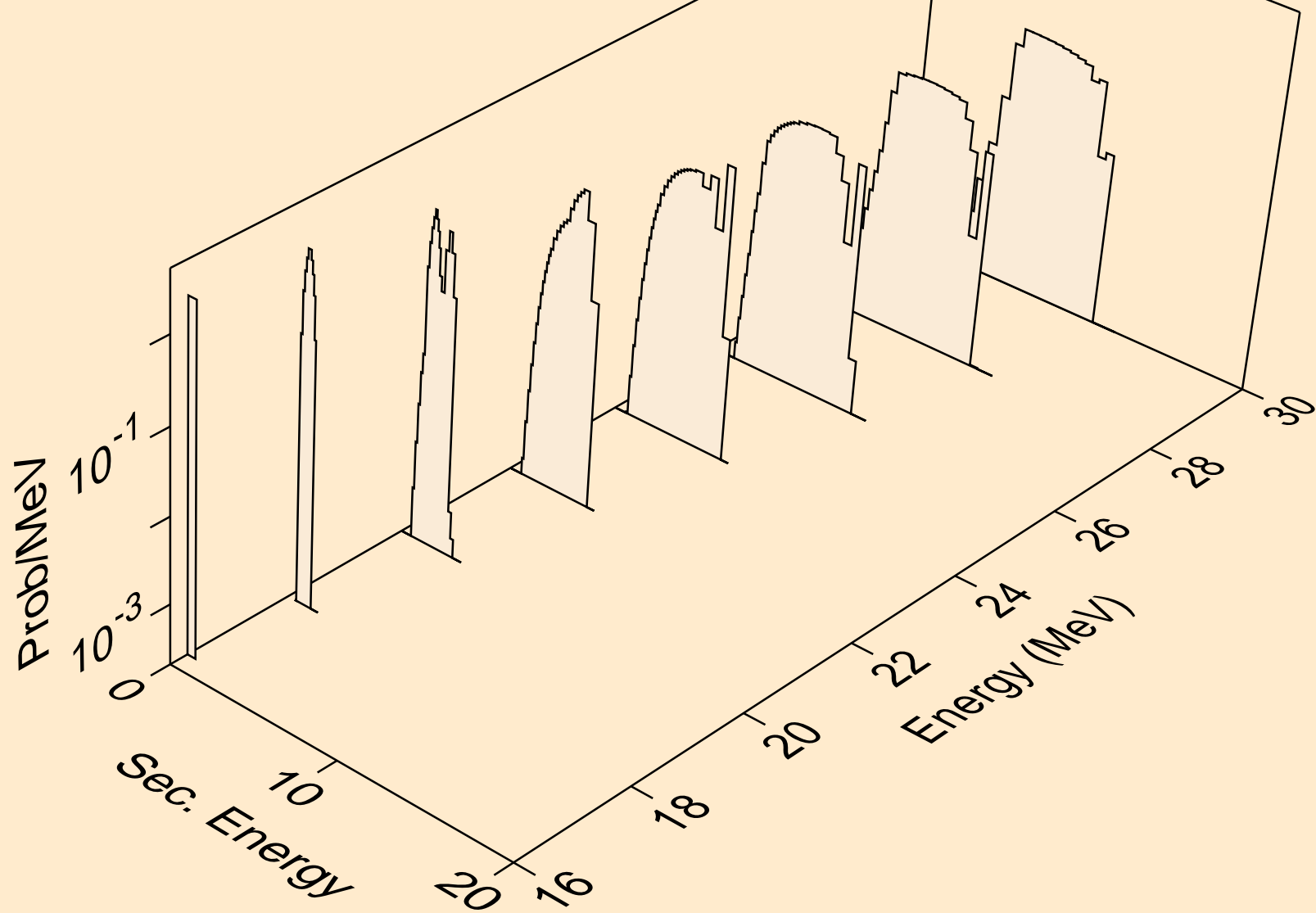

MG024 NEUTRON ACER TENDL-2023 LIBRARY; T=0.K  
tritons from (n,pt)

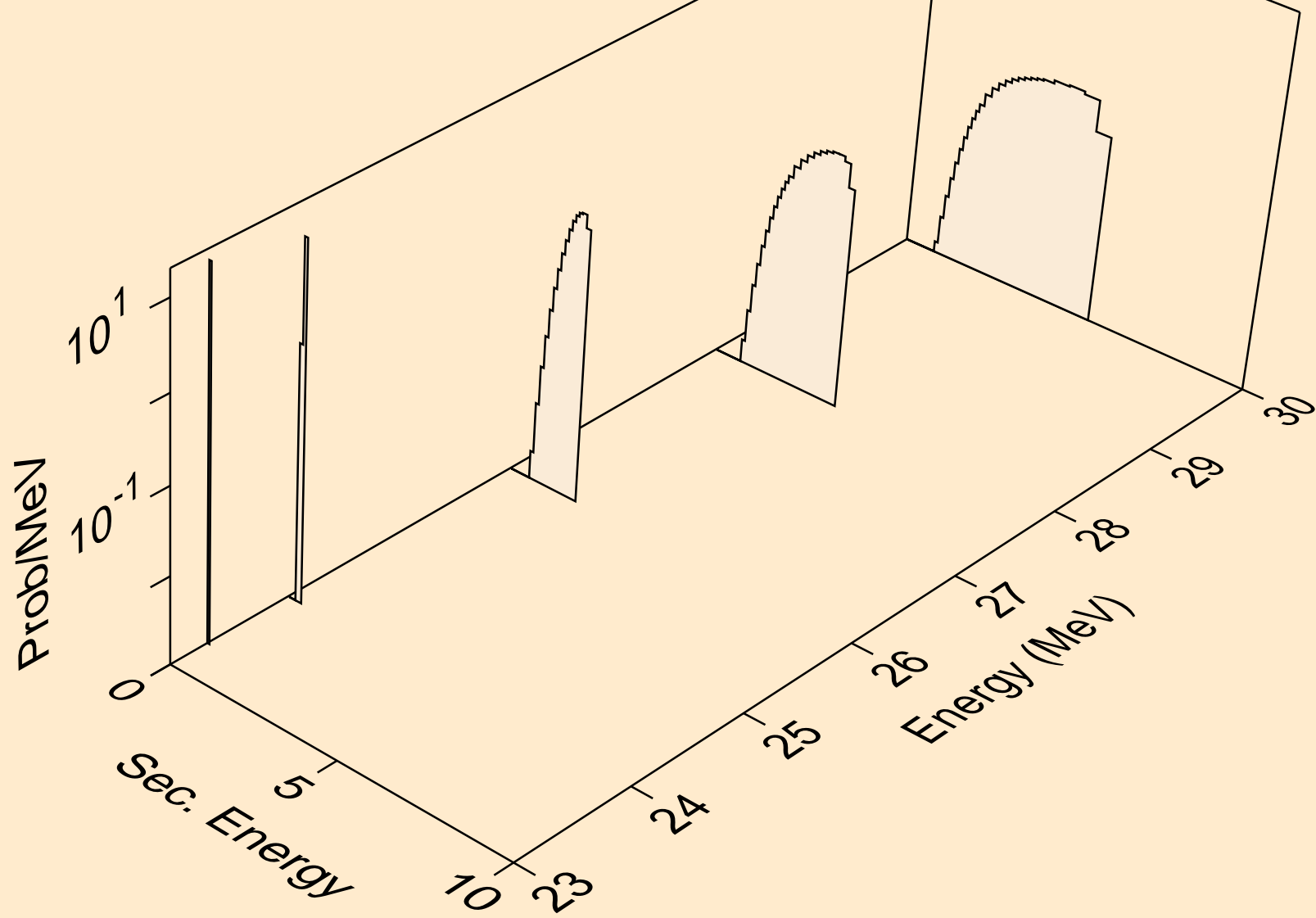

MG024 NEUTRON ACER TENDL-2023 LIBRARY; T=0.K  
he3s from (n,x)

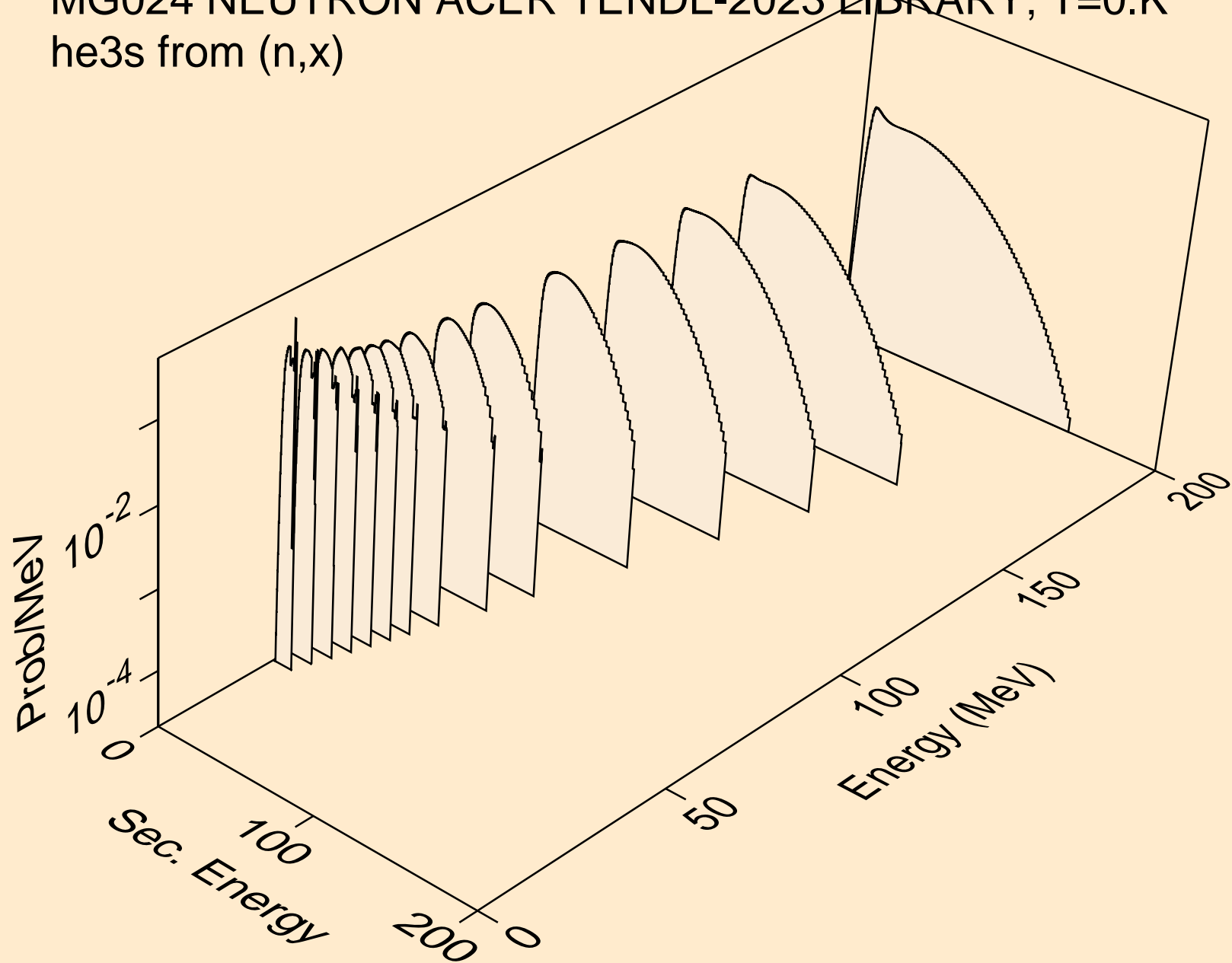

MG024 NEUTRON ACER TENDL-2023 LIBRARY; T=0.K  
he3s from (n,n\*)he3

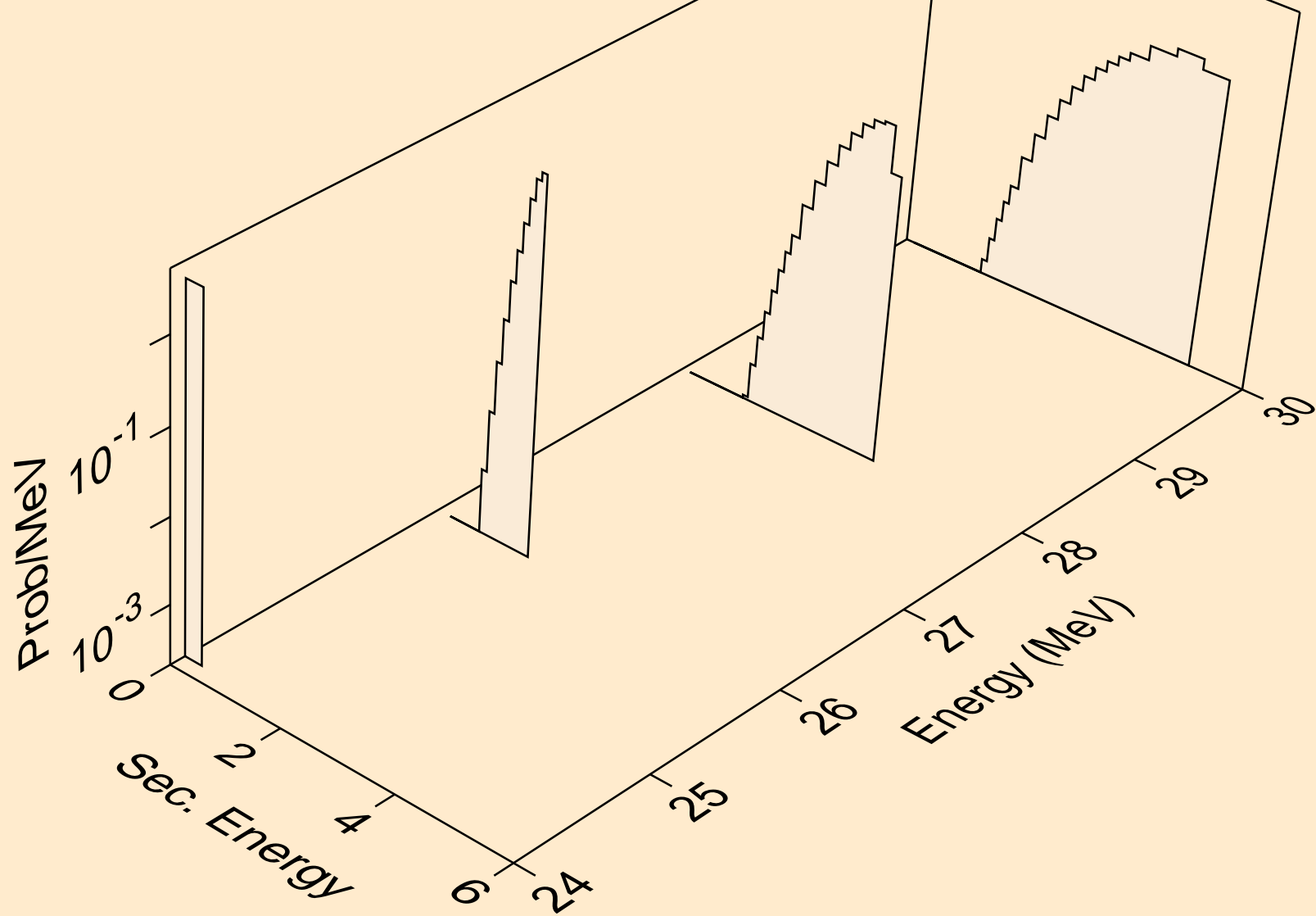

MG024 NEUTRON ACER TENDL-2023 LIBRARY; T=0.K  
he3s from (n,he3)

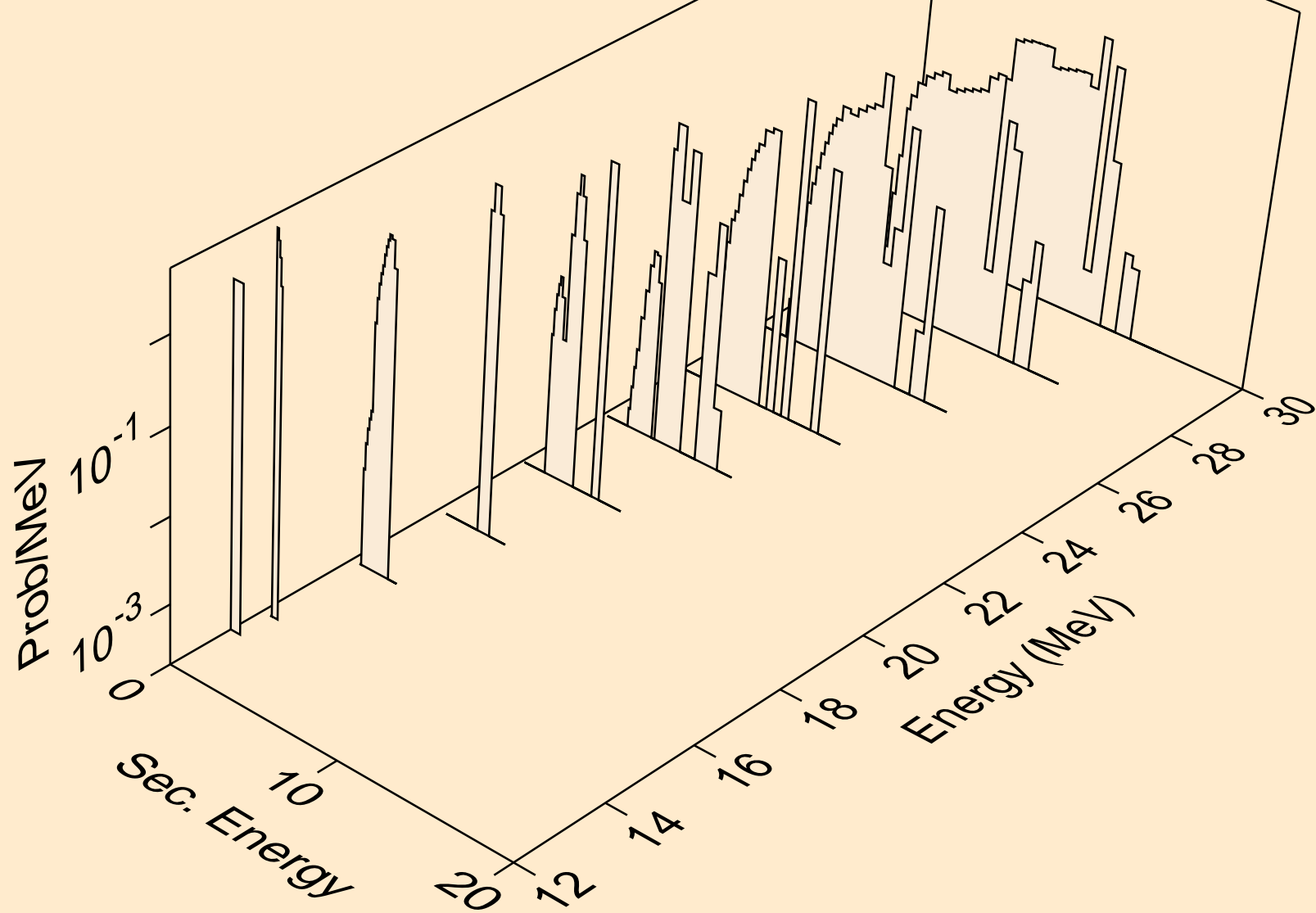

MG024 NEUTRON ACER TENDL-2023 LIBRARY; T=0.K  
alphas from (n,x)

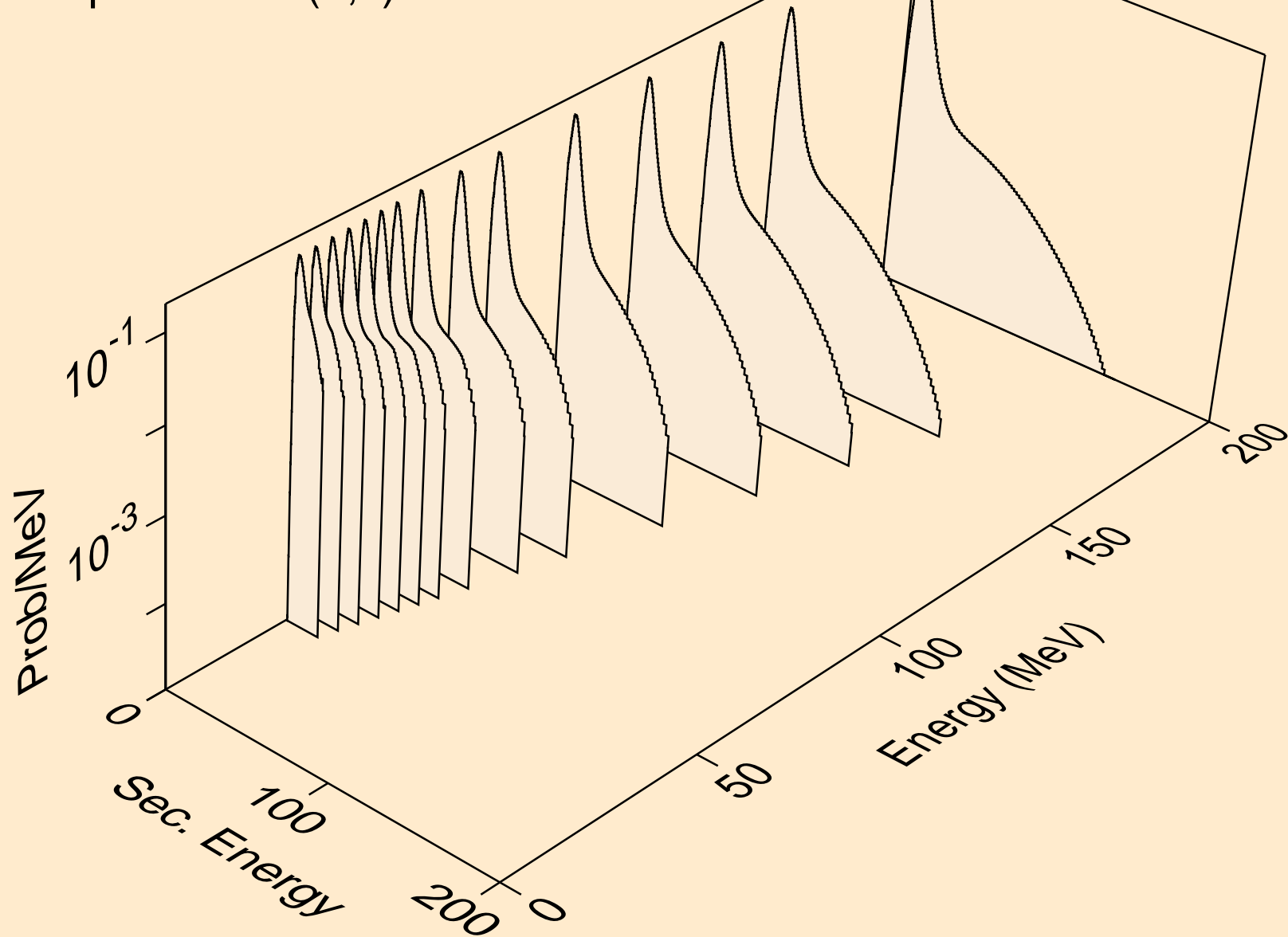

MG024 NEUTRON ACER TENDL-2023 LIBRARY; T=0.K  
alphas from (n,n\*)a

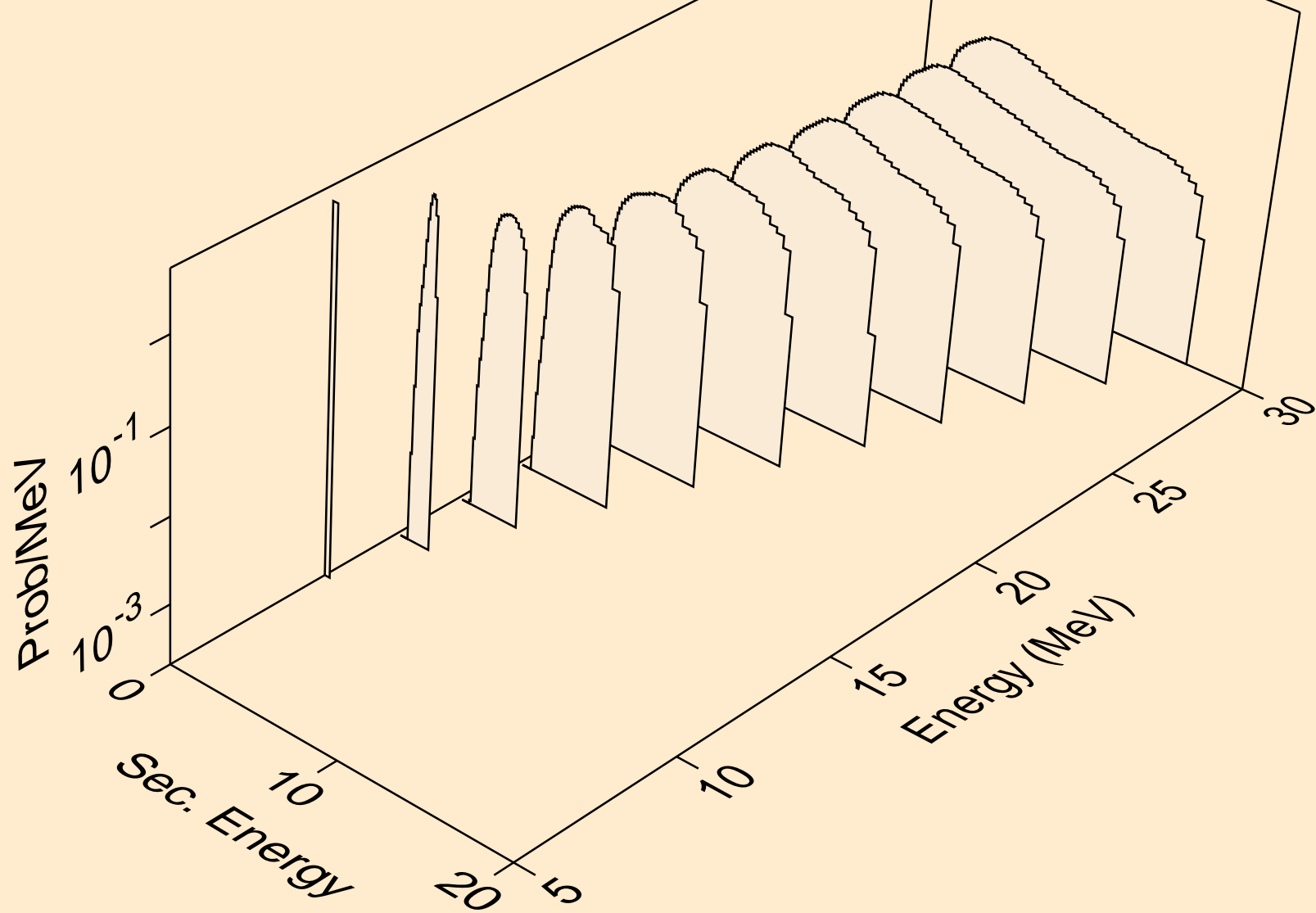

MG024 NEUTRON ACER TENDL-2023 LIBRARY; T=0.K  
alphas from (n,2n)a

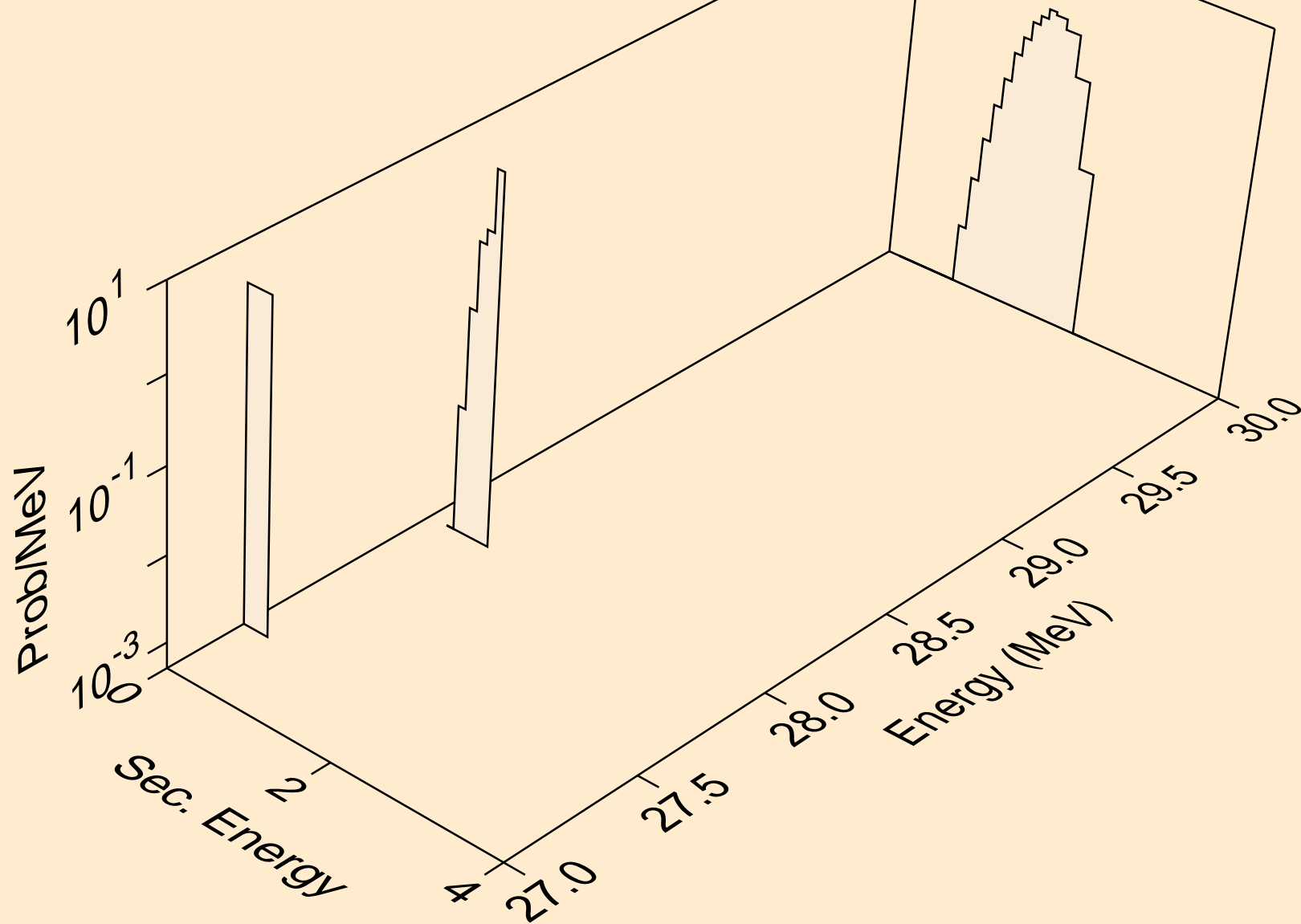



MG024 NEUTRON ACER TENDL-2023 LIBRARY; T=0.K  
alphas from (n,n\*)2a

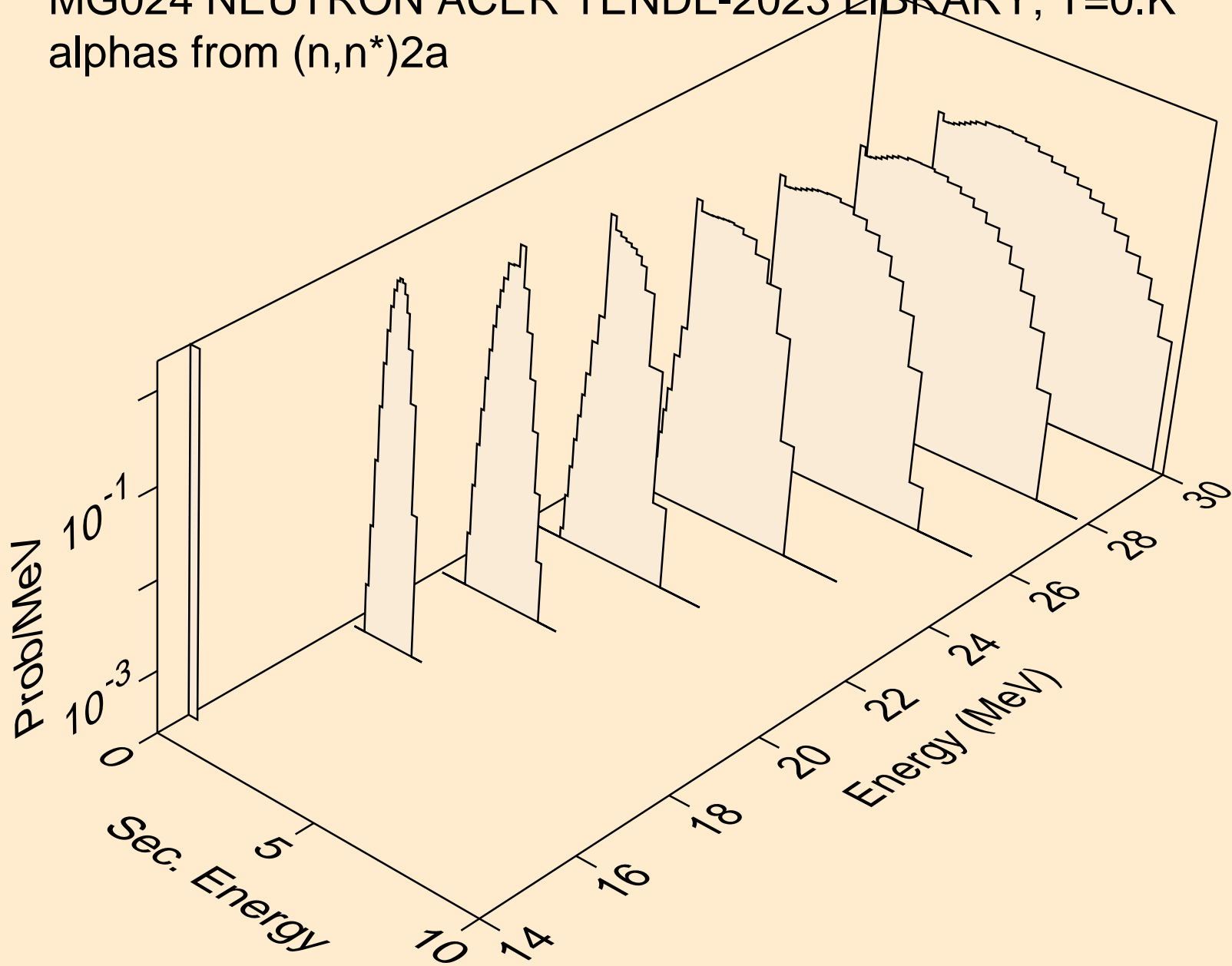

MG024 NEUTRON ACER TENDL-2023 LIBRARY; T=0.K  
alphas from (n,npa)

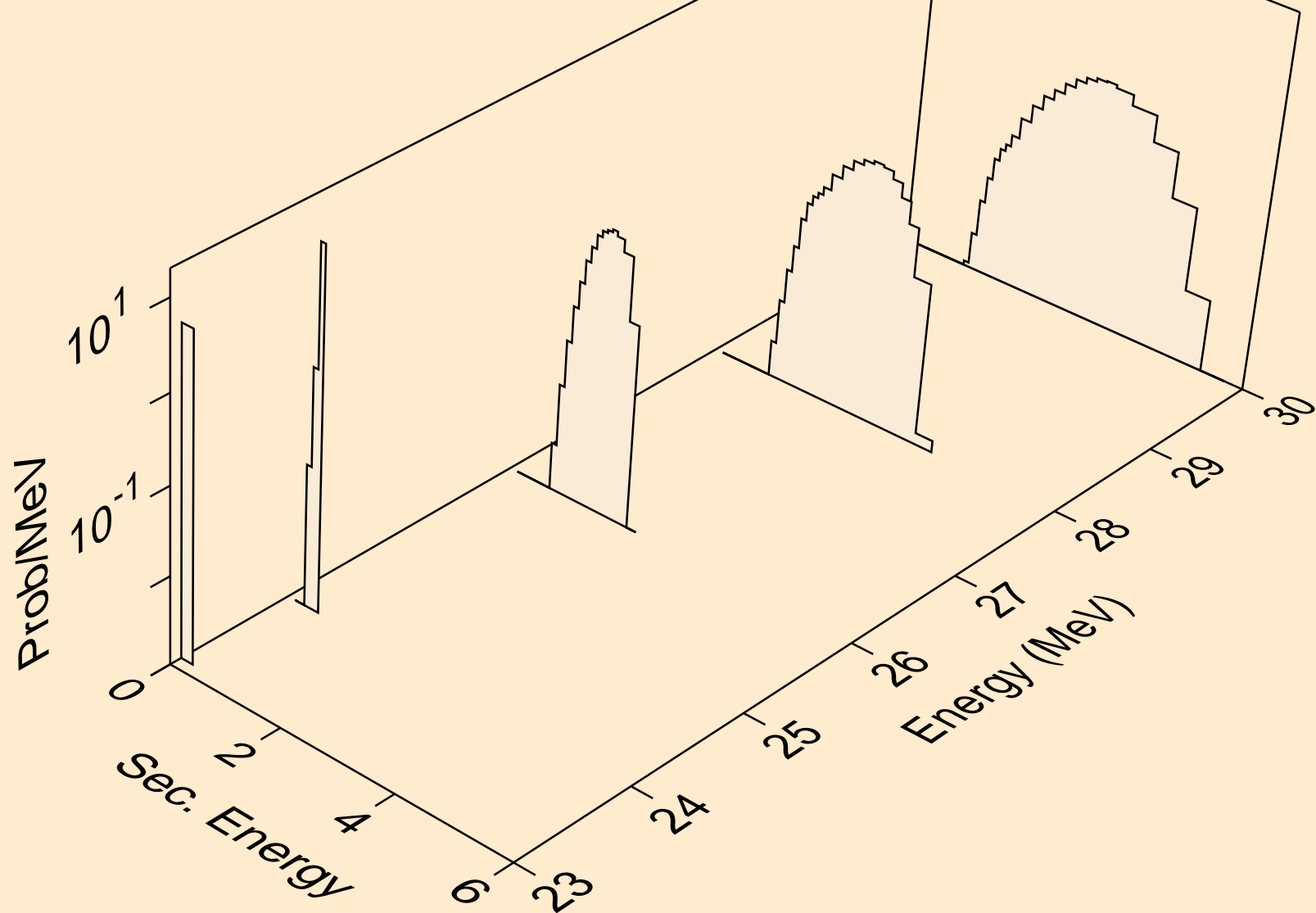

MG024 NEUTRON ACER TENDL-2023 LIBRARY; T=0.K  
alphas from (n,a)

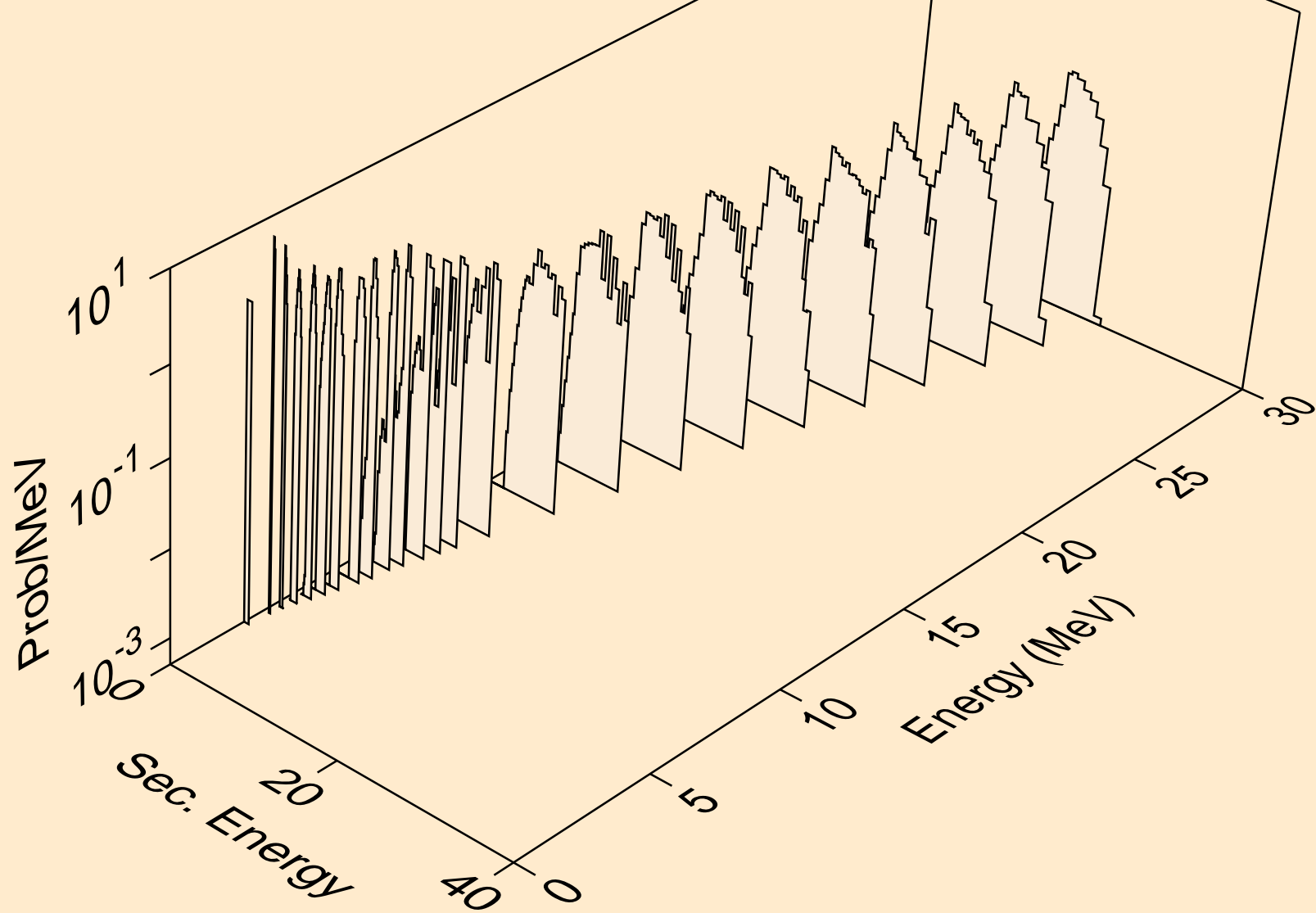

MG024 NEUTRON ACER TENDL-2023 LIBRARY; T=0.K  
alphas from (n,2a)

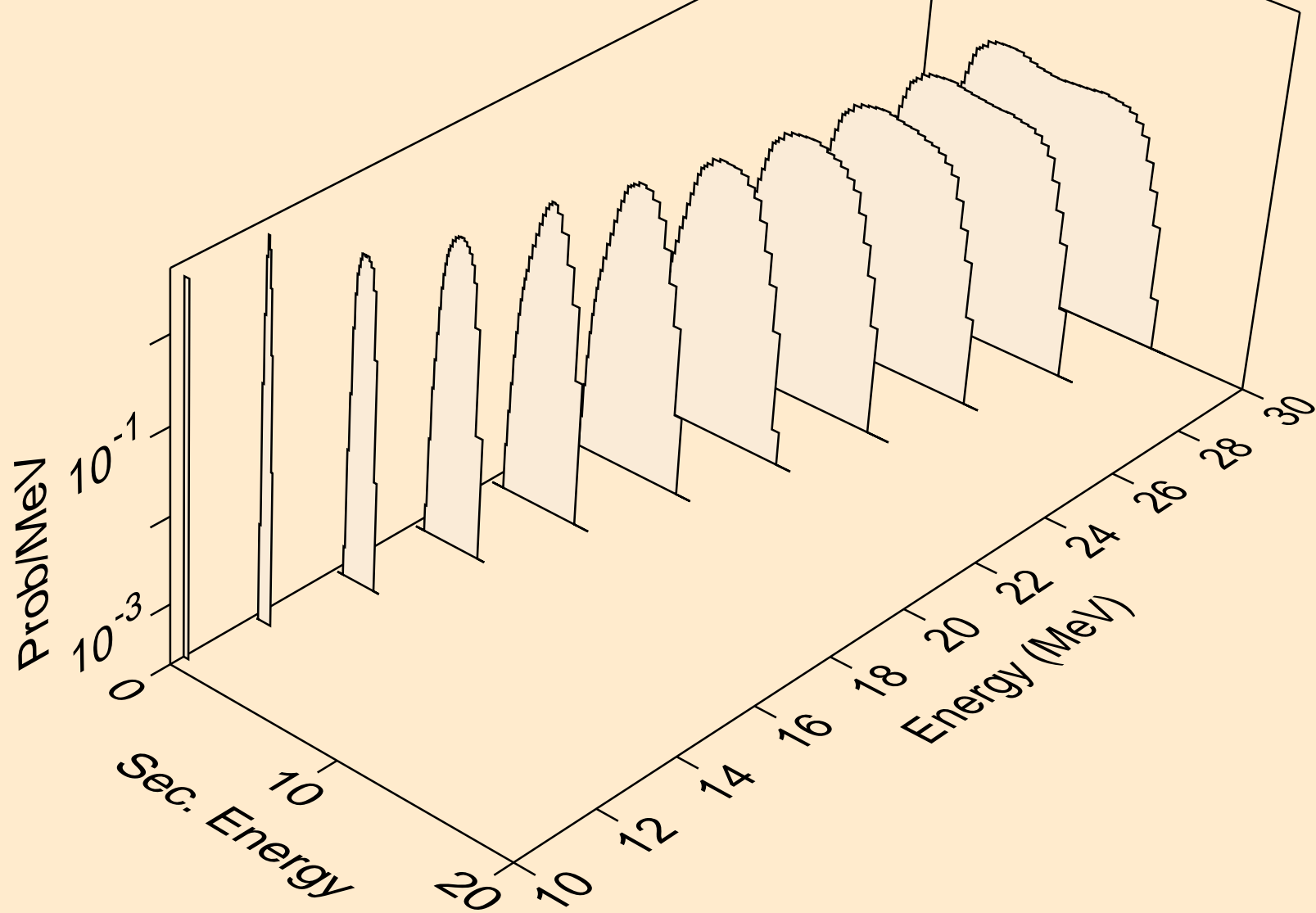

MG024 NEUTRON ACER TENDL-2023 LIBRARY; T=0.K  
alphas from (n,3a)

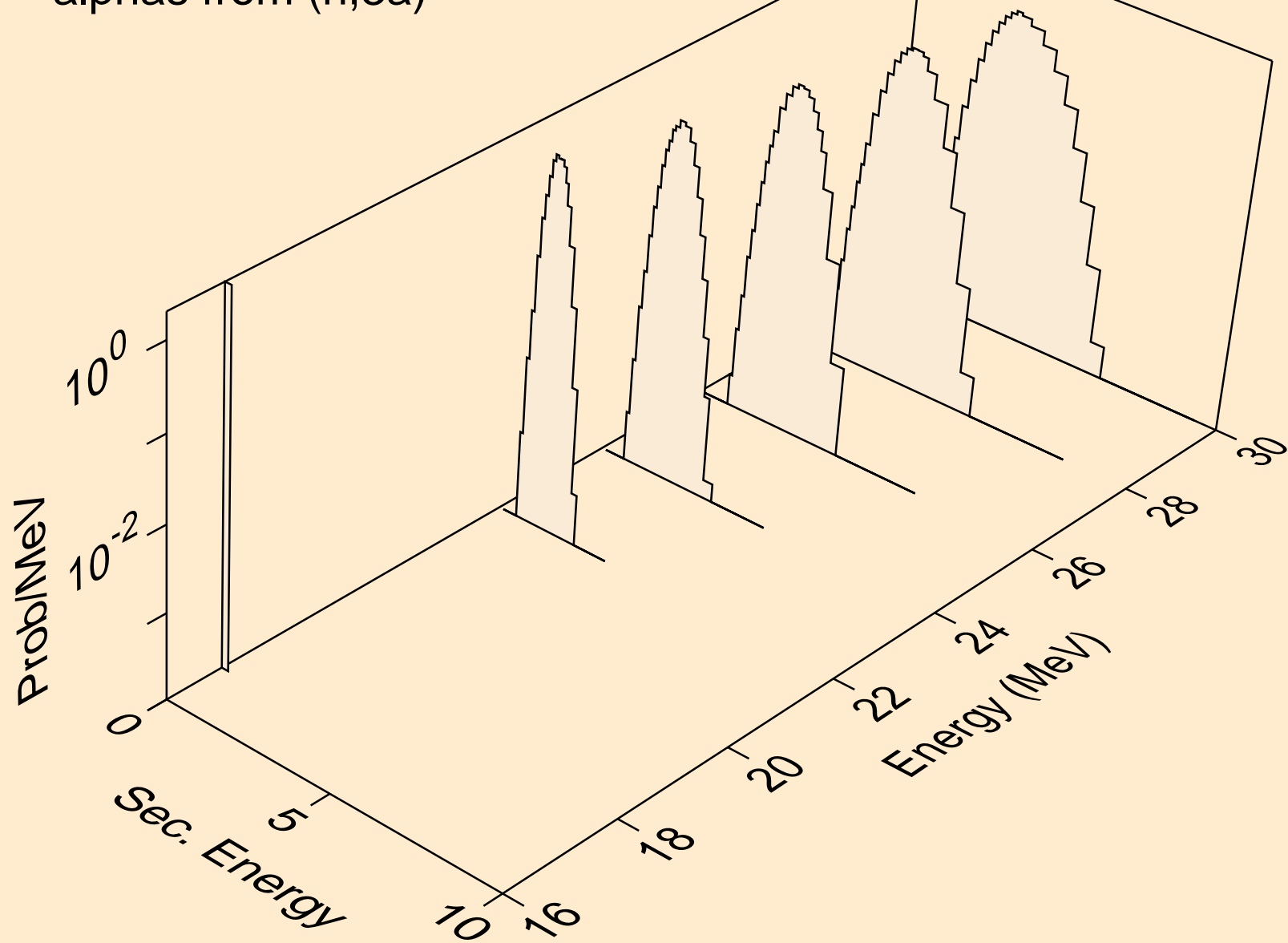

MG024 NEUTRON ACER TENDL-2023 LIBRARY; T=0.K  
alphas from (n,pa)

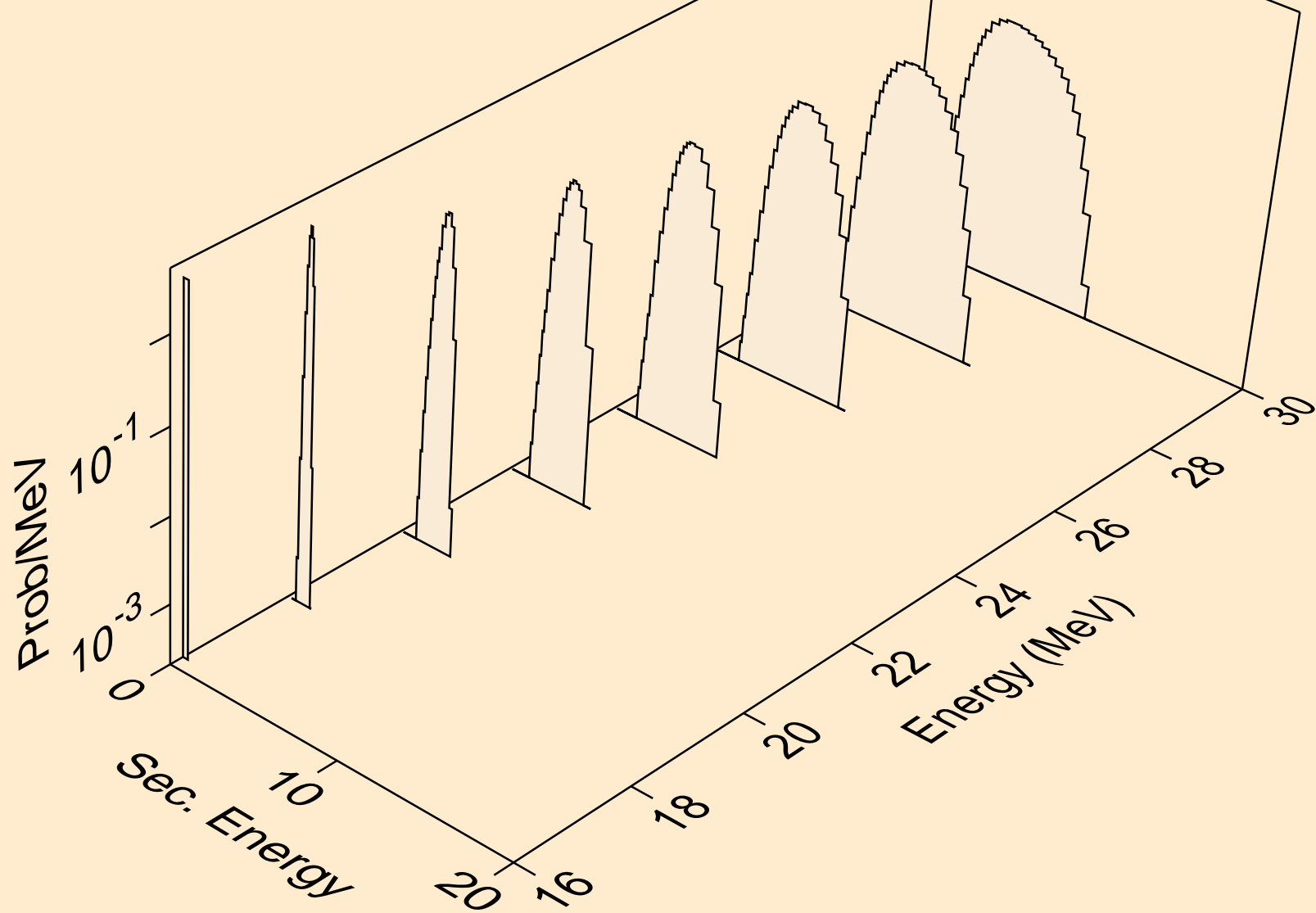

MG024 NEUTRON ACER TENDL-2023 LIBRARY; T=0.K  
alphas from (n,d2a)

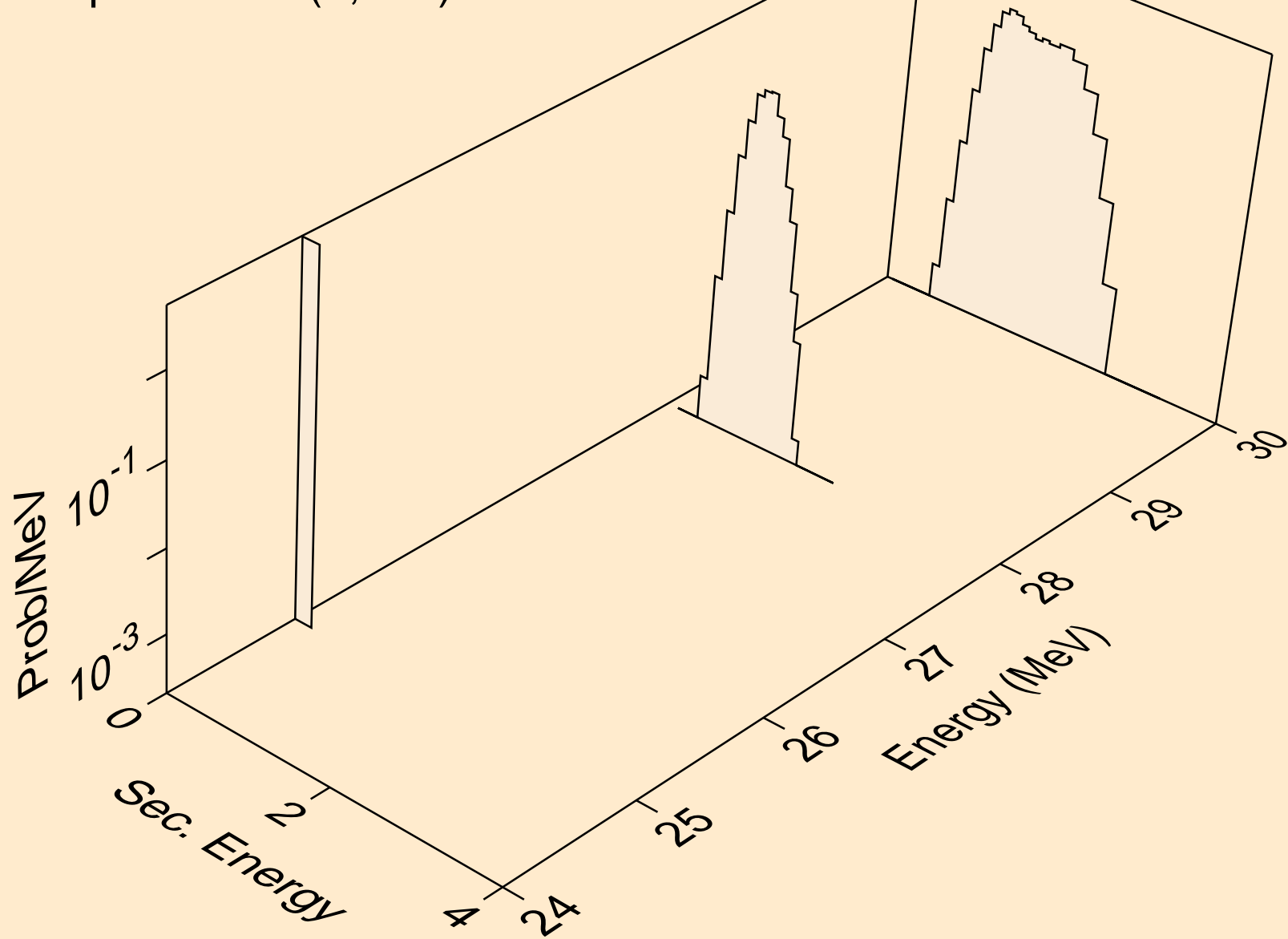

MG024 NEUTRON ACER TENDL-2023 LIBRARY; T=0.K  
alphas from (n,da)

