

# MT279 NEUTRON ACER TENDL-2023 LIBRARY; T=0.K

## Principal cross sections

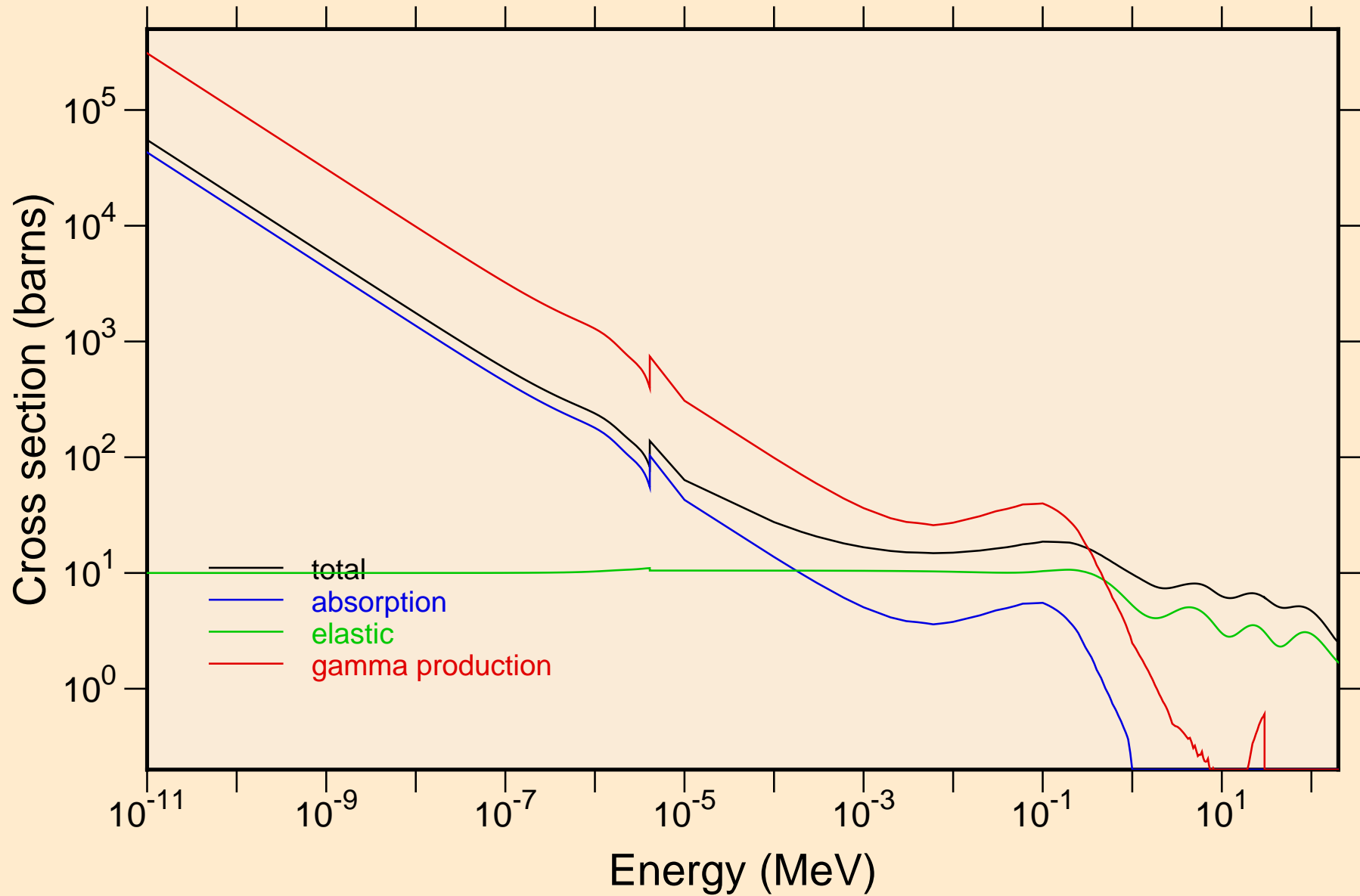

# MT279 NEUTRON ACER TENDL-2023 LIBRARY; T=0.K

## Heating

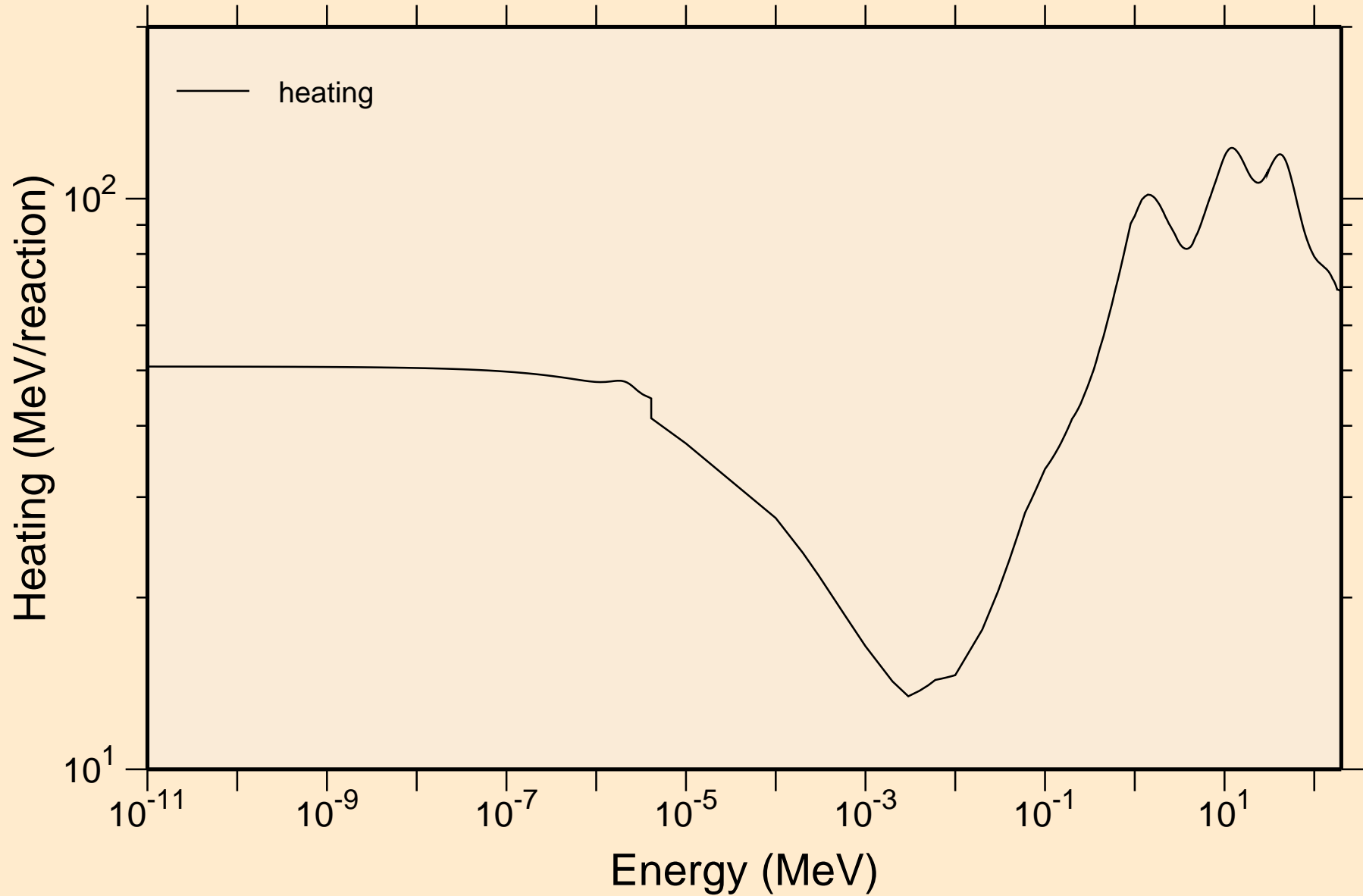

MT279 NEUTRON ACER TENDL-2023 LIBRARY; T=0.K  
Damage

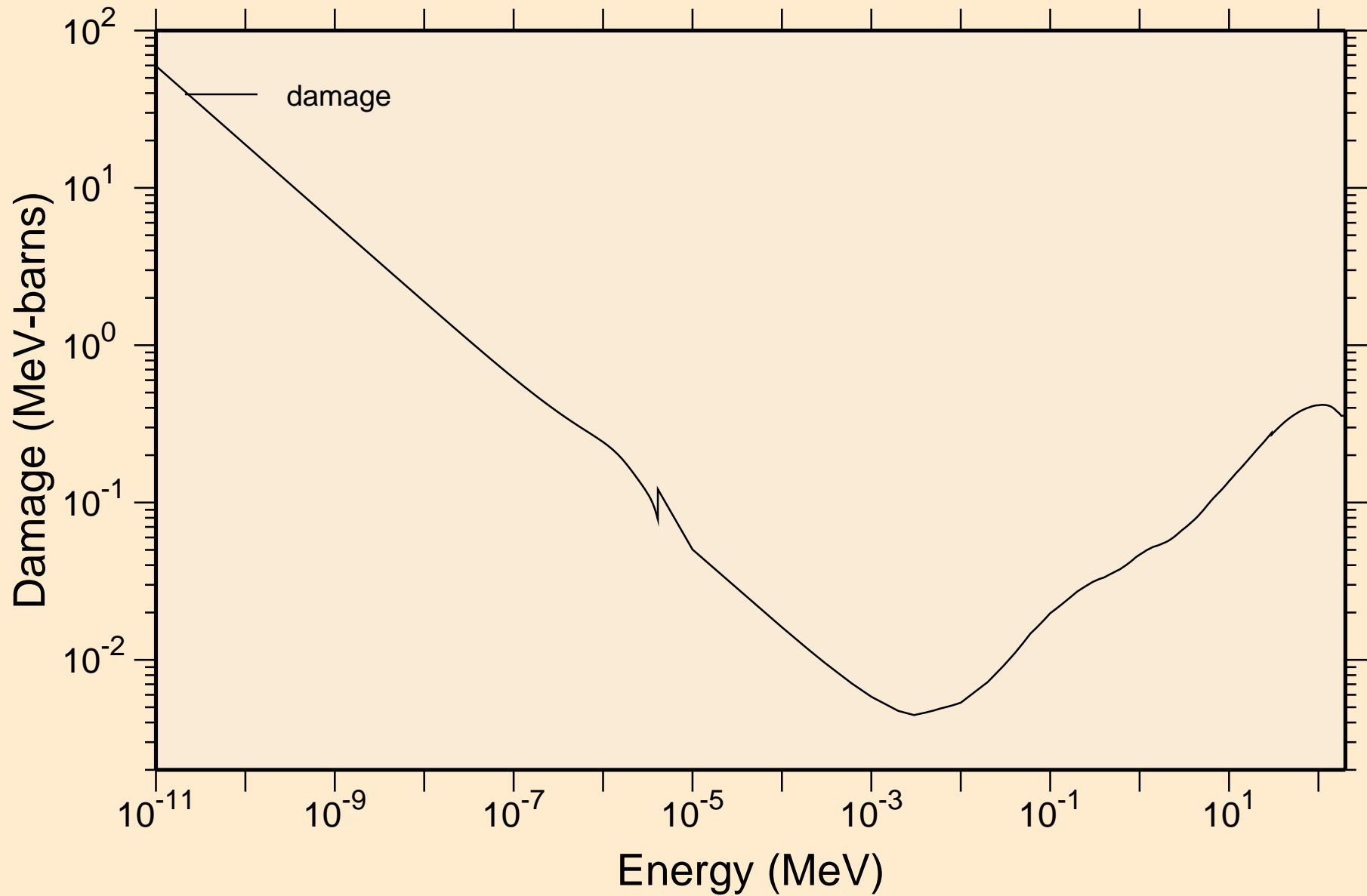

MT279 NEUTRON ACER TENDL-2023 LIBRARY; T=0.K  
Non-threshold reactions

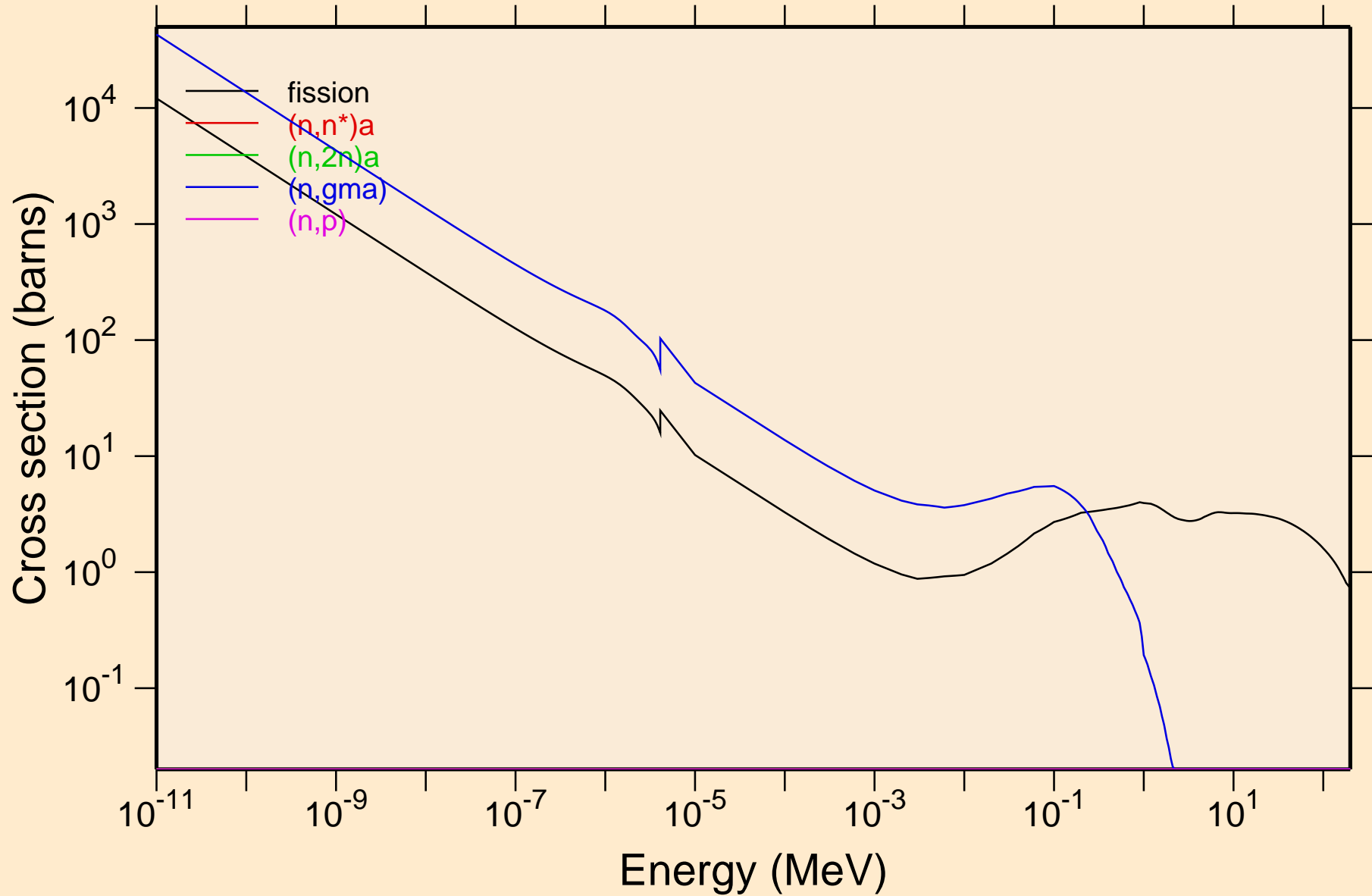

MT279 NEUTRON ACER TENDL-2023 LIBRARY; T=0.K  
Non-threshold reactions

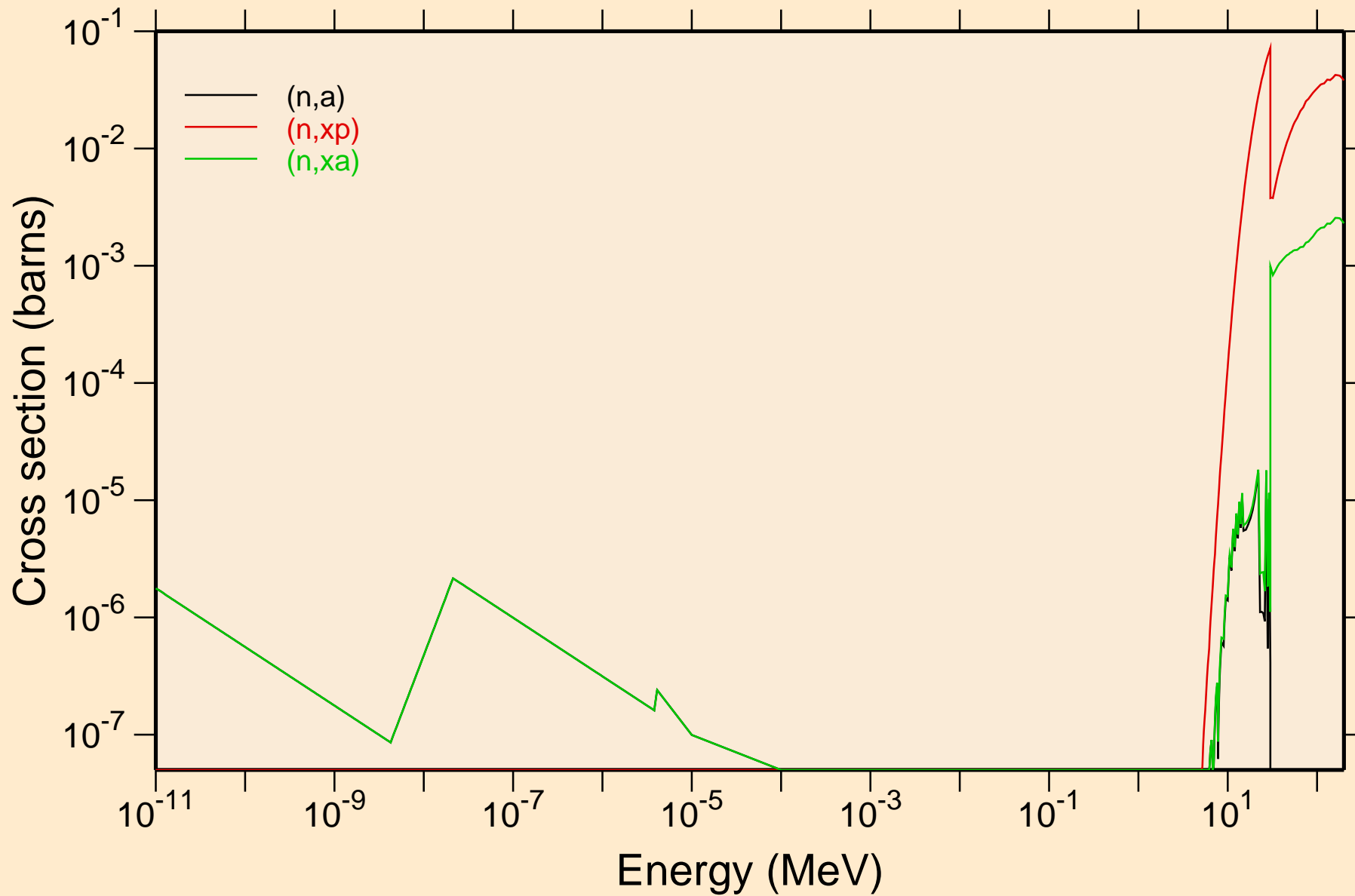

# MT279 NEUTRON ACER TENDL-2023 LIBRARY; T=0.K

## Principal cross sections

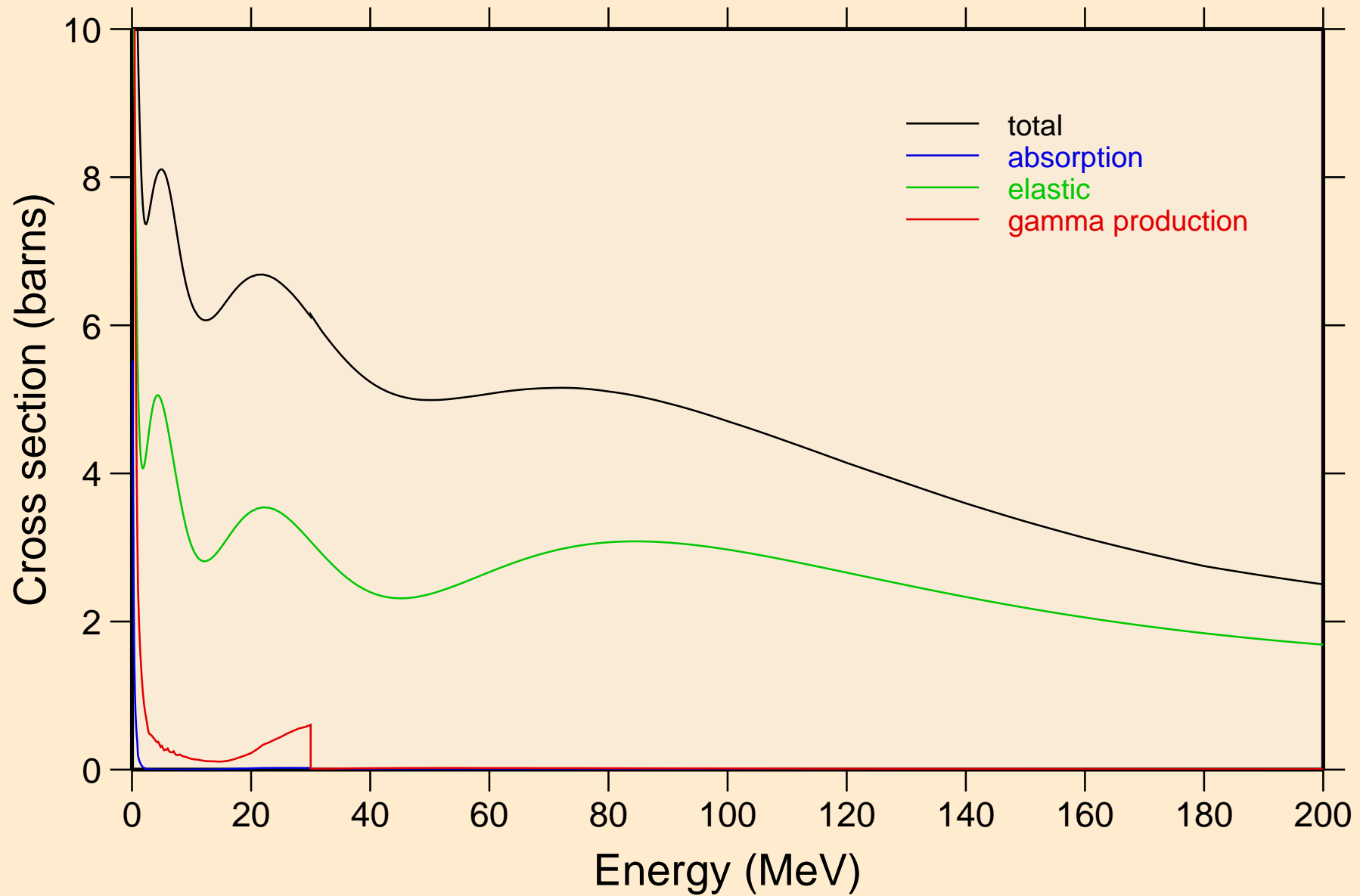

MT279 NEUTRON ACER TENDL-2023 LIBRARY; T=0.K  
Heating

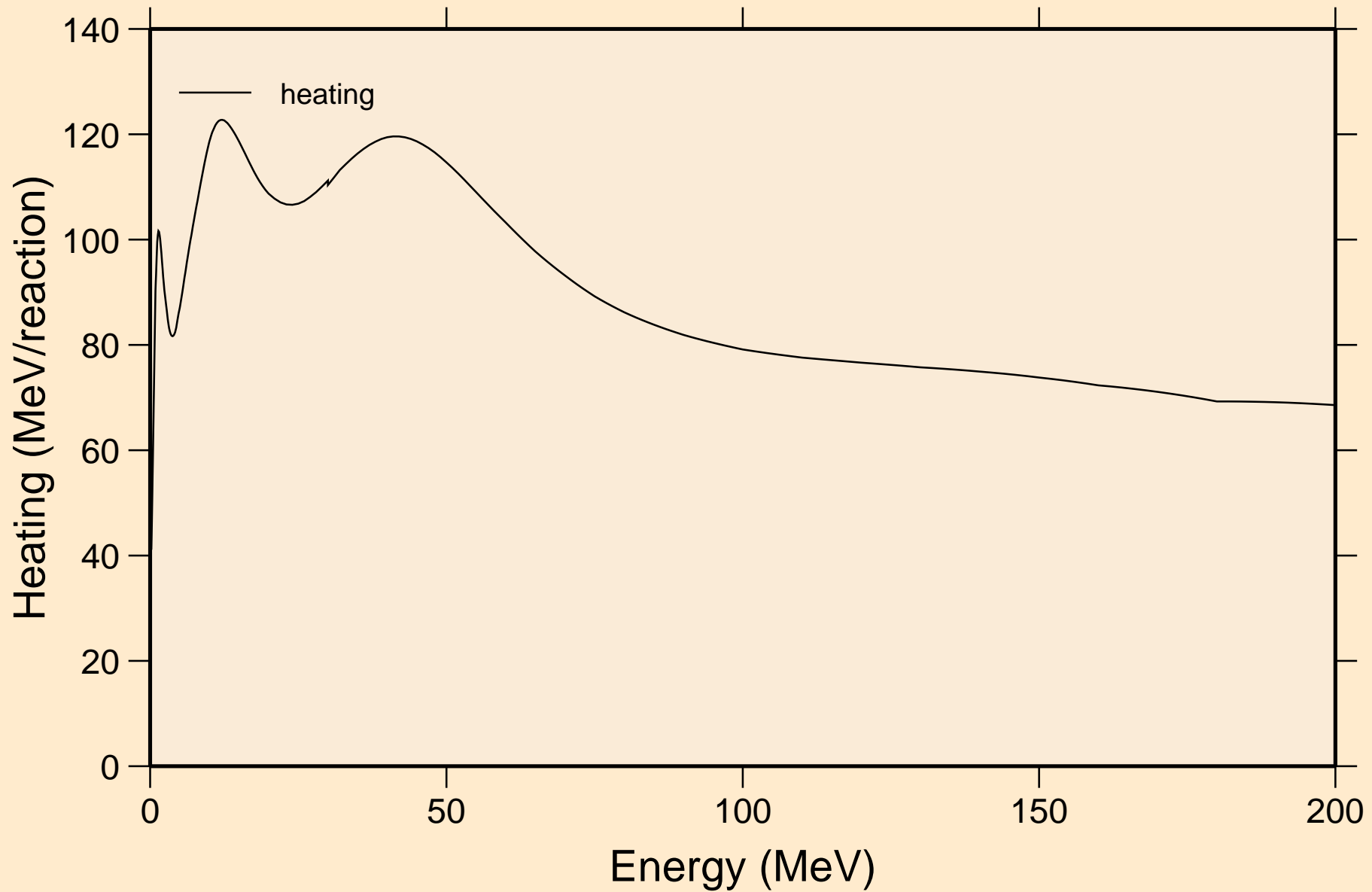

MT279 NEUTRON ACER TENDL-2023 LIBRARY; T=0.K  
Damage

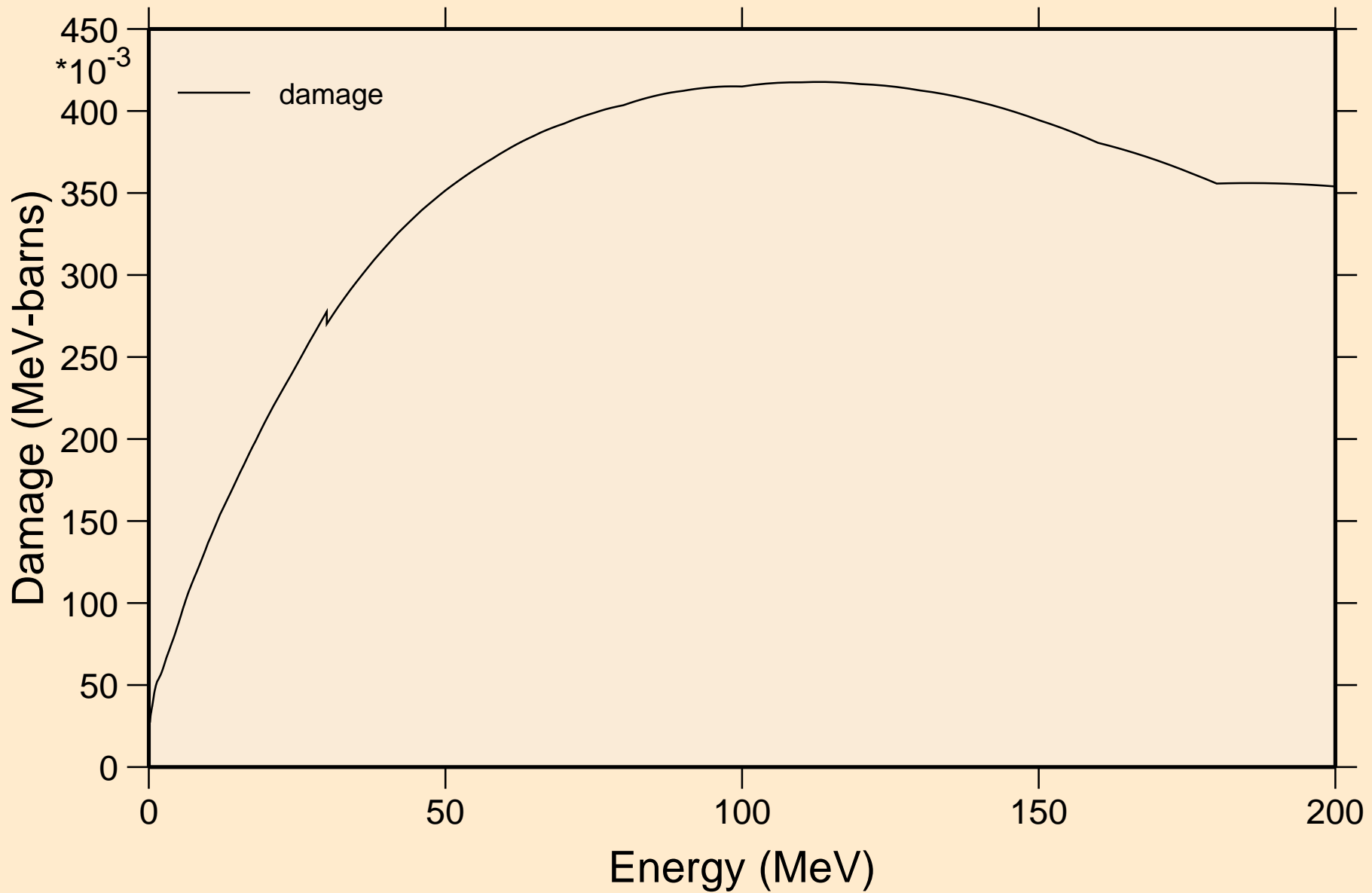



# MT279 NEUTRON ACER TENDL-2023 LIBRARY; T=0.K

## Non-threshold reactions

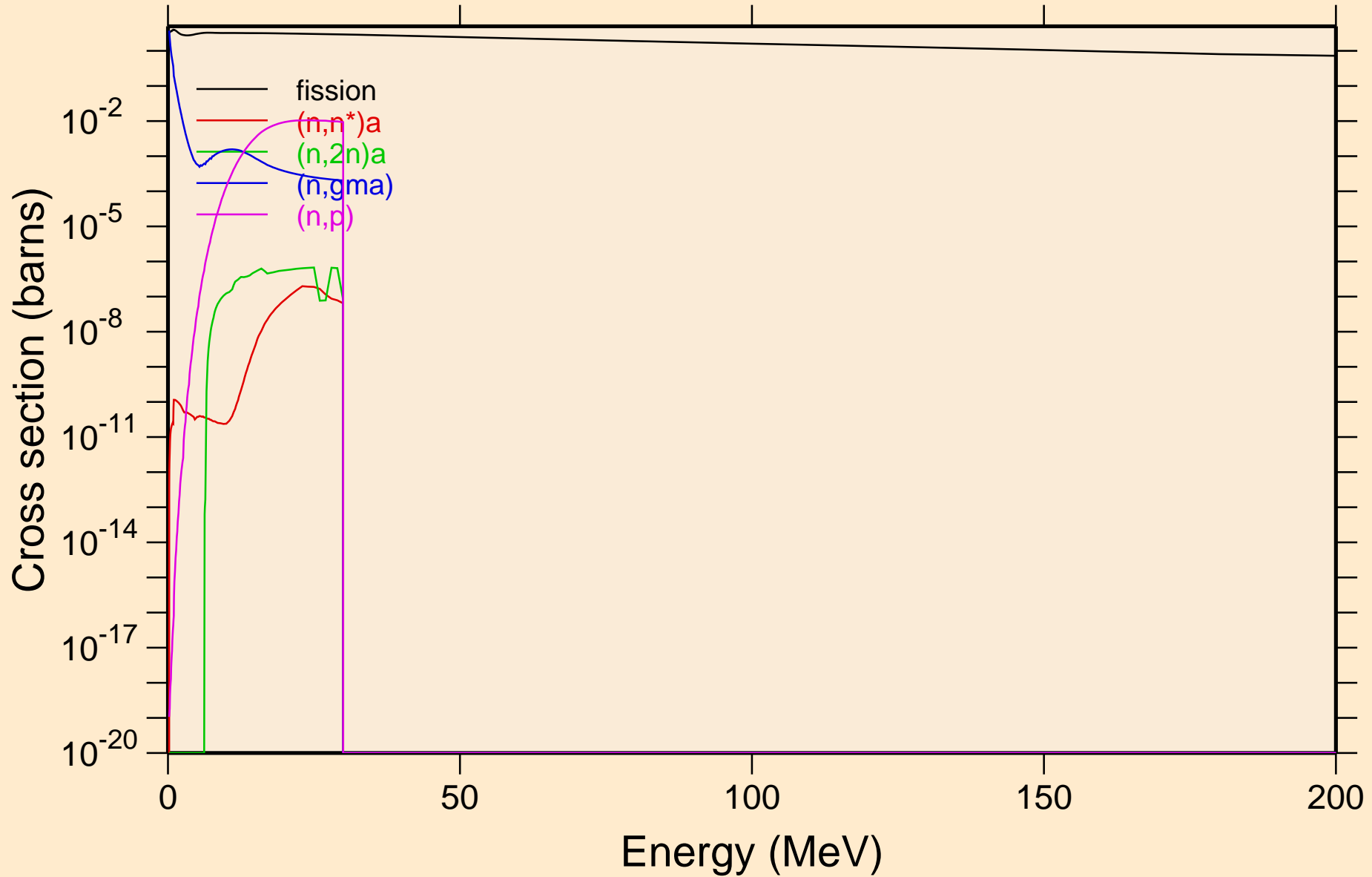

MT279 NEUTRON ACER TENDL-2023 LIBRARY; T=0.K  
Non-threshold reactions

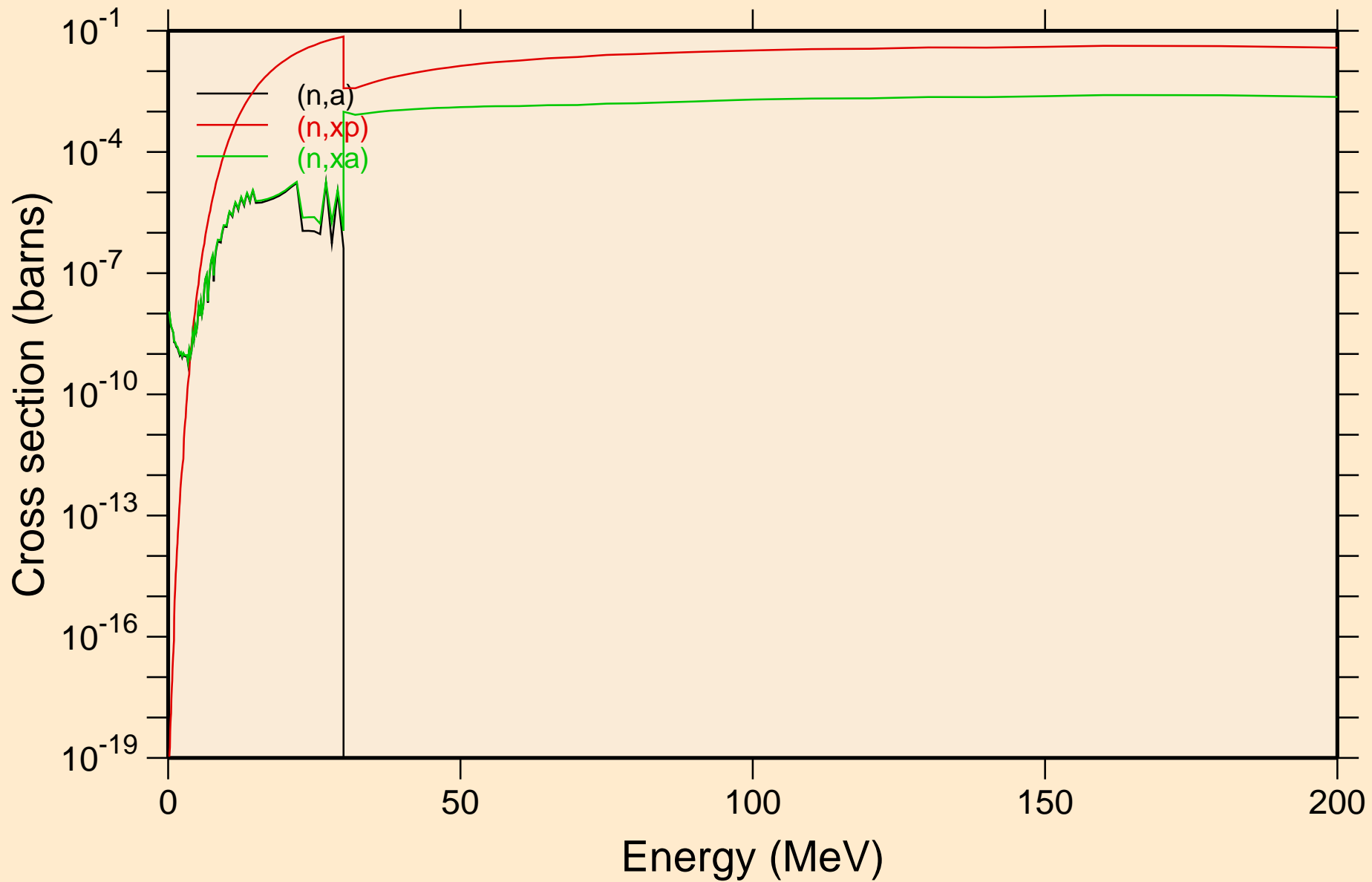

MT279 NEUTRON ACER TENDL-2023 LIBRARY; T=0.K  
Inelastic levels

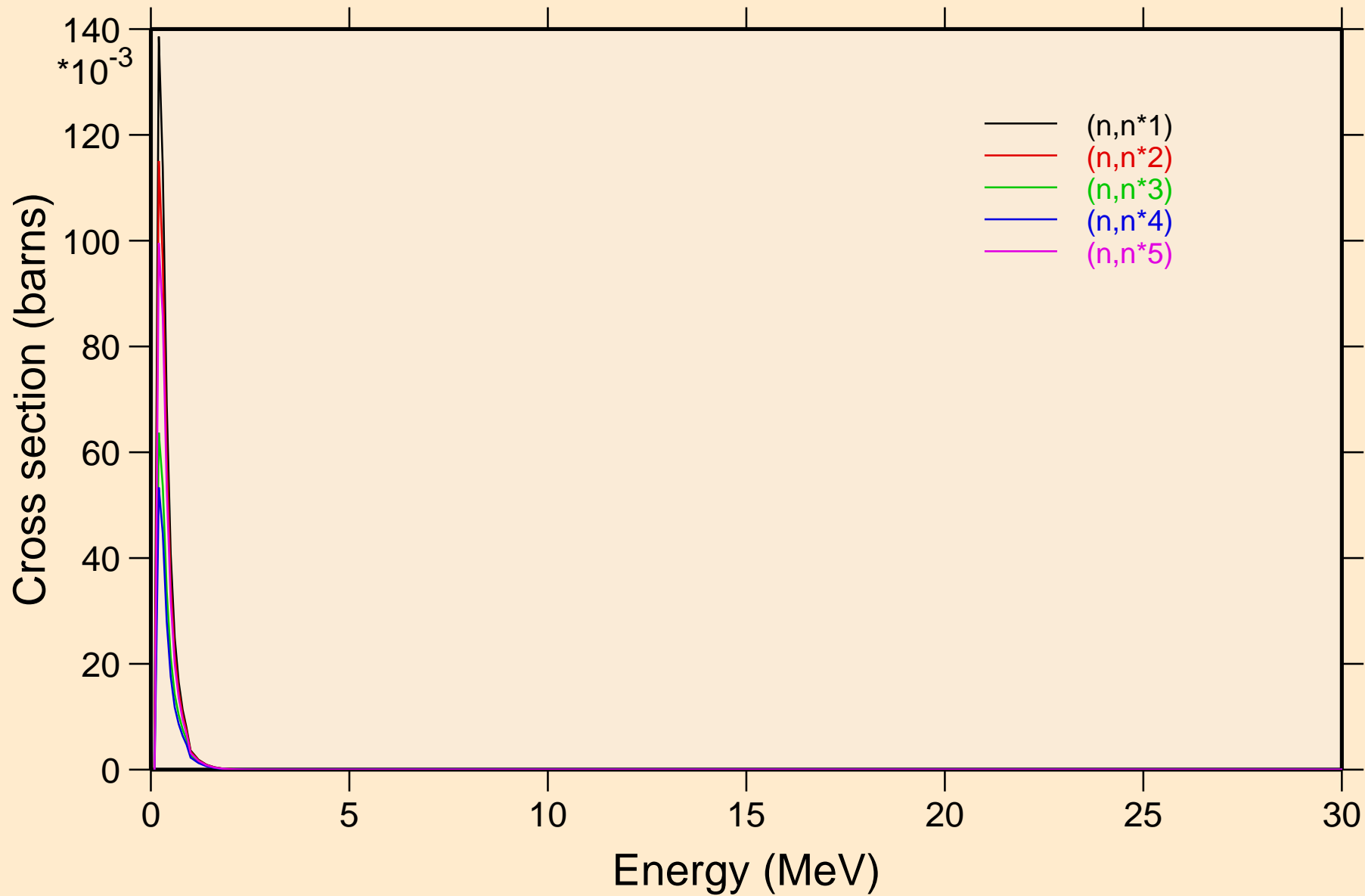

MT279 NEUTRON ACER TENDL-2023 LIBRARY; T=0.K  
Inelastic levels

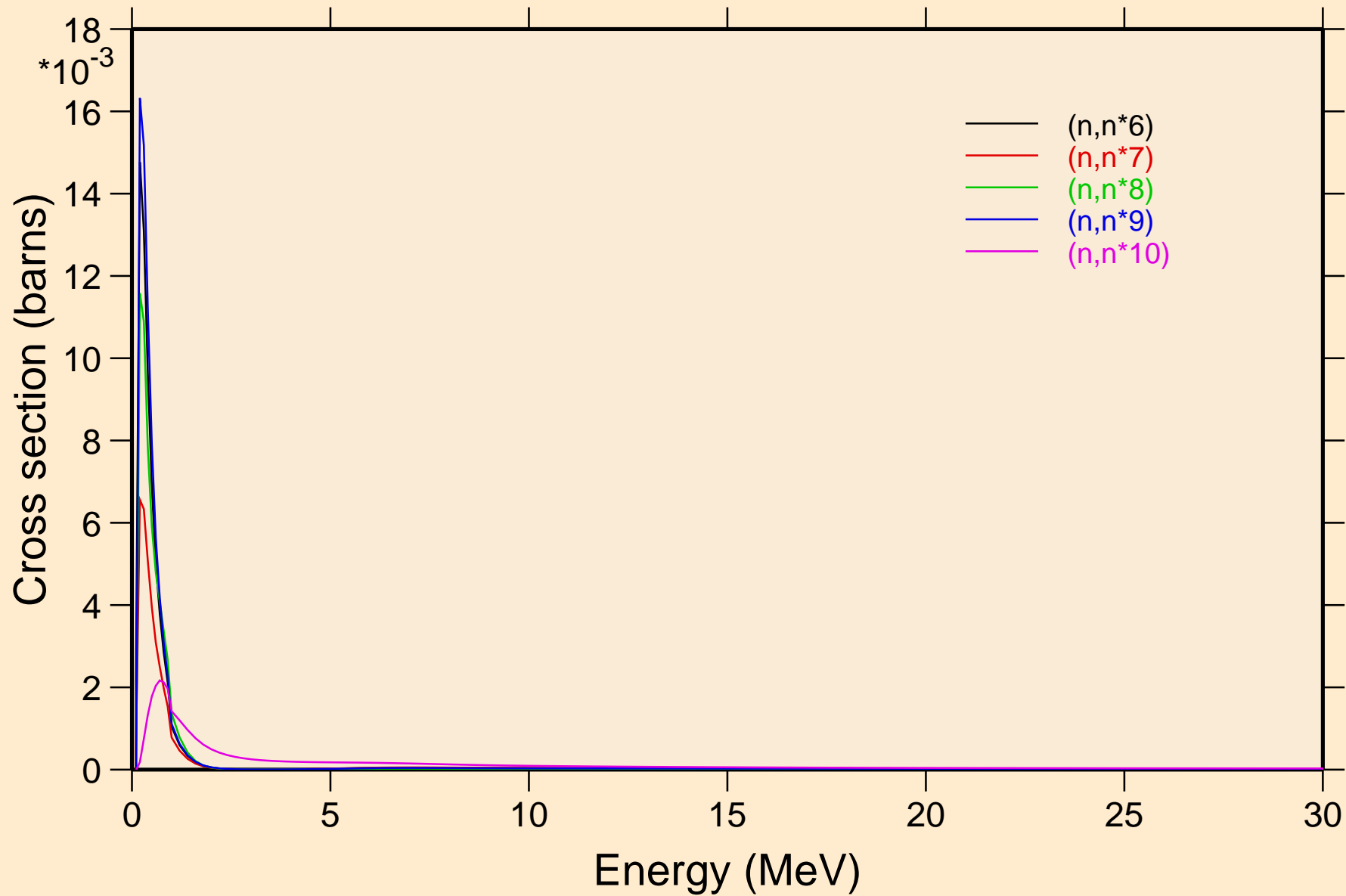

MT279 NEUTRON ACER TENDL-2023 LIBRARY; T=0.K  
Inelastic levels

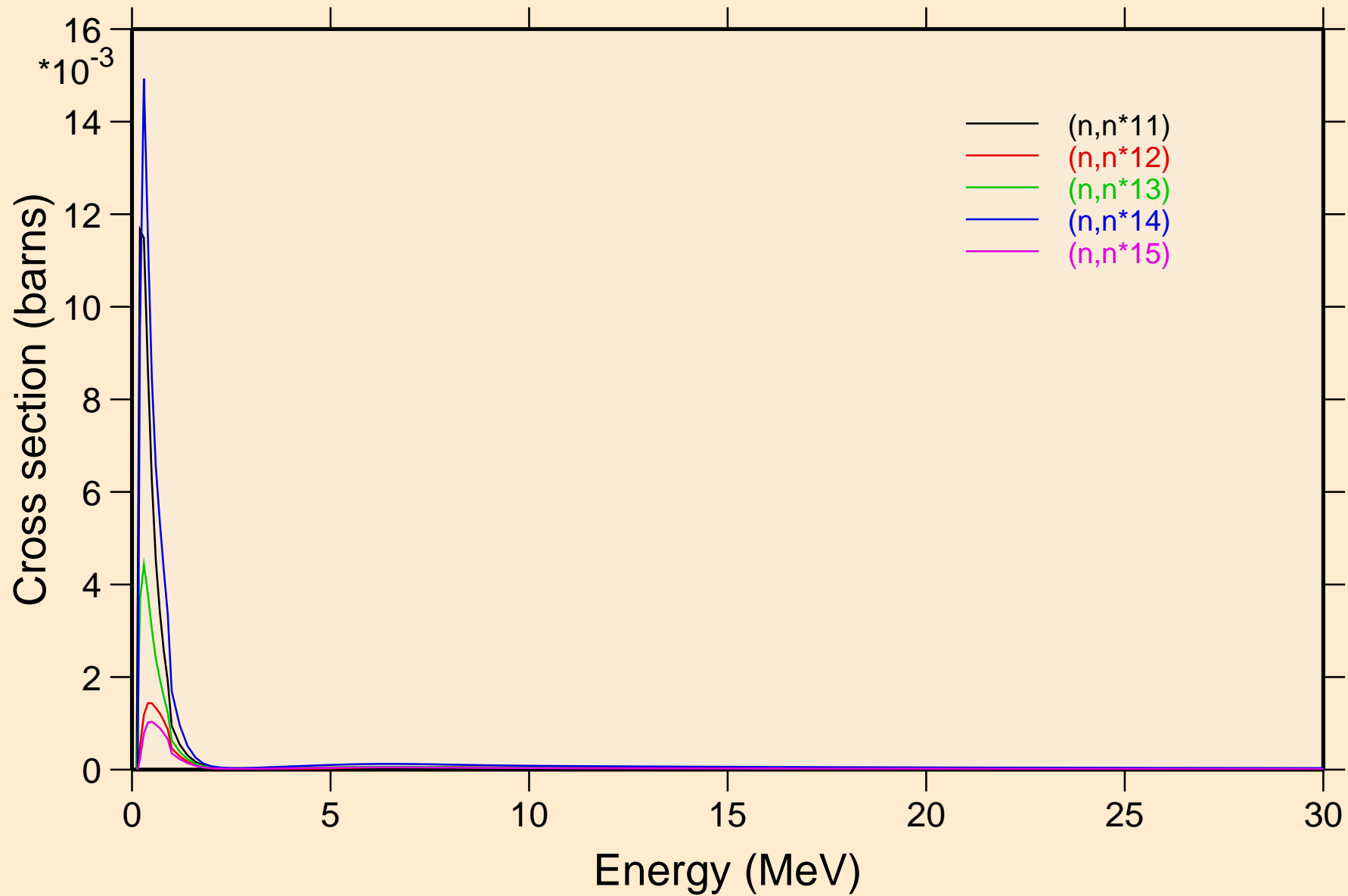

MT279 NEUTRON ACER TENDL-2023 LIBRARY; T=0.K  
Inelastic levels

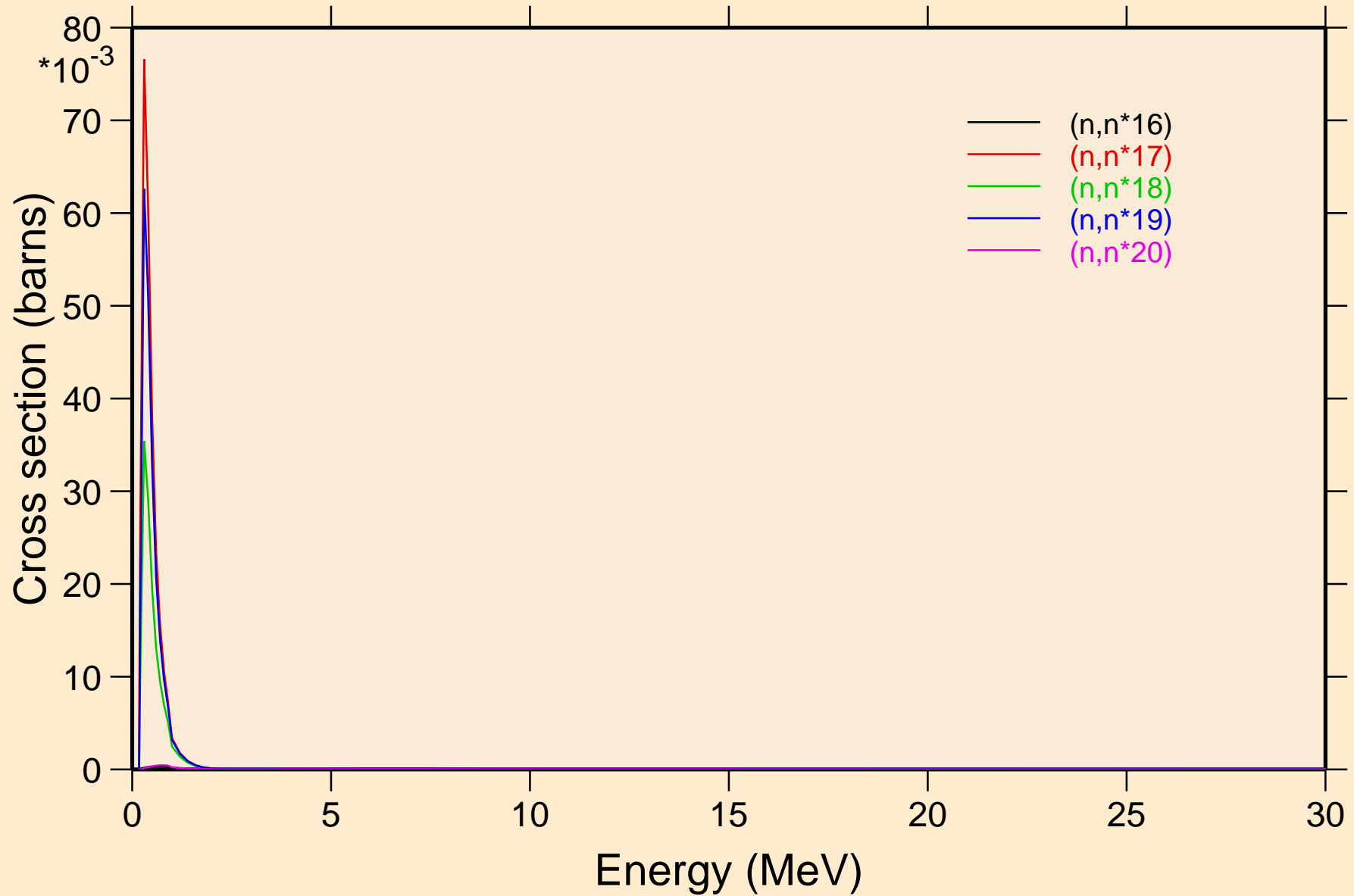

MT279 NEUTRON ACER TENDL-2023 LIBRARY; T=0.K  
Inelastic levels

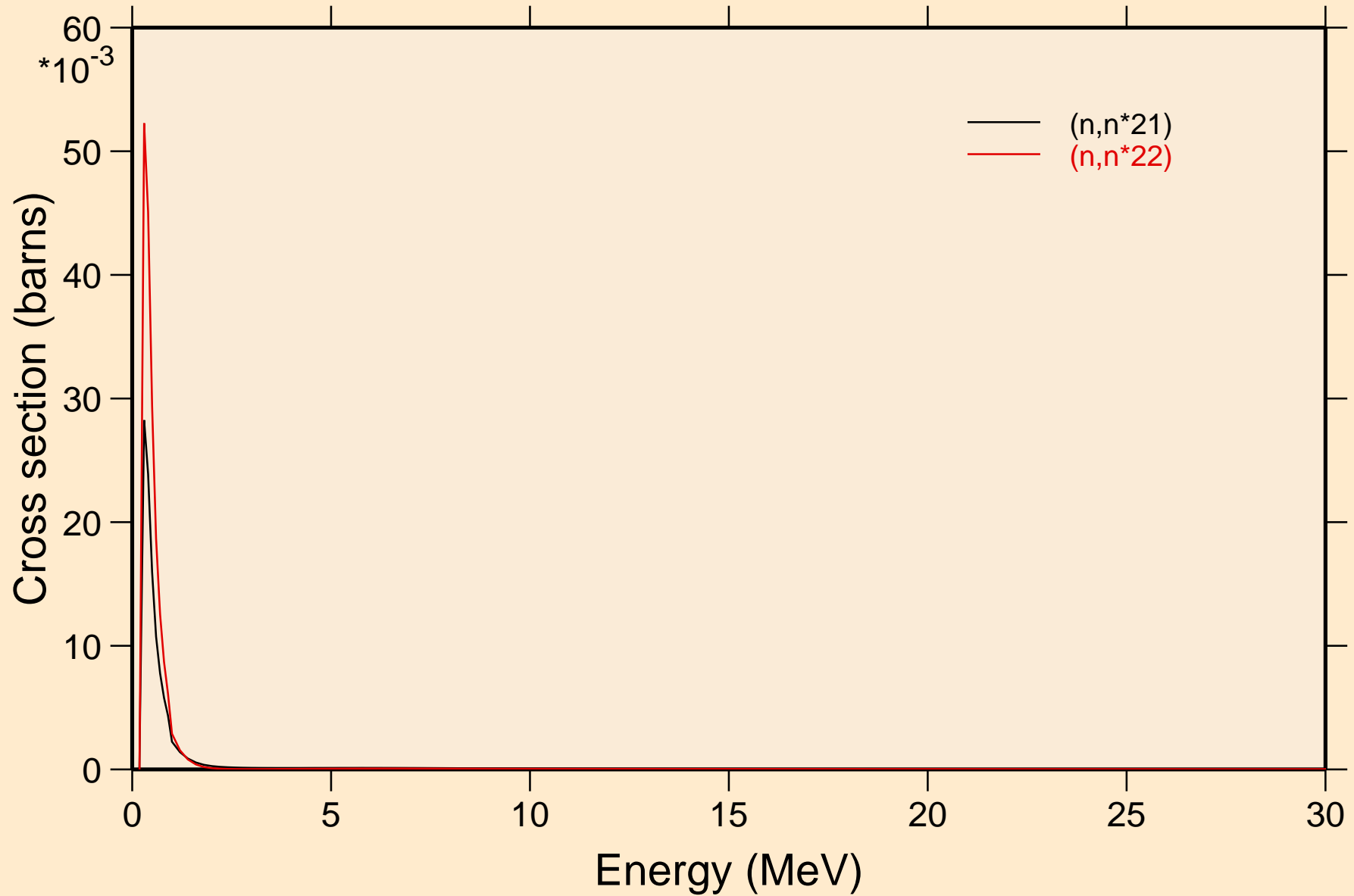

# MT279 NEUTRON ACER TENDL-2023 LIBRARY; T=0.K

## Threshold reactions

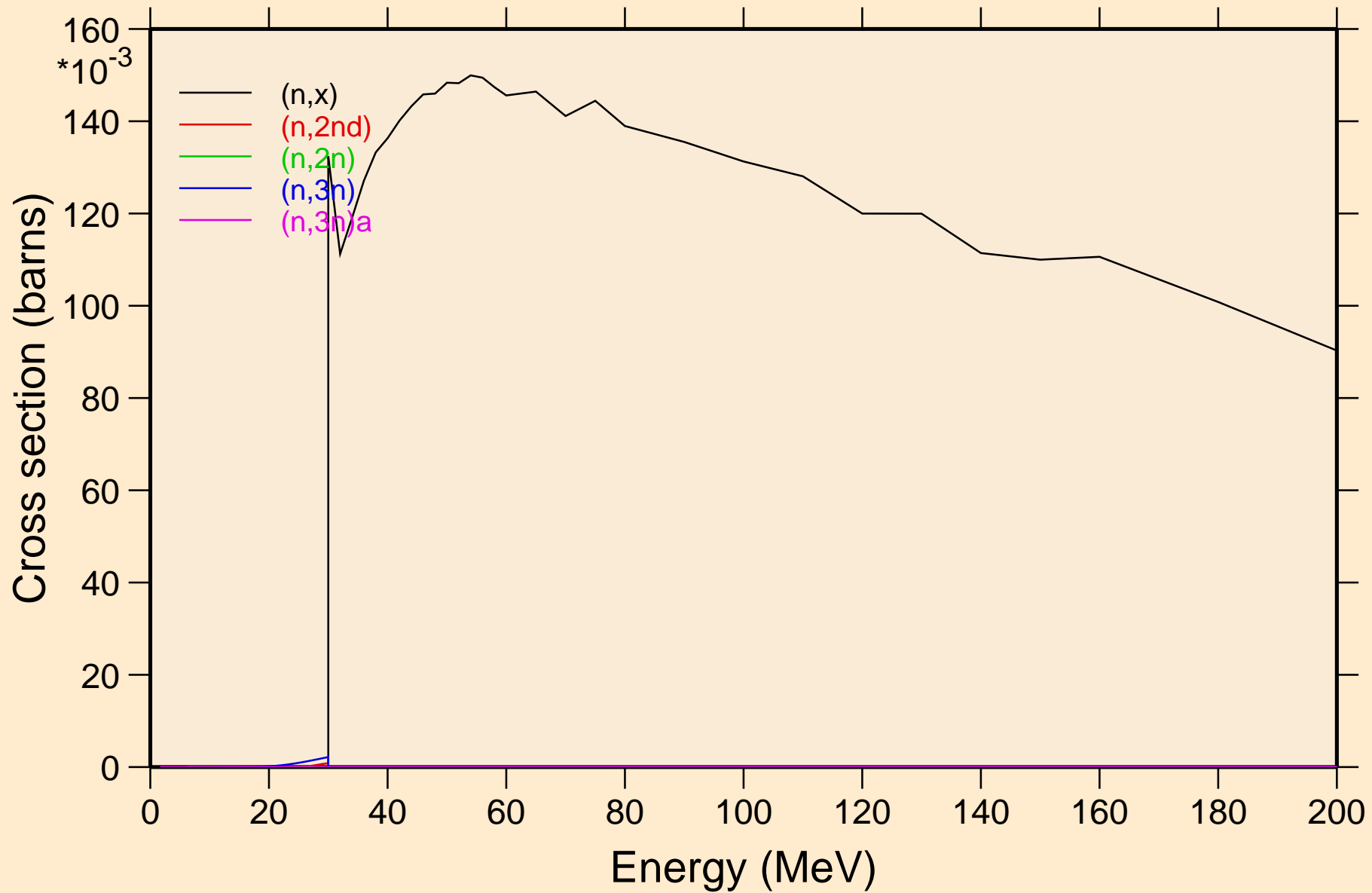



MT279 NEUTRON ACER TENDL-2023 LIBRARY; T=0.K  
Threshold reactions

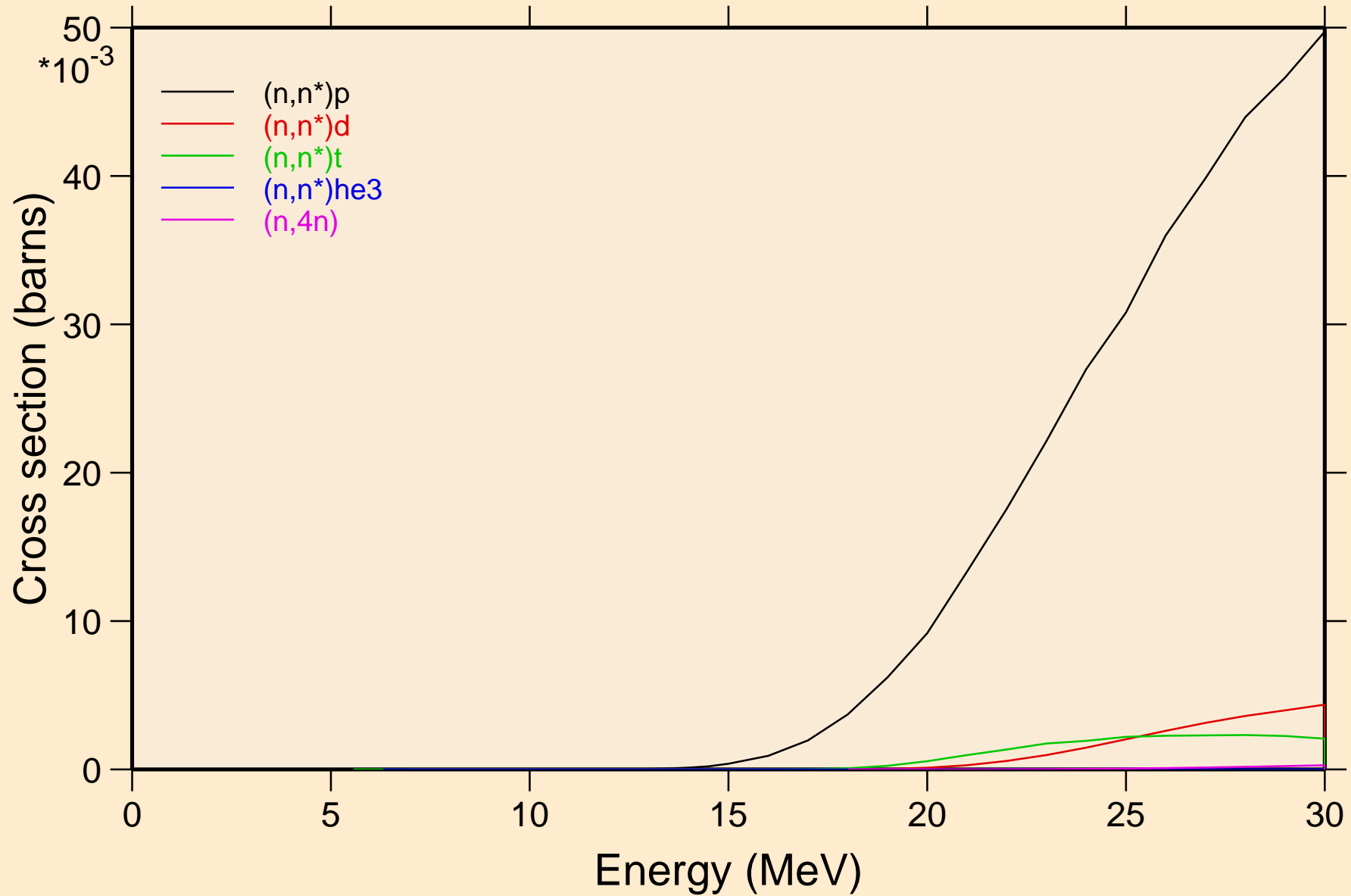

# MT279 NEUTRON ACER TENDL-2023 LIBRARY; T=0.K

## Threshold reactions

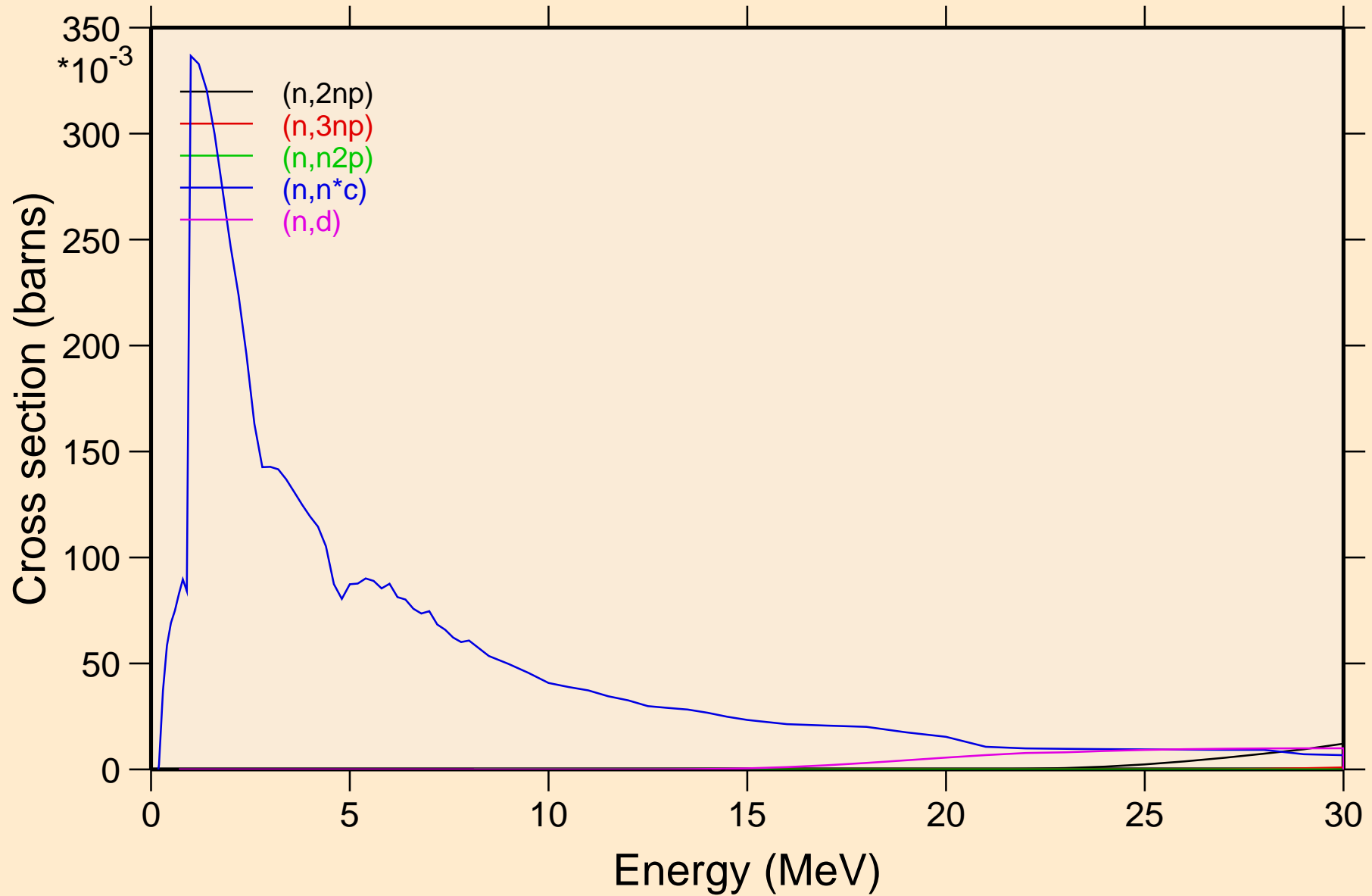

MT279 NEUTRON ACER TENDL-2023 LIBRARY; T=0.K  
Threshold reactions

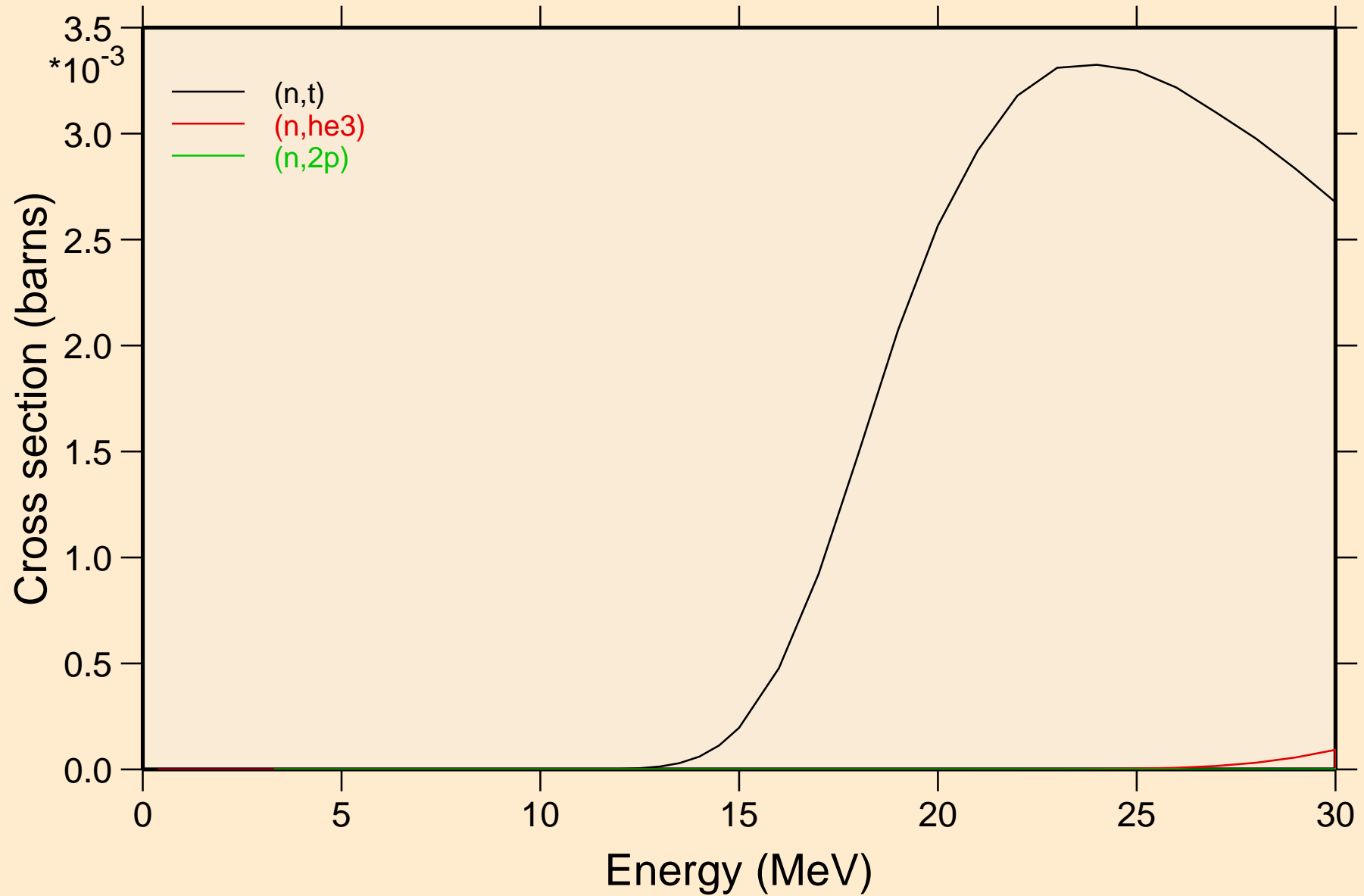

# MT279 NEUTRON ACER TENDL-2023 LIBRARY; T=0.K

## Threshold reactions

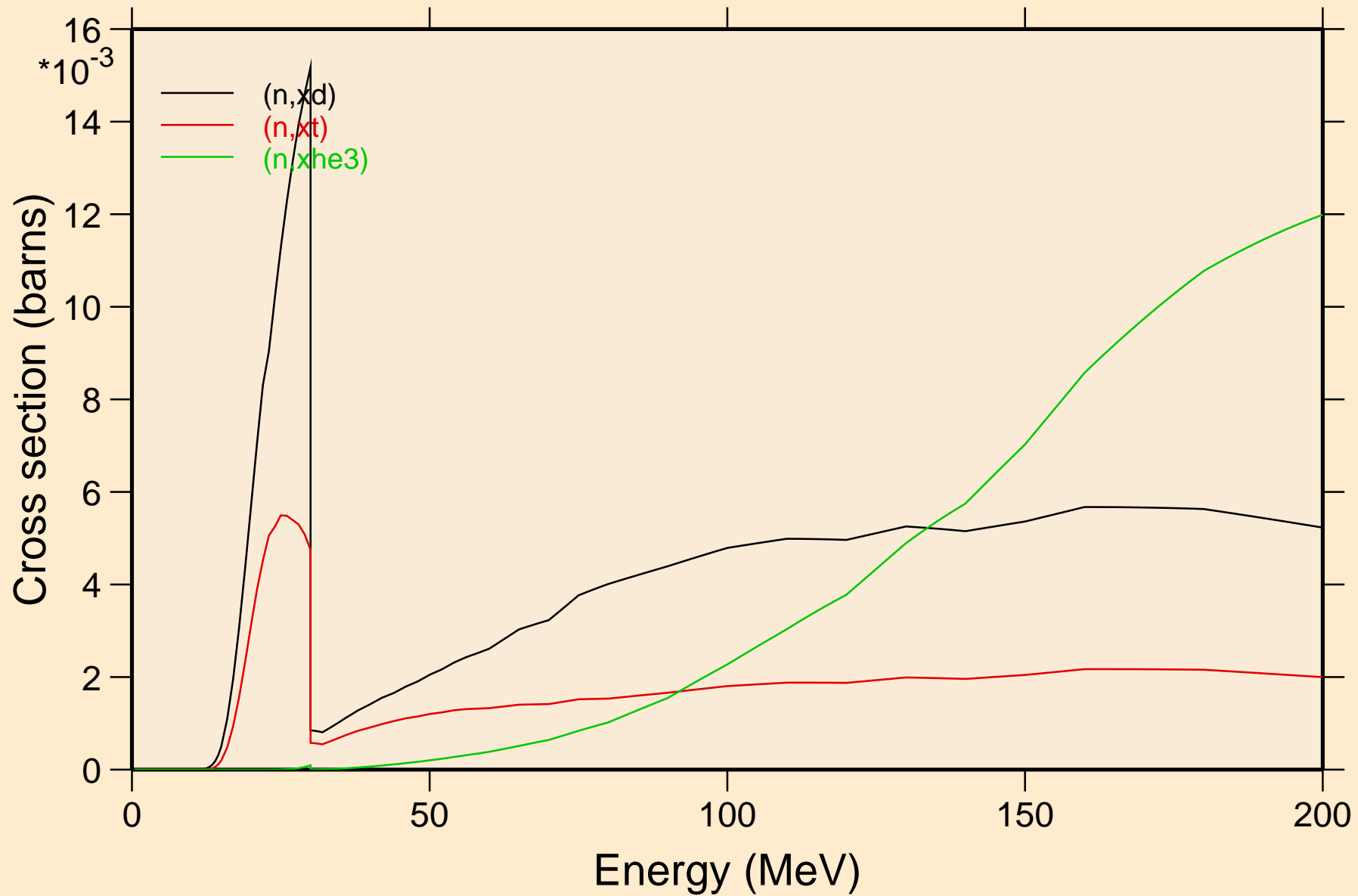

MT279 NEUTRON ACER TENDL-2023 LIBRARY; T=0.K  
angular distribution for elastic

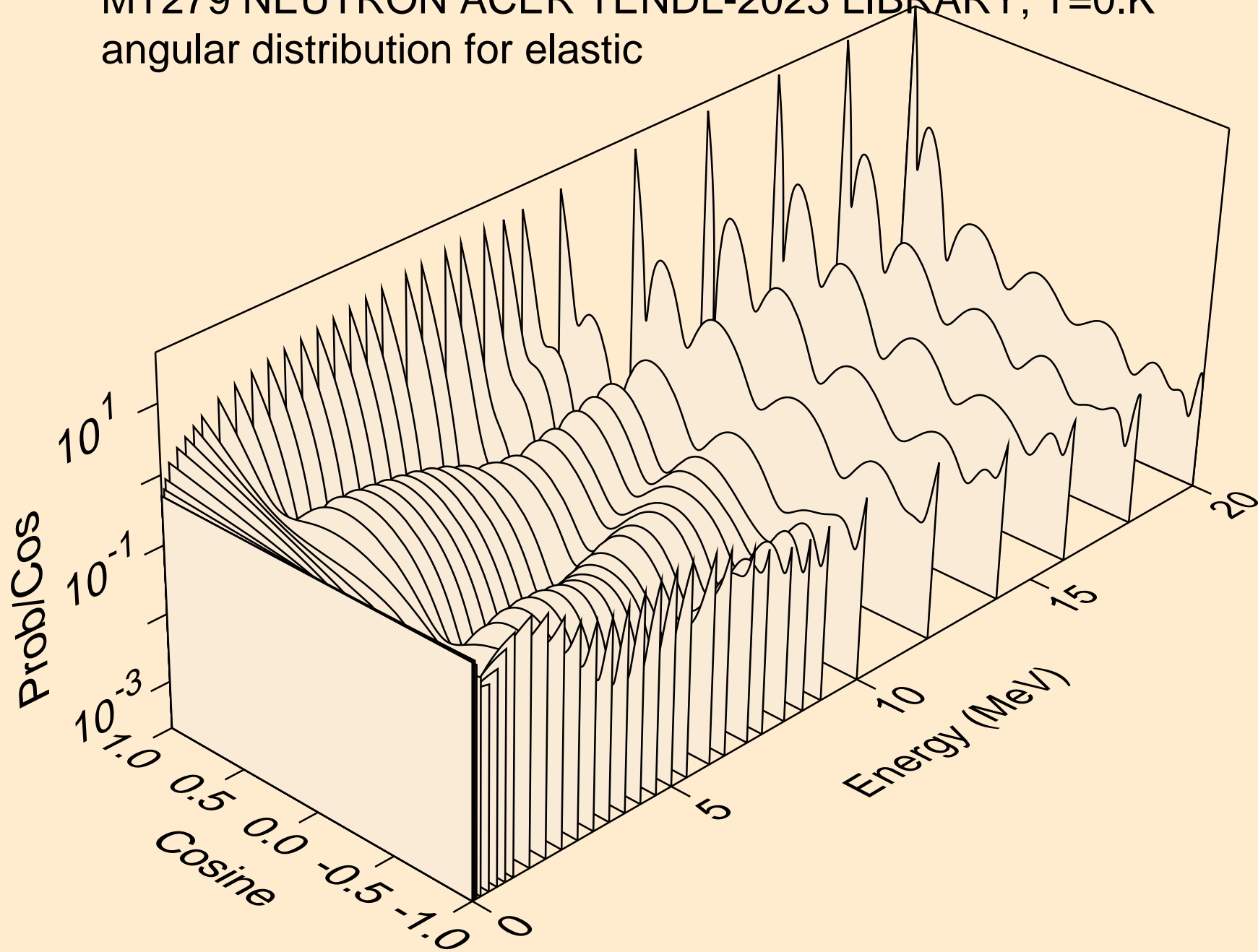

MT279 NEUTRON ACER TENDL-2023 LIBRARY; T=0.K  
angular distribution for elastic

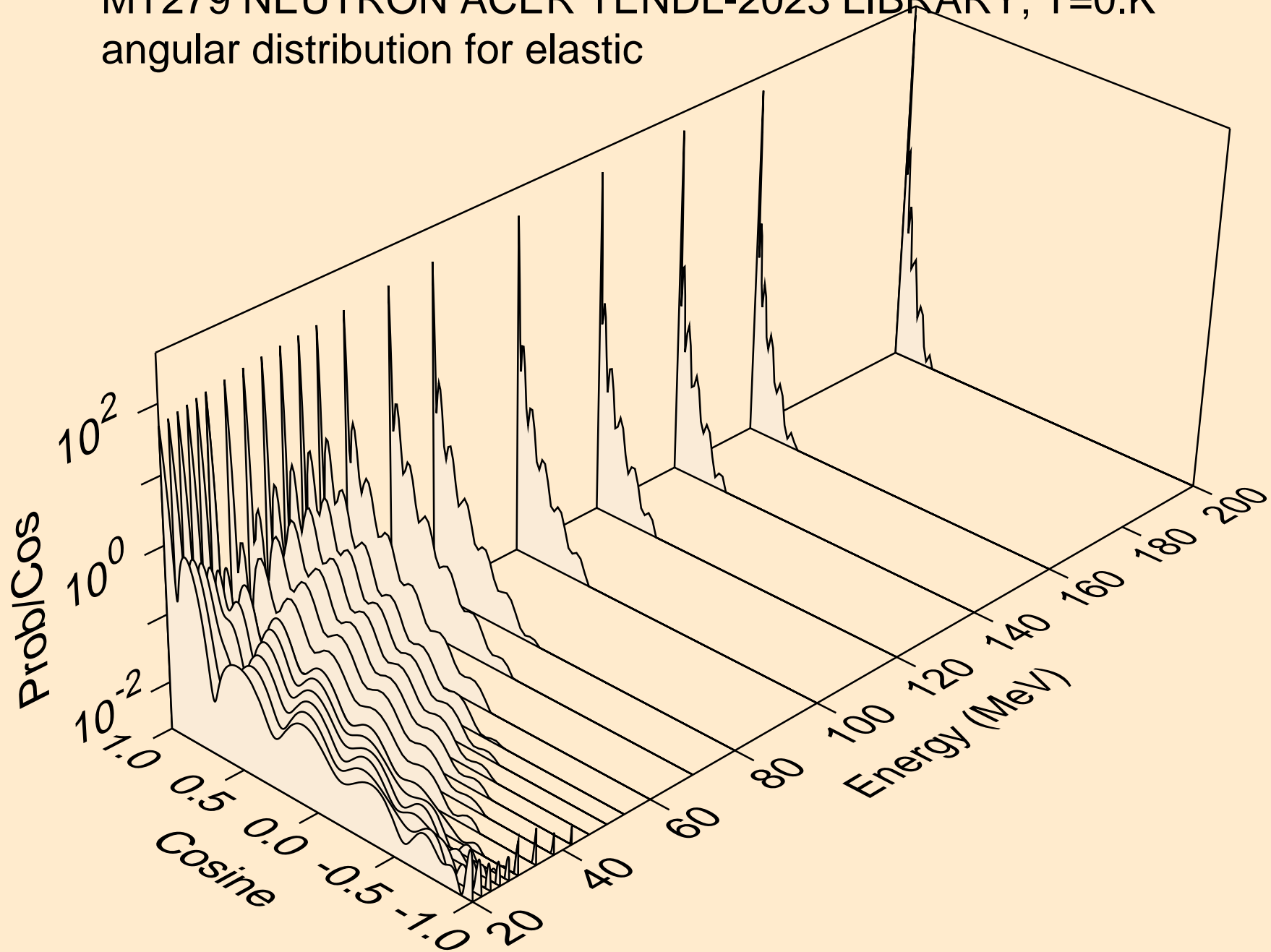

MT279 NEUTRON ACER TENDL-2023 LIBRARY; T=0.K  
angular distribution for (n,n\*1)

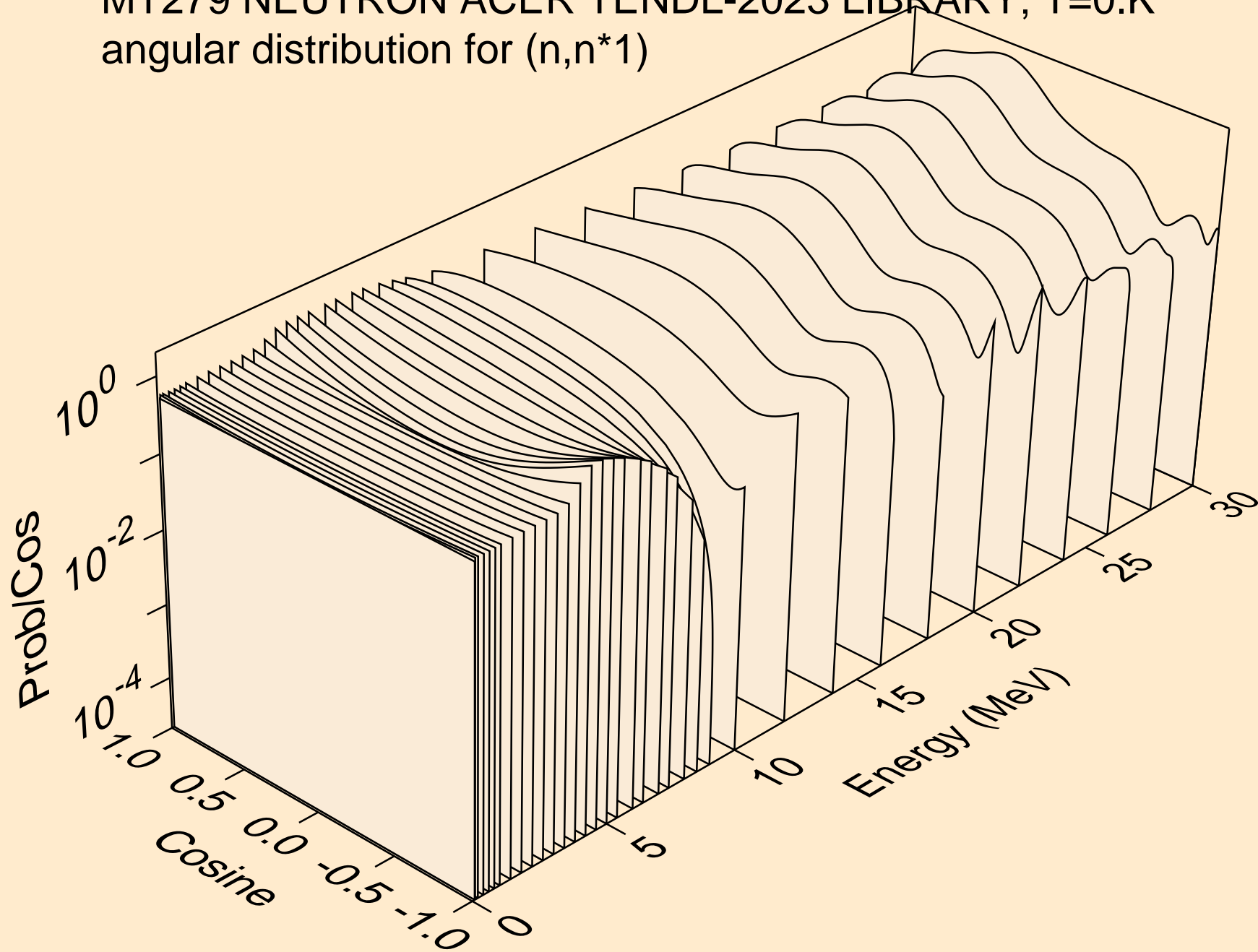

MT279 NEUTRON ACER TENDL-2023 LIBRARY; T=0.K  
angular distribution for (n,n\*2)

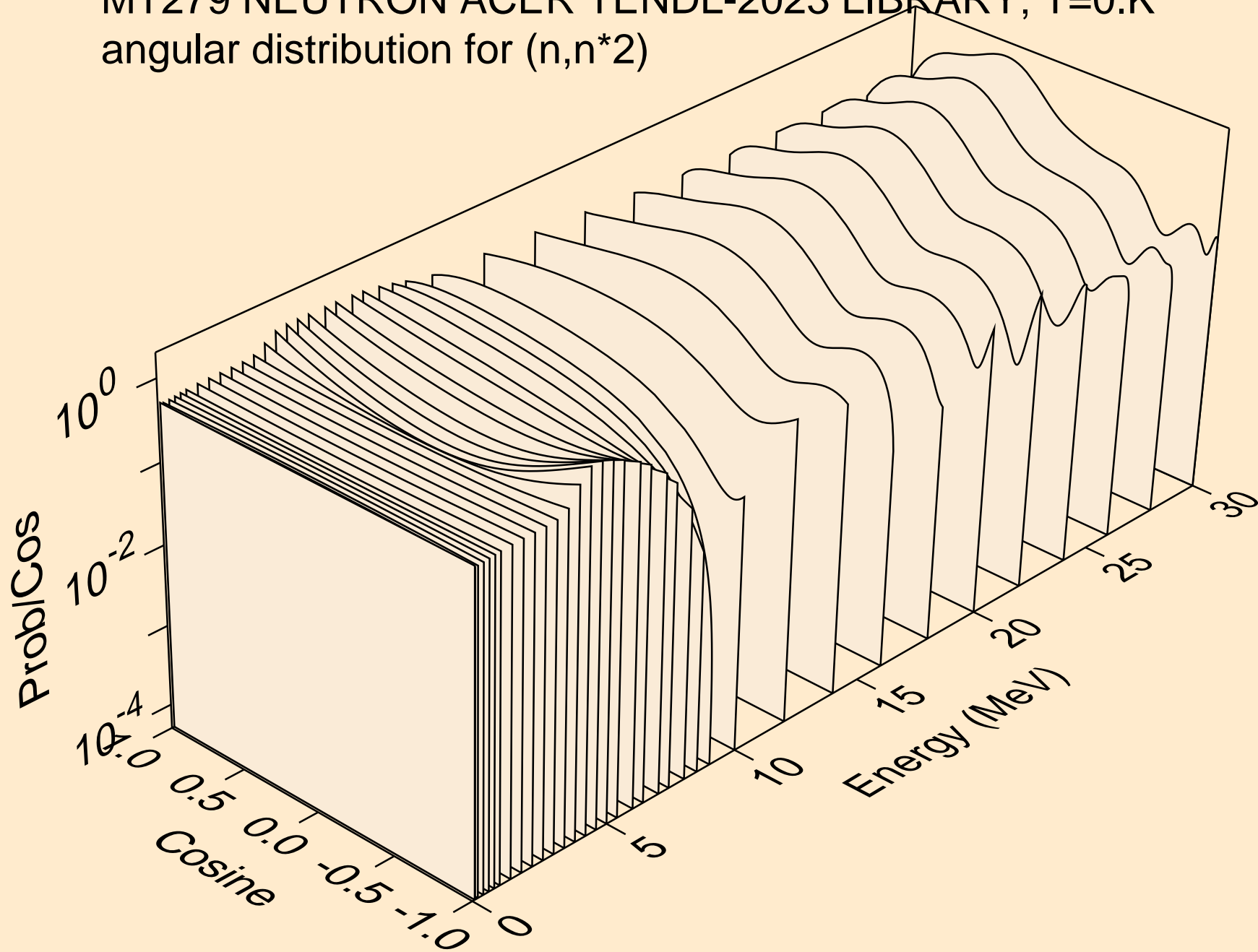



MT279 NEUTRON ACER TENDL-2023 LIBRARY; T=0.K  
angular distribution for (n,n\*3)

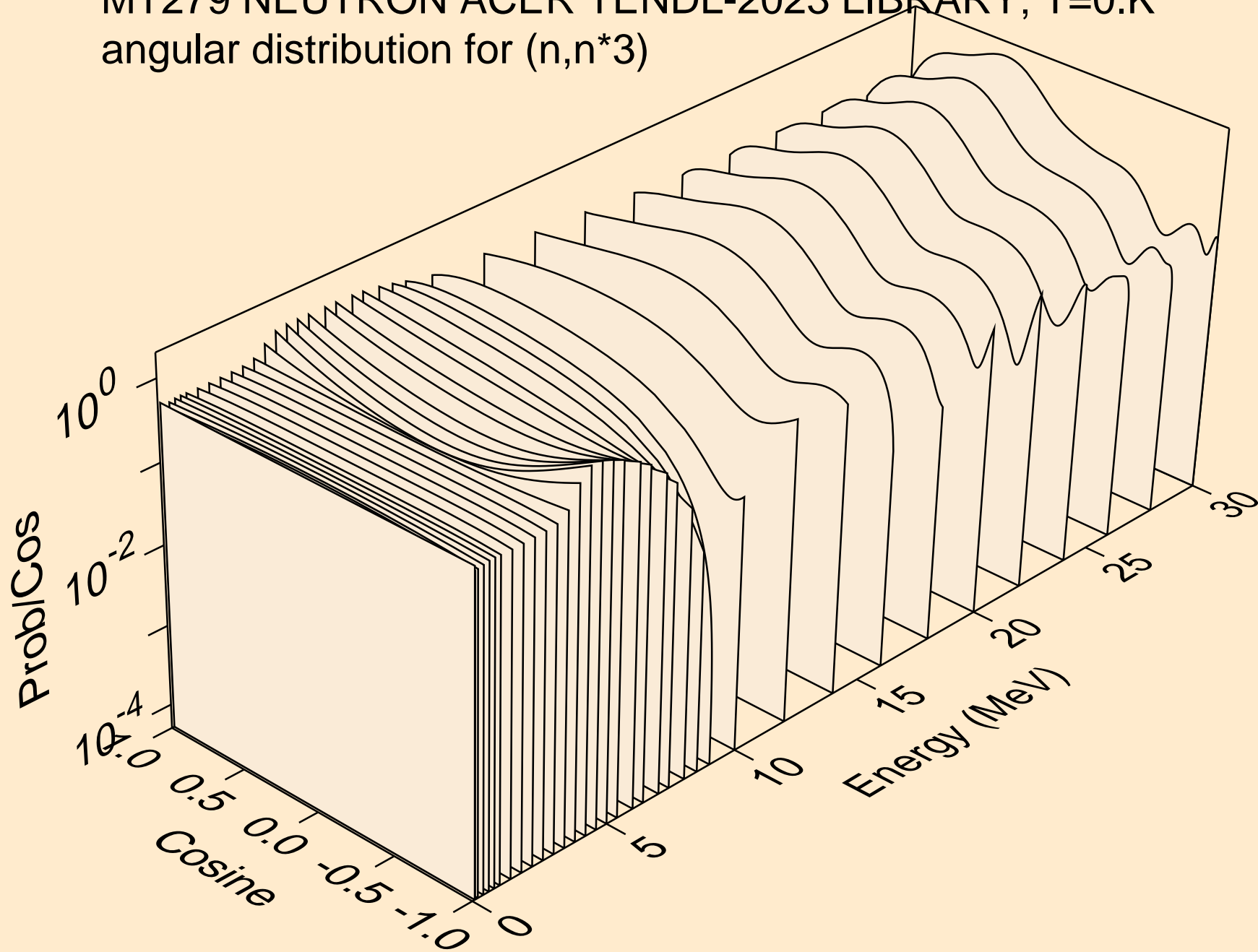

MT279 NEUTRON ACER TENDL-2023 LIBRARY; T=0.K  
angular distribution for (n,n\*4)

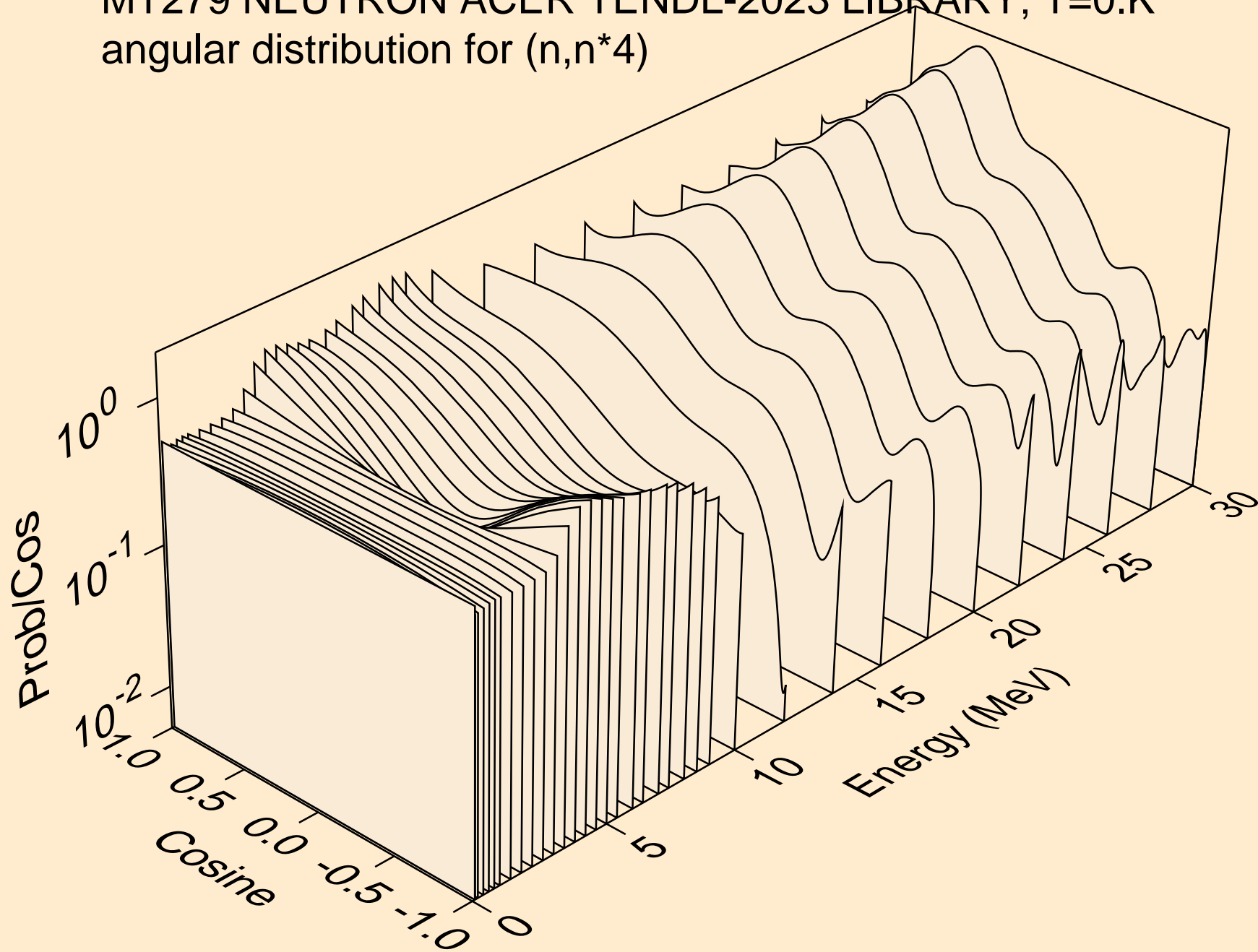

MT279 NEUTRON ACER TENDL-2023 LIBRARY; T=0.K  
angular distribution for (n,n\*5)

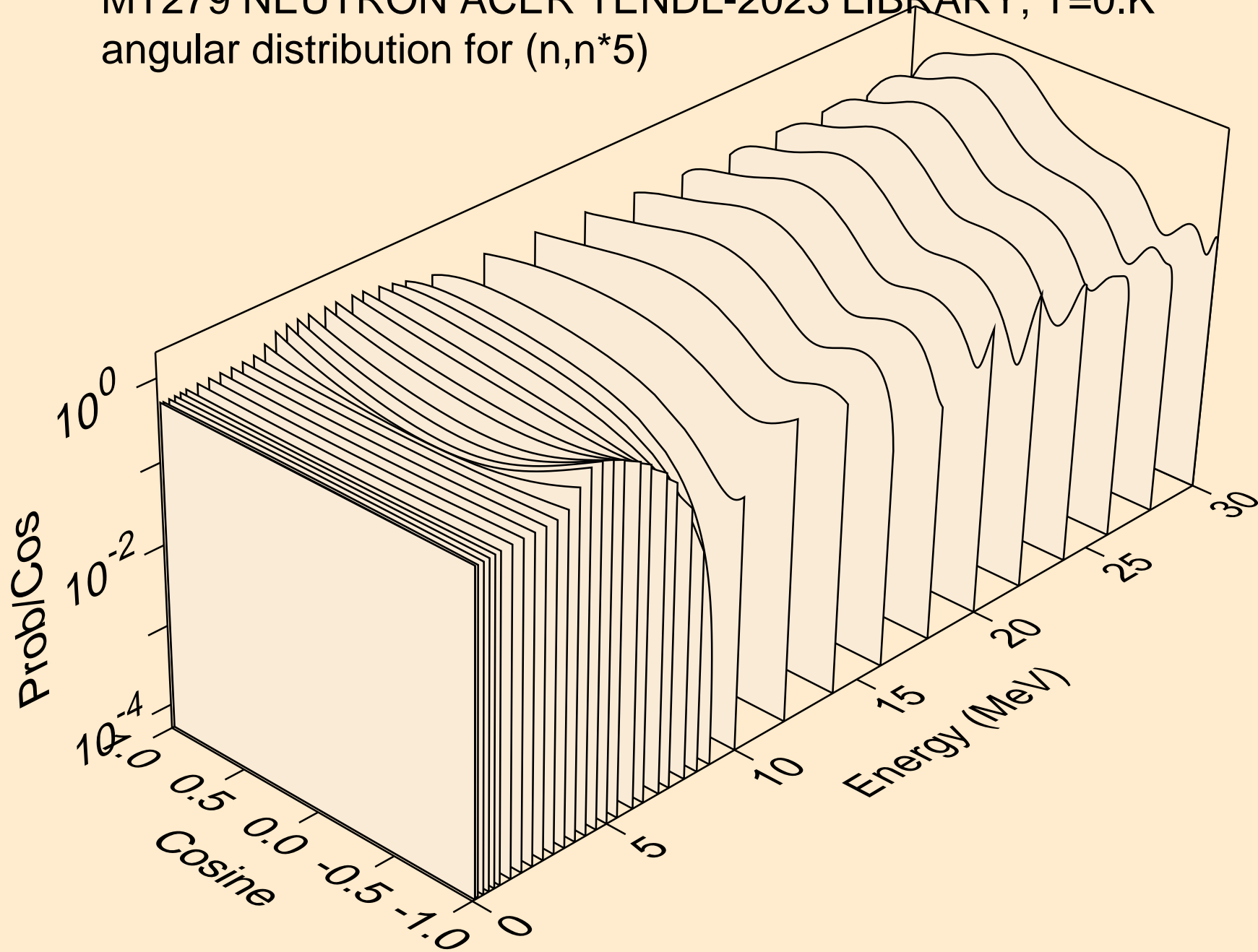

MT279 NEUTRON ACER TENDL-2023 LIBRARY; T=0.K  
angular distribution for (n,n\*6)

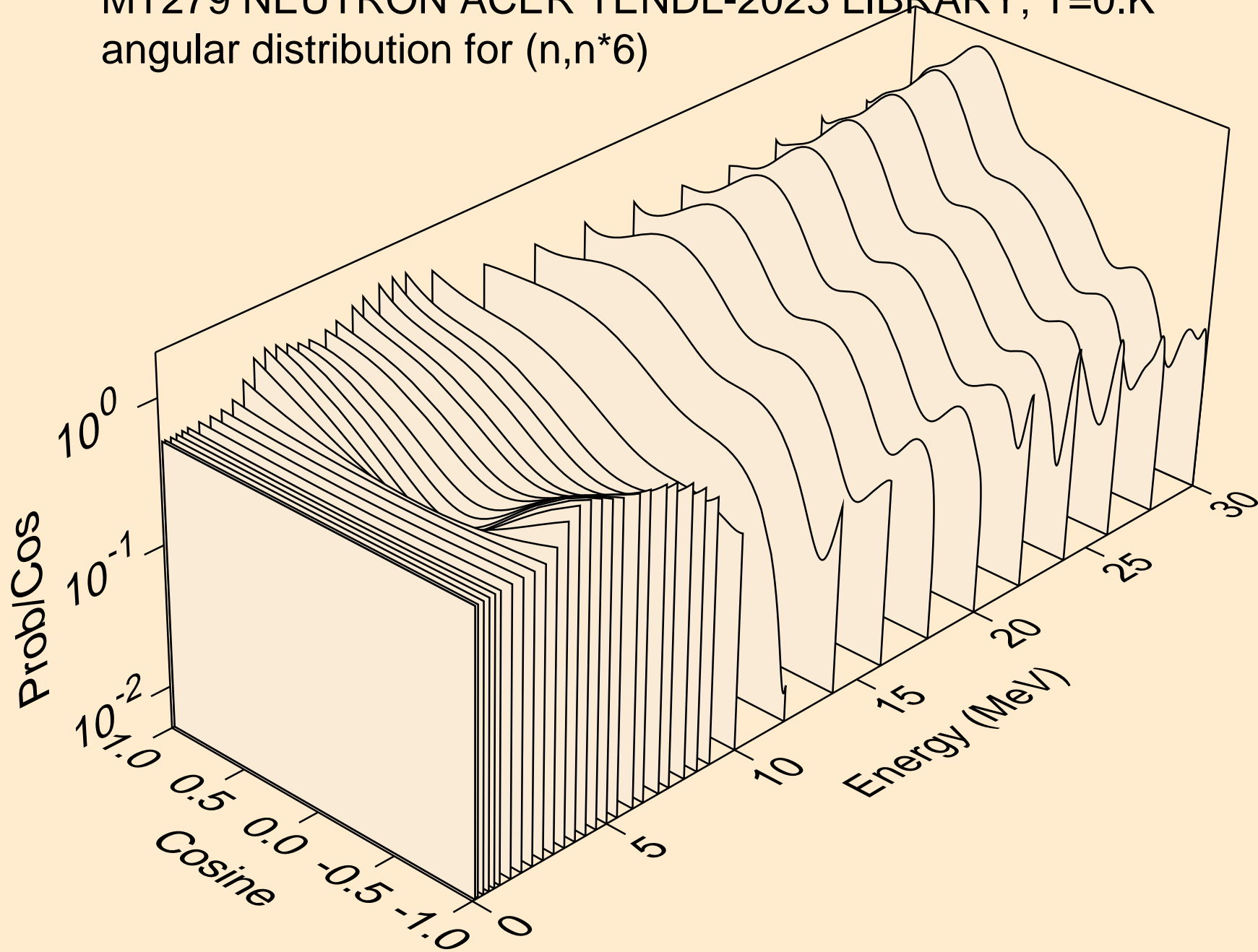

MT279 NEUTRON ACER TENDL-2023 LIBRARY; T=0.K  
angular distribution for (n,n\*7)

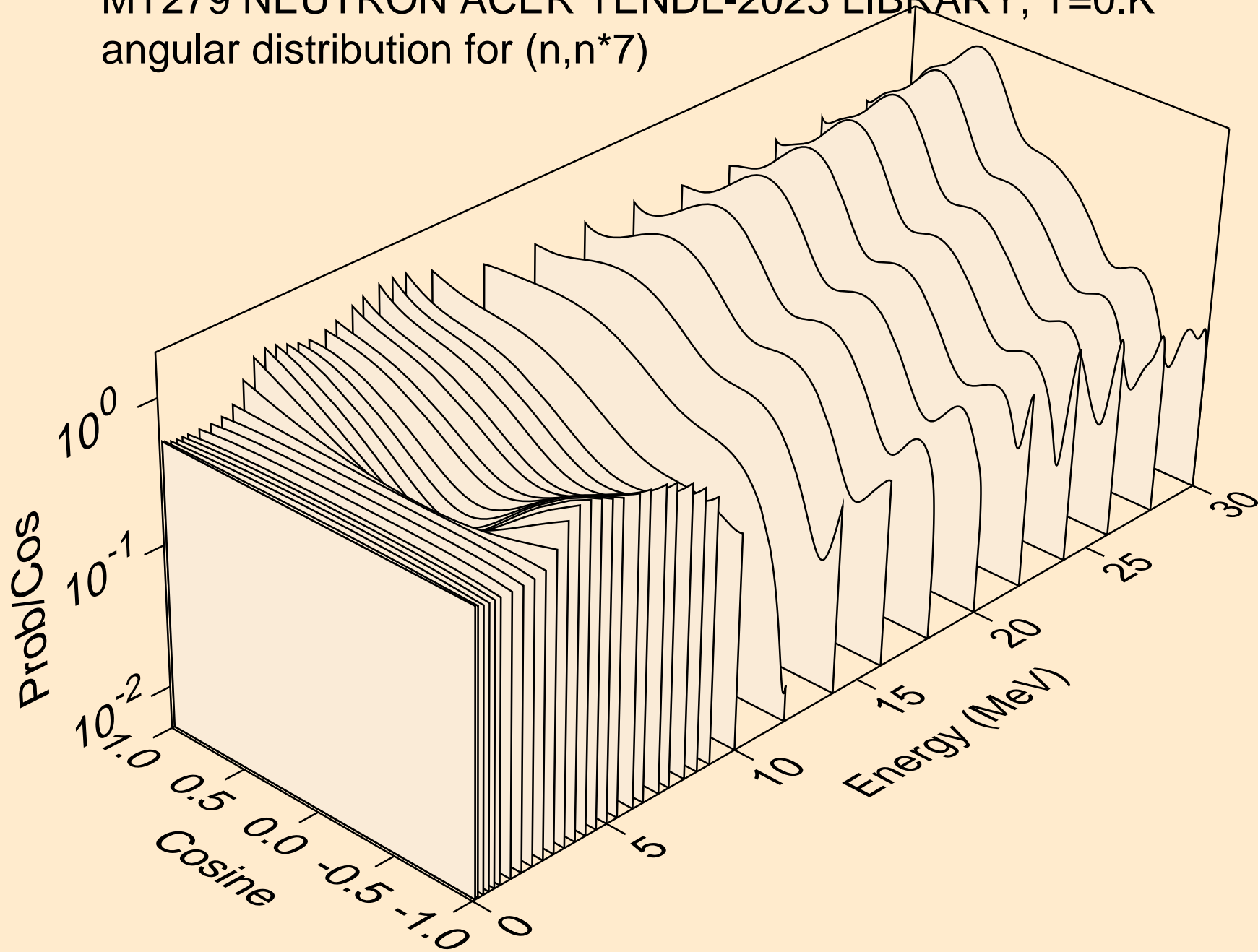

MT279 NEUTRON ACER TENDL-2023 LIBRARY; T=0.K  
angular distribution for (n,n\*8)

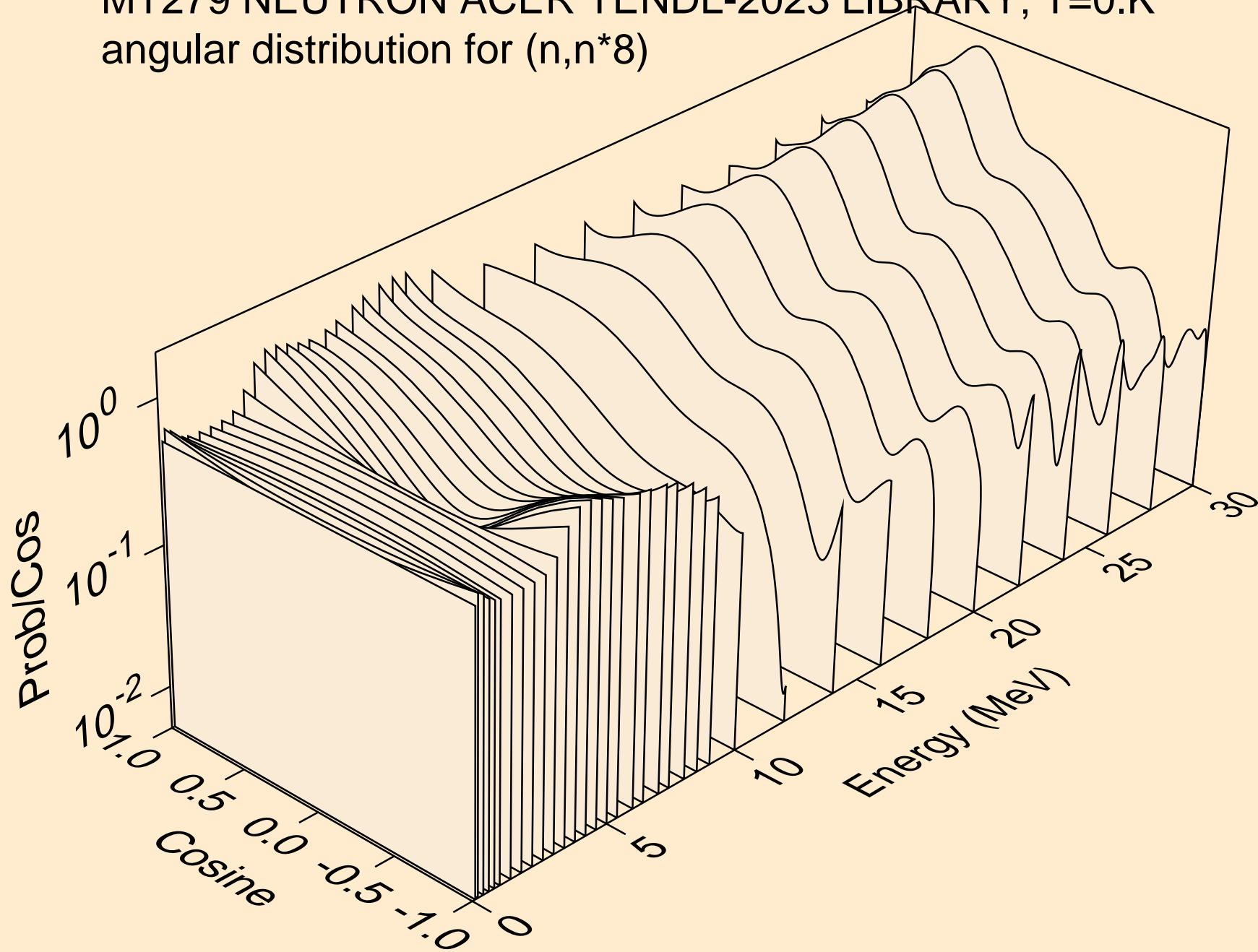

MT279 NEUTRON ACER TENDL-2023 LIBRARY; T=0.K  
angular distribution for (n,n\*9)

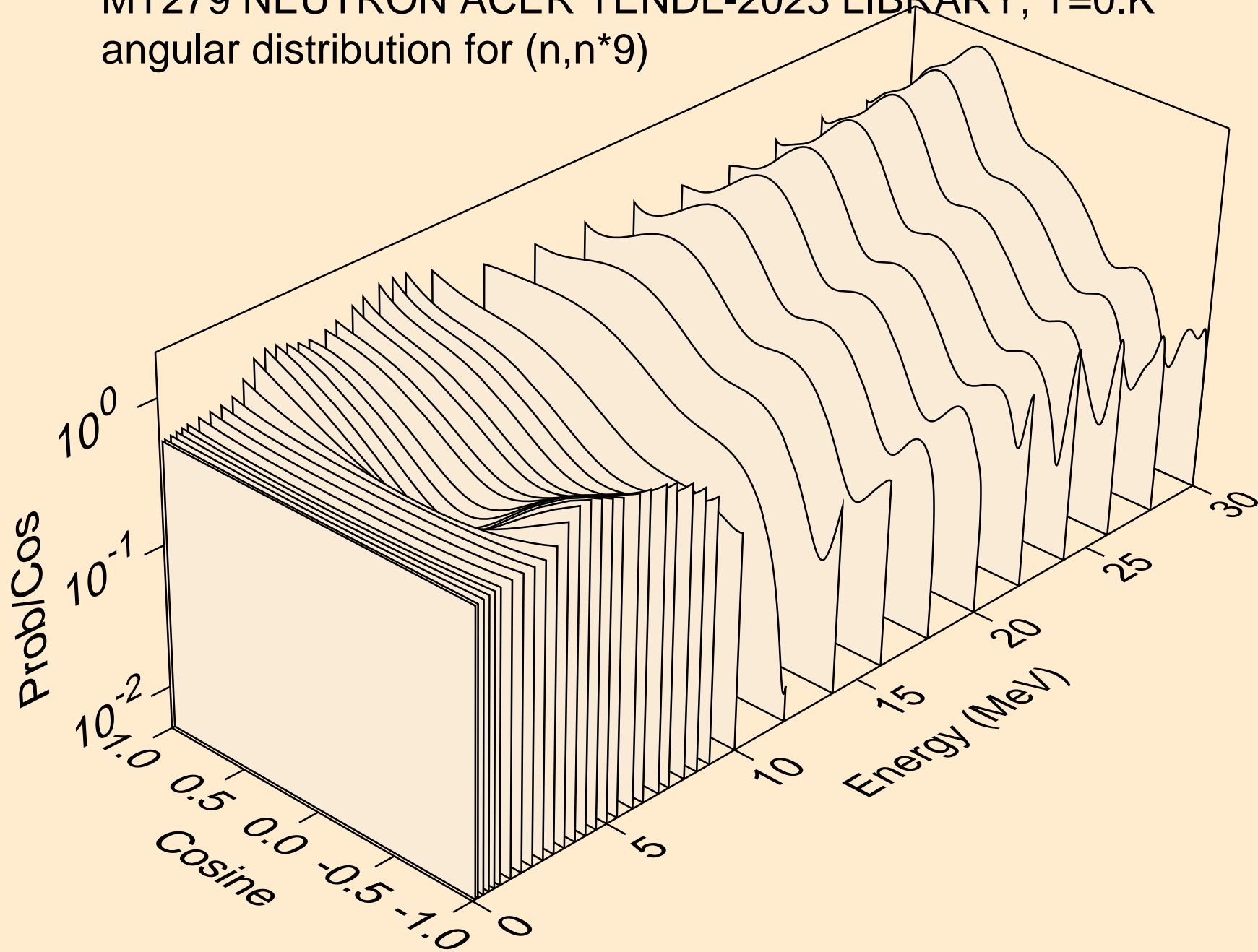



MT279 NEUTRON ACER TENDL-2023 LIBRARY; T=0.K  
angular distribution for (n,n\*10)

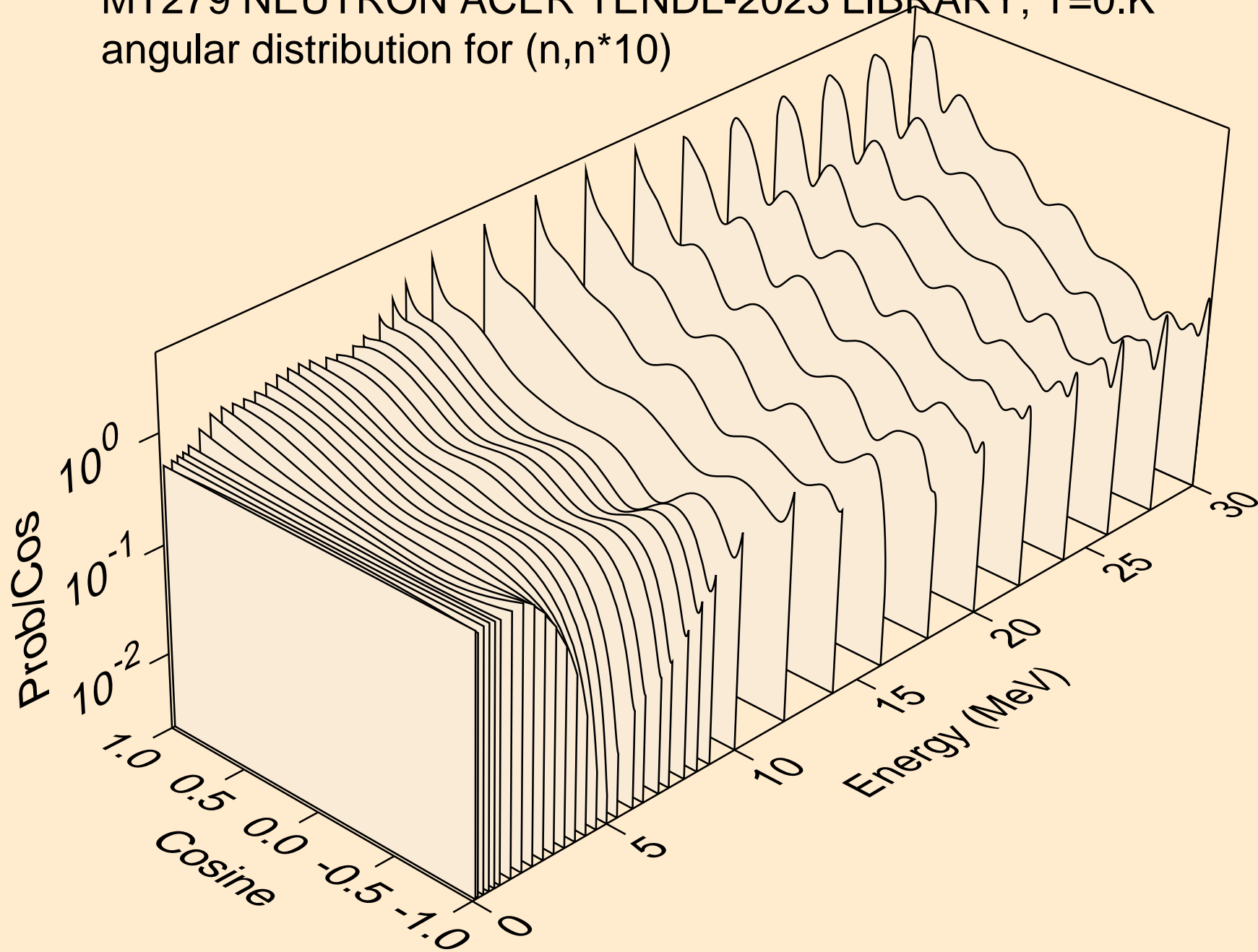



MT279 NEUTRON ACER TENDL-2023 LIBRARY; T=0.K  
angular distribution for (n,n\*11)

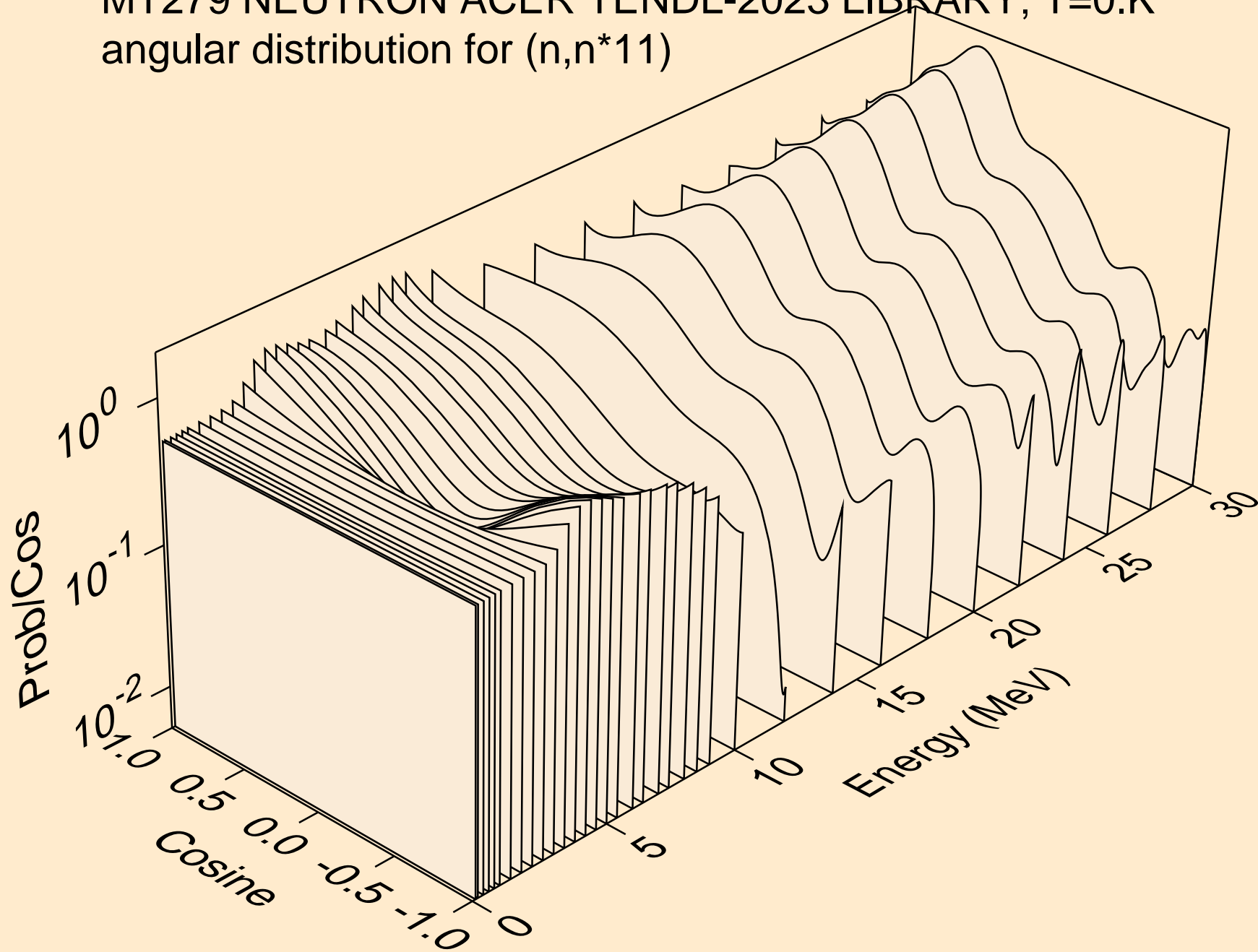

MT279 NEUTRON ACER TENDL-2023 LIBRARY; T=0.K  
angular distribution for (n,n\*12)

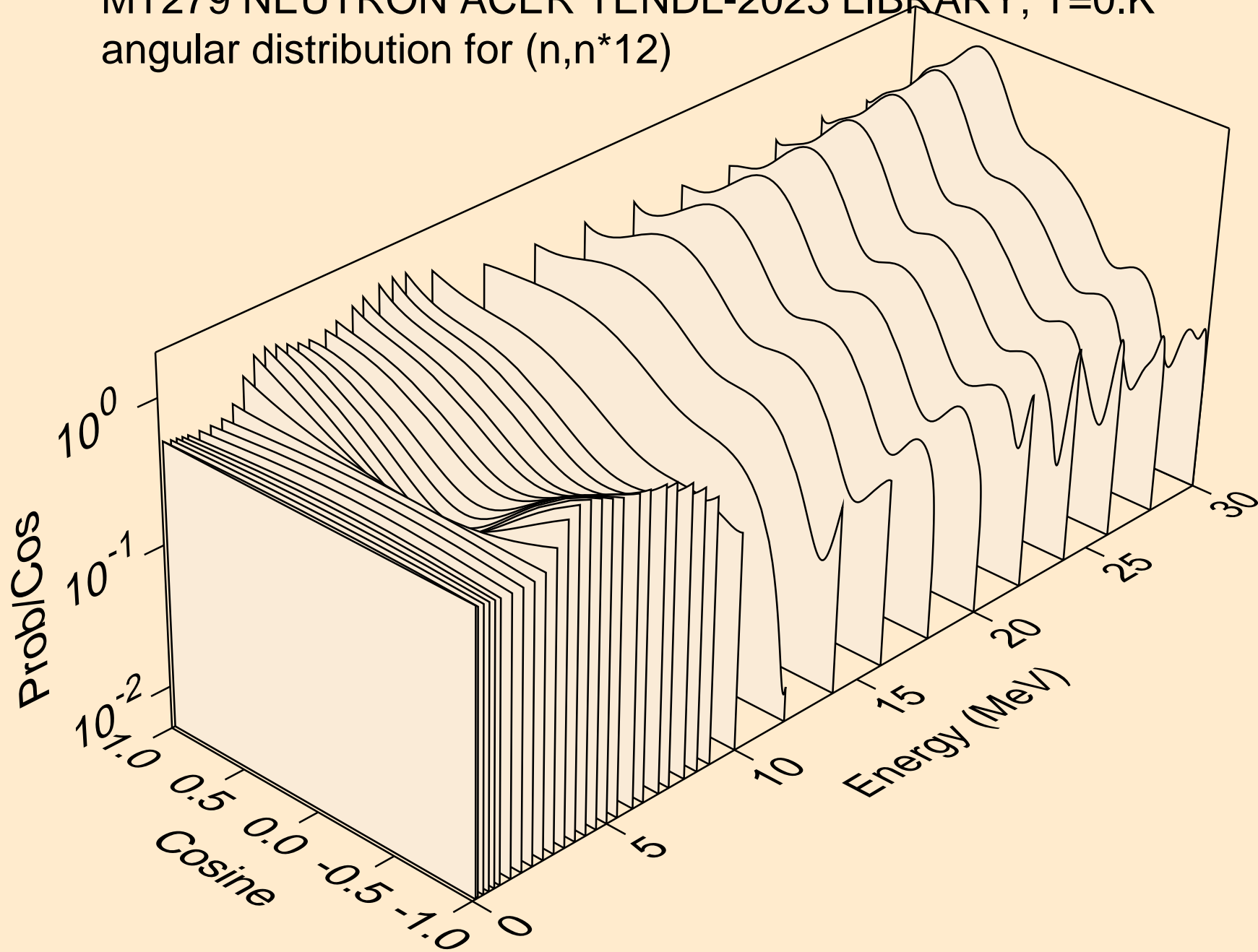

MT279 NEUTRON ACER TENDL-2023 LIBRARY; T=0.K  
angular distribution for (n,n\*13)

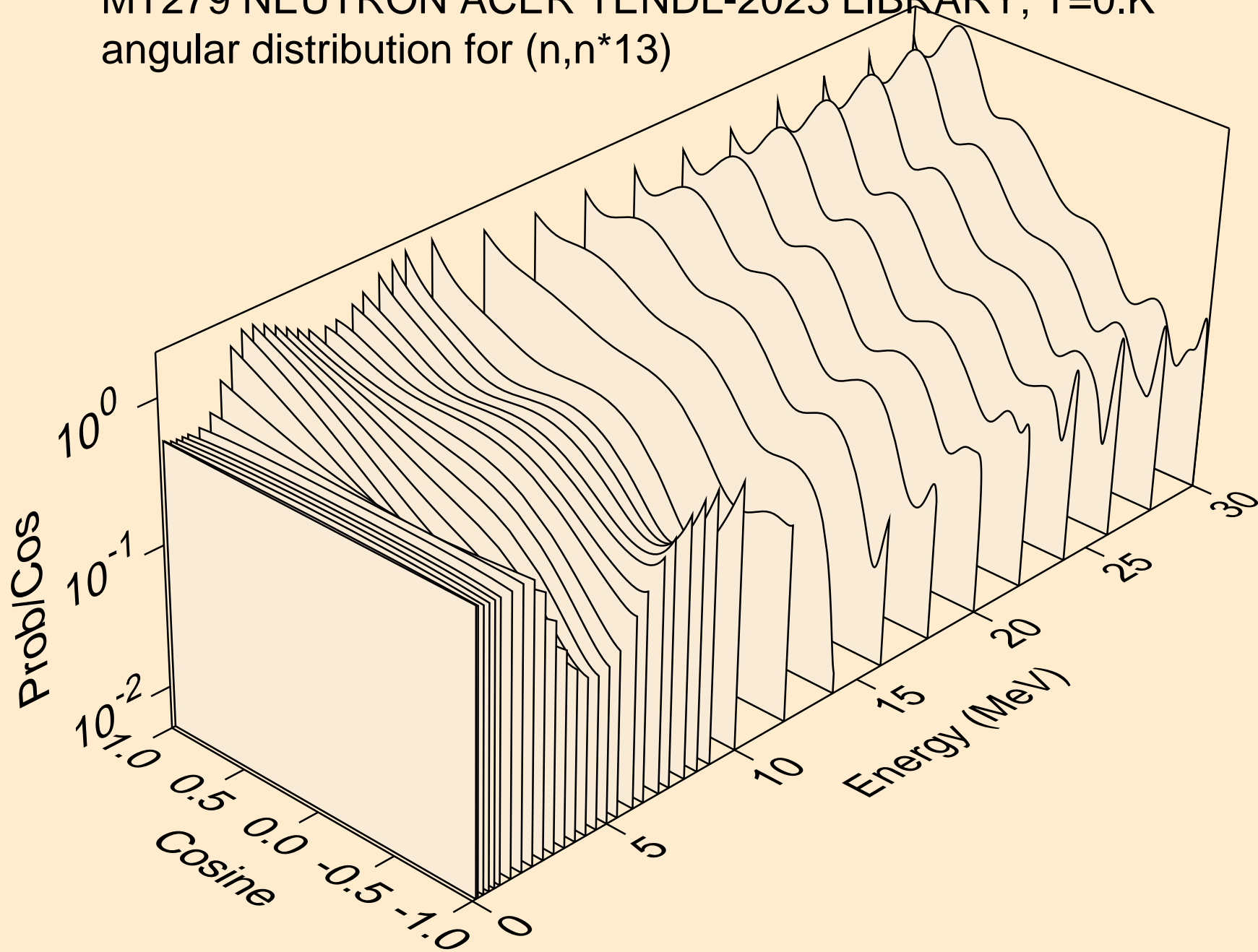

MT279 NEUTRON ACER TENDL-2023 LIBRARY; T=0.K  
angular distribution for (n,n\*14)

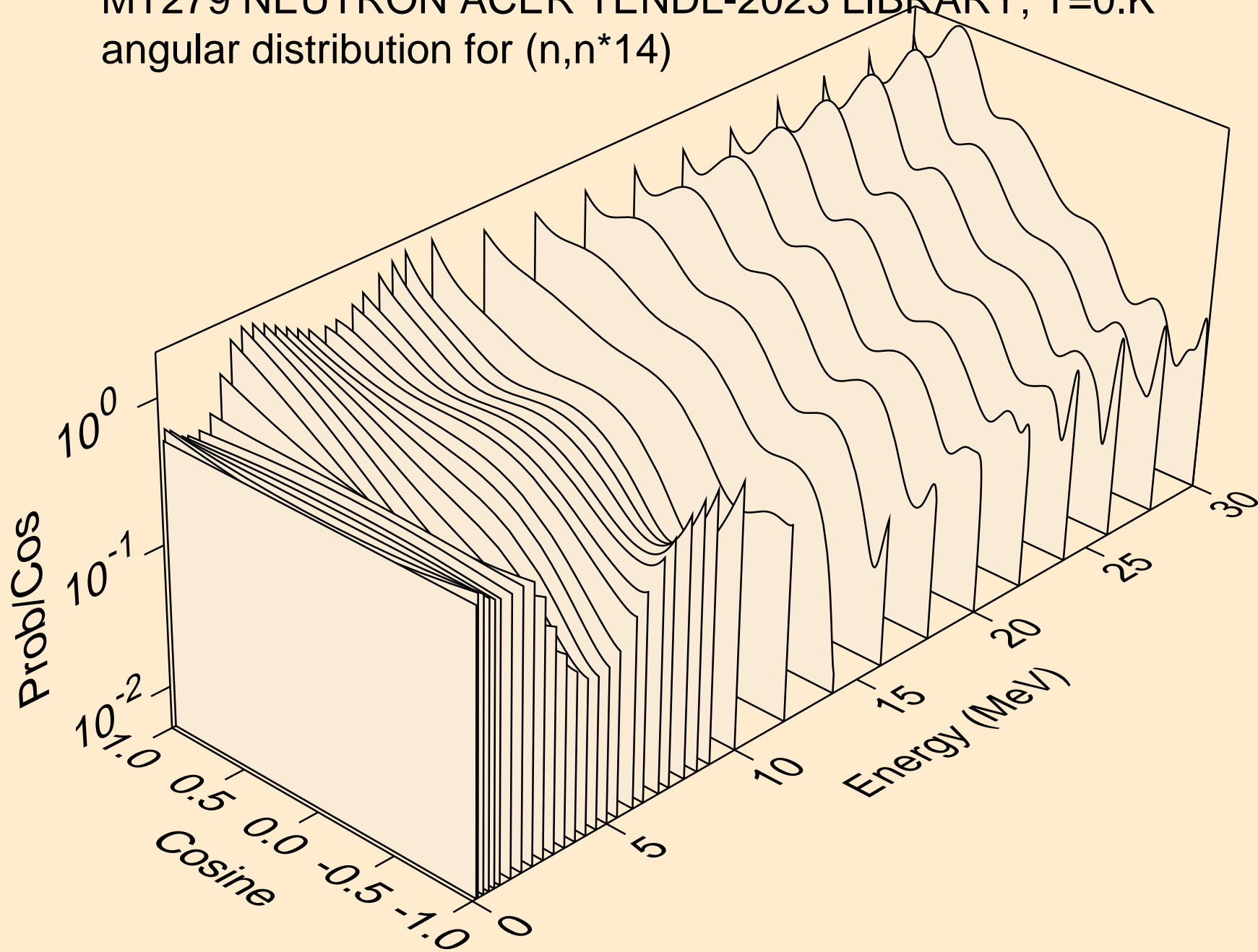

MT279 NEUTRON ACER TENDL-2023 LIBRARY; T=0.K  
angular distribution for (n,n\*15)

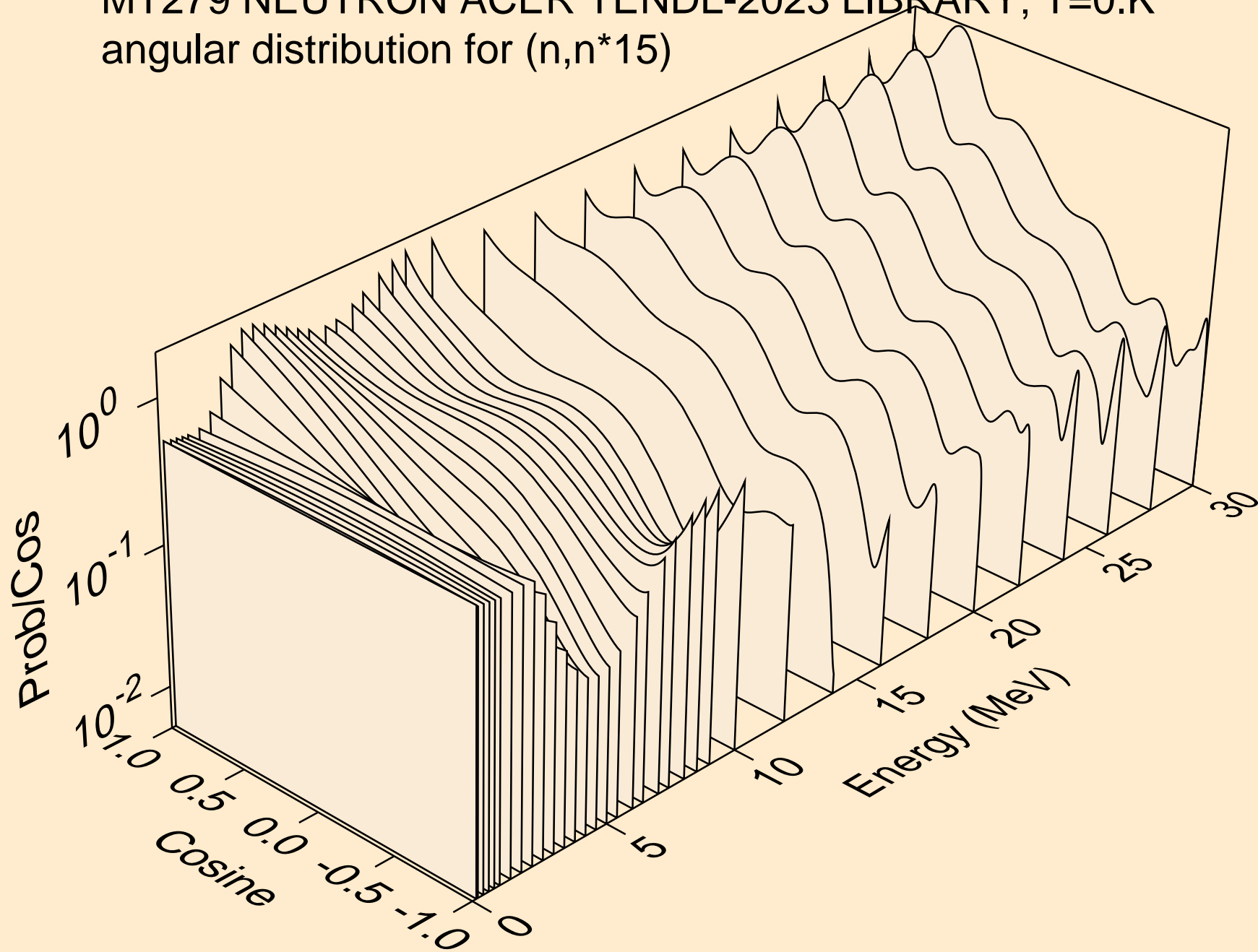

MT279 NEUTRON ACER TENDL-2023 LIBRARY; T=0.K  
angular distribution for (n,n\*16)

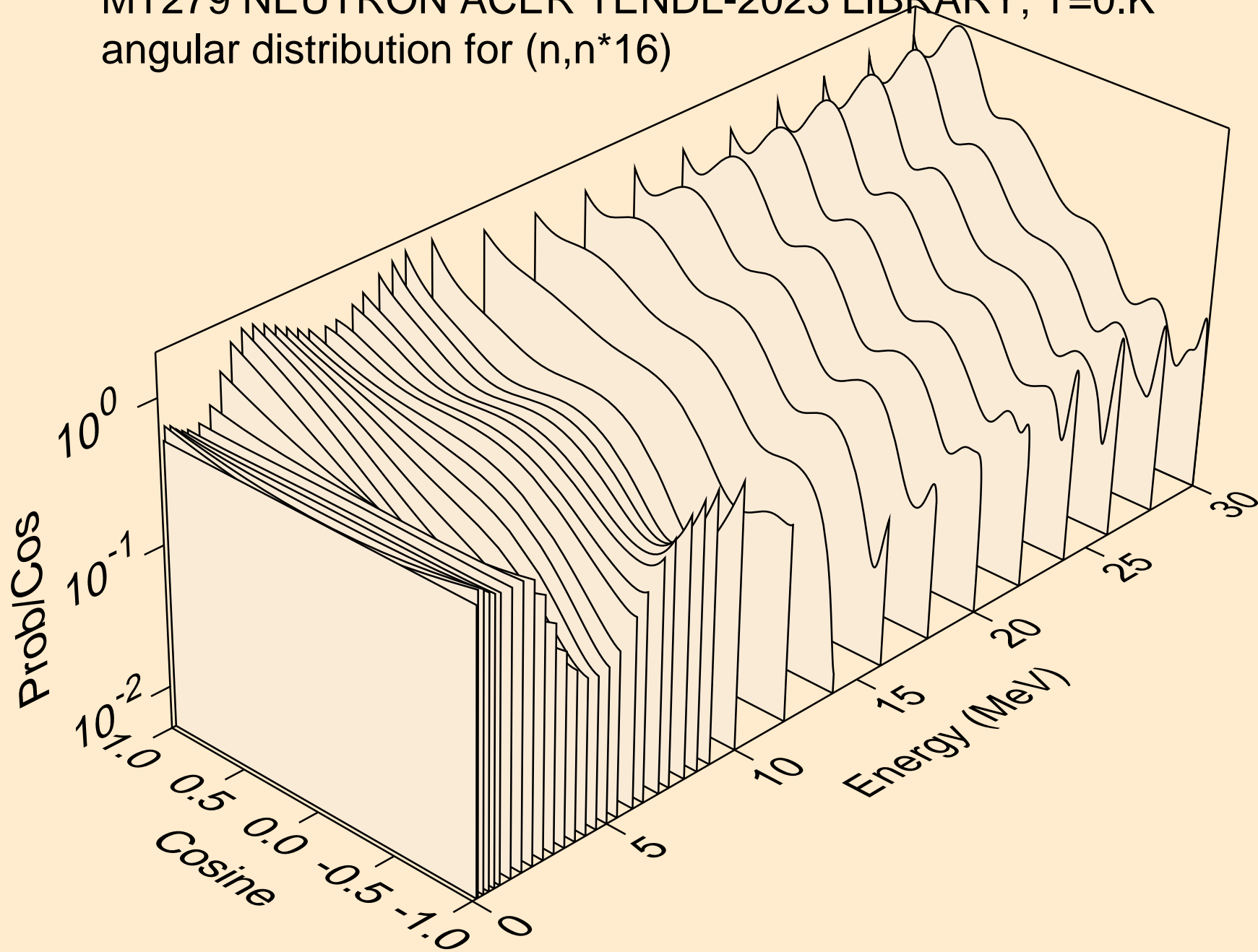

MT279 NEUTRON ACER TENDL-2023 LIBRARY; T=0.K  
angular distribution for (n,n\*17)

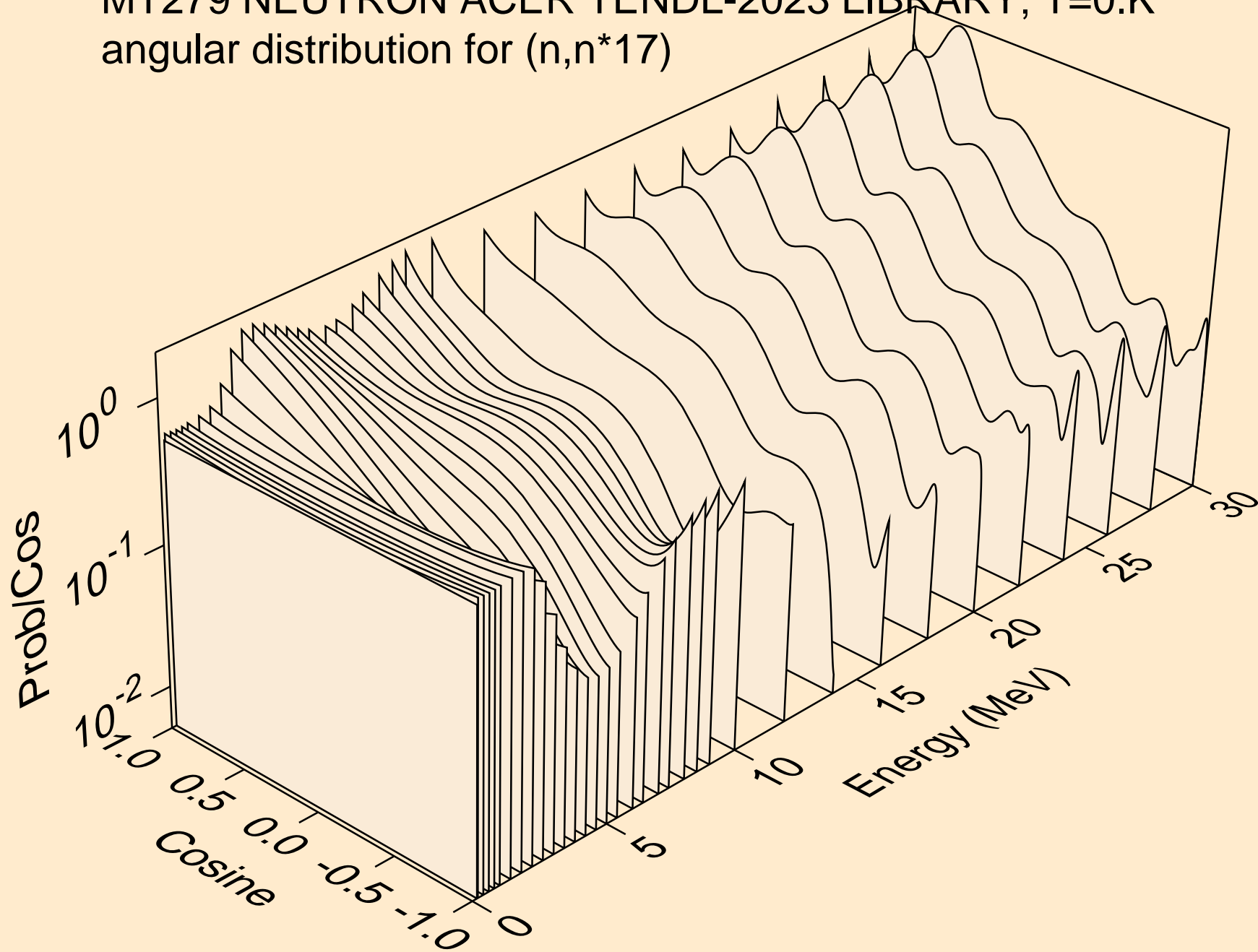



MT279 NEUTRON ACER TENDL-2023 LIBRARY; T=0.K  
angular distribution for (n,n\*18)

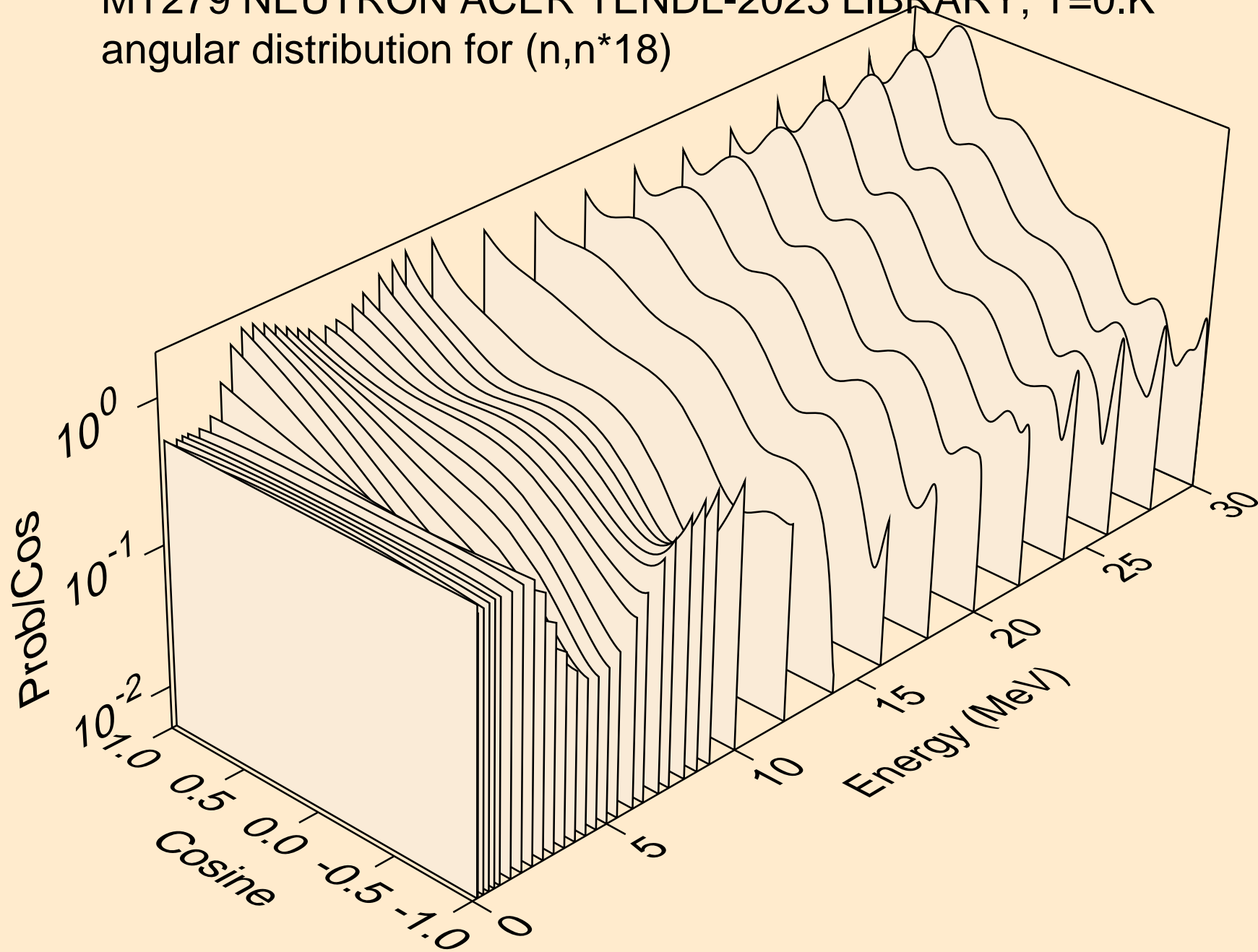



MT279 NEUTRON ACER TENDL-2023 LIBRARY; T=0.K  
angular distribution for (n,n\*19)

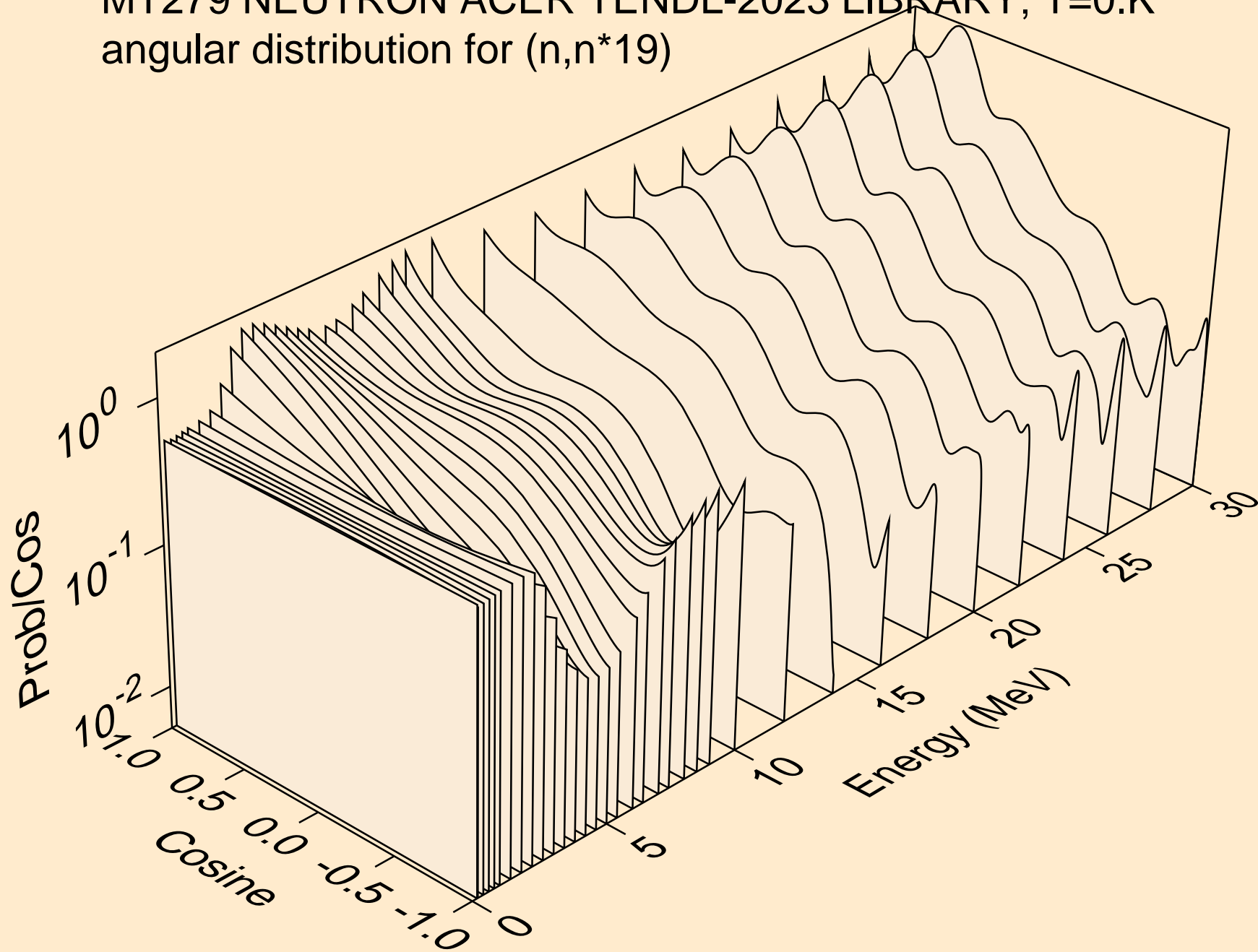

MT279 NEUTRON ACER TENDL-2023 LIBRARY; T=0.K  
angular distribution for (n,n\*20)

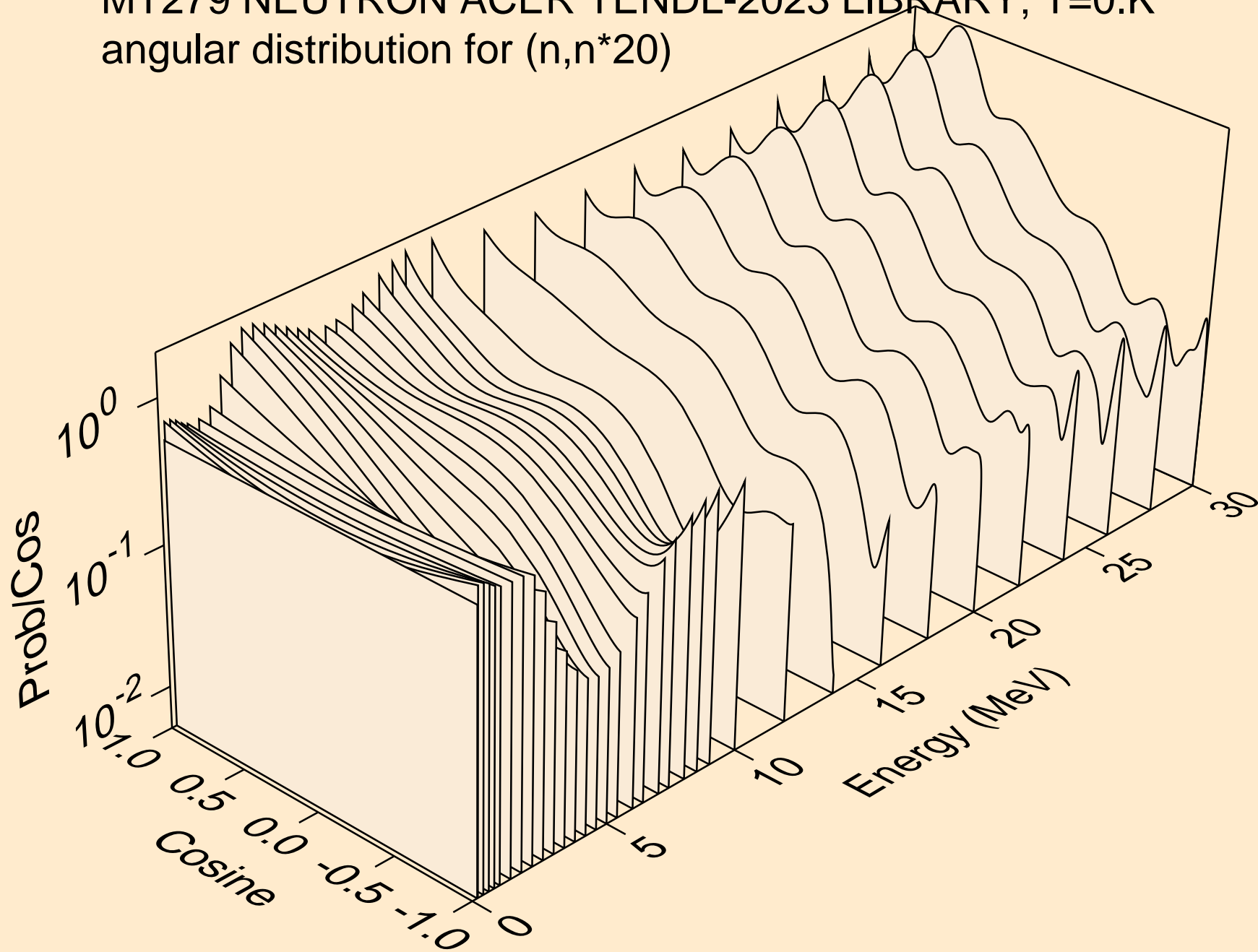

MT279 NEUTRON ACER TENDL-2023 LIBRARY; T=0.K  
angular distribution for (n,n\*21)

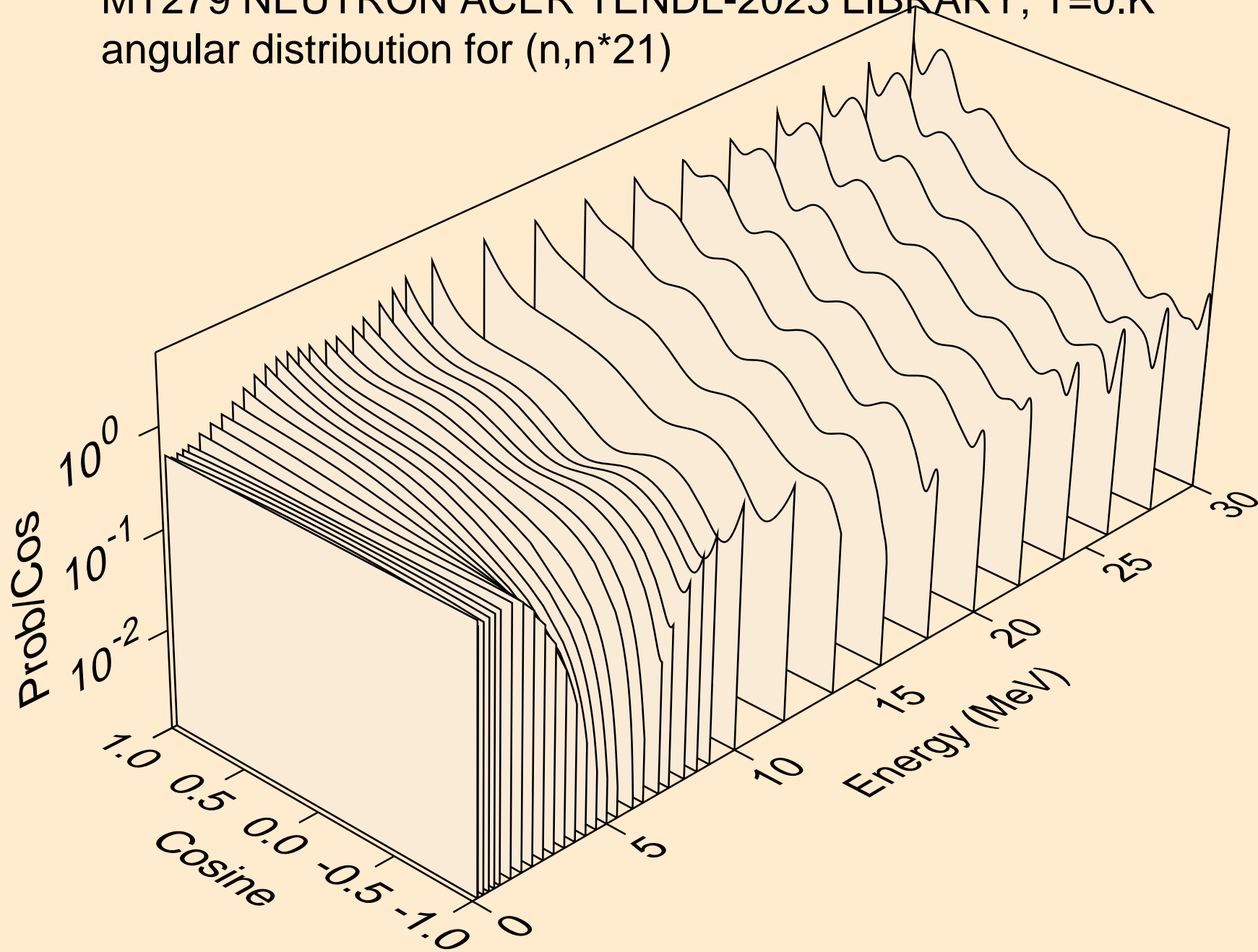

MT279 NEUTRON ACER TENDL-2023 LIBRARY; T=0.K  
angular distribution for (n,n\*22)

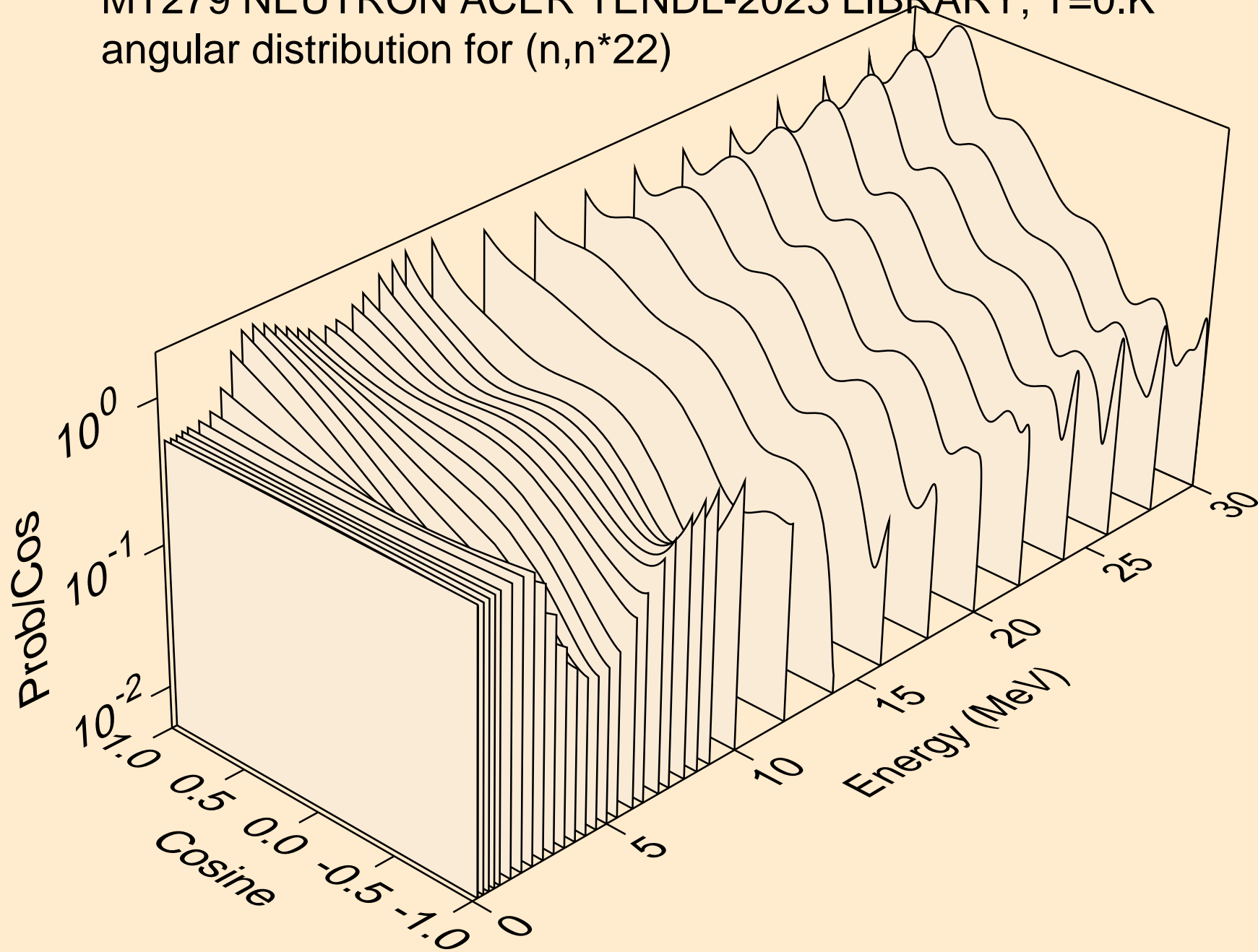

MT279 NEUTRON ACER TENDL-2023 LIBRARY; T=0.K  
Total fission nubar

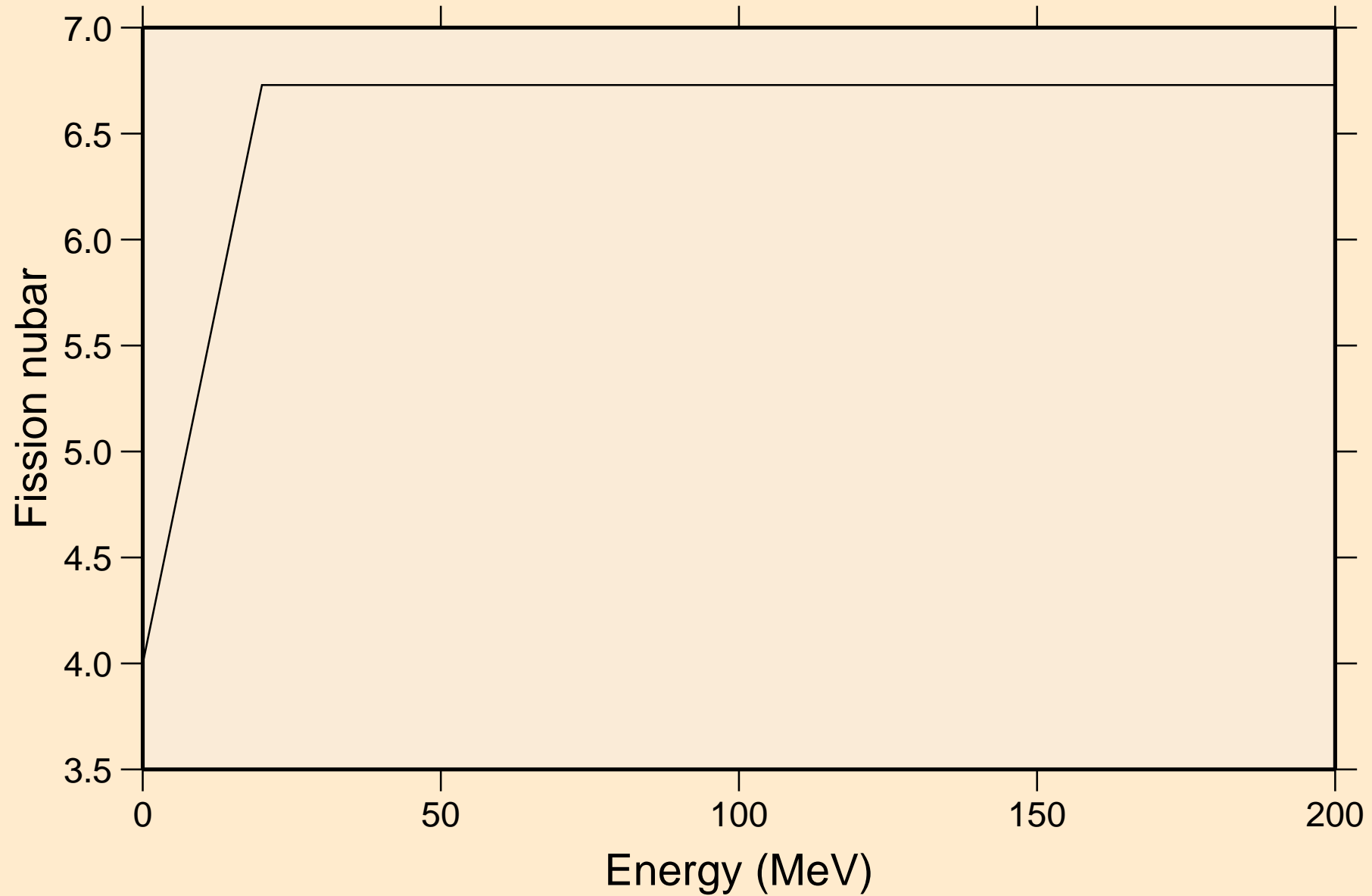

MT279 NEUTRON ACER TENDL-2023 LIBRARY; T=0.K  
Neutron emission for (n,x)

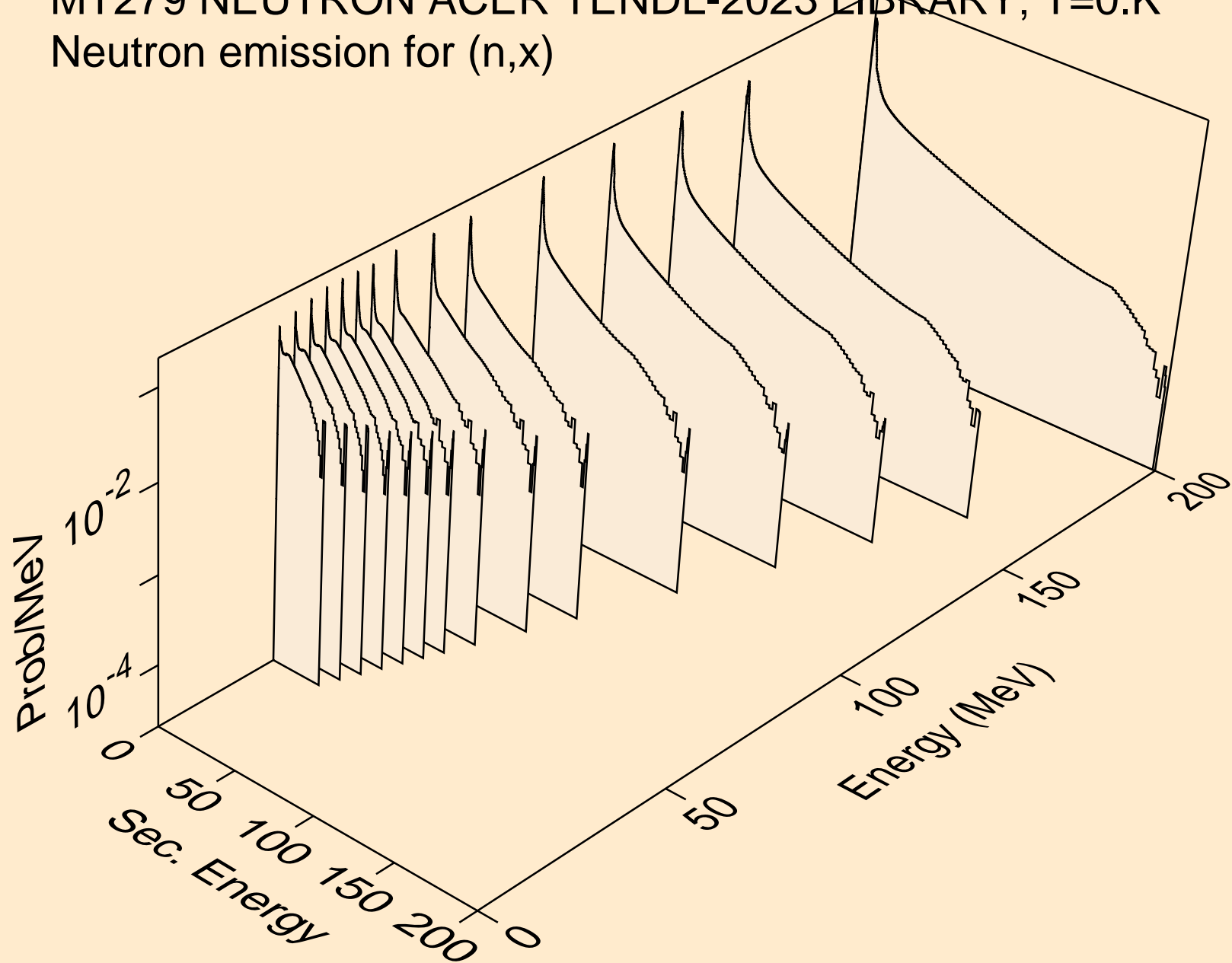

MT279 NEUTRON ACER TENDL-2023 LIBRARY; T=0.K  
Neutron emission for (n,2nd)

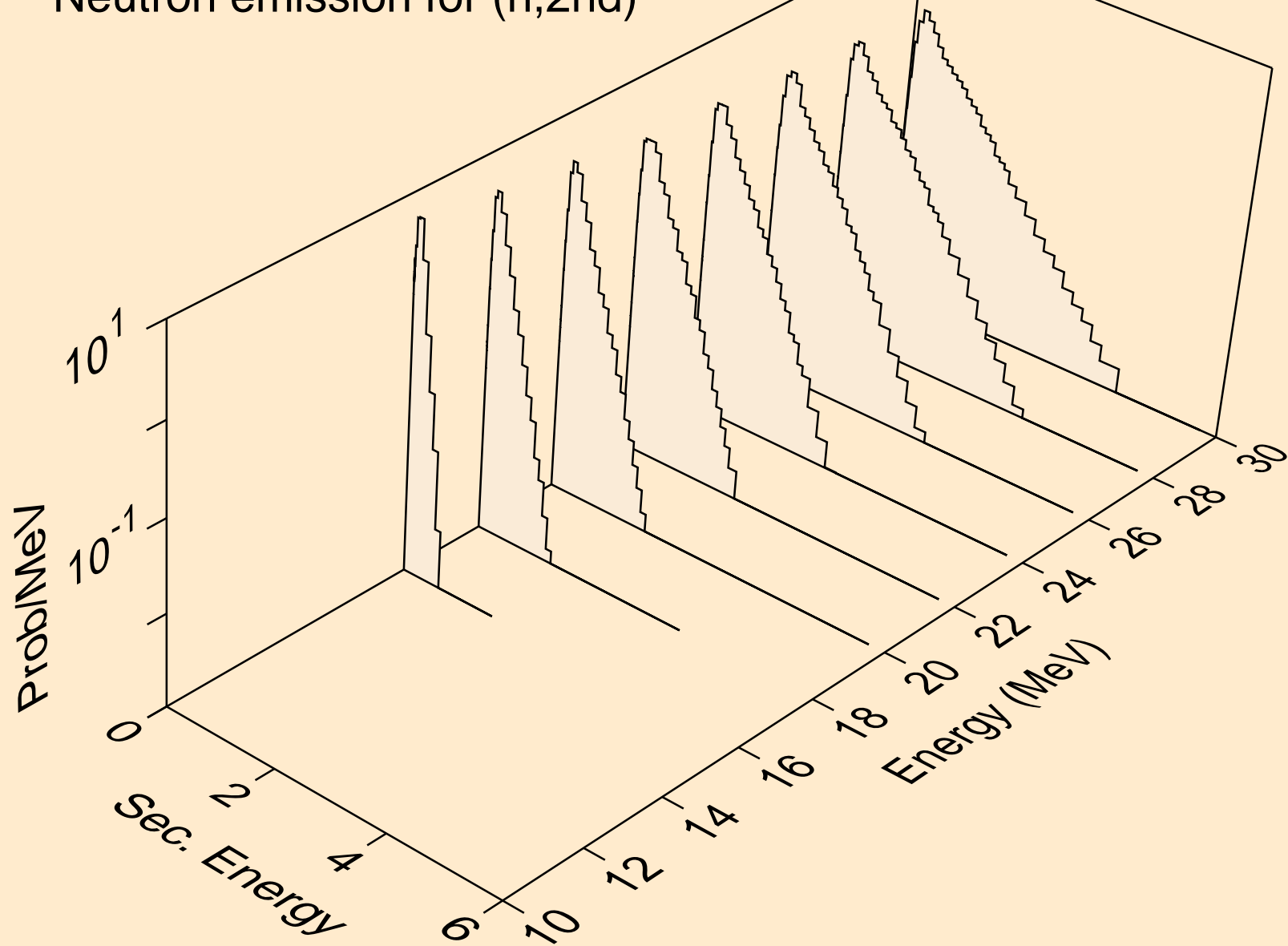

MT279 NEUTRON ACER TENDL-2023 LIBRARY; T=0.K  
Neutron emission for (n,2n)

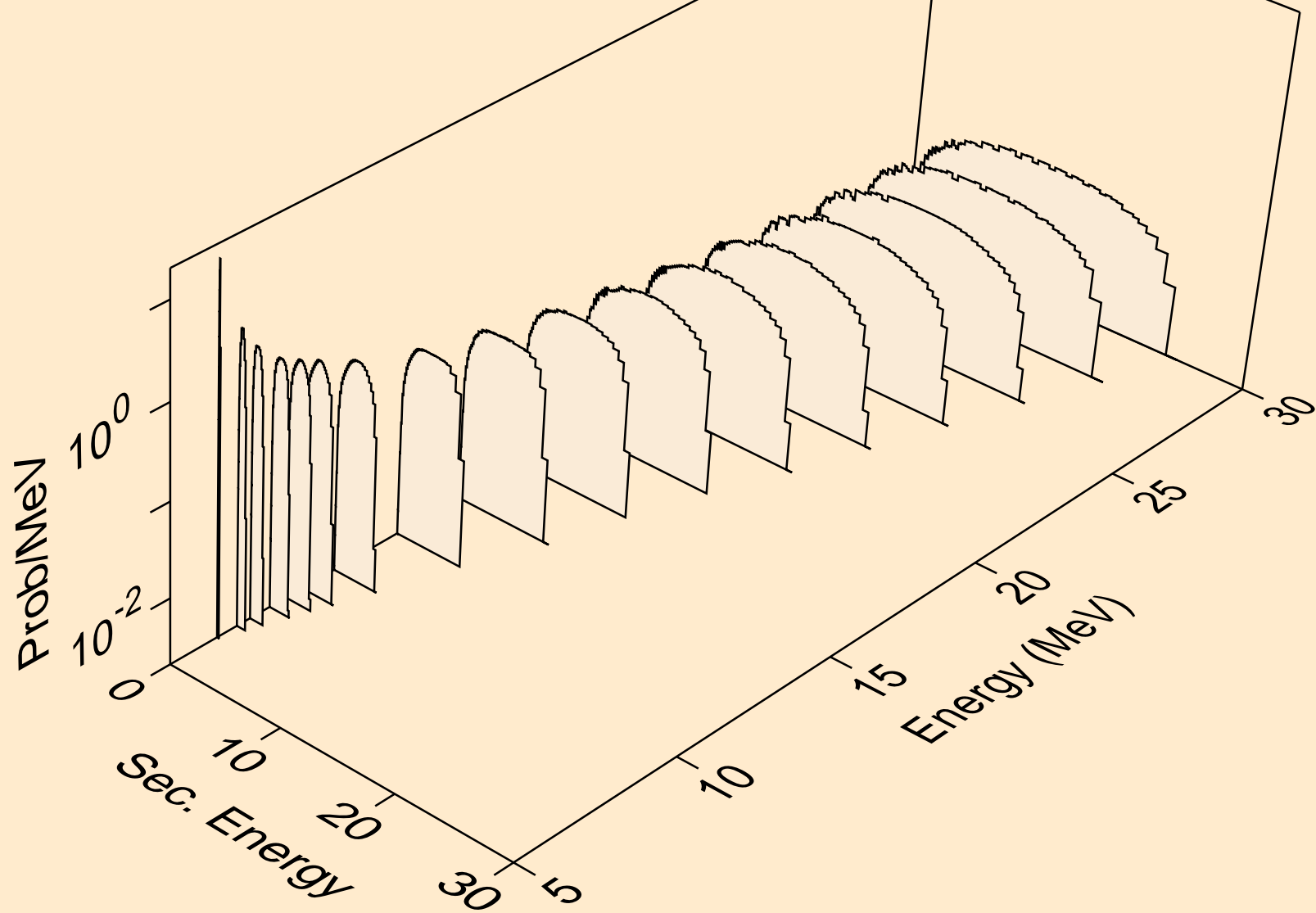



MT279 NEUTRON ACER TENDL-2023 LIBRARY; T=0.K  
Neutron emission for (n,3n)

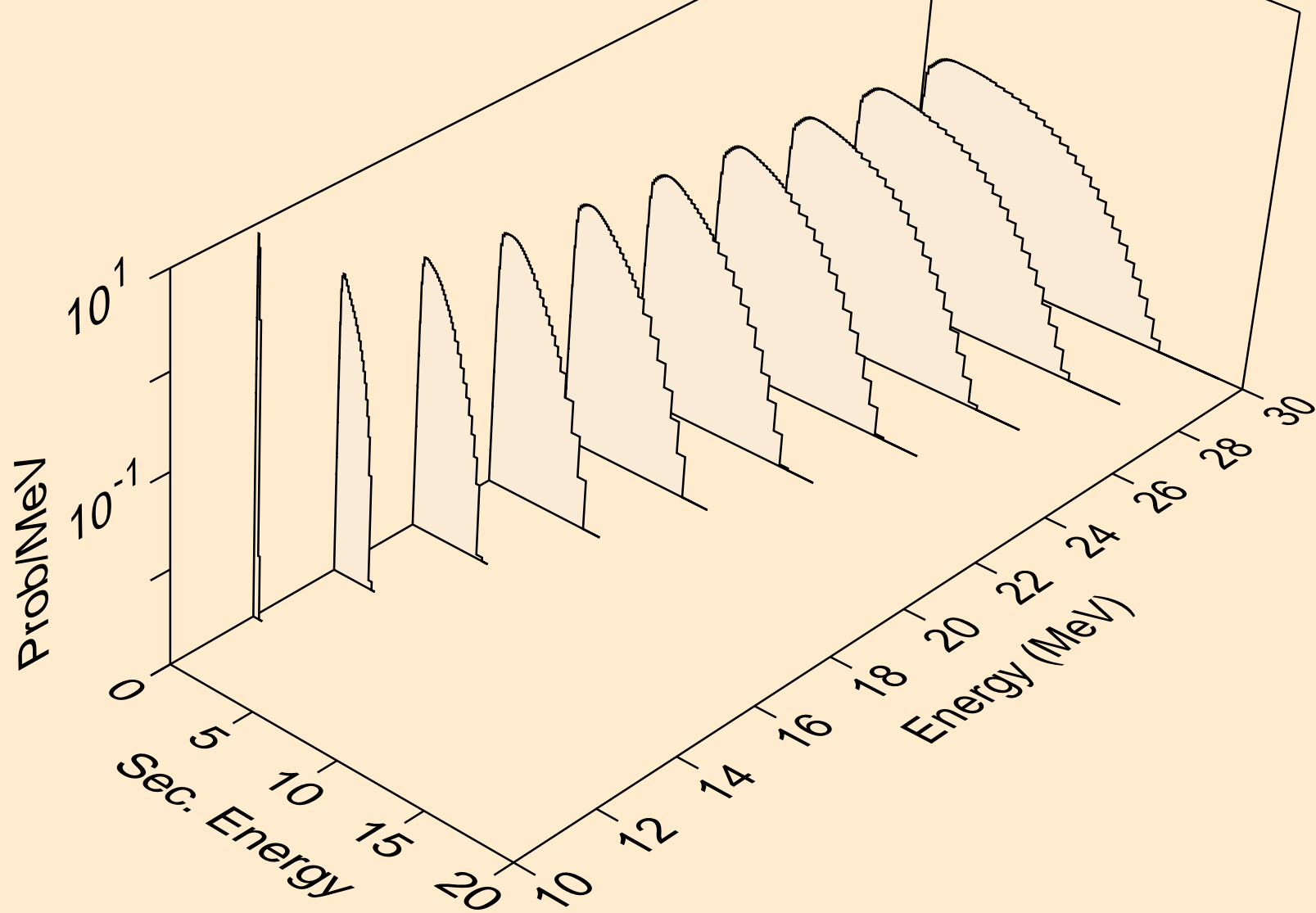

MT279 NEUTRON ACER TENDL-2023 LIBRARY; T=0.K  
Neutron emission for fission

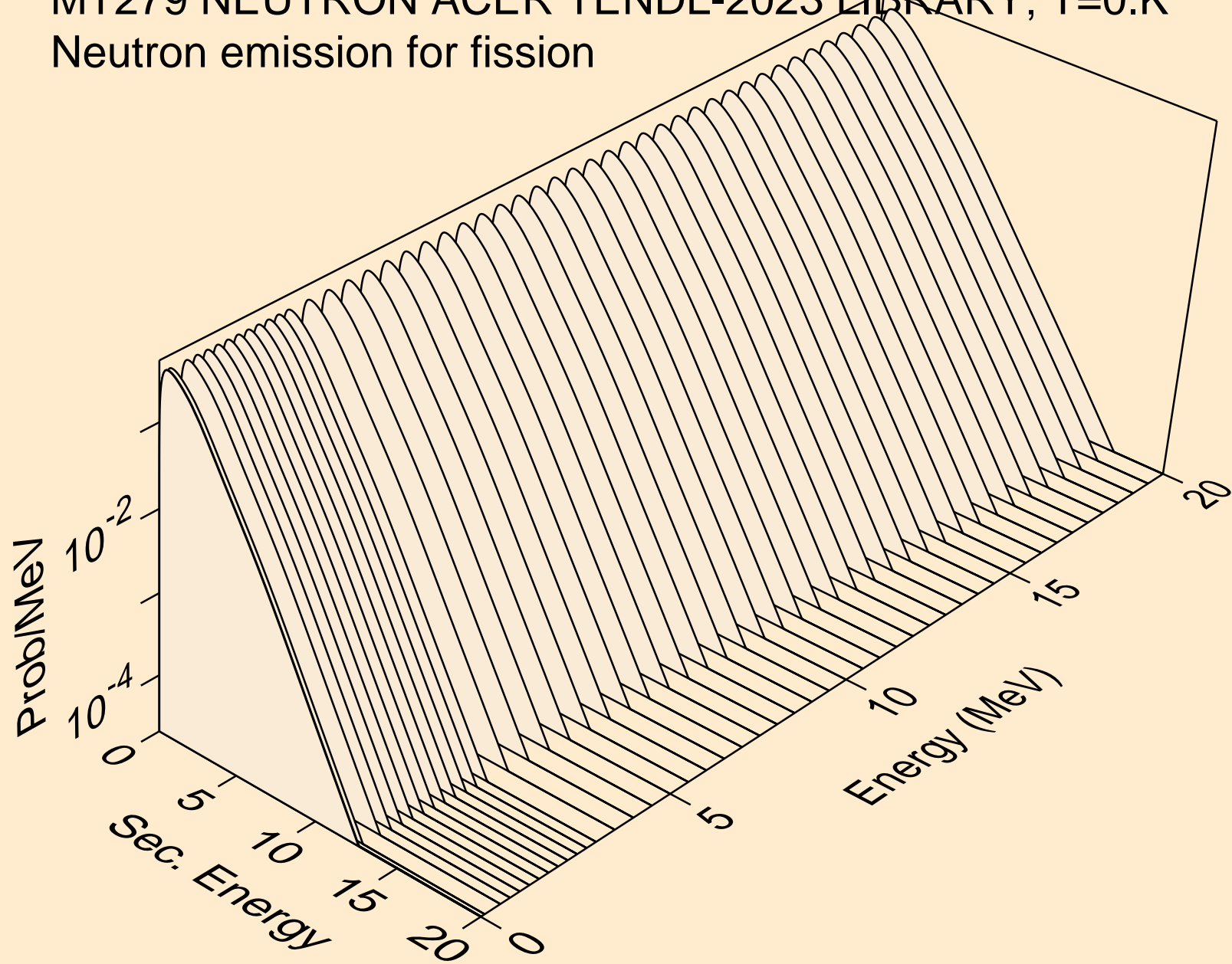

MT279 NEUTRON ACER TENDL-2023 LIBRARY; T=0.K  
Neutron emission for (n,n\*)a

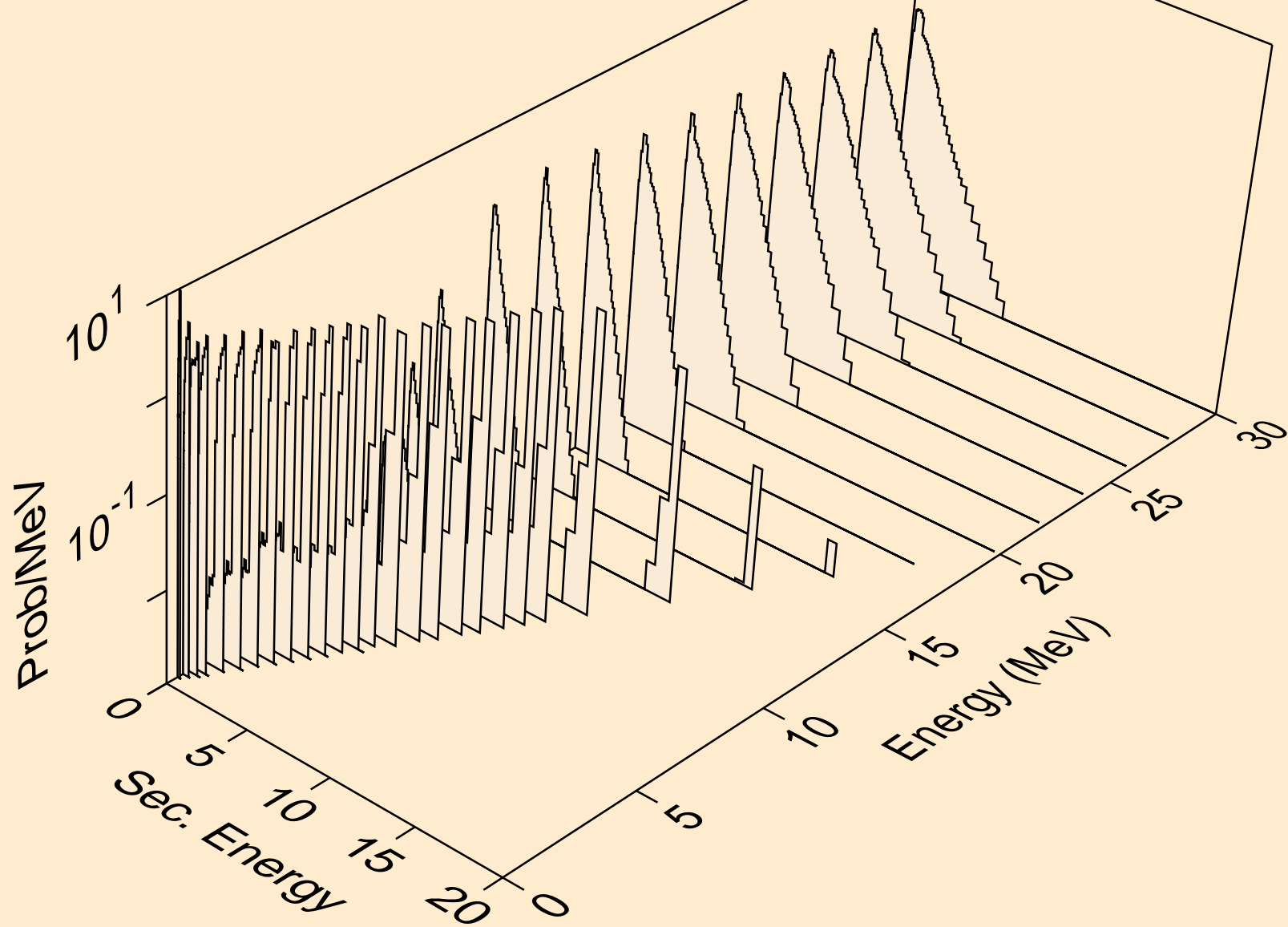

MT279 NEUTRON ACER TENDL-2023 LIBRARY; T=0.K  
Neutron emission for (n,2n)a

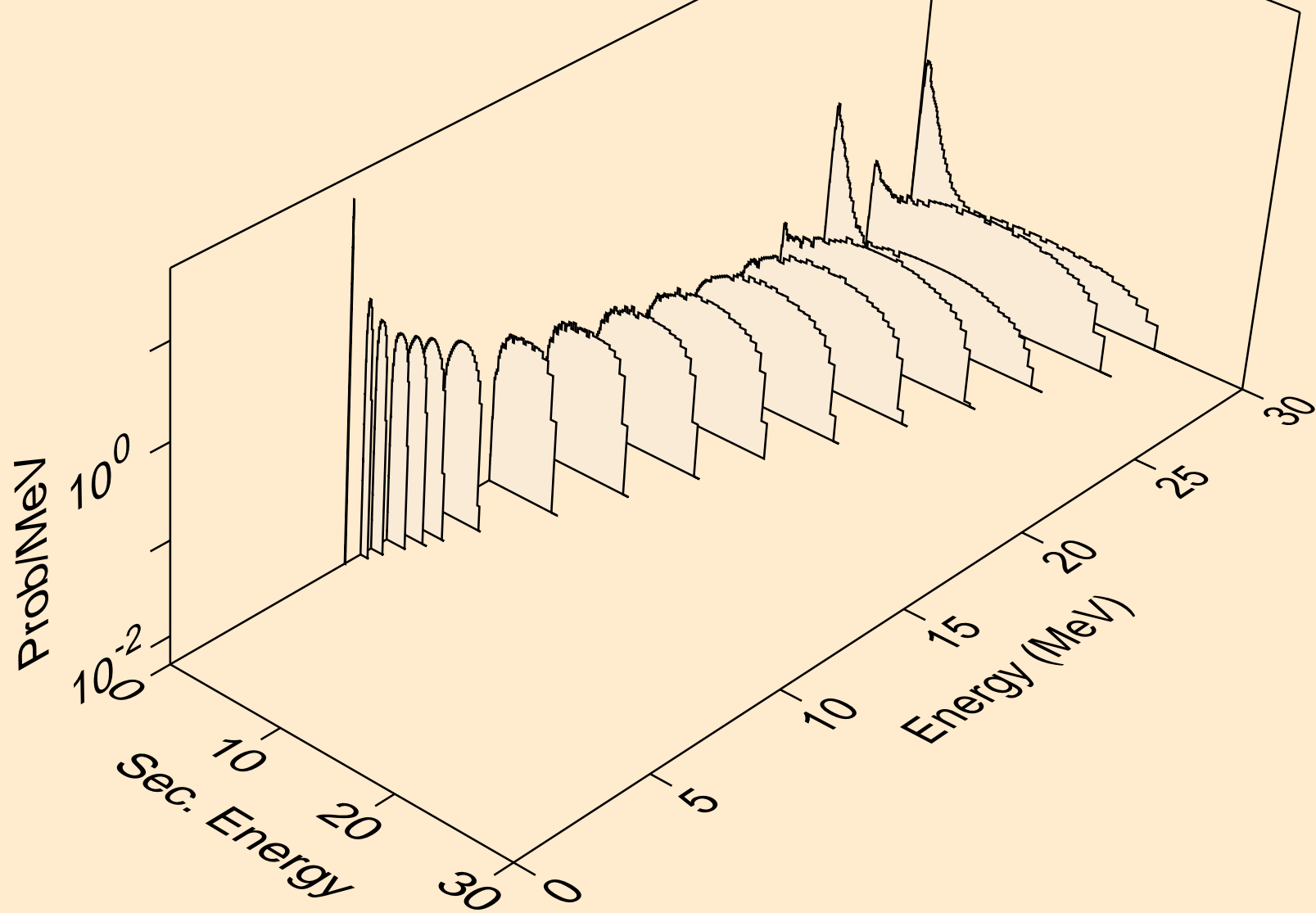

MT279 NEUTRON ACER TENDL-2023 LIBRARY; T=0.K  
Neutron emission for (n,3n)a

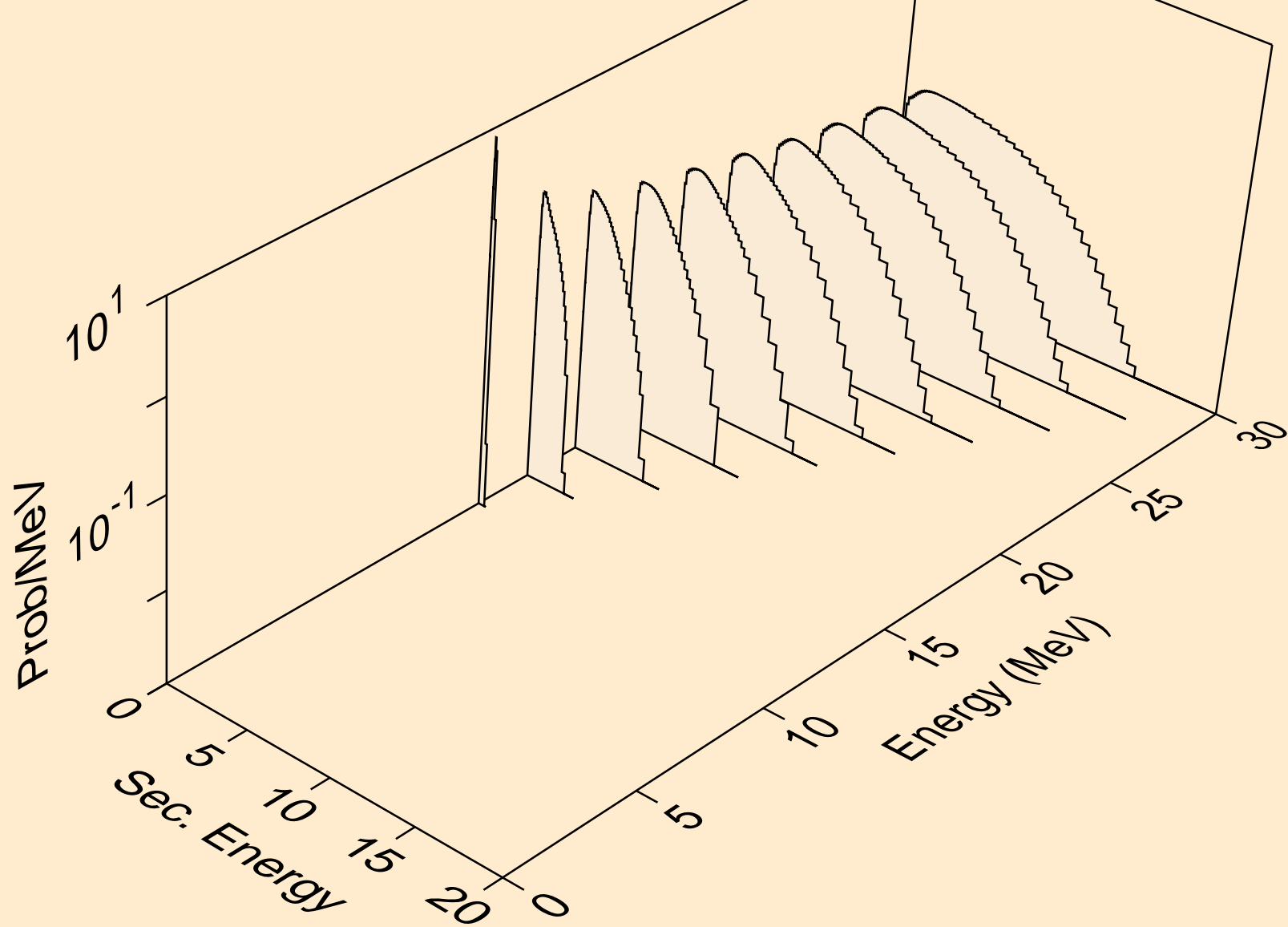

MT279 NEUTRON ACER TENDL-2023 LIBRARY; T=0.K  
Neutron emission for (n,n\*)p

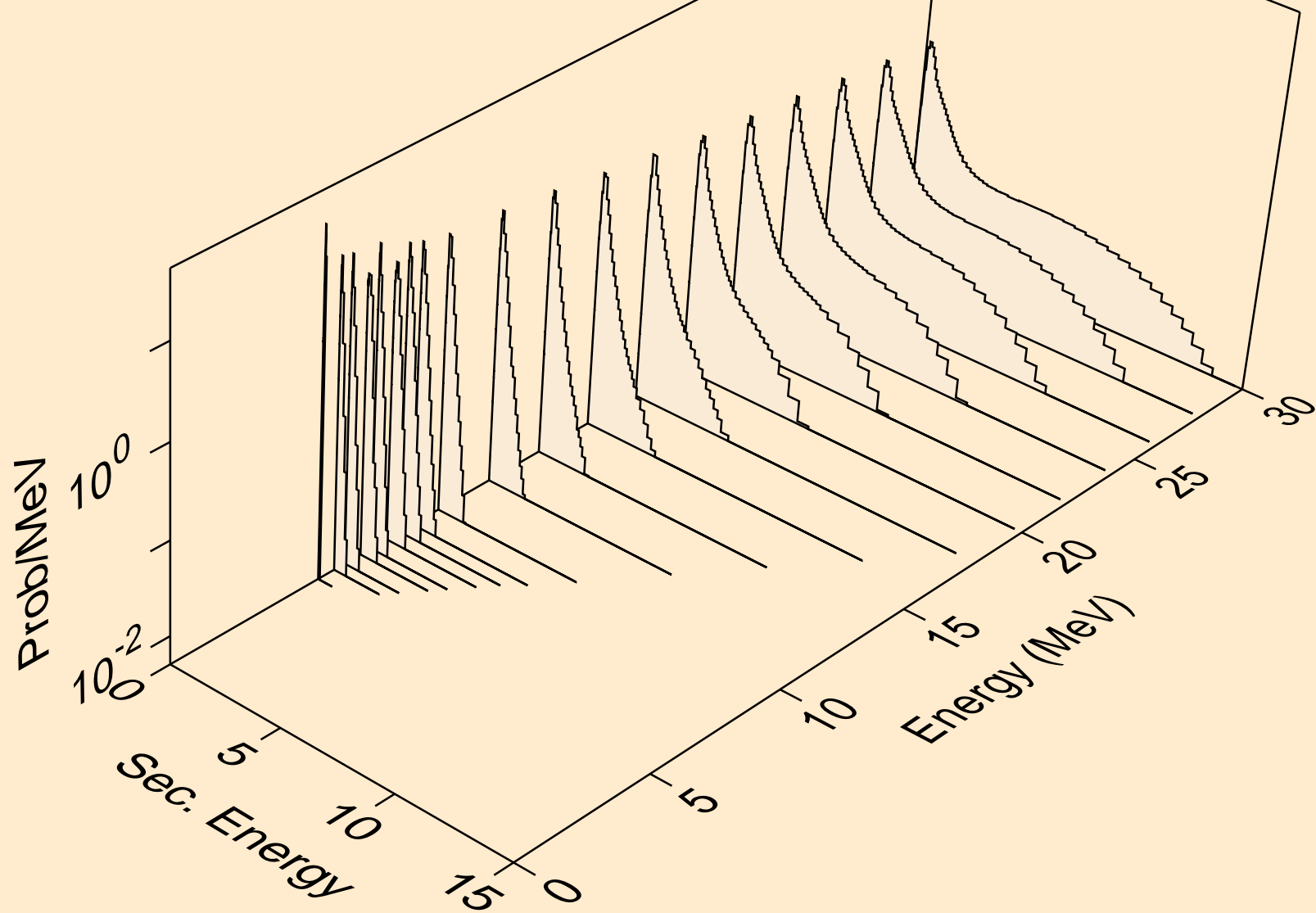

MT279 NEUTRON ACER TENDL-2023 LIBRARY; T=0.K  
Neutron emission for (n,n\*)d

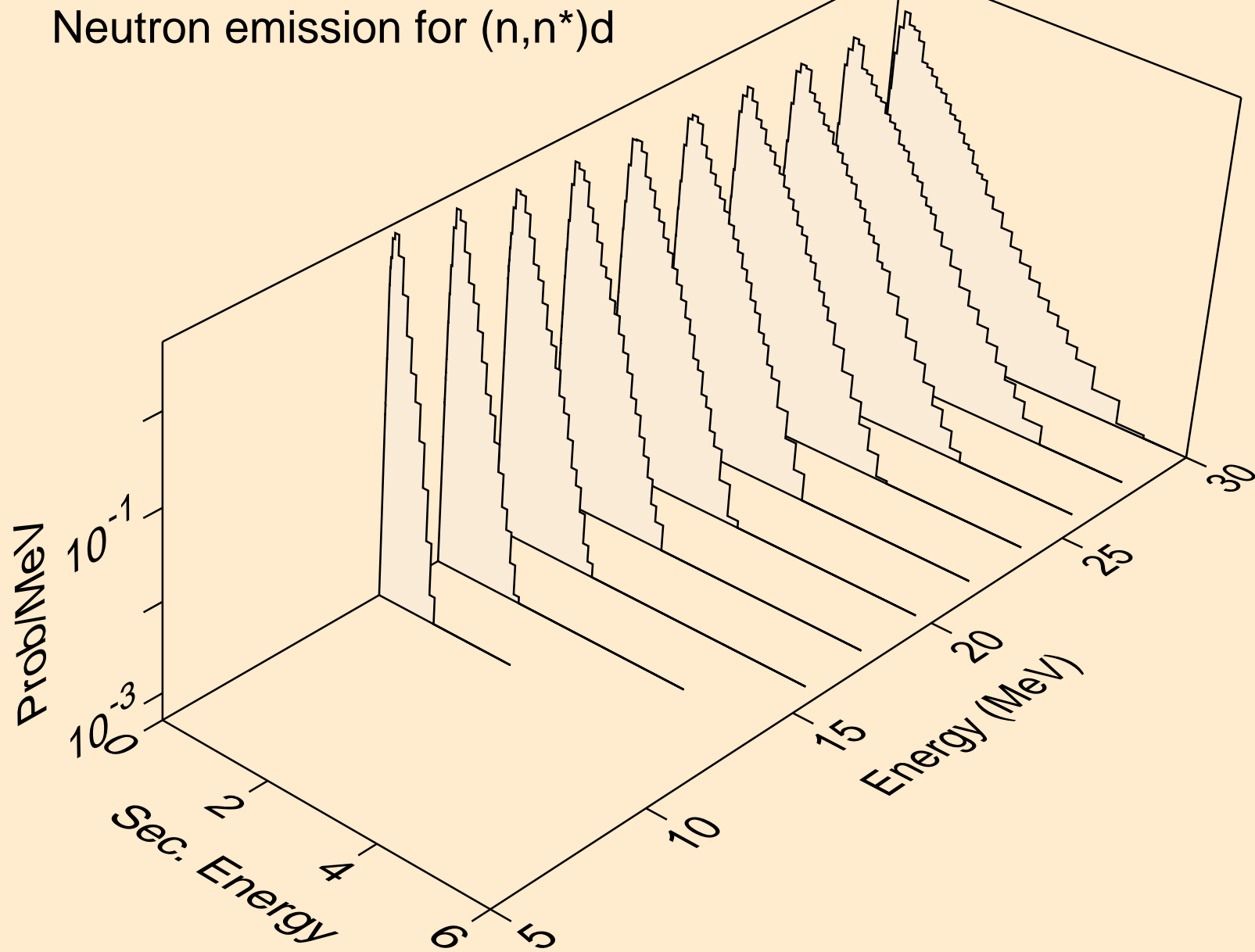

MT279 NEUTRON ACER TENDL-2023 LIBRARY; T=0.K  
Neutron emission for (n,n\*)t

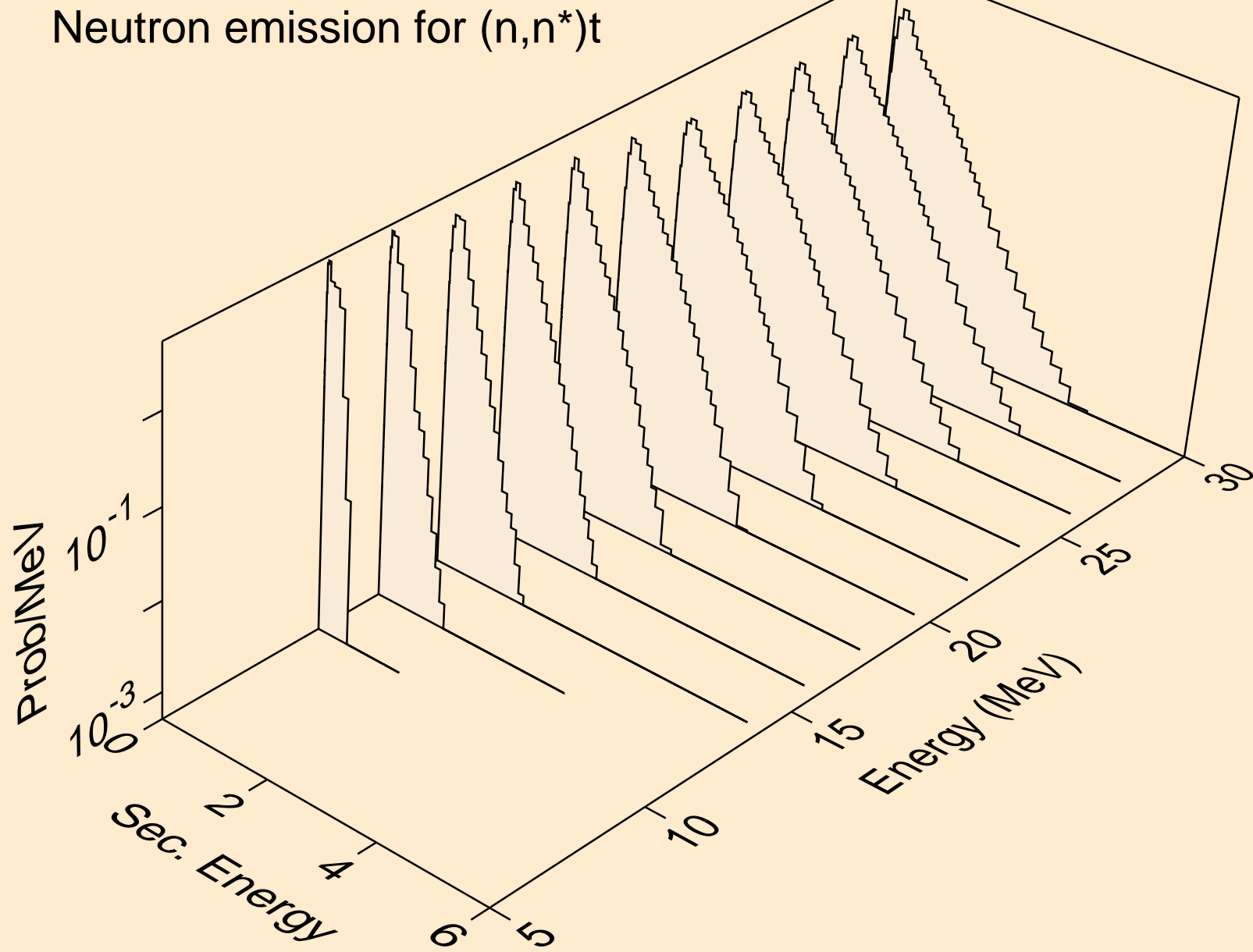



MT279 NEUTRON ACER TENDL-2023 LIBRARY; T=0.K  
Neutron emission for (n,n\*)he3

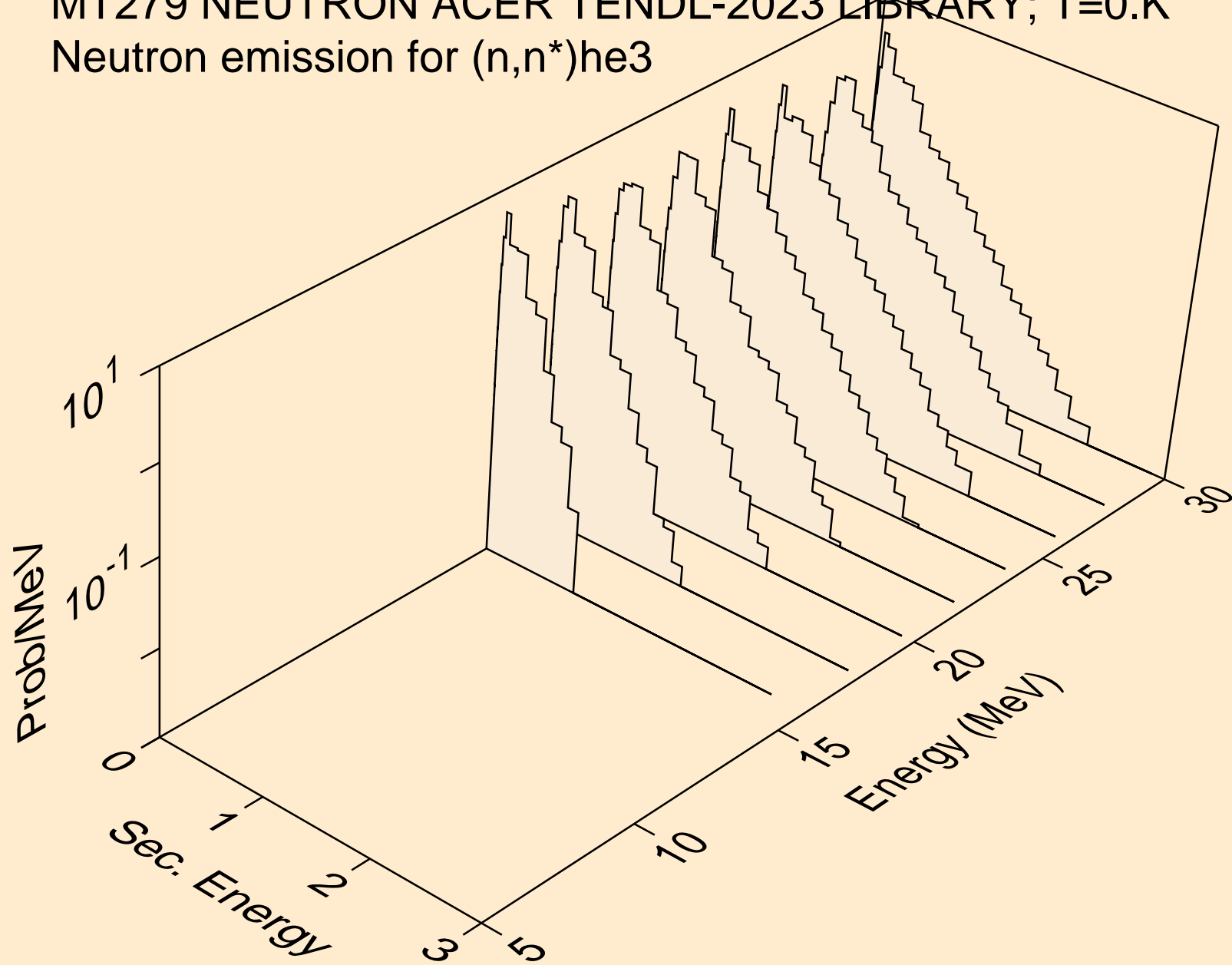

MT279 NEUTRON ACER TENDL-2023 LIBRARY; T=0.K  
Neutron emission for (n,4n)

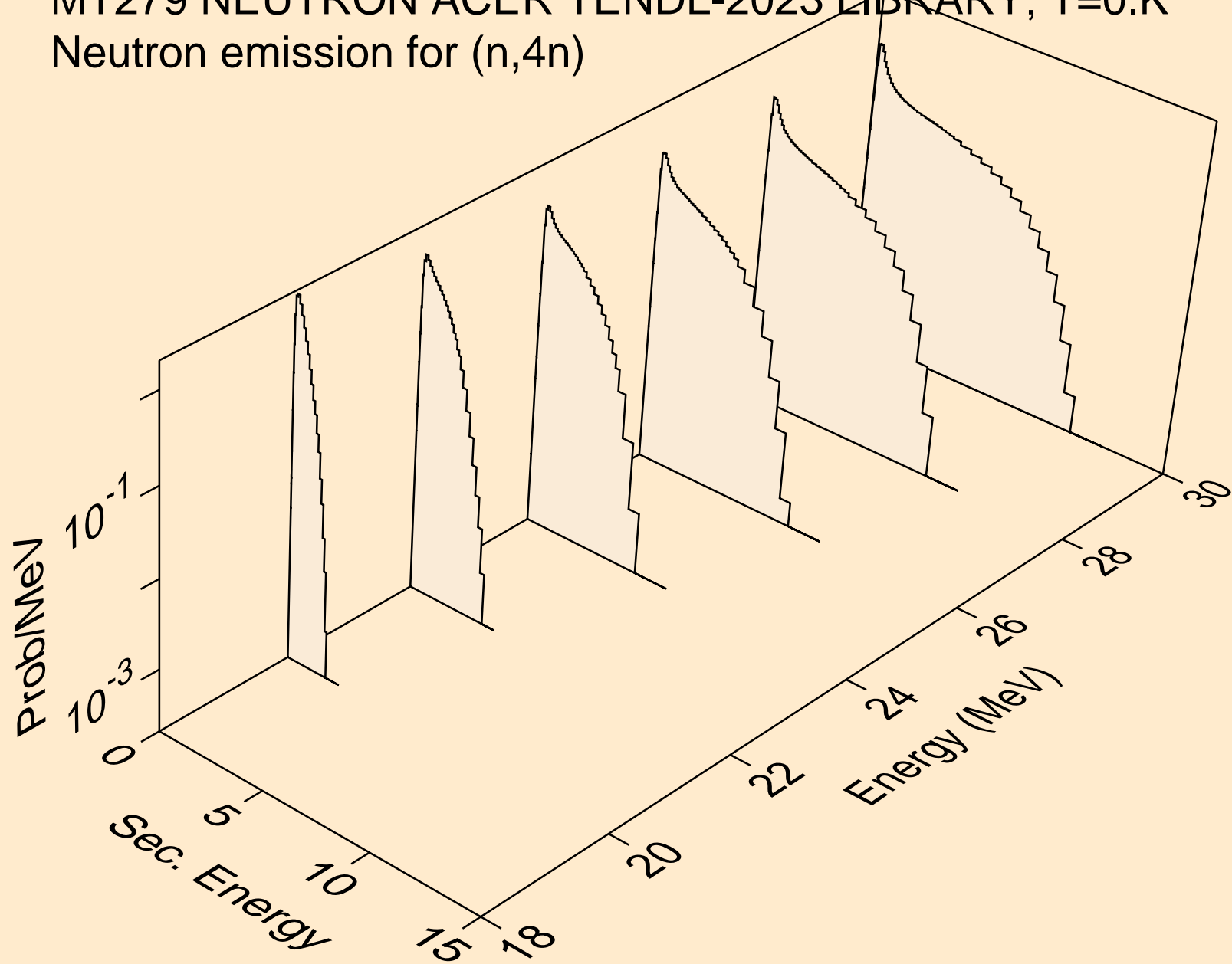

MT279 NEUTRON ACER TENDL-2023 LIBRARY; T=0.K  
Neutron emission for (n,2np)

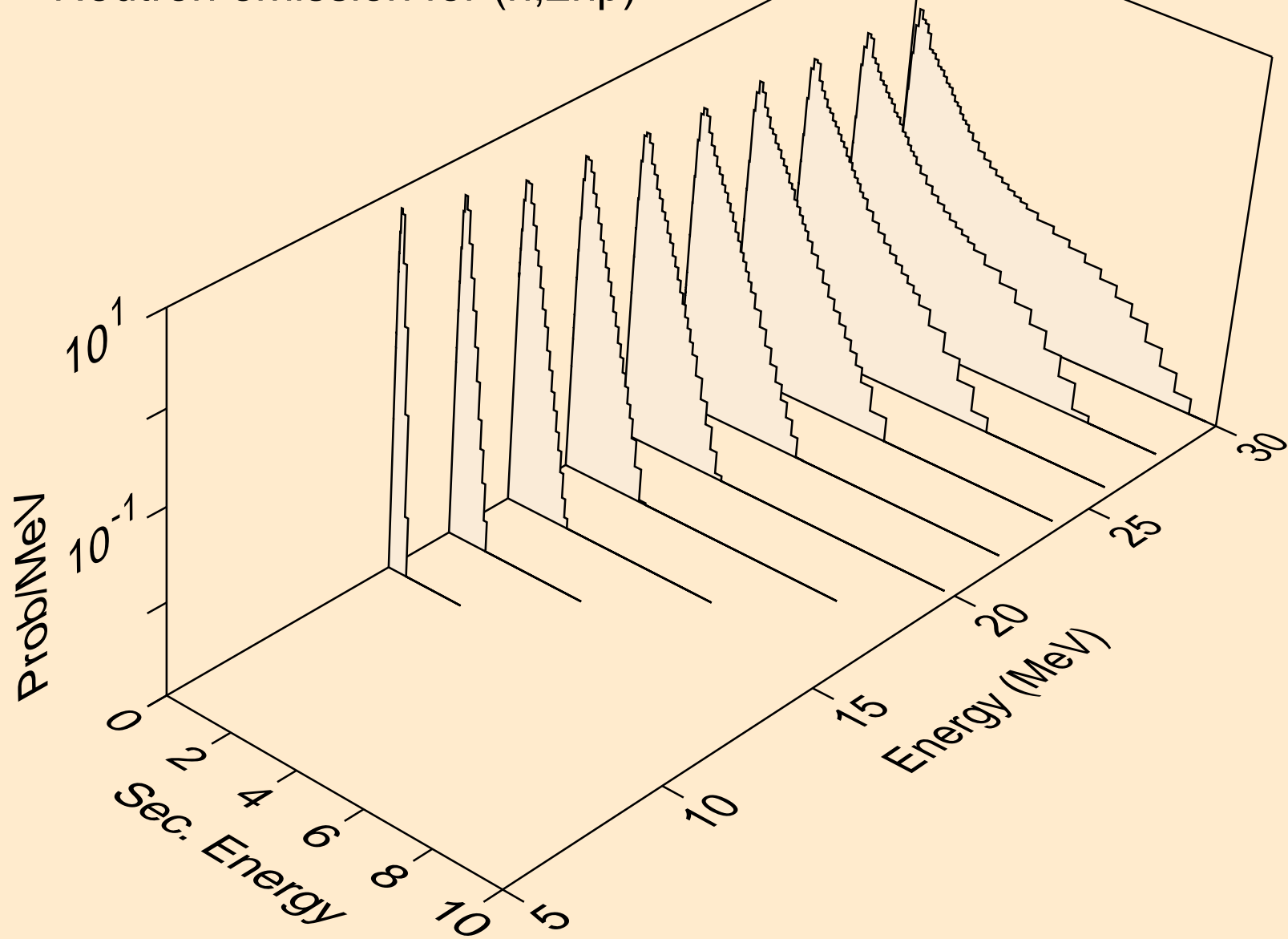

MT279 NEUTRON ACER TENDL-2023 LIBRARY; T=0.K  
Neutron emission for (n,3np)

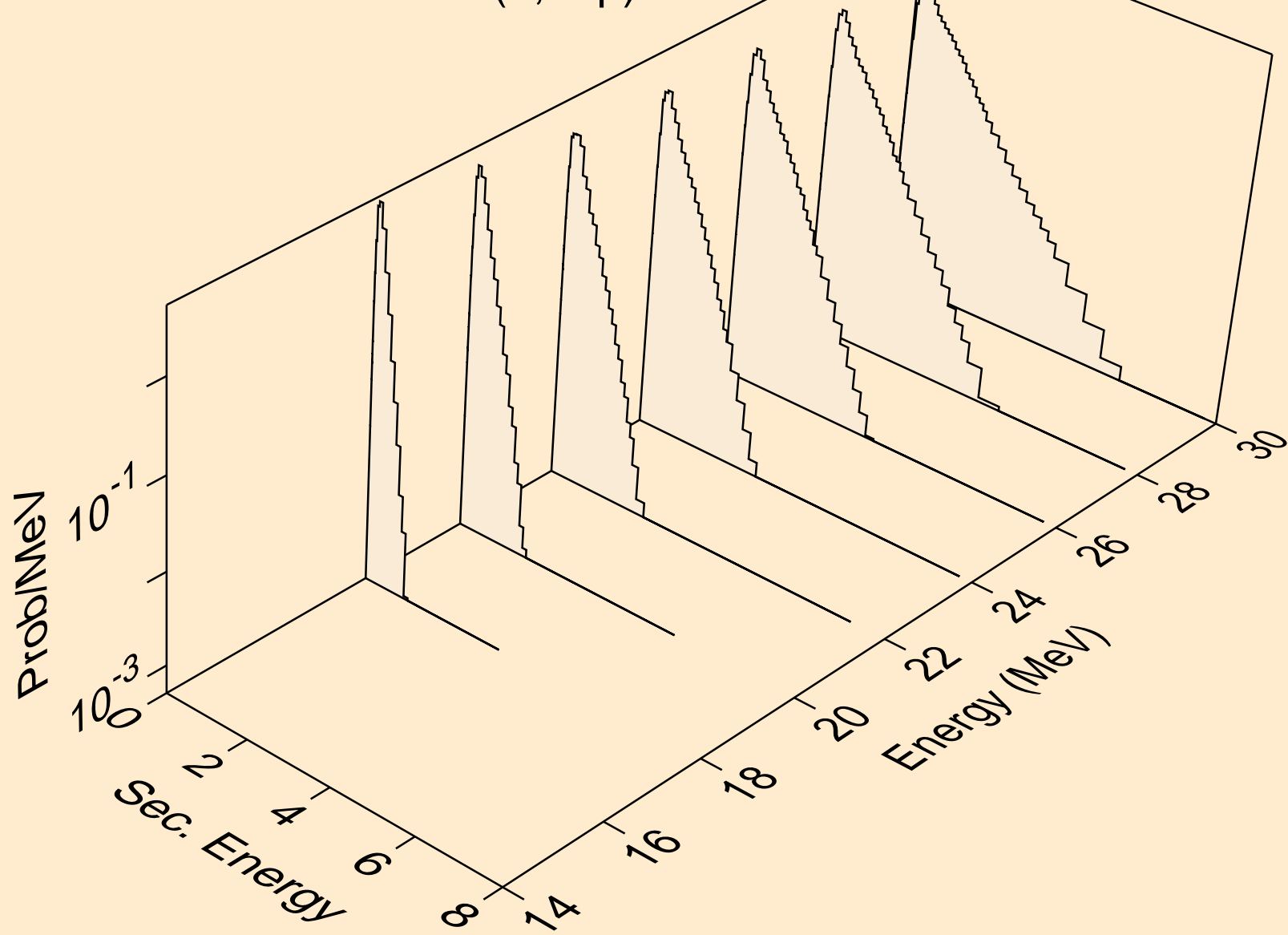

MT279 NEUTRON ACER TENDL-2023 LIBRARY; T=0.K  
Neutron emission for (n,n2p)

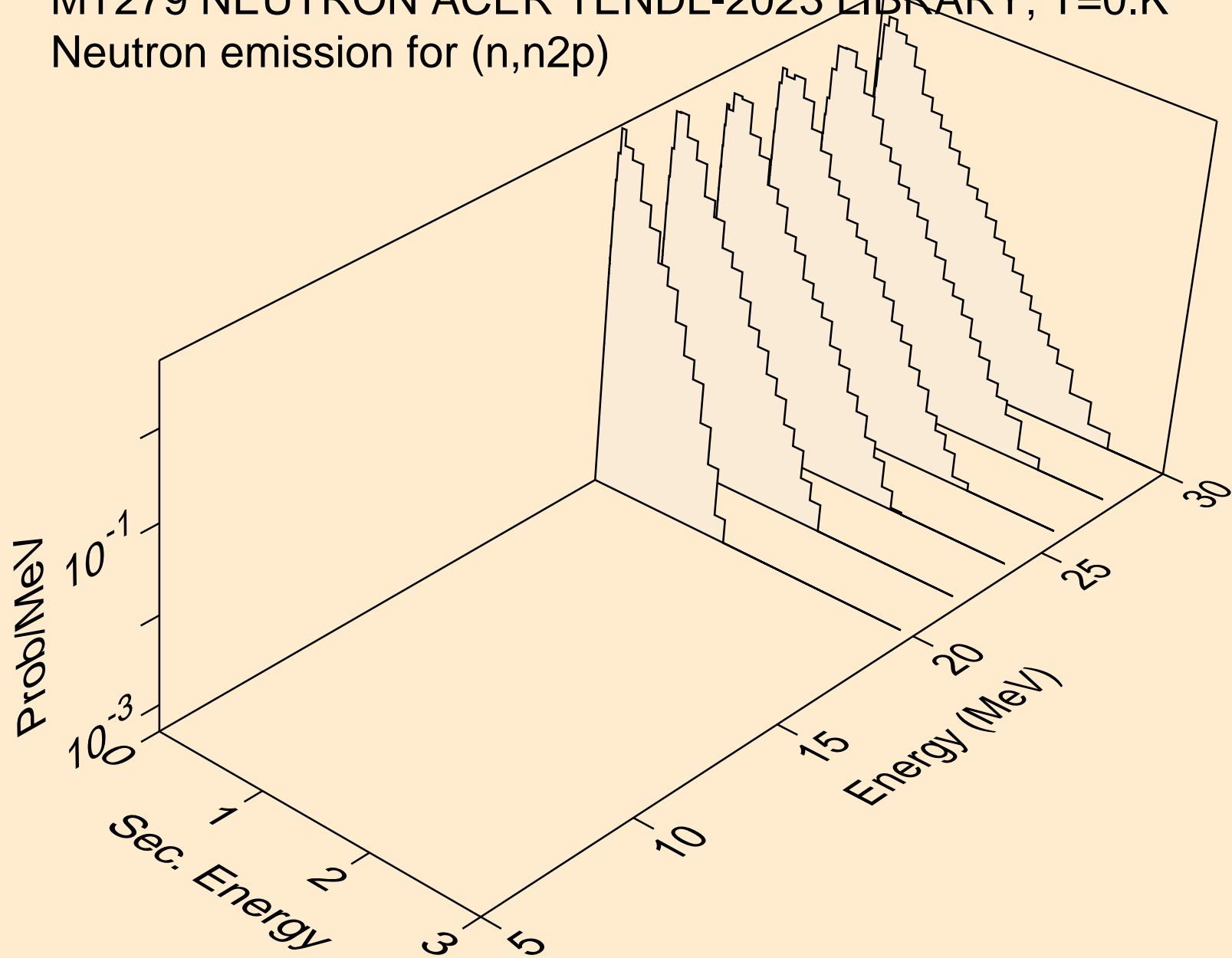

MT279 NEUTRON ACER TENDL-2023 LIBRARY; T=0.K  
Neutron emission for (n,n\*c)

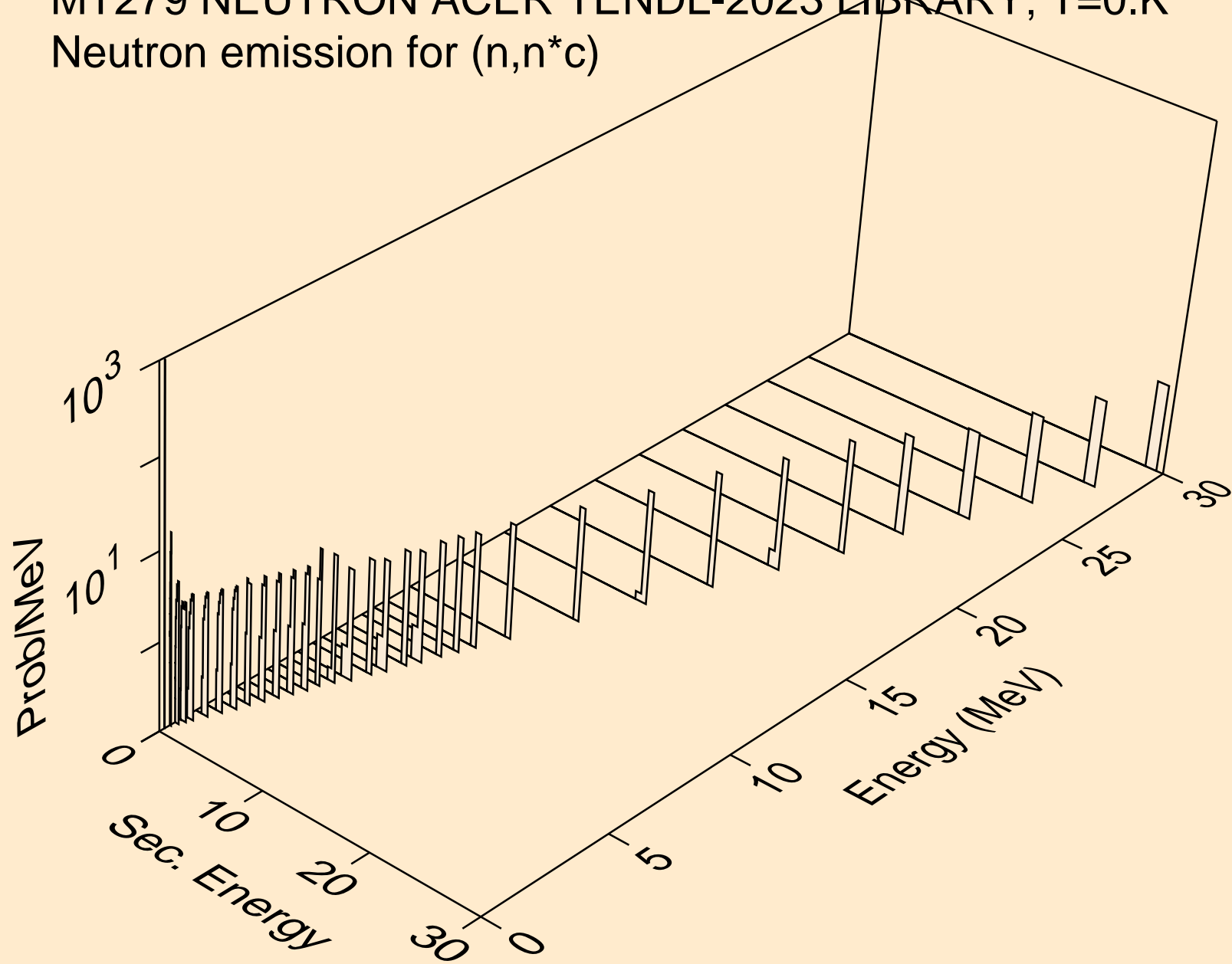

# MT279 NEUTRON ACER TENDL-2023 LIBRARY; T=0.K

## Delayed nubar

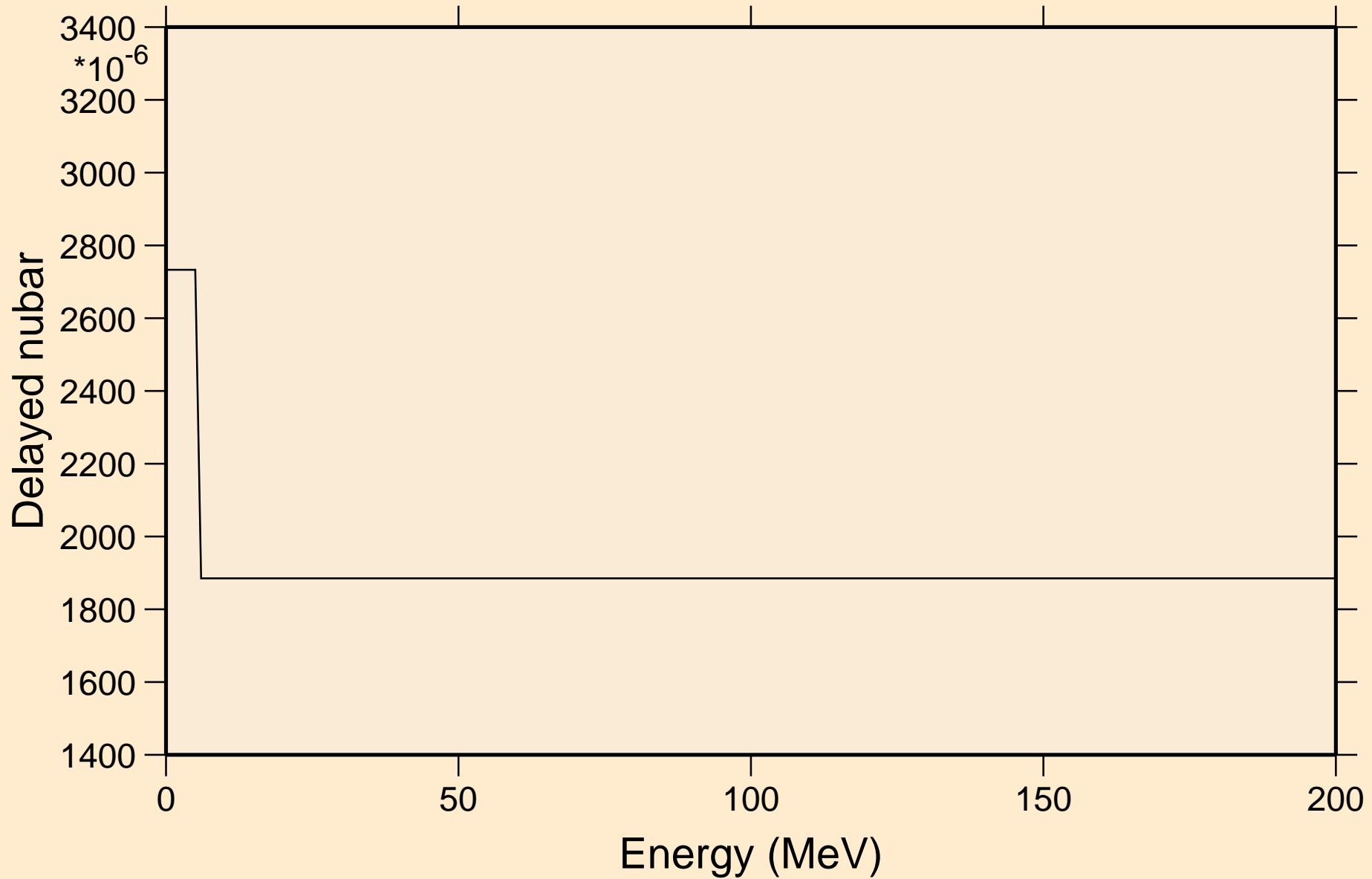

# MT279 NEUTRON ACER TENDL-2023 LIBRARY; T=0.K

## Delayed neutron spectra

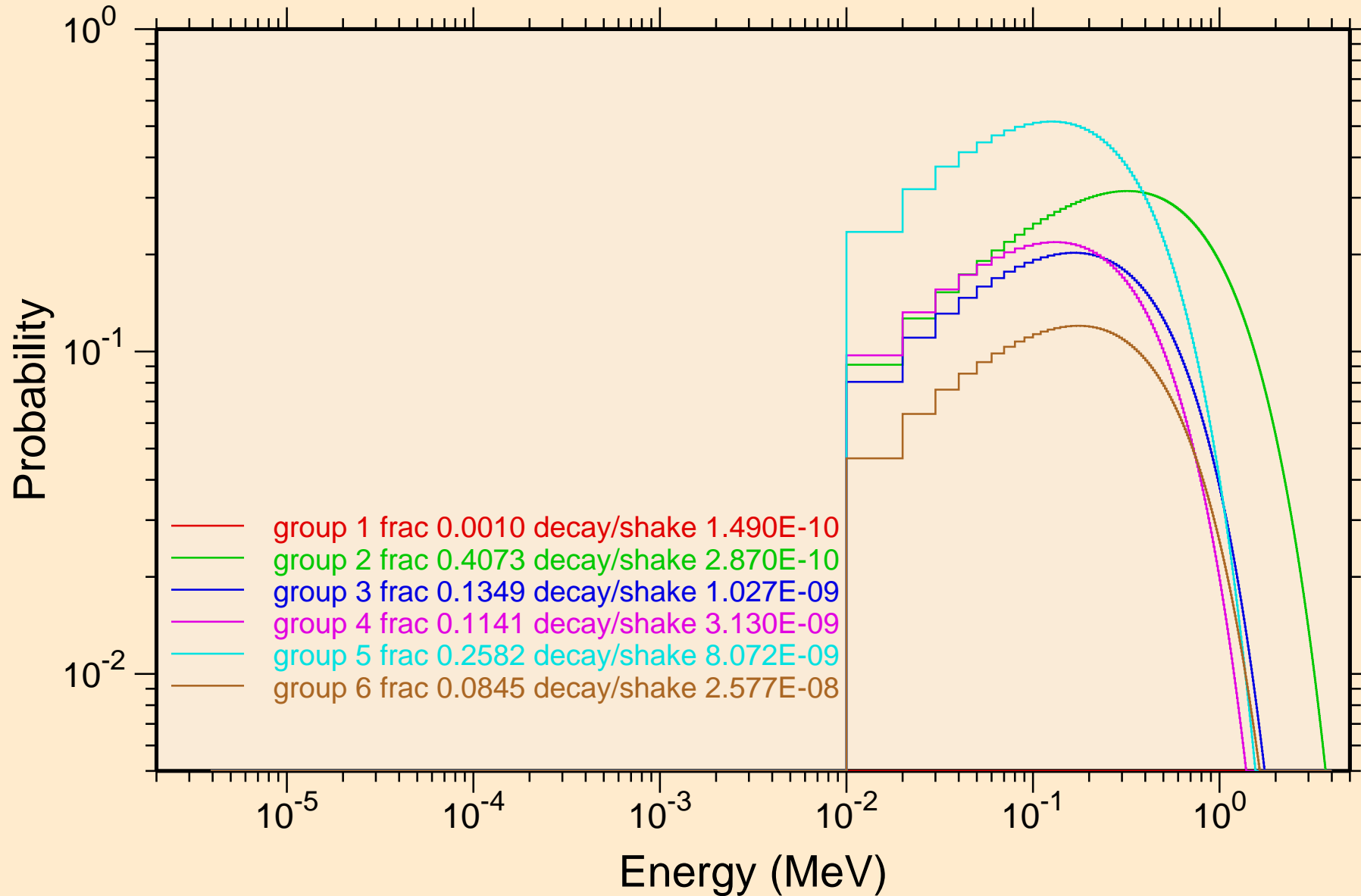



MT279 NEUTRON ACER TENDL-2023 LIBRARY; T=0.K  
Photon emission for (n,x)

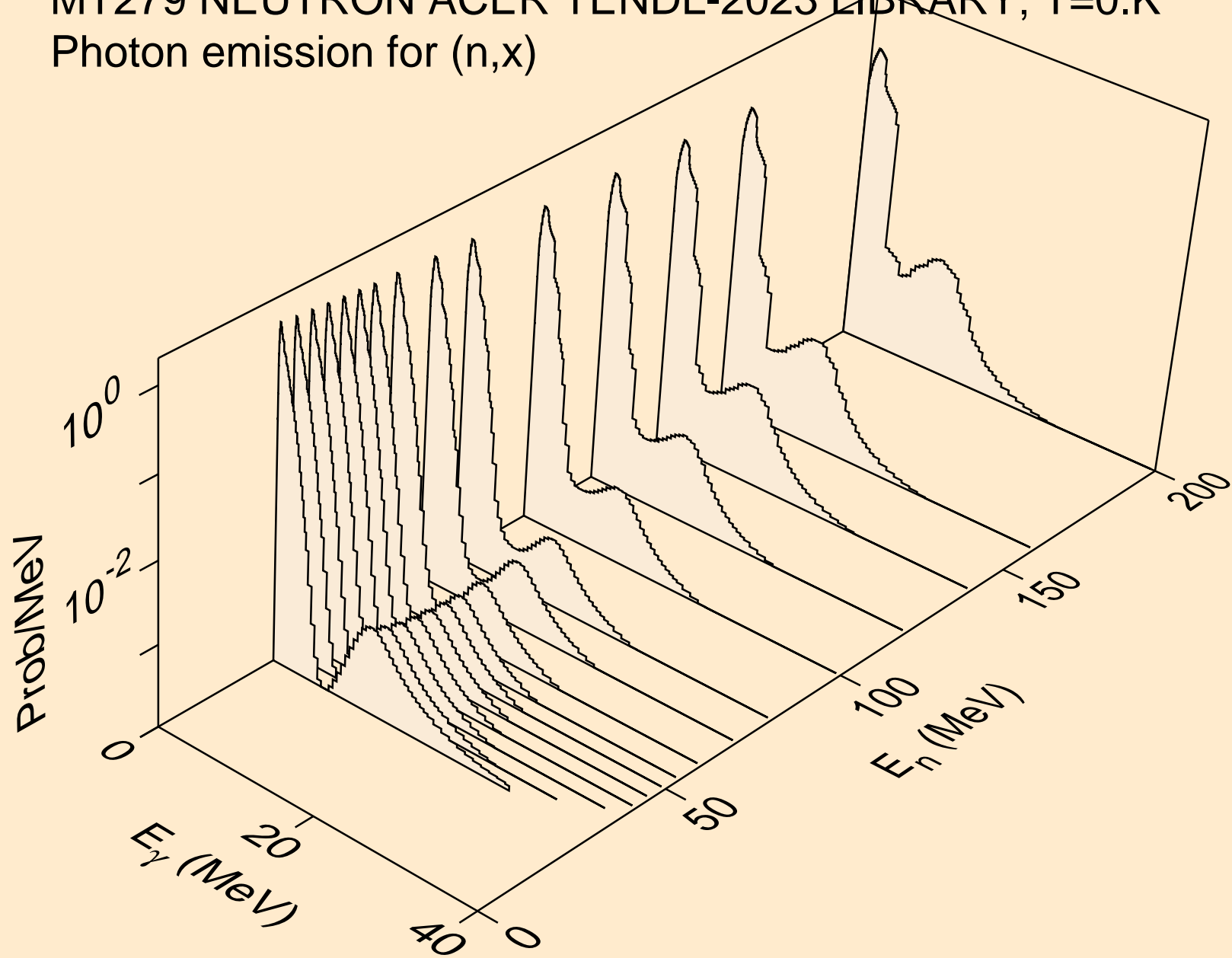

MT279 NEUTRON ACER TENDL-2023 LIBRARY; T=0.K  
Photon emission for (n,2nd)

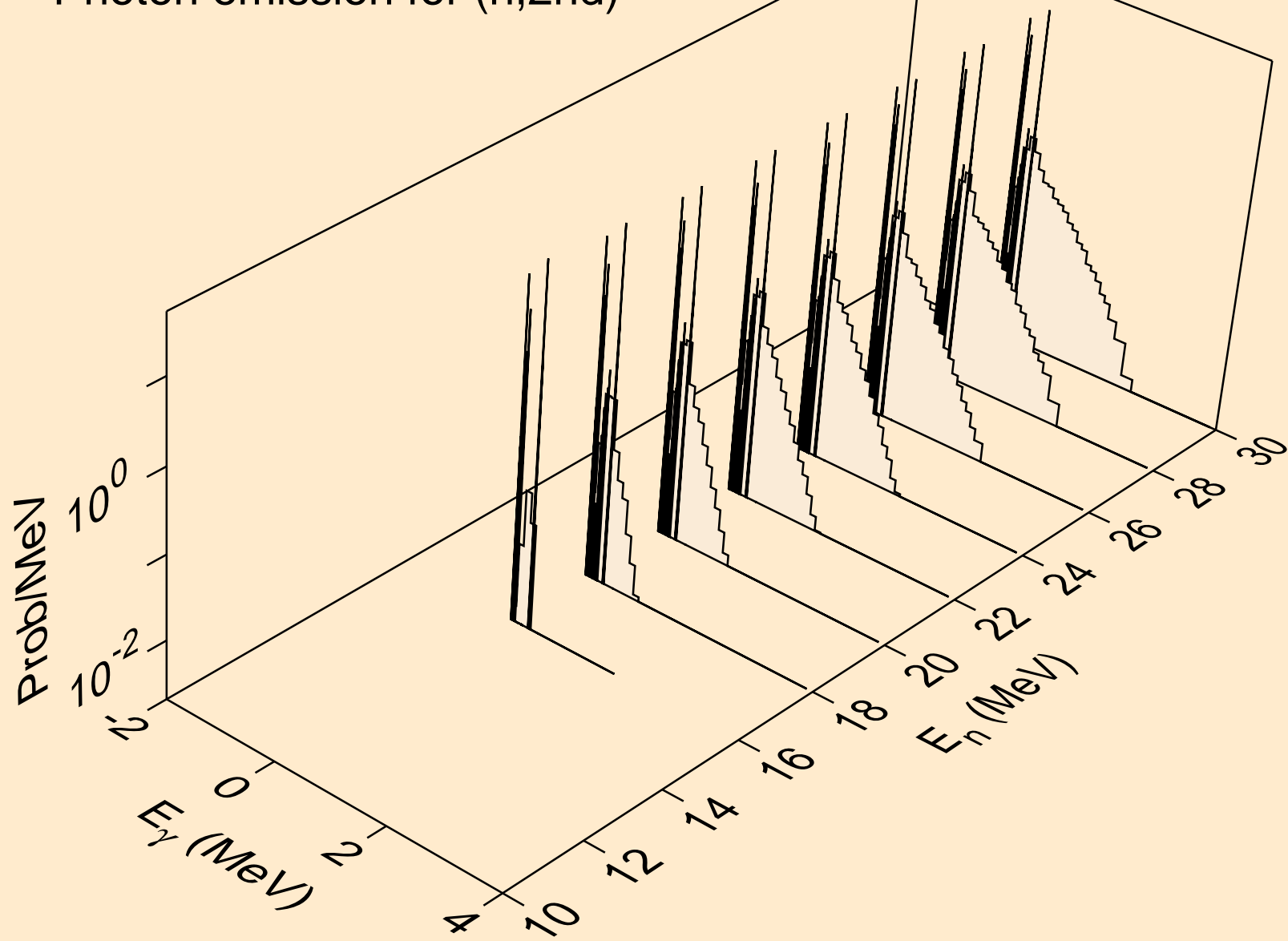

MT279 NEUTRON ACER TENDL-2023 LIBRARY; T=0.K  
Photon emission for (n,2n)

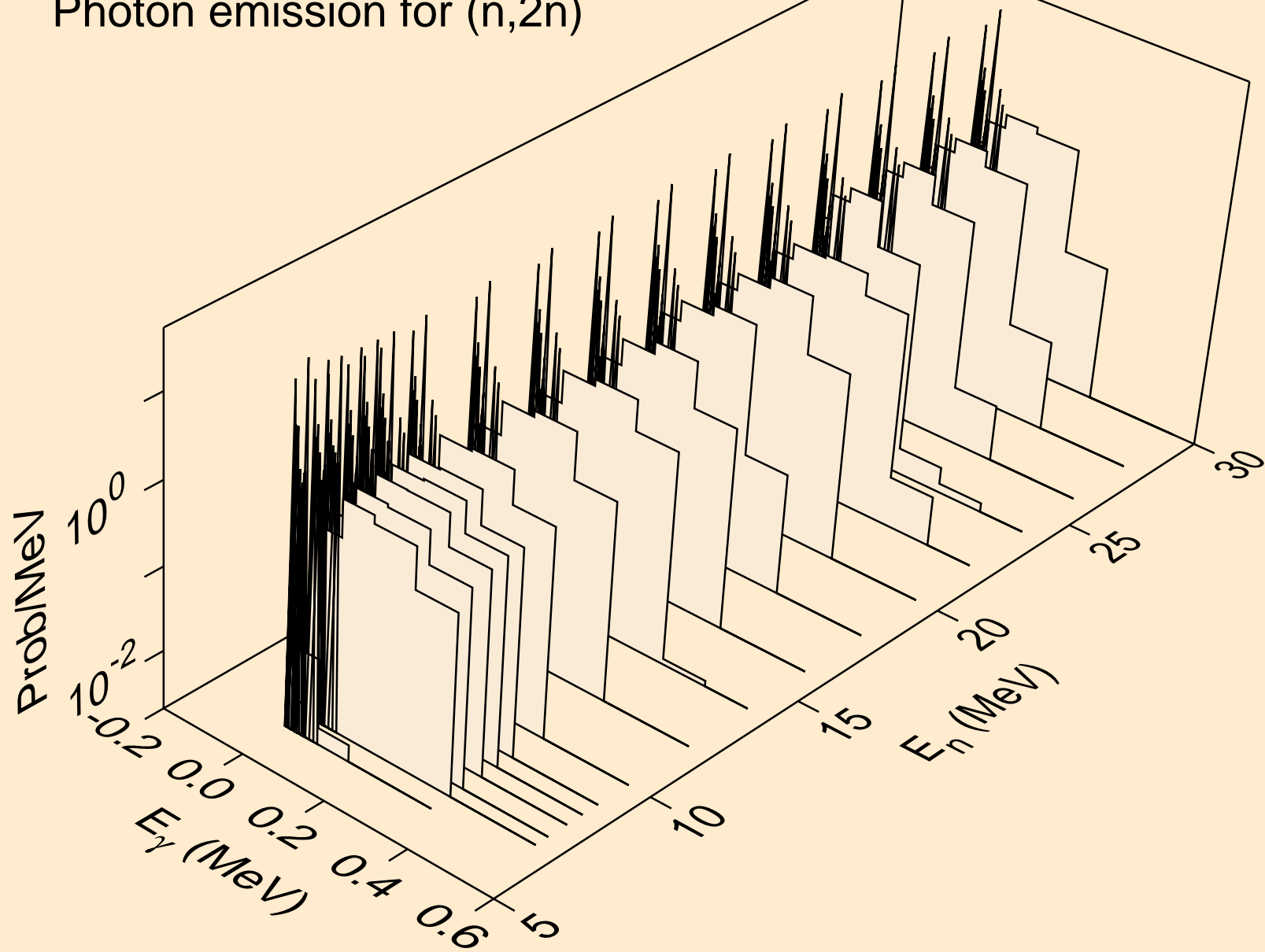

MT279 NEUTRON ACER TENDL-2023 LIBRARY; T=0.K  
Photon emission for (n,3n)

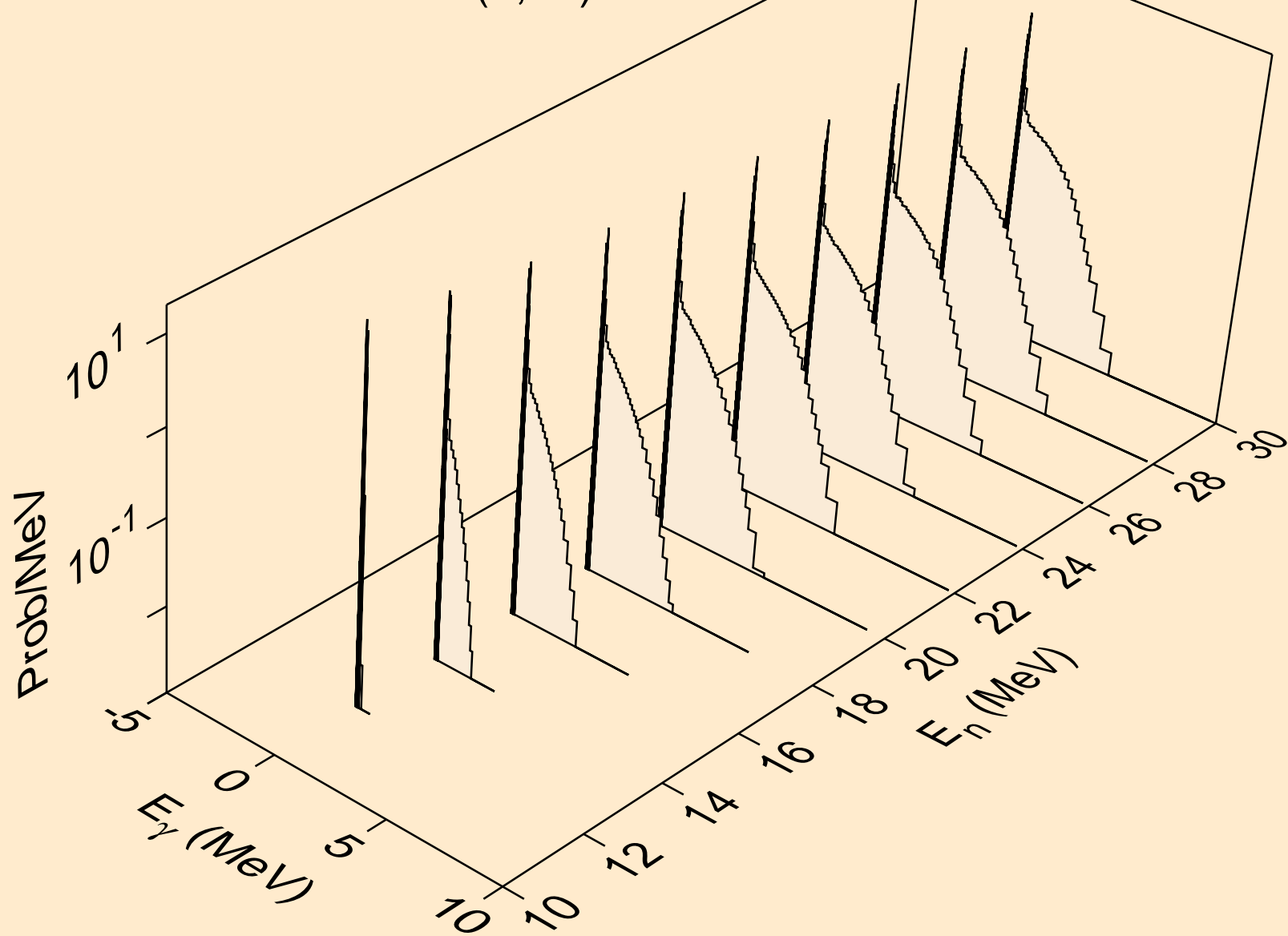

MT279 NEUTRON ACER TENDL-2023 LIBRARY; T=0.K  
Photon emission for (n,n\*)a

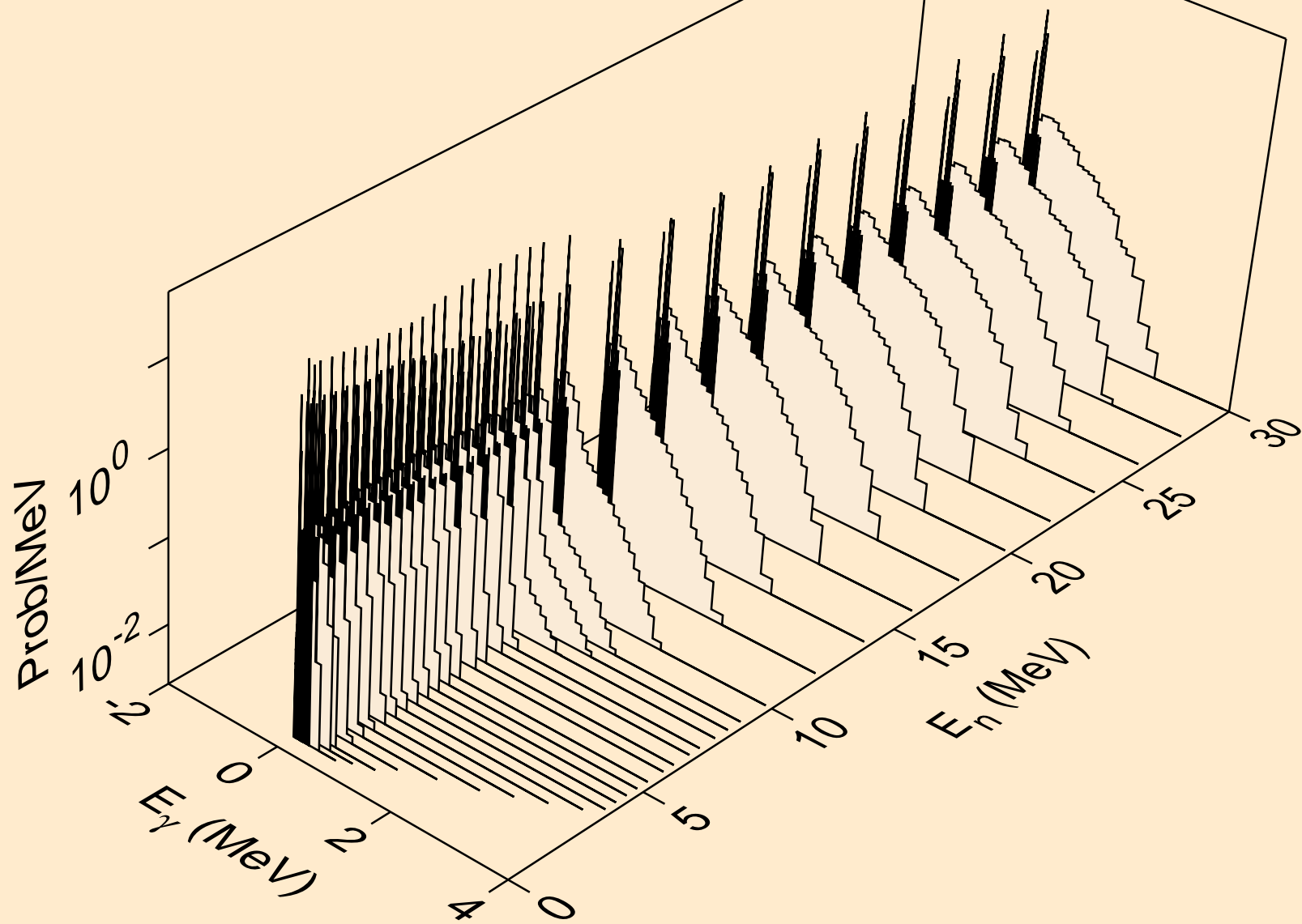

MT279 NEUTRON ACER TENDL-2023 LIBRARY; T=0.K  
Photon emission for (n,2n)a

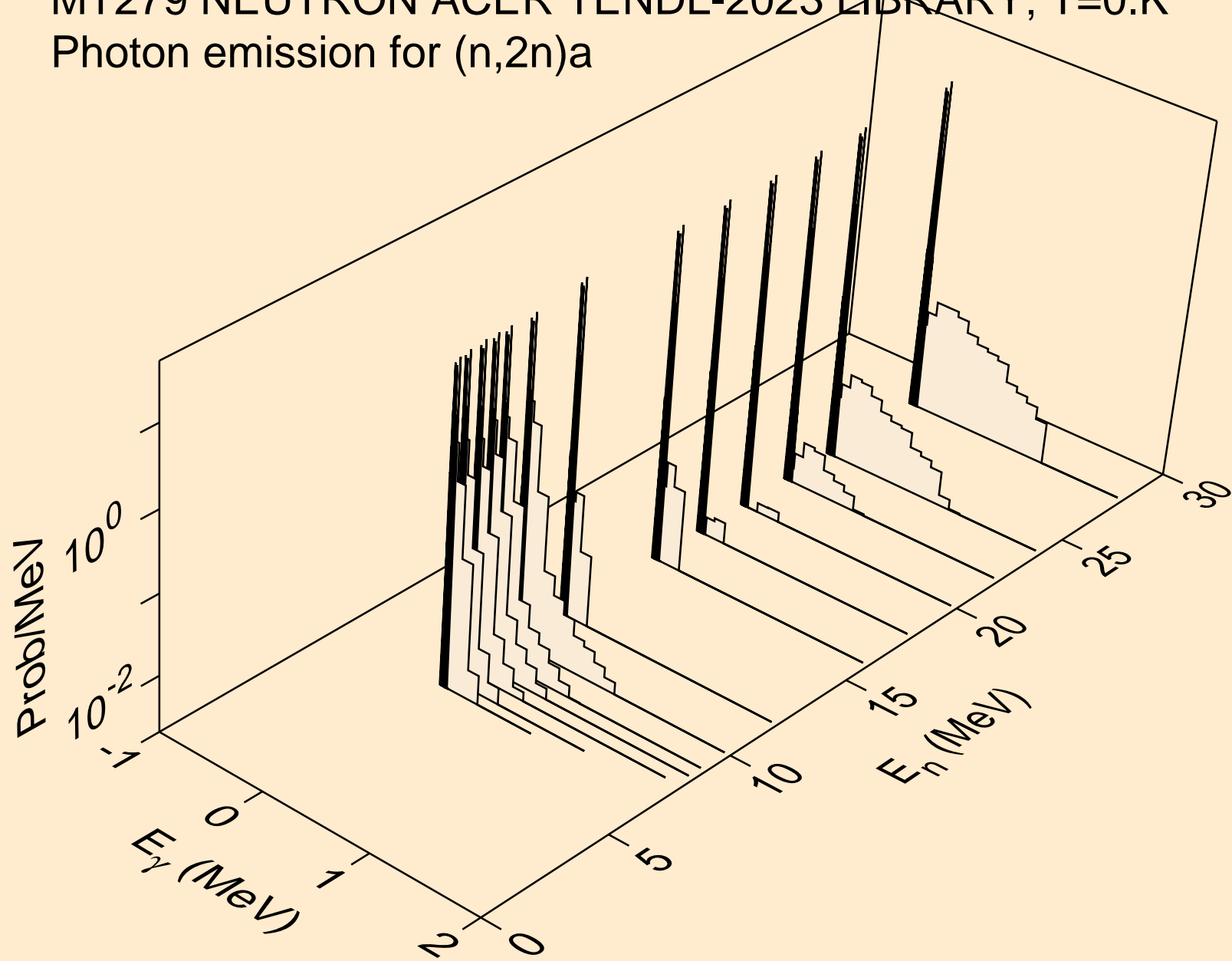

MT279 NEUTRON ACER TENDL-2023 LIBRARY; T=0.K  
Photon emission for (n,3n)a

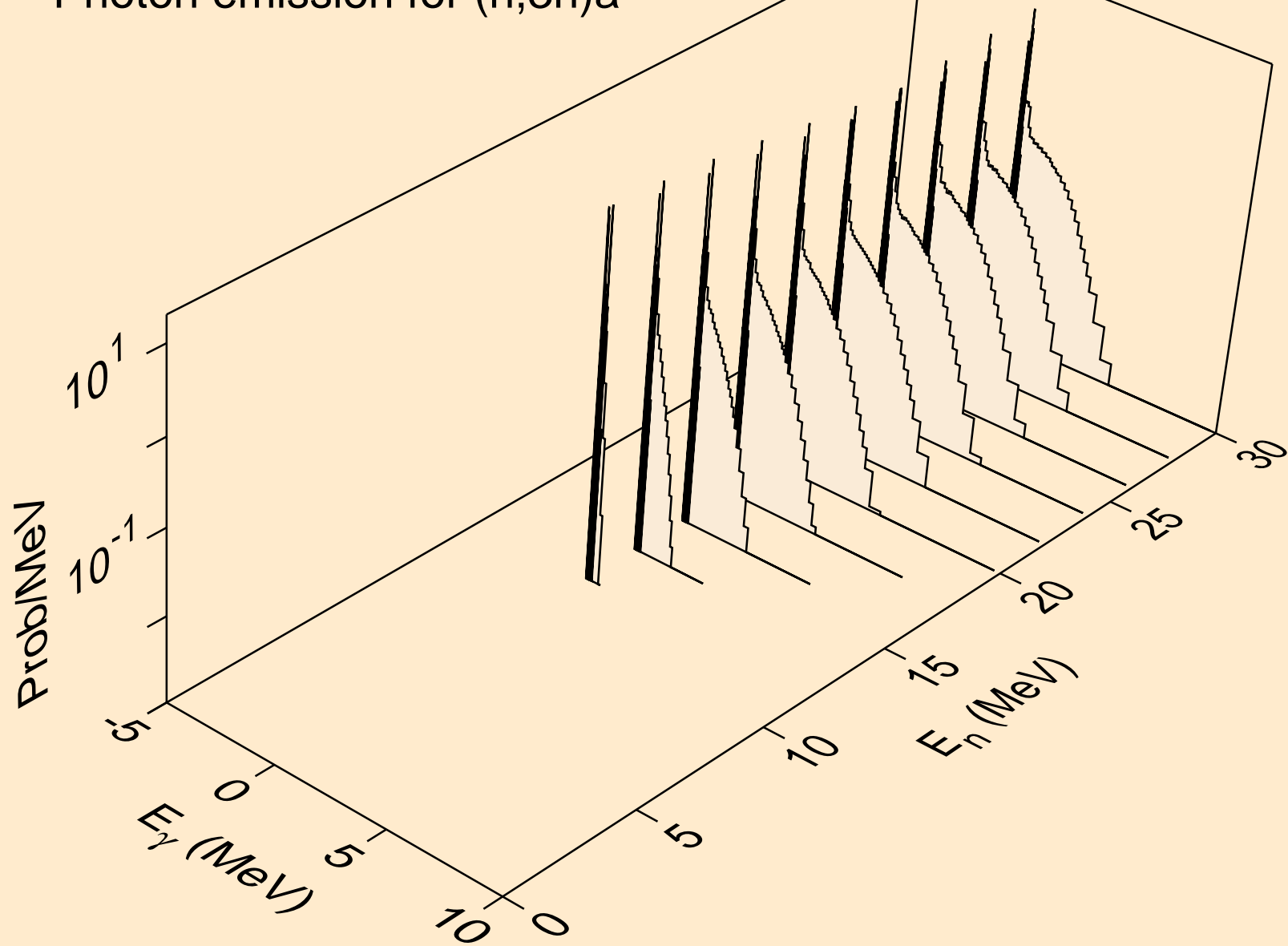

MT279 NEUTRON ACER TENDL-2023 LIBRARY; T=0.K  
Photon emission for (n,n\*)p

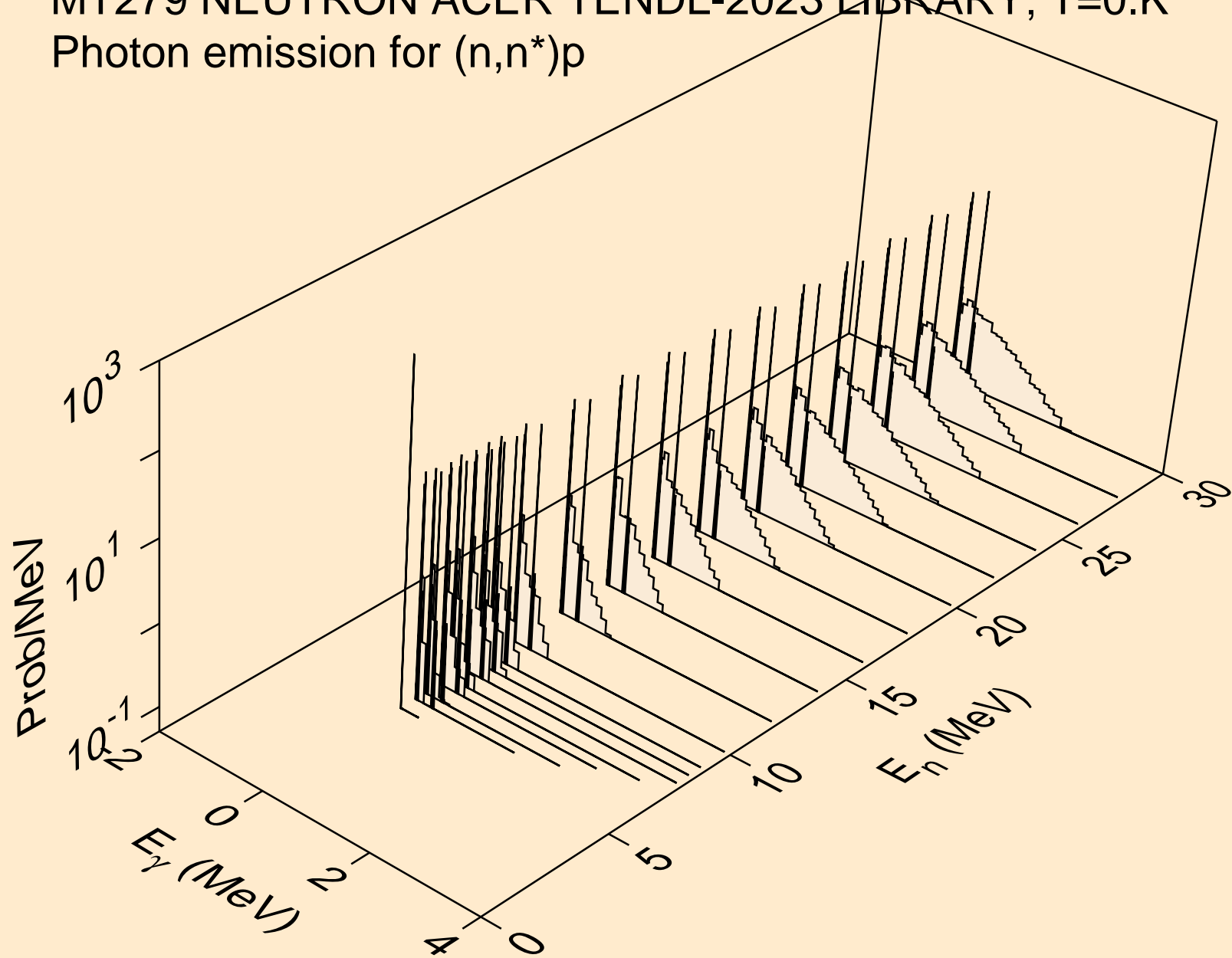



MT279 NEUTRON ACER TENDL-2023 LIBRARY; T=0.K  
Photon emission for (n,n\*)d

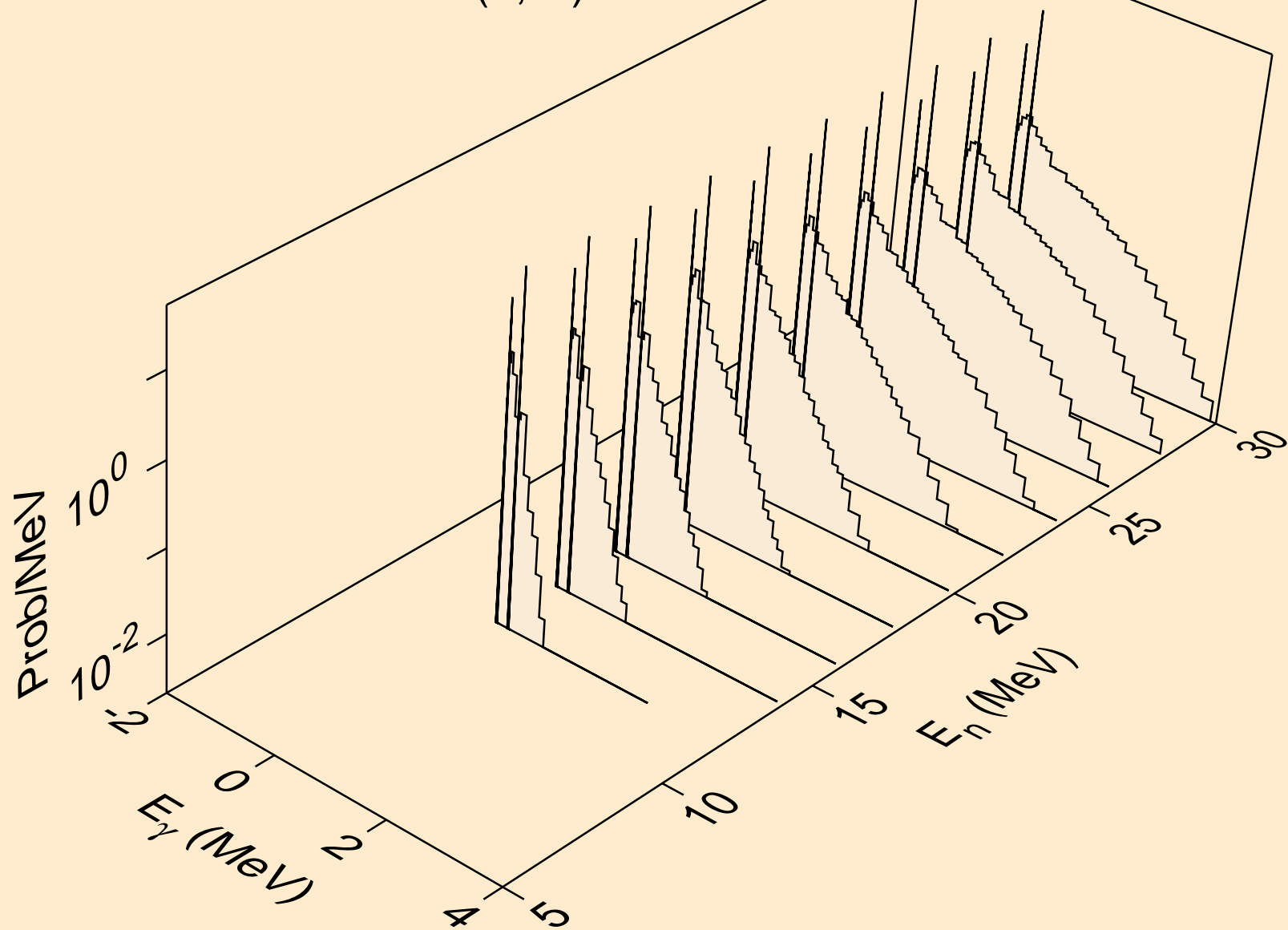

MT279 NEUTRON ACER TENDL-2023 LIBRARY; T=0.K  
Photon emission for (n,n\*)t

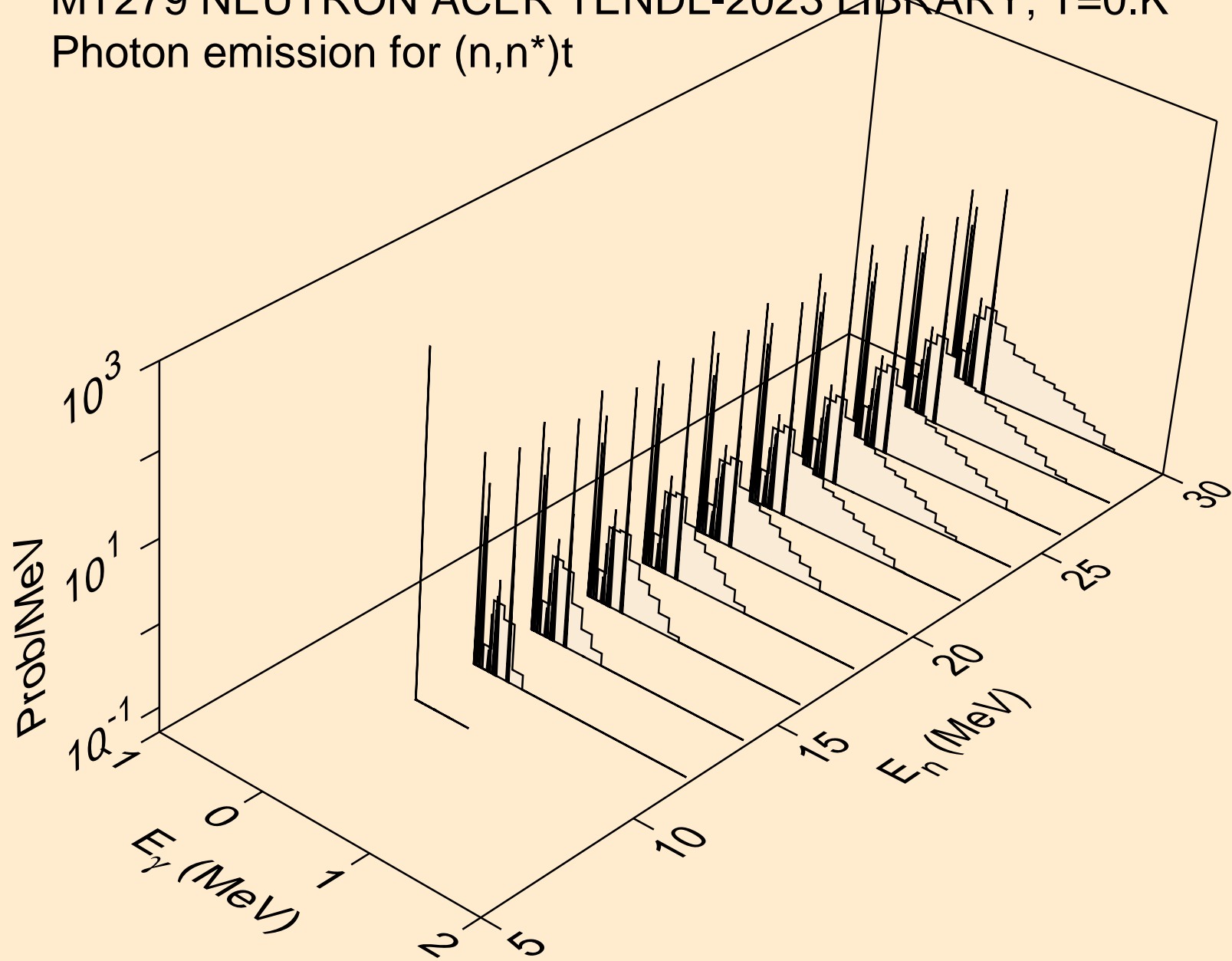

MT279 NEUTRON ACER TENDL-2023 LIBRARY; T=0.K  
Photon emission for (n,n\*)he3

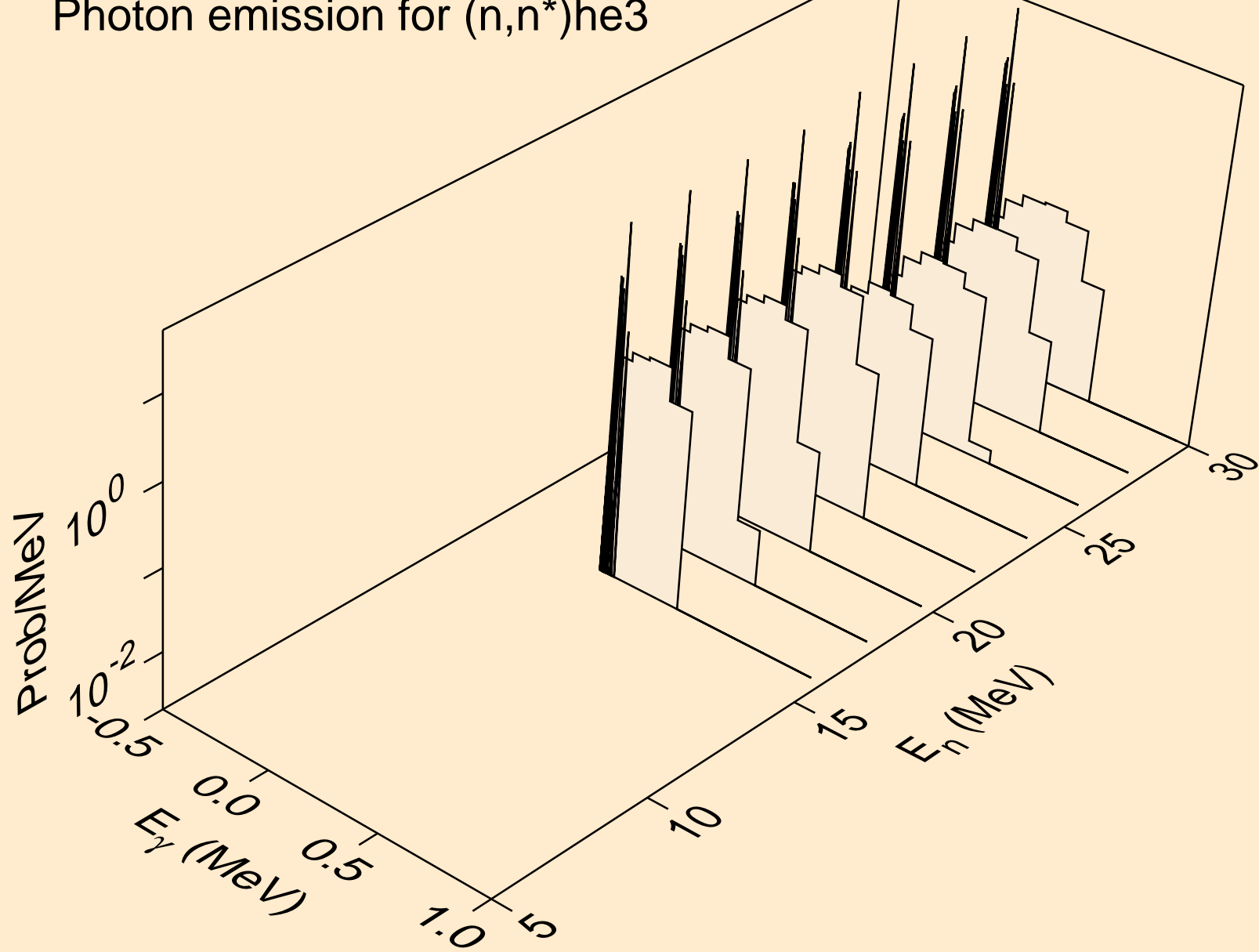

MT279 NEUTRON ACER TENDL-2023 LIBRARY; T=0.K  
Photon emission for (n,4n)

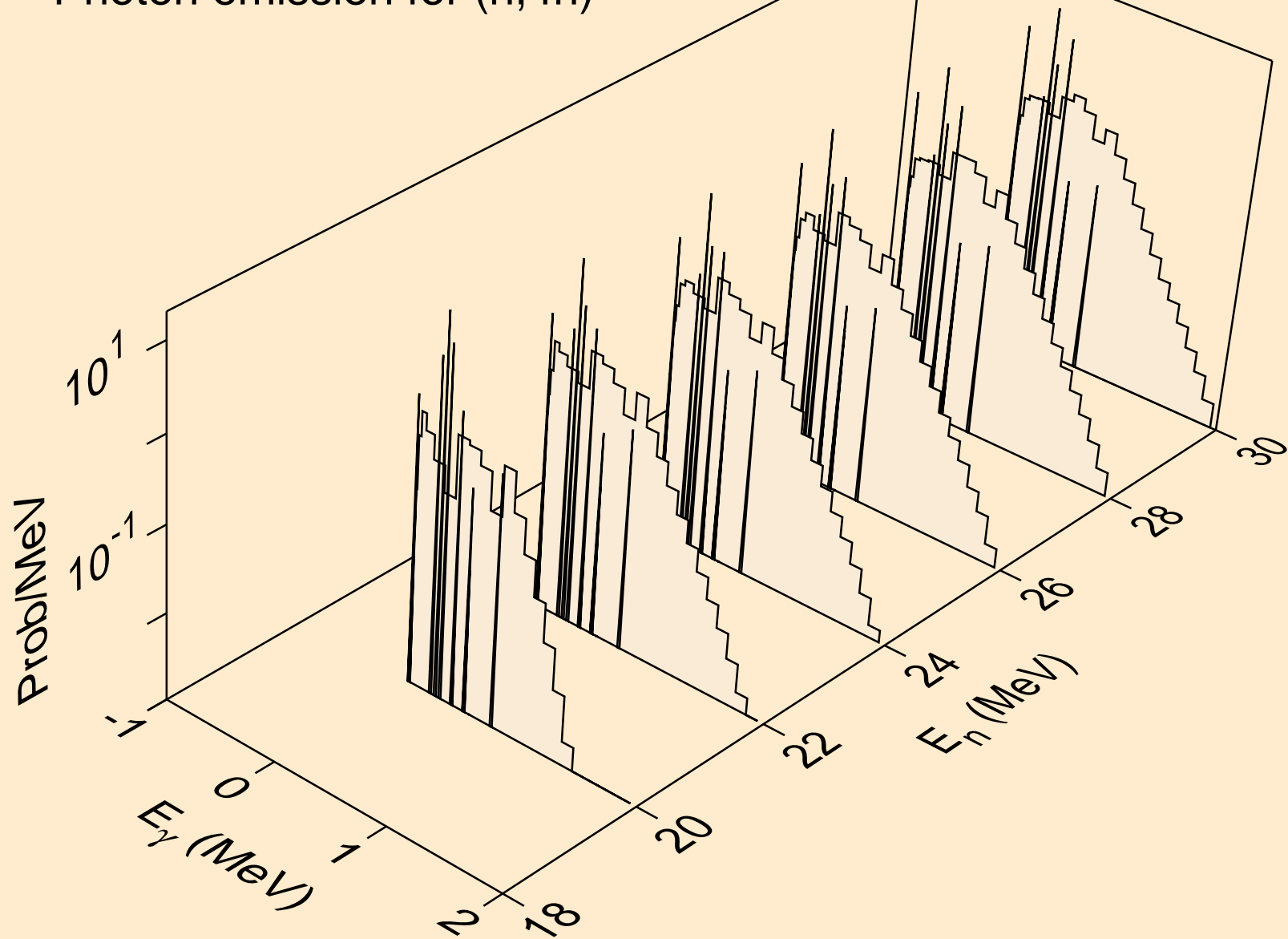

MT279 NEUTRON ACER TENDL-2023 LIBRARY; T=0.K  
Photon emission for (n,2np)

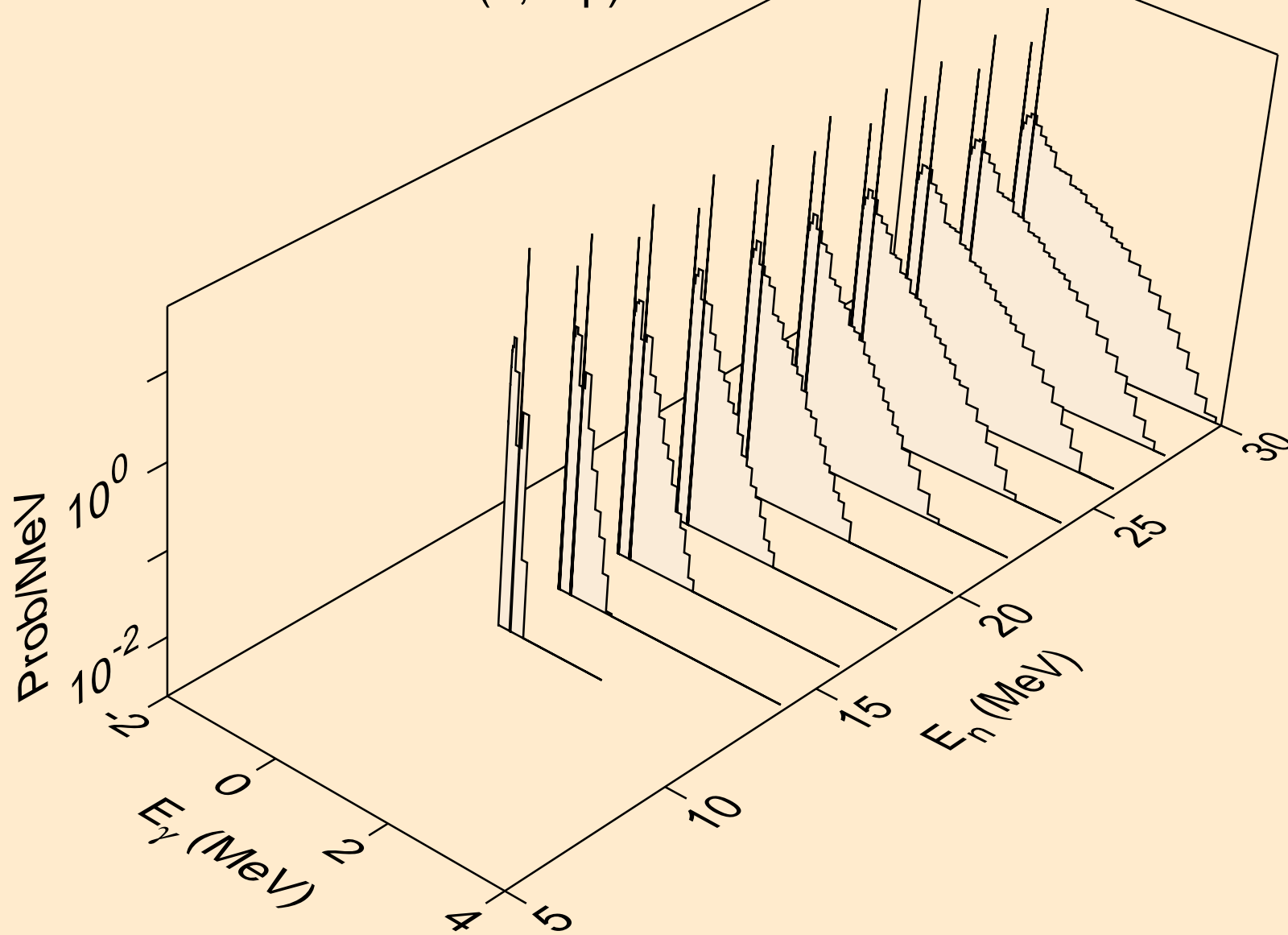

MT279 NEUTRON ACER TENDL-2023 LIBRARY; T=0.K  
Photon emission for (n,3np)

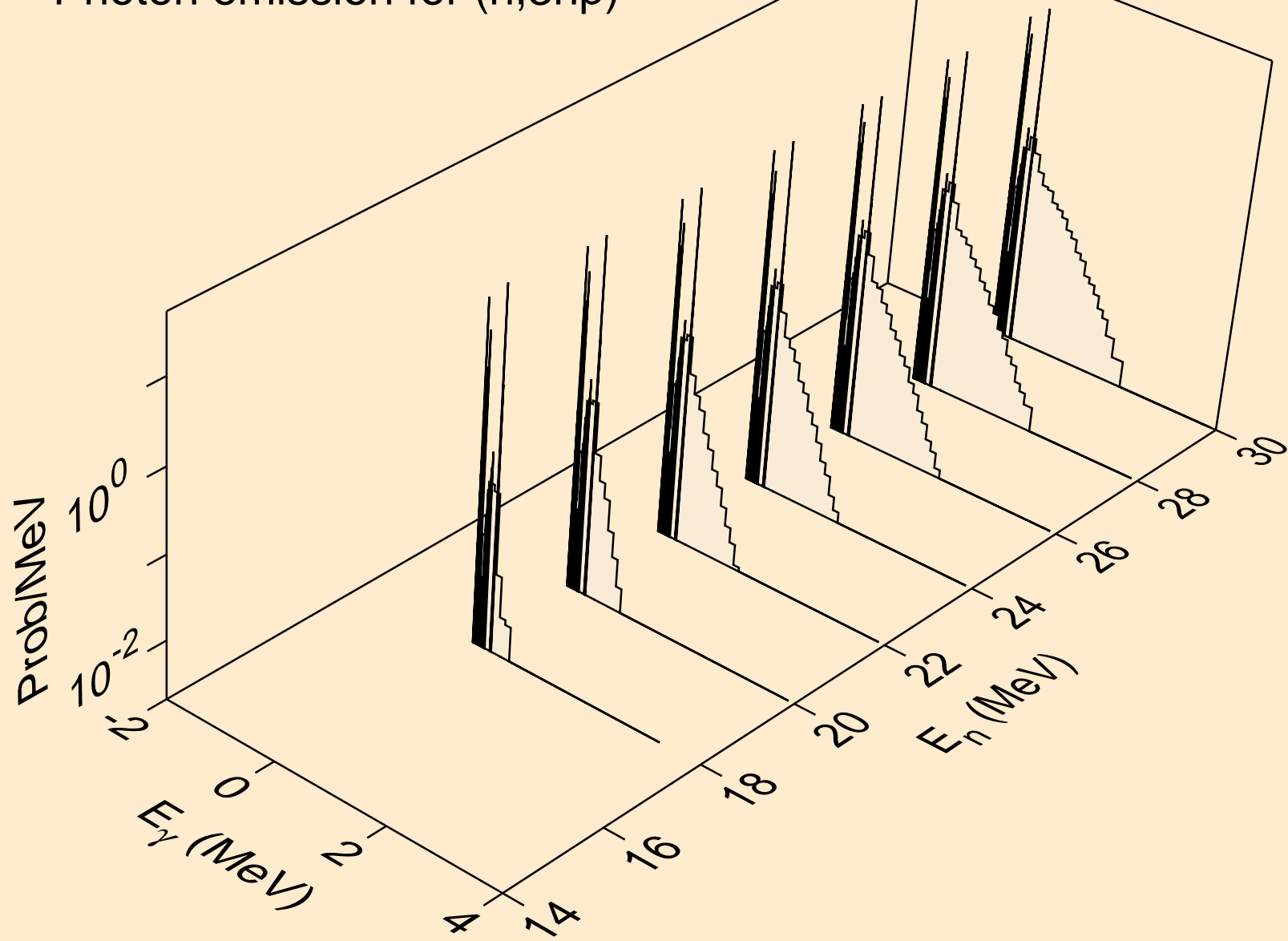

MT279 NEUTRON ACER TENDL-2023 LIBRARY; T=0.K  
Photon emission for (n,n2p)

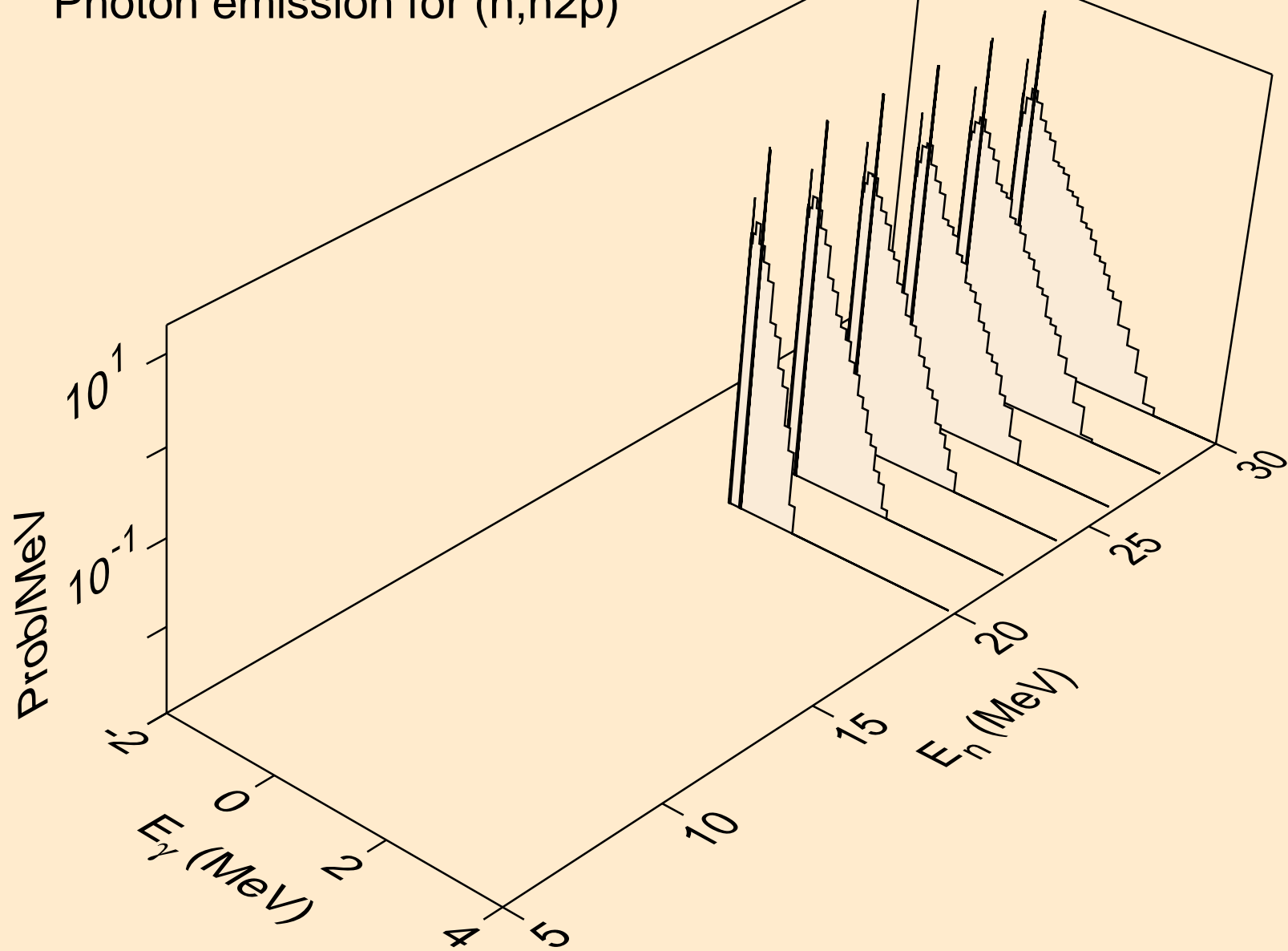

MT279 NEUTRON ACER TENDL-2023 LIBRARY; T=0.K  
Photon emission for (n,n\*c)

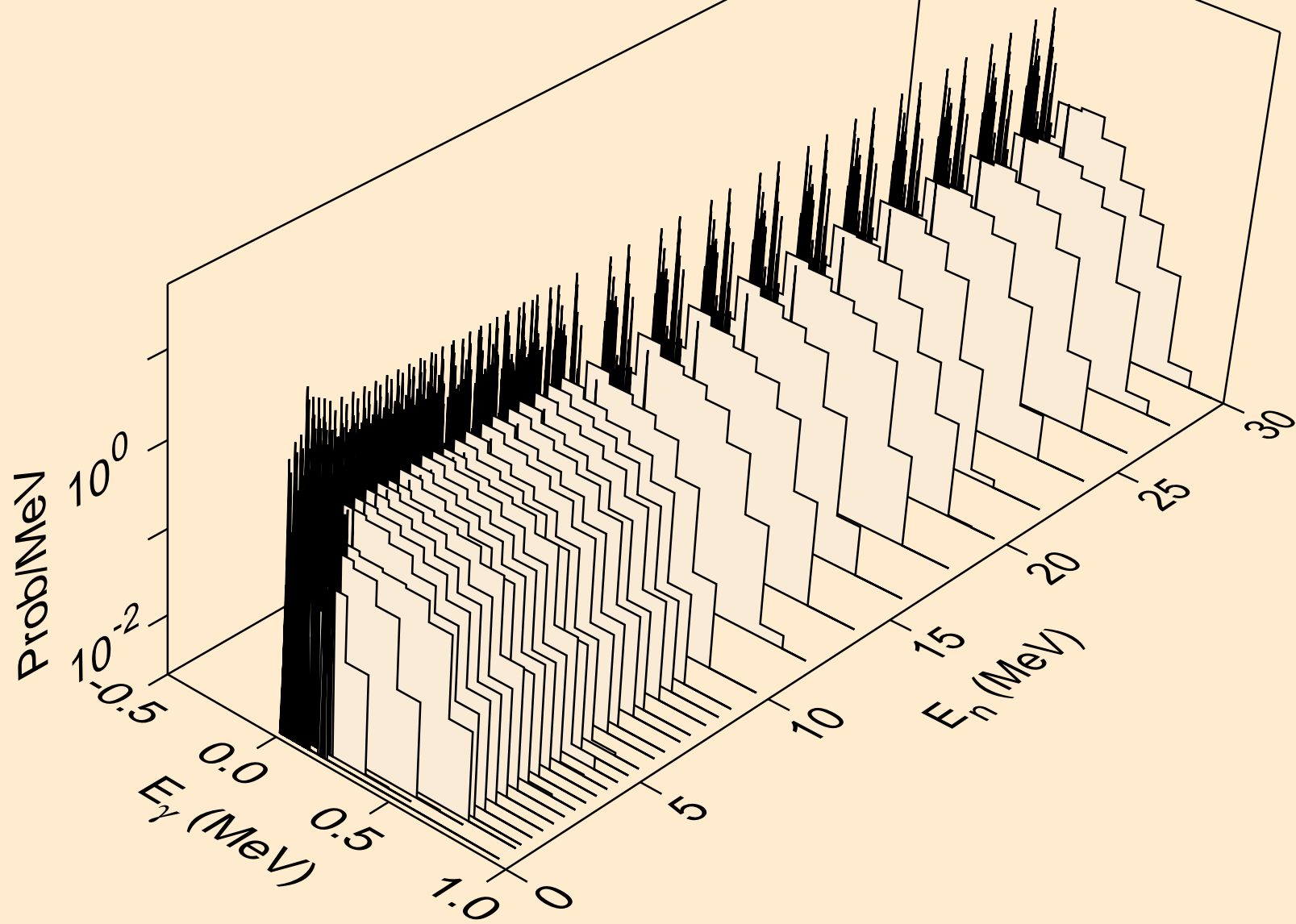



MT279 NEUTRON ACER TENDL-2023 LIBRARY; T=0.K  
Photon emission for (n,gma)

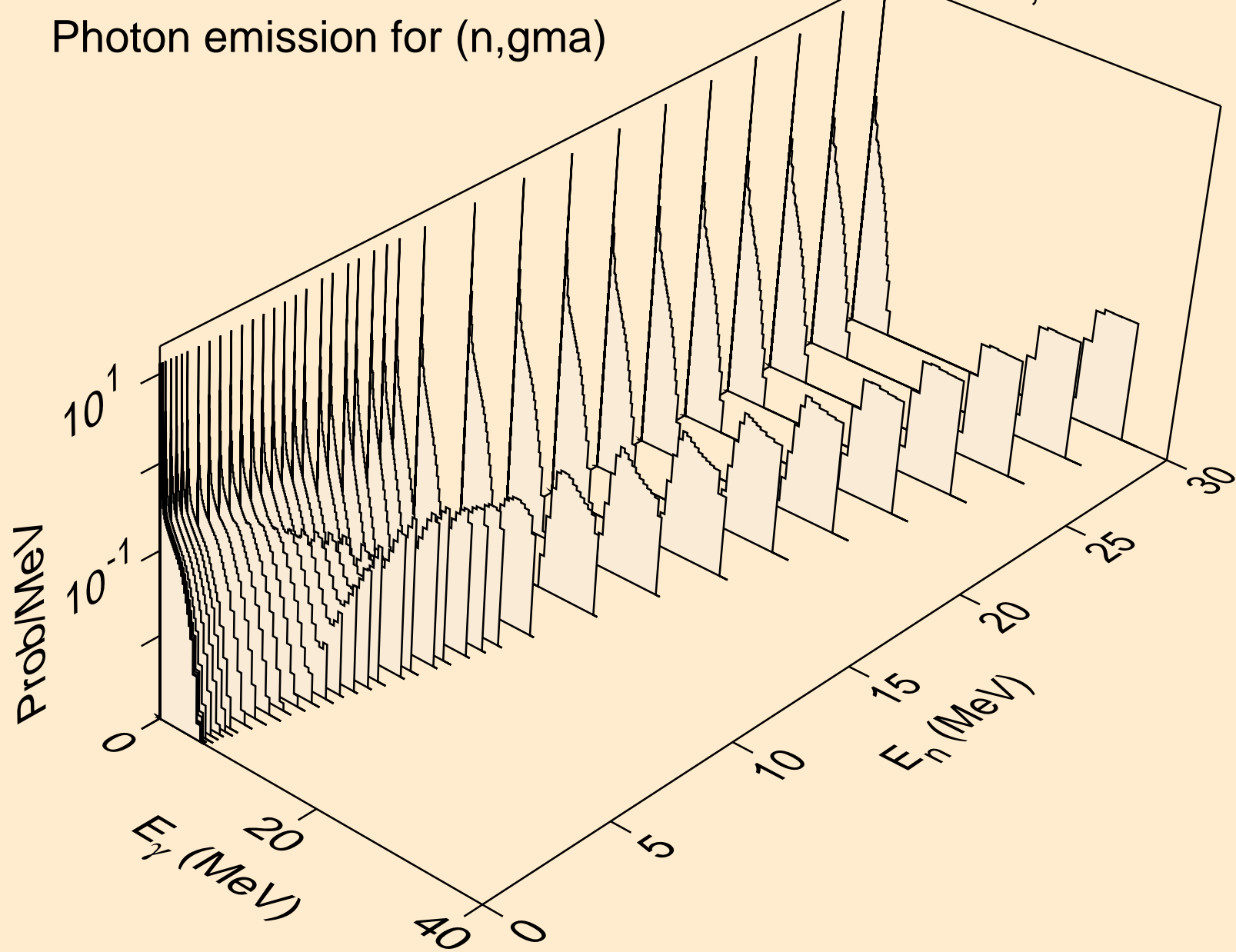

MT279 NEUTRON ACER TENDL-2023 LIBRARY; T=0.K  
Photon emission for (n,p)

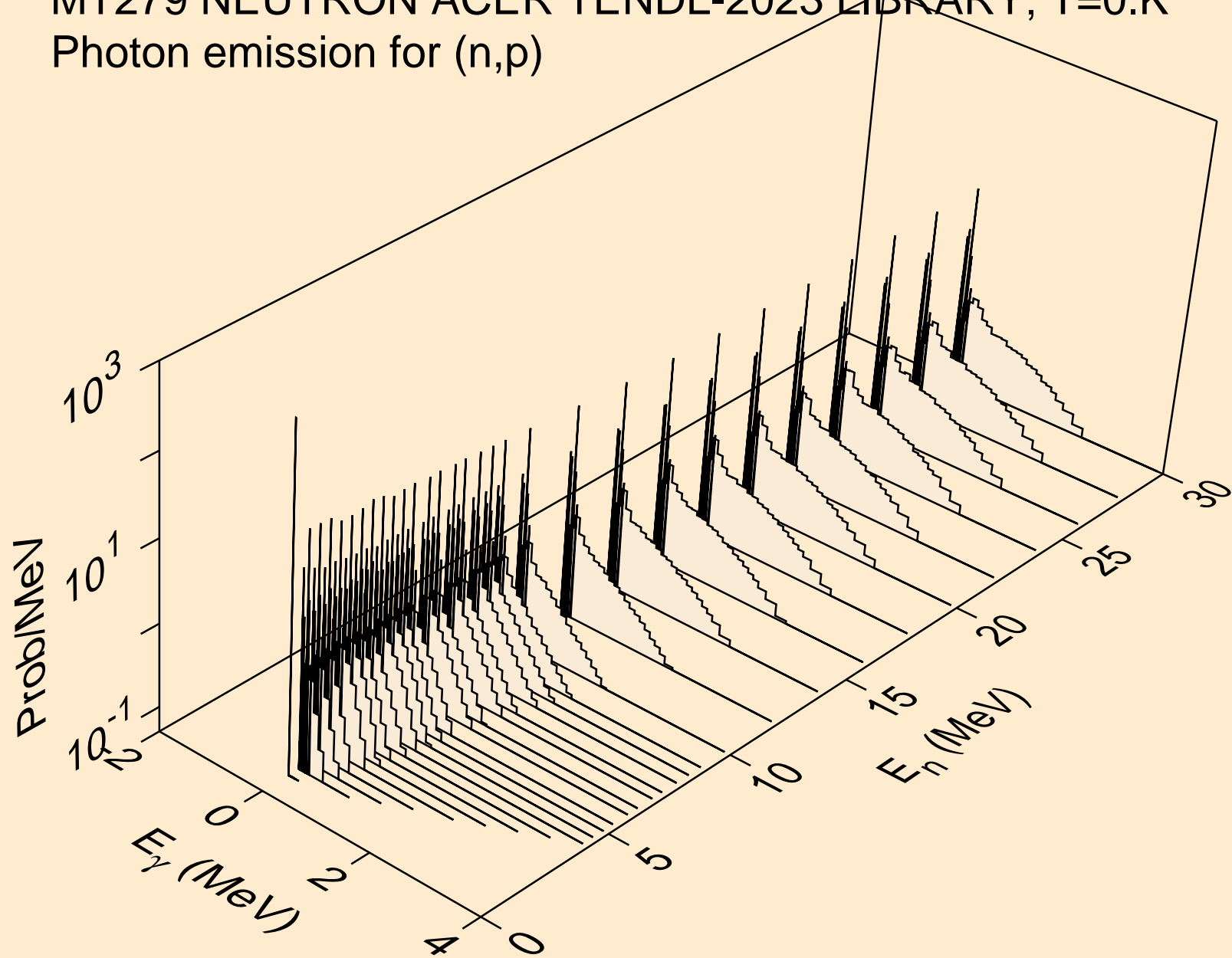

MT279 NEUTRON ACER TENDL-2023 LIBRARY; T=0.K  
Photon emission for (n,d)

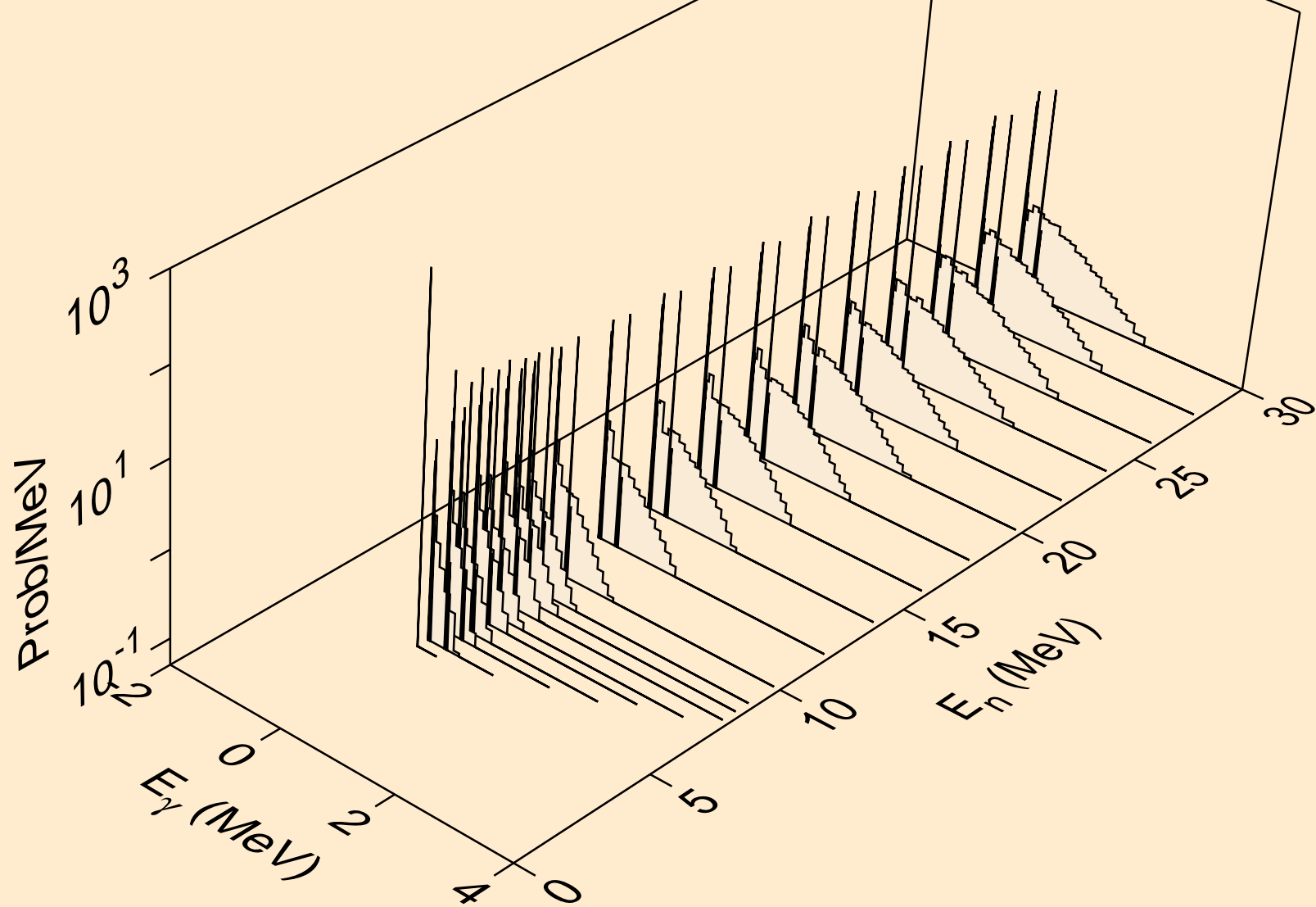

MT279 NEUTRON ACER TENDL-2023 LIBRARY; T=0.K  
Photon emission for (n,t)

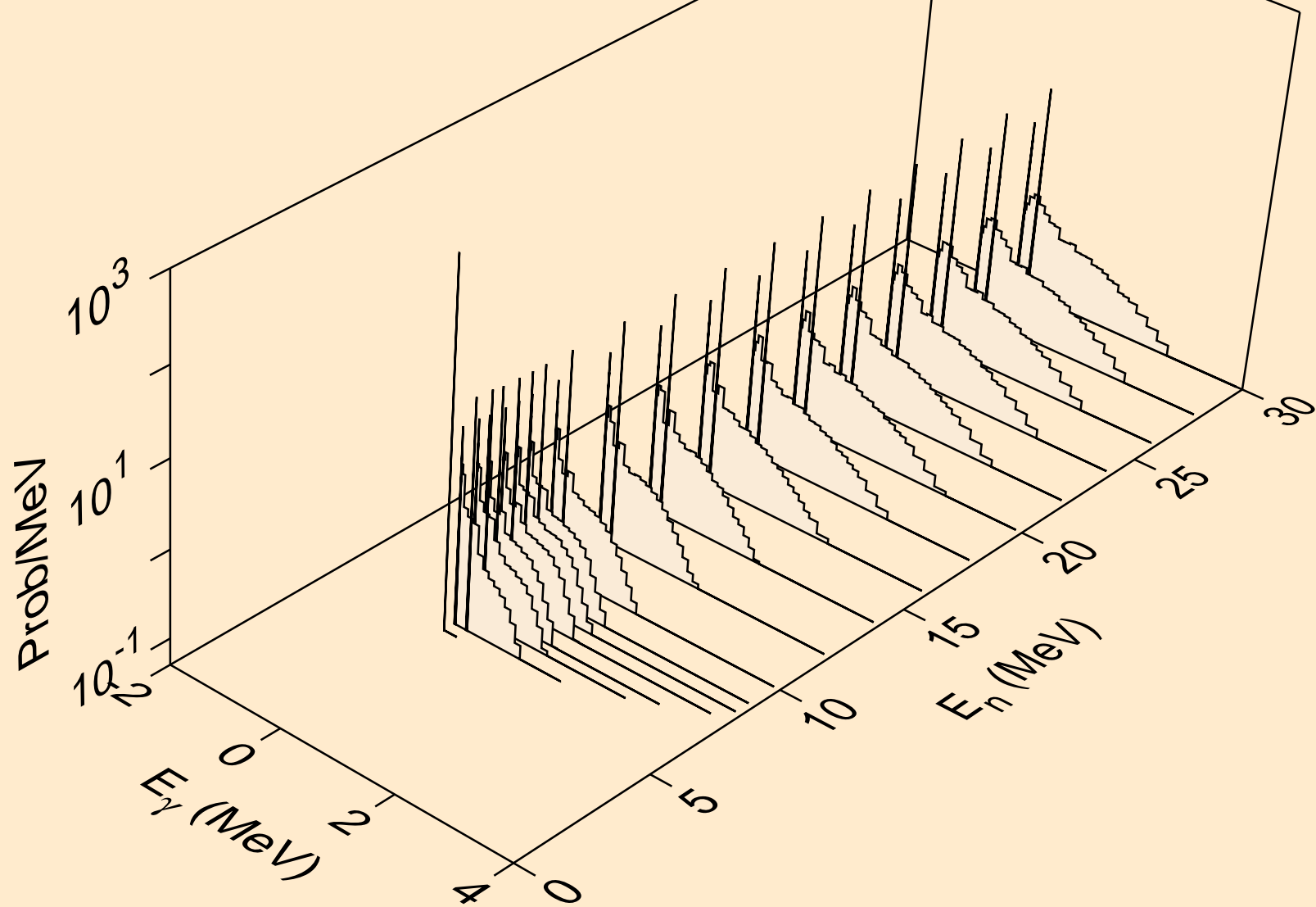

MT279 NEUTRON ACER TENDL-2023 LIBRARY; T=0.K  
Photon emission for (n,he3)

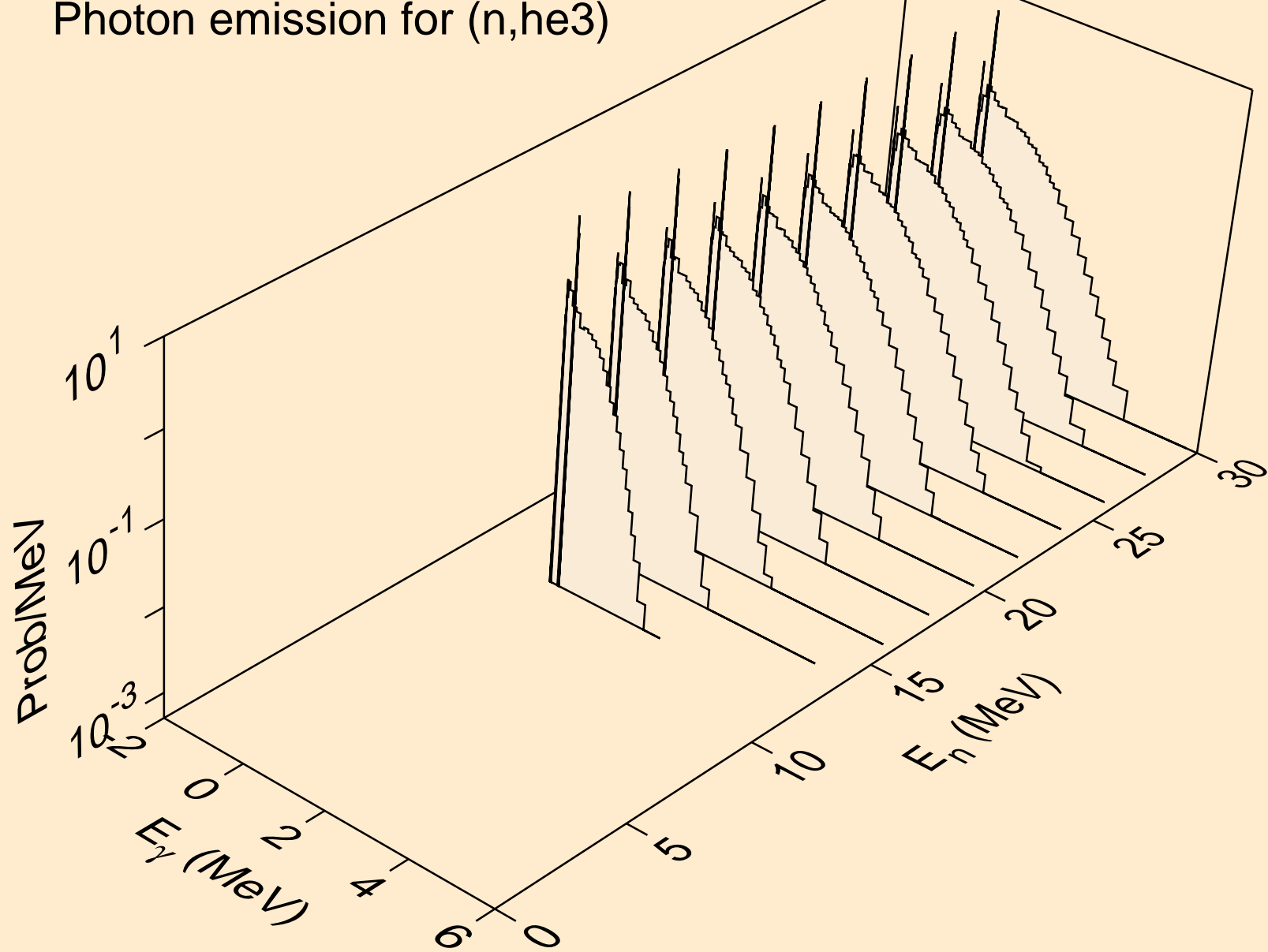

MT279 NEUTRON ACER TENDL-2023 LIBRARY; T=0.K  
Photon emission for (n,a)

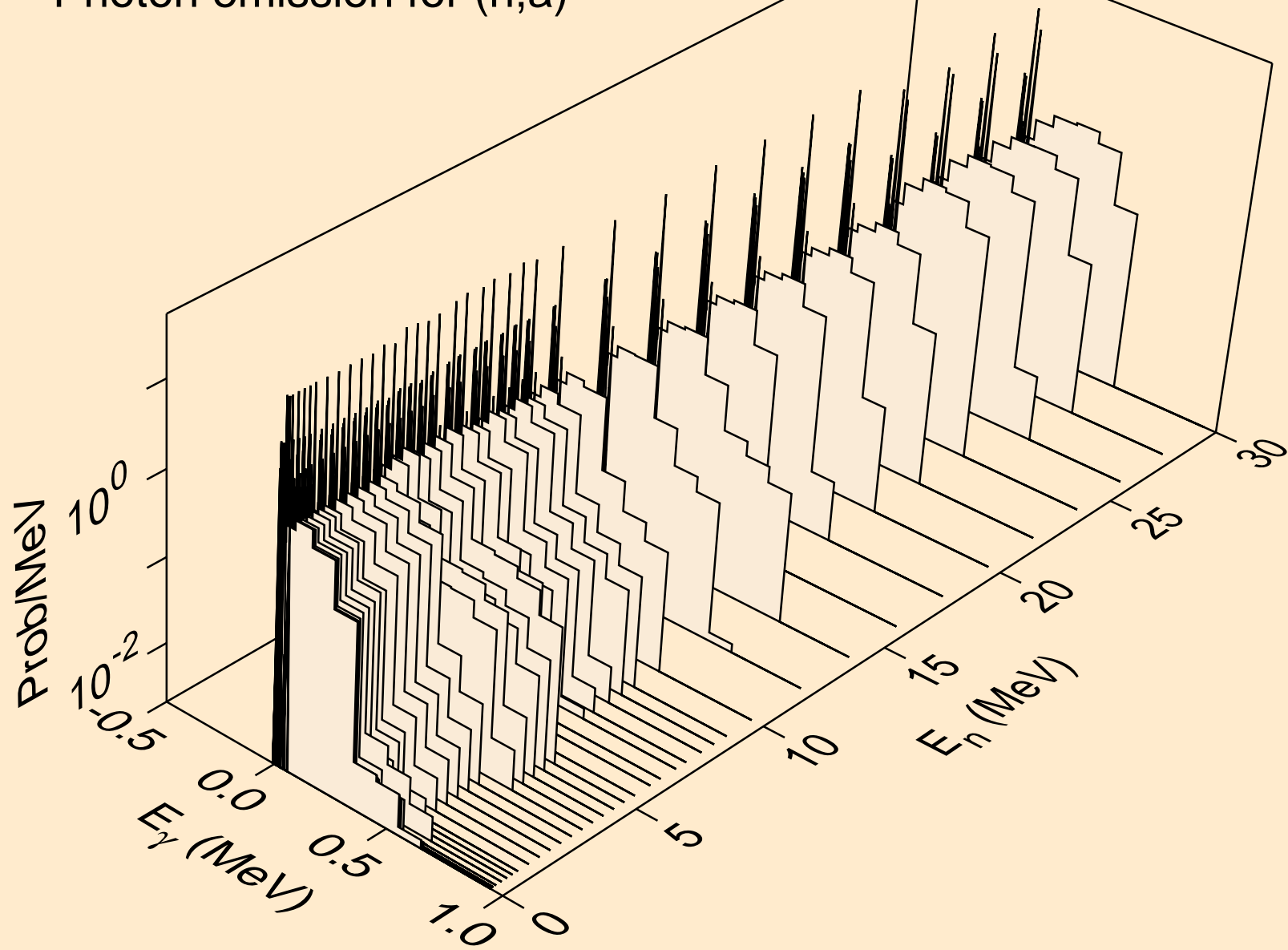

MT279 NEUTRON ACER TENDL-2023 LIBRARY; T=0.K  
Photon emission for (n,2p)

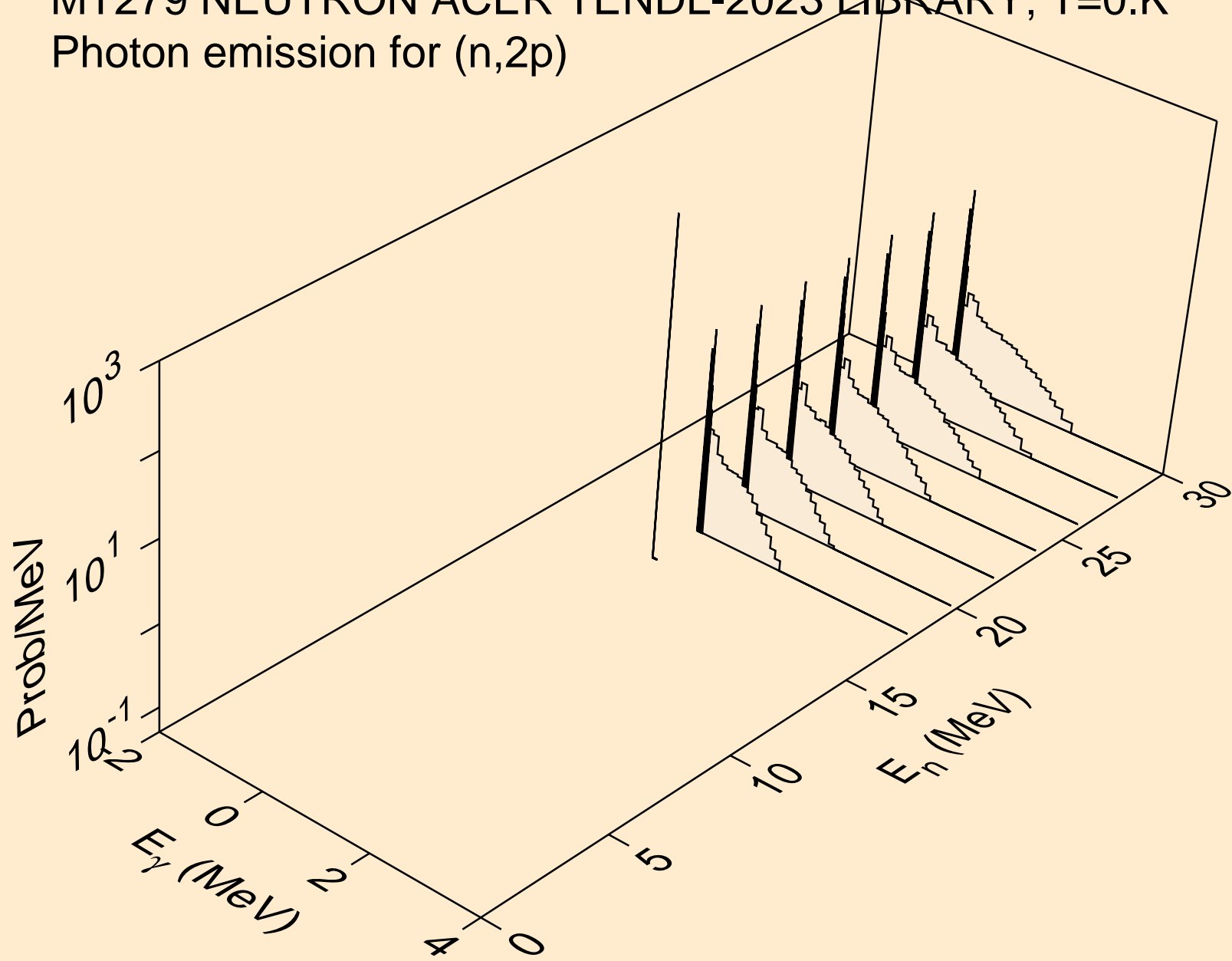

MT279 NEUTRON ACER TENDL-2023 LIBRARY; T=0.K  
thermal capture photon spectrum

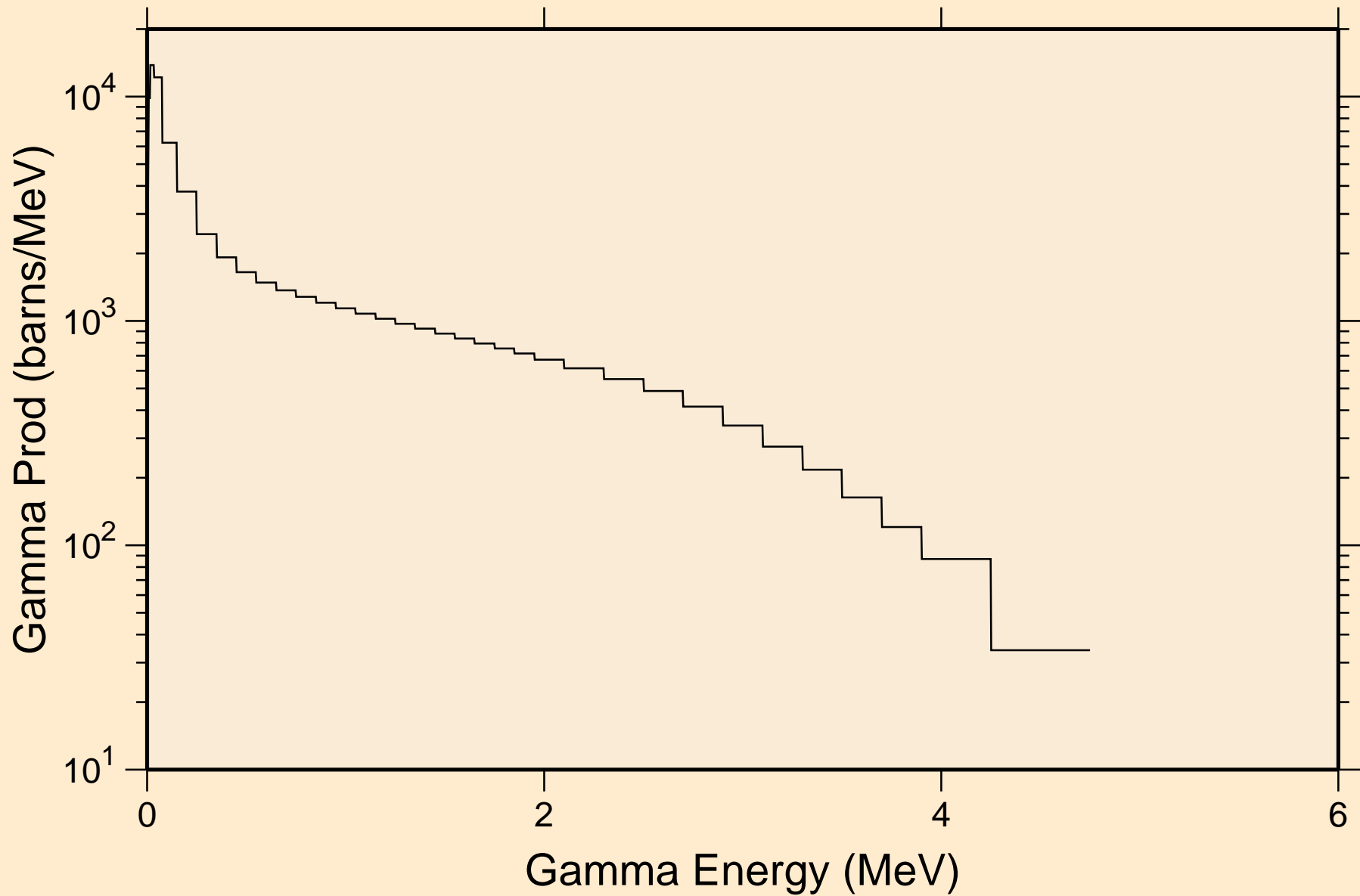



MT279 NEUTRON ACER TENDL-2023 LIBRARY; T=0.K  
14 MeV photon spectrum

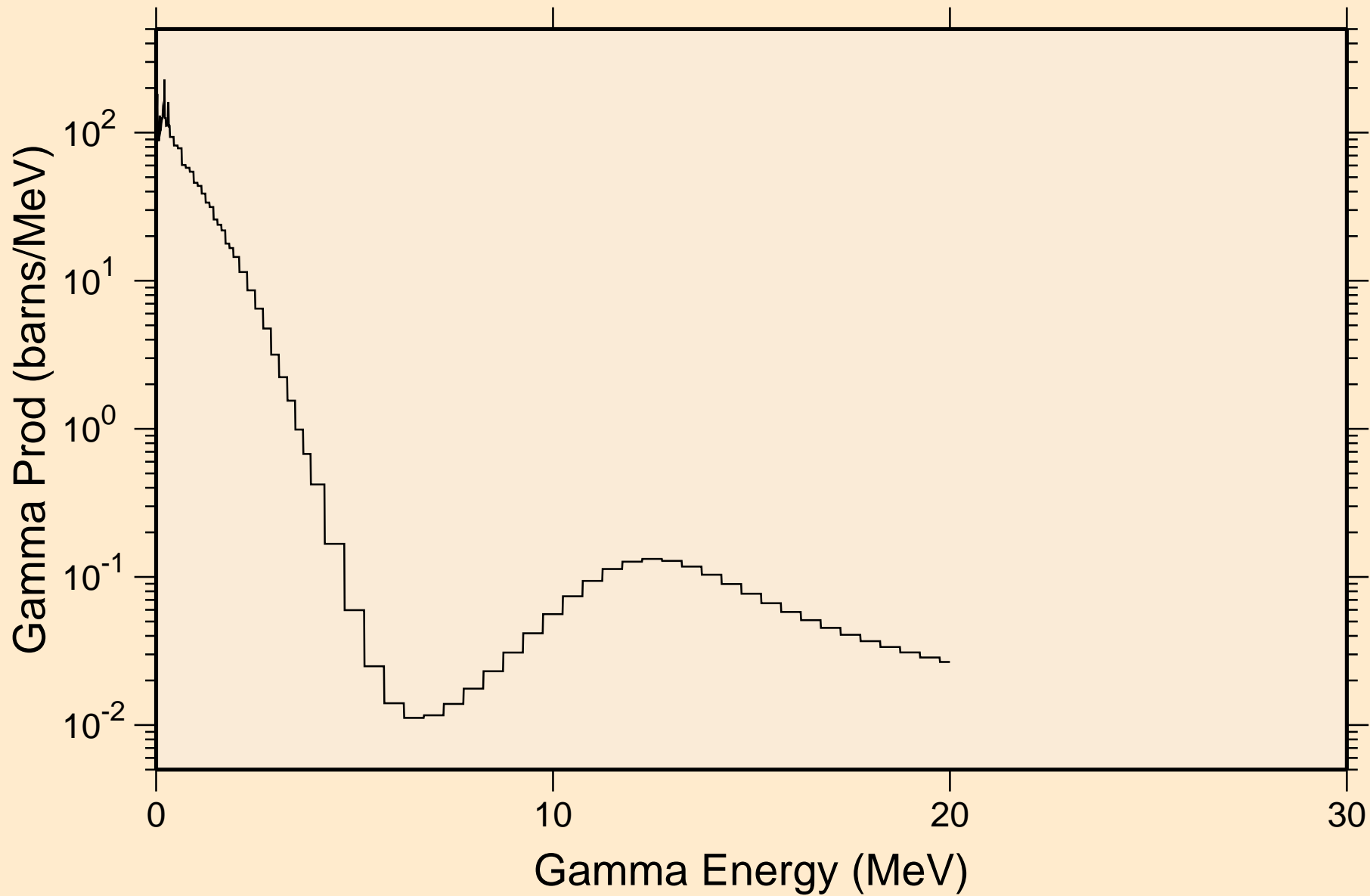

MT279 NEUTRON ACER TENDL-2023 LIBRARY; T=0.K  
Particle heating contributions

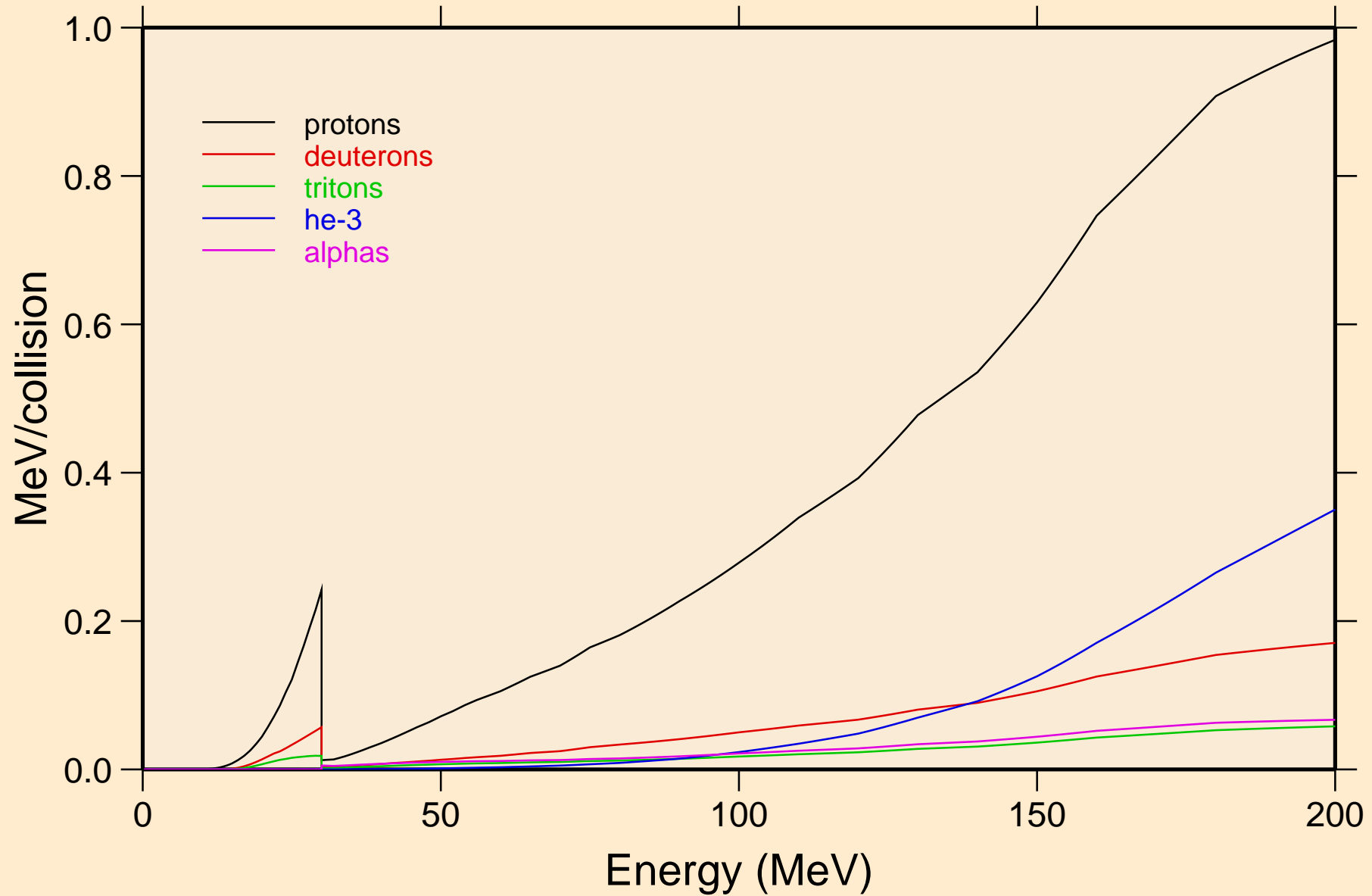

MT279 NEUTRON ACER TENDL-2023 LIBRARY; T=0.K  
Recoil Heating

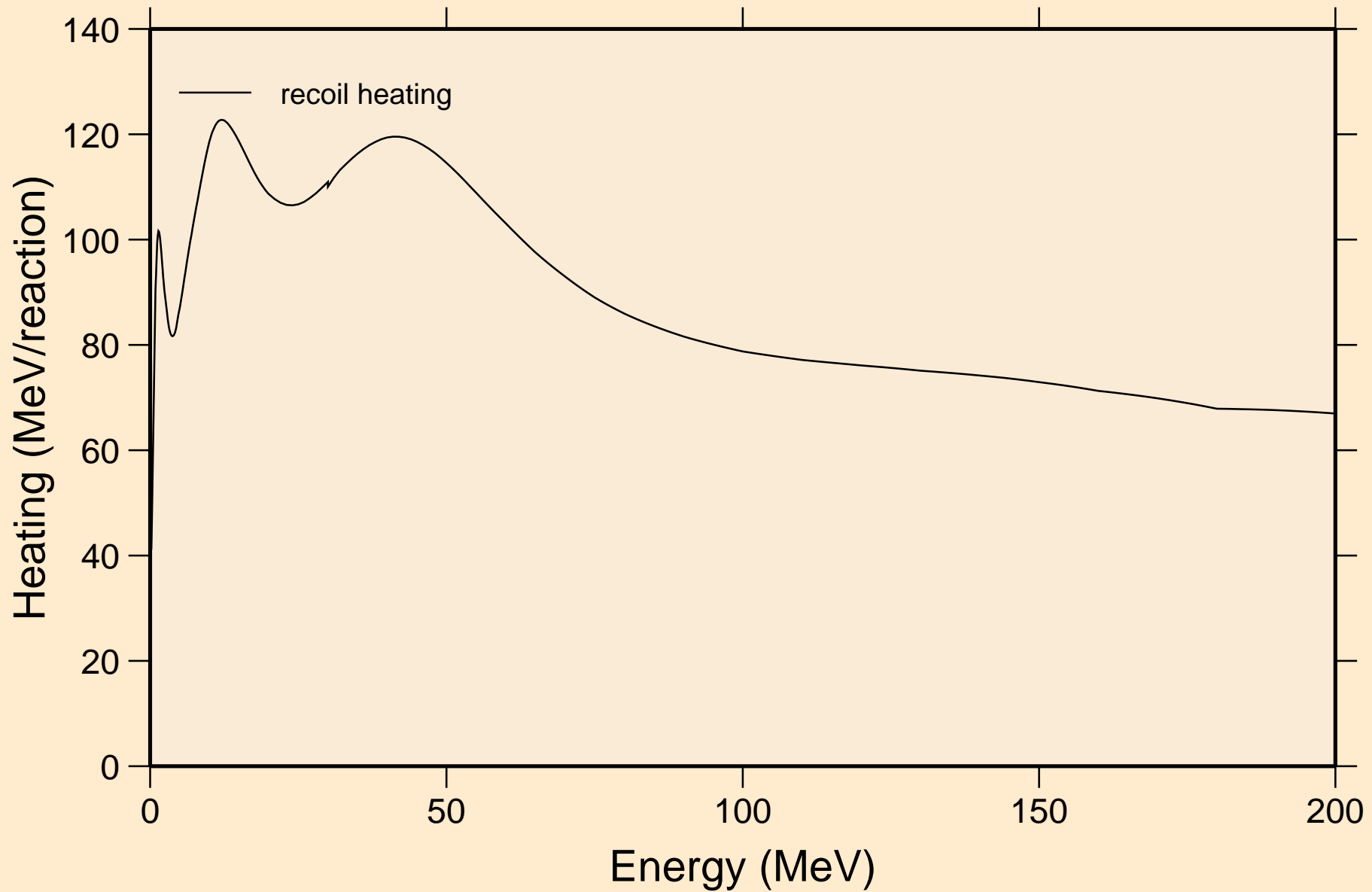

# MT279 NEUTRON ACER TENDL-2023 LIBRARY; T=0.K

## Particle production cross sections

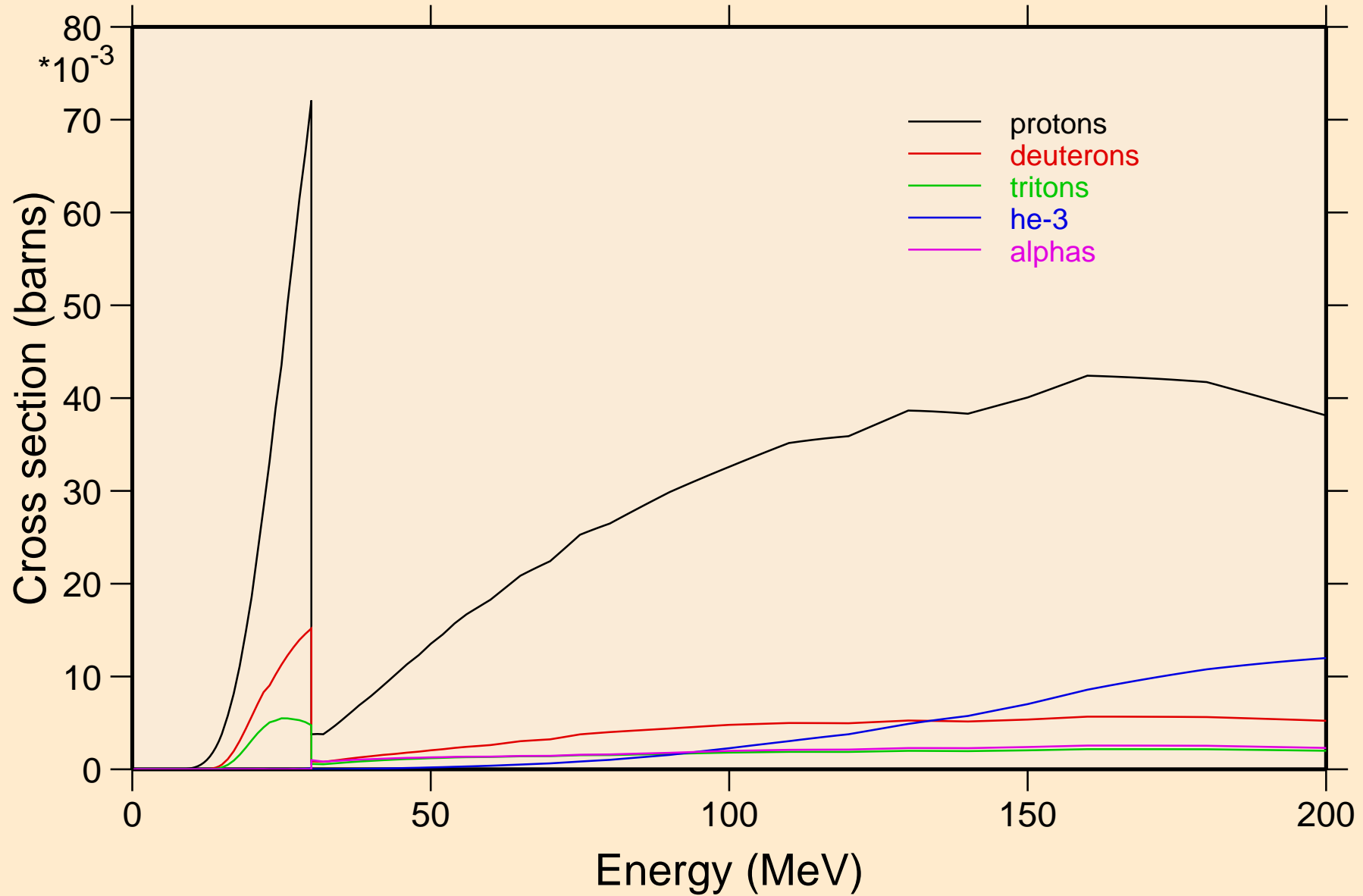

MT279 NEUTRON ACER TENDL-2023 LIBRARY; T=0.K  
protons from (n,x)

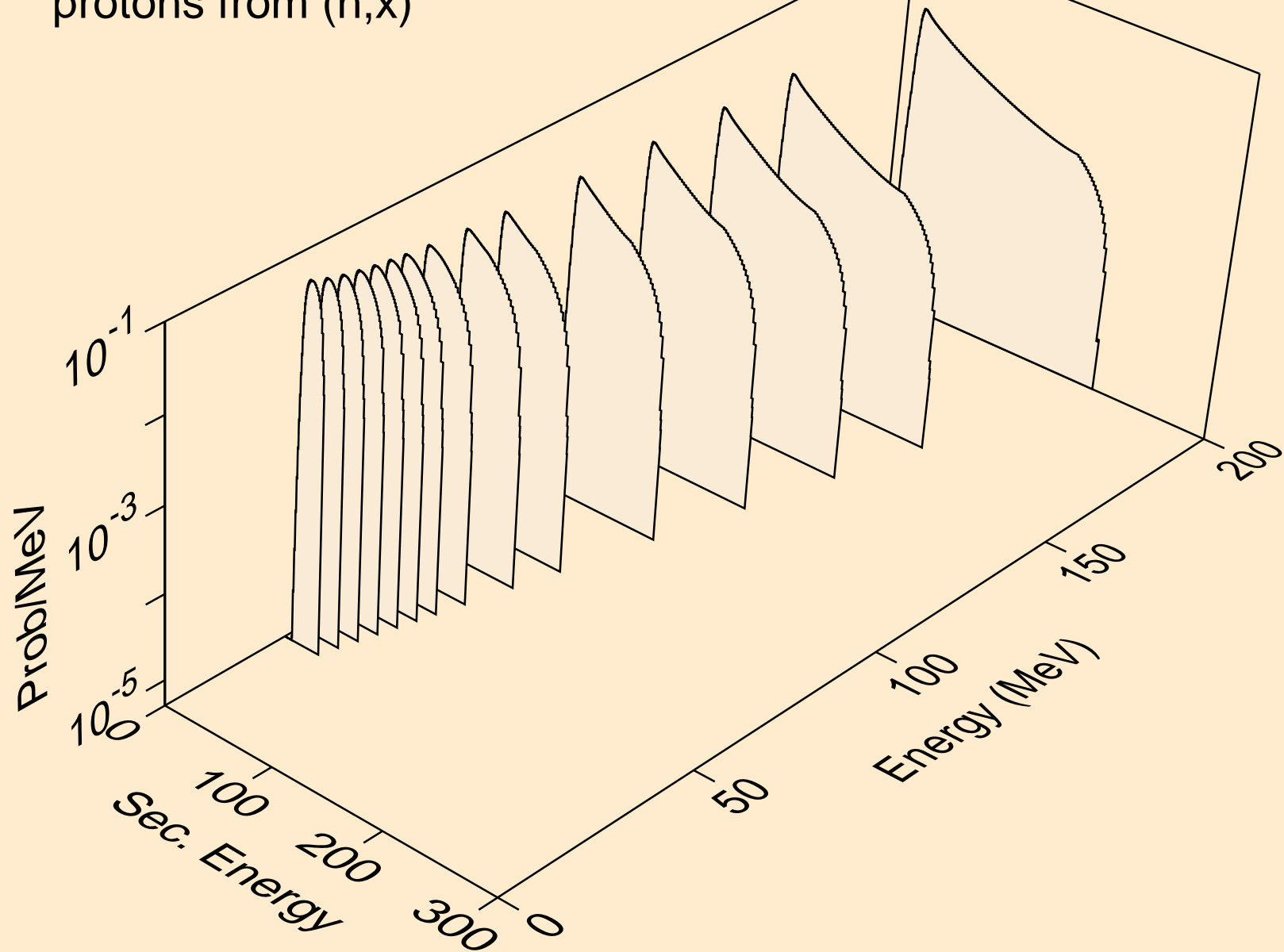

MT279 NEUTRON ACER TENDL-2023 LIBRARY; T=0.K  
protons from (n,n\*)p

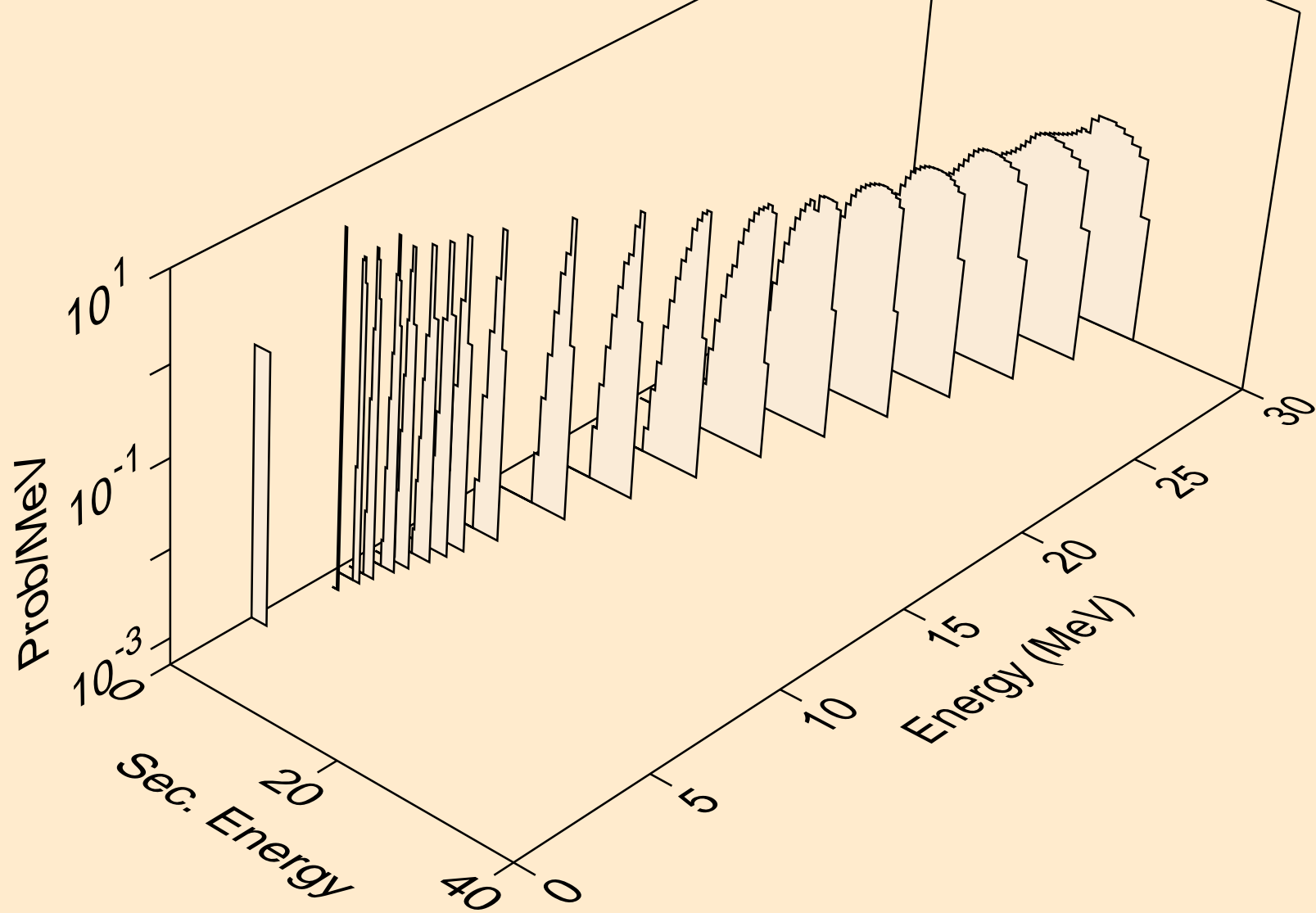

MT279 NEUTRON ACER TENDL-2023 LIBRARY; T=0.K  
protons from (n,2np)

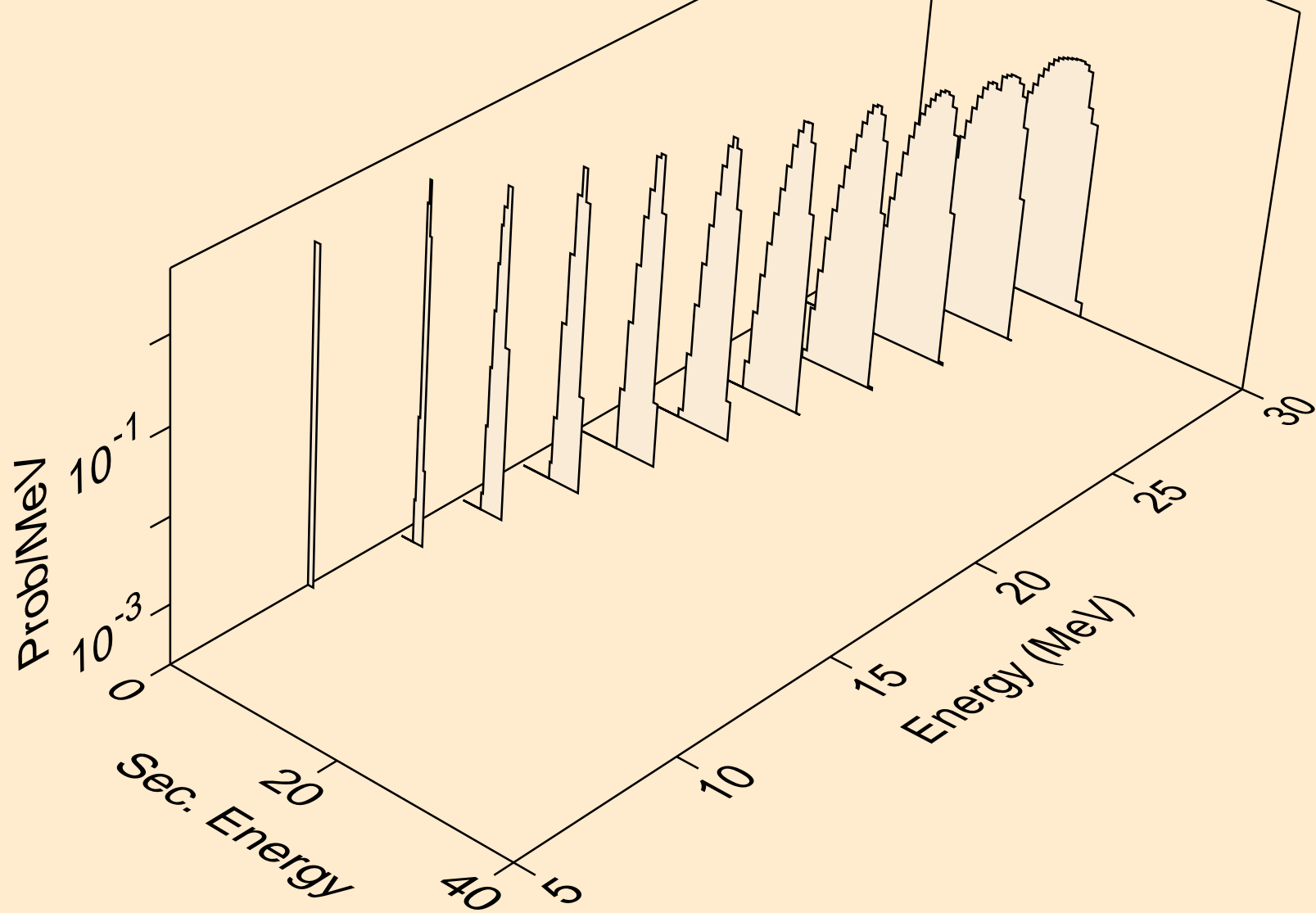

MT279 NEUTRON ACER TENDL-2023 LIBRARY; T=0.K  
protons from (n,3np)

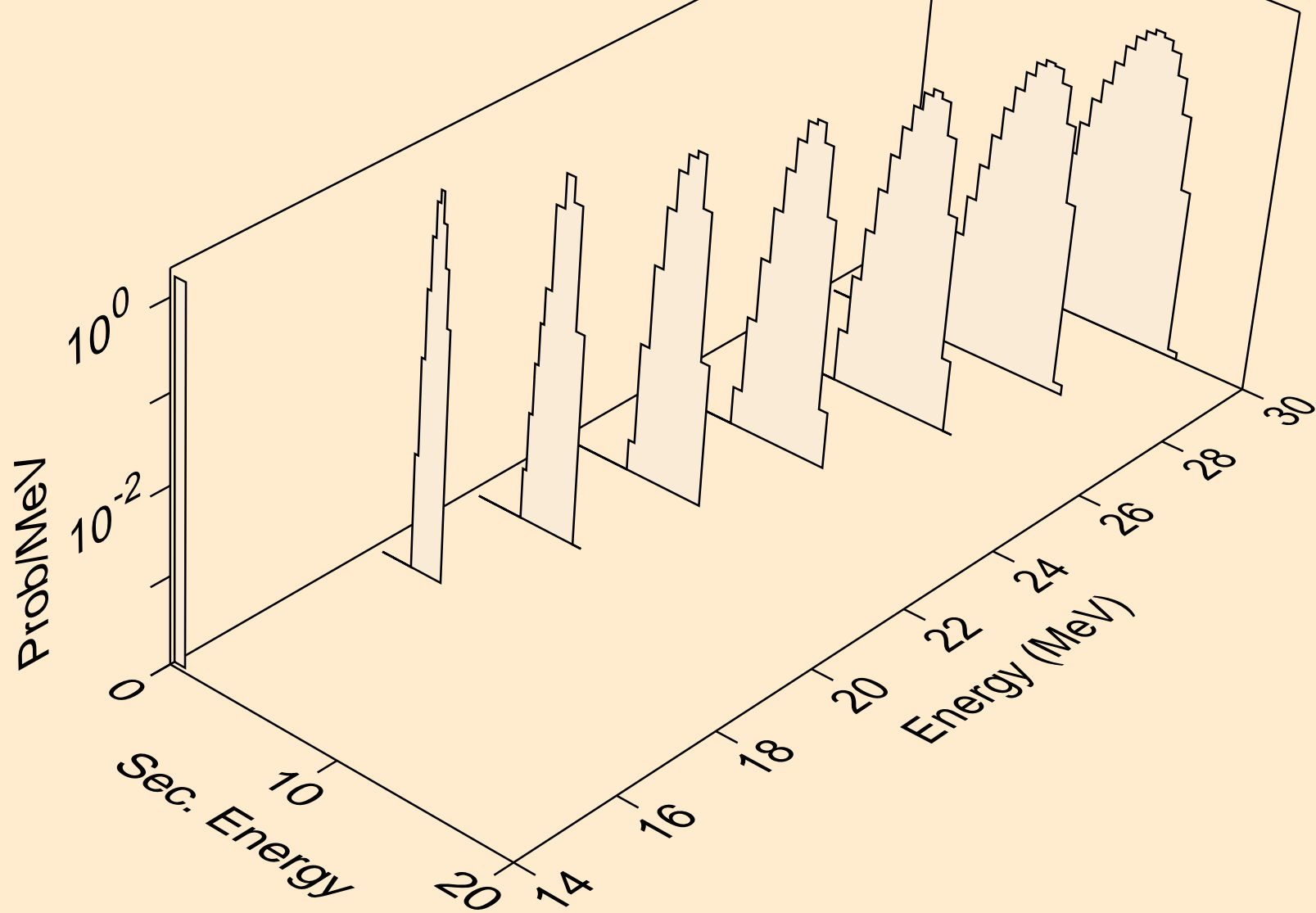



MT279 NEUTRON ACER TENDL-2023 LIBRARY; T=0.K  
protons from (n,n2p)

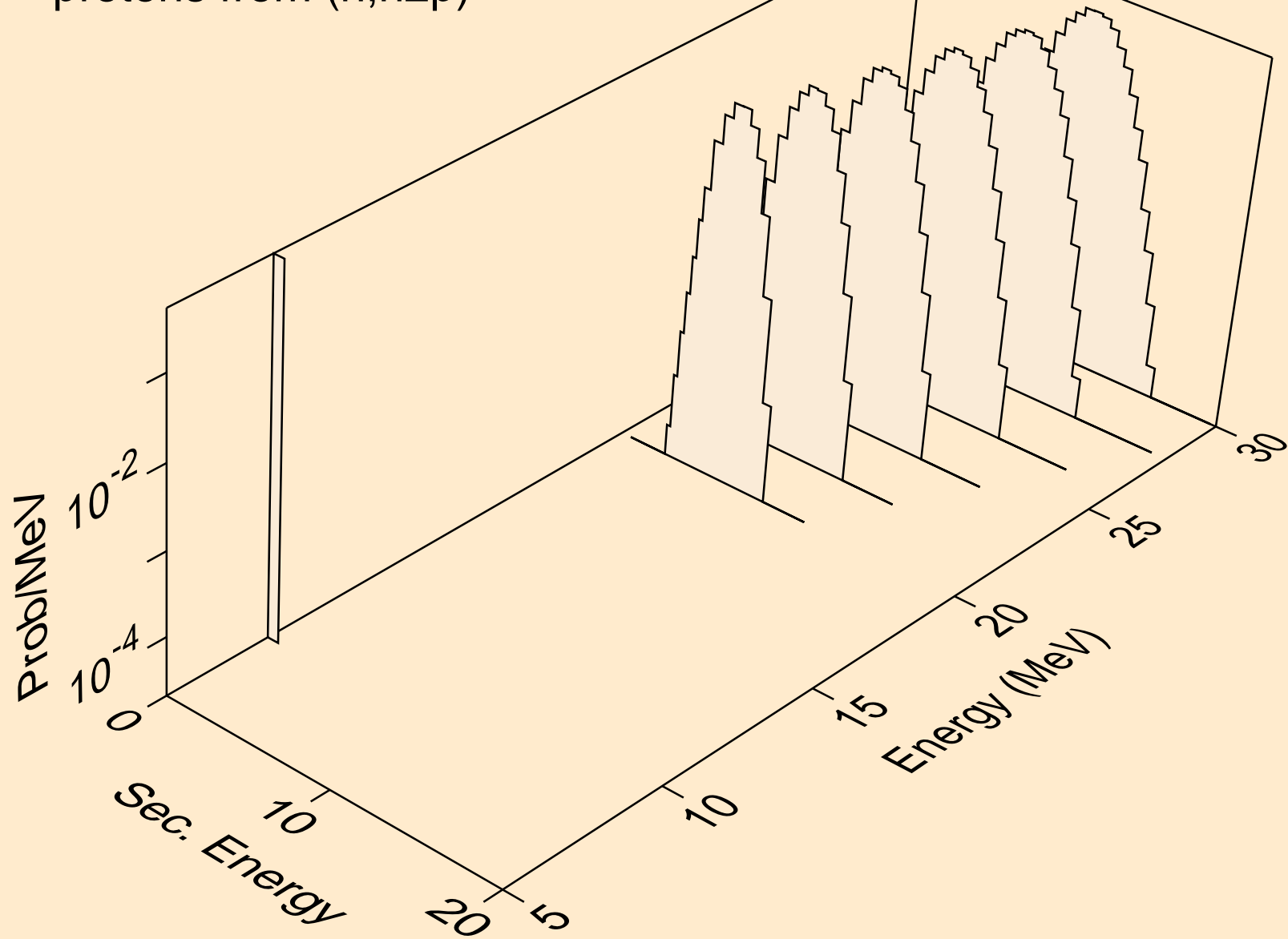

MT279 NEUTRON ACER TENDL-2023 LIBRARY; T=0.K  
protons from (n,p)

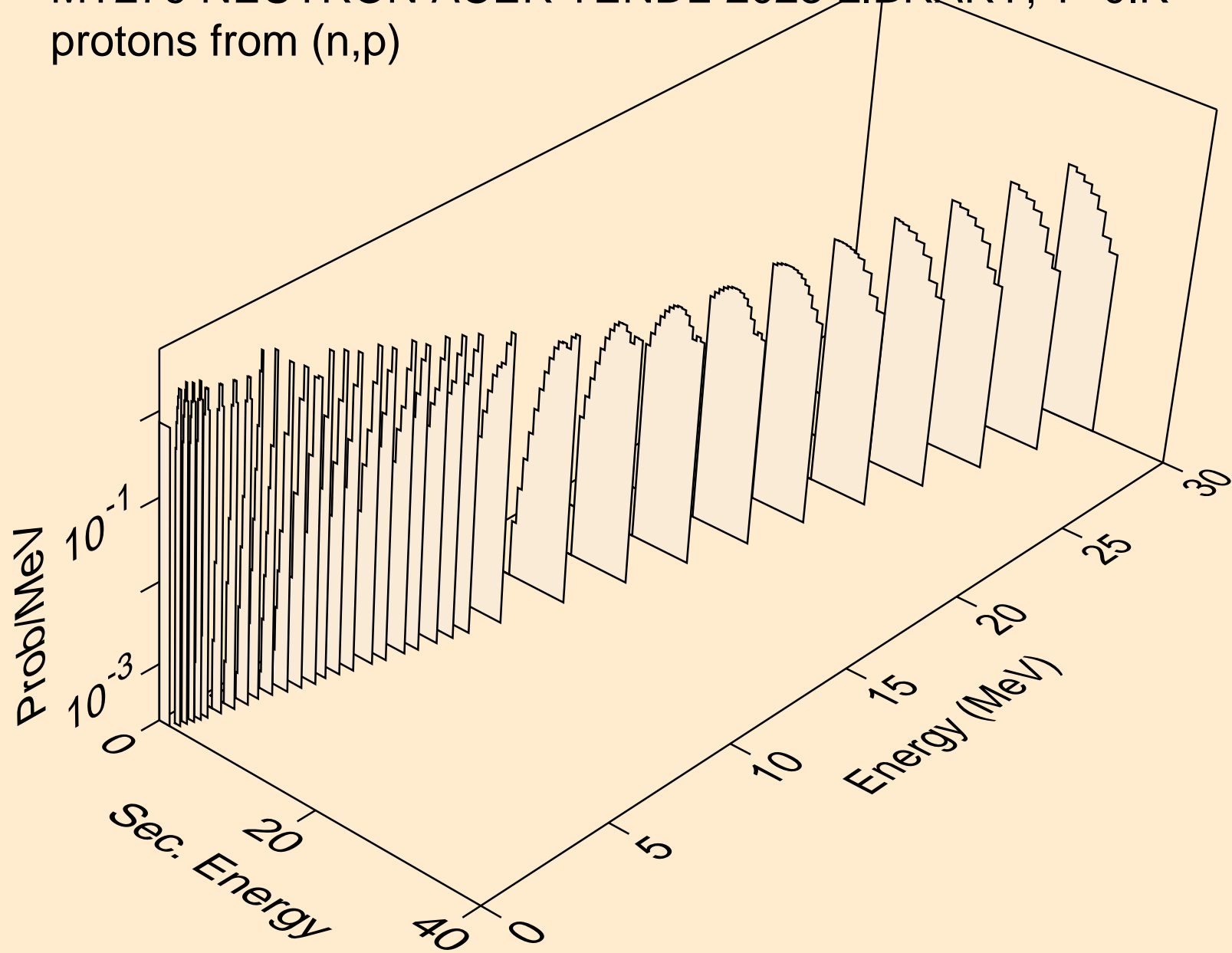

MT279 NEUTRON ACER TENDL-2023 LIBRARY; T=0.K  
protons from (n,2p)

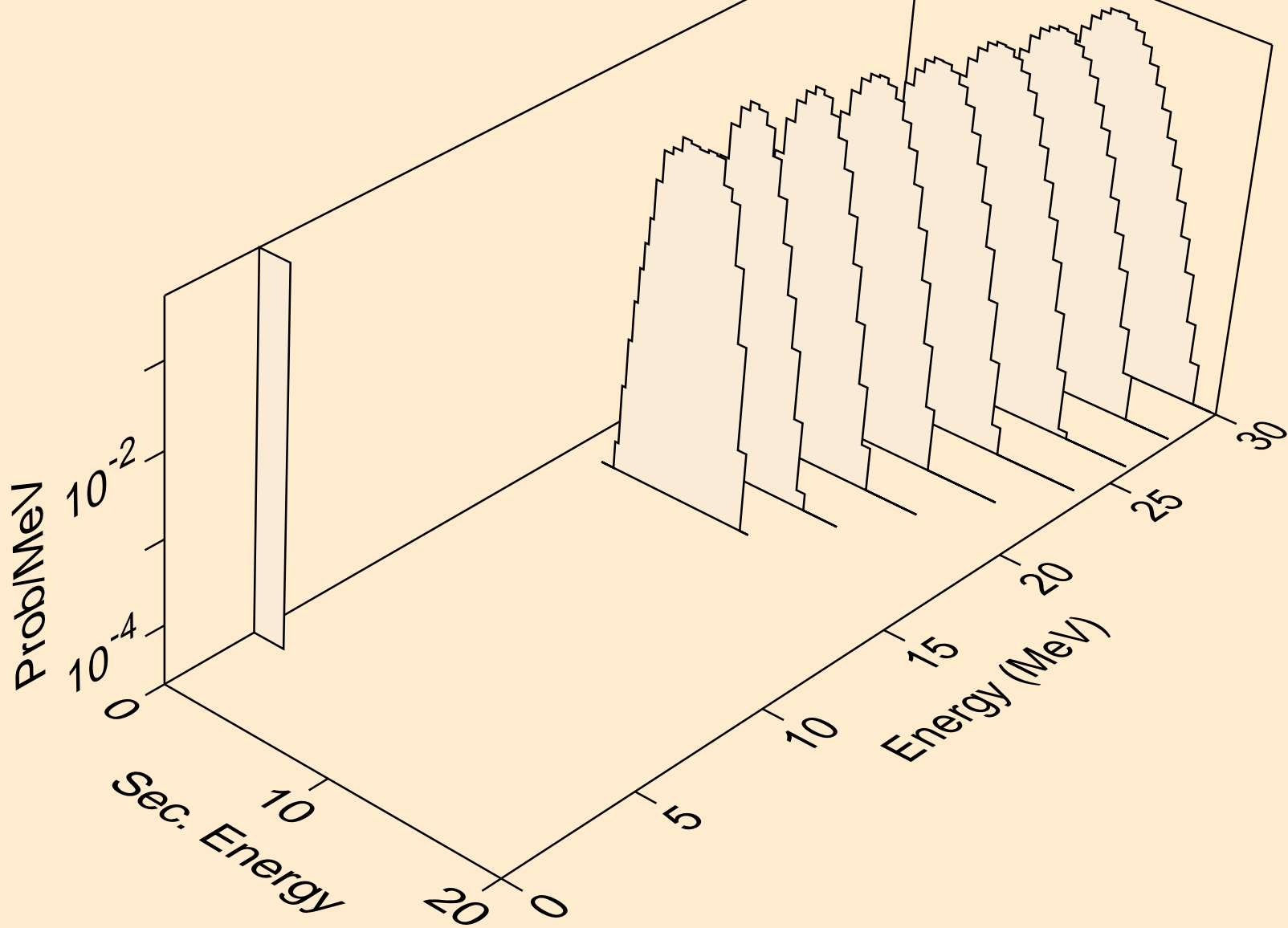

MT279 NEUTRON ACER TENDL-2023 LIBRARY; T=0.K  
deuterons from (n,x)

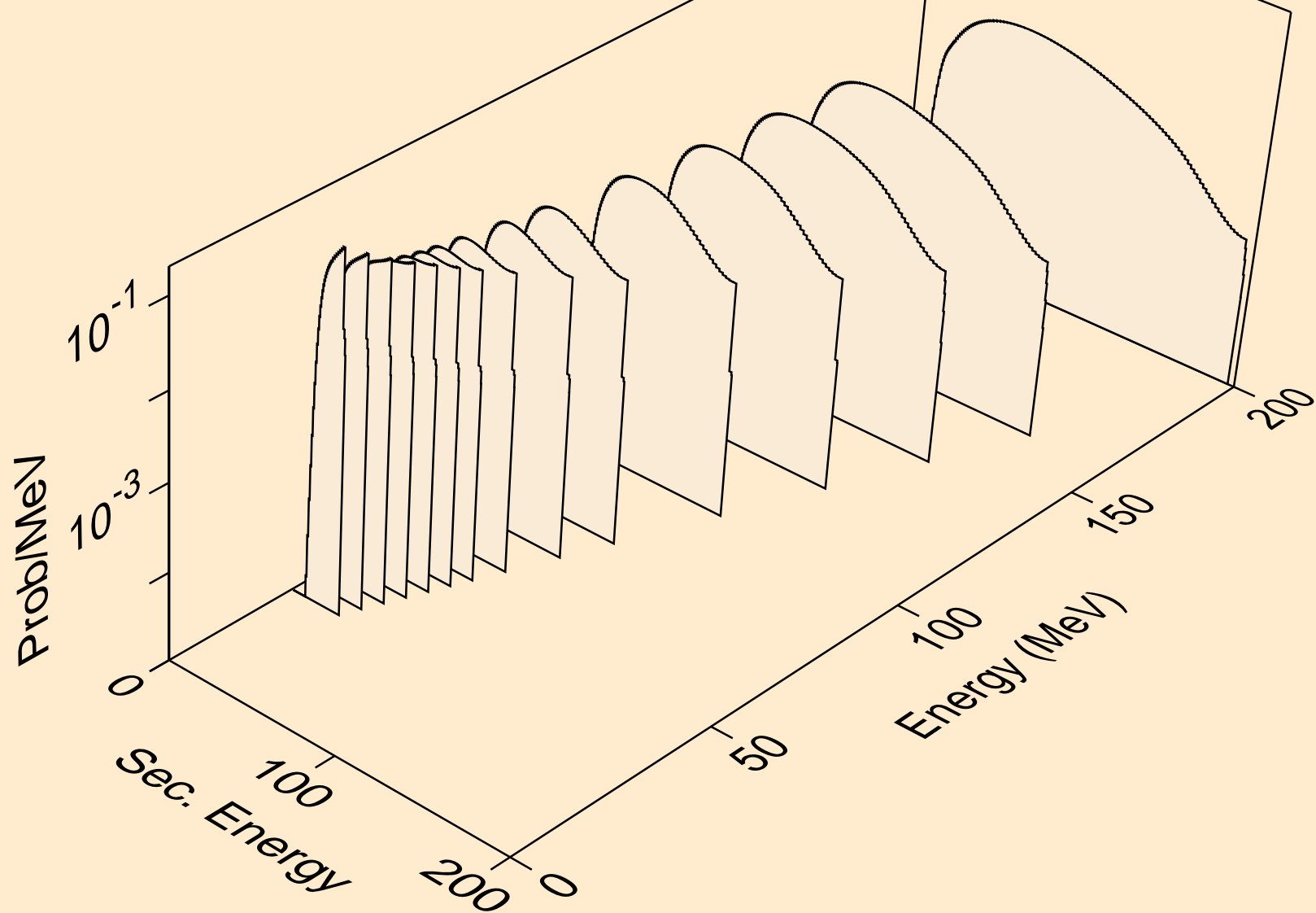

MT279 NEUTRON ACER TENDL-2023 LIBRARY; T=0.K  
deuterons from (n,2nd)

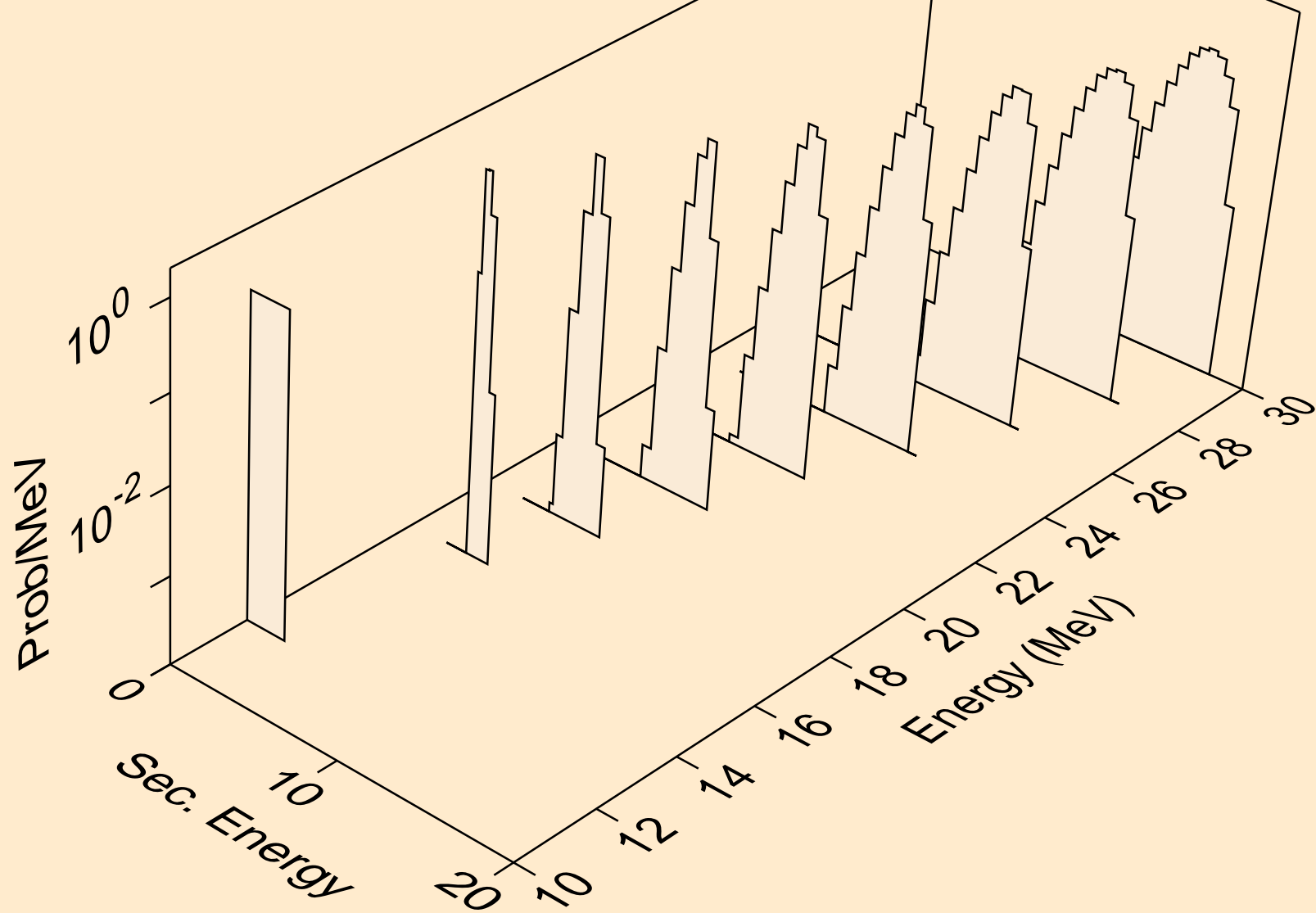

MT279 NEUTRON ACER TENDL-2023 LIBRARY; T=0.K  
deuterons from (n,n\*)d

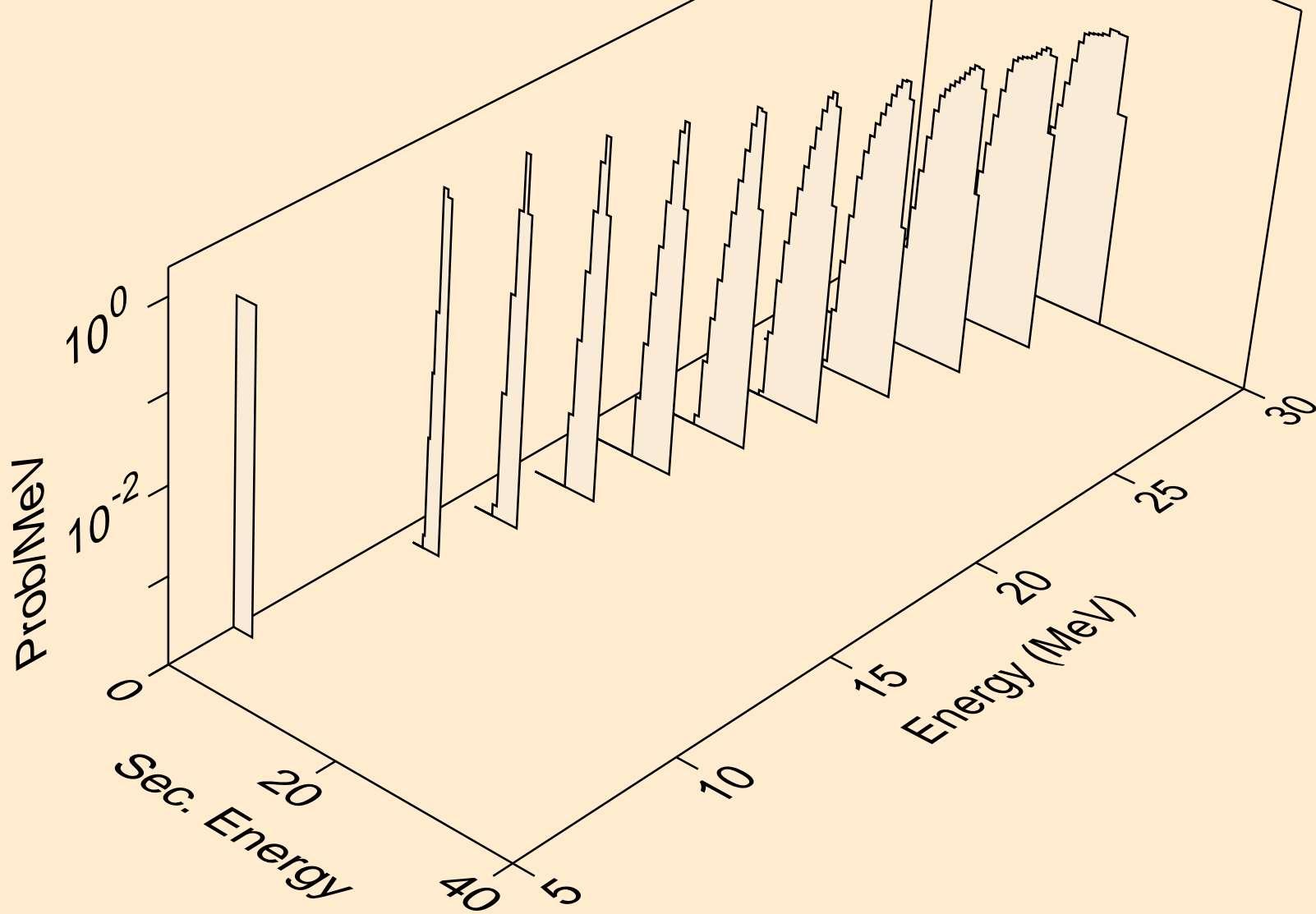

MT279 NEUTRON ACER TENDL-2023 LIBRARY; T=0.K  
deuterons from (n,d)

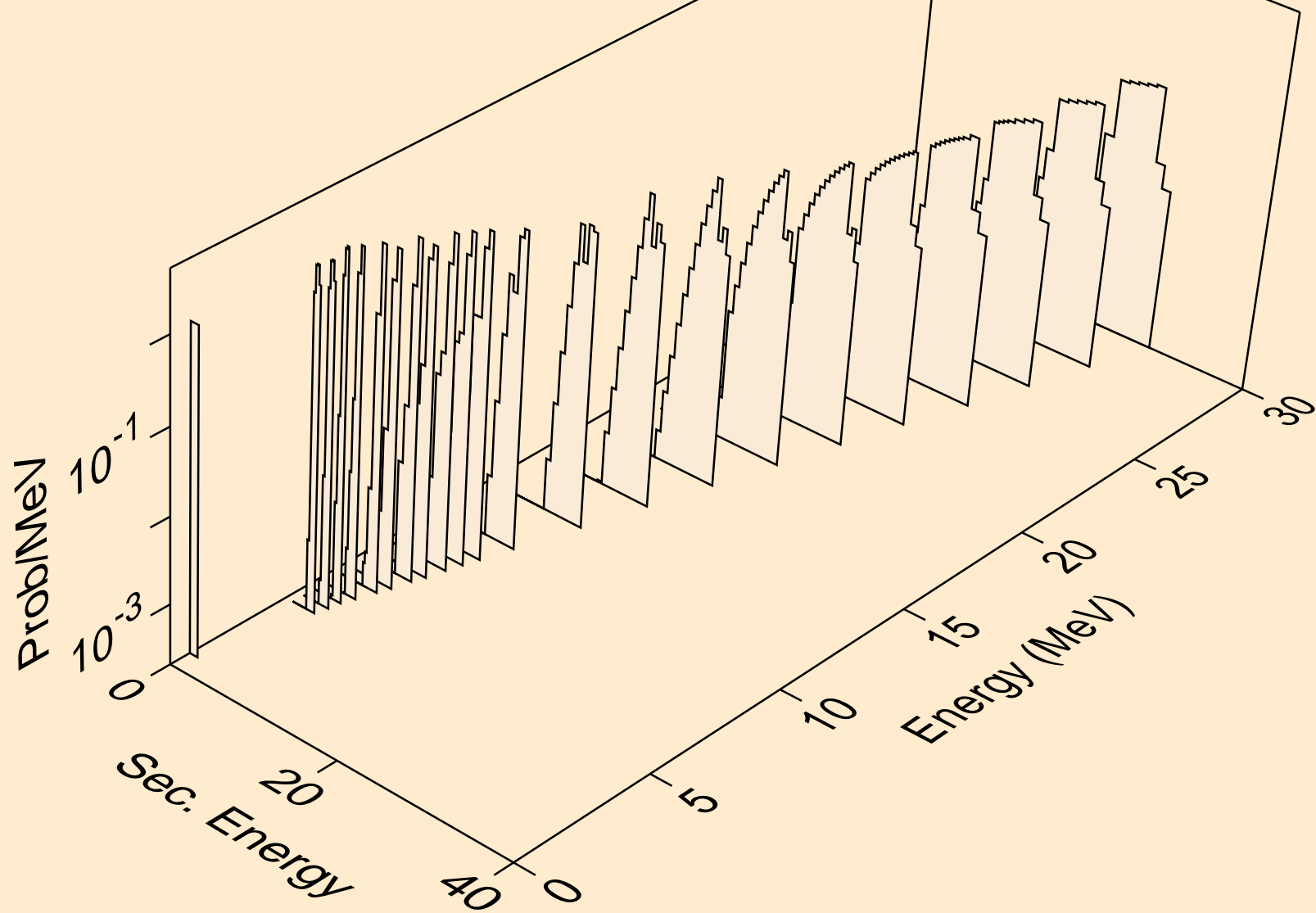

MT279 NEUTRON ACER TENDL-2023 LIBRARY; T=0.K  
tritons from (n,x)

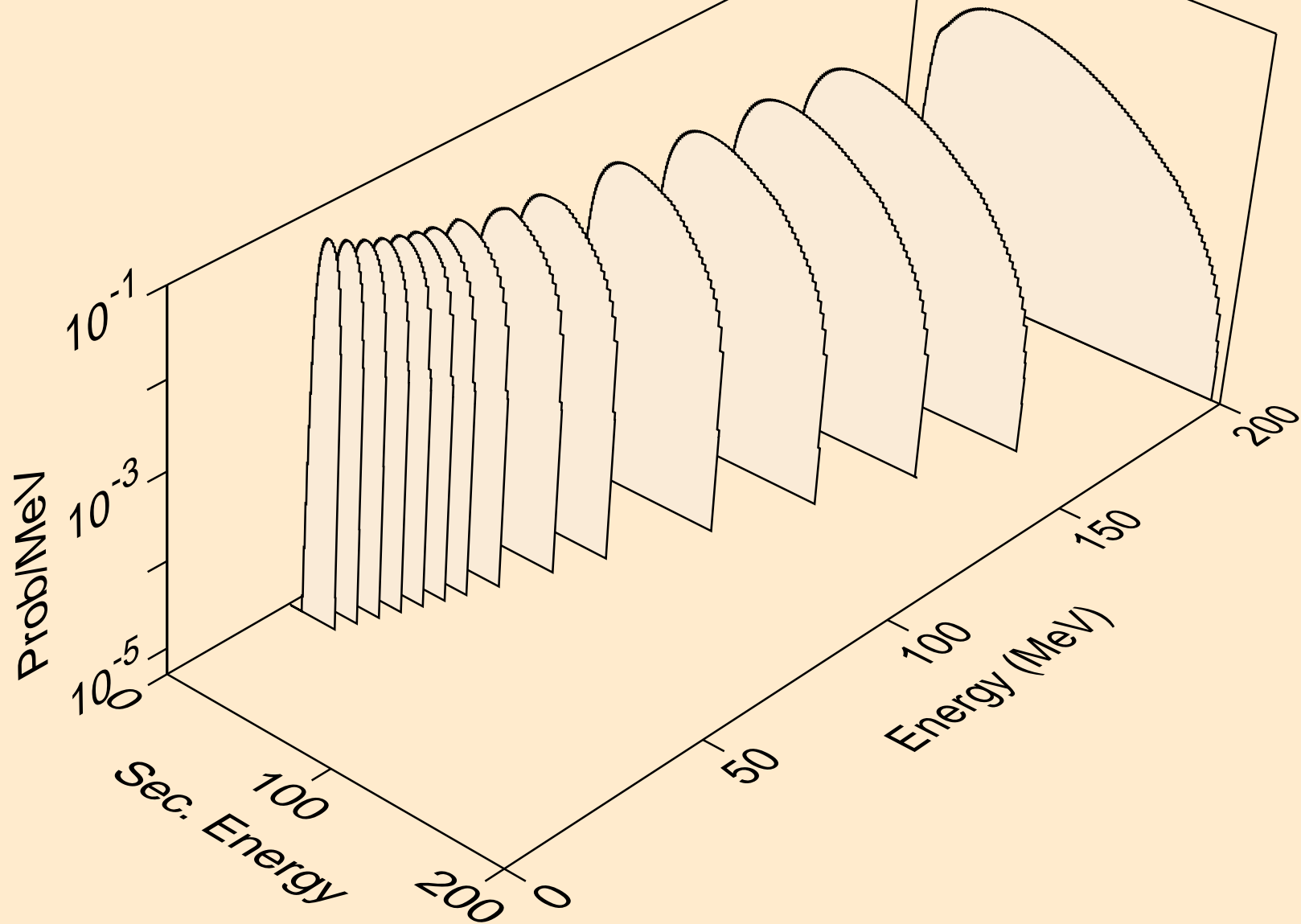



MT279 NEUTRON ACER TENDL-2023 LIBRARY; T=0.K  
tritons from (n,n\*)t

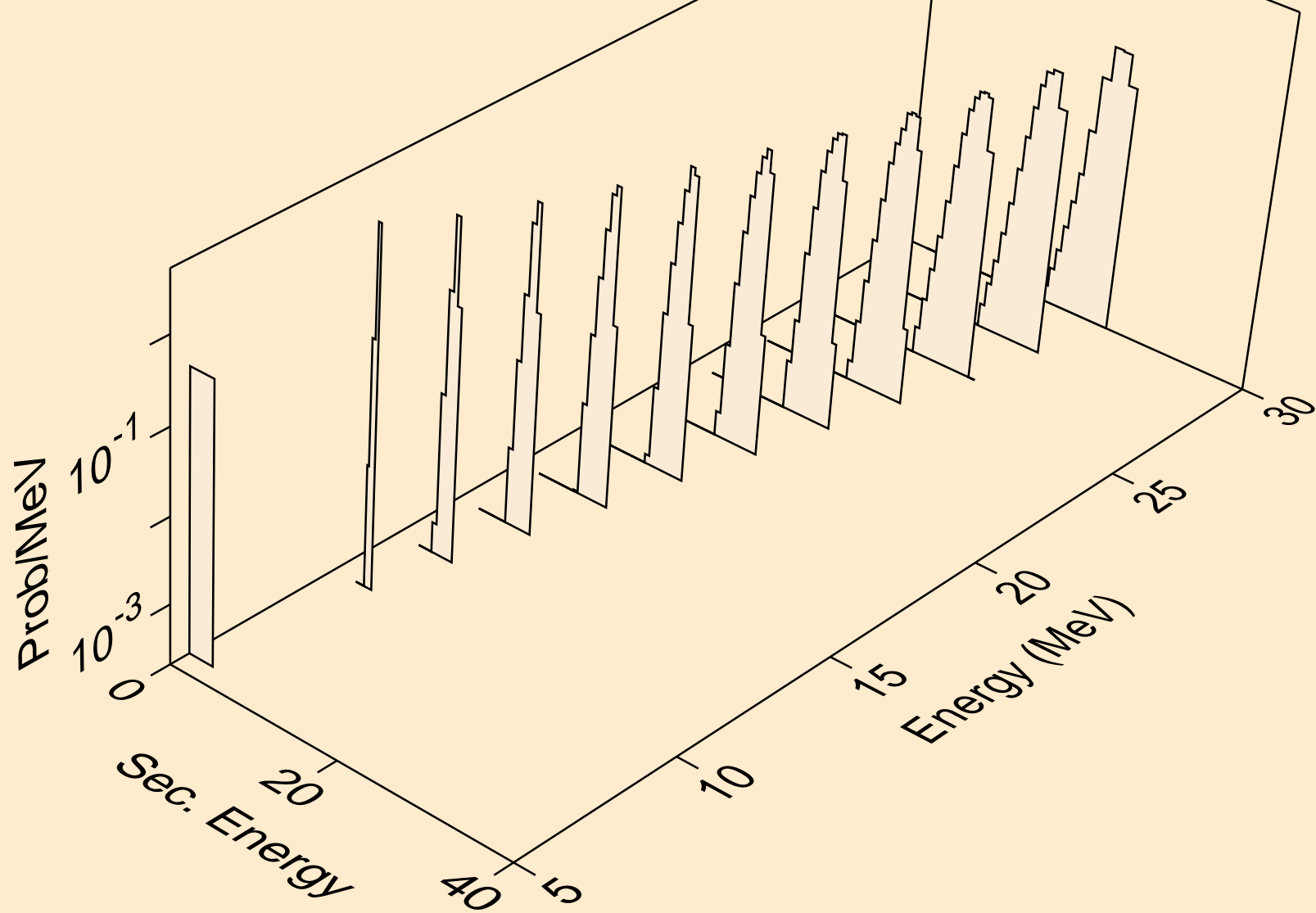

MT279 NEUTRON ACER TENDL-2023 LIBRARY; T=0.K  
tritons from (n,t)

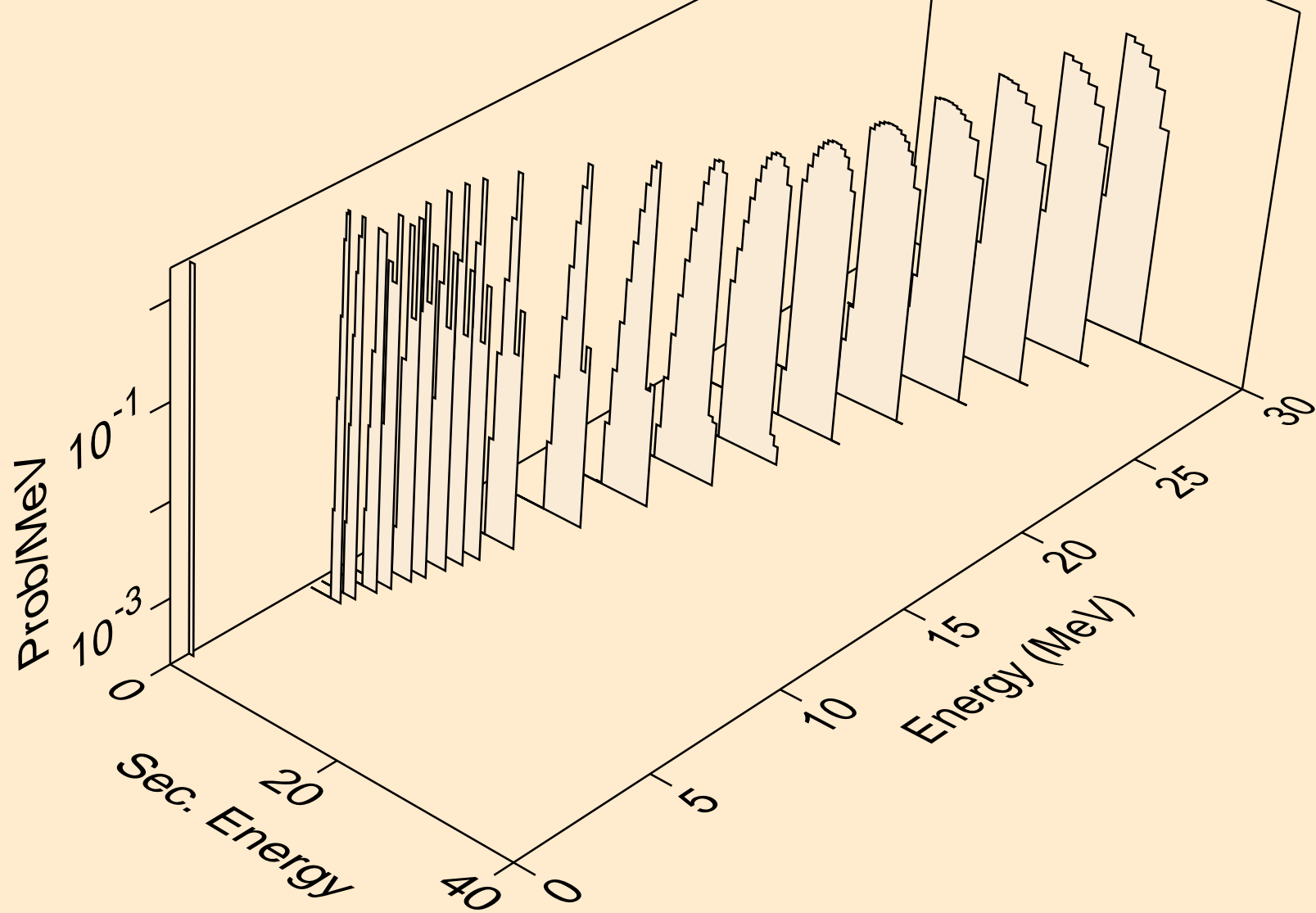

MT279 NEUTRON ACER TENDL-2023 LIBRARY; T=0.K  
he3s from (n,x)

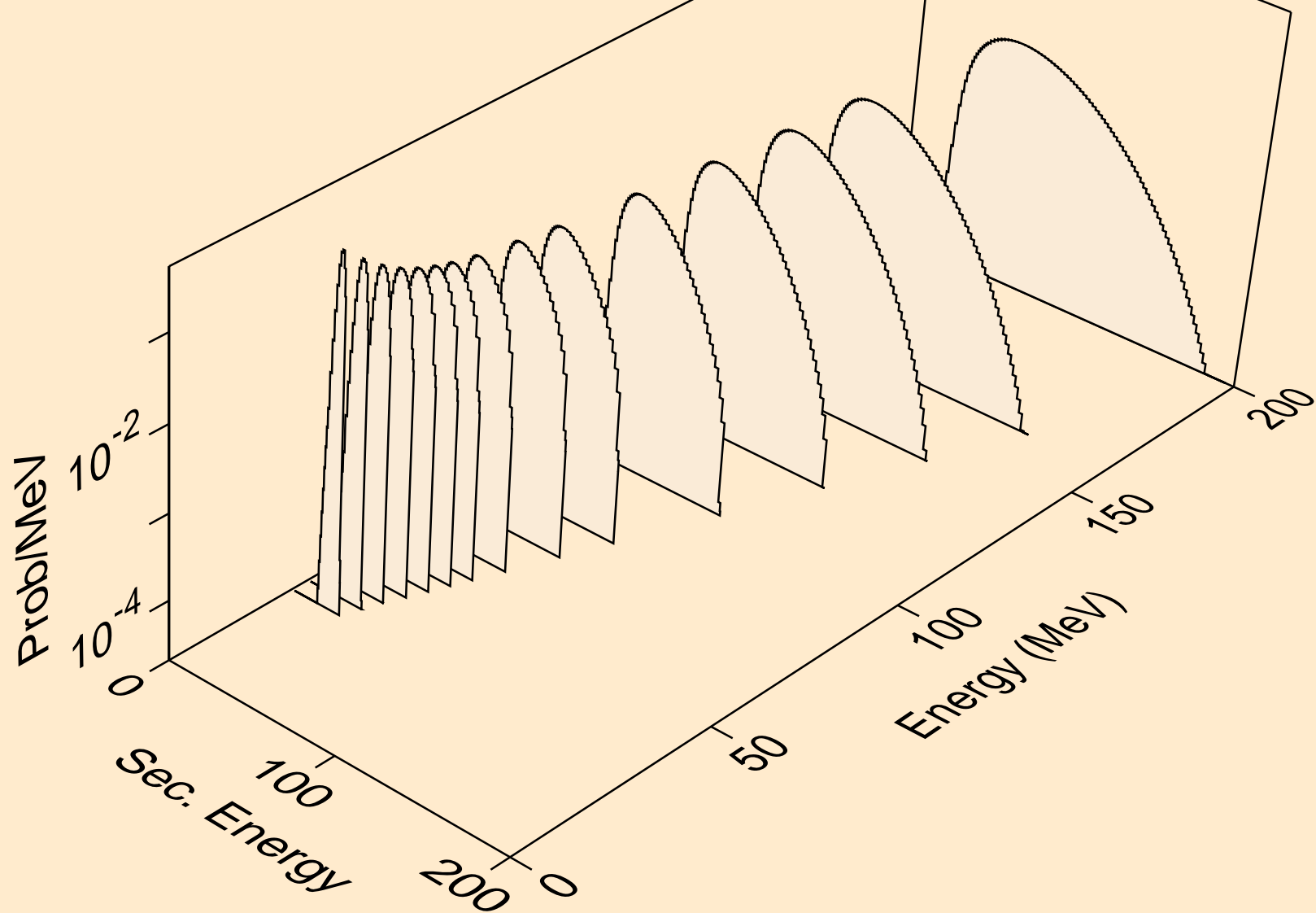

MT279 NEUTRON ACER TENDL-2023 LIBRARY; T=0.K  
he3s from (n,n\*)he3

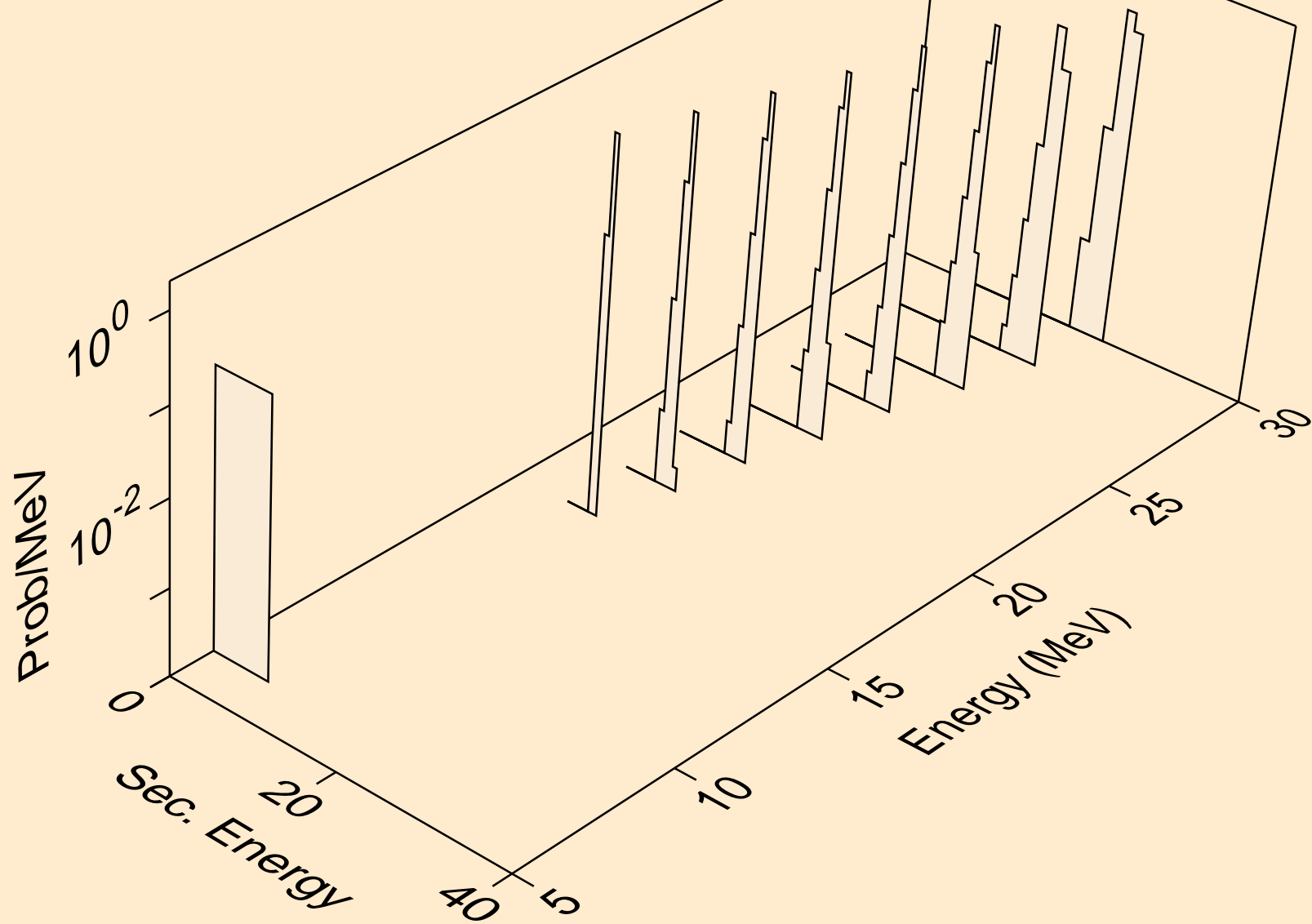

MT279 NEUTRON ACER TENDL-2023 LIBRARY; T=0.K  
he3s from (n,he3)

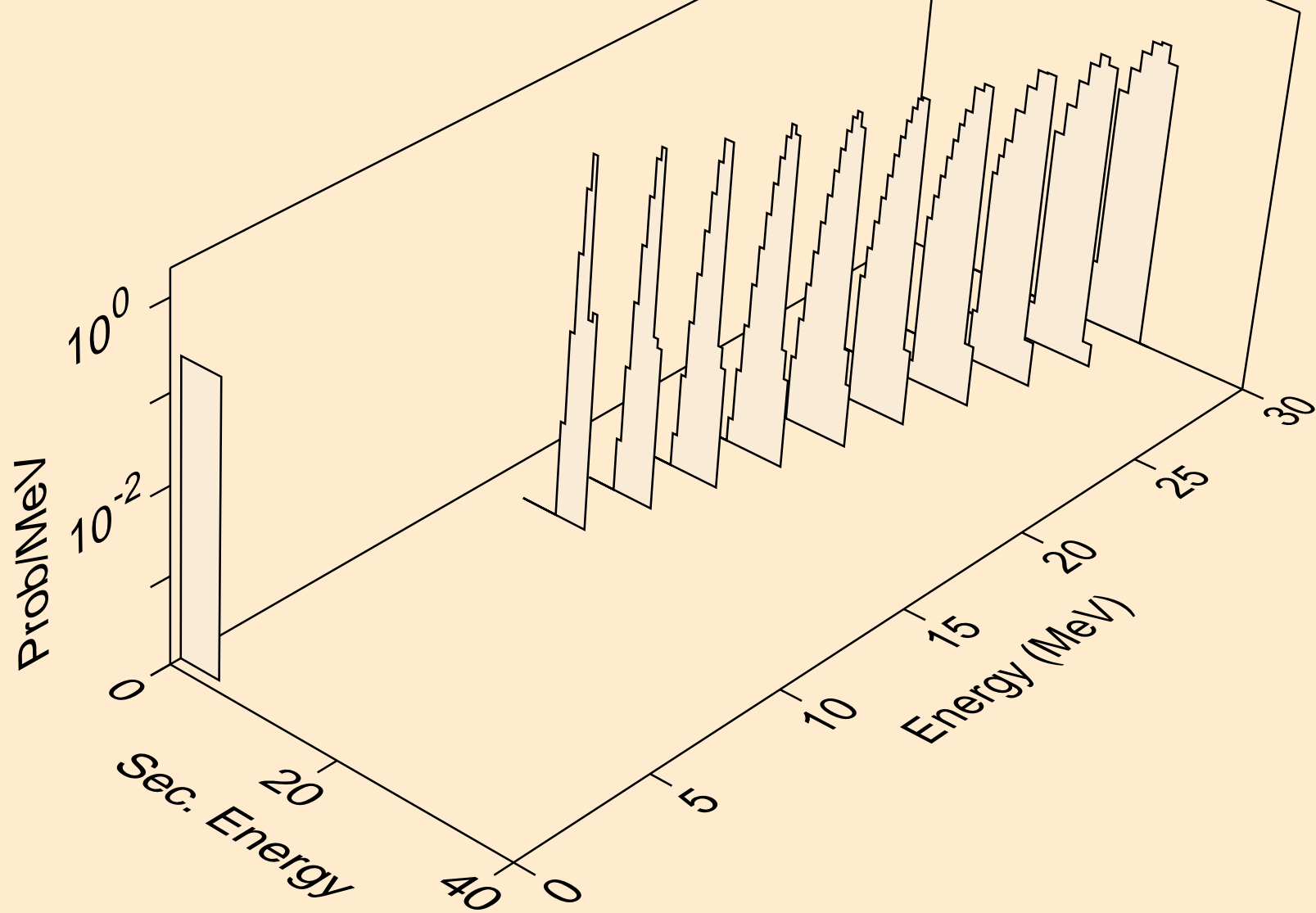

MT279 NEUTRON ACER TENDL-2023 LIBRARY; T=0.K  
alphas from (n,x)

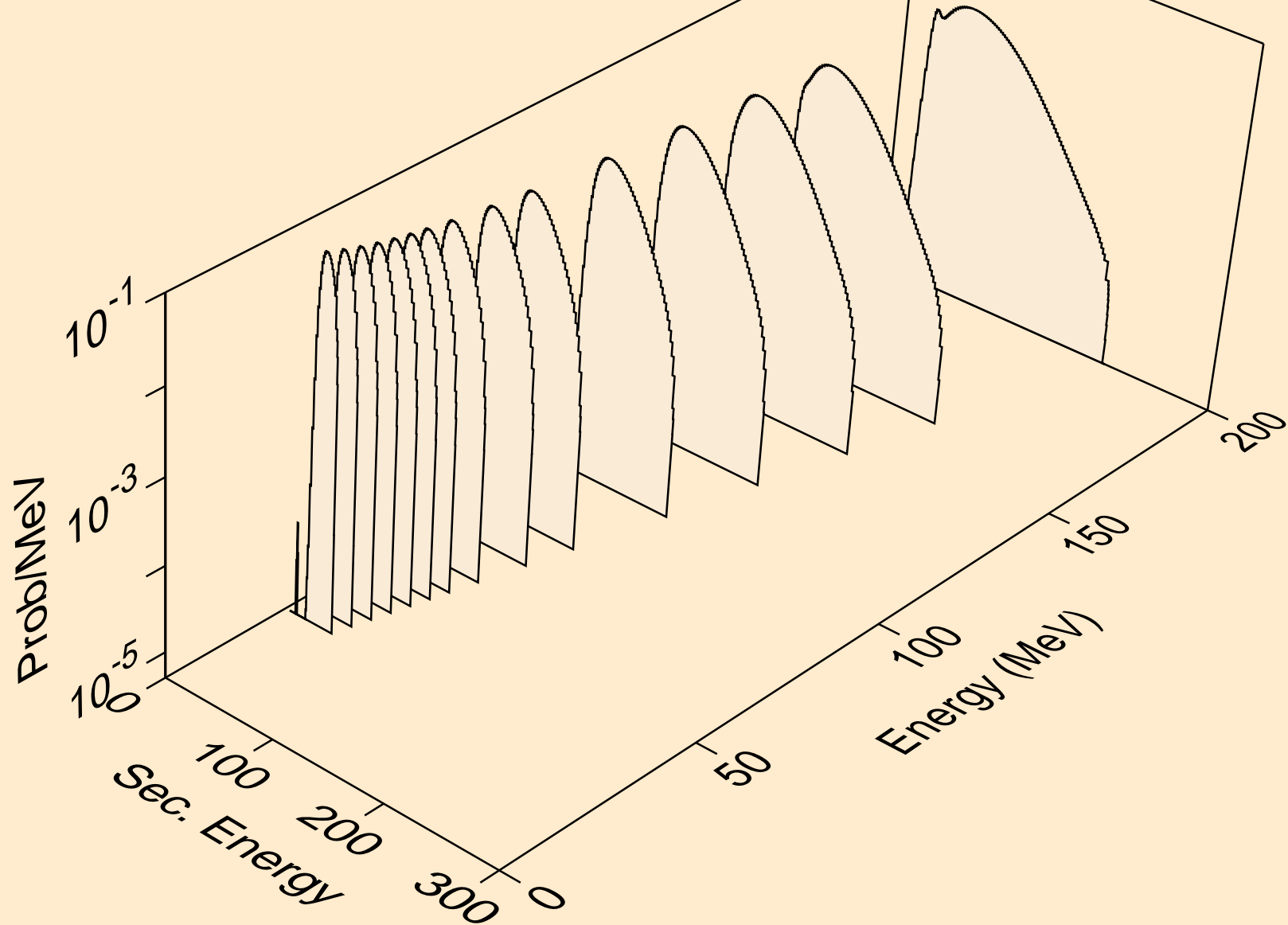

MT279 NEUTRON ACER TENDL-2023 LIBRARY; T=0.K  
alphas from (n,n\*)a

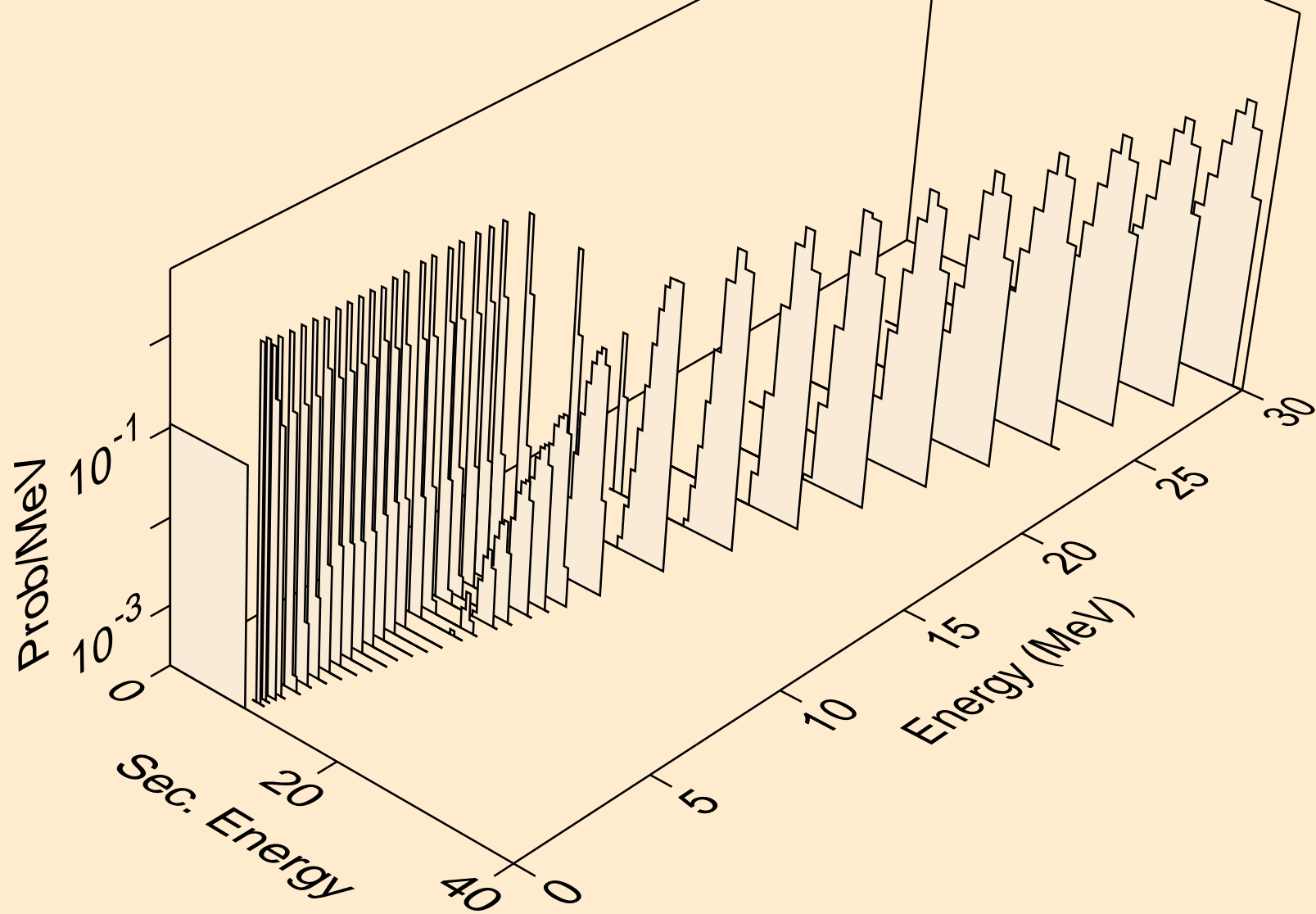

MT279 NEUTRON ACER TENDL-2023 LIBRARY; T=0.K  
alphas from (n,2n)a

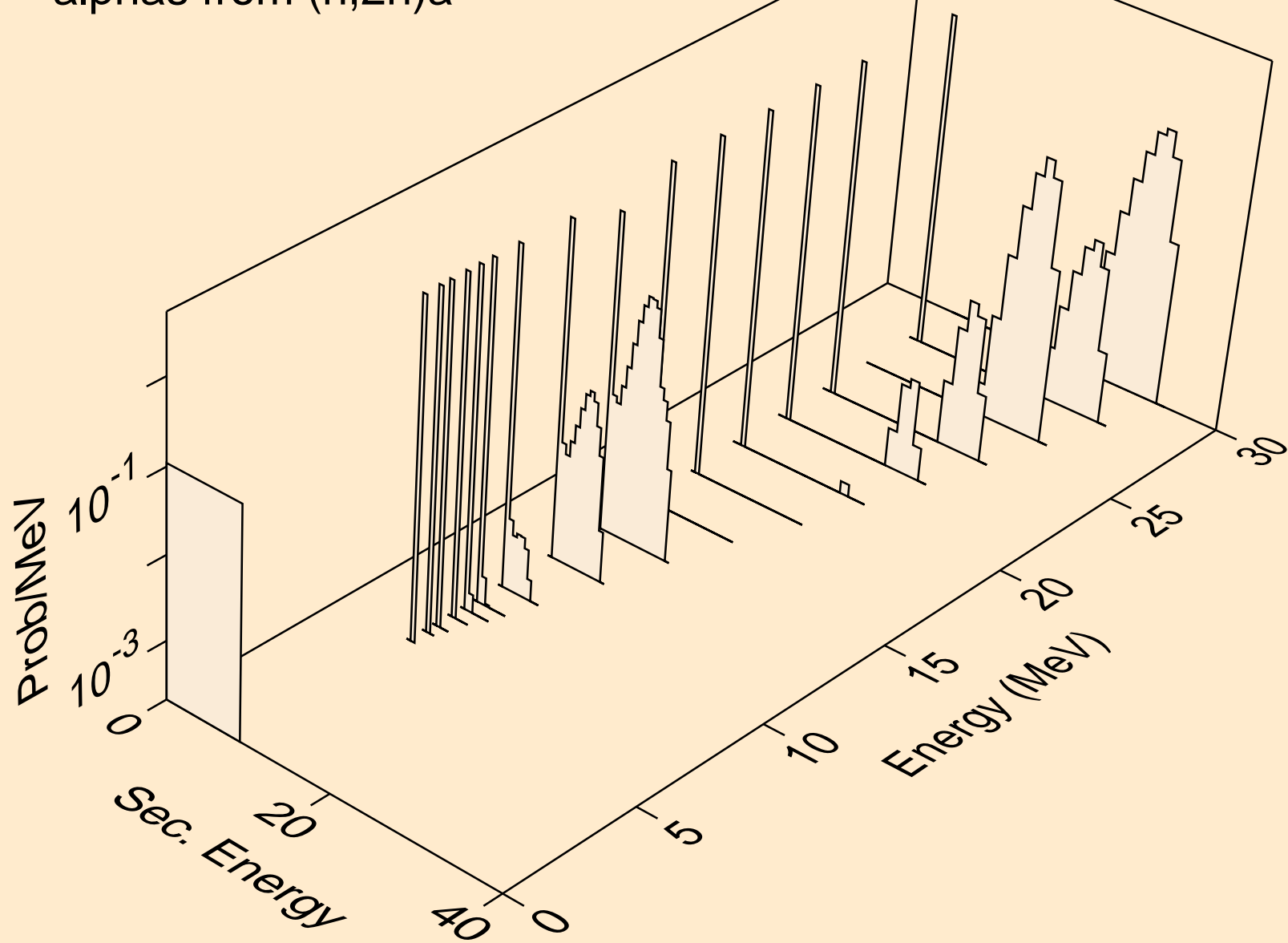



MT279 NEUTRON ACER TENDL-2023 LIBRARY; T=0.K  
alphas from (n,3n)a

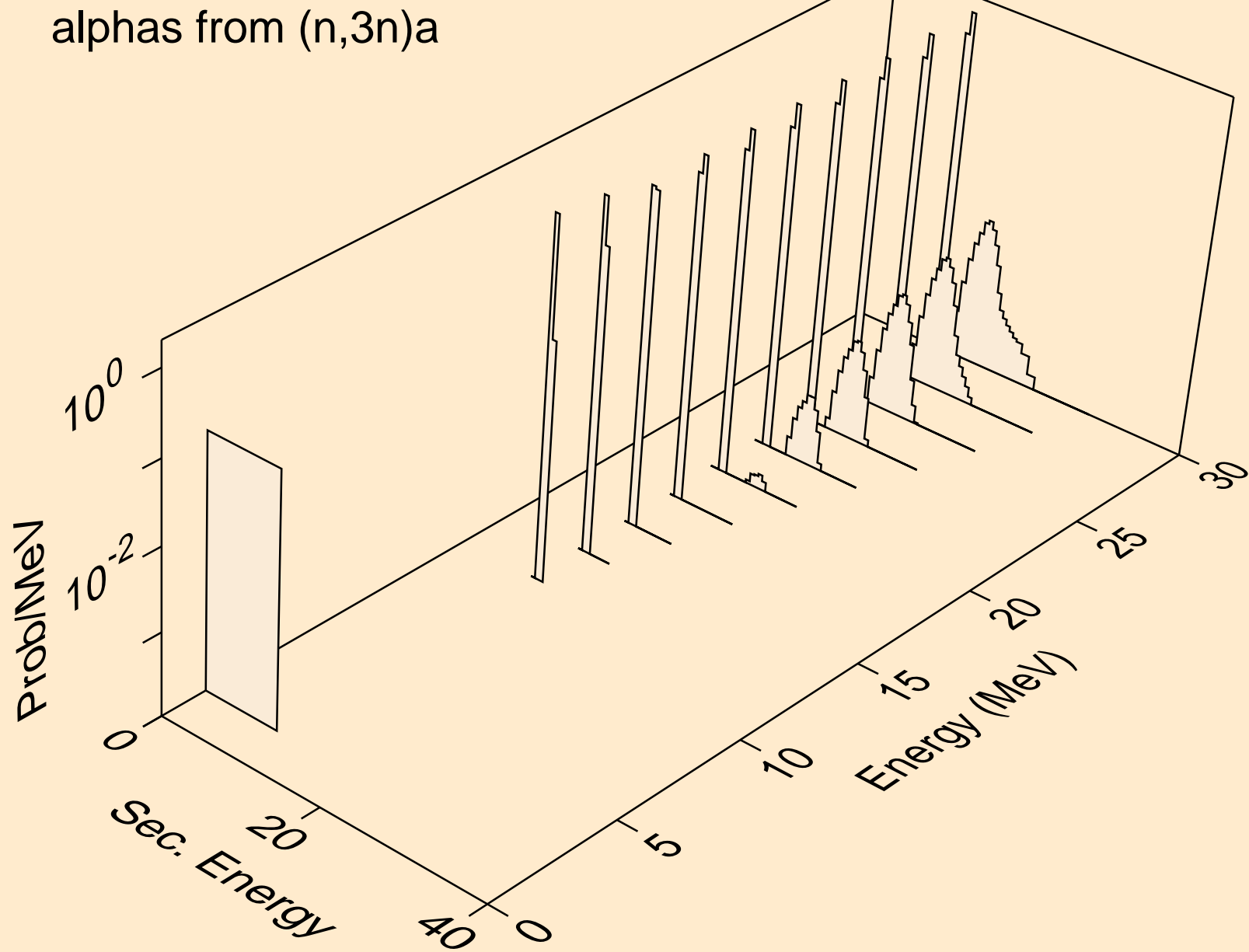

MT279 NEUTRON ACER TENDL-2023 LIBRARY; T=0.K  
alphas from (n,a)

