

N016 NEUTRON ACER TENDL-2023 LIBRARY; T=0.K

Principal cross sections

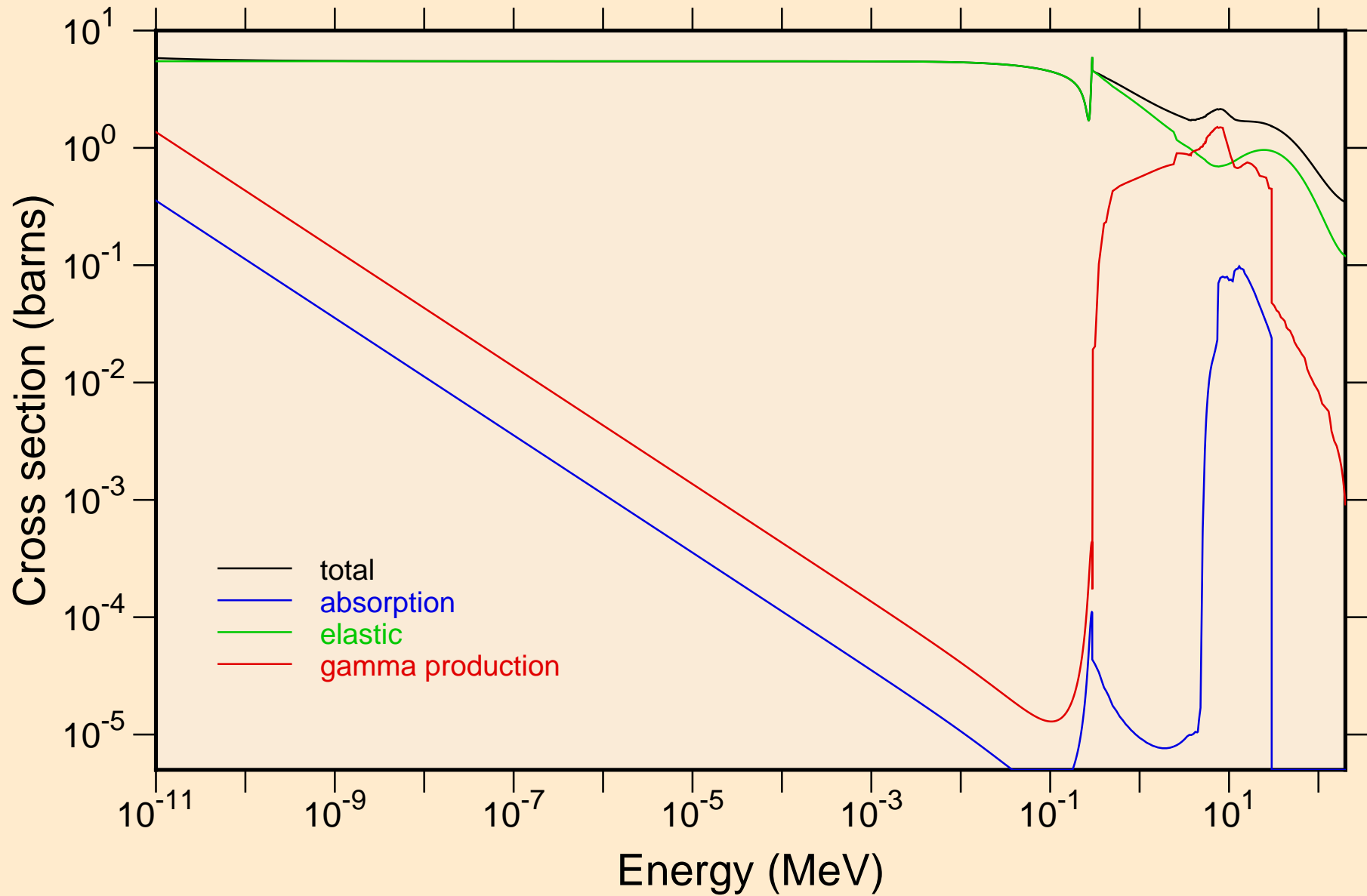

N016 NEUTRON ACER TENDL-2023 LIBRARY; T=0.K

Heating

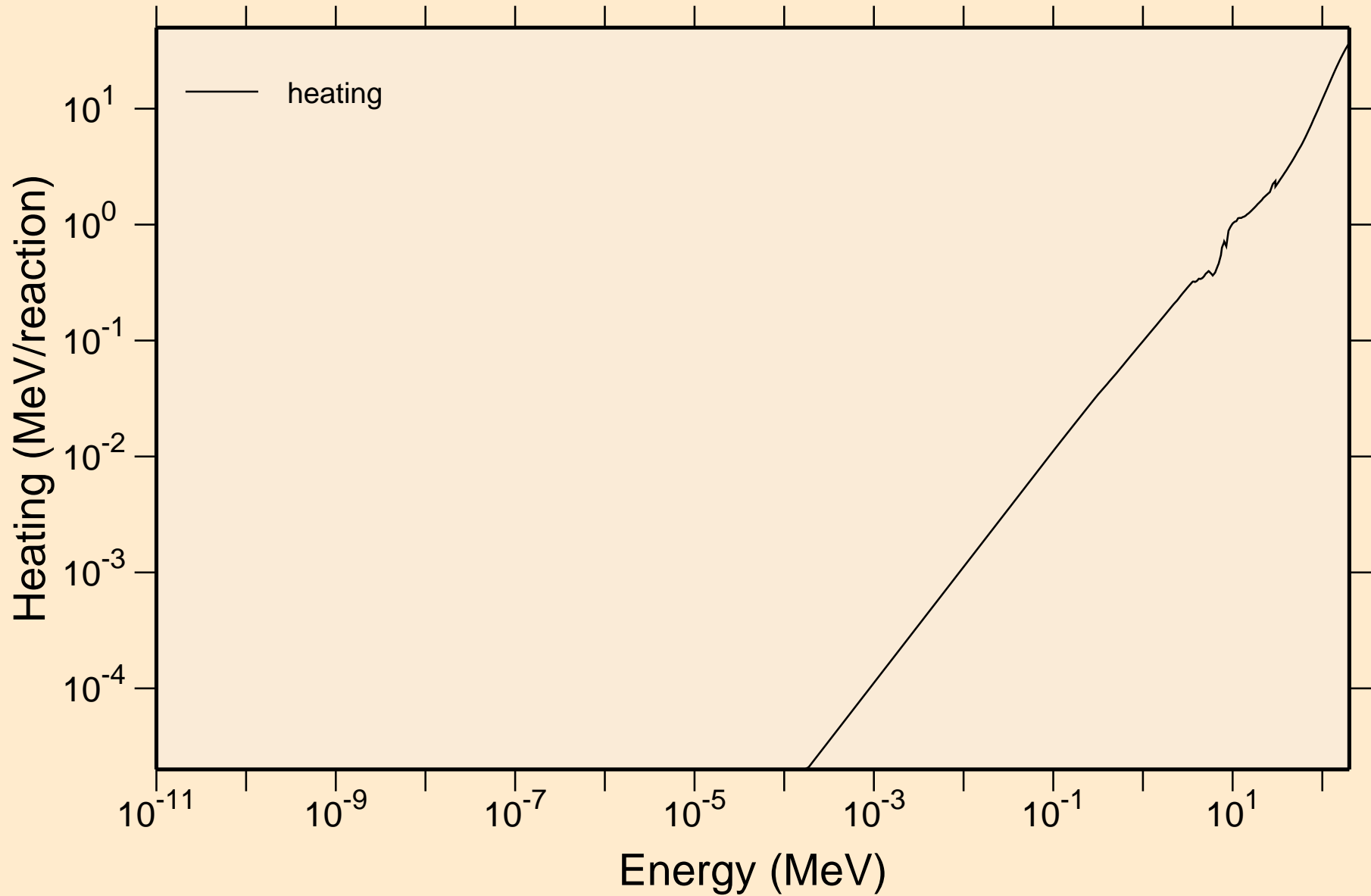

N016 NEUTRON ACER TENDL-2023 LIBRARY; T=0.K

Damage

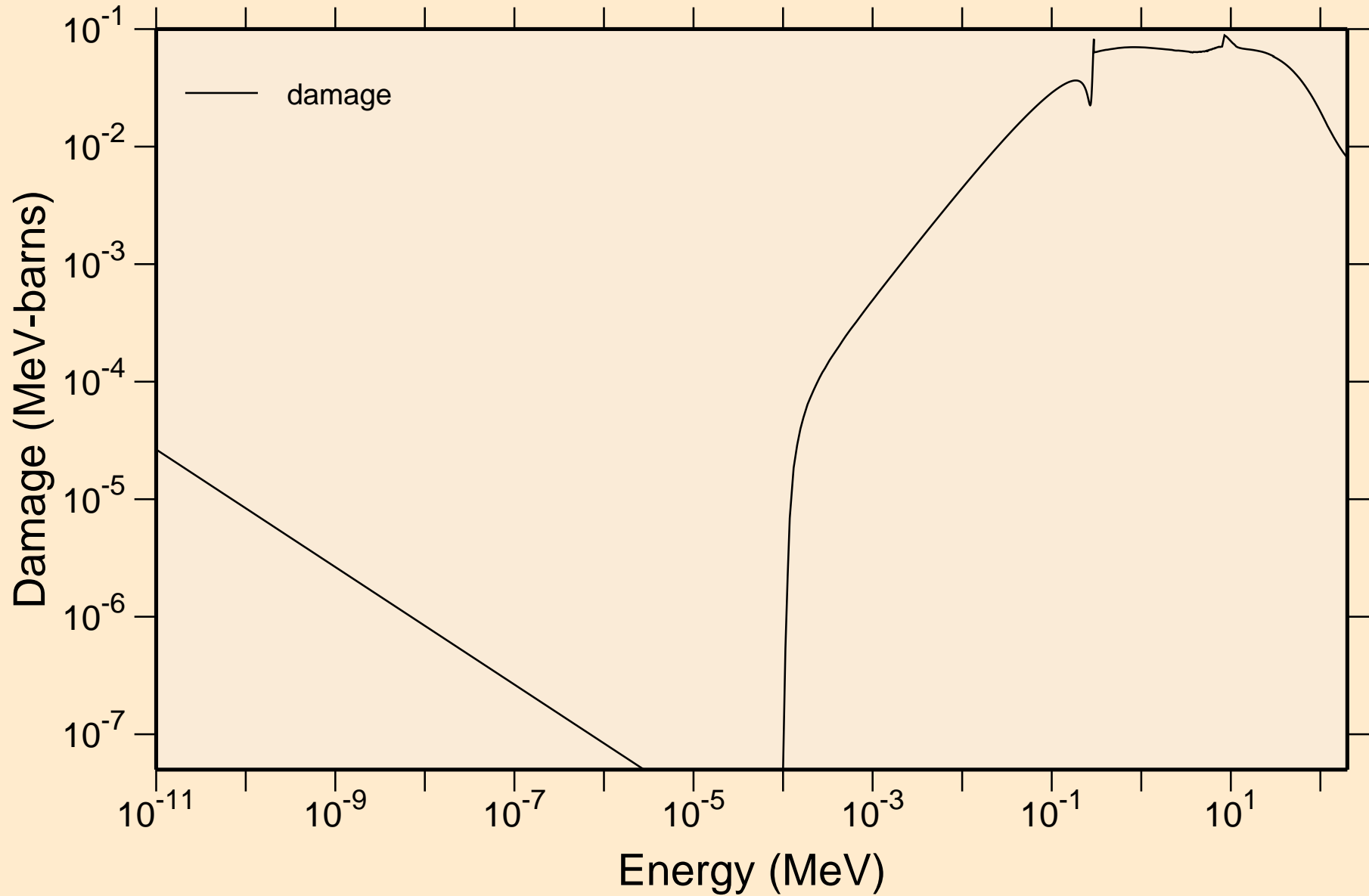

N016 NEUTRON ACER TENDL-2023 LIBRARY; T=0.K
Non-threshold reactions

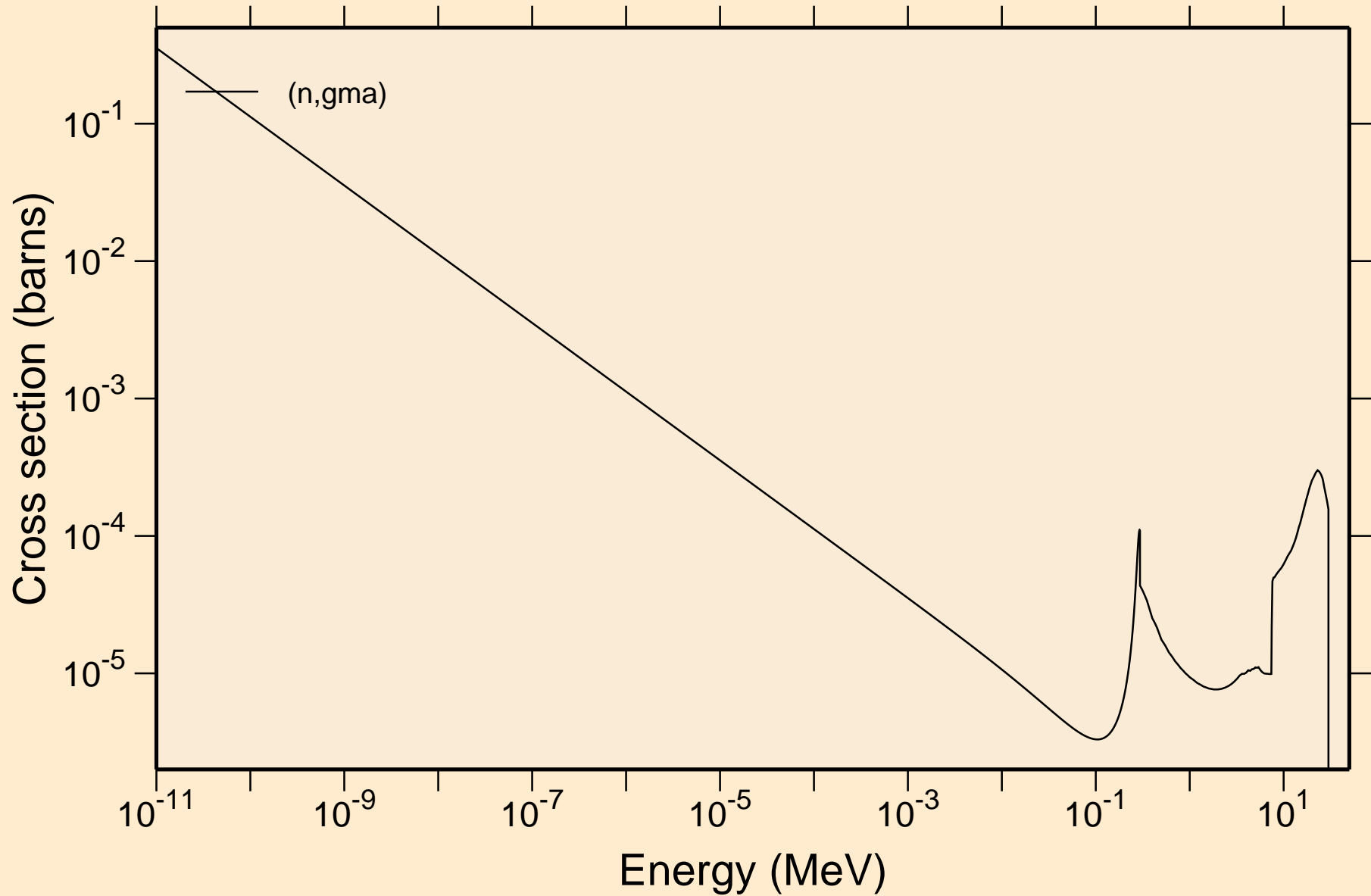

N016 NEUTRON ACER TENDL-2023 LIBRARY; T=0.K

Principal cross sections

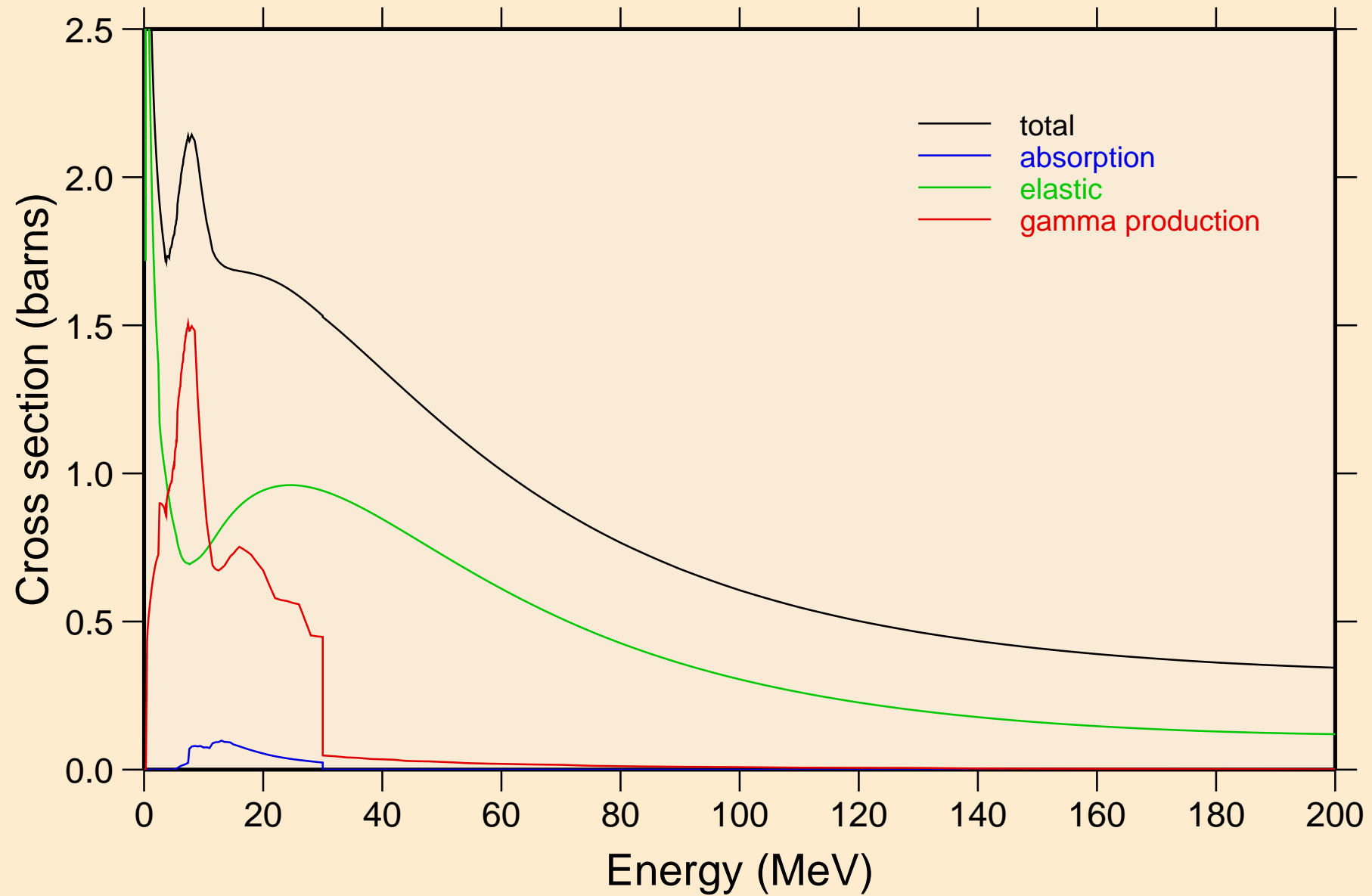

N016 NEUTRON ACER TENDL-2023 LIBRARY; T=0.K

Heating

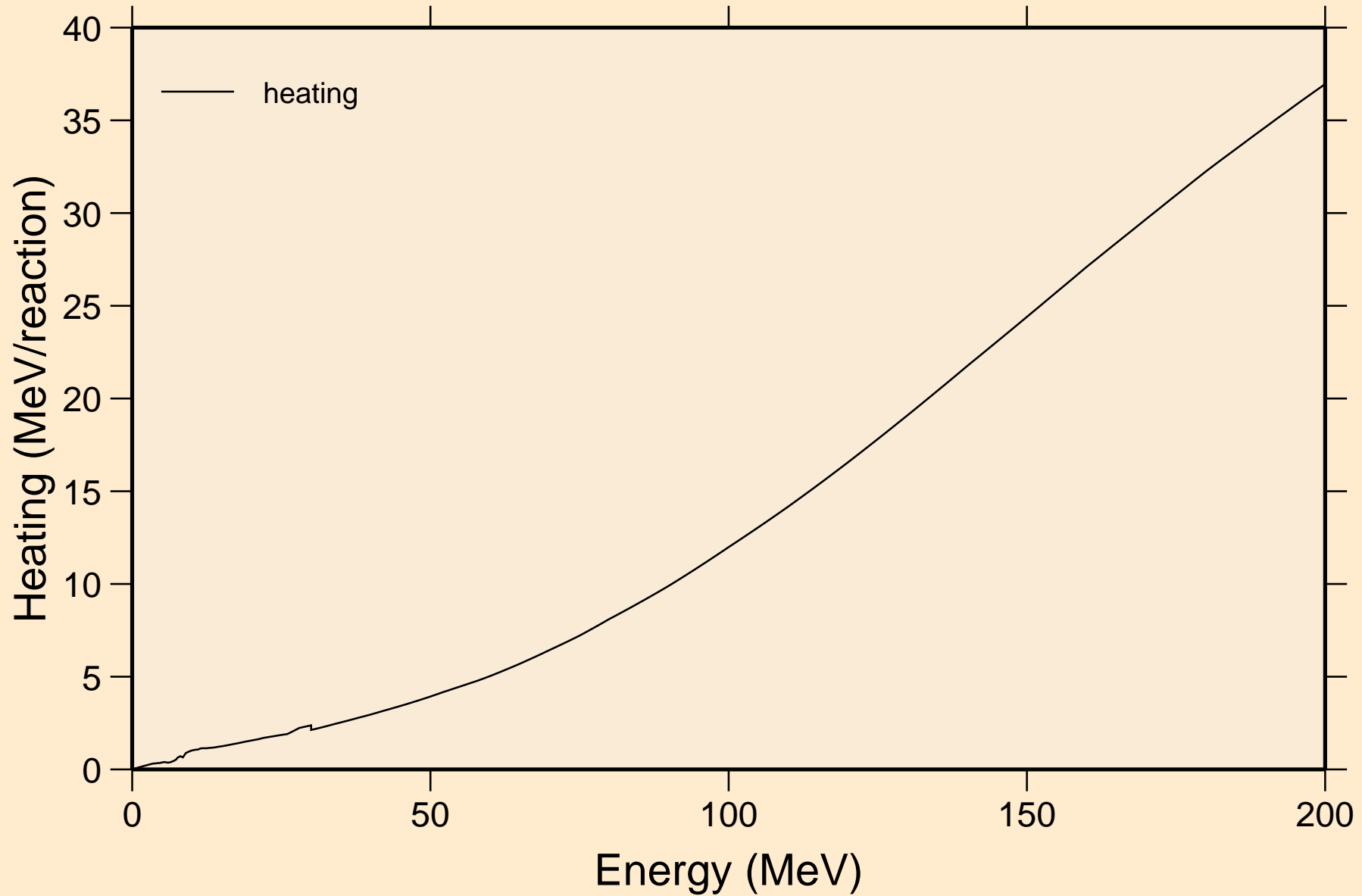

N016 NEUTRON ACER TENDL-2023 LIBRARY; T=0.K

Damage

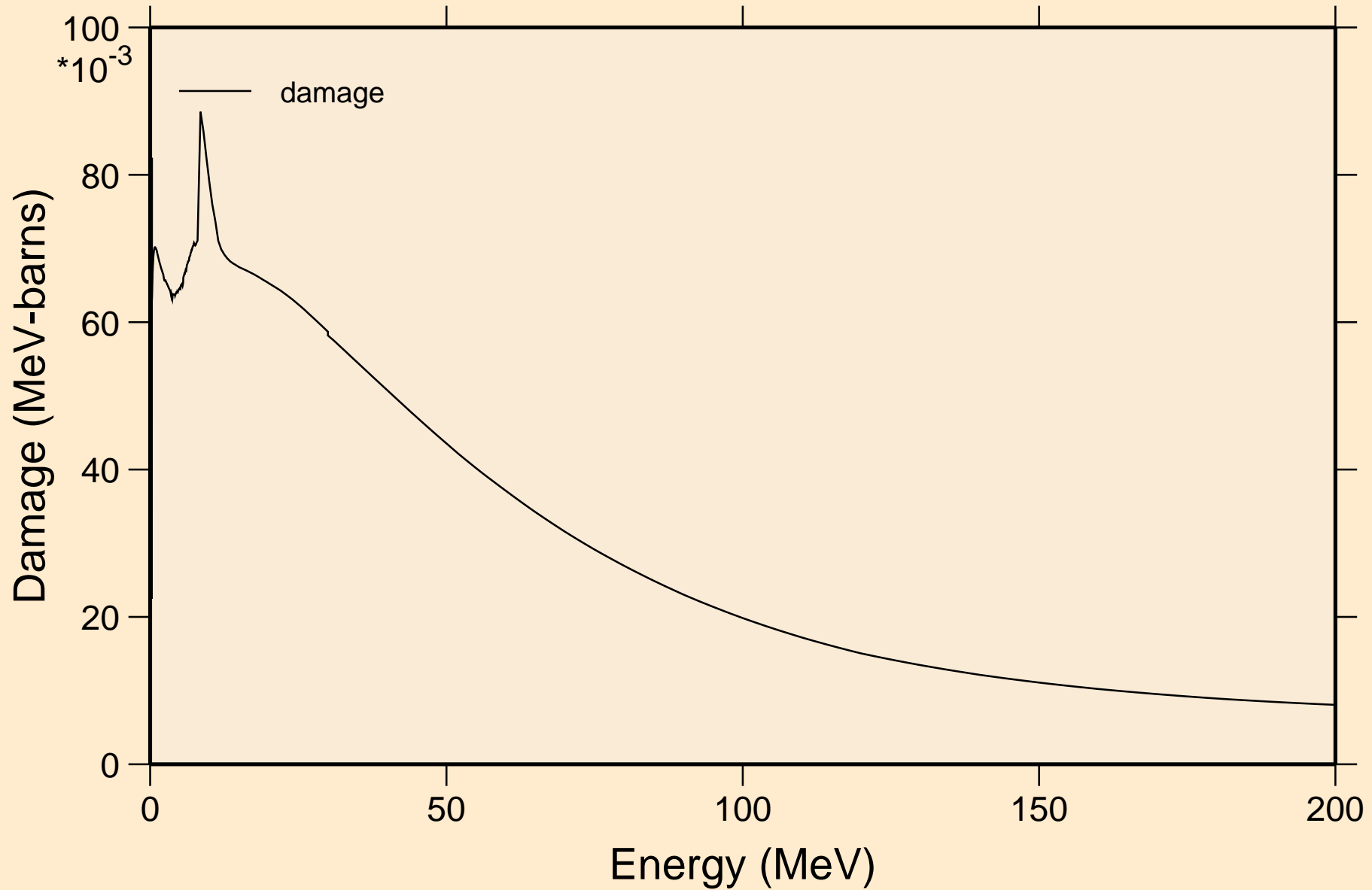

N016 NEUTRON ACER TENDL-2023 LIBRARY; T=0.K
Non-threshold reactions

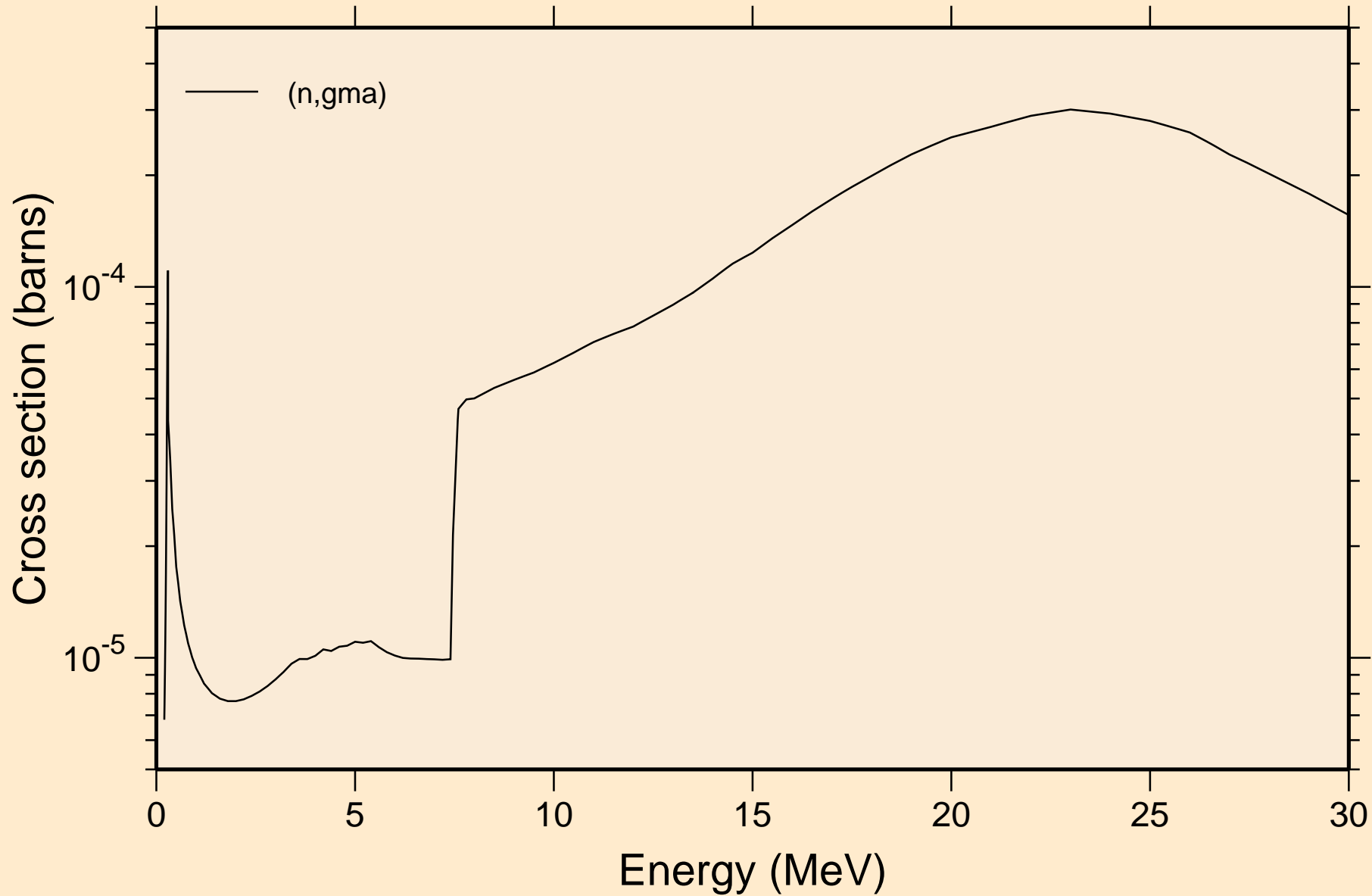

N016 NEUTRON ACER TENDL-2023 LIBRARY; T=0.K
Inelastic levels

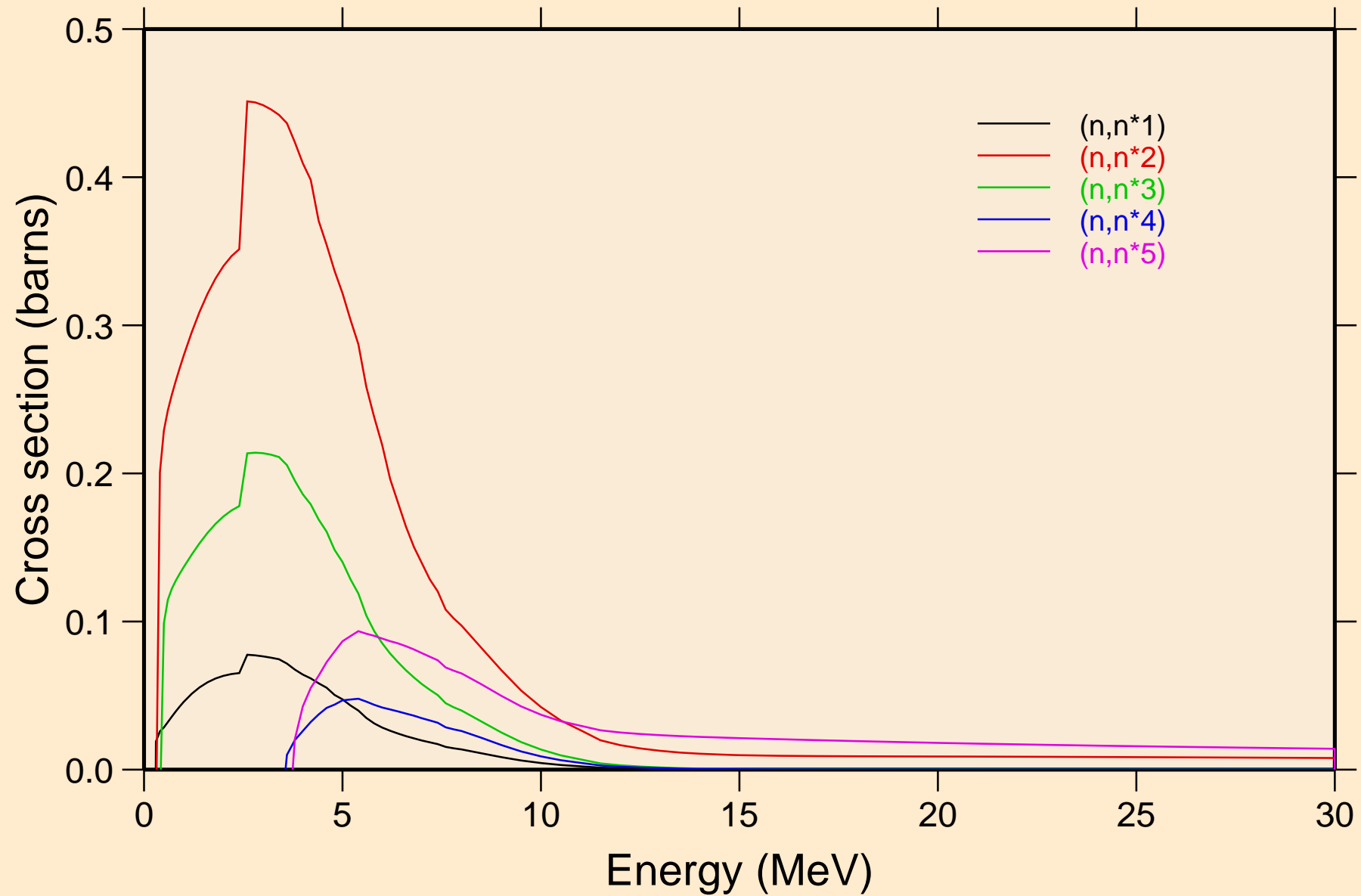

N016 NEUTRON ACER TENDL-2023 LIBRARY; T=0.K

Inelastic levels

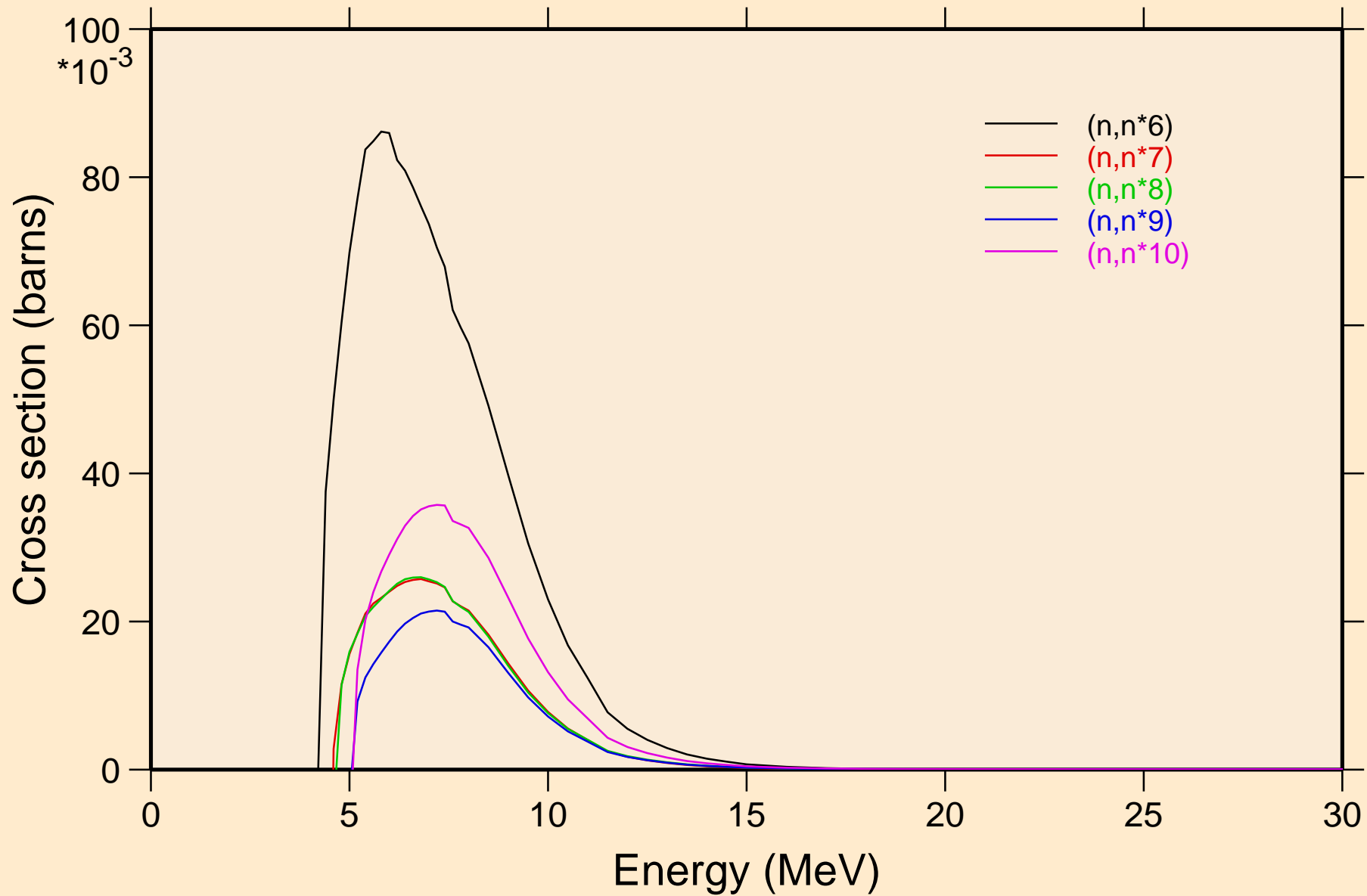

N016 NEUTRON ACER TENDL-2023 LIBRARY; T=0.K
Inelastic levels

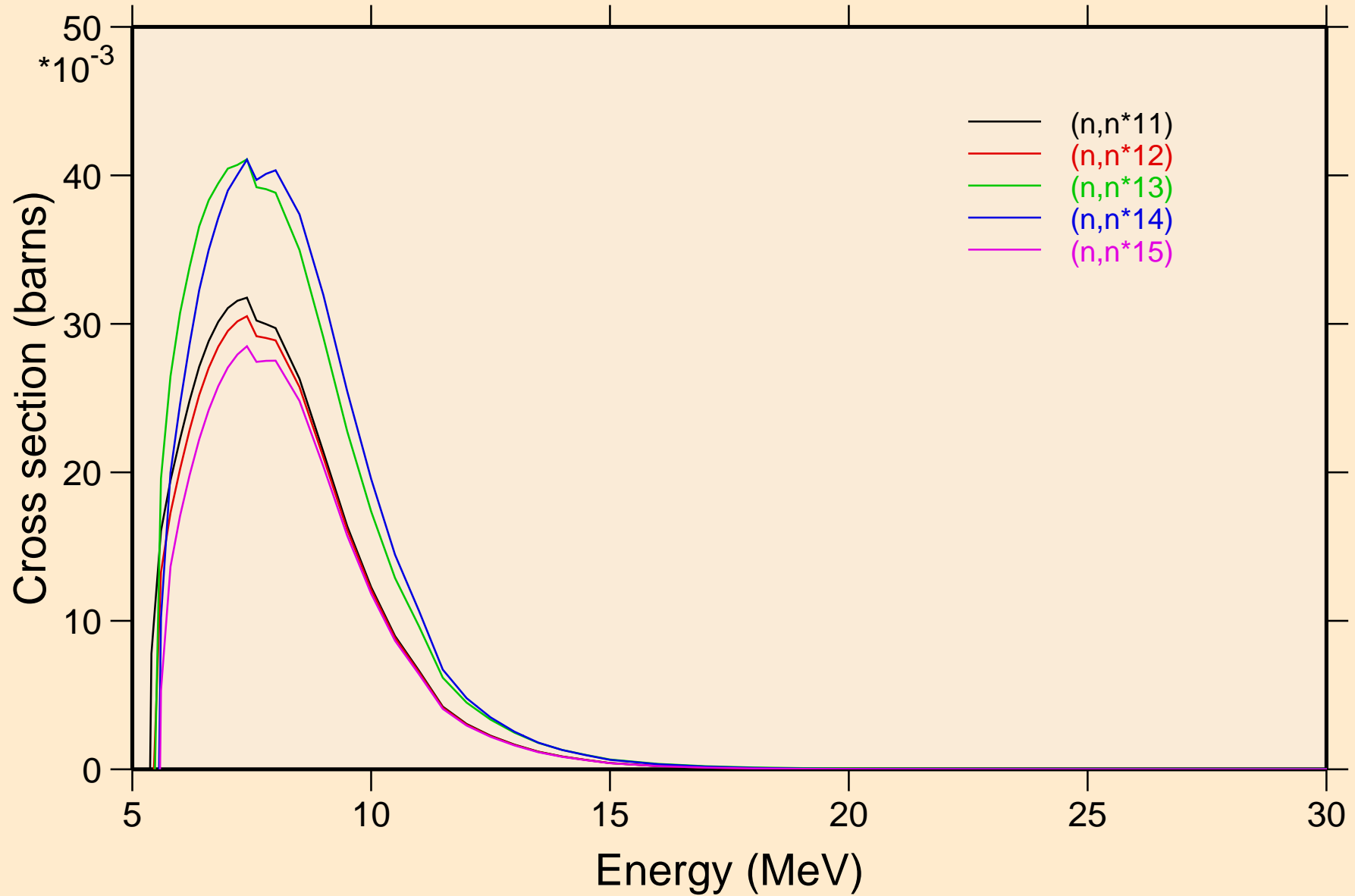

N016 NEUTRON ACER TENDL-2023 LIBRARY; T=0.K
Inelastic levels

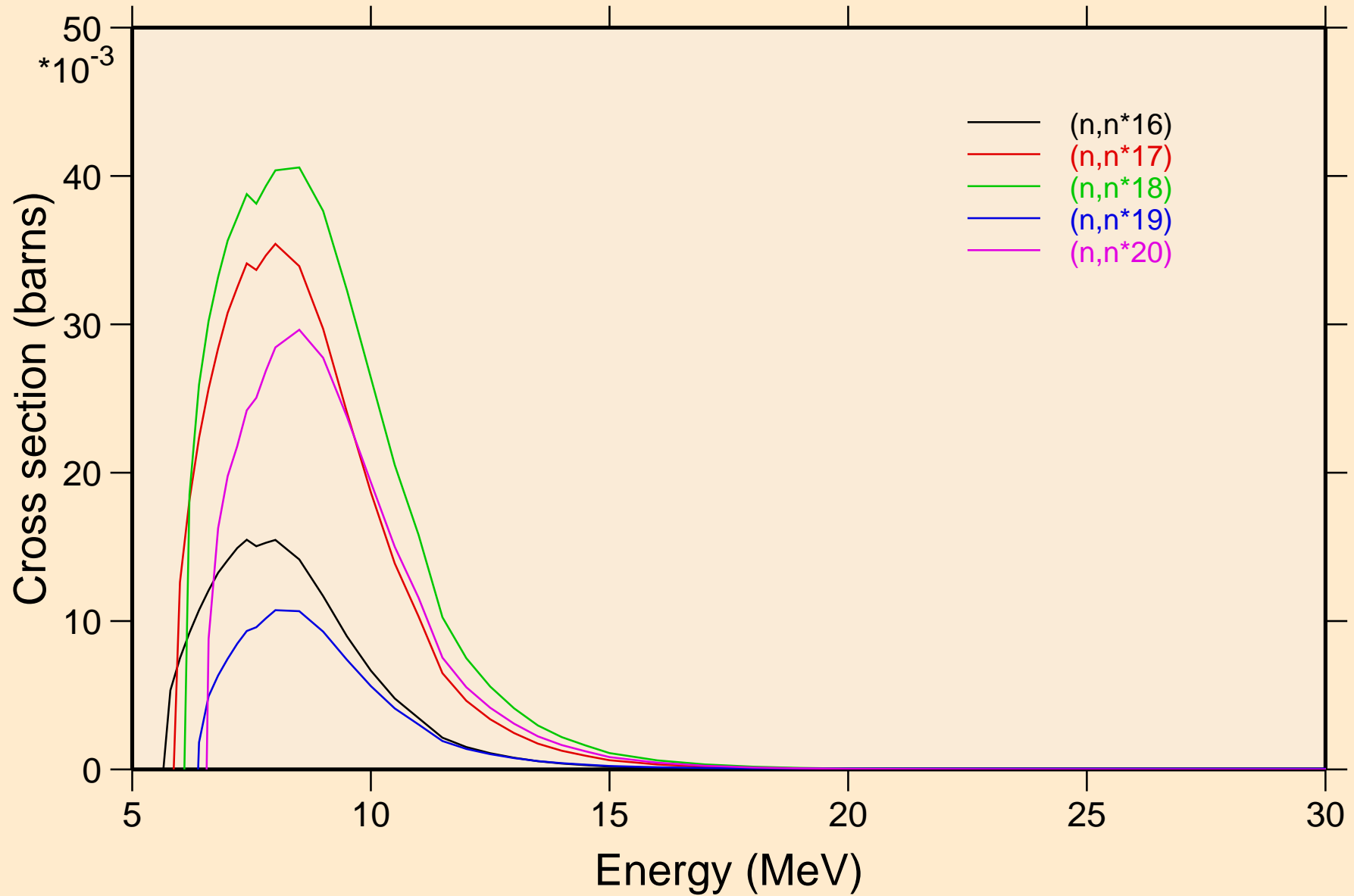

N016 NEUTRON ACER TENDL-2023 LIBRARY; T=0.K
Inelastic levels

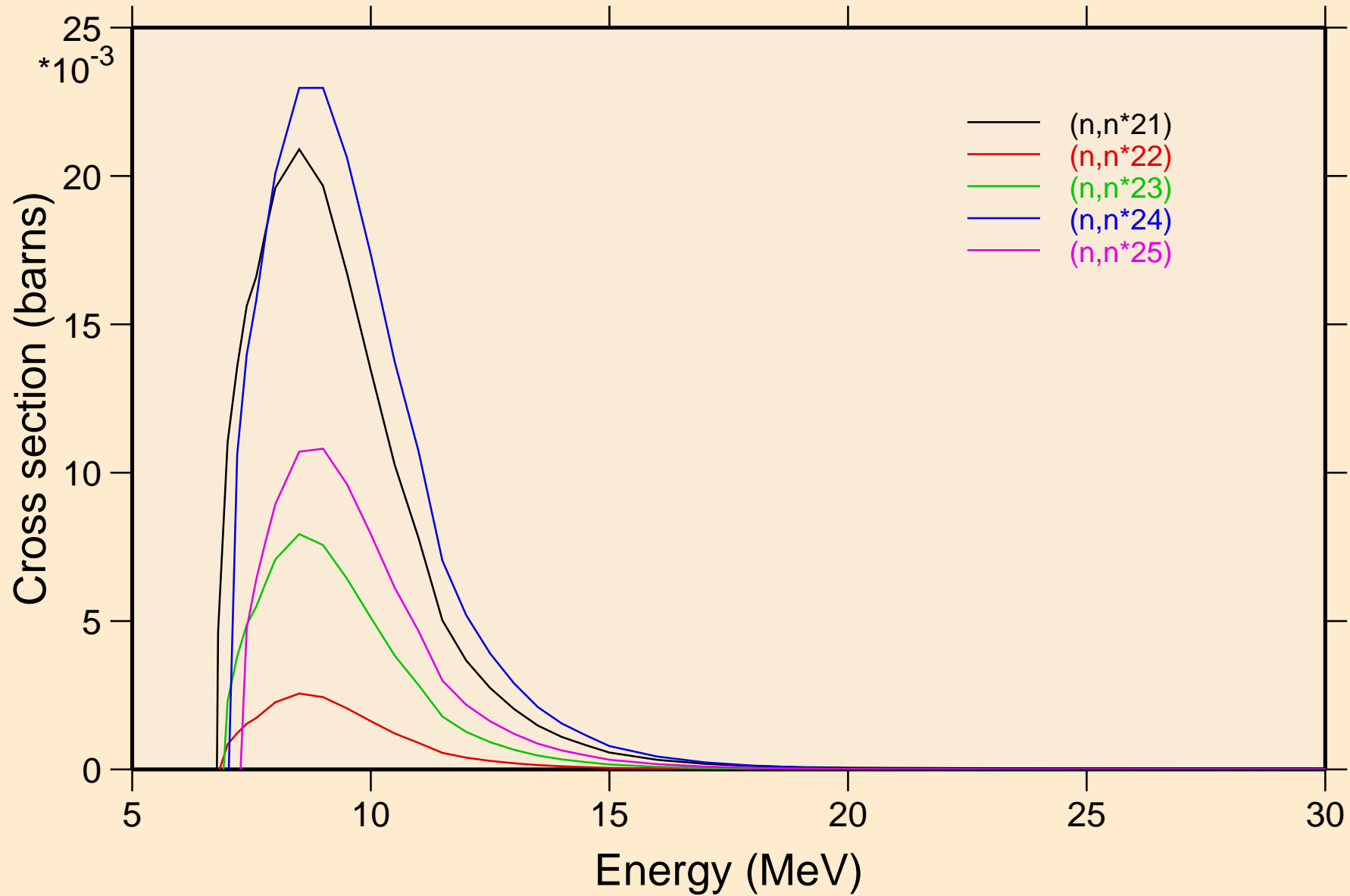

N016 NEUTRON ACER TENDL-2023 LIBRARY; T=0.K
Inelastic levels

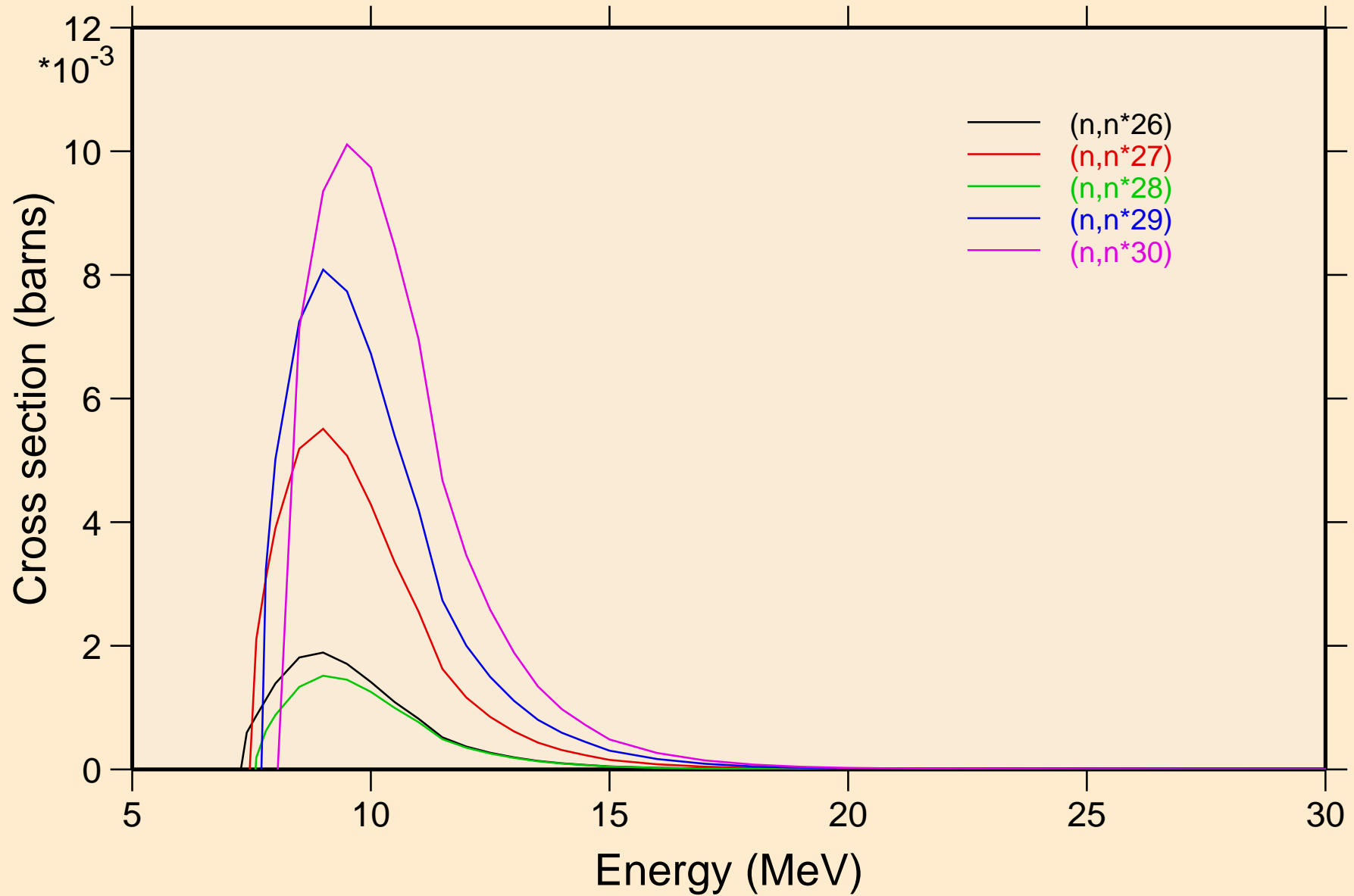

N016 NEUTRON ACER TENDL-2023 LIBRARY; T=0.K

Threshold reactions

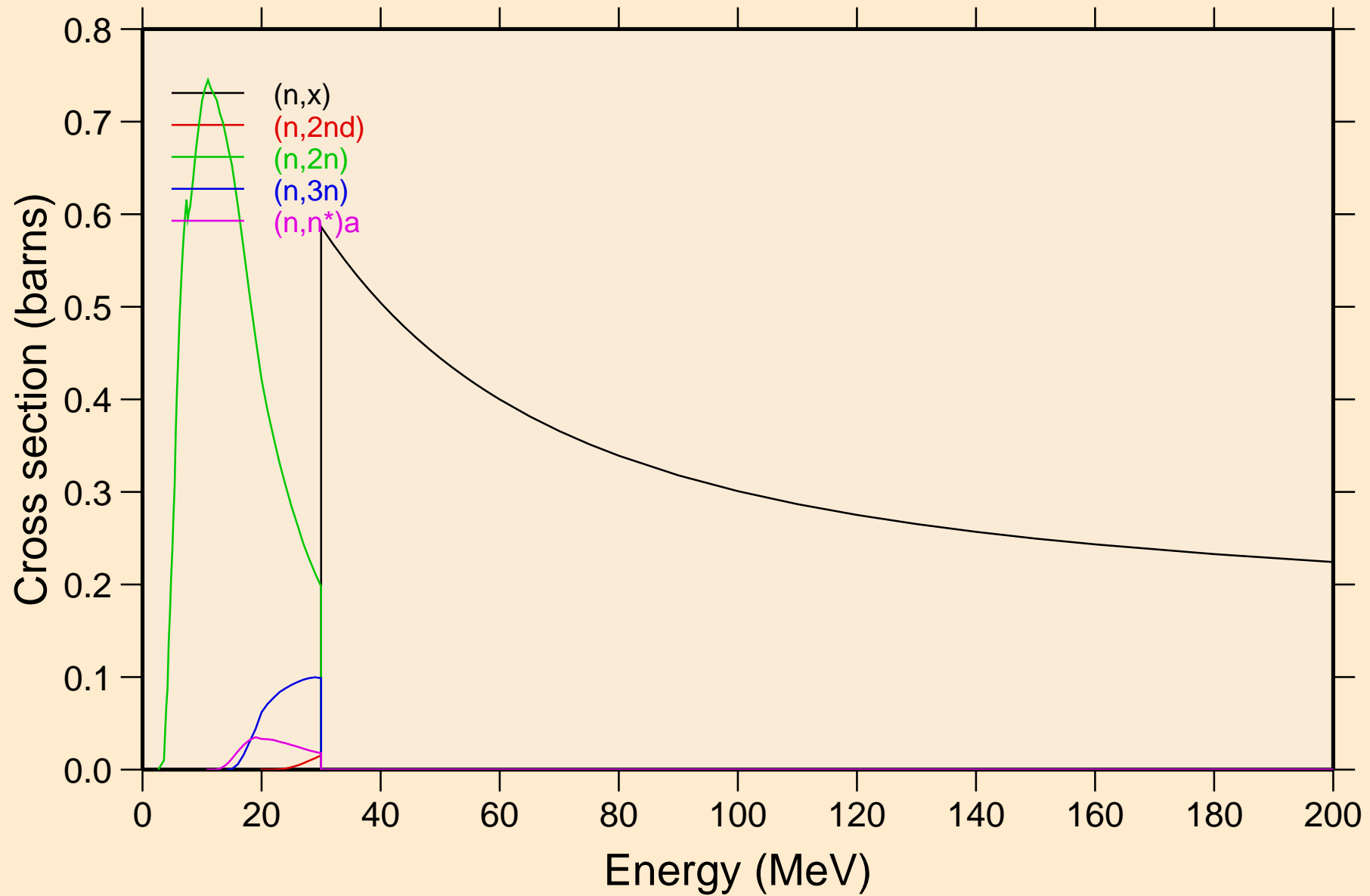

N016 NEUTRON ACER TENDL-2023 LIBRARY; T=0.K

Threshold reactions

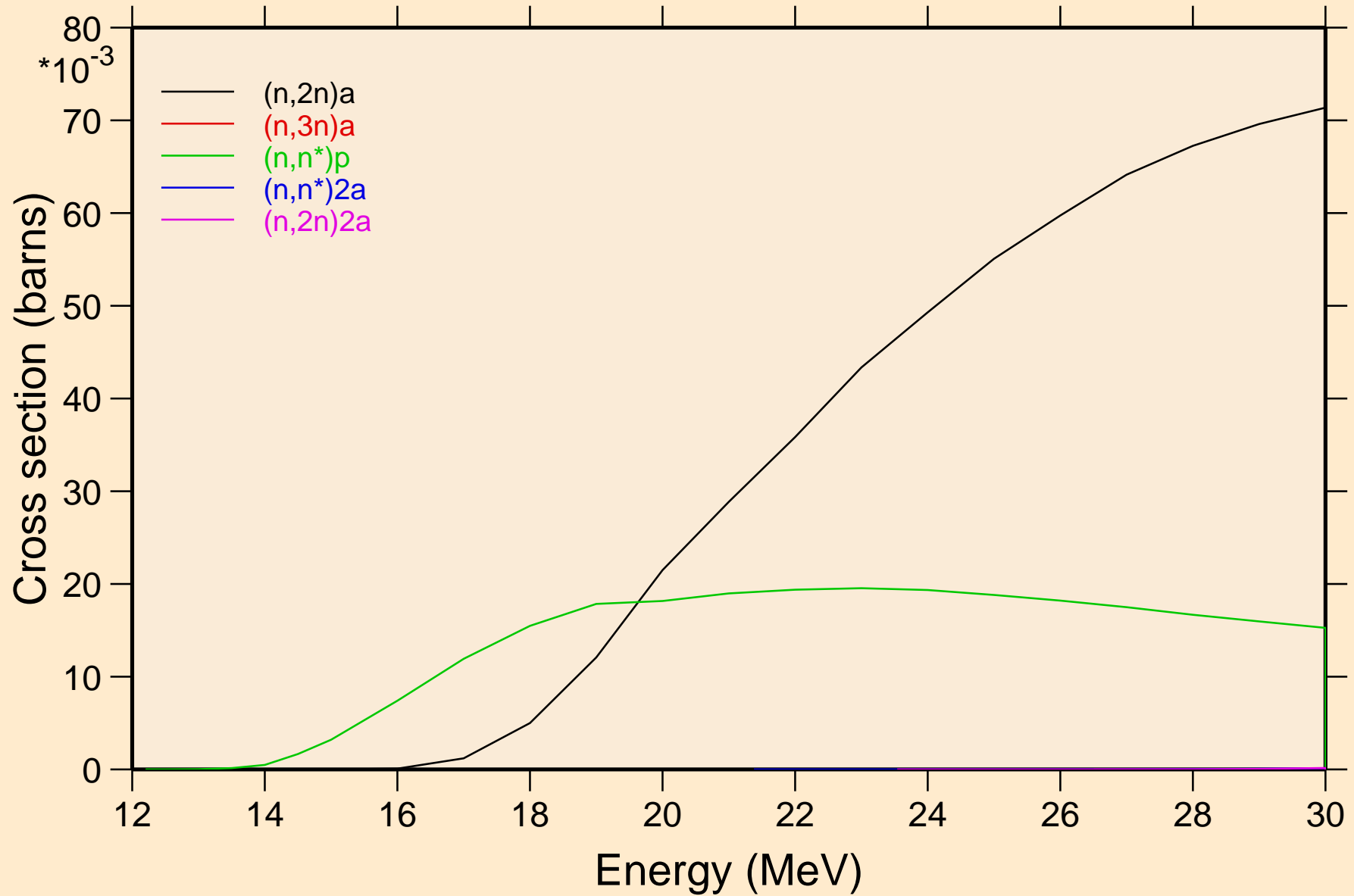

N016 NEUTRON ACER TENDL-2023 LIBRARY; T=0.K

Threshold reactions

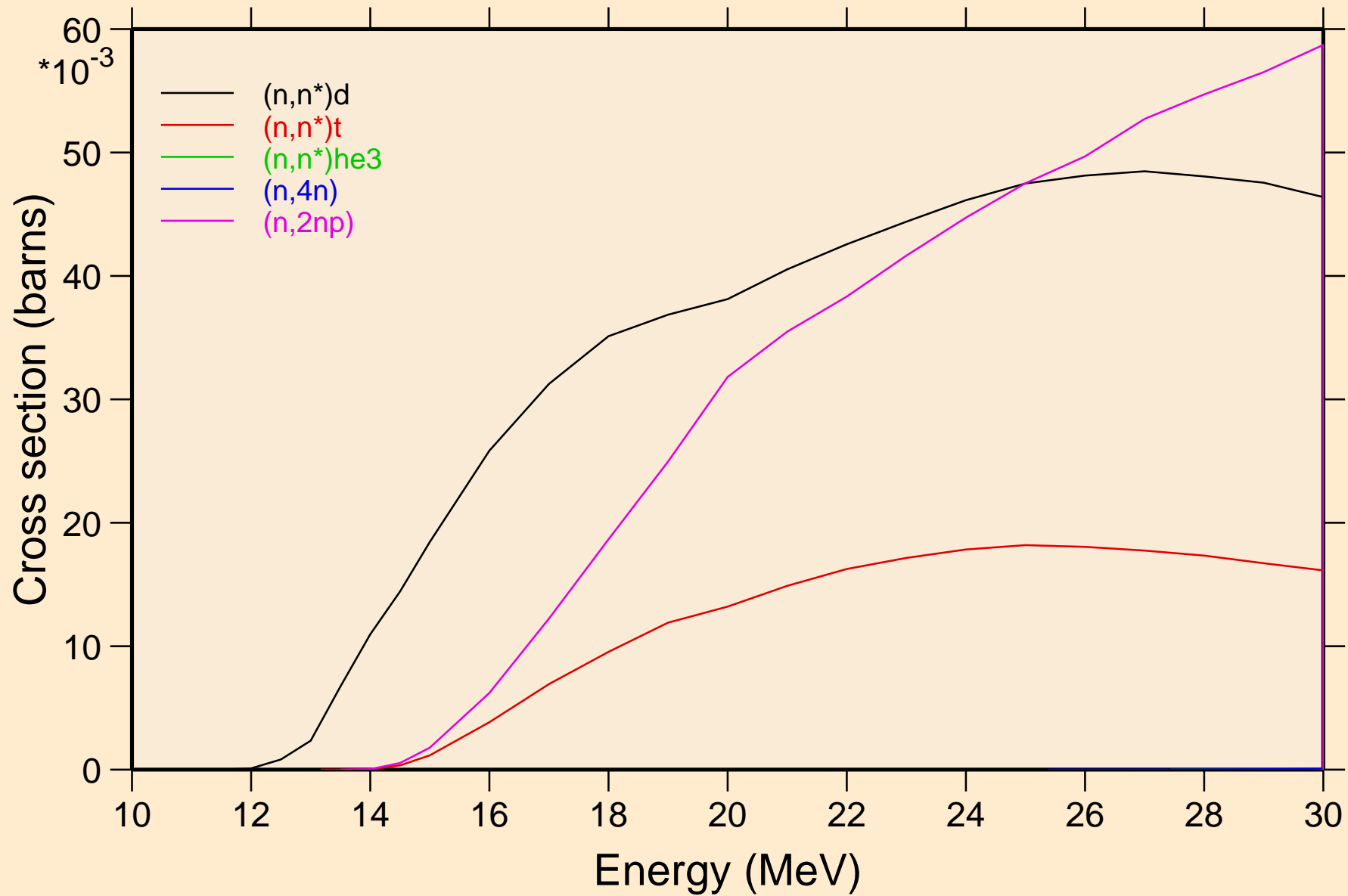

N016 NEUTRON ACER TENDL-2023 LIBRARY; T=0.K

Threshold reactions

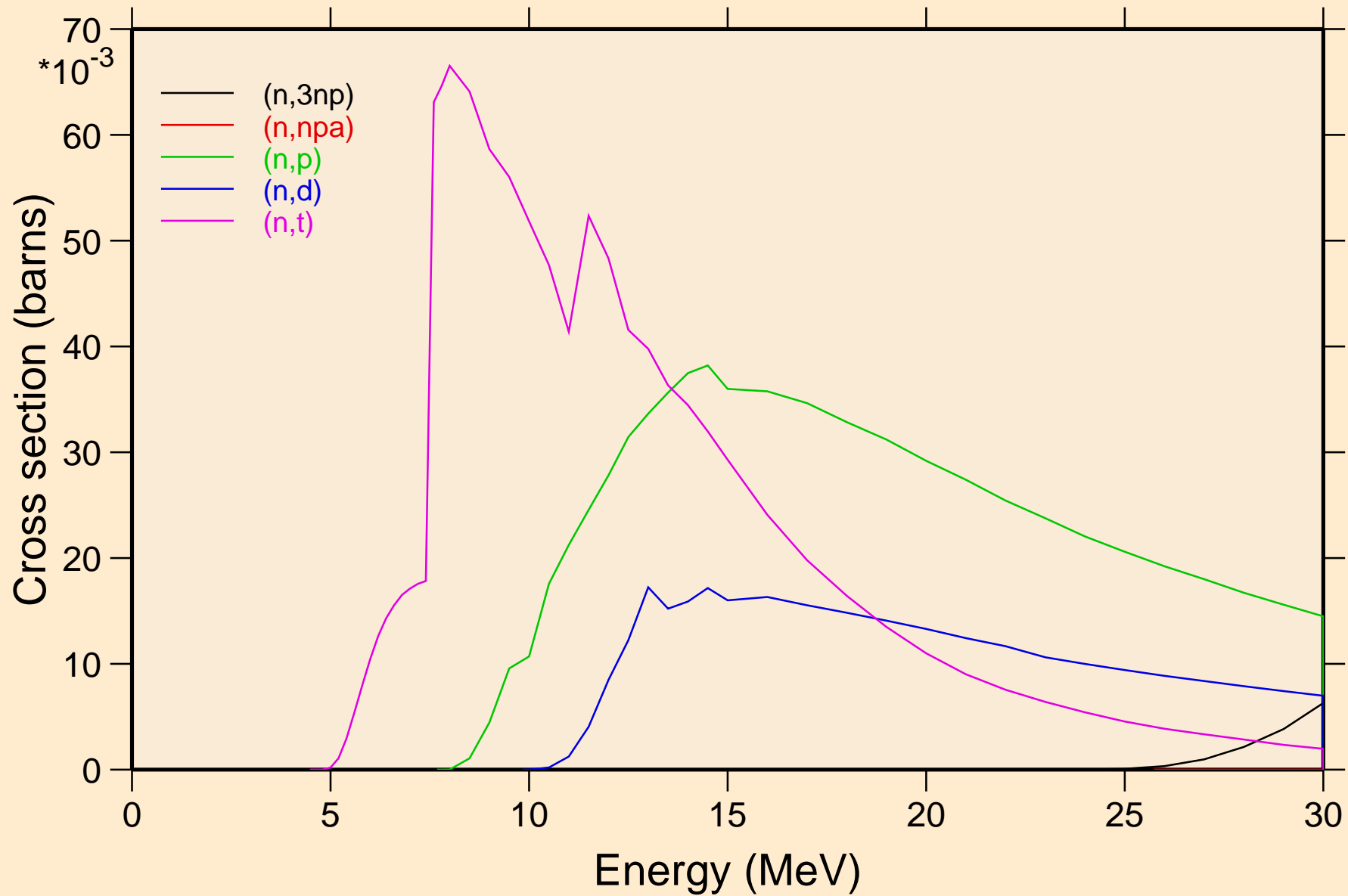

N016 NEUTRON ACER TENDL-2023 LIBRARY; T=0.K

Threshold reactions

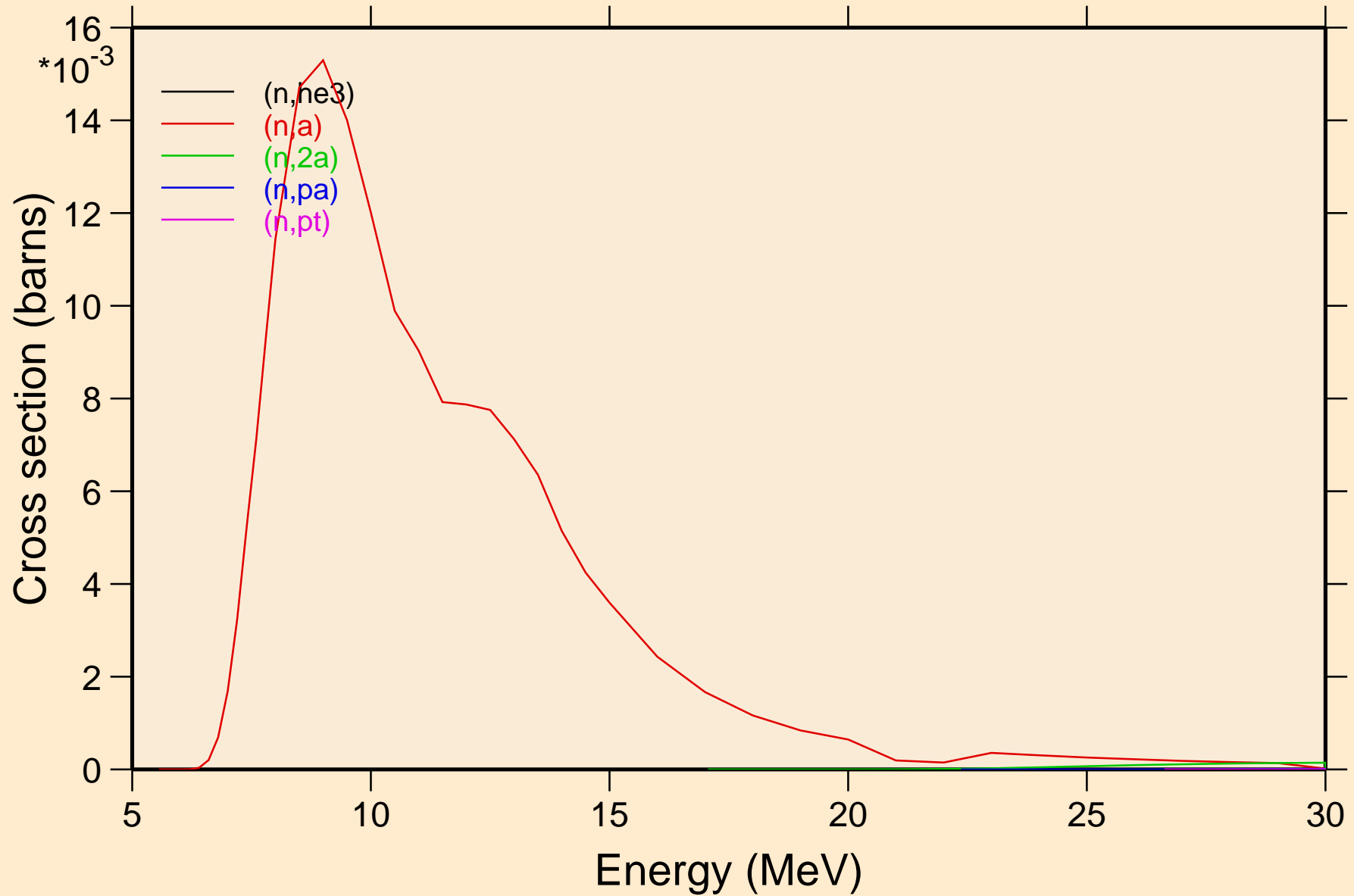

N016 NEUTRON ACER TENDL-2023 LIBRARY; T=0.K
Threshold reactions

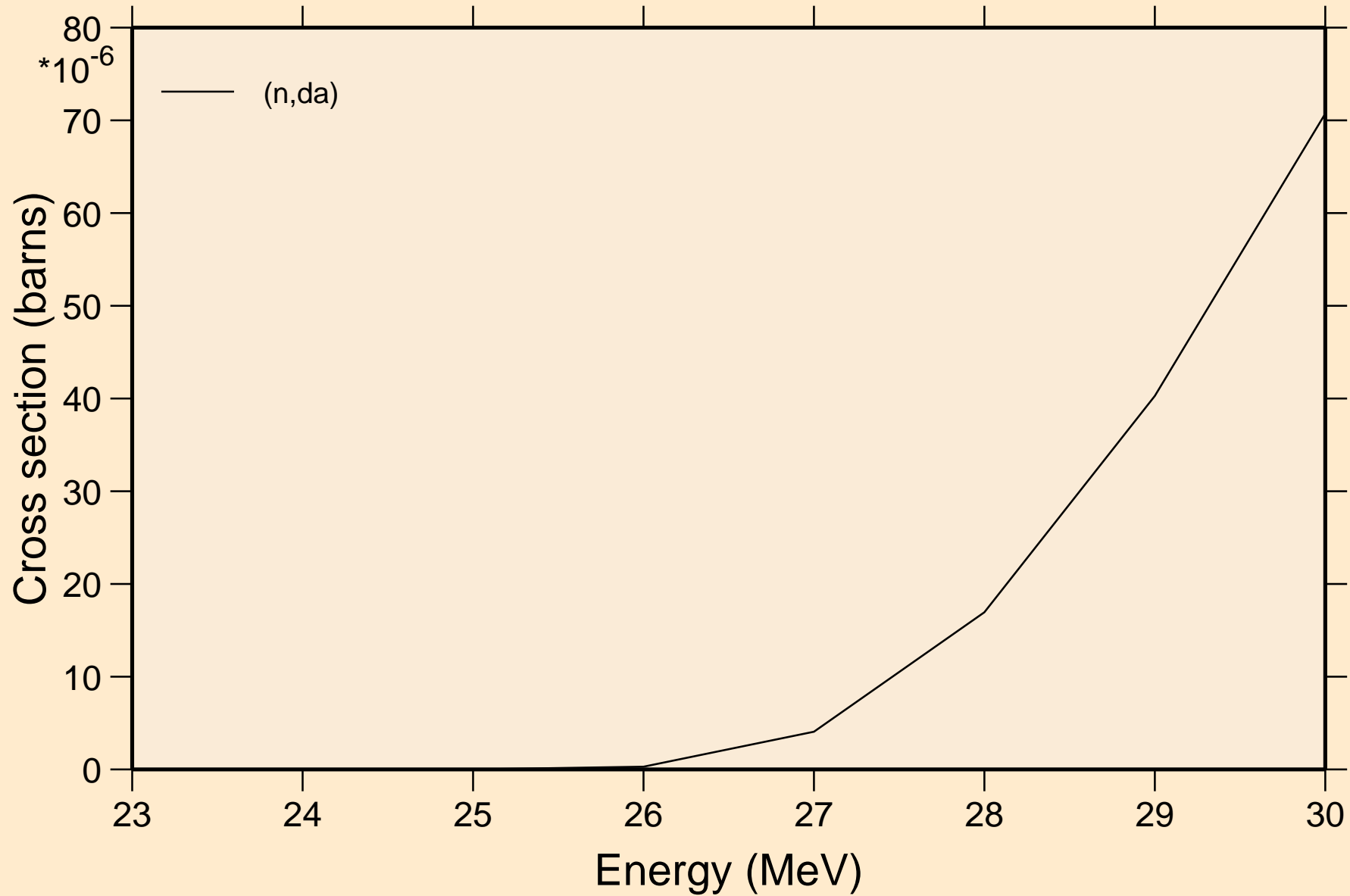

N016 NEUTRON ACER TENDL-2023 LIBRARY; T=0.K

Threshold reactions

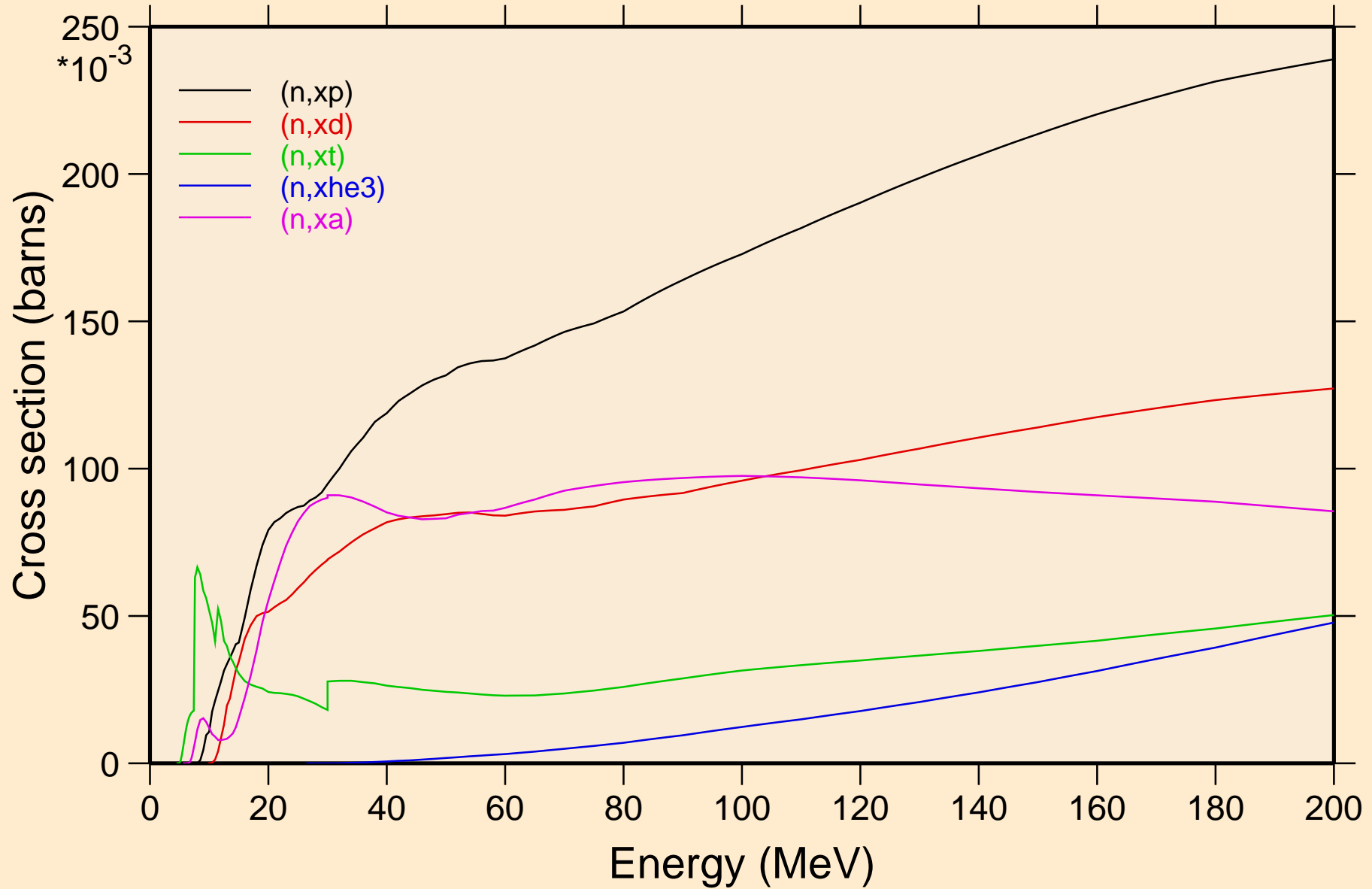

N016 NEUTRON ACER TENDL-2023 LIBRARY; T=0.K
angular distribution for elastic

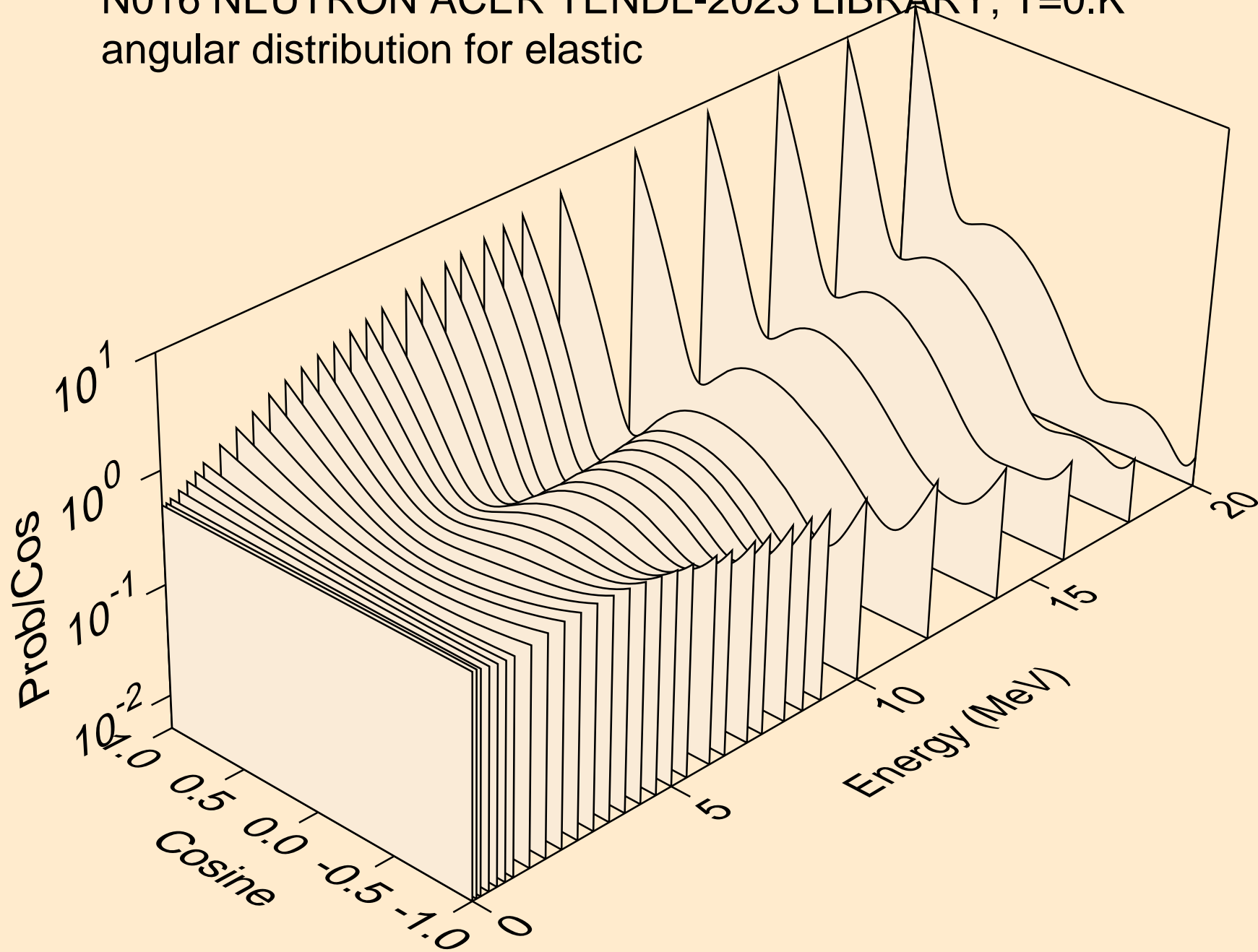

N016 NEUTRON ACER TENDL-2023 LIBRARY; T=0.K
angular distribution for elastic

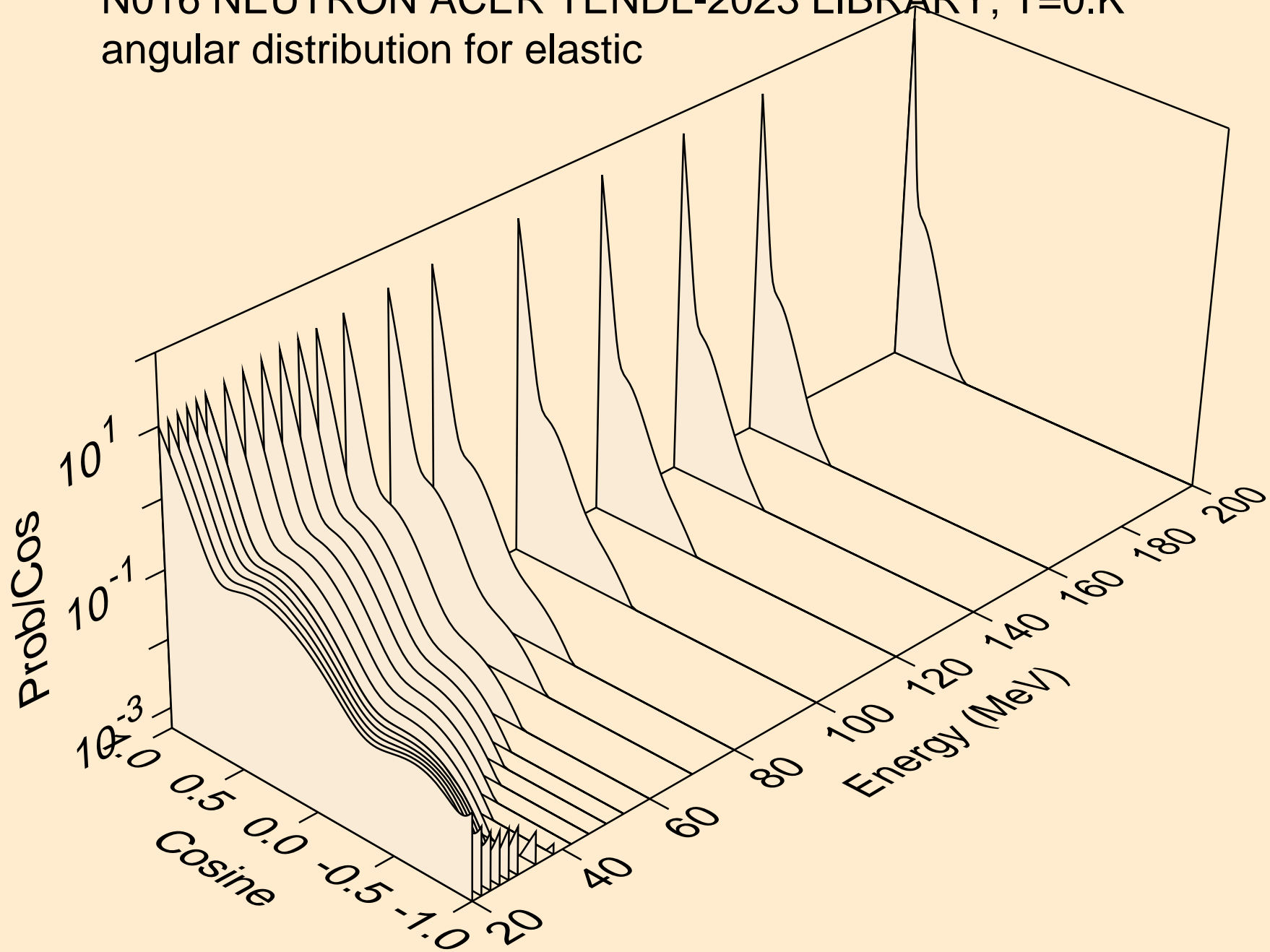

N016 NEUTRON ACER TENDL-2023 LIBRARY; T=0.K
angular distribution for (n,n*1)

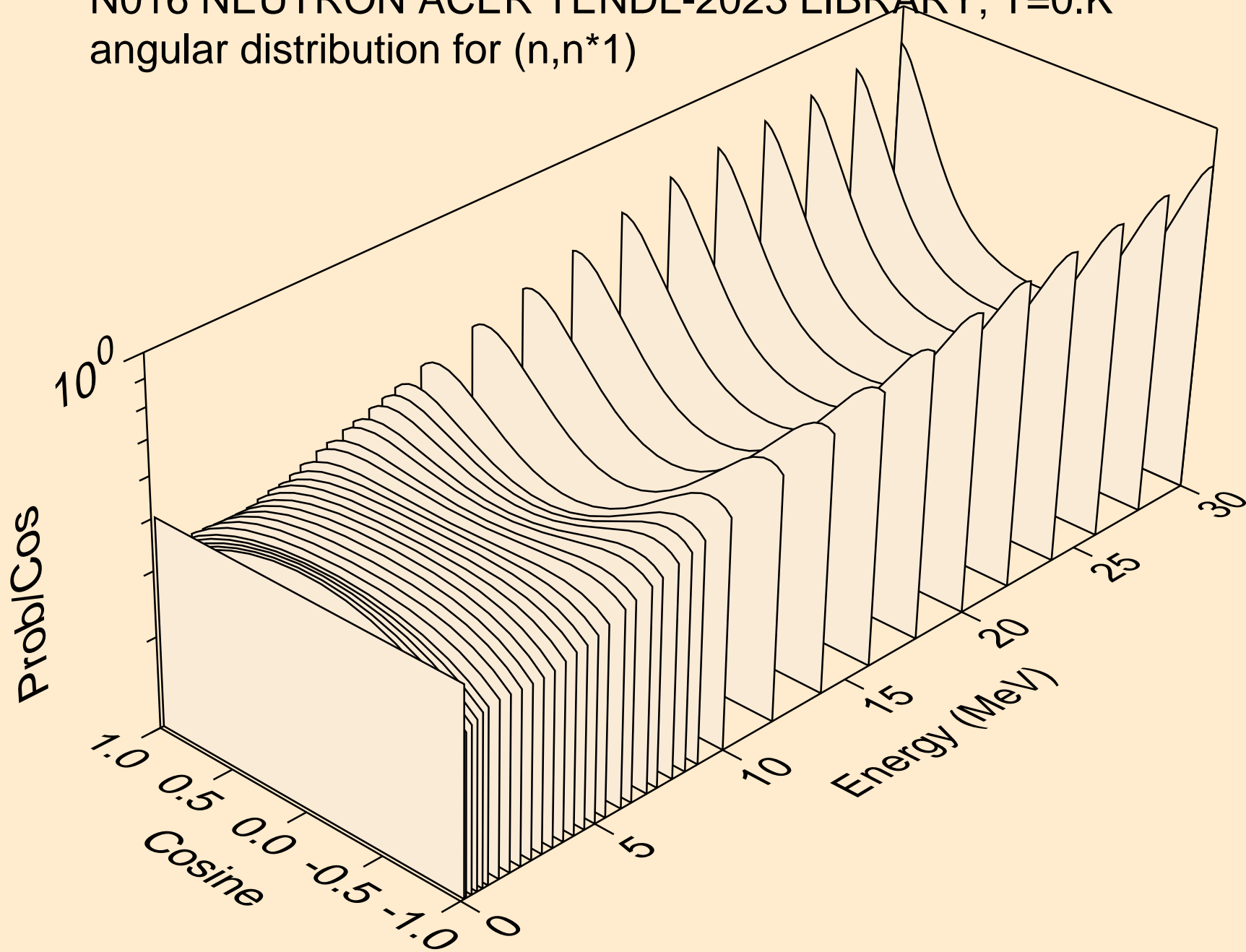

N016 NEUTRON ACER TENDL-2023 LIBRARY; T=0.K
angular distribution for (n,n*2)

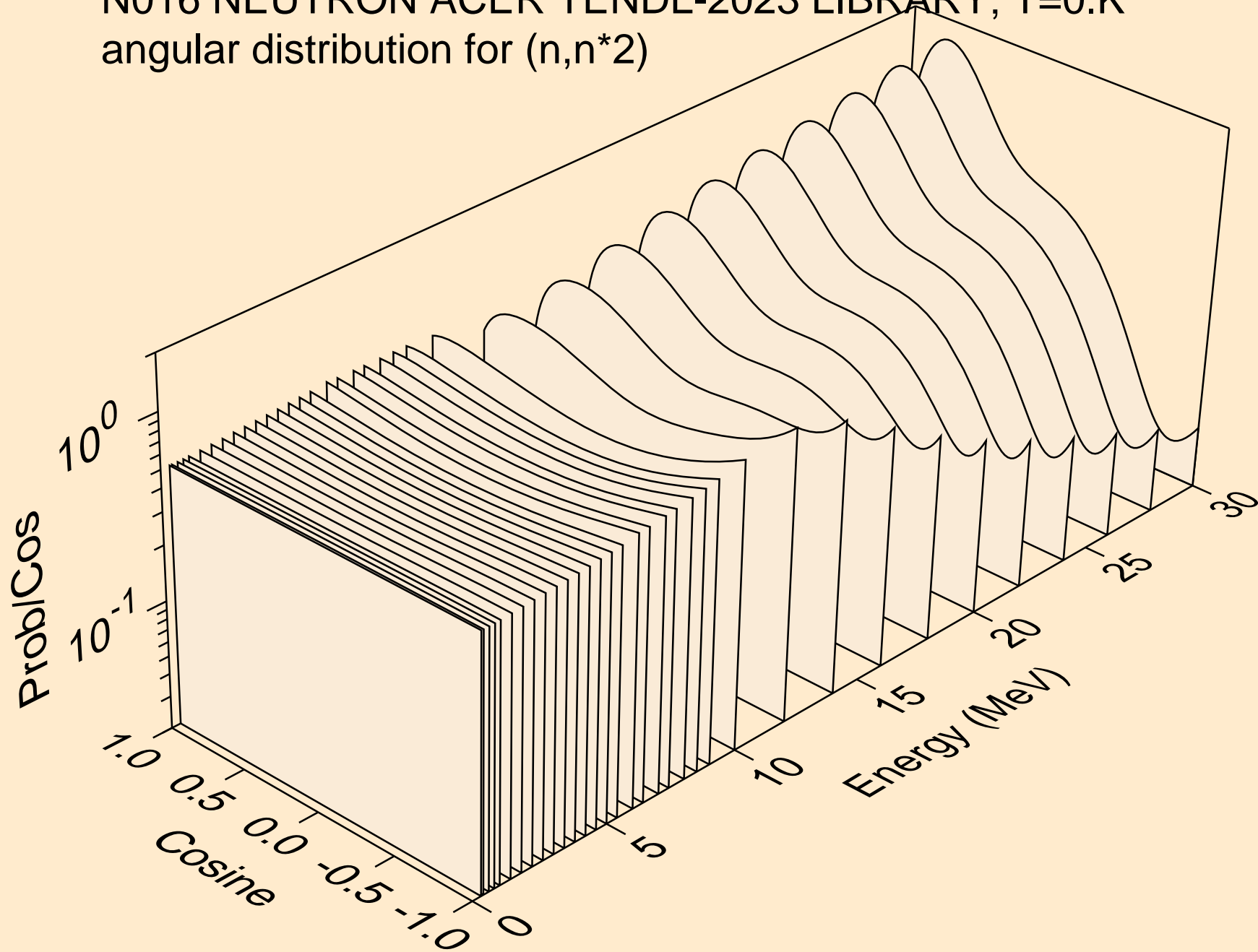

N016 NEUTRON ACER TENDL-2023 LIBRARY; T=0.K
angular distribution for (n,n*3)

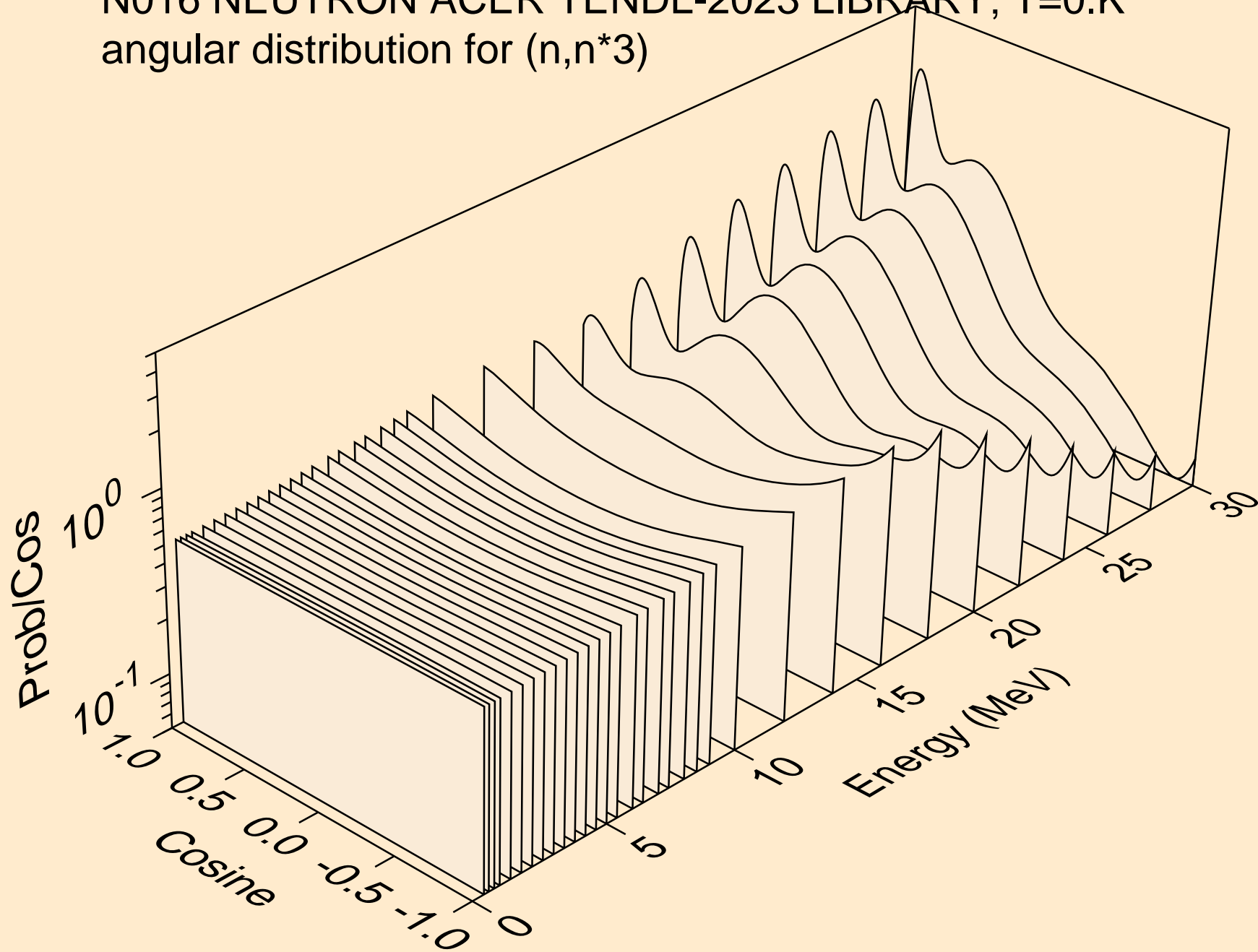

N016 NEUTRON ACER TENDL-2023 LIBRARY; T=0.K
angular distribution for (n,n*4)

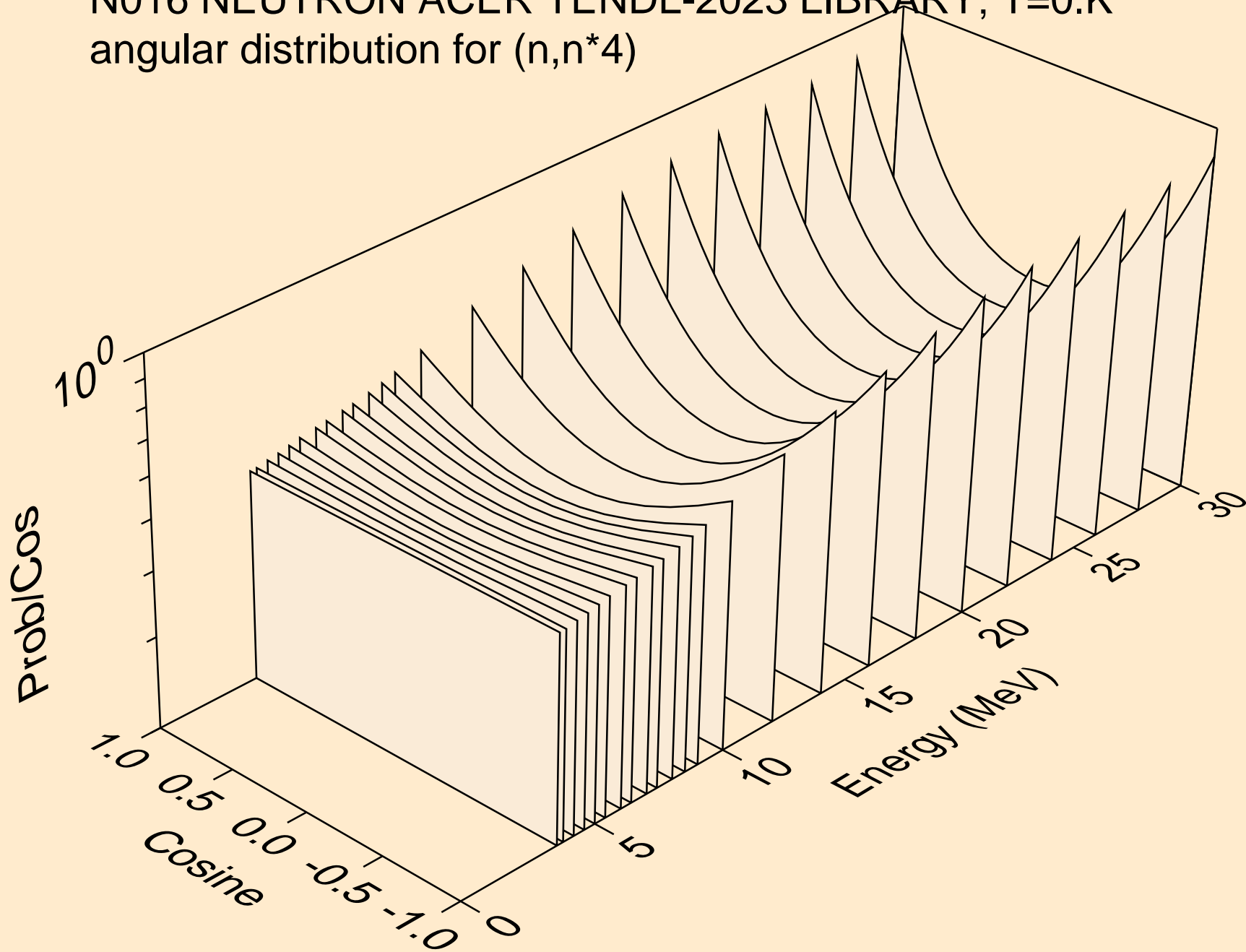

N016 NEUTRON ACER TENDL-2023 LIBRARY; T=0.K
angular distribution for (n,n*5)

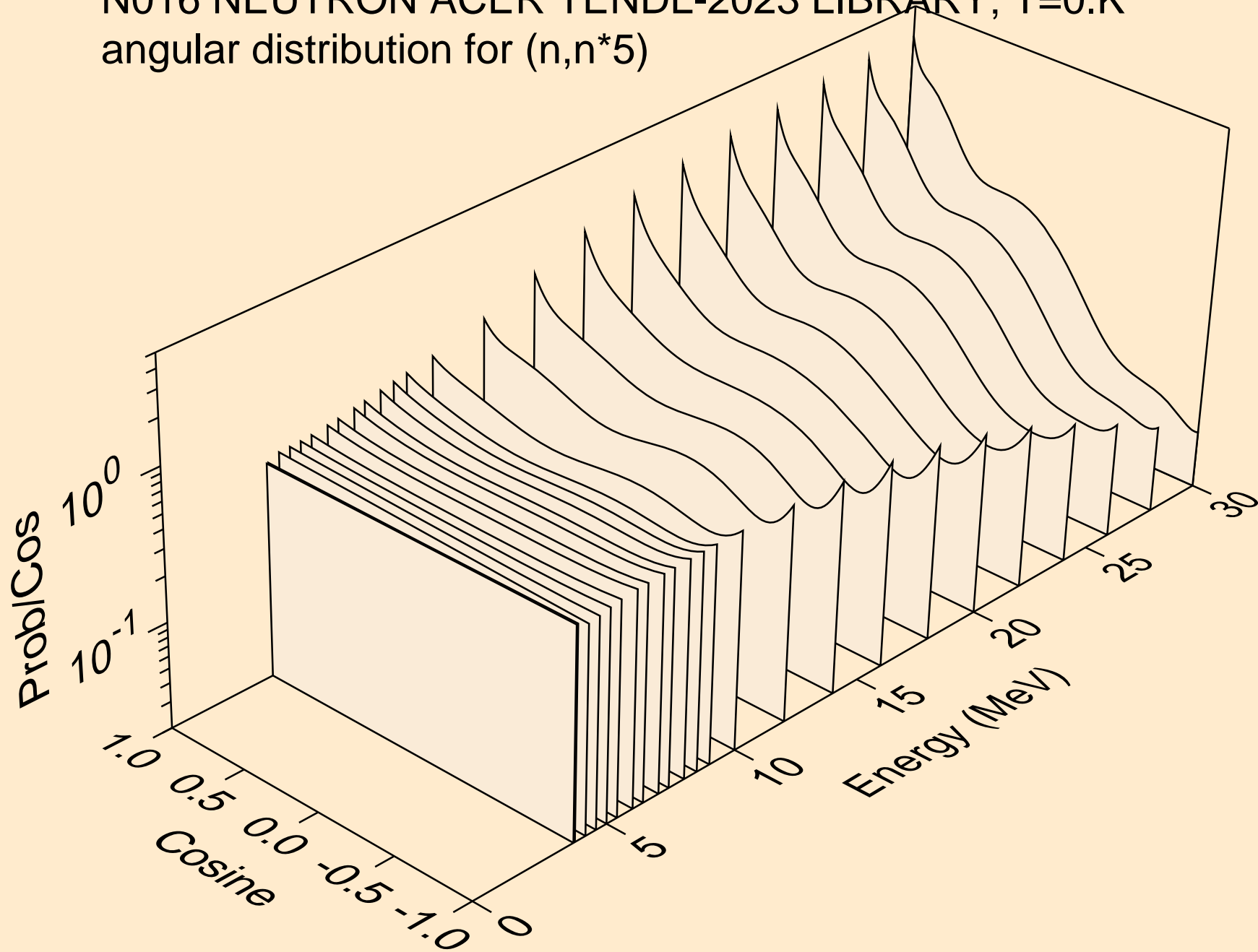

N016 NEUTRON ACER TENDL-2023 LIBRARY; T=0.K
angular distribution for (n,n*6)

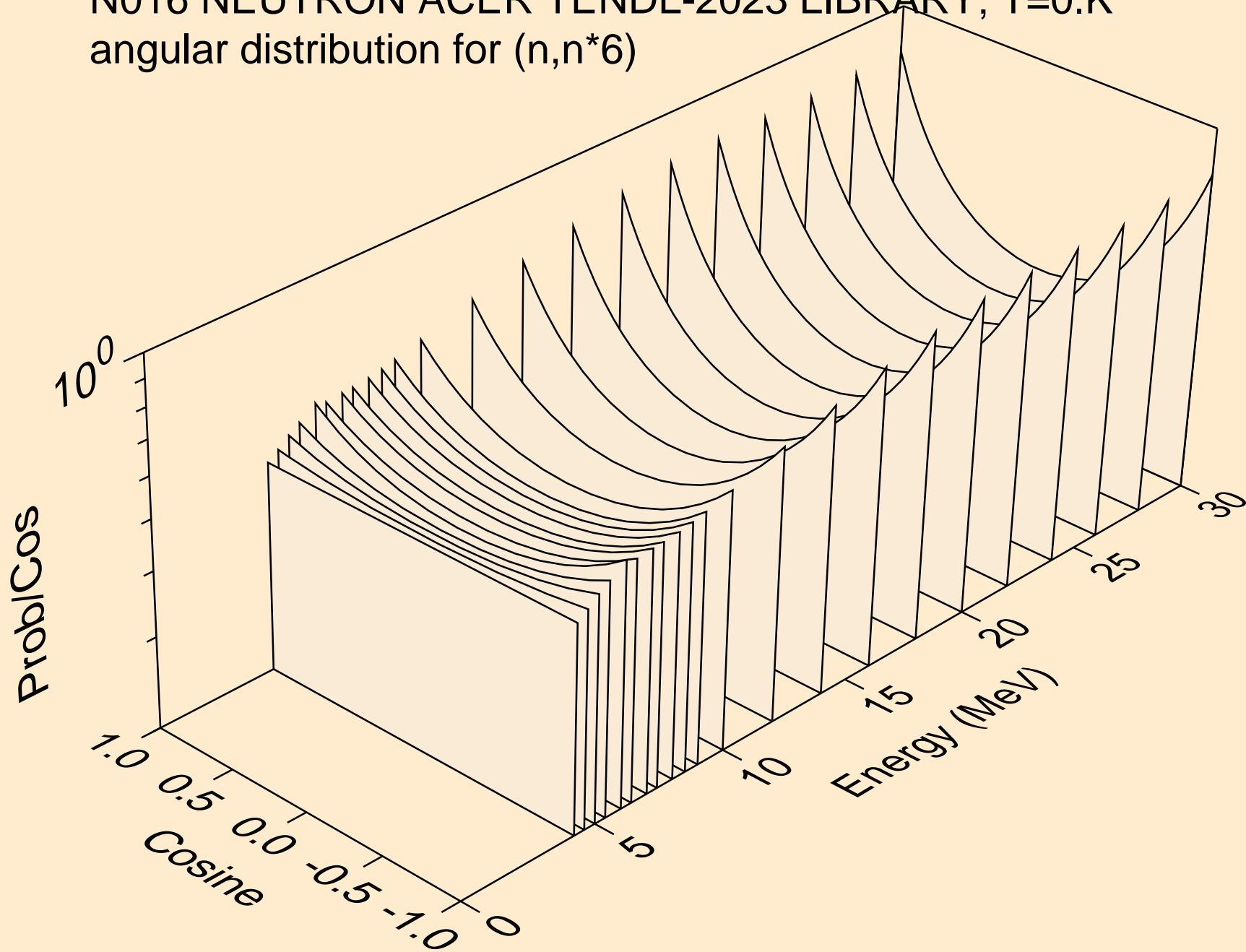

N016 NEUTRON ACER TENDL-2023 LIBRARY; T=0.K
angular distribution for (n,n*7)

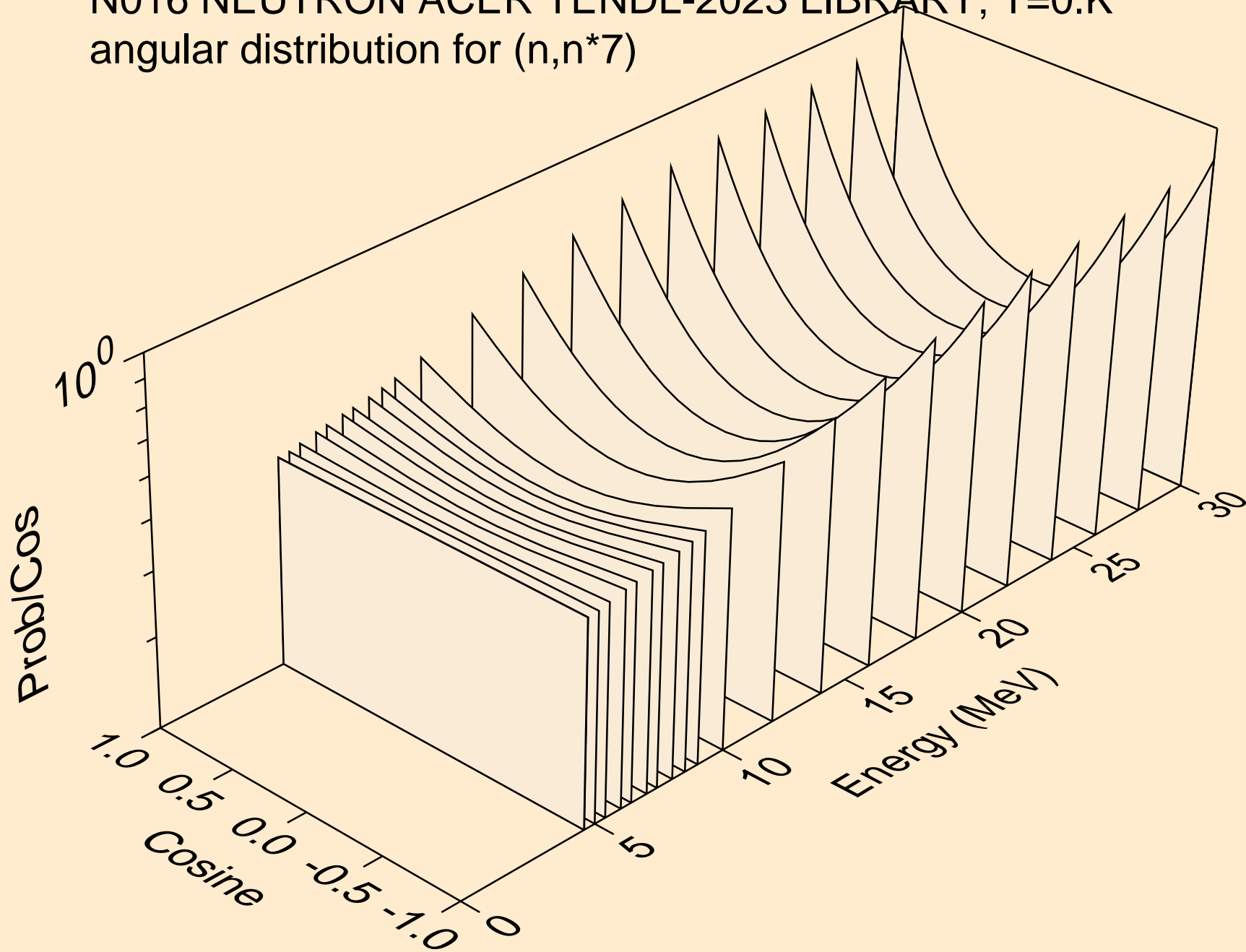

N016 NEUTRON ACER TENDL-2023 LIBRARY; T=0.K
angular distribution for (n,n*8)

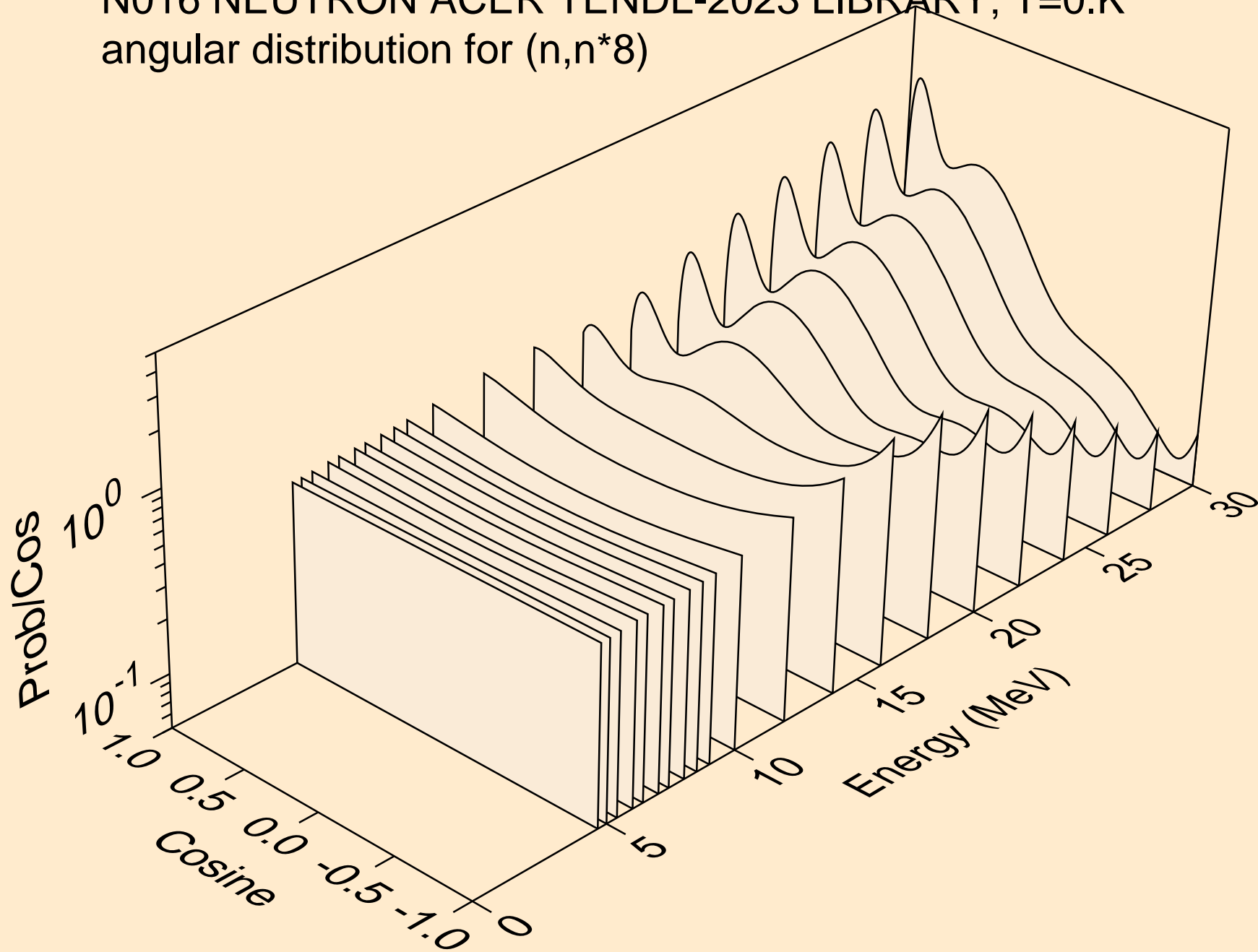

N016 NEUTRON ACER TENDL-2023 LIBRARY; T=0.K
angular distribution for (n,n*9)

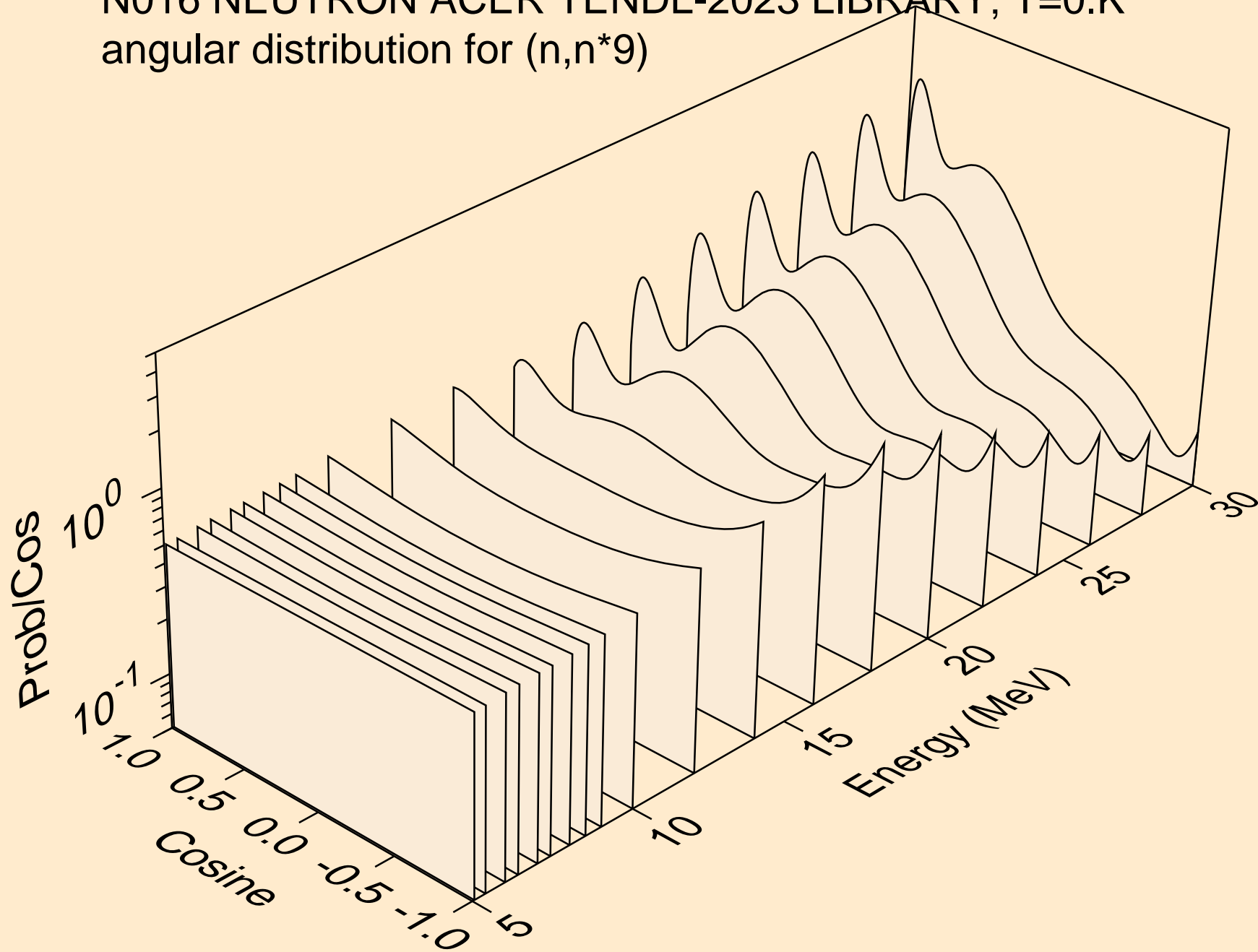

N016 NEUTRON ACER TENDL-2023 LIBRARY; T=0.K
angular distribution for (n,n*10)

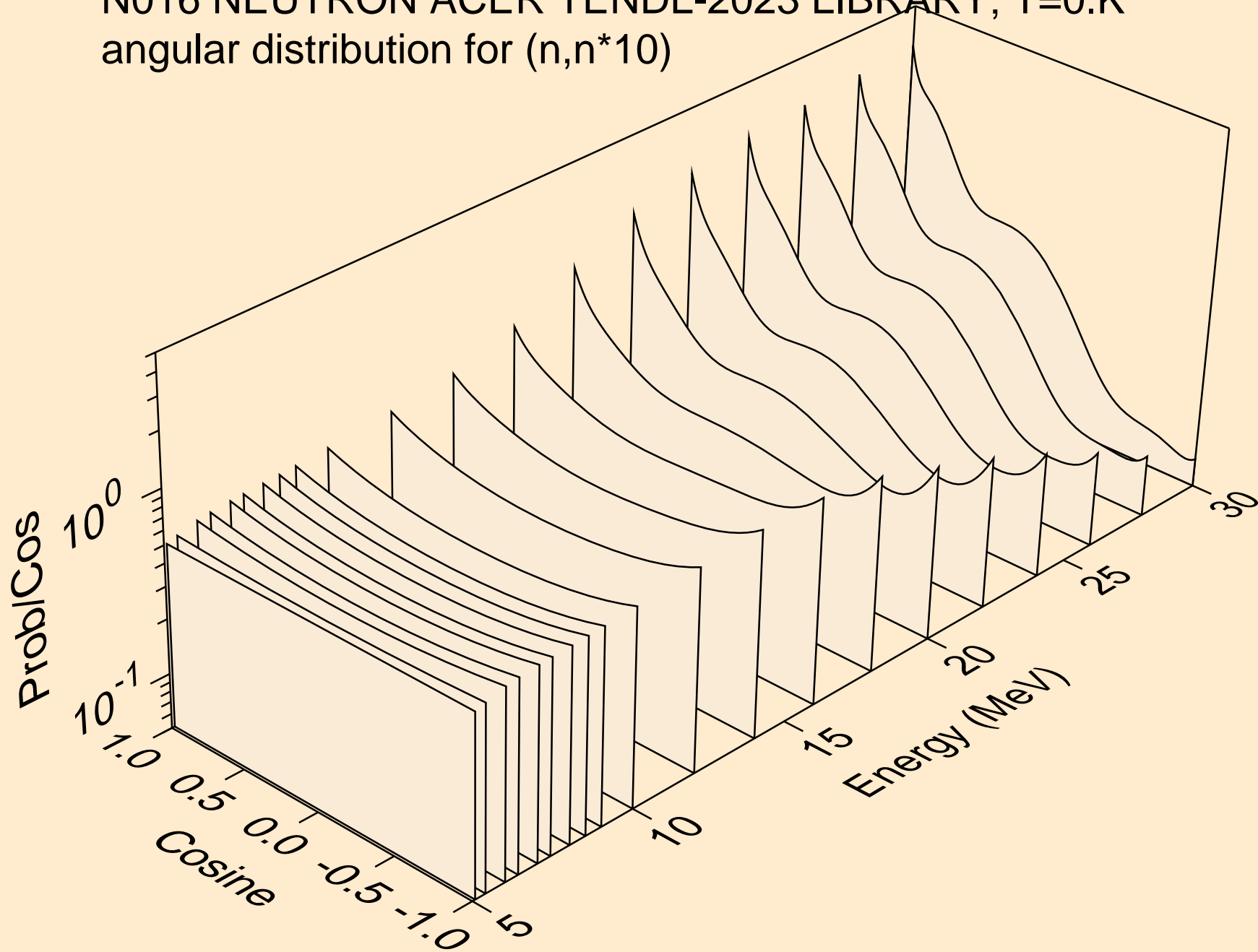

N016 NEUTRON ACER TENDL-2023 LIBRARY; T=0.K
angular distribution for (n,n*11)

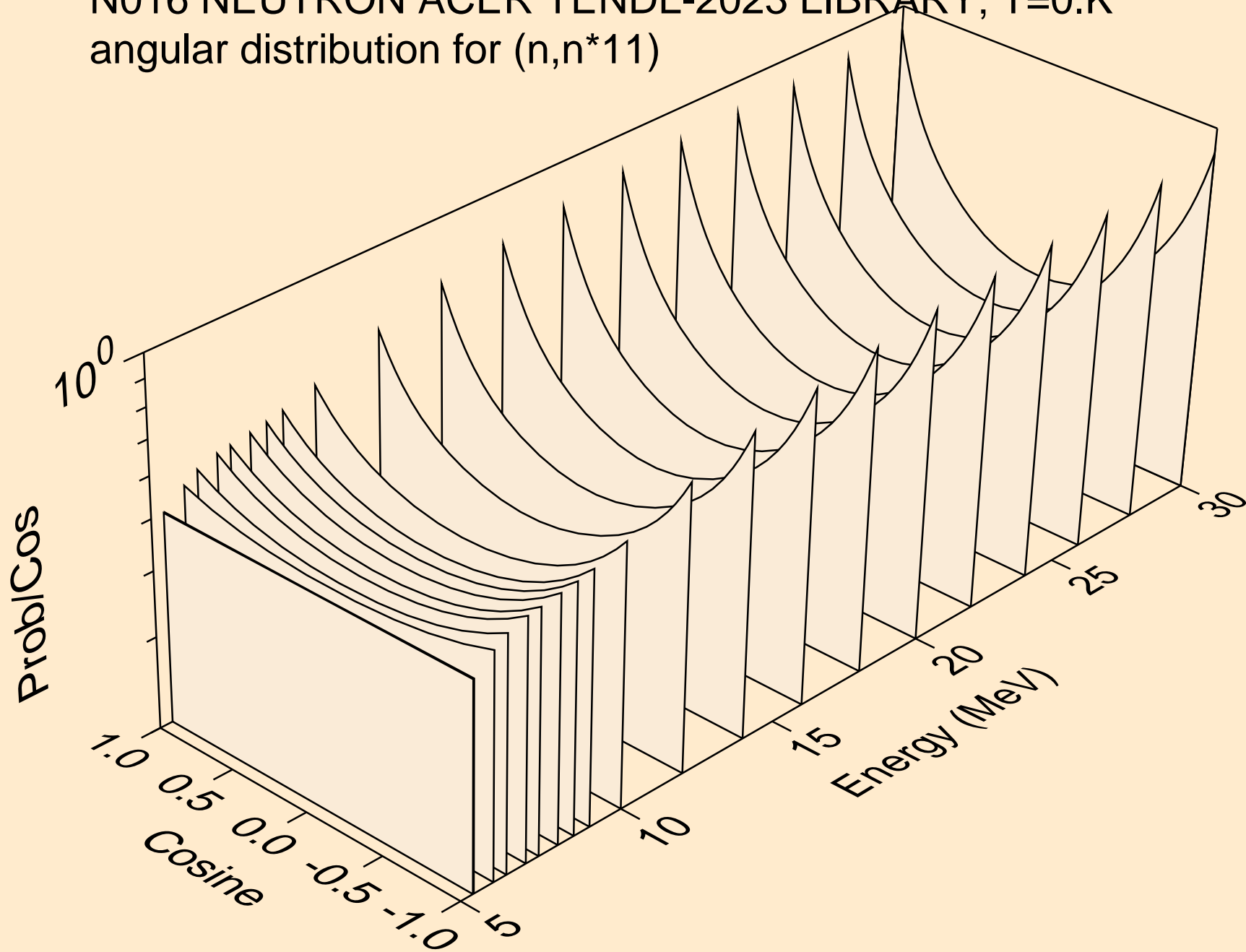

N016 NEUTRON ACER TENDL-2023 LIBRARY; T=0.K
angular distribution for (n,n*12)

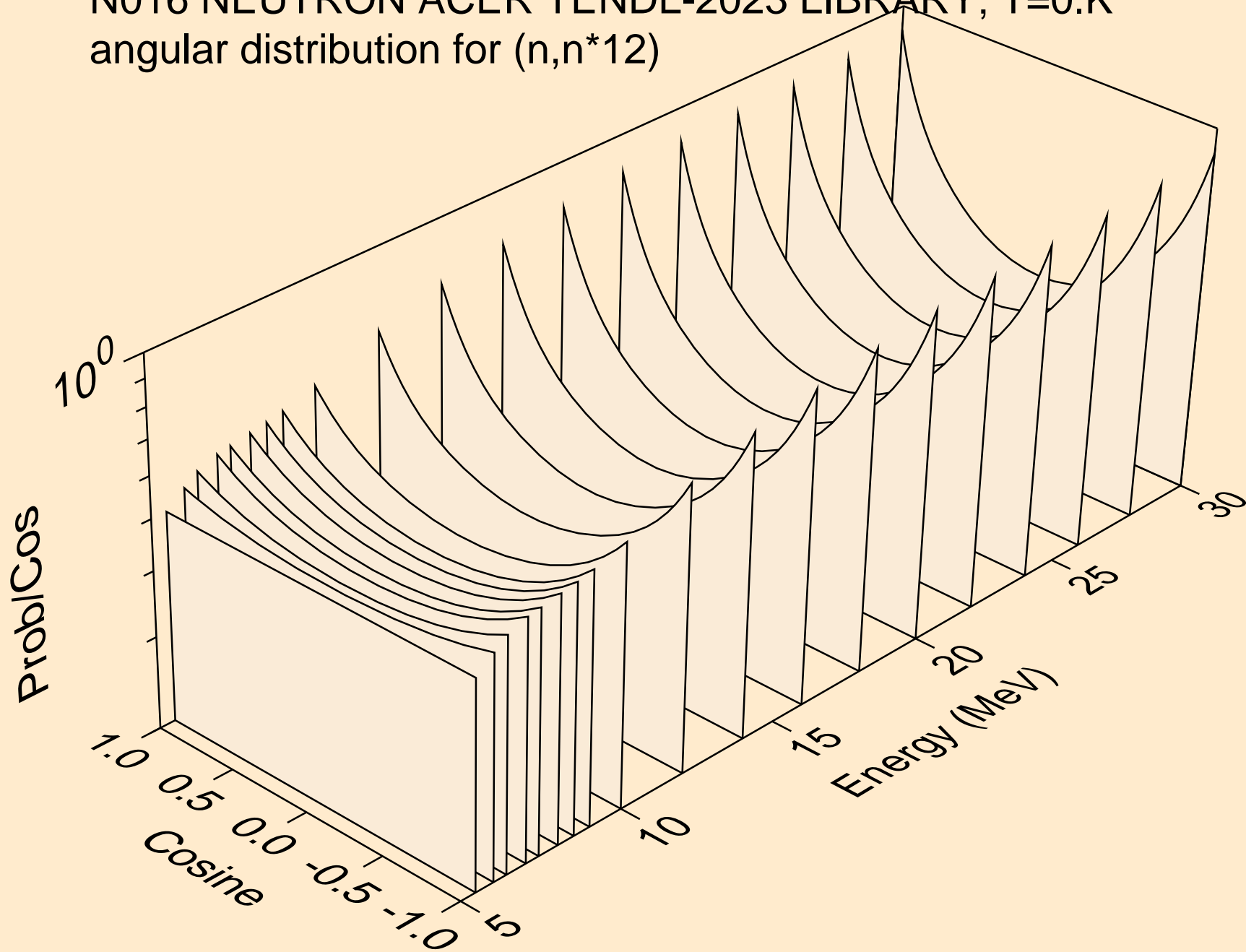

N016 NEUTRON ACER TENDL-2023 LIBRARY; T=0.K
angular distribution for (n,n*13)

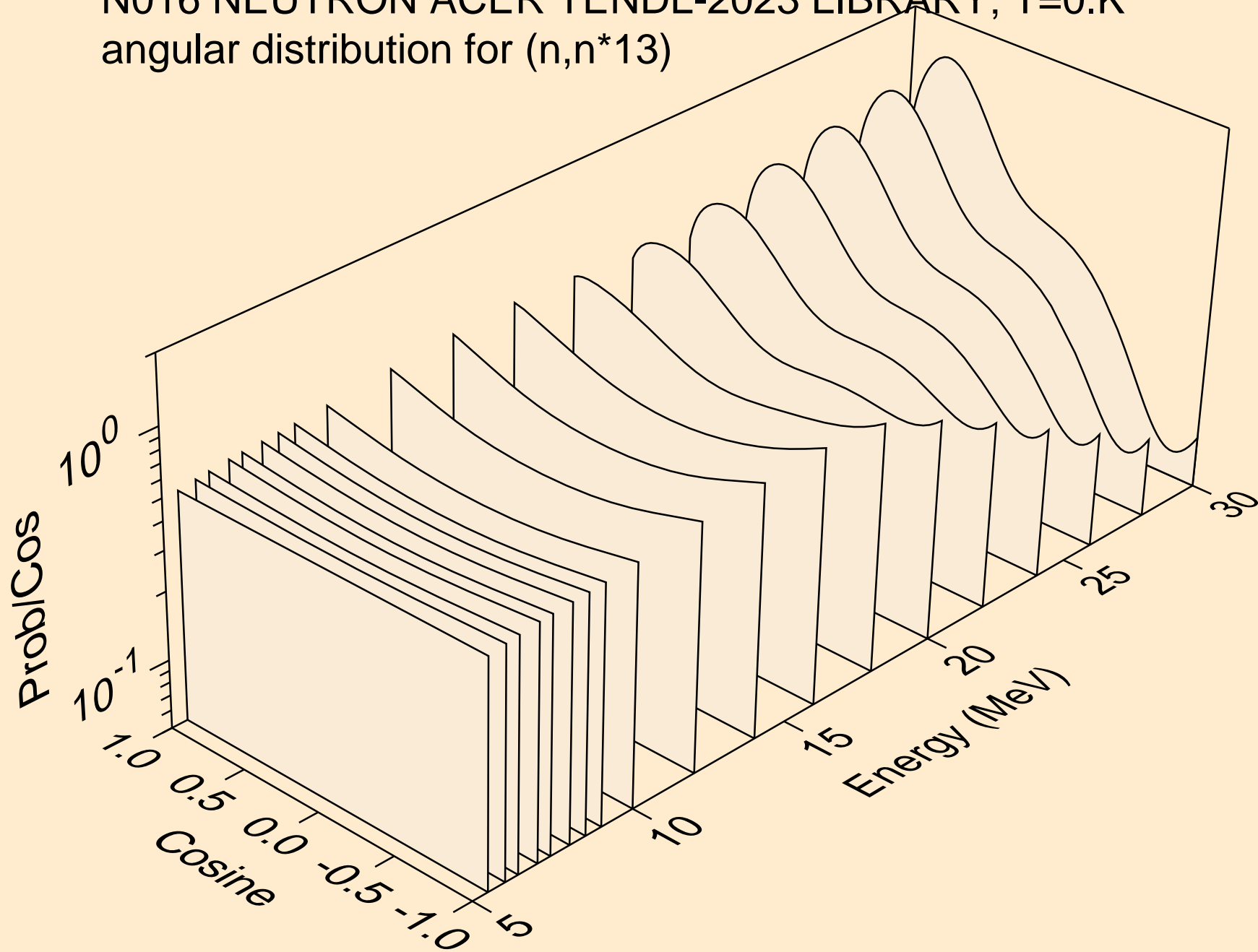

N016 NEUTRON ACER TENDL-2023 LIBRARY; T=0.K
angular distribution for (n,n*14)

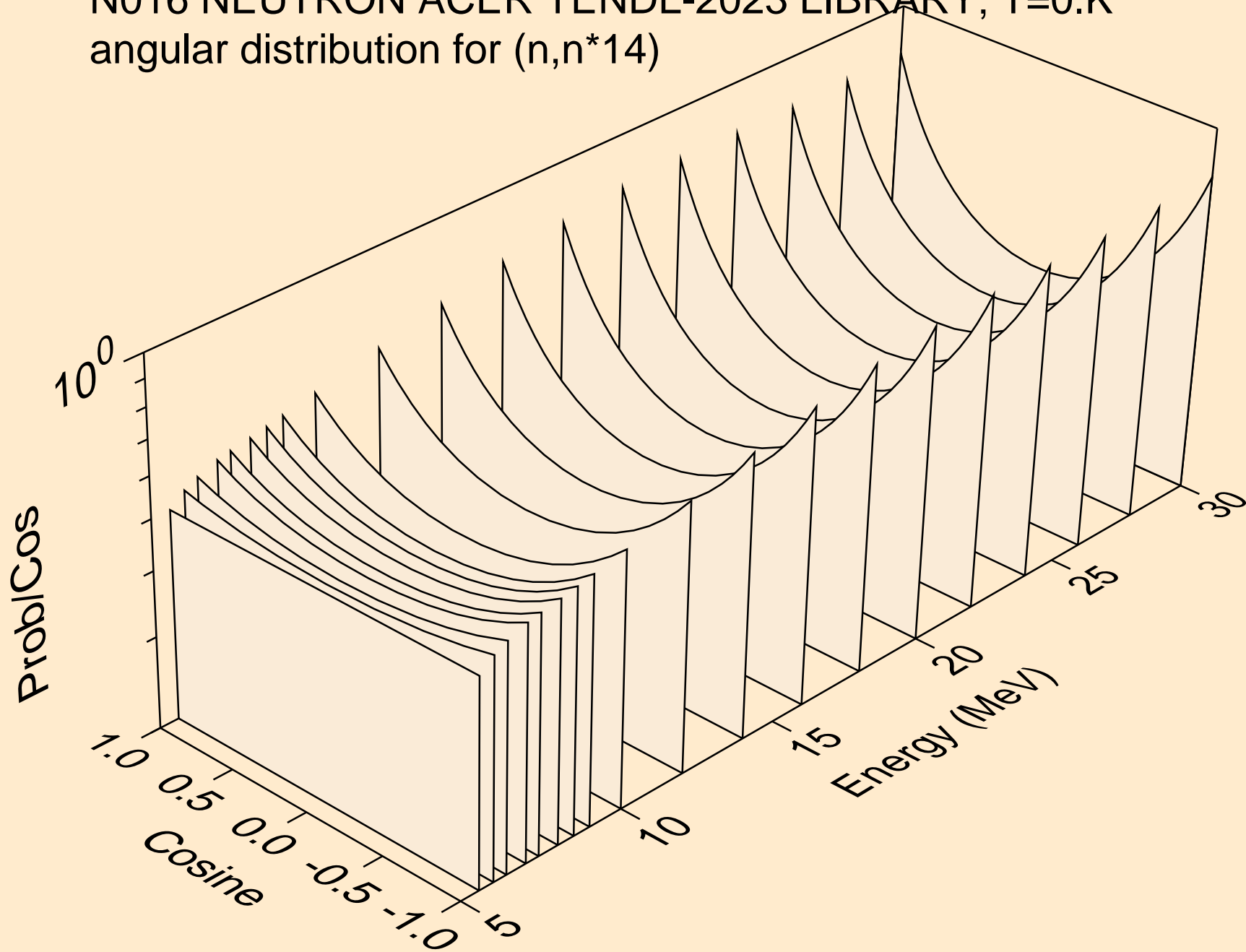

N016 NEUTRON ACER TENDL-2023 LIBRARY; T=0.K
angular distribution for (n,n*15)

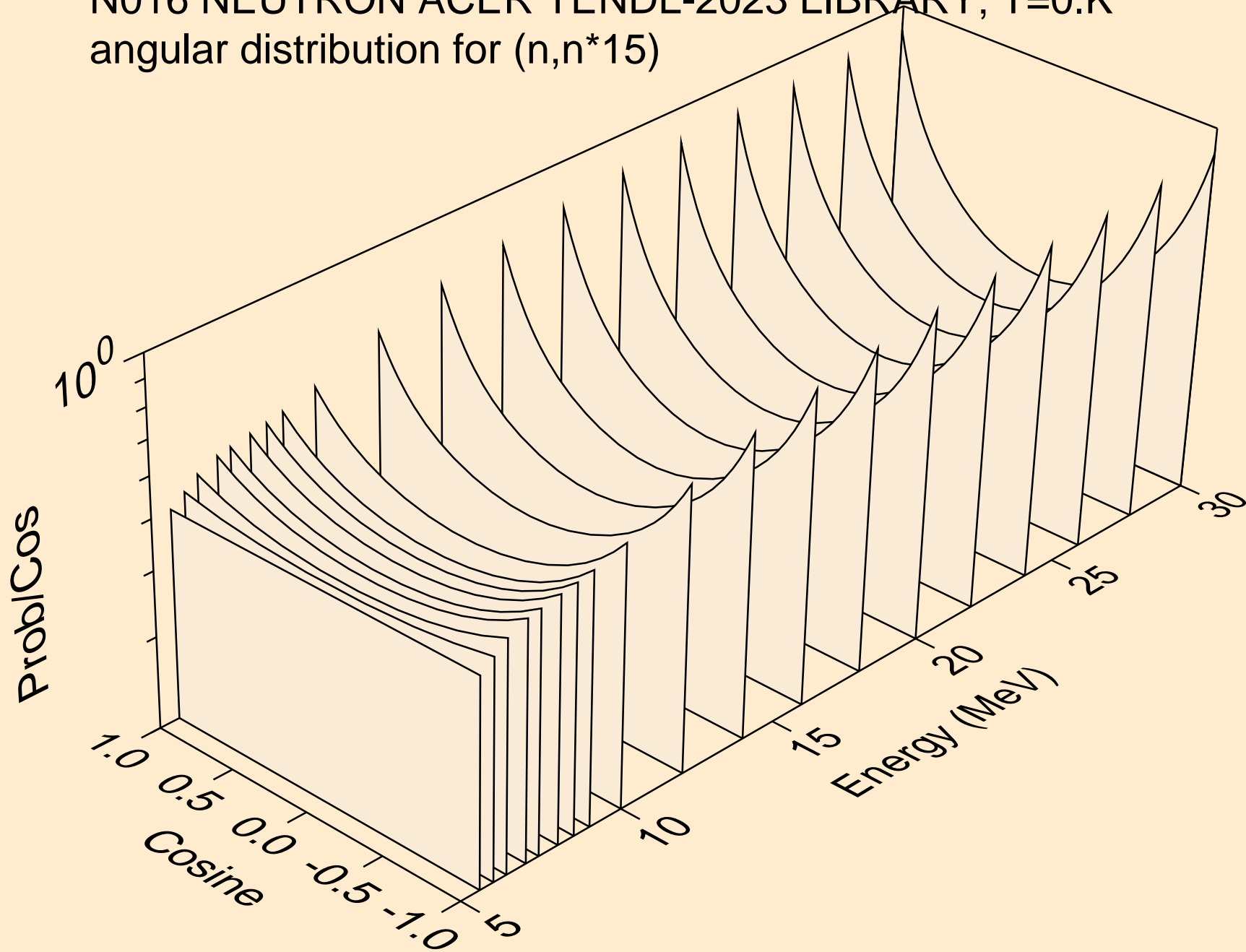

N016 NEUTRON ACER TENDL-2023 LIBRARY; T=0.K
angular distribution for (n,n*16)

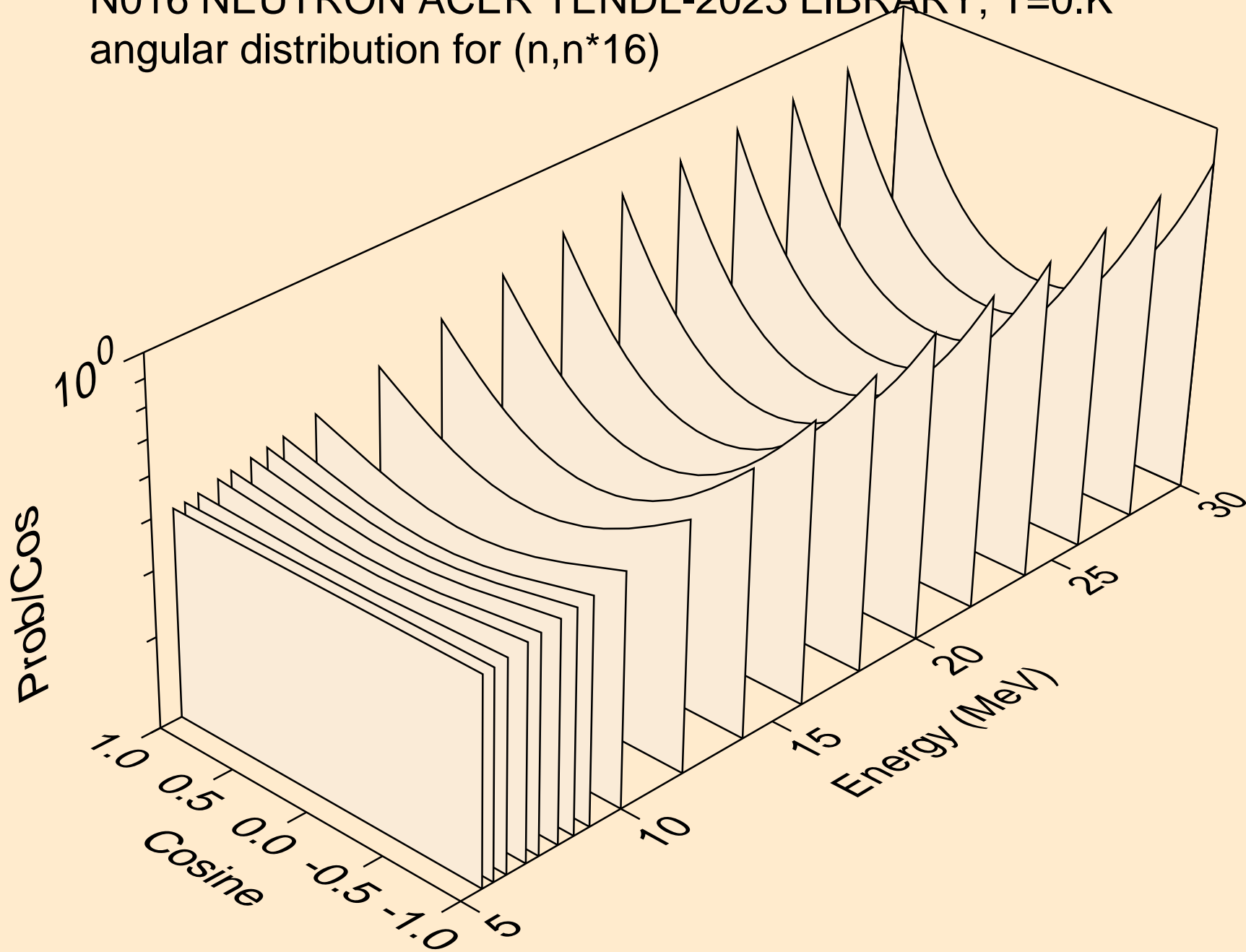

N016 NEUTRON ACER TENDL-2023 LIBRARY; T=0.K
angular distribution for (n,n*17)

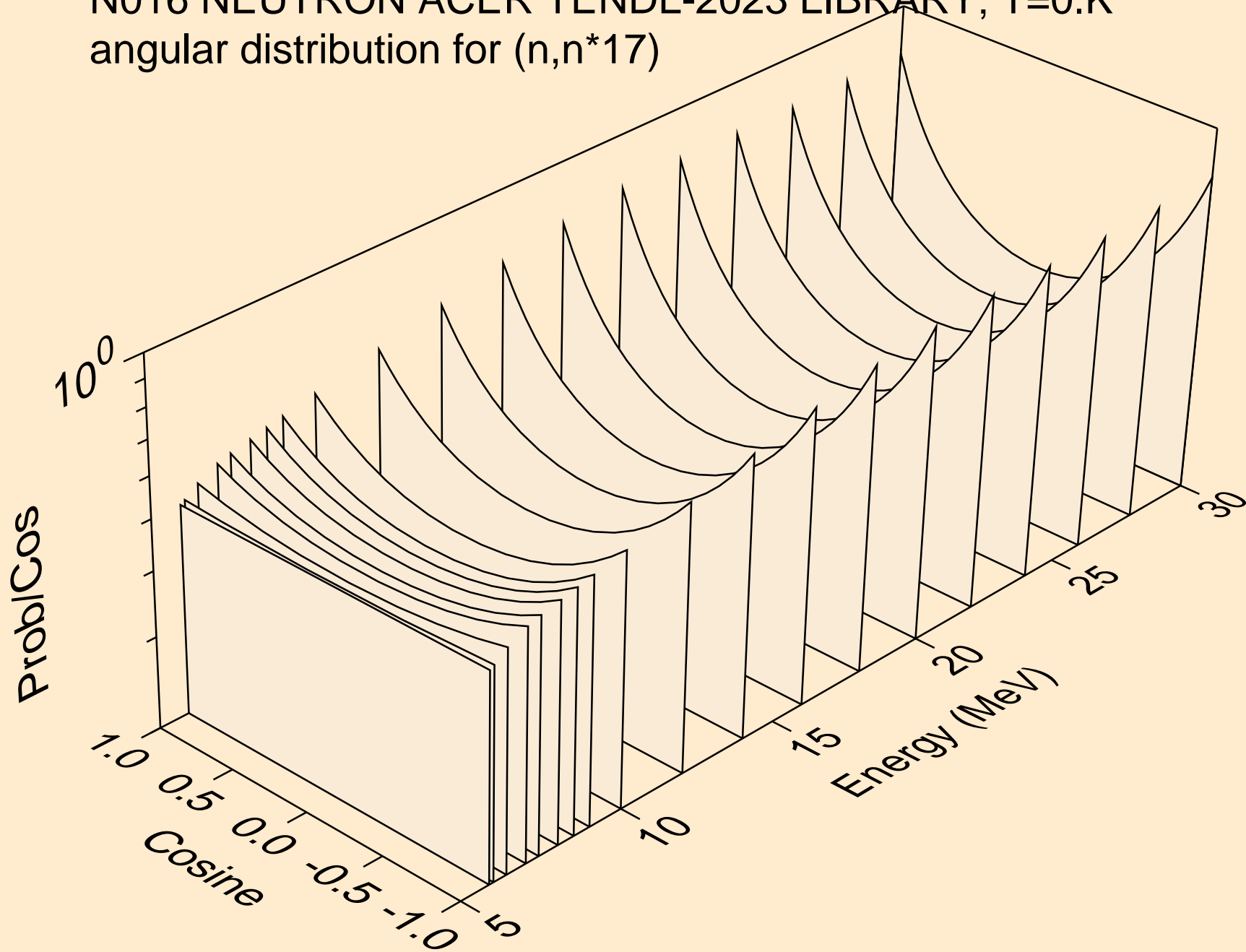

N016 NEUTRON ACER TENDL-2023 LIBRARY; T=0.K
angular distribution for (n,n*18)

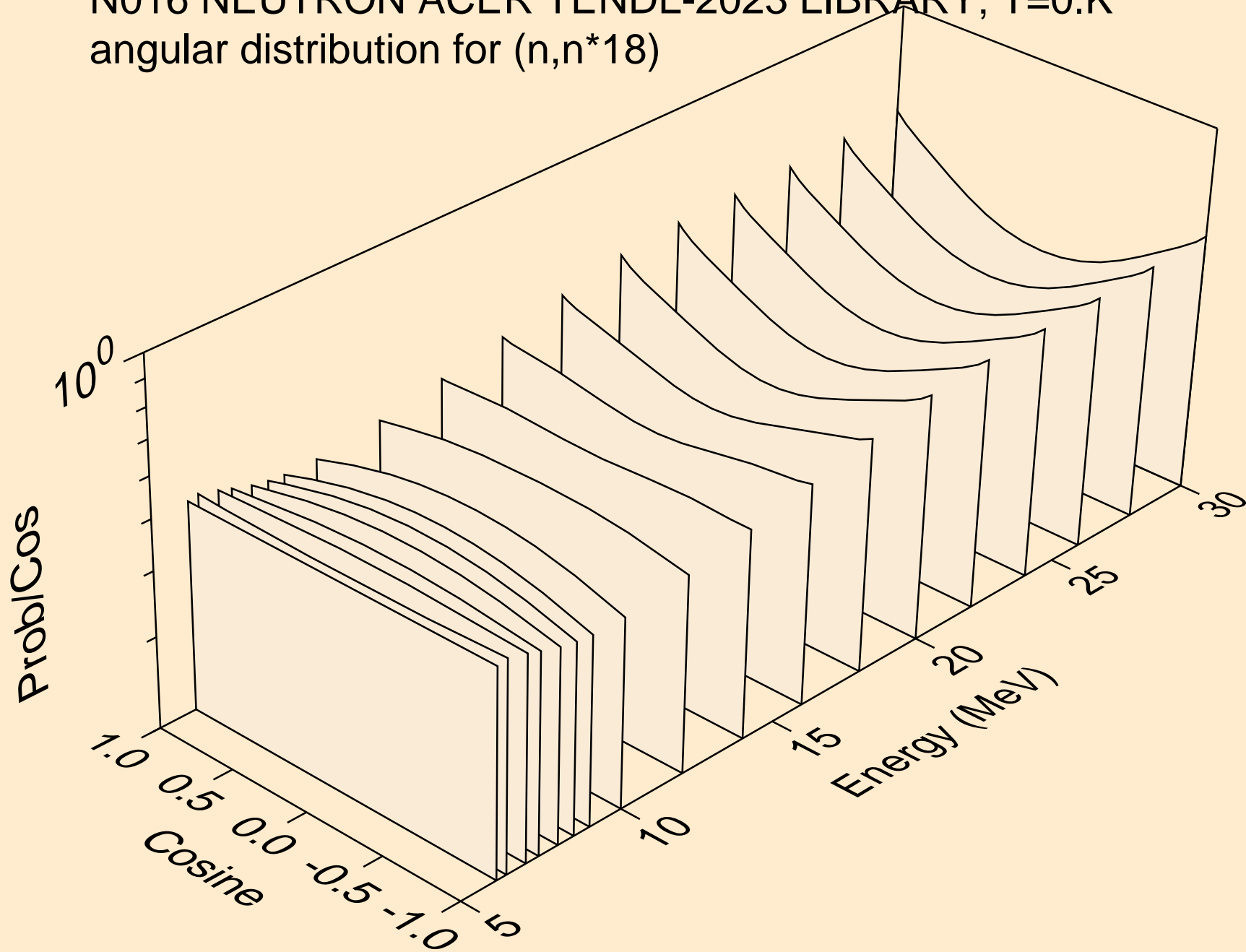

N016 NEUTRON ACER TENDL-2023 LIBRARY; T=0.K
angular distribution for (n,n*19)

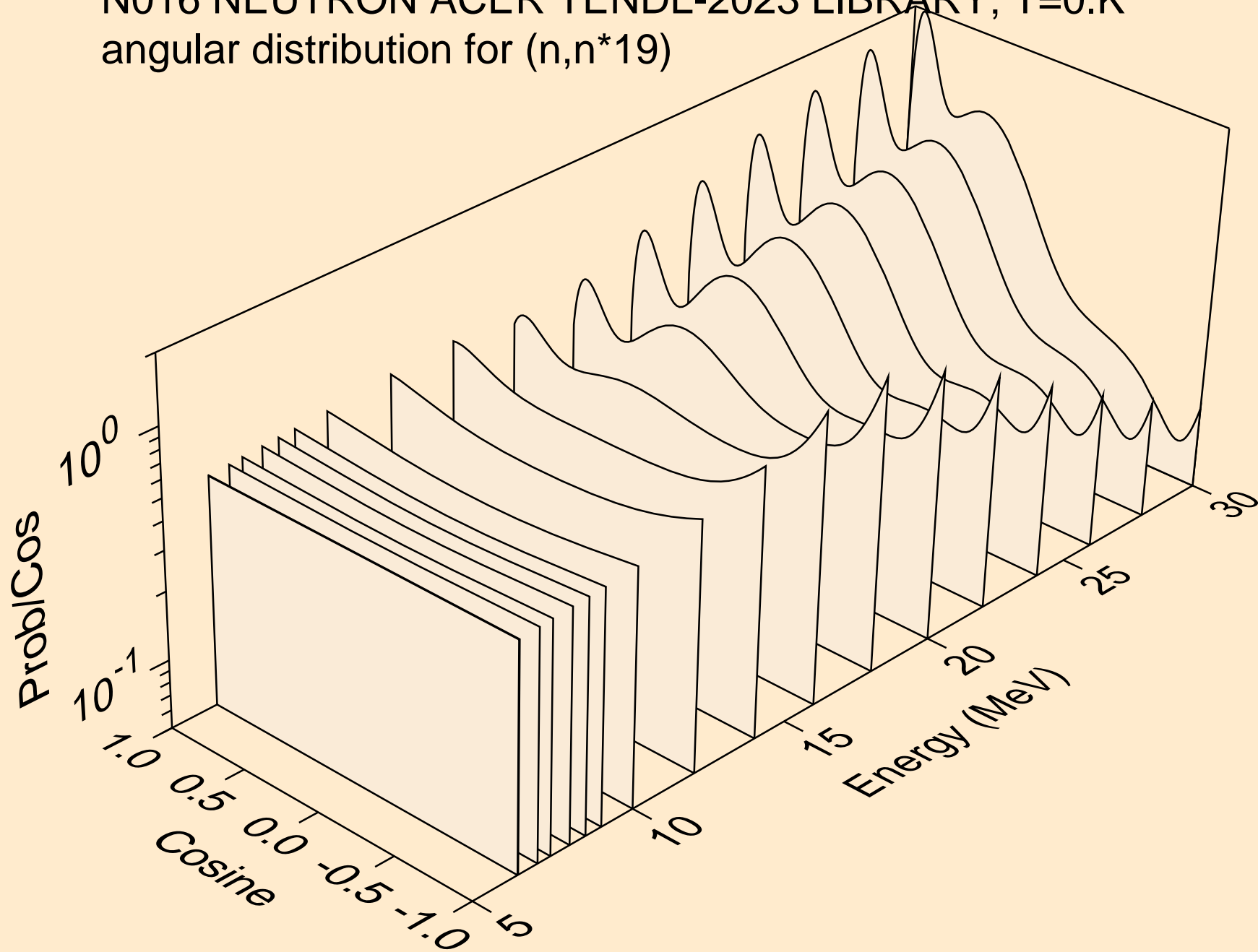

N016 NEUTRON ACER TENDL-2023 LIBRARY; T=0.K
angular distribution for (n,n*20)

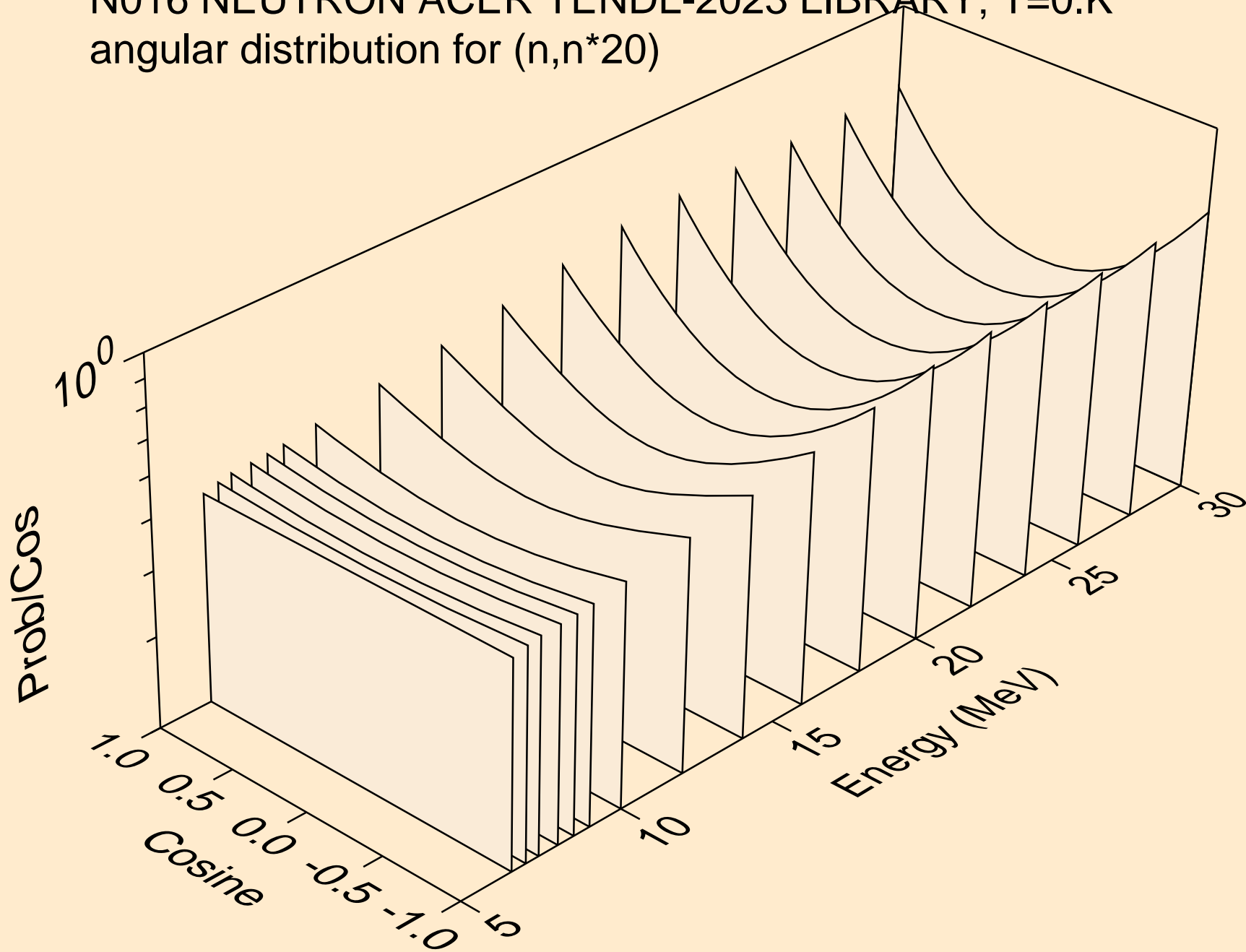

N016 NEUTRON ACER TENDL-2023 LIBRARY; T=0.K
angular distribution for (n,n*21)

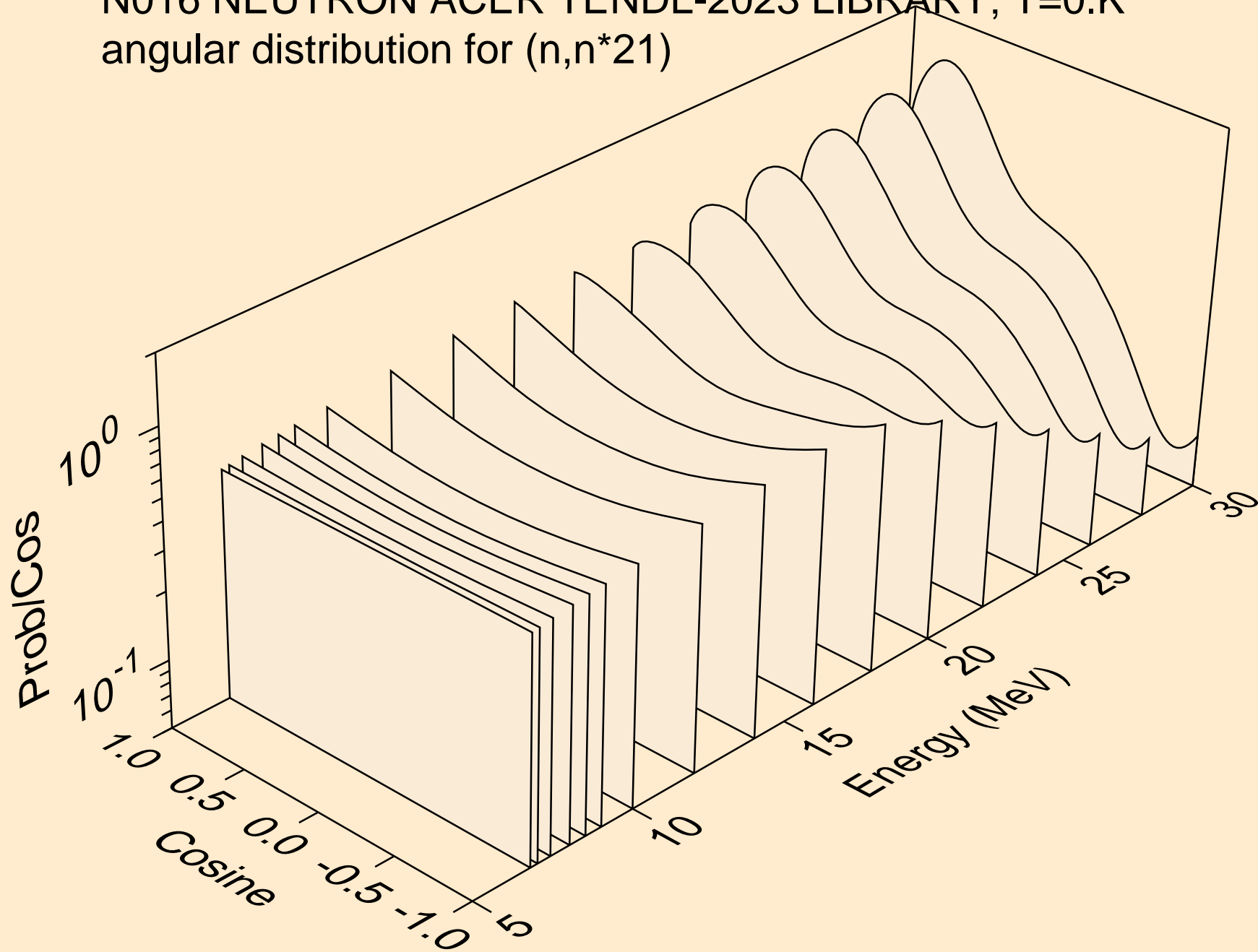

N016 NEUTRON ACER TENDL-2023 LIBRARY; T=0.K
angular distribution for (n,n*22)

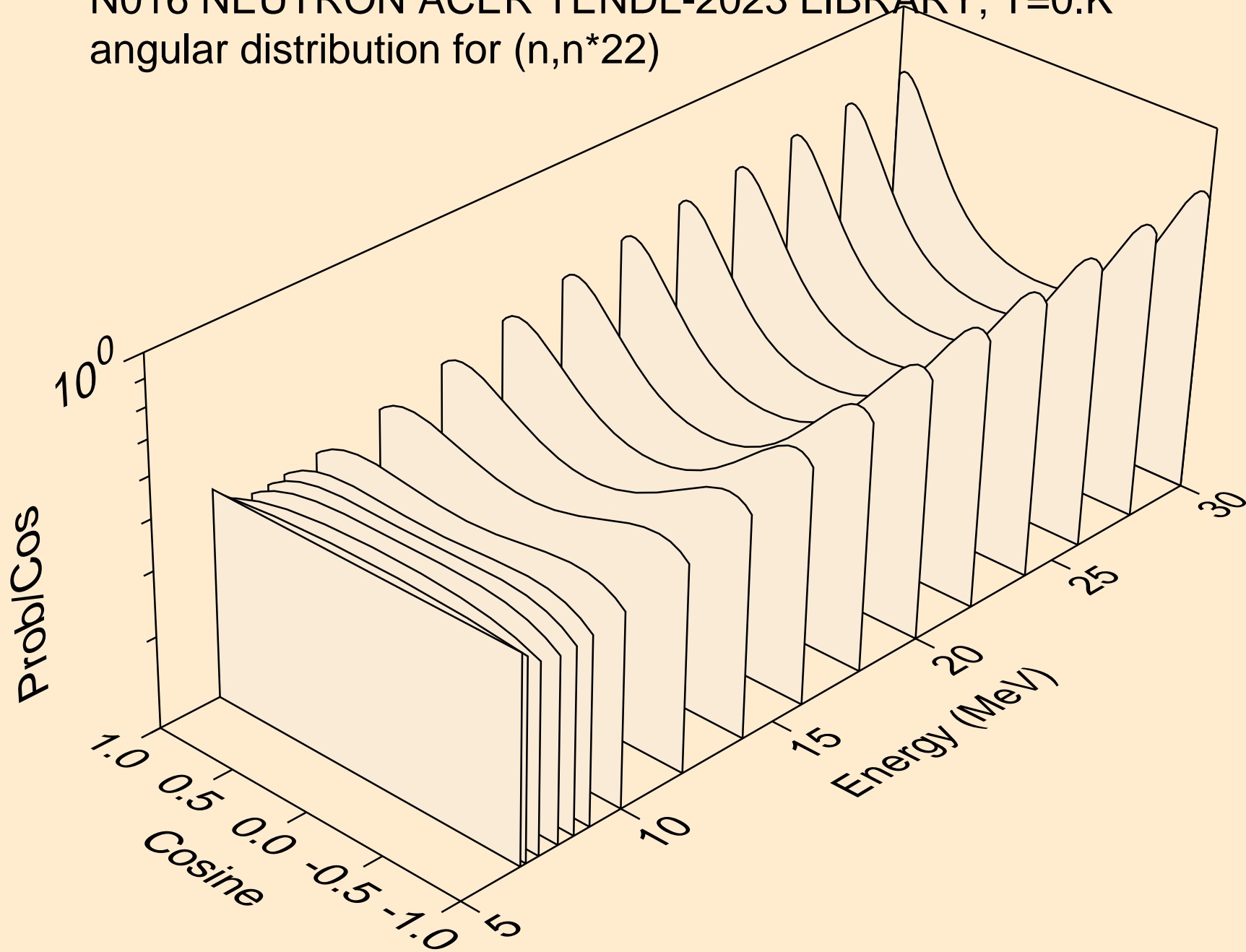

N016 NEUTRON ACER TENDL-2023 LIBRARY; T=0.K
angular distribution for (n,n*23)

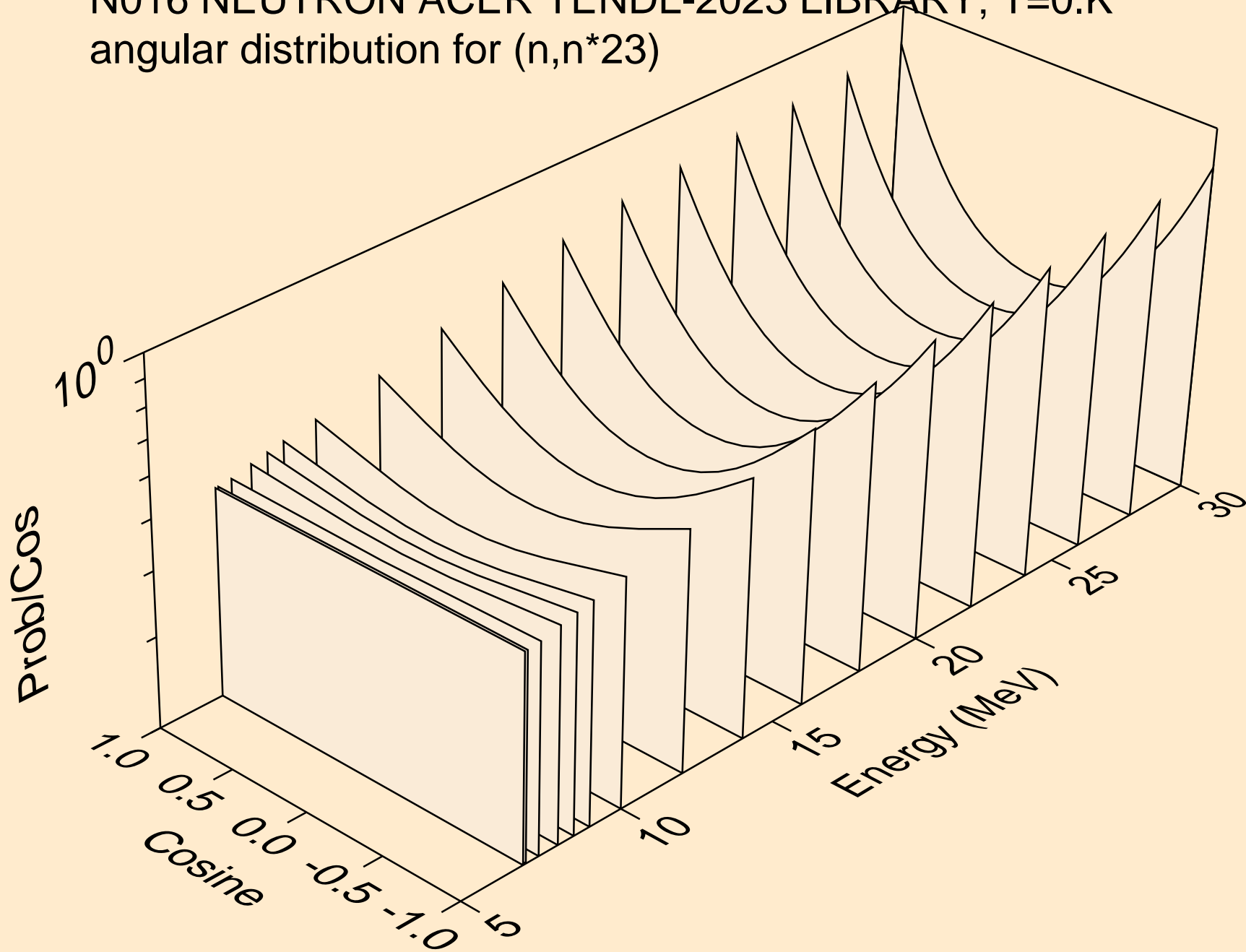

N016 NEUTRON ACER TENDL-2023 LIBRARY; T=0.K
angular distribution for (n,n*24)

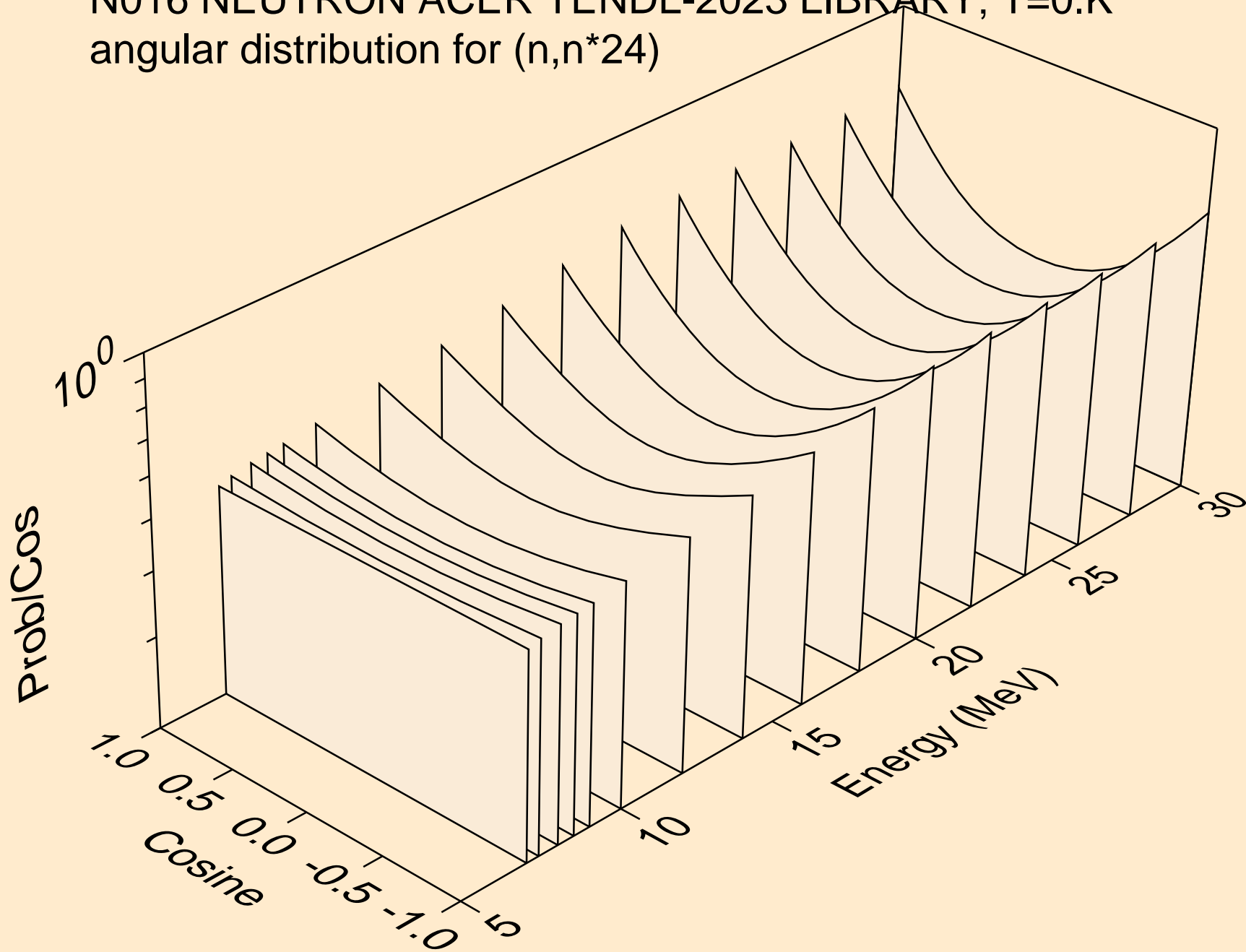

N016 NEUTRON ACER TENDL-2023 LIBRARY; T=0.K
angular distribution for (n,n*25)

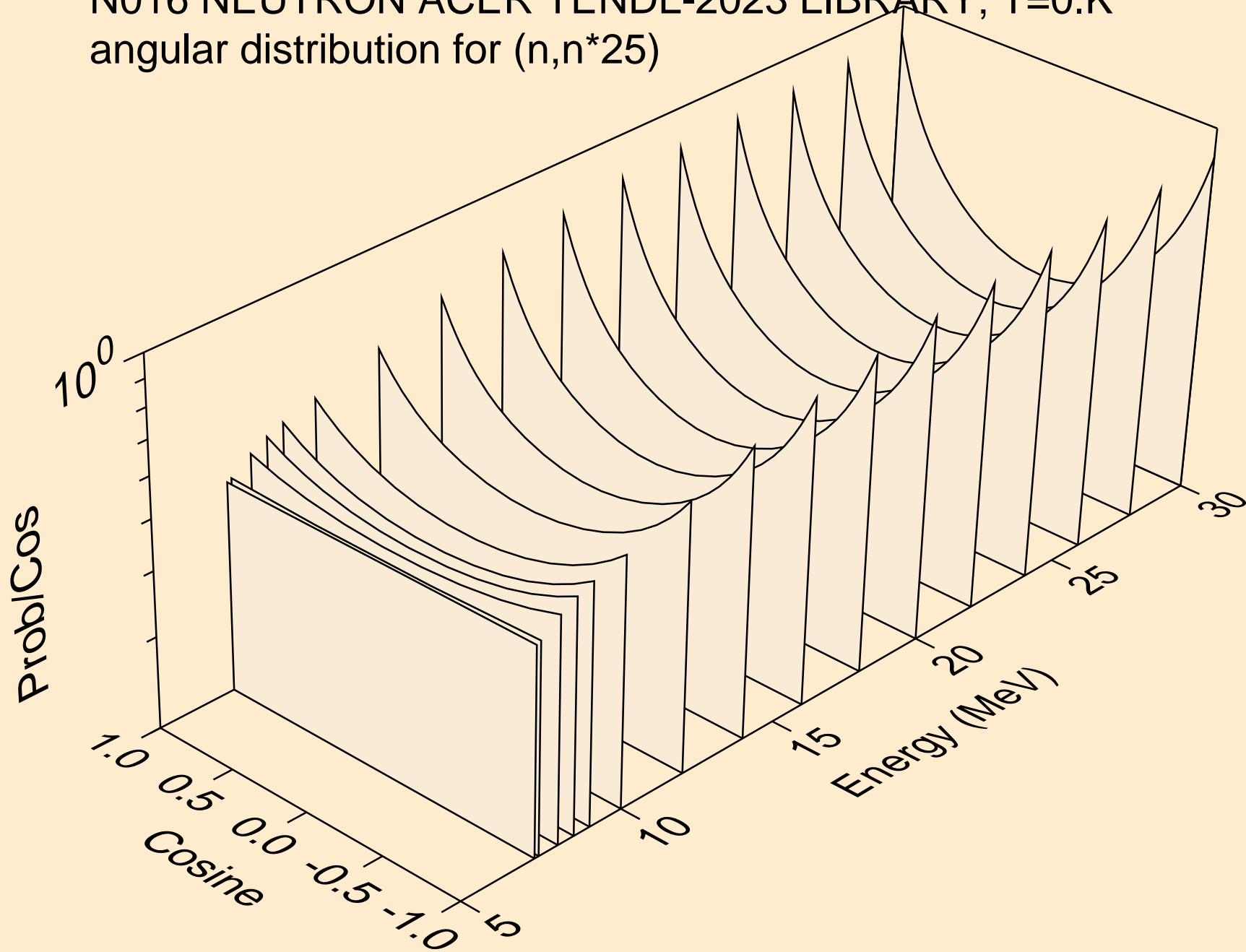

N016 NEUTRON ACER TENDL-2023 LIBRARY; T=0.K
angular distribution for (n,n*26)

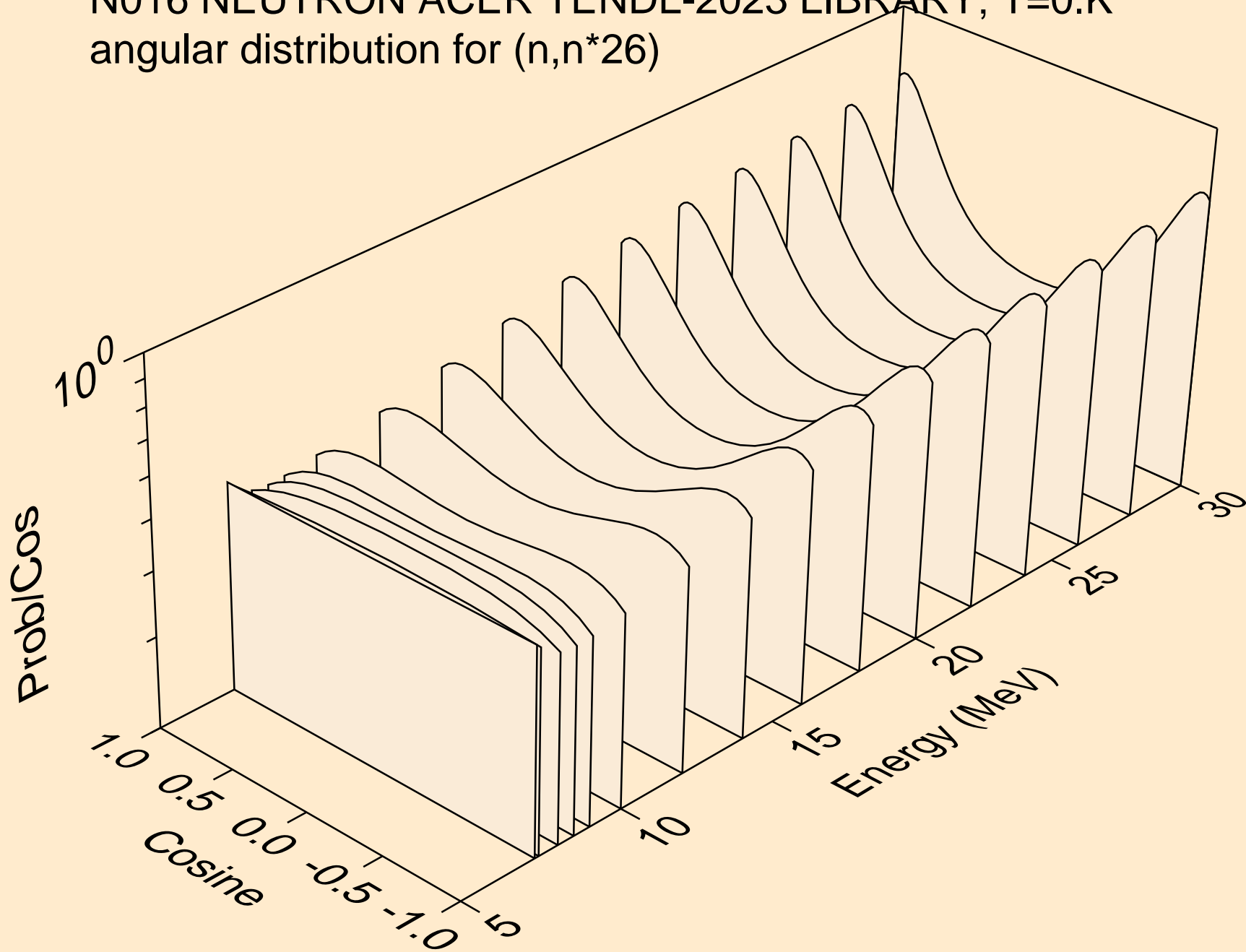

N016 NEUTRON ACER TENDL-2023 LIBRARY; T=0.K
angular distribution for (n,n*27)

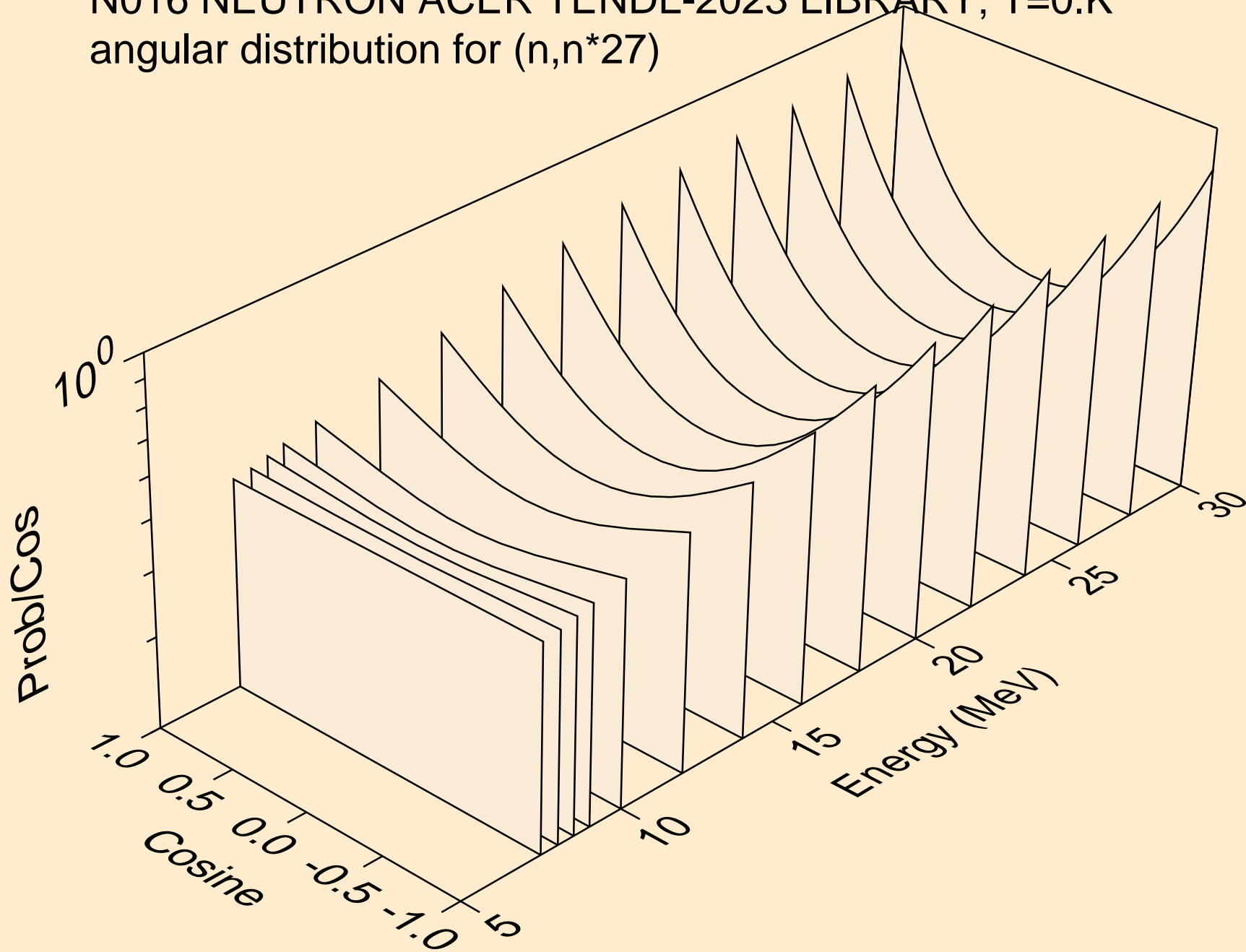

N016 NEUTRON ACER TENDL-2023 LIBRARY; T=0.K
angular distribution for (n,n*28)

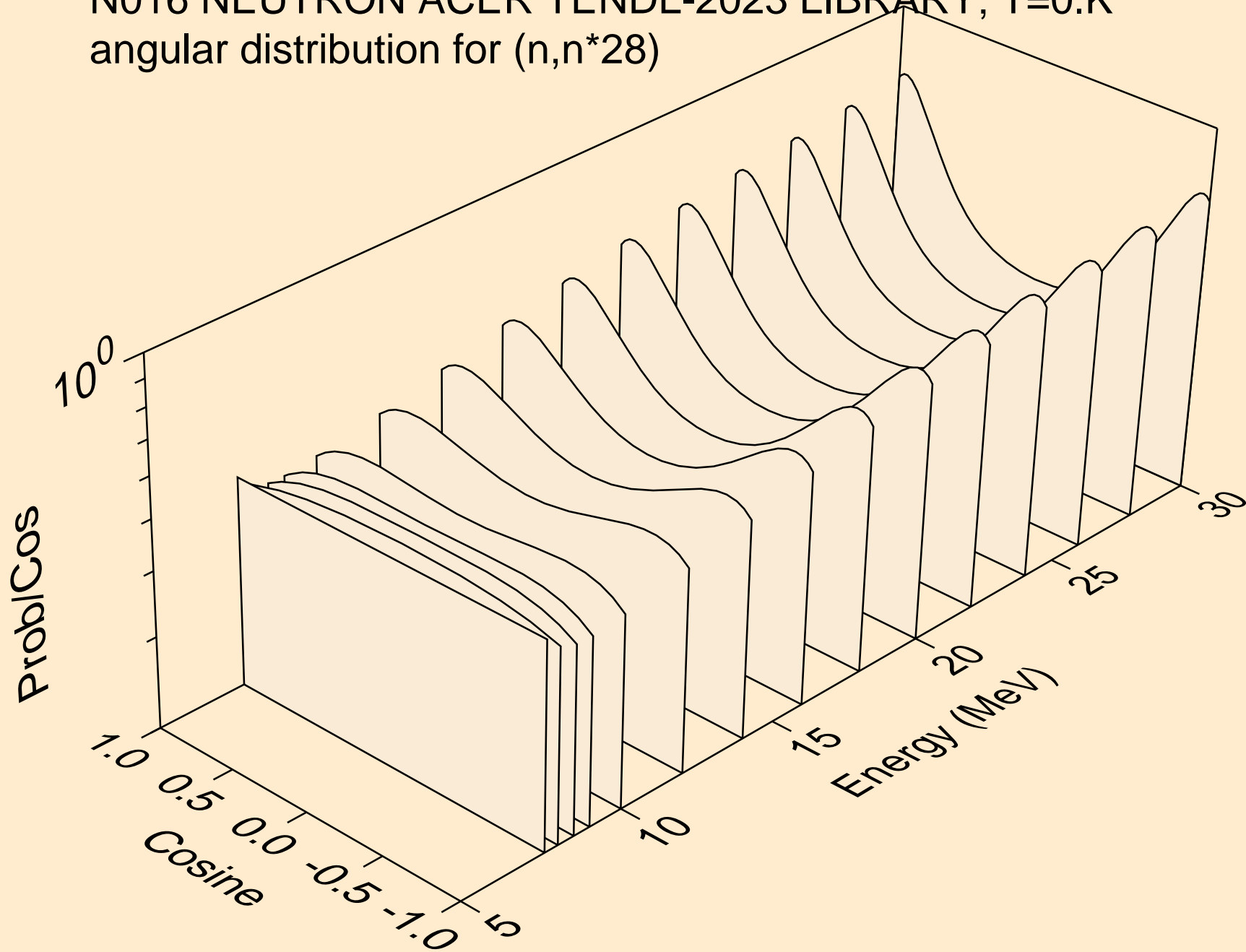

N016 NEUTRON ACER TENDL-2023 LIBRARY; T=0.K
angular distribution for (n,n*29)

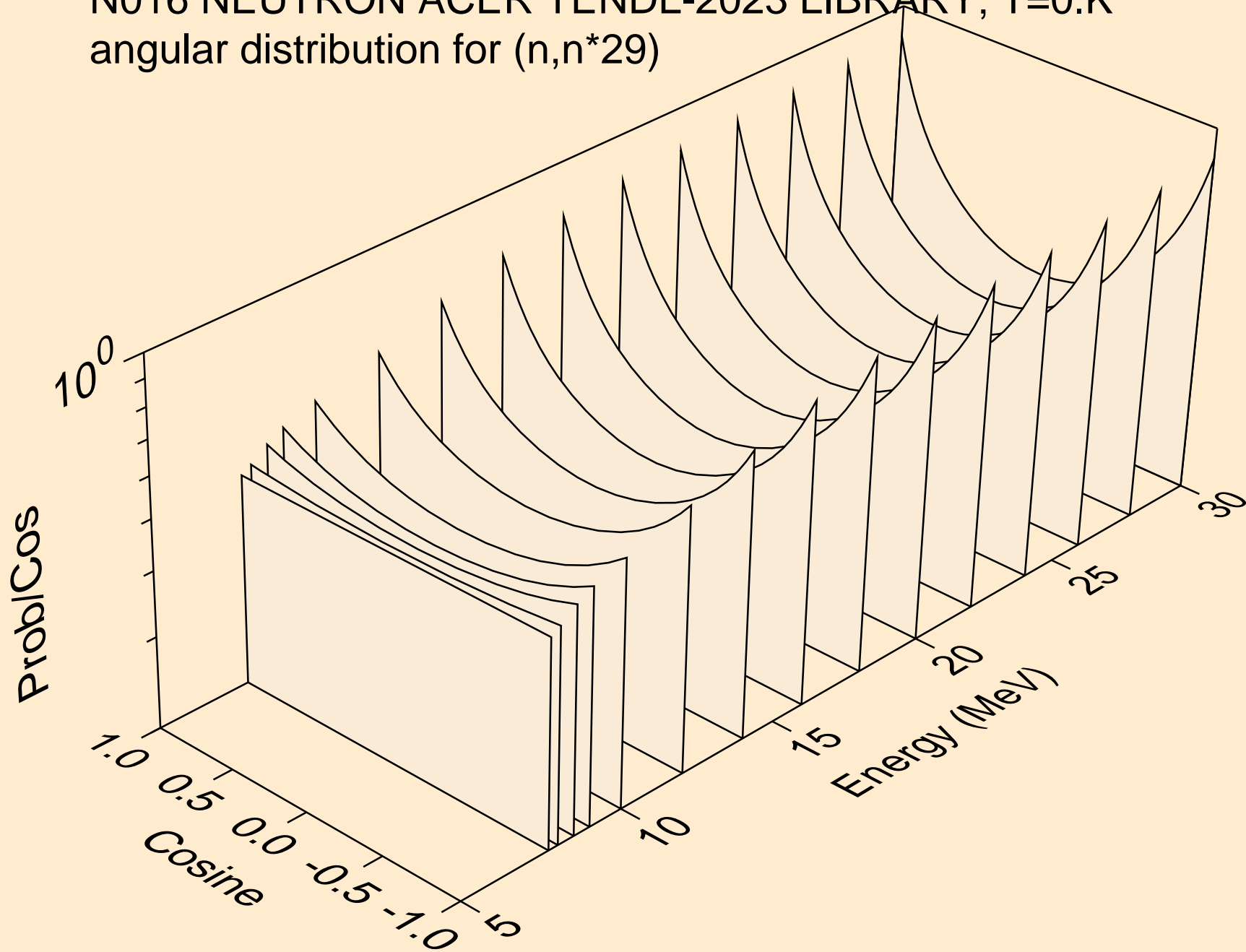

N016 NEUTRON ACER TENDL-2023 LIBRARY; T=0.K
angular distribution for (n,n*30)

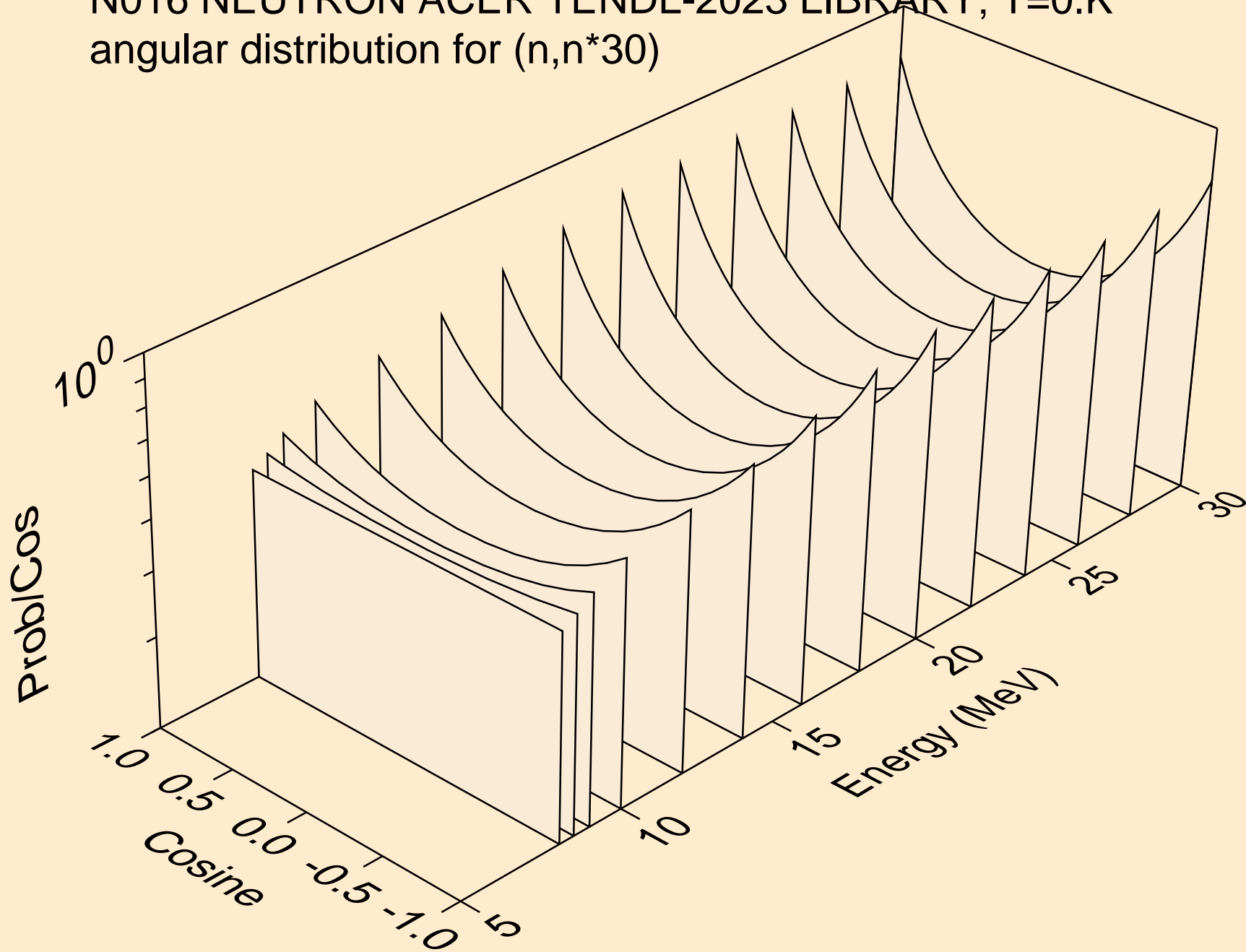

N016 NEUTRON ACER TENDL-2023 LIBRARY; T=0.K
Neutron emission for (n,x)

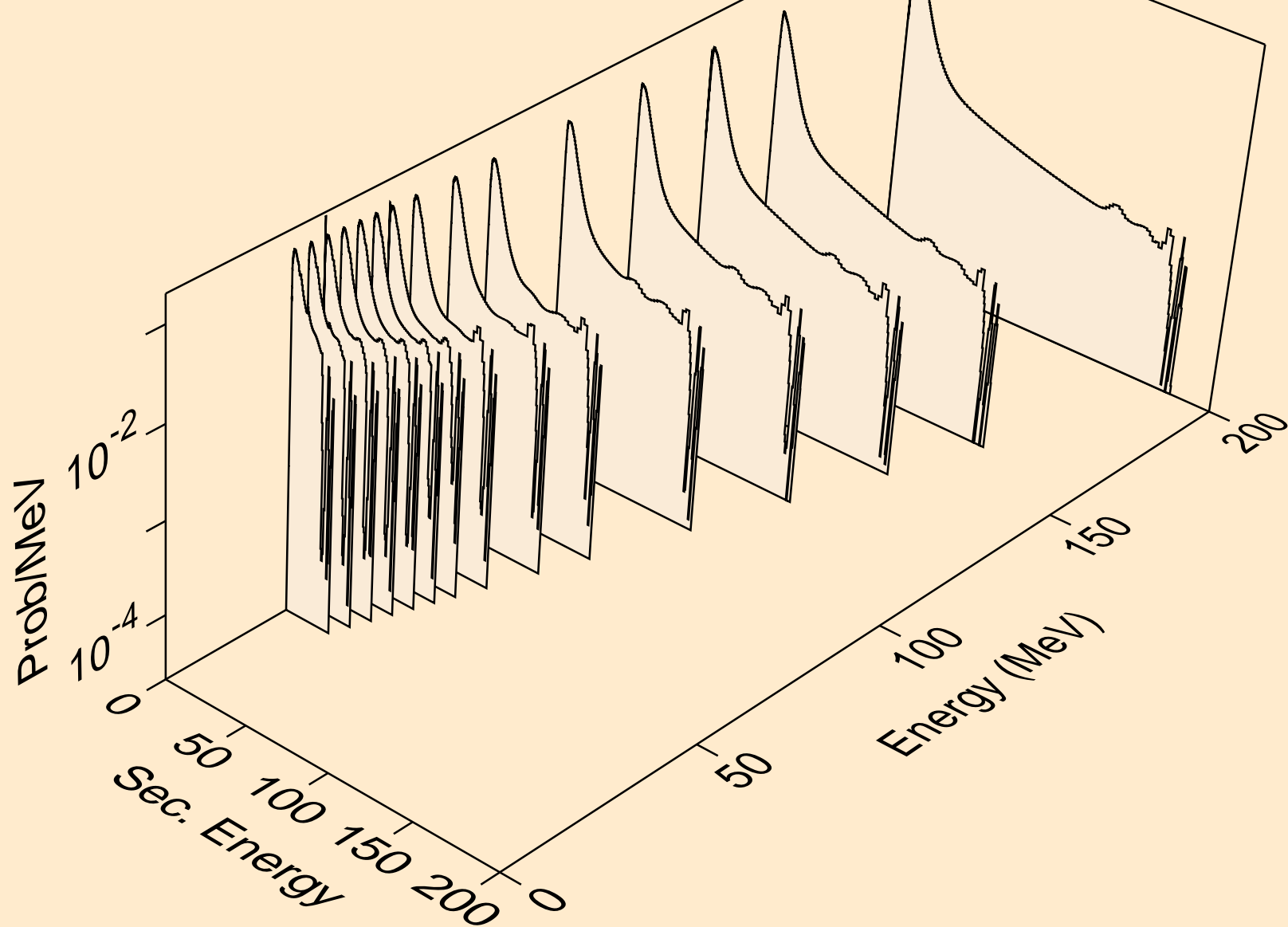

N016 NEUTRON ACER TENDL-2023 LIBRARY; T=0.K
Neutron emission for (n,2nd)

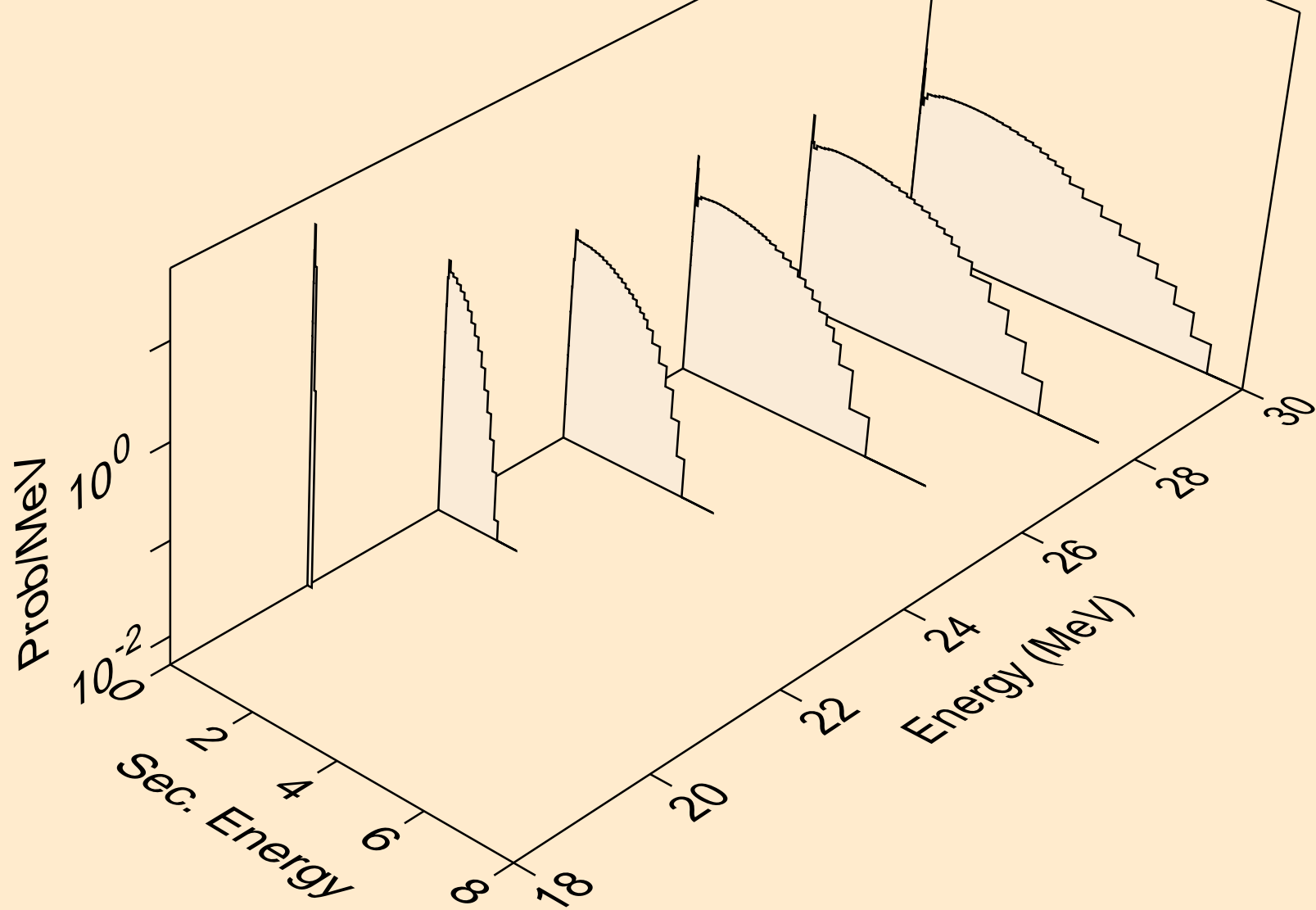

N016 NEUTRON ACER TENDL-2023 LIBRARY; T=0.K
Neutron emission for (n,2n)

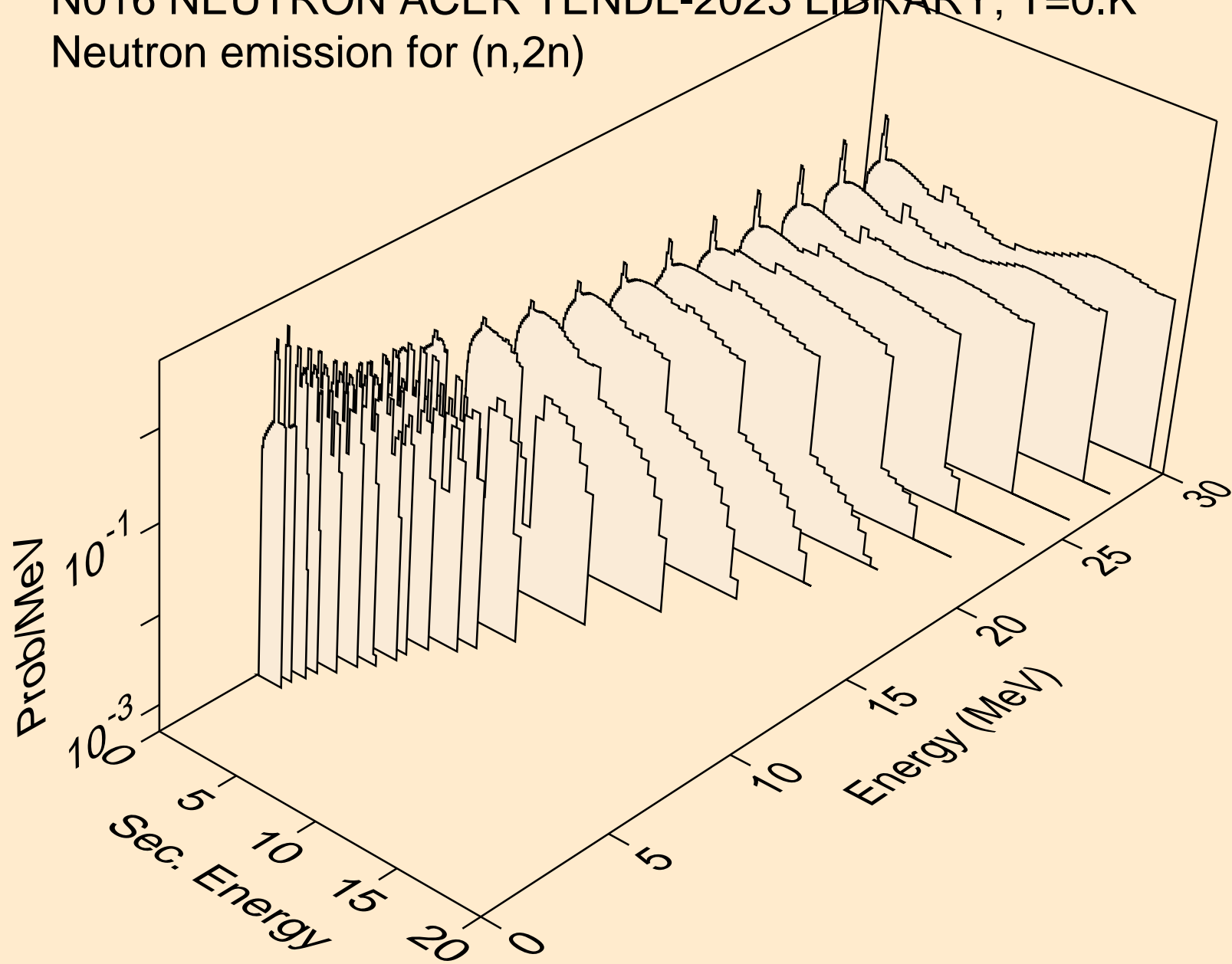

N016 NEUTRON ACER TENDL-2023 LIBRARY; T=0.K
Neutron emission for (n,3n)

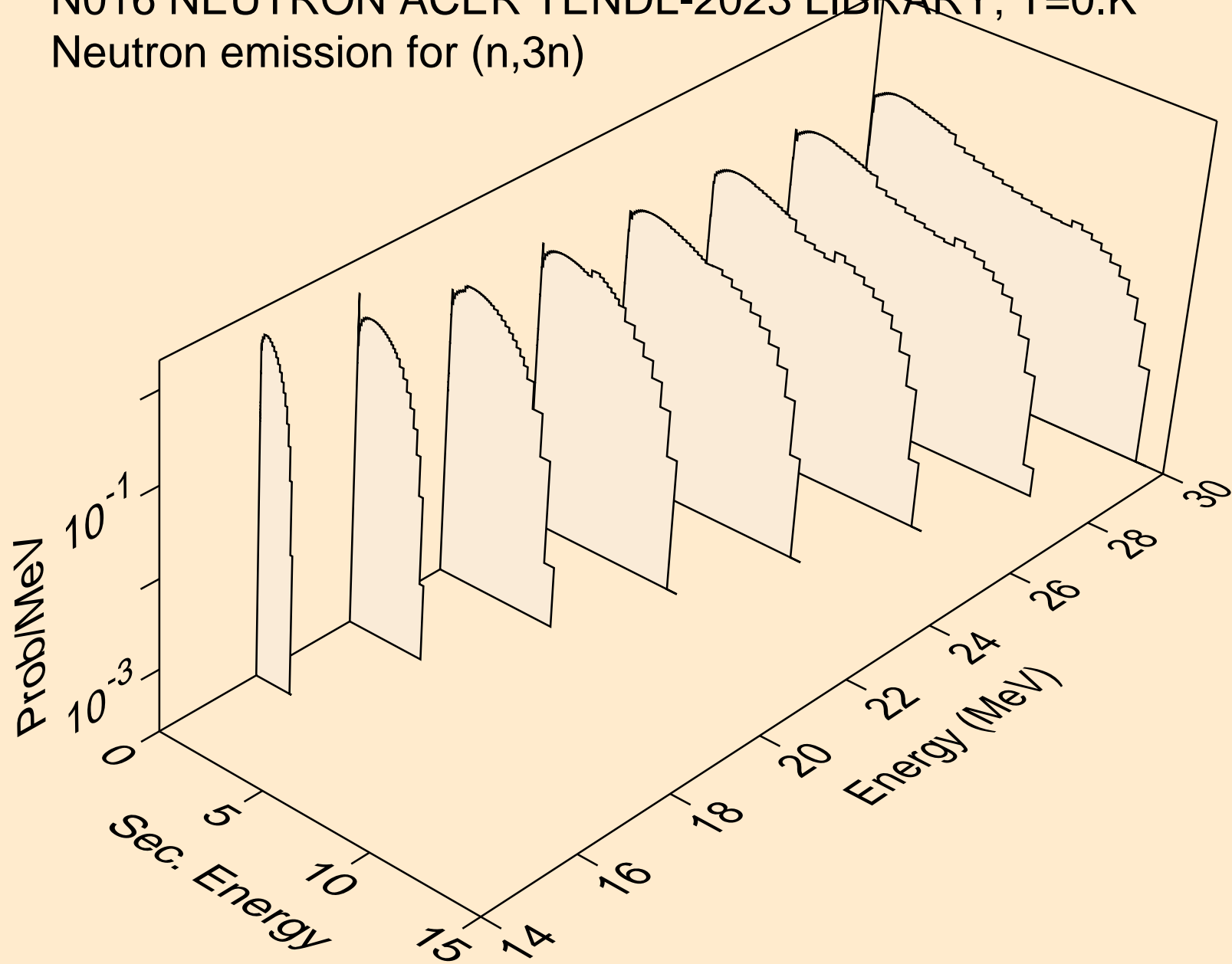

N016 NEUTRON ACER TENDL-2023 LIBRARY; T=0.K
Neutron emission for (n,n*)a

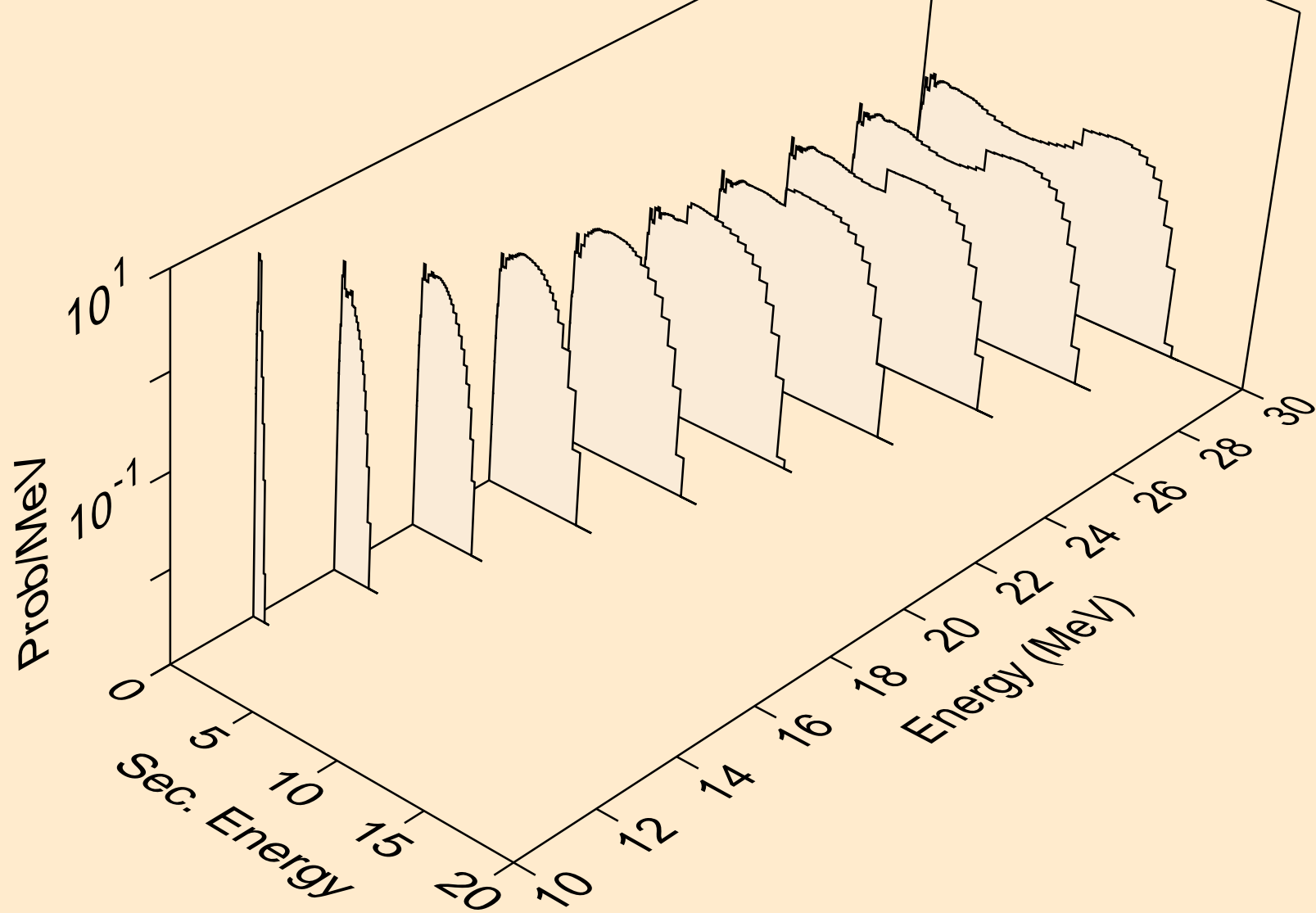

N016 NEUTRON ACER TENDL-2023 LIBRARY; T=0.K
Neutron emission for (n,2n)a

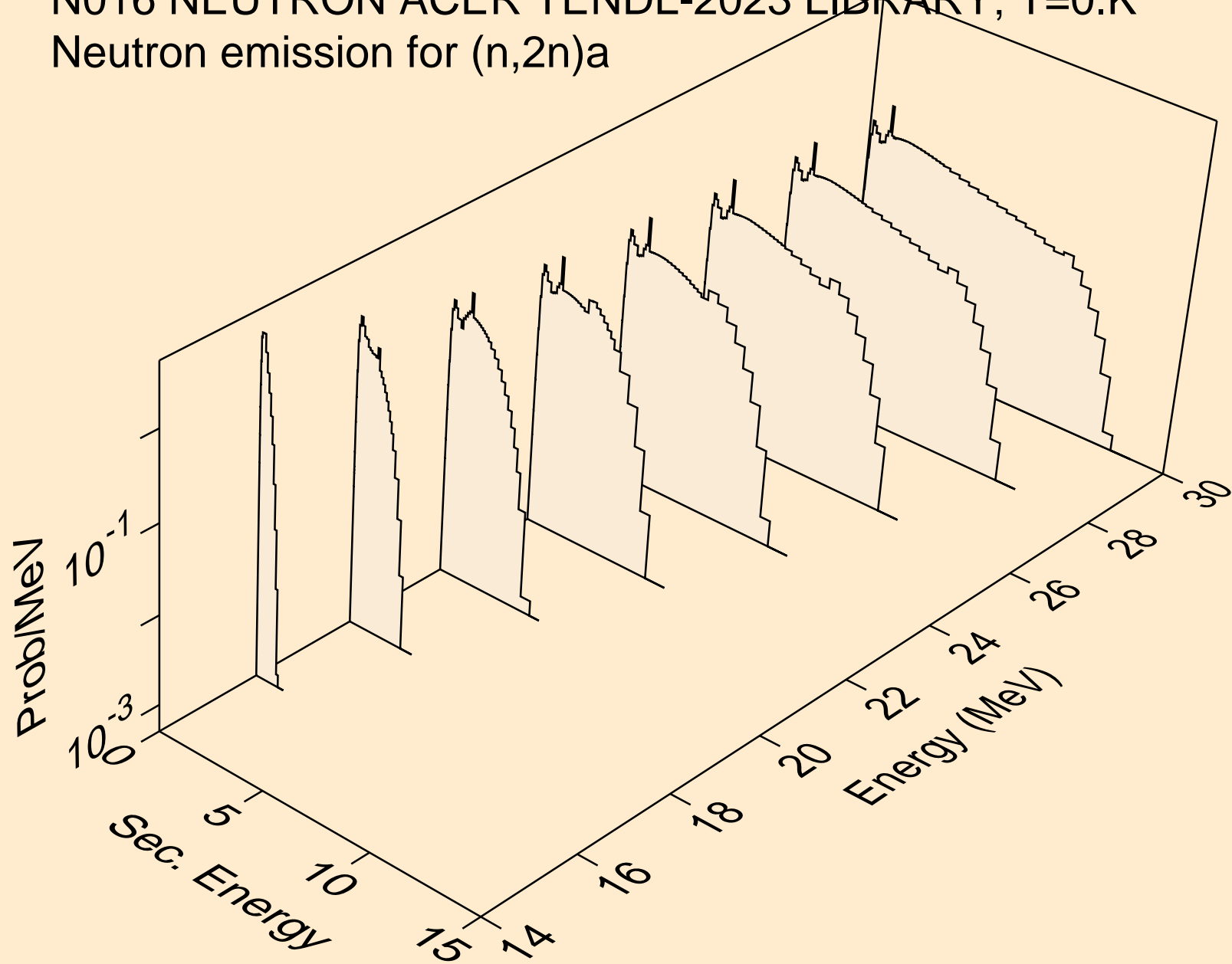

N016 NEUTRON ACER TENDL-2023 LIBRARY; T=0.K
Neutron emission for (n,3n)a

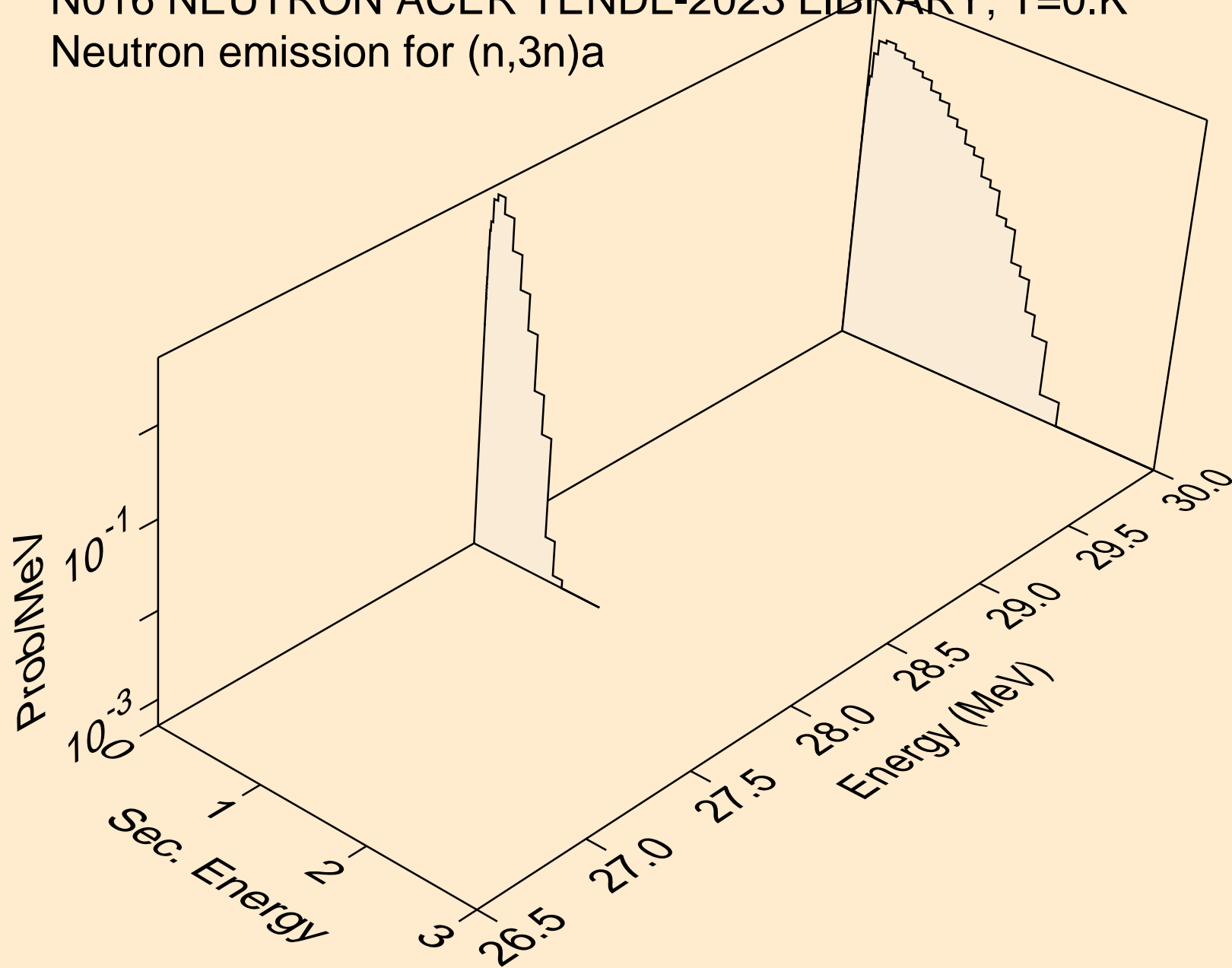

N016 NEUTRON ACER TENDL-2023 LIBRARY; T=0.K
Neutron emission for (n,n*)p

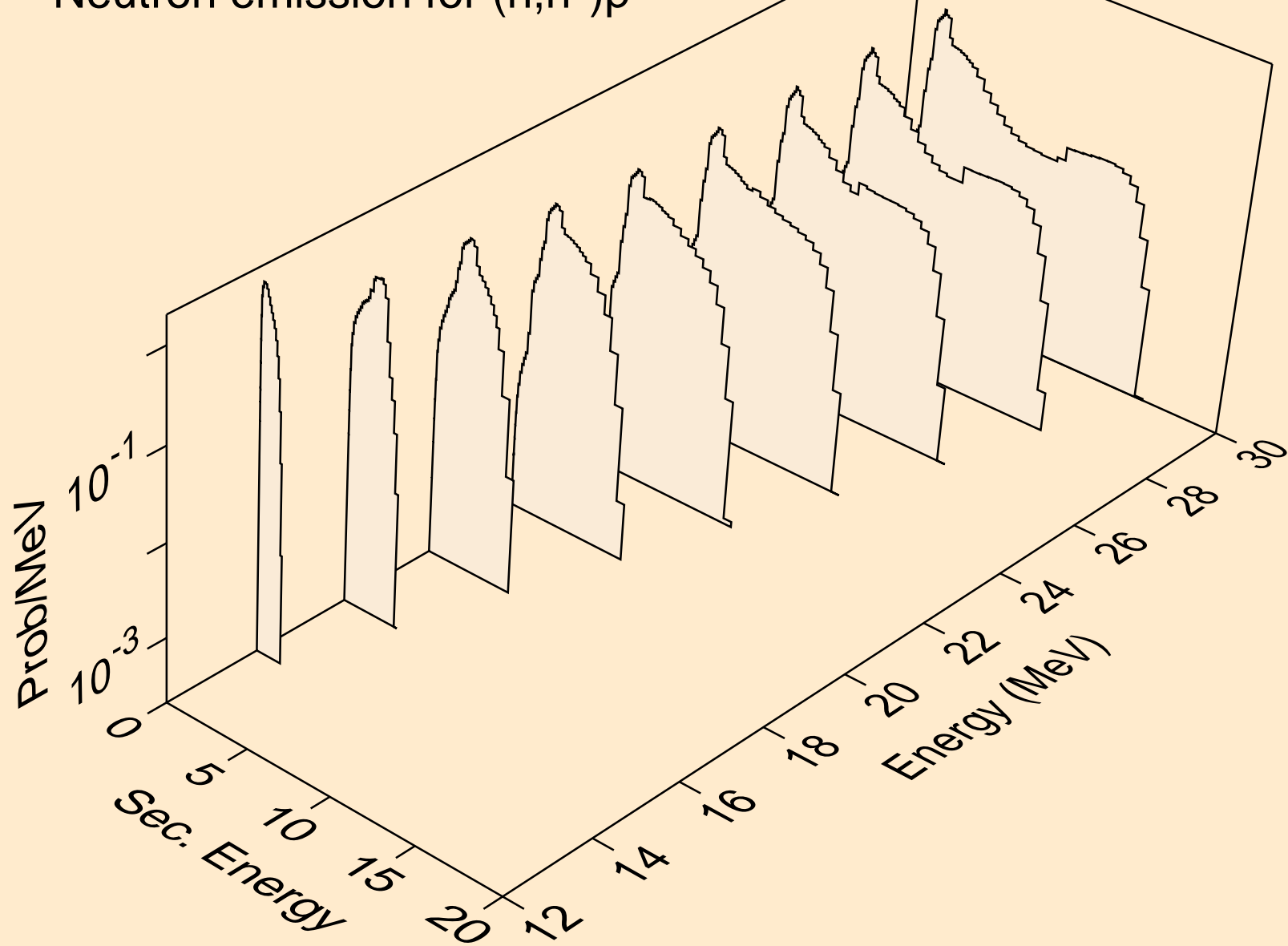

N016 NEUTRON ACER TENDL-2023 LIBRARY; T=0.K
Neutron emission for (n,n*)2a

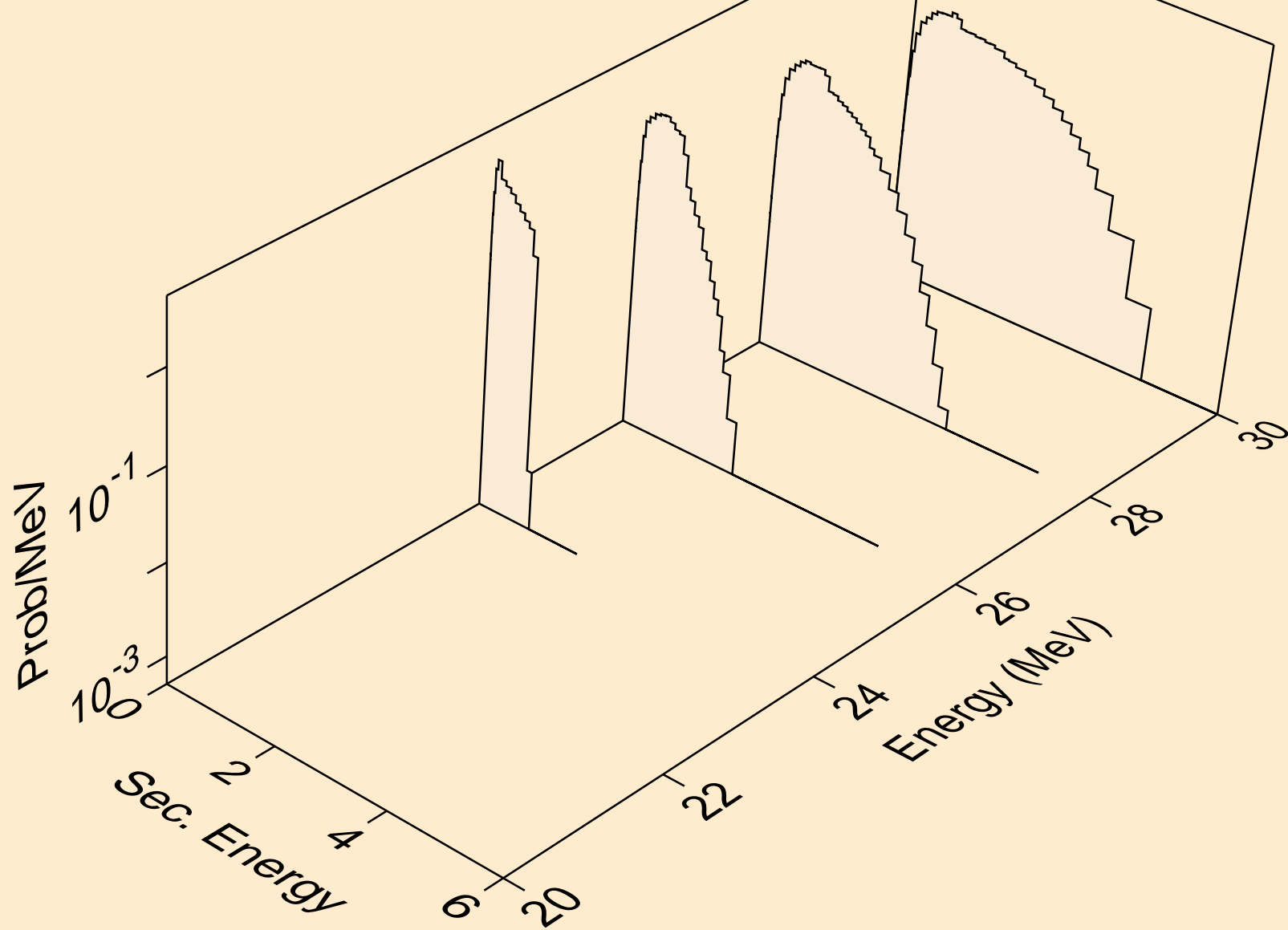

N016 NEUTRON ACER TENDL-2023 LIBRARY; T=0.K
Neutron emission for (n,2n)2a

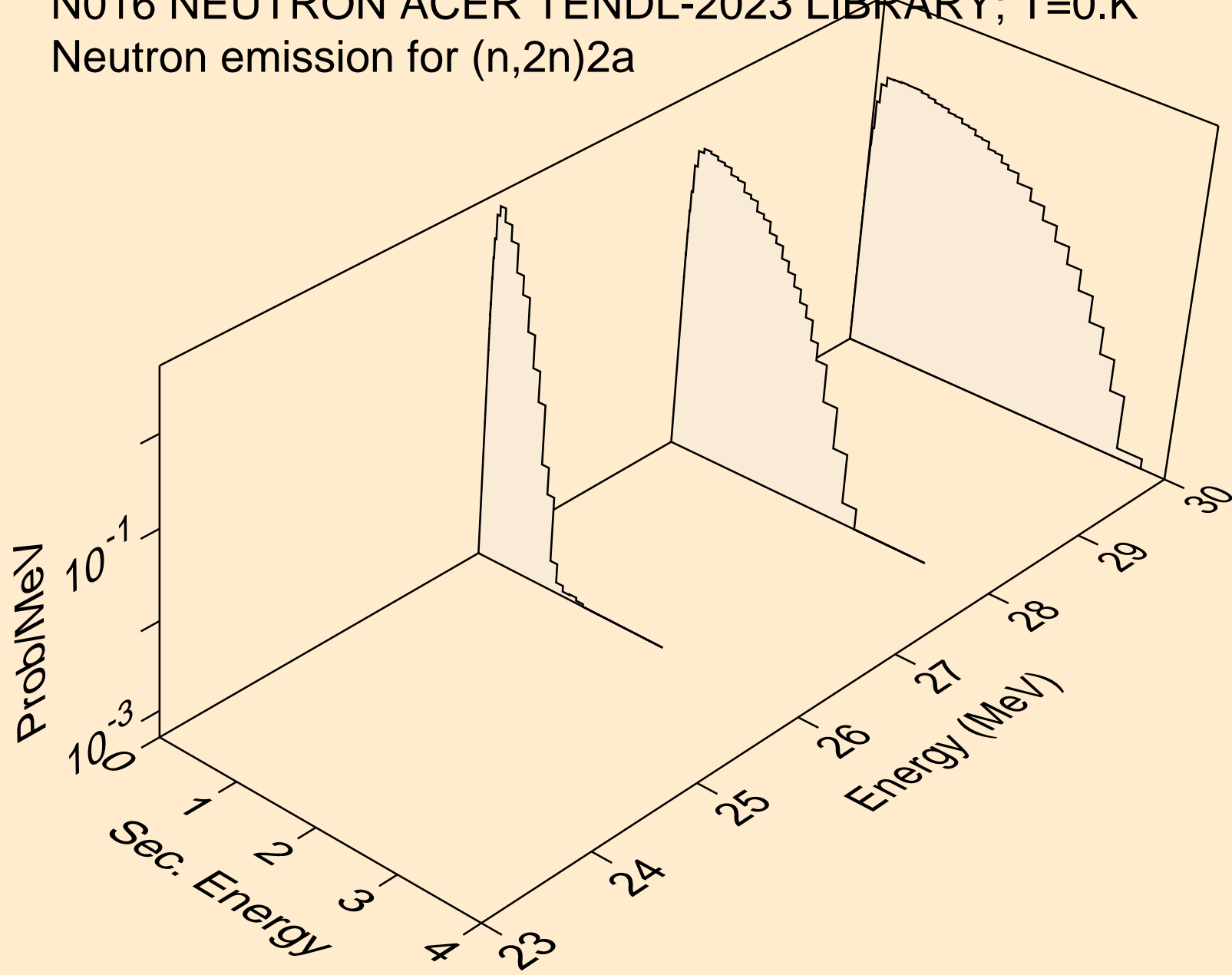

N016 NEUTRON ACER TENDL-2023 LIBRARY; T=0.K
Neutron emission for (n,n*)d

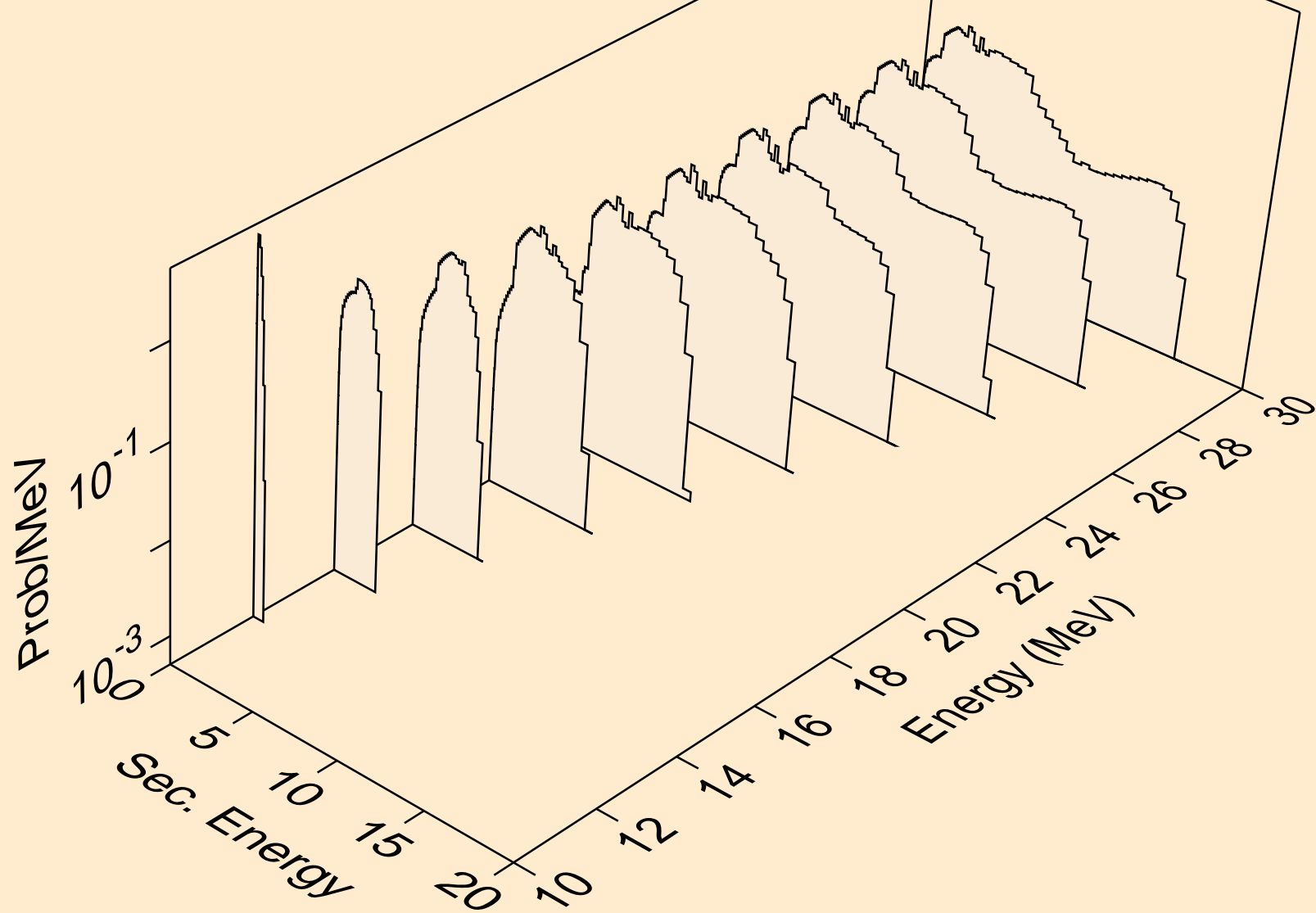

N016 NEUTRON ACER TENDL-2023 LIBRARY; T=0.K
Neutron emission for (n,n*)t

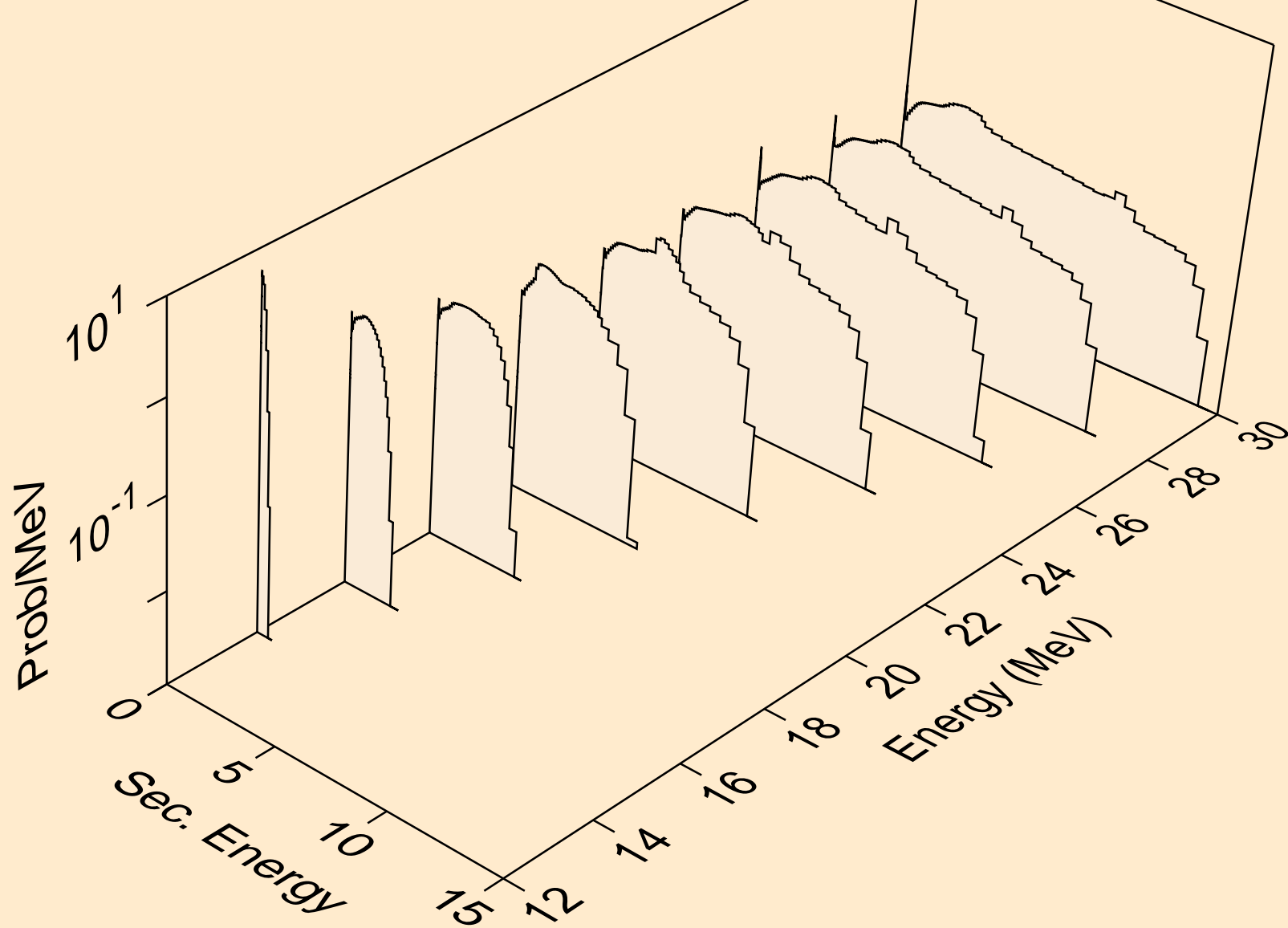

N016 NEUTRON ACER TENDL-2023 LIBRARY; T=0.K
Neutron emission for (n,n*)he3

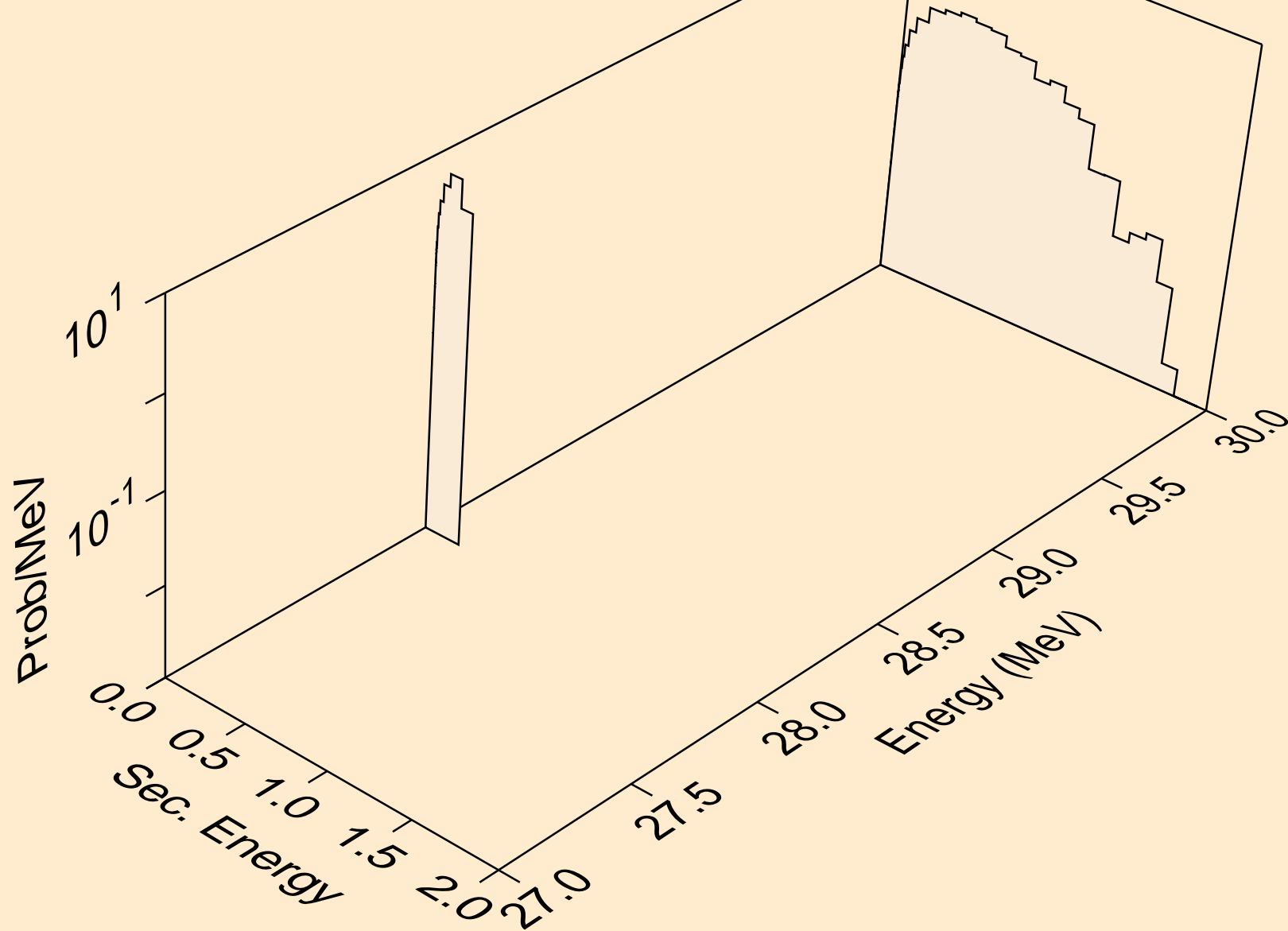

N016 NEUTRON ACER TENDL-2023 LIBRARY; T=0.K
Neutron emission for (n,4n)

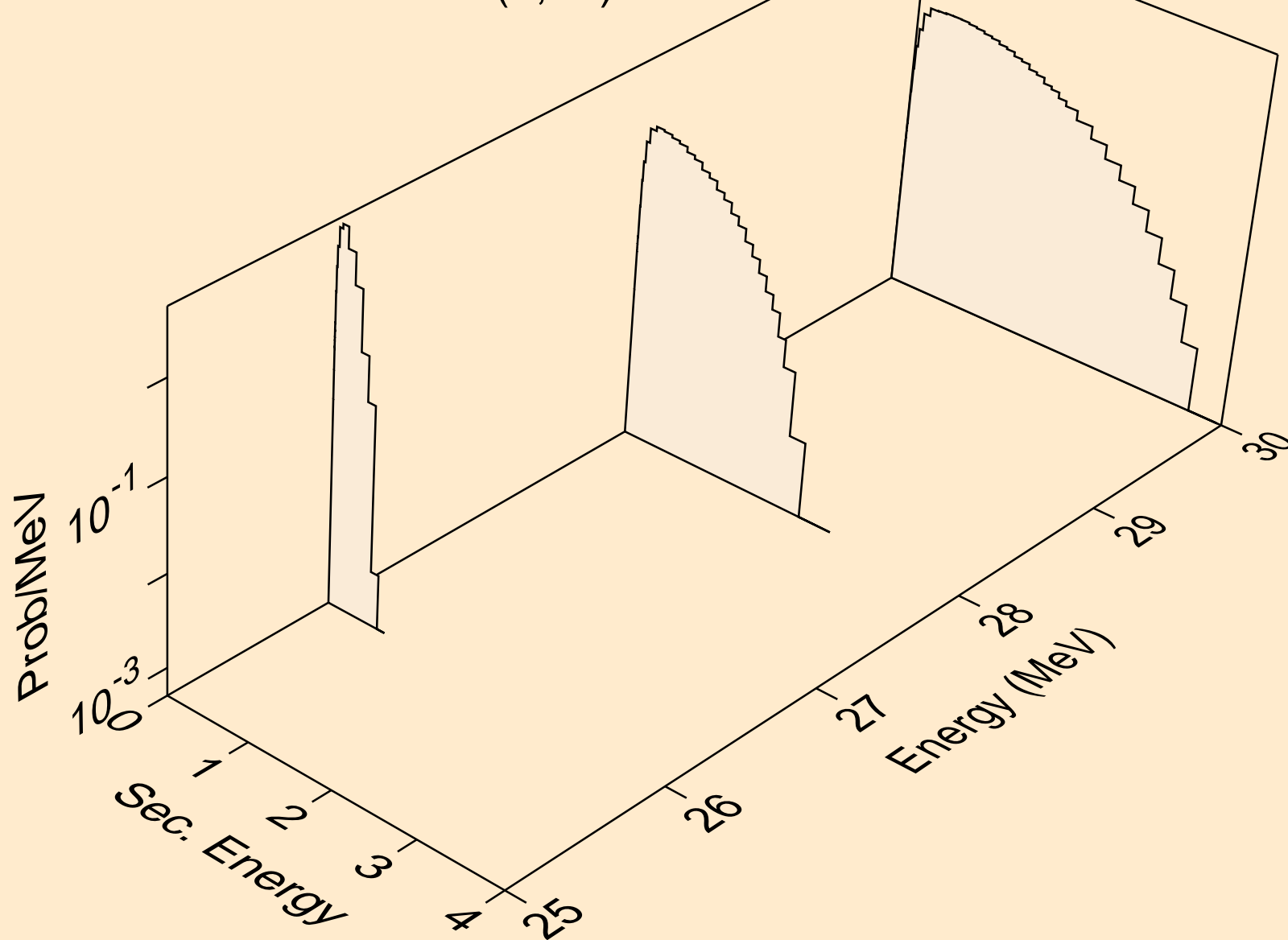

N016 NEUTRON ACER TENDL-2023 LIBRARY; T=0.K
Neutron emission for (n,2np)

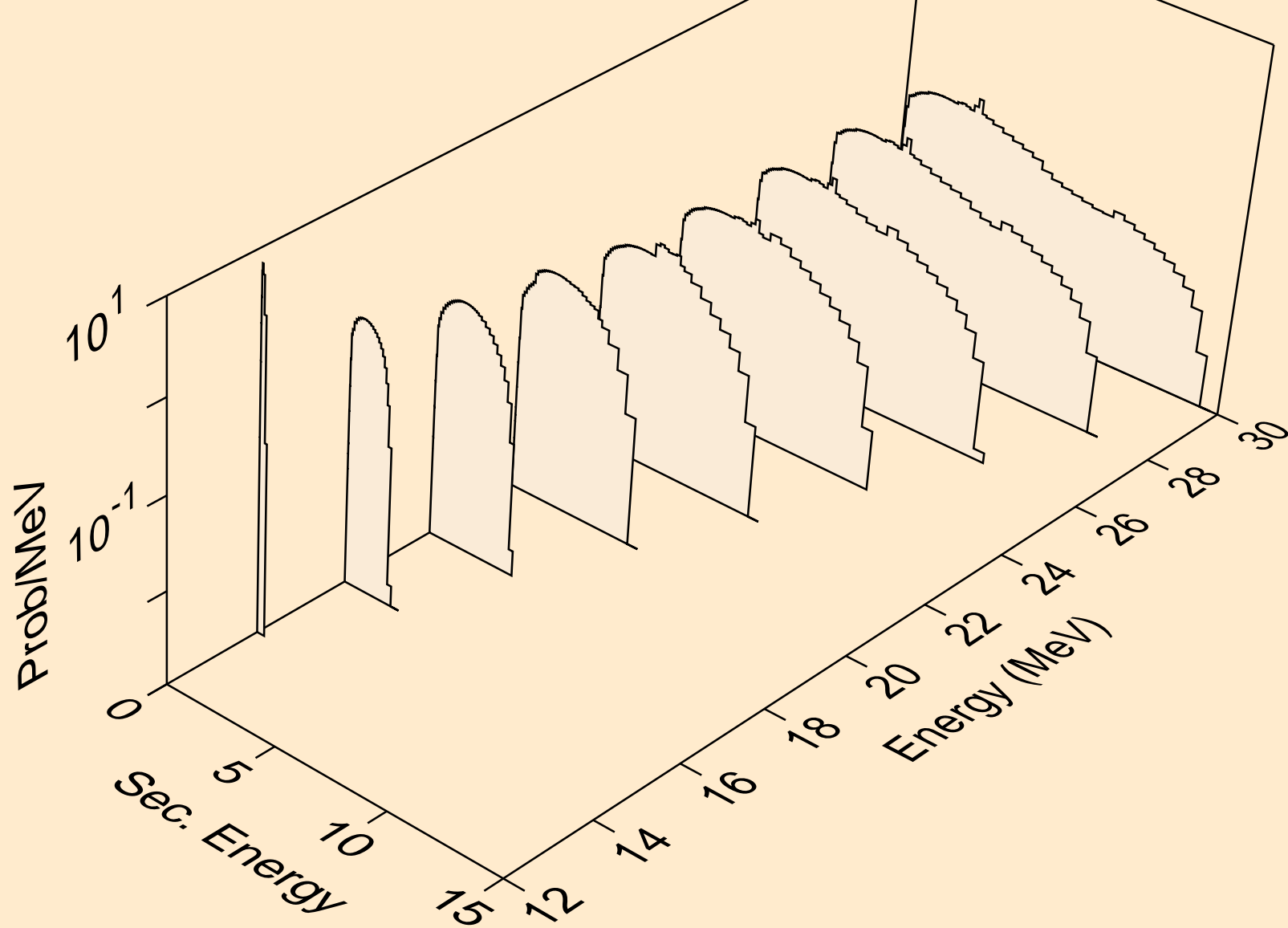

N016 NEUTRON ACER TENDL-2023 LIBRARY; T=0.K
Neutron emission for (n,3np)

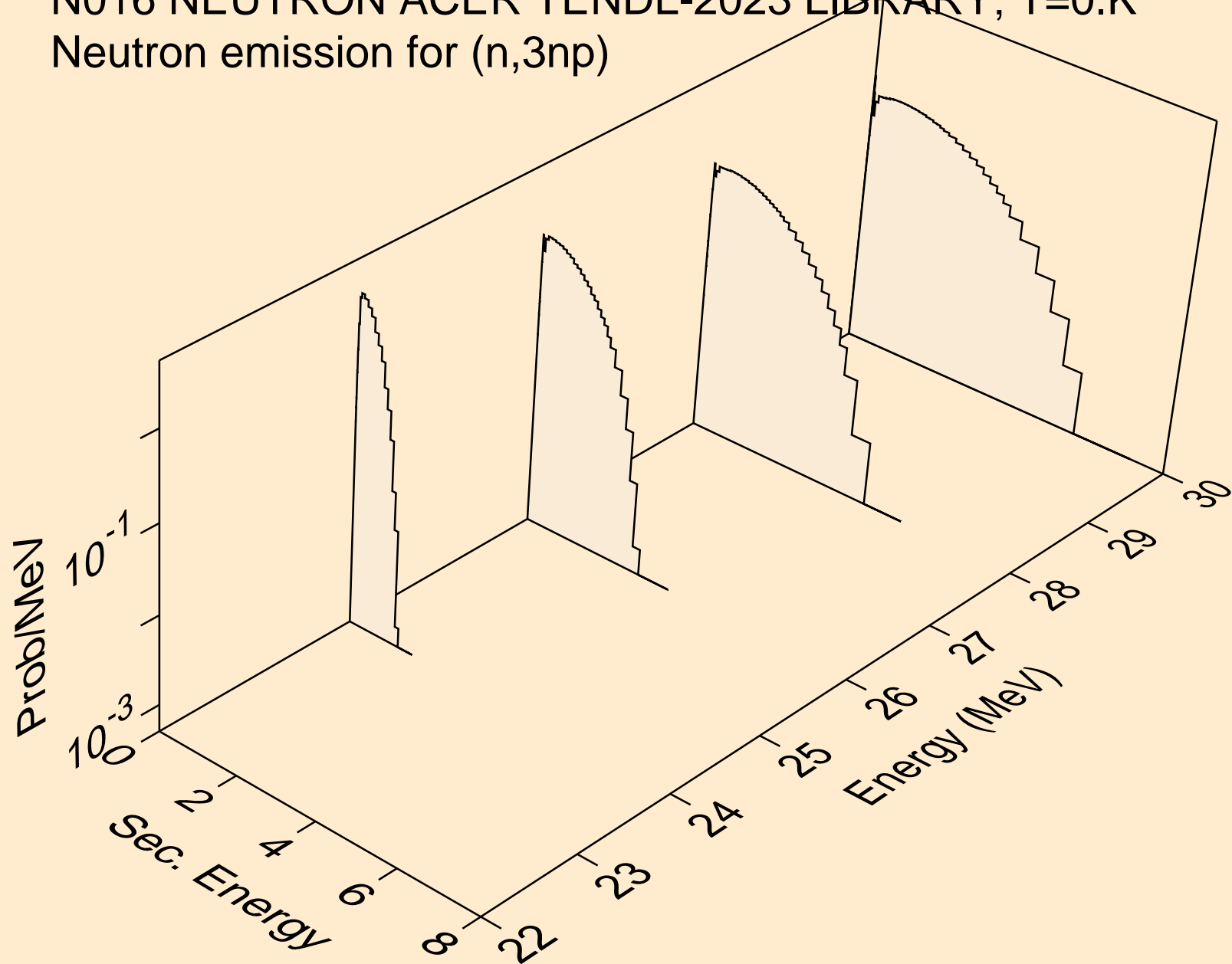

N016 NEUTRON ACER TENDL-2023 LIBRARY; T=0.K
Neutron emission for (n,npa)

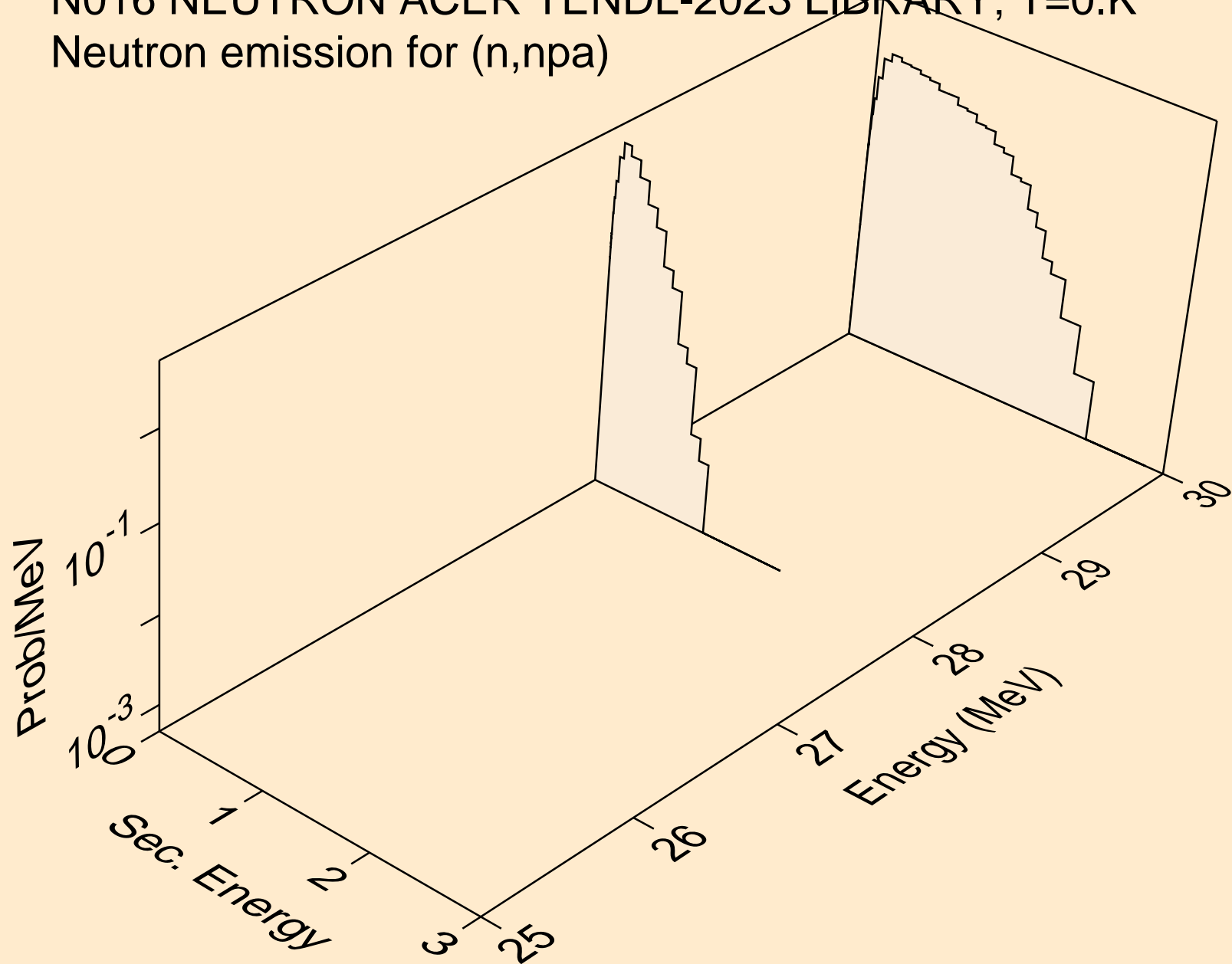

N016 NEUTRON ACER TENDL-2023 LIBRARY; T=0.K
Photon emission for (n,x)

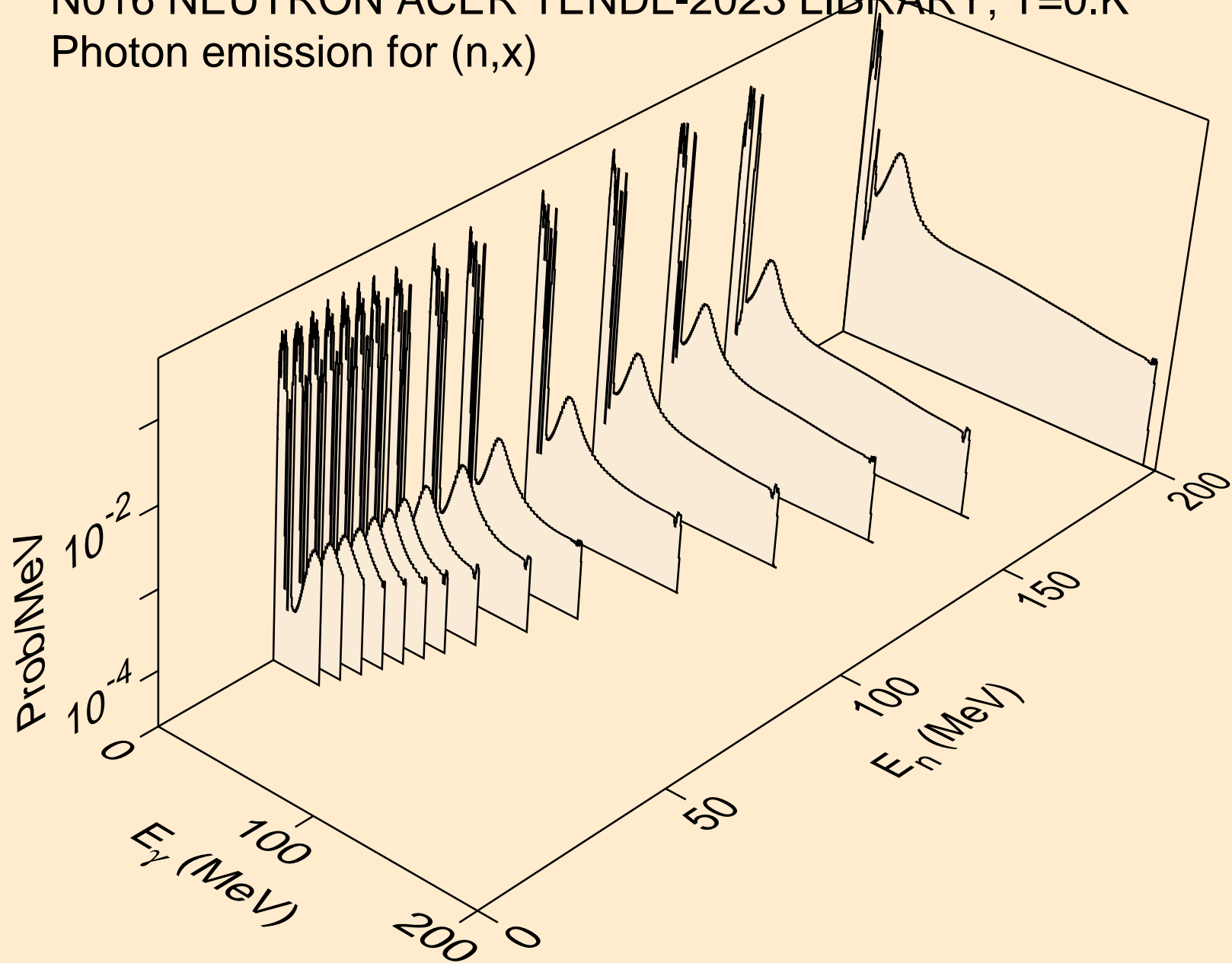

N016 NEUTRON ACER TENDL-2023 LIBRARY; T=0.K
Photon emission for (n,2nd)

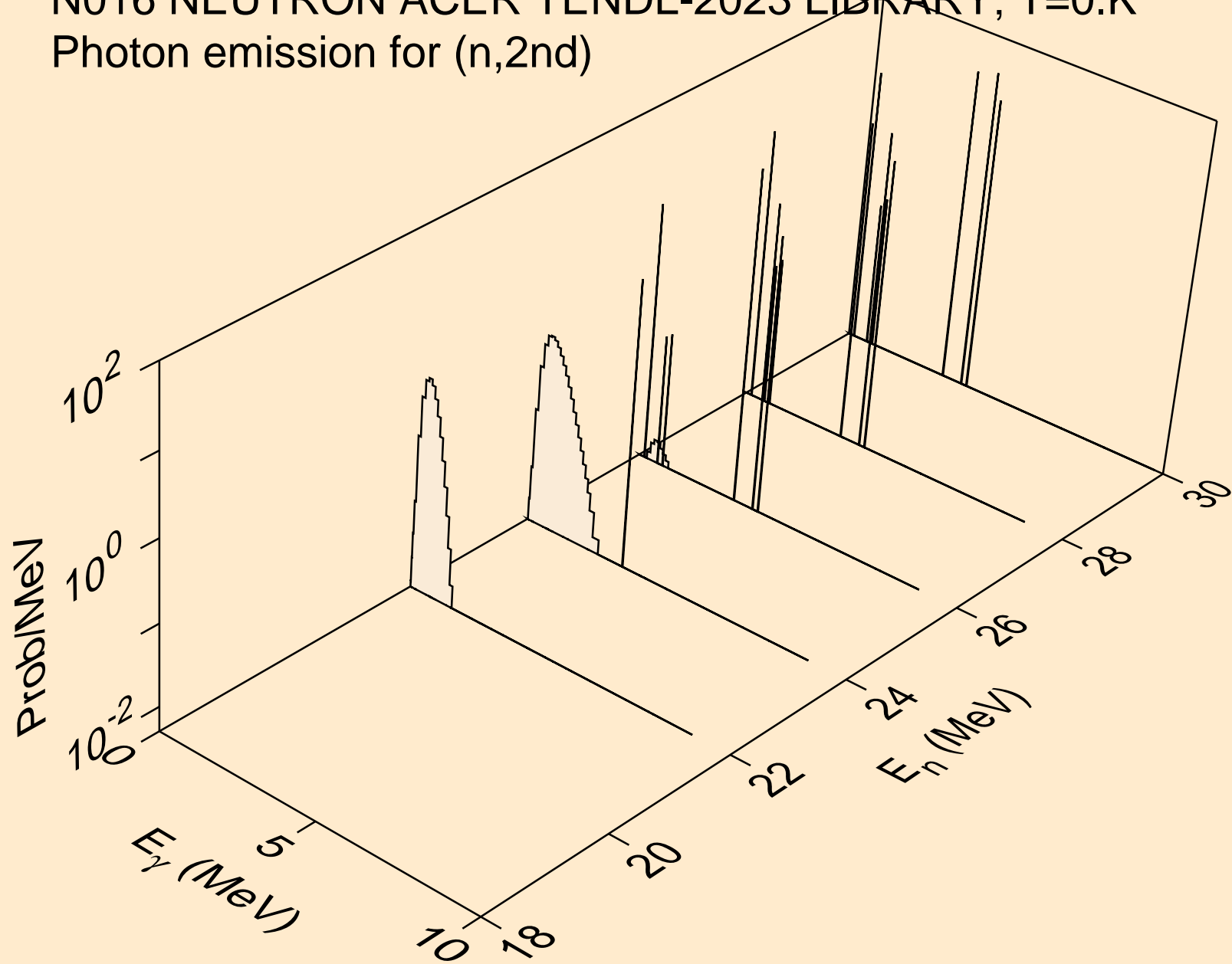

N016 NEUTRON ACER TENDL-2023 LIBRARY; T=0.K
Photon emission for (n,2n)

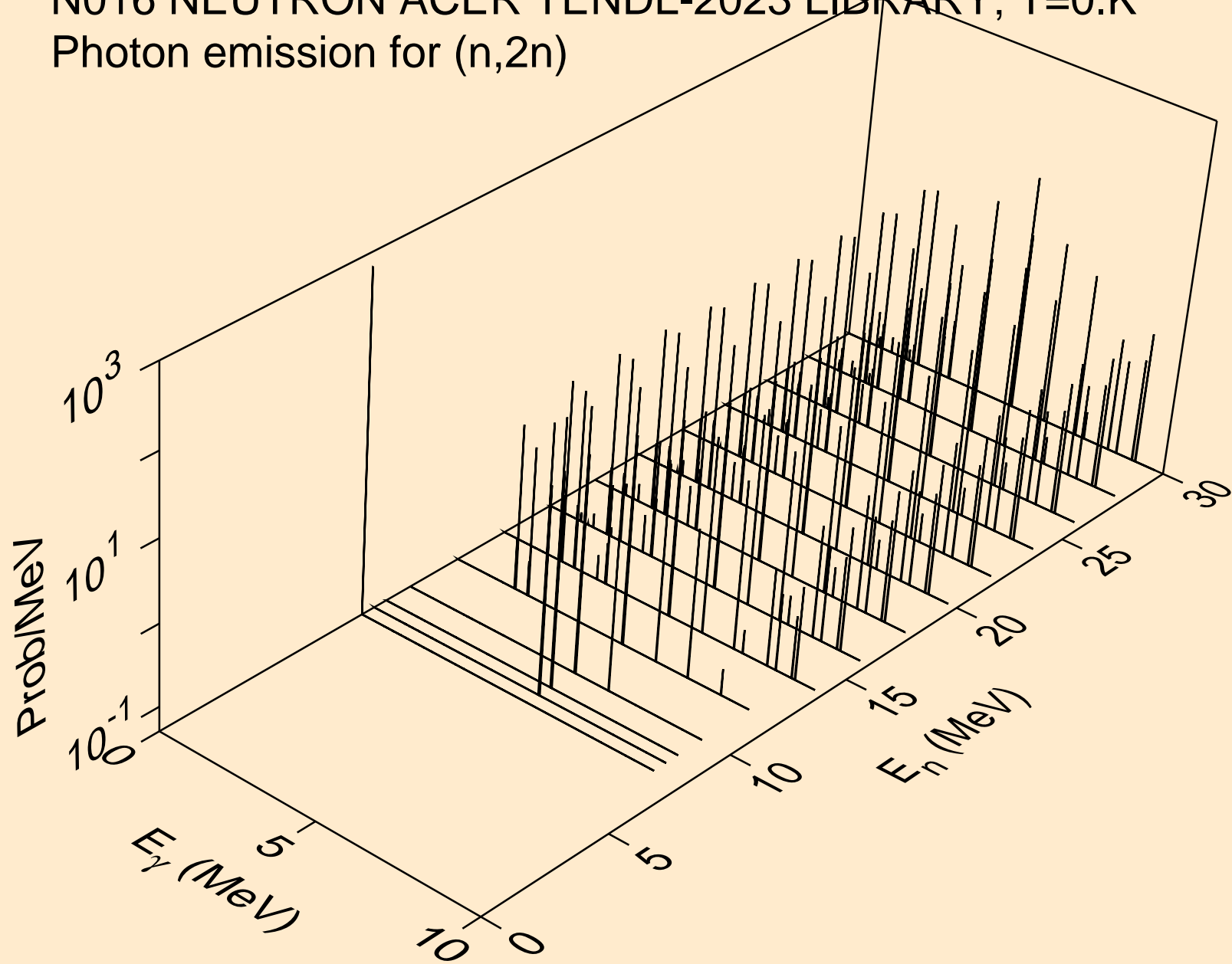

N016 NEUTRON ACER TENDL-2023 LIBRARY; T=0.K
Photon emission for (n,3n)

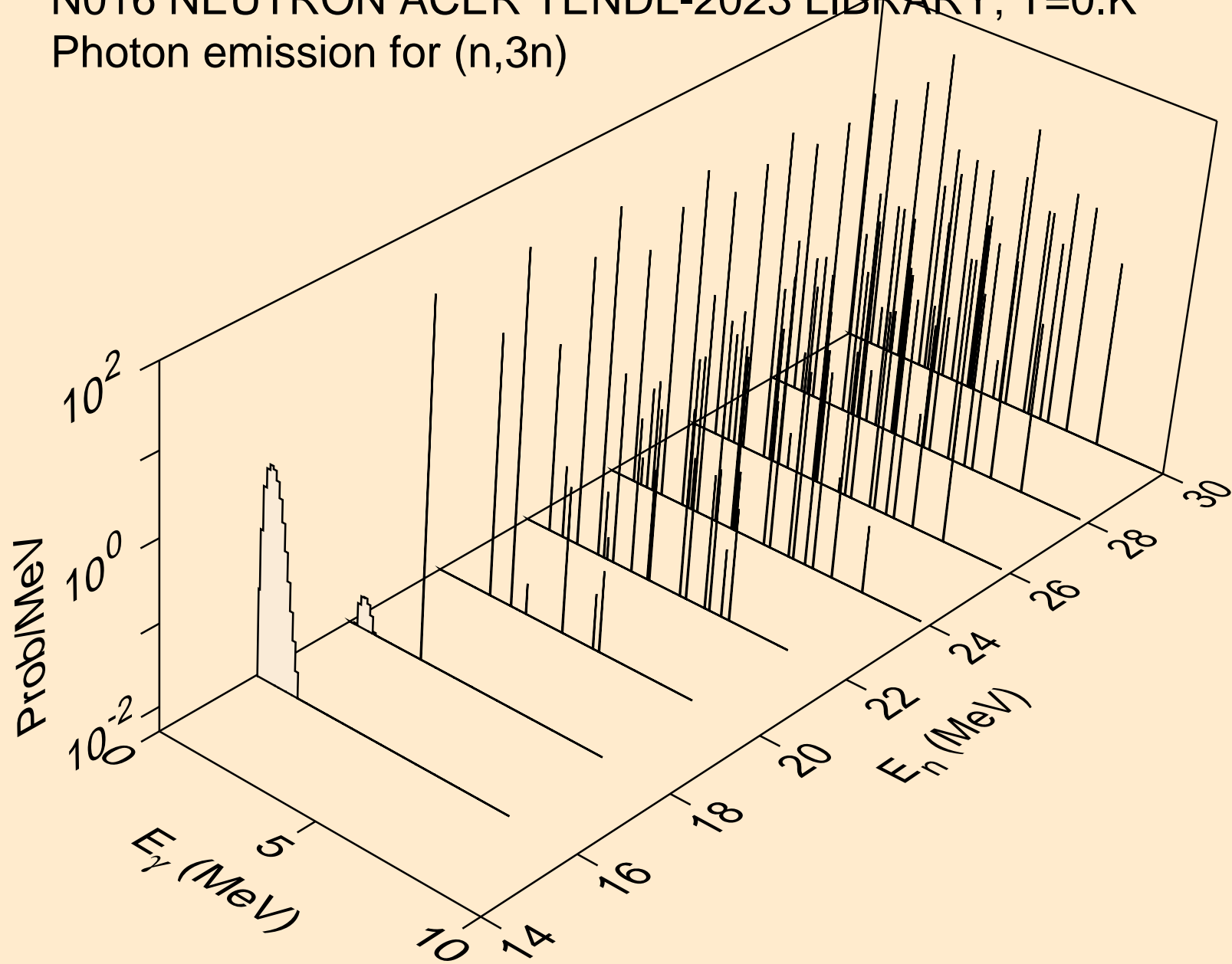

N016 NEUTRON ACER TENDL-2023 LIBRARY; T=0.K
Photon emission for (n,n*)a

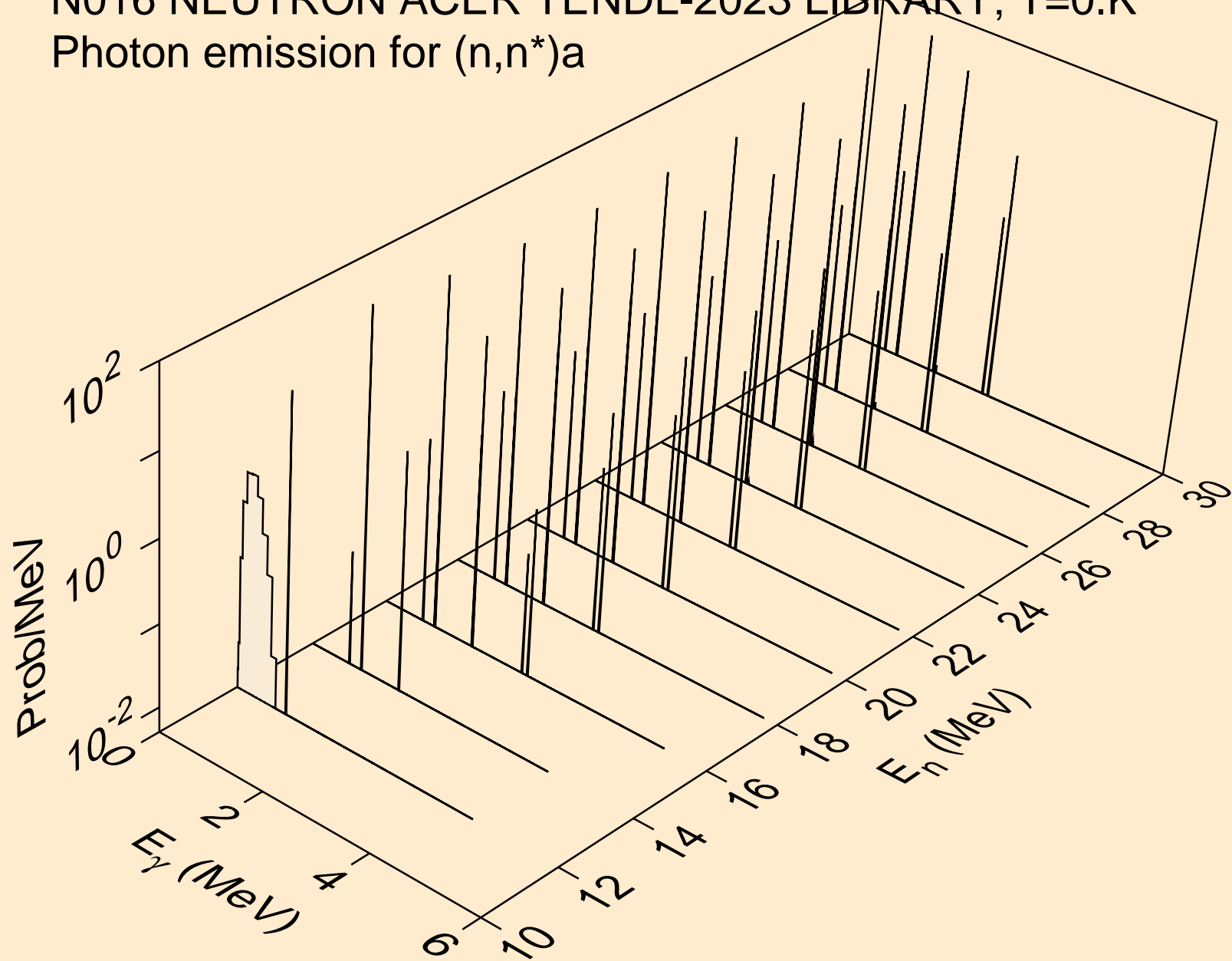

N016 NEUTRON ACER TENDL-2023 LIBRARY; T=0.K
Photon emission for (n,2n)a

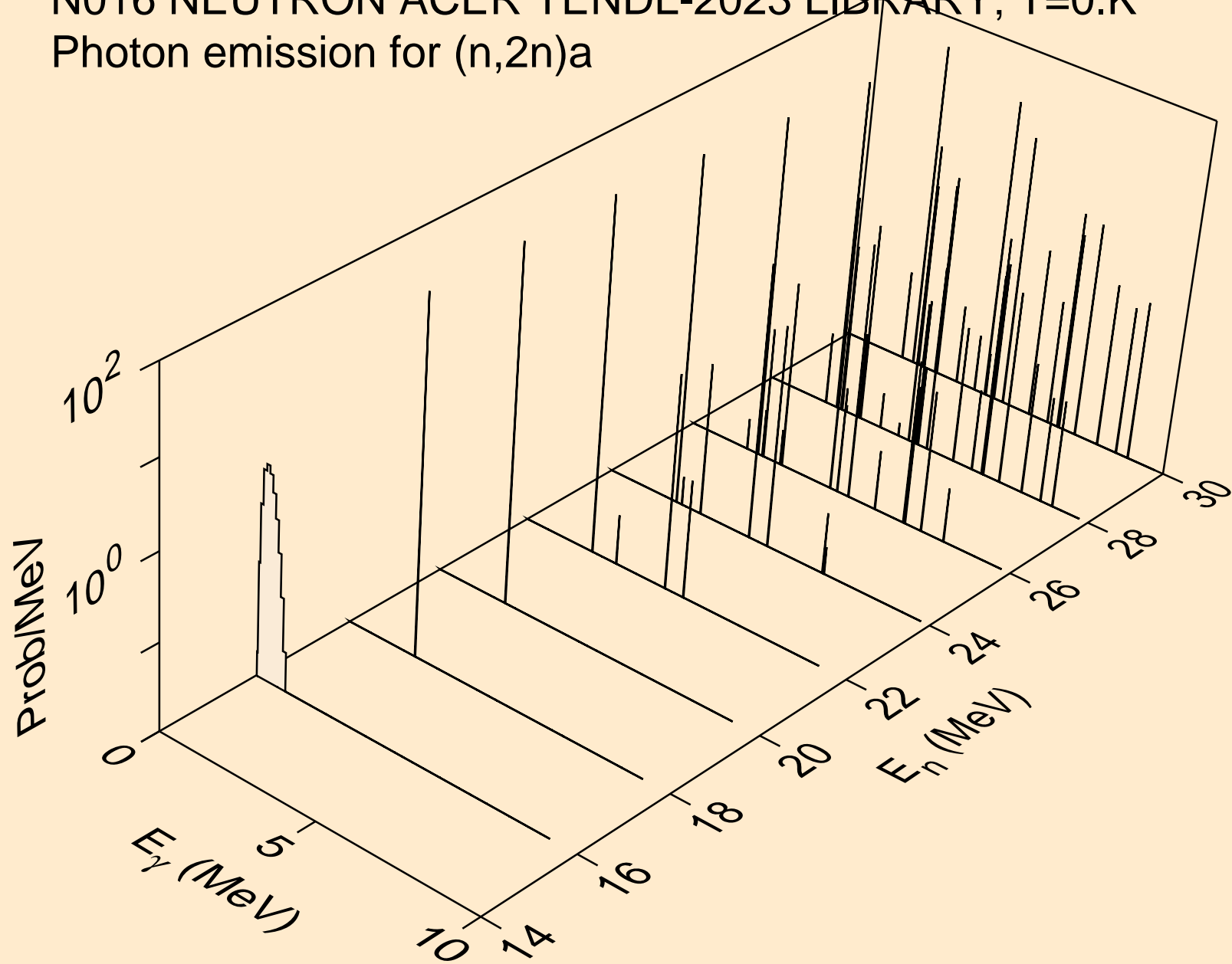

N016 NEUTRON ACER TENDL-2023 LIBRARY; T=0.K
Photon emission for (n,3n)a

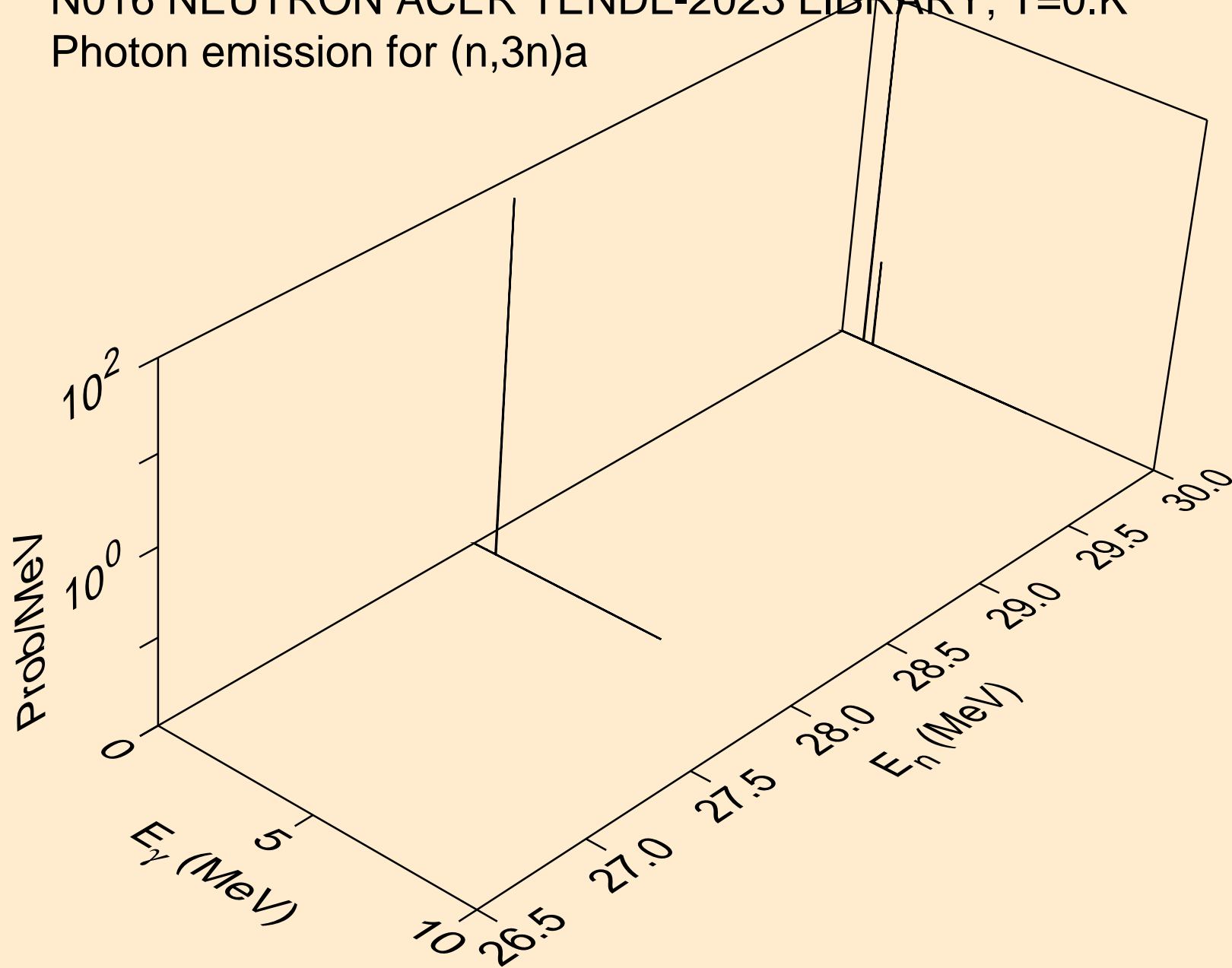

N016 NEUTRON ACER TENDL-2023 LIBRARY; T=0.K
Photon emission for (n,n*)p

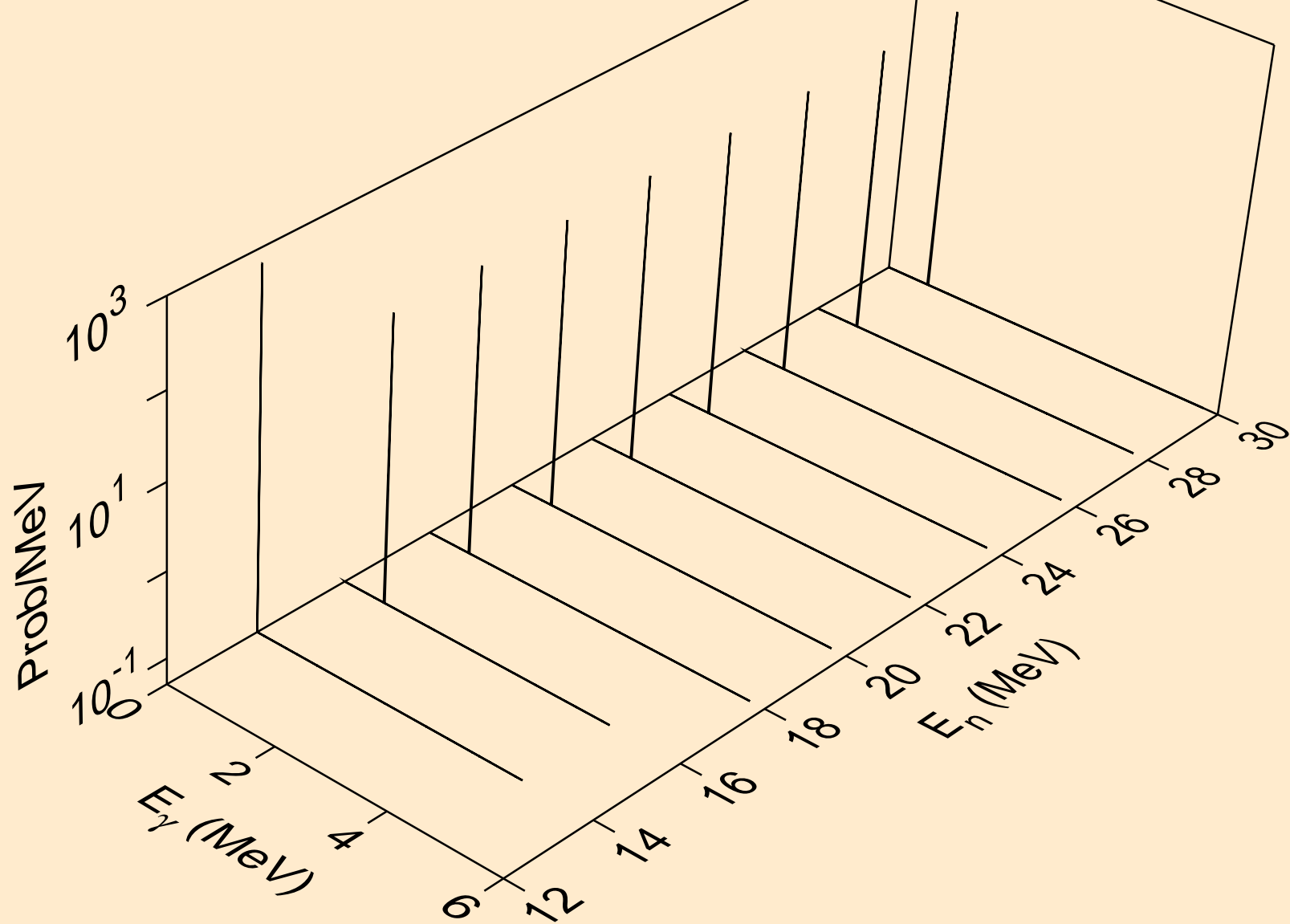

N016 NEUTRON ACER TENDL-2023 LIBRARY; T=0.K
Photon emission for (n,n*)2a

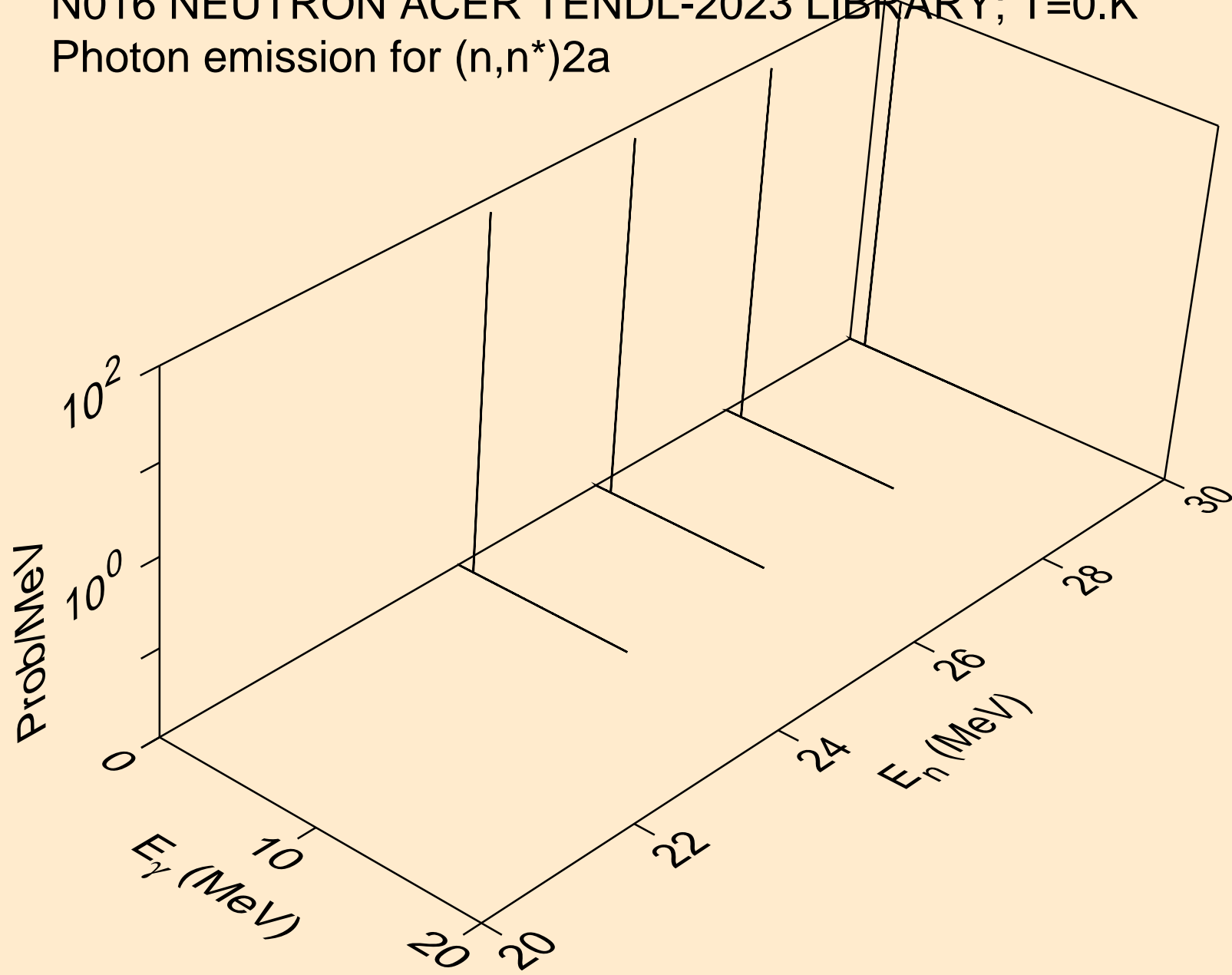

N016 NEUTRON ACER TENDL-2023 LIBRARY; T=0.K
Photon emission for (n,2n)2a

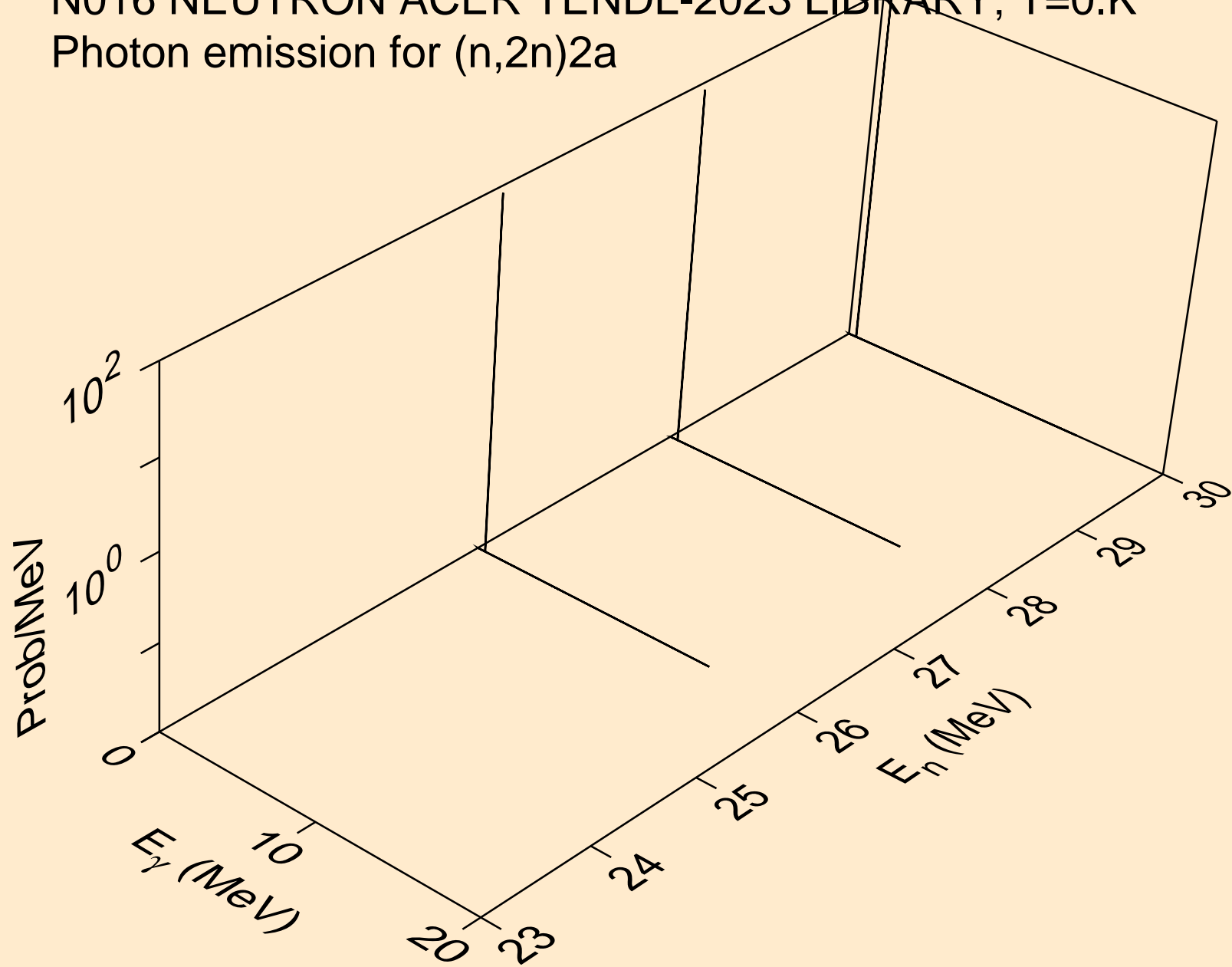

N016 NEUTRON ACER TENDL-2023 LIBRARY; T=0.K
Photon emission for (n,n*)d

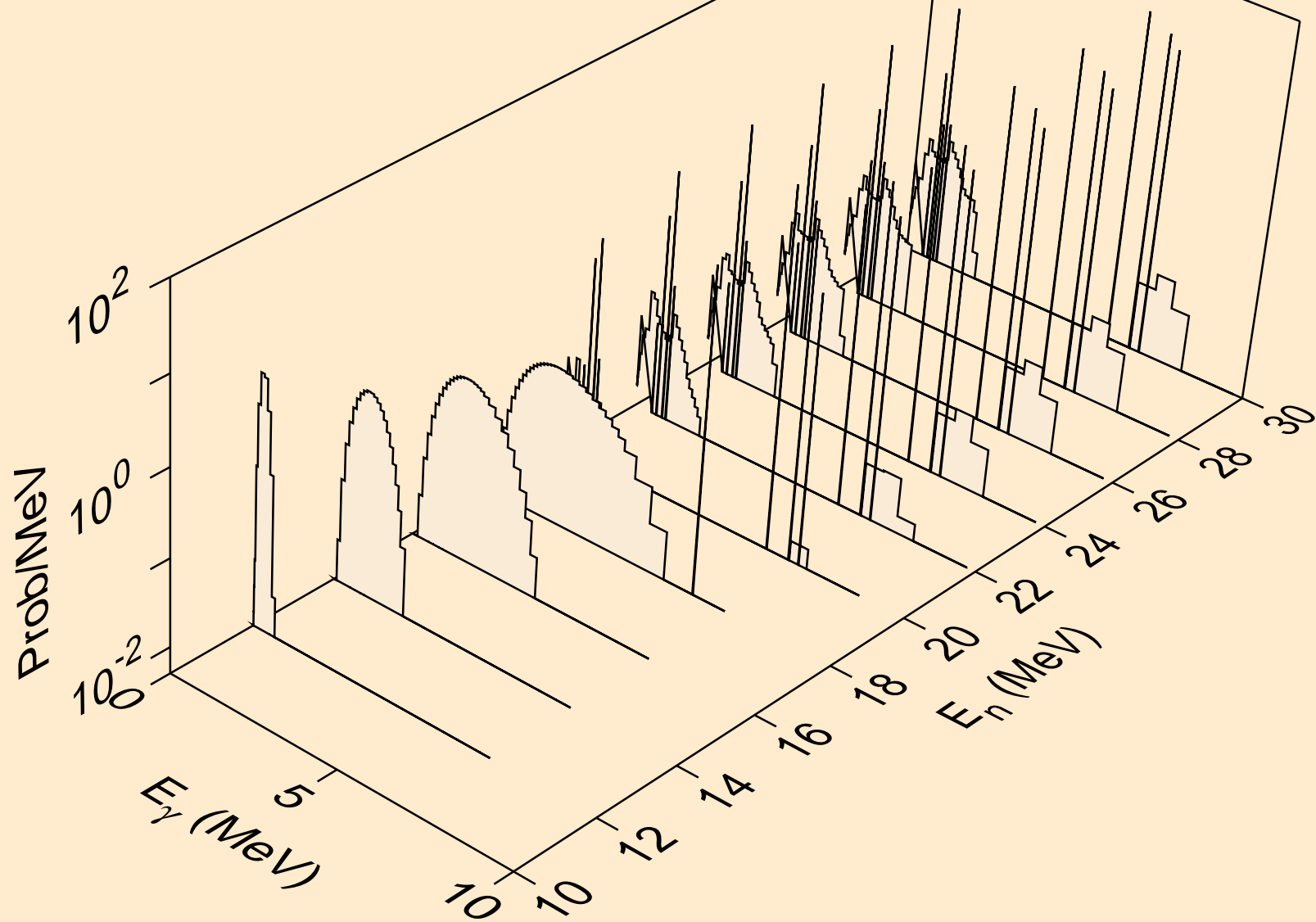

N016 NEUTRON ACER TENDL-2023 LIBRARY; T=0.K
Photon emission for (n,n*)t

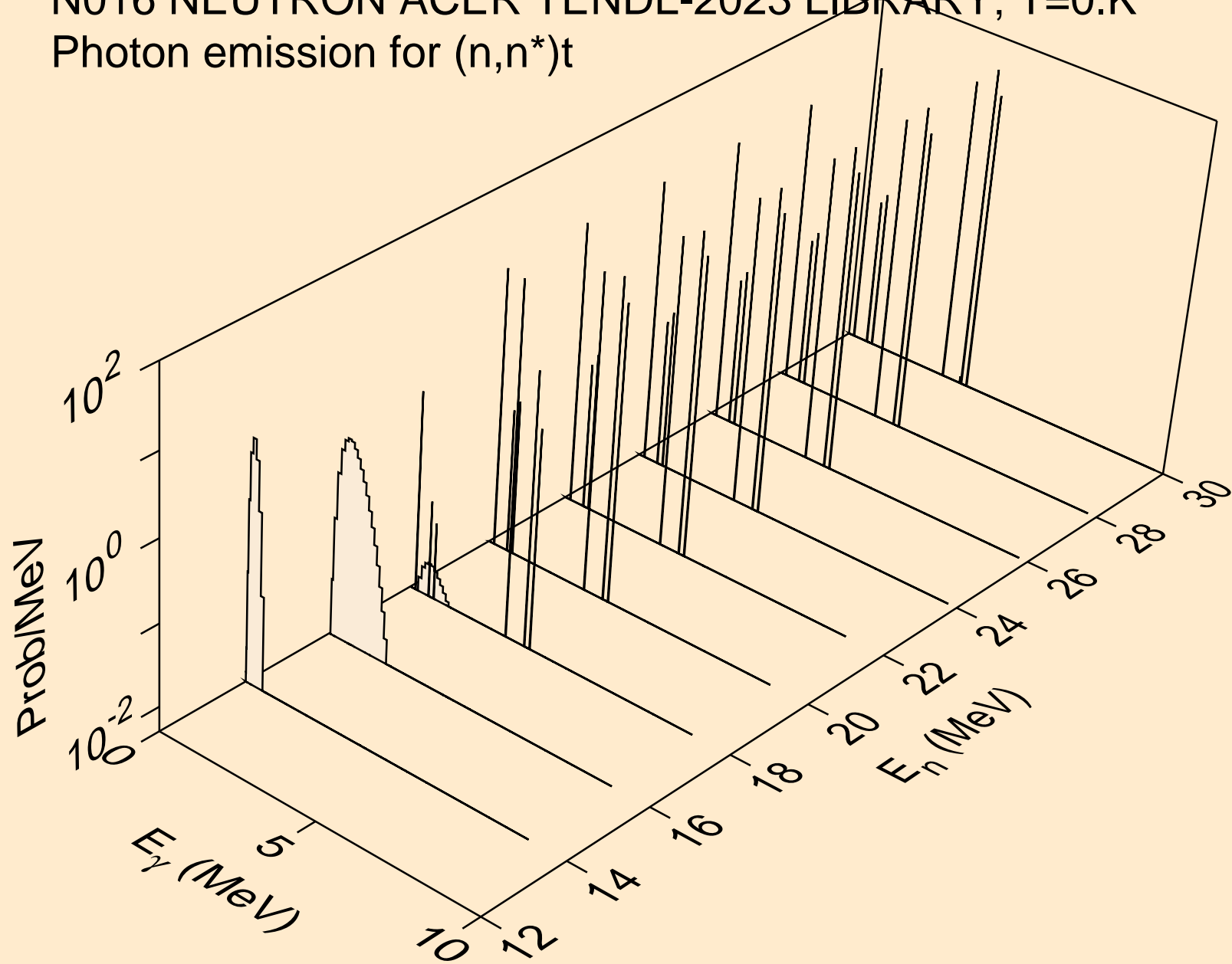

N016 NEUTRON ACER TENDL-2023 LIBRARY; T=0.K
Photon emission for (n,n*)he3

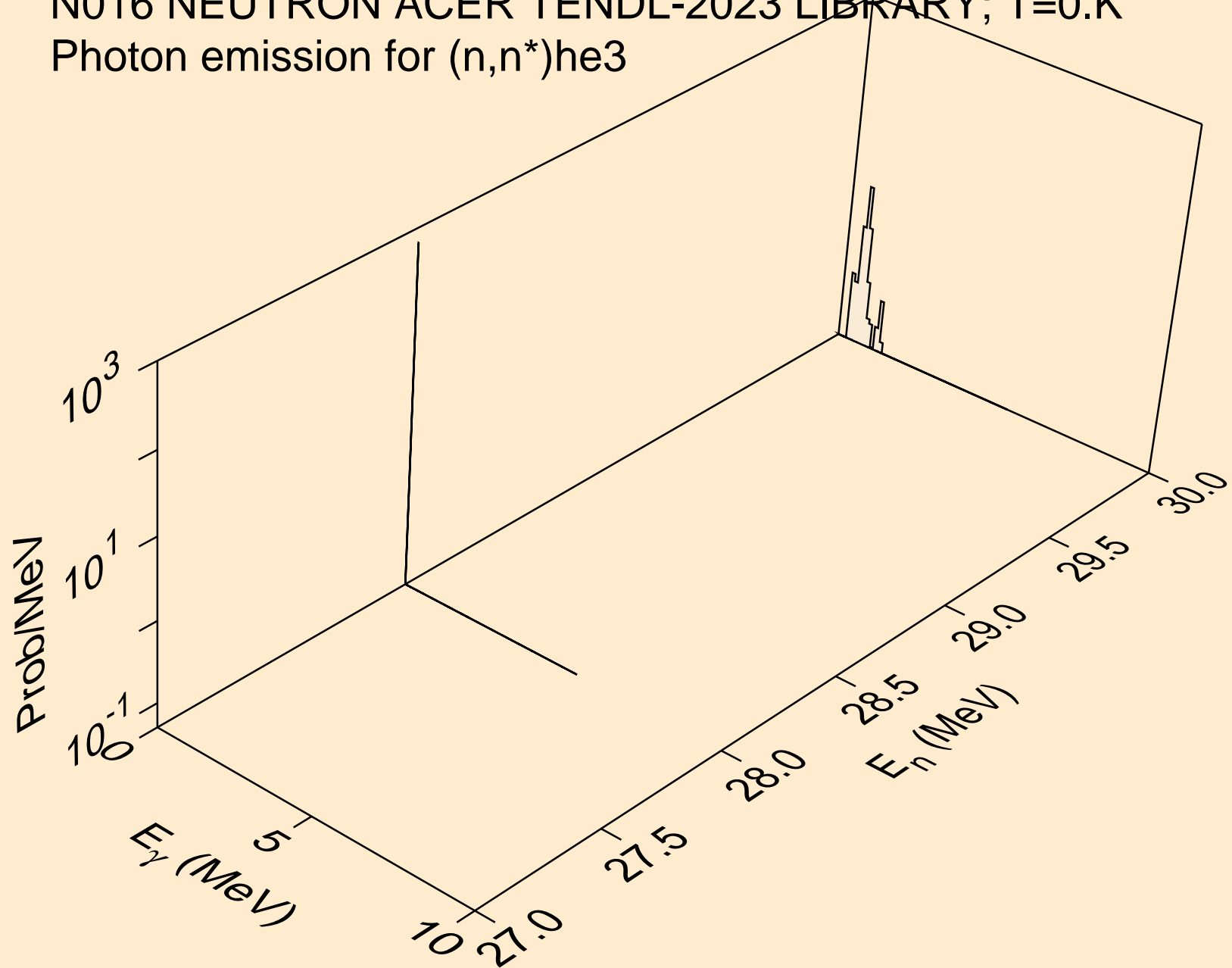

N016 NEUTRON ACER TENDL-2023 LIBRARY; T=0.K
Photon emission for (n,4n)

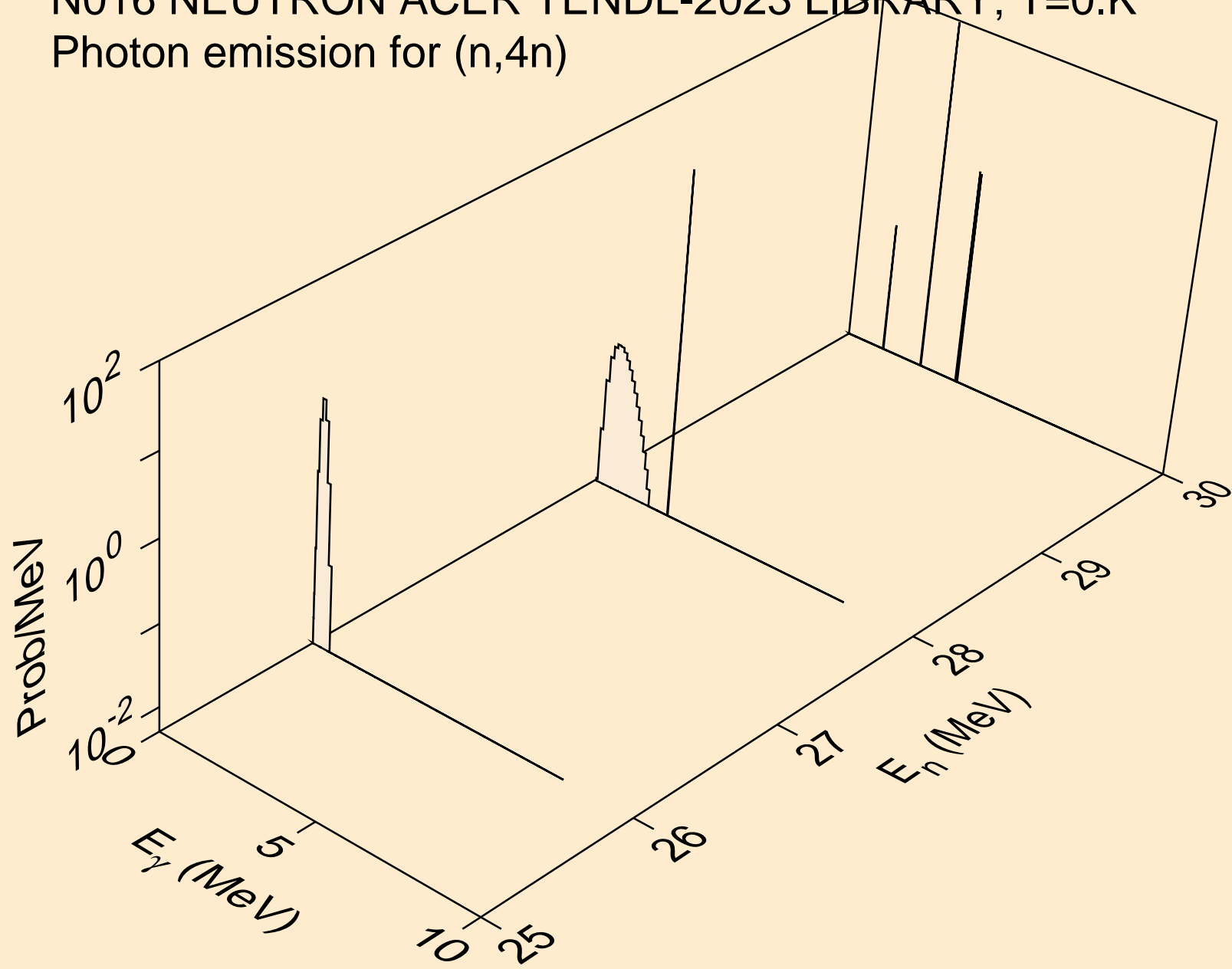

N016 NEUTRON ACER TENDL-2023 LIBRARY; T=0.K
Photon emission for (n,2np)

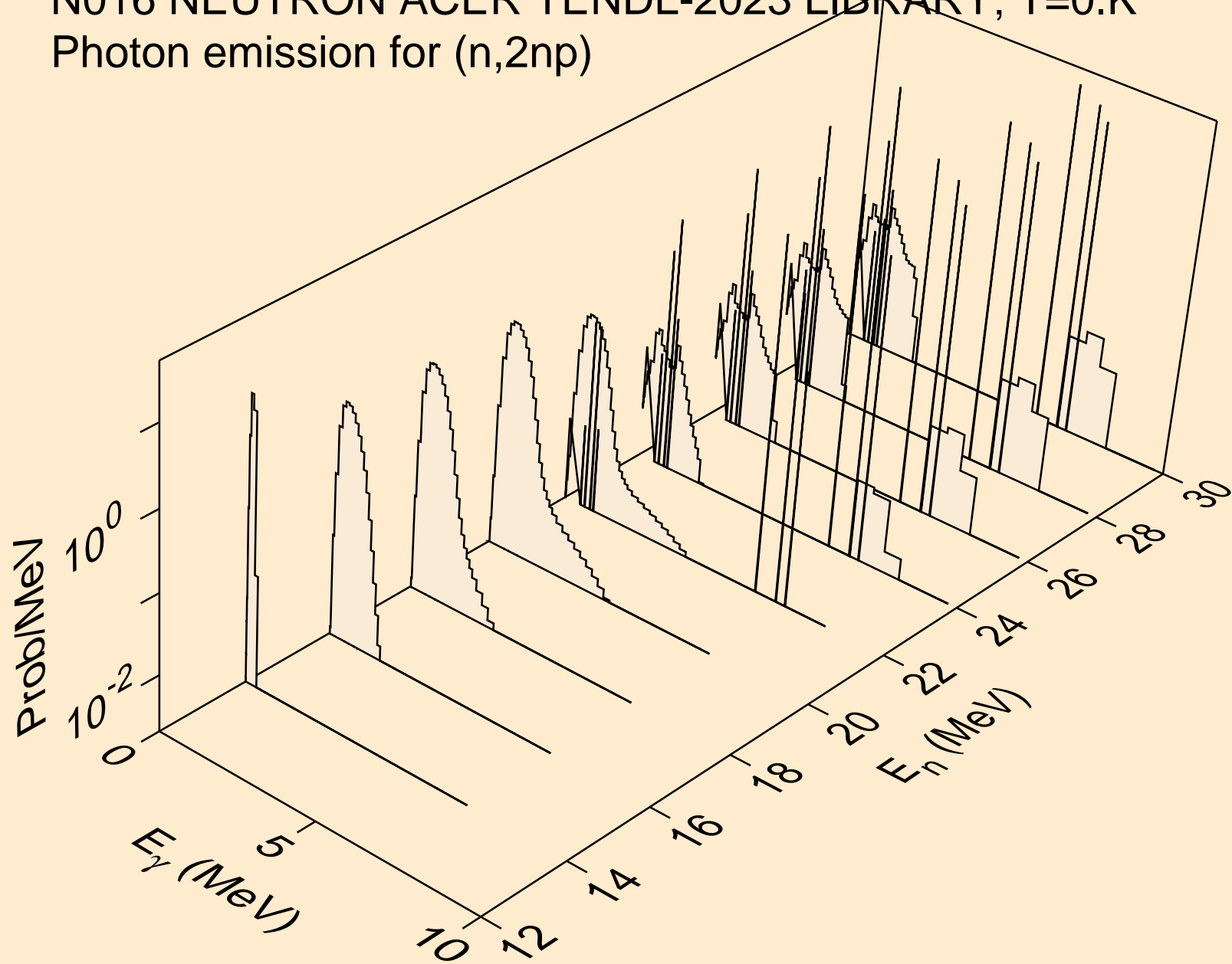

N016 NEUTRON ACER TENDL-2023 LIBRARY; T=0.K
Photon emission for (n,3np)

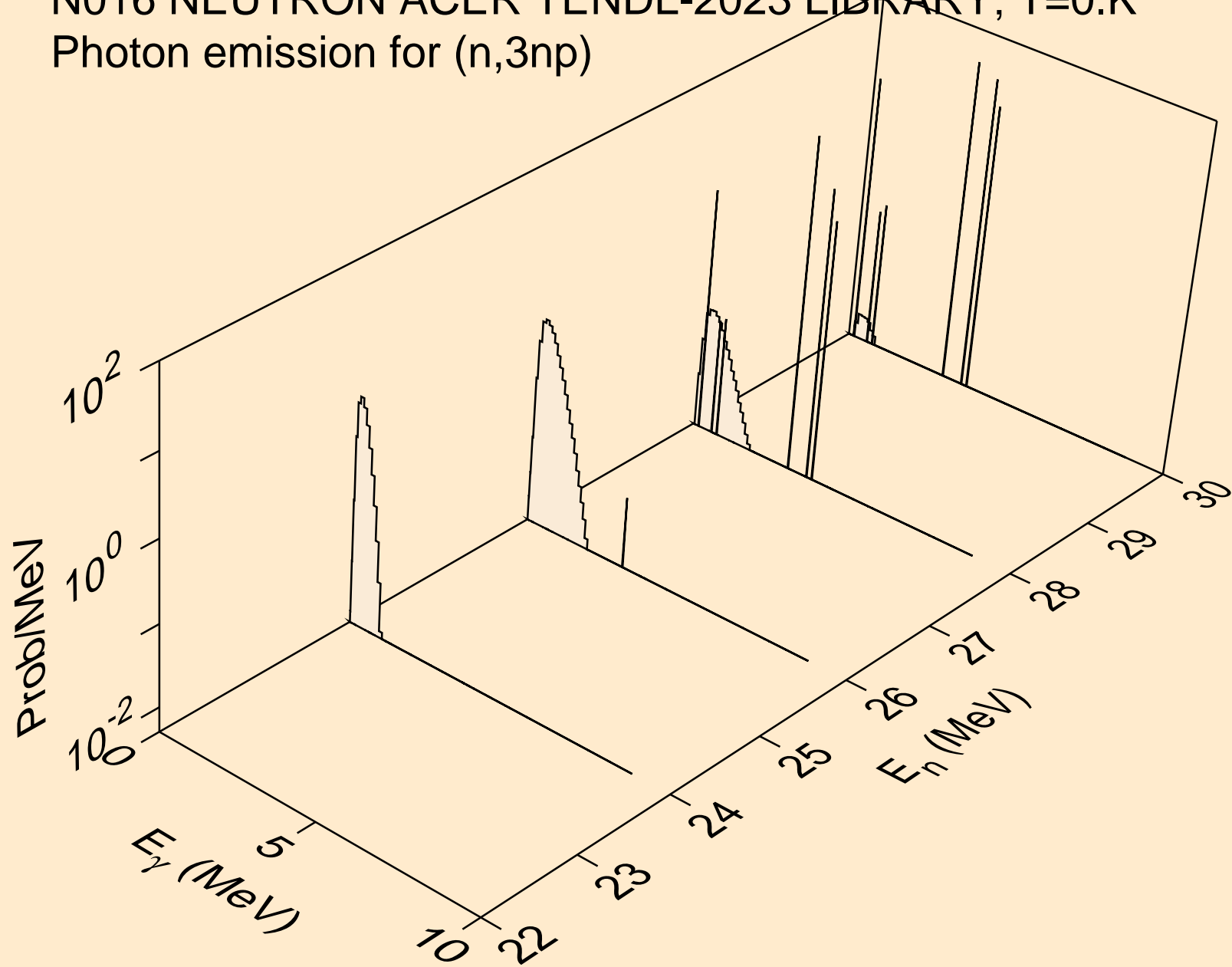

N016 NEUTRON ACER TENDL-2023 LIBRARY; T=0.K
Photon emission for (n,npa)

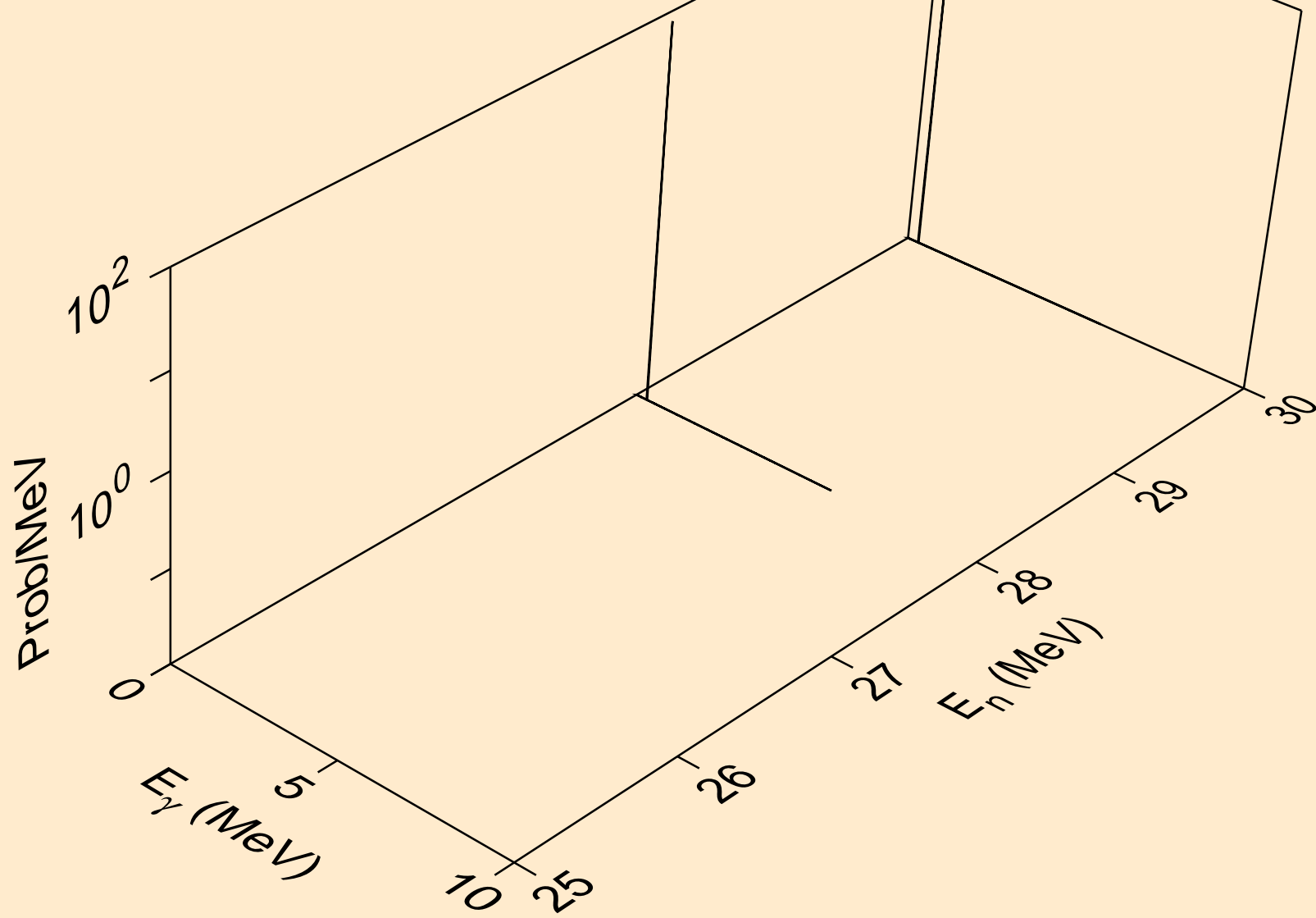

N016 NEUTRON ACER TENDL-2023 LIBRARY; T=0.K
Photon emission for (n,gma)

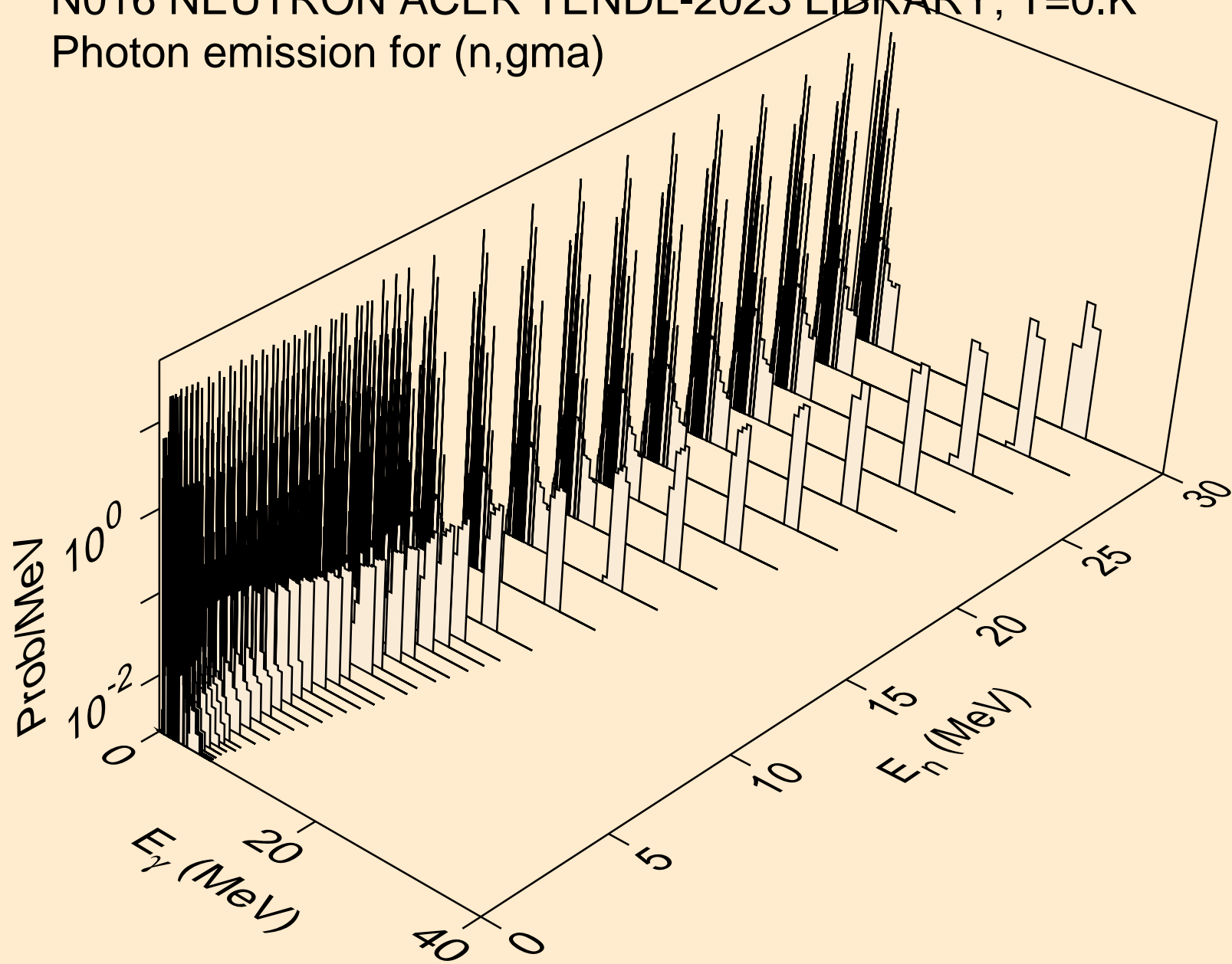

N016 NEUTRON ACER TENDL-2023 LIBRARY; T=0.K
Photon emission for (n,p)

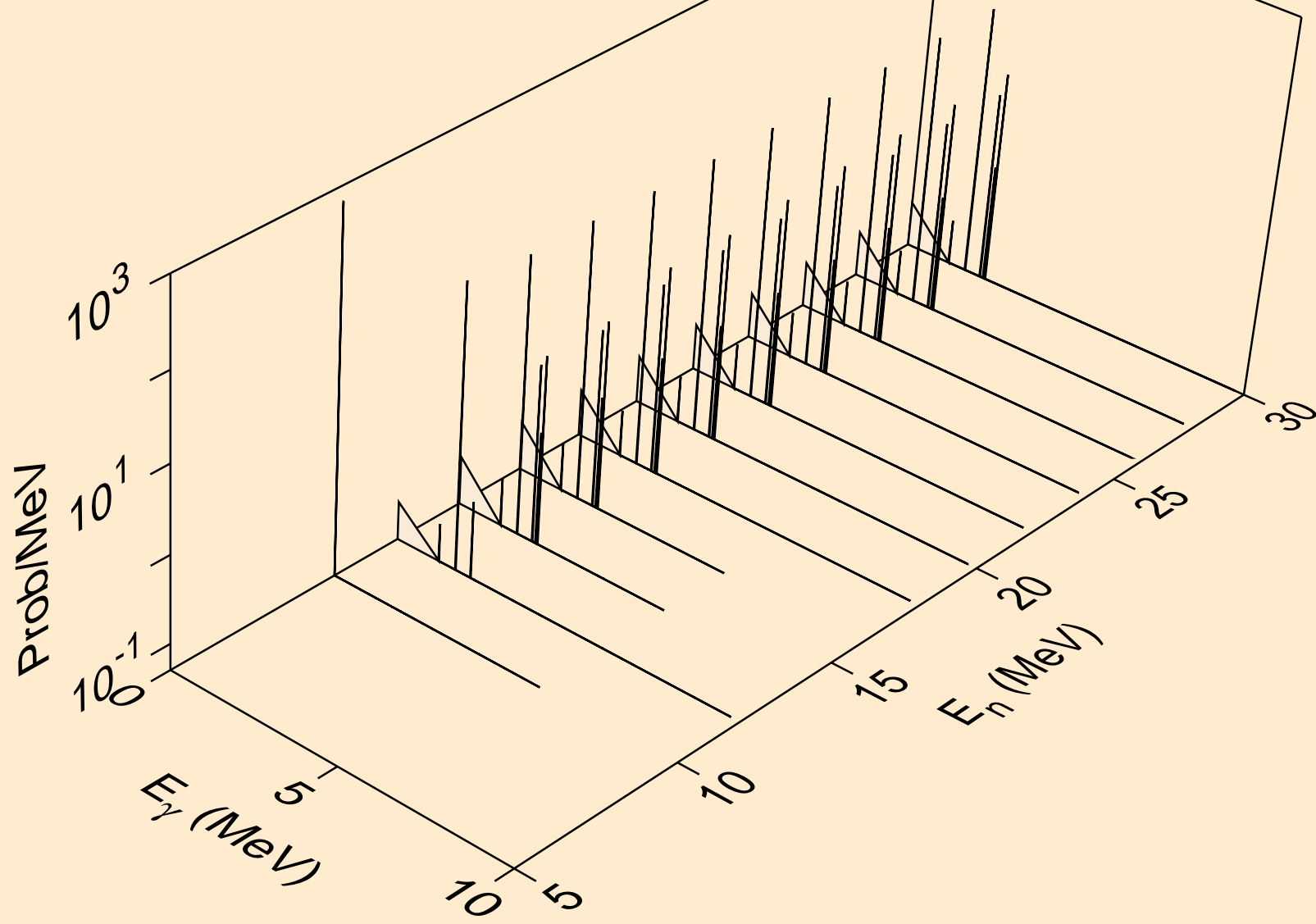

N016 NEUTRON ACER TENDL-2023 LIBRARY; T=0.K
Photon emission for (n,d)

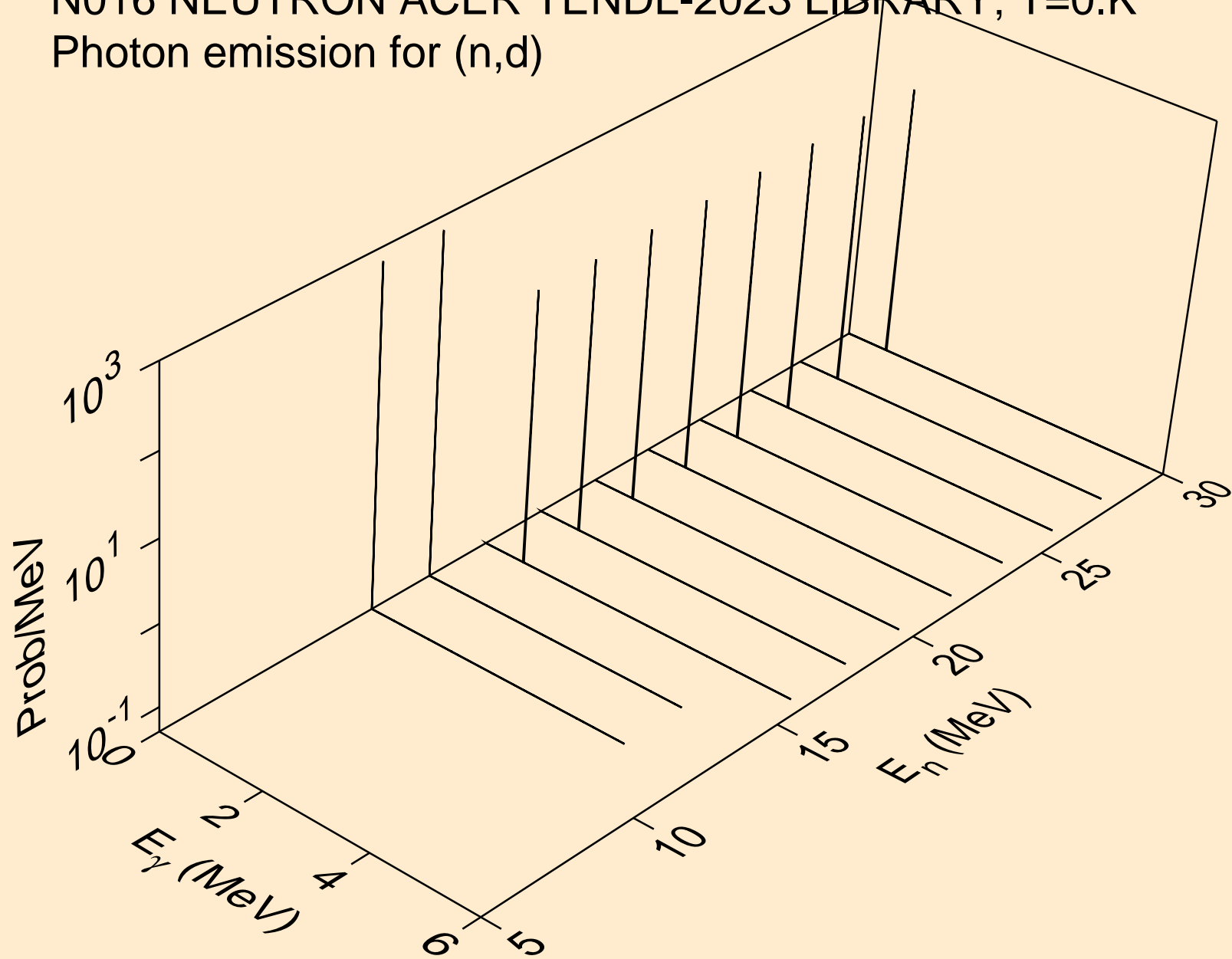

N016 NEUTRON ACER TENDL-2023 LIBRARY; T=0.K
Photon emission for (n,t)

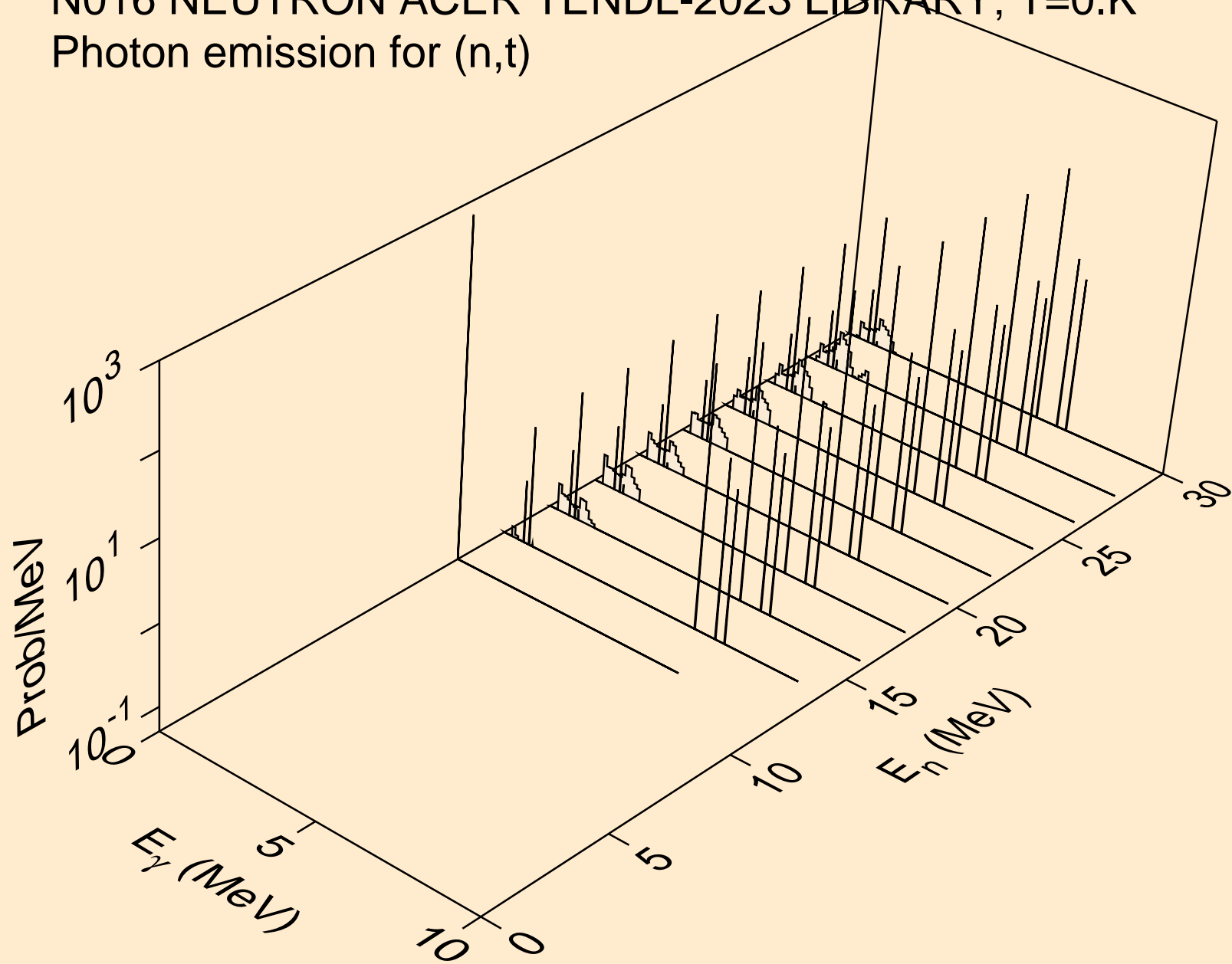

N016 NEUTRON ACER TENDL-2023 LIBRARY; T=0.K
Photon emission for (n,he3)

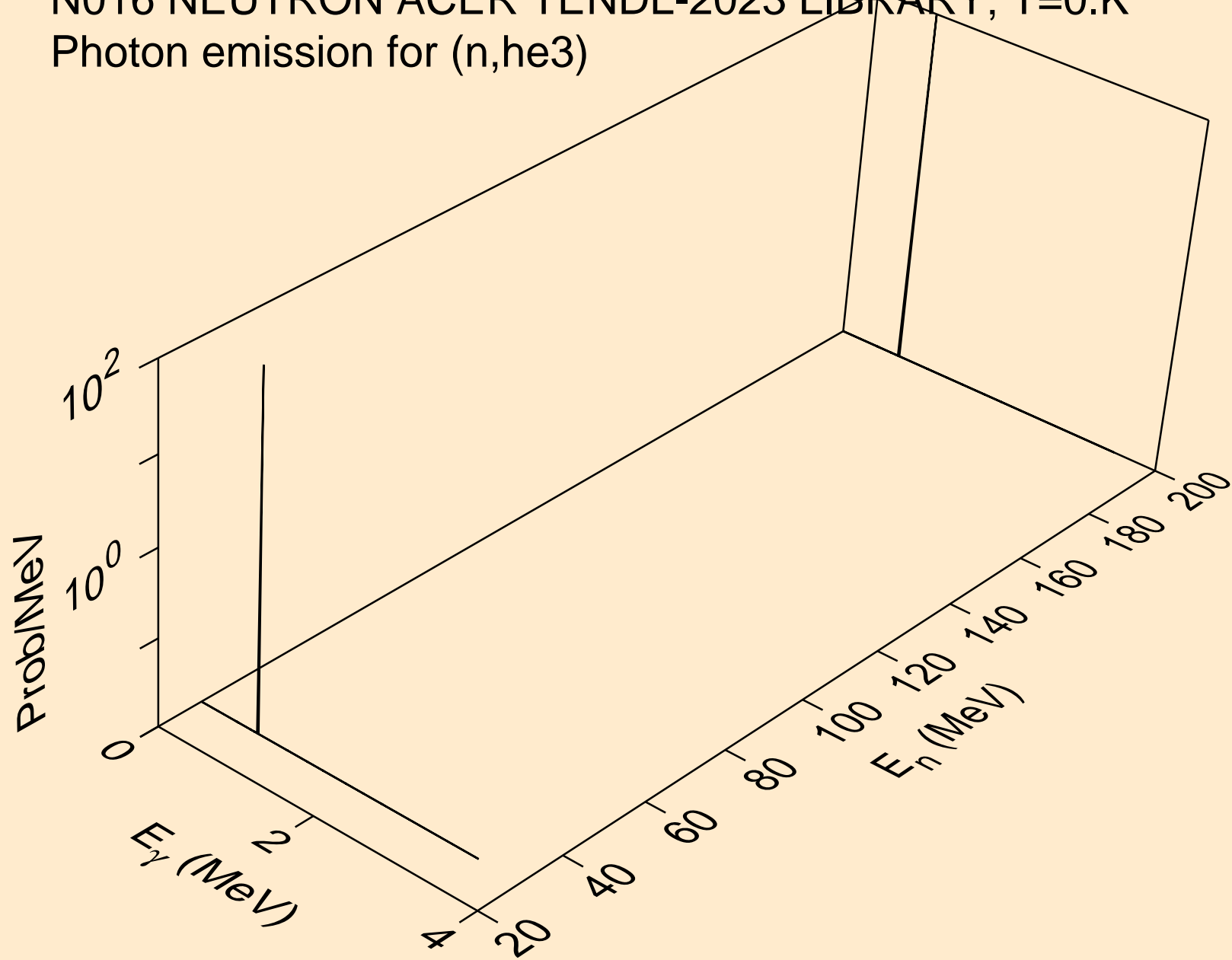

N016 NEUTRON ACER TENDL-2023 LIBRARY; T=0.K
Photon emission for (n,a)

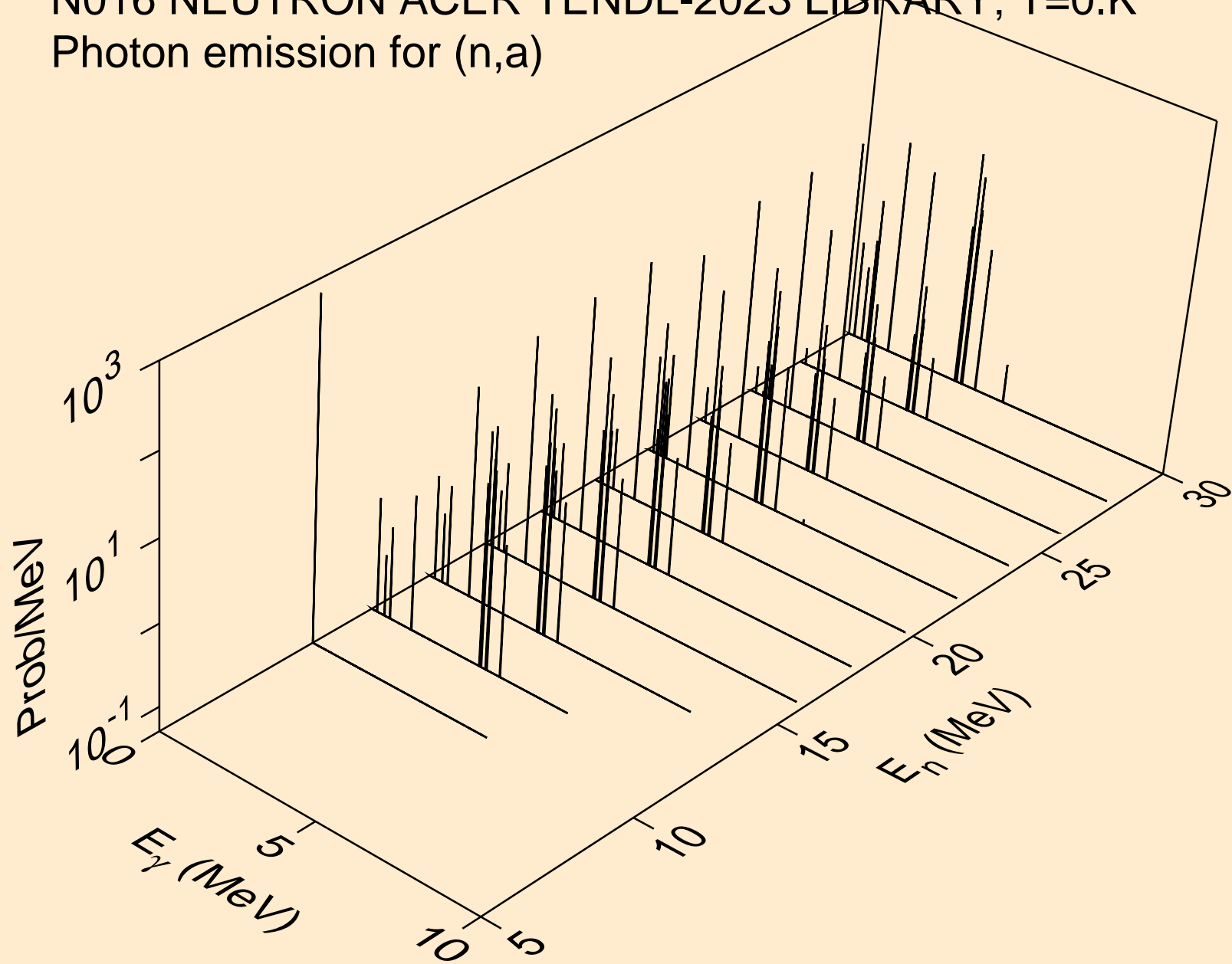

N016 NEUTRON ACER TENDL-2023 LIBRARY; T=0.K
Photon emission for (n,2a)

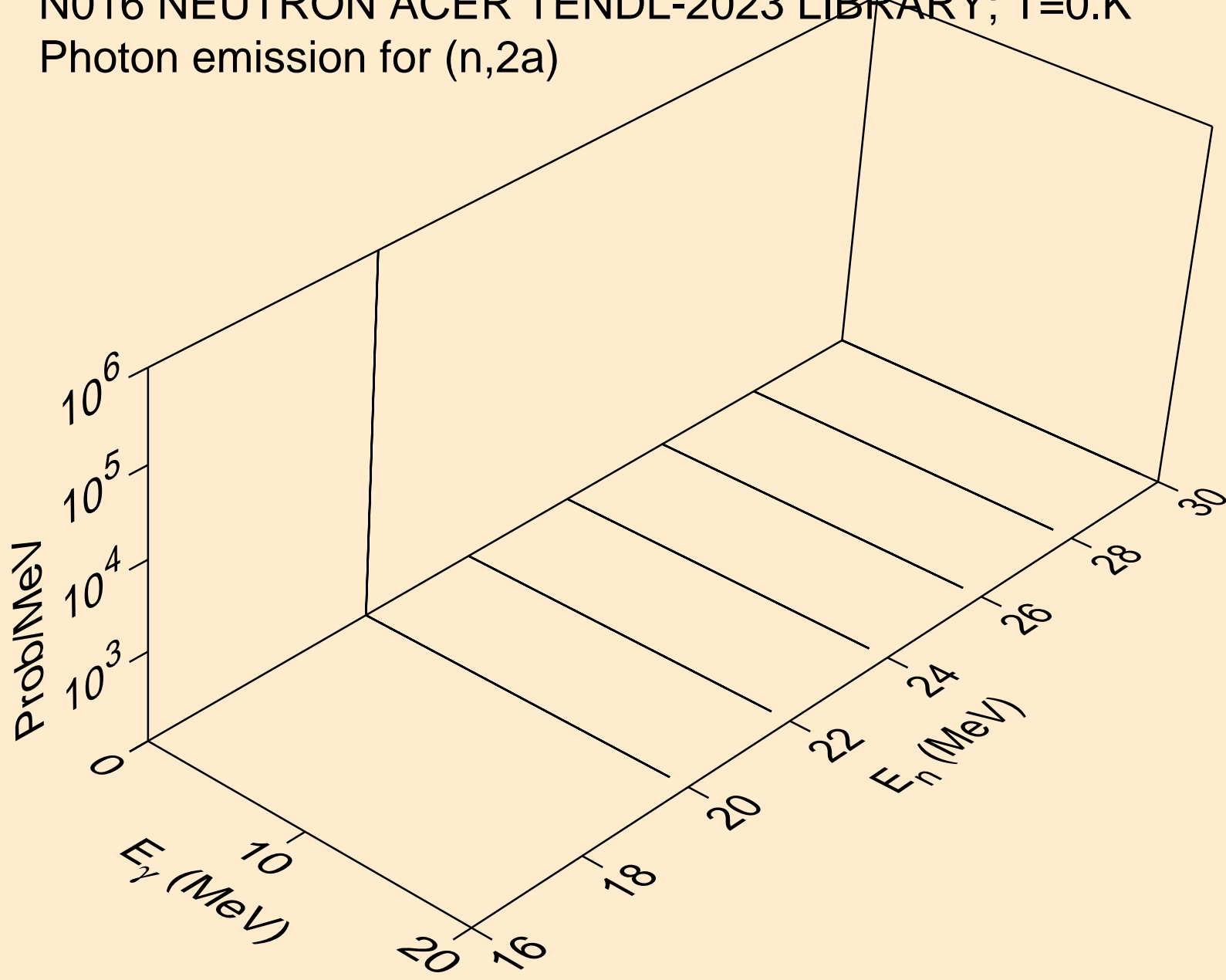

N016 NEUTRON ACER TENDL-2023 LIBRARY; T=0.K
Photon emission for (n,p α)

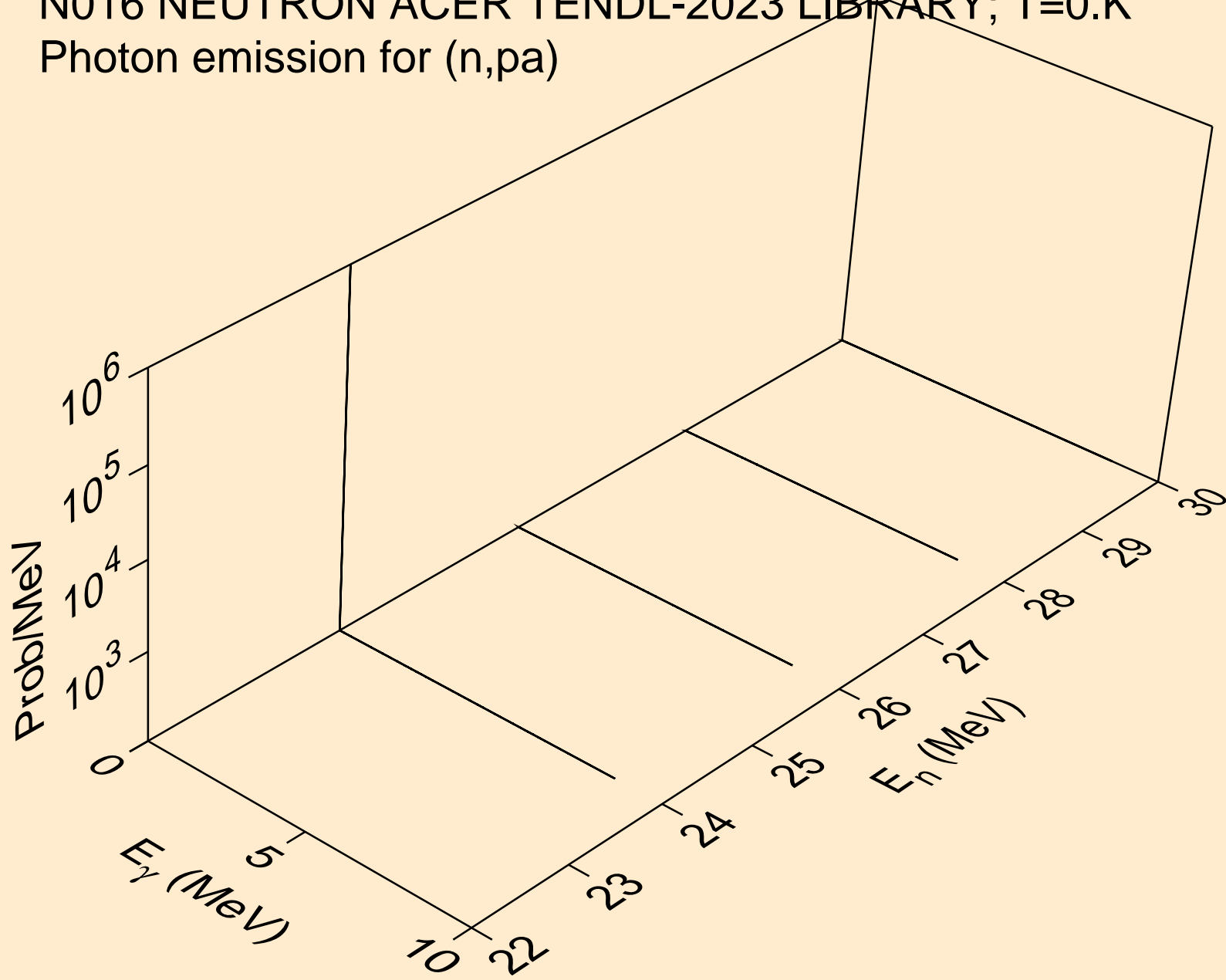

N016 NEUTRON ACER TENDL-2023 LIBRARY; T=0.K
Photon emission for (n,pt)

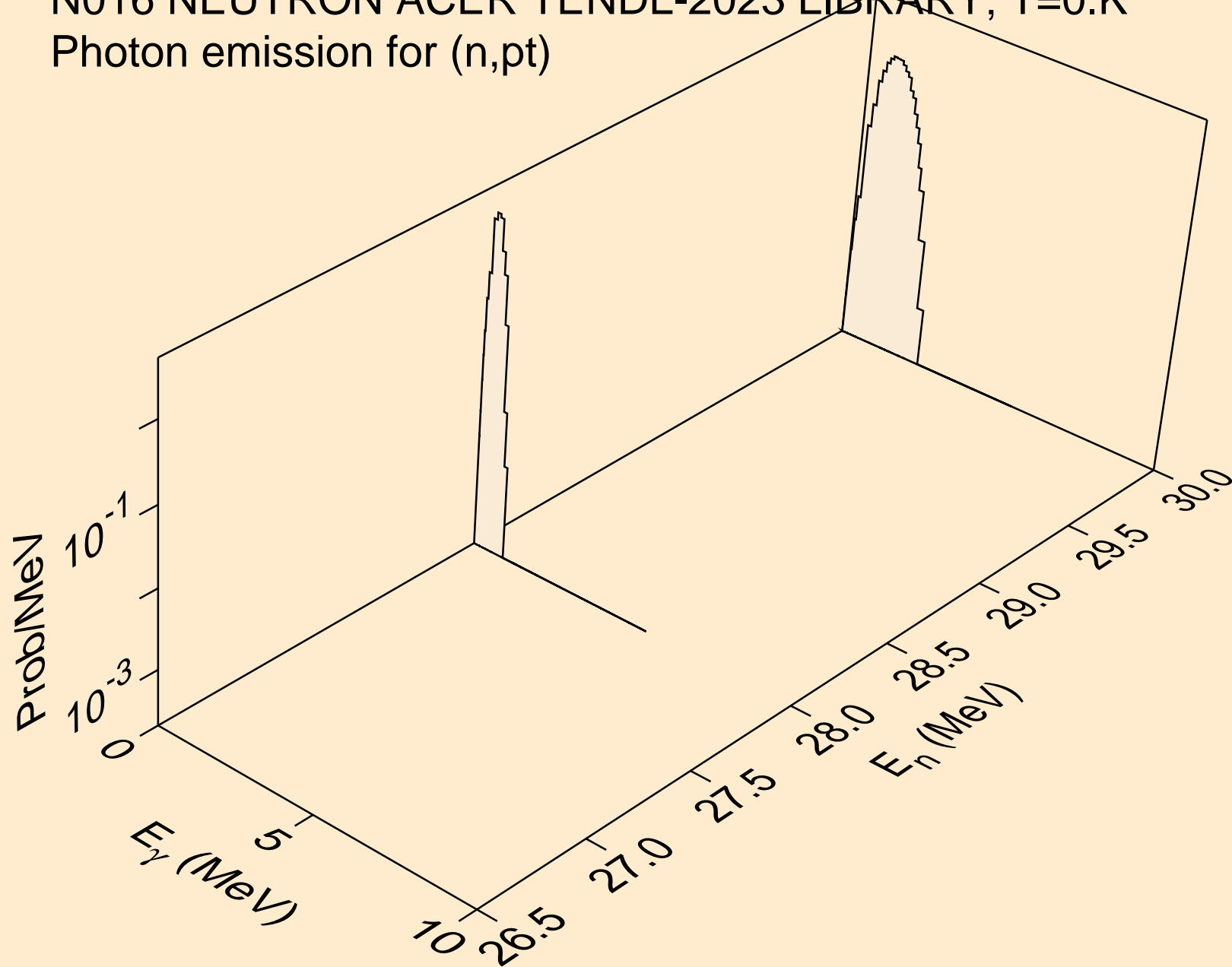

N016 NEUTRON ACER TENDL-2023 LIBRARY; T=0.K
Photon emission for (n,da)

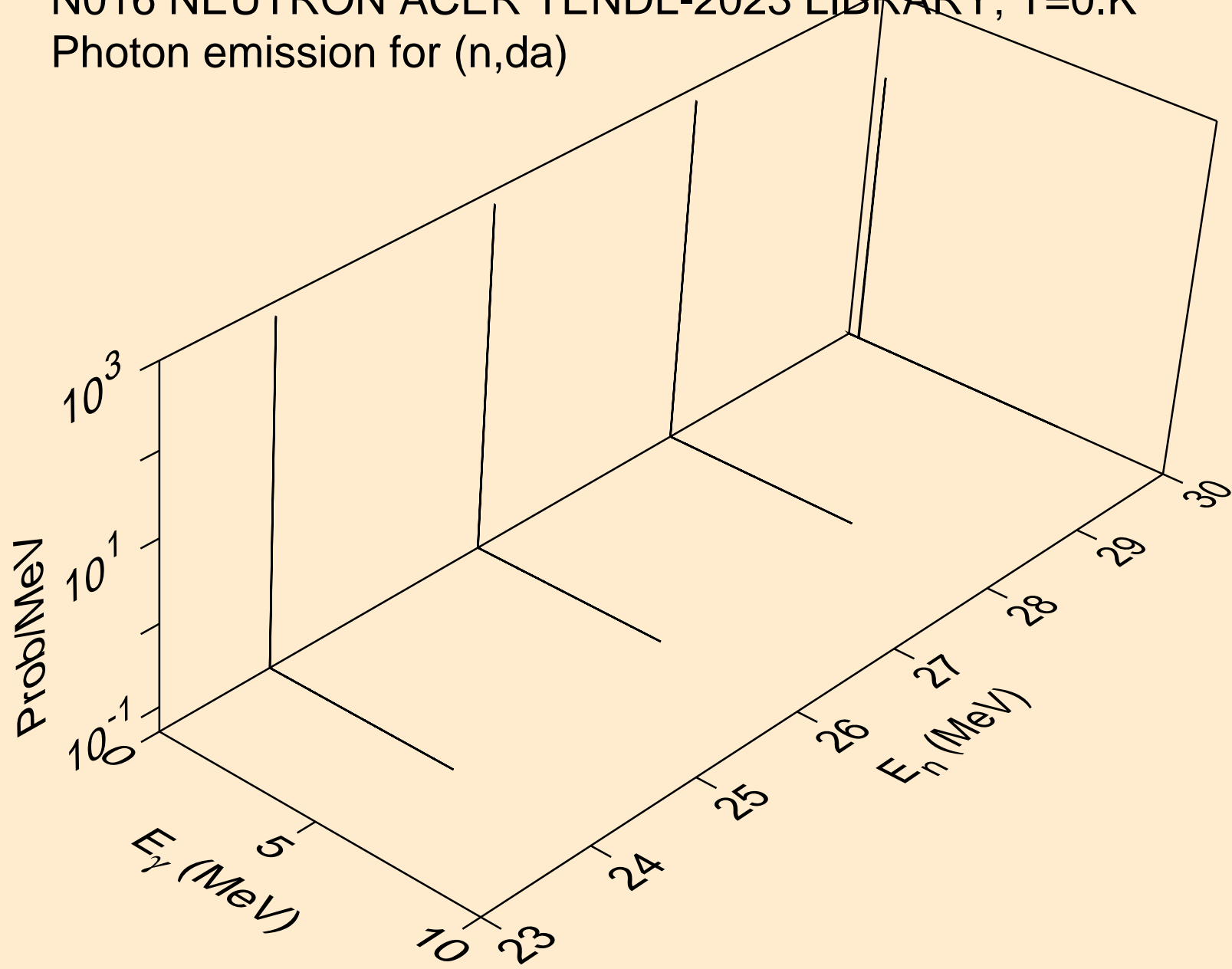

N016 NEUTRON ACER TENDL-2023 LIBRARY; T=0.K
thermal capture photon spectrum

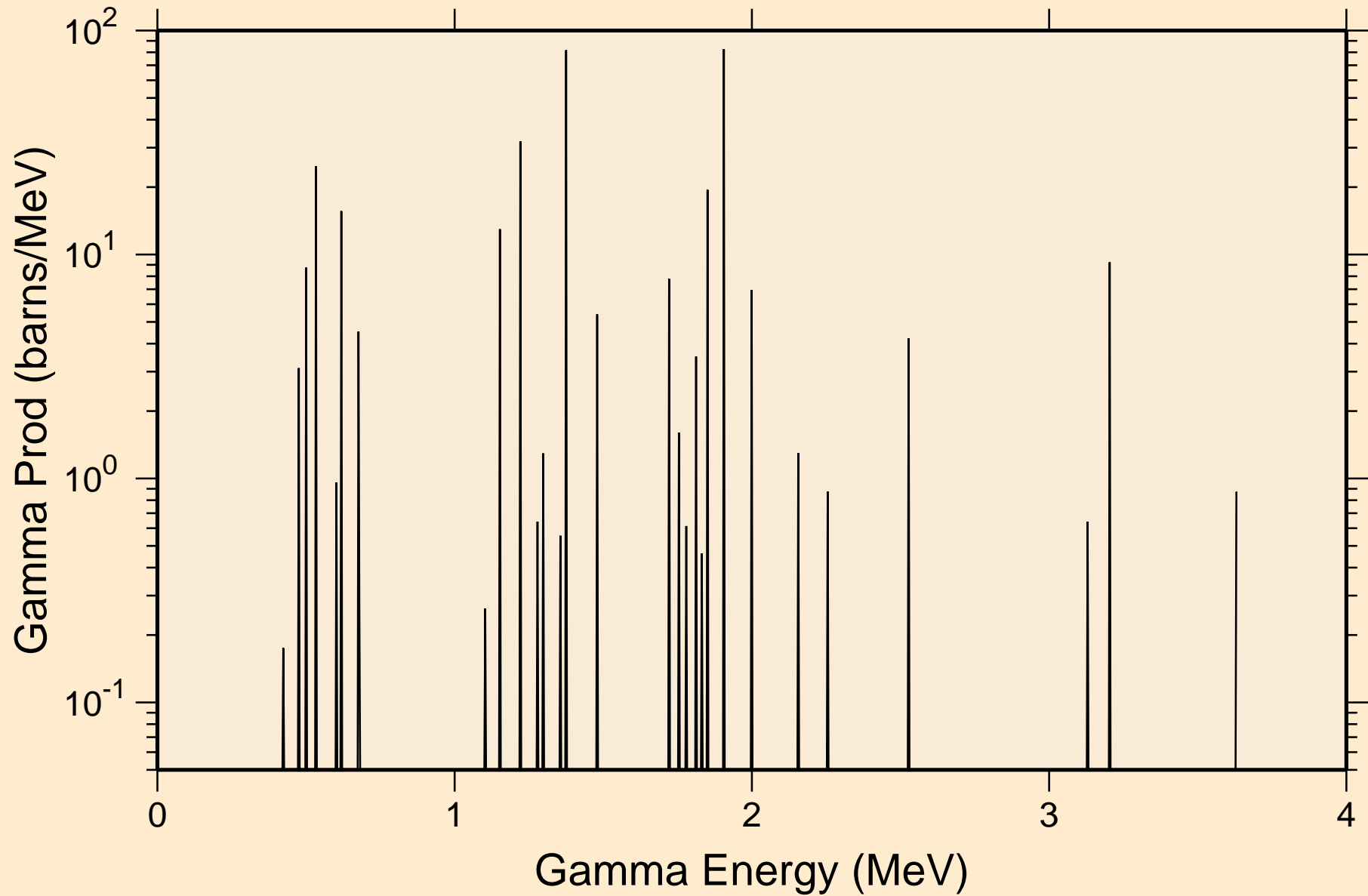

N016 NEUTRON ACER TENDL-2023 LIBRARY; T=0.K
14 MeV photon spectrum

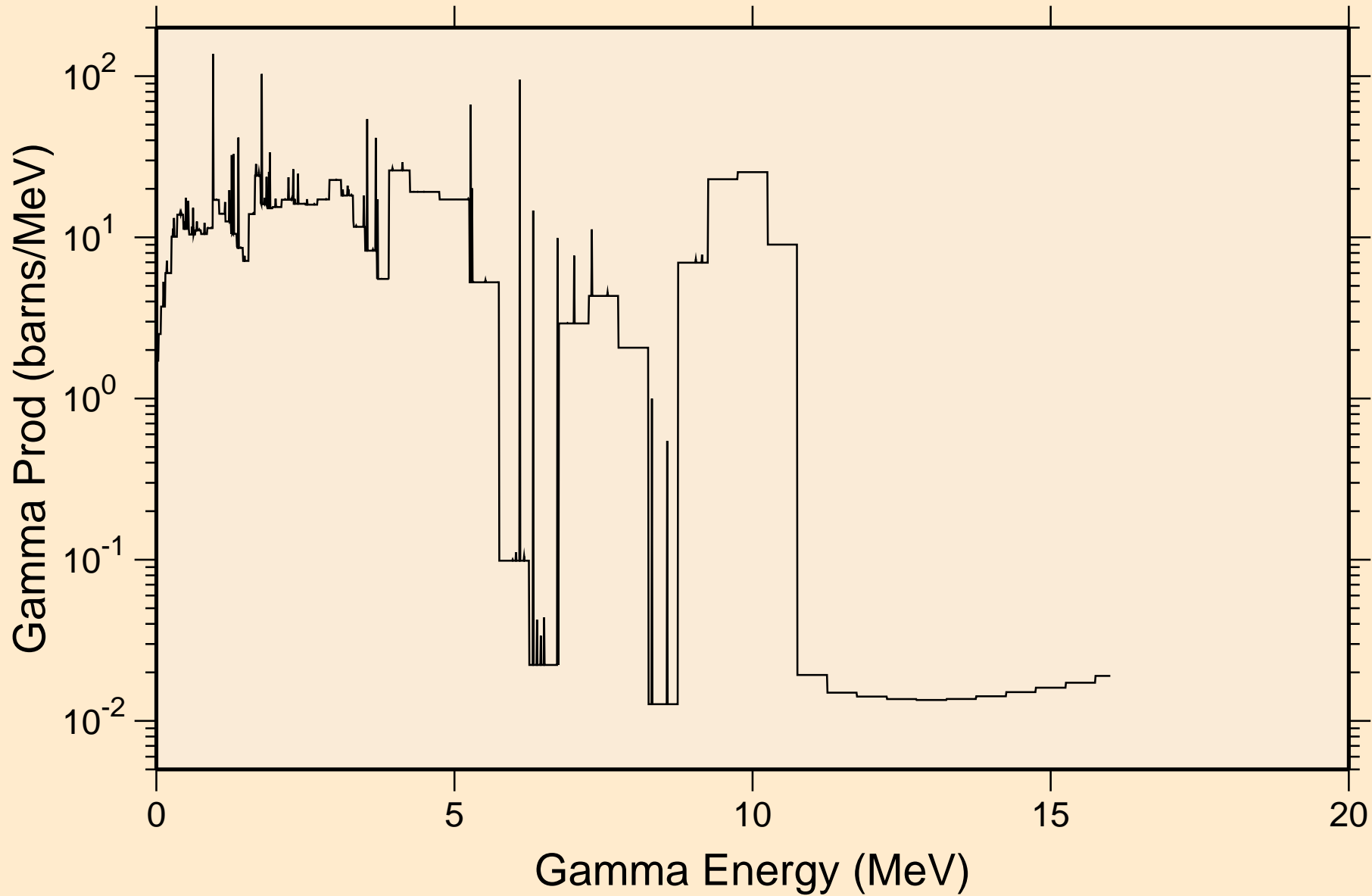

N016 NEUTRON ACER TENDL-2023 LIBRARY; T=0.K

Particle heating contributions

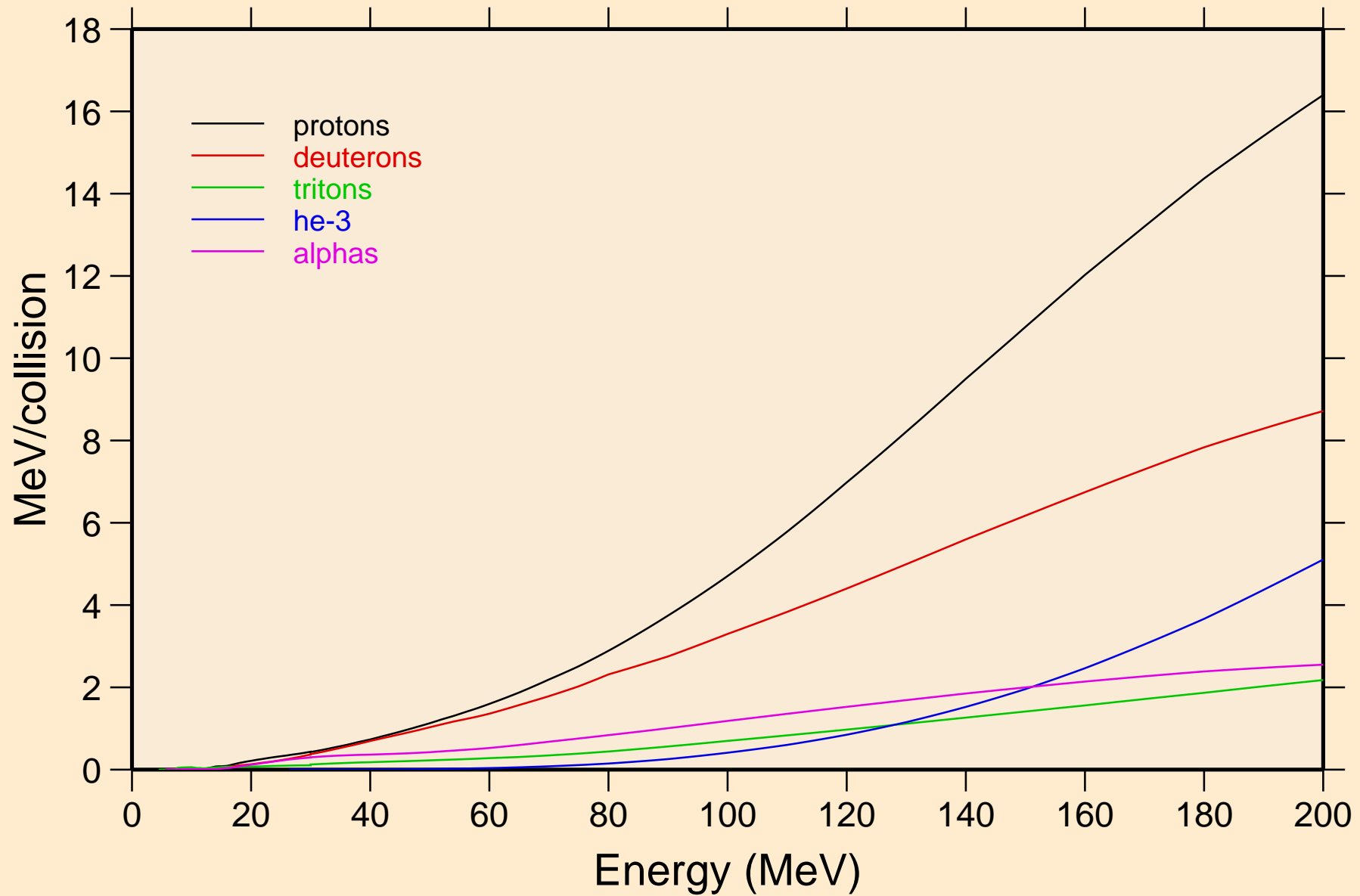

N016 NEUTRON ACER TENDL-2023 LIBRARY; T=0.K
Recoil Heating

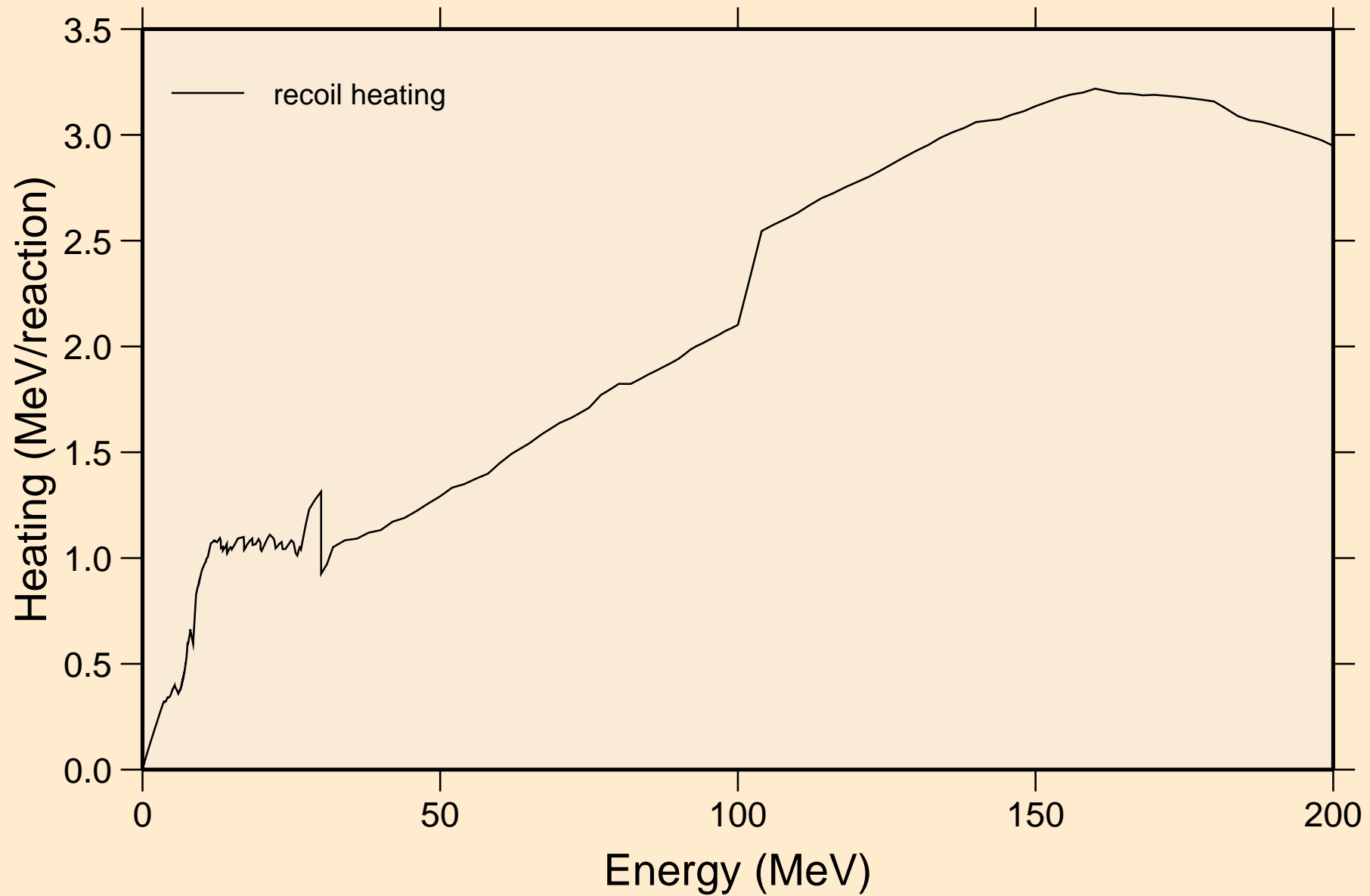

N016 NEUTRON ACER TENDL-2023 LIBRARY; T=0.K

Particle production cross sections

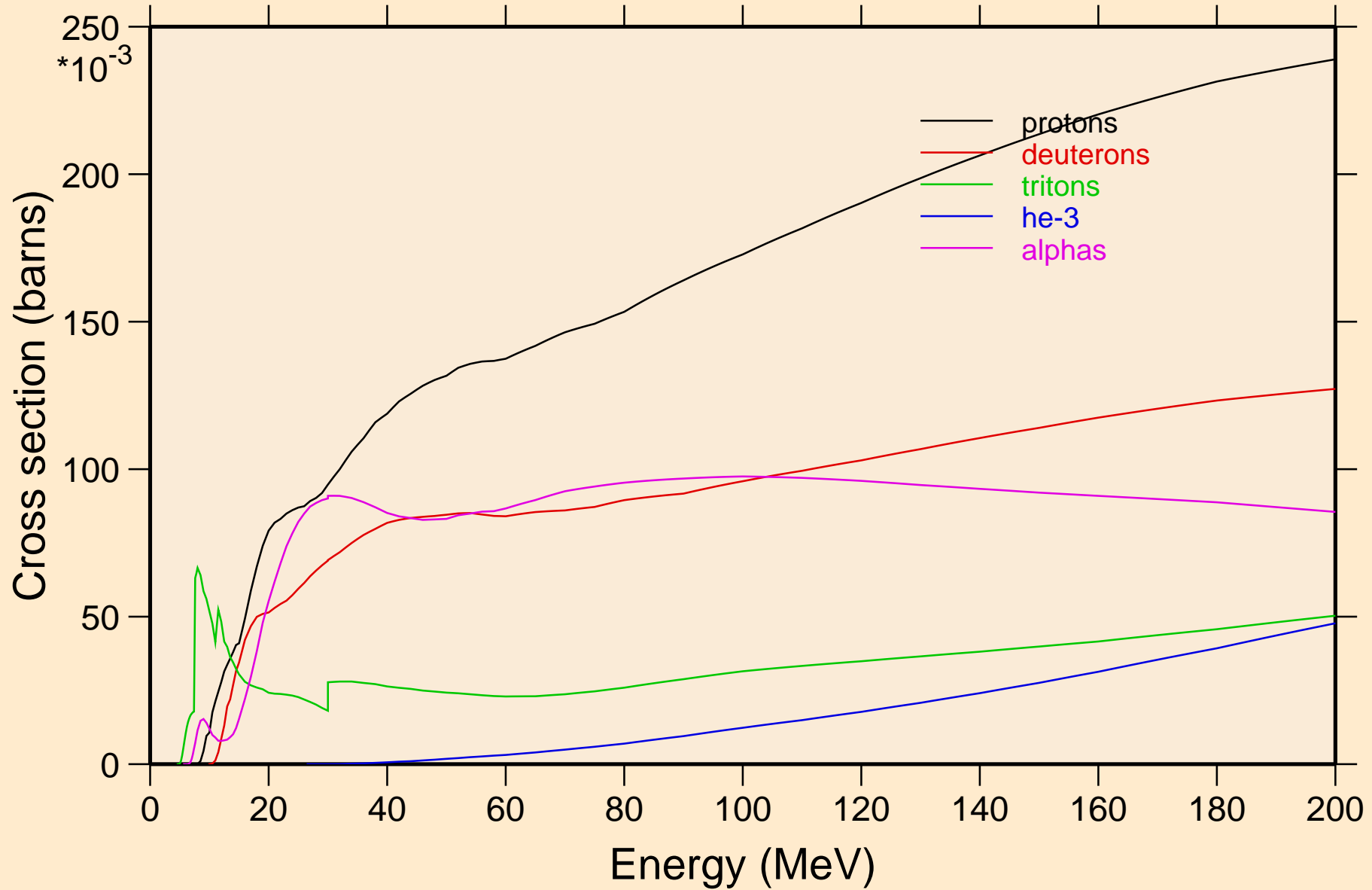

N016 NEUTRON ACER TENDL-2023 LIBRARY; T=0.K
protons from (n,x)

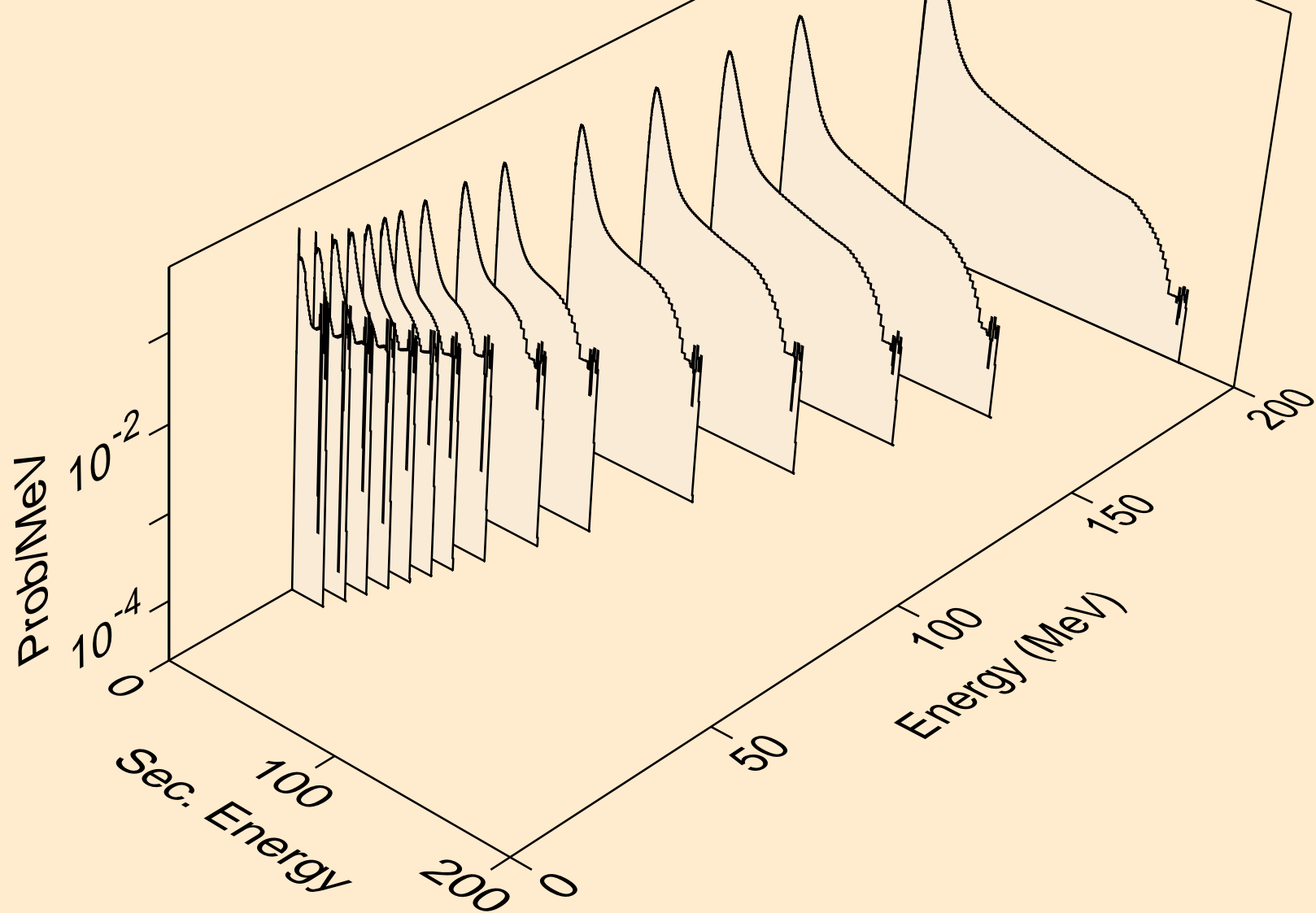

N016 NEUTRON ACER TENDL-2023 LIBRARY; T=0.K
protons from (n,n*)p

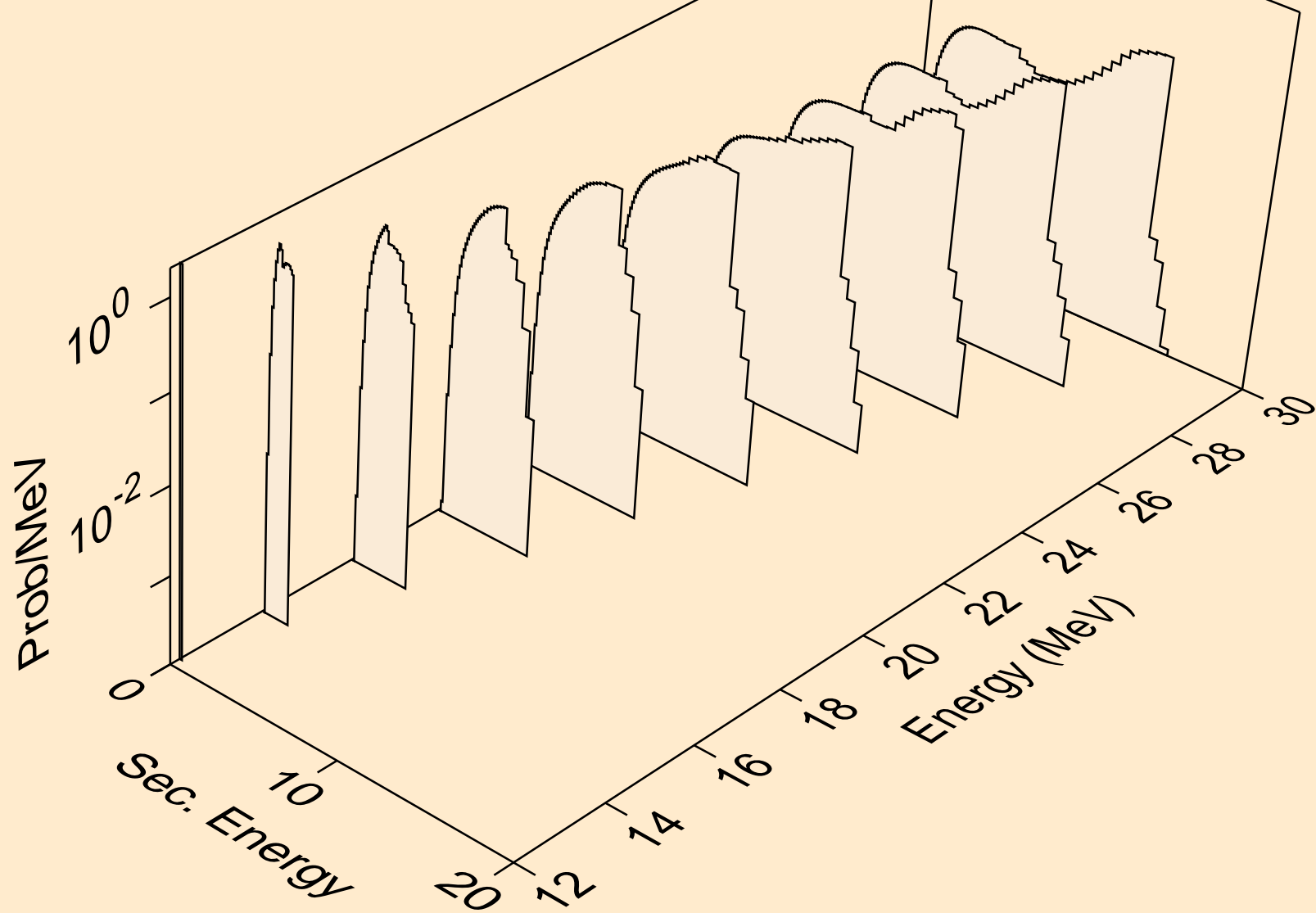

N016 NEUTRON ACER TENDL-2023 LIBRARY; T=0.K
protons from (n,2np)

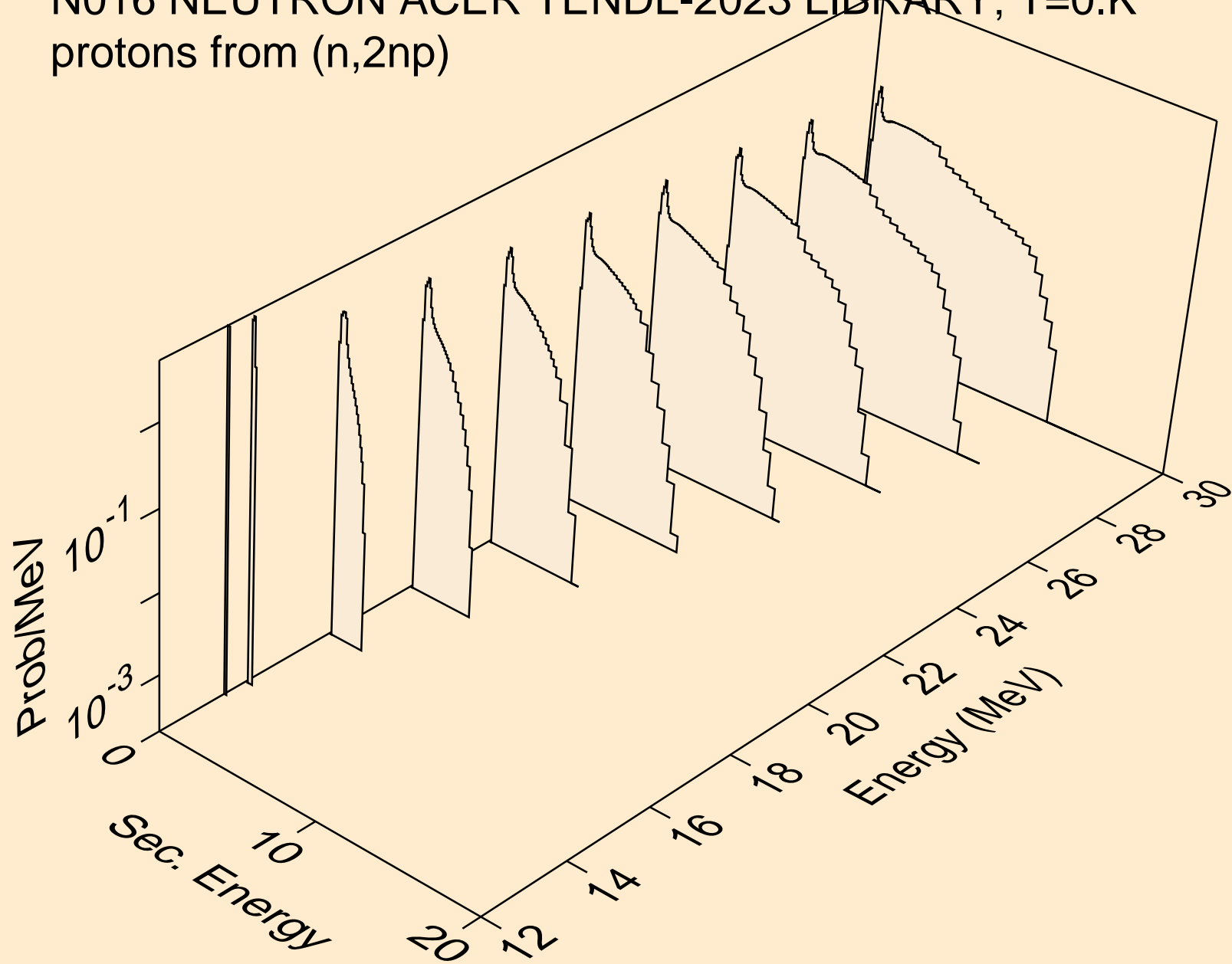

N016 NEUTRON ACER TENDL-2023 LIBRARY; T=0.K
protons from (n,3np)

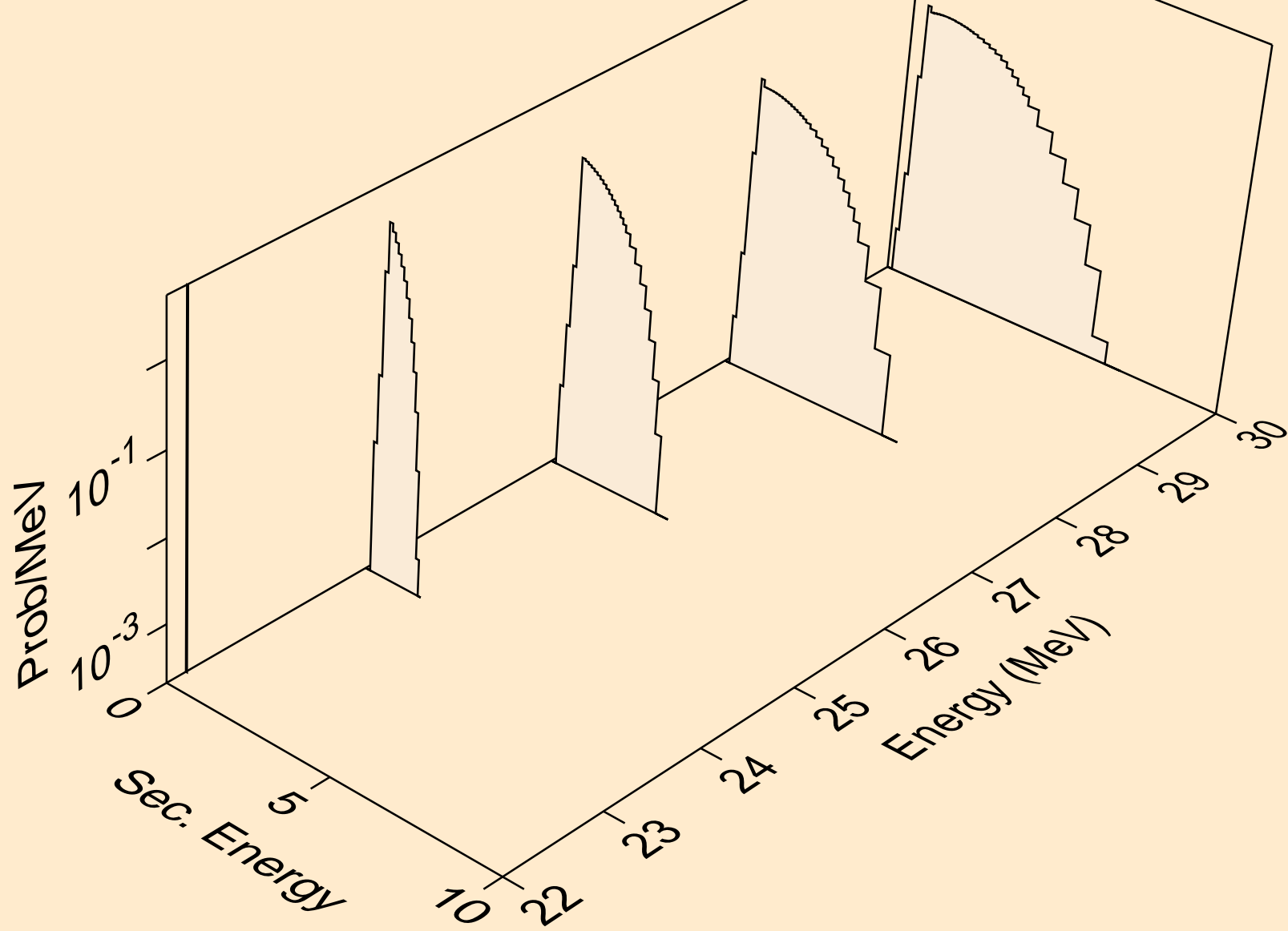

N016 NEUTRON ACER TENDL-2023 LIBRARY; T=0.K
protons from (n,npa)

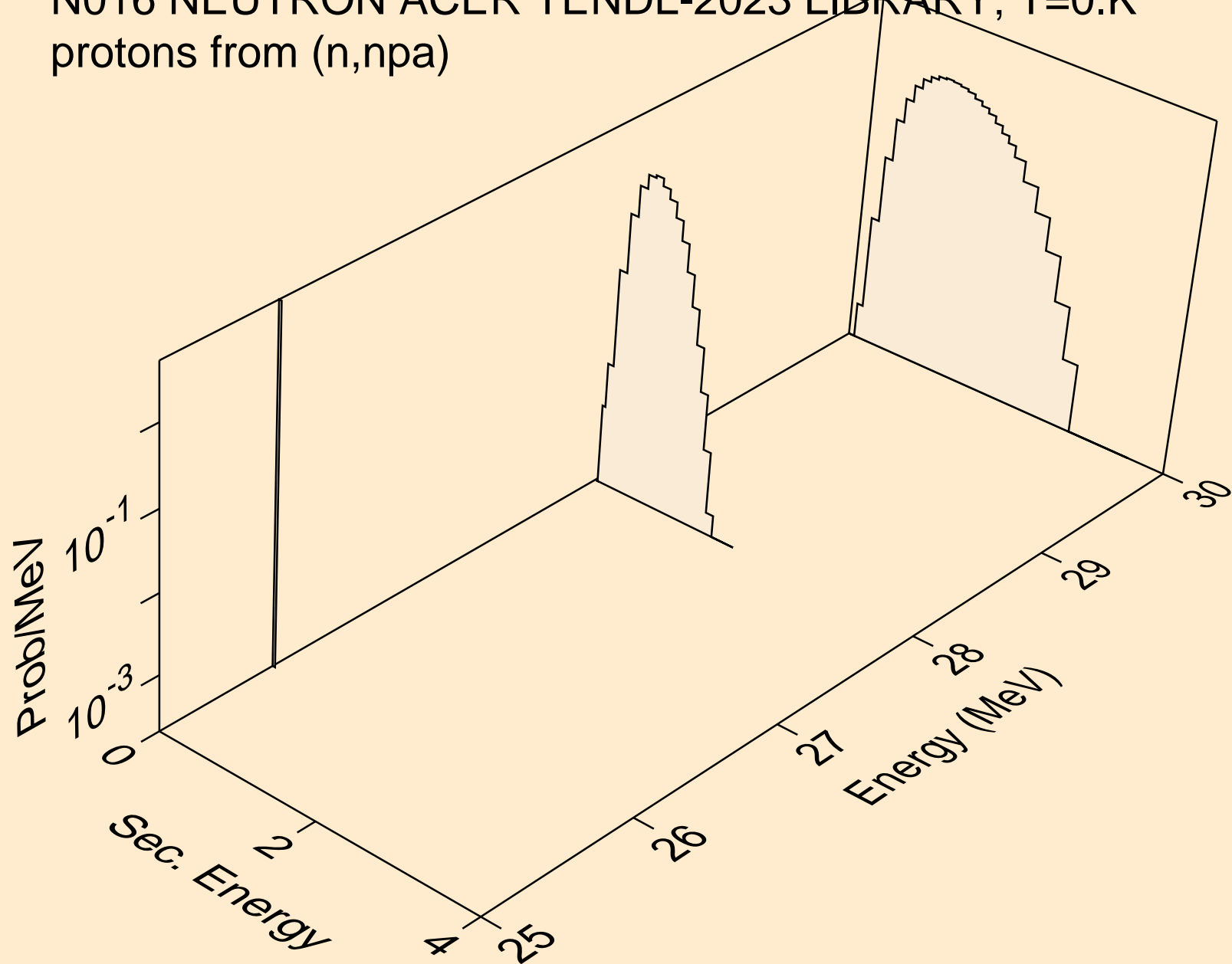

N016 NEUTRON ACER TENDL-2023 LIBRARY; T=0.K
protons from (n,p)

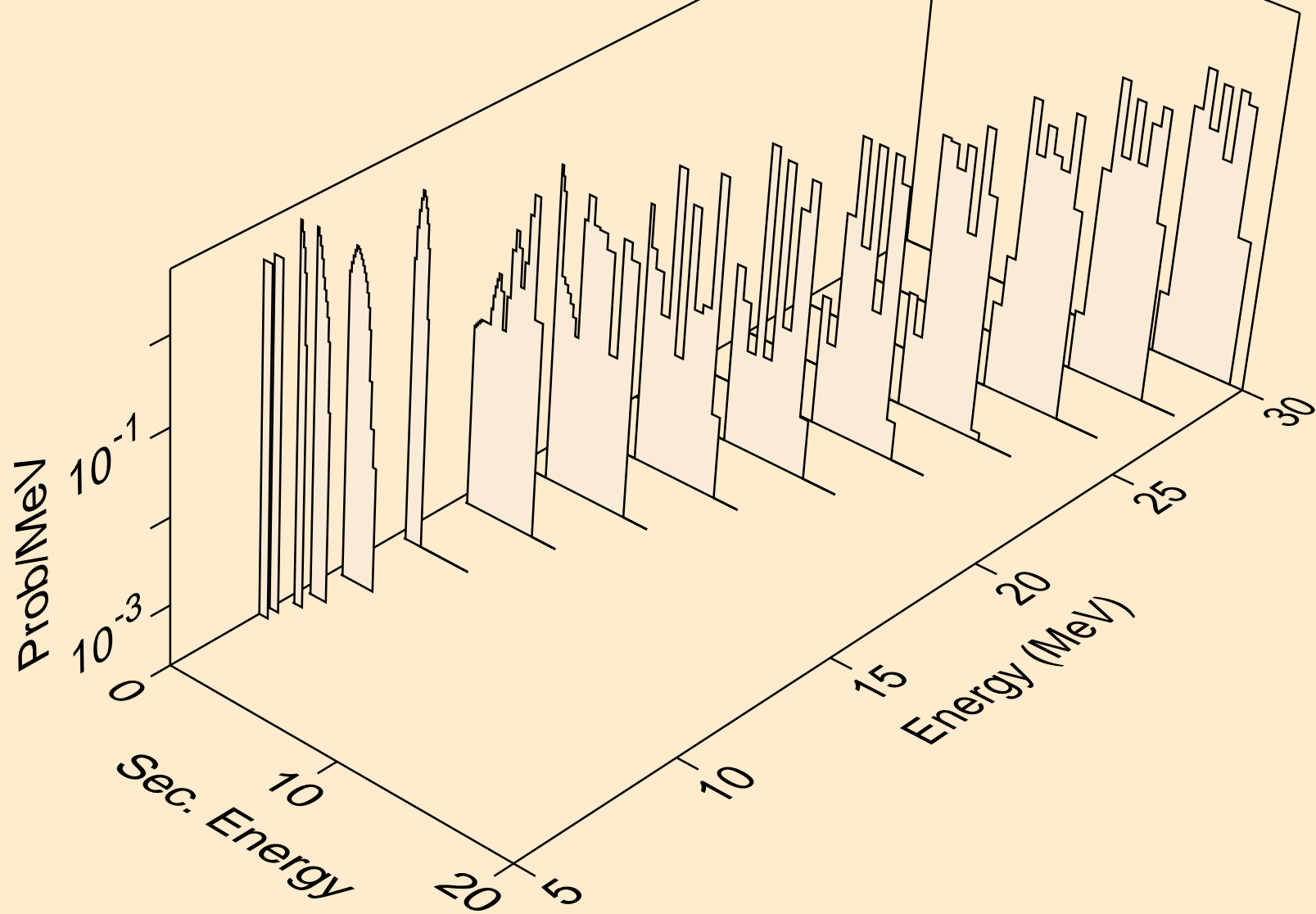

N016 NEUTRON ACER TENDL-2023 LIBRARY; T=0.K
protons from (n,p)

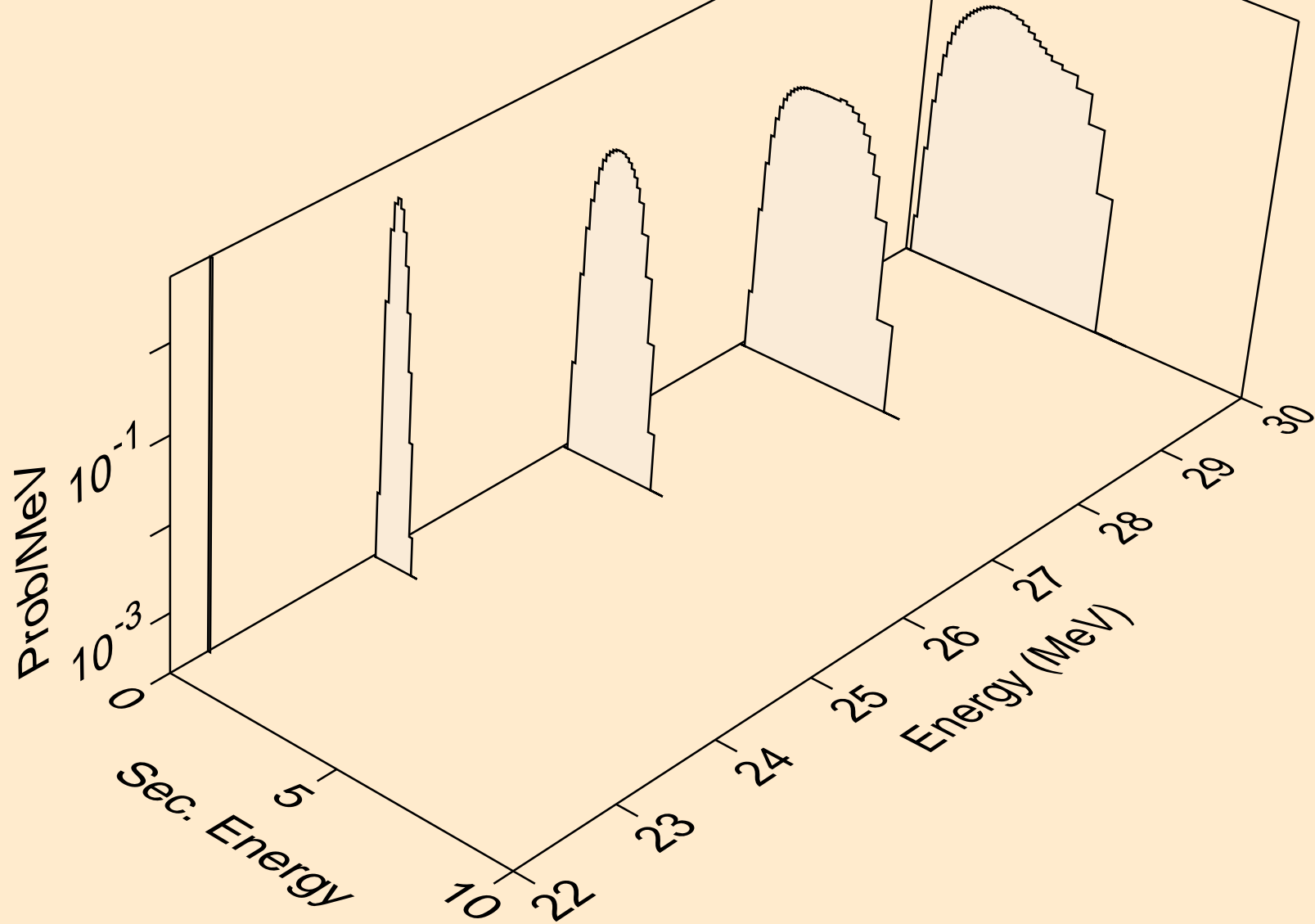

N016 NEUTRON ACER TENDL-2023 LIBRARY; T=0.K
protons from (n,pt)

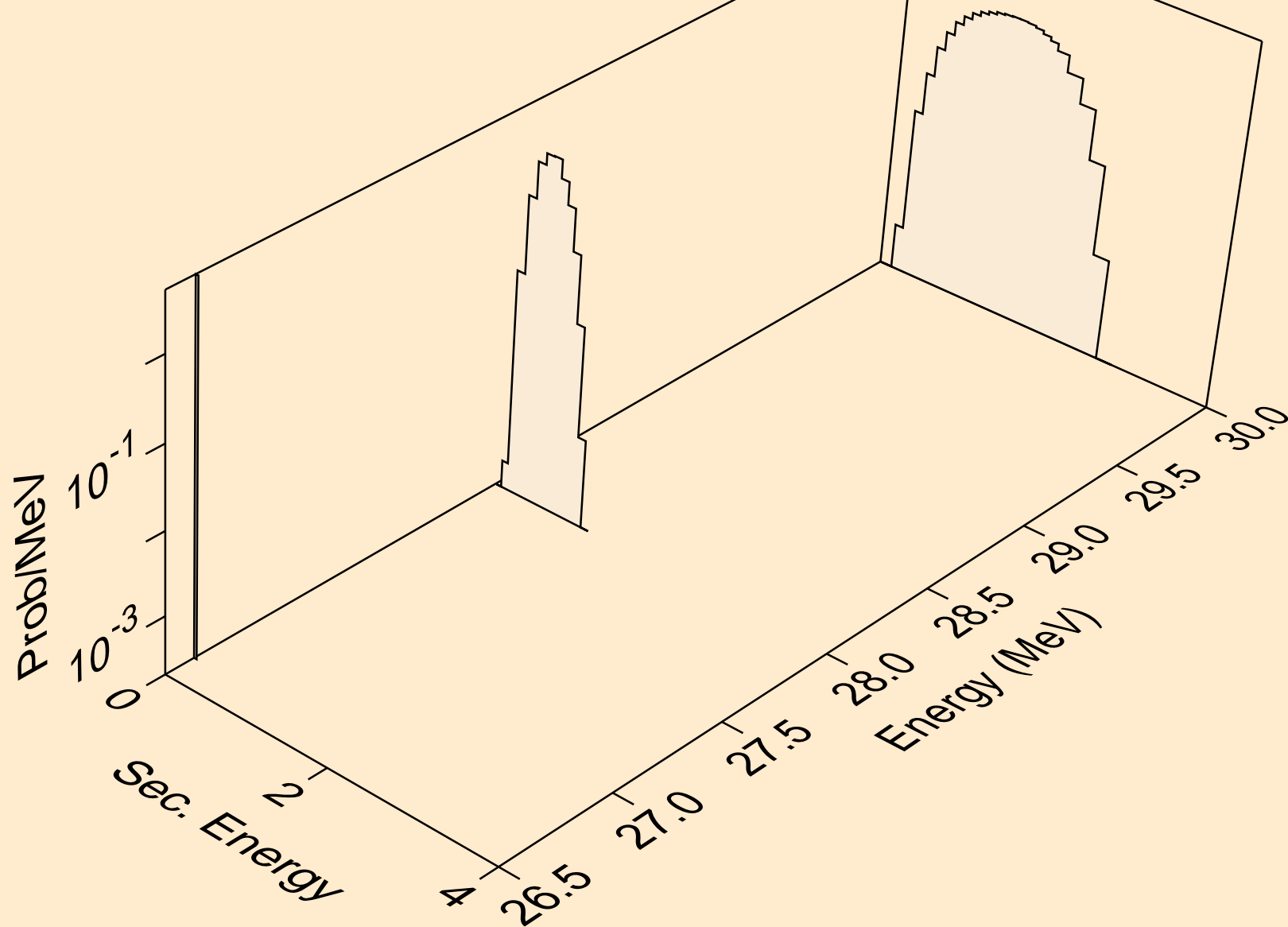

N016 NEUTRON ACER TENDL-2023 LIBRARY; T=0.K
deuterons from (n,x)

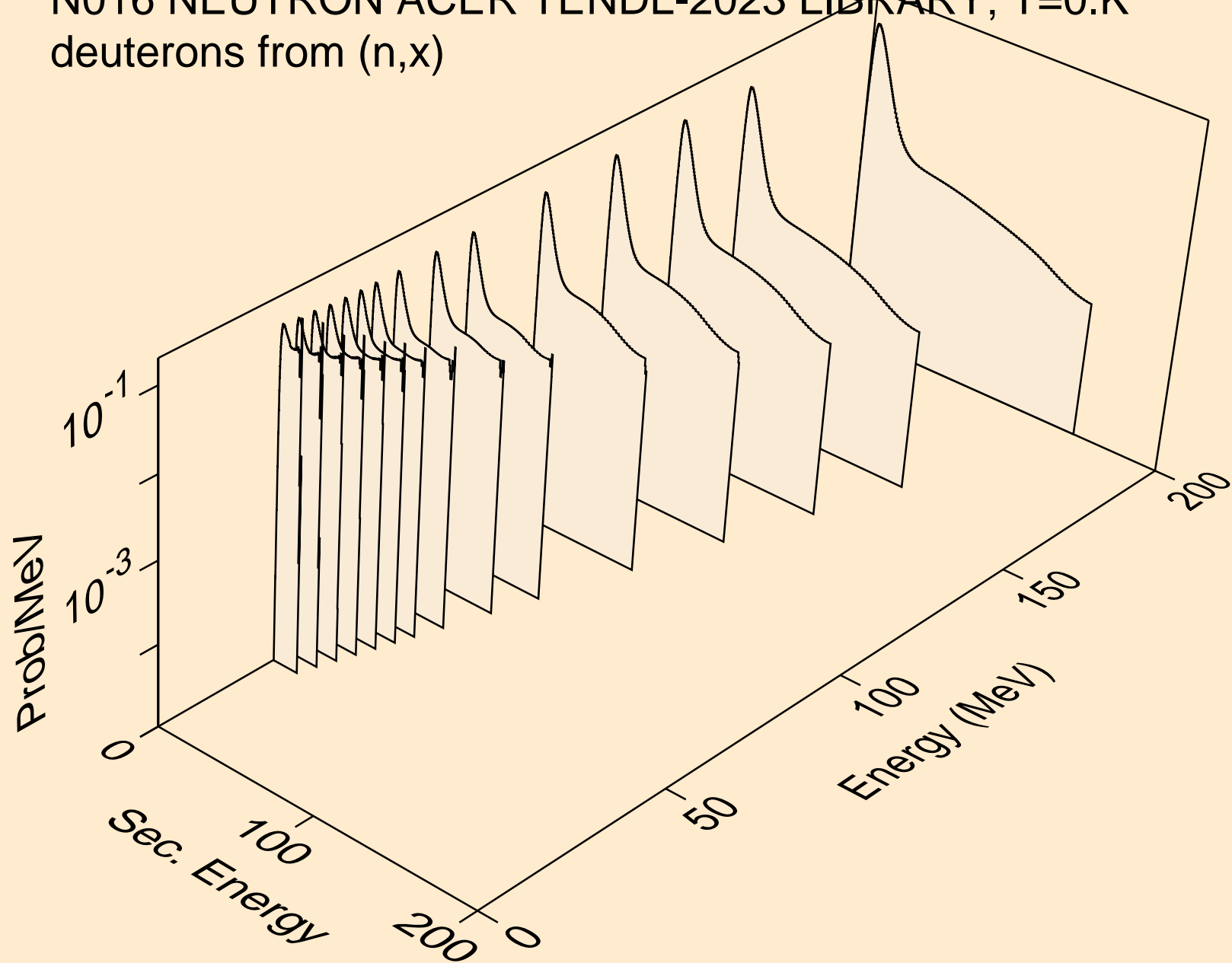

N016 NEUTRON ACER TENDL-2023 LIBRARY; T=0.K
deuterons from (n,2nd)

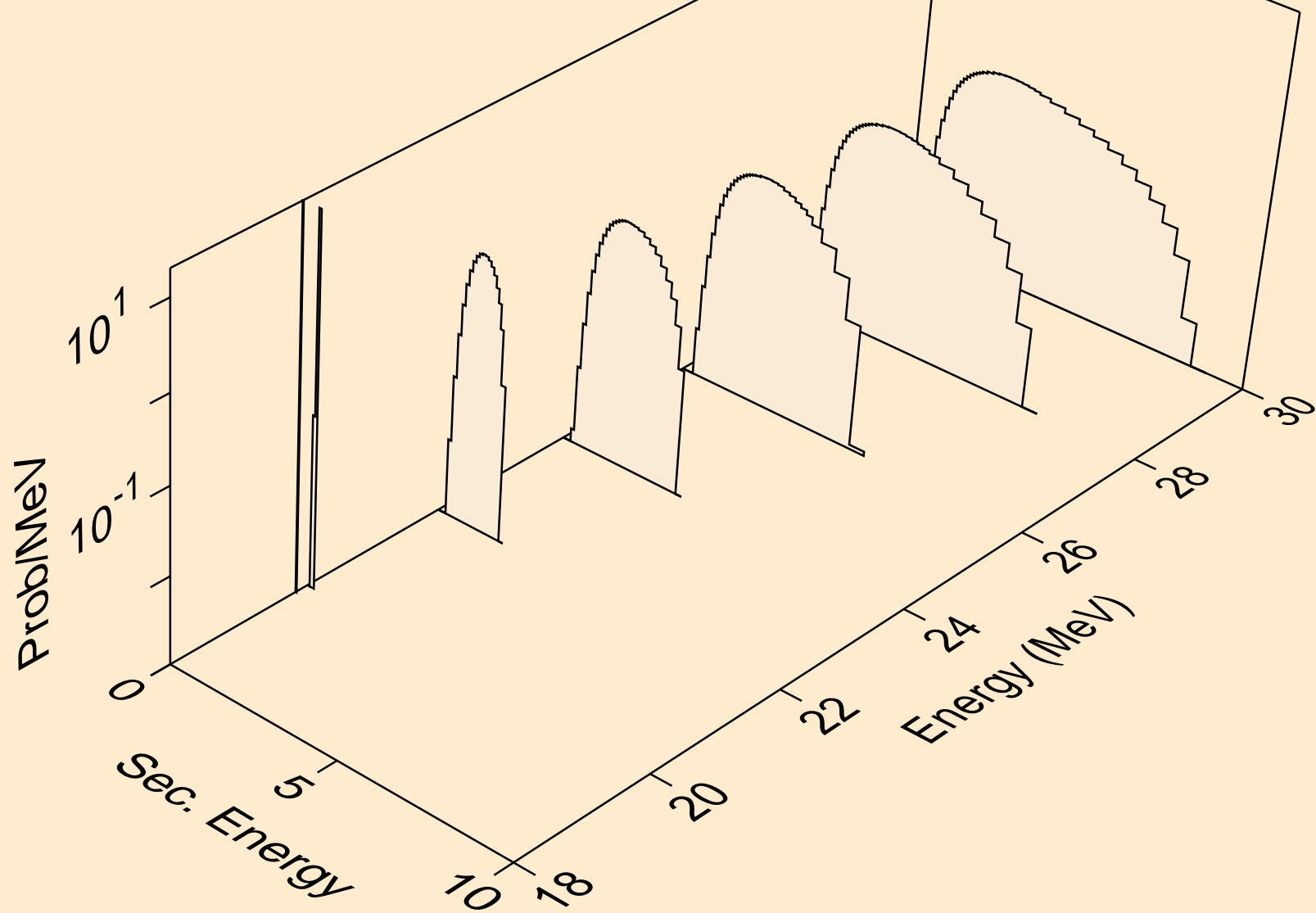

N016 NEUTRON ACER TENDL-2023 LIBRARY; T=0.K
deuterons from (n,n*)d

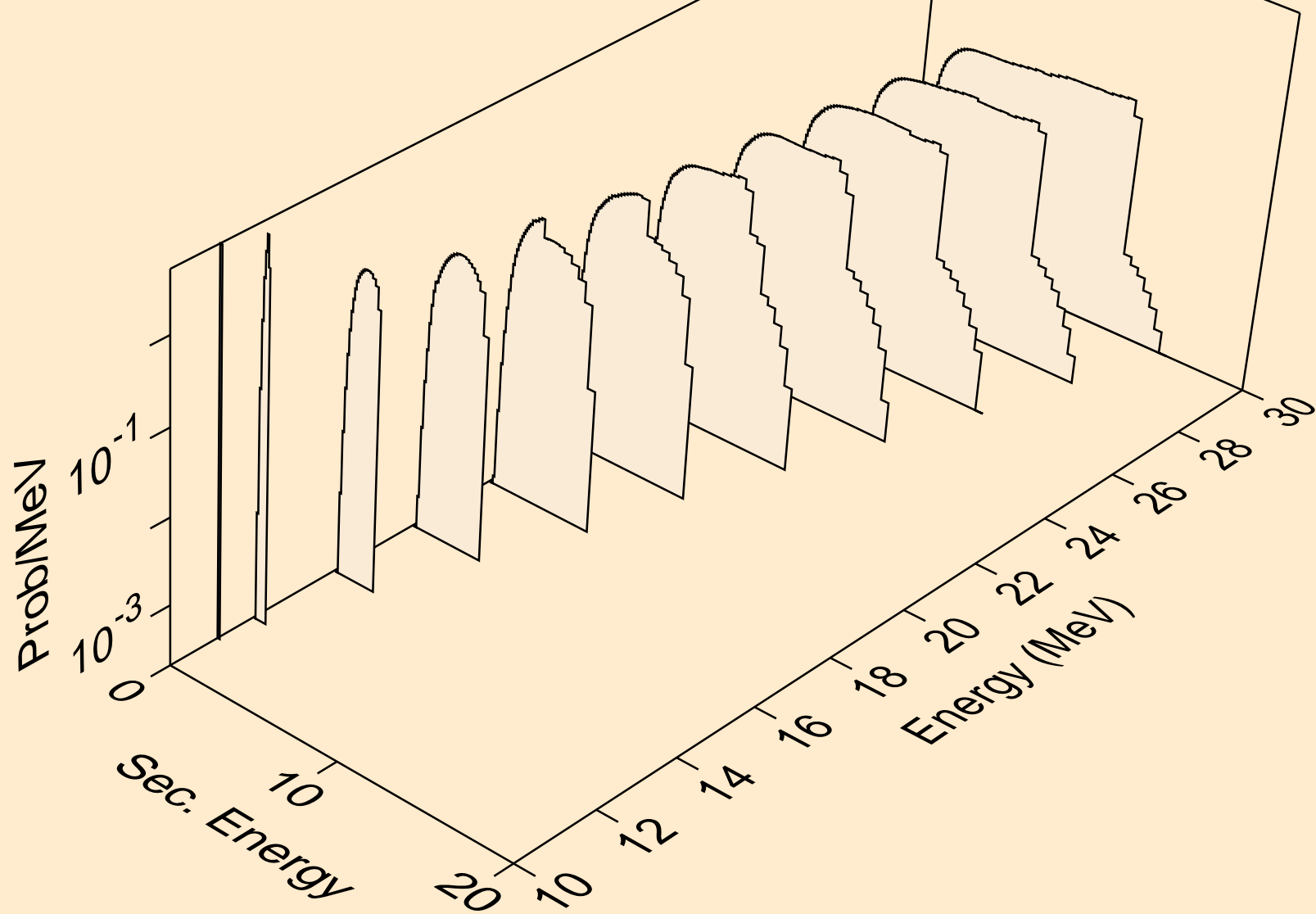

N016 NEUTRON ACER TENDL-2023 LIBRARY; T=0.K
deuterons from (n,d)

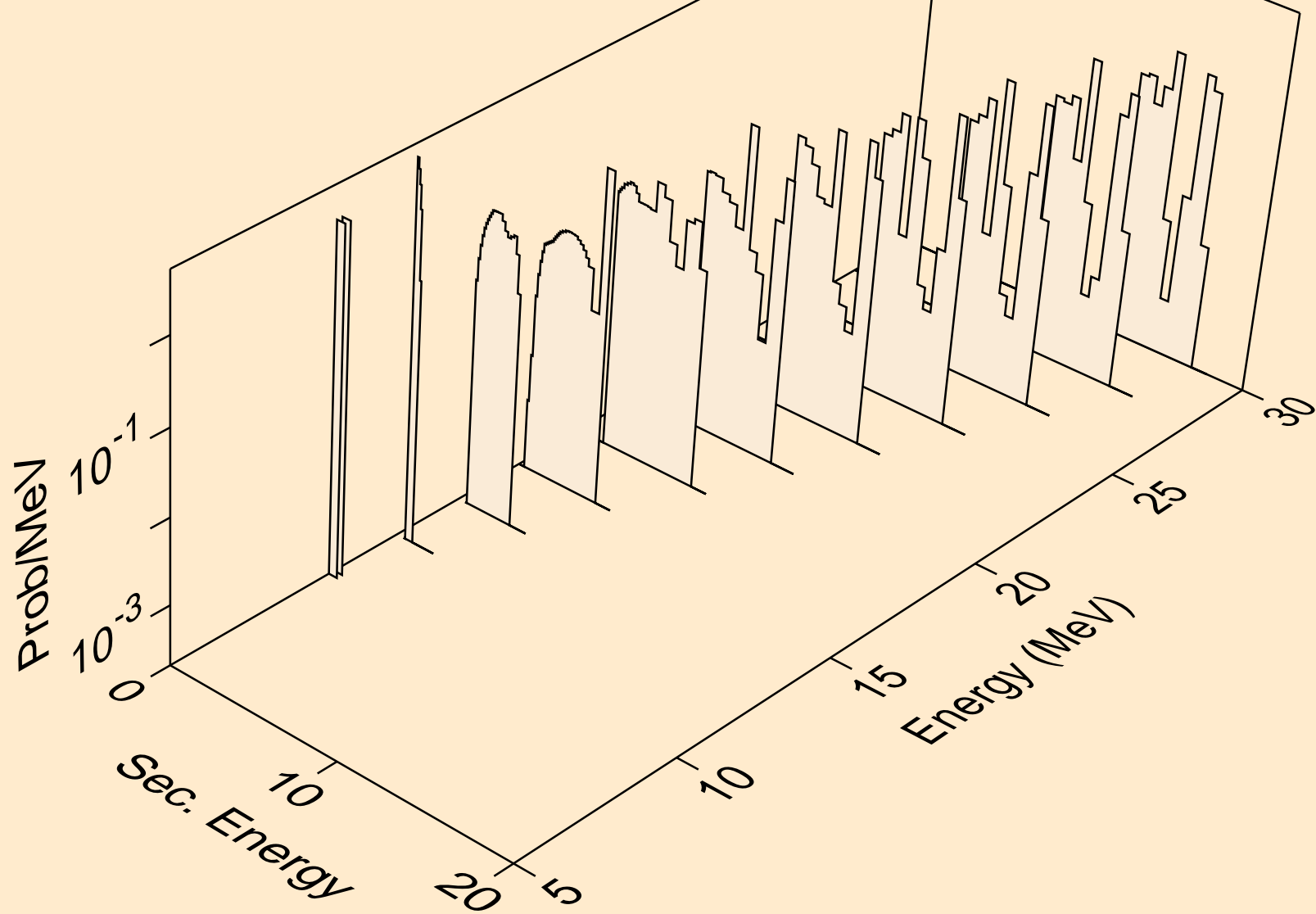

N016 NEUTRON ACER TENDL-2023 LIBRARY; T=0.K
deuterons from (n,da)

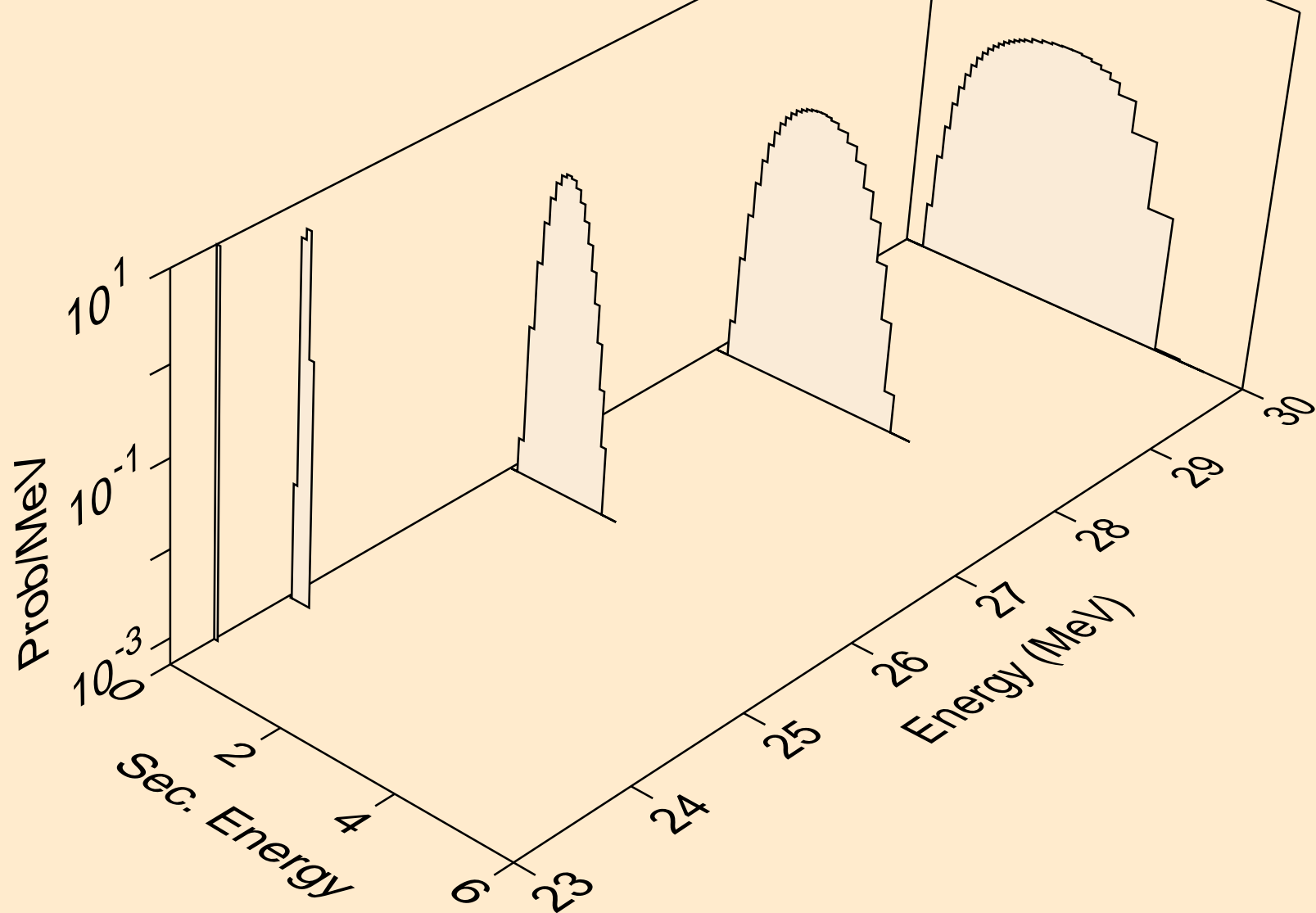

N016 NEUTRON ACER TENDL-2023 LIBRARY; T=0.K
tritons from (n,x)

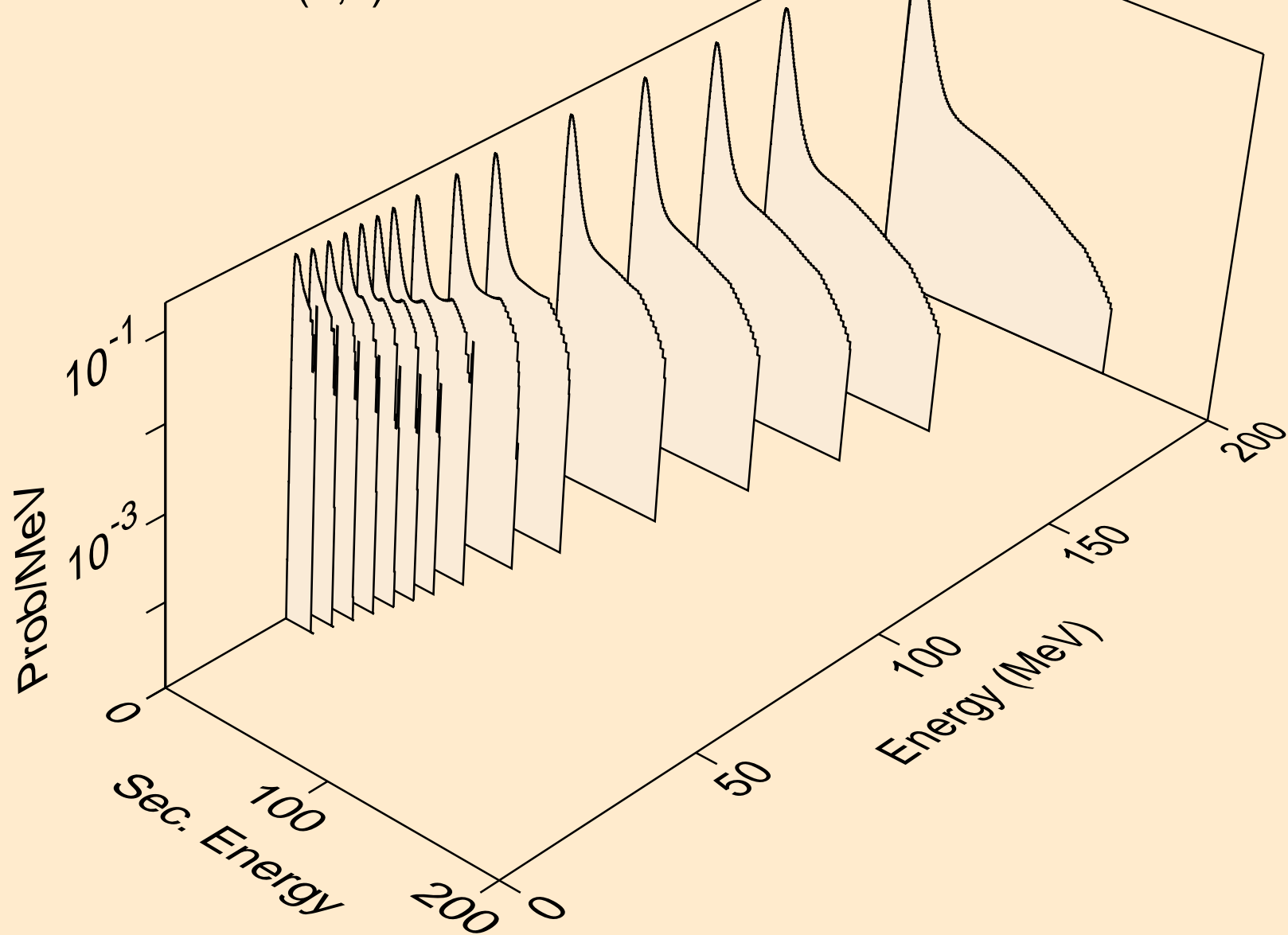

N016 NEUTRON ACER TENDL-2023 LIBRARY; T=0.K
tritons from (n,n*)t

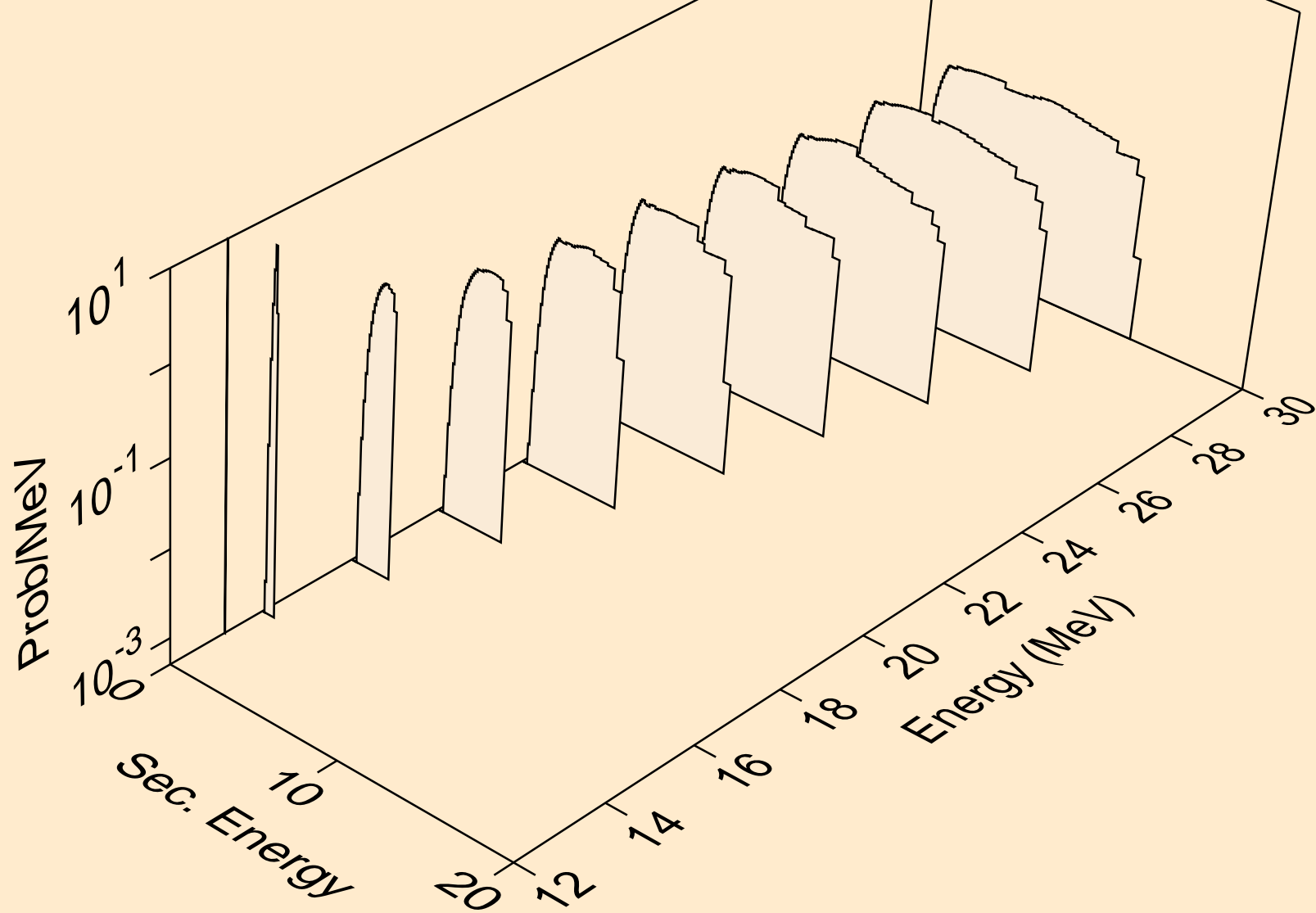

N016 NEUTRON ACER TENDL-2023 LIBRARY; T=0.K
tritons from (n,t)

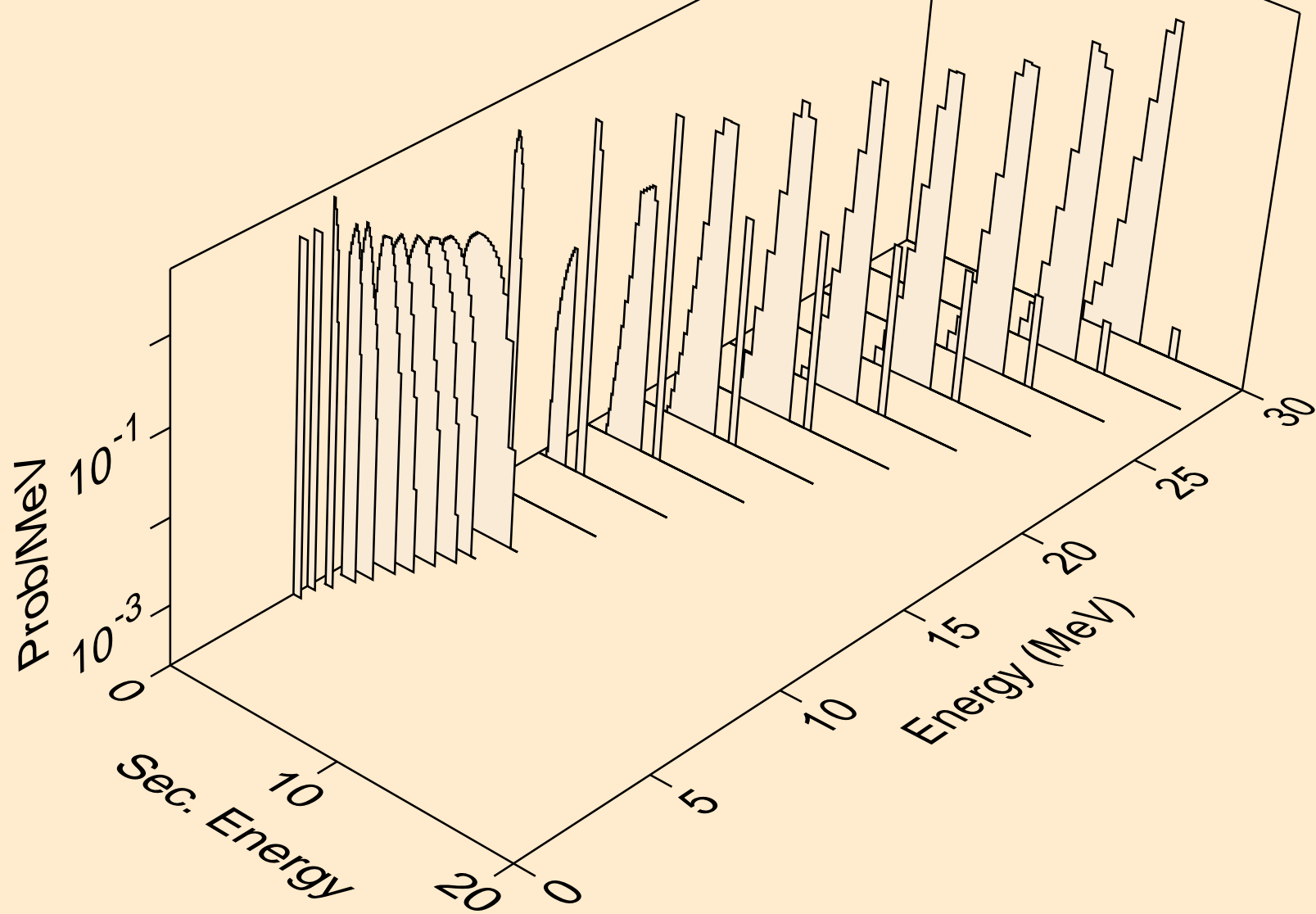

N016 NEUTRON ACER TENDL-2023 LIBRARY; T=0.K
tritons from (n,pt)

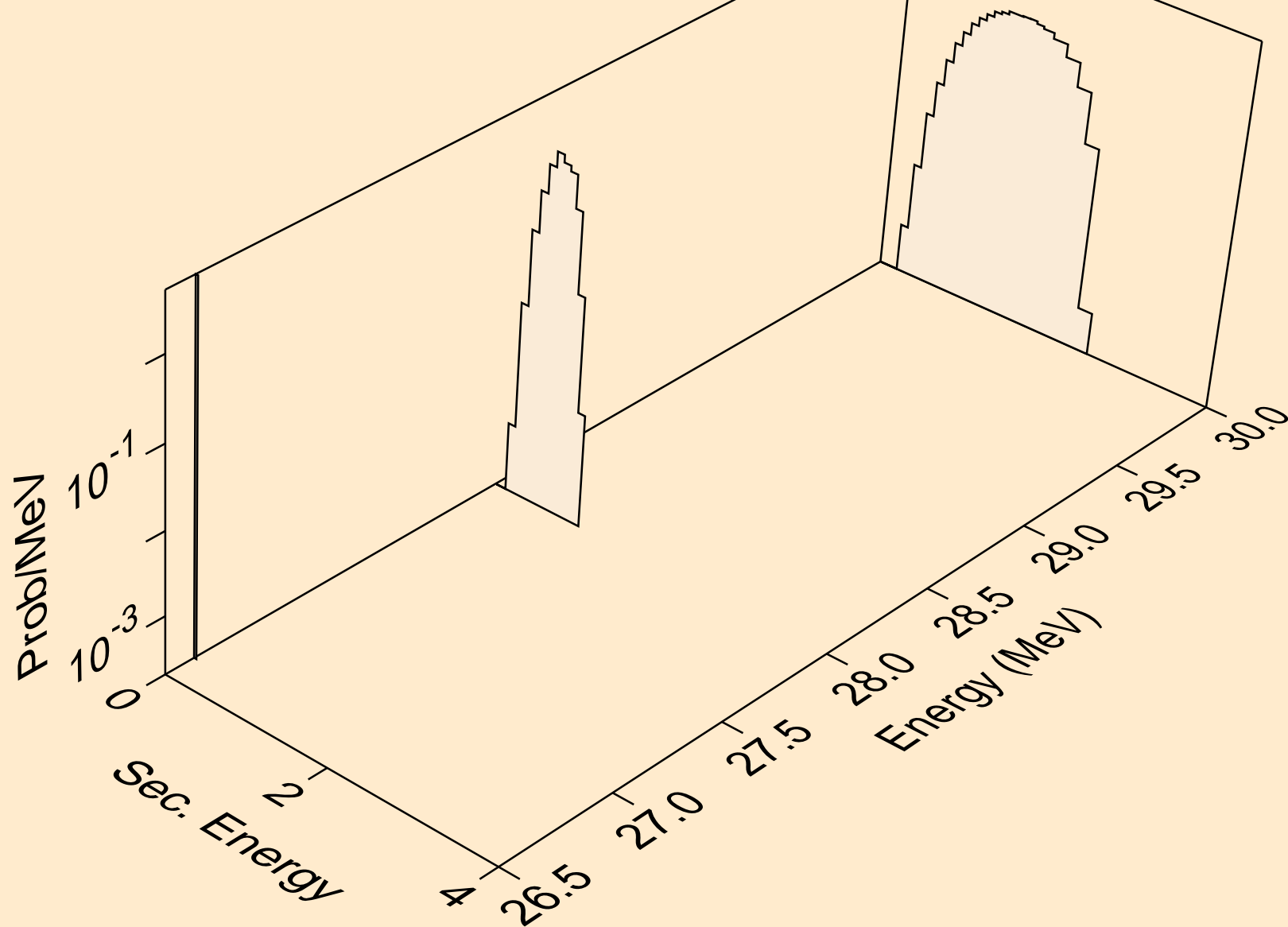

N016 NEUTRON ACER TENDL-2023 LIBRARY; T=0.K
he3s from (n,x)

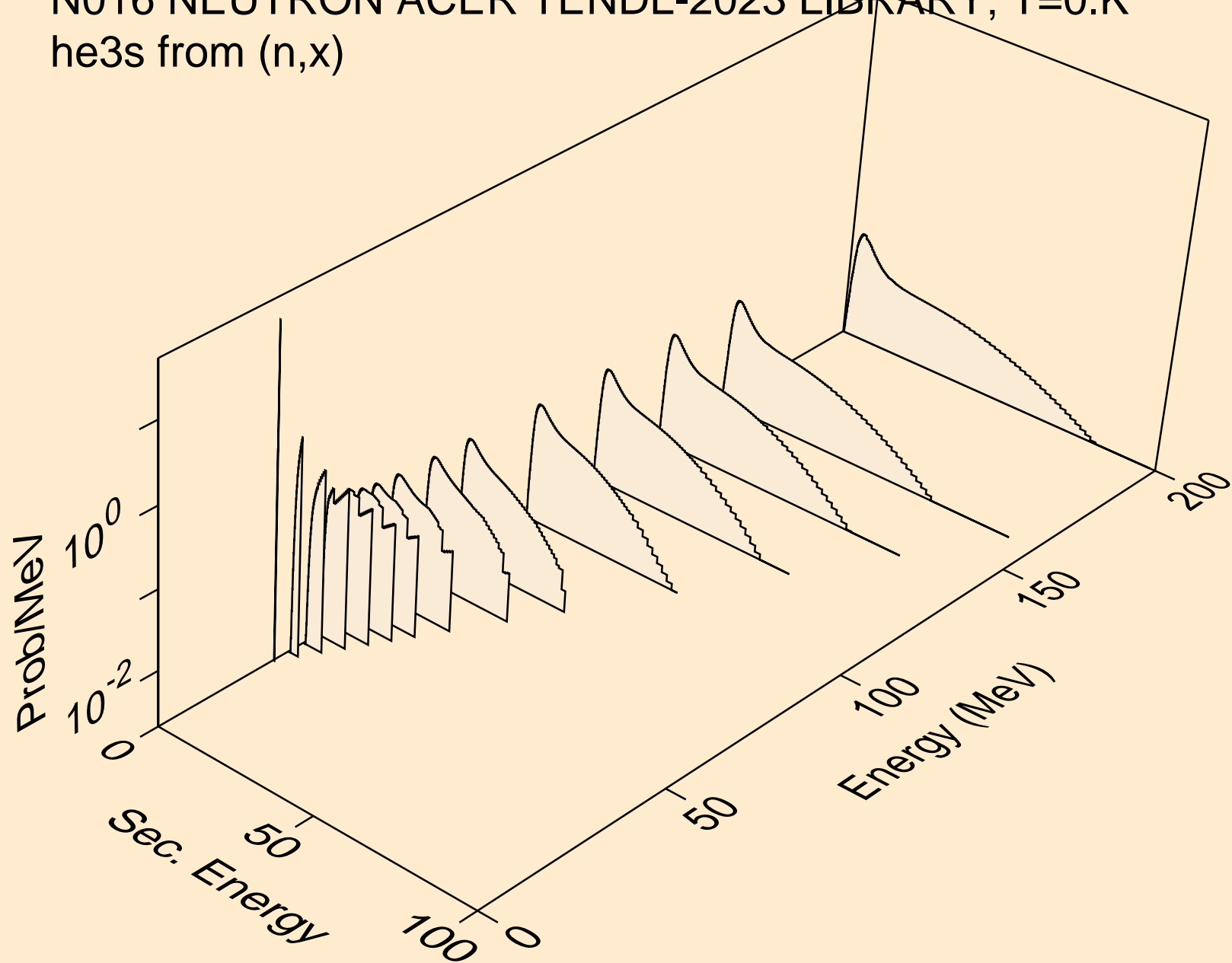

N016 NEUTRON ACER TENDL-2023 LIBRARY; T=0.K
he3s from (n,n*)he3

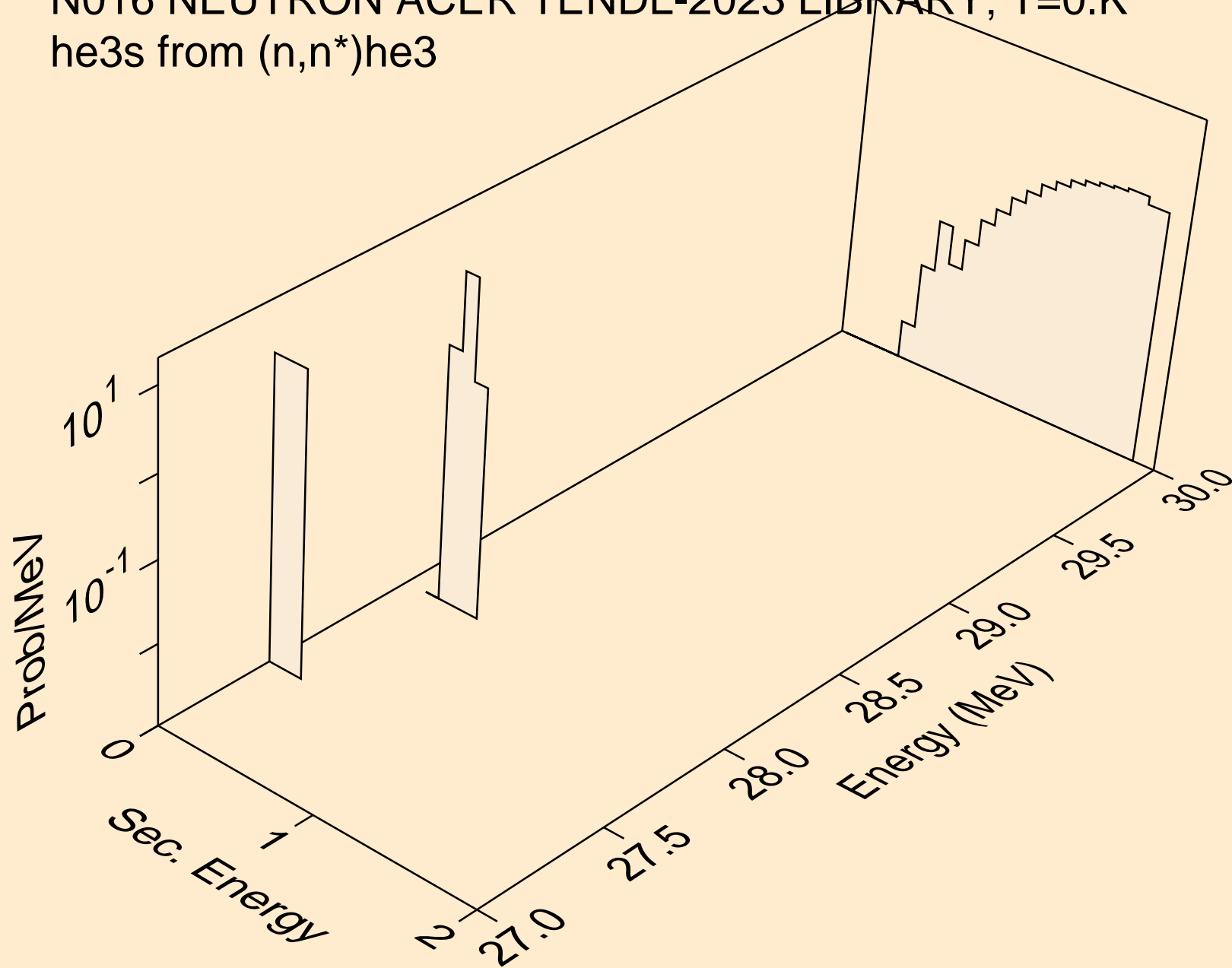

N016 NEUTRON ACER TENDL-2023 LIBRARY; T=0.K
he3s from (n,he3)

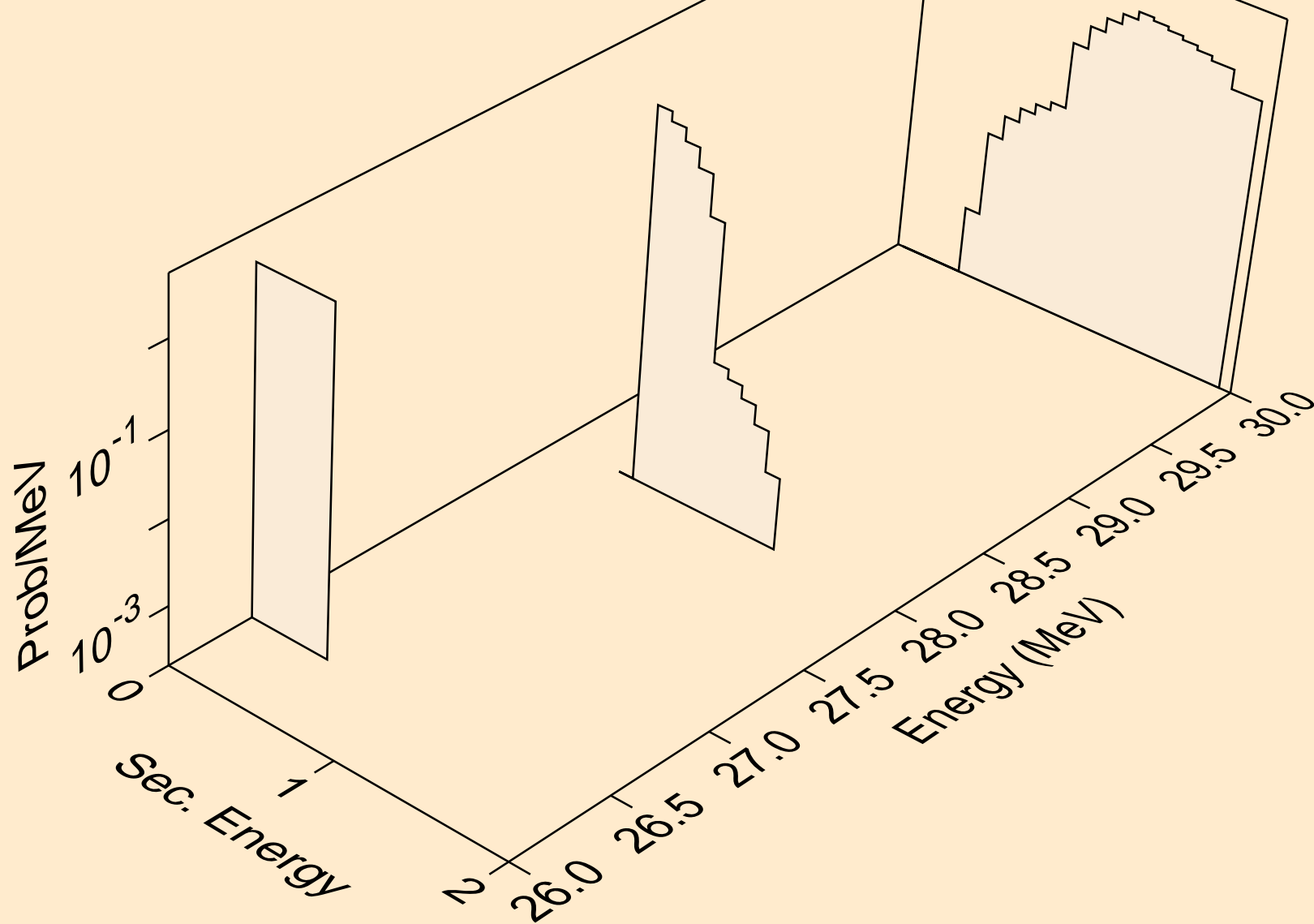

N016 NEUTRON ACER TENDL-2023 LIBRARY; T=0.K
alphas from (n,x)

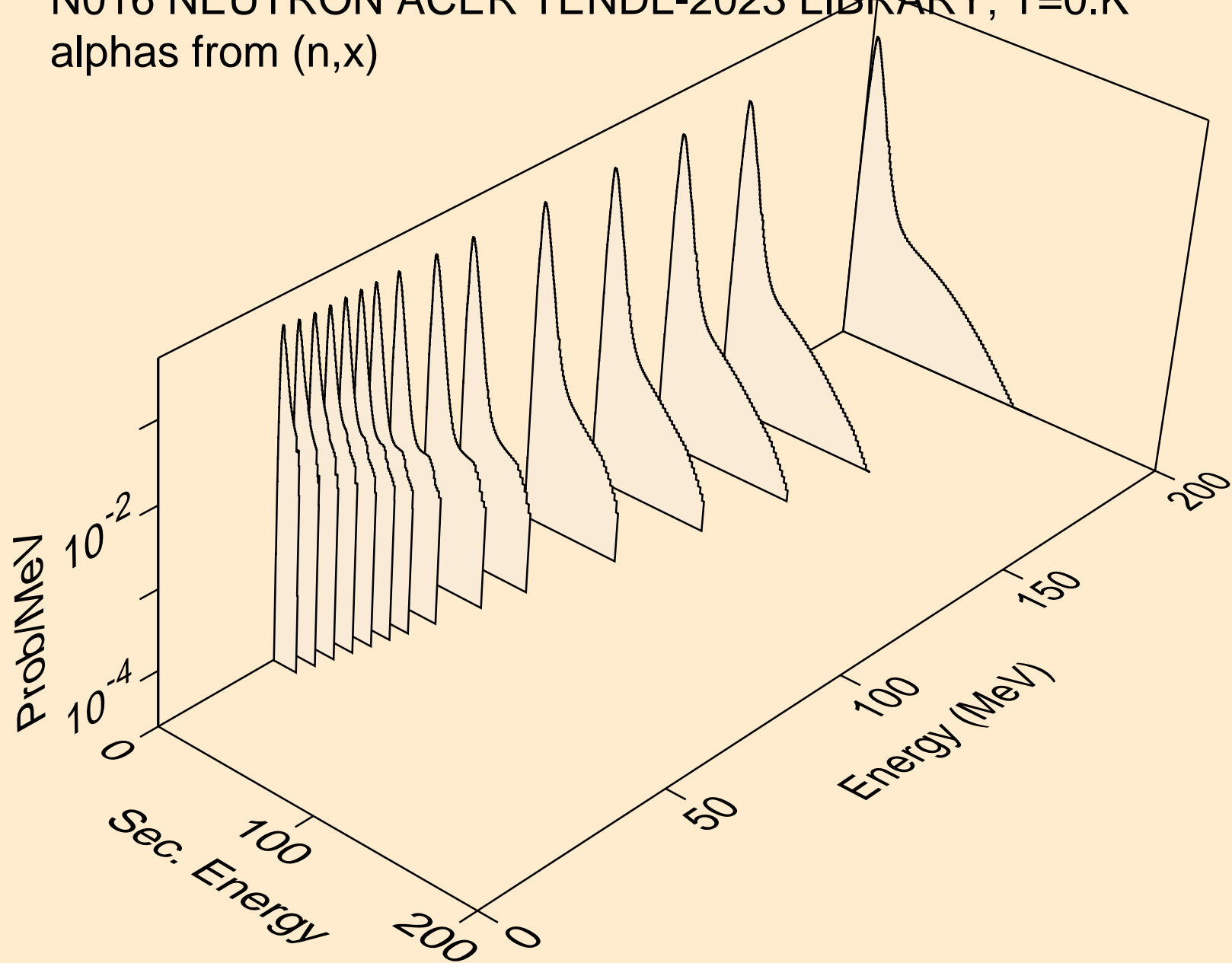

N016 NEUTRON ACER TENDL-2023 LIBRARY; T=0.K
alphas from (n,n*)a

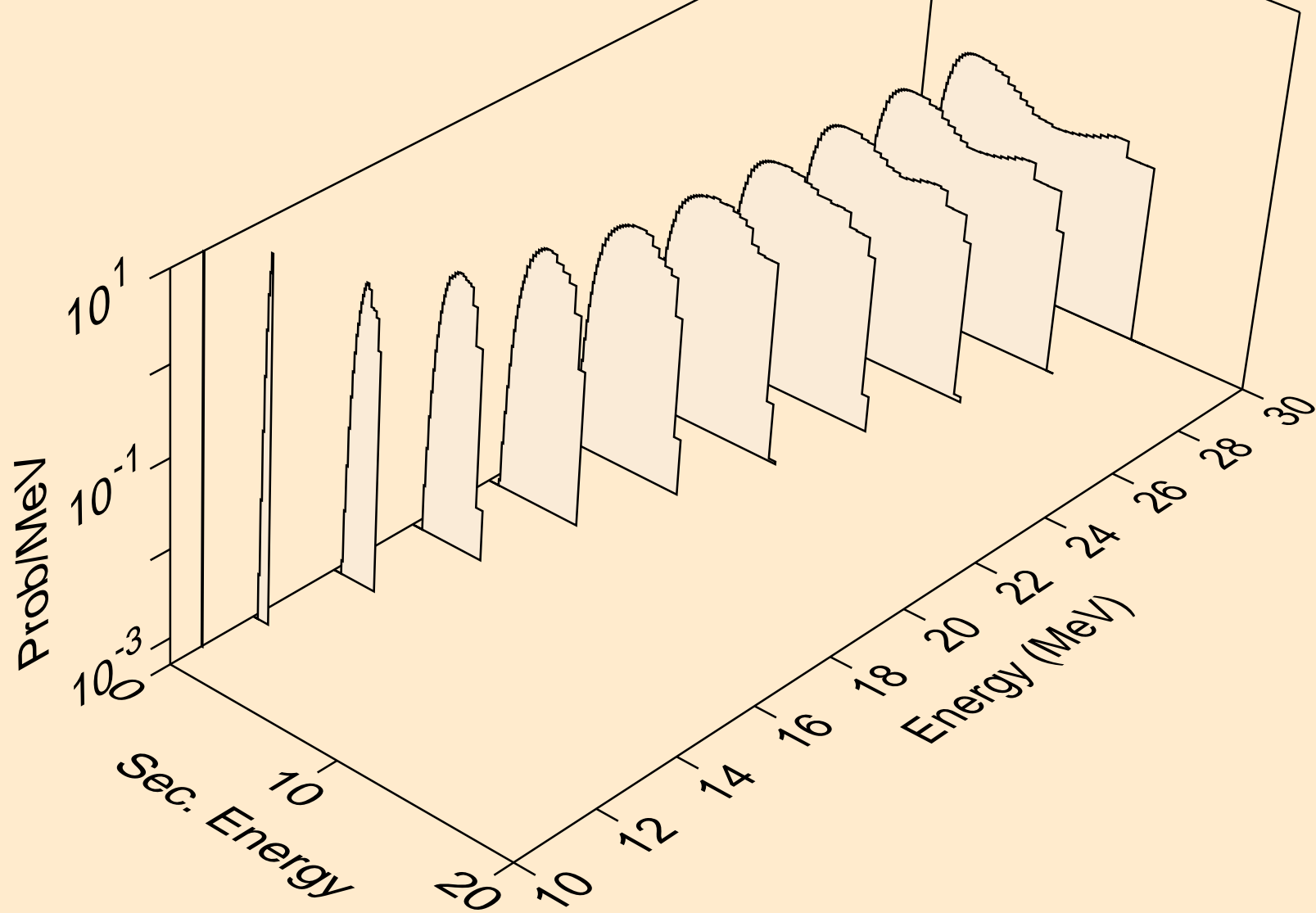

N016 NEUTRON ACER TENDL-2023 LIBRARY; T=0.K
alphas from (n,2n)a

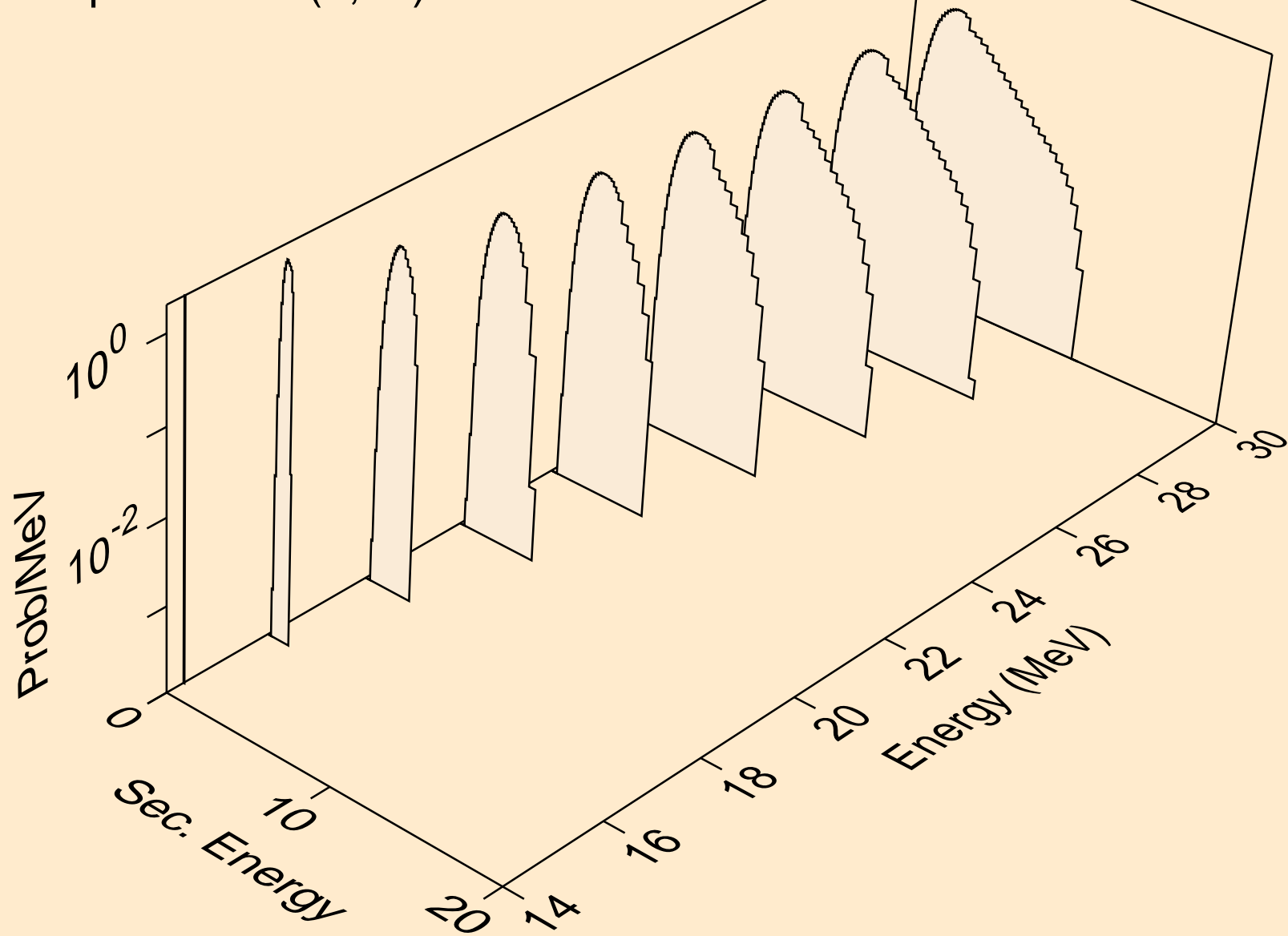

N016 NEUTRON ACER TENDL-2023 LIBRARY; T=0.K
alphas from (n,3n)a

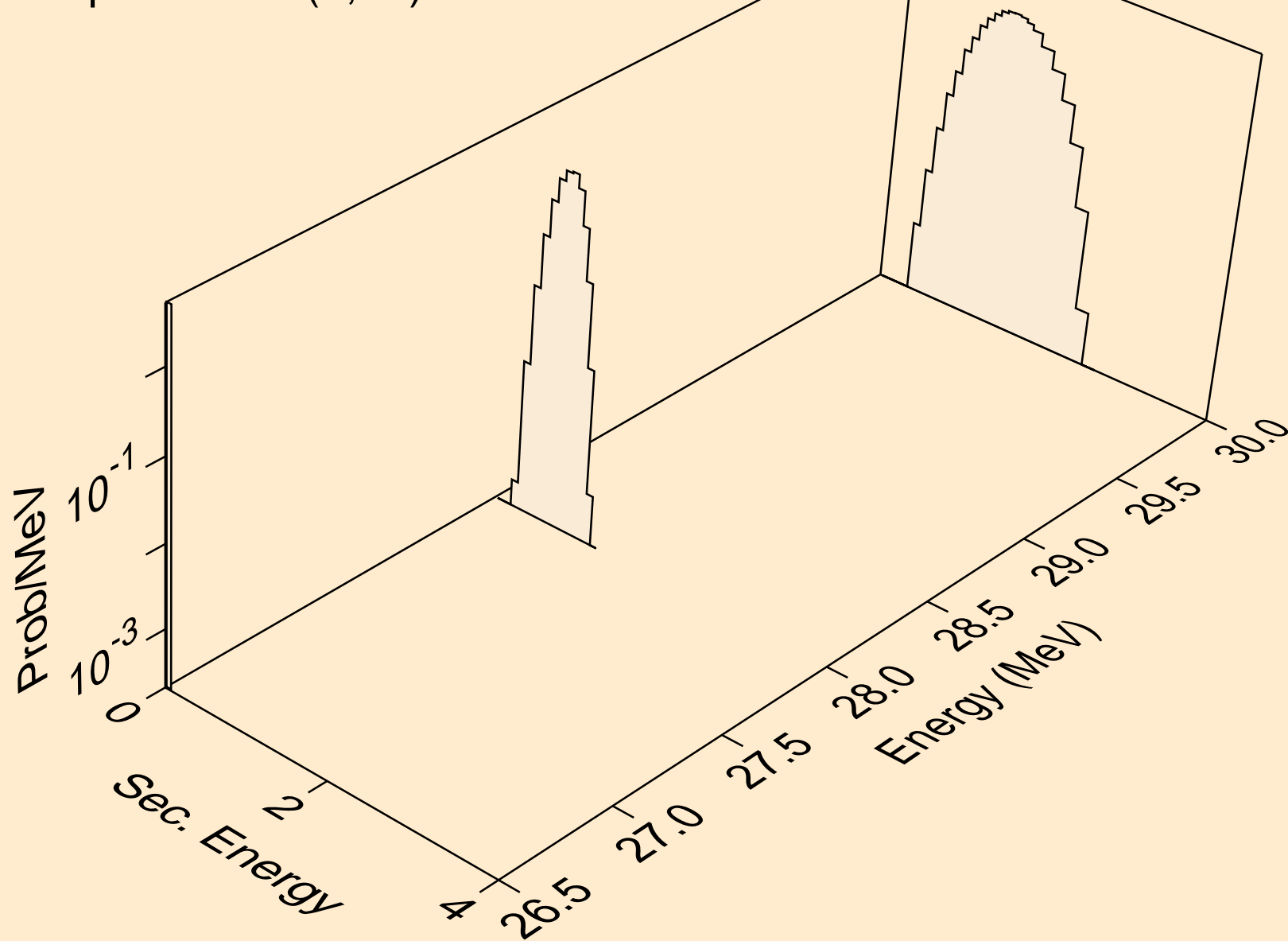

N016 NEUTRON ACER TENDL-2023 LIBRARY; T=0.K
alphas from (n,n*)2a

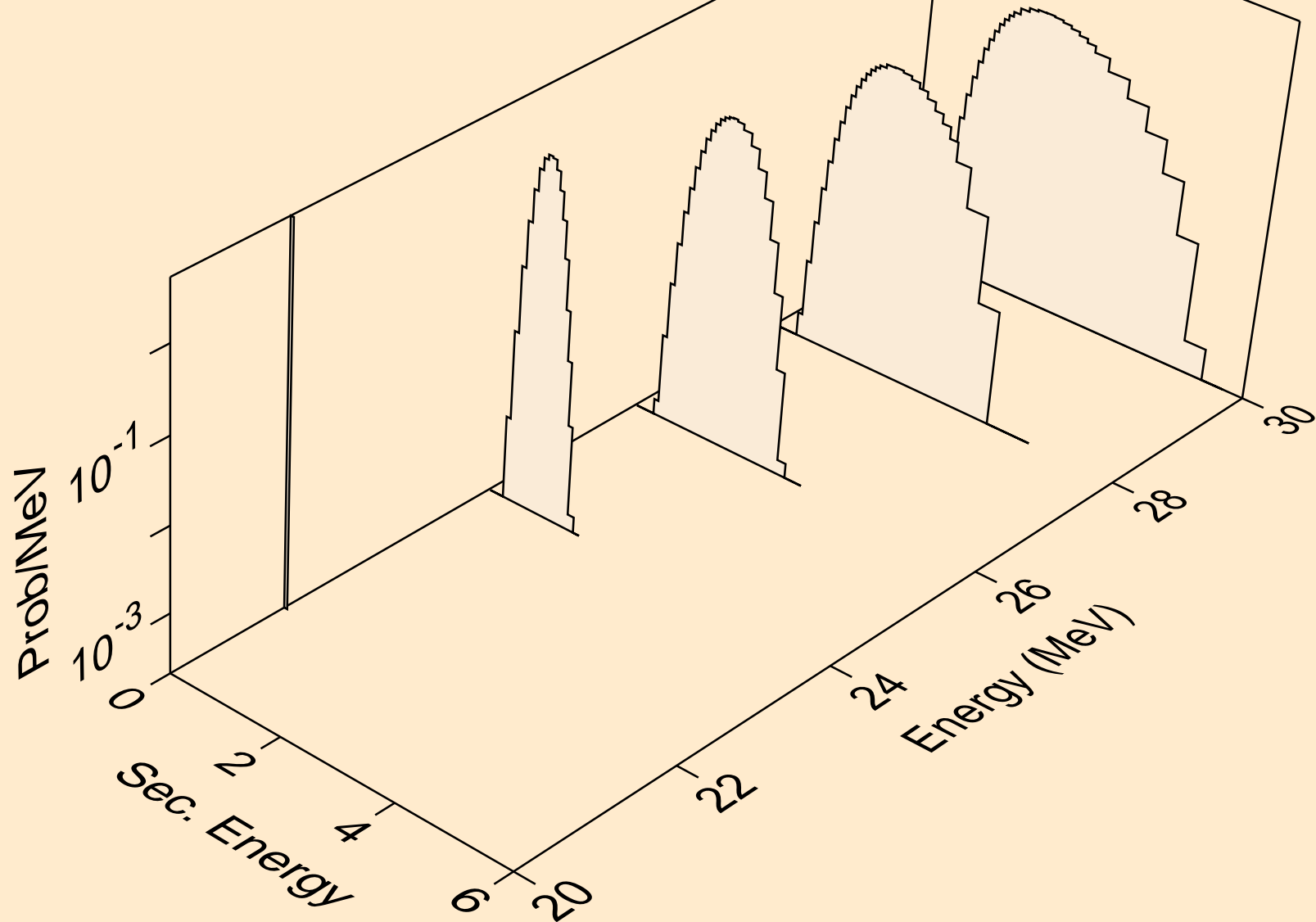

N016 NEUTRON ACER TENDL-2023 LIBRARY; T=0.K
alphas from (n,2n)2a

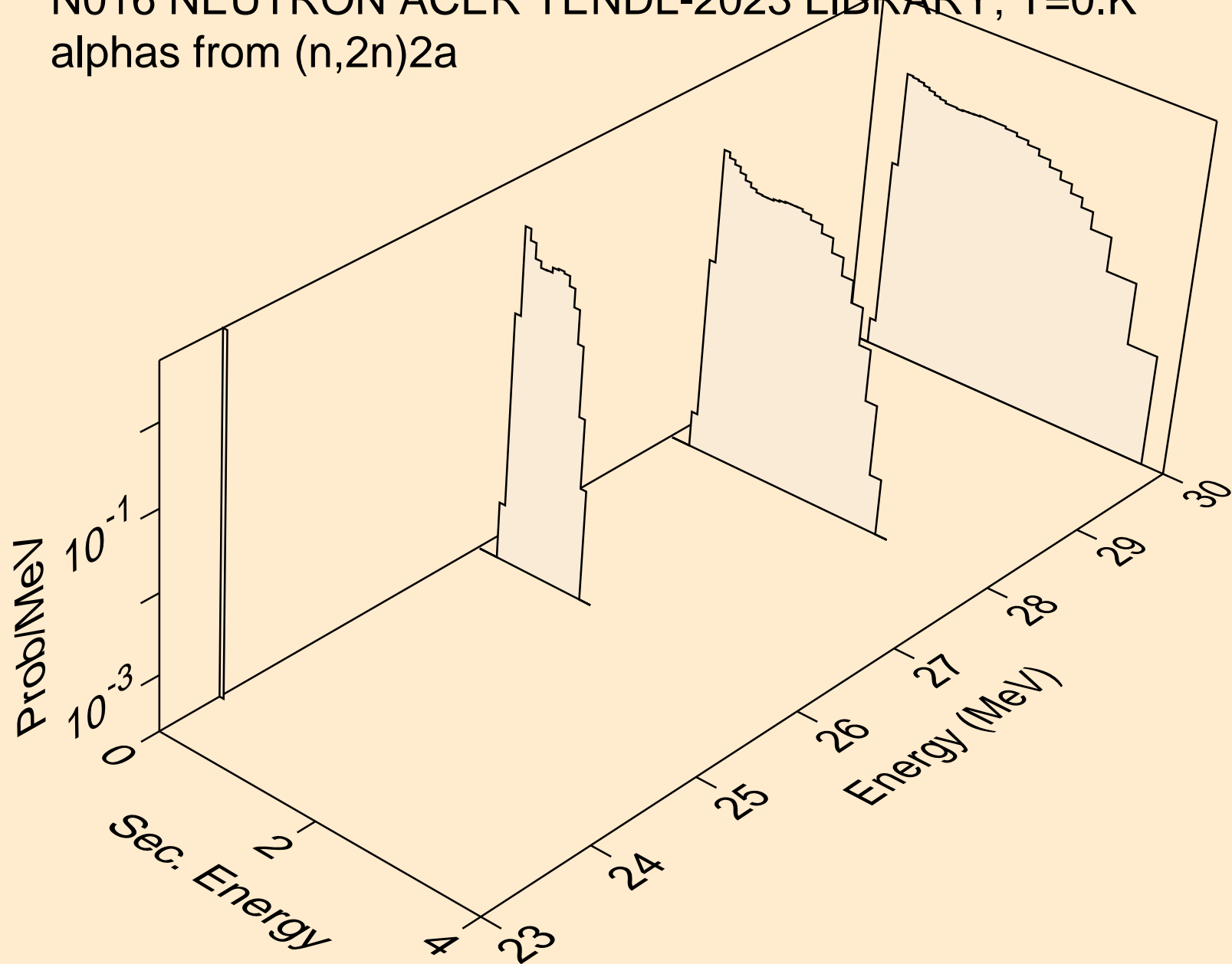

N016 NEUTRON ACER TENDL-2023 LIBRARY; T=0.K
alphas from (n,npa)

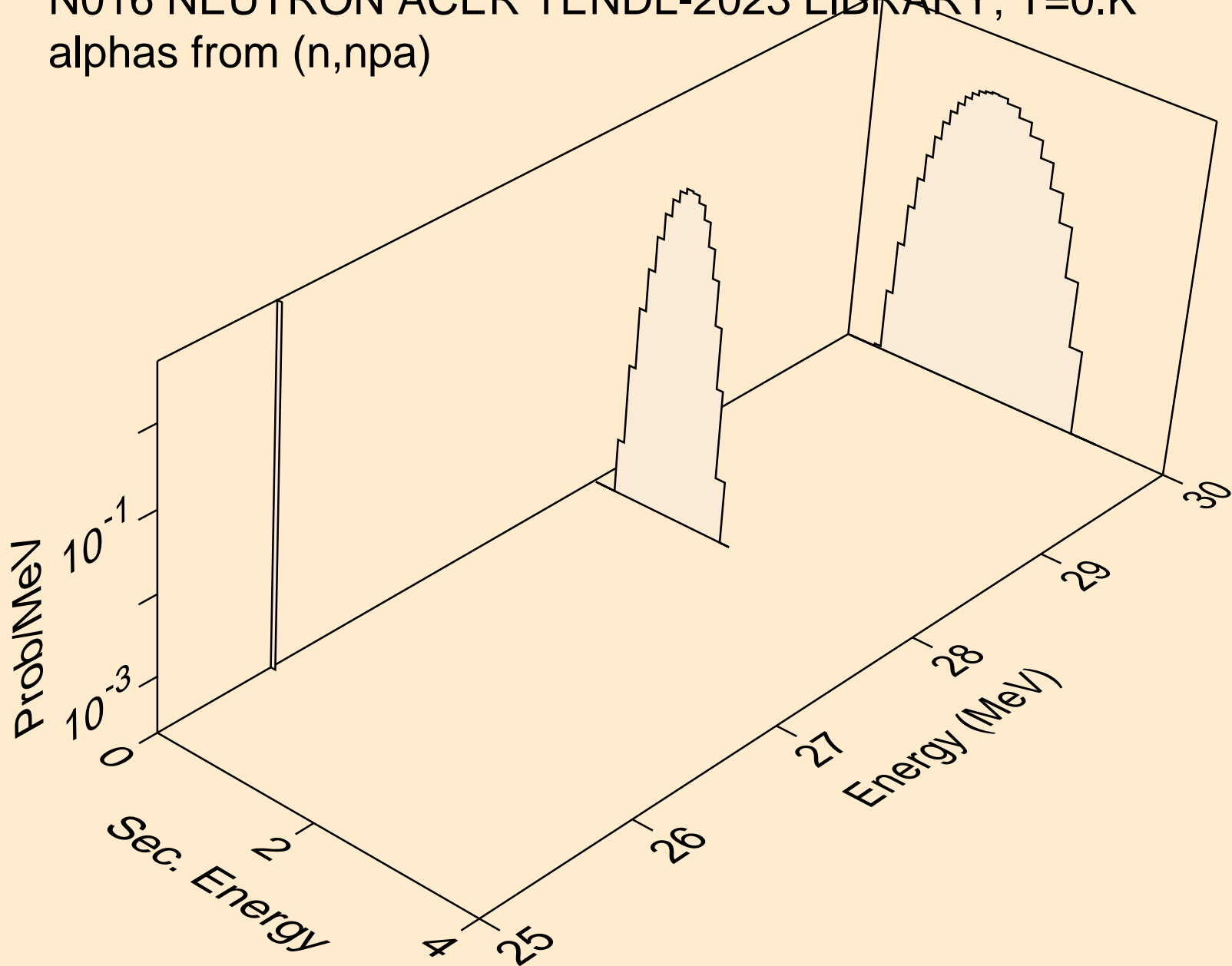

N016 NEUTRON ACER TENDL-2023 LIBRARY; T=0.K
alphas from (n,a)

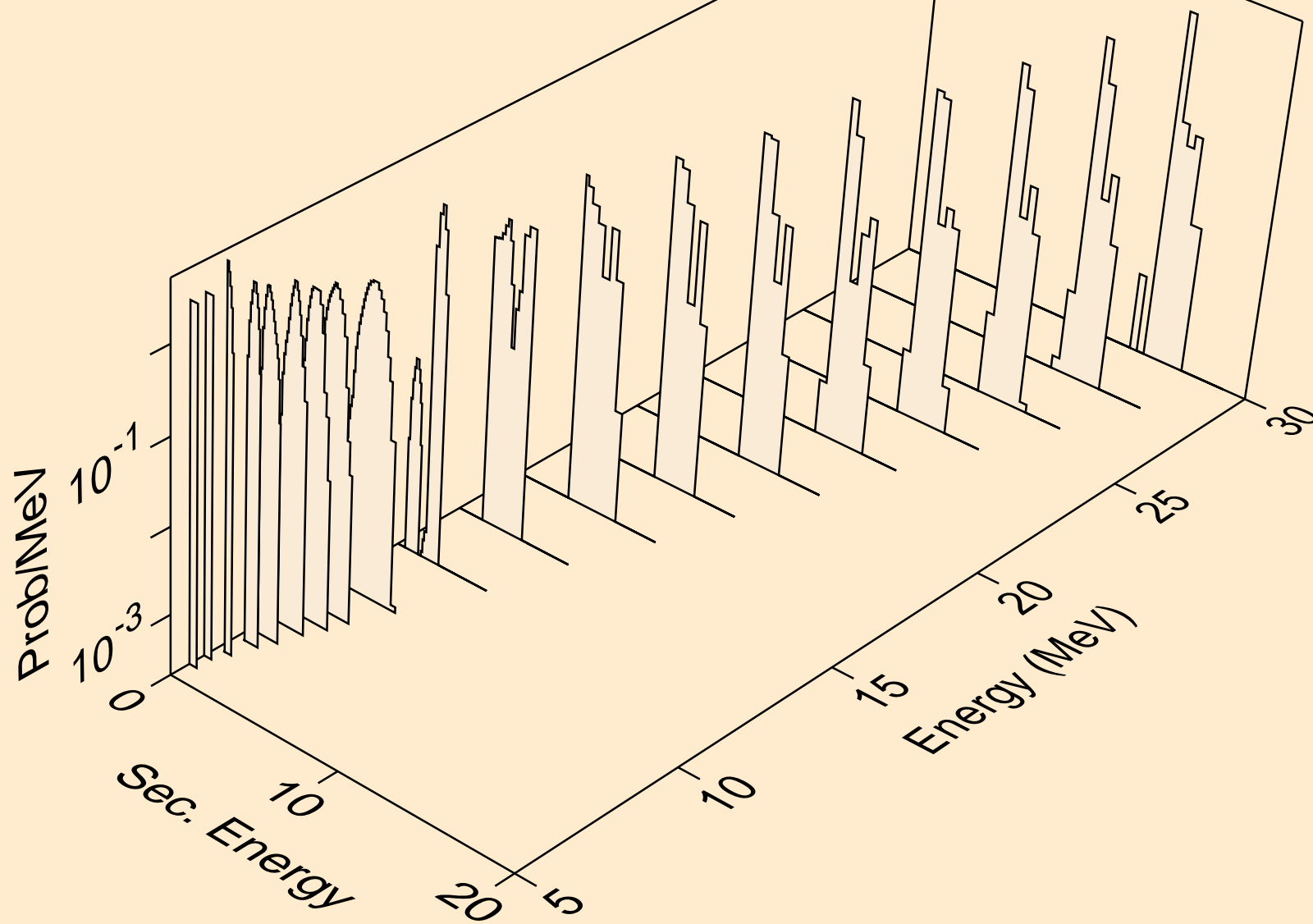

N016 NEUTRON ACER TENDL-2023 LIBRARY; T=0.K
alphas from (n,2a)

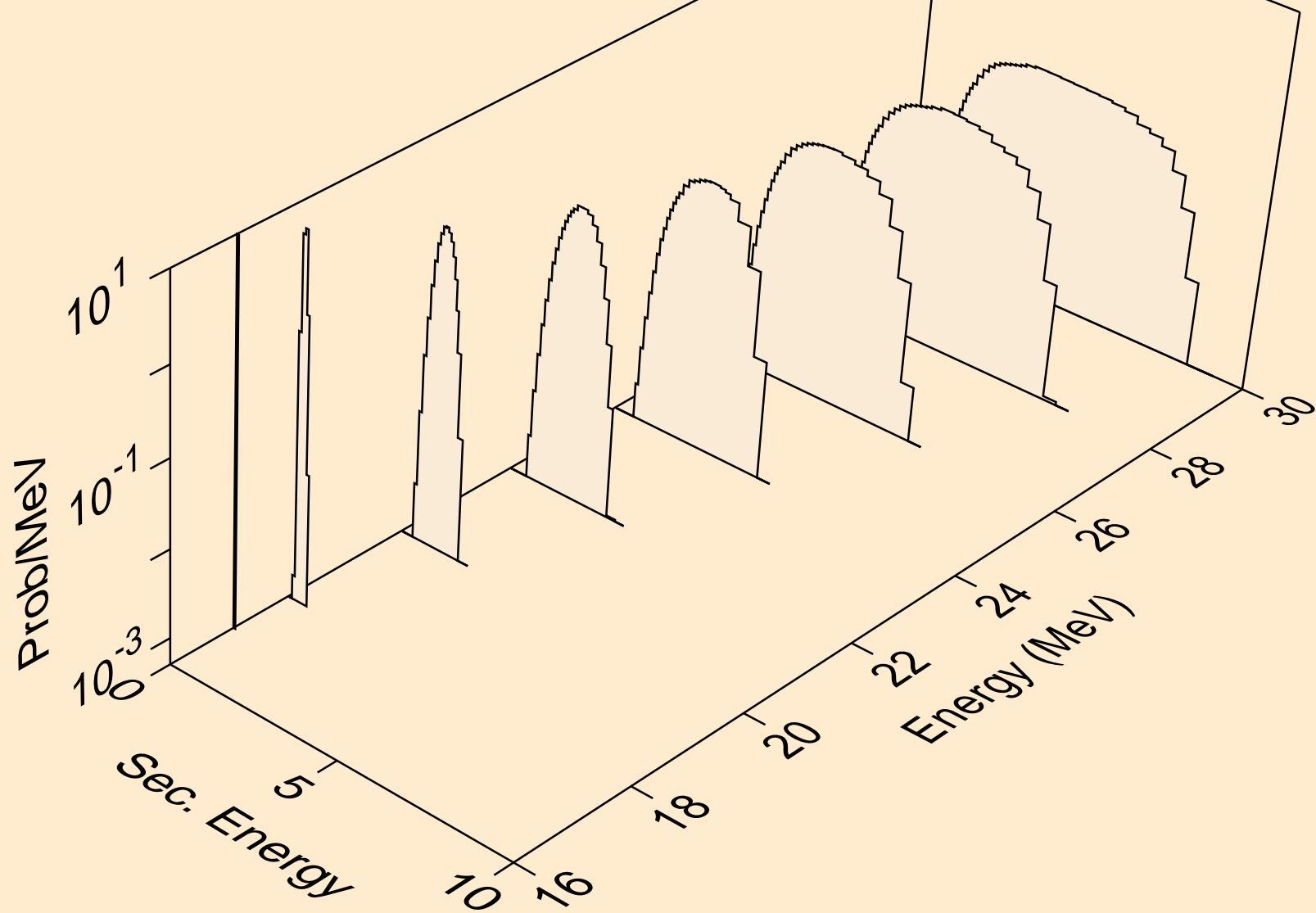

N016 NEUTRON ACER TENDL-2023 LIBRARY; T=0.K
alphas from (n,pa)

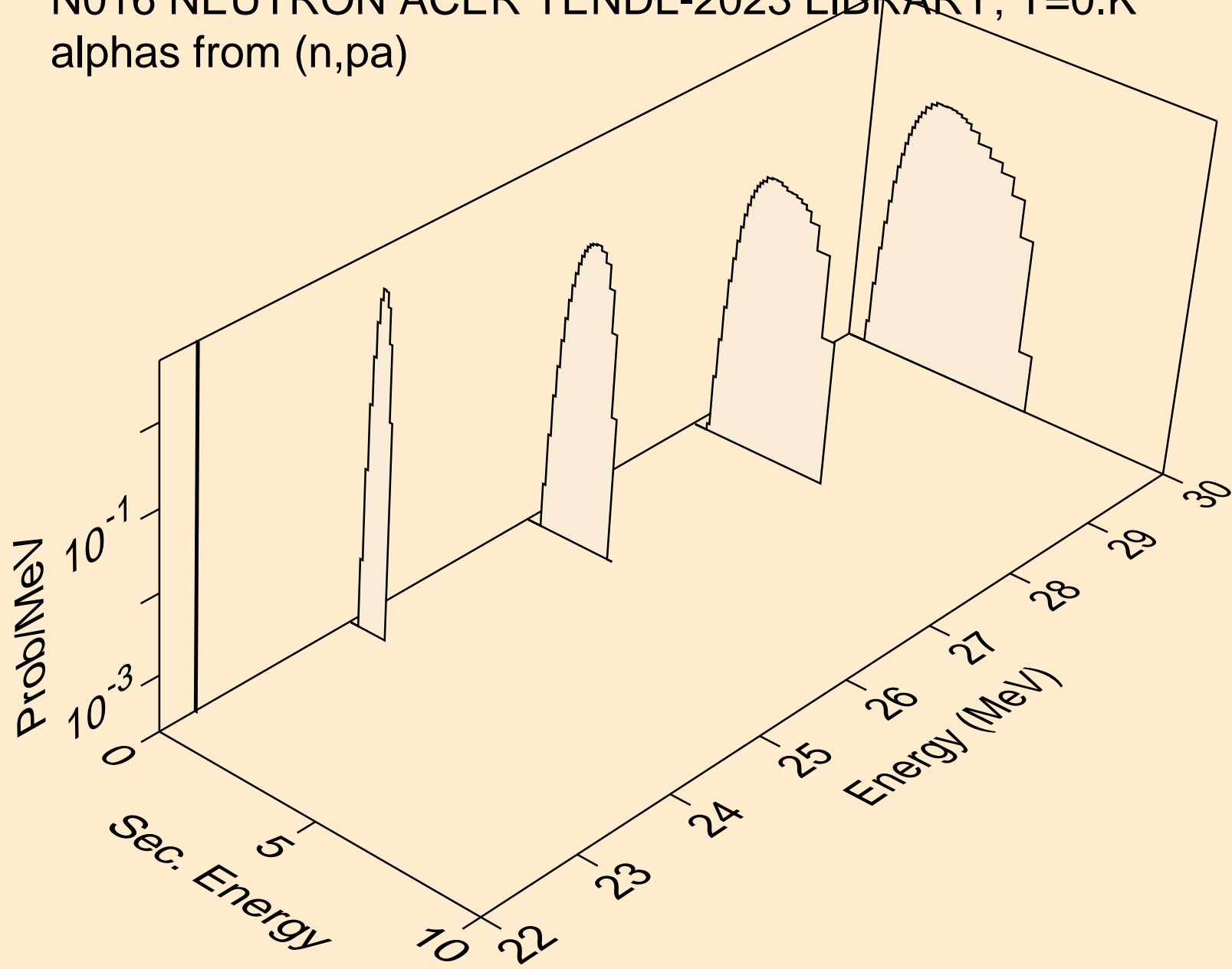

N016 NEUTRON ACER TENDL-2023 LIBRARY; T=0.K
alphas from (n,da)

