

# NB088 NEUTRON ACER TENDL-2023 LIBRARY; T=0.K

## Principal cross sections

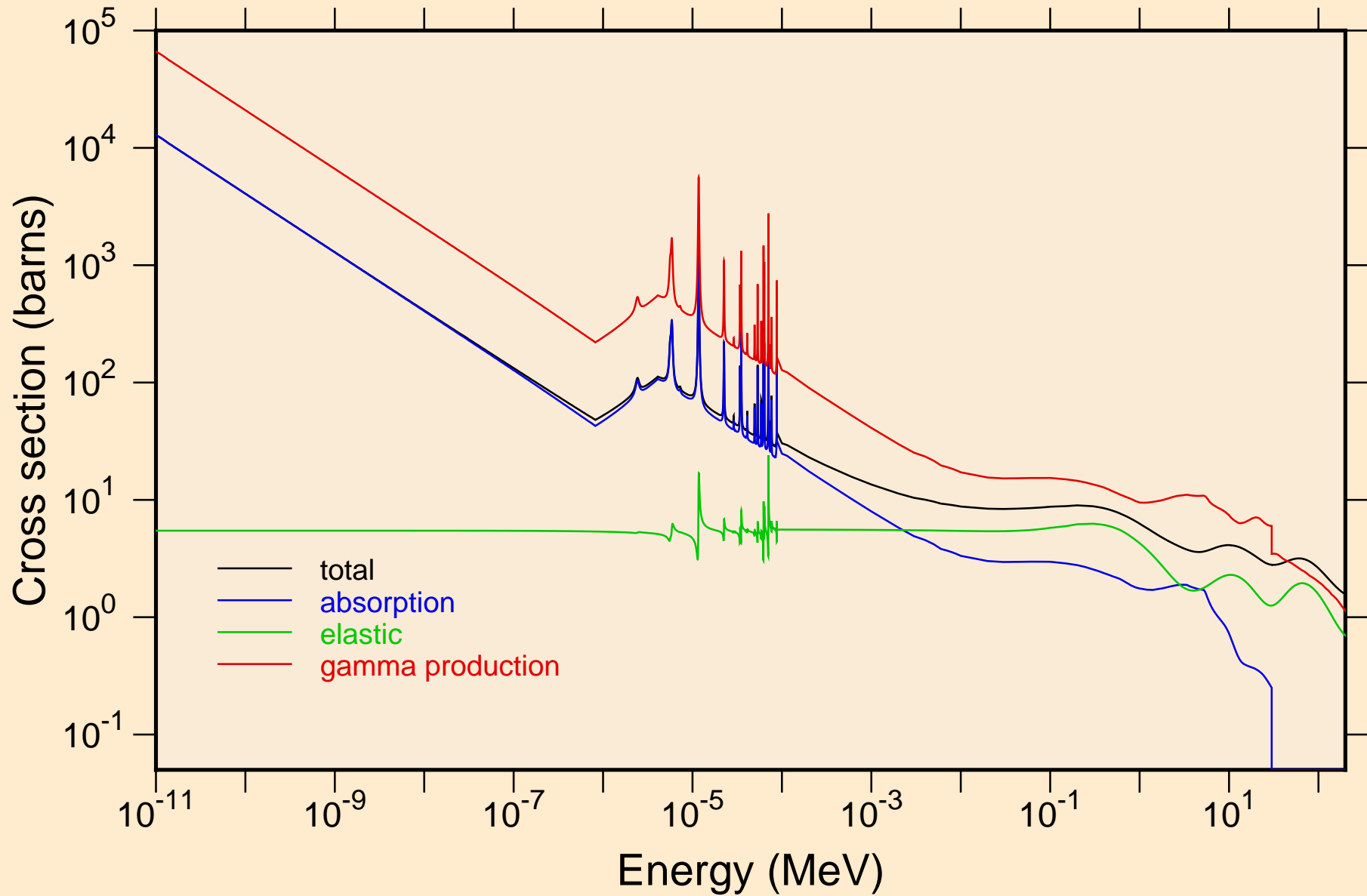

NB088 NEUTRON ACER TENDL-2023 LIBRARY; T=0.K  
resonance total cross section

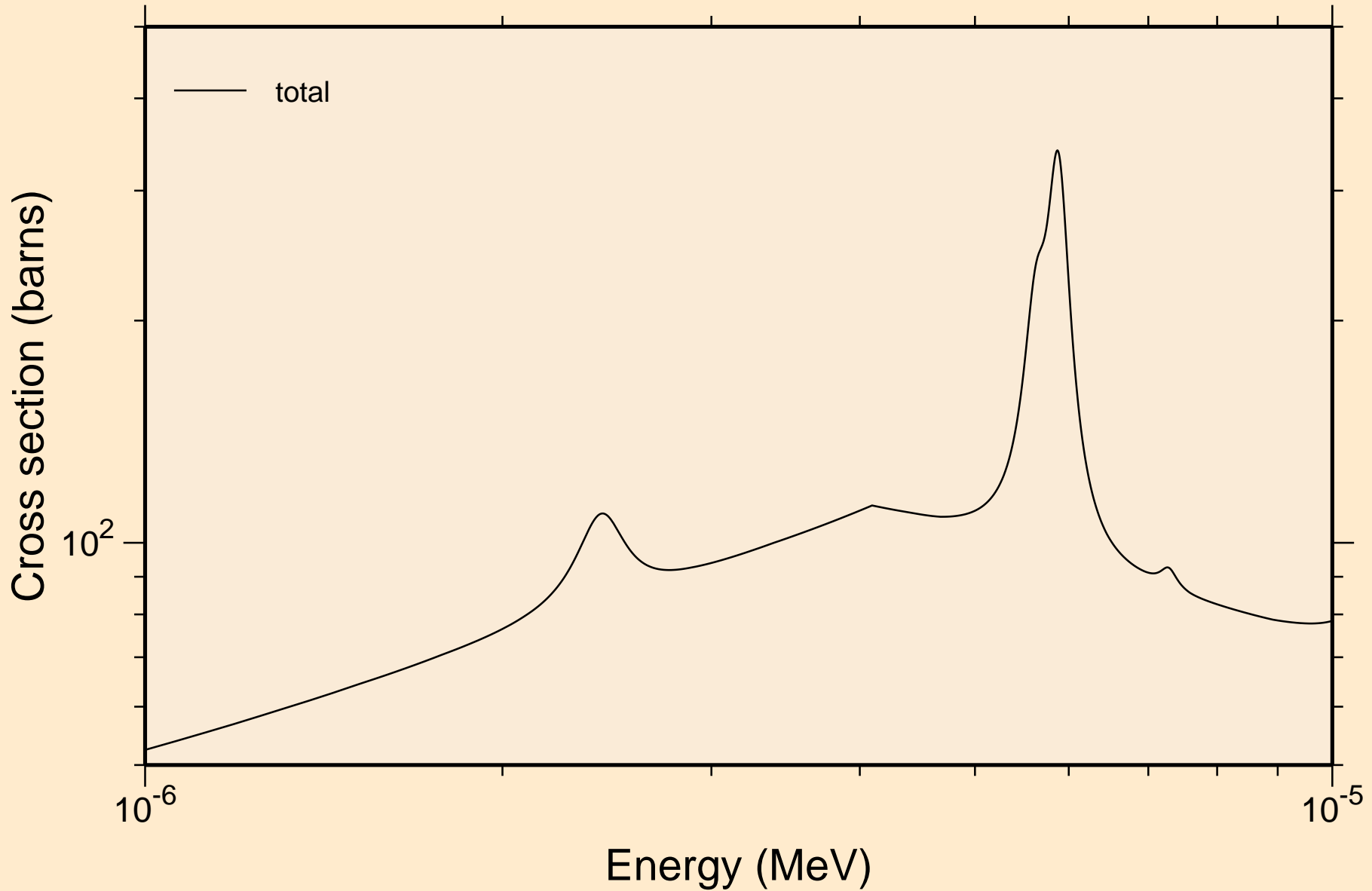

NB088 NEUTRON ACER TENDL-2023 LIBRARY; T=0.K  
resonance total cross section

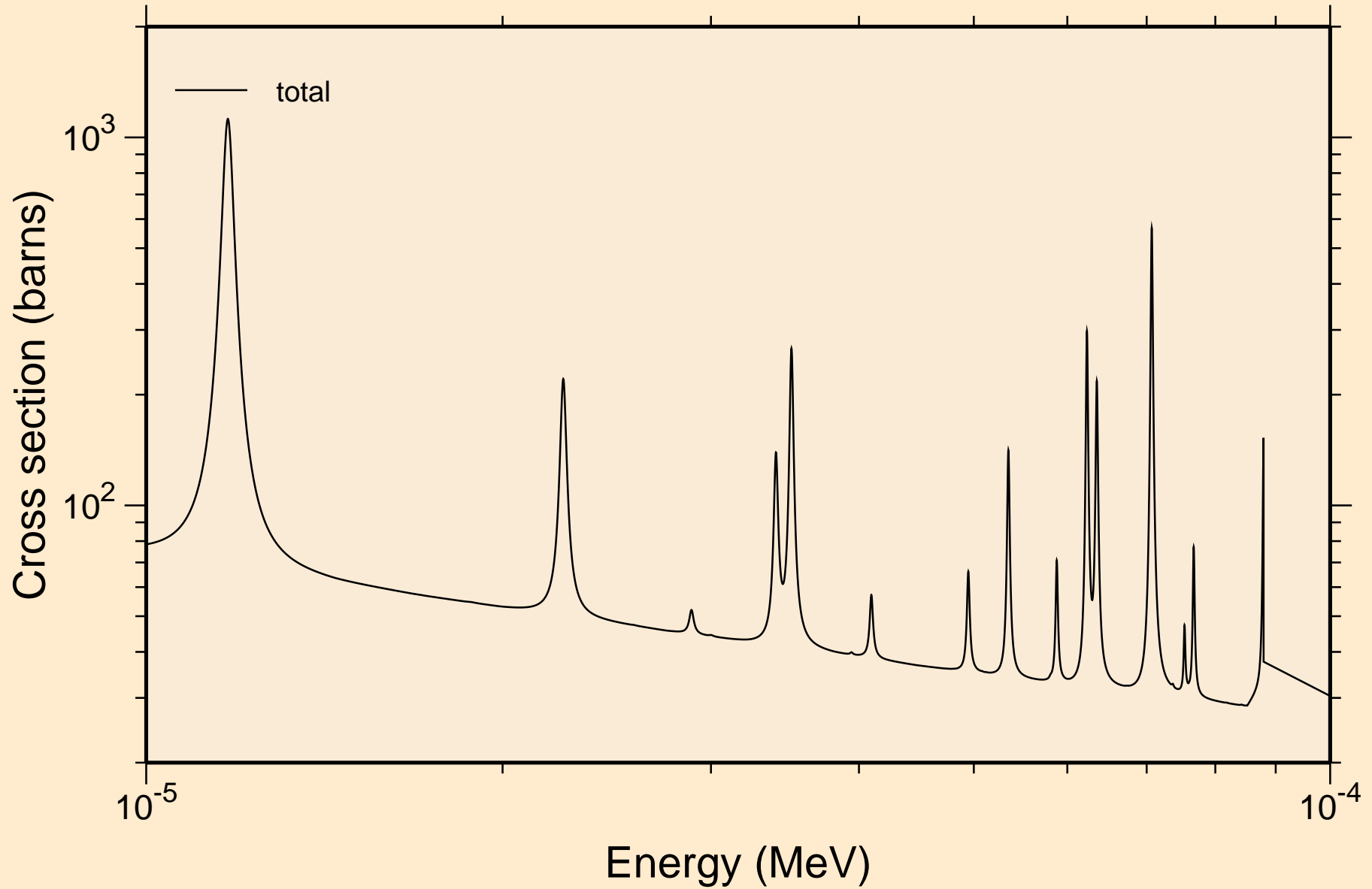

NB088 NEUTRON ACER TENDL-2023 LIBRARY; T=0.K  
resonance total cross section

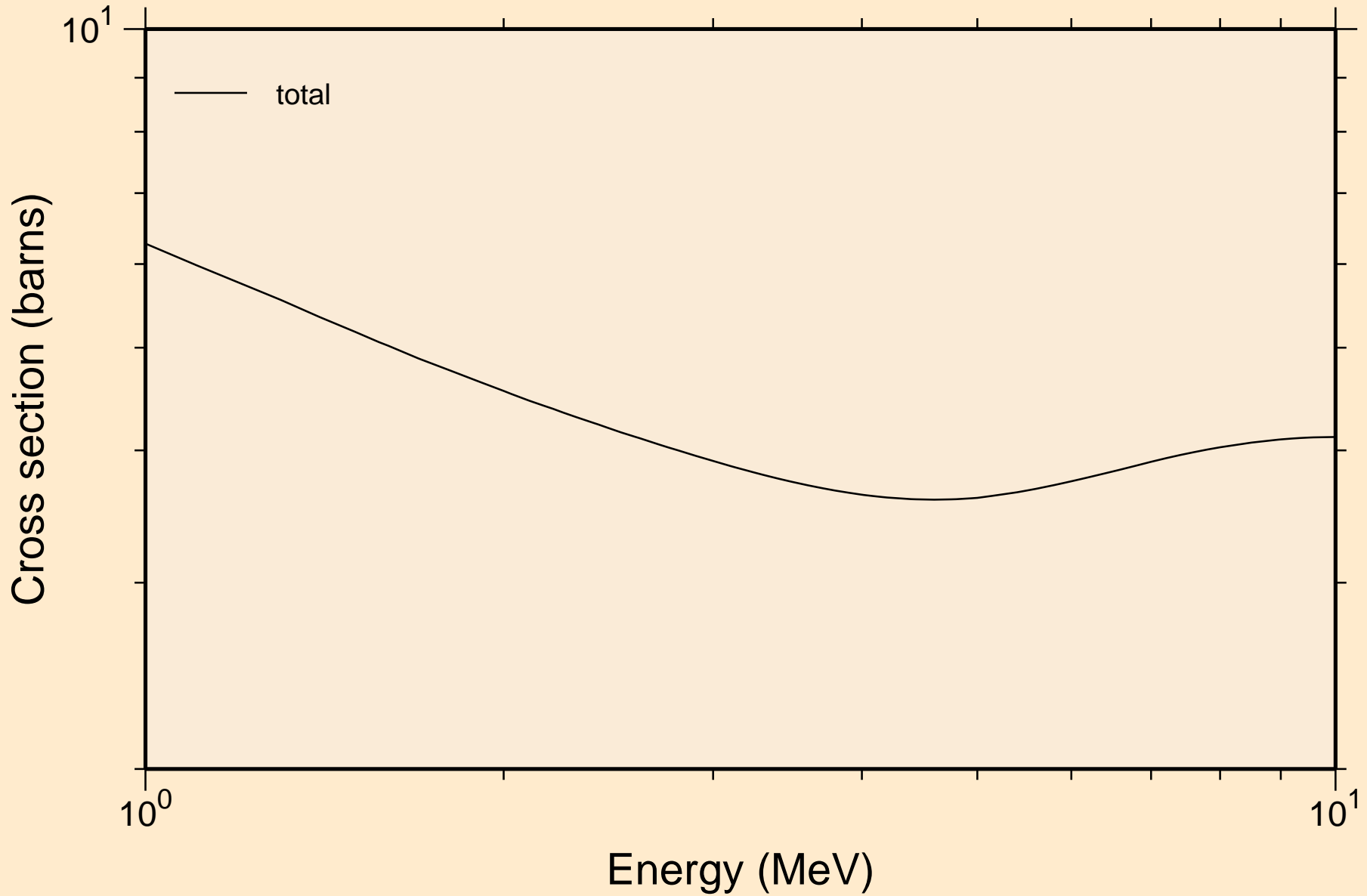

NB088 NEUTRON ACER TENDL-2023 LIBRARY; T=0.K  
resonance absorption cross sections

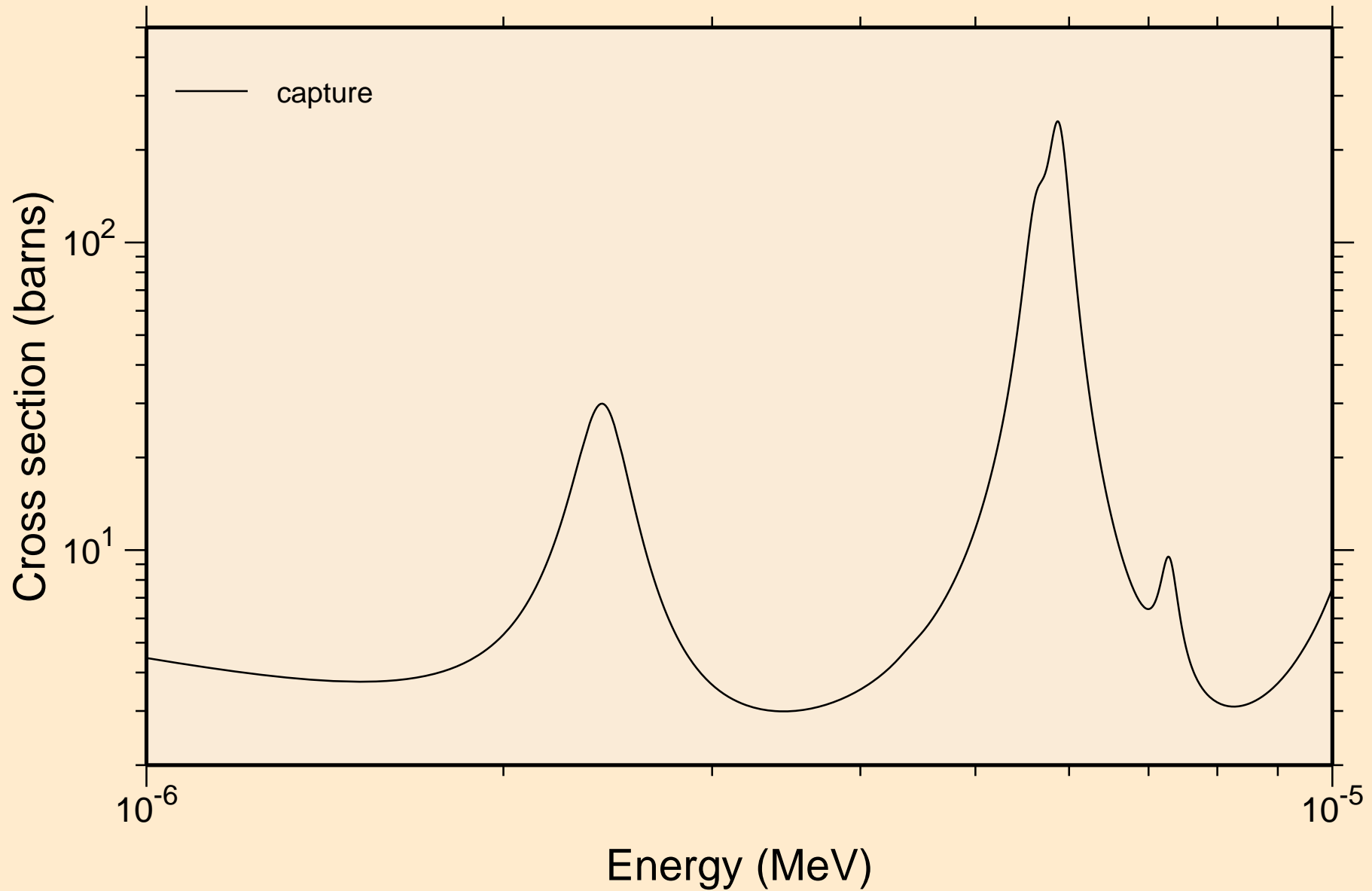

NB088 NEUTRON ACER TENDL-2023 LIBRARY; T=0.K  
resonance absorption cross sections

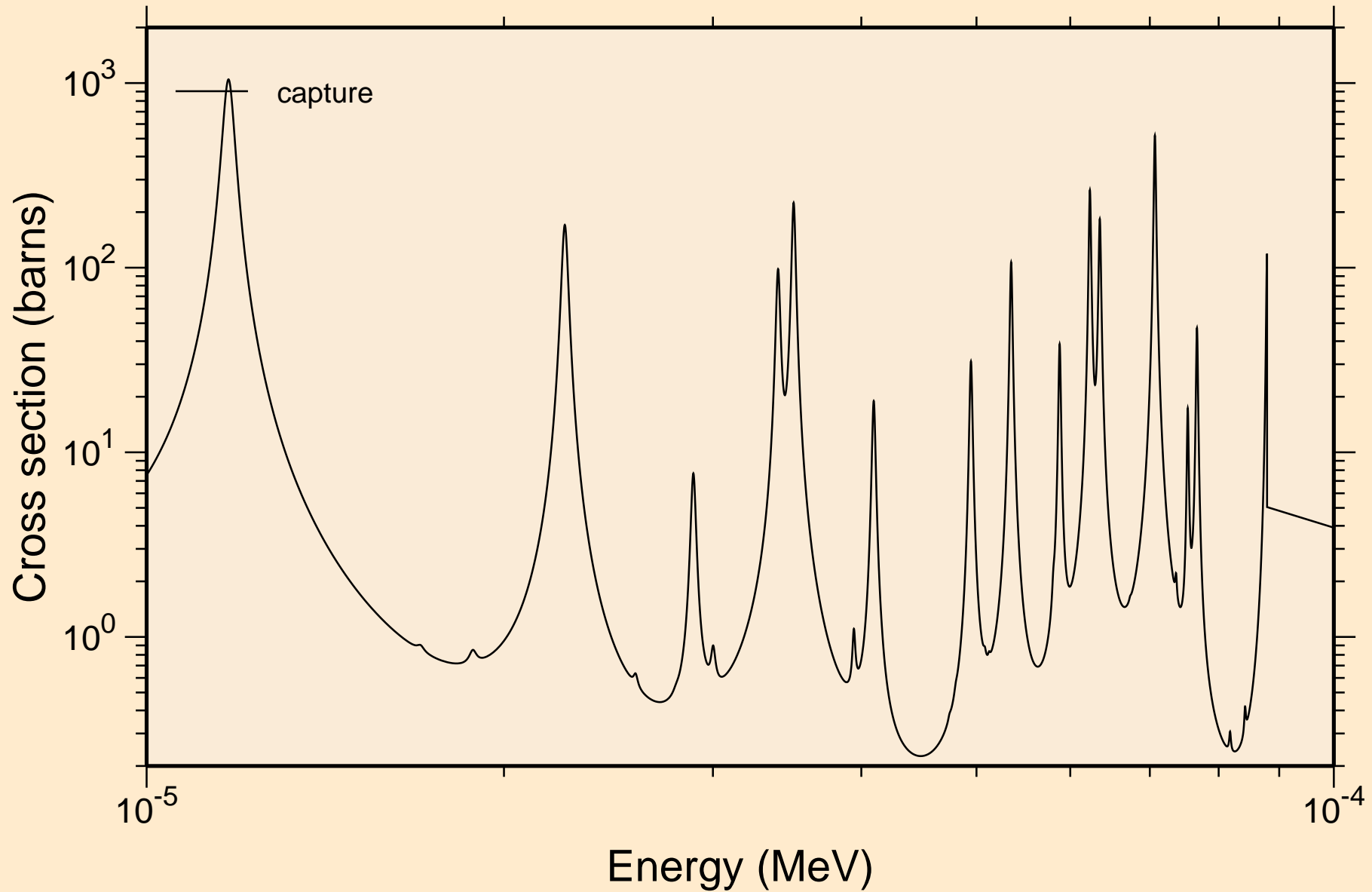

NB088 NEUTRON ACER TENDL-2023 LIBRARY; T=0.K  
resonance absorption cross sections

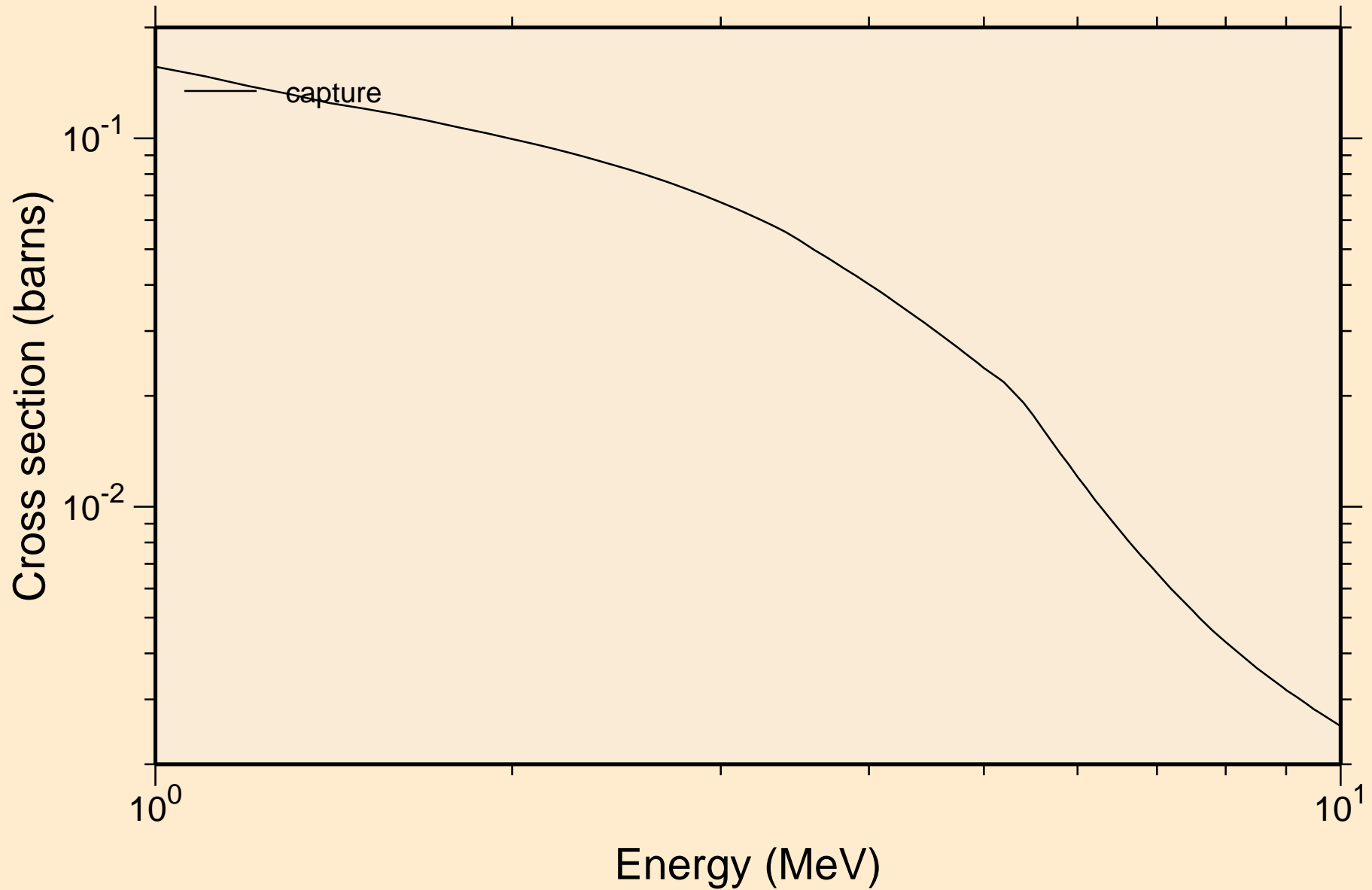

# NB088 NEUTRON ACER TENDL-2023 LIBRARY; T=0.K

## Heating

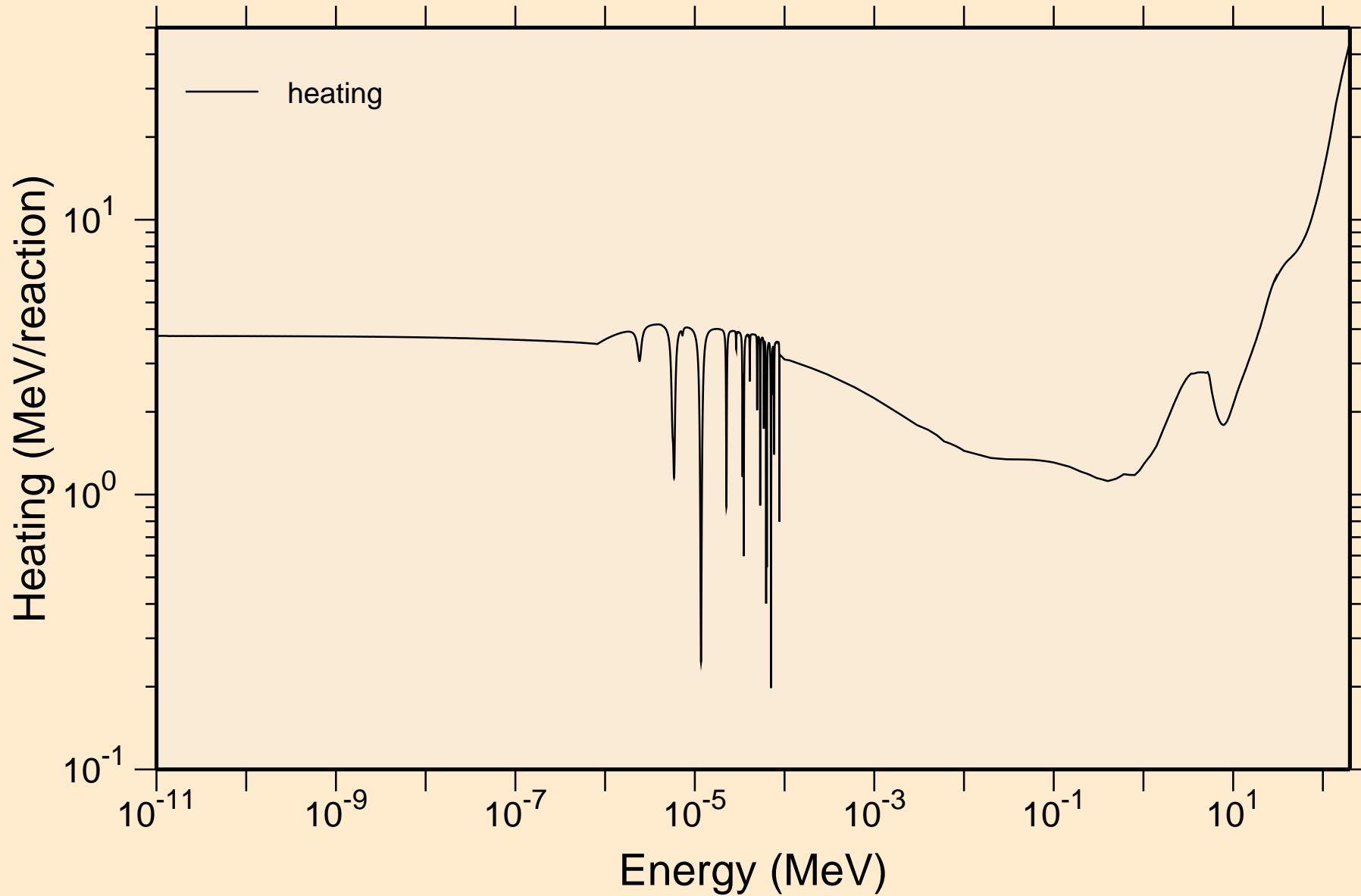



NB088 NEUTRON ACER TENDL-2023 LIBRARY; T=0.K  
Damage

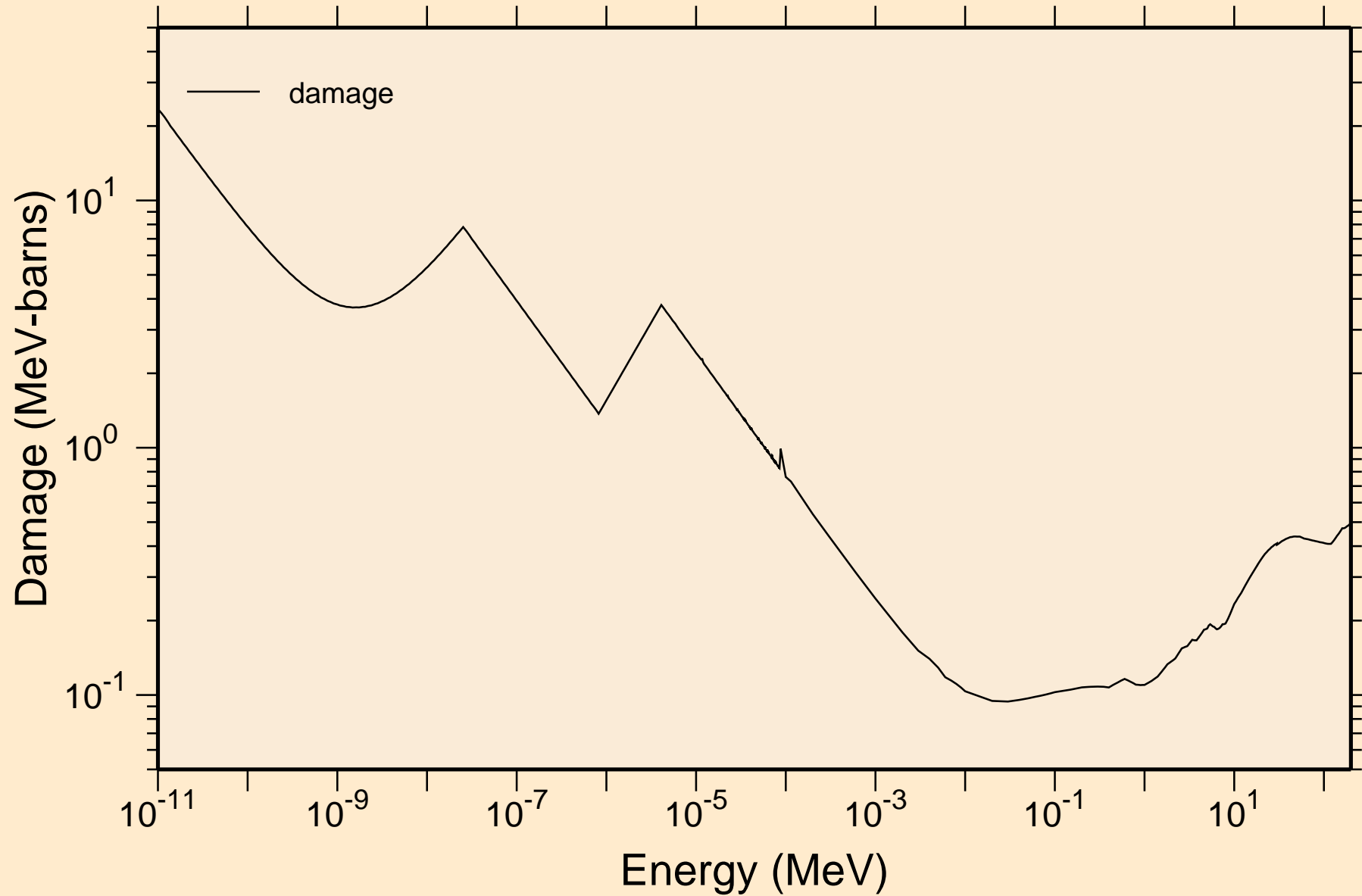

NB088 NEUTRON ACER TENDL-2023 LIBRARY; T=0.K  
Non-threshold reactions

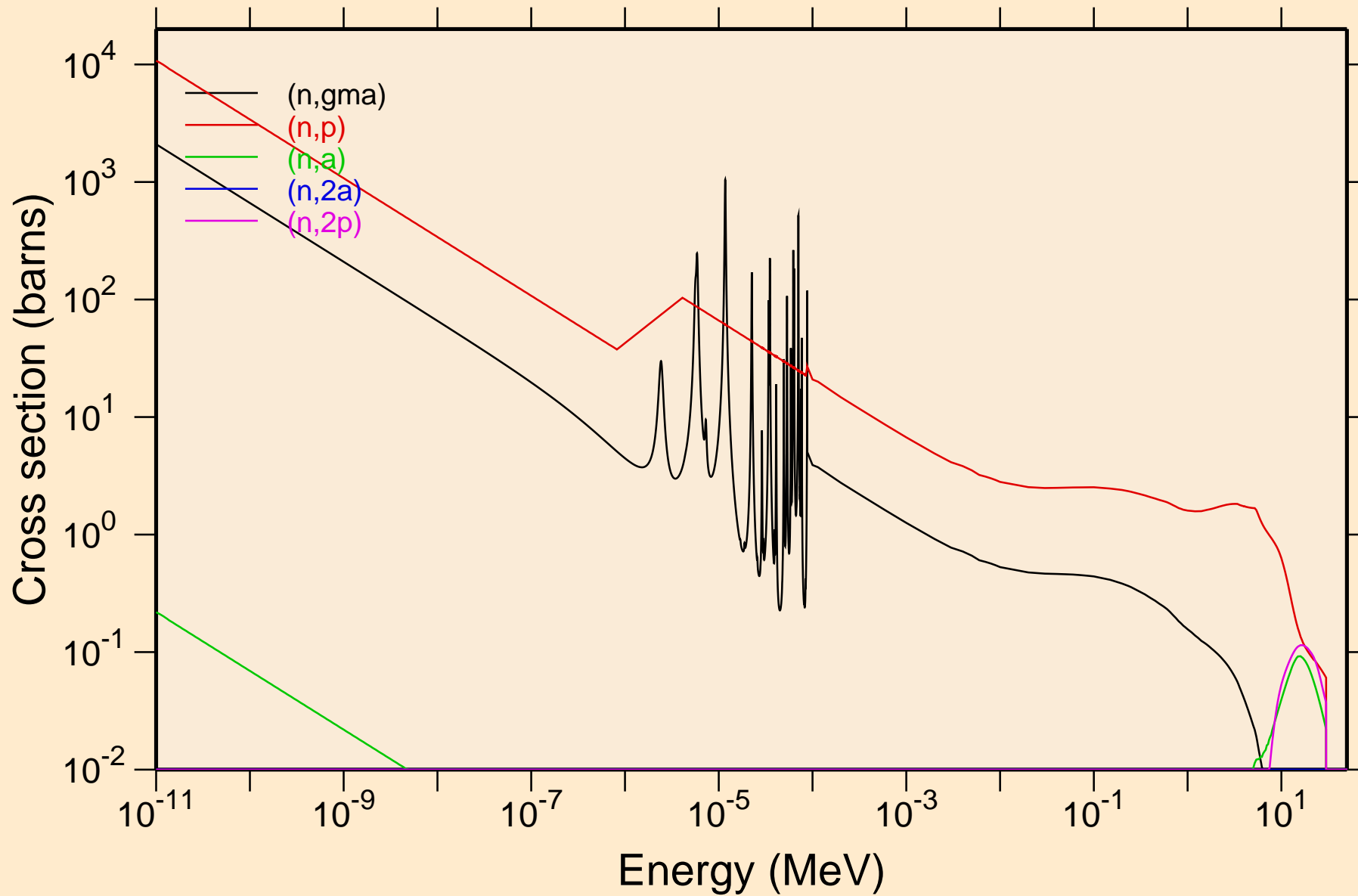

NB088 NEUTRON ACER TENDL-2023 LIBRARY; T=0.K  
Non-threshold reactions

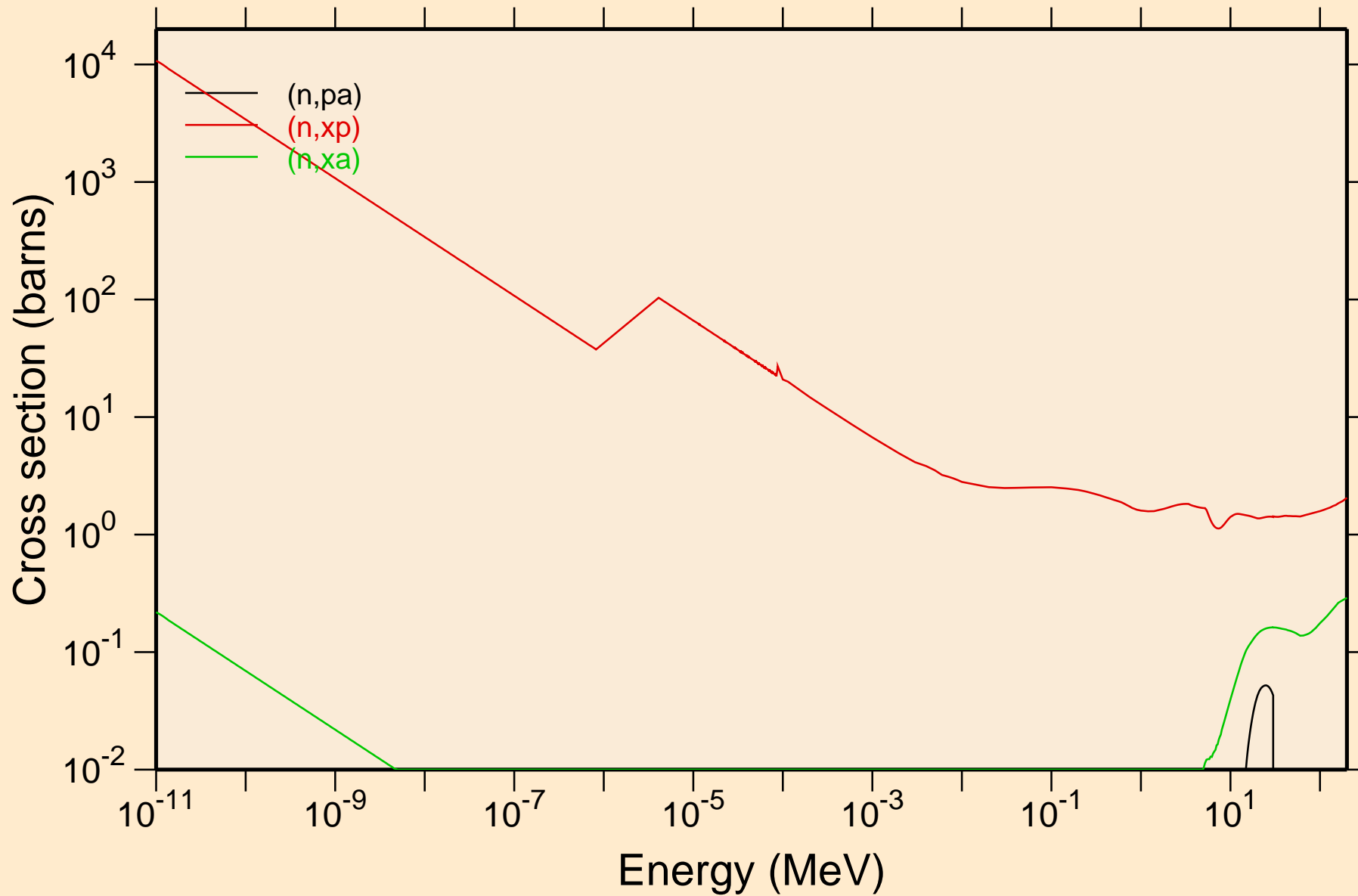

# NB088 NEUTRON ACER TENDL-2023 LIBRARY; T=0.K

## Principal cross sections

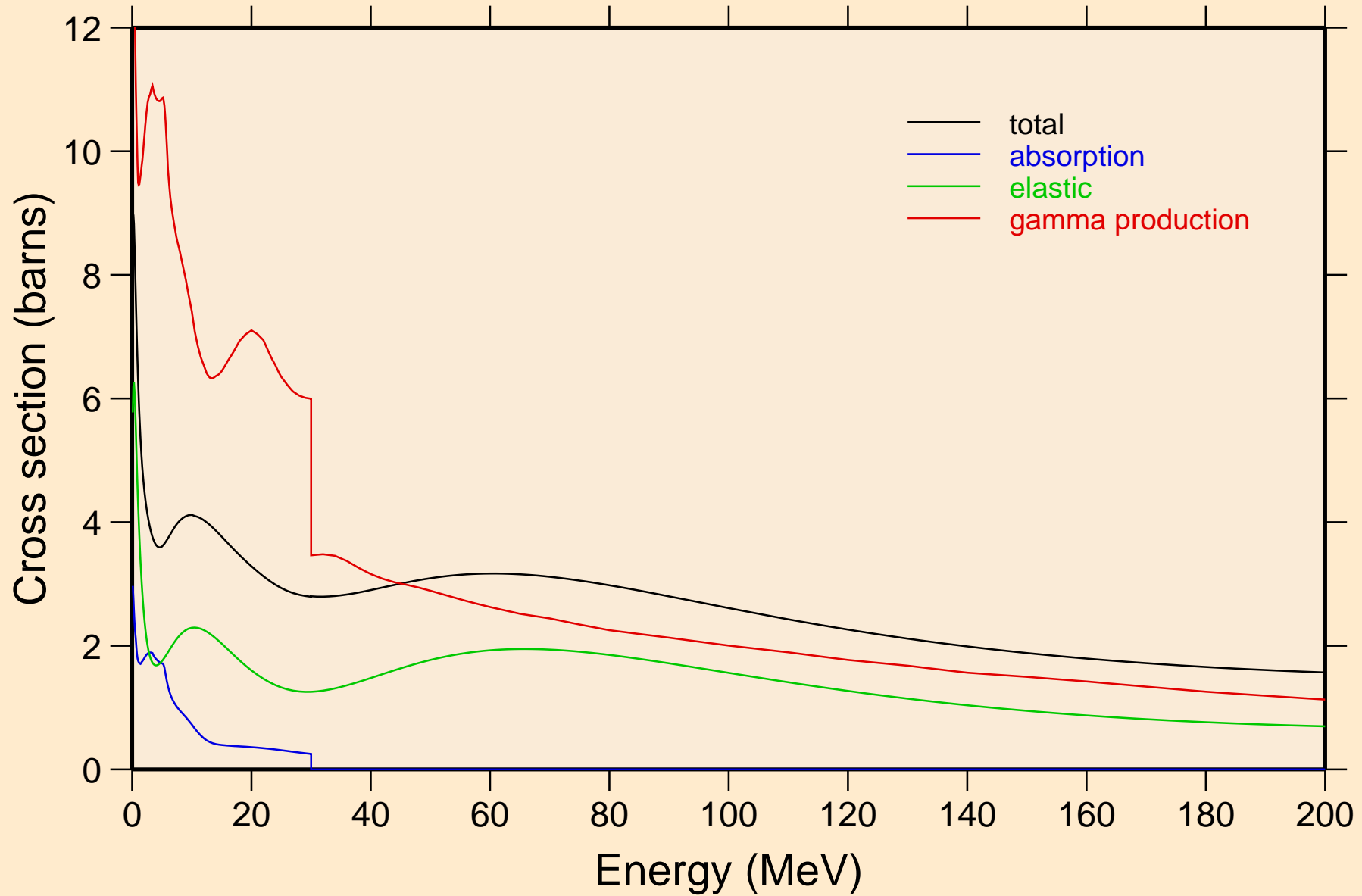

# NB088 NEUTRON ACER TENDL-2023 LIBRARY; T=0.K

## Heating

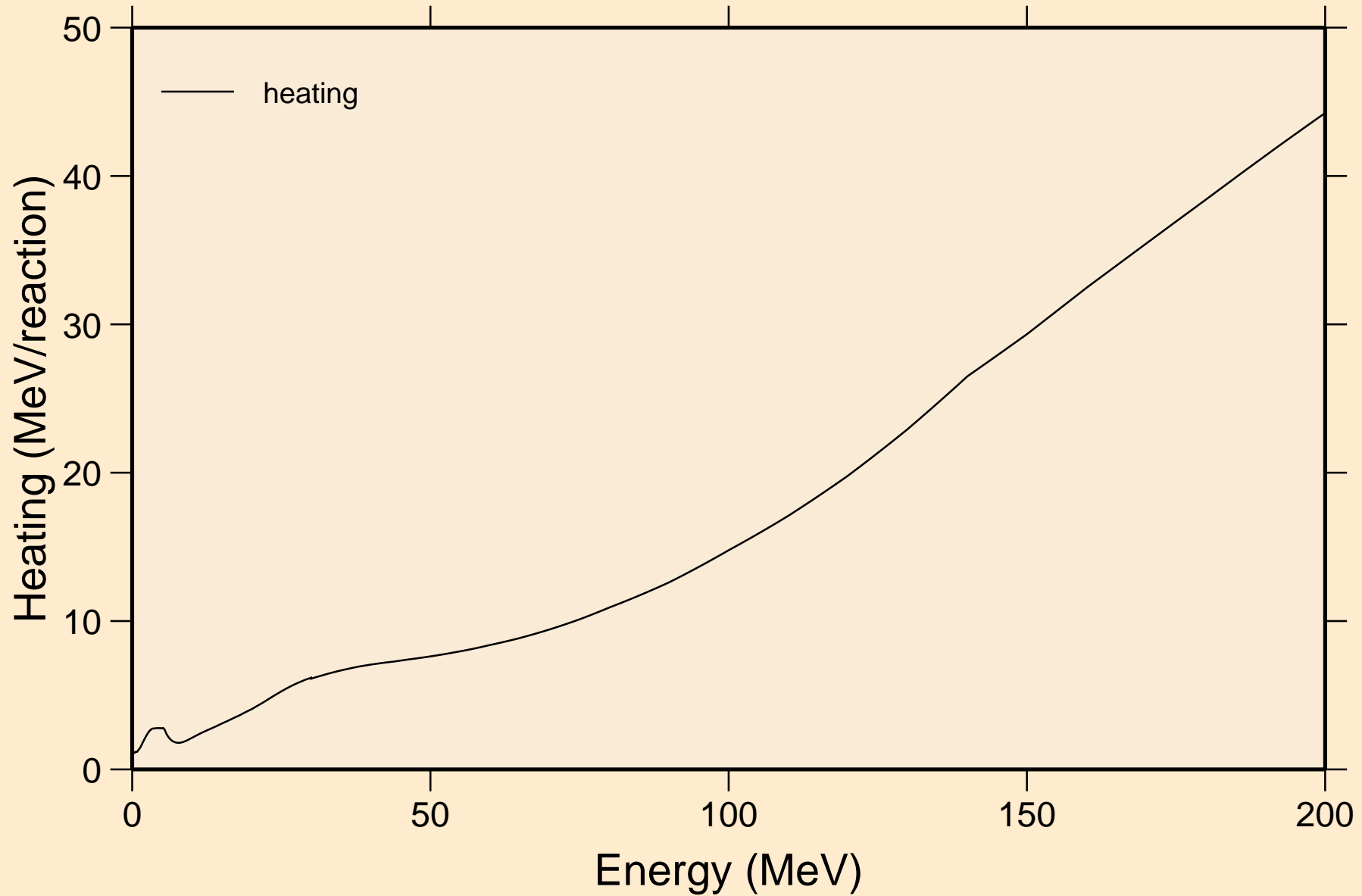

NB088 NEUTRON ACER TENDL-2023 LIBRARY; T=0.K  
Damage

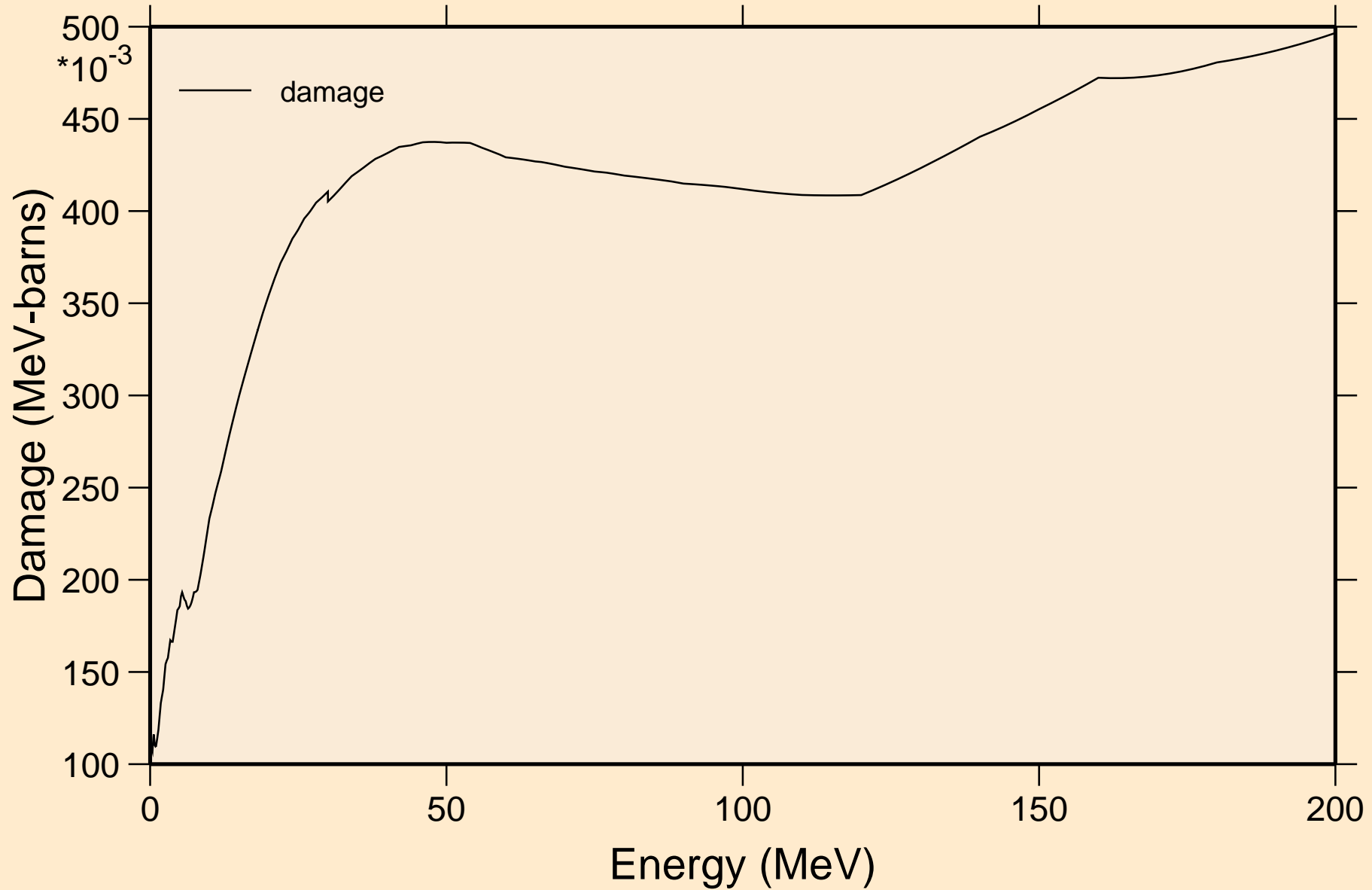

# NB088 NEUTRON ACER TENDL-2023 LIBRARY; T=0.K

## Non-threshold reactions

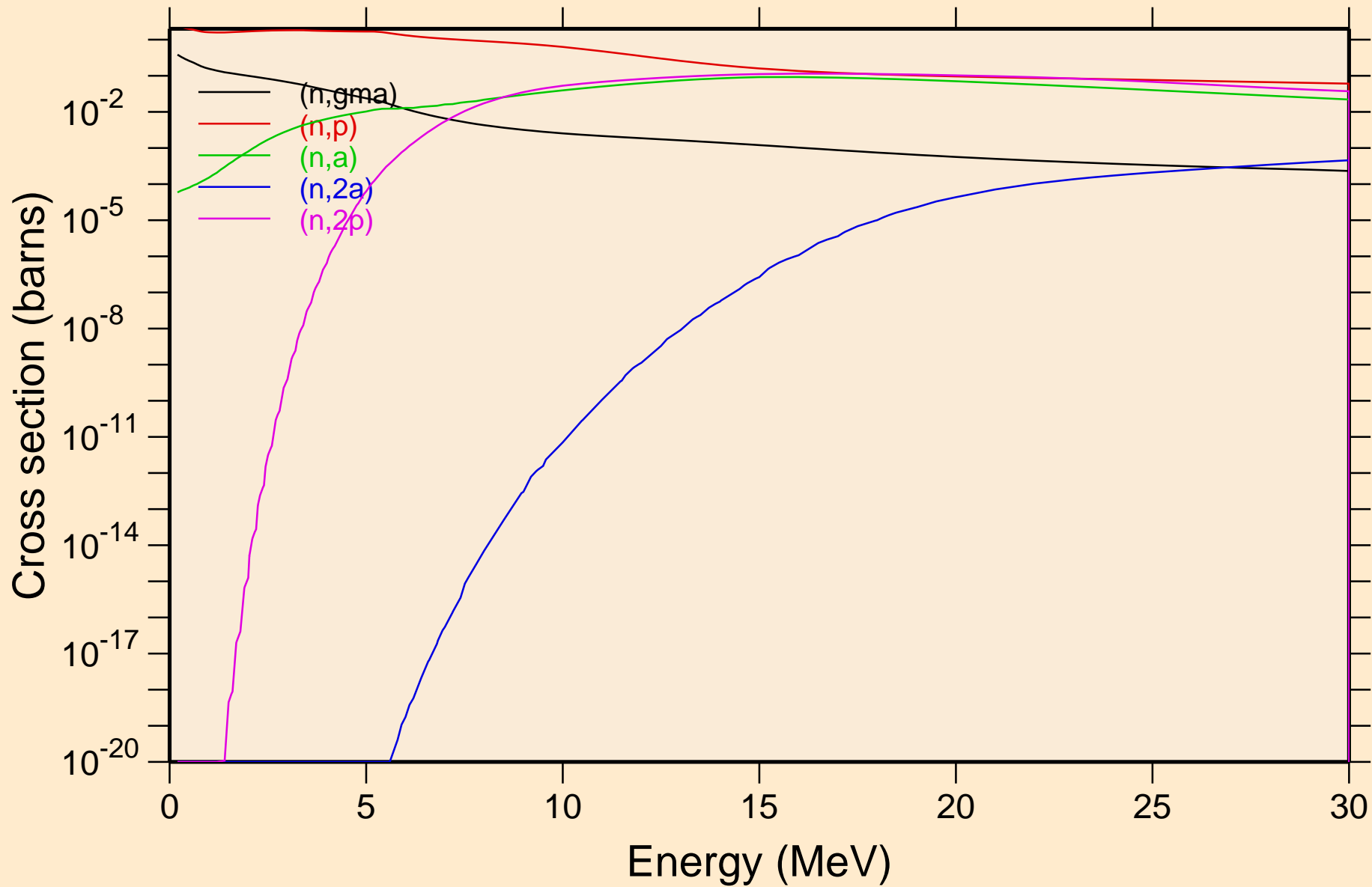

NB088 NEUTRON ACER TENDL-2023 LIBRARY; T=0.K  
Non-threshold reactions

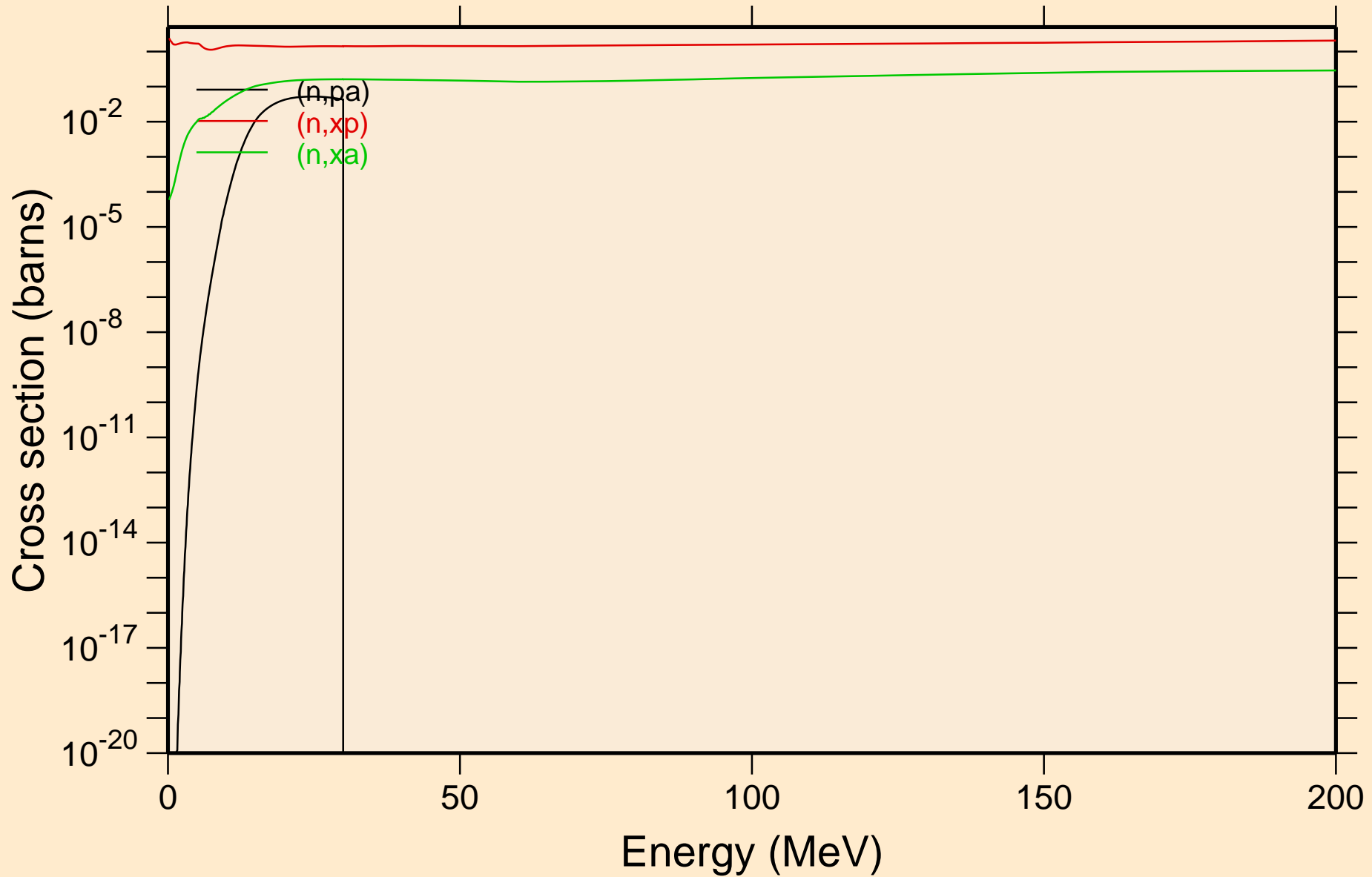



NB088 NEUTRON ACER TENDL-2023 LIBRARY; T=0.K  
Inelastic levels

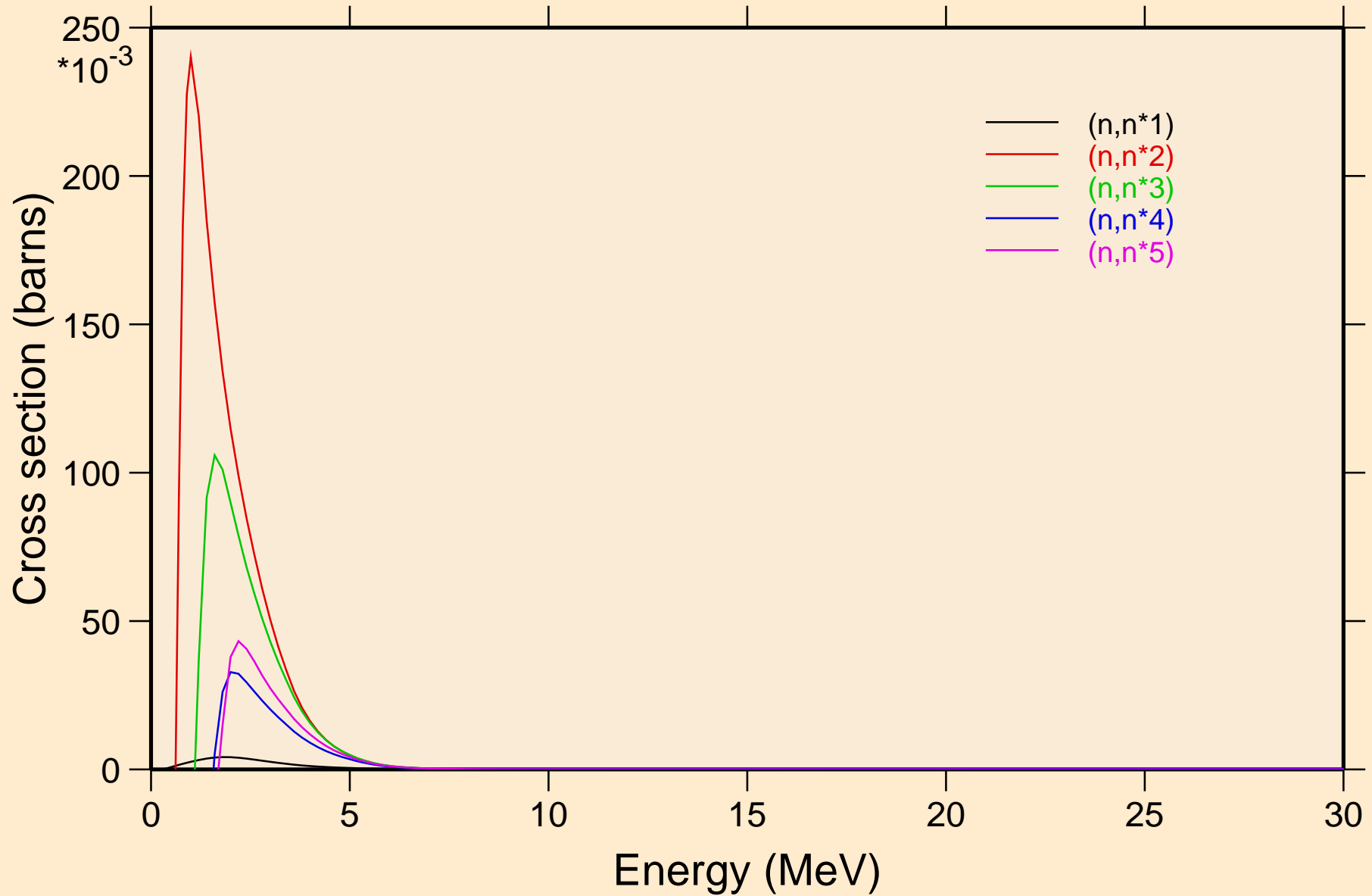

NB088 NEUTRON ACER TENDL-2023 LIBRARY; T=0.K  
Inelastic levels

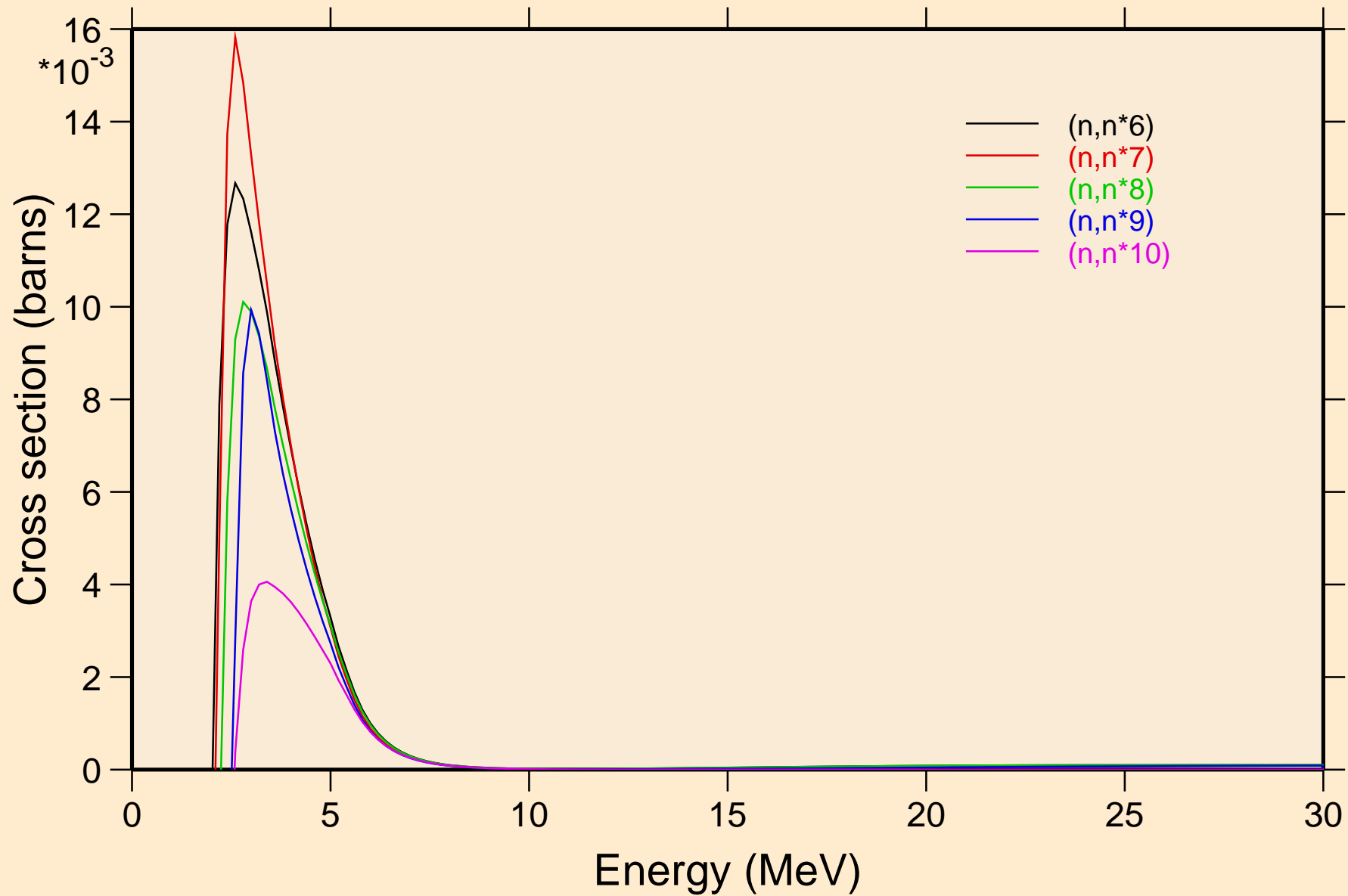

NB088 NEUTRON ACER TENDL-2023 LIBRARY; T=0.K  
Inelastic levels

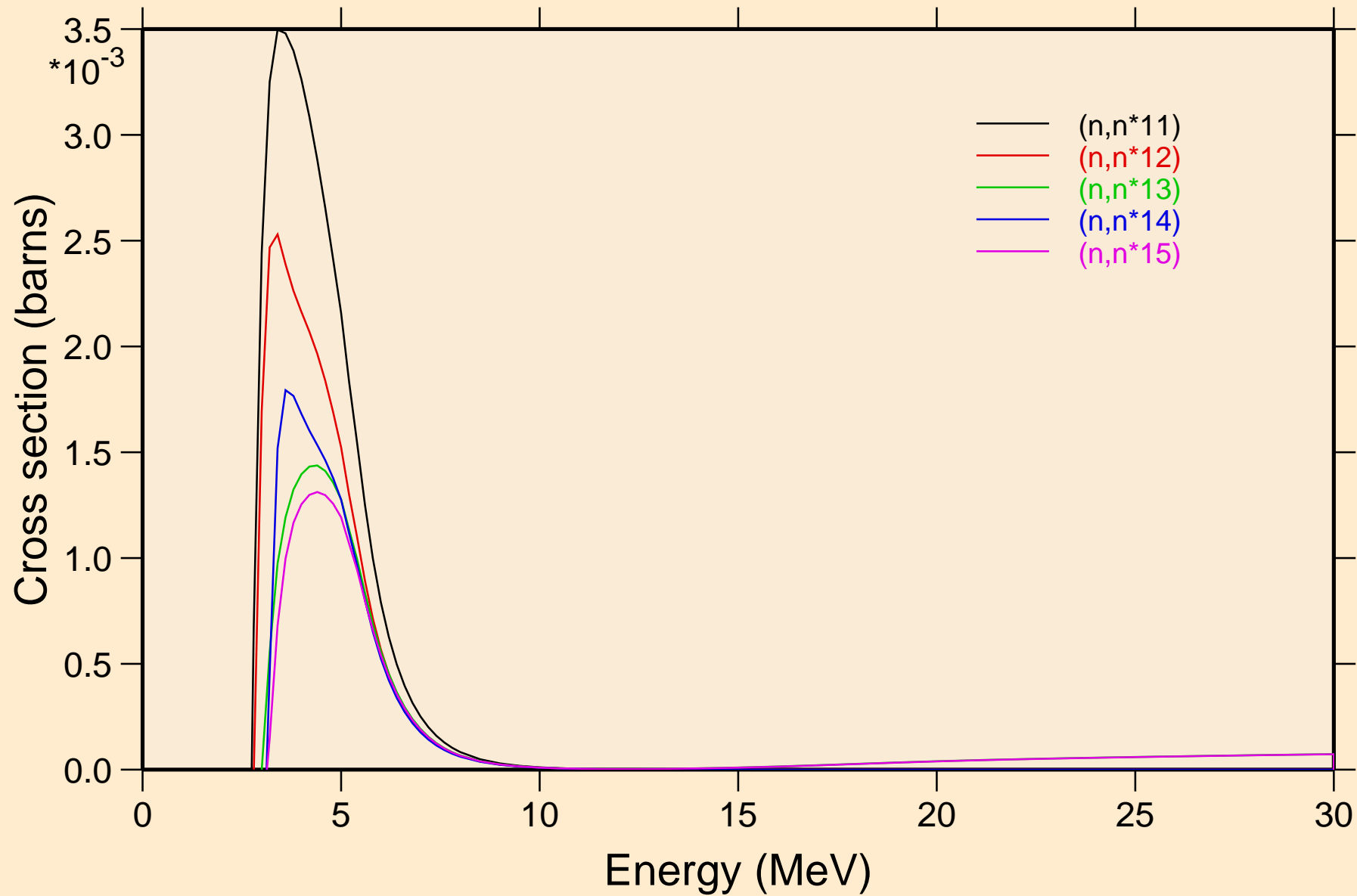

NB088 NEUTRON ACER TENDL-2023 LIBRARY; T=0.K  
Inelastic levels

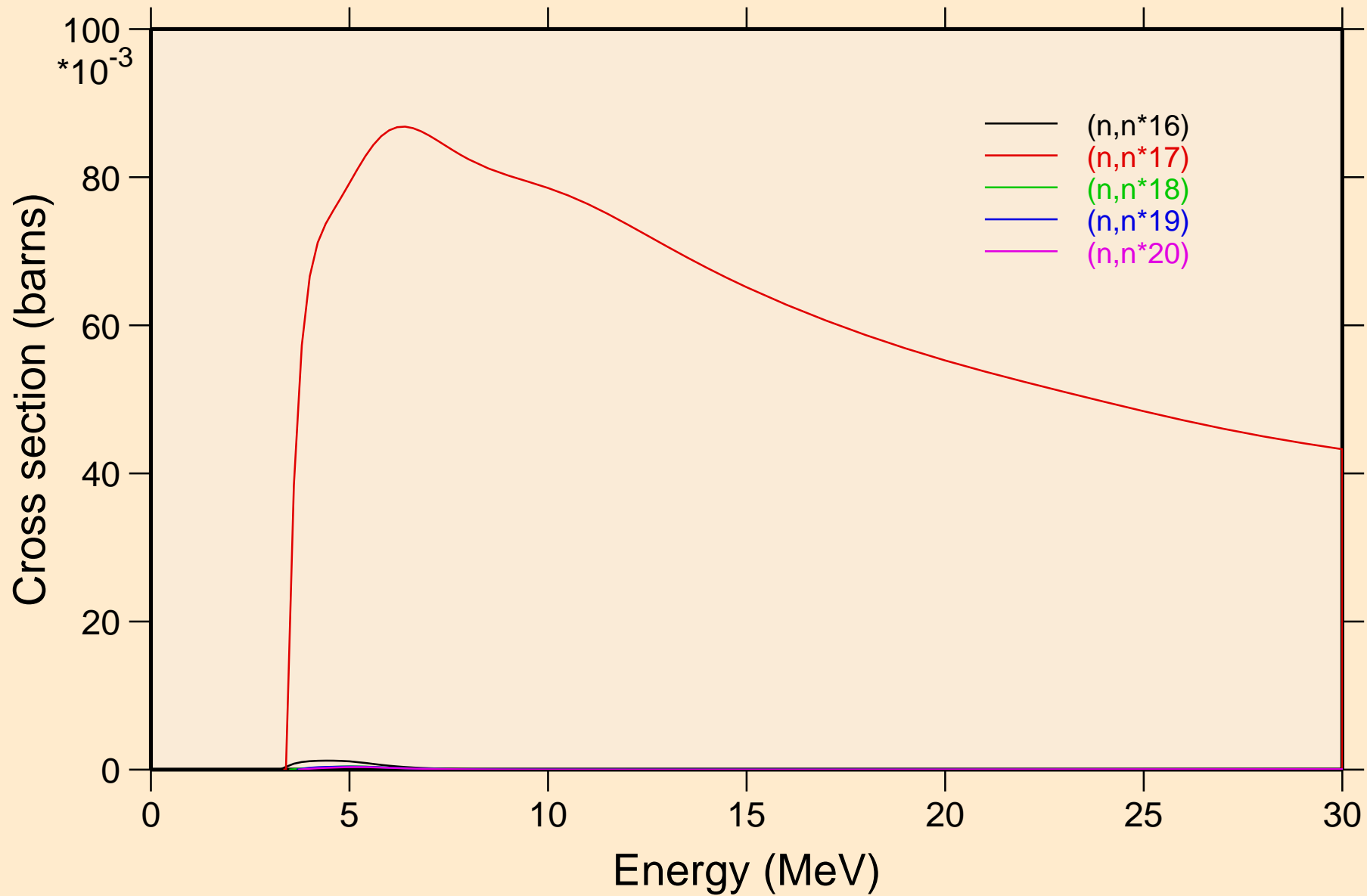

NB088 NEUTRON ACER TENDL-2023 LIBRARY; T=0.K  
Inelastic levels

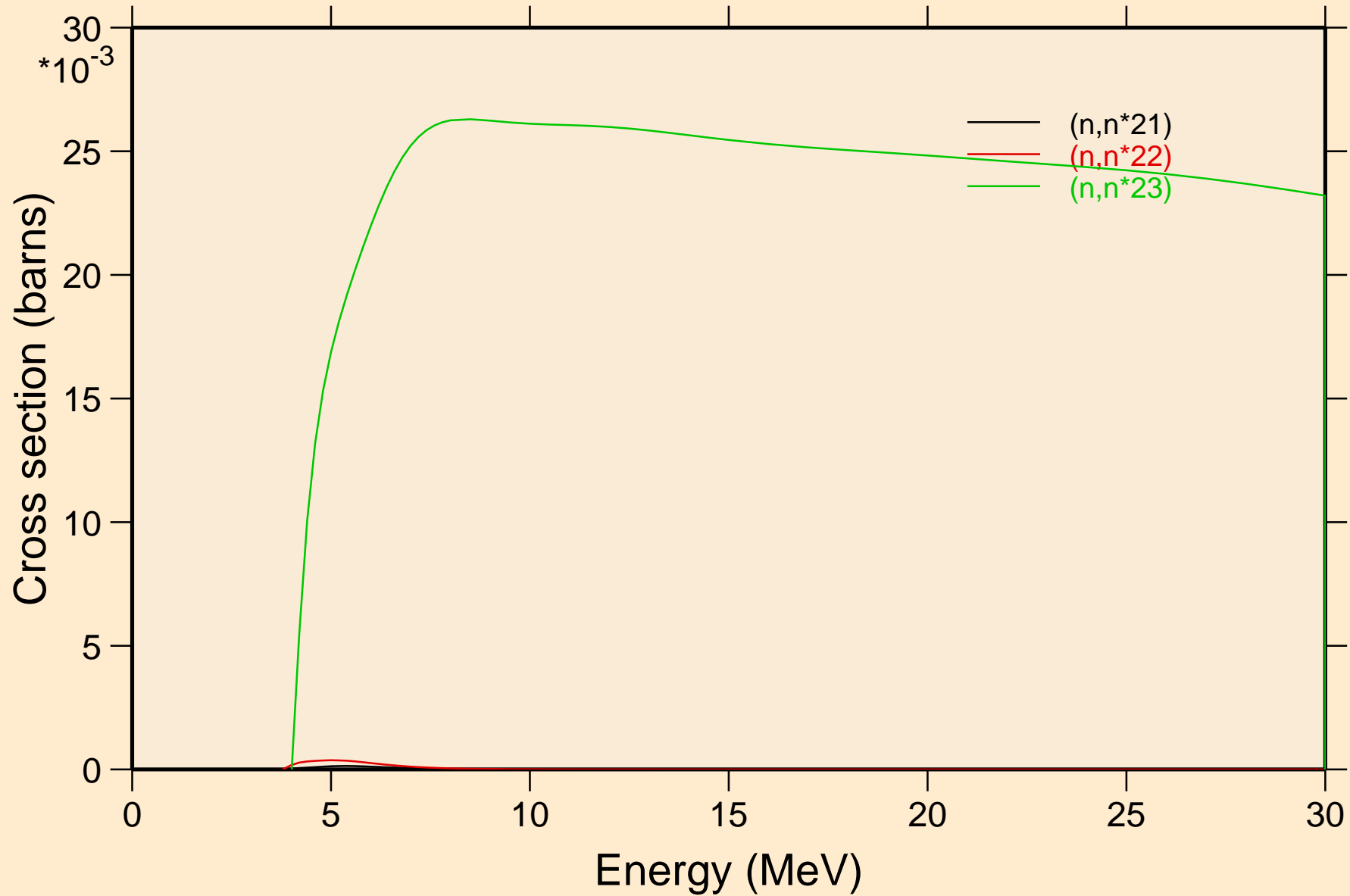

# NB088 NEUTRON ACER TENDL-2023 LIBRARY; T=0.K

## Threshold reactions

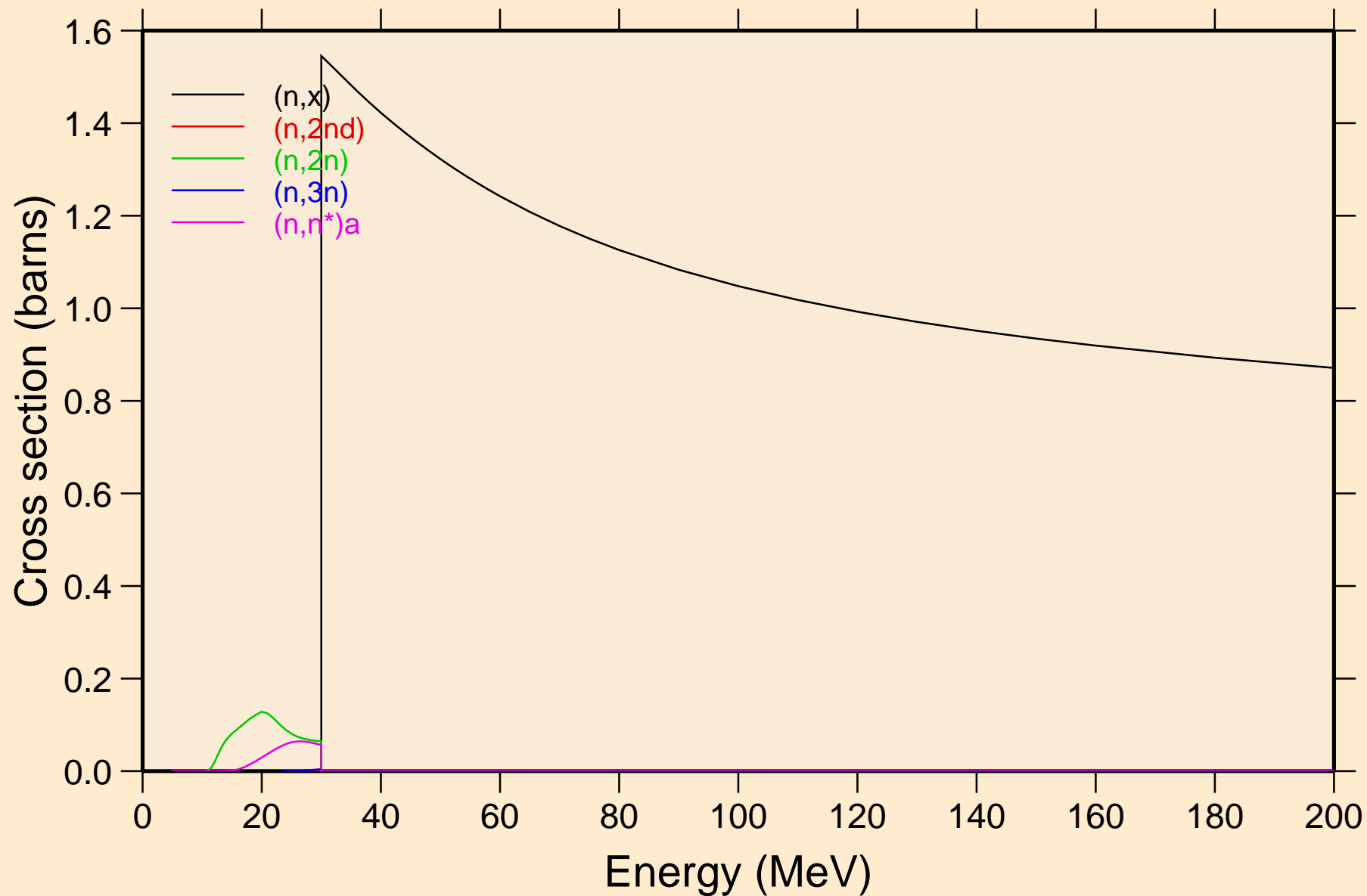

NB088 NEUTRON ACER TENDL-2023 LIBRARY; T=0.K  
Threshold reactions

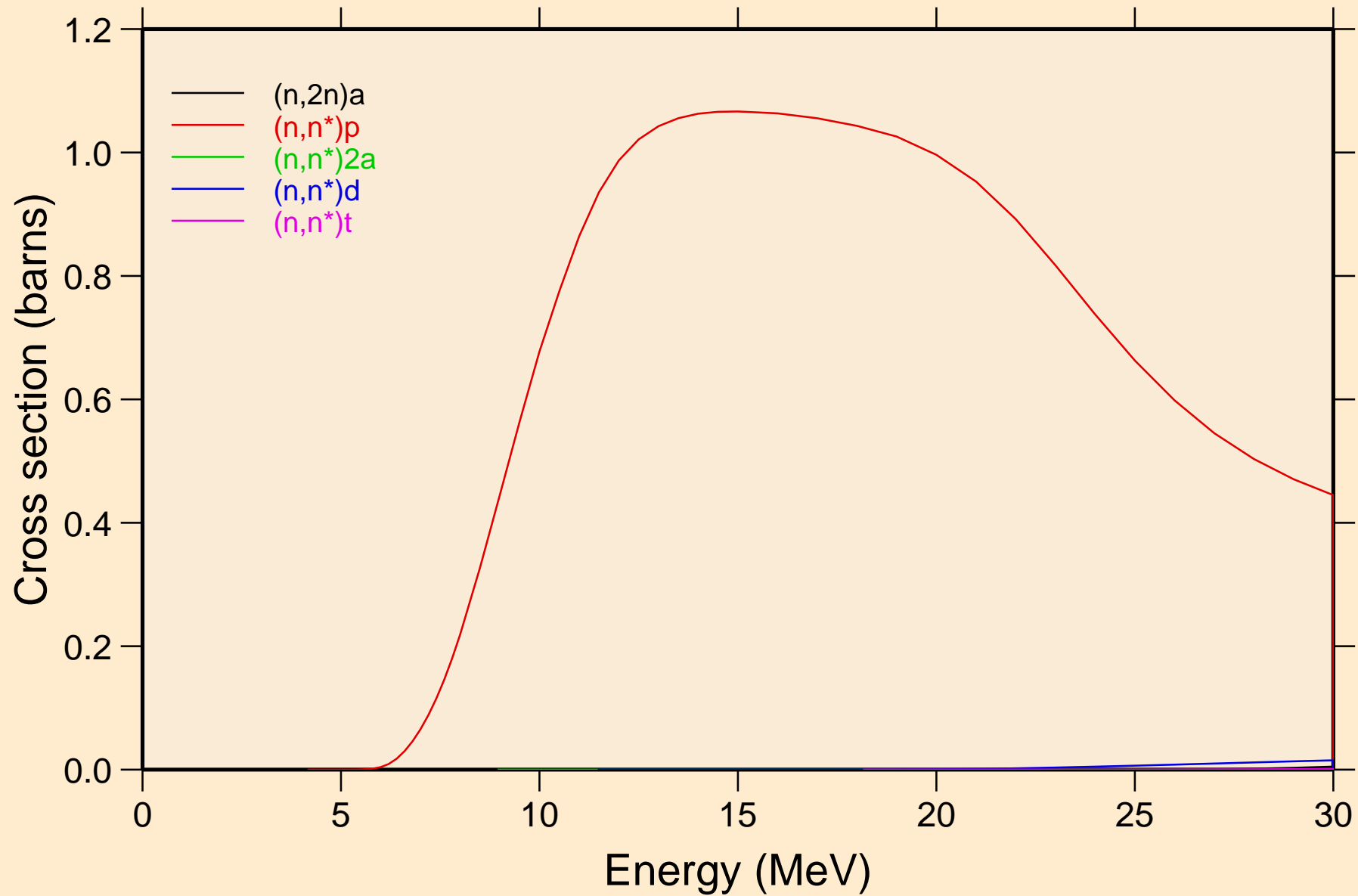

# NB088 NEUTRON ACER TENDL-2023 LIBRARY; T=0.K

## Threshold reactions

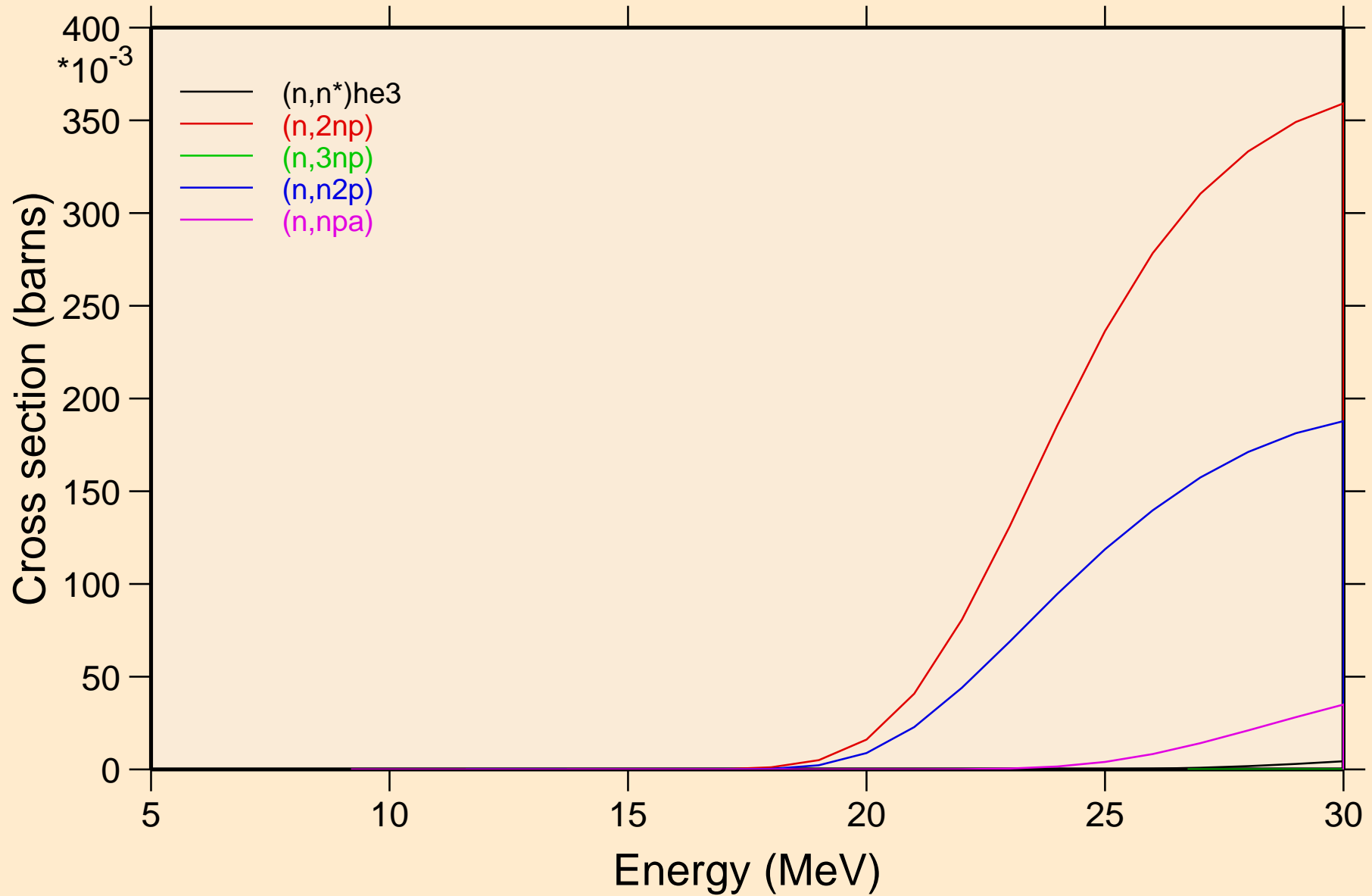



# NB088 NEUTRON ACER TENDL-2023 LIBRARY; T=0.K

## Threshold reactions

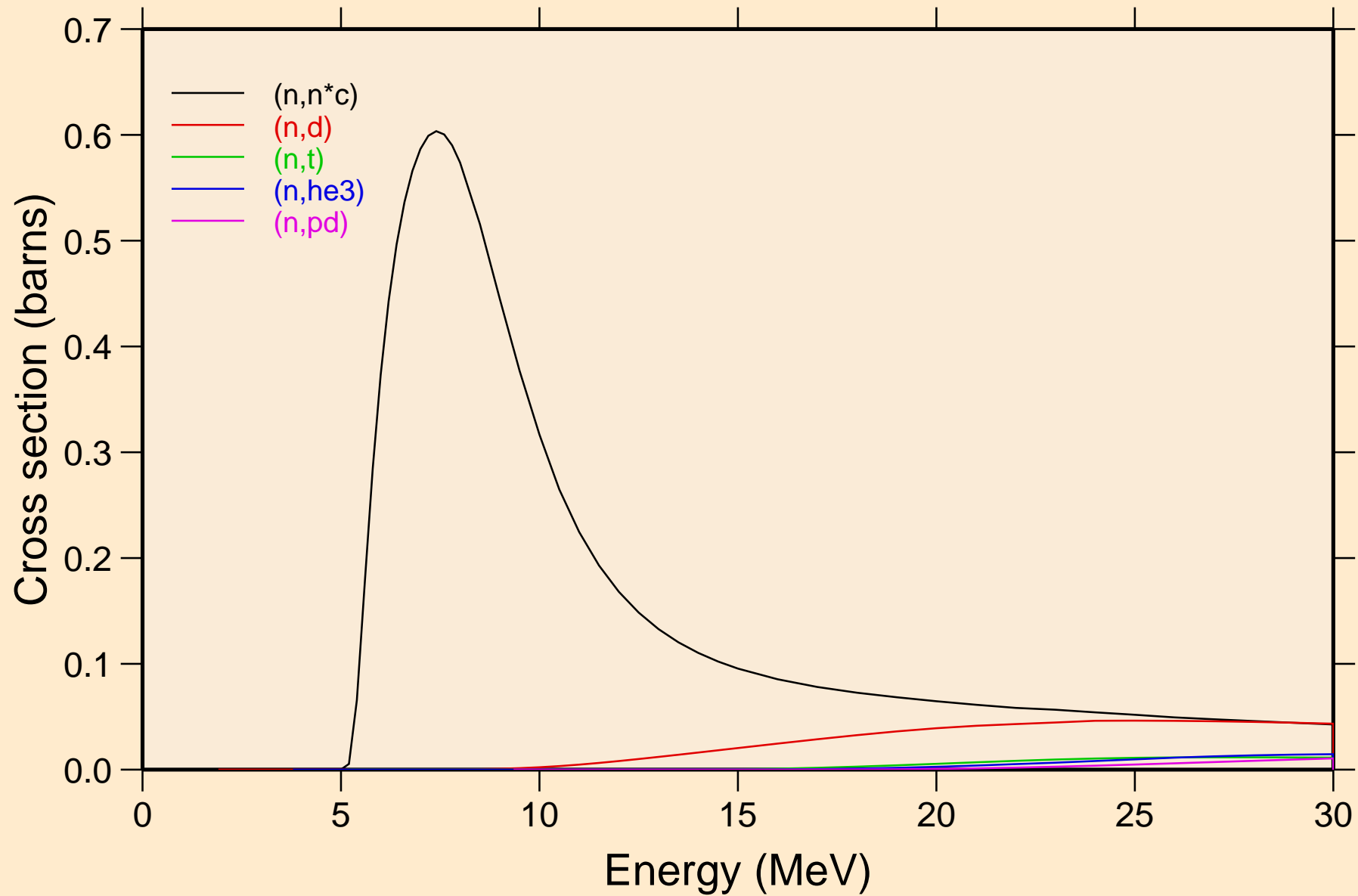

NB088 NEUTRON ACER TENDL-2023 LIBRARY; T=0.K  
Threshold reactions

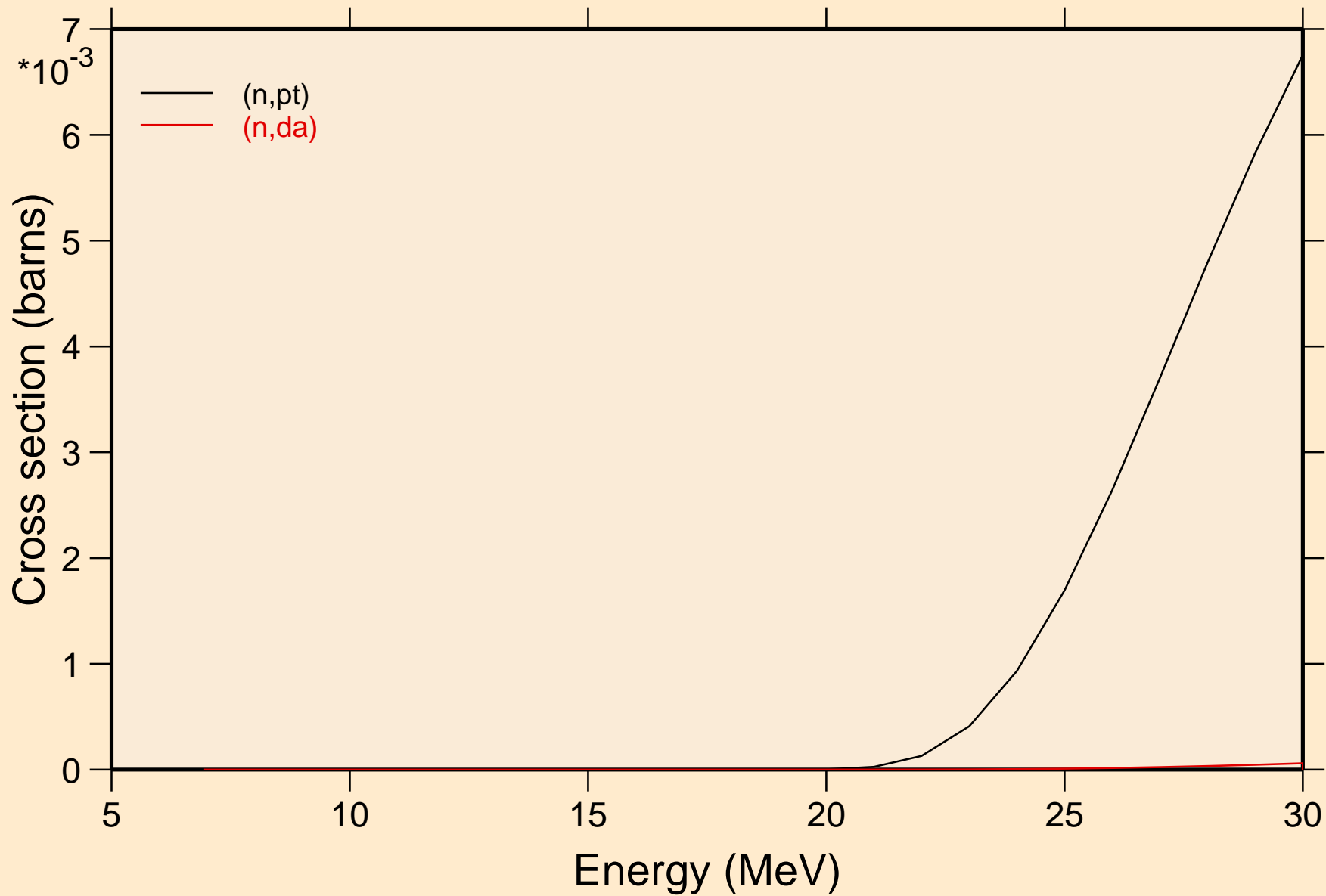

# NB088 NEUTRON ACER TENDL-2023 LIBRARY; T=0.K

## Threshold reactions

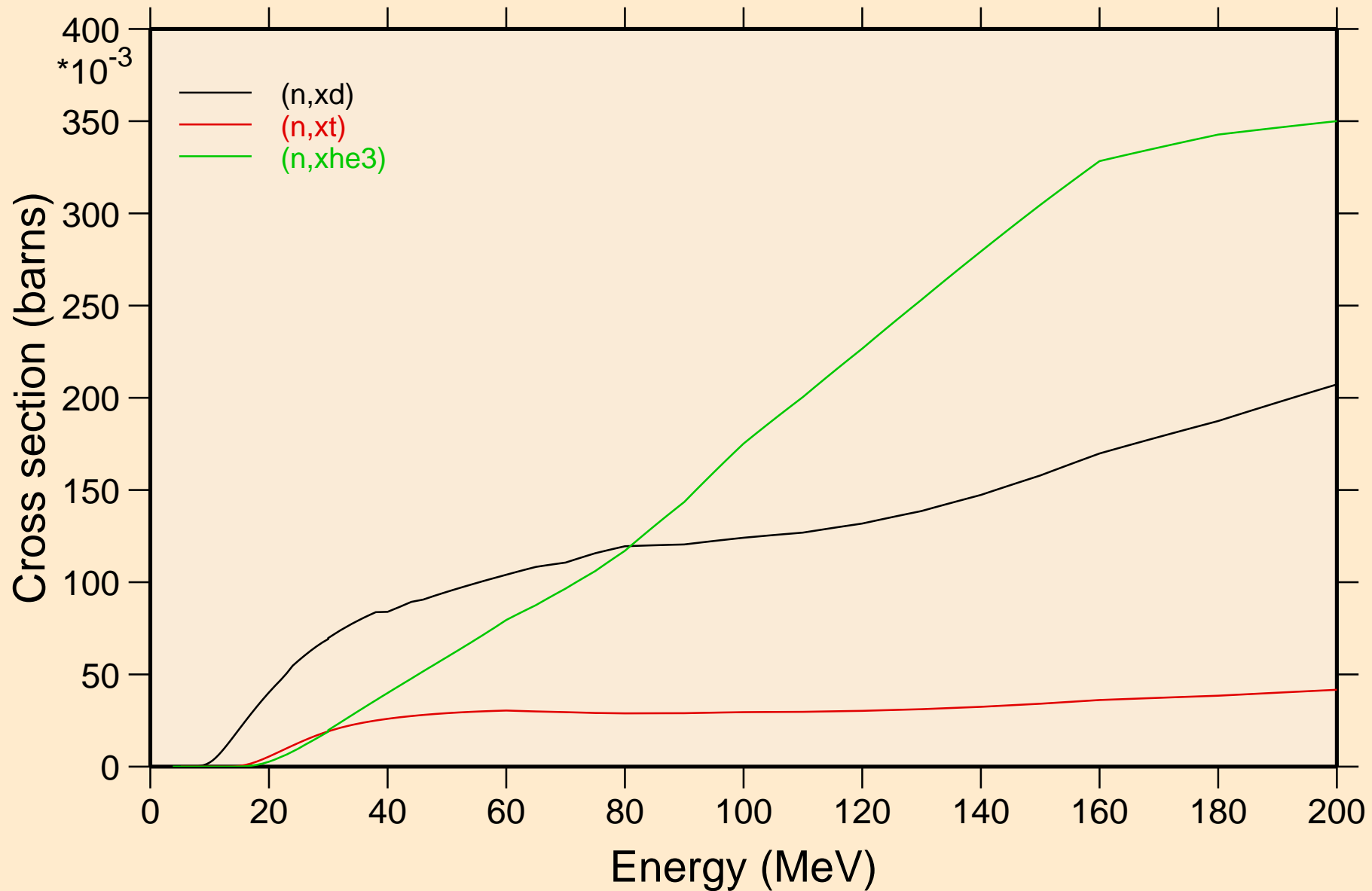

NB088 NEUTRON ACER TENDL-2023 LIBRARY; T=0.K  
angular distribution for elastic

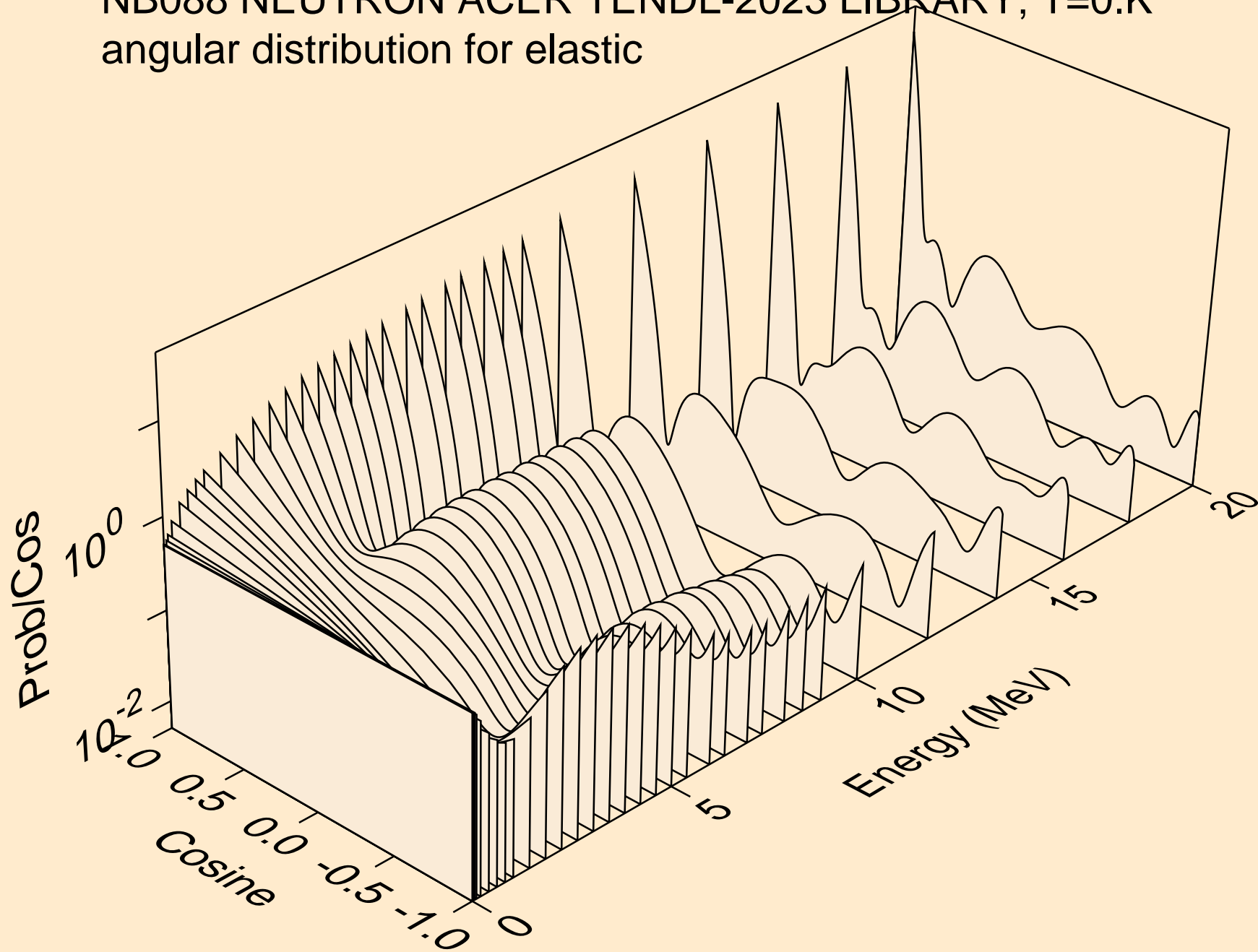

NB088 NEUTRON ACER TENDL-2023 LIBRARY; T=0.K  
angular distribution for elastic

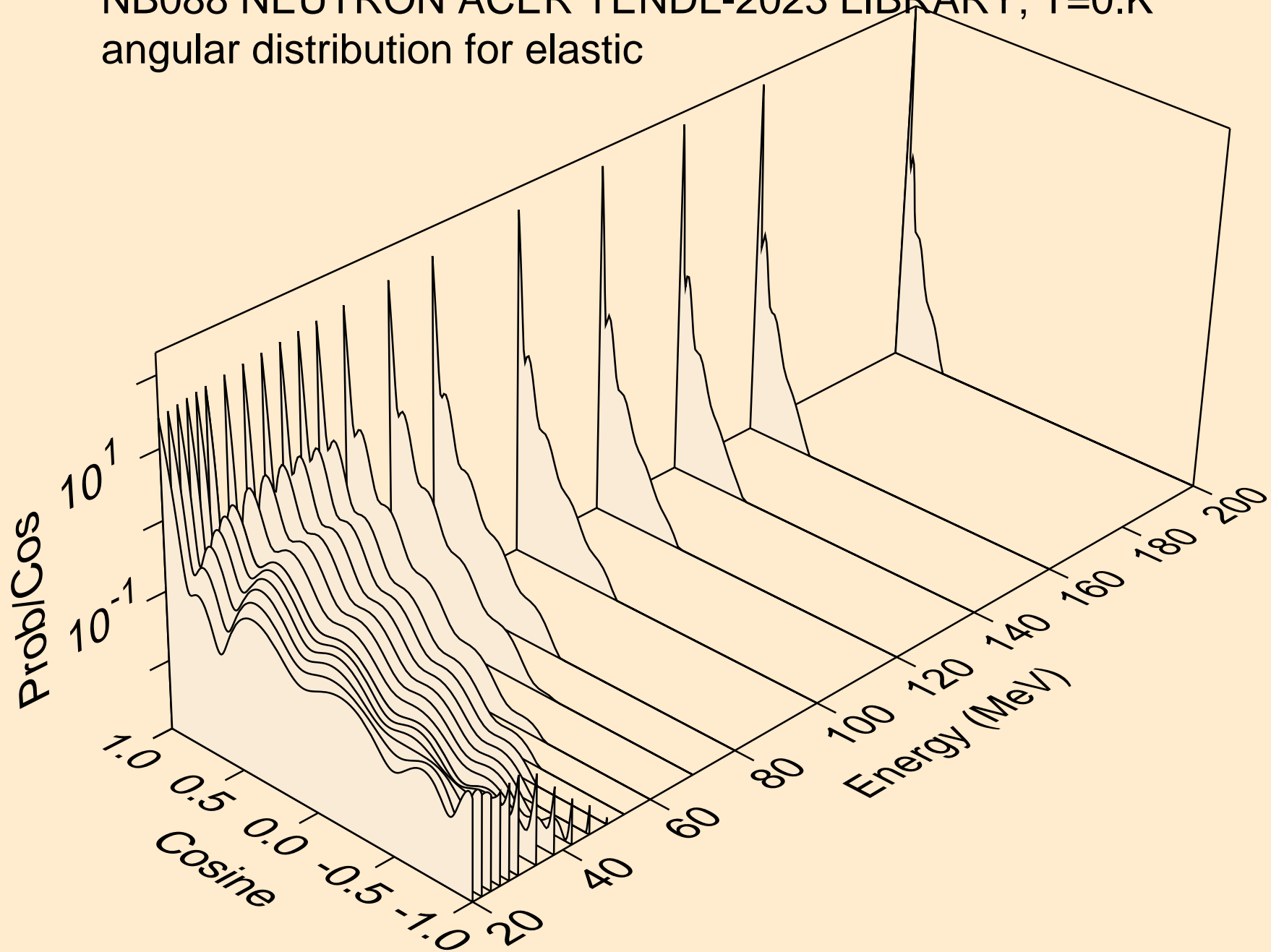

NB088 NEUTRON ACER TENDL-2023 LIBRARY; T=0.K  
angular distribution for (n,n\*1)

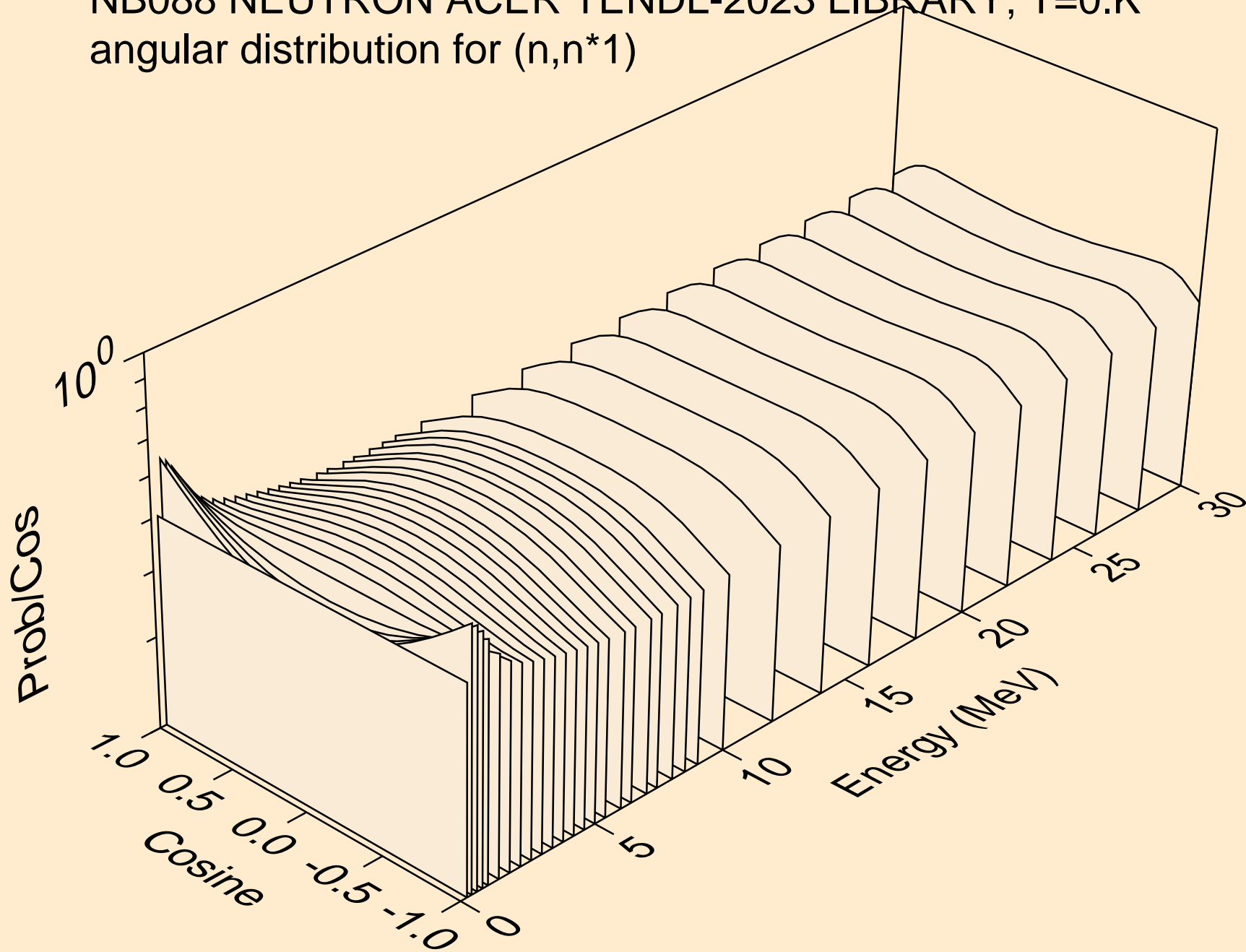

NB088 NEUTRON ACER TENDL-2023 LIBRARY; T=0.K  
angular distribution for (n,n\*2)

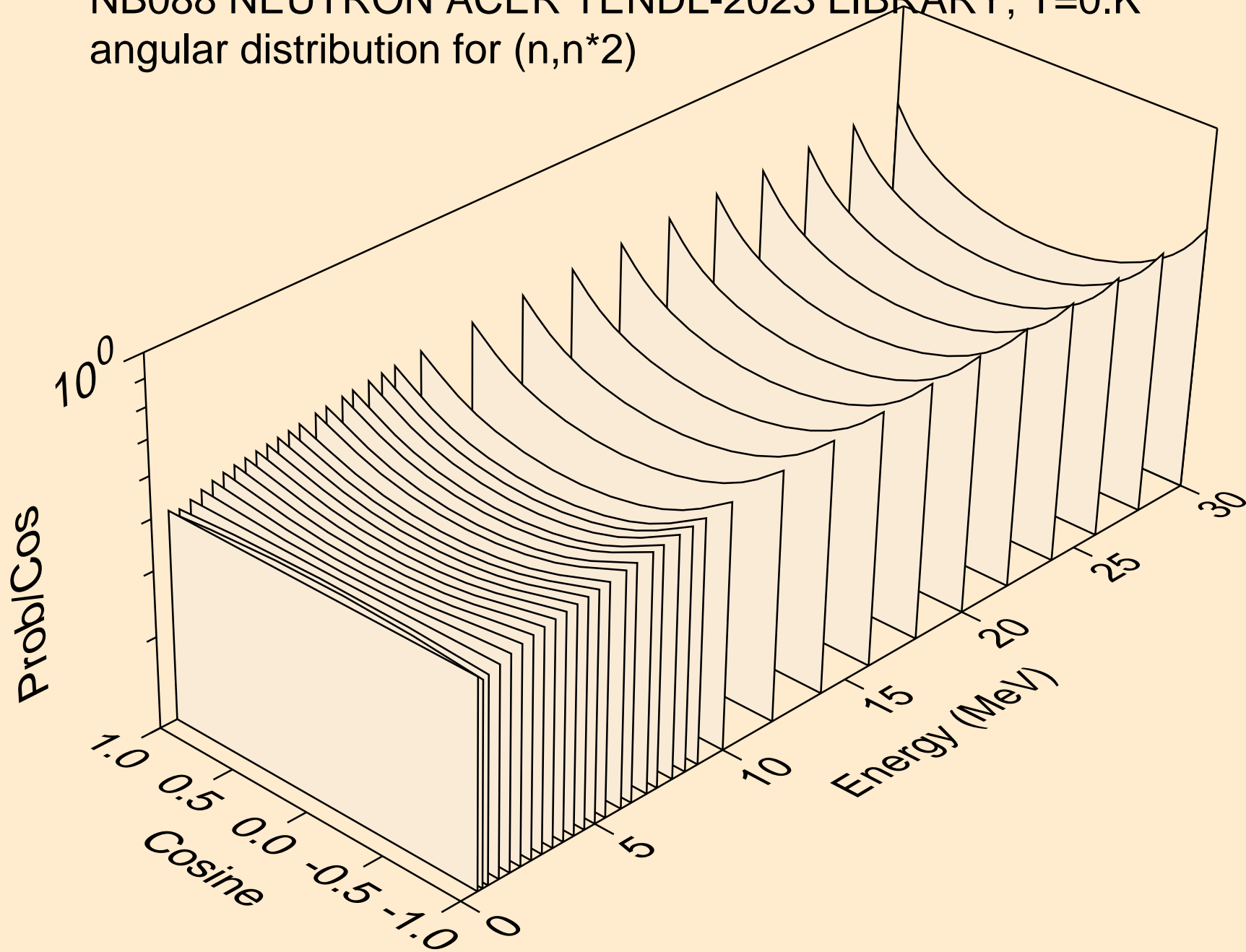

NB088 NEUTRON ACER TENDL-2023 LIBRARY; T=0.K  
angular distribution for (n,n\*3)

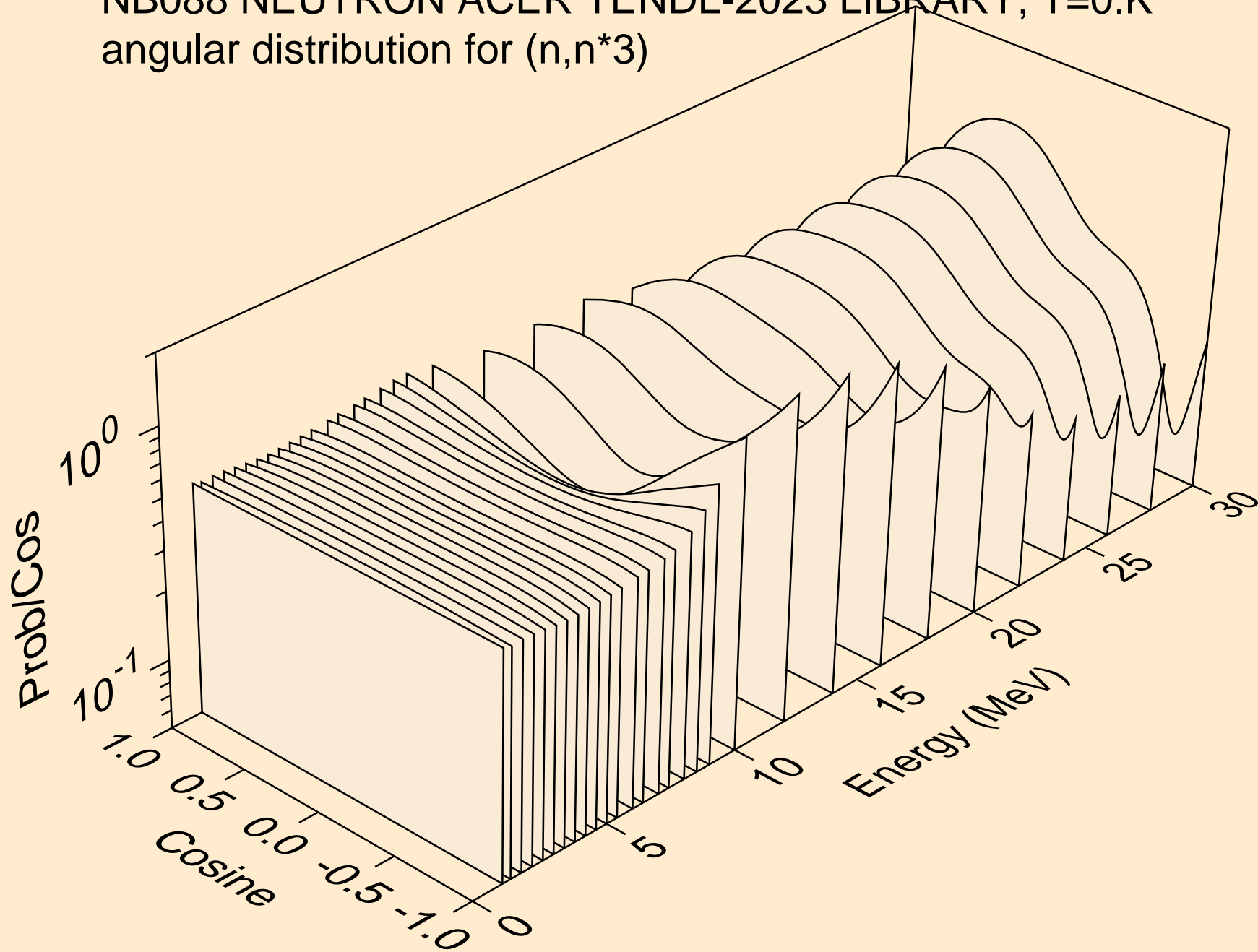



NB088 NEUTRON ACER TENDL-2023 LIBRARY; T=0.K  
angular distribution for (n,n\*4)

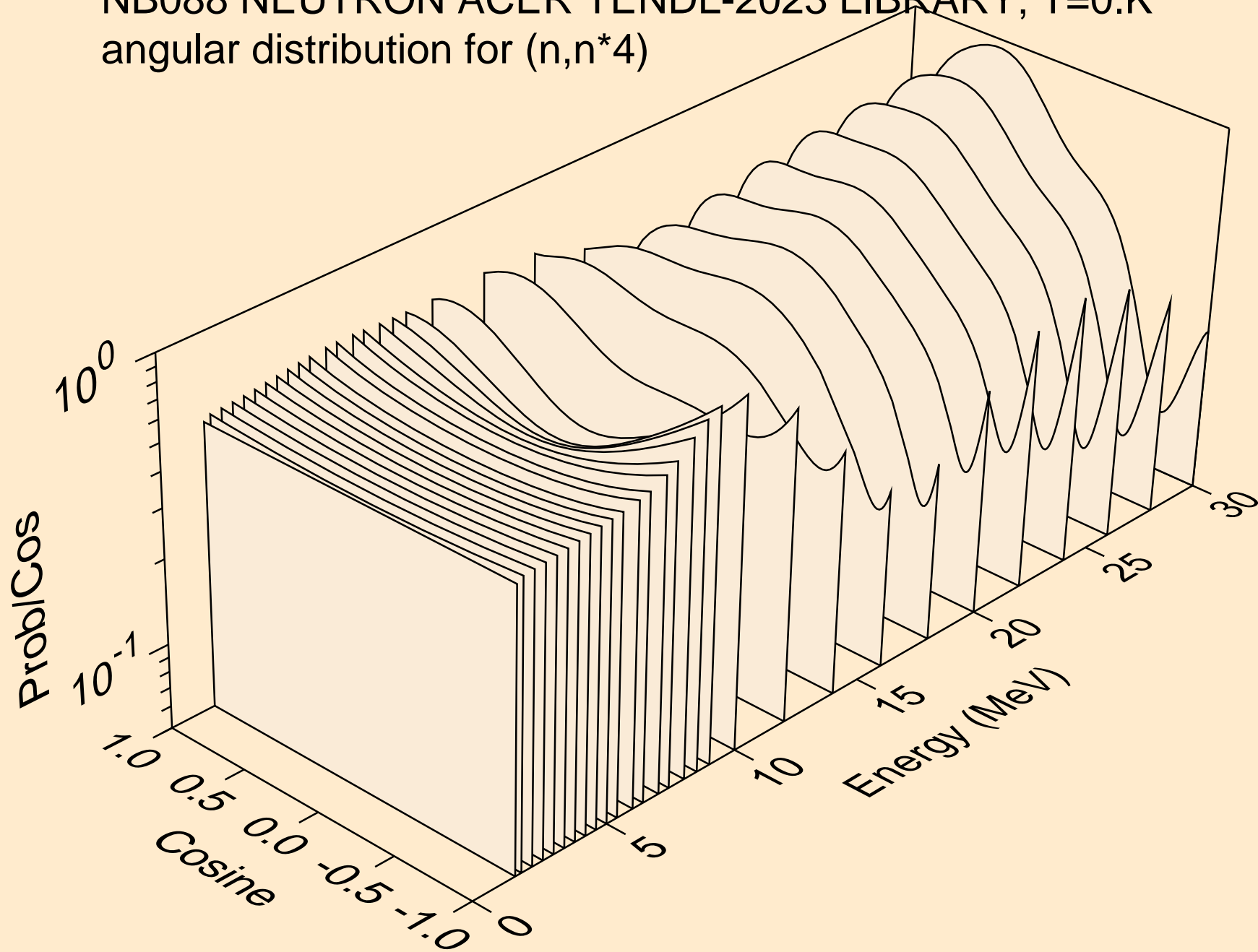

NB088 NEUTRON ACER TENDL-2023 LIBRARY; T=0.K  
angular distribution for (n,n\*5)

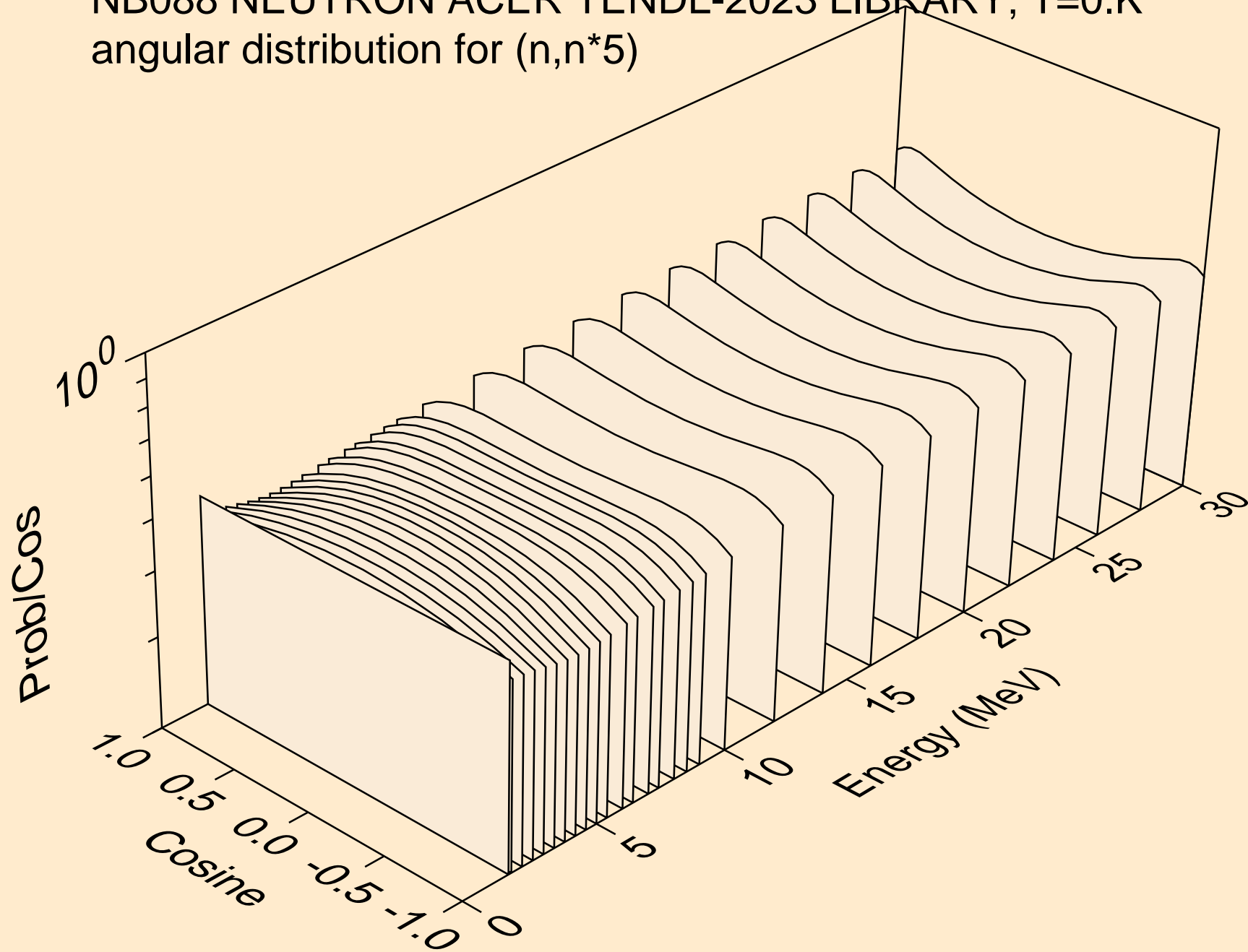

NB088 NEUTRON ACER TENDL-2023 LIBRARY; T=0.K  
angular distribution for (n,n\*6)

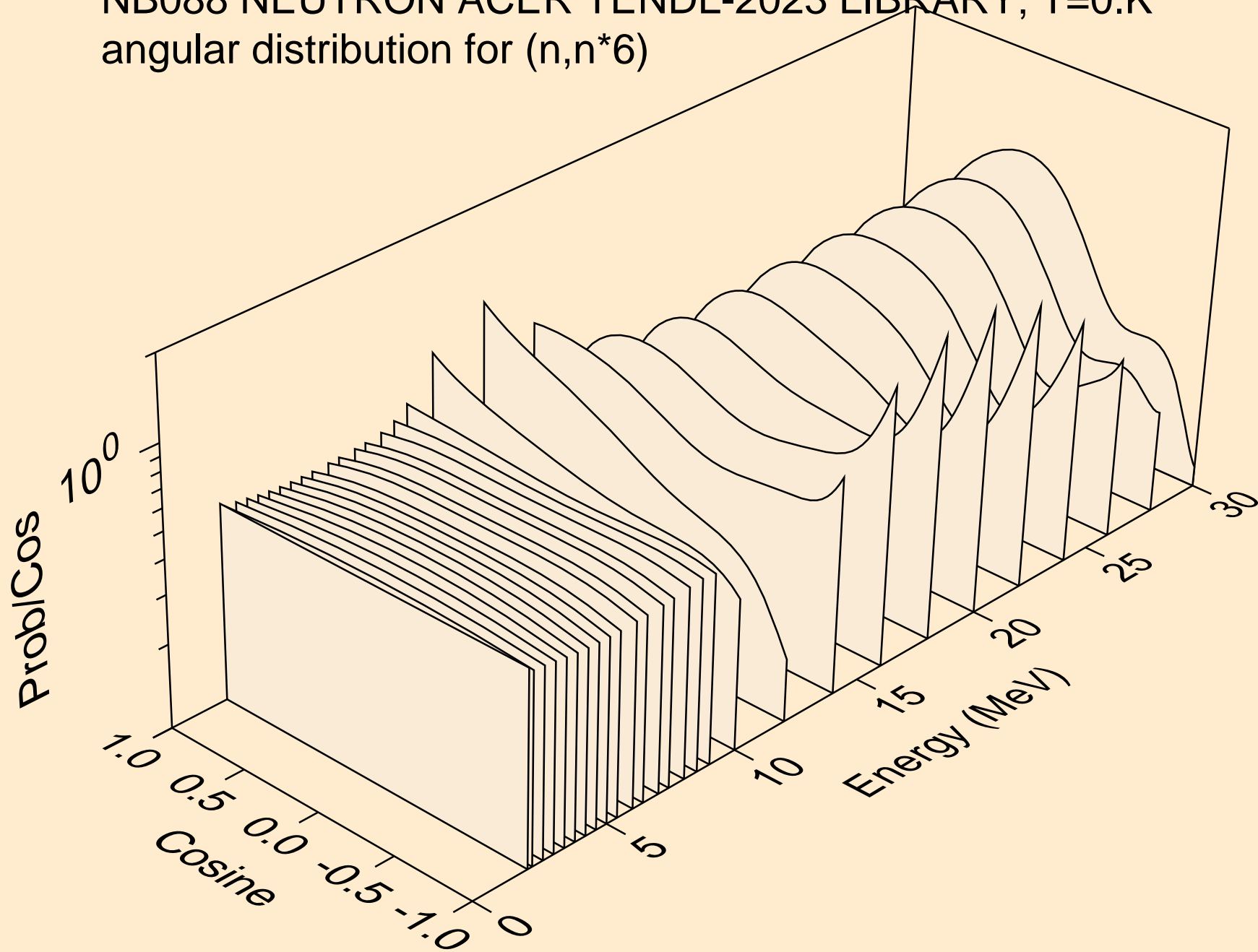

NB088 NEUTRON ACER TENDL-2023 LIBRARY; T=0.K  
angular distribution for (n,n\*7)

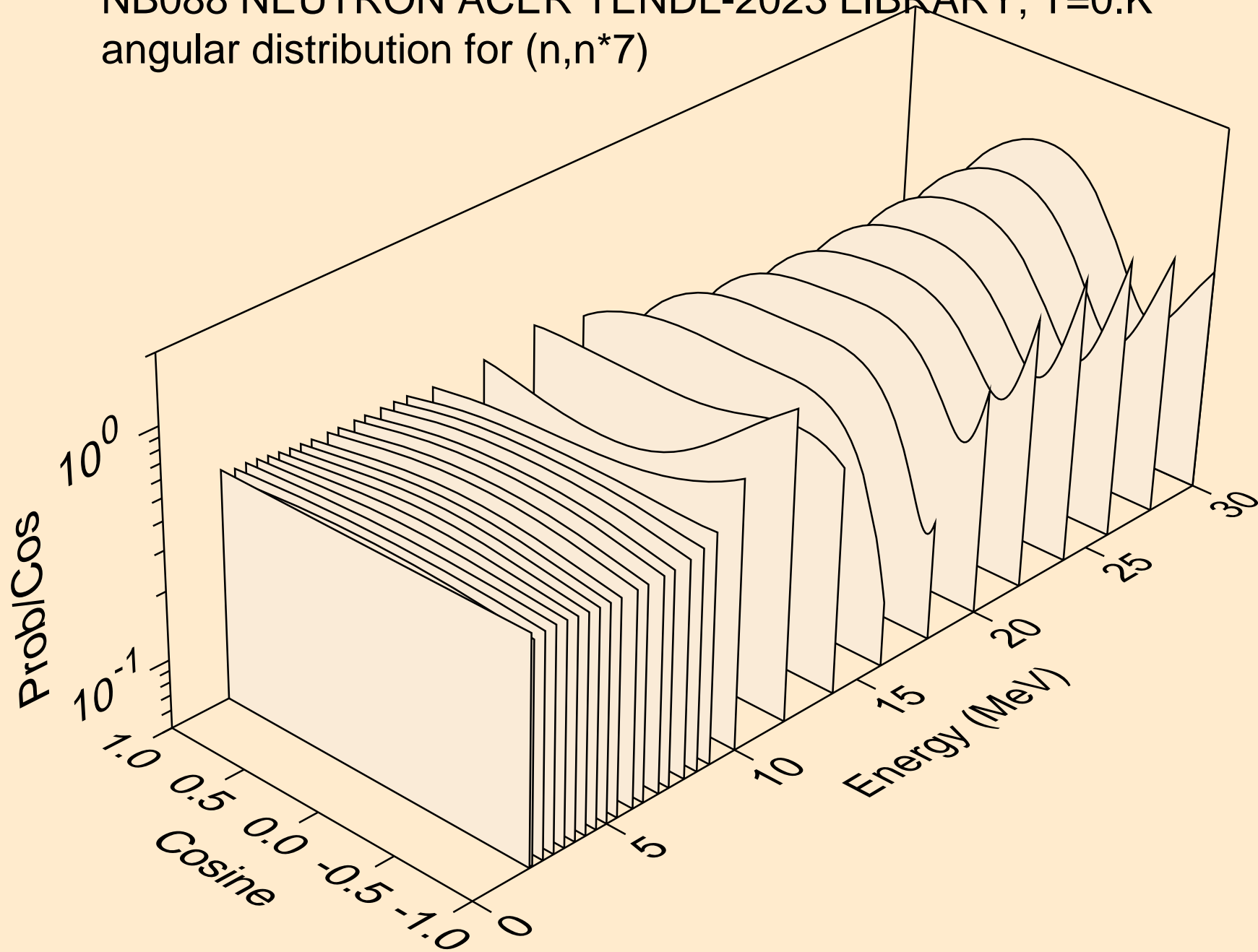

NB088 NEUTRON ACER TENDL-2023 LIBRARY; T=0.K  
angular distribution for (n,n\*8)

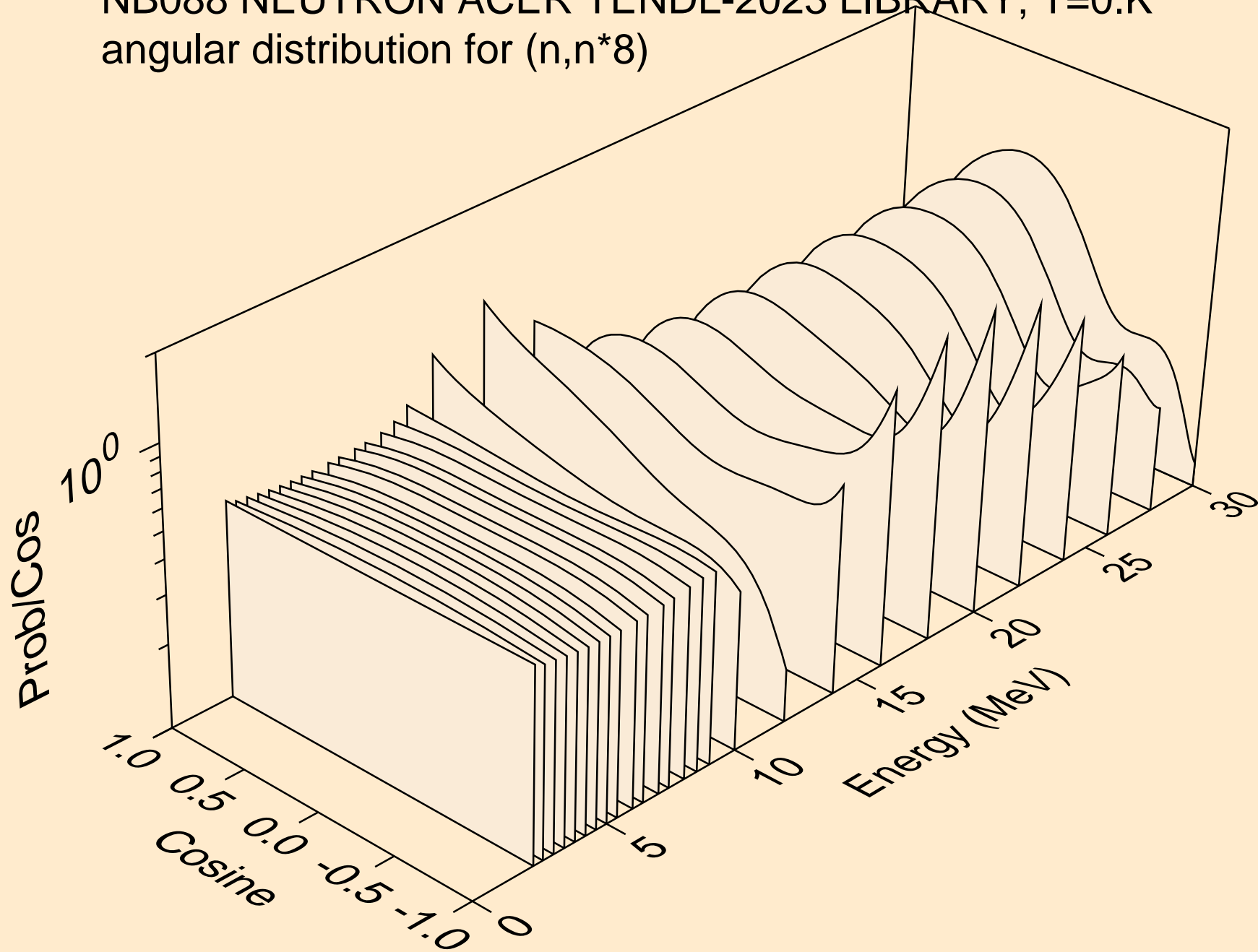

NB088 NEUTRON ACER TENDL-2023 LIBRARY; T=0.K  
angular distribution for (n,n\*9)

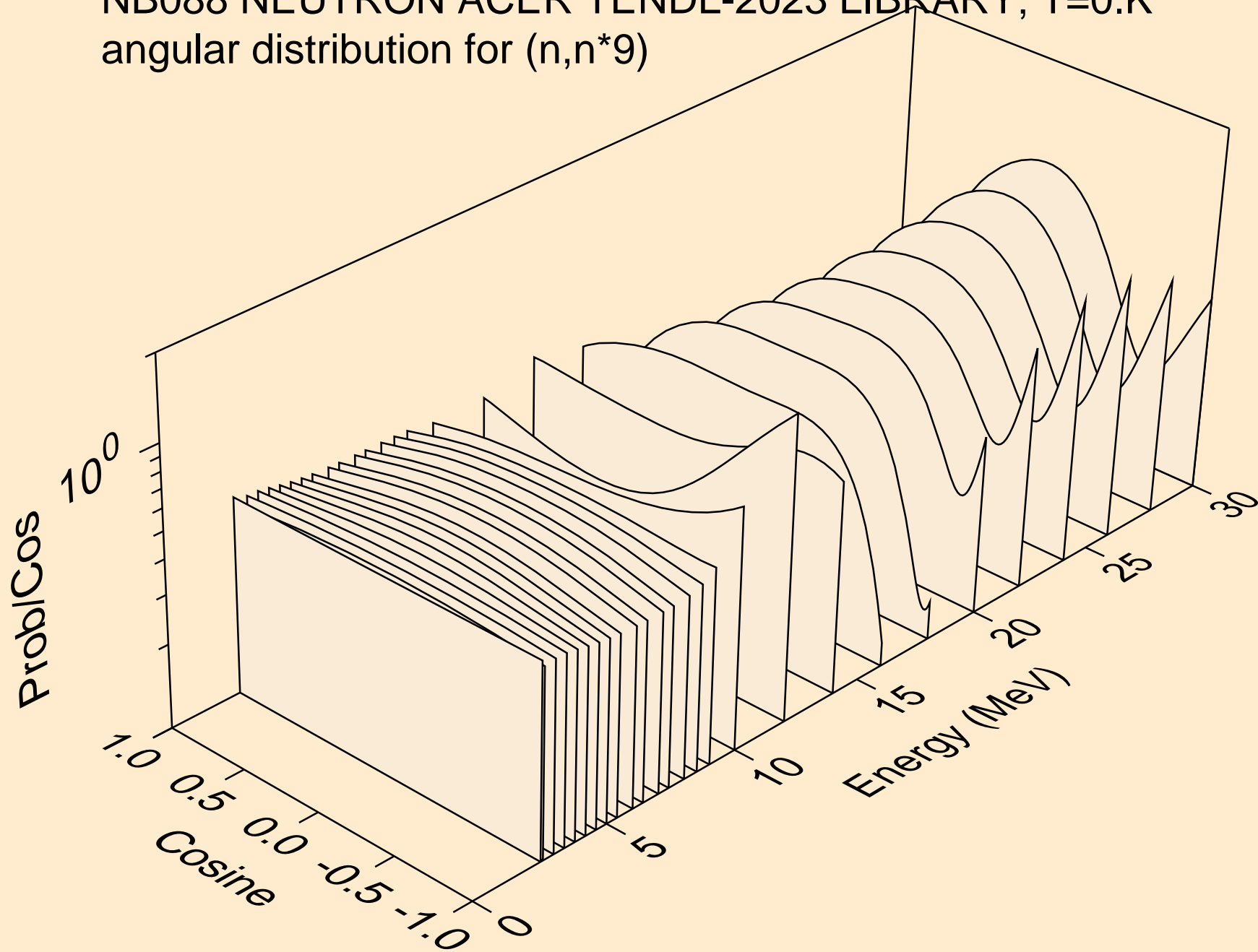

NB088 NEUTRON ACER TENDL-2023 LIBRARY; T=0.K  
angular distribution for (n,n\*10)

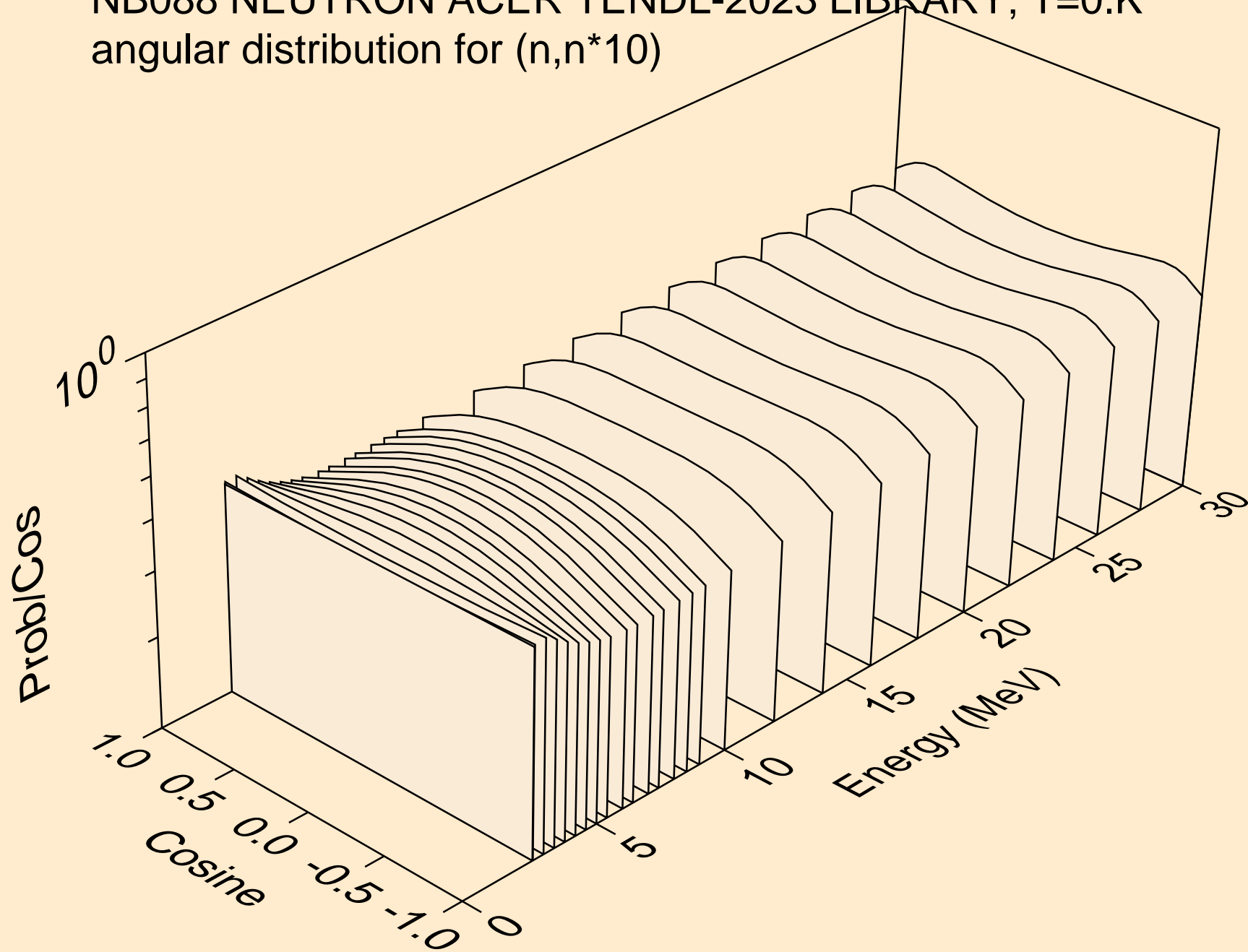

NB088 NEUTRON ACER TENDL-2023 LIBRARY; T=0.K  
angular distribution for (n,n\*11)

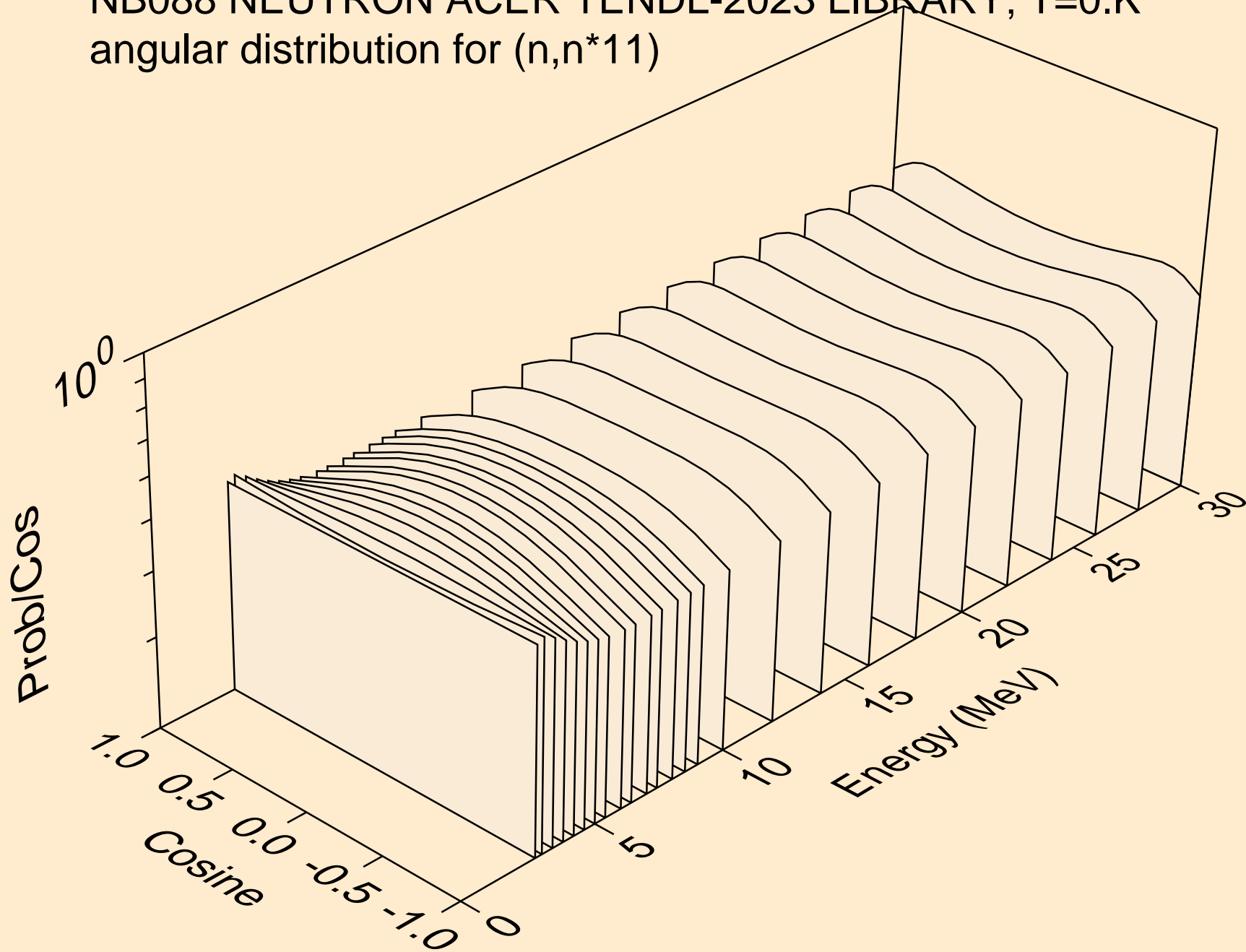



NB088 NEUTRON ACER TENDL-2023 LIBRARY; T=0.K  
angular distribution for (n,n\*12)

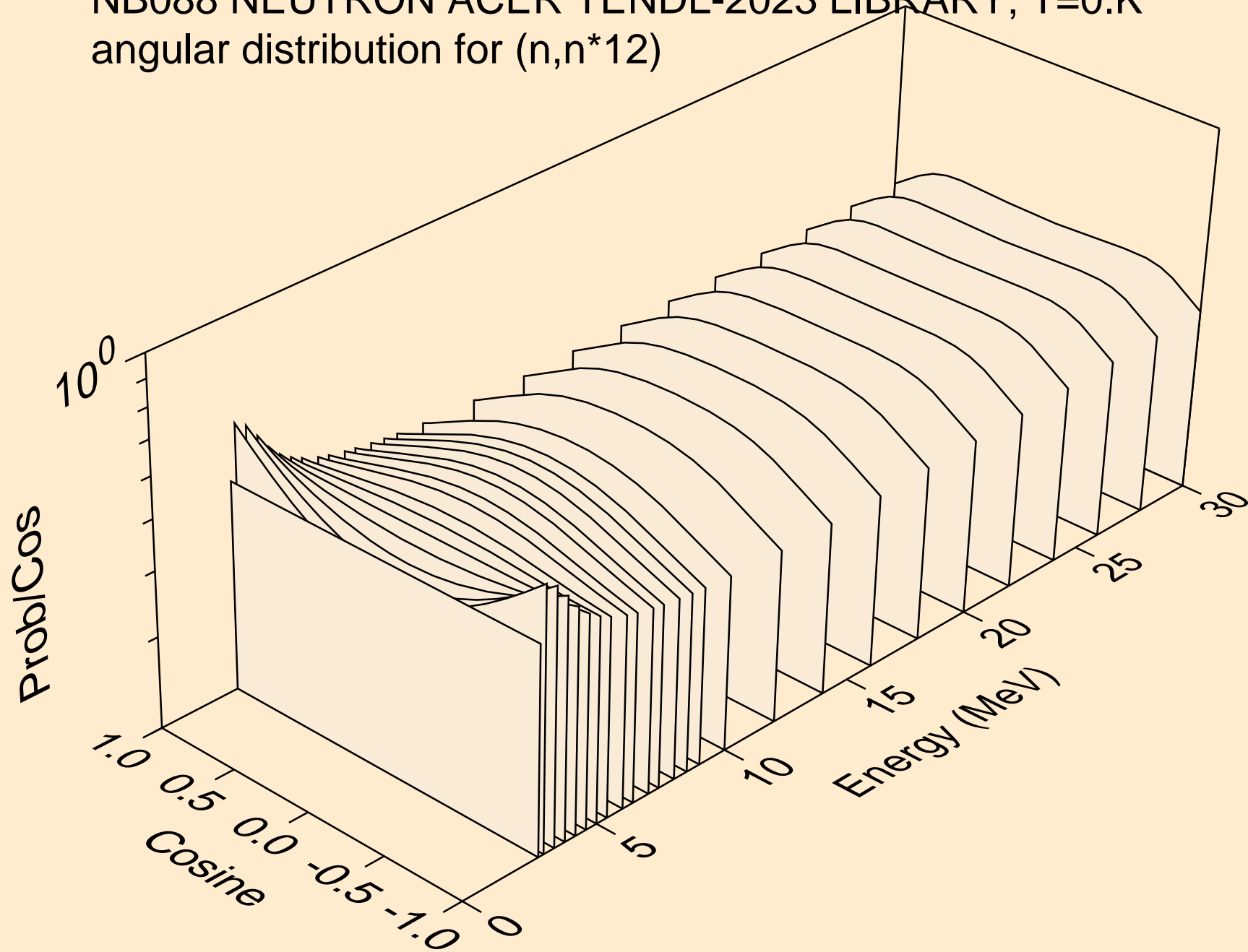

NB088 NEUTRON ACER TENDL-2023 LIBRARY; T=0.K  
angular distribution for (n,n\*13)

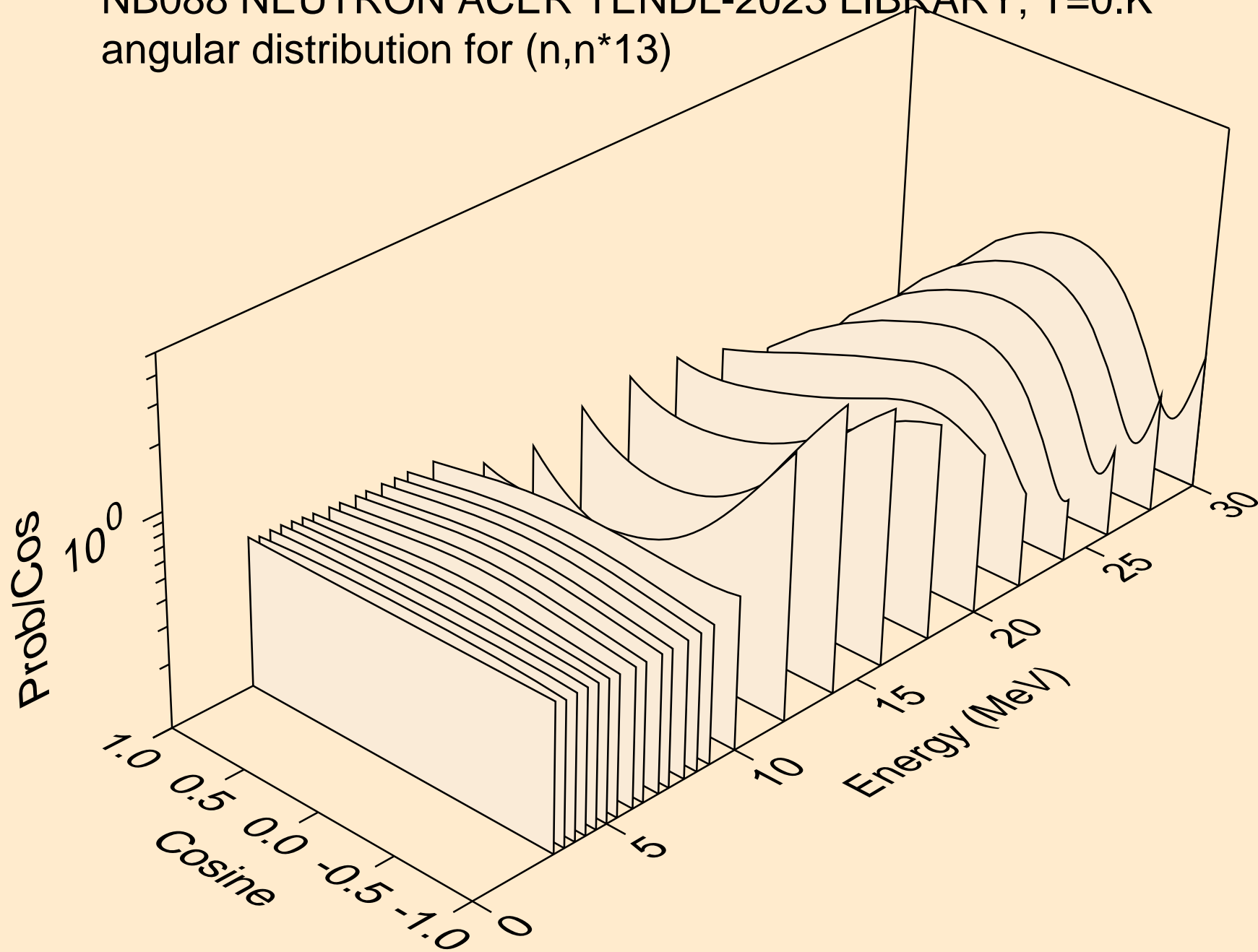

NB088 NEUTRON ACER TENDL-2023 LIBRARY; T=0.K  
angular distribution for (n,n\*14)

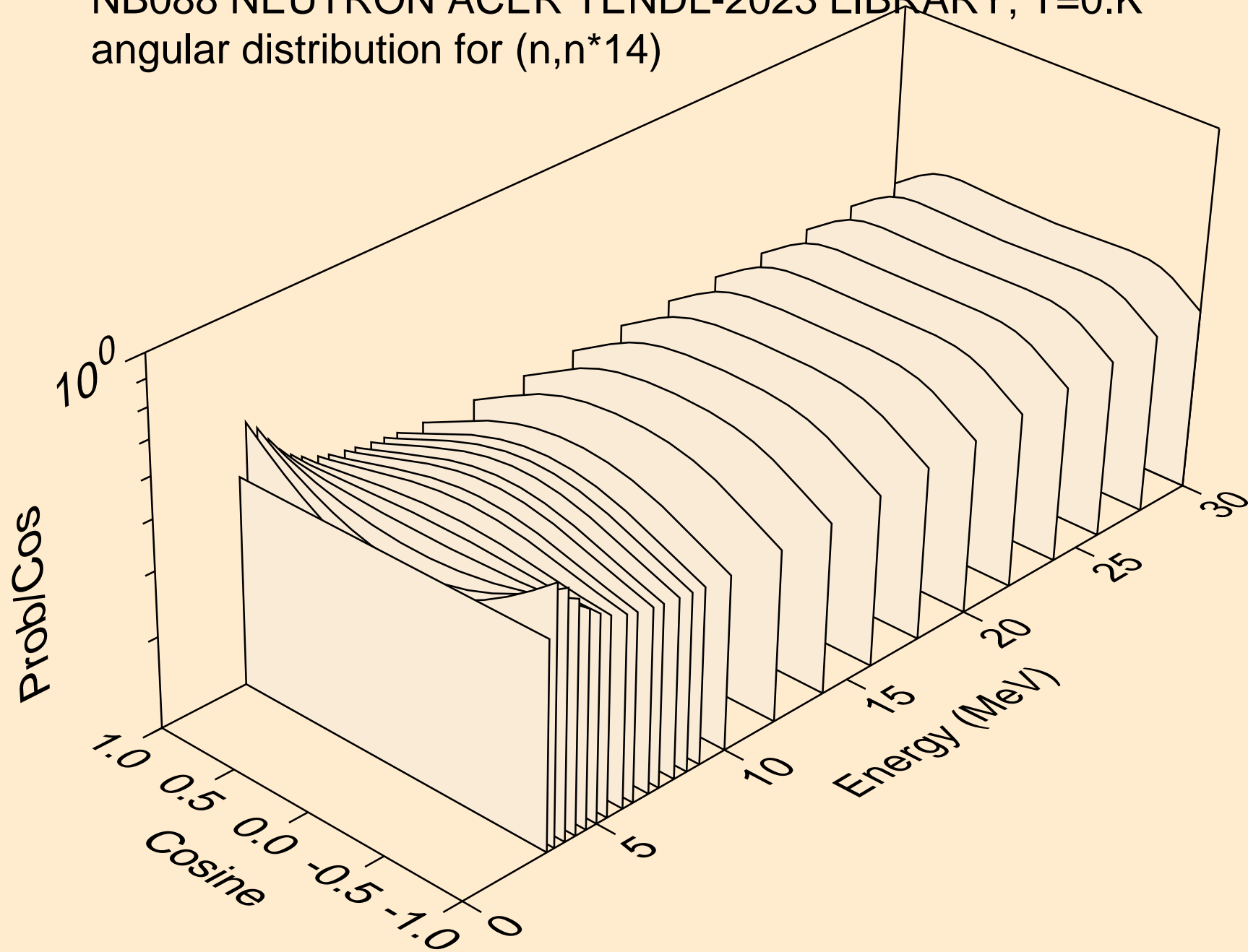

NB088 NEUTRON ACER TENDL-2023 LIBRARY; T=0.K  
angular distribution for (n,n\*15)

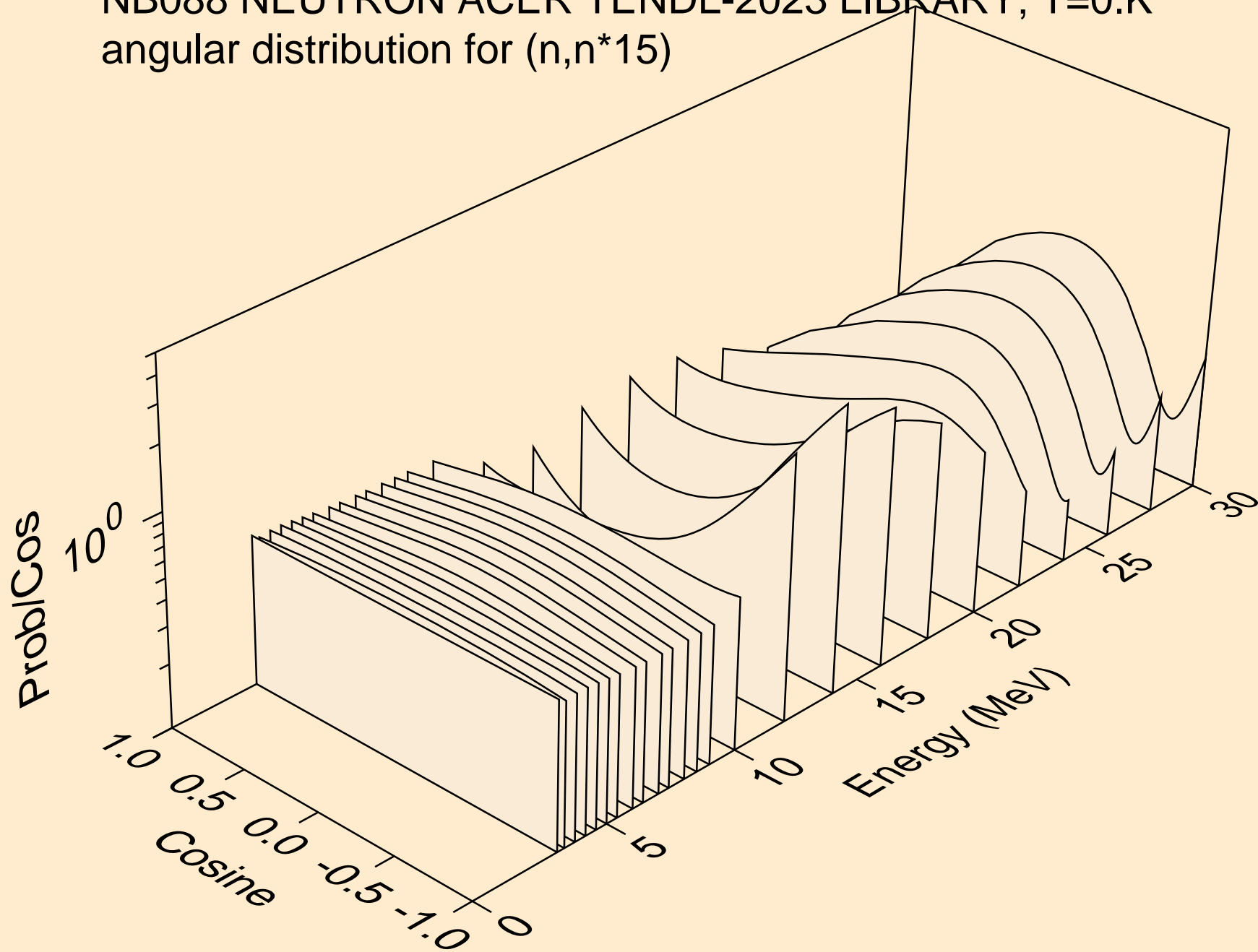

NB088 NEUTRON ACER TENDL-2023 LIBRARY; T=0.K  
angular distribution for (n,n\*16)

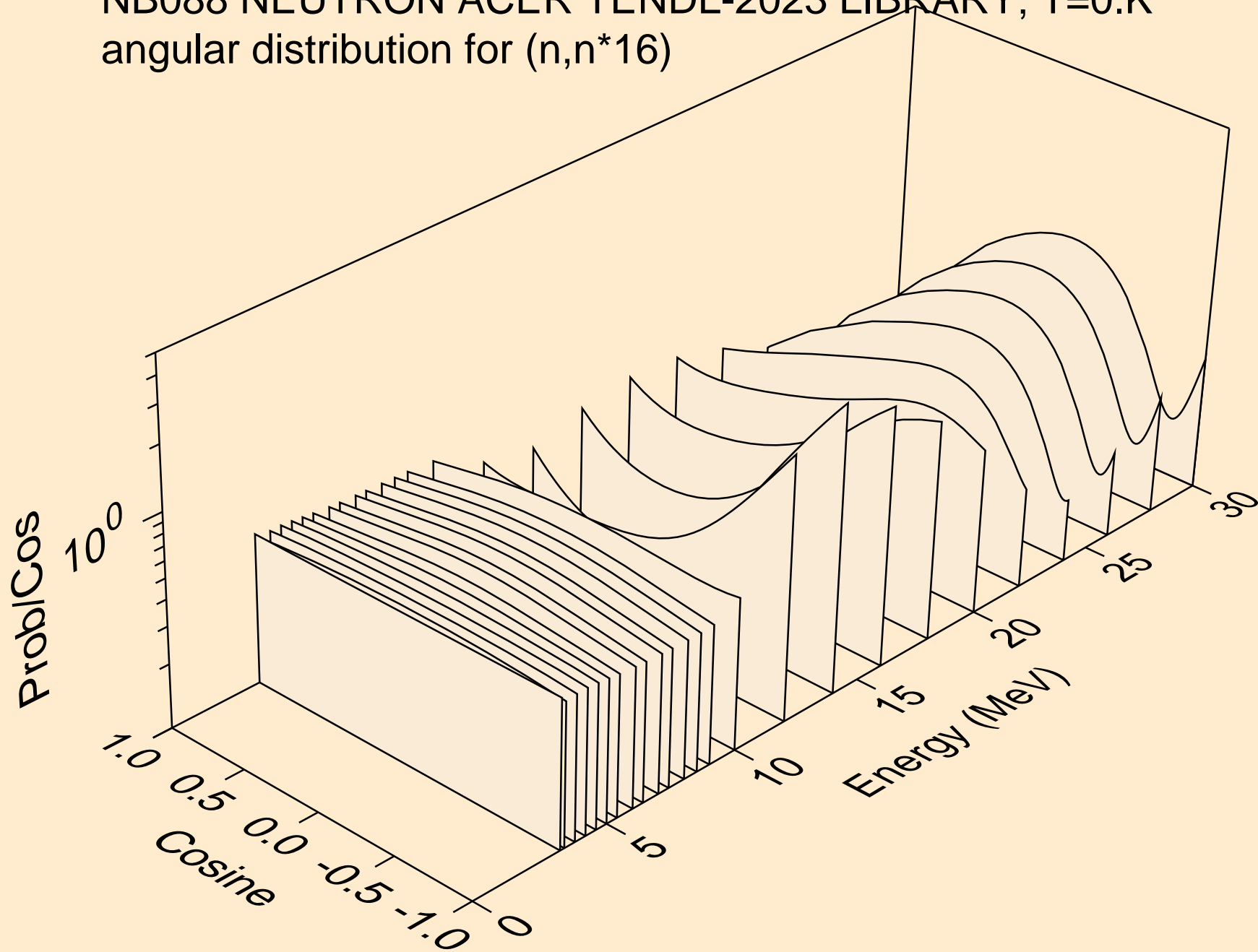

NB088 NEUTRON ACER TENDL-2023 LIBRARY; T=0.K  
angular distribution for (n,n\*17)

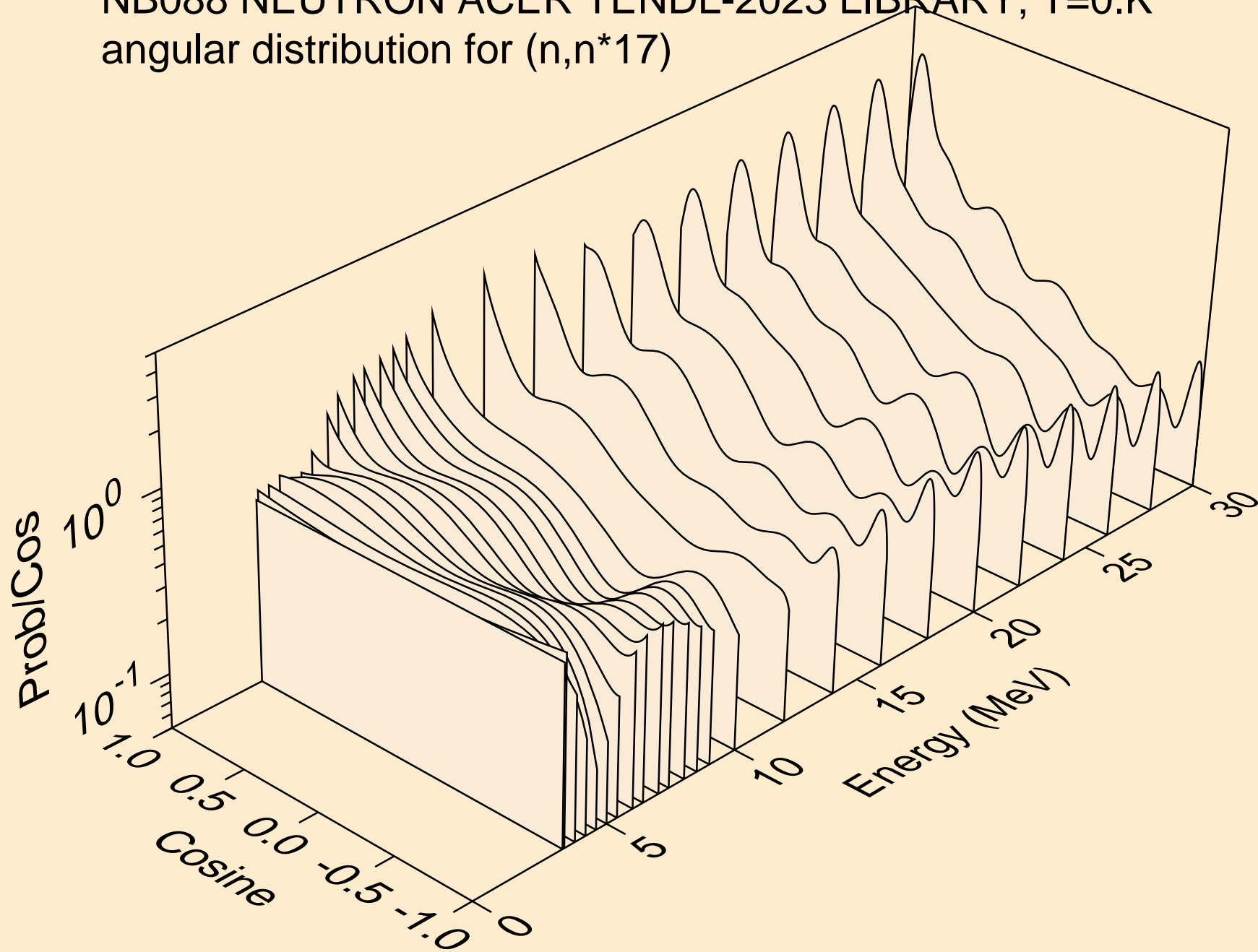

NB088 NEUTRON ACER TENDL-2023 LIBRARY; T=0.K  
angular distribution for (n,n\*18)

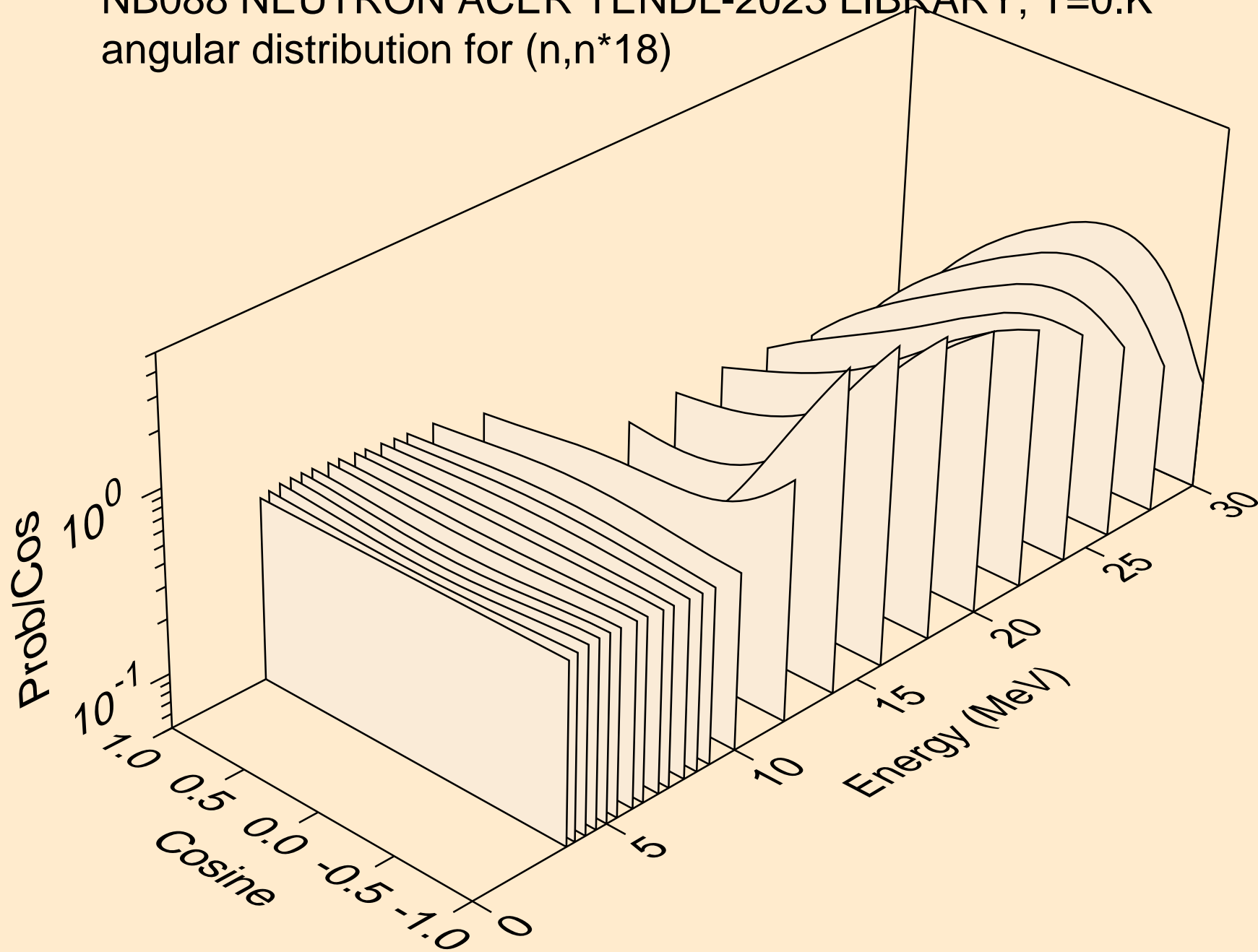

NB088 NEUTRON ACER TENDL-2023 LIBRARY; T=0.K  
angular distribution for (n,n\*19)

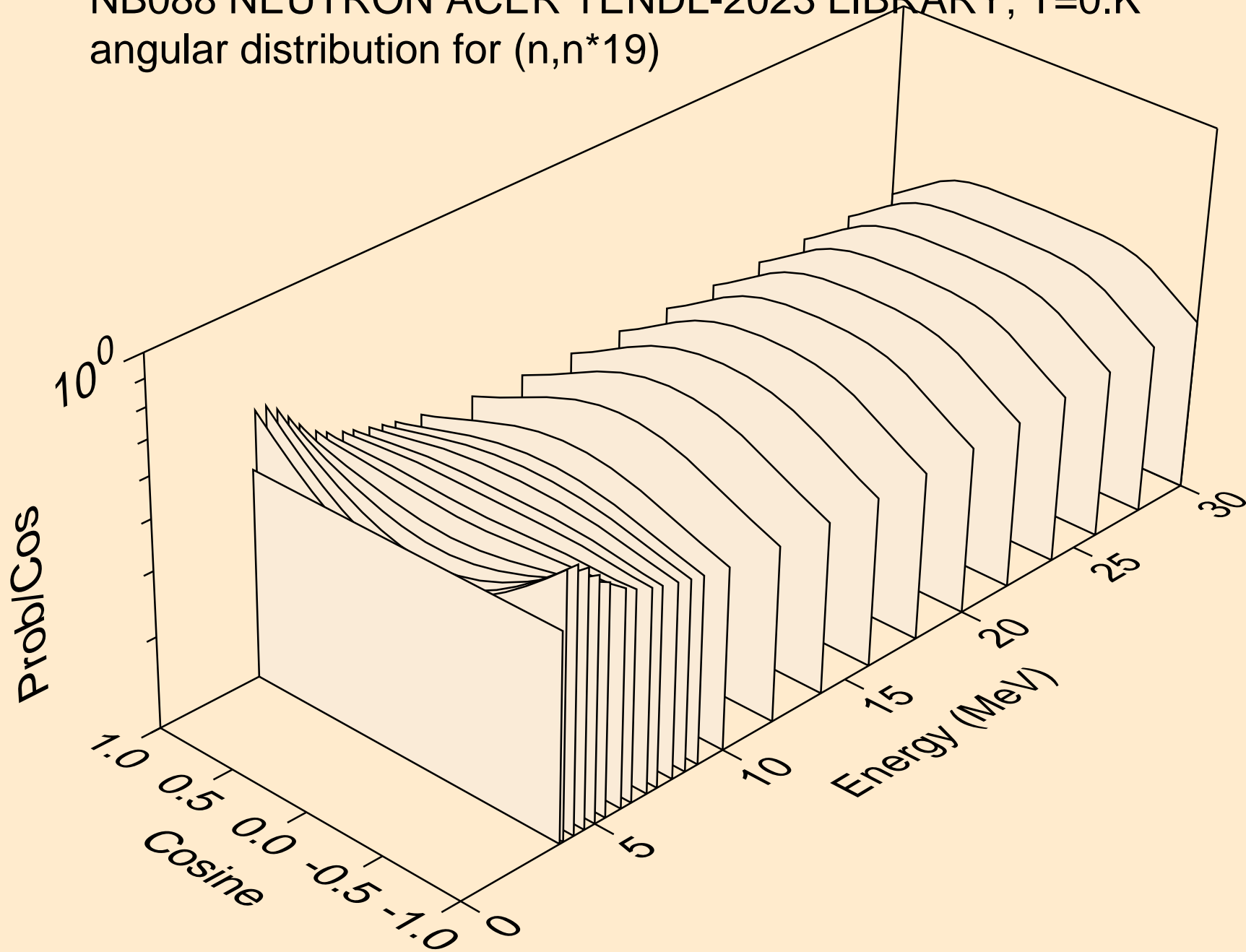



NB088 NEUTRON ACER TENDL-2023 LIBRARY; T=0.K  
angular distribution for (n,n\*20)

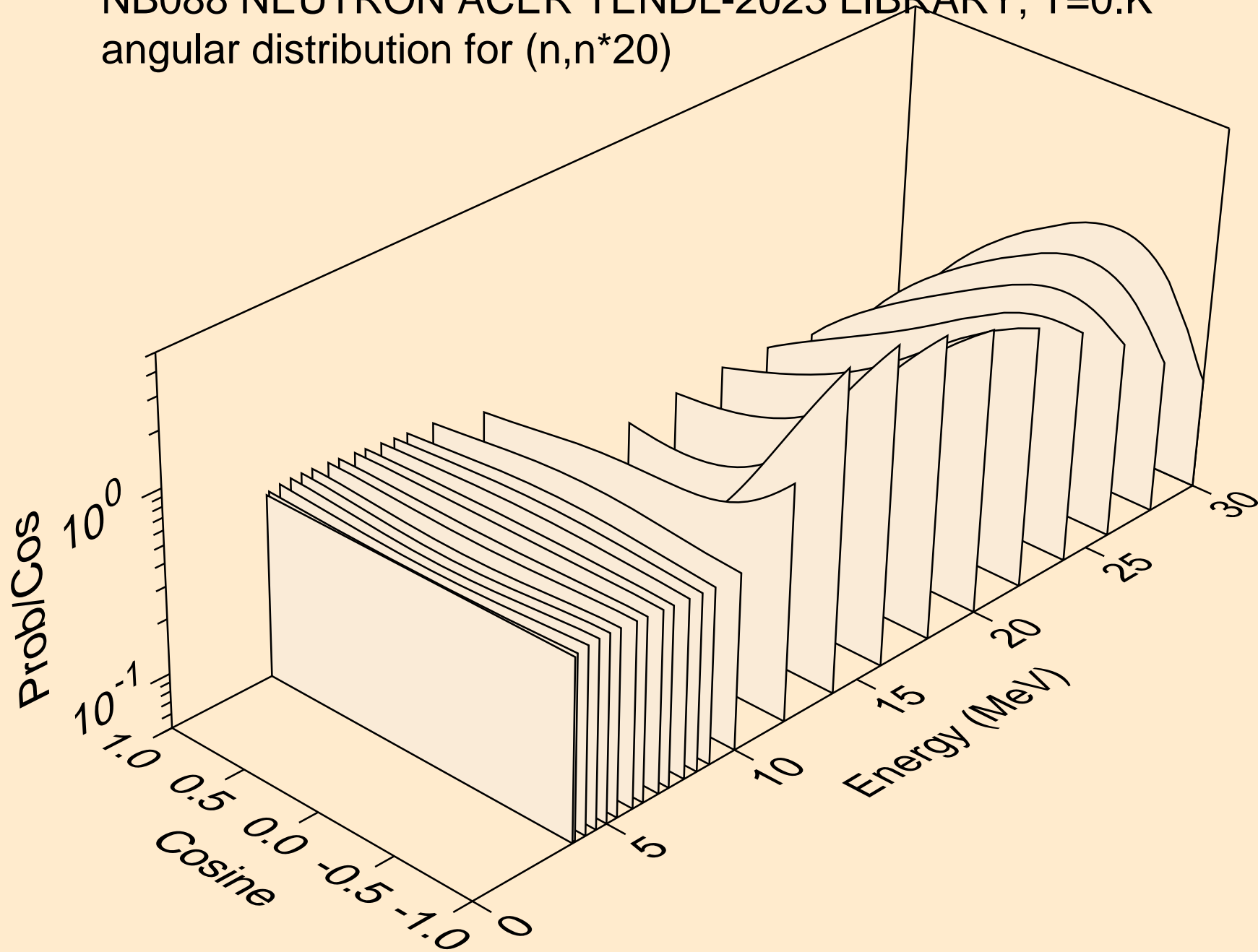

NB088 NEUTRON ACER TENDL-2023 LIBRARY; T=0.K  
angular distribution for (n,n\*21)

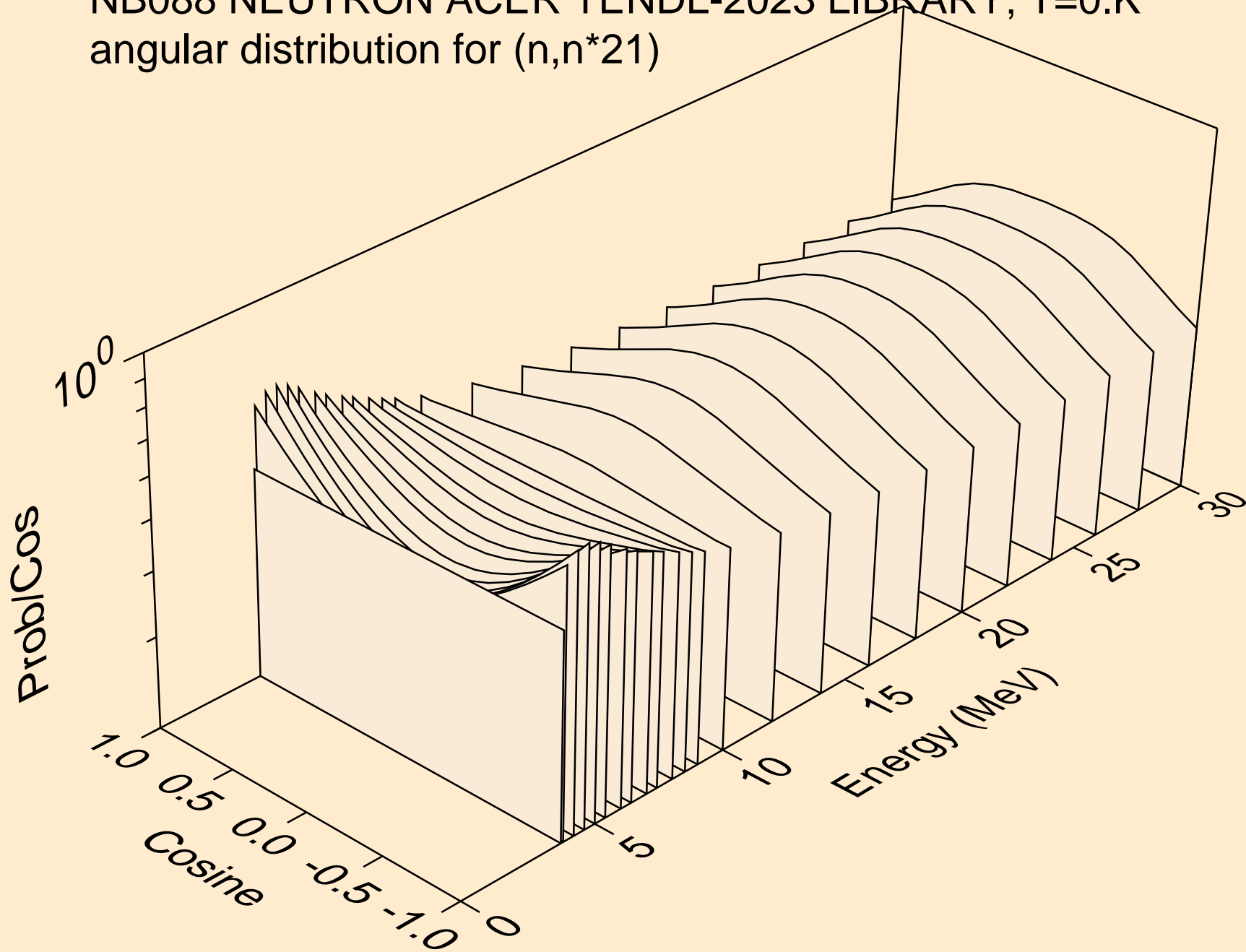

NB088 NEUTRON ACER TENDL-2023 LIBRARY; T=0.K  
angular distribution for (n,n\*22)

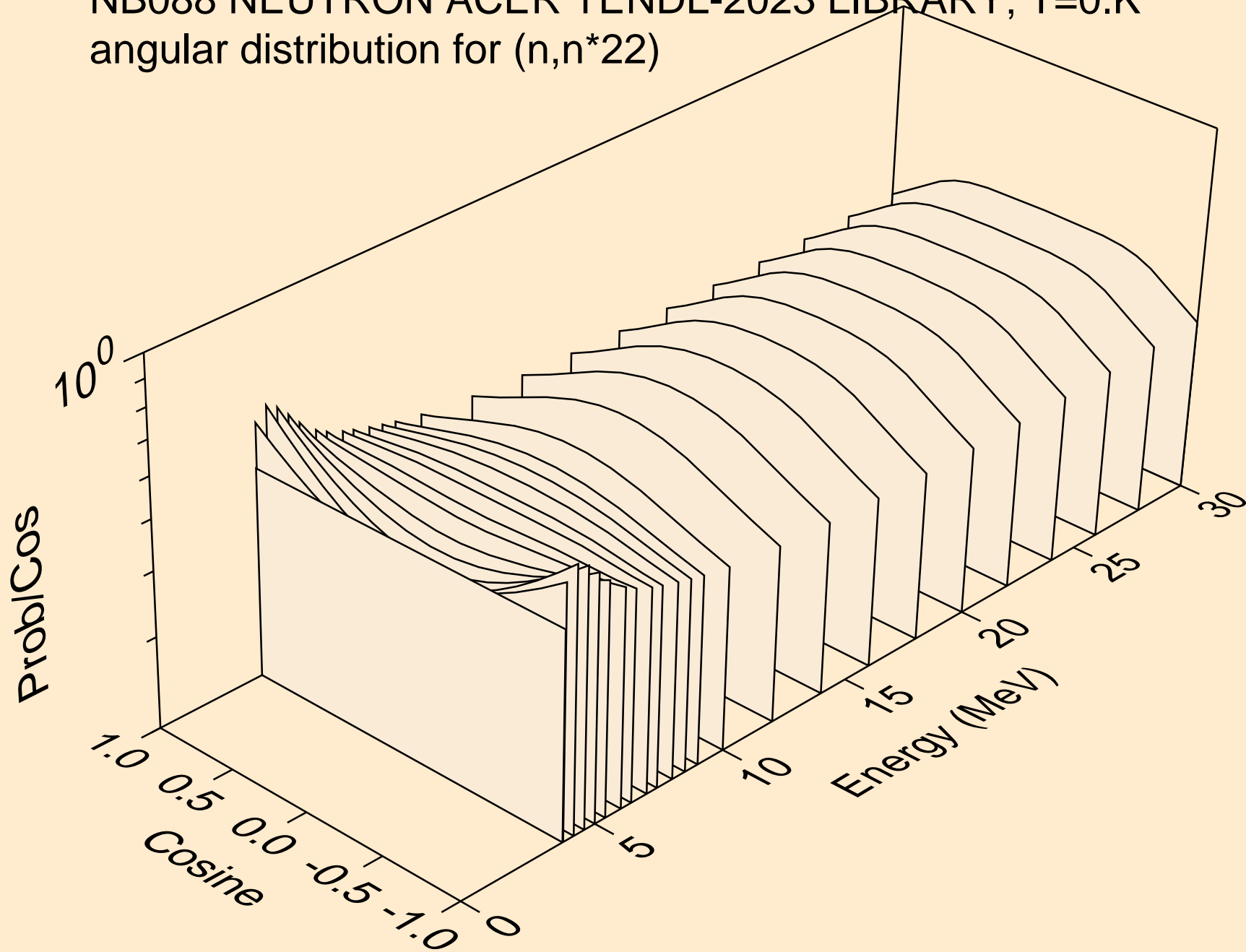

NB088 NEUTRON ACER TENDL-2023 LIBRARY; T=0.K  
angular distribution for (n,n\*23)

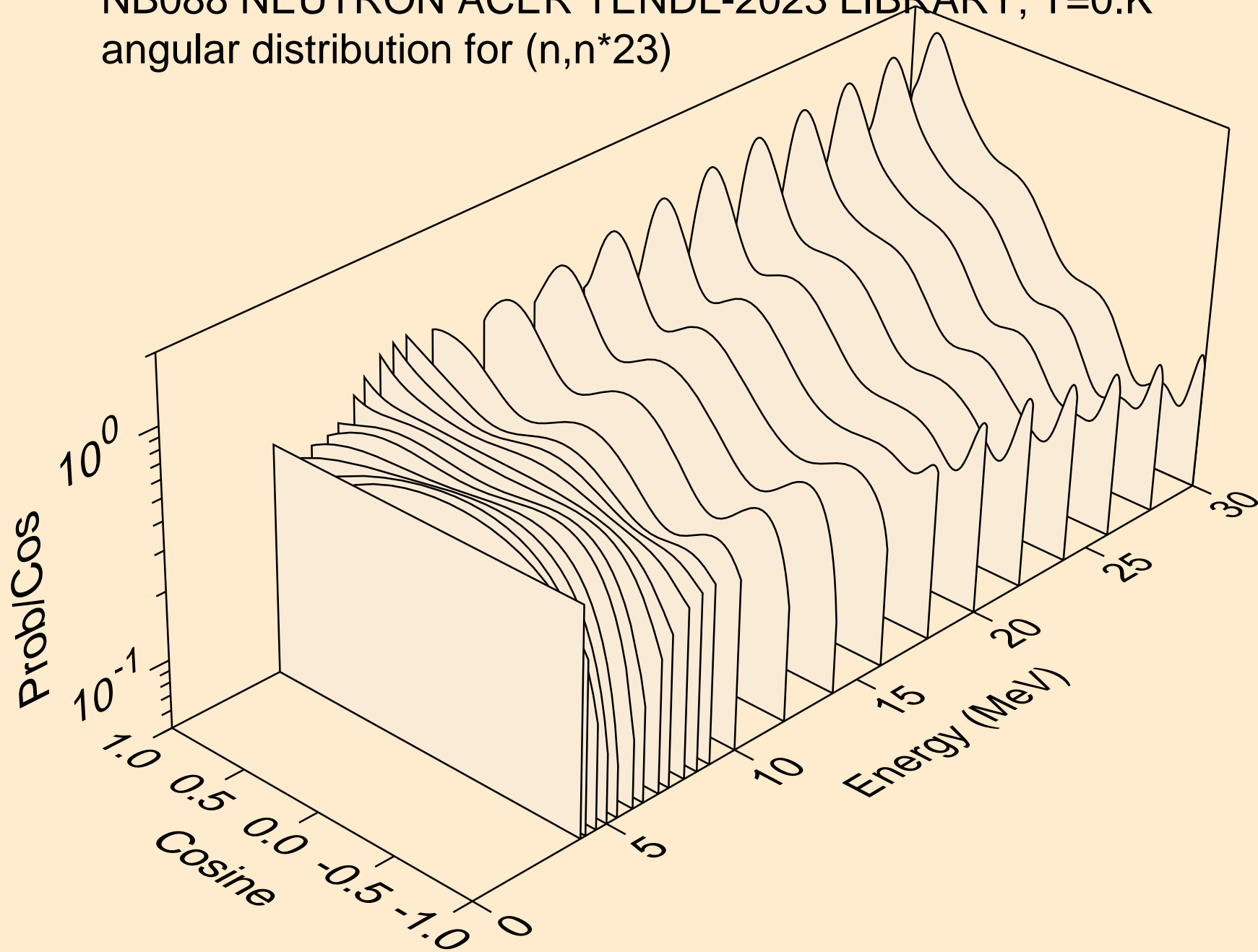

NB088 NEUTRON ACER TENDL-2023 LIBRARY; T=0.K  
Neutron emission for (n,x)

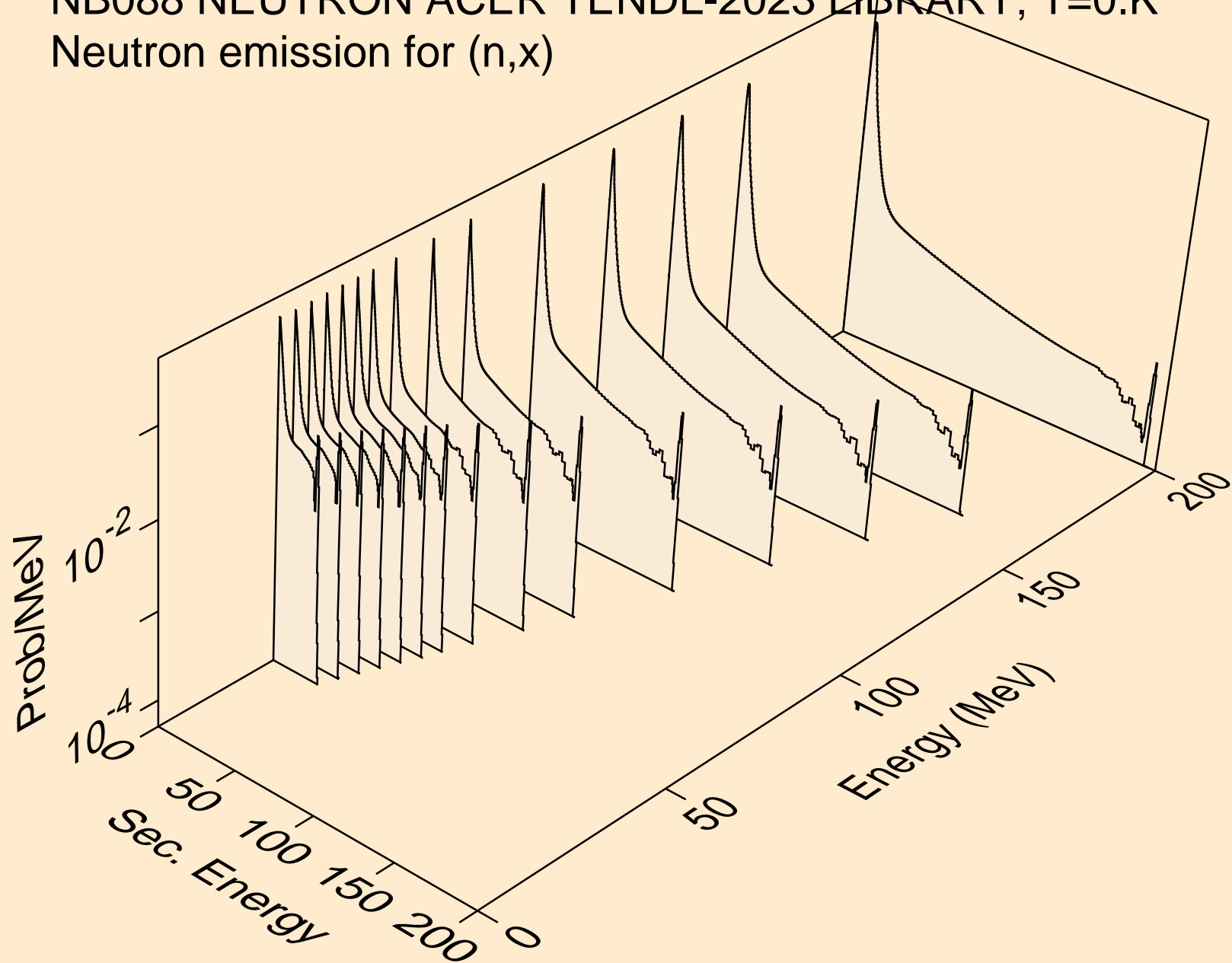

NB088 NEUTRON ACER TENDL-2023 LIBRARY; T=0.K  
Neutron emission for (n,2nd)

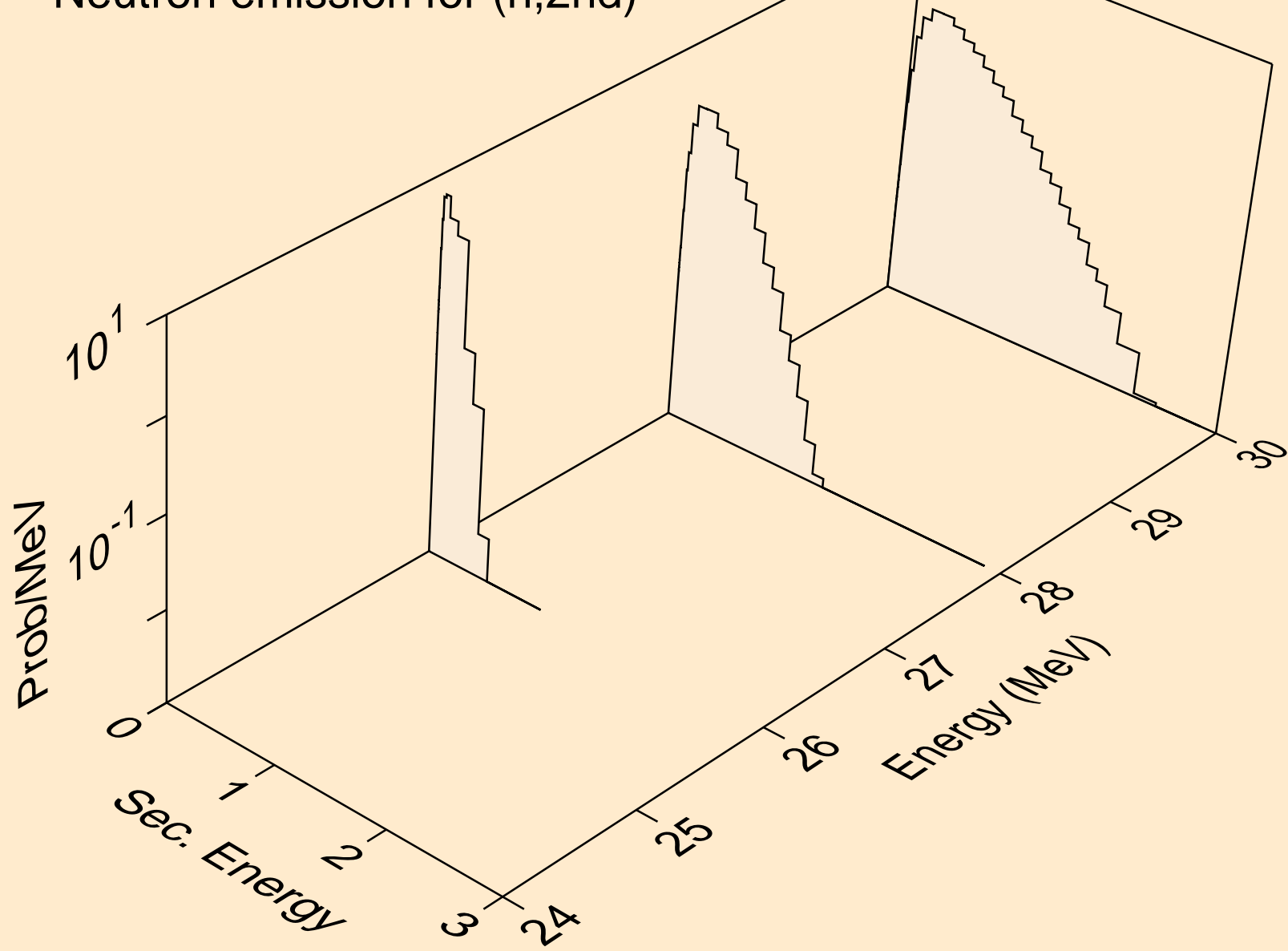

NB088 NEUTRON ACER TENDL-2023 LIBRARY; T=0.K  
Neutron emission for (n,2n)

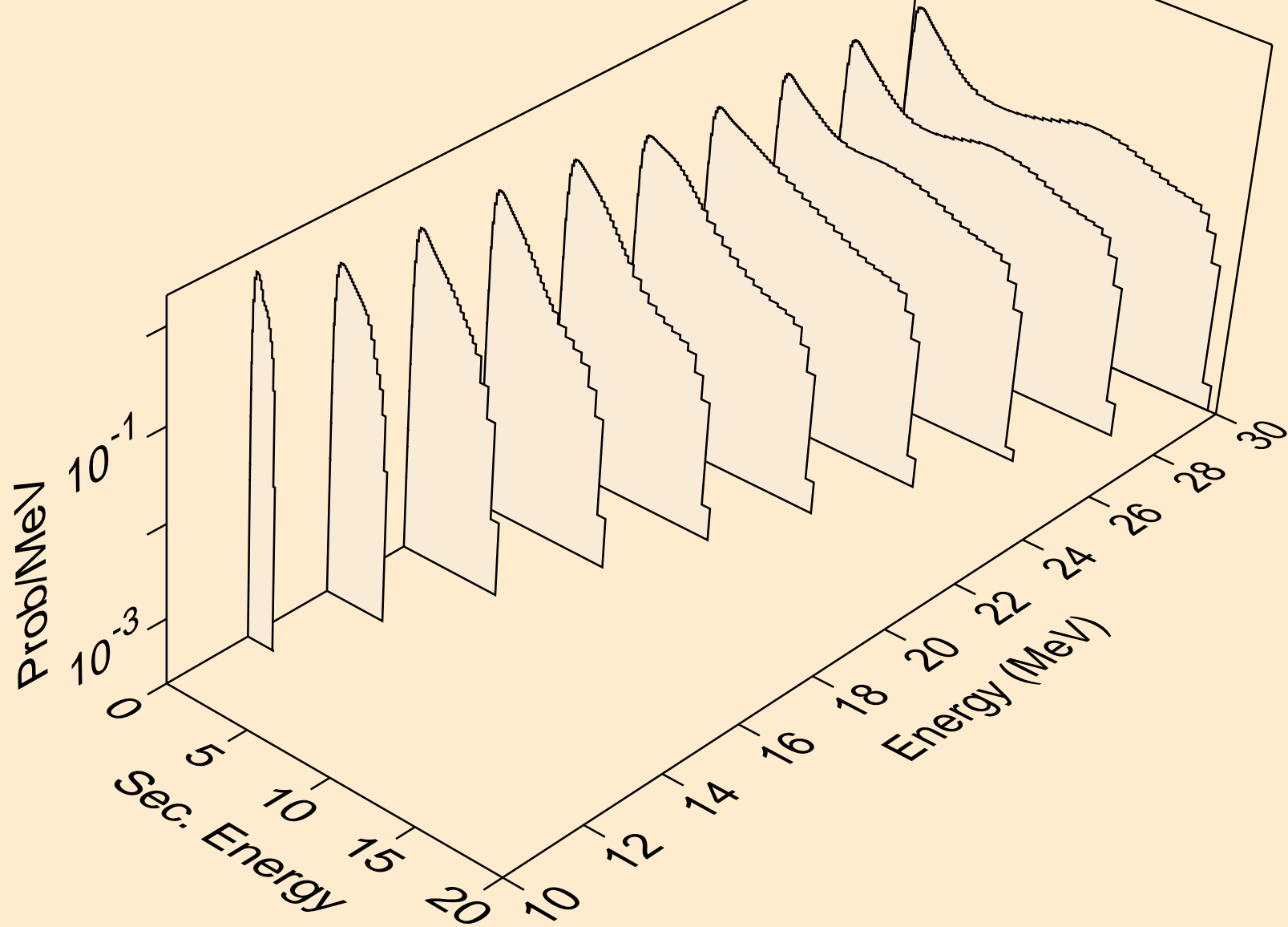

NB088 NEUTRON ACER TENDL-2023 LIBRARY; T=0.K  
Neutron emission for (n,3n)

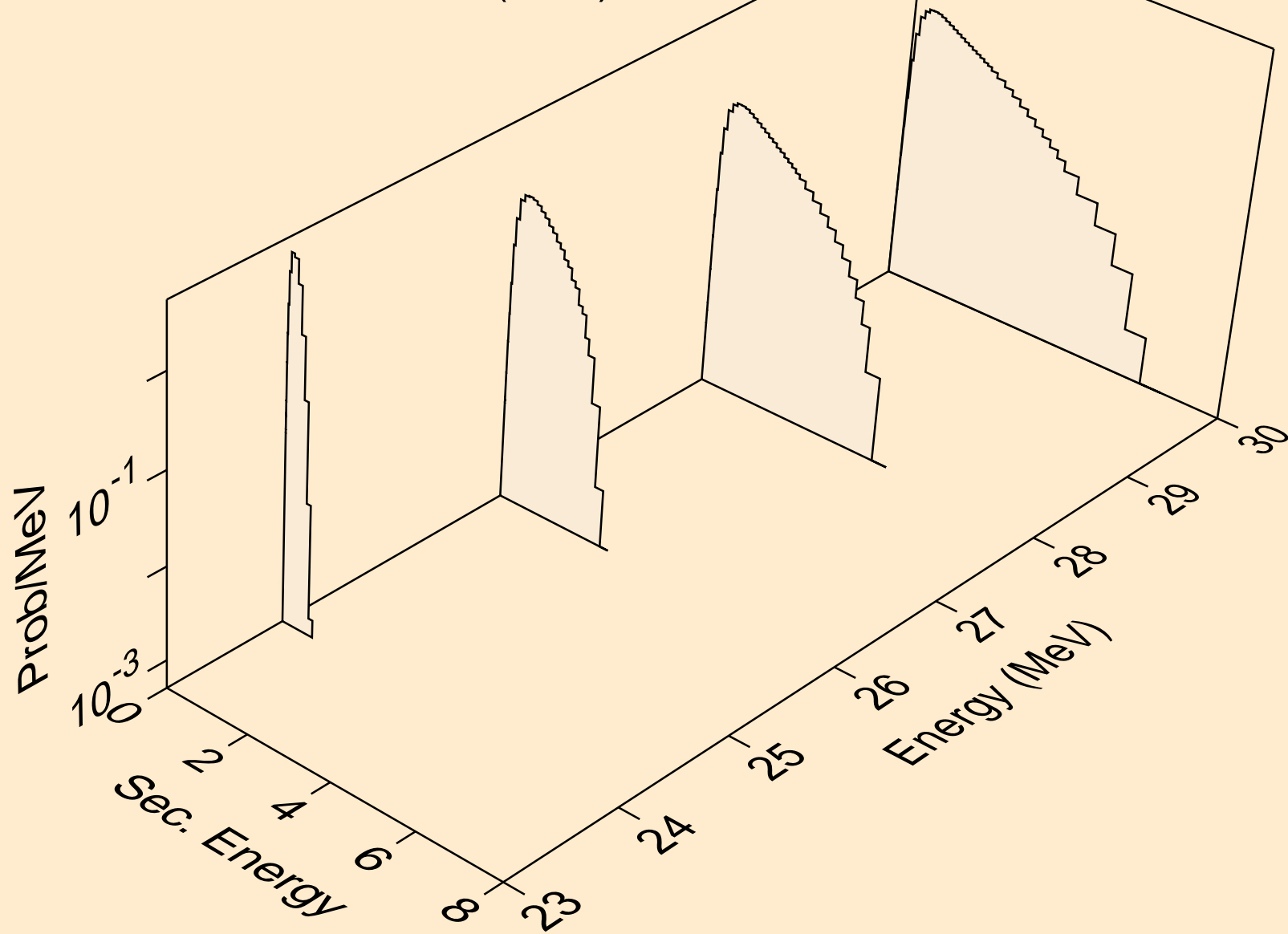



NB088 NEUTRON ACER TENDL-2023 LIBRARY; T=0.K  
Neutron emission for (n,n\*)a

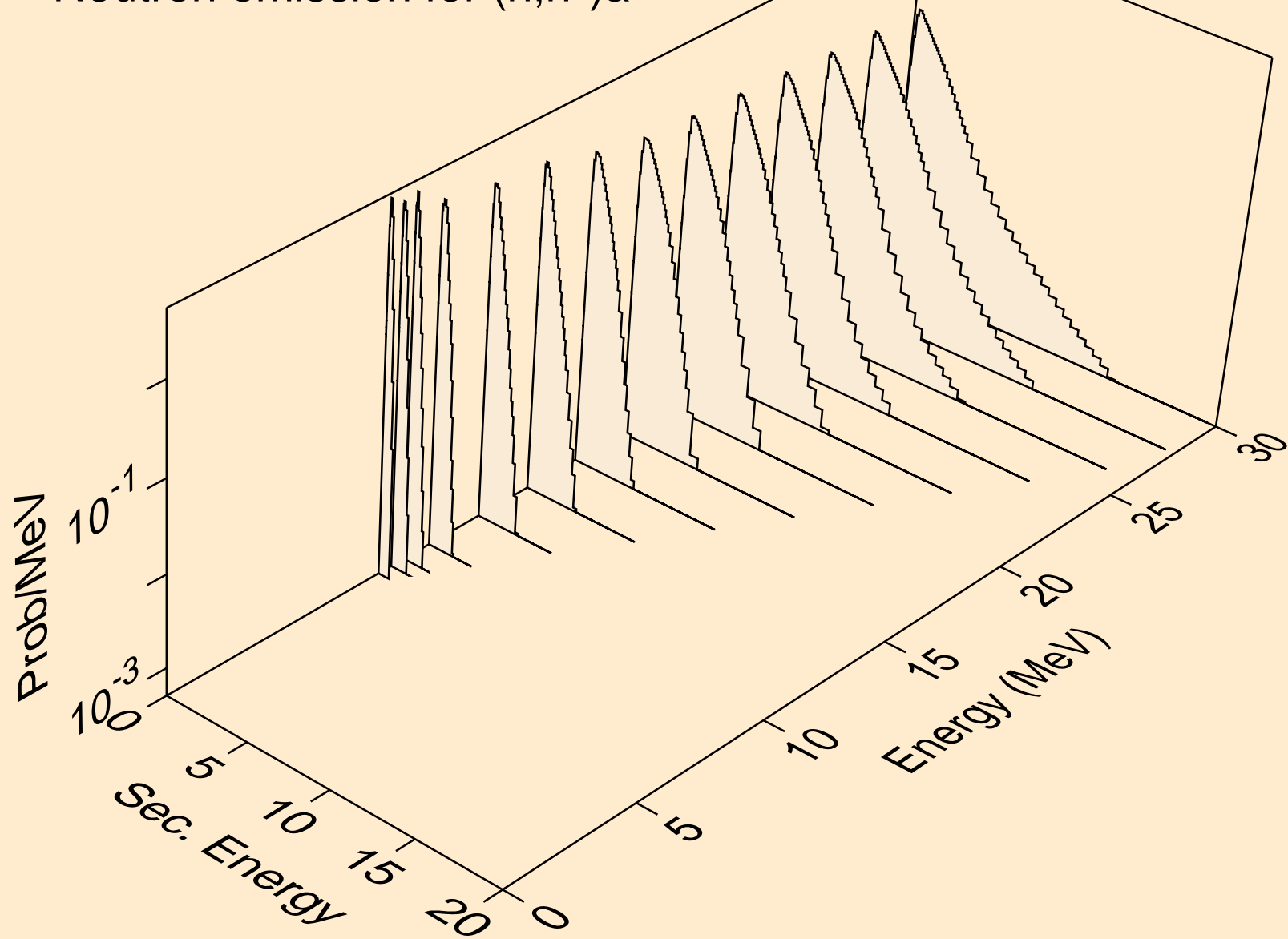

NB088 NEUTRON ACER TENDL-2023 LIBRARY; T=0.K  
Neutron emission for (n,2n)a

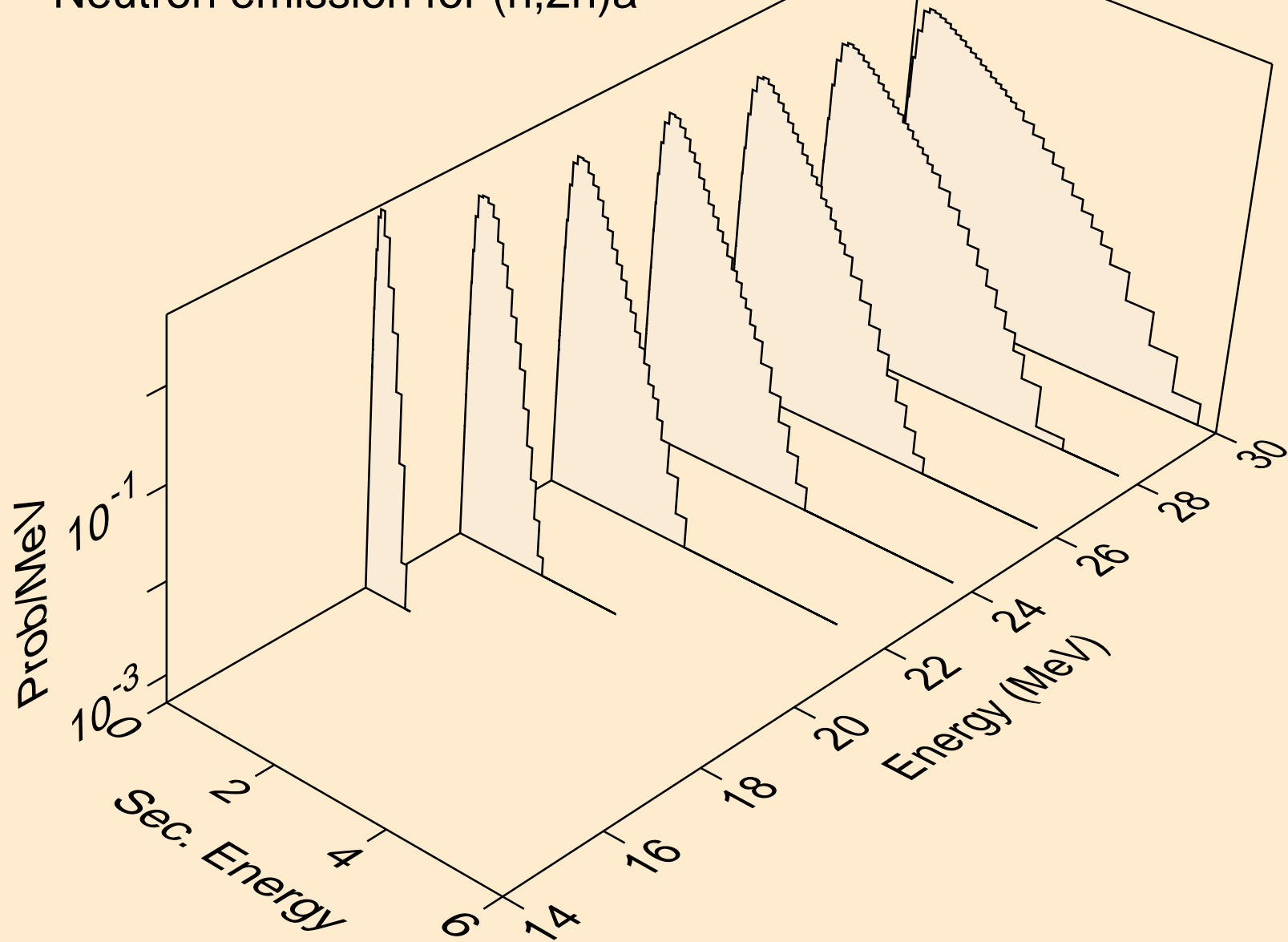

NB088 NEUTRON ACER TENDL-2023 LIBRARY; T=0.K  
Neutron emission for (n,n\*)p

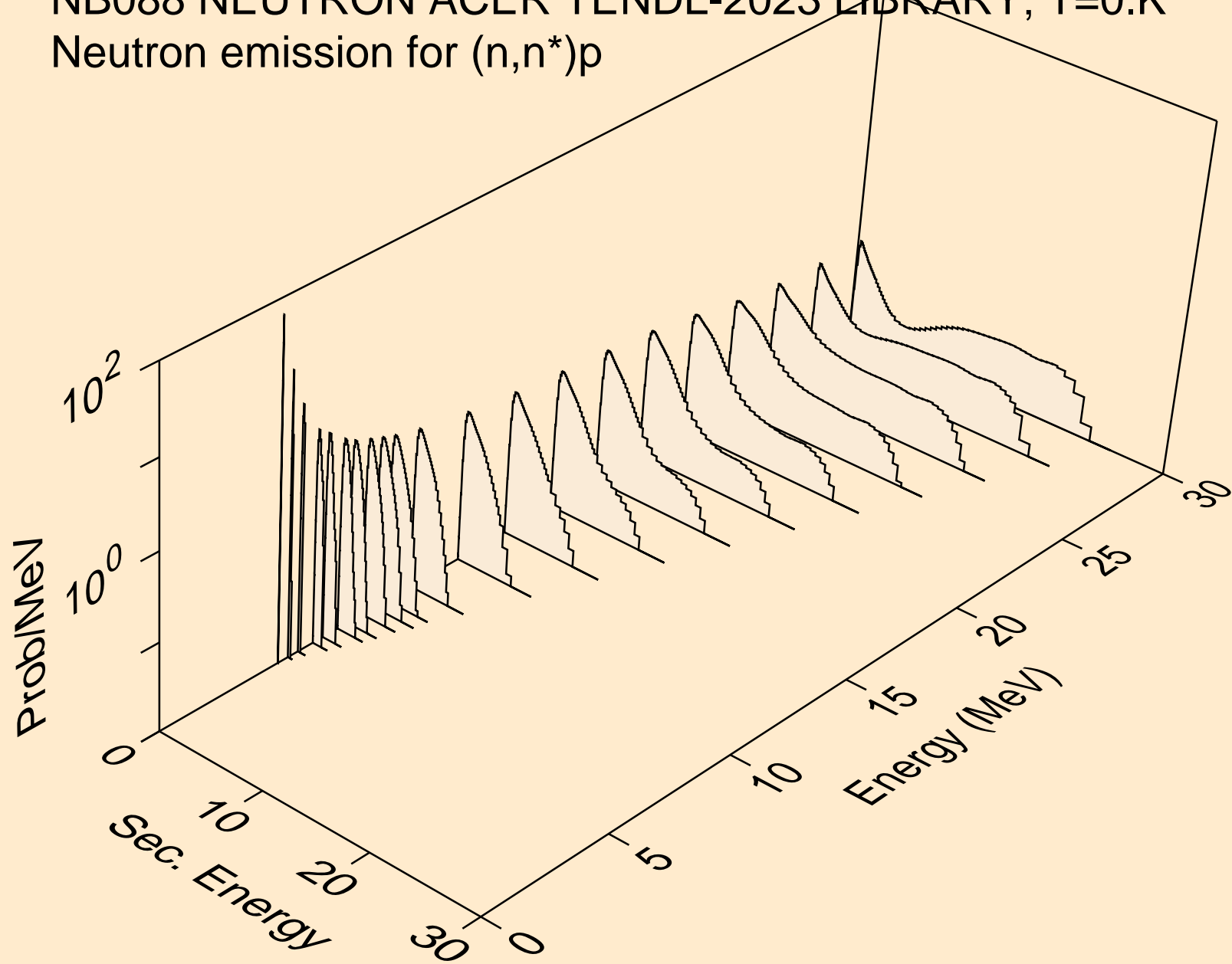

NB088 NEUTRON ACER TENDL-2023 LIBRARY; T=0.K  
Neutron emission for (n,n\*)2a

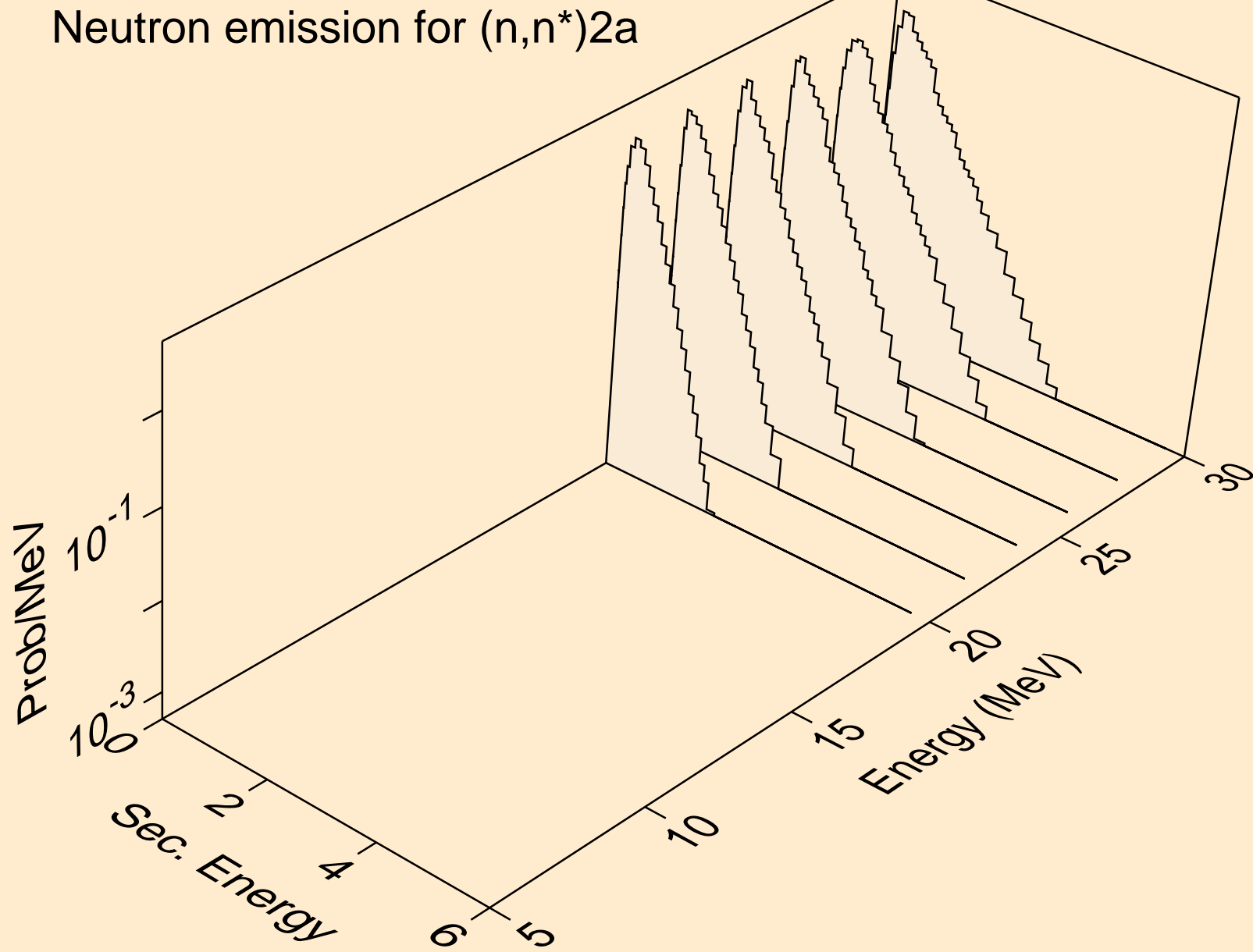

NB088 NEUTRON ACER TENDL-2023 LIBRARY; T=0.K  
Neutron emission for (n,n\*)d

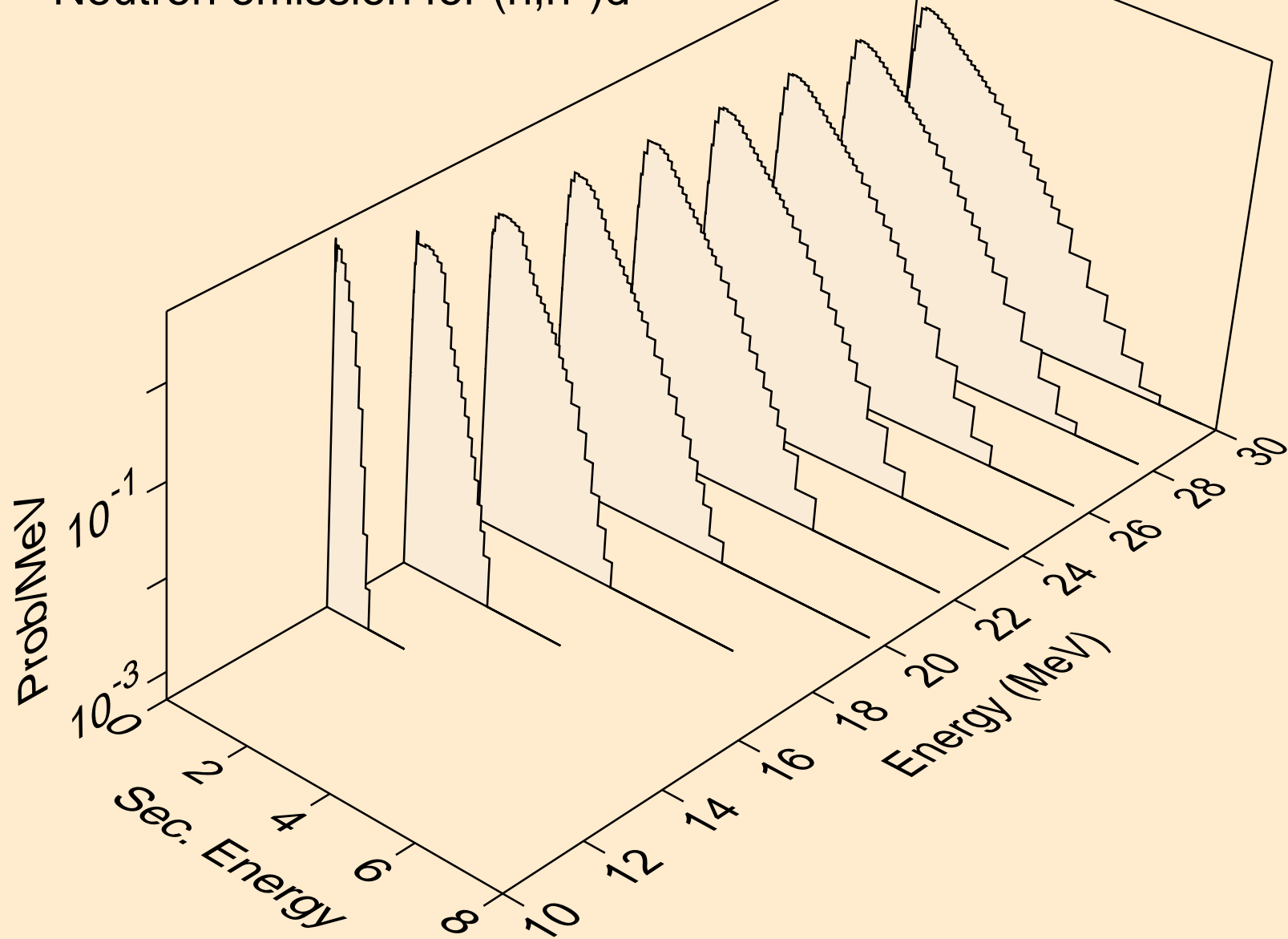

NB088 NEUTRON ACER TENDL-2023 LIBRARY; T=0.K  
Neutron emission for (n,n\*)t

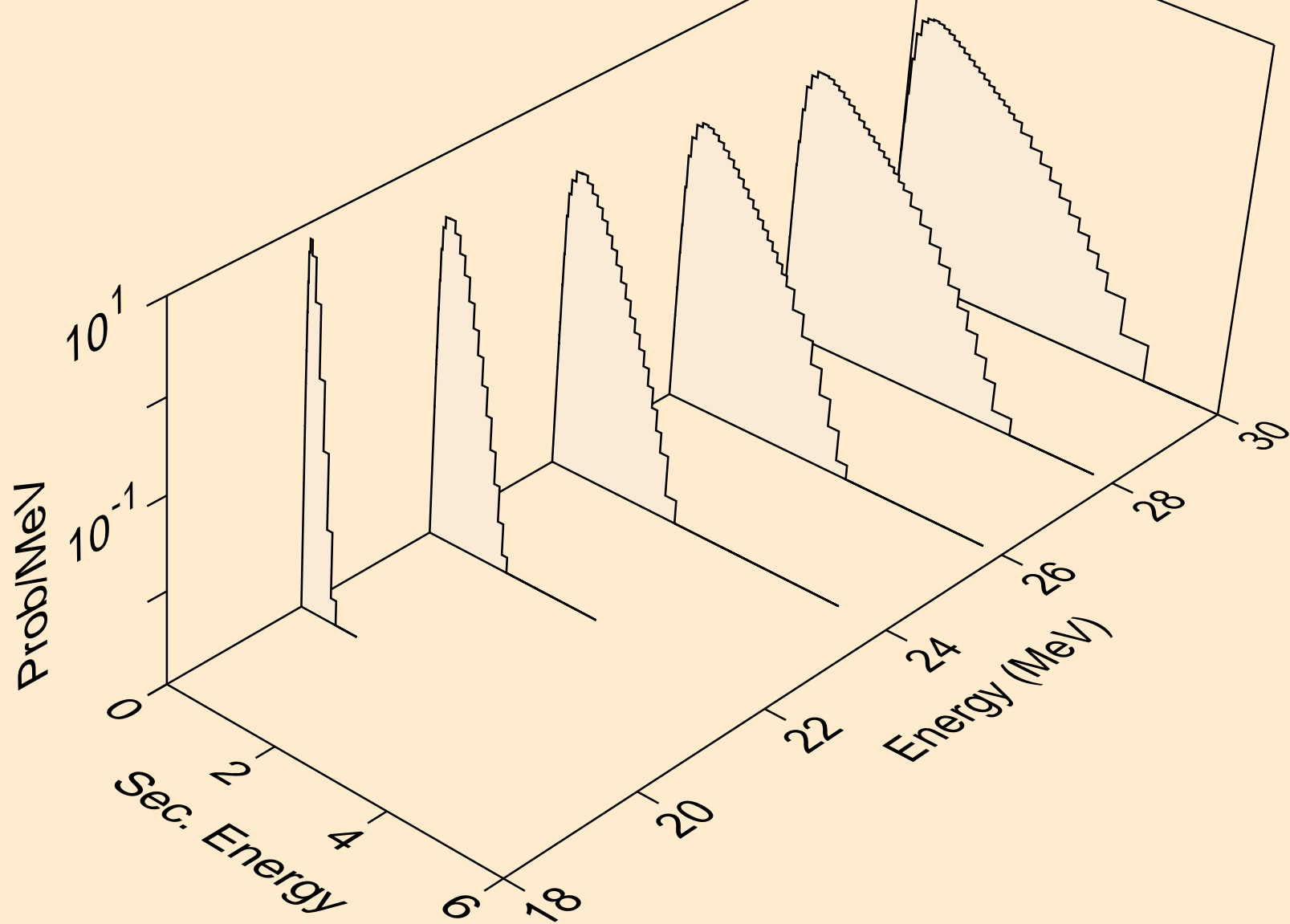

NB088 NEUTRON ACER TENDL-2023 LIBRARY; T=0.K  
Neutron emission for (n,n\*)he3

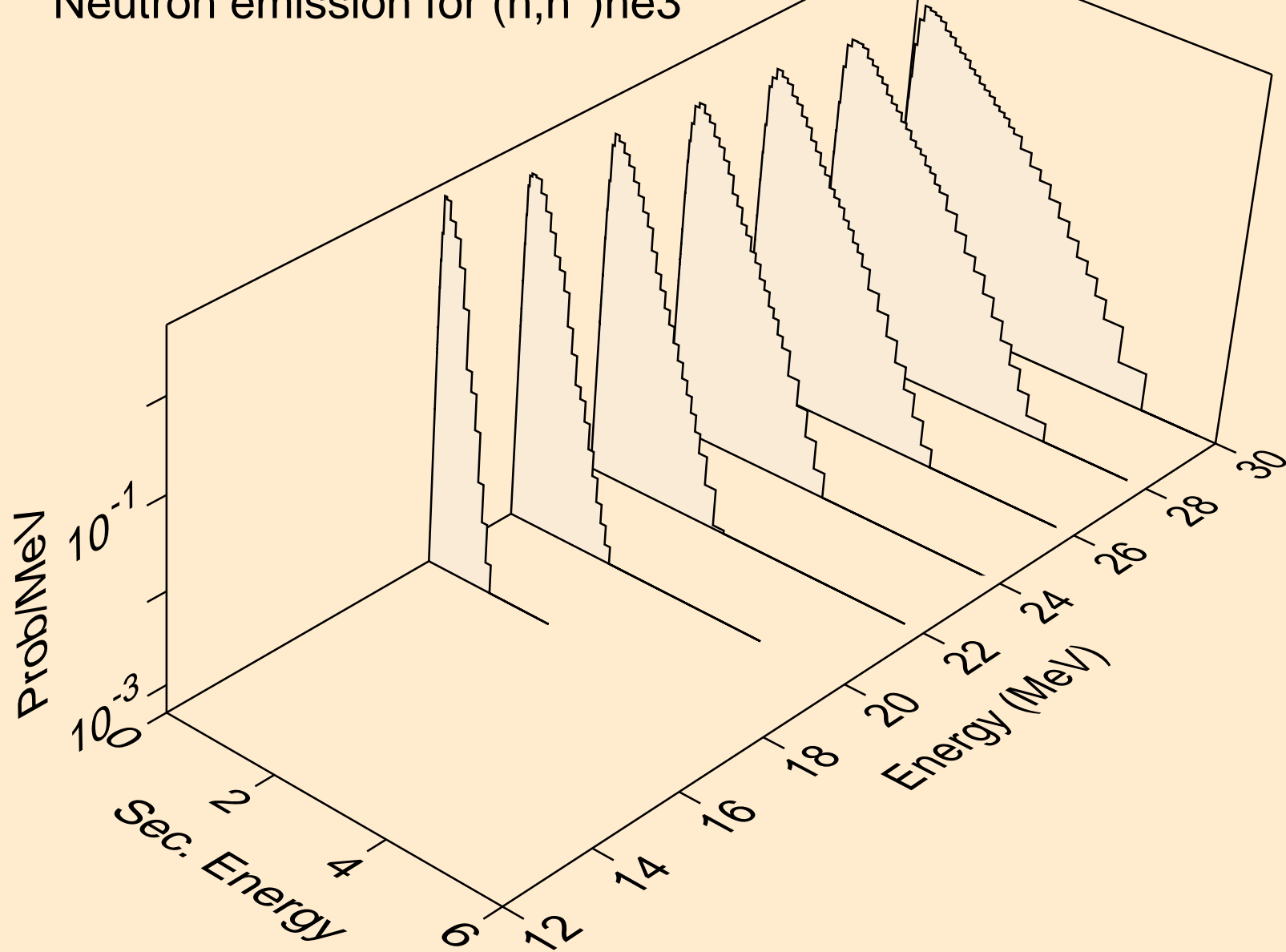

NB088 NEUTRON ACER TENDL-2023 LIBRARY; T=0.K  
Neutron emission for (n,2np)

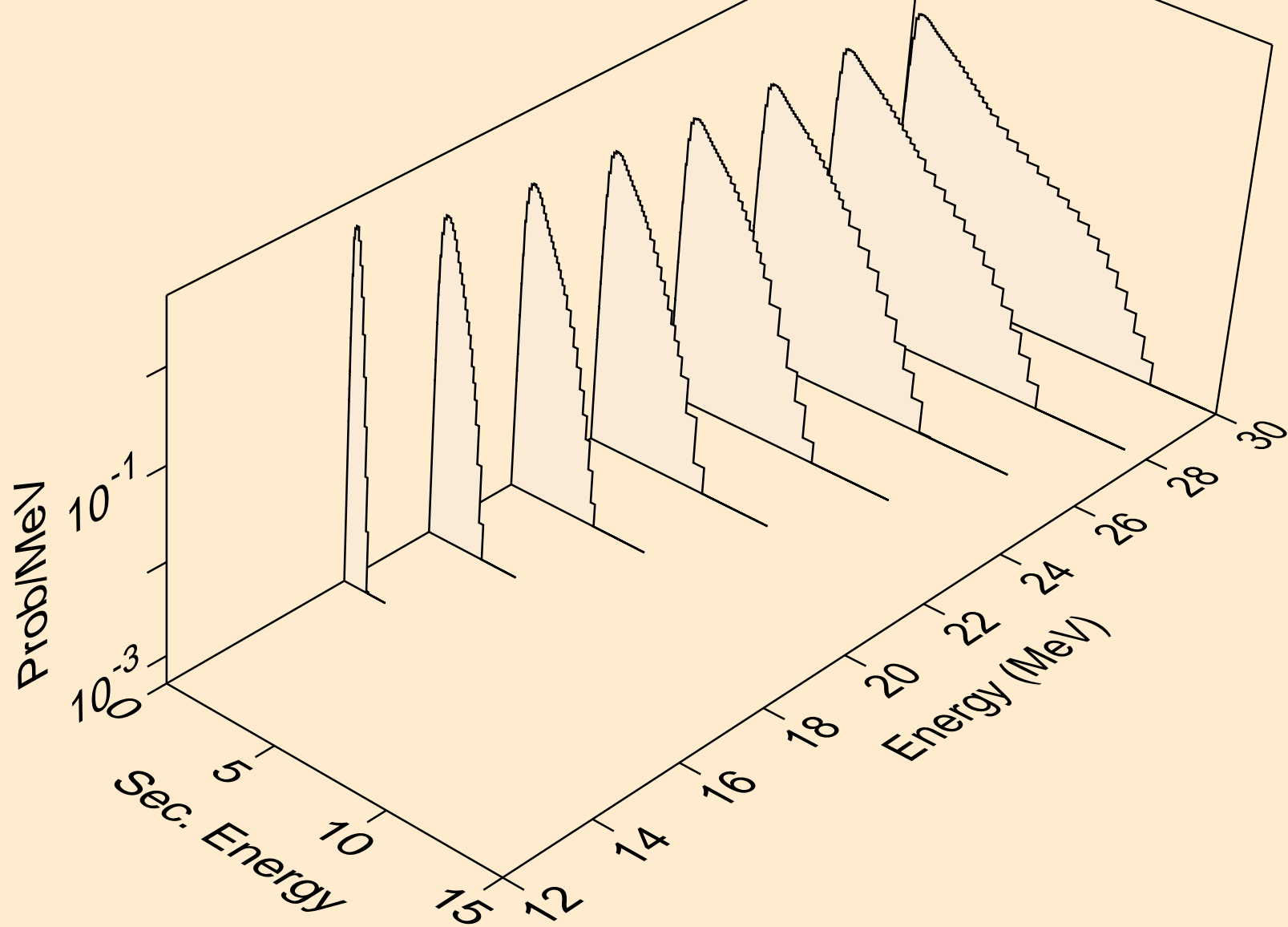



NB088 NEUTRON ACER TENDL-2023 LIBRARY; T=0.K  
Neutron emission for (n,3np)

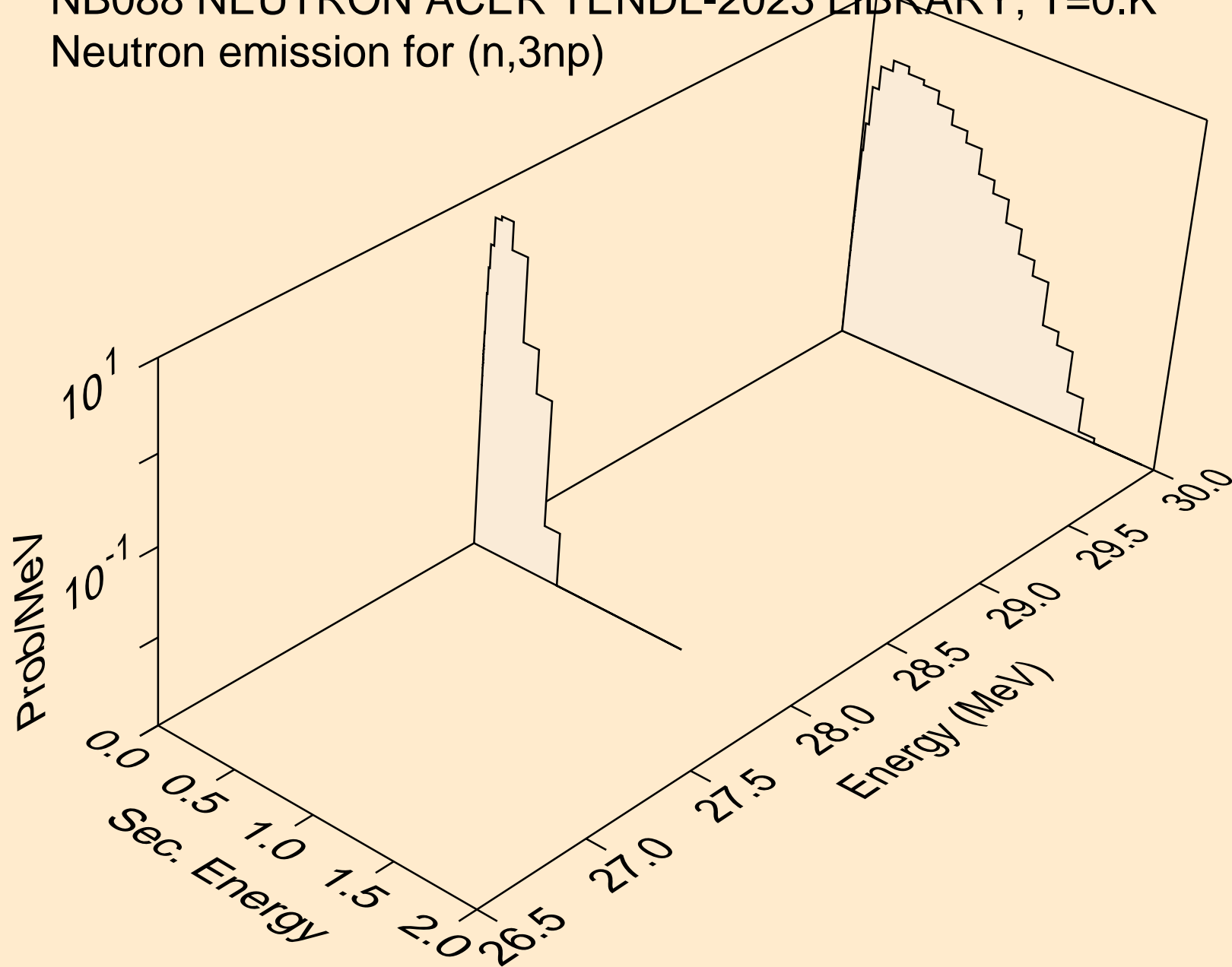

NB088 NEUTRON ACER TENDL-2023 LIBRARY; T=0.K  
Neutron emission for (n,n2p)

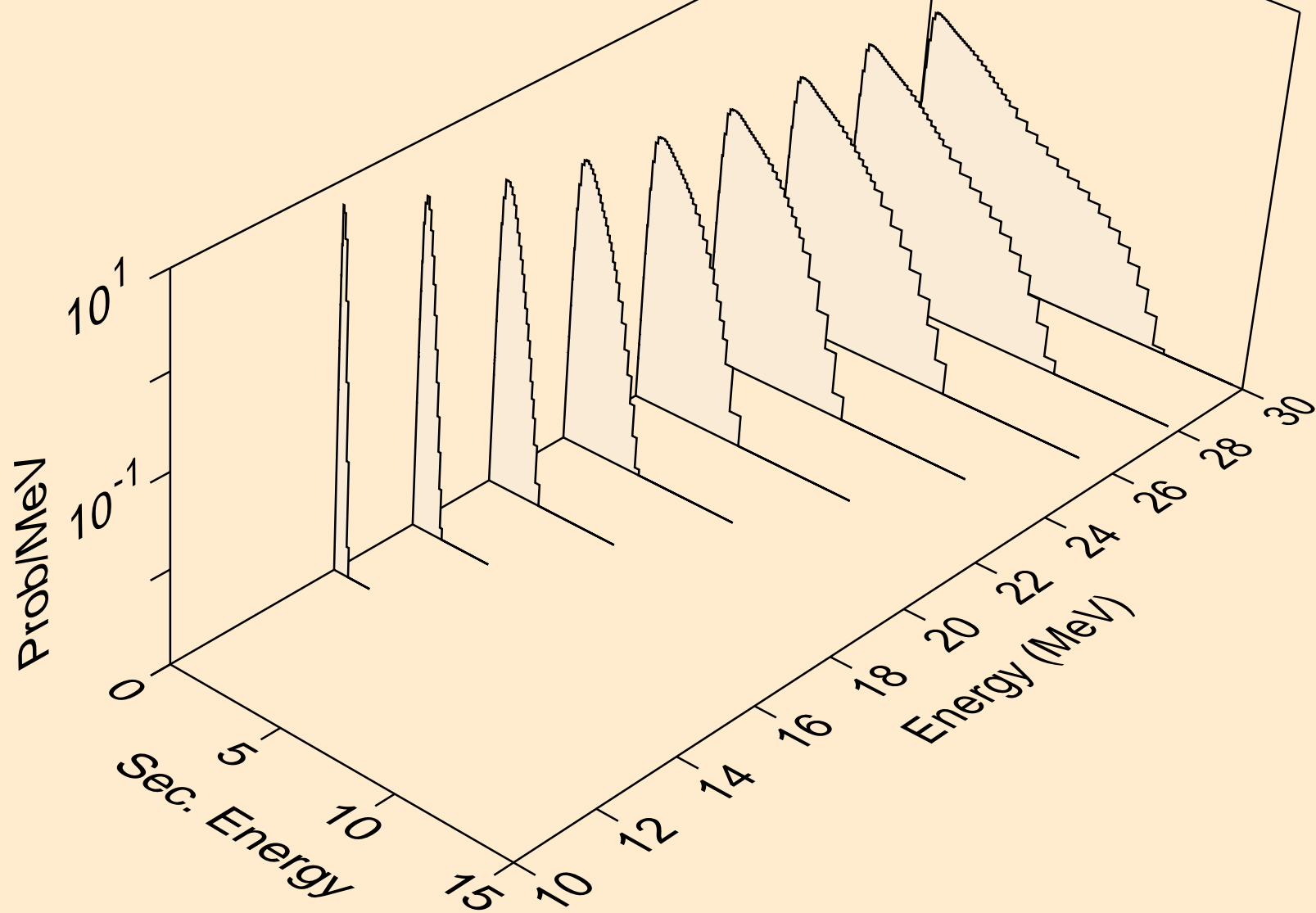

NB088 NEUTRON ACER TENDL-2023 LIBRARY; T=0.K  
Neutron emission for (n,npa)

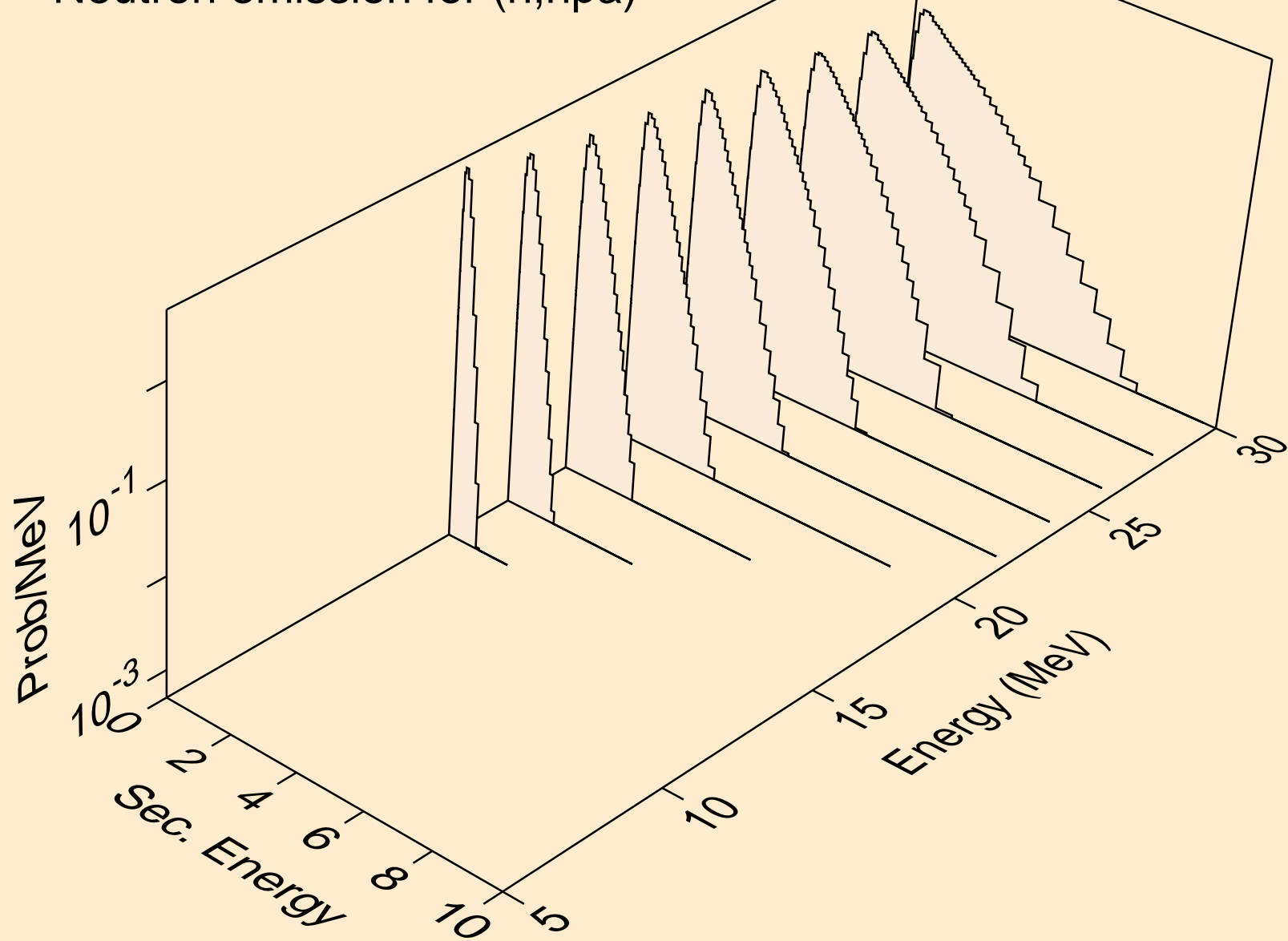

NB088 NEUTRON ACER TENDL-2023 LIBRARY; T=0.K  
Neutron emission for (n,n\*c)

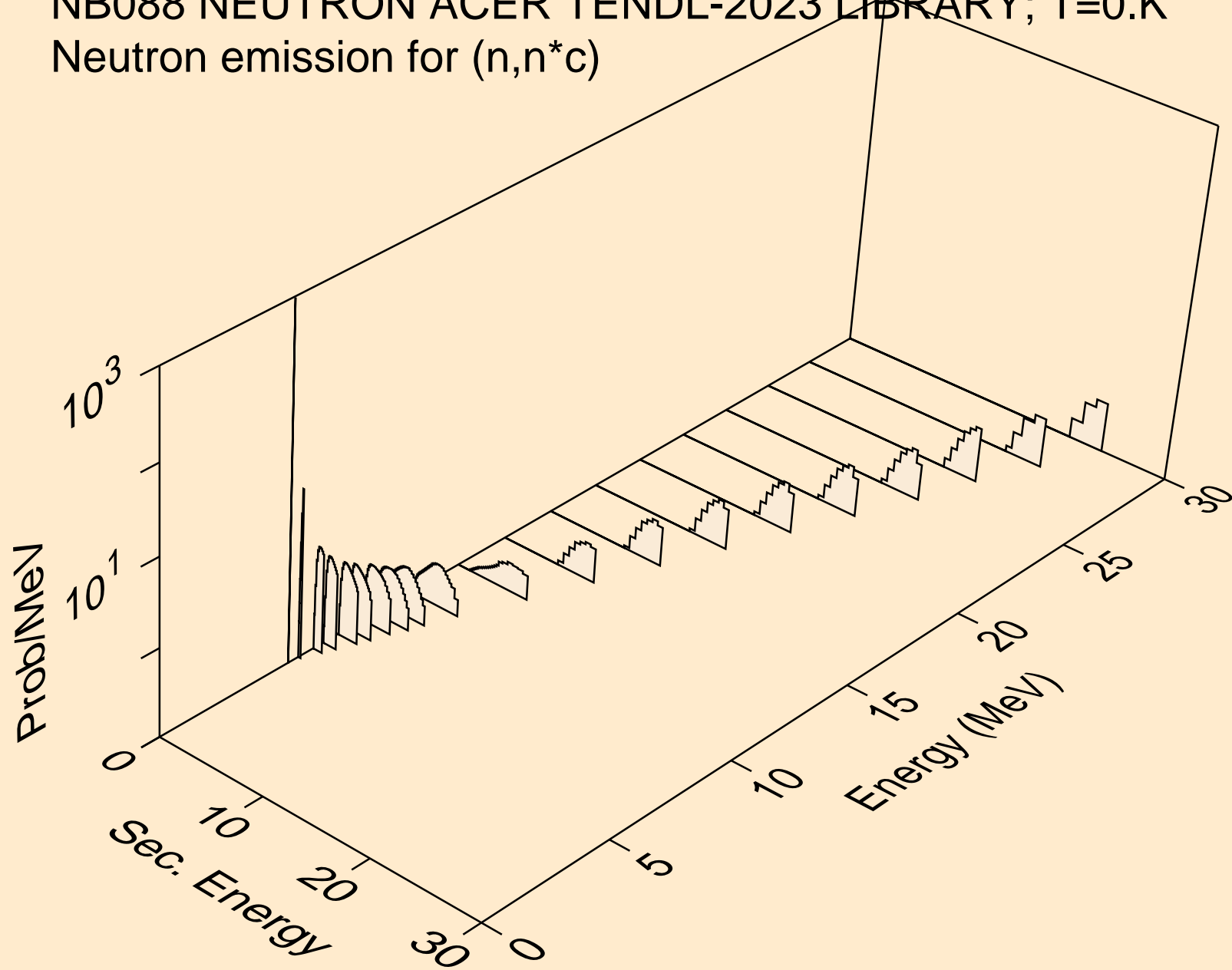

NB088 NEUTRON ACER TENDL-2023 LIBRARY; T=0.K  
Photon emission for (n,x)

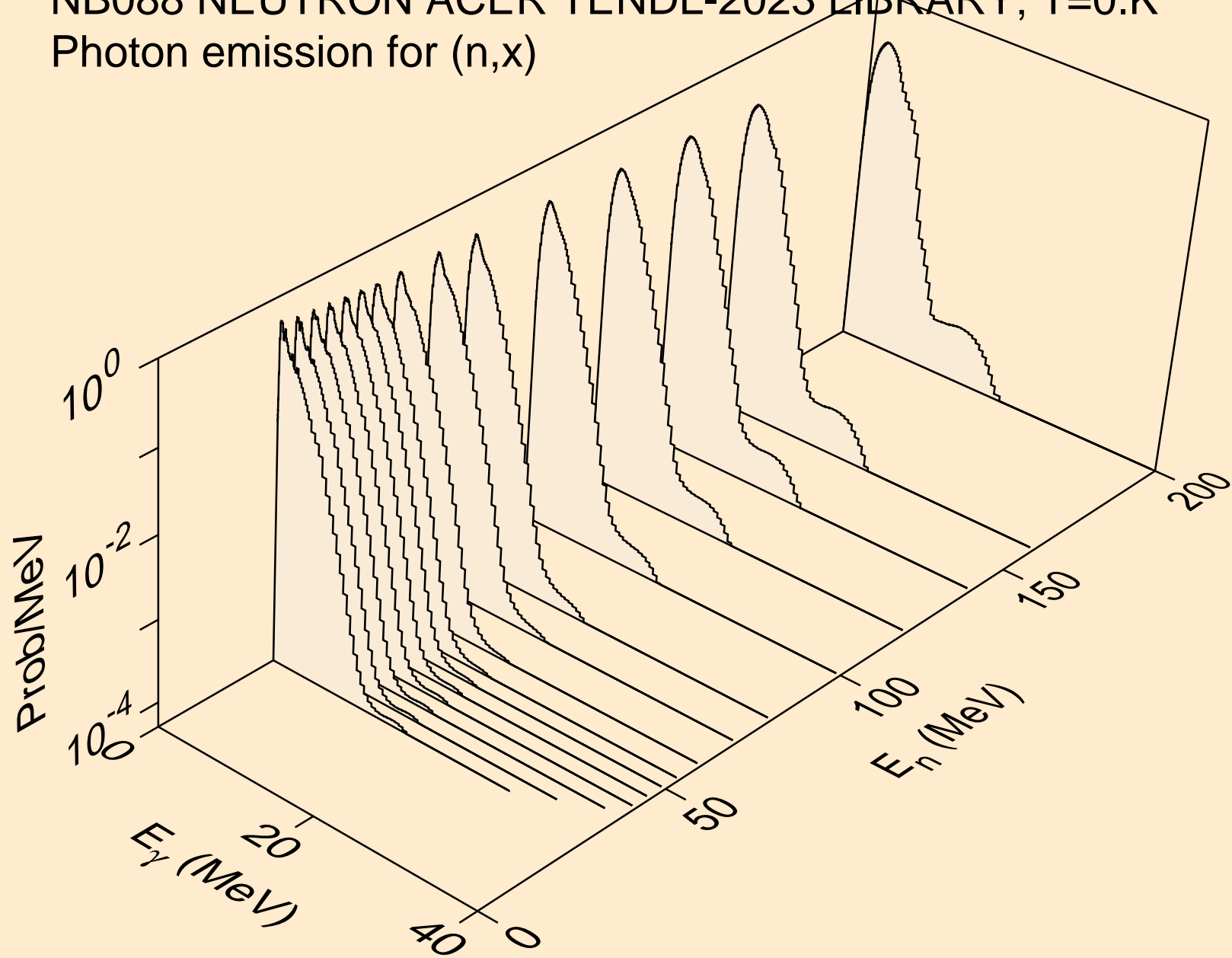

NB088 NEUTRON ACER TENDL-2023 LIBRARY; T=0.K  
Photon emission for (n,2nd)

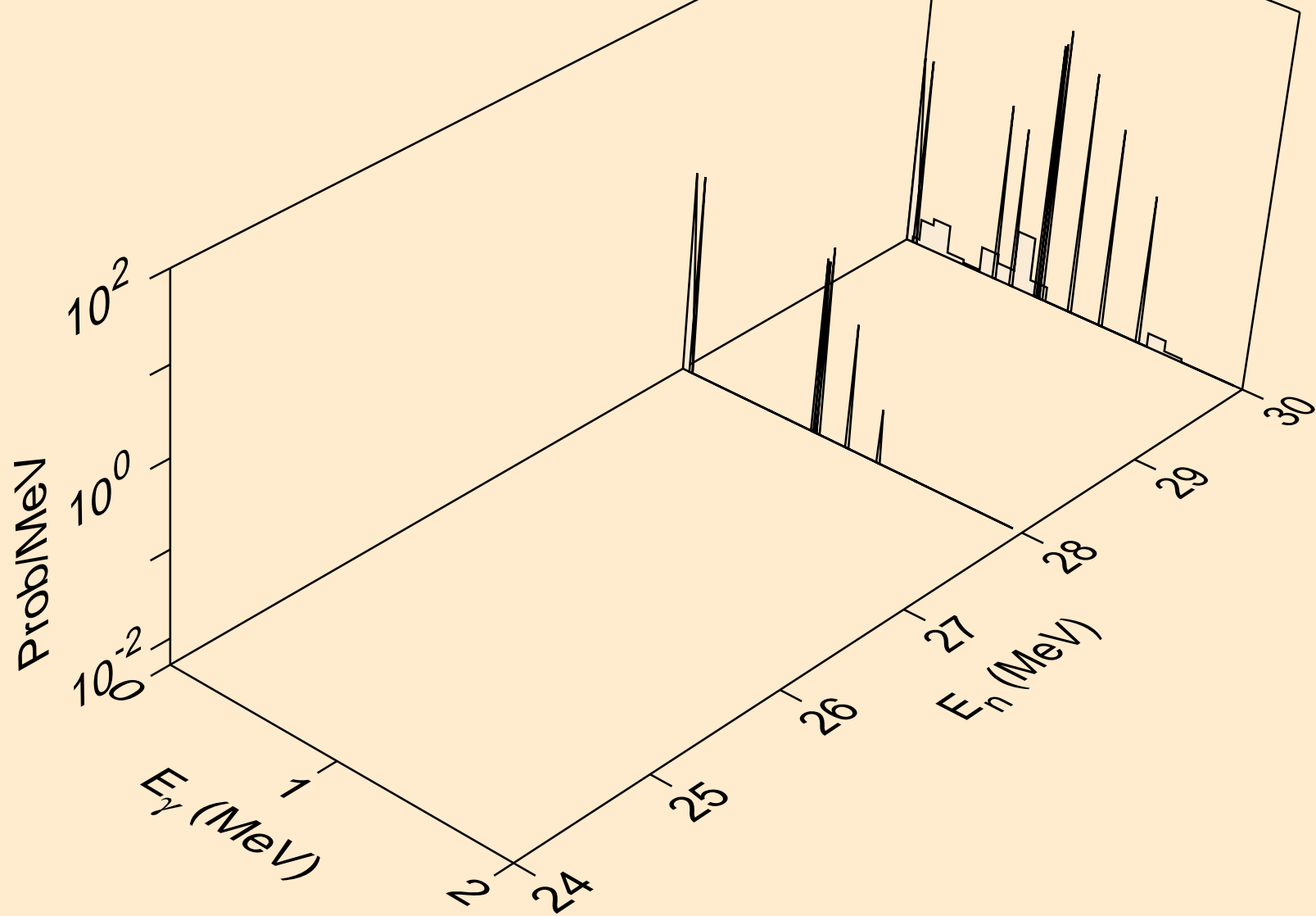

NB088 NEUTRON ACER TENDL-2023 LIBRARY; T=0.K  
Photon emission for (n,2n)

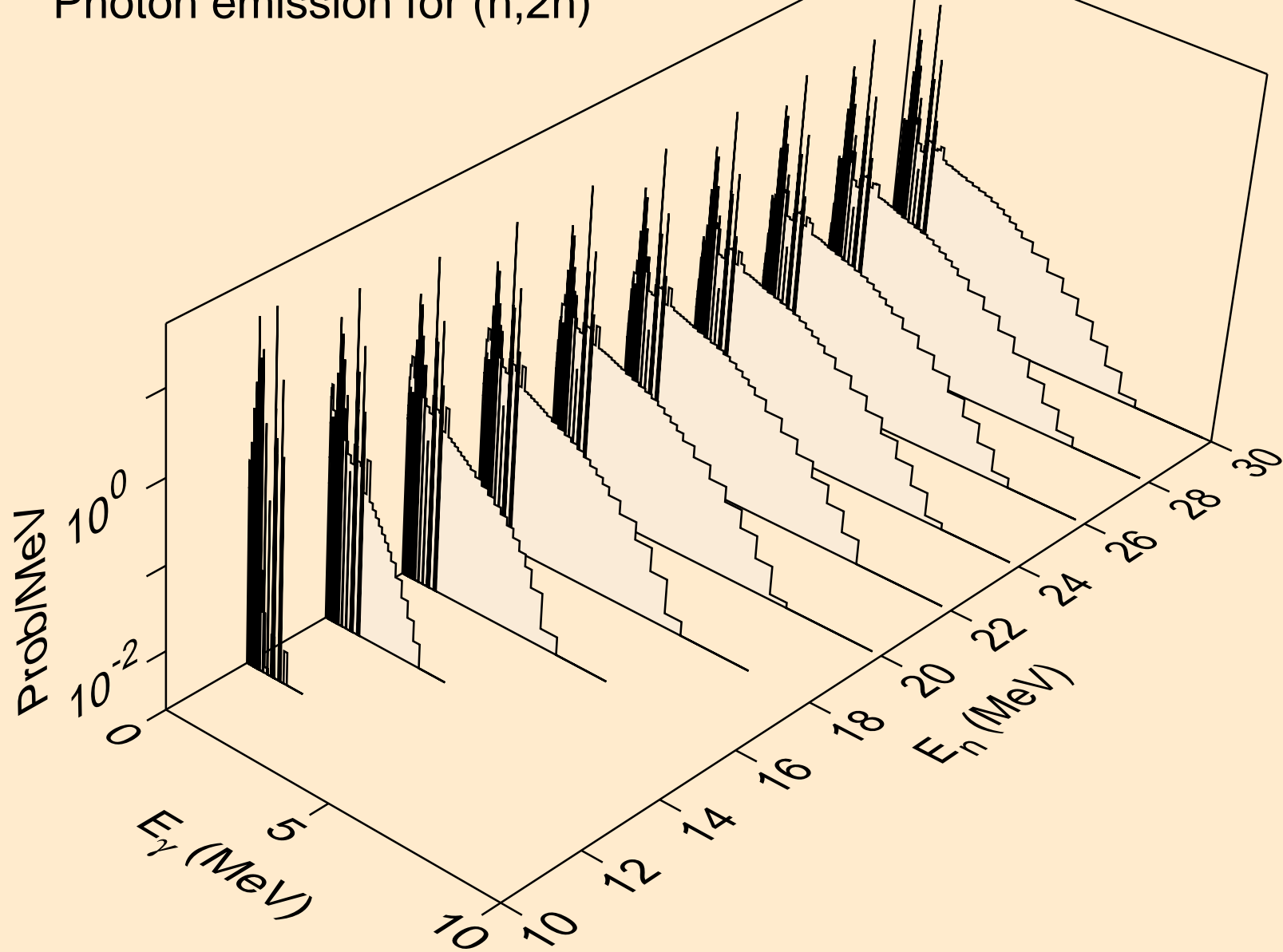

NB088 NEUTRON ACER TENDL-2023 LIBRARY; T=0.K  
Photon emission for (n,3n)

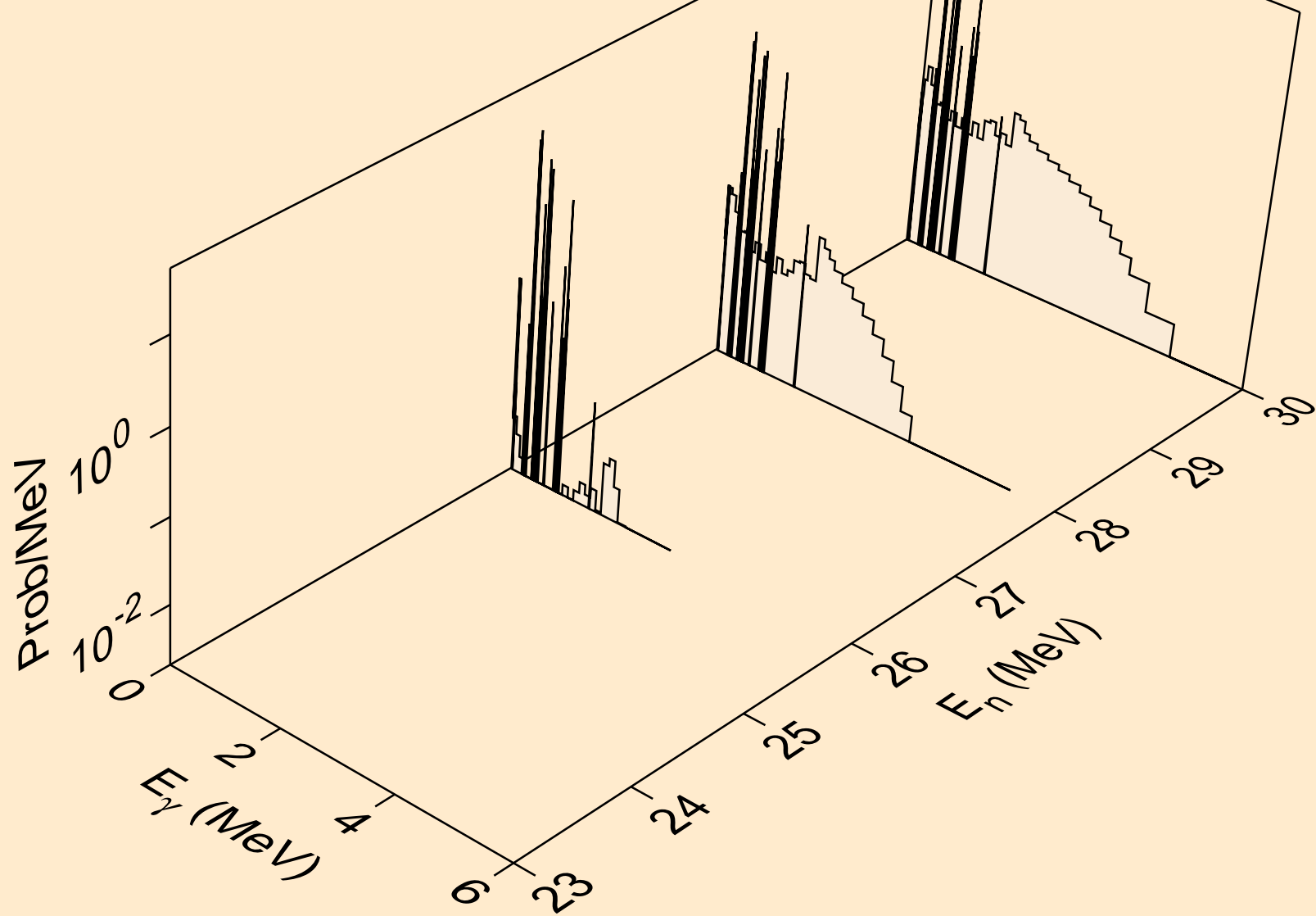



NB088 NEUTRON ACER TENDL-2023 LIBRARY; T=0.K  
Photon emission for (n,n\*)a

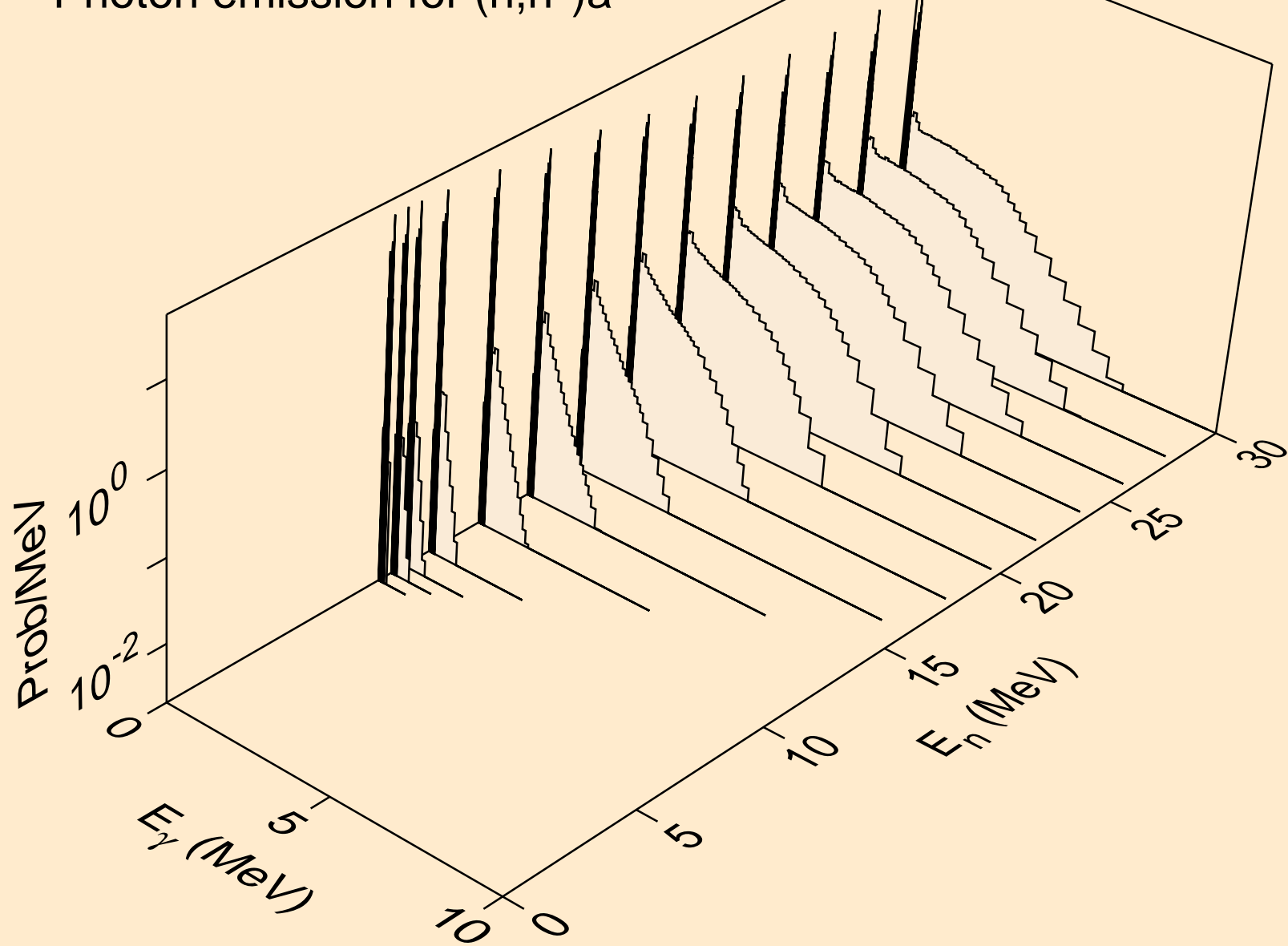

NB088 NEUTRON ACER TENDL-2023 LIBRARY; T=0.K  
Photon emission for (n,2n)a

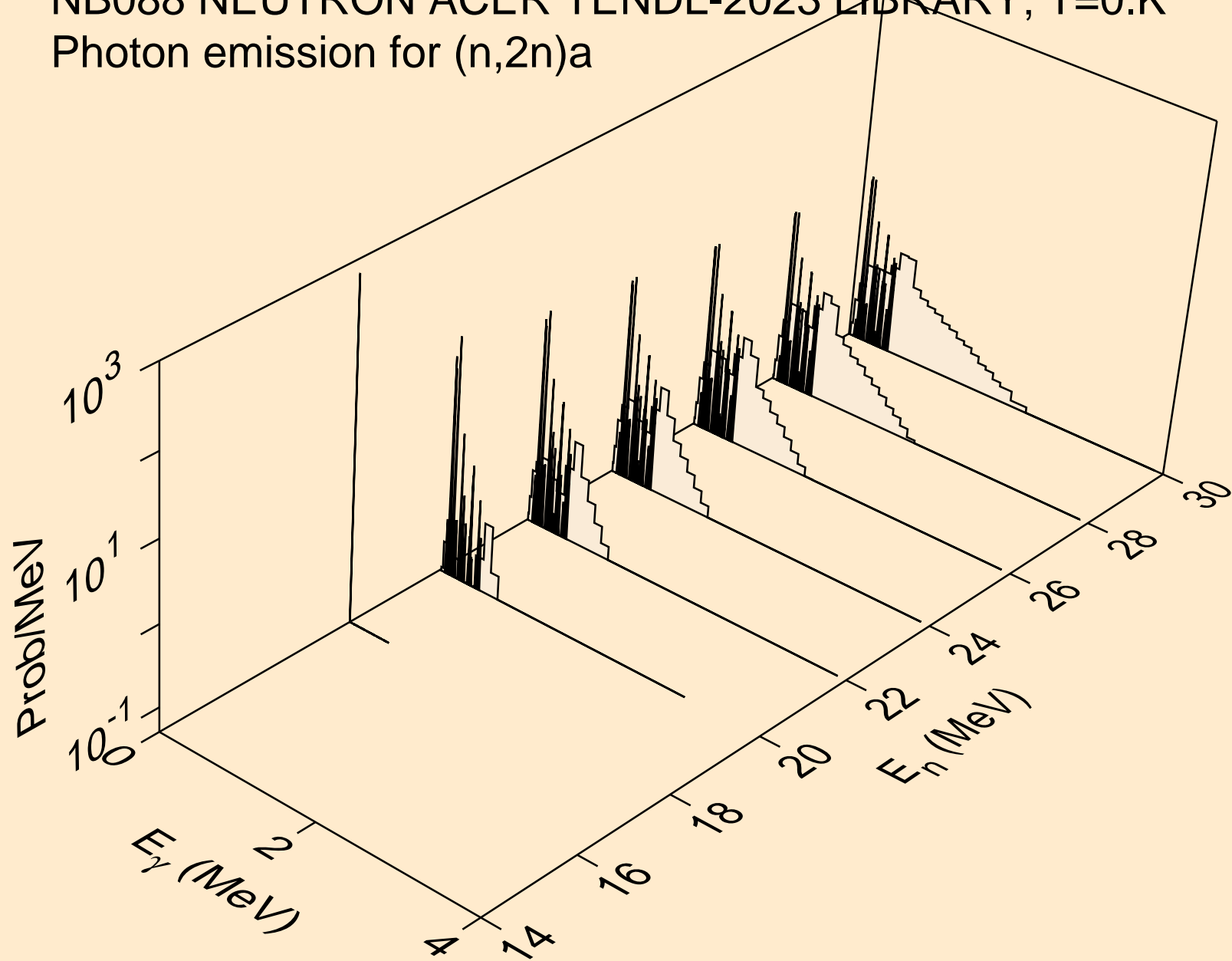

NB088 NEUTRON ACER TENDL-2023 LIBRARY; T=0.K  
Photon emission for (n,n\*)p

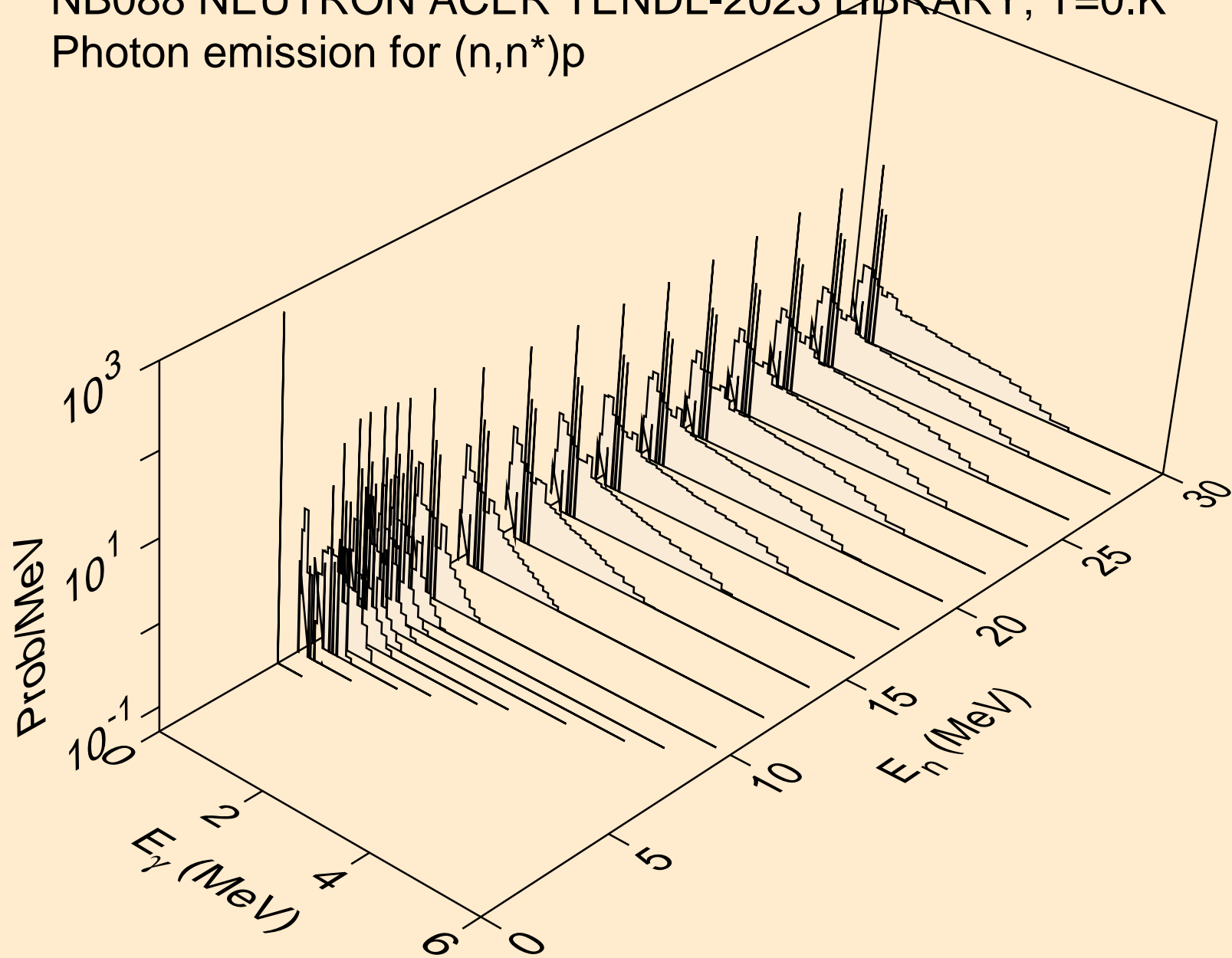

NB088 NEUTRON ACER TENDL-2023 LIBRARY; T=0.K  
Photon emission for (n,n\*)2a

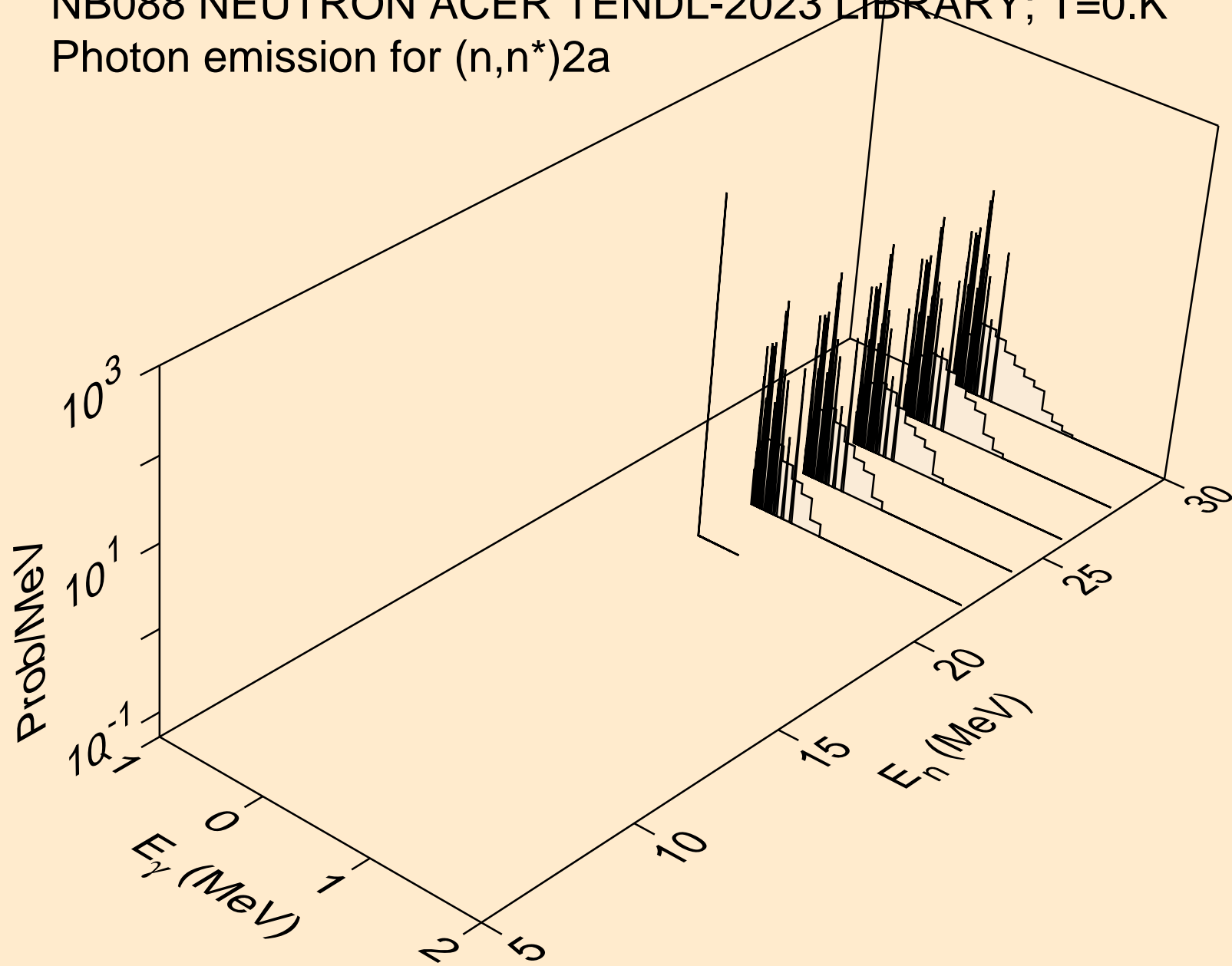

NB088 NEUTRON ACER TENDL-2023 LIBRARY; T=0.K  
Photon emission for (n,n\*)d

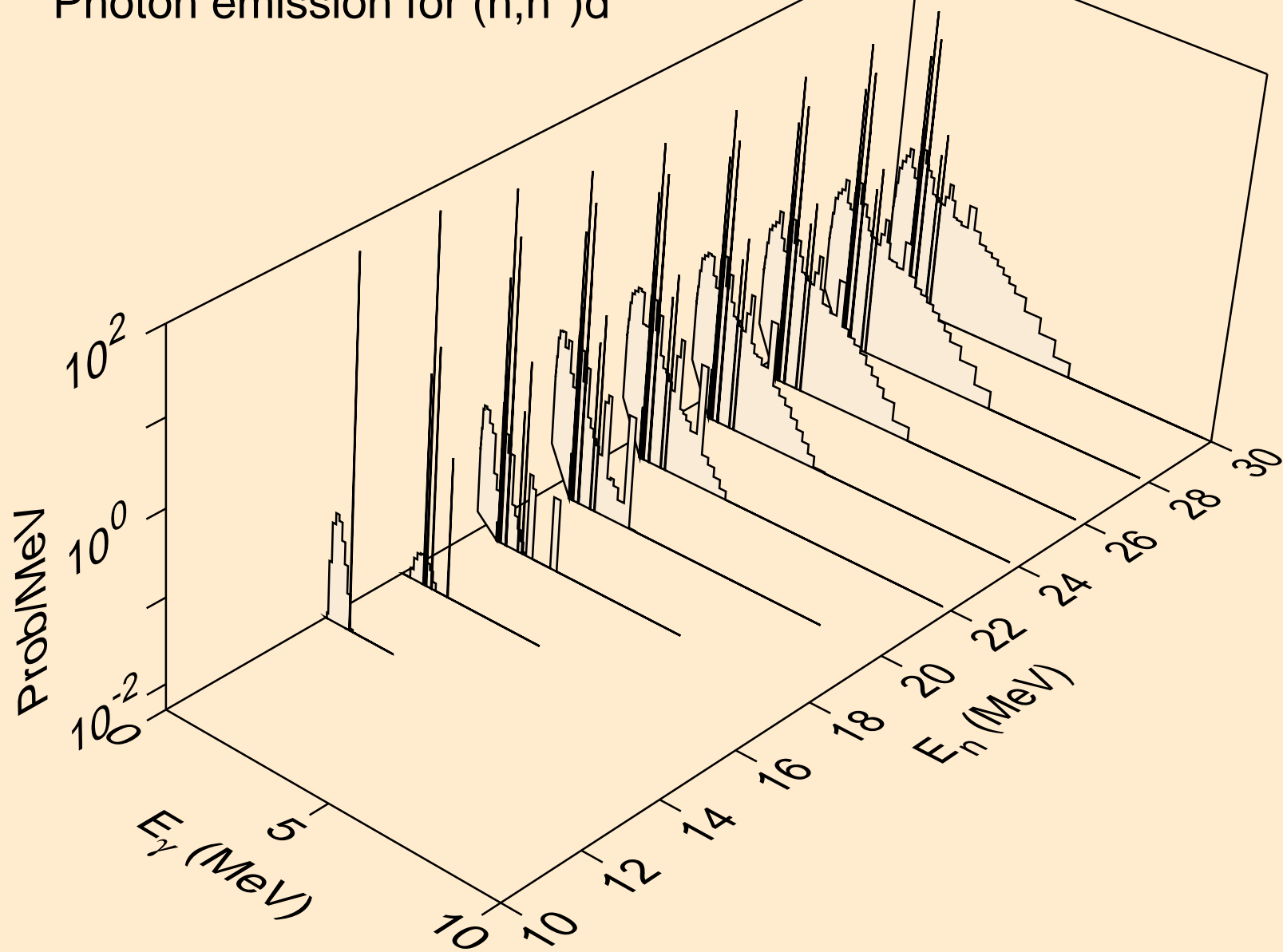

NB088 NEUTRON ACER TENDL-2023 LIBRARY; T=0.K  
Photon emission for (n,n\*)t

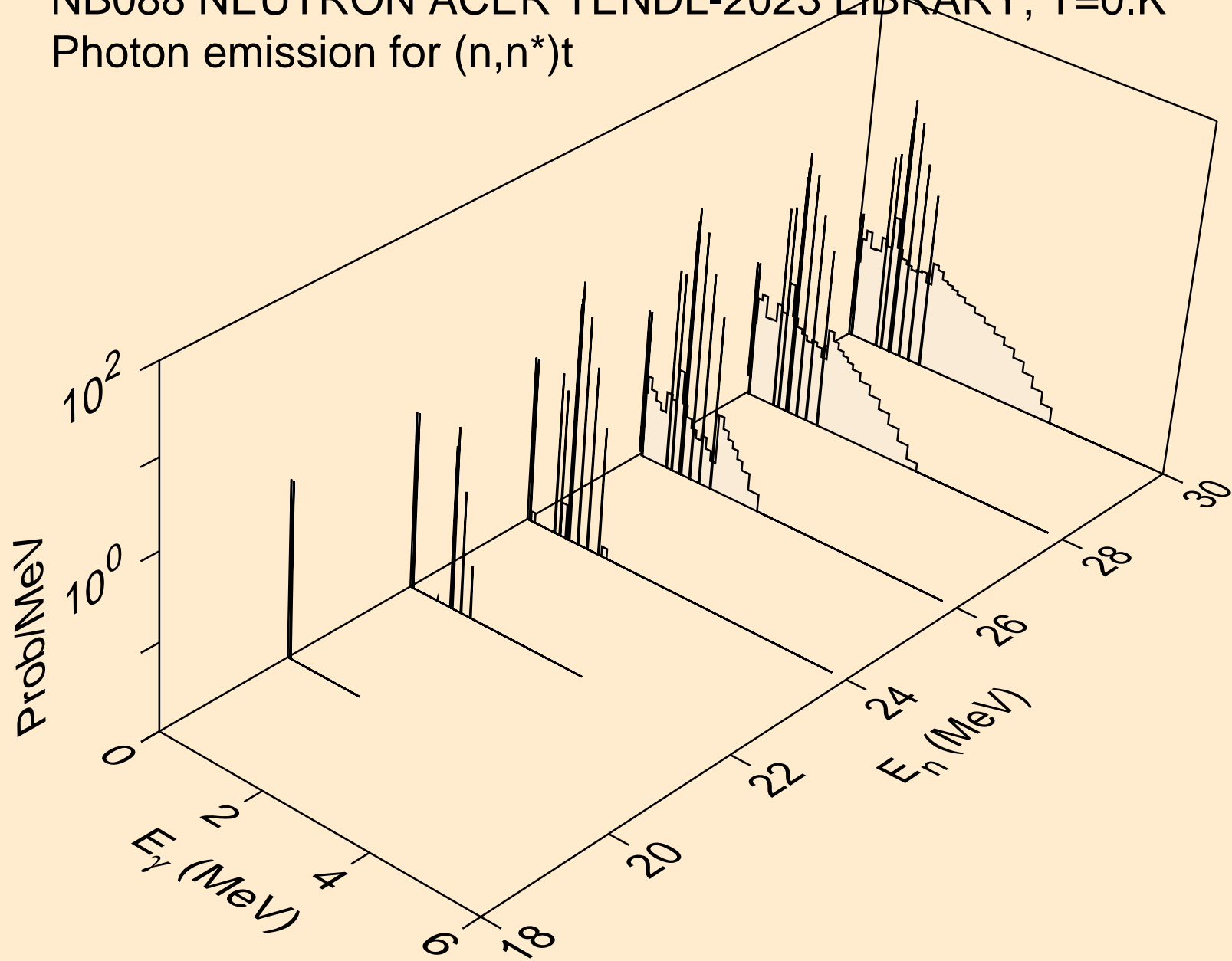

NB088 NEUTRON ACER TENDL-2023 LIBRARY; T=0.K  
Photon emission for (n,n\*)he3

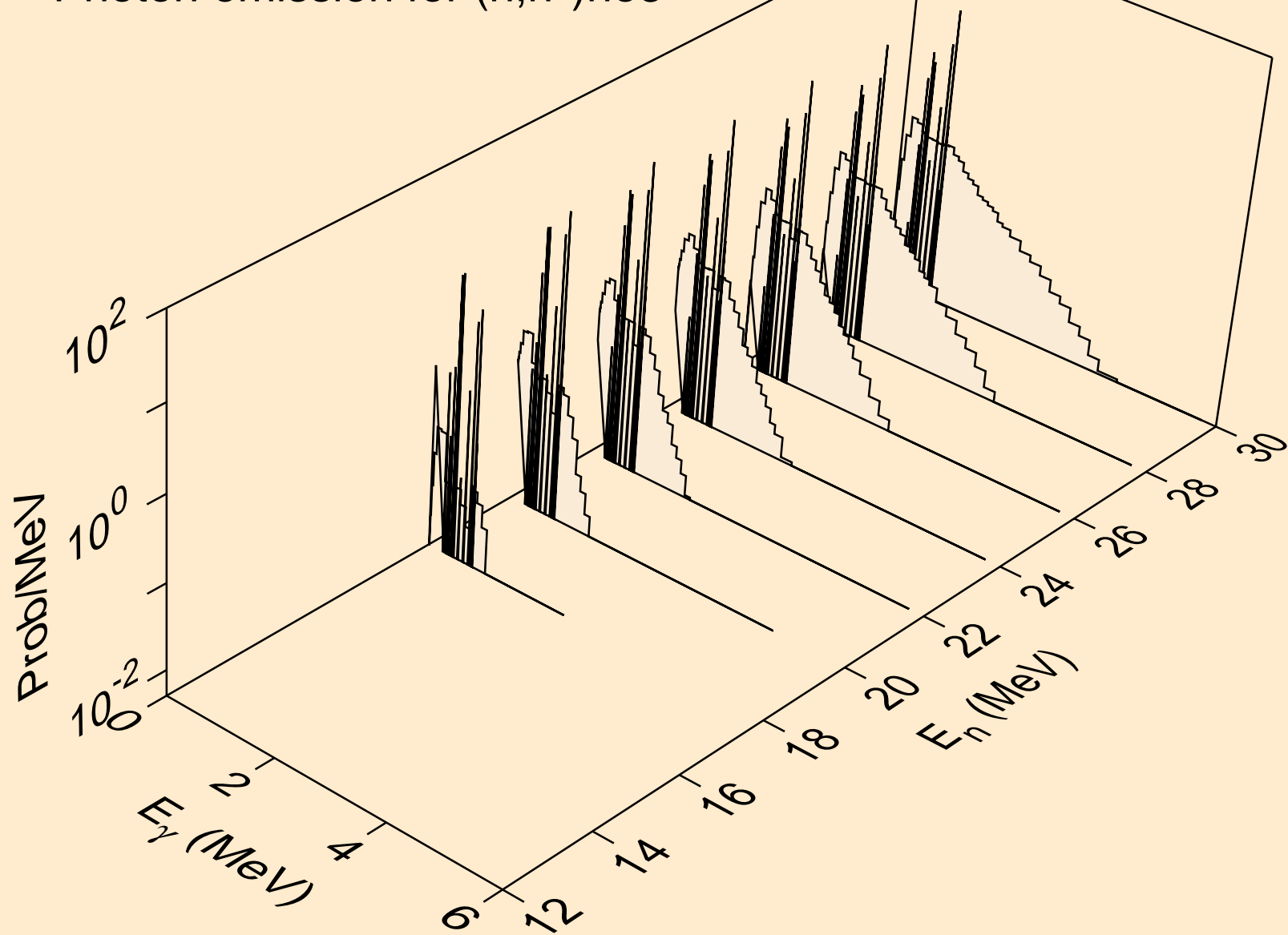

NB088 NEUTRON ACER TENDL-2023 LIBRARY; T=0.K  
Photon emission for (n,2np)

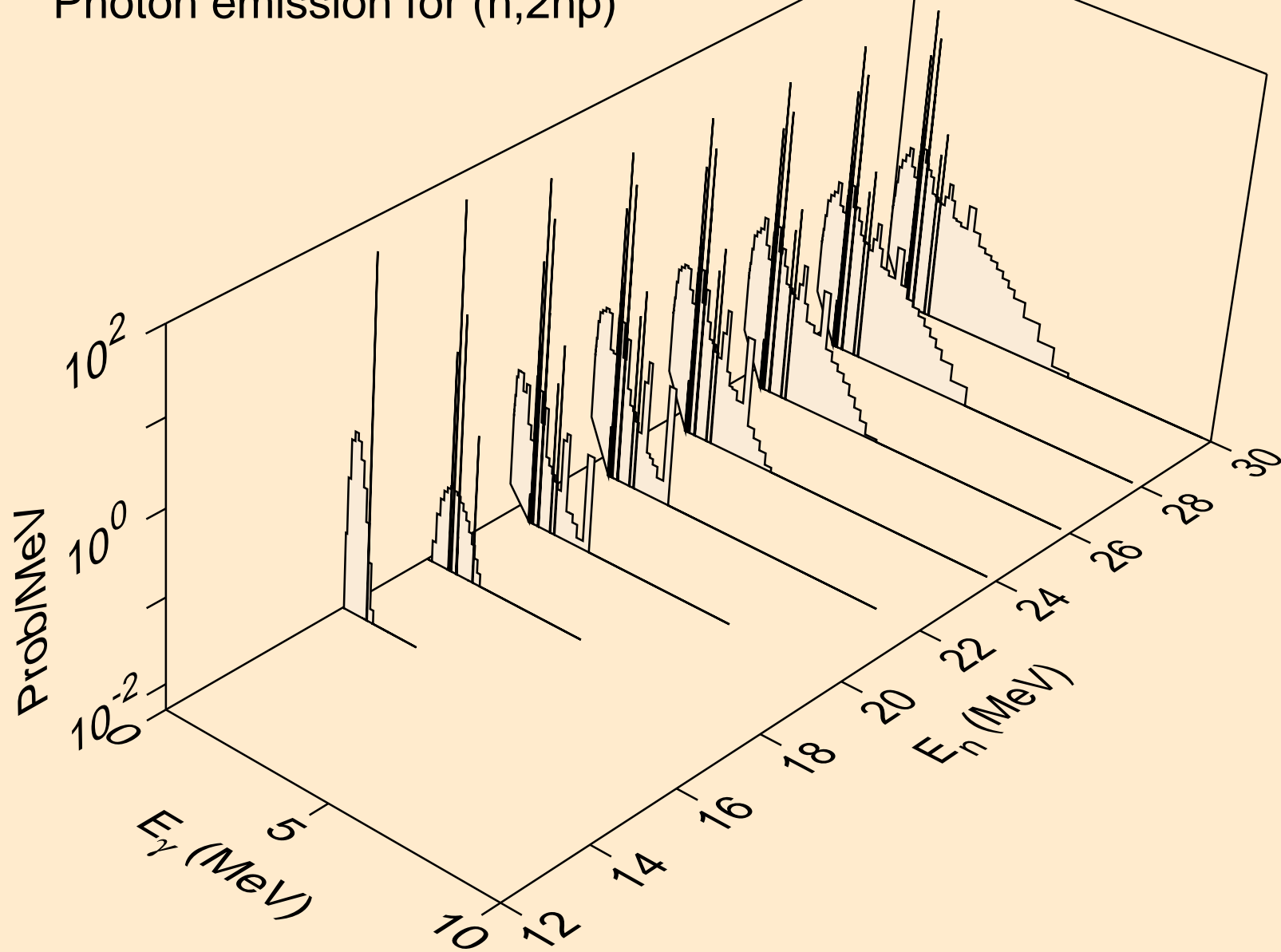



NB088 NEUTRON ACER TENDL-2023 LIBRARY; T=0.K  
Photon emission for (n,3np)

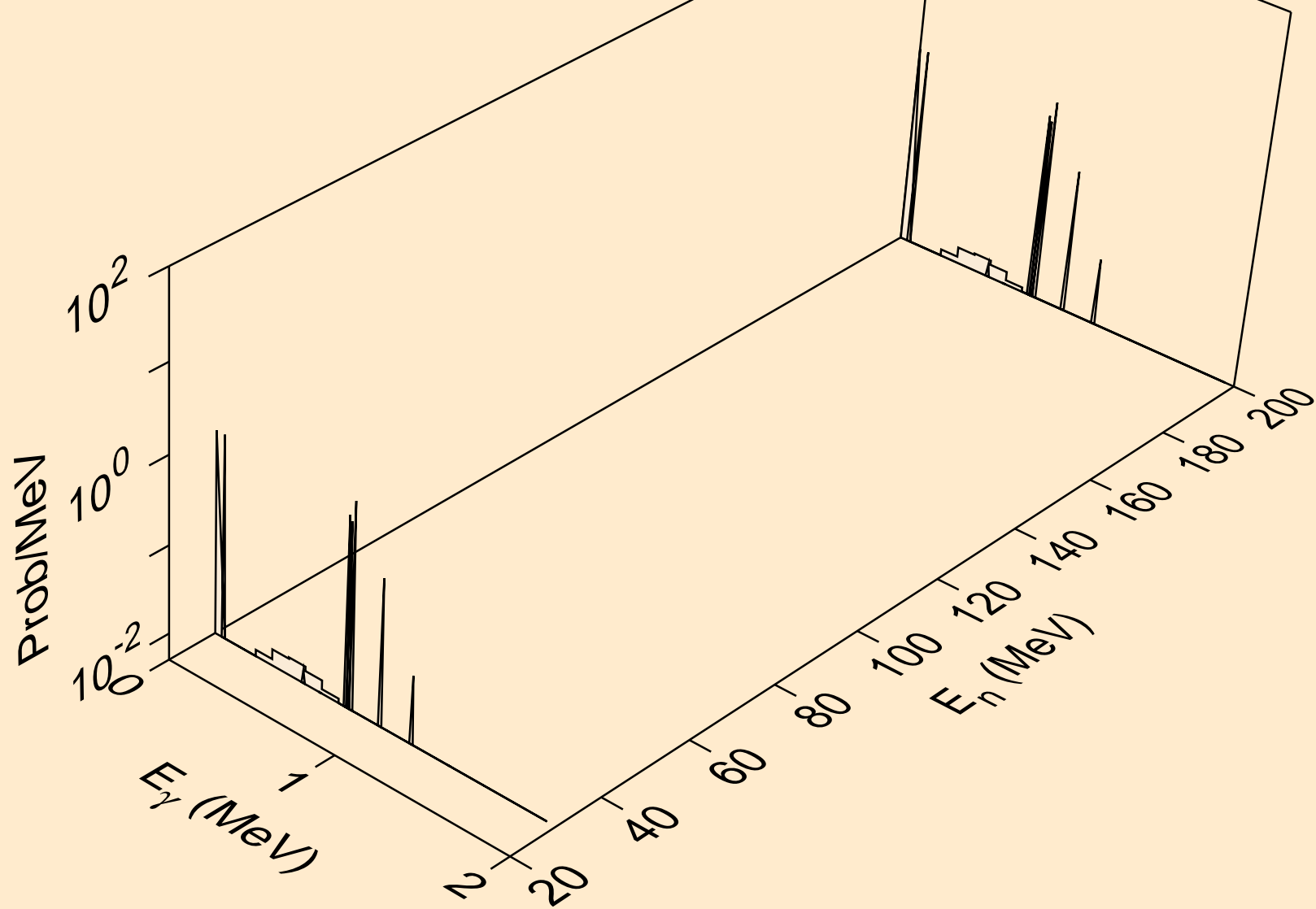

NB088 NEUTRON ACER TENDL-2023 LIBRARY; T=0.K  
Photon emission for (n,n2p)

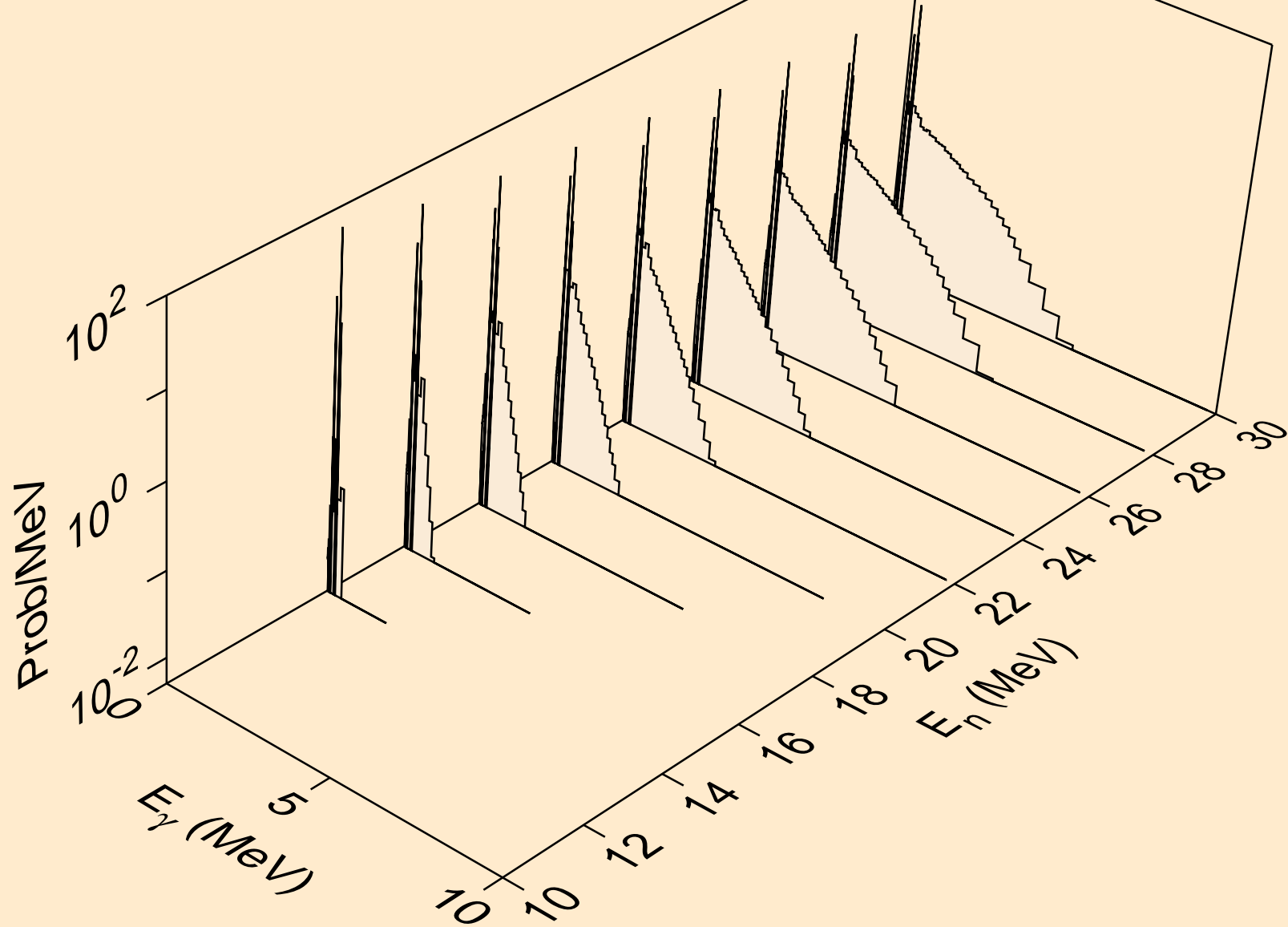

NB088 NEUTRON ACER TENDL-2023 LIBRARY; T=0.K  
Photon emission for (n,npa)

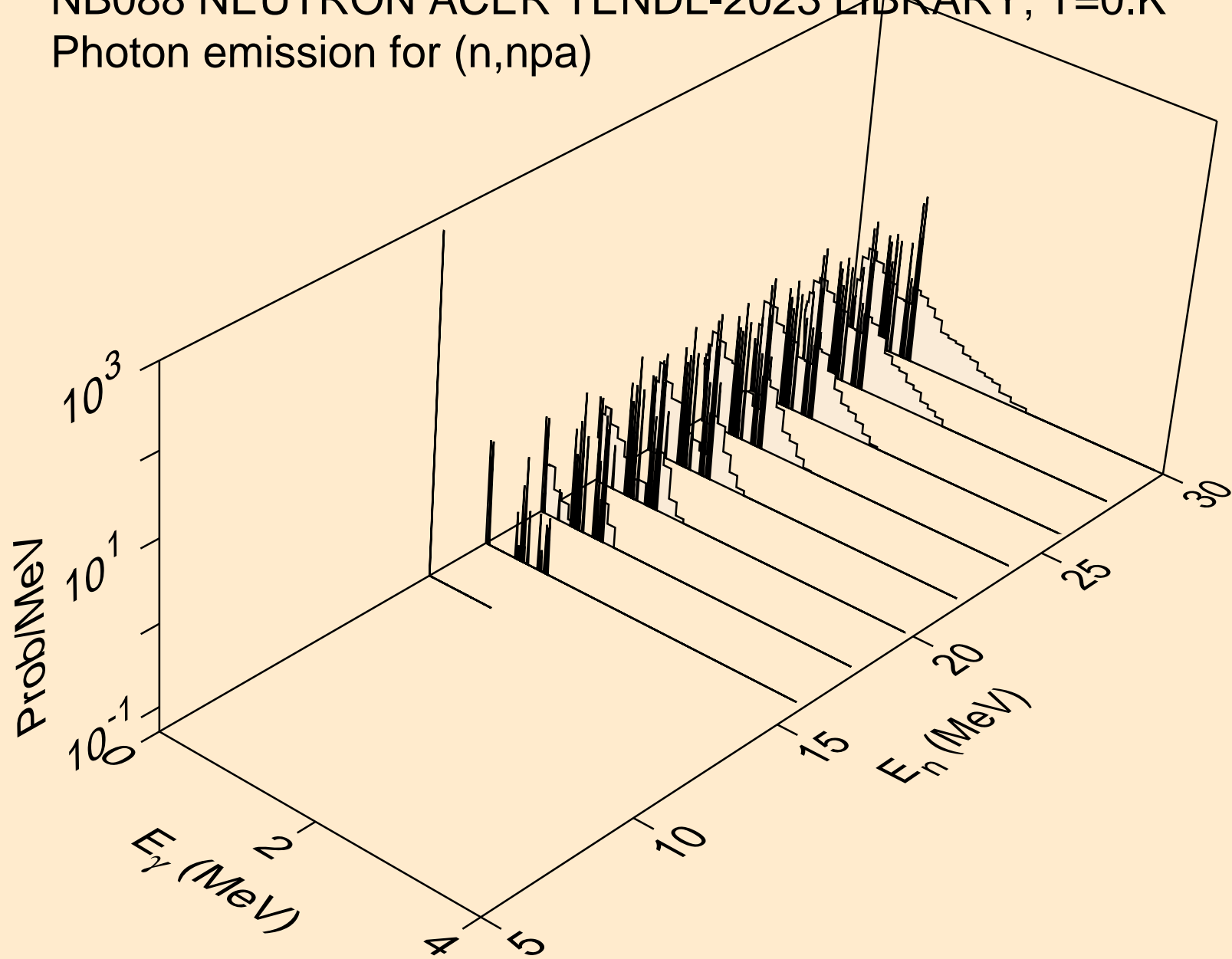

NB088 NEUTRON ACER TENDL-2023 LIBRARY; T=0.K  
Photon emission for (n,n\*c)

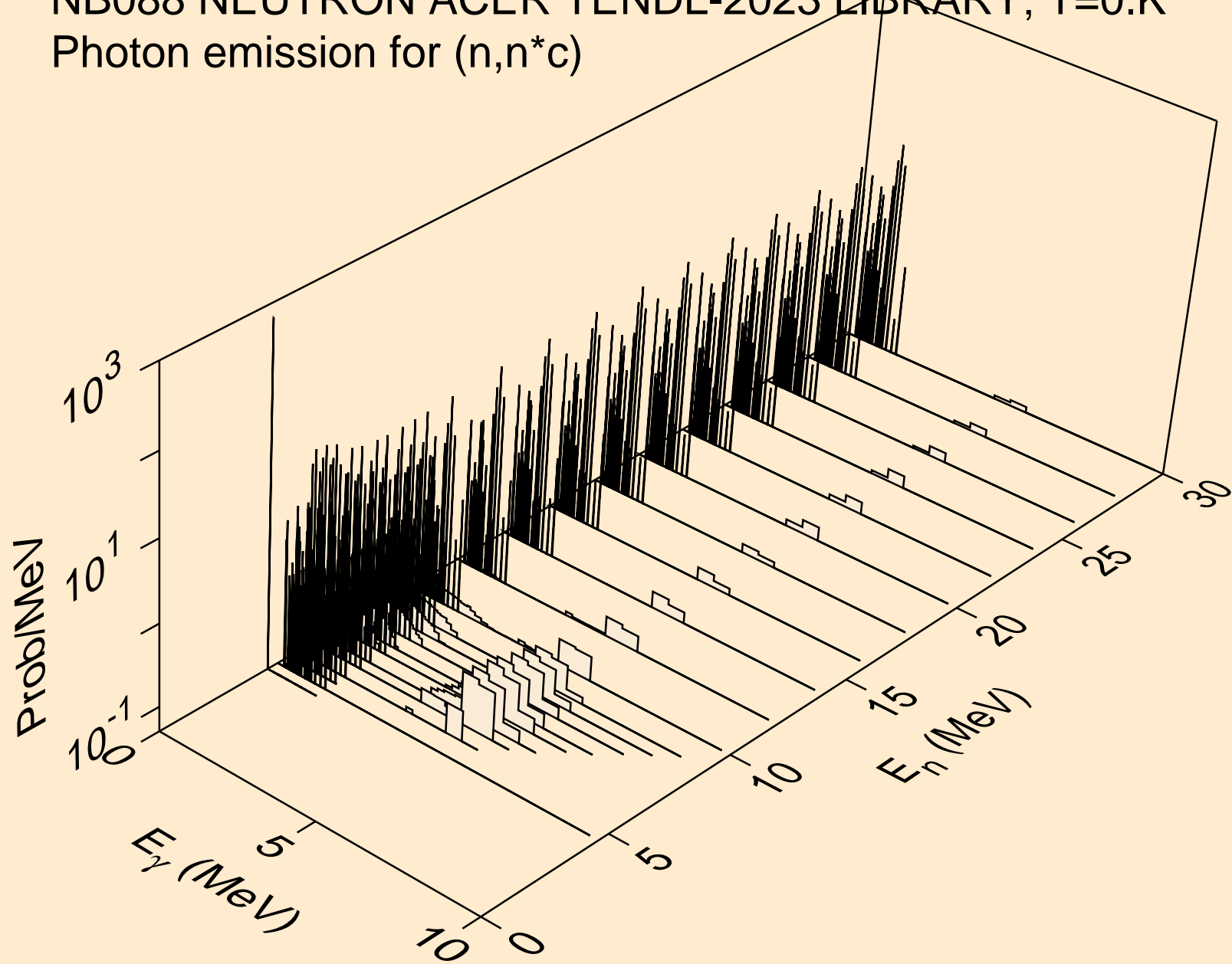

NB088 NEUTRON ACER TENDL-2023 LIBRARY; T=0.K  
Photon emission for (n,gma)

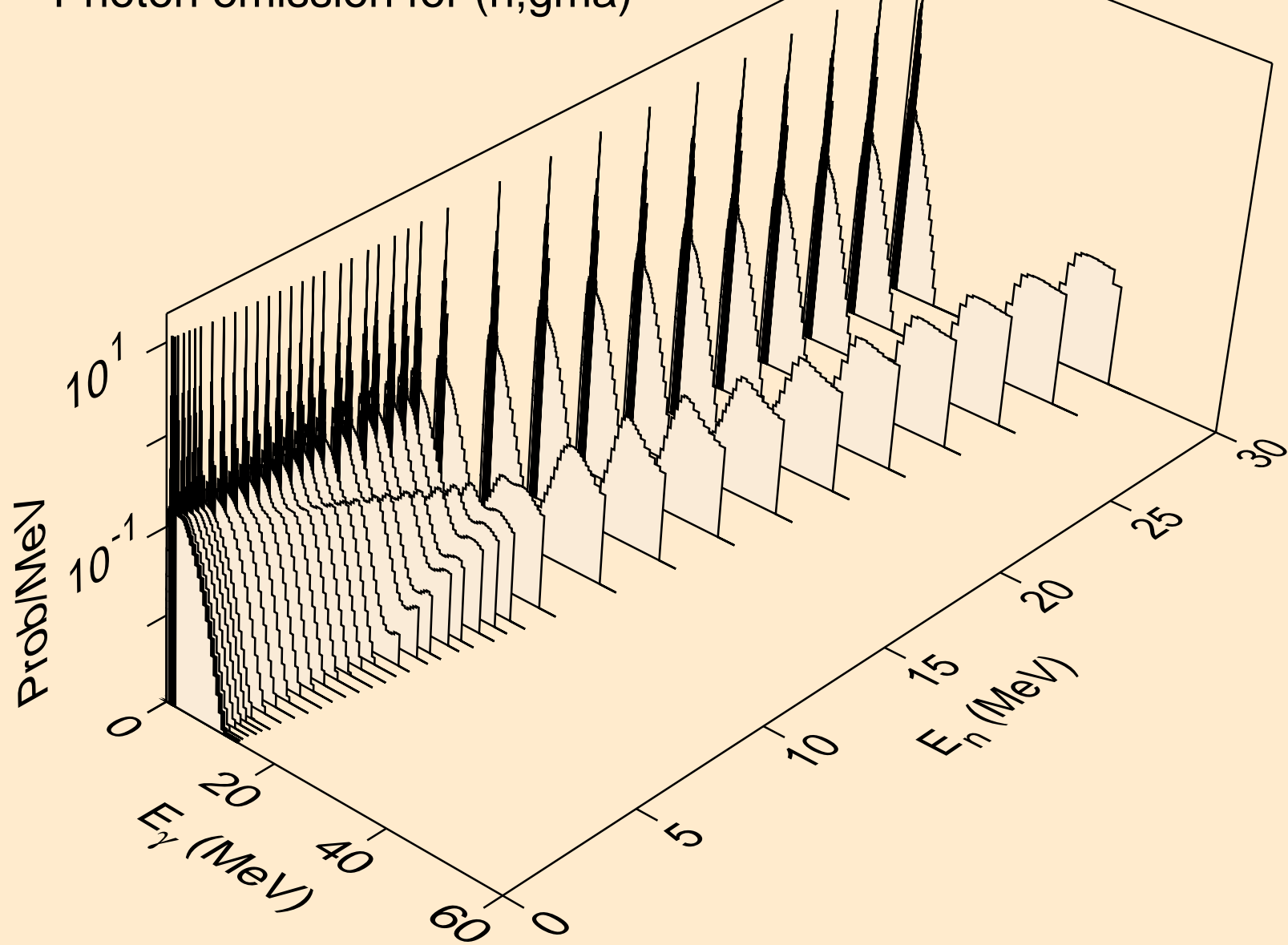

NB088 NEUTRON ACER TENDL-2023 LIBRARY; T=0.K  
Photon emission for (n,p)

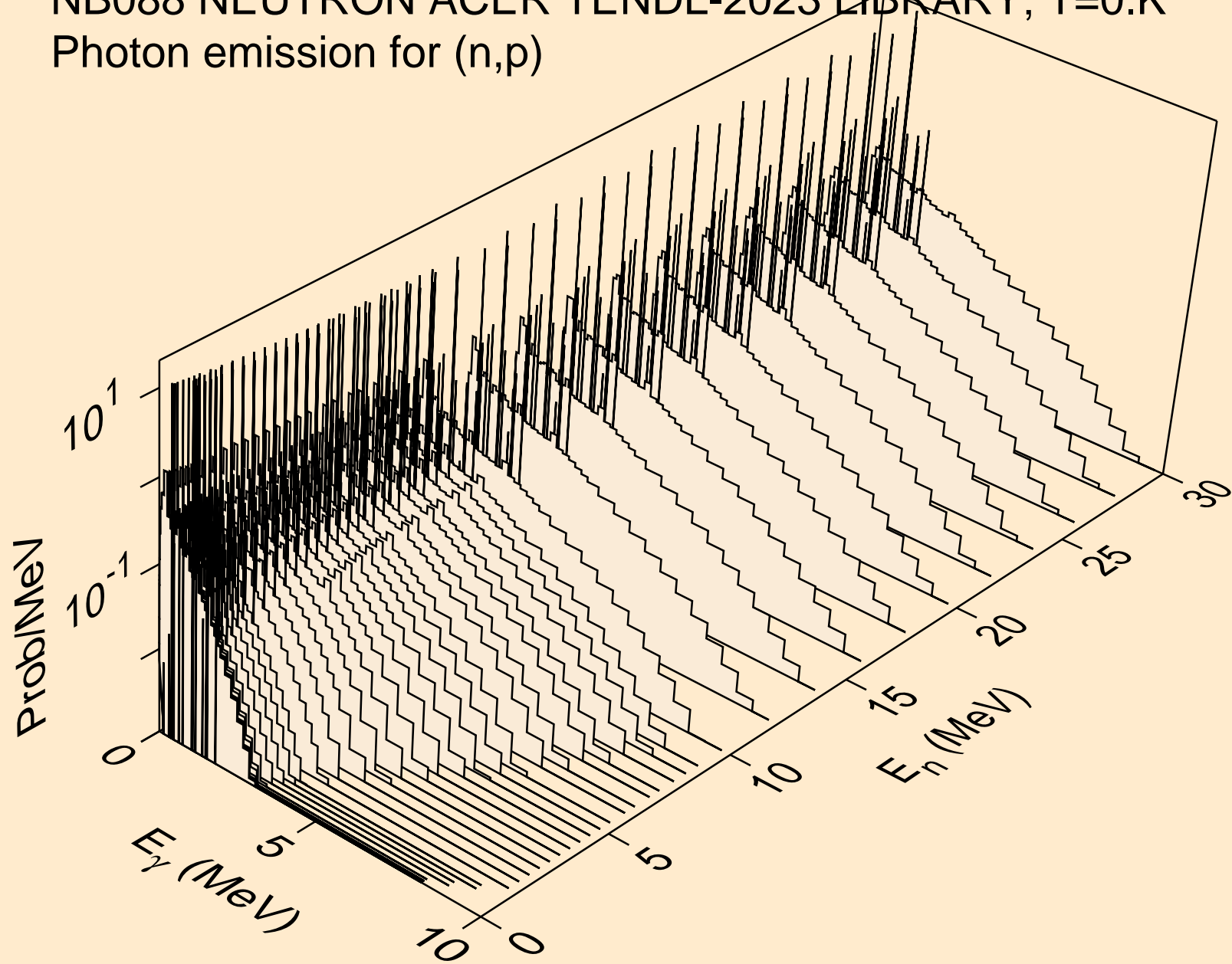

NB088 NEUTRON ACER TENDL-2023 LIBRARY; T=0.K  
Photon emission for (n,d)

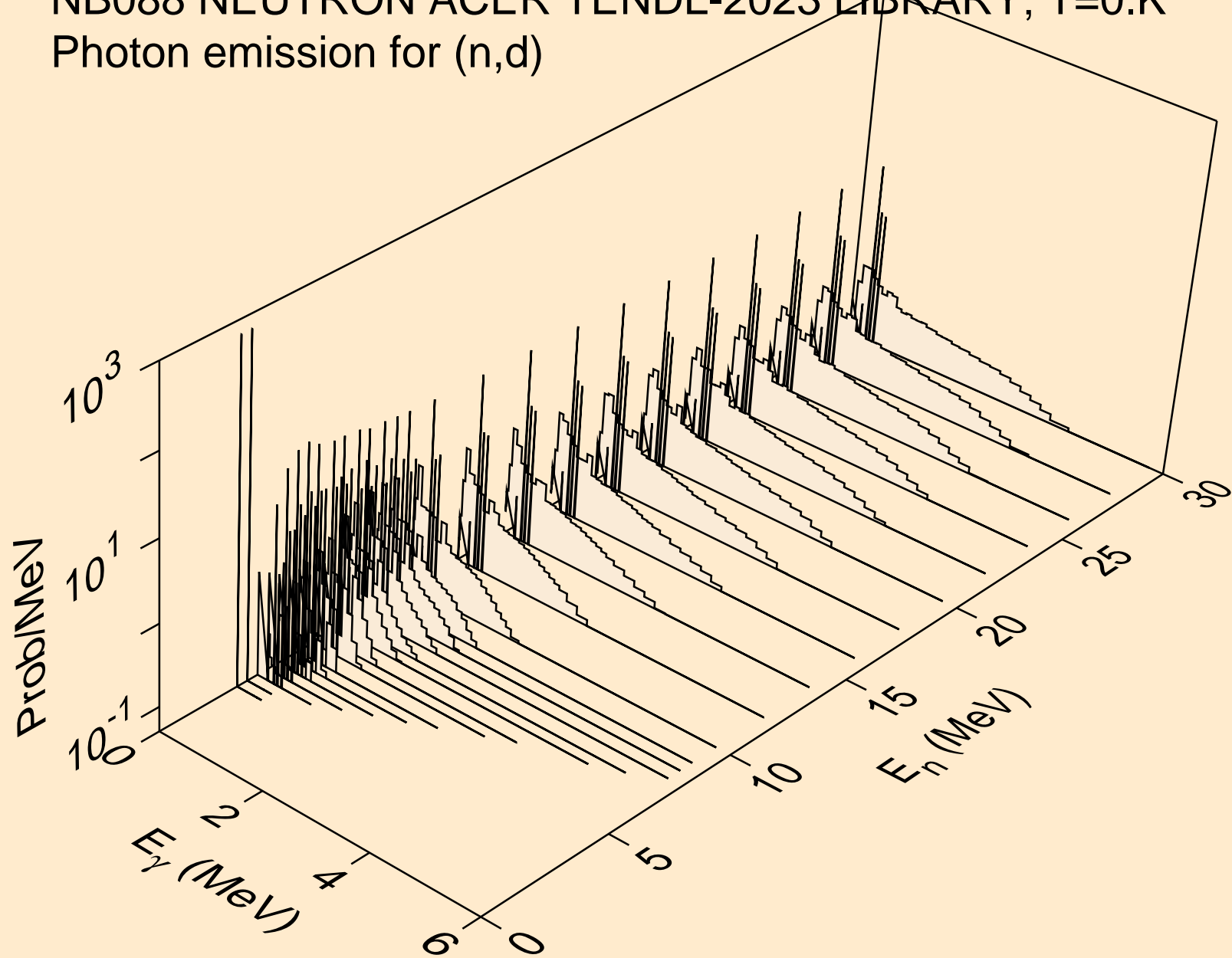

NB088 NEUTRON ACER TENDL-2023 LIBRARY; T=0.K  
Photon emission for (n,t)

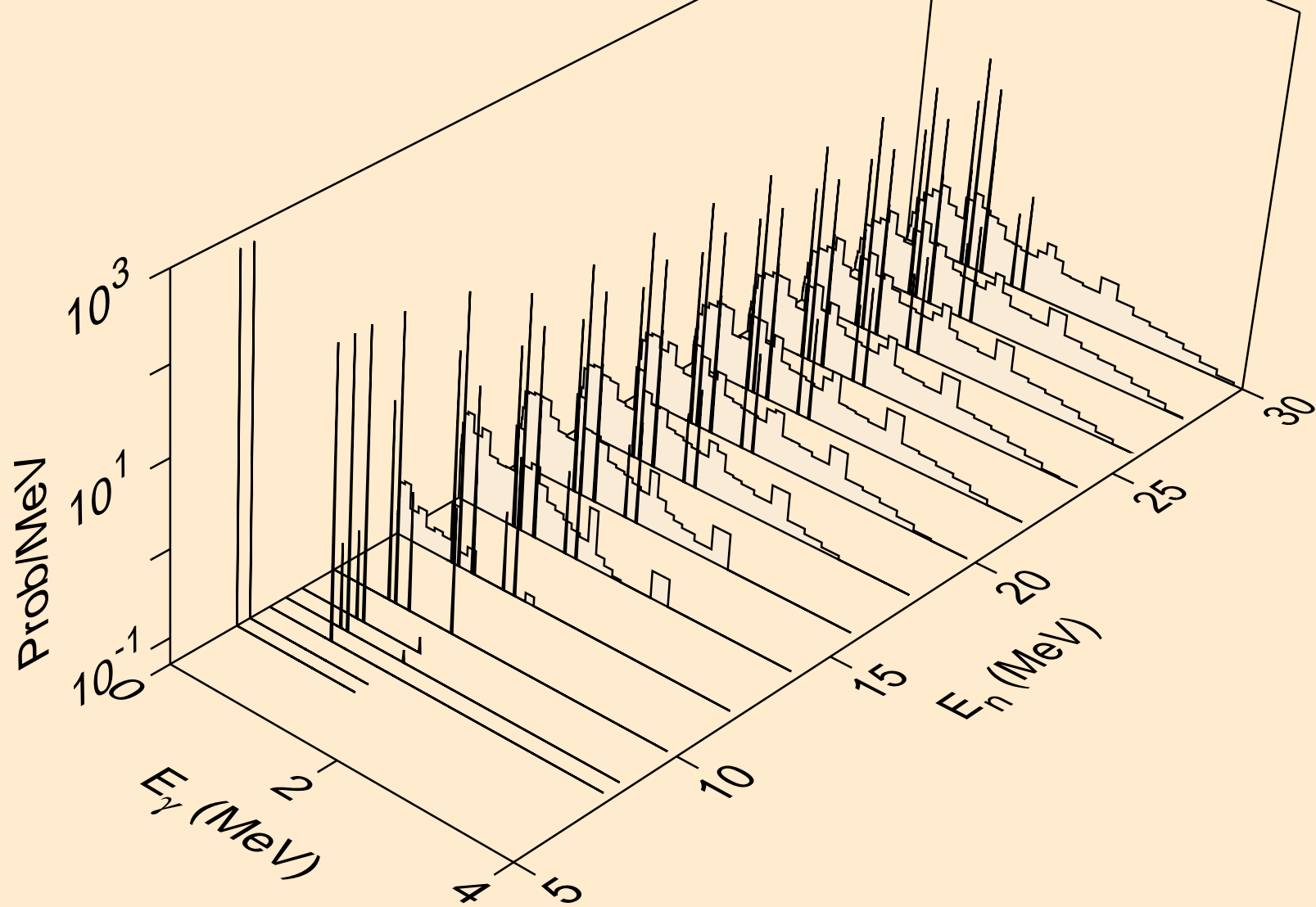



NB088 NEUTRON ACER TENDL-2023 LIBRARY; T=0.K  
Photon emission for (n,he3)

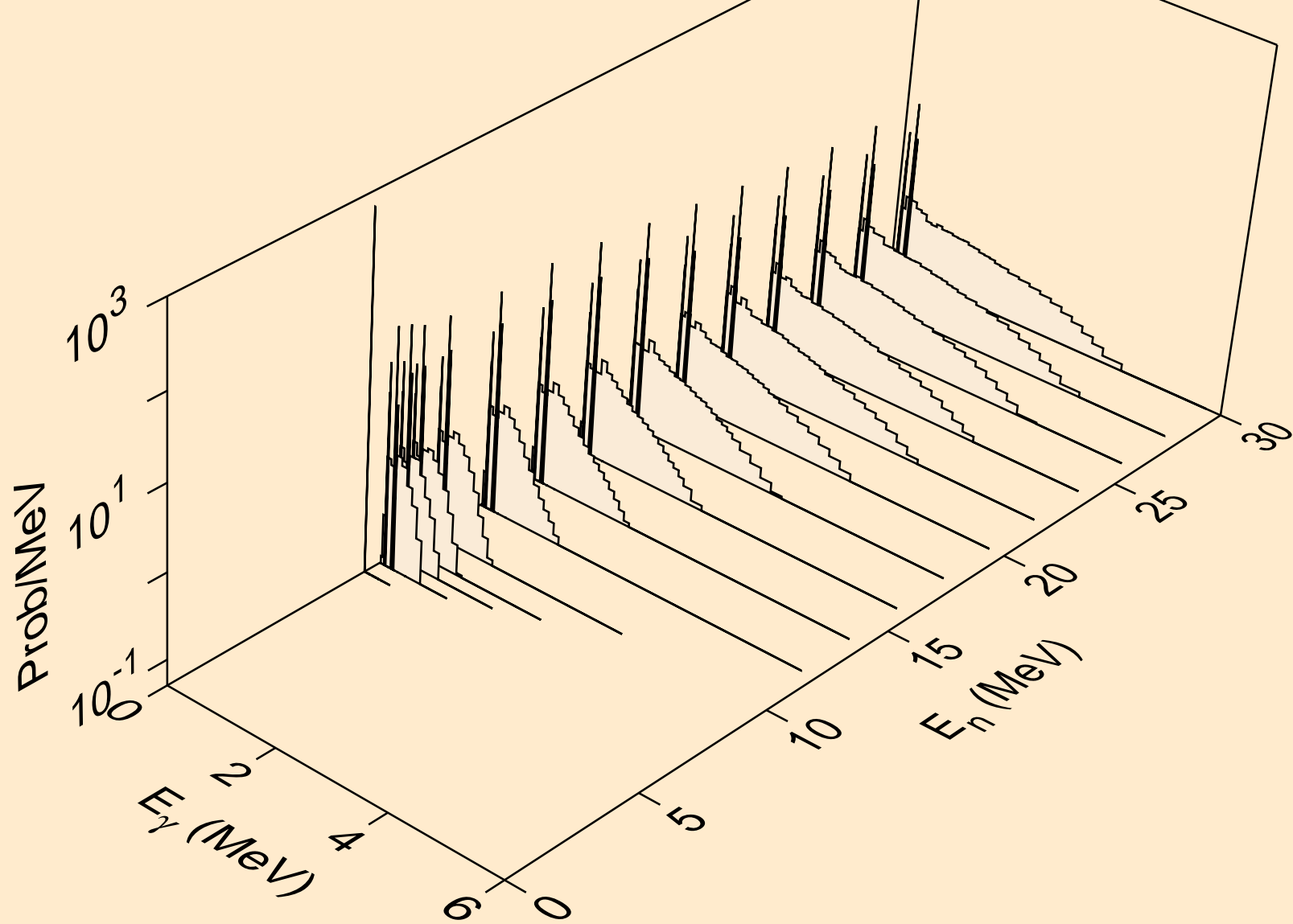

NB088 NEUTRON ACER TENDL-2023 LIBRARY; T=0.K  
Photon emission for (n,a)

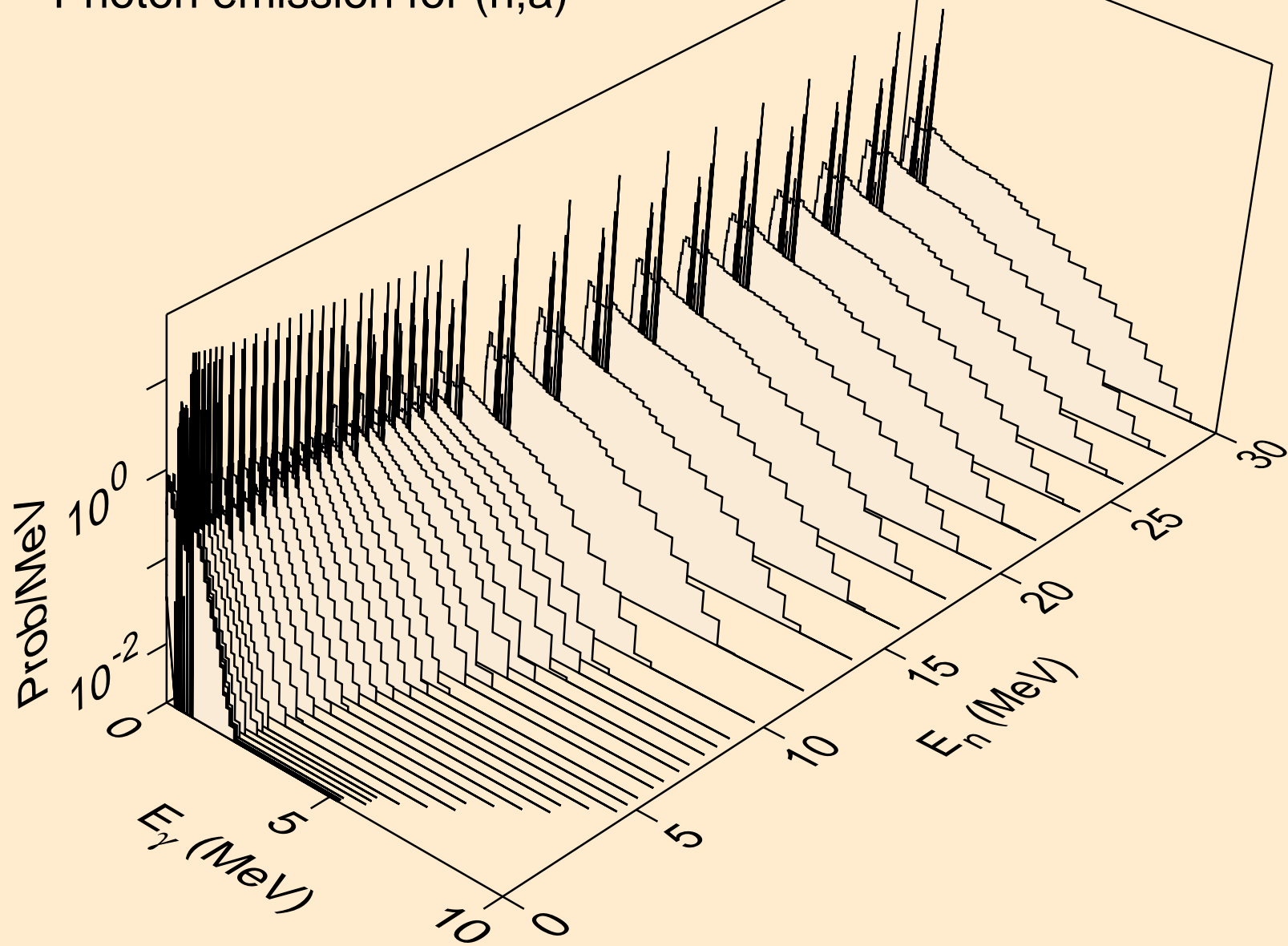

NB088 NEUTRON ACER TENDL-2023 LIBRARY; T=0.K  
Photon emission for (n,2a)

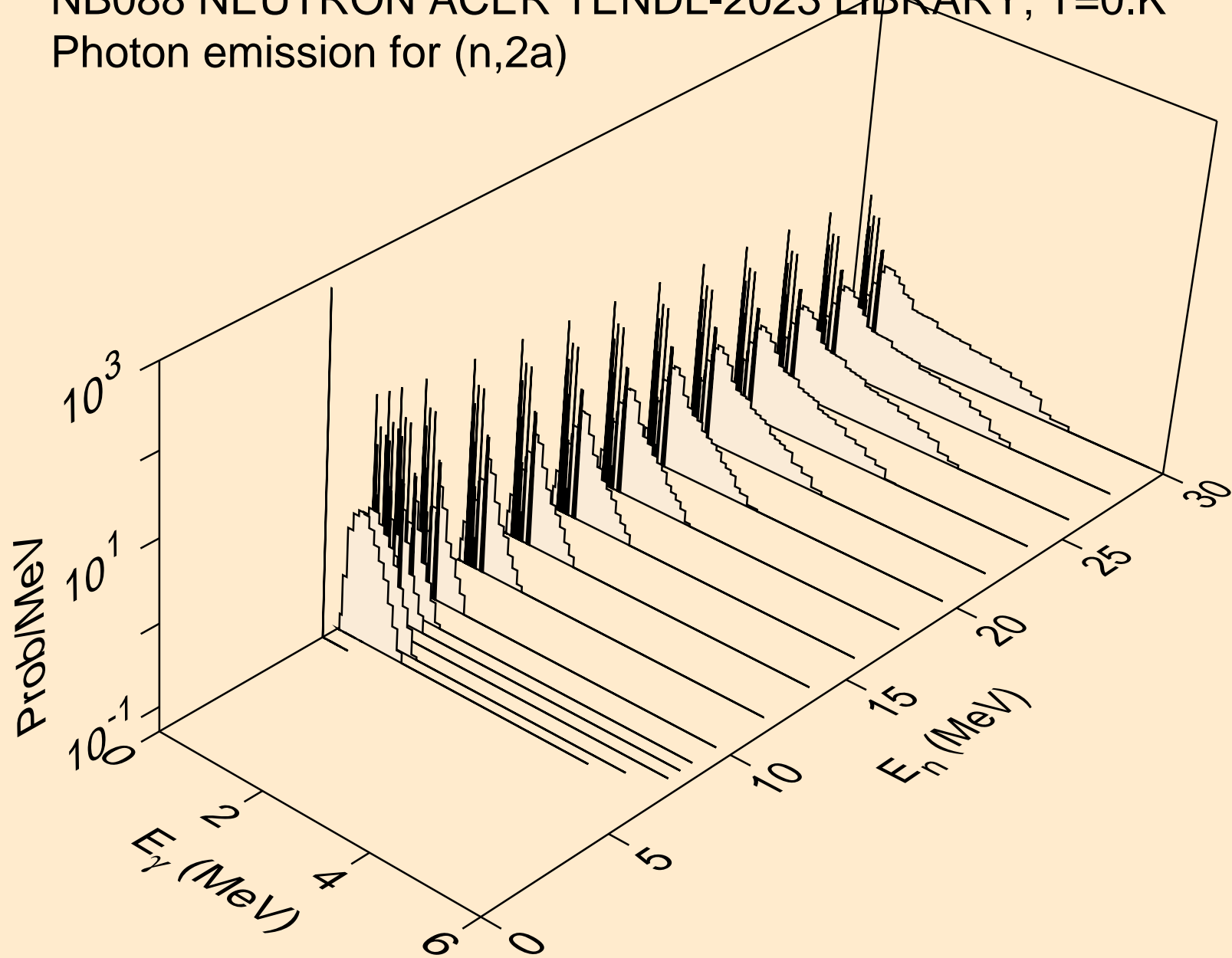

NB088 NEUTRON ACER TENDL-2023 LIBRARY; T=0.K  
Photon emission for (n,2p)

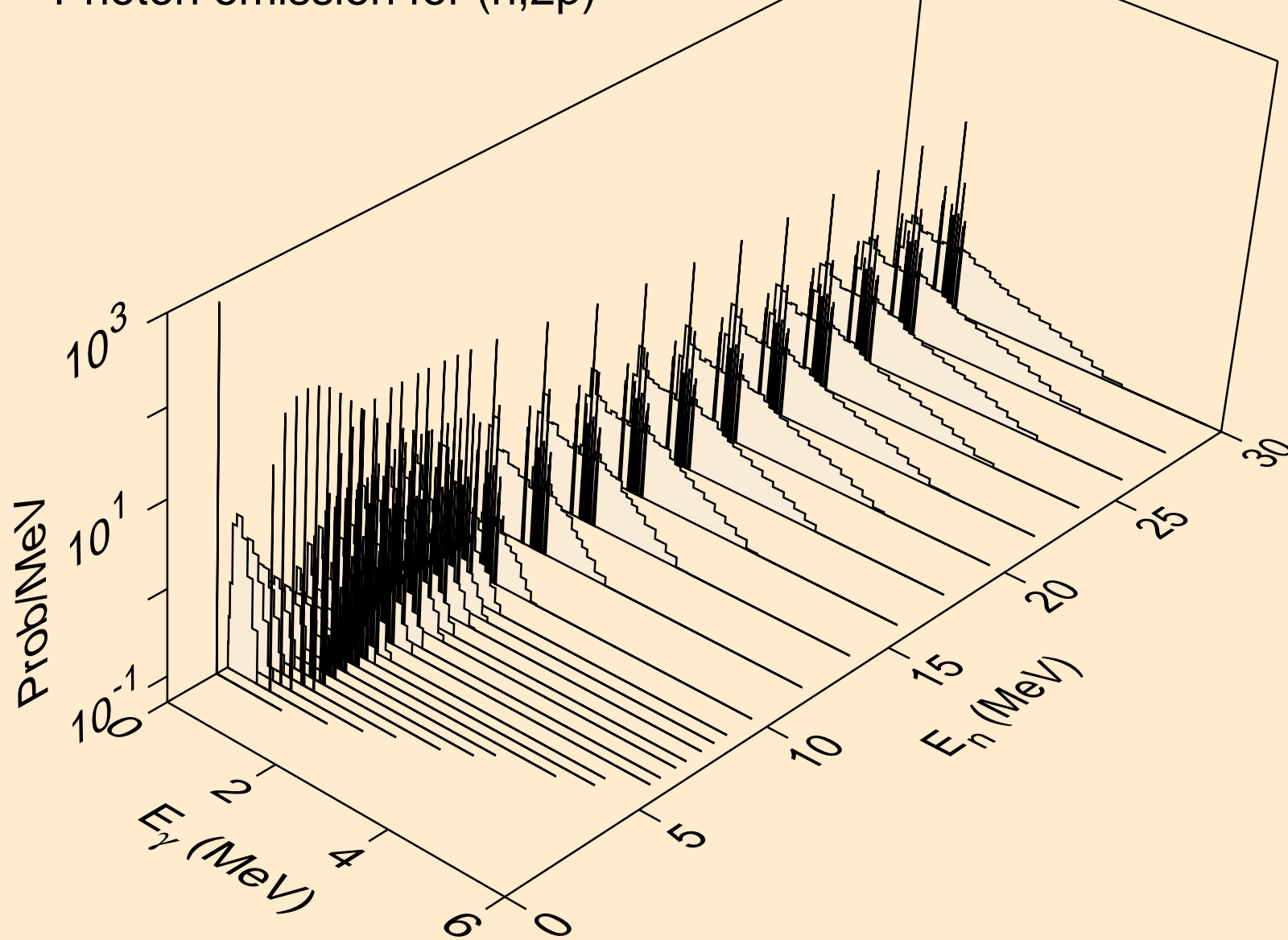

NB088 NEUTRON ACER TENDL-2023 LIBRARY; T=0.K  
Photon emission for (n,p $\alpha$ )

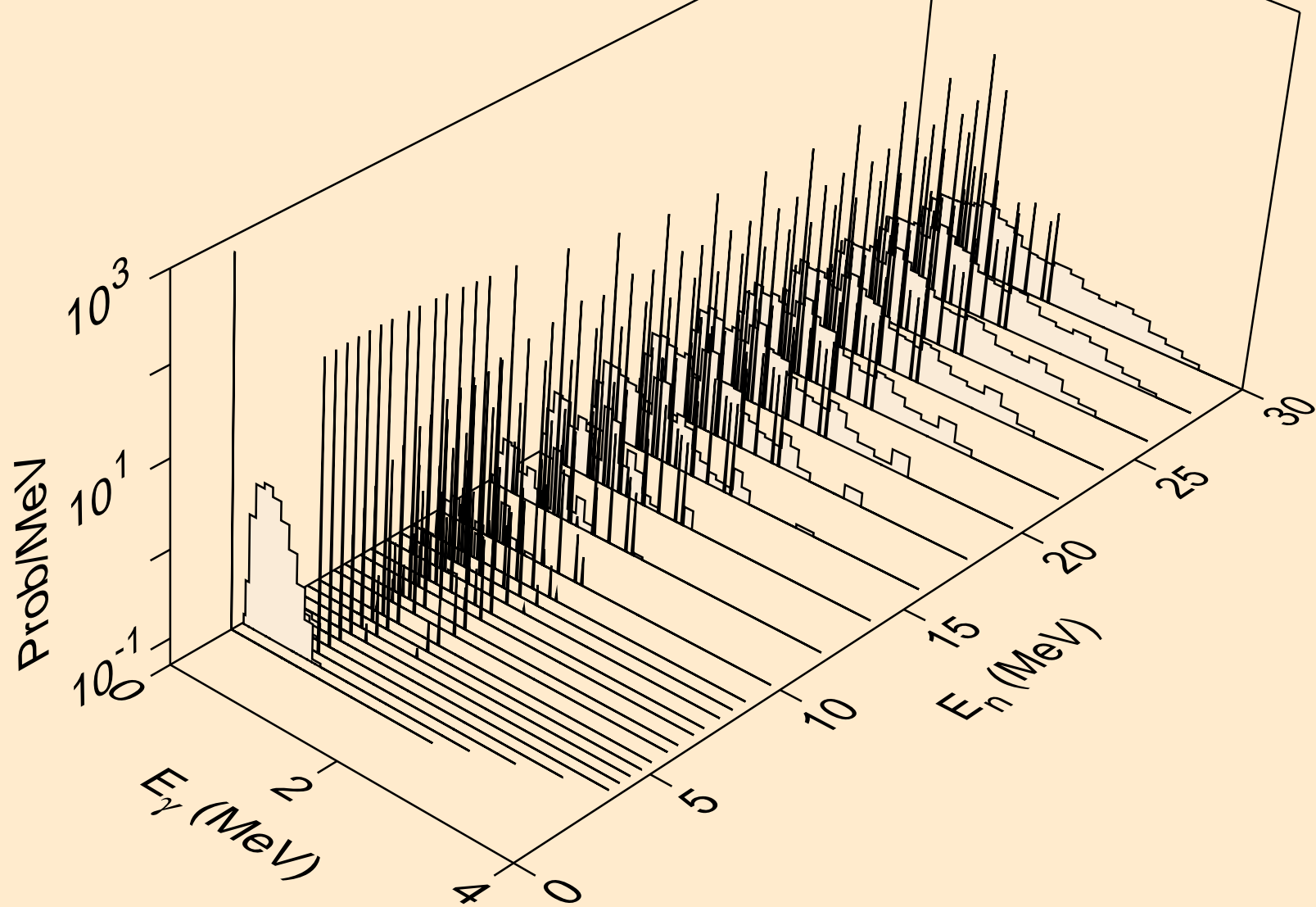

NB088 NEUTRON ACER TENDL-2023 LIBRARY; T=0.K  
Photon emission for (n,pd)

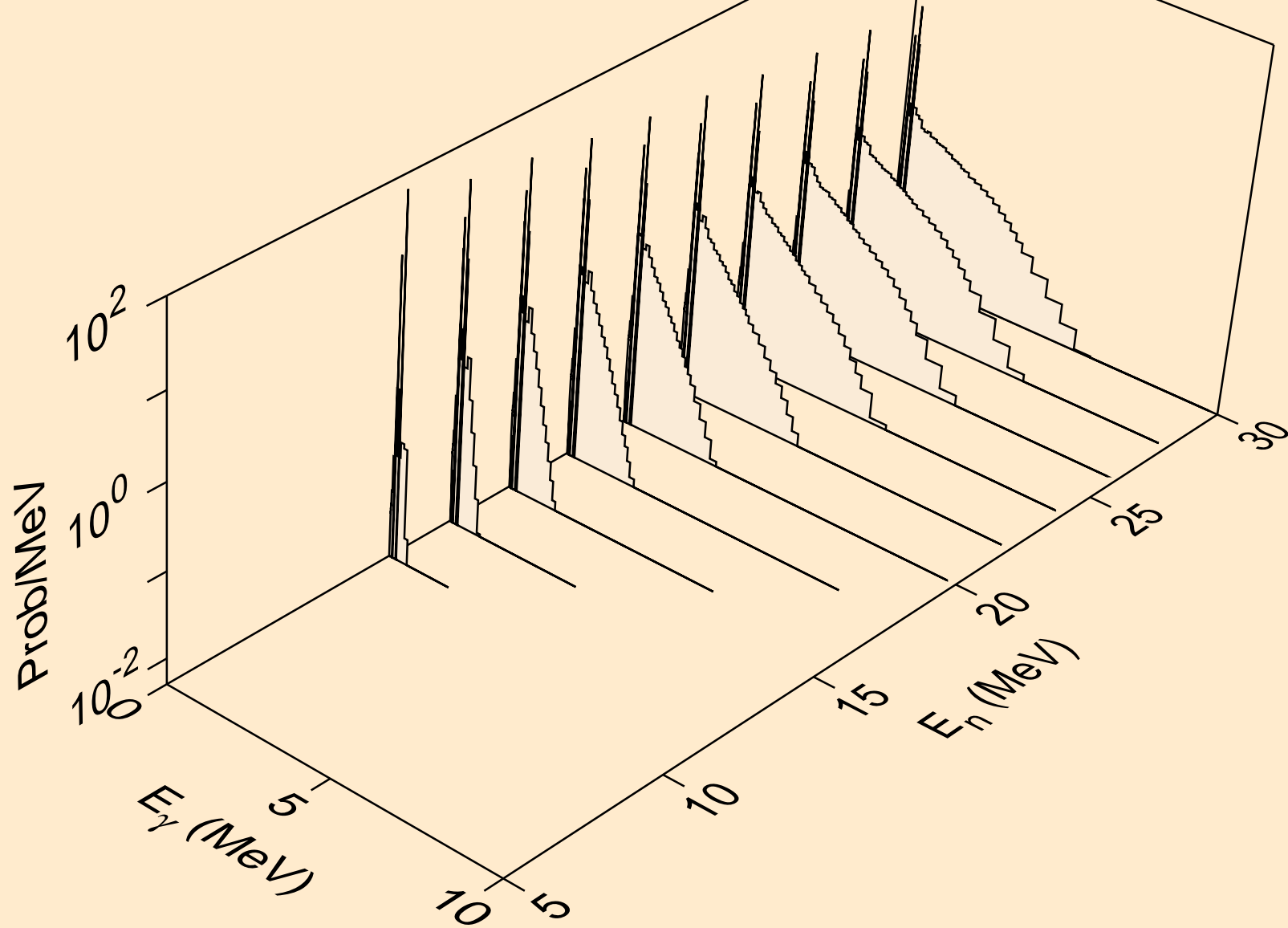

NB088 NEUTRON ACER TENDL-2023 LIBRARY; T=0.K  
Photon emission for (n,pt)

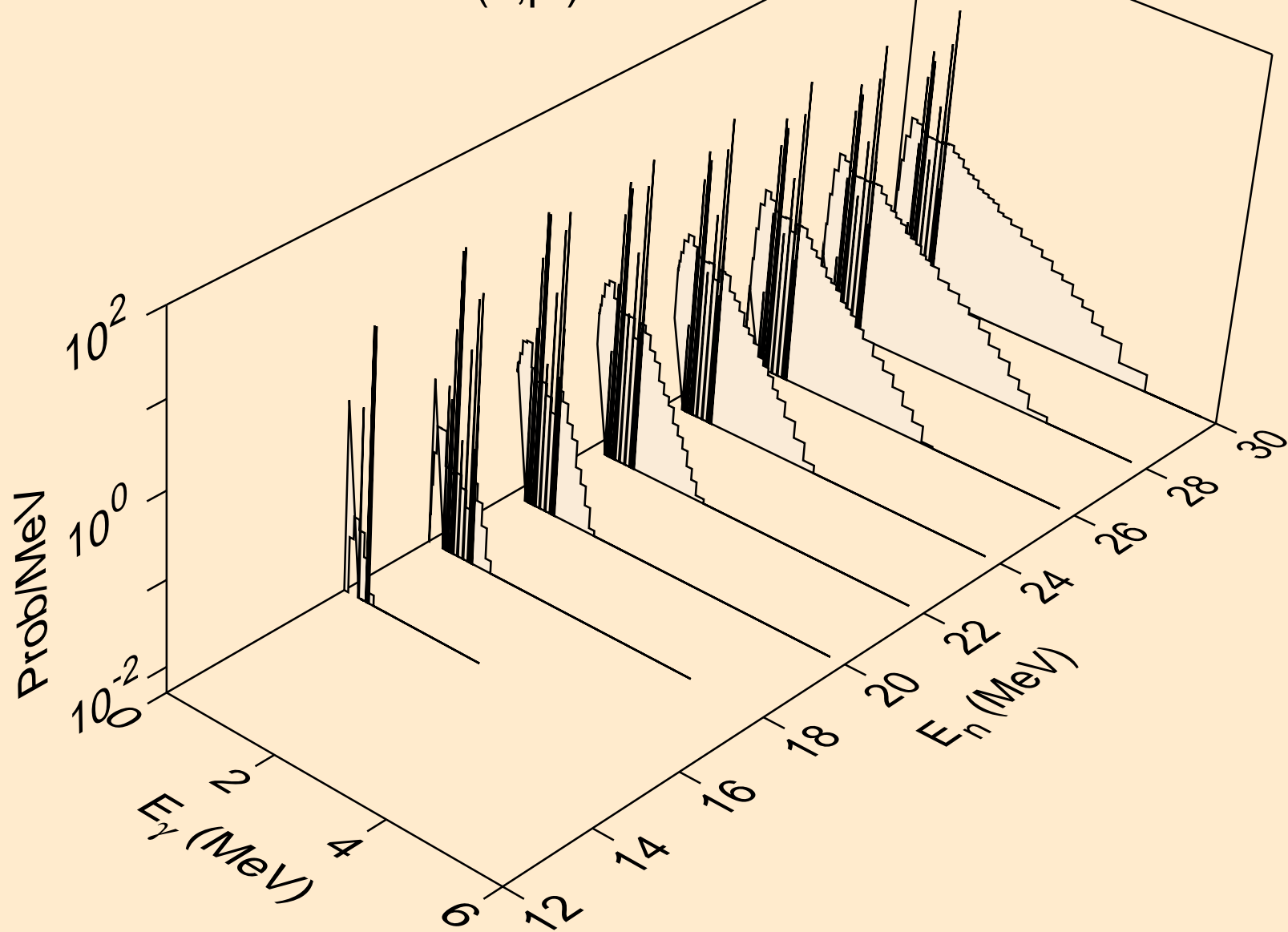

NB088 NEUTRON ACER TENDL-2023 LIBRARY; T=0.K  
Photon emission for (n,da)

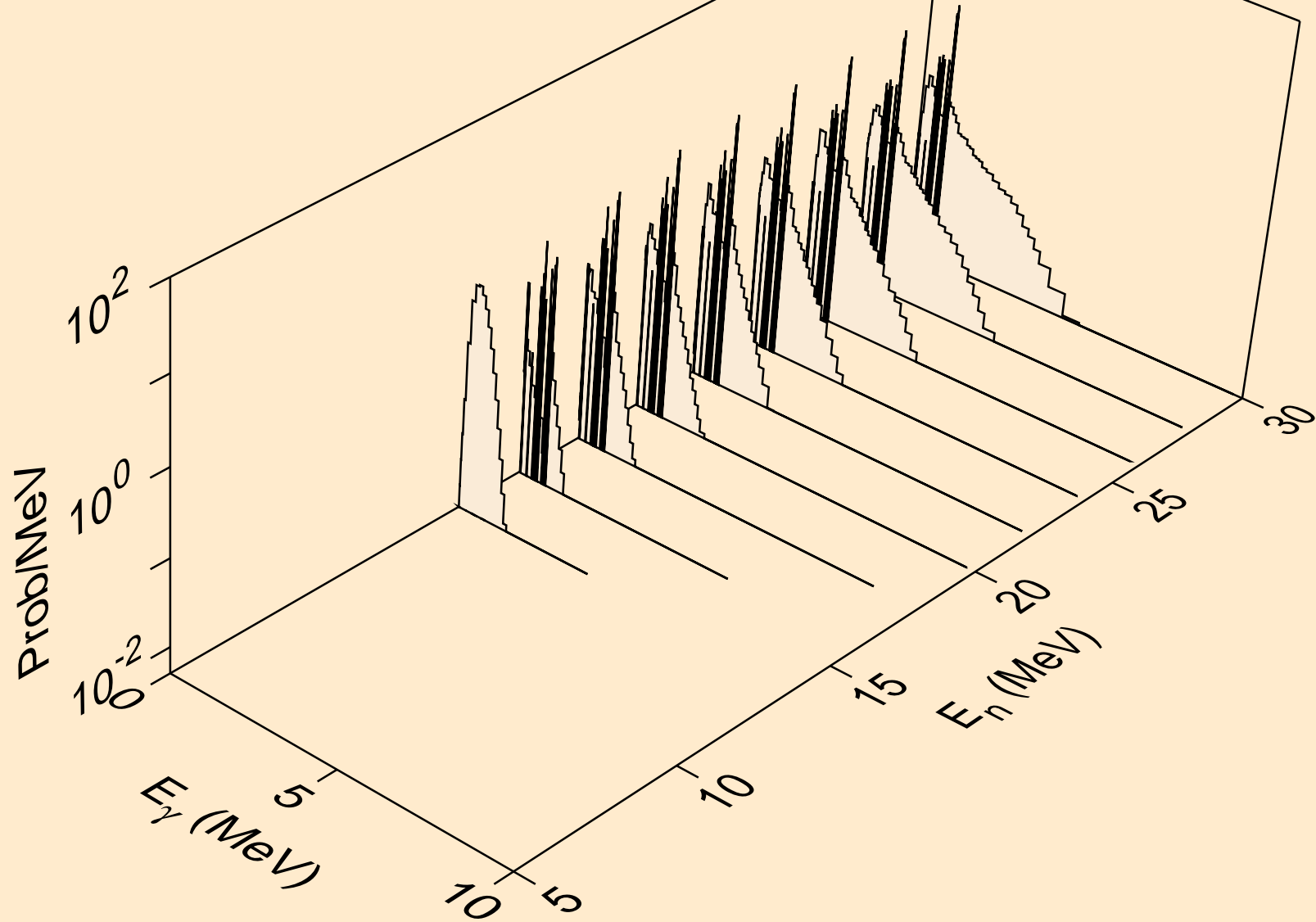



NB088 NEUTRON ACER TENDL-2023 LIBRARY; T=0.K  
thermal capture photon spectrum

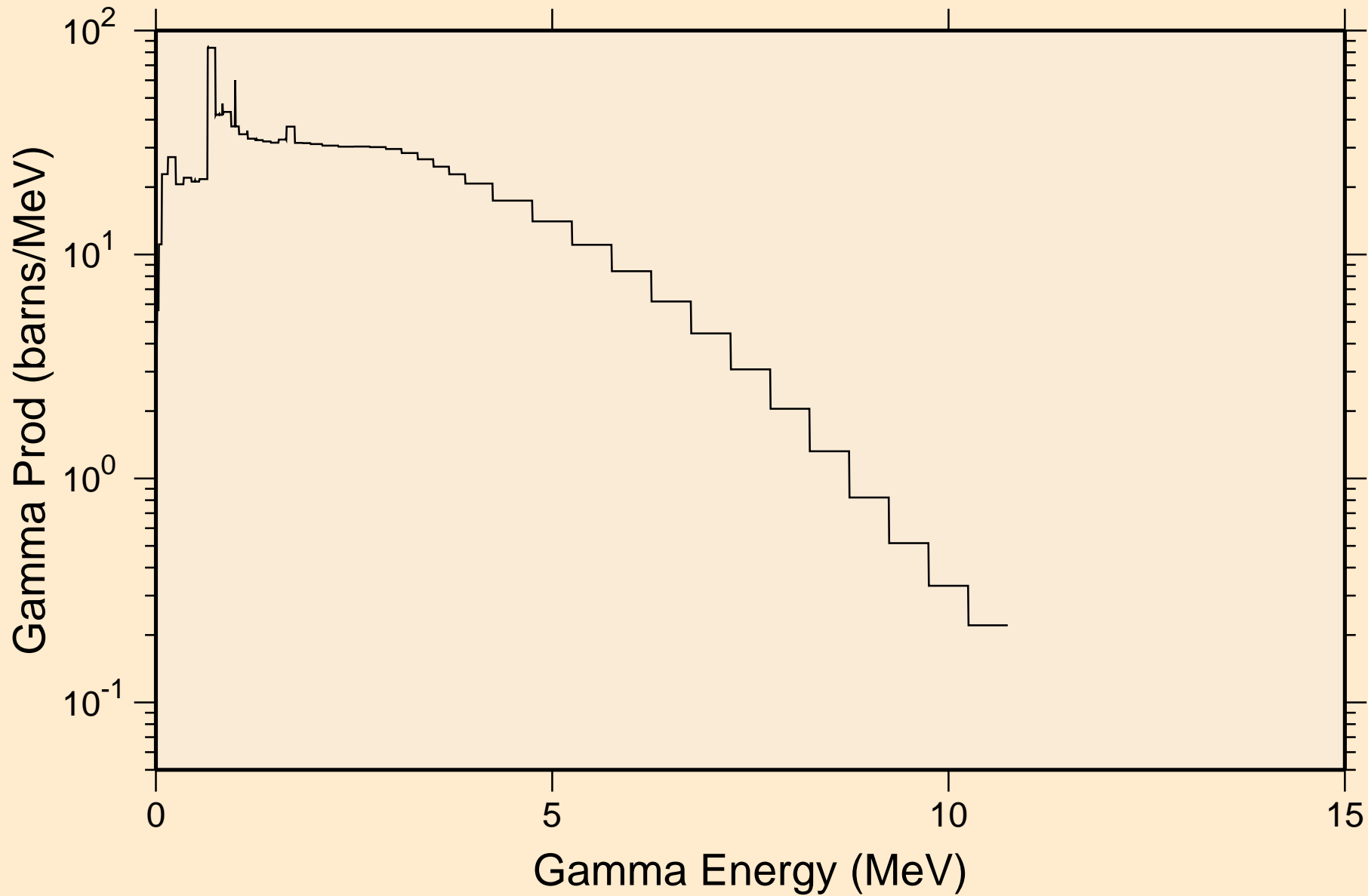

NB088 NEUTRON ACER TENDL-2023 LIBRARY; T=0.K  
14 MeV photon spectrum

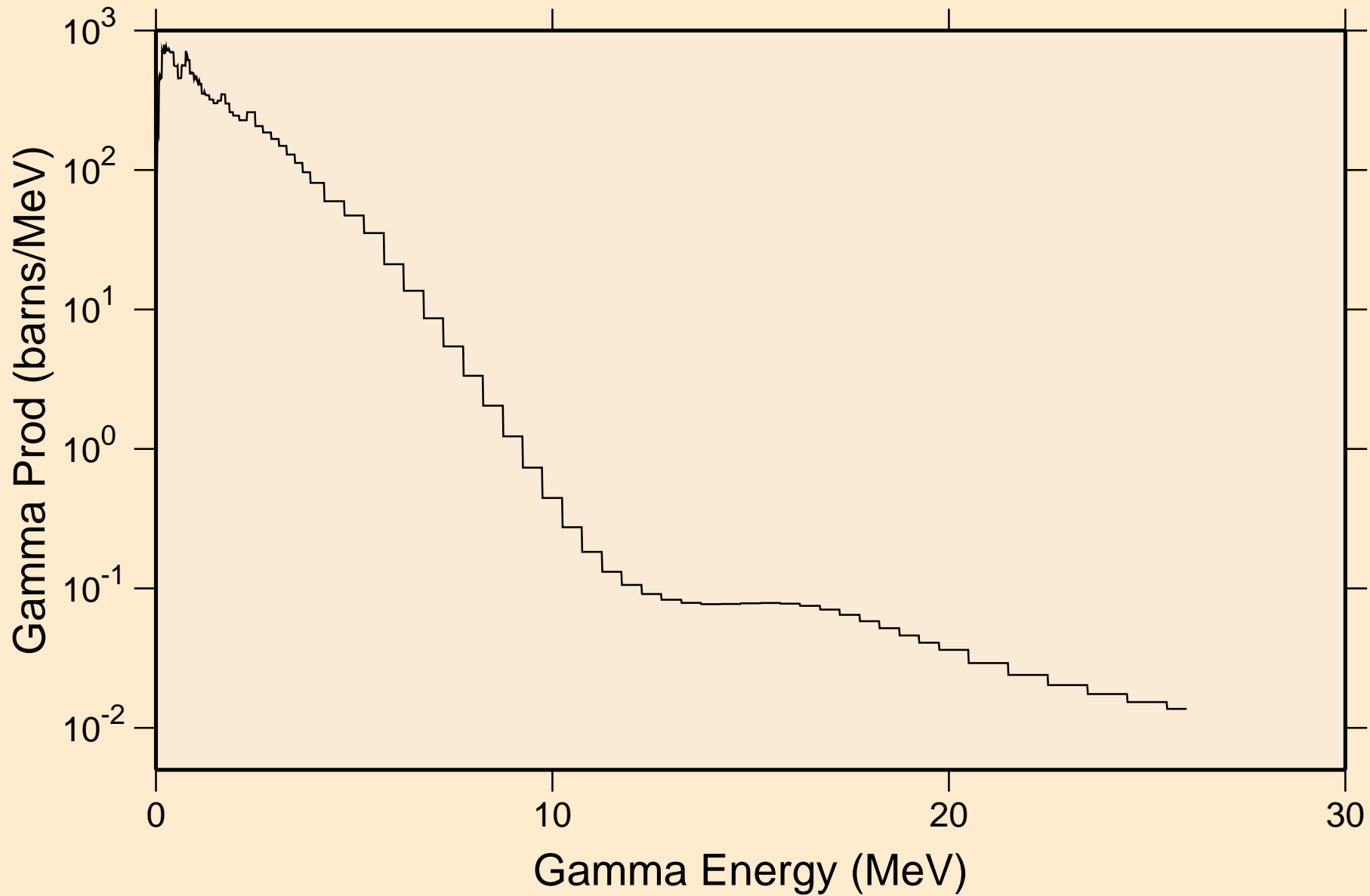

# NB088 NEUTRON ACER TENDL-2023 LIBRARY; T=0.K

## Particle heating contributions

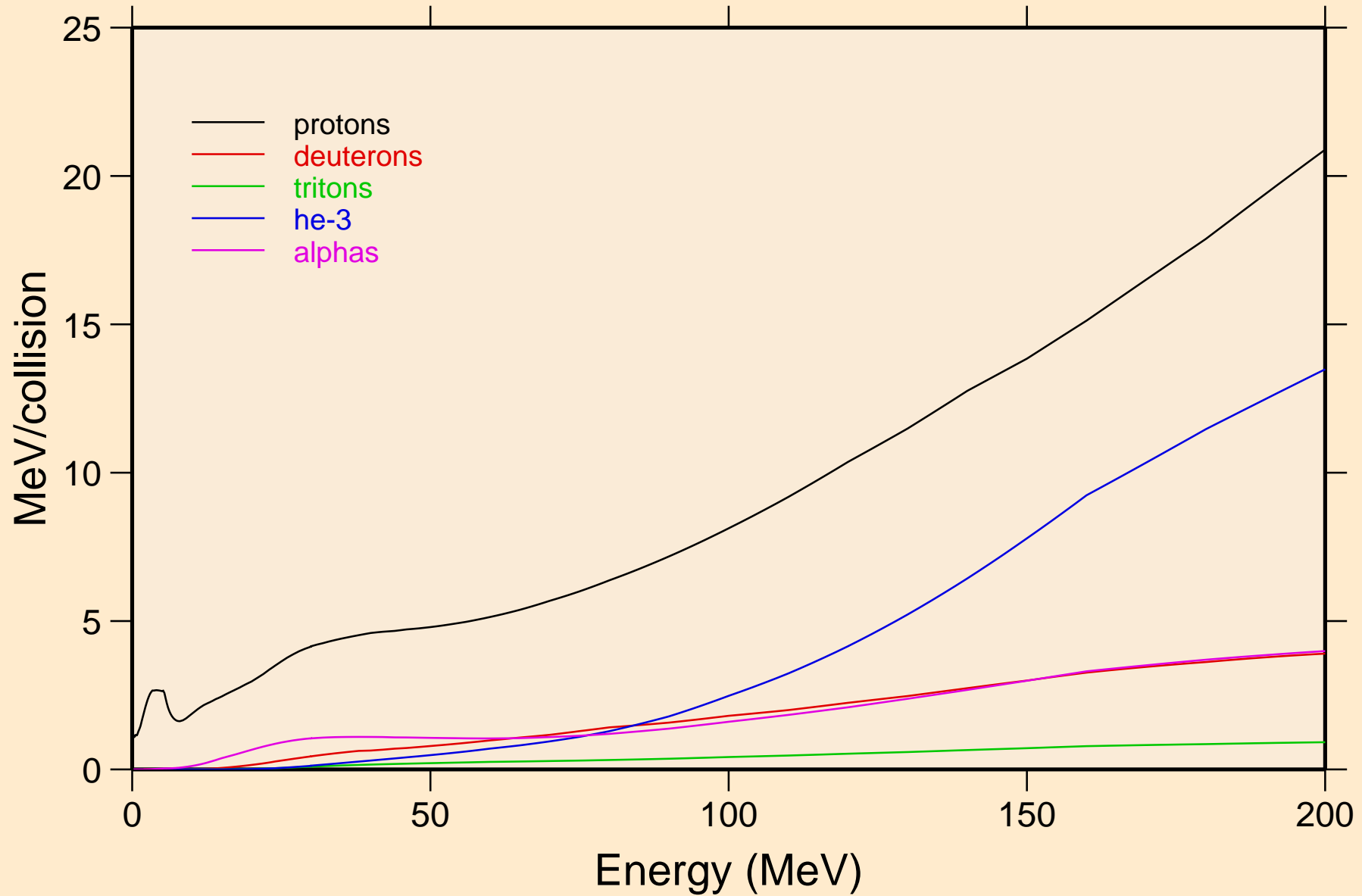

NB088 NEUTRON ACER TENDL-2023 LIBRARY; T=0.K  
Recoil Heating

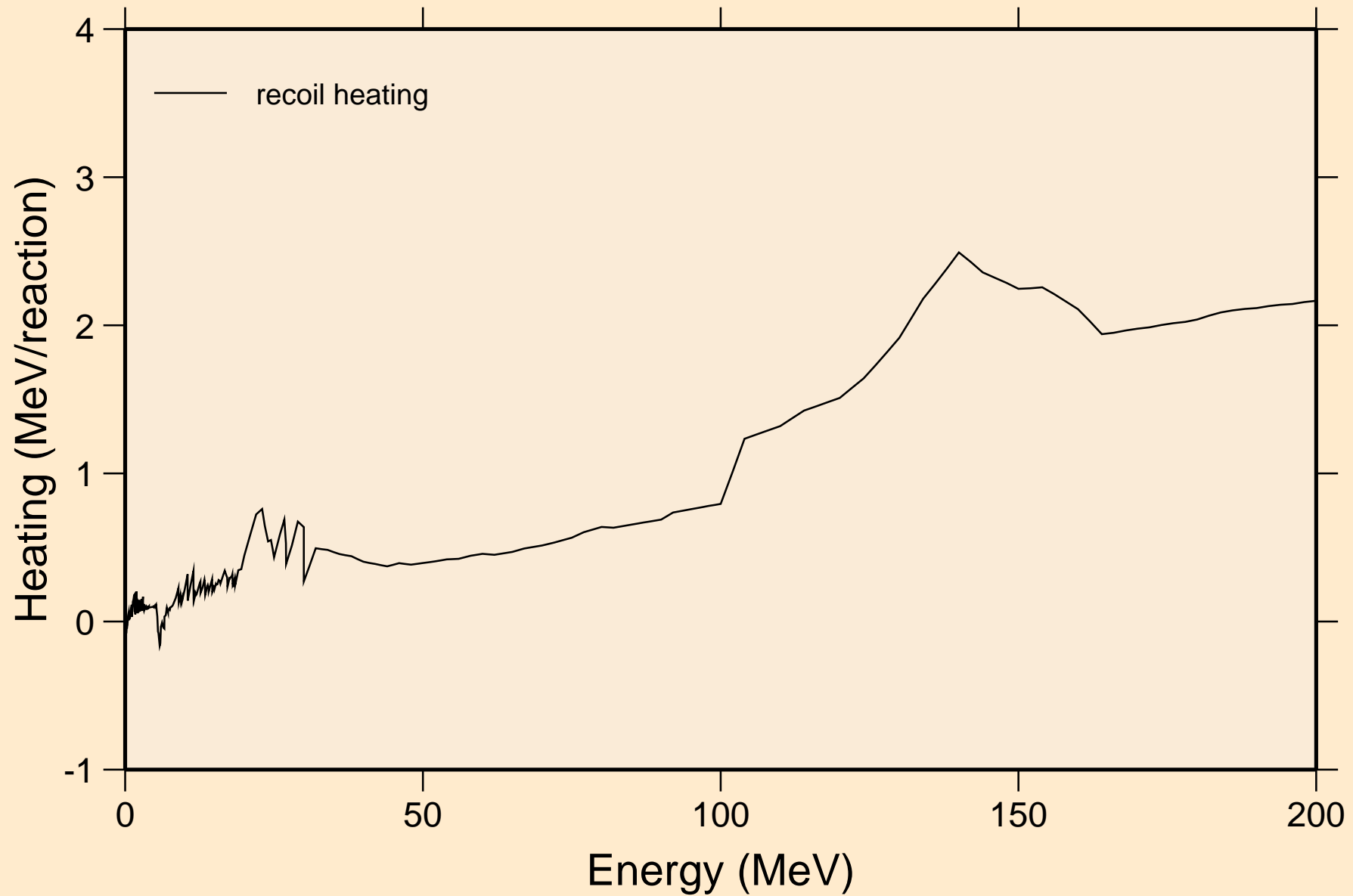

# NB088 NEUTRON ACER TENDL-2023 LIBRARY; T=0.K

## Particle production cross sections

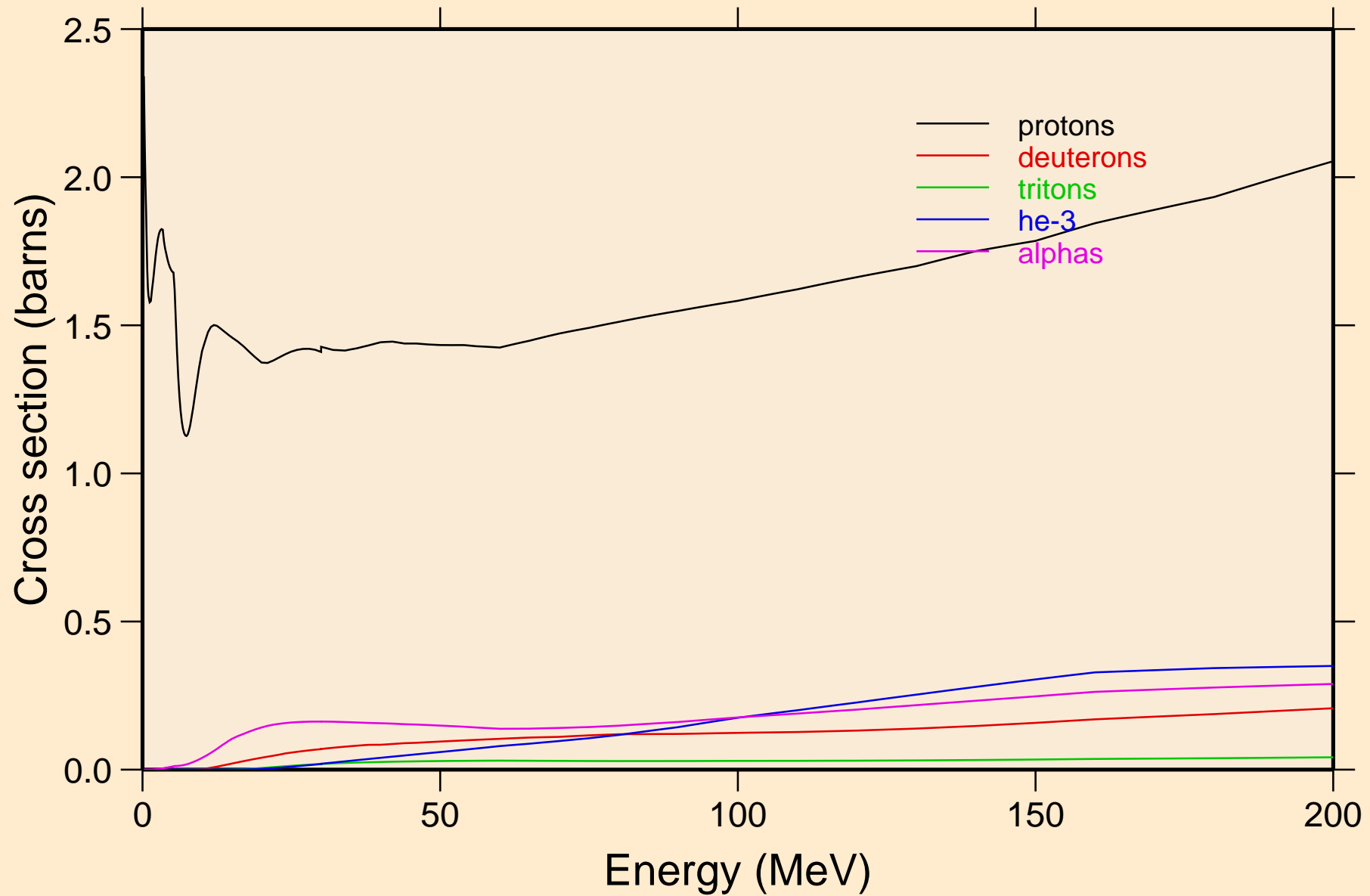

NB088 NEUTRON ACER TENDL-2023 LIBRARY; T=0.K  
protons from (n,x)

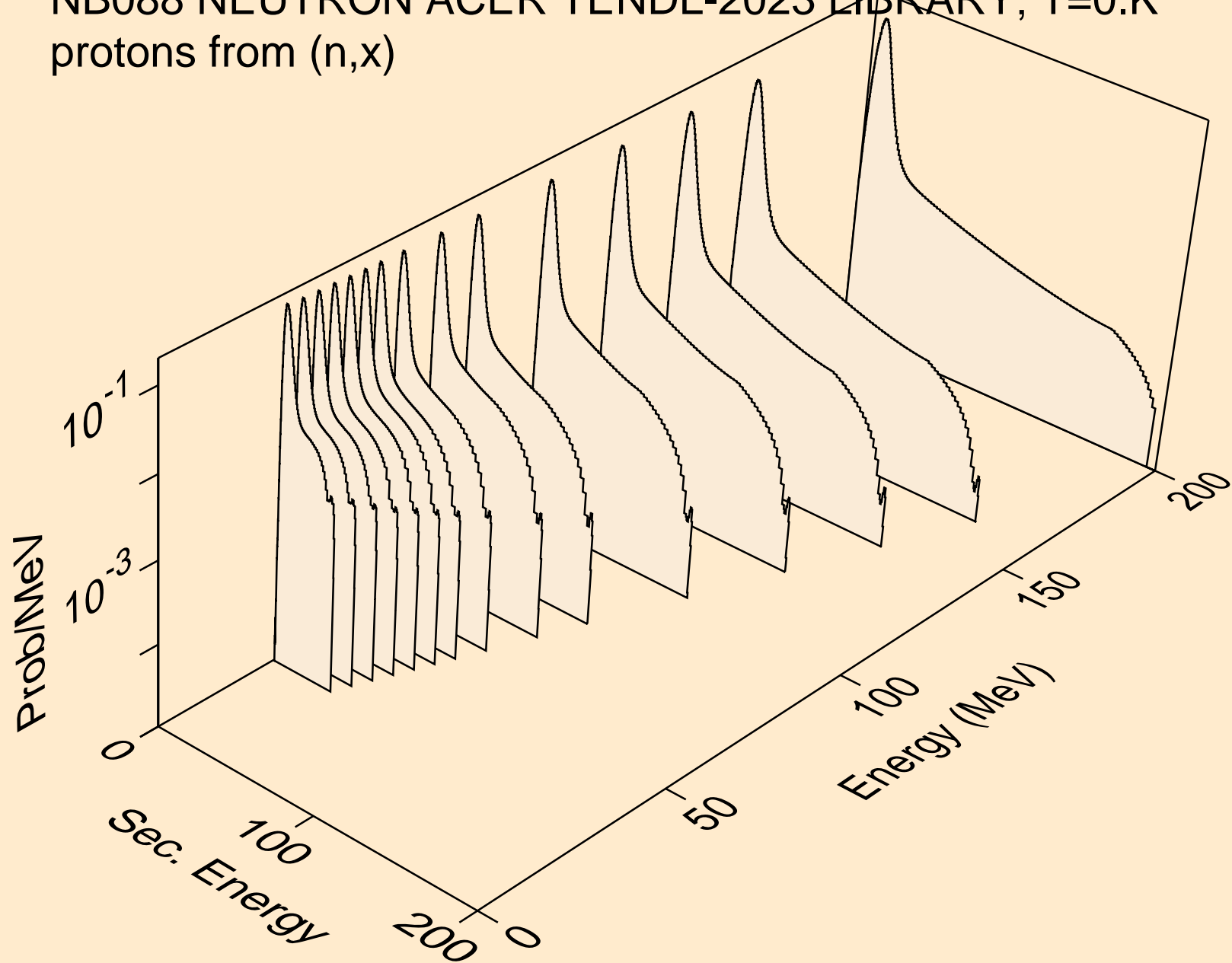

NB088 NEUTRON ACER TENDL-2023 LIBRARY; T=0.K  
protons from (n,n\*)p

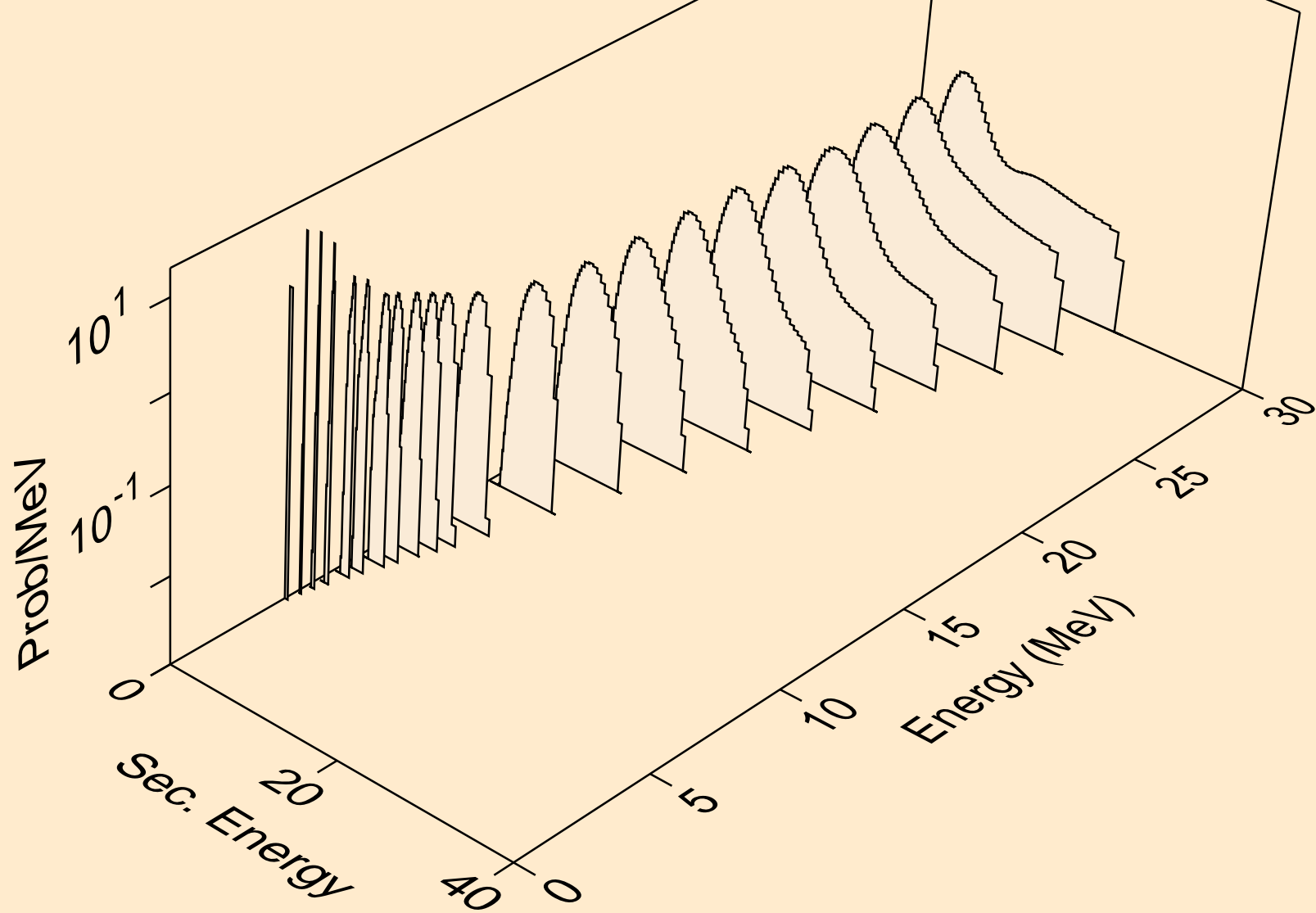

NB088 NEUTRON ACER TENDL-2023 LIBRARY; T=0.K  
protons from (n,2np)

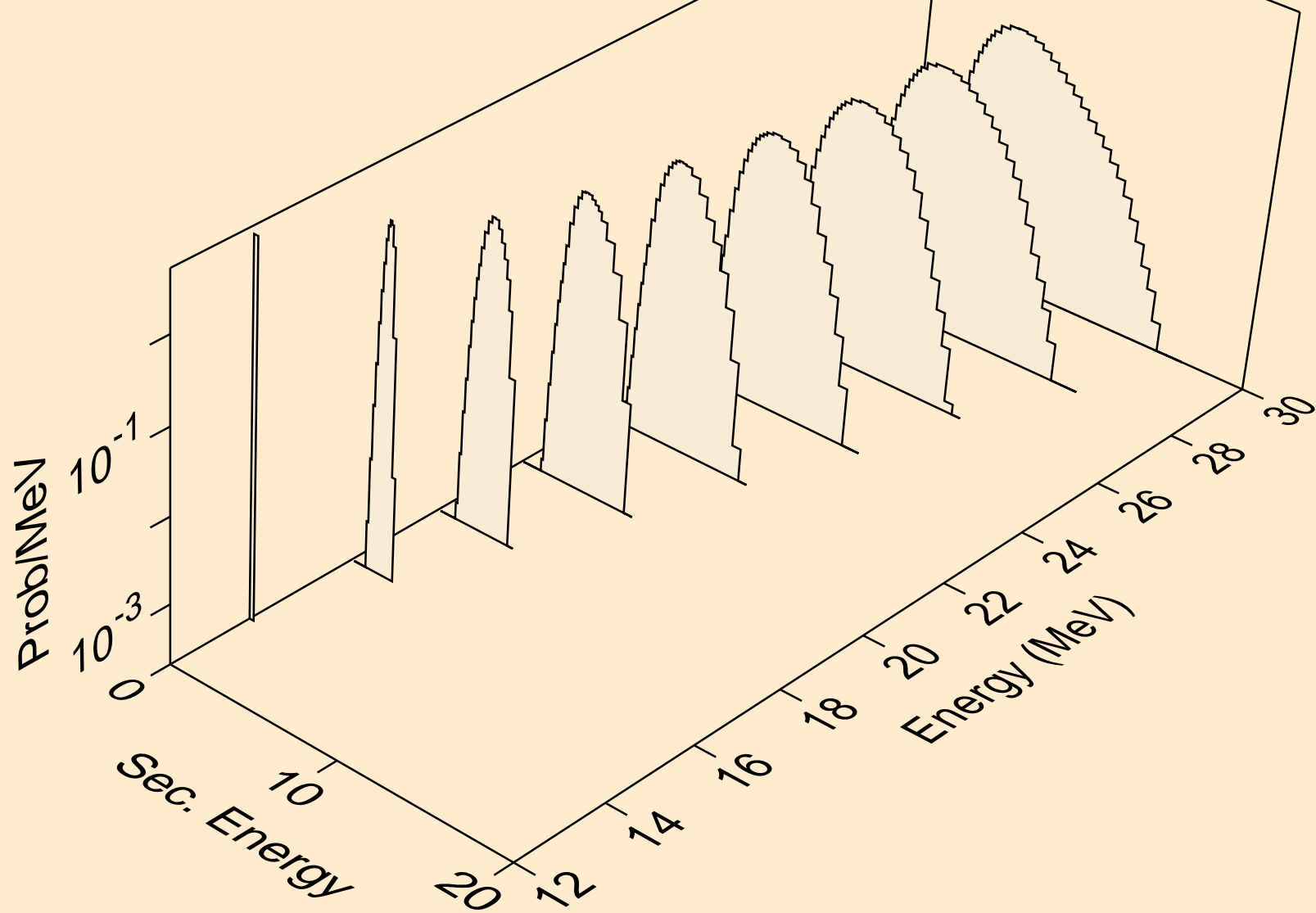



NB088 NEUTRON ACER TENDL-2023 LIBRARY; T=0.K  
protons from (n,3np)

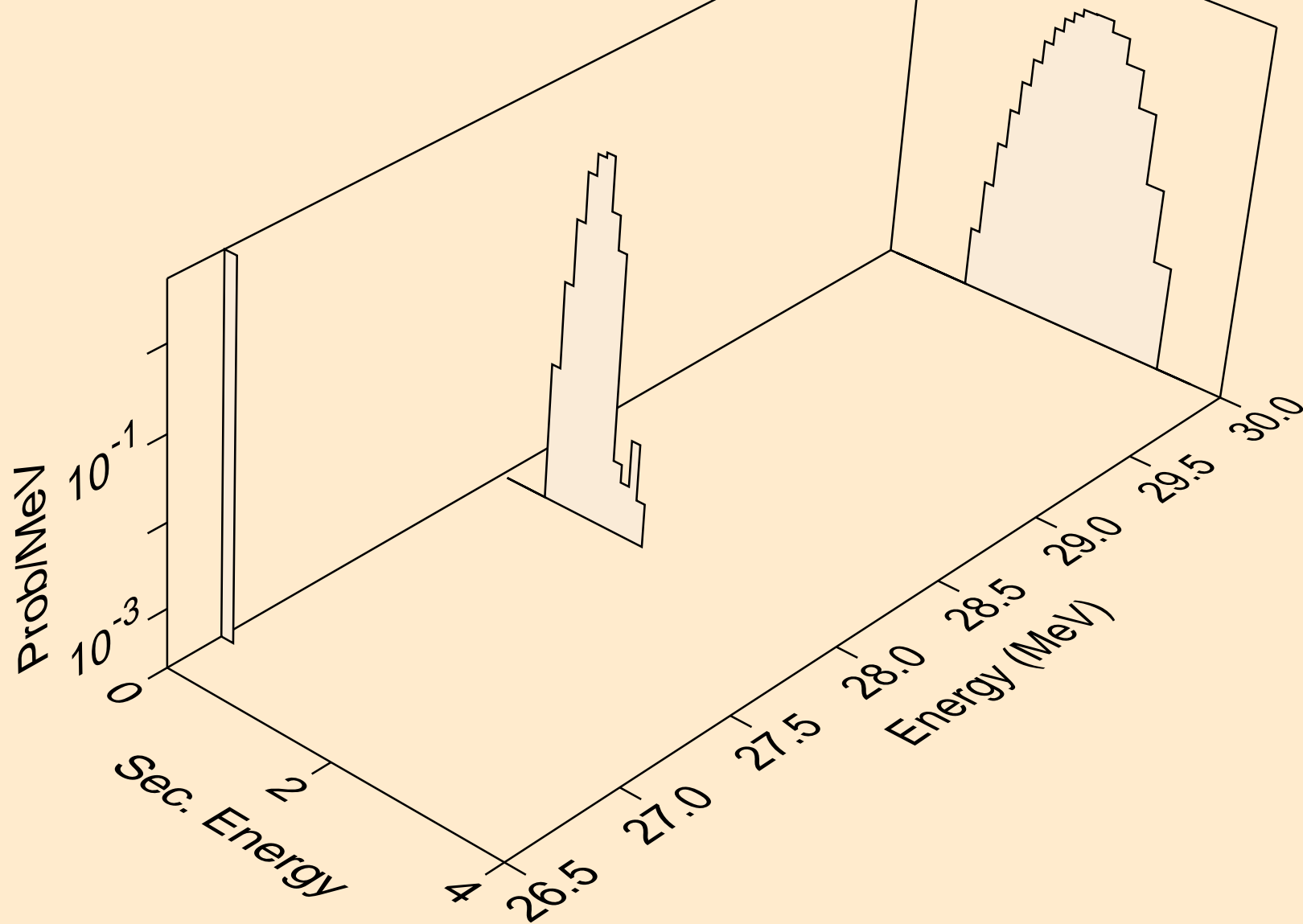

NB088 NEUTRON ACER TENDL-2023 LIBRARY; T=0.K  
protons from (n,n2p)

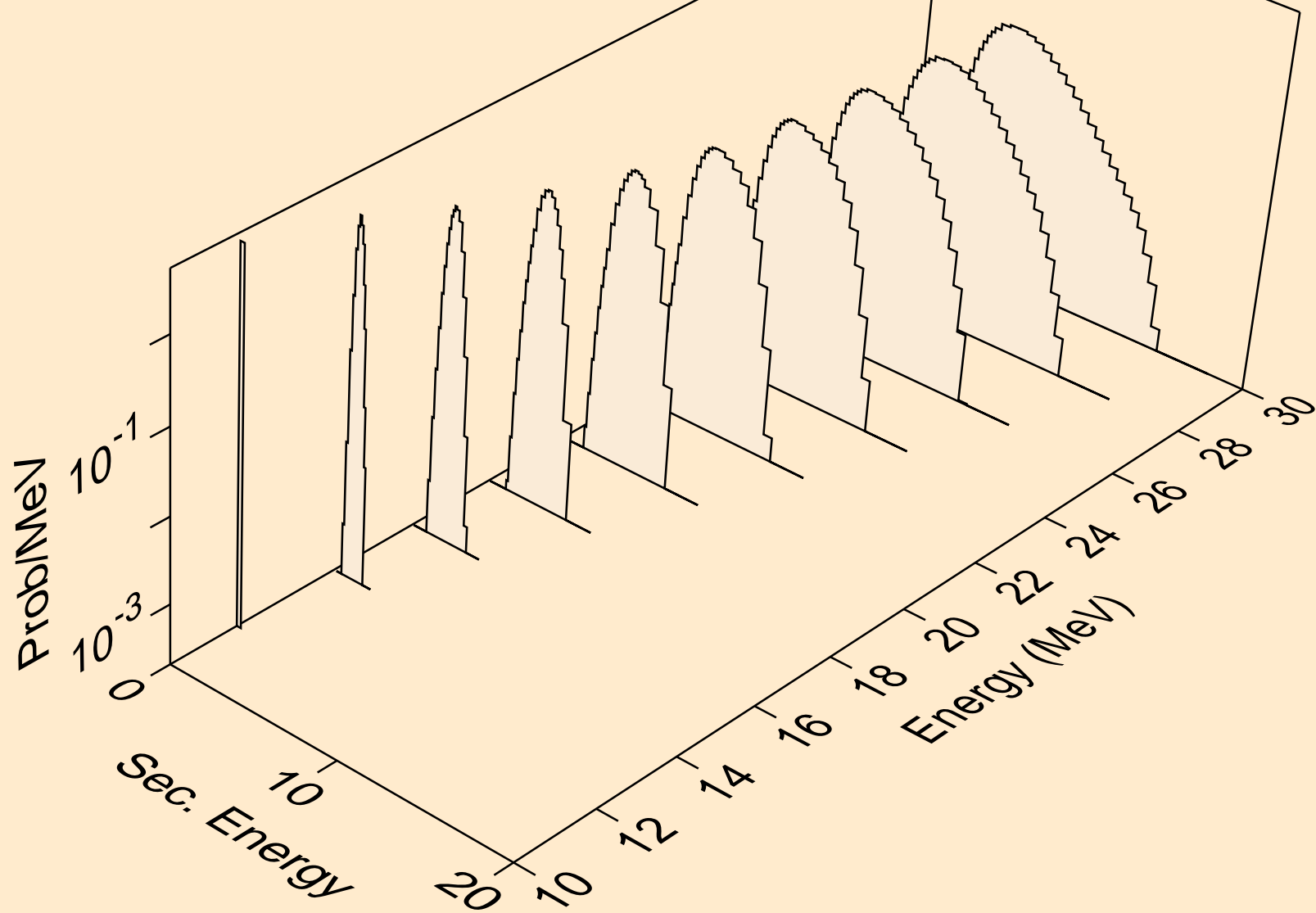

NB088 NEUTRON ACER TENDL-2023 LIBRARY; T=0.K  
protons from (n,npa)

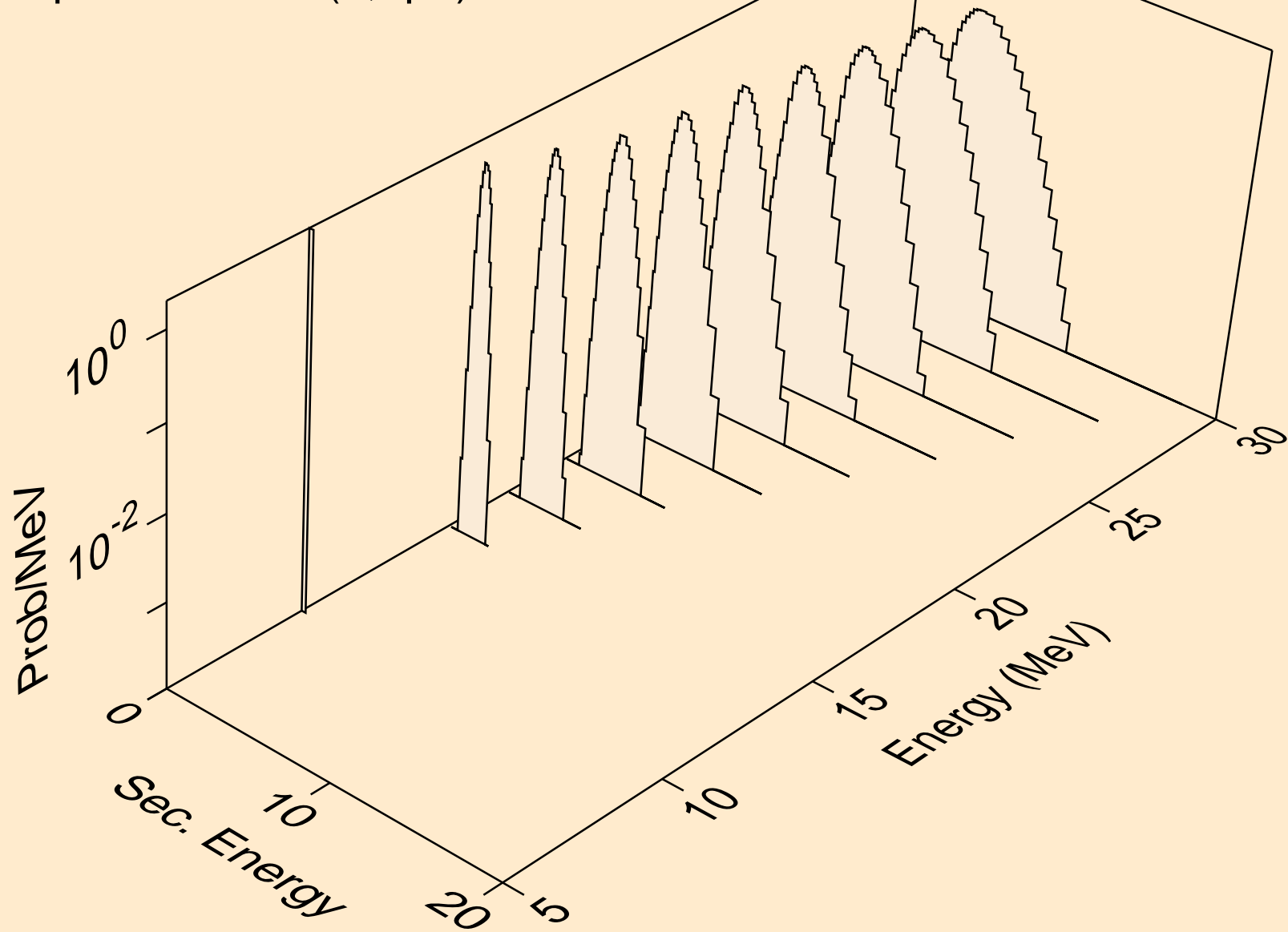

NB088 NEUTRON ACER TENDL-2023 LIBRARY; T=0.K  
protons from (n,p)

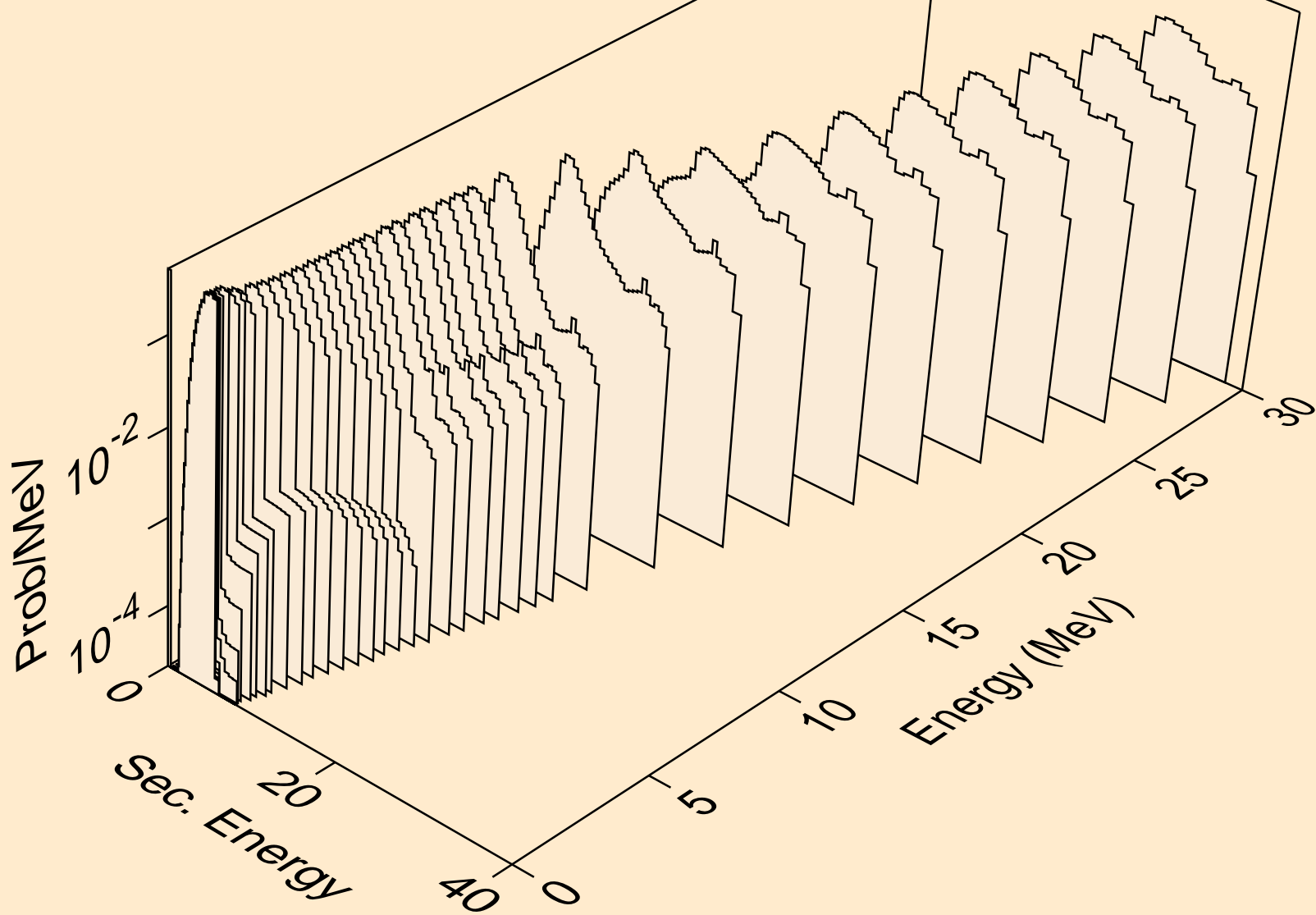

NB088 NEUTRON ACER TENDL-2023 LIBRARY; T=0.K  
protons from (n,2p)

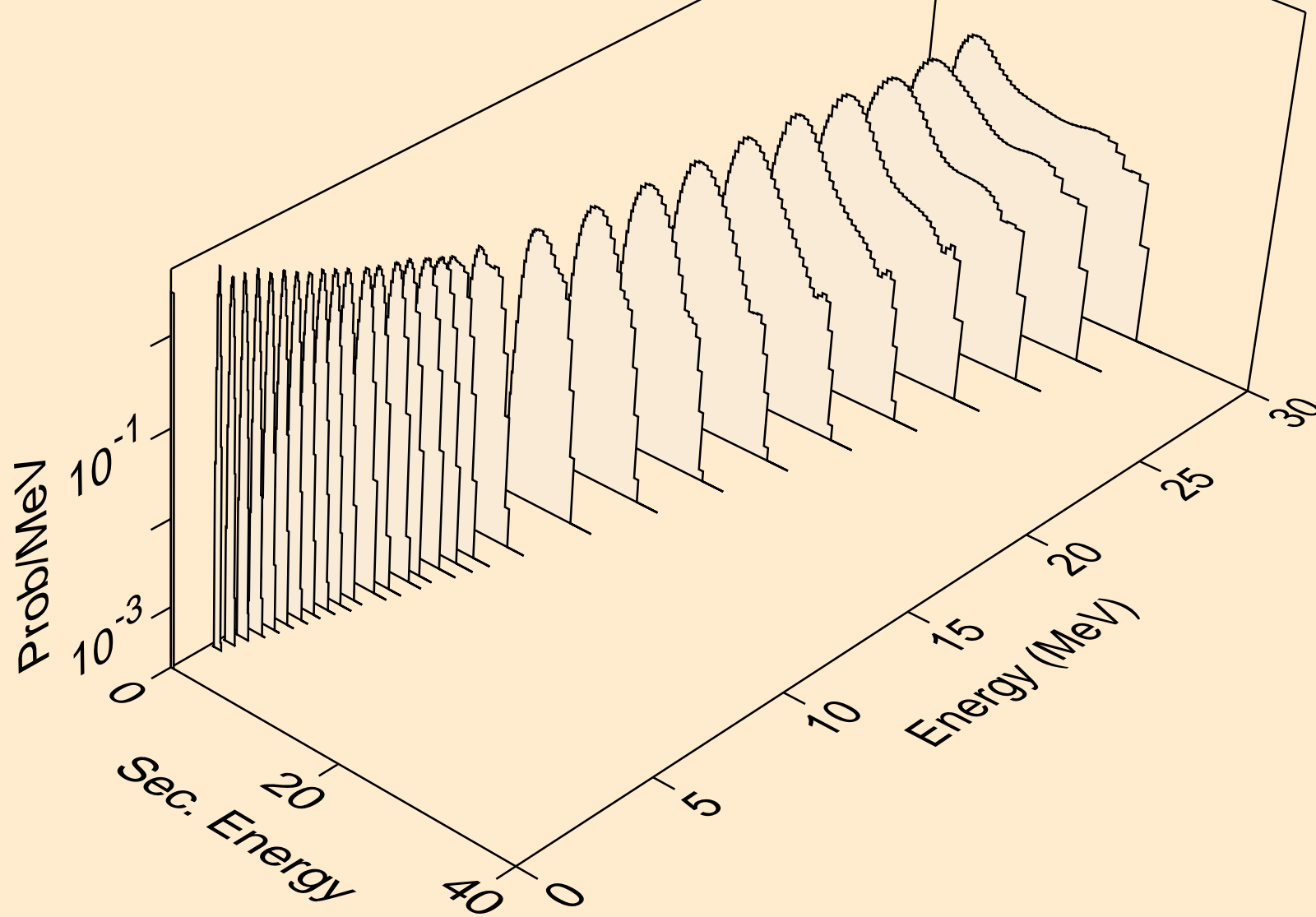

NB088 NEUTRON ACER TENDL-2023 LIBRARY; T=0.K  
protons from (n,p)

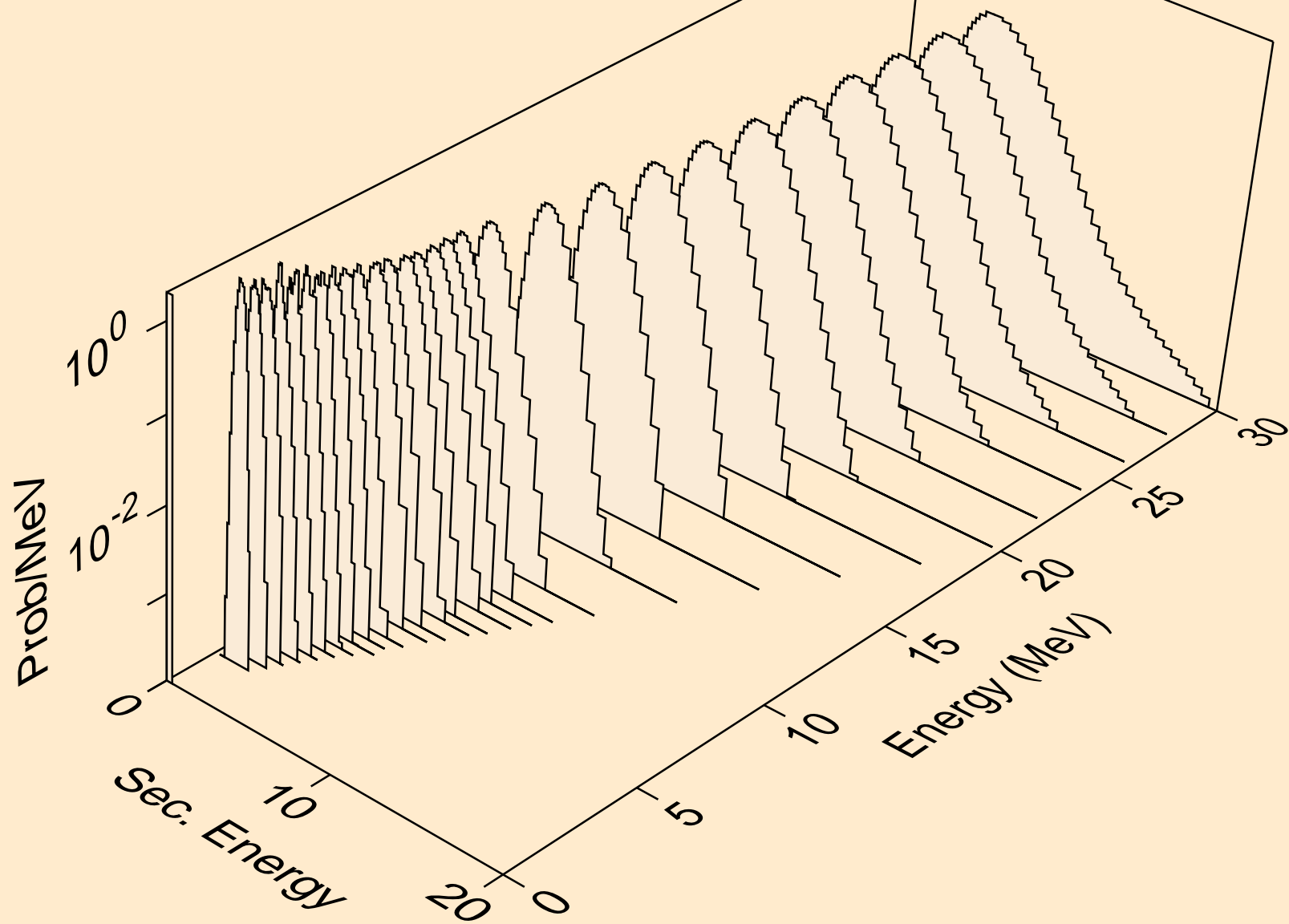

NB088 NEUTRON ACER TENDL-2023 LIBRARY; T=0.K  
protons from (n,pd)

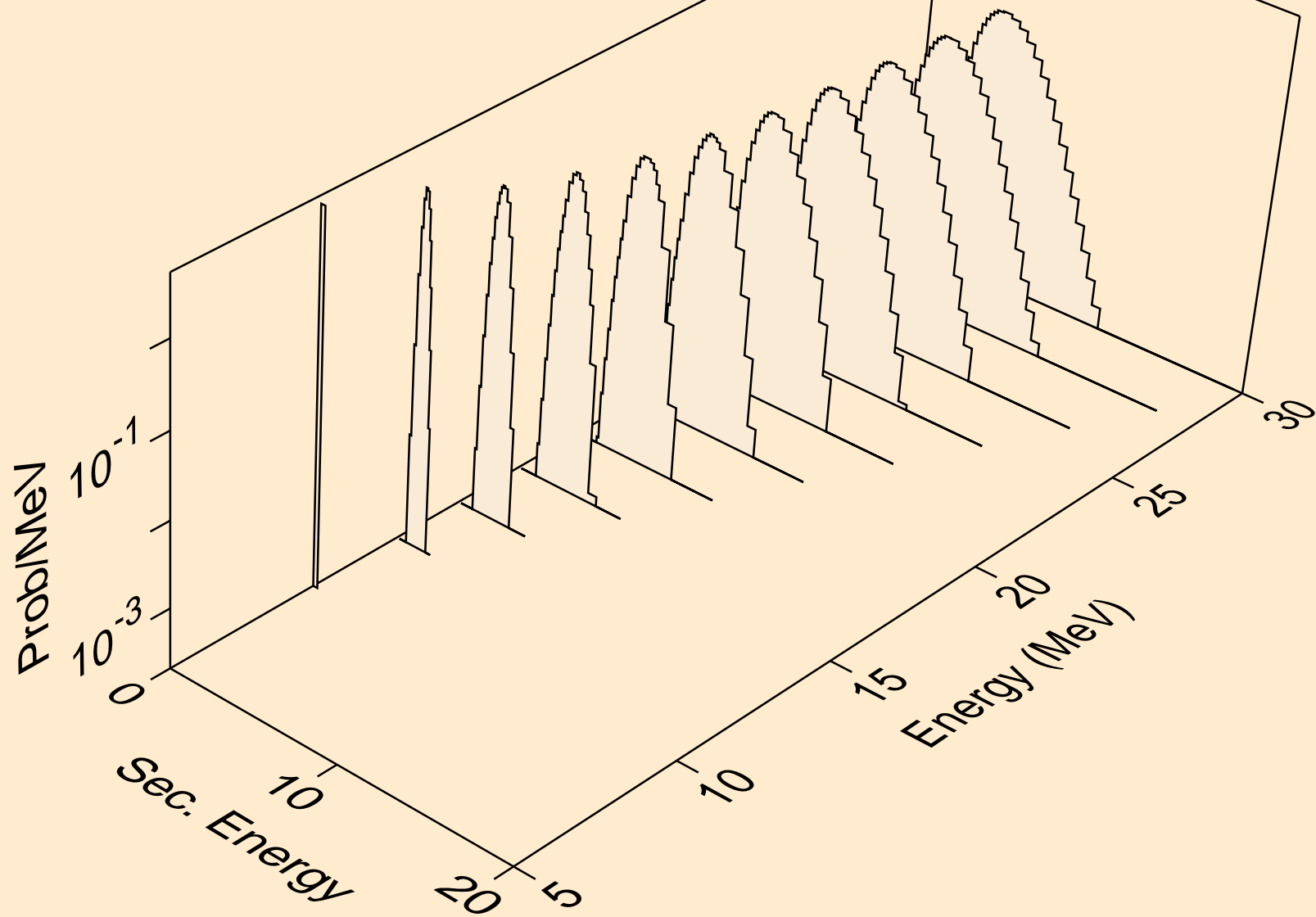

NB088 NEUTRON ACER TENDL-2023 LIBRARY; T=0.K  
protons from (n,pt)

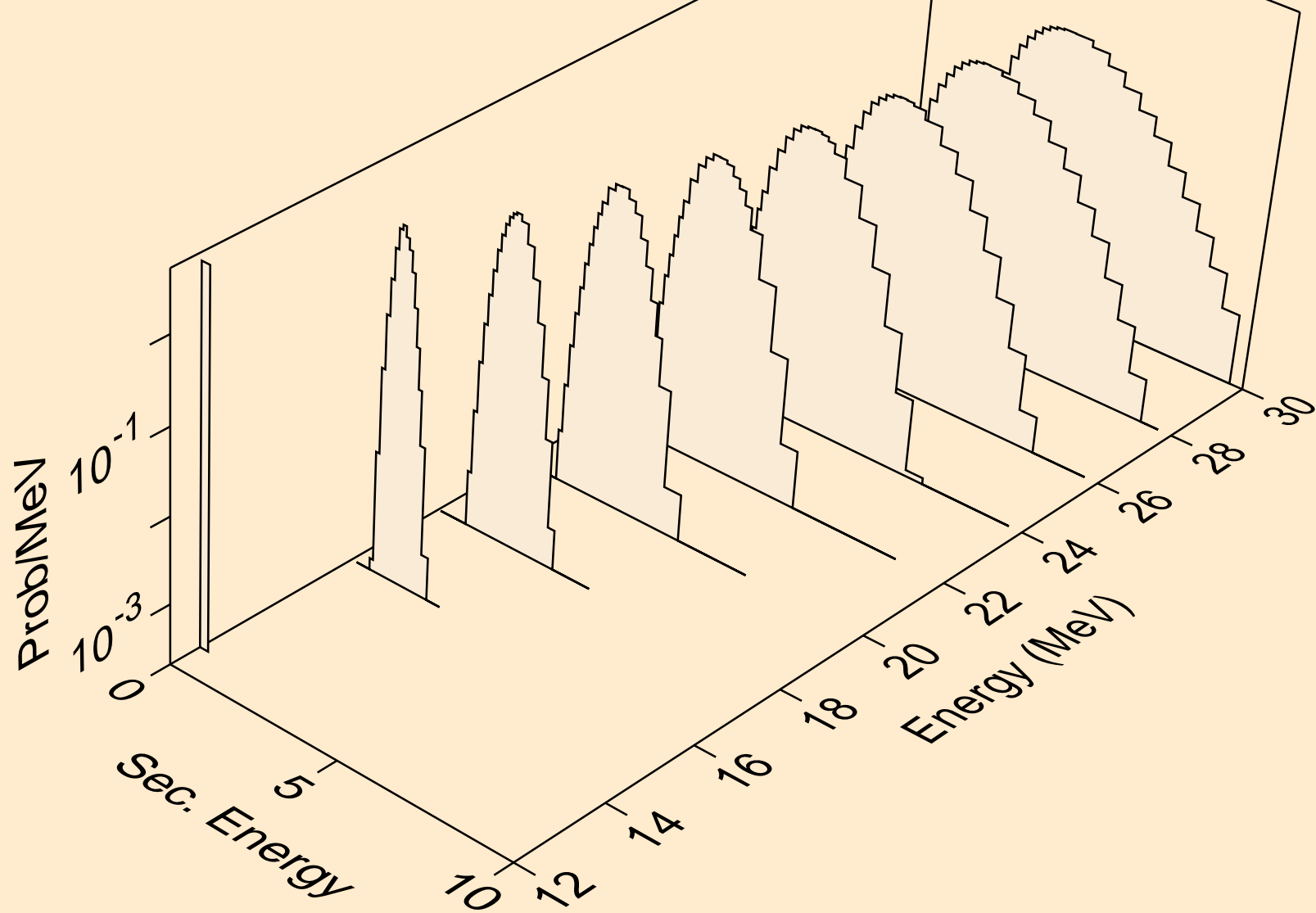



NB088 NEUTRON ACER TENDL-2023 LIBRARY; T=0.K  
deuterons from (n,x)

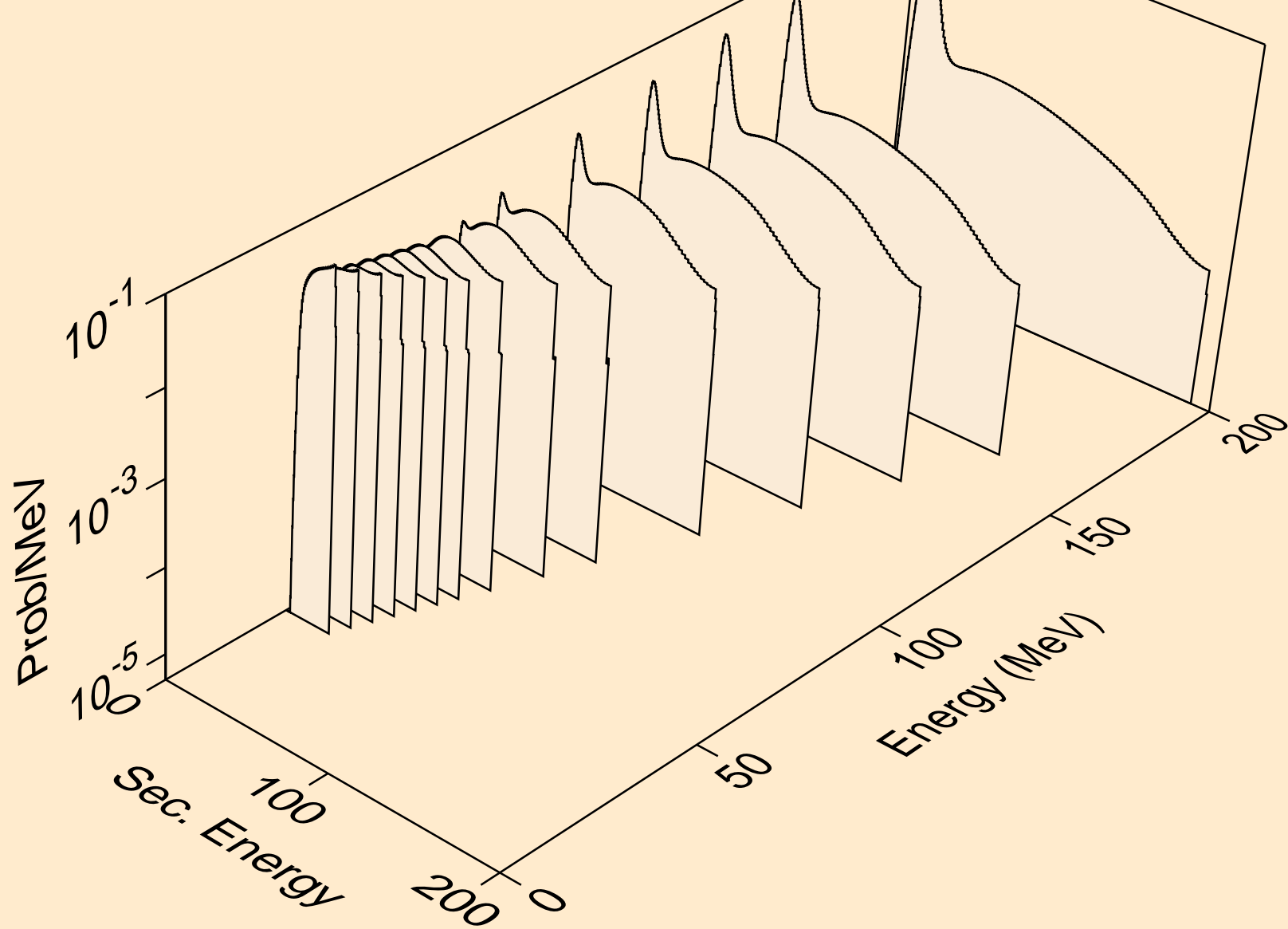

NB088 NEUTRON ACER TENDL-2023 LIBRARY; T=0.K  
deuterons from (n,2nd)

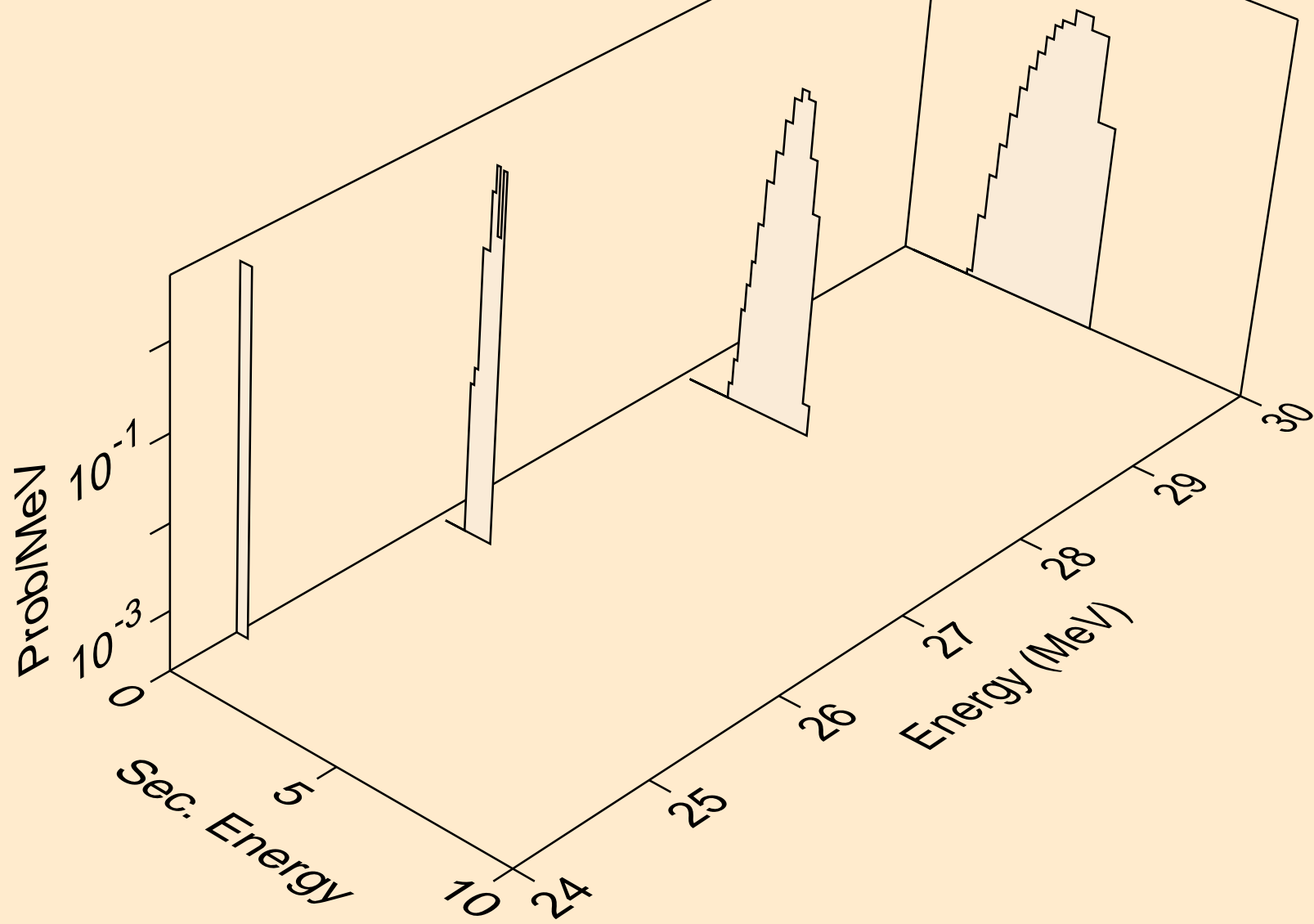

NB088 NEUTRON ACER TENDL-2023 LIBRARY; T=0.K  
deuterons from (n,n\*)d

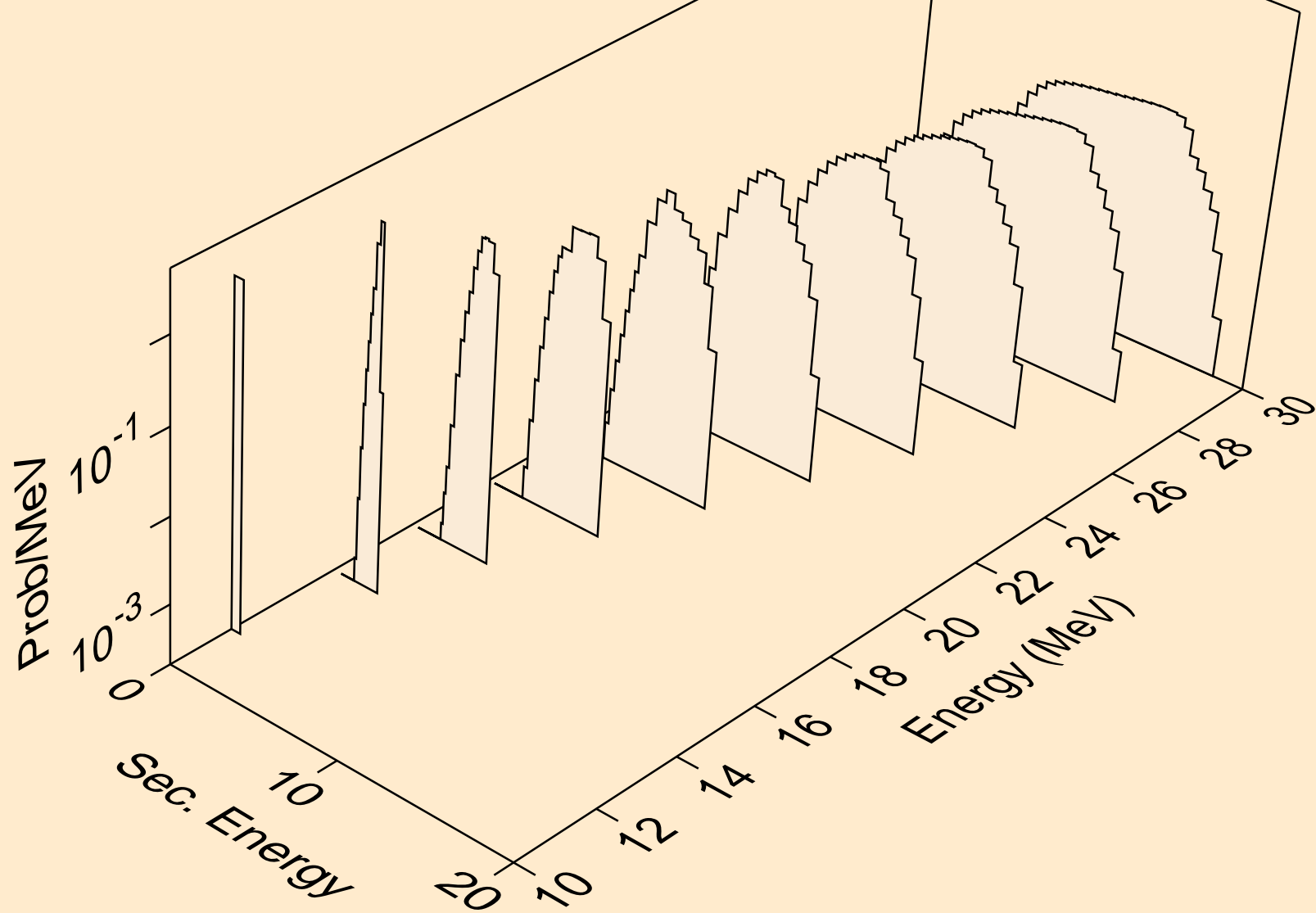

NB088 NEUTRON ACER TENDL-2023 LIBRARY; T=0.K  
deuterons from (n,d)

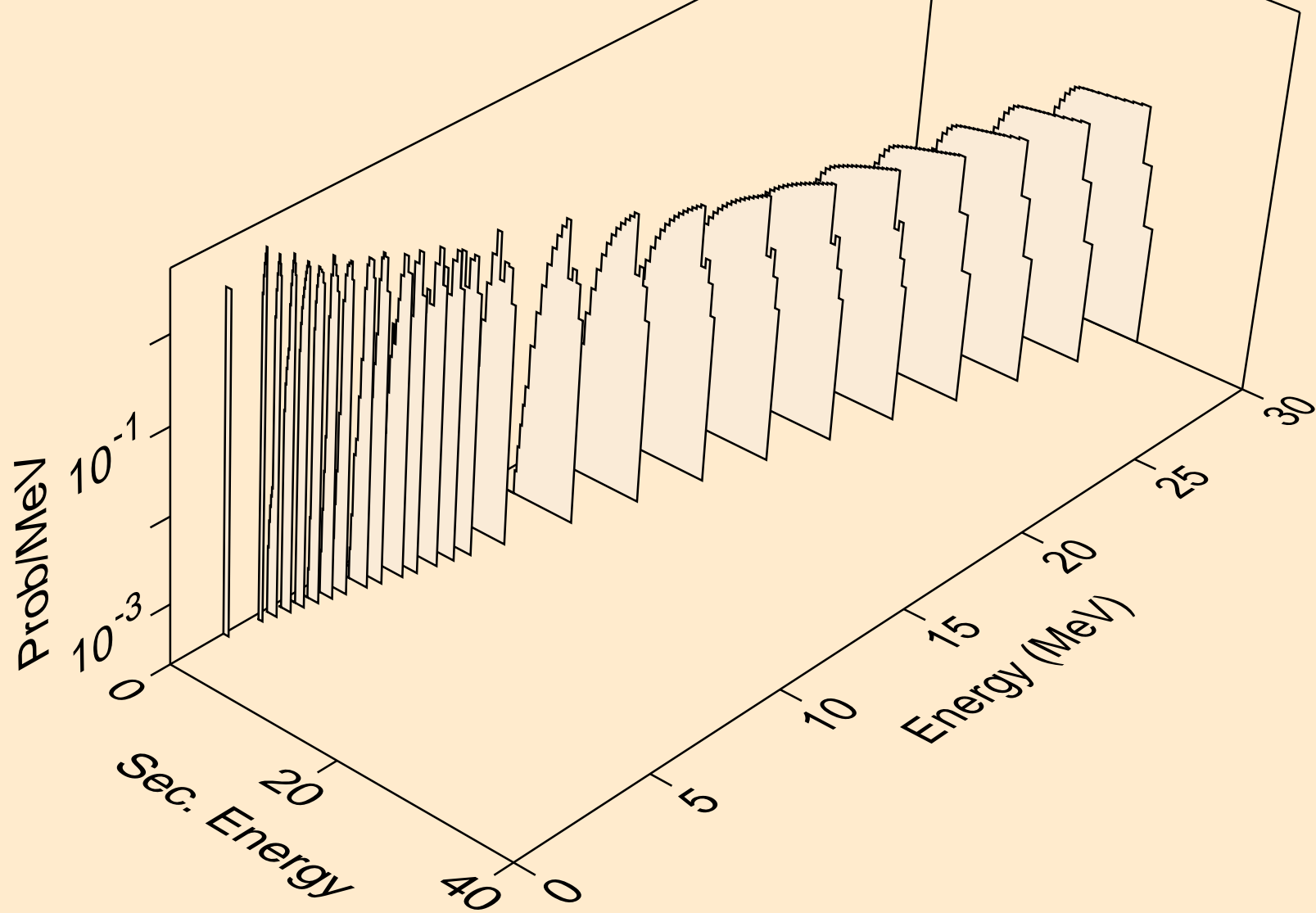

NB088 NEUTRON ACER TENDL-2023 LIBRARY; T=0.K  
deuterons from (n,pd)

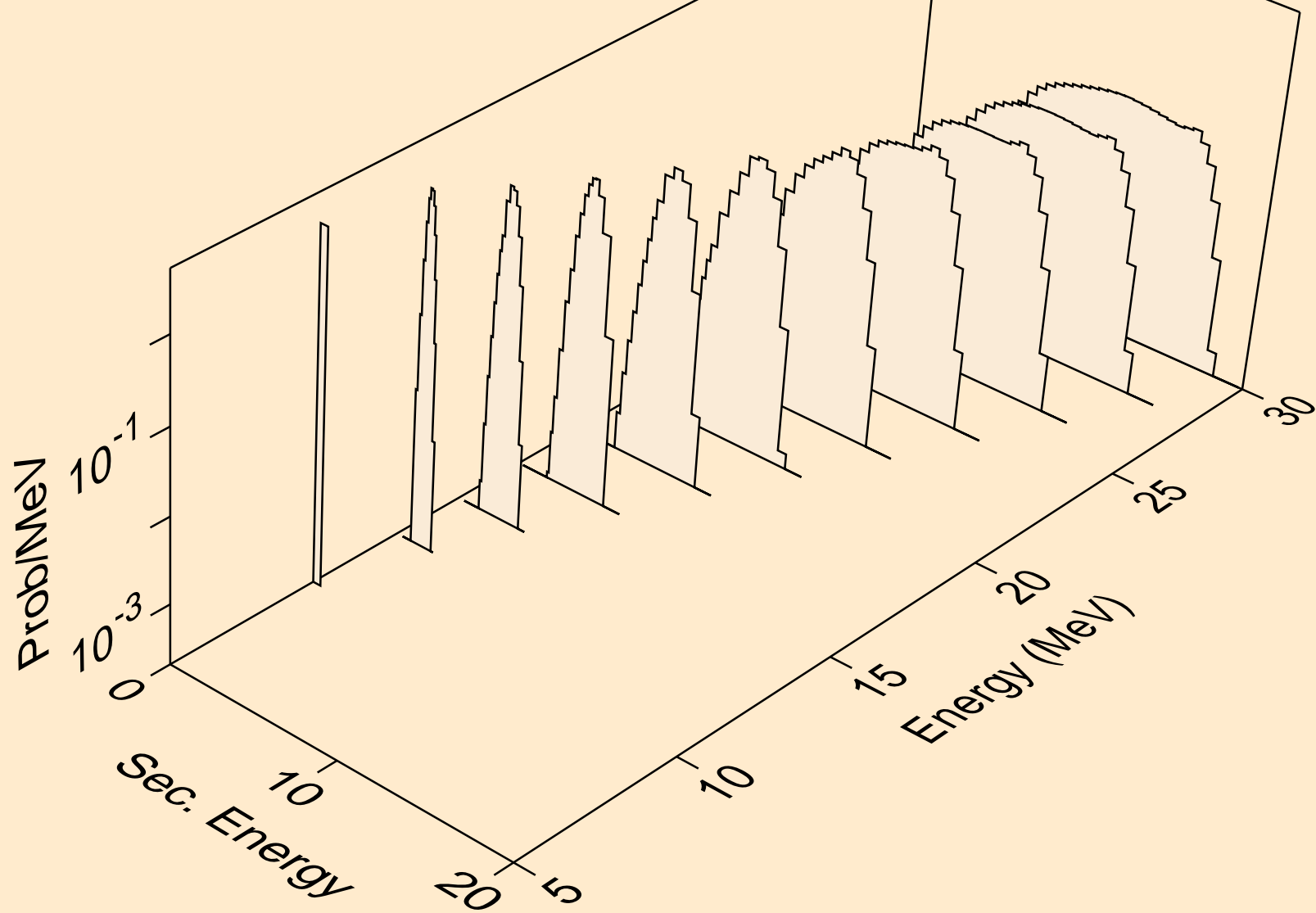

NB088 NEUTRON ACER TENDL-2023 LIBRARY; T=0.K  
deuterons from (n,da)

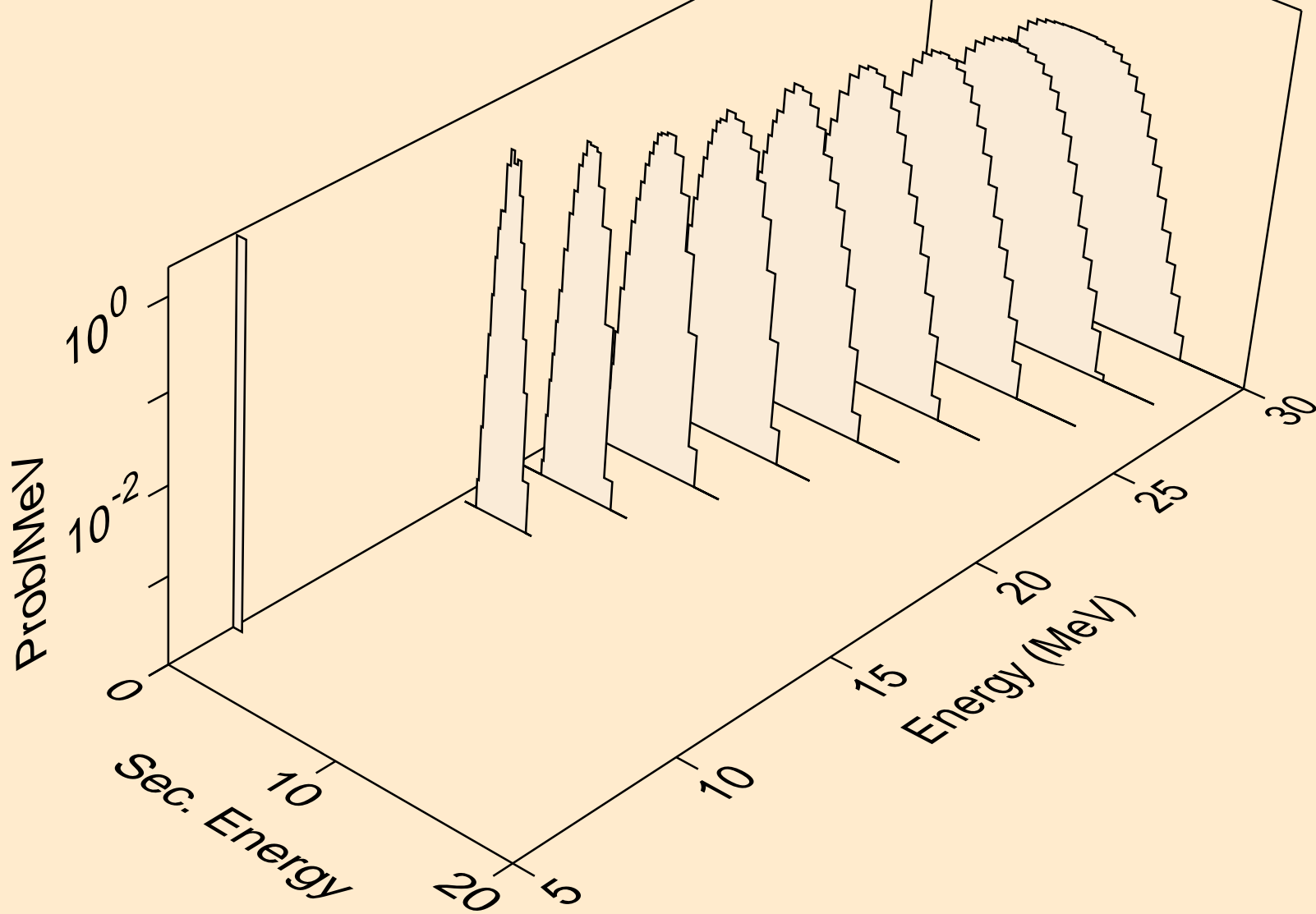

NB088 NEUTRON ACER TENDL-2023 LIBRARY; T=0.K  
tritons from (n,x)

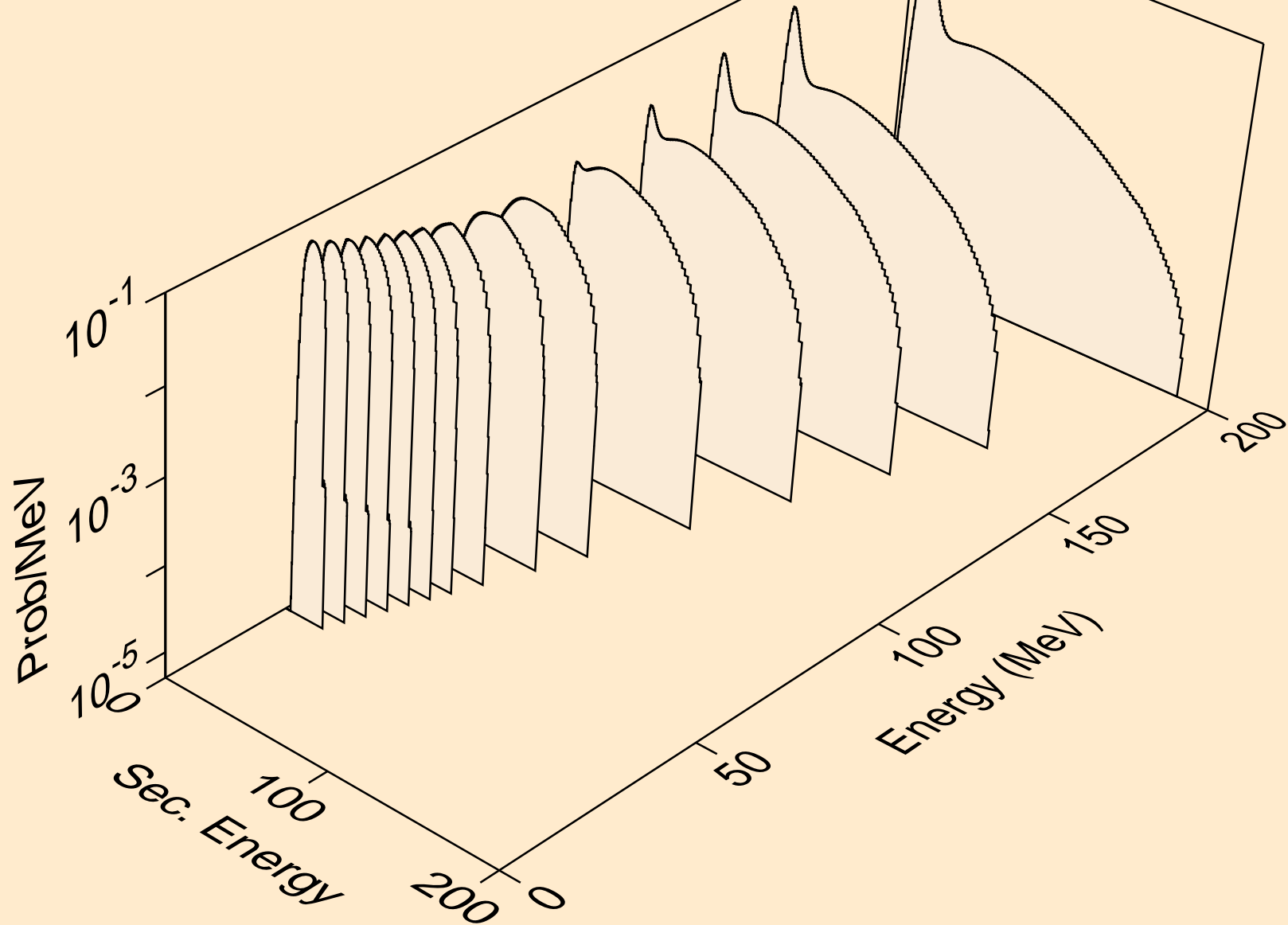

NB088 NEUTRON ACER TENDL-2023 LIBRARY; T=0.K  
tritons from (n,n\*)t

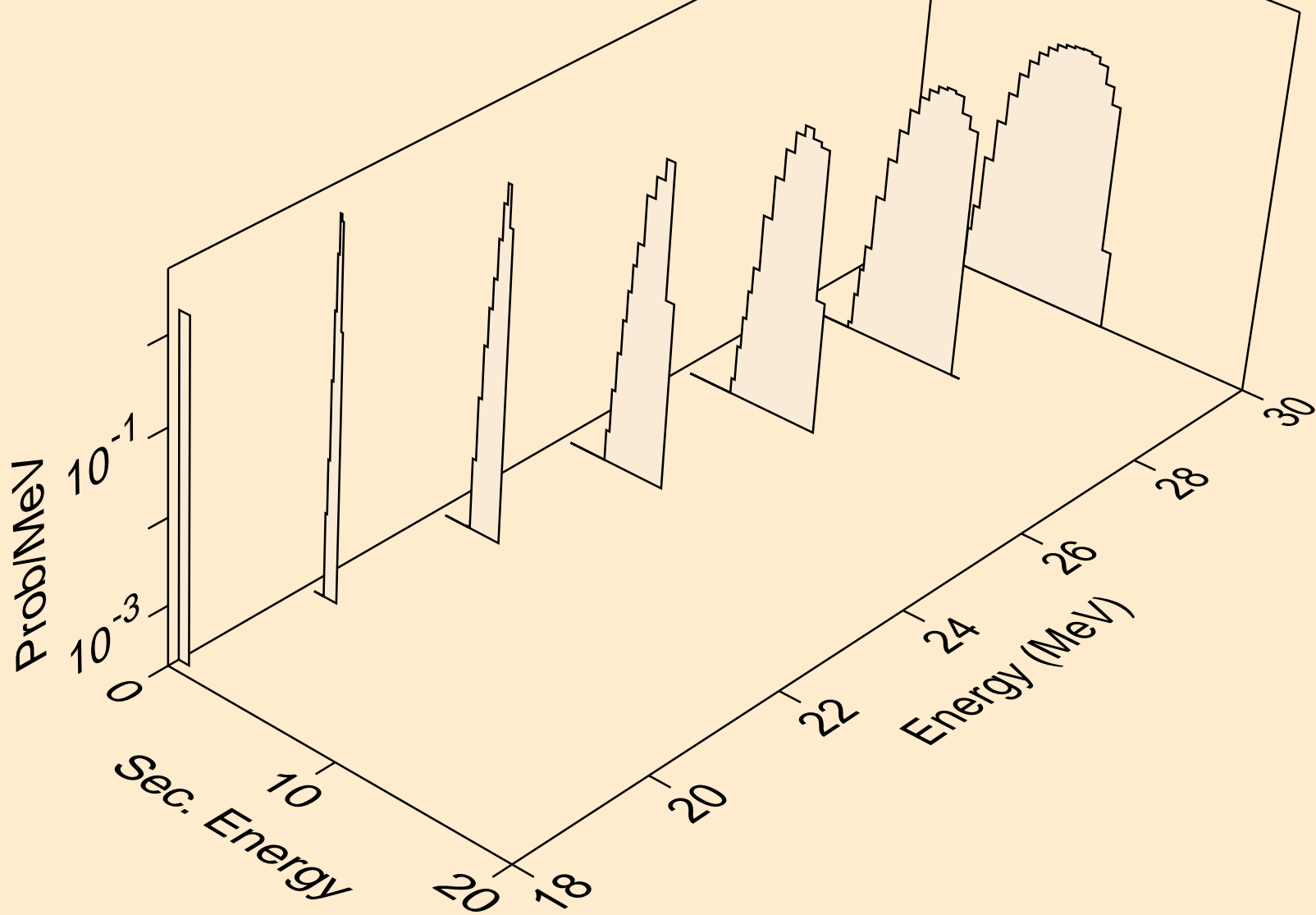



NB088 NEUTRON ACER TENDL-2023 LIBRARY; T=0.K  
tritons from (n,t)

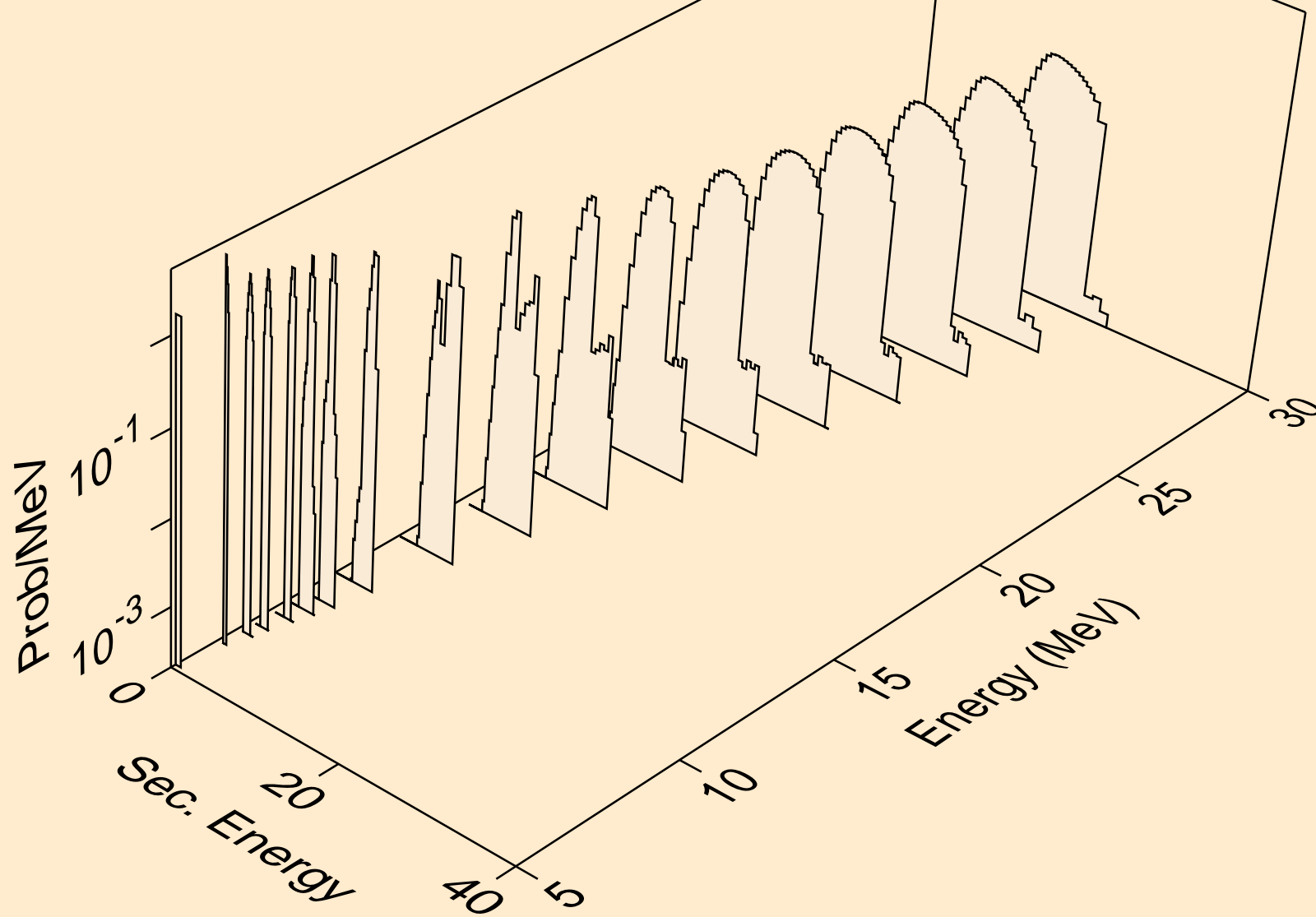

NB088 NEUTRON ACER TENDL-2023 LIBRARY; T=0.K  
tritons from (n,pt)

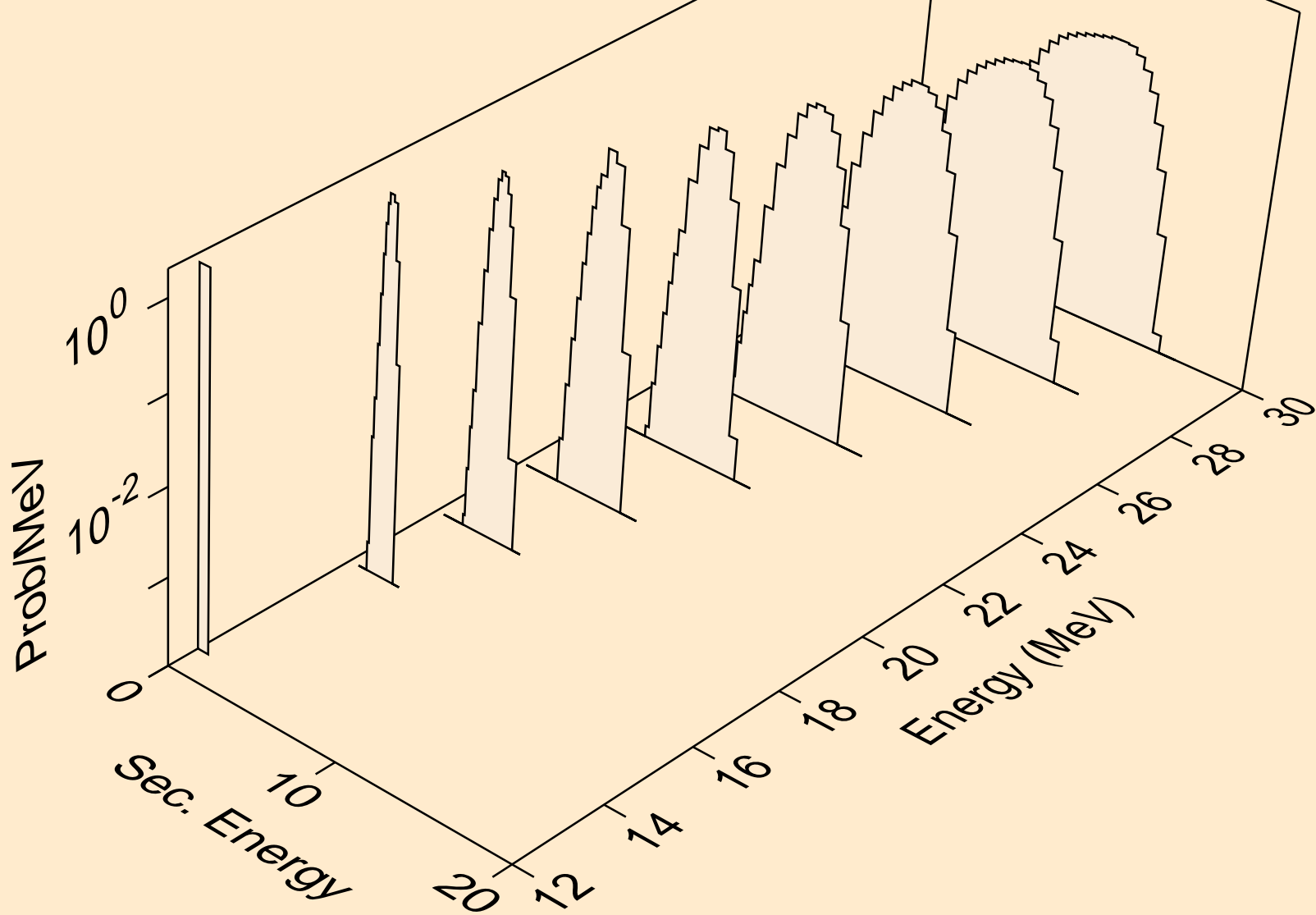

NB088 NEUTRON ACER TENDL-2023 LIBRARY; T=0.K  
he3s from (n,x)

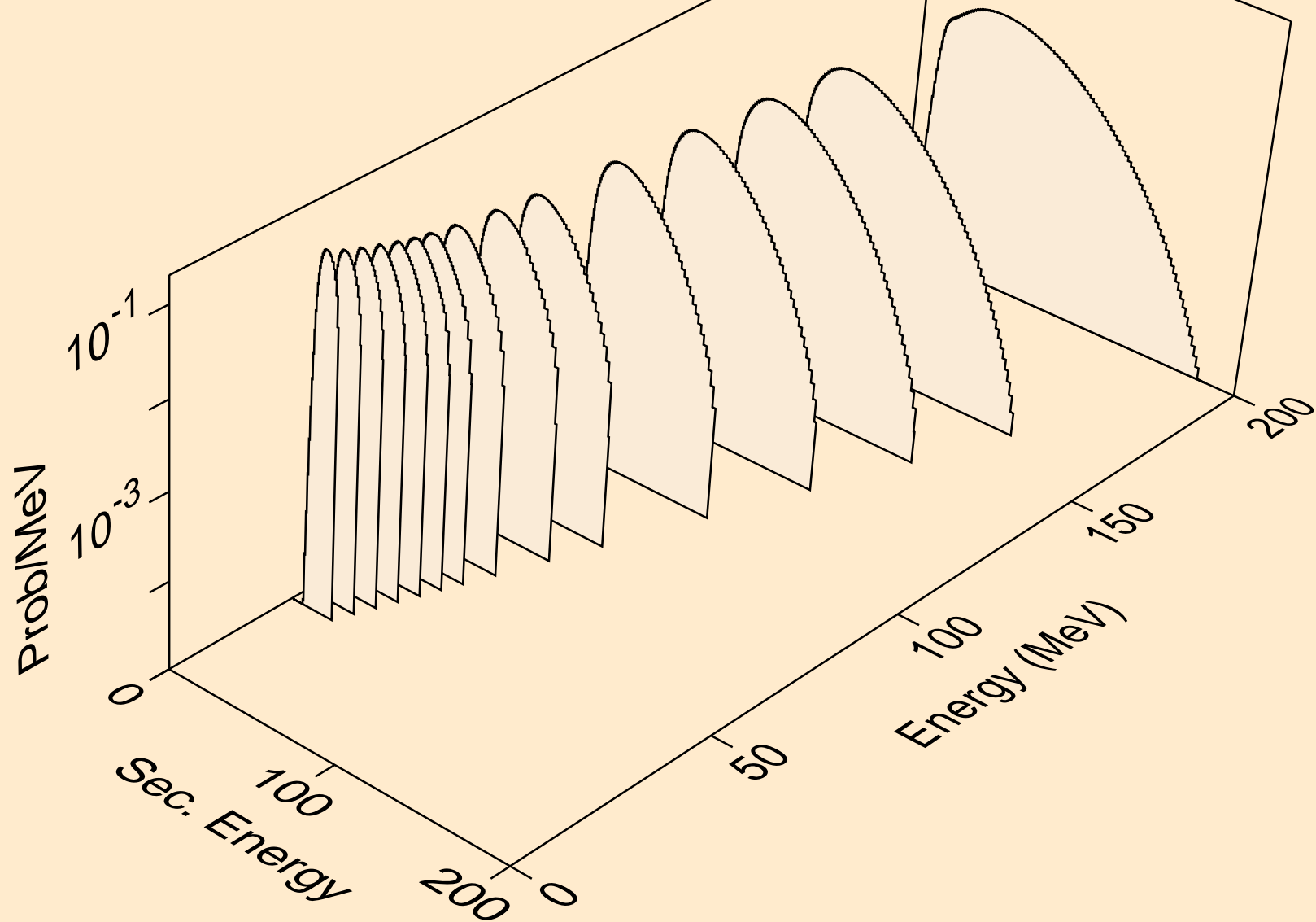

NB088 NEUTRON ACER TENDL-2023 LIBRARY; T=0.K  
he3s from (n,n\*)he3

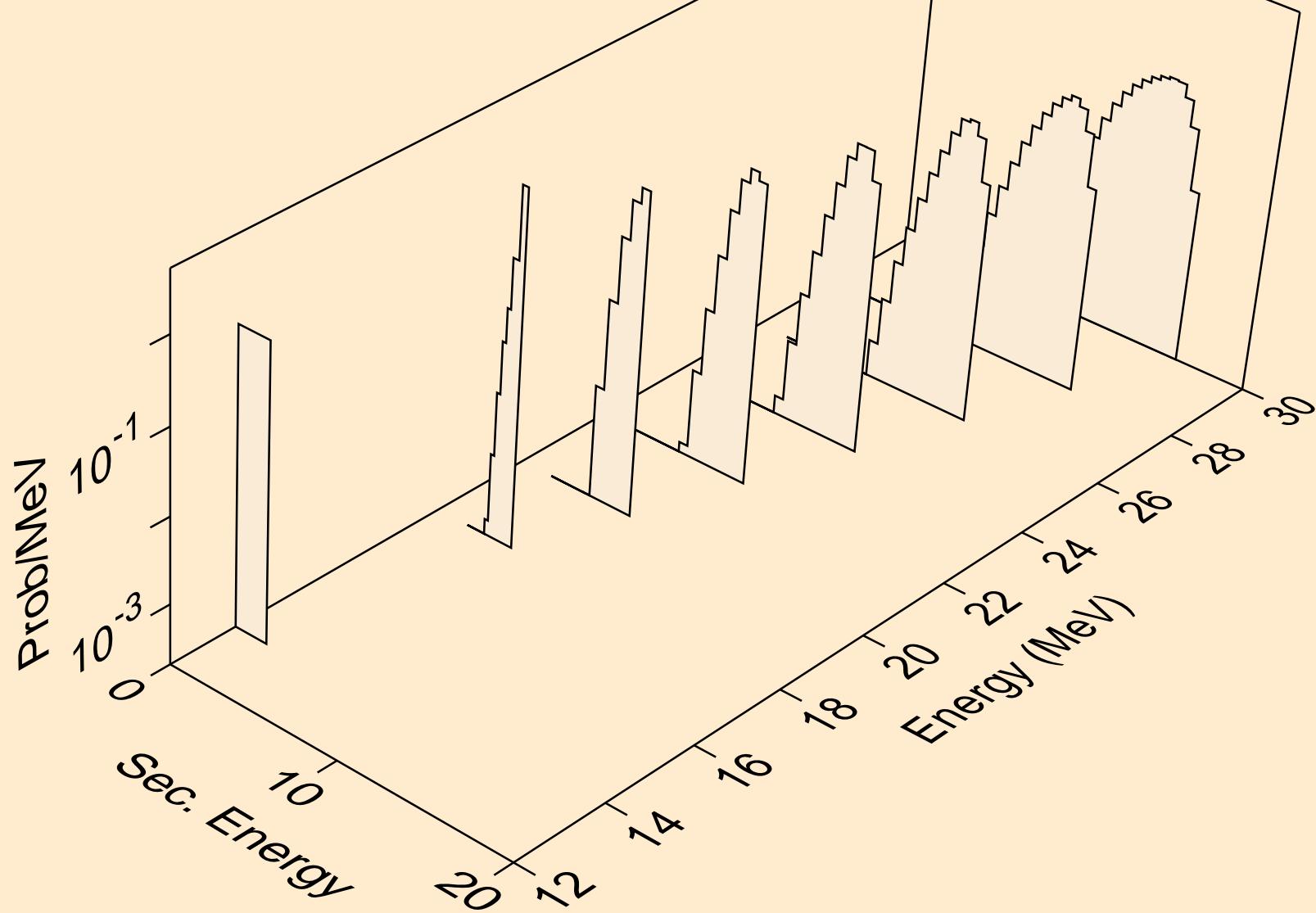

NB088 NEUTRON ACER TENDL-2023 LIBRARY; T=0.K  
he3s from (n,he3)

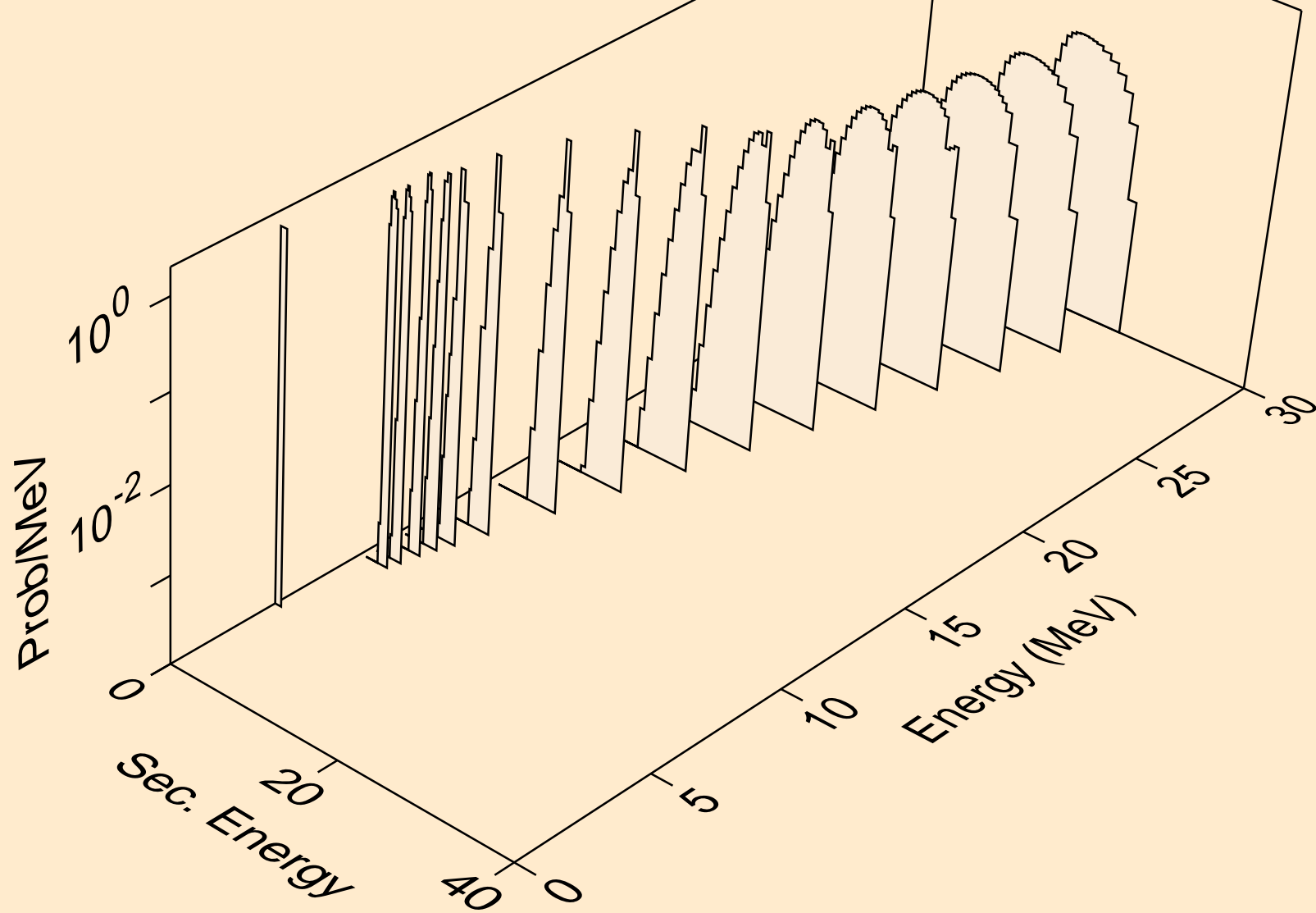

NB088 NEUTRON ACER TENDL-2023 LIBRARY; T=0.K  
alphas from (n,x)

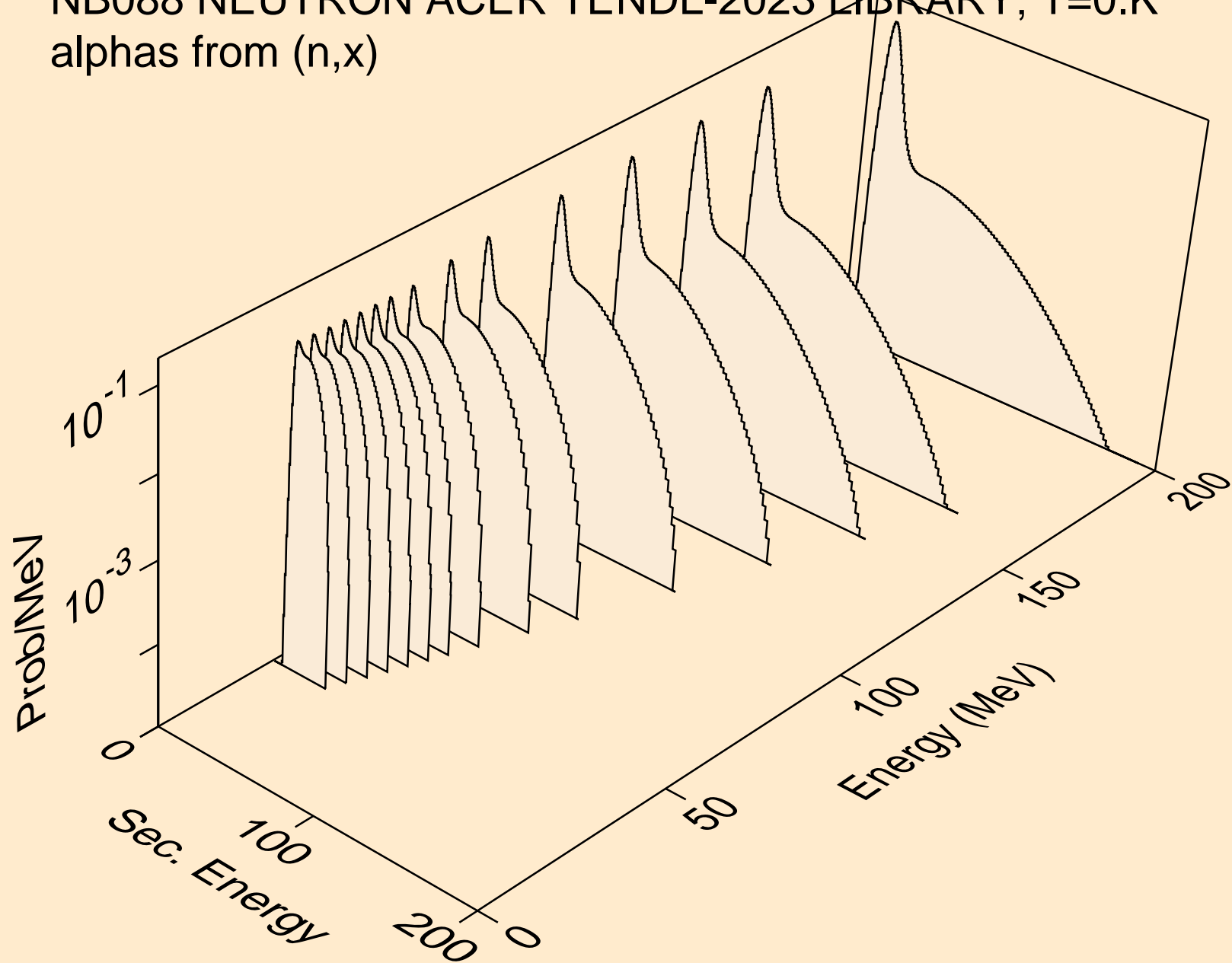

NB088 NEUTRON ACER TENDL-2023 LIBRARY; T=0.K  
alphas from (n,n\*)a

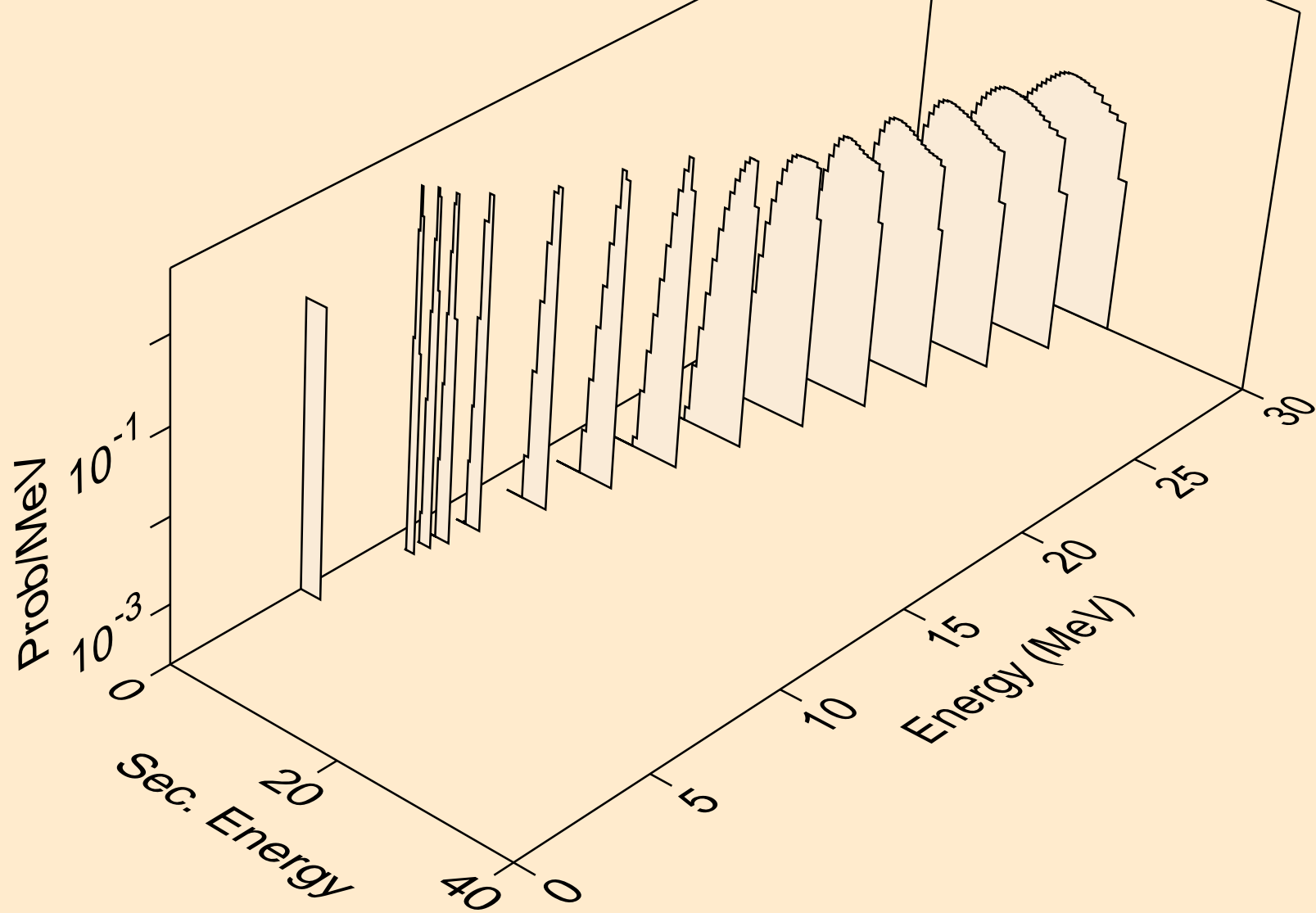

NB088 NEUTRON ACER TENDL-2023 LIBRARY; T=0.K  
alphas from (n,2n)a

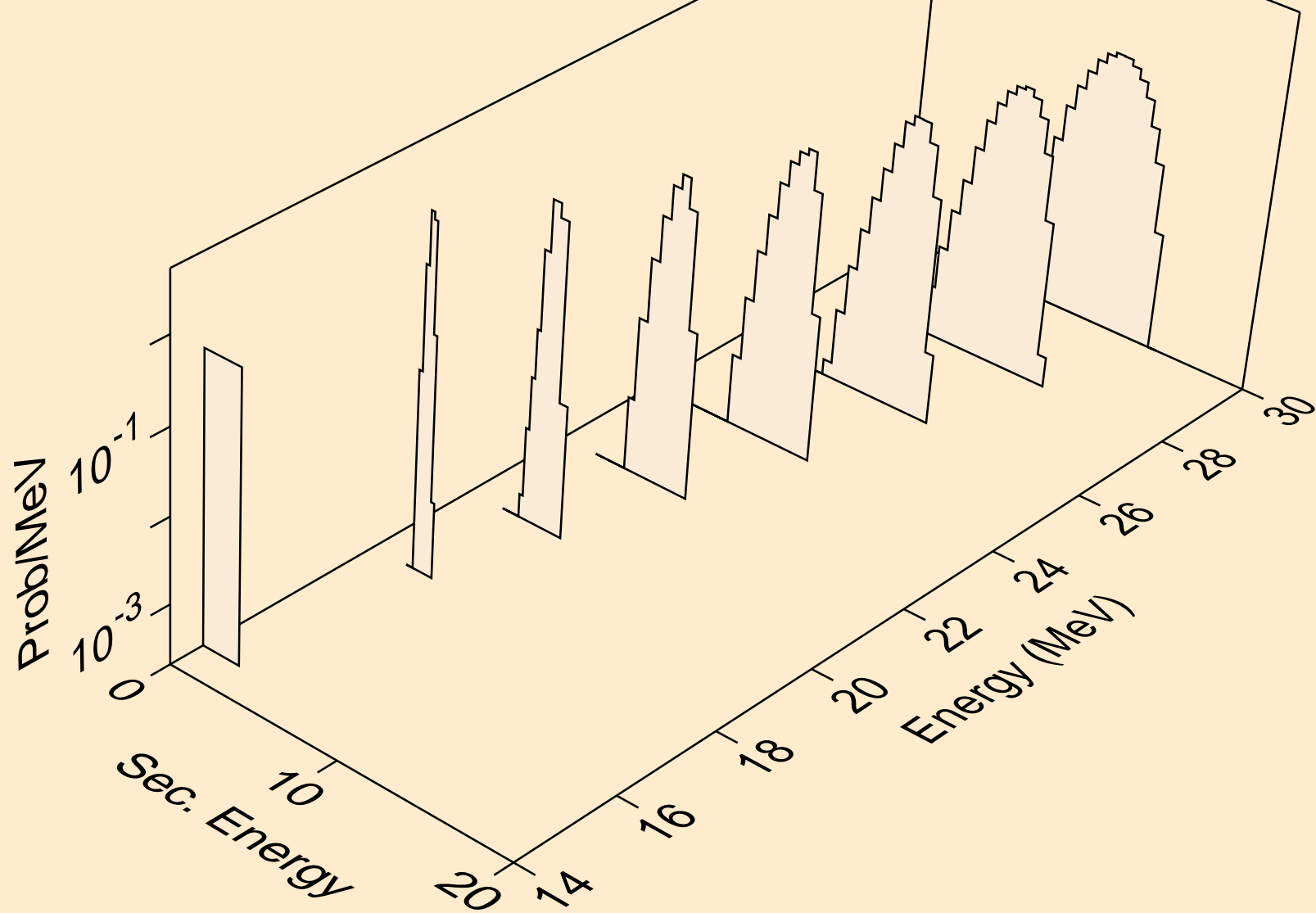



NB088 NEUTRON ACER TENDL-2023 LIBRARY; T=0.K  
alphas from (n,n\*)2a

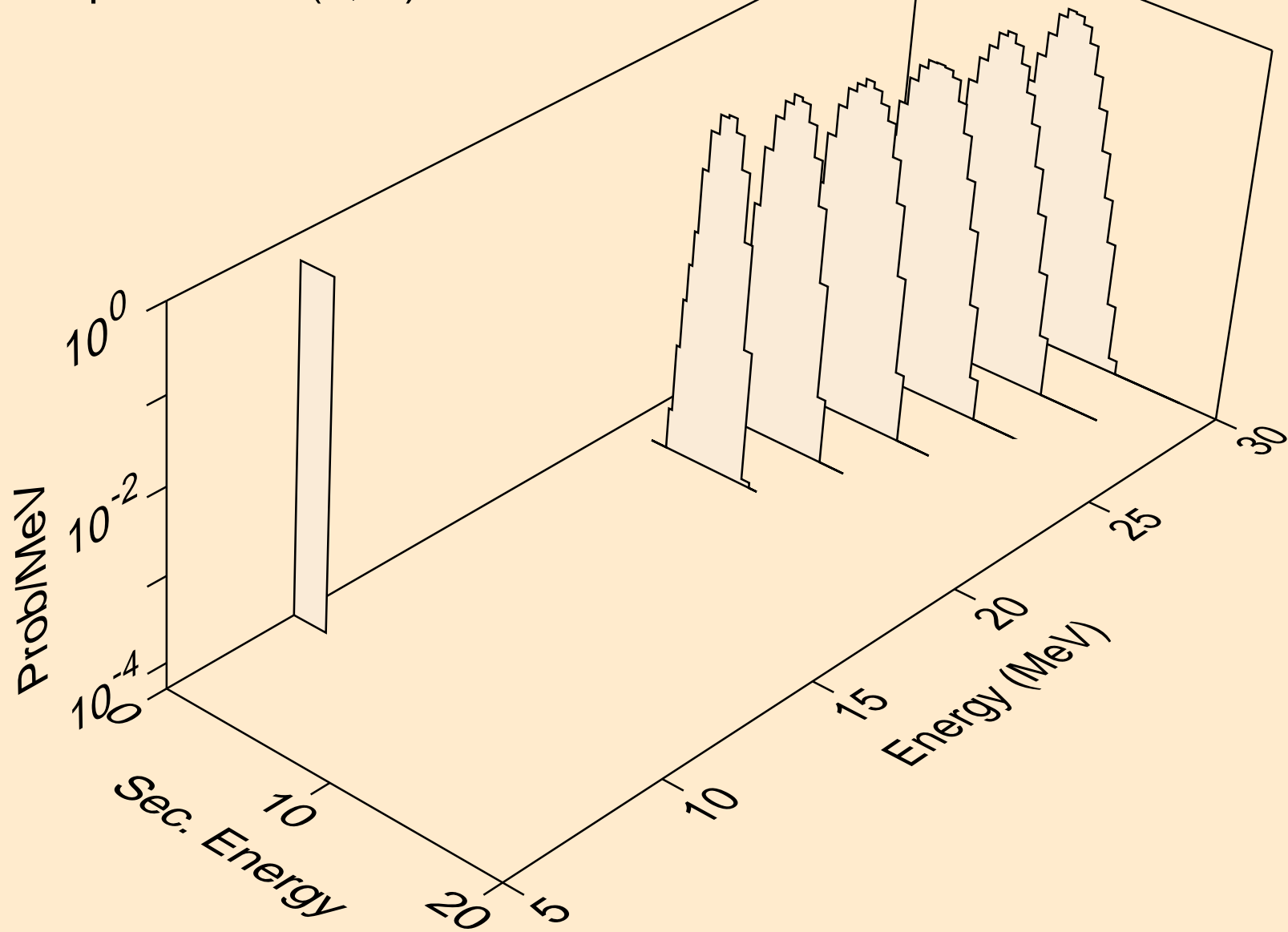

NB088 NEUTRON ACER TENDL-2023 LIBRARY; T=0.K  
alphas from (n,npa)

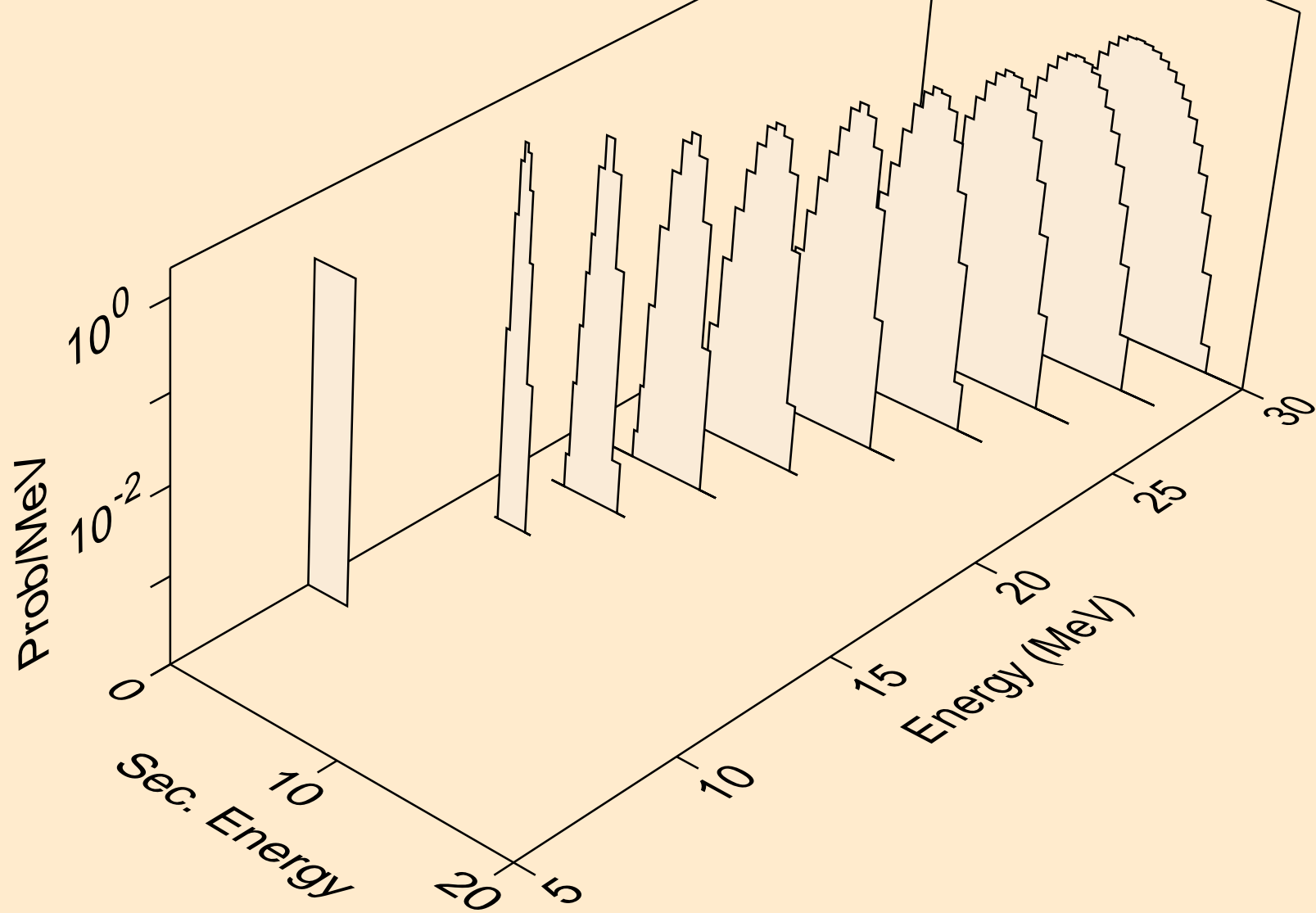

NB088 NEUTRON ACER TENDL-2023 LIBRARY; T=0.K  
alphas from (n,a)

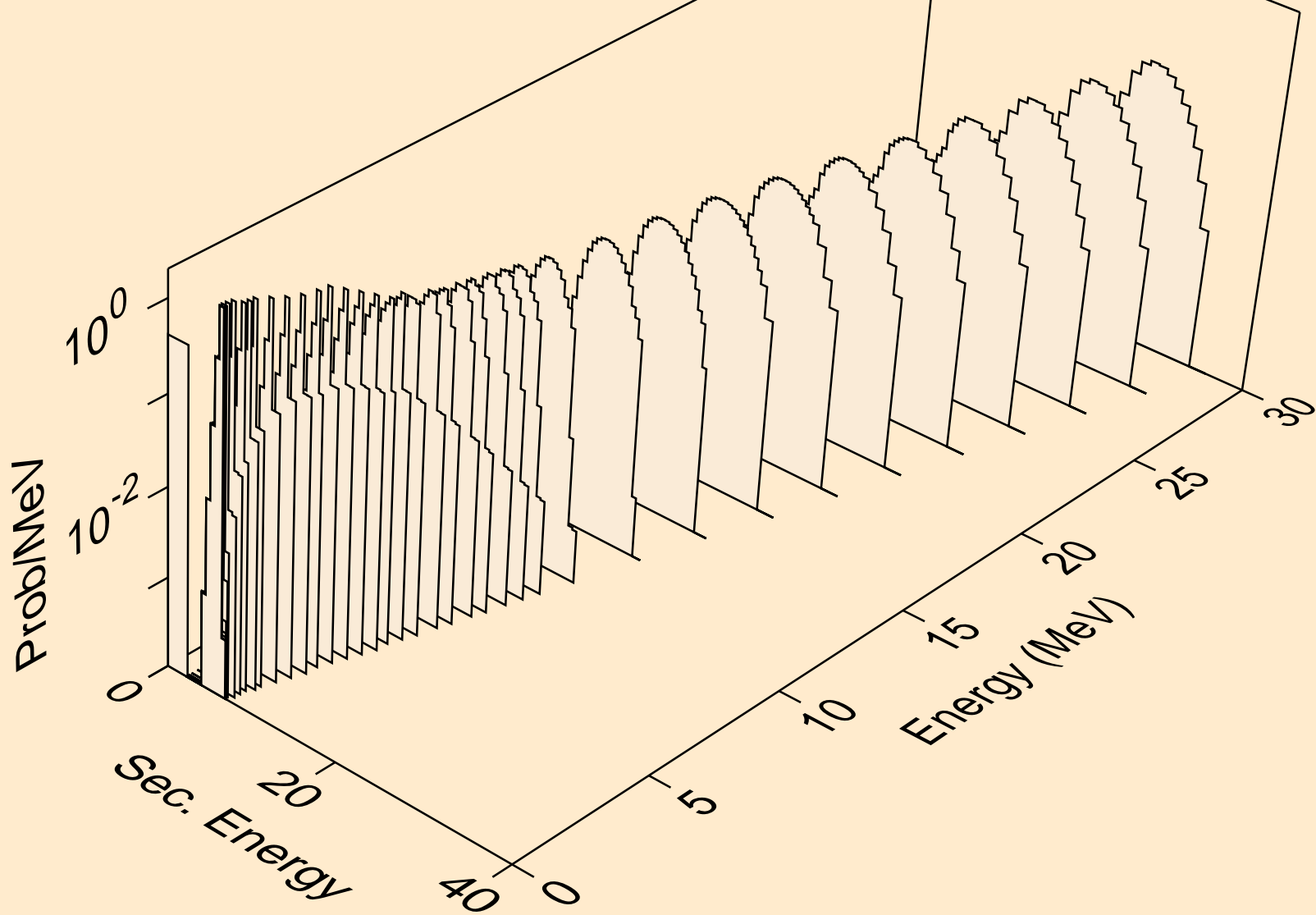

NB088 NEUTRON ACER TENDL-2023 LIBRARY; T=0.K  
alphas from (n,2a)

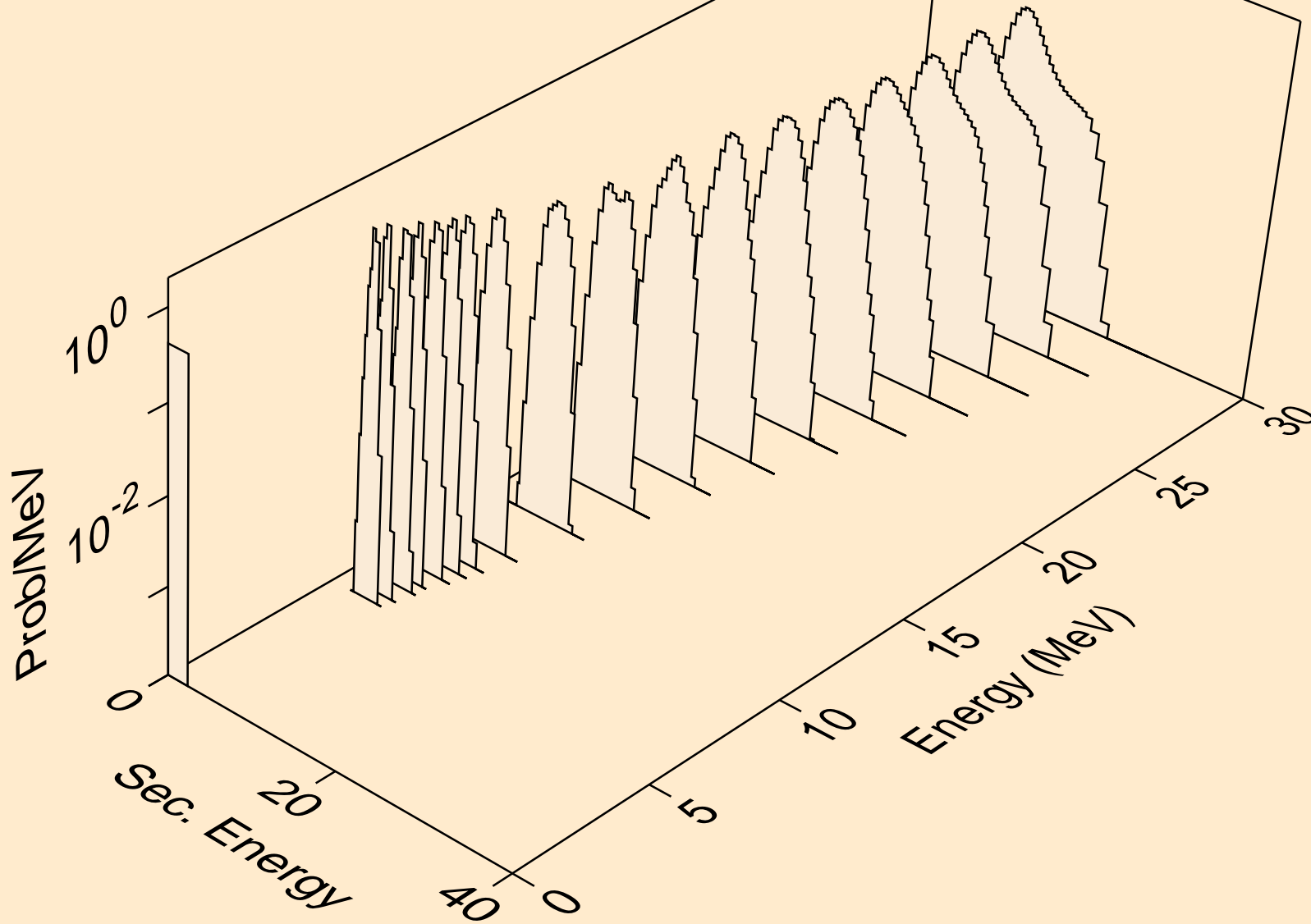

NB088 NEUTRON ACER TENDL-2023 LIBRARY; T=0.K  
alphas from (n,pa)

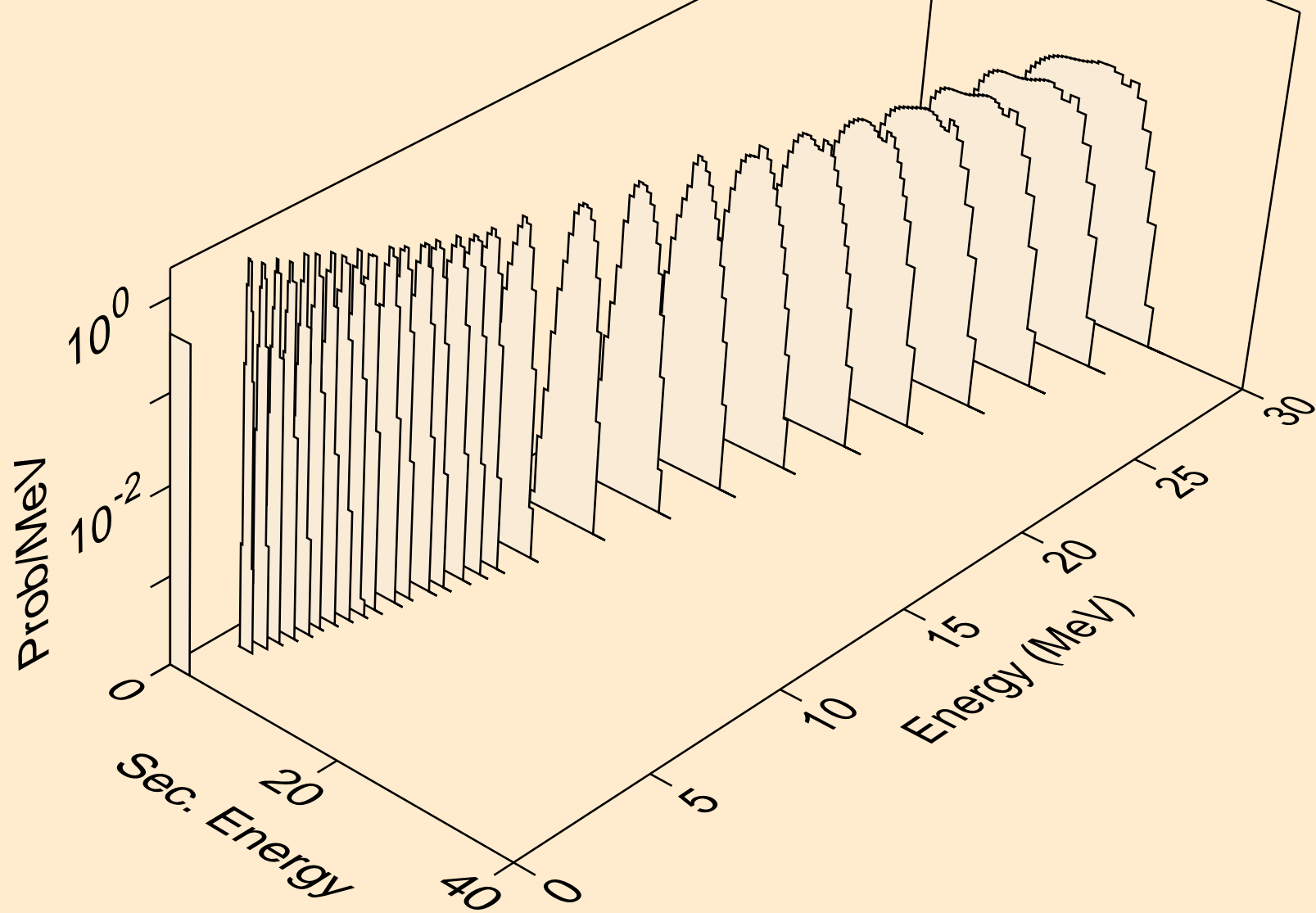

NB088 NEUTRON ACER TENDL-2023 LIBRARY; T=0.K  
alphas from (n,da)

