

# NB099 NEUTRON ACER TENDL-2023 LIBRARY; T=0.K

## Principal cross sections

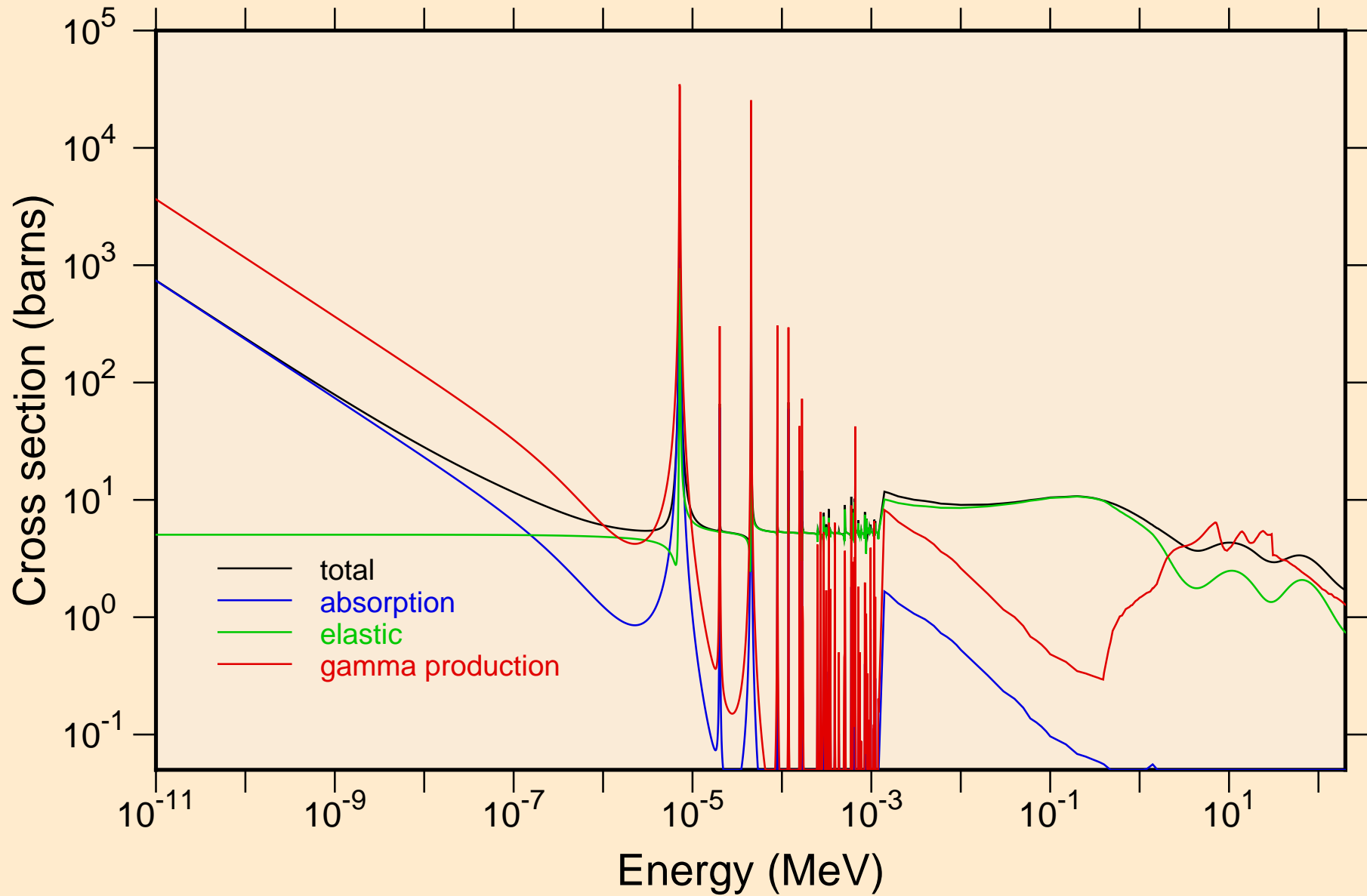

NB099 NEUTRON ACER TENDL-2023 LIBRARY; T=0.K  
resonance total cross section

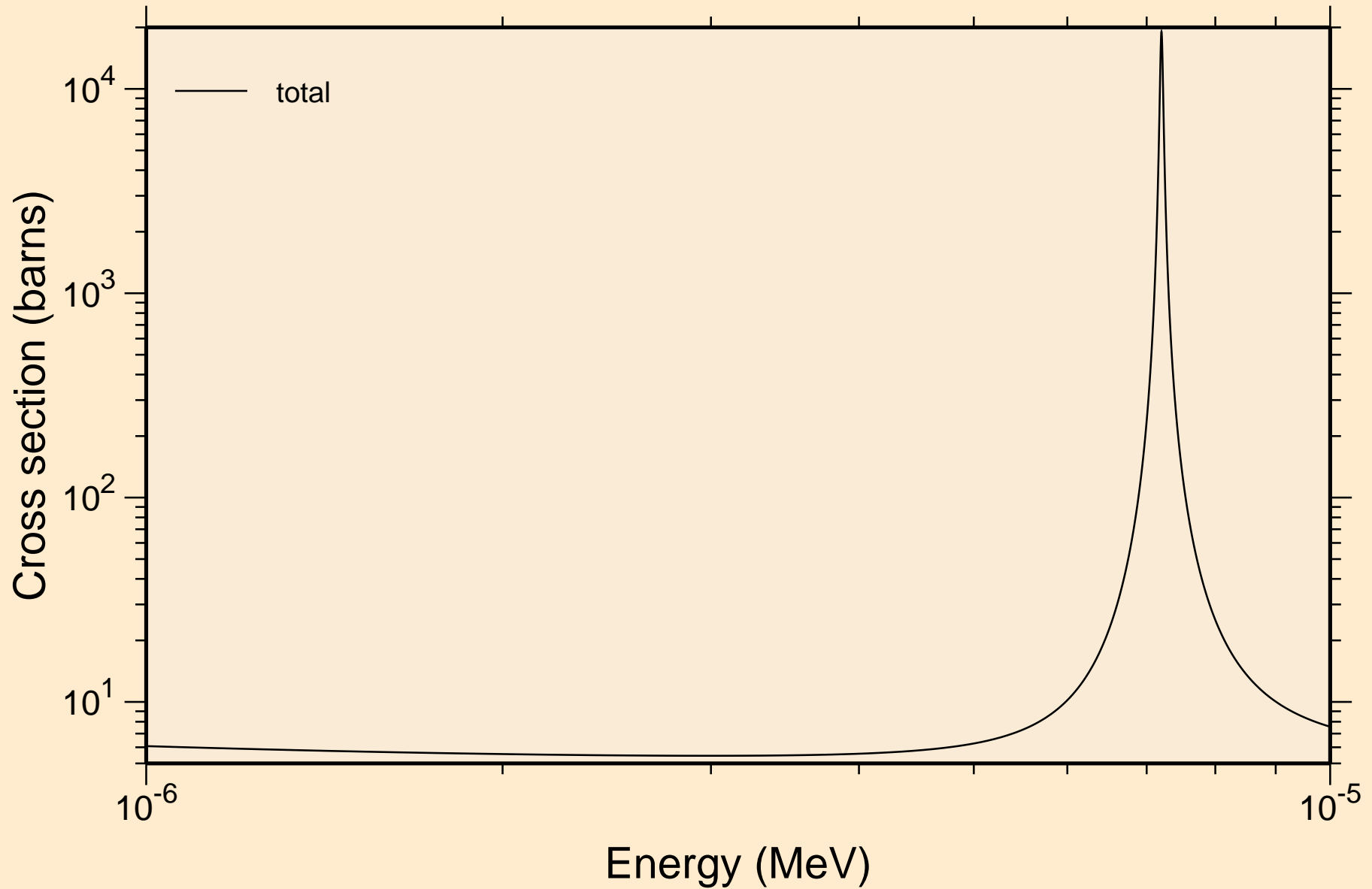

NB099 NEUTRON ACER TENDL-2023 LIBRARY; T=0.K  
resonance total cross section

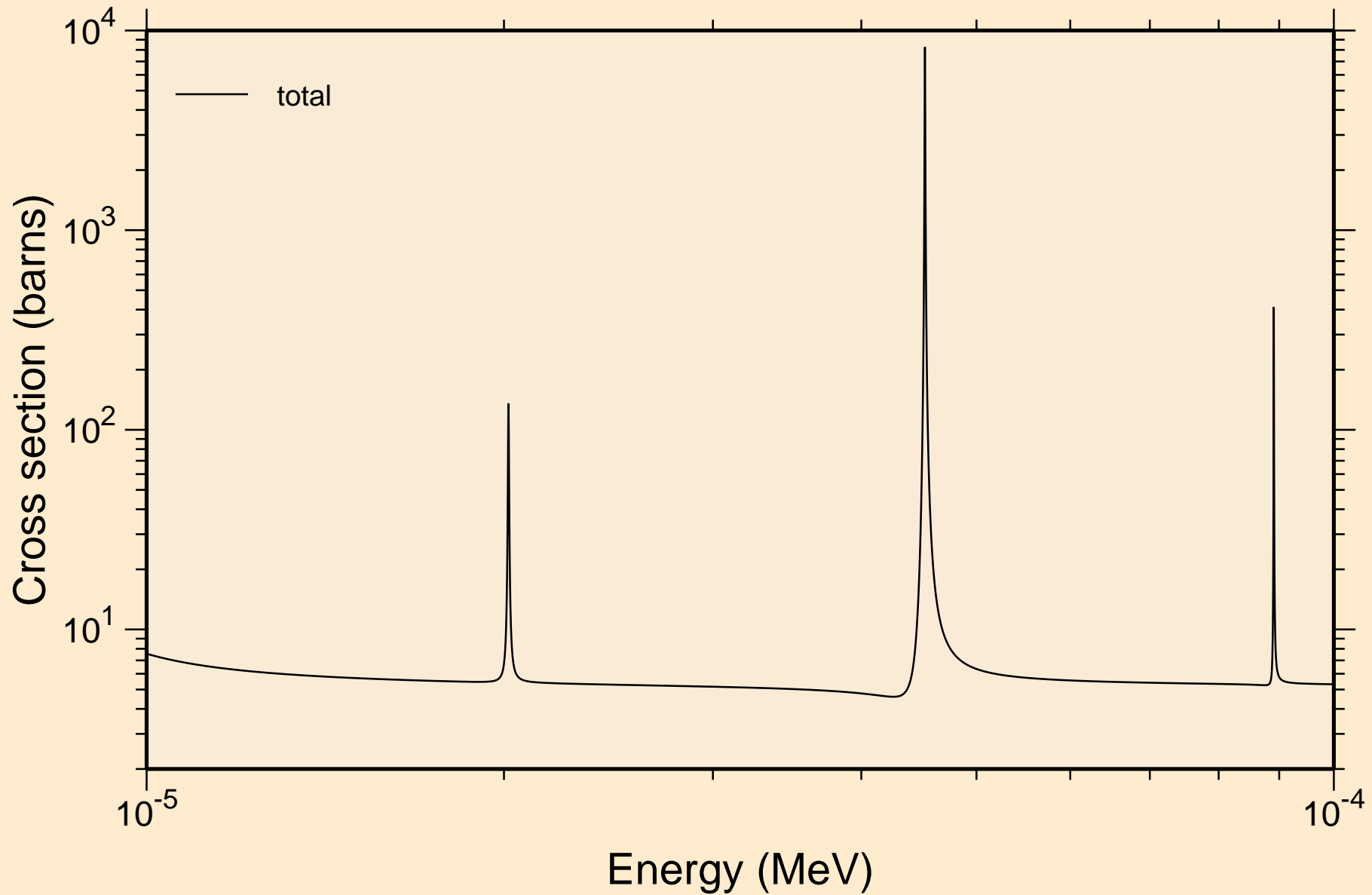

NB099 NEUTRON ACER TENDL-2023 LIBRARY; T=0.K  
resonance total cross section

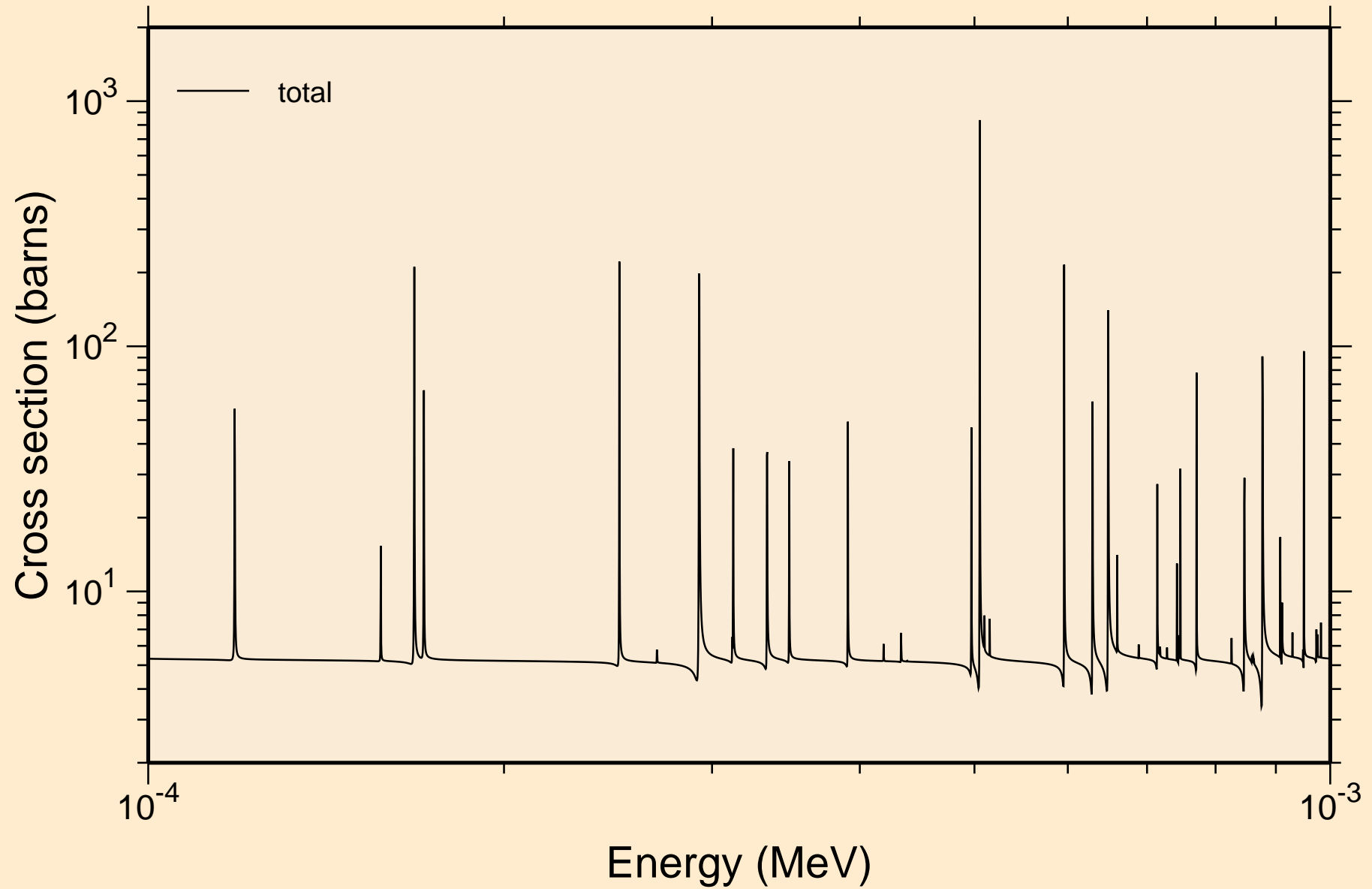

NB099 NEUTRON ACER TENDL-2023 LIBRARY; T=0.K  
resonance total cross section

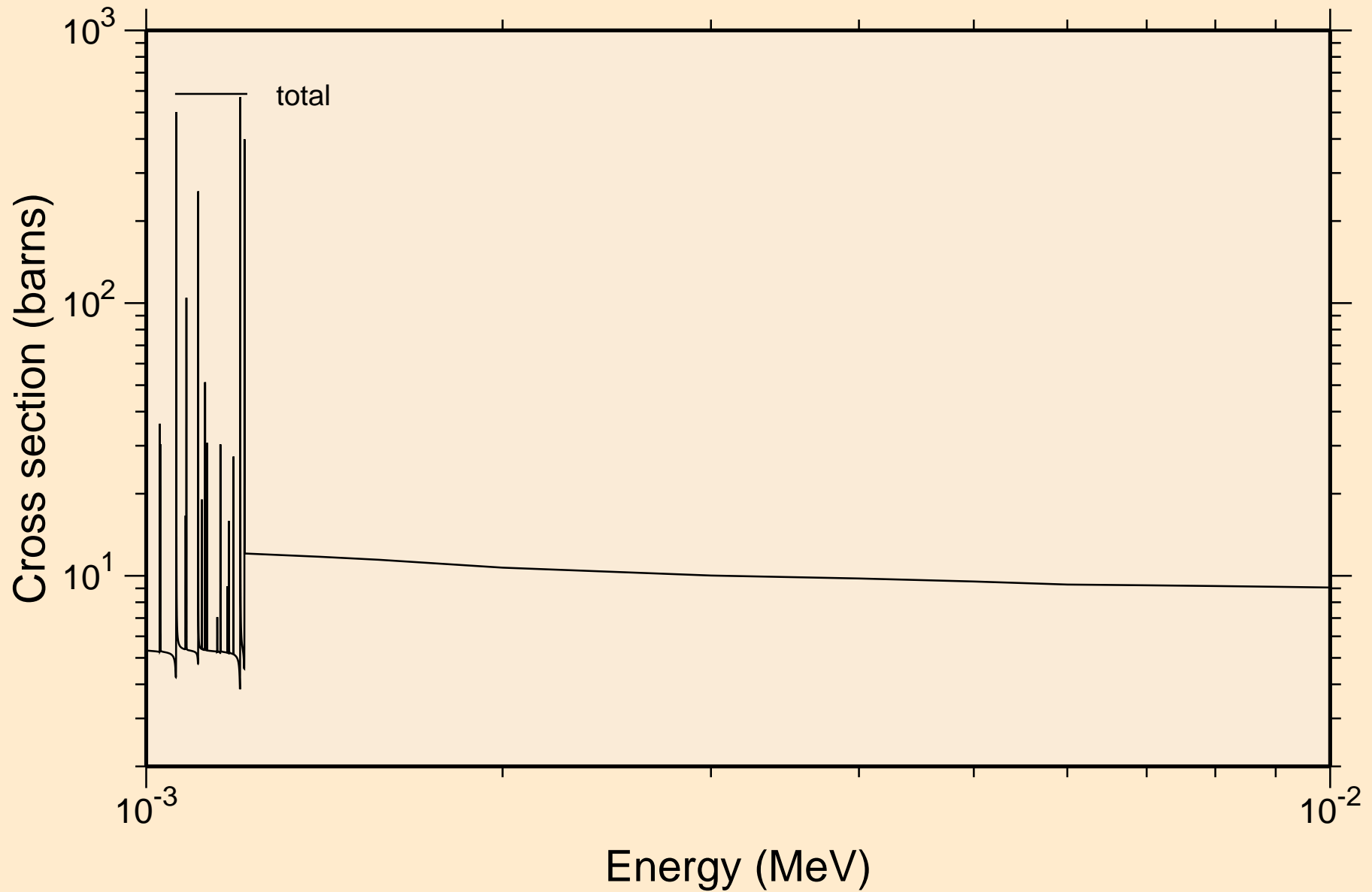

NB099 NEUTRON ACER TENDL-2023 LIBRARY; T=0.K  
resonance total cross section

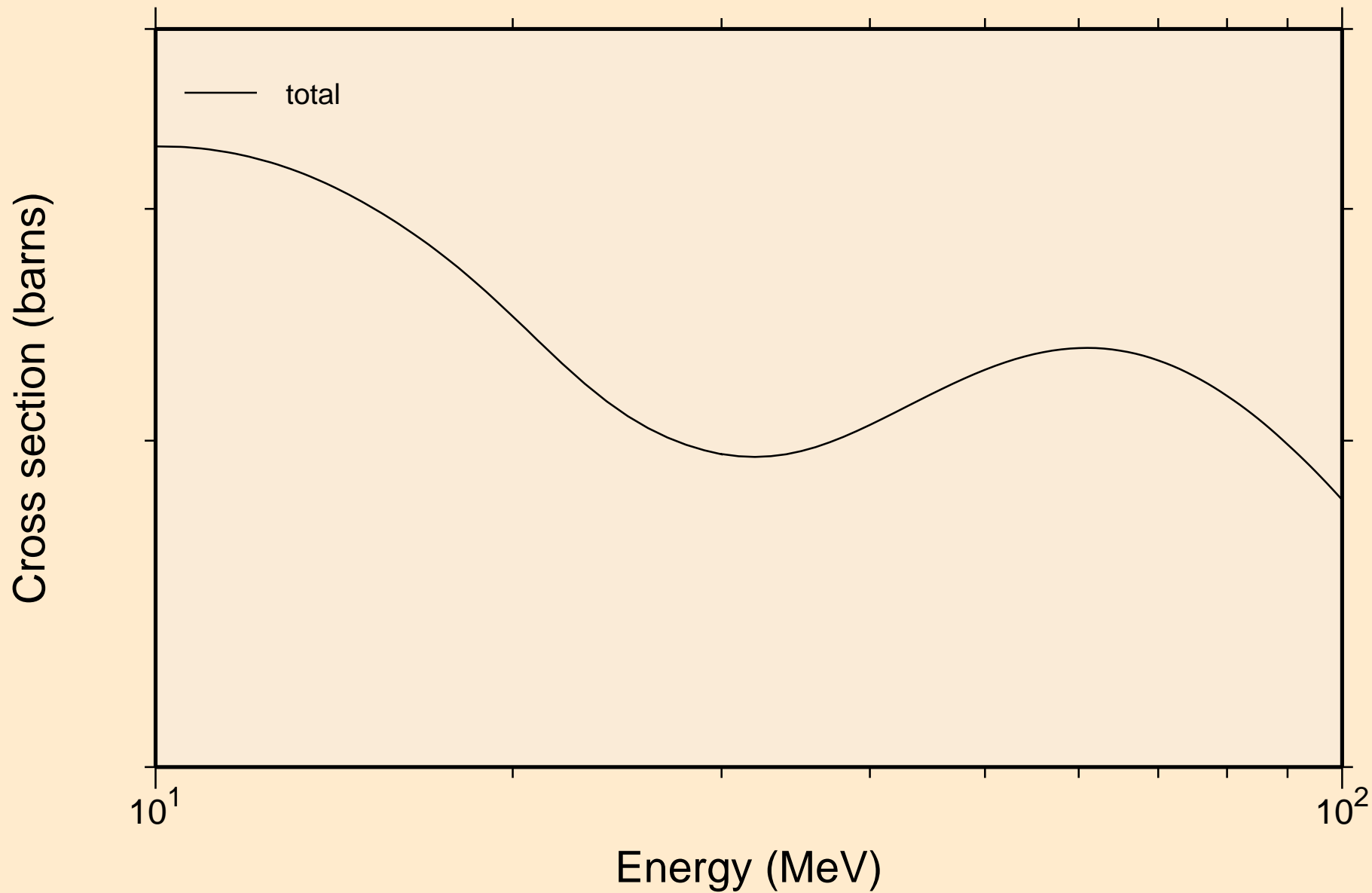

NB099 NEUTRON ACER TENDL-2023 LIBRARY; T=0.K  
resonance absorption cross sections

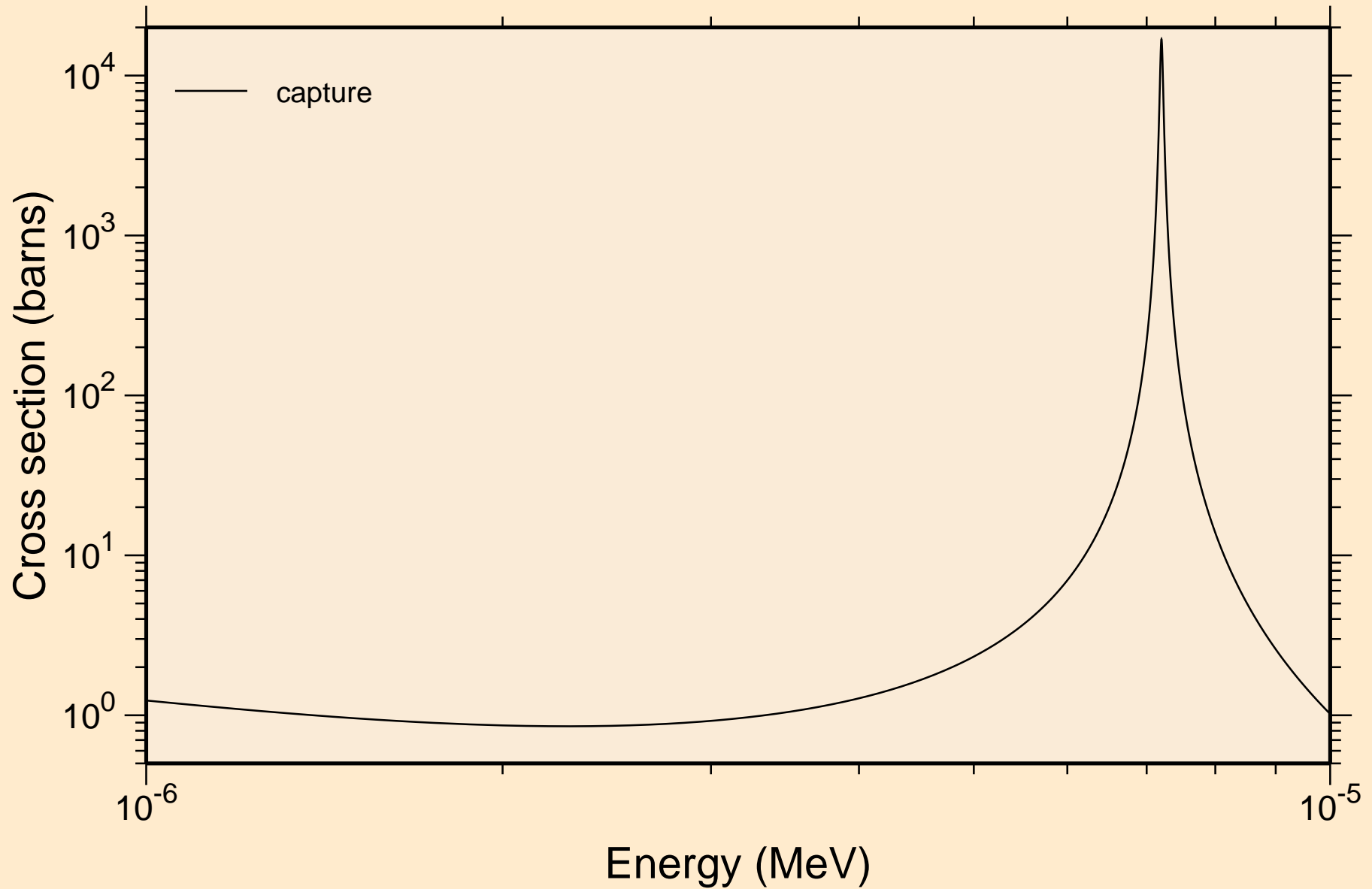

NB099 NEUTRON ACER TENDL-2023 LIBRARY; T=0.K  
resonance absorption cross sections

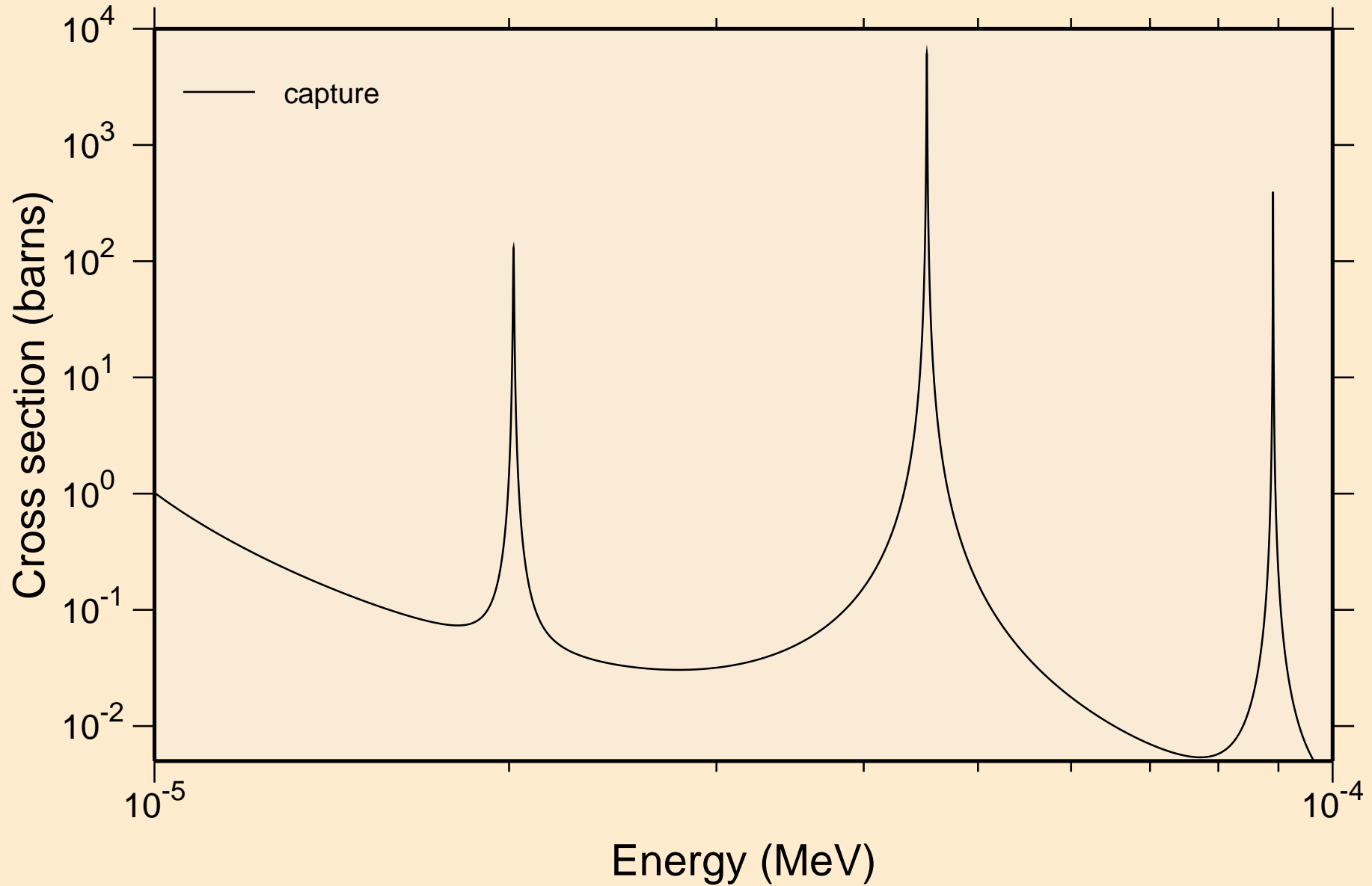



NB099 NEUTRON ACER TENDL-2023 LIBRARY; T=0.K  
resonance absorption cross sections

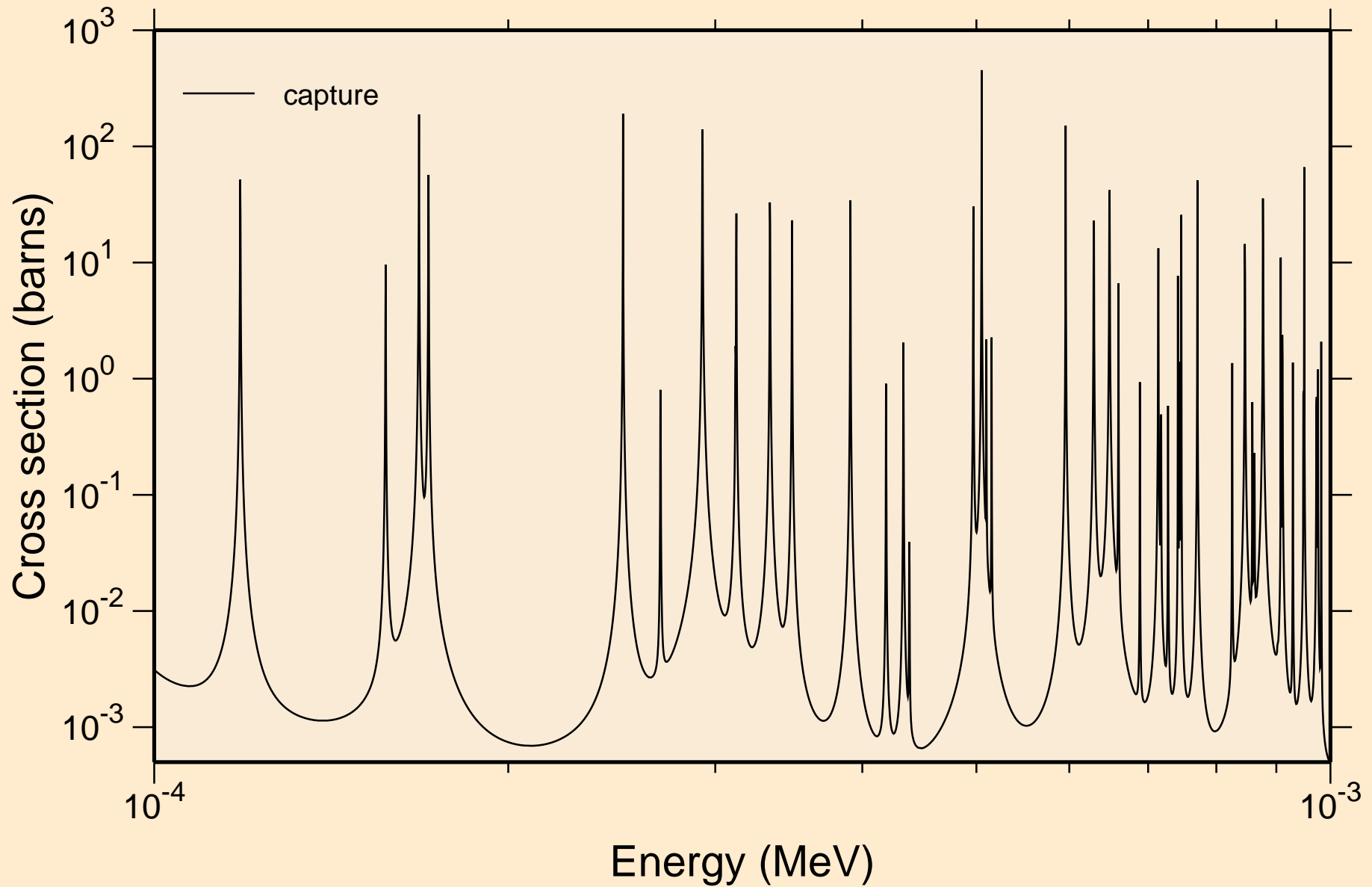

NB099 NEUTRON ACER TENDL-2023 LIBRARY; T=0.K  
resonance absorption cross sections

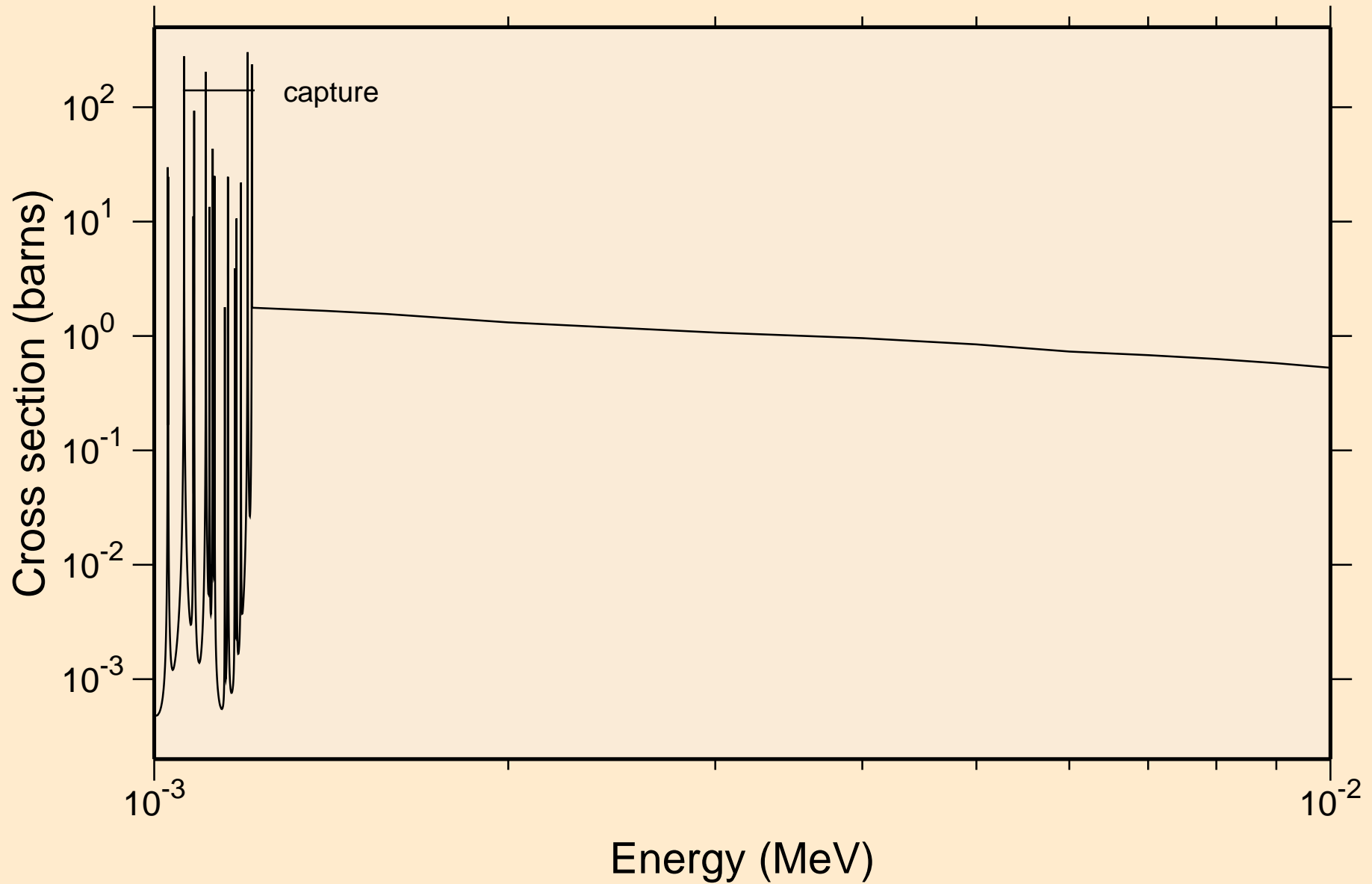

NB099 NEUTRON ACER TENDL-2023 LIBRARY; T=0.K  
resonance absorption cross sections

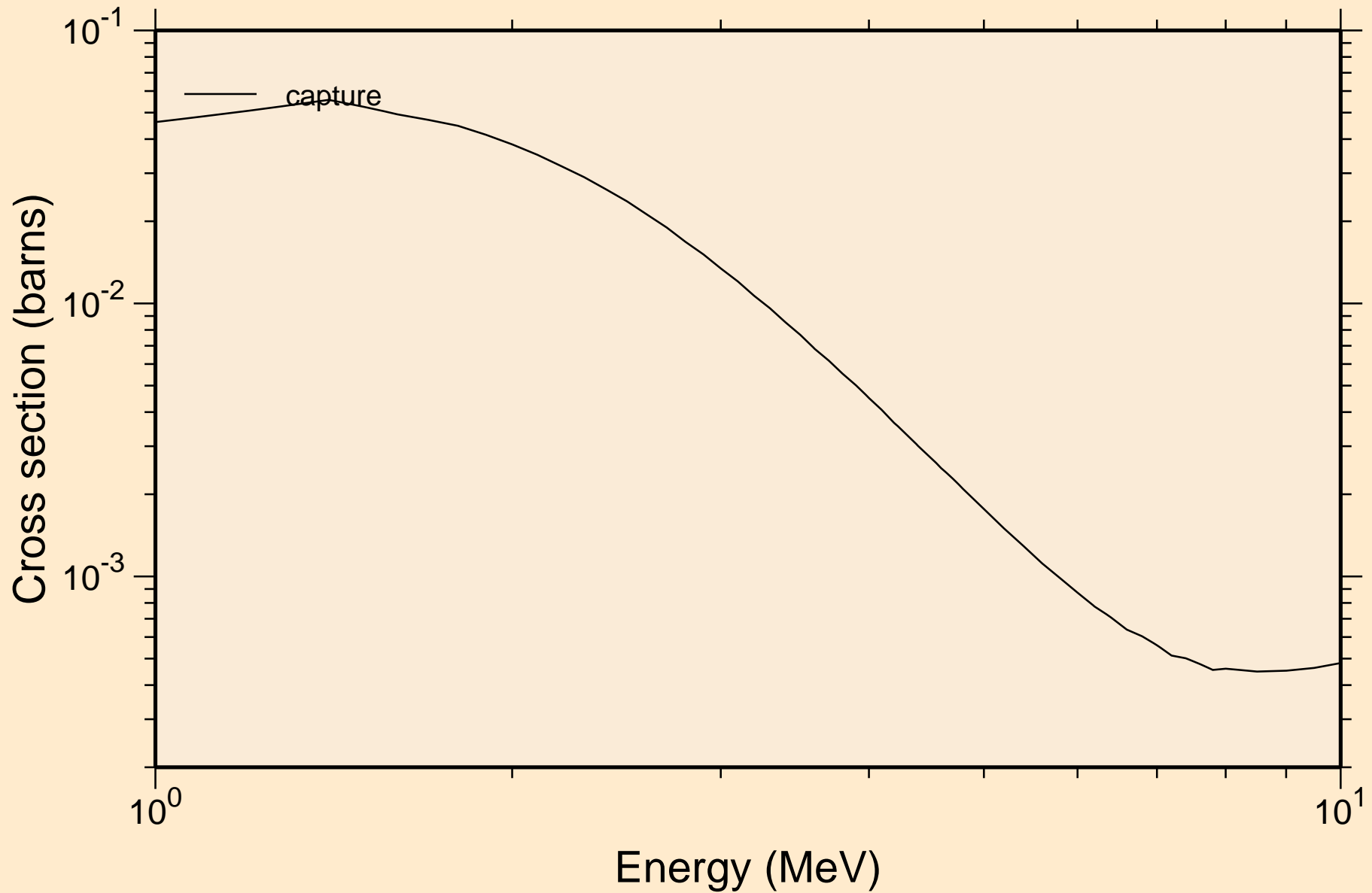

NB099 NEUTRON ACER TENDL-2023 LIBRARY; T=0.K  
Heating

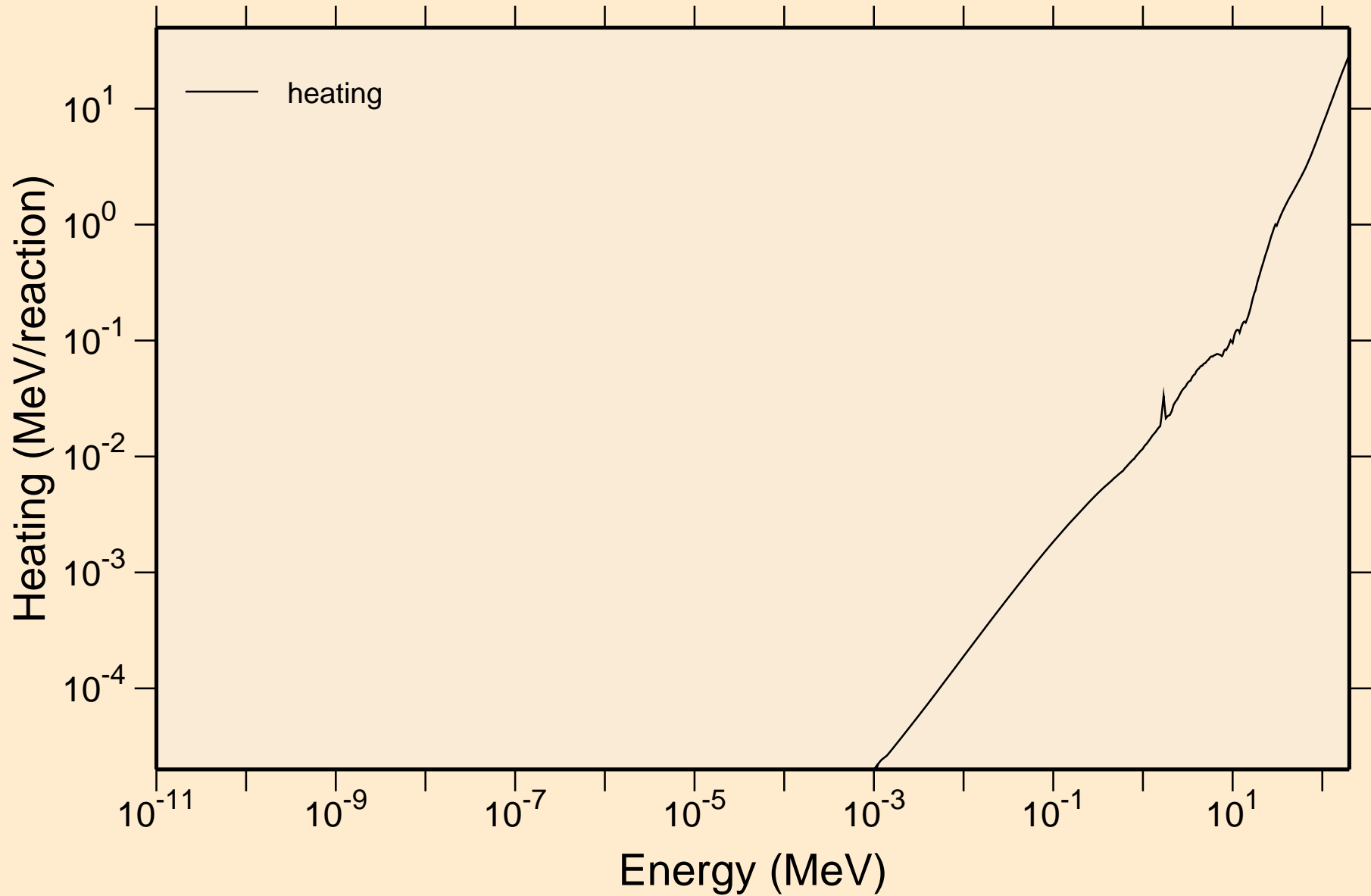

# NB099 NEUTRON ACER TENDL-2023 LIBRARY; T=0.K

## Damage

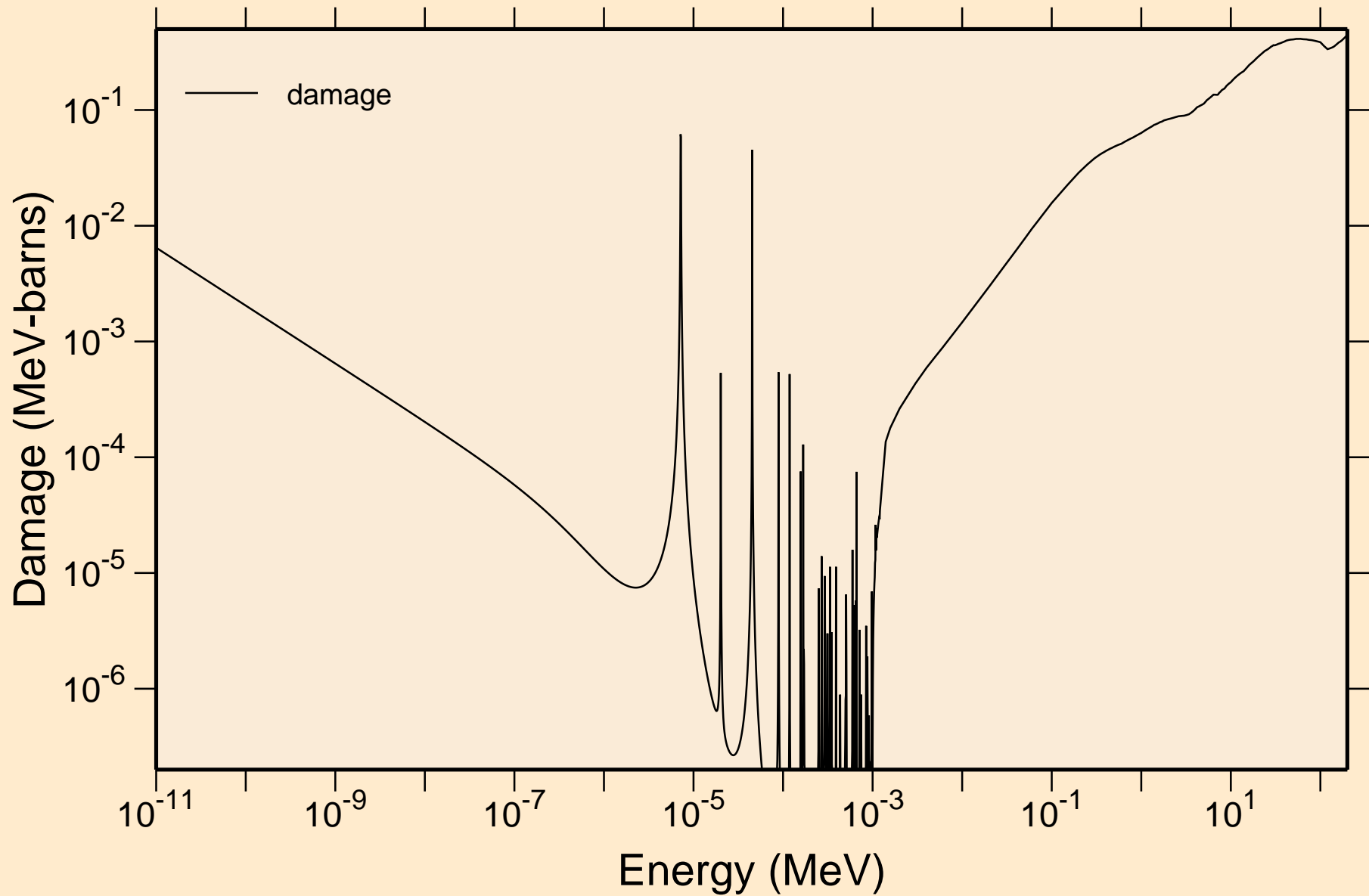

NB099 NEUTRON ACER TENDL-2023 LIBRARY; T=0.K  
Non-threshold reactions

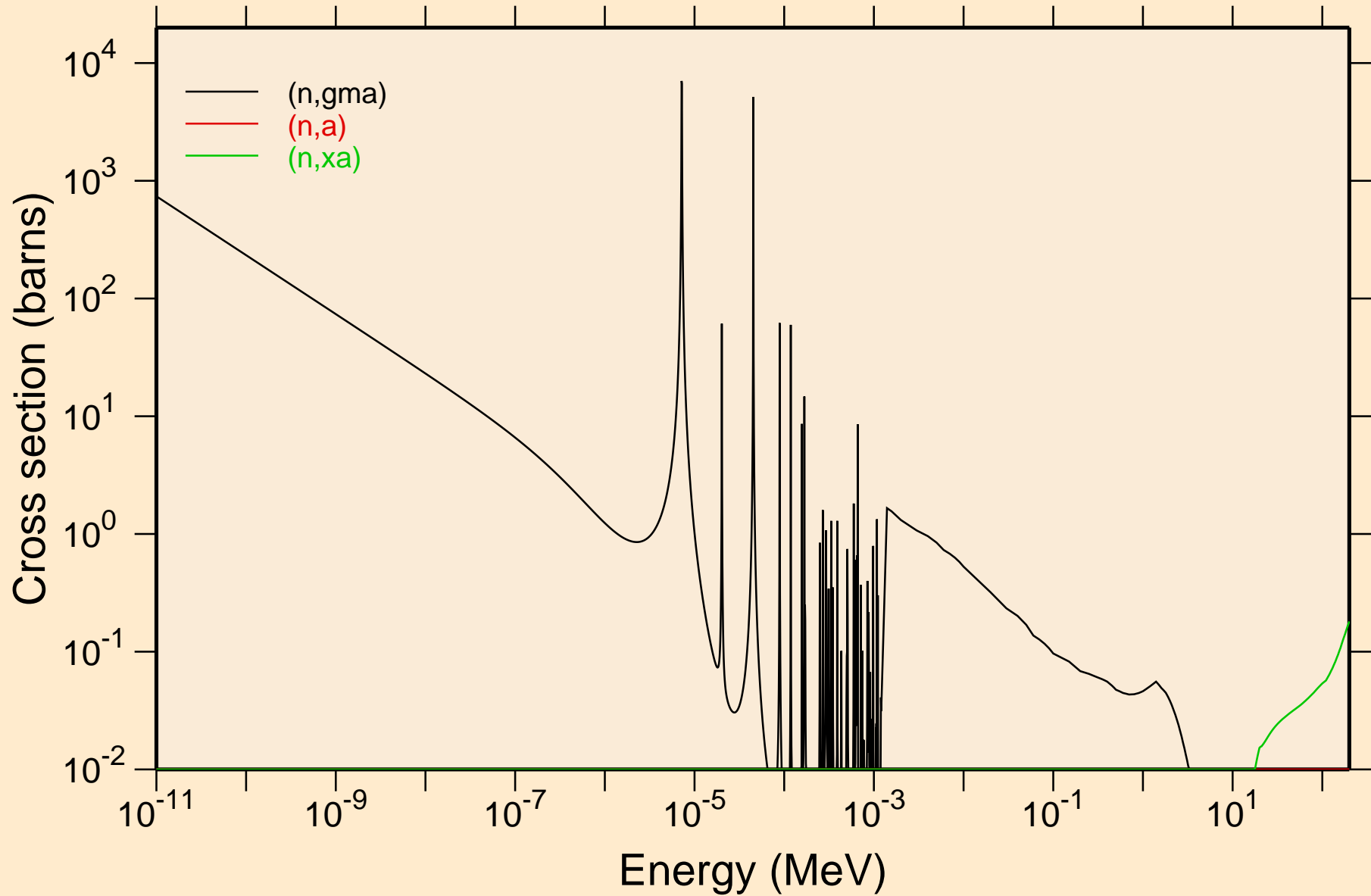

# NB099 NEUTRON ACER TENDL-2023 LIBRARY; T=0.K

## Principal cross sections

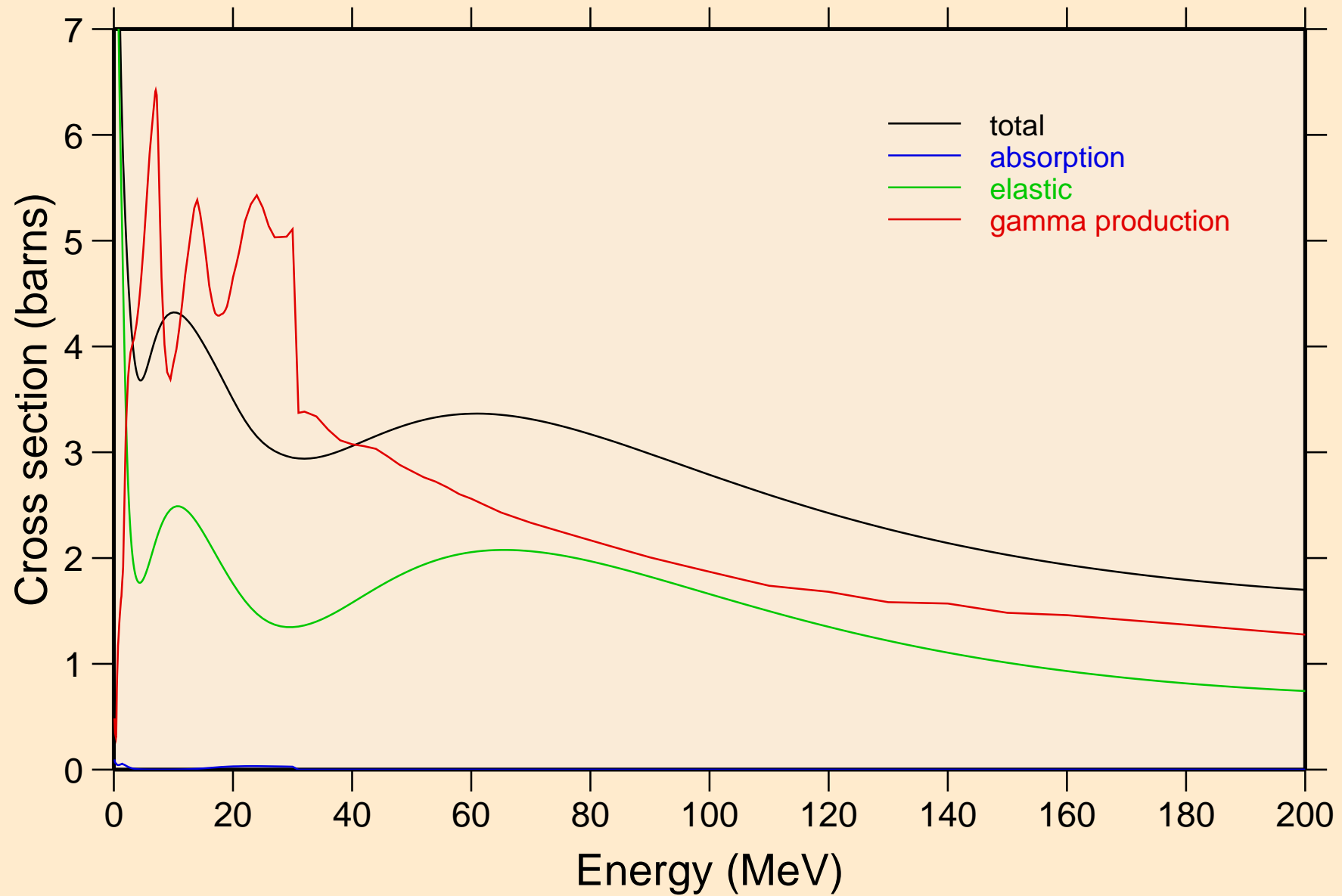

# NB099 NEUTRON ACER TENDL-2023 LIBRARY; T=0.K

## Heating

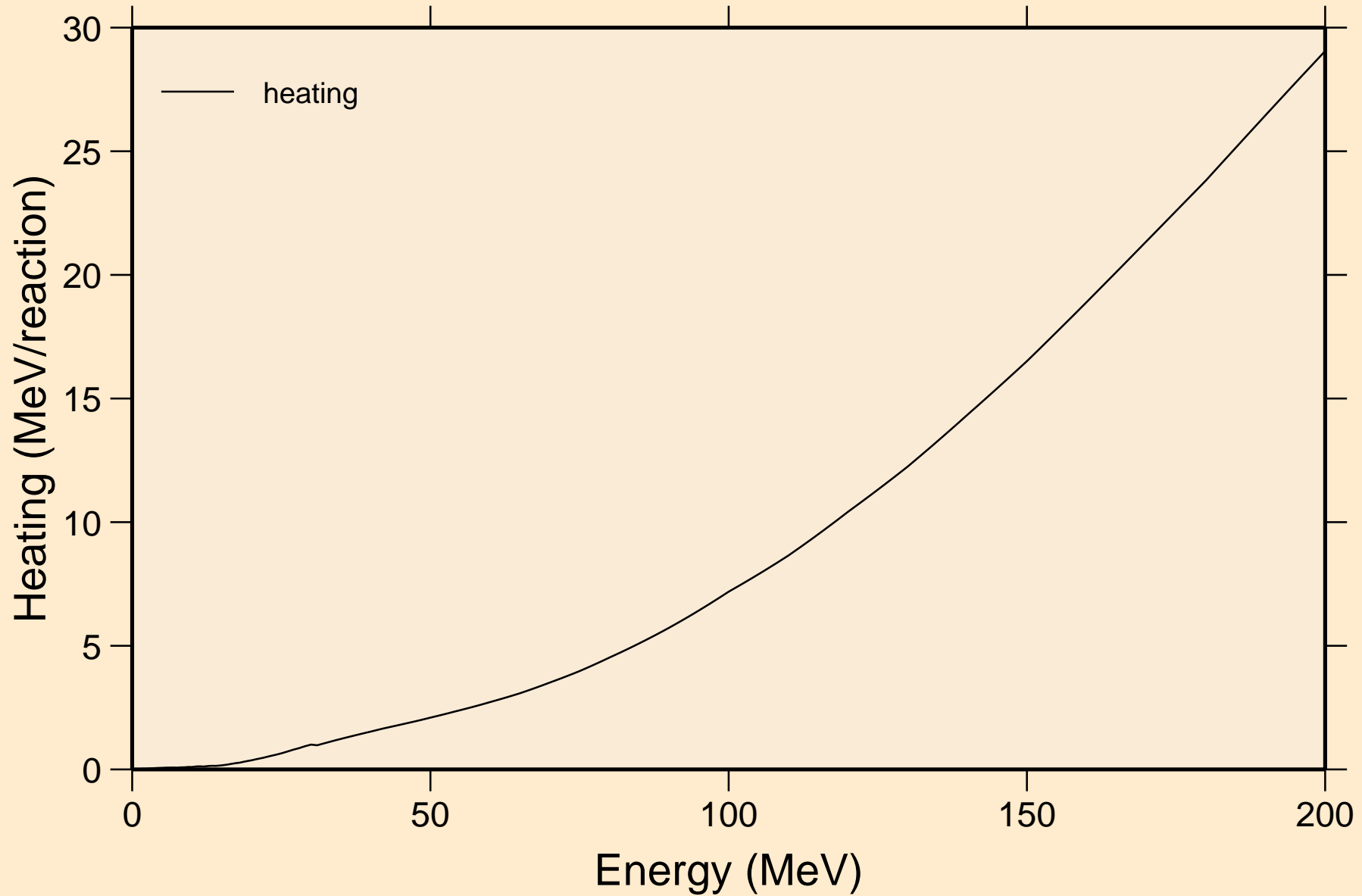



NB099 NEUTRON ACER TENDL-2023 LIBRARY; T=0.K  
Damage

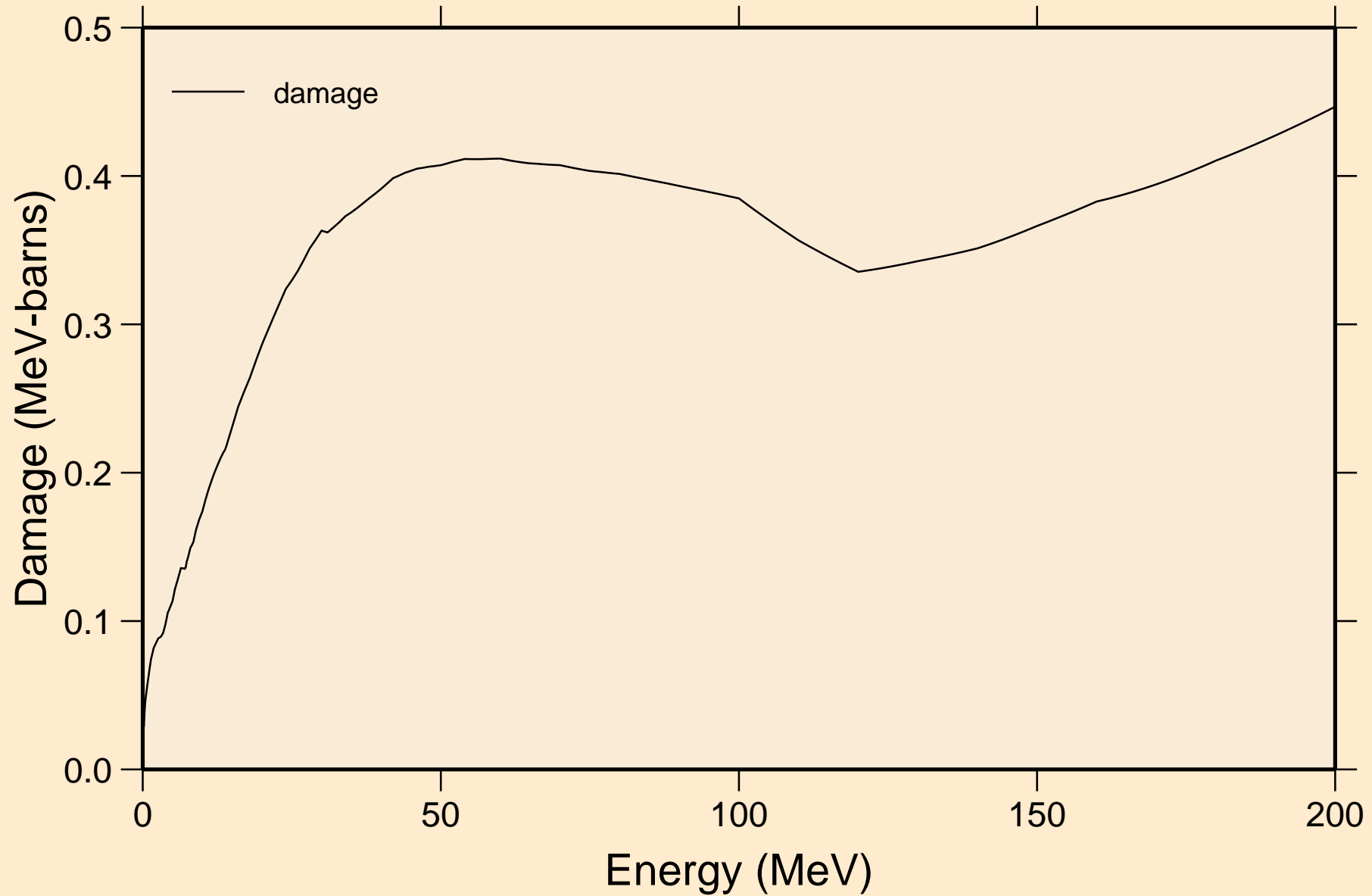

NB099 NEUTRON ACER TENDL-2023 LIBRARY; T=0.K  
Non-threshold reactions

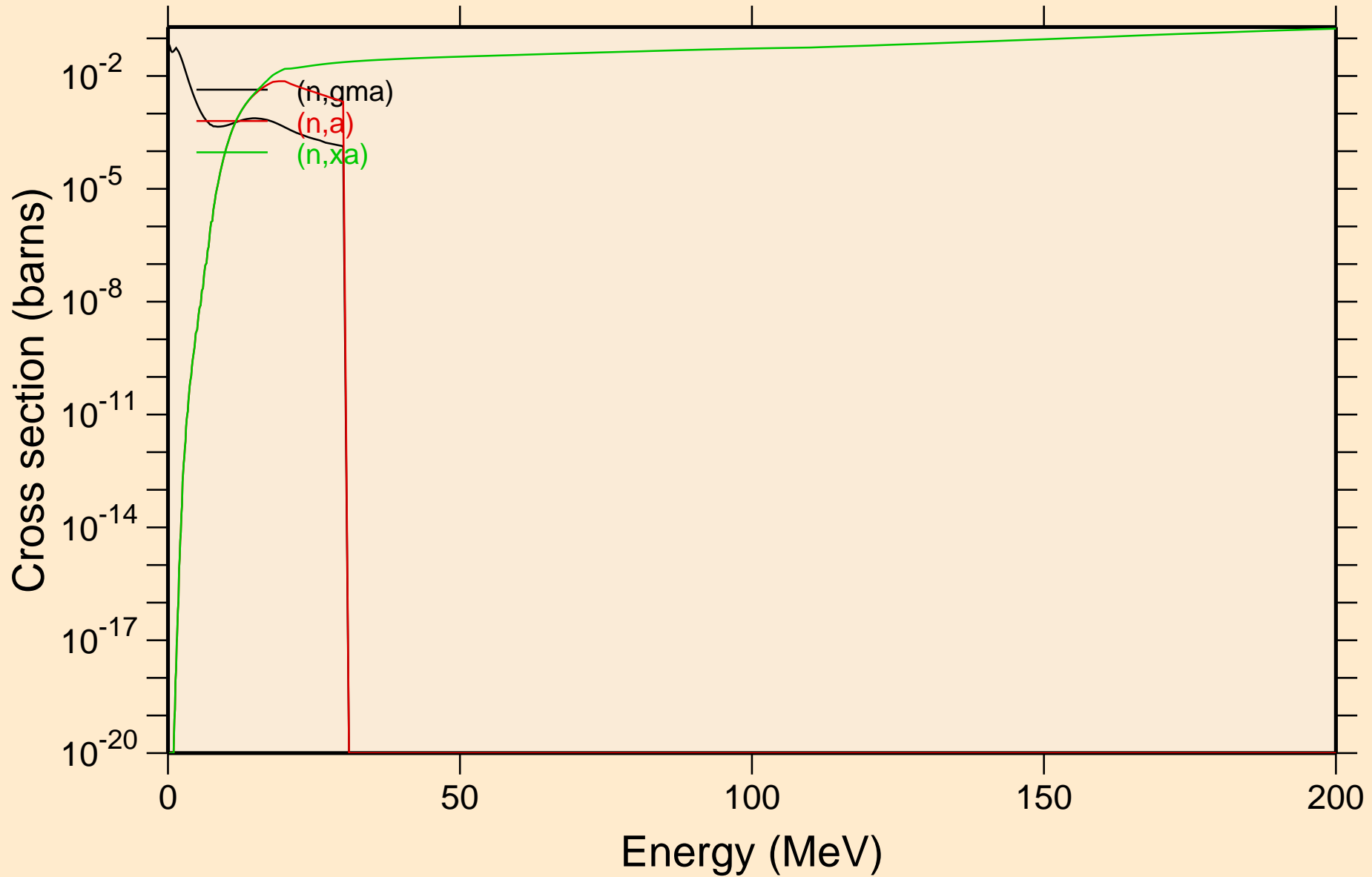

NB099 NEUTRON ACER TENDL-2023 LIBRARY; T=0.K  
Inelastic levels

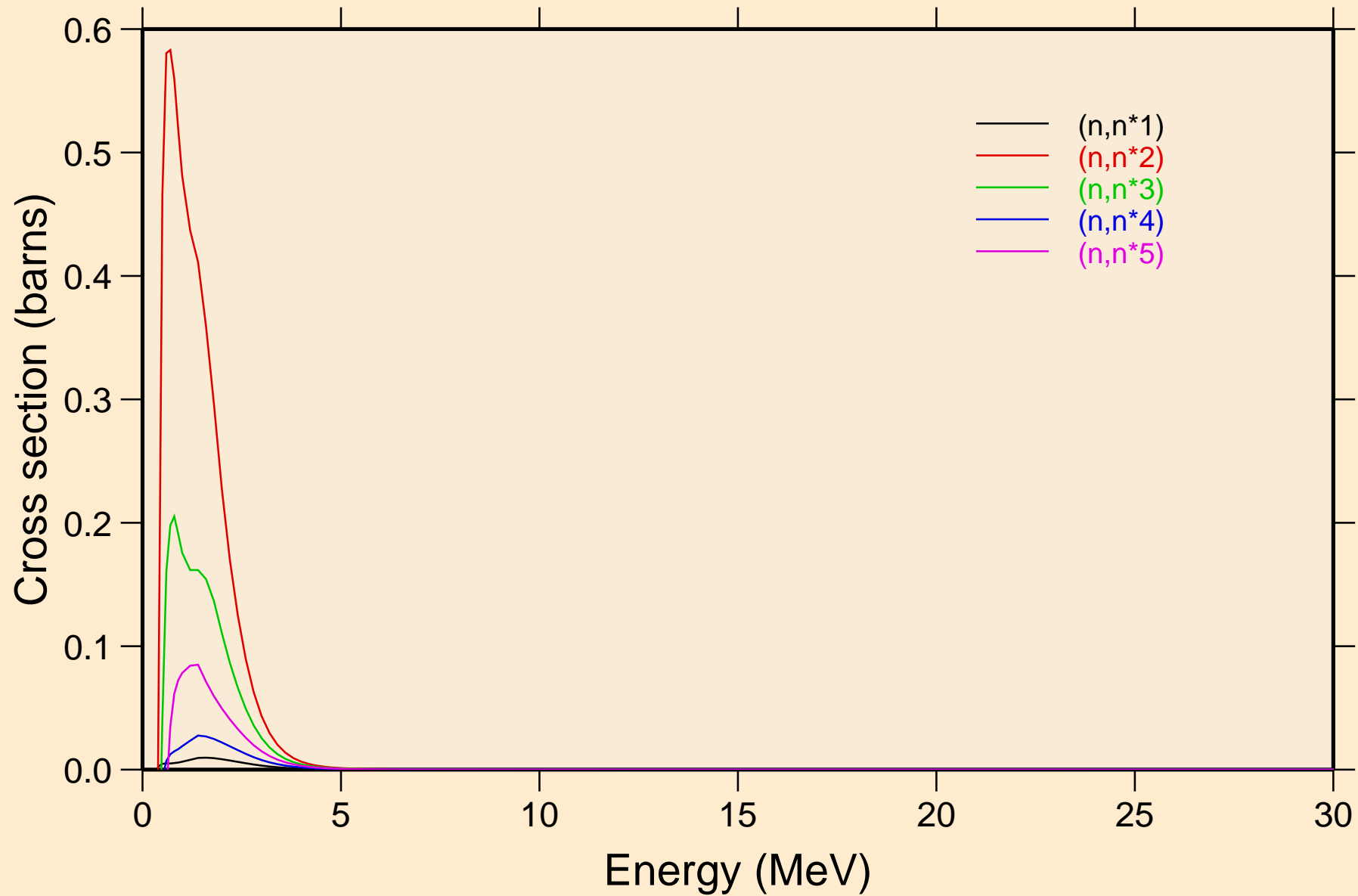

NB099 NEUTRON ACER TENDL-2023 LIBRARY; T=0.K  
Inelastic levels

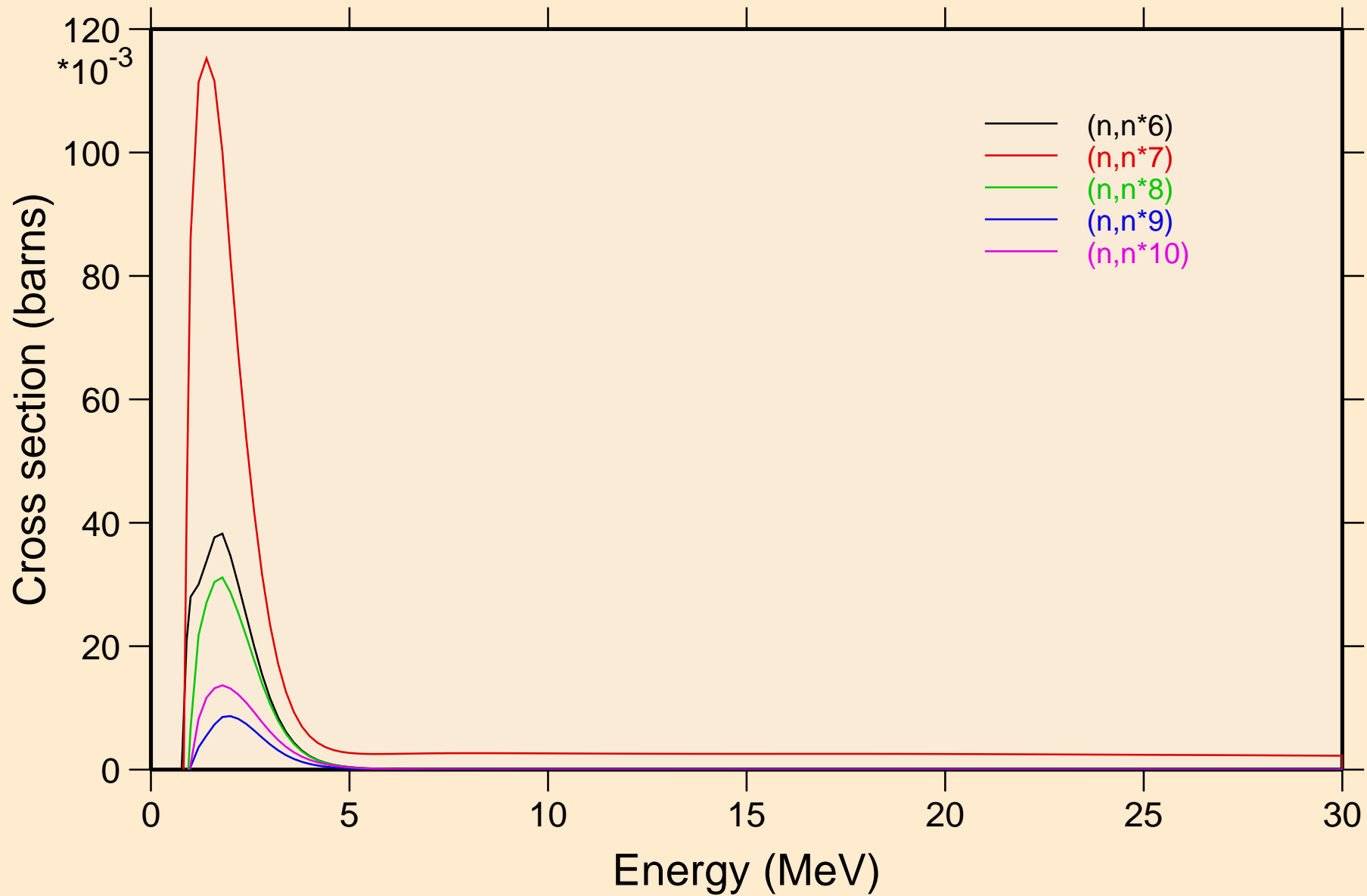

# NB099 NEUTRON ACER TENDL-2023 LIBRARY; T=0.K

## Inelastic levels

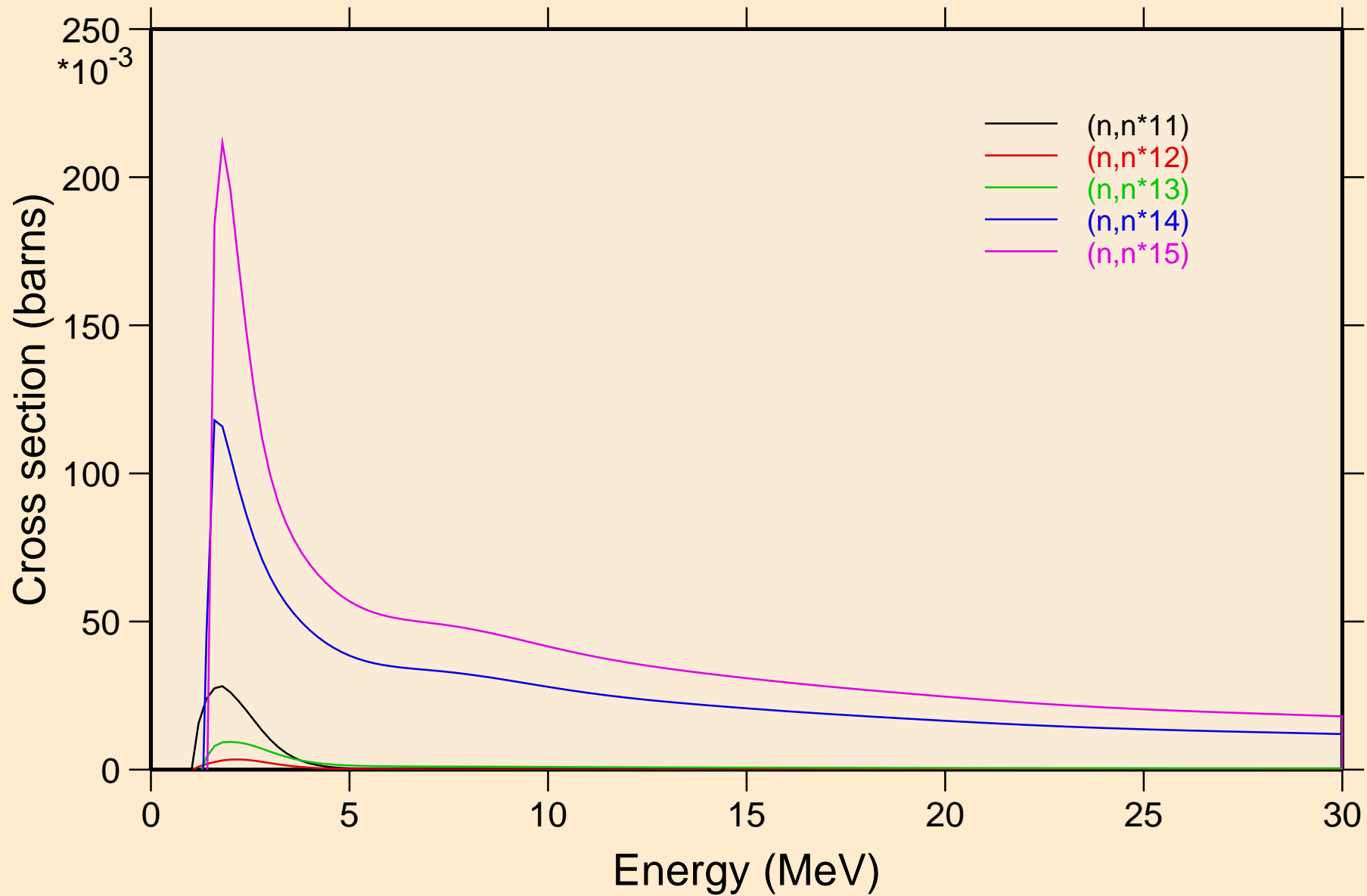

NB099 NEUTRON ACER TENDL-2023 LIBRARY; T=0.K  
Inelastic levels

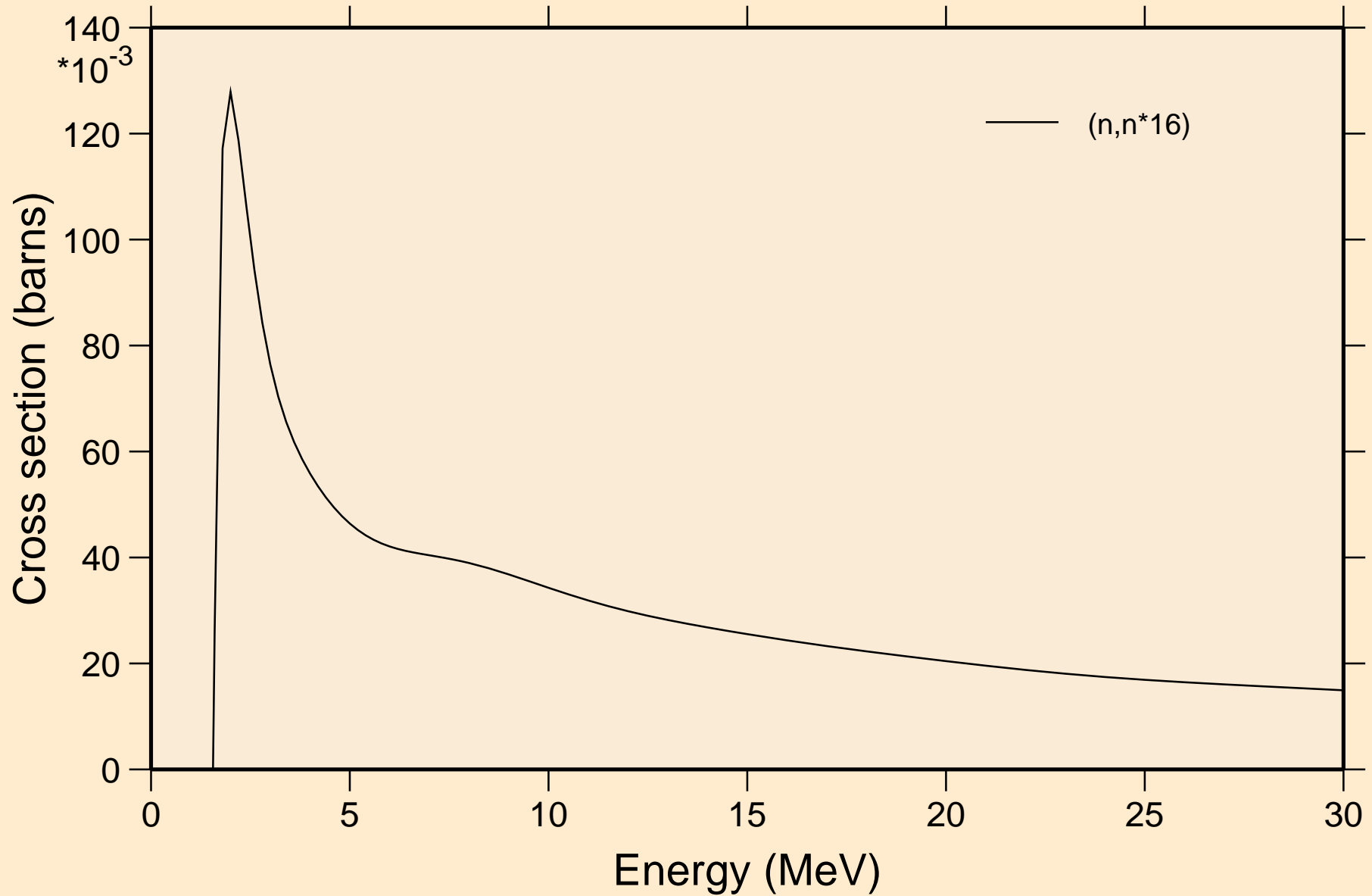

NB099 NEUTRON ACER TENDL-2023 LIBRARY; T=0.K  
Threshold reactions

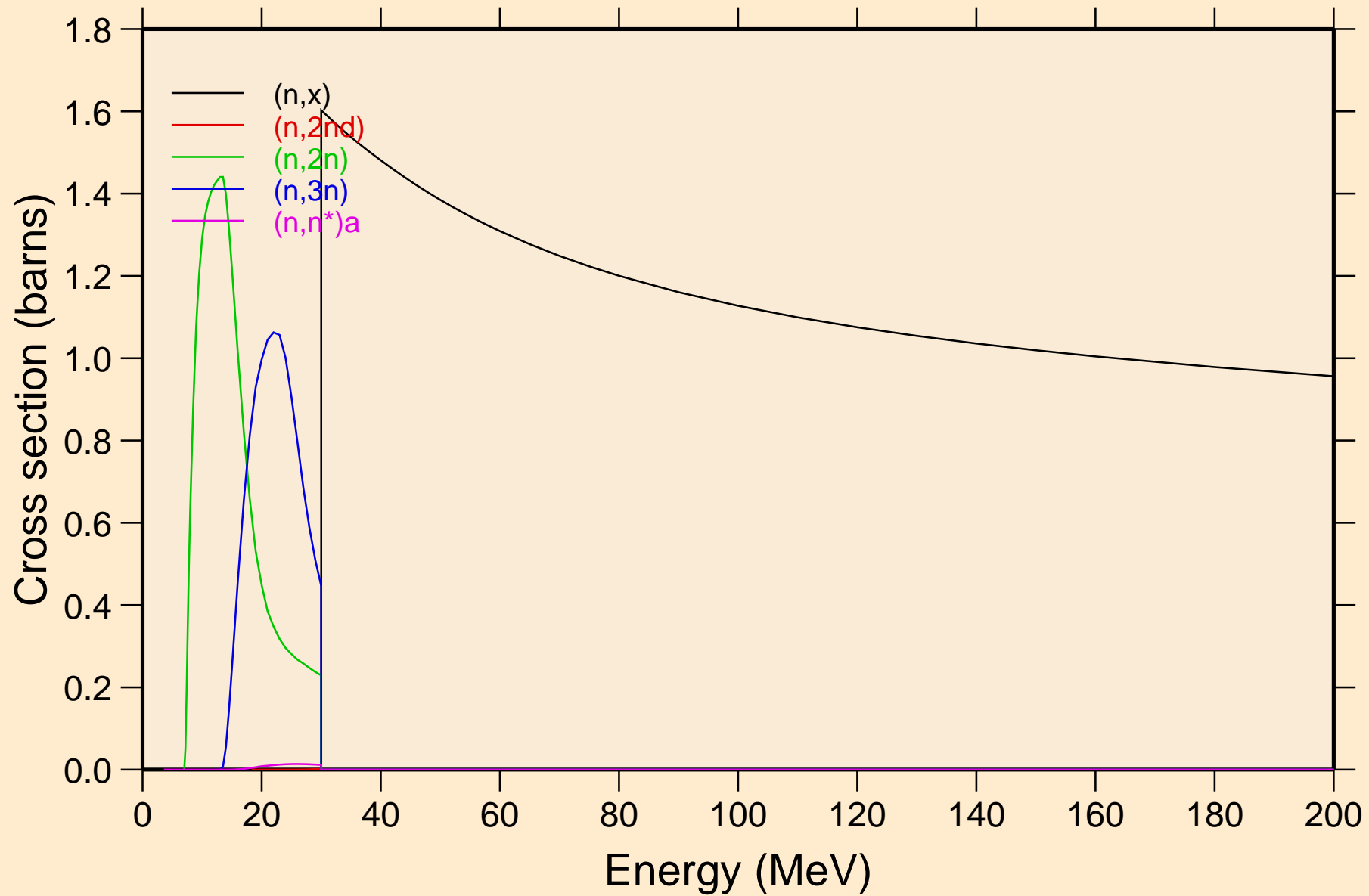

# NB099 NEUTRON ACER TENDL-2023 LIBRARY; T=0.K

## Threshold reactions

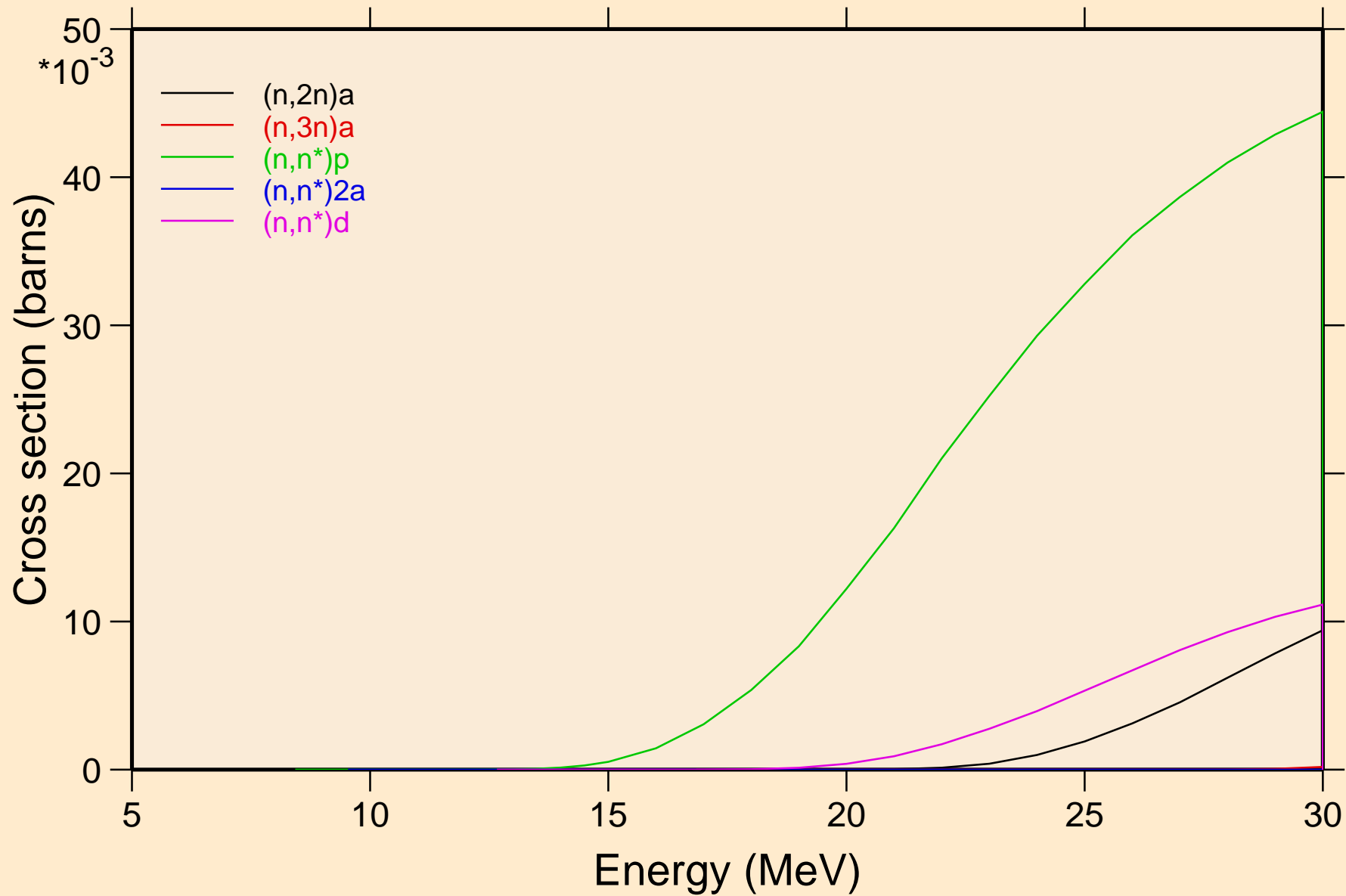



NB099 NEUTRON ACER TENDL-2023 LIBRARY; T=0.K  
Threshold reactions

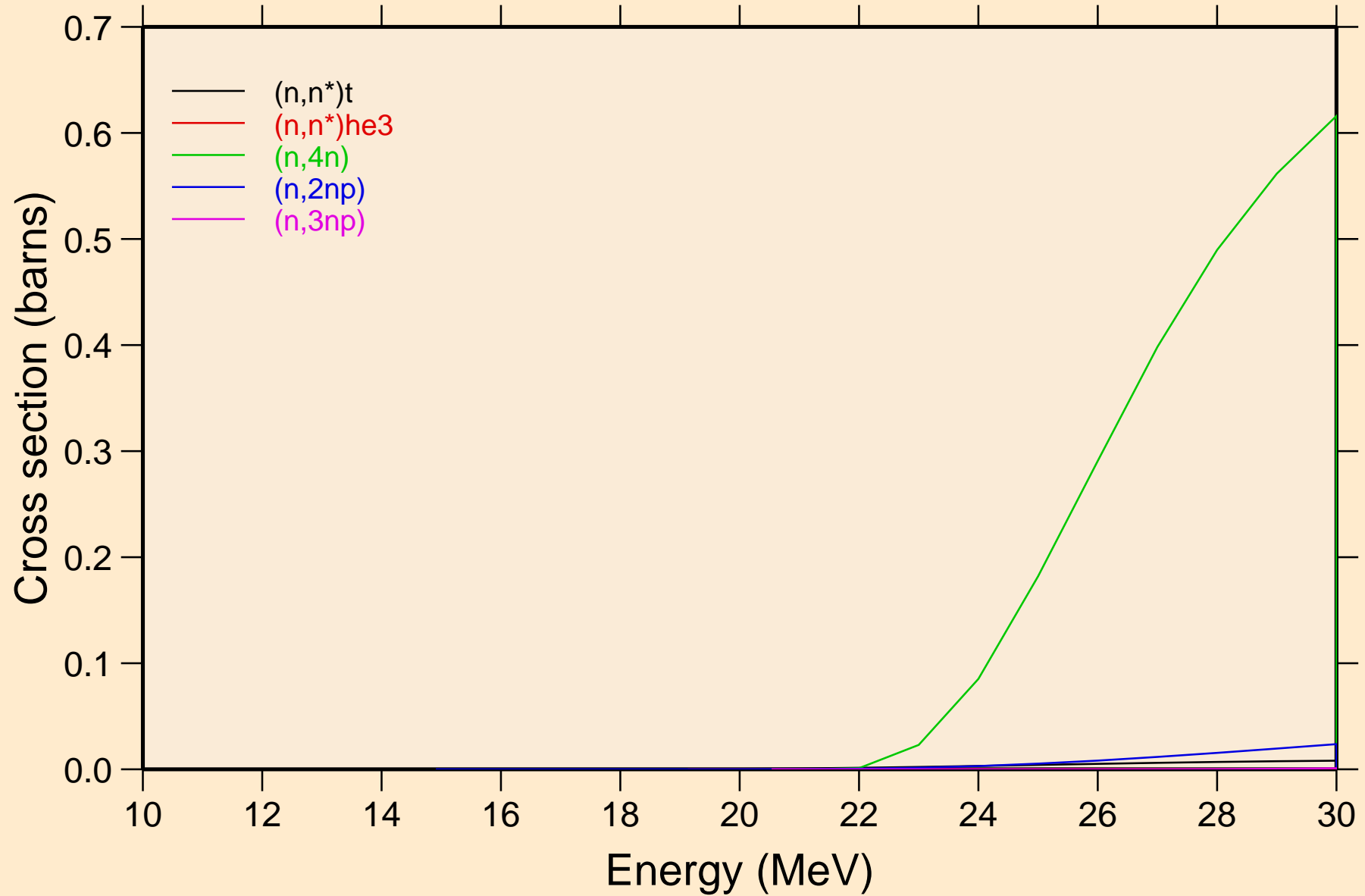

NB099 NEUTRON ACER TENDL-2023 LIBRARY; T=0.K  
Threshold reactions

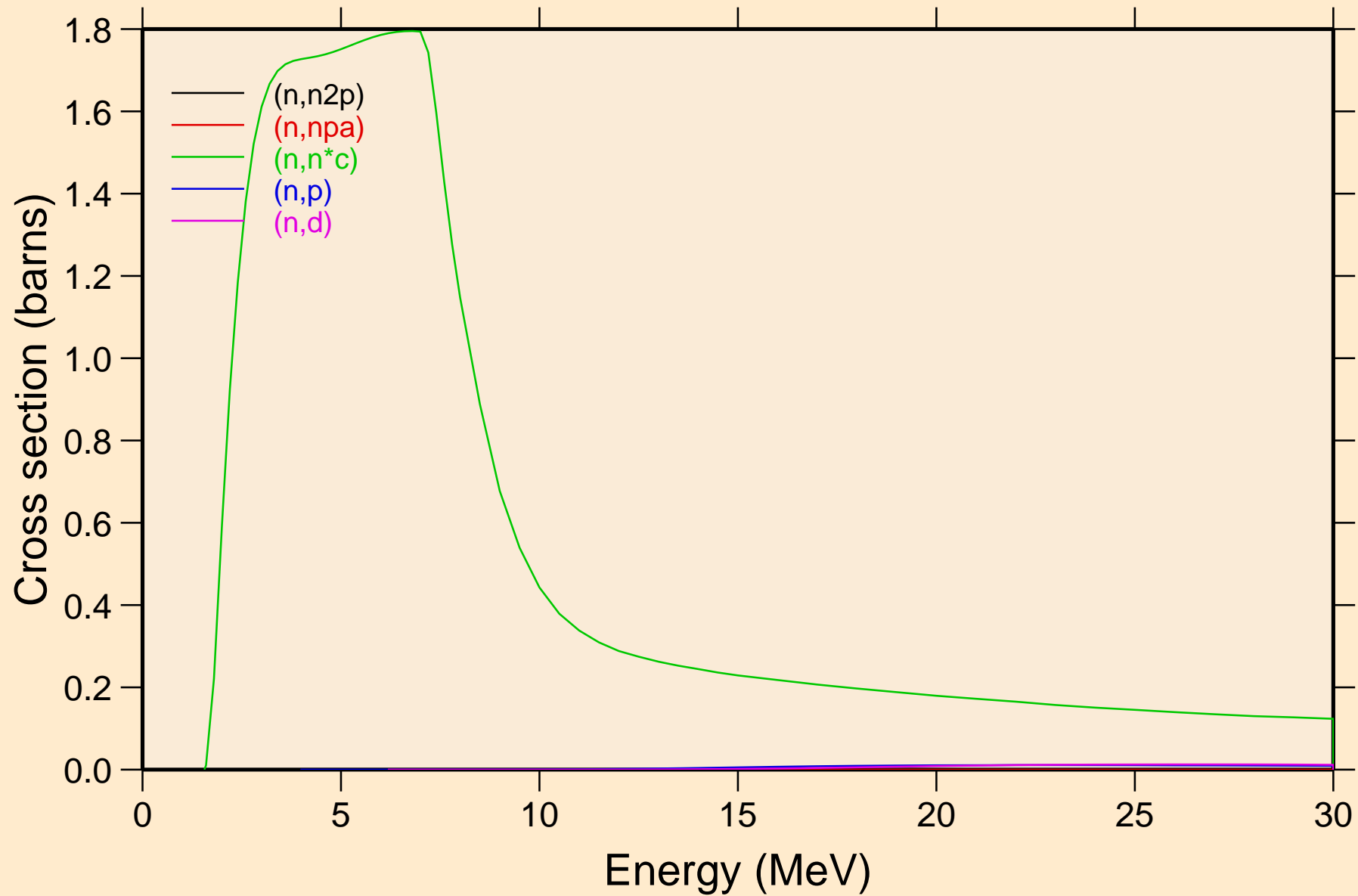

NB099 NEUTRON ACER TENDL-2023 LIBRARY; T=0.K  
Threshold reactions

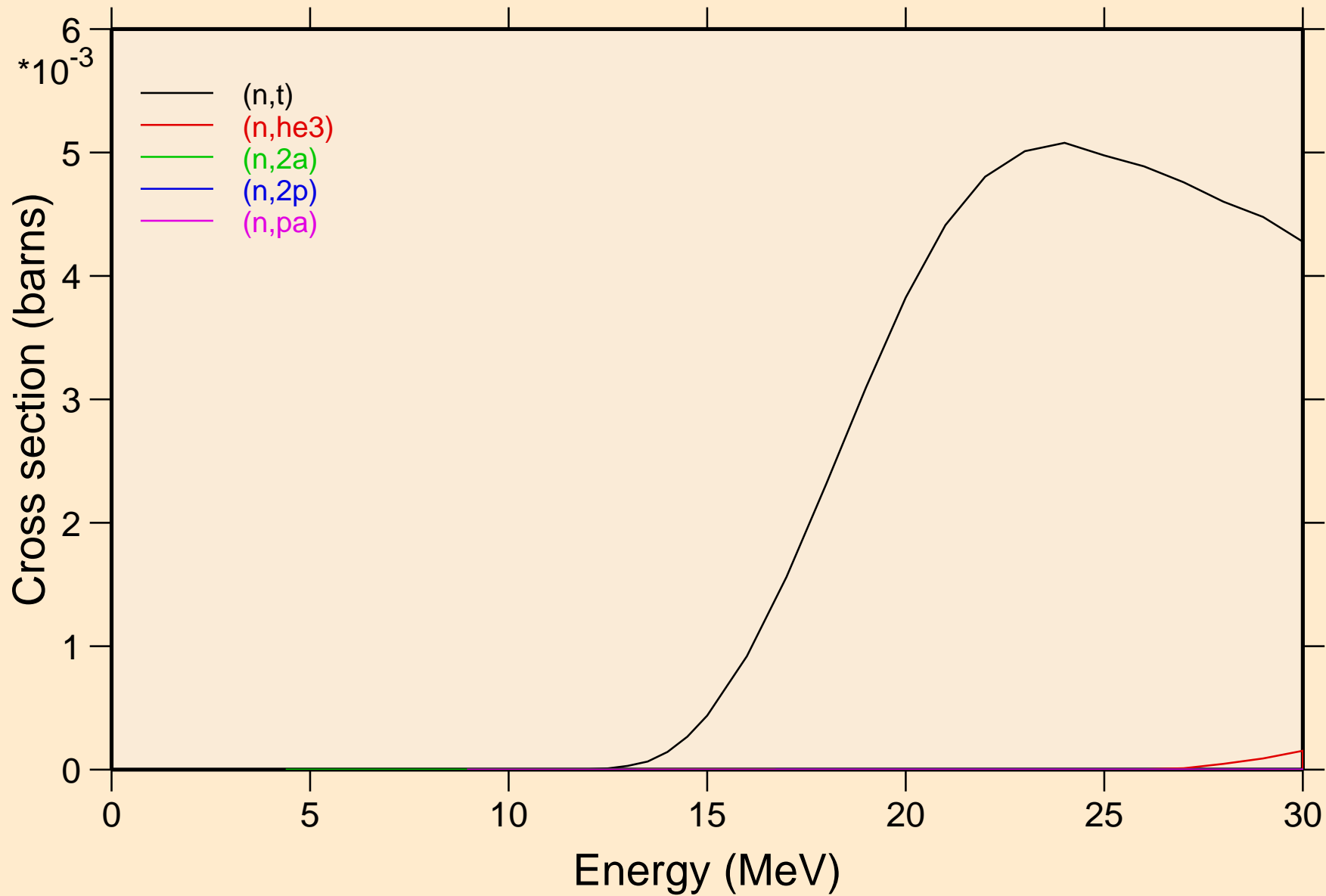

# NB099 NEUTRON ACER TENDL-2023 LIBRARY; T=0.K

## Threshold reactions

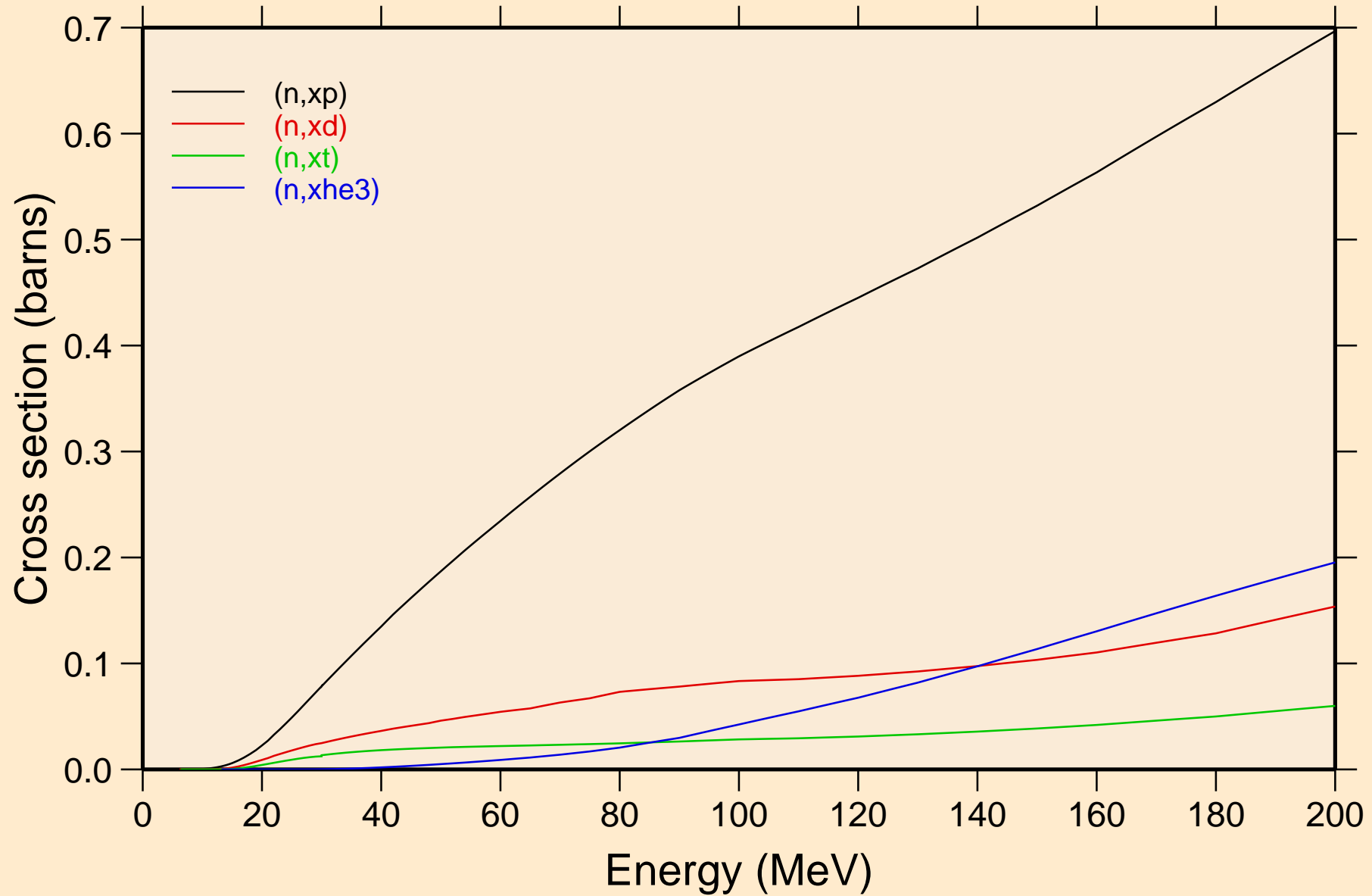

NB099 NEUTRON ACER TENDL-2023 LIBRARY; T=0.K  
angular distribution for elastic

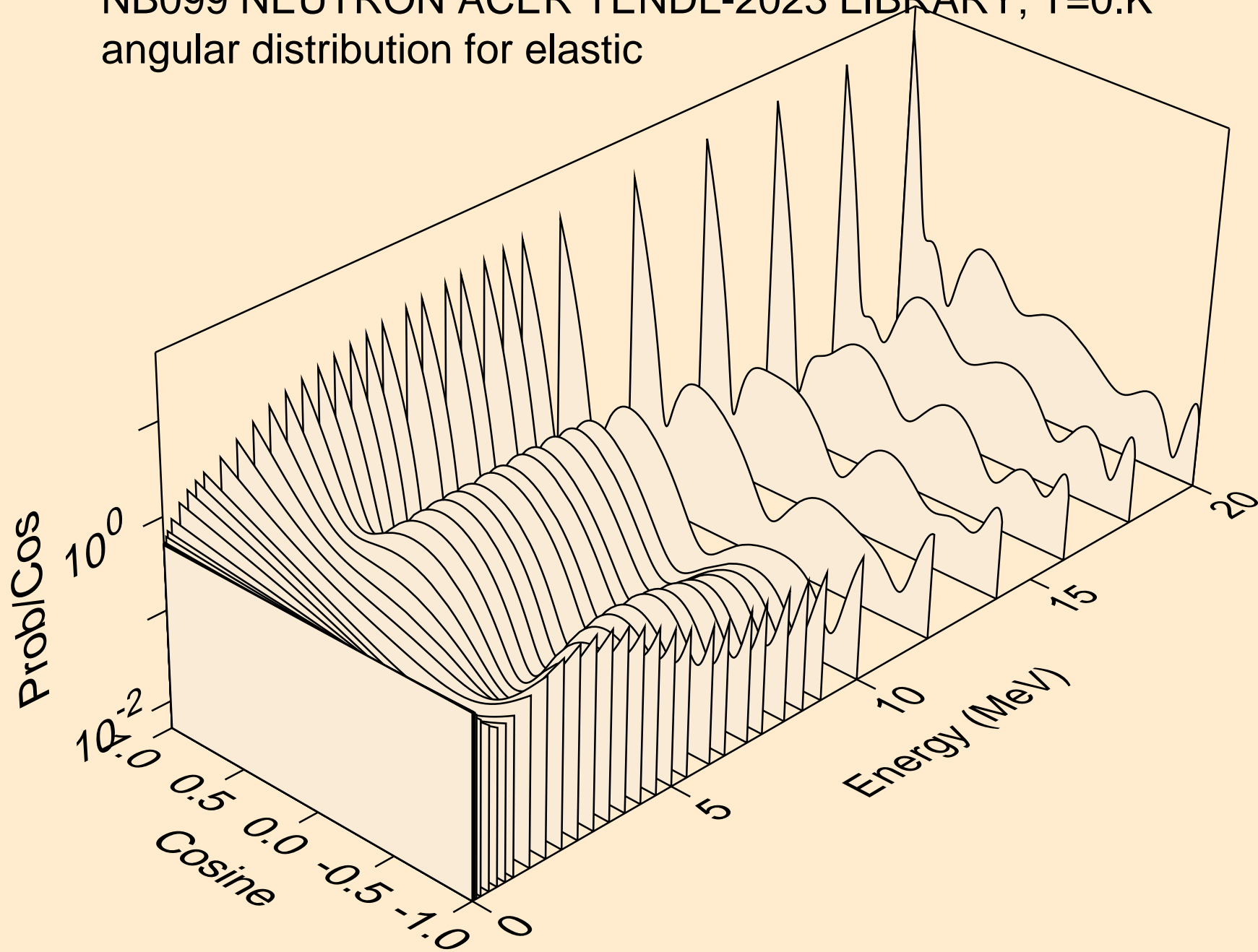

NB099 NEUTRON ACER TENDL-2023 LIBRARY; T=0.K  
angular distribution for elastic

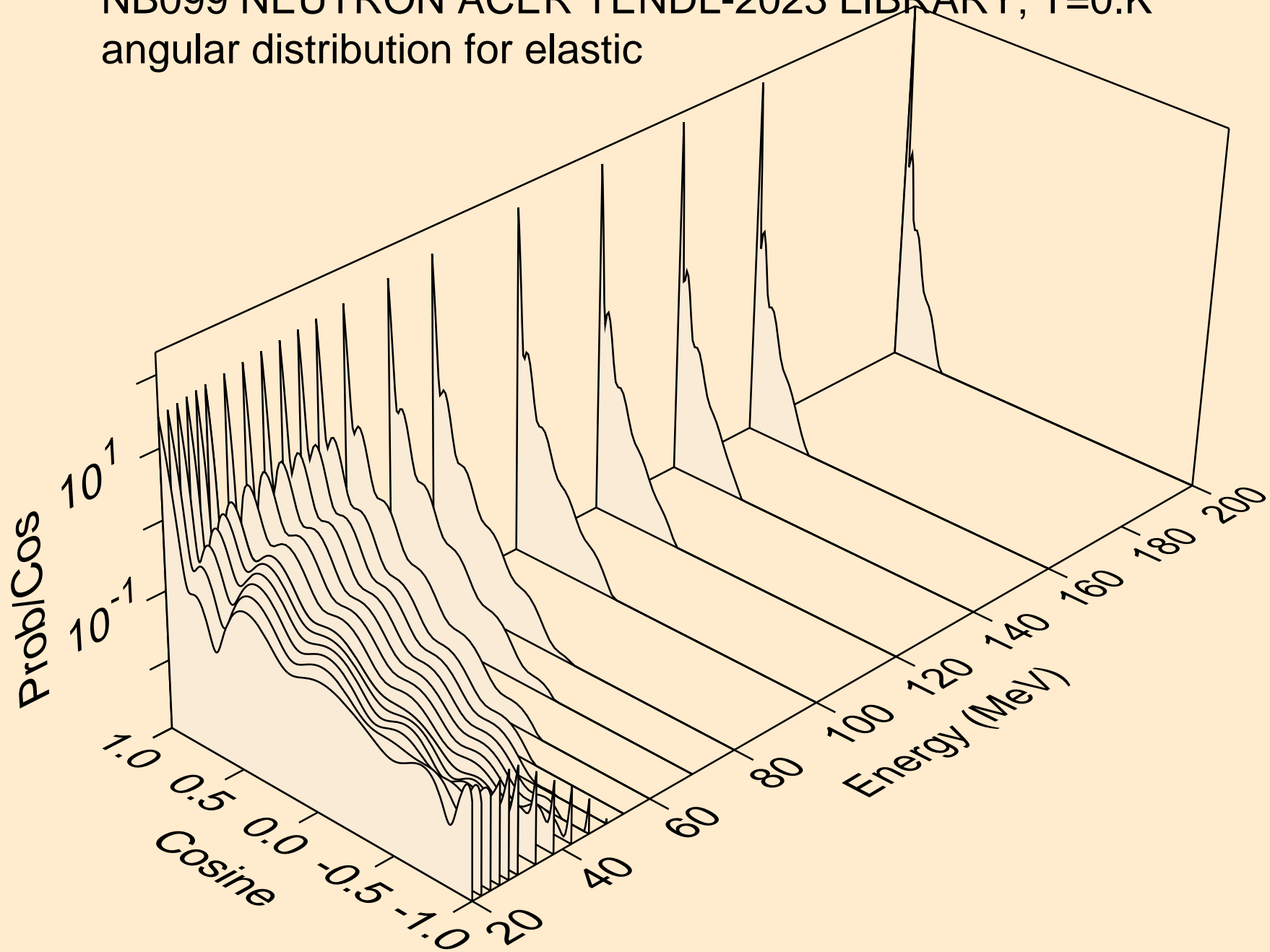

NB099 NEUTRON ACER TENDL-2023 LIBRARY; T=0.K  
angular distribution for (n,n\*1)

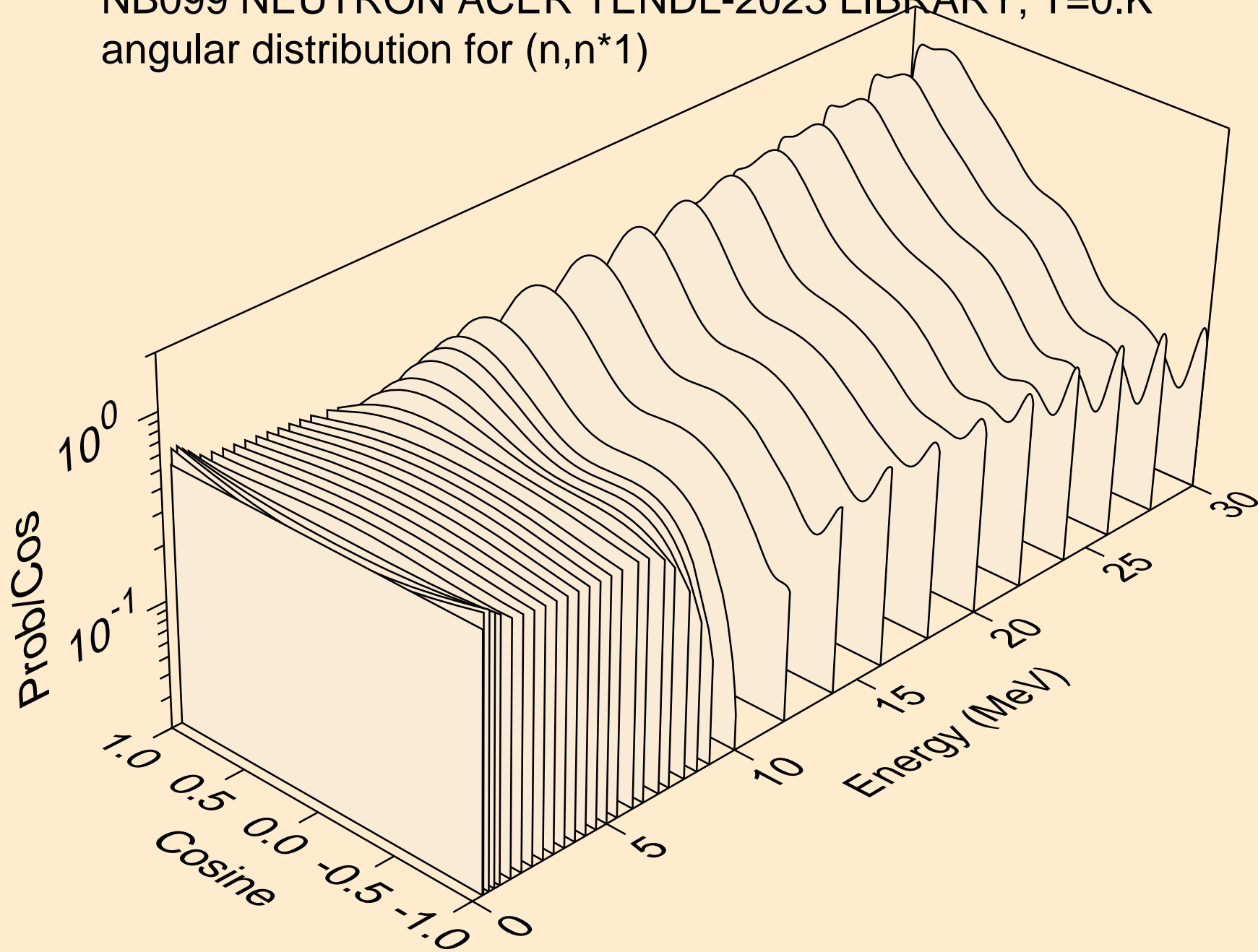

NB099 NEUTRON ACER TENDL-2023 LIBRARY; T=0.K  
angular distribution for (n,n\*2)

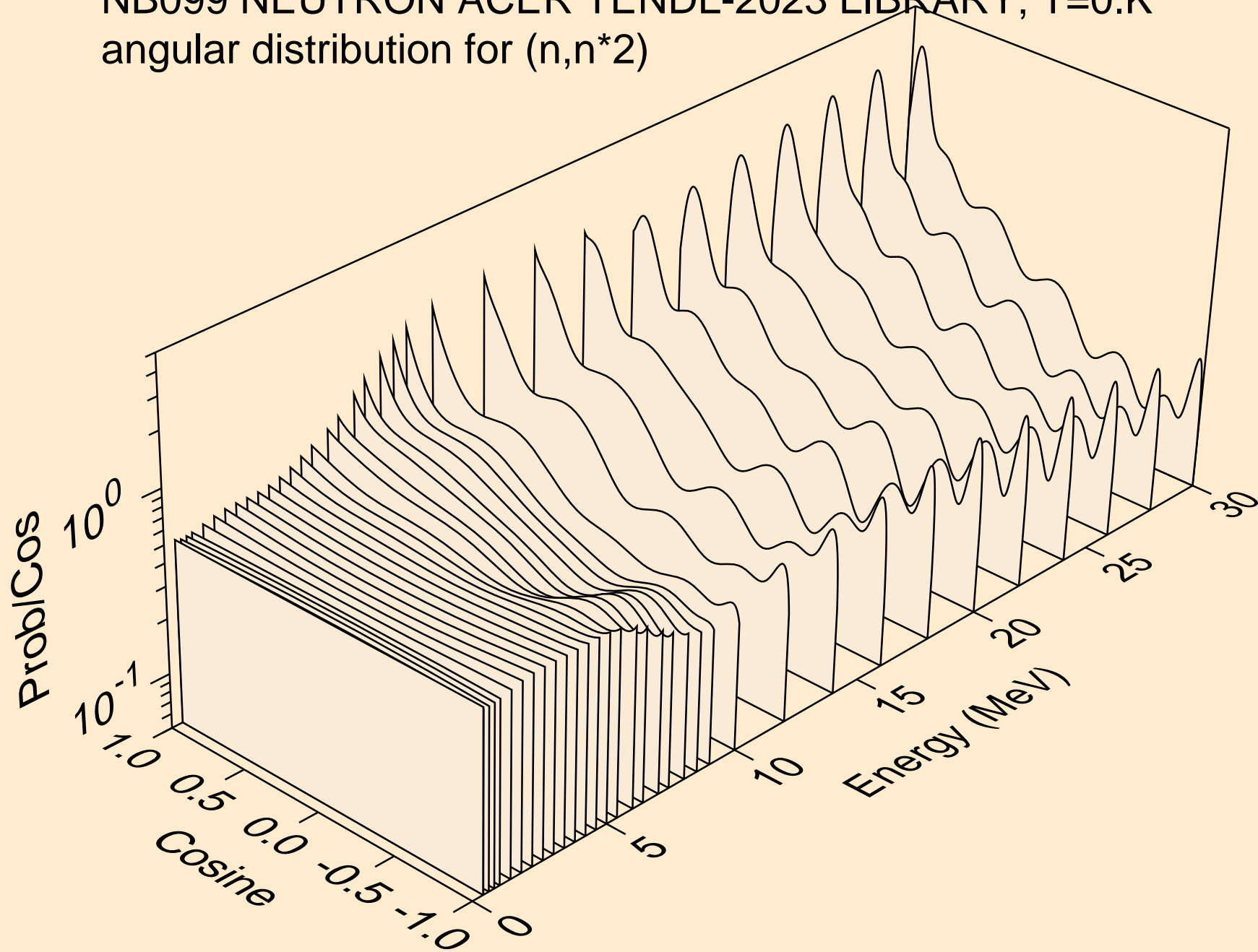



NB099 NEUTRON ACER TENDL-2023 LIBRARY; T=0.K  
angular distribution for (n,n\*3)

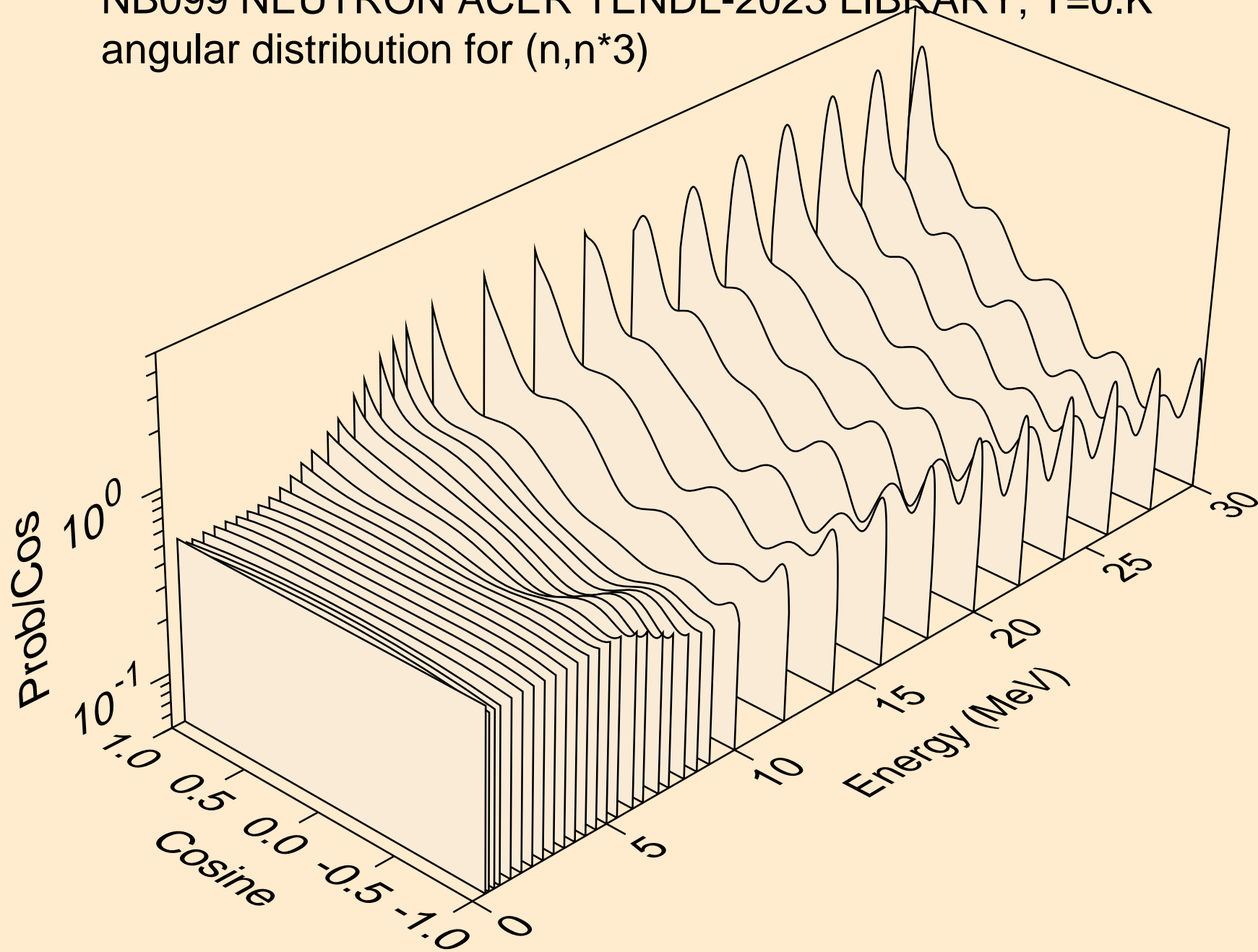

NB099 NEUTRON ACER TENDL-2023 LIBRARY; T=0.K  
angular distribution for (n,n\*4)

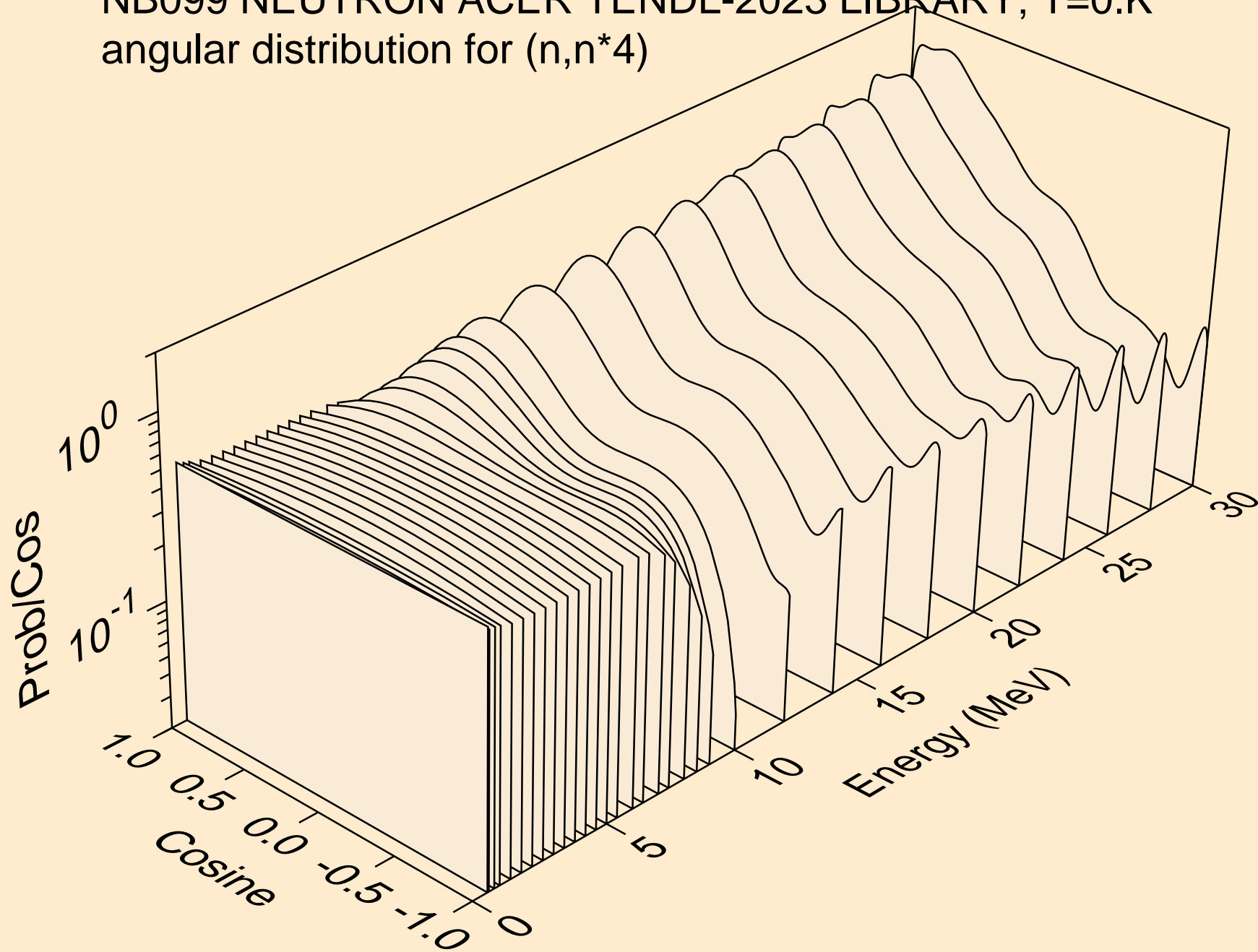

NB099 NEUTRON ACER TENDL-2023 LIBRARY; T=0.K  
angular distribution for (n,n\*5)

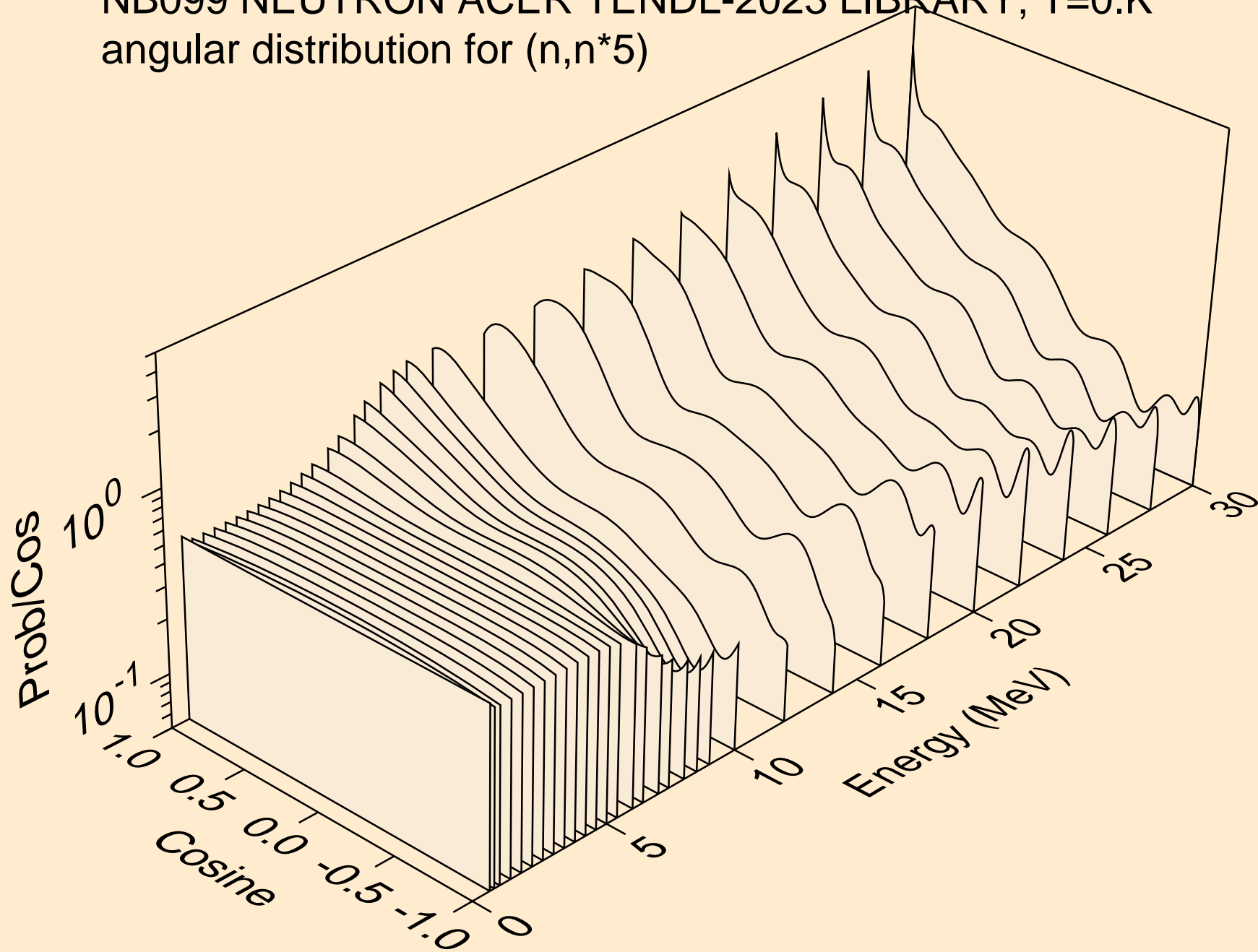

NB099 NEUTRON ACER TENDL-2023 LIBRARY; T=0.K  
angular distribution for (n,n\*6)

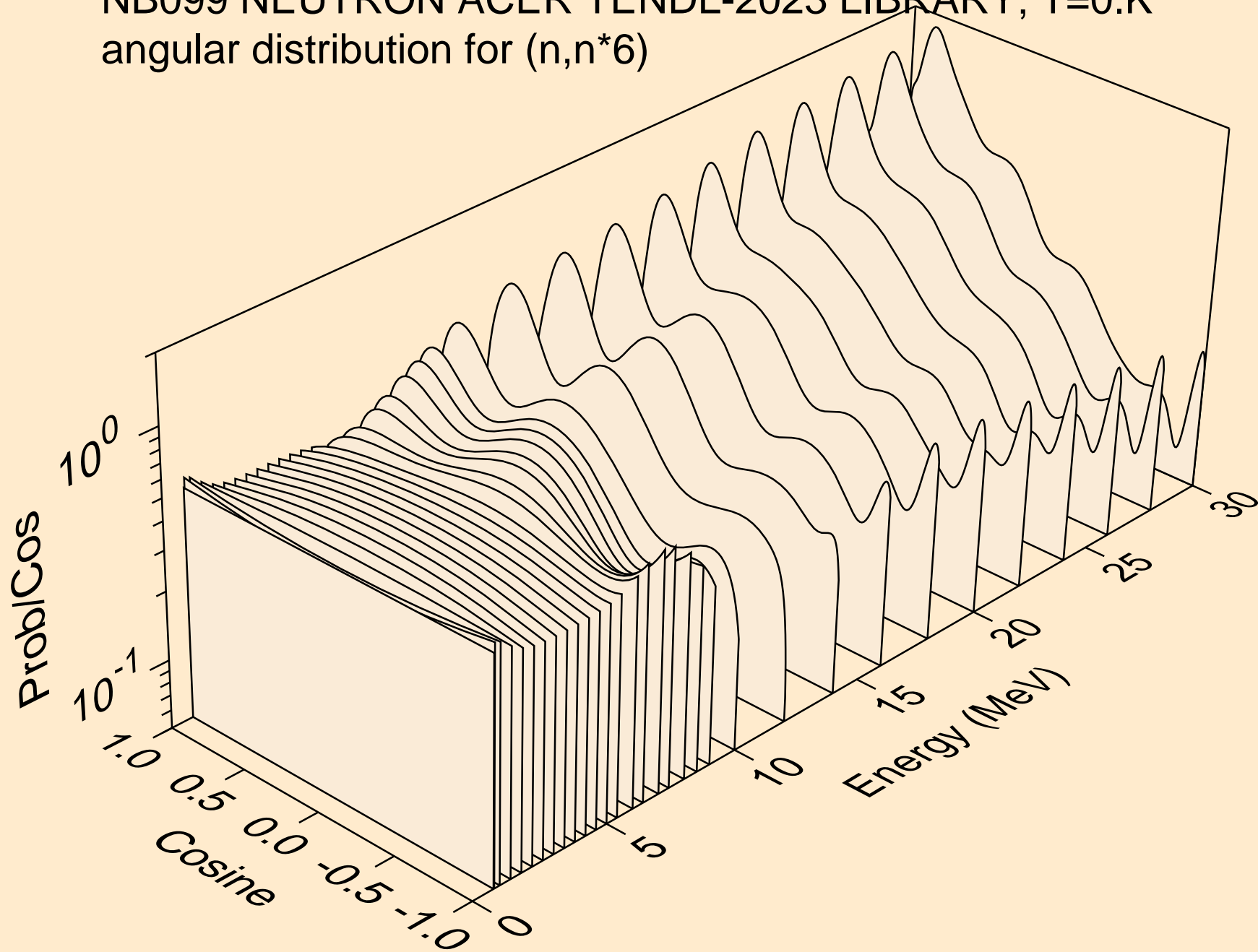

NB099 NEUTRON ACER TENDL-2023 LIBRARY; T=0.K  
angular distribution for (n,n\*7)

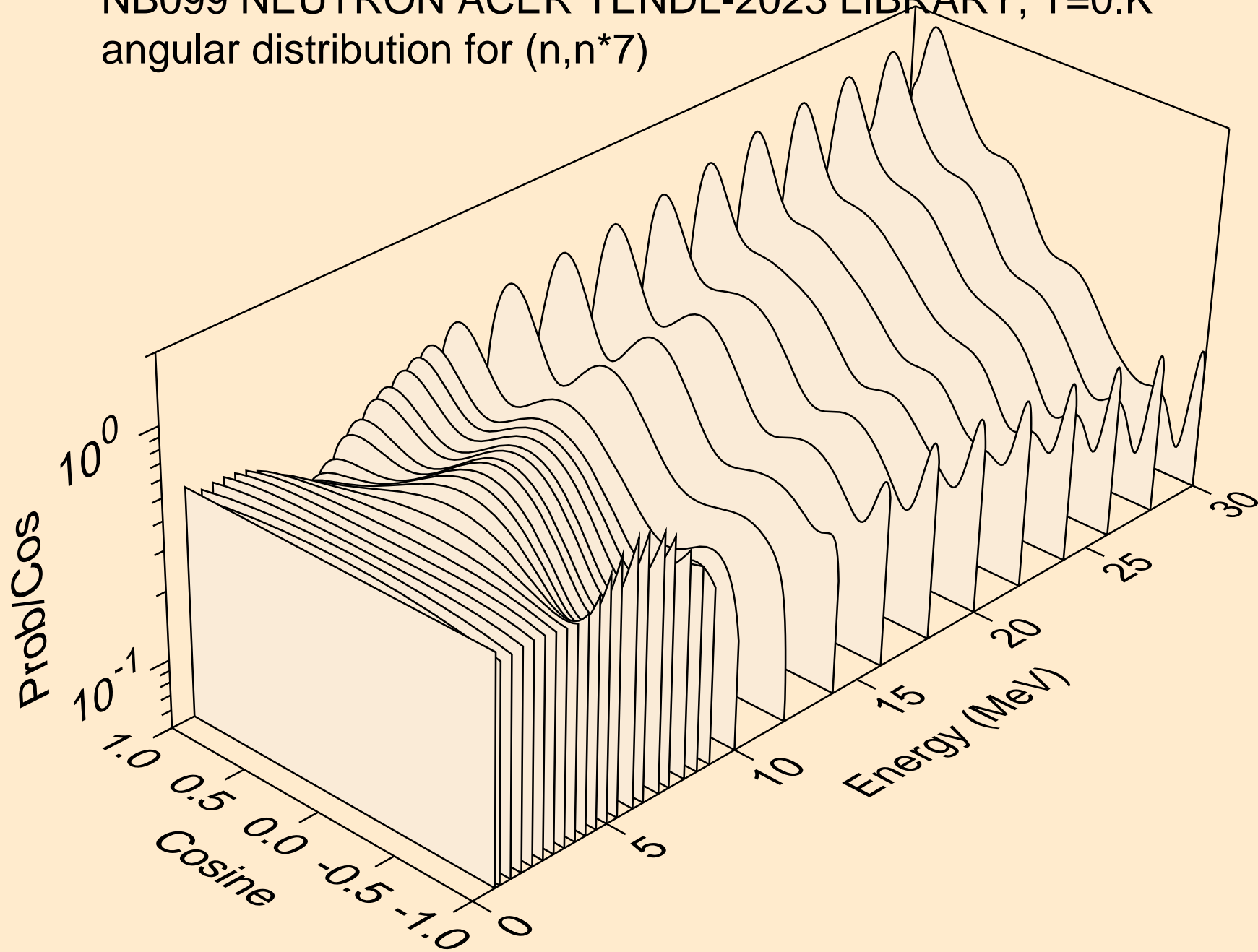

NB099 NEUTRON ACER TENDL-2023 LIBRARY; T=0.K  
angular distribution for (n,n\*8)

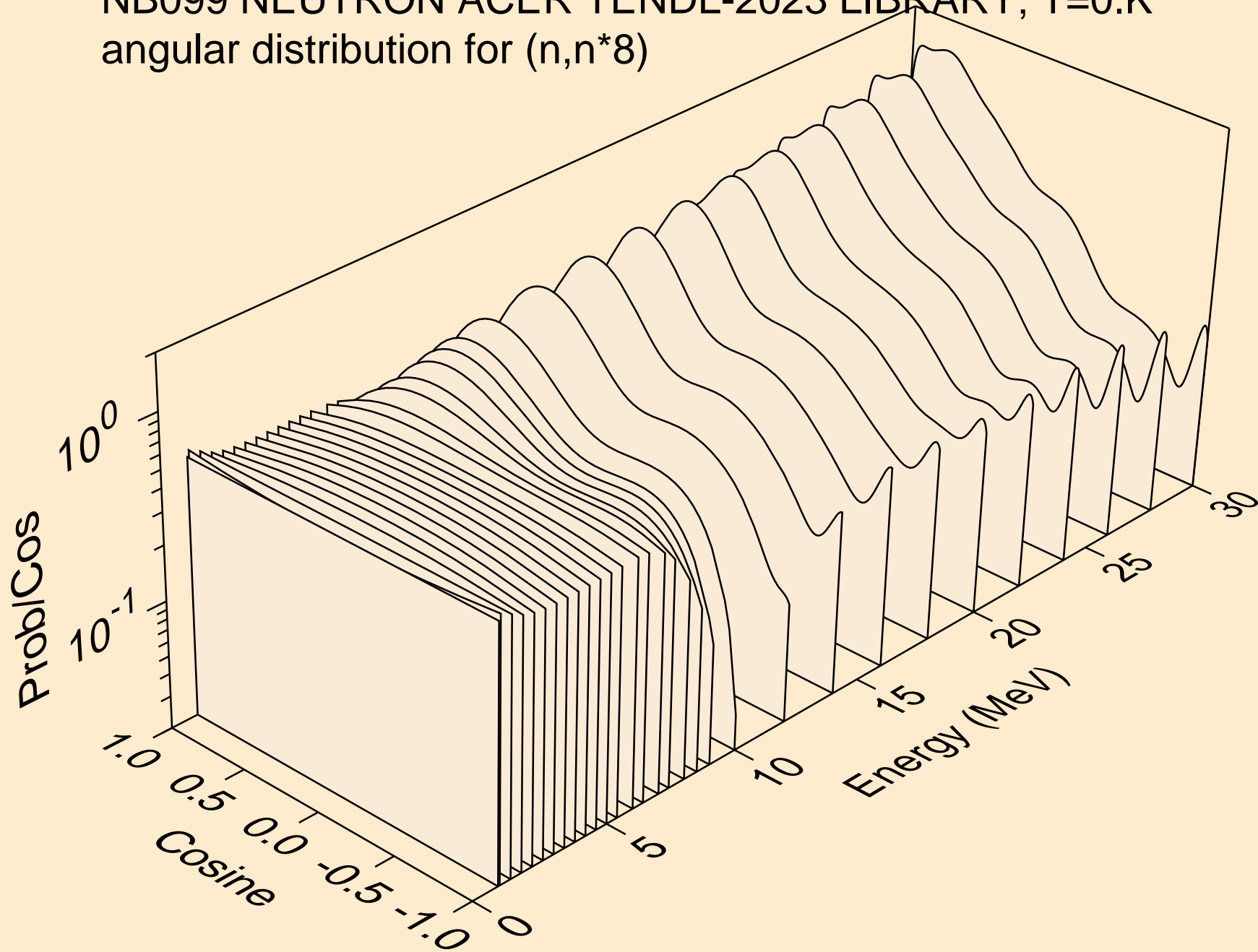

NB099 NEUTRON ACER TENDL-2023 LIBRARY; T=0.K  
angular distribution for (n,n\*9)

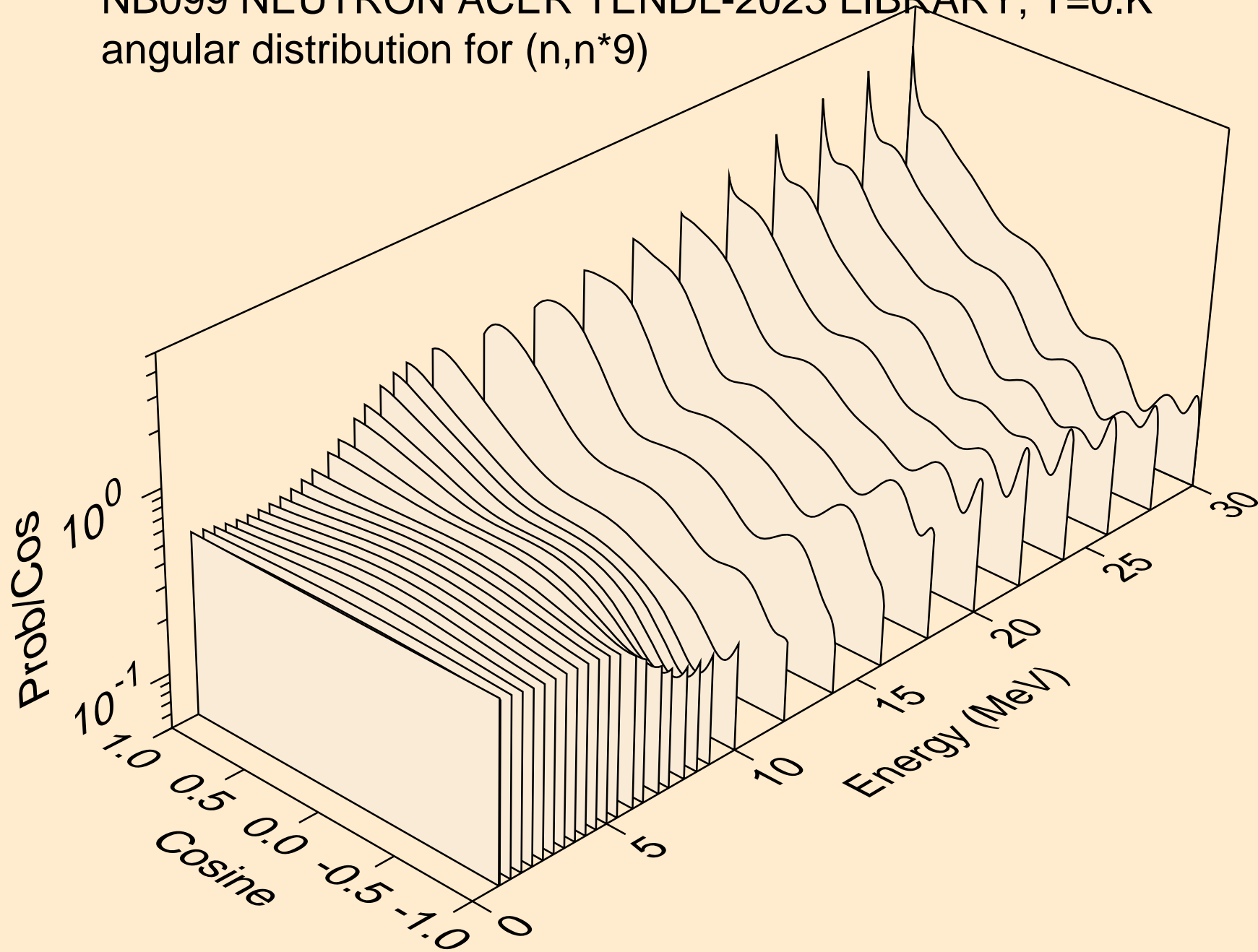

NB099 NEUTRON ACER TENDL-2023 LIBRARY; T=0.K  
angular distribution for (n,n\*10)

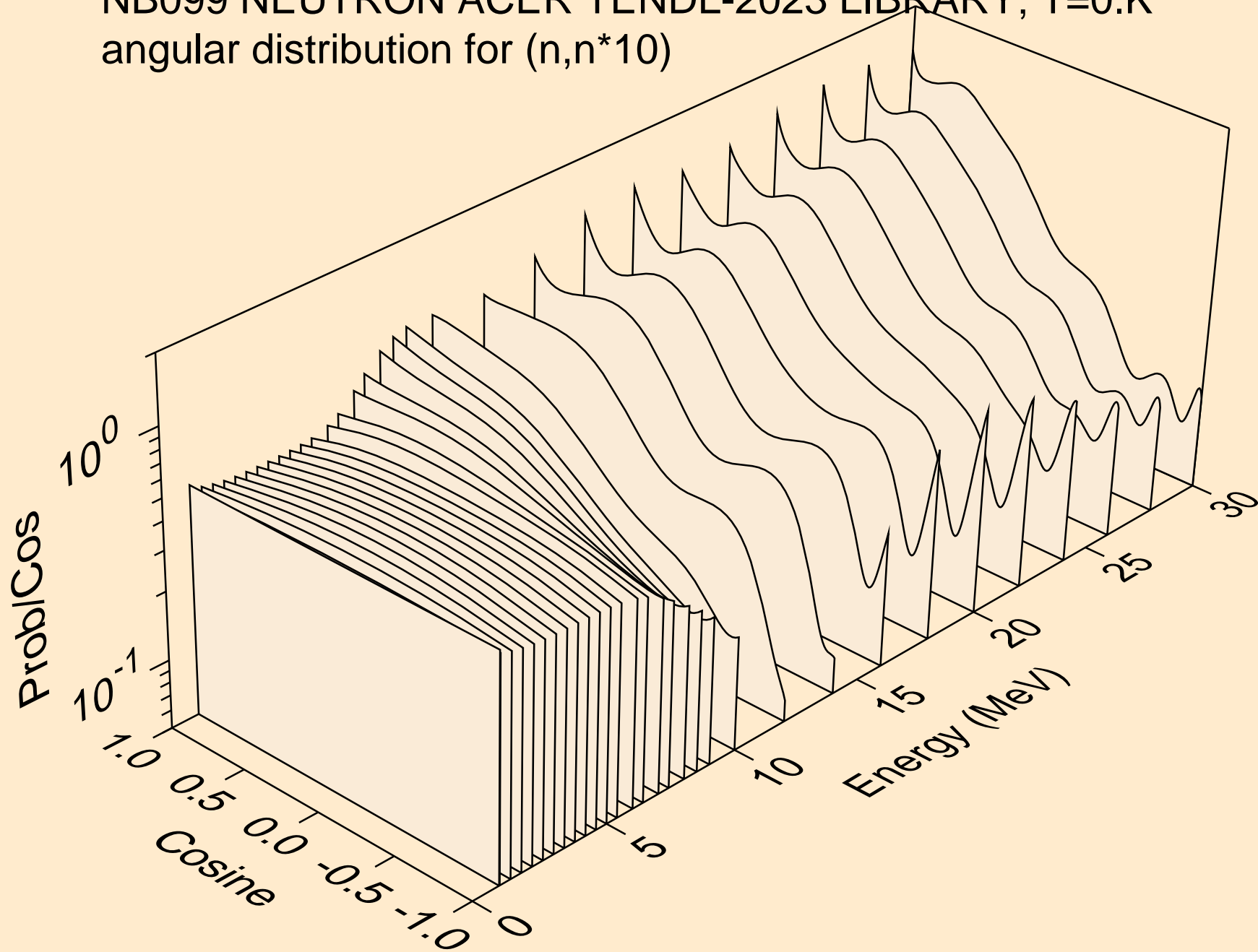



NB099 NEUTRON ACER TENDL-2023 LIBRARY; T=0.K  
angular distribution for (n,n\*11)

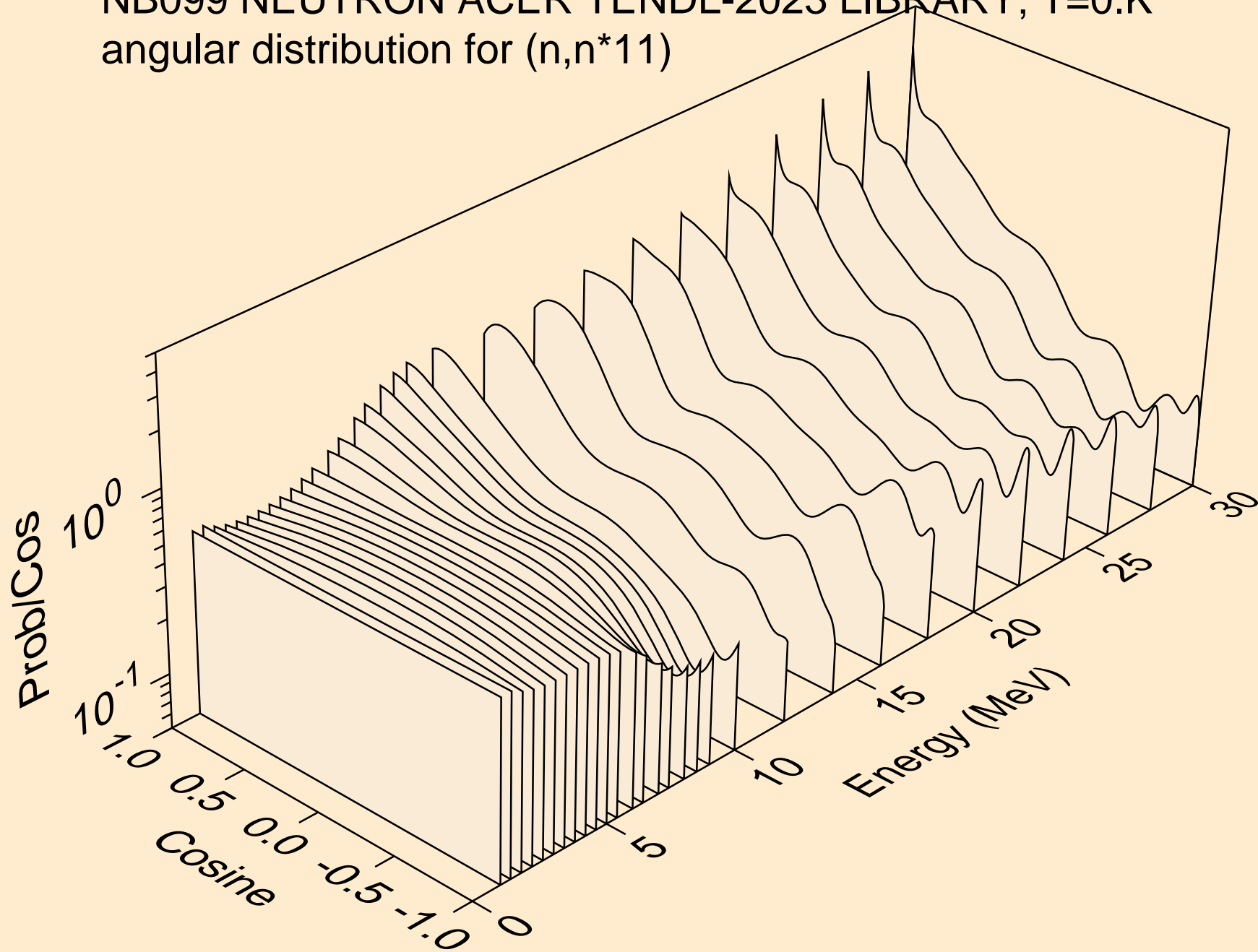

NB099 NEUTRON ACER TENDL-2023 LIBRARY; T=0.K  
angular distribution for (n,n\*12)

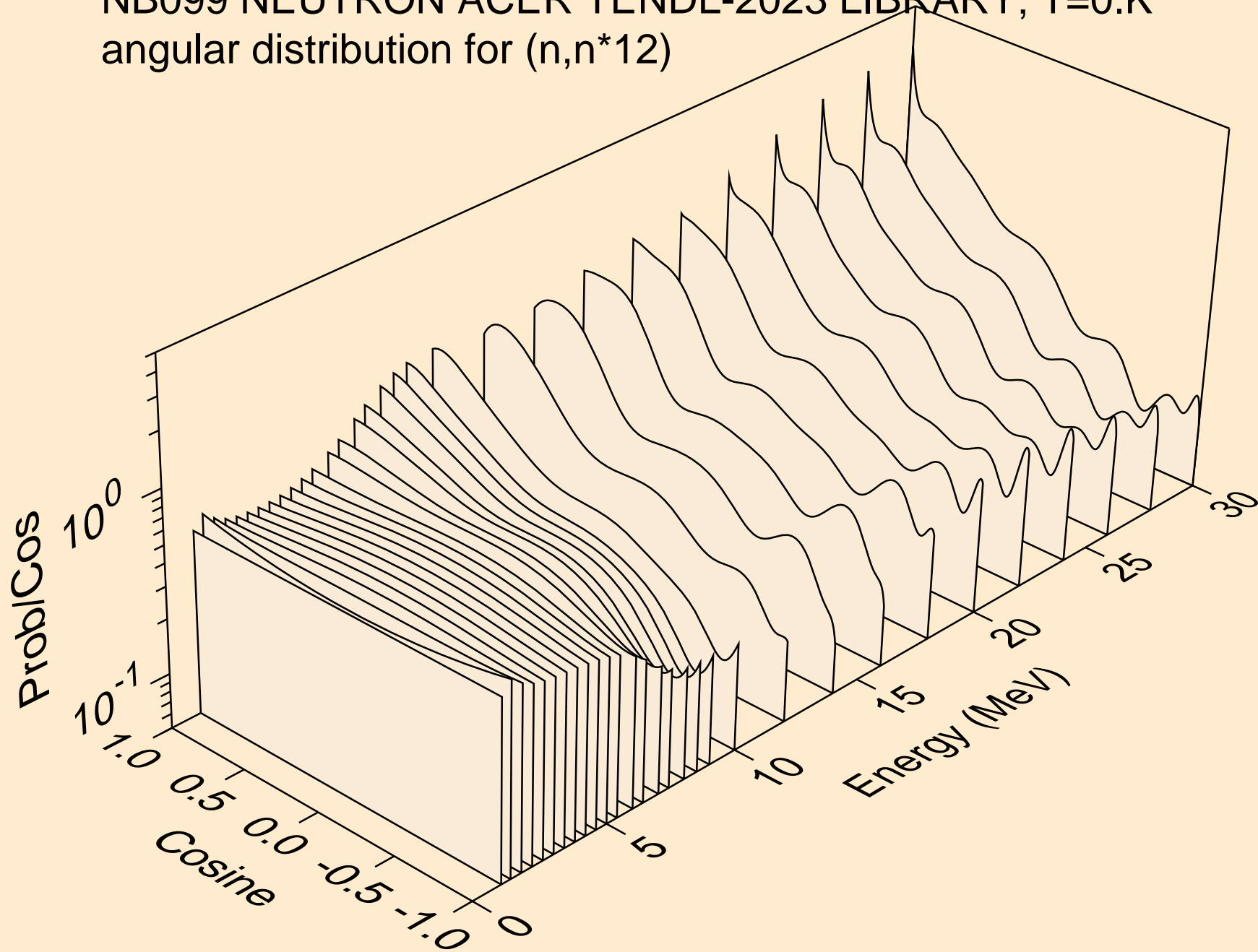

NB099 NEUTRON ACER TENDL-2023 LIBRARY; T=0.K  
angular distribution for (n,n\*13)

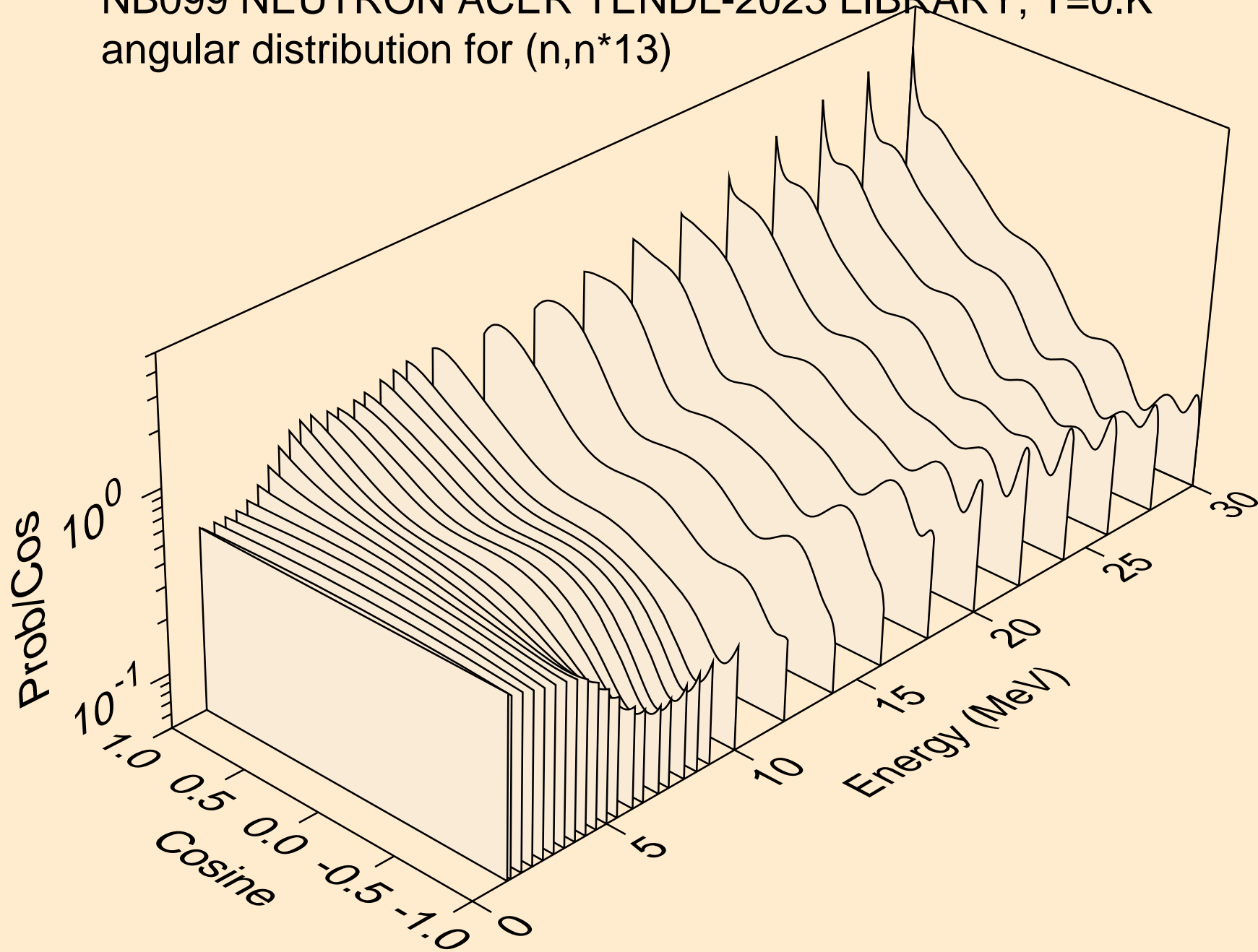

NB099 NEUTRON ACER TENDL-2023 LIBRARY; T=0.K  
angular distribution for (n,n\*14)

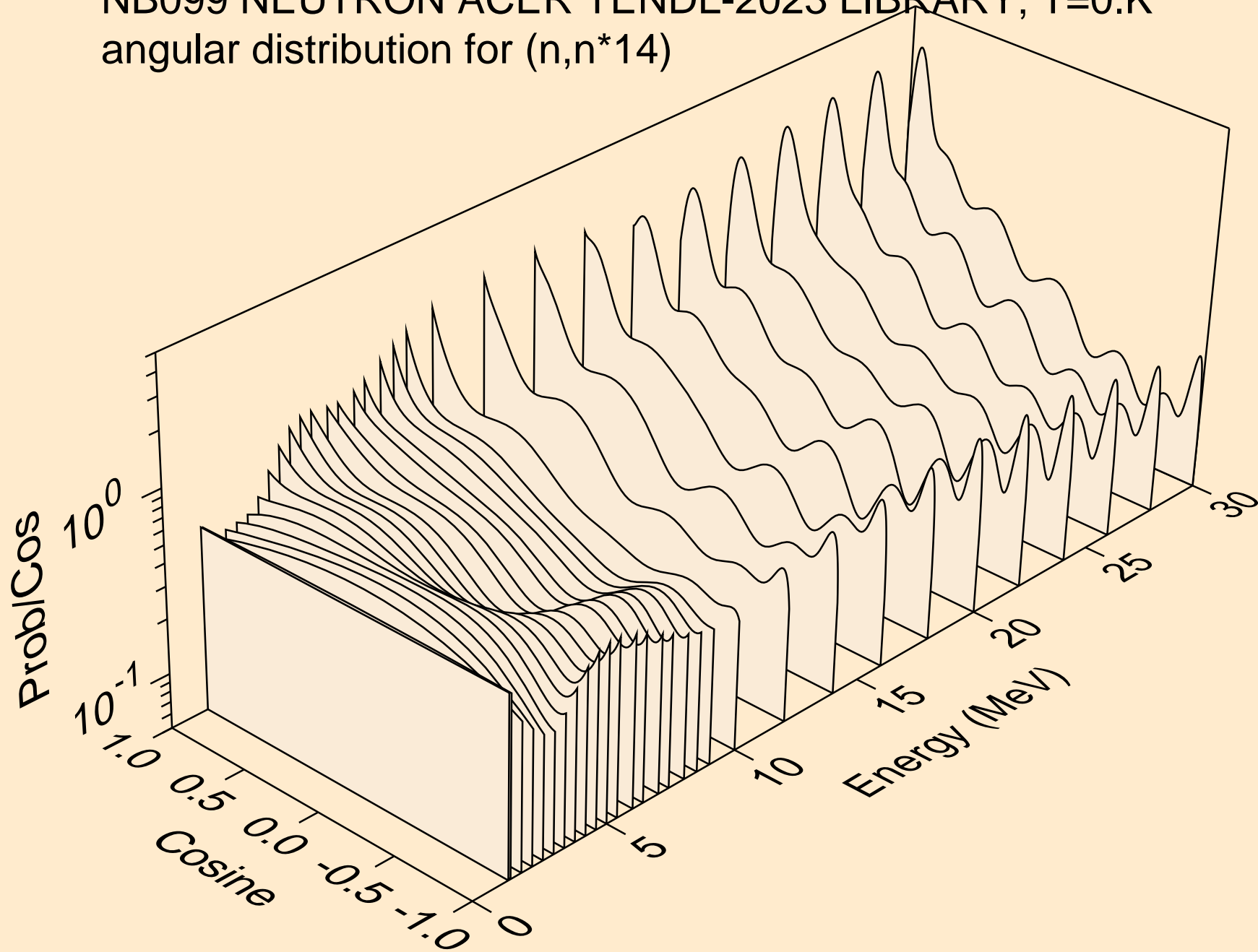

NB099 NEUTRON ACER TENDL-2023 LIBRARY; T=0.K  
angular distribution for (n,n\*15)

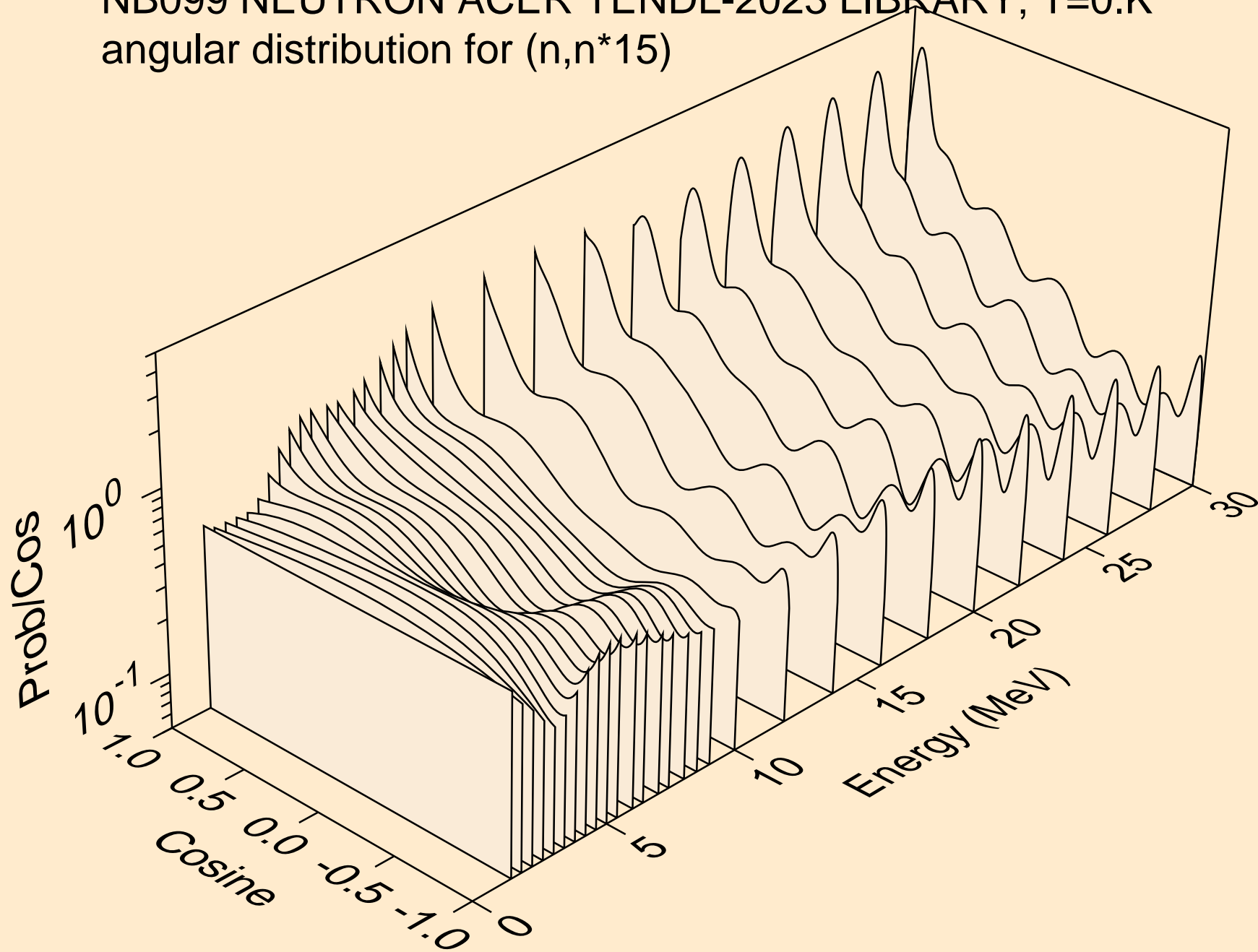

NB099 NEUTRON ACER TENDL-2023 LIBRARY; T=0.K  
angular distribution for (n,n\*16)

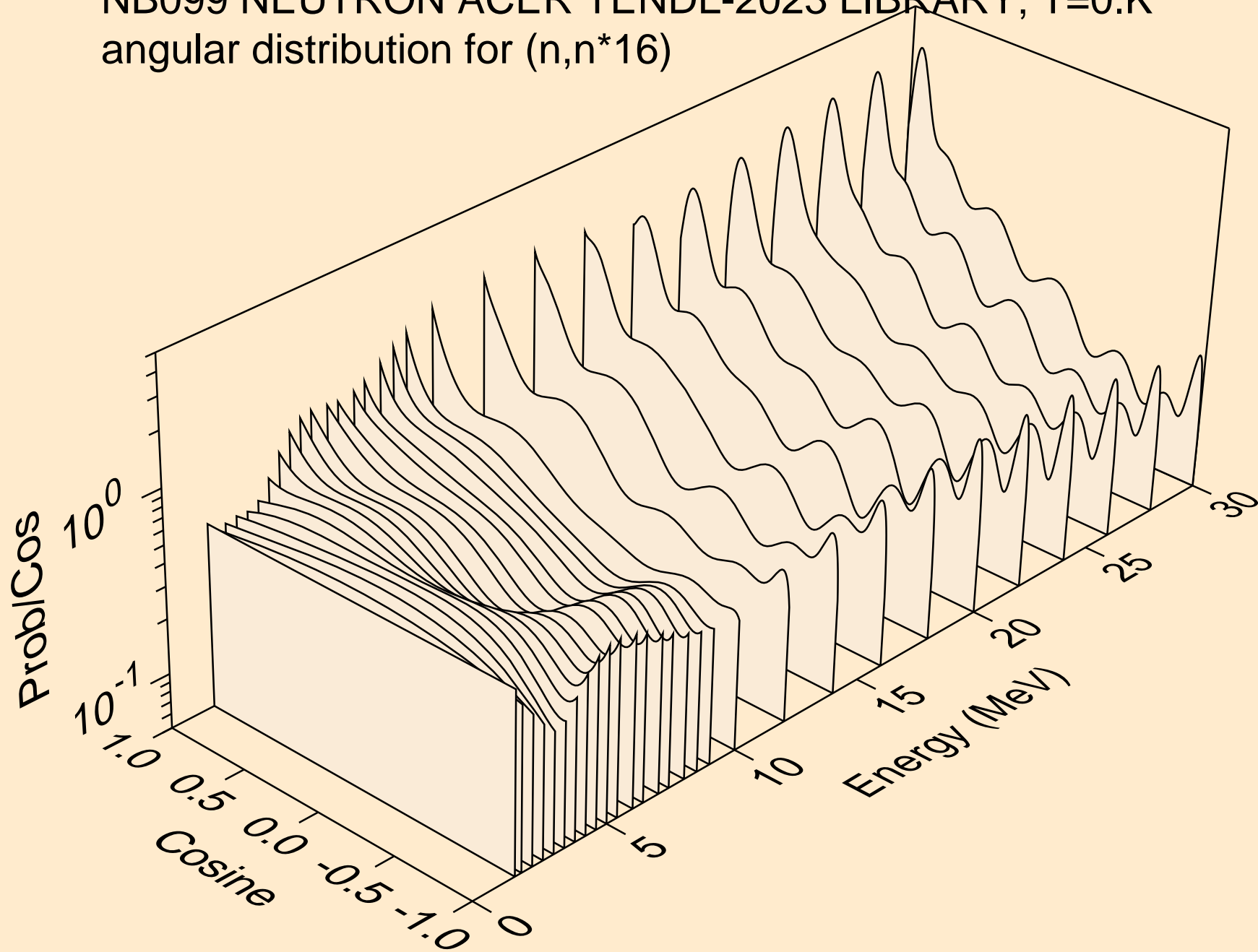

NB099 NEUTRON ACER TENDL-2023 LIBRARY; T=0.K  
Neutron emission for (n,x)

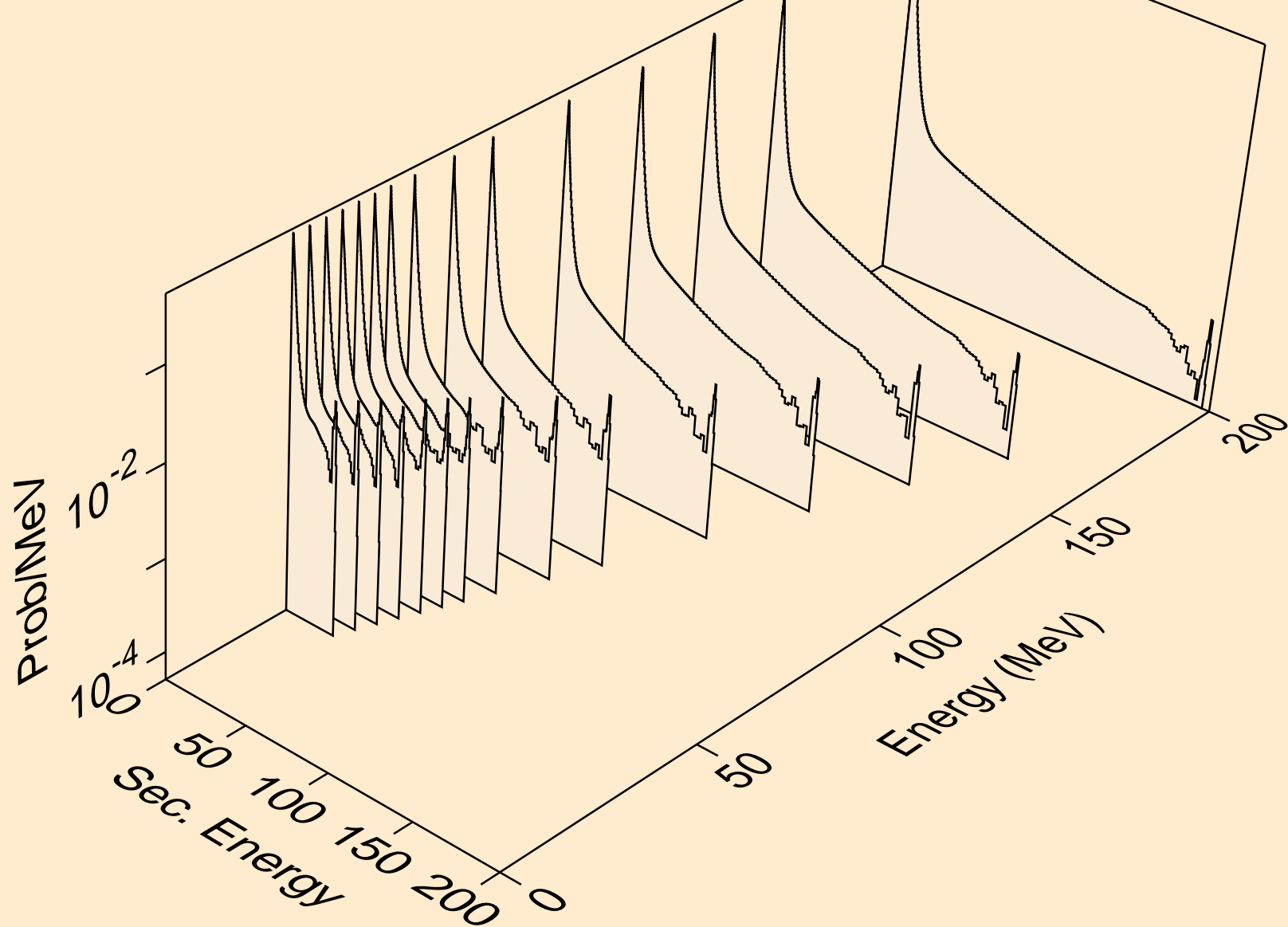

NB099 NEUTRON ACER TENDL-2023 LIBRARY; T=0.K  
Neutron emission for (n,2nd)

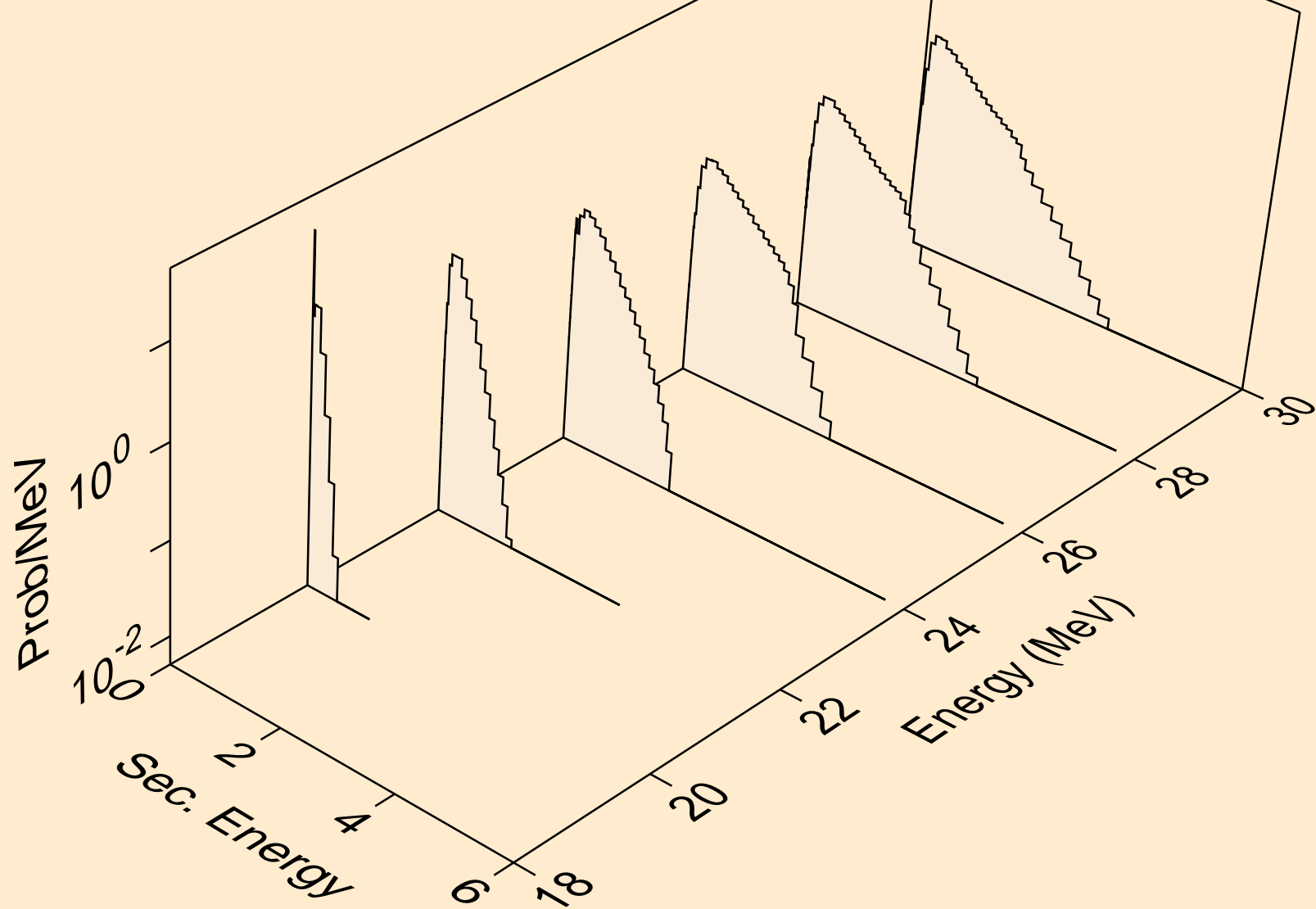



NB099 NEUTRON ACER TENDL-2023 LIBRARY; T=0.K  
Neutron emission for (n,2n)

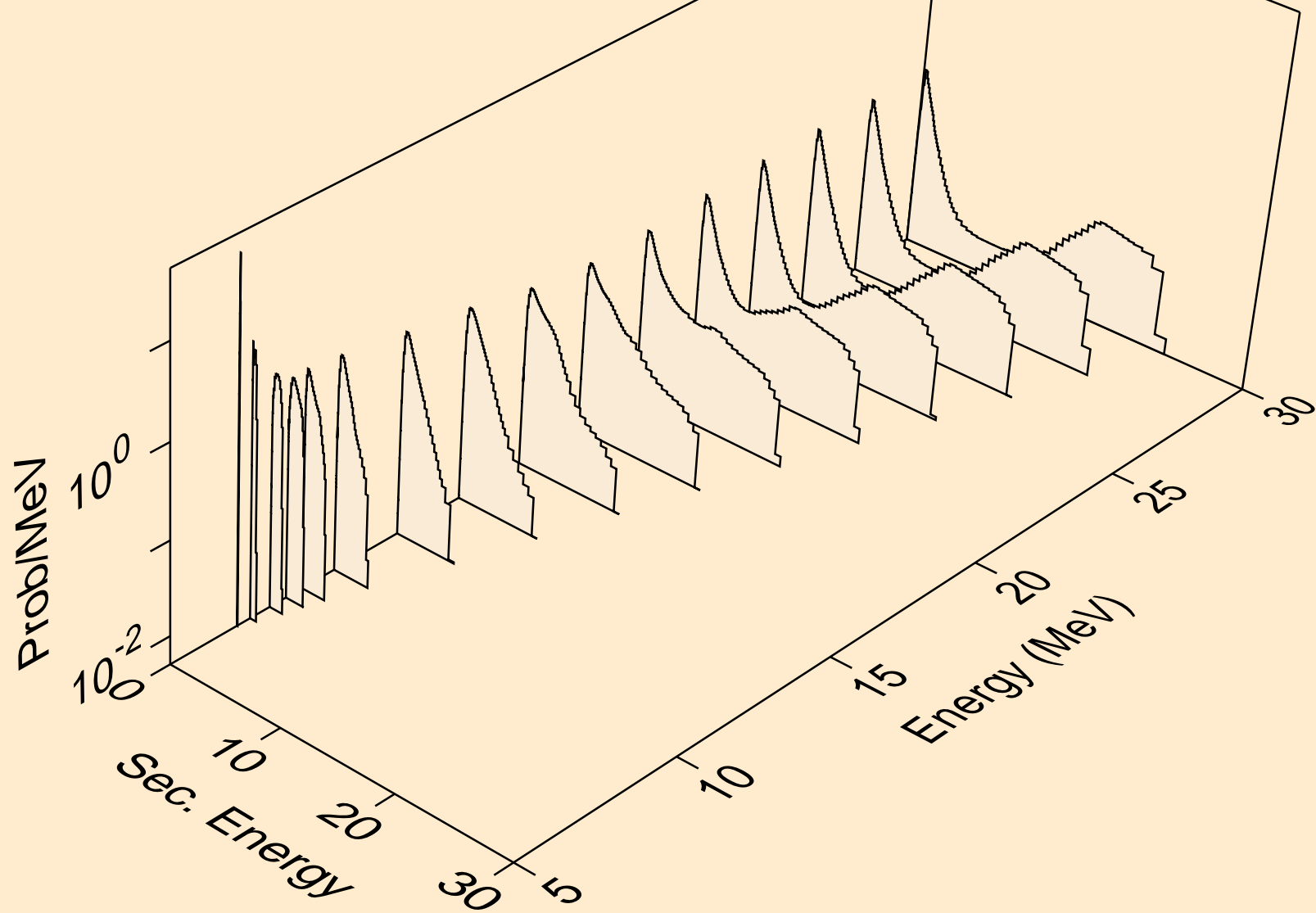

NB099 NEUTRON ACER TENDL-2023 LIBRARY; T=0.K  
Neutron emission for (n,3n)

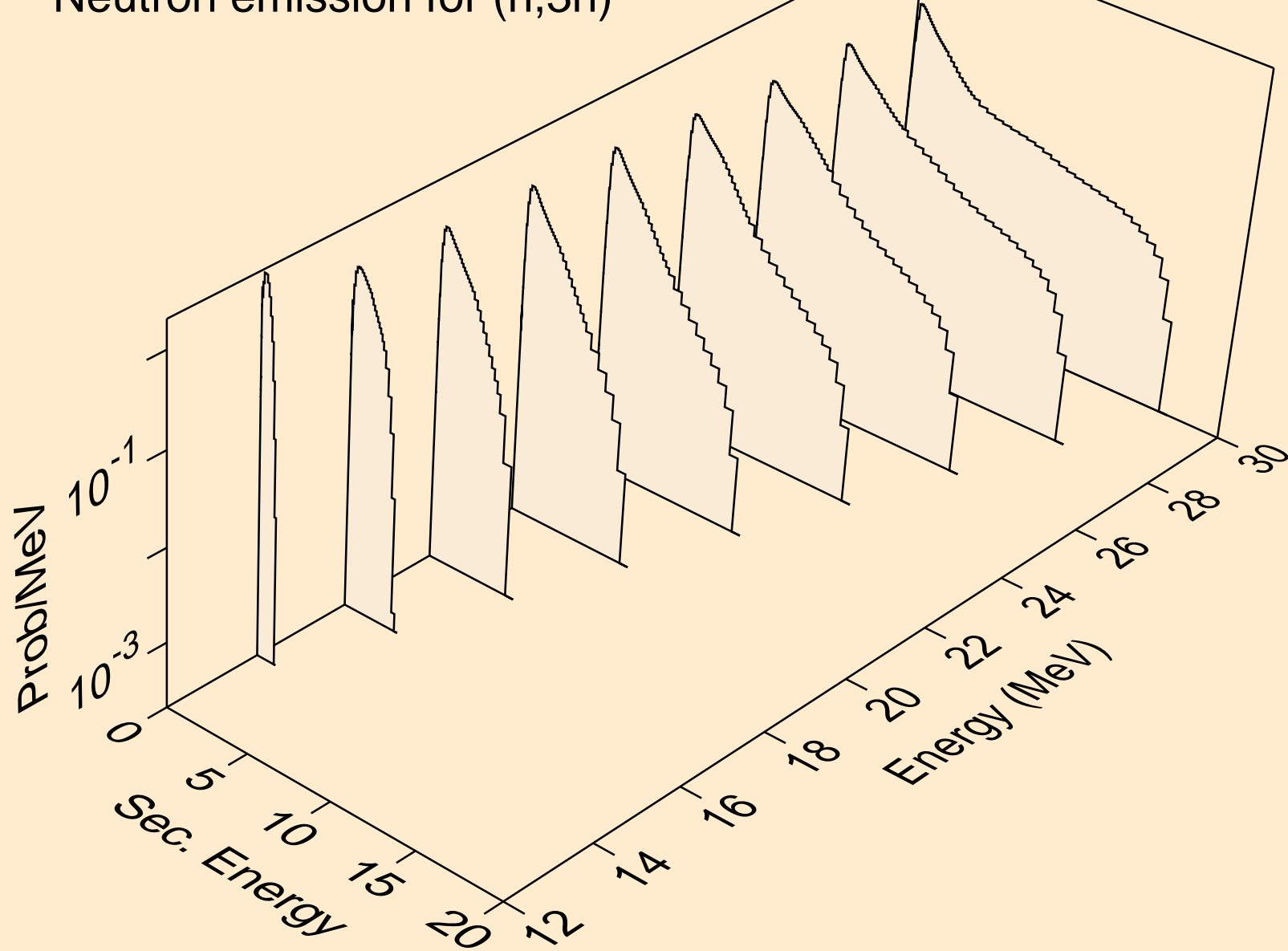

NB099 NEUTRON ACER TENDL-2023 LIBRARY; T=0.K  
Neutron emission for (n,n\*)a

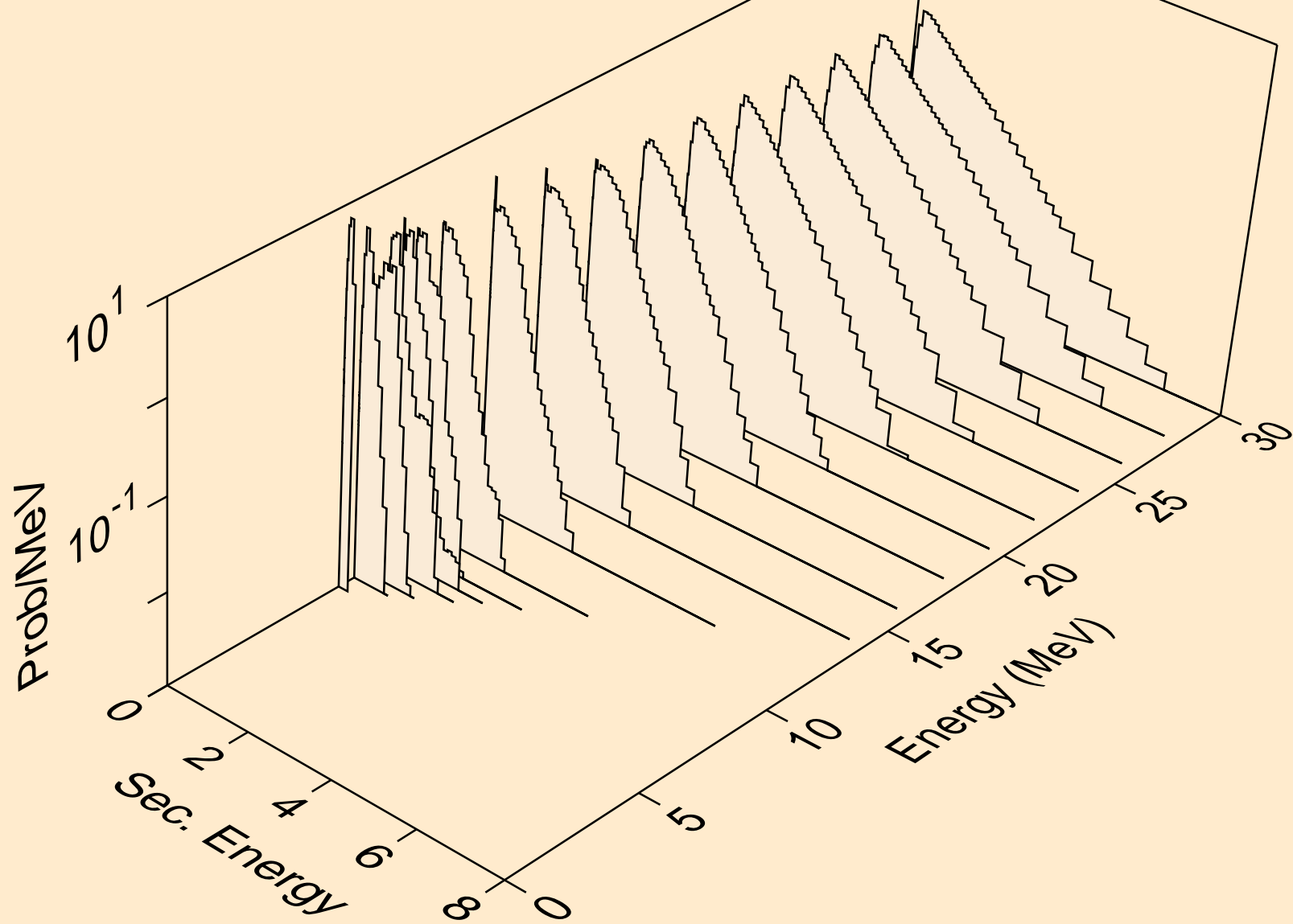

NB099 NEUTRON ACER TENDL-2023 LIBRARY; T=0.K  
Neutron emission for (n,2n)a

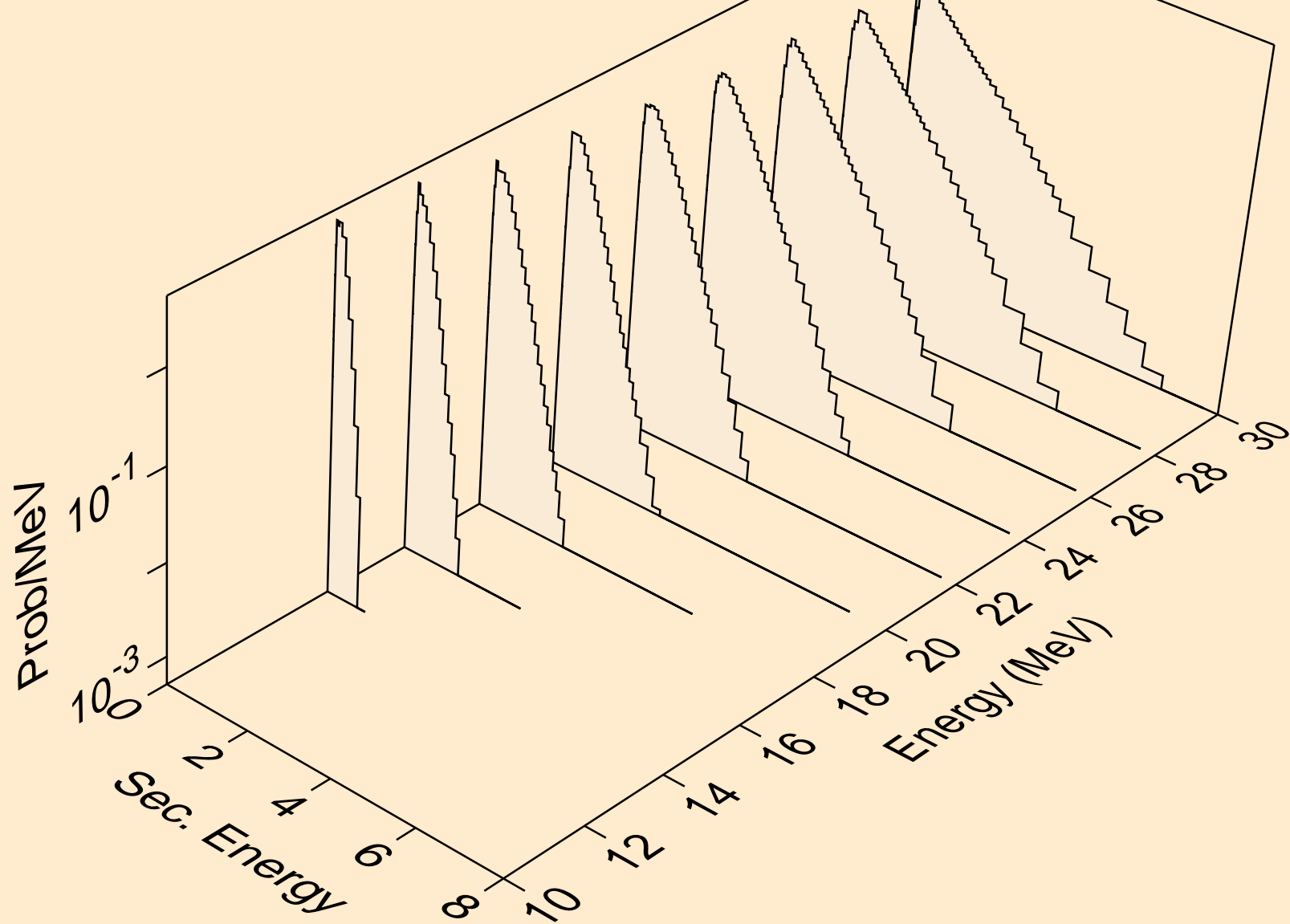

NB099 NEUTRON ACER TENDL-2023 LIBRARY; T=0.K  
Neutron emission for (n,3n)a

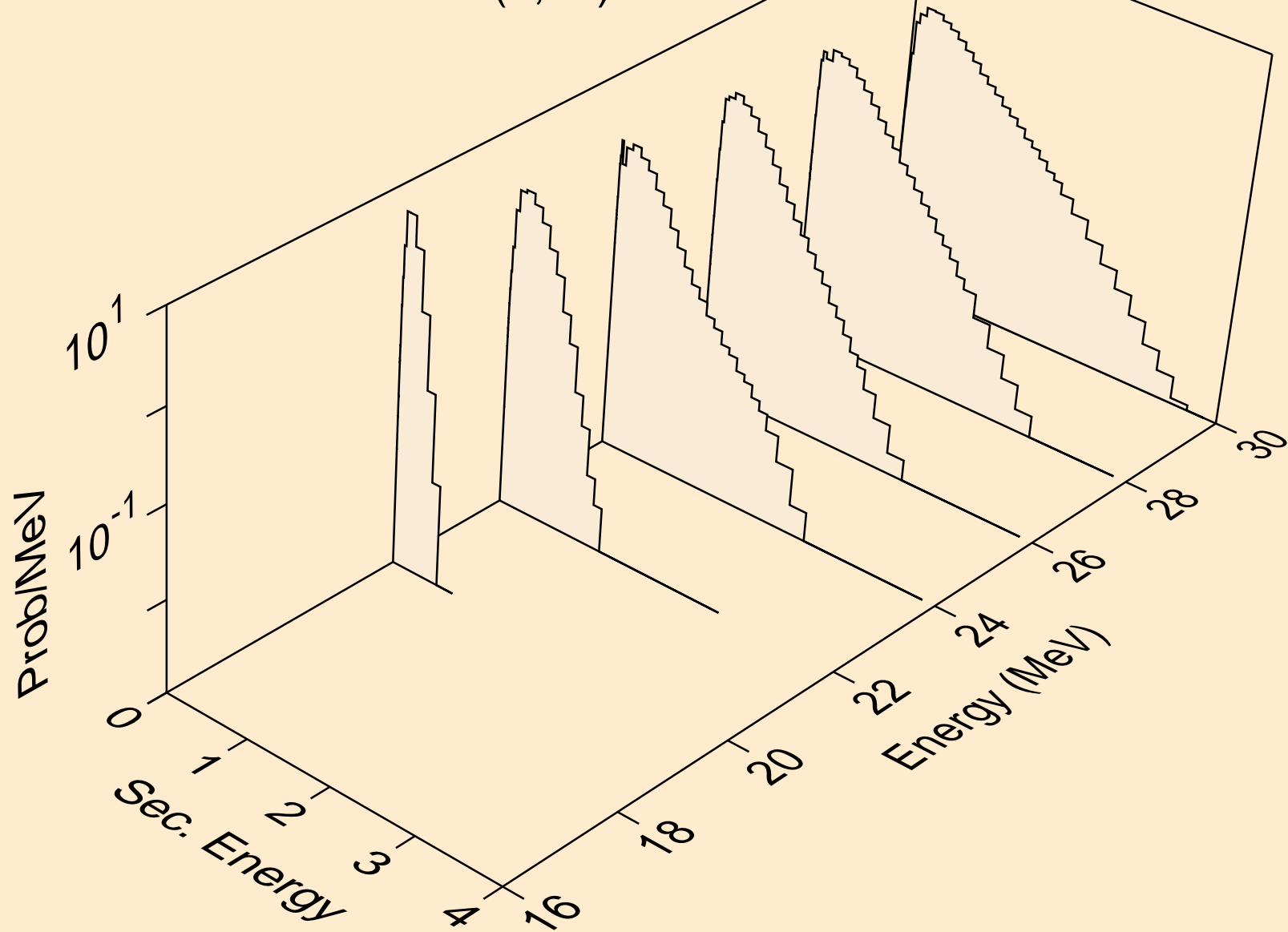

NB099 NEUTRON ACER TENDL-2023 LIBRARY; T=0.K  
Neutron emission for (n,n\*)p

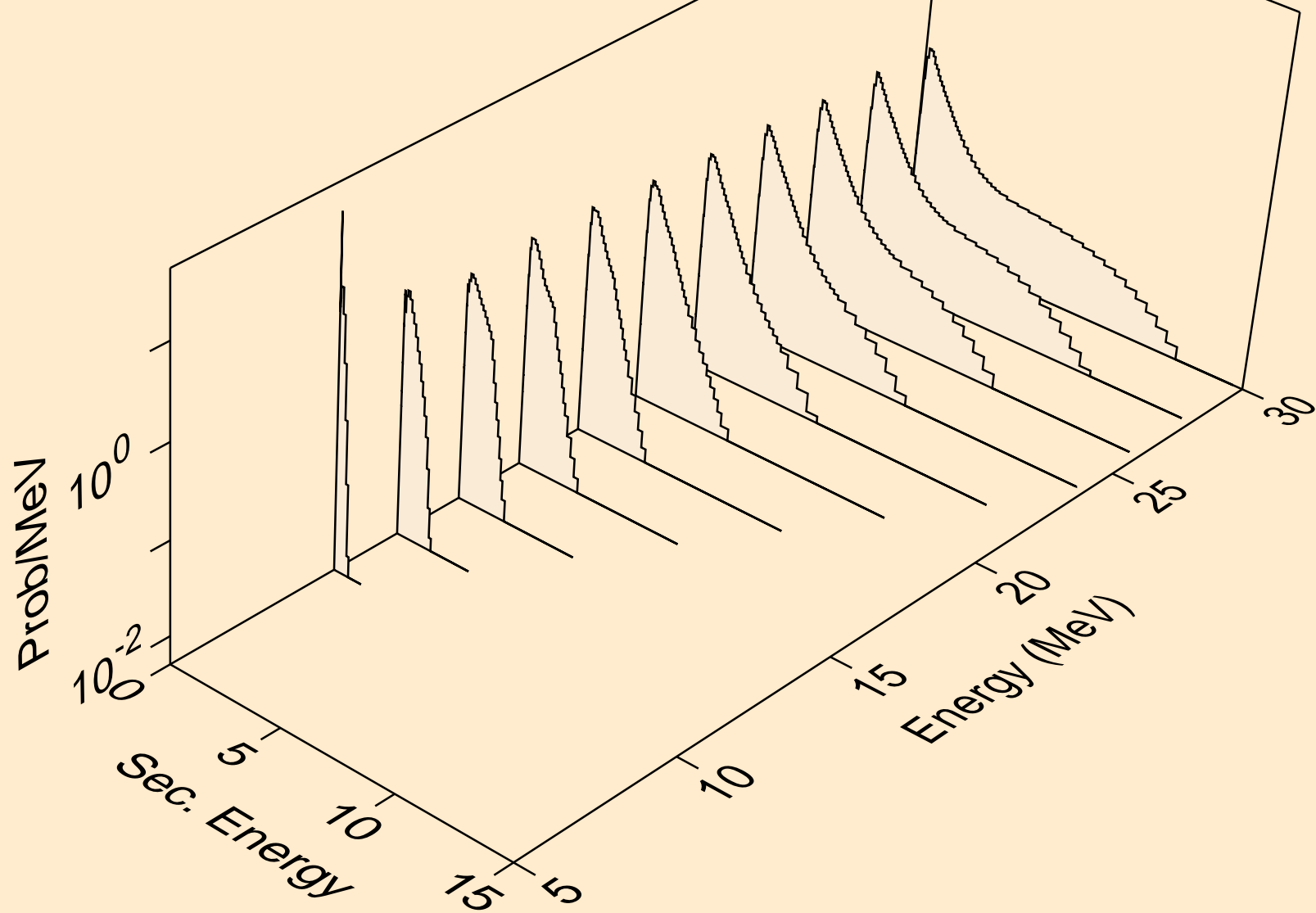

NB099 NEUTRON ACER TENDL-2023 LIBRARY; T=0.K  
Neutron emission for (n,n\*)2a

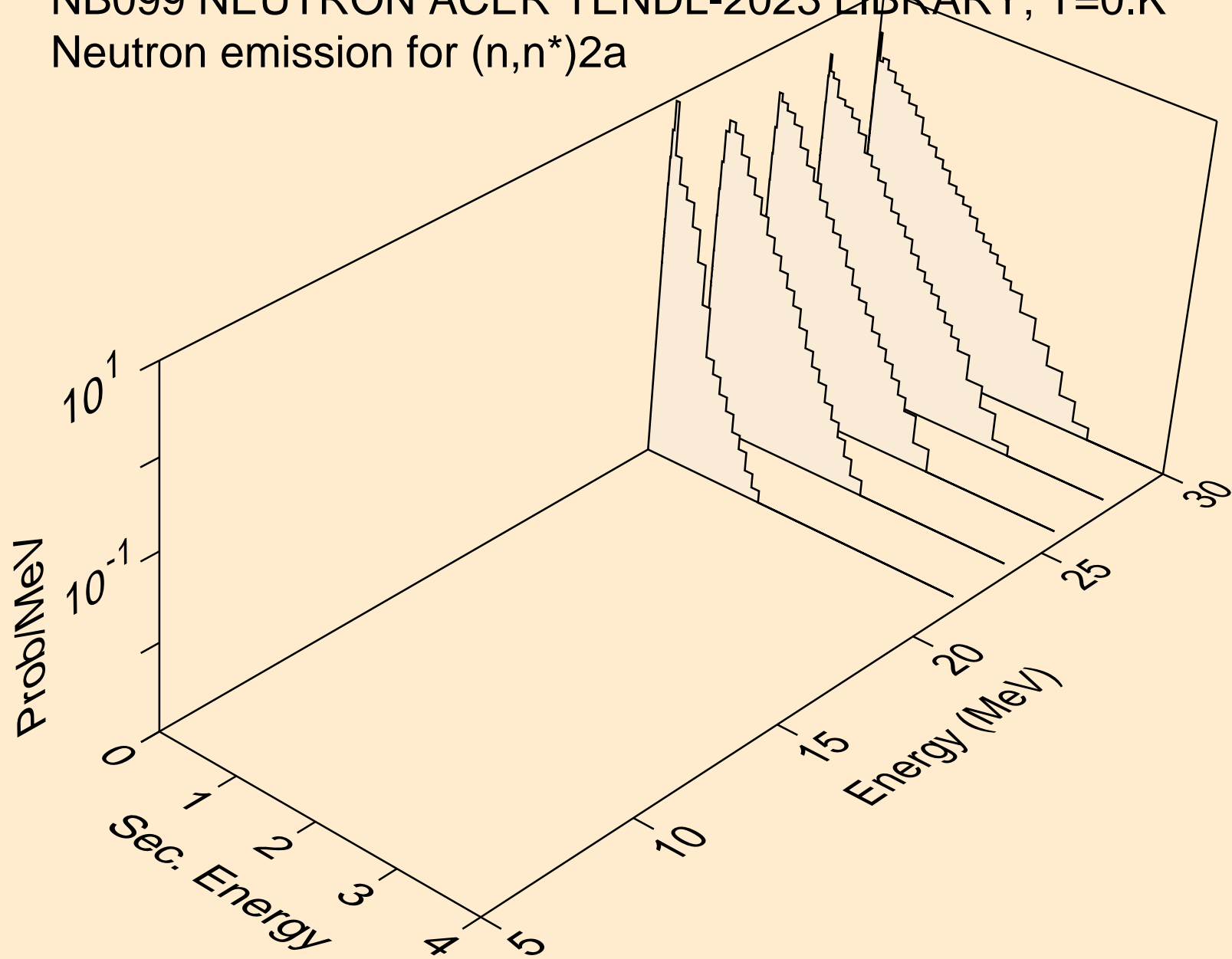

NB099 NEUTRON ACER TENDL-2023 LIBRARY; T=0.K  
Neutron emission for (n,n\*)d

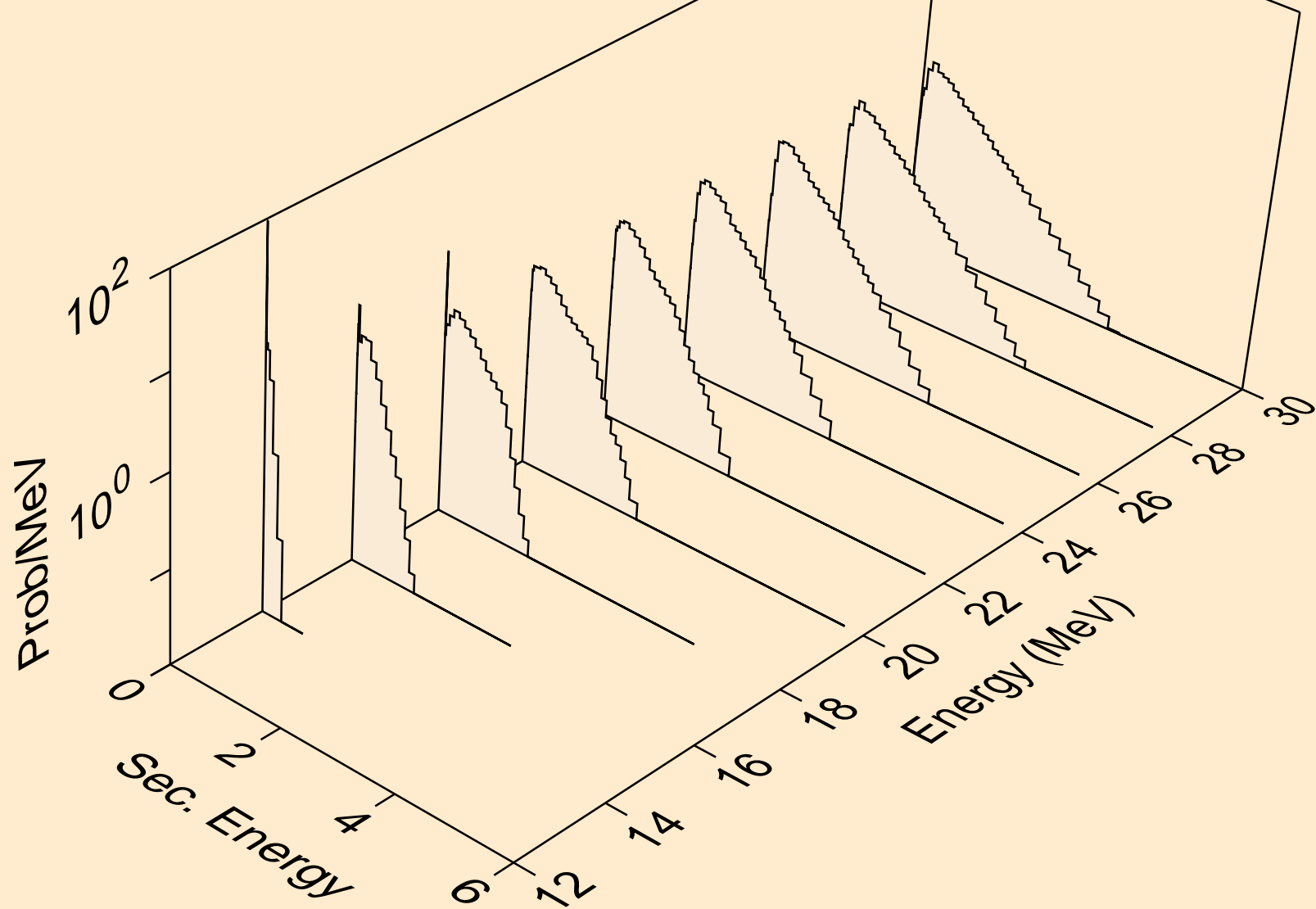



NB099 NEUTRON ACER TENDL-2023 LIBRARY; T=0.K  
Neutron emission for (n,n\*)t

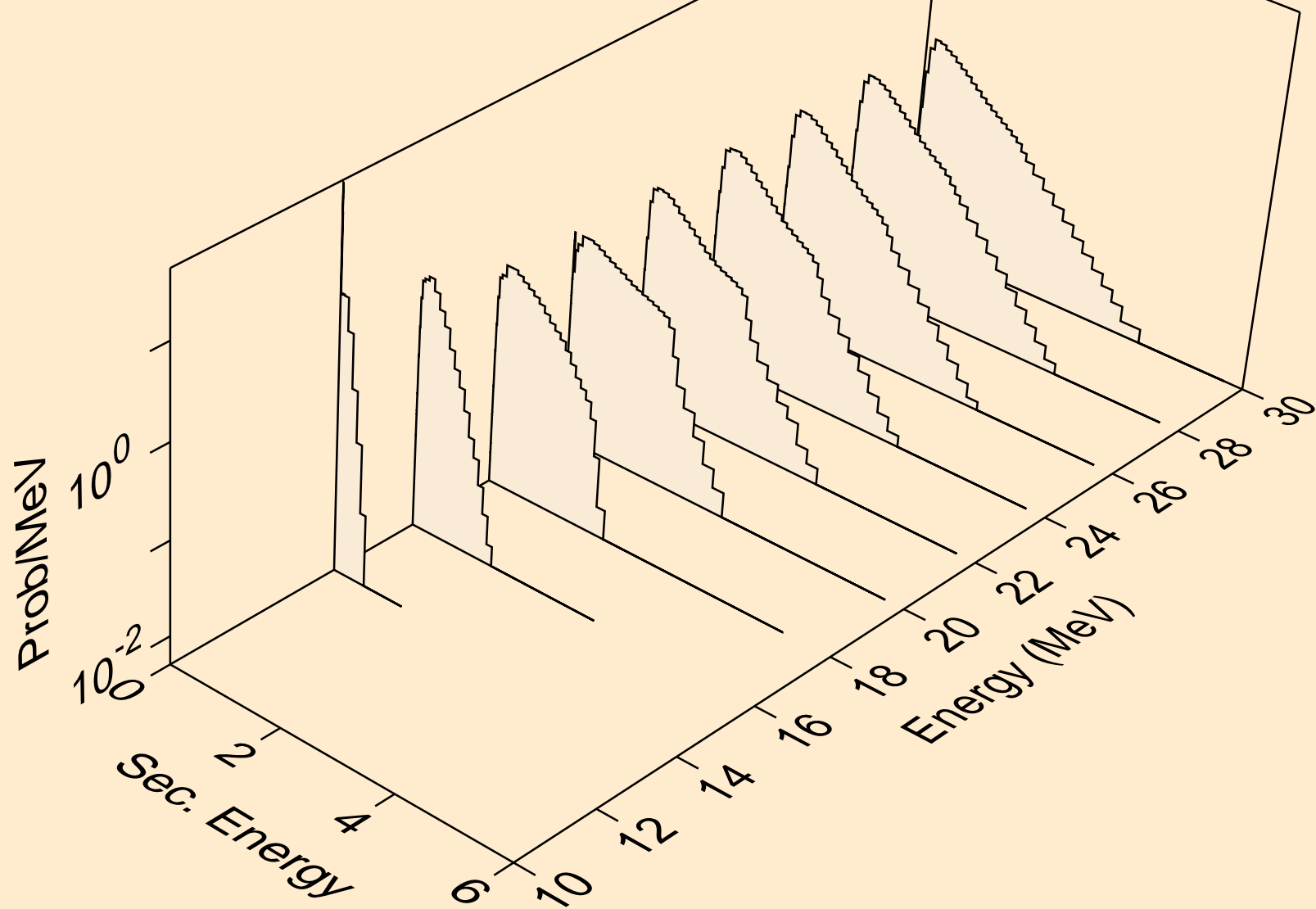

NB099 NEUTRON ACER TENDL-2023 LIBRARY; T=0.K  
Neutron emission for (n,n\*)he3

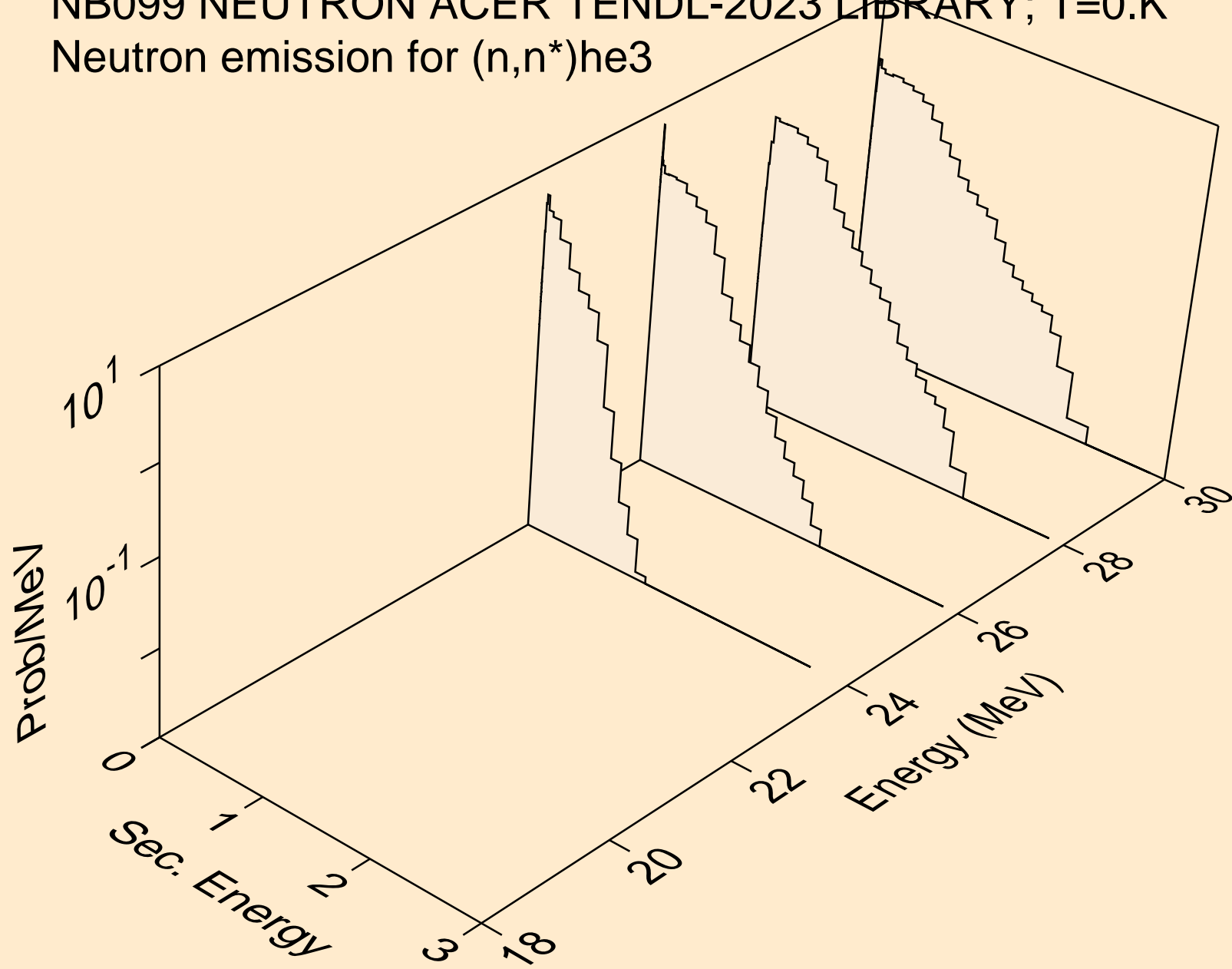

NB099 NEUTRON ACER TENDL-2023 LIBRARY; T=0.K  
Neutron emission for (n,4n)

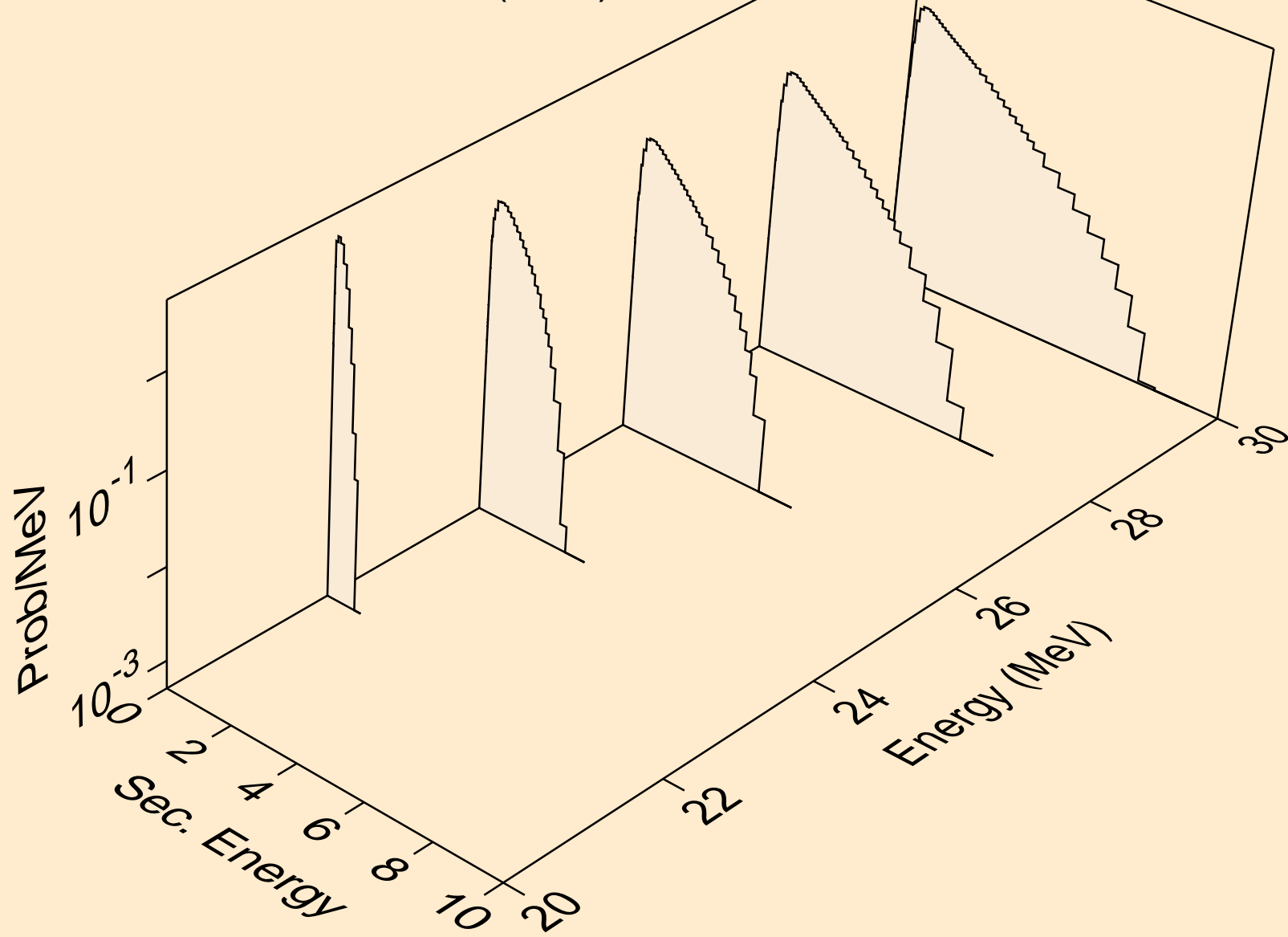

NB099 NEUTRON ACER TENDL-2023 LIBRARY; T=0.K  
Neutron emission for (n,2np)

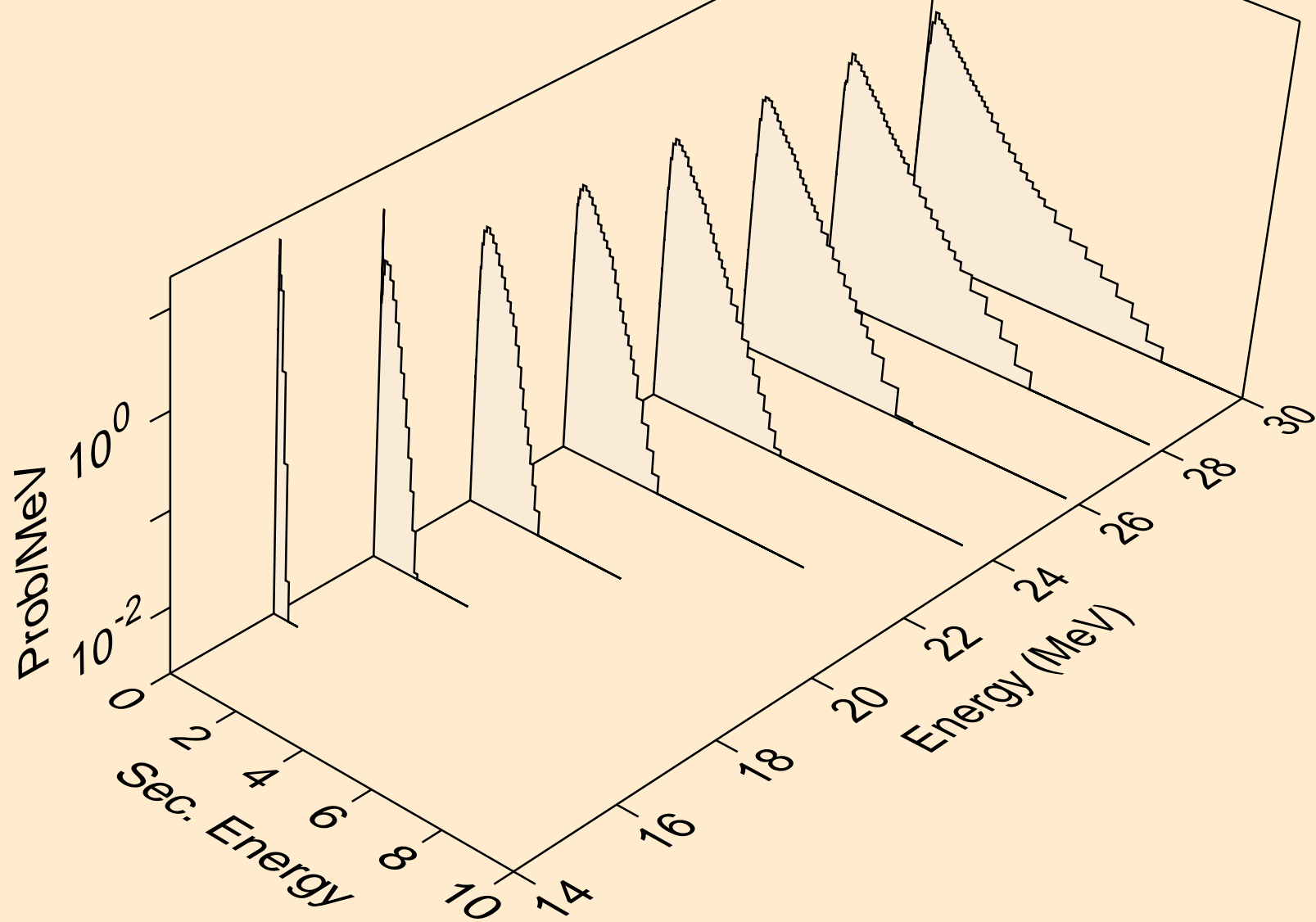

NB099 NEUTRON ACER TENDL-2023 LIBRARY; T=0.K  
Neutron emission for (n,3np)

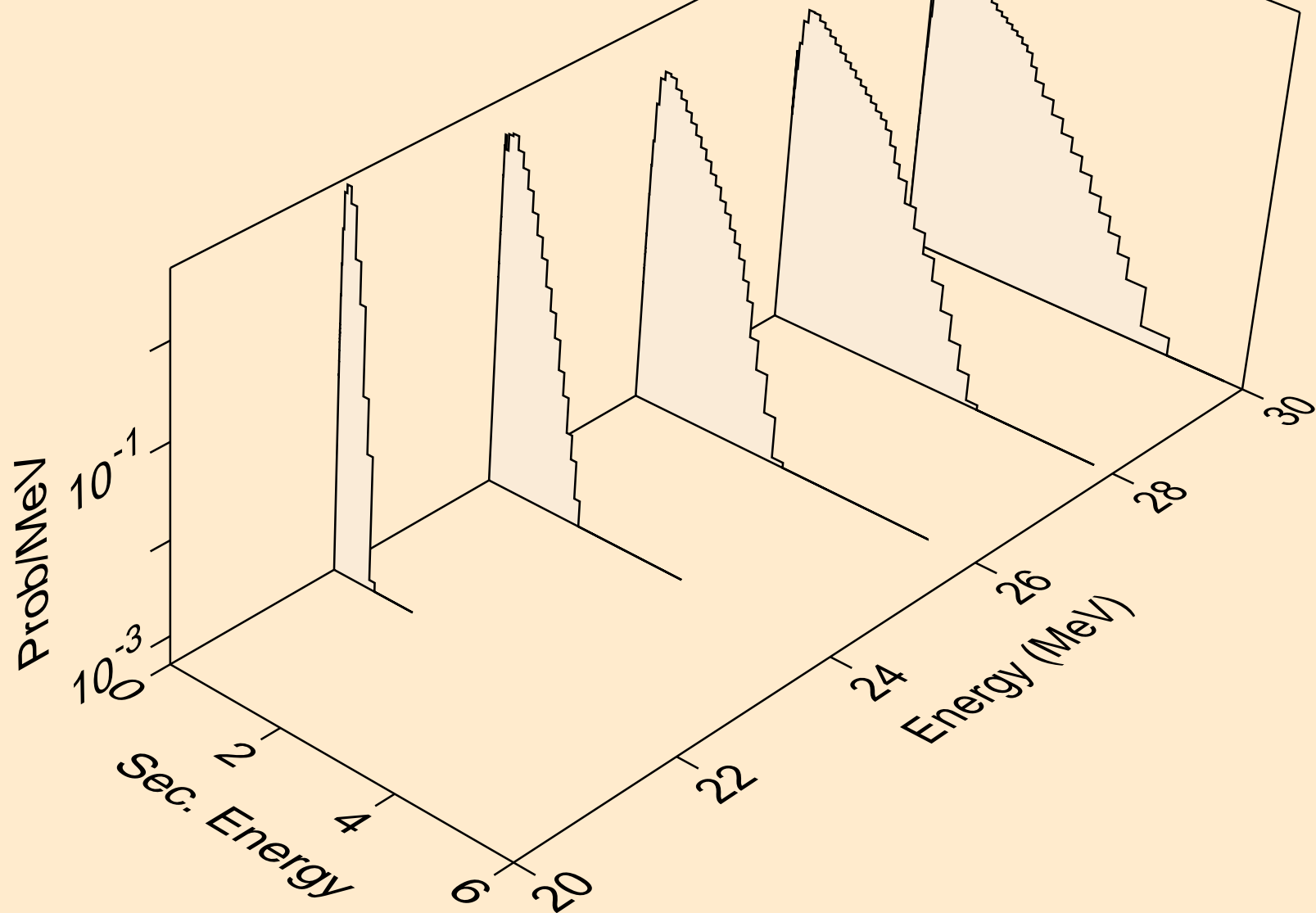

NB099 NEUTRON ACER TENDL-2023 LIBRARY; T=0.K  
Neutron emission for (n,n2p)

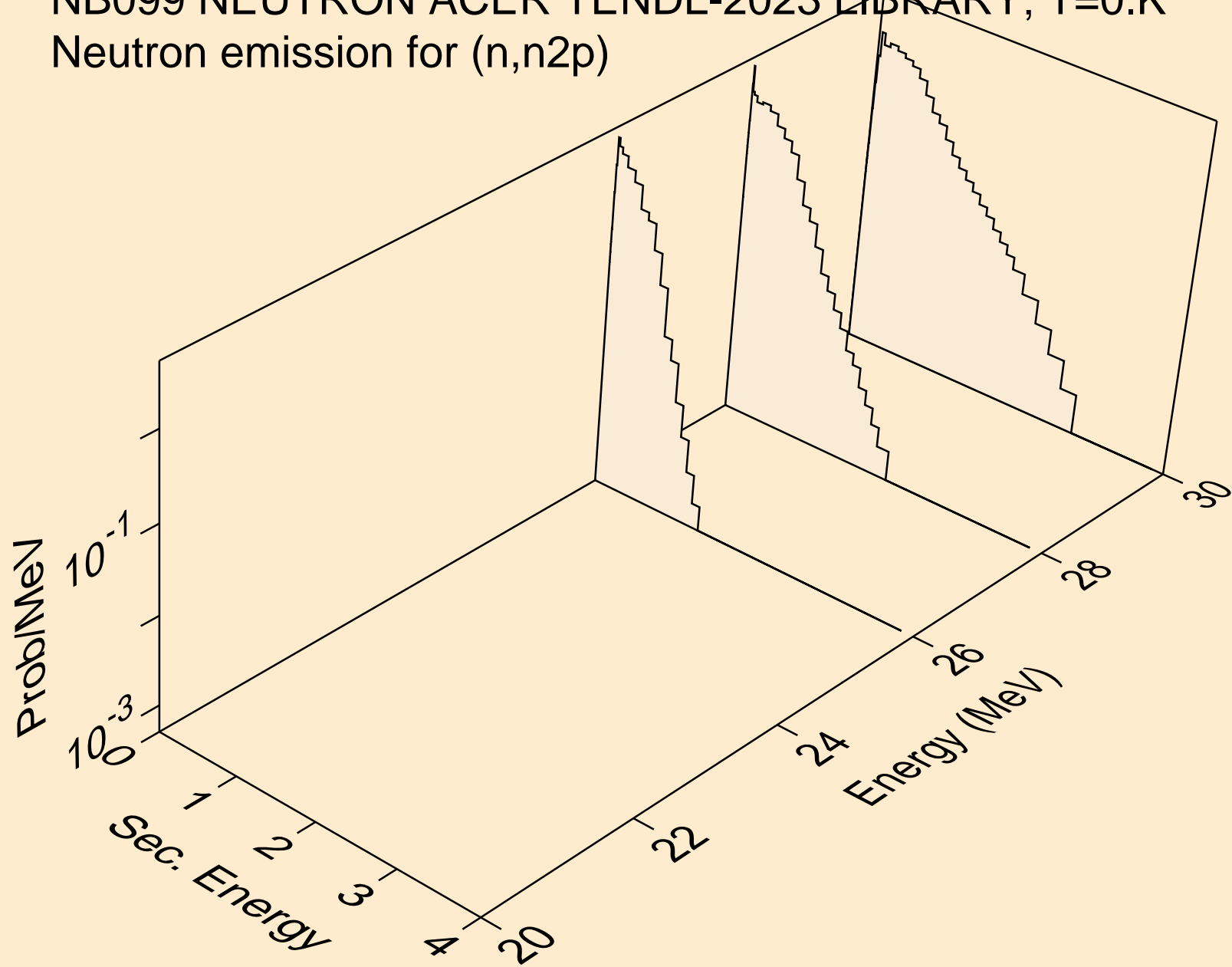

NB099 NEUTRON ACER TENDL-2023 LIBRARY; T=0.K  
Neutron emission for (n,npa)

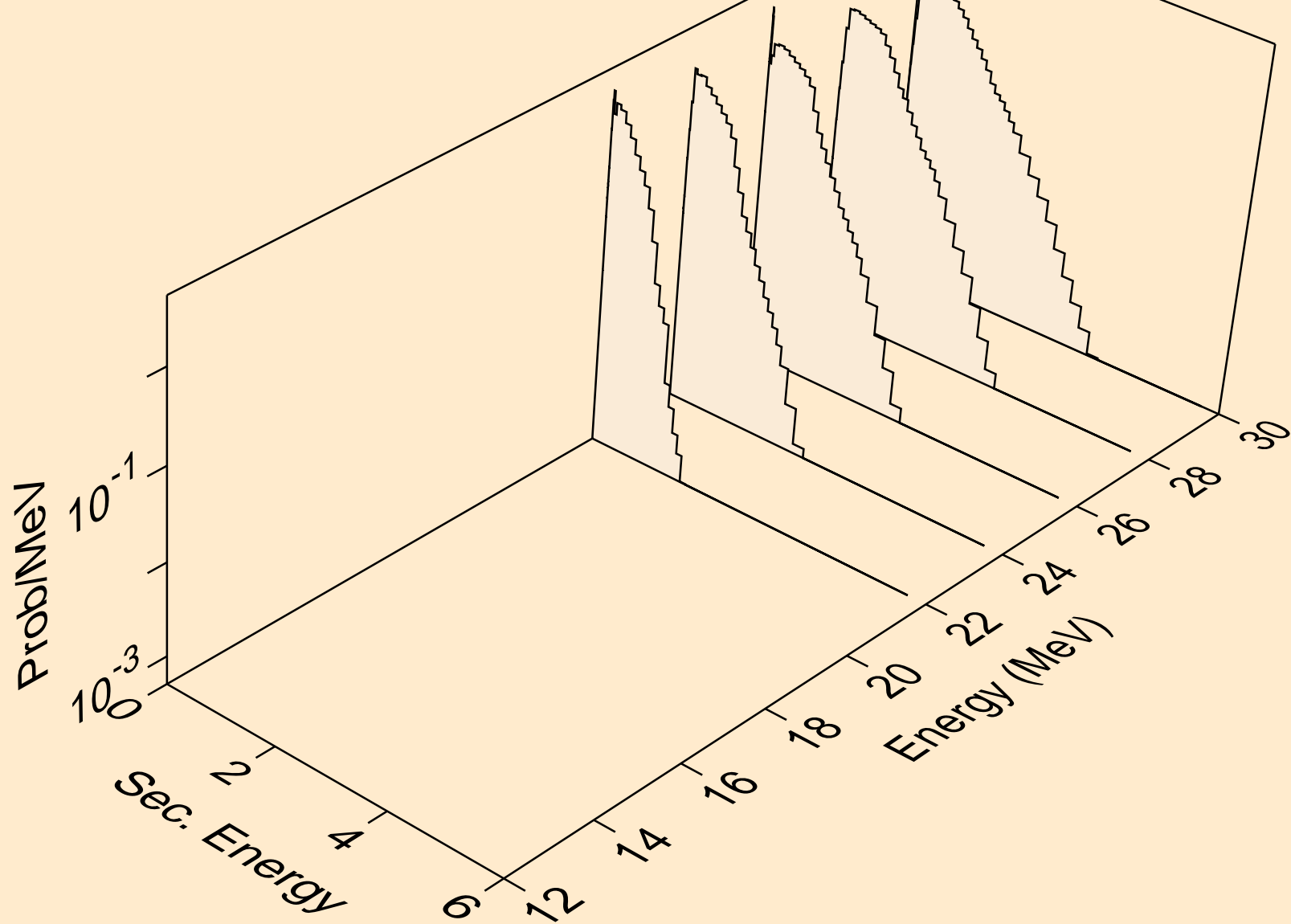

NB099 NEUTRON ACER TENDL-2023 LIBRARY; T=0.K  
Neutron emission for (n,n\*c)

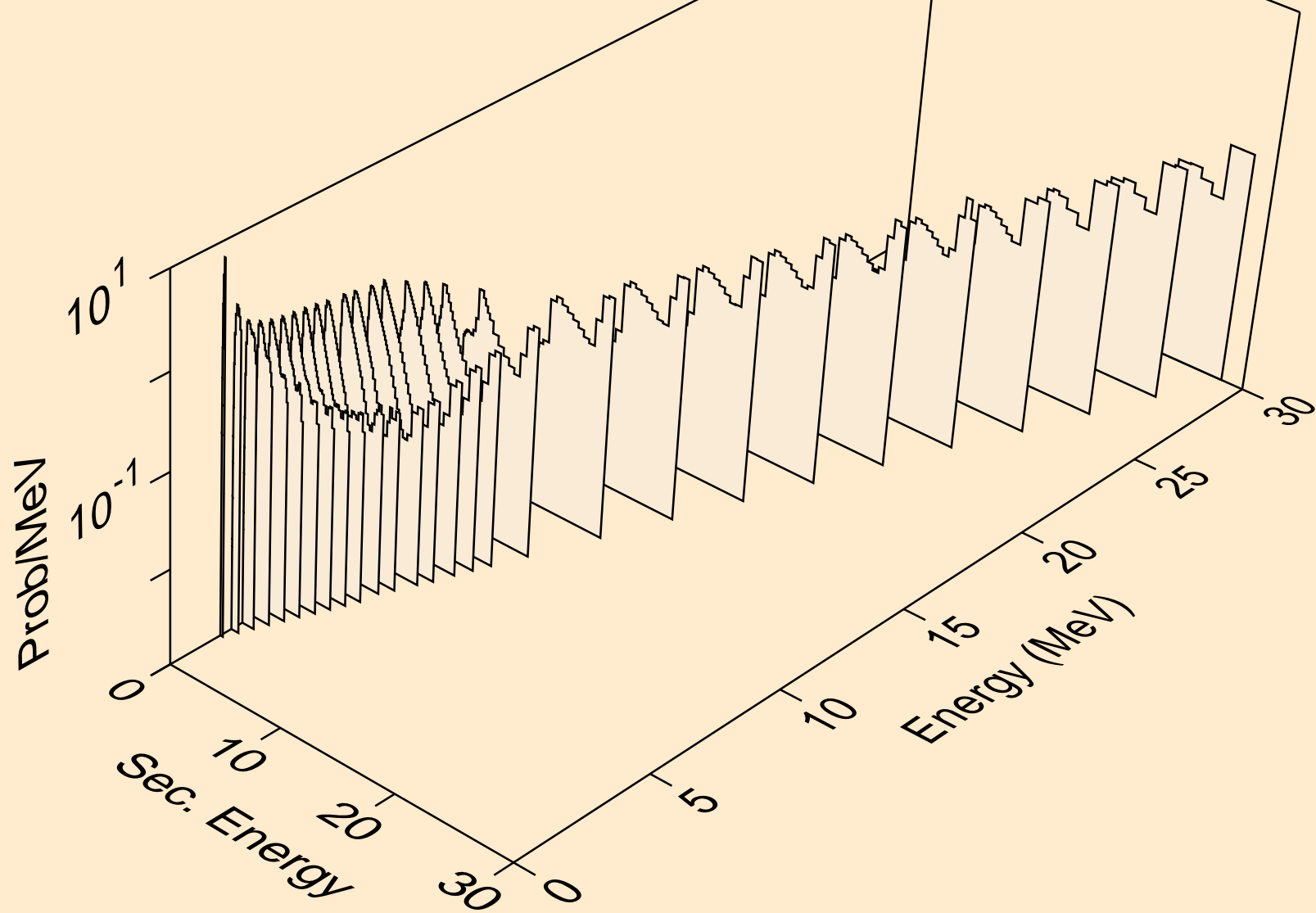



NB099 NEUTRON ACER TENDL-2023 LIBRARY; T=0.K  
Photon emission for (n,x)

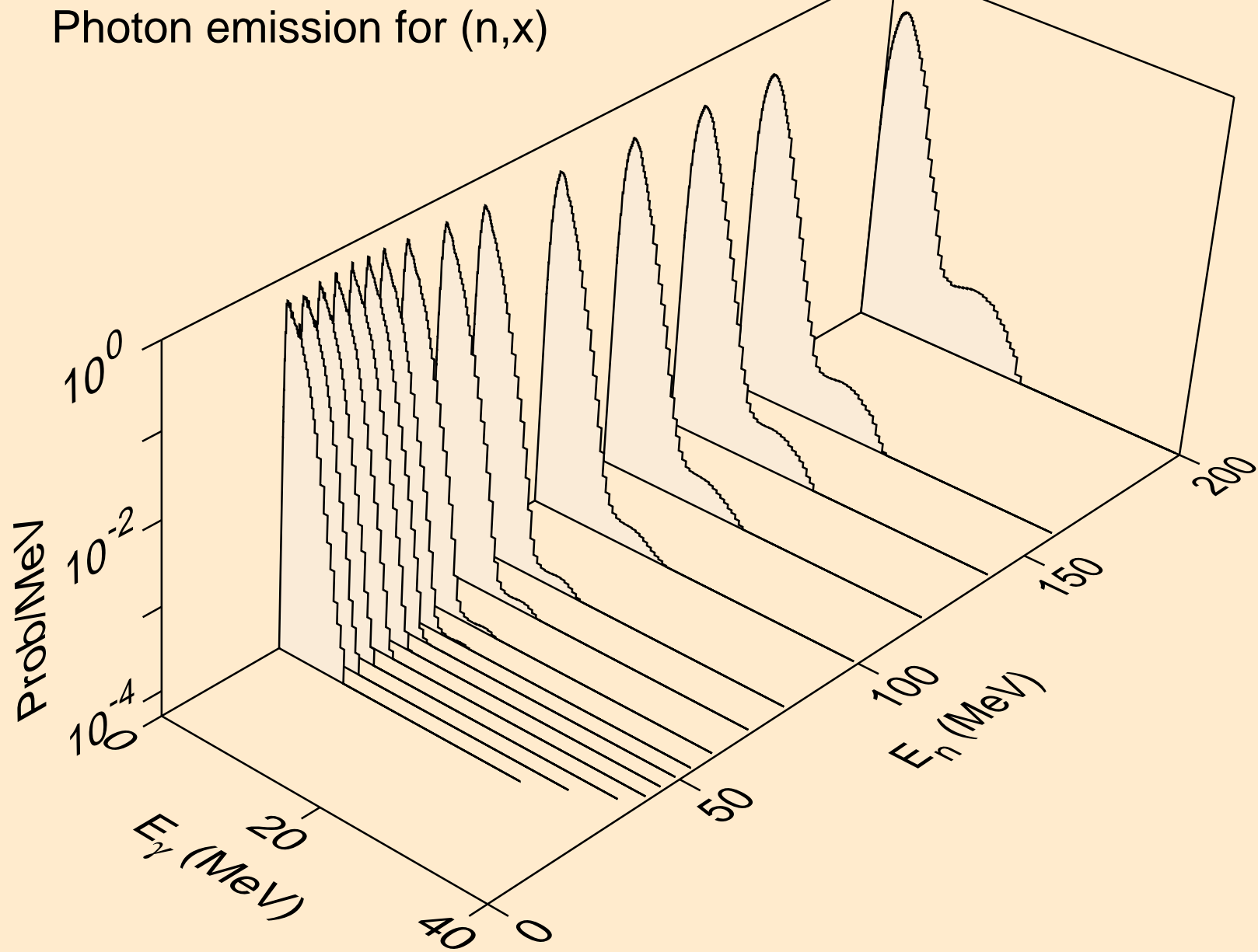

NB099 NEUTRON ACER TENDL-2023 LIBRARY; T=0.K  
Photon emission for (n,2nd)

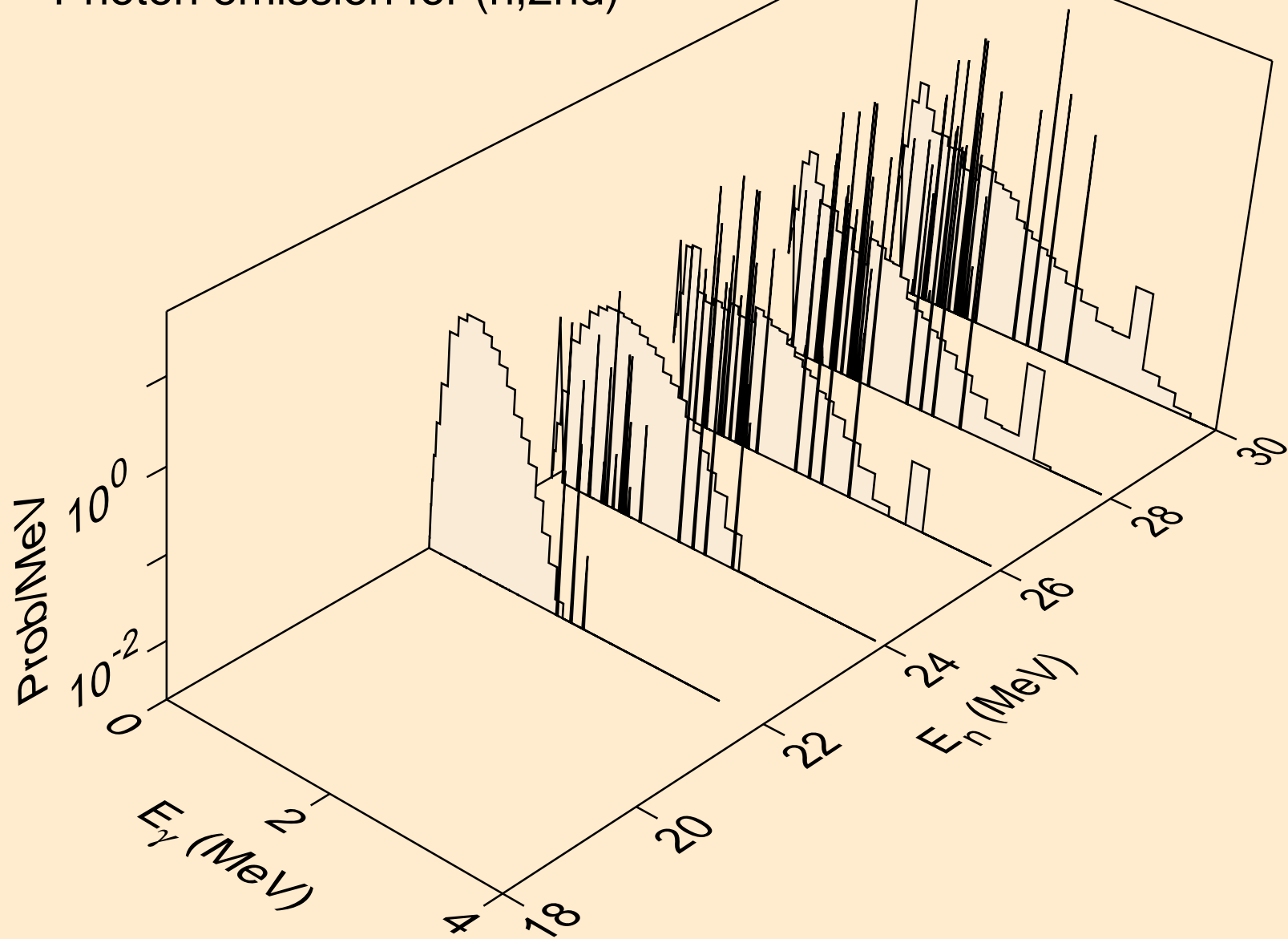

NB099 NEUTRON ACER TENDL-2023 LIBRARY; T=0.K  
Photon emission for (n,2n)

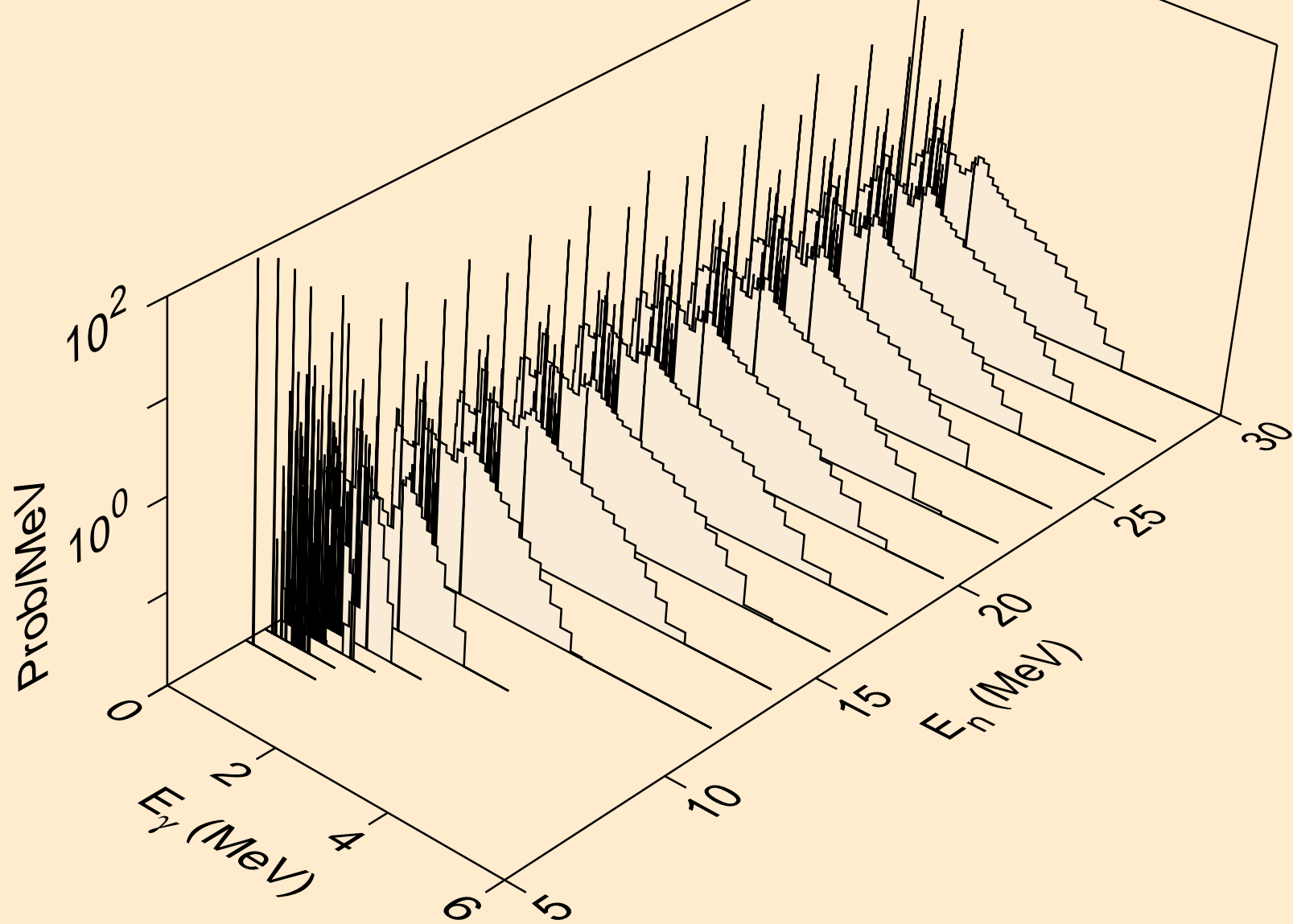

NB099 NEUTRON ACER TENDL-2023 LIBRARY; T=0.K  
Photon emission for (n,3n)

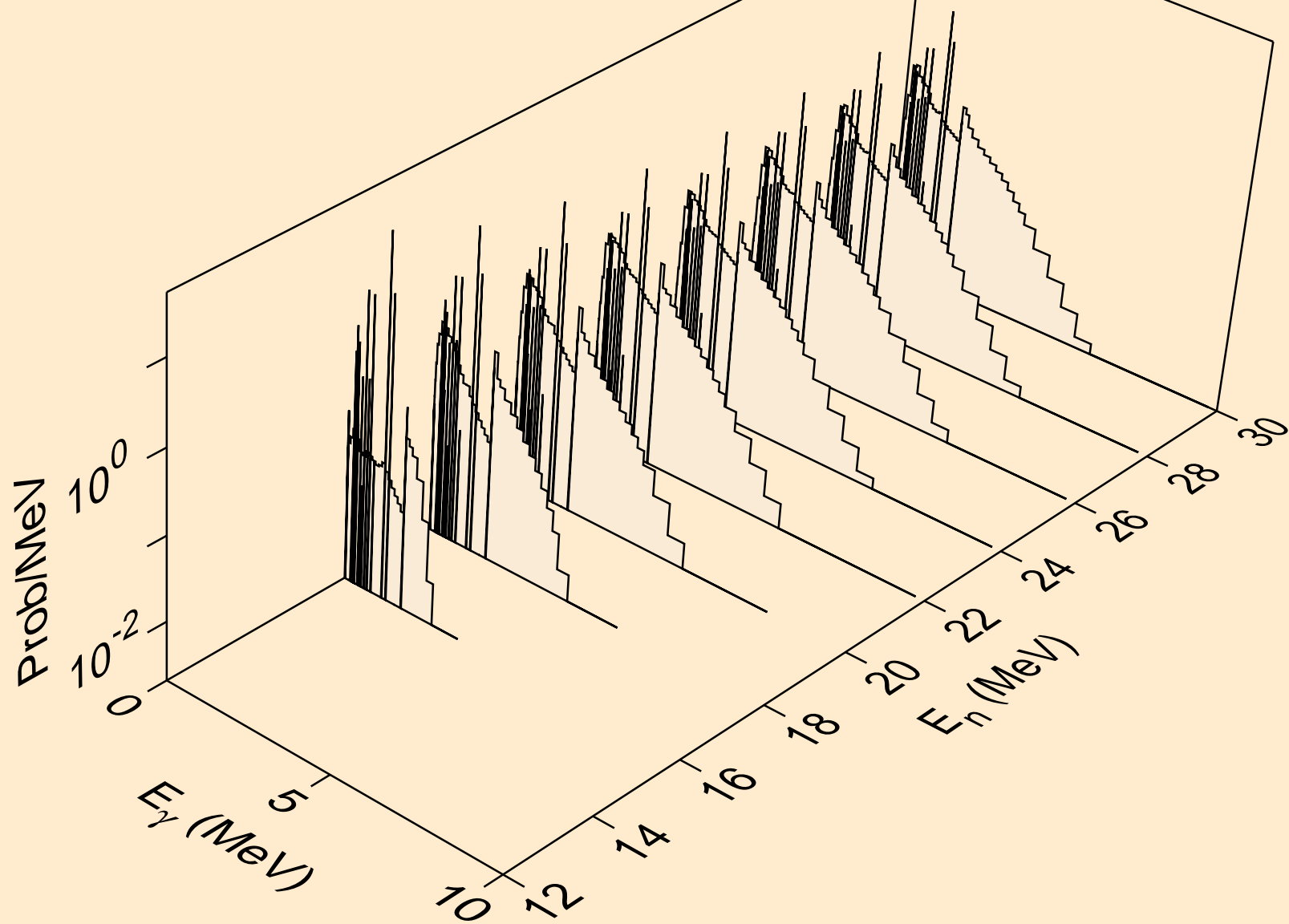

NB099 NEUTRON ACER TENDL-2023 LIBRARY; T=0.K  
Photon emission for (n,n\*)a

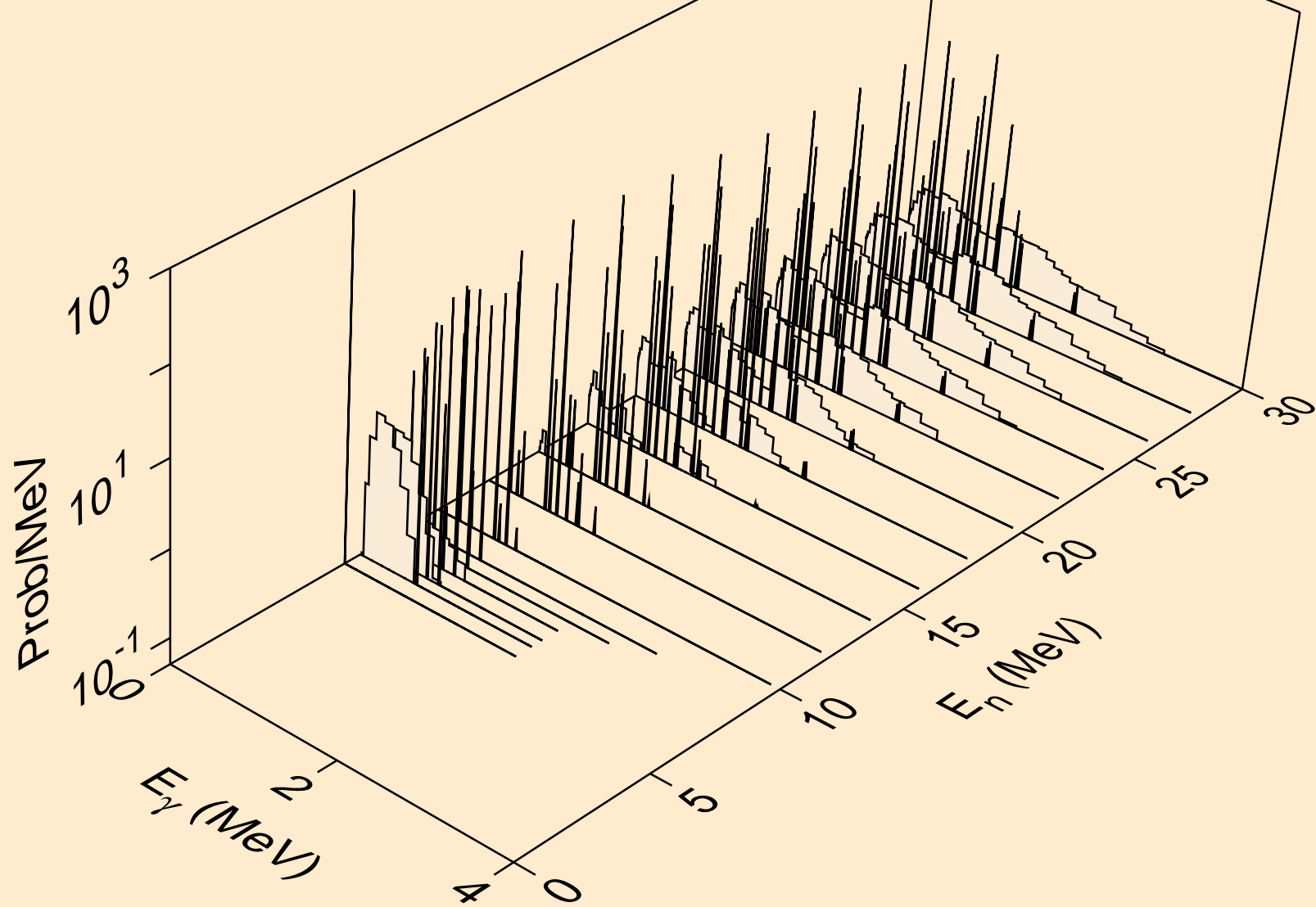

NB099 NEUTRON ACER TENDL-2023 LIBRARY; T=0.K  
Photon emission for (n,2n)a

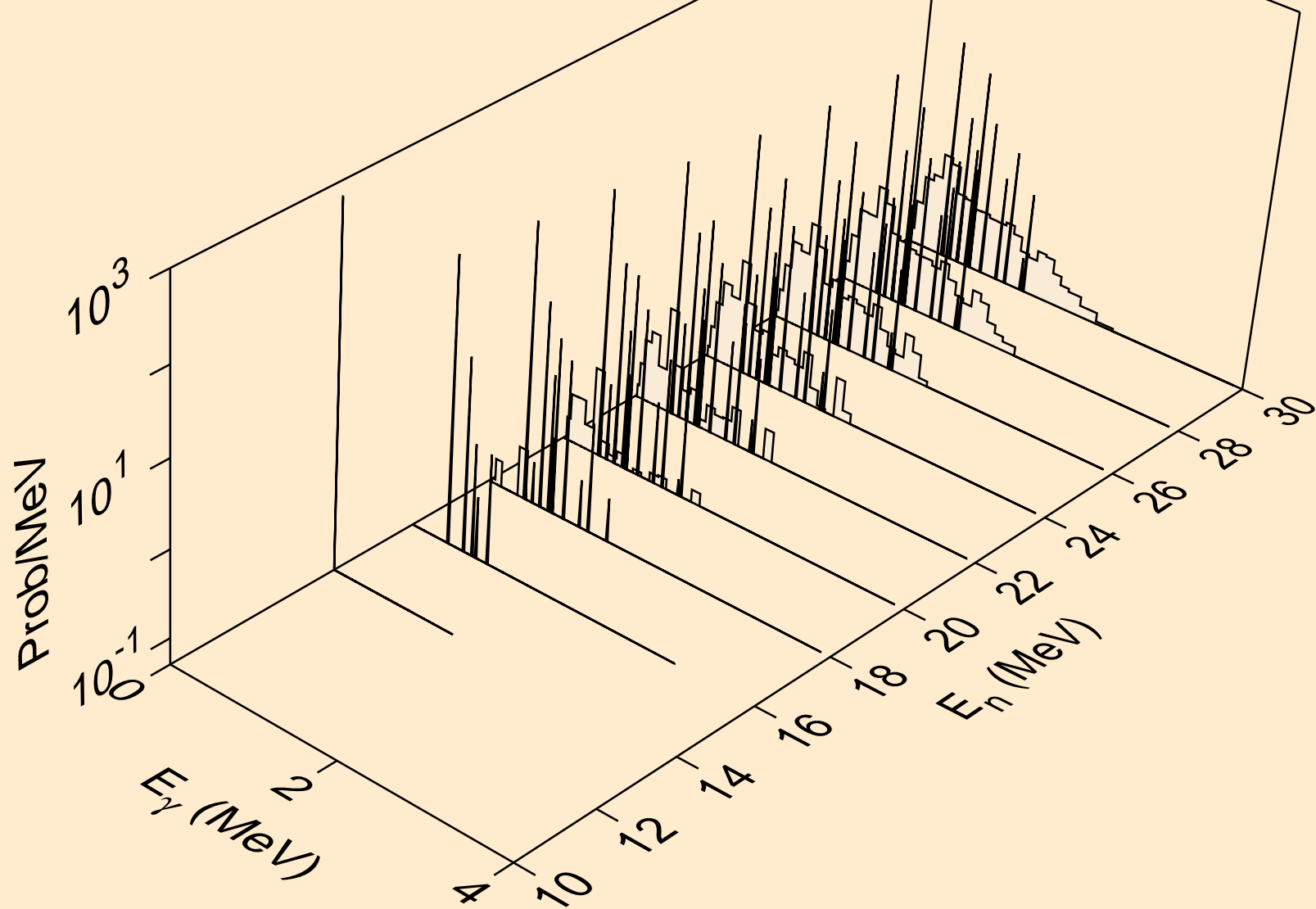

NB099 NEUTRON ACER TENDL-2023 LIBRARY; T=0.K  
Photon emission for (n,3n)a

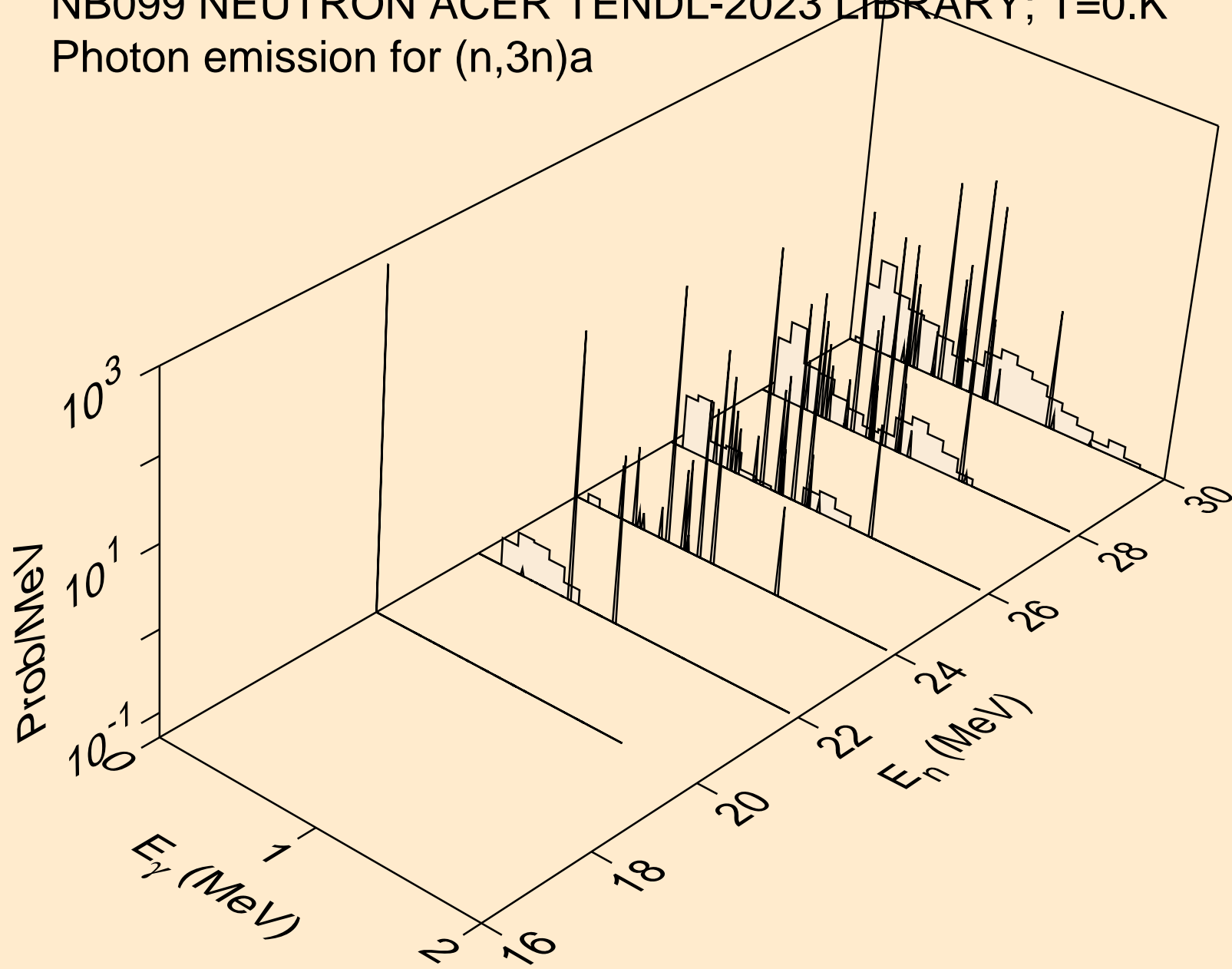

NB099 NEUTRON ACER TENDL-2023 LIBRARY; T=0.K  
Photon emission for (n,n\*)p

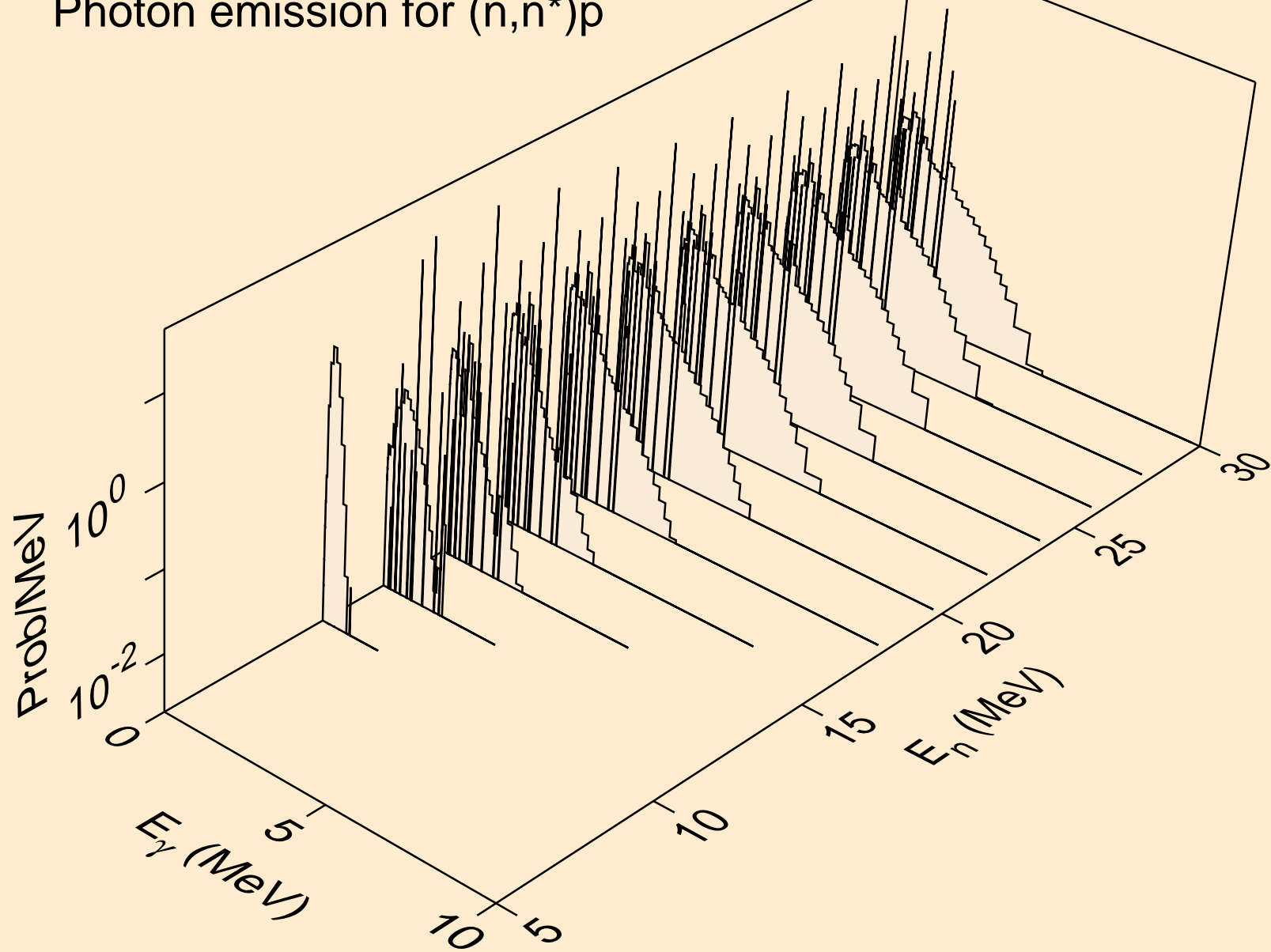



NB099 NEUTRON ACER TENDL-2023 LIBRARY; T=0.K  
Photon emission for (n,n\*)2a

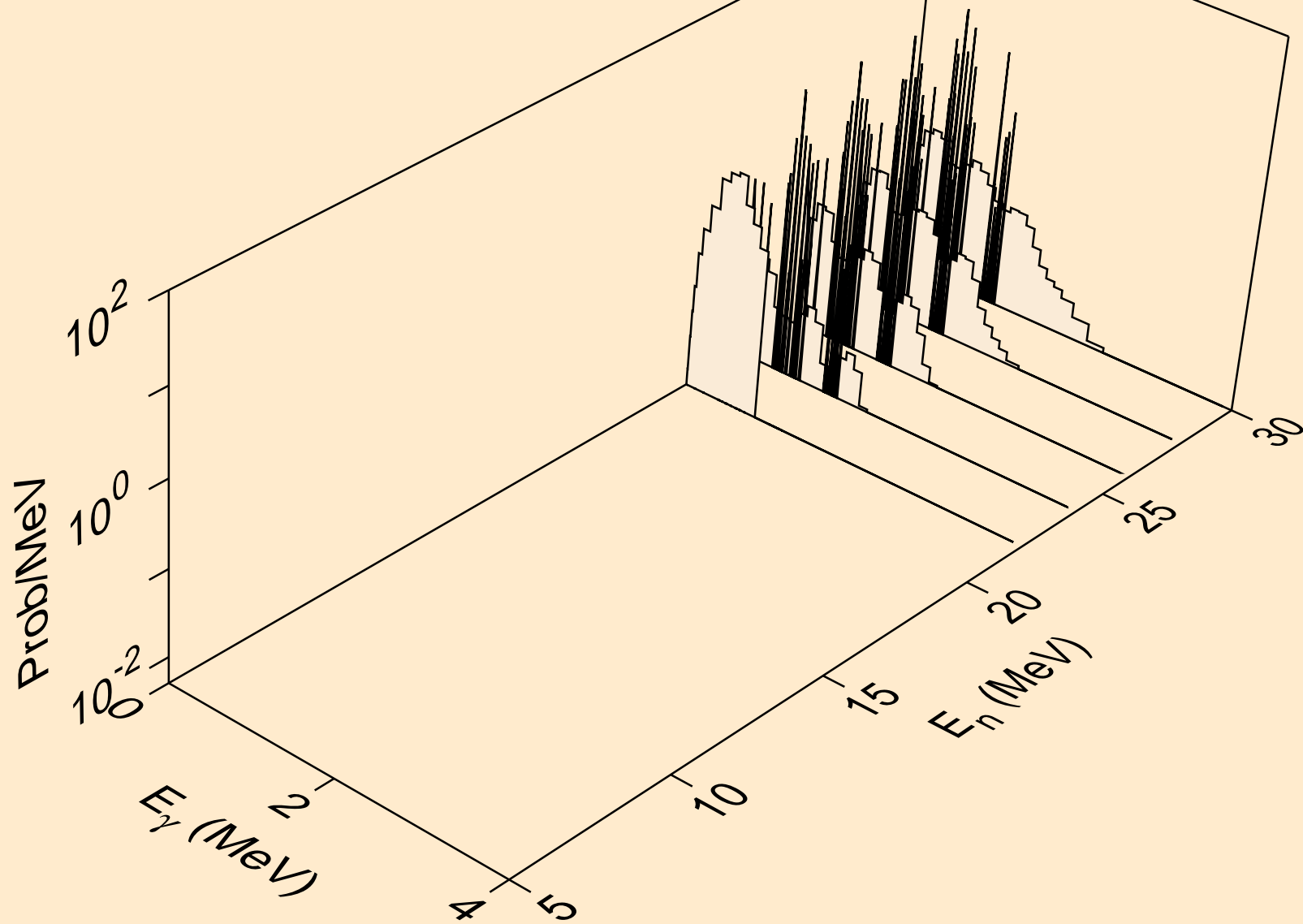

NB099 NEUTRON ACER TENDL-2023 LIBRARY; T=0.K  
Photon emission for (n,n\*)d

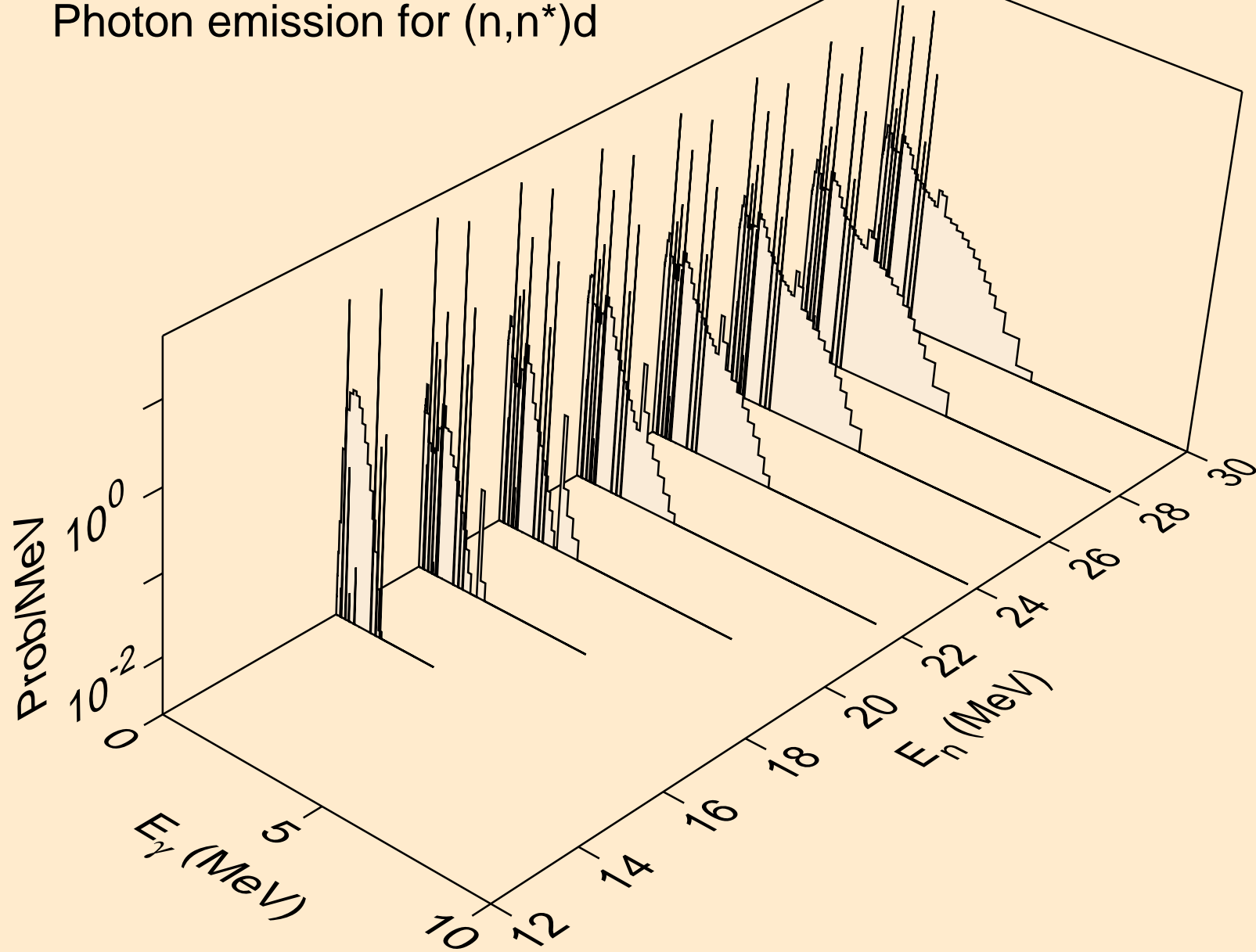

NB099 NEUTRON ACER TENDL-2023 LIBRARY; T=0.K  
Photon emission for (n,n\*)t

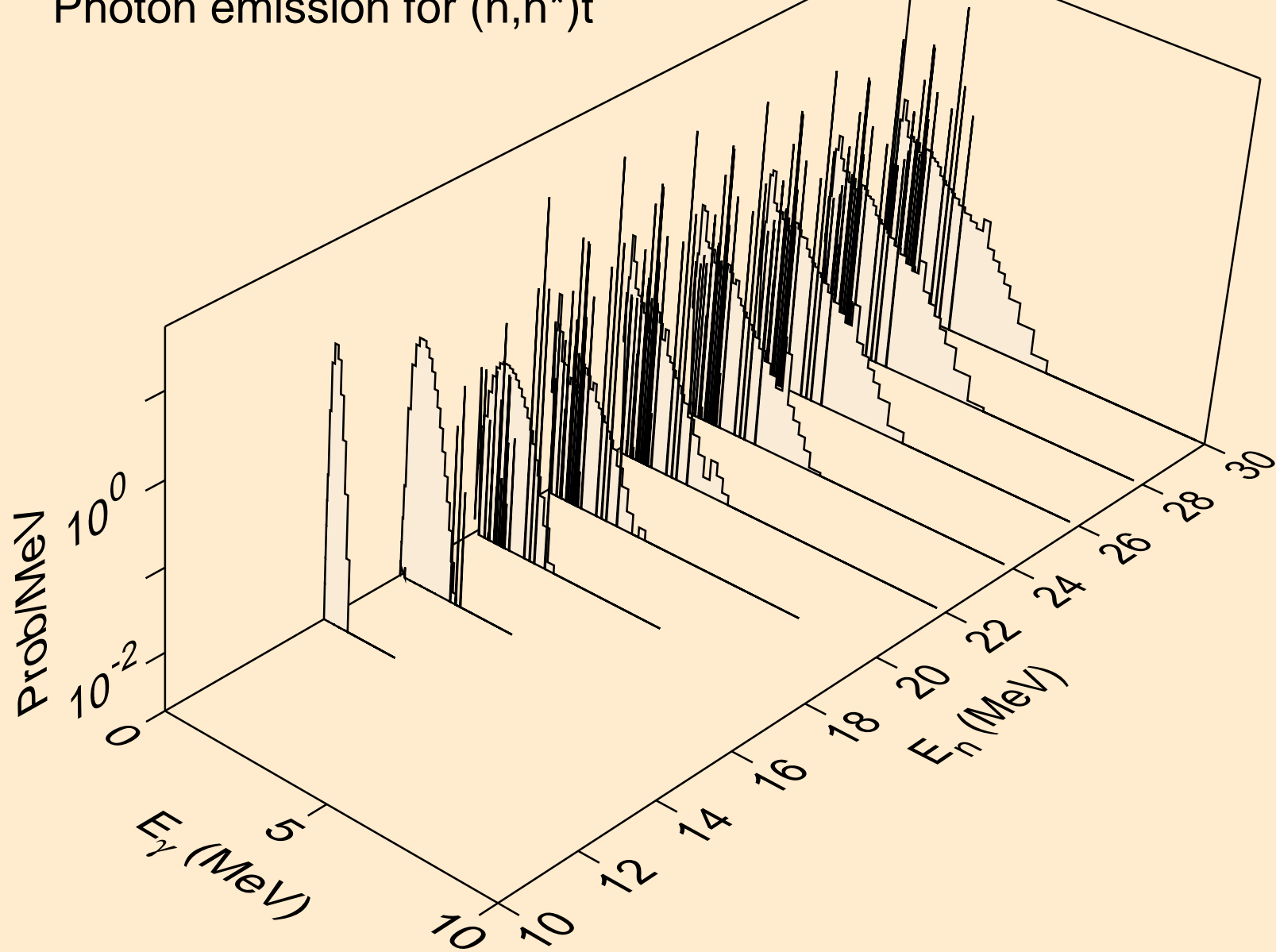

NB099 NEUTRON ACER TENDL-2023 LIBRARY; T=0.K  
Photon emission for (n,n\*)he3

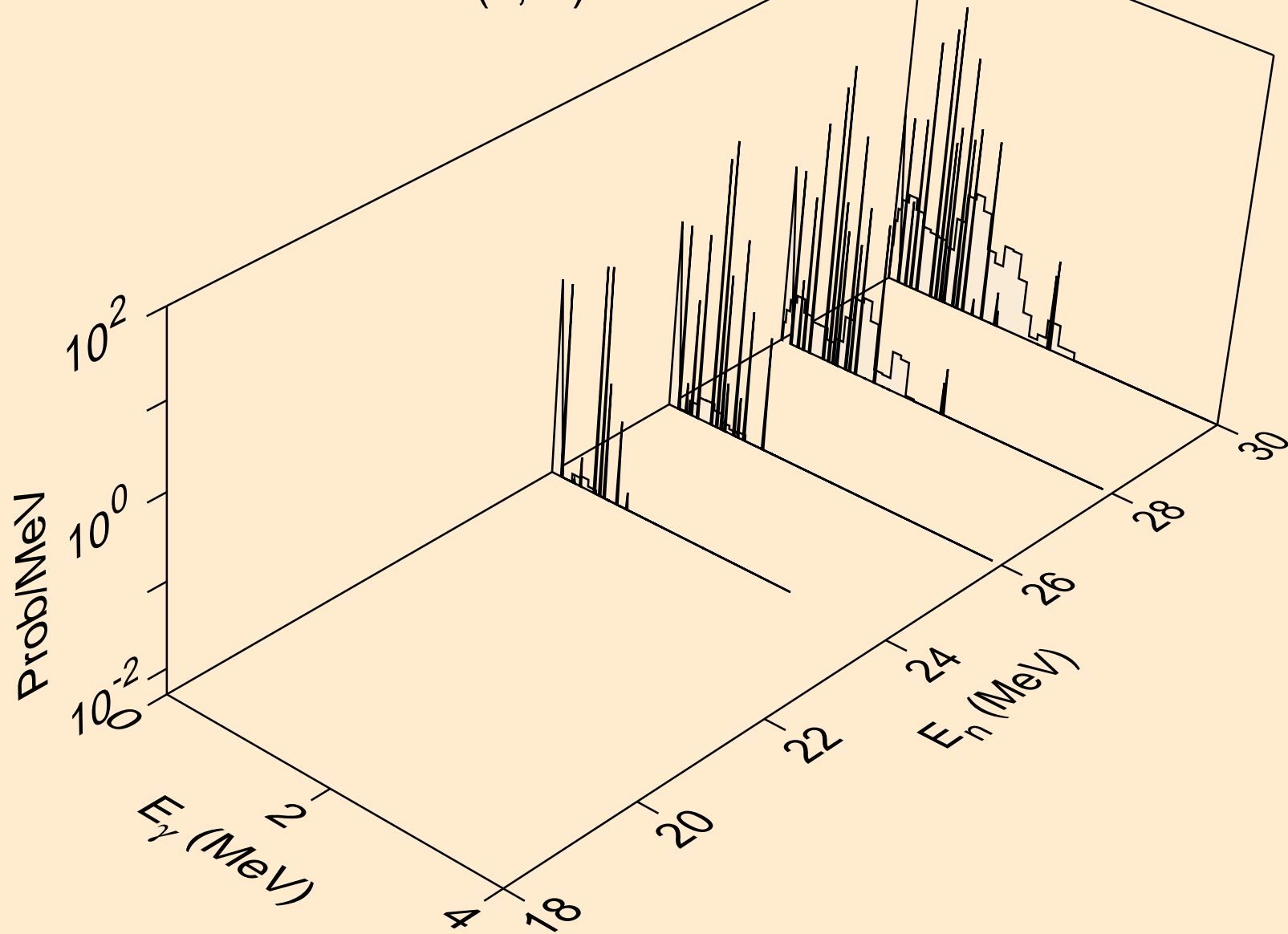

NB099 NEUTRON ACER TENDL-2023 LIBRARY; T=0.K  
Photon emission for (n,4n)

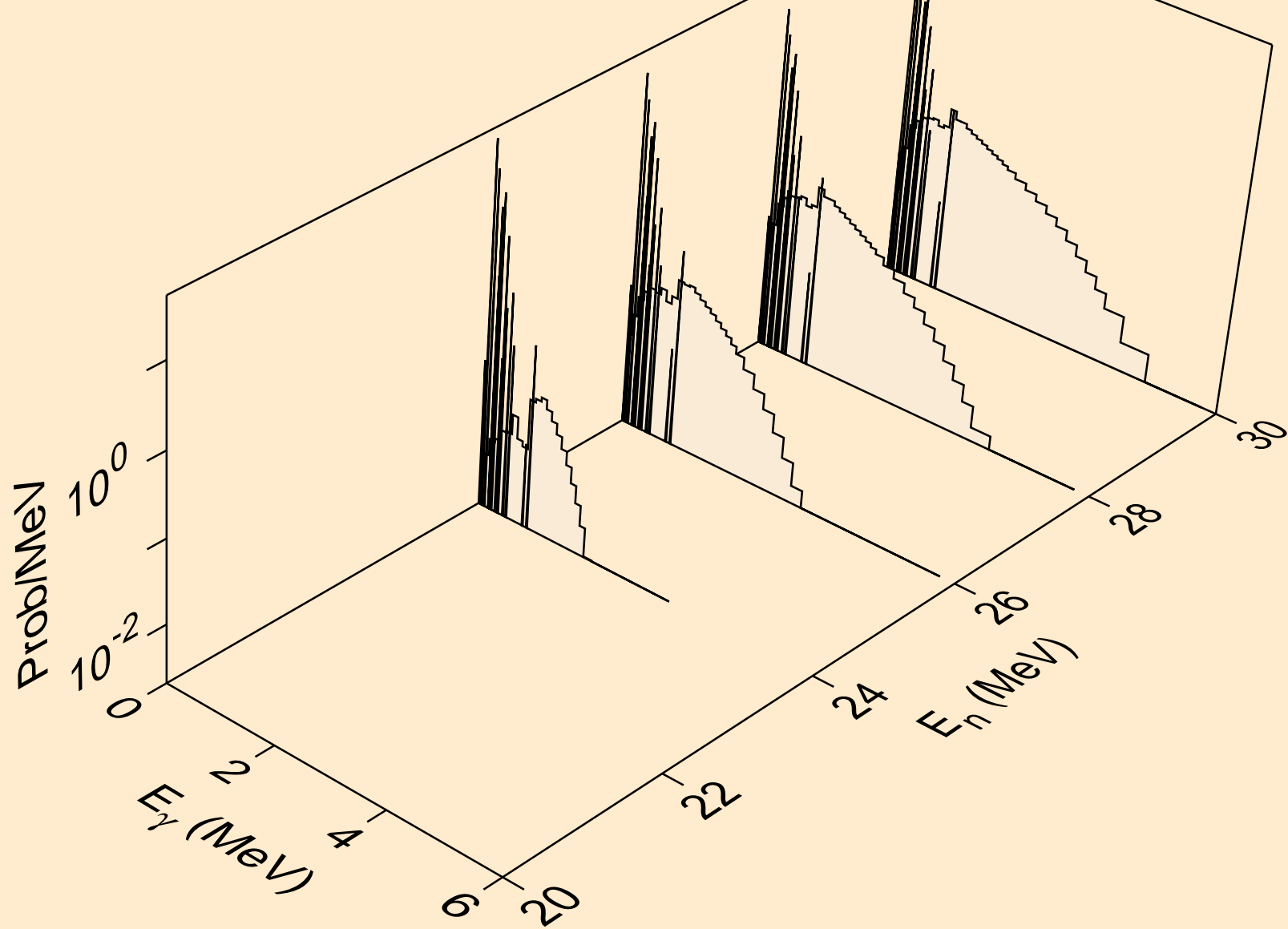

NB099 NEUTRON ACER TENDL-2023 LIBRARY; T=0.K  
Photon emission for (n,2np)

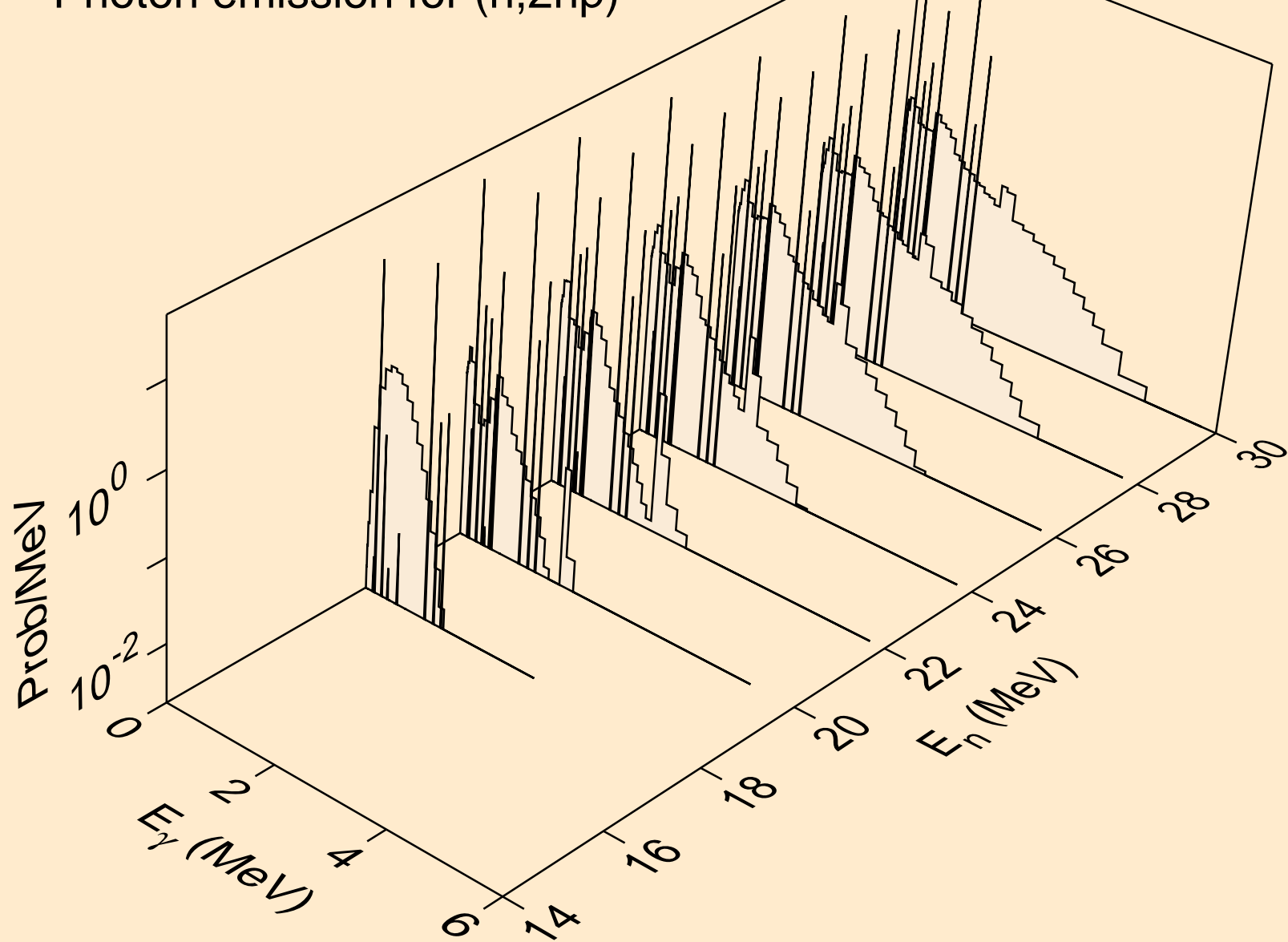

NB099 NEUTRON ACER TENDL-2023 LIBRARY; T=0.K  
Photon emission for (n,3np)

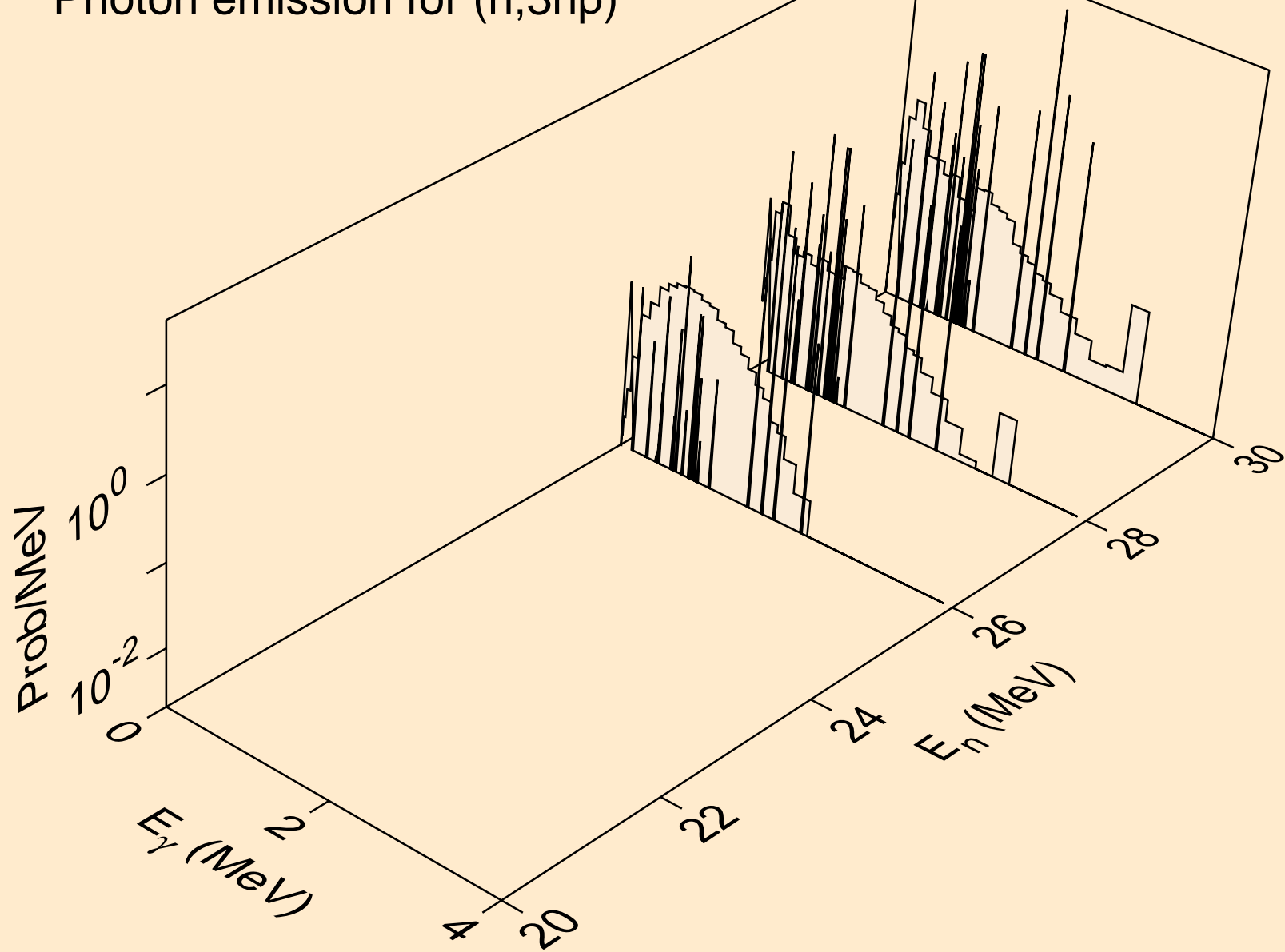

NB099 NEUTRON ACER TENDL-2023 LIBRARY; T=0.K  
Photon emission for (n,n2p)

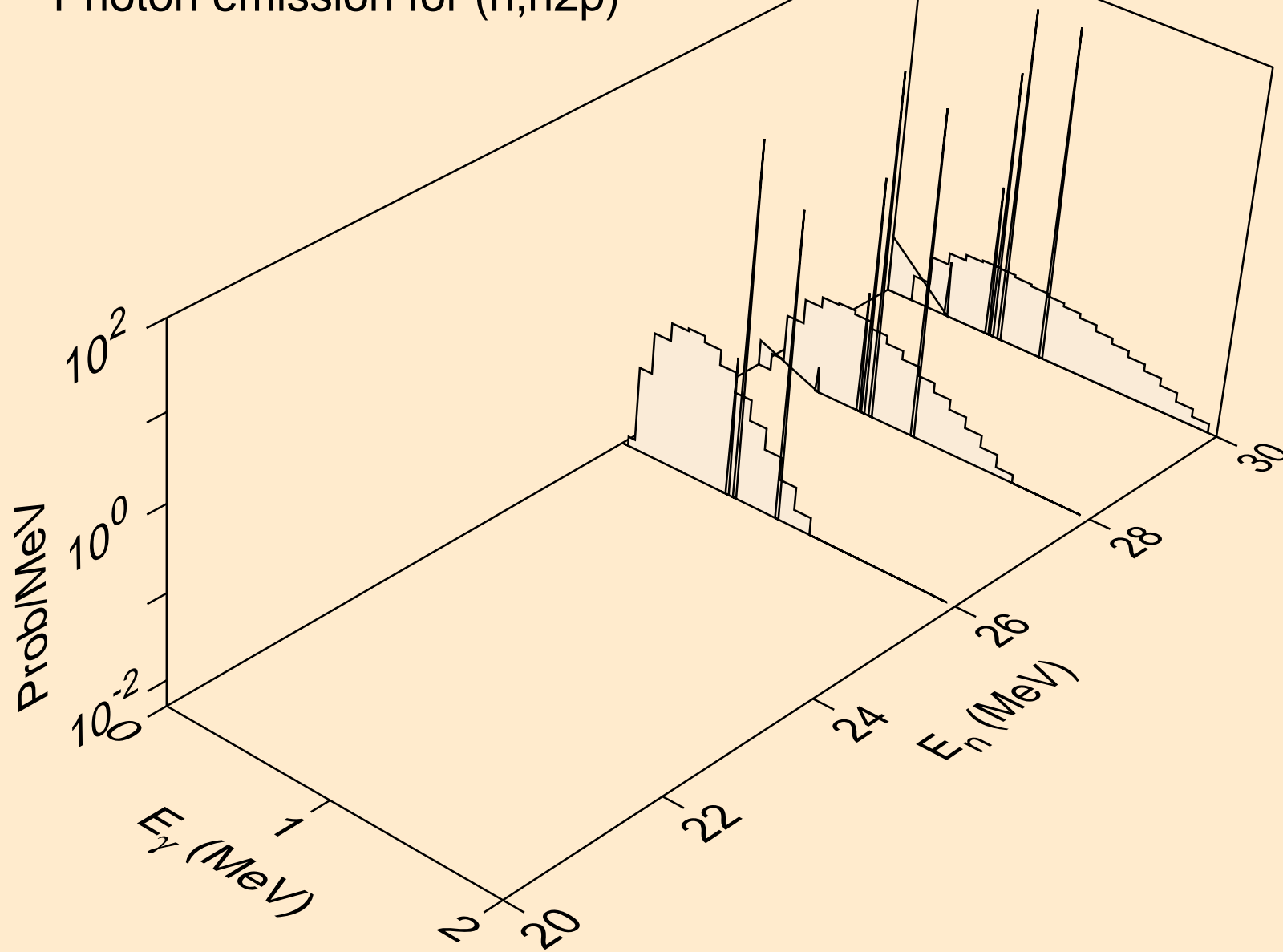



NB099 NEUTRON ACER TENDL-2023 LIBRARY; T=0.K  
Photon emission for (n,npa)

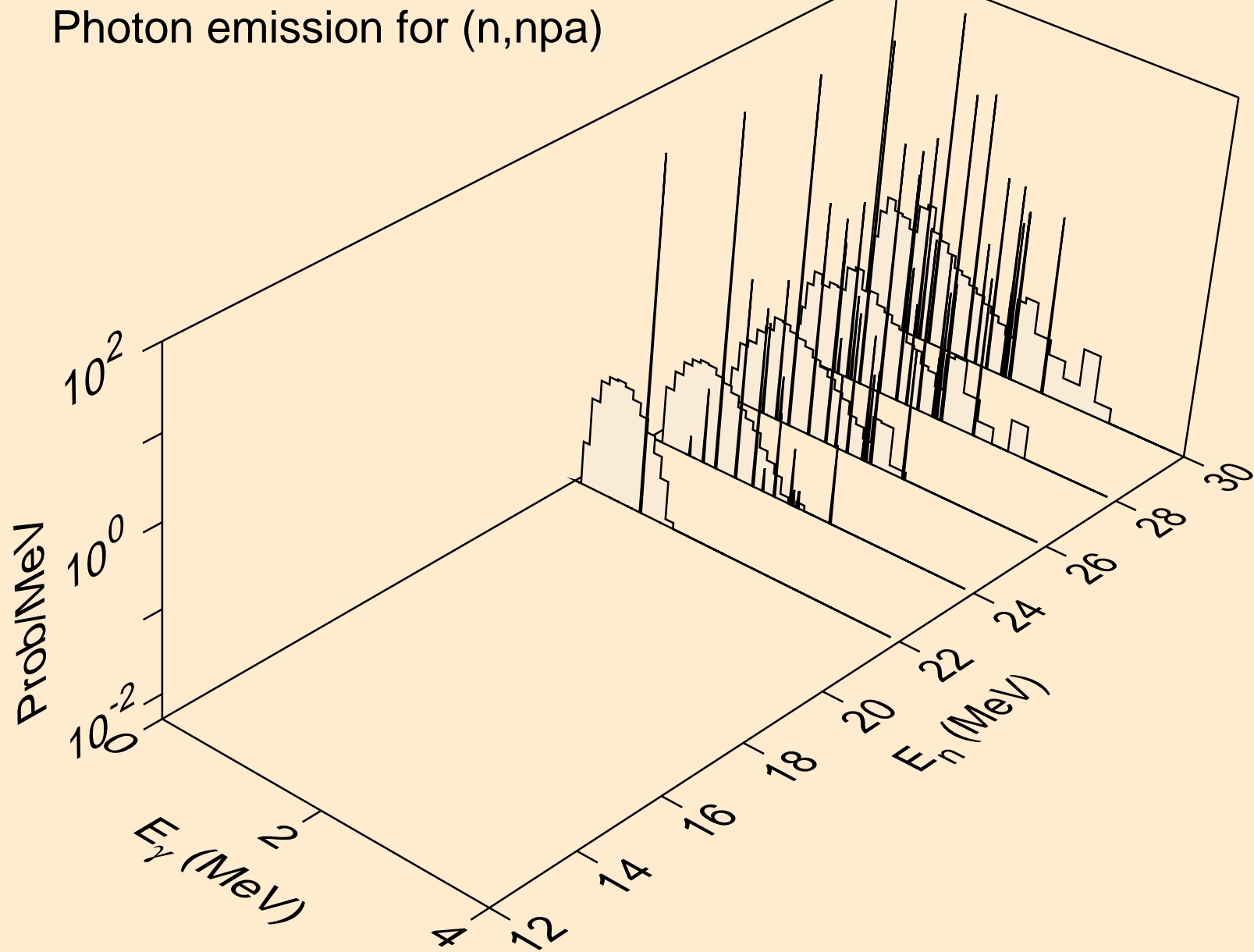

NB099 NEUTRON ACER TENDL-2023 LIBRARY; T=0.K  
Photon emission for (n,n\*c)

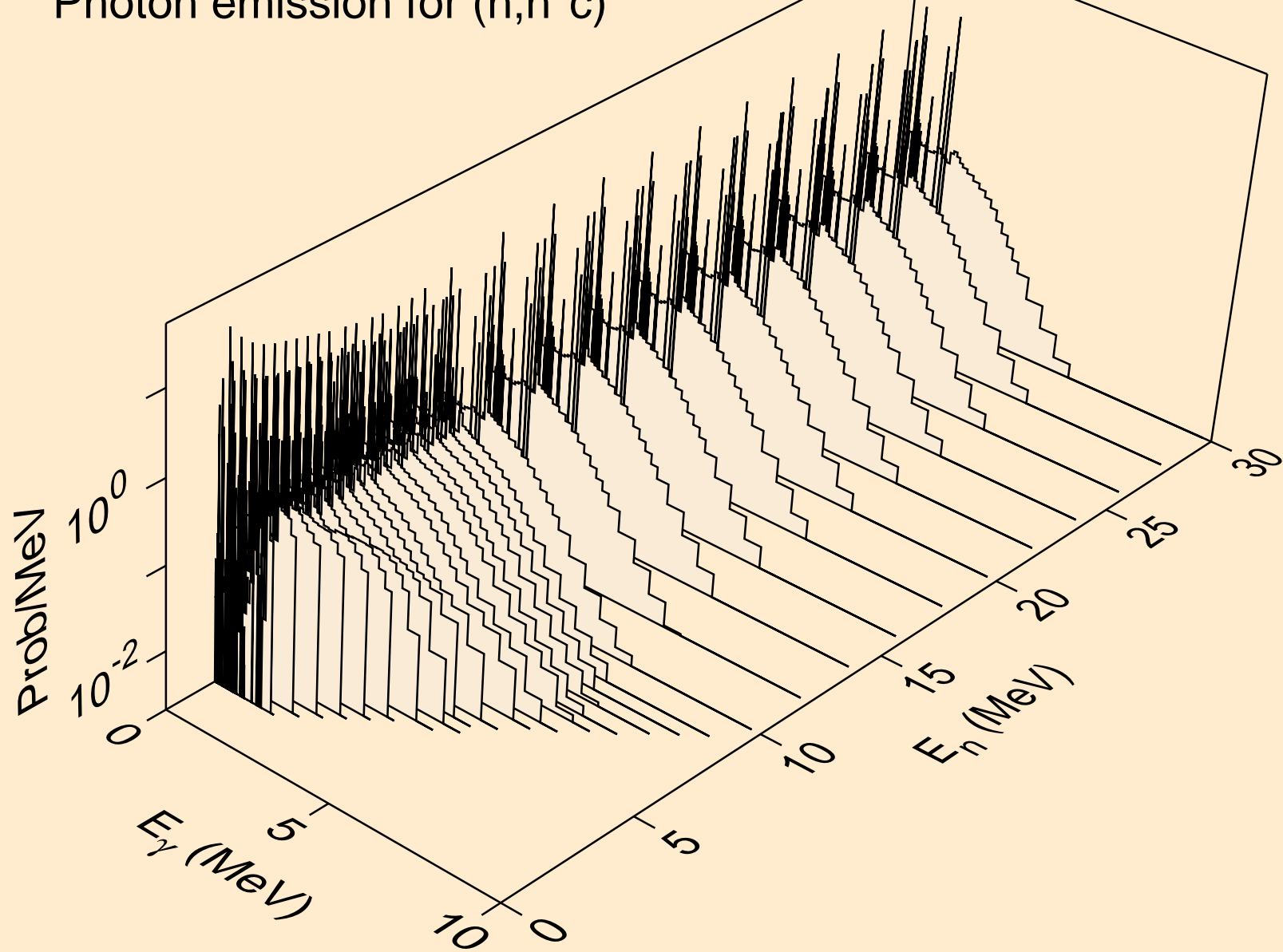

NB099 NEUTRON ACER TENDL-2023 LIBRARY; T=0.K  
Photon emission for (n,gma)

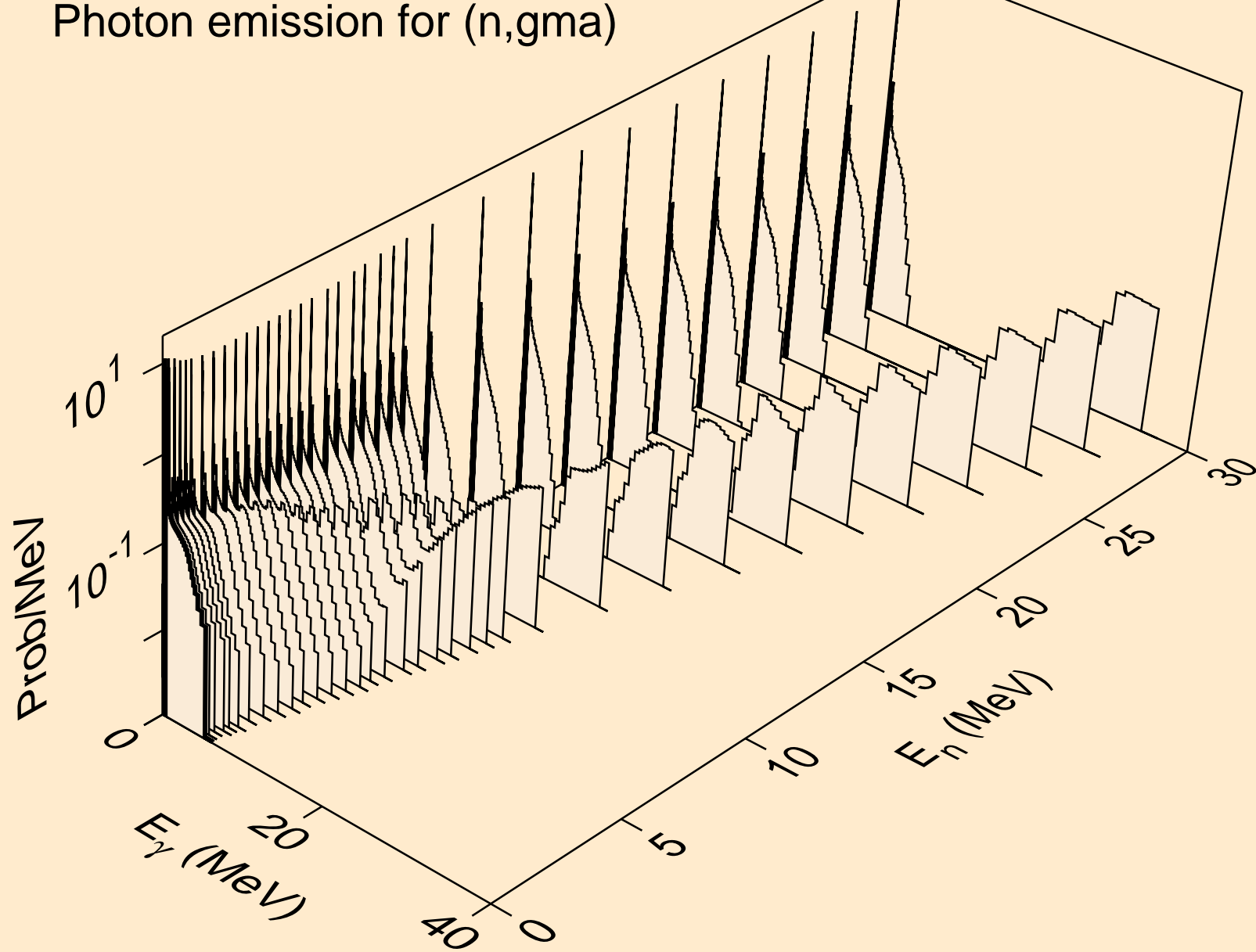

NB099 NEUTRON ACER TENDL-2023 LIBRARY; T=0.K  
Photon emission for (n,p)

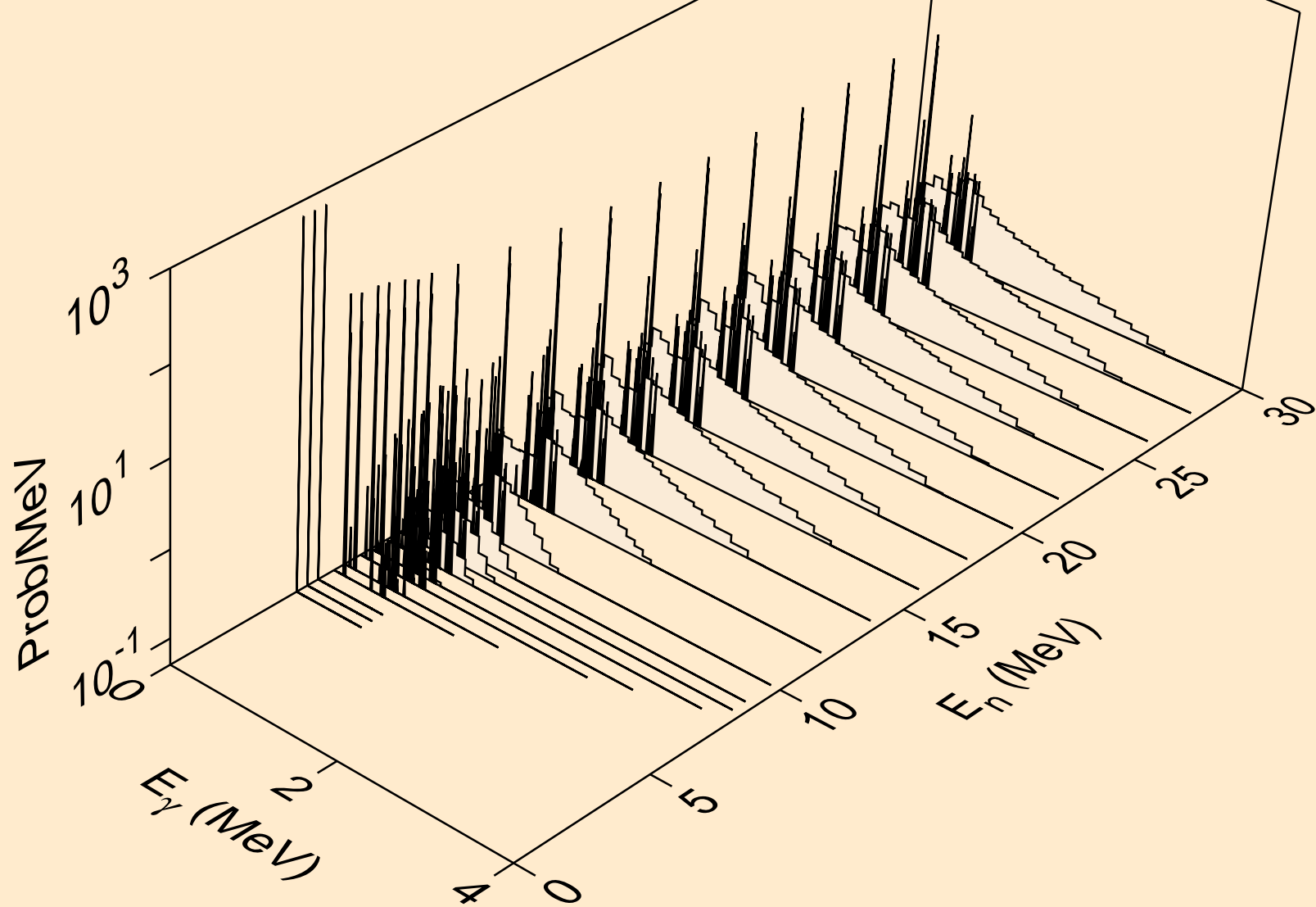

NB099 NEUTRON ACER TENDL-2023 LIBRARY; T=0.K  
Photon emission for (n,d)

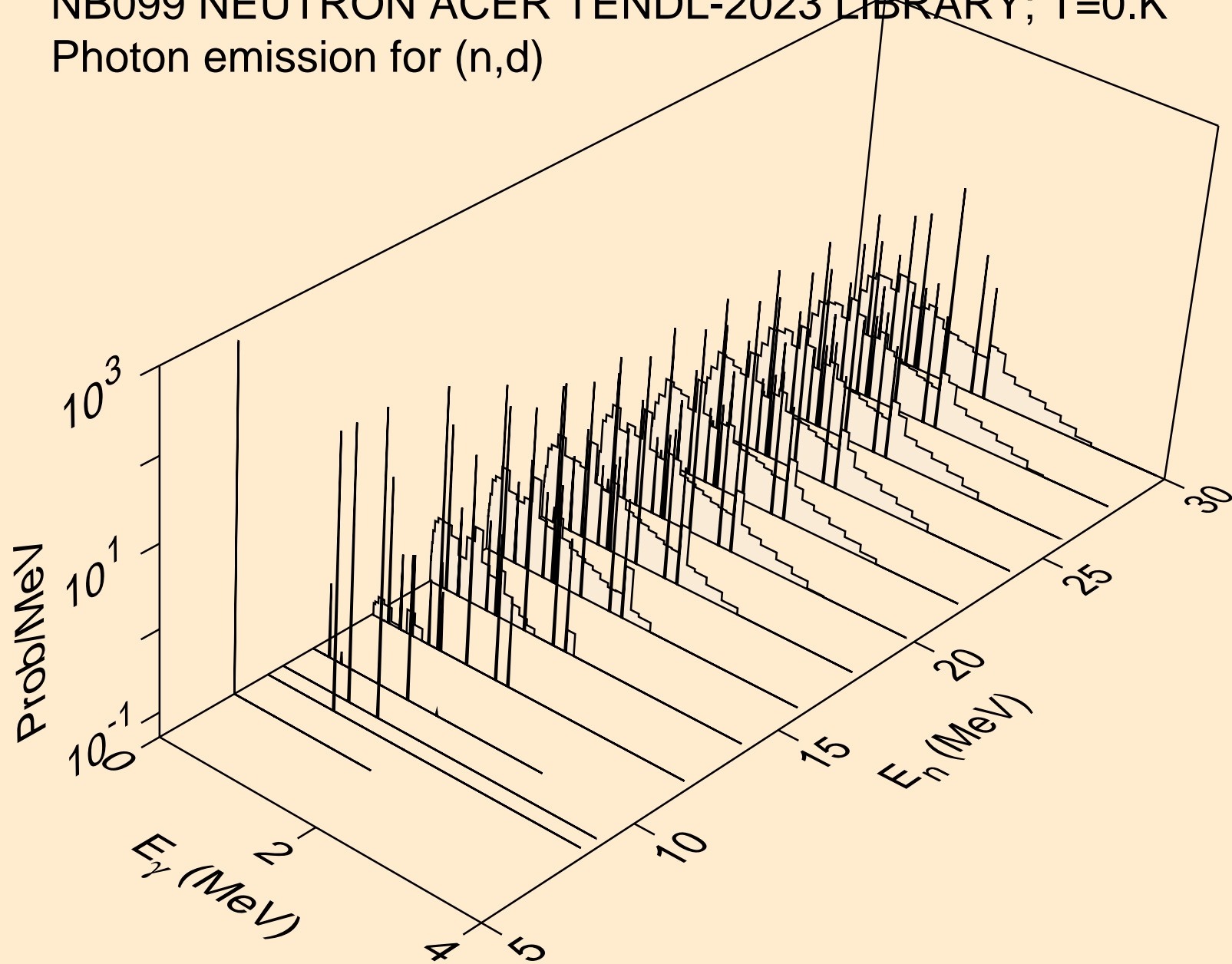

NB099 NEUTRON ACER TENDL-2023 LIBRARY; T=0.K  
Photon emission for (n,t)

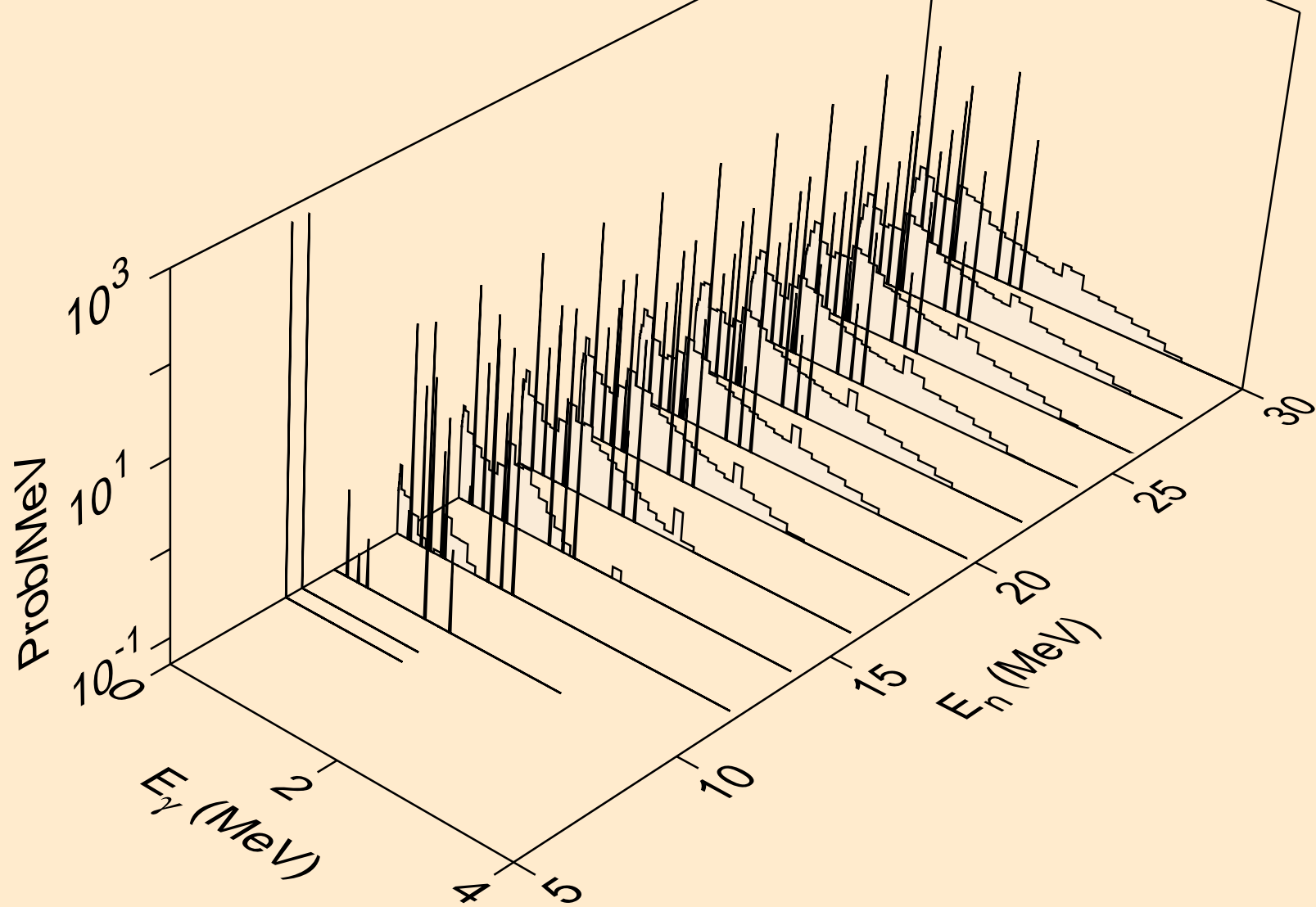

NB099 NEUTRON ACER TENDL-2023 LIBRARY; T=0.K  
Photon emission for (n,he3)

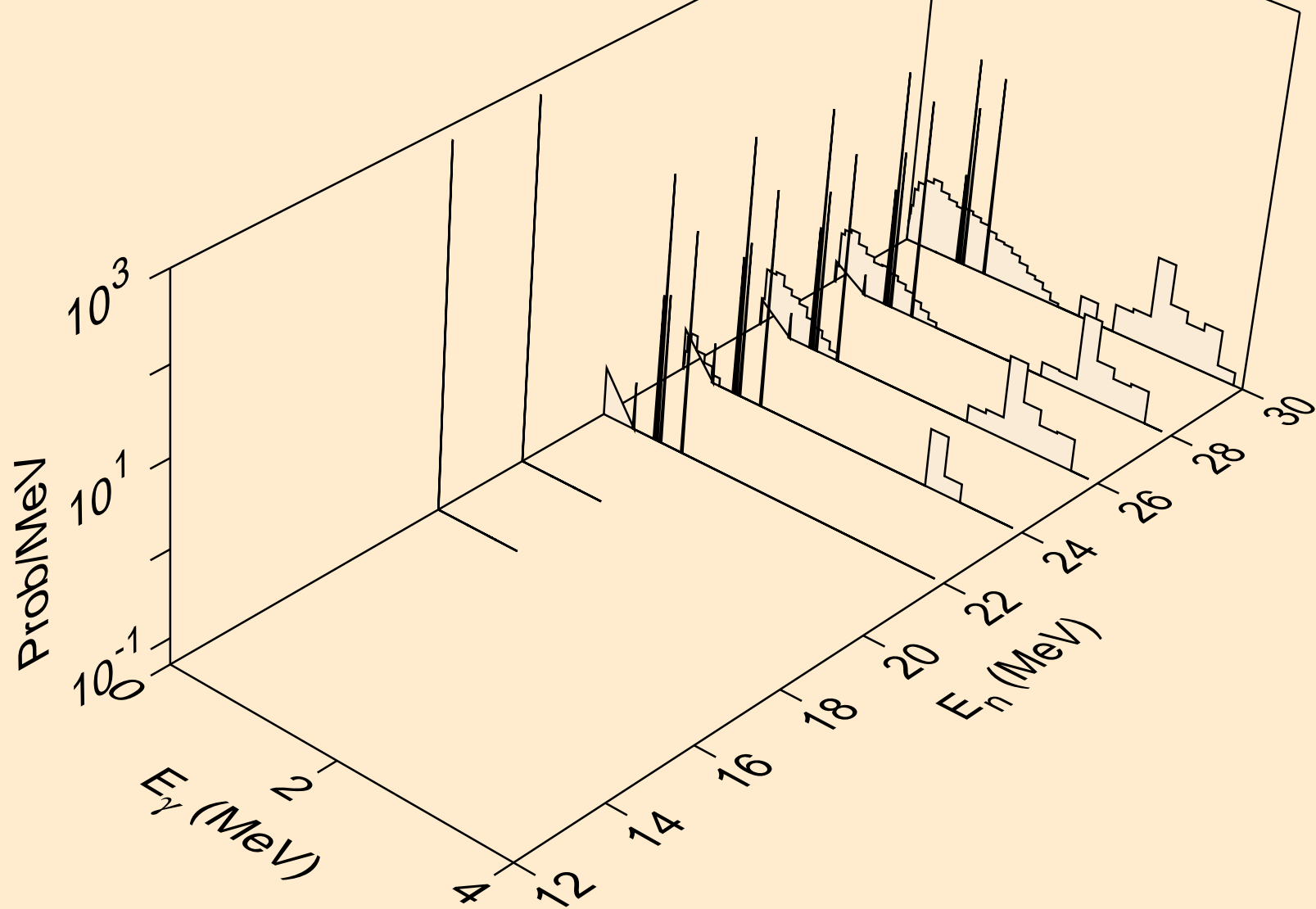

NB099 NEUTRON ACER TENDL-2023 LIBRARY; T=0.K  
Photon emission for (n,a)

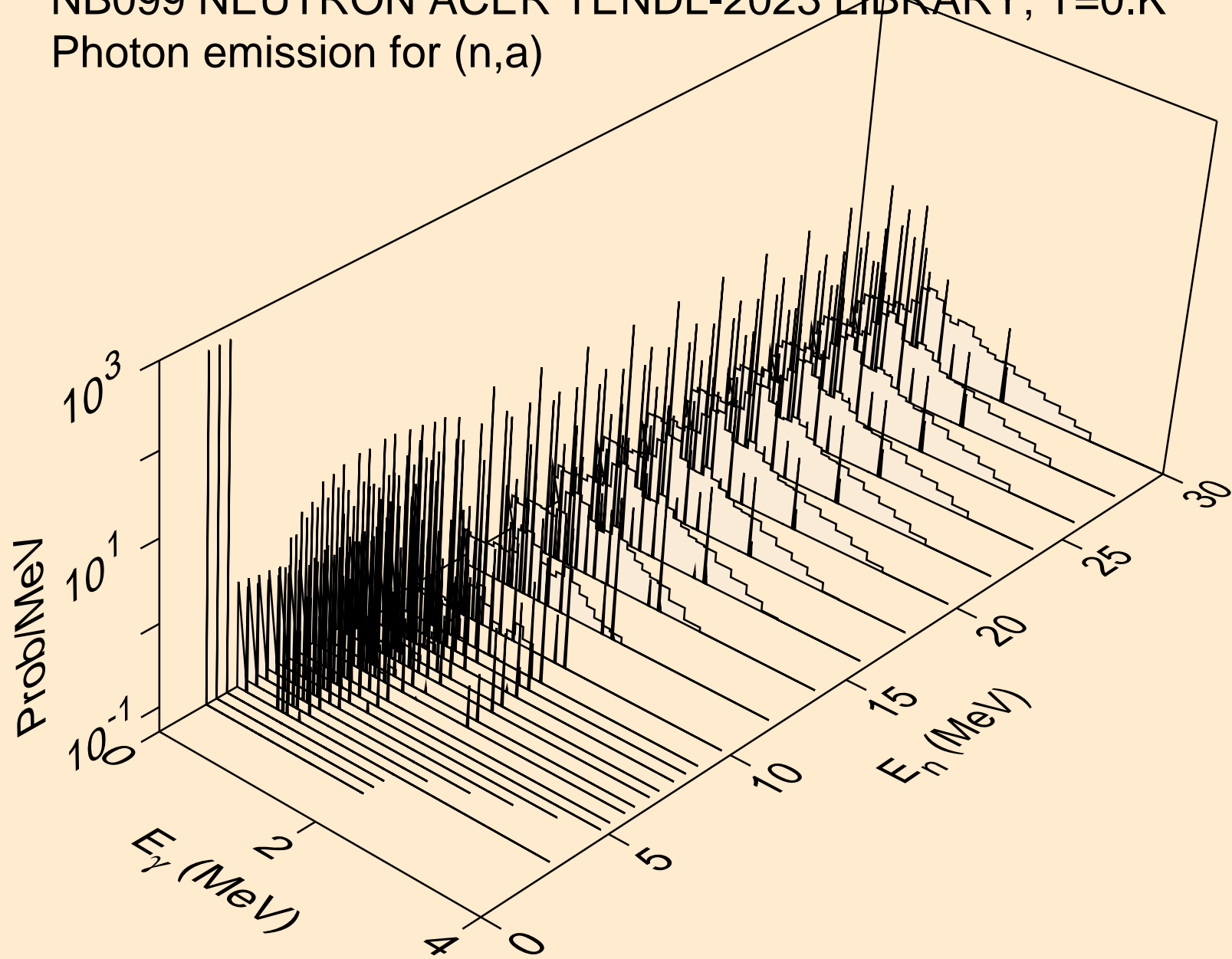



NB099 NEUTRON ACER TENDL-2023 LIBRARY; T=0.K  
Photon emission for (n,2a)

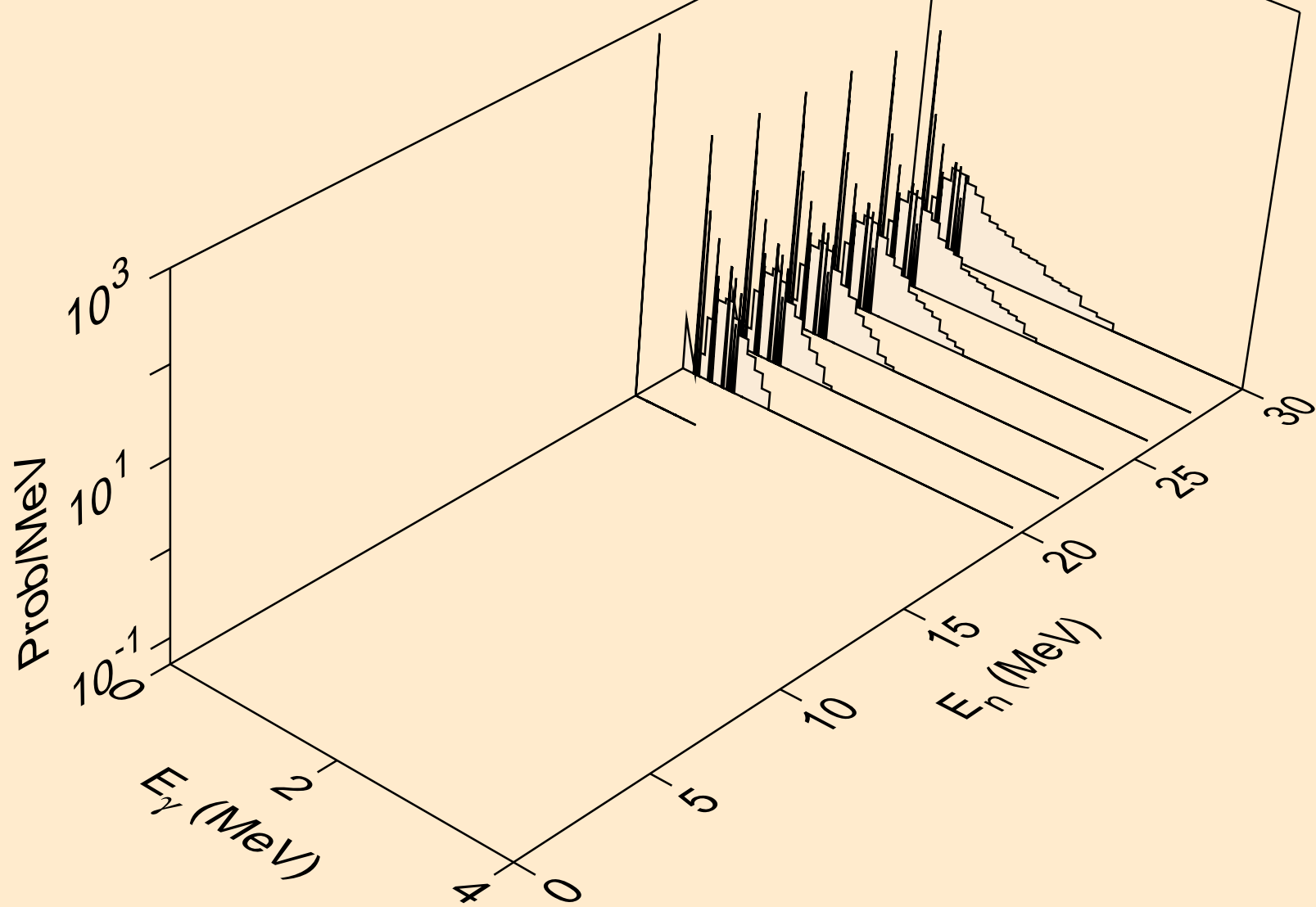

NB099 NEUTRON ACER TENDL-2023 LIBRARY; T=0.K  
Photon emission for (n,2p)

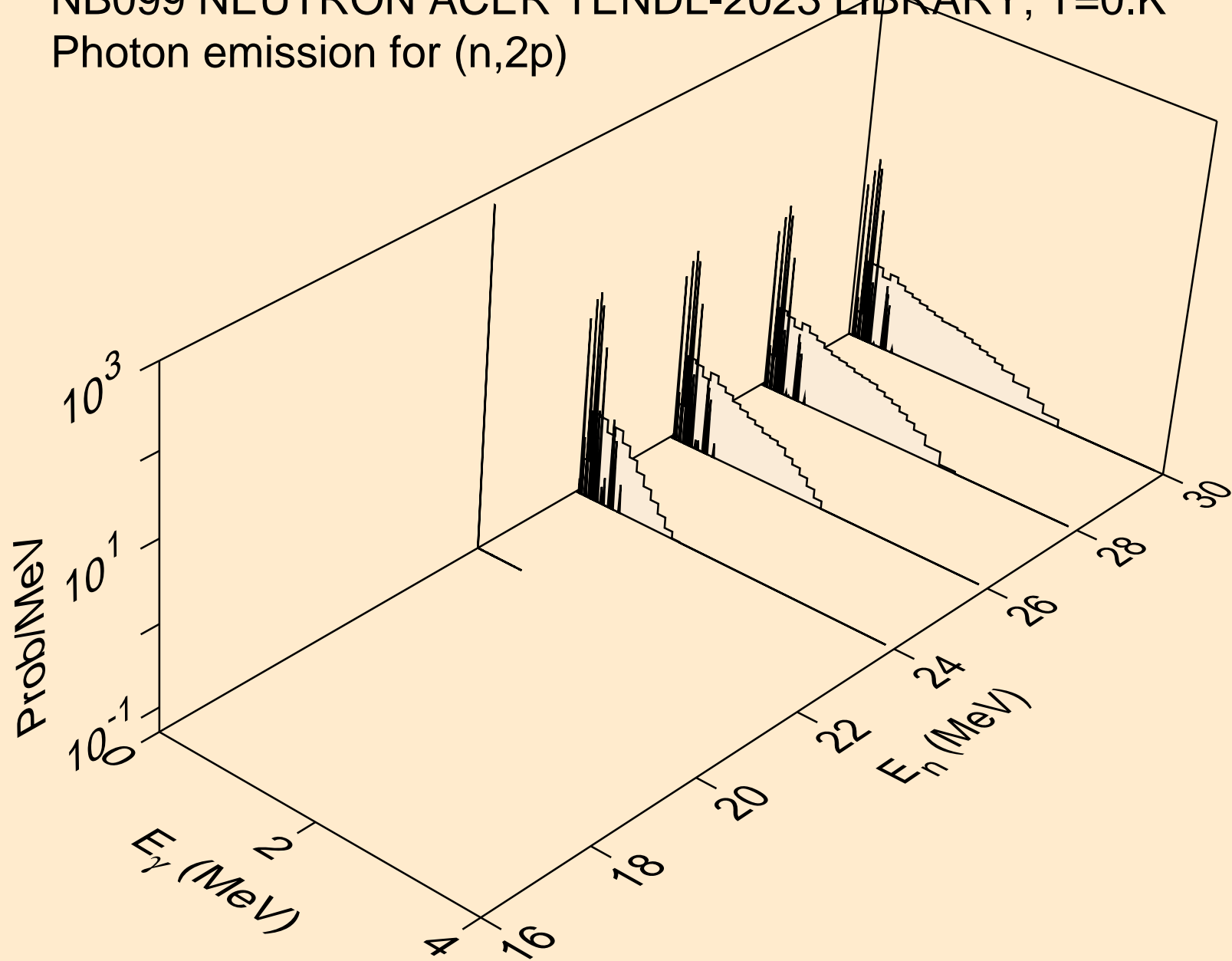

NB099 NEUTRON ACER TENDL-2023 LIBRARY; T=0.K  
Photon emission for (n,p)

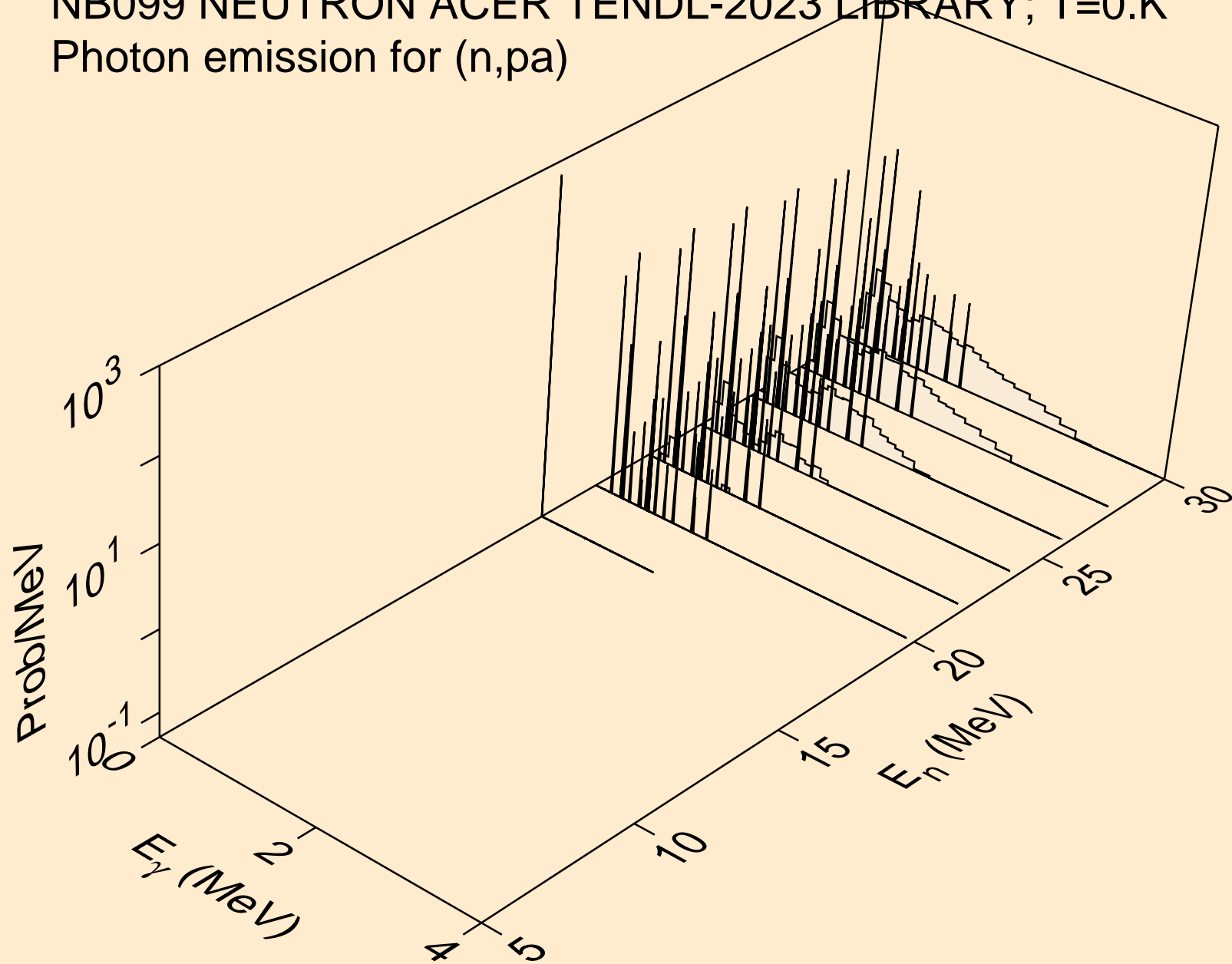

NB099 NEUTRON ACER TENDL-2023 LIBRARY; T=0.K  
thermal capture photon spectrum

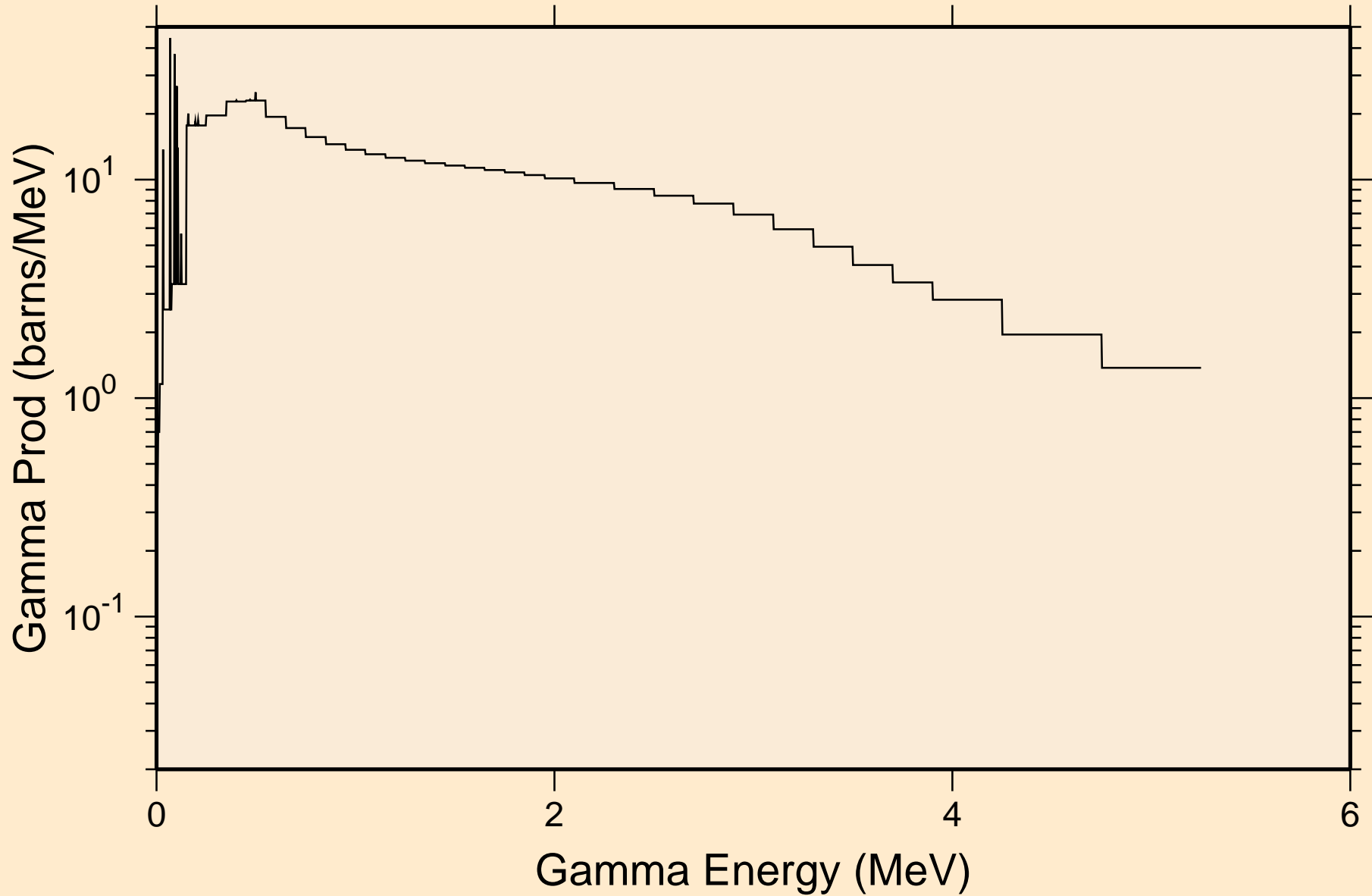

NB099 NEUTRON ACER TENDL-2023 LIBRARY; T=0.K  
14 MeV photon spectrum

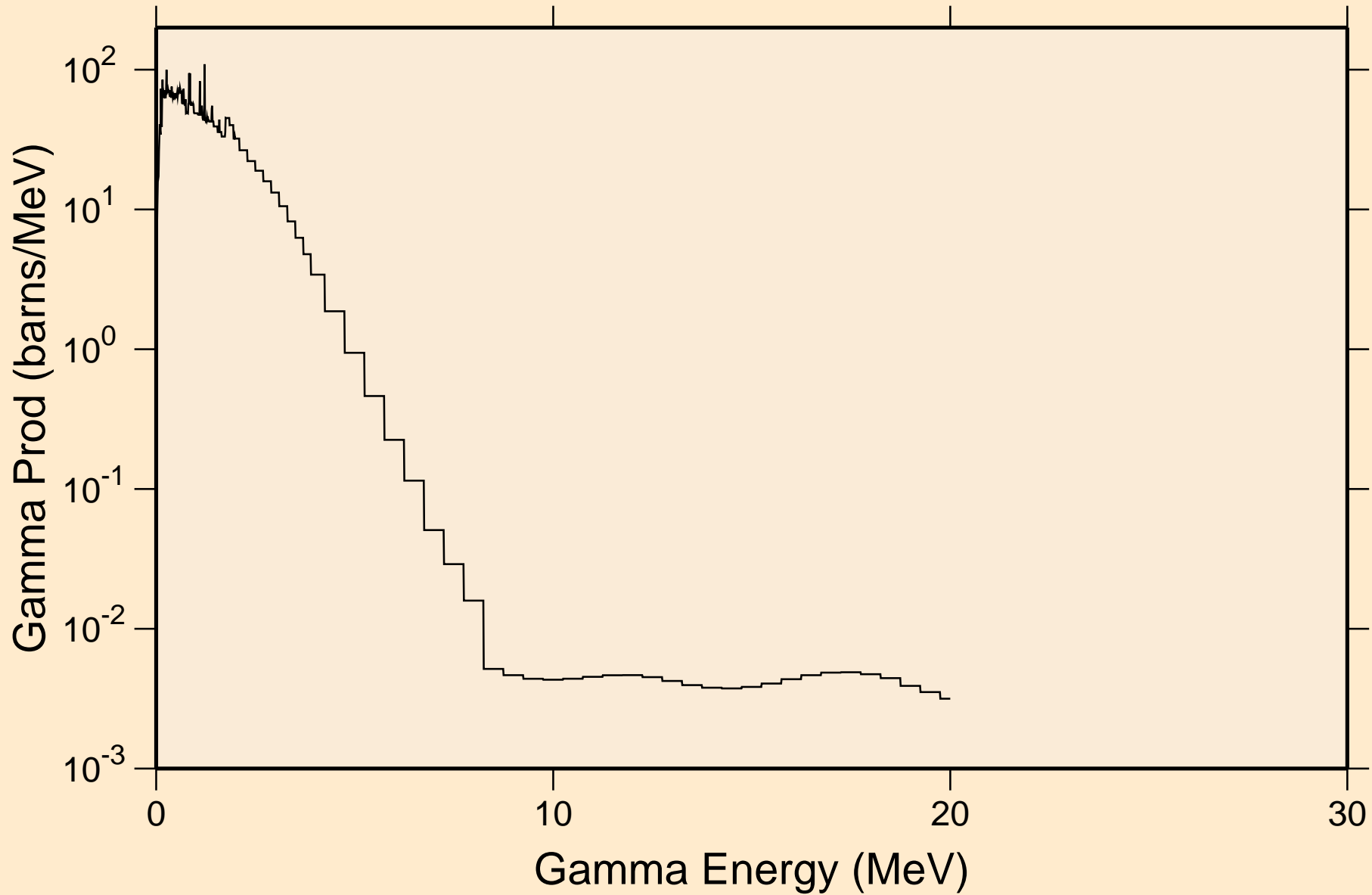

NB099 NEUTRON ACER TENDL-2023 LIBRARY; T=0.K  
Particle heating contributions

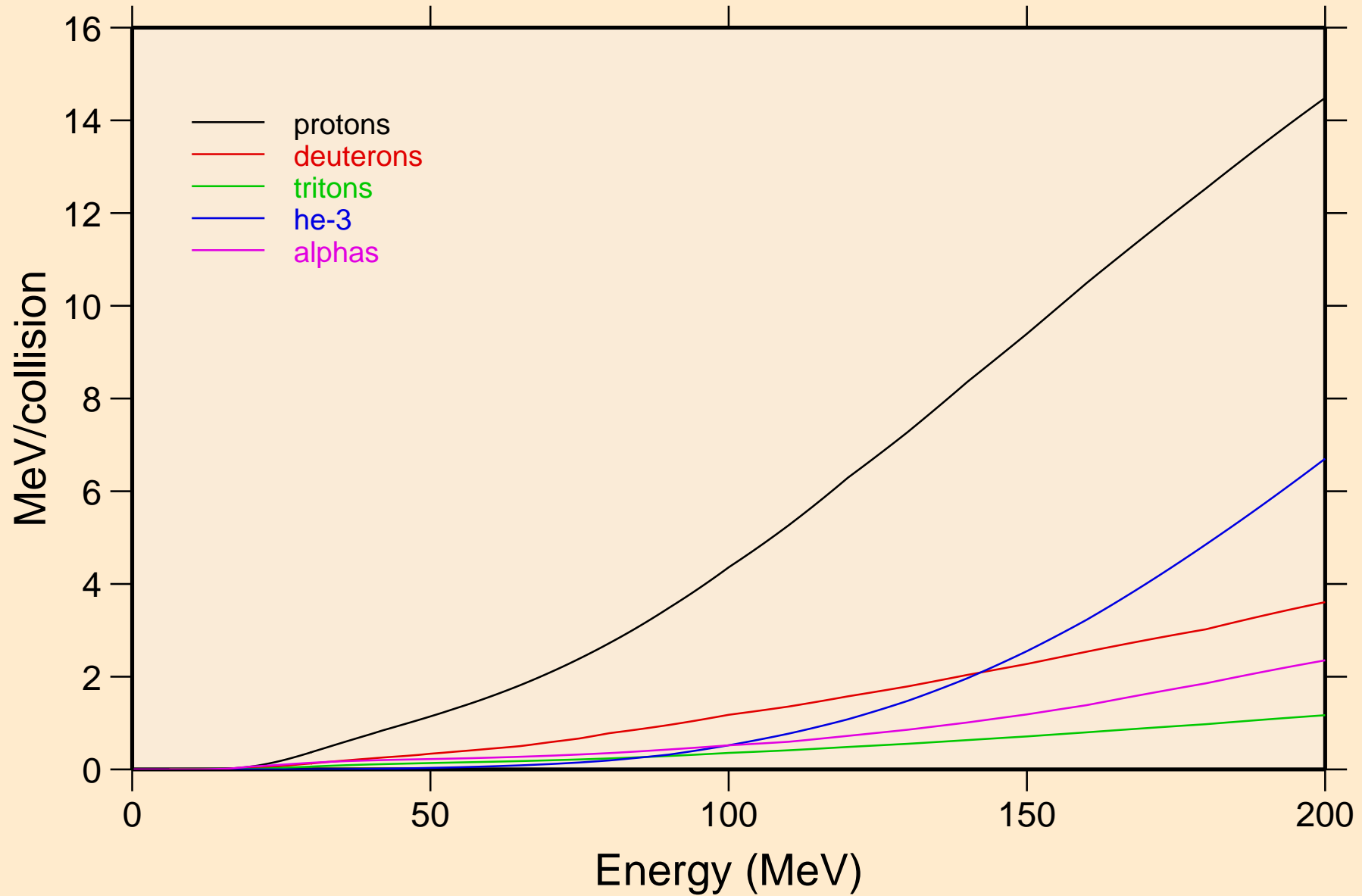

NB099 NEUTRON ACER TENDL-2023 LIBRARY; T=0.K  
Recoil Heating

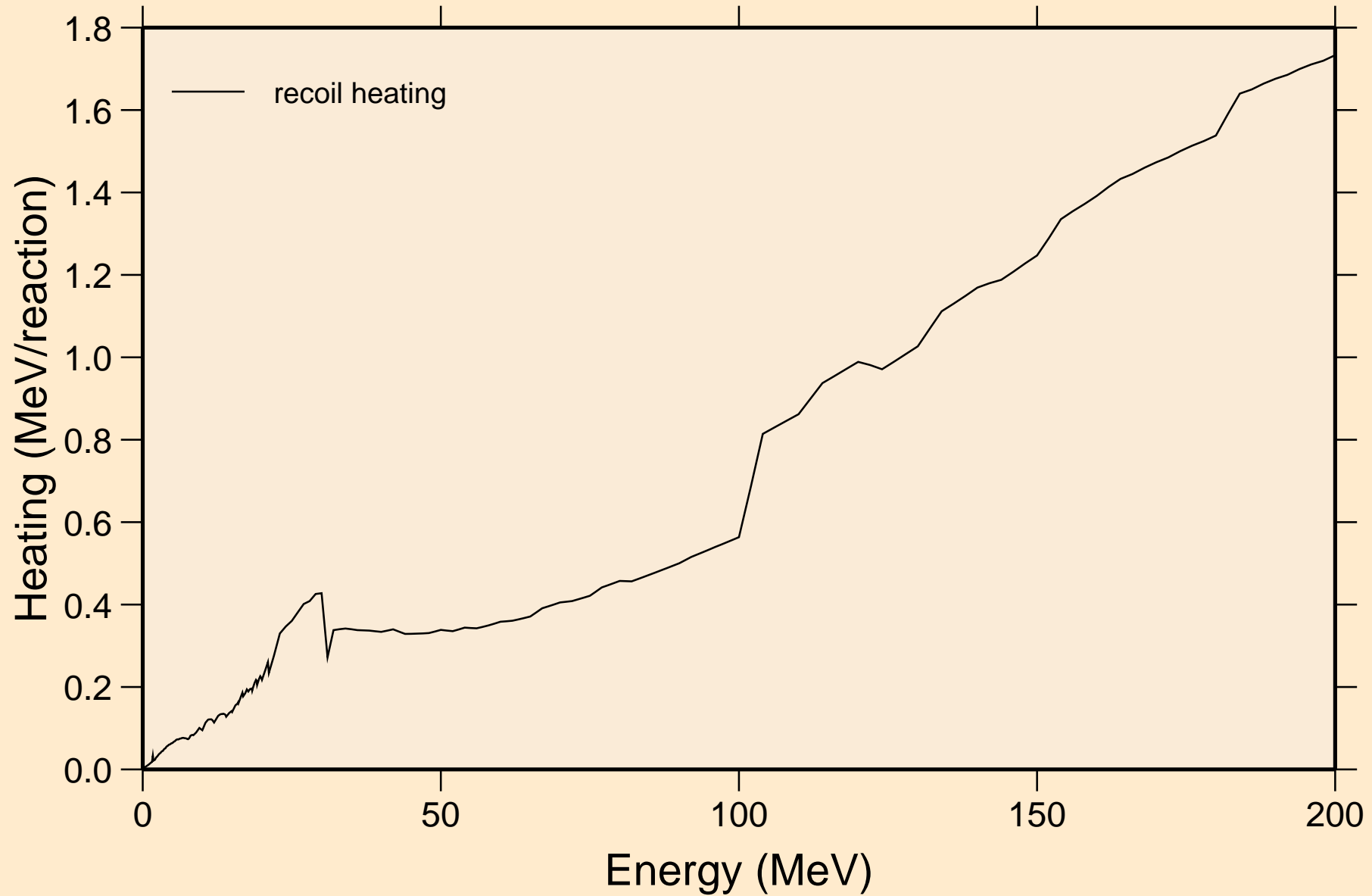

NB099 NEUTRON ACER TENDL-2023 LIBRARY; T=0.K  
Particle production cross sections

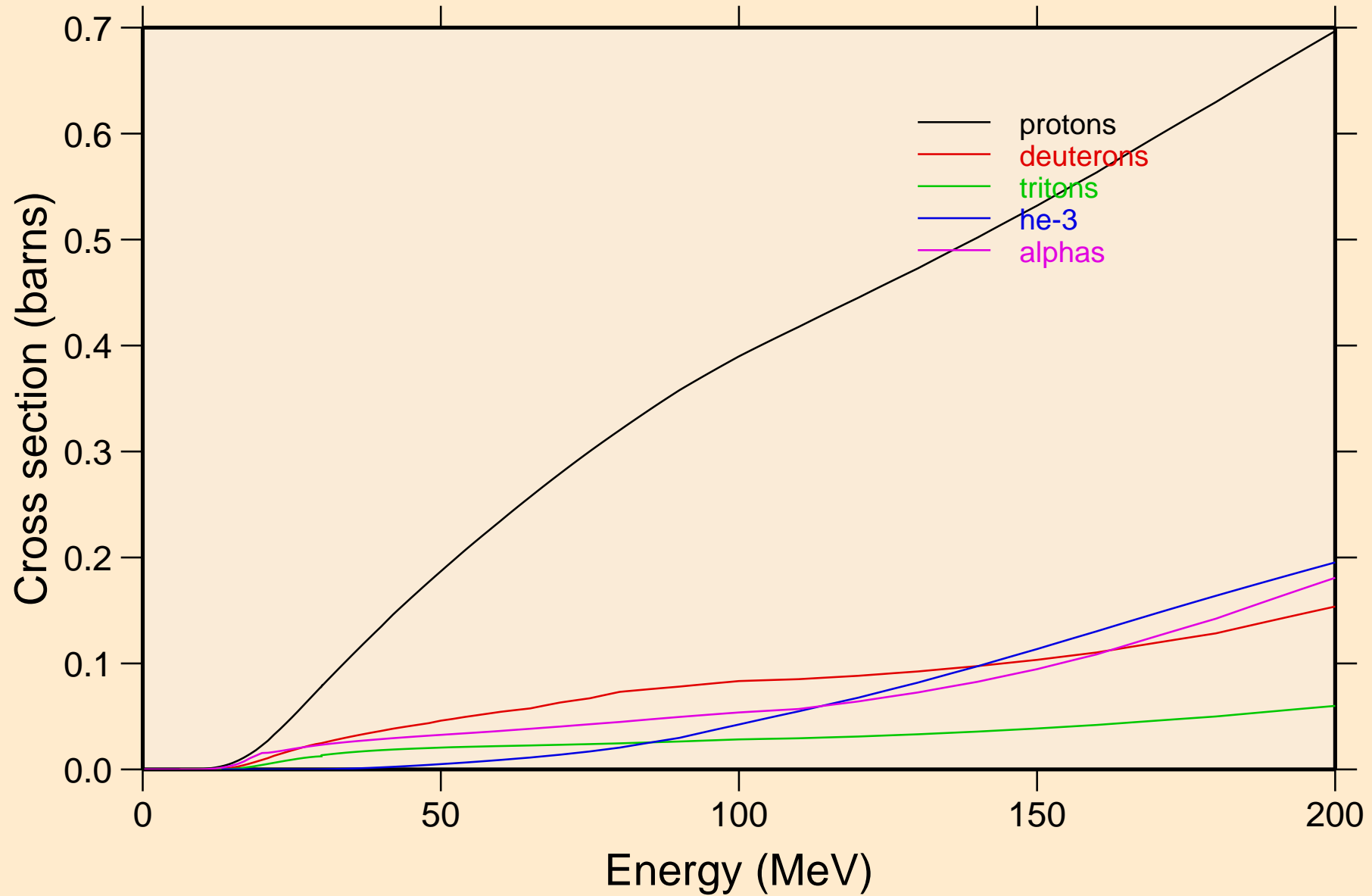



NB099 NEUTRON ACER TENDL-2023 LIBRARY; T=0.K  
protons from (n,x)

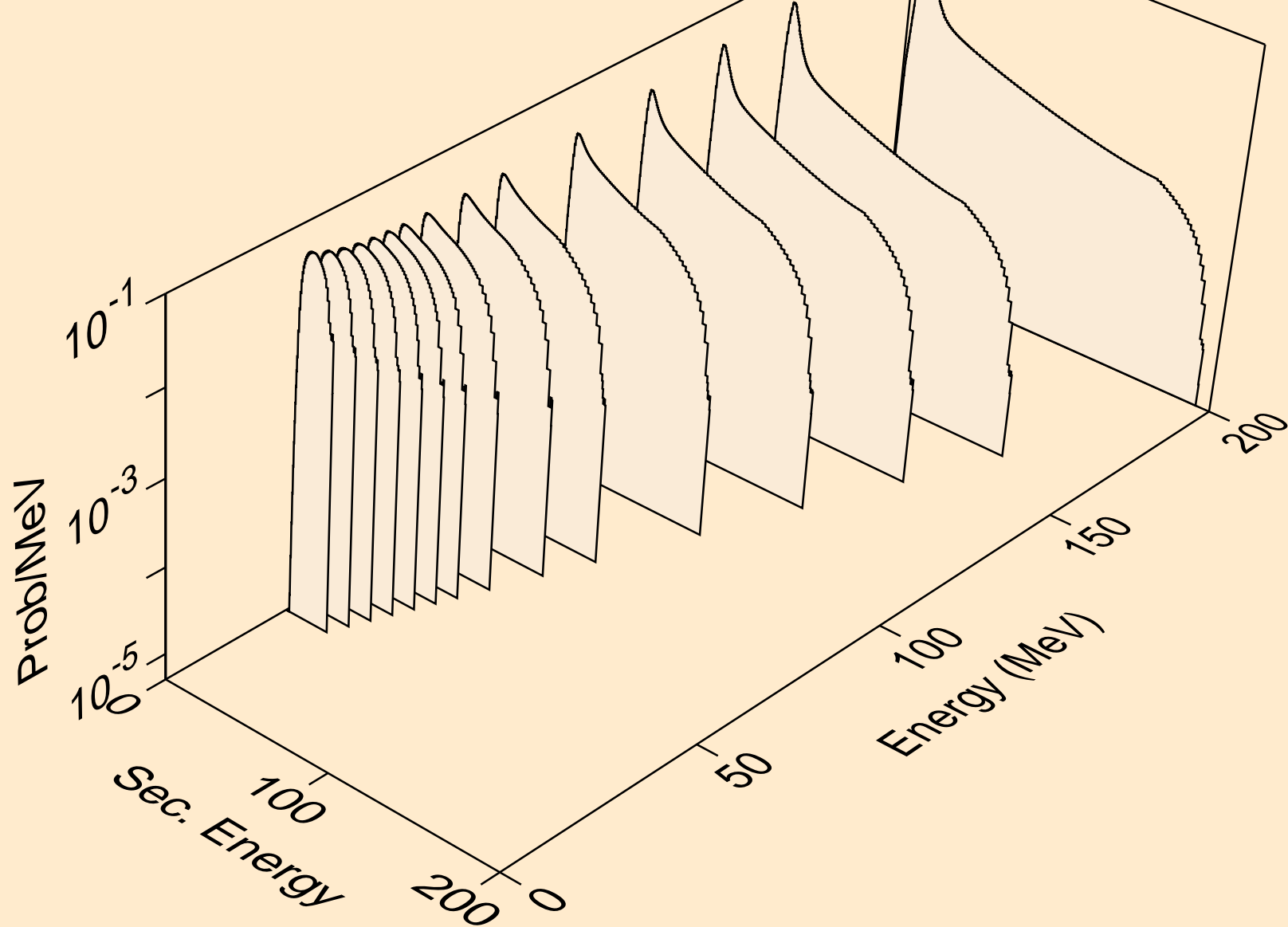

NB099 NEUTRON ACER TENDL-2023 LIBRARY; T=0.K  
protons from (n,n\*)p

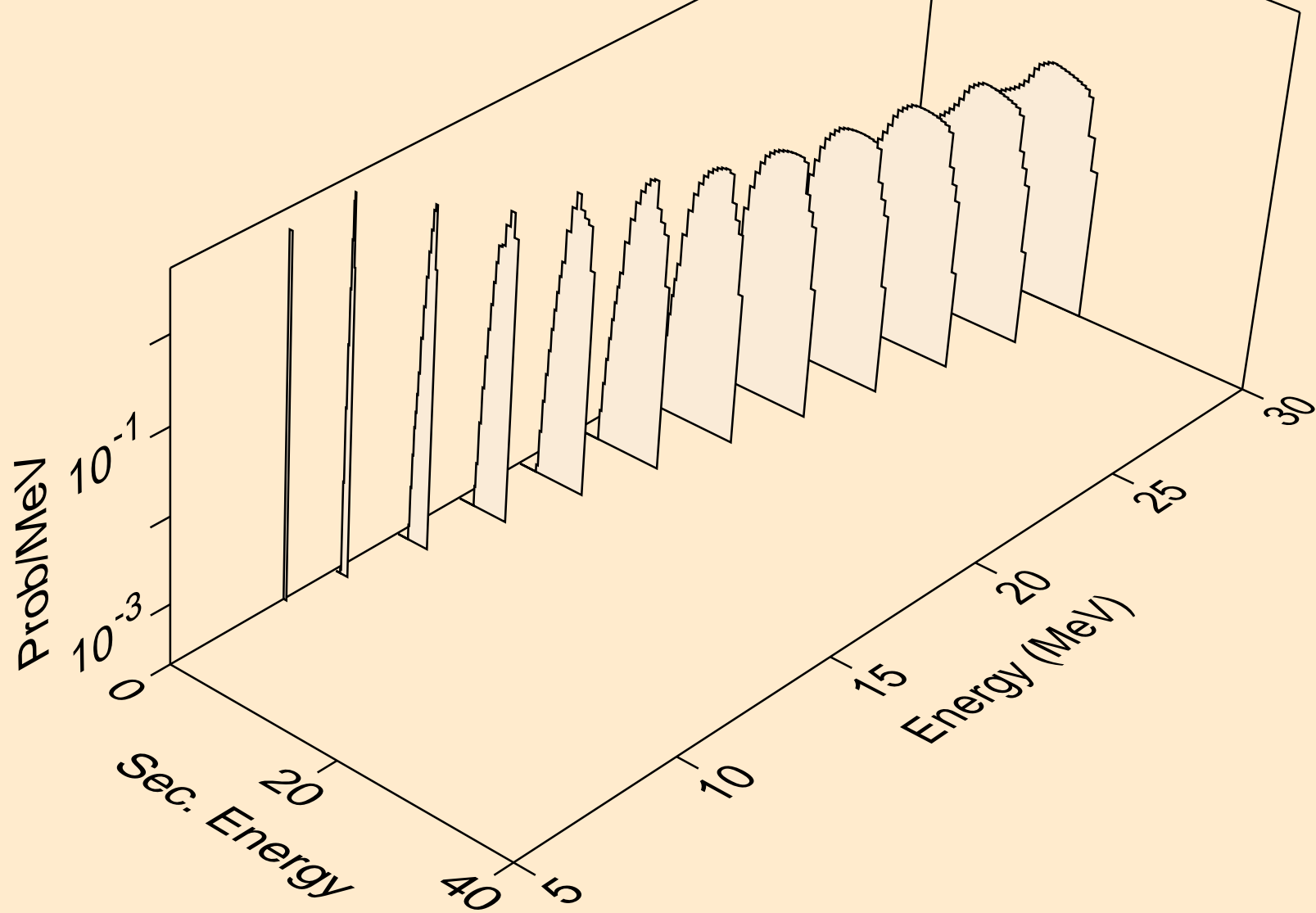

NB099 NEUTRON ACER TENDL-2023 LIBRARY; T=0.K  
protons from (n,2np)

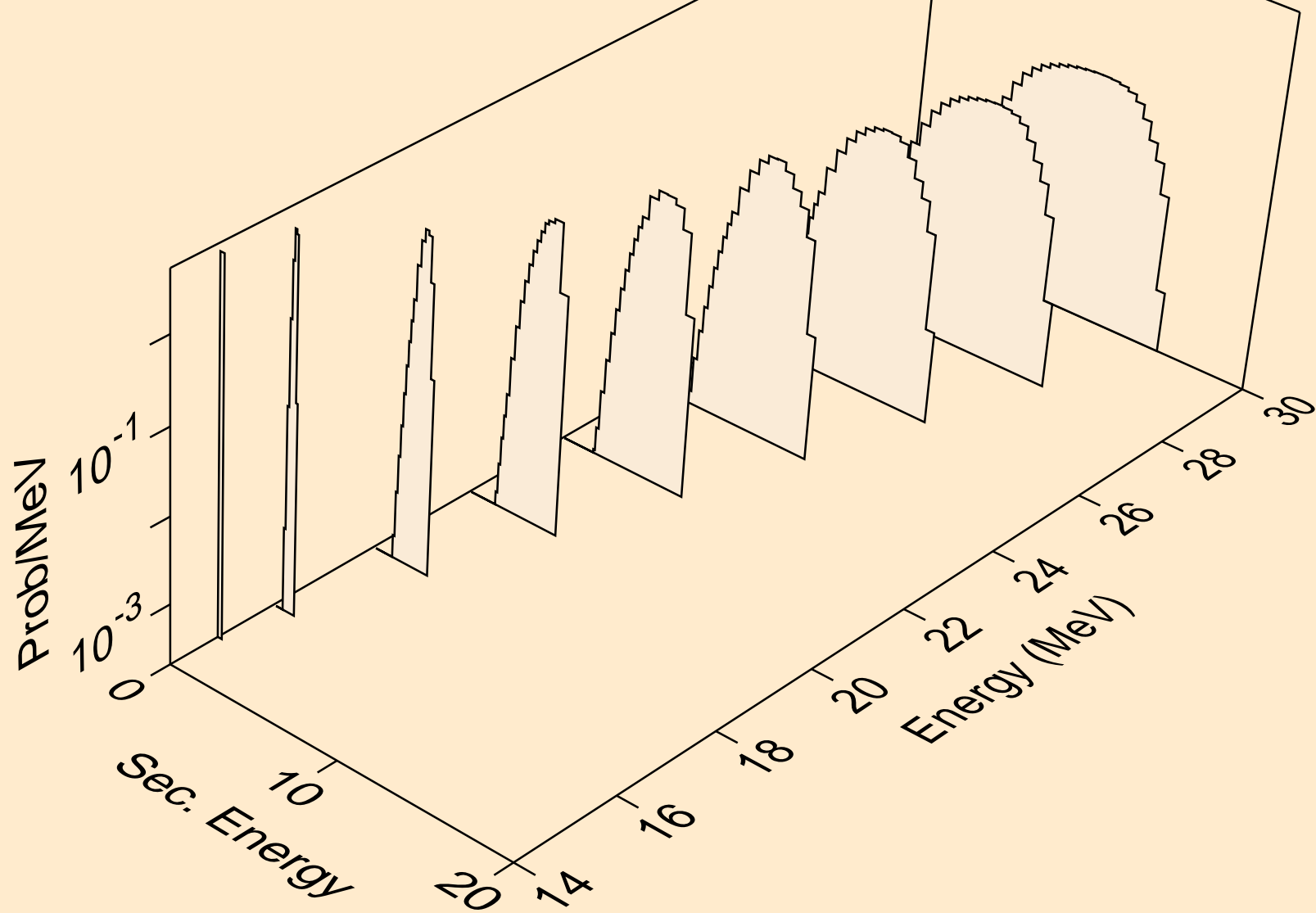

NB099 NEUTRON ACER TENDL-2023 LIBRARY; T=0.K  
protons from (n,3np)

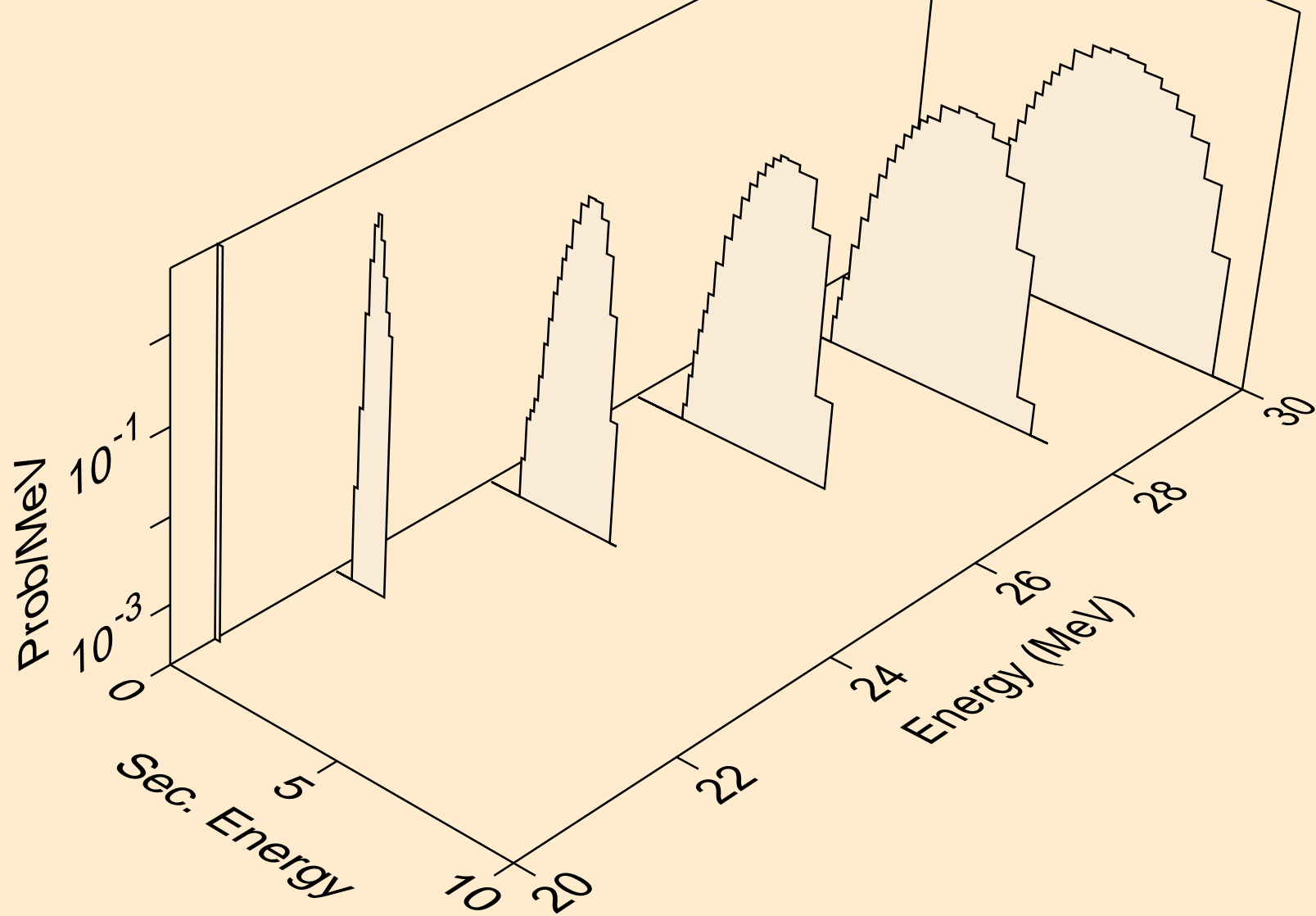

NB099 NEUTRON ACER TENDL-2023 LIBRARY; T=0.K  
protons from (n,n2p)

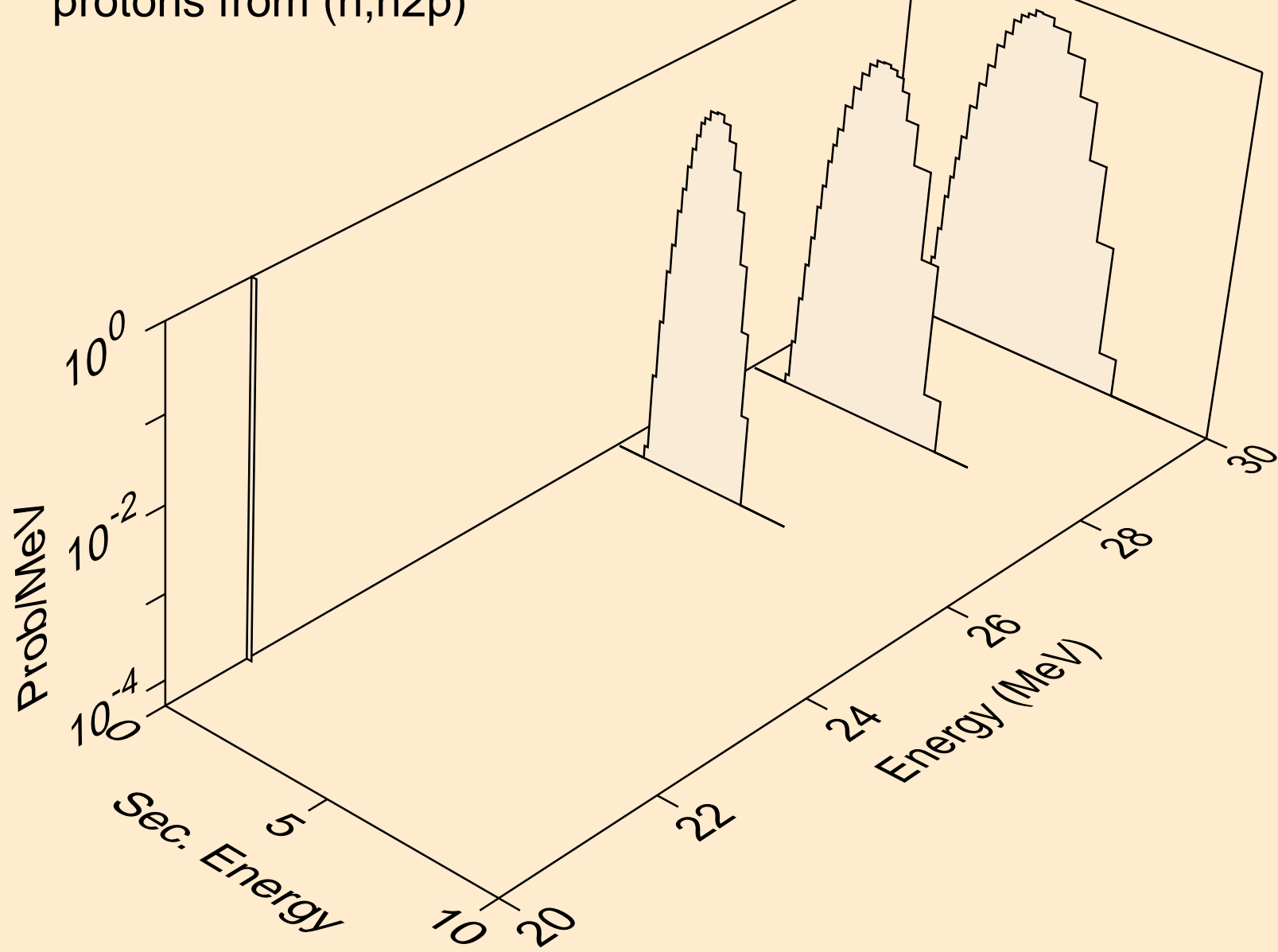

NB099 NEUTRON ACER TENDL-2023 LIBRARY; T=0.K  
protons from (n,npa)

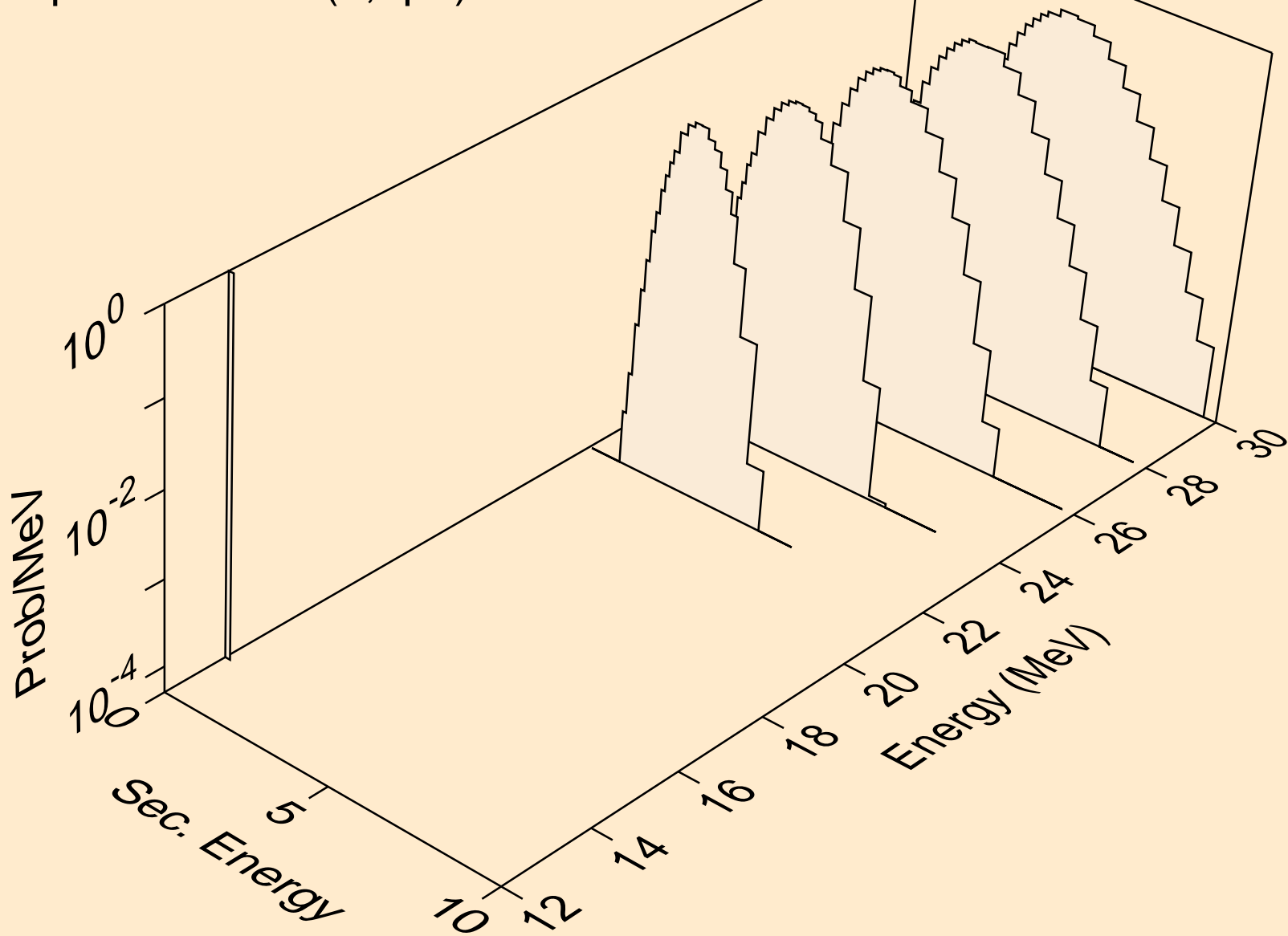

NB099 NEUTRON ACER TENDL-2023 LIBRARY; T=0.K  
protons from (n,p)

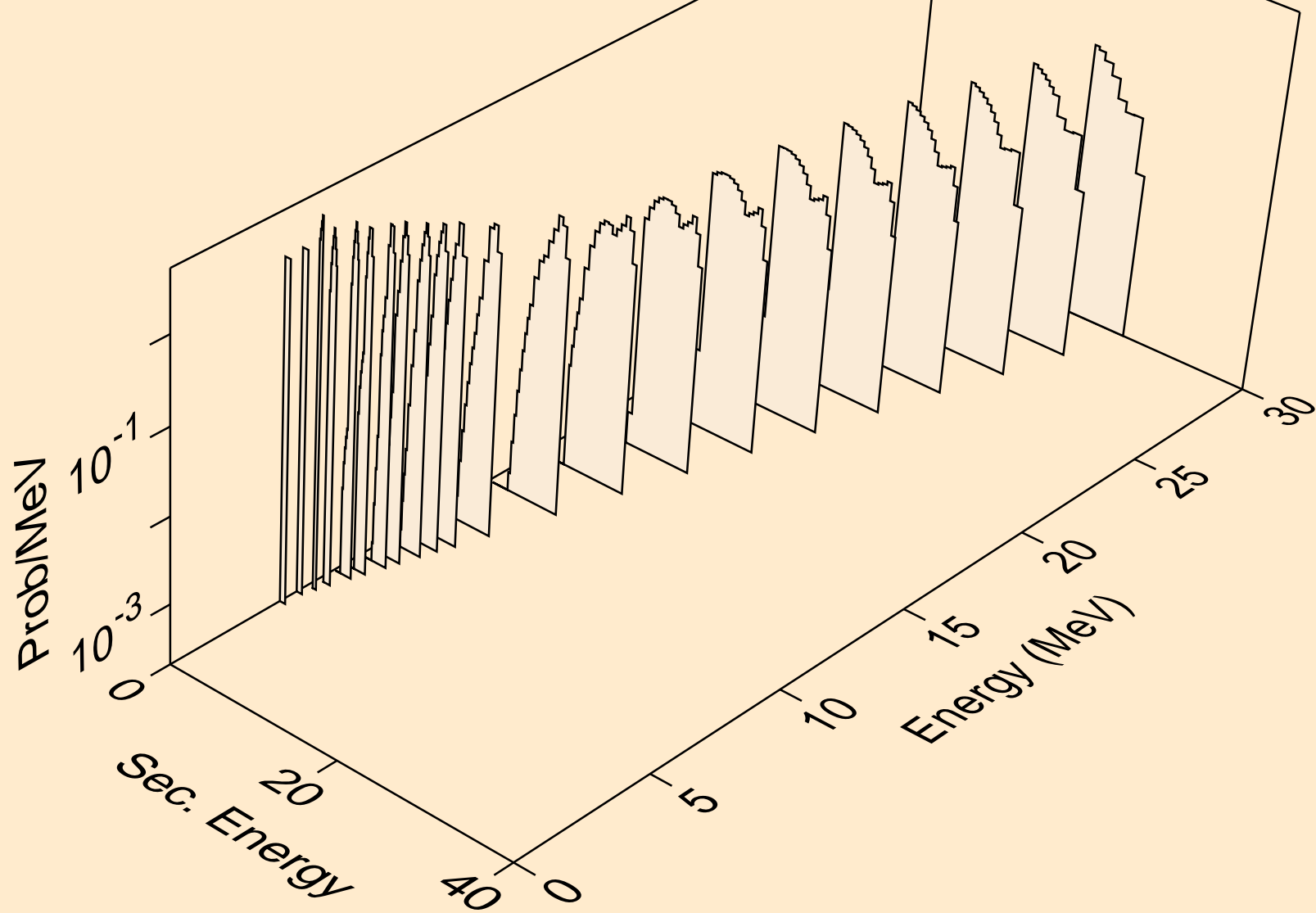

NB099 NEUTRON ACER TENDL-2023 LIBRARY; T=0.K  
protons from (n,2p)

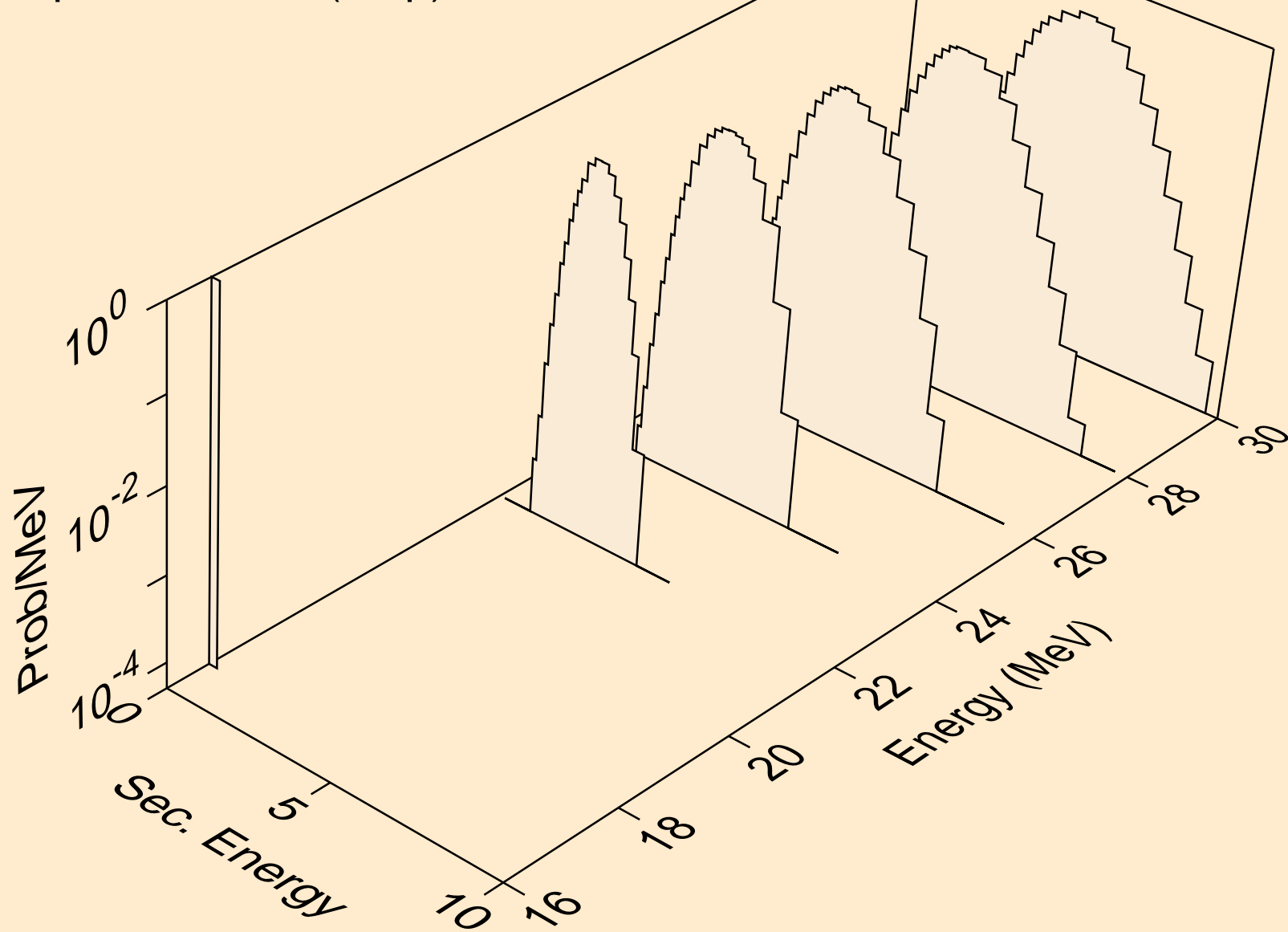



NB099 NEUTRON ACER TENDL-2023 LIBRARY; T=0.K  
protons from (n,p)

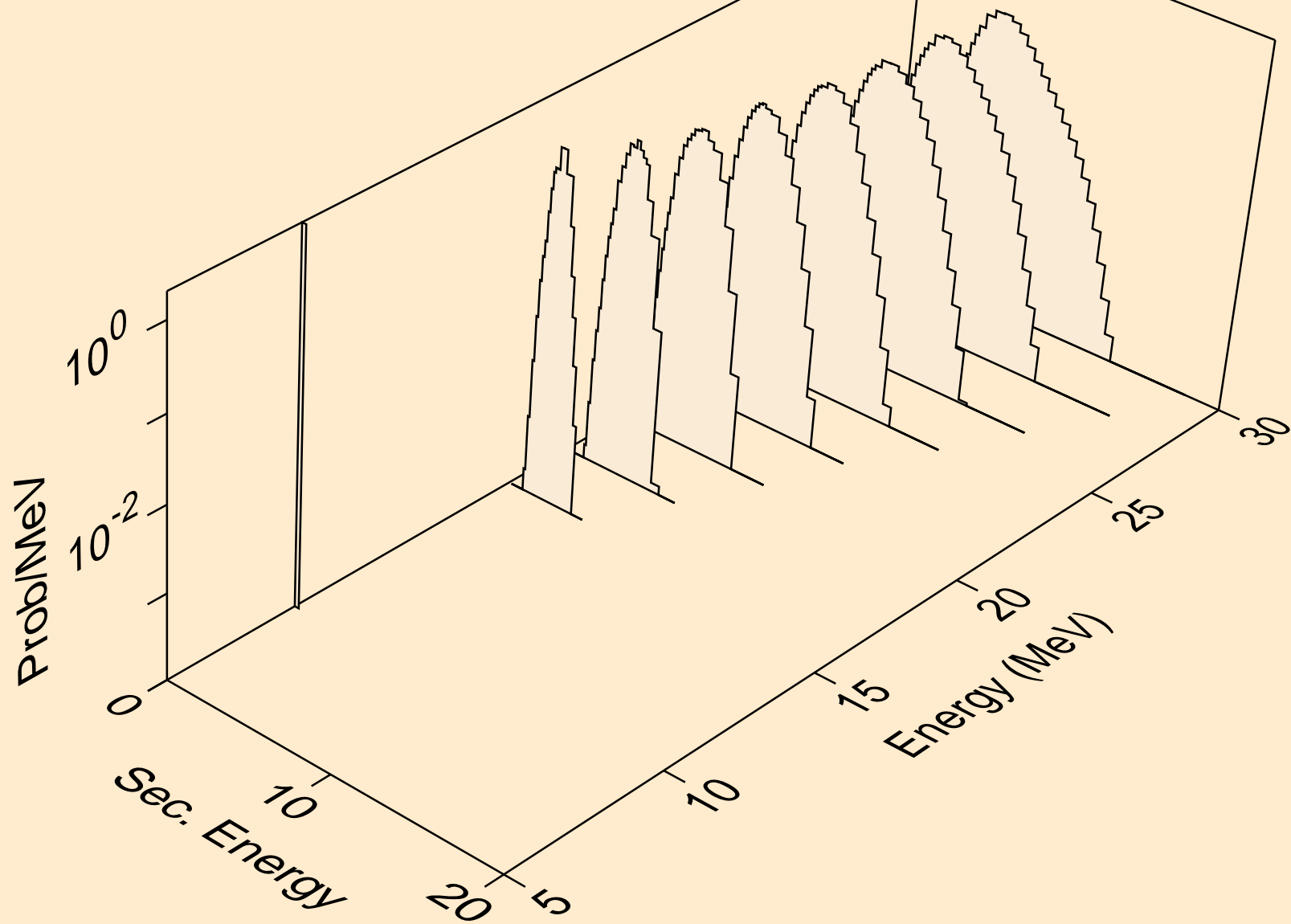

NB099 NEUTRON ACER TENDL-2023 LIBRARY; T=0.K  
deuterons from (n,x)

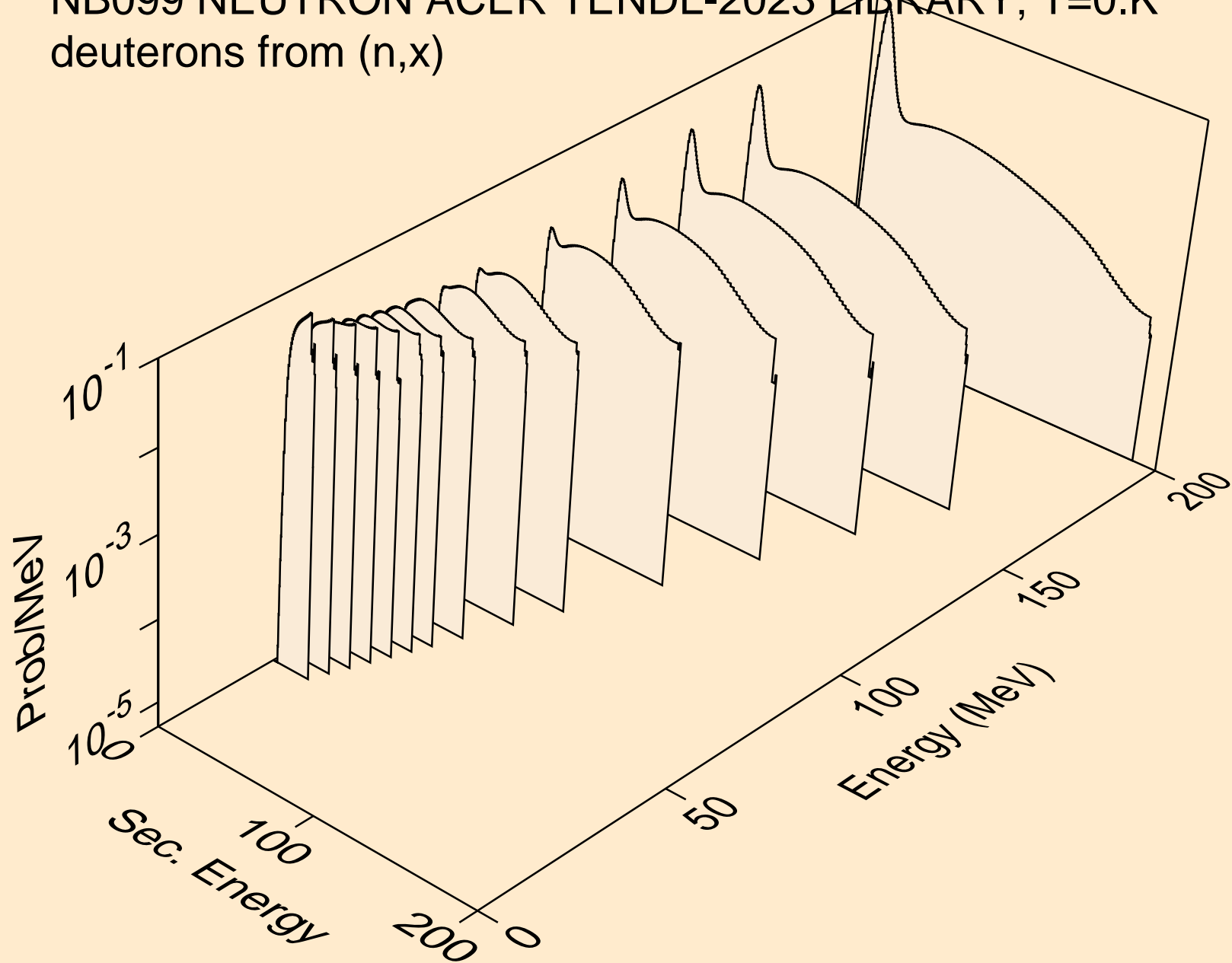

NB099 NEUTRON ACER TENDL-2023 LIBRARY; T=0.K  
deuterons from (n,2nd)

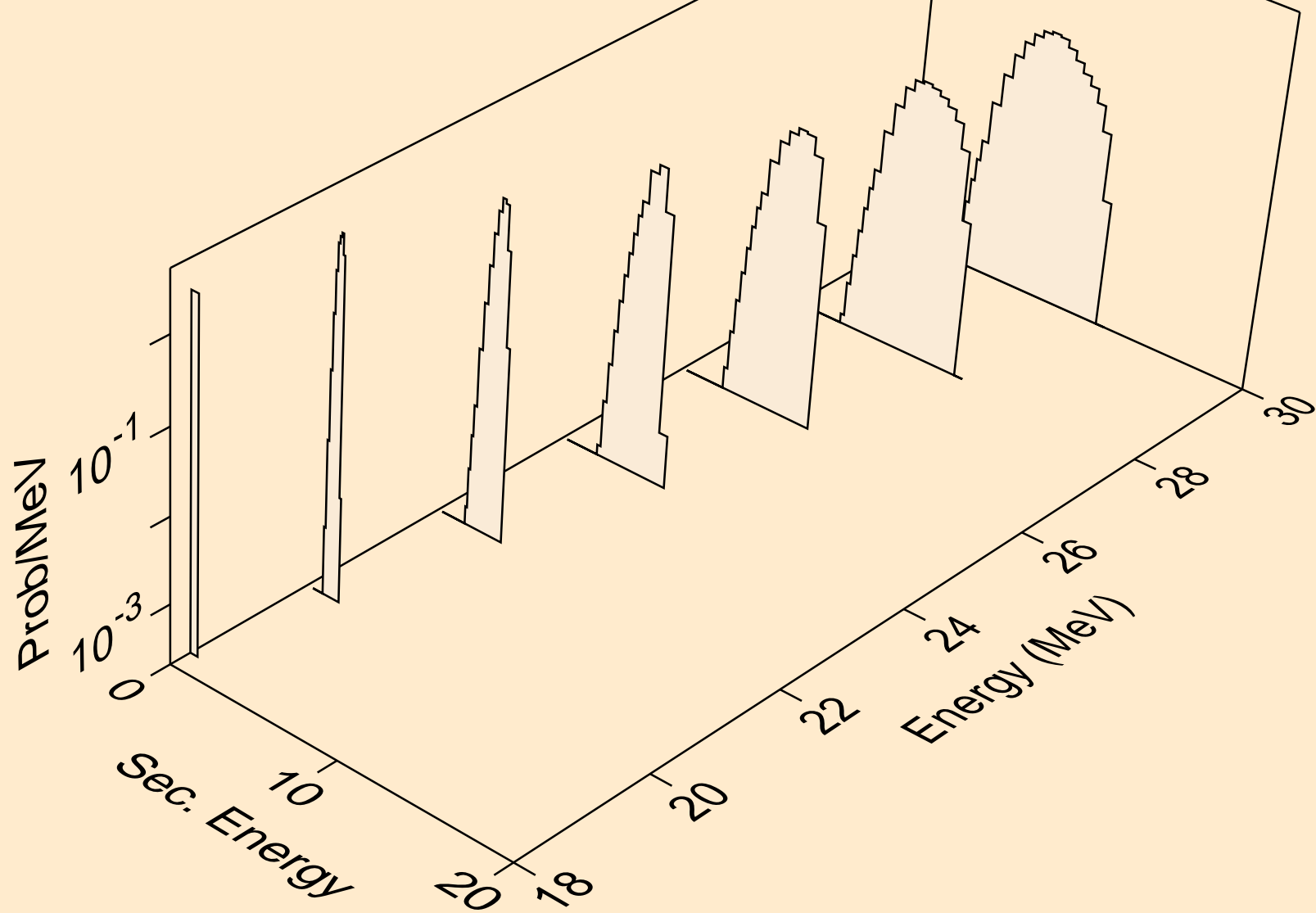

NB099 NEUTRON ACER TENDL-2023 LIBRARY; T=0.K  
deuterons from (n,n\*)d

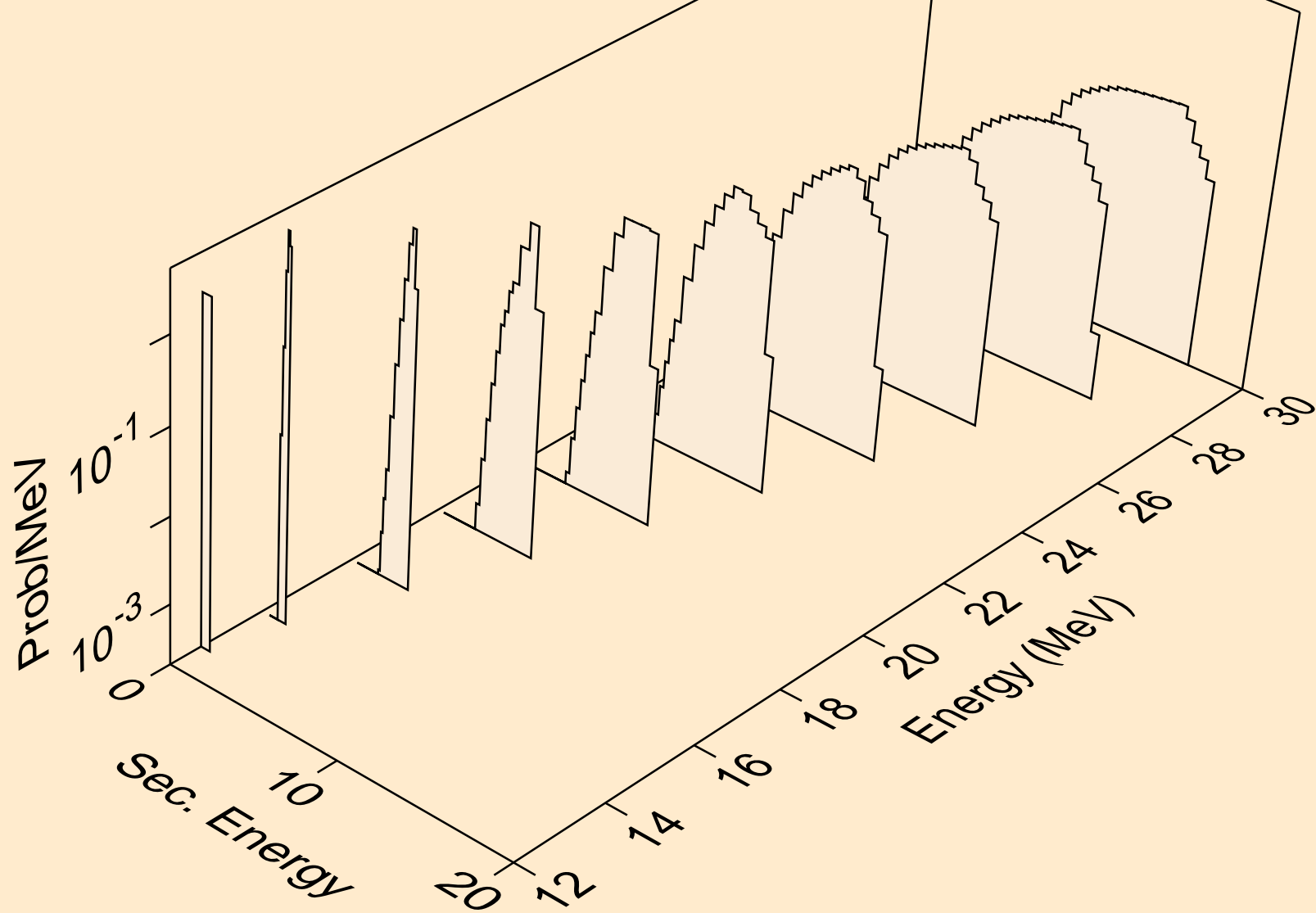

NB099 NEUTRON ACER TENDL-2023 LIBRARY; T=0.K  
deuterons from (n,d)

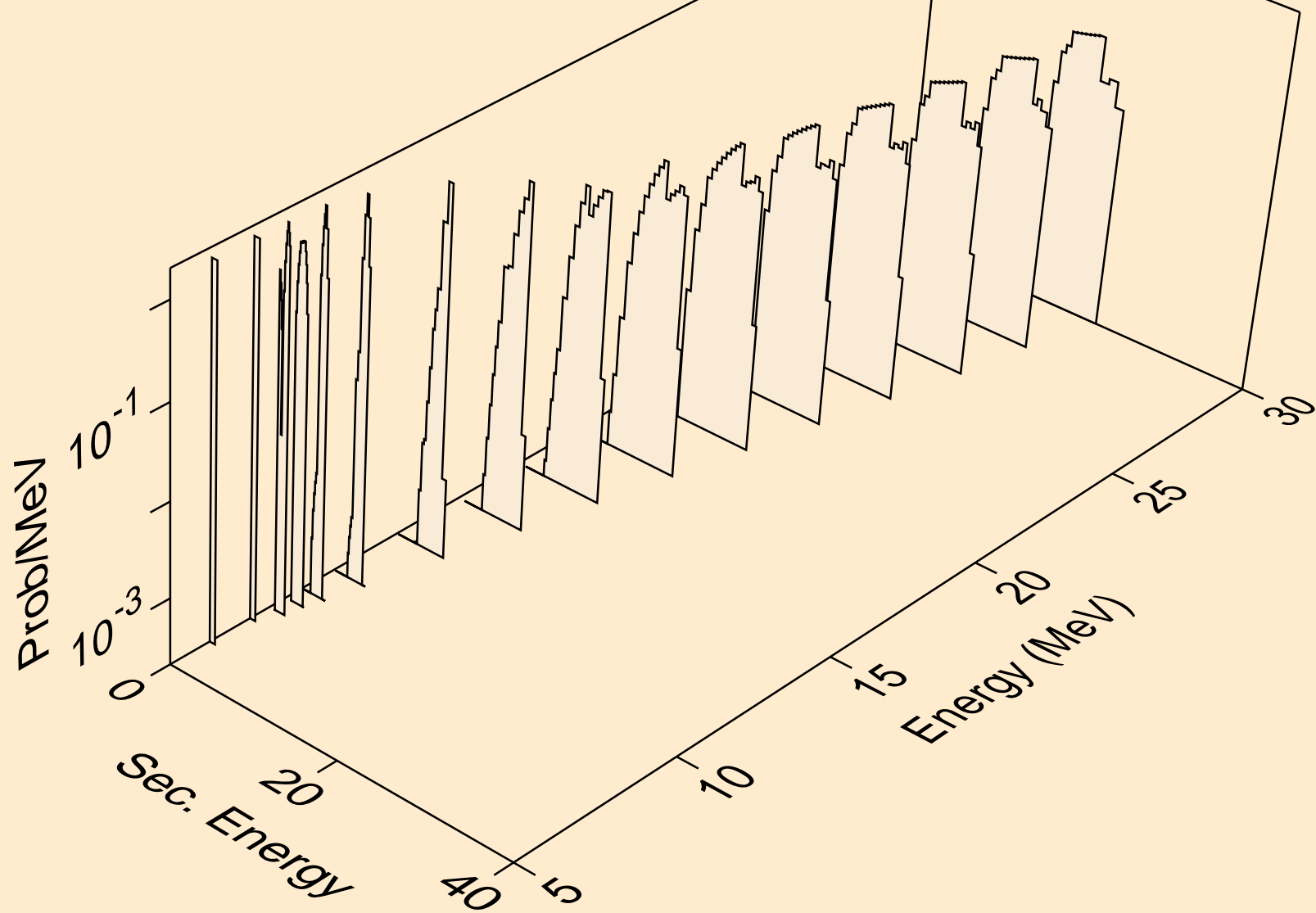

NB099 NEUTRON ACER TENDL-2023 LIBRARY; T=0.K  
tritons from (n,x)

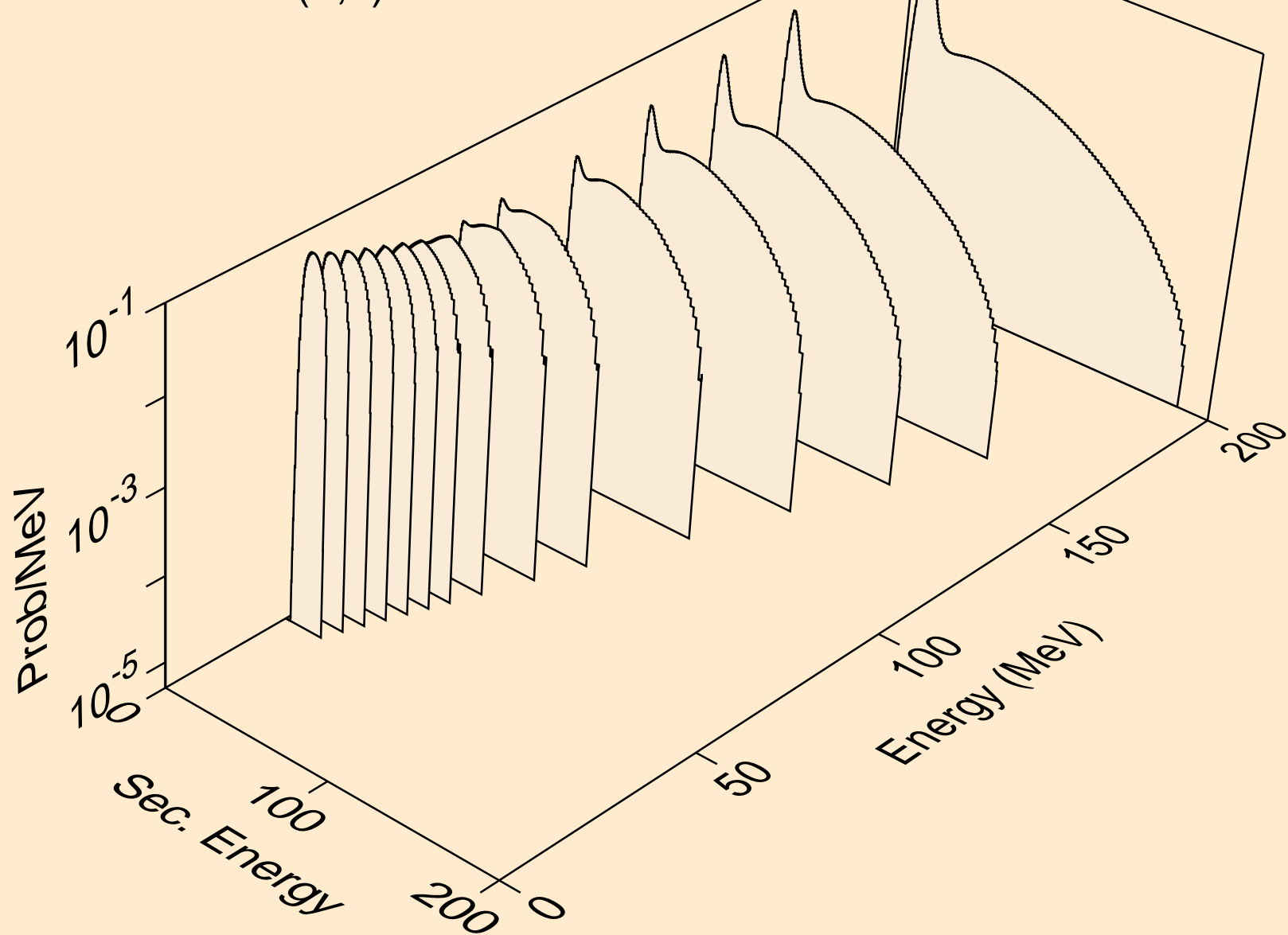

NB099 NEUTRON ACER TENDL-2023 LIBRARY; T=0.K  
tritons from (n,n\*)t

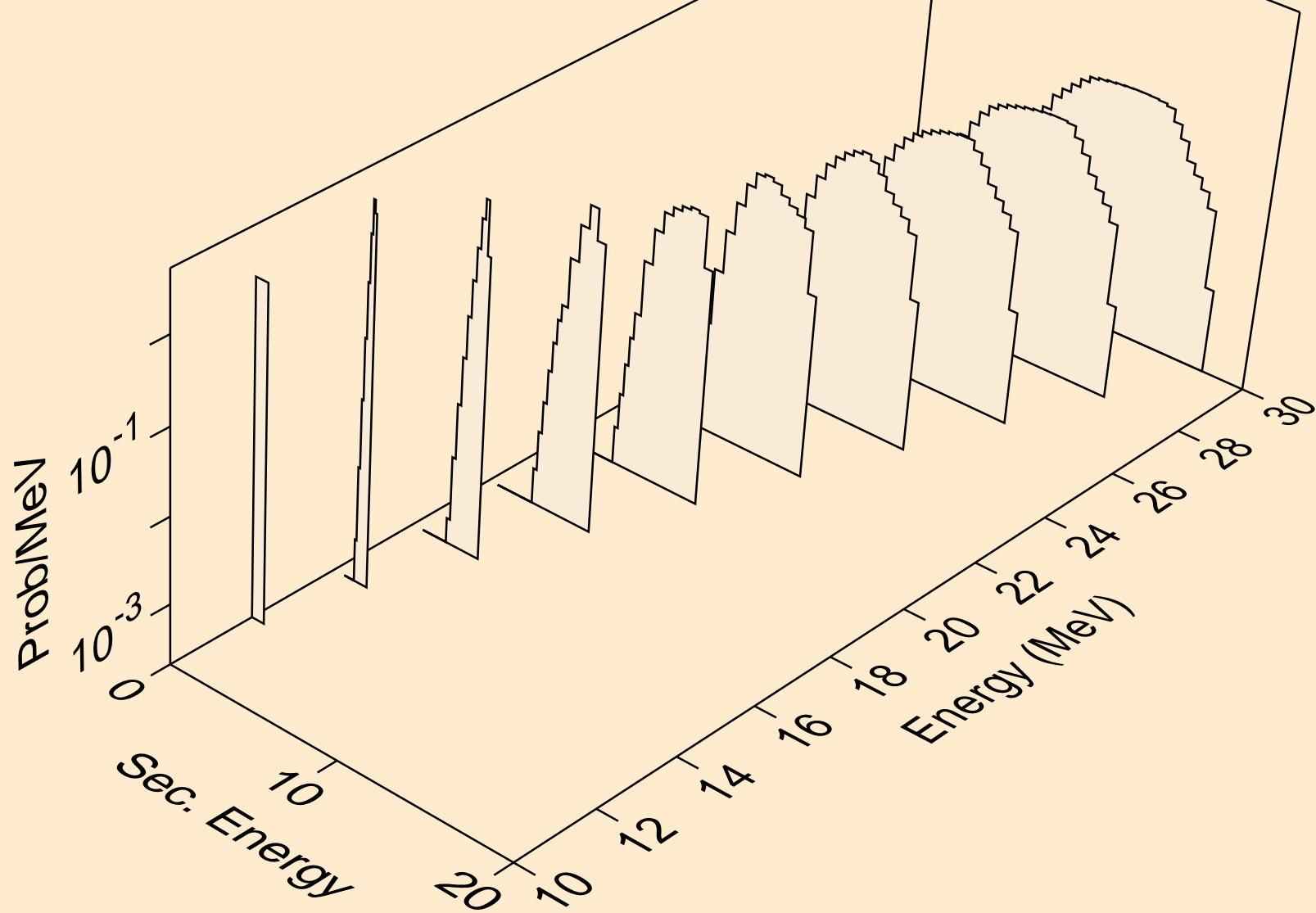

NB099 NEUTRON ACER TENDL-2023 LIBRARY; T=0.K  
tritons from (n,t)

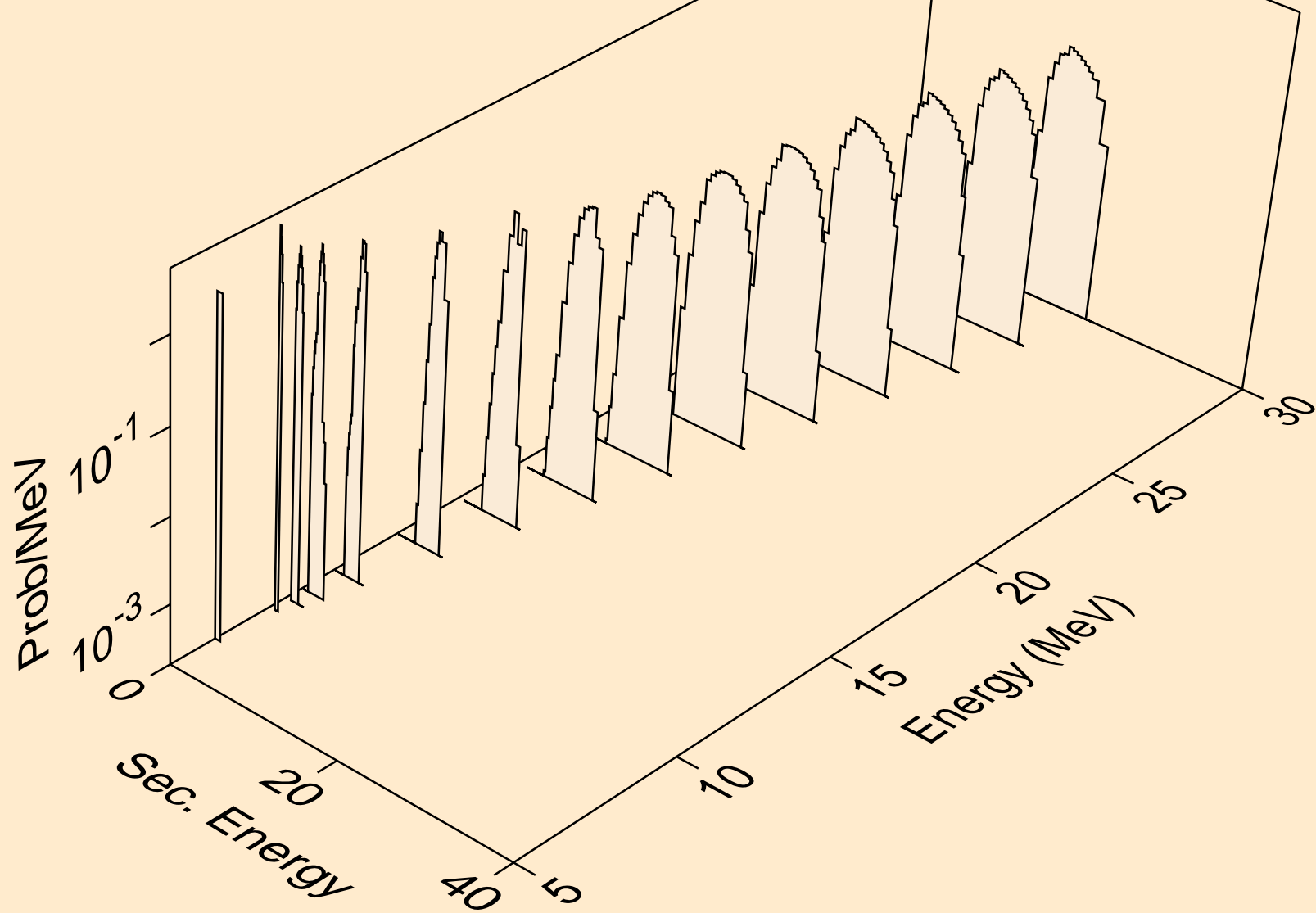



NB099 NEUTRON ACER TENDL-2023 LIBRARY; T=0.K  
he3s from (n,x)

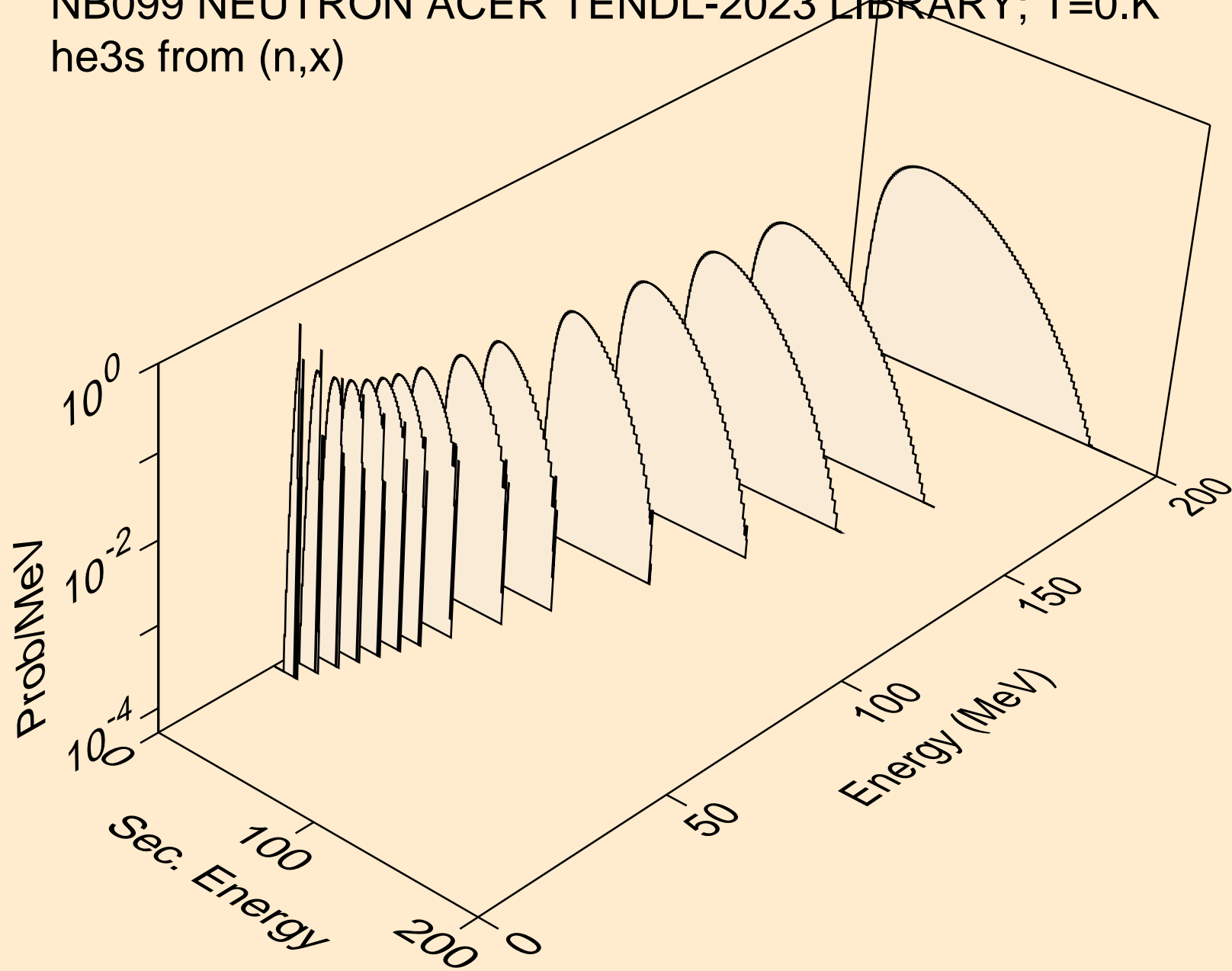

NB099 NEUTRON ACER TENDL-2023 LIBRARY; T=0.K  
he3s from (n,n\*)he3

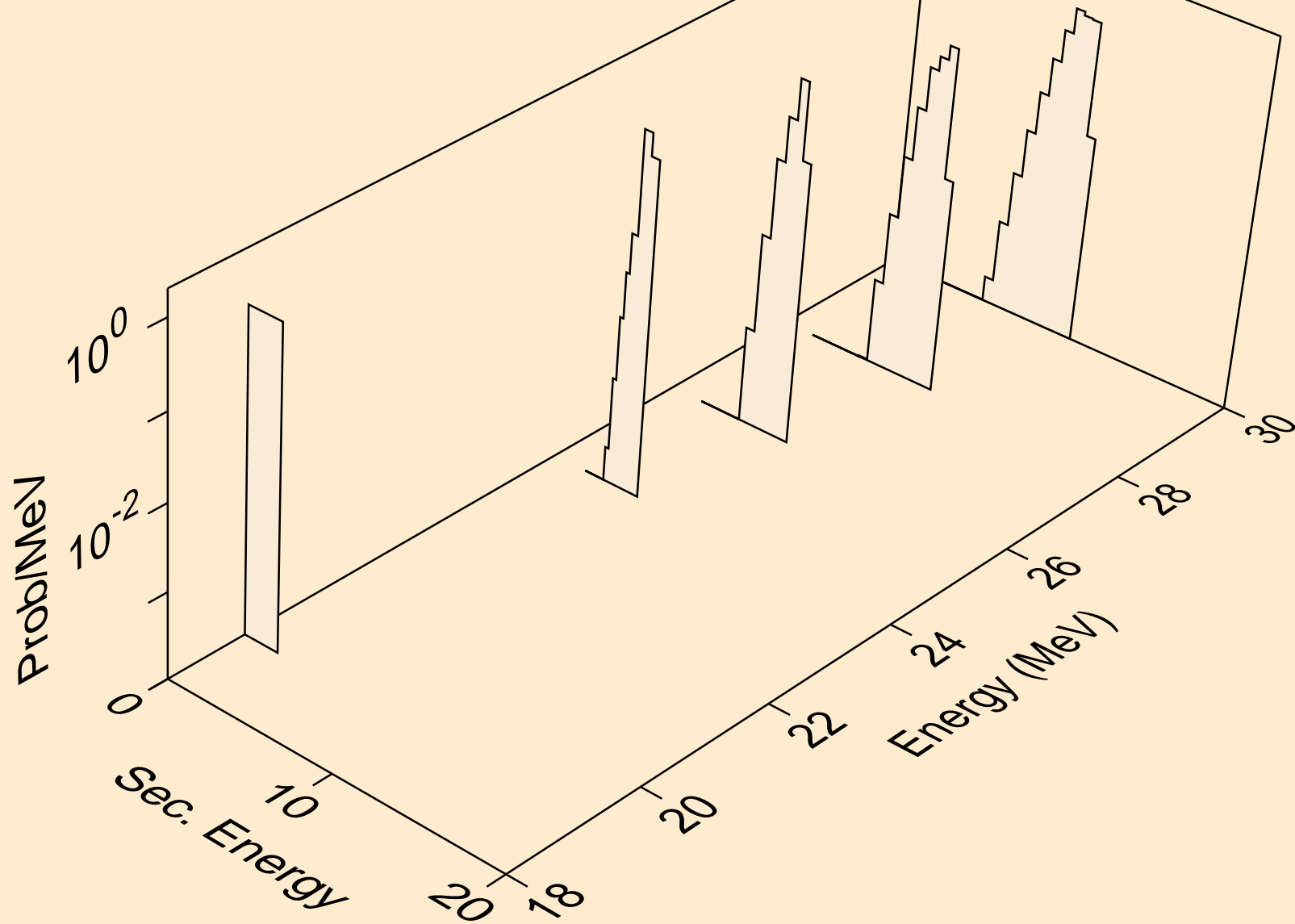

NB099 NEUTRON ACER TENDL-2023 LIBRARY; T=0.K  
he3s from (n,he3)

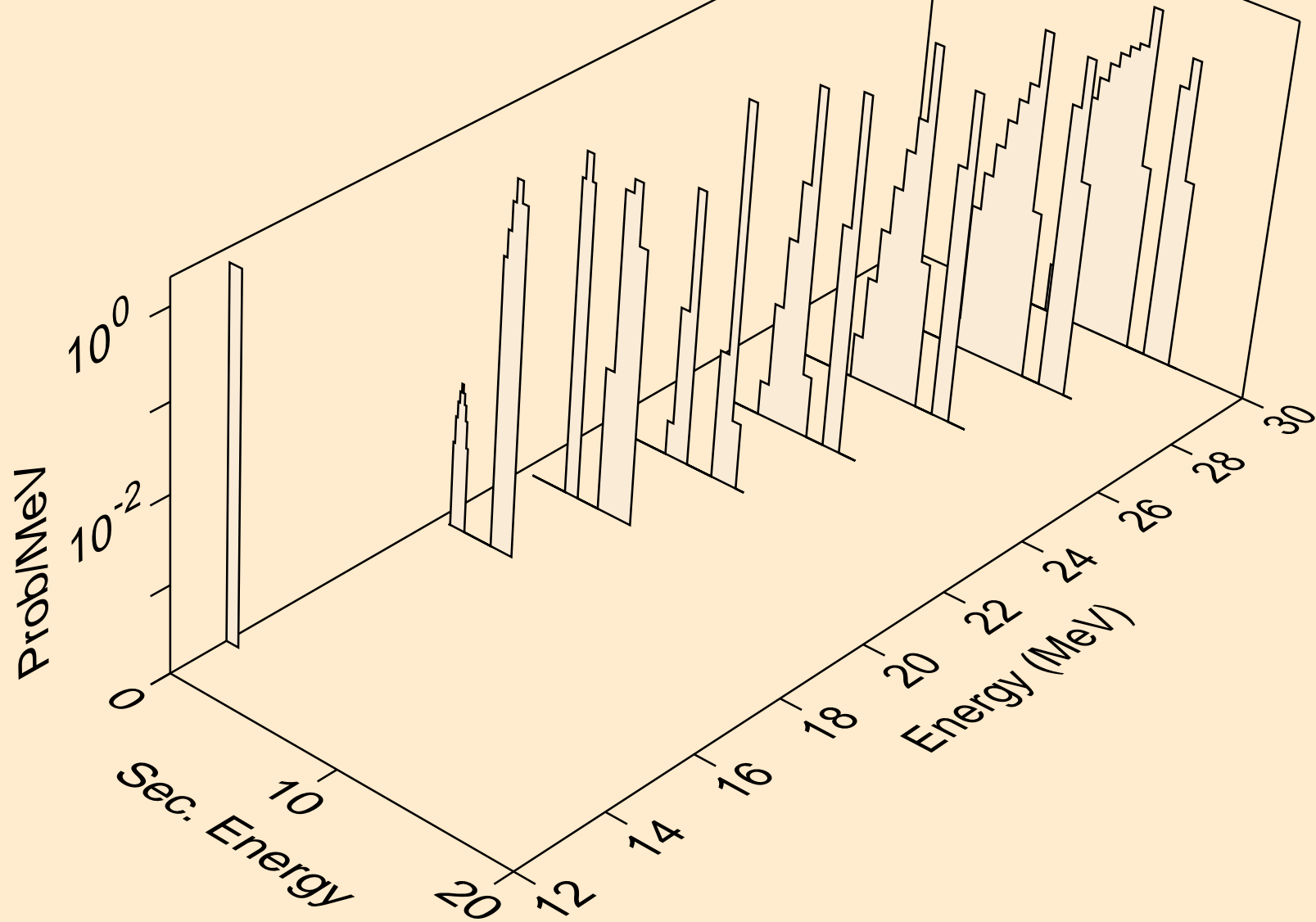

NB099 NEUTRON ACER TENDL-2023 LIBRARY; T=0.K  
alphas from (n,x)

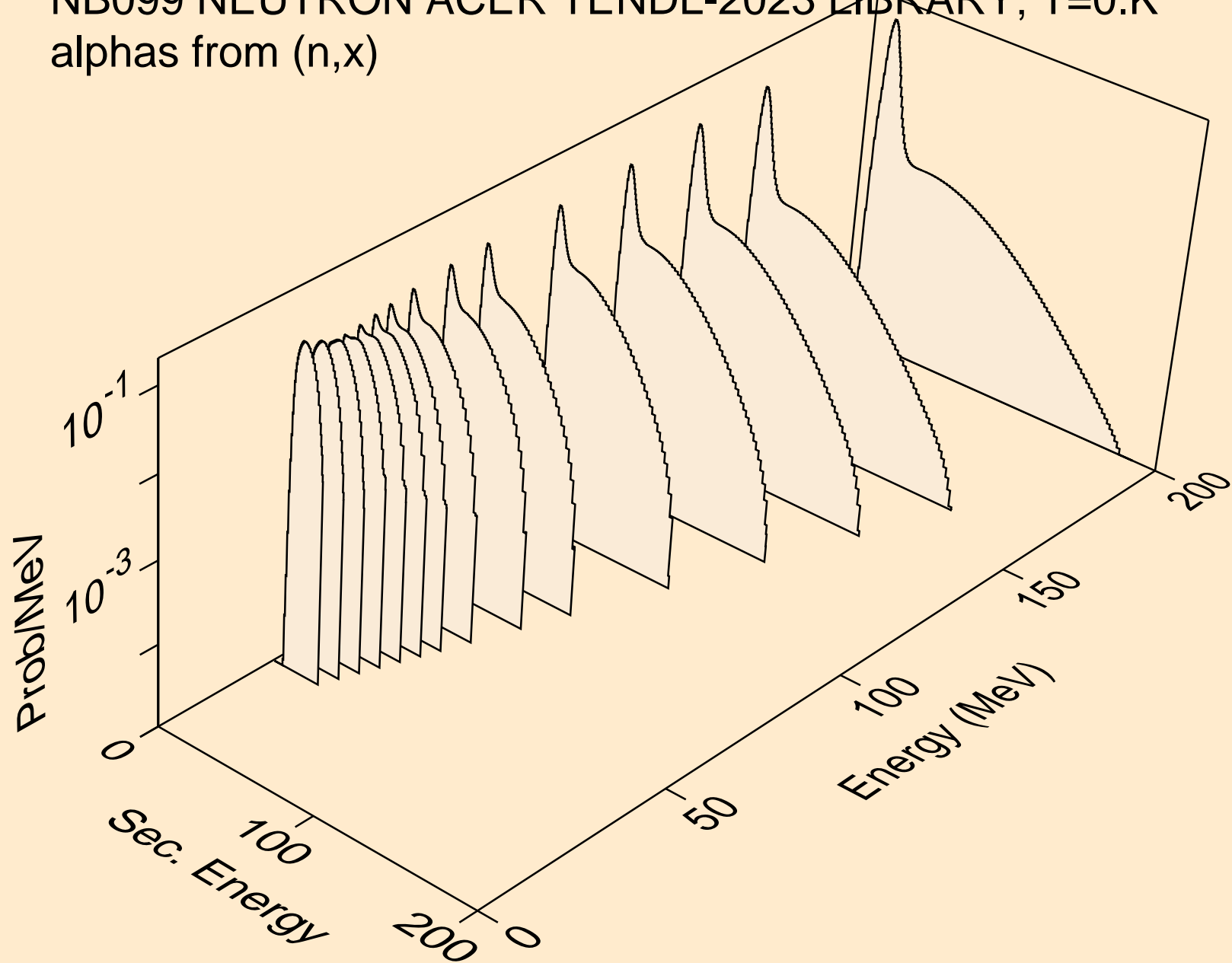

NB099 NEUTRON ACER TENDL-2023 LIBRARY; T=0.K  
alphas from (n,n\*)a

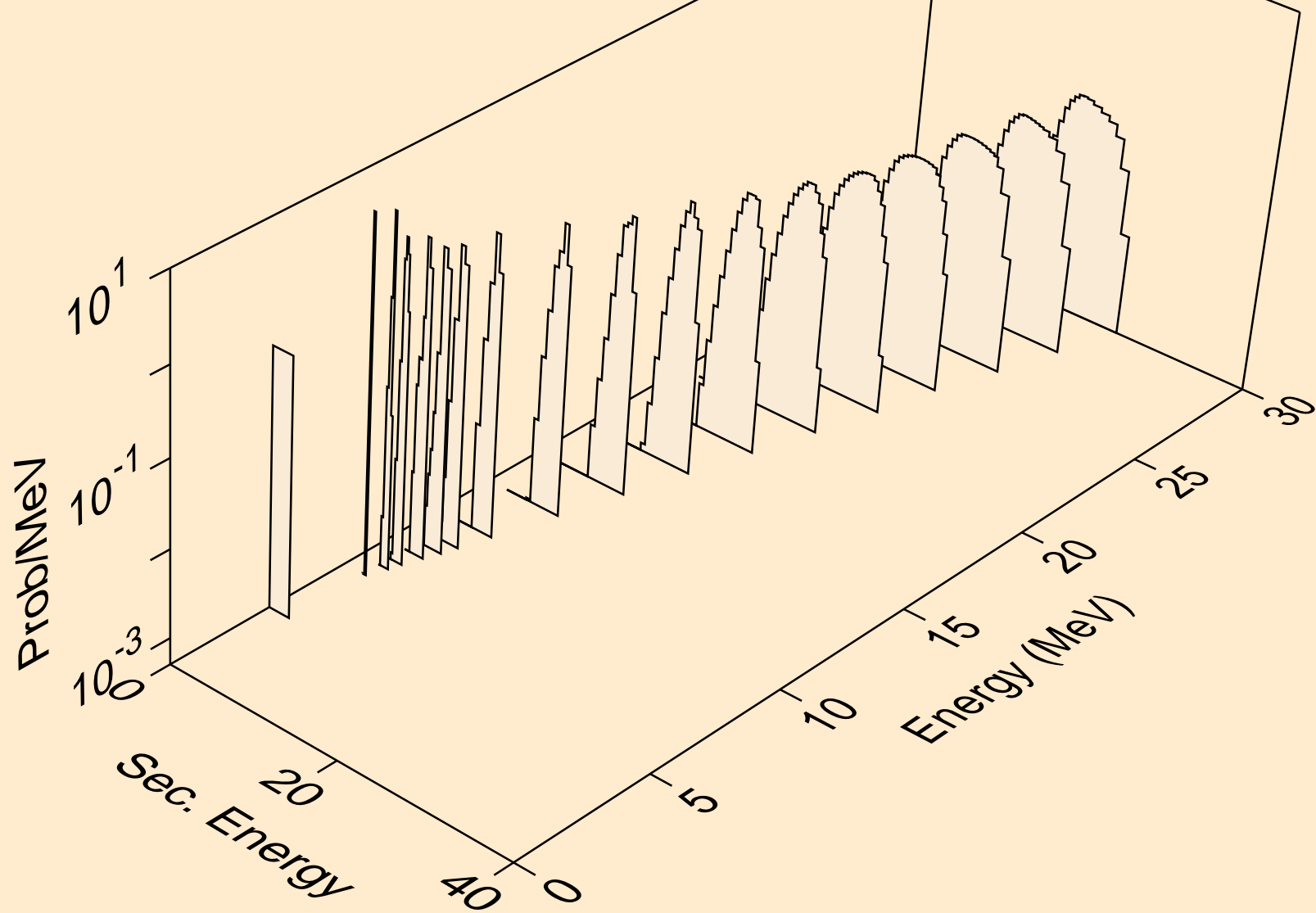

NB099 NEUTRON ACER TENDL-2023 LIBRARY; T=0.K  
alphas from (n,2n)a

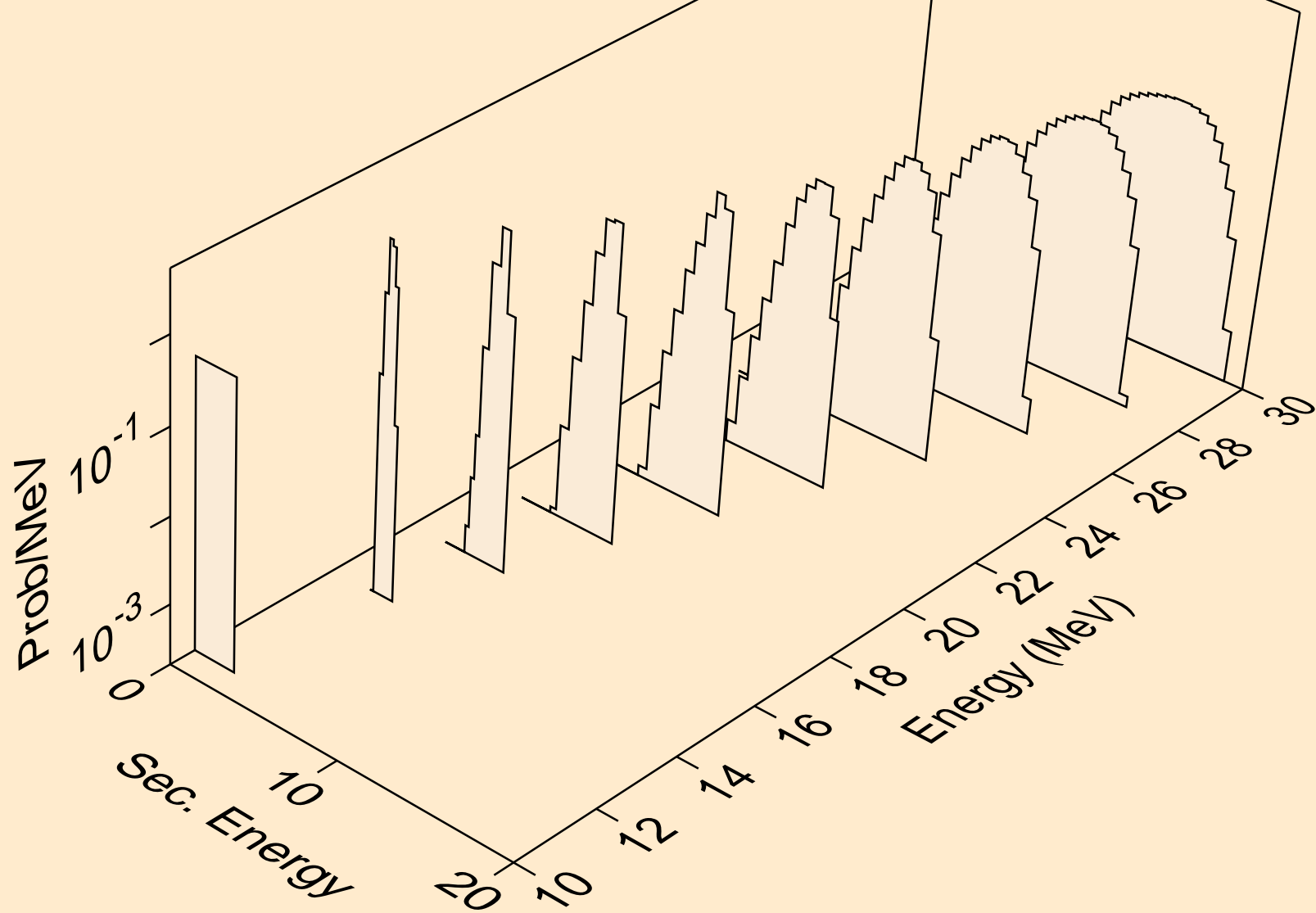

NB099 NEUTRON ACER TENDL-2023 LIBRARY; T=0.K  
alphas from (n,3n)a

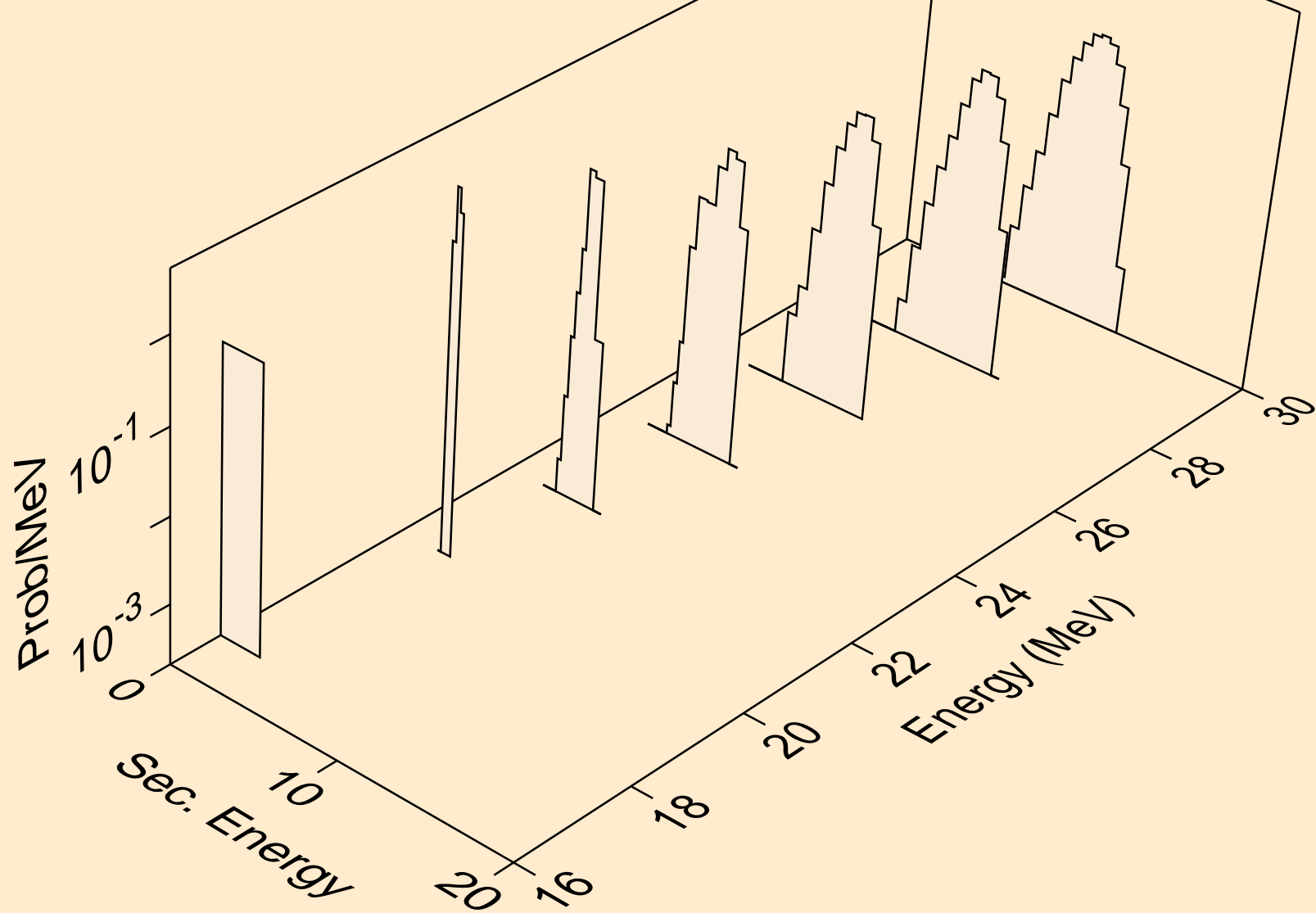

NB099 NEUTRON ACER TENDL-2023 LIBRARY; T=0.K  
alphas from (n,n\*)2a

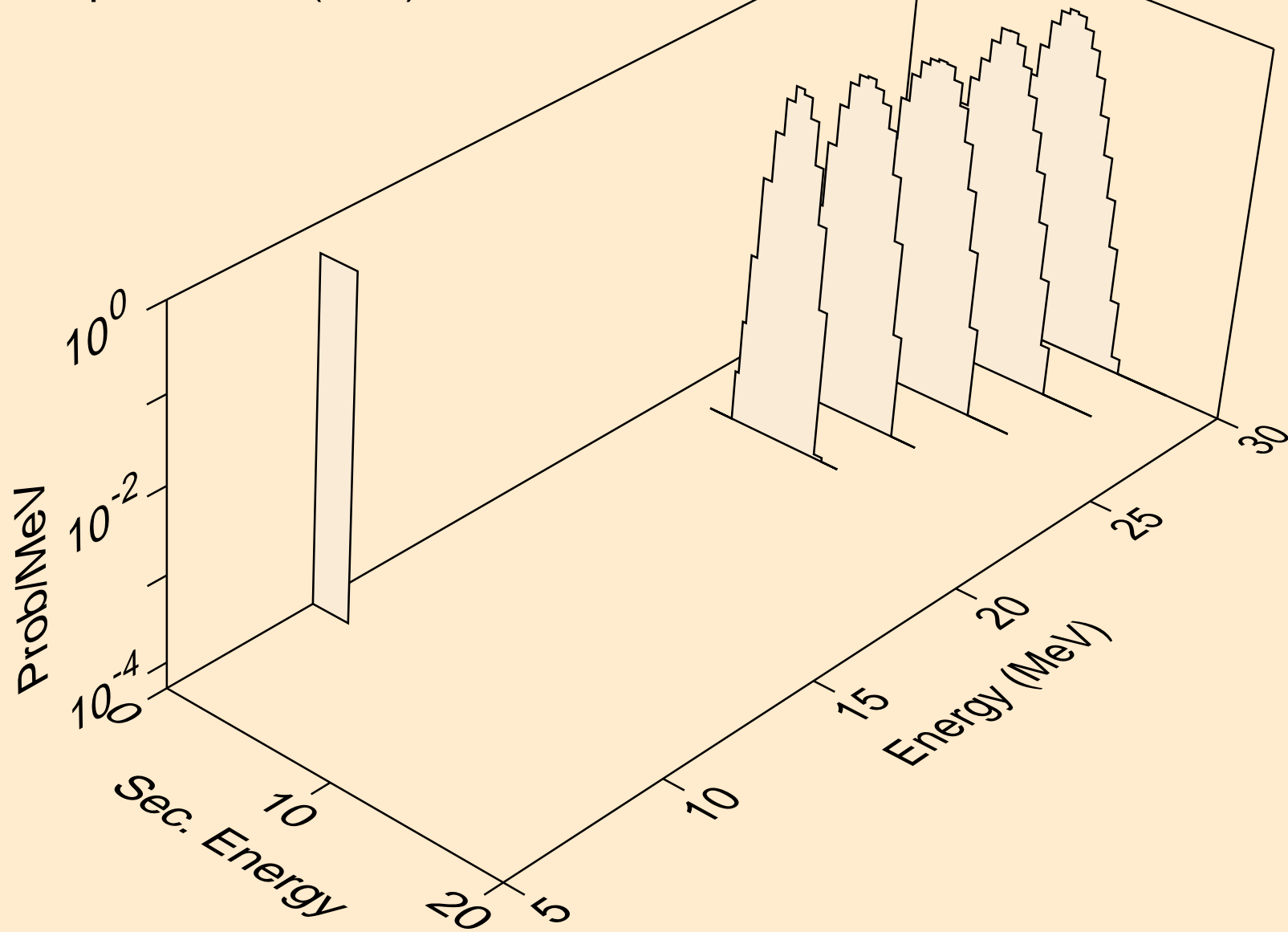



NB099 NEUTRON ACER TENDL-2023 LIBRARY; T=0.K  
alphas from (n,npa)

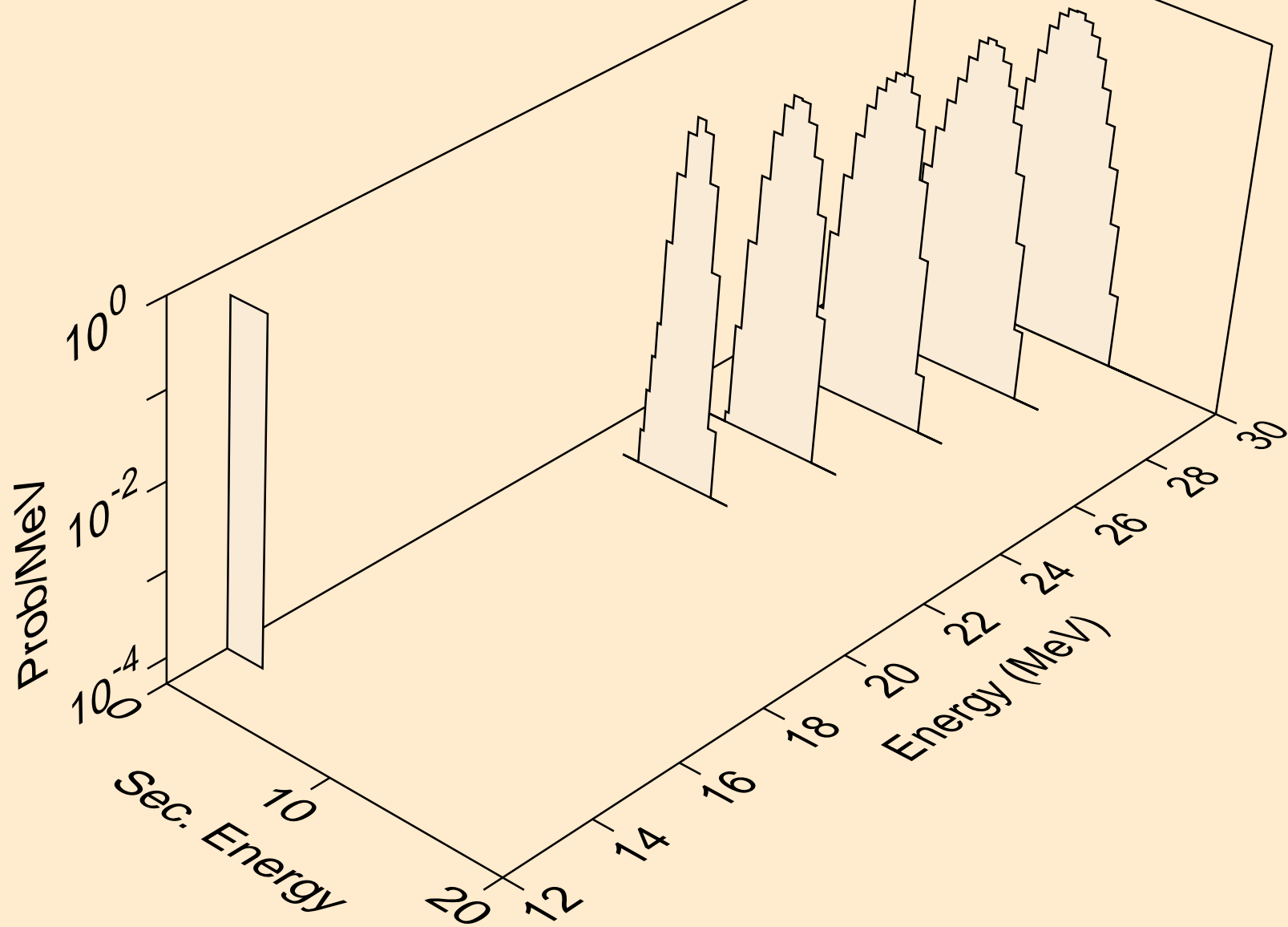

NB099 NEUTRON ACER TENDL-2023 LIBRARY; T=0.K  
alphas from (n,a)

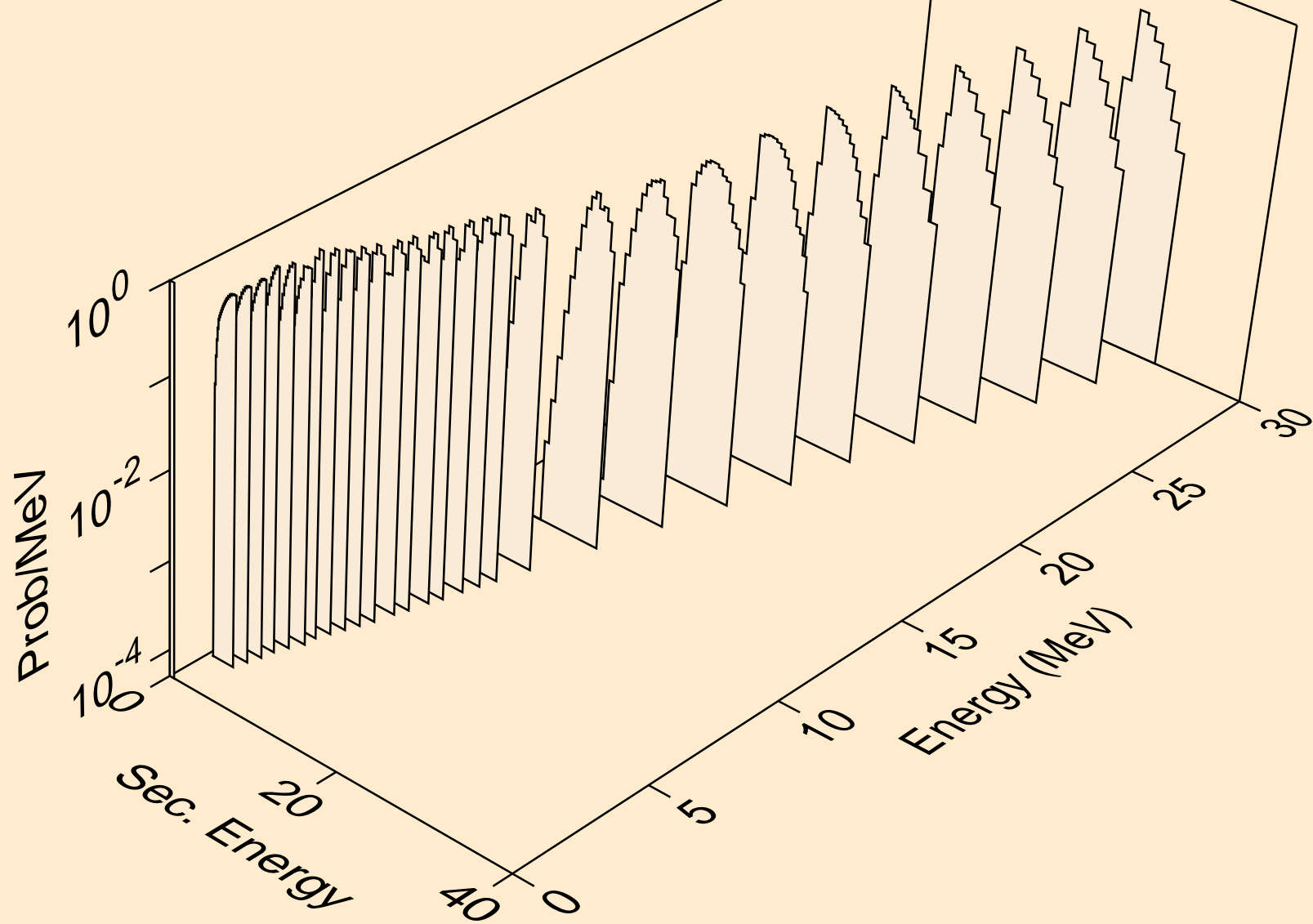

NB099 NEUTRON ACER TENDL-2023 LIBRARY; T=0.K  
alphas from (n,2a)

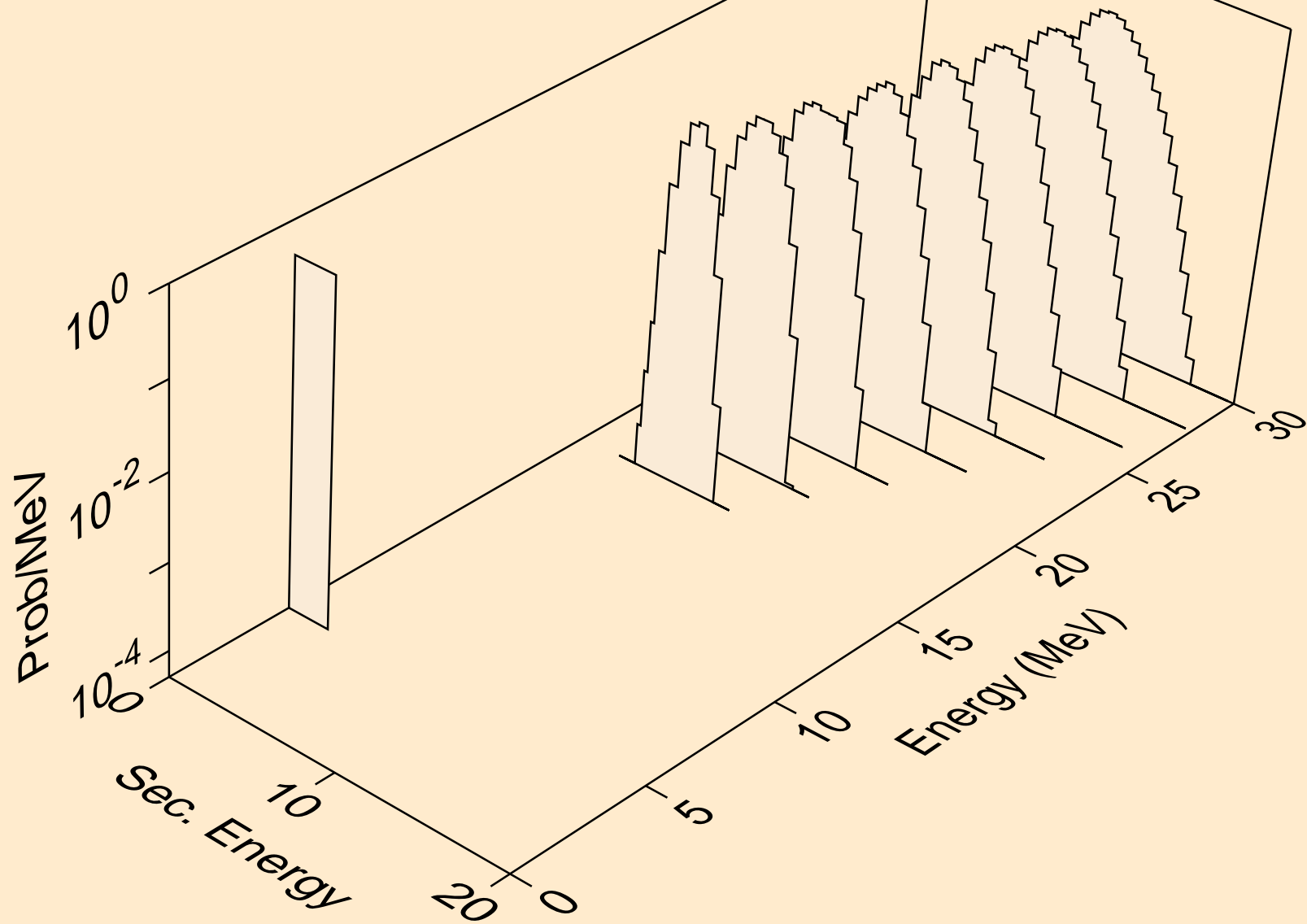

NB099 NEUTRON ACER TENDL-2023 LIBRARY; T=0.K  
alphas from (n,pa)

