

NB099M NEUTRON ACER TENDL-2023 LIBRARY; T=0.K

Principal cross sections

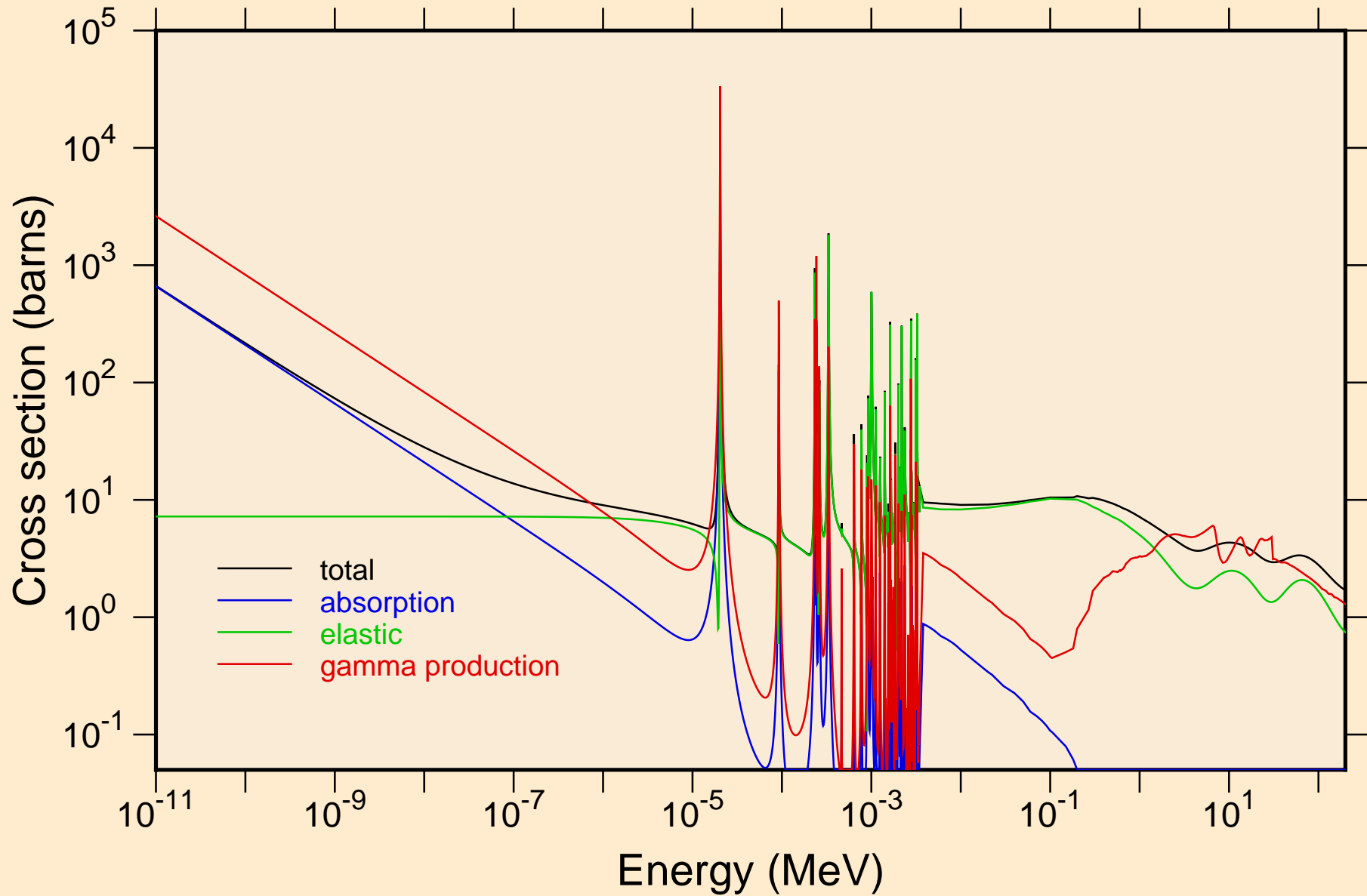

NB099M NEUTRON ACER TENDL-2023 LIBRARY; T=0.K
resonance total cross section

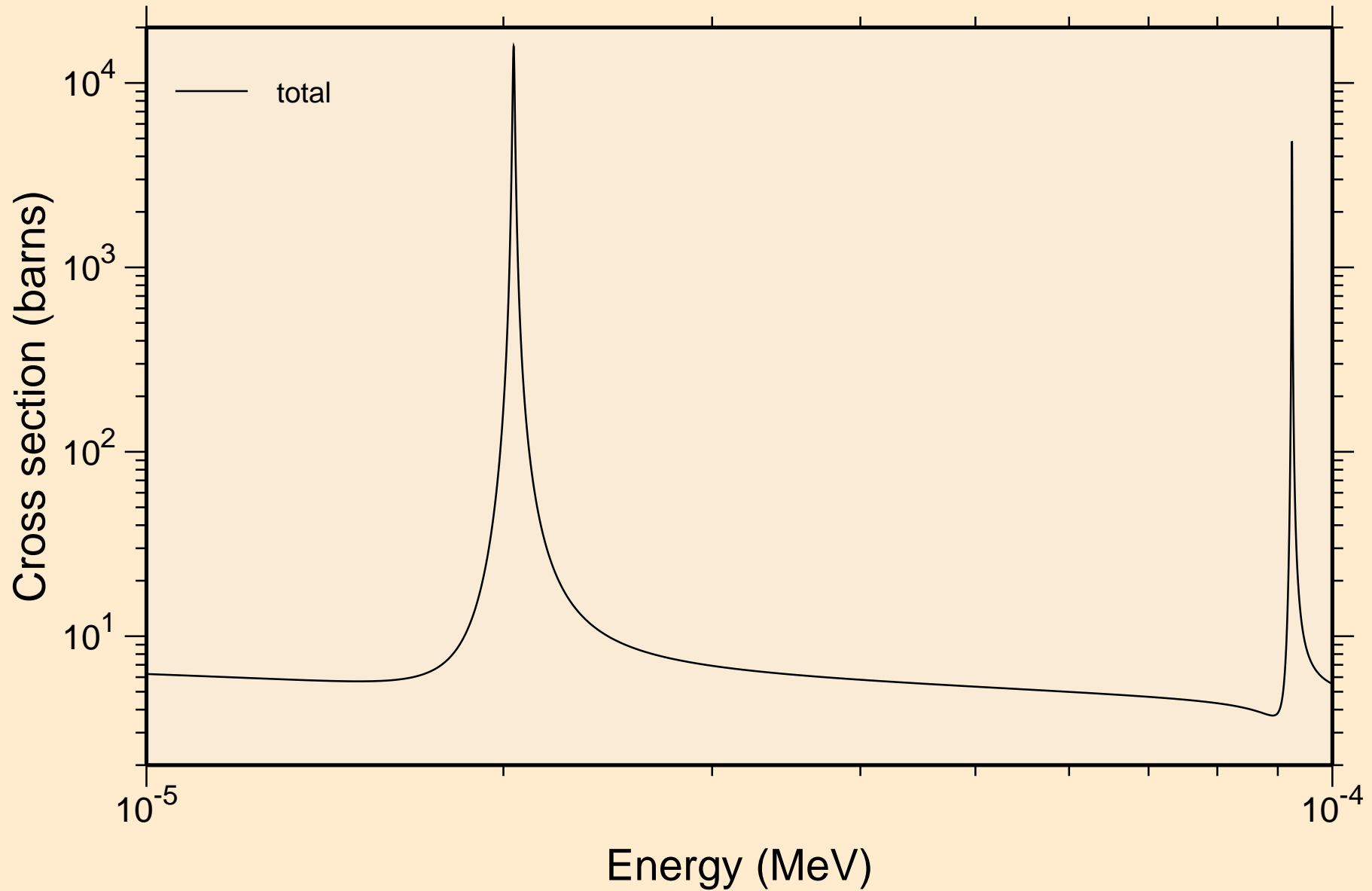

NB099M NEUTRON ACER TENDL-2023 LIBRARY; T=0.K
resonance total cross section

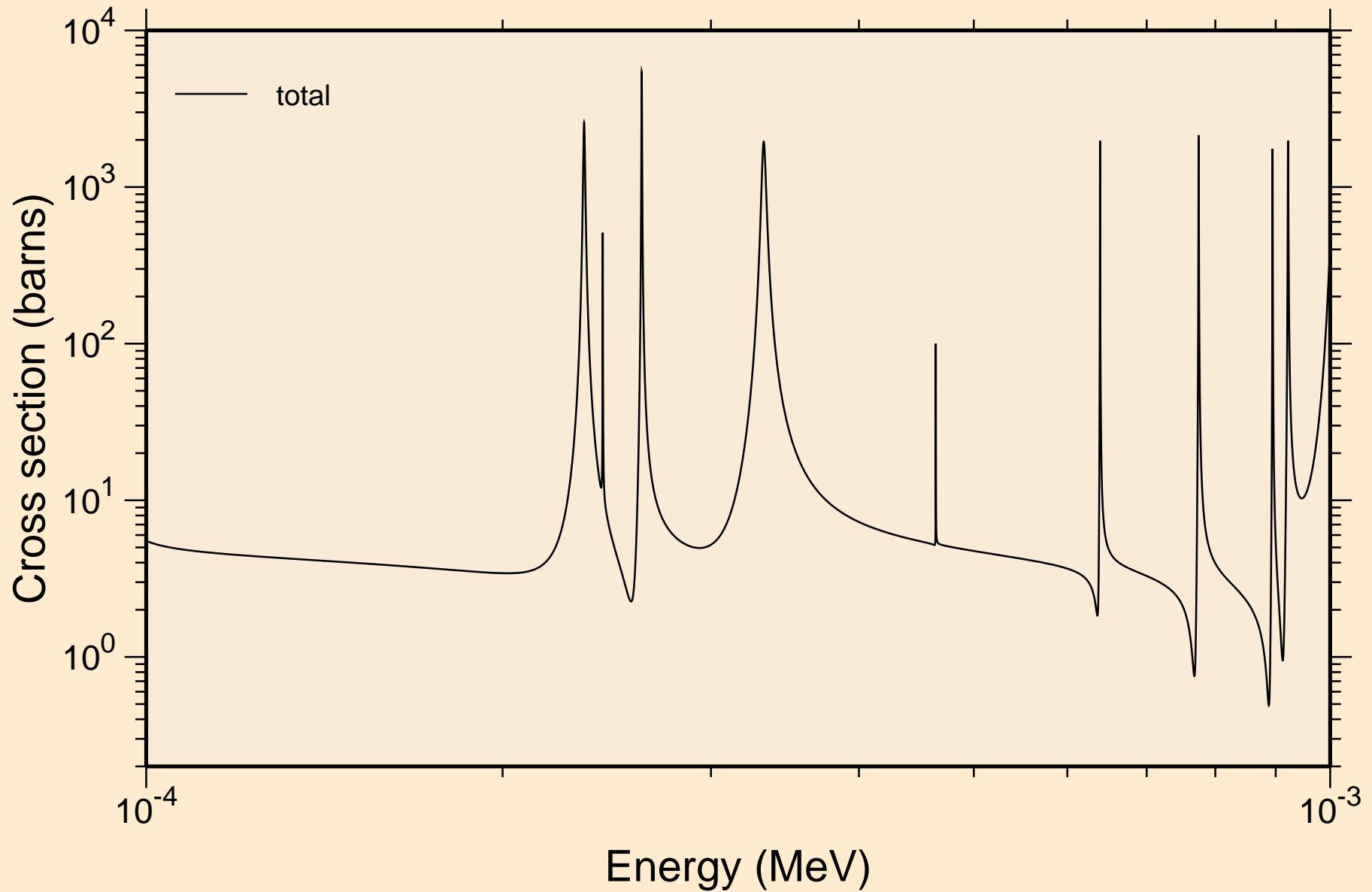

NB099M NEUTRON ACER TENDL-2023 LIBRARY; T=0.K
resonance total cross section

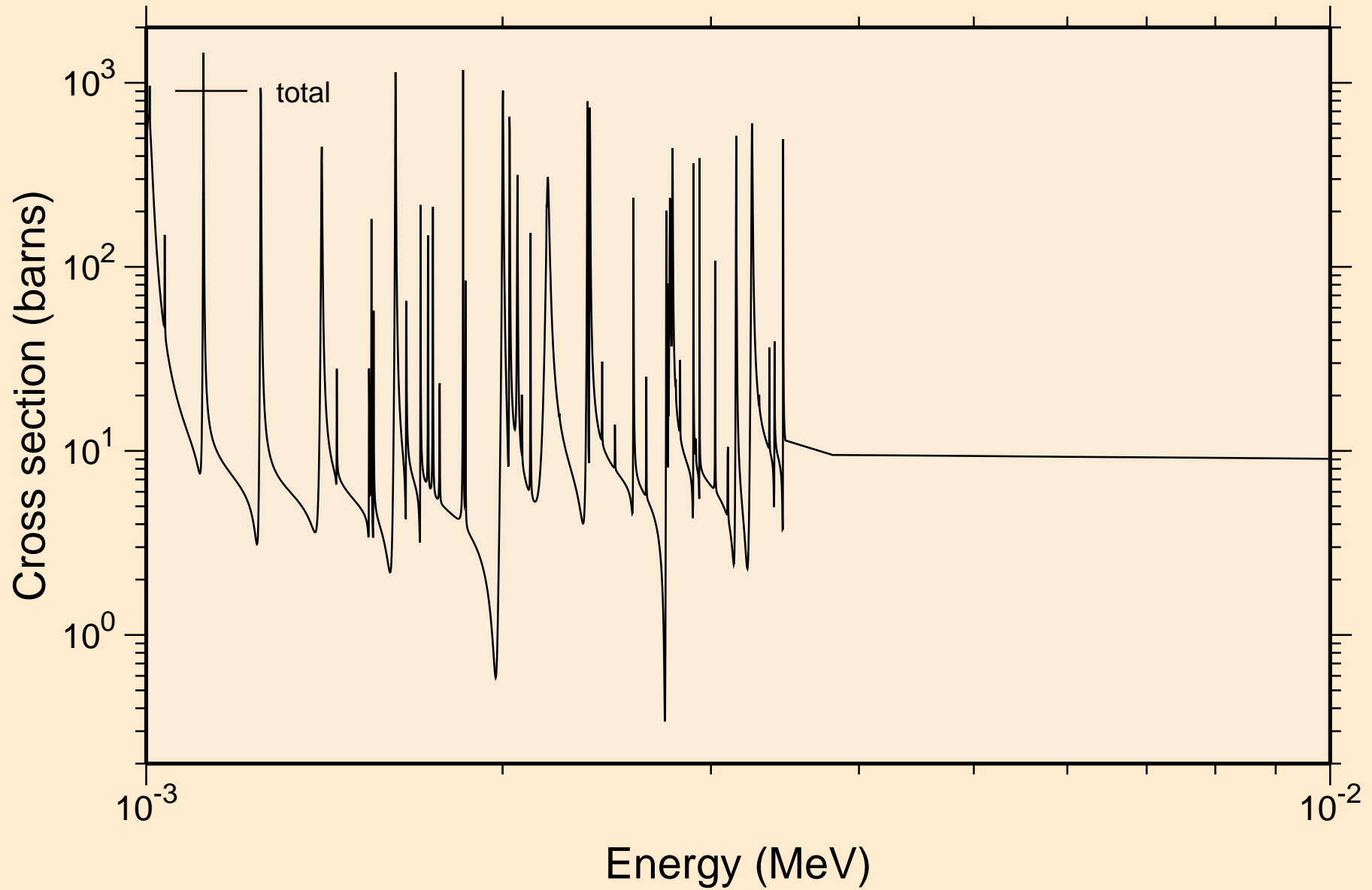

NB099M NEUTRON ACER TENDL-2023 LIBRARY; T=0.K
resonance total cross section

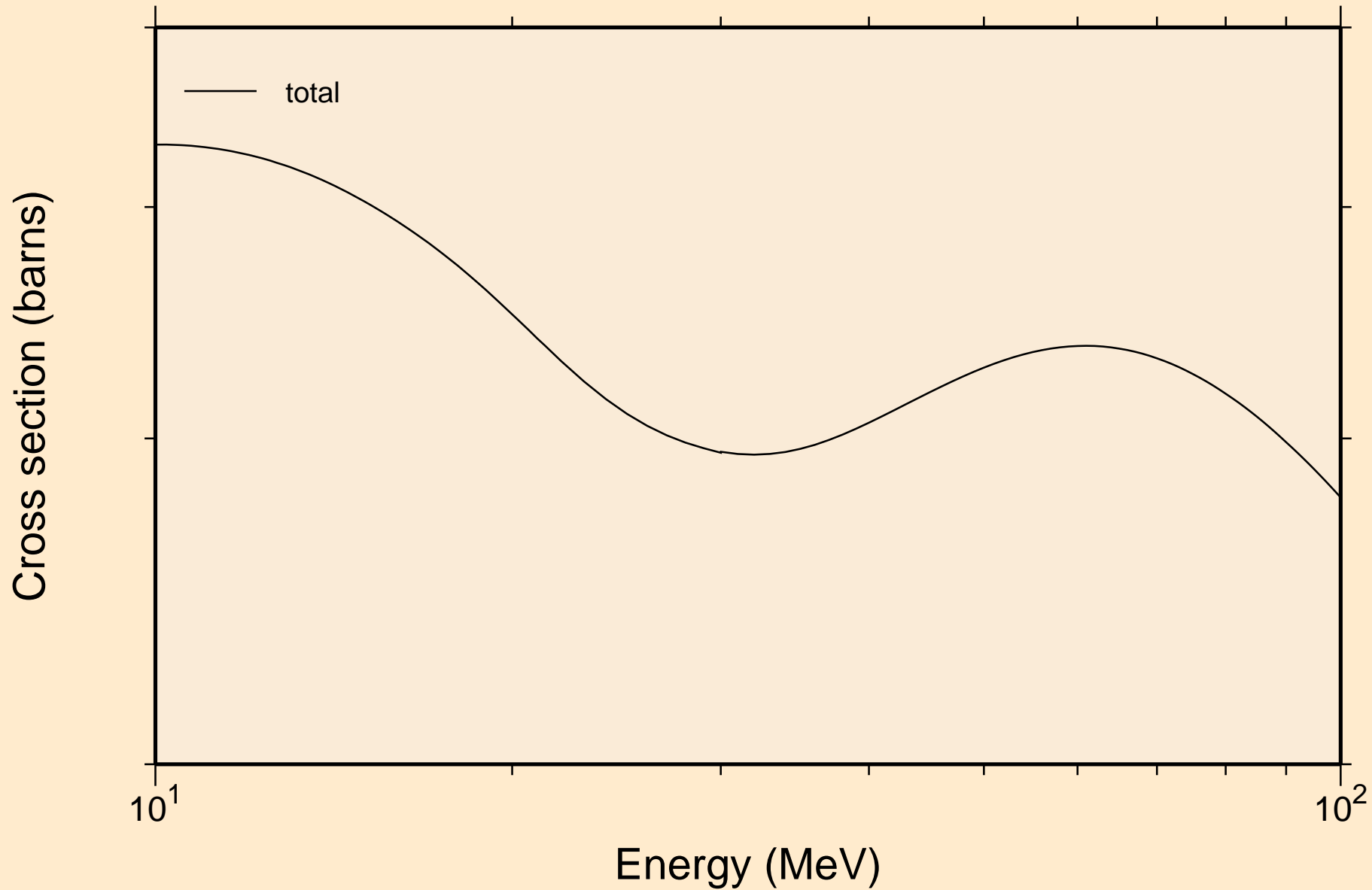

NB099M NEUTRON ACER TENDL-2023 LIBRARY; T=0.K
resonance absorption cross sections

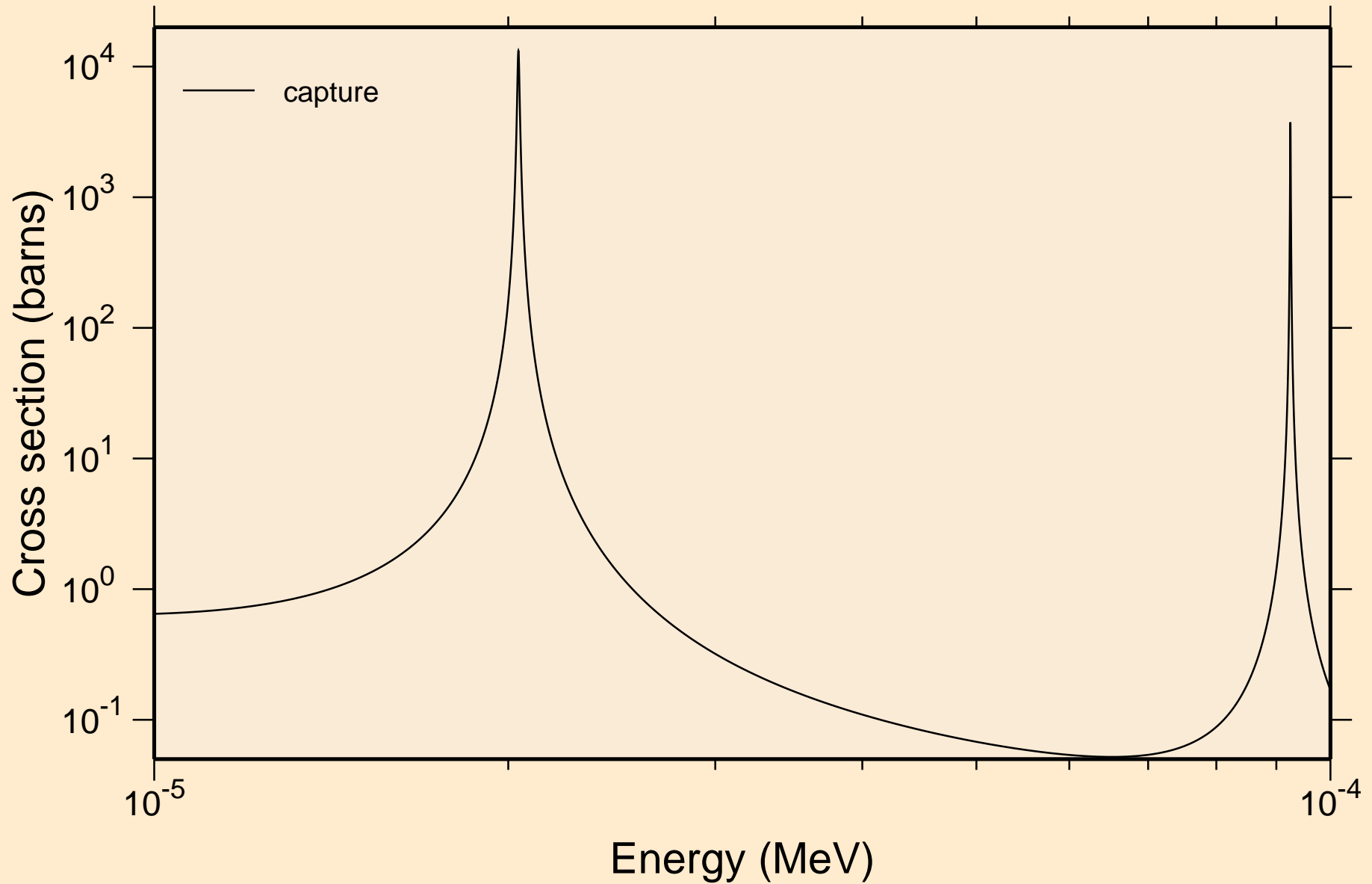

NB099M NEUTRON ACER TENDL-2023 LIBRARY; T=0.K
resonance absorption cross sections

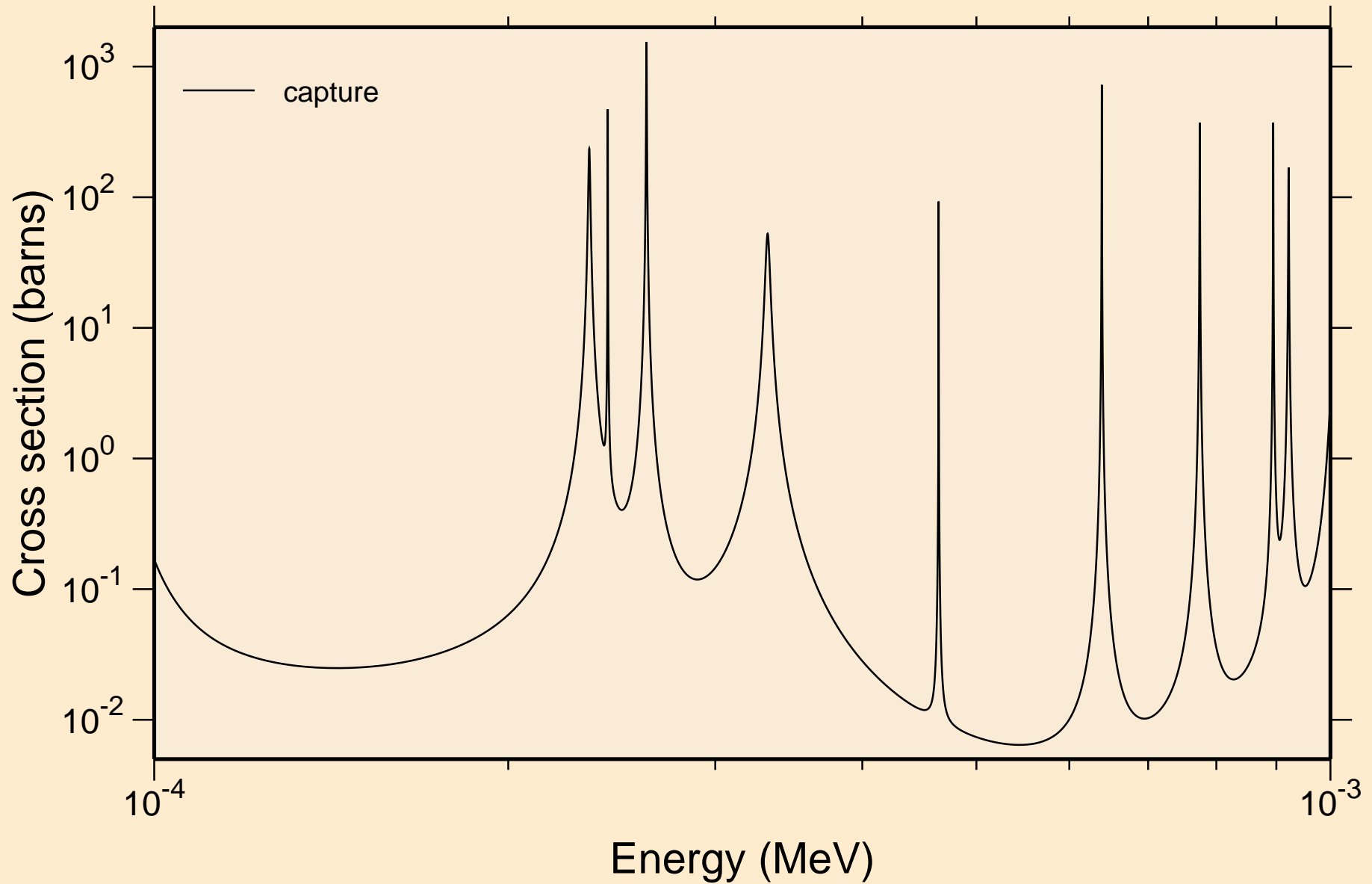

NB099M NEUTRON ACER TENDL-2023 LIBRARY; T=0.K
resonance absorption cross sections

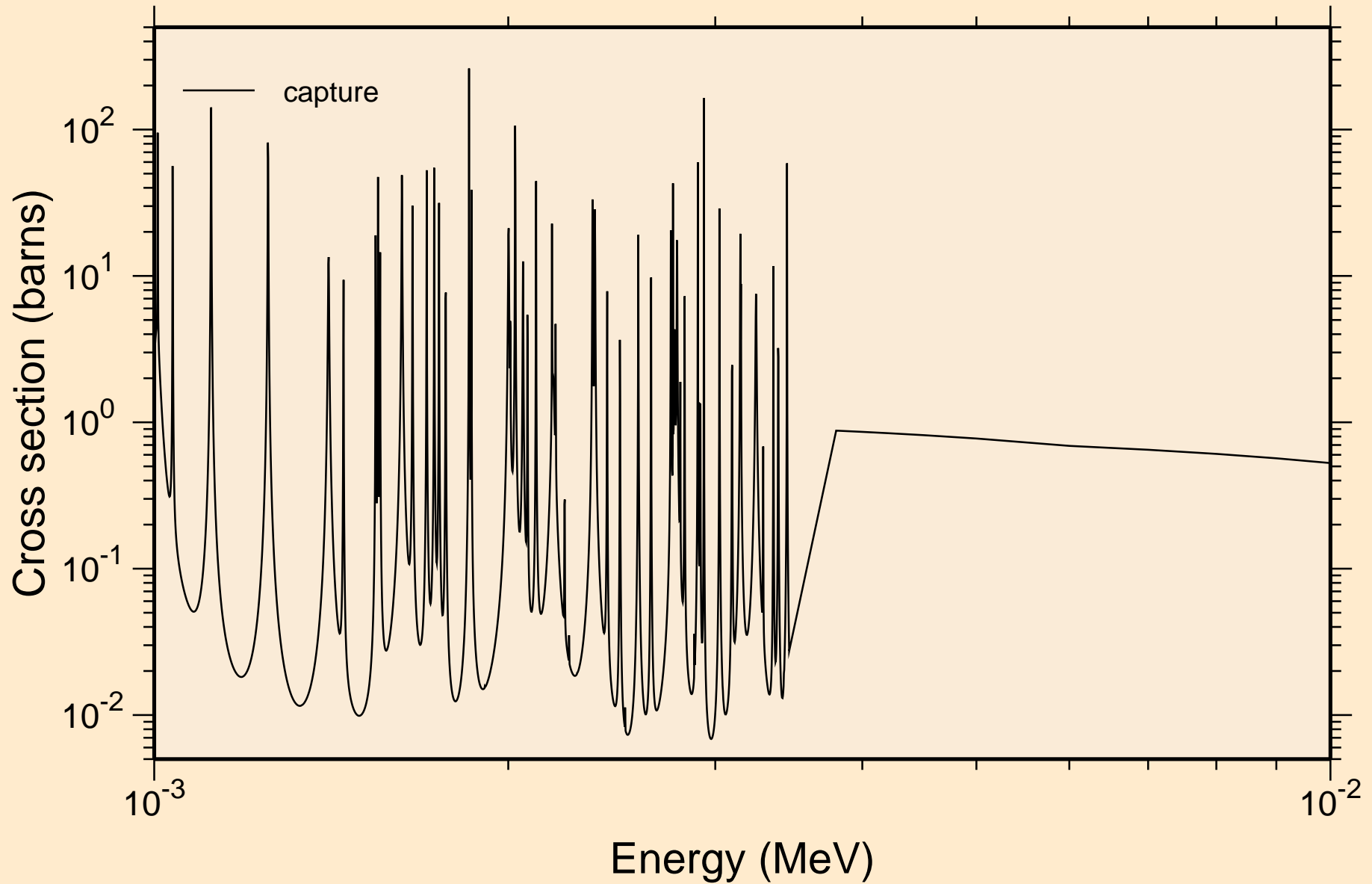

NB099M NEUTRON ACER TENDL-2023 LIBRARY; T=0.K
resonance absorption cross sections

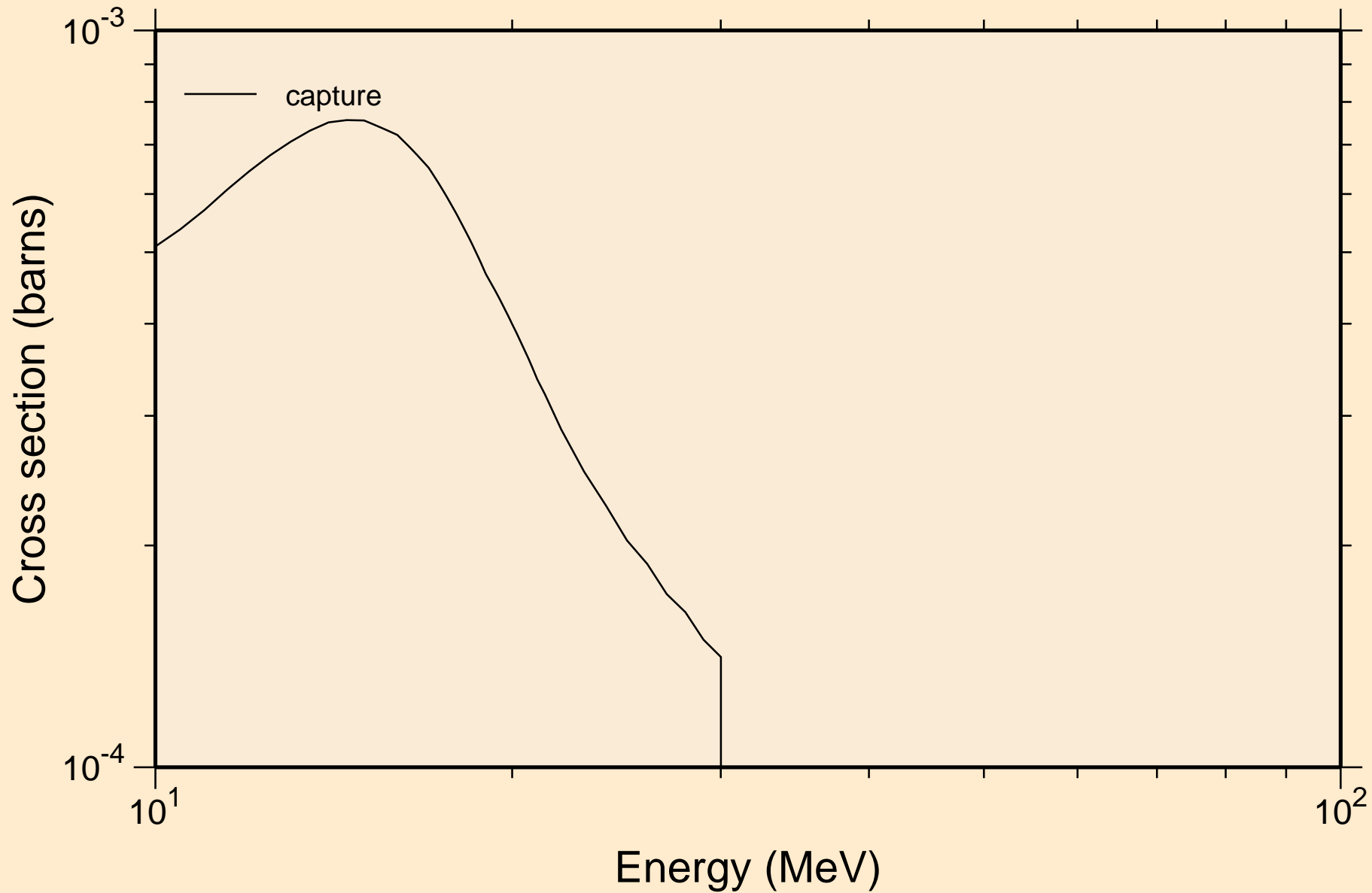

NB099M NEUTRON ACER TENDL-2023 LIBRARY; T=0.K
Heating

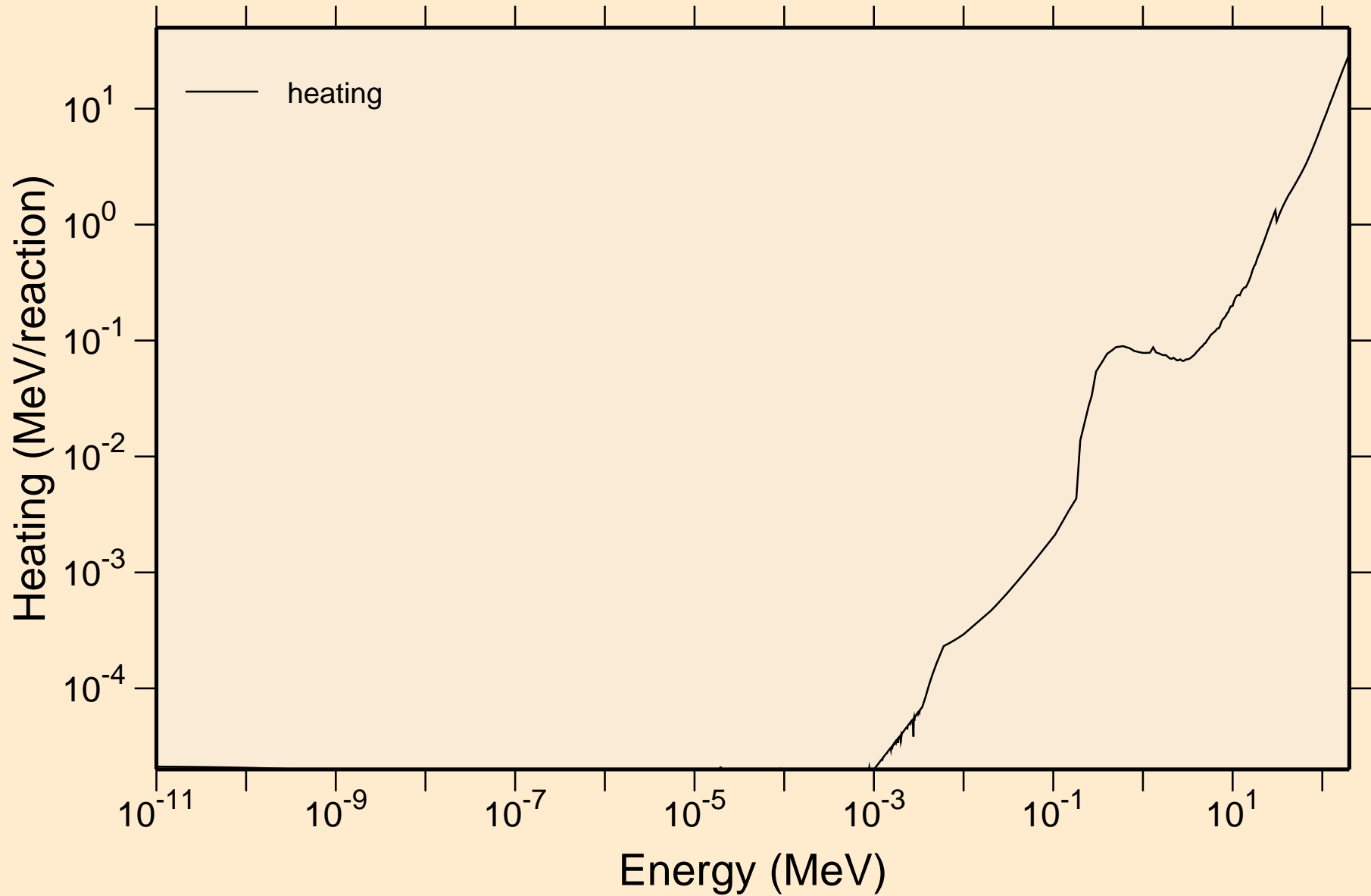

NB099M NEUTRON ACER TENDL-2023 LIBRARY; T=0.K

Damage

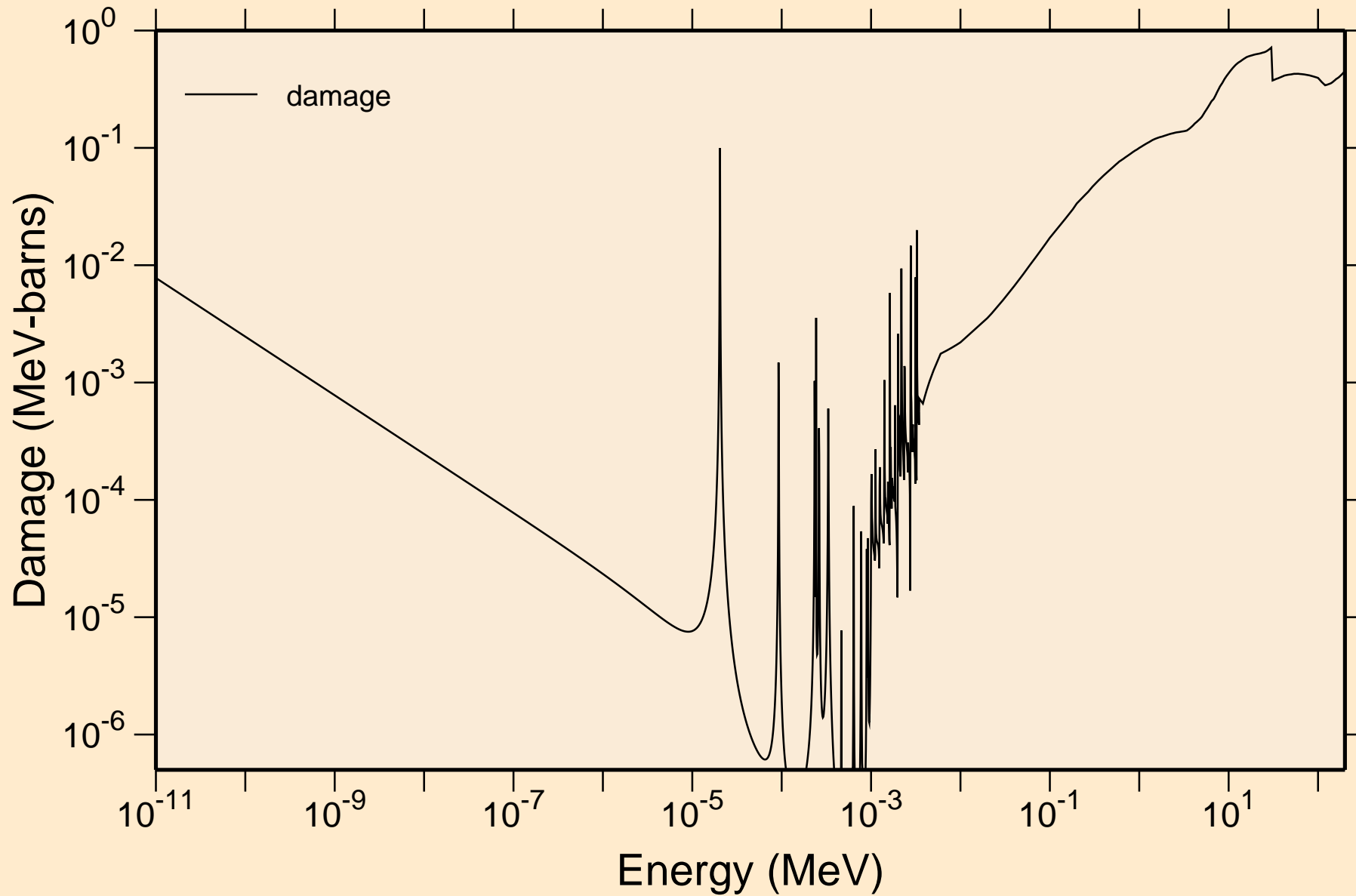

NB099M NEUTRON ACER TENDL-2023 LIBRARY; T=0.K
Non-threshold reactions

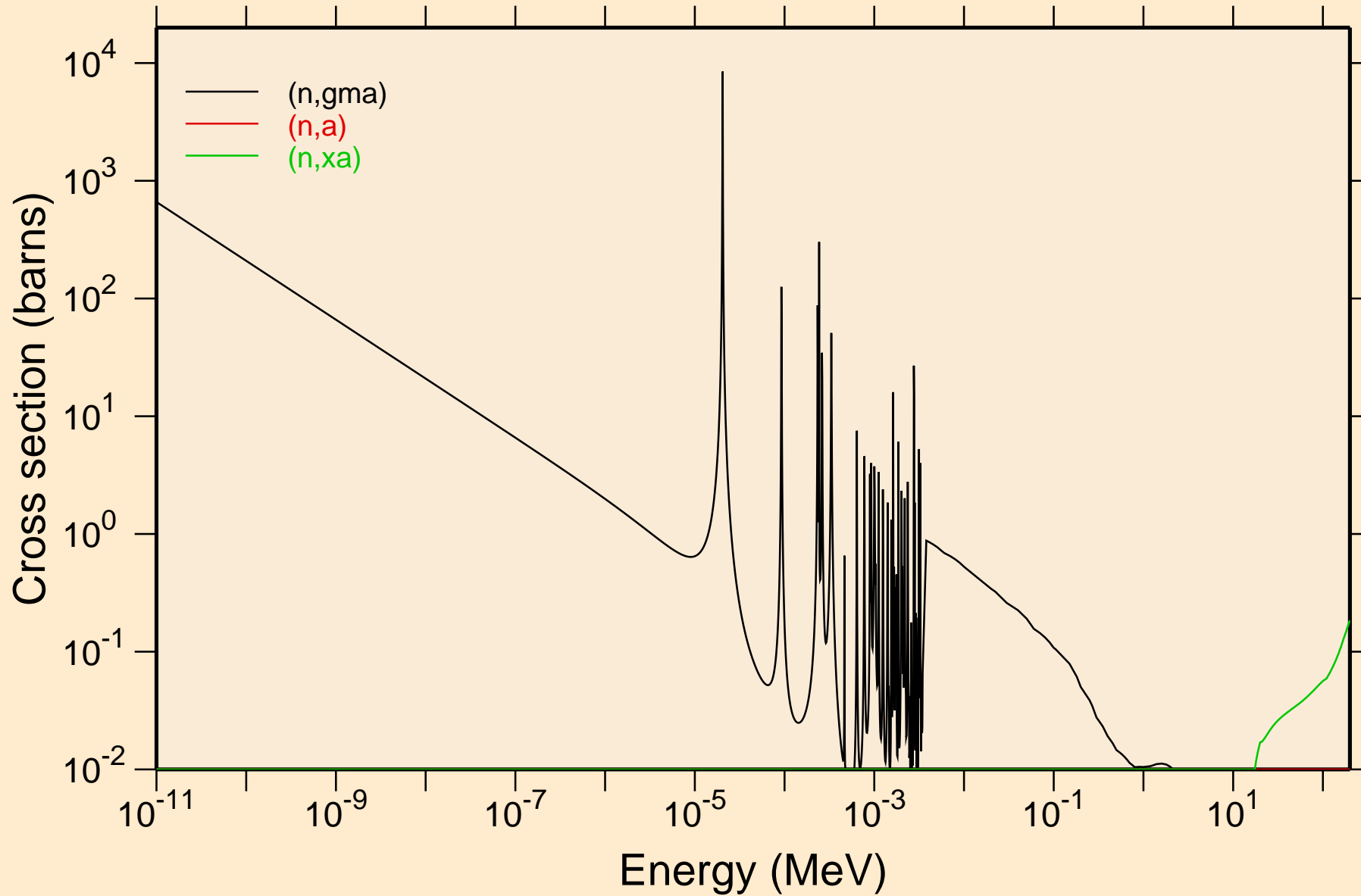

NB099M NEUTRON ACER TENDL-2023 LIBRARY; T=0.K
Principal cross sections

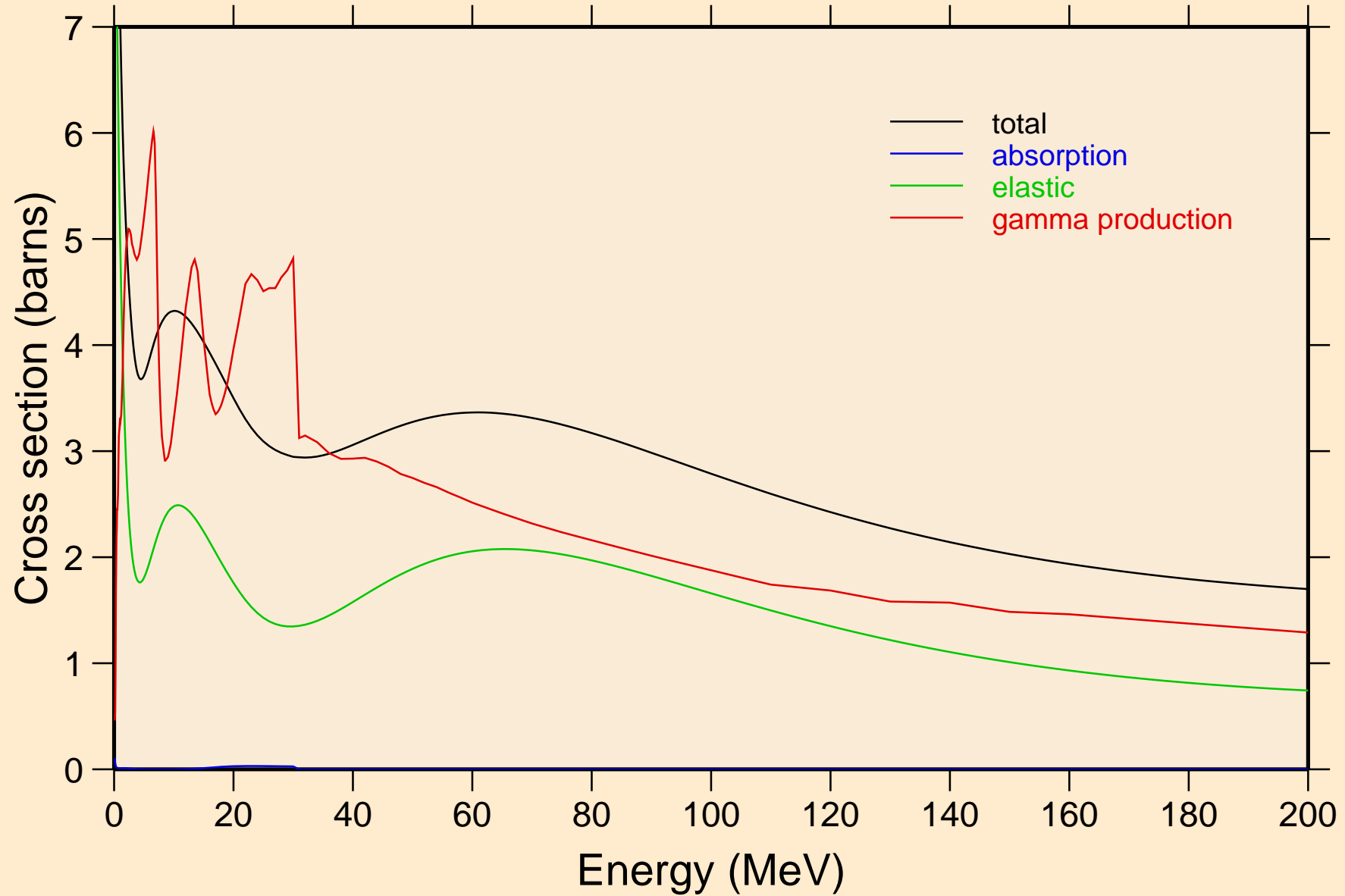

NB099M NEUTRON ACER TENDL-2023 LIBRARY; T=0.K

Heating

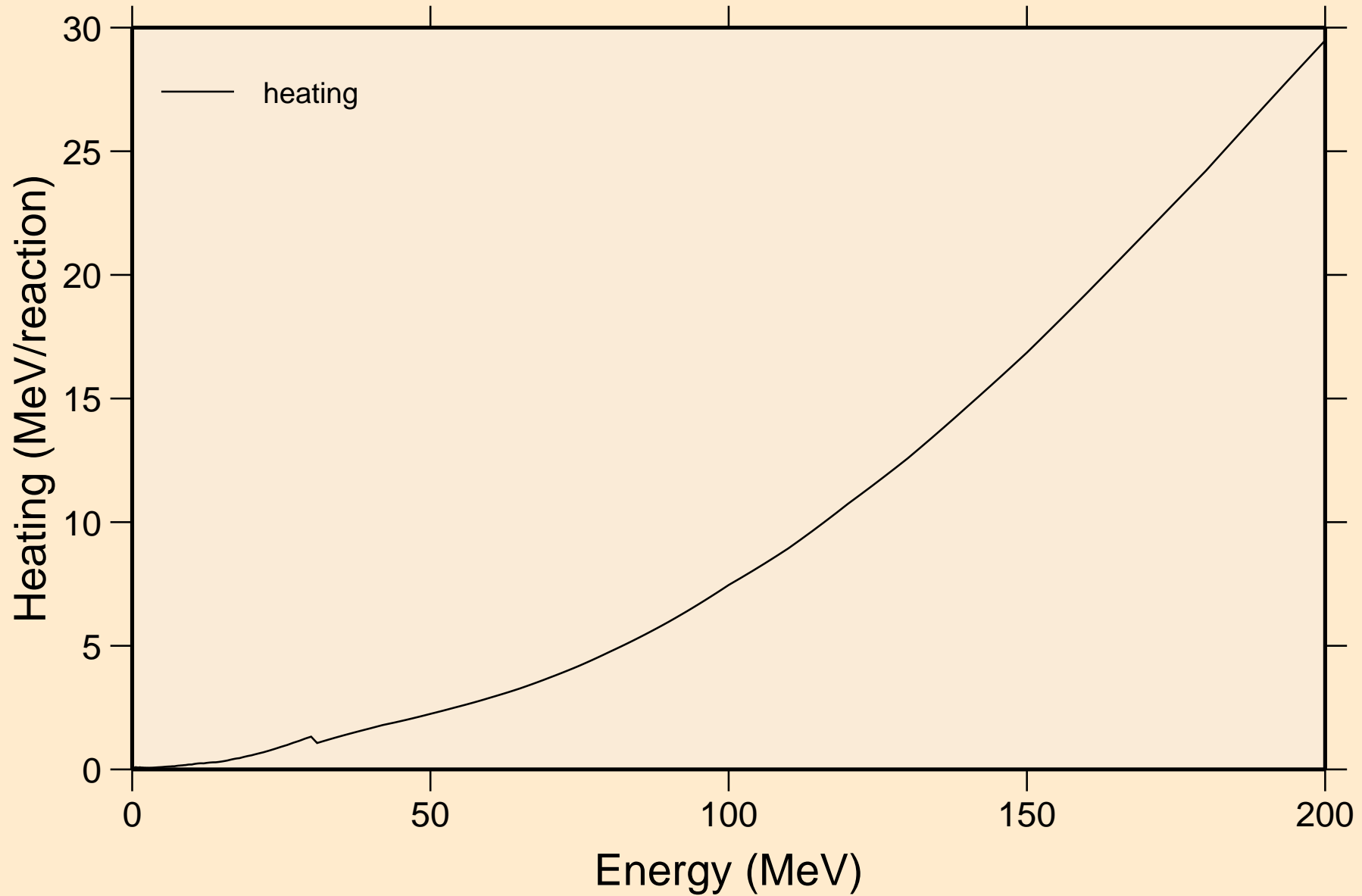

NB099M NEUTRON ACER TENDL-2023 LIBRARY; T=0.K
Damage

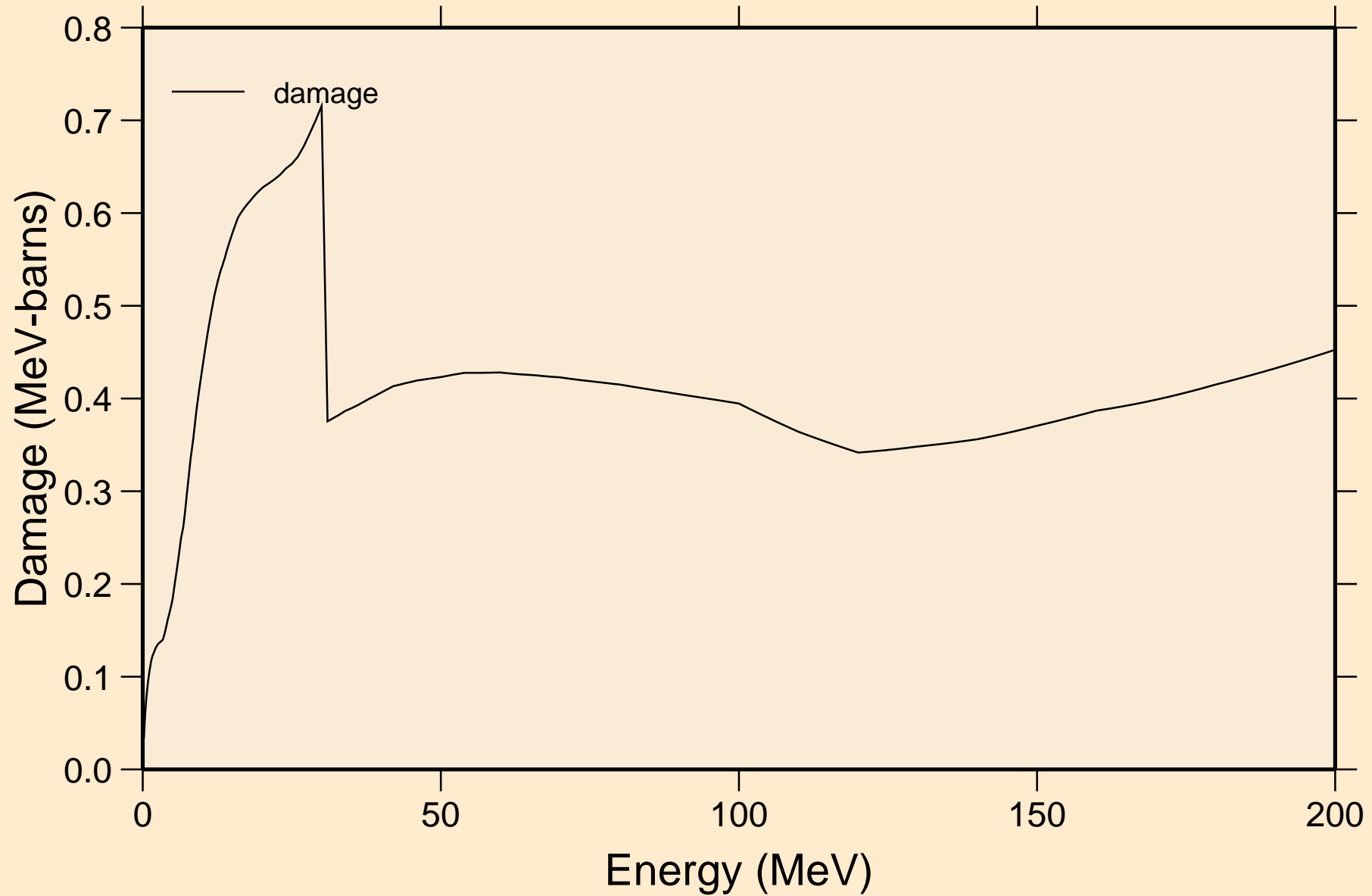

NB099M NEUTRON ACER TENDL-2023 LIBRARY; T=0.K
Non-threshold reactions

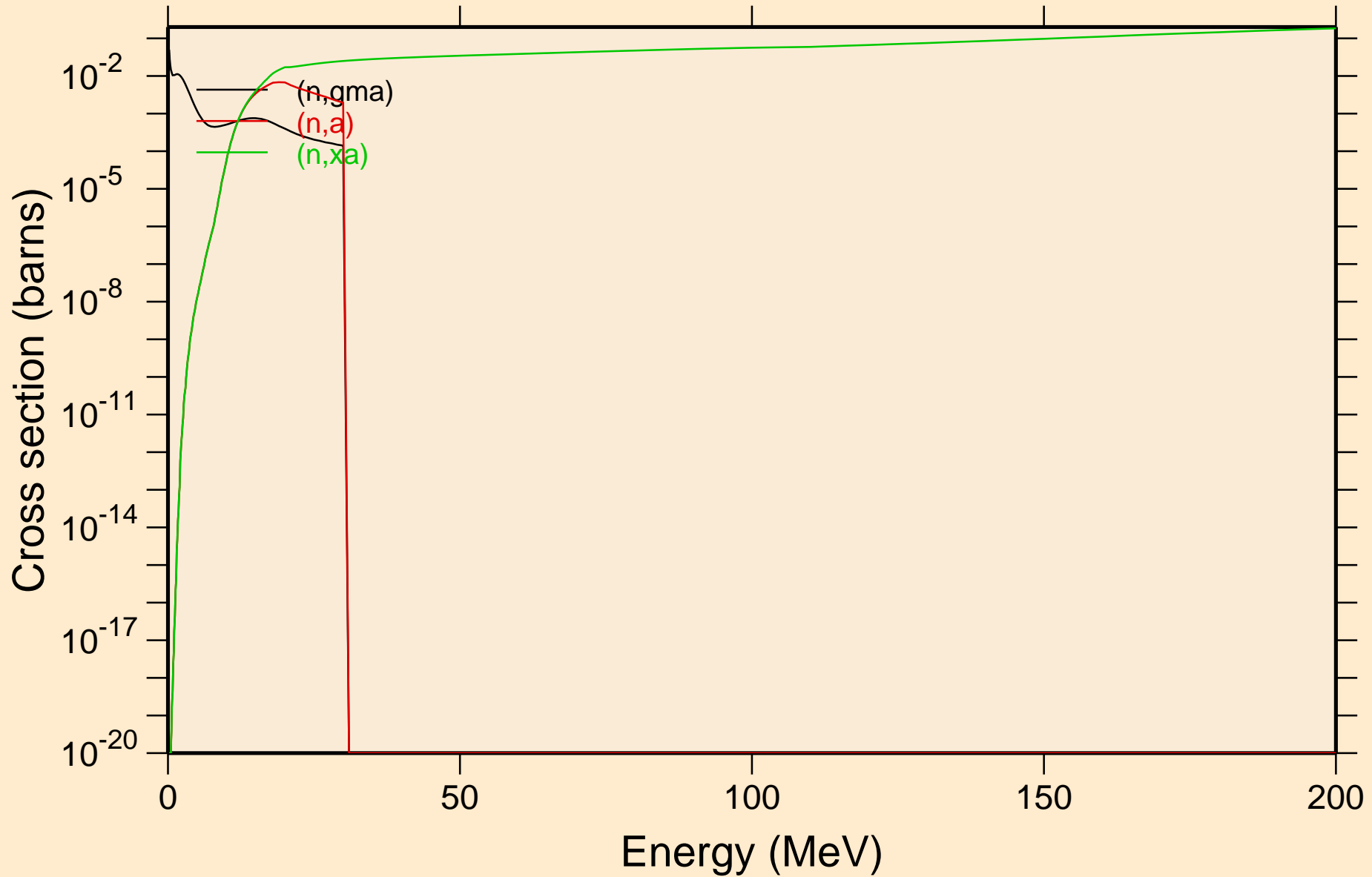

NB099M NEUTRON ACER TENDL-2023 LIBRARY; T=0.K
Inelastic levels

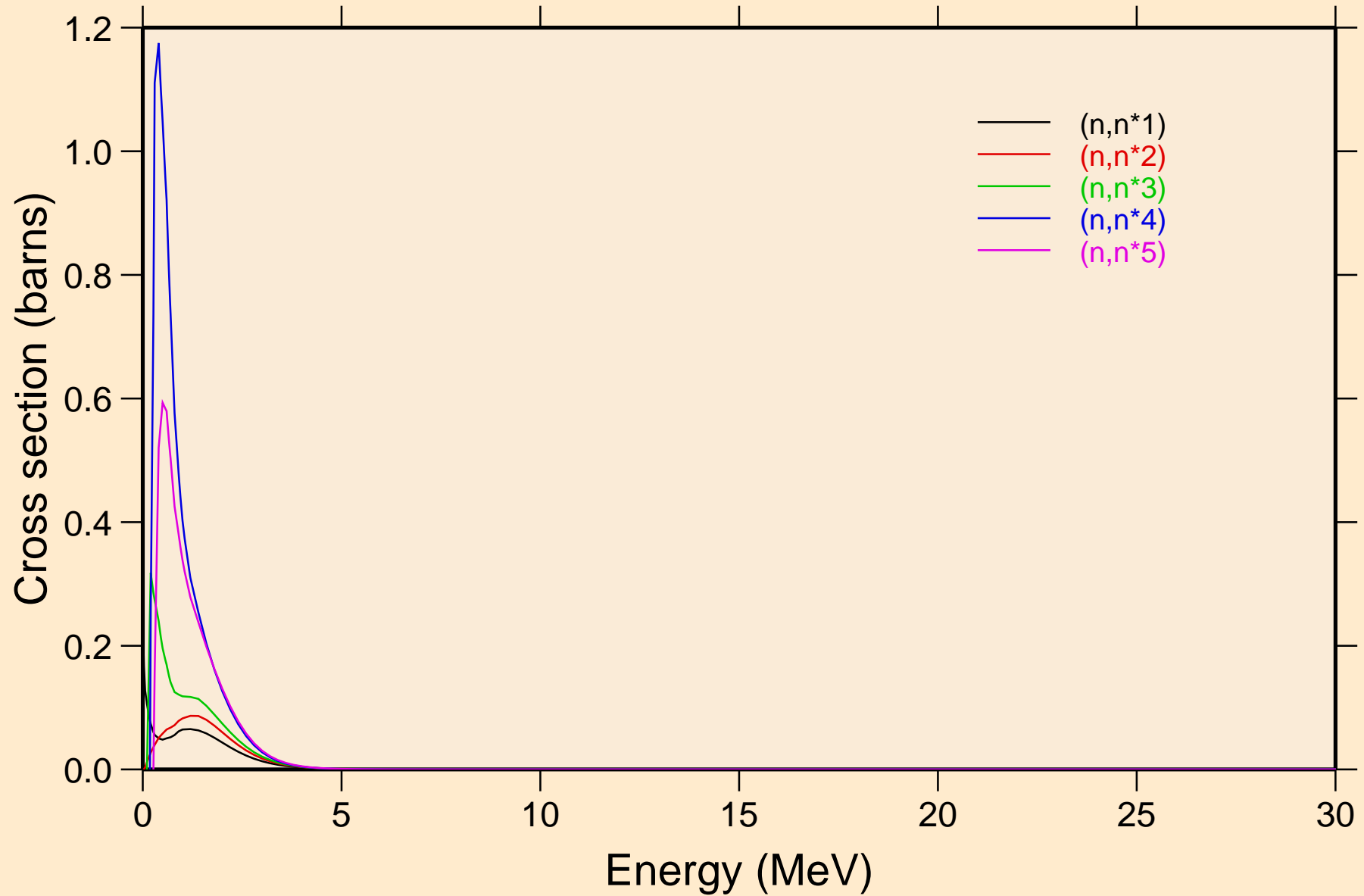

NB099M NEUTRON ACER TENDL-2023 LIBRARY; T=0.K
Inelastic levels

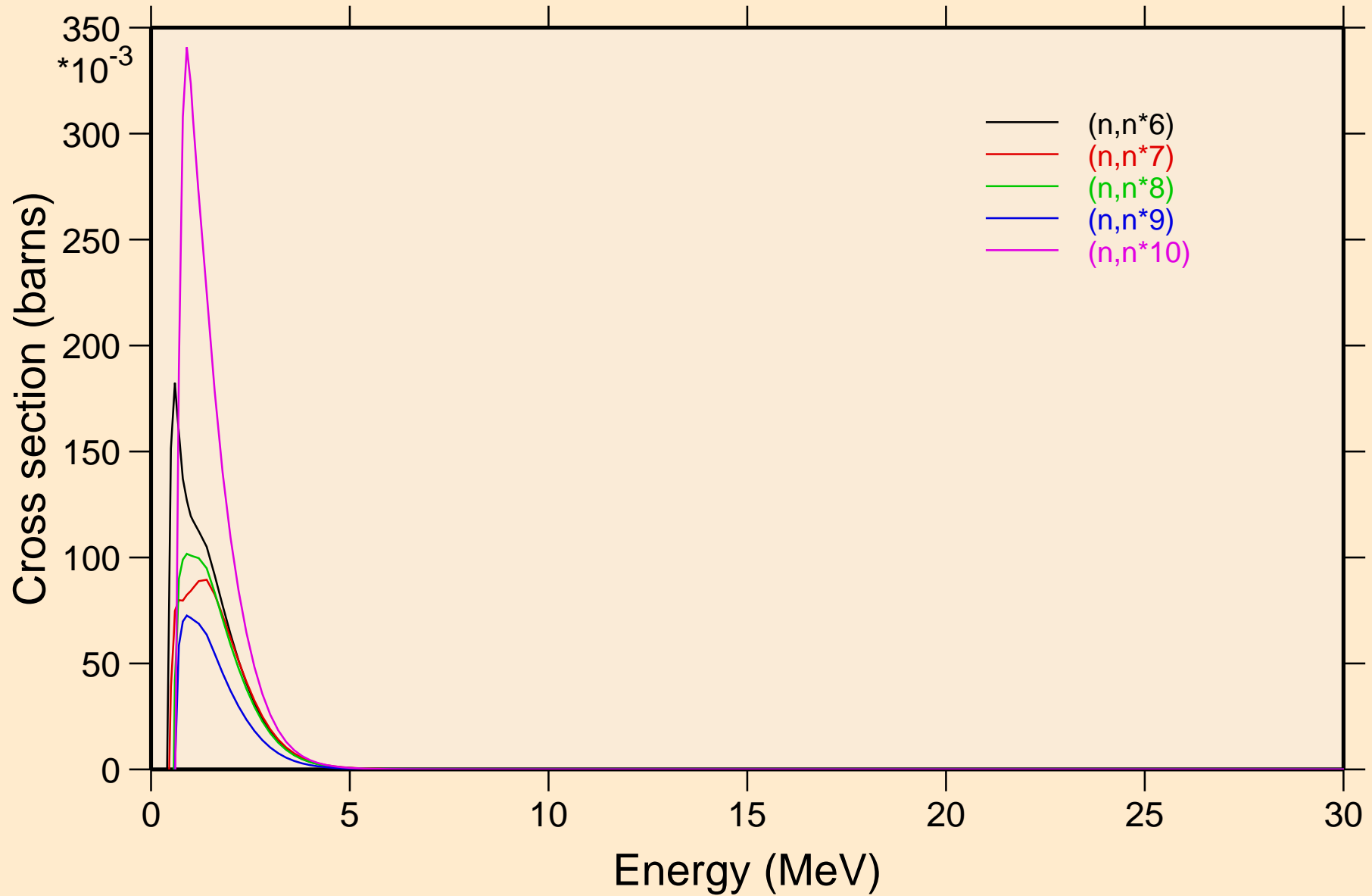

NB099M NEUTRON ACER TENDL-2023 LIBRARY; T=0.K
Inelastic levels

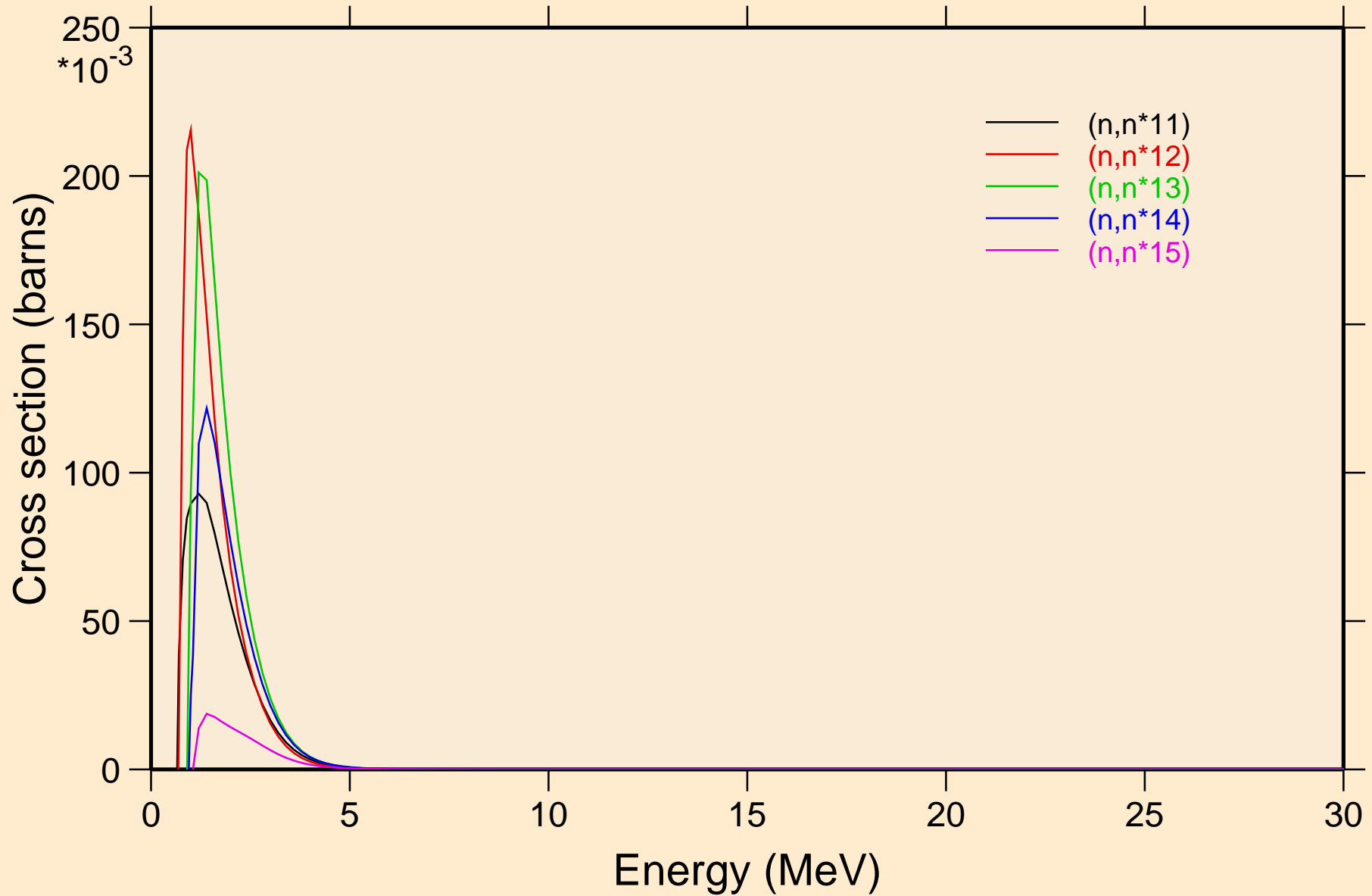

NB099M NEUTRON ACER TENDL-2023 LIBRARY; T=0.K
Inelastic levels

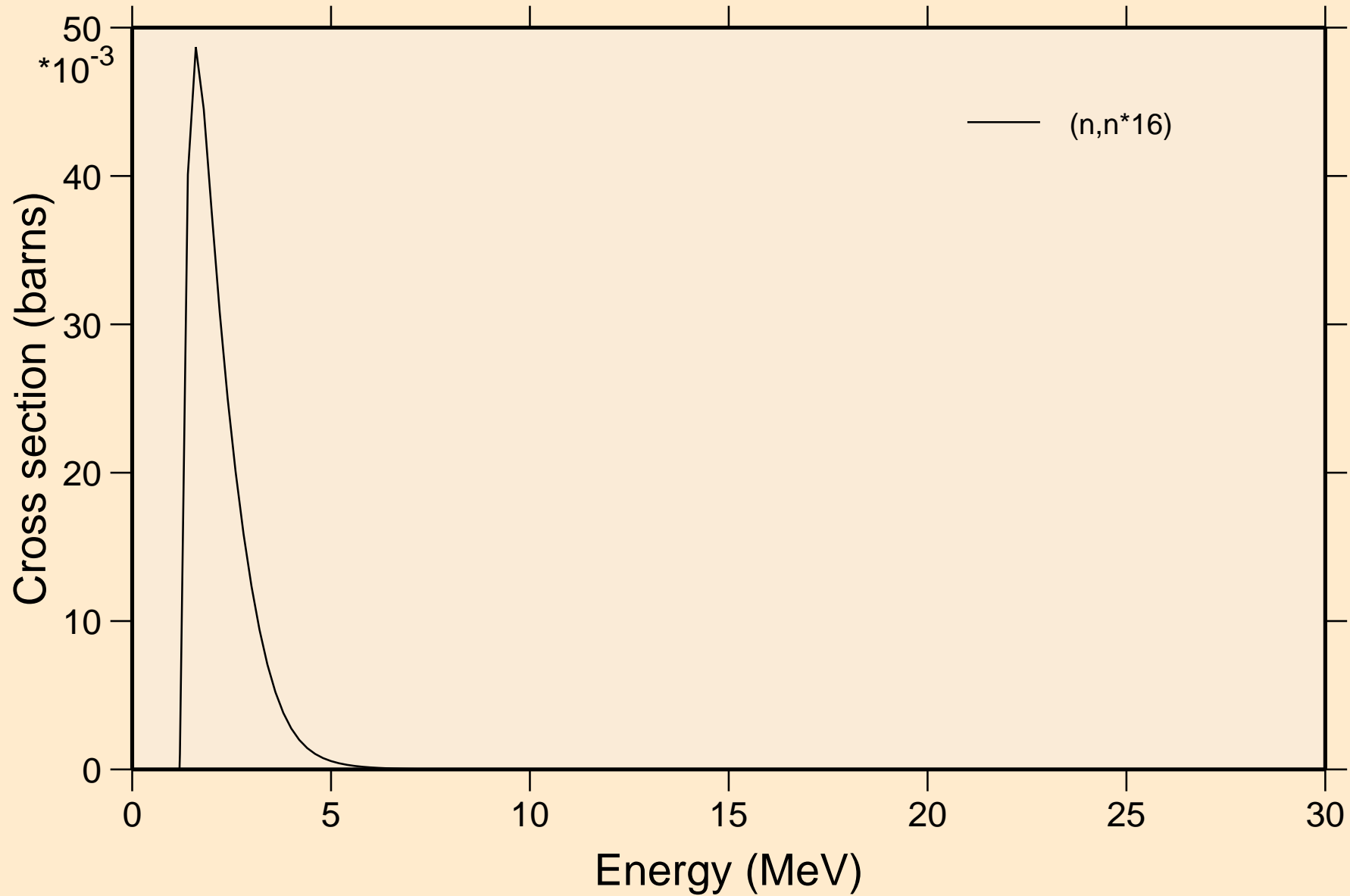

NB099M NEUTRON ACER TENDL-2023 LIBRARY; T=0.K

Threshold reactions

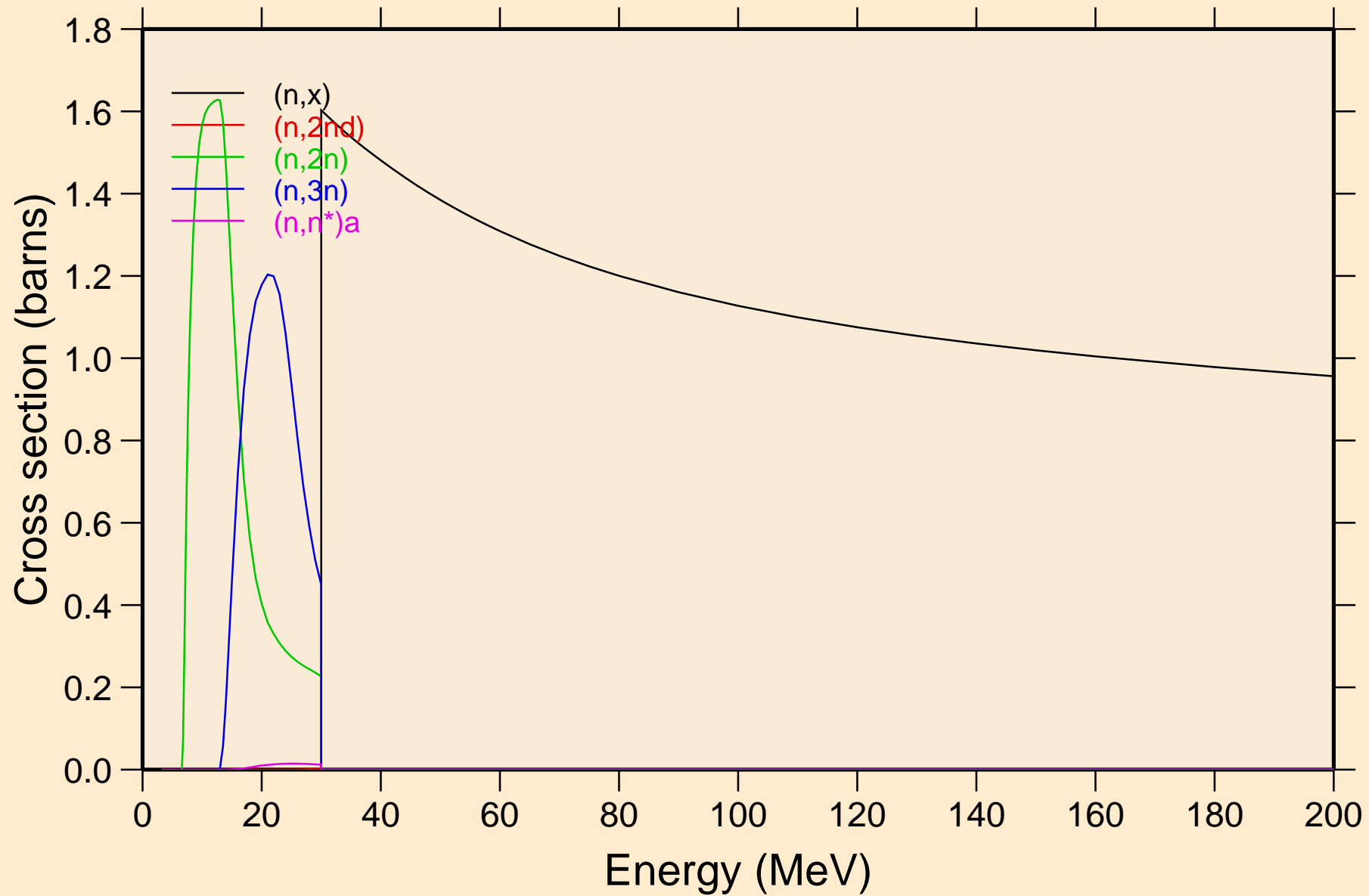

NB099M NEUTRON ACER TENDL-2023 LIBRARY; T=0.K

Threshold reactions

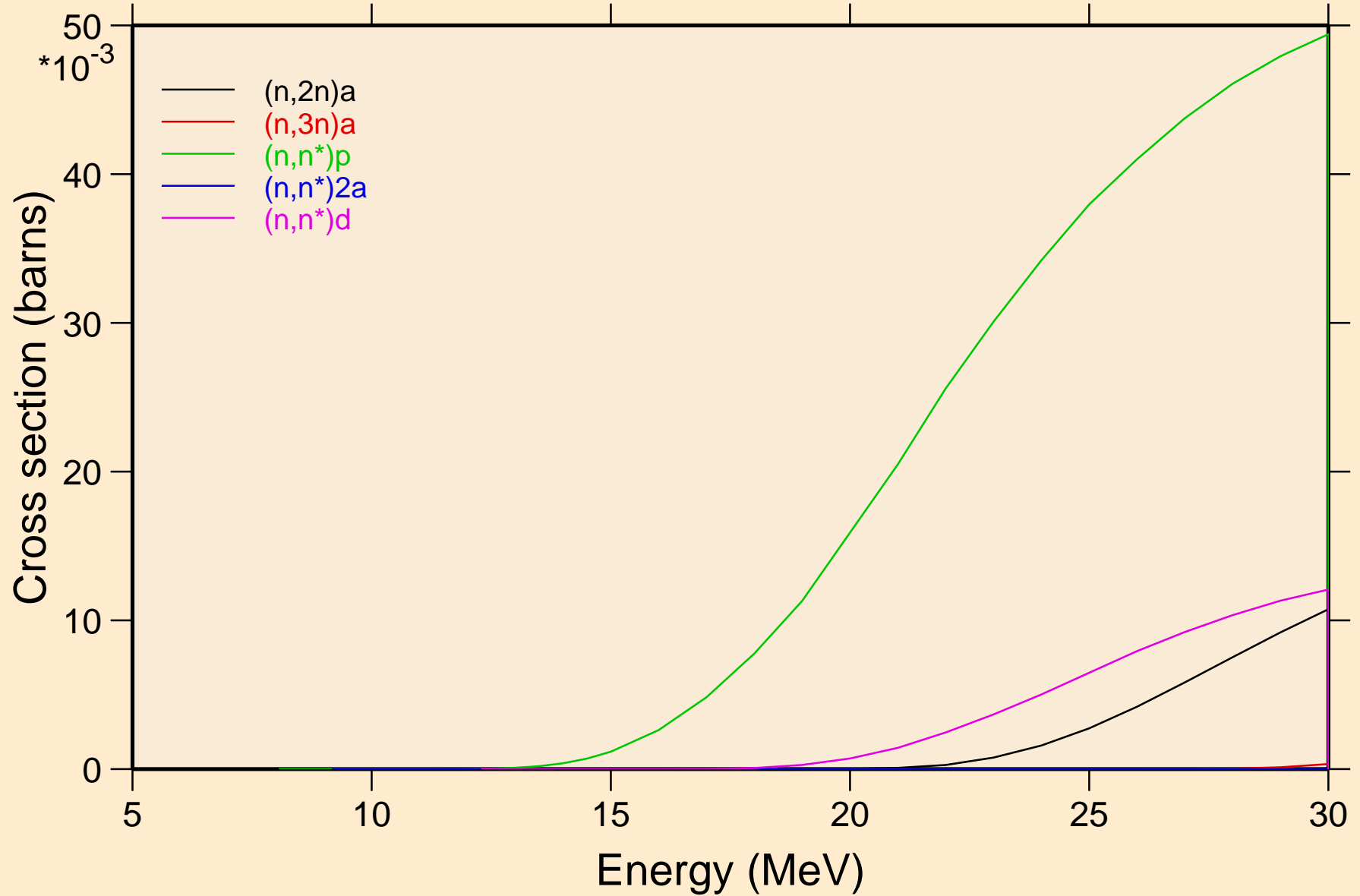

NB099M NEUTRON ACER TENDL-2023 LIBRARY; T=0.K
Threshold reactions

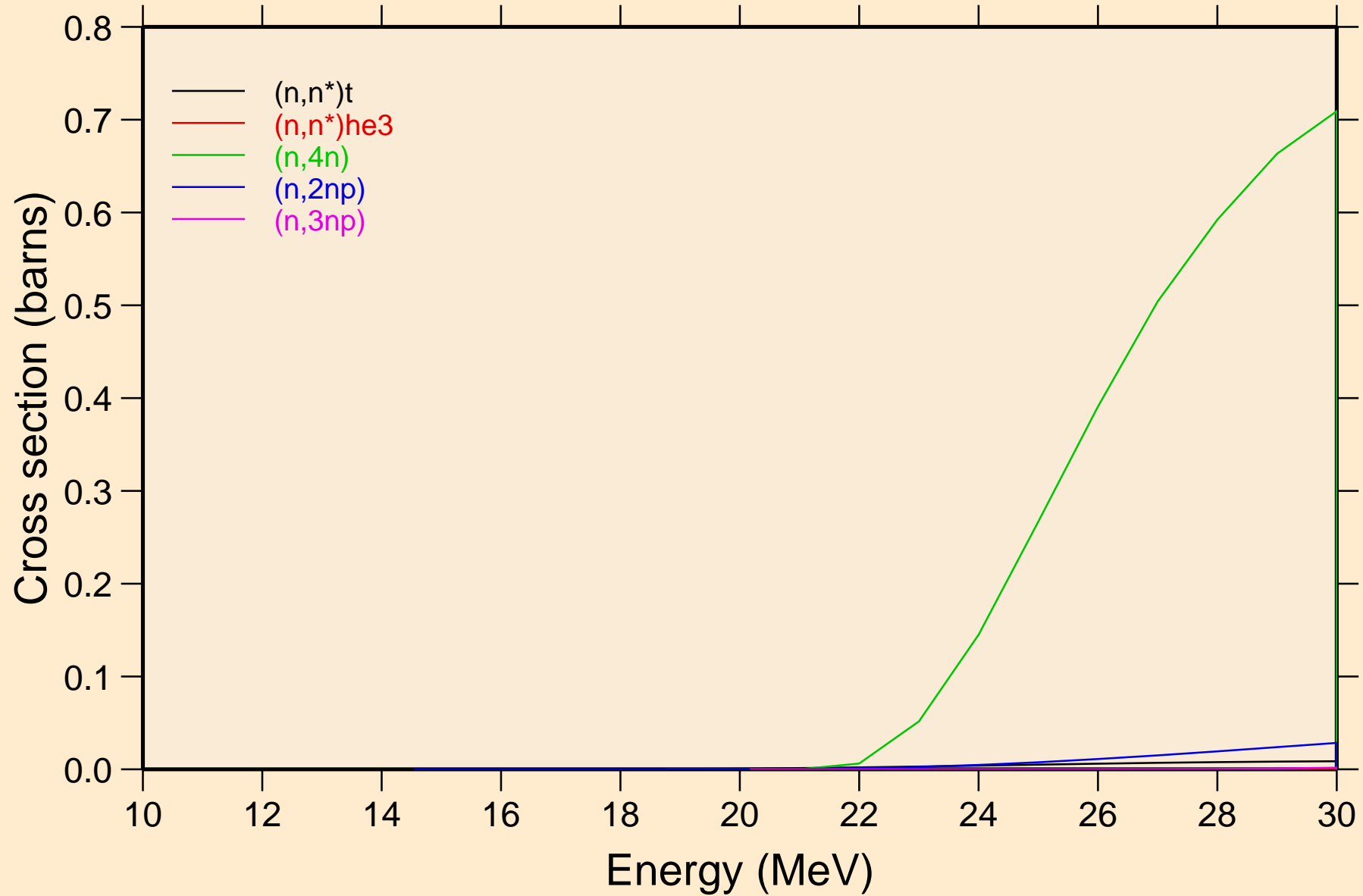

NB099M NEUTRON ACER TENDL-2023 LIBRARY; T=0.K
Threshold reactions

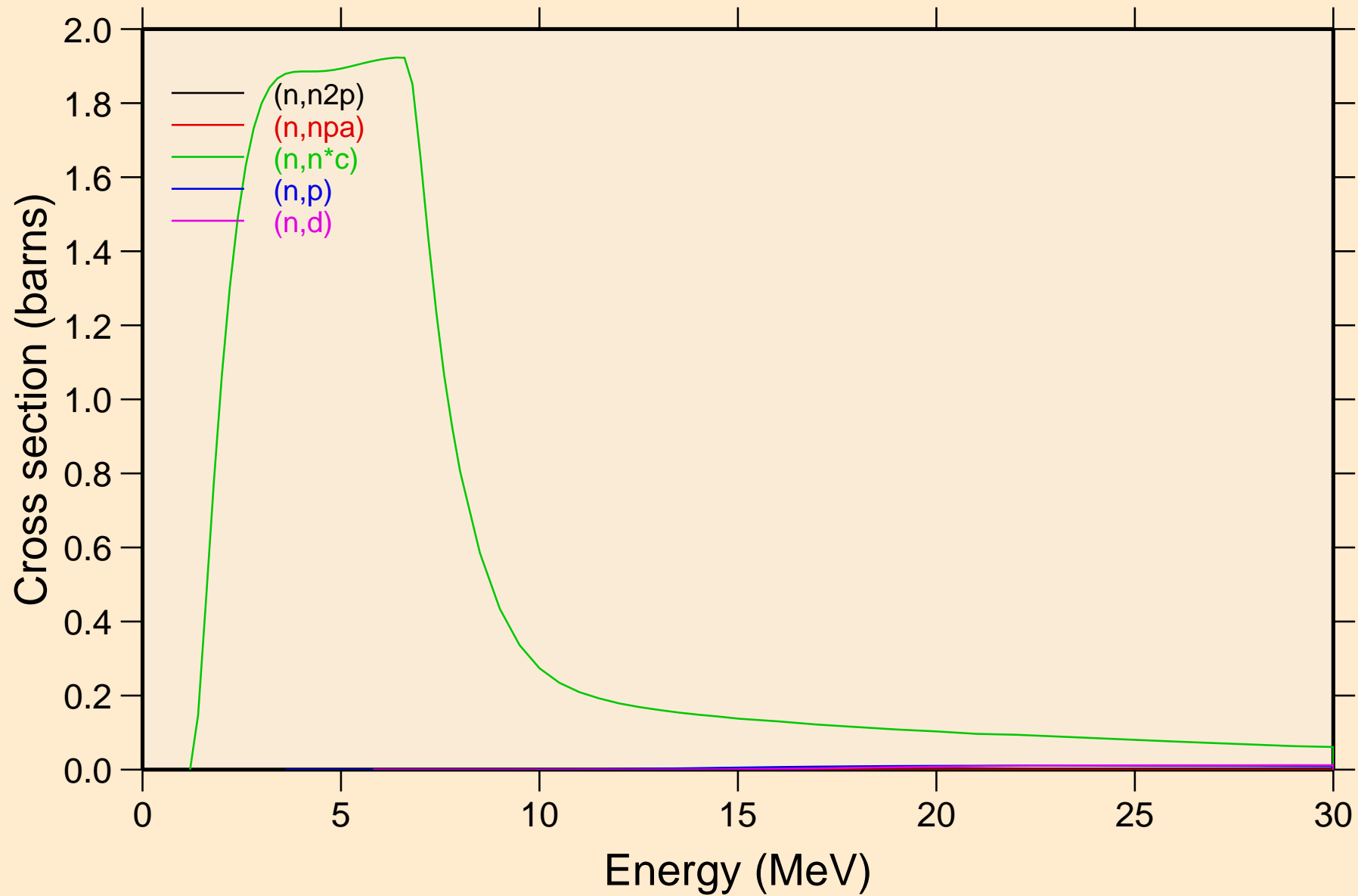

NB099M NEUTRON ACER TENDL-2023 LIBRARY; T=0.K
Threshold reactions

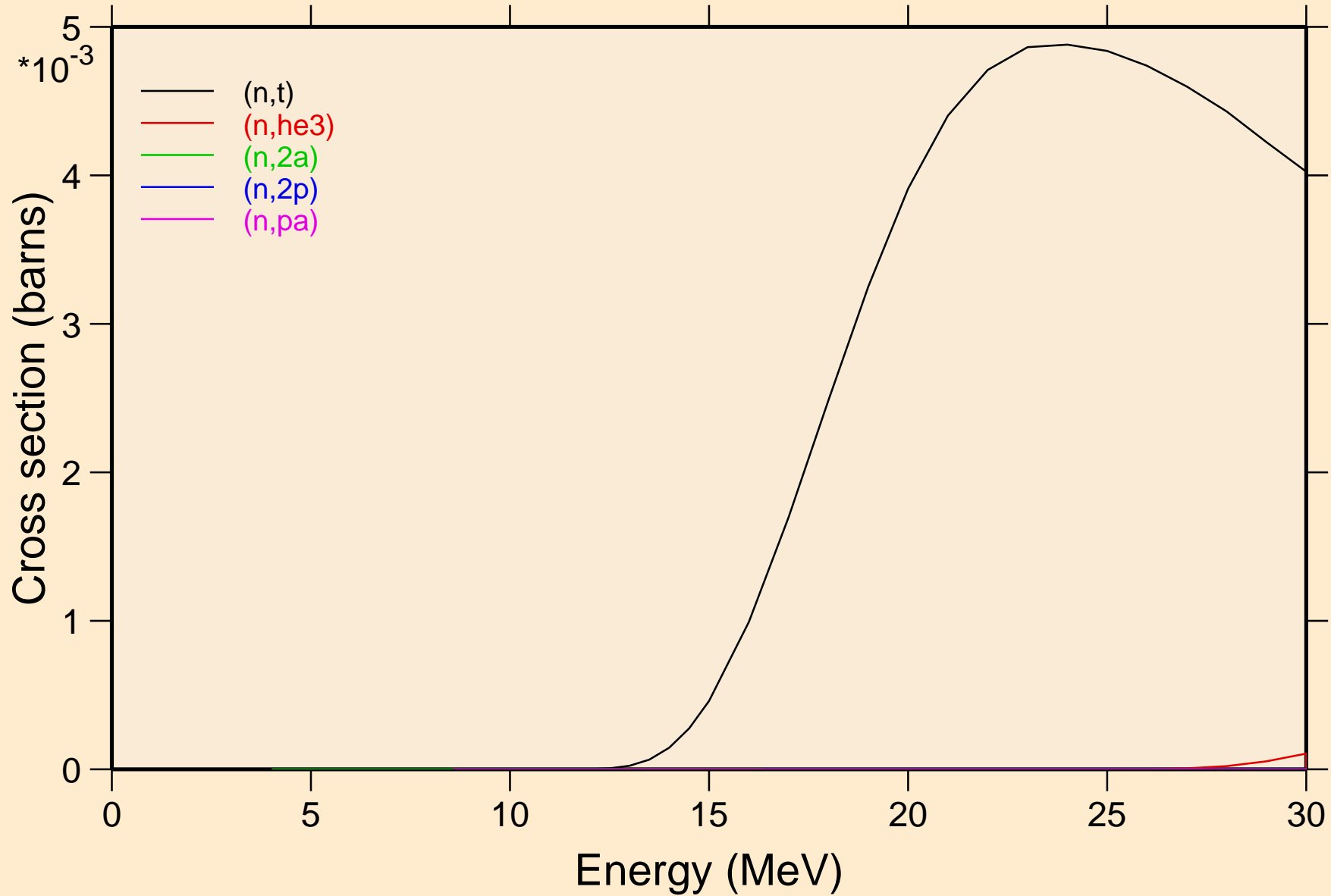

NB099M NEUTRON ACER TENDL-2023 LIBRARY; T=0.K

Threshold reactions

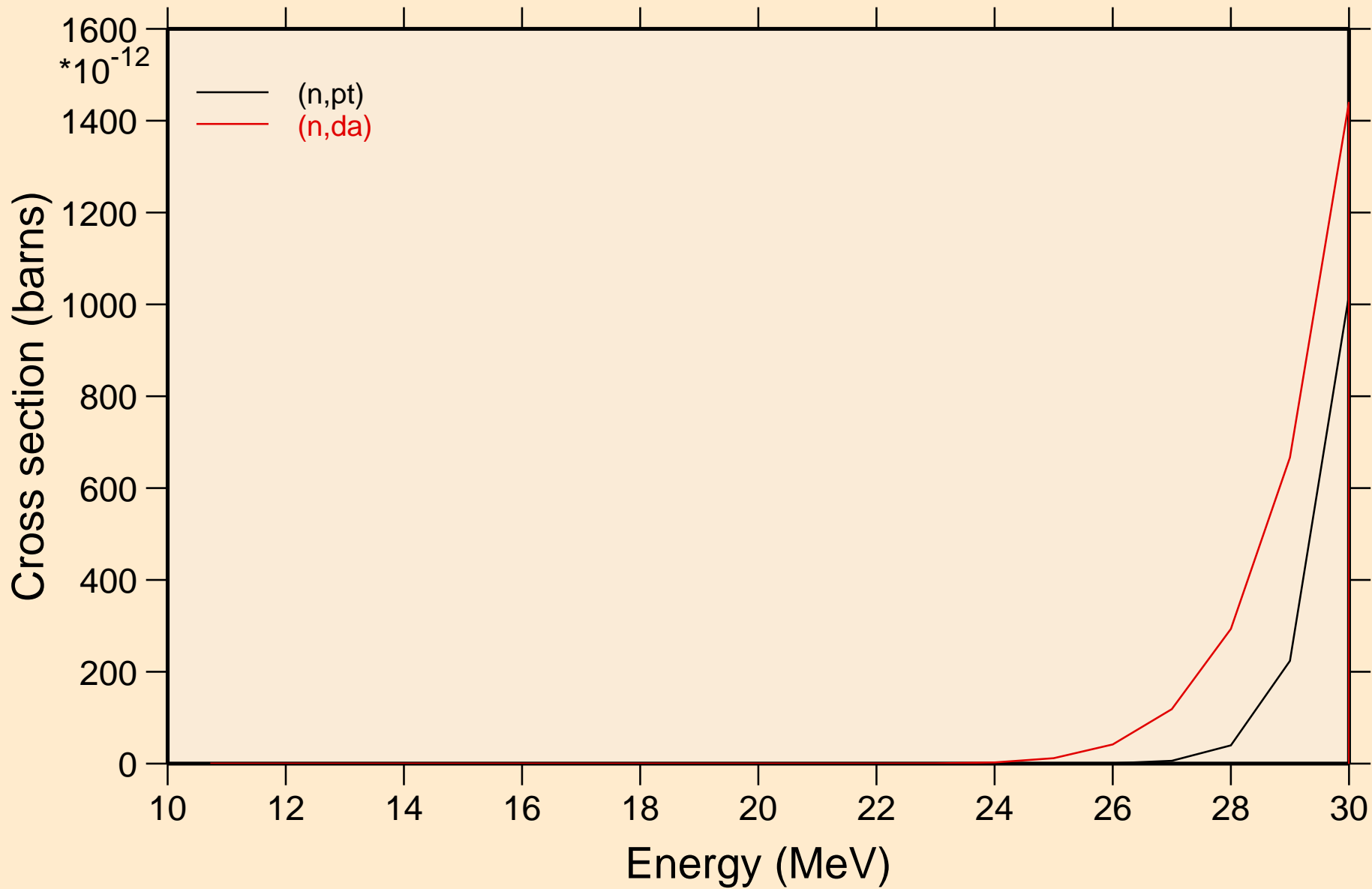

NB099M NEUTRON ACER TENDL-2023 LIBRARY; T=0.K
Threshold reactions

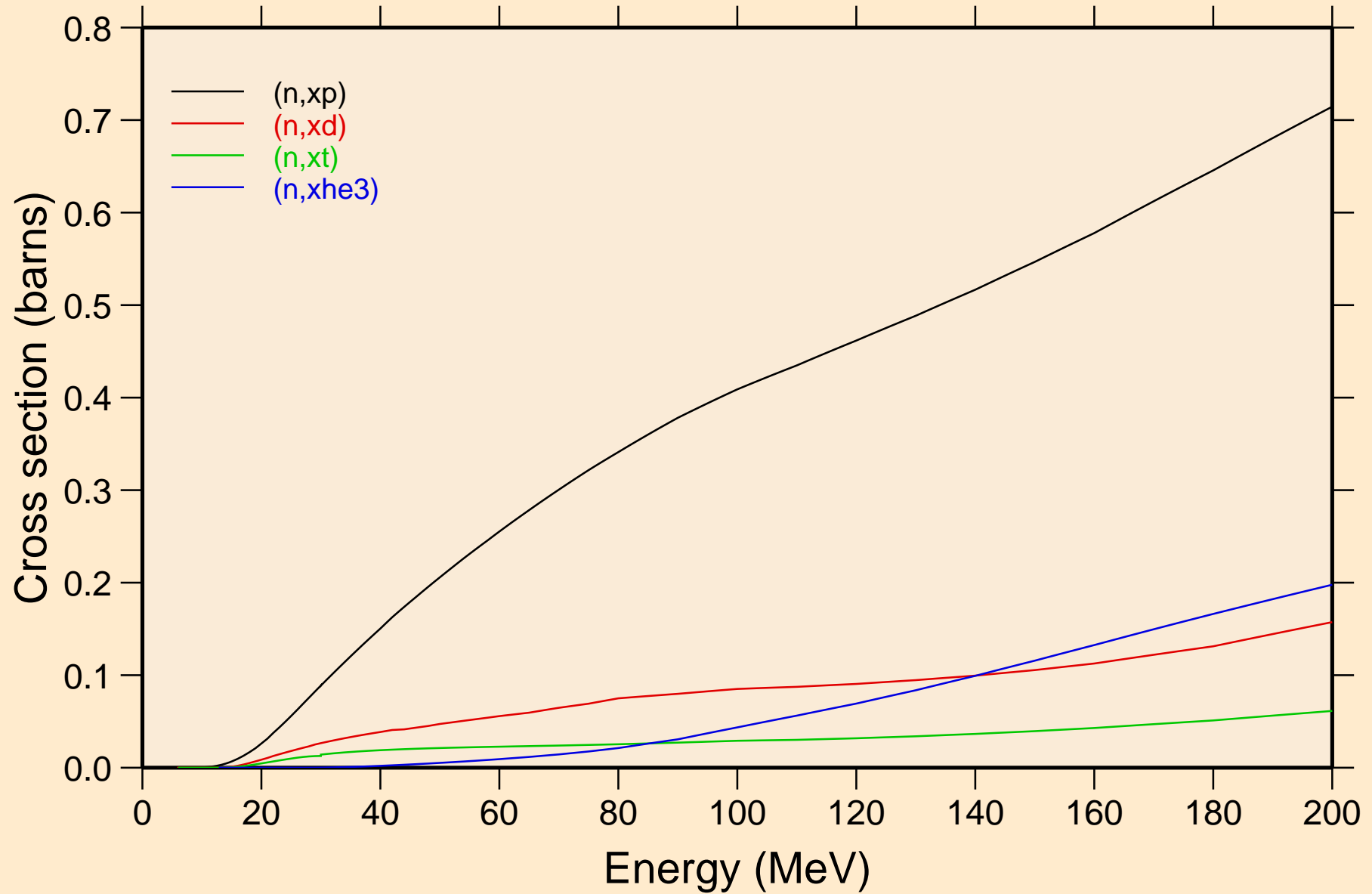

NB099M NEUTRON ACER TENDL-2023 LIBRARY; T=0.K
angular distribution for elastic

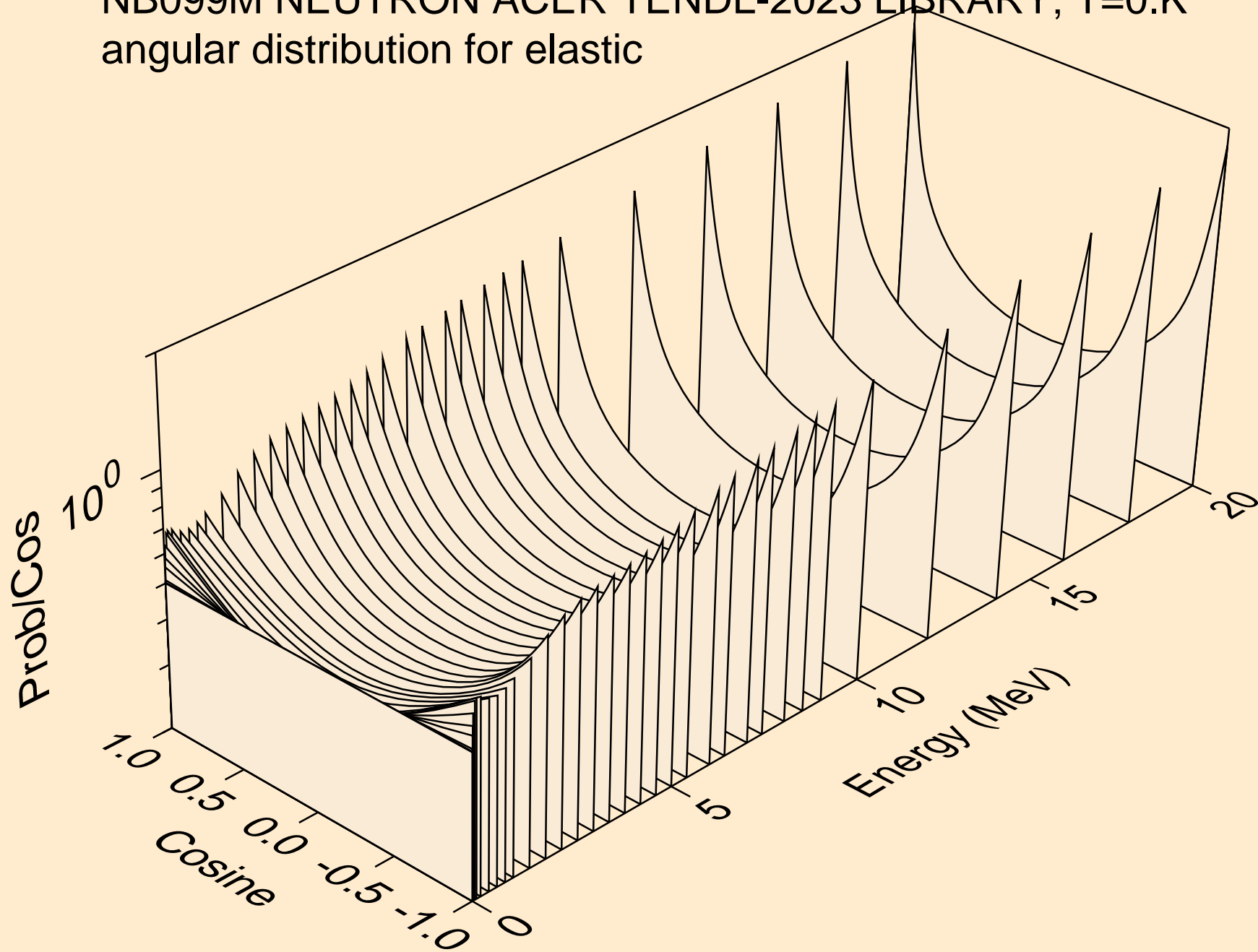

NB099M NEUTRON ACER TENDL-2023 LIBRARY; T=0.K
angular distribution for elastic

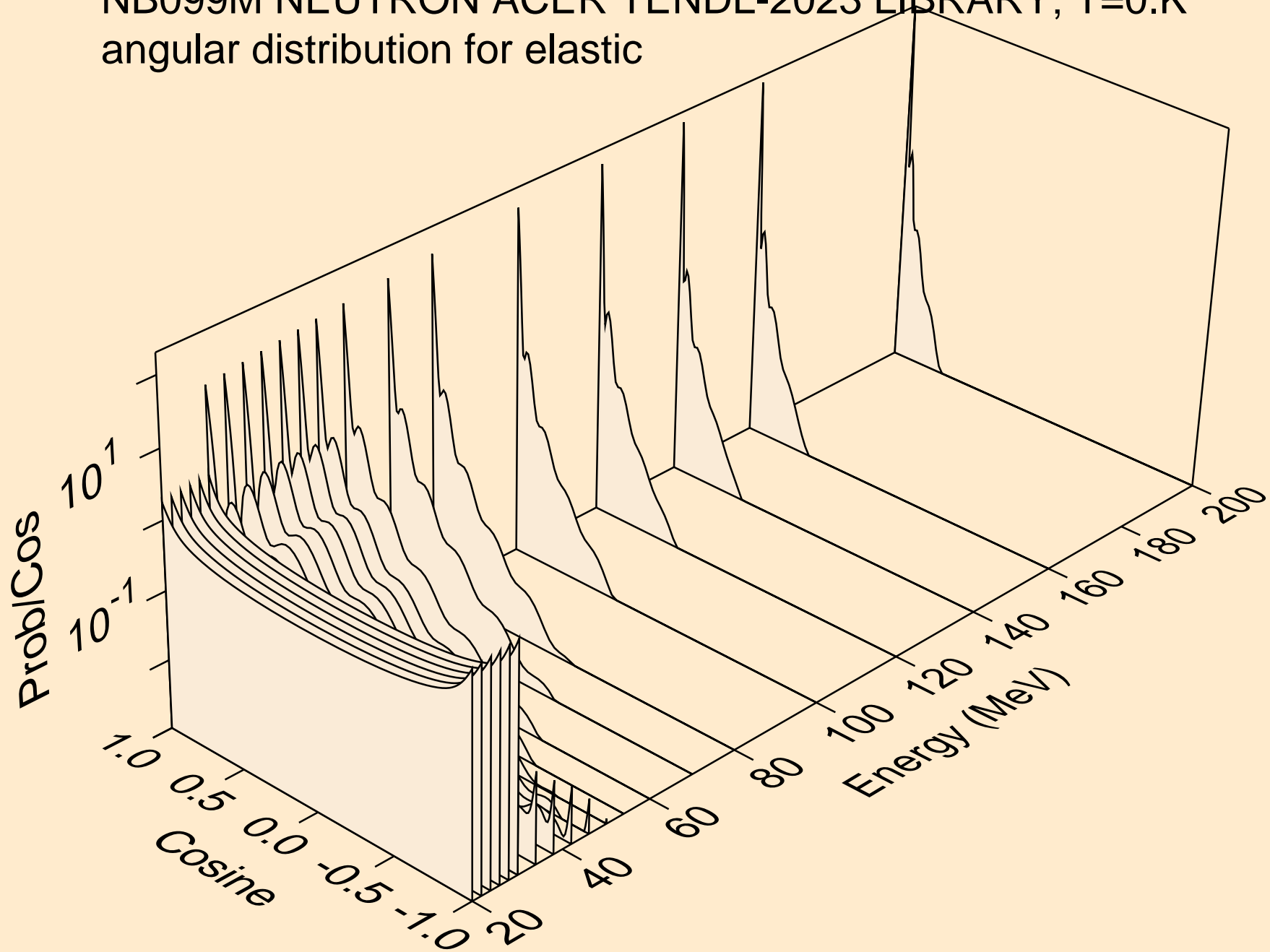

NB099M NEUTRON ACER TENDL-2023 LIBRARY; T=0.K
angular distribution for (n,n*1)

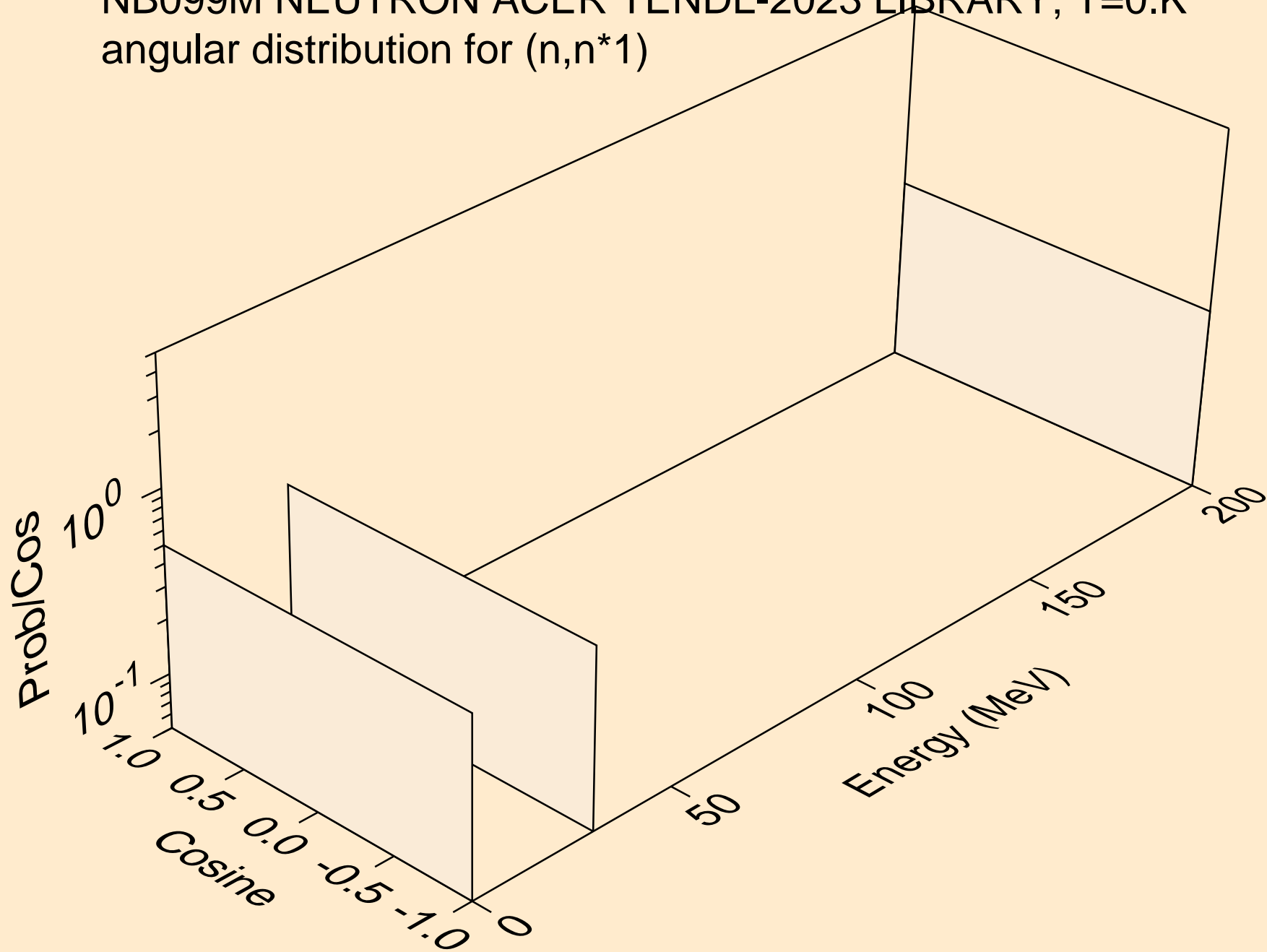

NB099M NEUTRON ACER TENDL-2023 LIBRARY; T=0.K
angular distribution for (n,n*2)

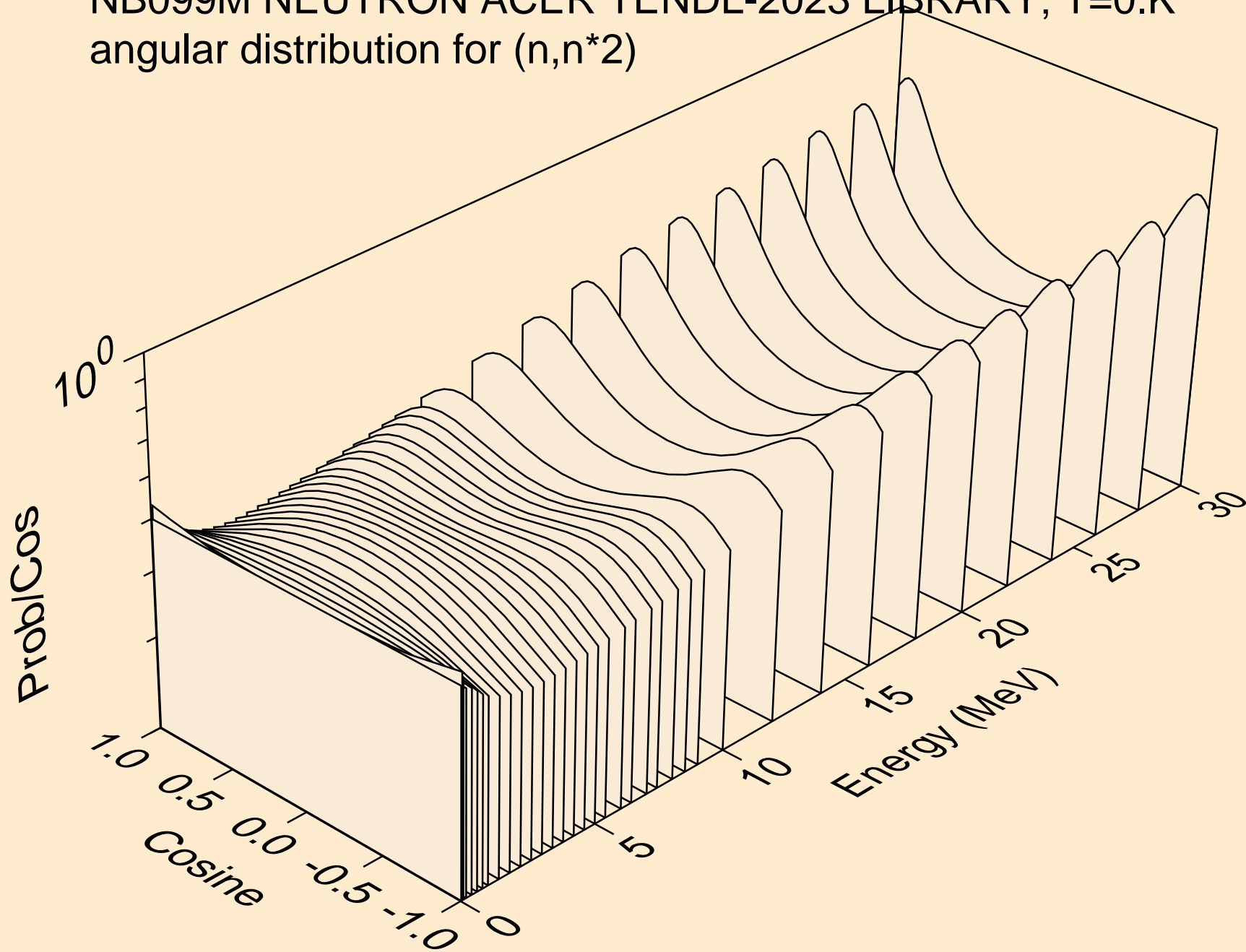

NB099M NEUTRON ACER TENDL-2023 LIBRARY; T=0.K
angular distribution for (n,n*3)

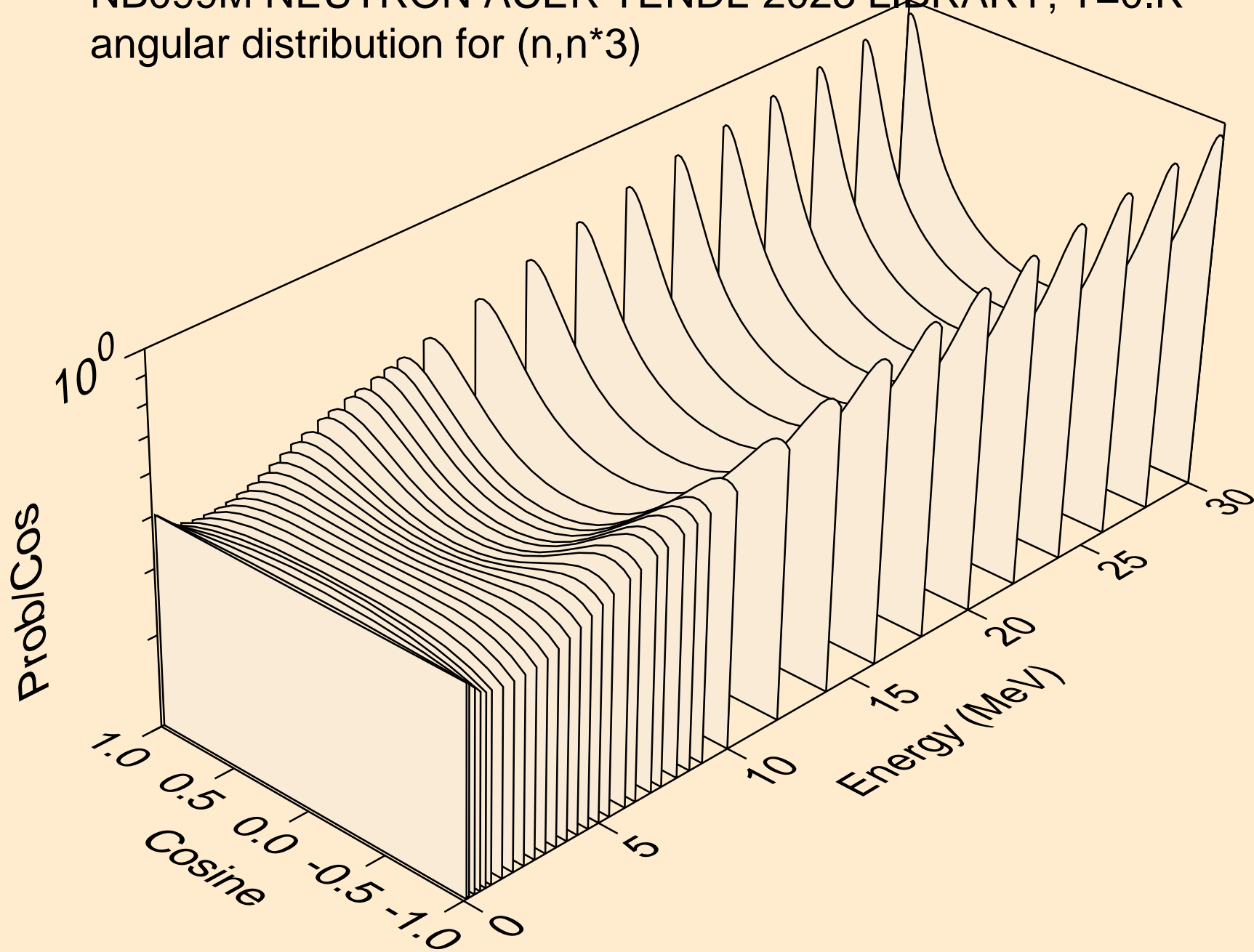

NB099M NEUTRON ACER TENDL-2023 LIBRARY; T=0.K
angular distribution for (n,n*4)

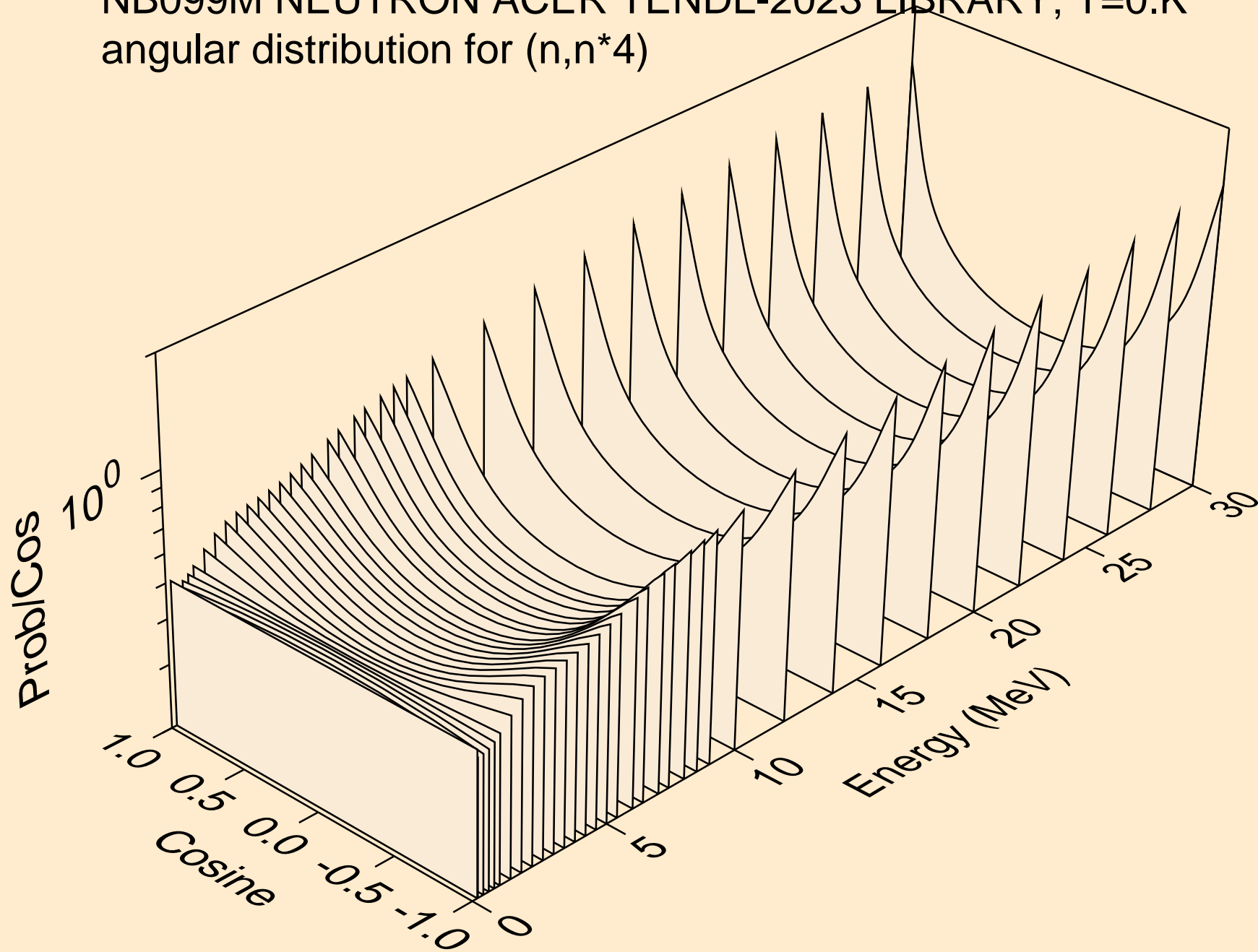

NB099M NEUTRON ACER TENDL-2023 LIBRARY; T=0.K
angular distribution for (n,n*5)

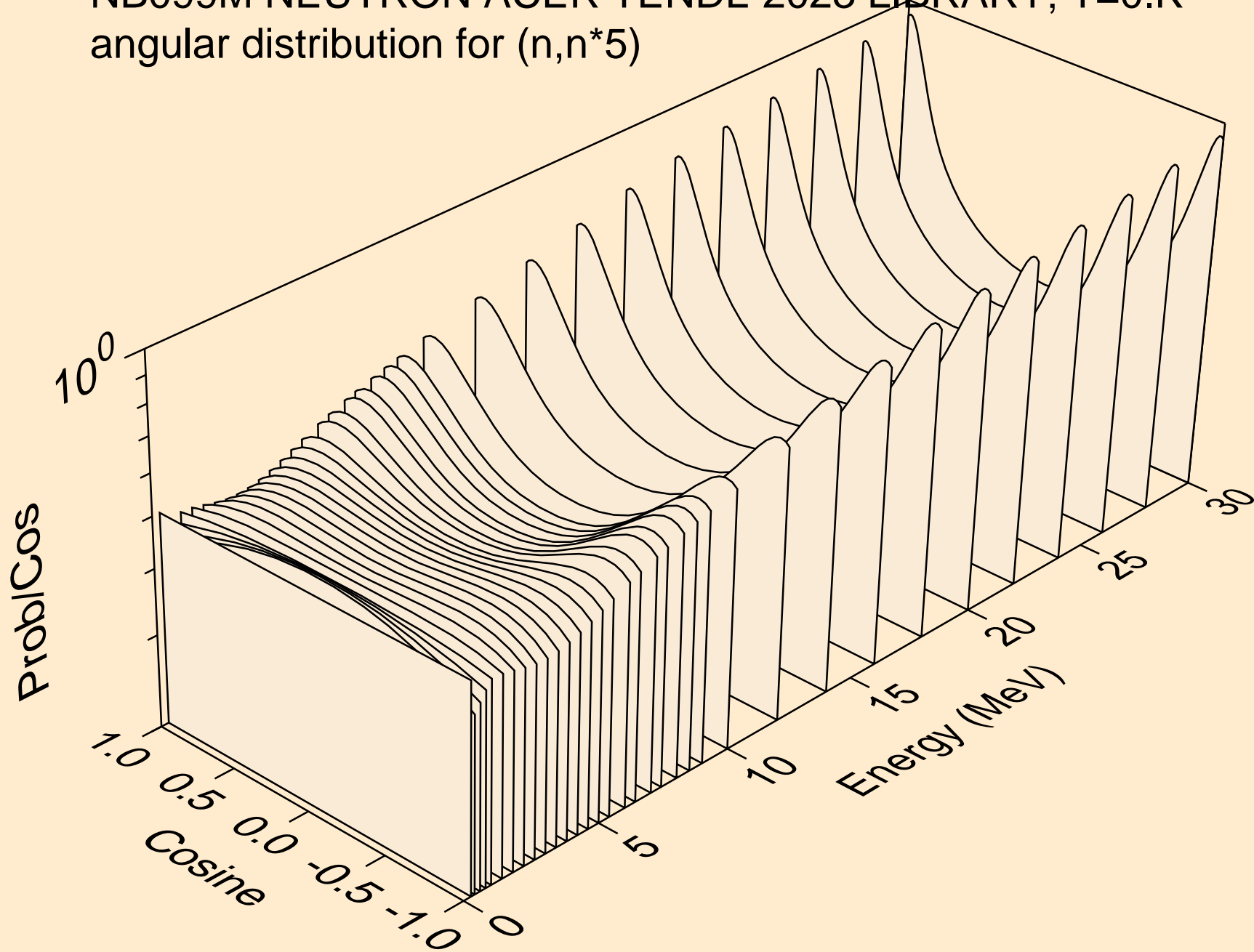

NB099M NEUTRON ACER TENDL-2023 LIBRARY; T=0.K
angular distribution for (n,n*6)

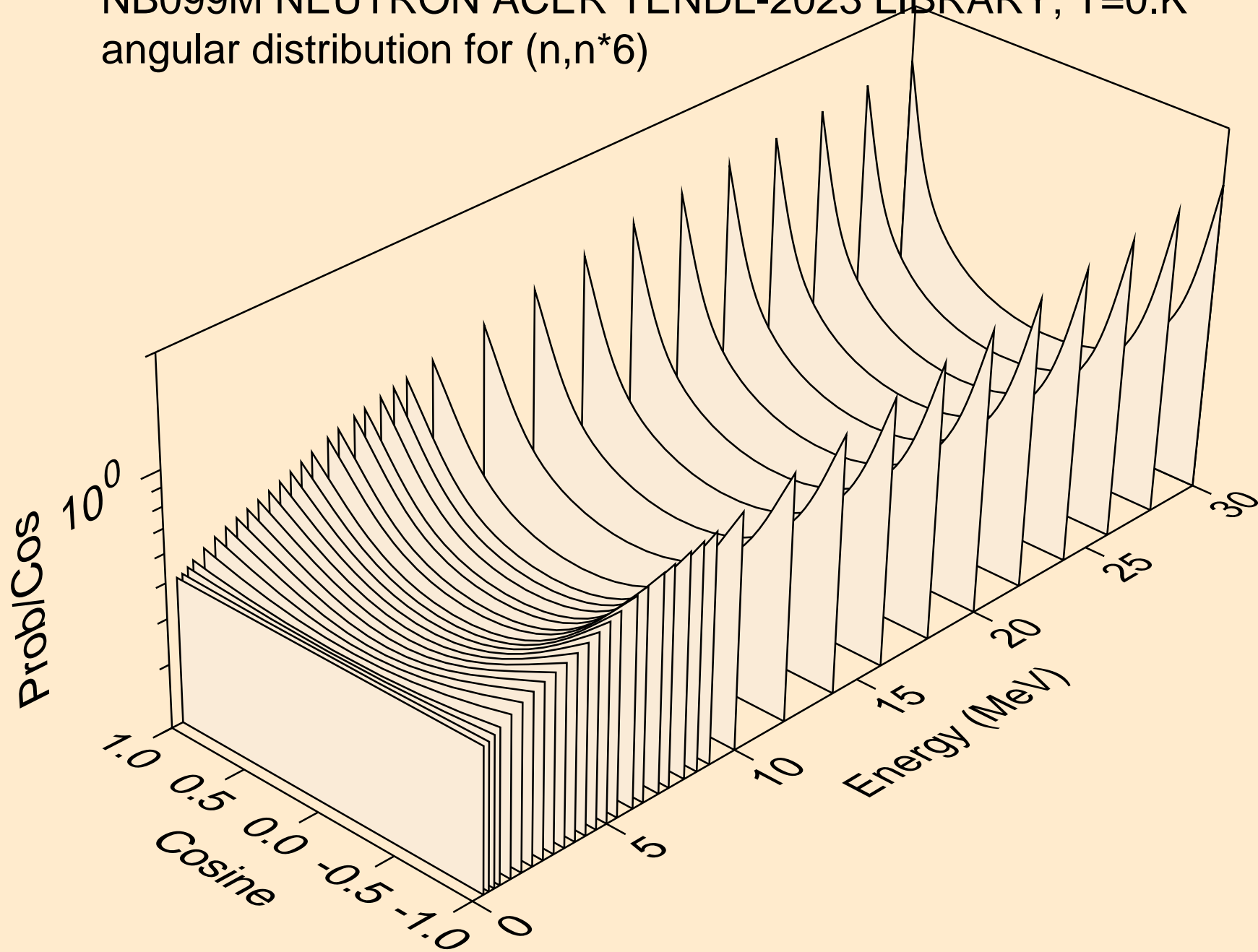

NB099M NEUTRON ACER TENDL-2023 LIBRARY; T=0.K
angular distribution for (n,n*7)

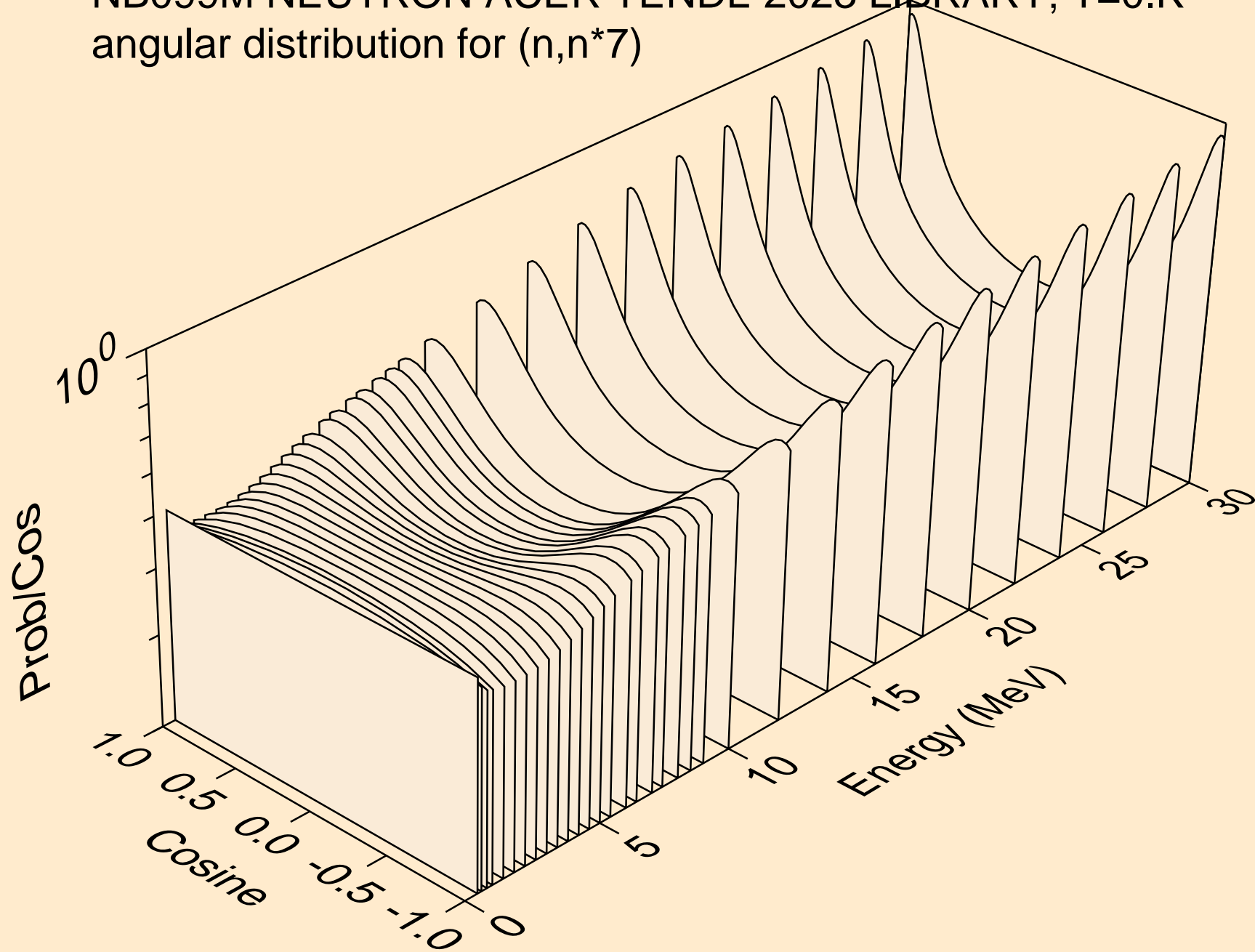

NB099M NEUTRON ACER TENDL-2023 LIBRARY; T=0.K
angular distribution for (n,n*8)

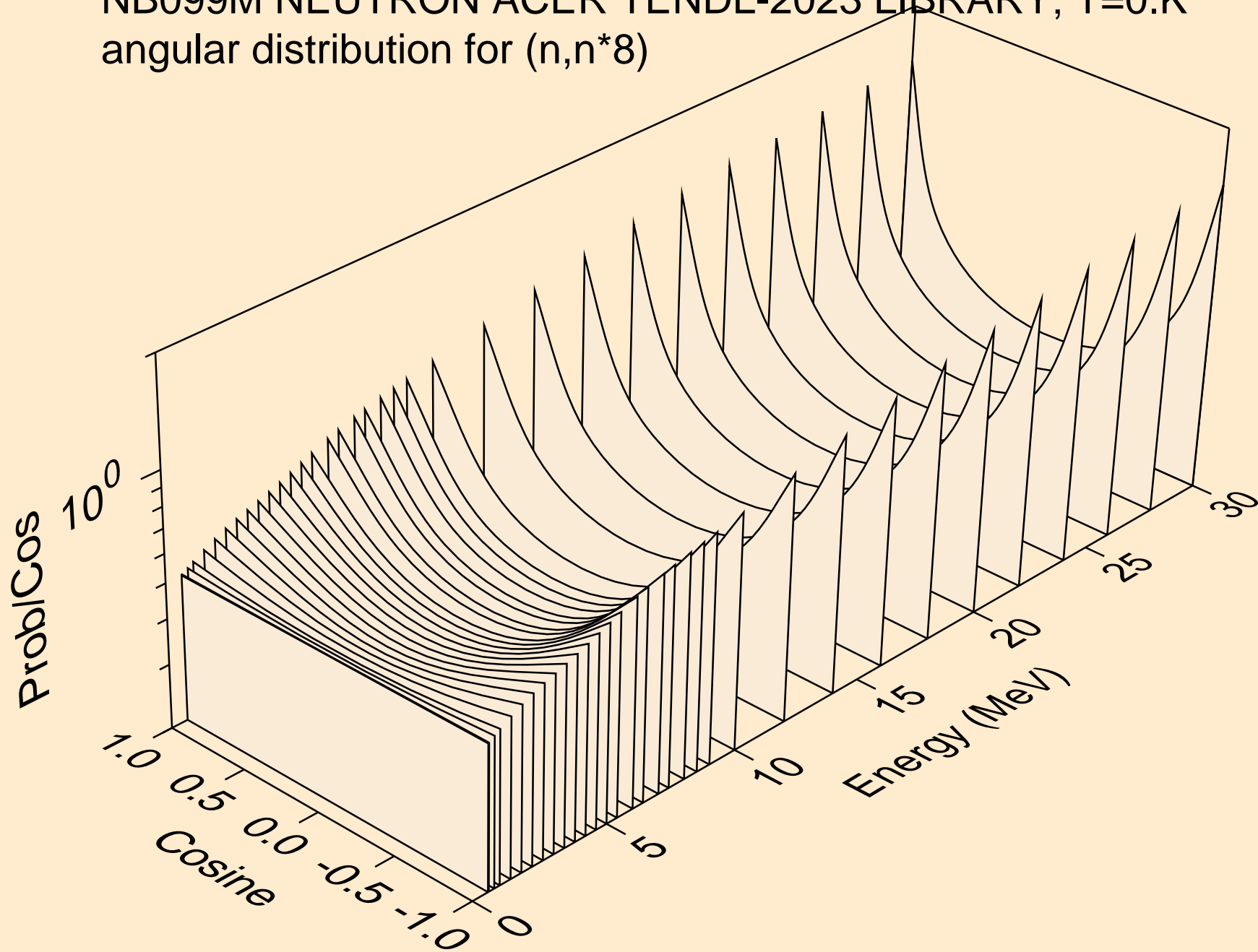

NB099M NEUTRON ACER TENDL-2023 LIBRARY; T=0.K
angular distribution for (n,n*9)

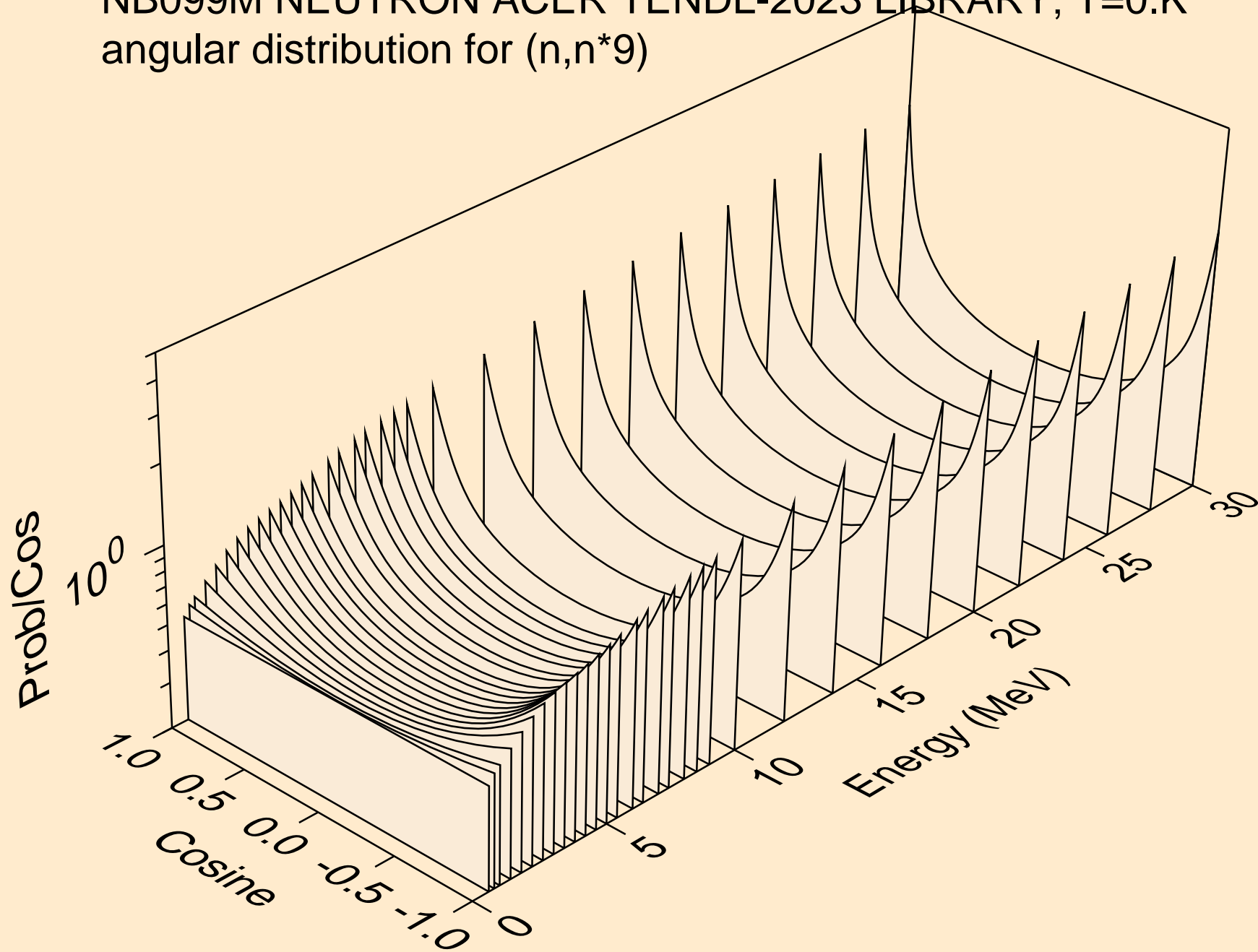

NB099M NEUTRON ACER TENDL-2023 LIBRARY; T=0.K
angular distribution for (n,n*10)

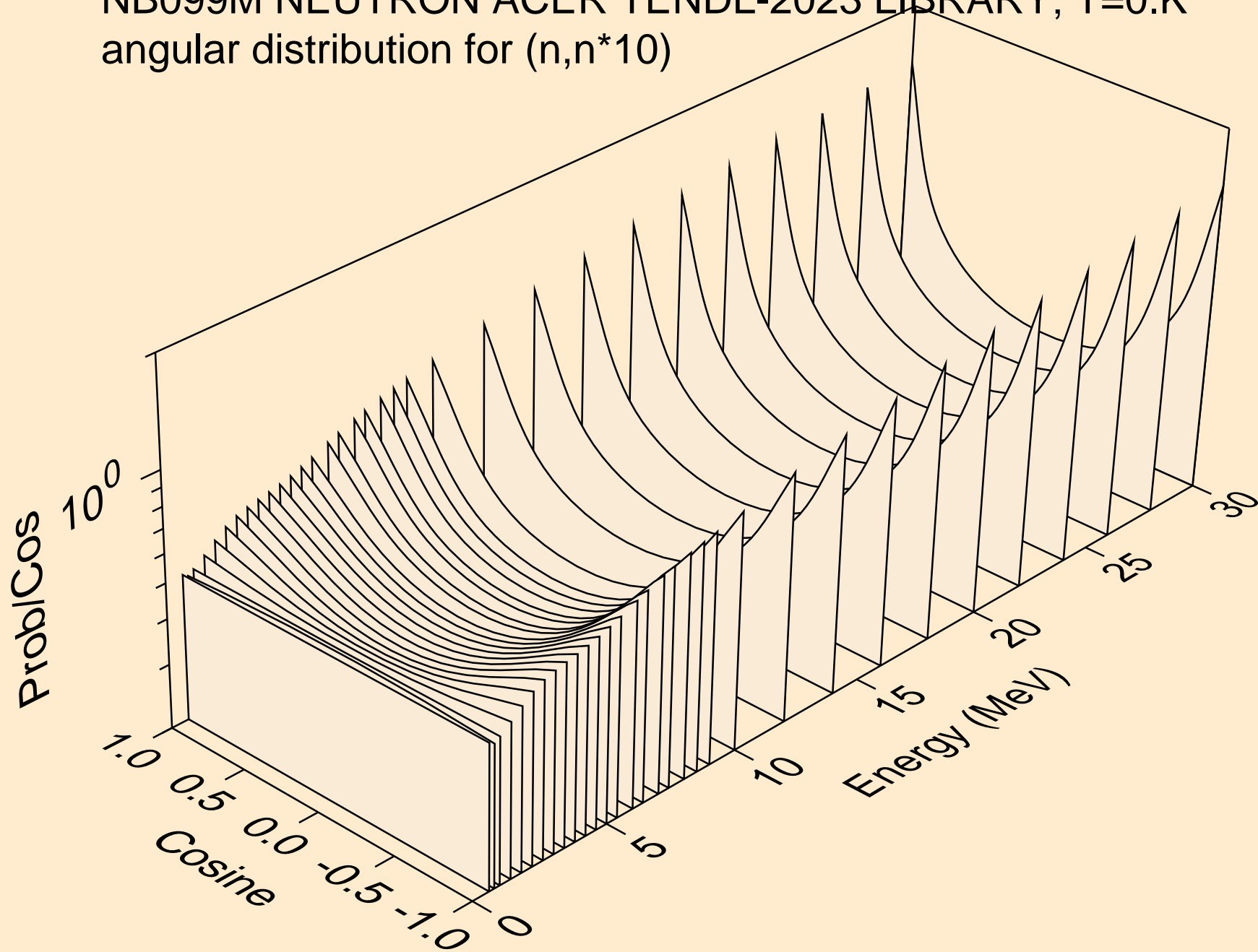

NB099M NEUTRON ACER TENDL-2023 LIBRARY; T=0.K
angular distribution for (n,n*11)

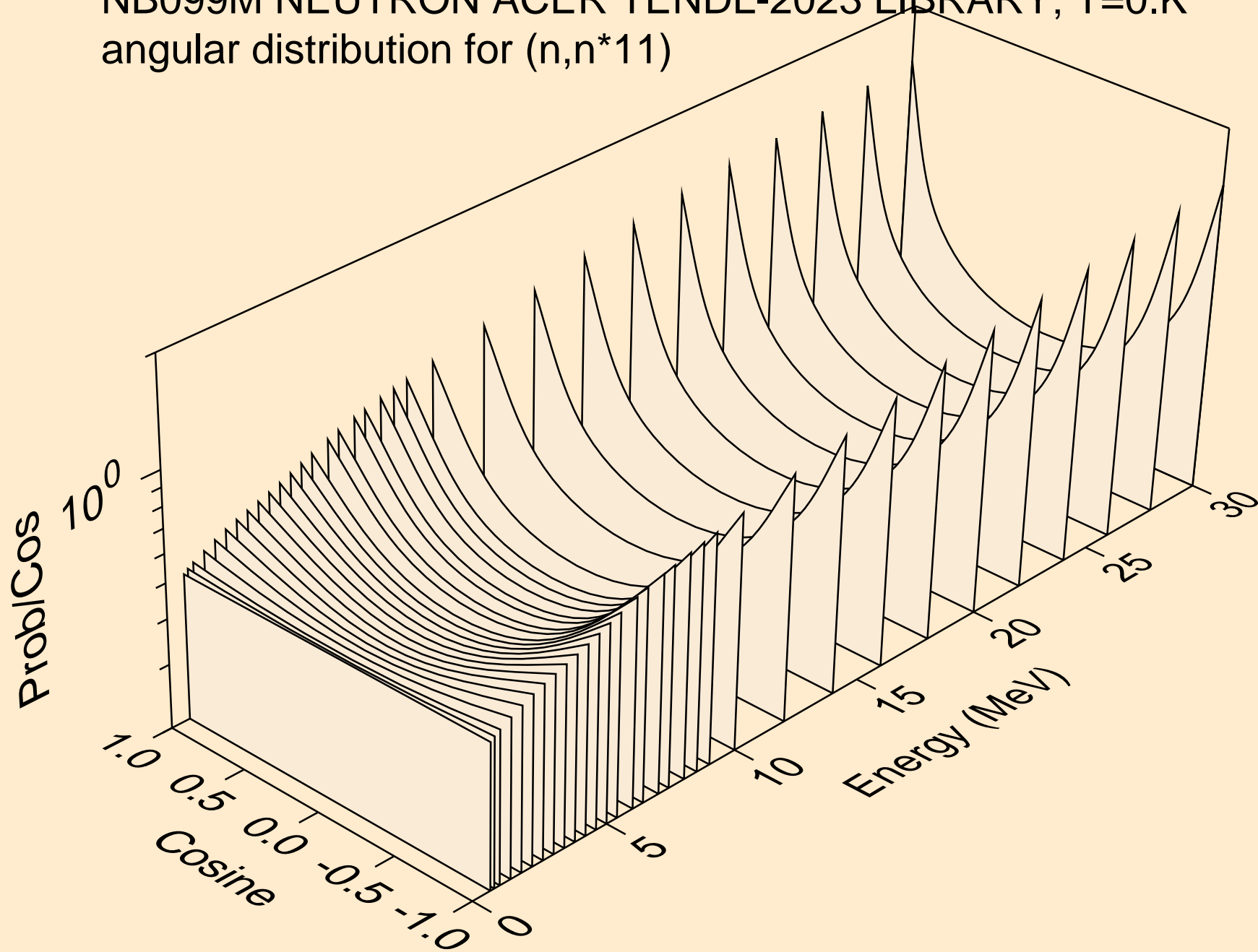

NB099M NEUTRON ACER TENDL-2023 LIBRARY; T=0.K
angular distribution for (n,n*12)

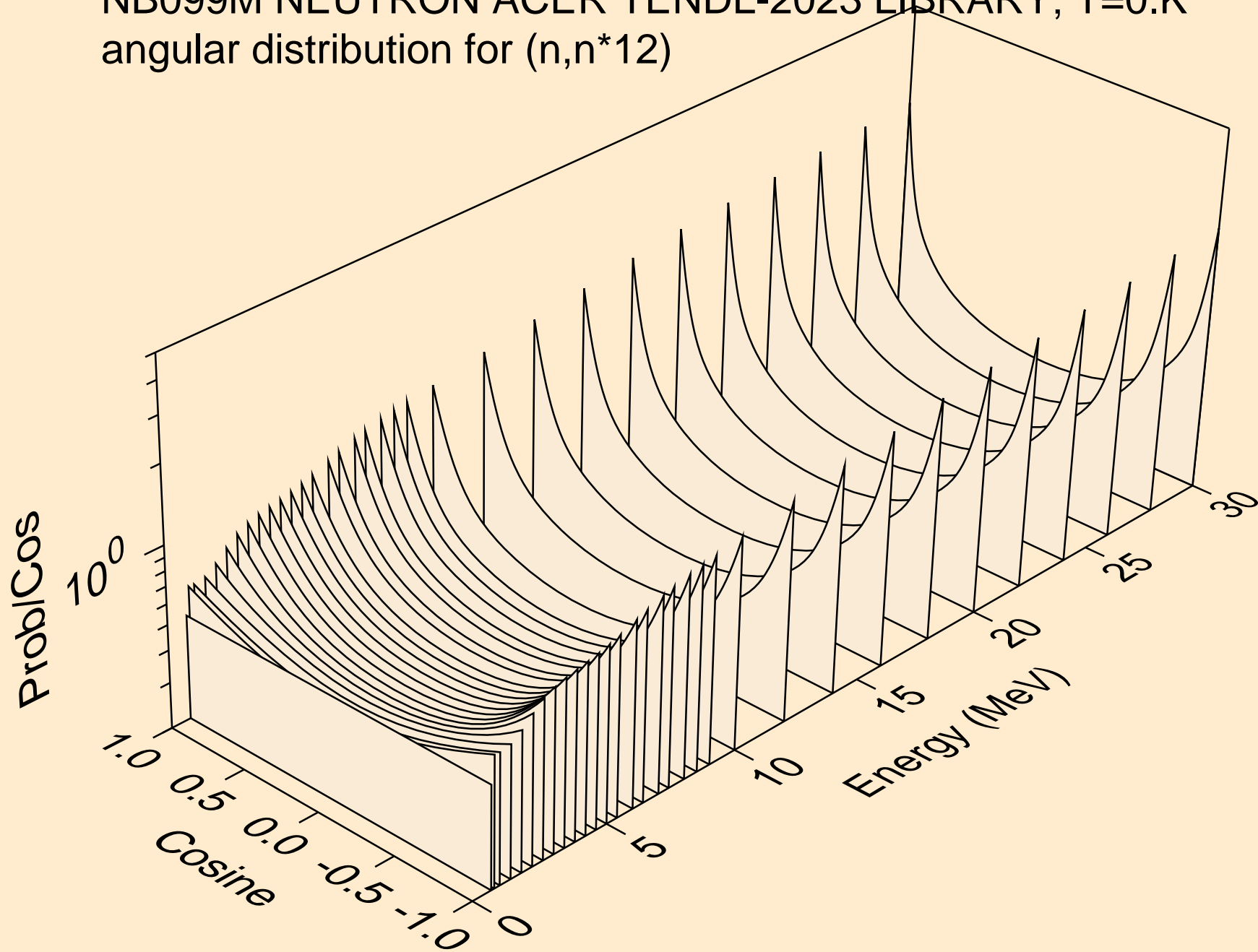

NB099M NEUTRON ACER TENDL-2023 LIBRARY; T=0.K
angular distribution for (n,n*13)

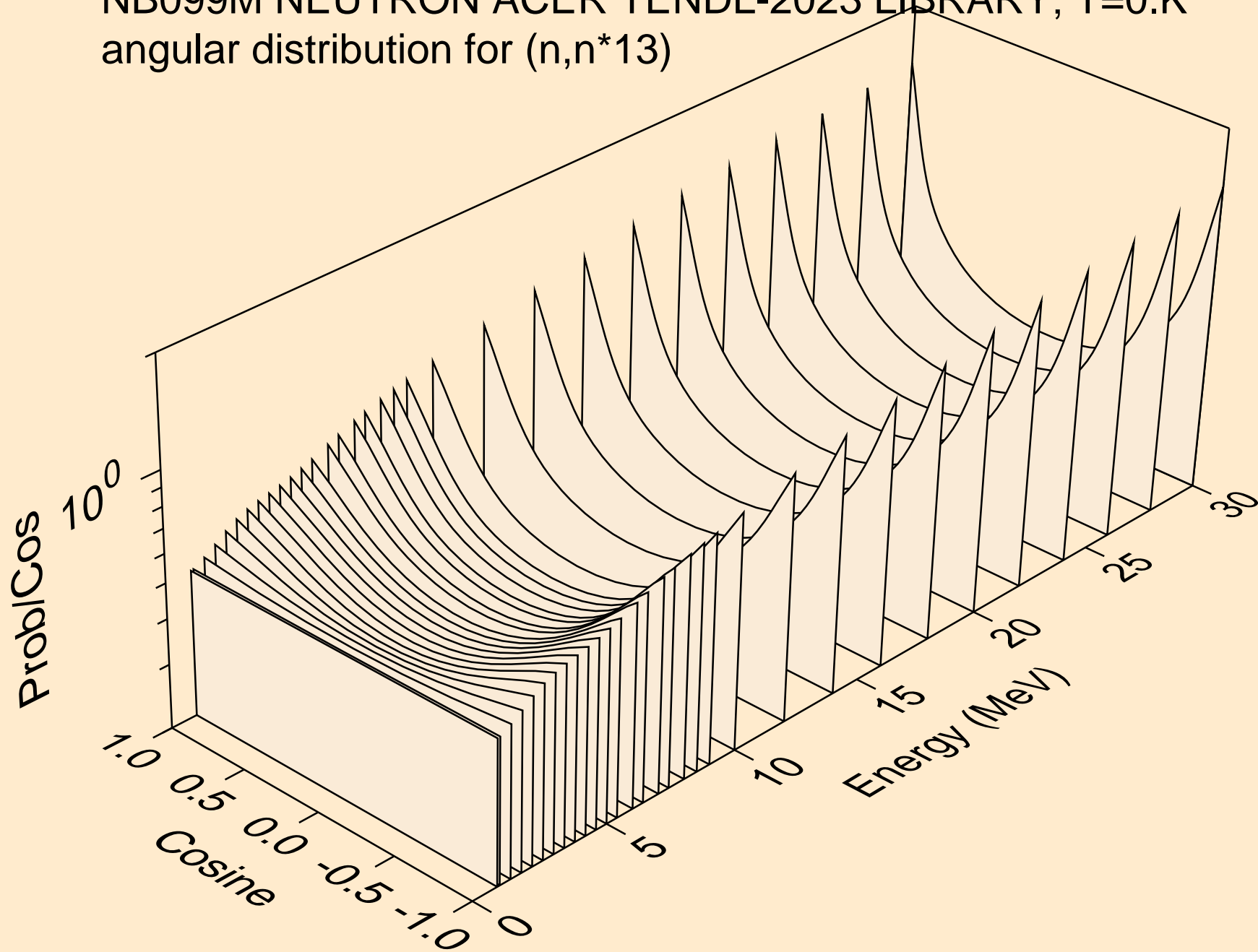

NB099M NEUTRON ACER TENDL-2023 LIBRARY; T=0.K
angular distribution for (n,n*14)

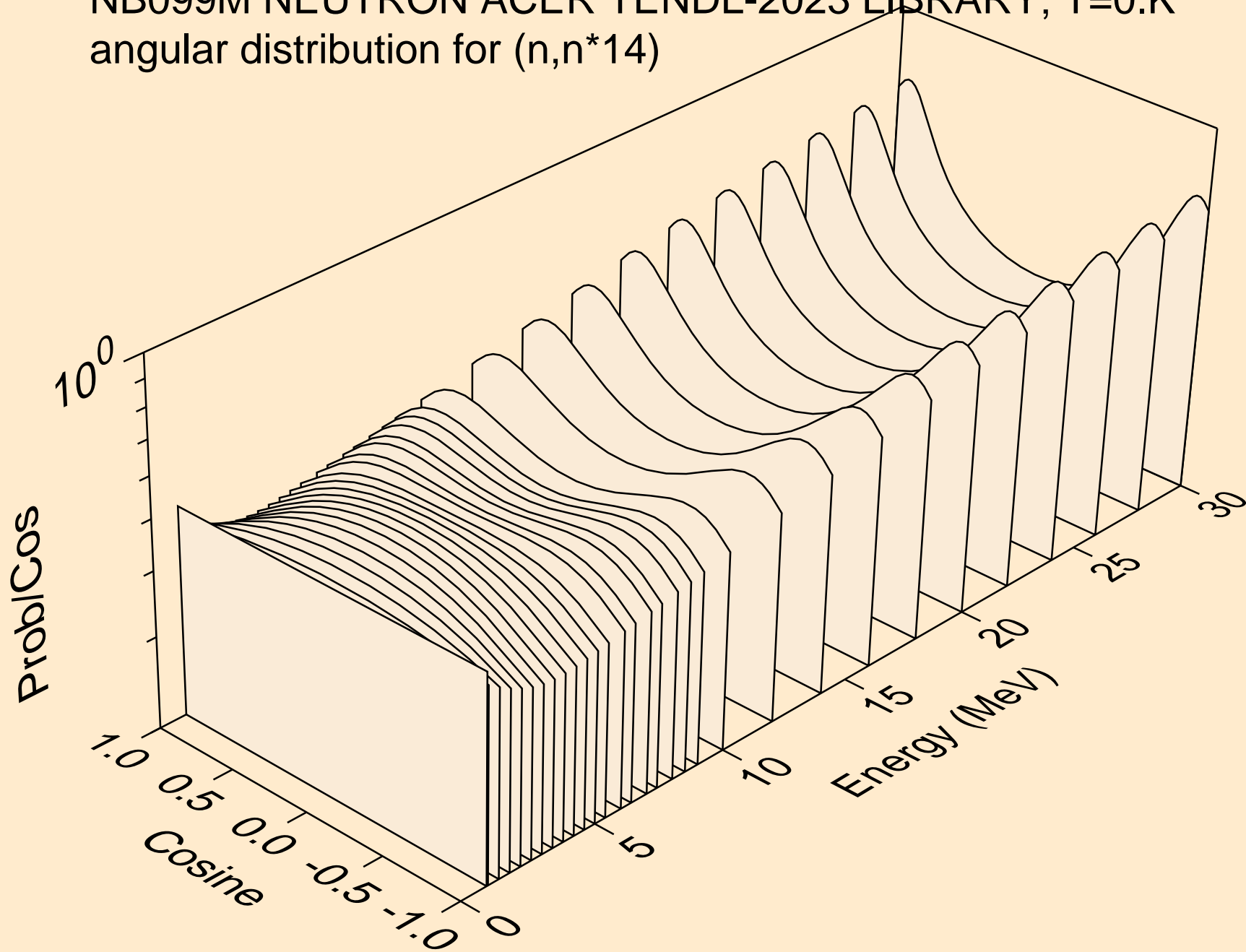

NB099M NEUTRON ACER TENDL-2023 LIBRARY; T=0.K
angular distribution for (n,n*15)

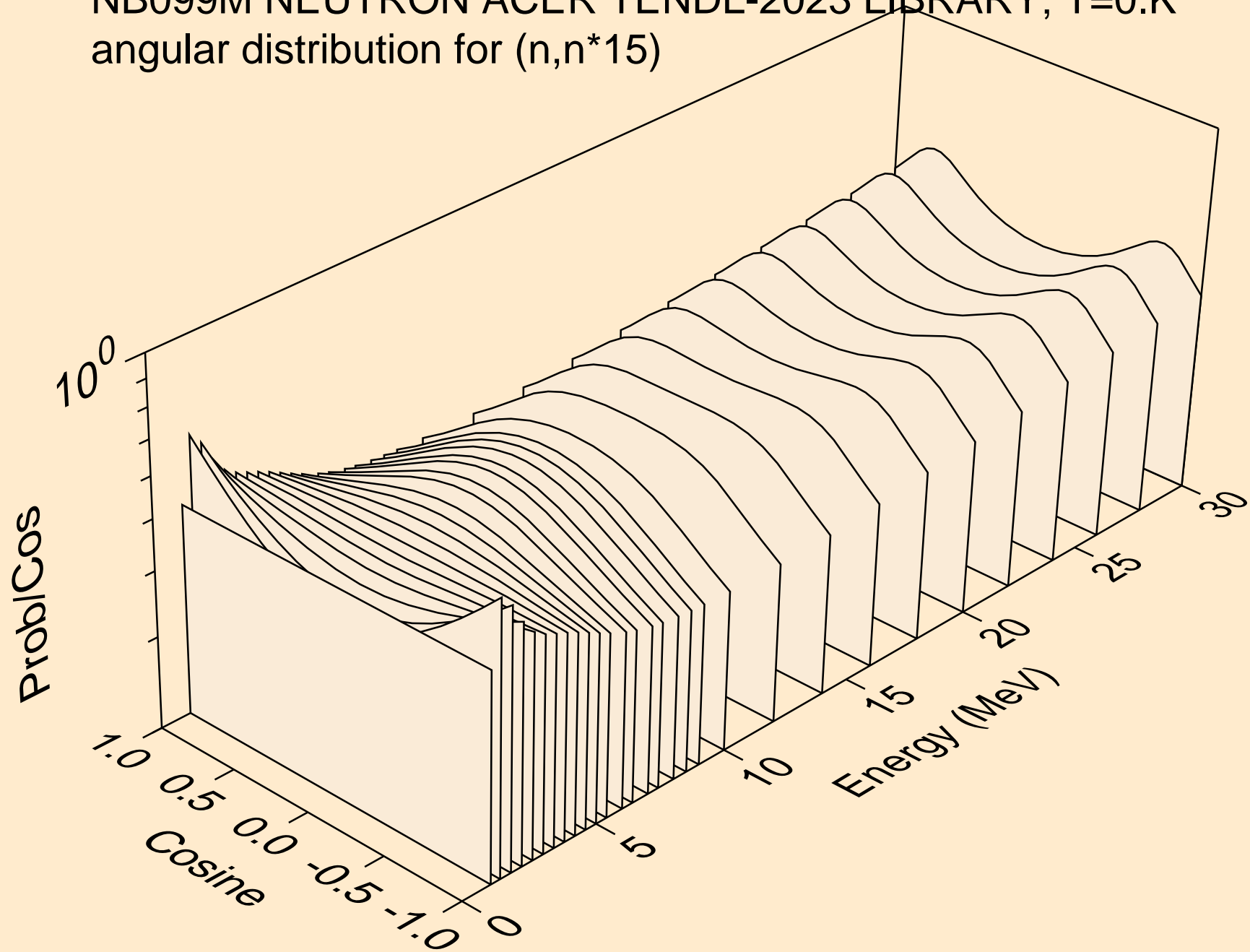

NB099M NEUTRON ACER TENDL-2023 LIBRARY; T=0.K
angular distribution for (n,n*16)

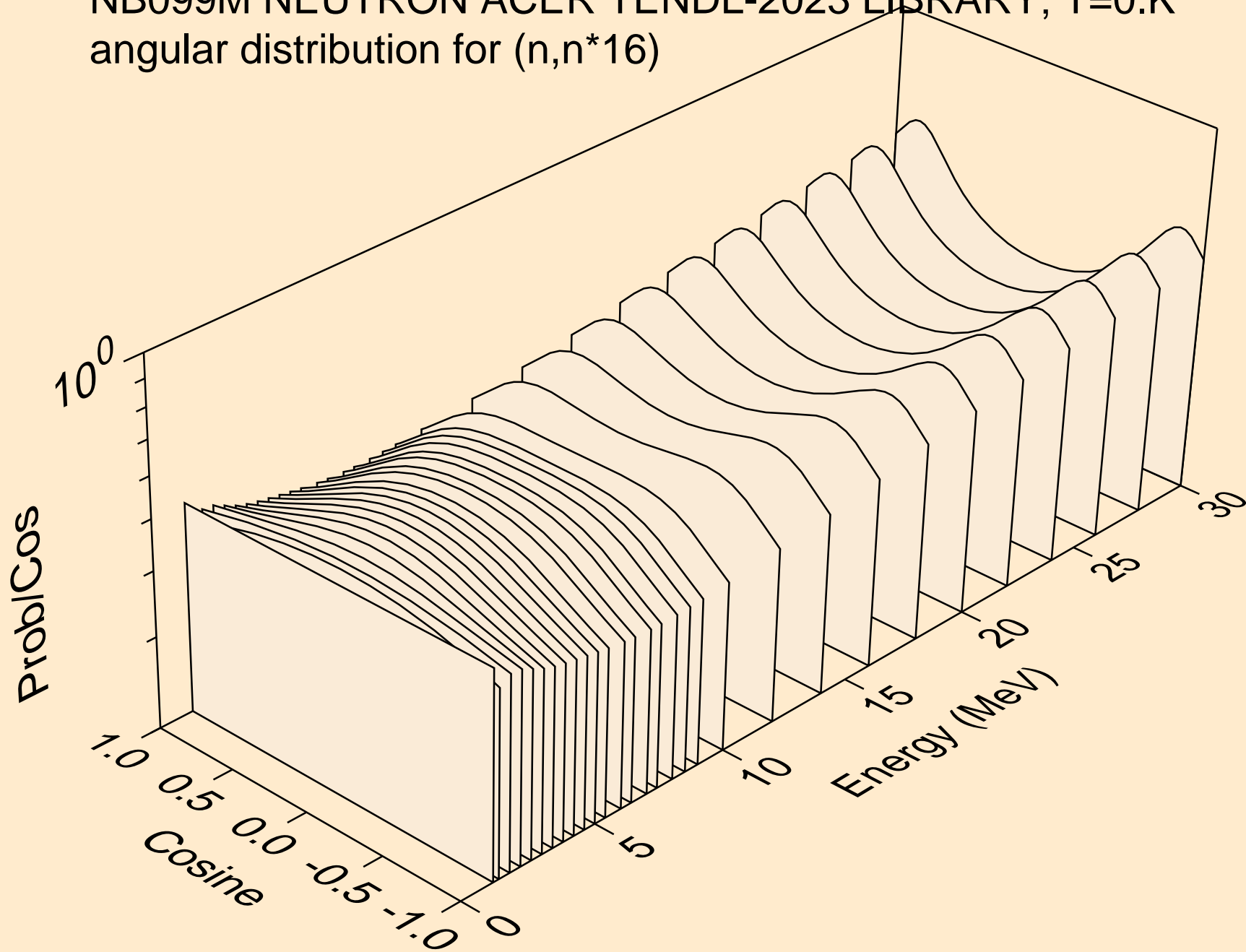

NB099M NEUTRON ACER TENDL-2023 LIBRARY; T=0.K
Neutron emission for (n,x)

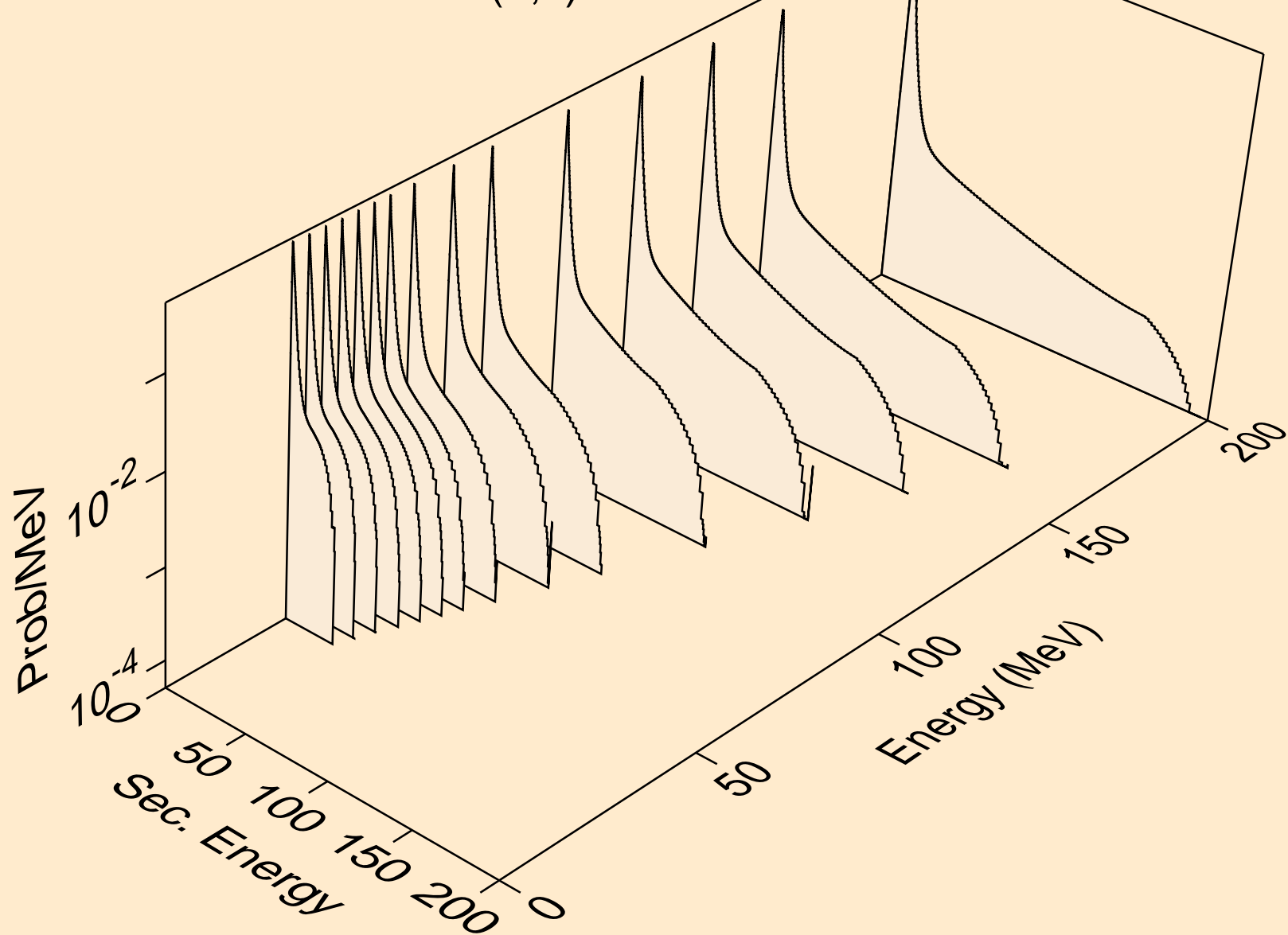

NB099M NEUTRON ACER TENDL-2023 LIBRARY; T=0.K
Neutron emission for (n,2nd)

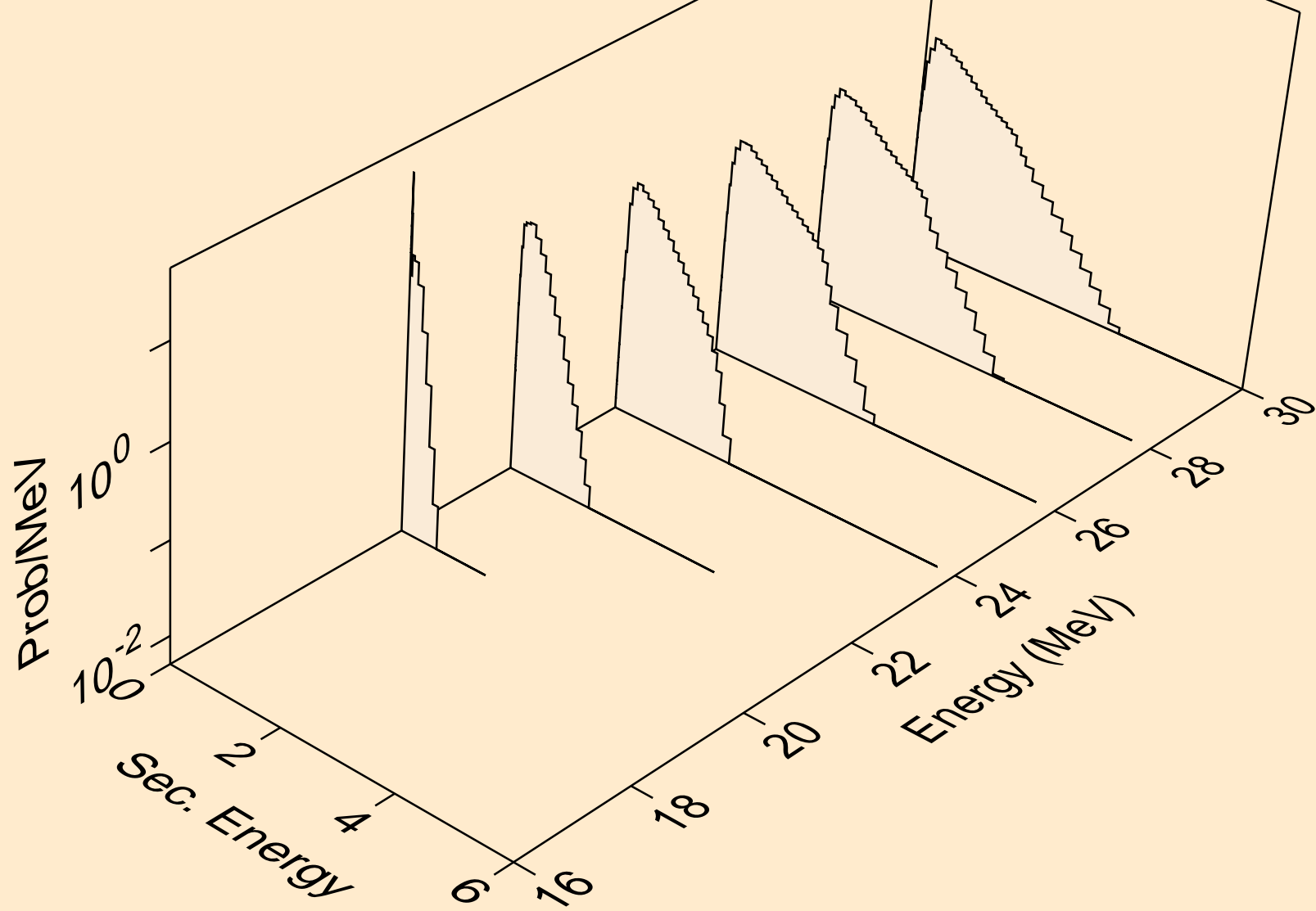

NB099M NEUTRON ACER TENDL-2023 LIBRARY; T=0.K
Neutron emission for (n,2n)

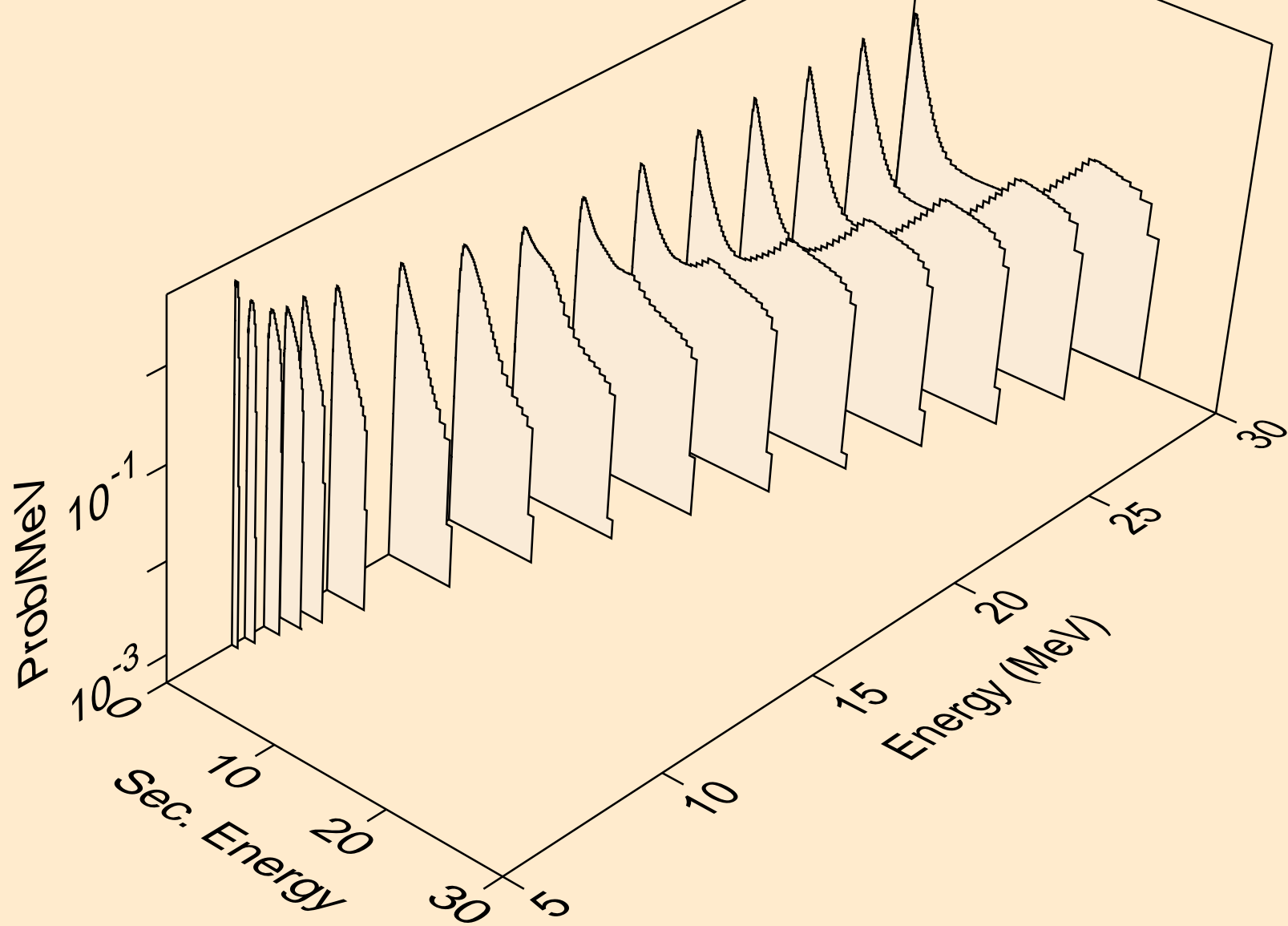

NB099M NEUTRON ACER TENDL-2023 LIBRARY; T=0.K
Neutron emission for (n,3n)

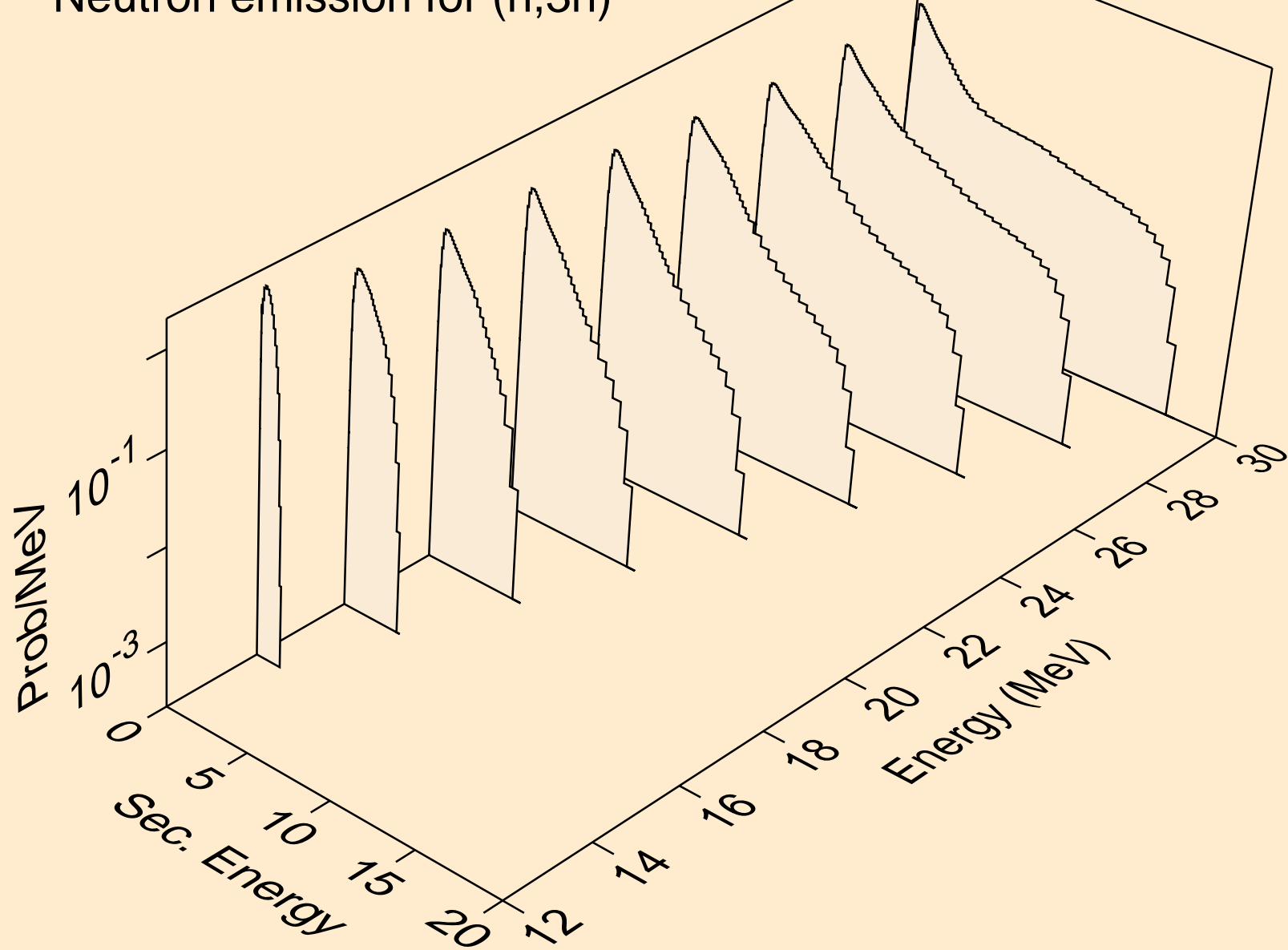

NB099M NEUTRON ACER TENDL-2023 LIBRARY; T=0.K
Neutron emission for (n,n*)a

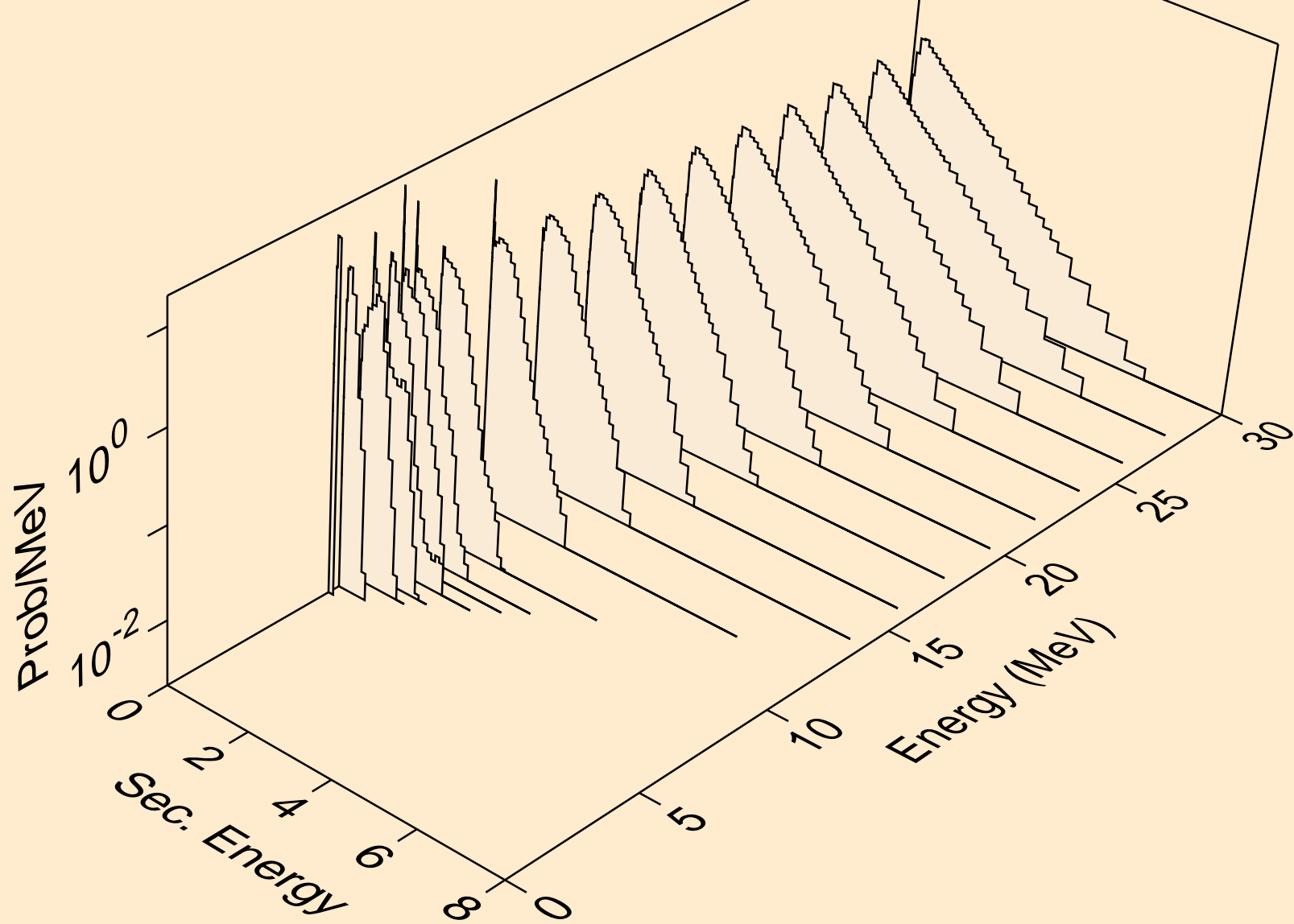

NB099M NEUTRON ACER TENDL-2023 LIBRARY; T=0.K
Neutron emission for (n,2n)a

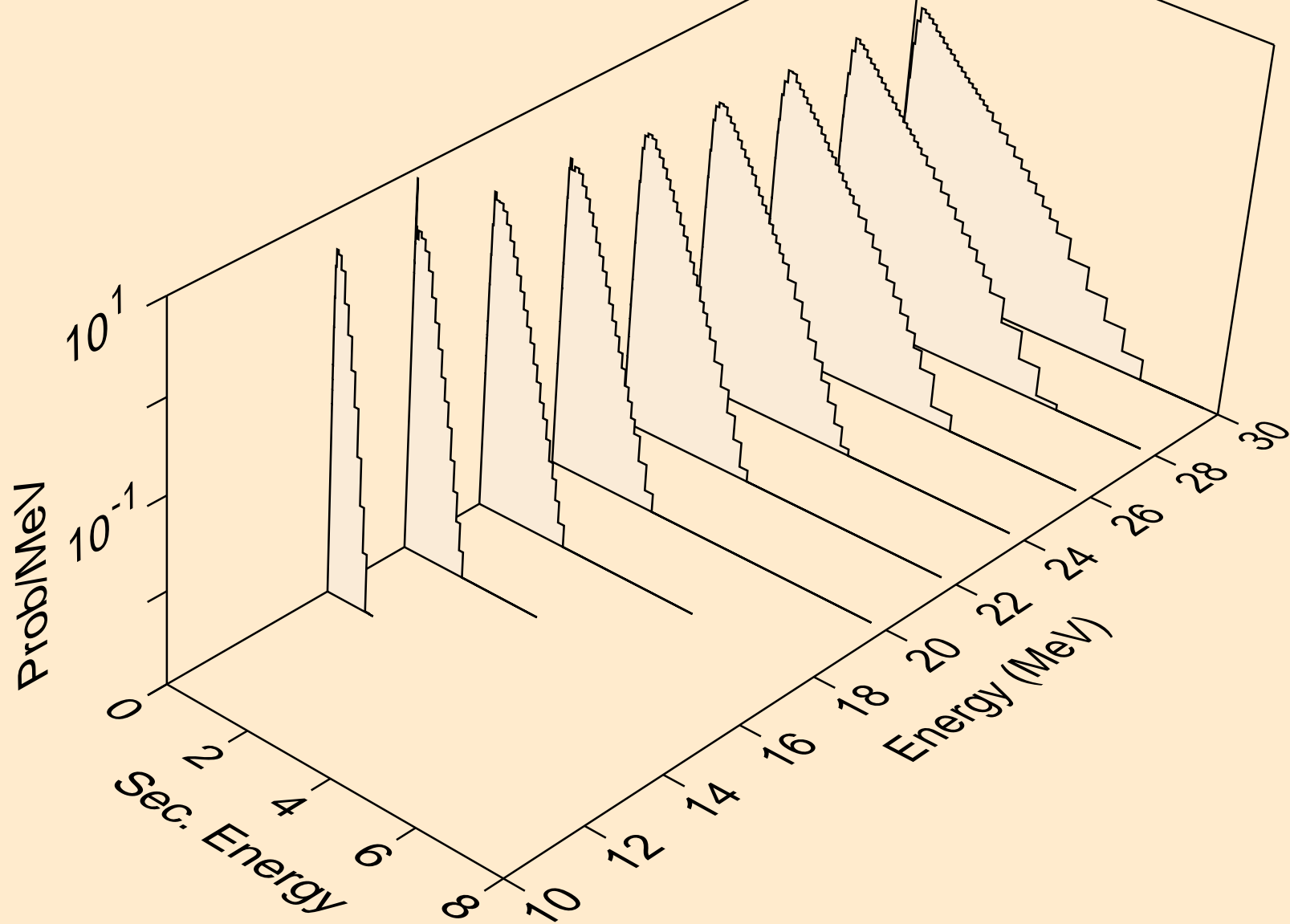

NB099M NEUTRON ACER TENDL-2023 LIBRARY; T=0.K
Neutron emission for (n,3n)a

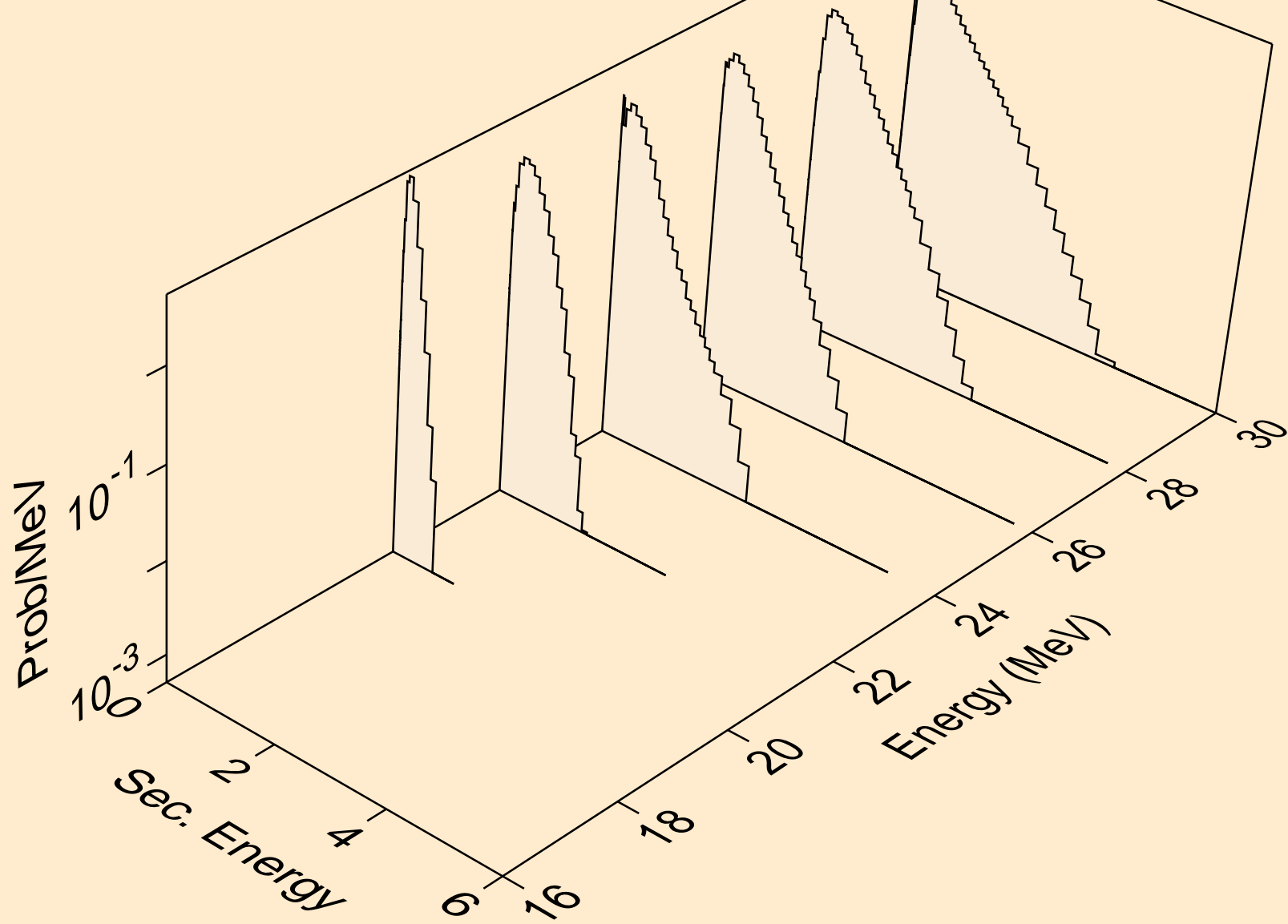

NB099M NEUTRON ACER TENDL-2023 LIBRARY; T=0.K
Neutron emission for (n,n*)p

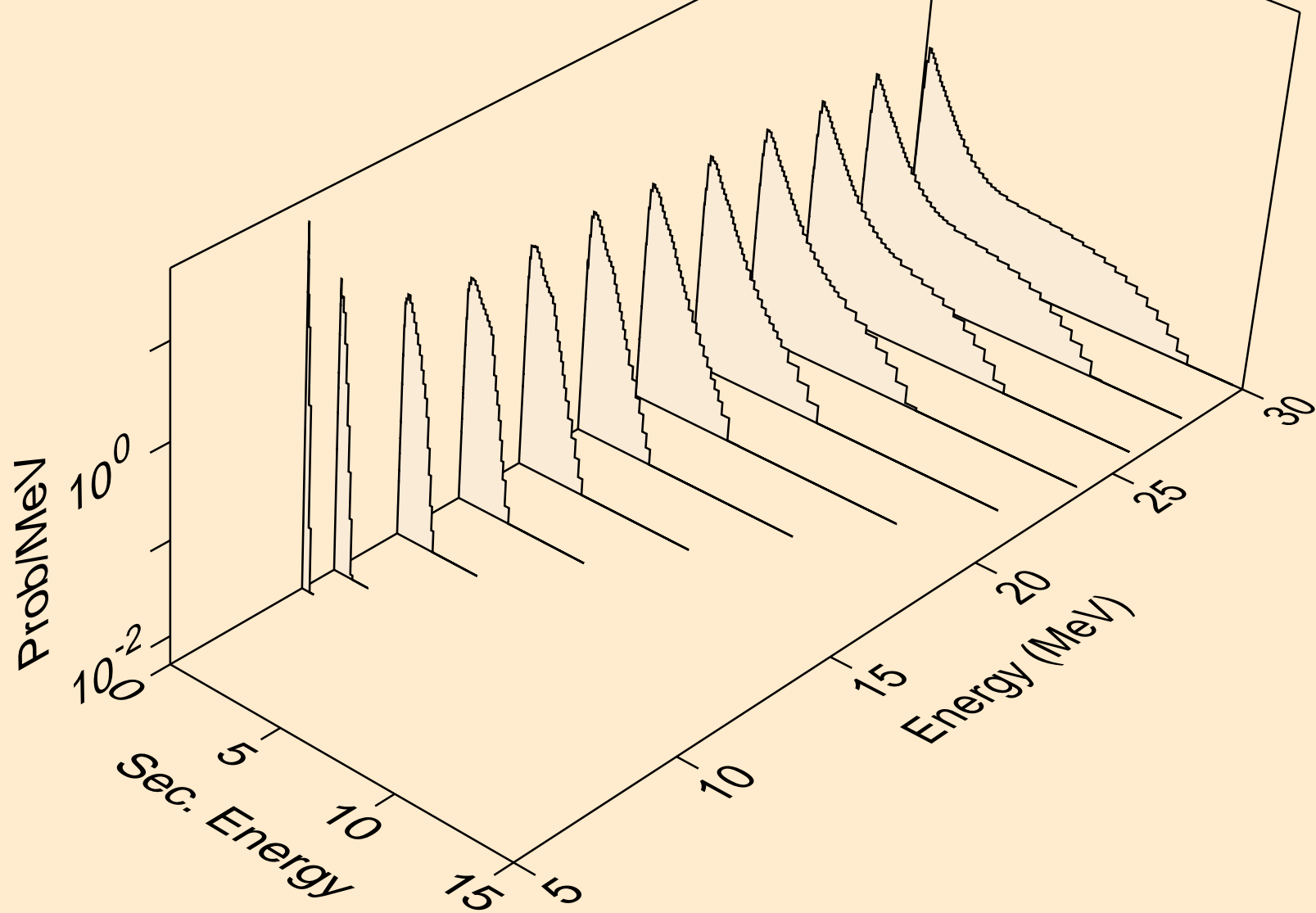

NB099M NEUTRON ACER TENDL-2023 LIBRARY; T=0.K
Neutron emission for (n,n*)2a

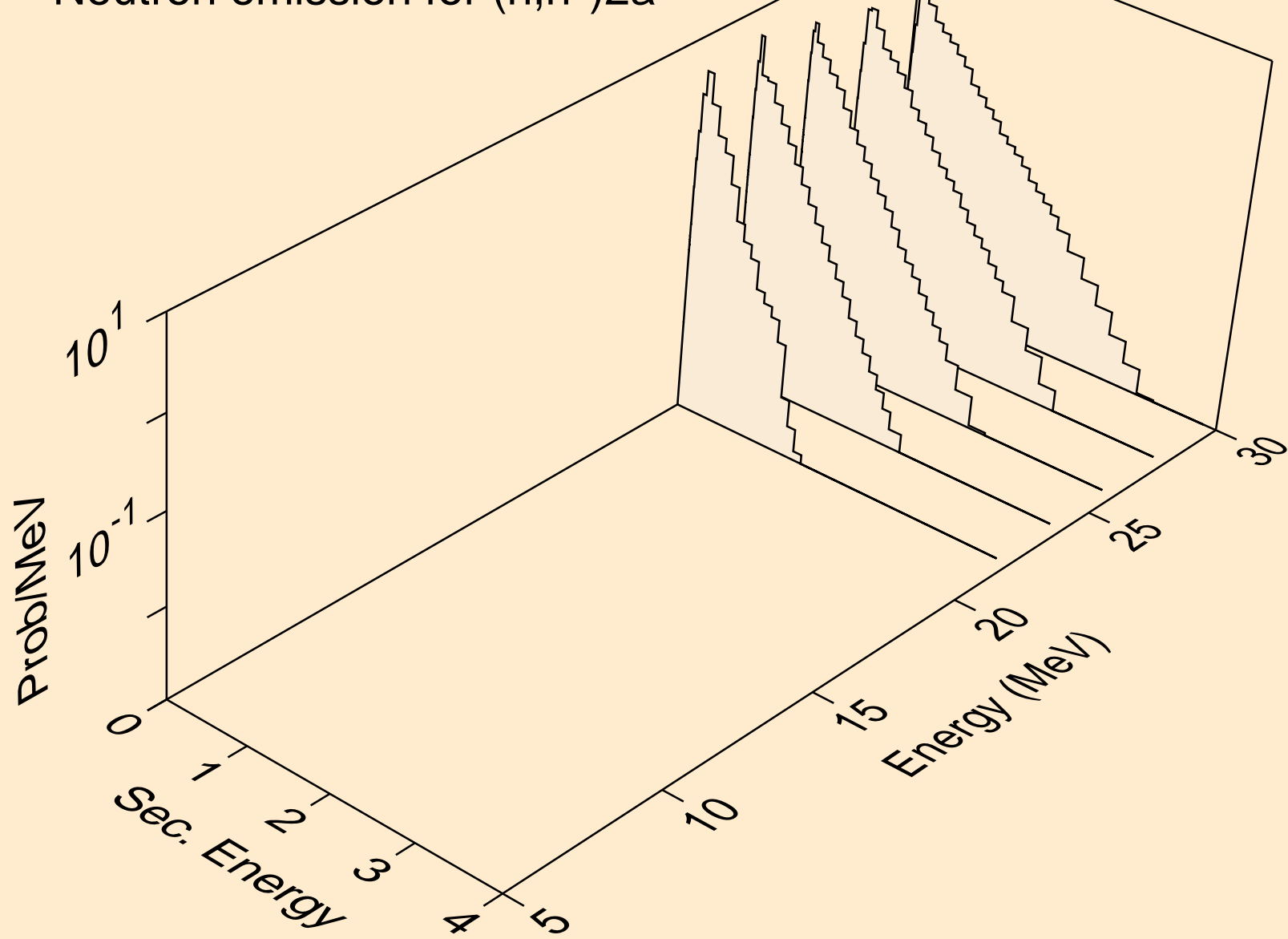

NB099M NEUTRON ACER TENDL-2023 LIBRARY; T=0.K
Neutron emission for (n,n*)d

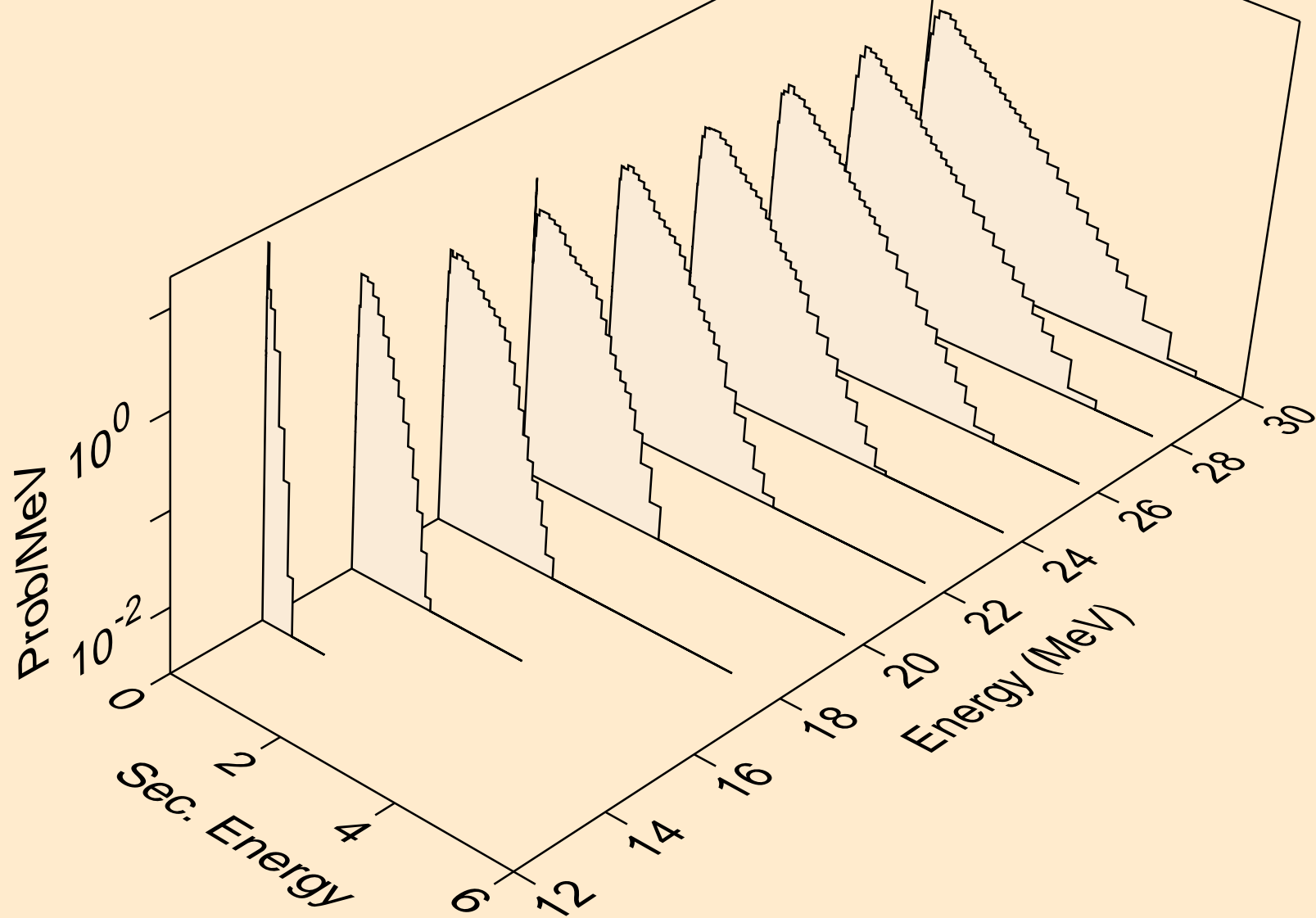

NB099M NEUTRON ACER TENDL-2023 LIBRARY; T=0.K
Neutron emission for (n,n*)t

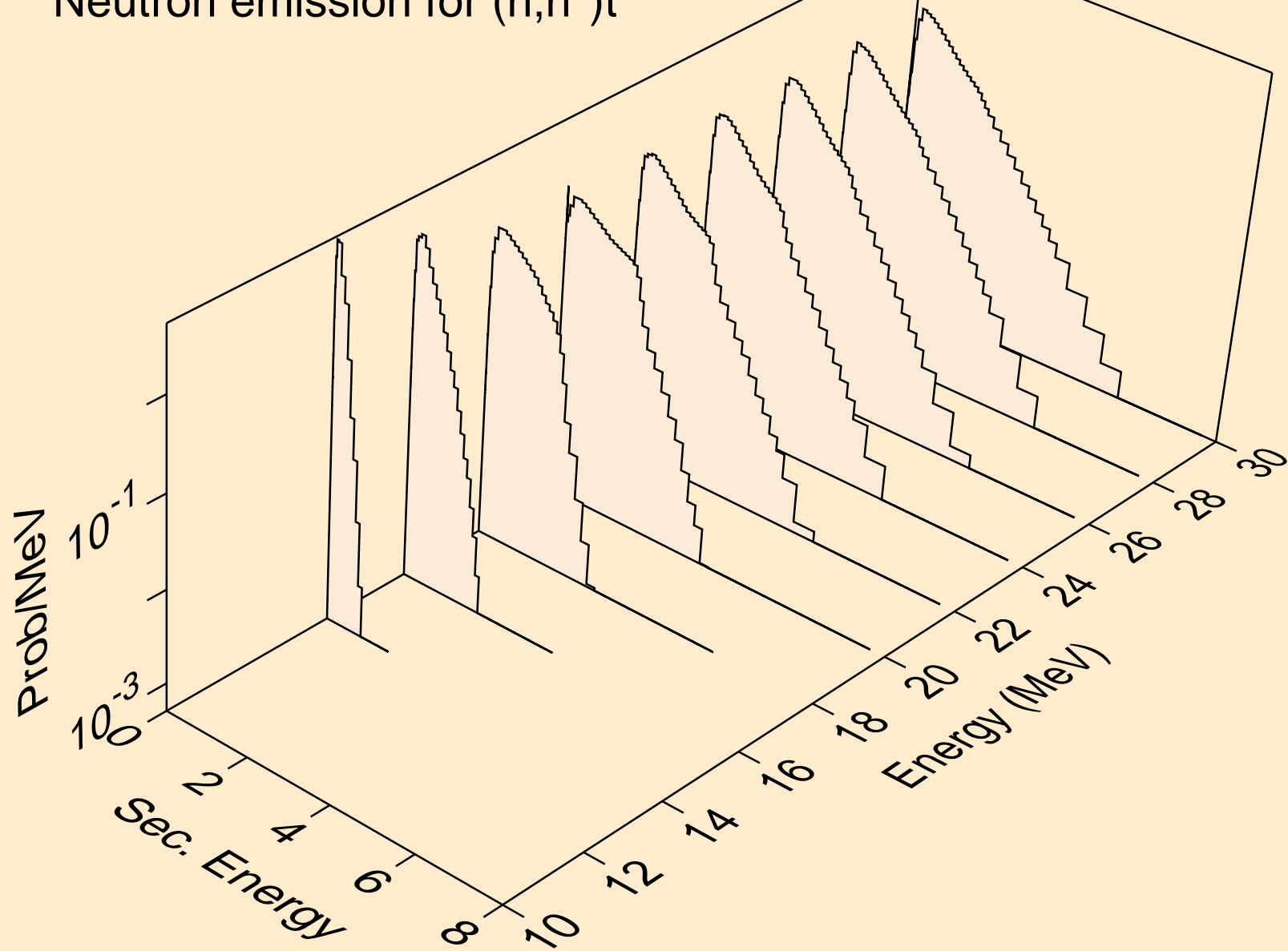

NB099M NEUTRON ACER TENDL-2023 LIBRARY; T=0.K
Neutron emission for (n,n*)he3

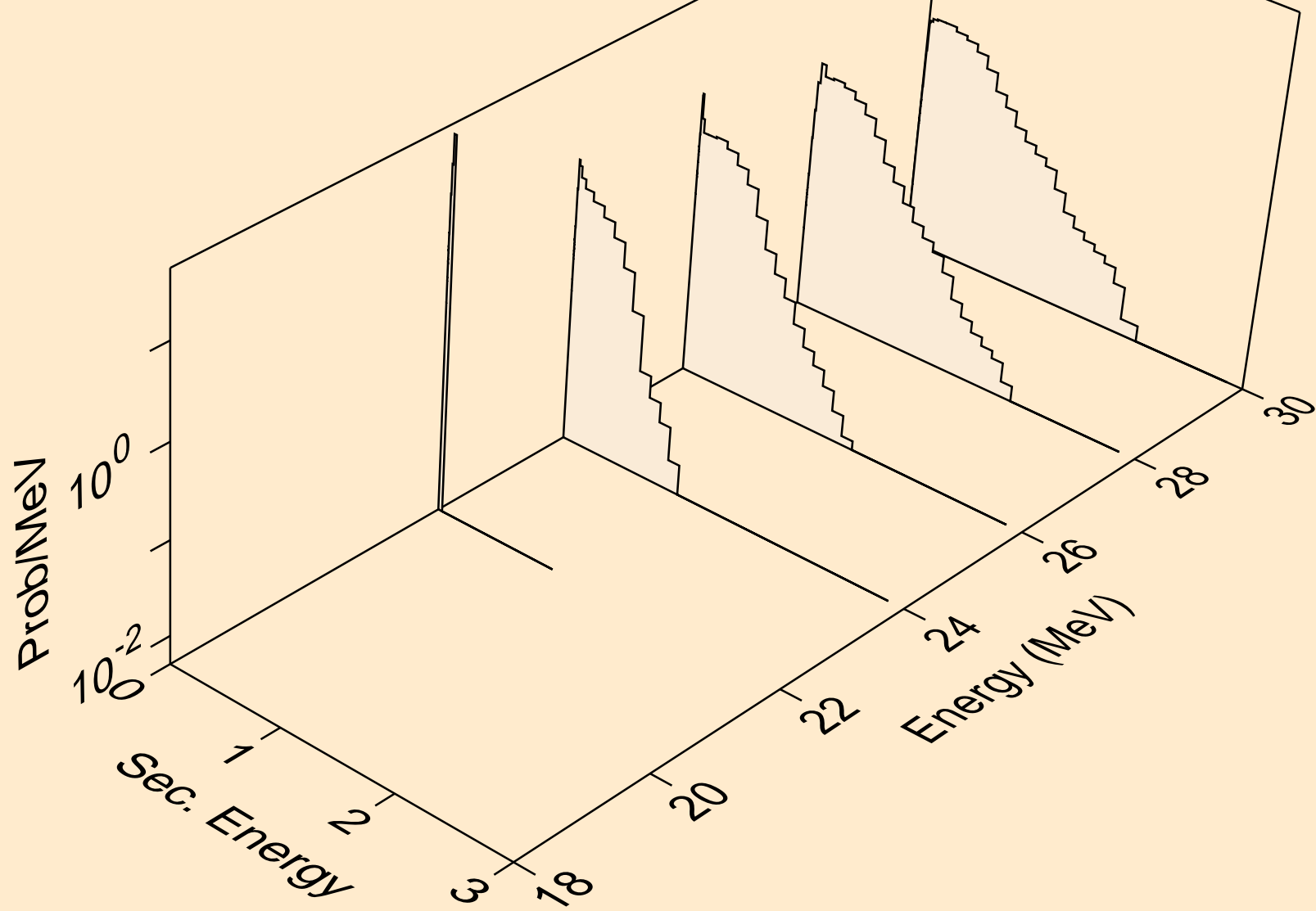

NB099M NEUTRON ACER TENDL-2023 LIBRARY; T=0.K
Neutron emission for (n,4n)

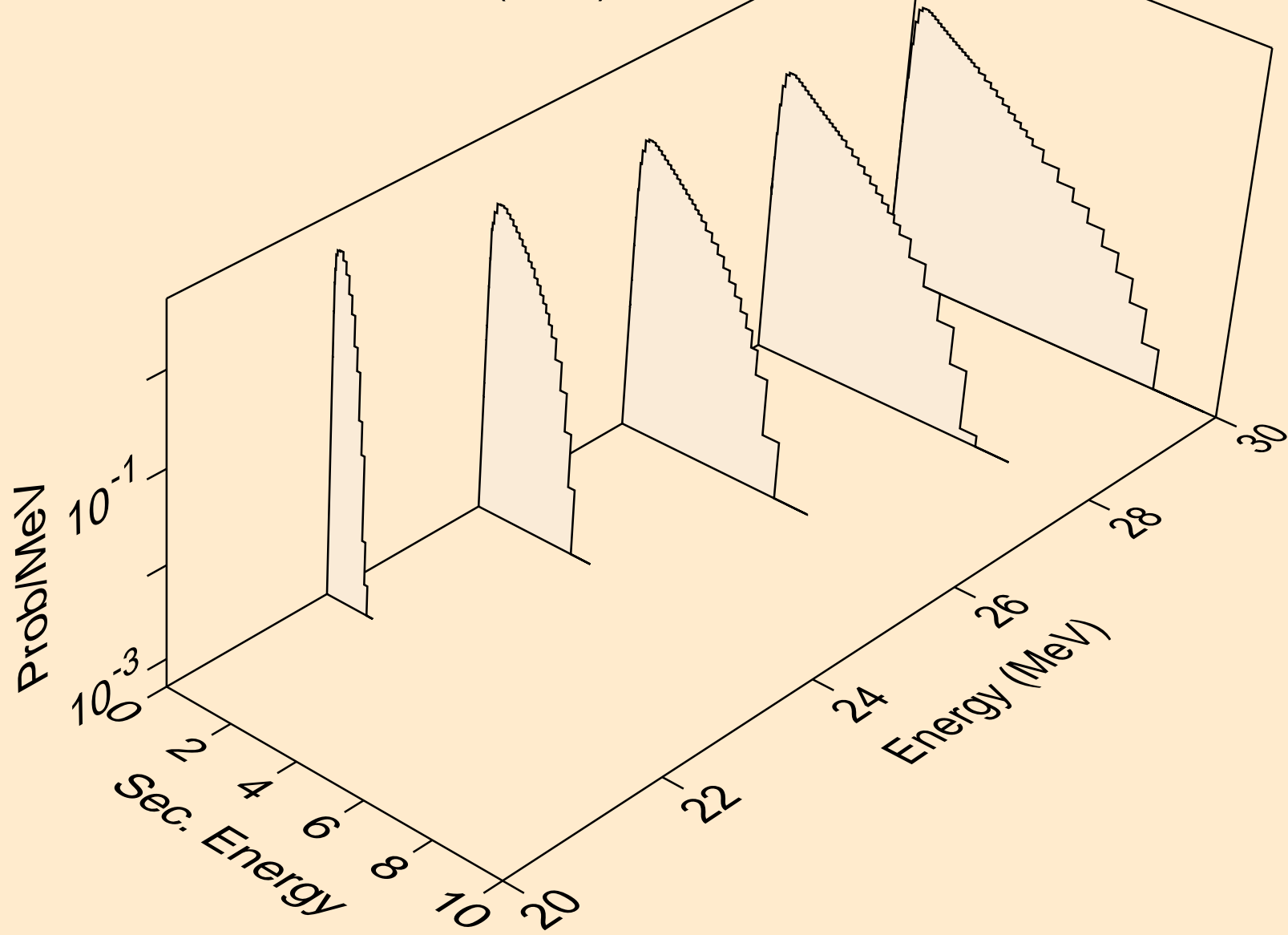

NB099M NEUTRON ACER TENDL-2023 LIBRARY; T=0.K
Neutron emission for (n,2np)

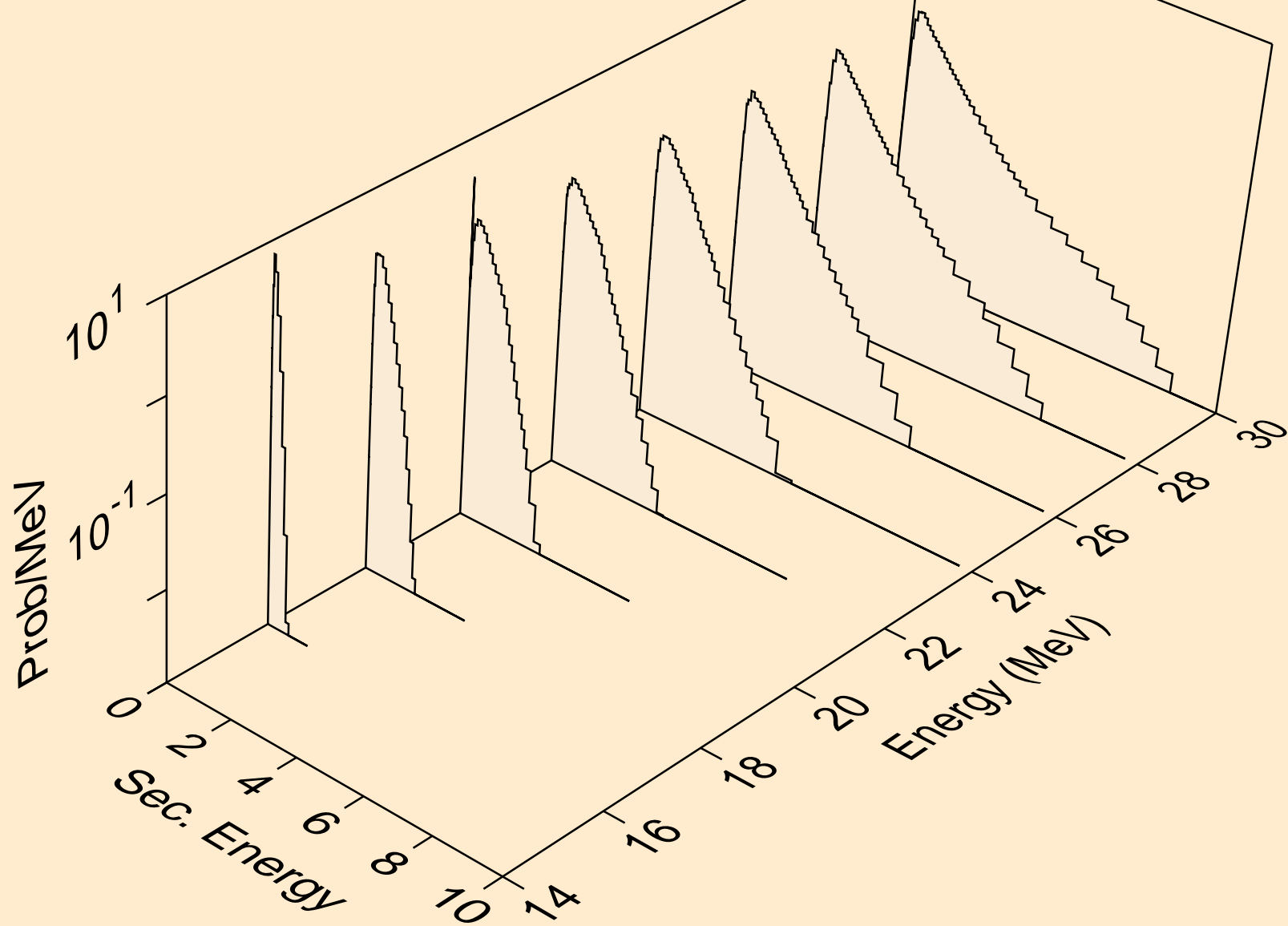

NB099M NEUTRON ACER TENDL-2023 LIBRARY; T=0.K
Neutron emission for (n,3np)

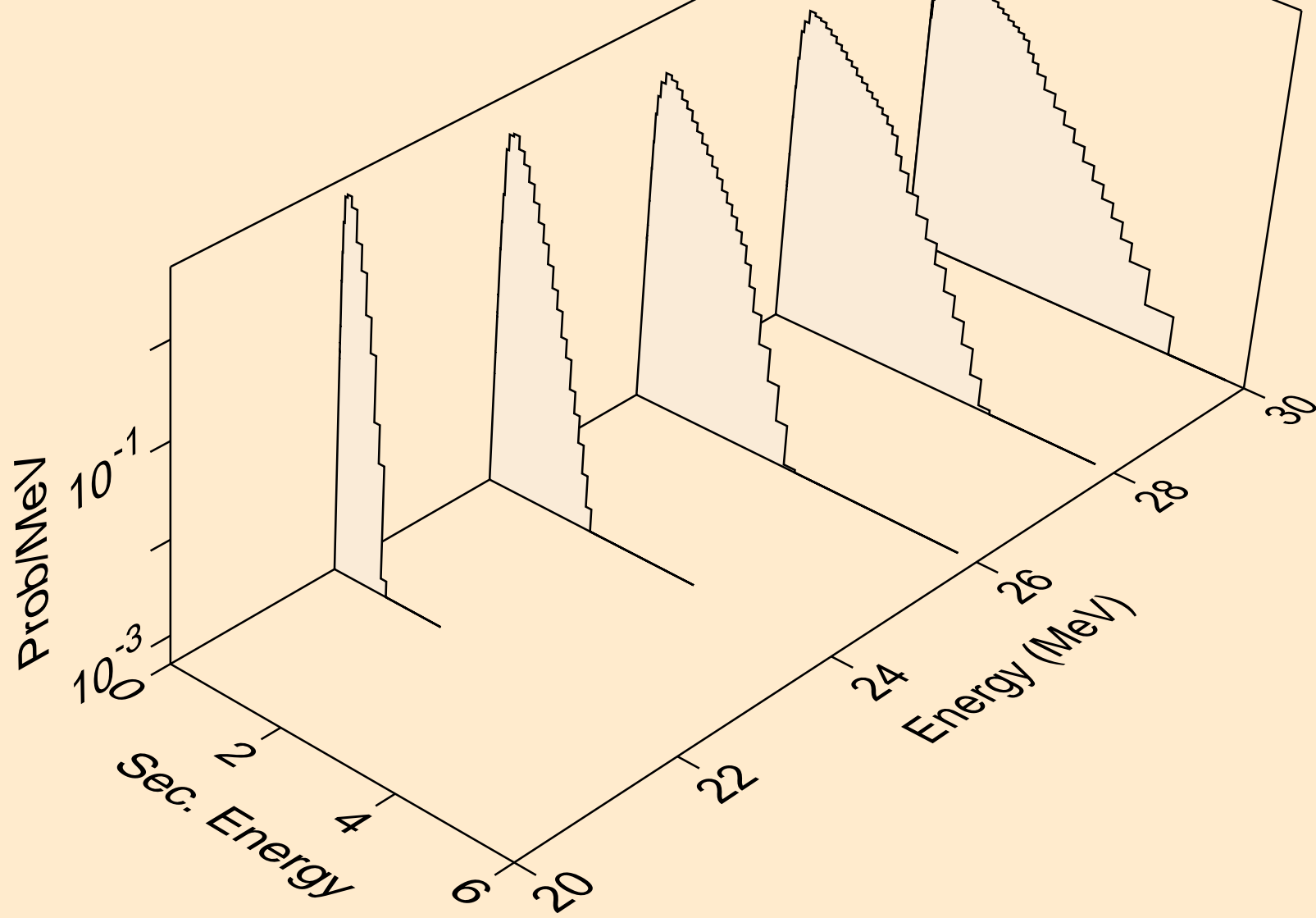

NB099M NEUTRON ACER TENDL-2023 LIBRARY; T=0.K
Neutron emission for (n,n2p)

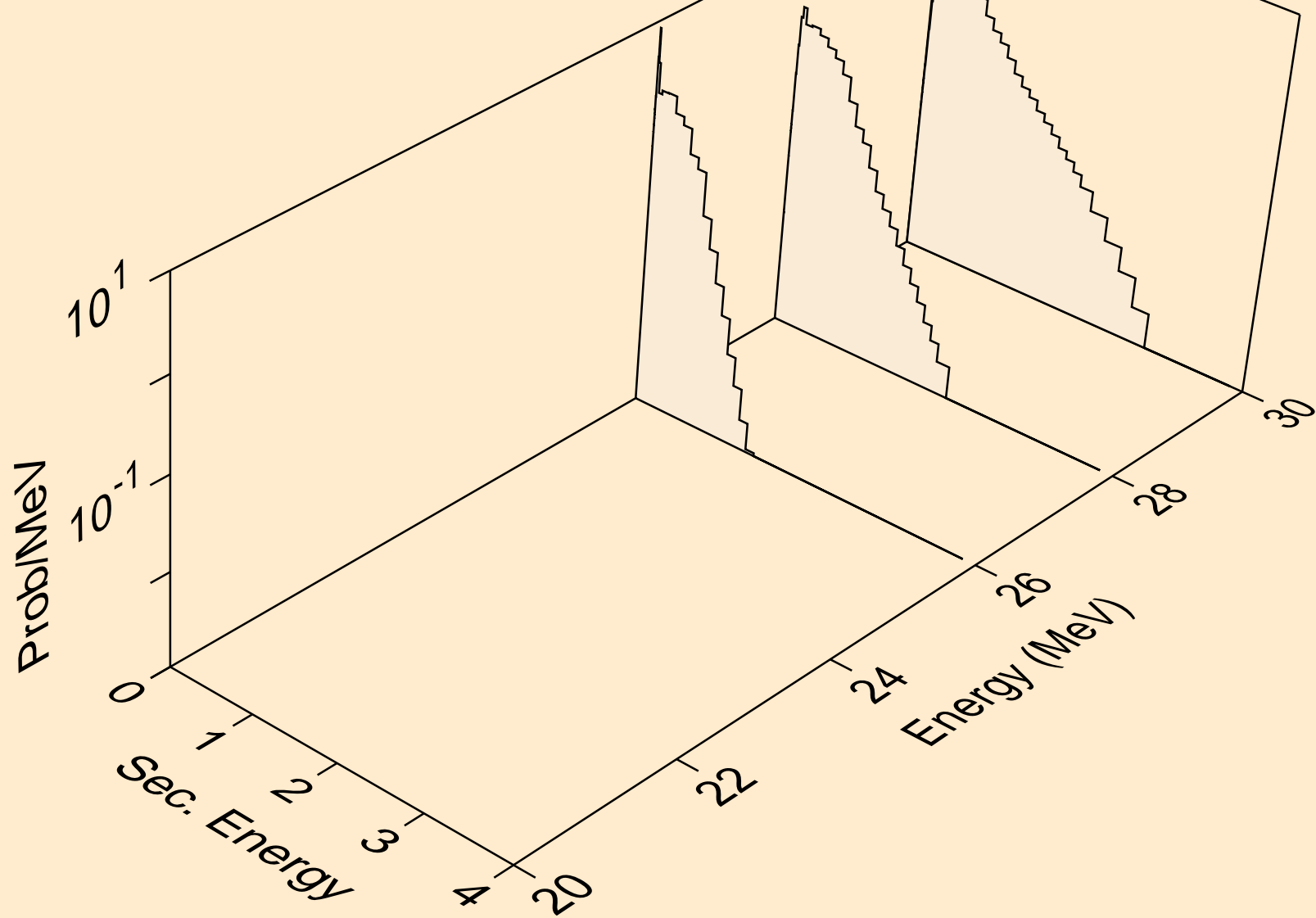

NB099M NEUTRON ACER TENDL-2023 LIBRARY; T=0.K
Neutron emission for (n,npa)

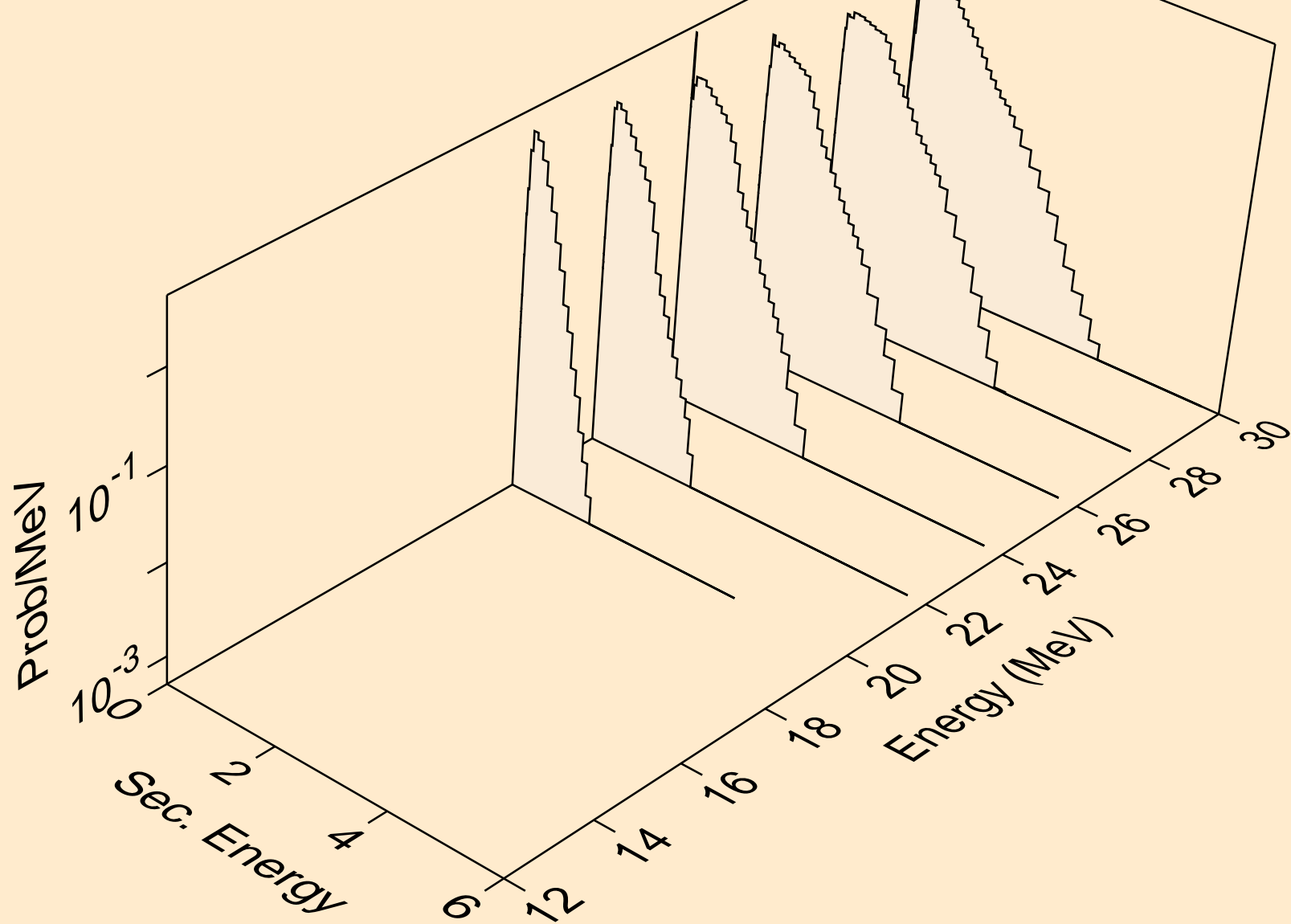

NB099M NEUTRON ACER TENDL-2023 LIBRARY; T=0.K
Neutron emission for (n,n*c)

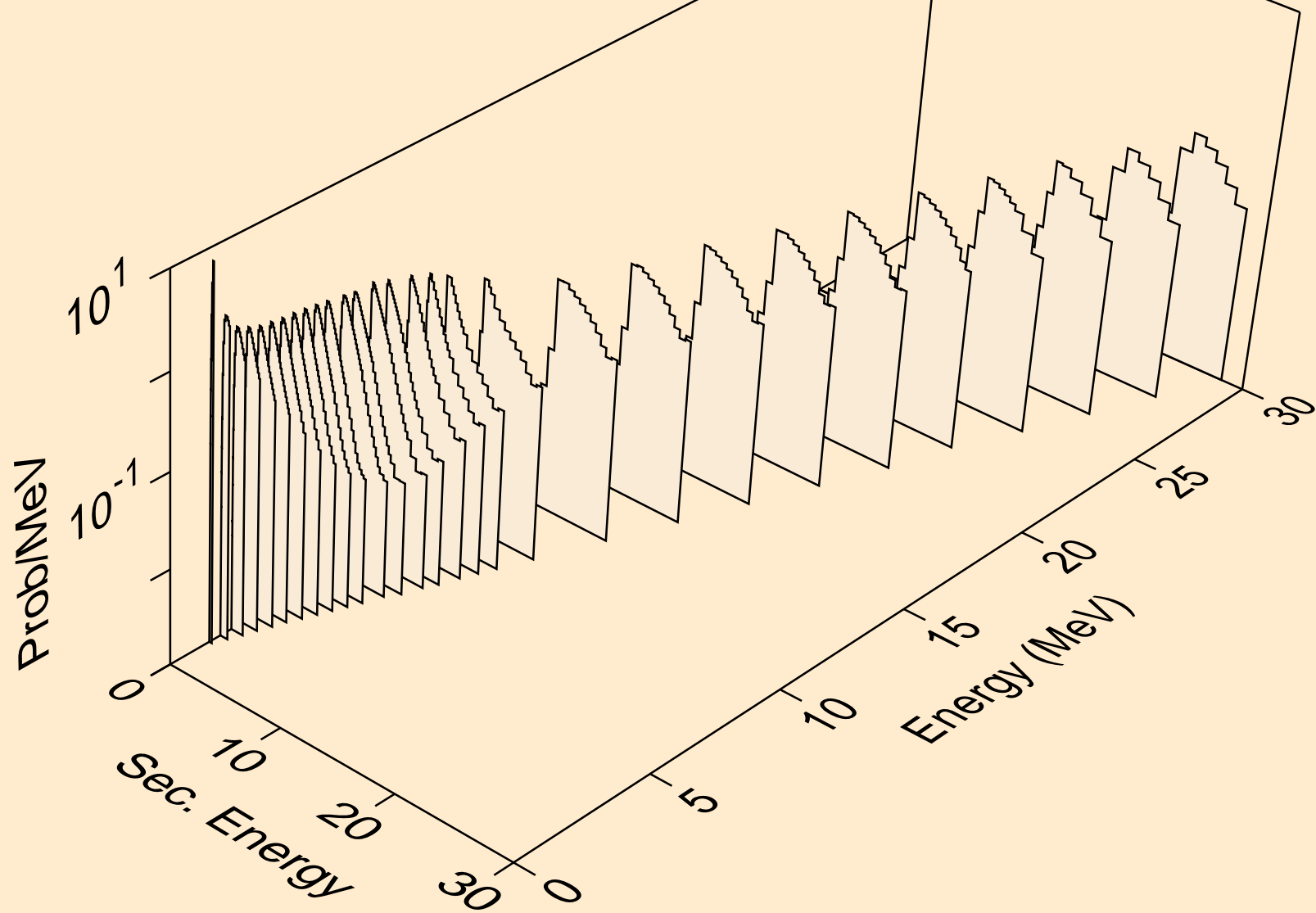

NB099M NEUTRON ACER TENDL-2023 LIBRARY; T=0.K
Photon emission for (n,x)

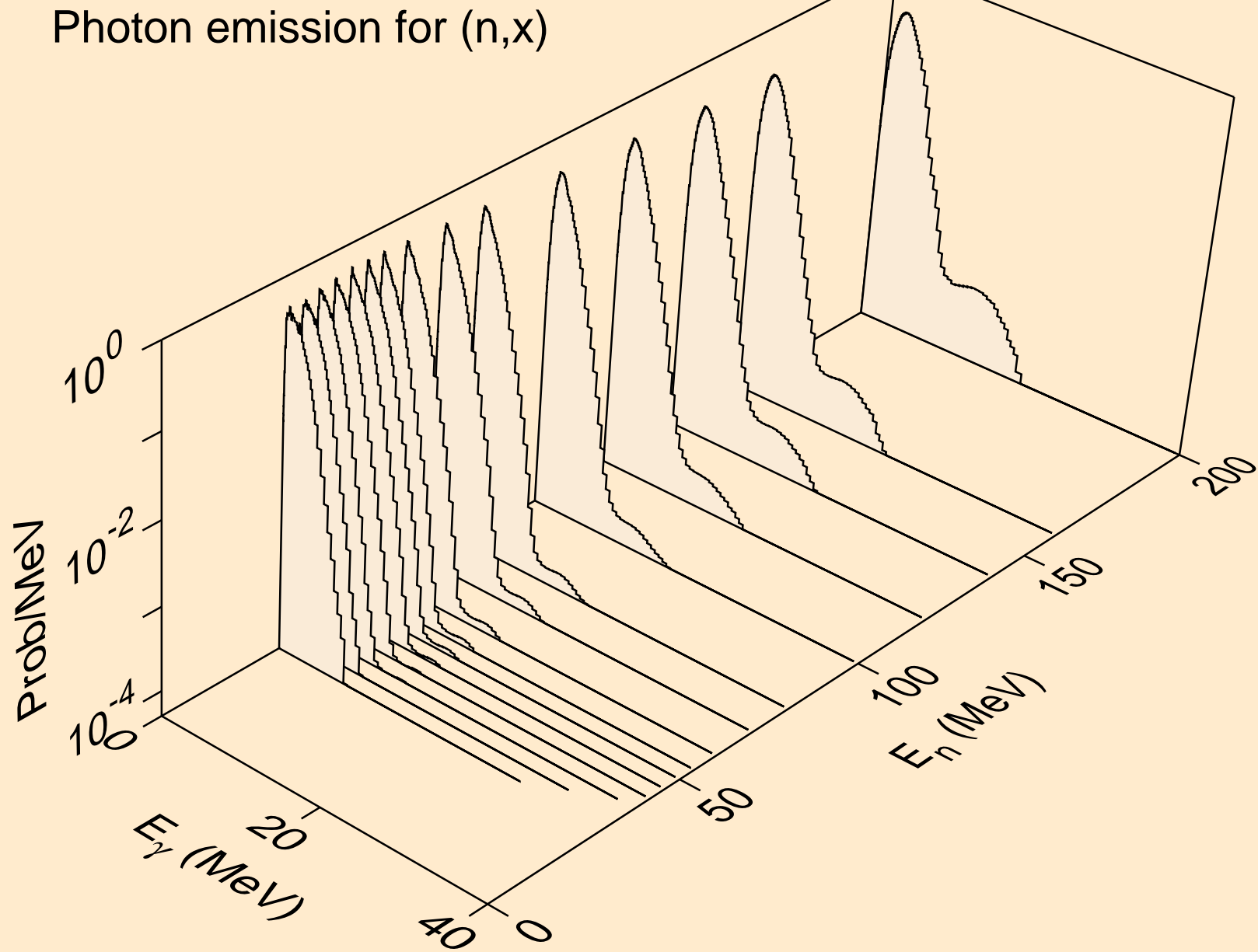

NB099M NEUTRON ACER TENDL-2023 LIBRARY; T=0.K
Photon emission for (n,2nd)

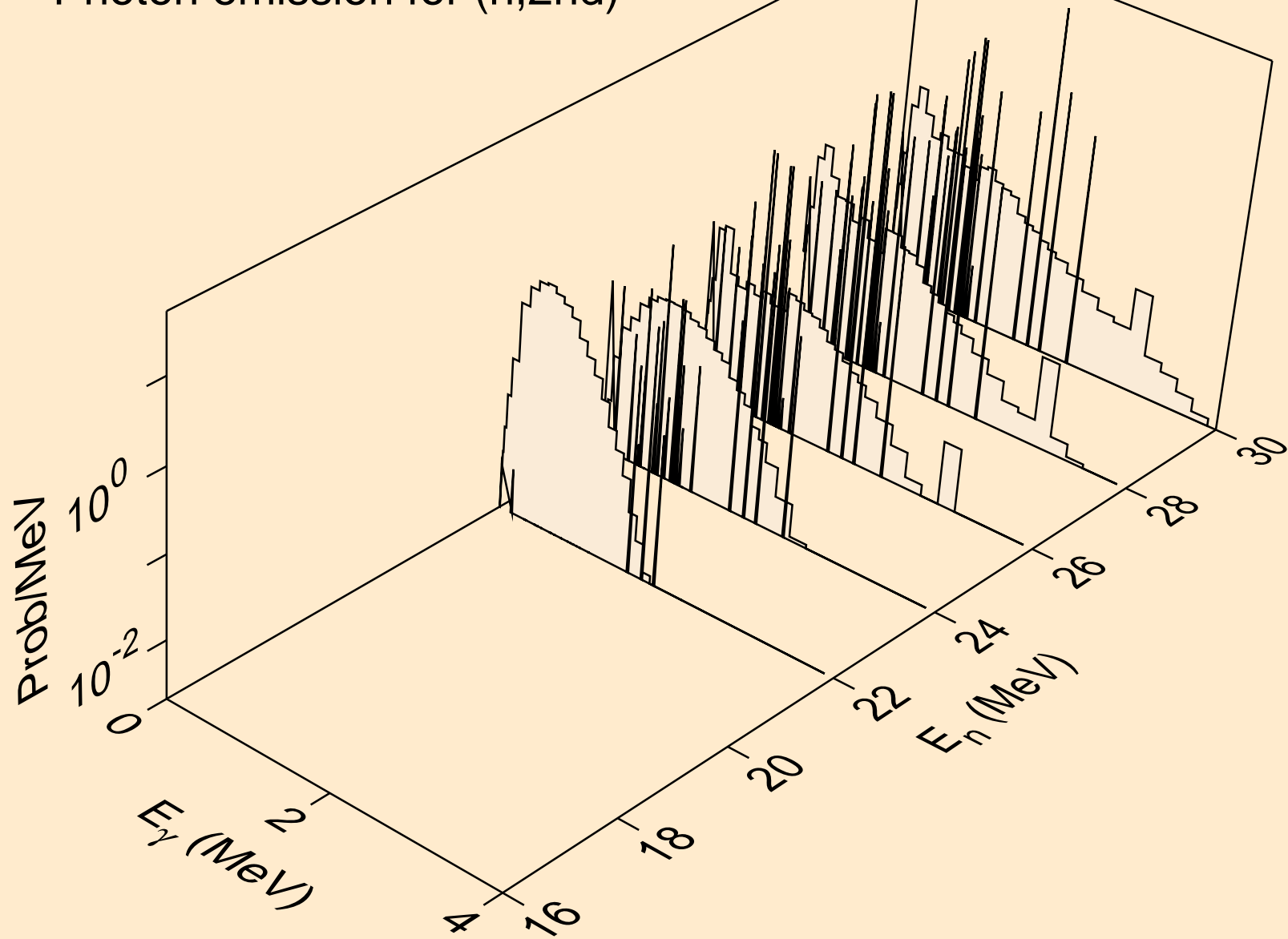

NB099M NEUTRON ACER TENDL-2023 LIBRARY; T=0.K
Photon emission for (n,2n)

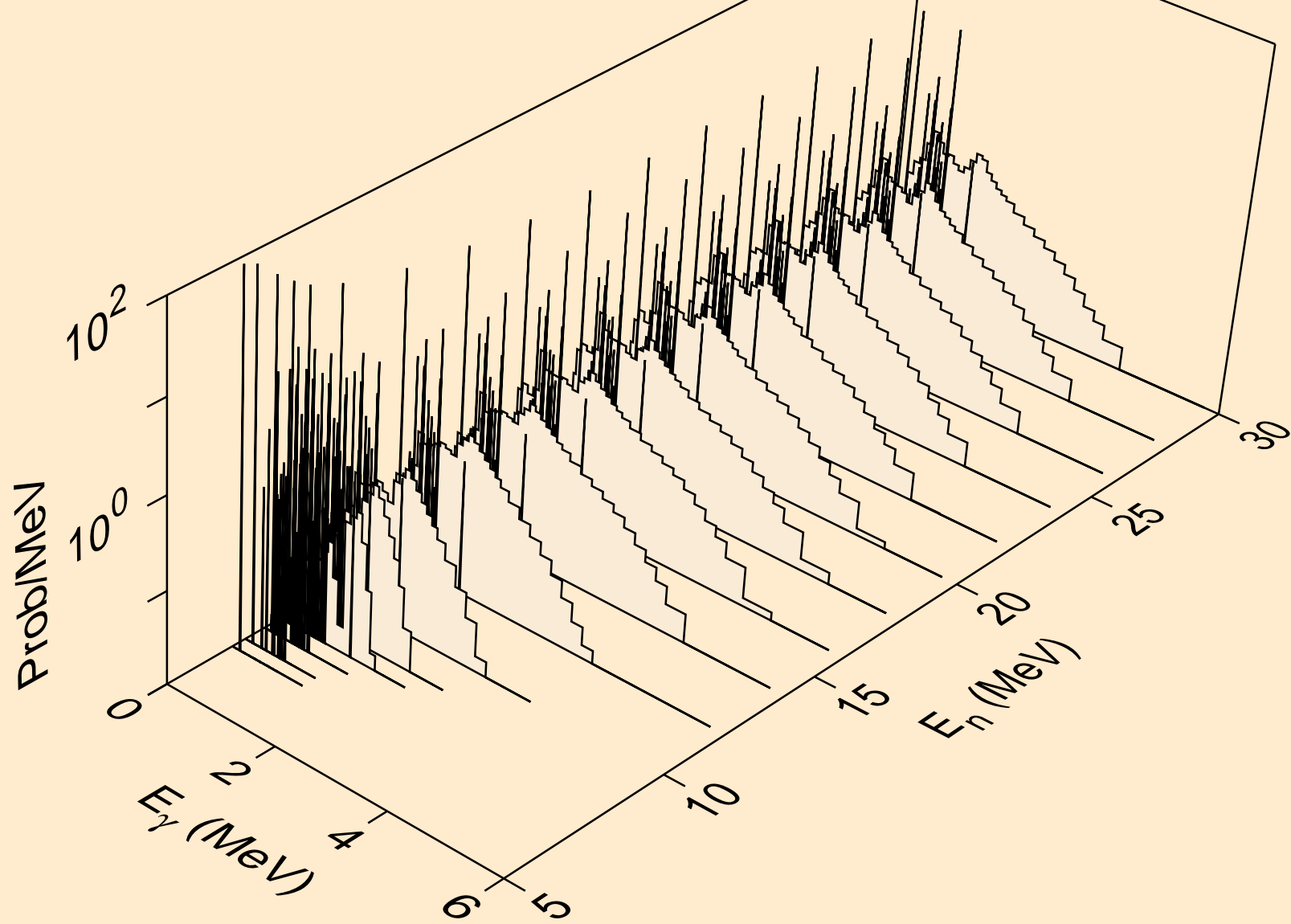

NB099M NEUTRON ACER TENDL-2023 LIBRARY; T=0.K
Photon emission for (n,3n)

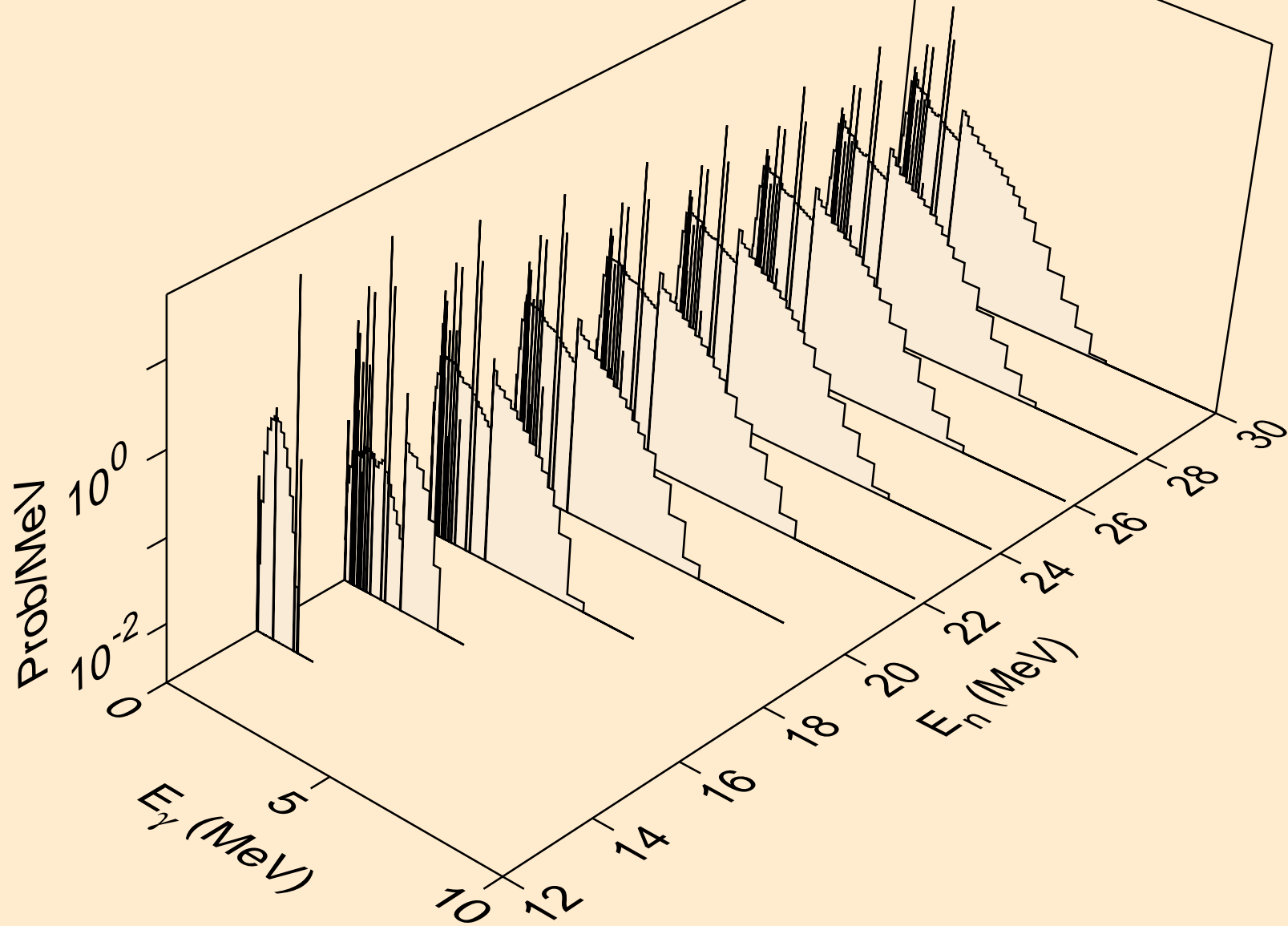

NB099M NEUTRON ACER TENDL-2023 LIBRARY; T=0.K
Photon emission for (n,n*)a

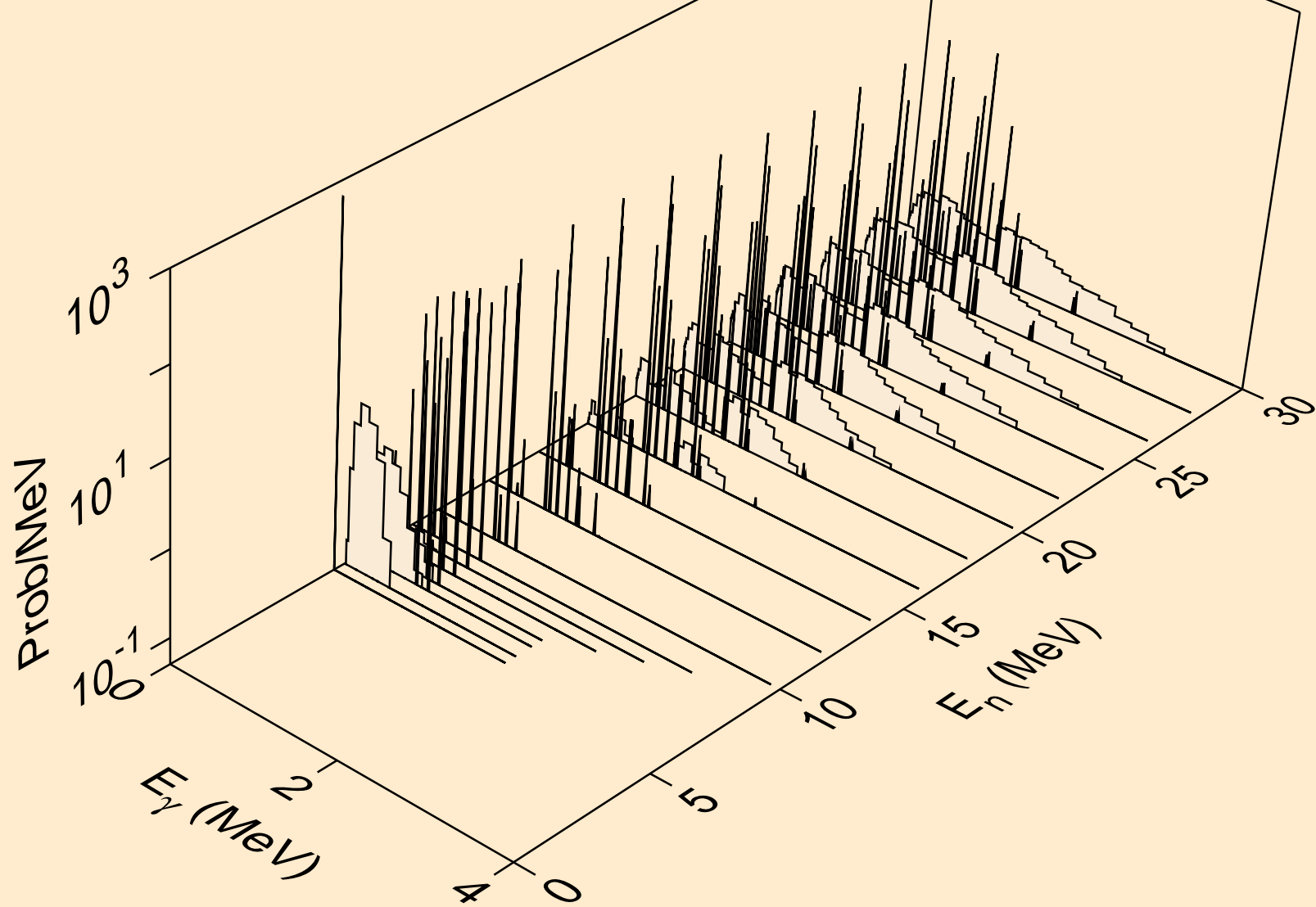

NB099M NEUTRON ACER TENDL-2023 LIBRARY; T=0.K
Photon emission for (n,2n)a

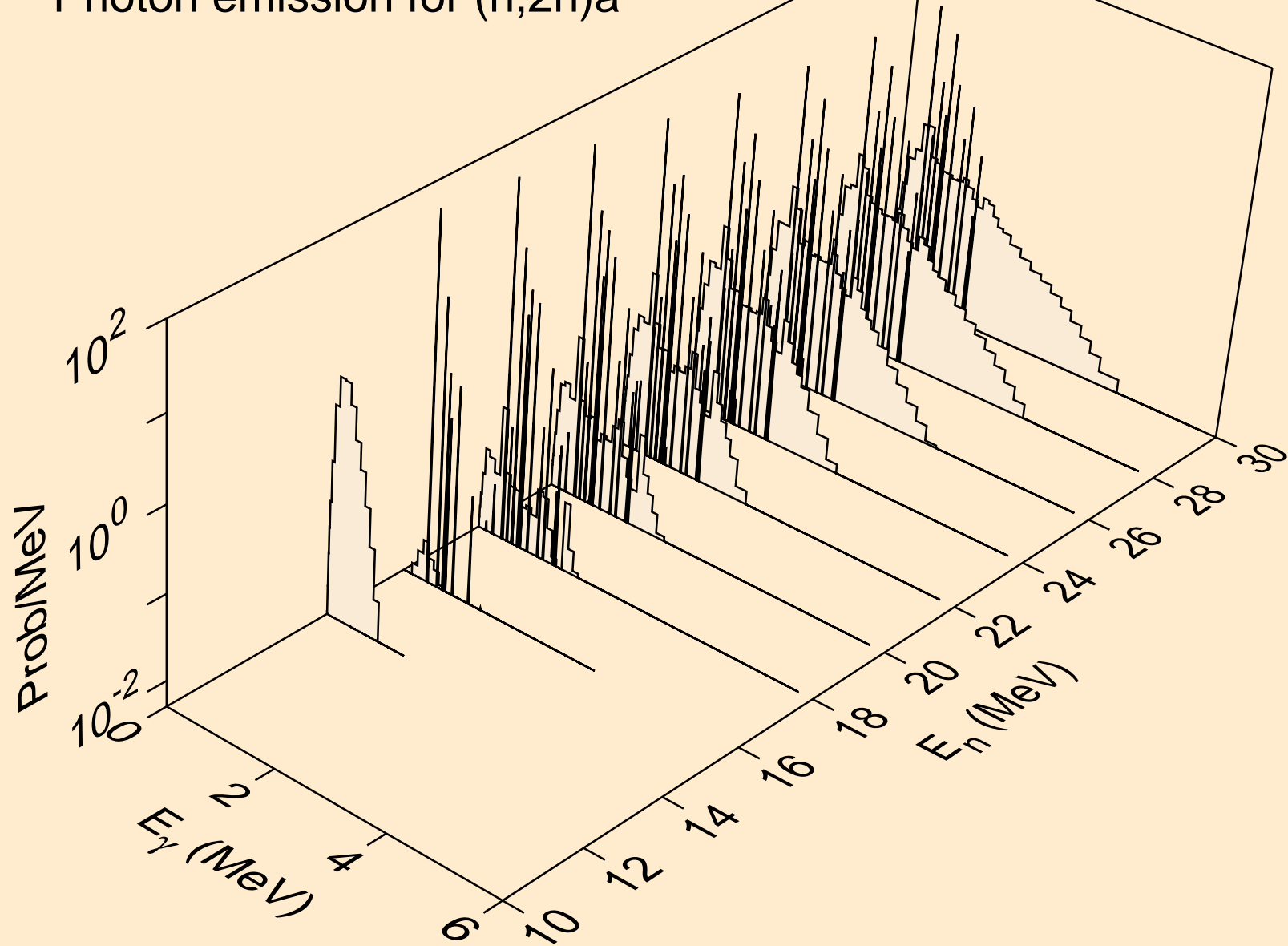

NB099M NEUTRON ACER TENDL-2023 LIBRARY; T=0.K
Photon emission for (n,3n)a

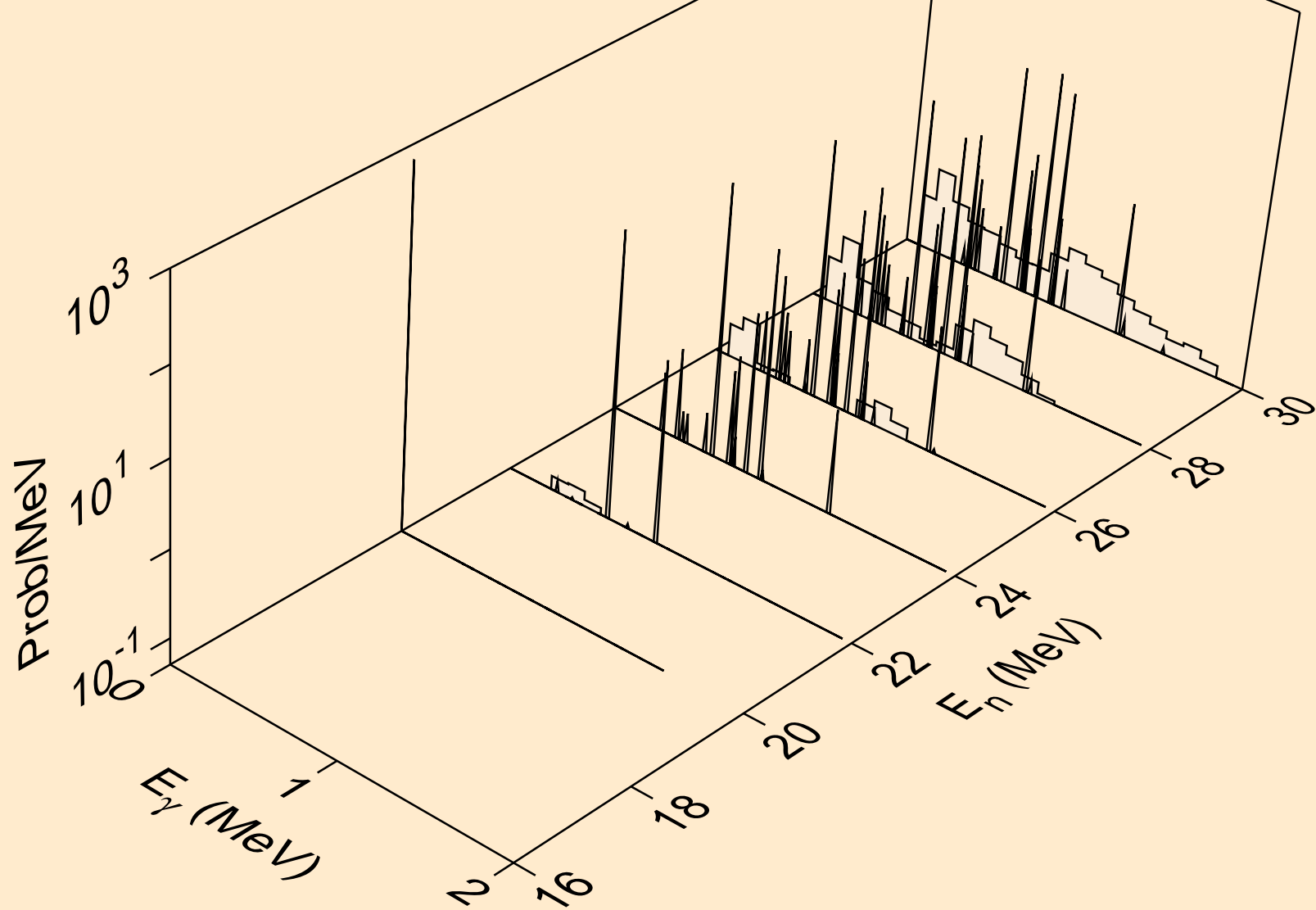

NB099M NEUTRON ACER TENDL-2023 LIBRARY; T=0.K
Photon emission for (n,n*)p

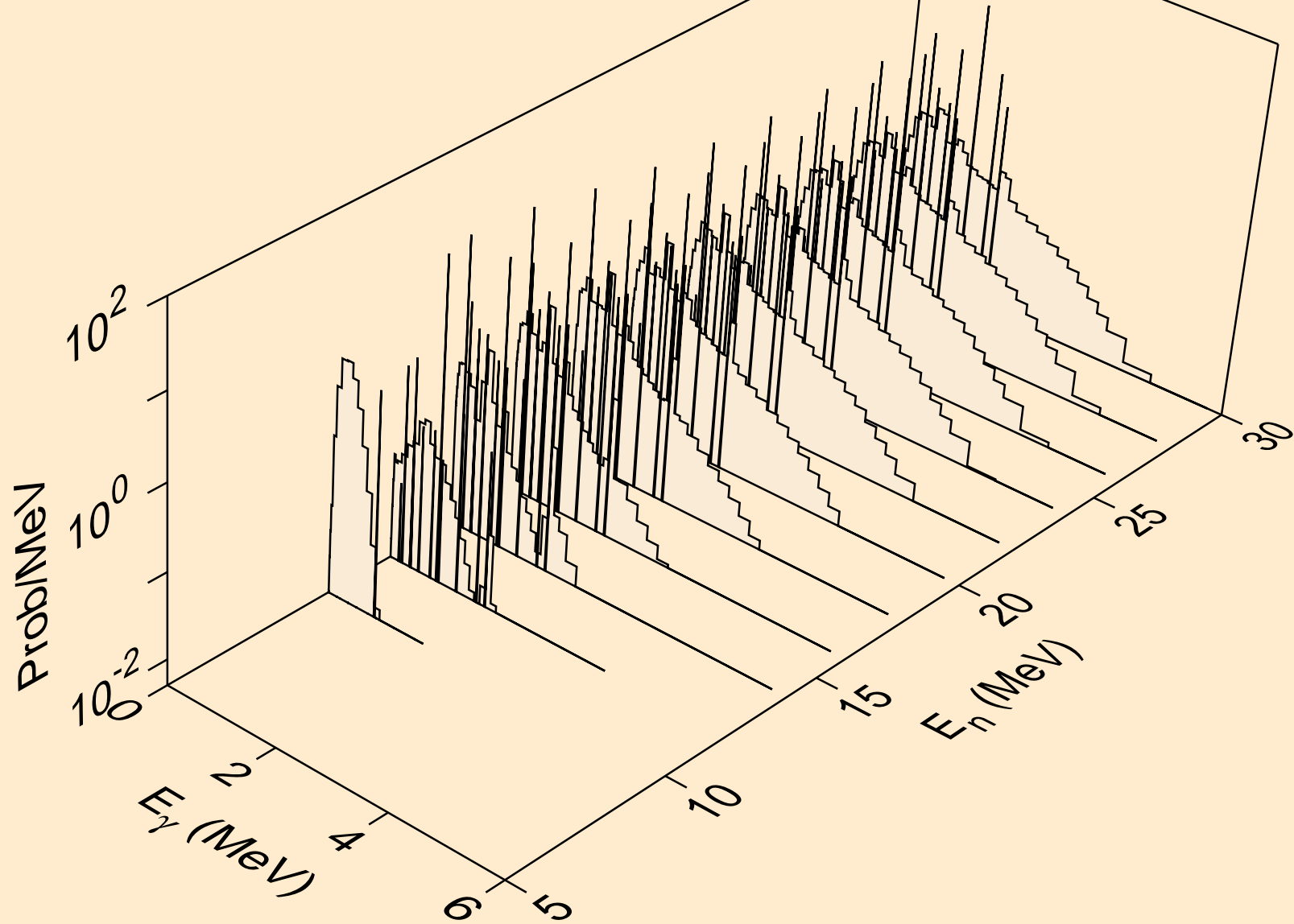

NB099M NEUTRON ACER TENDL-2023 LIBRARY; T=0.K
Photon emission for (n,n*)2a

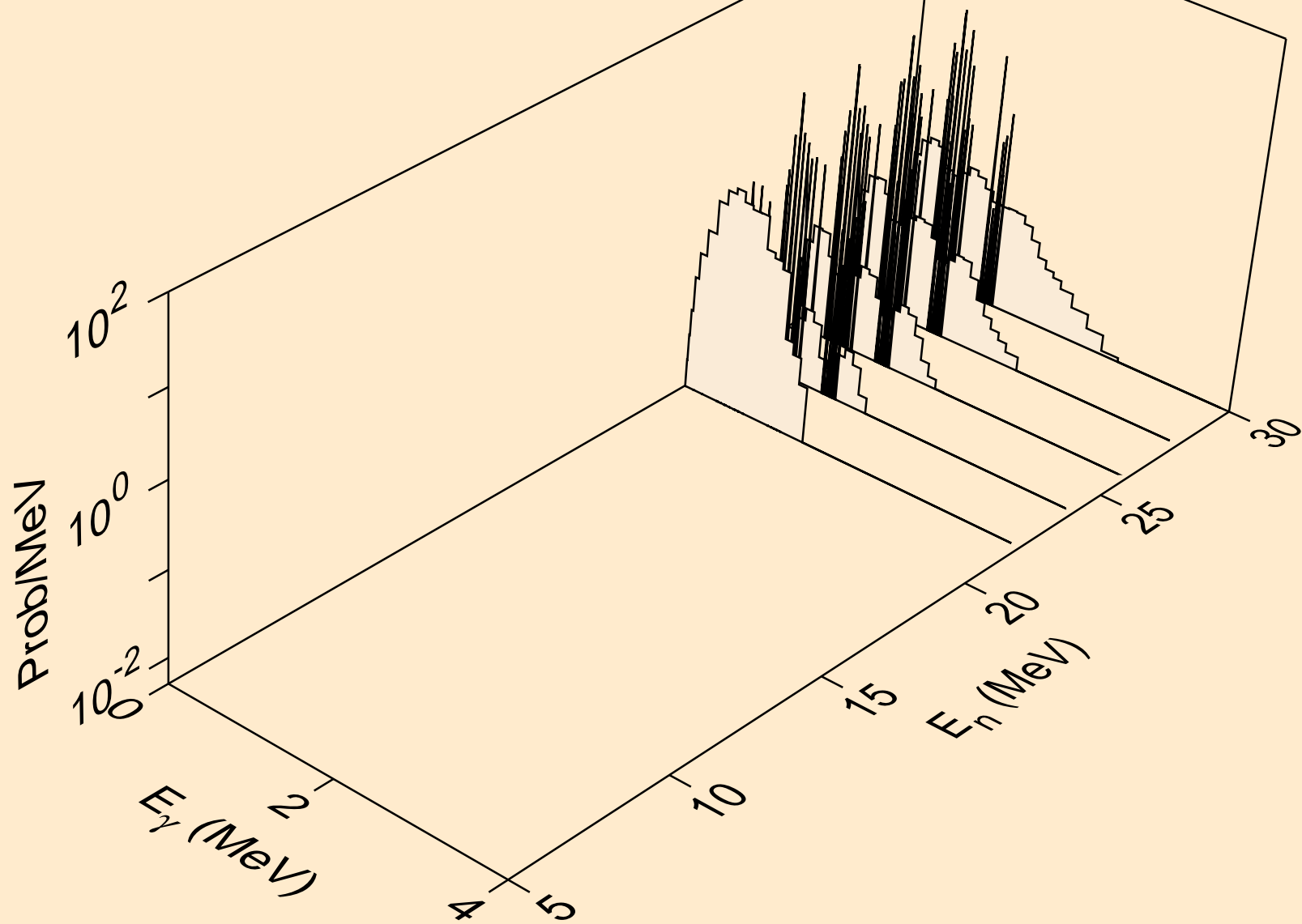

NB099M NEUTRON ACER TENDL-2023 LIBRARY; T=0.K
Photon emission for (n,n*)d

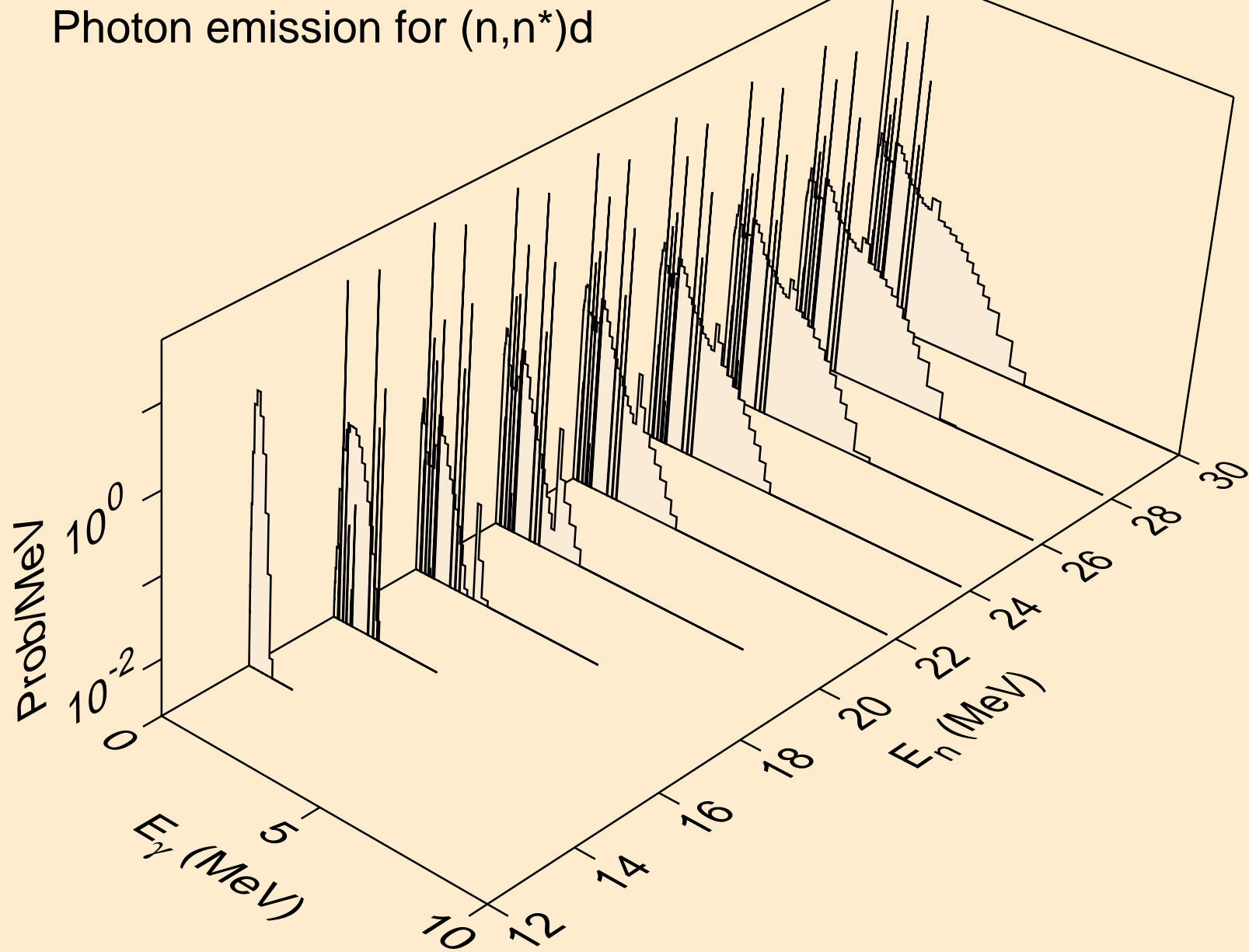

NB099M NEUTRON ACER TENDL-2023 LIBRARY; T=0.K
Photon emission for (n,n*)t

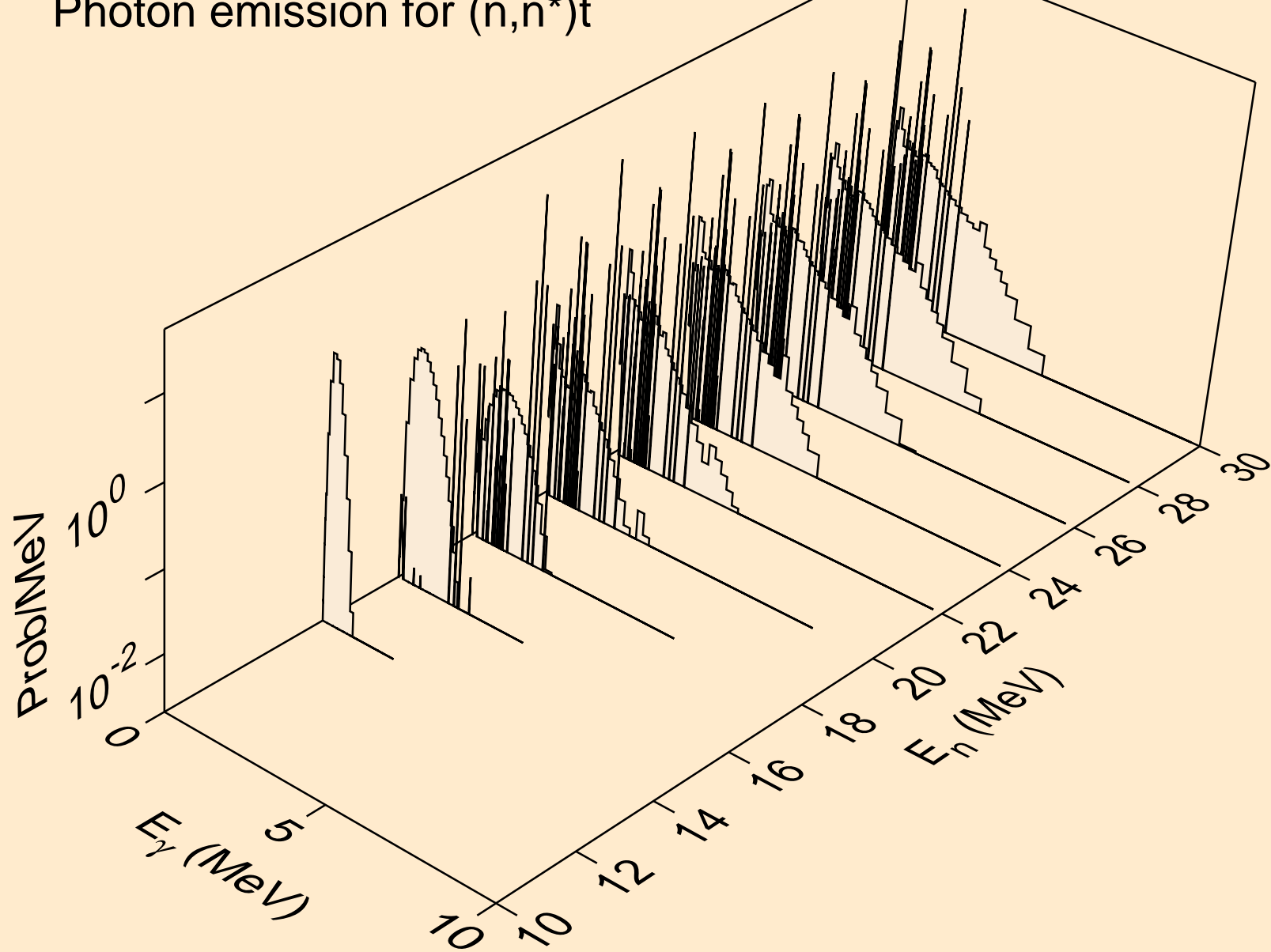

NB099M NEUTRON ACER TENDL-2023 LIBRARY; T=0.K
Photon emission for (n,n*)he3

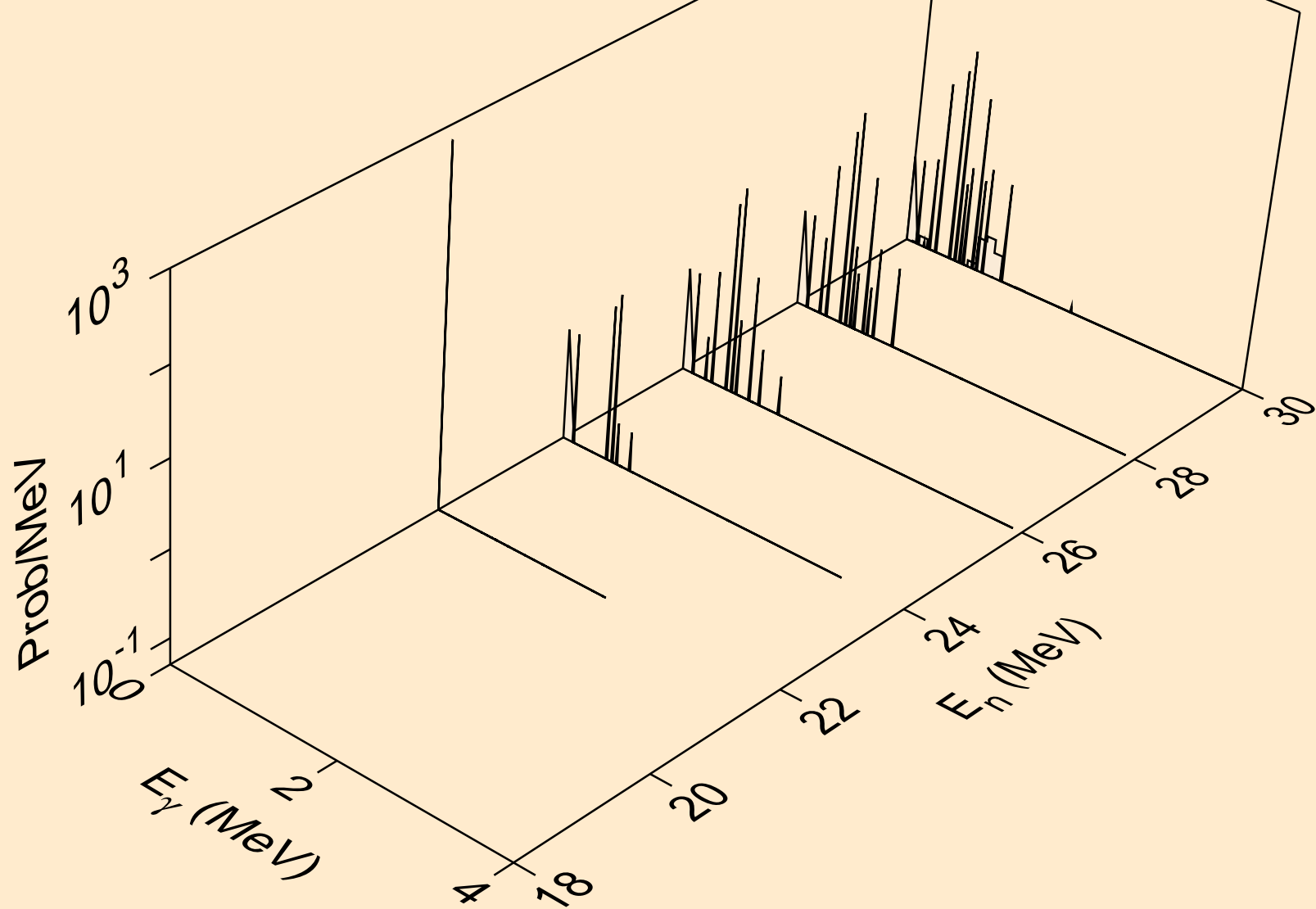

NB099M NEUTRON ACER TENDL-2023 LIBRARY; T=0.K
Photon emission for (n,4n)

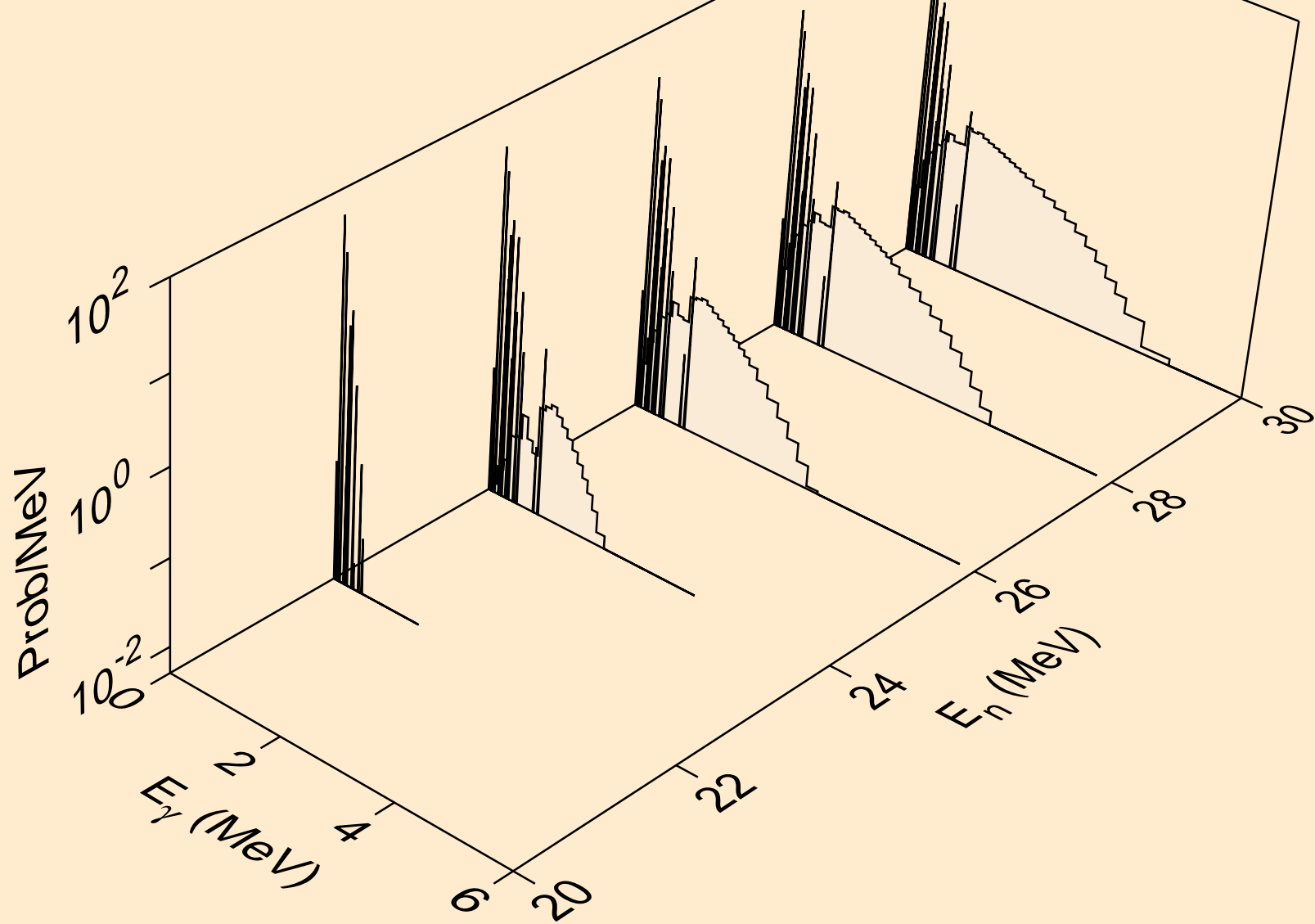

NB099M NEUTRON ACER TENDL-2023 LIBRARY; T=0.K
Photon emission for (n,2np)

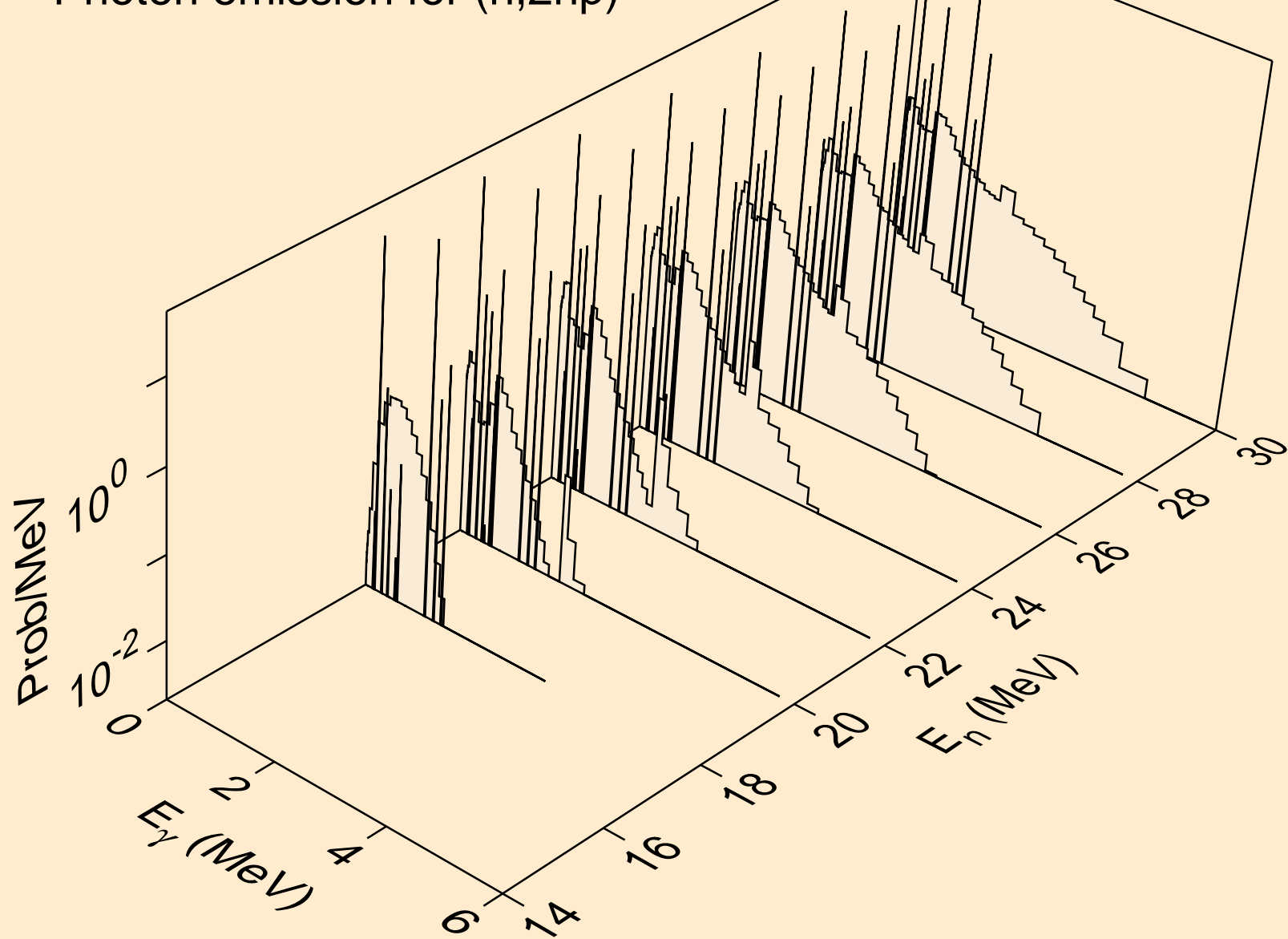

NB099M NEUTRON ACER TENDL-2023 LIBRARY; T=0.K
Photon emission for (n,3np)

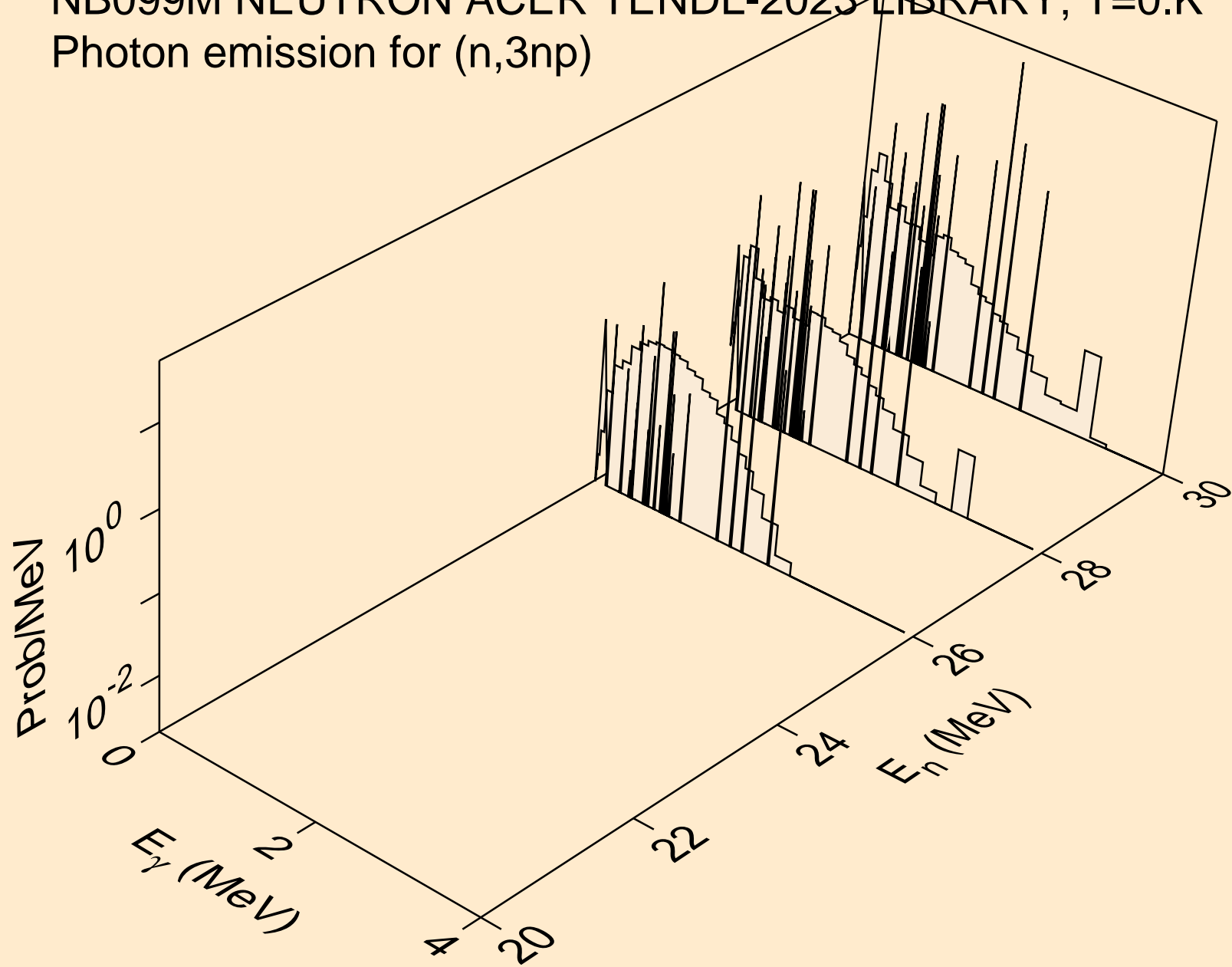

NB099M NEUTRON ACER TENDL-2023 LIBRARY; T=0.K
Photon emission for (n,n2p)

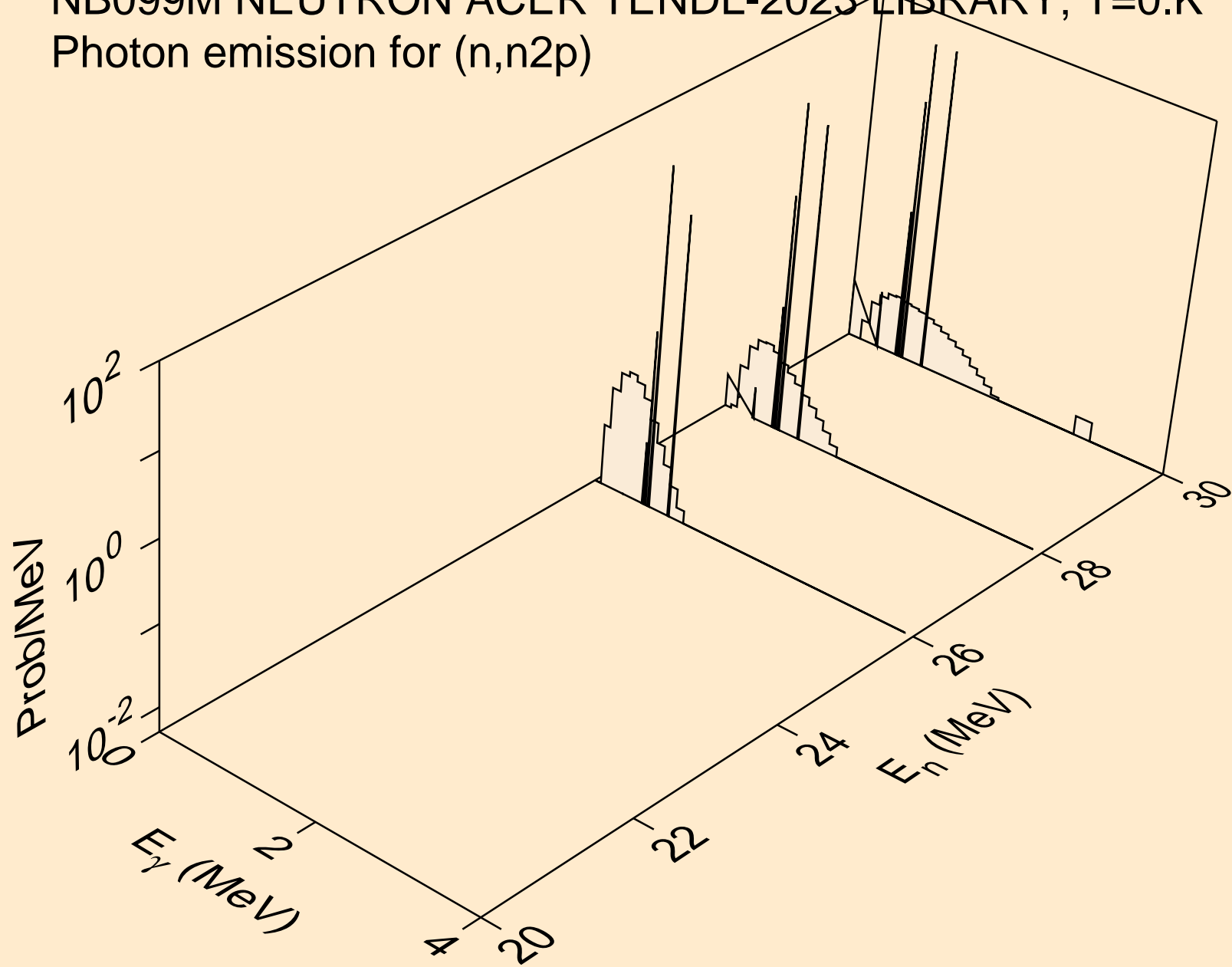

NB099M NEUTRON ACER TENDL-2023 LIBRARY; T=0.K
Photon emission for (n,npa)

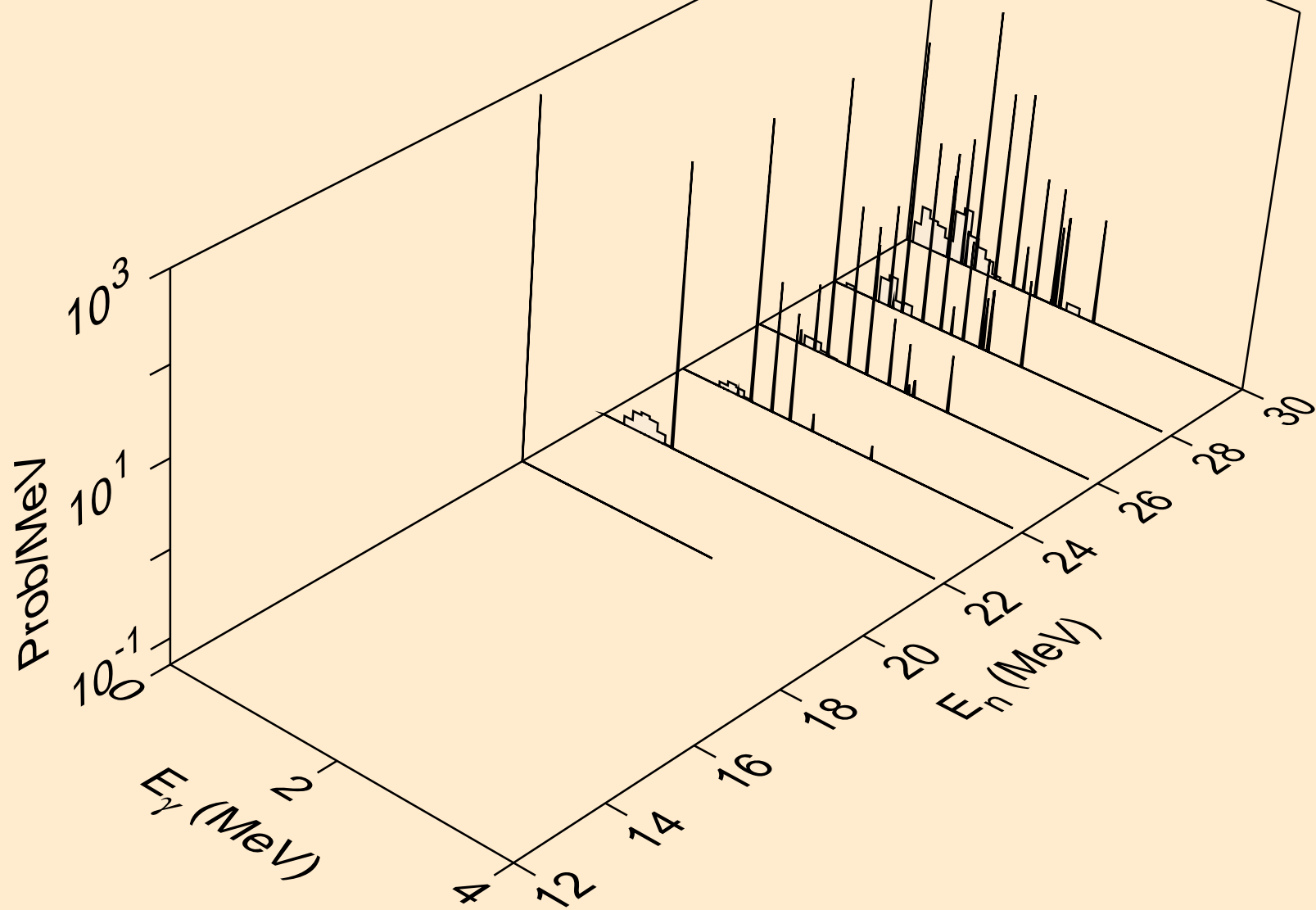

NB099M NEUTRON ACER TENDL-2023 LIBRARY; T=0.K
Photon emission for (n,n*2)

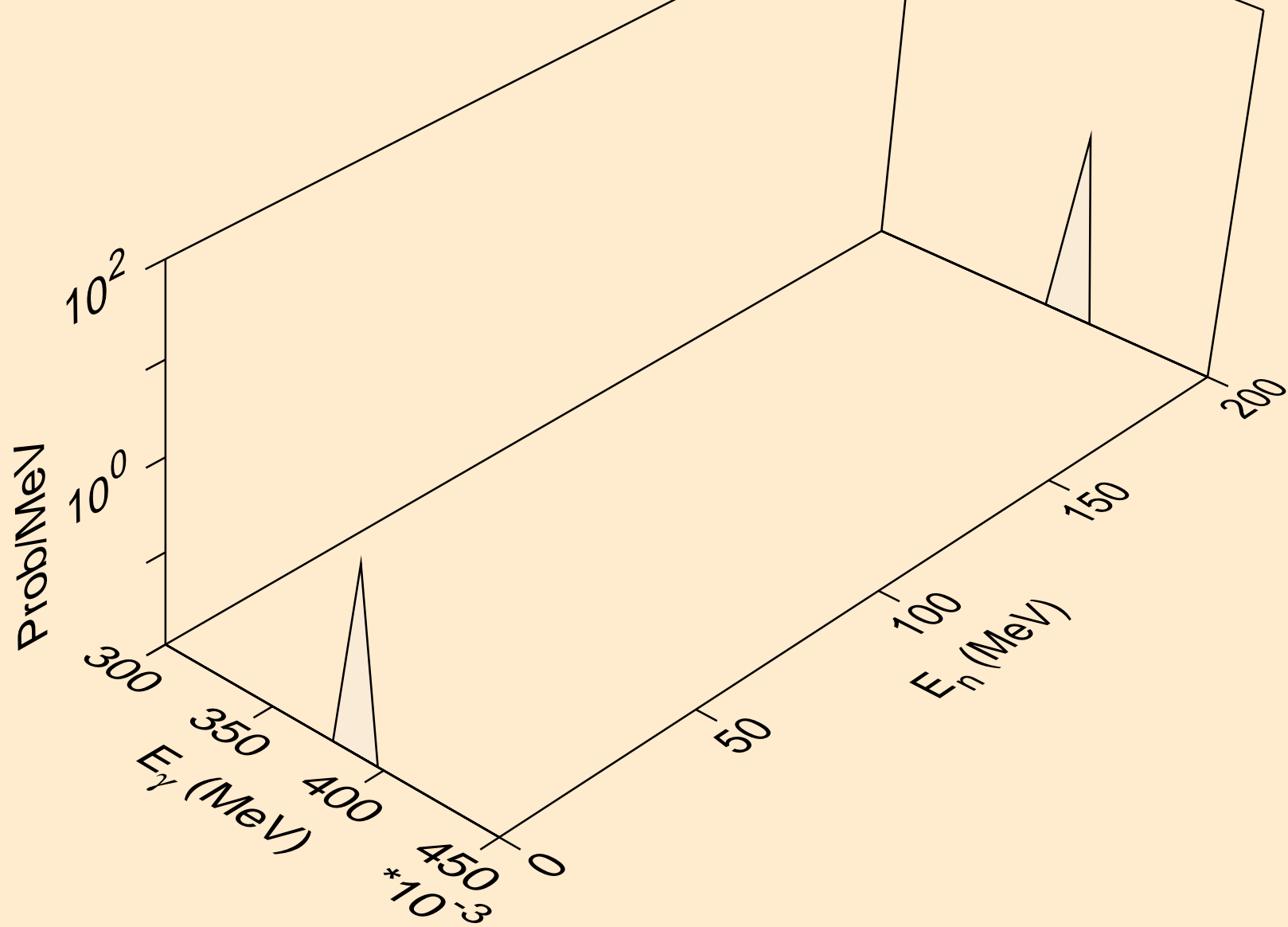

NB099M NEUTRON ACER TENDL-2023 LIBRARY; T=0.K
Photon emission for (n,n*3)

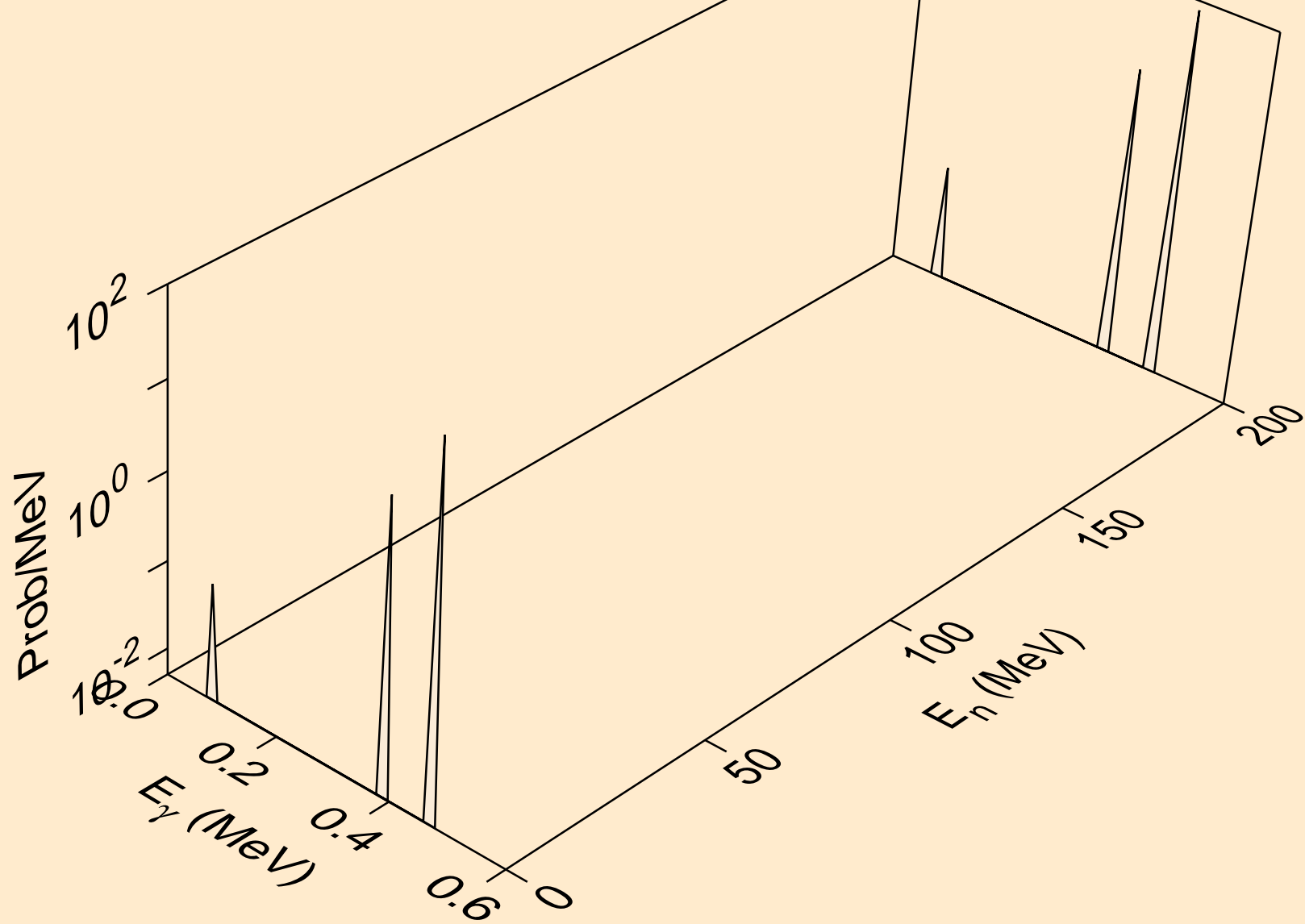

NB099M NEUTRON ACER TENDL-2023 LIBRARY; T=0.K
Photon emission for (n,n*4)

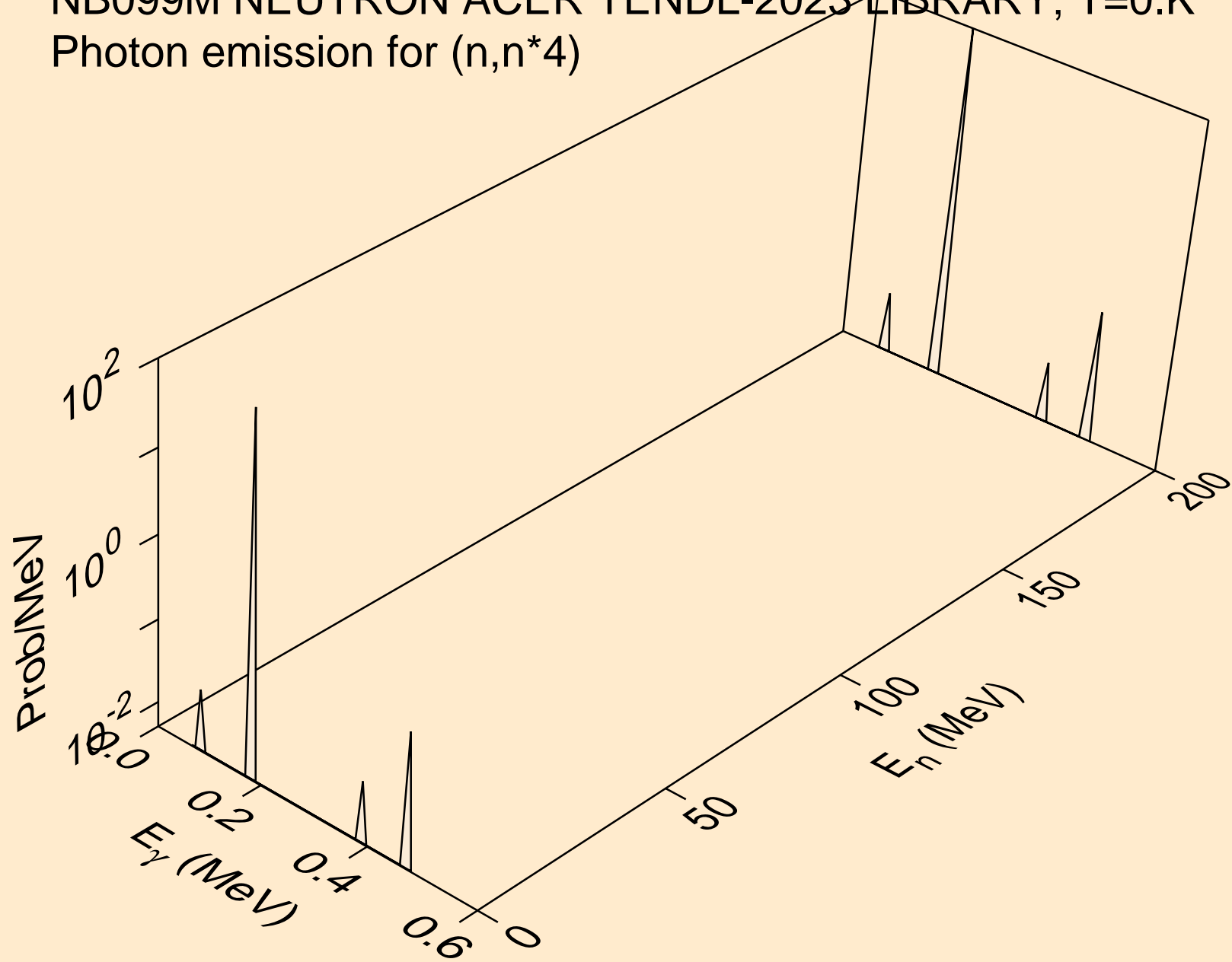

NB099M NEUTRON ACER TENDL-2023 LIBRARY; T=0.K
Photon emission for (n,n*5)

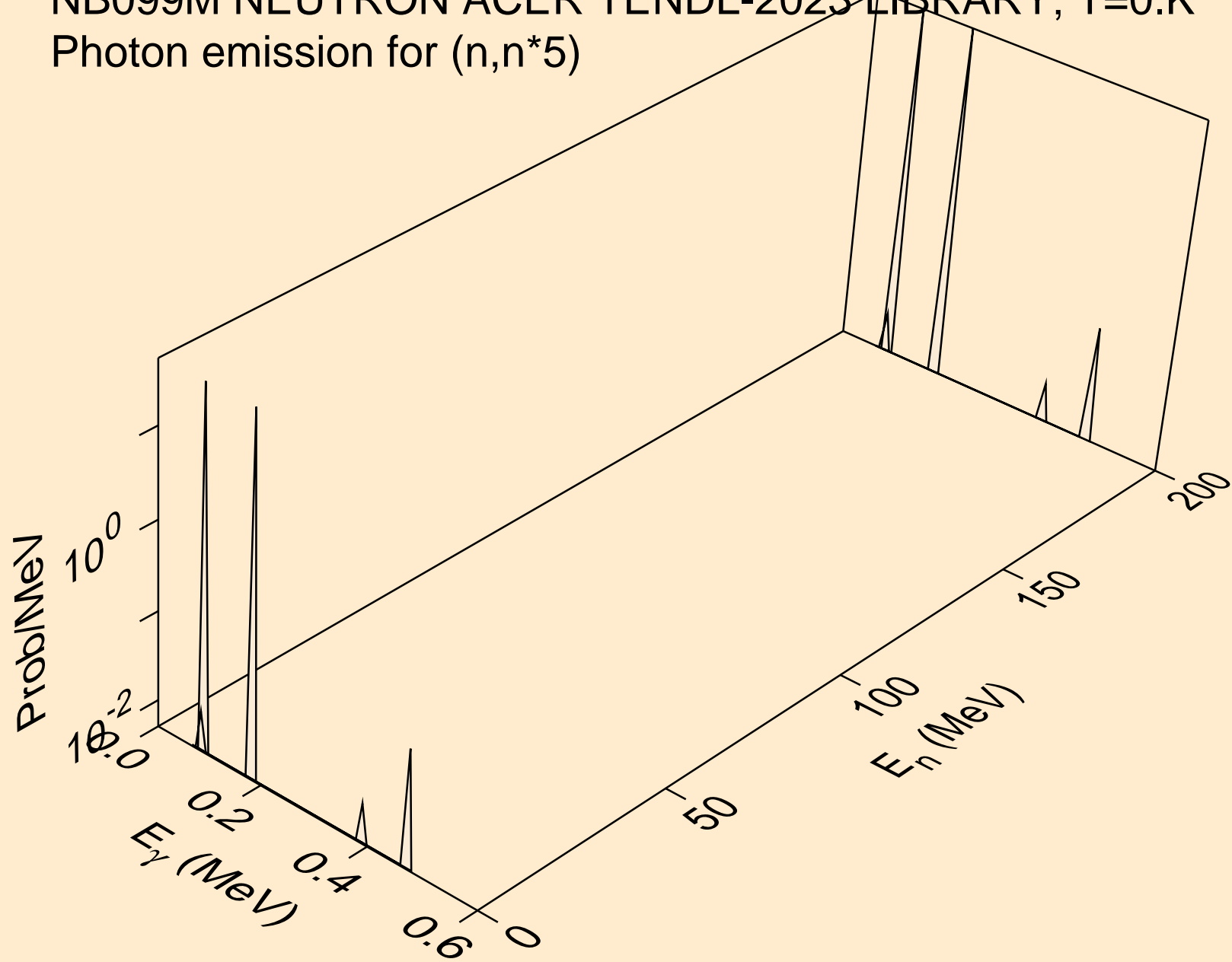

NB099M NEUTRON ACER TENDL-2023 LIBRARY; T=0.K
Photon emission for (n,n*6)

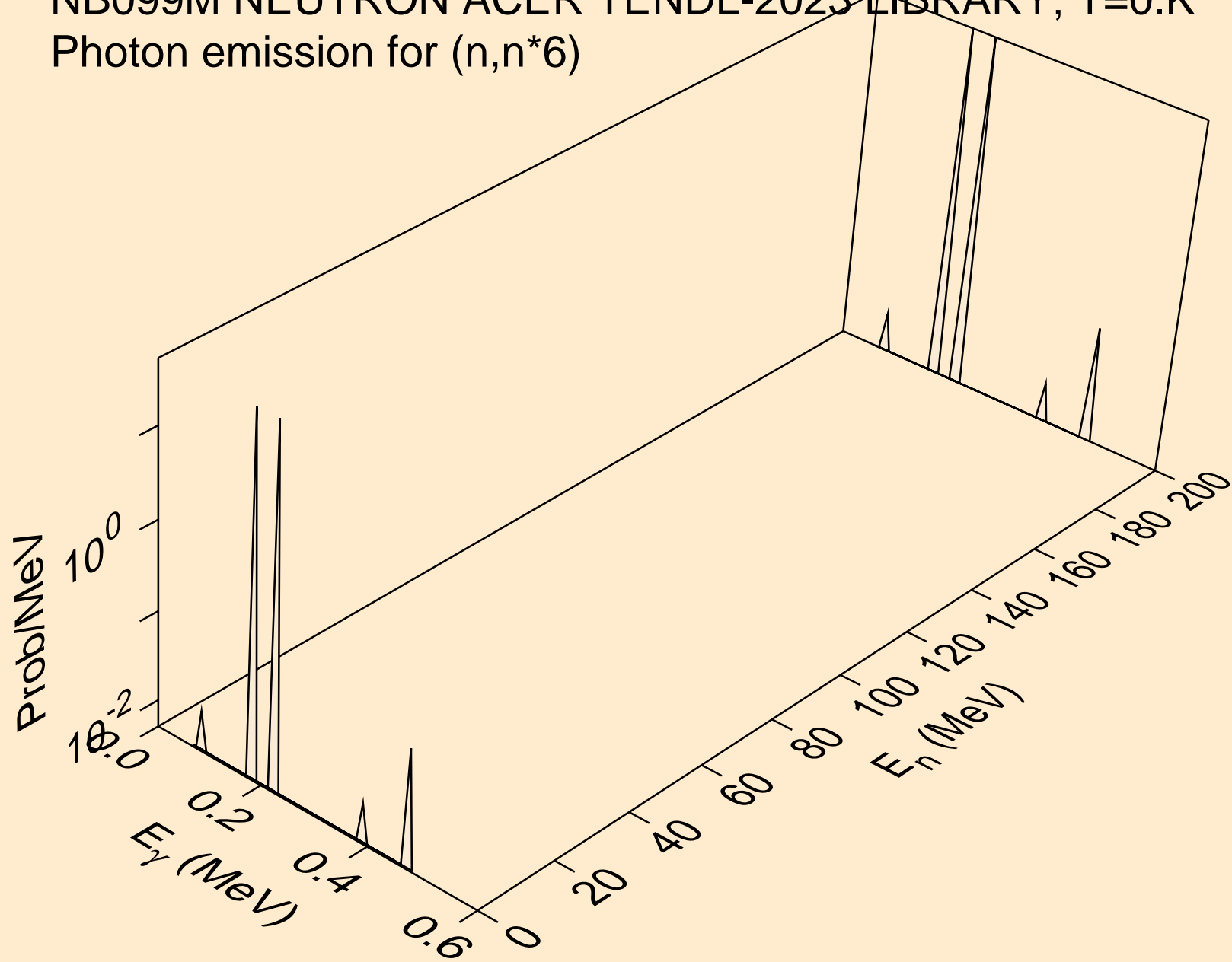

NB099M NEUTRON ACER TENDL-2023 LIBRARY; T=0.K
Photon emission for (n,n*7)

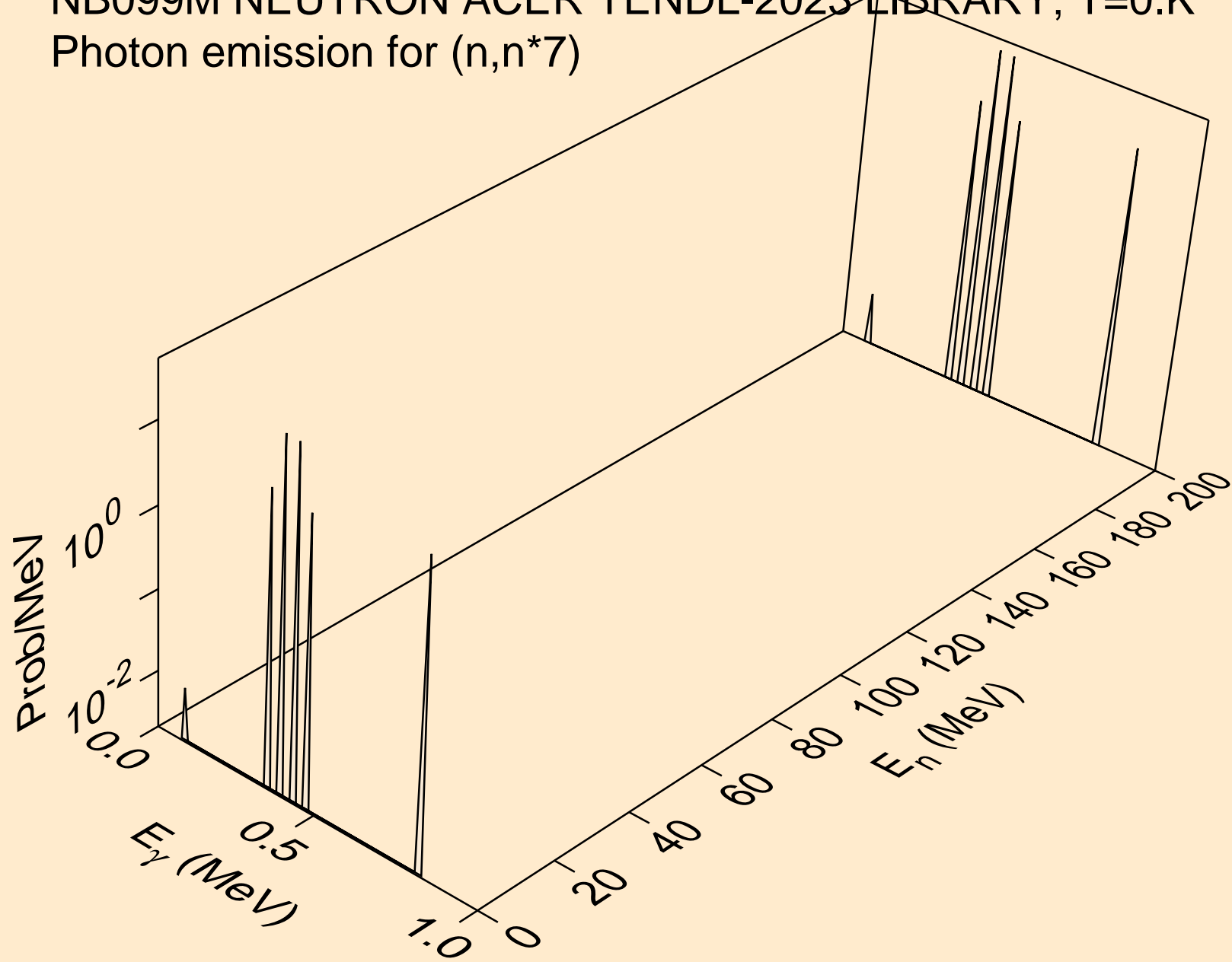

NB099M NEUTRON ACER TENDL-2023 LIBRARY; T=0.K
Photon emission for (n,n*8)

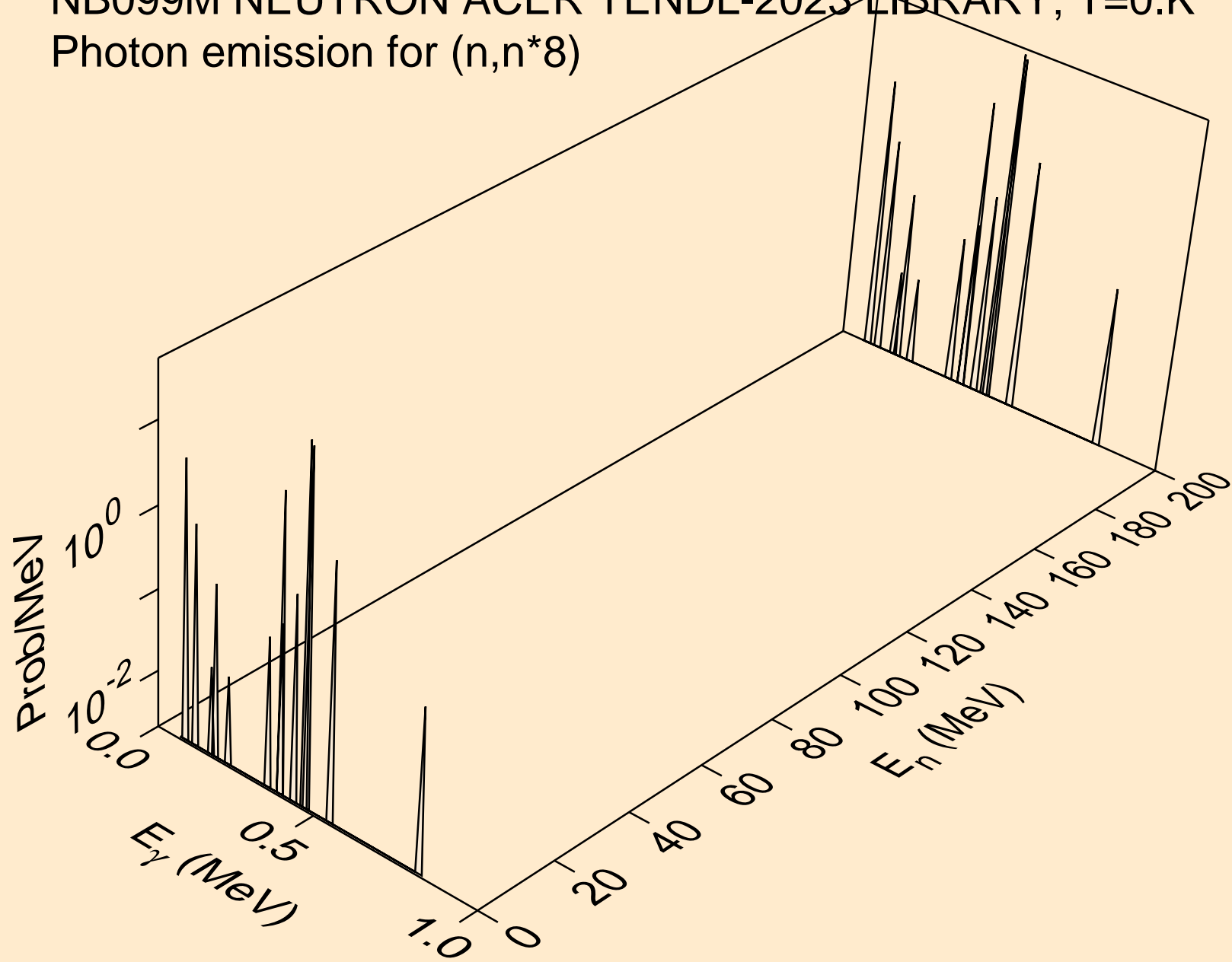

NB099M NEUTRON ACER TENDL-2023 LIBRARY; T=0.K
Photon emission for (n,n*9)

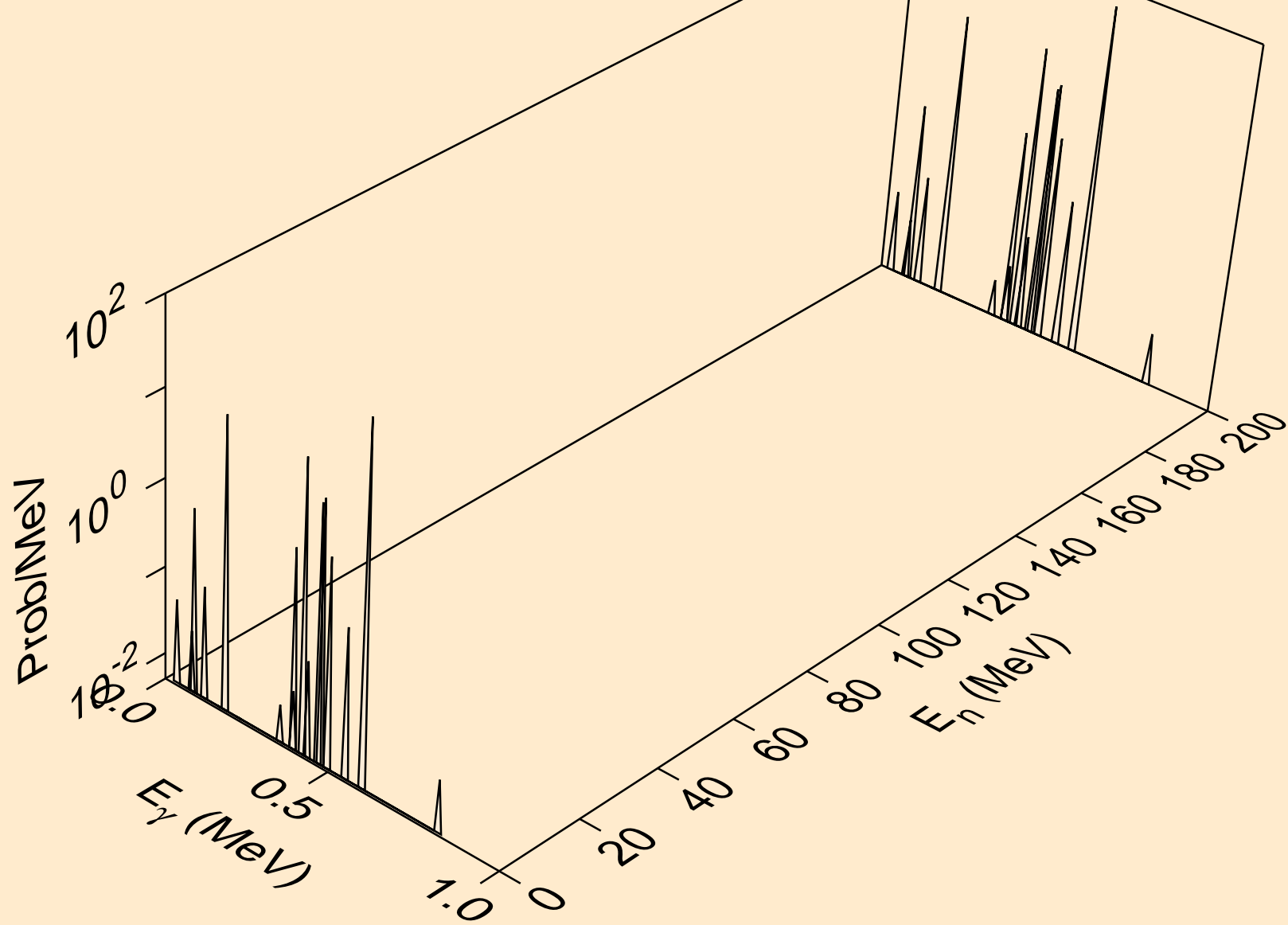

NB099M NEUTRON ACER TENDL-2023 LIBRARY; T=0.K
Photon emission for (n,n*10)

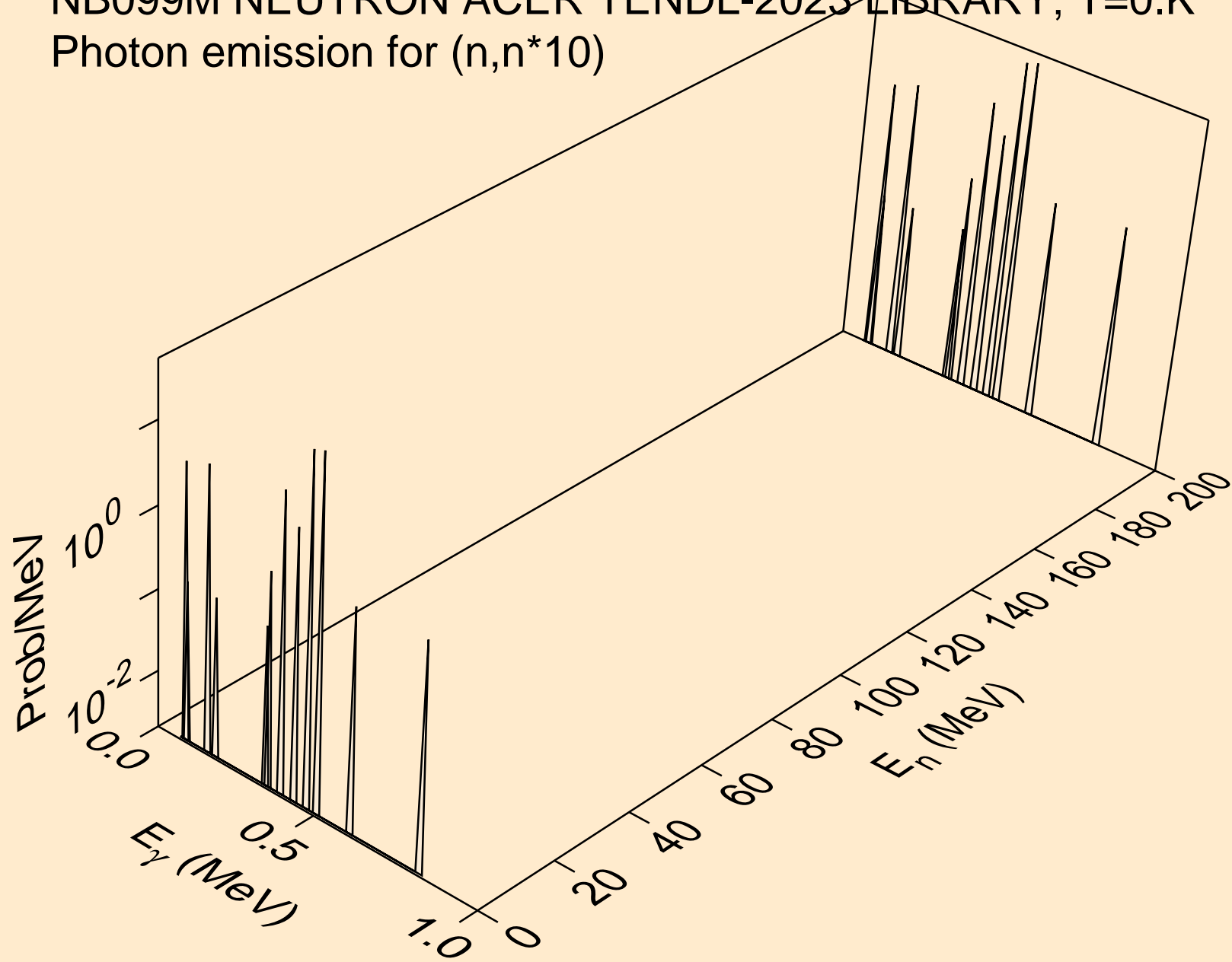

NB099M NEUTRON ACER TENDL-2023 LIBRARY; T=0.K
Photon emission for (n,n*11)

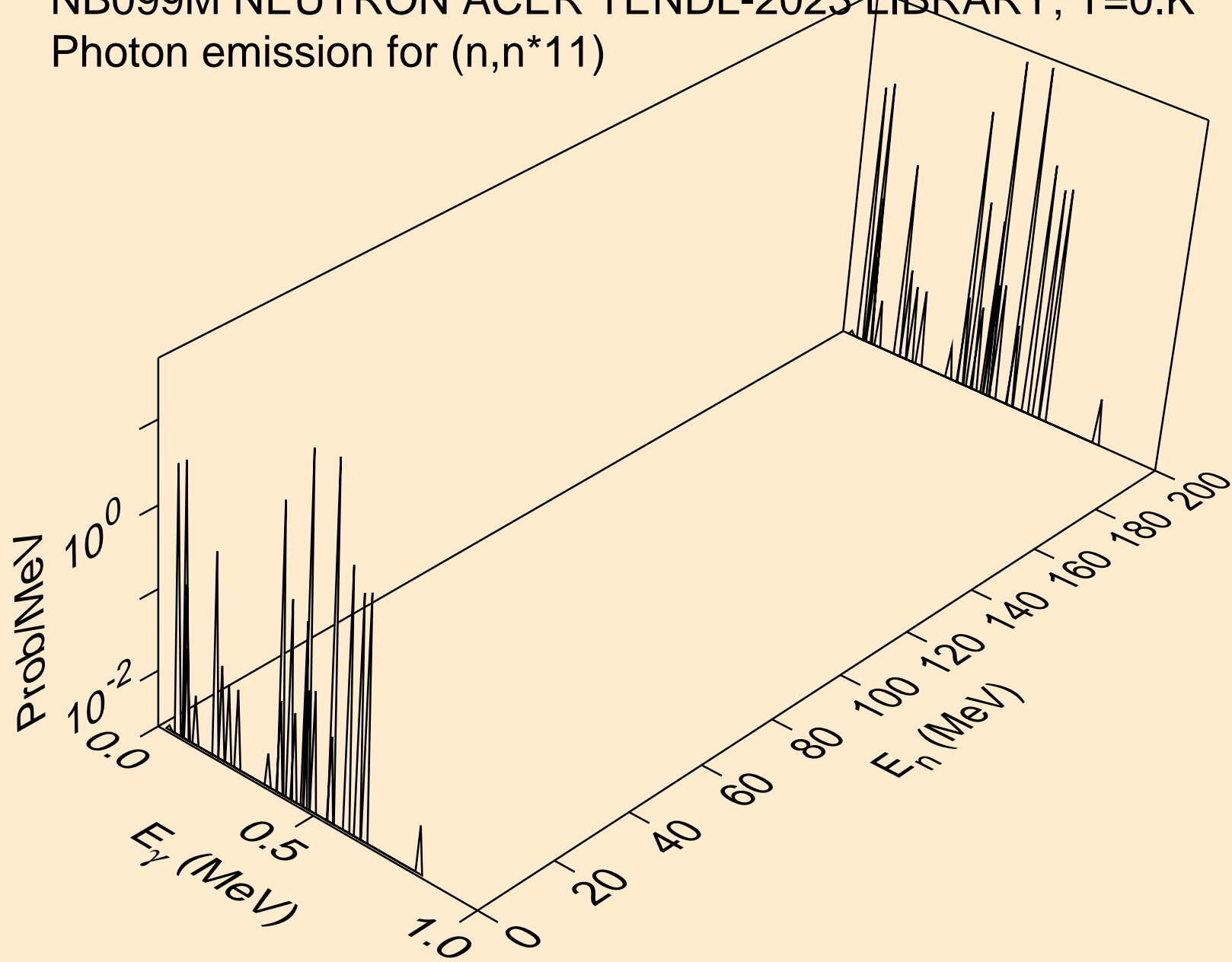

NB099M NEUTRON ACER TENDL-2023 LIBRARY; T=0.K
Photon emission for (n,n*12)

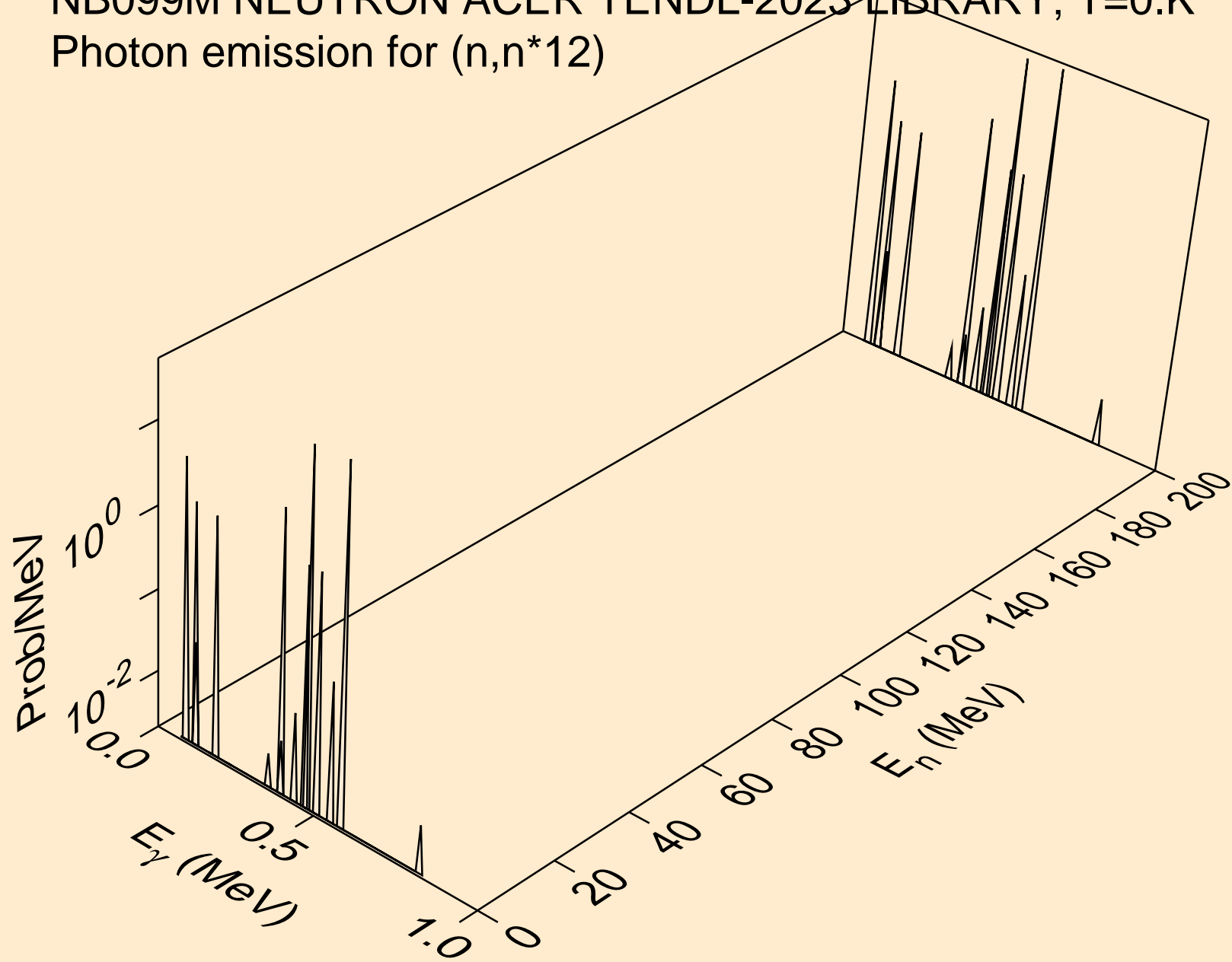

NB099M NEUTRON ACER TENDL-2023 LIBRARY; T=0.K
Photon emission for (n,n*13)

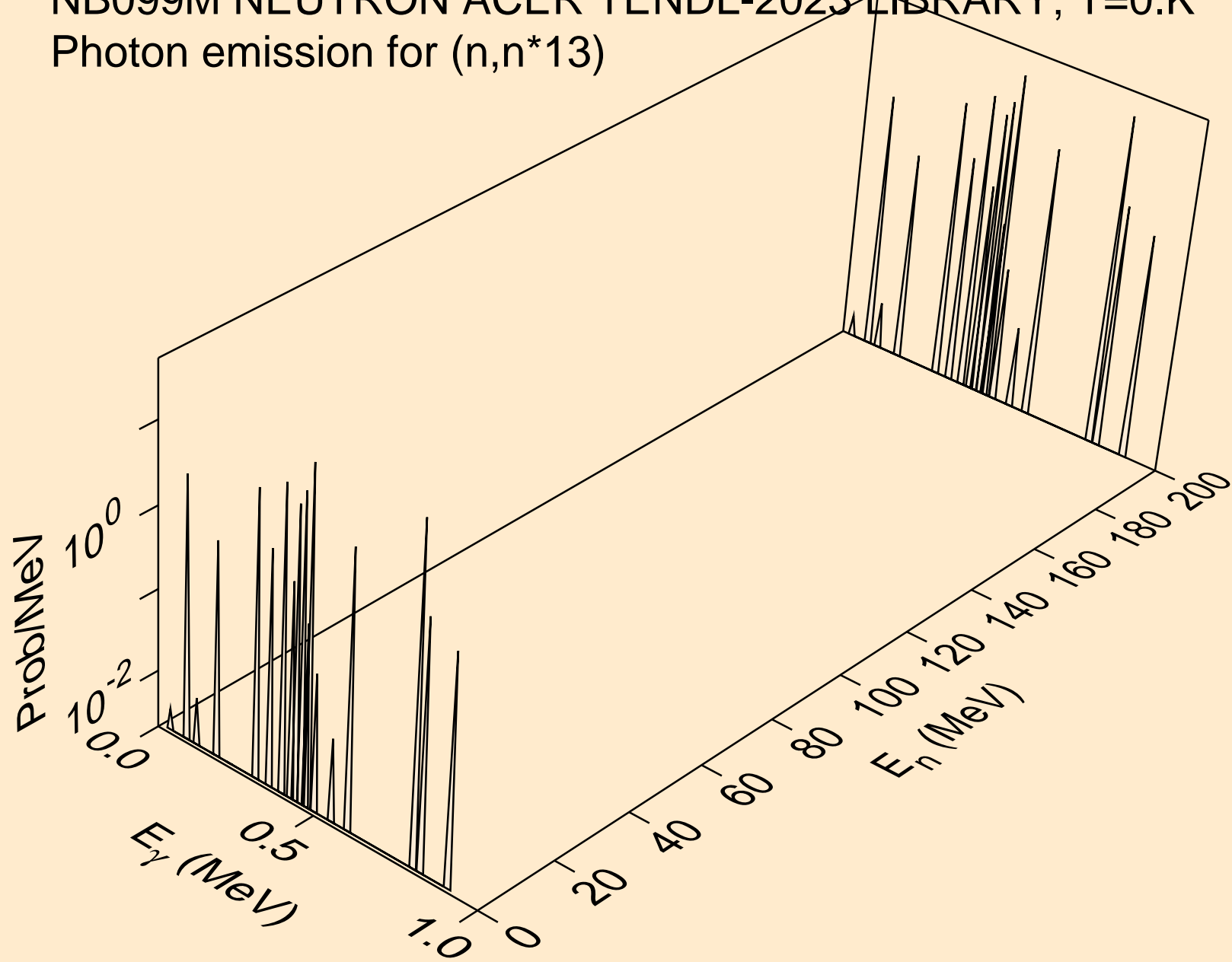

NB099M NEUTRON ACER TENDL-2023 LIBRARY; T=0.K
Photon emission for (n,n*14)

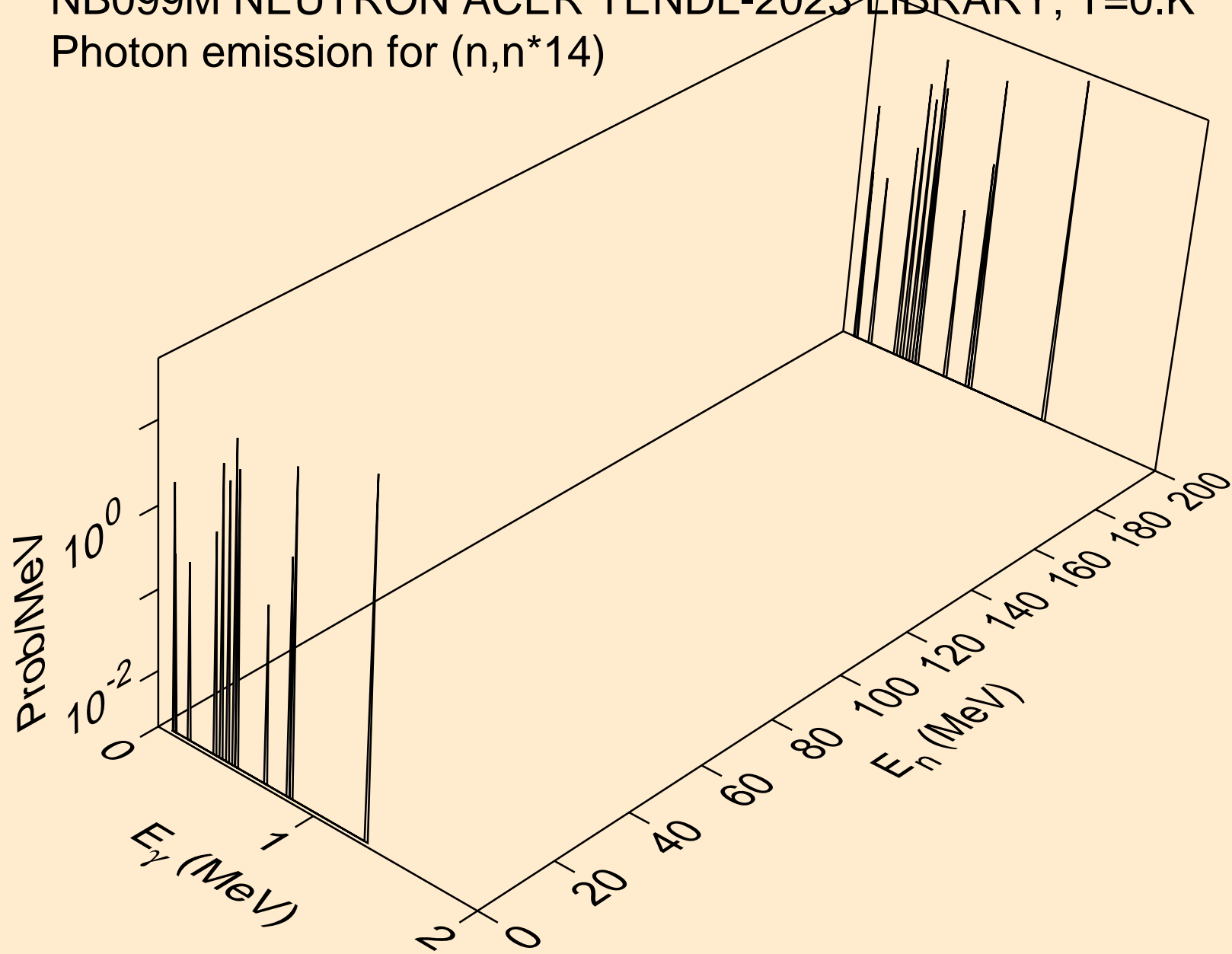

NB099M NEUTRON ACER TENDL-2023 LIBRARY; T=0.K
Photon emission for (n,n*15)

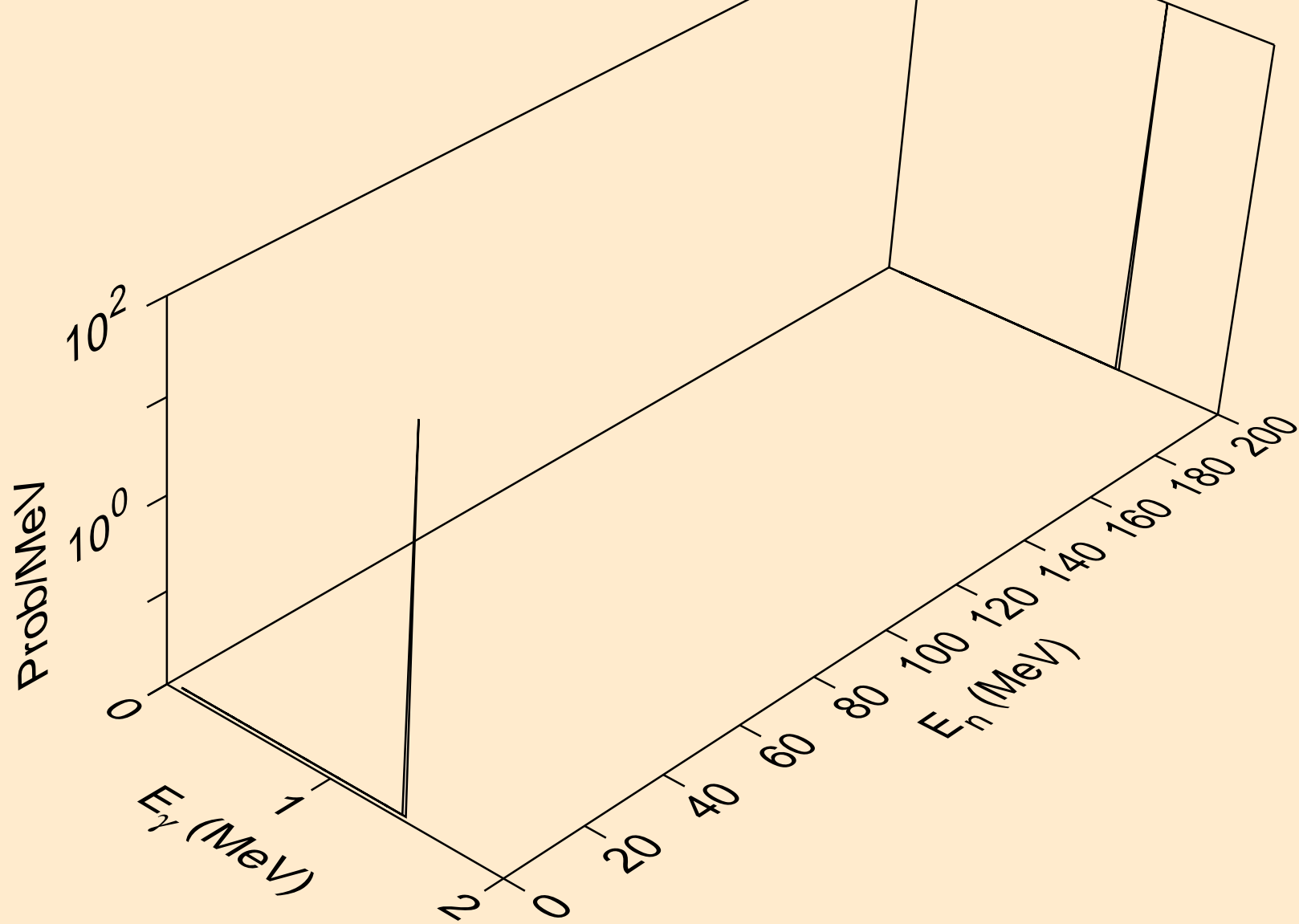

NB099M NEUTRON ACER TENDL-2023 LIBRARY; T=0.K
Photon emission for (n,n*16)

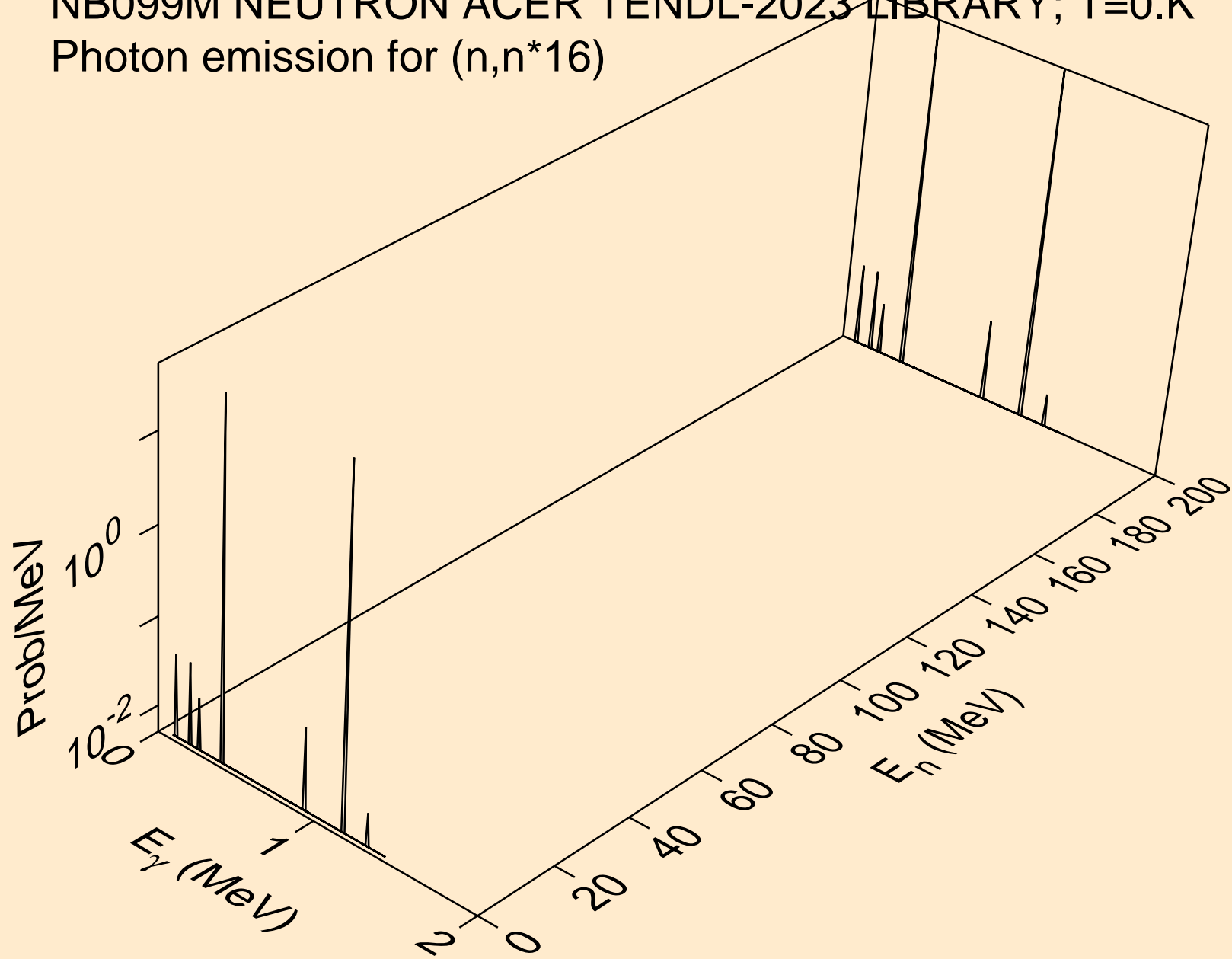

NB099M NEUTRON ACER TENDL-2023 LIBRARY; T=0.K
Photon emission for (n,n*c)

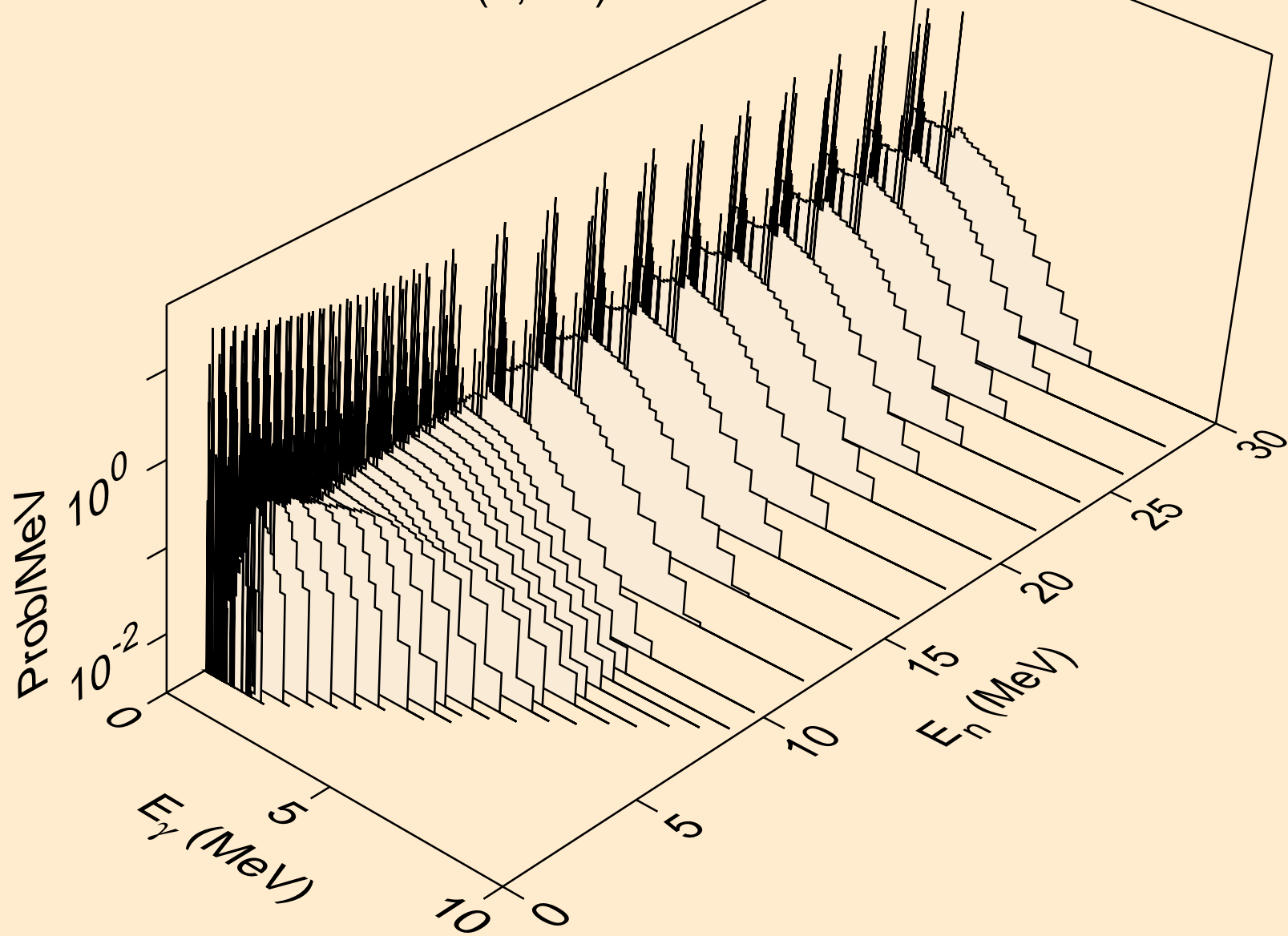

NB099M NEUTRON ACER TENDL-2023 LIBRARY; T=0.K
Photon emission for (n,gma)

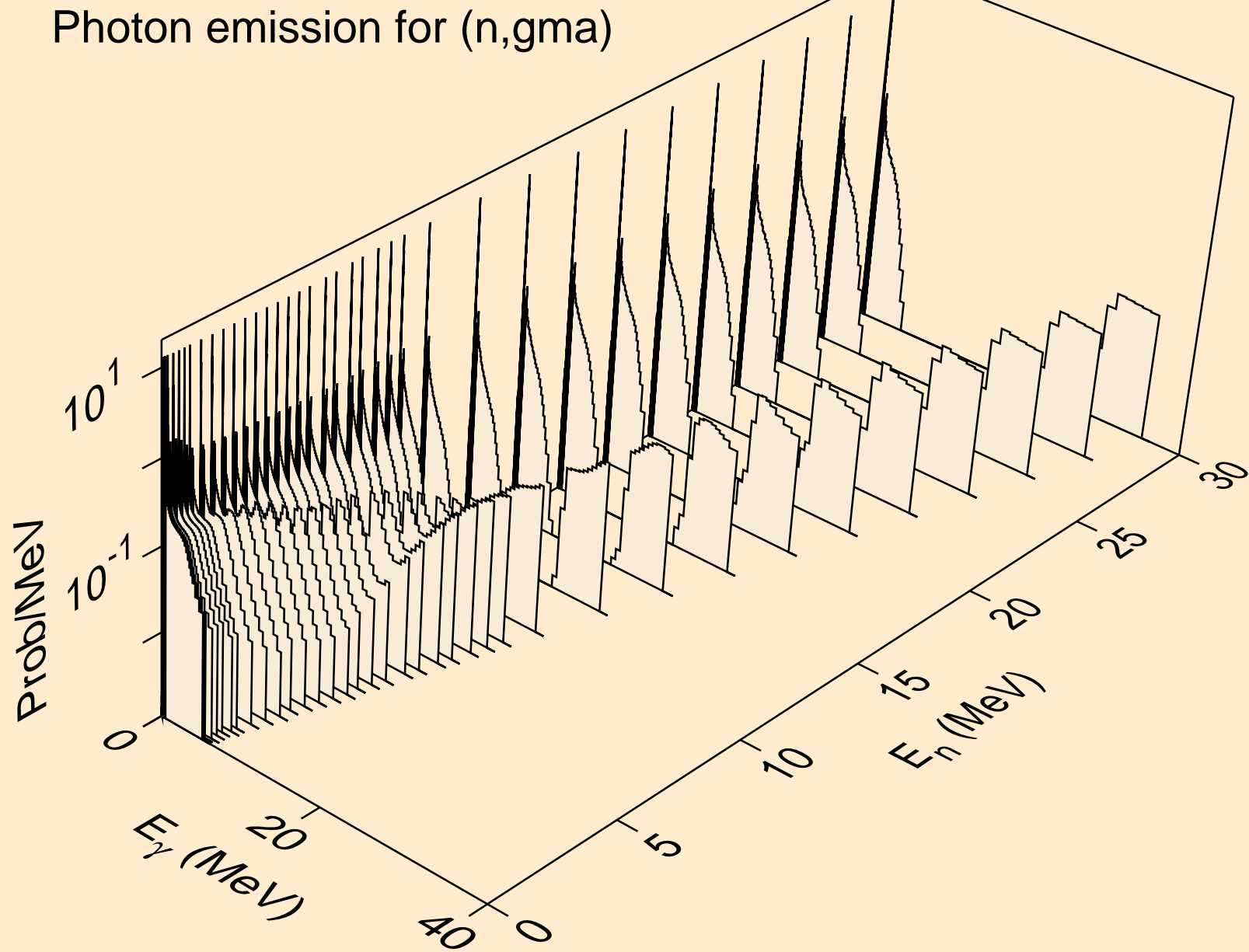

NB099M NEUTRON ACER TENDL-2023 LIBRARY; T=0.K
Photon emission for (n,p)

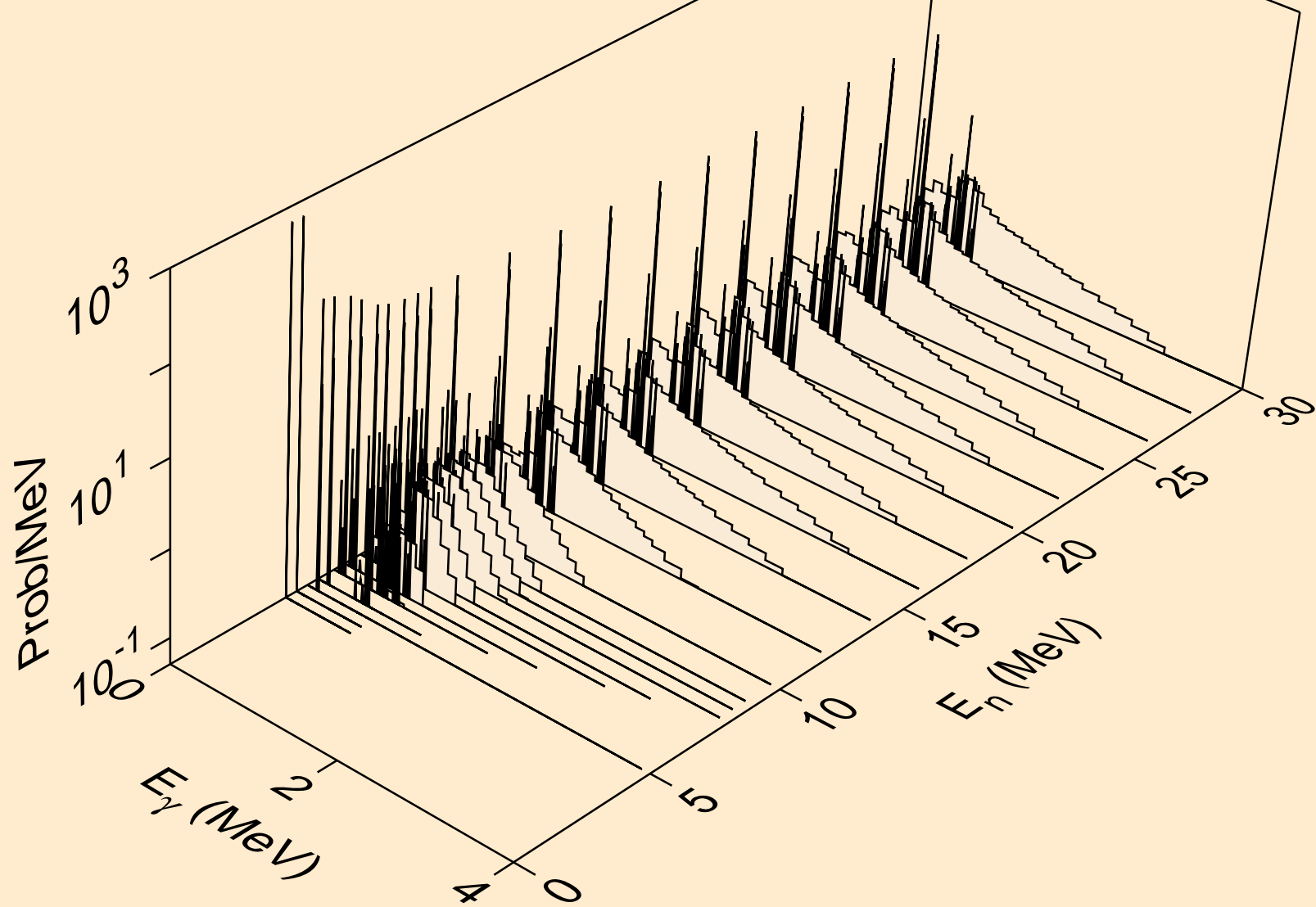

NB099M NEUTRON ACER TENDL-2023 LIBRARY; T=0.K
Photon emission for (n,d)

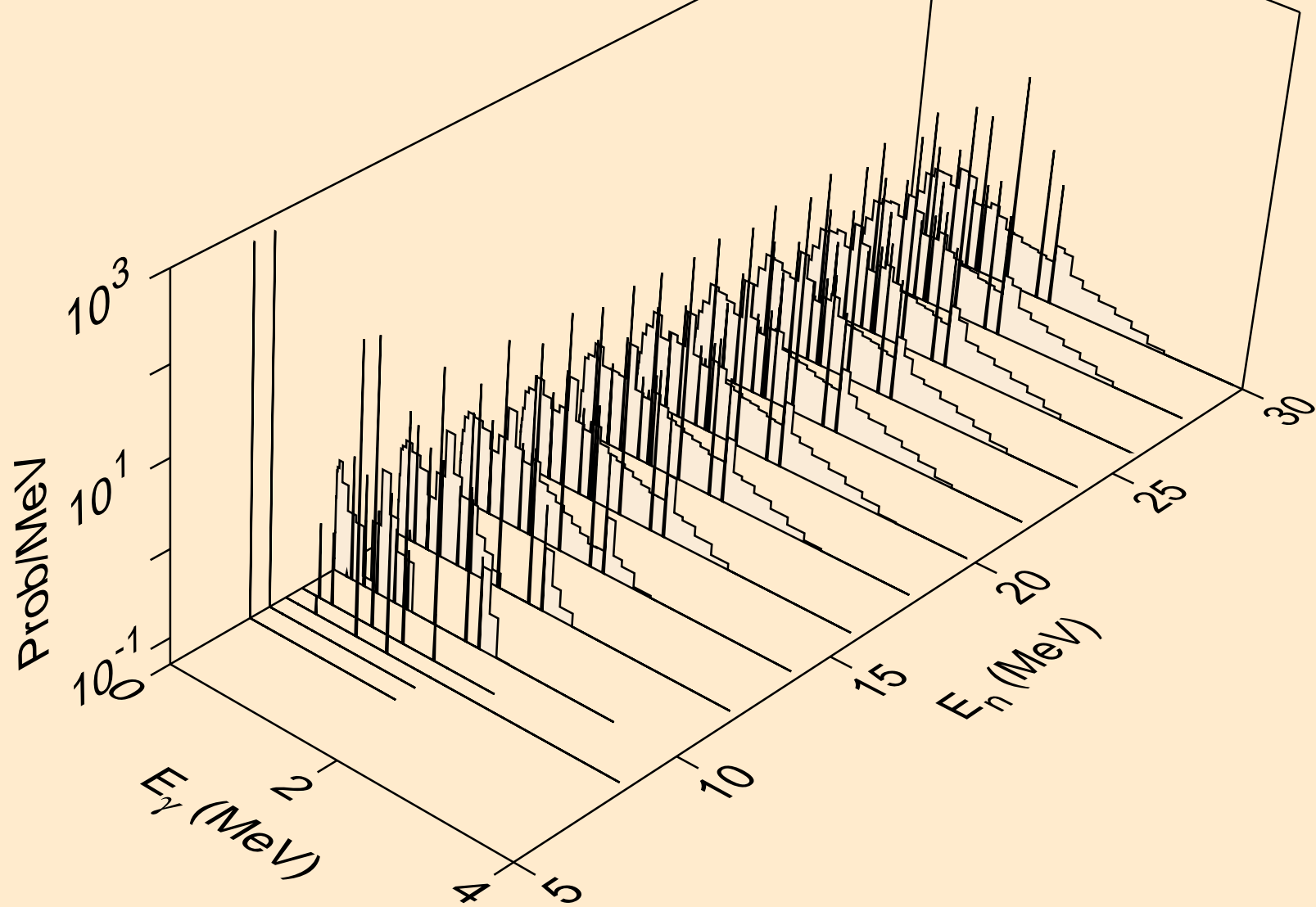

NB099M NEUTRON ACER TENDL-2023 LIBRARY; T=0.K
Photon emission for (n,t)

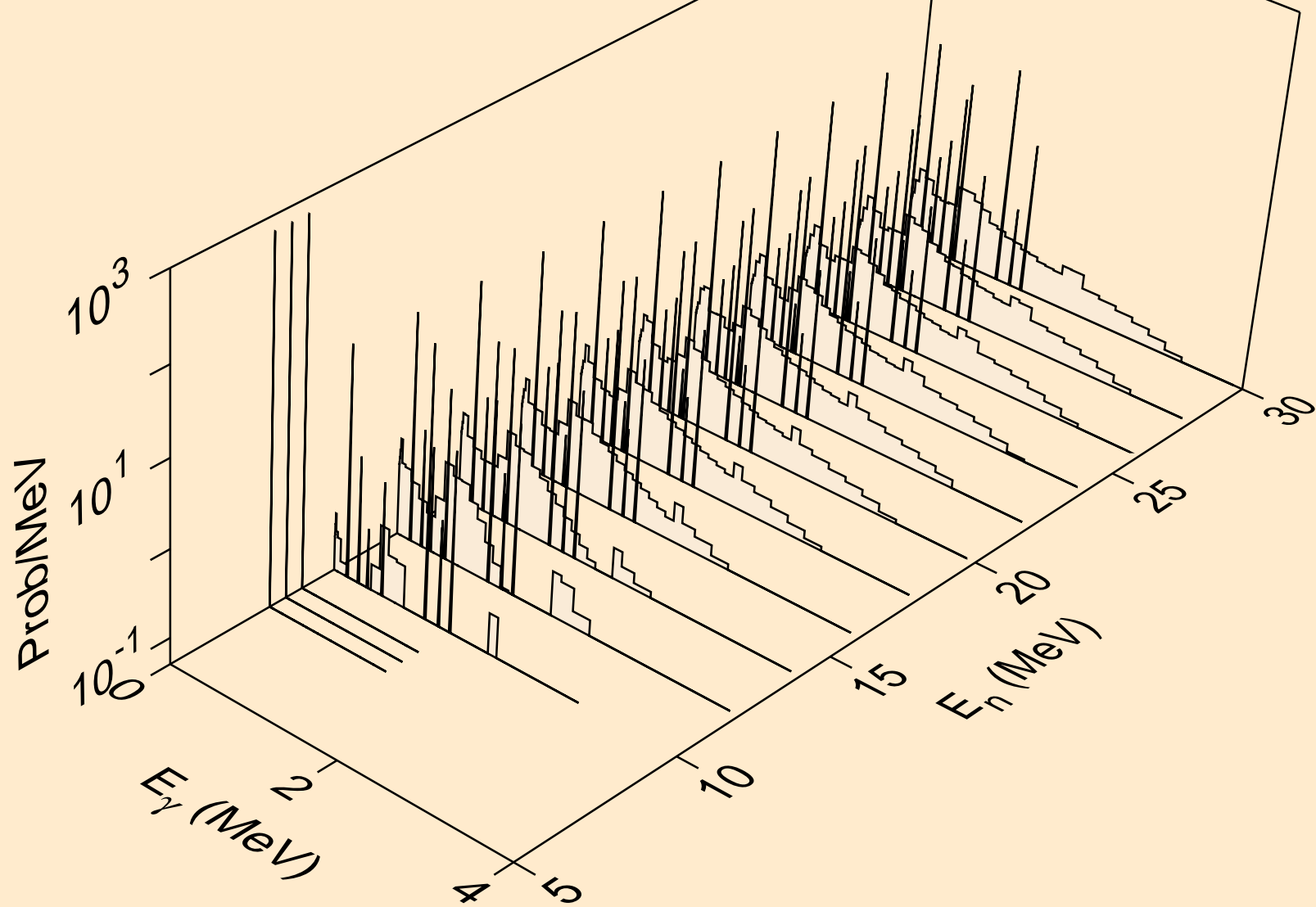

NB099M NEUTRON ACER TENDL-2023 LIBRARY; T=0.K
Photon emission for (n,he3)

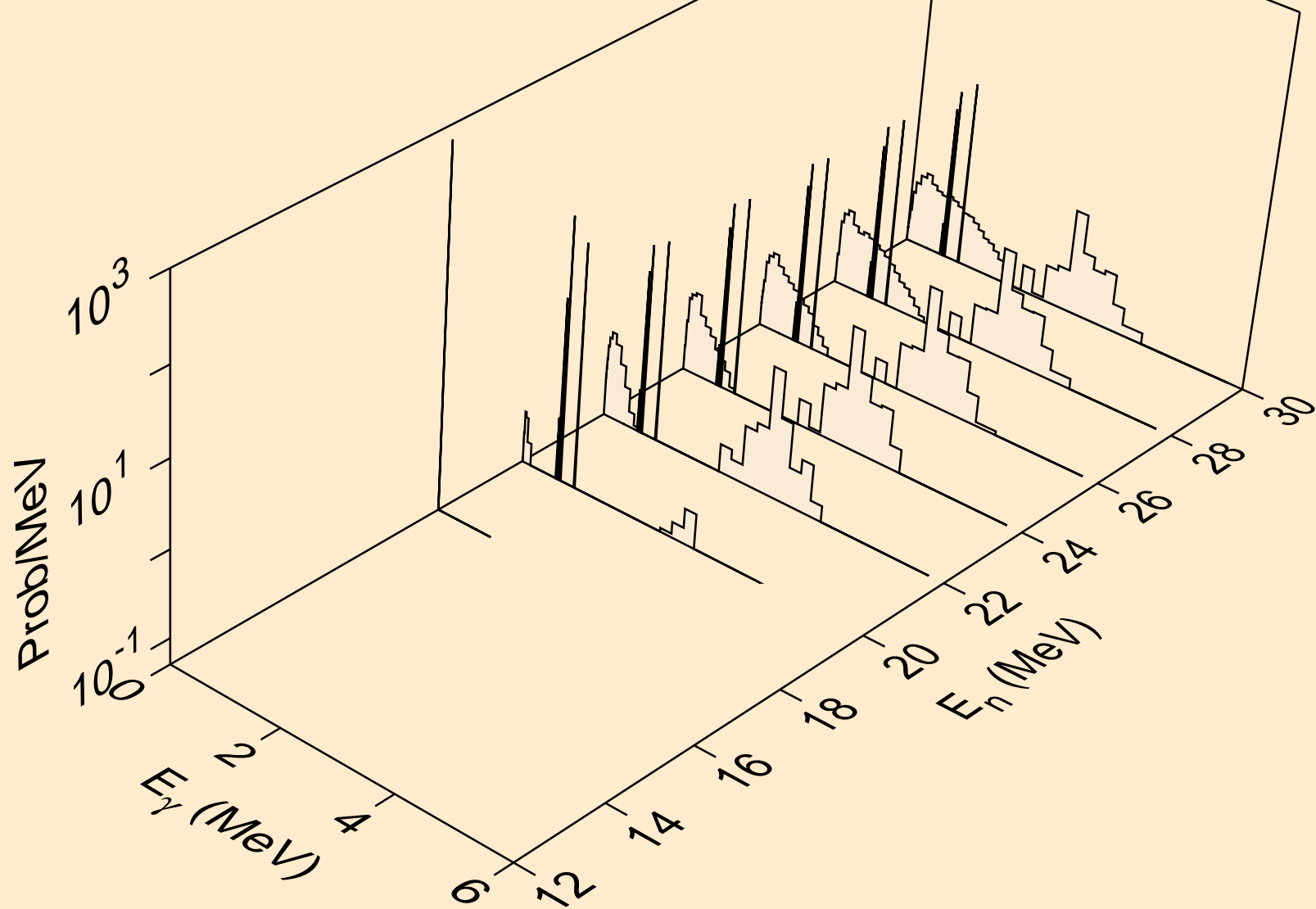

NB099M NEUTRON ACER TENDL-2023 LIBRARY; T=0.K
Photon emission for (n,a)

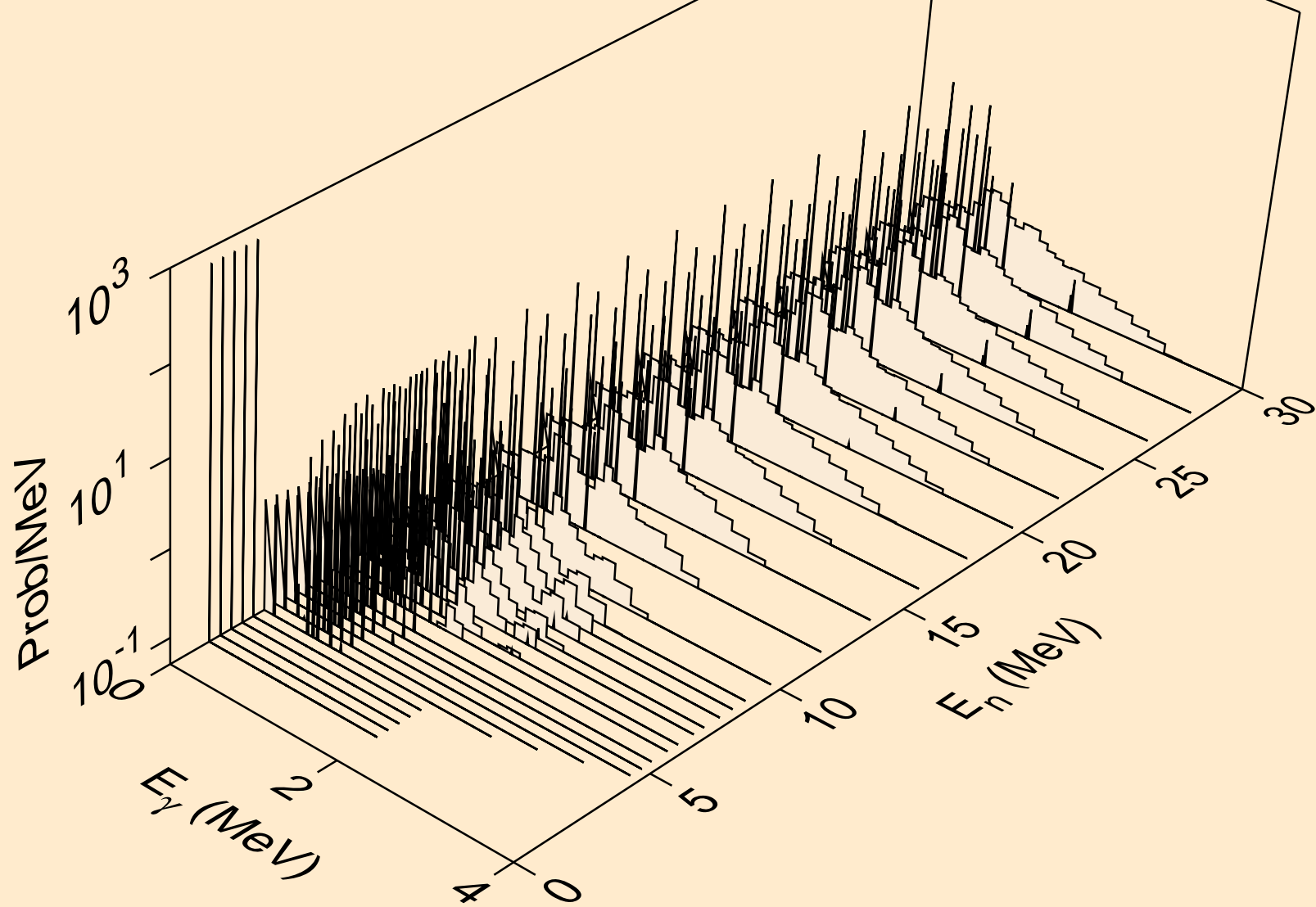

NB099M NEUTRON ACER TENDL-2023 LIBRARY; T=0.K
Photon emission for (n,2a)

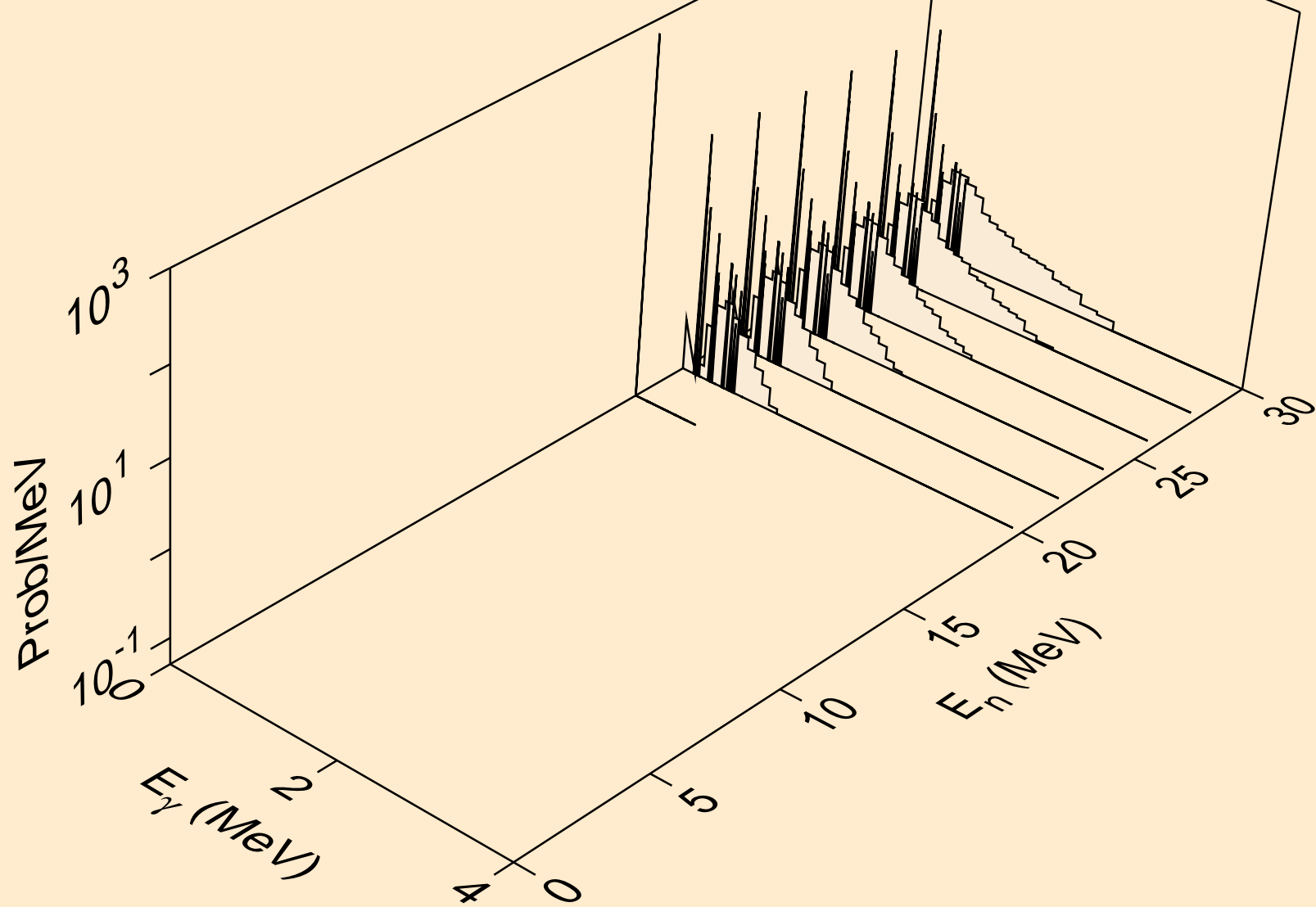

NB099M NEUTRON ACER TENDL-2023 LIBRARY; T=0.K
Photon emission for (n,2p)

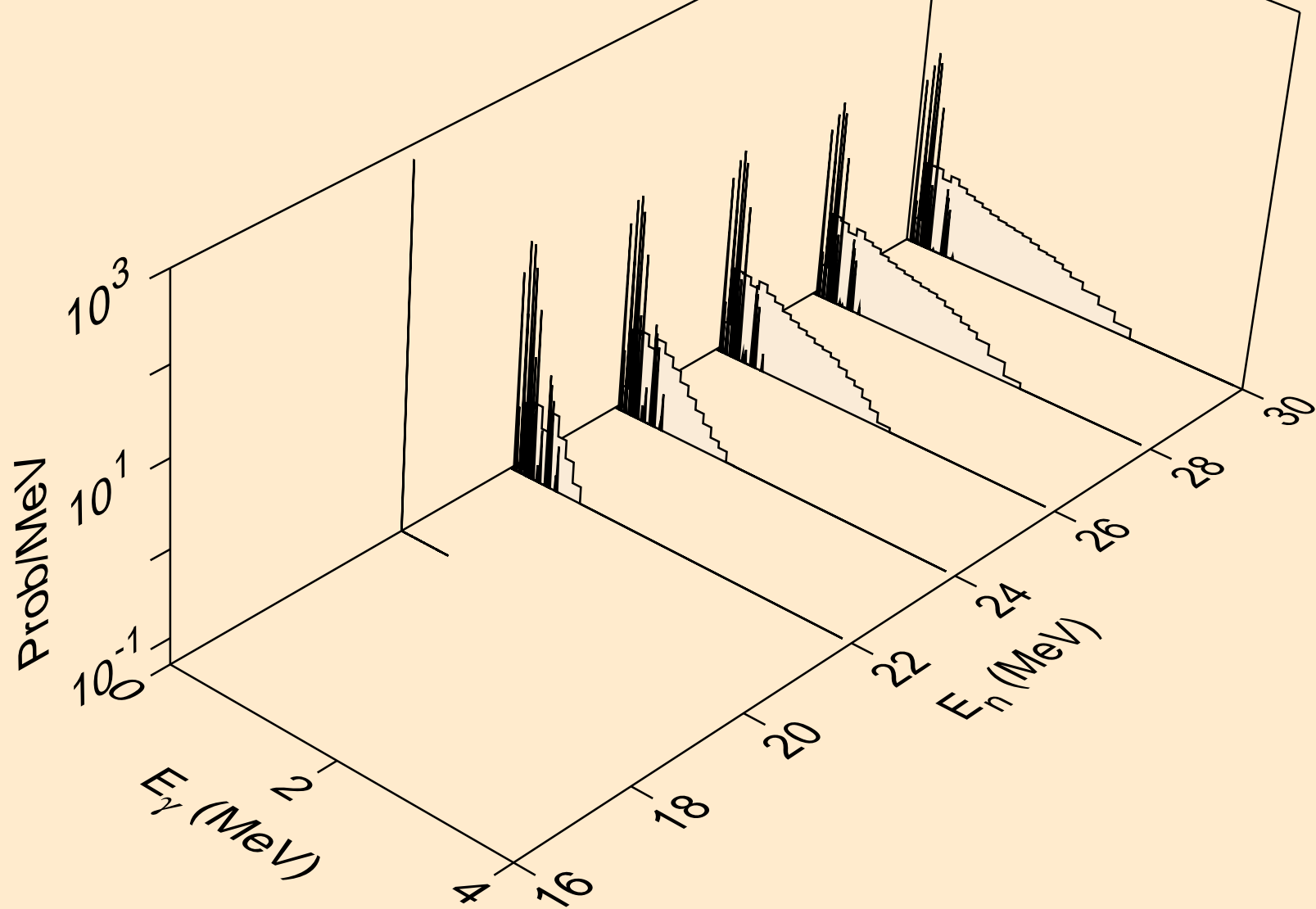

NB099M NEUTRON ACER TENDL-2023 LIBRARY; T=0.K
Photon emission for (n,p α)

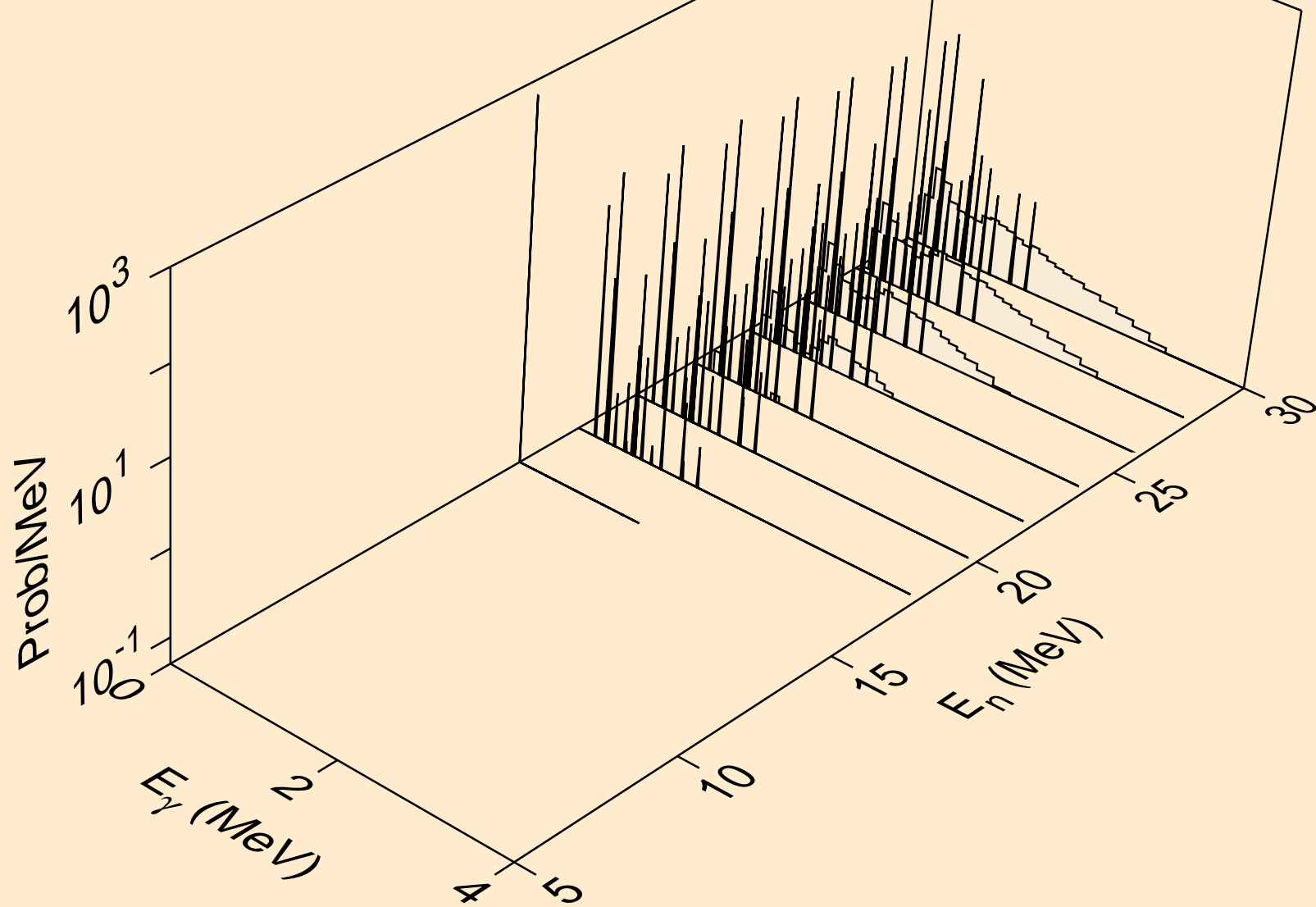

NB099M NEUTRON ACER TENDL-2023 LIBRARY; T=0.K
Photon emission for (n,pt)

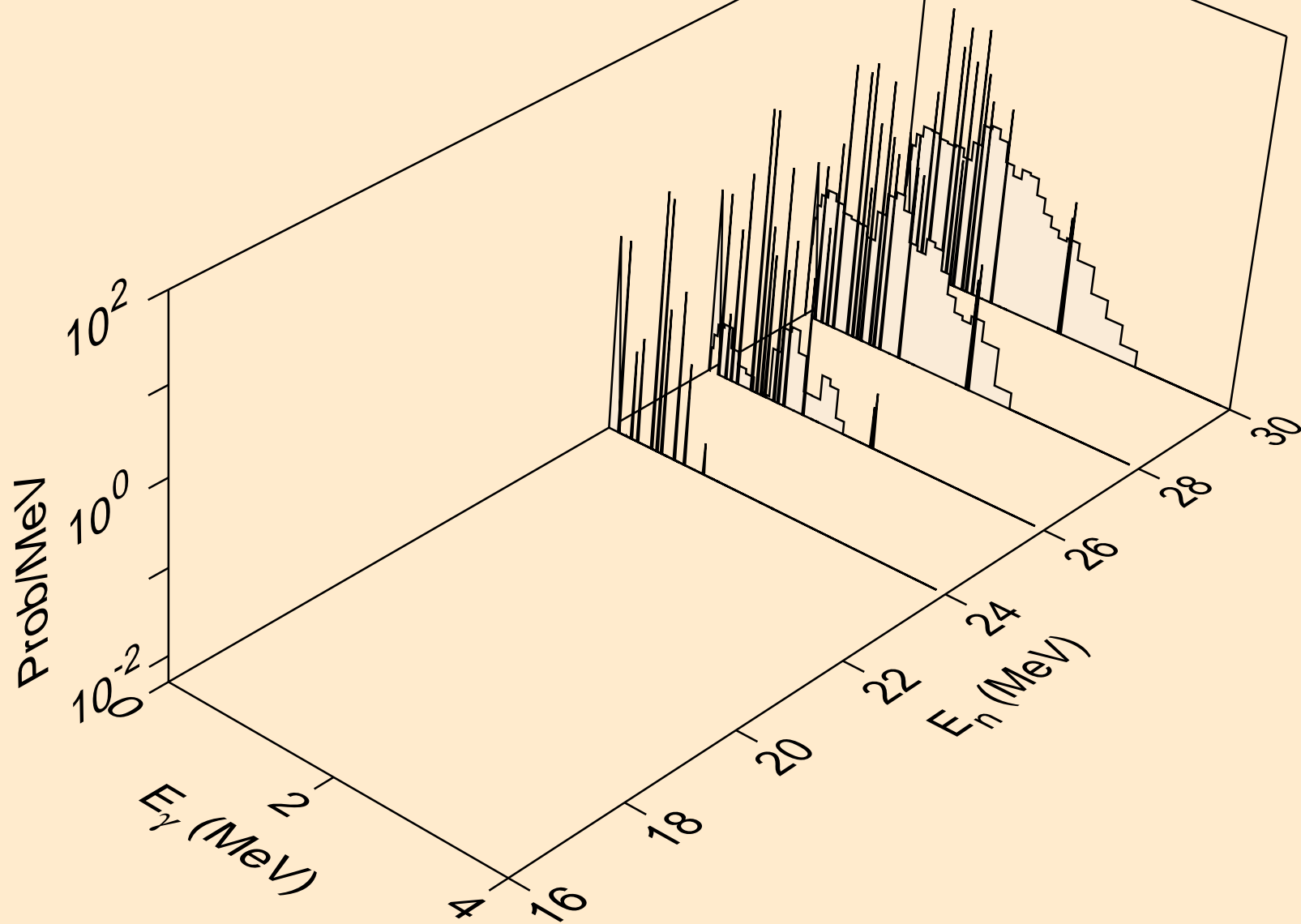

NB099M NEUTRON ACER TENDL-2023 LIBRARY; T=0.K
Photon emission for (n,da)

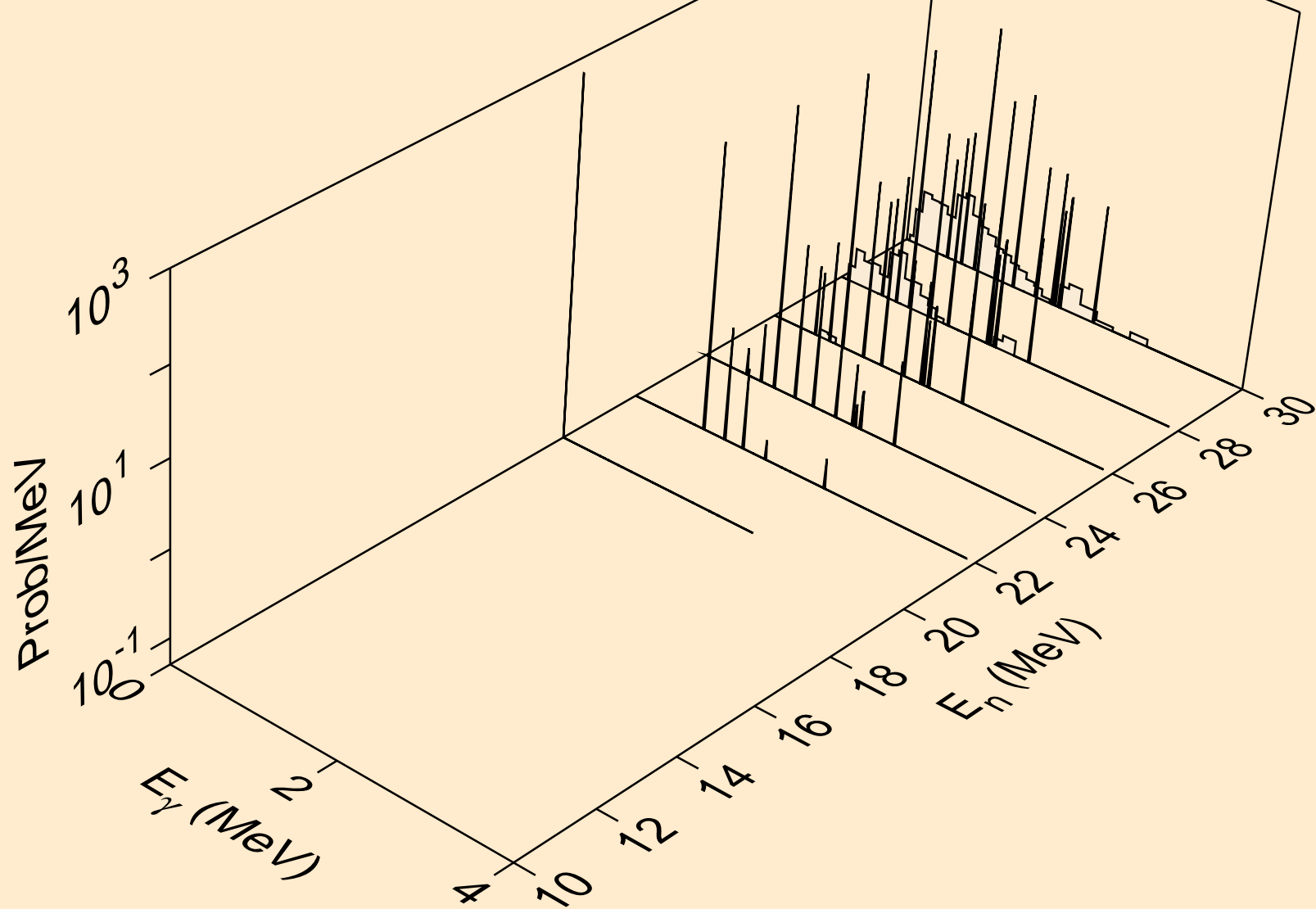

NB099M NEUTRON ACER TENDL-2023 LIBRARY; T=0.K
thermal capture photon spectrum

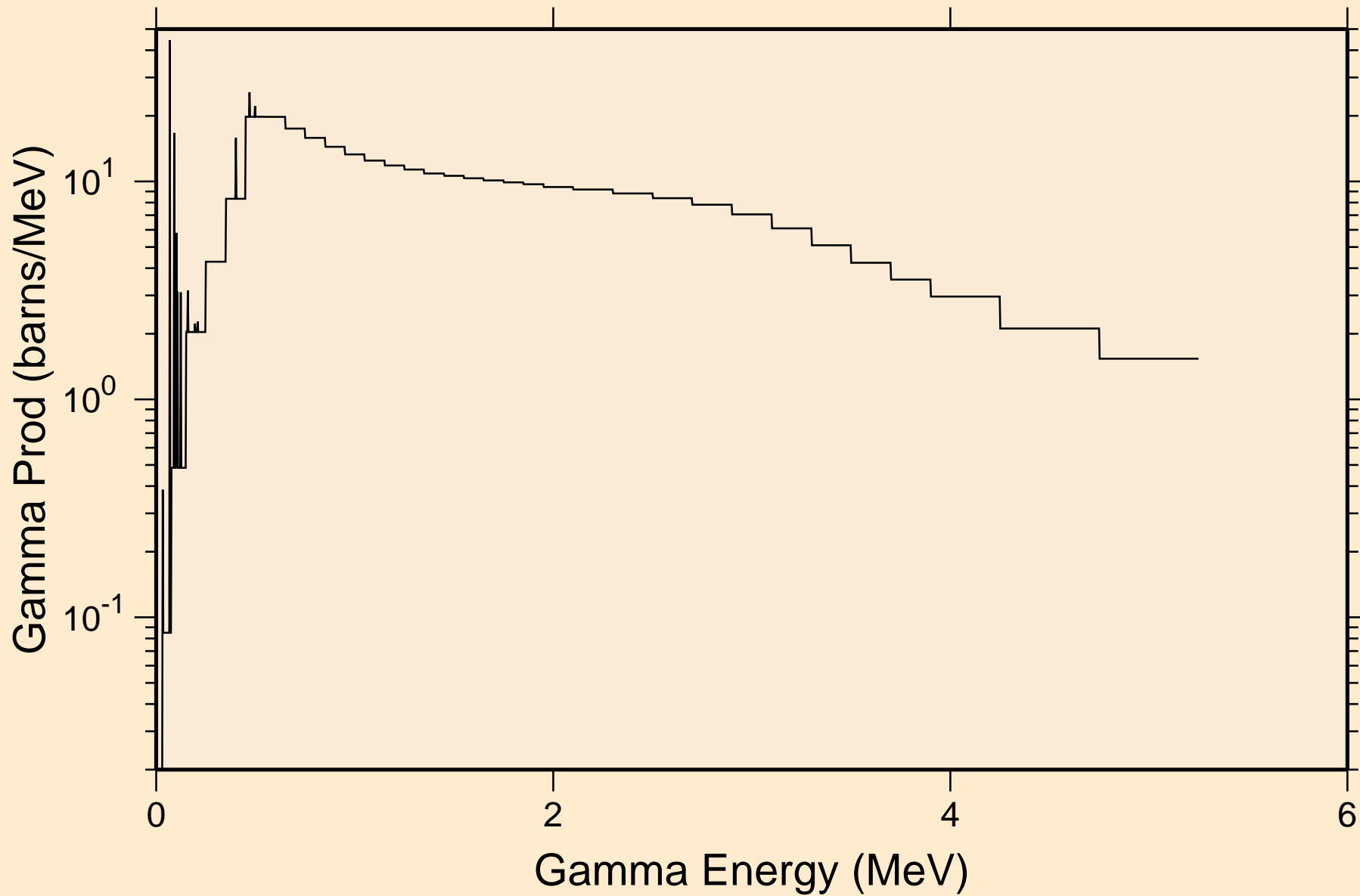

NB099M NEUTRON ACER TENDL-2023 LIBRARY; T=0.K
14 MeV photon spectrum

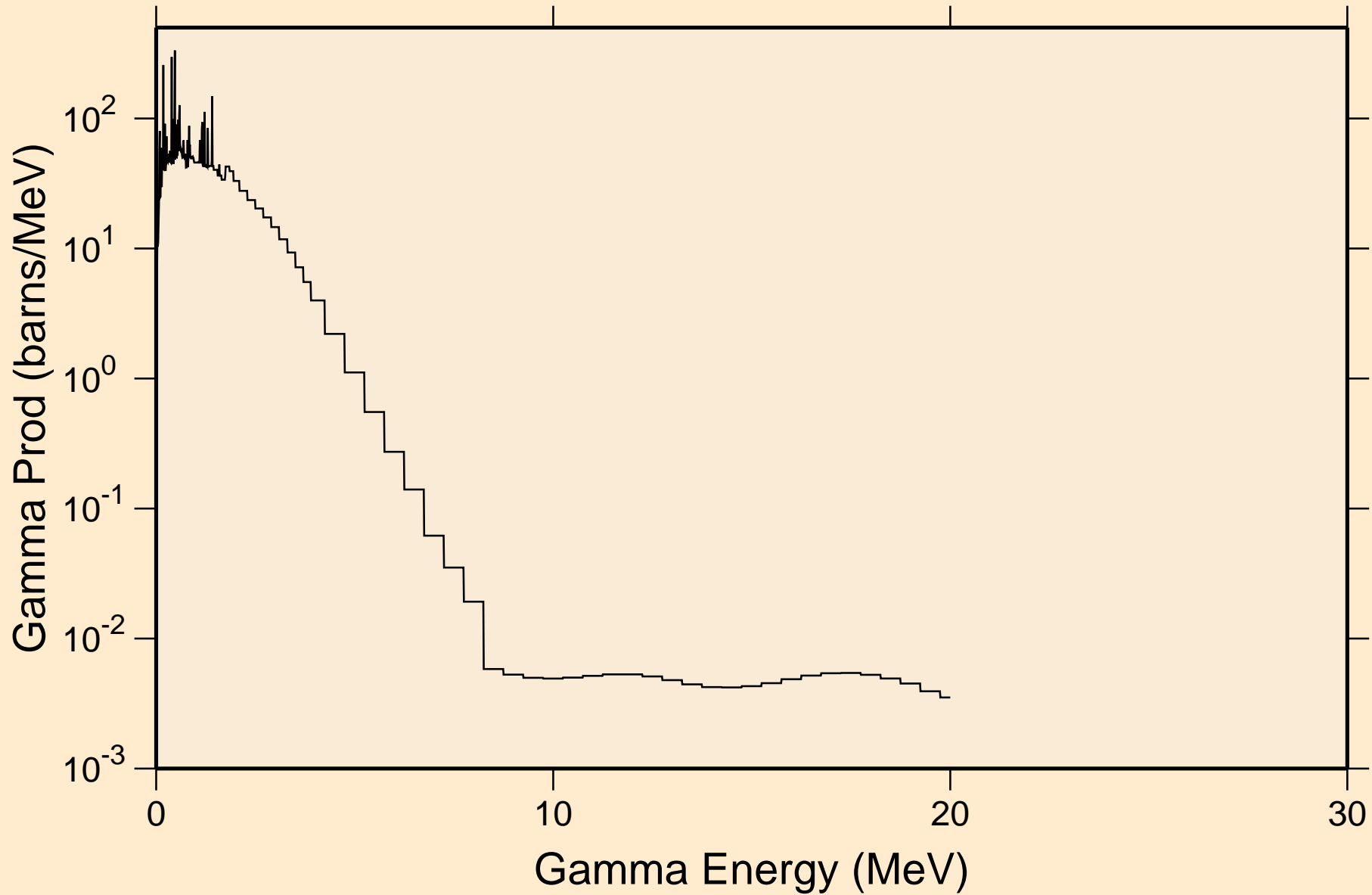

NB099M NEUTRON ACER TENDL-2023 LIBRARY; T=0.K

Particle heating contributions

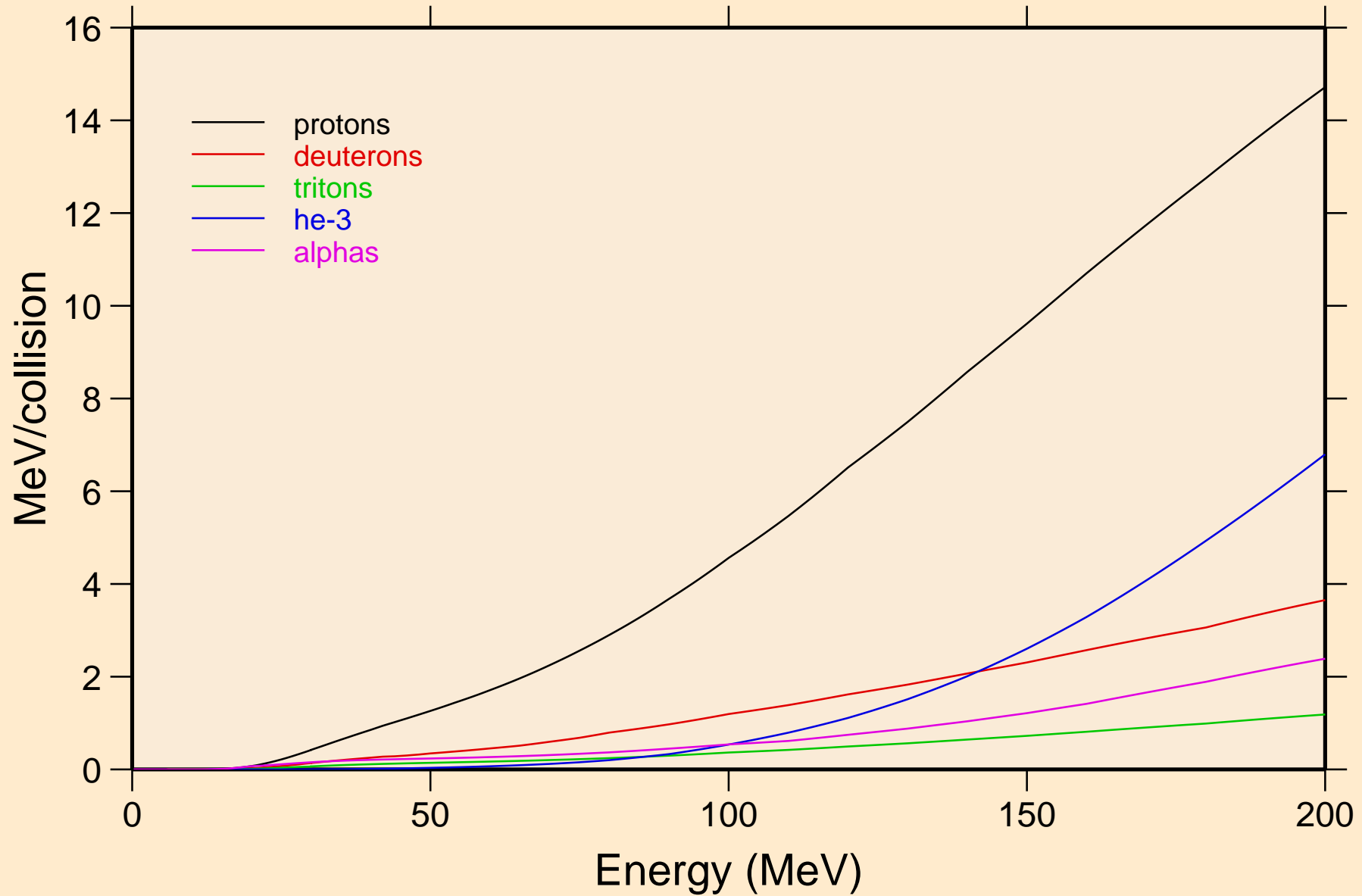

NB099M NEUTRON ACER TENDL-2023 LIBRARY; T=0.K
Recoil Heating

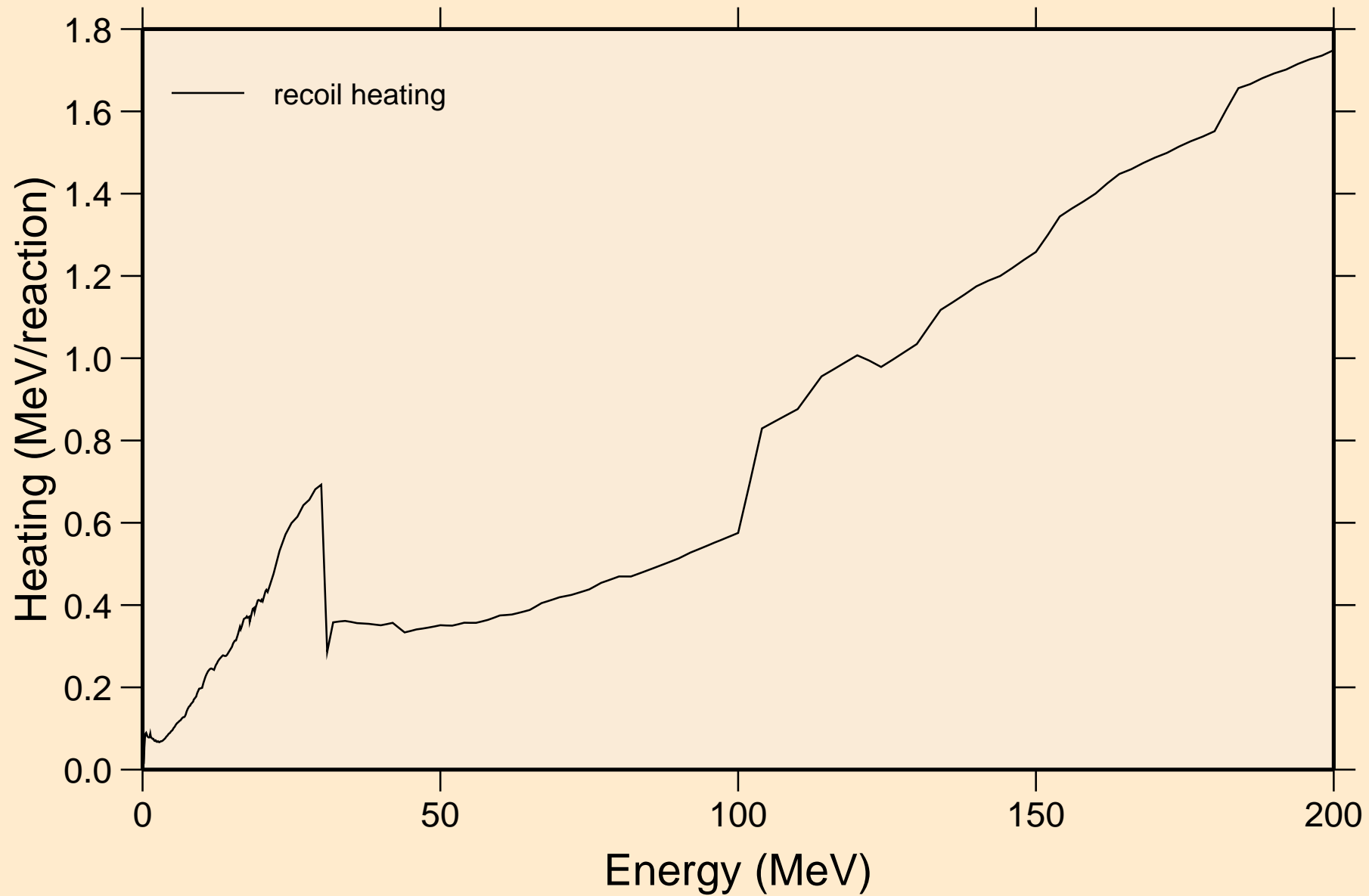

NB099M NEUTRON ACER TENDL-2023 LIBRARY; T=0.K
Particle production cross sections

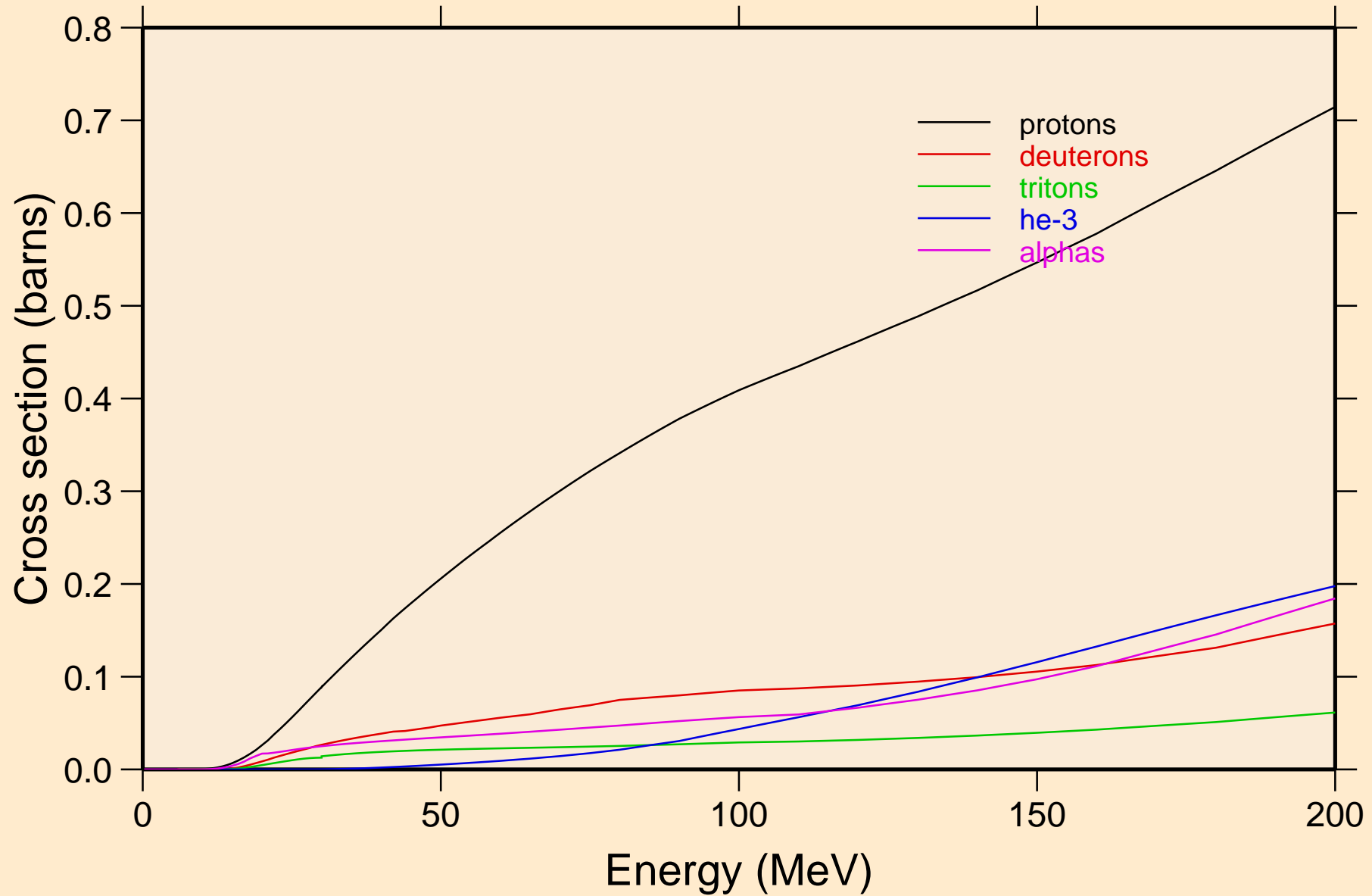

NB099M NEUTRON ACER TENDL-2023 LIBRARY; T=0.K
protons from (n,x)

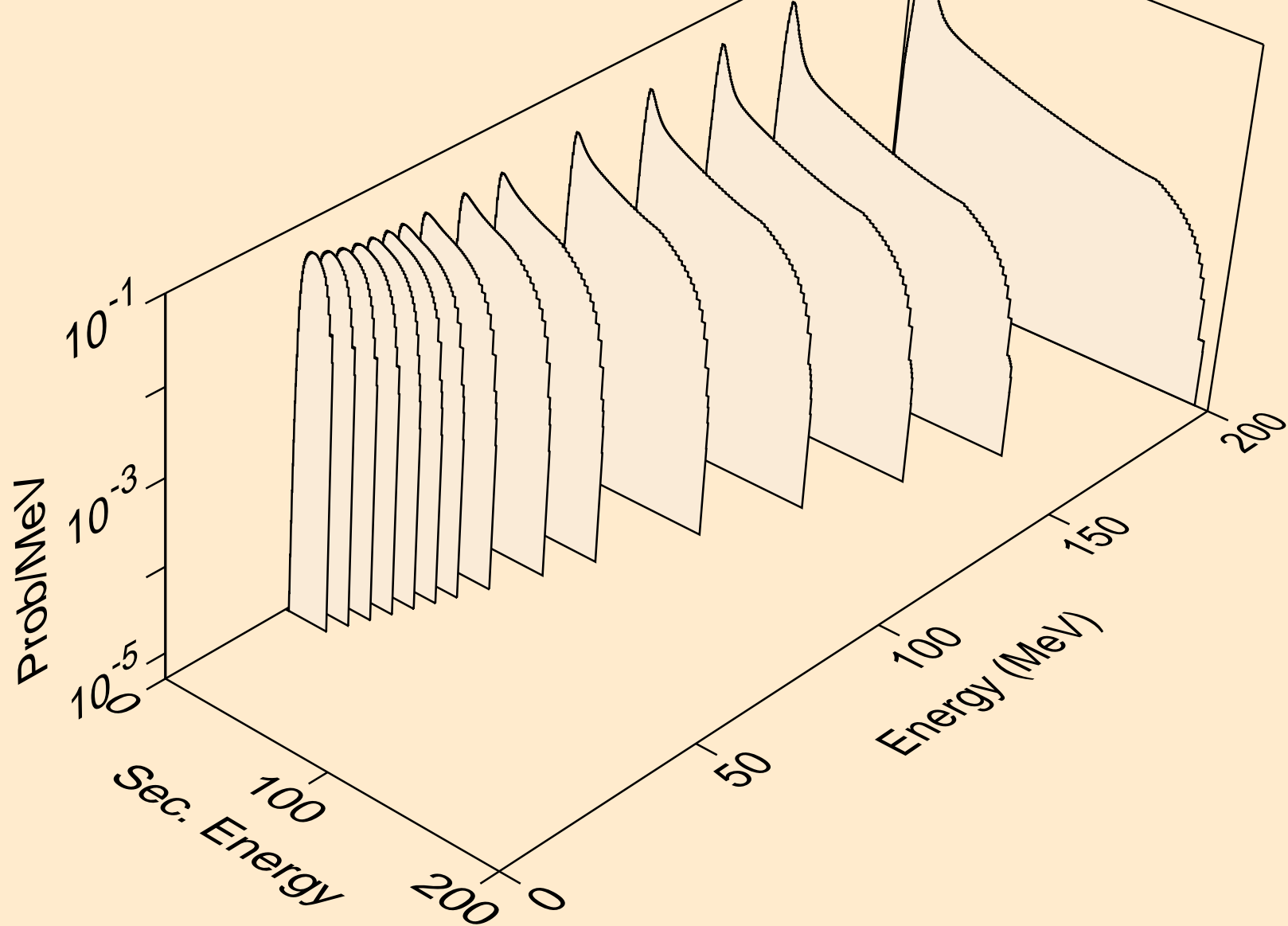

NB099M NEUTRON ACER TENDL-2023 LIBRARY; T=0.K
protons from (n,n*)p

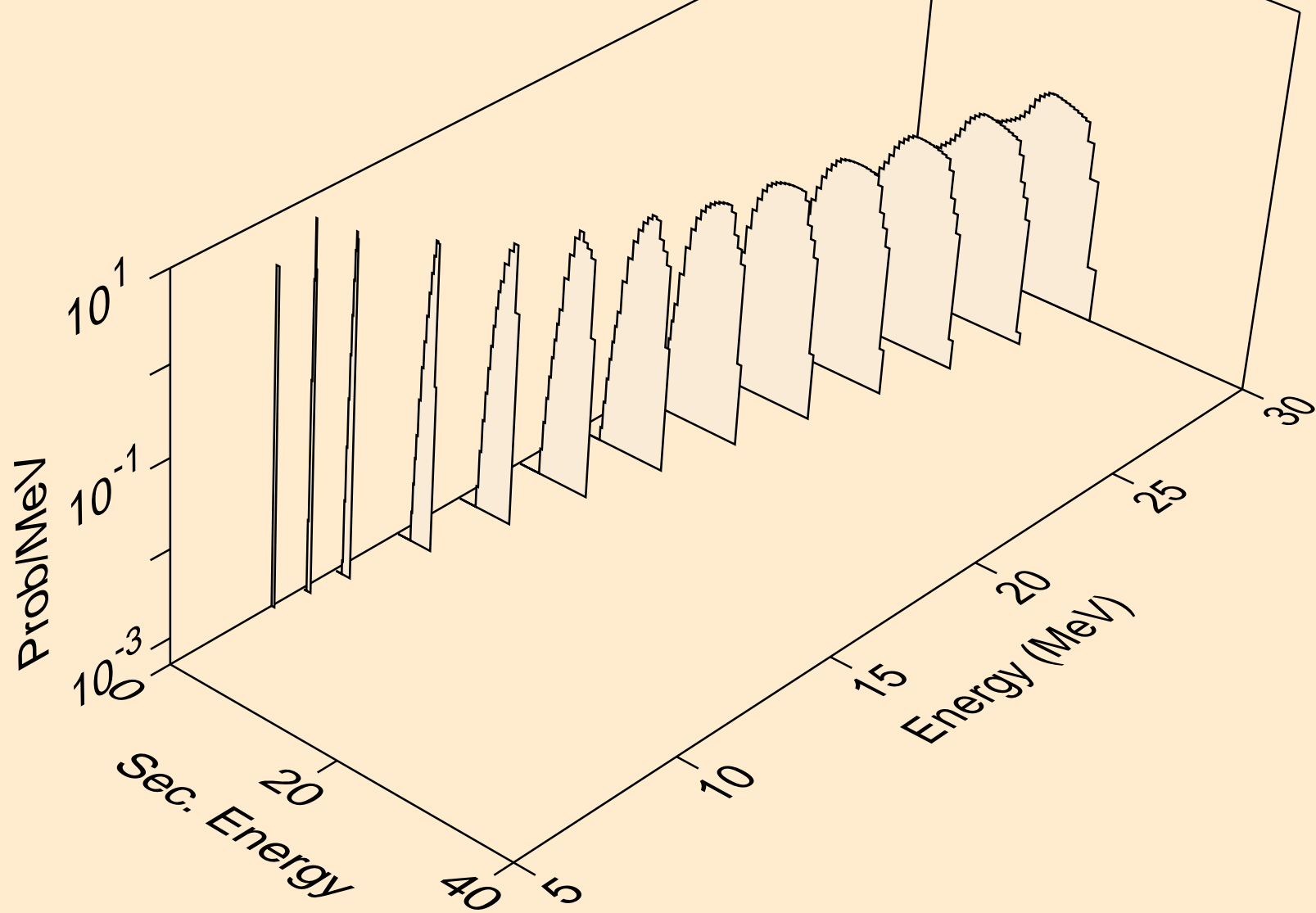

NB099M NEUTRON ACER TENDL-2023 LIBRARY; T=0.K
protons from (n,2np)

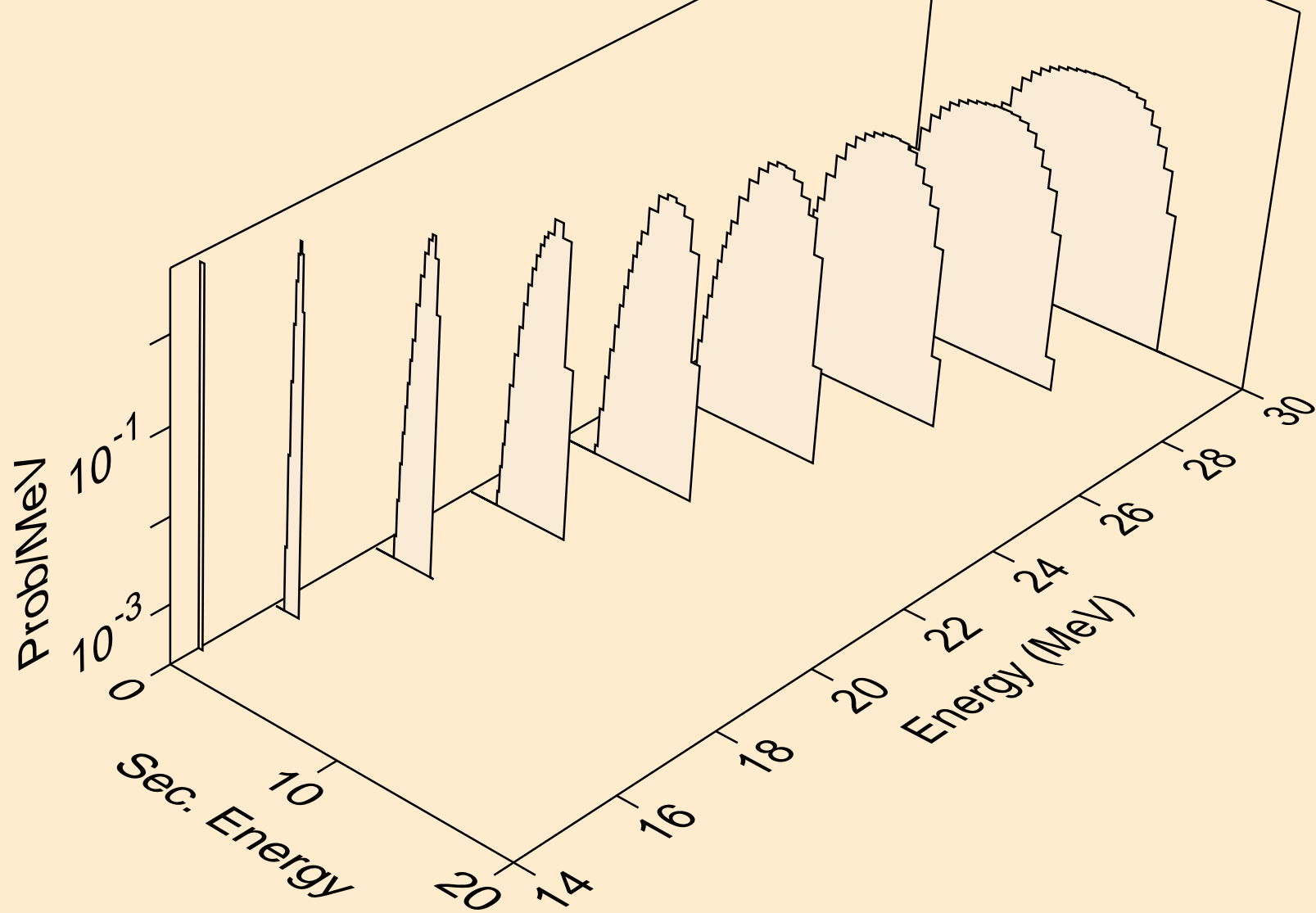

NB099M NEUTRON ACER TENDL-2023 LIBRARY; T=0.K
protons from (n,3np)

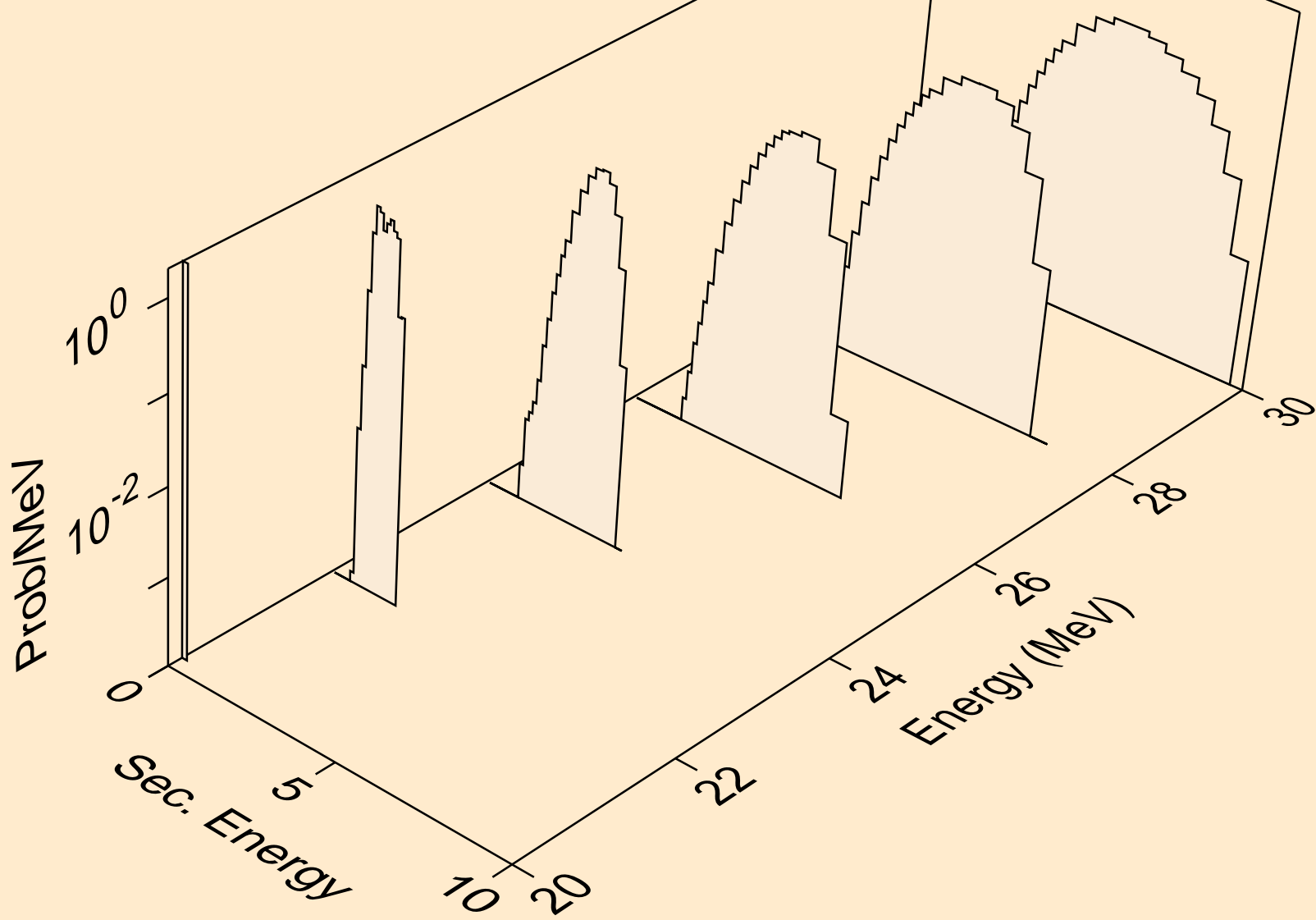

NB099M NEUTRON ACER TENDL-2023 LIBRARY; T=0.K
protons from (n,n2p)

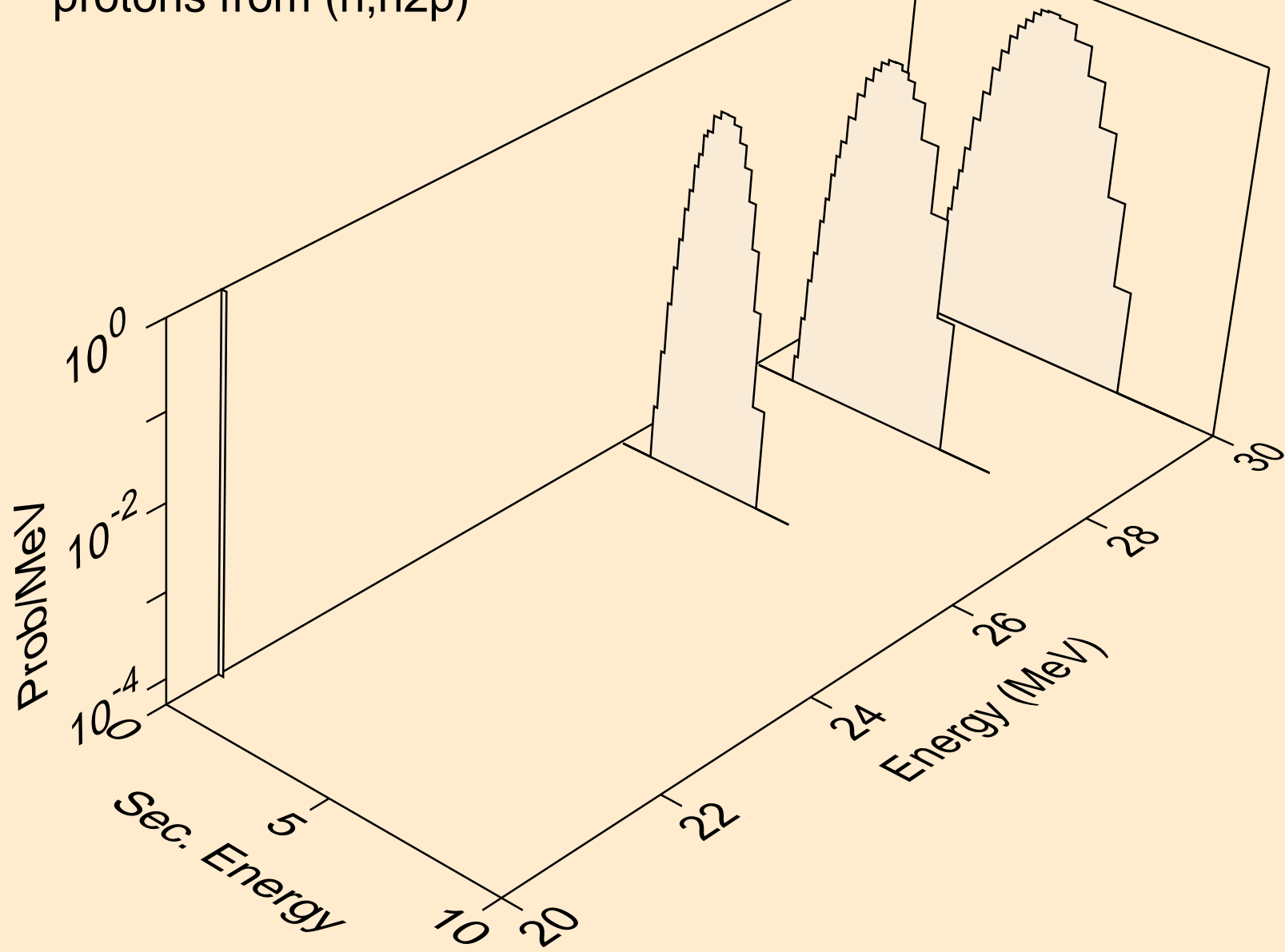

NB099M NEUTRON ACER TENDL-2023 LIBRARY; T=0.K
protons from (n,npa)

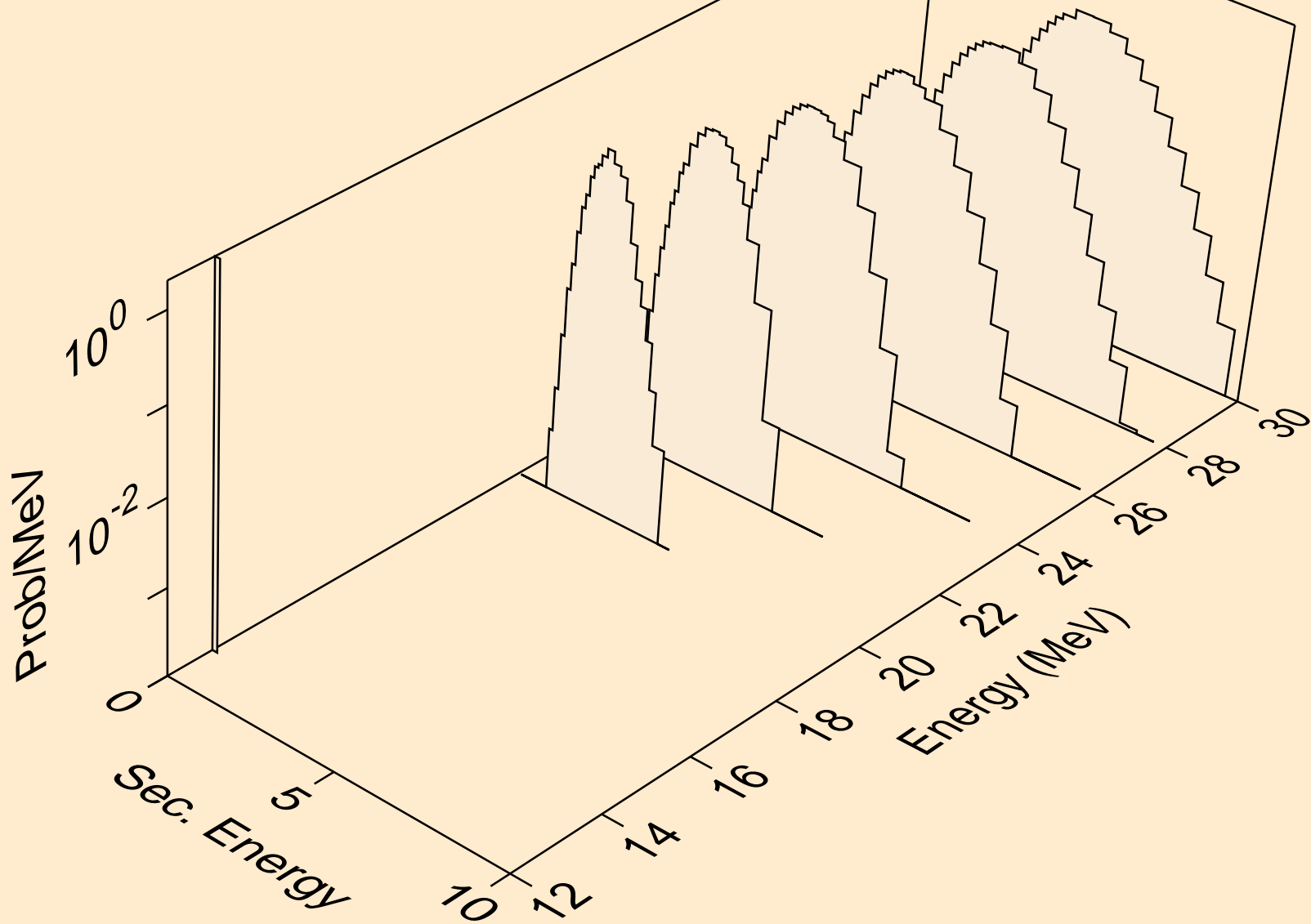

NB099M NEUTRON ACER TENDL-2023 LIBRARY; T=0.K
protons from (n,p)

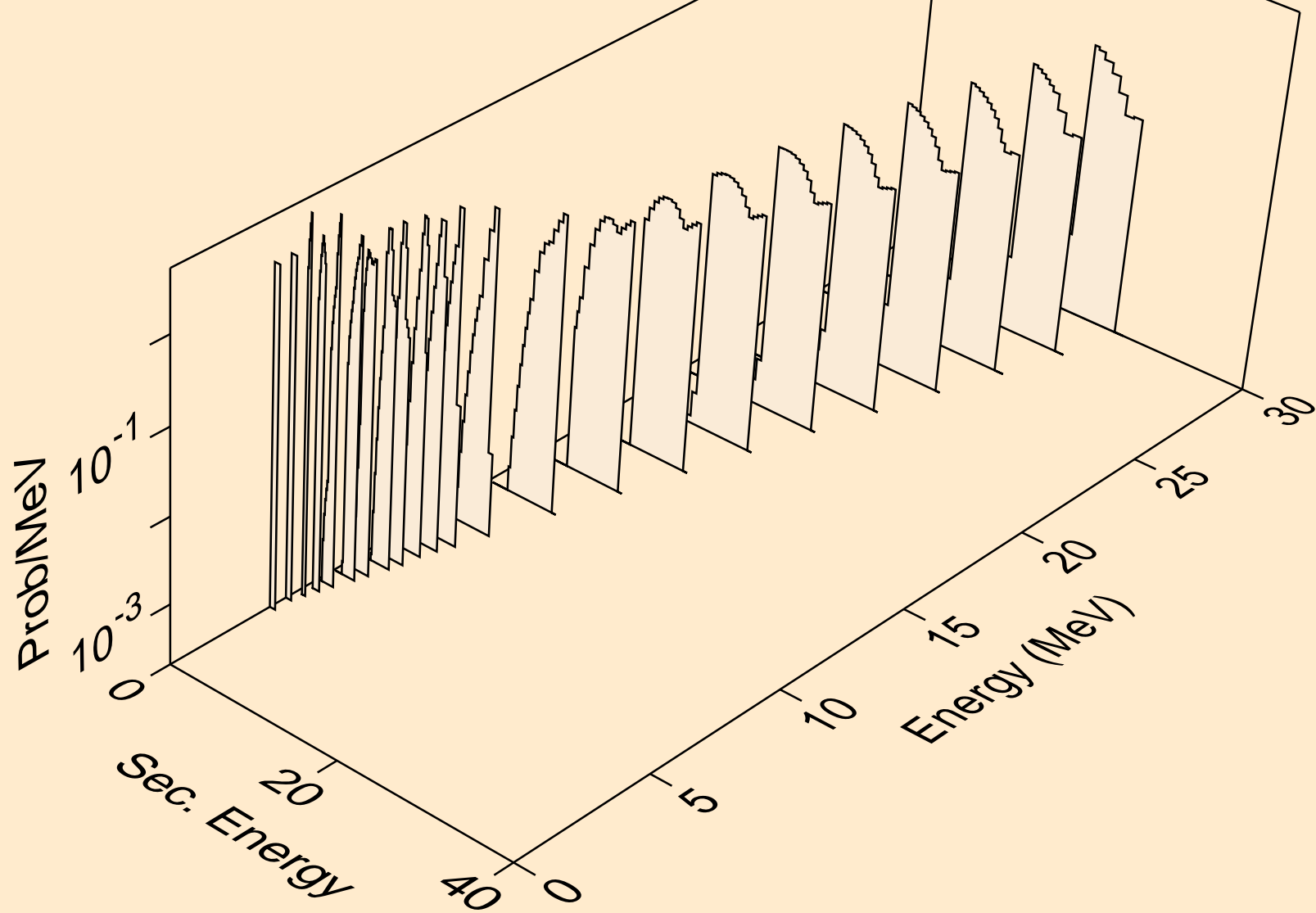

NB099M NEUTRON ACER TENDL-2023 LIBRARY; T=0.K
protons from (n,2p)

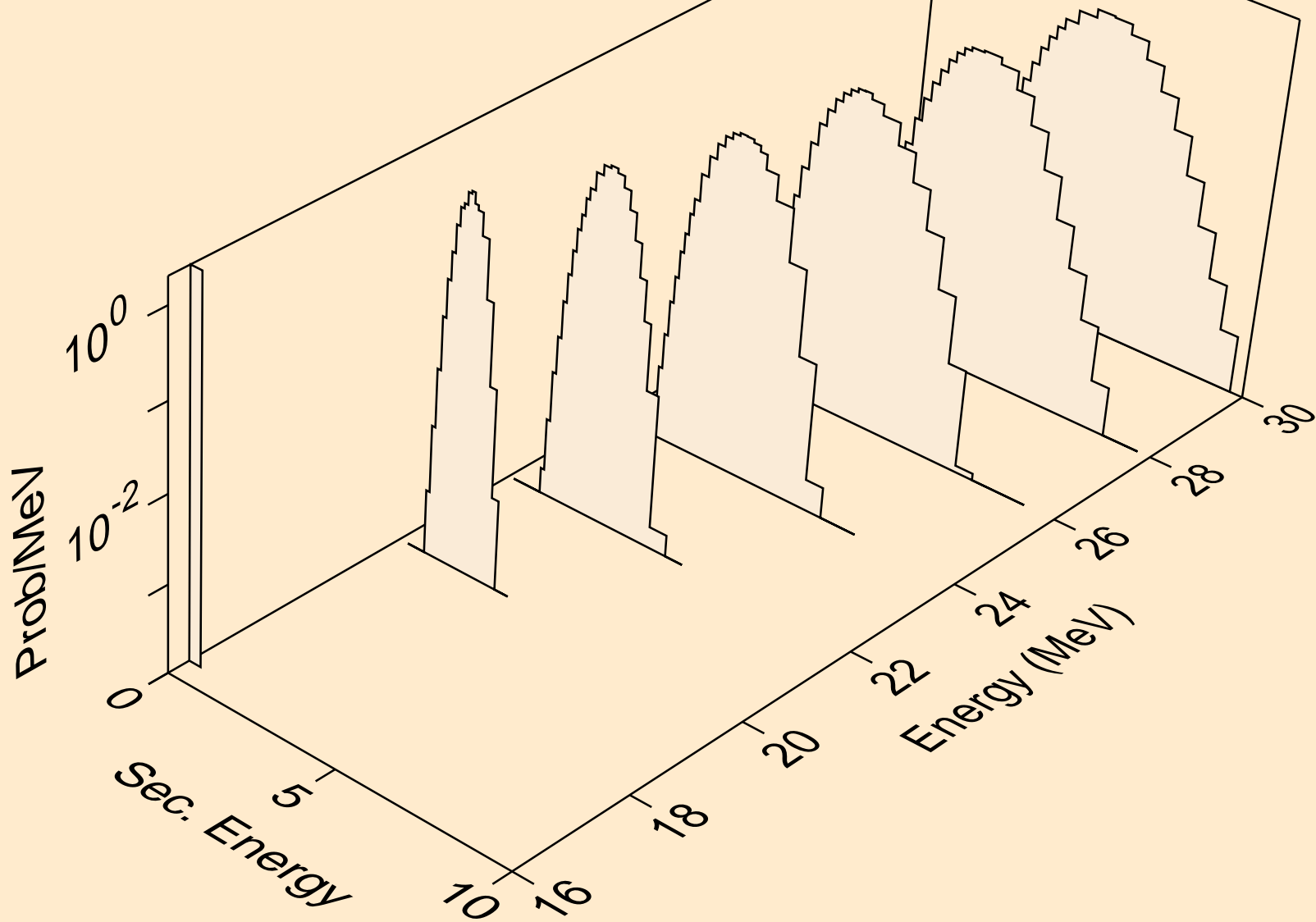

NB099M NEUTRON ACER TENDL-2023 LIBRARY; T=0.K
protons from (n,p)

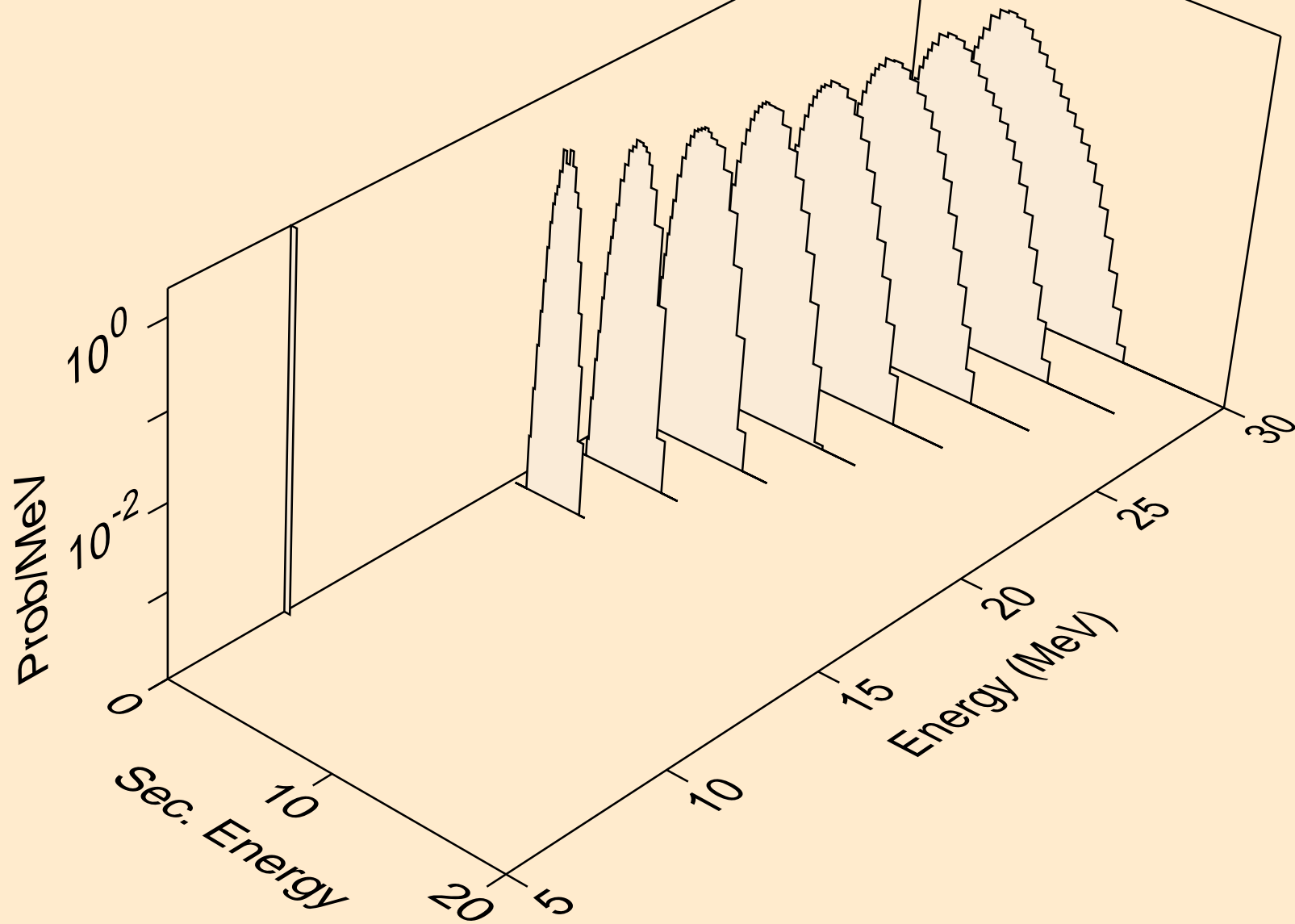

NB099M NEUTRON ACER TENDL-2023 LIBRARY; T=0.K
protons from (n,pt)

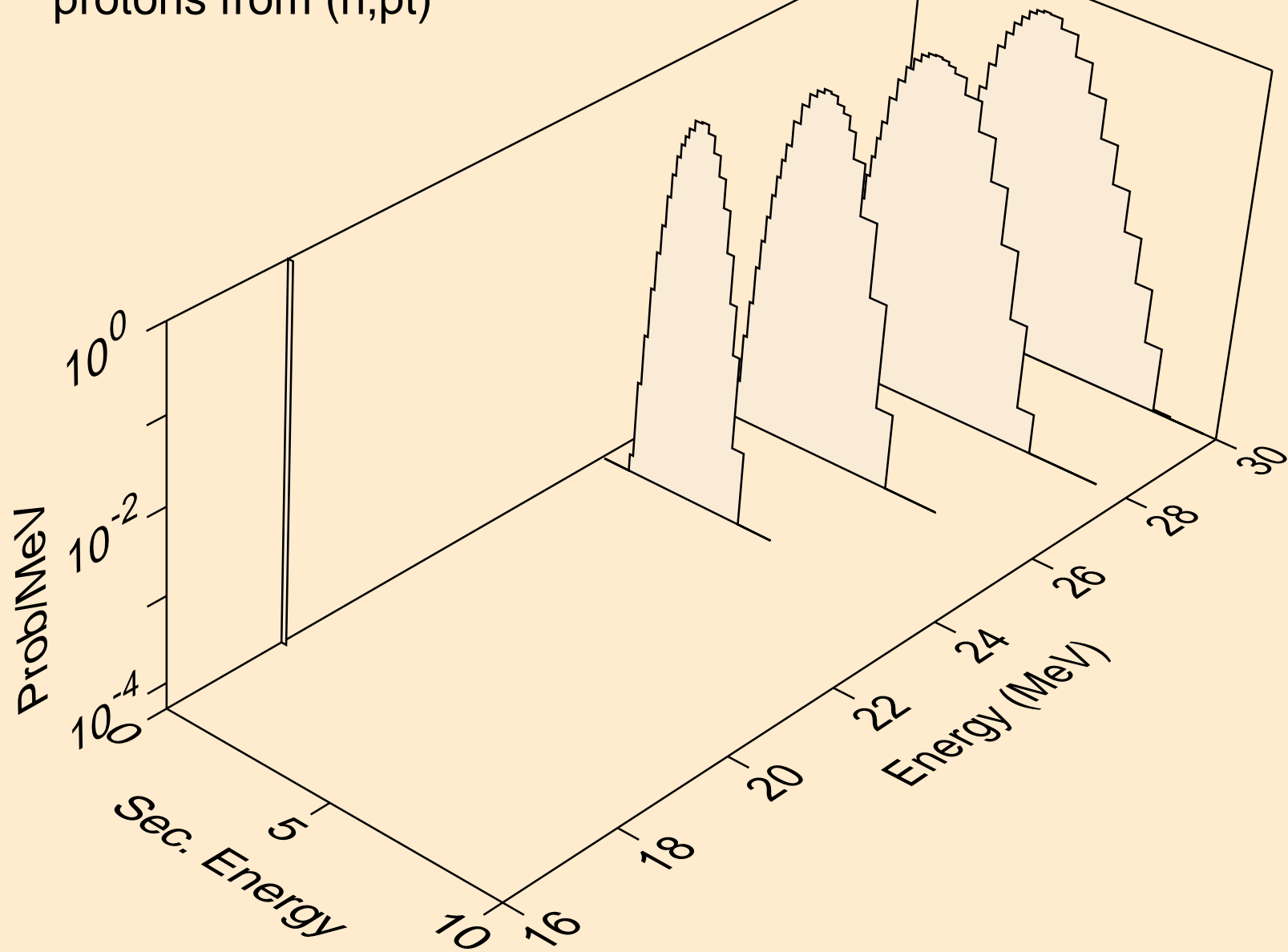

NB099M NEUTRON ACER TENDL-2023 LIBRARY; T=0.K
deuterons from (n,x)

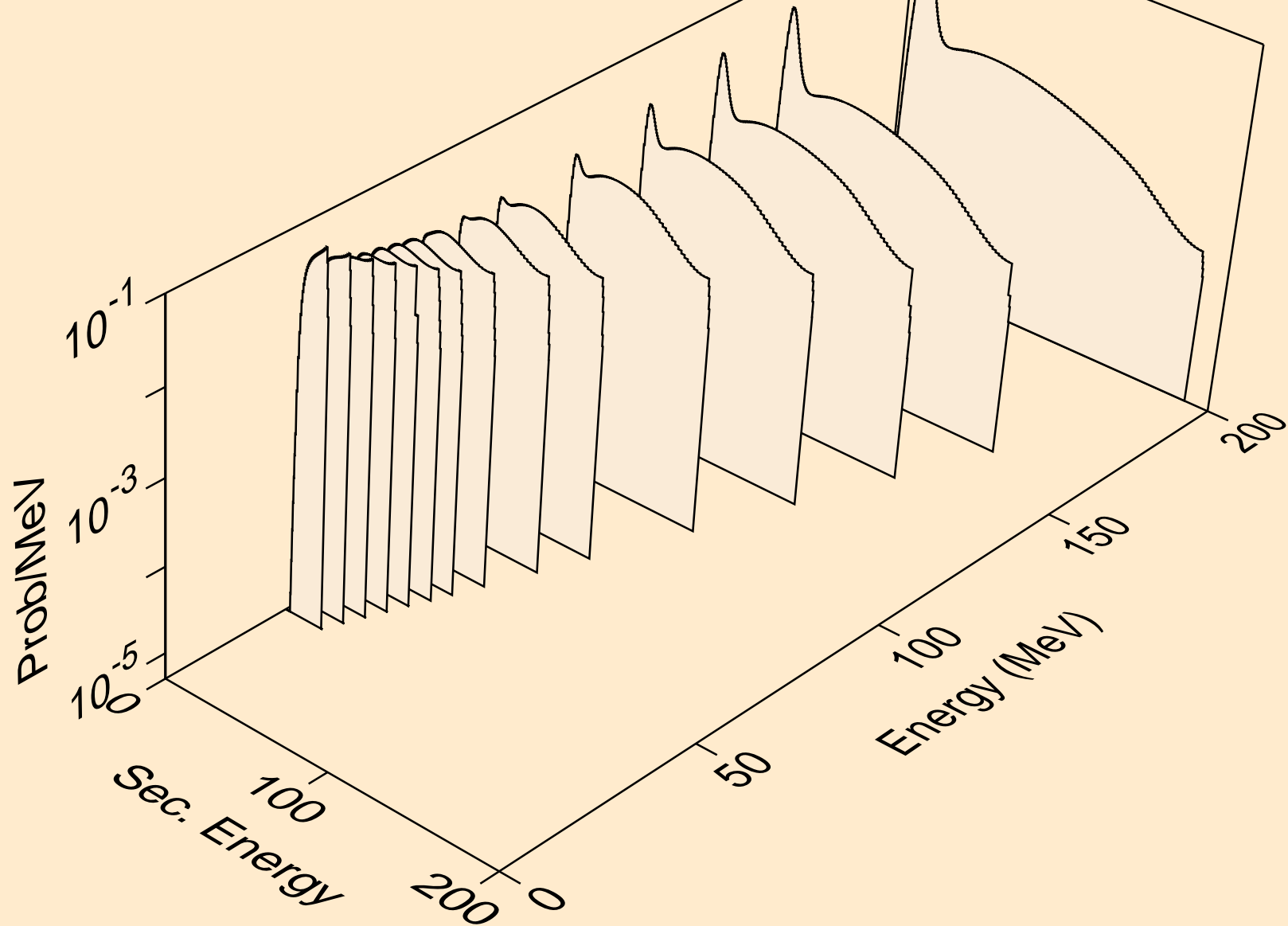

NB099M NEUTRON ACER TENDL-2023 LIBRARY; T=0.K
deuterons from (n,2nd)

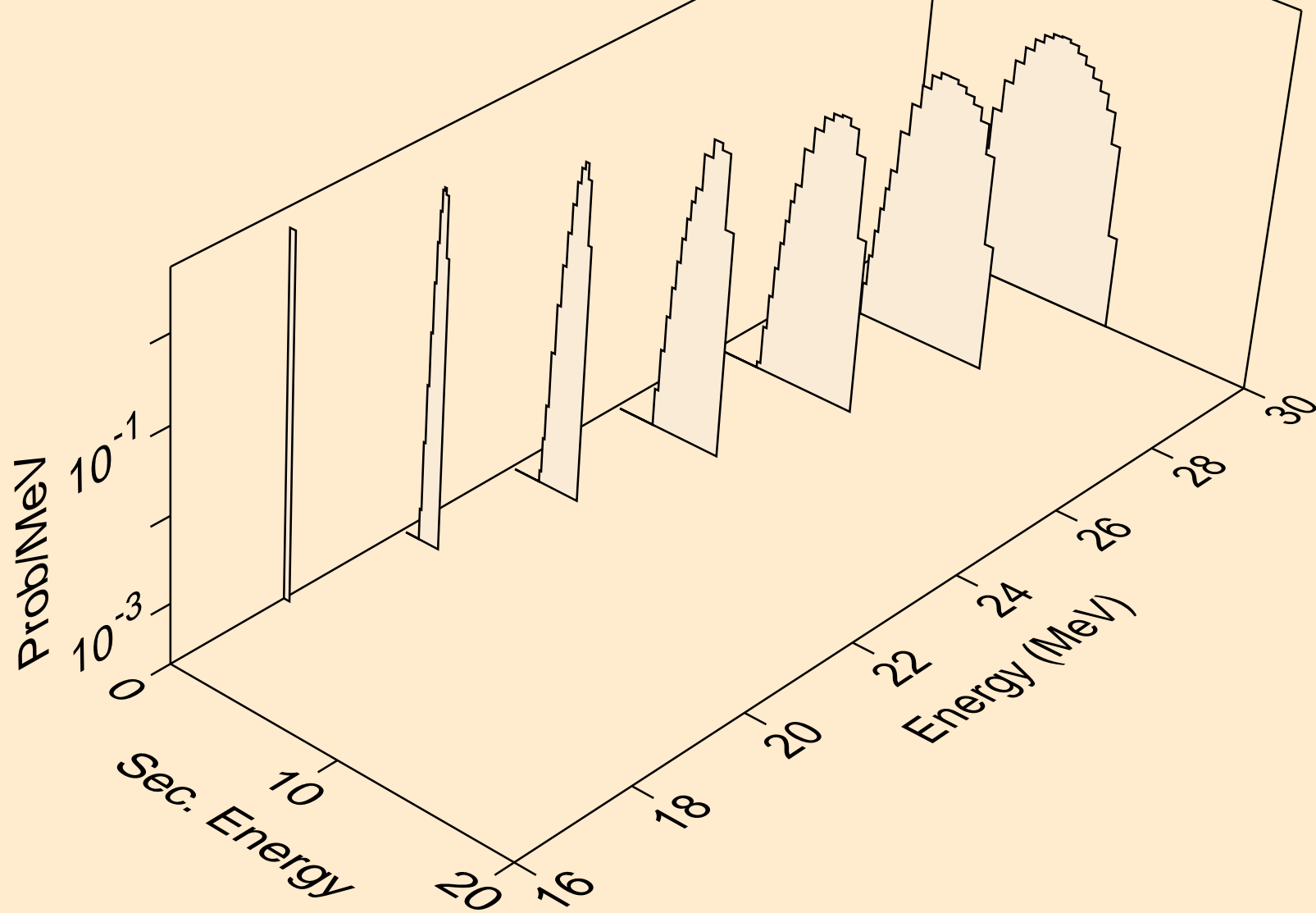

NB099M NEUTRON ACER TENDL-2023 LIBRARY; T=0.K
deuterons from (n,n*)d

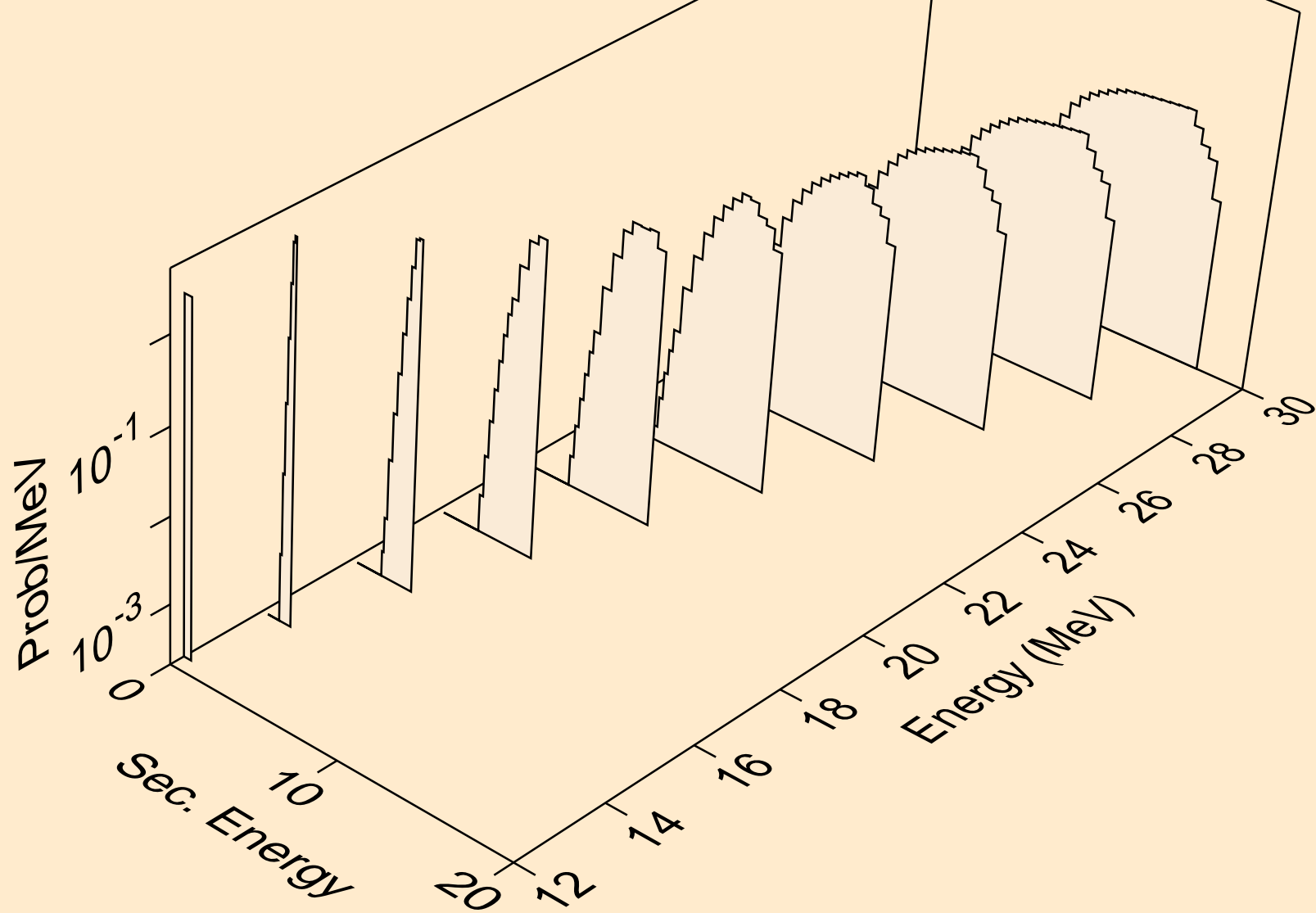

NB099M NEUTRON ACER TENDL-2023 LIBRARY; T=0.K
deuterons from (n,d)

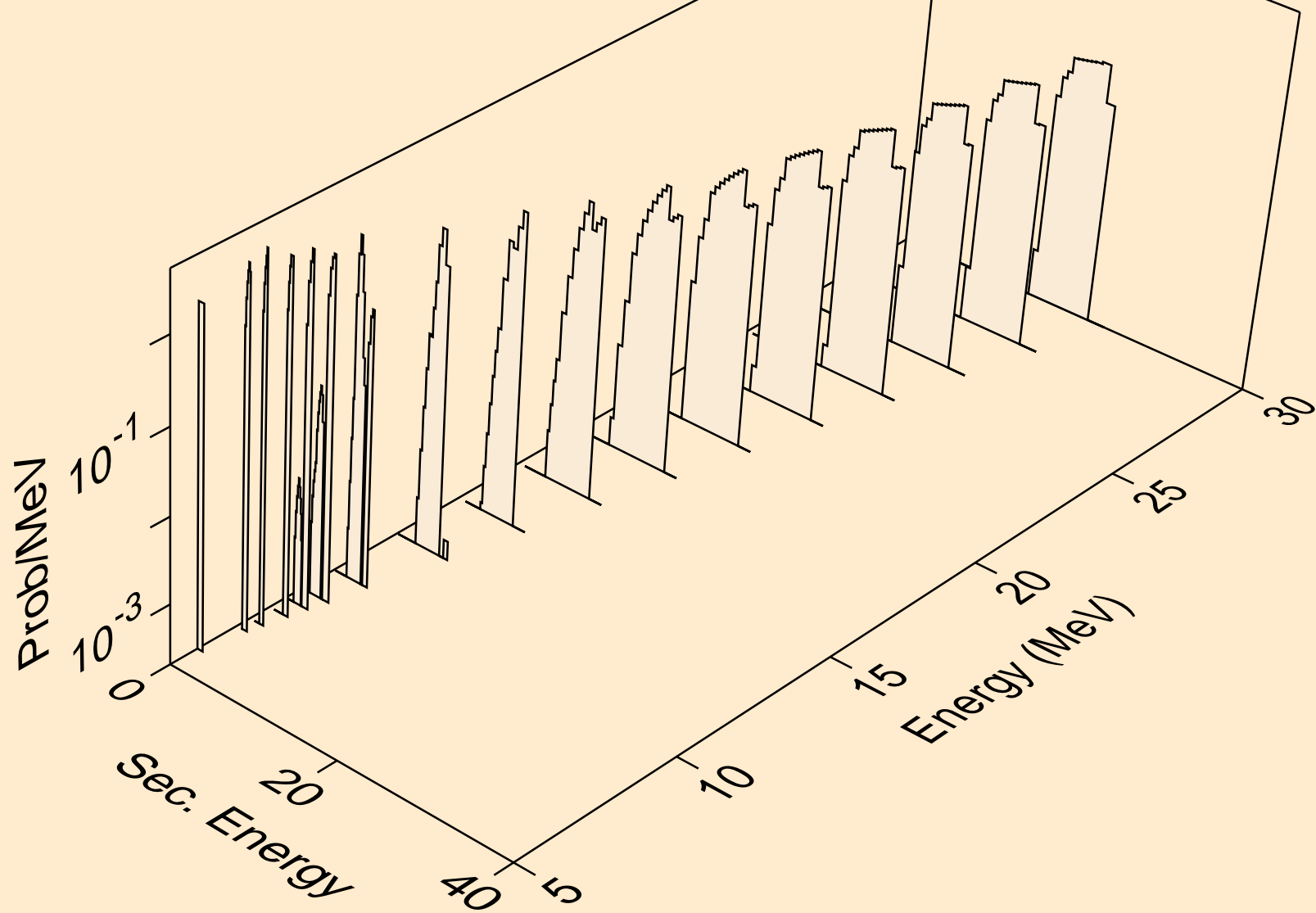

NB099M NEUTRON ACER TENDL-2023 LIBRARY; T=0.K
deuterons from (n,da)

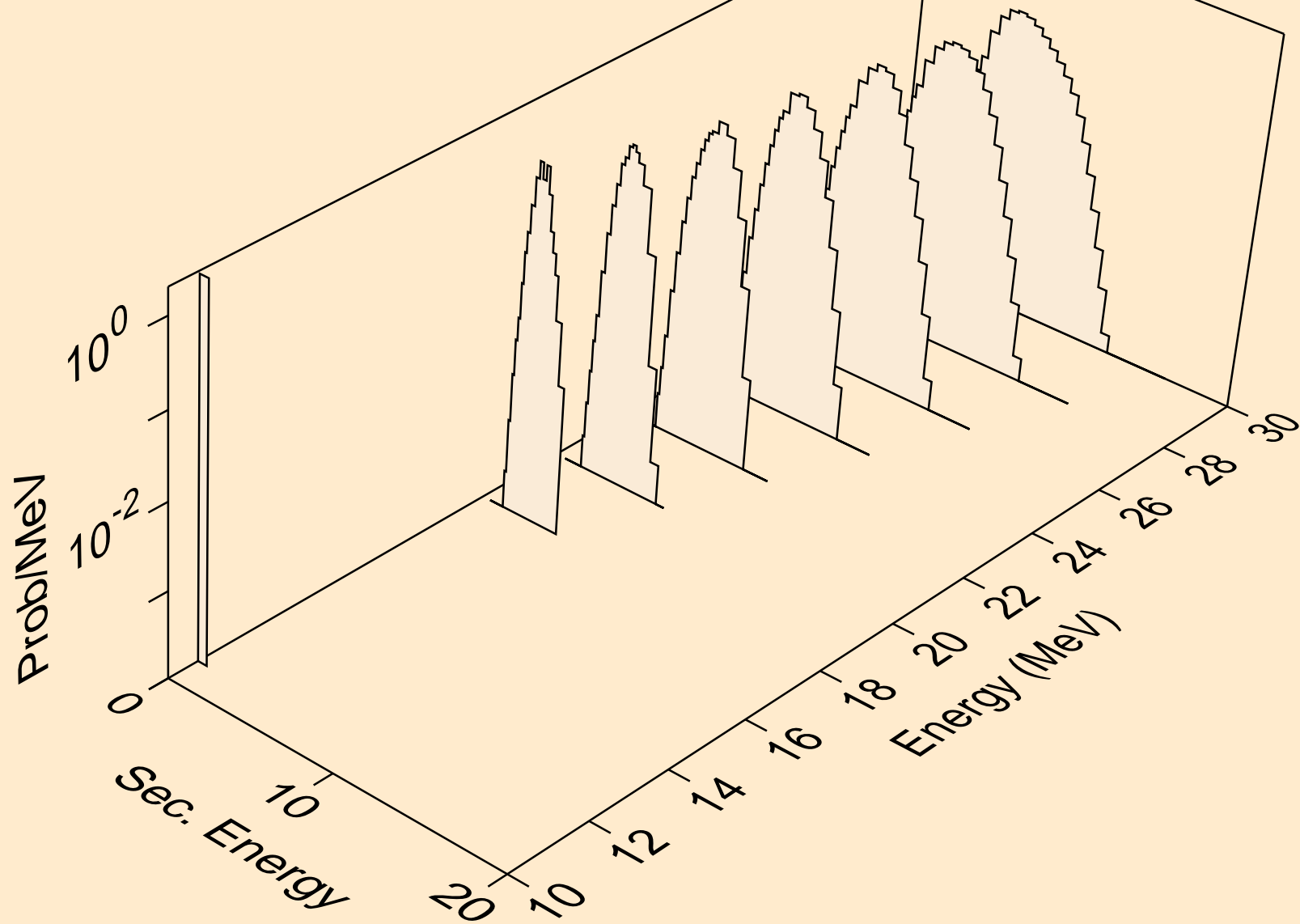

NB099M NEUTRON ACER TENDL-2023 LIBRARY; T=0.K
tritons from (n,x)

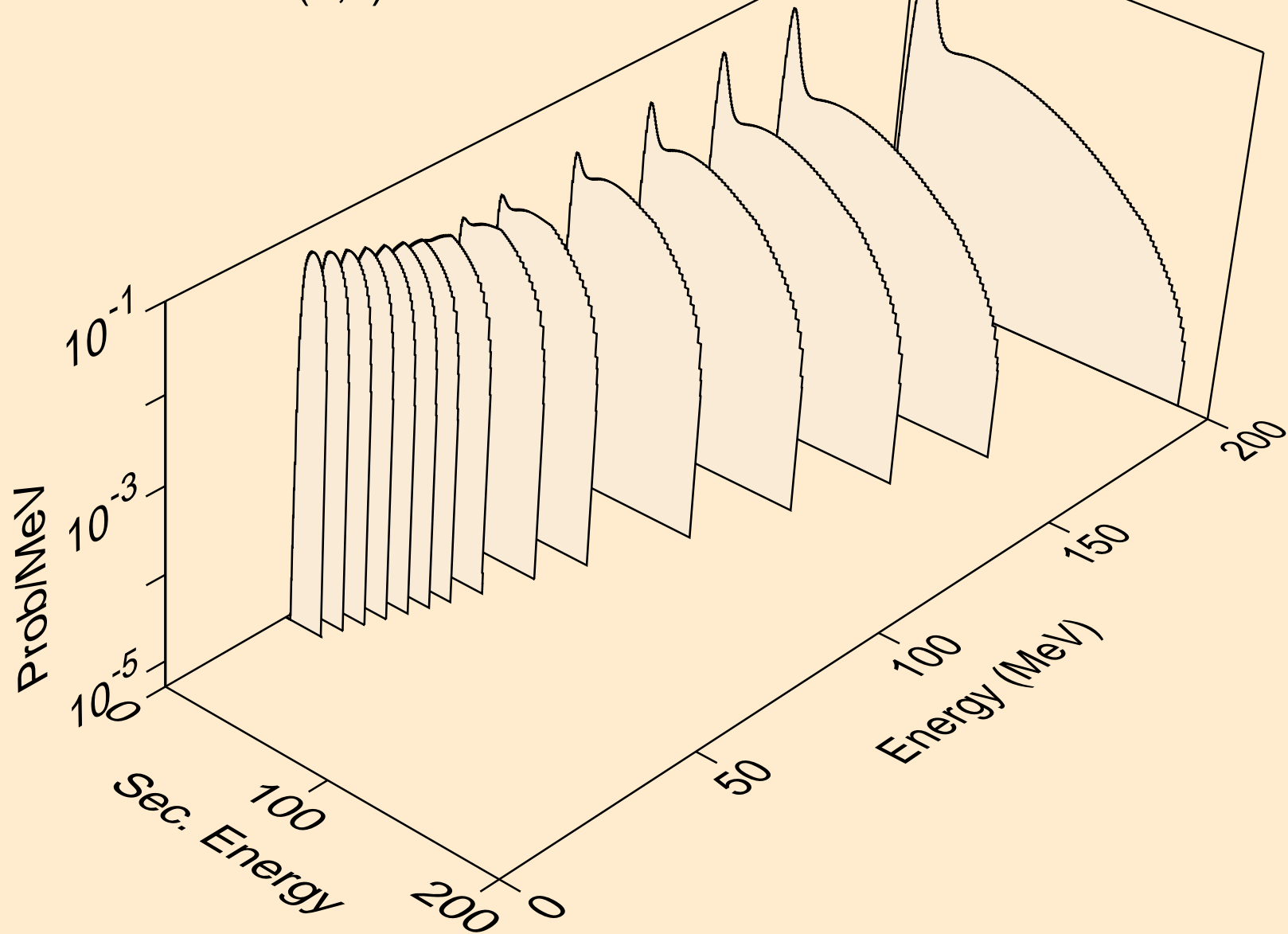

NB099M NEUTRON ACER TENDL-2023 LIBRARY; T=0.K
tritons from (n,n*)t

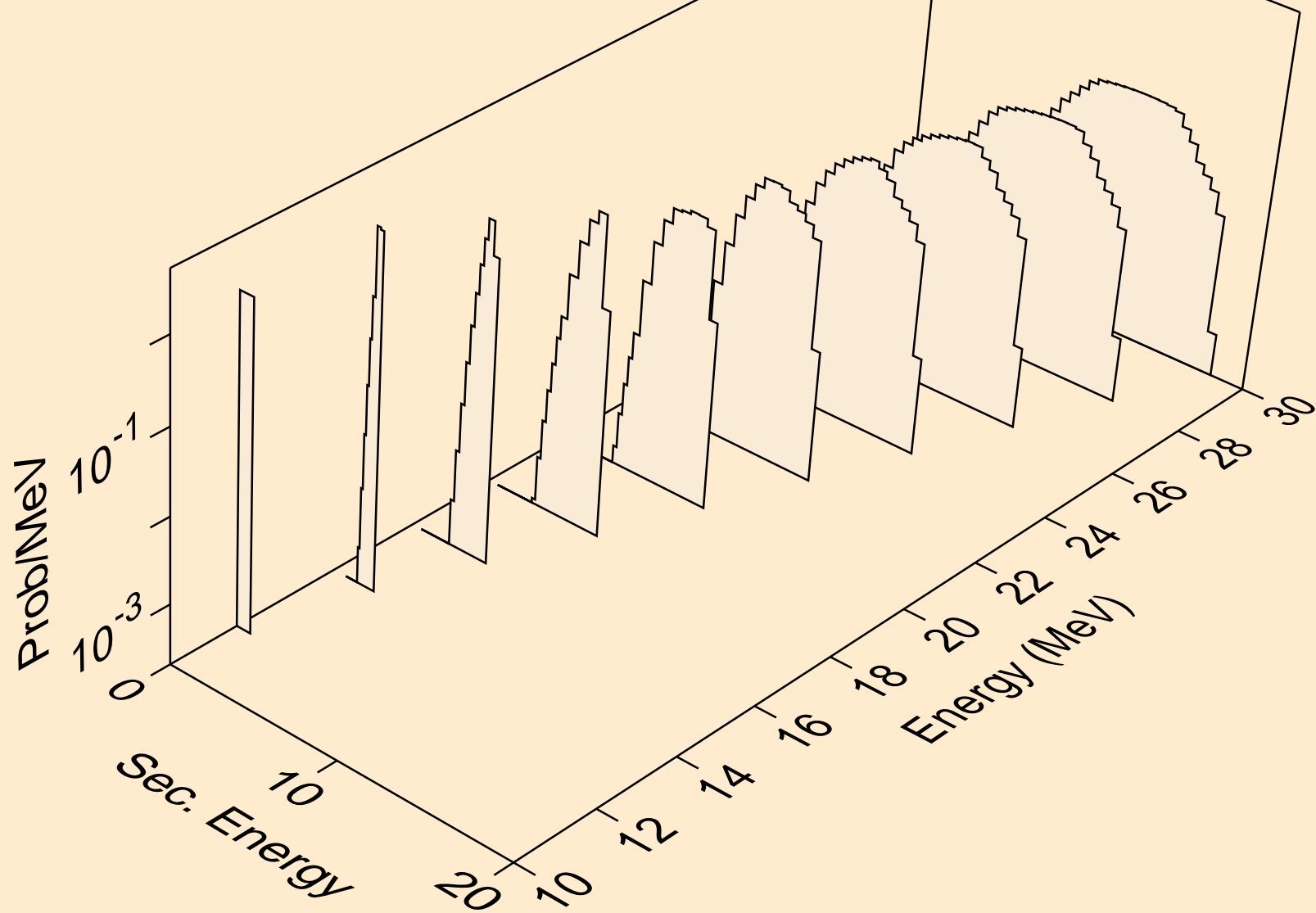

NB099M NEUTRON ACER TENDL-2023 LIBRARY; T=0.K
tritons from (n,t)

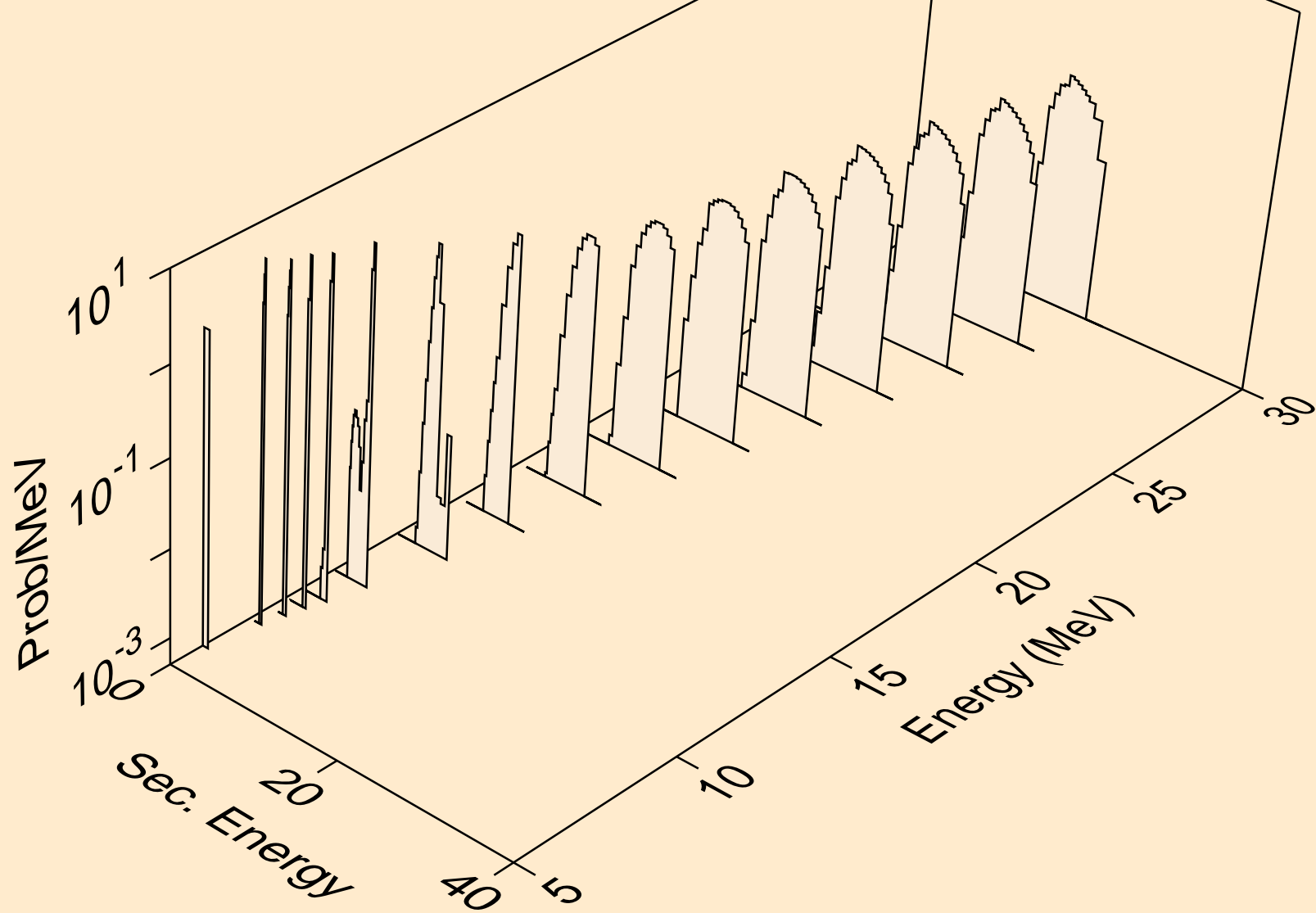

NB099M NEUTRON ACER TENDL-2023 LIBRARY; T=0.K
tritons from (n,pt)

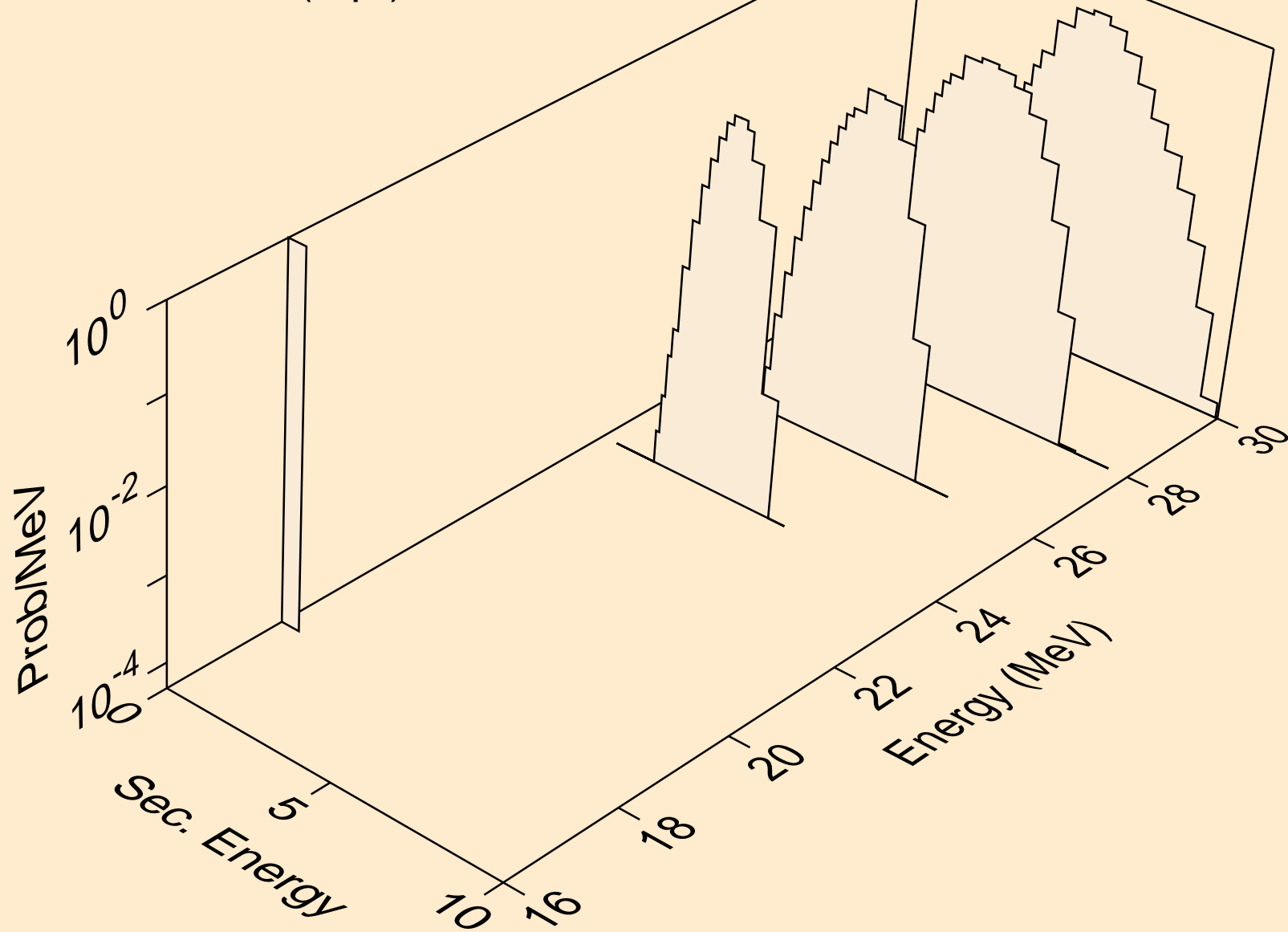

NB099M NEUTRON ACER TENDL-2023 LIBRARY; T=0.K
he3s from (n,x)

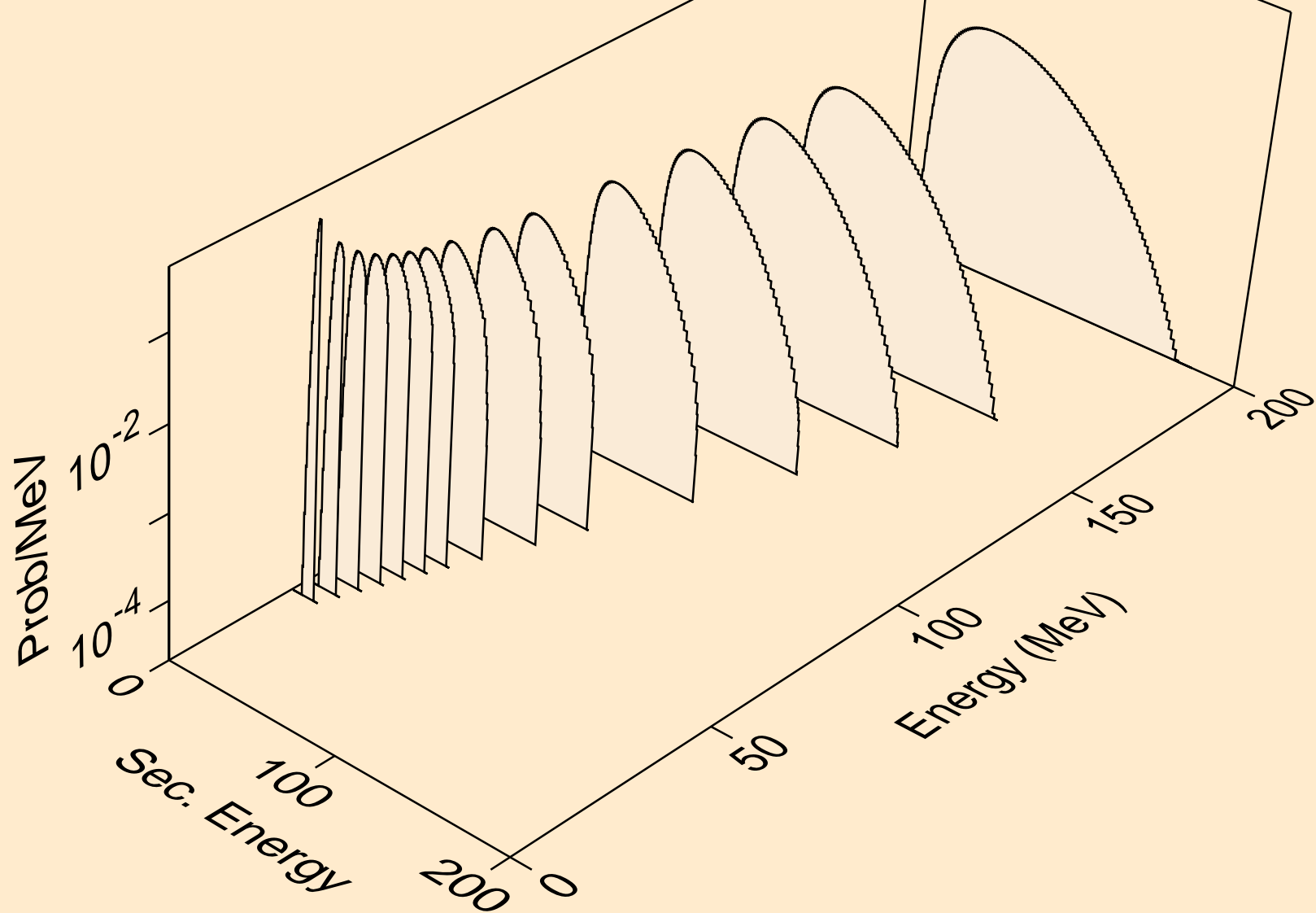

NB099M NEUTRON ACER TENDL-2023 LIBRARY; T=0.K
he3s from (n,n*)he3

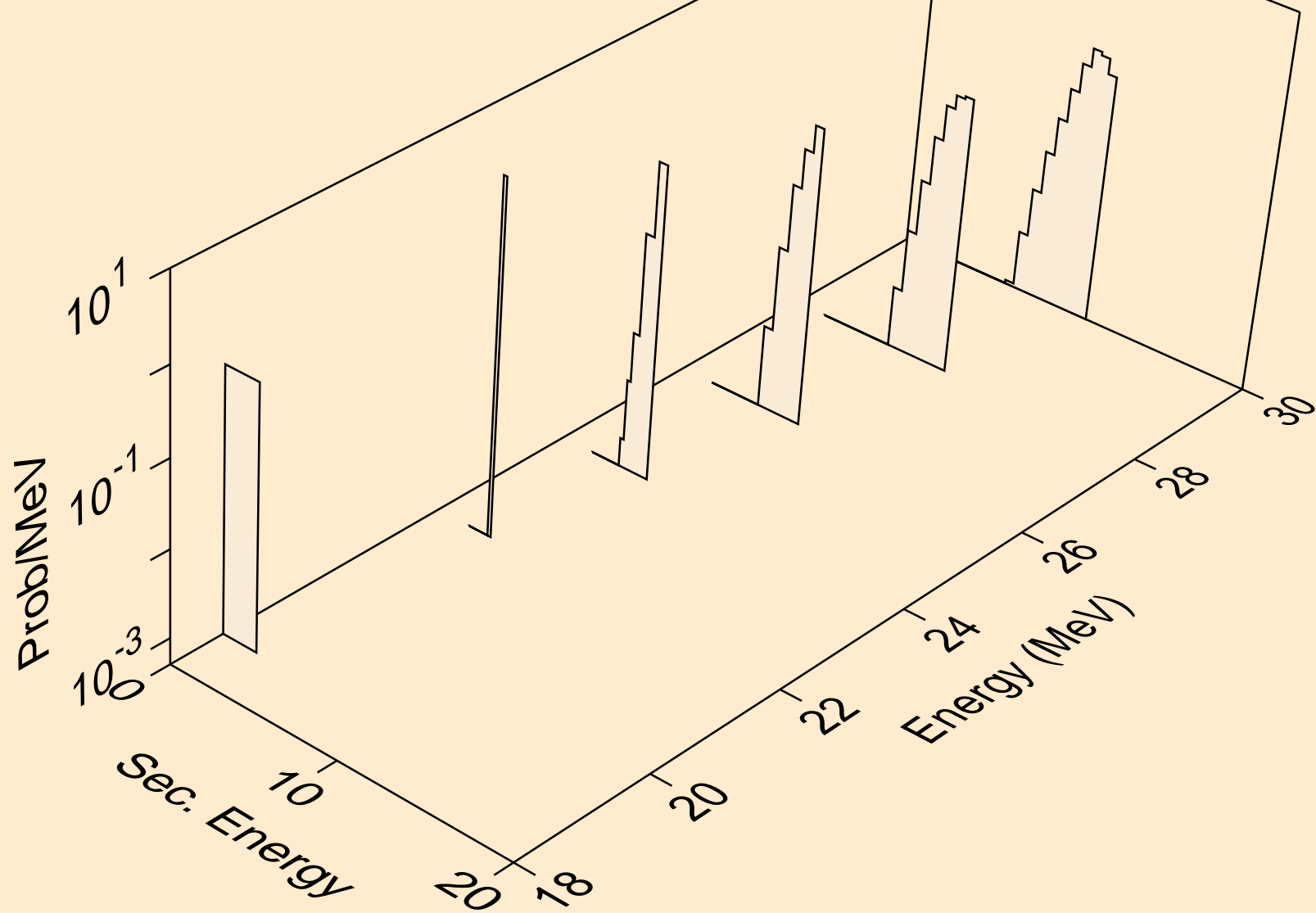

NB099M NEUTRON ACER TENDL-2023 LIBRARY; T=0.K
he3s from (n,he3)

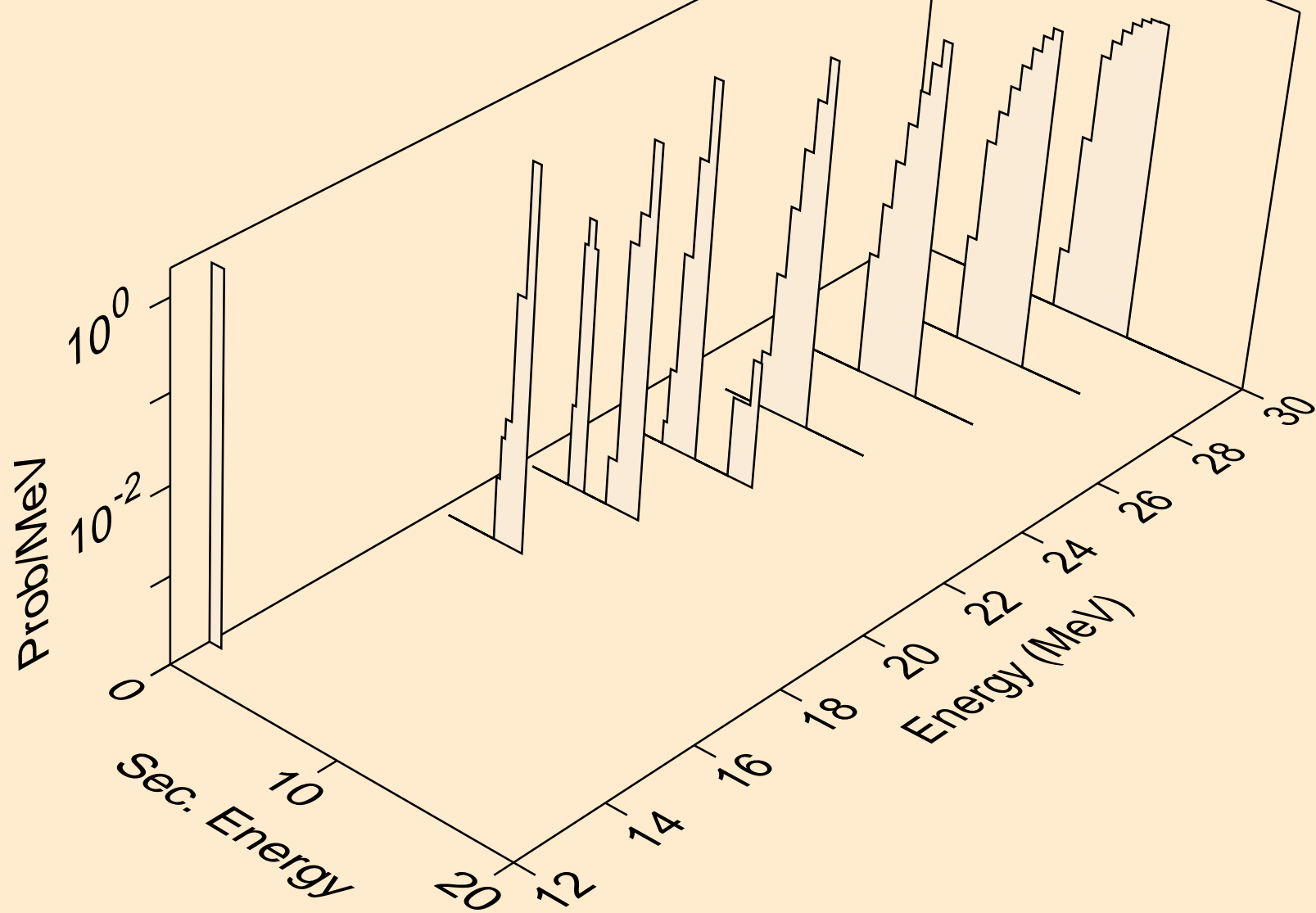

NB099M NEUTRON ACER TENDL-2023 LIBRARY; T=0.K
alphas from (n,x)

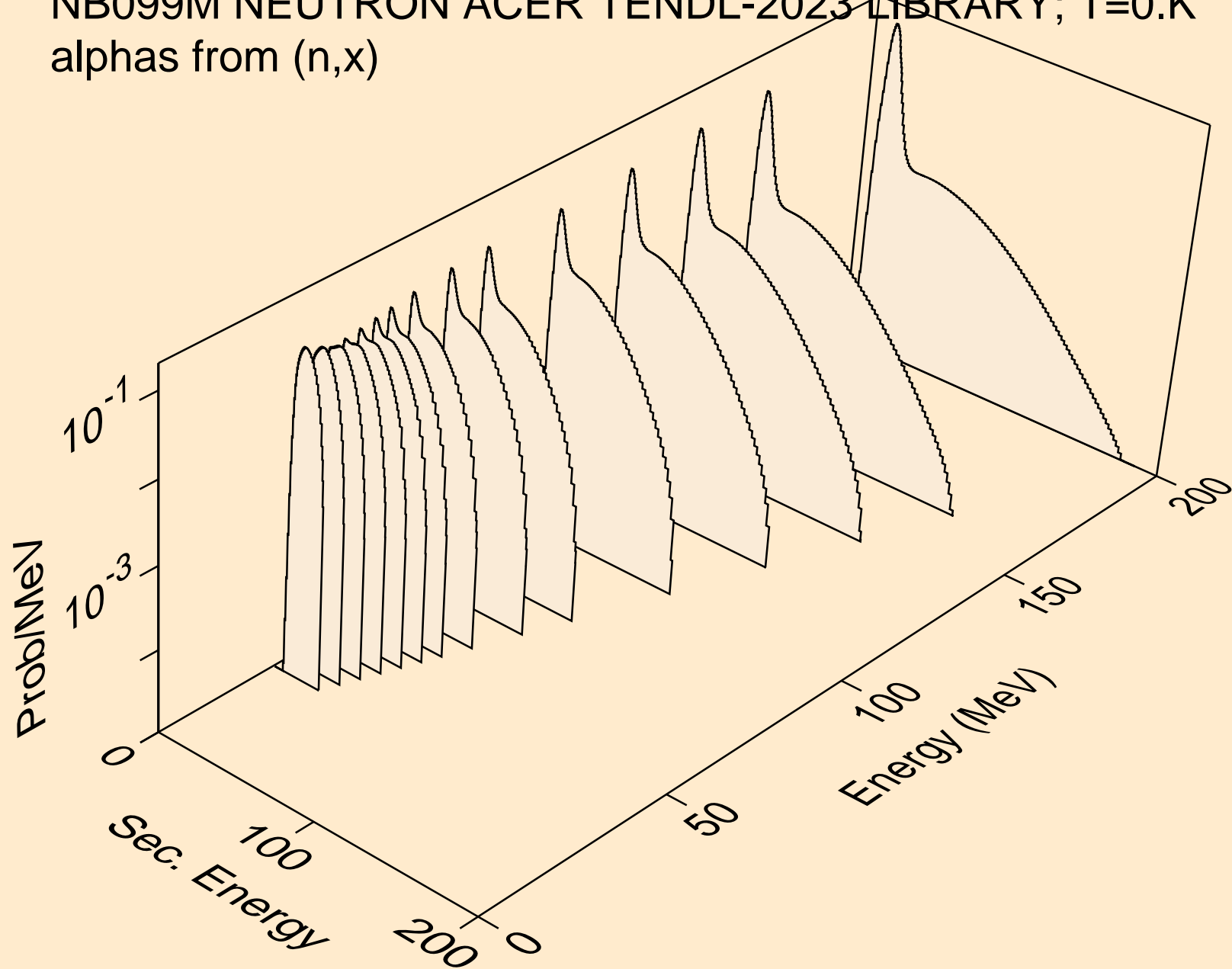

NB099M NEUTRON ACER TENDL-2023 LIBRARY; T=0.K
alphas from (n,n*)a

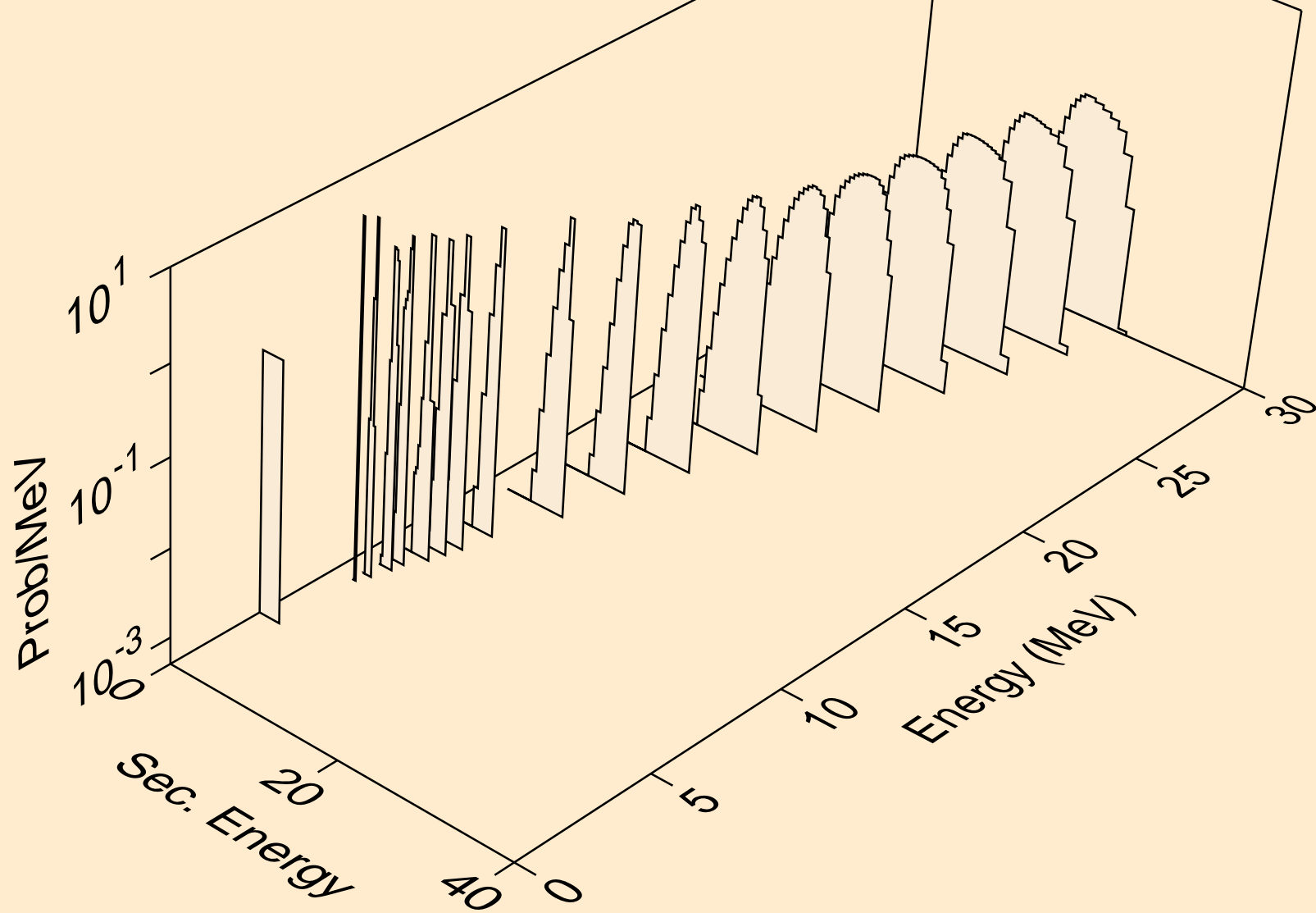

NB099M NEUTRON ACER TENDL-2023 LIBRARY; T=0.K
alphas from (n,2n)a

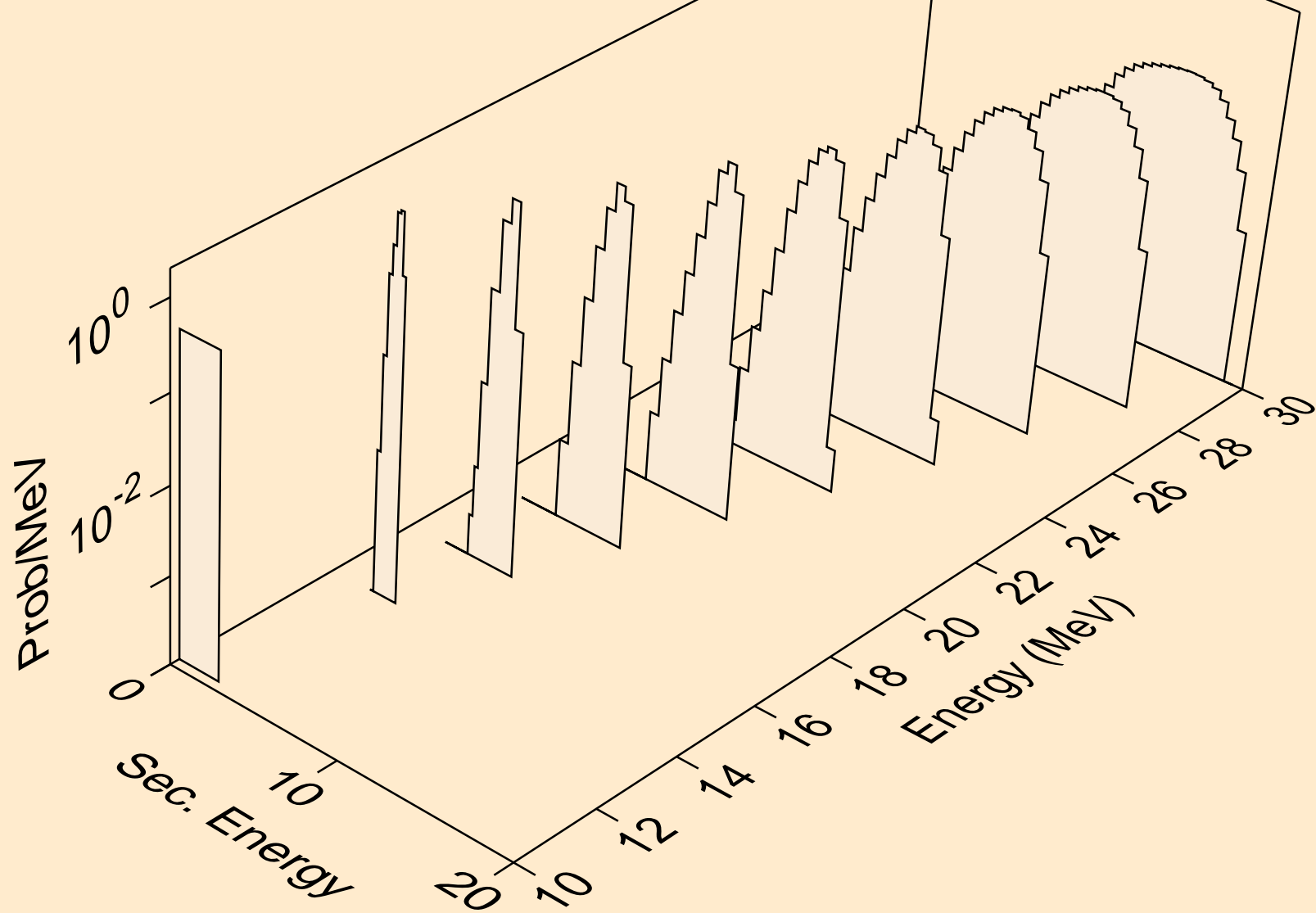

NB099M NEUTRON ACER TENDL-2023 LIBRARY; T=0.K
alphas from (n,3n)a

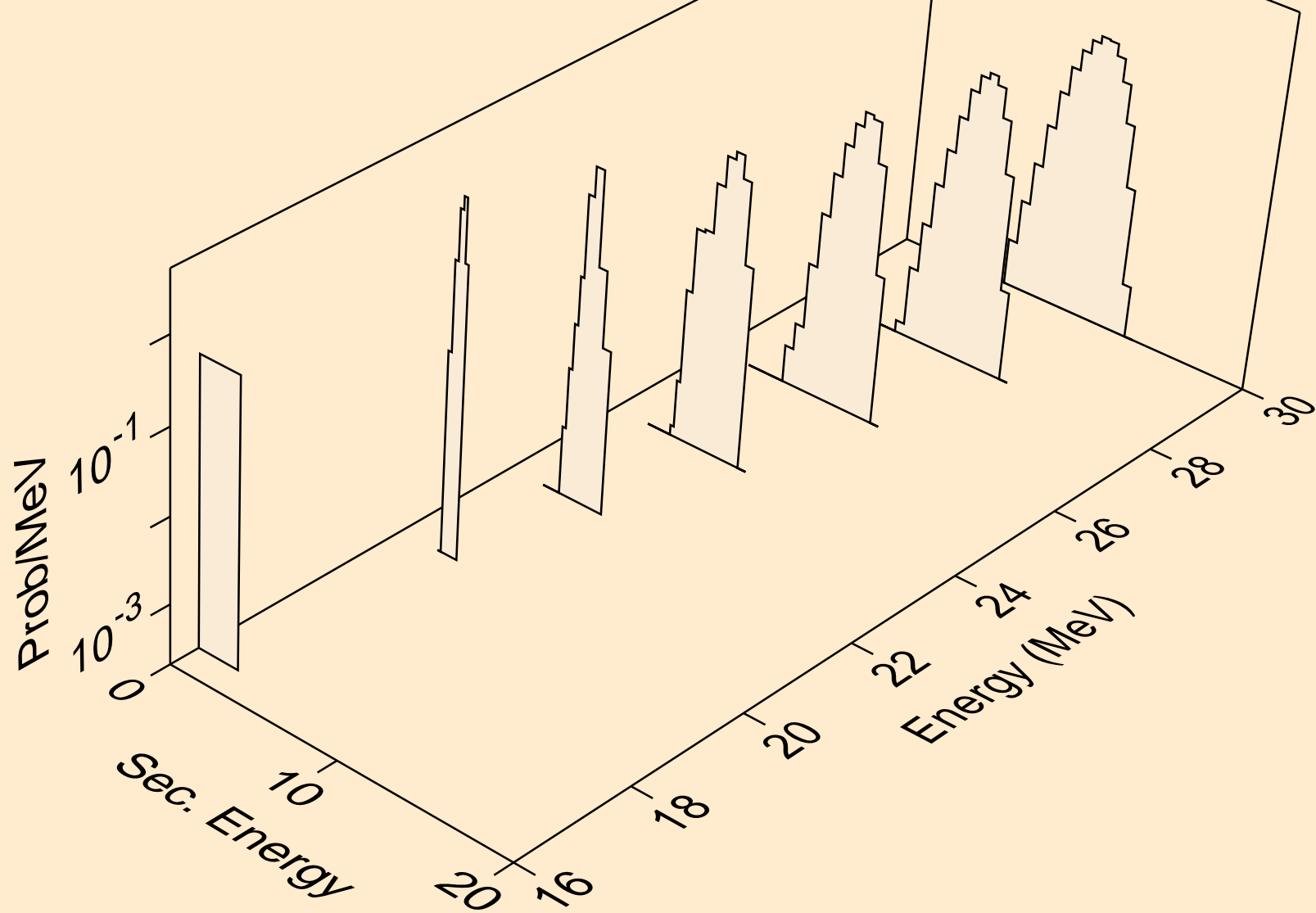

NB099M NEUTRON ACER TENDL-2023 LIBRARY; T=0.K
alphas from (n,n*)2a

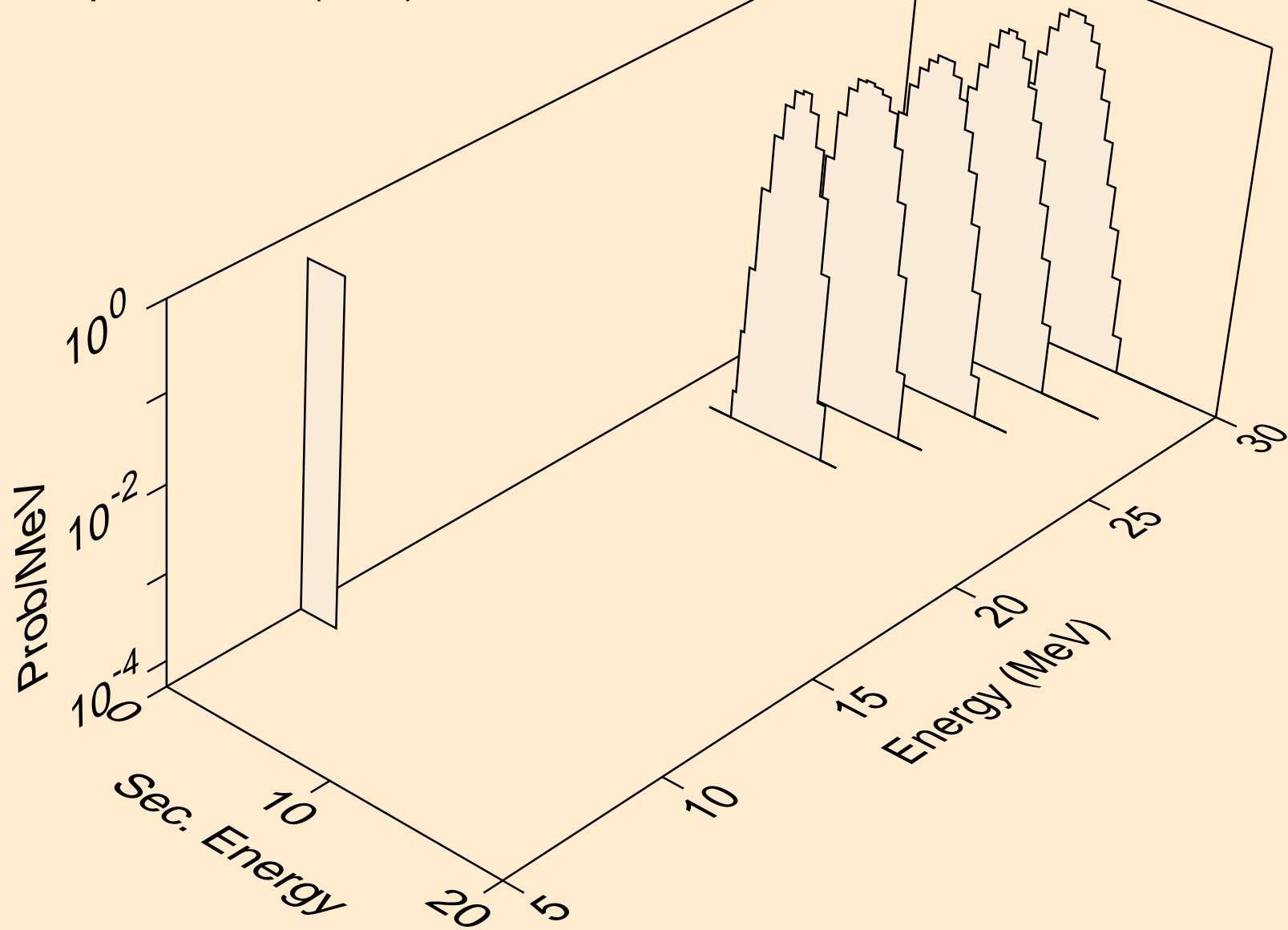

NB099M NEUTRON ACER TENDL-2023 LIBRARY; T=0.K
alphas from (n,npa)

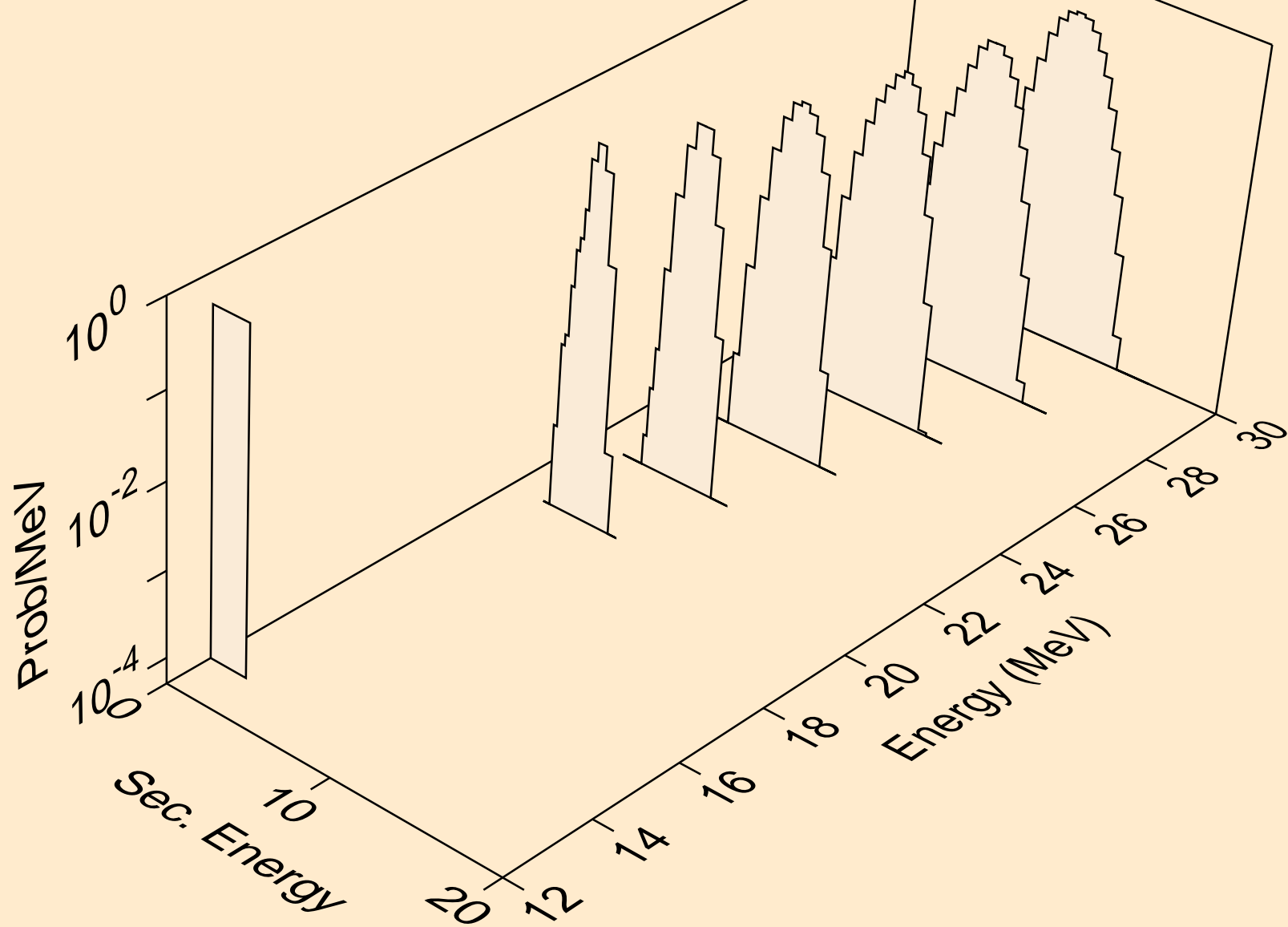

NB099M NEUTRON ACER TENDL-2023 LIBRARY; T=0.K
alphas from (n,a)

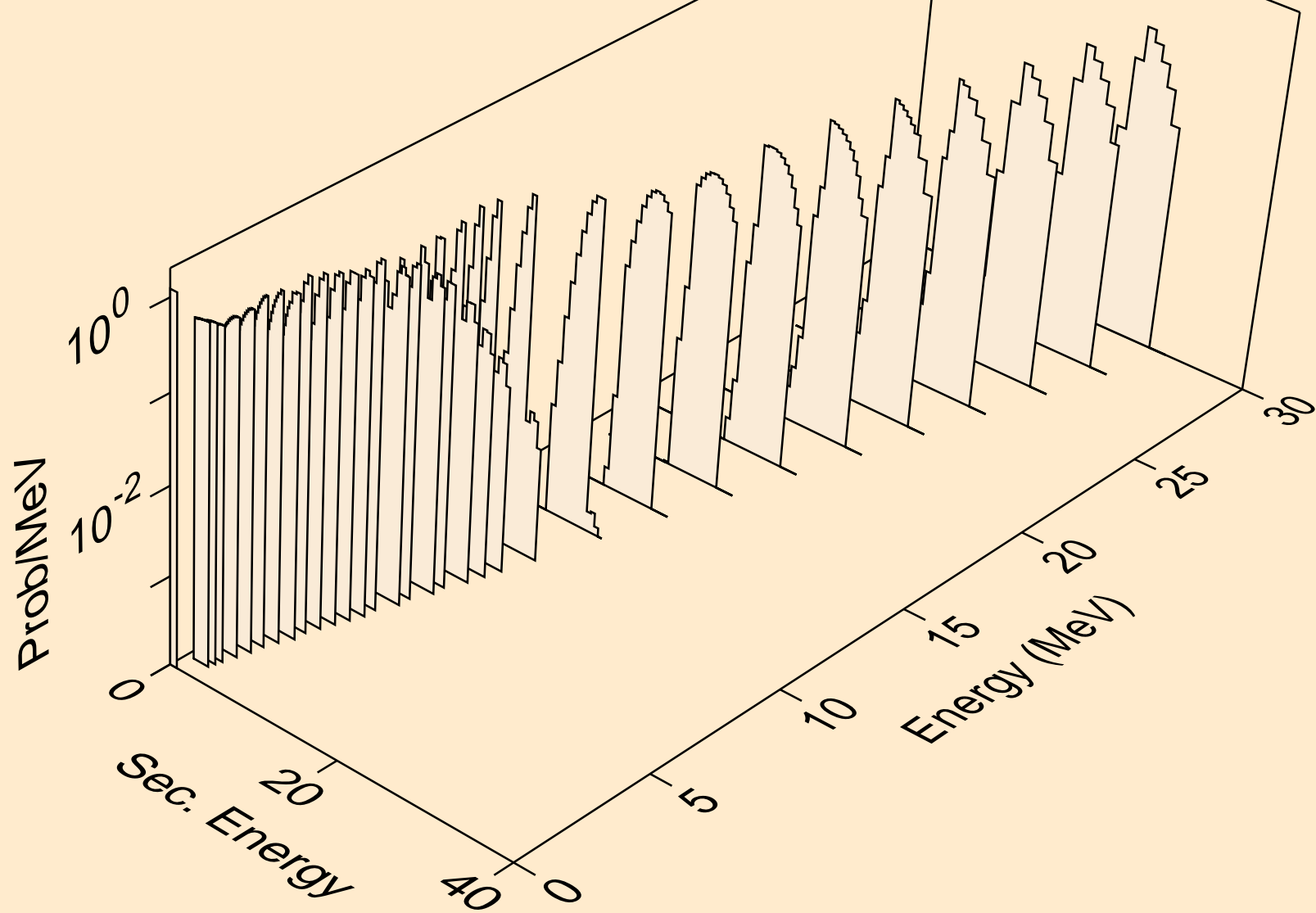

NB099M NEUTRON ACER TENDL-2023 LIBRARY; T=0.K
alphas from (n,2a)

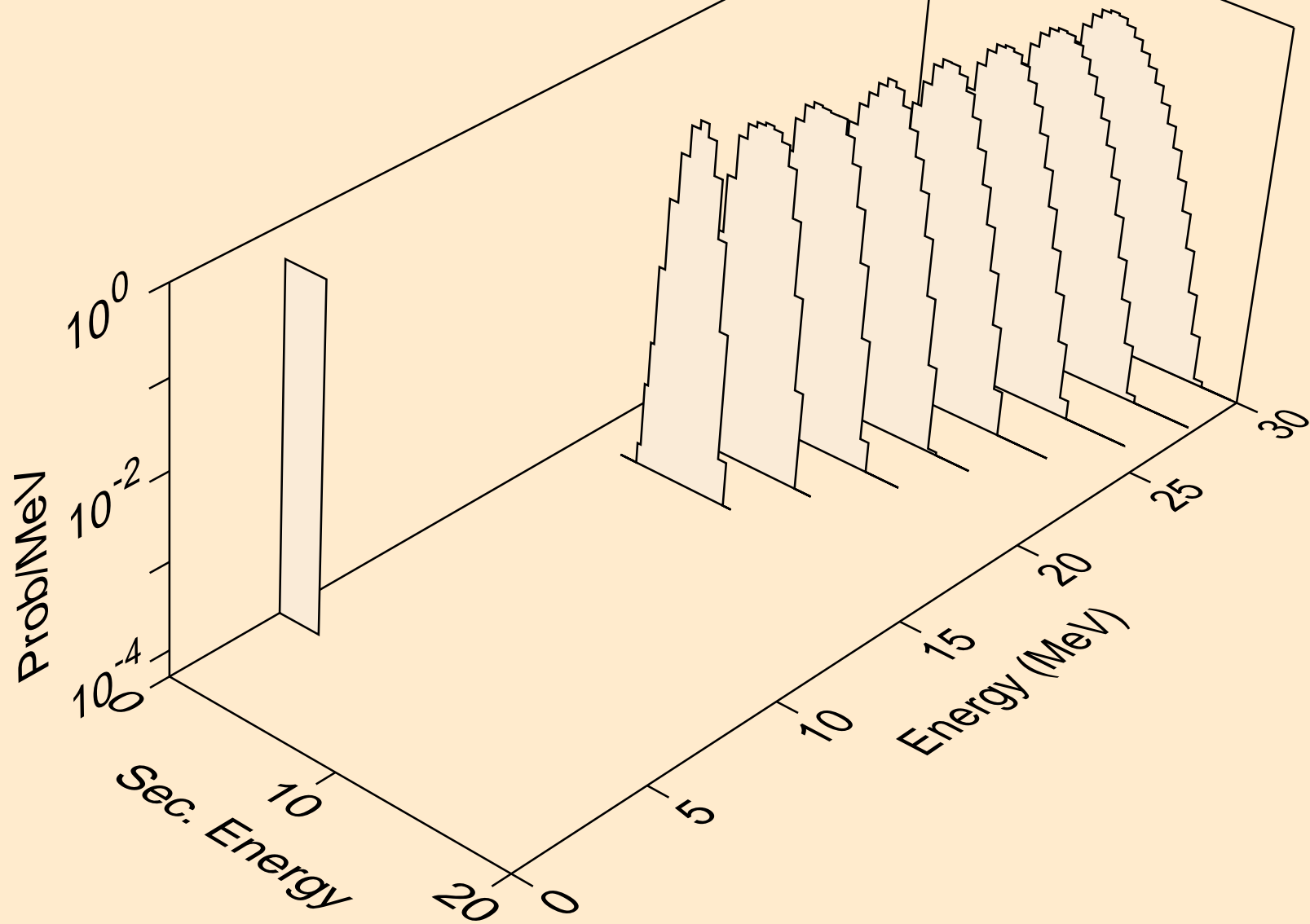

NB099M NEUTRON ACER TENDL-2023 LIBRARY; T=0.K
alphas from (n,pa)

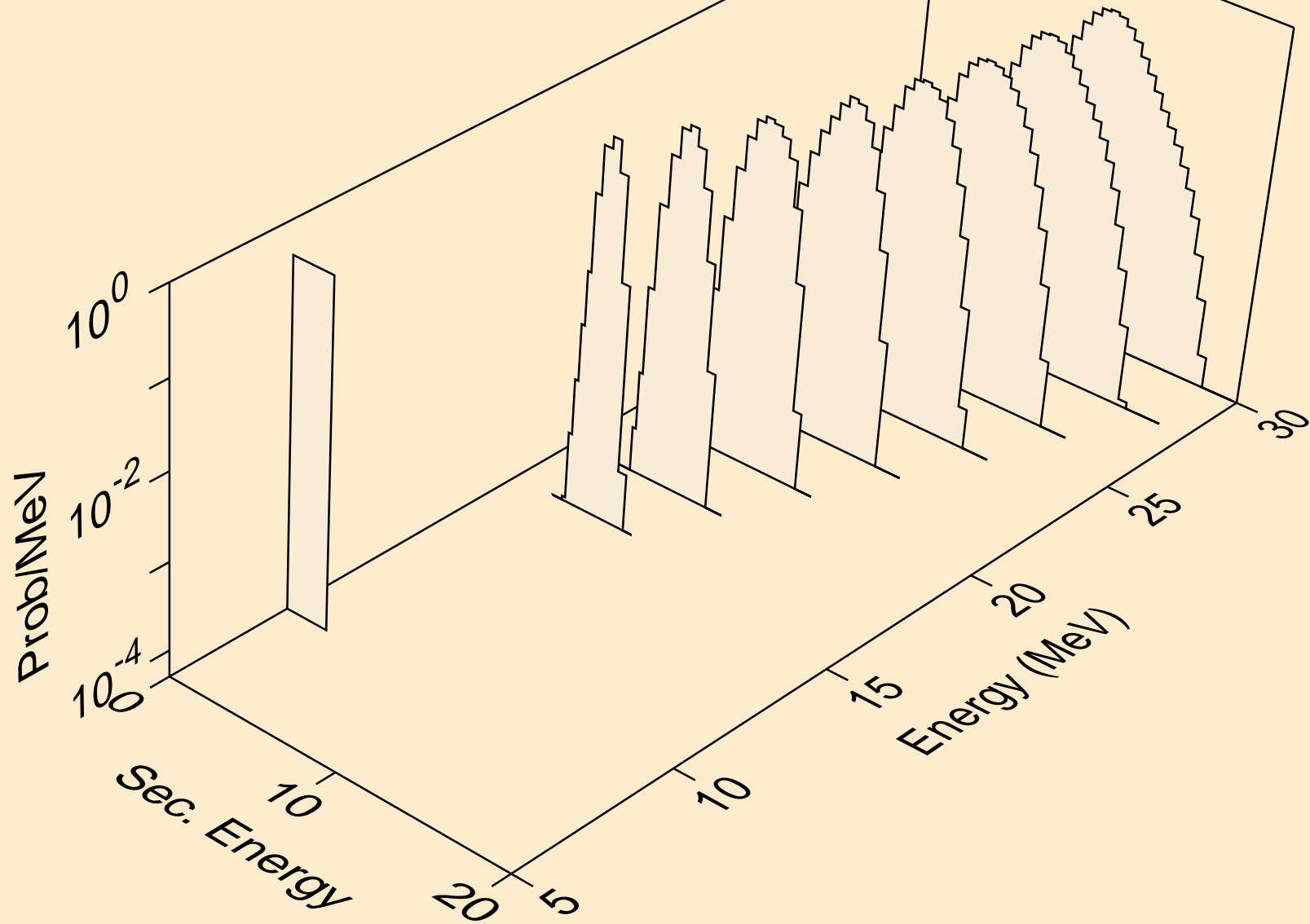

NB099M NEUTRON ACER TENDL-2023 LIBRARY; T=0.K
alphas from (n,da)

