

# NI059 NEUTRON ACER TENDL-2023 LIBRARY; T=0.K

## Principal cross sections

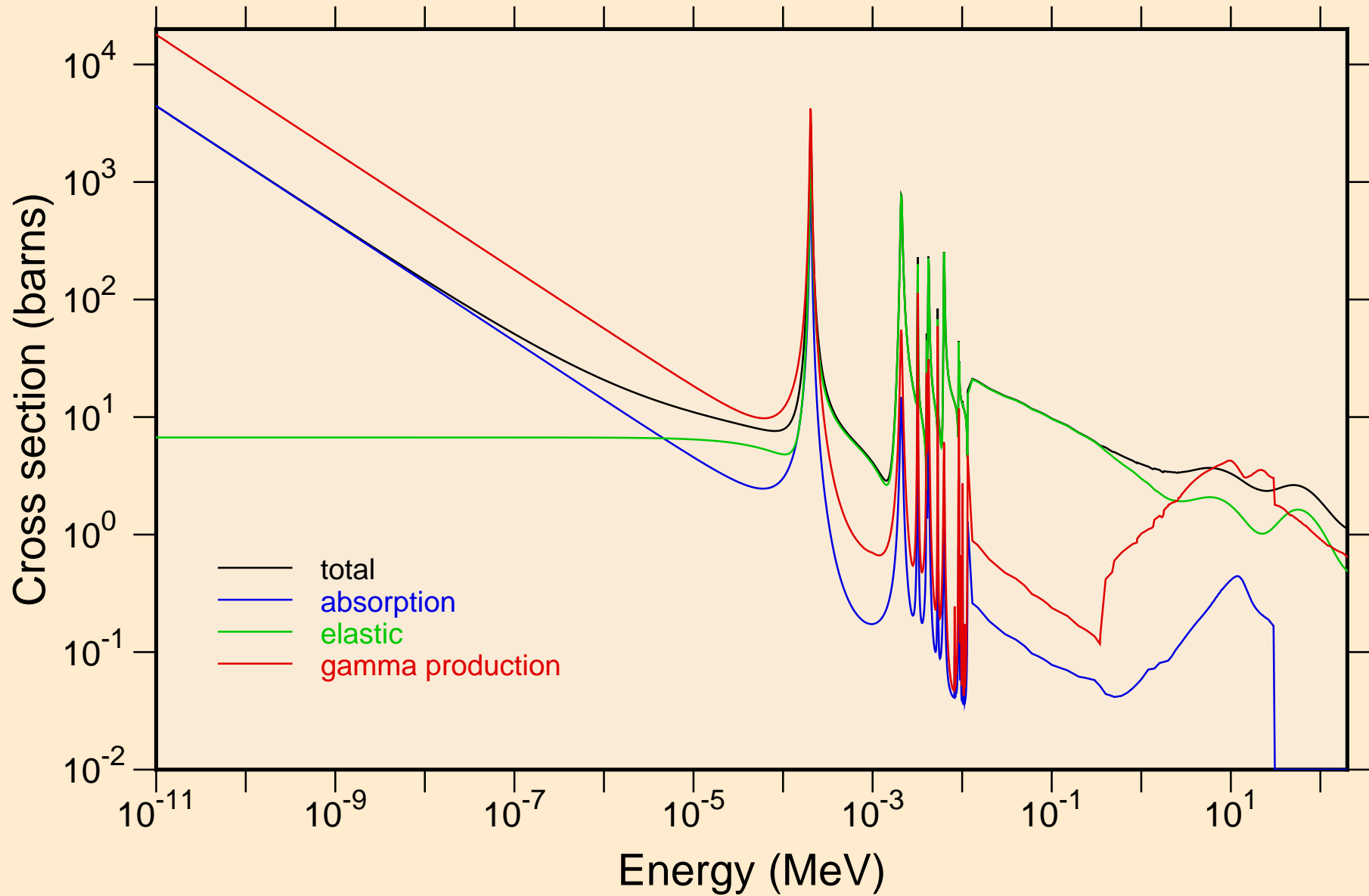

NI059 NEUTRON ACER TENDL-2023 LIBRARY; T=0.K  
resonance total cross section

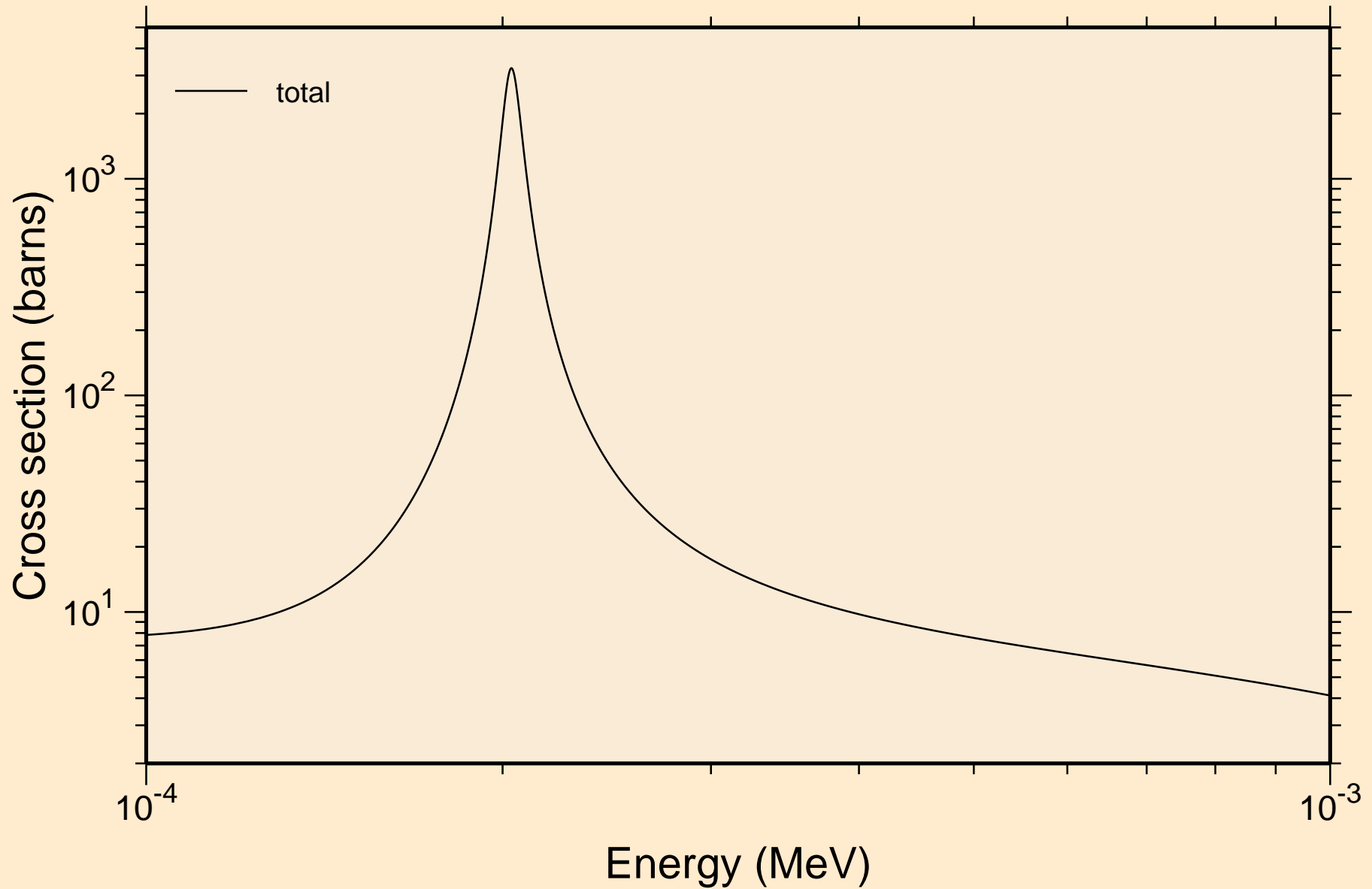

NI059 NEUTRON ACER TENDL-2023 LIBRARY; T=0.K  
resonance total cross section

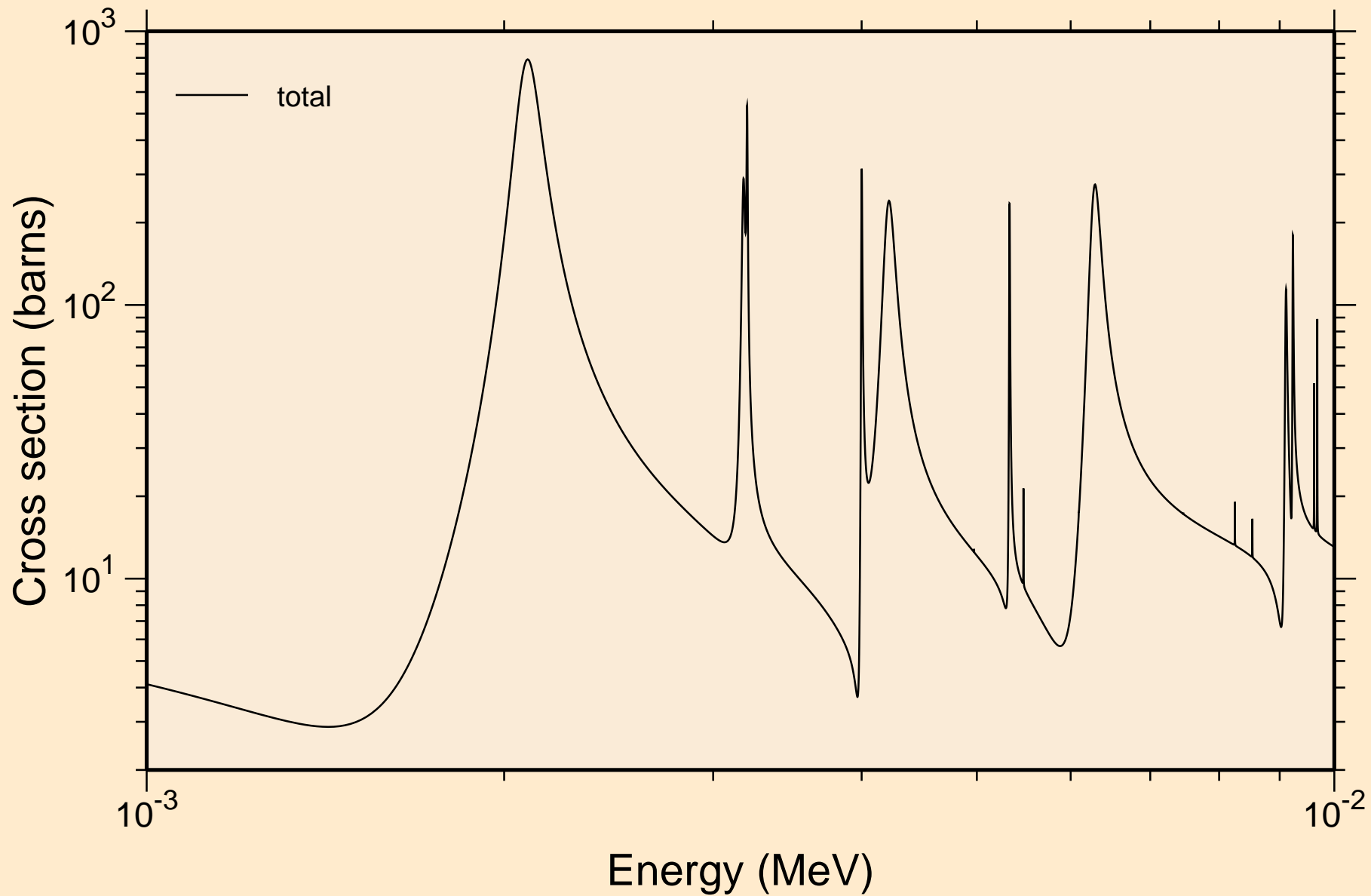

NI059 NEUTRON ACER TENDL-2023 LIBRARY; T=0.K  
resonance total cross section

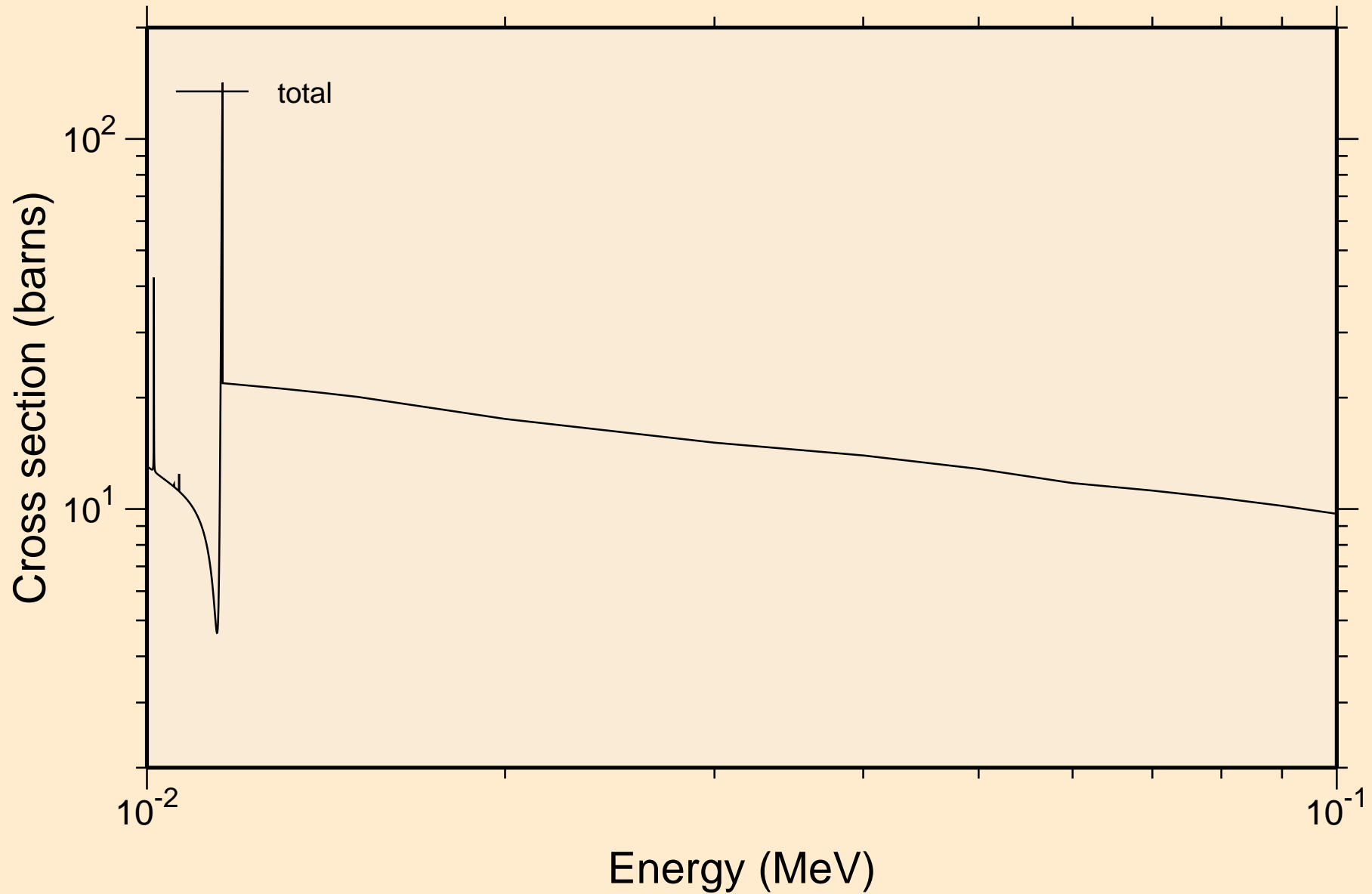

Ni059 NEUTRON ACER TENDL-2023 LIBRARY; T=0.K  
resonance total cross section

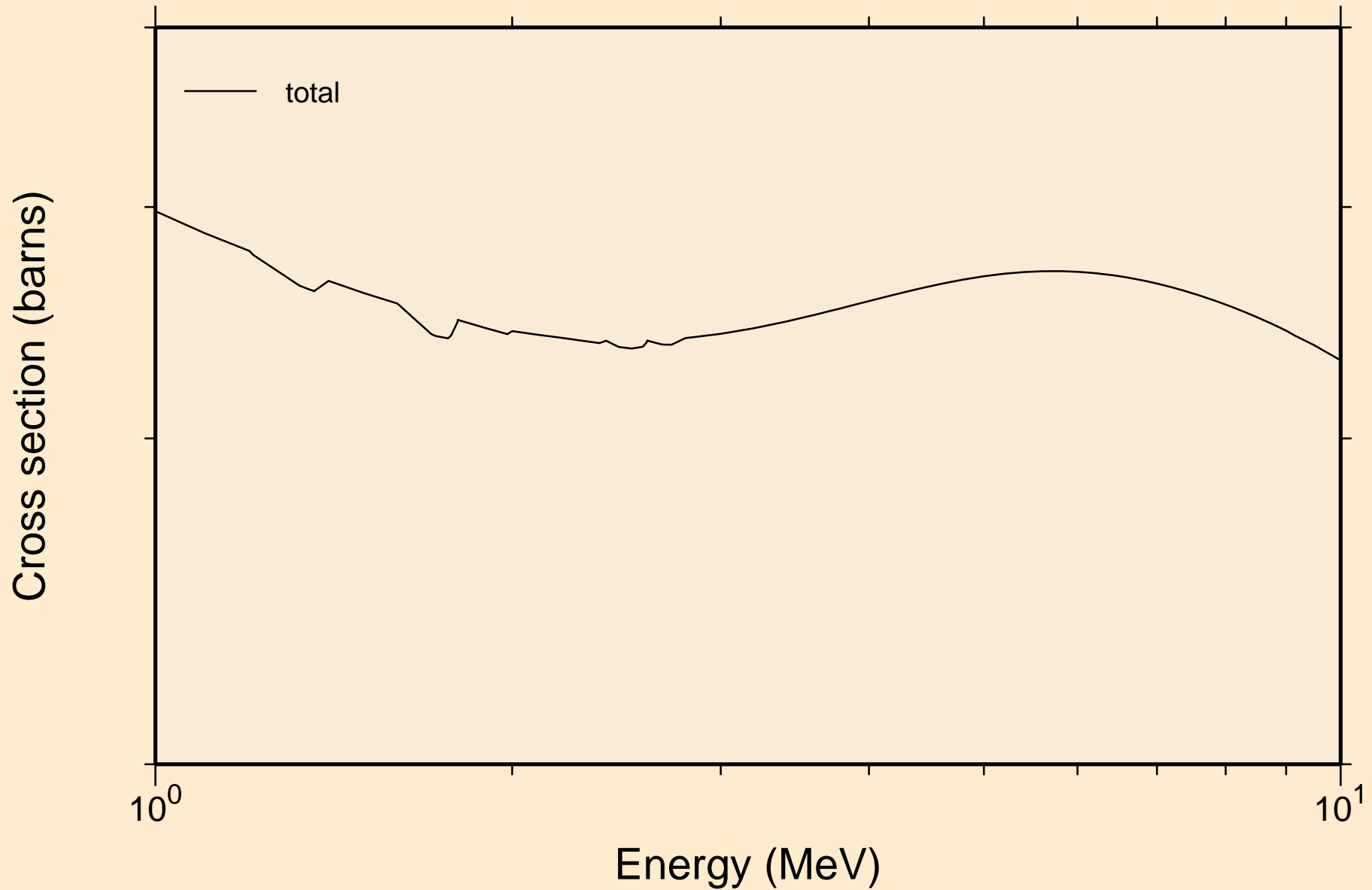

NI059 NEUTRON ACER TENDL-2023 LIBRARY; T=0.K  
resonance absorption cross sections

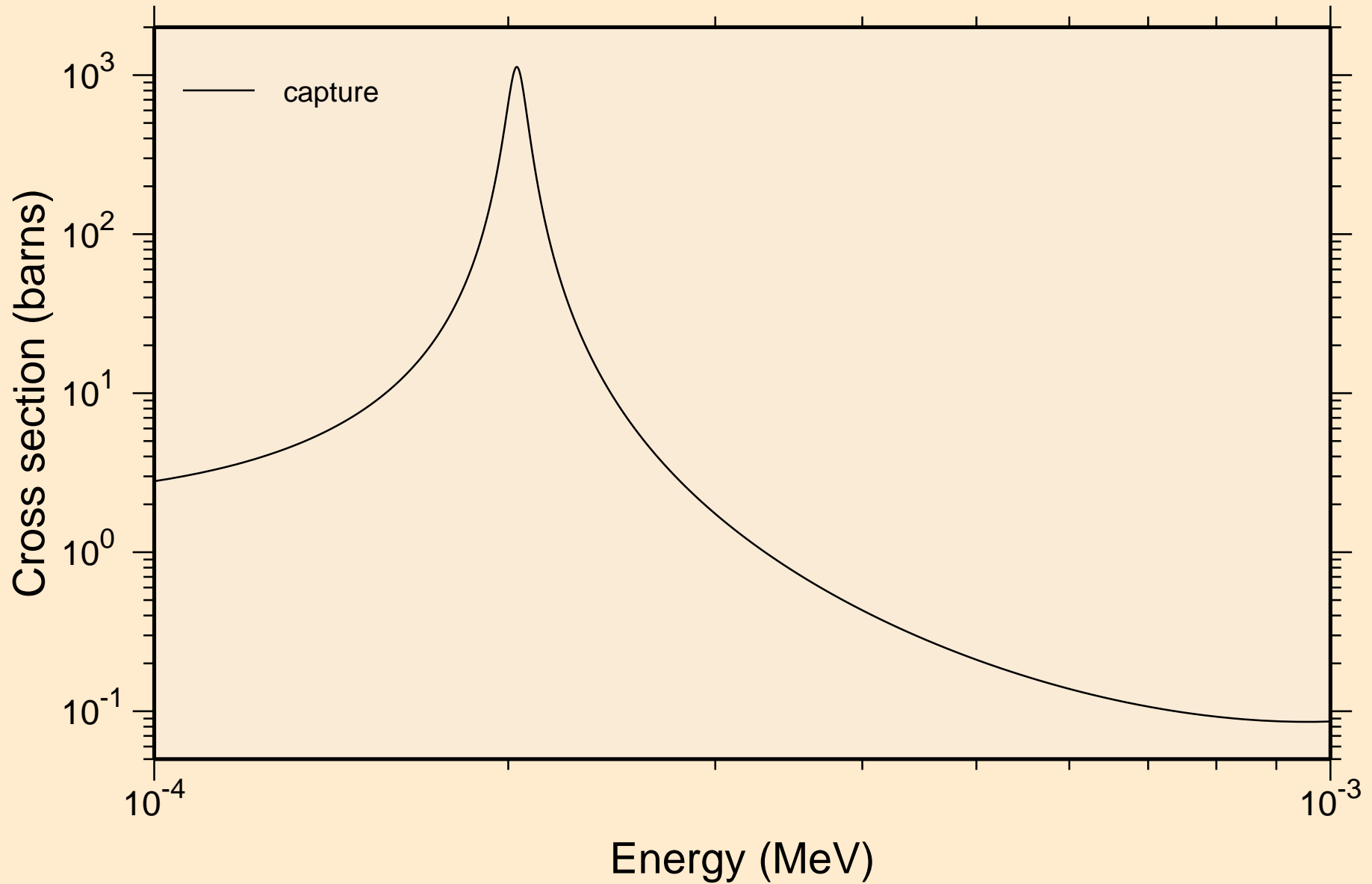

NI059 NEUTRON ACER TENDL-2023 LIBRARY; T=0.K  
resonance absorption cross sections

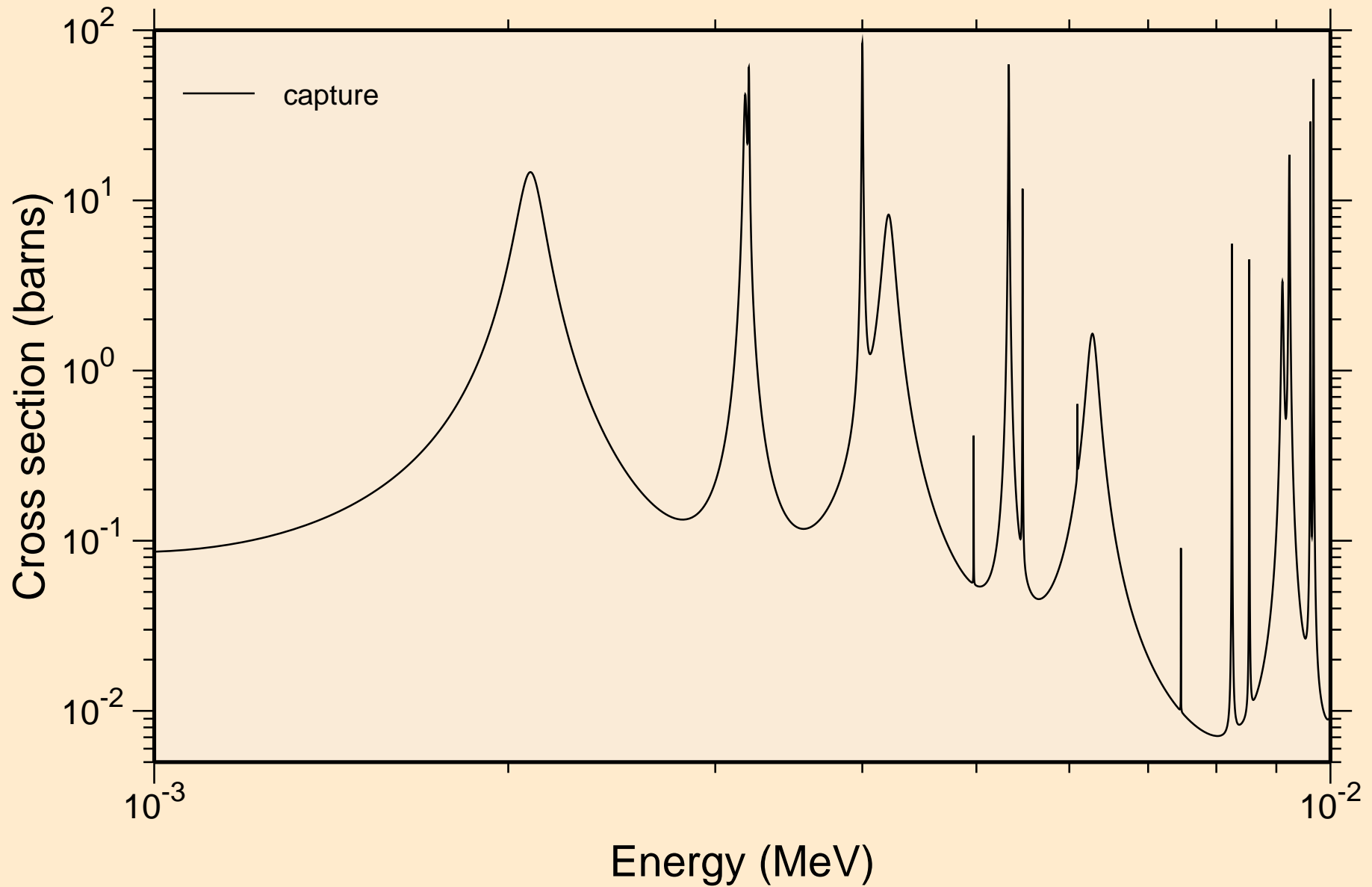

NI059 NEUTRON ACER TENDL-2023 LIBRARY; T=0.K  
resonance absorption cross sections

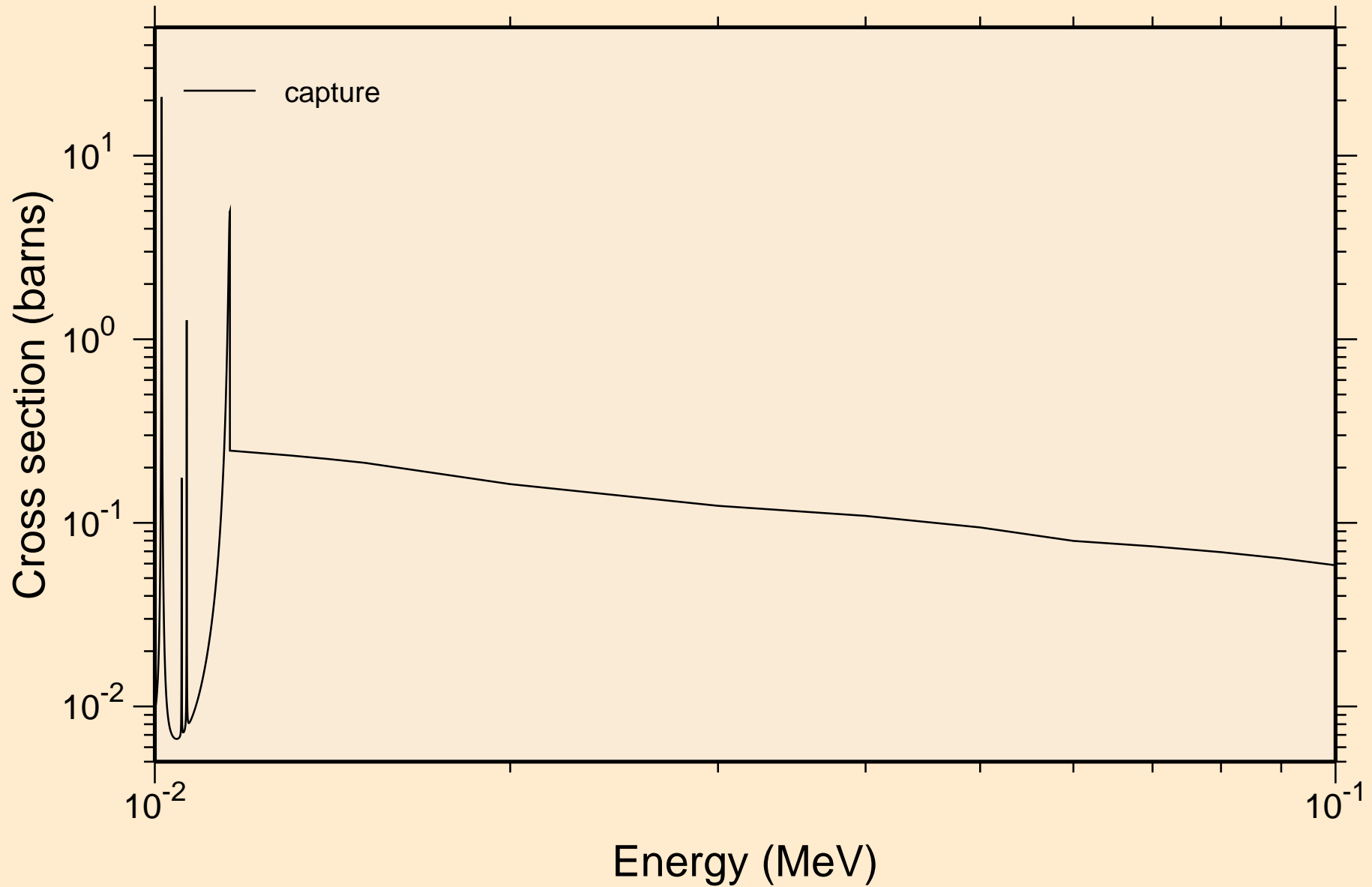



NI059 NEUTRON ACER TENDL-2023 LIBRARY; T=0.K  
resonance absorption cross sections

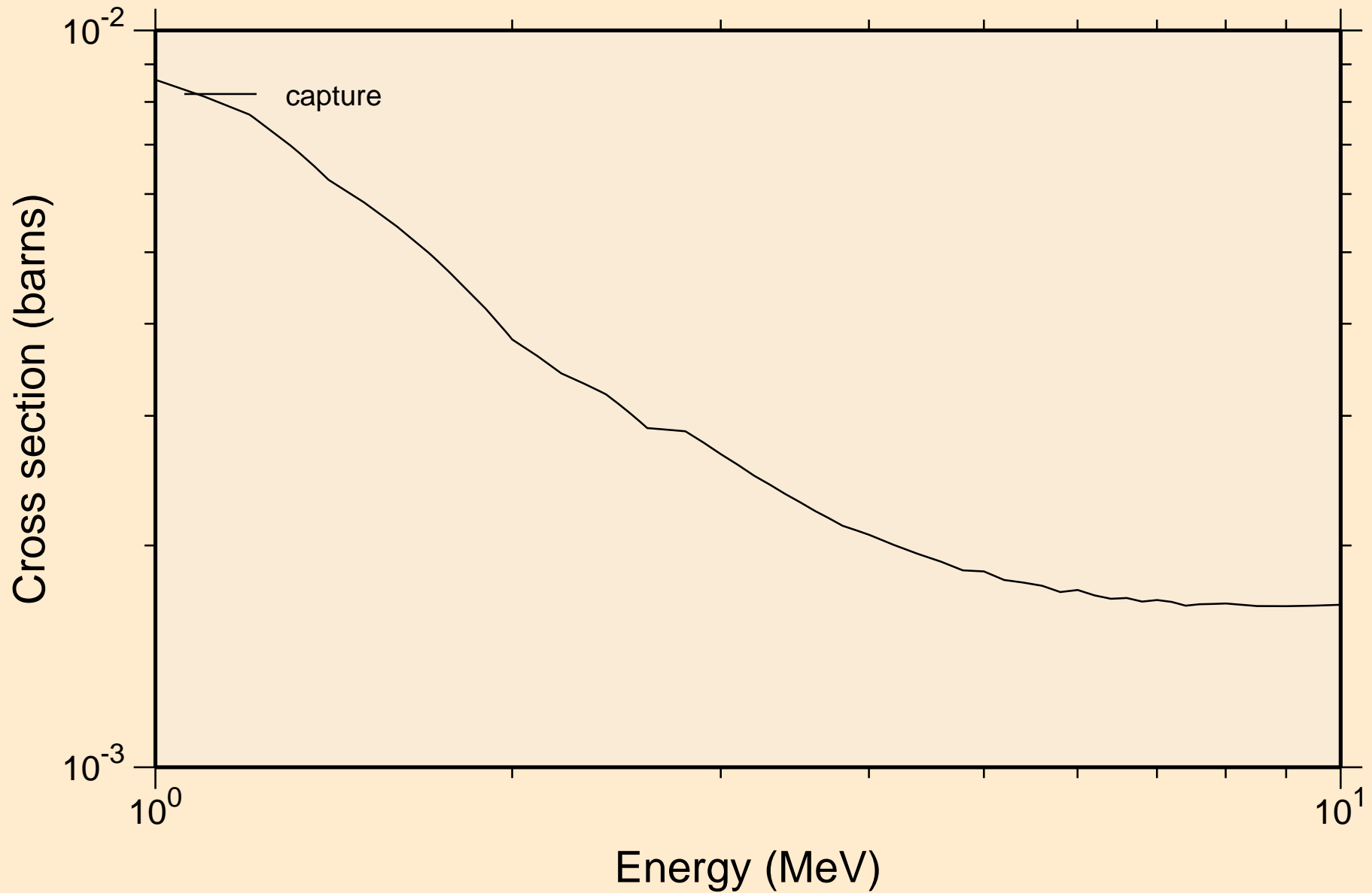

# NI059 NEUTRON ACER TENDL-2023 LIBRARY; T=0.K

## Heating

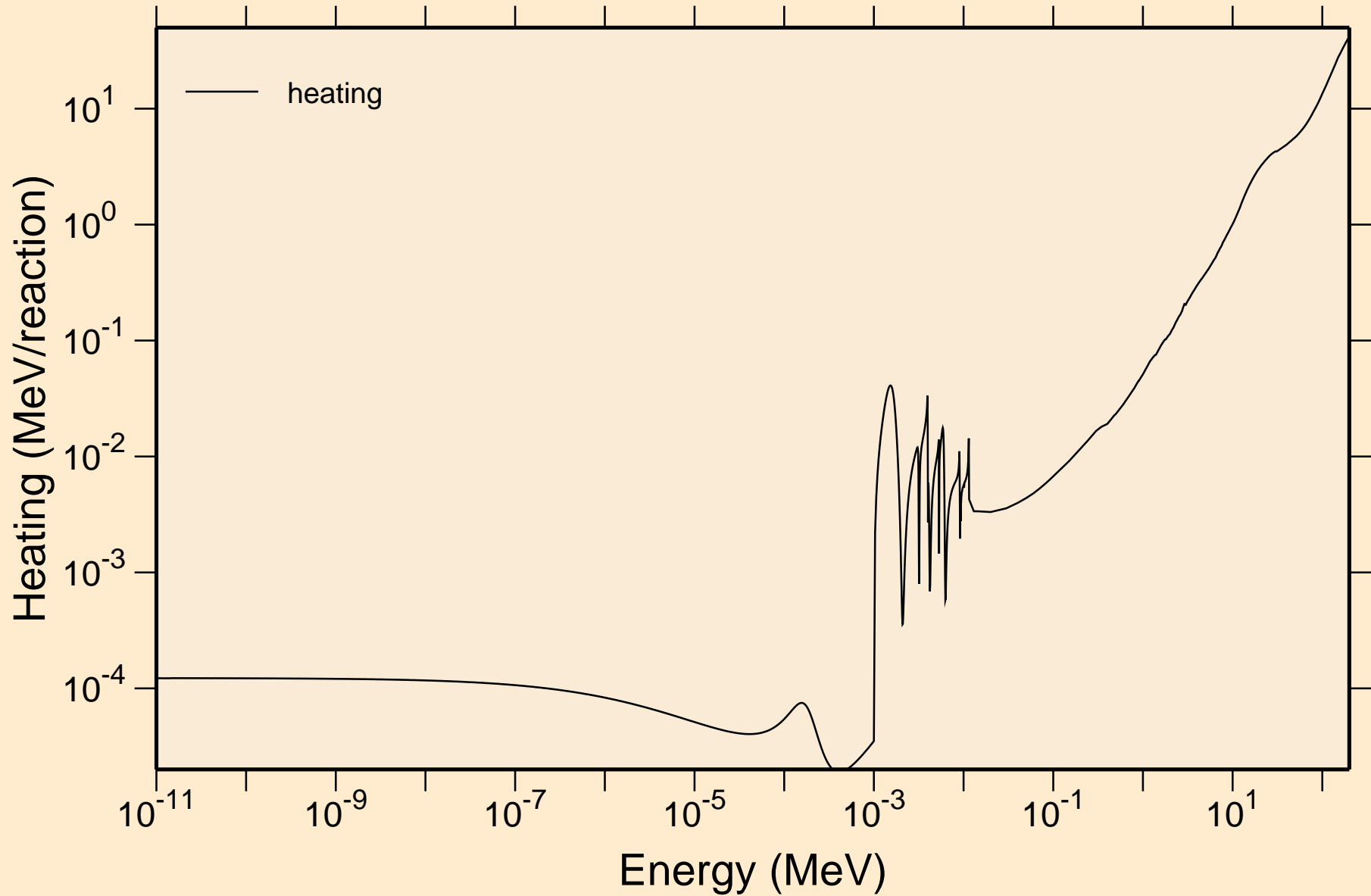

NI059 NEUTRON ACER TENDL-2023 LIBRARY; T=0.K  
Damage

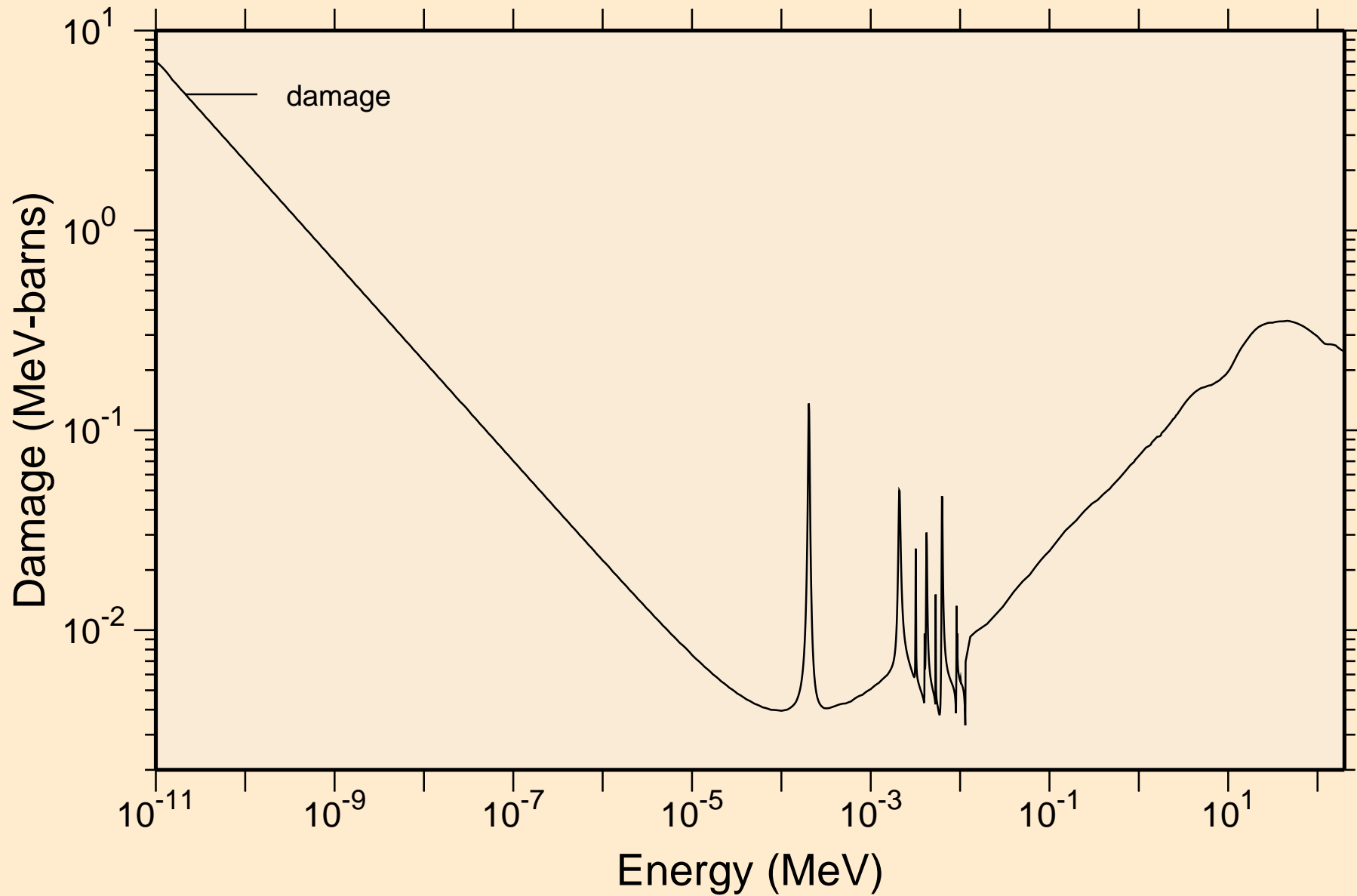

# NI059 NEUTRON ACER TENDL-2023 LIBRARY; T=0.K

## Non-threshold reactions

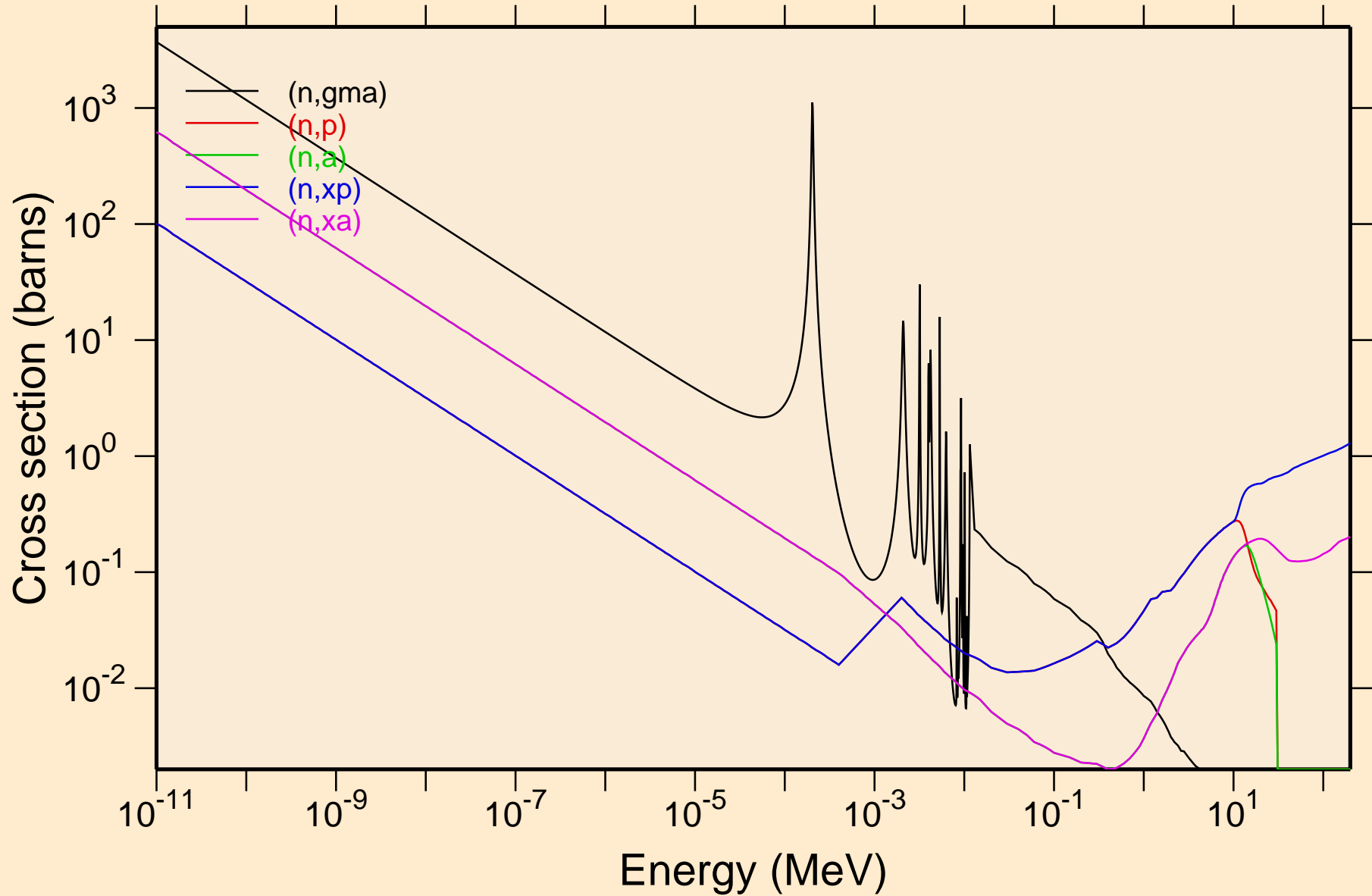

# NI059 NEUTRON ACER TENDL-2023 LIBRARY; T=0.K

## Principal cross sections

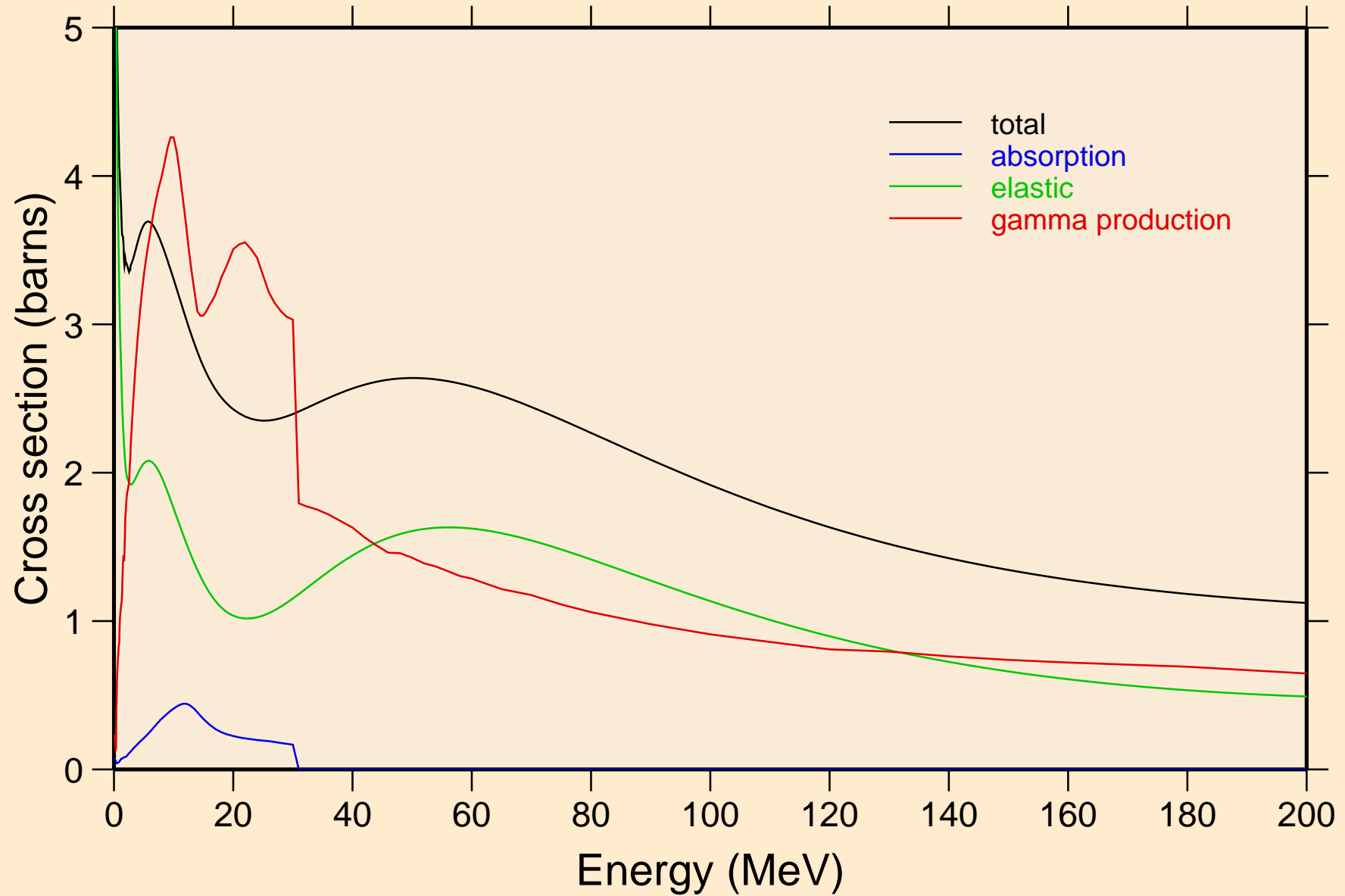

# NI059 NEUTRON ACER TENDL-2023 LIBRARY; T=0.K

## Heating

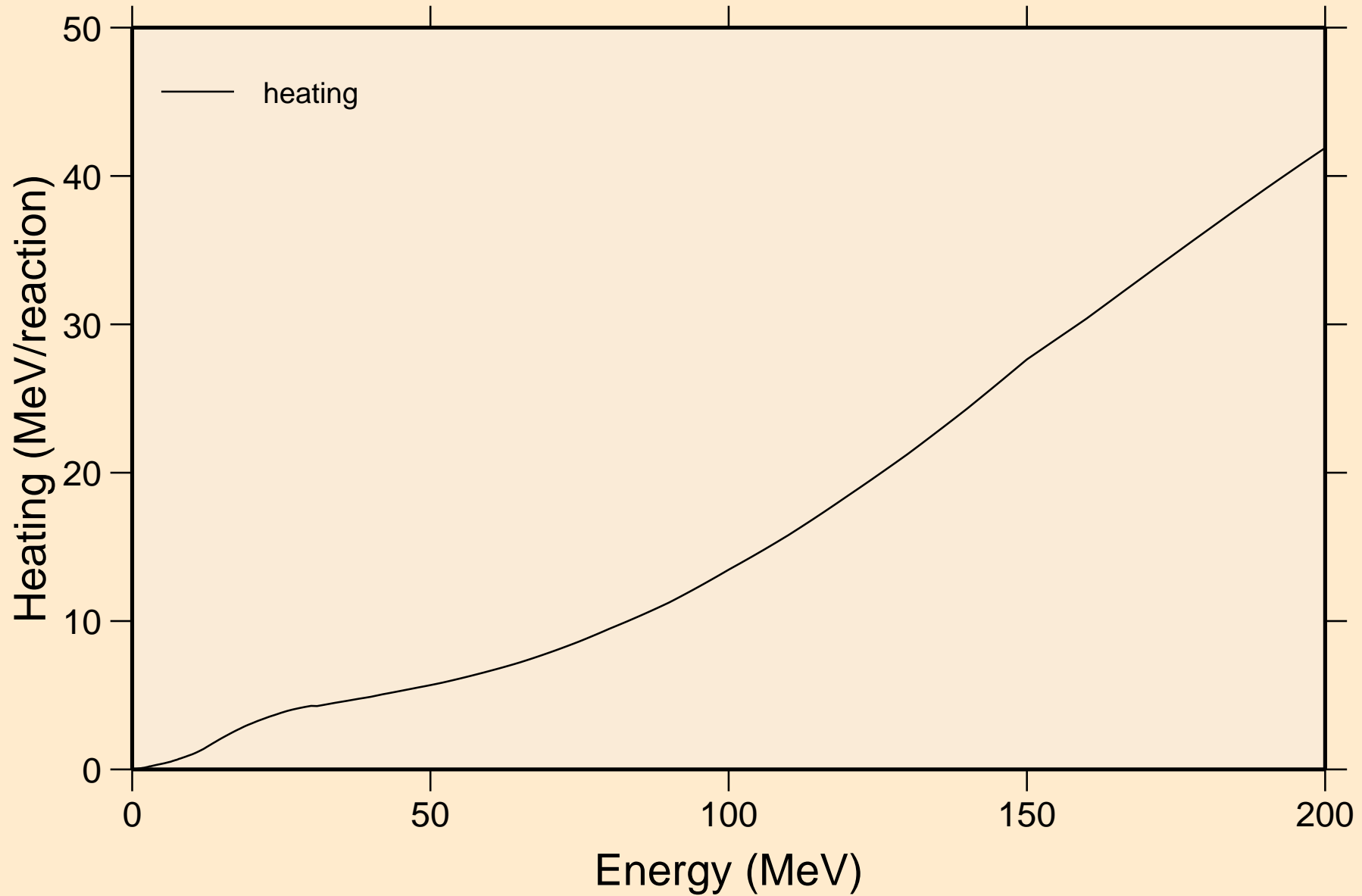

# NI059 NEUTRON ACER TENDL-2023 LIBRARY; T=0.K

## Damage

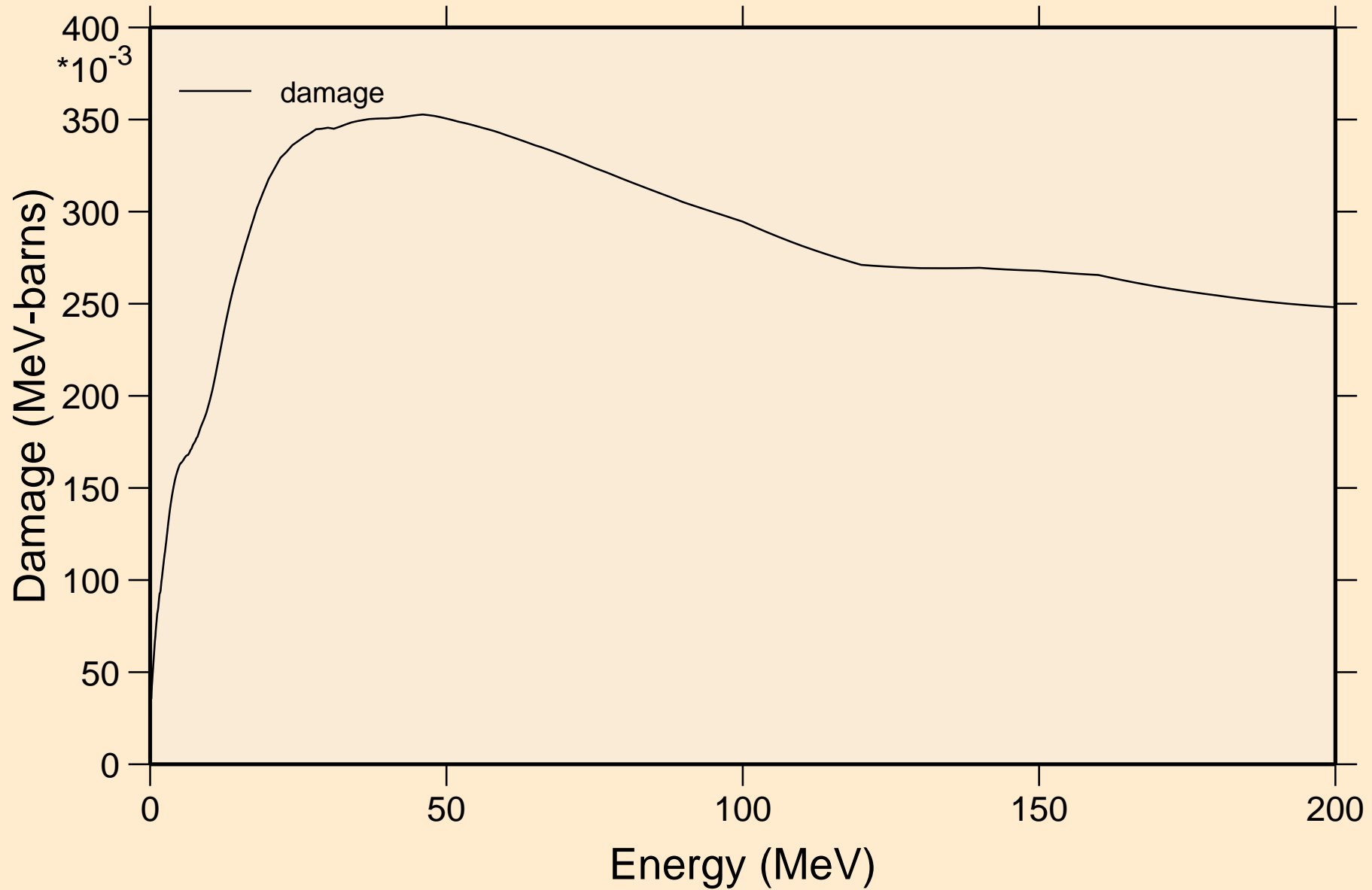

# NI059 NEUTRON ACER TENDL-2023 LIBRARY; T=0.K

## Non-threshold reactions

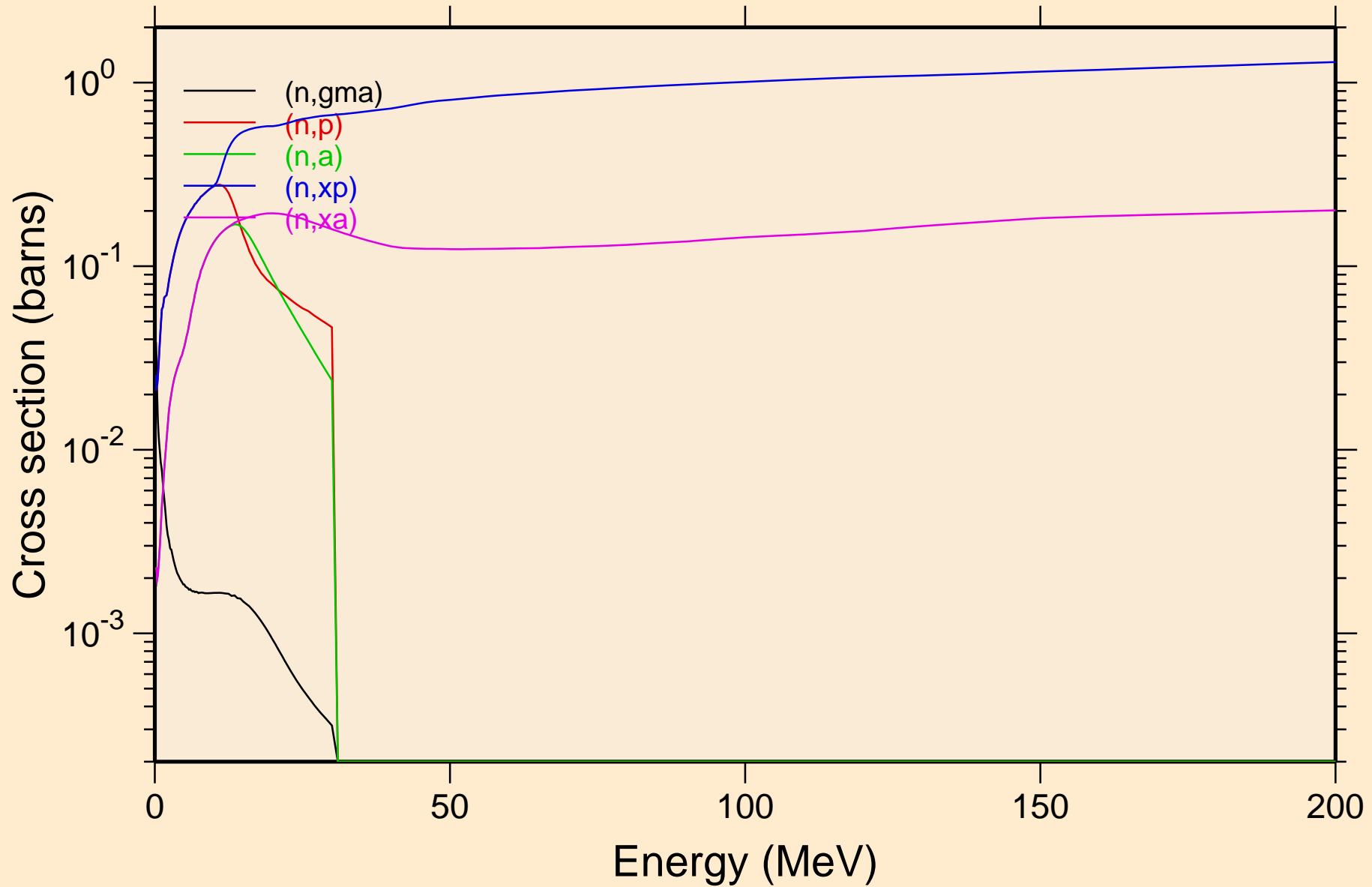



NI059 NEUTRON ACER TENDL-2023 LIBRARY; T=0.K  
Inelastic levels

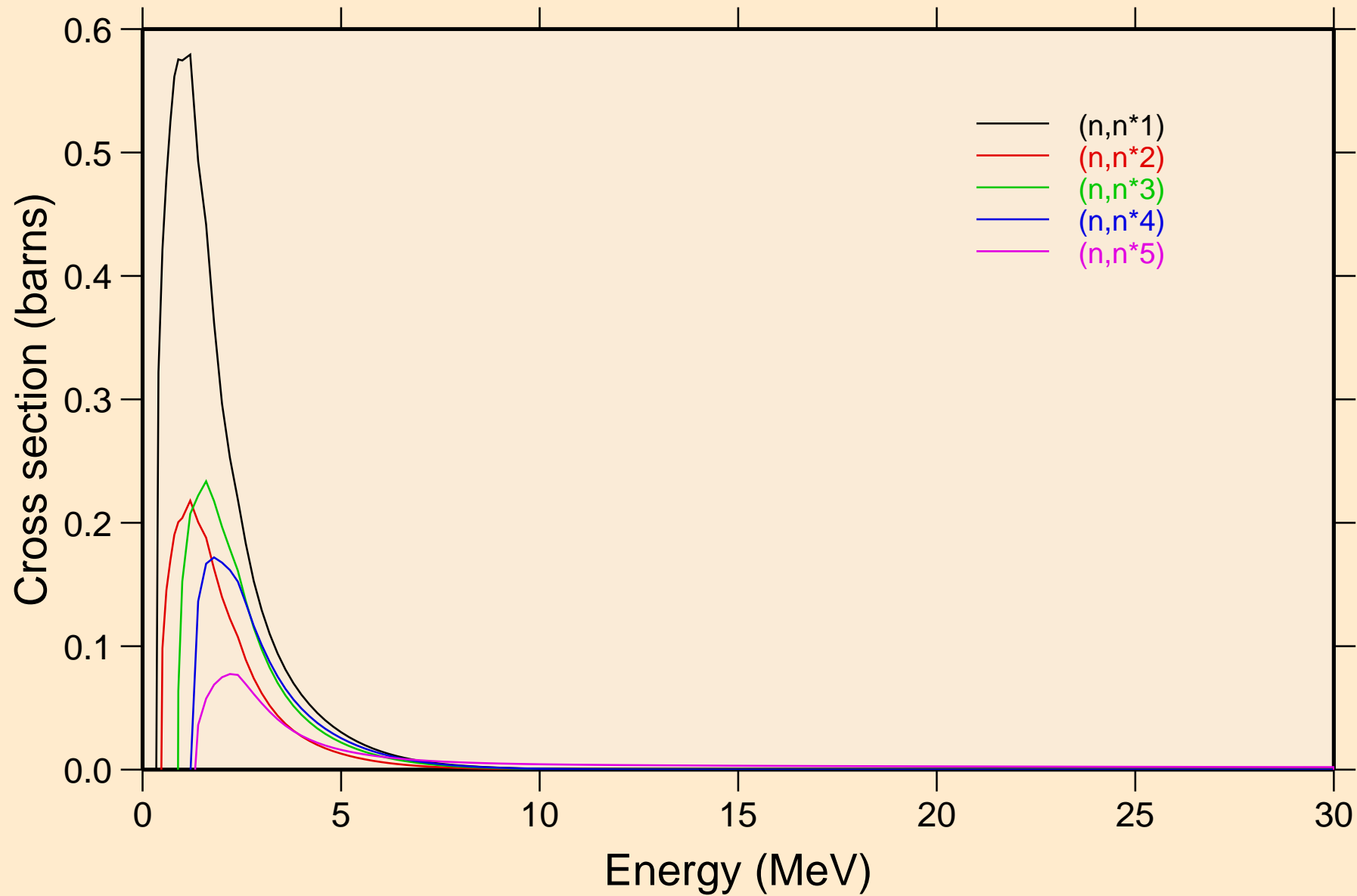

NI059 NEUTRON ACER TENDL-2023 LIBRARY; T=0.K  
Inelastic levels

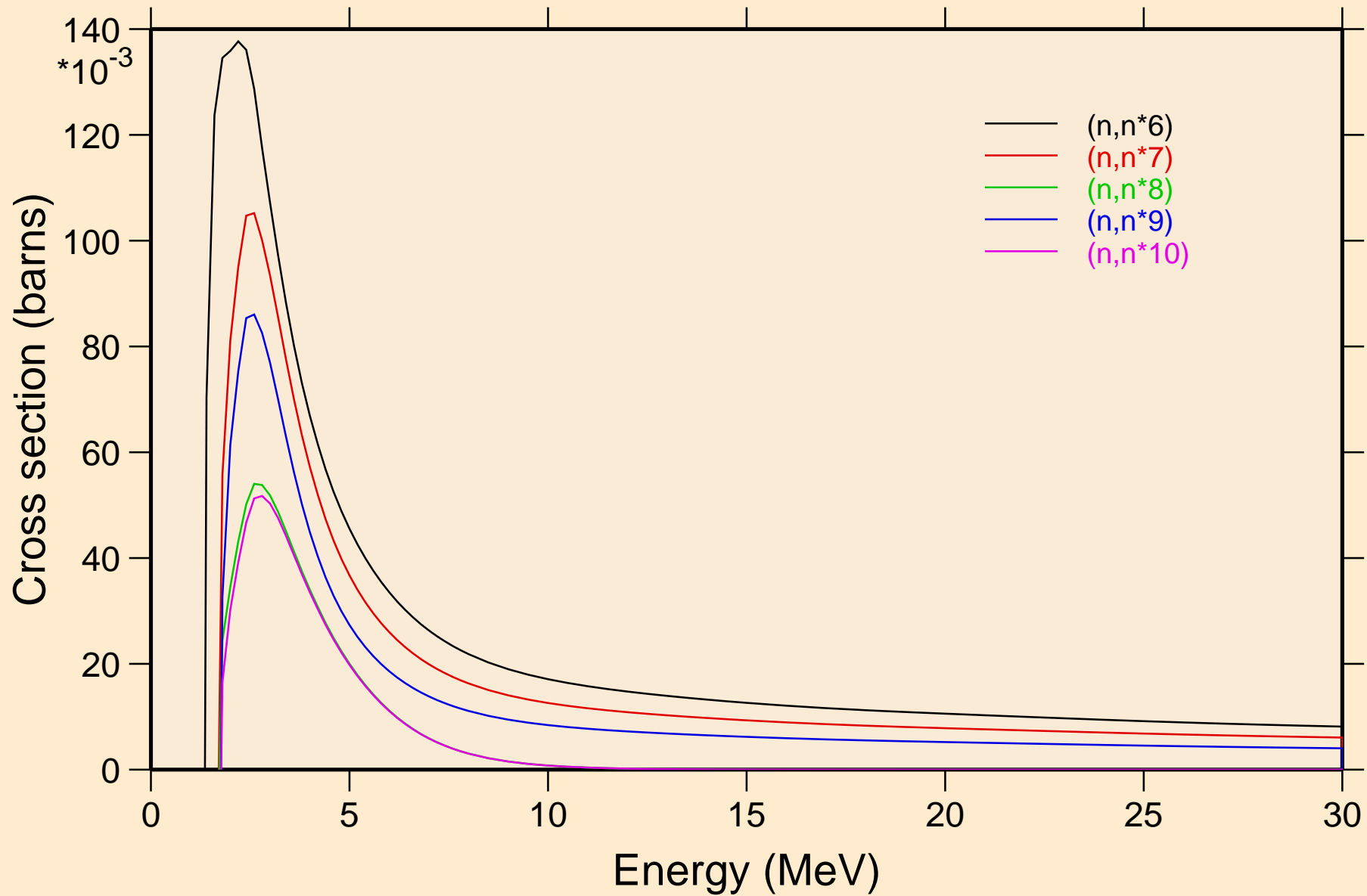

NI059 NEUTRON ACER TENDL-2023 LIBRARY; T=0.K  
Inelastic levels

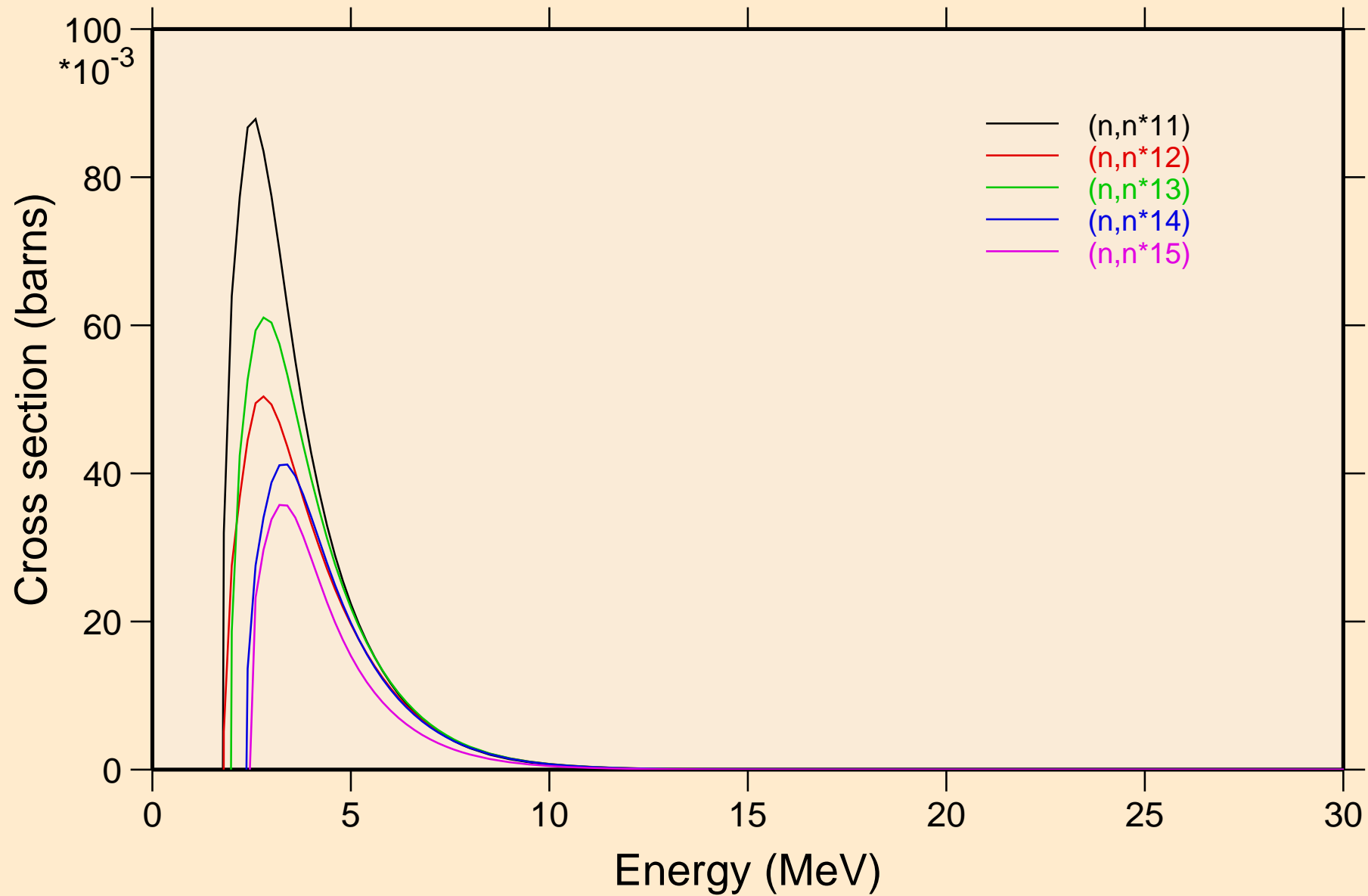

NI059 NEUTRON ACER TENDL-2023 LIBRARY; T=0.K  
Inelastic levels

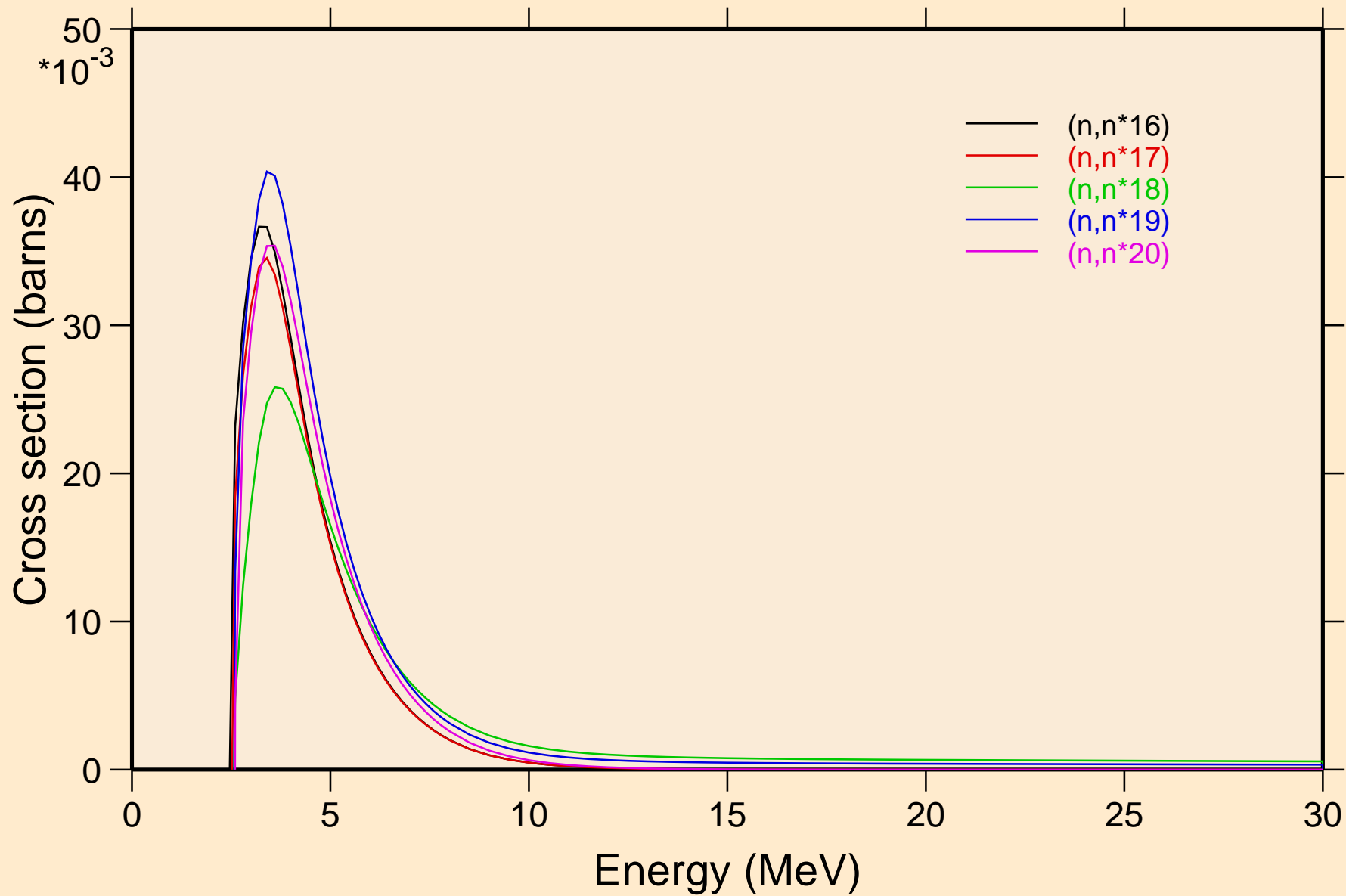

NI059 NEUTRON ACER TENDL-2023 LIBRARY; T=0.K  
Inelastic levels

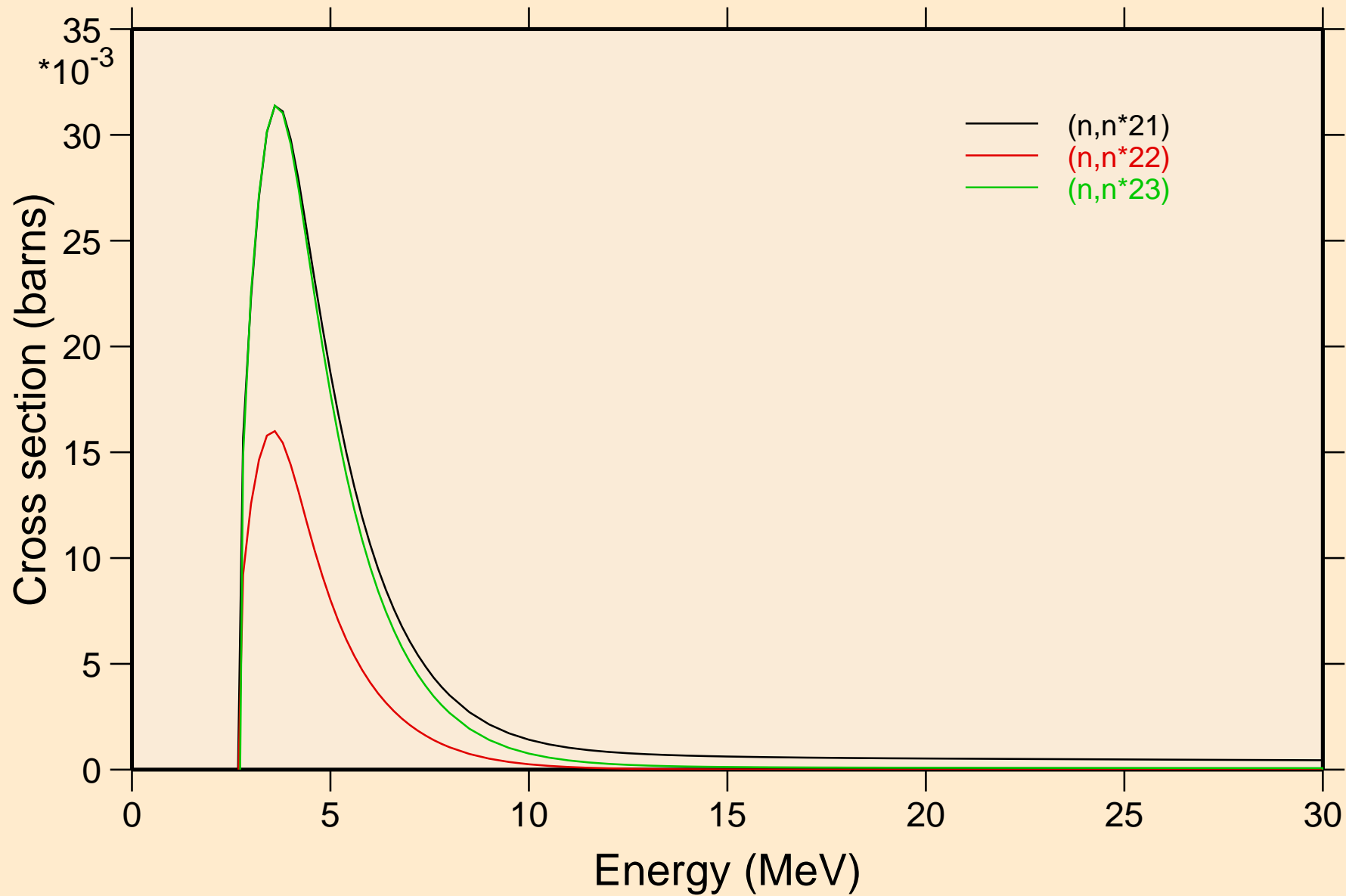

# NI059 NEUTRON ACER TENDL-2023 LIBRARY; T=0.K

## Threshold reactions

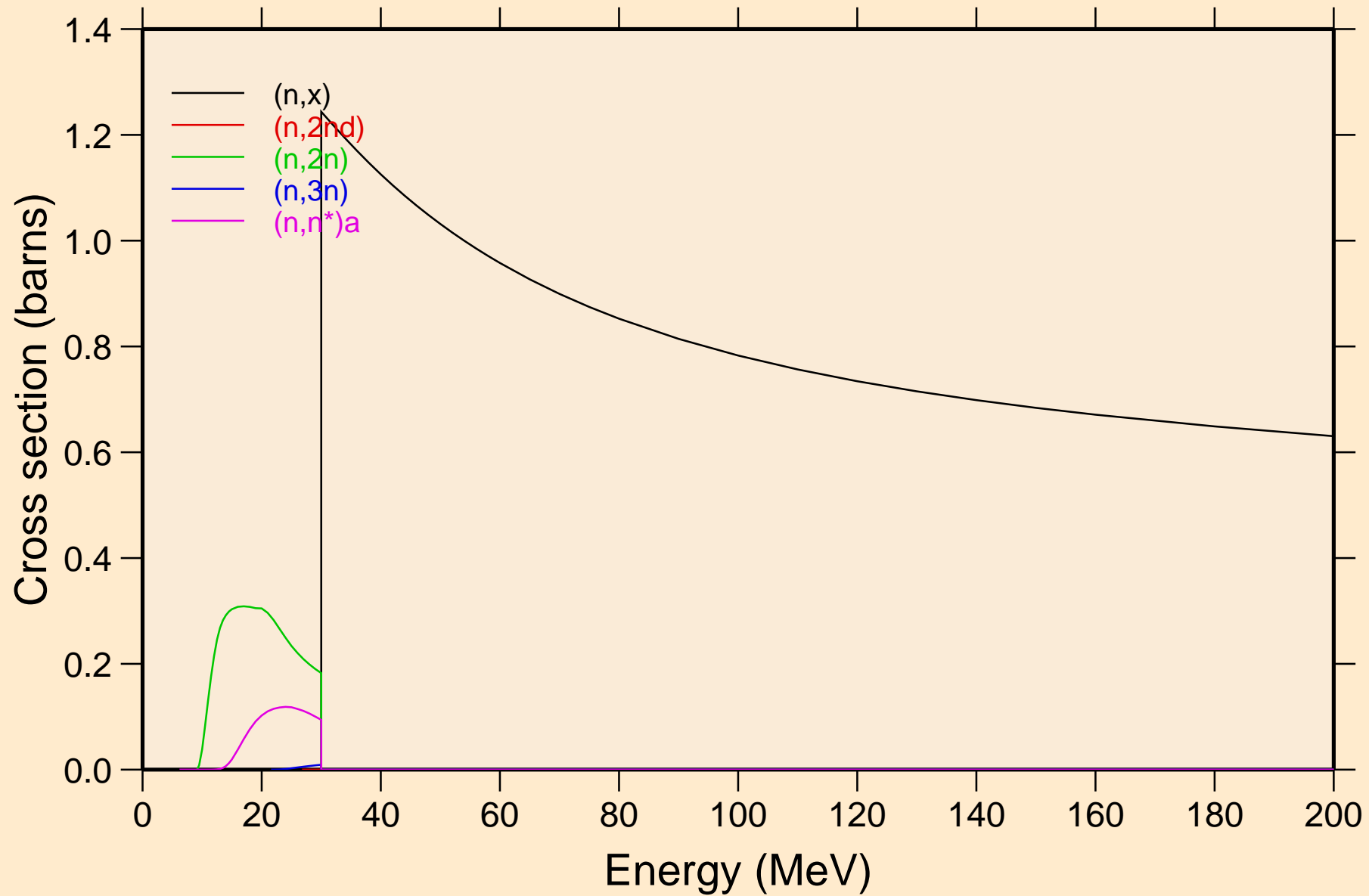

# NI059 NEUTRON ACER TENDL-2023 LIBRARY; T=0.K

## Threshold reactions

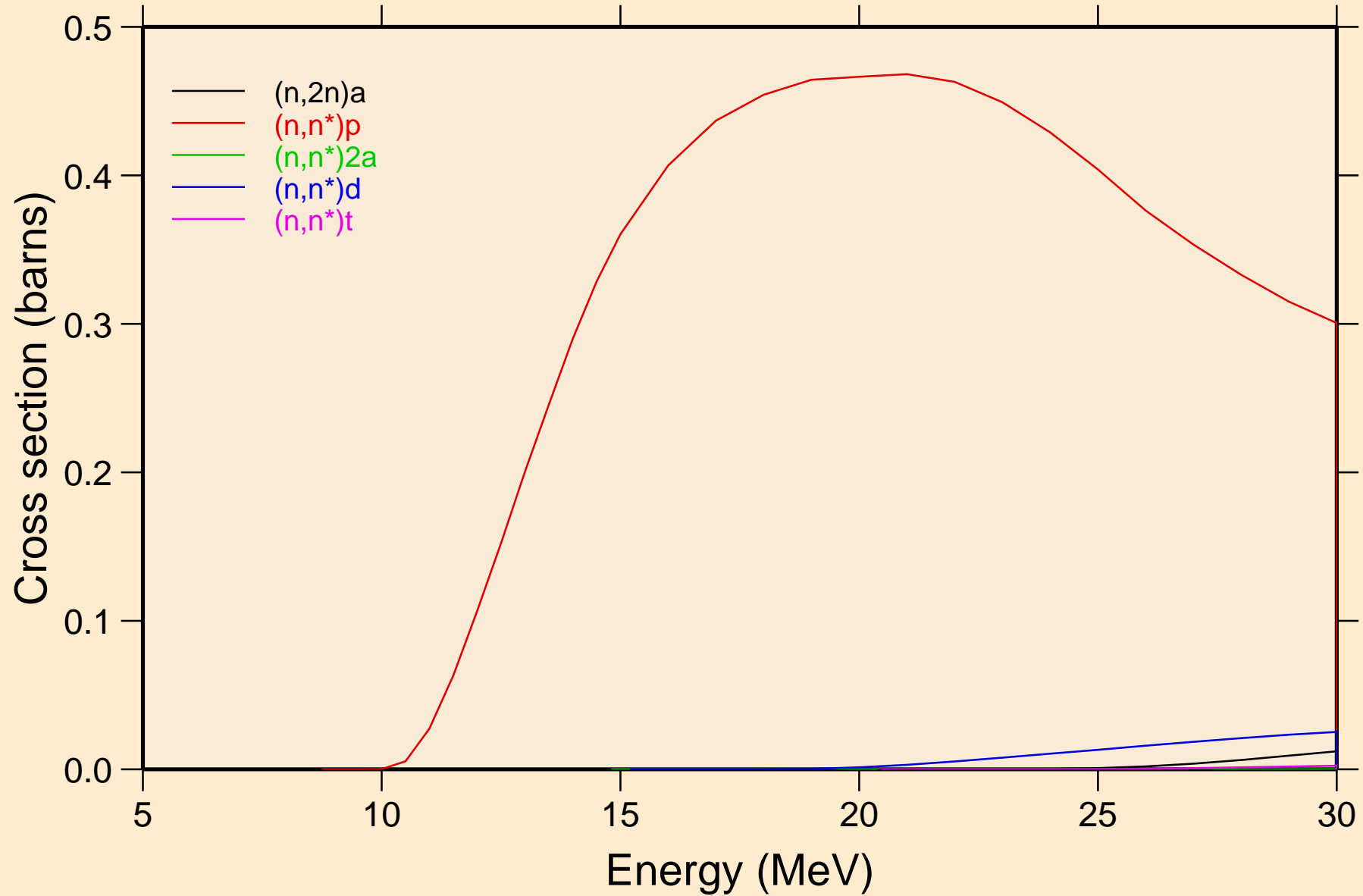

NI059 NEUTRON ACER TENDL-2023 LIBRARY; T=0.K  
Threshold reactions

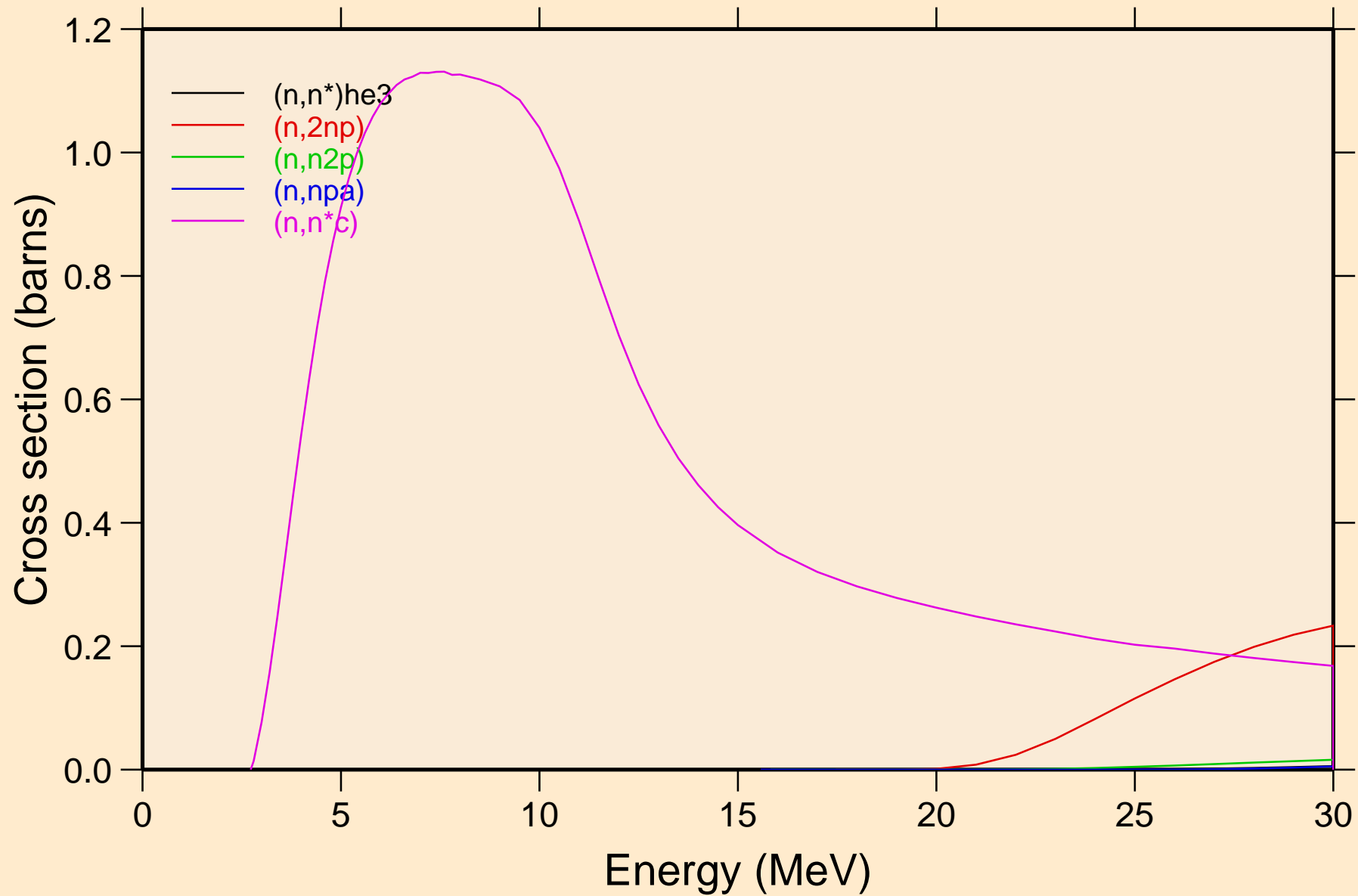



NI059 NEUTRON ACER TENDL-2023 LIBRARY; T=0.K  
Threshold reactions

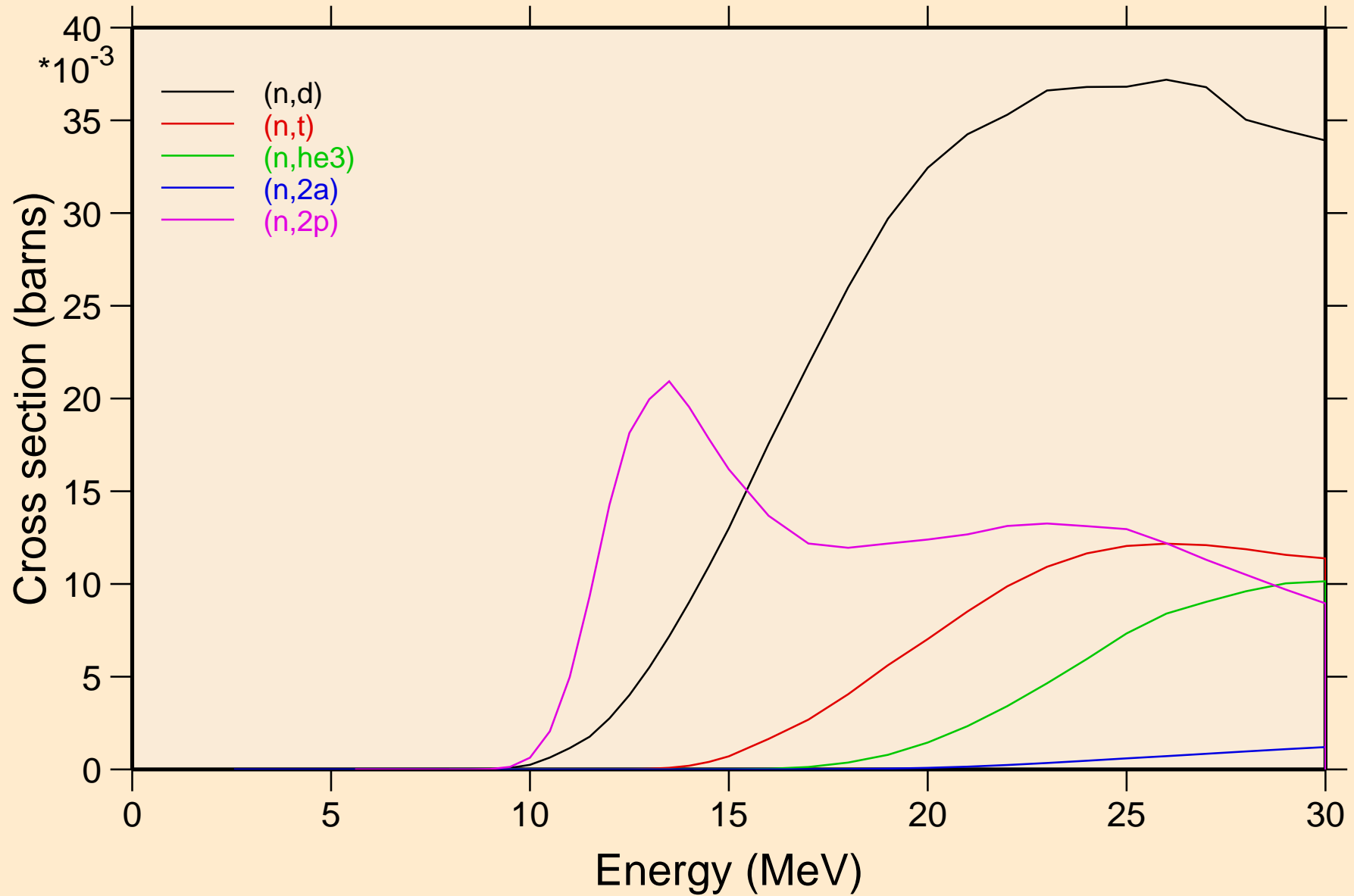

NI059 NEUTRON ACER TENDL-2023 LIBRARY; T=0.K  
Threshold reactions

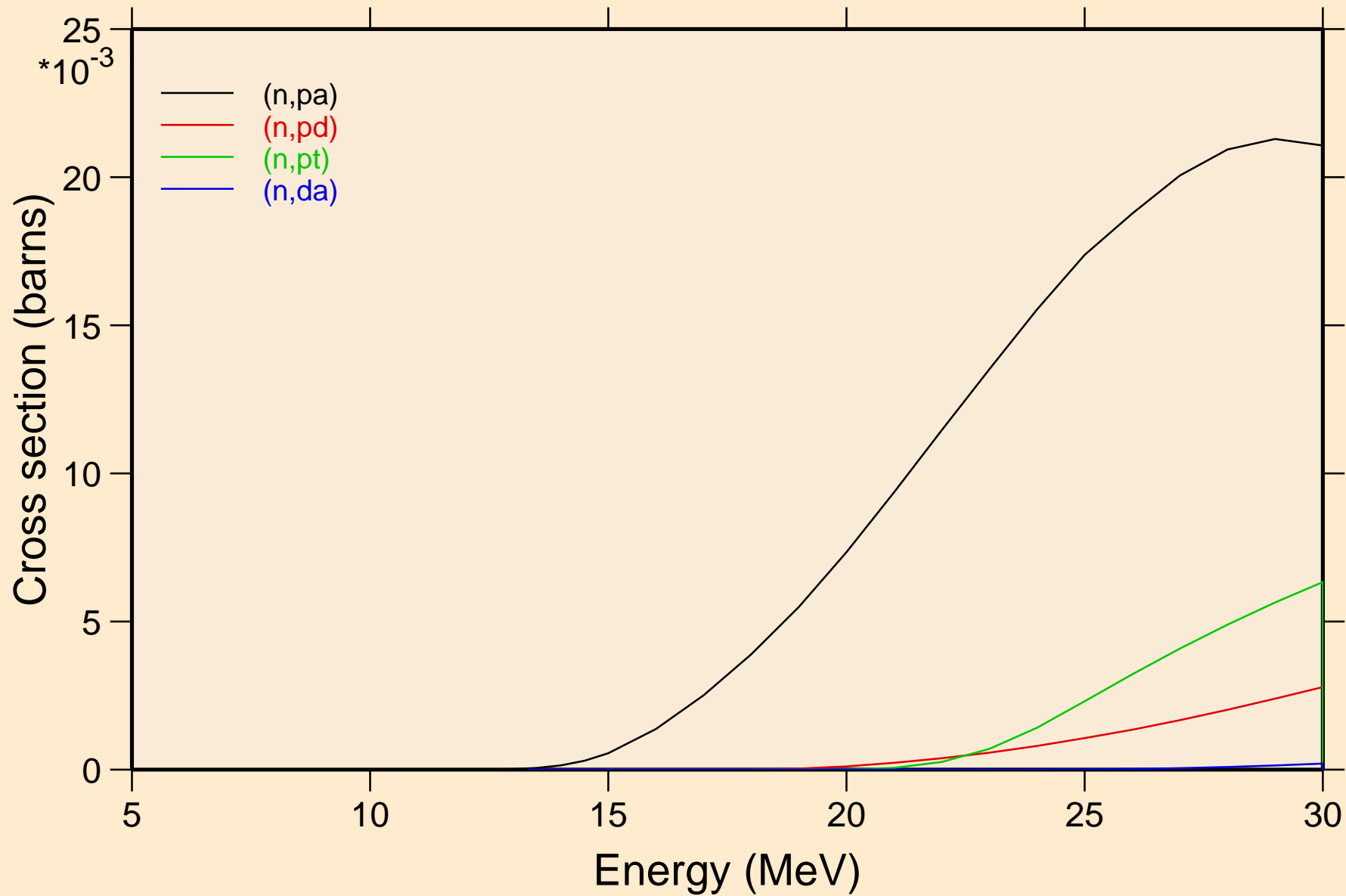

# NI059 NEUTRON ACER TENDL-2023 LIBRARY; T=0.K

## Threshold reactions

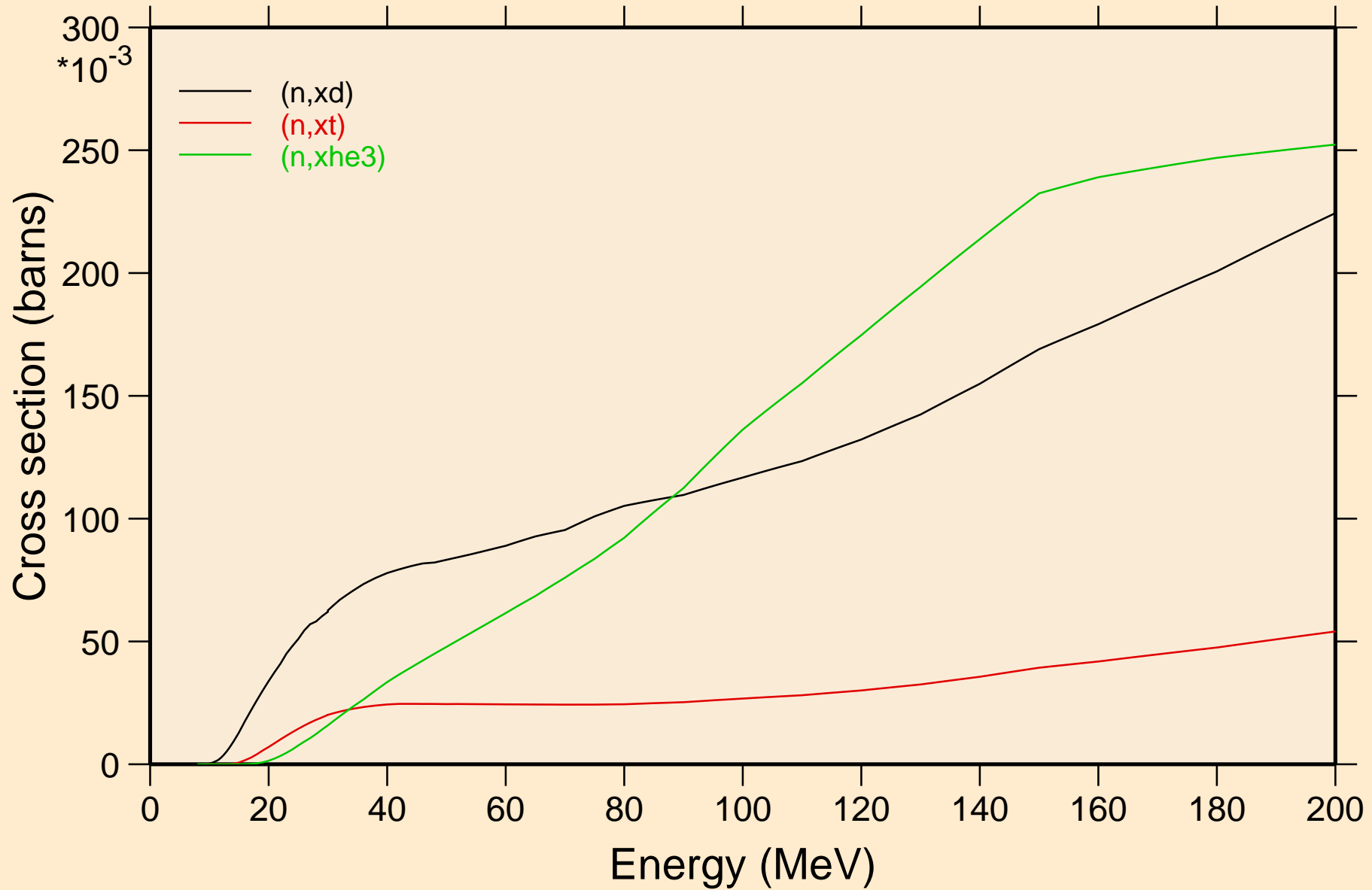

NI059 NEUTRON ACER TENDL-2023 LIBRARY; T=0.K  
angular distribution for elastic

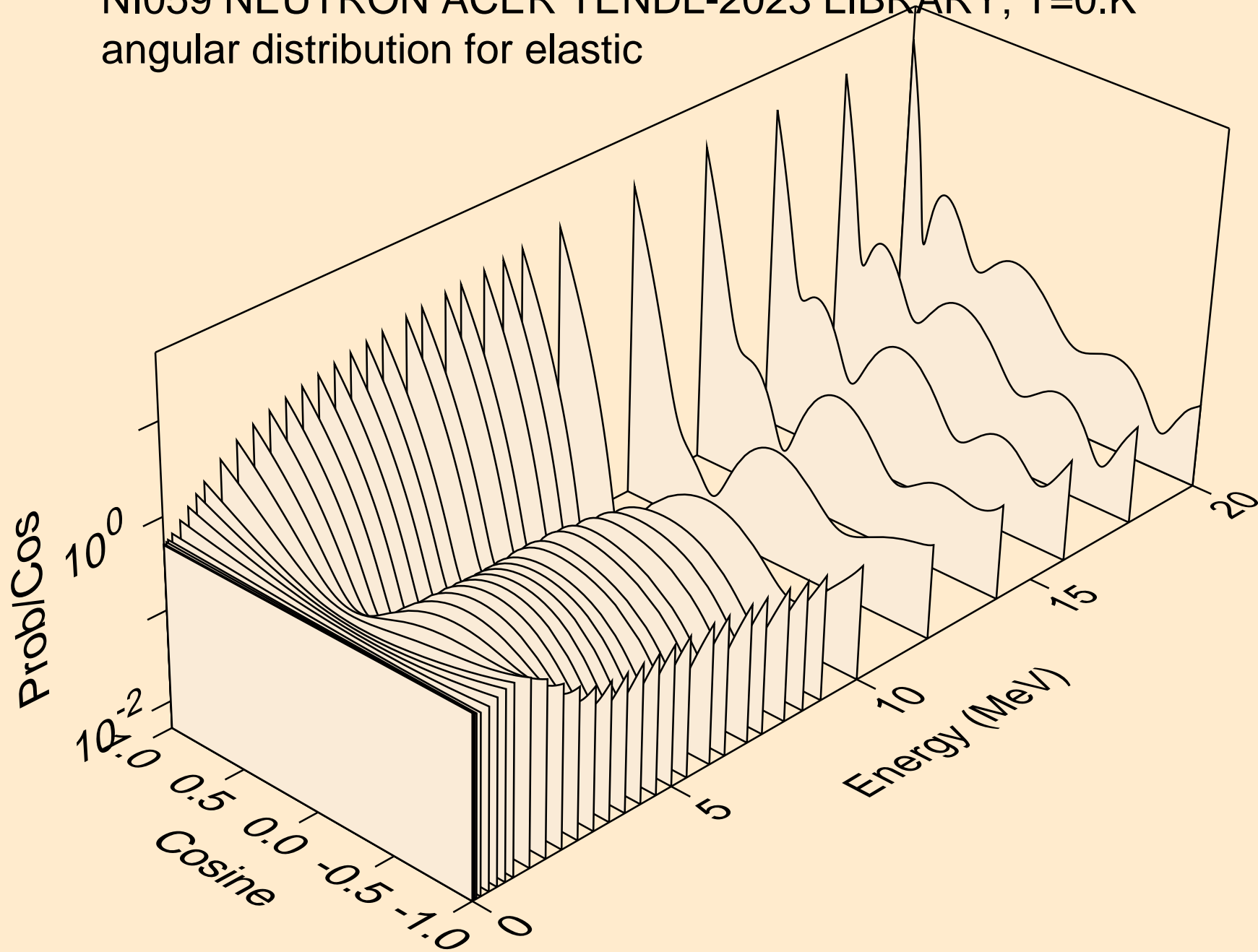

NI059 NEUTRON ACER TENDL-2023 LIBRARY; T=0.K  
angular distribution for elastic

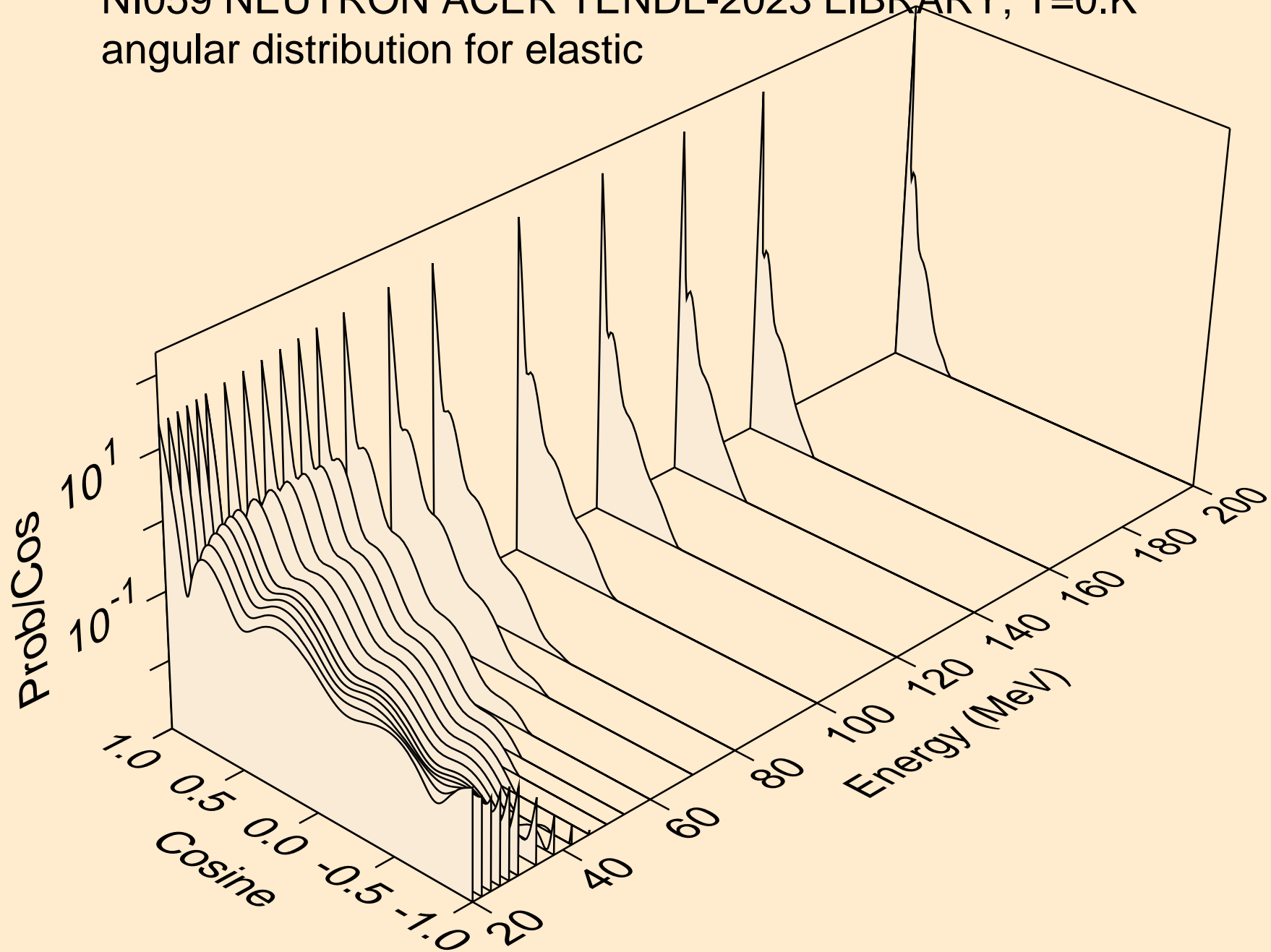

NI059 NEUTRON ACER TENDL-2023 LIBRARY; T=0.K  
angular distribution for (n,n\*1)

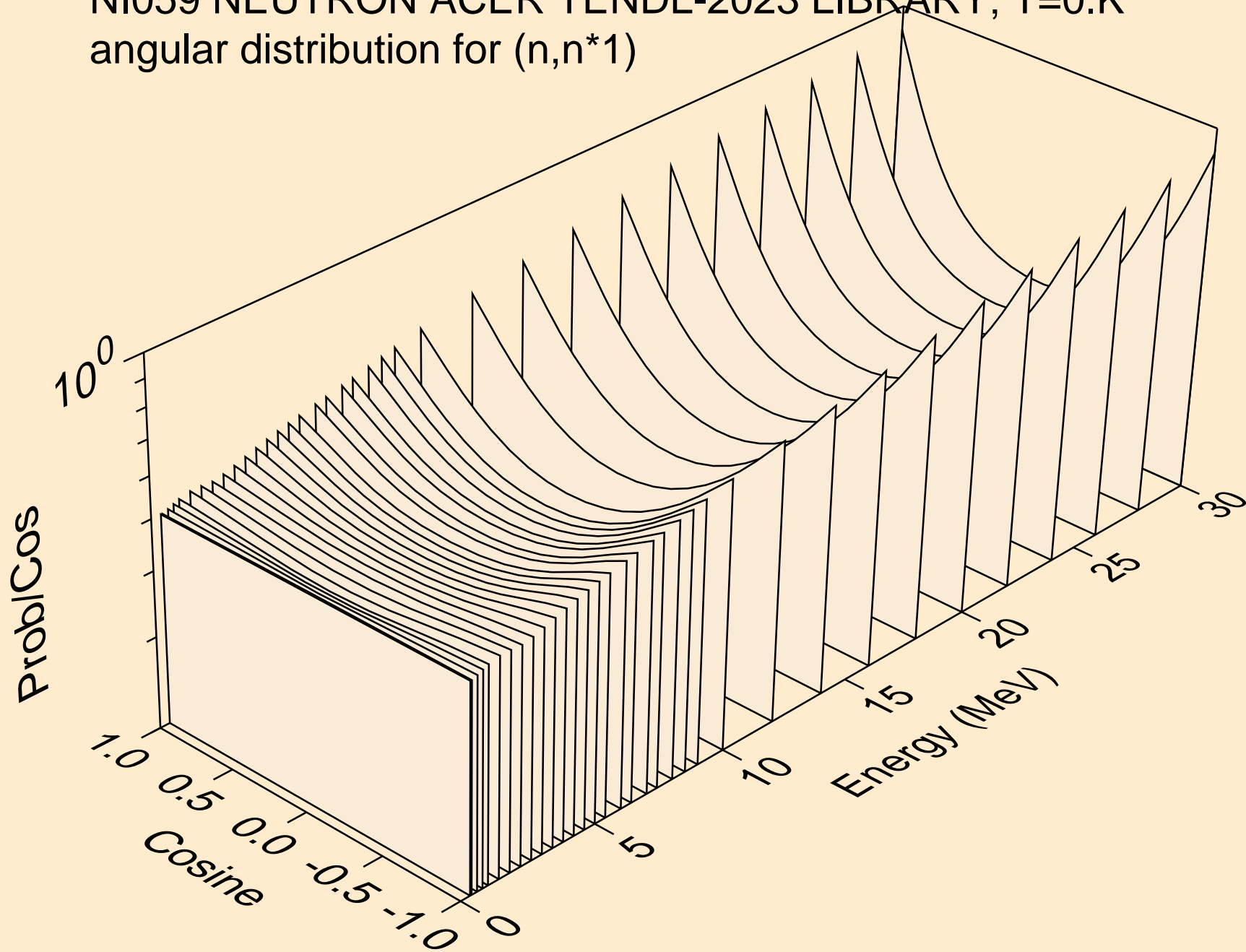

NI059 NEUTRON ACER TENDL-2023 LIBRARY; T=0.K  
angular distribution for (n,n\*2)

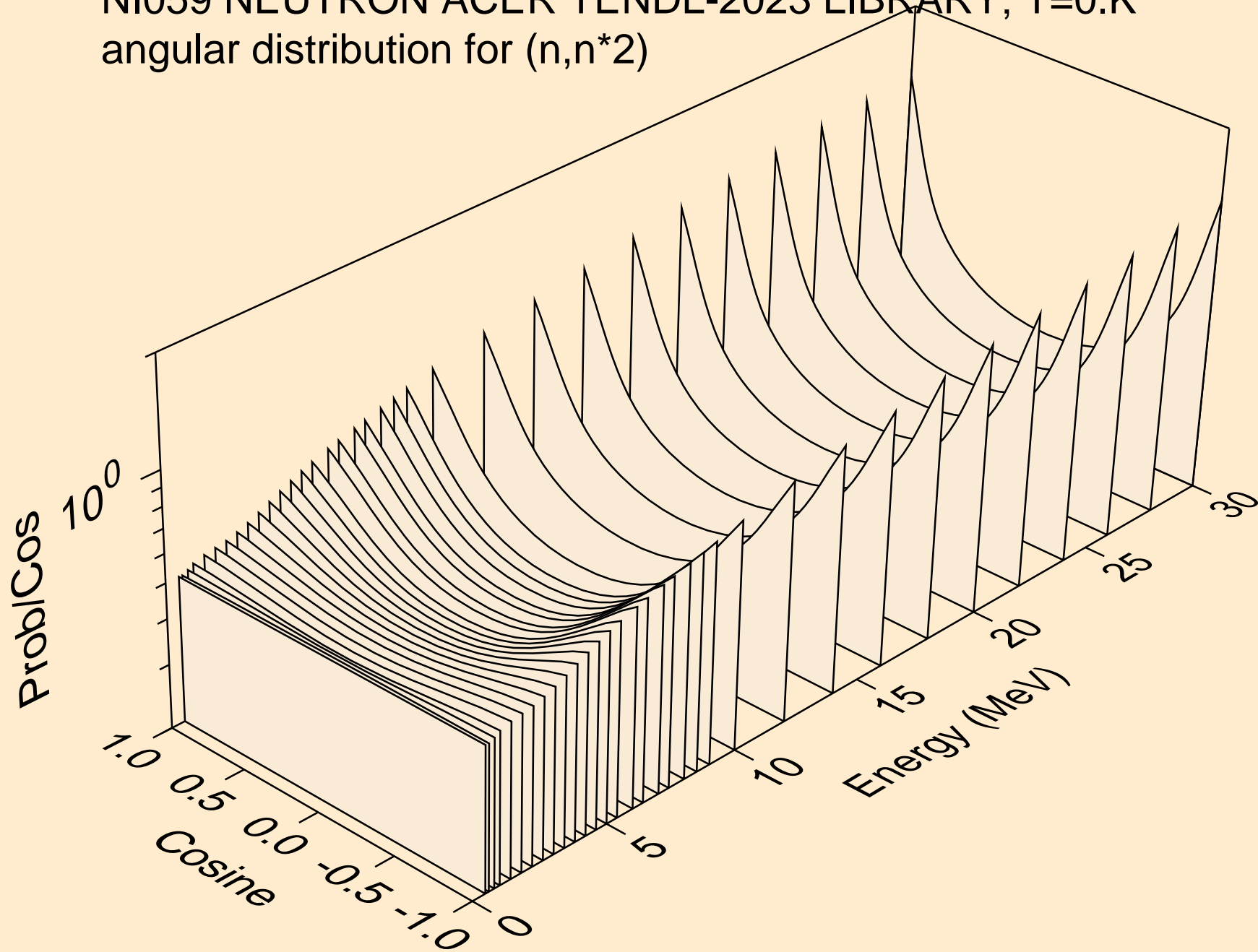

NI059 NEUTRON ACER TENDL-2023 LIBRARY; T=0.K  
angular distribution for (n,n\*3)

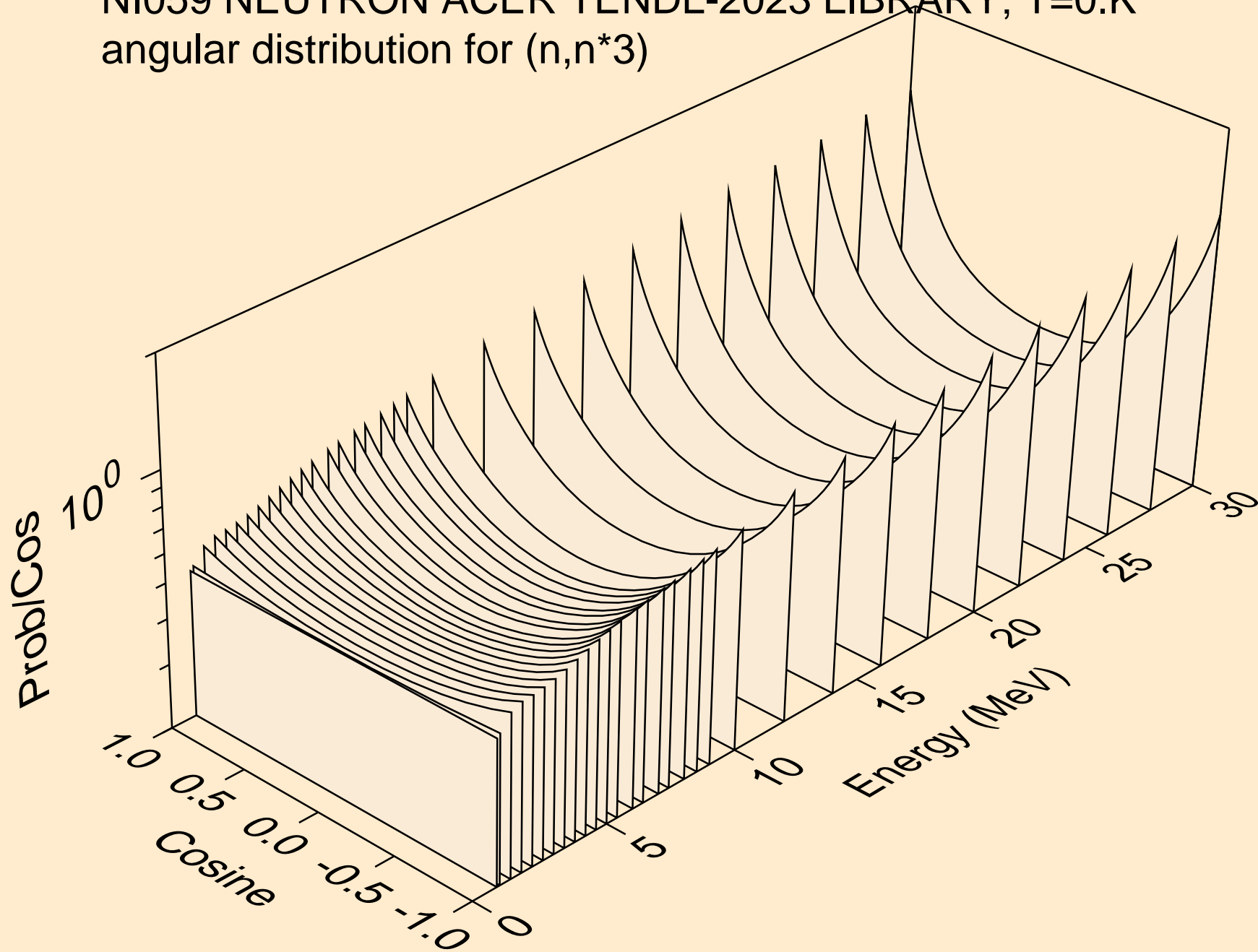



NI059 NEUTRON ACER TENDL-2023 LIBRARY; T=0.K  
angular distribution for (n,n\*4)

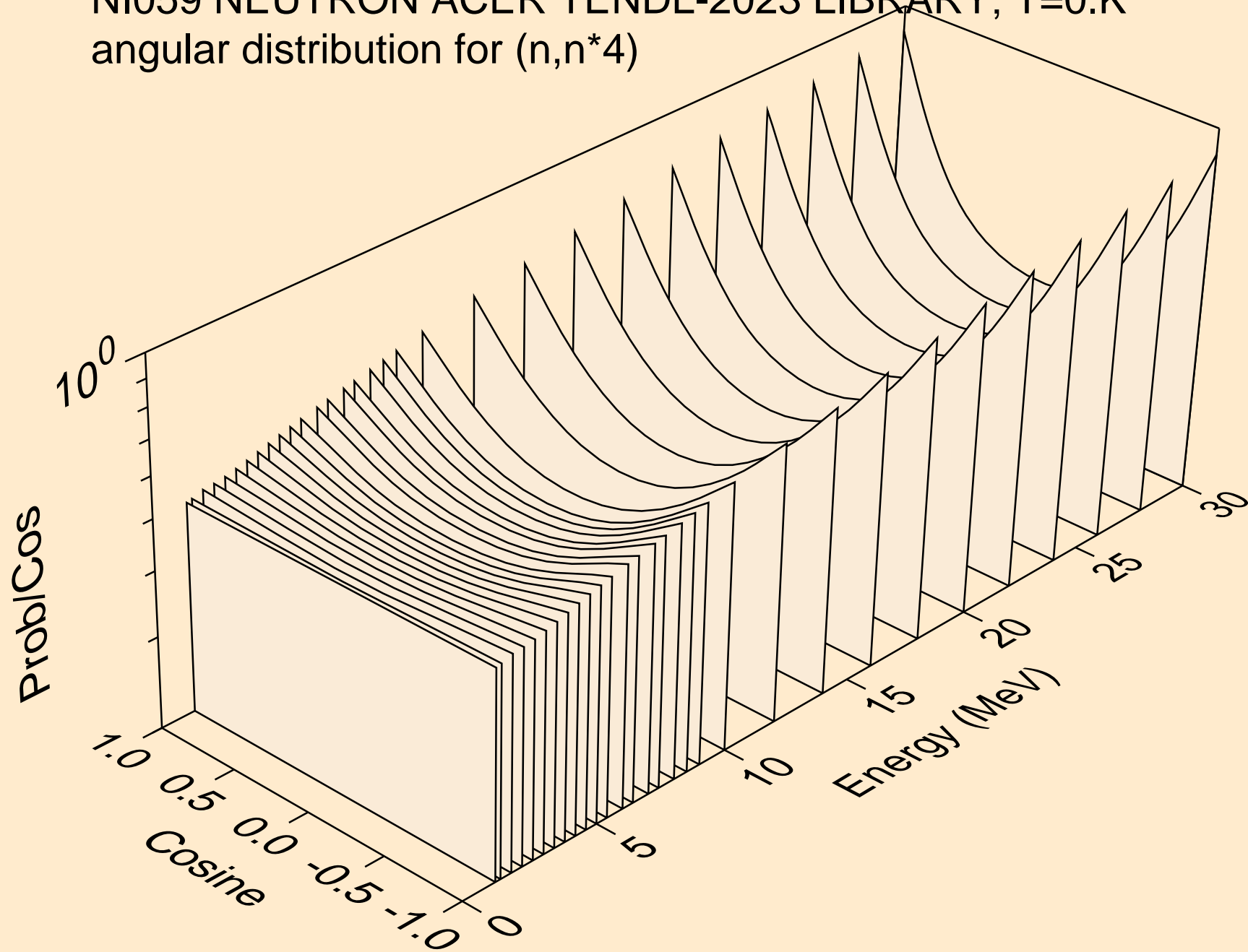

NI059 NEUTRON ACER TENDL-2023 LIBRARY; T=0.K  
angular distribution for (n,n\*5)

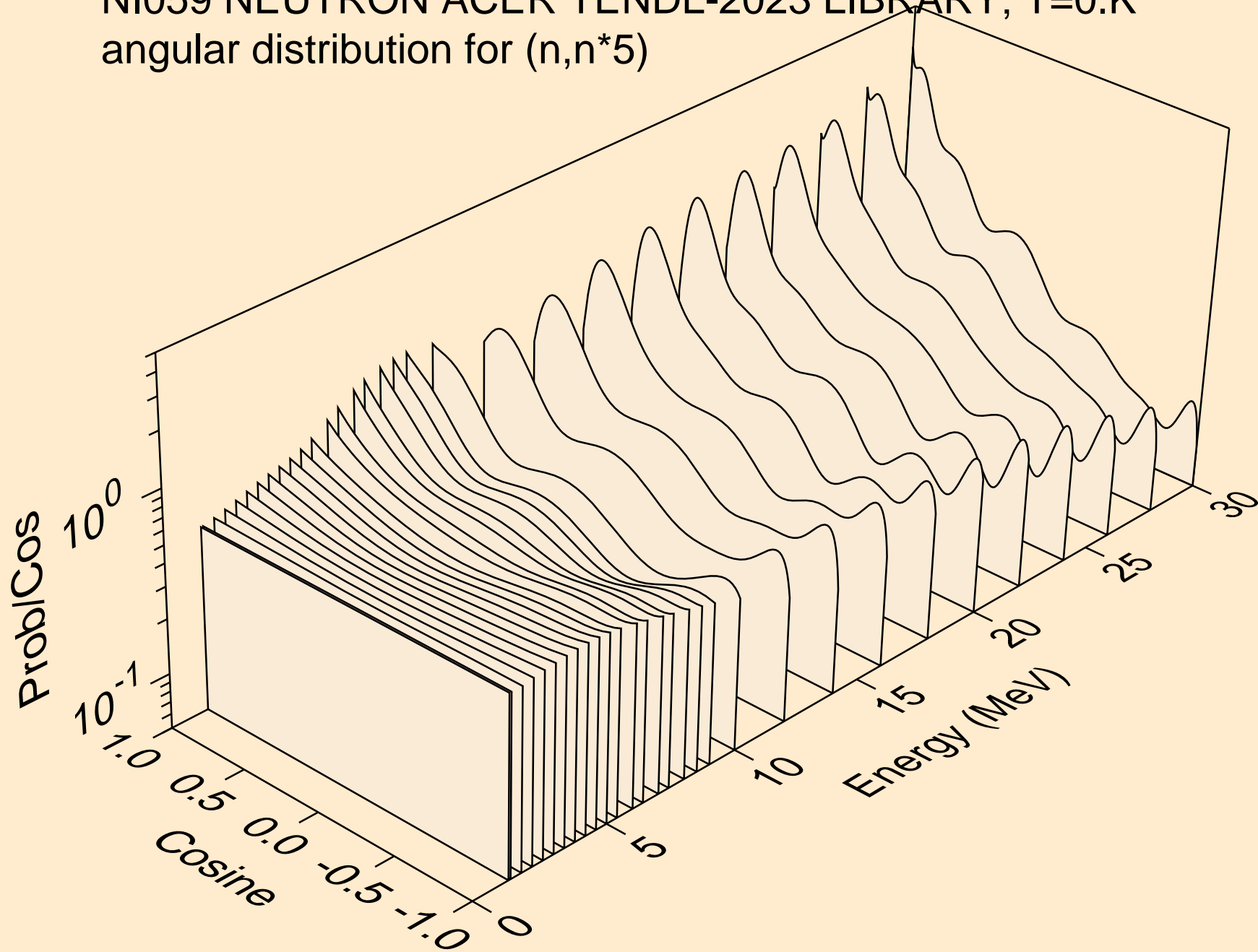

NI059 NEUTRON ACER TENDL-2023 LIBRARY; T=0.K  
angular distribution for (n,n\*6)

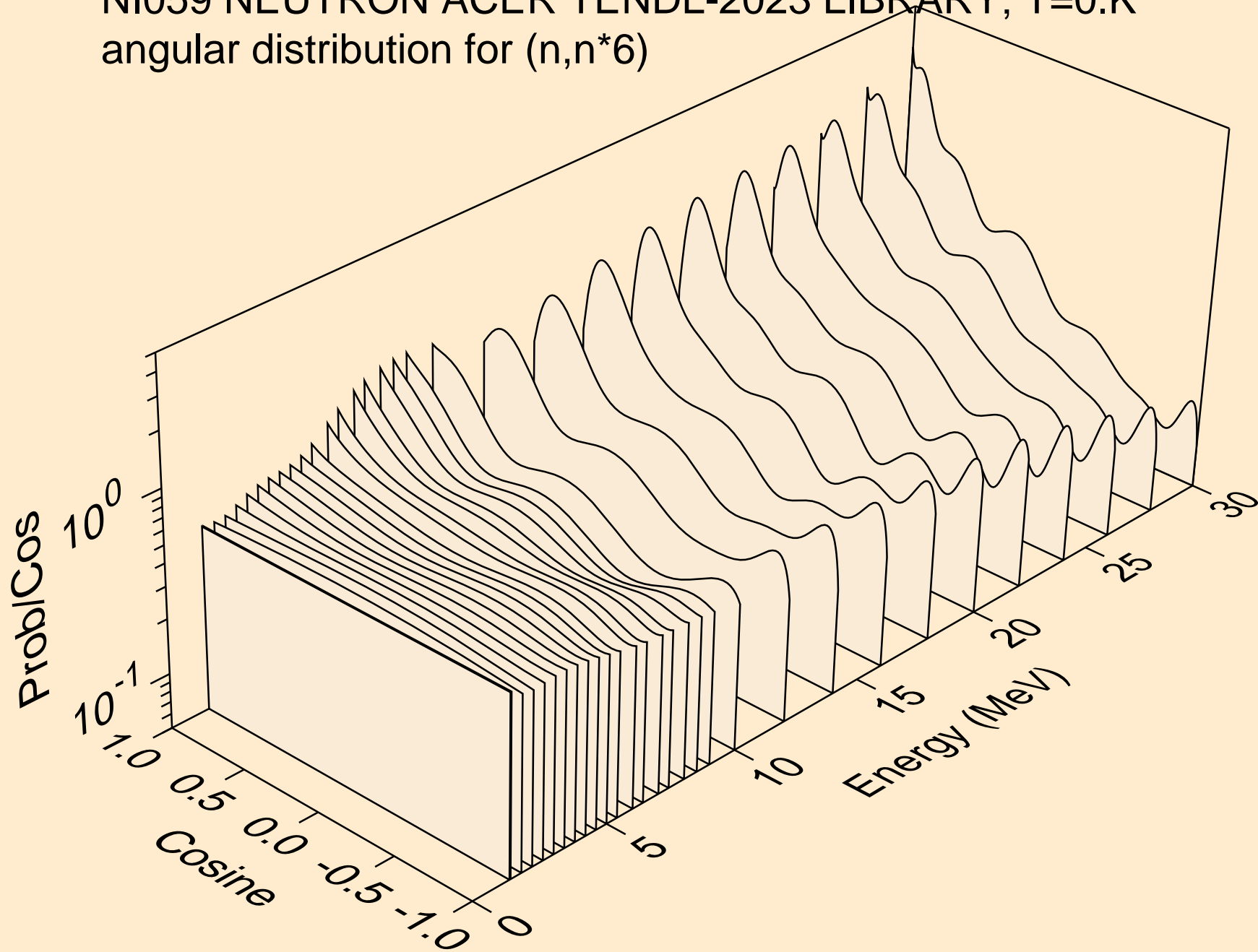

NI059 NEUTRON ACER TENDL-2023 LIBRARY; T=0.K  
angular distribution for (n,n\*7)

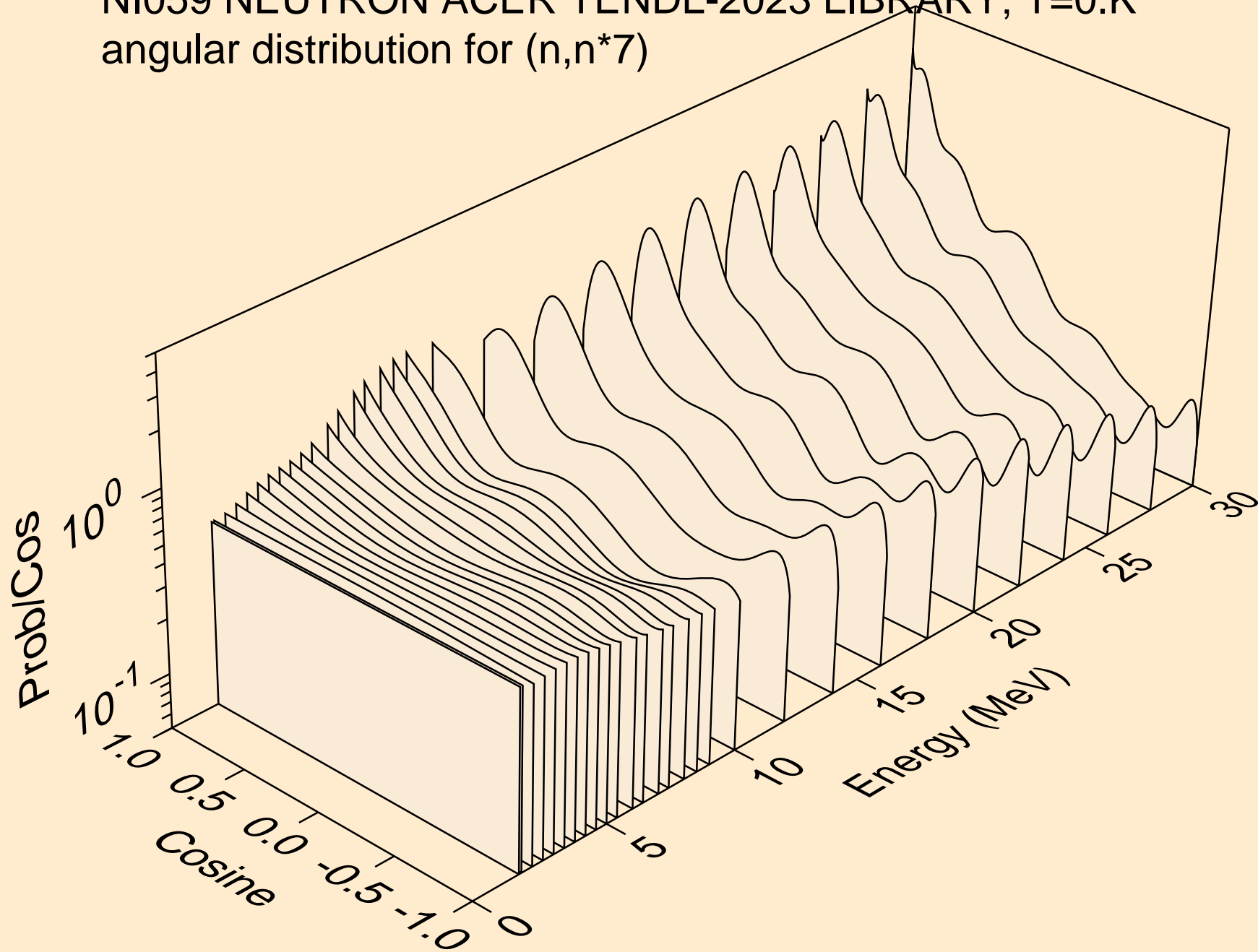

NI059 NEUTRON ACER TENDL-2023 LIBRARY; T=0.K  
angular distribution for (n,n\*8)

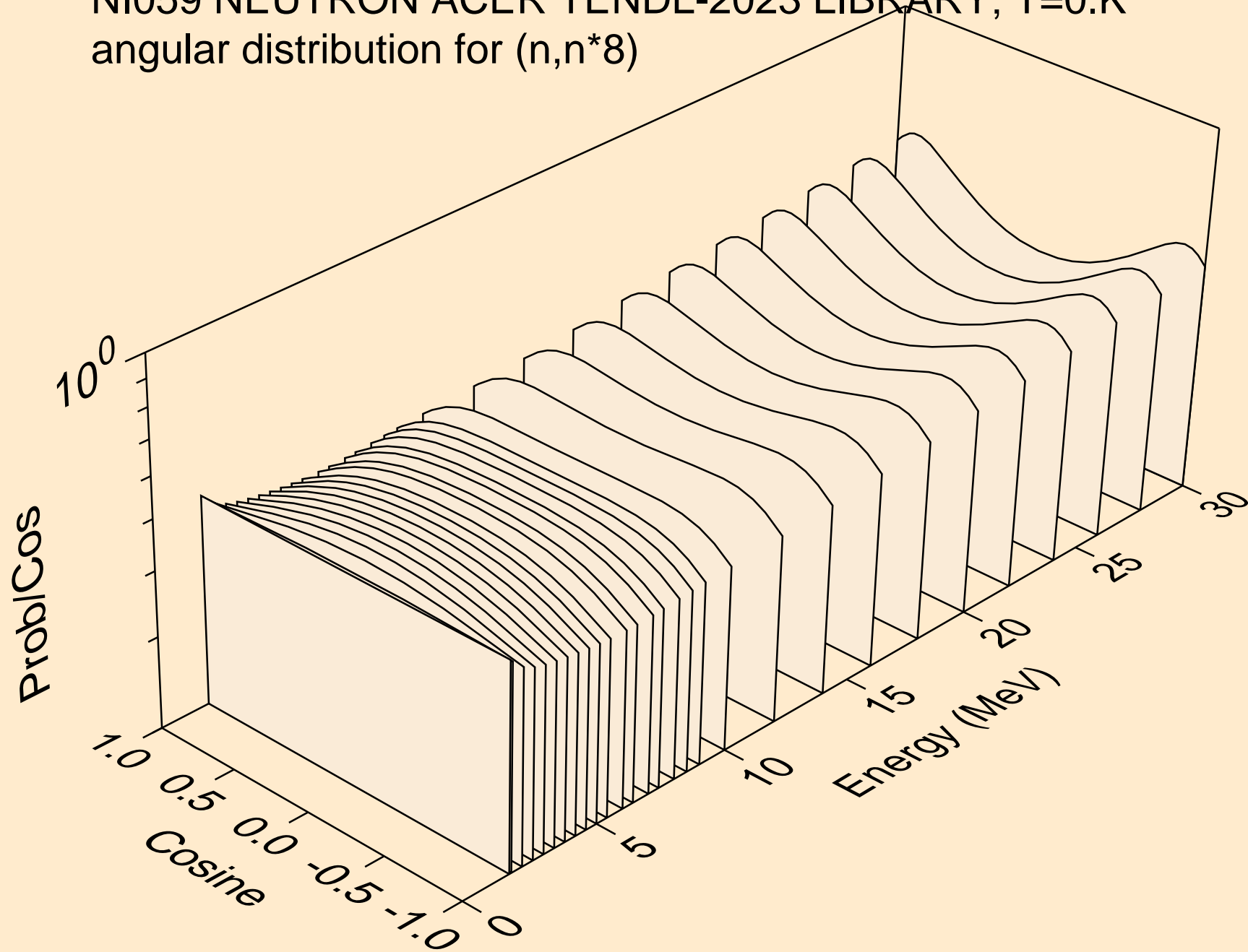

NI059 NEUTRON ACER TENDL-2023 LIBRARY; T=0.K  
angular distribution for (n,n\*9)

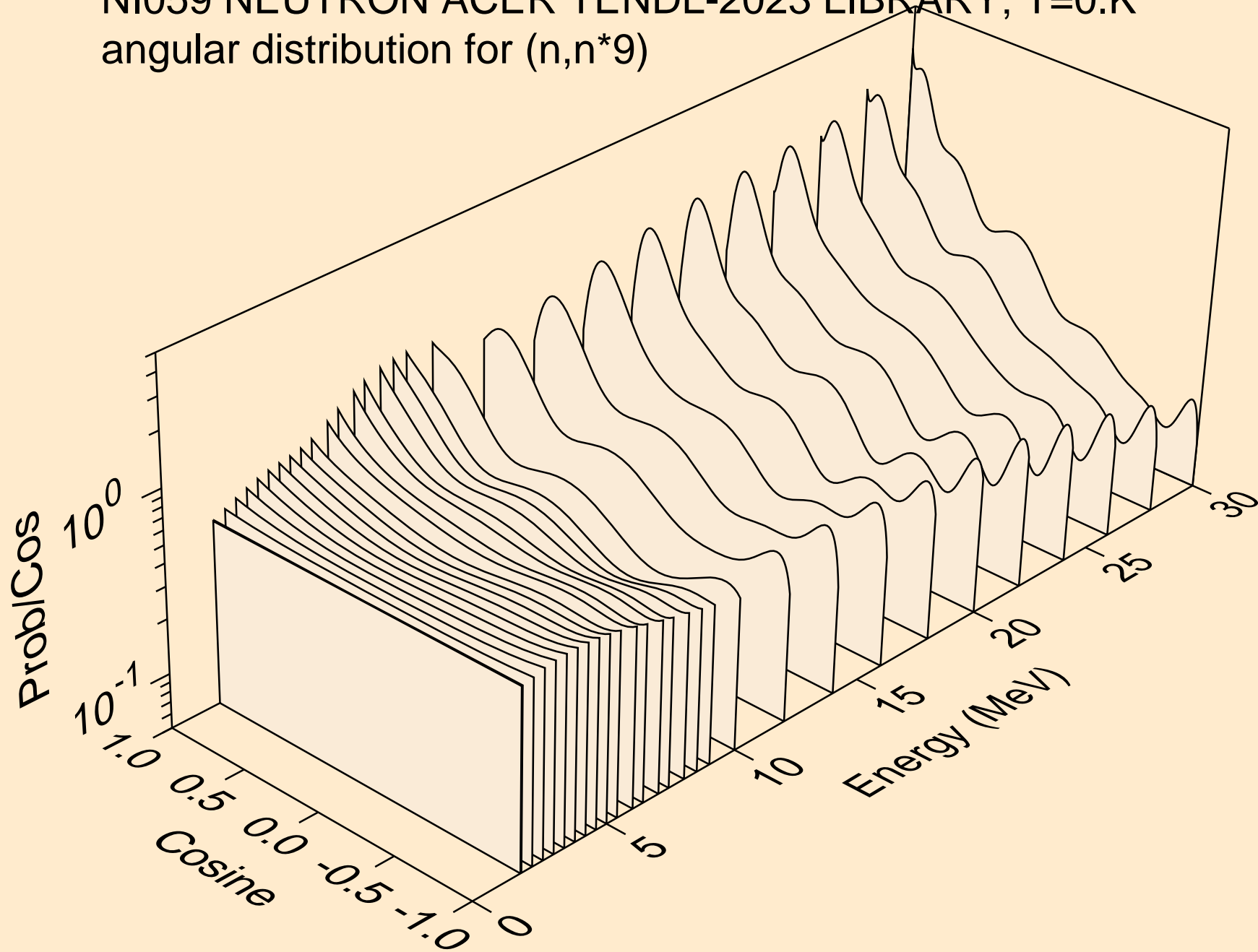

NI059 NEUTRON ACER TENDL-2023 LIBRARY; T=0.K  
angular distribution for (n,n\*10)

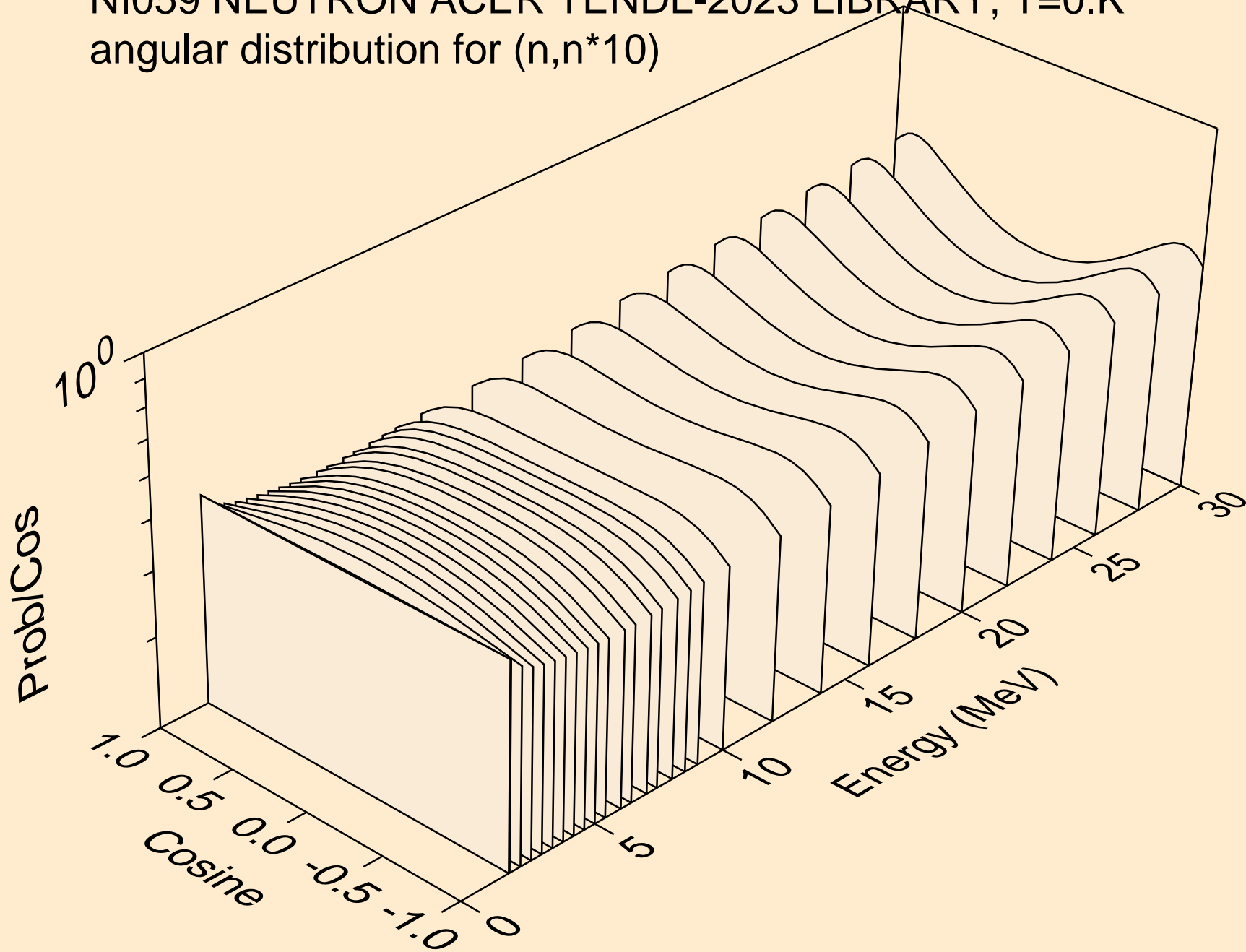

NI059 NEUTRON ACER TENDL-2023 LIBRARY; T=0.K  
angular distribution for (n,n\*11)

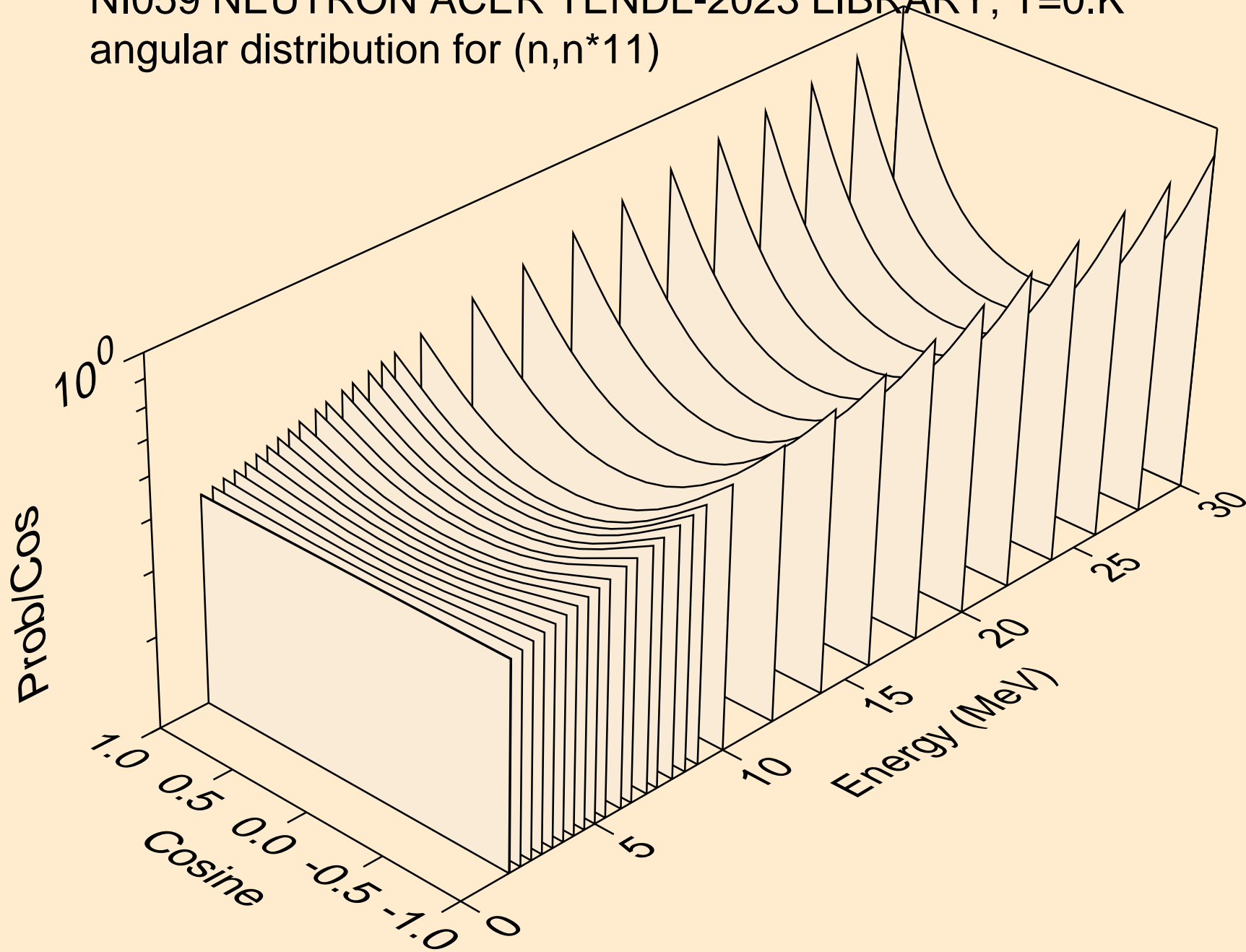



NI059 NEUTRON ACER TENDL-2023 LIBRARY; T=0.K  
angular distribution for (n,n\*12)

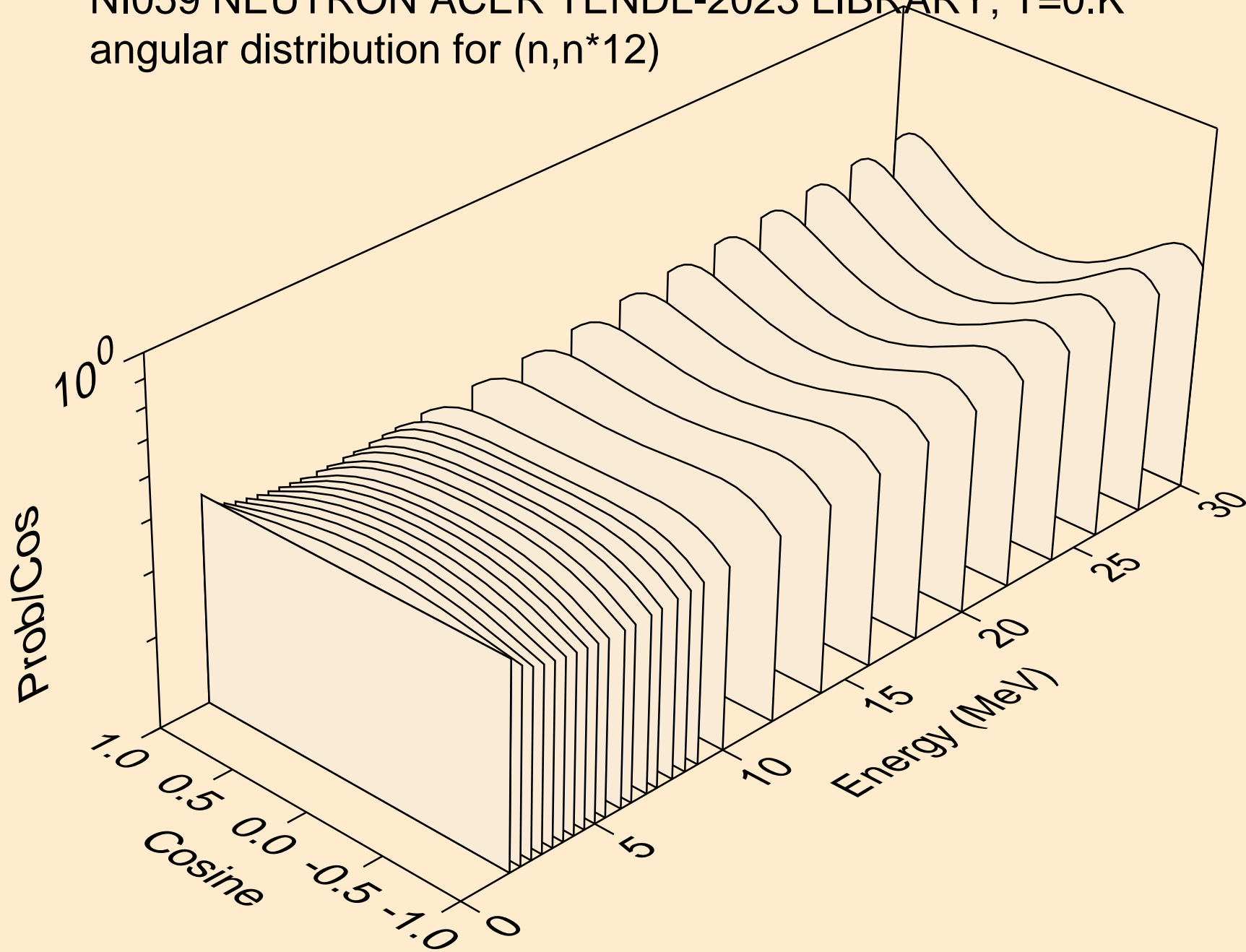

NI059 NEUTRON ACER TENDL-2023 LIBRARY; T=0.K  
angular distribution for (n,n\*13)

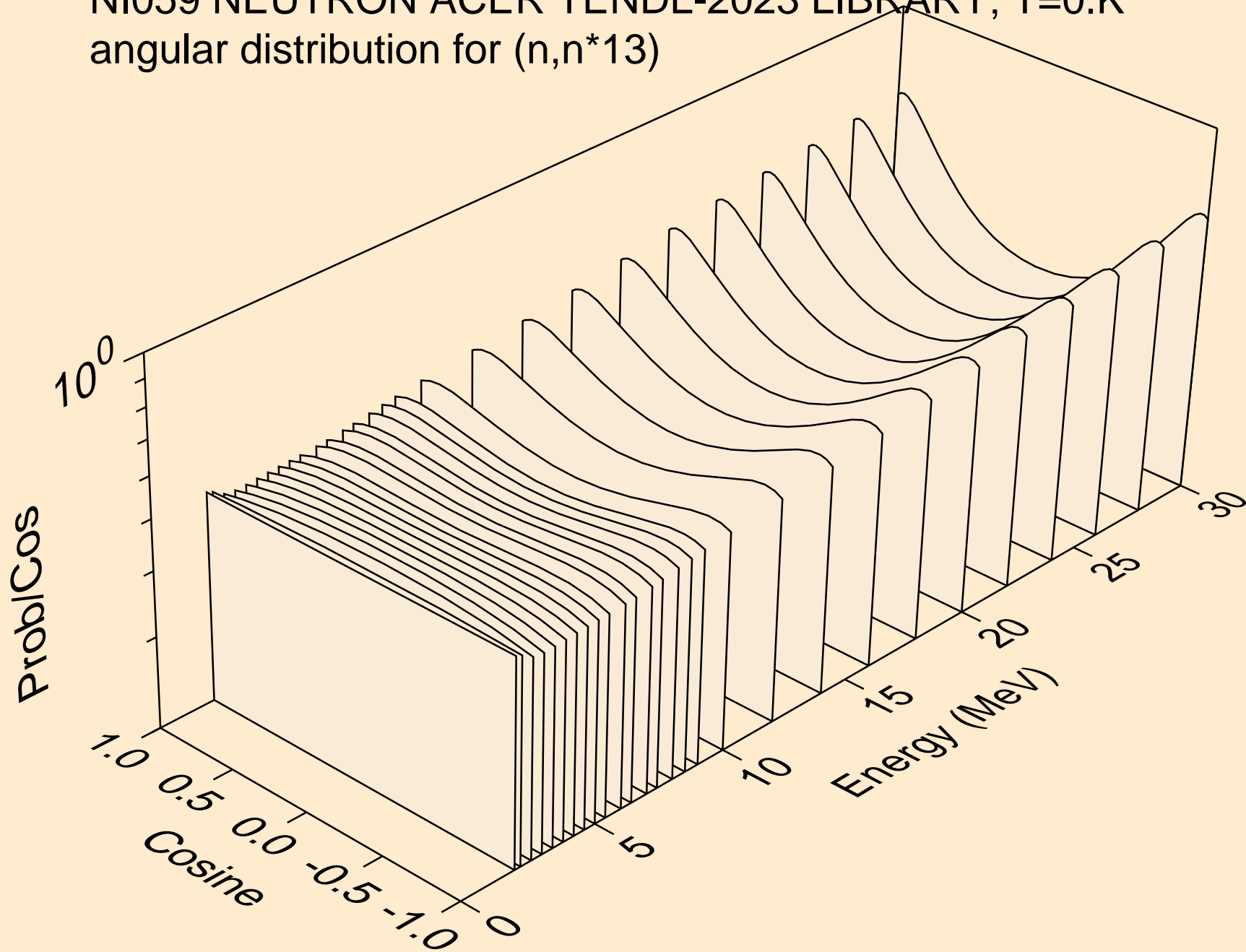

NI059 NEUTRON ACER TENDL-2023 LIBRARY; T=0.K  
angular distribution for (n,n\*14)

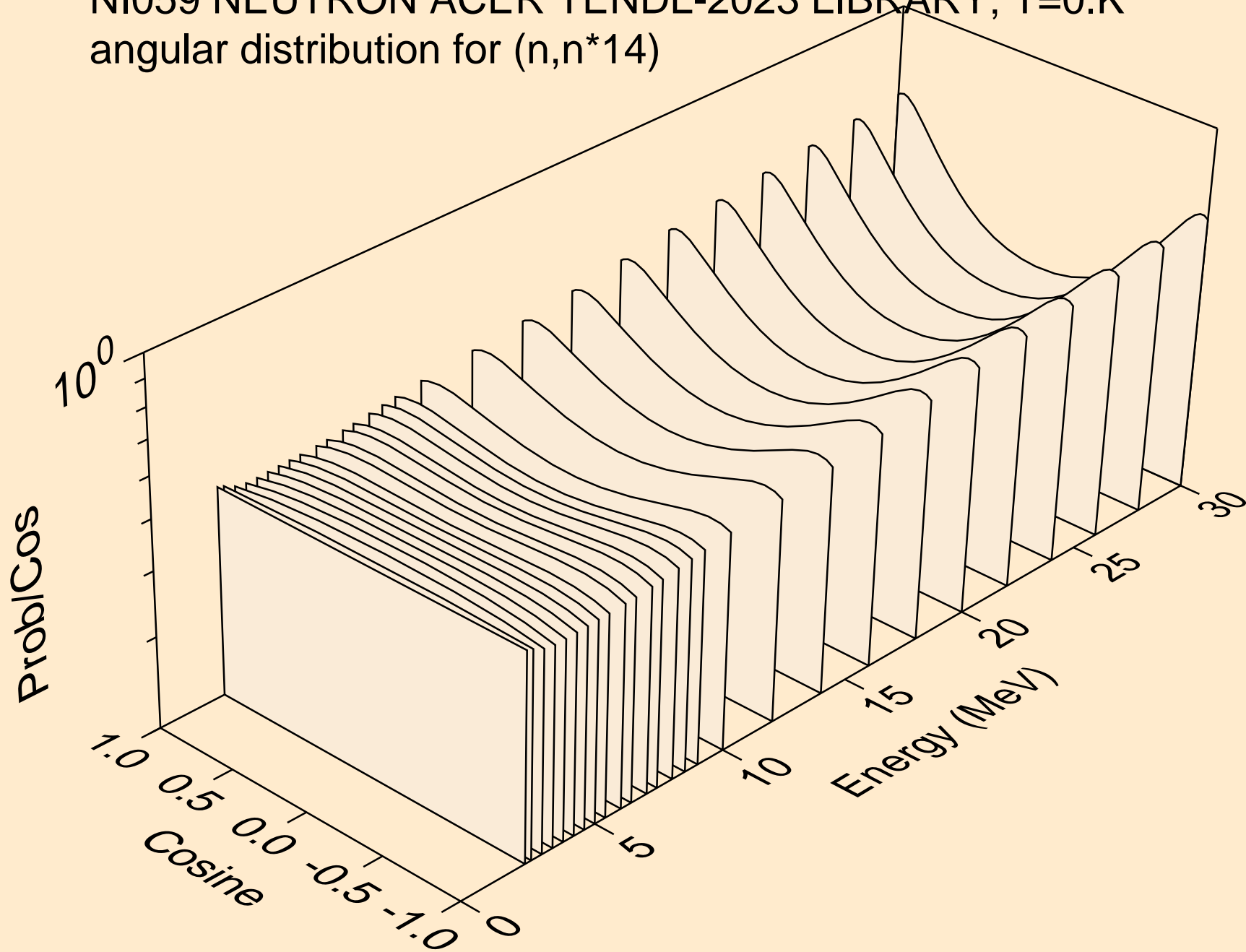

NI059 NEUTRON ACER TENDL-2023 LIBRARY; T=0.K  
angular distribution for (n,n\*15)

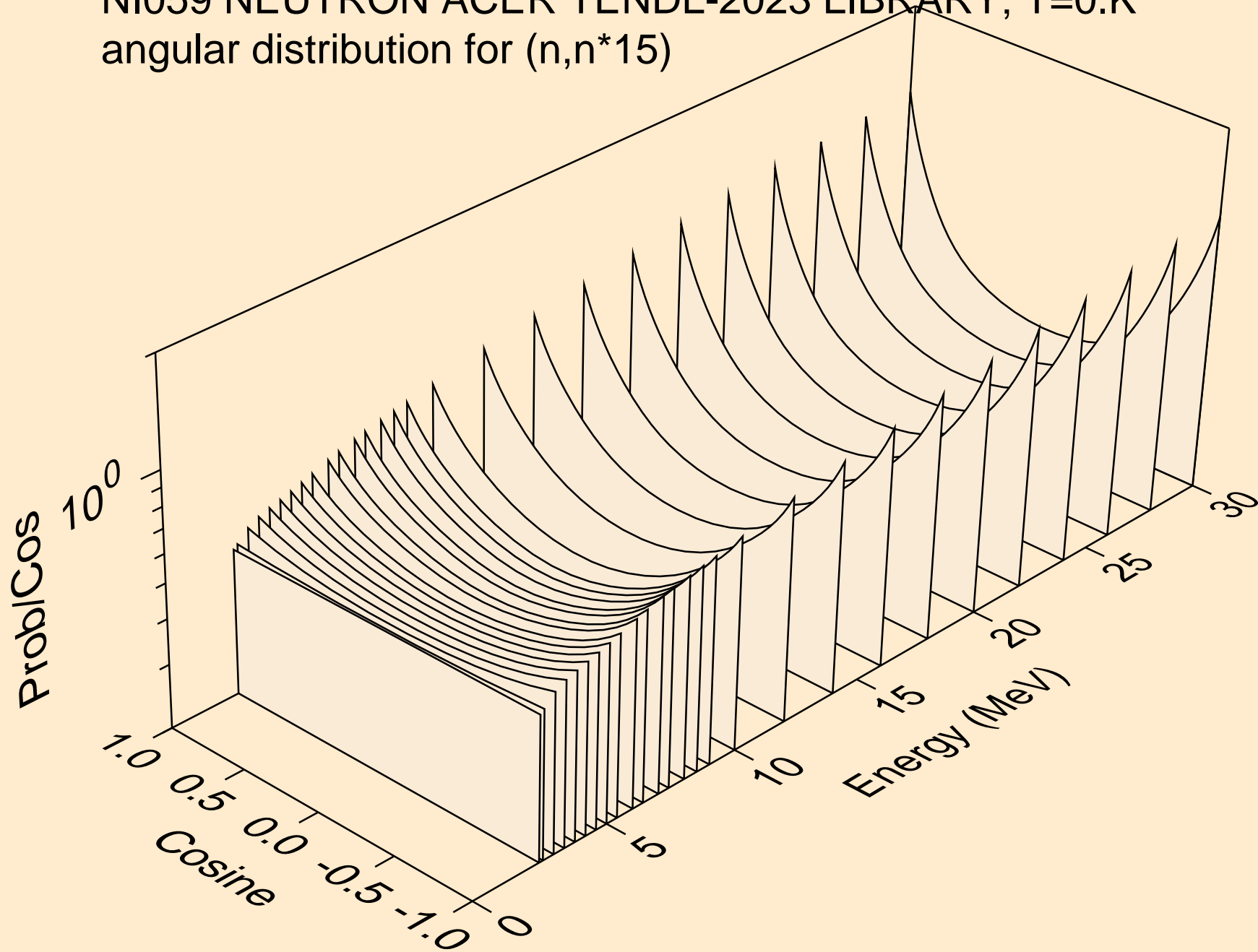

NI059 NEUTRON ACER TENDL-2023 LIBRARY; T=0.K  
angular distribution for (n,n\*16)

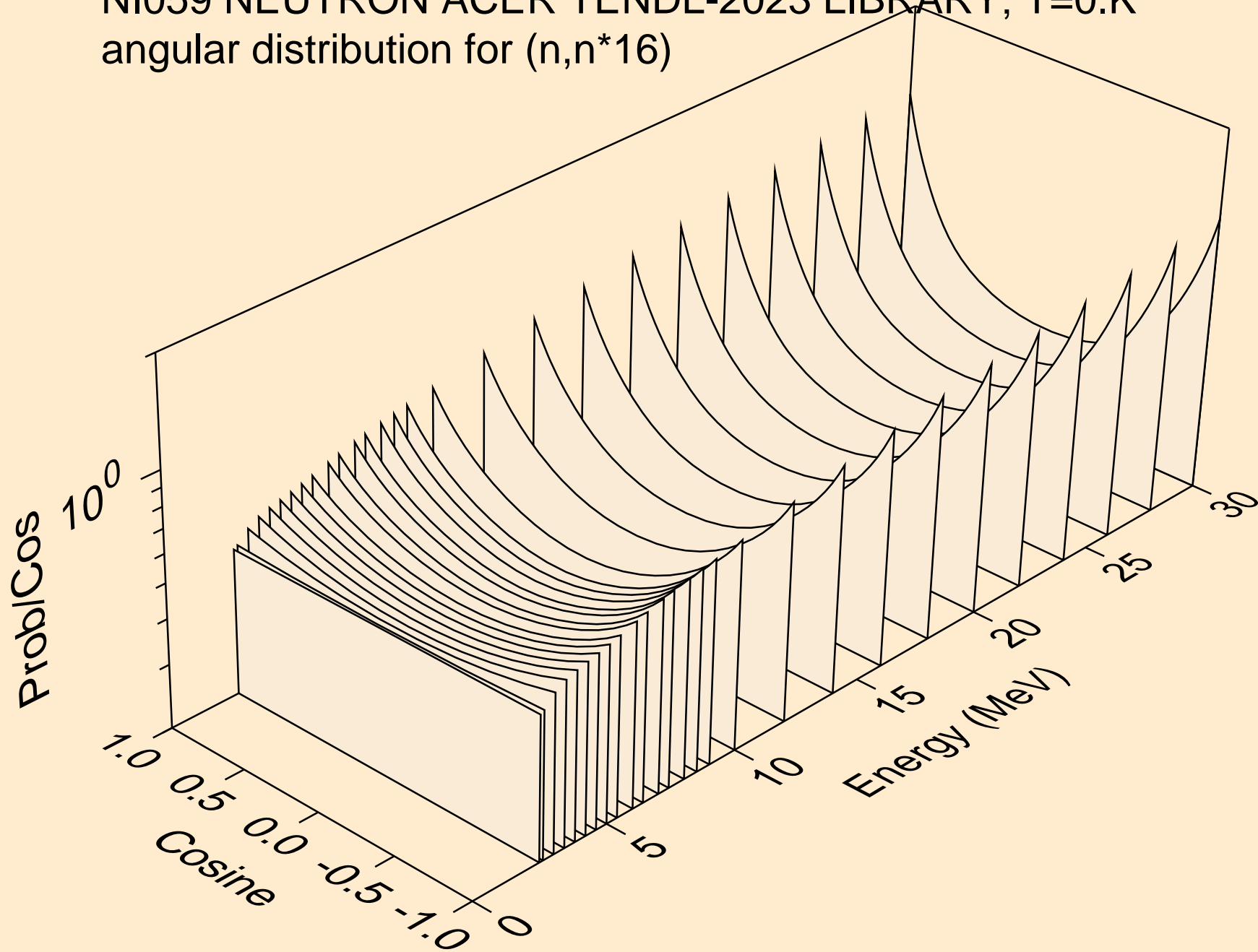

NI059 NEUTRON ACER TENDL-2023 LIBRARY; T=0.K  
angular distribution for (n,n\*17)

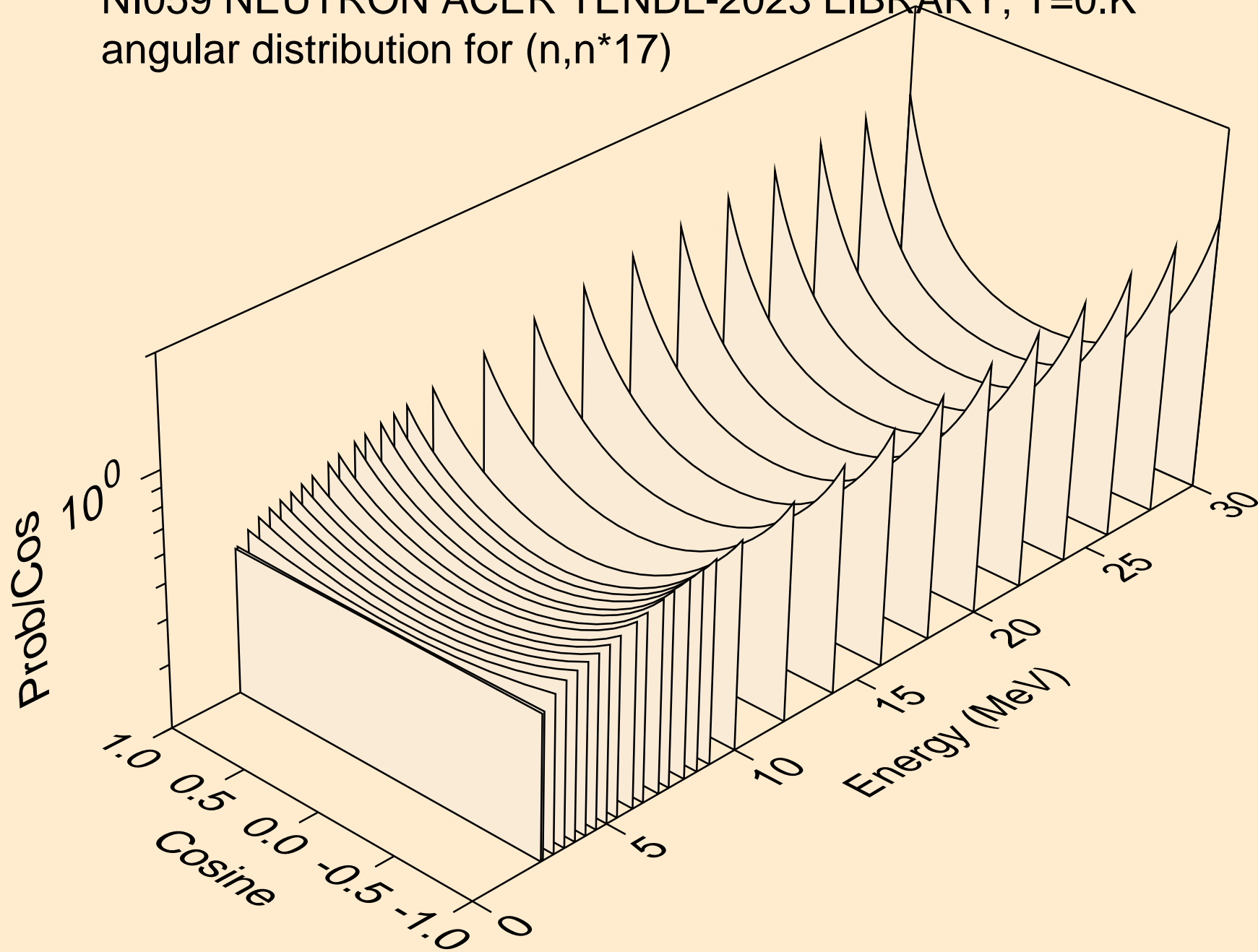

NI059 NEUTRON ACER TENDL-2023 LIBRARY; T=0.K  
angular distribution for (n,n\*18)

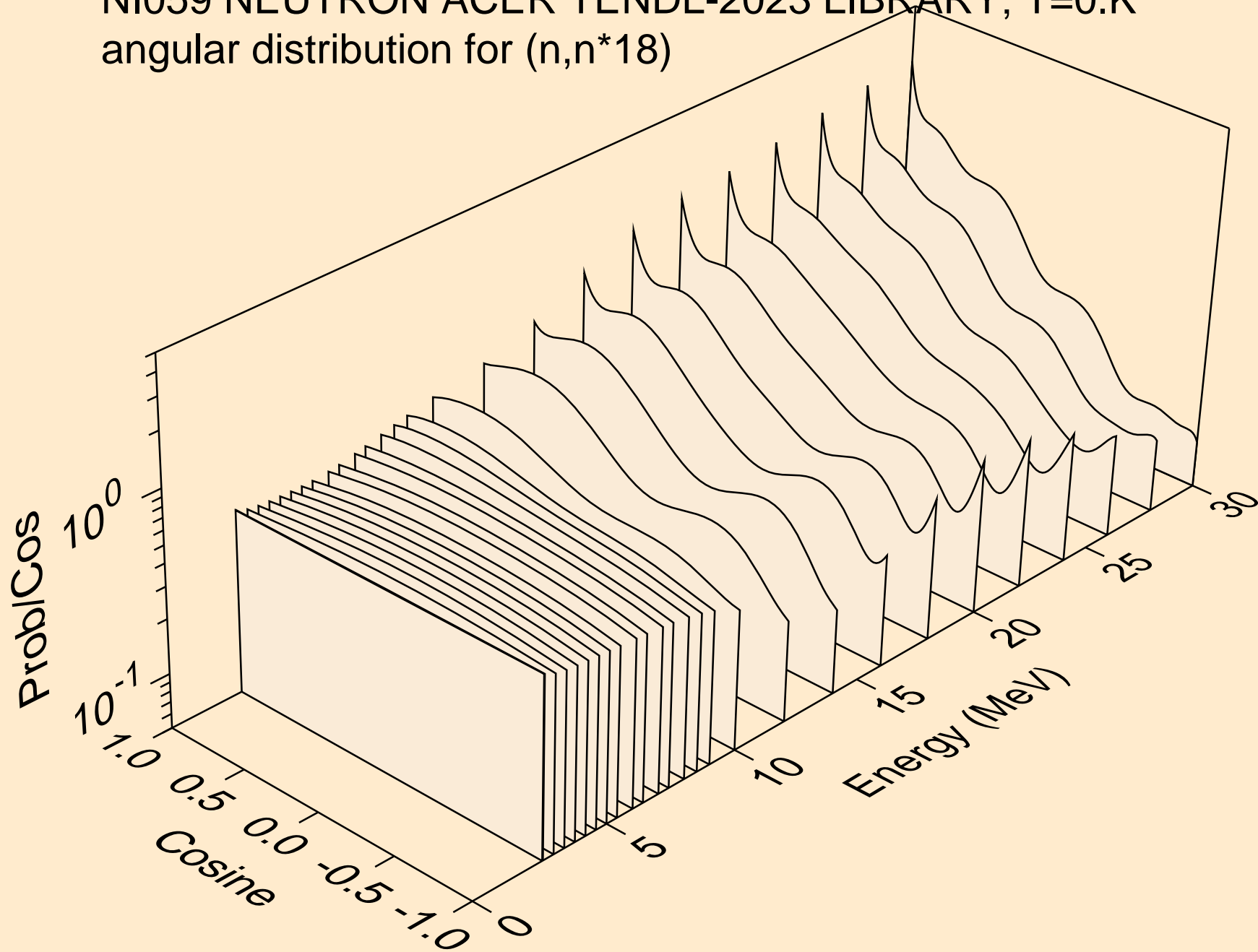

NI059 NEUTRON ACER TENDL-2023 LIBRARY; T=0.K  
angular distribution for (n,n\*19)

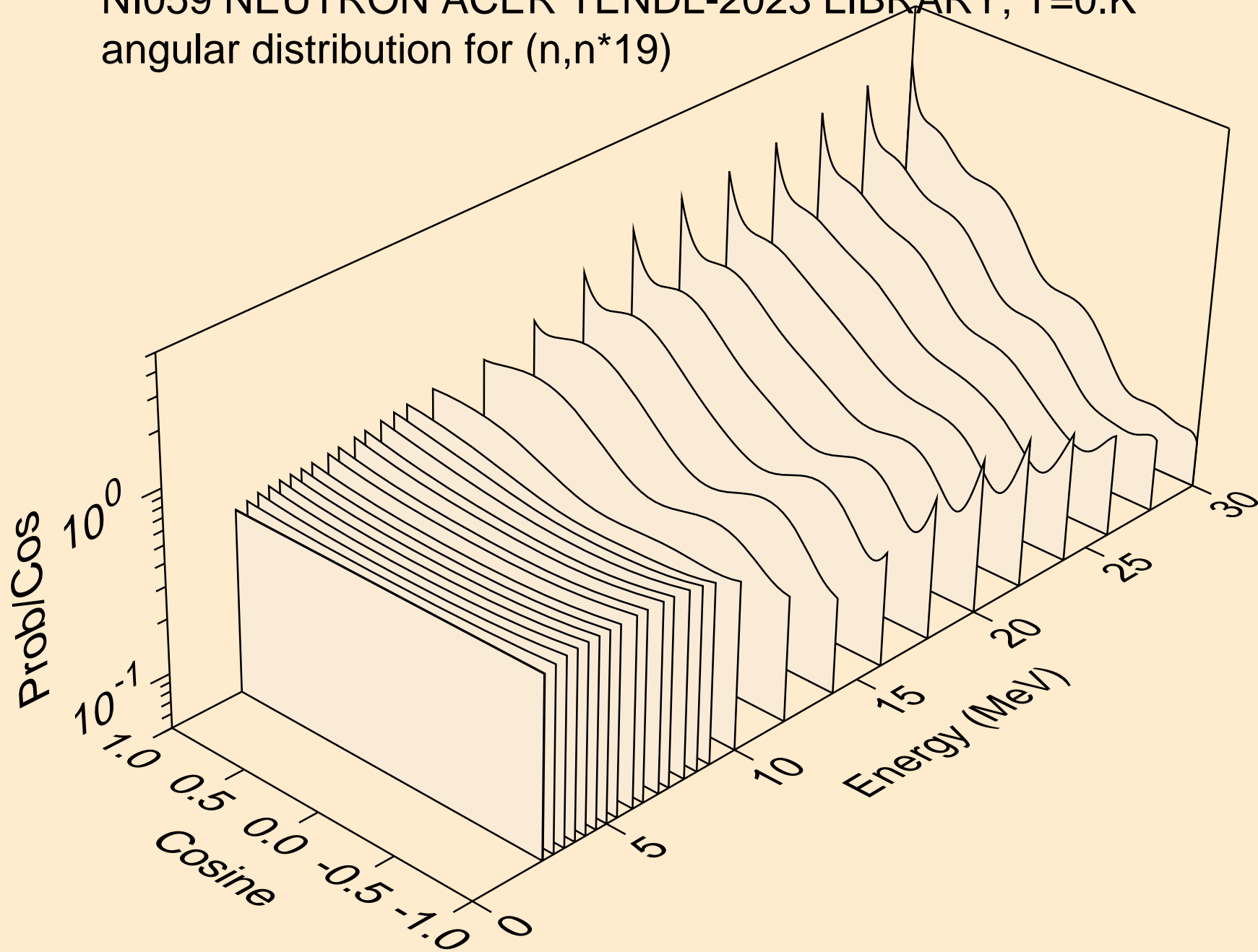



NI059 NEUTRON ACER TENDL-2023 LIBRARY; T=0.K  
angular distribution for (n,n\*20)

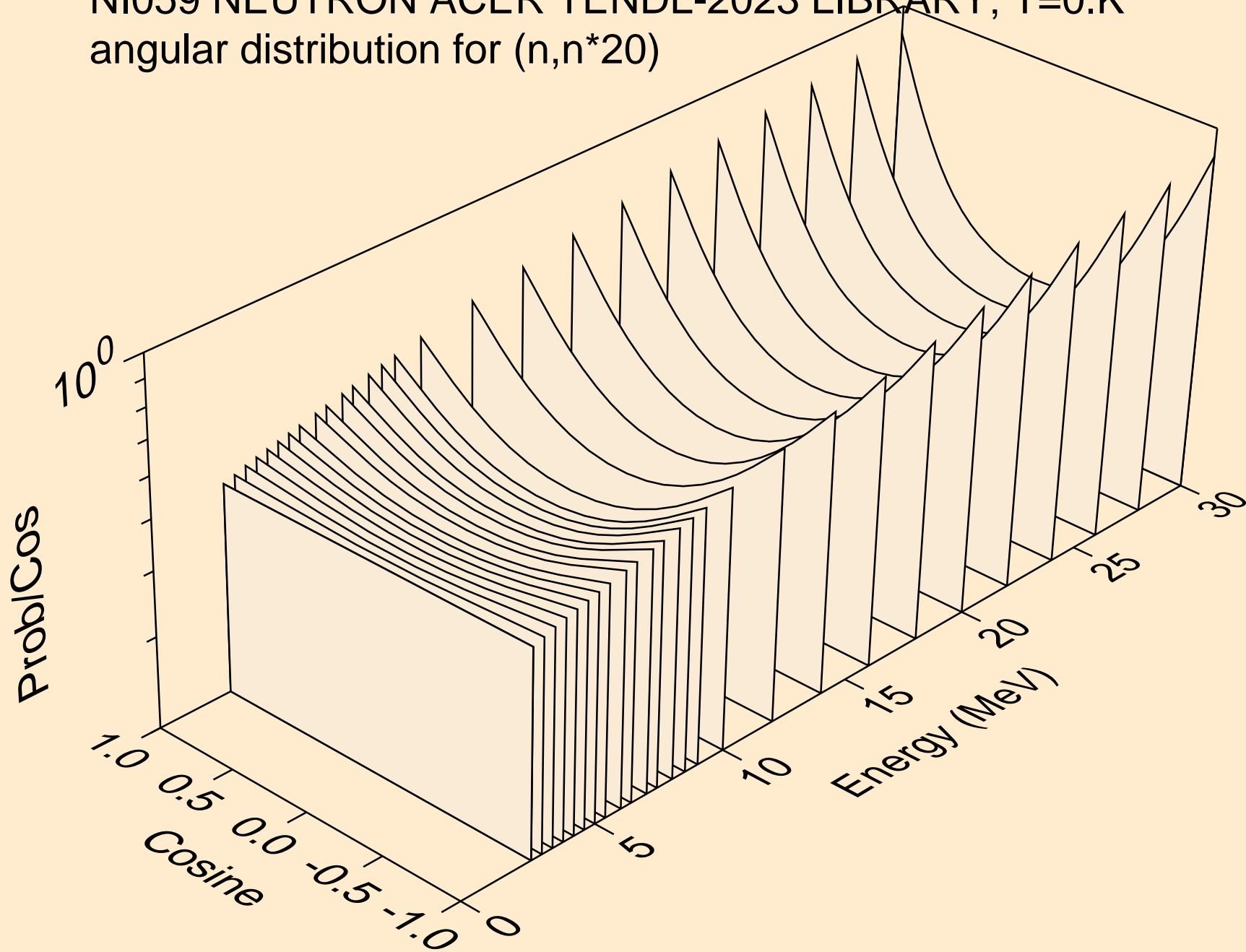

NI059 NEUTRON ACER TENDL-2023 LIBRARY; T=0.K  
angular distribution for (n,n\*21)

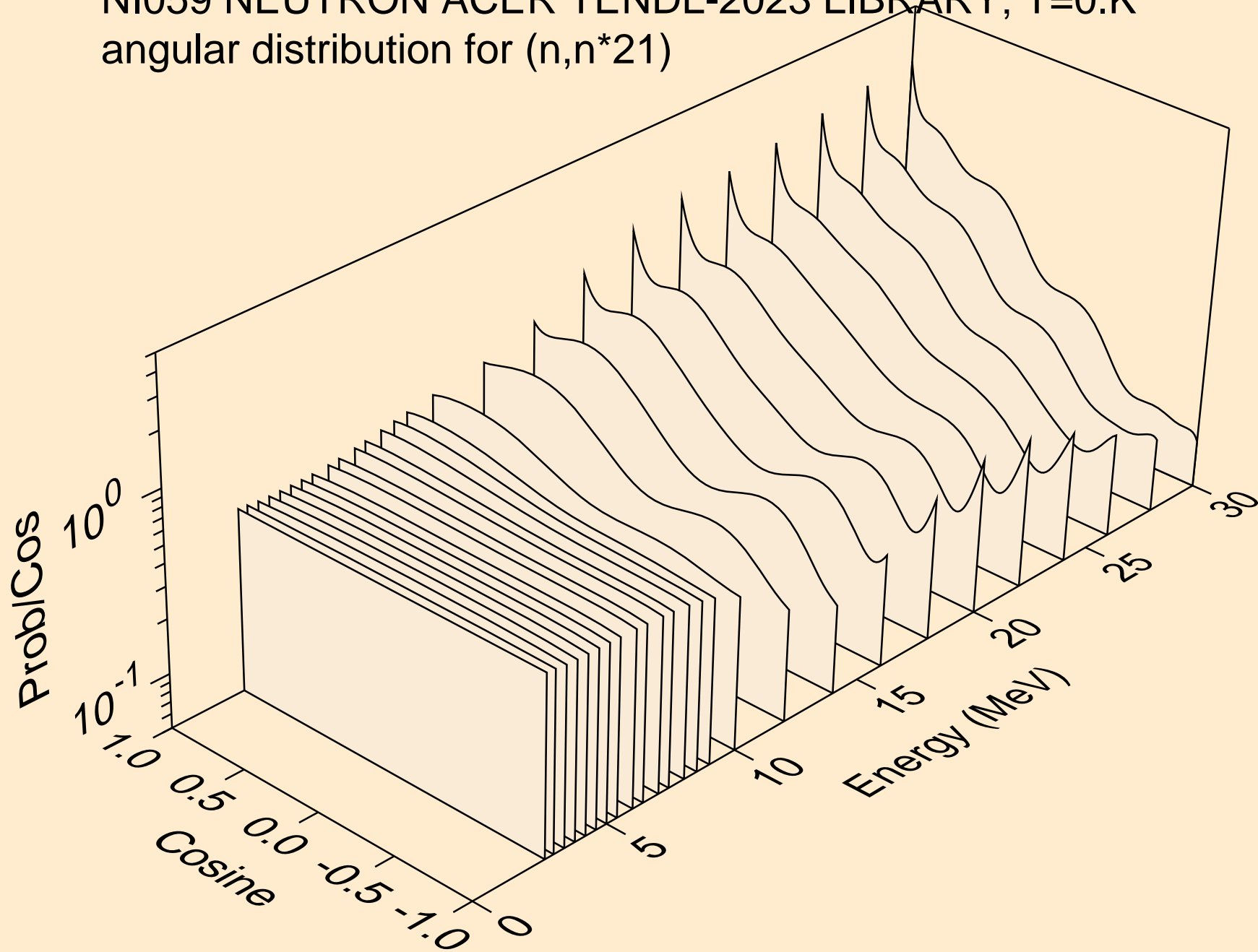

NI059 NEUTRON ACER TENDL-2023 LIBRARY; T=0.K  
angular distribution for (n,n\*22)

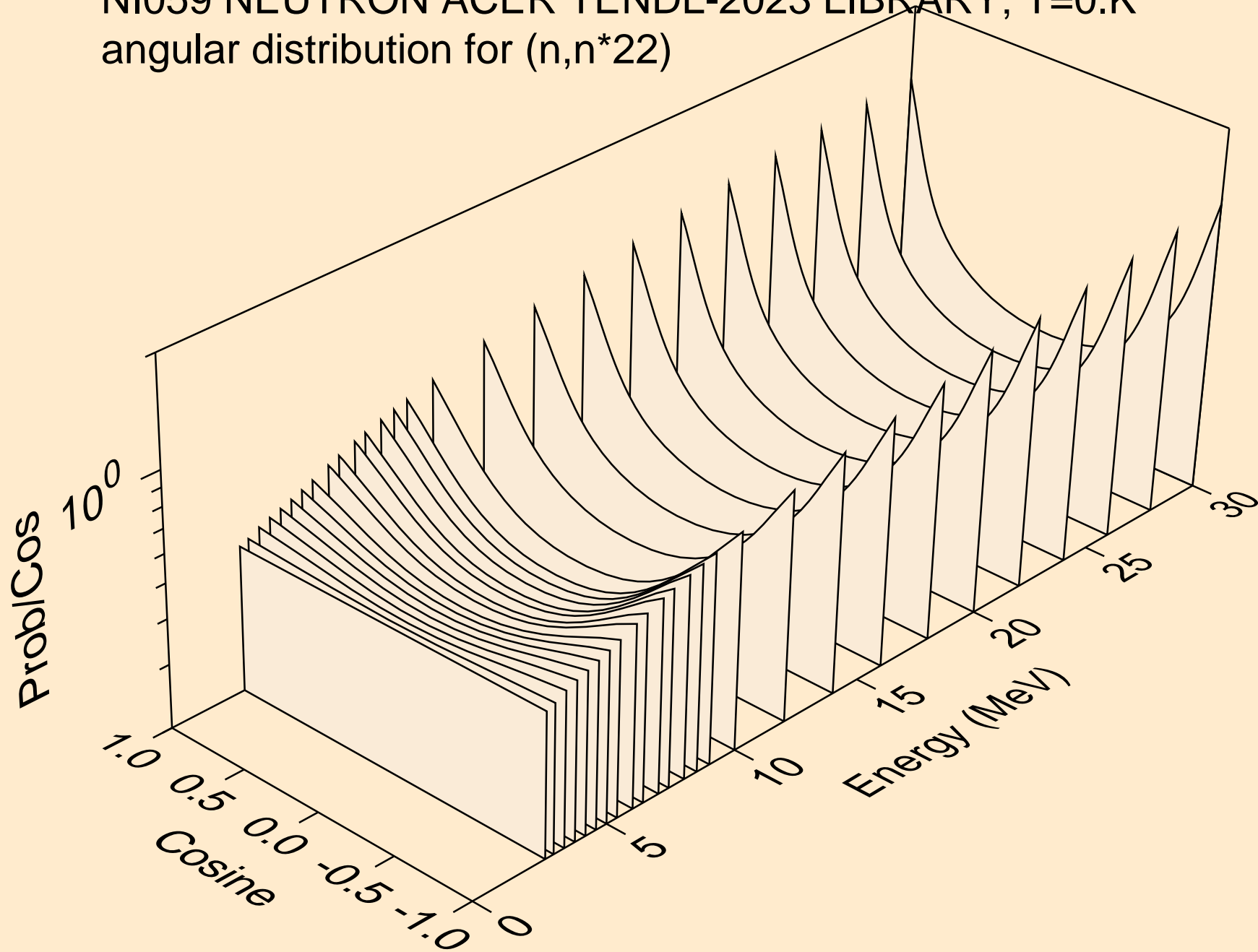

NI059 NEUTRON ACER TENDL-2023 LIBRARY; T=0.K  
angular distribution for (n,n\*23)

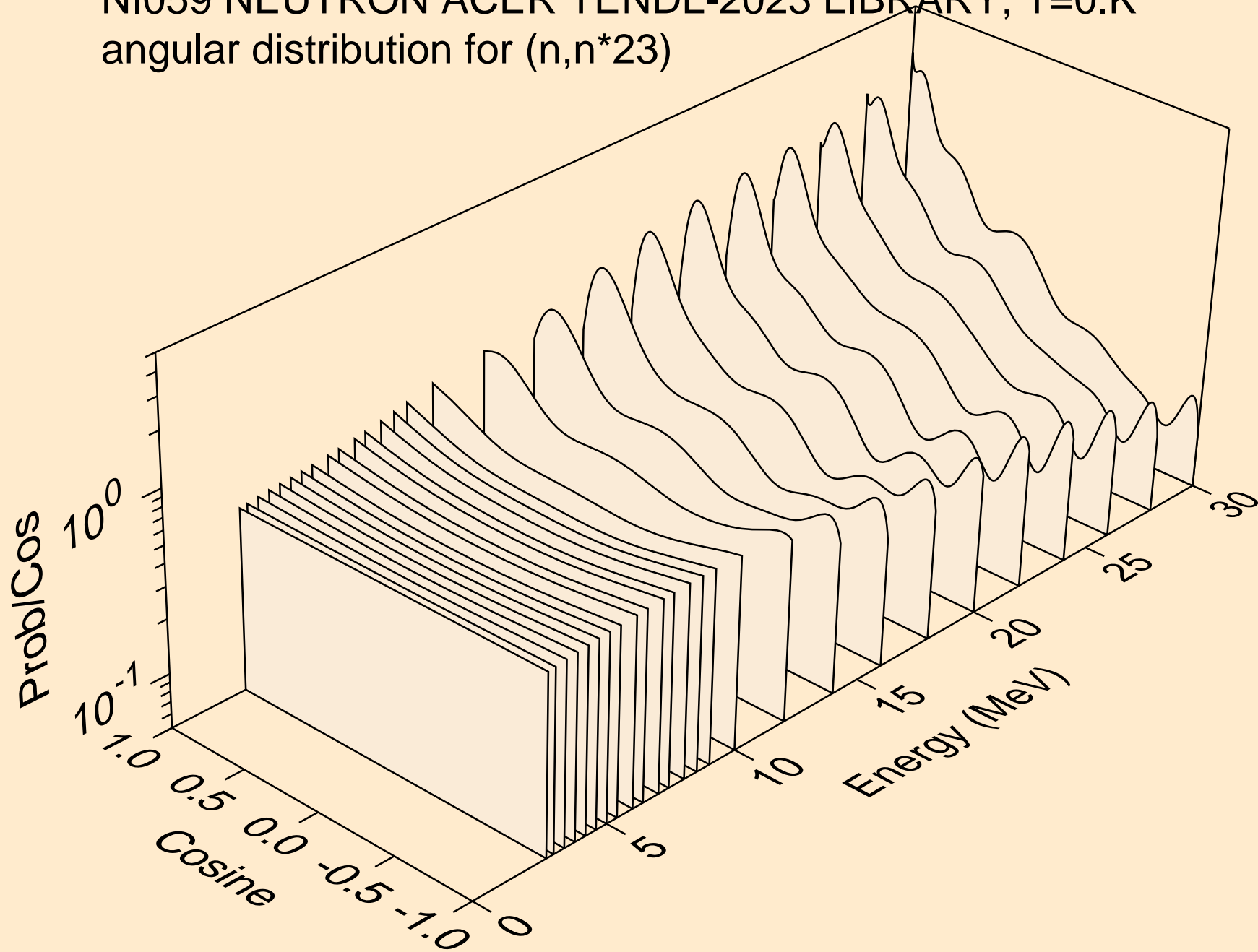

NI059 NEUTRON ACER TENDL-2023 LIBRARY; T=0.K  
Neutron emission for (n,x)

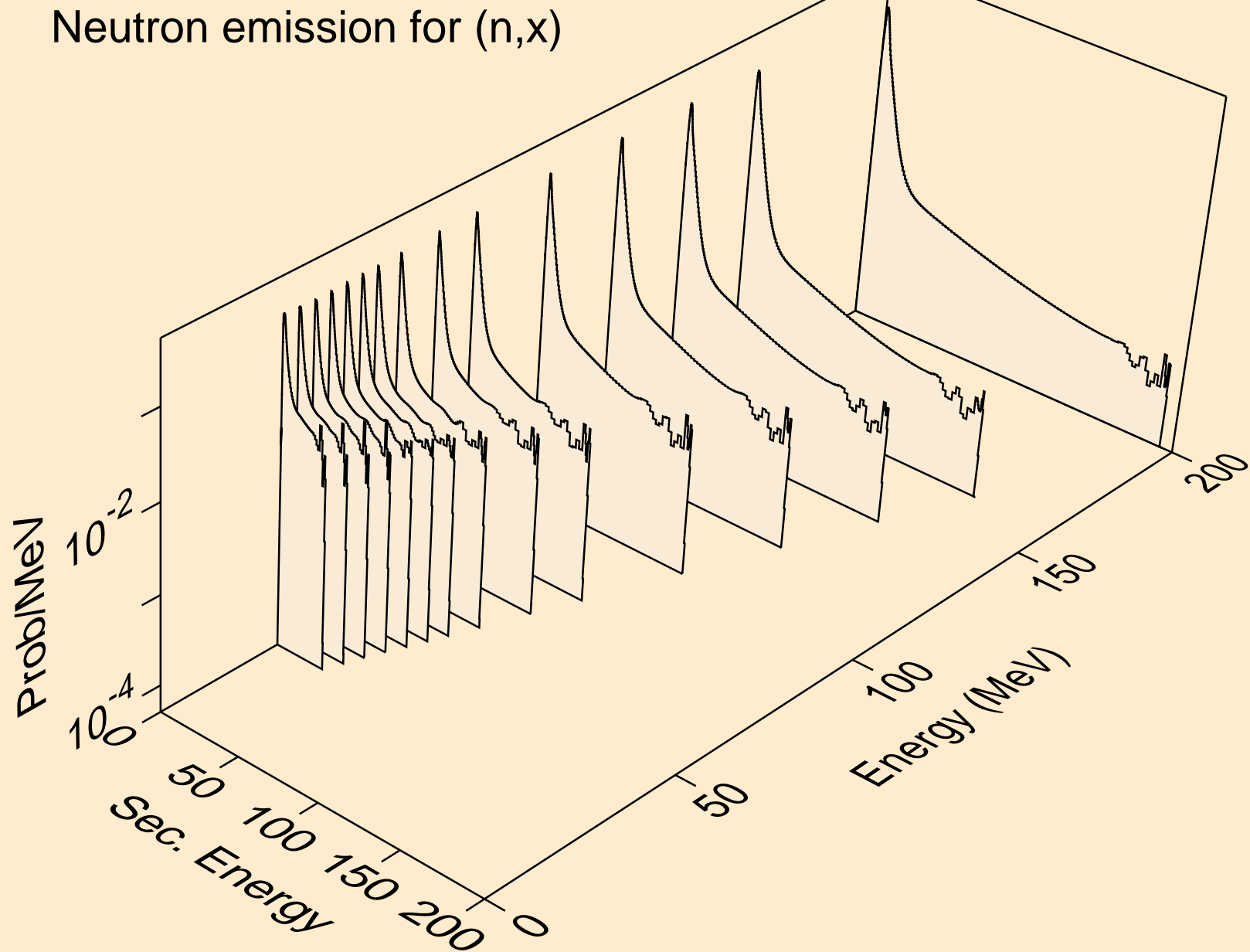

NI059 NEUTRON ACER TENDL-2023 LIBRARY; T=0.K  
Neutron emission for (n,2nd)

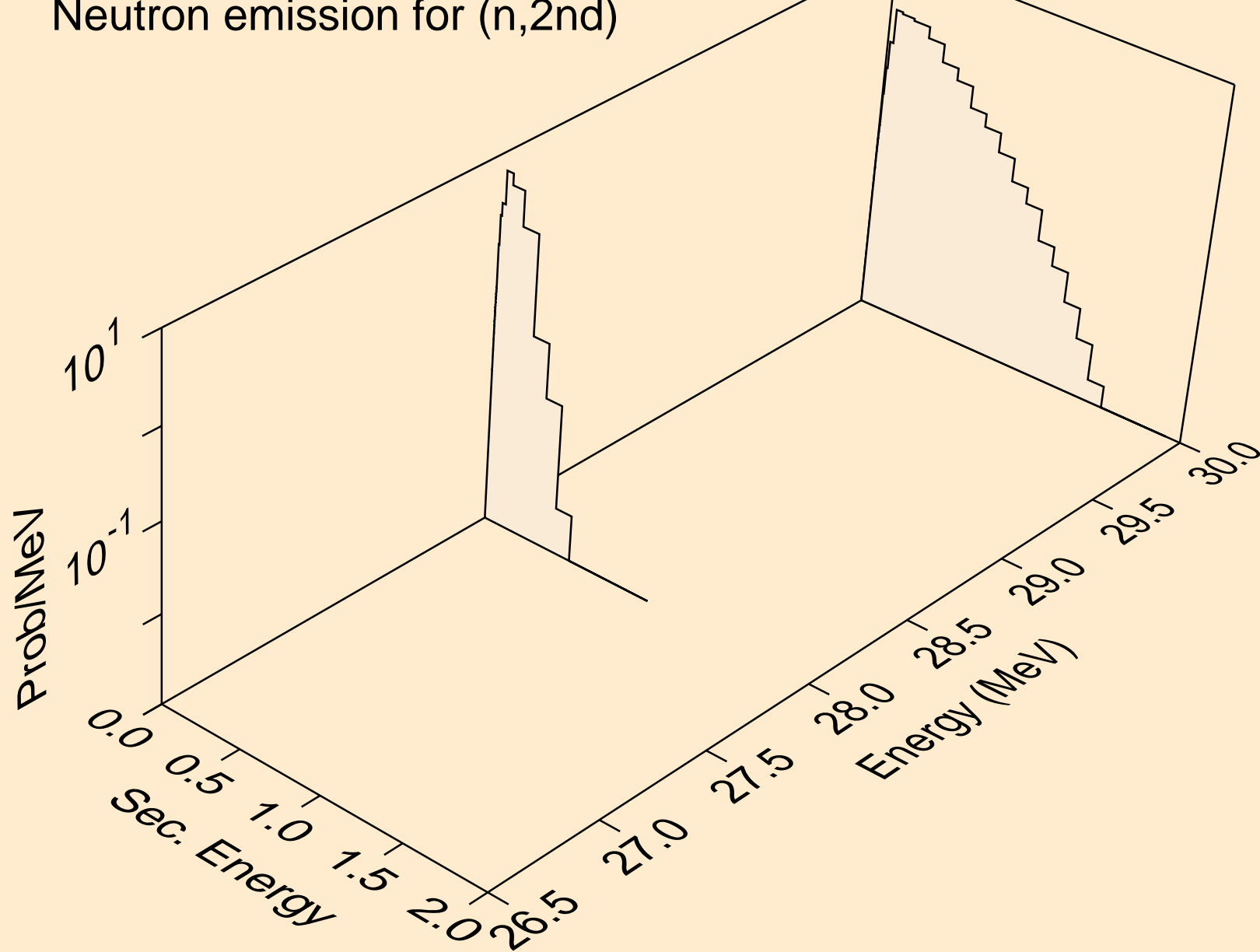

NI059 NEUTRON ACER TENDL-2023 LIBRARY; T=0.K  
Neutron emission for (n,2n)

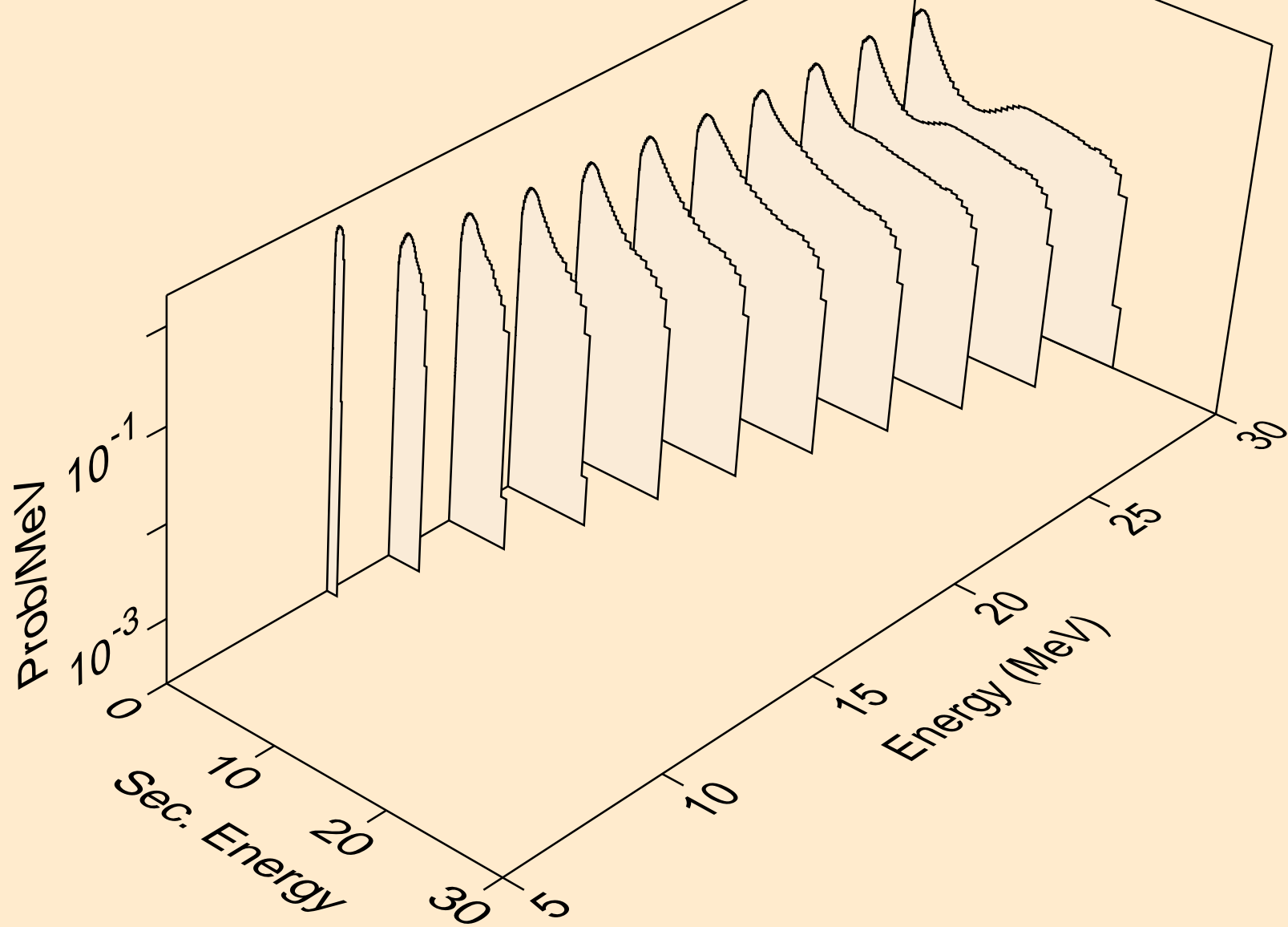

NI059 NEUTRON ACER TENDL-2023 LIBRARY; T=0.K  
Neutron emission for (n,3n)

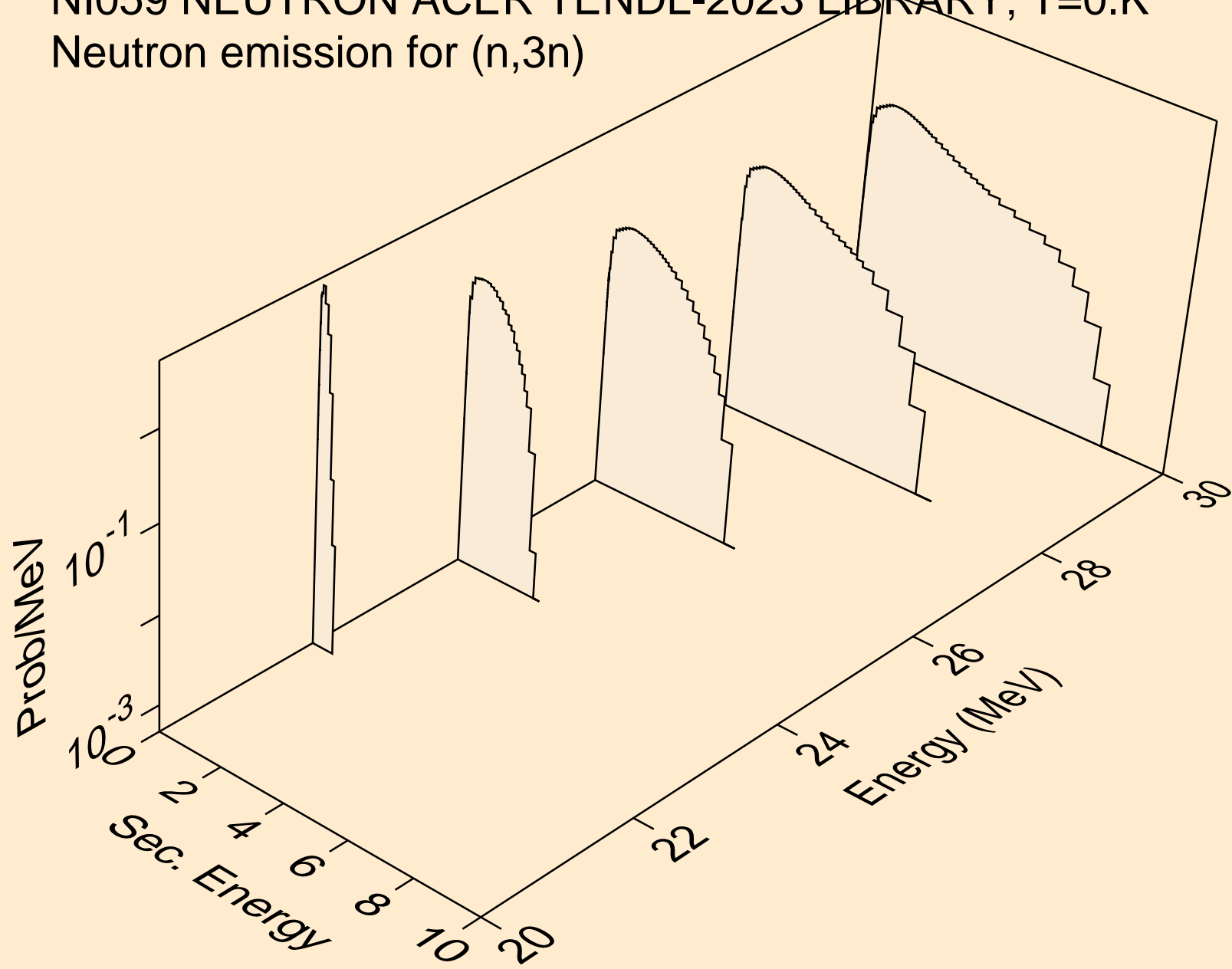



NI059 NEUTRON ACER TENDL-2023 LIBRARY; T=0.K  
Neutron emission for (n,n\*)a

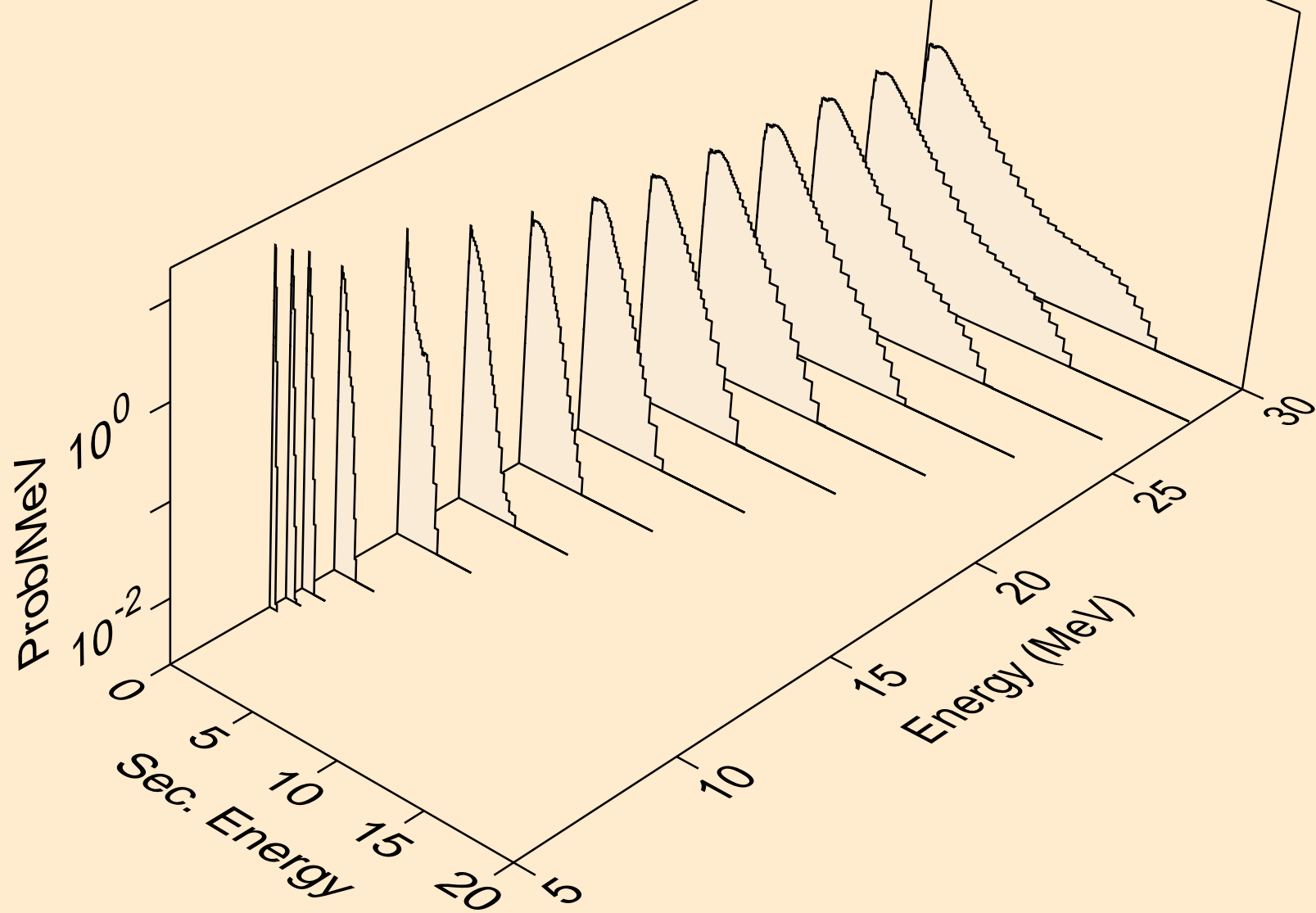

NI059 NEUTRON ACER TENDL-2023 LIBRARY; T=0.K  
Neutron emission for (n,2n)a

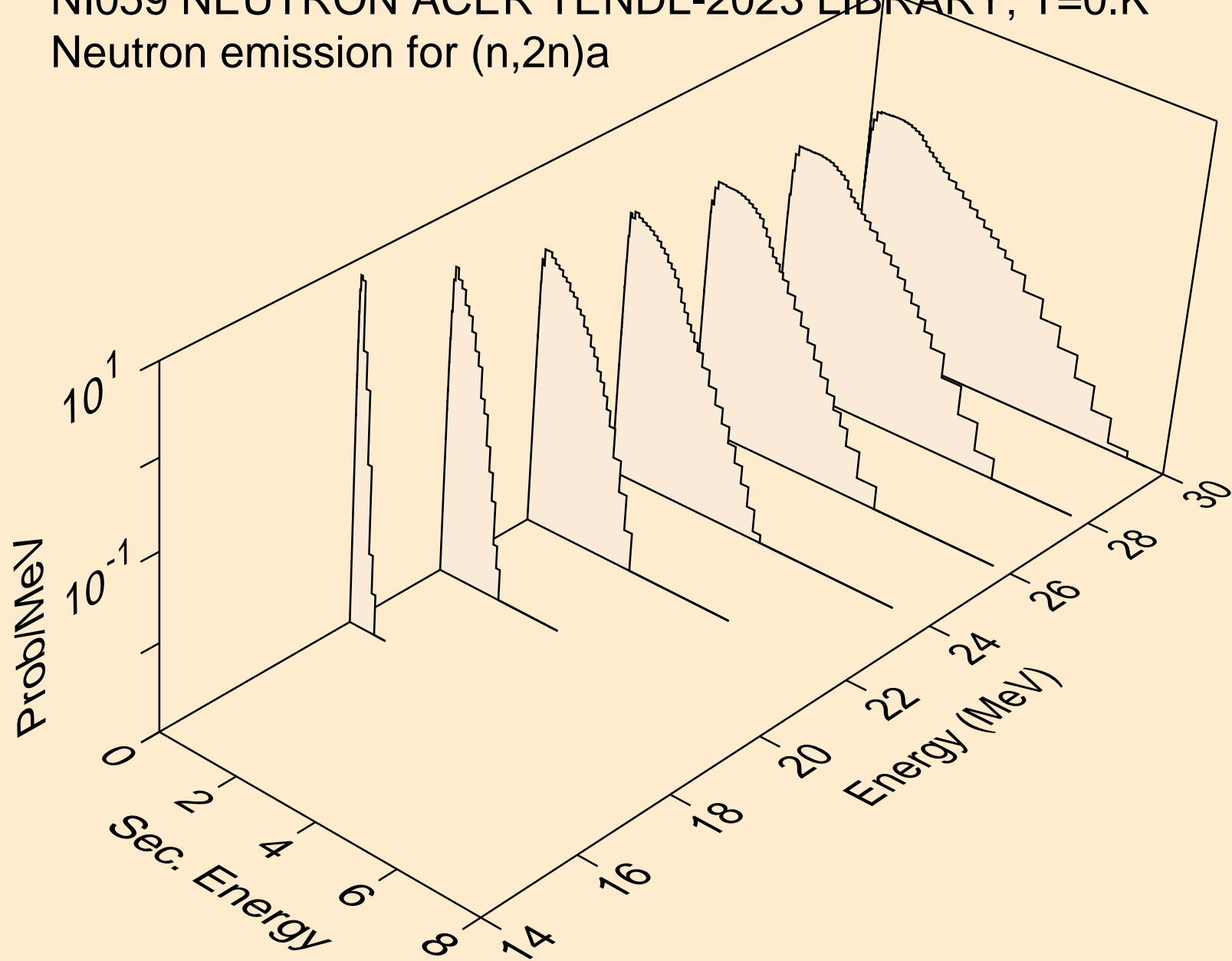

NI059 NEUTRON ACER TENDL-2023 LIBRARY; T=0.K  
Neutron emission for (n,n\*)p

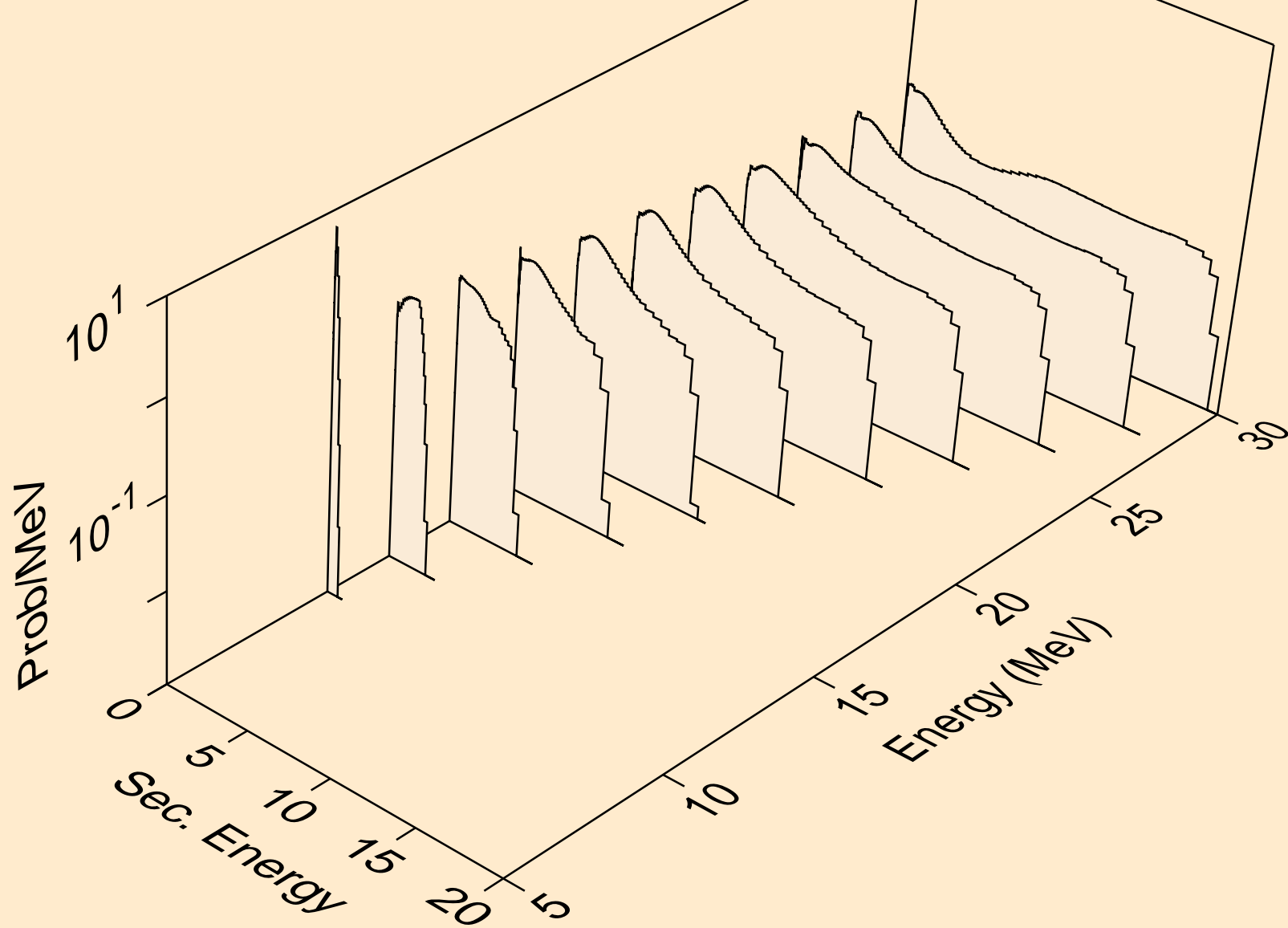

NI059 NEUTRON ACER TENDL-2023 LIBRARY; T=0.K  
Neutron emission for (n,n\*)2a

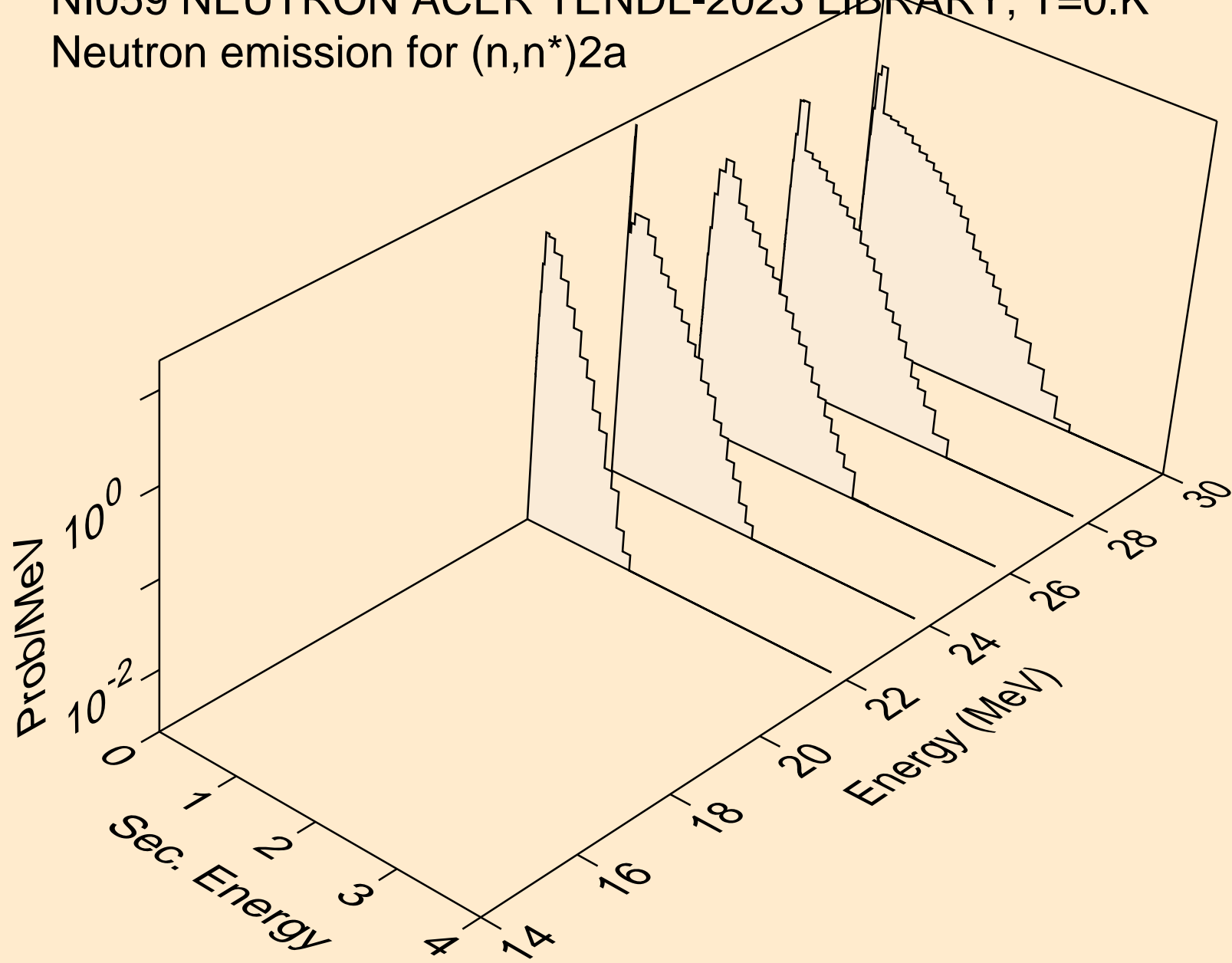

NI059 NEUTRON ACER TENDL-2023 LIBRARY; T=0.K  
Neutron emission for (n,n\*)d

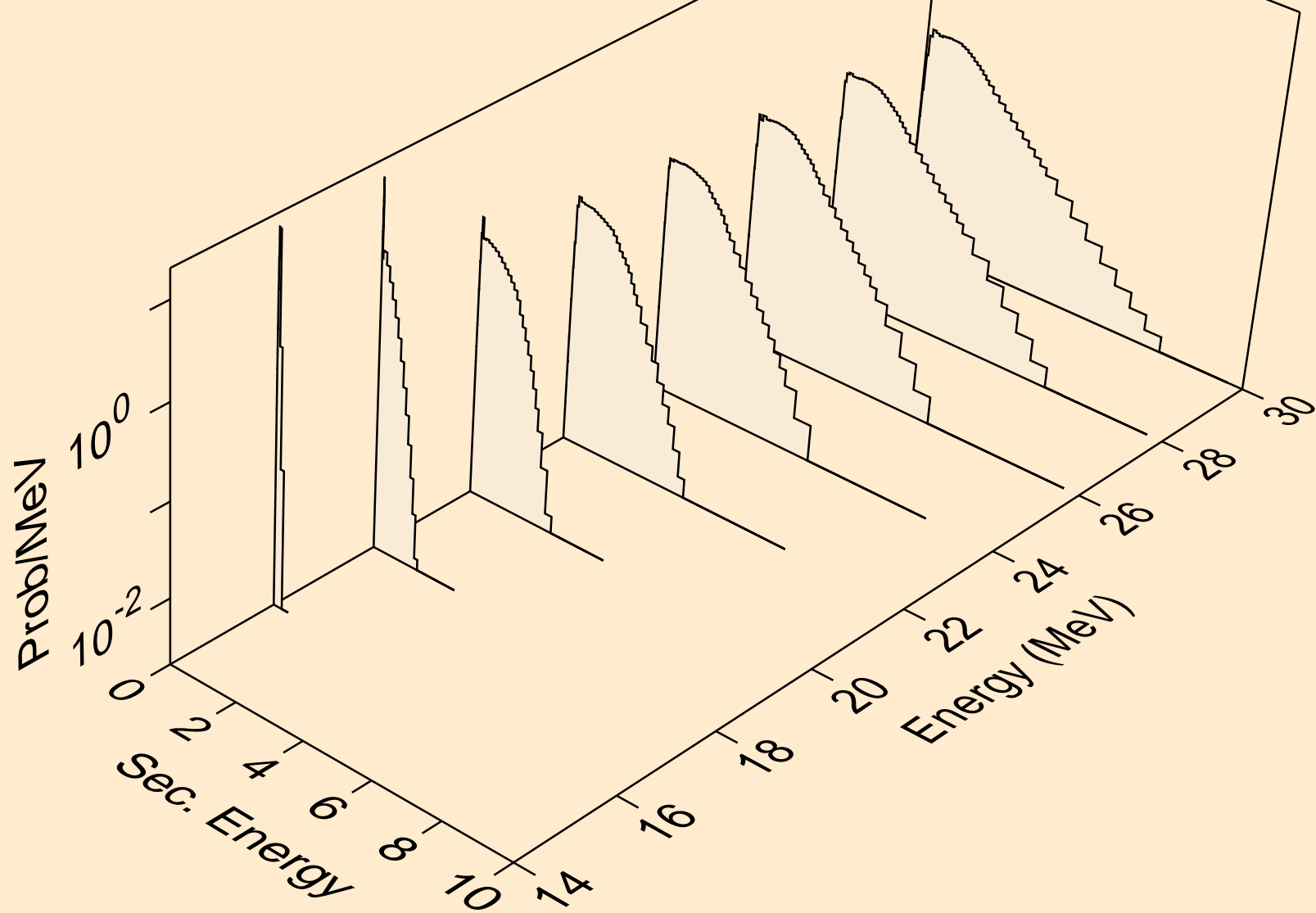

NI059 NEUTRON ACER TENDL-2023 LIBRARY; T=0.K  
Neutron emission for (n,n\*)t

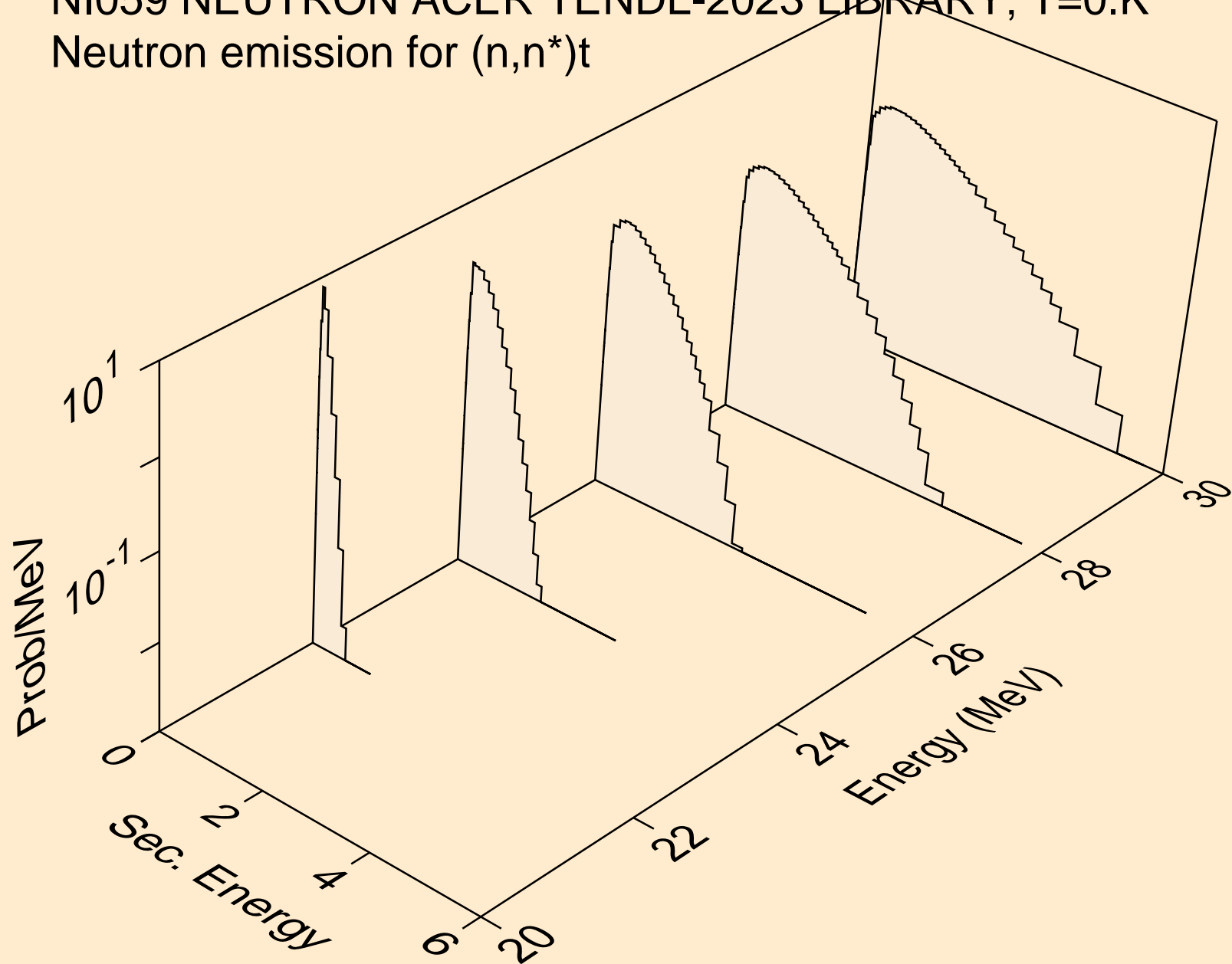

NI059 NEUTRON ACER TENDL-2023 LIBRARY; T=0.K  
Neutron emission for (n,n\*)he3

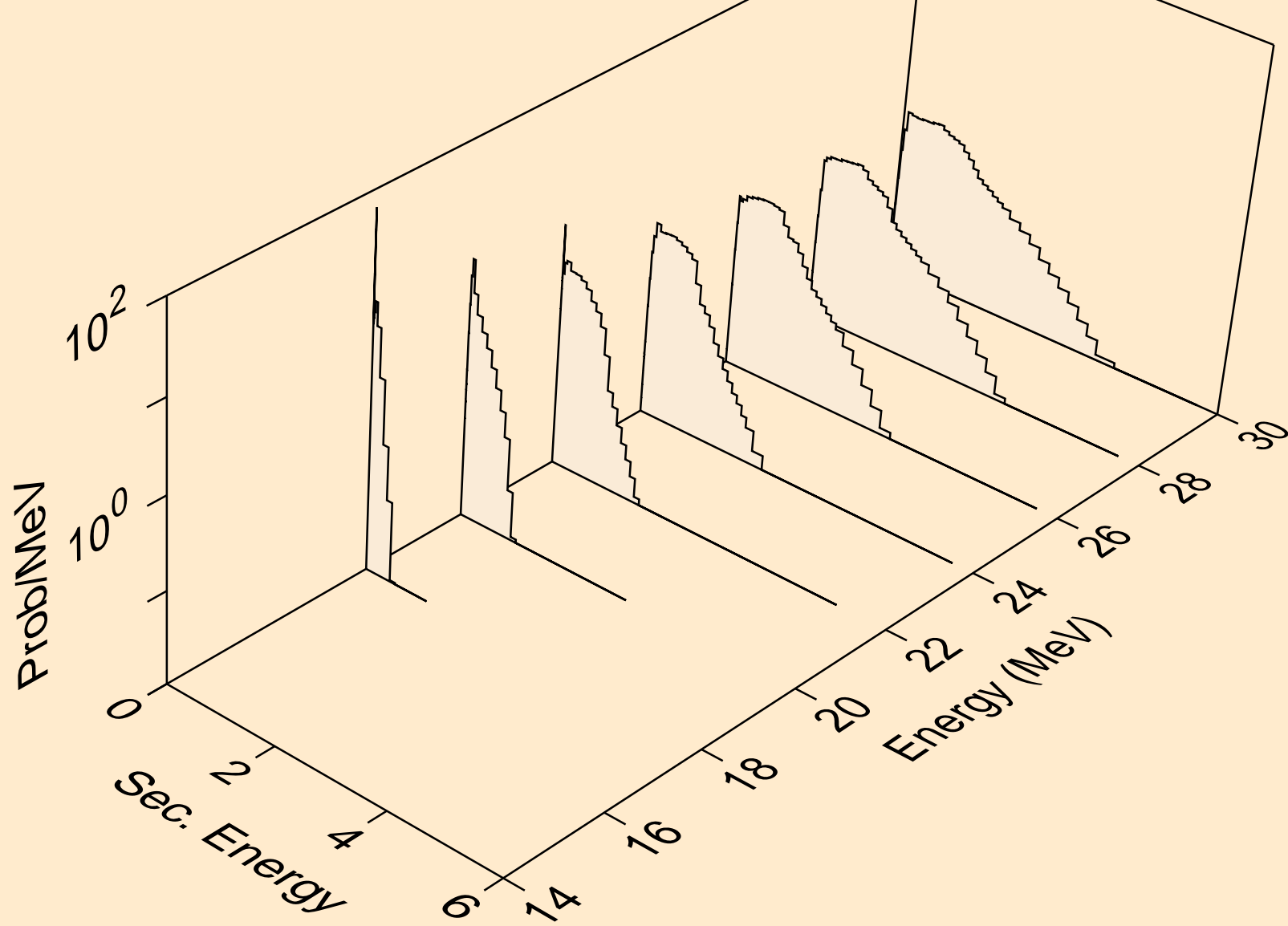

NI059 NEUTRON ACER TENDL-2023 LIBRARY; T=0.K  
Neutron emission for (n,2np)

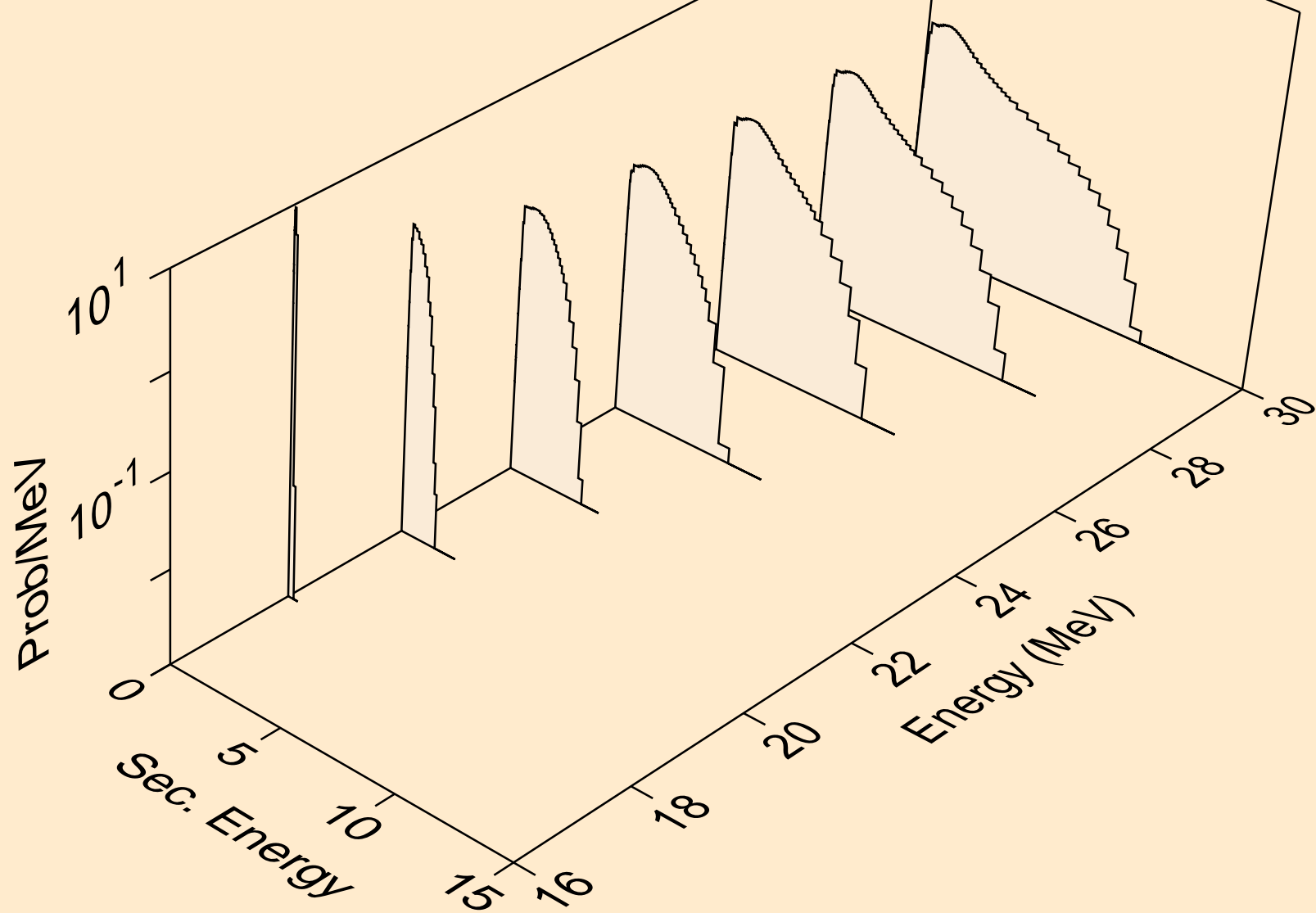



NI059 NEUTRON ACER TENDL-2023 LIBRARY; T=0.K  
Neutron emission for (n,n2p)

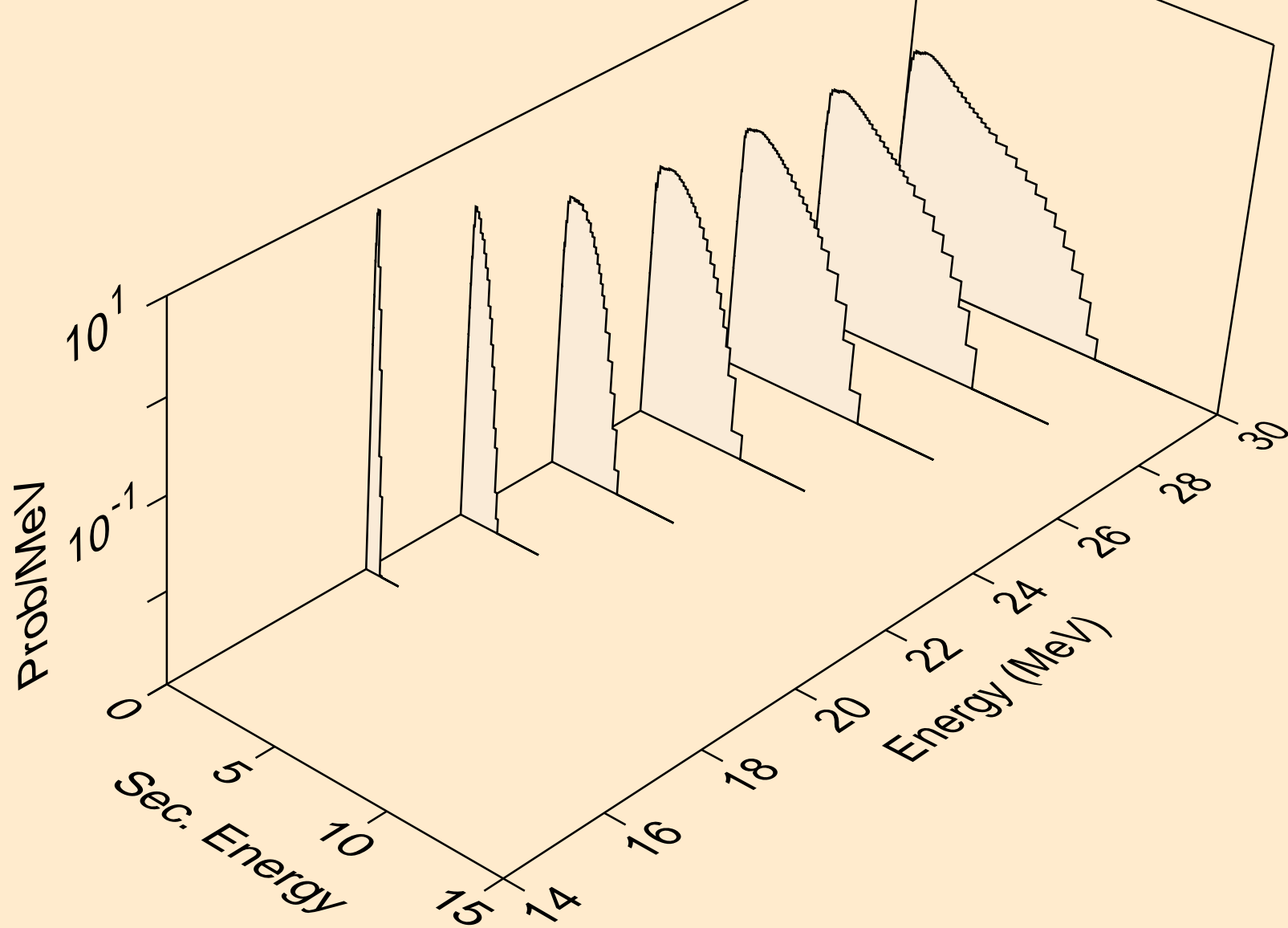

NI059 NEUTRON ACER TENDL-2023 LIBRARY; T=0.K  
Neutron emission for (n,npa)

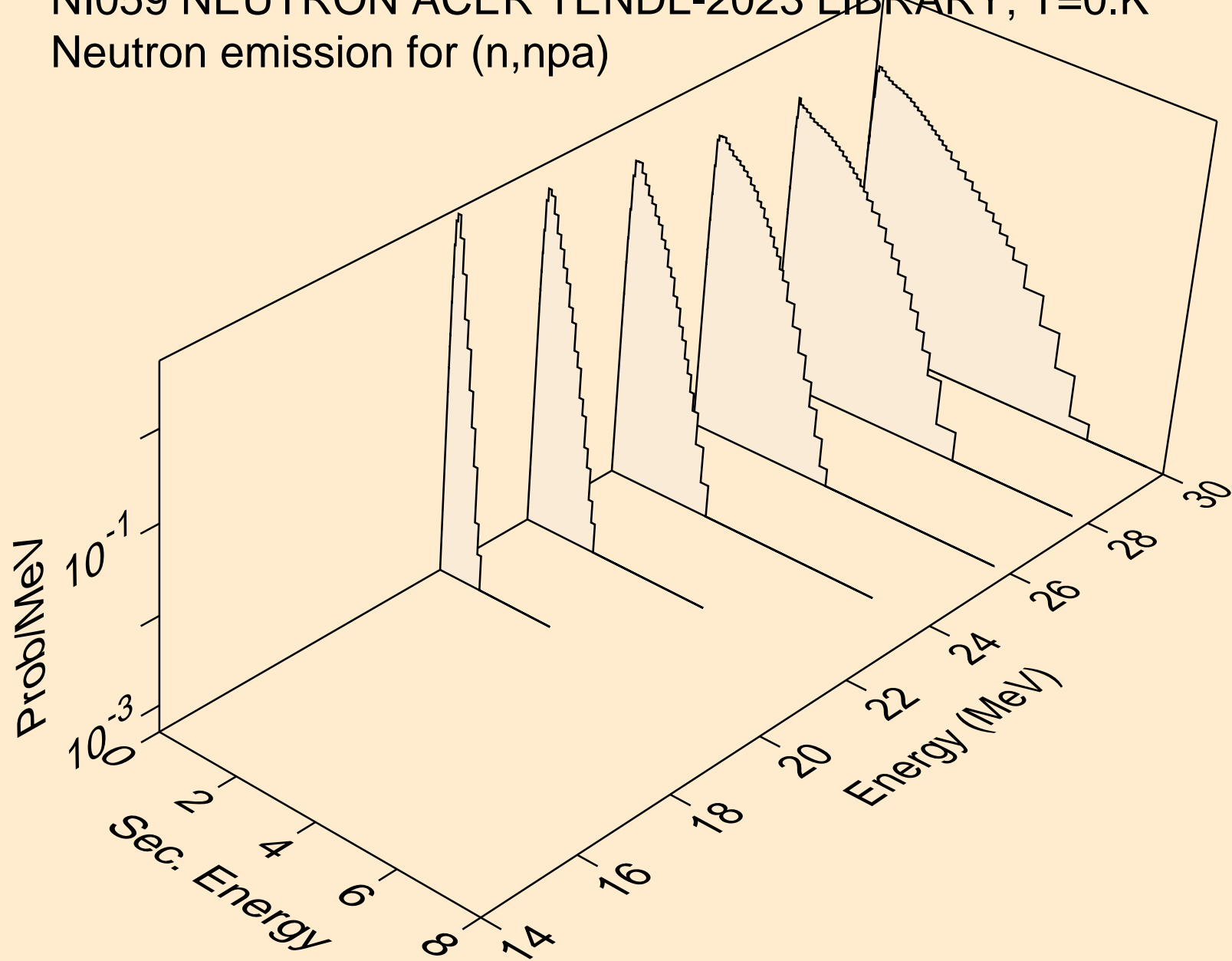

NI059 NEUTRON ACER TENDL-2023 LIBRARY; T=0.K  
Neutron emission for (n,n\*c)

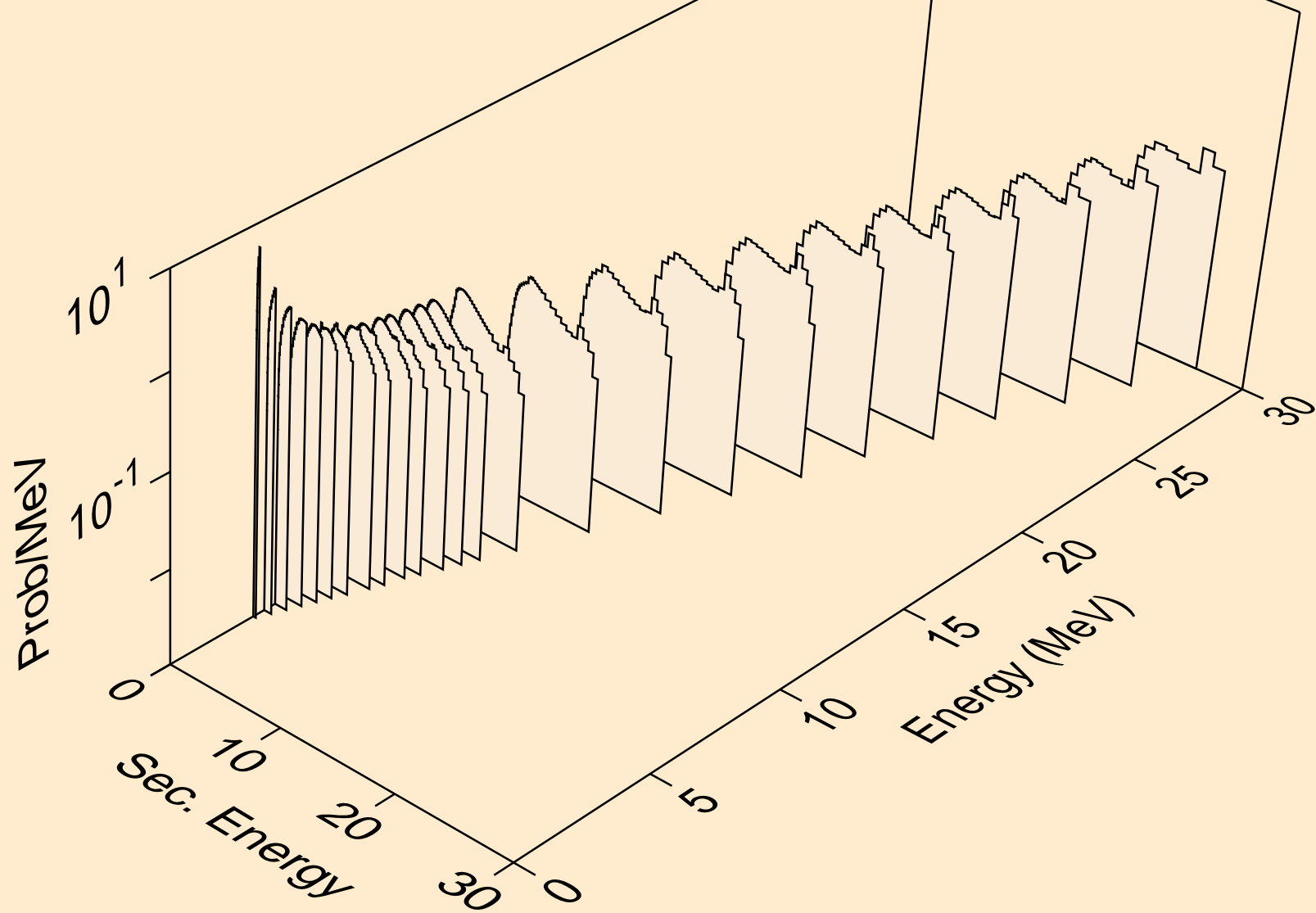

NI059 NEUTRON ACER TENDL-2023 LIBRARY; T=0.K  
Photon emission for (n,x)

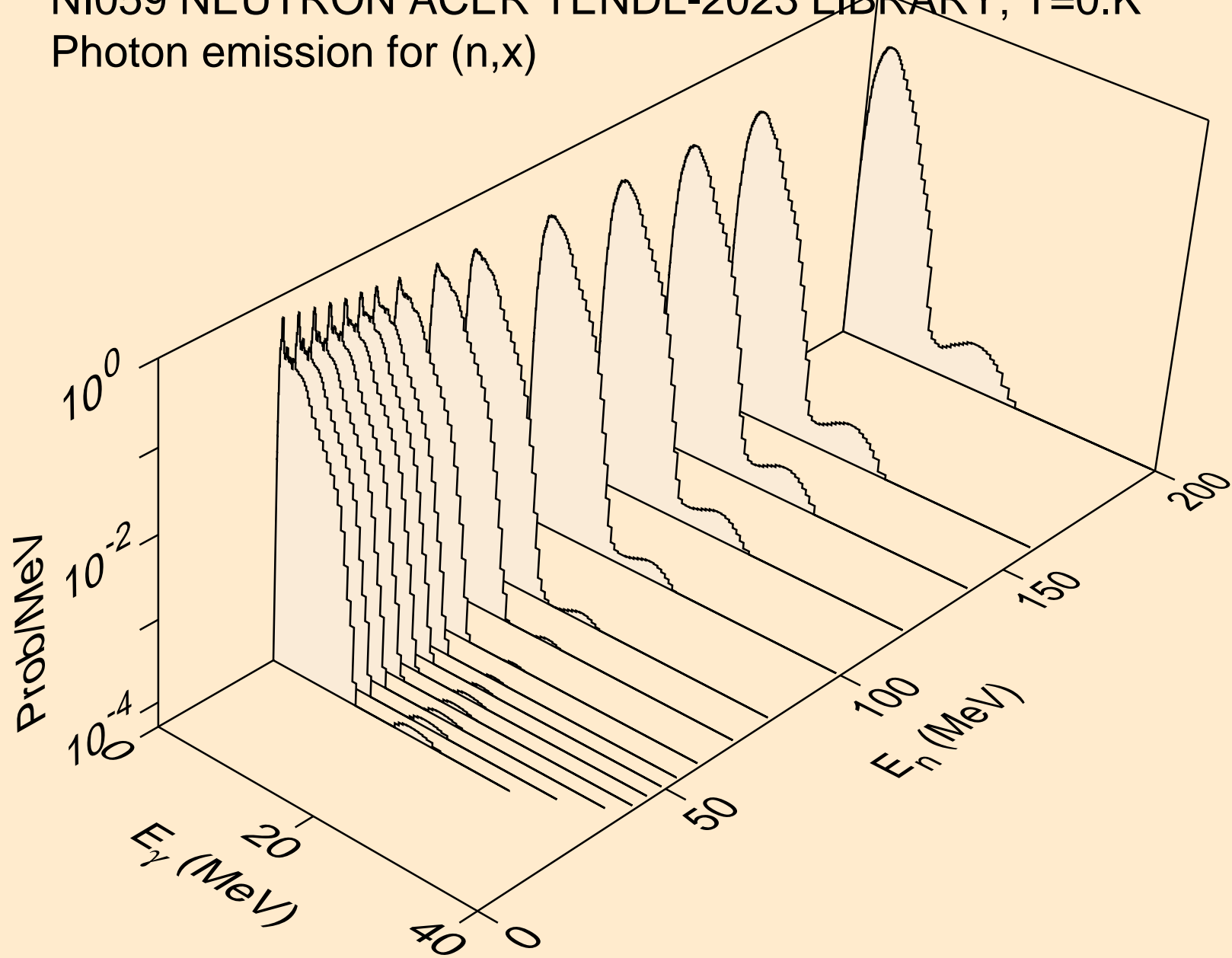

NI059 NEUTRON ACER TENDL-2023 LIBRARY; T=0.K  
Photon emission for (n,2nd)

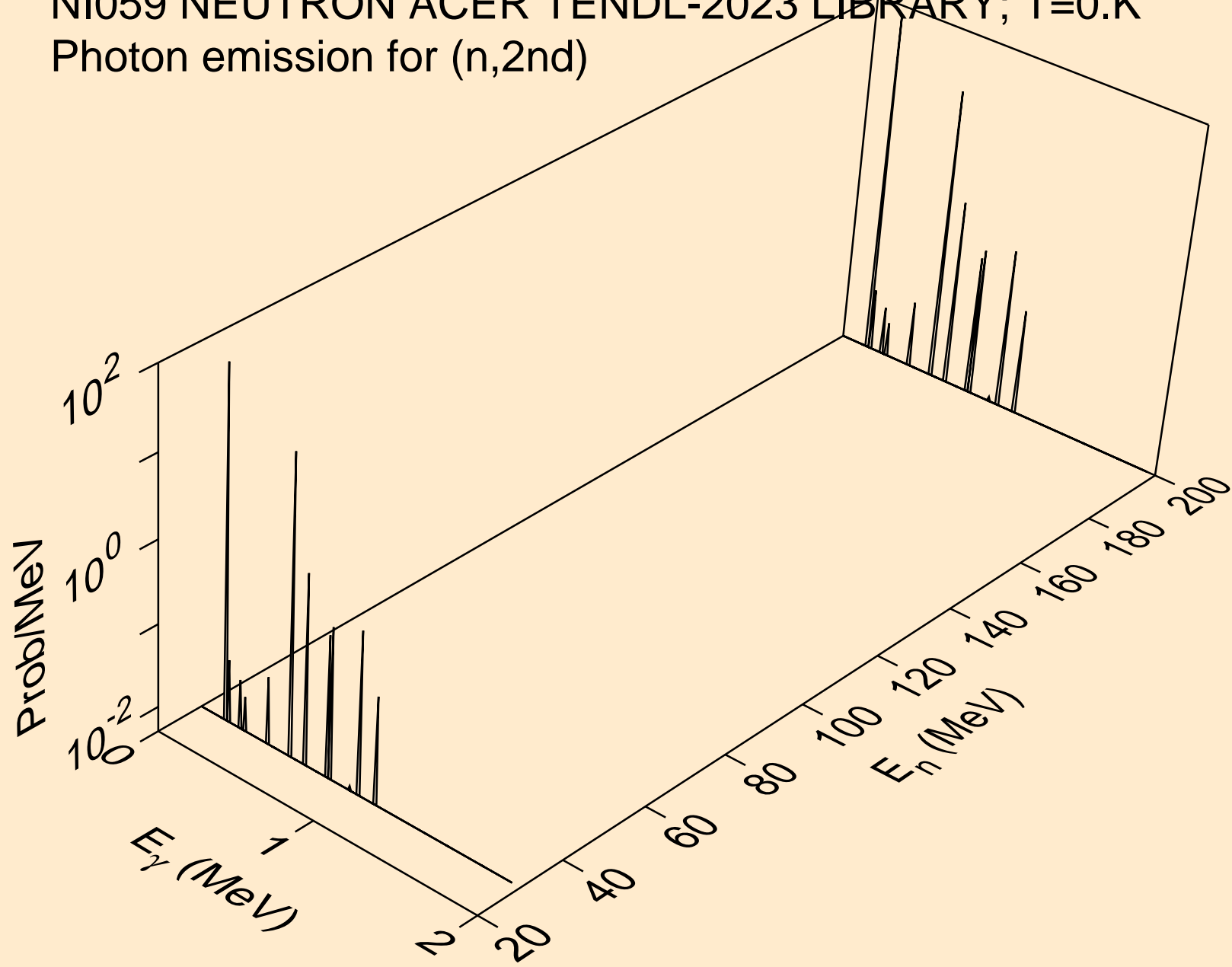

NI059 NEUTRON ACER TENDL-2023 LIBRARY; T=0.K  
Photon emission for (n,2n)

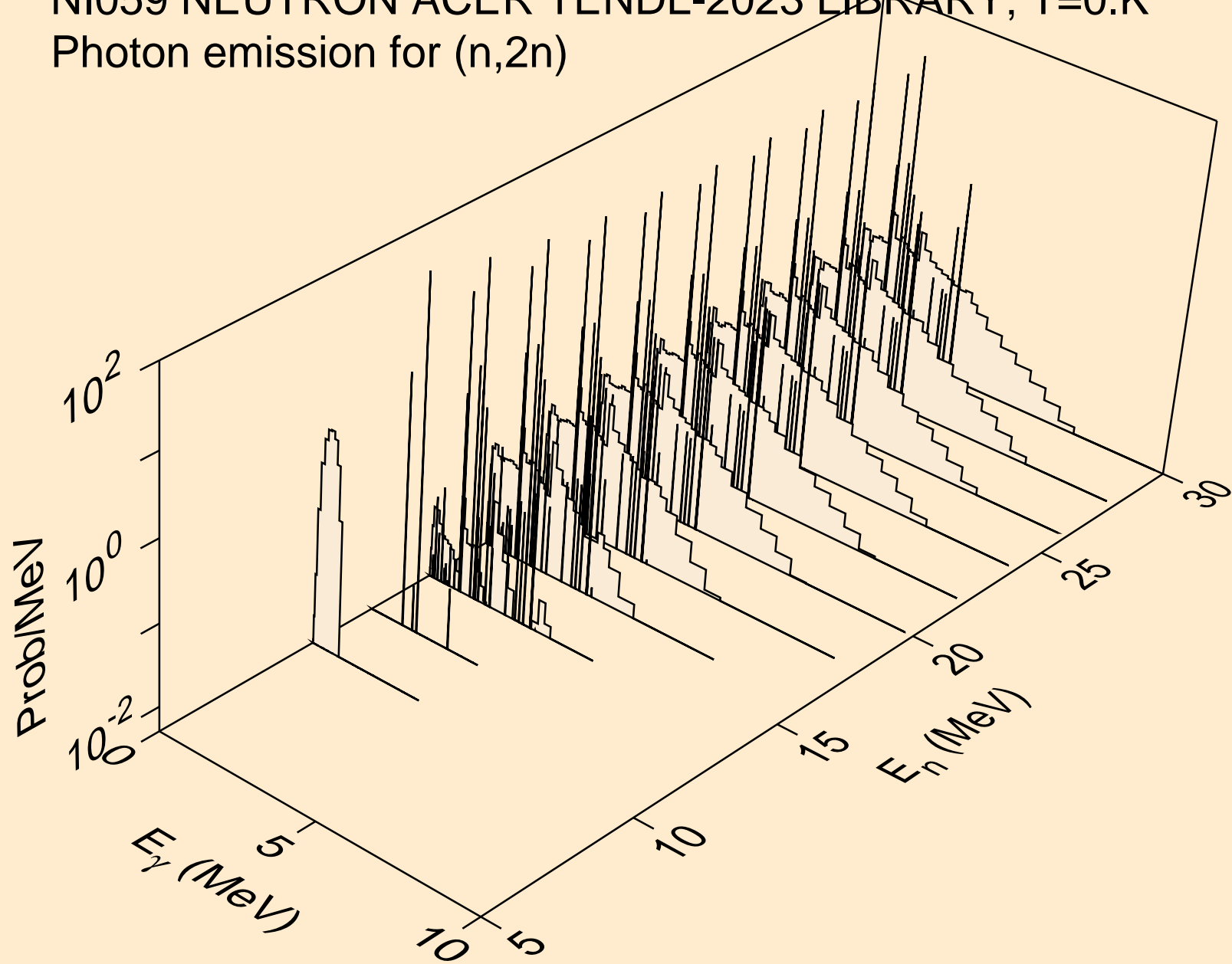

NI059 NEUTRON ACER TENDL-2023 LIBRARY; T=0.K  
Photon emission for (n,3n)

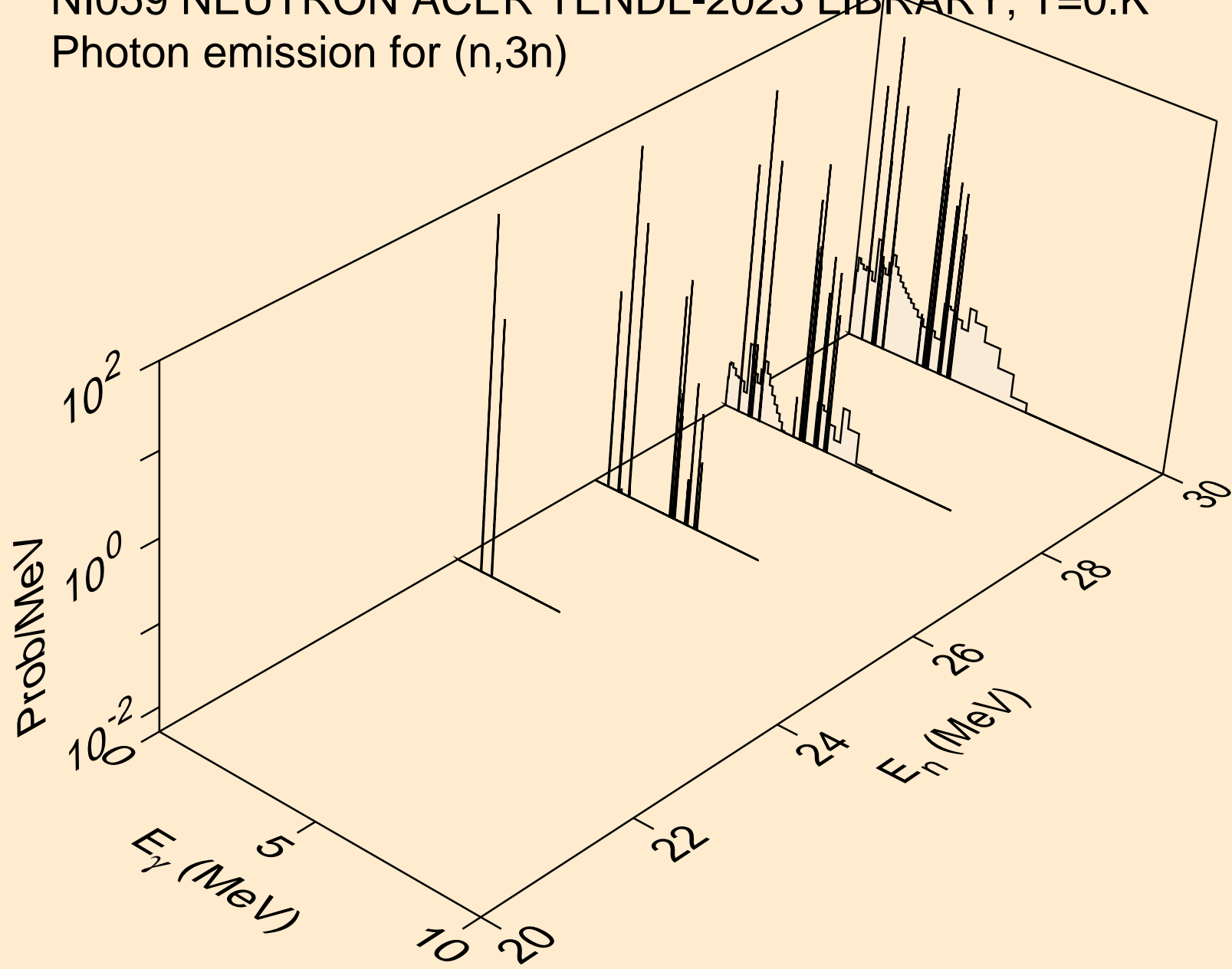

NI059 NEUTRON ACER TENDL-2023 LIBRARY; T=0.K  
Photon emission for (n,n\*)a

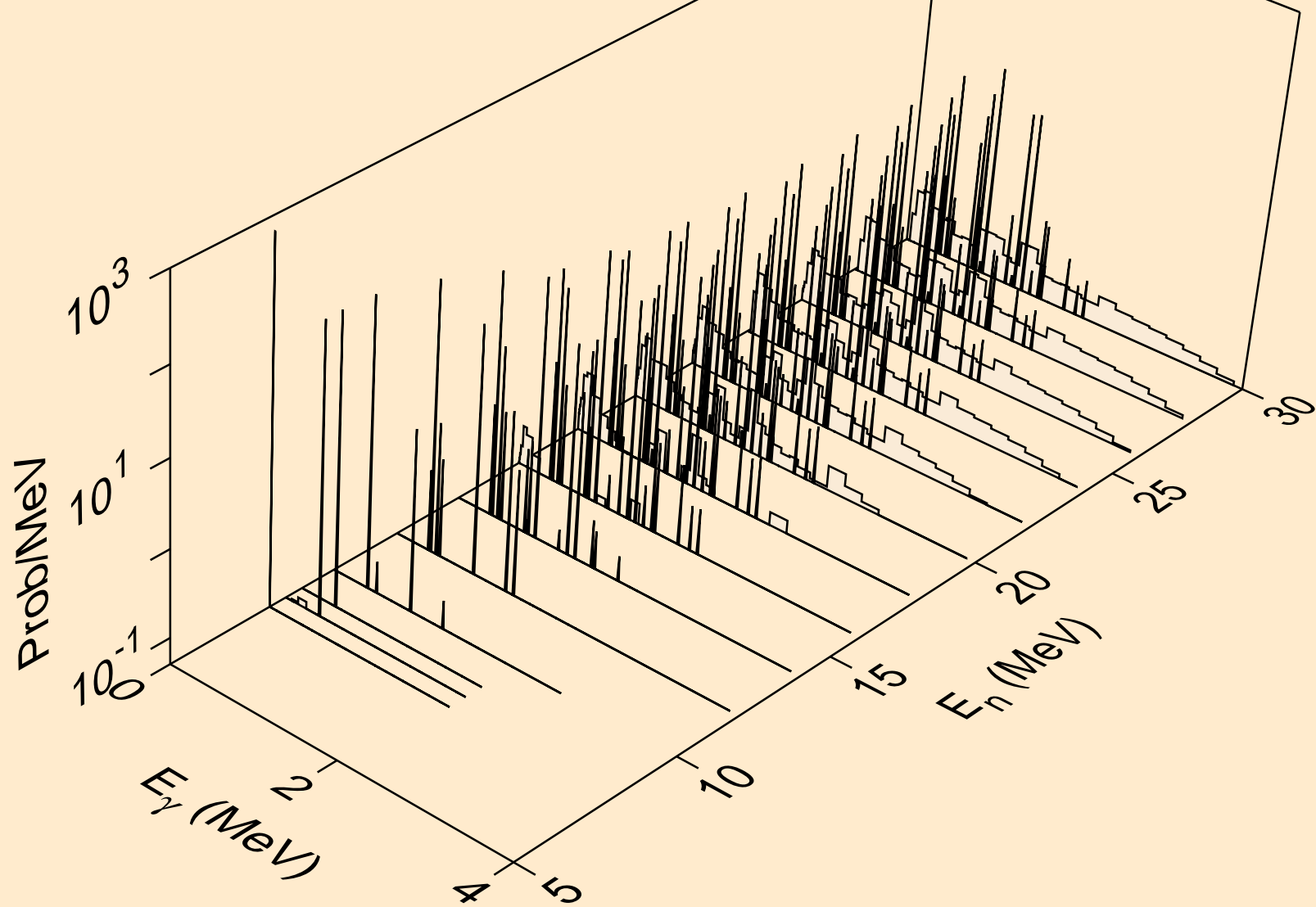



NI059 NEUTRON ACER TENDL-2023 LIBRARY; T=0.K  
Photon emission for (n,2n)a

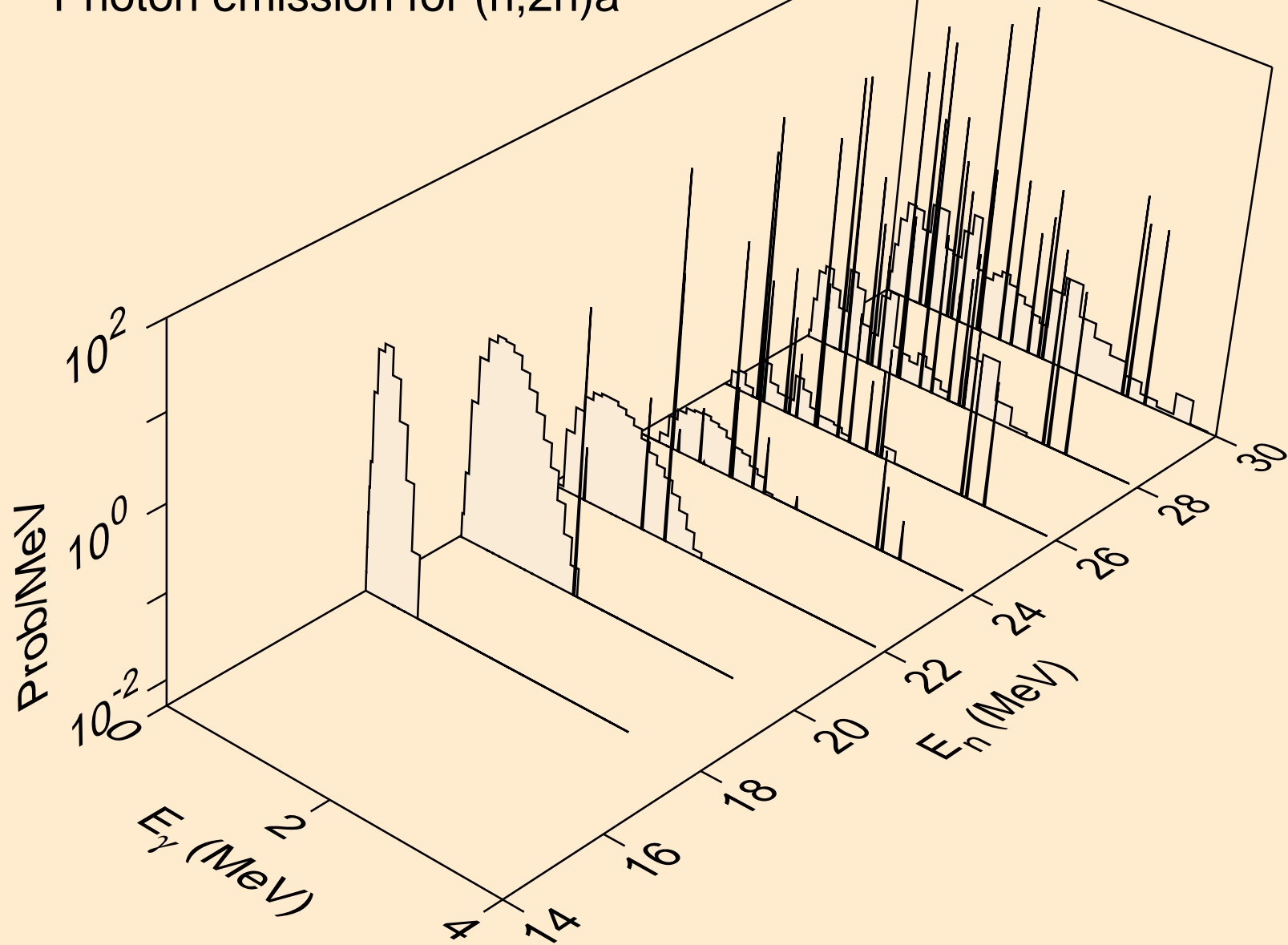

NI059 NEUTRON ACER TENDL-2023 LIBRARY; T=0.K  
Photon emission for (n,n\*)p

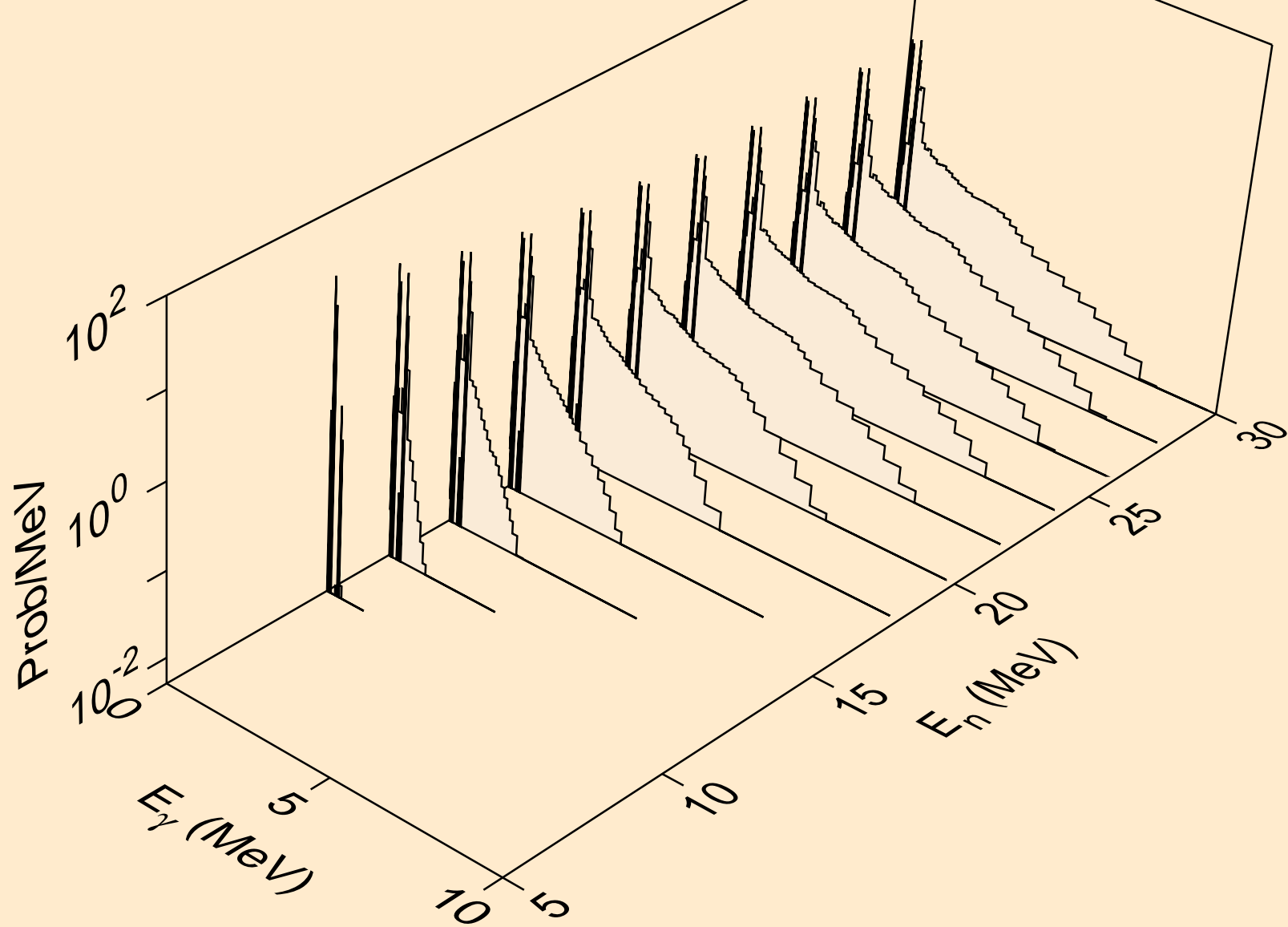

NI059 NEUTRON ACER TENDL-2023 LIBRARY; T=0.K  
Photon emission for (n,n\*)2a

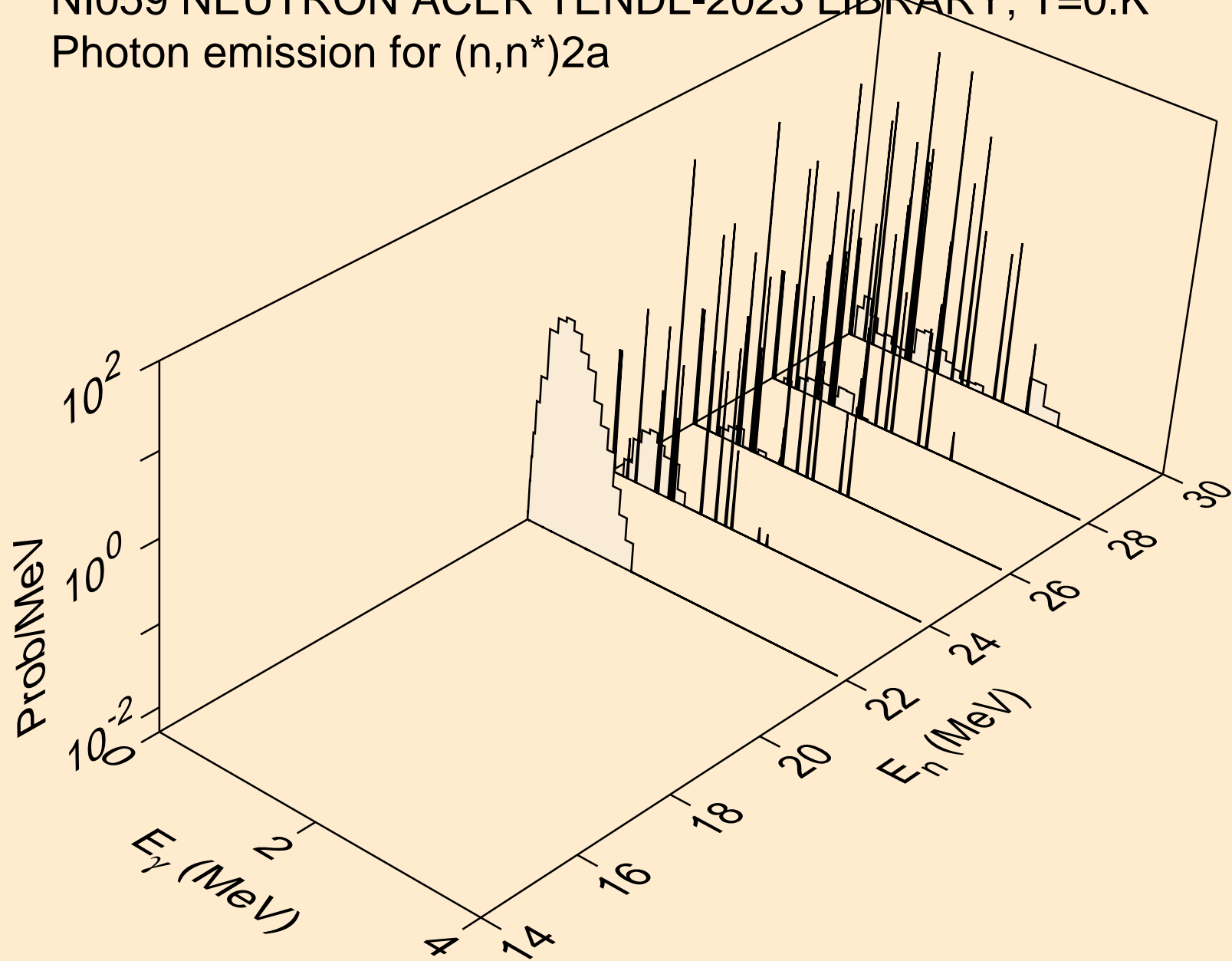

NI059 NEUTRON ACER TENDL-2023 LIBRARY; T=0.K  
Photon emission for (n,n\*)d

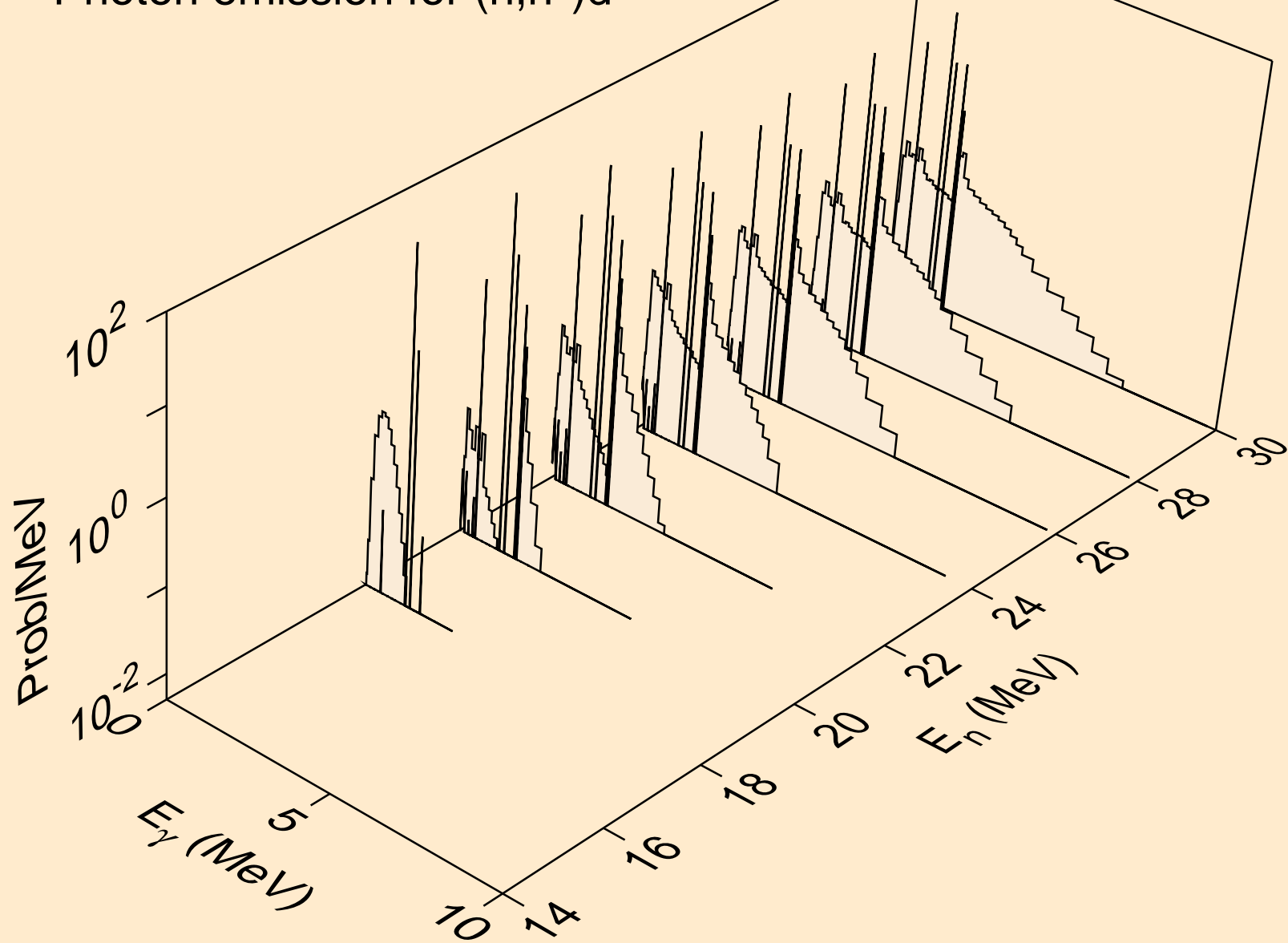

NI059 NEUTRON ACER TENDL-2023 LIBRARY; T=0.K  
Photon emission for (n,n\*)t

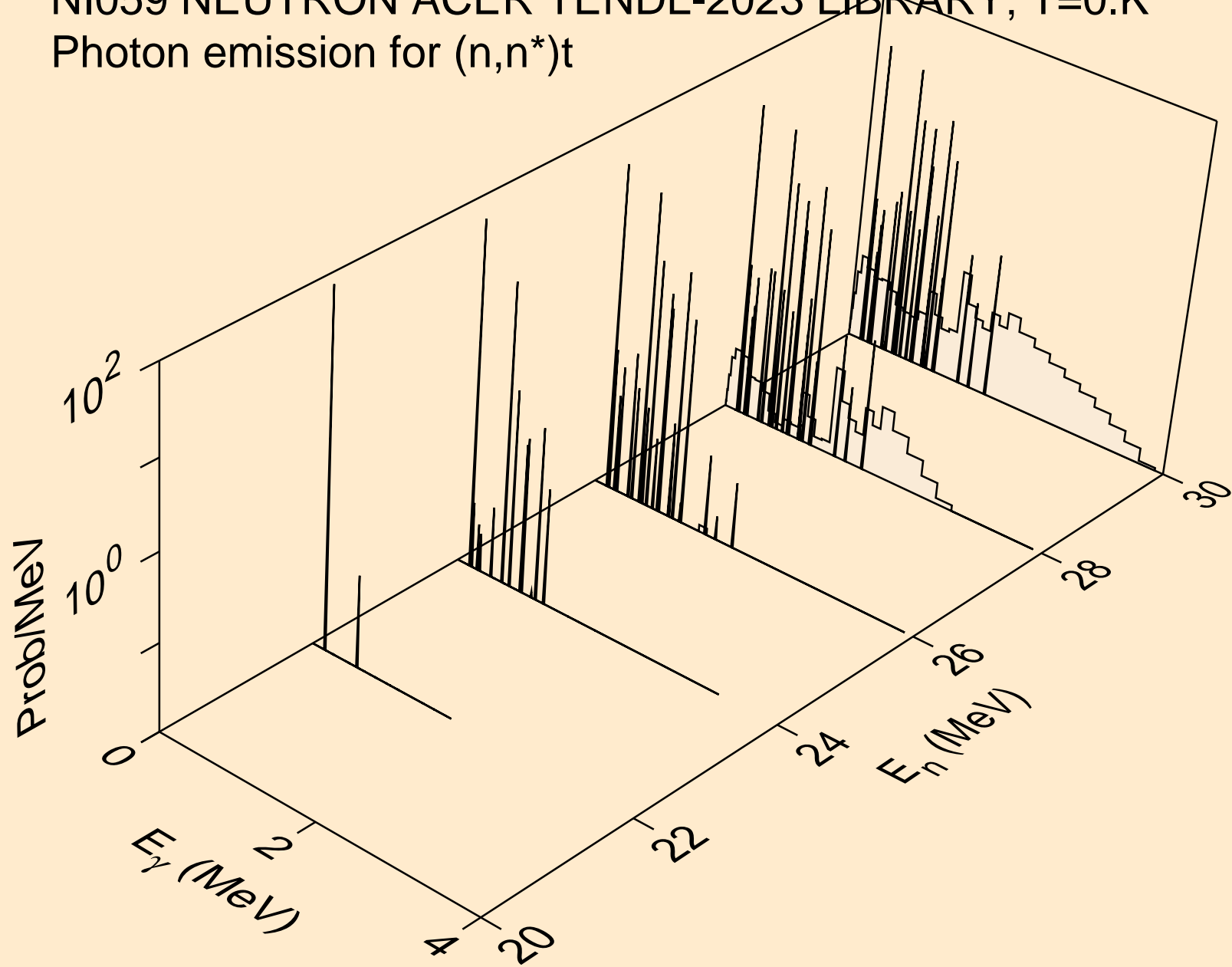

NI059 NEUTRON ACER TENDL-2023 LIBRARY; T=0.K  
Photon emission for (n,n\*)he3

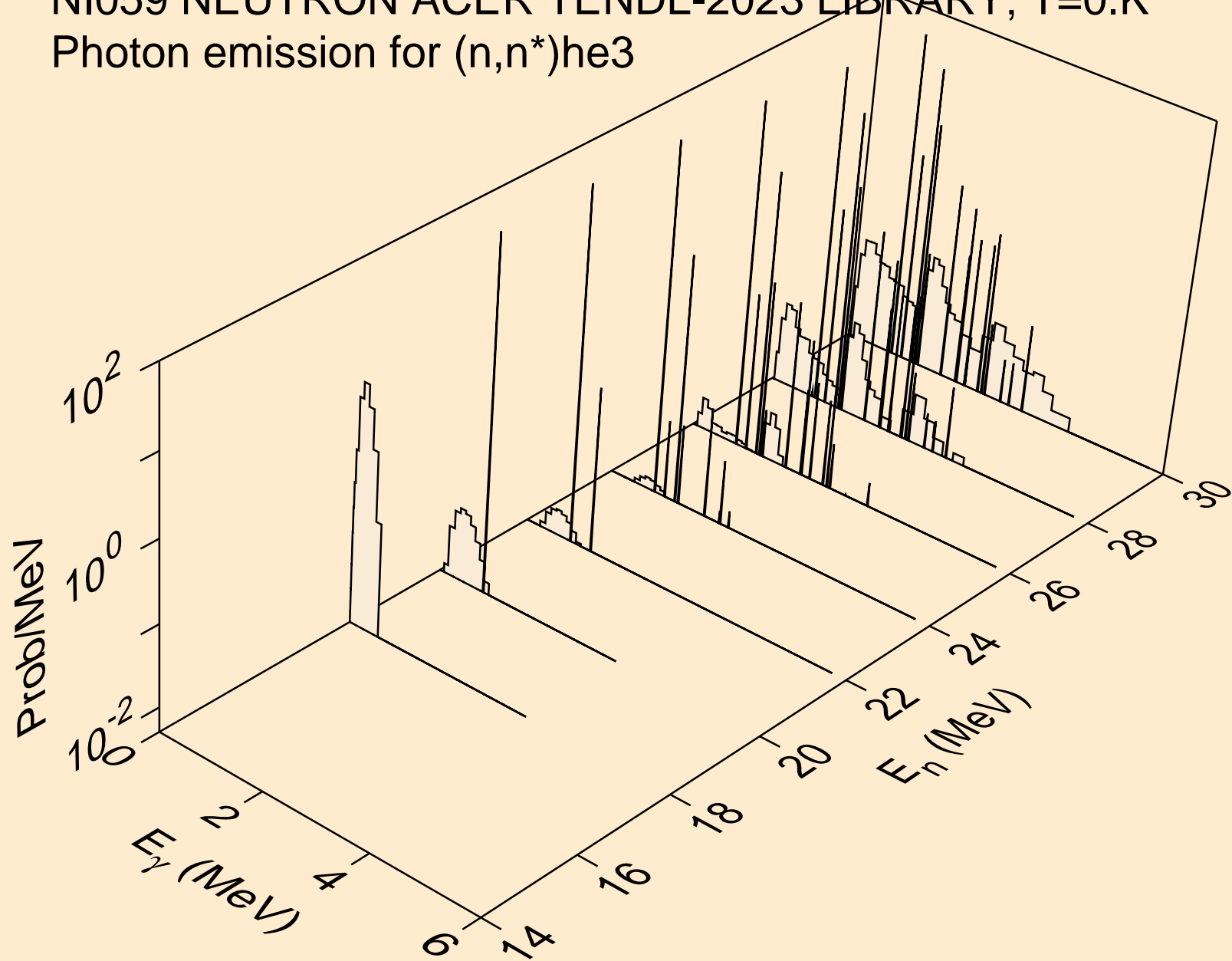

NI059 NEUTRON ACER TENDL-2023 LIBRARY; T=0.K  
Photon emission for (n,2np)

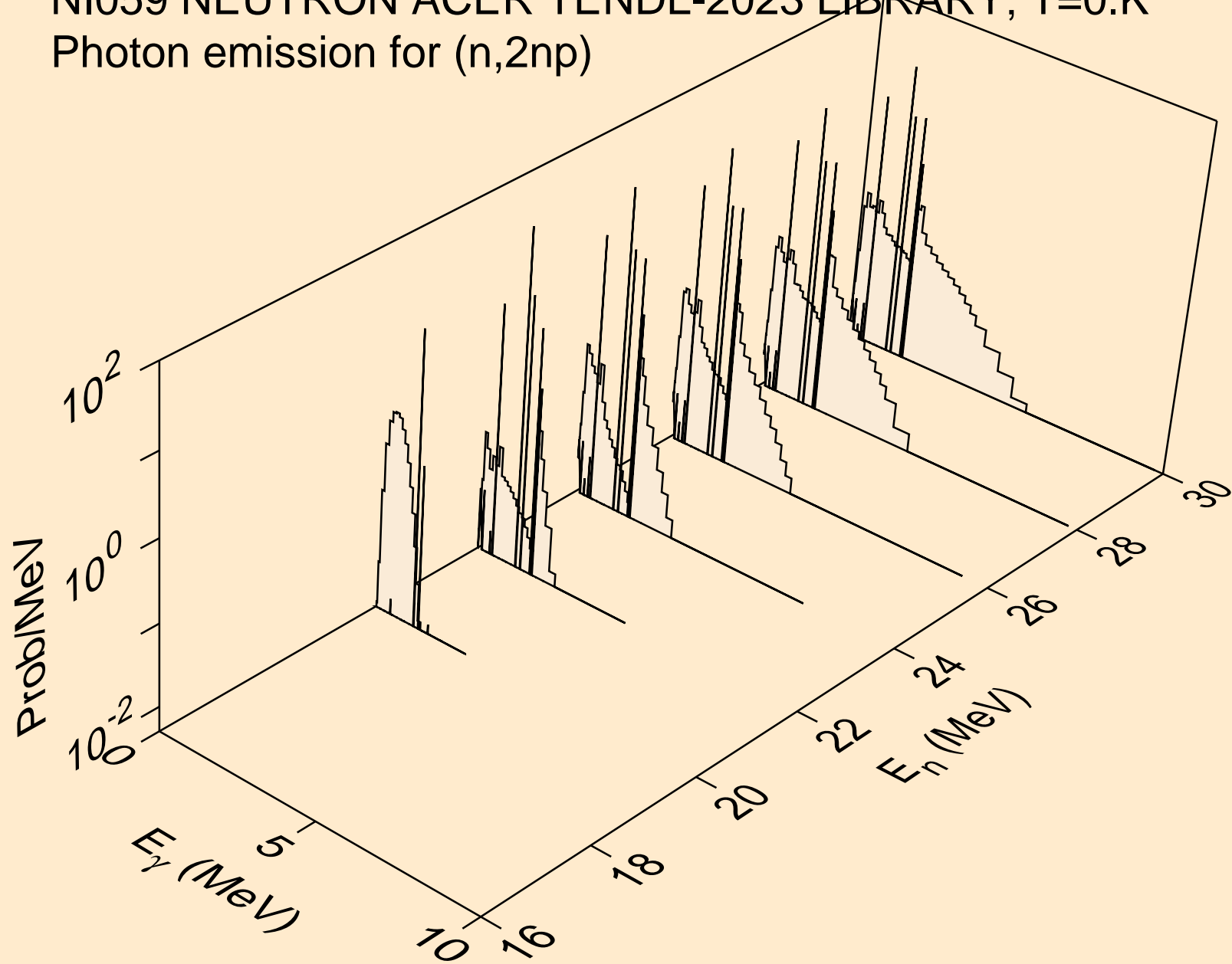

NI059 NEUTRON ACER TENDL-2023 LIBRARY; T=0.K  
Photon emission for (n,n2p)

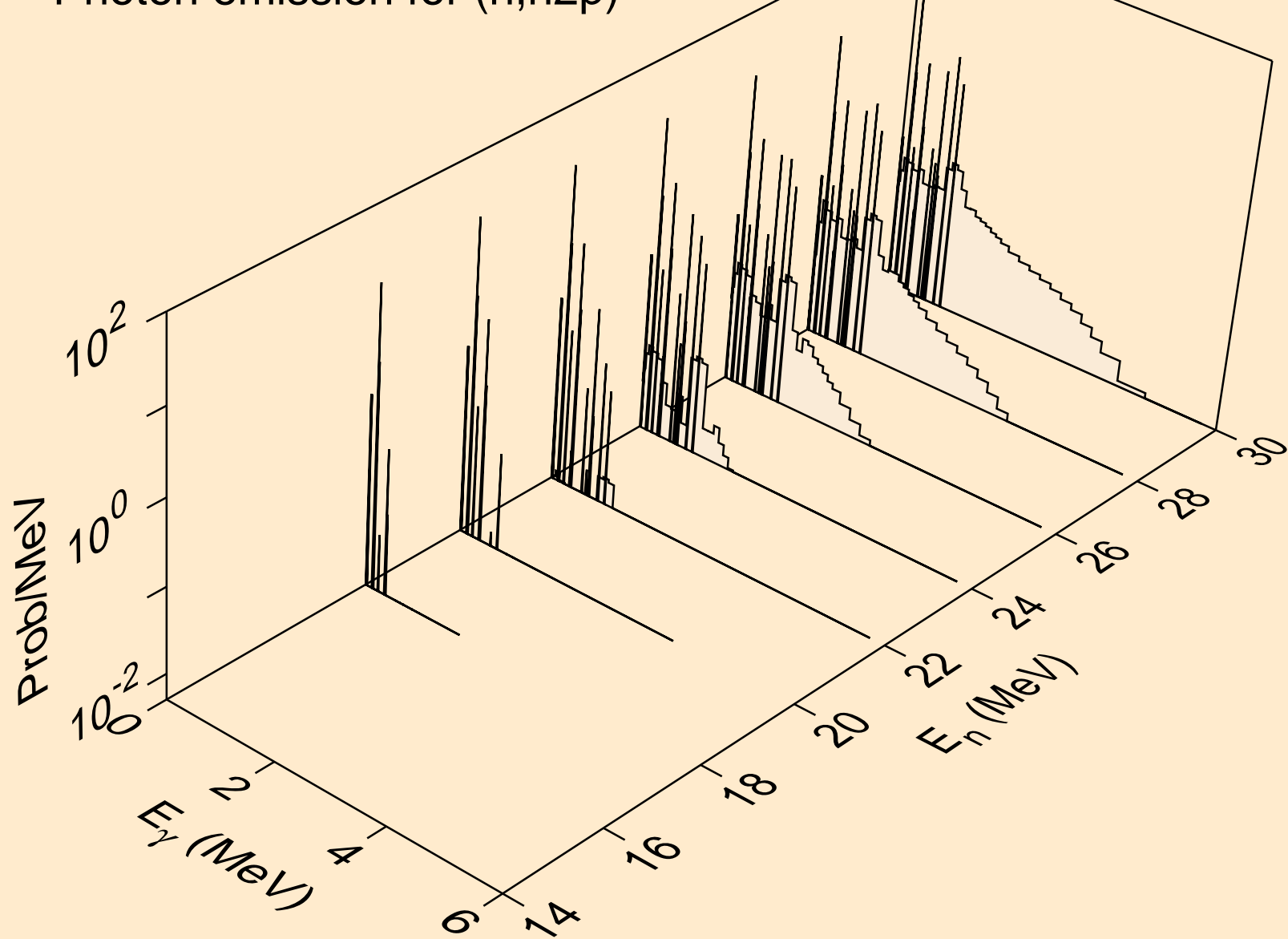



NI059 NEUTRON ACER TENDL-2023 LIBRARY; T=0.K  
Photon emission for (n,npa)

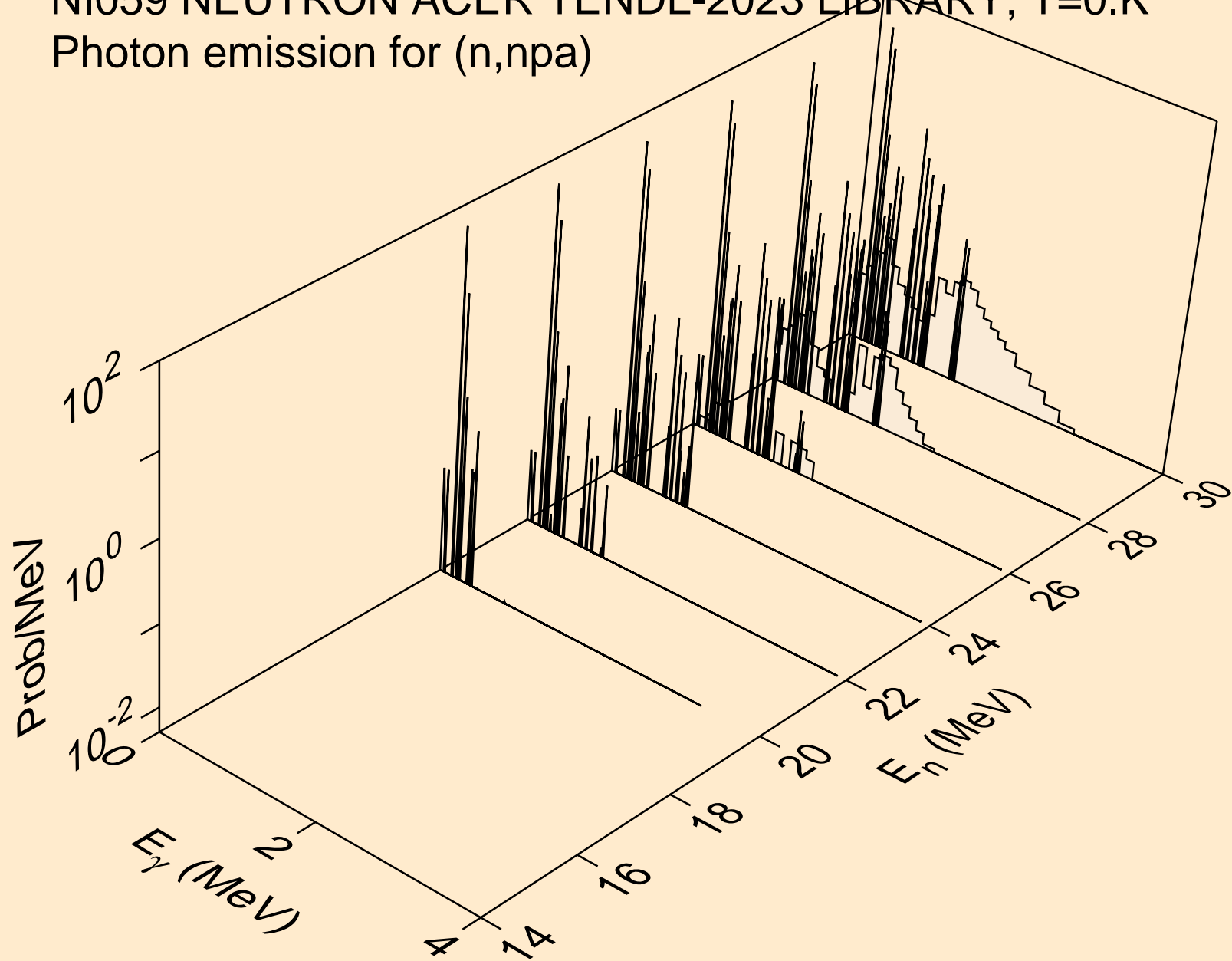

NI059 NEUTRON ACER TENDL-2023 LIBRARY; T=0.K  
Photon emission for (n,n\*c)

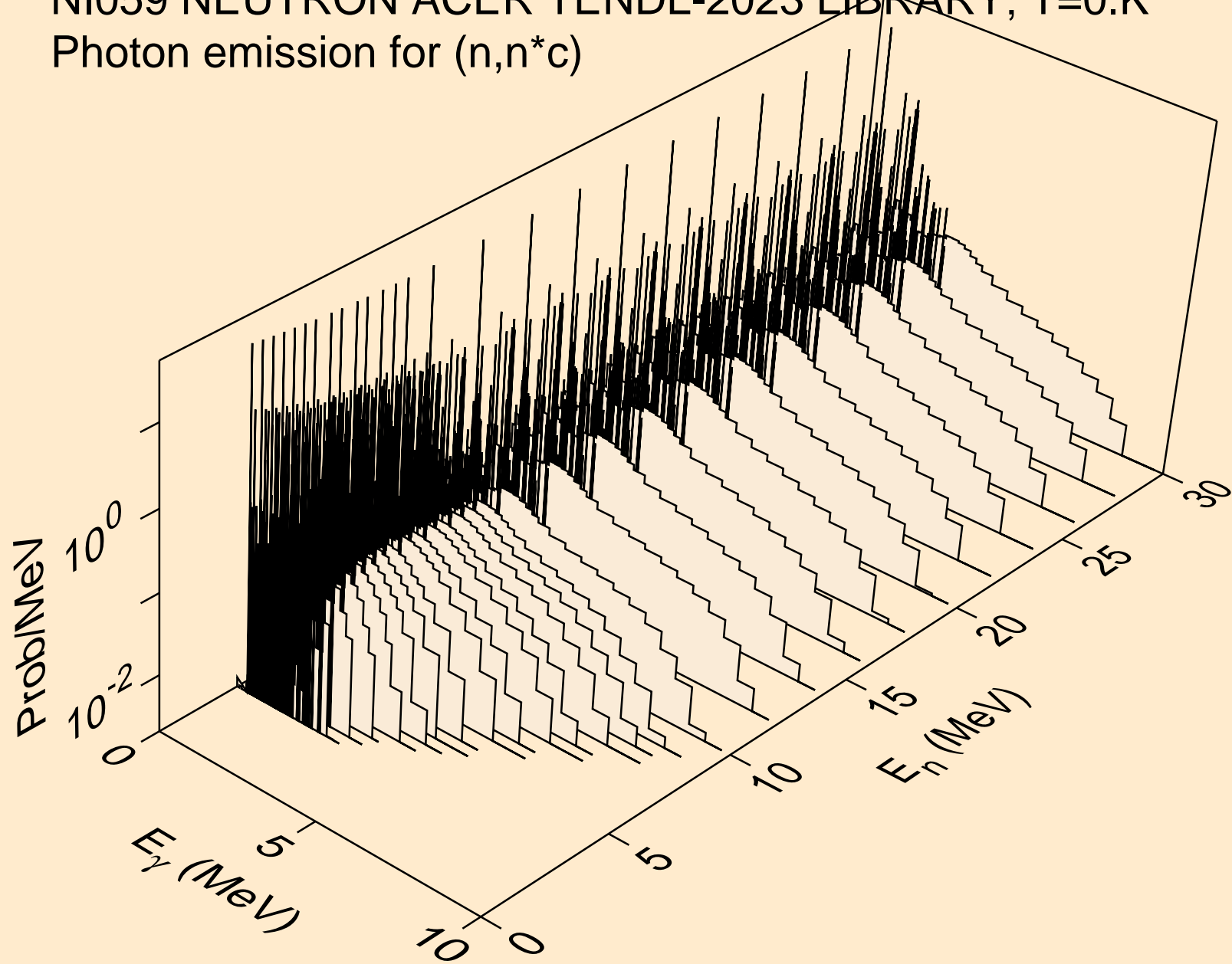

NI059 NEUTRON ACER TENDL-2023 LIBRARY; T=0.K  
Photon emission for (n,gma)

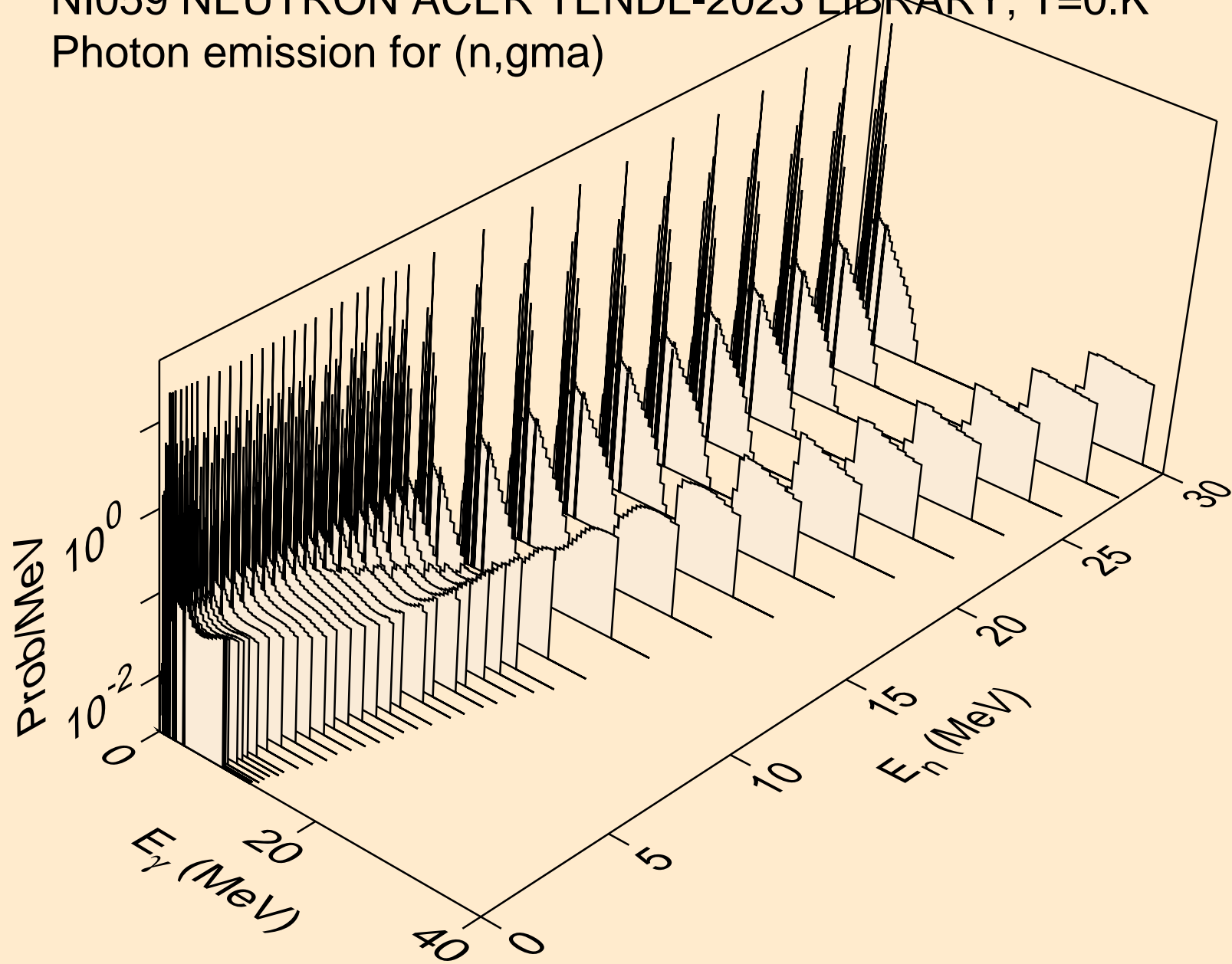

NI059 NEUTRON ACER TENDL-2023 LIBRARY; T=0.K  
Photon emission for (n,p)

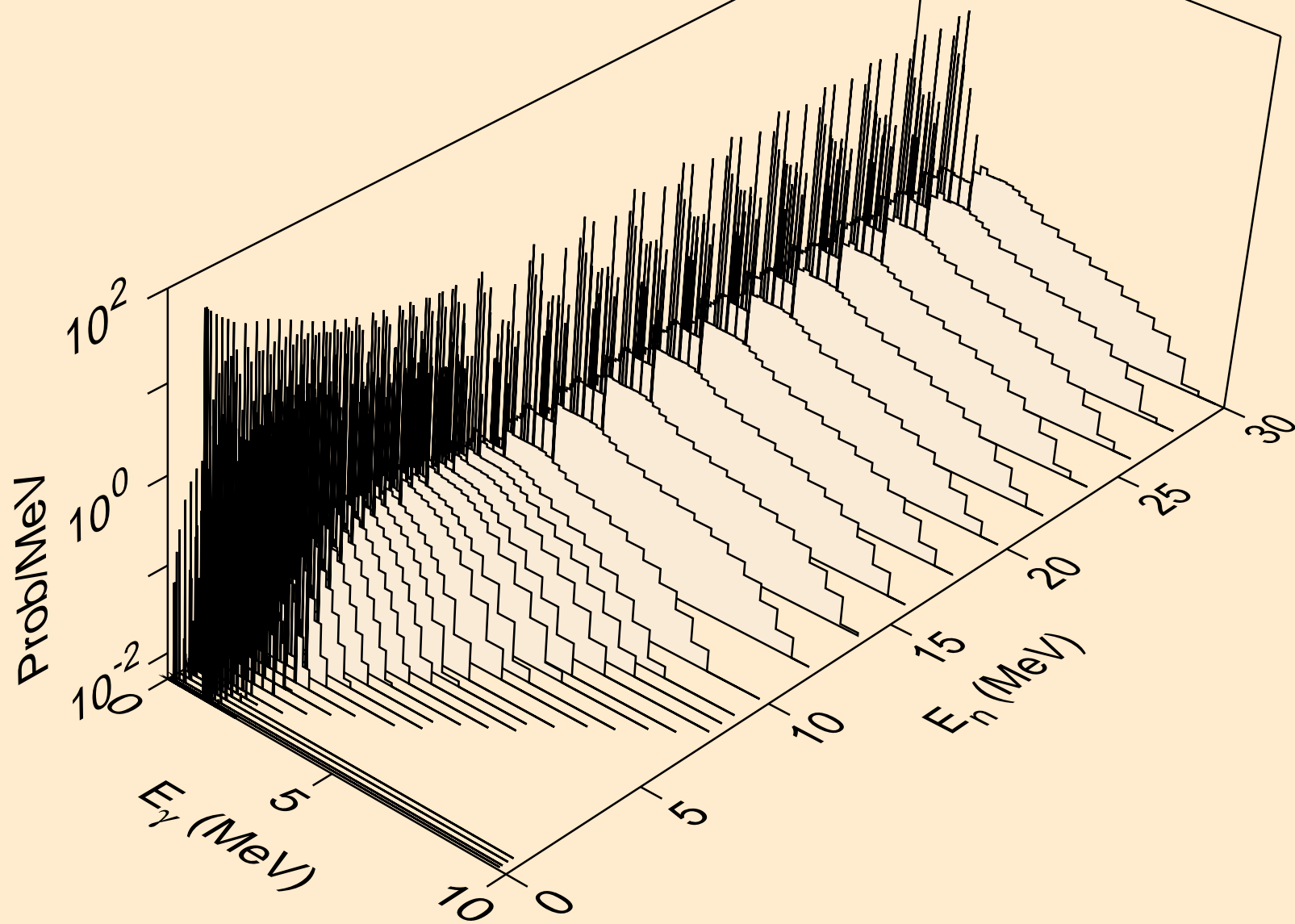

NI059 NEUTRON ACER TENDL-2023 LIBRARY; T=0.K  
Photon emission for (n,d)

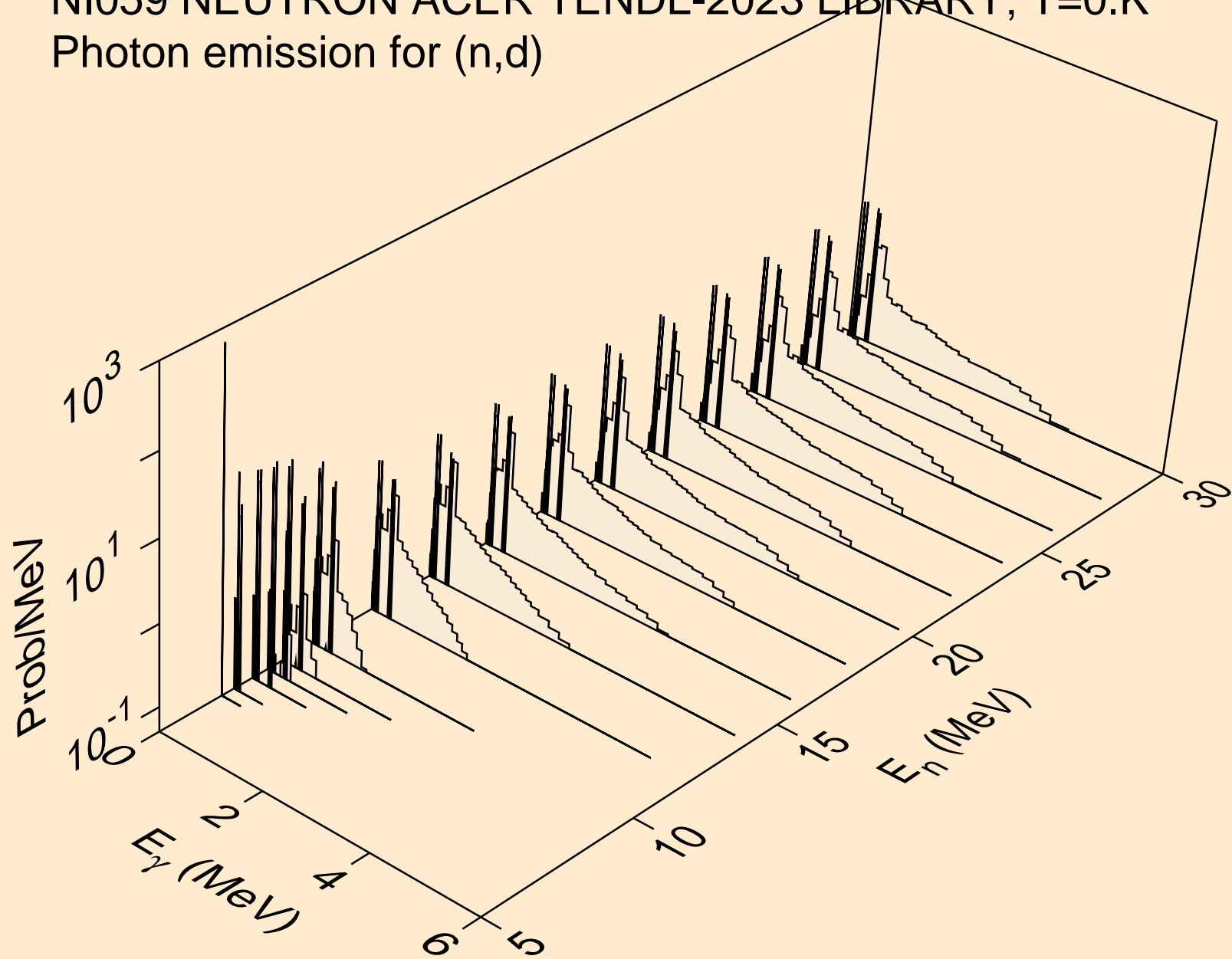

NI059 NEUTRON ACER TENDL-2023 LIBRARY; T=0.K  
Photon emission for (n,t)

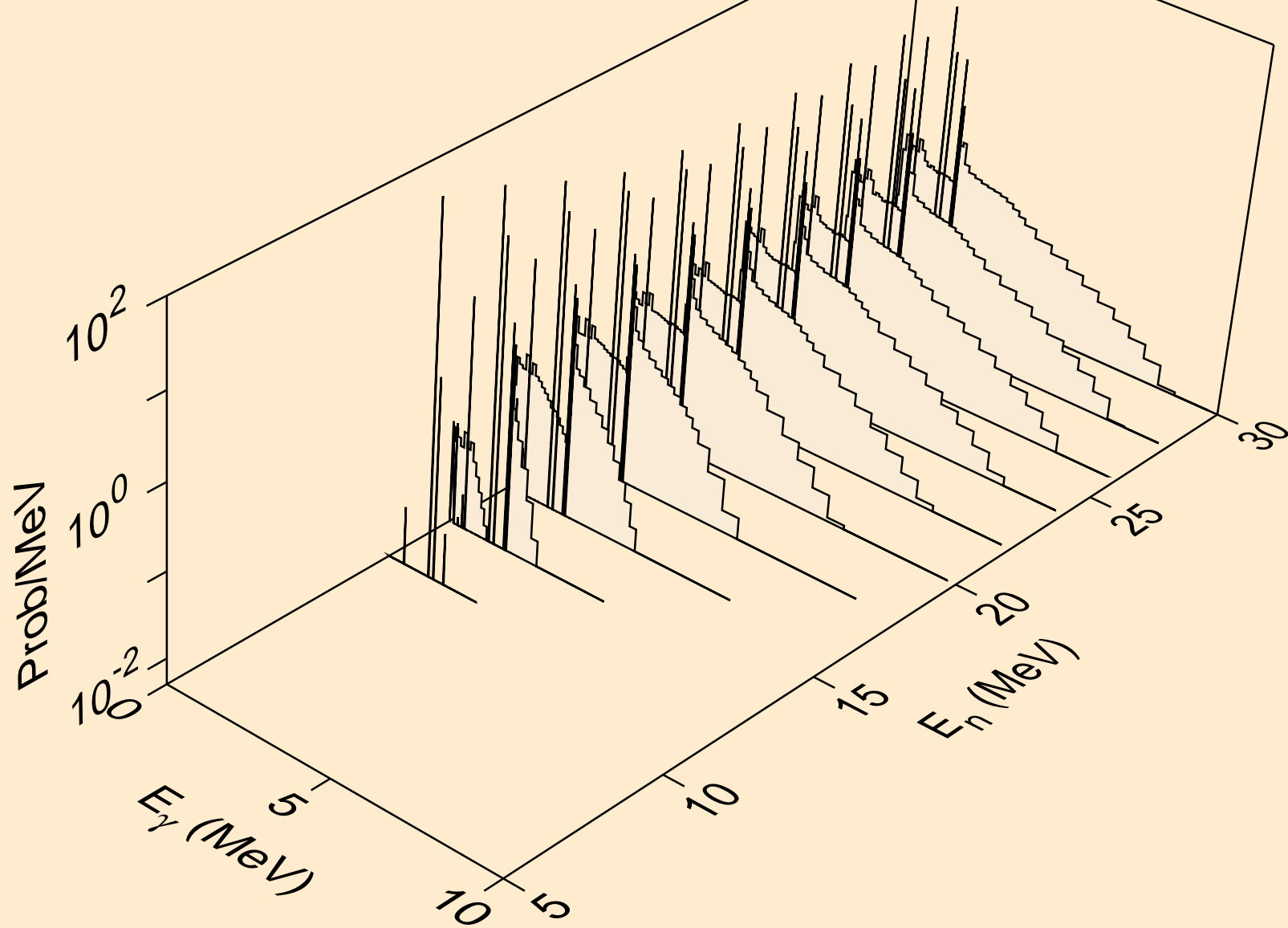

NI059 NEUTRON ACER TENDL-2023 LIBRARY; T=0.K  
Photon emission for (n,he3)

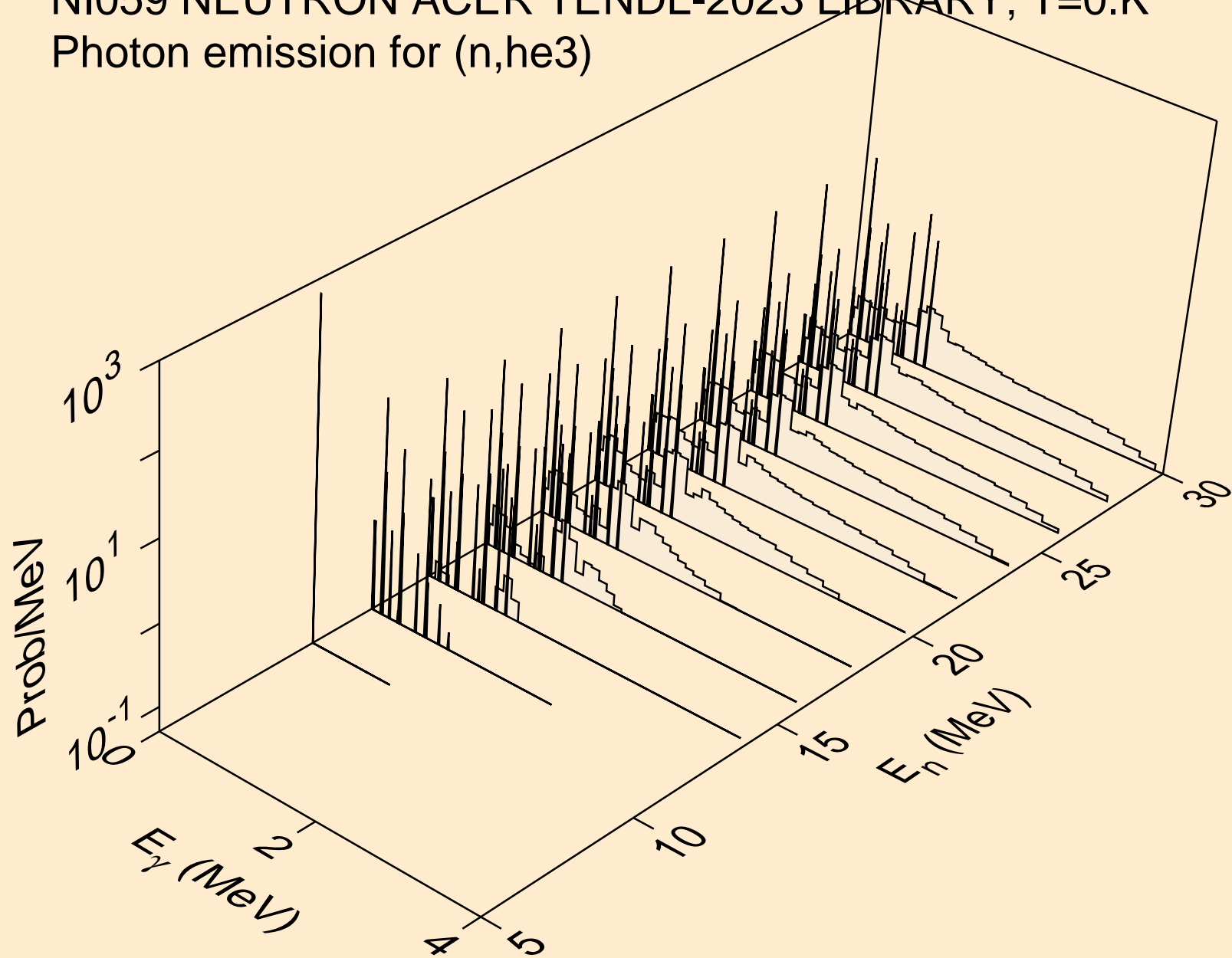

NI059 NEUTRON ACER TENDL-2023 LIBRARY; T=0.K  
Photon emission for (n,a)

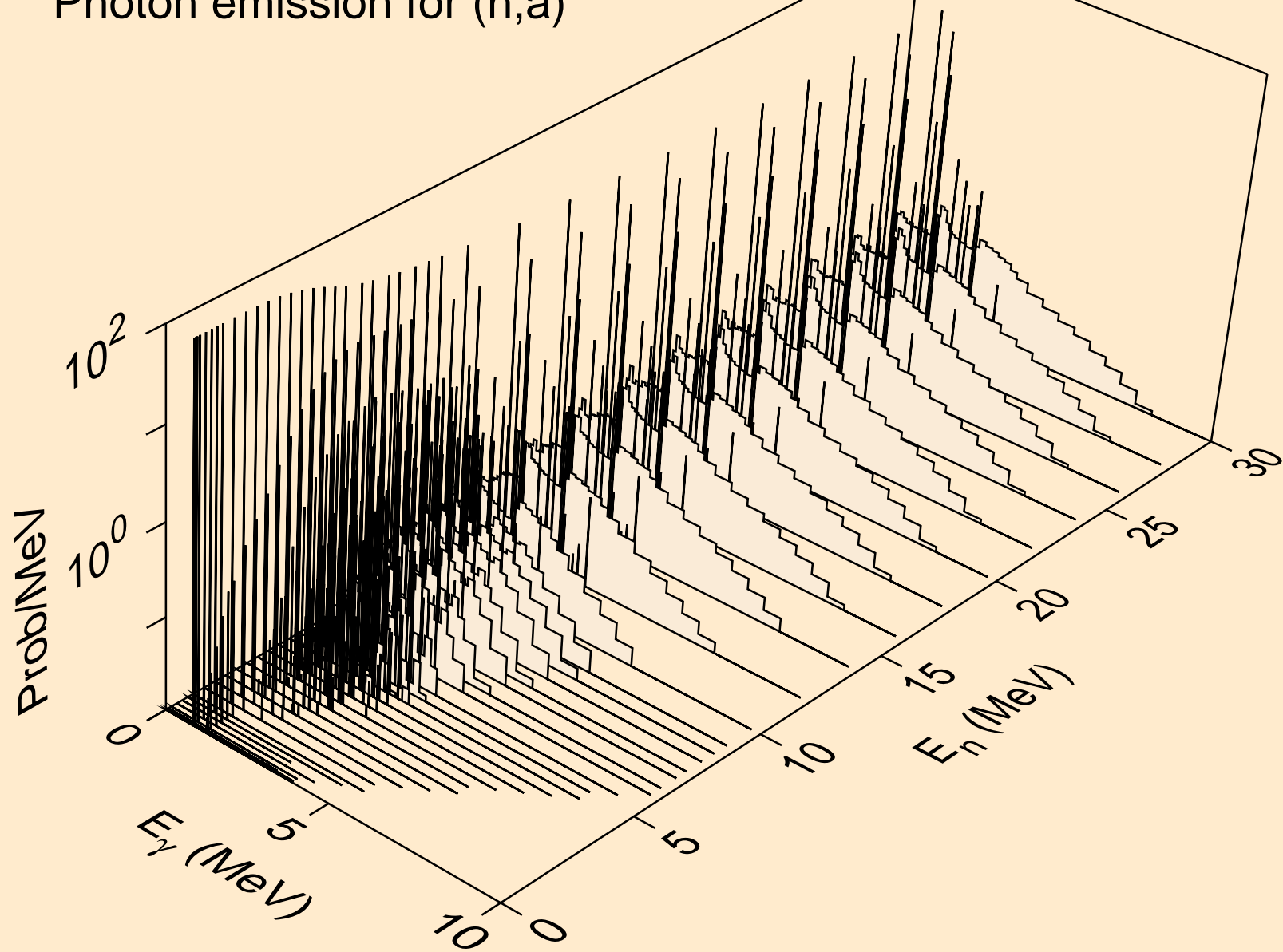



NI059 NEUTRON ACER TENDL-2023 LIBRARY; T=0.K  
Photon emission for (n,2a)

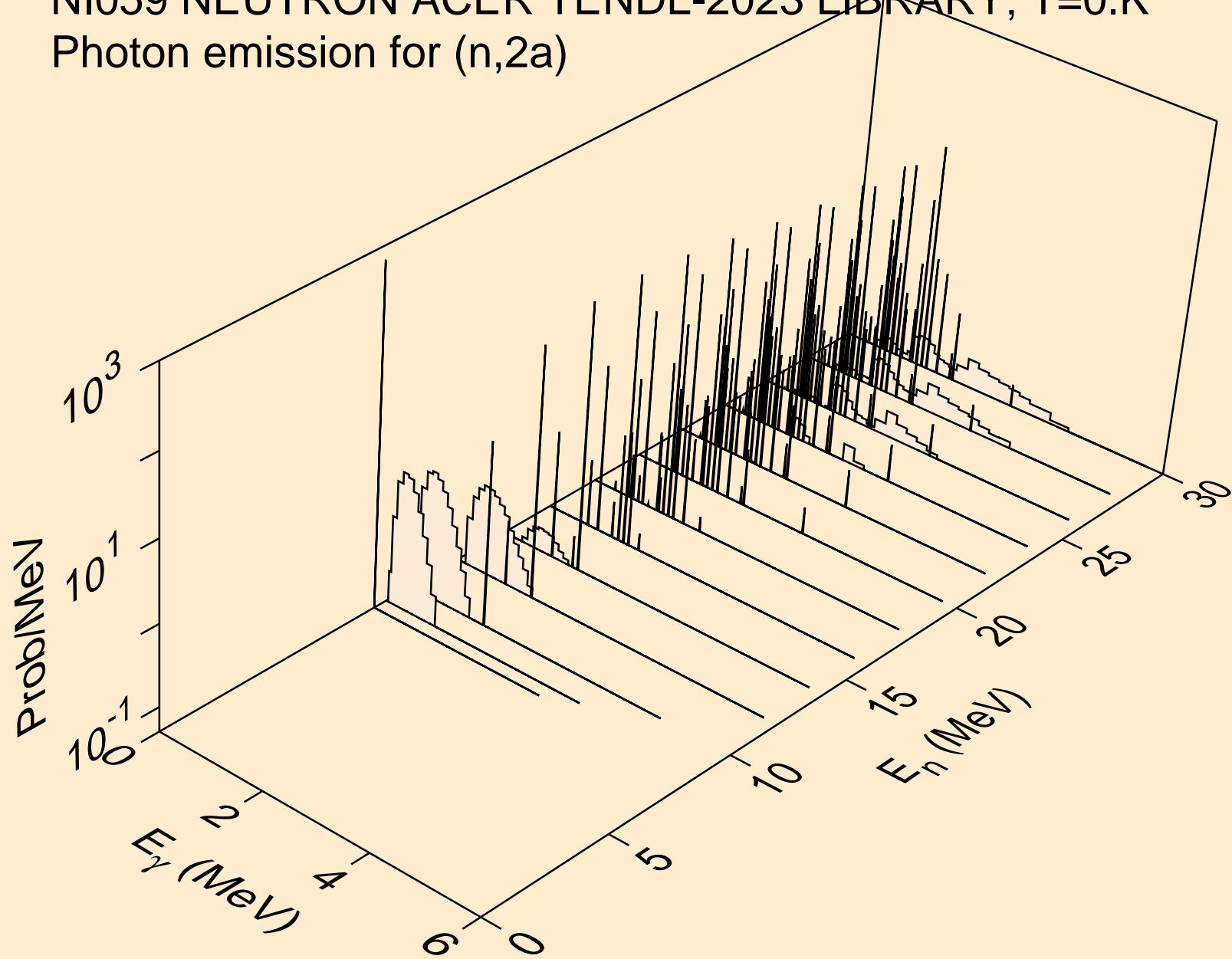

NI059 NEUTRON ACER TENDL-2023 LIBRARY; T=0.K  
Photon emission for (n,2p)

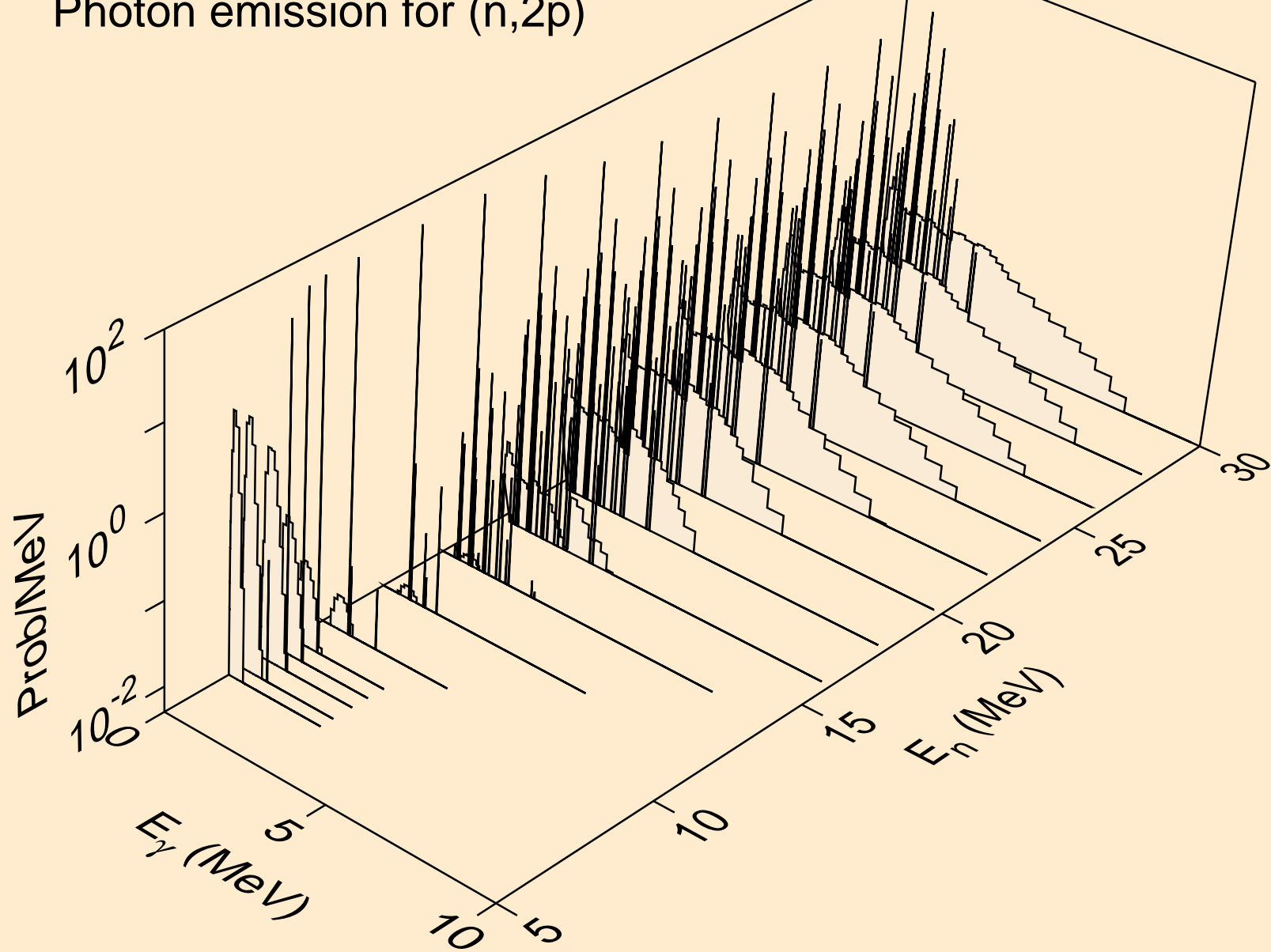

NI059 NEUTRON ACER TENDL-2023 LIBRARY; T=0.K  
Photon emission for (n,p $\alpha$ )

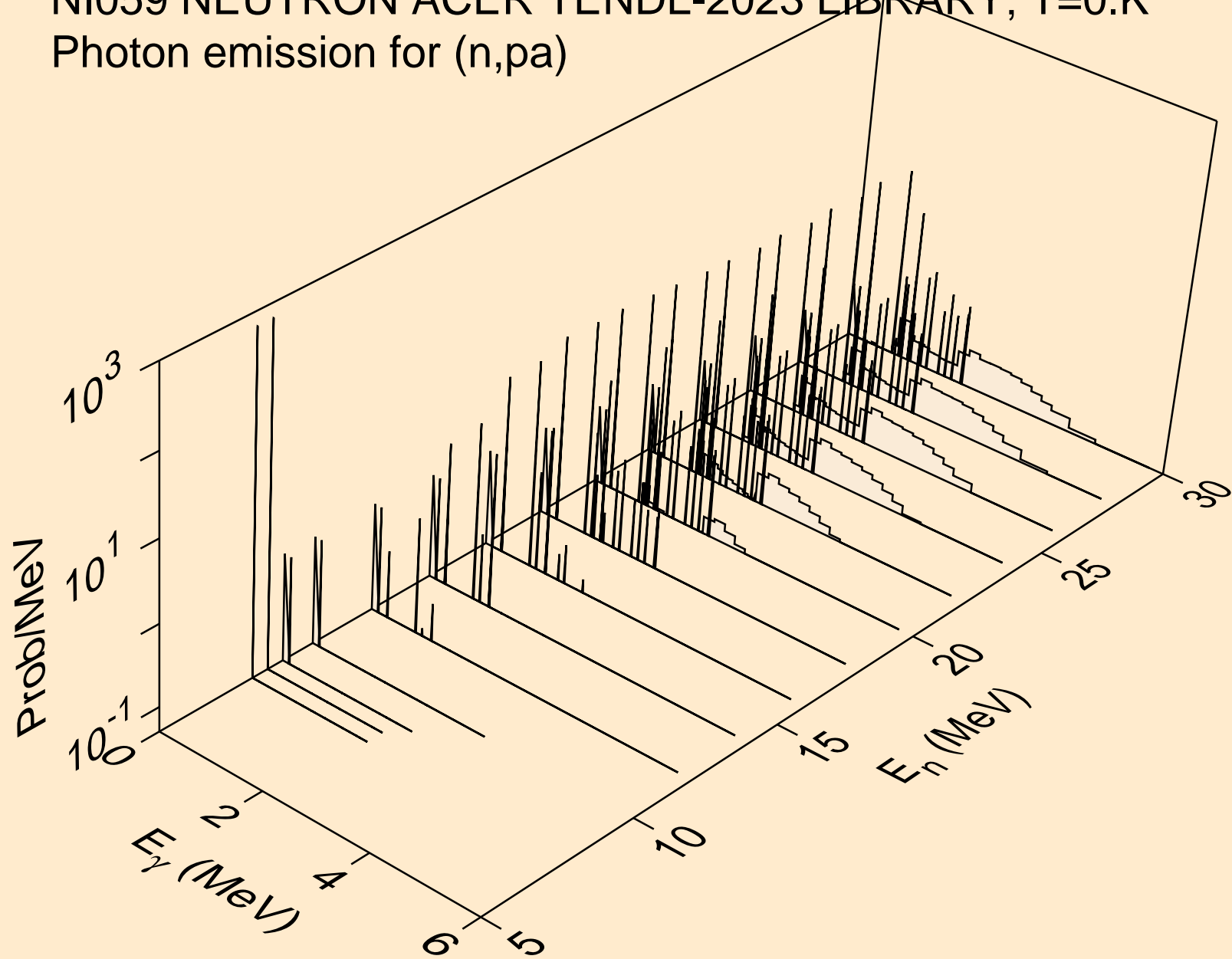

NI059 NEUTRON ACER TENDL-2023 LIBRARY; T=0.K  
Photon emission for (n,pd)

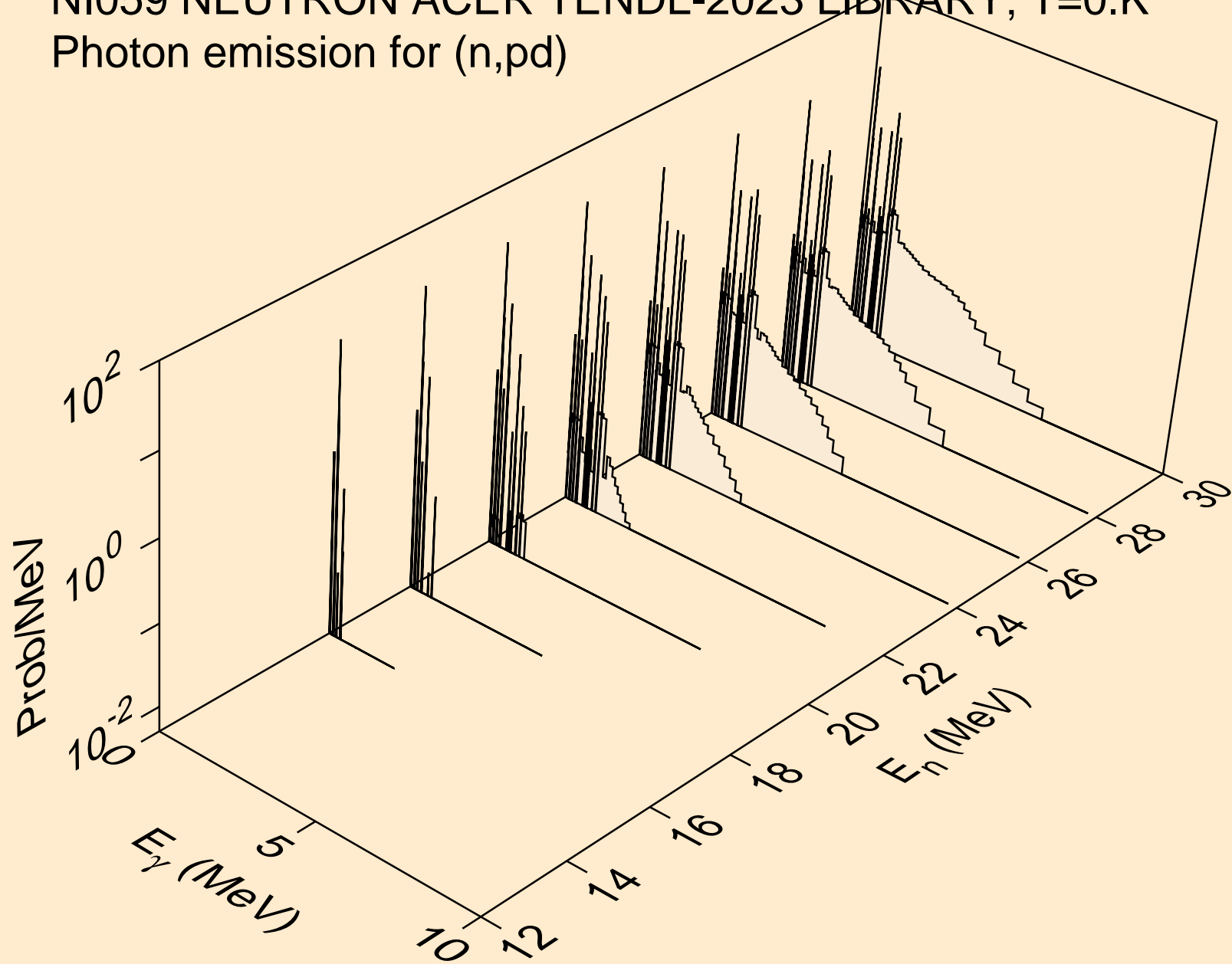

NI059 NEUTRON ACER TENDL-2023 LIBRARY; T=0.K  
Photon emission for (n,pt)

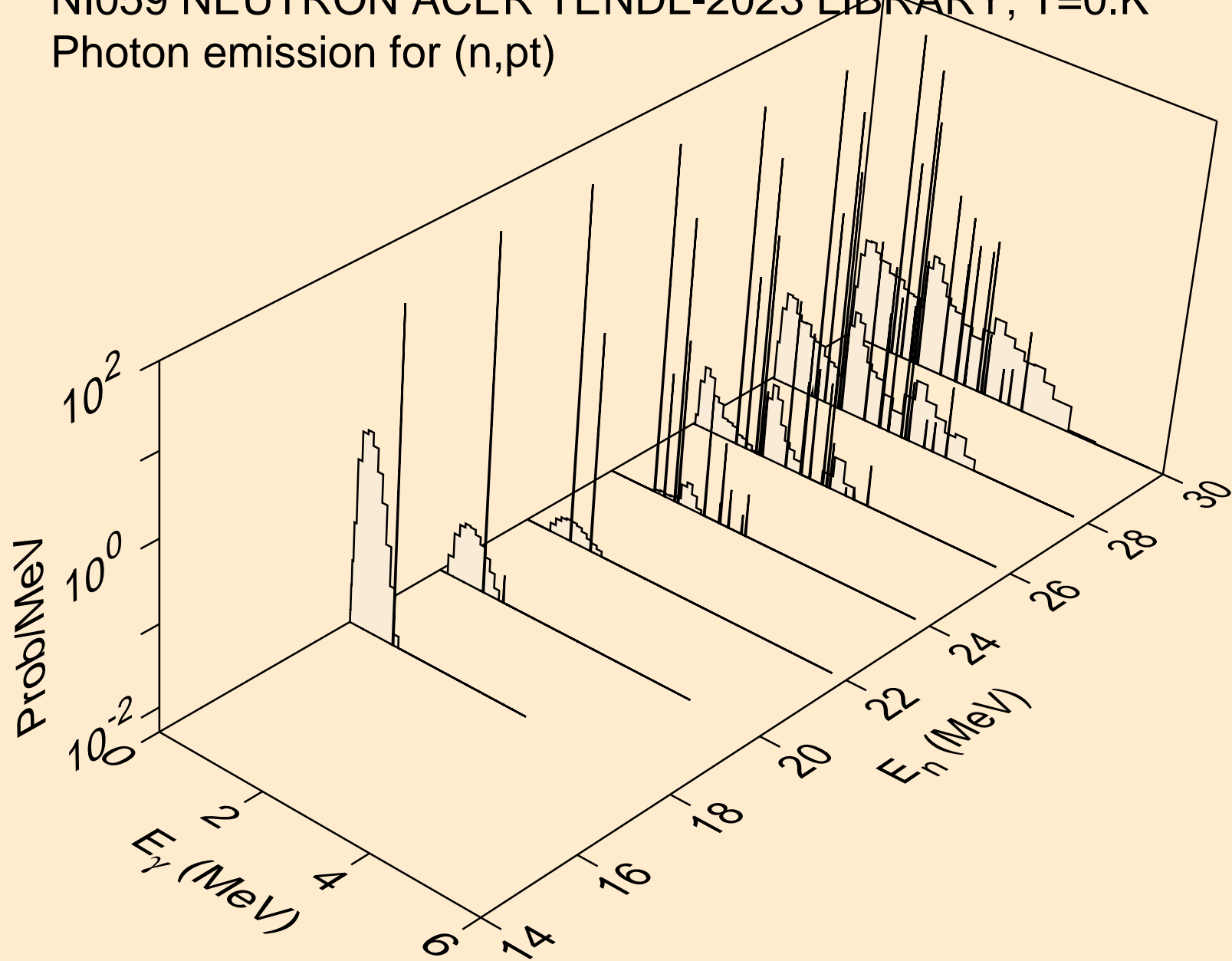

NI059 NEUTRON ACER TENDL-2023 LIBRARY; T=0.K  
Photon emission for (n,da)

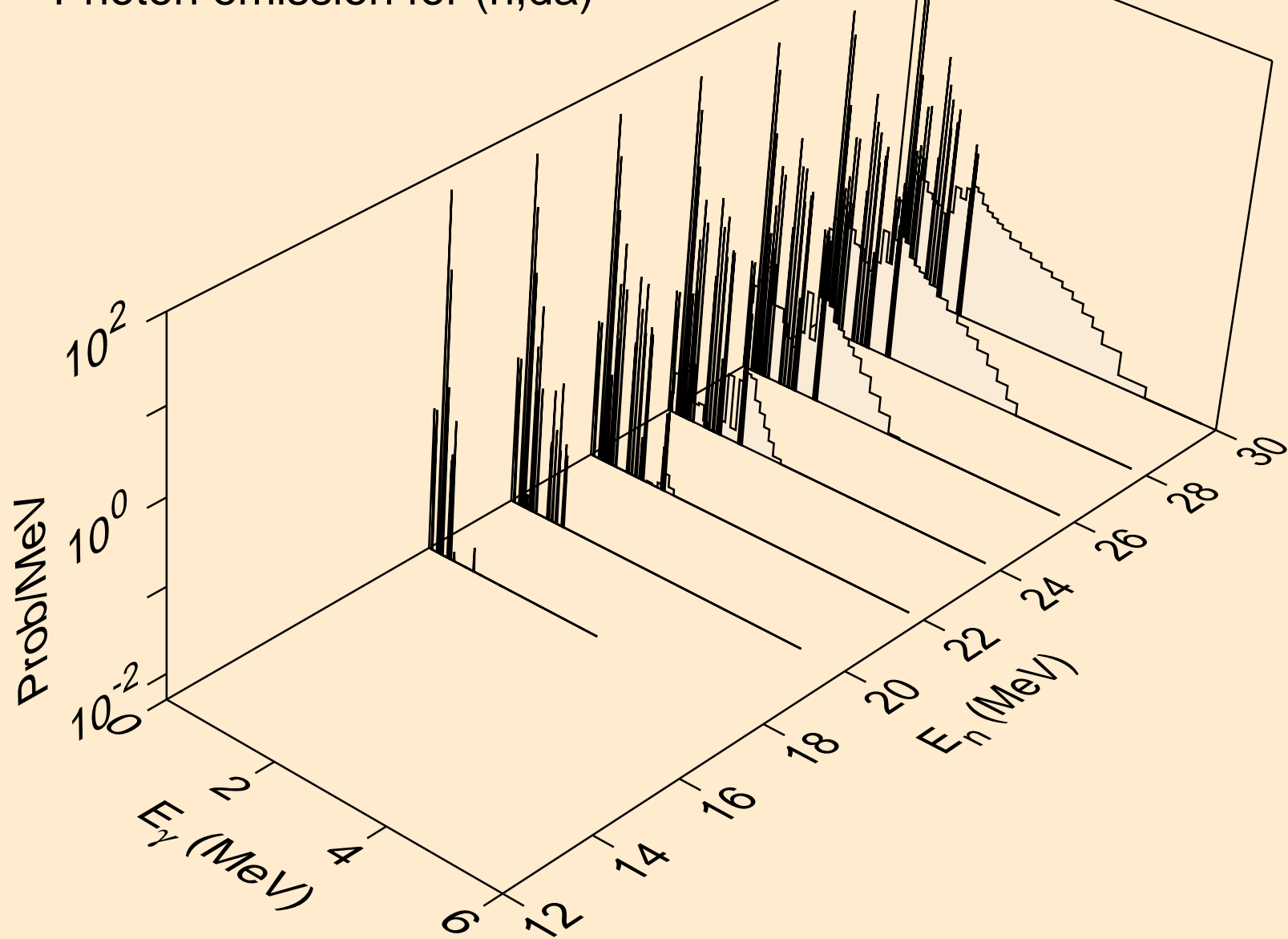

NI059 NEUTRON ACER TENDL-2023 LIBRARY; T=0.K  
thermal capture photon spectrum

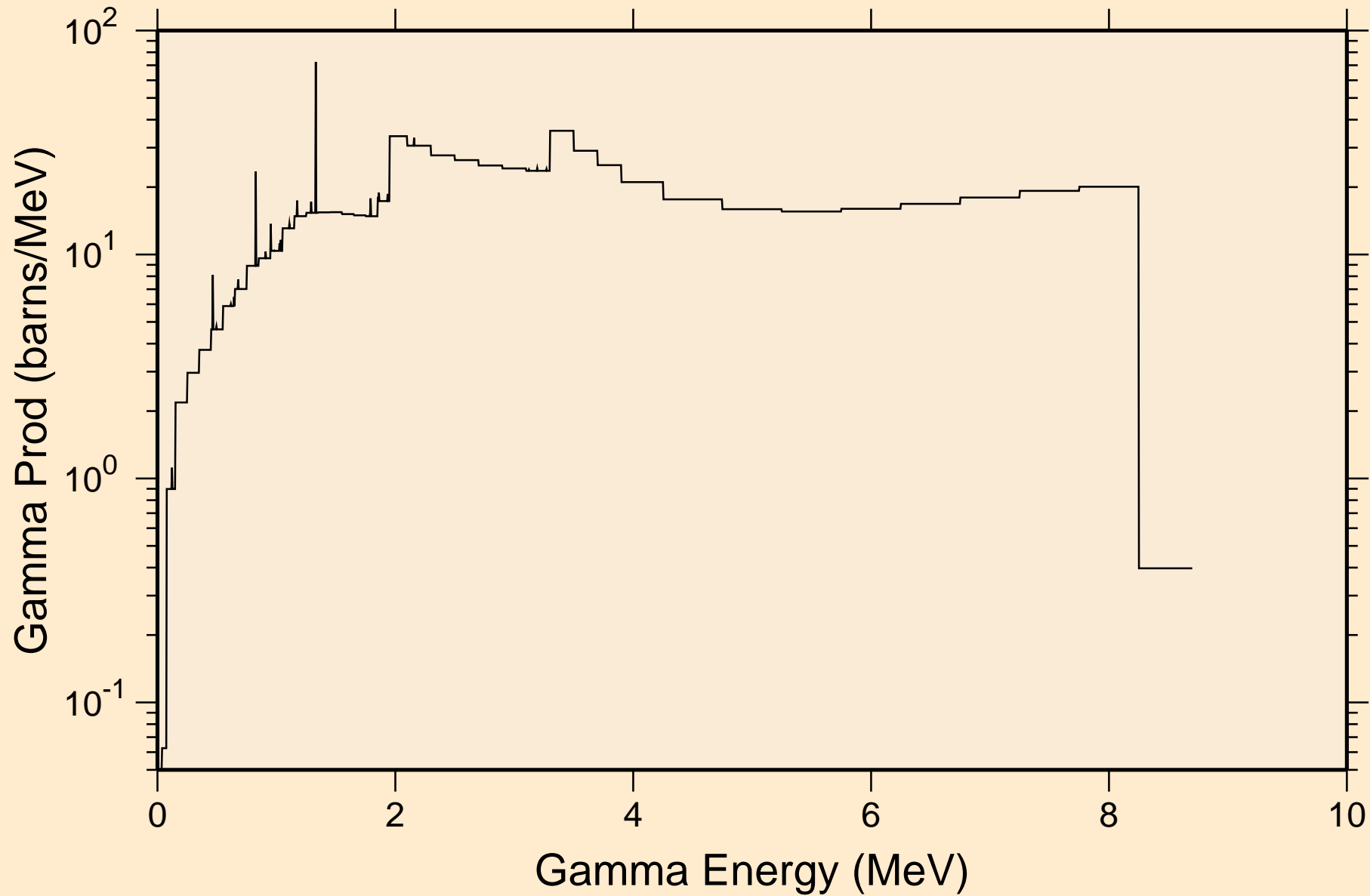

NI059 NEUTRON ACER TENDL-2023 LIBRARY; T=0.K  
14 MeV photon spectrum

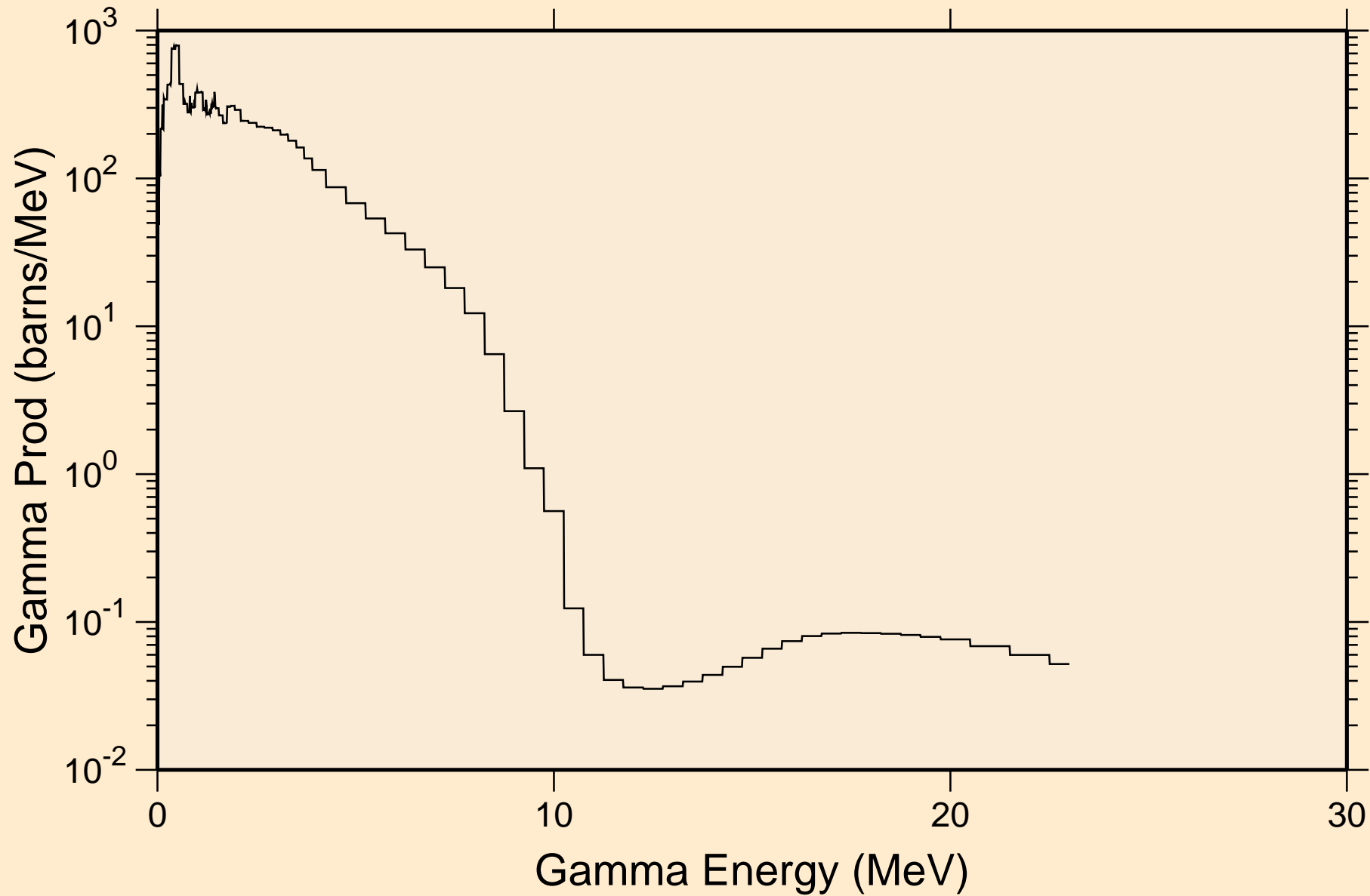



# NI059 NEUTRON ACER TENDL-2023 LIBRARY; T=0.K

## Particle heating contributions

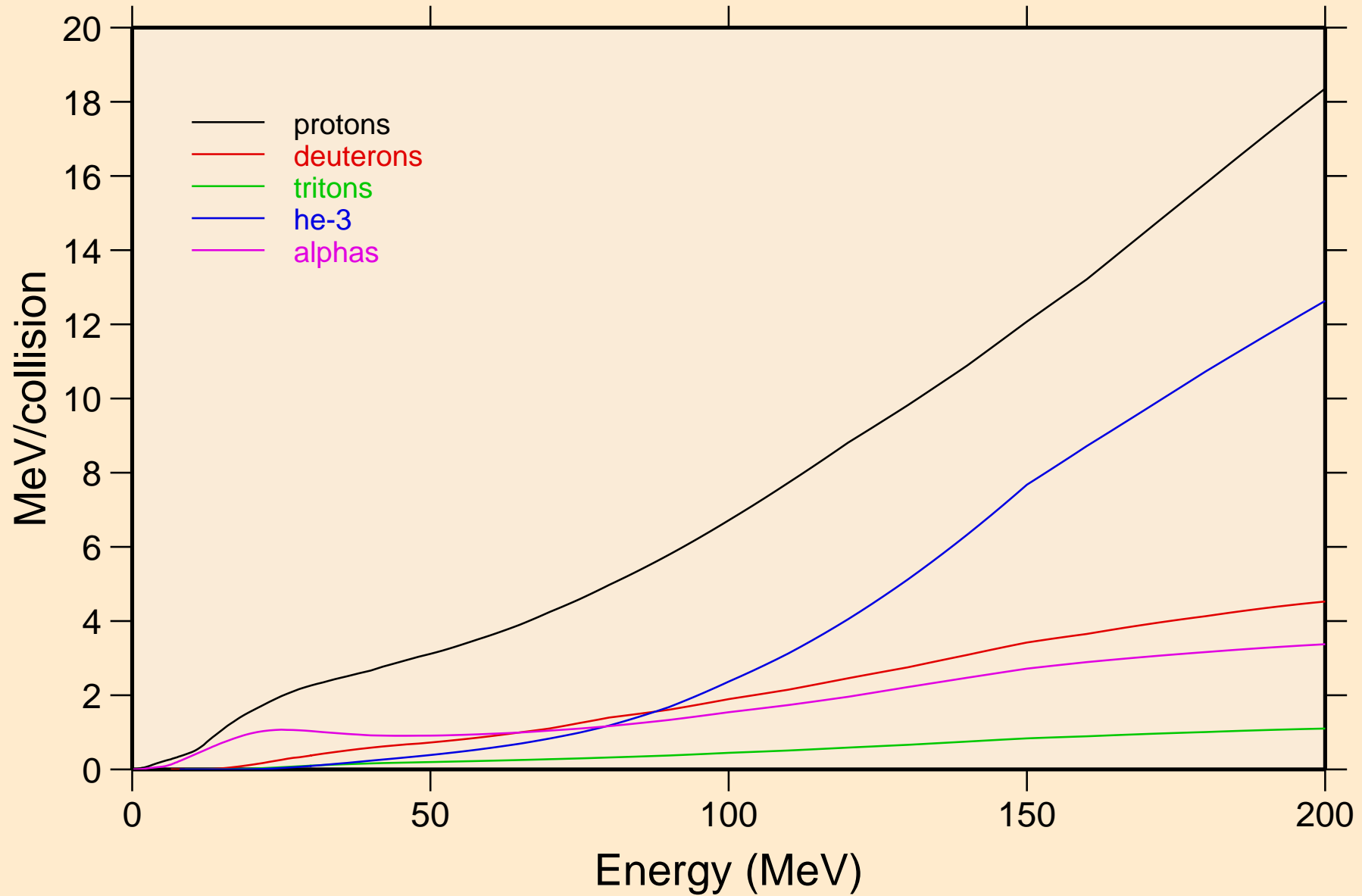

# NI059 NEUTRON ACER TENDL-2023 LIBRARY; T=0.K

## Recoil Heating

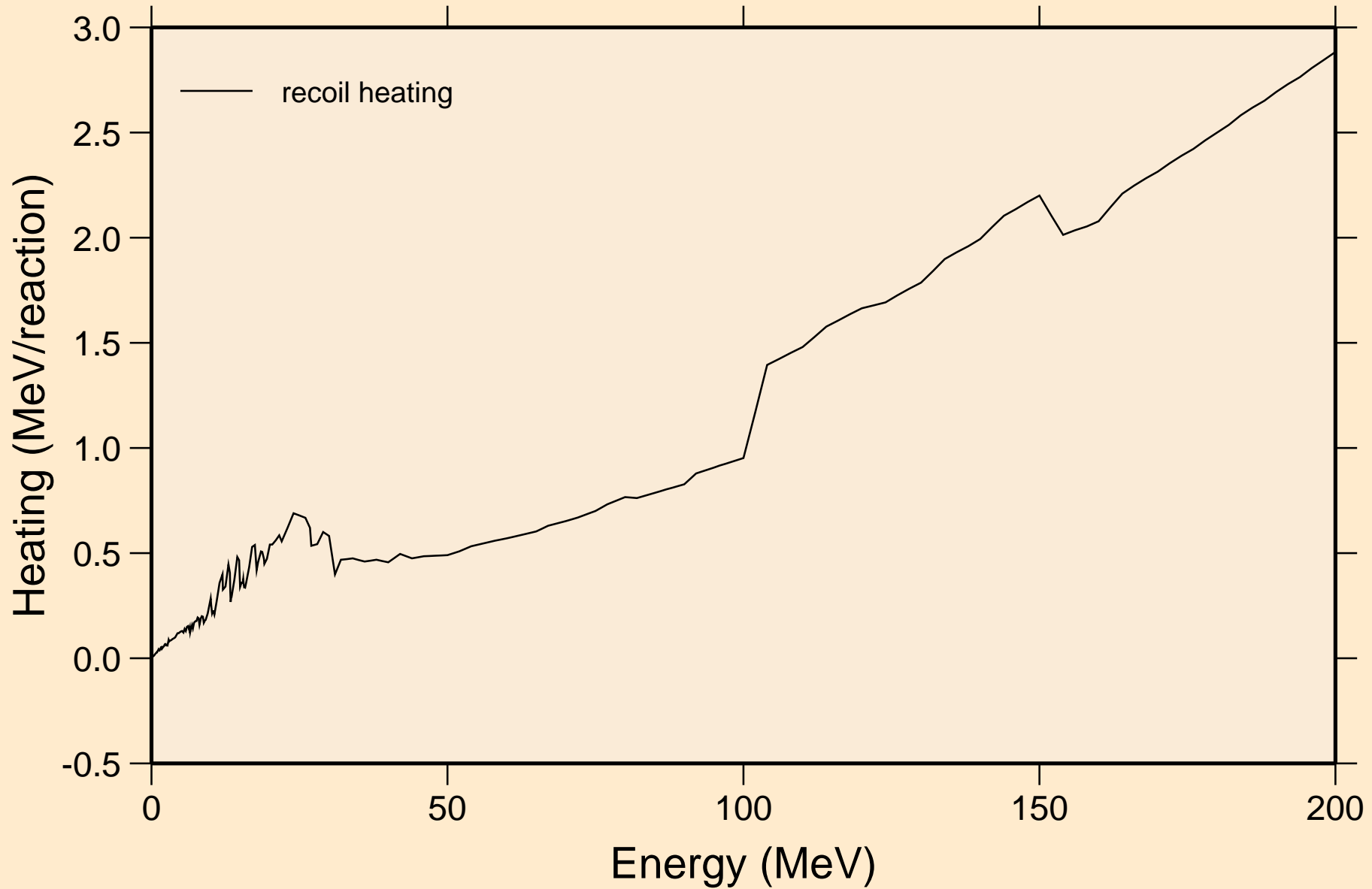

NI059 NEUTRON ACER TENDL-2023 LIBRARY; T=0.K  
Particle production cross sections

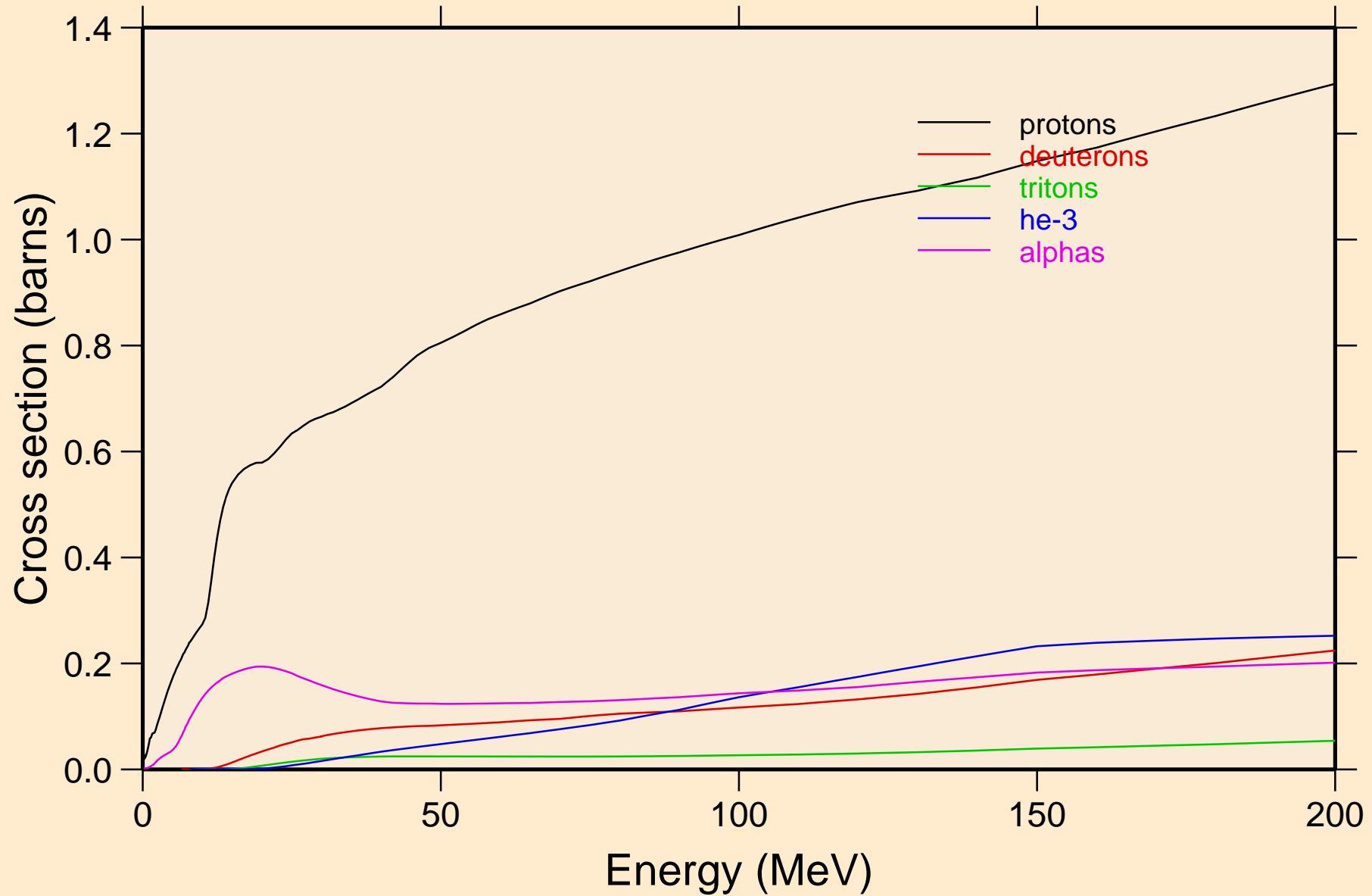

NI059 NEUTRON ACER TENDL-2023 LIBRARY; T=0.K  
protons from (n,x)

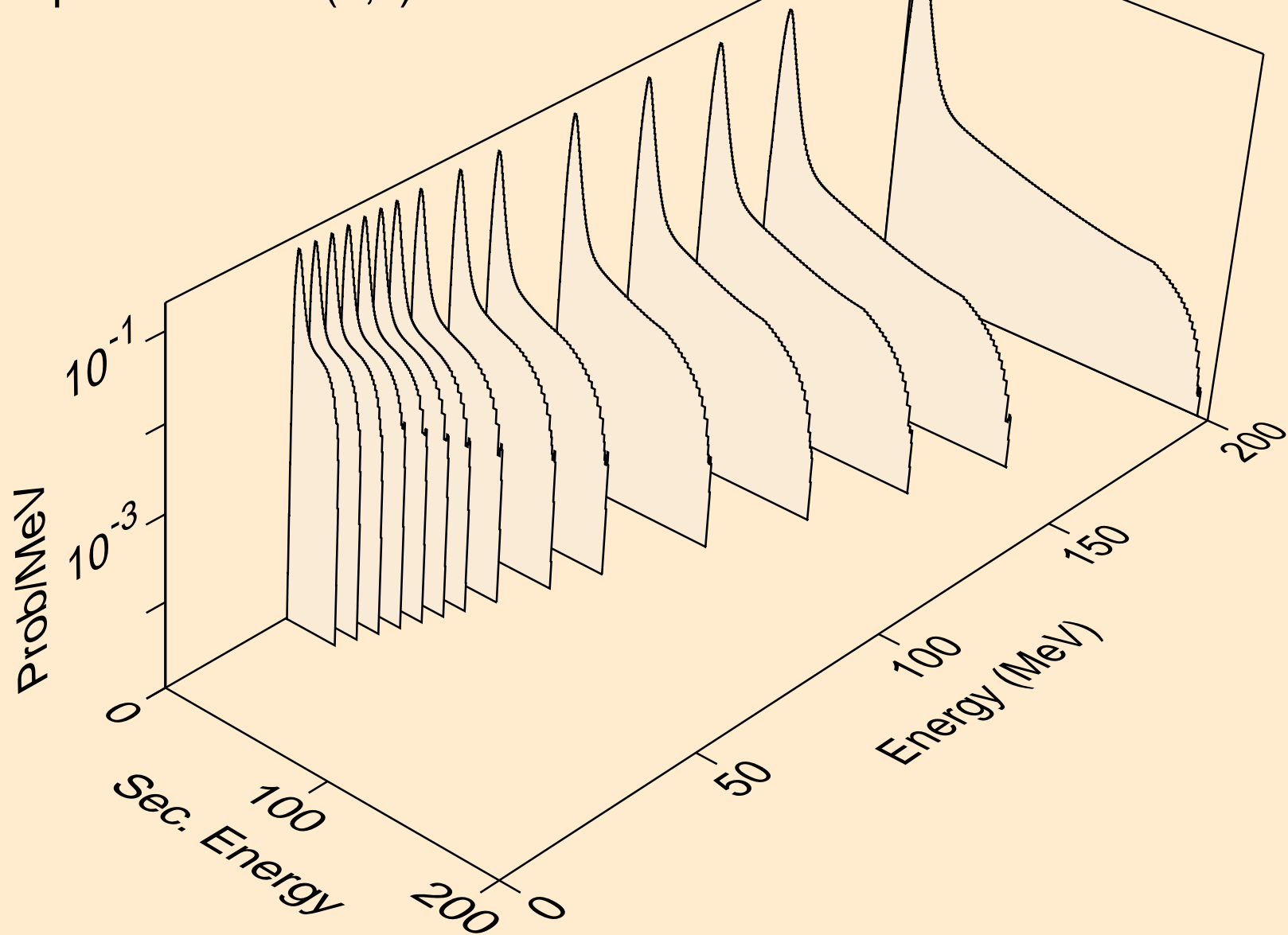

NI059 NEUTRON ACER TENDL-2023 LIBRARY; T=0.K  
protons from (n,n\*)p

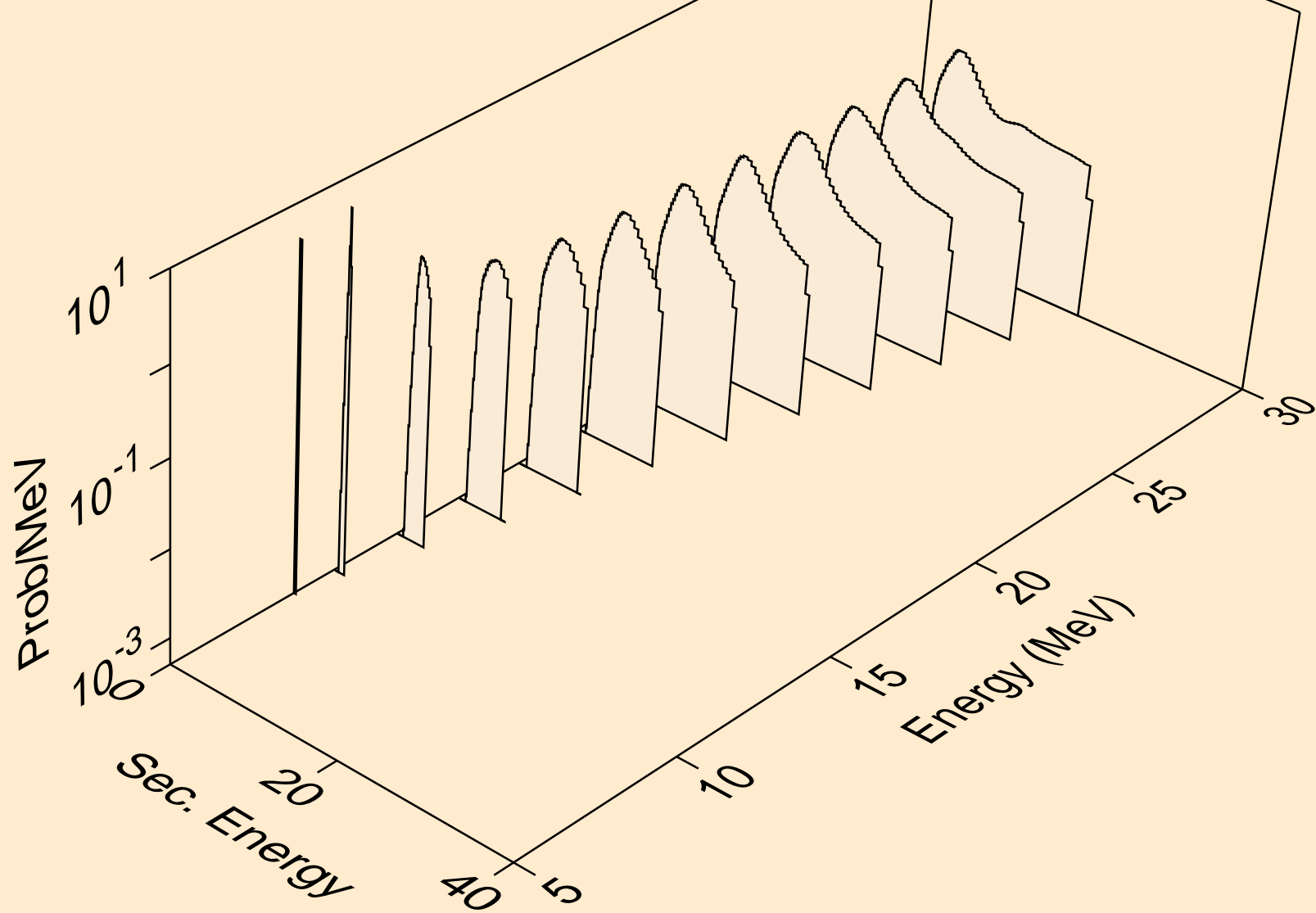

NI059 NEUTRON ACER TENDL-2023 LIBRARY; T=0.K  
protons from (n,2np)

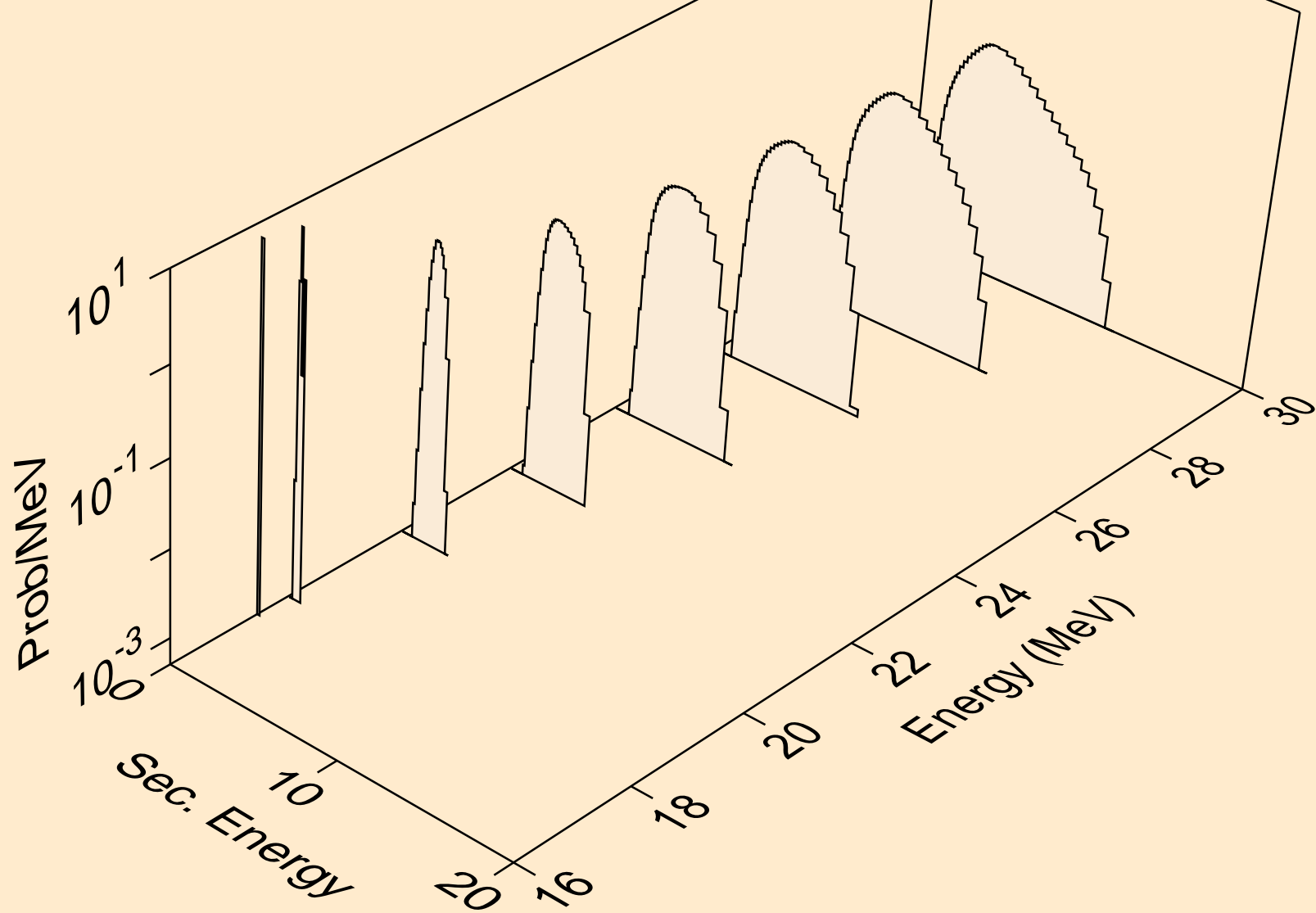

NI059 NEUTRON ACER TENDL-2023 LIBRARY; T=0.K  
protons from (n,n2p)

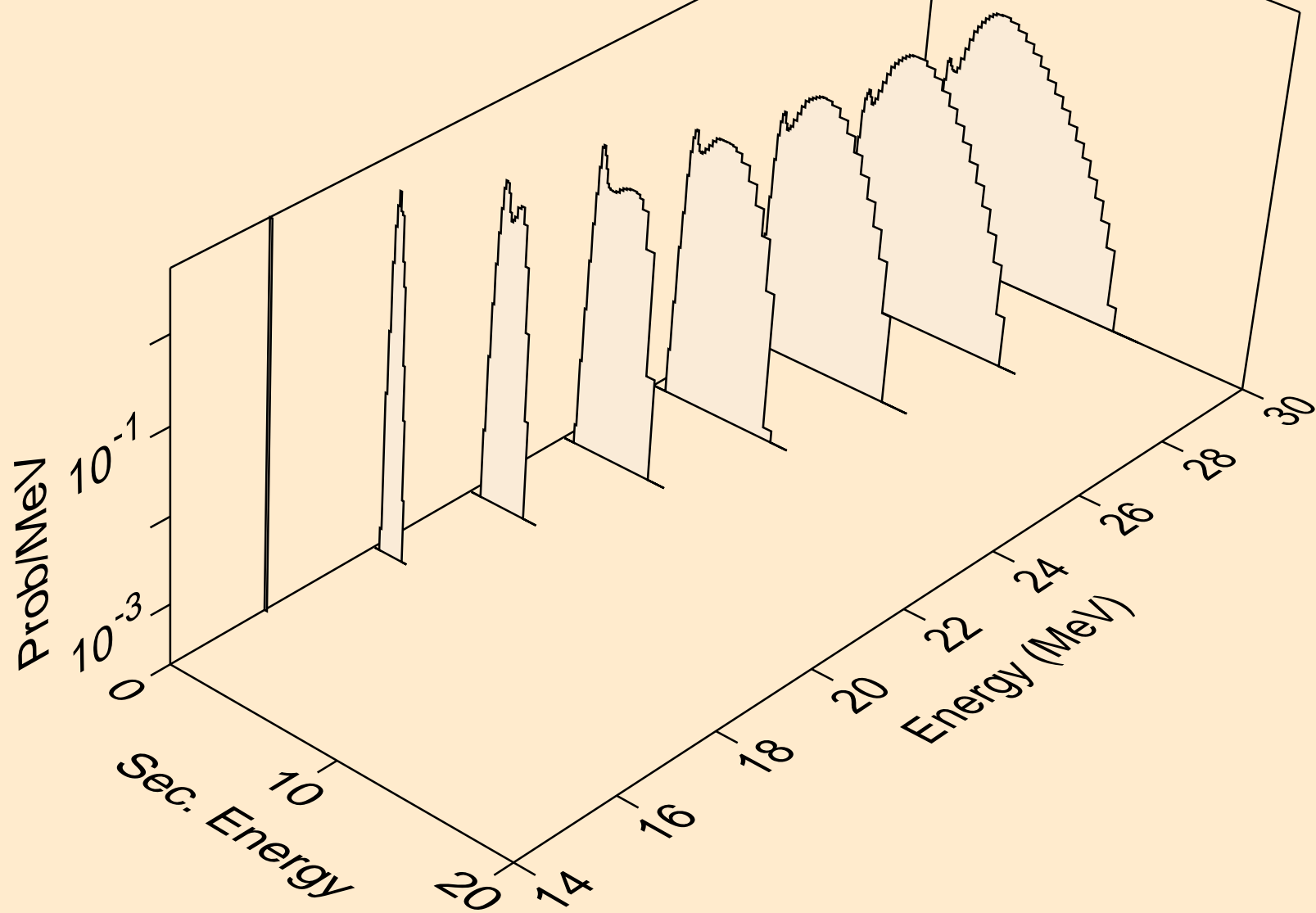

NI059 NEUTRON ACER TENDL-2023 LIBRARY; T=0.K  
protons from (n,npa)

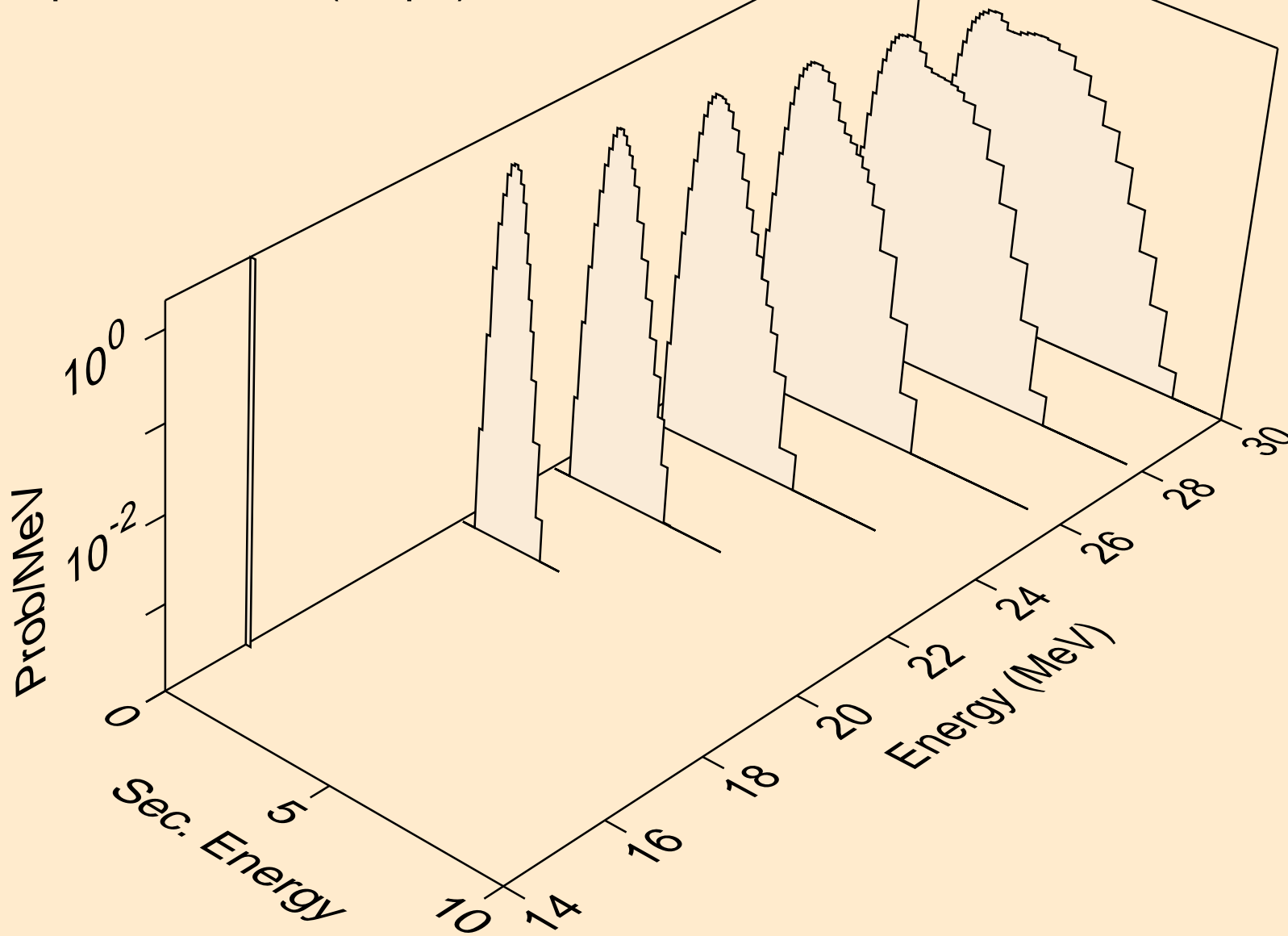



NI059 NEUTRON ACER TENDL-2023 LIBRARY; T=0.K  
protons from (n,p)

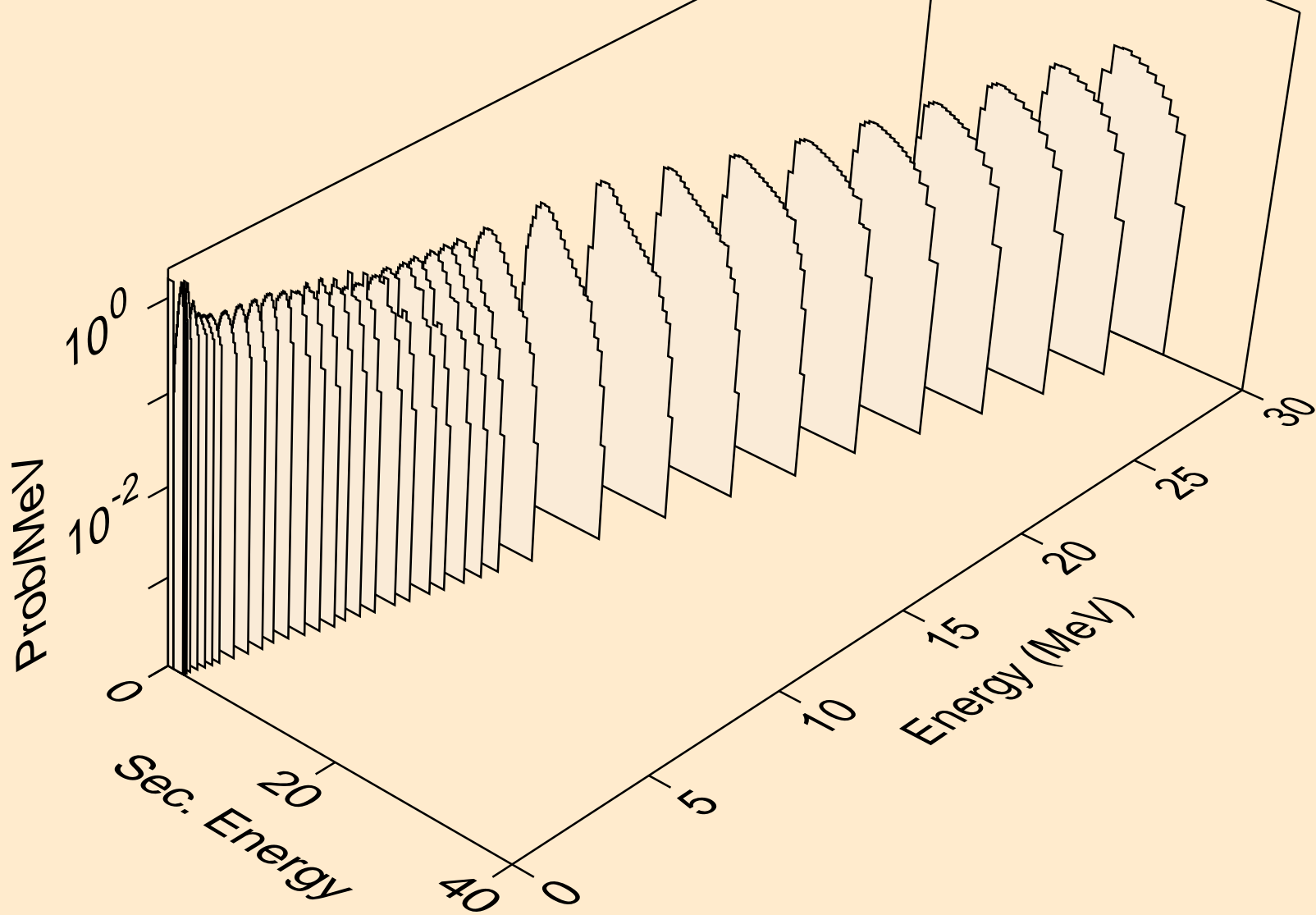

NI059 NEUTRON ACER TENDL-2023 LIBRARY; T=0.K  
protons from (n,2p)

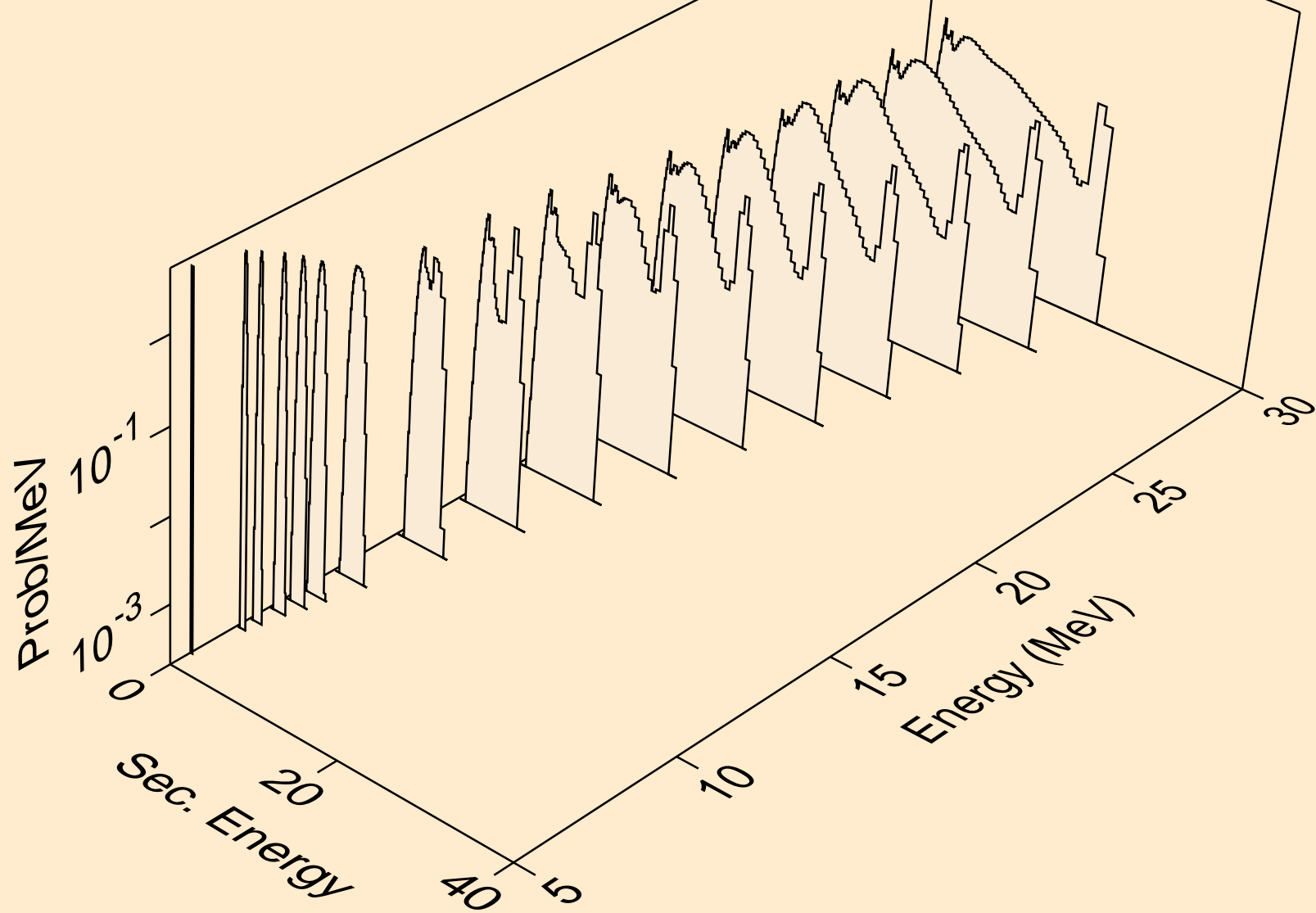

NI059 NEUTRON ACER TENDL-2023 LIBRARY; T=0.K  
protons from (n,p)

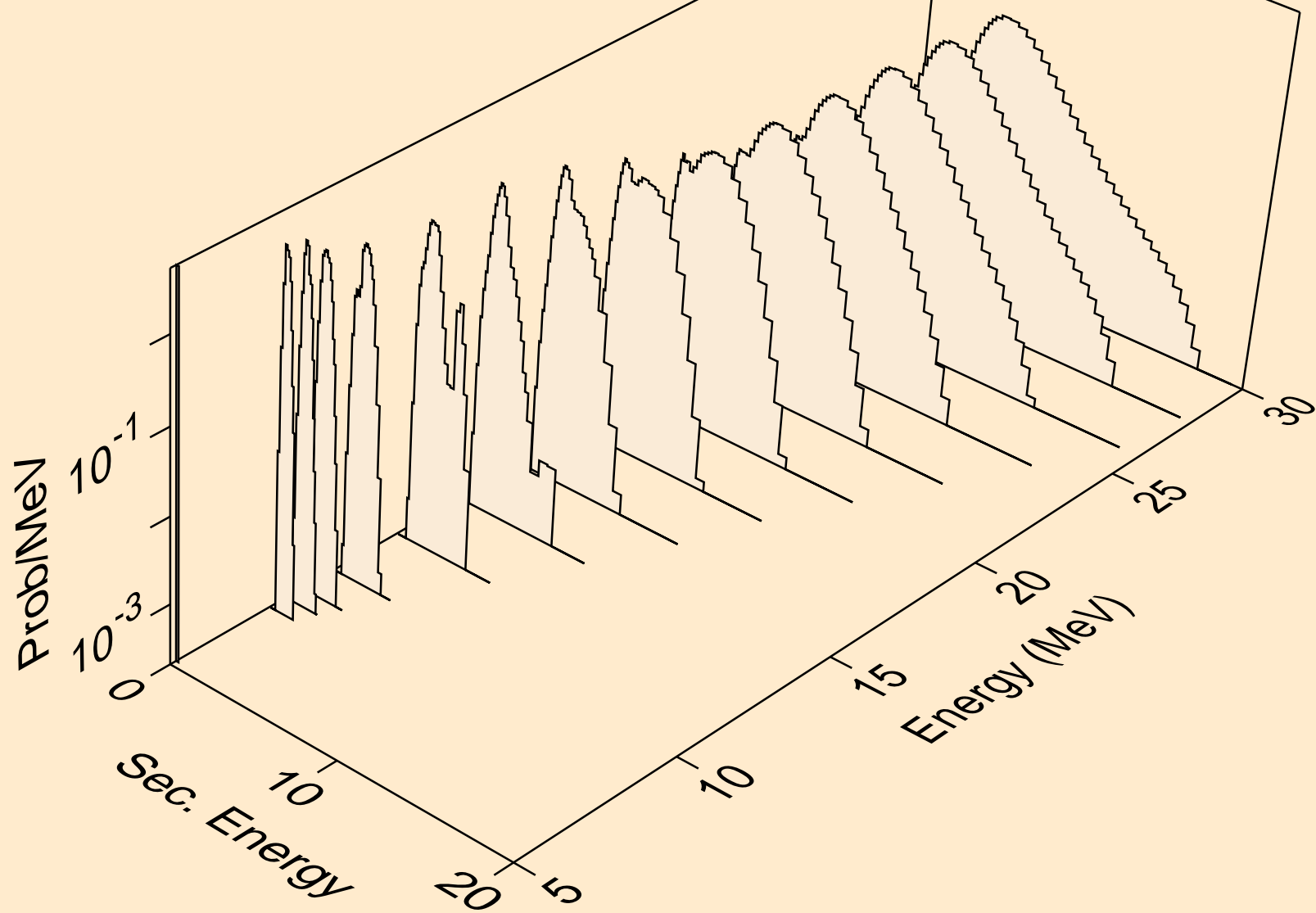

NI059 NEUTRON ACER TENDL-2023 LIBRARY; T=0.K  
protons from (n,pd)

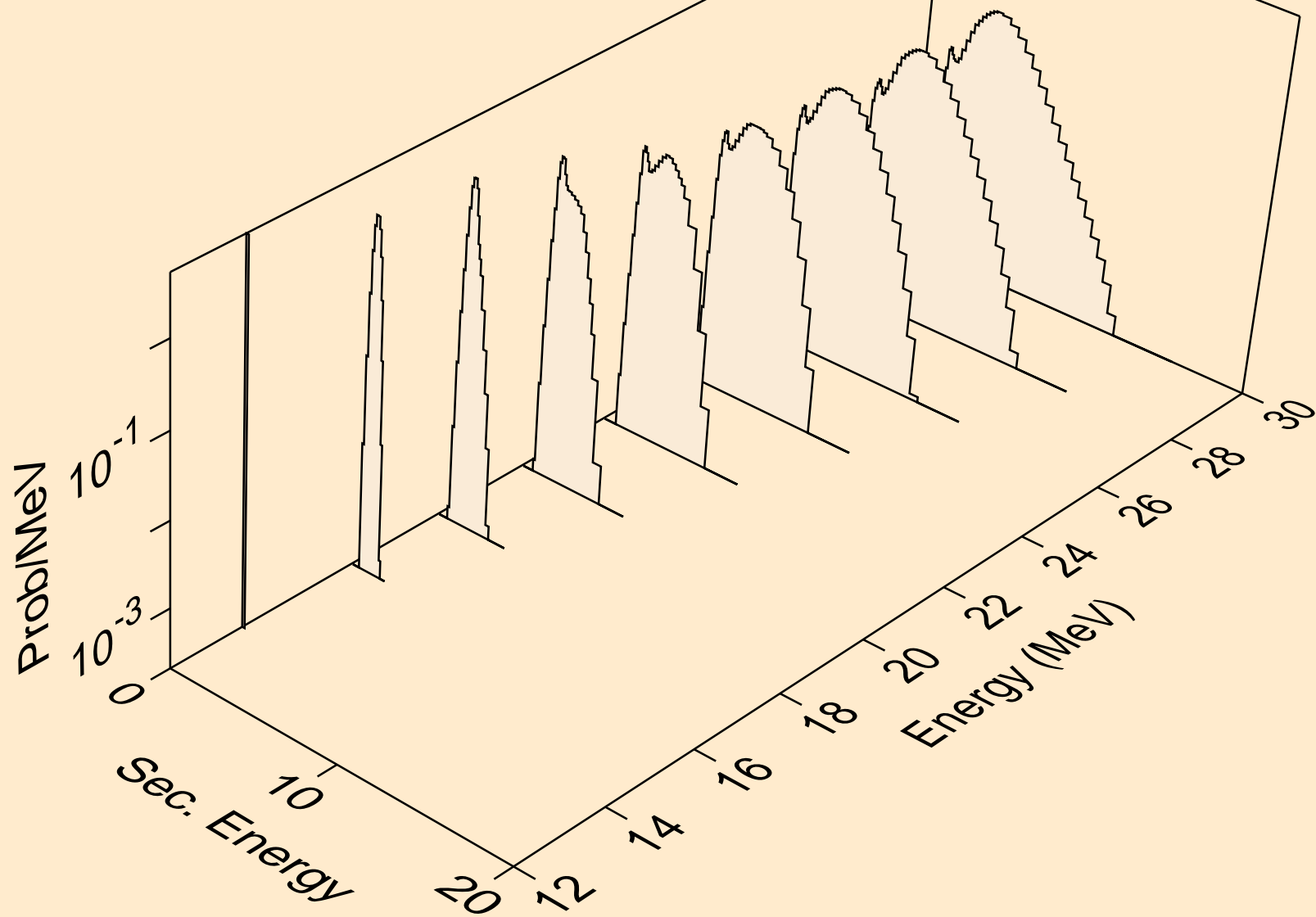

NI059 NEUTRON ACER TENDL-2023 LIBRARY; T=0.K  
protons from (n,pt)

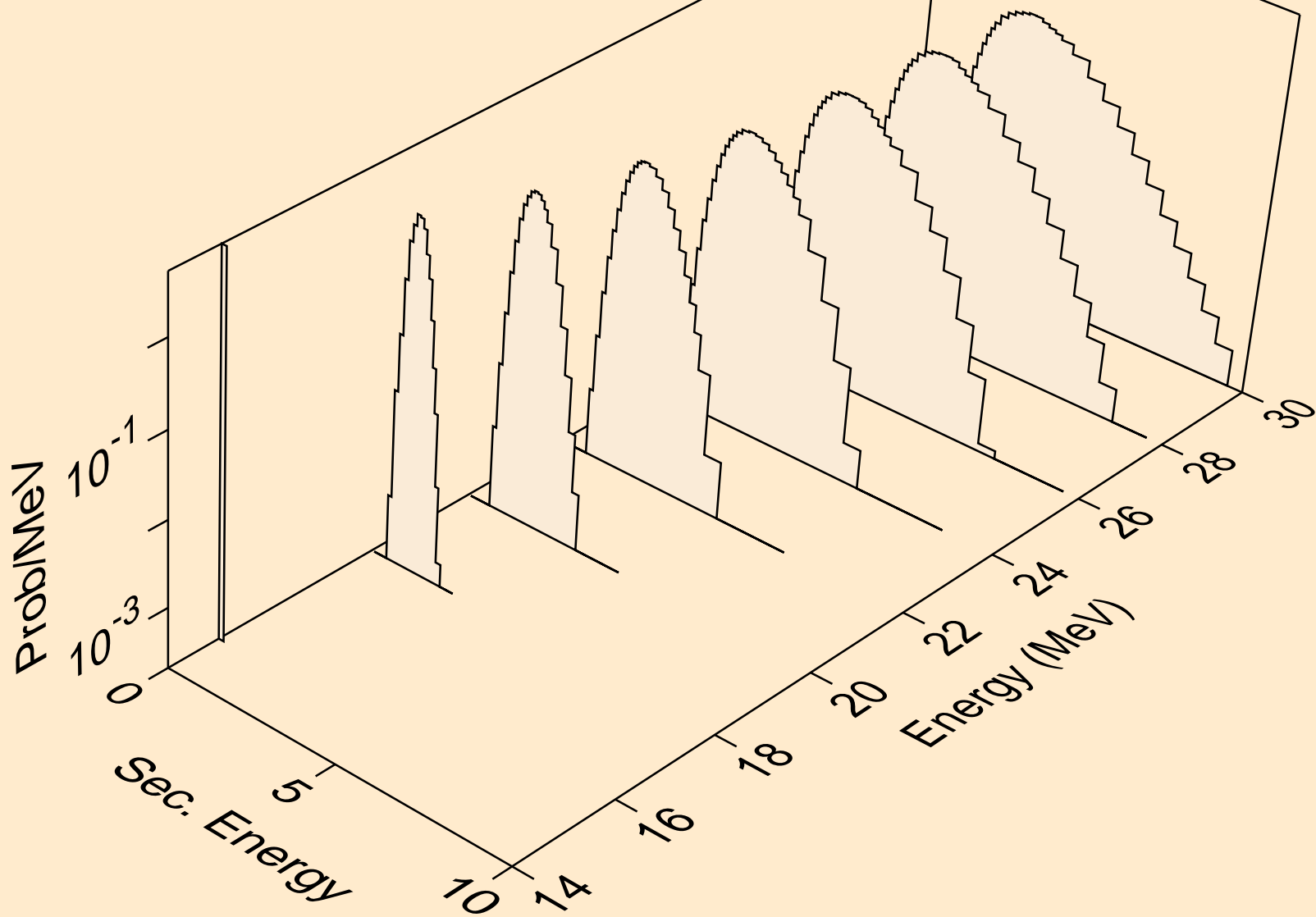

NI059 NEUTRON ACER TENDL-2023 LIBRARY; T=0.K  
deuterons from (n,x)

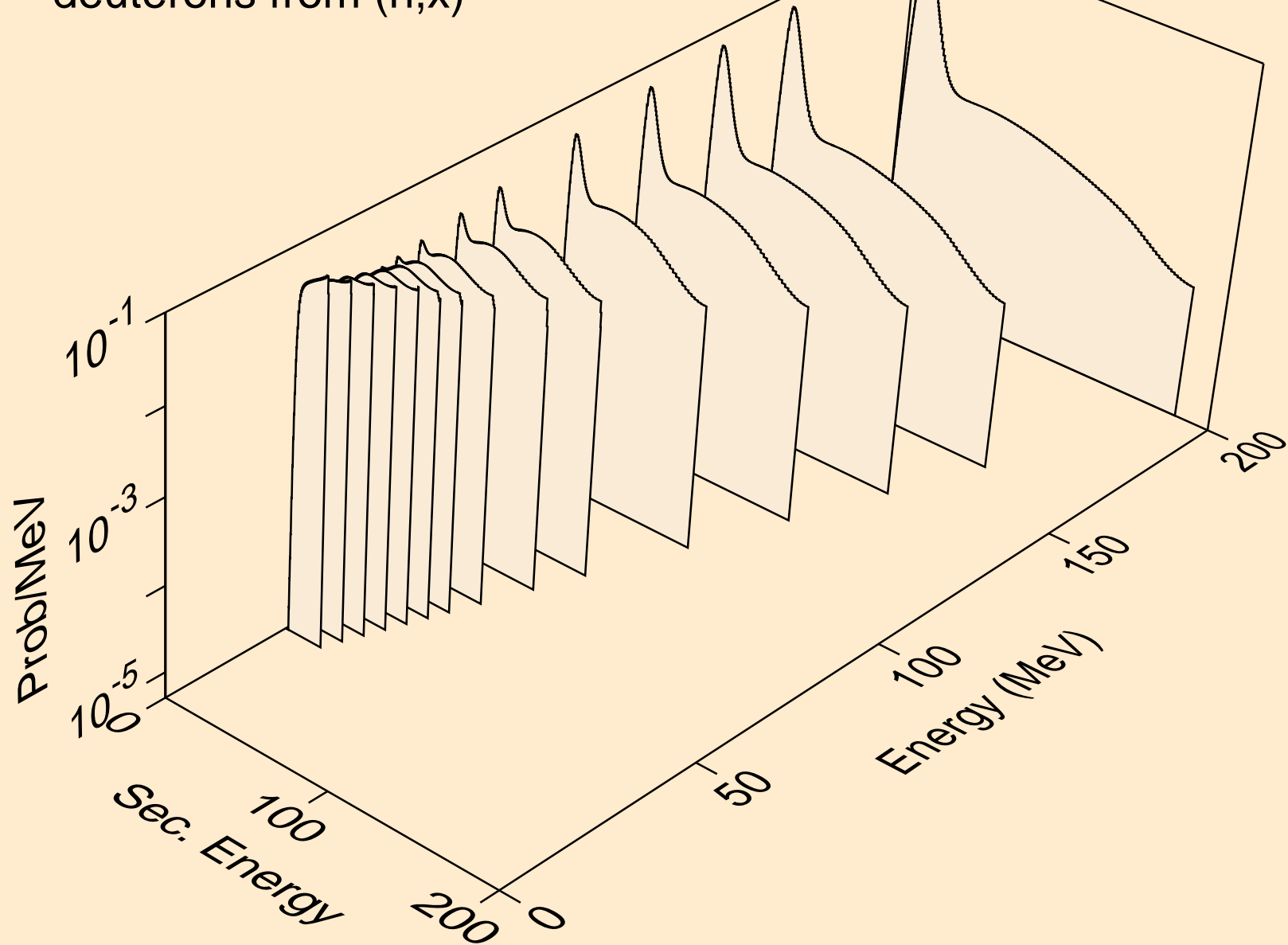

NI059 NEUTRON ACER TENDL-2023 LIBRARY; T=0.K  
deuterons from (n,2nd)

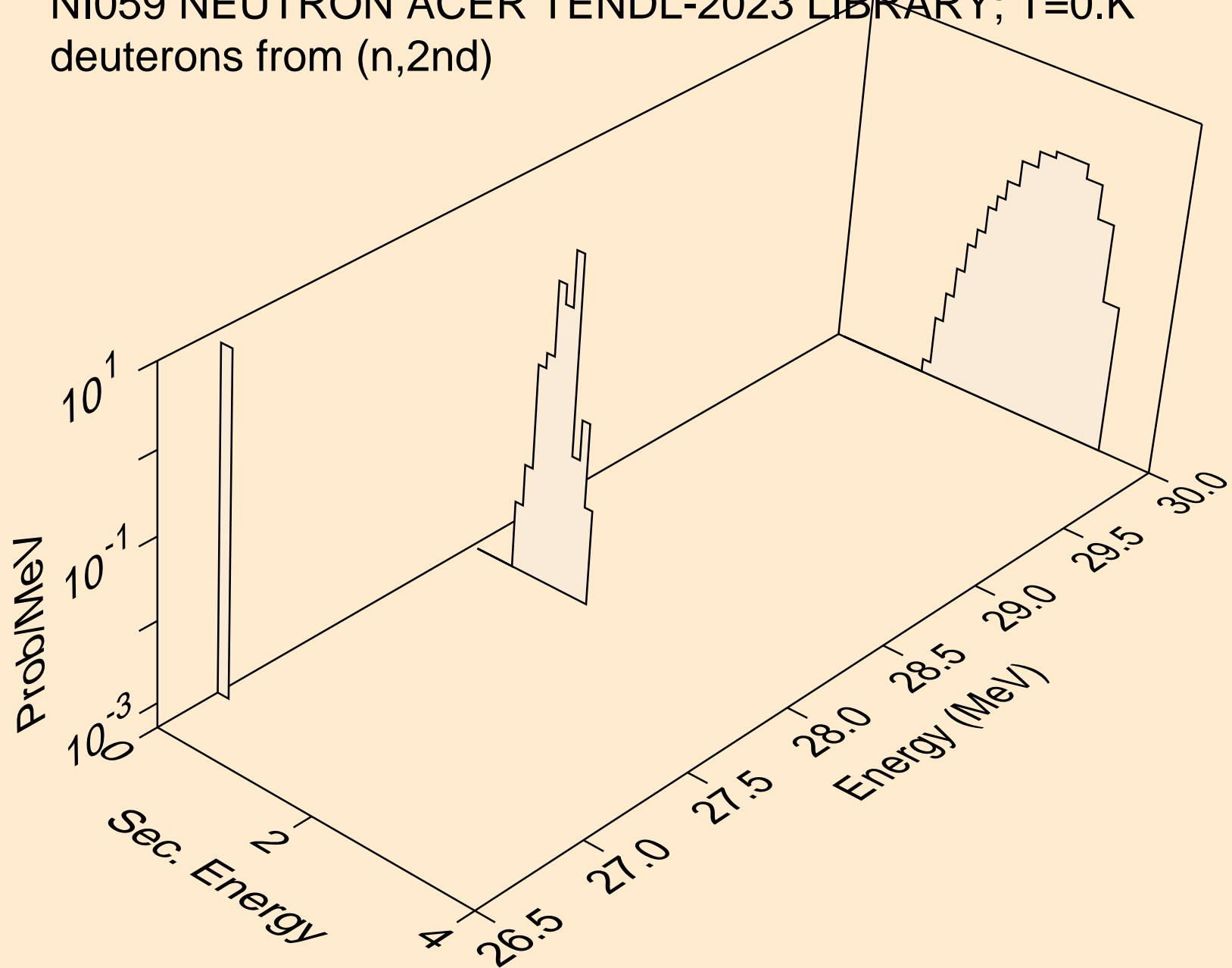

NI059 NEUTRON ACER TENDL-2023 LIBRARY; T=0.K  
deuterons from (n,n\*)d

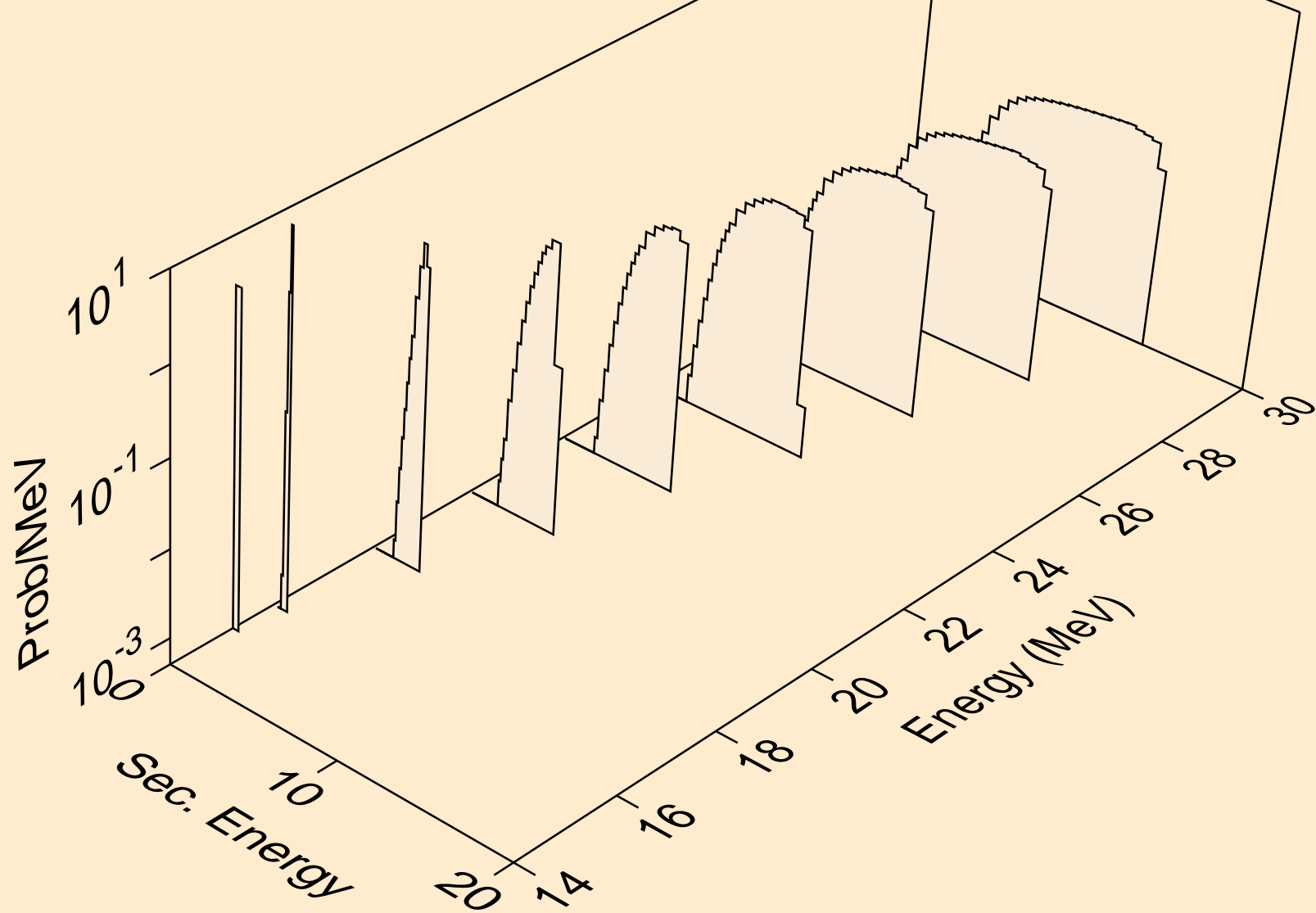



NI059 NEUTRON ACER TENDL-2023 LIBRARY; T=0.K  
deuterons from (n,d)

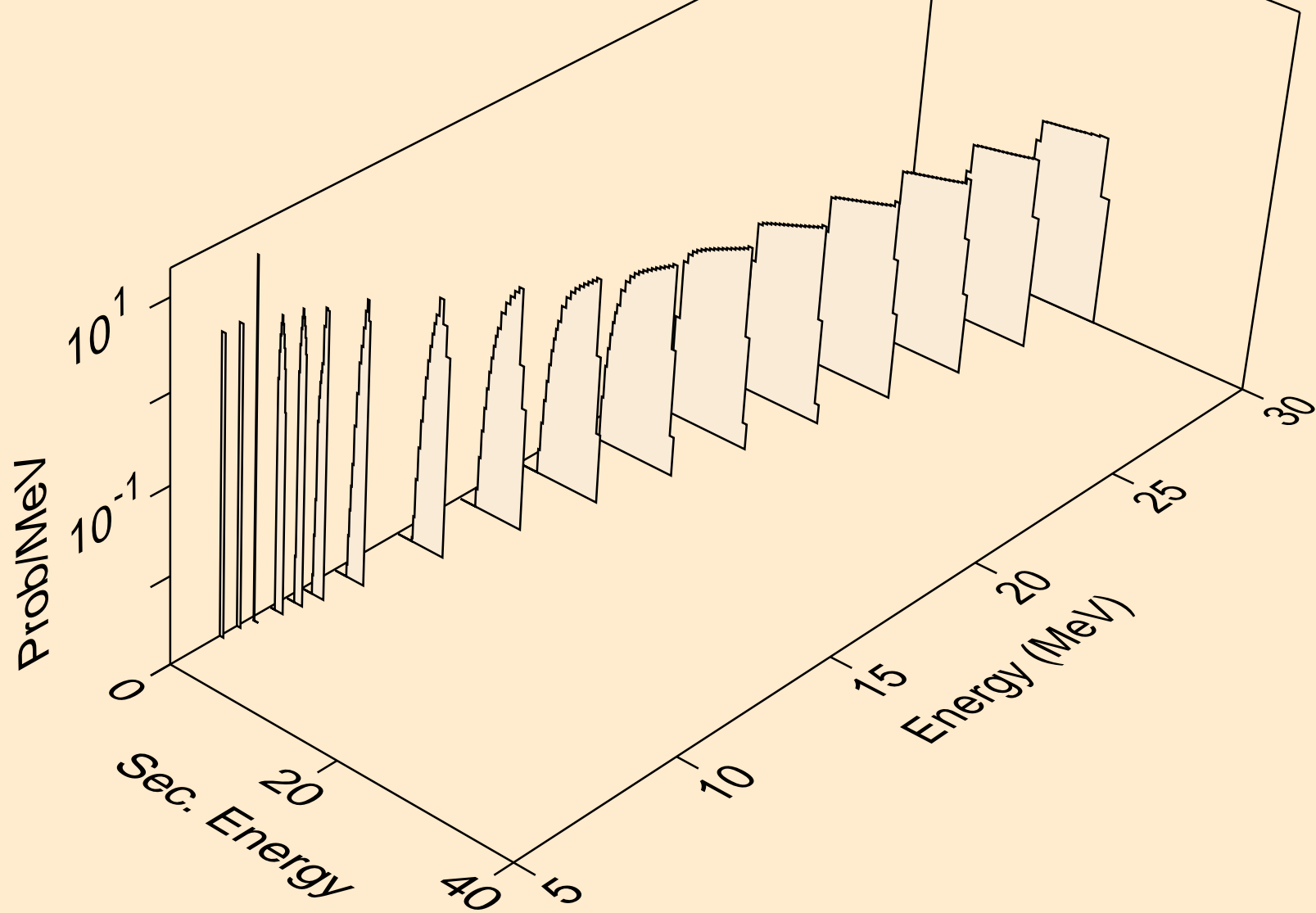

NI059 NEUTRON ACER TENDL-2023 LIBRARY; T=0.K  
deuterons from (n,pd)

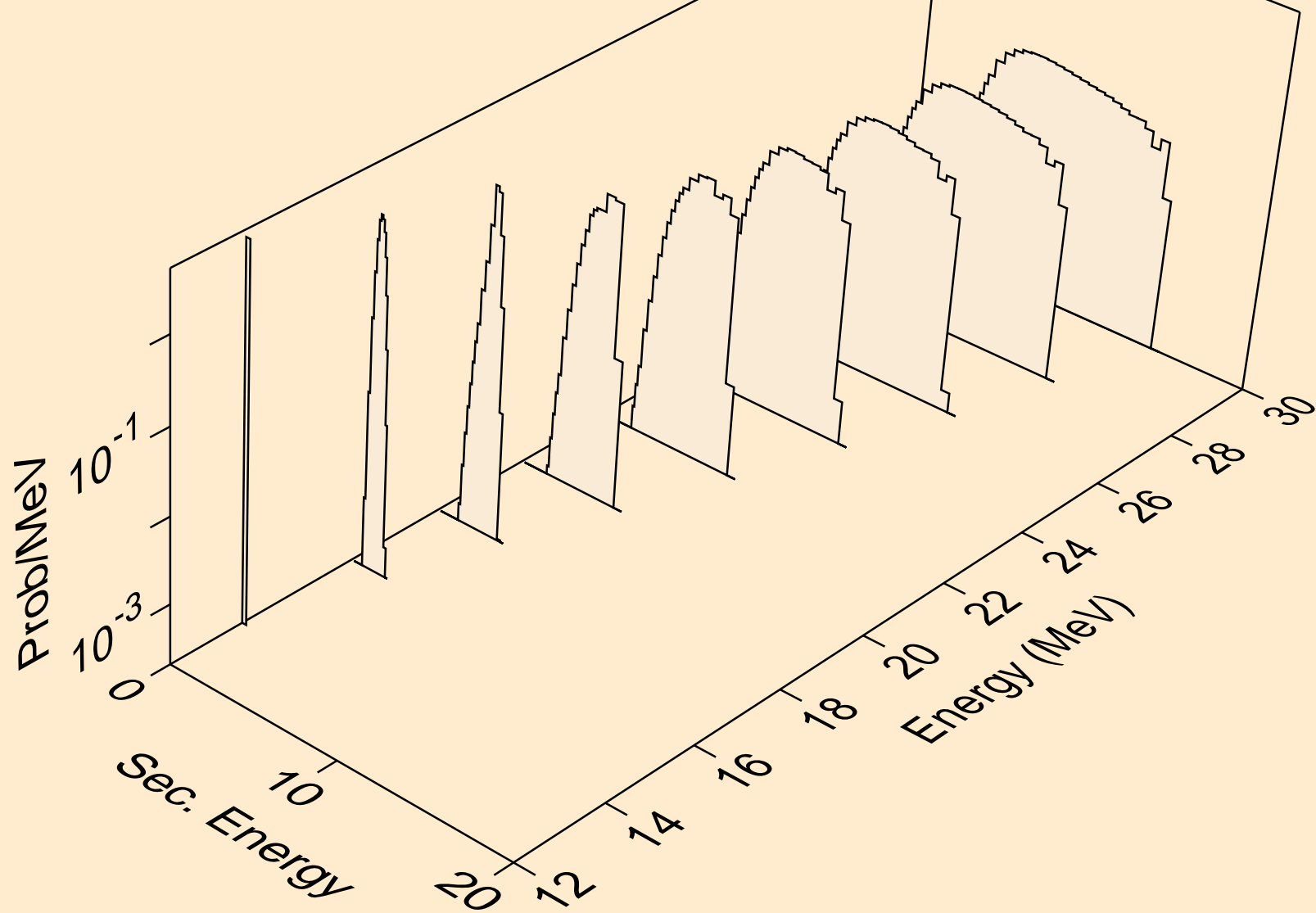

NI059 NEUTRON ACER TENDL-2023 LIBRARY; T=0.K  
deuterons from (n,da)

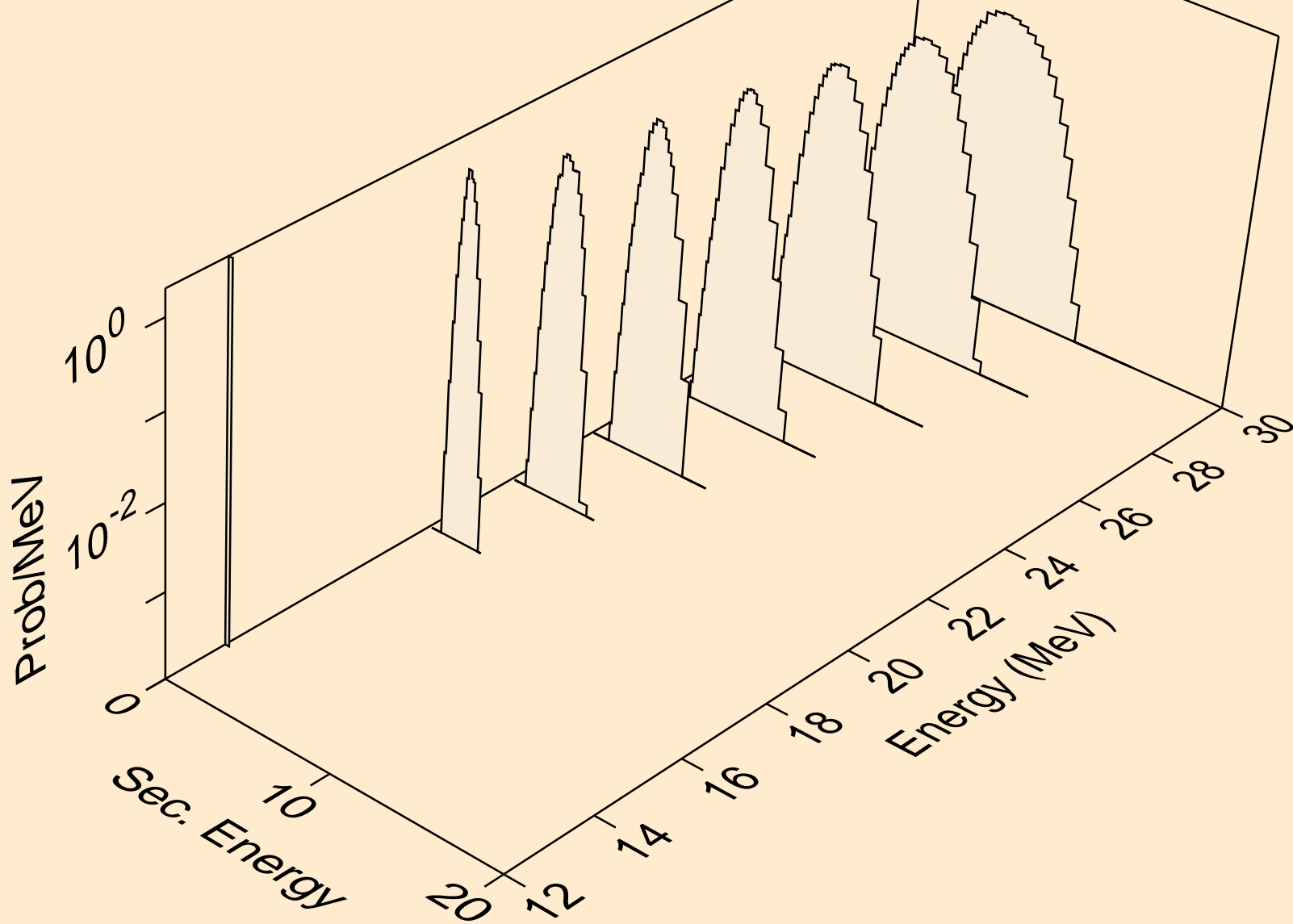

NI059 NEUTRON ACER TENDL-2023 LIBRARY; T=0.K  
tritons from (n,x)

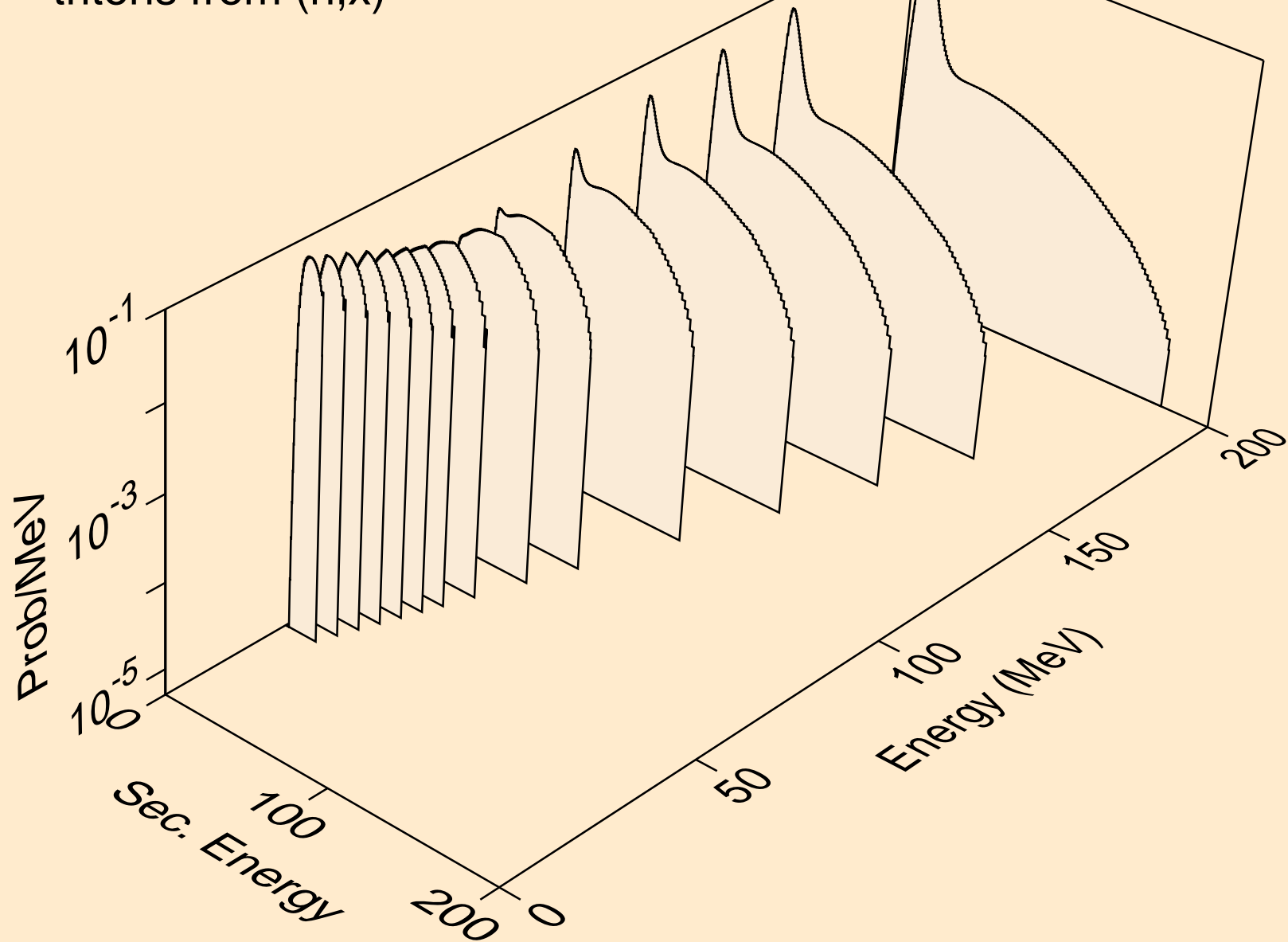

NI059 NEUTRON ACER TENDL-2023 LIBRARY; T=0.K  
tritons from (n,n\*)t

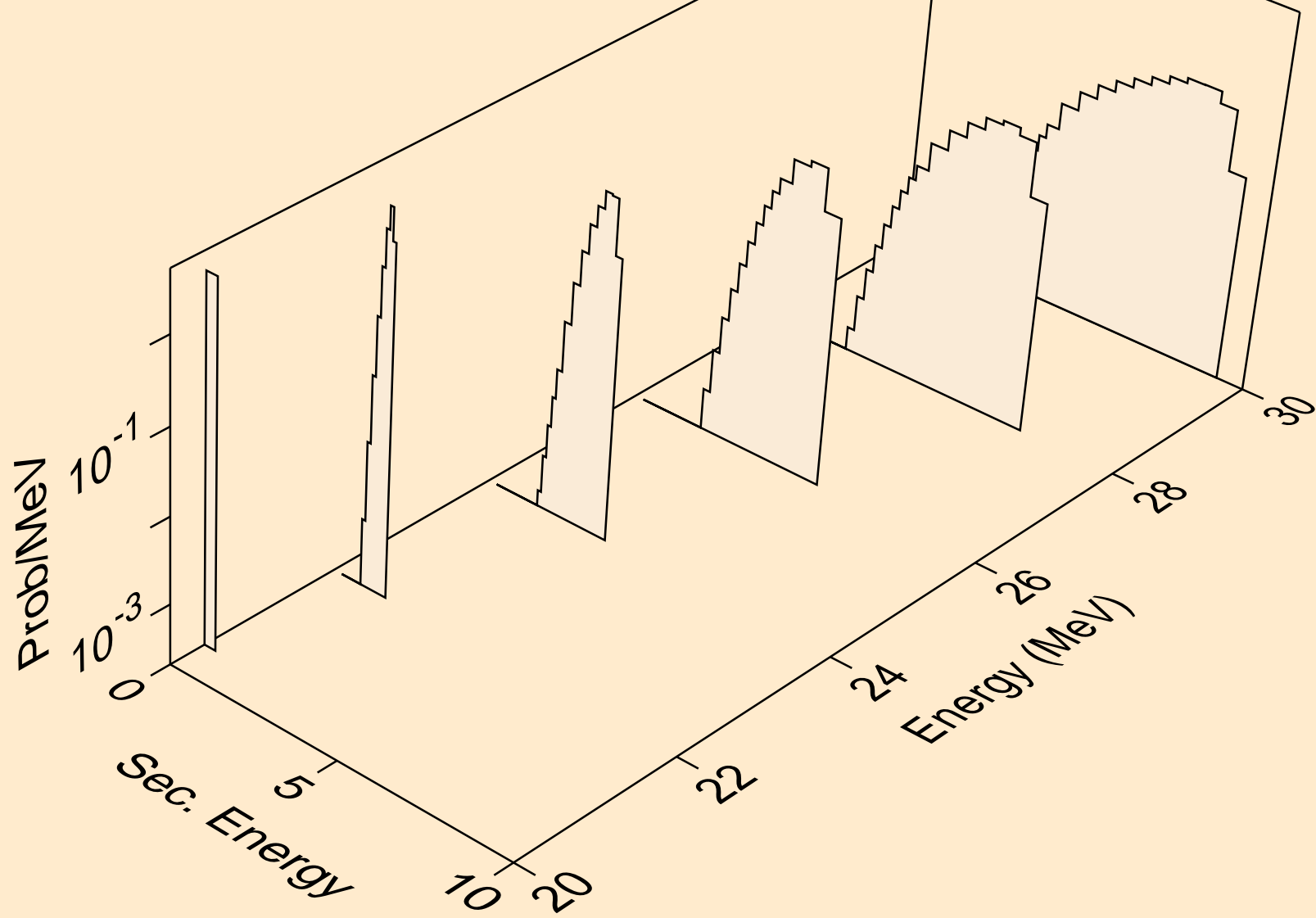

NI059 NEUTRON ACER TENDL-2023 LIBRARY; T=0.K  
tritons from (n,t)

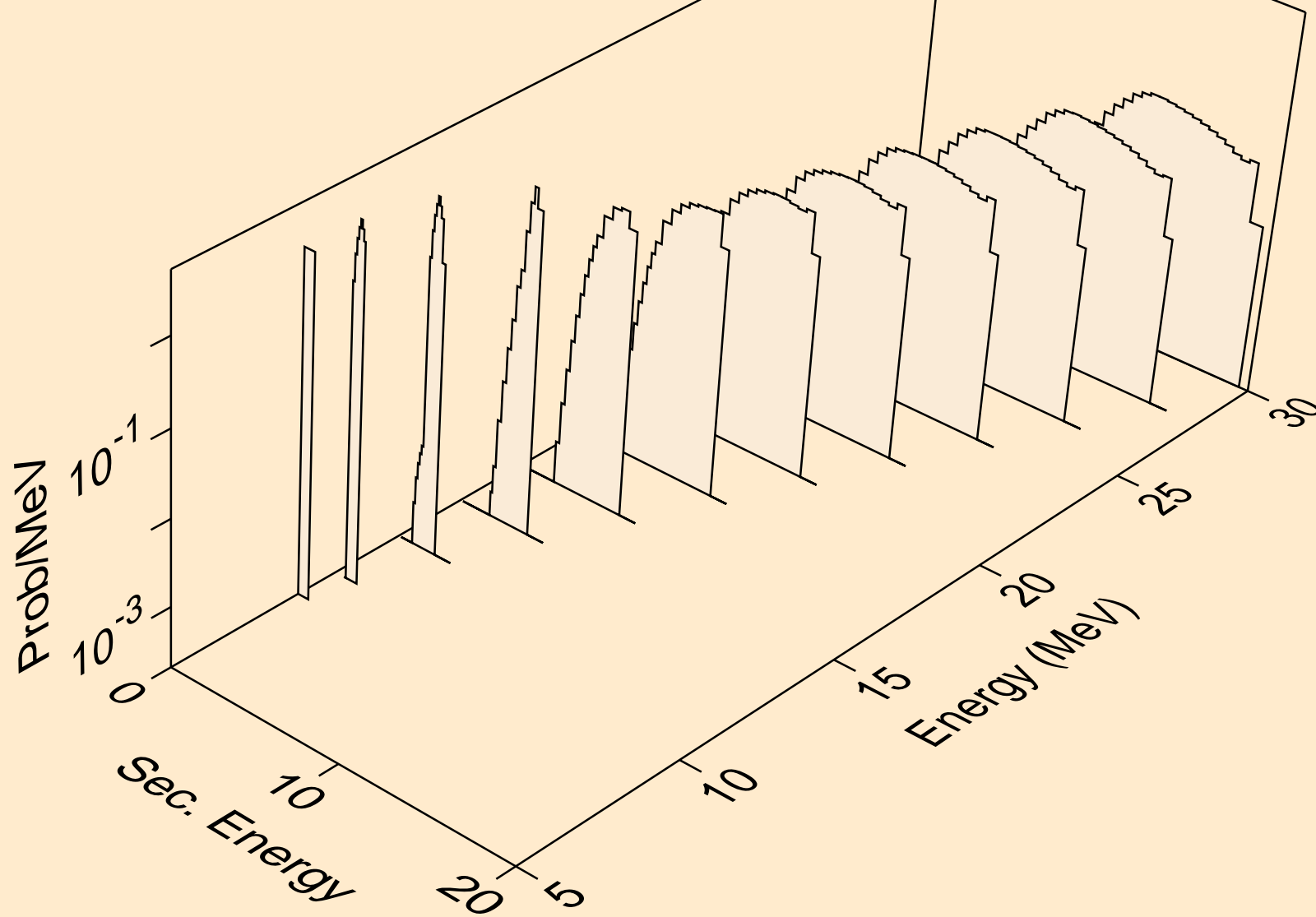

NI059 NEUTRON ACER TENDL-2023 LIBRARY; T=0.K  
tritons from (n,pt)

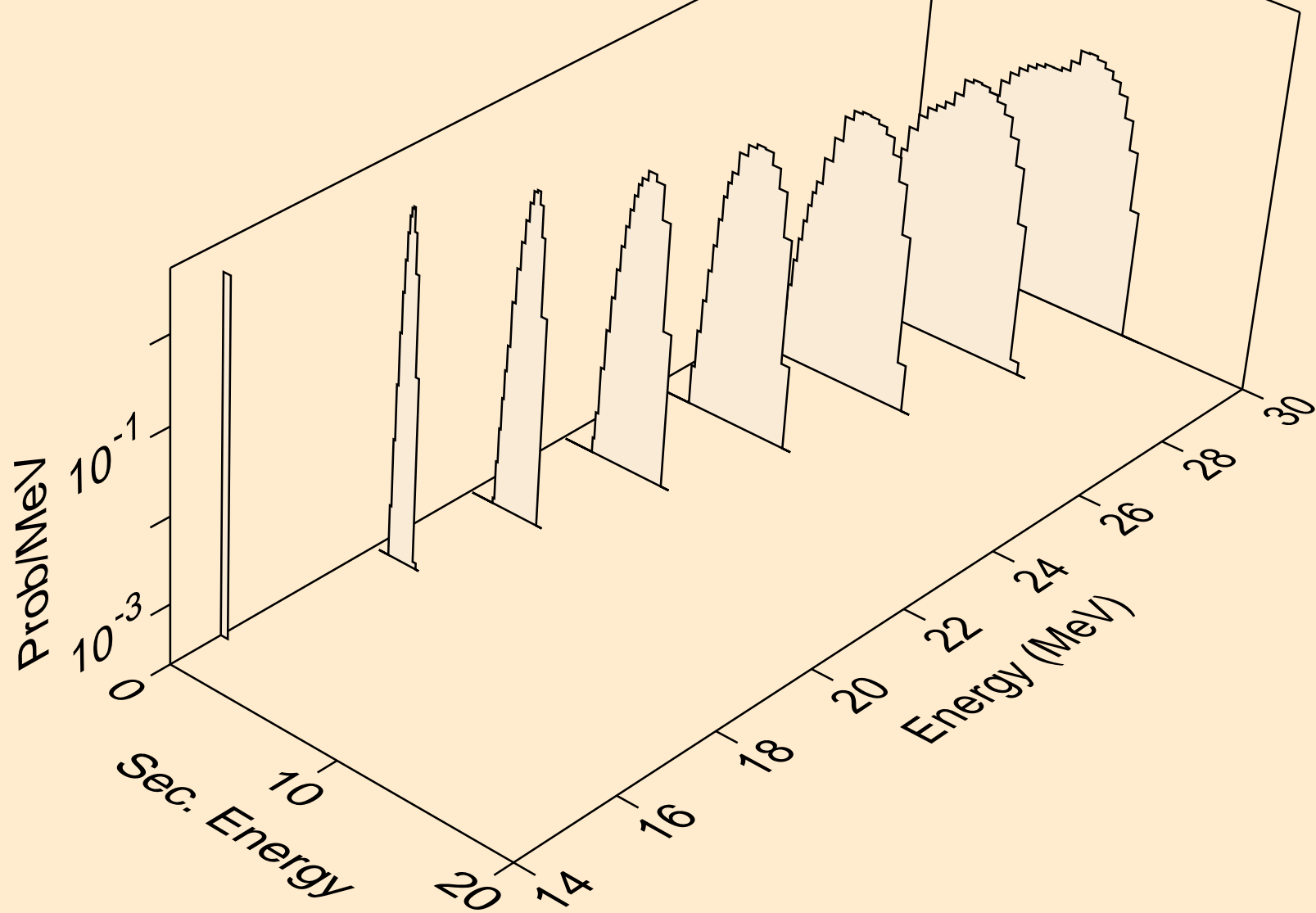

NI059 NEUTRON ACER TENDL-2023 LIBRARY; T=0.K  
he3s from (n,x)

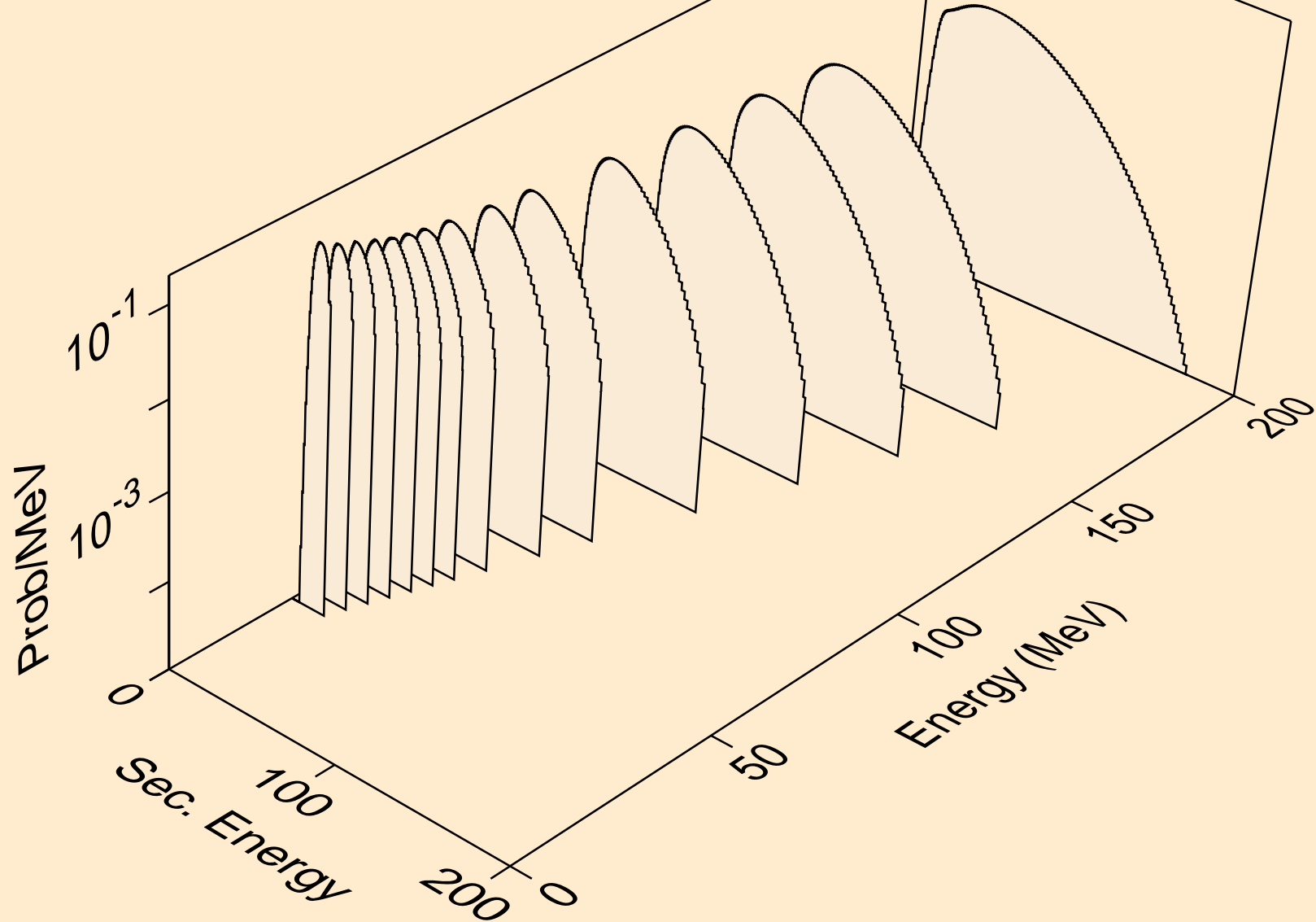



NI059 NEUTRON ACER TENDL-2023 LIBRARY; T=0.K  
he3s from (n,n\*)he3

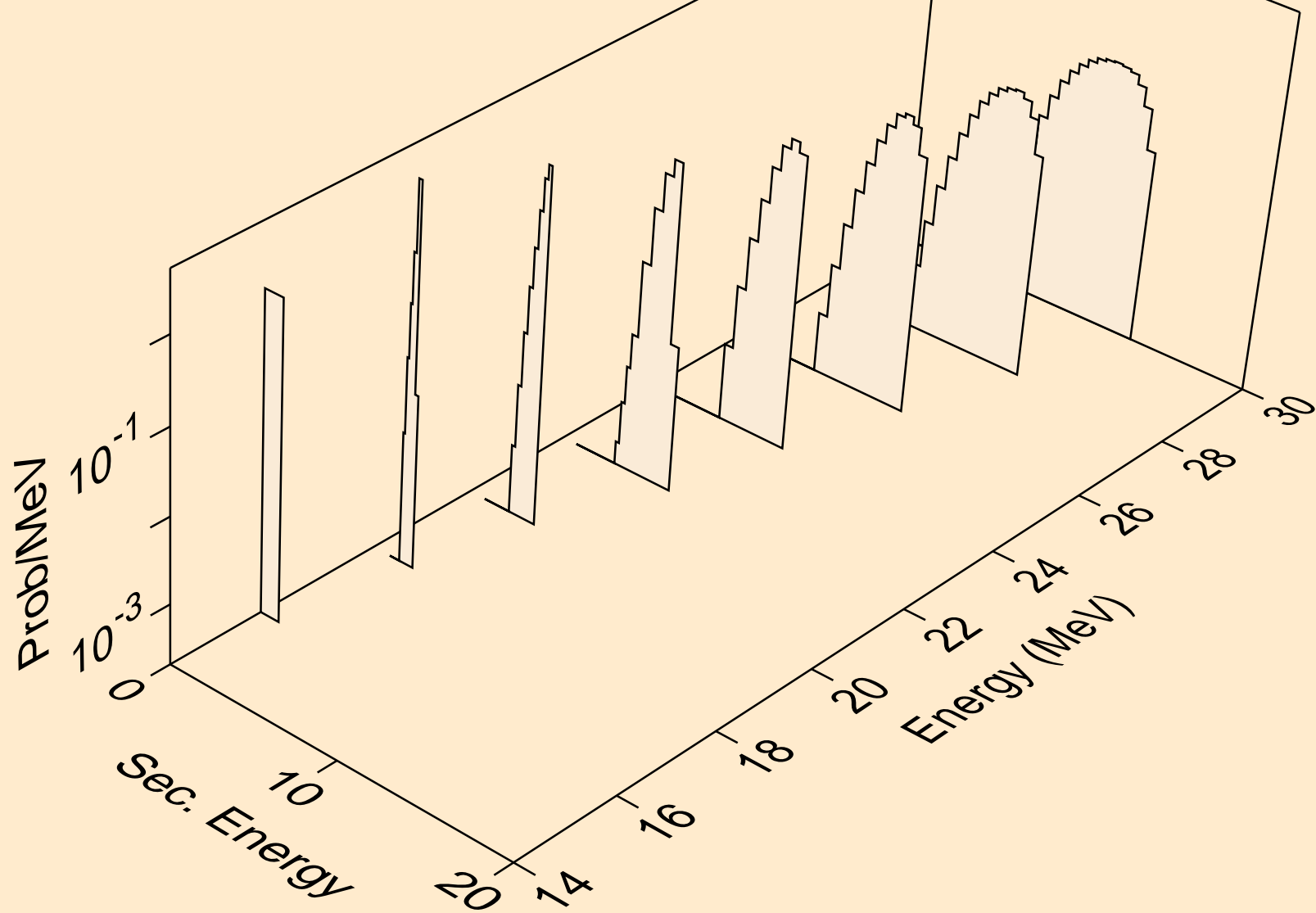

NI059 NEUTRON ACER TENDL-2023 LIBRARY; T=0.K  
he3s from (n,he3)

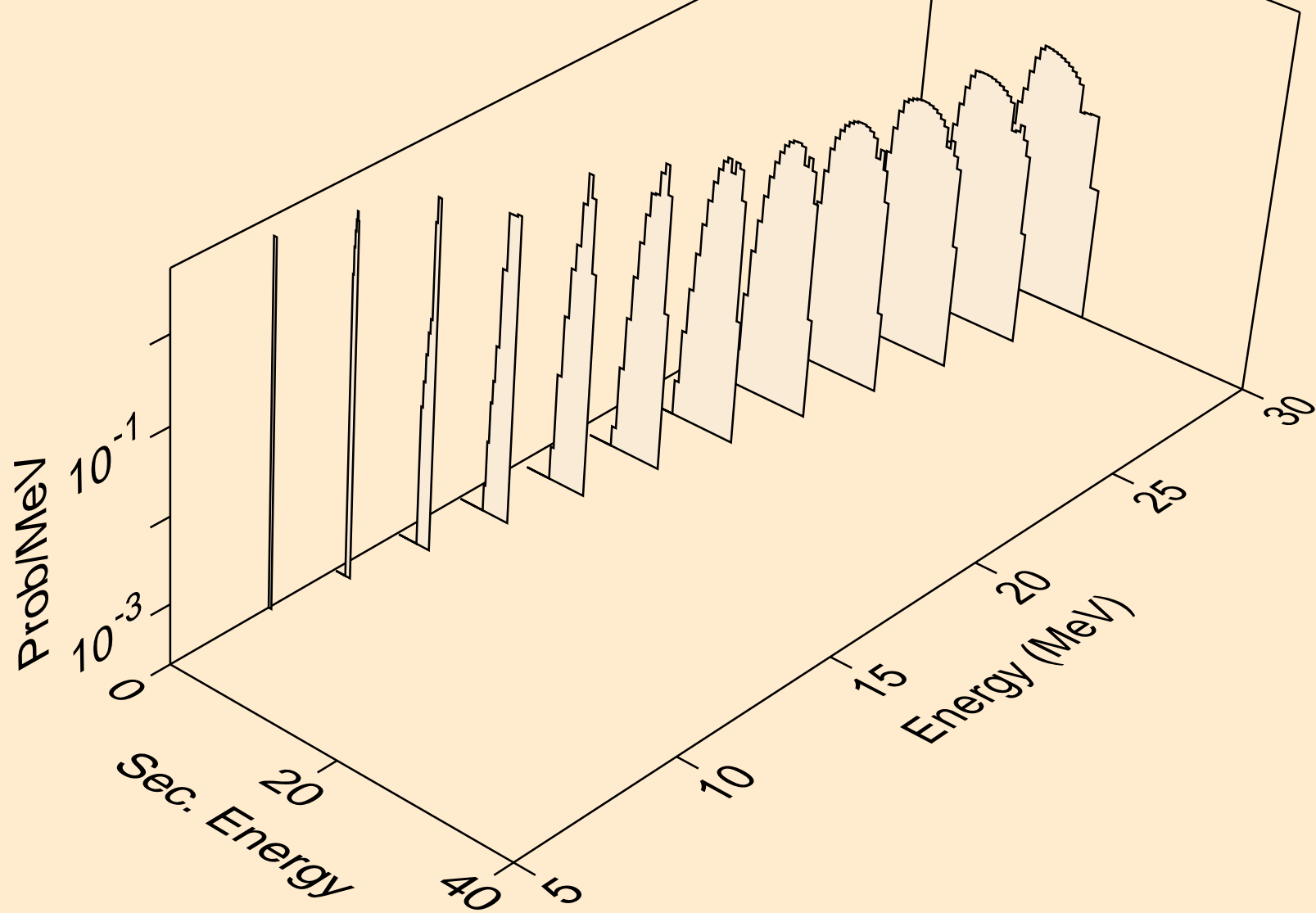

NI059 NEUTRON ACER TENDL-2023 LIBRARY; T=0.K  
alphas from (n,x)

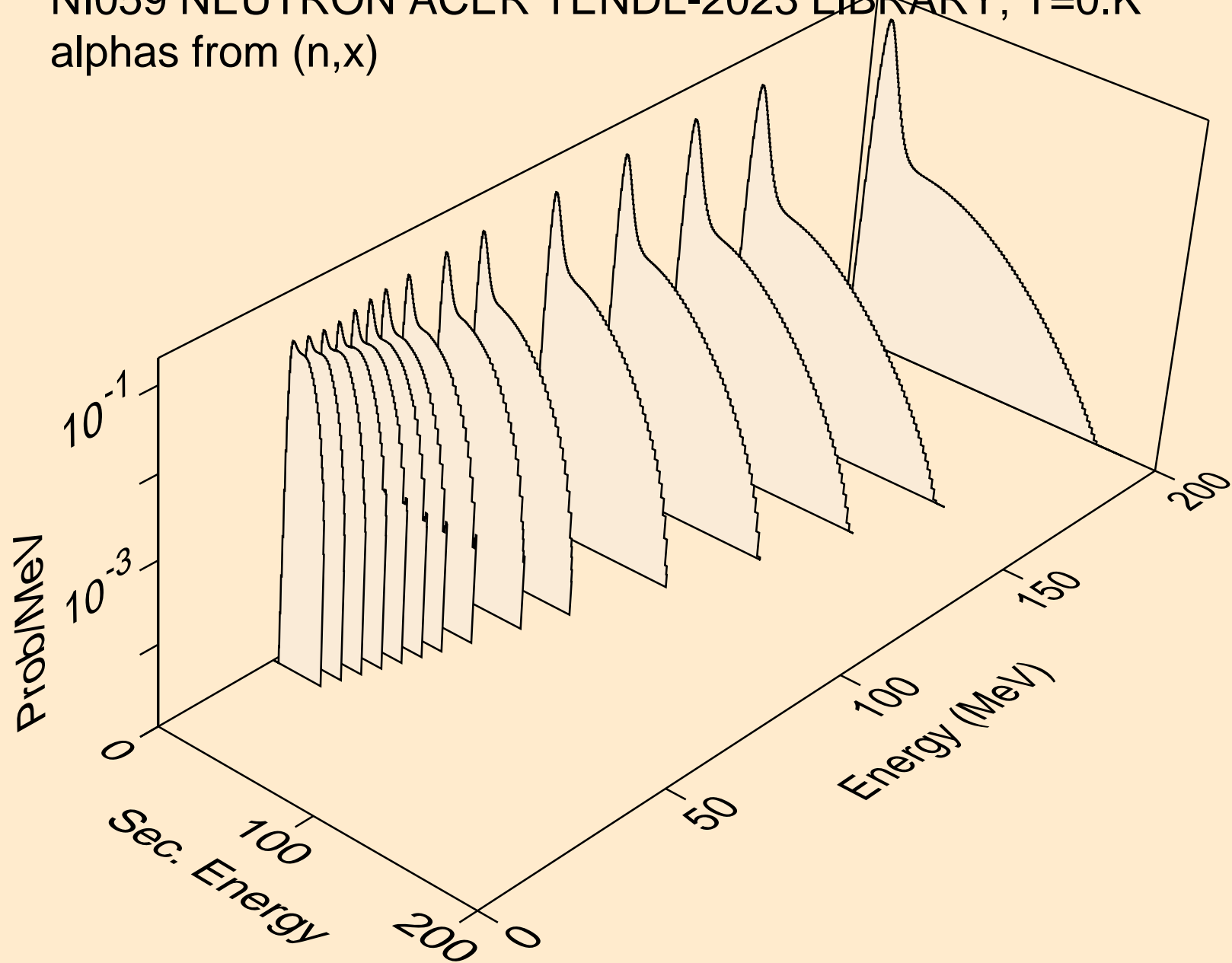

NI059 NEUTRON ACER TENDL-2023 LIBRARY; T=0.K  
alphas from (n,n\*)a

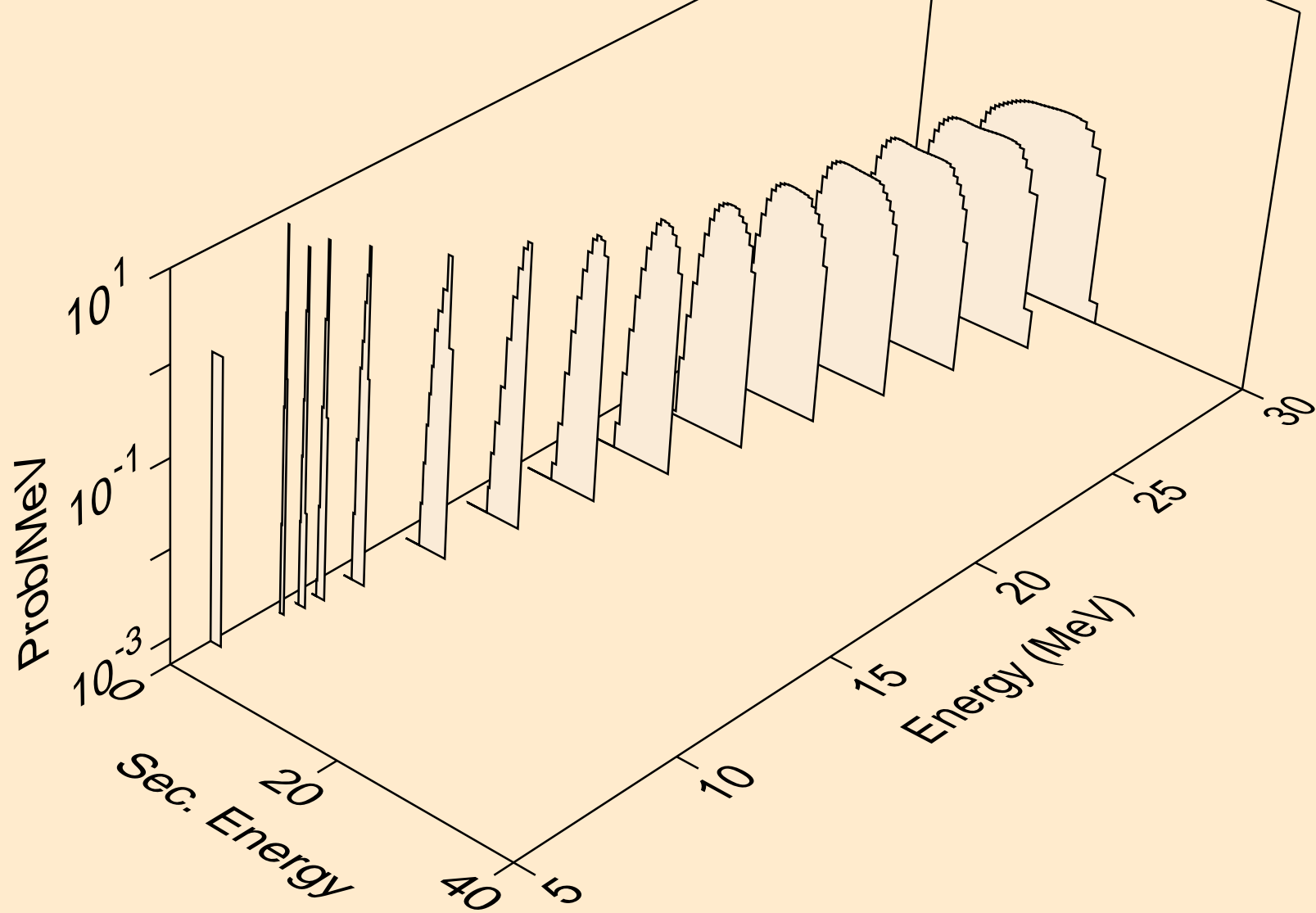

NI059 NEUTRON ACER TENDL-2023 LIBRARY; T=0.K  
alphas from (n,2n)a

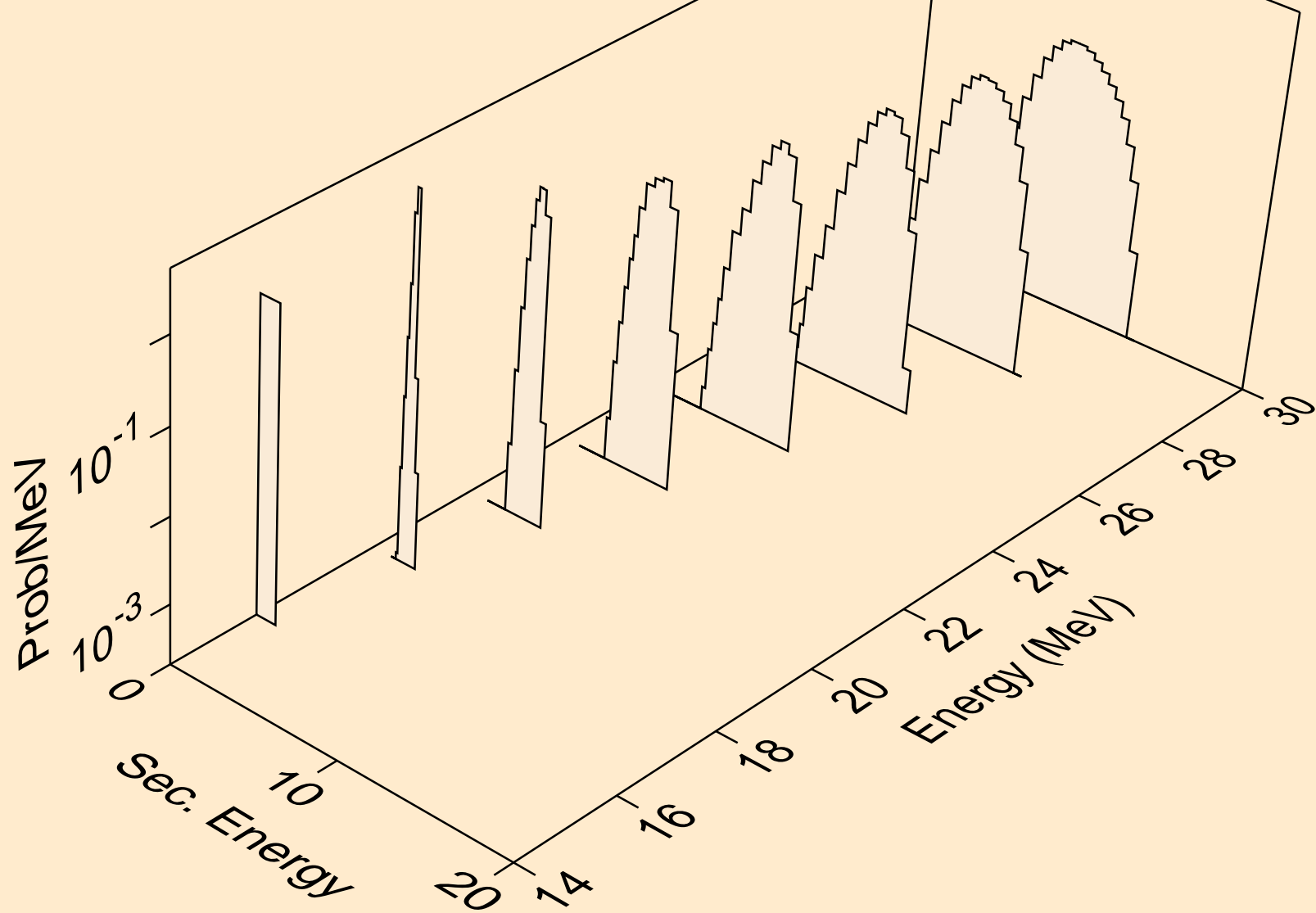

NI059 NEUTRON ACER TENDL-2023 LIBRARY; T=0.K  
alphas from (n,n\*)2a

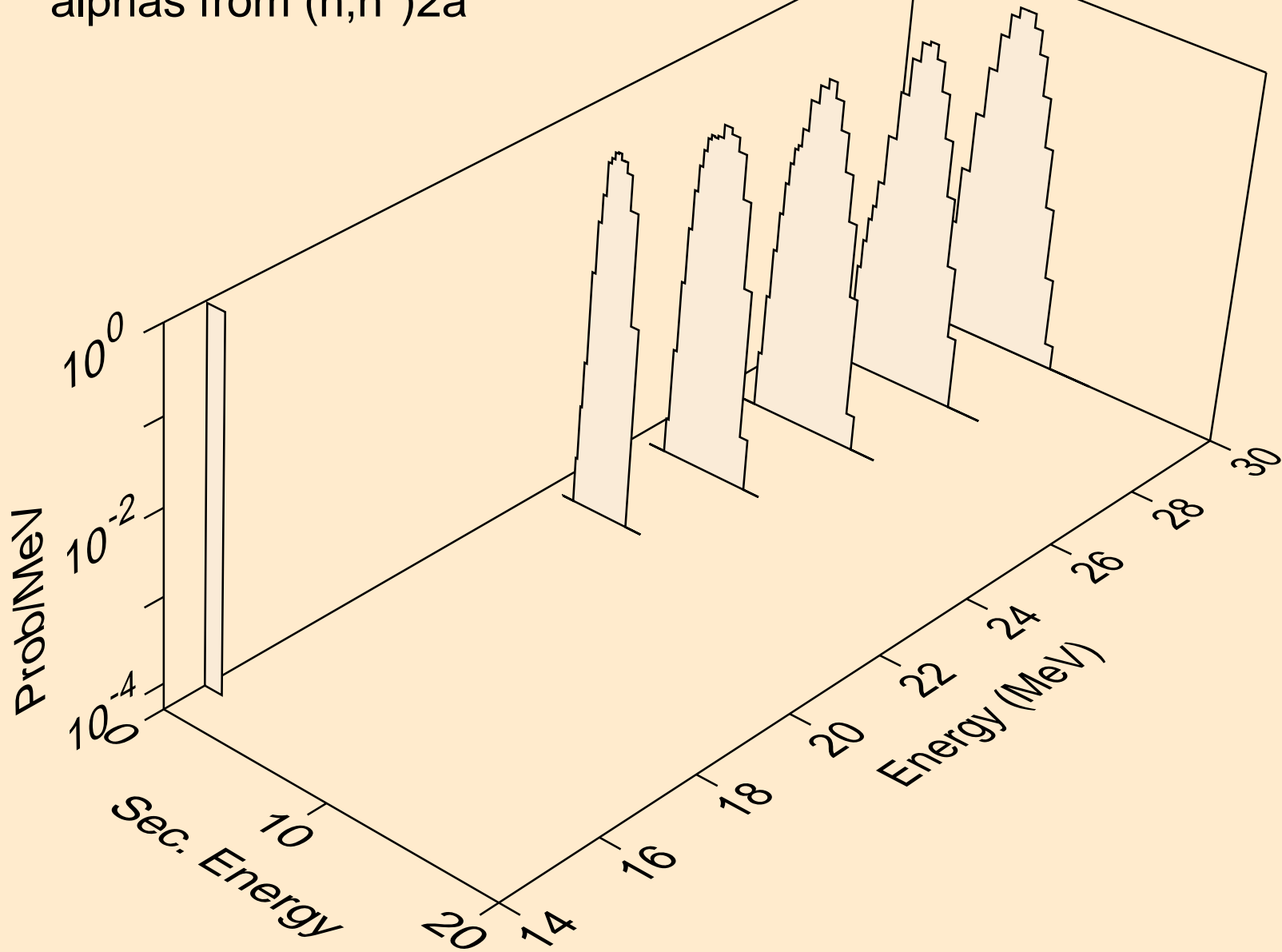

NI059 NEUTRON ACER TENDL-2023 LIBRARY; T=0.K  
alphas from (n,npa)

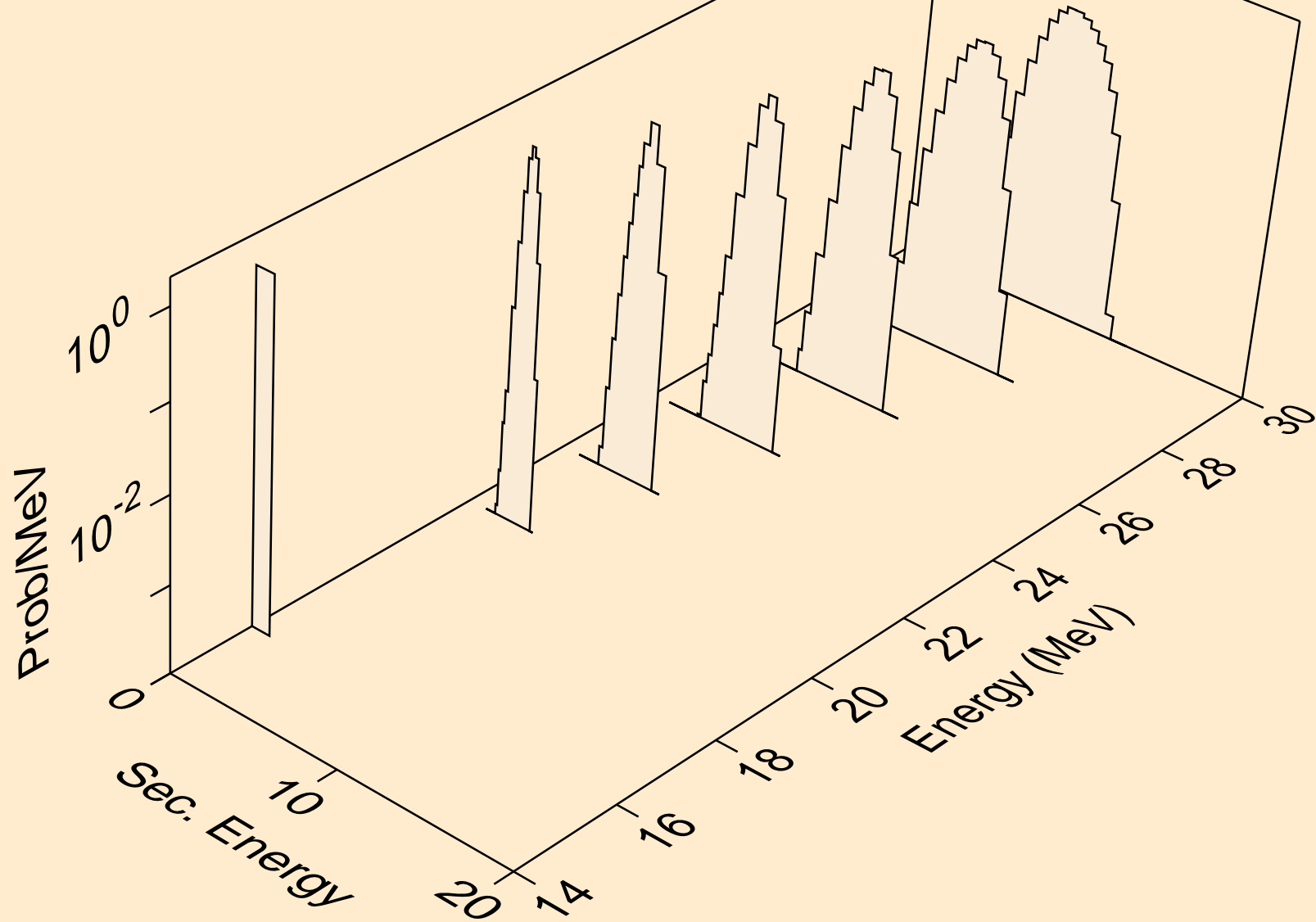

NI059 NEUTRON ACER TENDL-2023 LIBRARY; T=0.K  
alphas from (n,a)

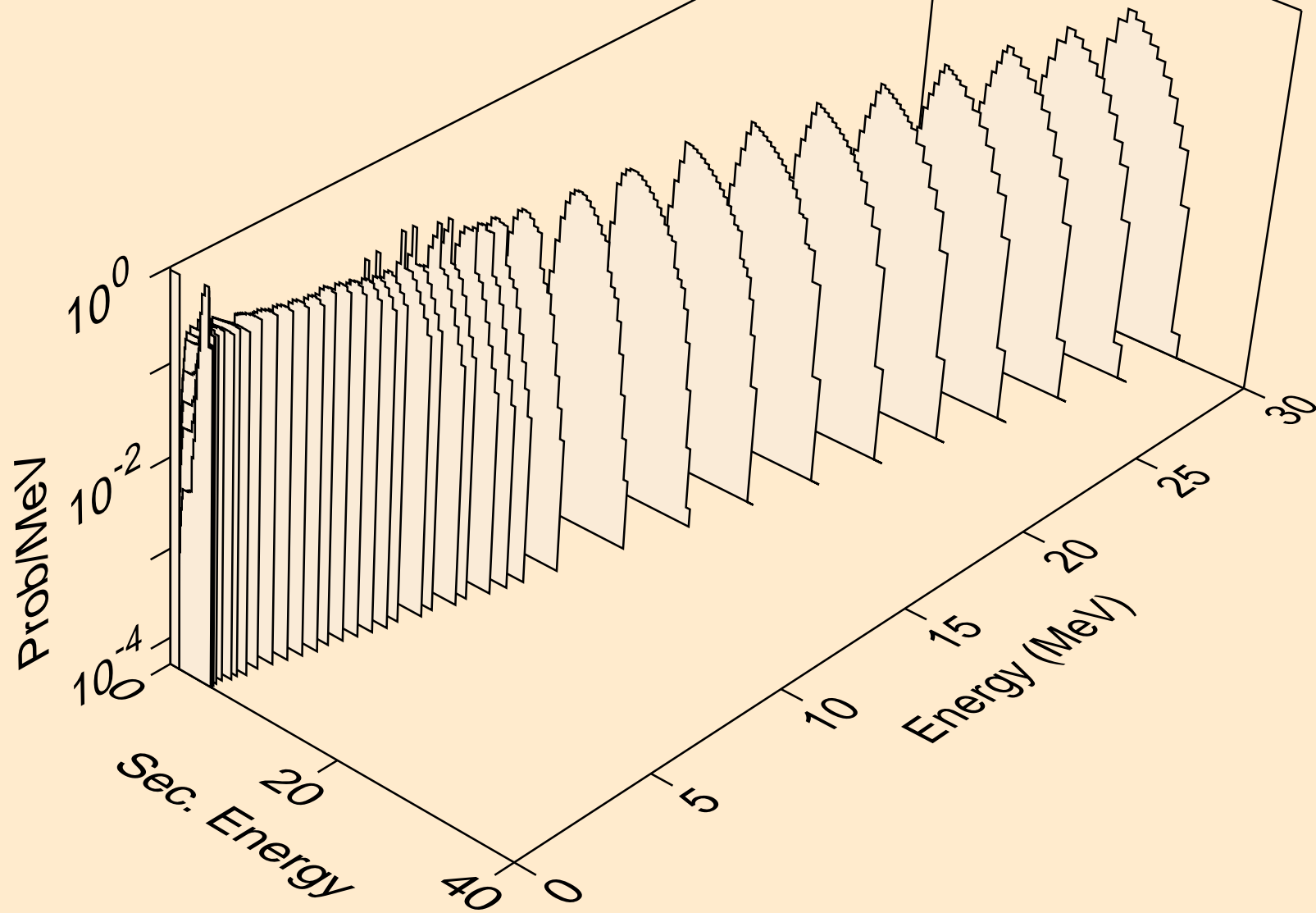



NI059 NEUTRON ACER TENDL-2023 LIBRARY; T=0.K  
alphas from (n,2a)

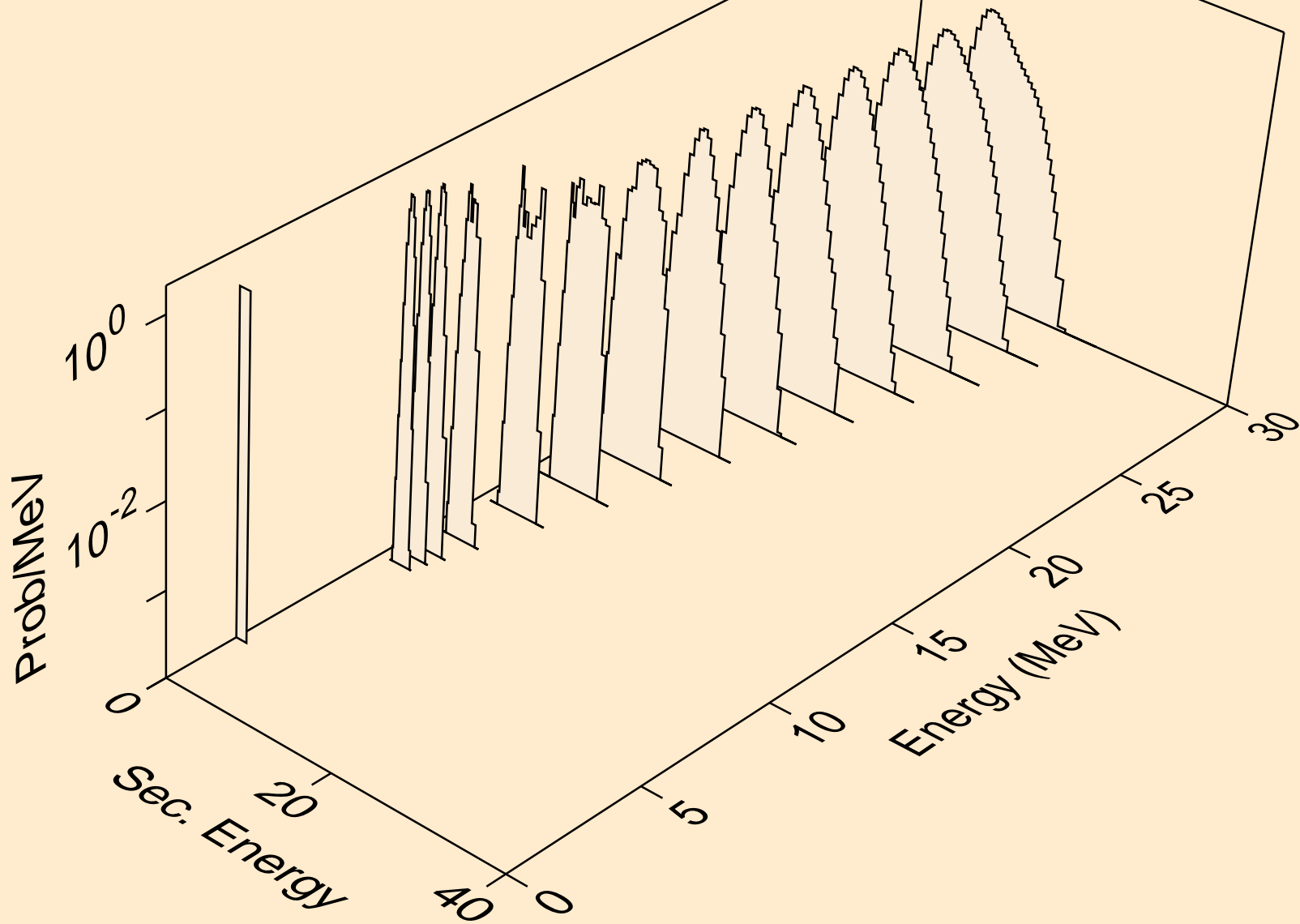

NI059 NEUTRON ACER TENDL-2023 LIBRARY; T=0.K  
alphas from (n,pa)

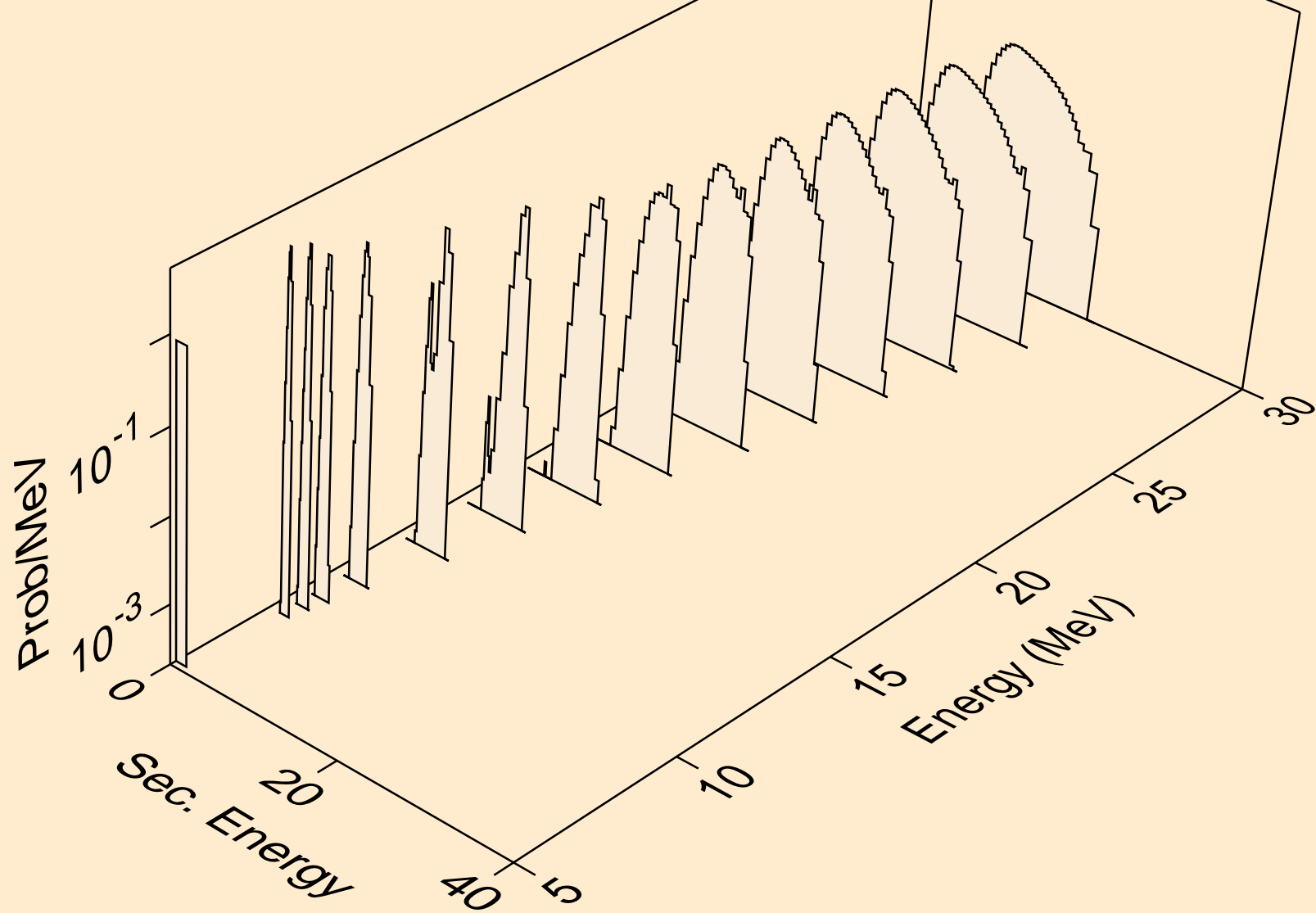

NI059 NEUTRON ACER TENDL-2023 LIBRARY; T=0.K  
alphas from (n,da)

