

NI062 NEUTRON ACER TENDL-2023 LIBRARY; T=0.K

Principal cross sections

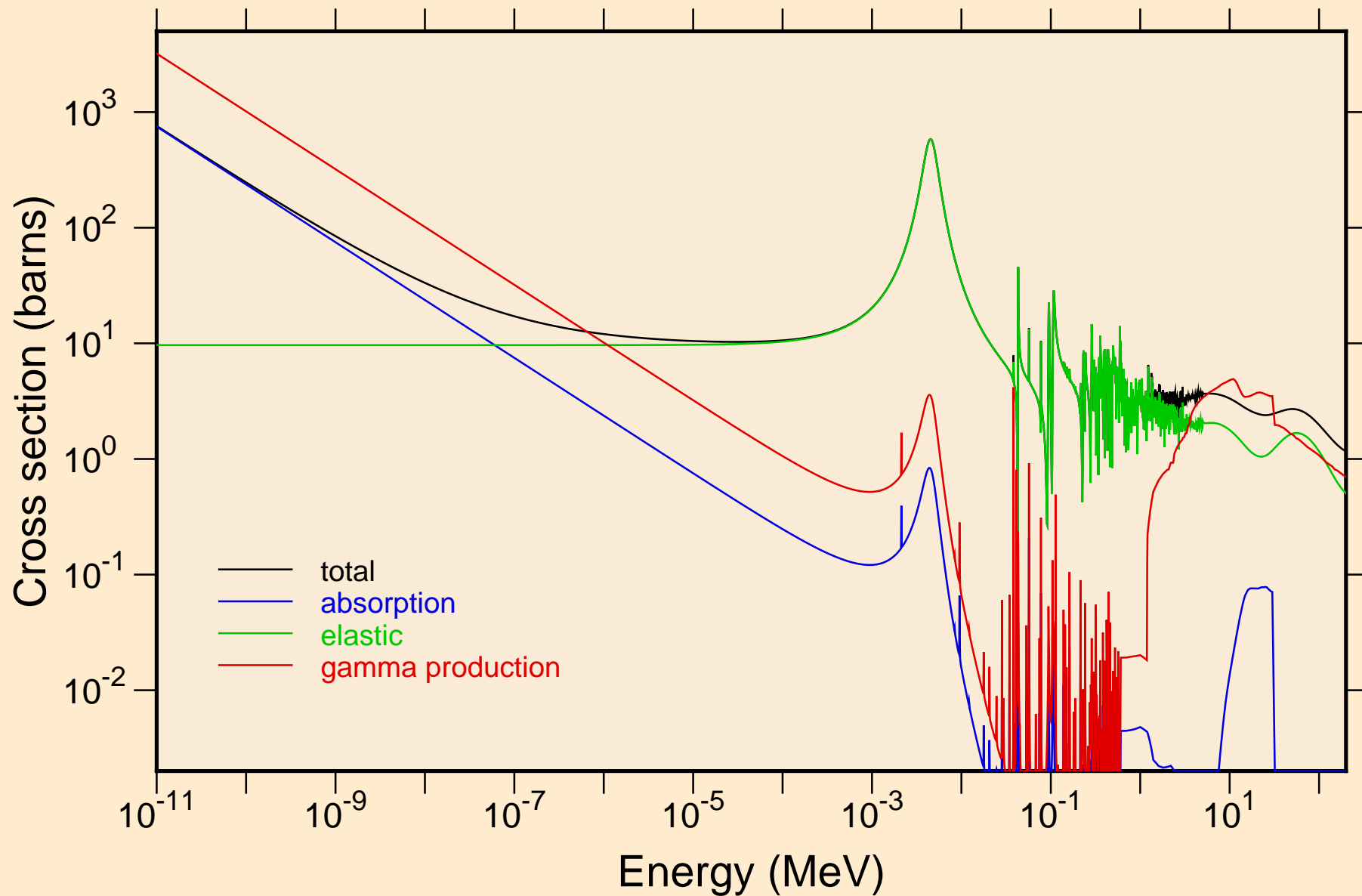

NI062 NEUTRON ACER TENDL-2023 LIBRARY; T=0.K
resonance total cross section

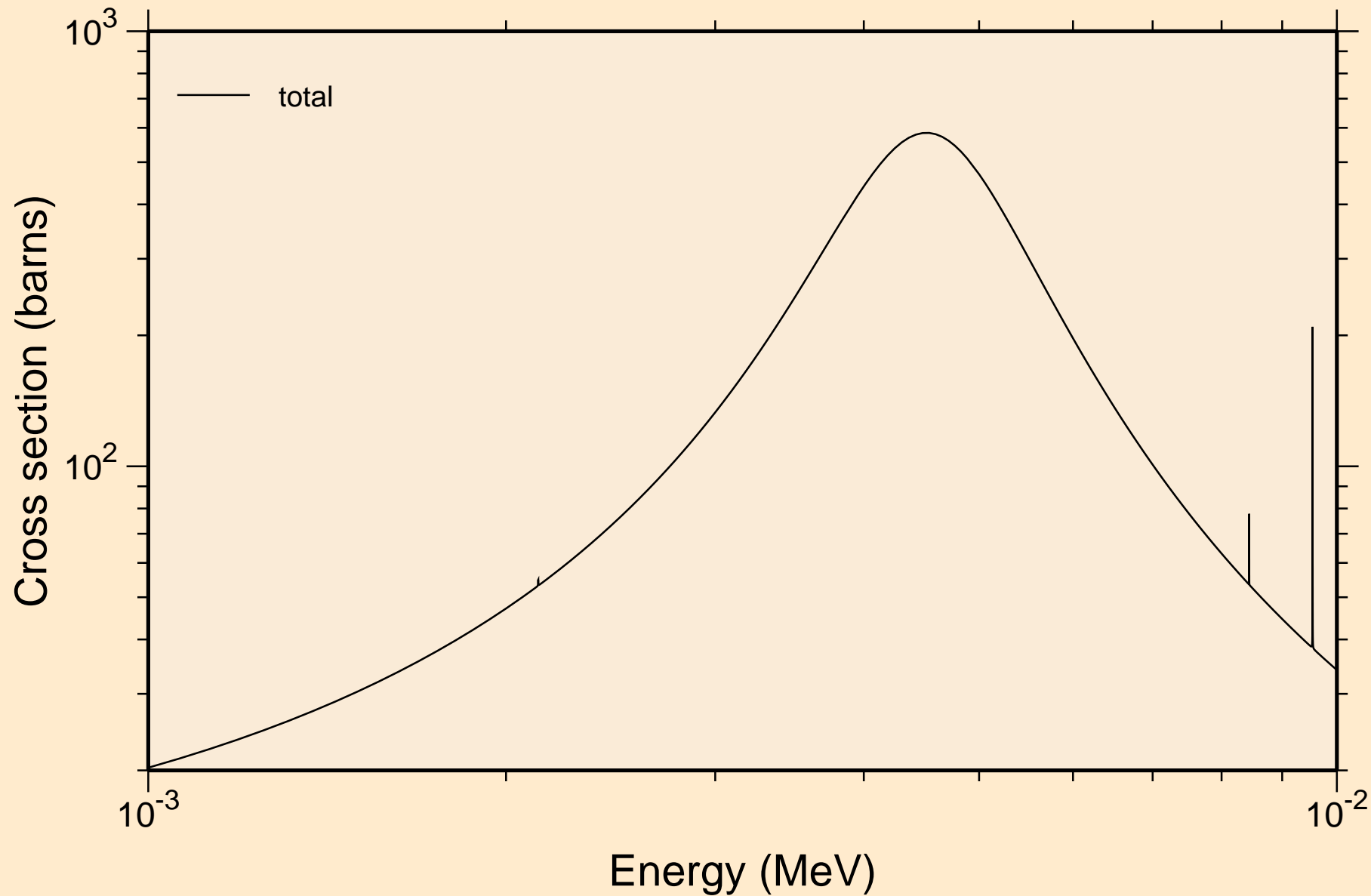

NI062 NEUTRON ACER TENDL-2023 LIBRARY; T=0.K
resonance total cross section

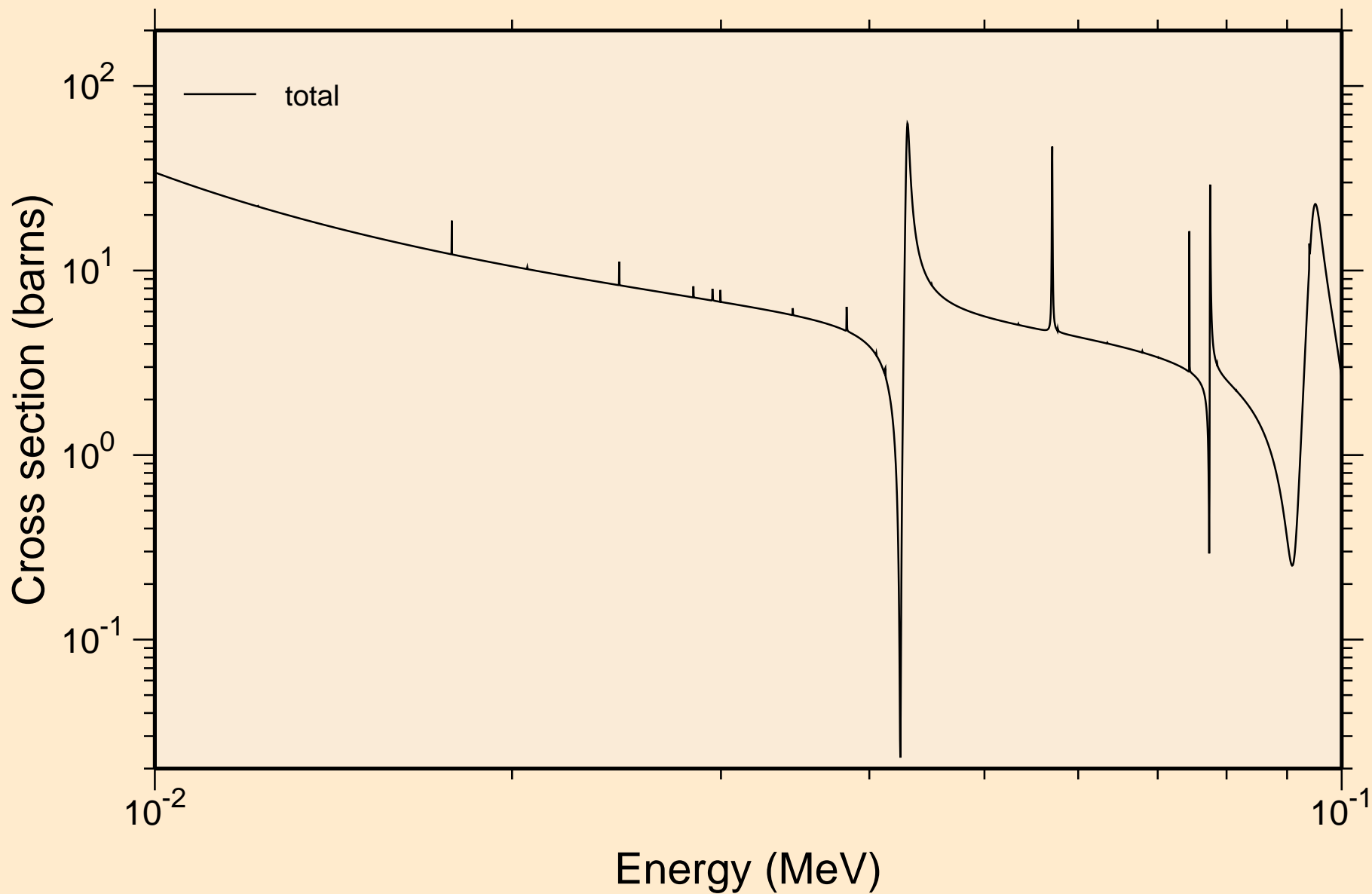

NI062 NEUTRON ACER TENDL-2023 LIBRARY; T=0.K
resonance total cross section

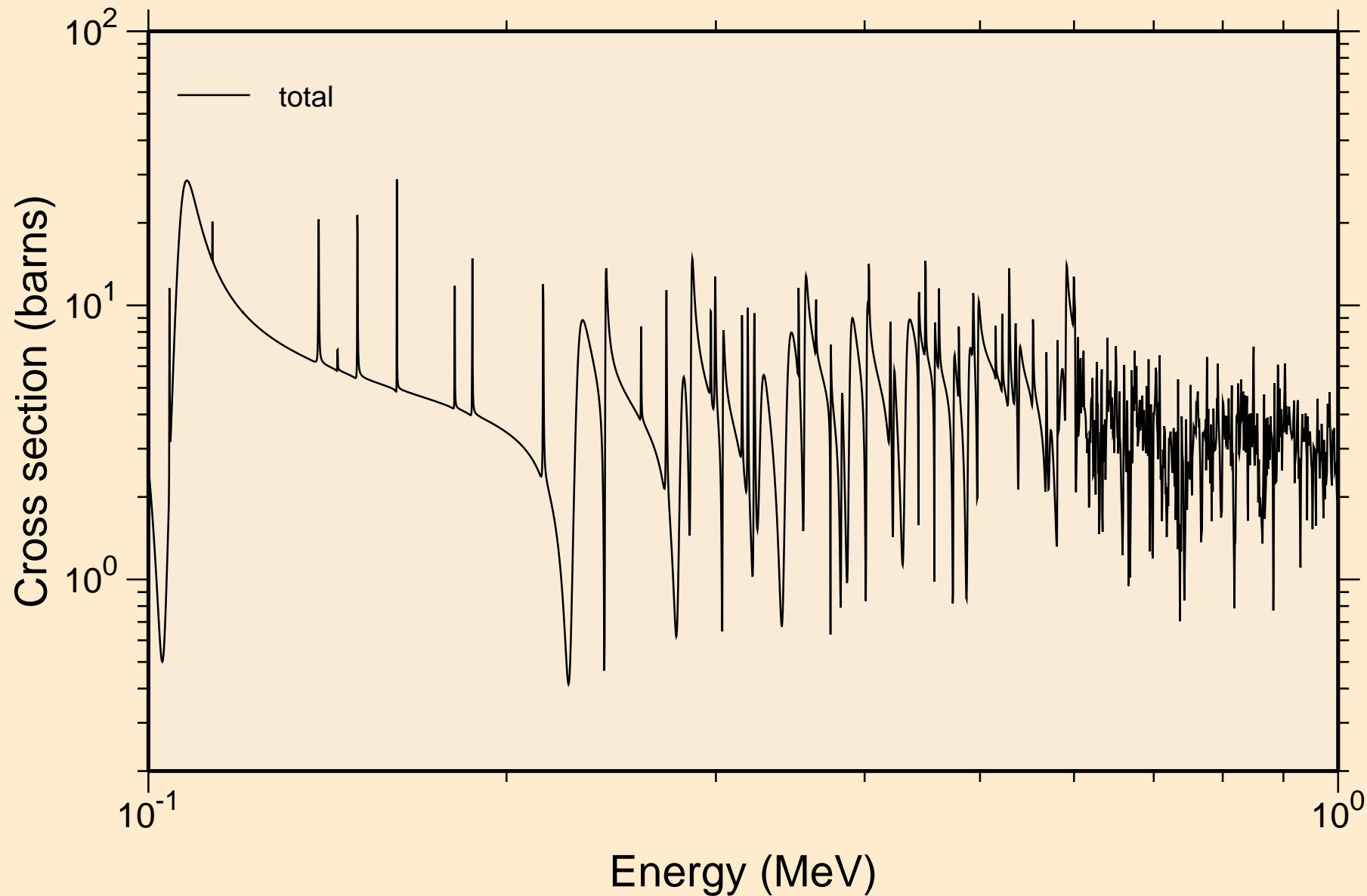

NI062 NEUTRON ACER TENDL-2023 LIBRARY; T=0.K
resonance total cross section

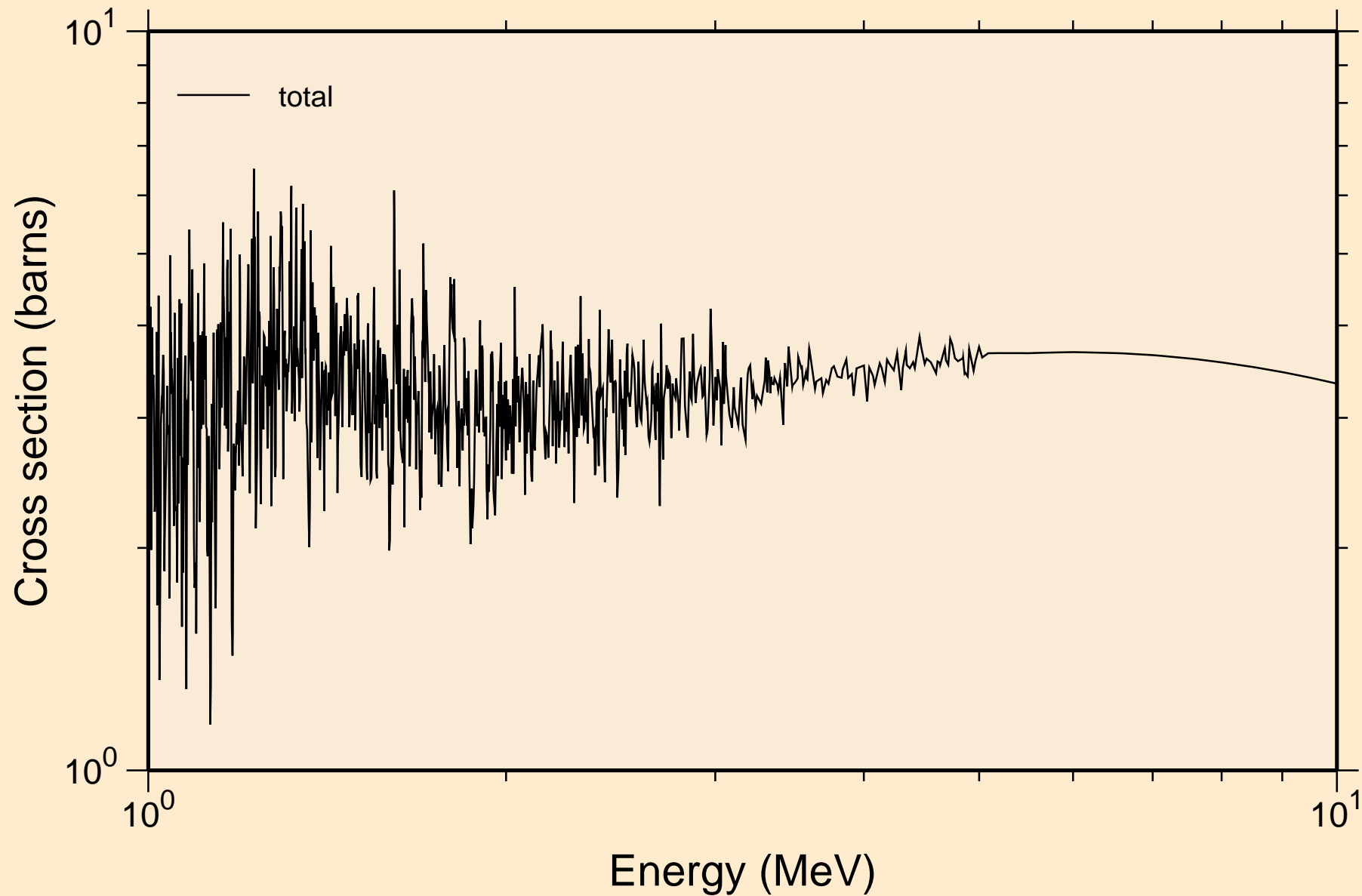

NI062 NEUTRON ACER TENDL-2023 LIBRARY; T=0.K
resonance absorption cross sections

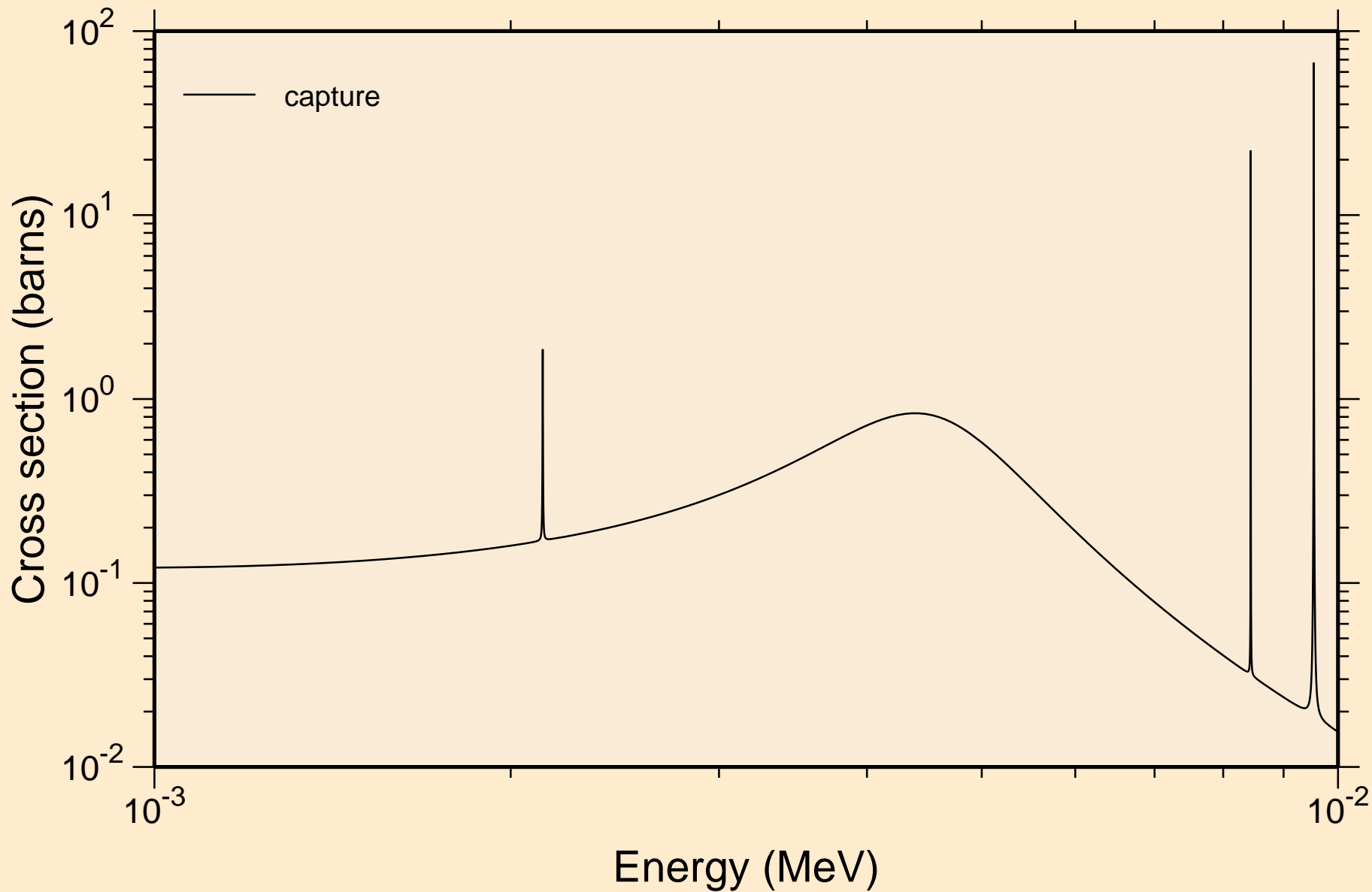

NI062 NEUTRON ACER TENDL-2023 LIBRARY; T=0.K
resonance absorption cross sections

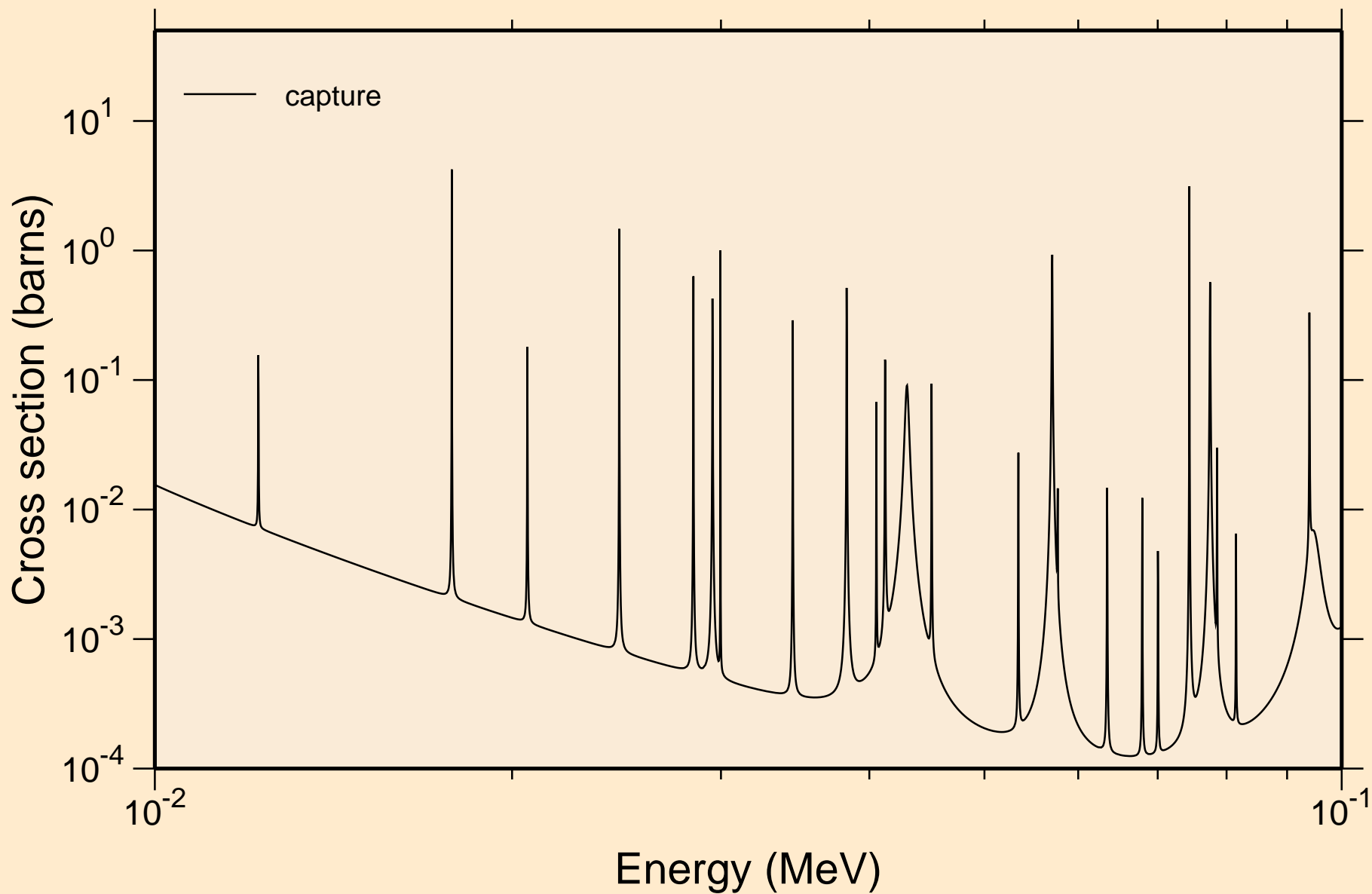

NI062 NEUTRON ACER TENDL-2023 LIBRARY; T=0.K
resonance absorption cross sections

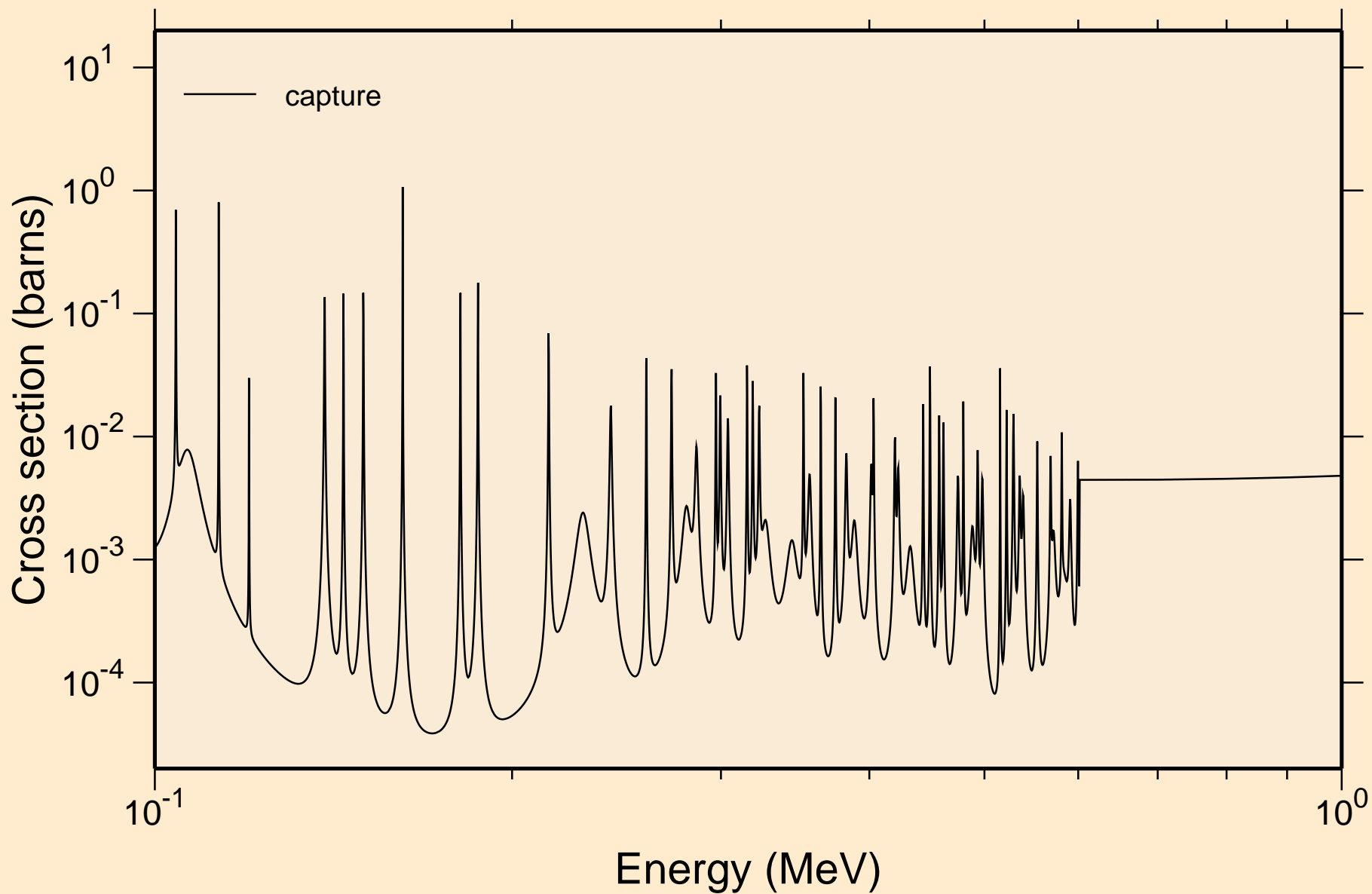

NI062 NEUTRON ACER TENDL-2023 LIBRARY; T=0.K
resonance absorption cross sections

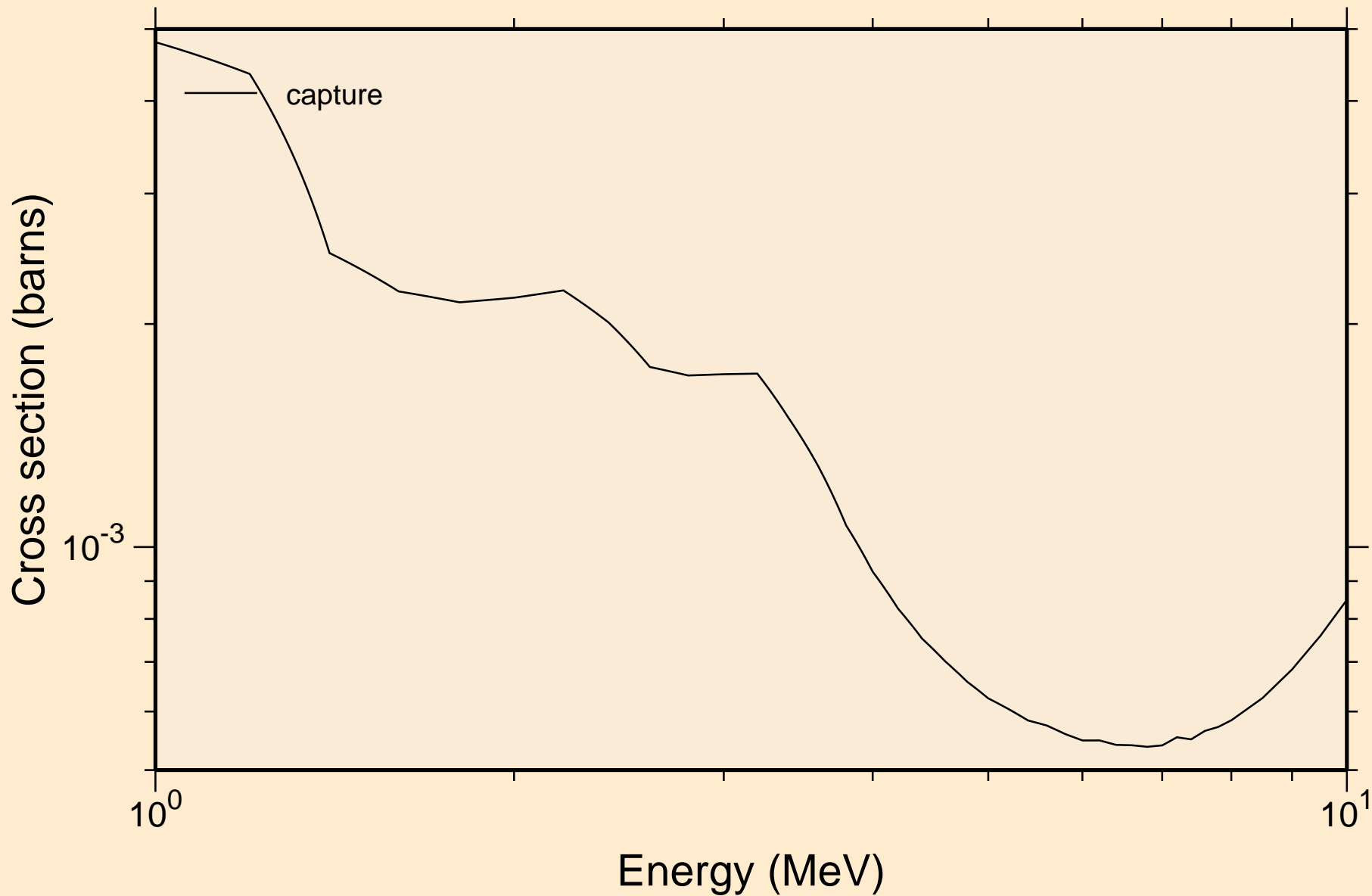

NI062 NEUTRON ACER TENDL-2023 LIBRARY; T=0.K
Heating

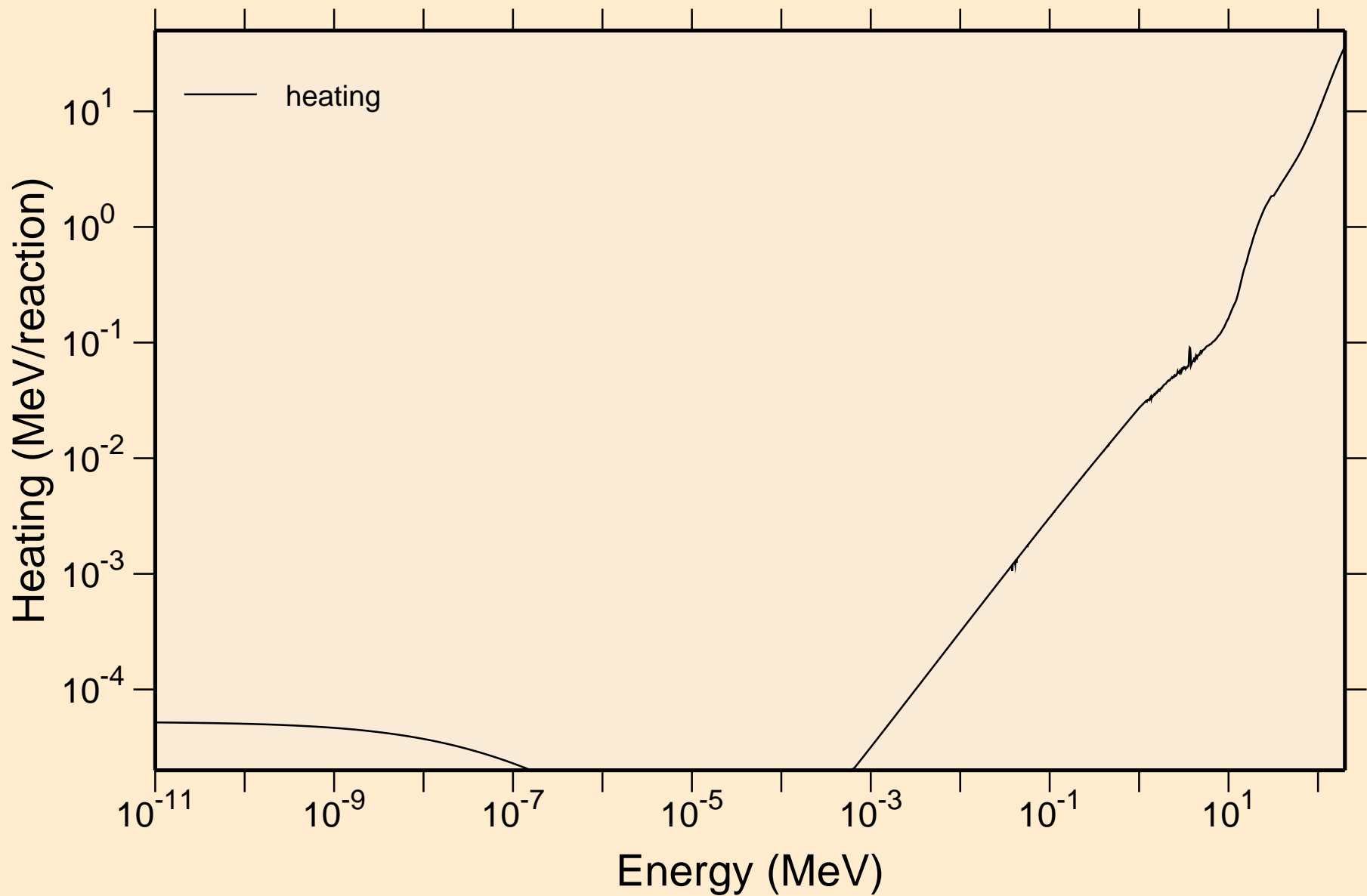

NI062 NEUTRON ACER TENDL-2023 LIBRARY; T=0.K

Damage

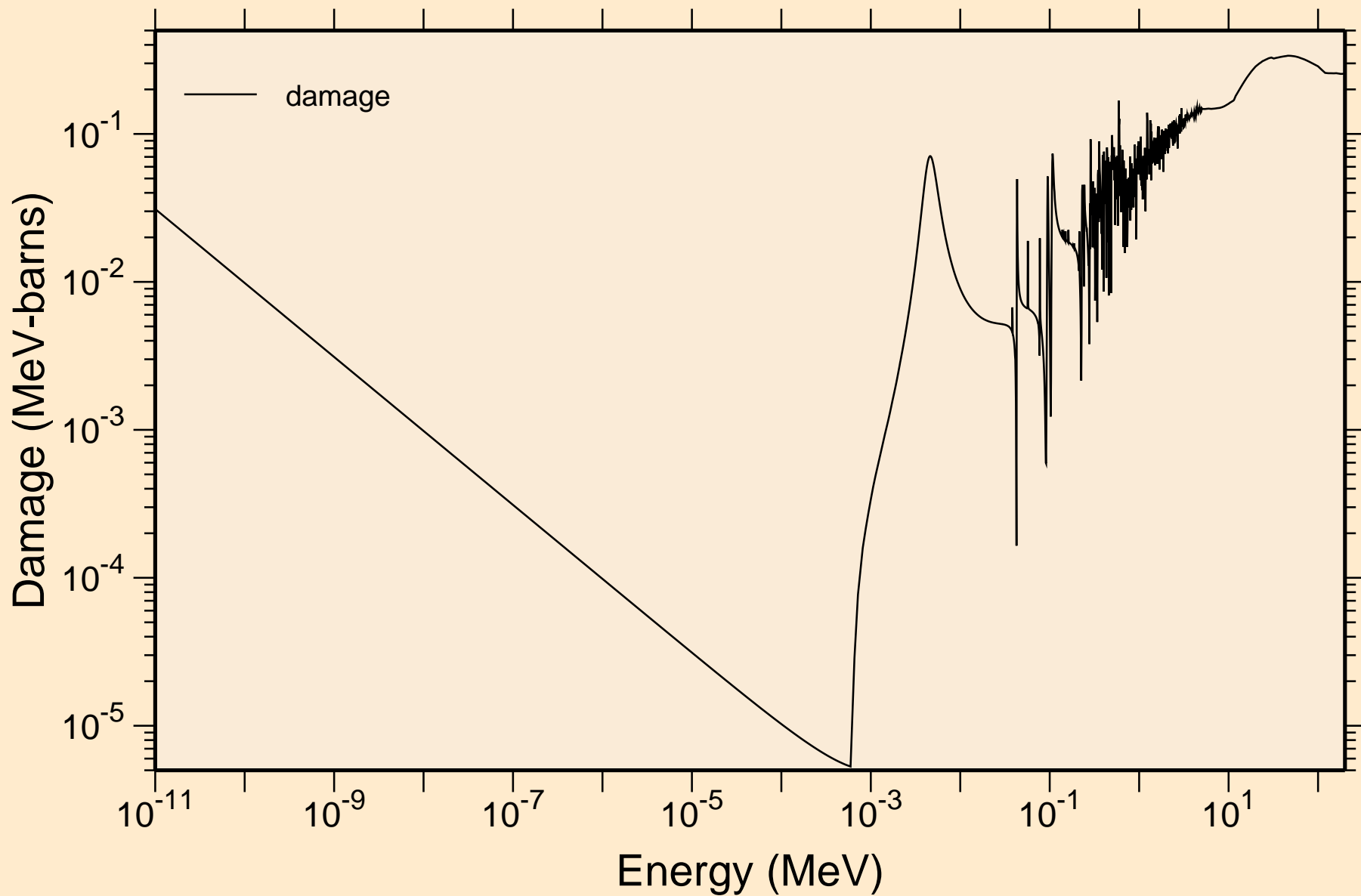

NI062 NEUTRON ACER TENDL-2023 LIBRARY; T=0.K
Non-threshold reactions

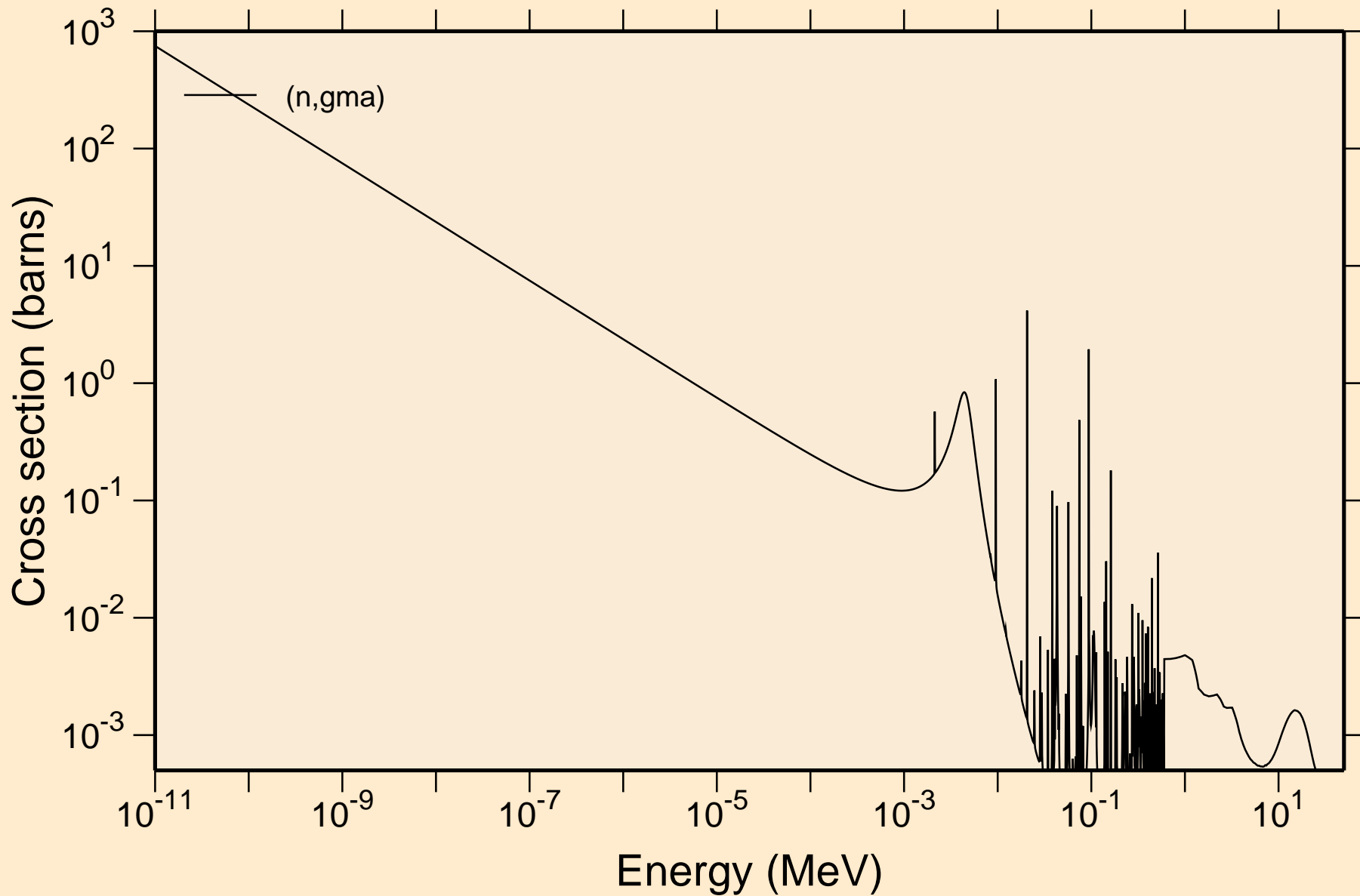

NI062 NEUTRON ACER TENDL-2023 LIBRARY; T=0.K

Principal cross sections

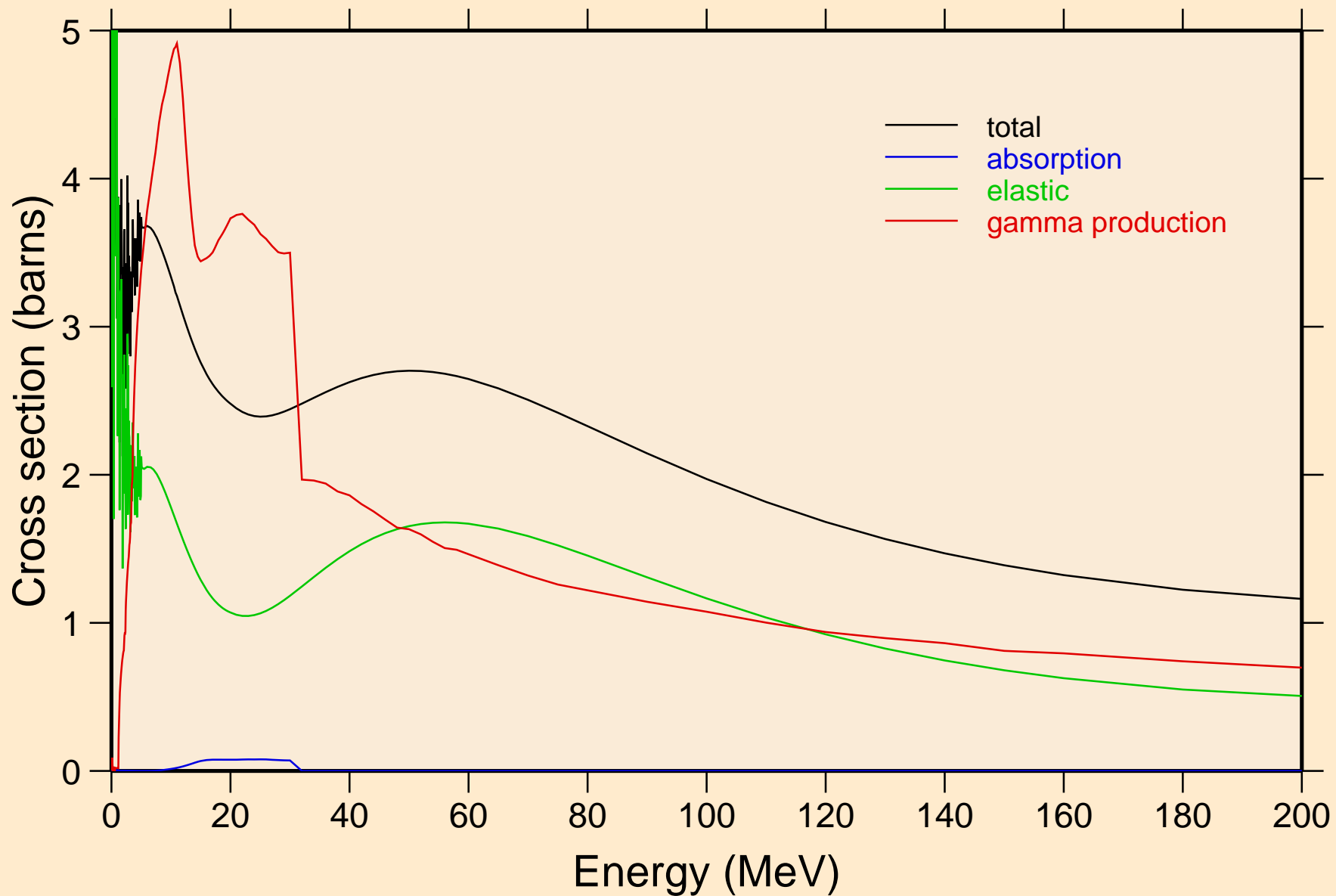

NI062 NEUTRON ACER TENDL-2023 LIBRARY; T=0.K

Heating

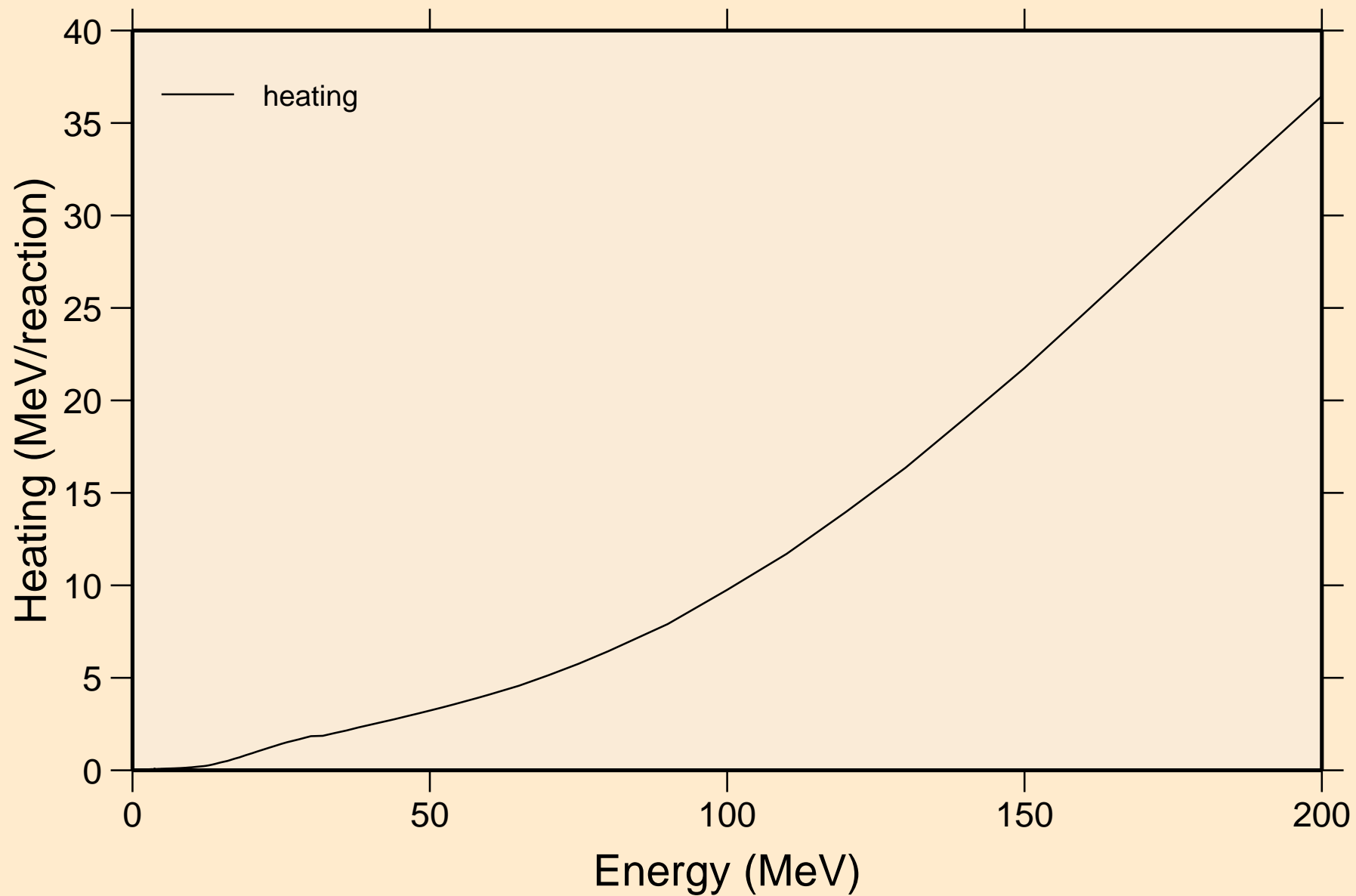

NI062 NEUTRON ACER TENDL-2023 LIBRARY; T=0.K

Damage

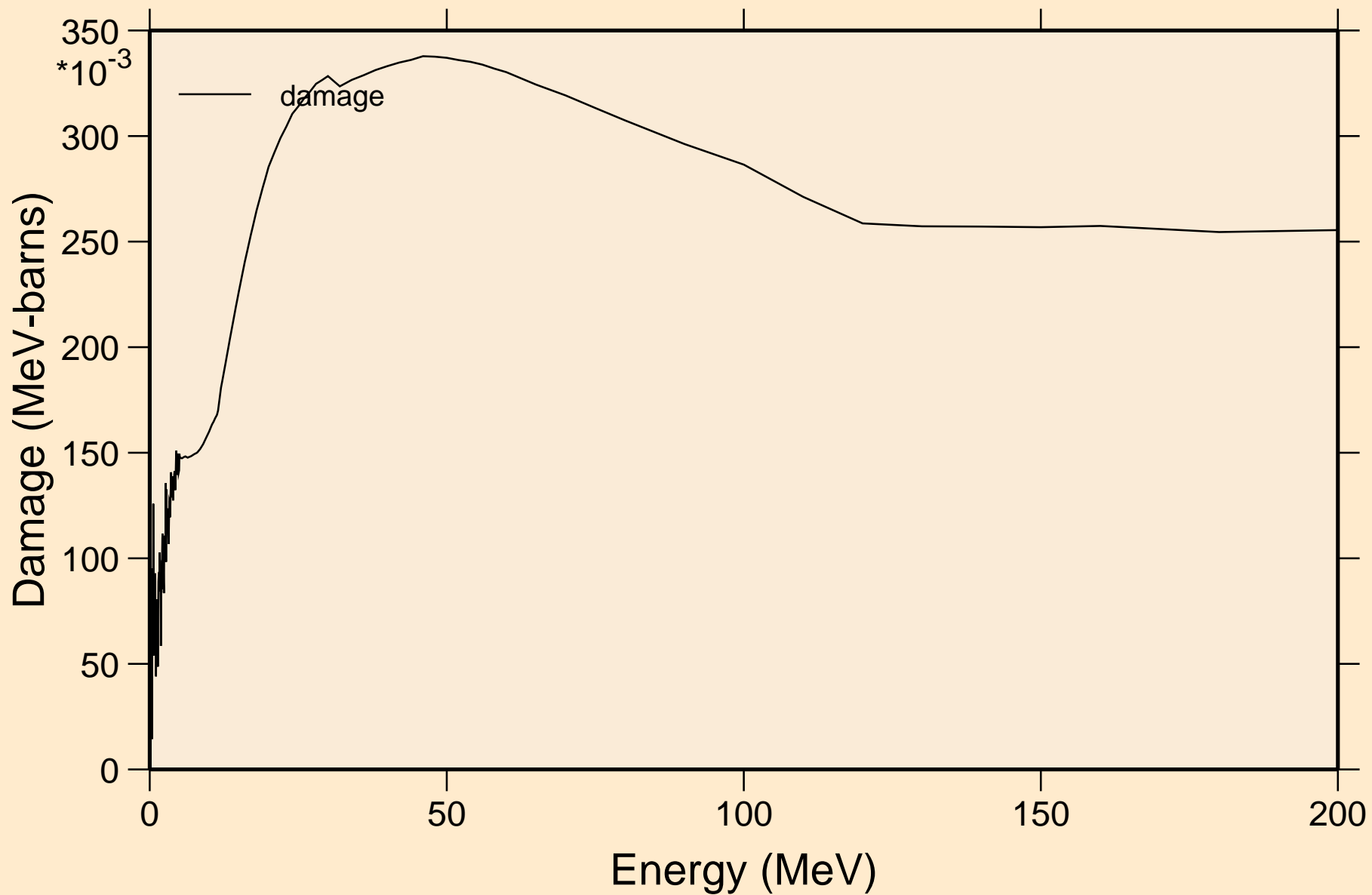

NI062 NEUTRON ACER TENDL-2023 LIBRARY; T=0.K
Non-threshold reactions

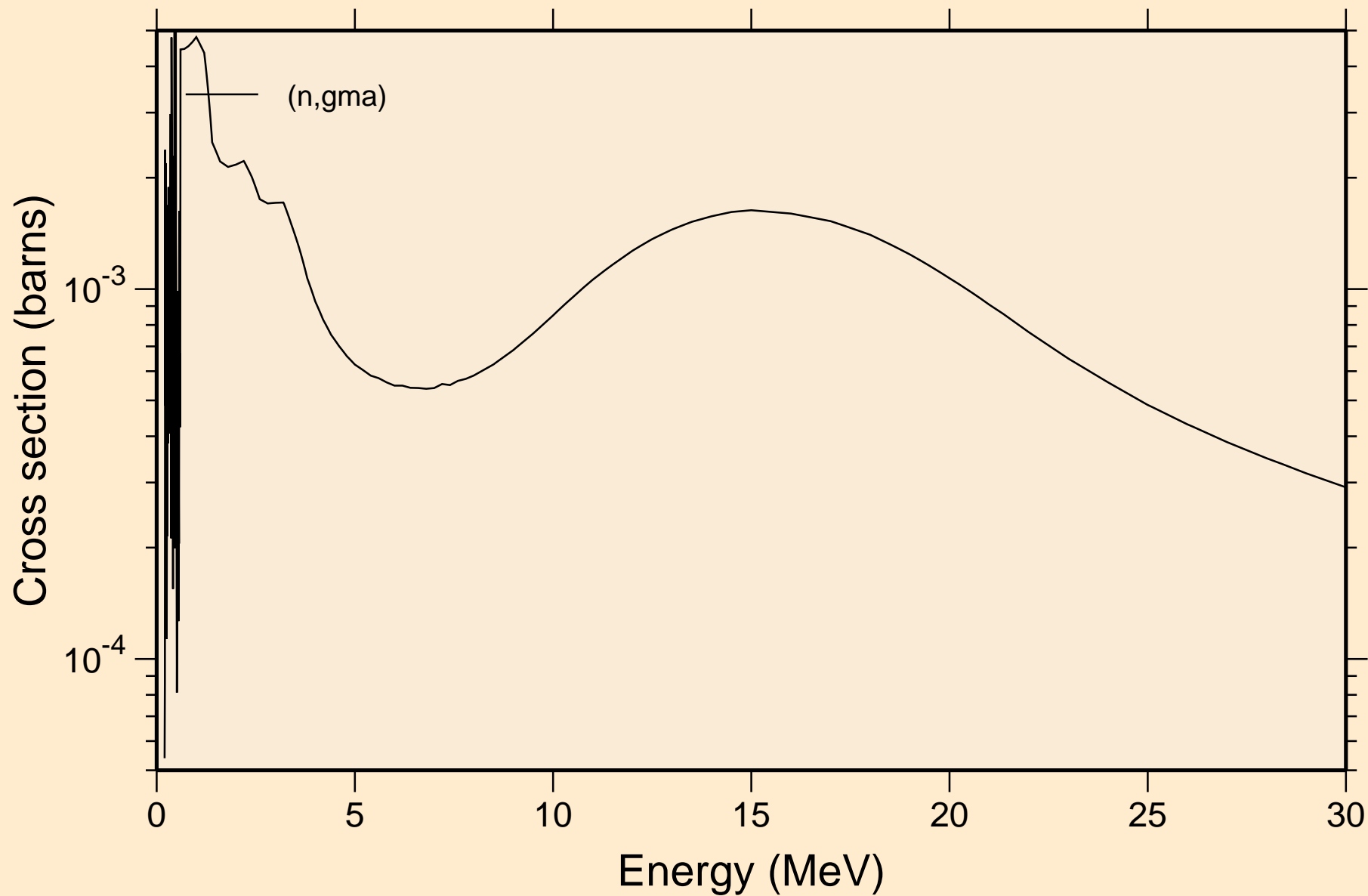

NI062 NEUTRON ACER TENDL-2023 LIBRARY; T=0.K
Inelastic levels

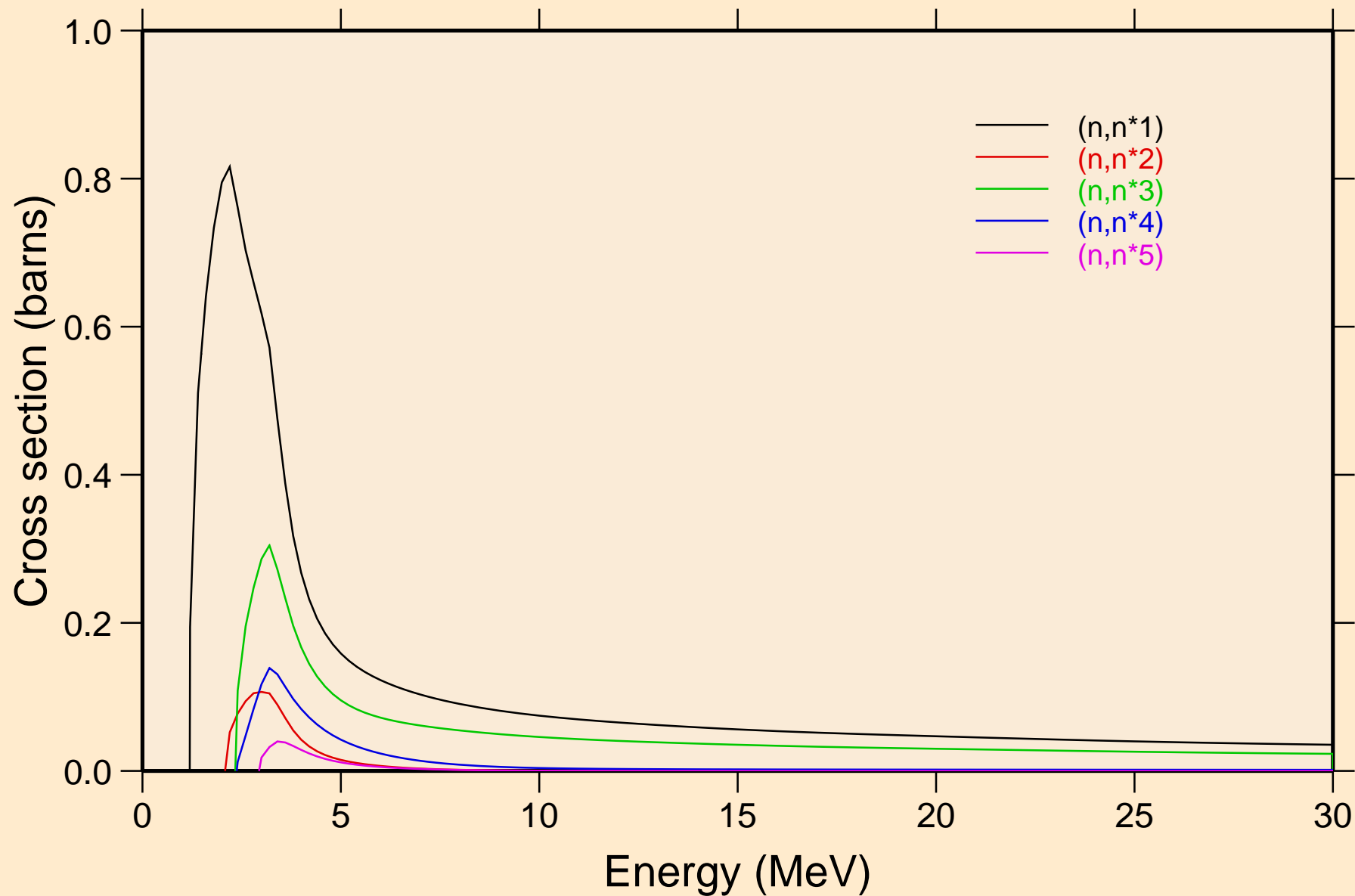

NI062 NEUTRON ACER TENDL-2023 LIBRARY; T=0.K
Inelastic levels

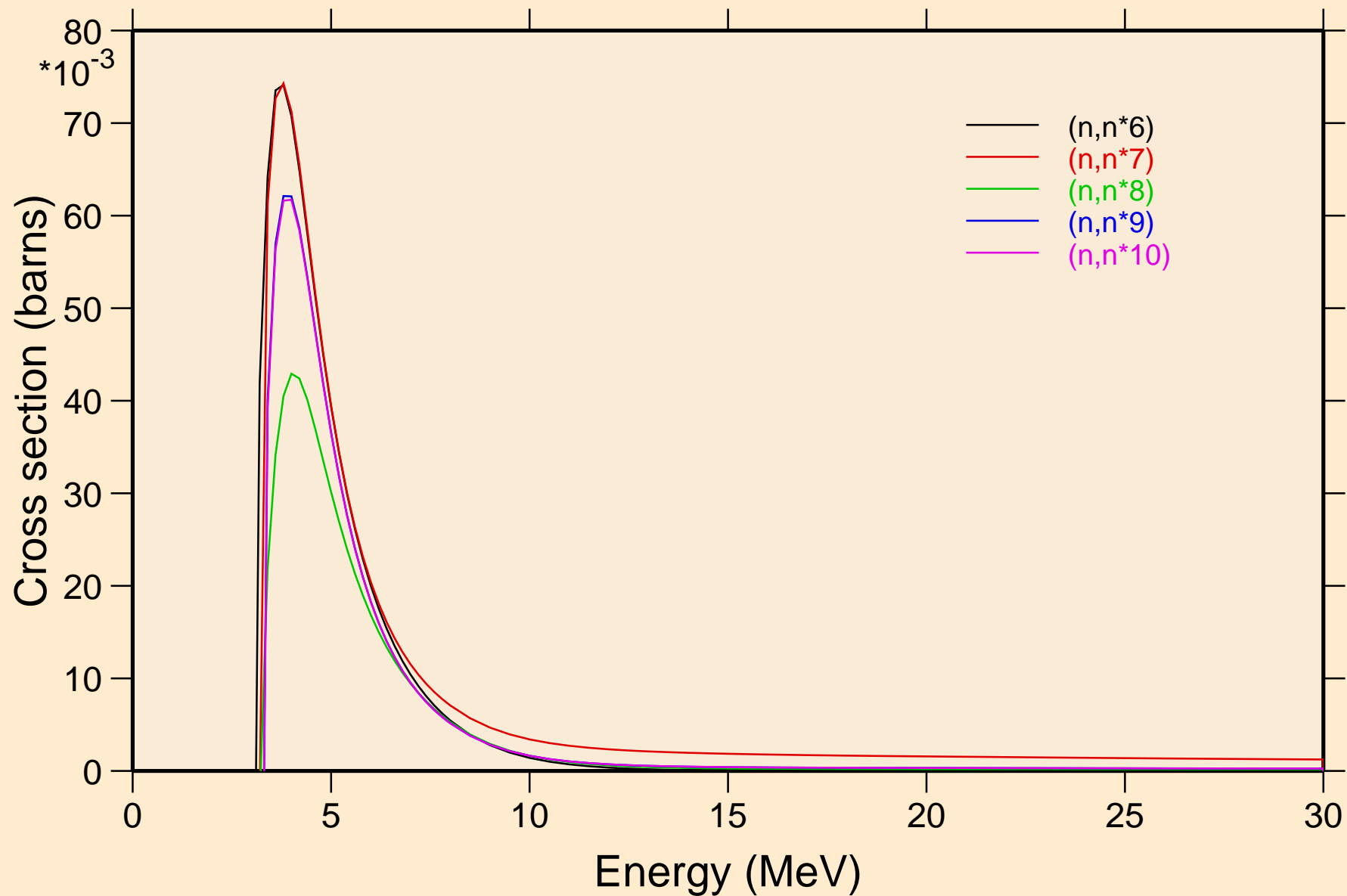

NI062 NEUTRON ACER TENDL-2023 LIBRARY; T=0.K
Inelastic levels

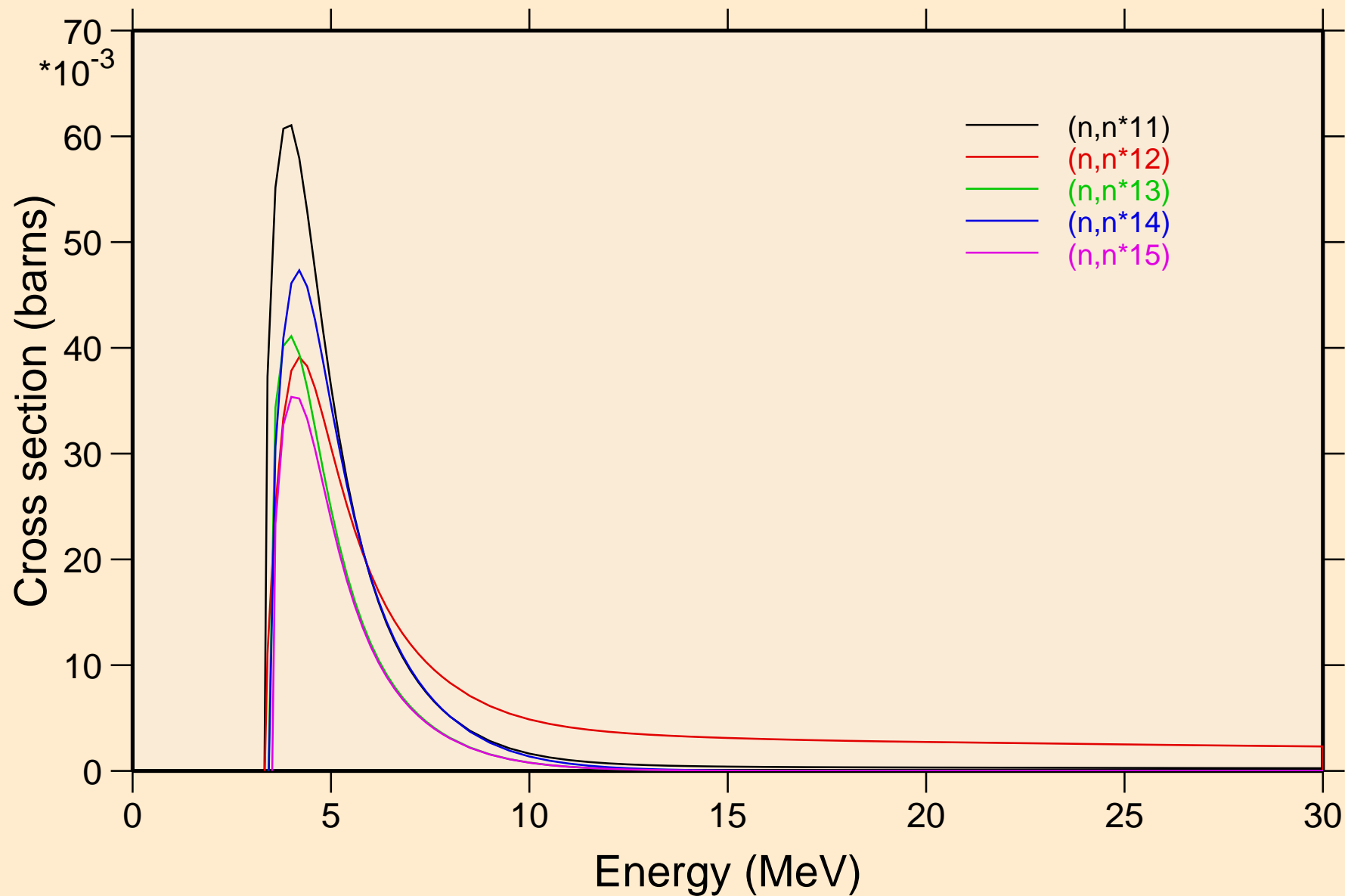

NI062 NEUTRON ACER TENDL-2023 LIBRARY; T=0.K
Inelastic levels

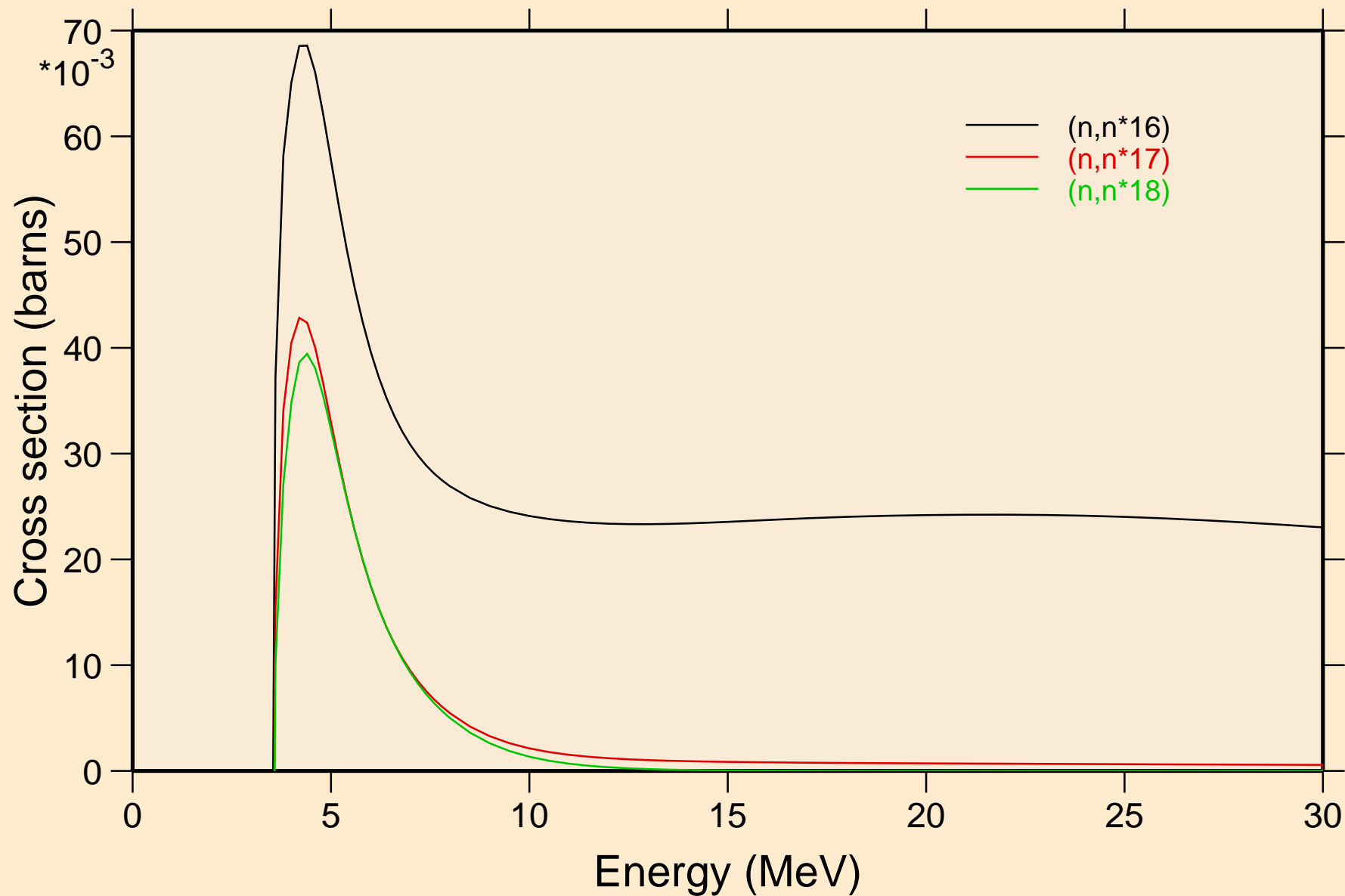

NI062 NEUTRON ACER TENDL-2023 LIBRARY; T=0.K
Threshold reactions

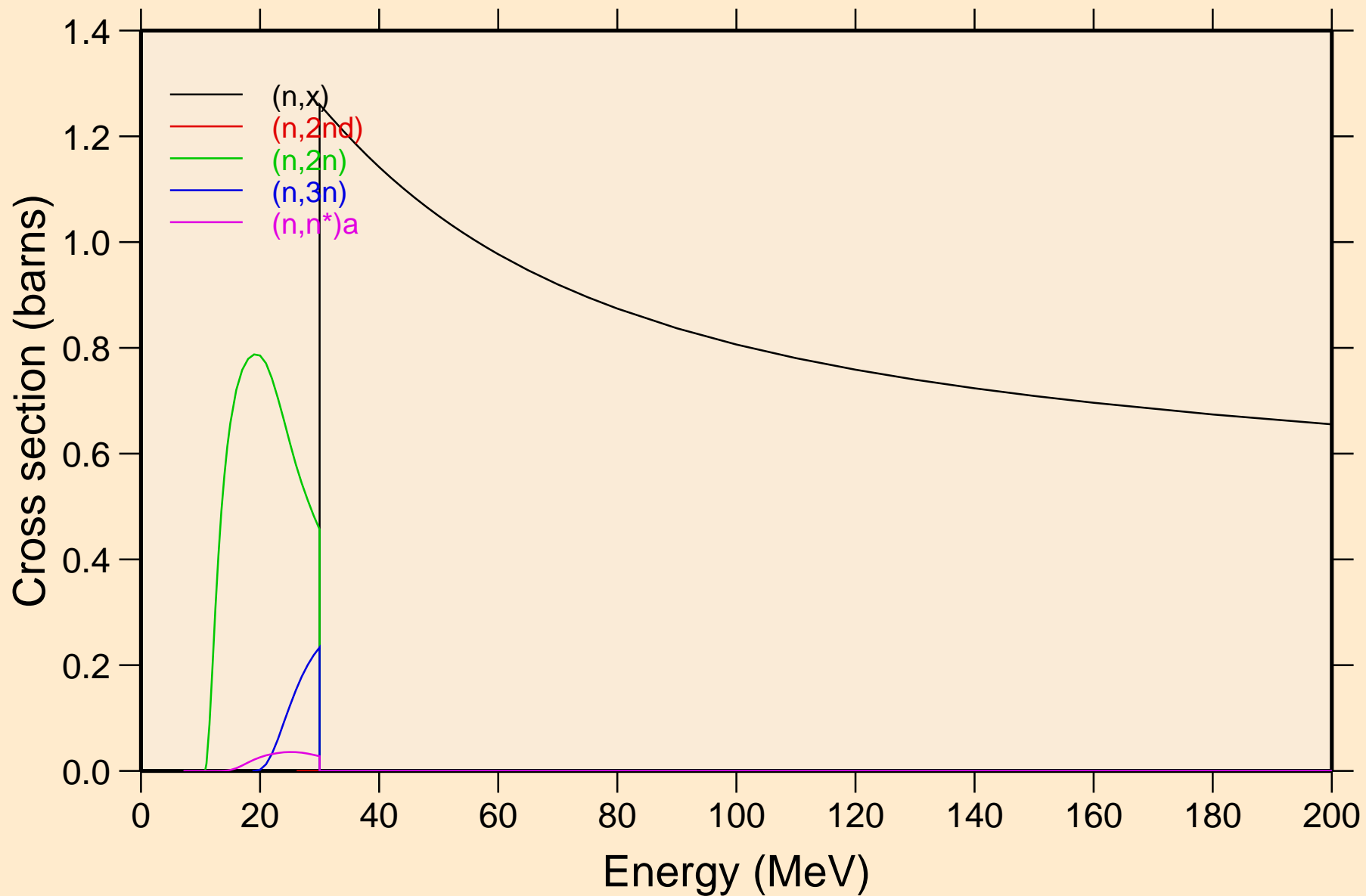

NI062 NEUTRON ACER TENDL-2023 LIBRARY; T=0.K

Threshold reactions

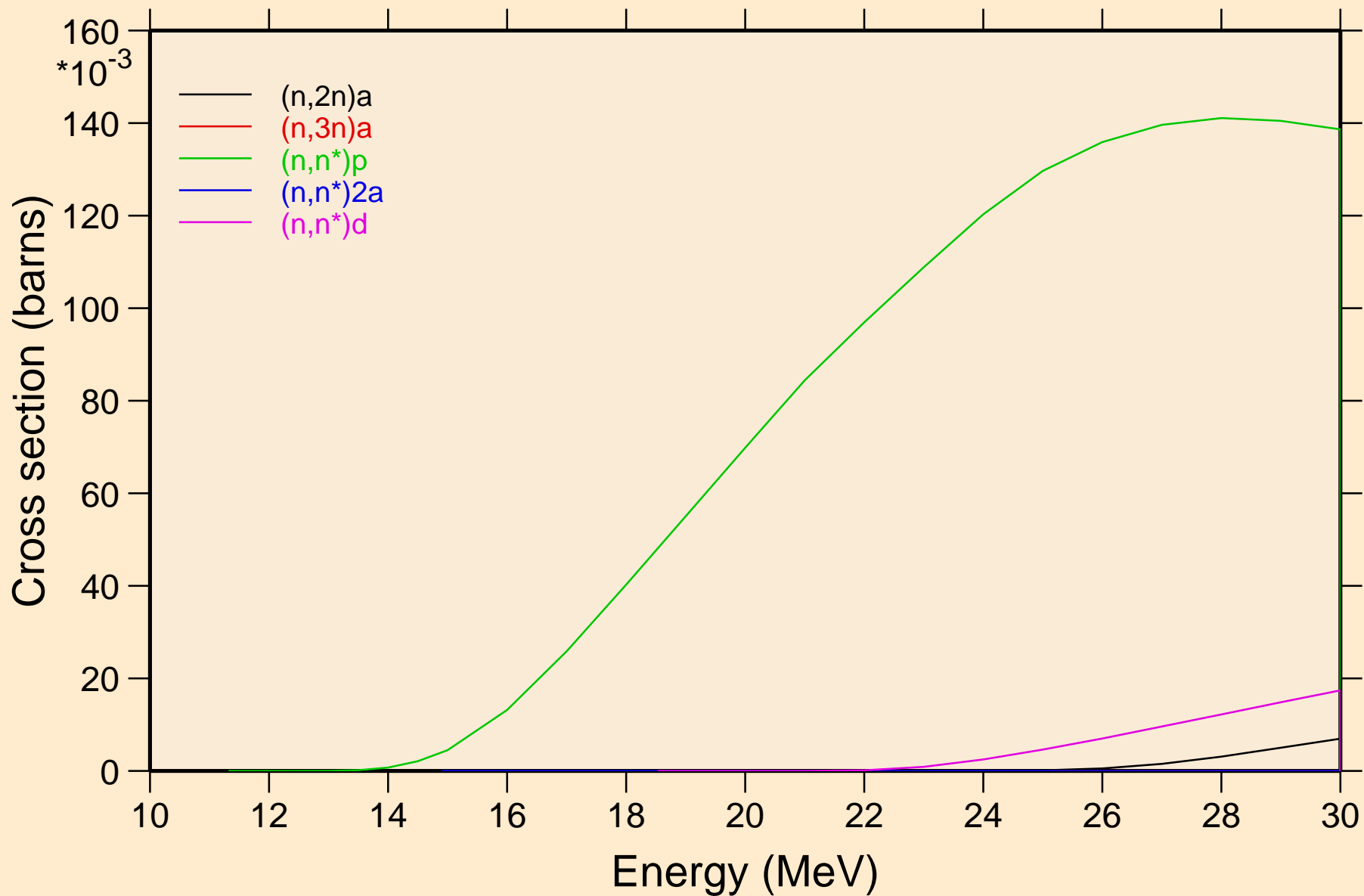

NI062 NEUTRON ACER TENDL-2023 LIBRARY; T=0.K

Threshold reactions

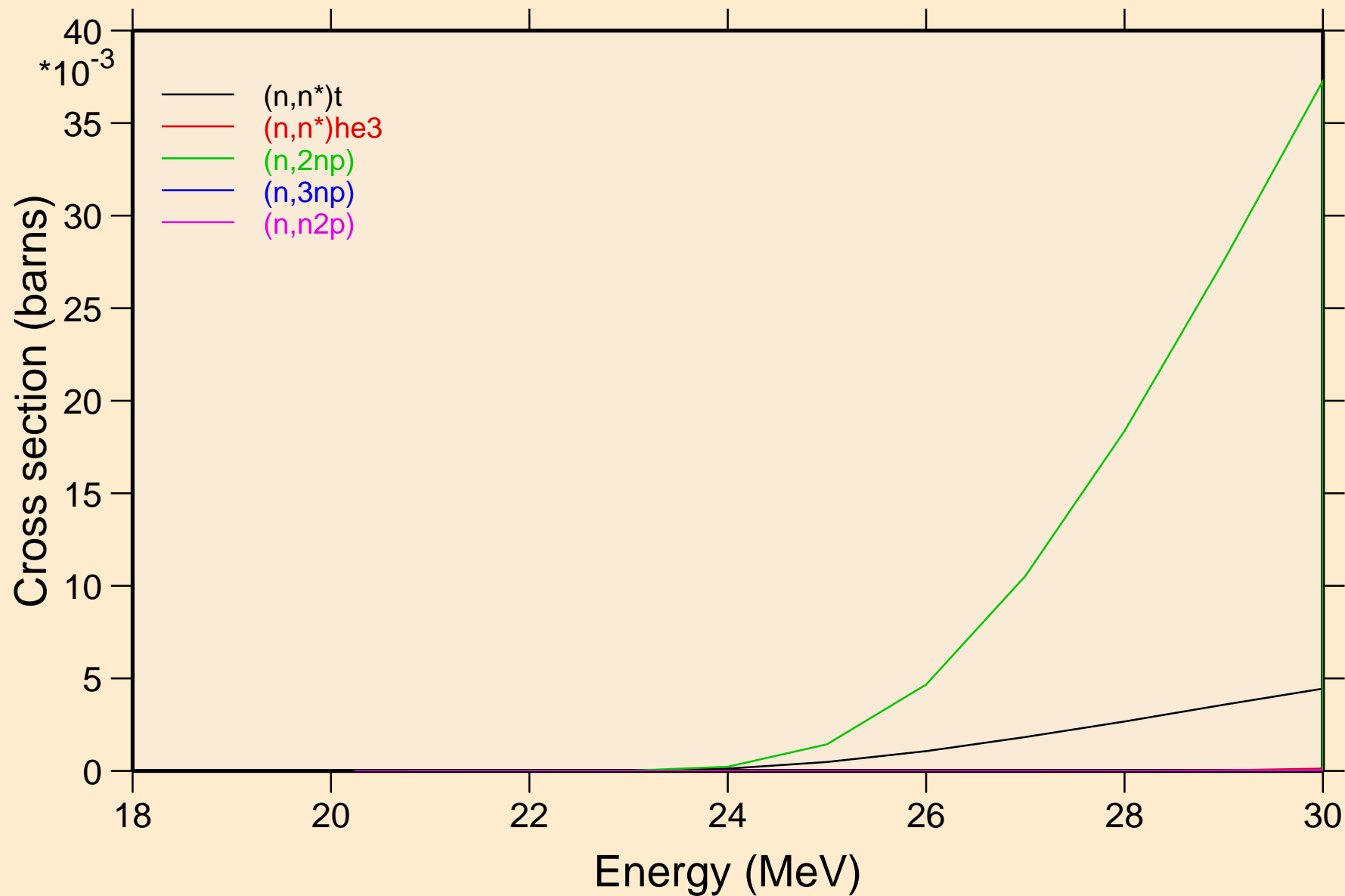

NI062 NEUTRON ACER TENDL-2023 LIBRARY; T=0.K

Threshold reactions

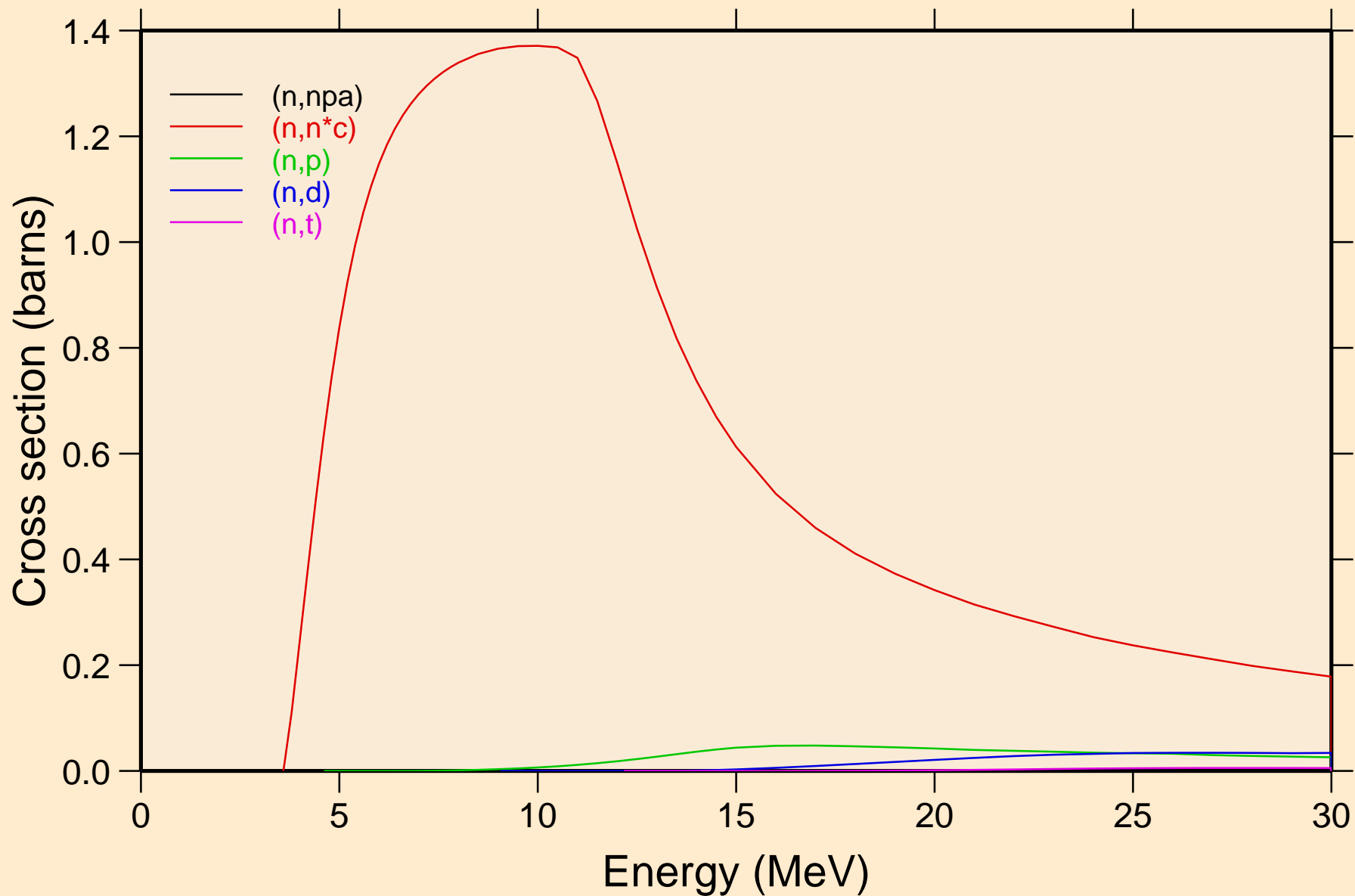

NI062 NEUTRON ACER TENDL-2023 LIBRARY; T=0.K
Threshold reactions

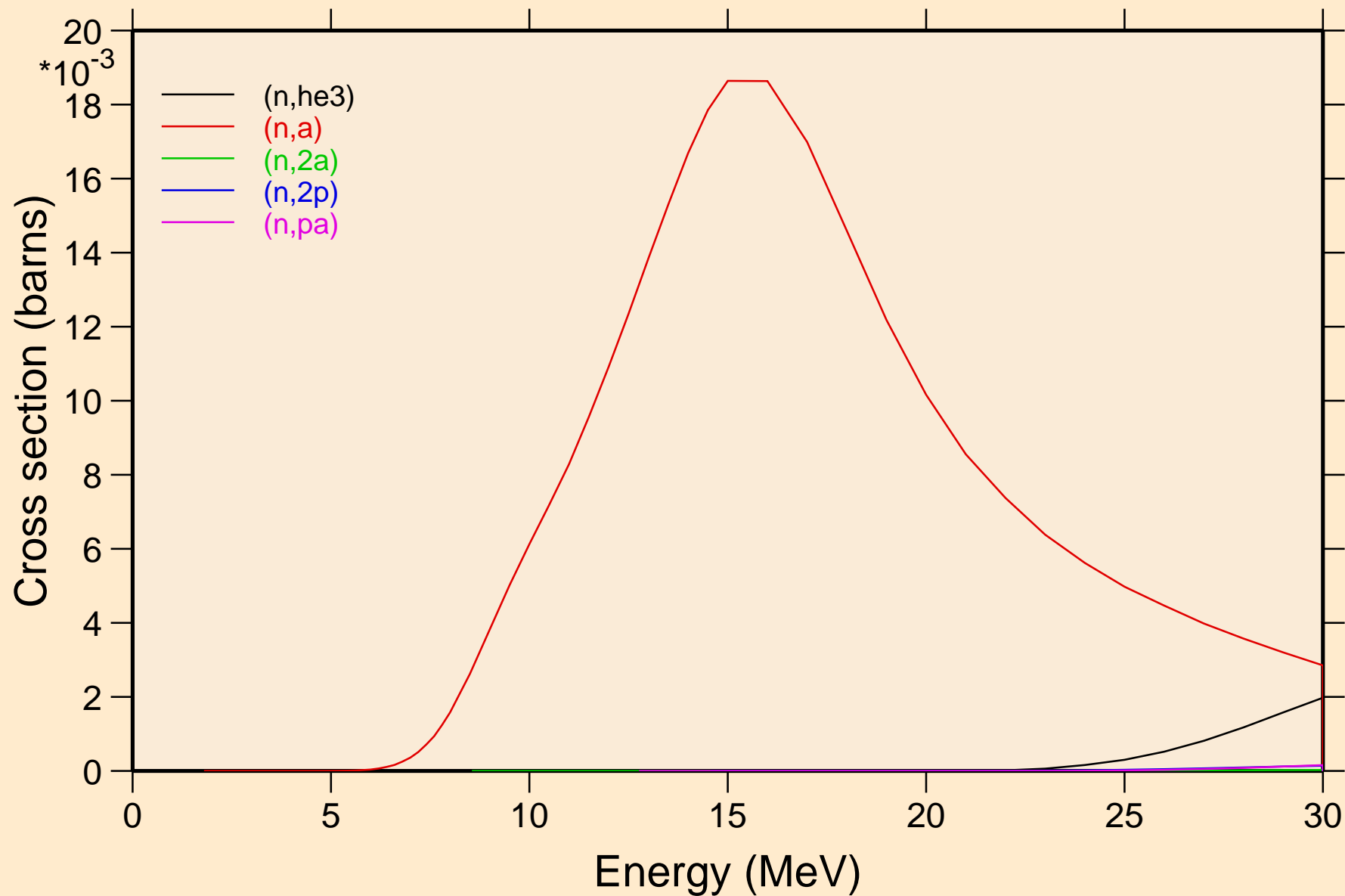

NI062 NEUTRON ACER TENDL-2023 LIBRARY; T=0.K
Threshold reactions

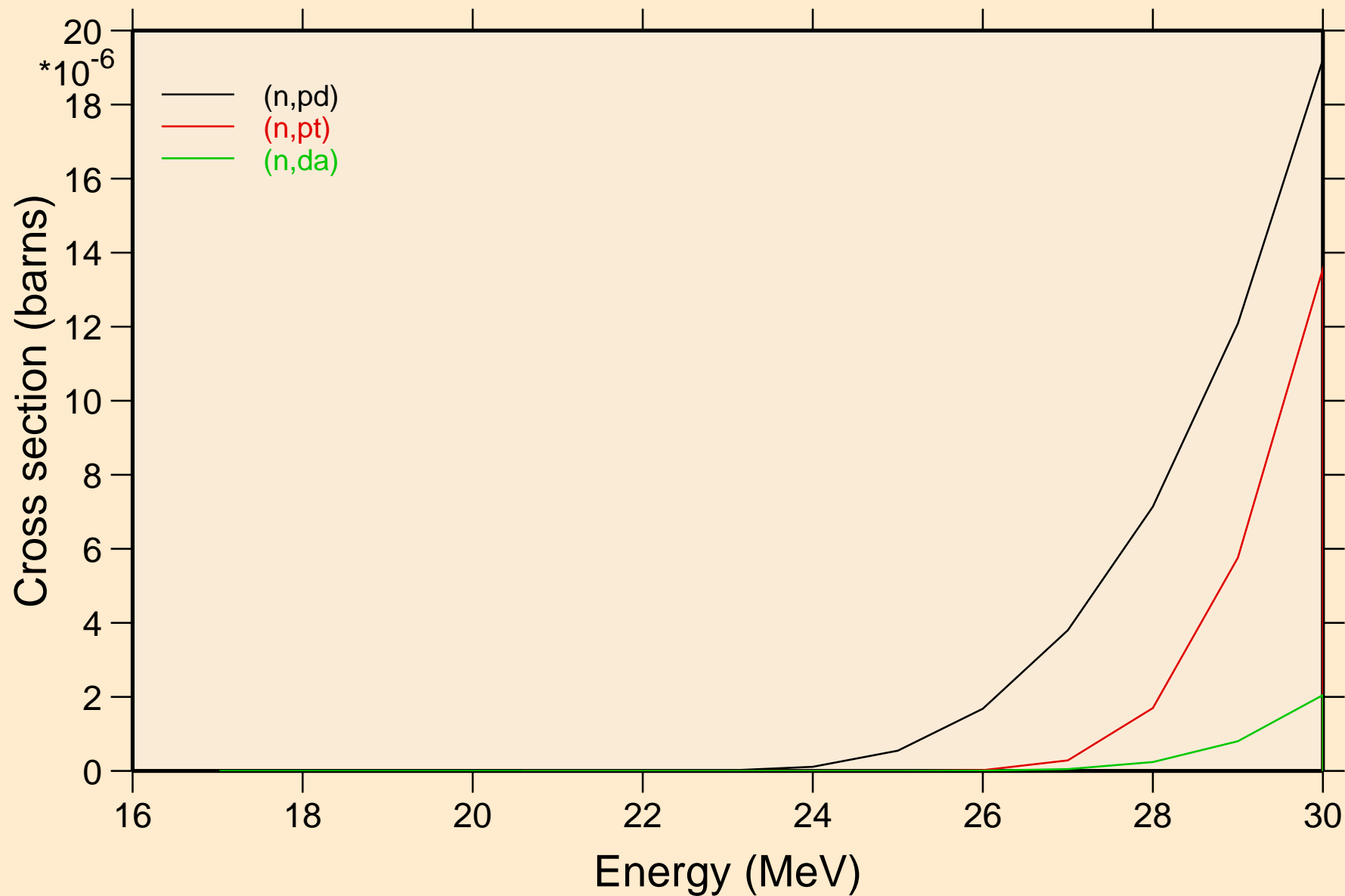

NI062 NEUTRON ACER TENDL-2023 LIBRARY; T=0.K

Threshold reactions

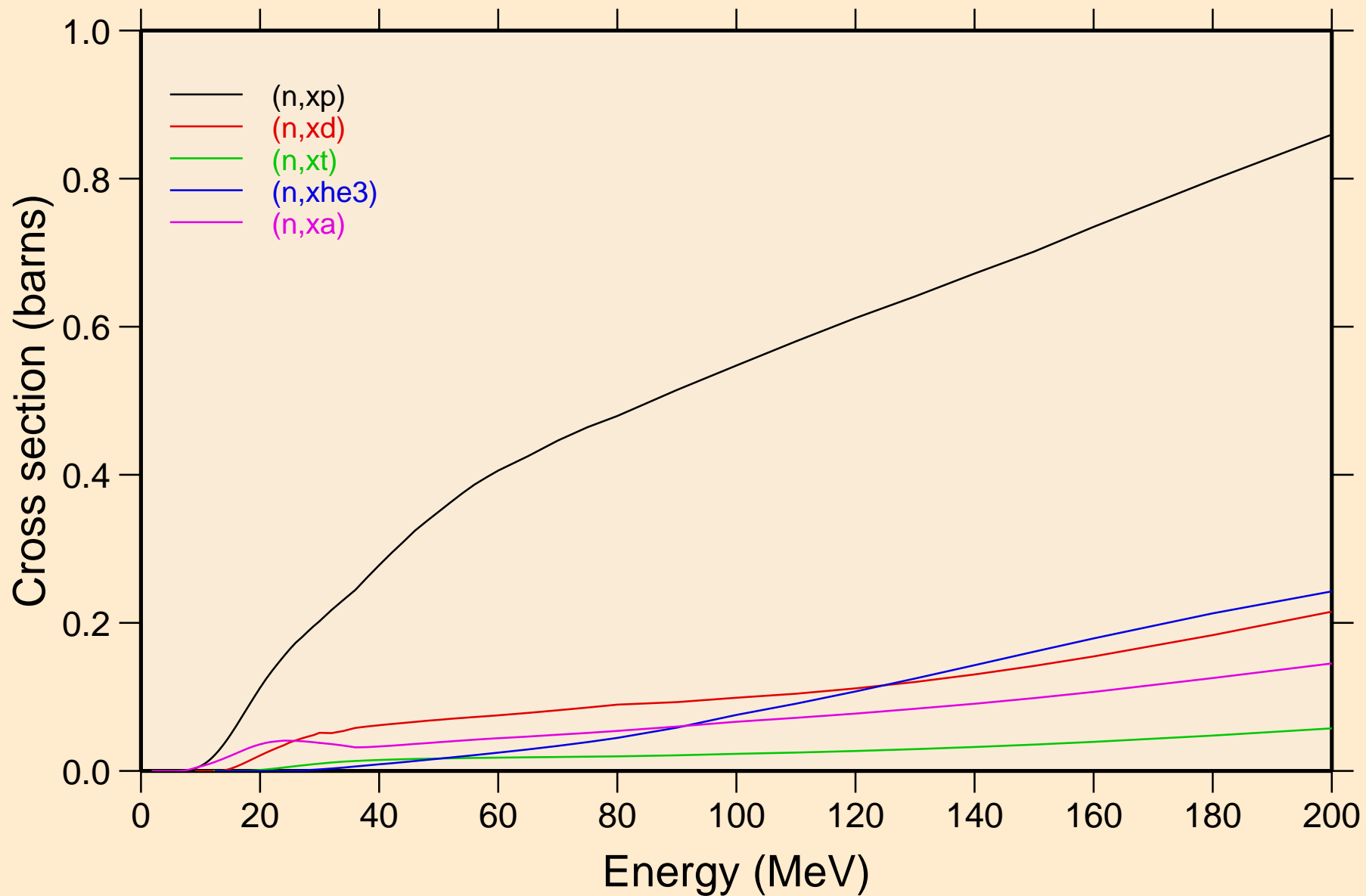

NI062 NEUTRON ACER TENDL-2023 LIBRARY; T=0.K
angular distribution for elastic

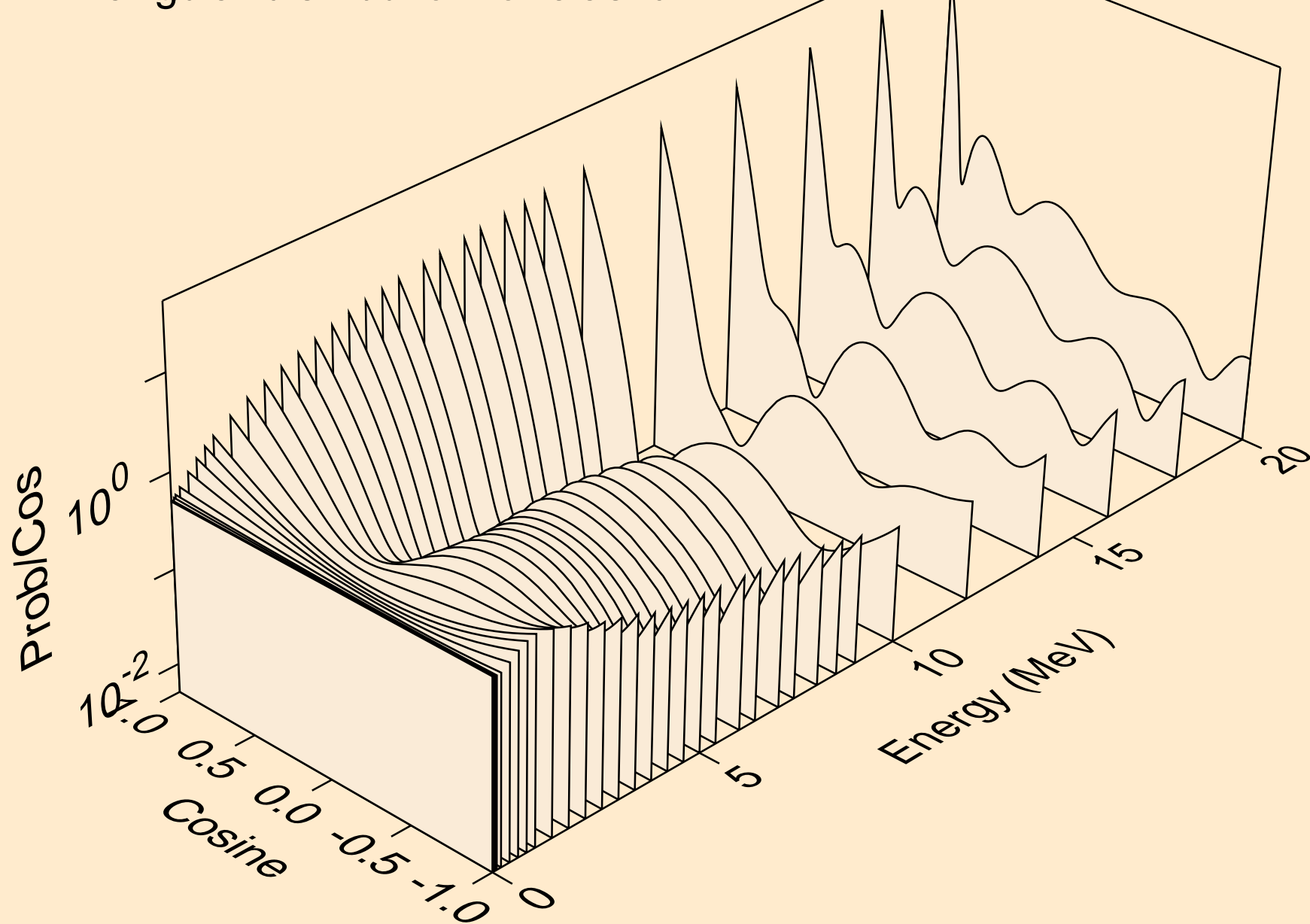

NI062 NEUTRON ACER TENDL-2023 LIBRARY; T=0.K
angular distribution for elastic

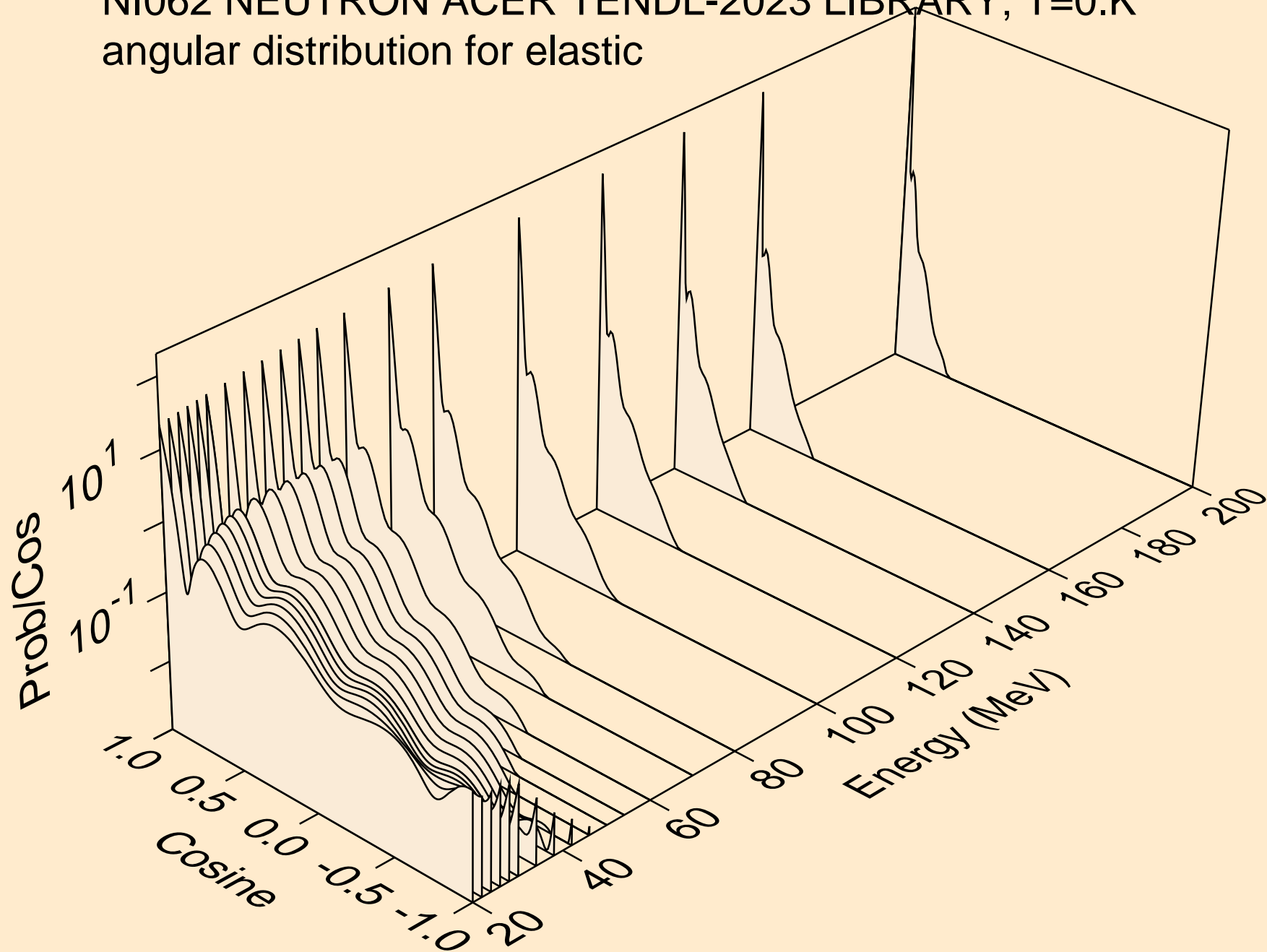

NI062 NEUTRON ACER TENDL-2023 LIBRARY; T=0.K
angular distribution for (n,n*1)

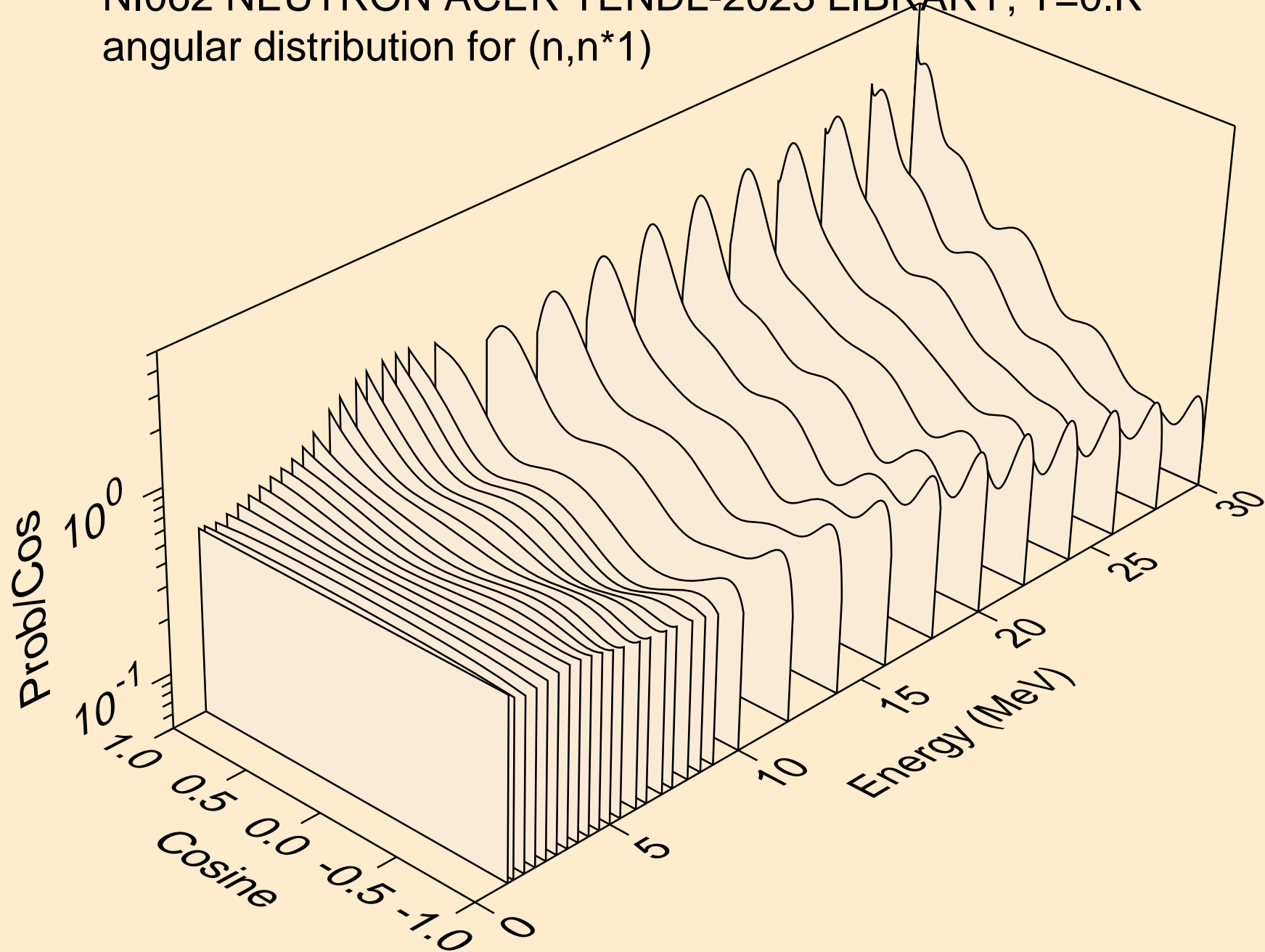

NI062 NEUTRON ACER TENDL-2023 LIBRARY; T=0.K
angular distribution for (n,n*2)

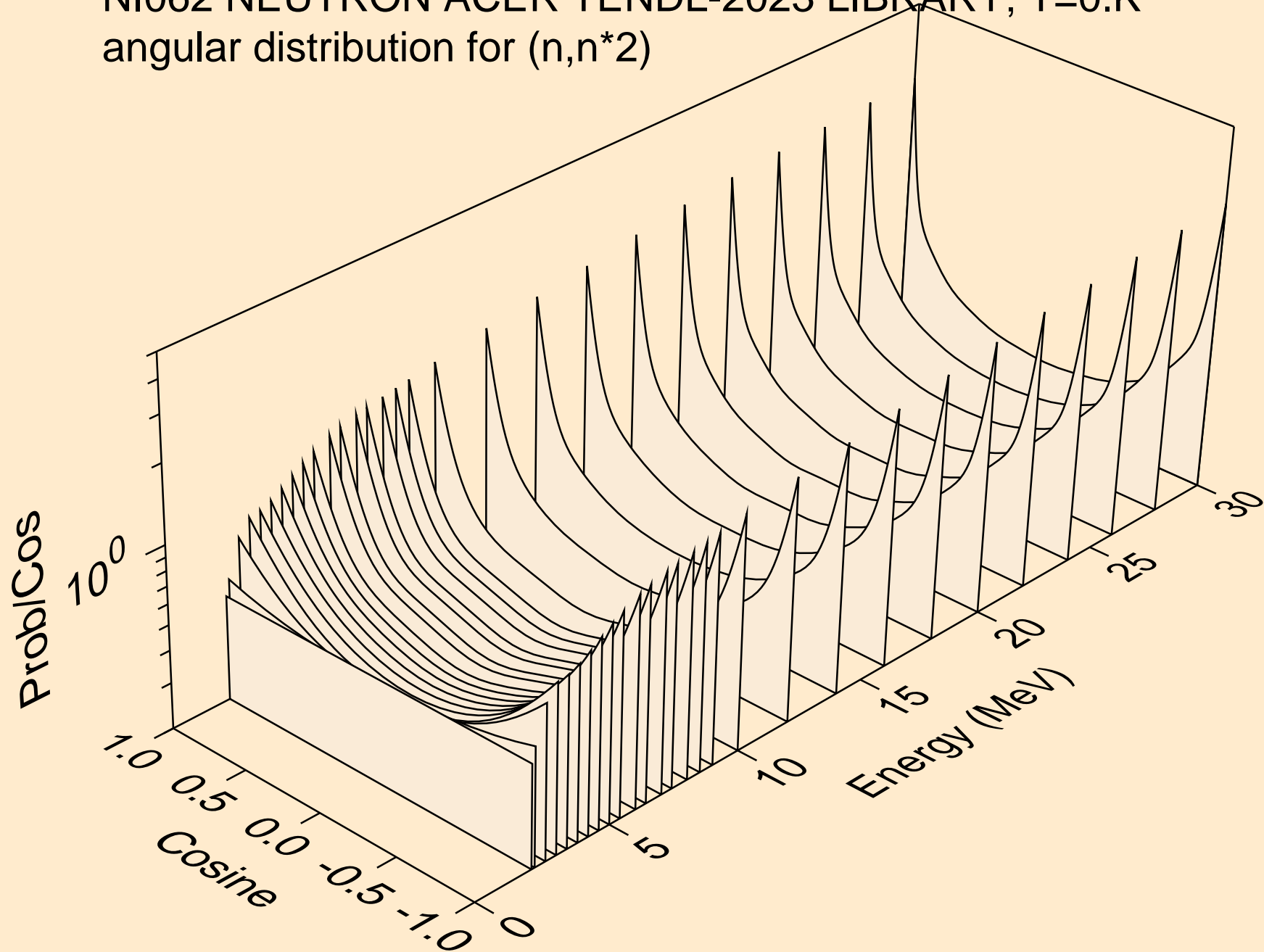

NI062 NEUTRON ACER TENDL-2023 LIBRARY; T=0.K
angular distribution for (n,n*3)

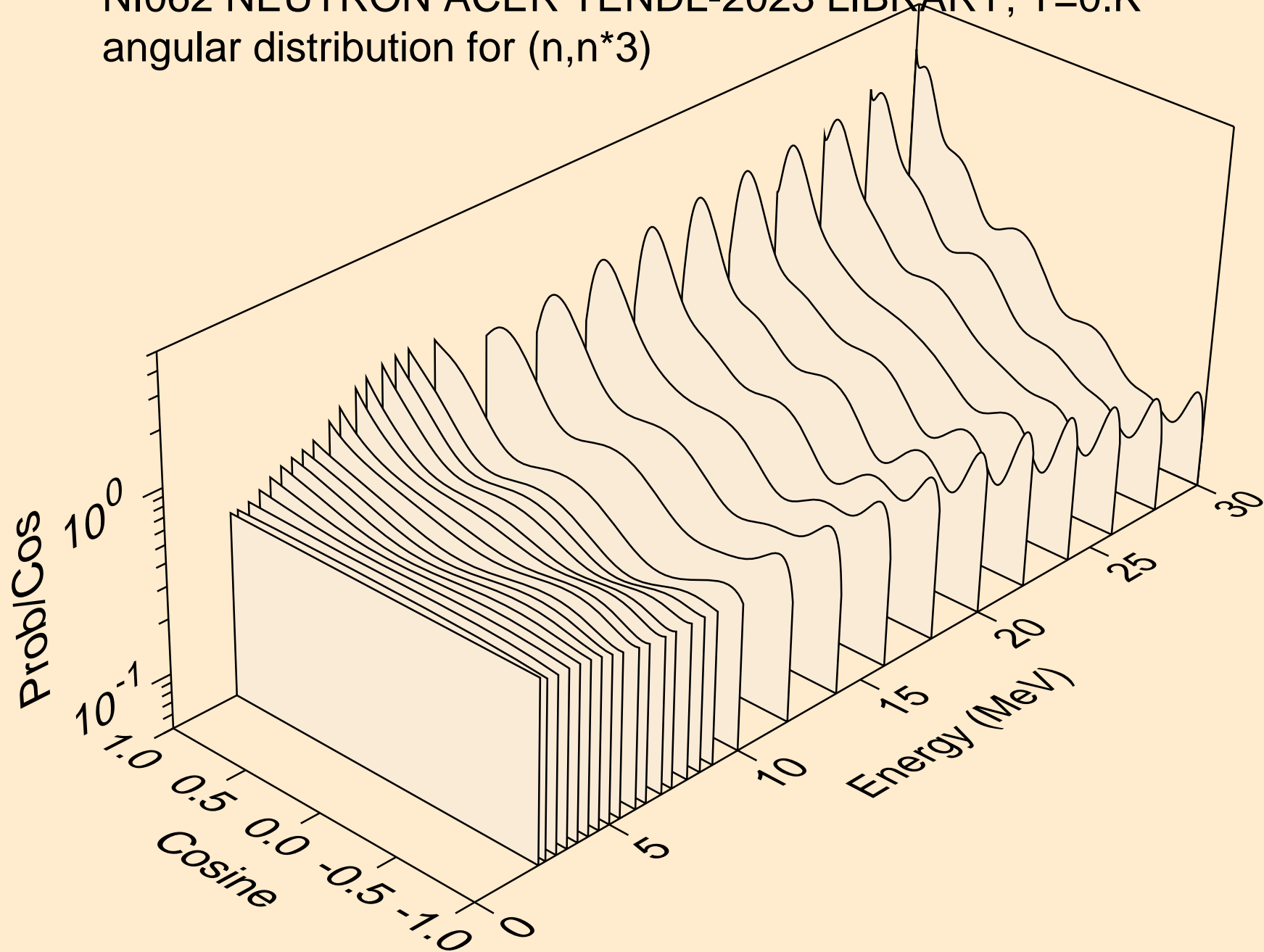

NI062 NEUTRON ACER TENDL-2023 LIBRARY; T=0.K
angular distribution for (n,n*4)

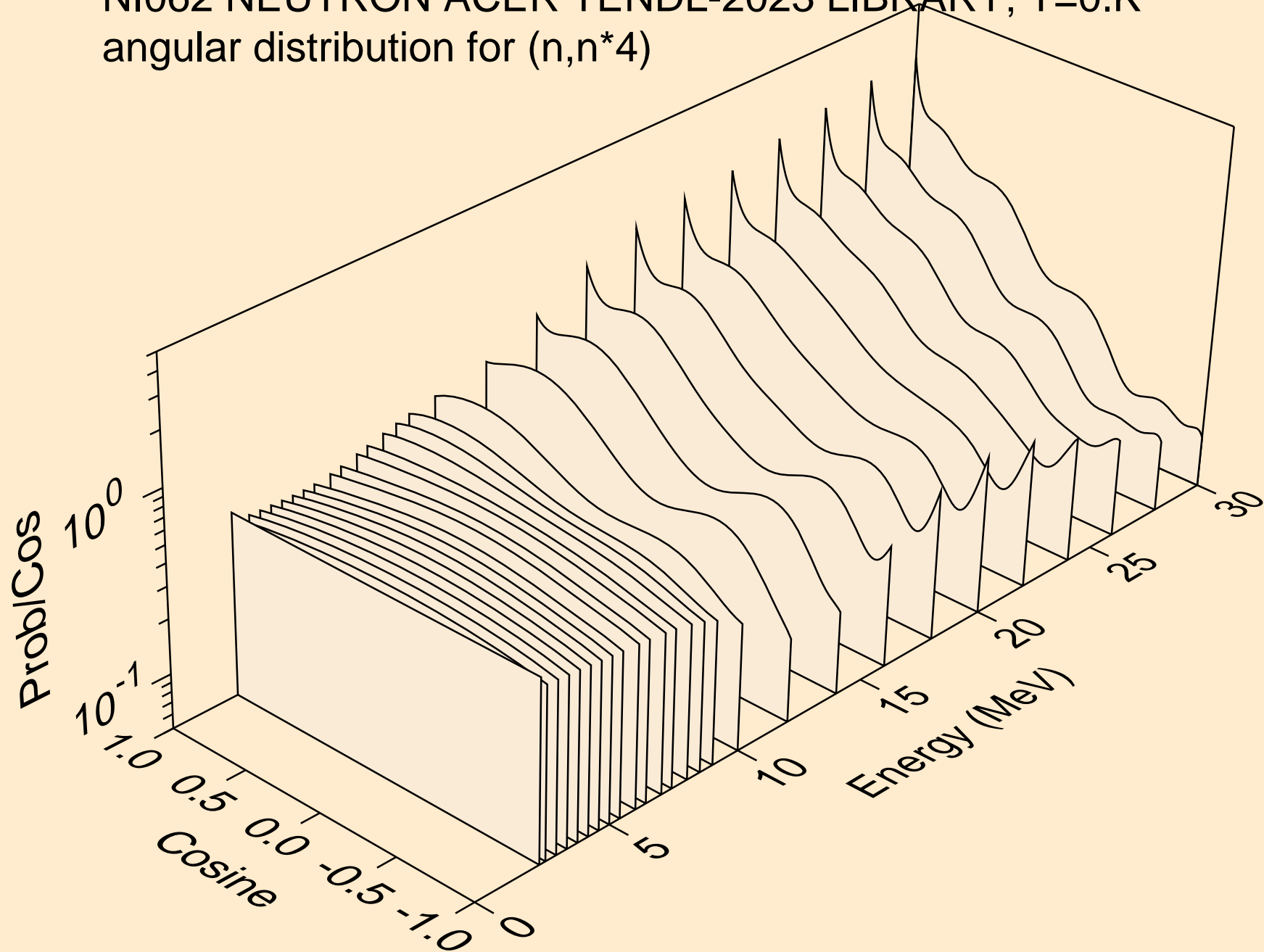

NI062 NEUTRON ACER TENDL-2023 LIBRARY; T=0.K
angular distribution for (n,n*5)

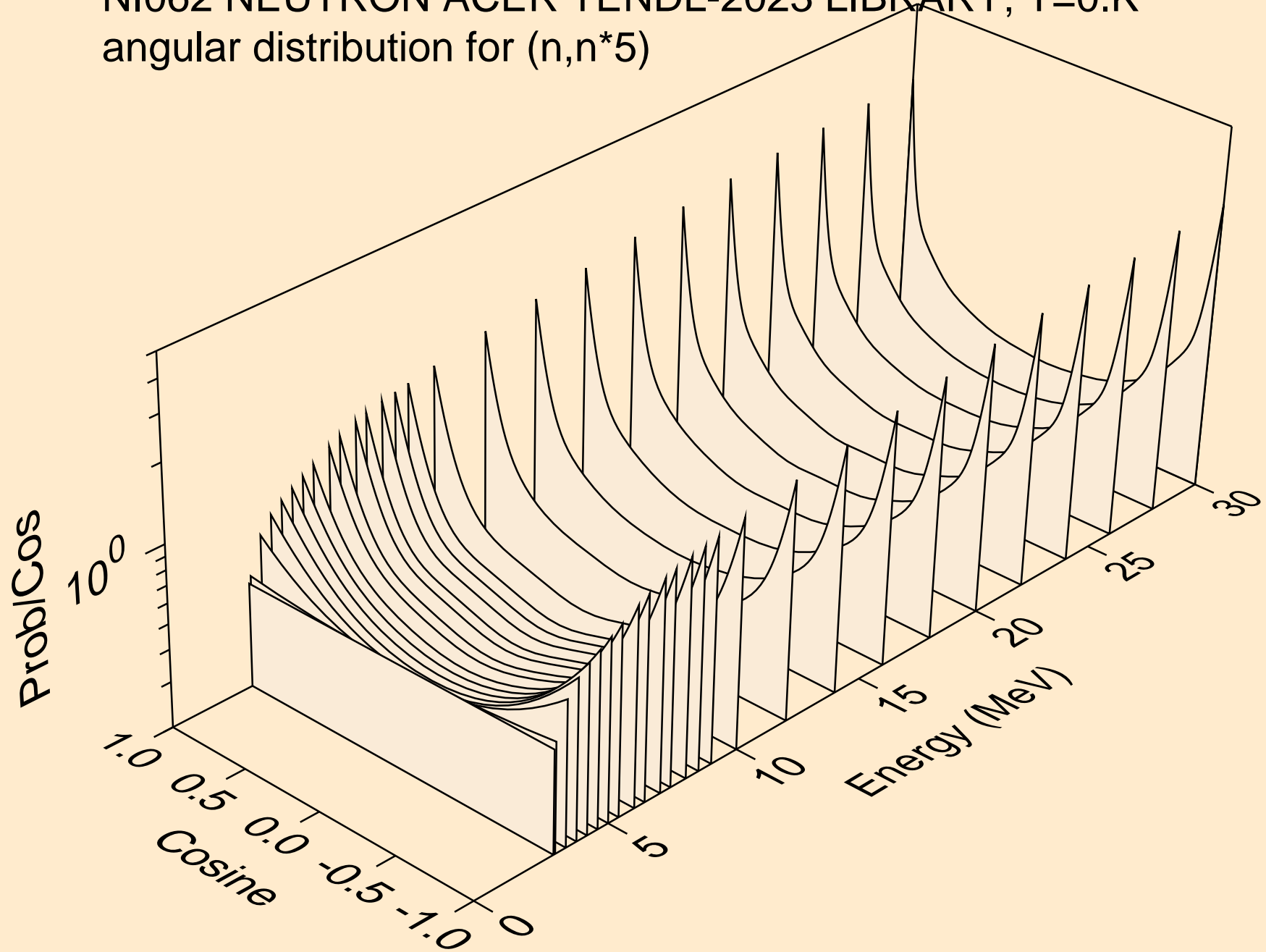

NI062 NEUTRON ACER TENDL-2023 LIBRARY; T=0.K
angular distribution for (n,n*6)

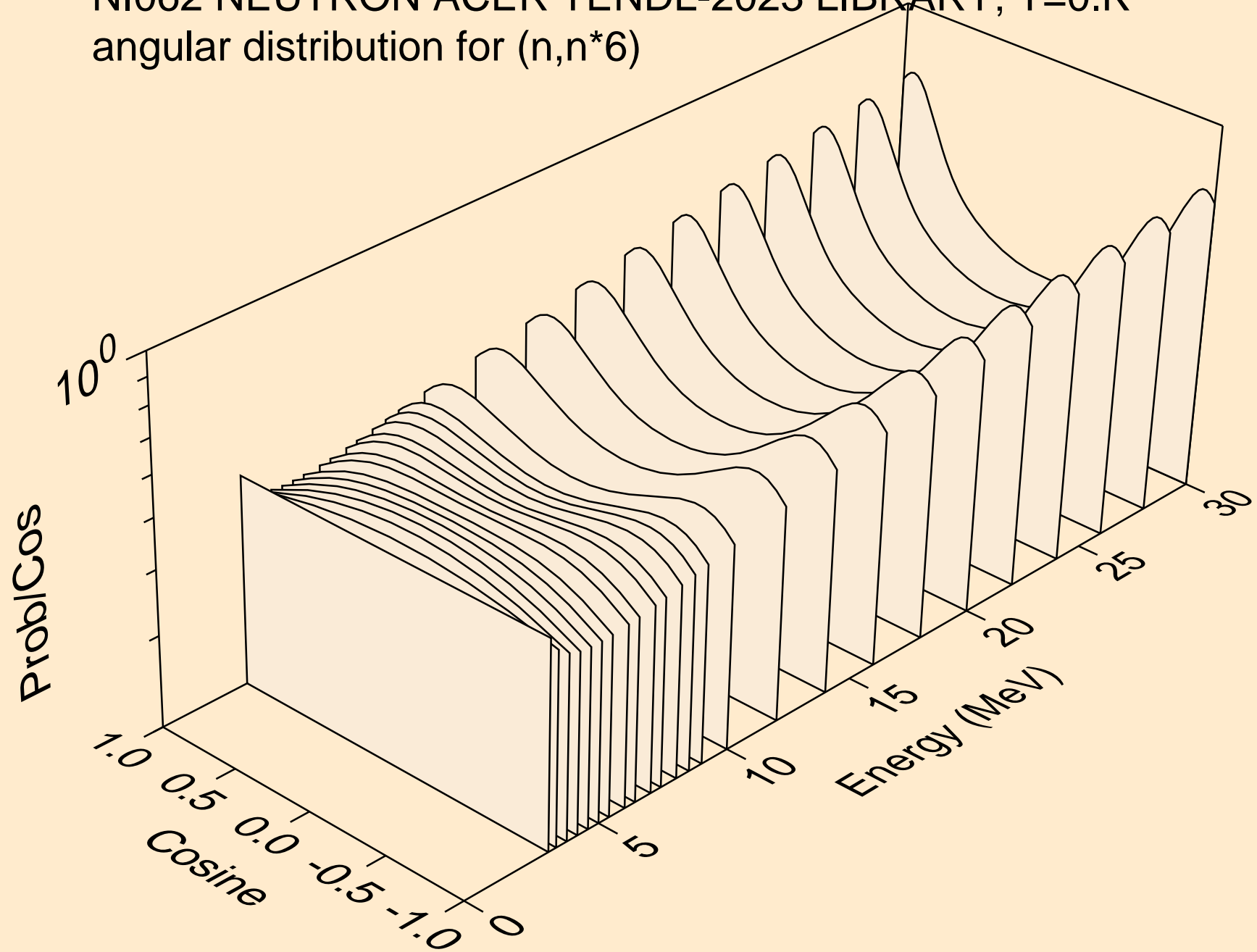

NI062 NEUTRON ACER TENDL-2023 LIBRARY; T=0.K
angular distribution for (n,n*7)

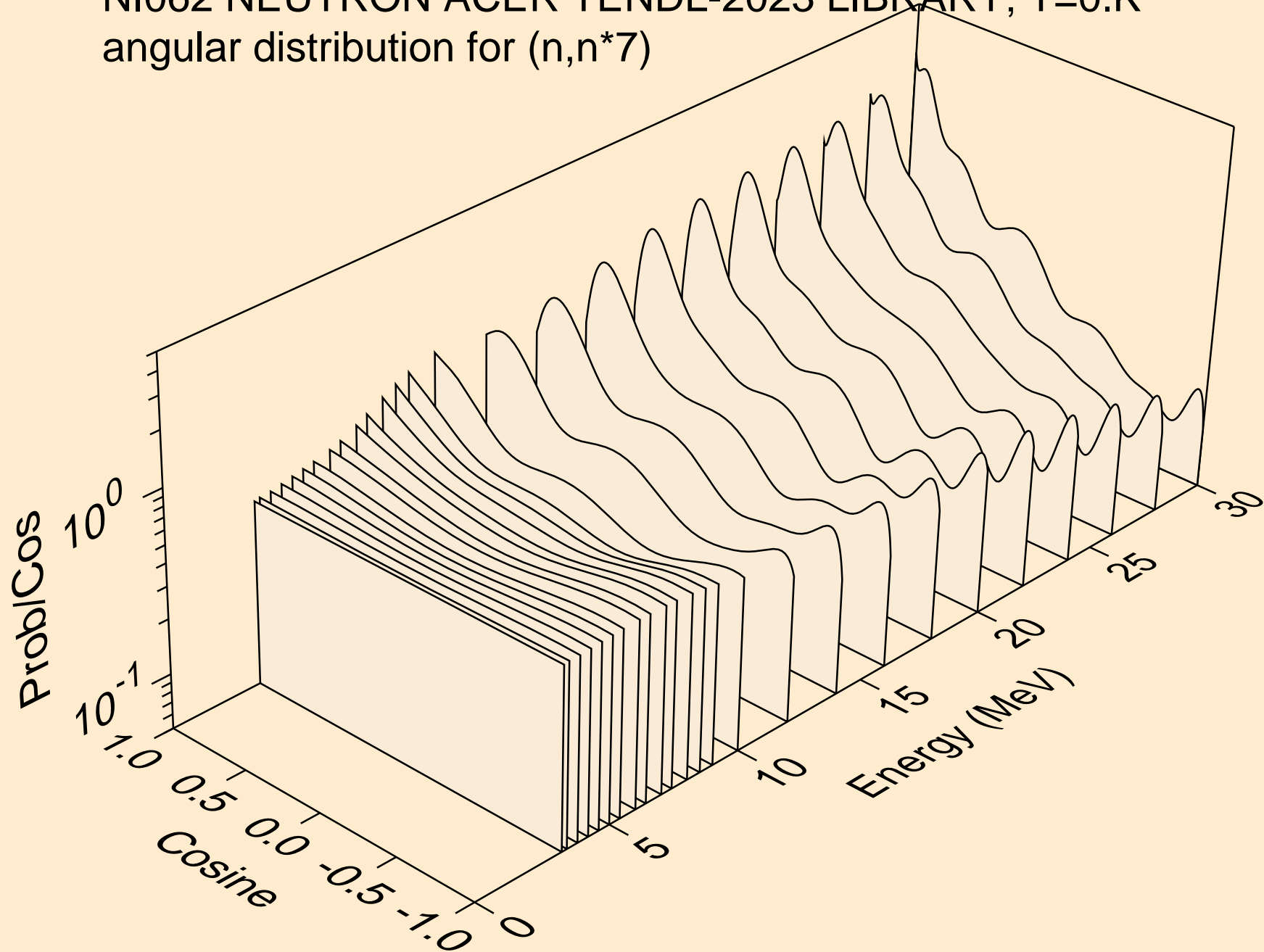

NI062 NEUTRON ACER TENDL-2023 LIBRARY; T=0.K
angular distribution for (n,n*8)

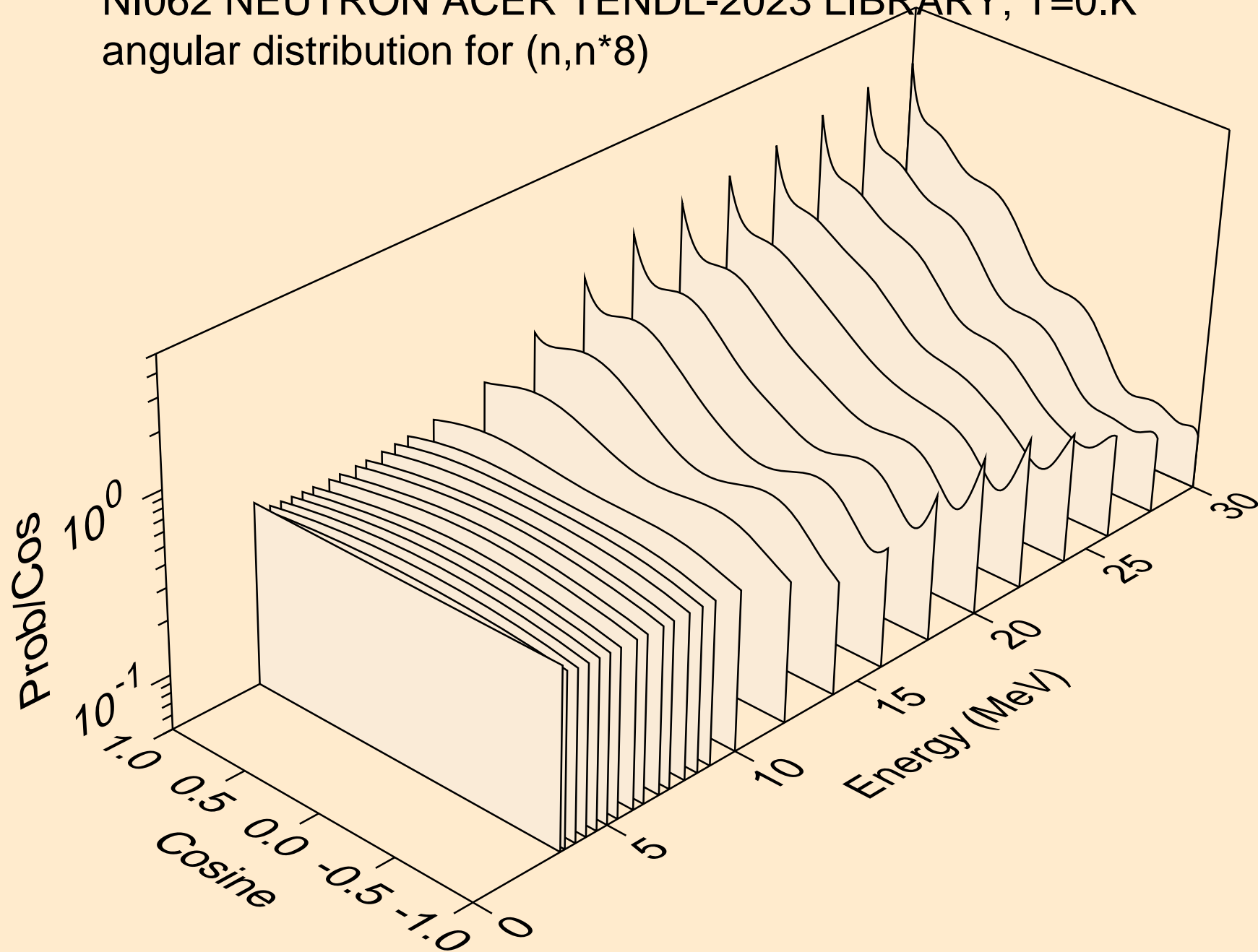

NI062 NEUTRON ACER TENDL-2023 LIBRARY; T=0.K
angular distribution for (n,n*9)

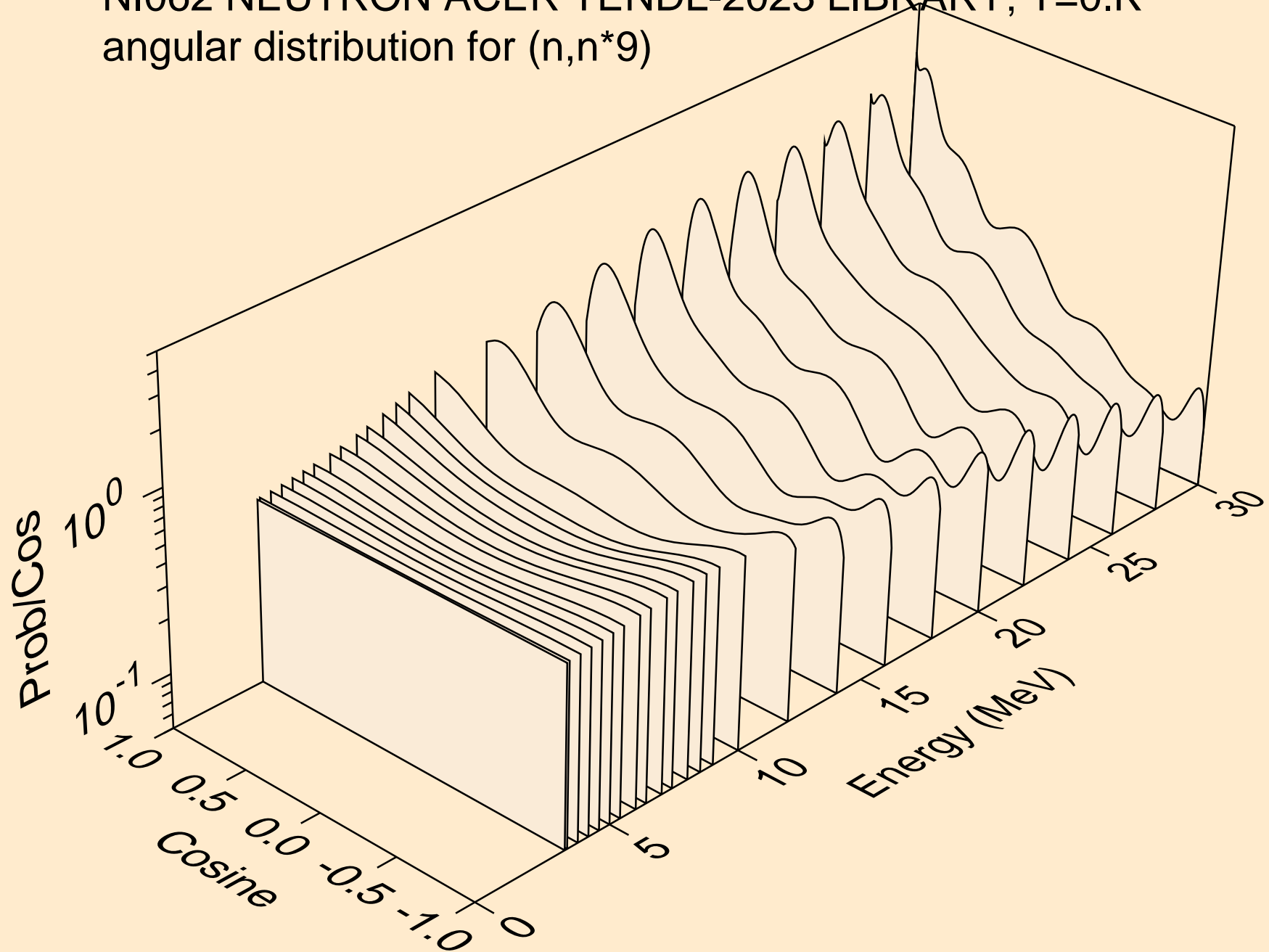

NI062 NEUTRON ACER TENDL-2023 LIBRARY; T=0.K
angular distribution for (n,n*10)

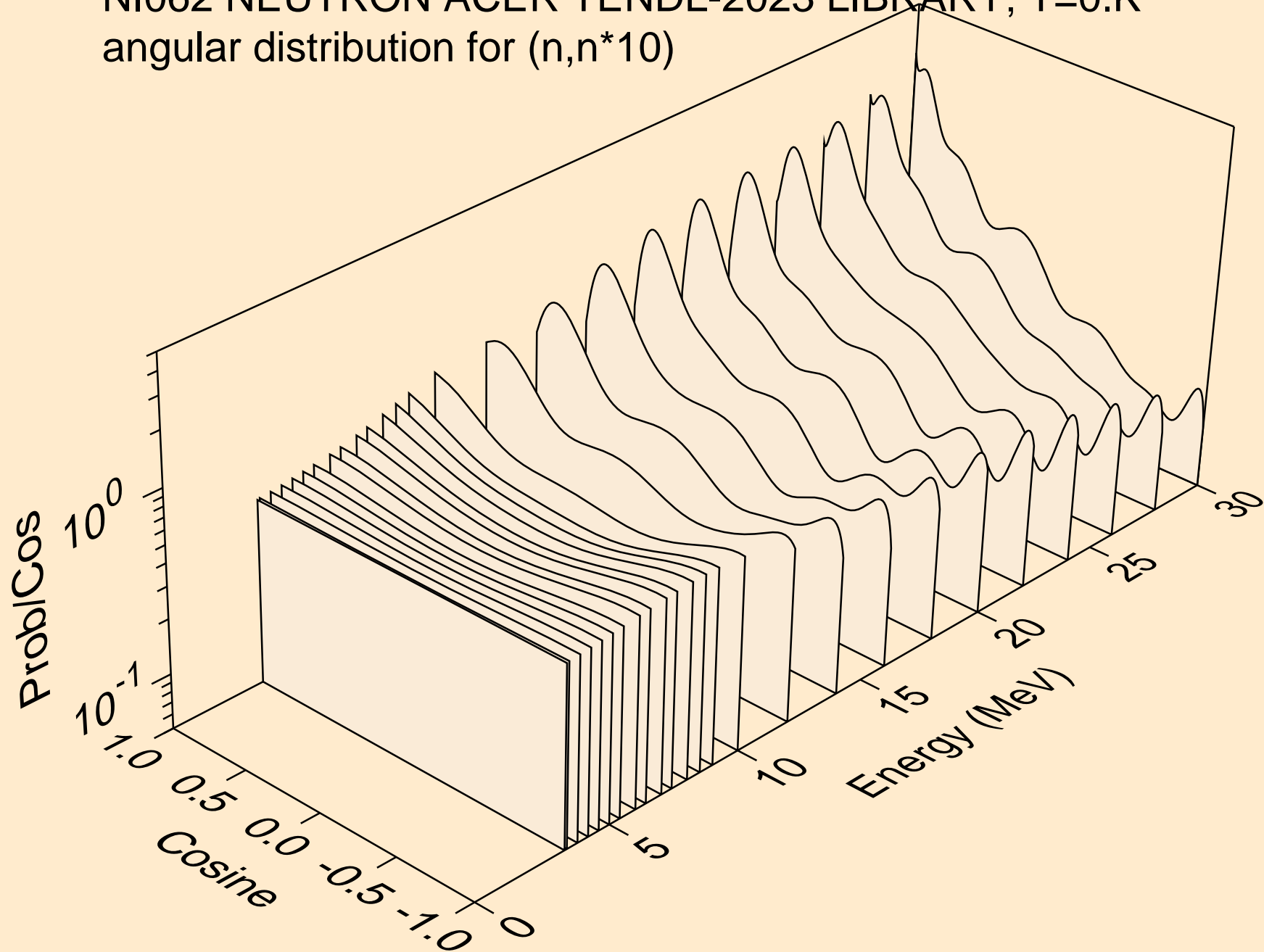

NI062 NEUTRON ACER TENDL-2023 LIBRARY; T=0.K
angular distribution for (n,n*11)

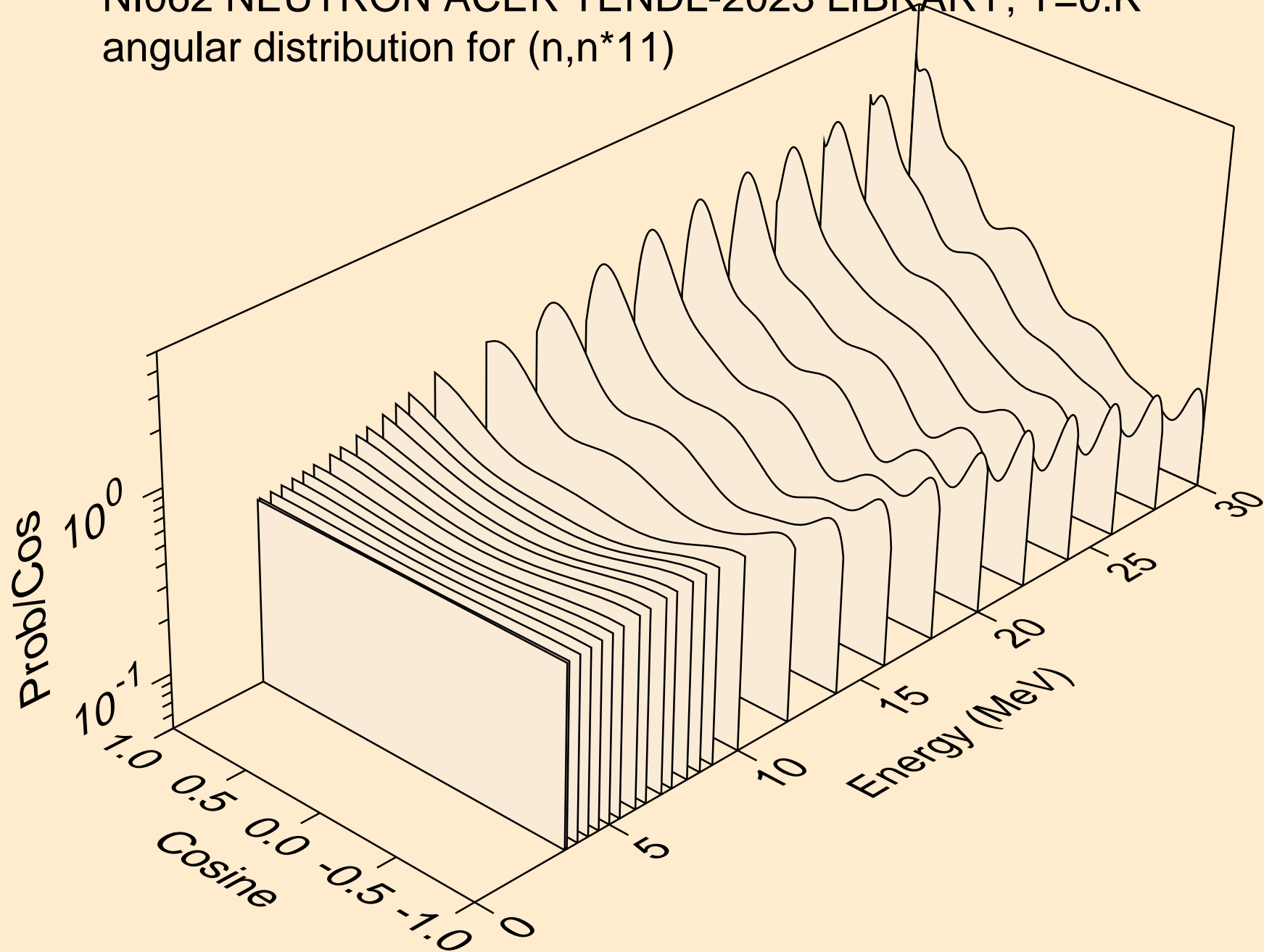

NI062 NEUTRON ACER TENDL-2023 LIBRARY; T=0.K
angular distribution for (n,n*12)

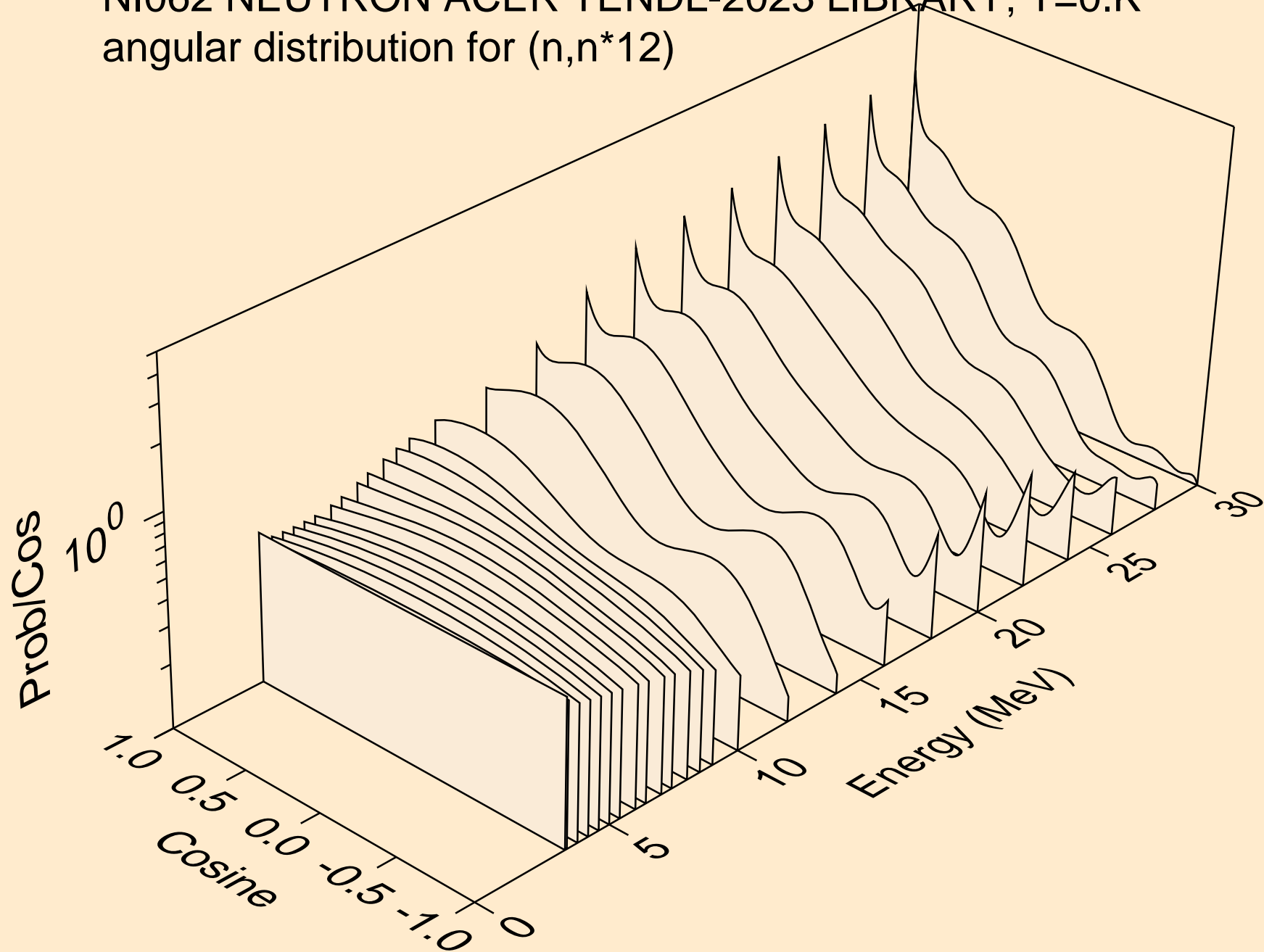

NI062 NEUTRON ACER TENDL-2023 LIBRARY; T=0.K
angular distribution for (n,n*13)

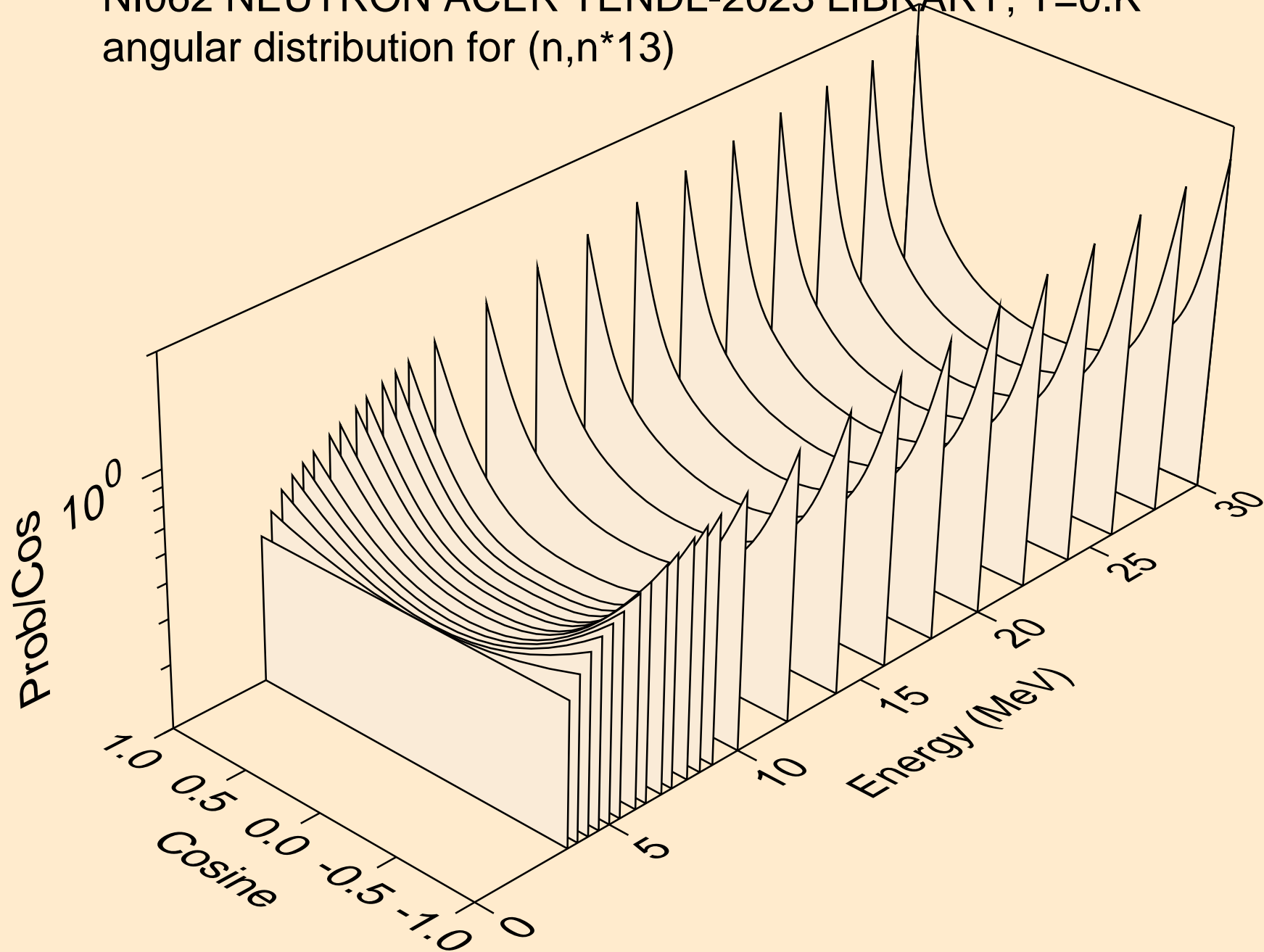

NI062 NEUTRON ACER TENDL-2023 LIBRARY; T=0.K
angular distribution for (n,n*14)

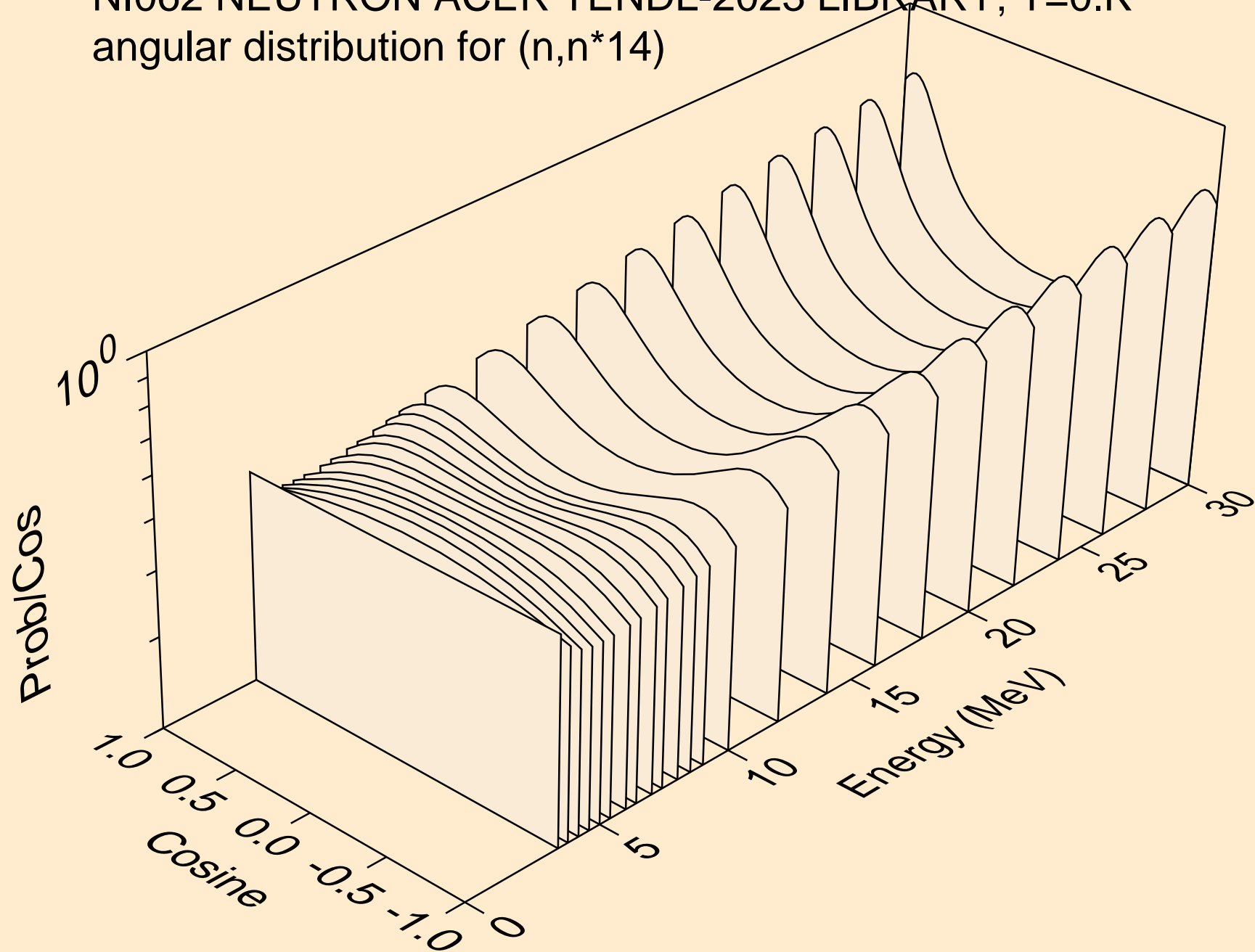

NI062 NEUTRON ACER TENDL-2023 LIBRARY; T=0.K
angular distribution for (n,n*15)

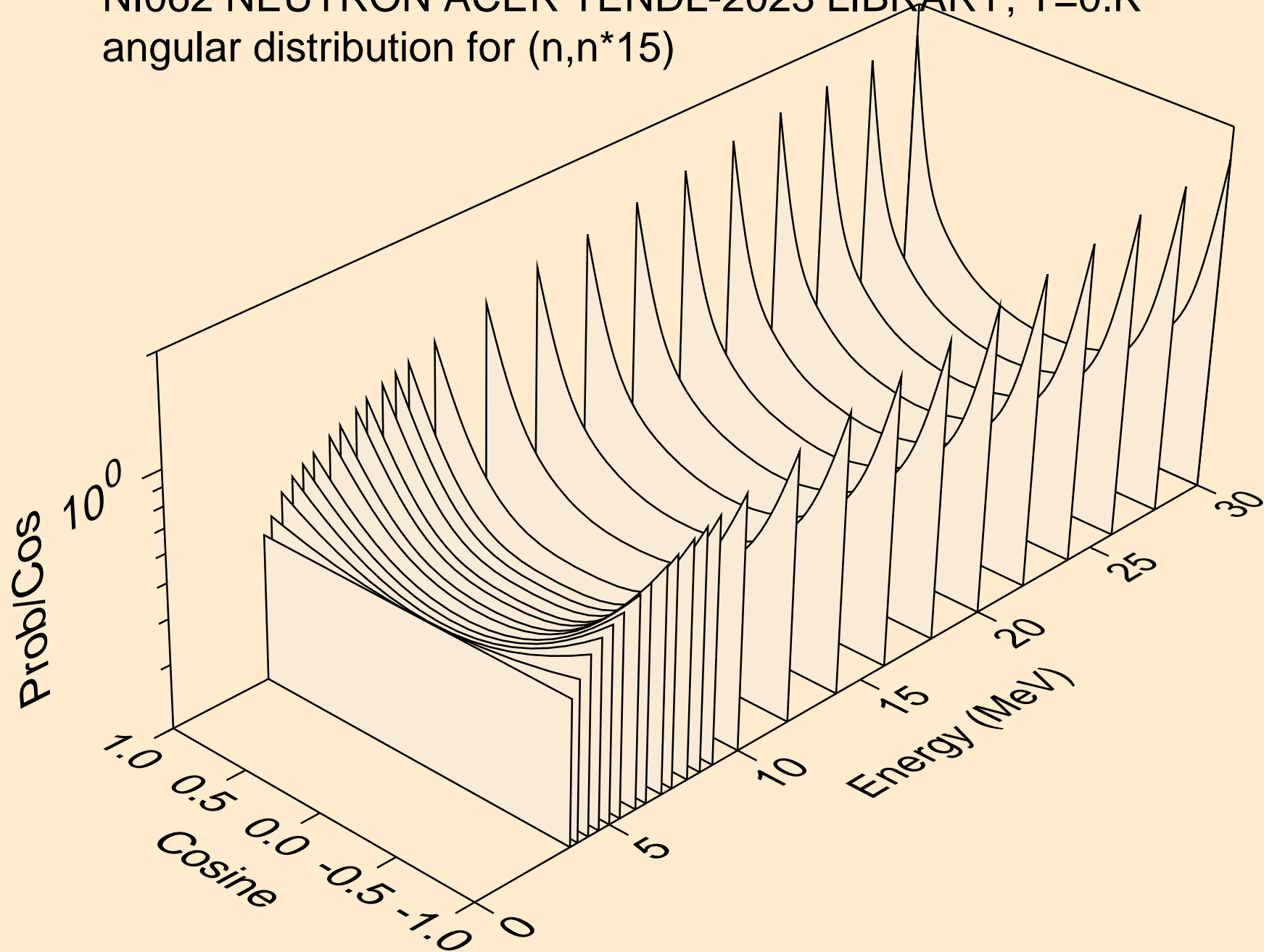

NI062 NEUTRON ACER TENDL-2023 LIBRARY; T=0.K
angular distribution for (n,n*16)

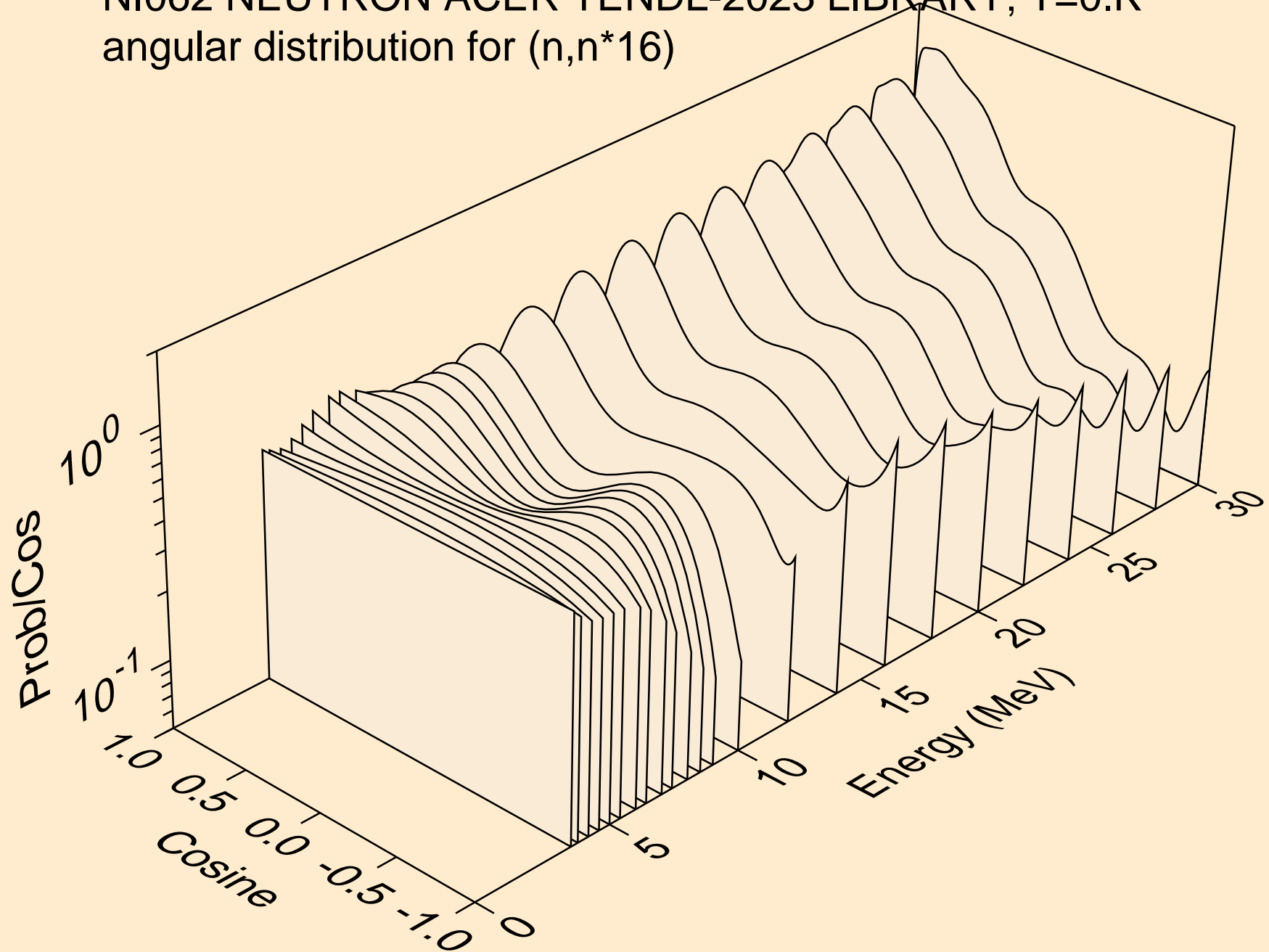

NI062 NEUTRON ACER TENDL-2023 LIBRARY; T=0.K
angular distribution for (n,n*17)

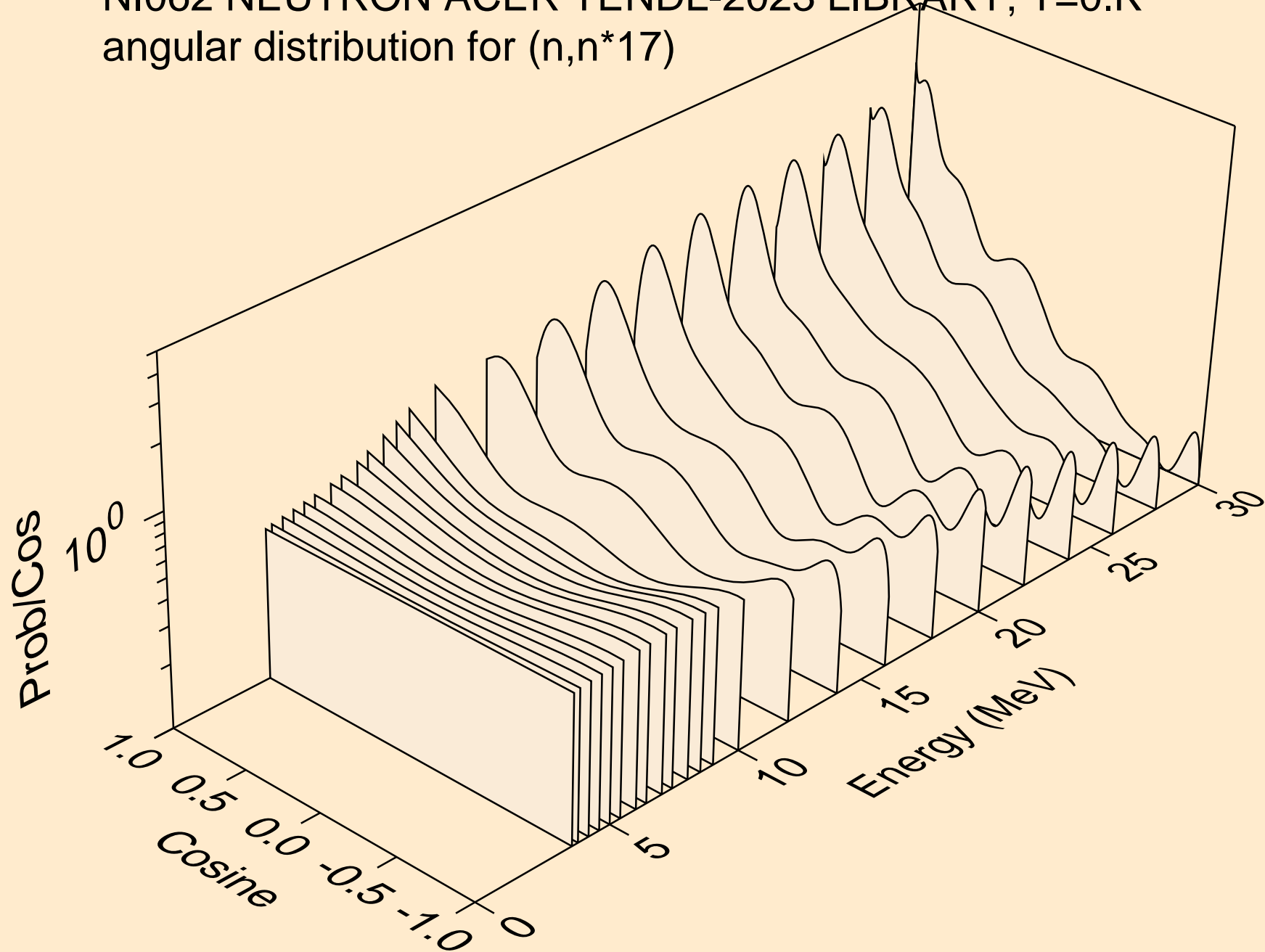

NI062 NEUTRON ACER TENDL-2023 LIBRARY; T=0.K
angular distribution for (n,n*18)

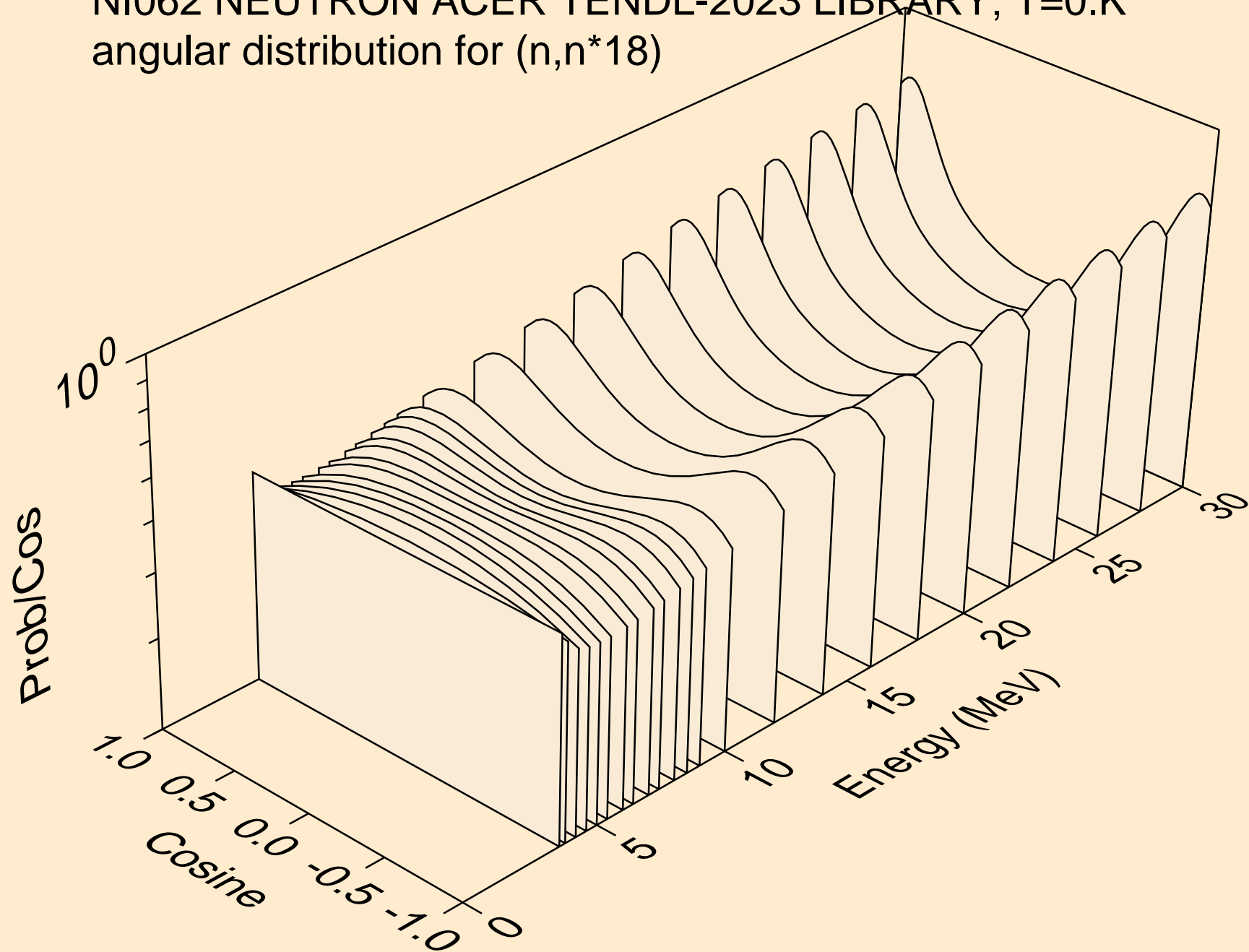

NI062 NEUTRON ACER TENDL-2023 LIBRARY; T=0.K
Neutron emission for (n,x)

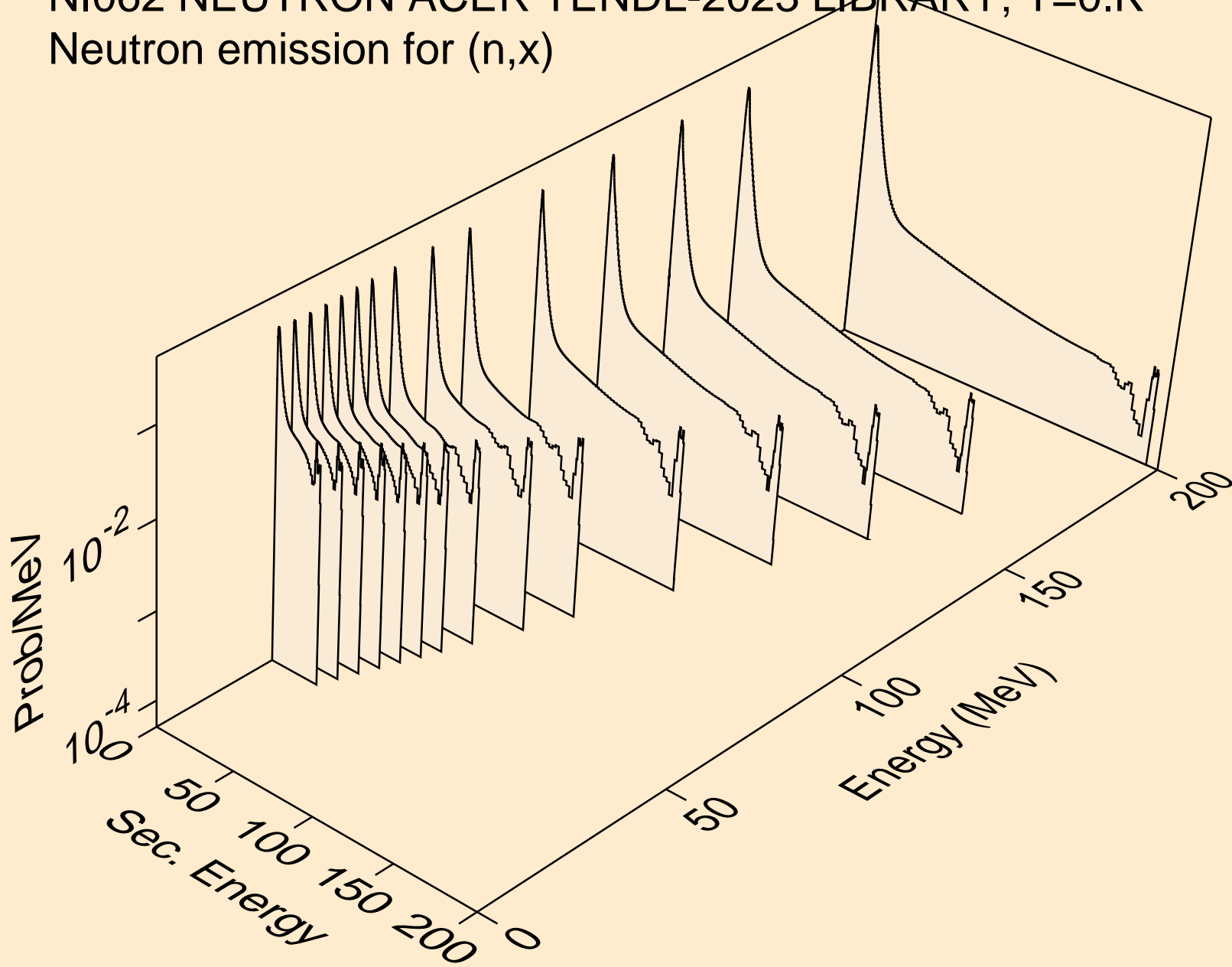

NI062 NEUTRON ACER TENDL-2023 LIBRARY; T=0.K
Neutron emission for (n,2nd)

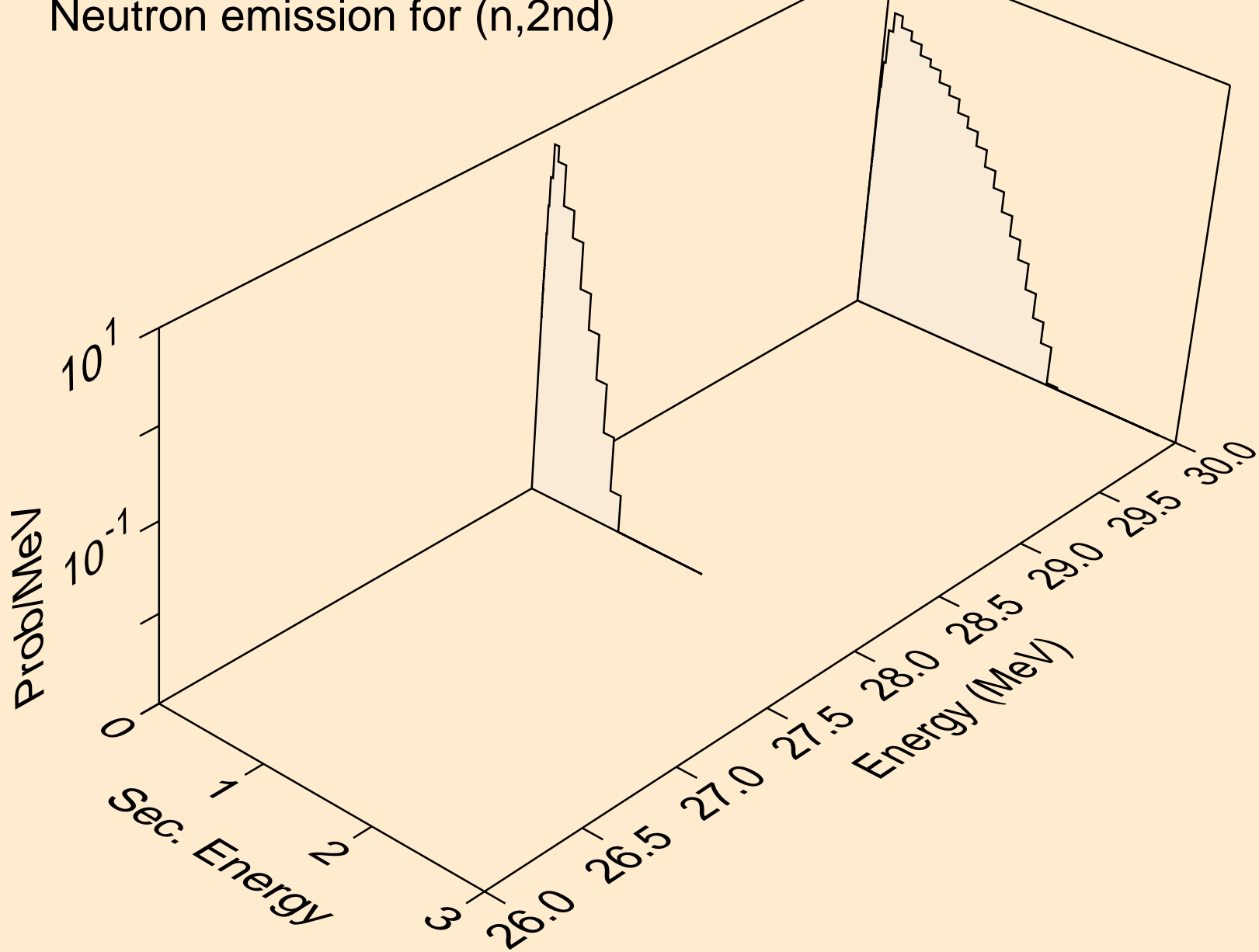

NI062 NEUTRON ACER TENDL-2023 LIBRARY; T=0.K
Neutron emission for (n,2n)

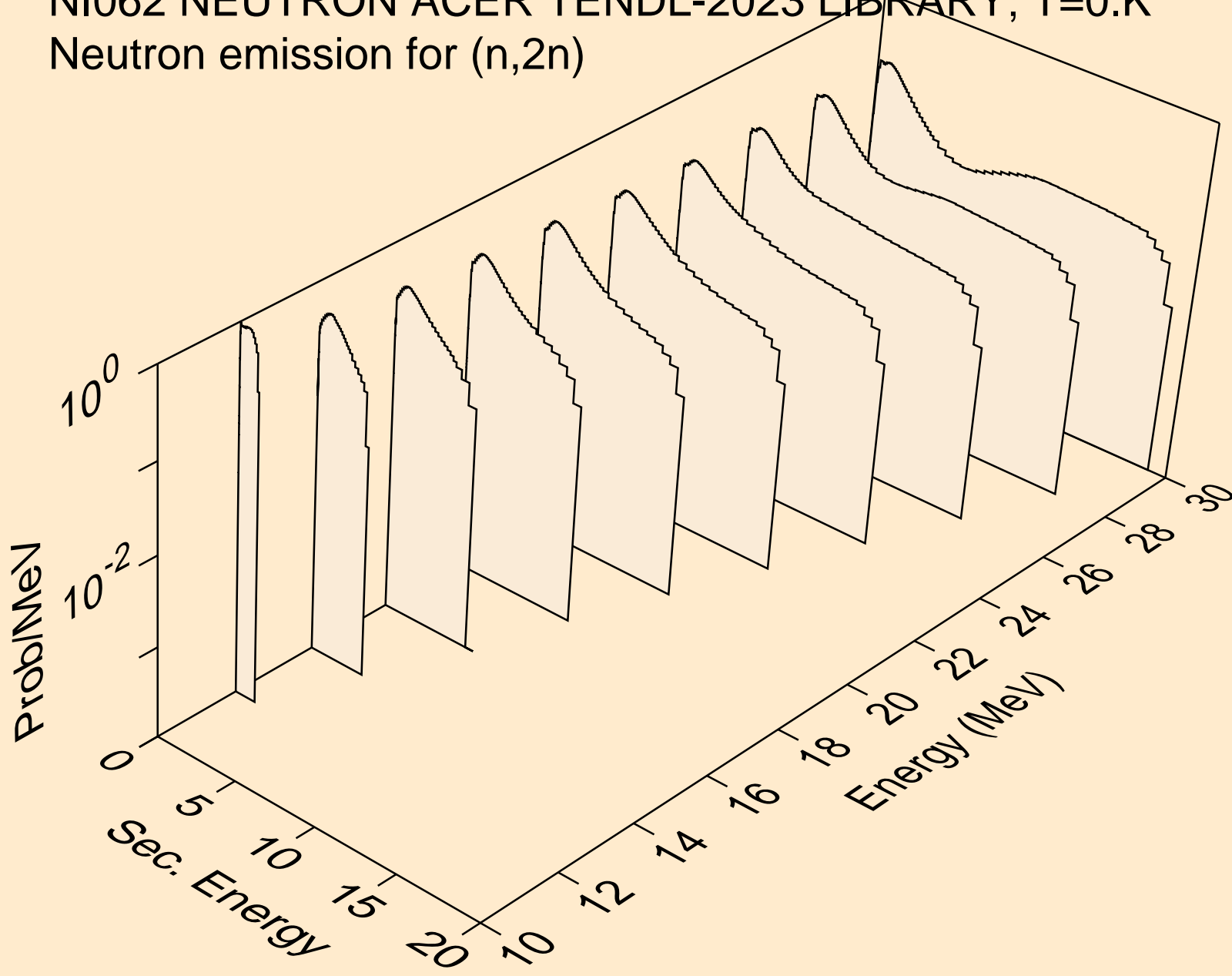

NI062 NEUTRON ACER TENDL-2023 LIBRARY; T=0.K
Neutron emission for (n,3n)

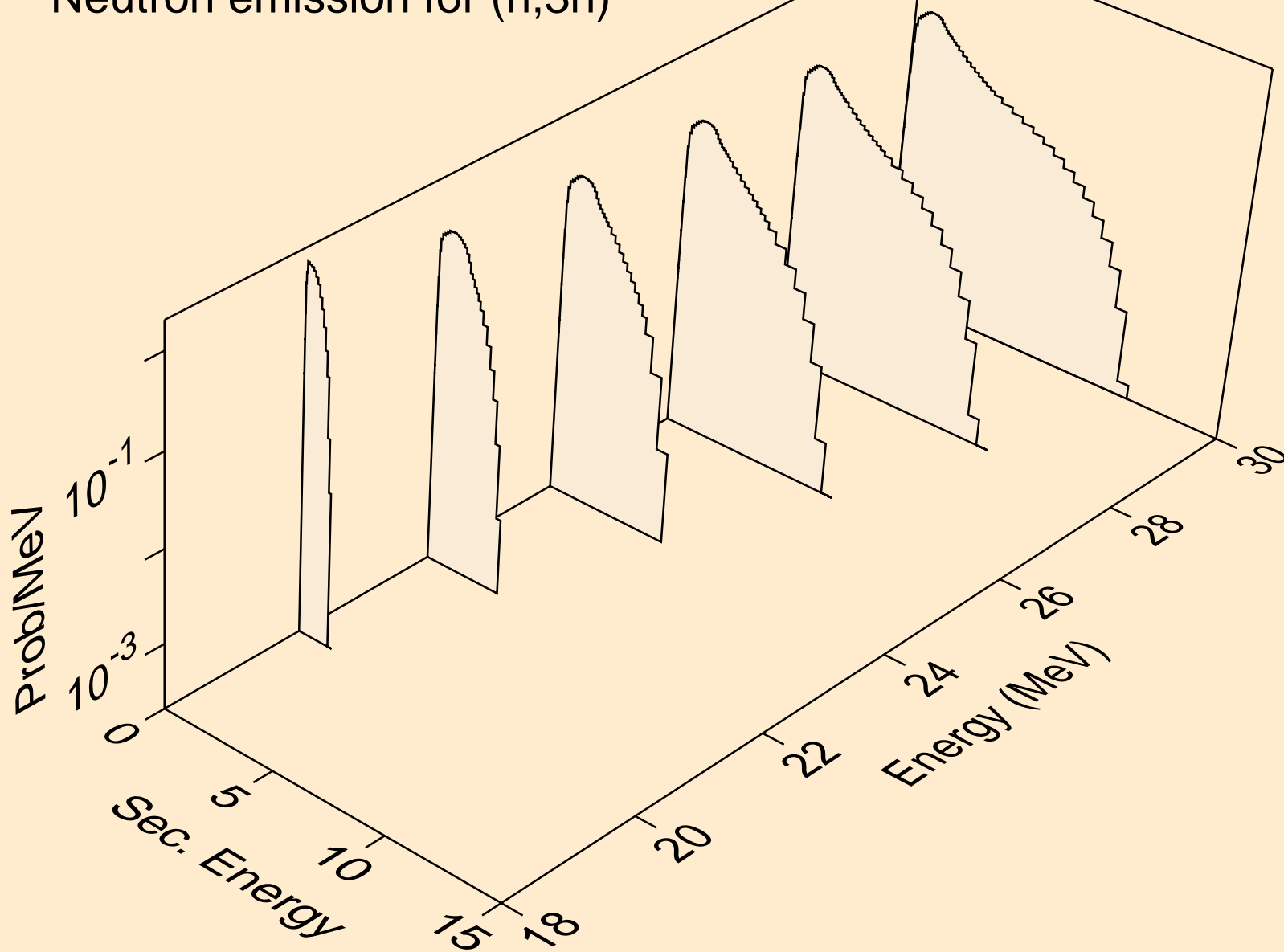

NI062 NEUTRON ACER TENDL-2023 LIBRARY; T=0.K
Neutron emission for (n,n*)a

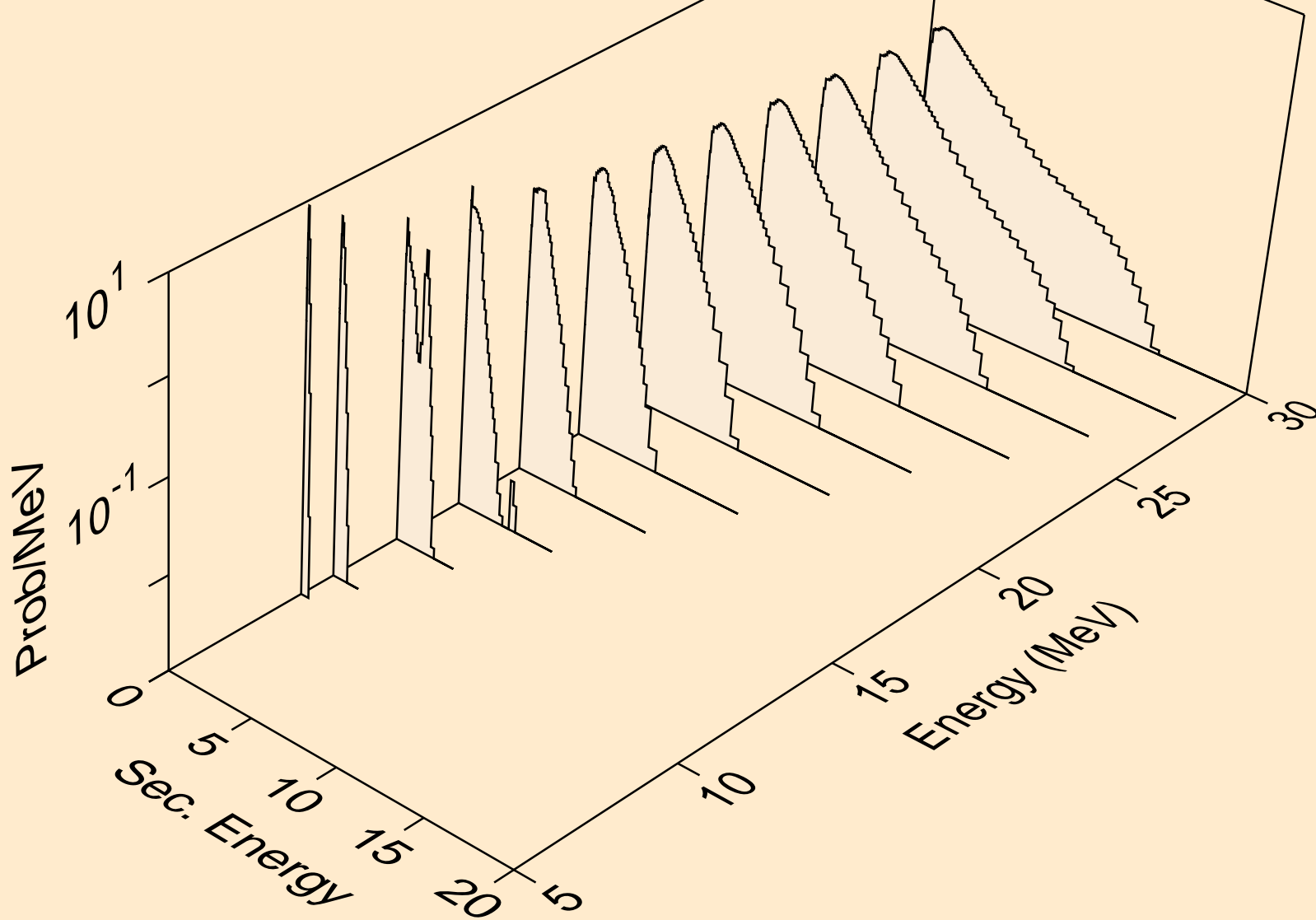

NI062 NEUTRON ACER TENDL-2023 LIBRARY; T=0.K
Neutron emission for (n,2n)a

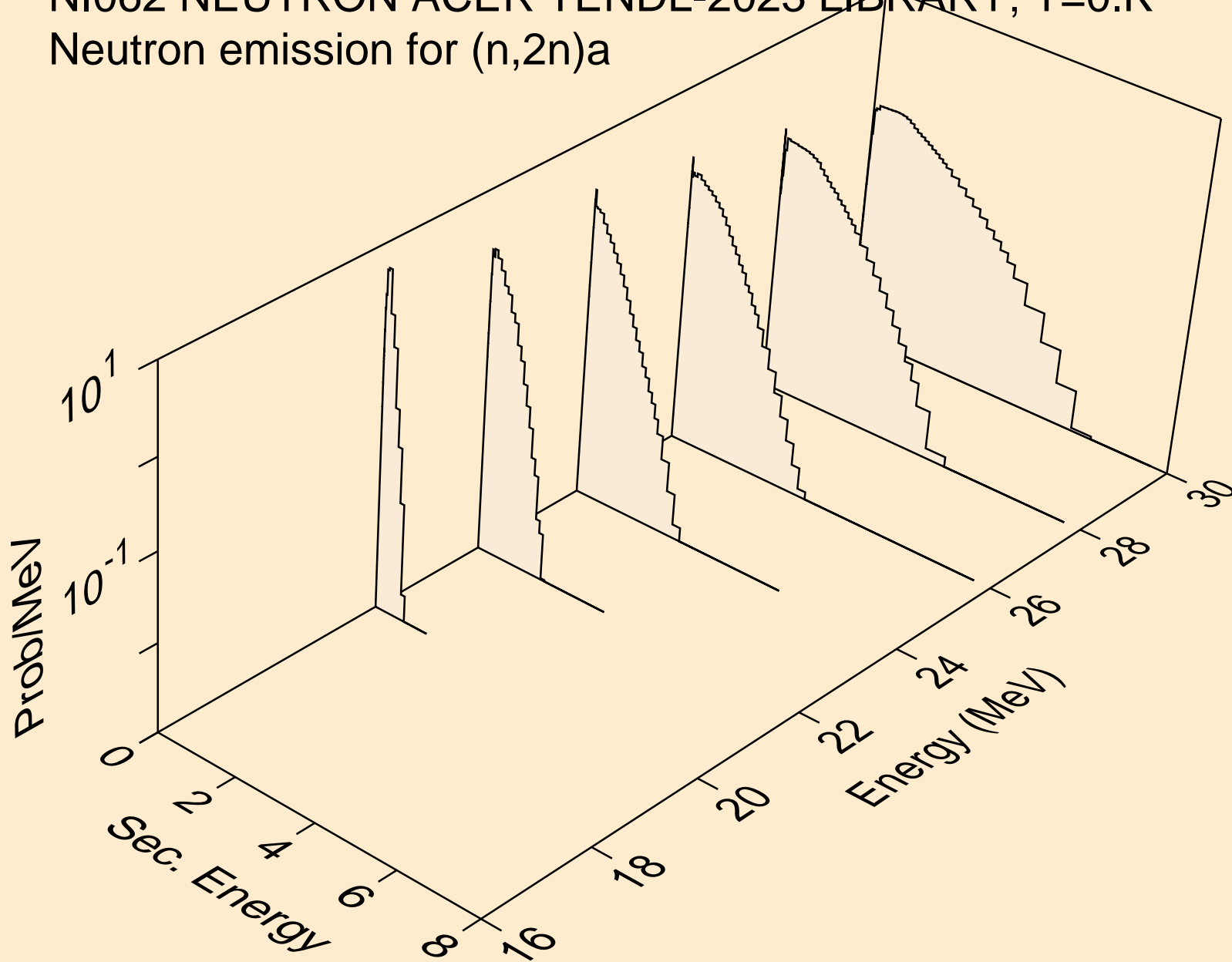

NI062 NEUTRON ACER TENDL-2023 LIBRARY; T=0.K
Neutron emission for (n,3n)a

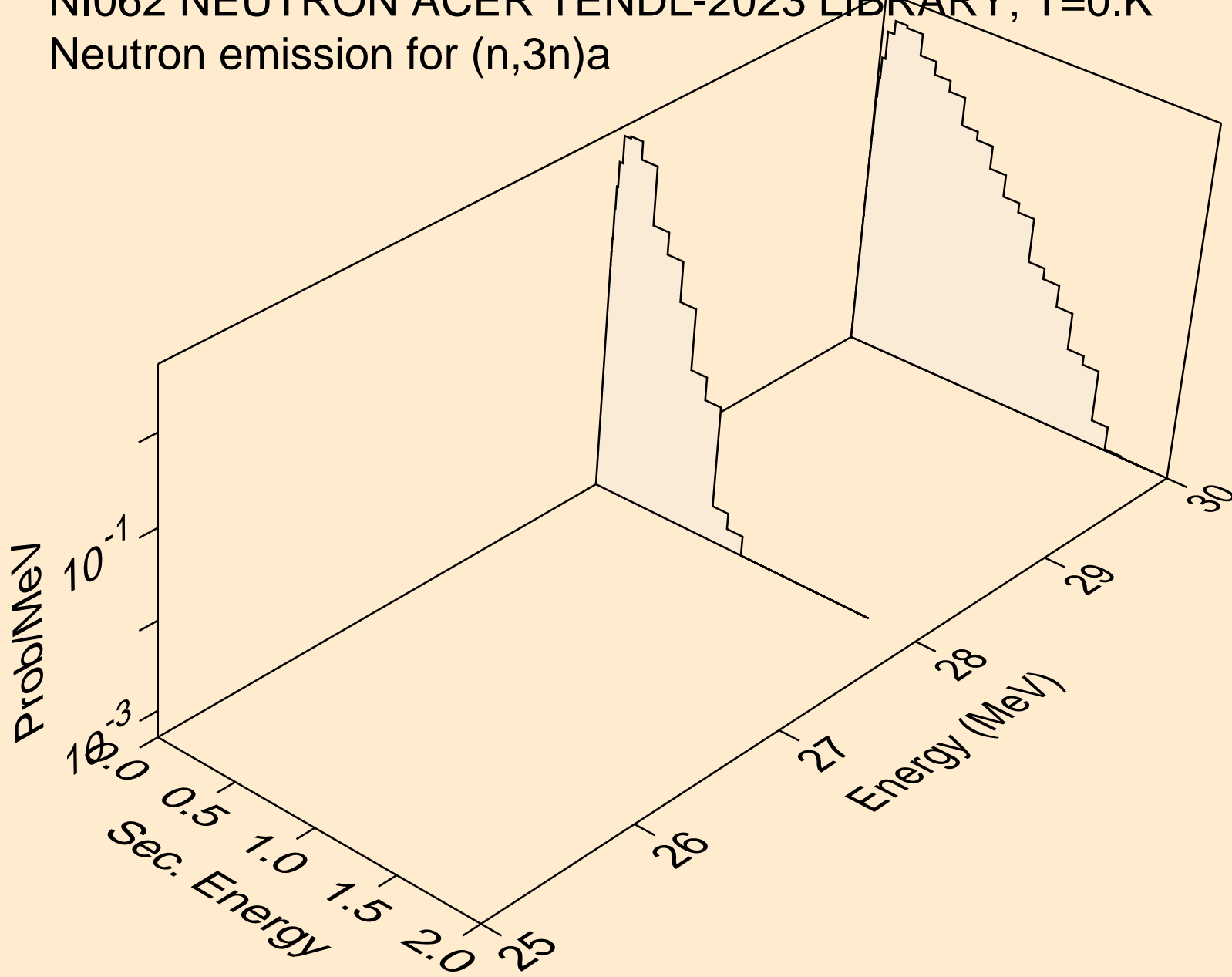

NI062 NEUTRON ACER TENDL-2023 LIBRARY; T=0.K
Neutron emission for (n,n*)p

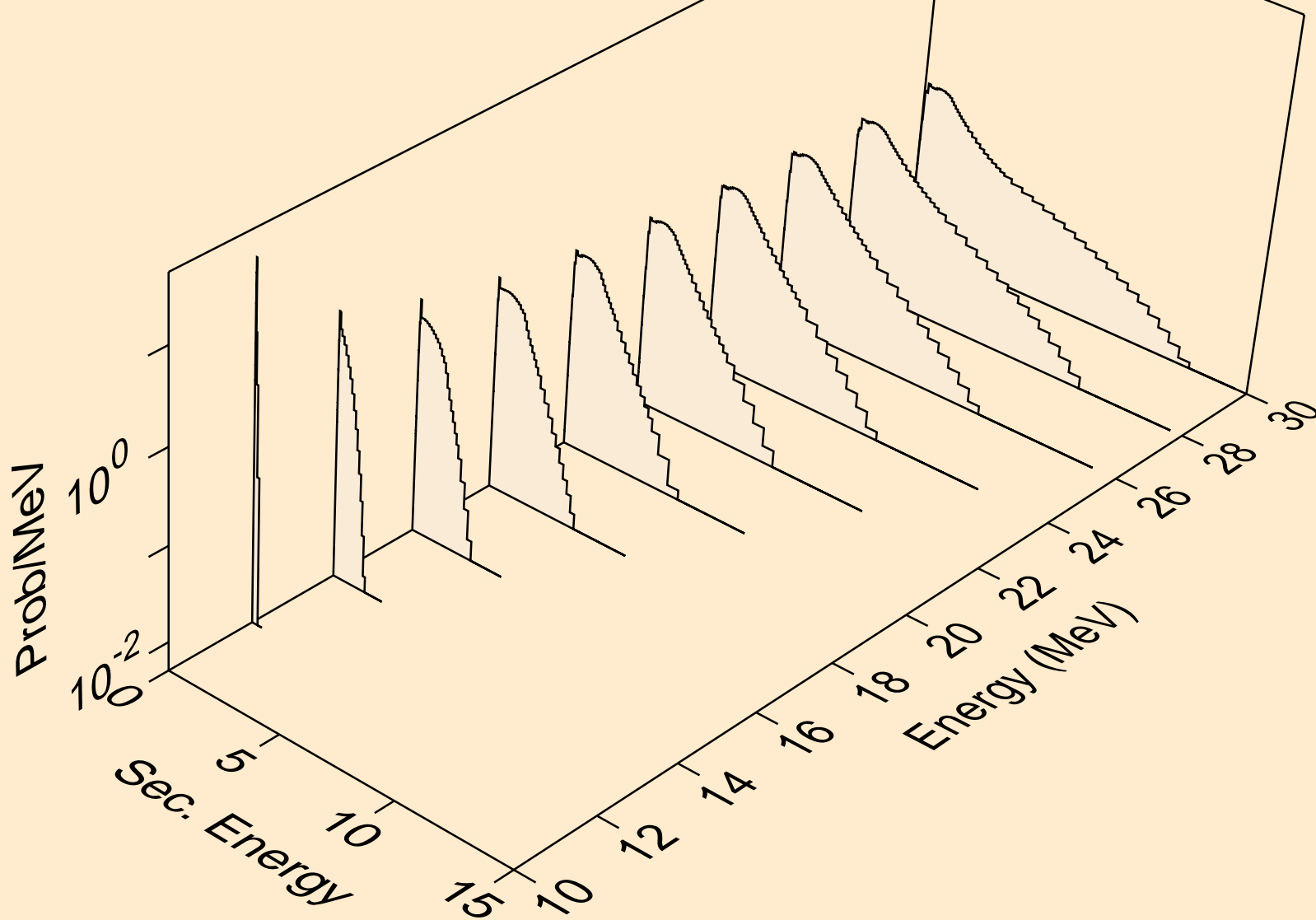

NI062 NEUTRON ACER TENDL-2023 LIBRARY; T=0.K
Neutron emission for (n,n*)2a

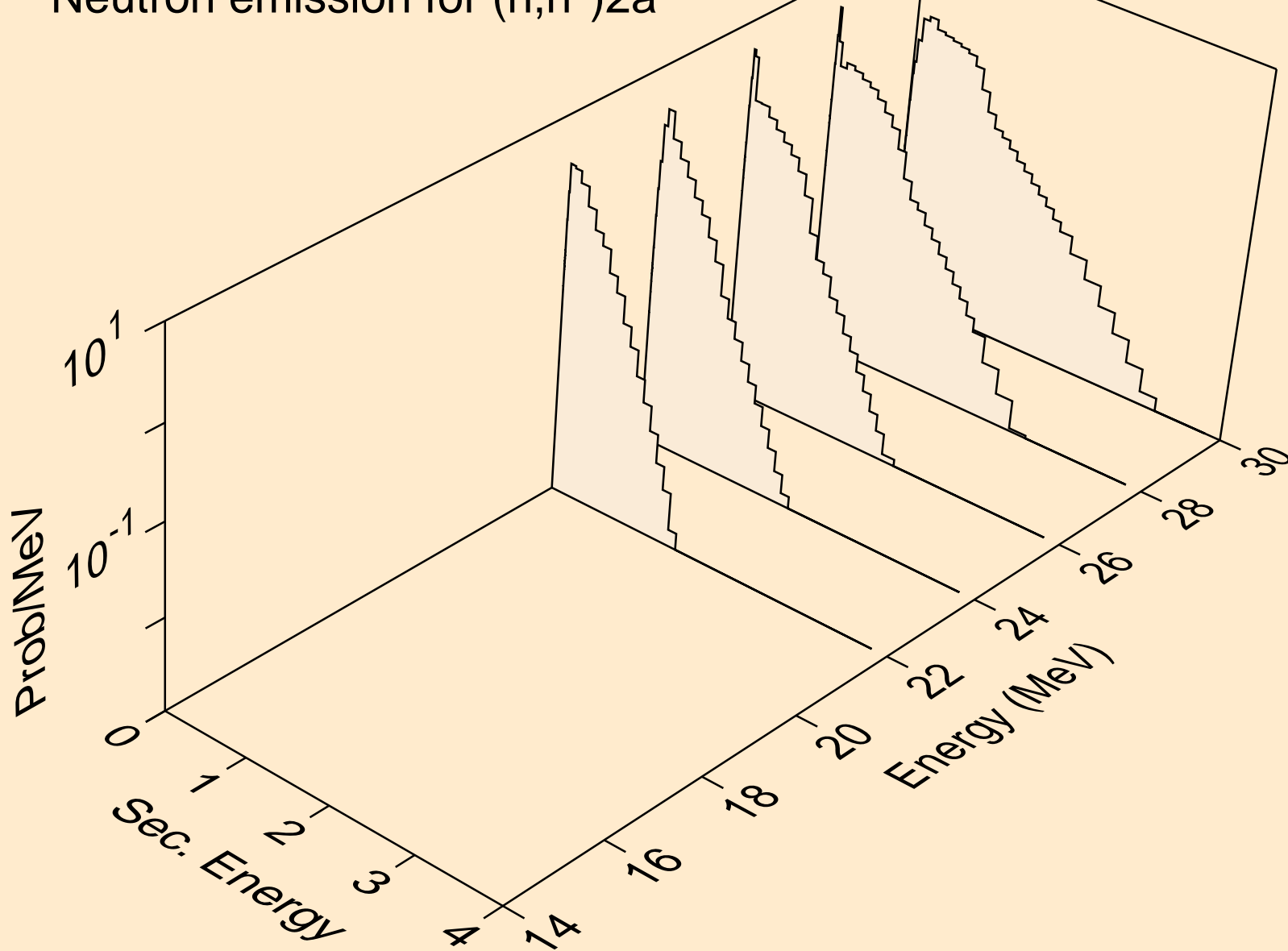

NI062 NEUTRON ACER TENDL-2023 LIBRARY; T=0.K
Neutron emission for (n,n*)d

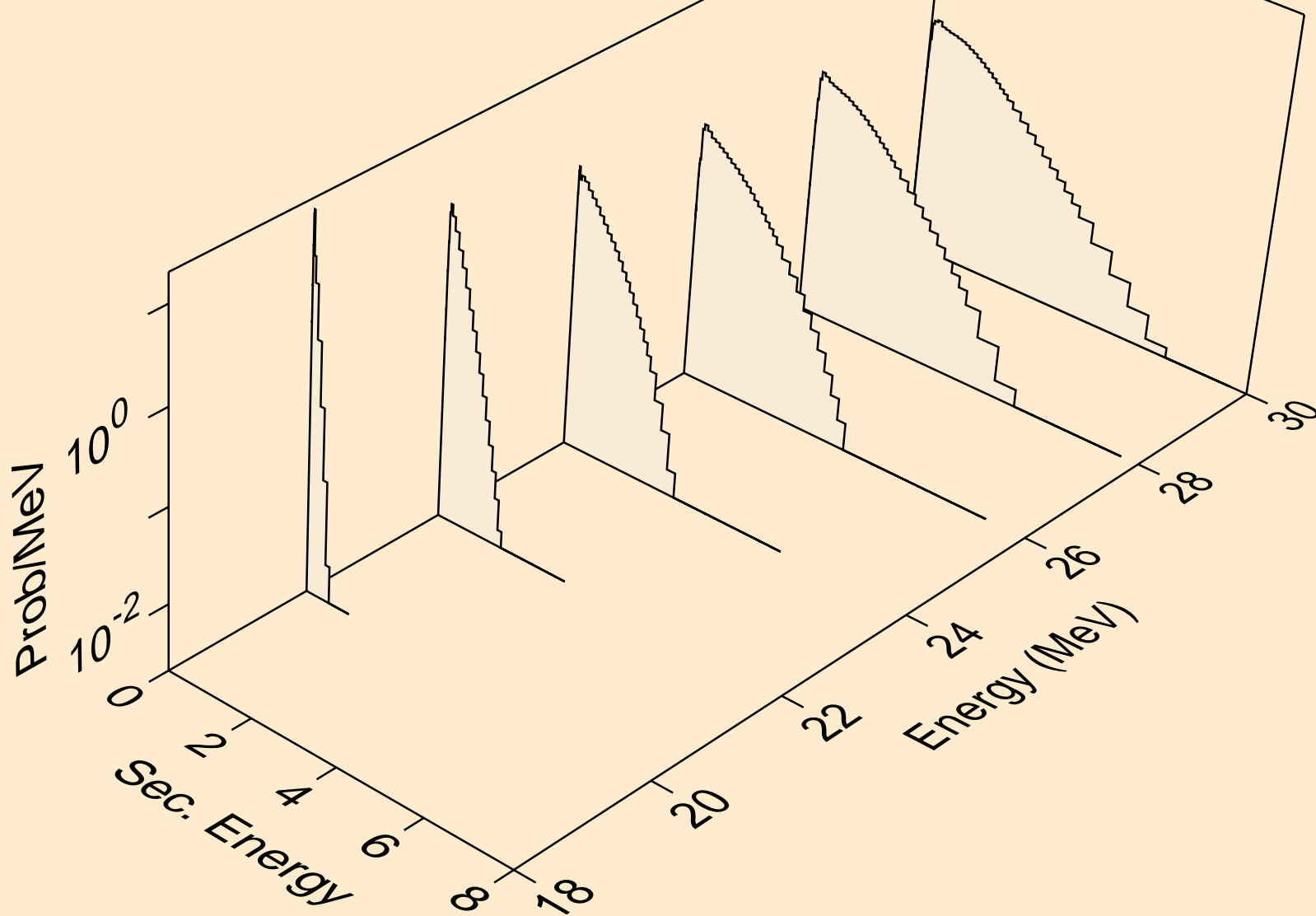

NI062 NEUTRON ACER TENDL-2023 LIBRARY; T=0.K
Neutron emission for (n,n*)t

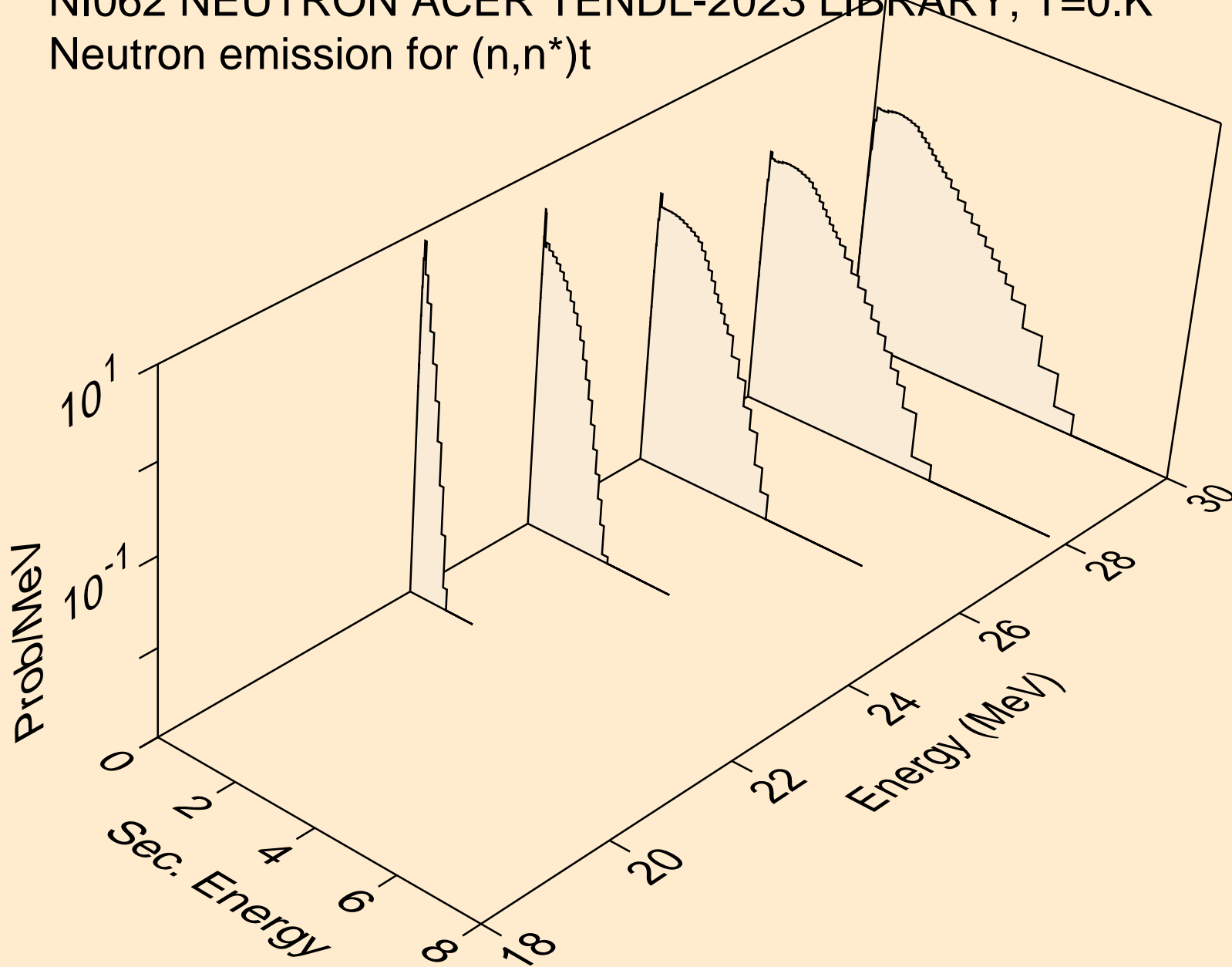

NI062 NEUTRON ACER TENDL-2023 LIBRARY; T=0.K
Neutron emission for (n,n*)he3

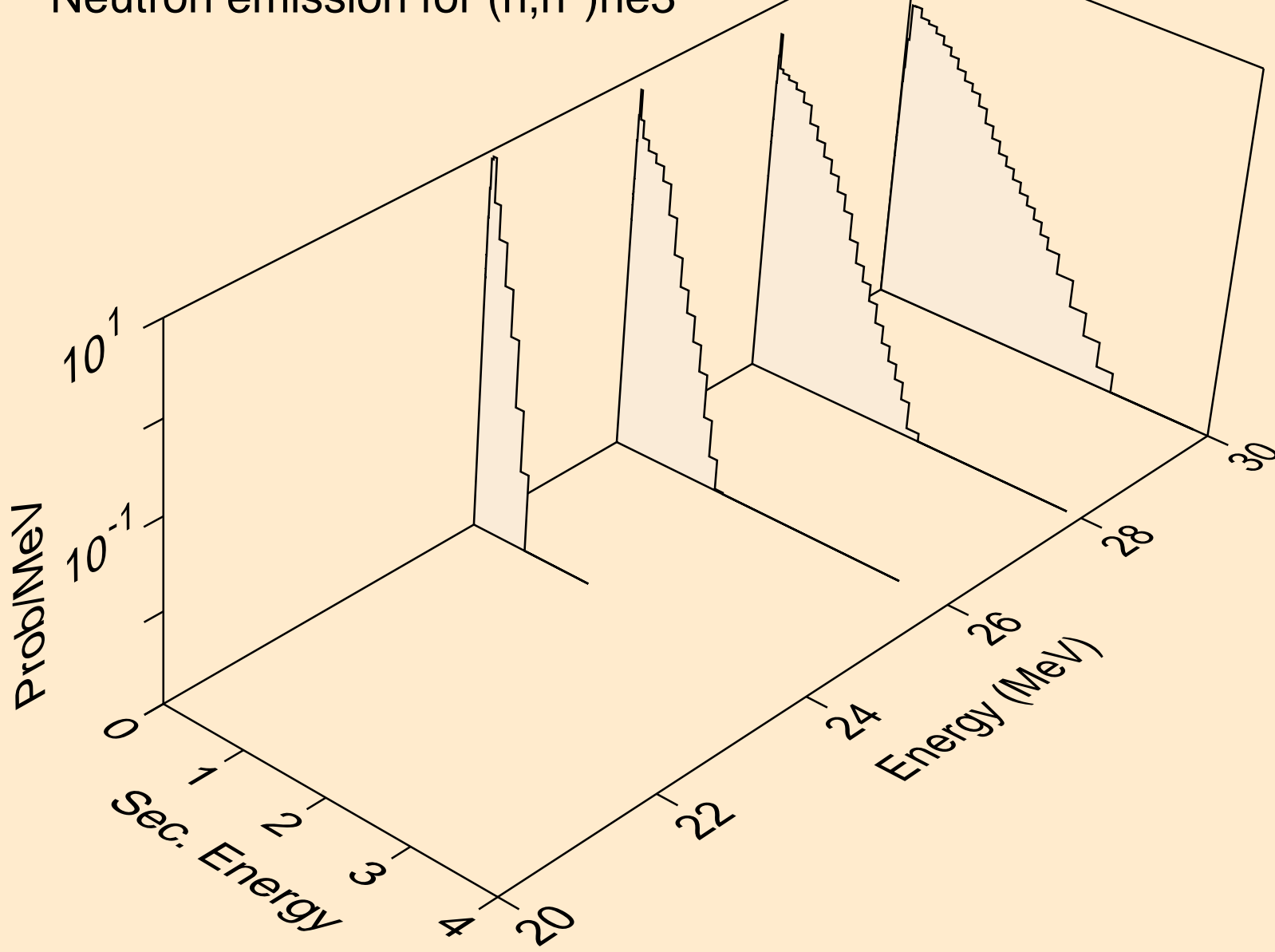

NI062 NEUTRON ACER TENDL-2023 LIBRARY; T=0.K
Neutron emission for (n,2np)

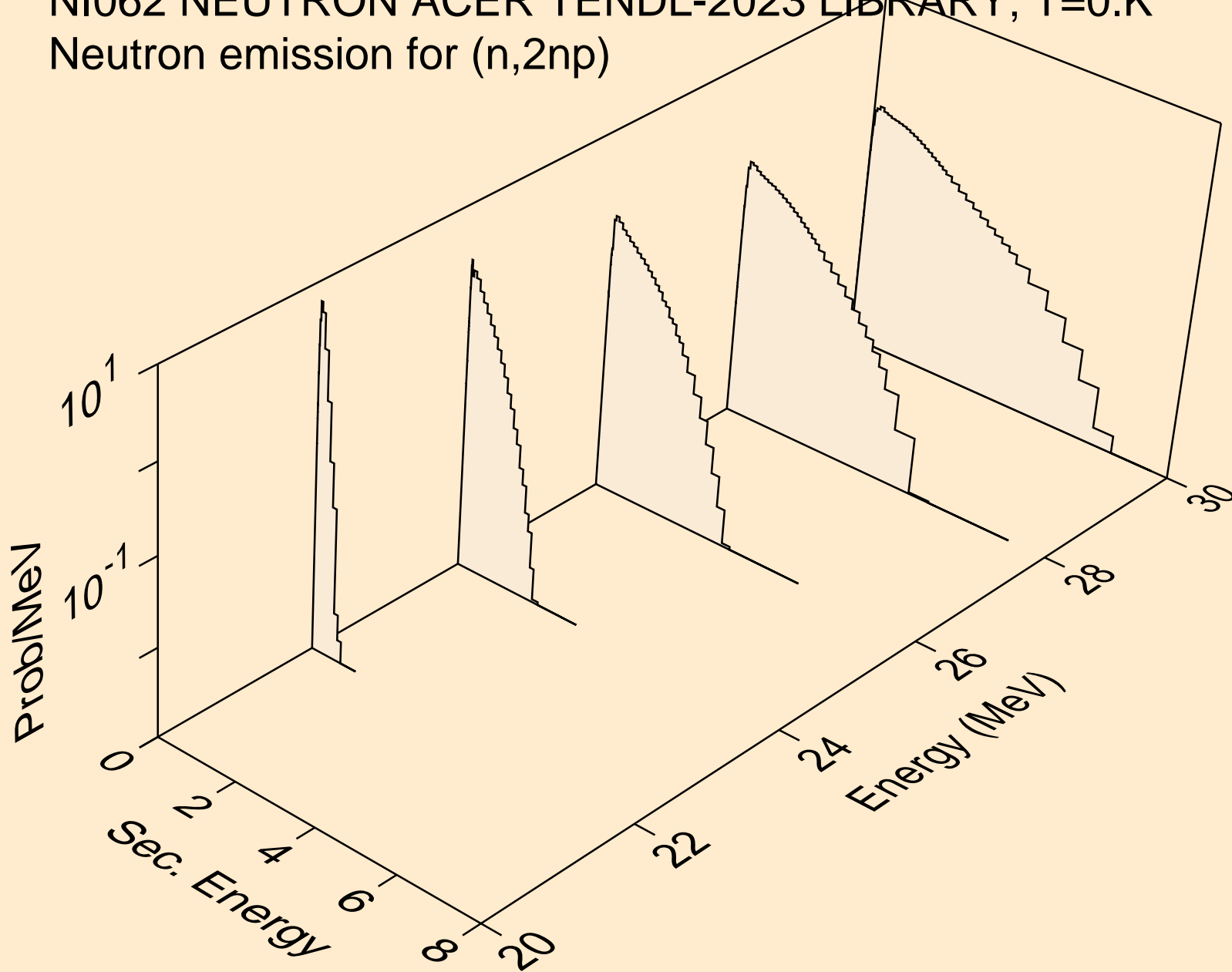

NI062 NEUTRON ACER TENDL-2023 LIBRARY; T=0.K
Neutron emission for (n,3np)

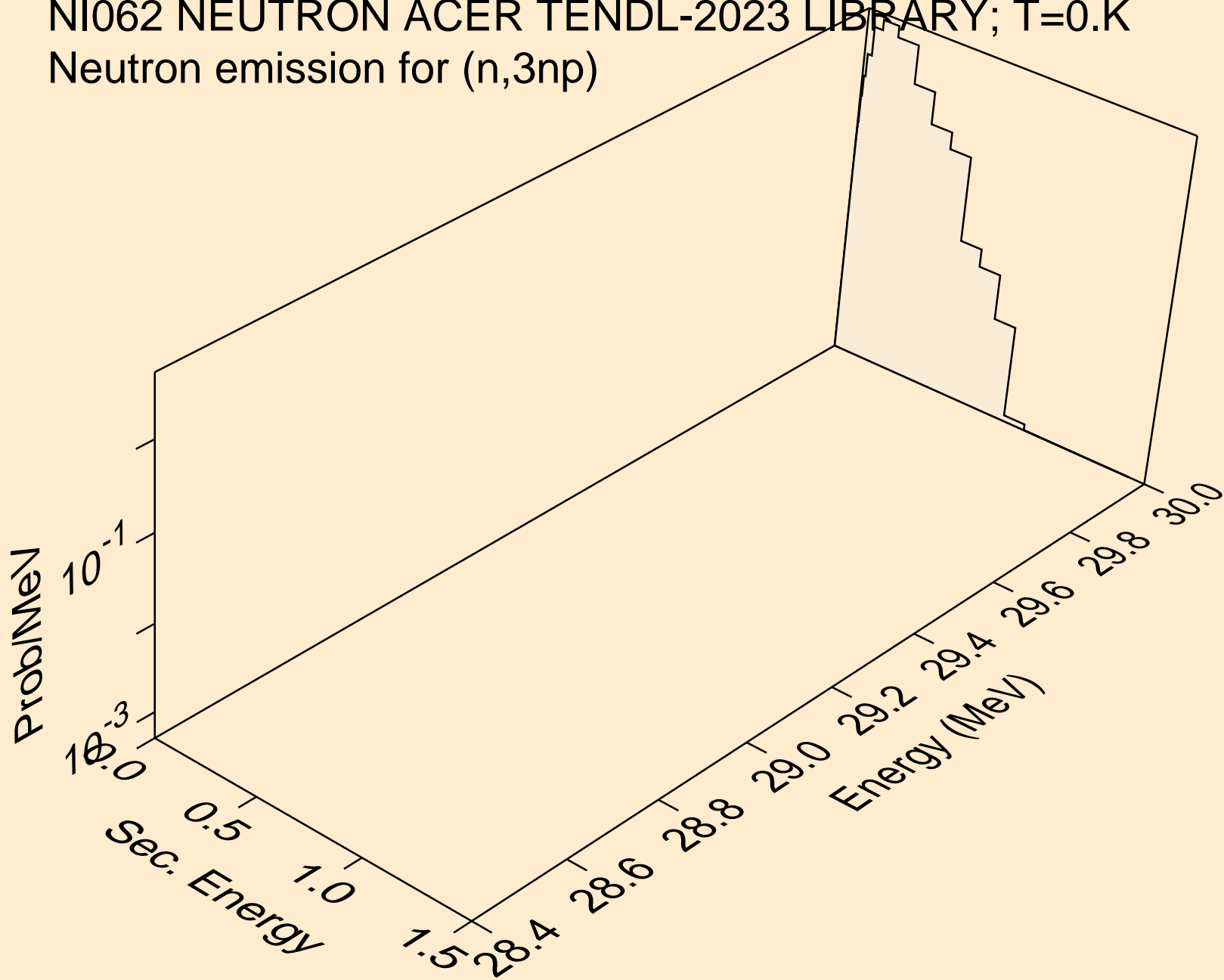

NI062 NEUTRON ACER TENDL-2023 LIBRARY; T=0.K
Neutron emission for (n,n2p)

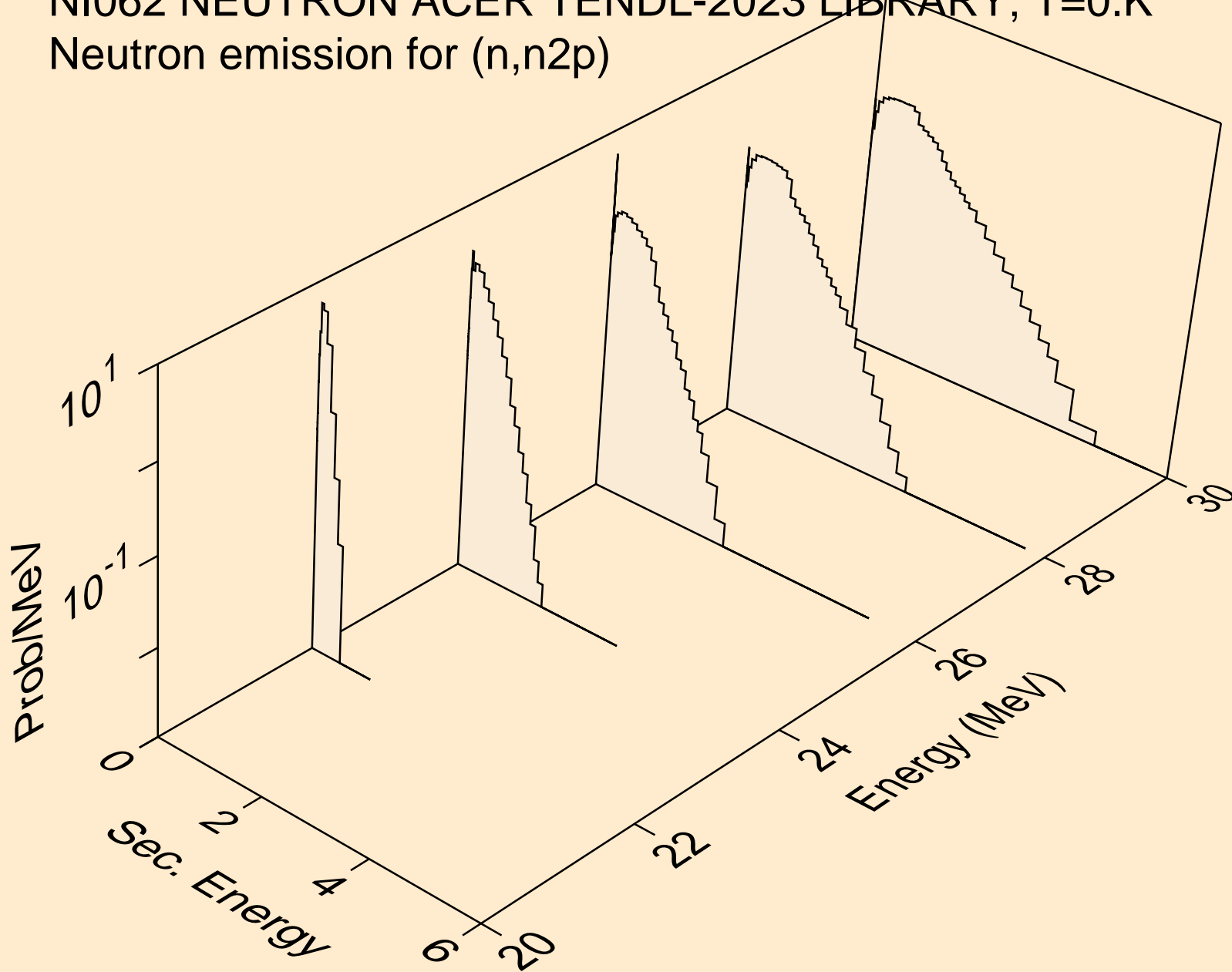

NI062 NEUTRON ACER TENDL-2023 LIBRARY; T=0.K
Neutron emission for (n,npa)

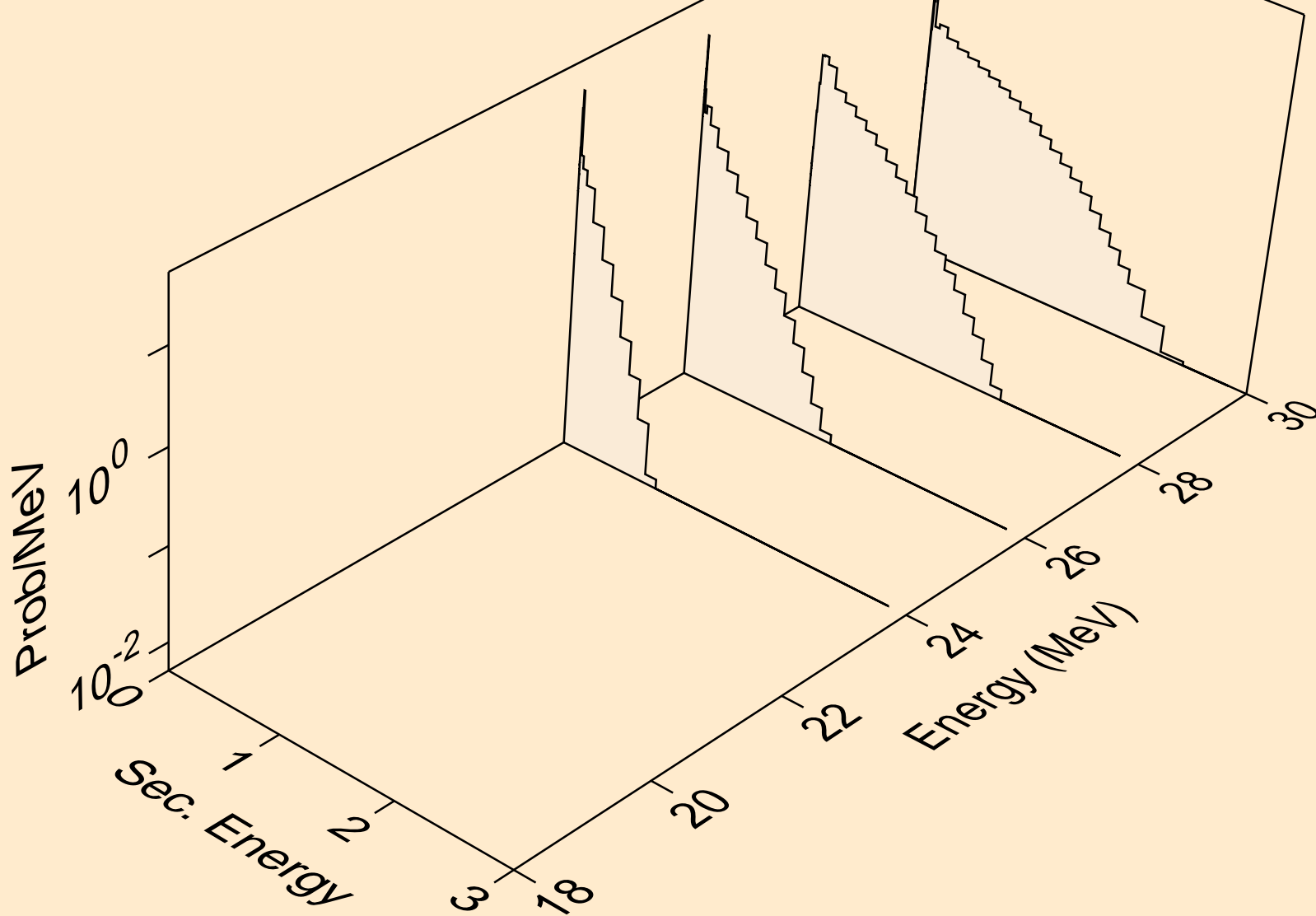

NI062 NEUTRON ACER TENDL-2023 LIBRARY; T=0.K
Neutron emission for (n,n*c)

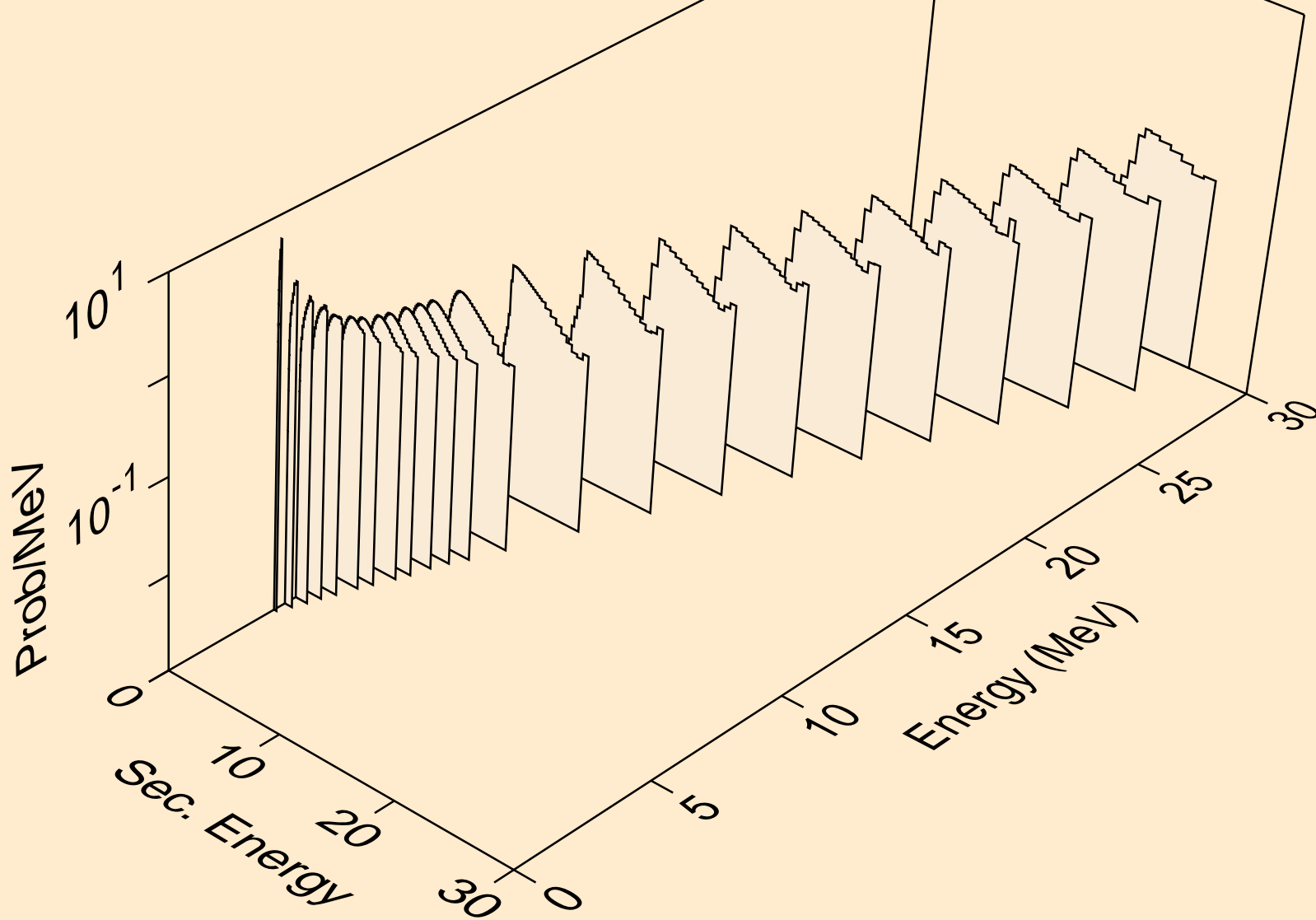

NI062 NEUTRON ACER TENDL-2023 LIBRARY; T=0.K
Photon emission for (n,x)

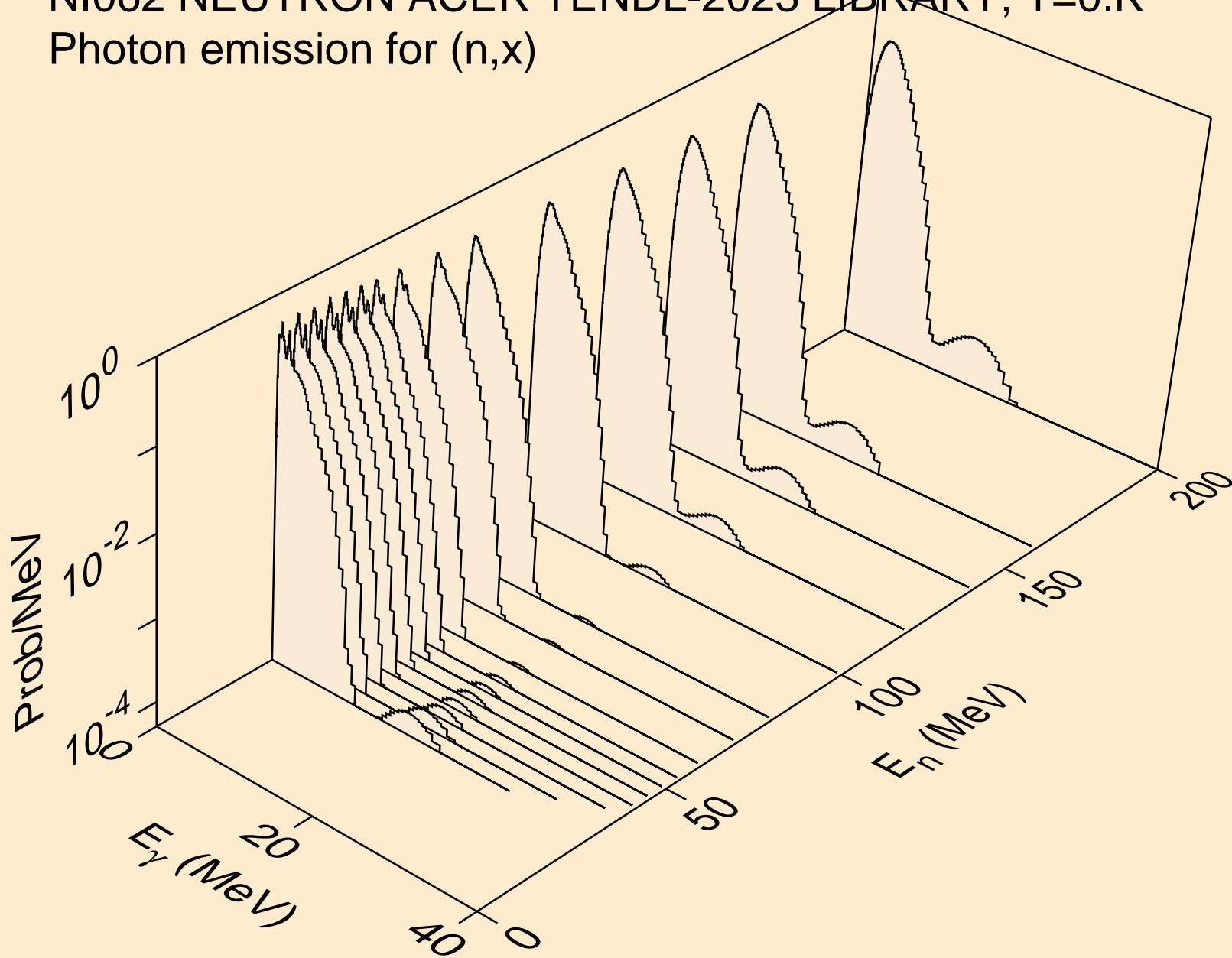

NI062 NEUTRON ACER TENDL-2023 LIBRARY; T=0.K
Photon emission for (n,2nd)

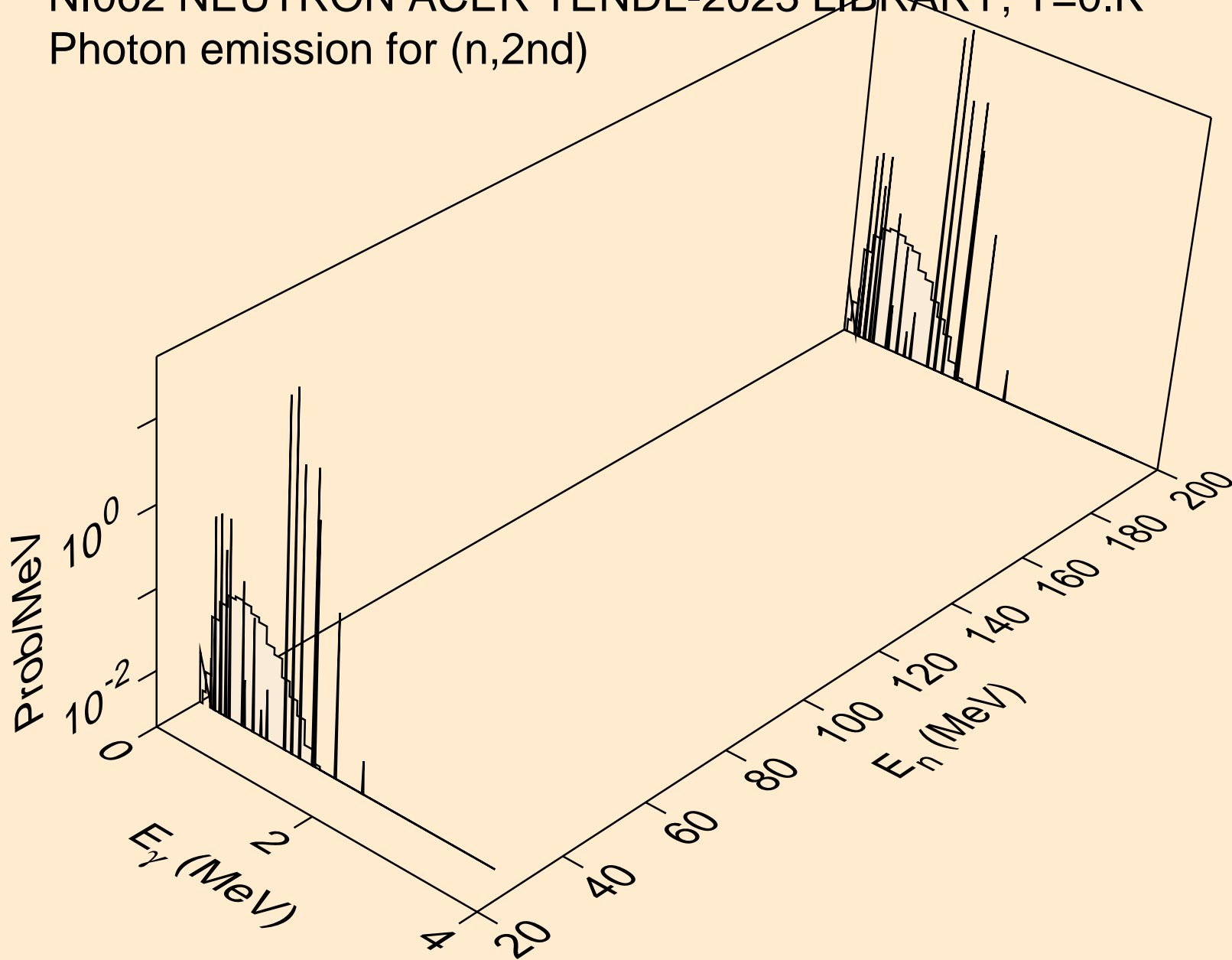

NI062 NEUTRON ACER TENDL-2023 LIBRARY; T=0.K
Photon emission for (n,2n)

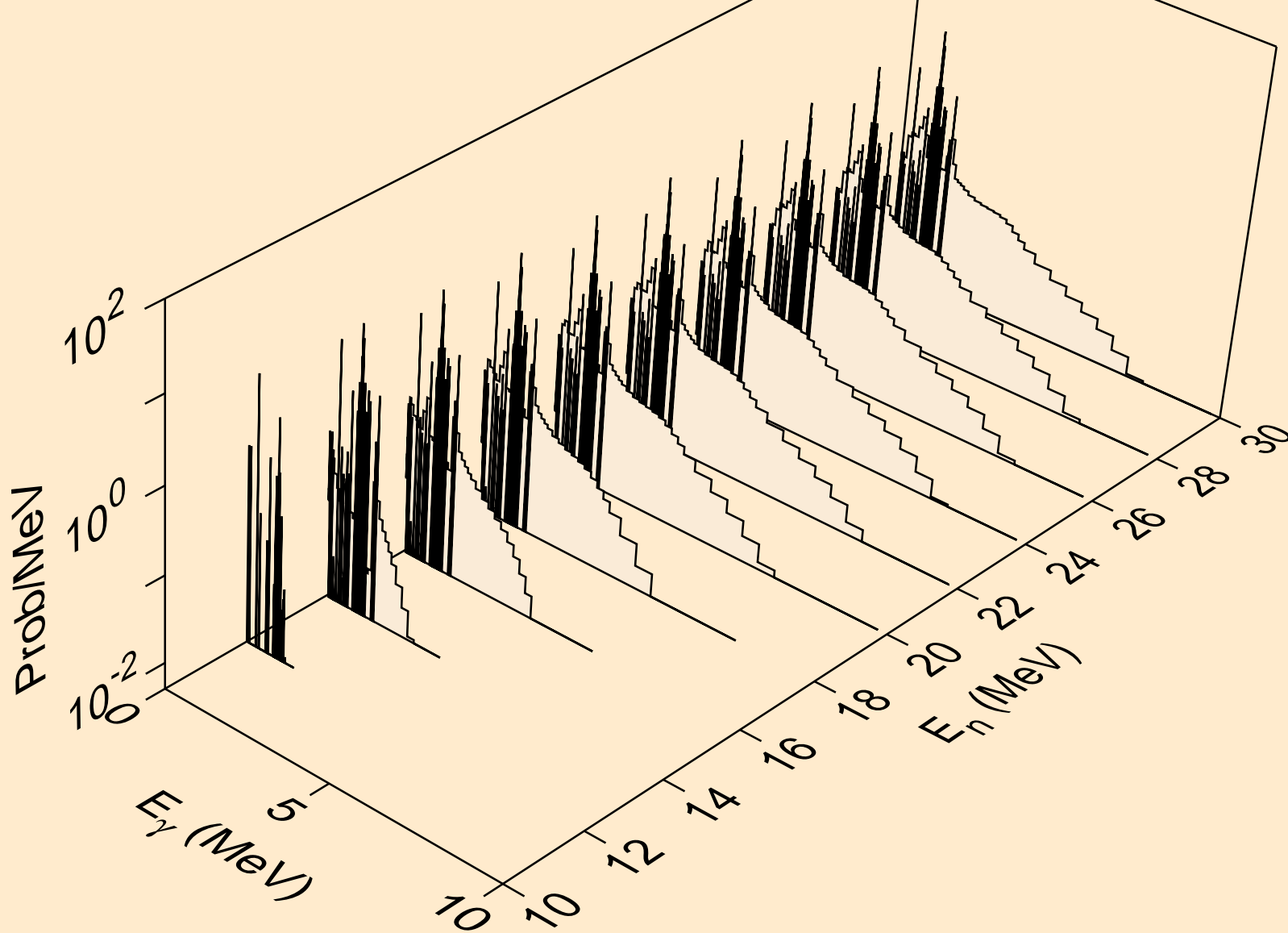

NI062 NEUTRON ACER TENDL-2023 LIBRARY; T=0.K
Photon emission for (n,3n)

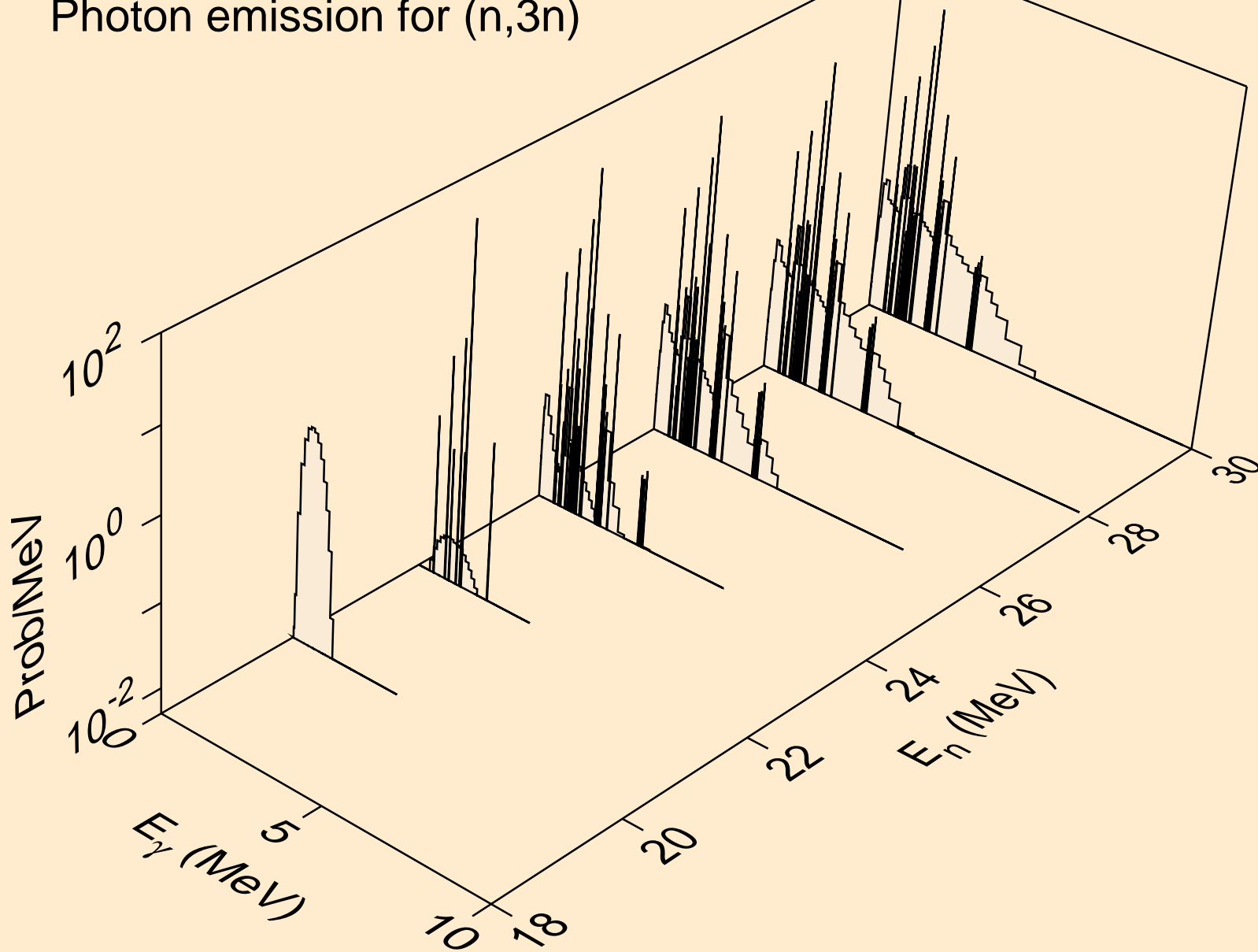

NI062 NEUTRON ACER TENDL-2023 LIBRARY; T=0.K
Photon emission for (n,n*)a

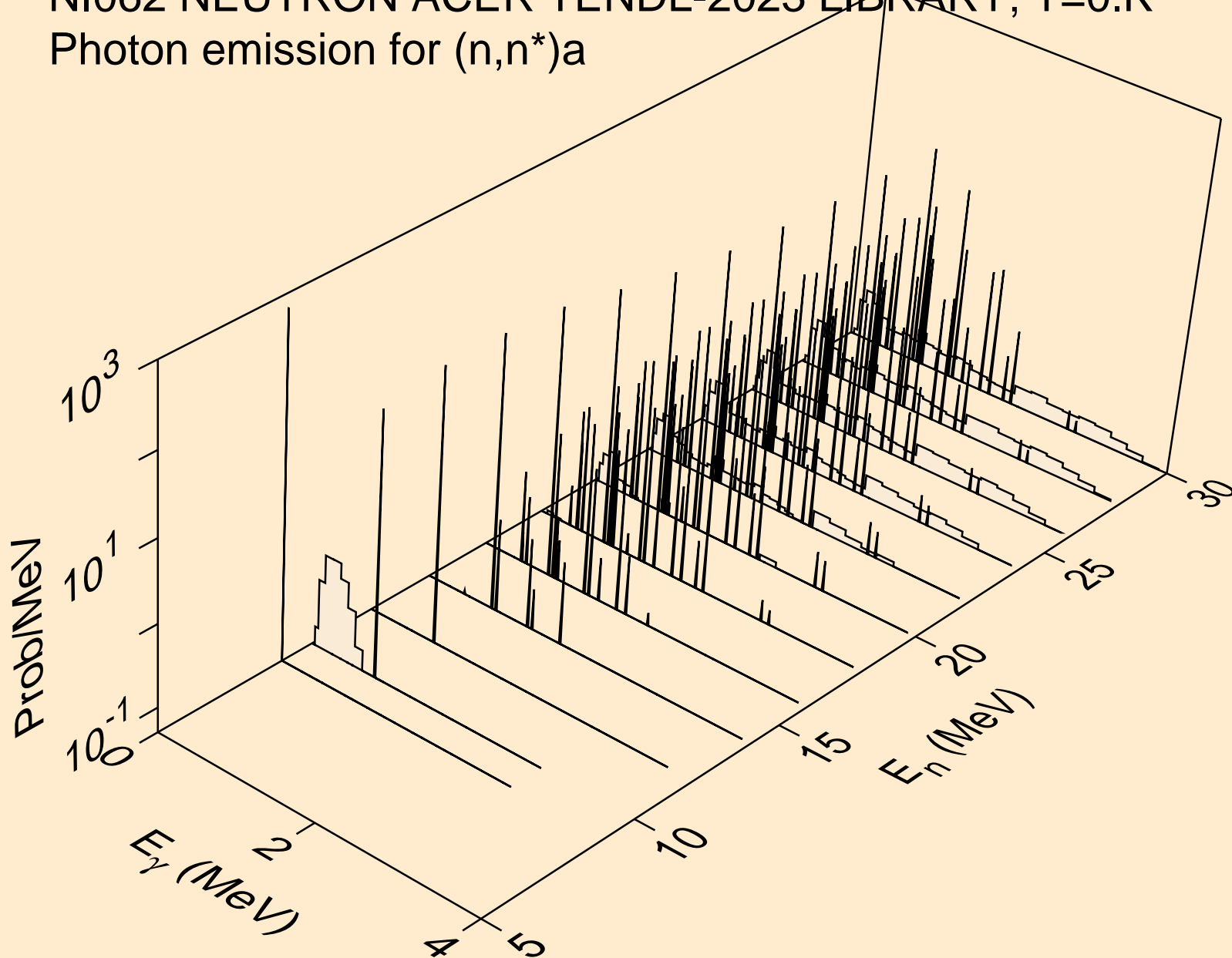

NI062 NEUTRON ACER TENDL-2023 LIBRARY; T=0.K
Photon emission for (n,2n)a

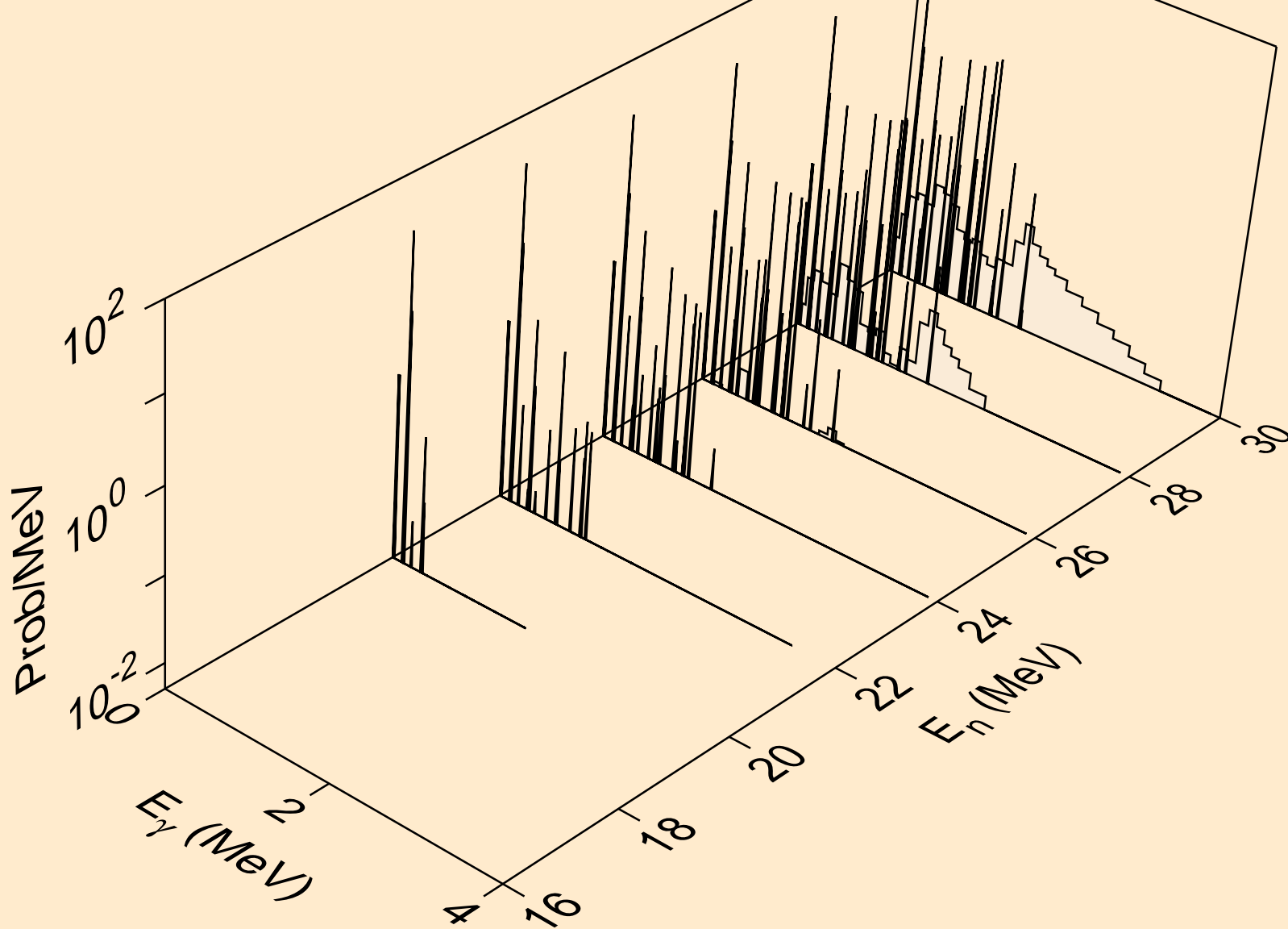

NI062 NEUTRON ACER TENDL-2023 LIBRARY; T=0.K
Photon emission for (n,3n)a

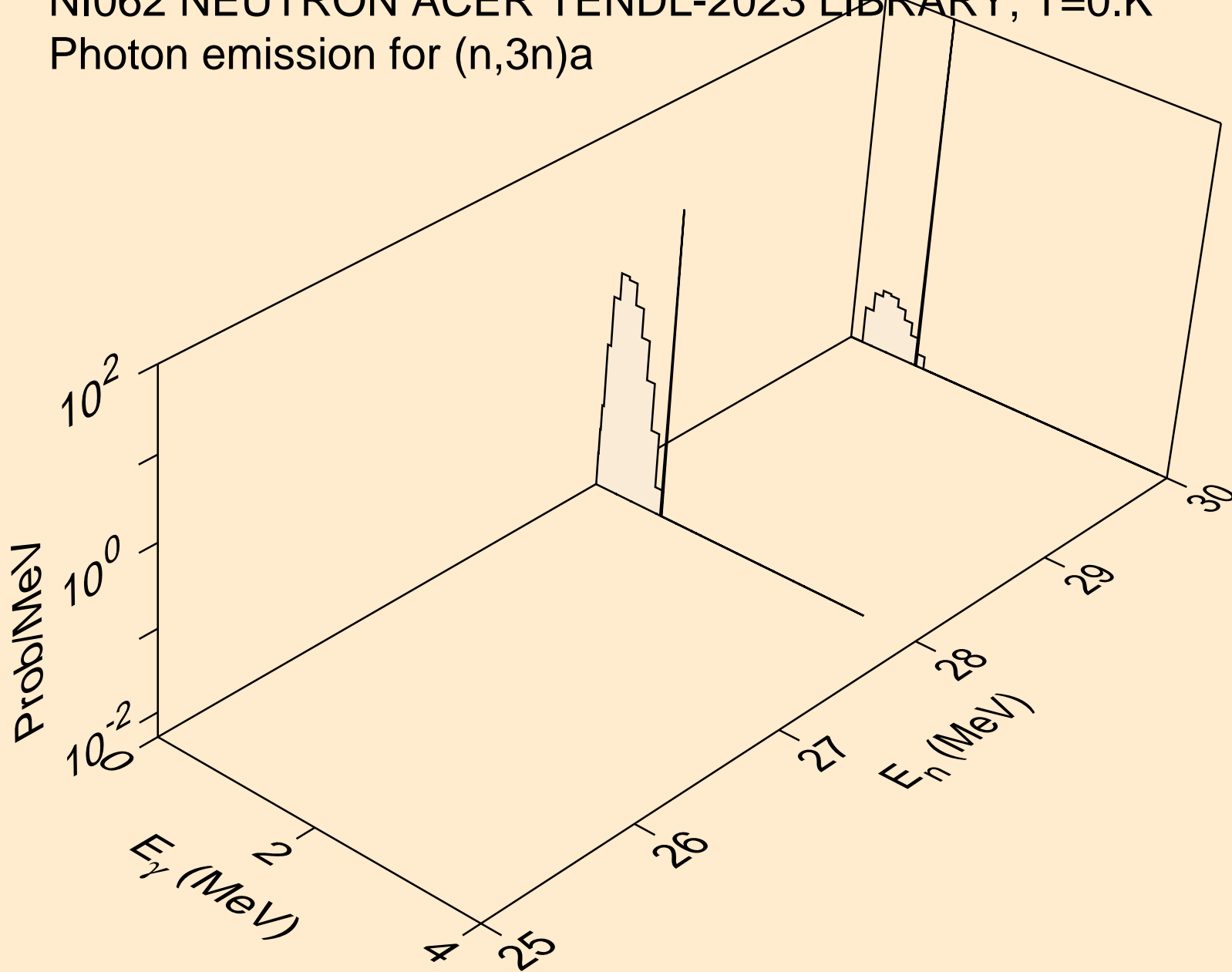

NI062 NEUTRON ACER TENDL-2023 LIBRARY; T=0.K
Photon emission for (n,n*)p

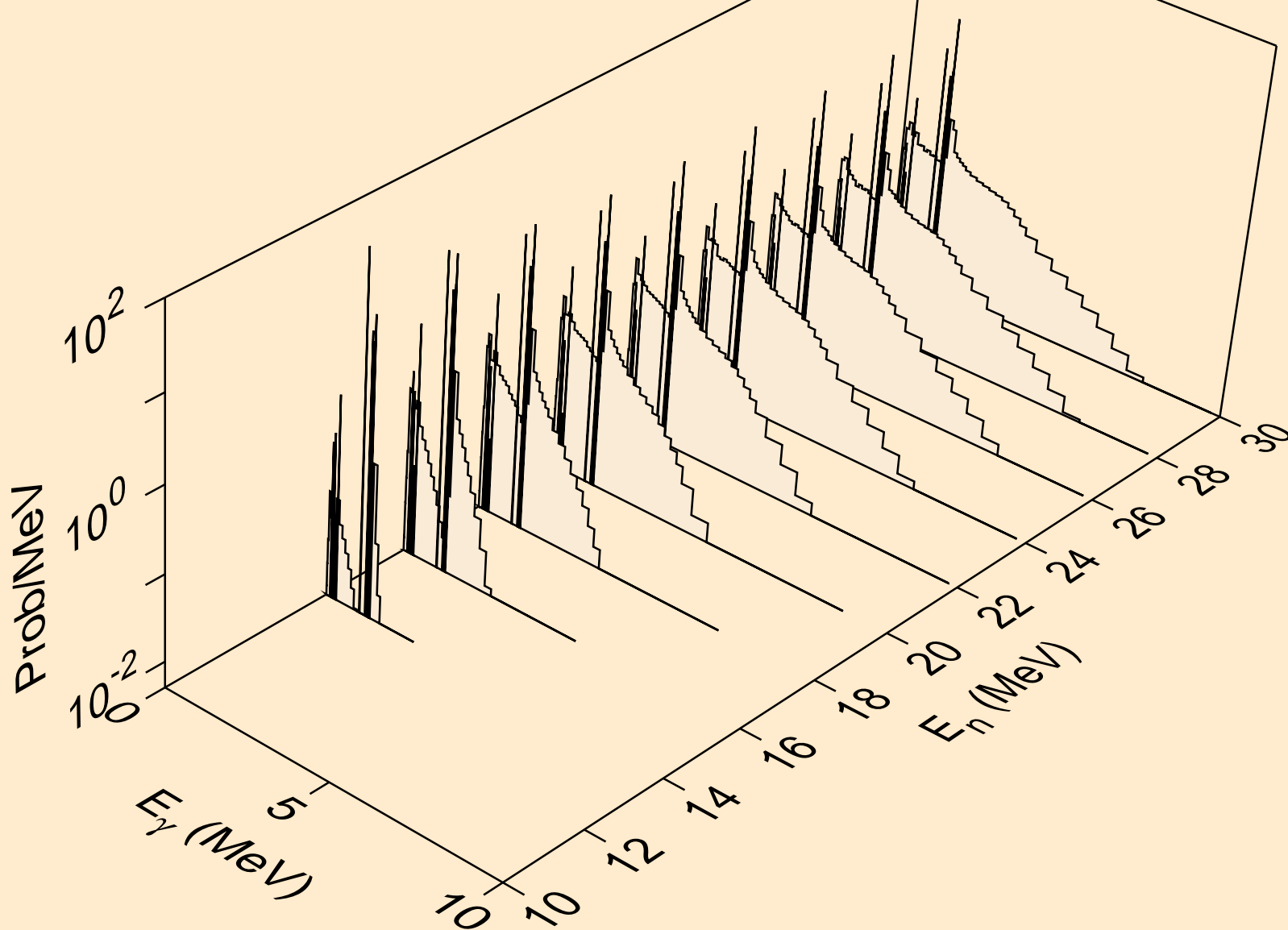

NI062 NEUTRON ACER TENDL-2023 LIBRARY; T=0.K
Photon emission for (n,n*)2a

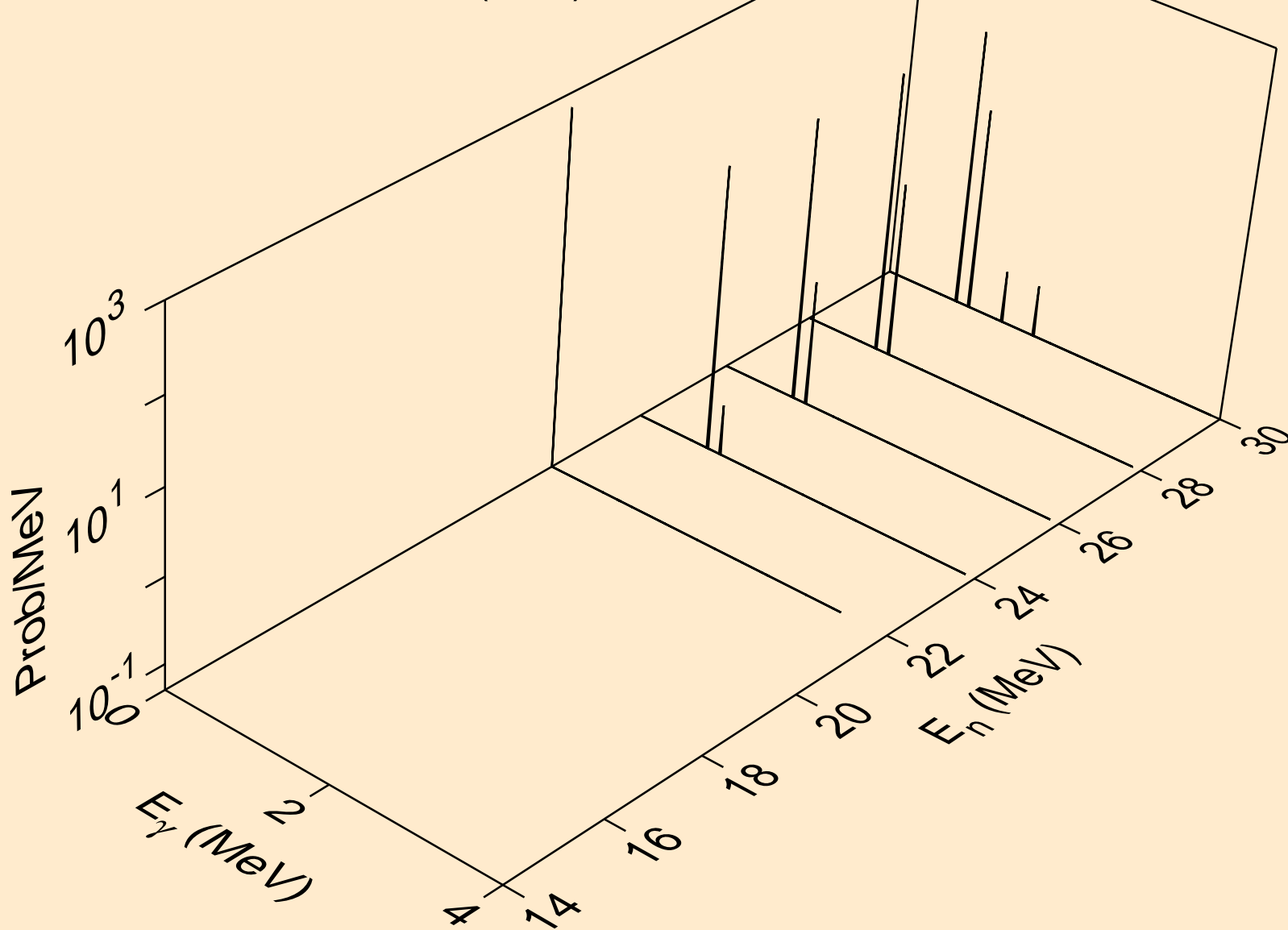

NI062 NEUTRON ACER TENDL-2023 LIBRARY; T=0.K
Photon emission for (n,n*)d

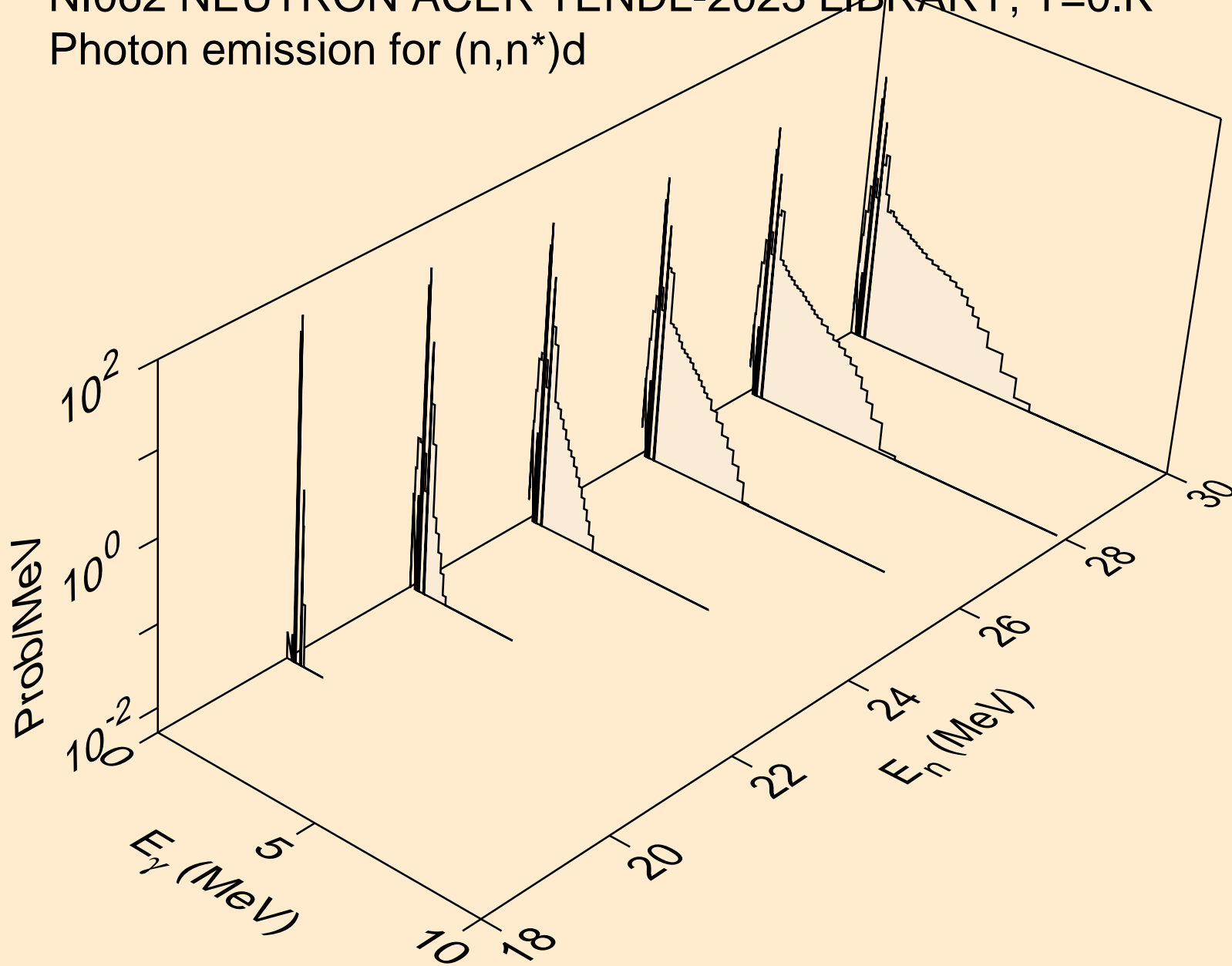

NI062 NEUTRON ACER TENDL-2023 LIBRARY; T=0.K
Photon emission for (n,n*)t

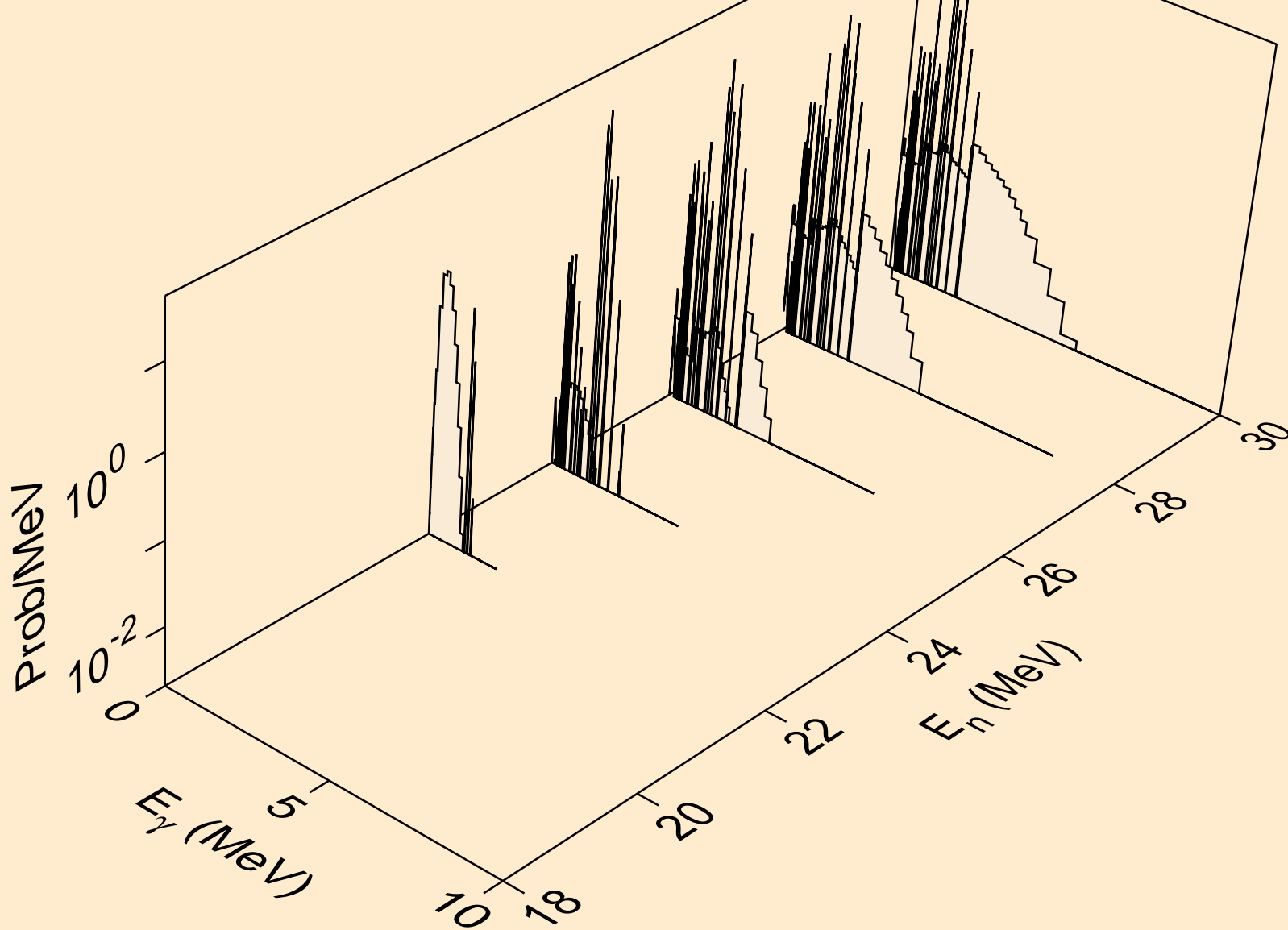

NI062 NEUTRON ACER TENDL-2023 LIBRARY; T=0.K
Photon emission for (n,n*)he3

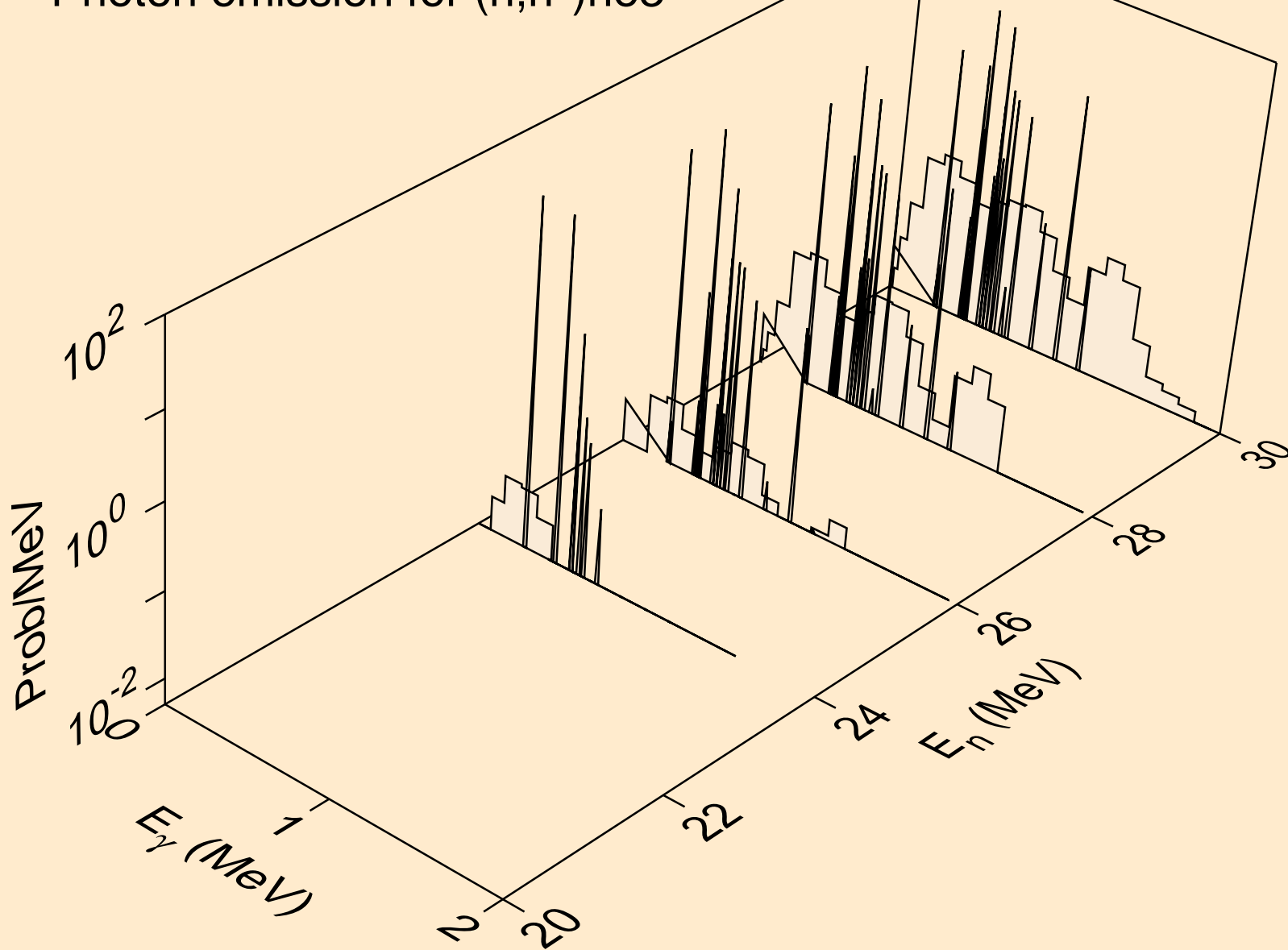

NI062 NEUTRON ACER TENDL-2023 LIBRARY; T=0.K
Photon emission for (n,2np)

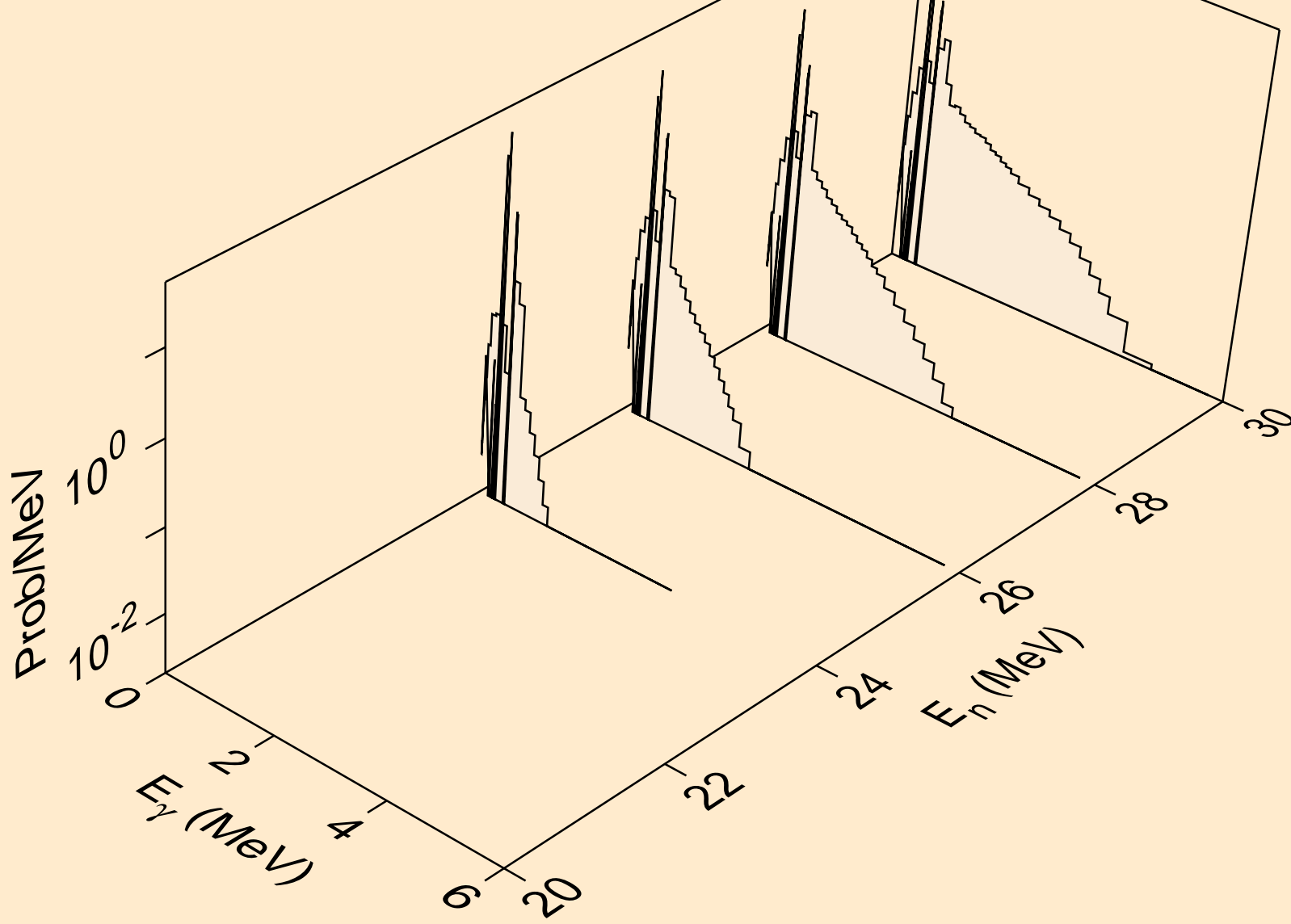

NI062 NEUTRON ACER TENDL-2023 LIBRARY; T=0.K
Photon emission for (n,3np)

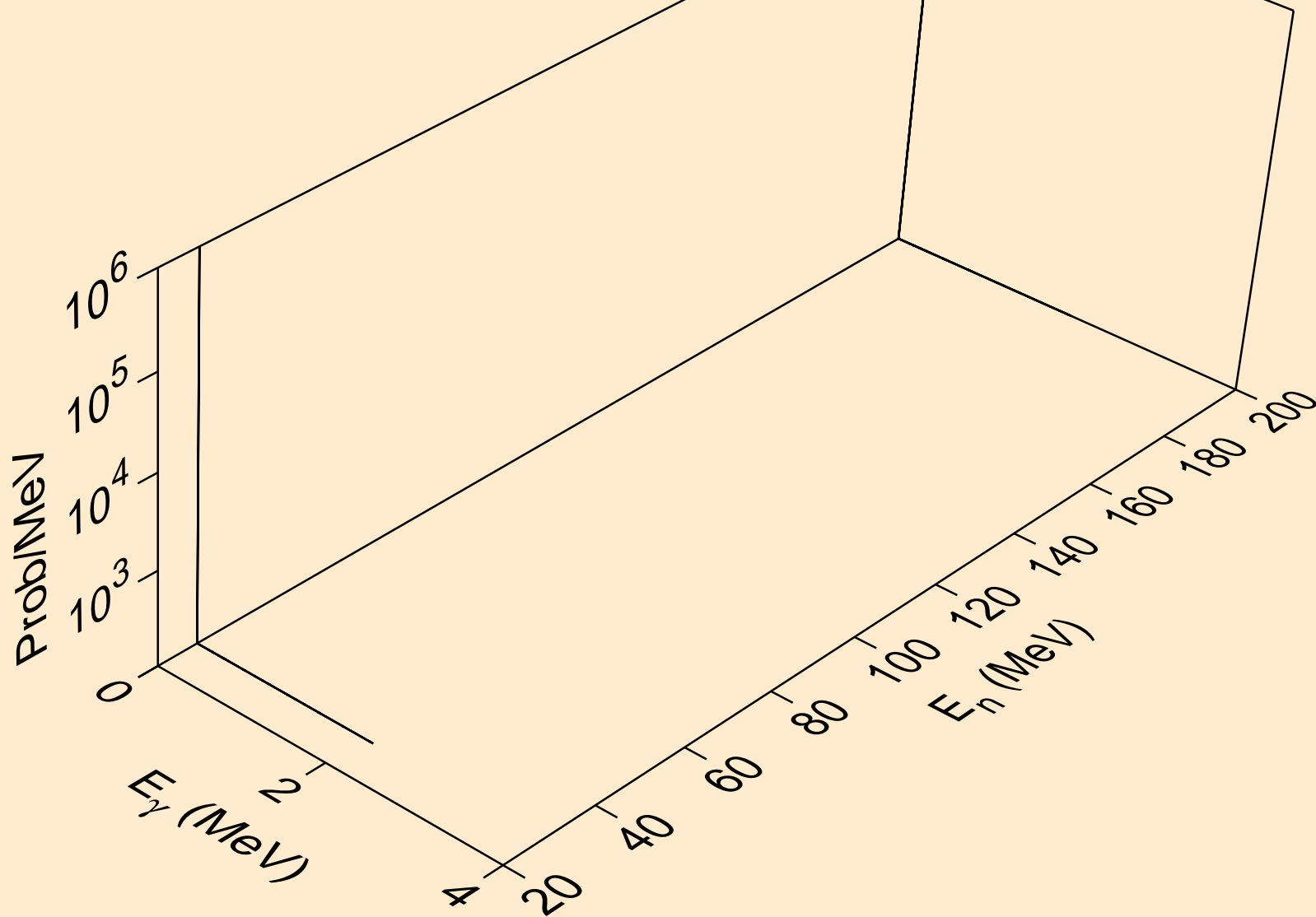

NI062 NEUTRON ACER TENDL-2023 LIBRARY; T=0.K
Photon emission for (n,n2p)

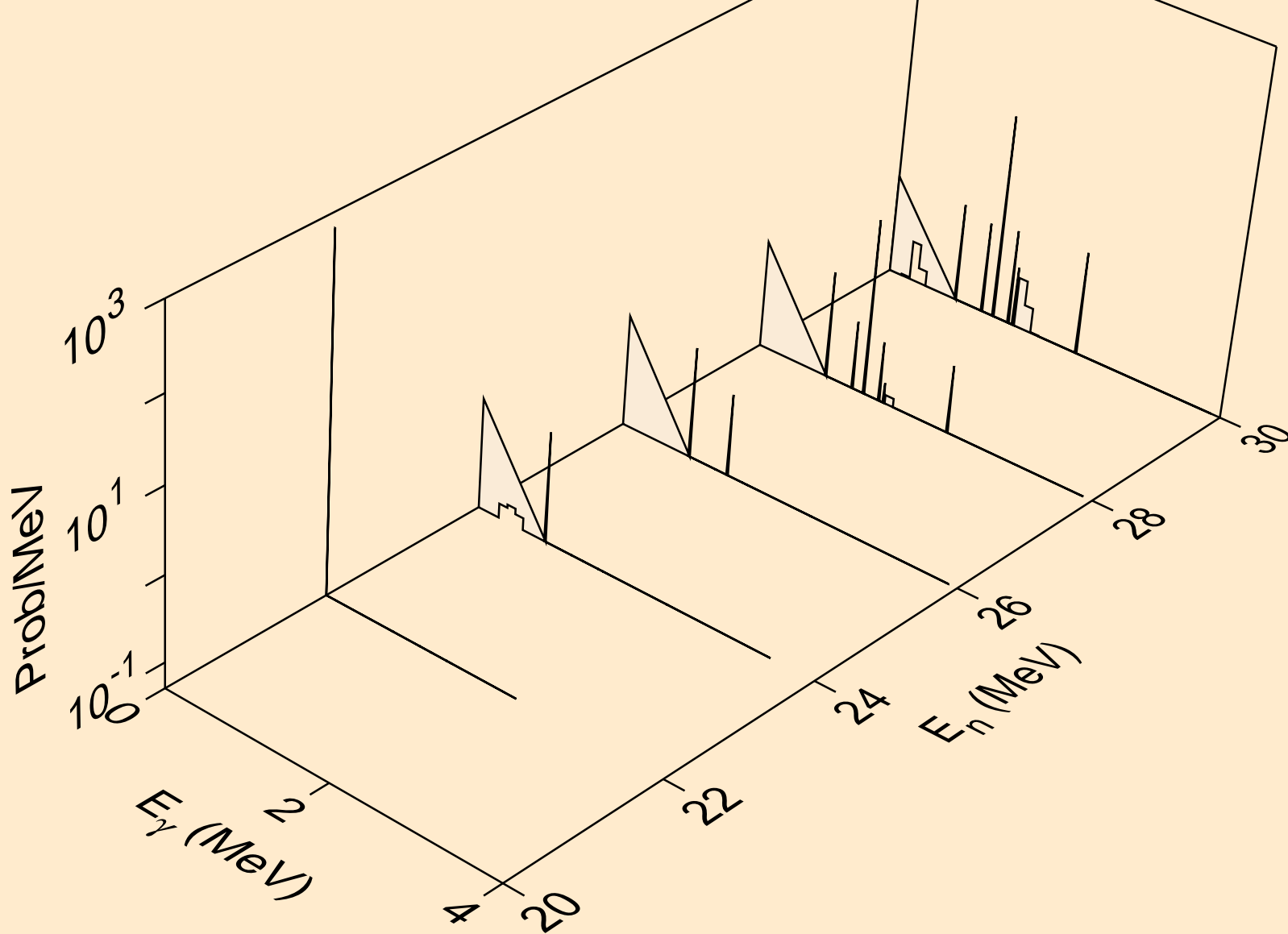

NI062 NEUTRON ACER TENDL-2023 LIBRARY; T=0.K
Photon emission for (n,npa)

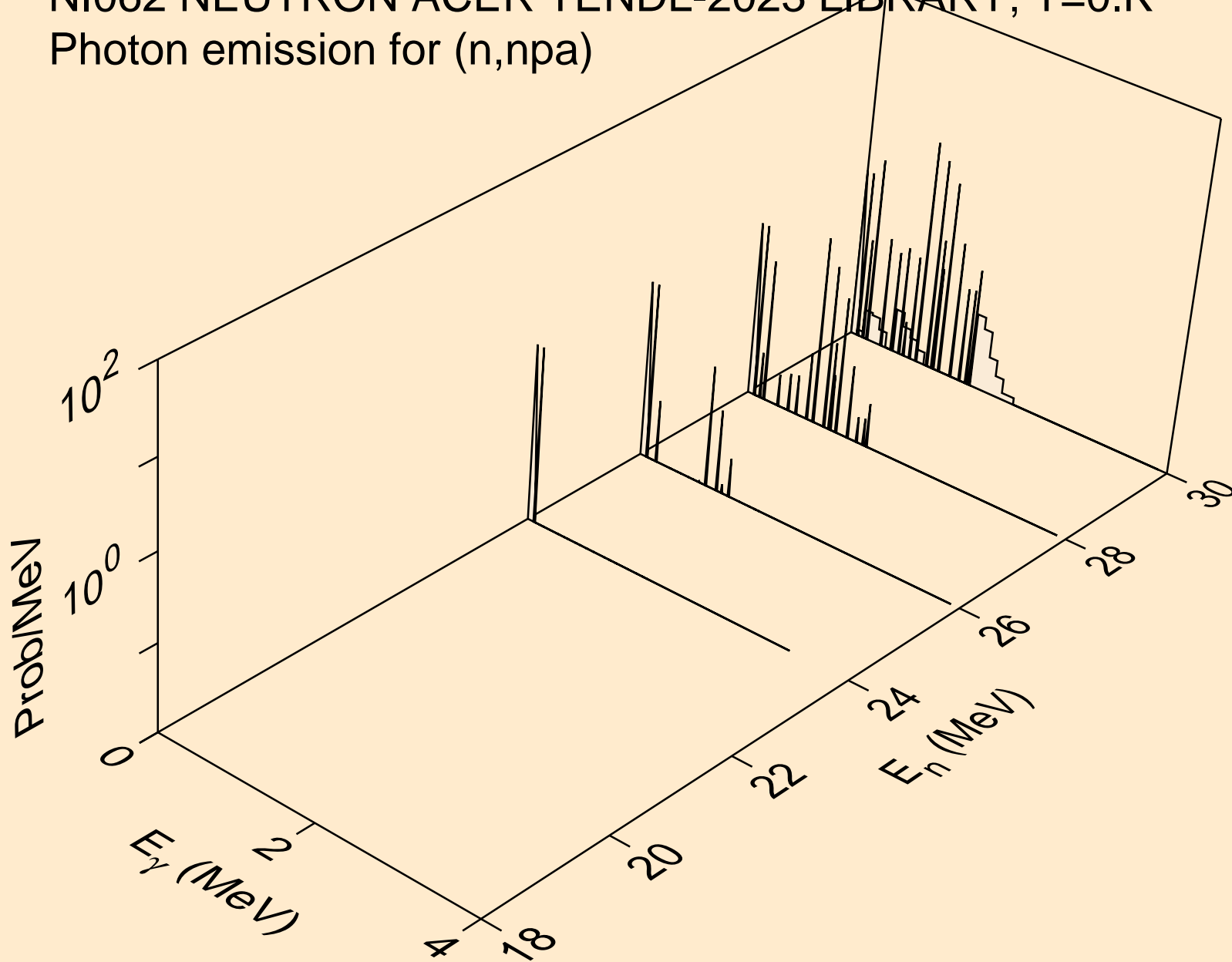

NI062 NEUTRON ACER TENDL-2023 LIBRARY; T=0.K
Photon emission for (n,n*c)

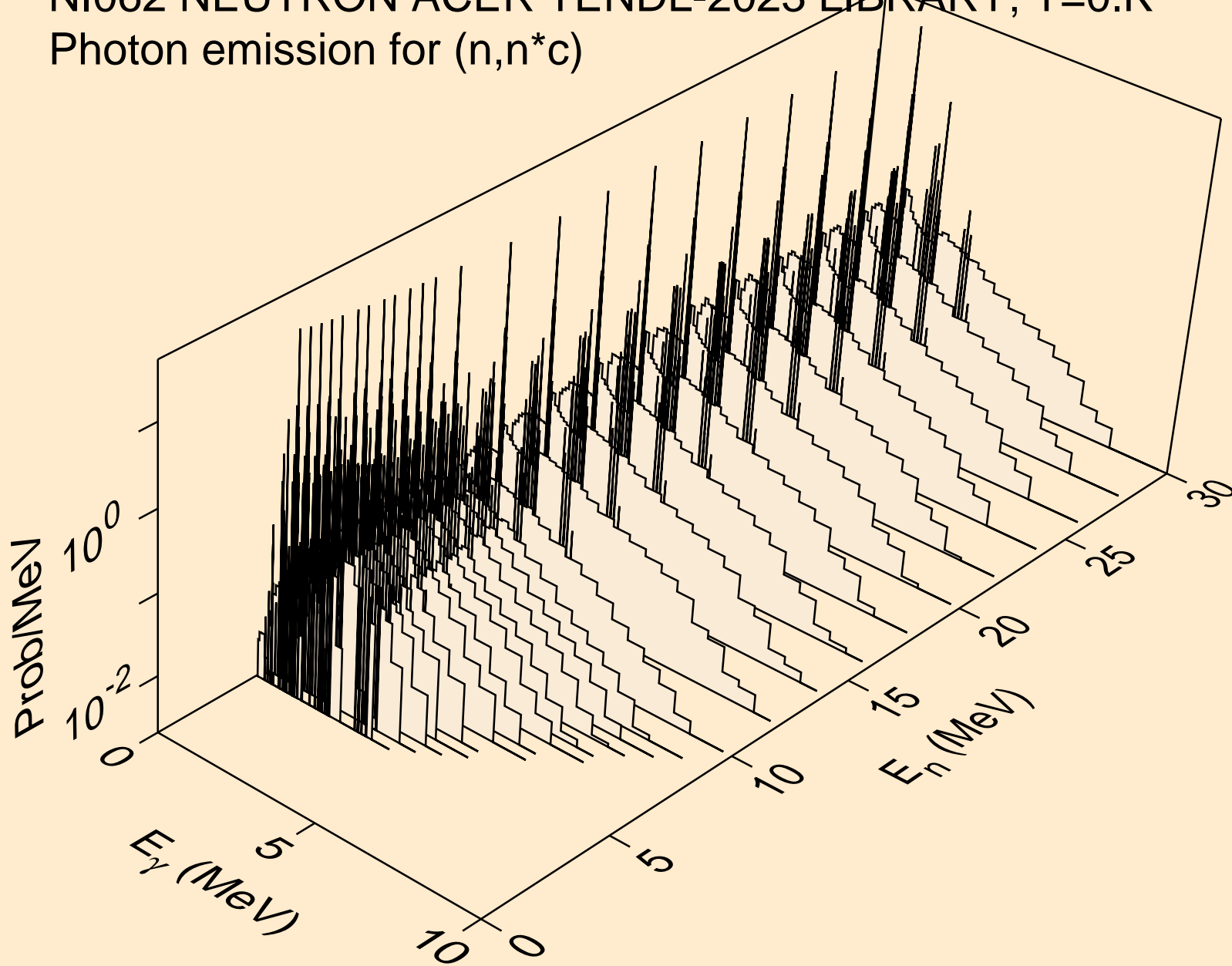

NI062 NEUTRON ACER TENDL-2023 LIBRARY; T=0.K
Photon emission for (n,gma)

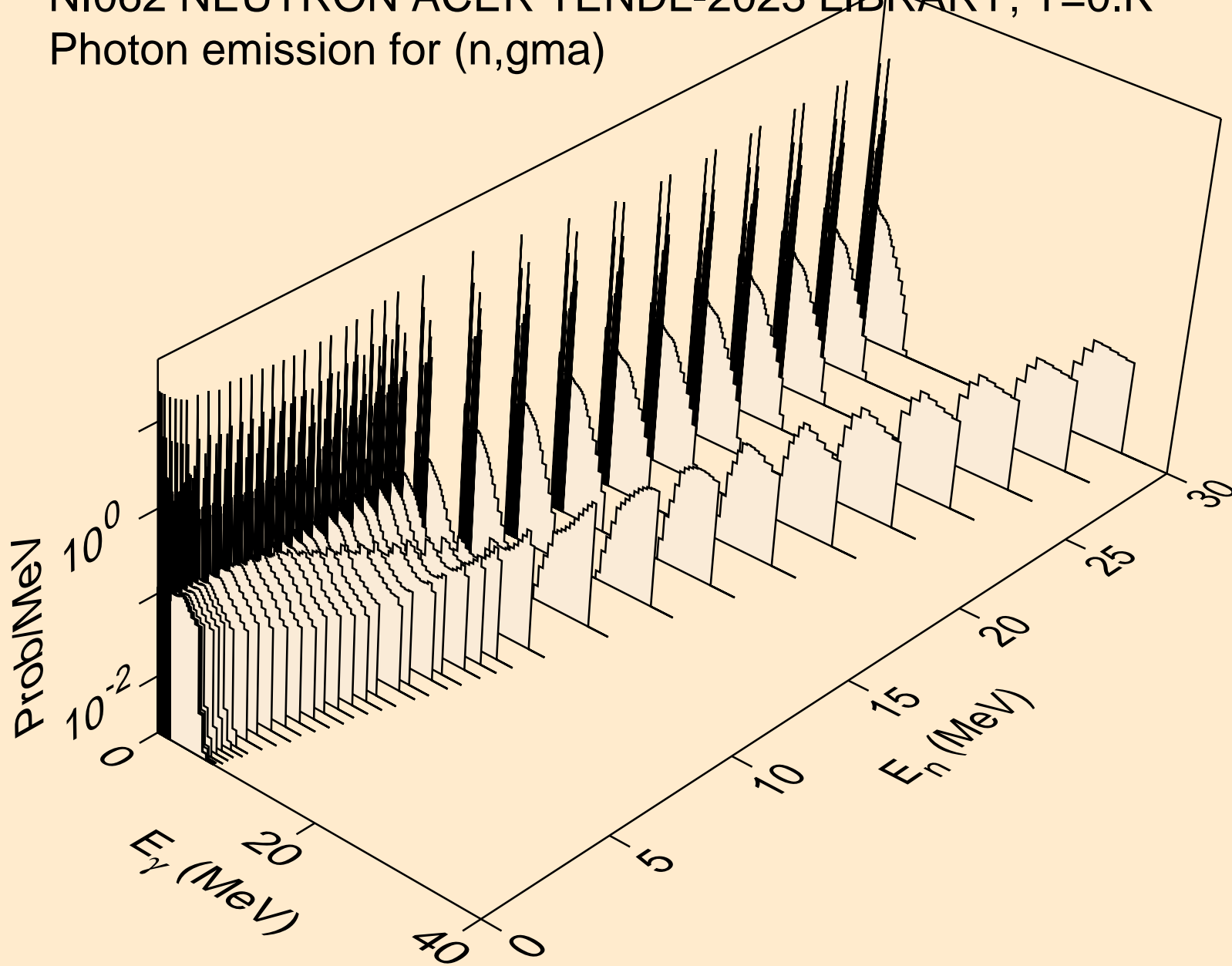

NI062 NEUTRON ACER TENDL-2023 LIBRARY; T=0.K
Photon emission for (n,p)

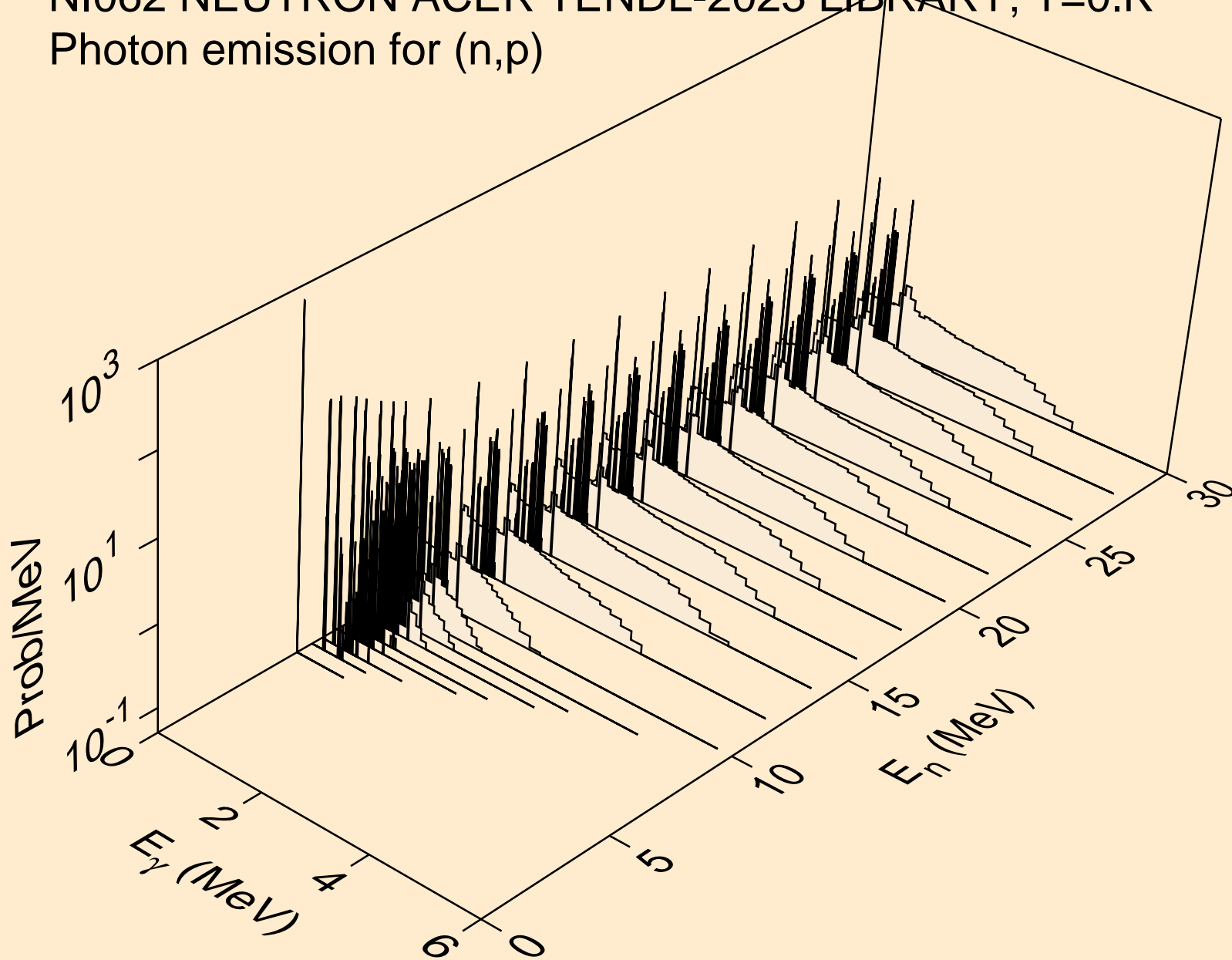

NI062 NEUTRON ACER TENDL-2023 LIBRARY; T=0.K
Photon emission for (n,d)

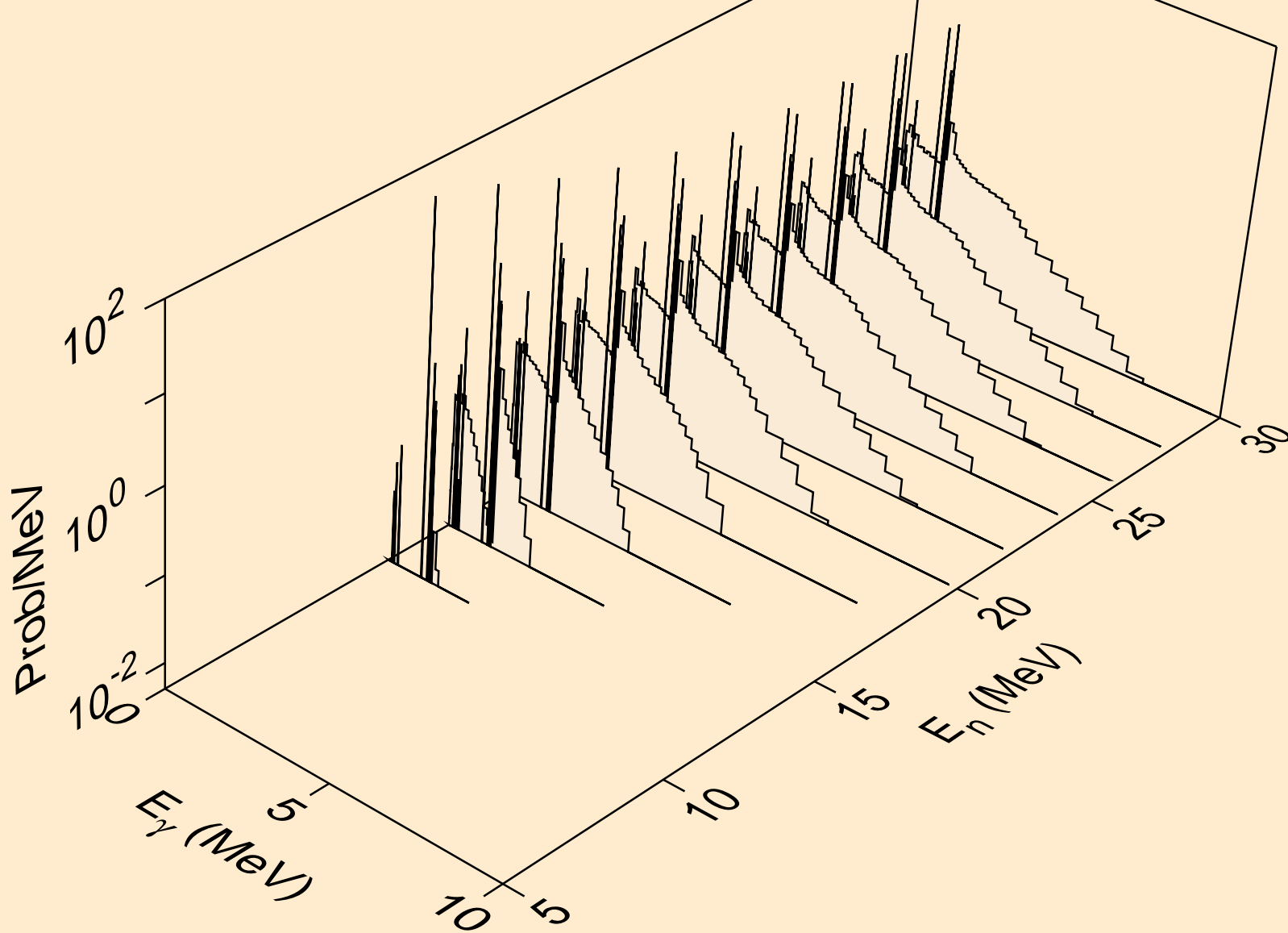

NI062 NEUTRON ACER TENDL-2023 LIBRARY; T=0.K
Photon emission for (n,t)

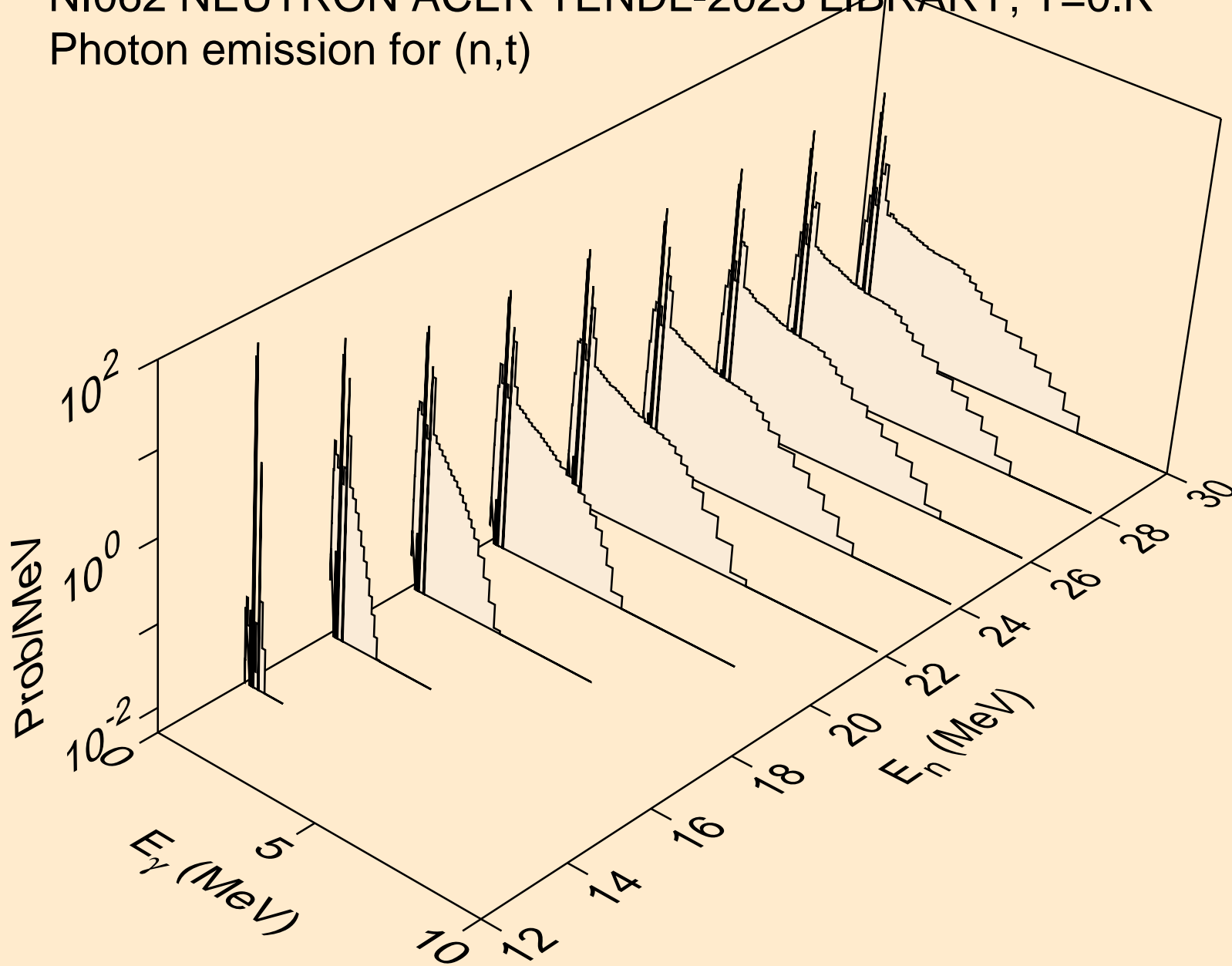

NI062 NEUTRON ACER TENDL-2023 LIBRARY; T=0.K
Photon emission for (n,he3)

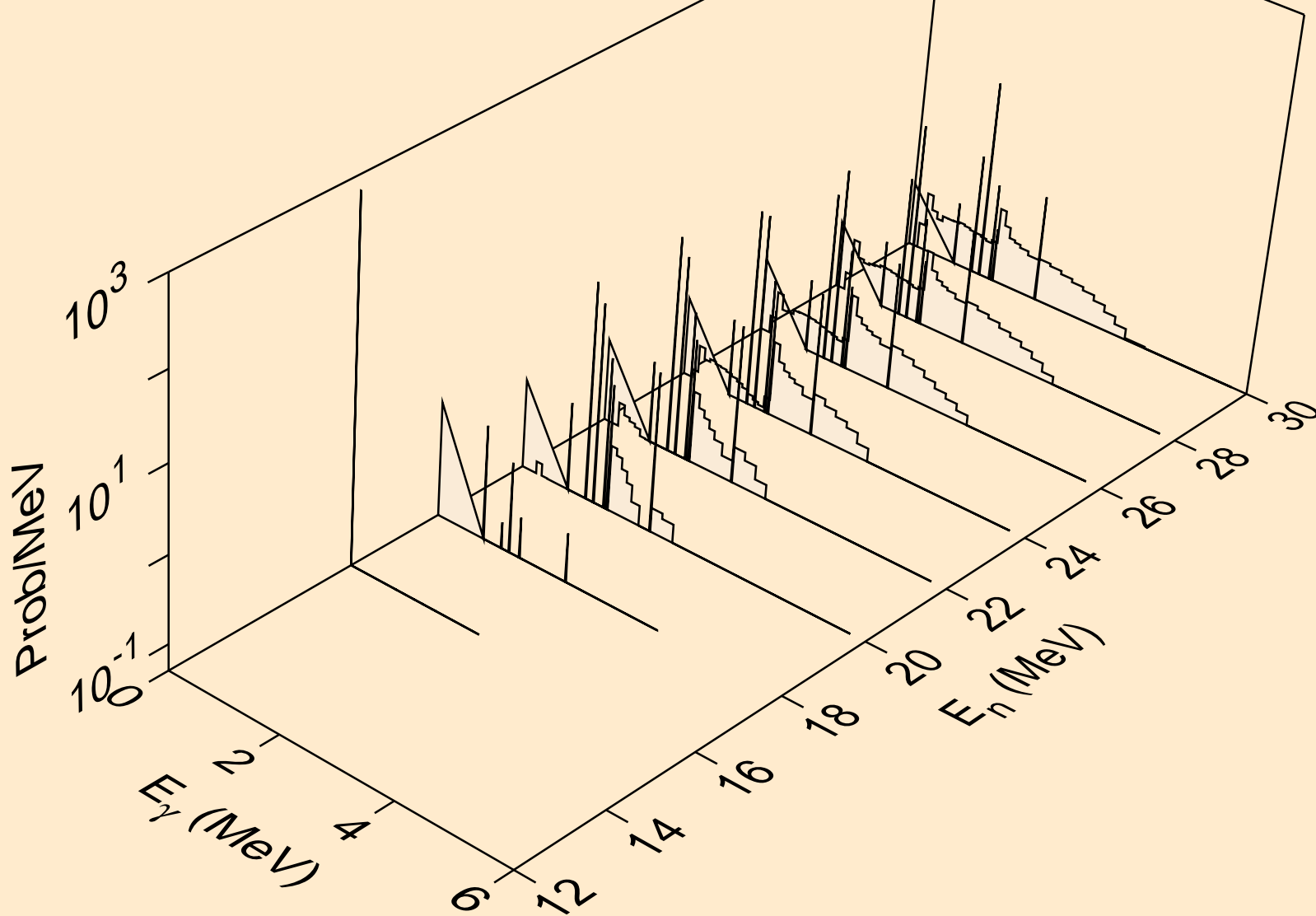

NI062 NEUTRON ACER TENDL-2023 LIBRARY; T=0.K
Photon emission for (n,a)

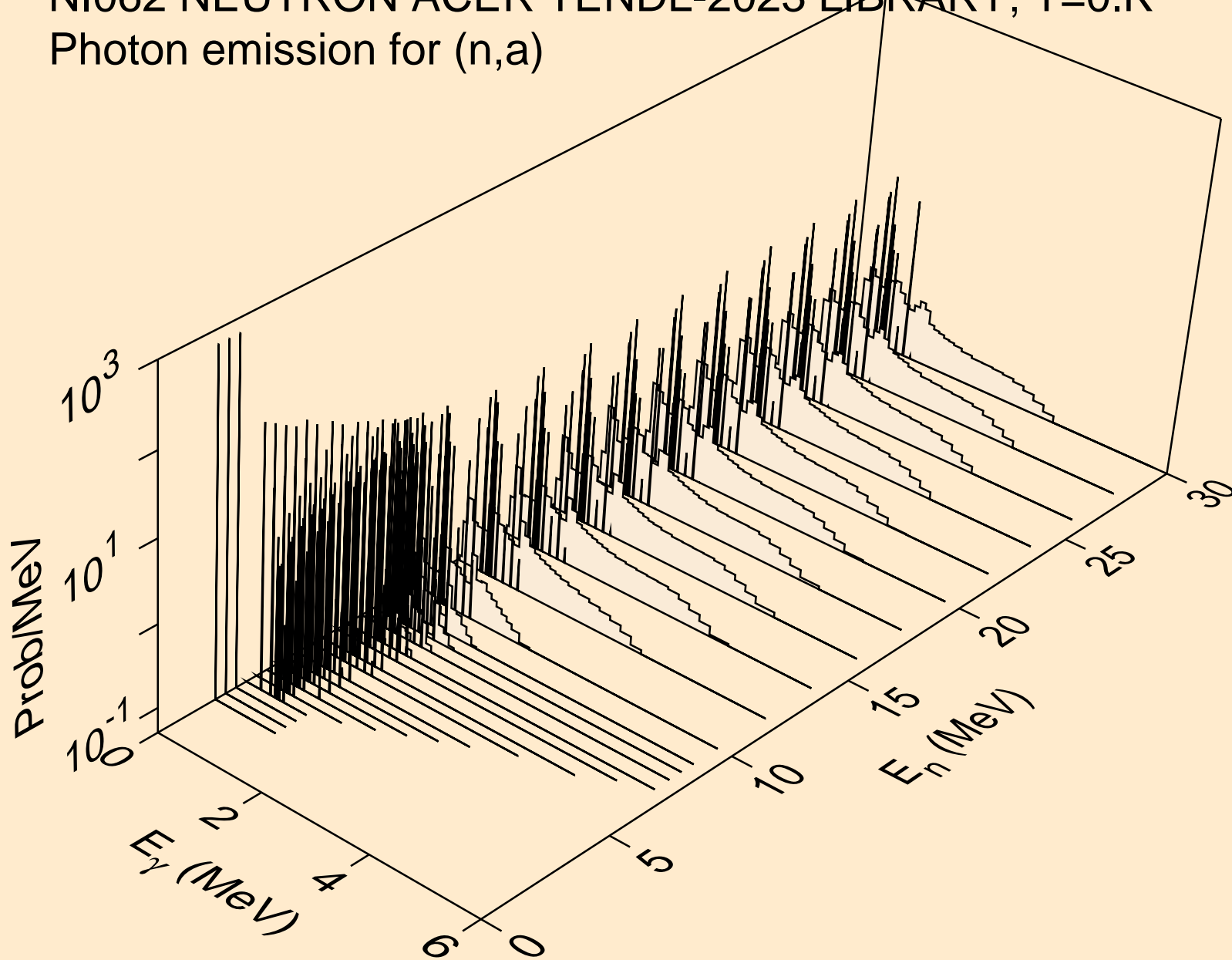

NI062 NEUTRON ACER TENDL-2023 LIBRARY; T=0.K
Photon emission for (n,2a)

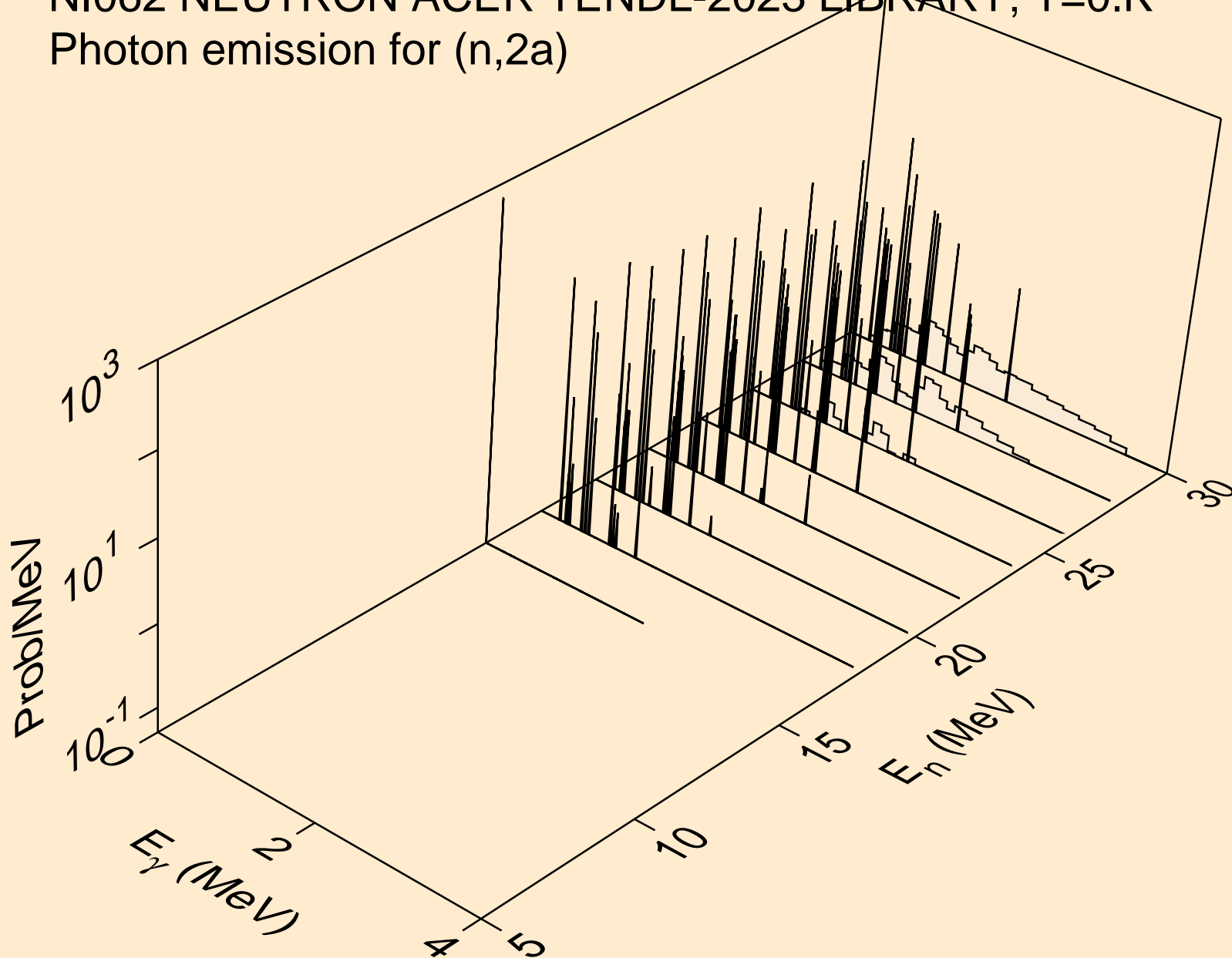

NI062 NEUTRON ACER TENDL-2023 LIBRARY; T=0.K
Photon emission for (n,2p)

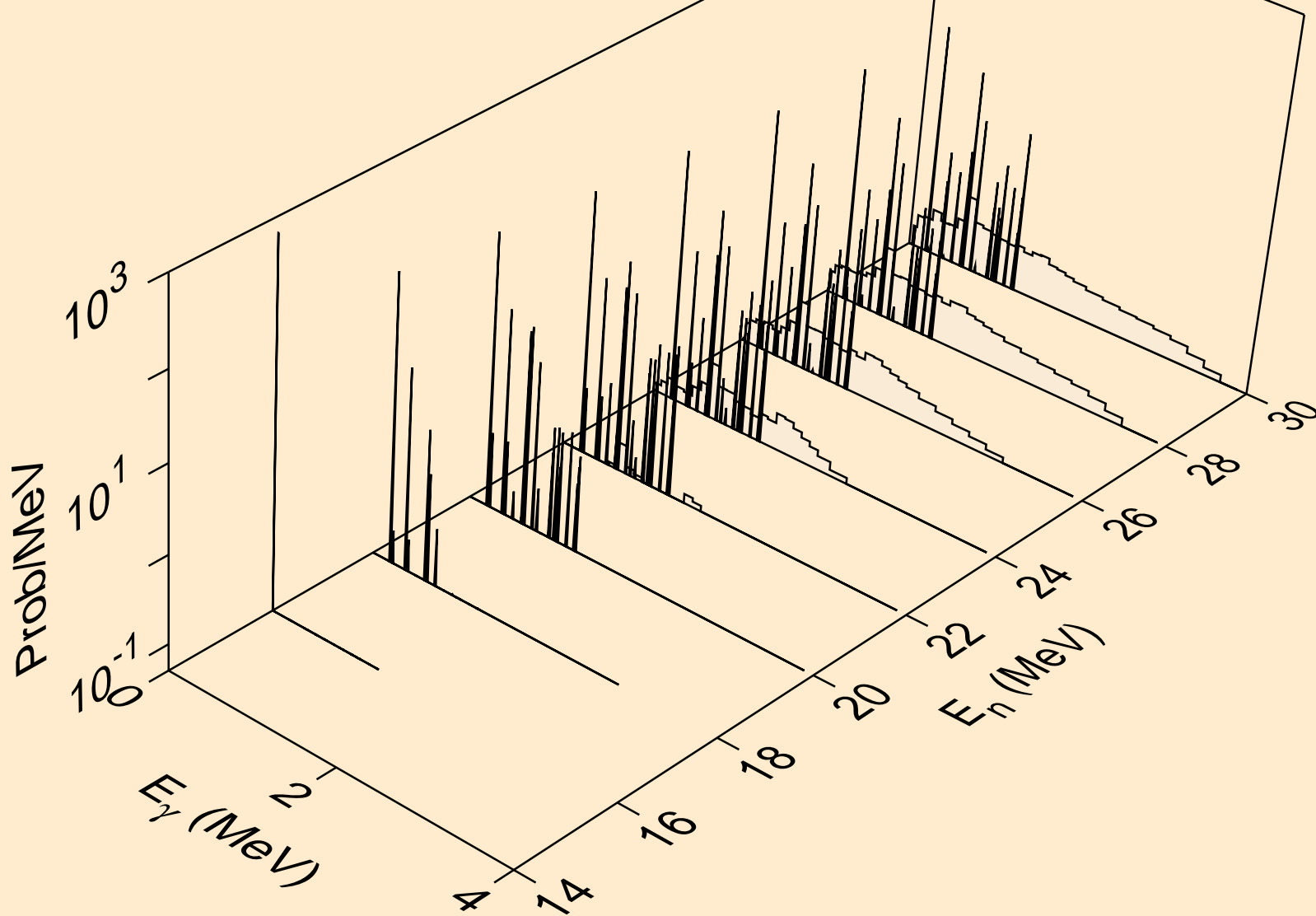

NI062 NEUTRON ACER TENDL-2023 LIBRARY; T=0.K
Photon emission for (n,p α)

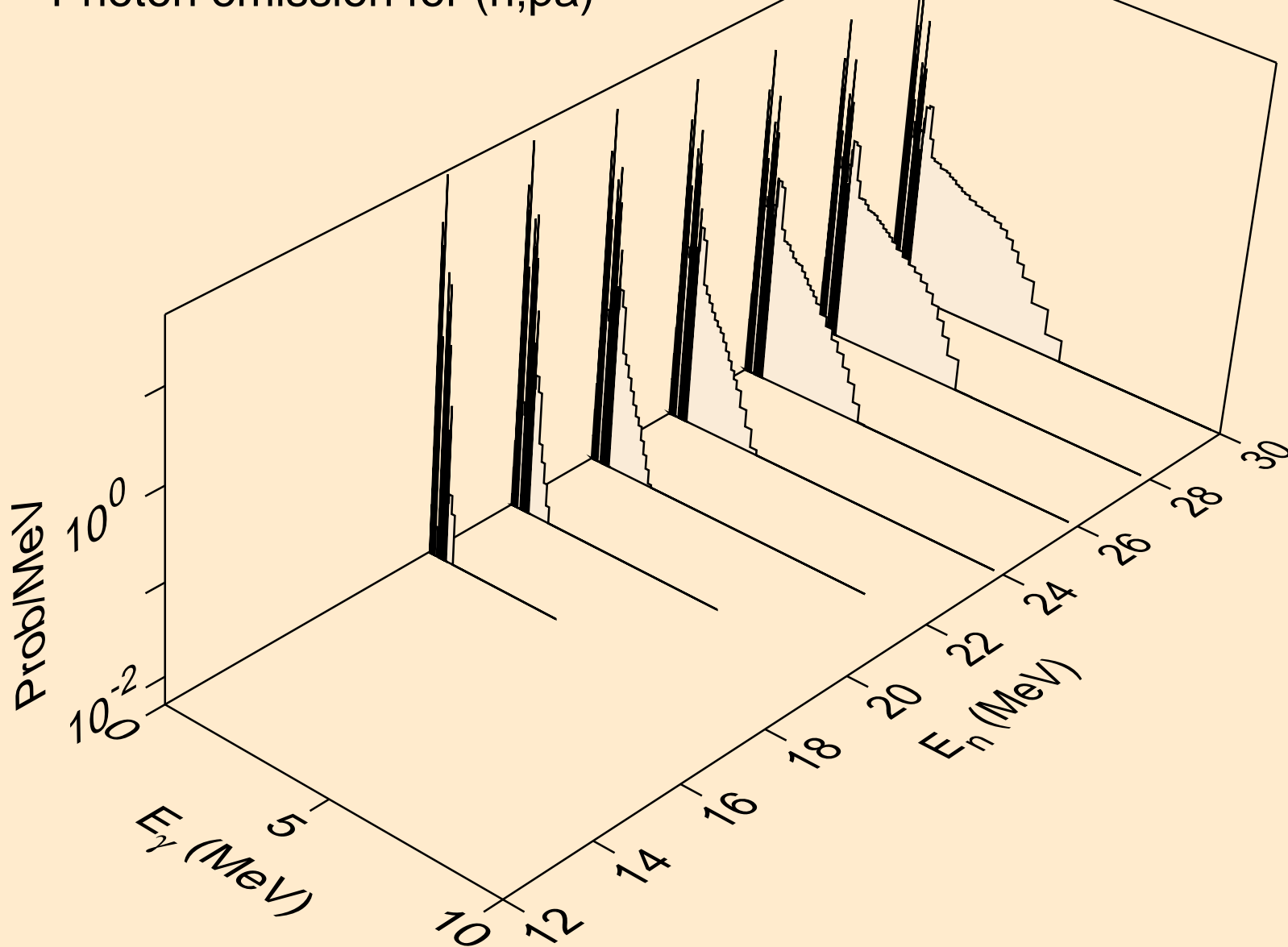

NI062 NEUTRON ACER TENDL-2023 LIBRARY; T=0.K
Photon emission for (n,pd)

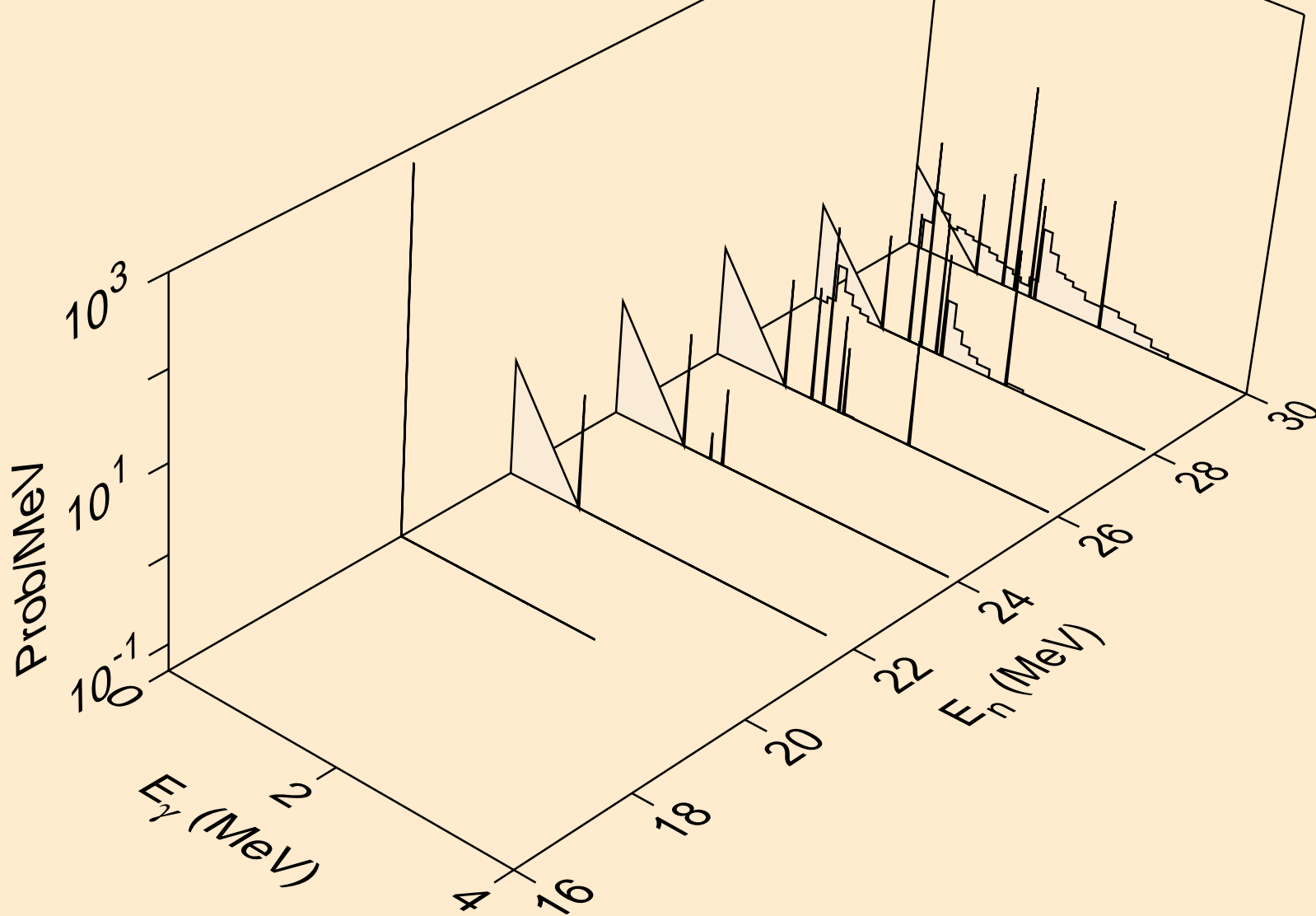

NI062 NEUTRON ACER TENDL-2023 LIBRARY; T=0.K
Photon emission for (n,pt)

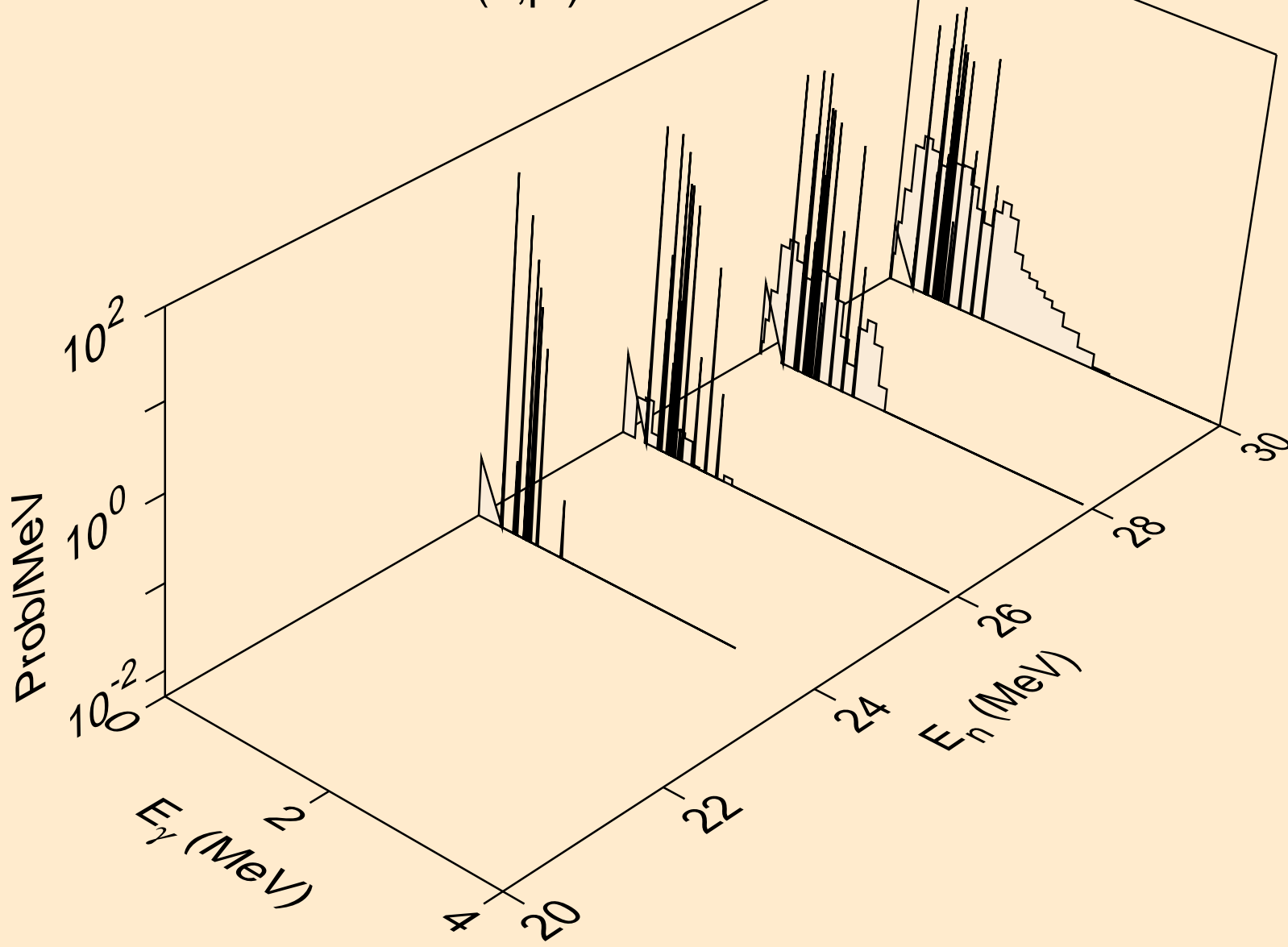

NI062 NEUTRON ACER TENDL-2023 LIBRARY; T=0.K
Photon emission for (n,da)

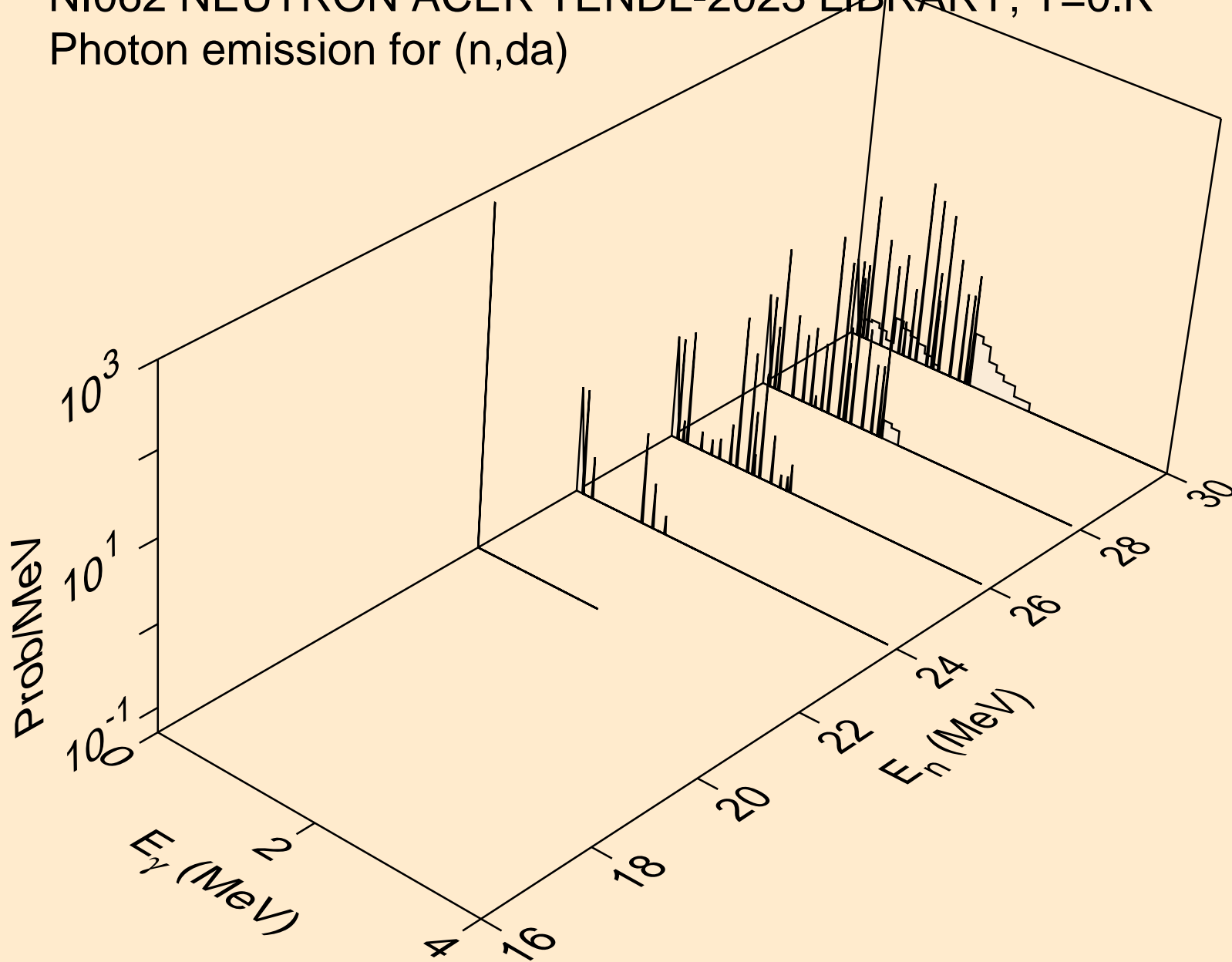

NI062 NEUTRON ACER TENDL-2023 LIBRARY; T=0.K
thermal capture photon spectrum

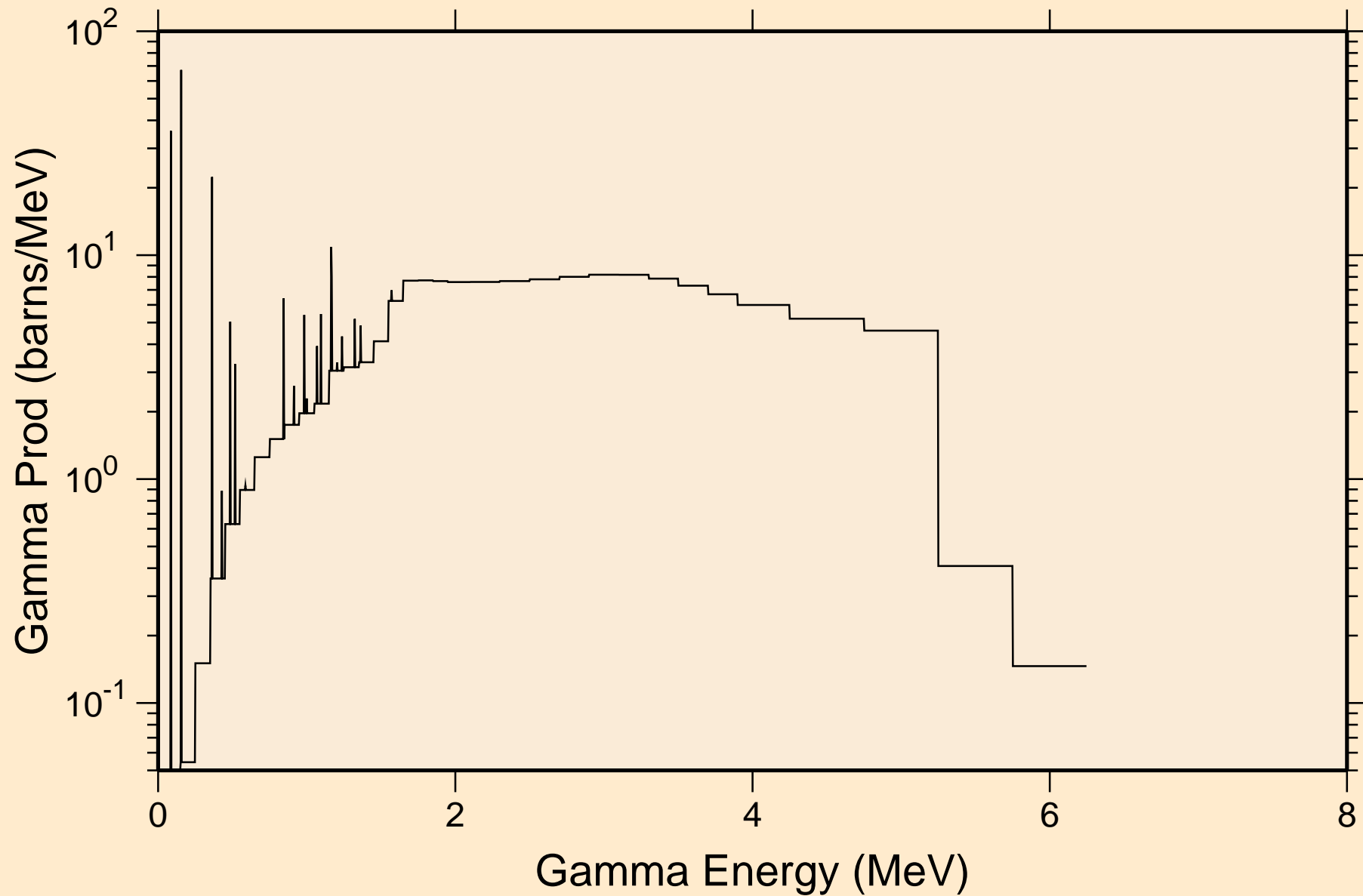

NI062 NEUTRON ACER TENDL-2023 LIBRARY; T=0.K
14 MeV photon spectrum

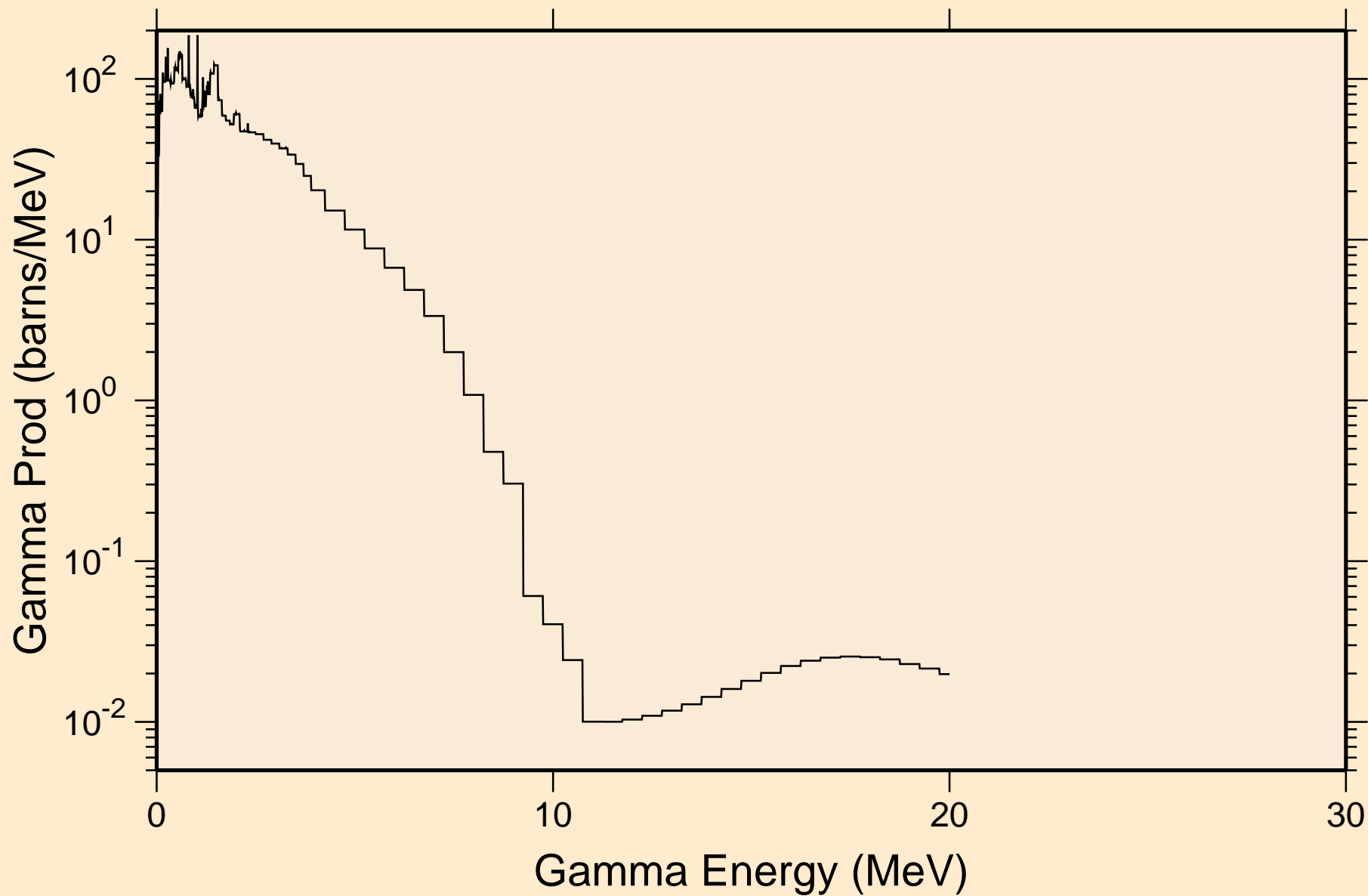

NI062 NEUTRON ACER TENDL-2023 LIBRARY; T=0.K

Particle heating contributions

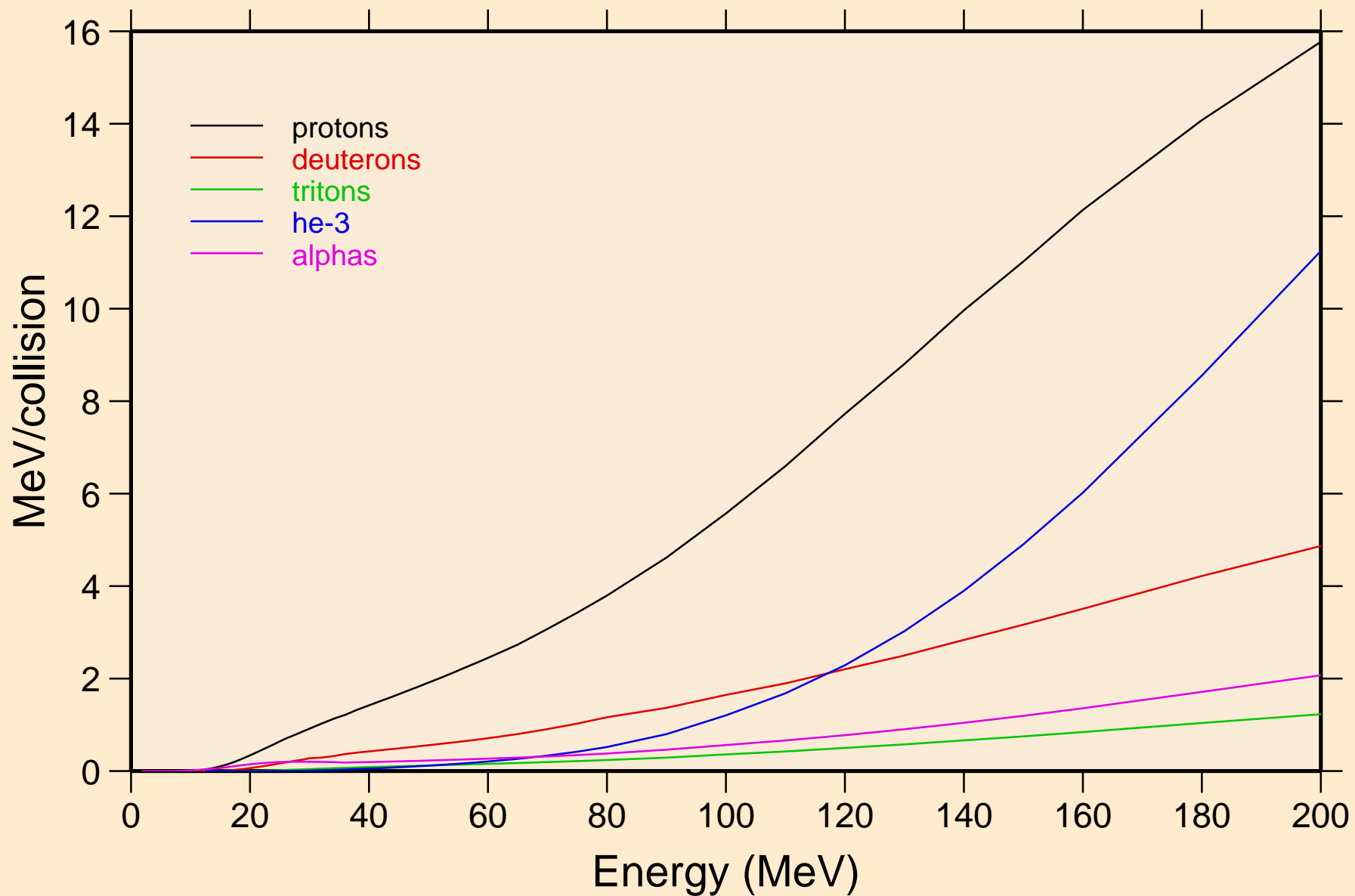

NI062 NEUTRON ACER TENDL-2023 LIBRARY; T=0.K
Recoil Heating

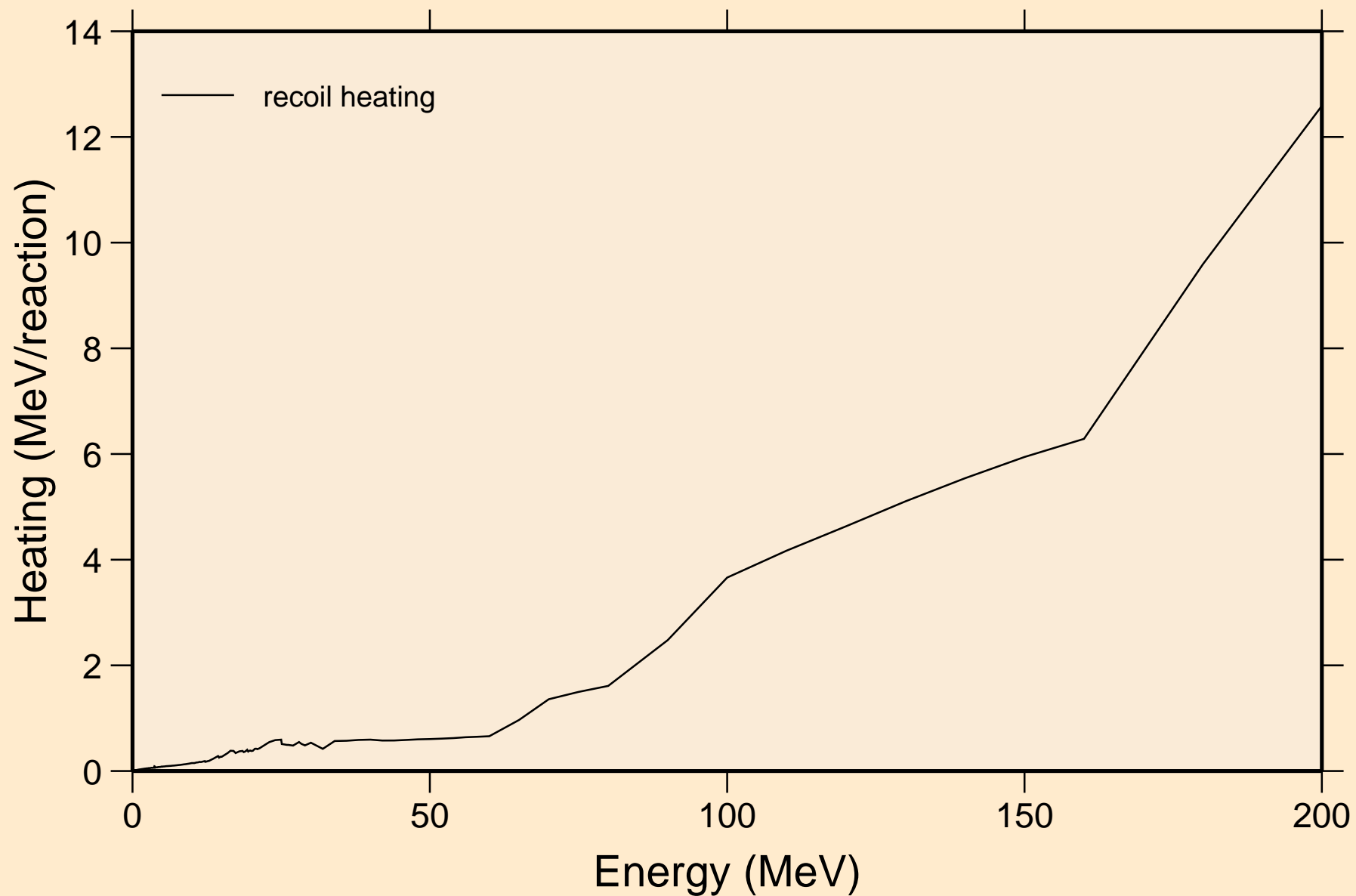

NI062 NEUTRON ACER TENDL-2023 LIBRARY; T=0.K
Particle production cross sections

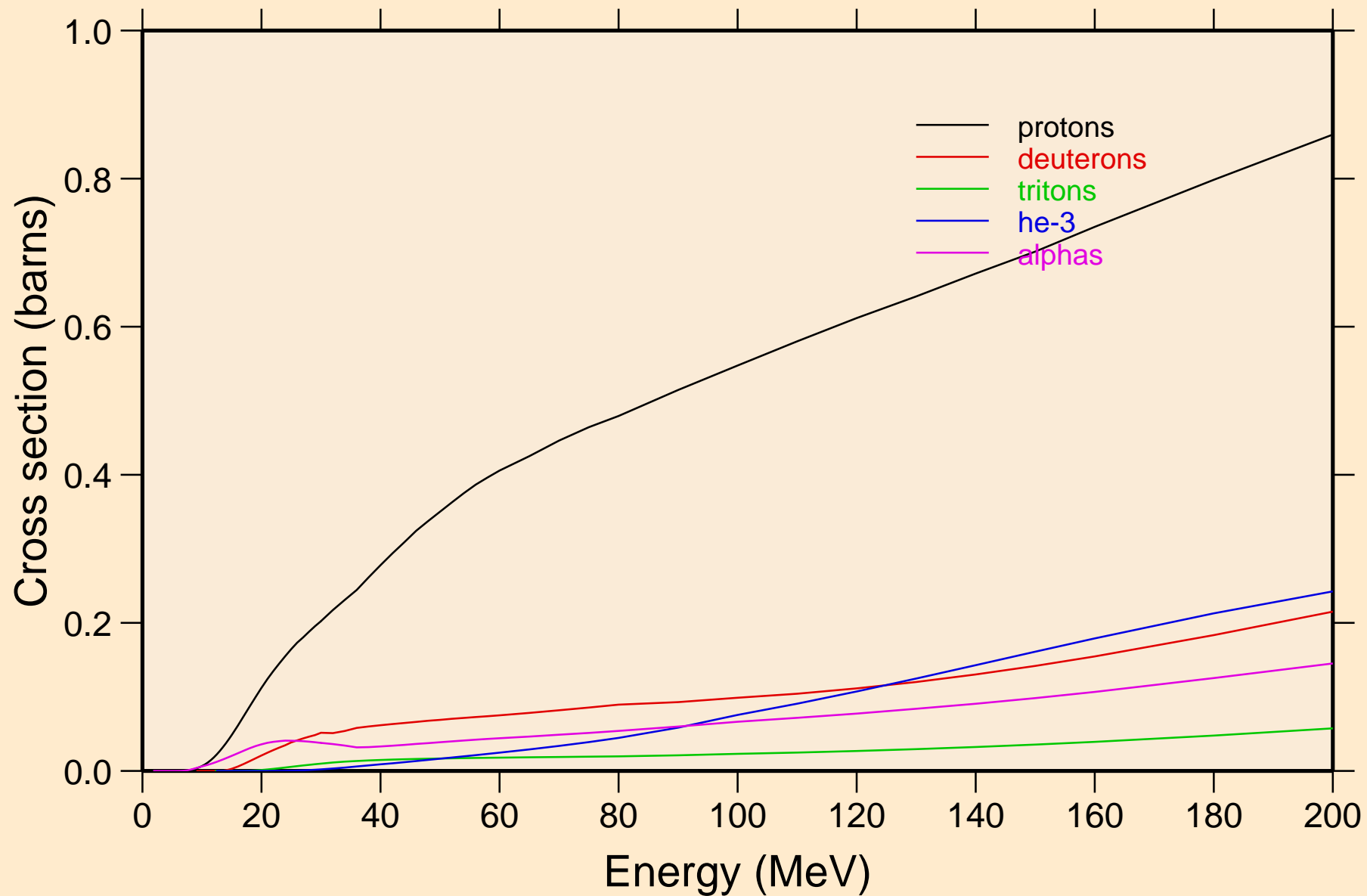

NI062 NEUTRON ACER TENDL-2023 LIBRARY; T=0.K
protons from (n,x)

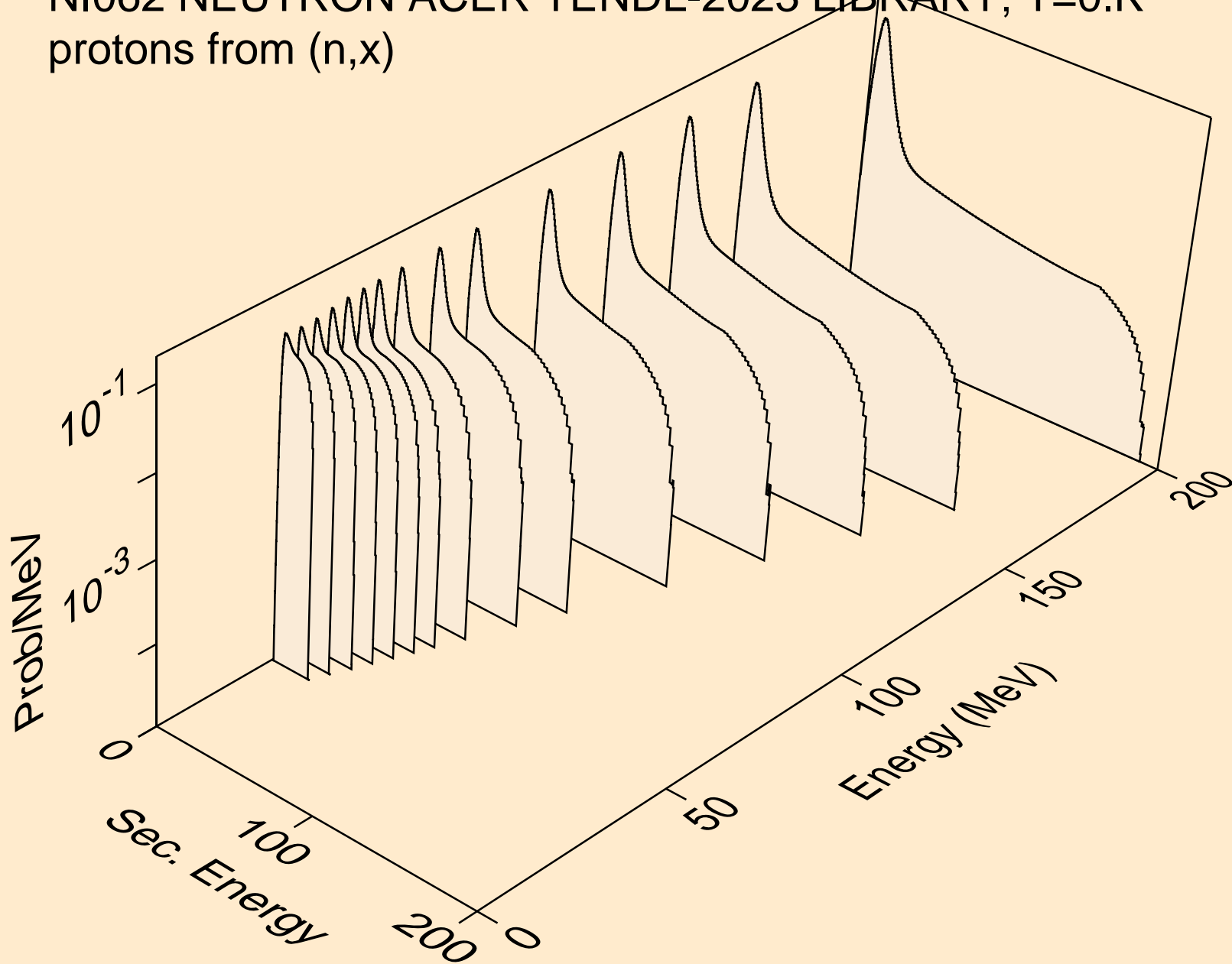

NI062 NEUTRON ACER TENDL-2023 LIBRARY; T=0.K
protons from (n,n*)p

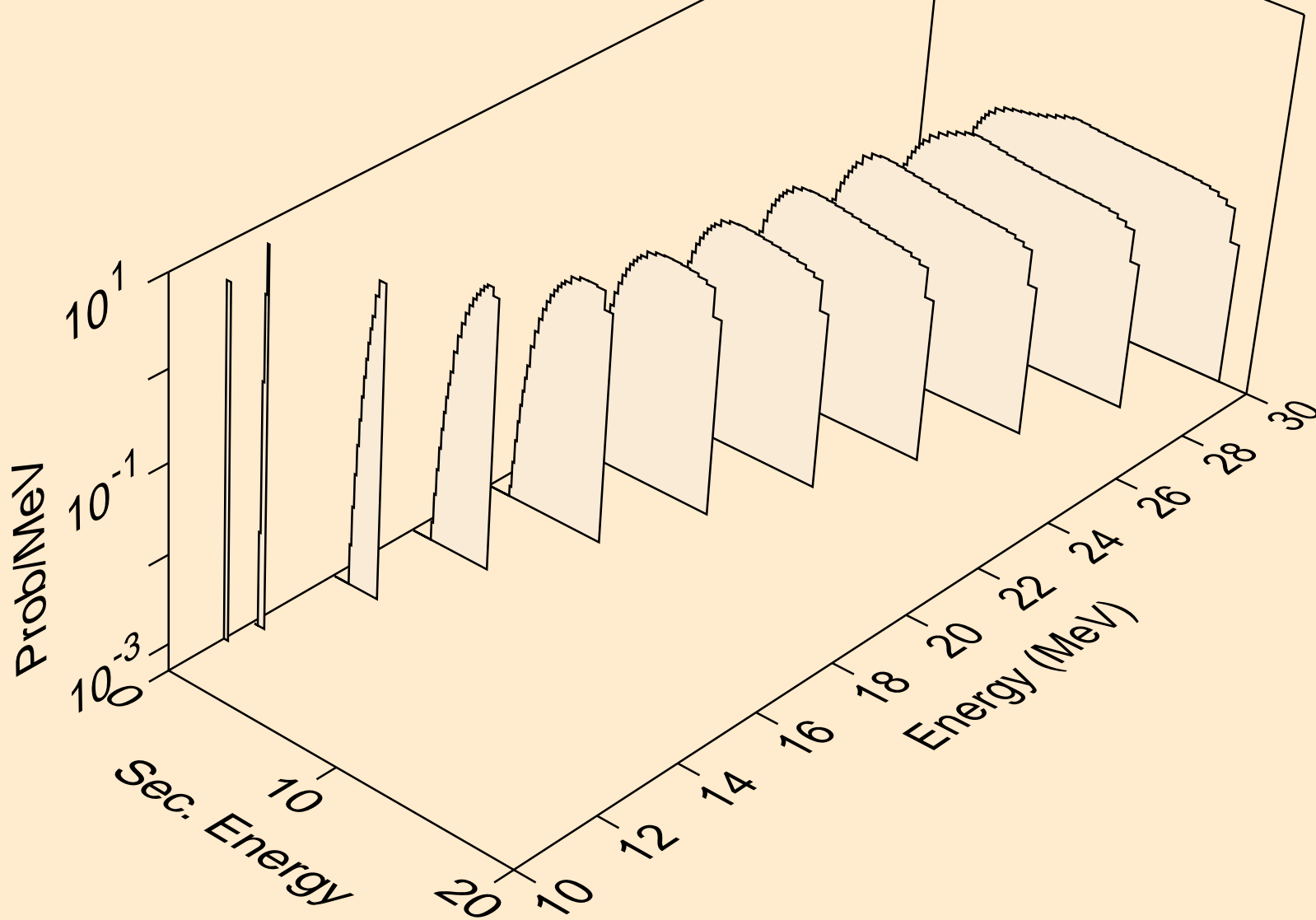

NI062 NEUTRON ACER TENDL-2023 LIBRARY; T=0.K
protons from (n,2np)

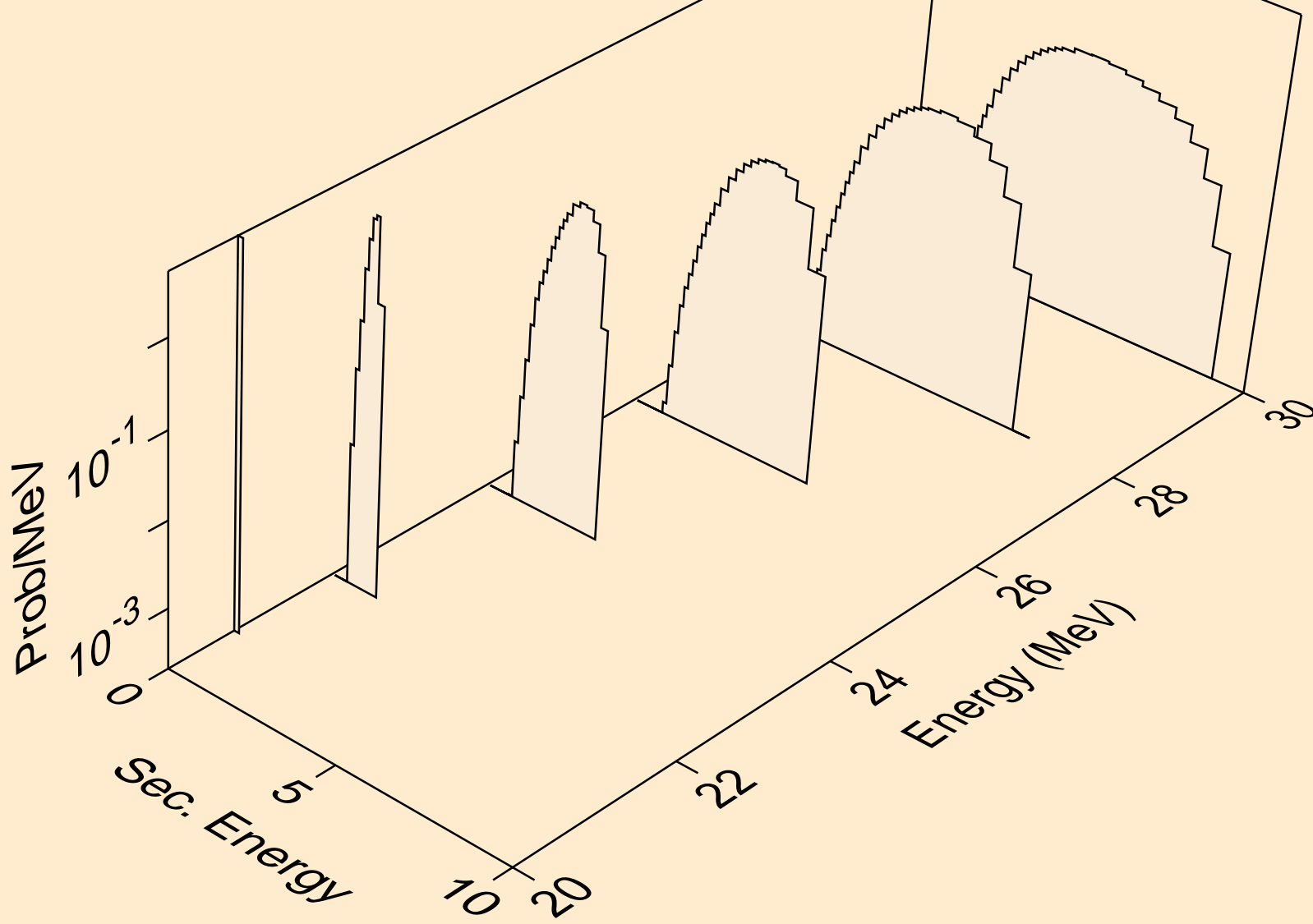

NI062 NEUTRON ACER TENDL-2023 LIBRARY; T=0.K
protons from (n,3np)

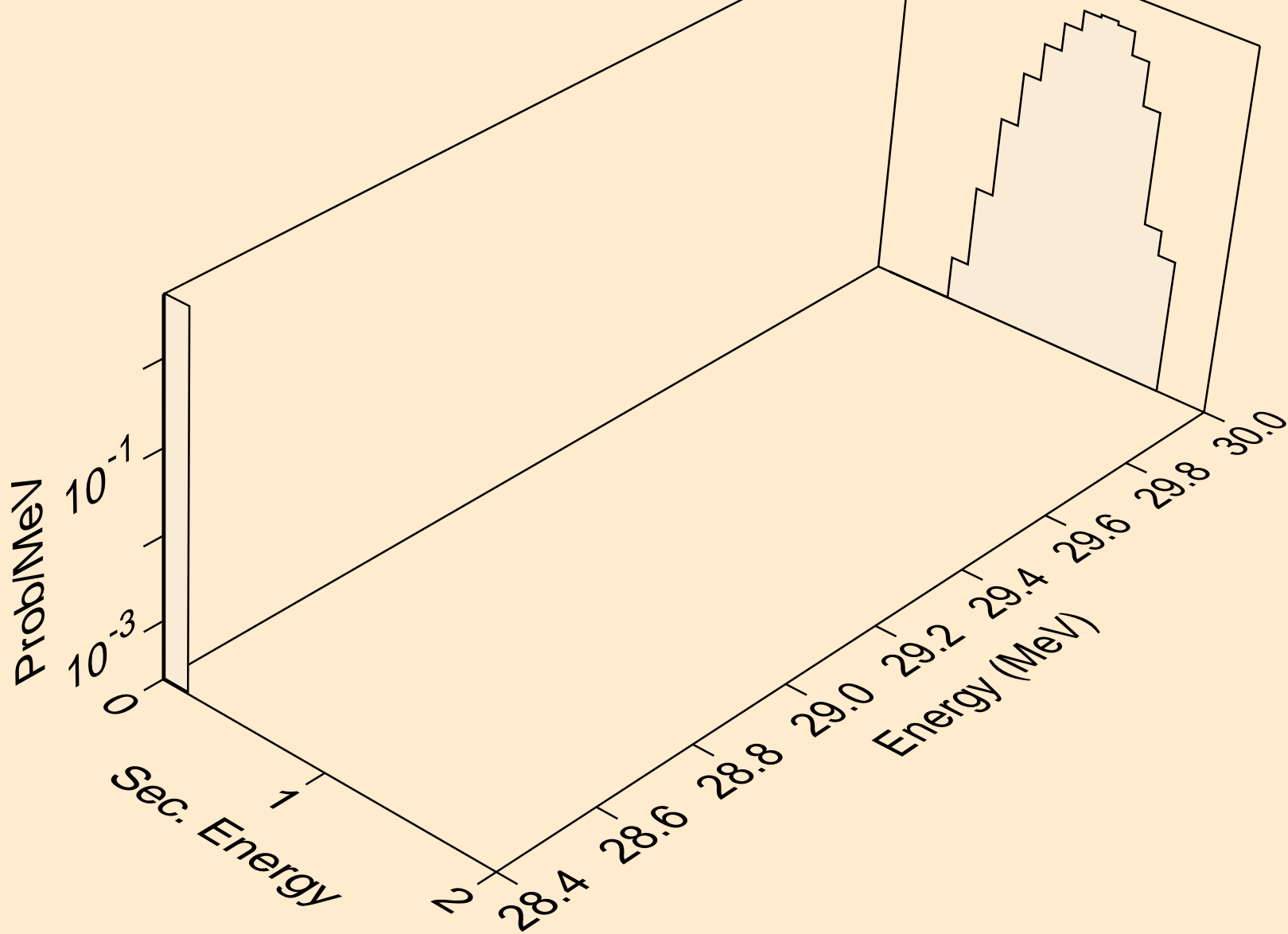

NI062 NEUTRON ACER TENDL-2023 LIBRARY; T=0.K
protons from (n,n2p)

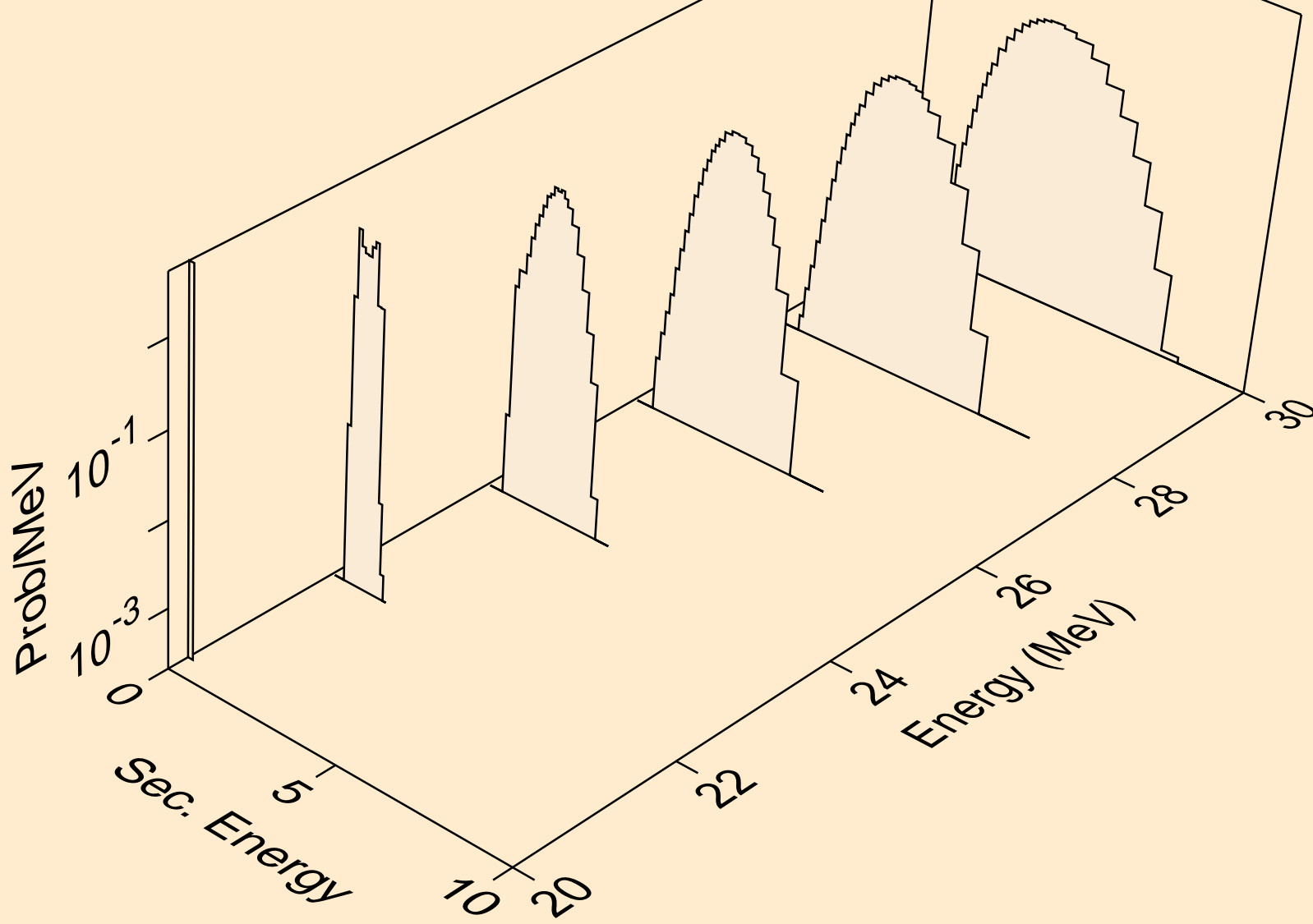

NI062 NEUTRON ACER TENDL-2023 LIBRARY; T=0.K
protons from (n,npa)

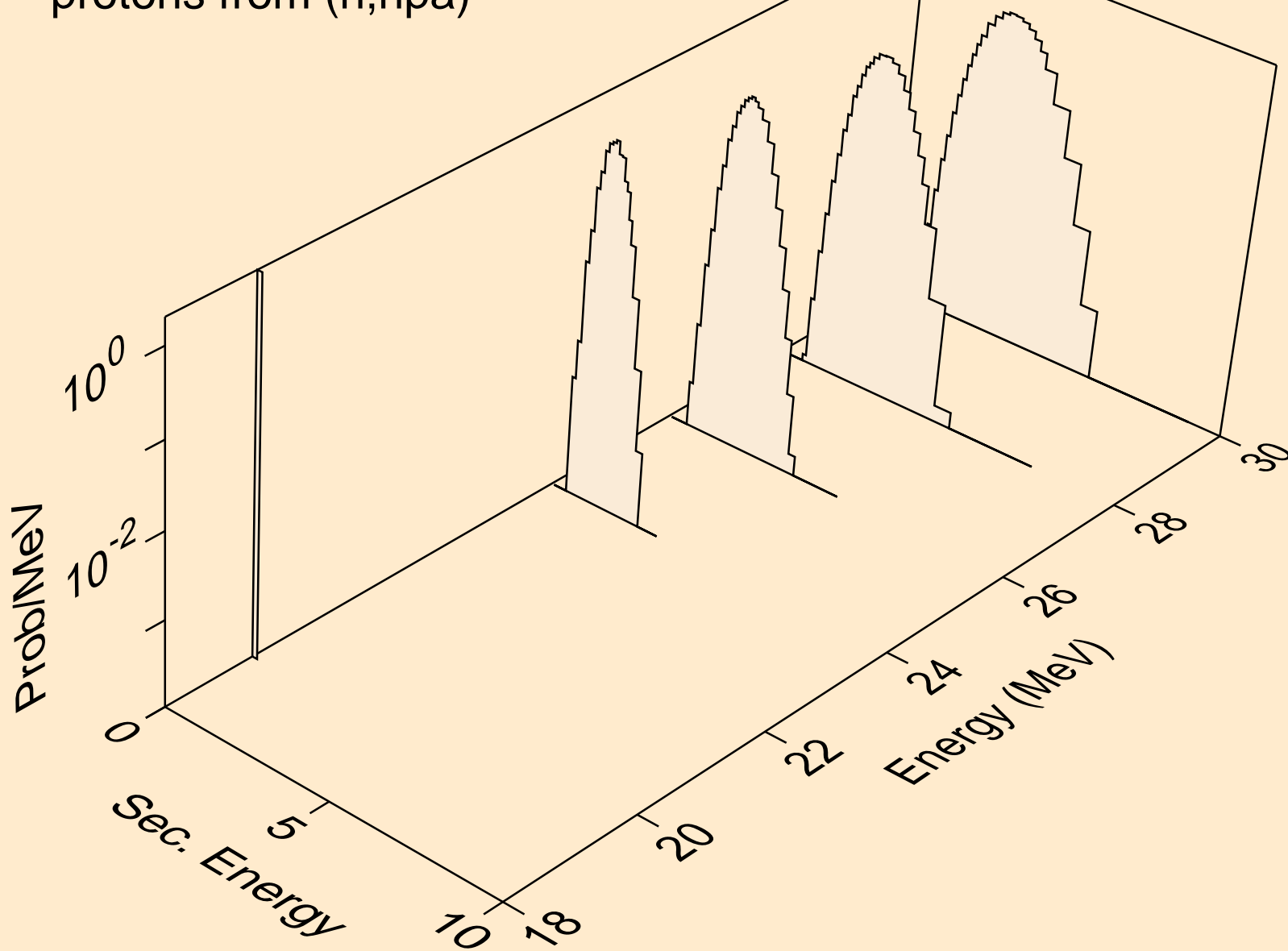

NI062 NEUTRON ACER TENDL-2023 LIBRARY; T=0.K
protons from (n,p)

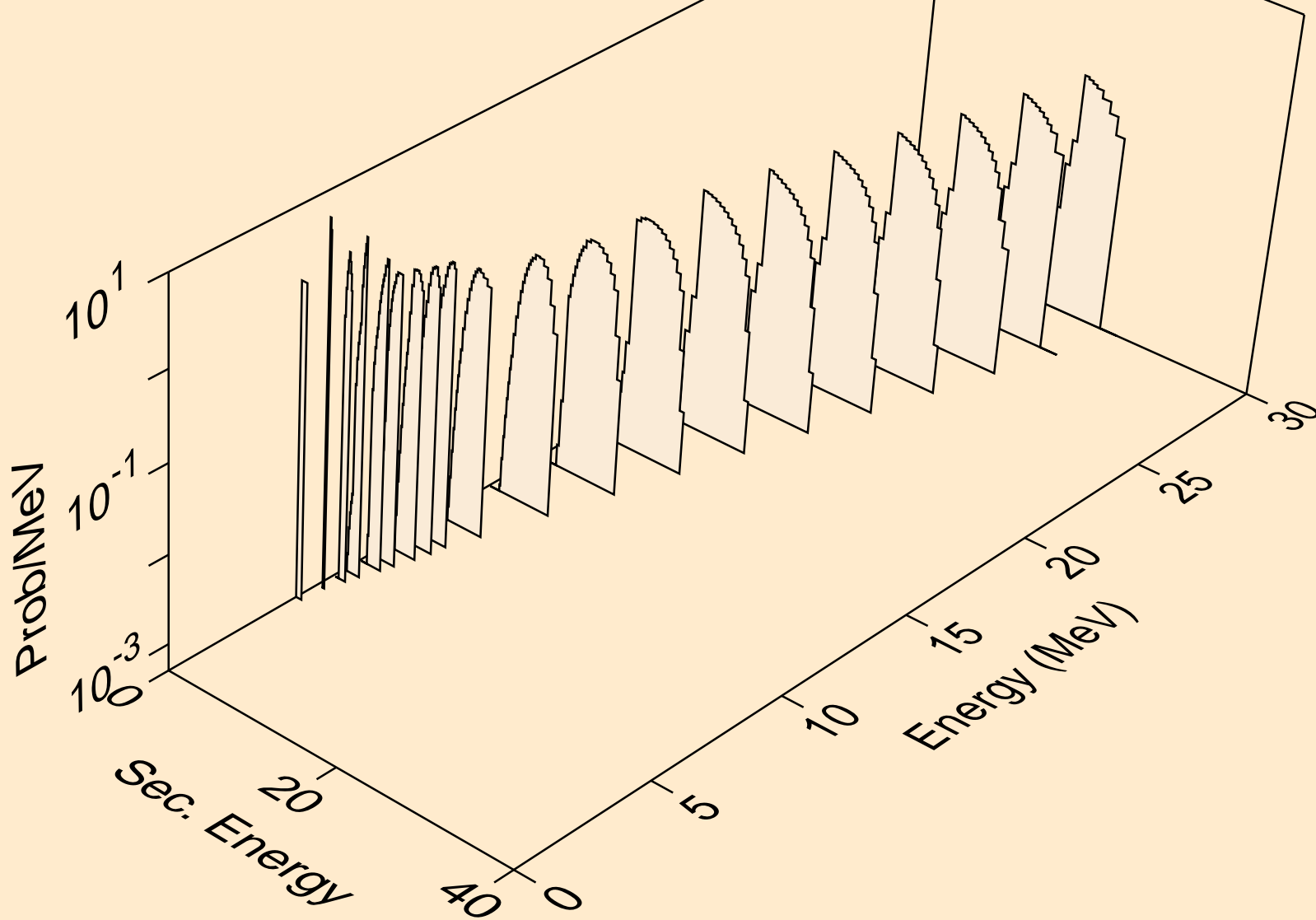

NI062 NEUTRON ACER TENDL-2023 LIBRARY; T=0.K
protons from (n,2p)

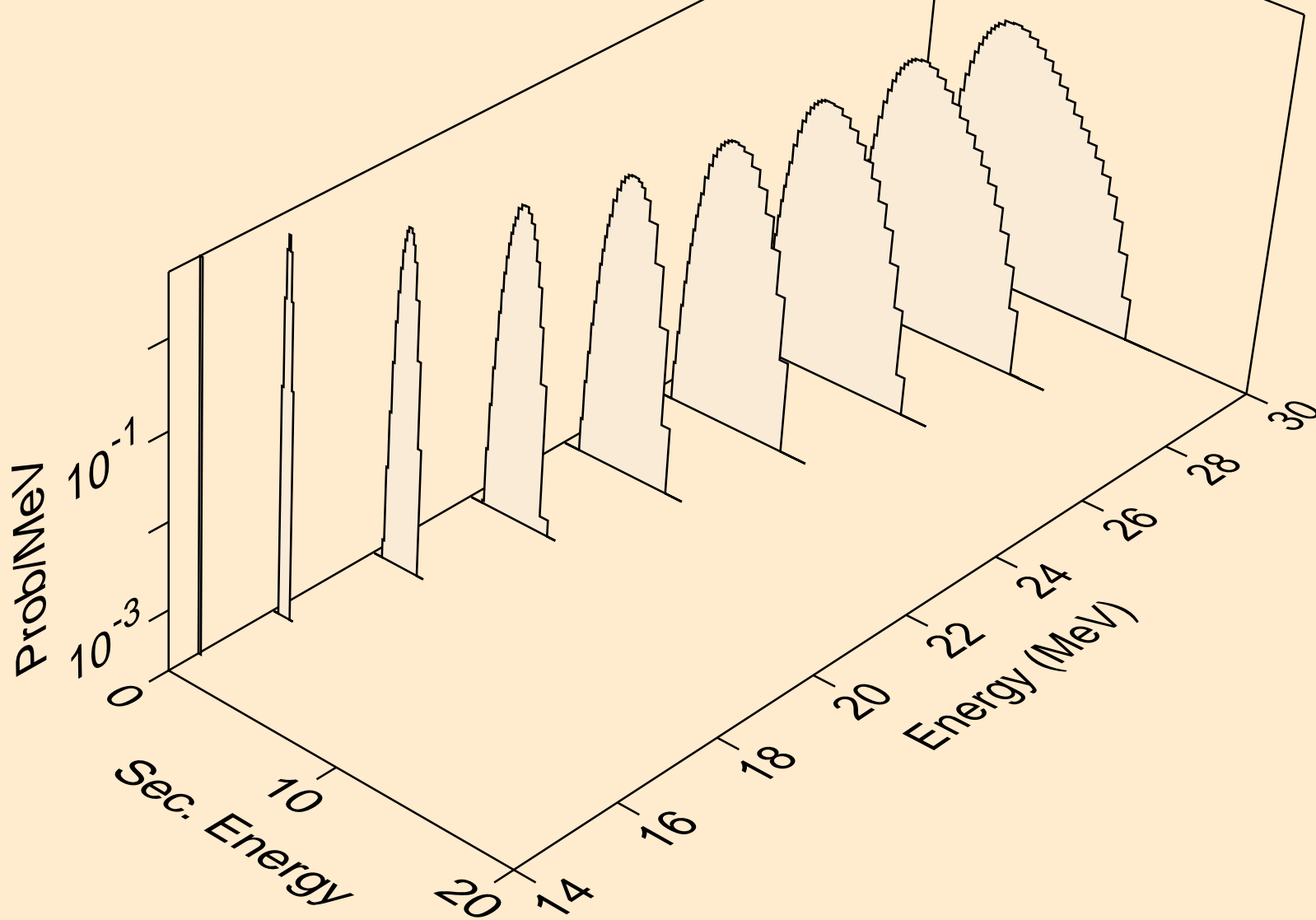

NI062 NEUTRON ACER TENDL-2023 LIBRARY; T=0.K
protons from (n,pa)

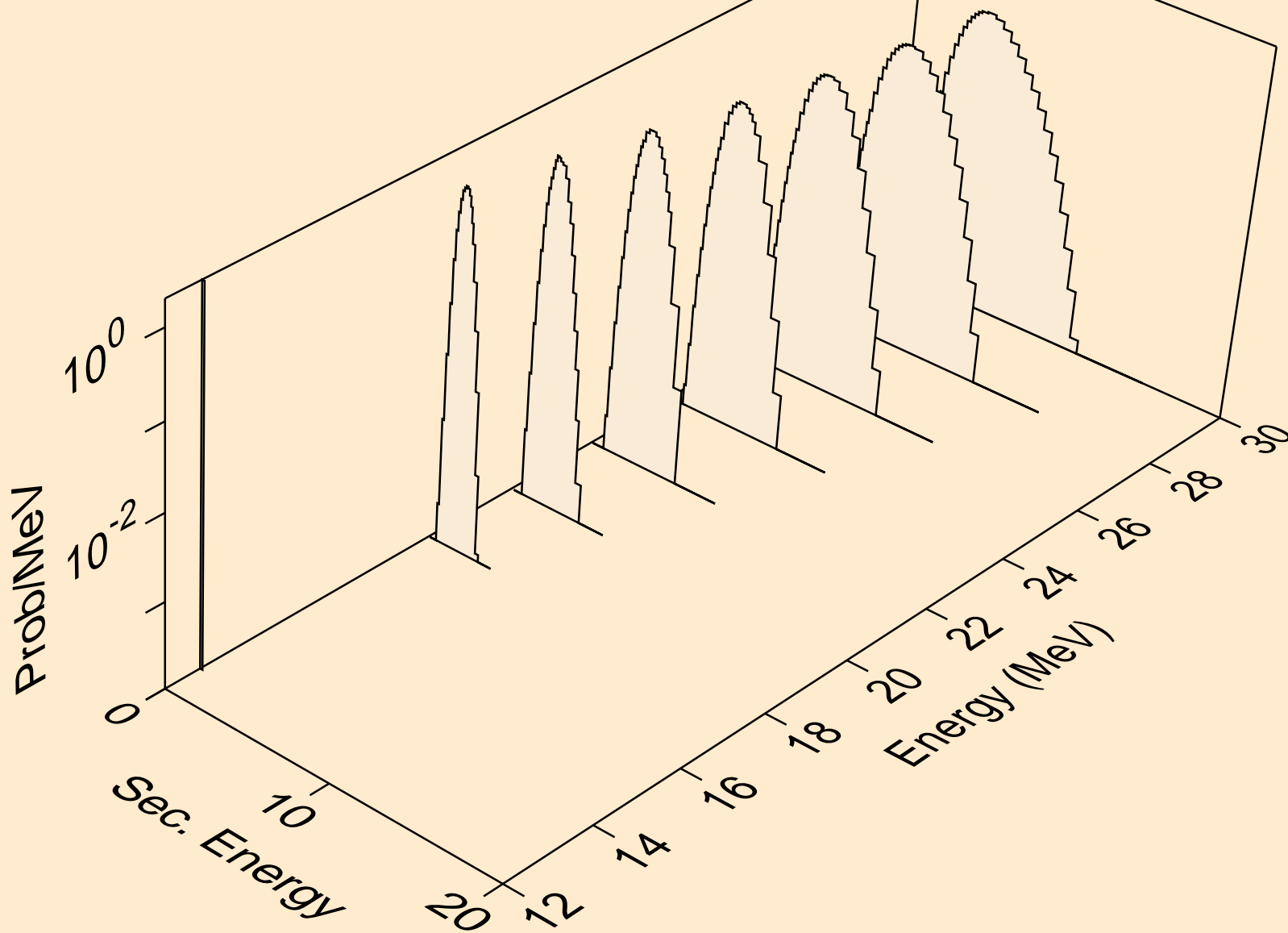

NI062 NEUTRON ACER TENDL-2023 LIBRARY; T=0.K
protons from (n,pd)

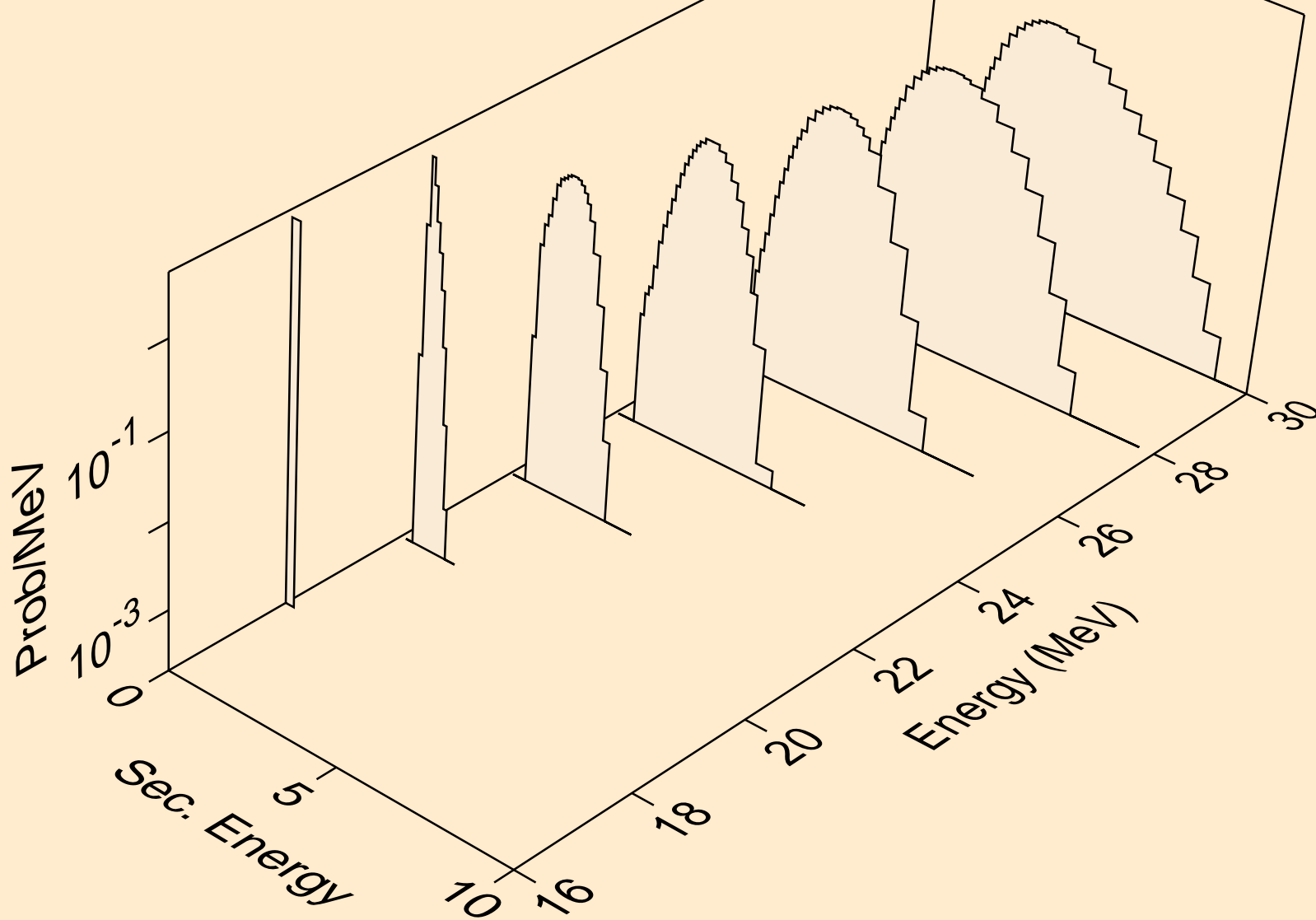

NI062 NEUTRON ACER TENDL-2023 LIBRARY; T=0.K
protons from (n,pt)

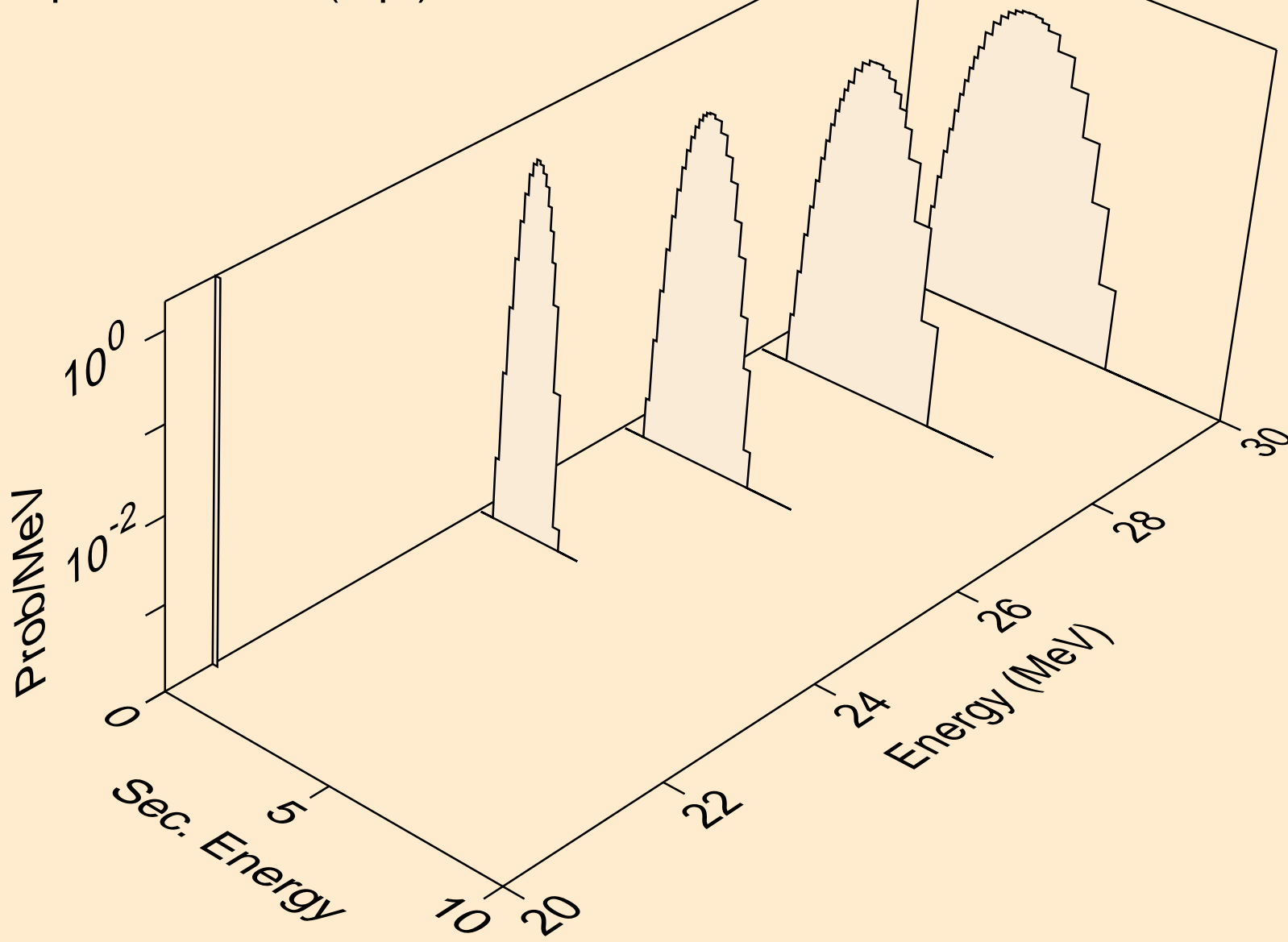

NI062 NEUTRON ACER TENDL-2023 LIBRARY; T=0.K
deuterons from (n,x)

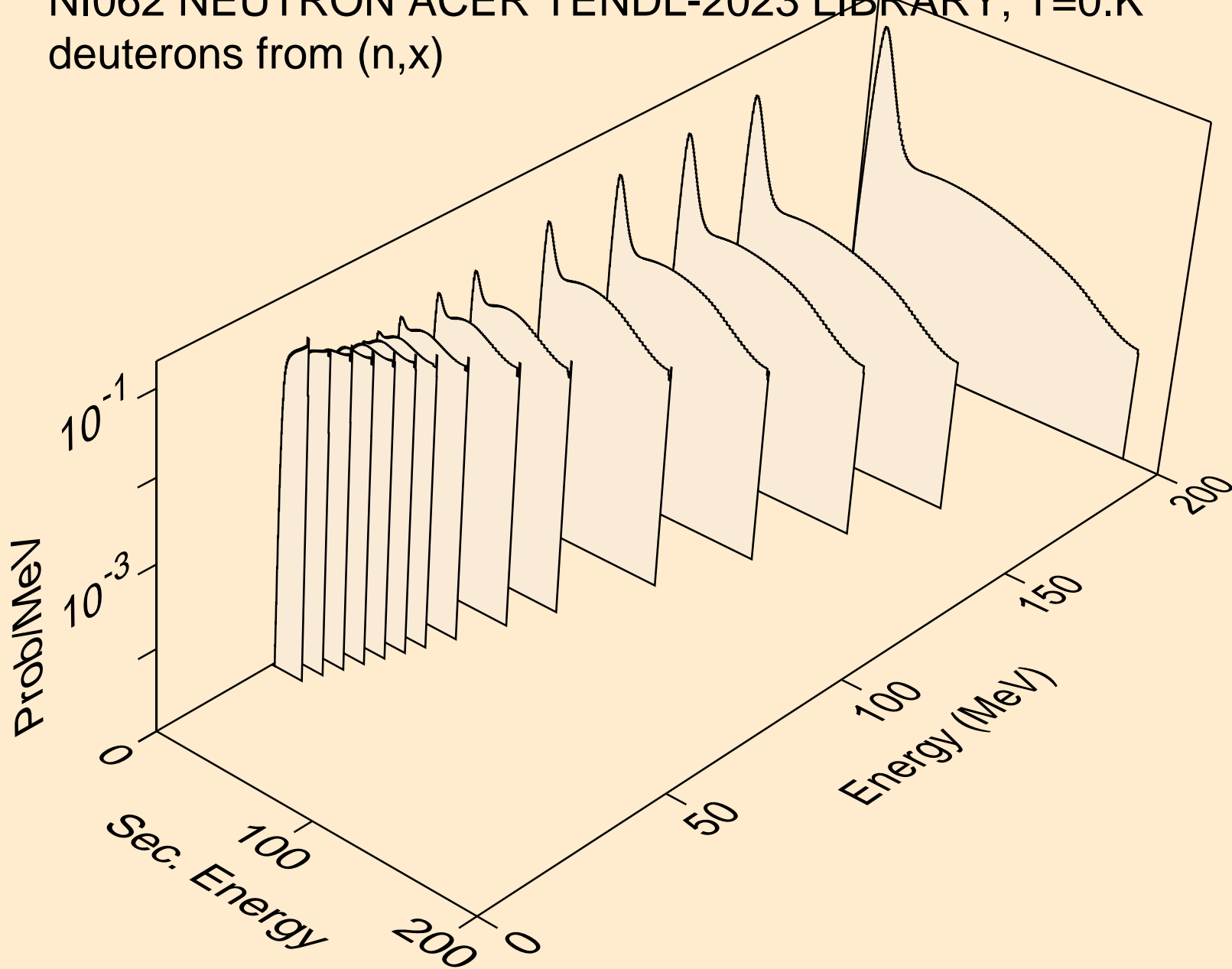

NI062 NEUTRON ACER TENDL-2023 LIBRARY; T=0.K
deuterons from (n,2nd)

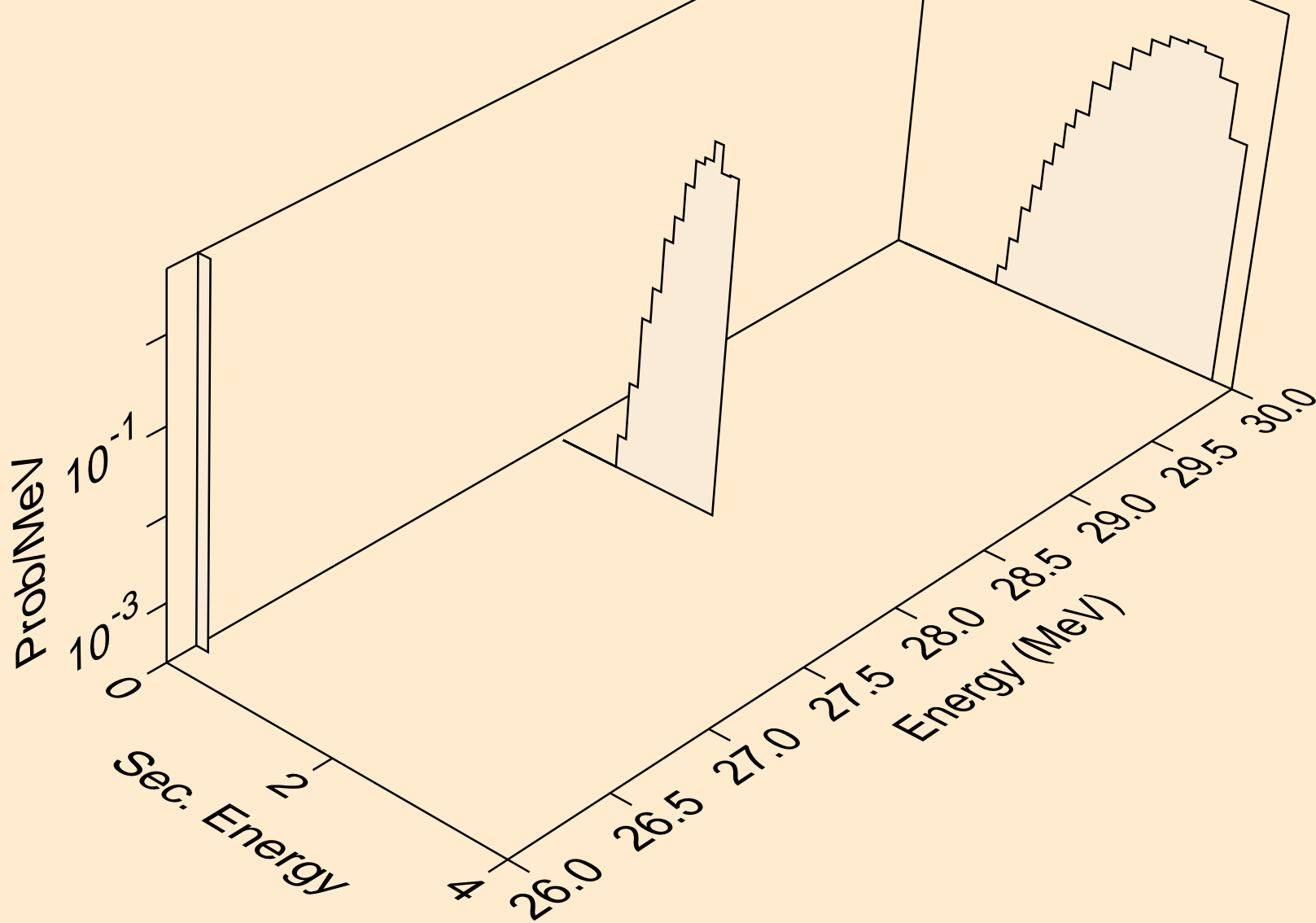

NI062 NEUTRON ACER TENDL-2023 LIBRARY; T=0.K
deuterons from (n,n*)d

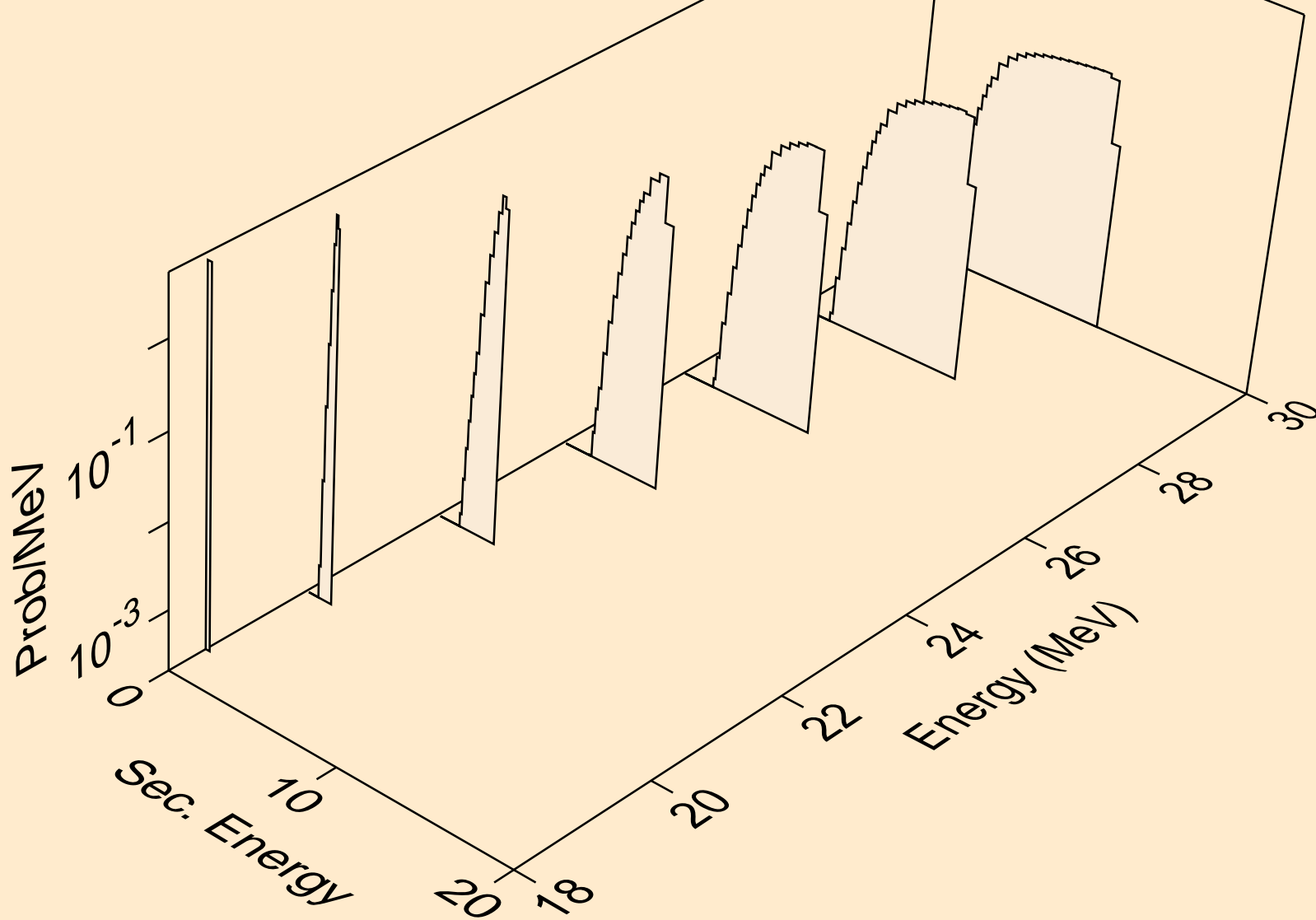

NI062 NEUTRON ACER TENDL-2023 LIBRARY; T=0.K
deuterons from (n,d)

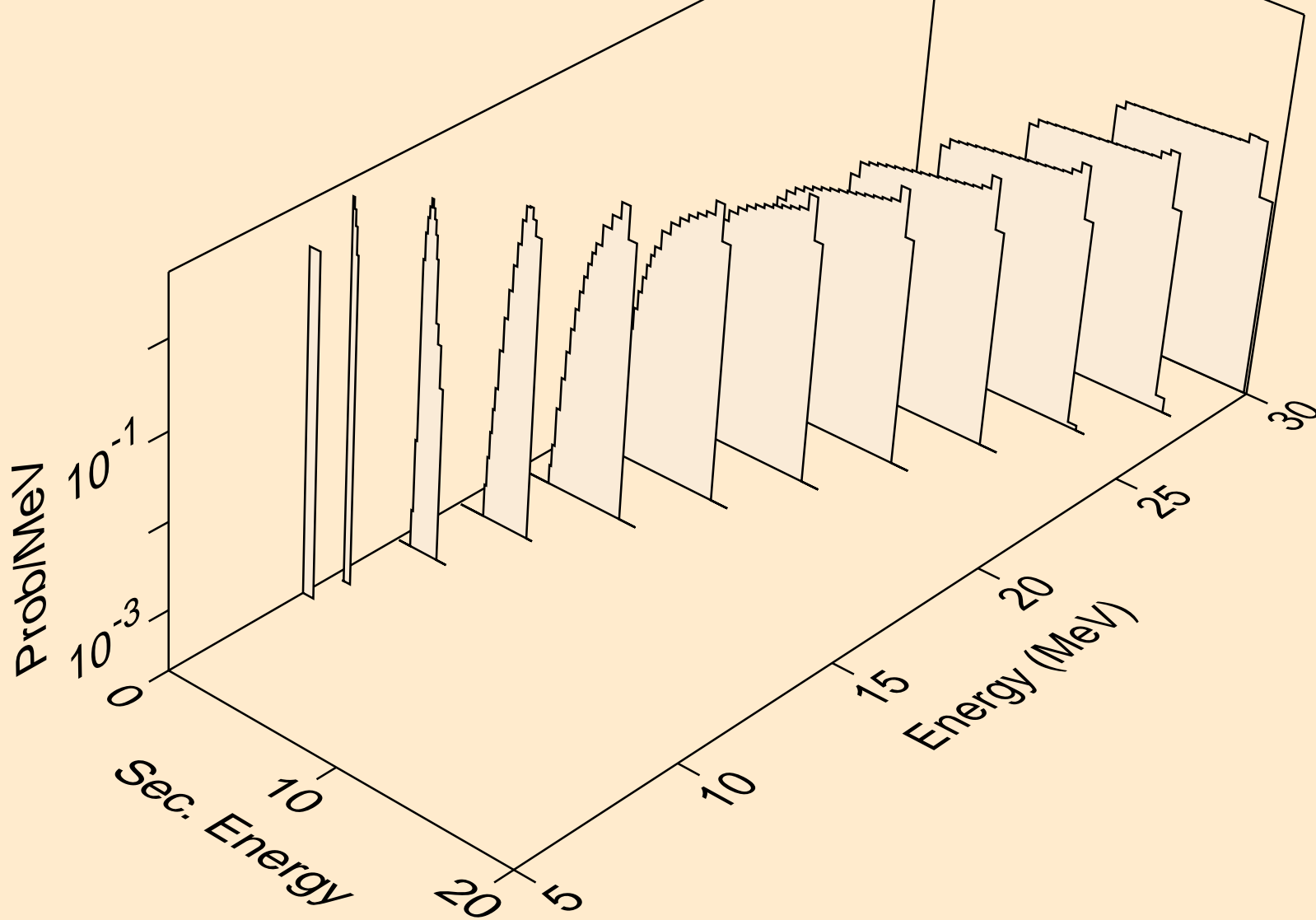

NI062 NEUTRON ACER TENDL-2023 LIBRARY; T=0.K
deuterons from (n,pd)

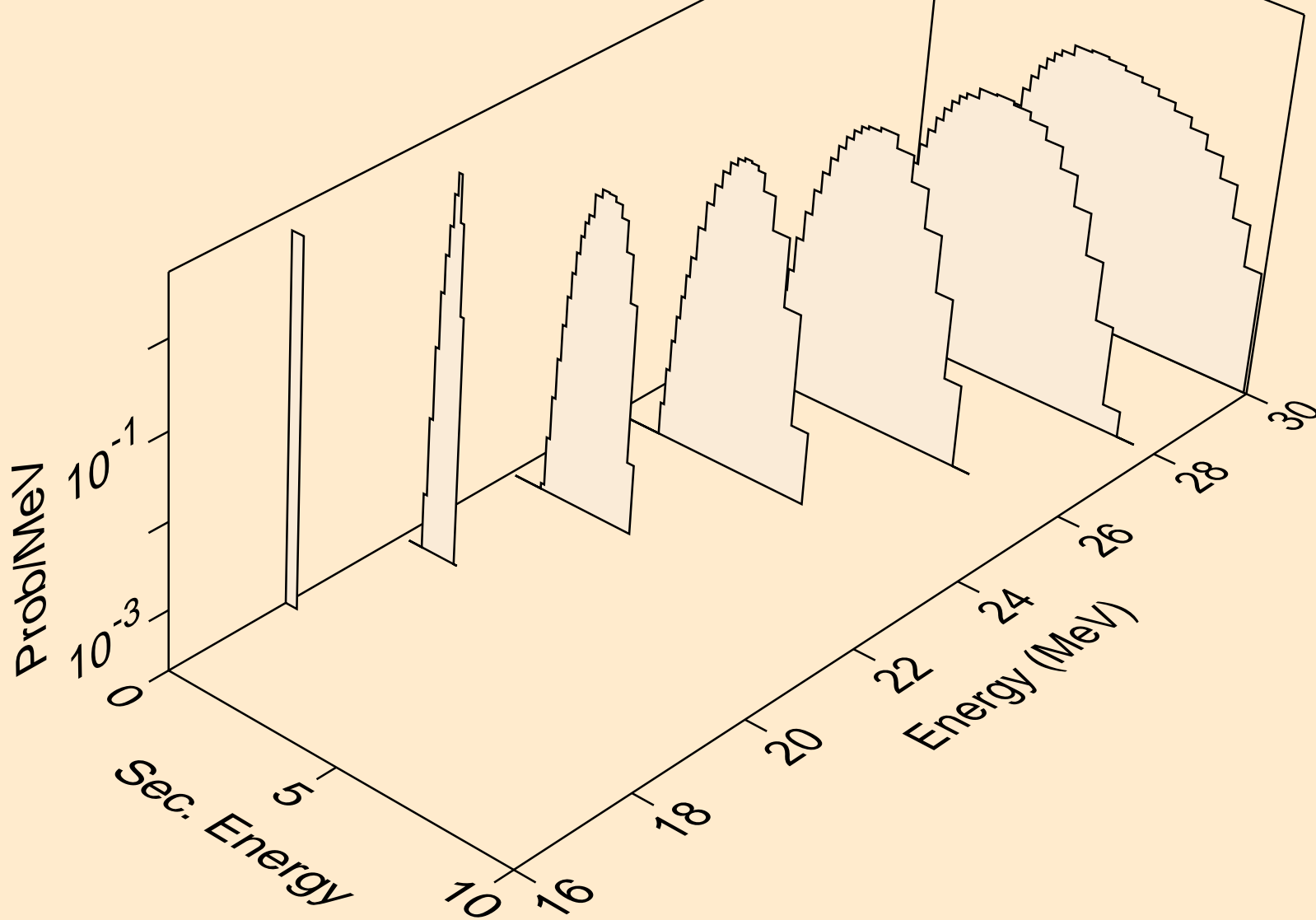

NI062 NEUTRON ACER TENDL-2023 LIBRARY; T=0.K
deuterons from (n,da)

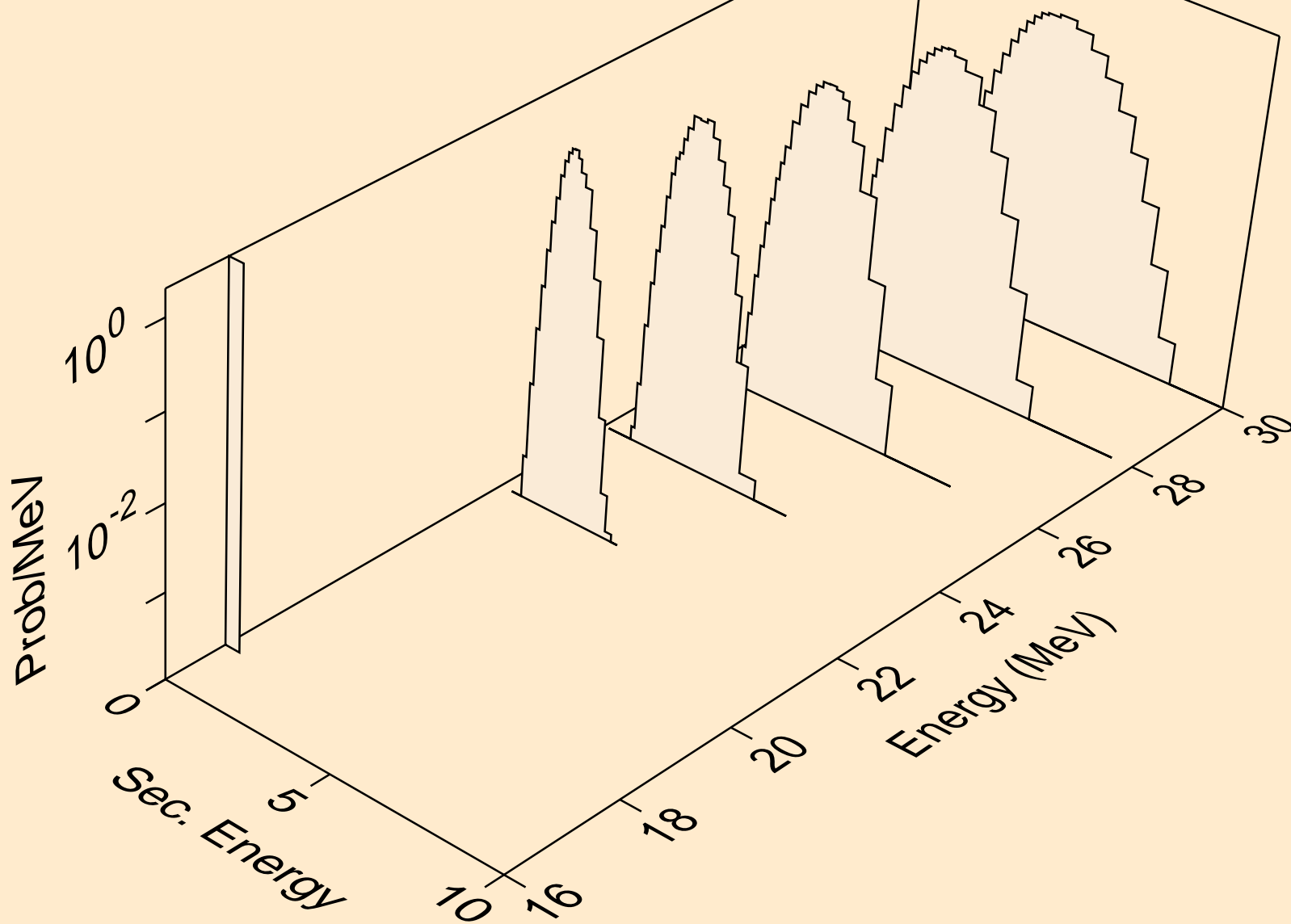

NI062 NEUTRON ACER TENDL-2023 LIBRARY; T=0.K
tritons from (n,x)

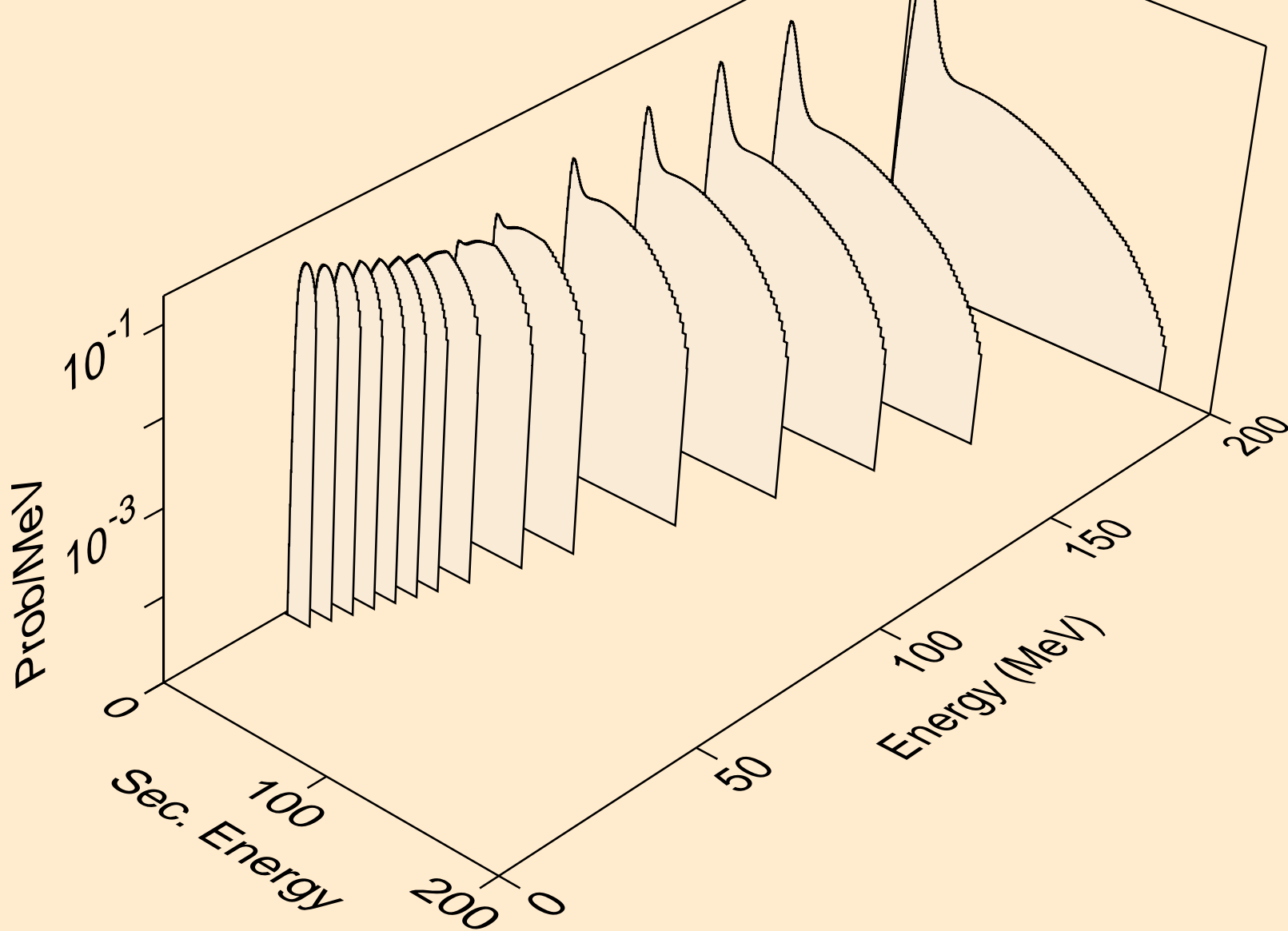

NI062 NEUTRON ACER TENDL-2023 LIBRARY; T=0.K
tritons from (n,n*)t

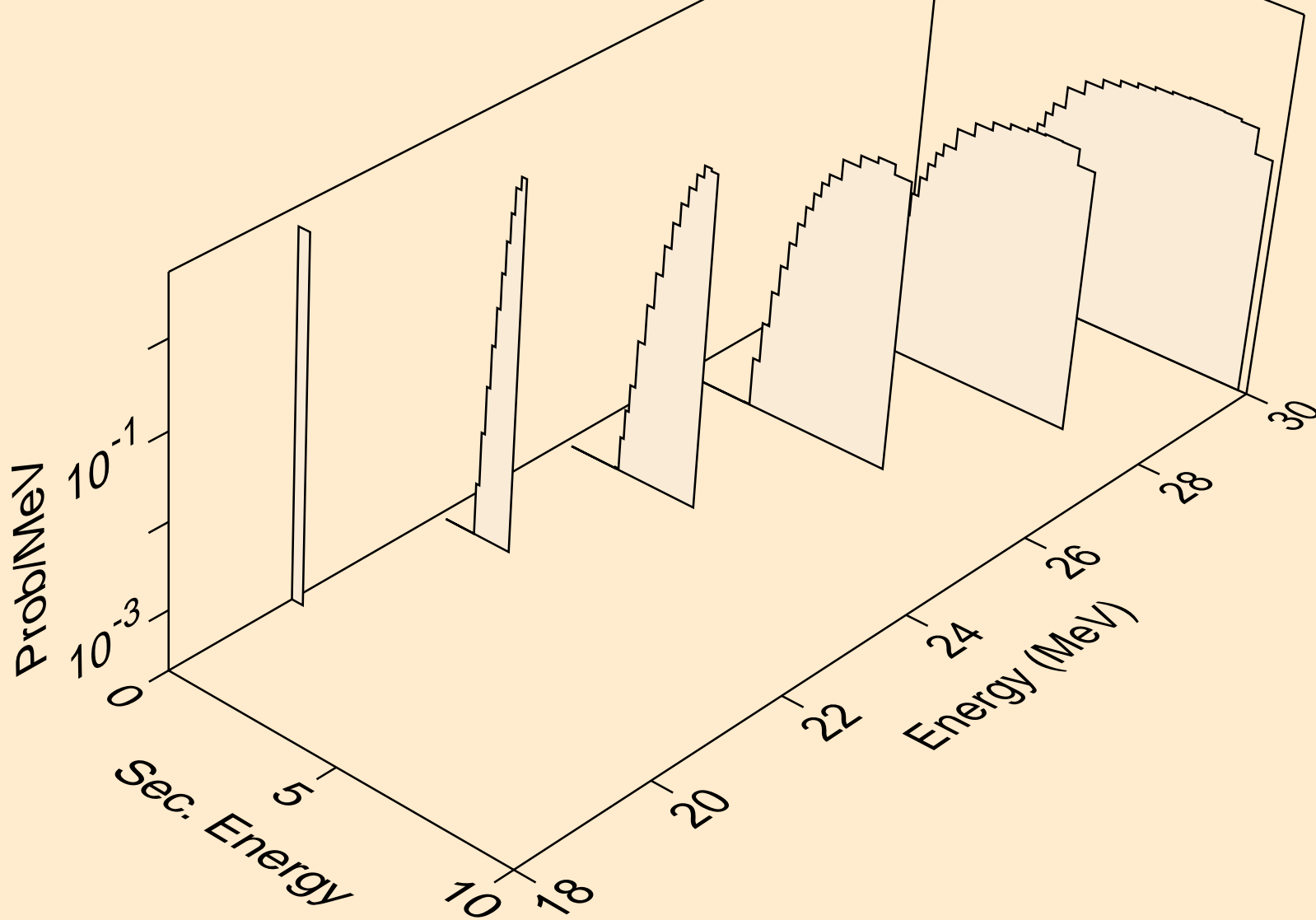

NI062 NEUTRON ACER TENDL-2023 LIBRARY; T=0.K
tritons from (n,t)

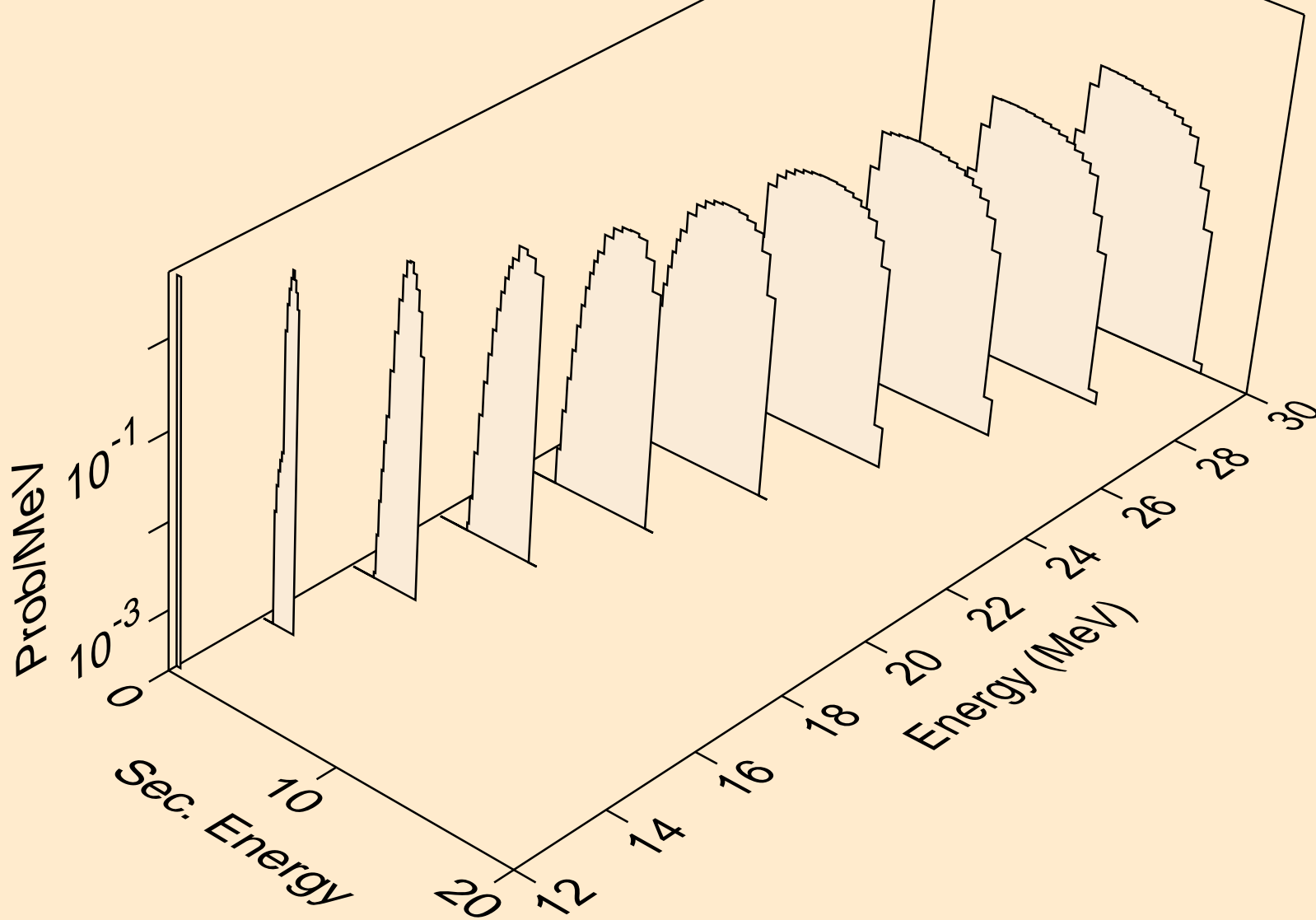

NI062 NEUTRON ACER TENDL-2023 LIBRARY; T=0.K
tritons from (n,pt)

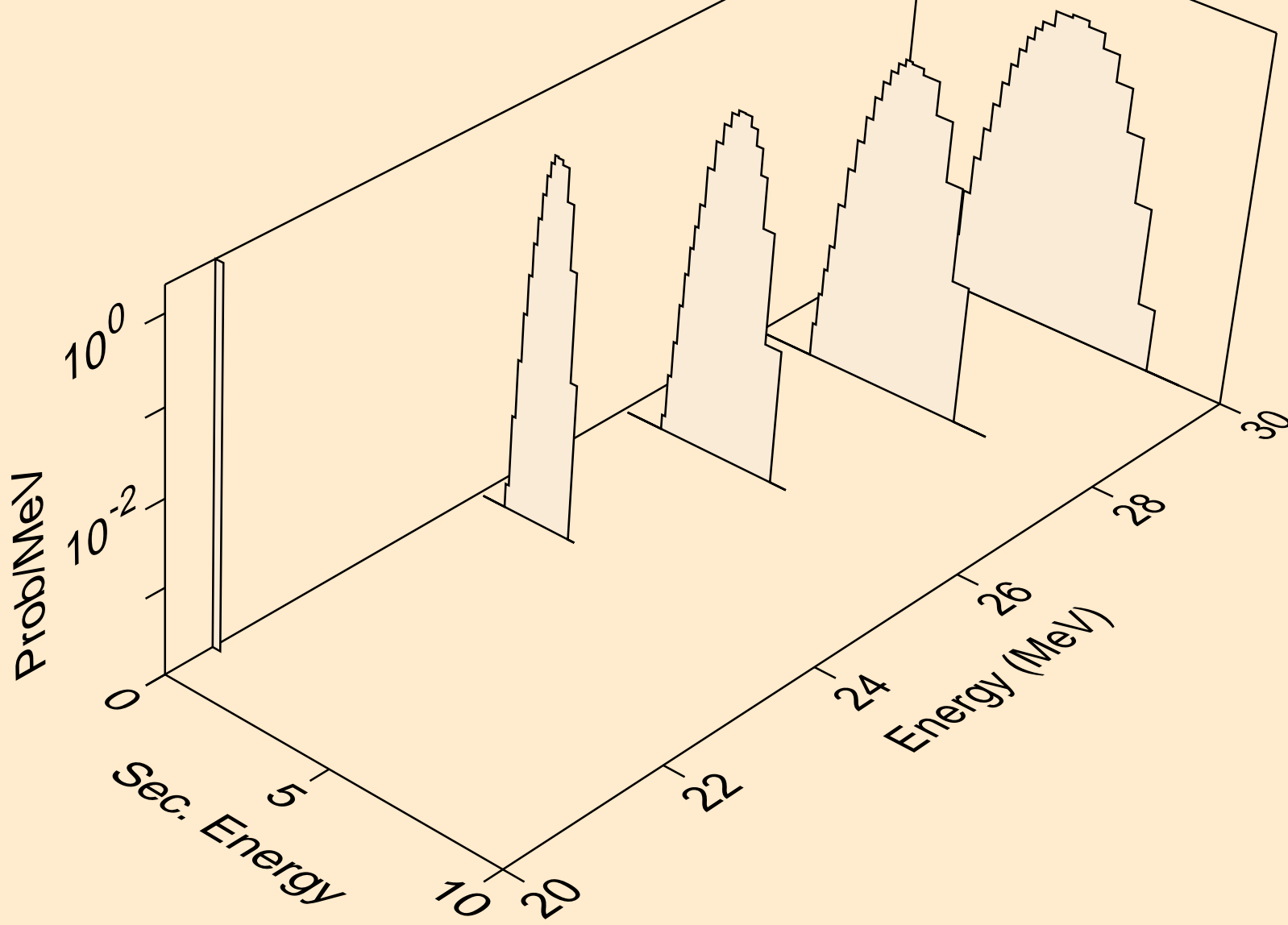

NI062 NEUTRON ACER TENDL-2023 LIBRARY; T=0.K
he3s from (n,x)

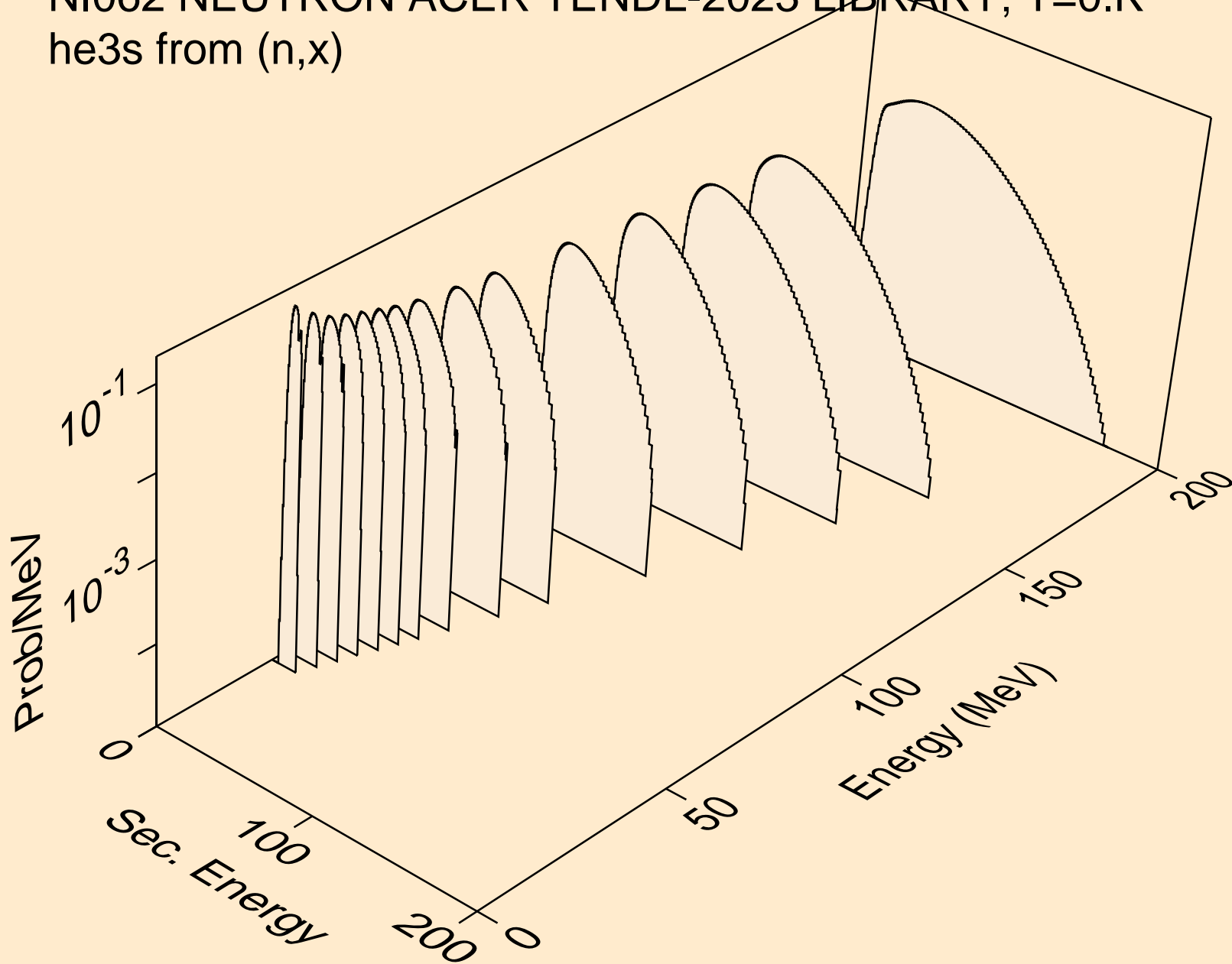

NI062 NEUTRON ACER TENDL-2023 LIBRARY; T=0.K
he3s from (n,n*)he3

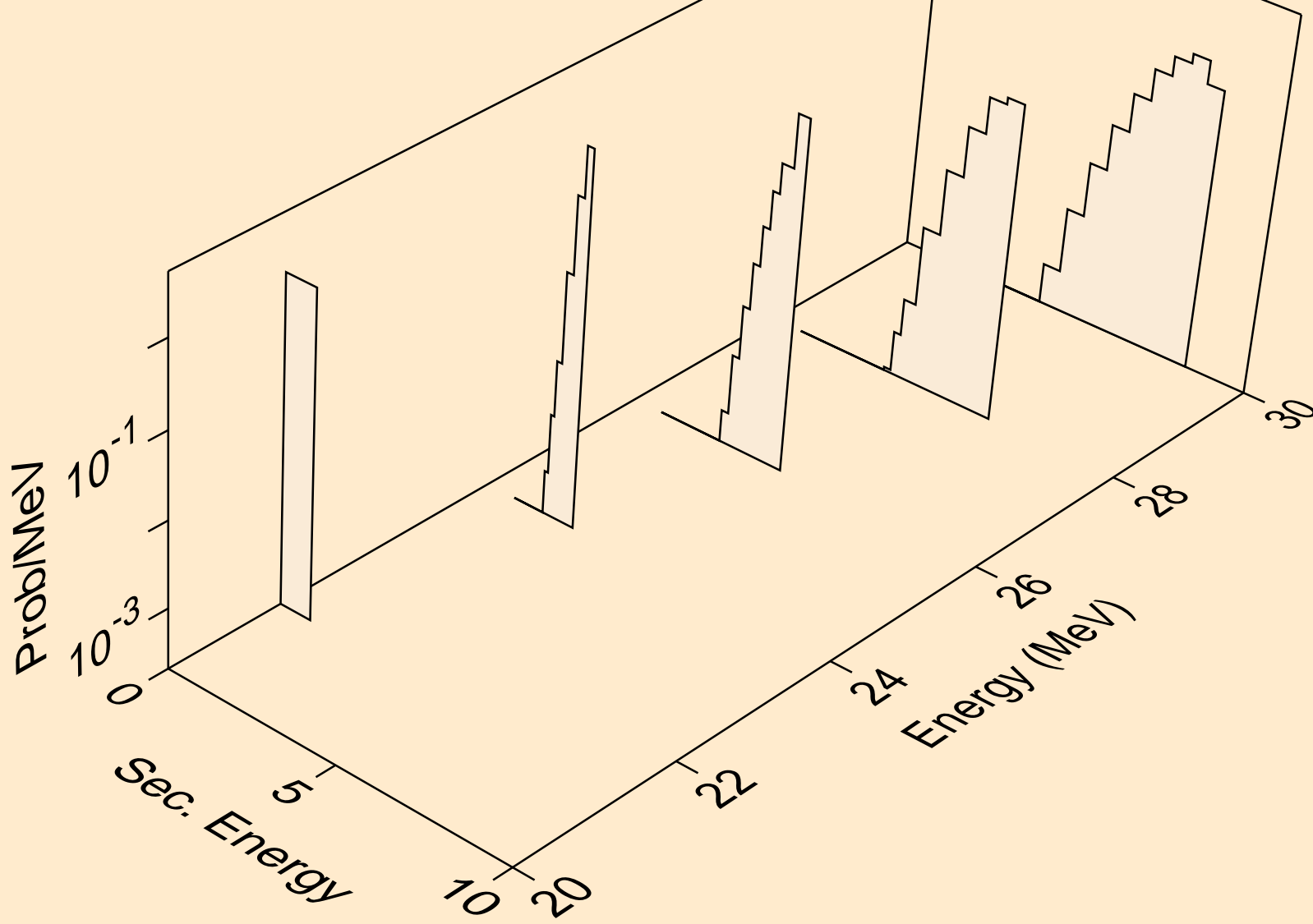

NI062 NEUTRON ACER TENDL-2023 LIBRARY; T=0.K
he3s from (n,he3)

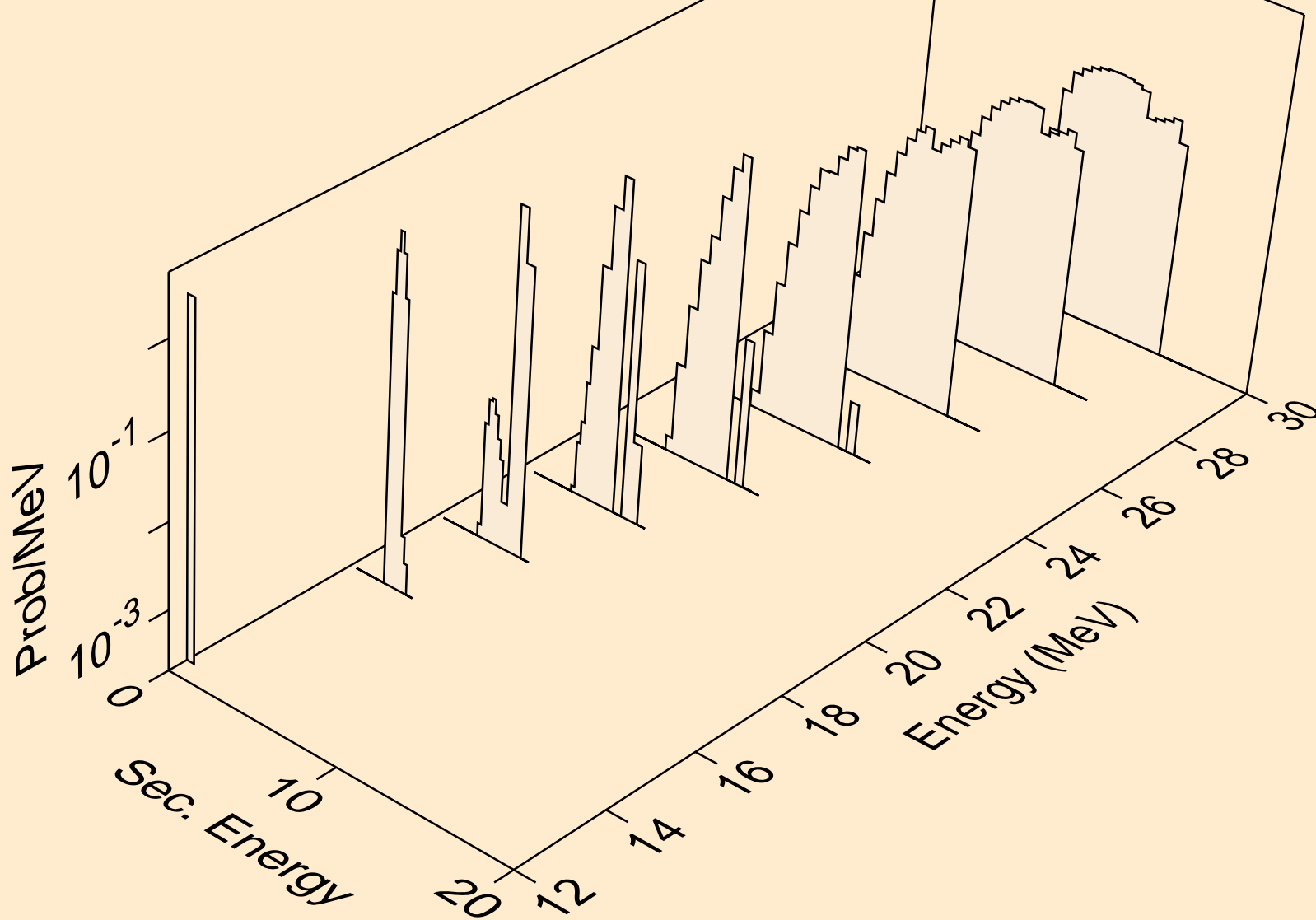

NI062 NEUTRON ACER TENDL-2023 LIBRARY; T=0.K
alphas from (n,x)

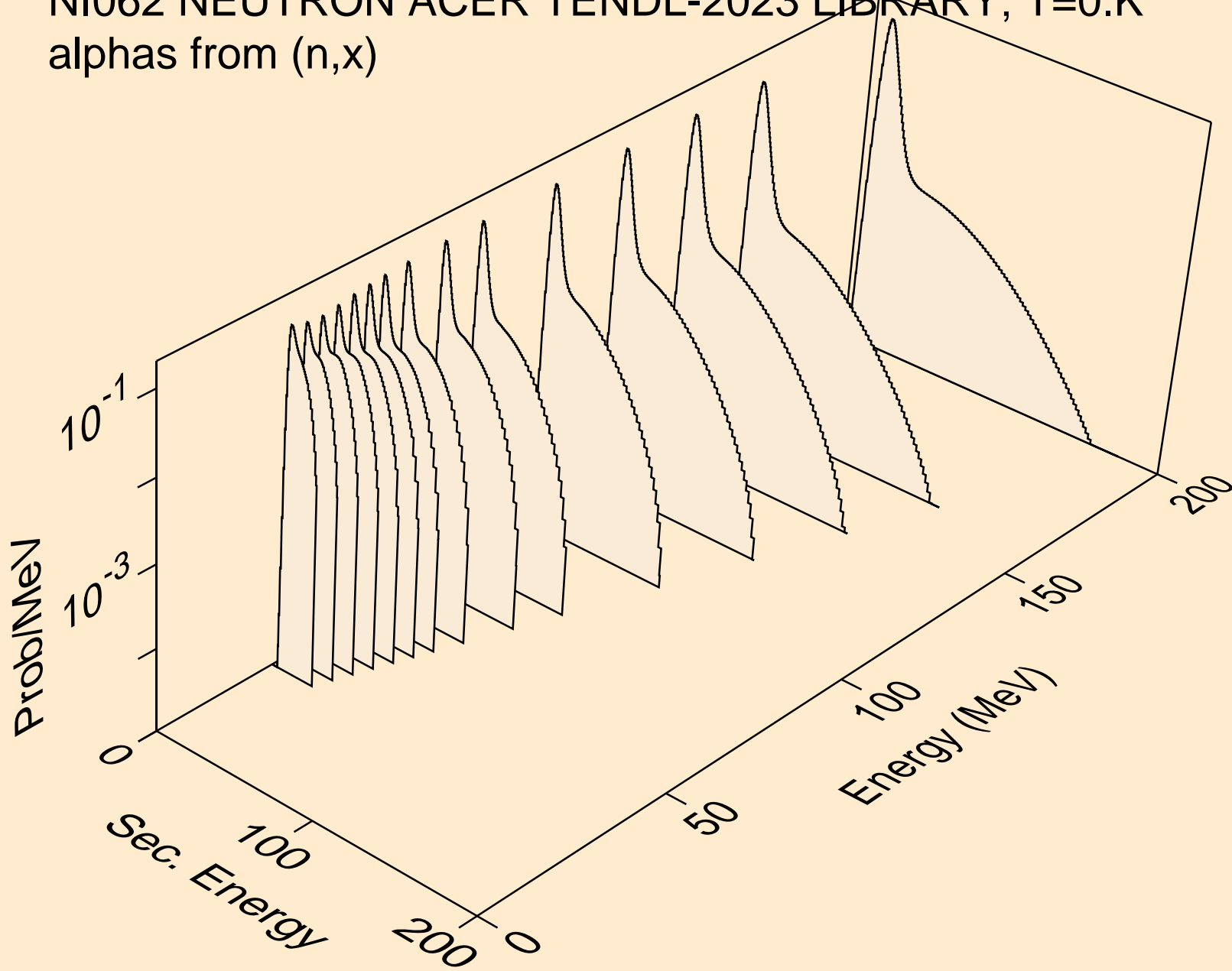

NI062 NEUTRON ACER TENDL-2023 LIBRARY; T=0.K
alphas from (n,n*)a

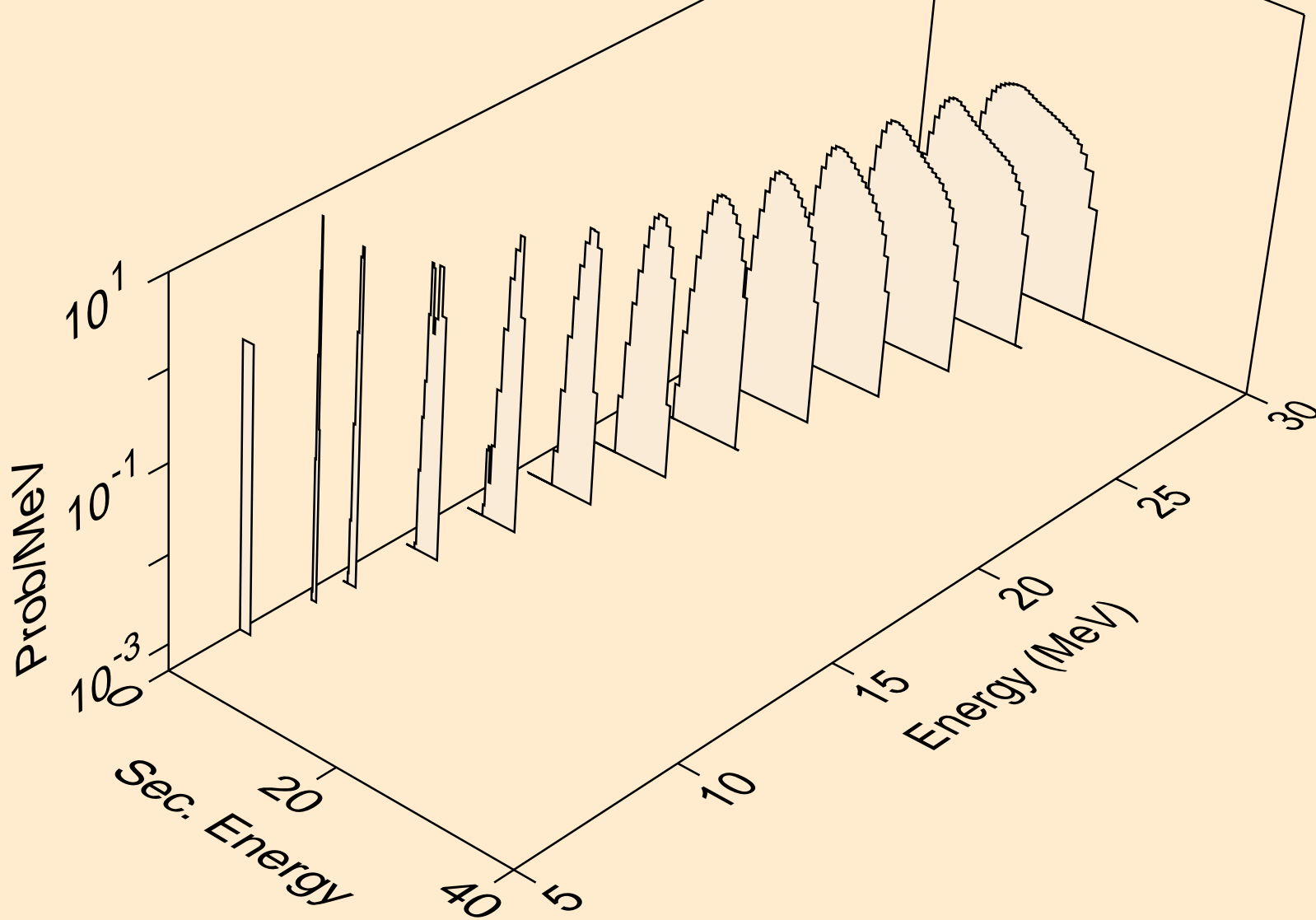

NI062 NEUTRON ACER TENDL-2023 LIBRARY; T=0.K
alphas from (n,2n)a

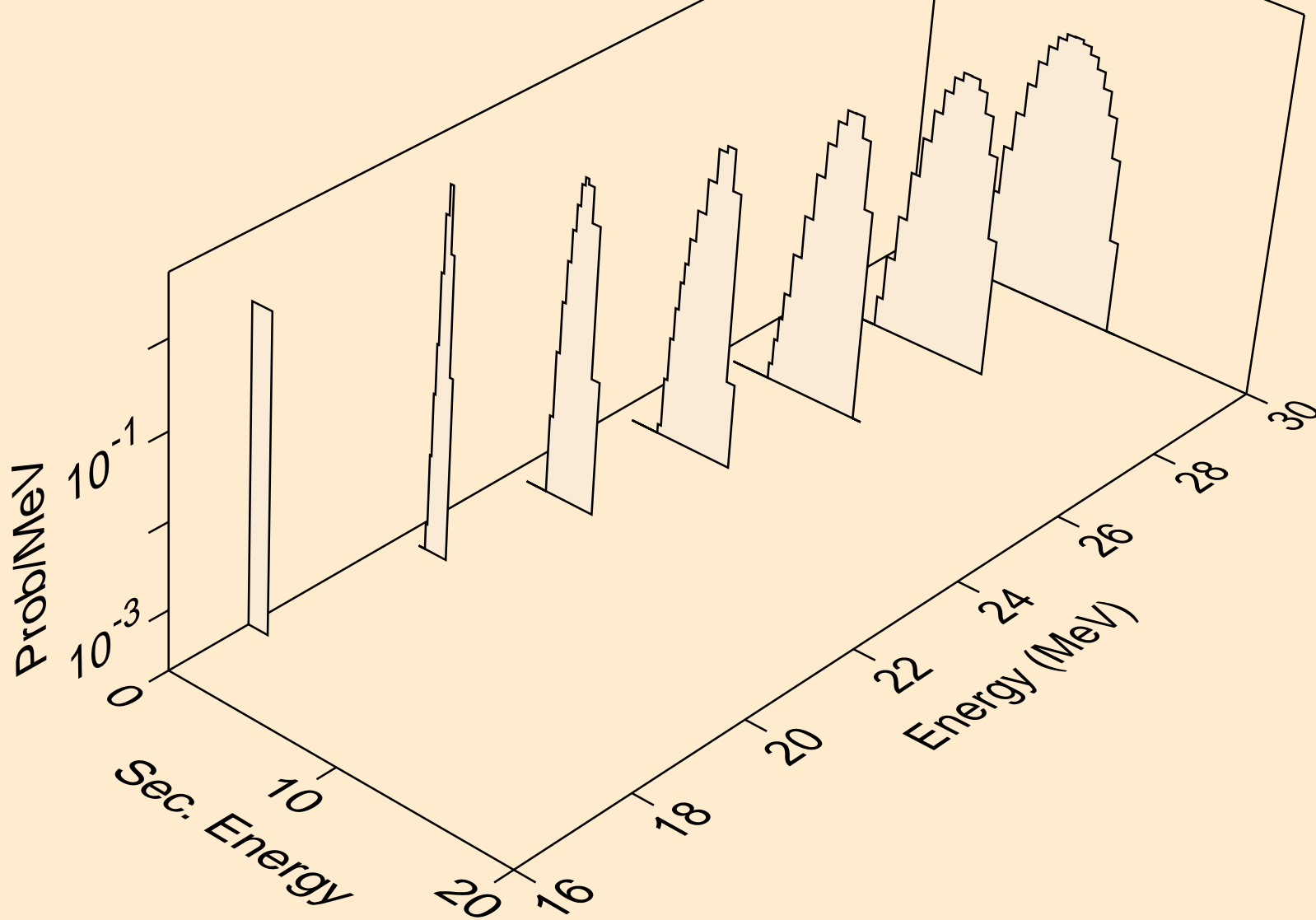

NI062 NEUTRON ACER TENDL-2023 LIBRARY; T=0.K
alphas from (n,3n)a

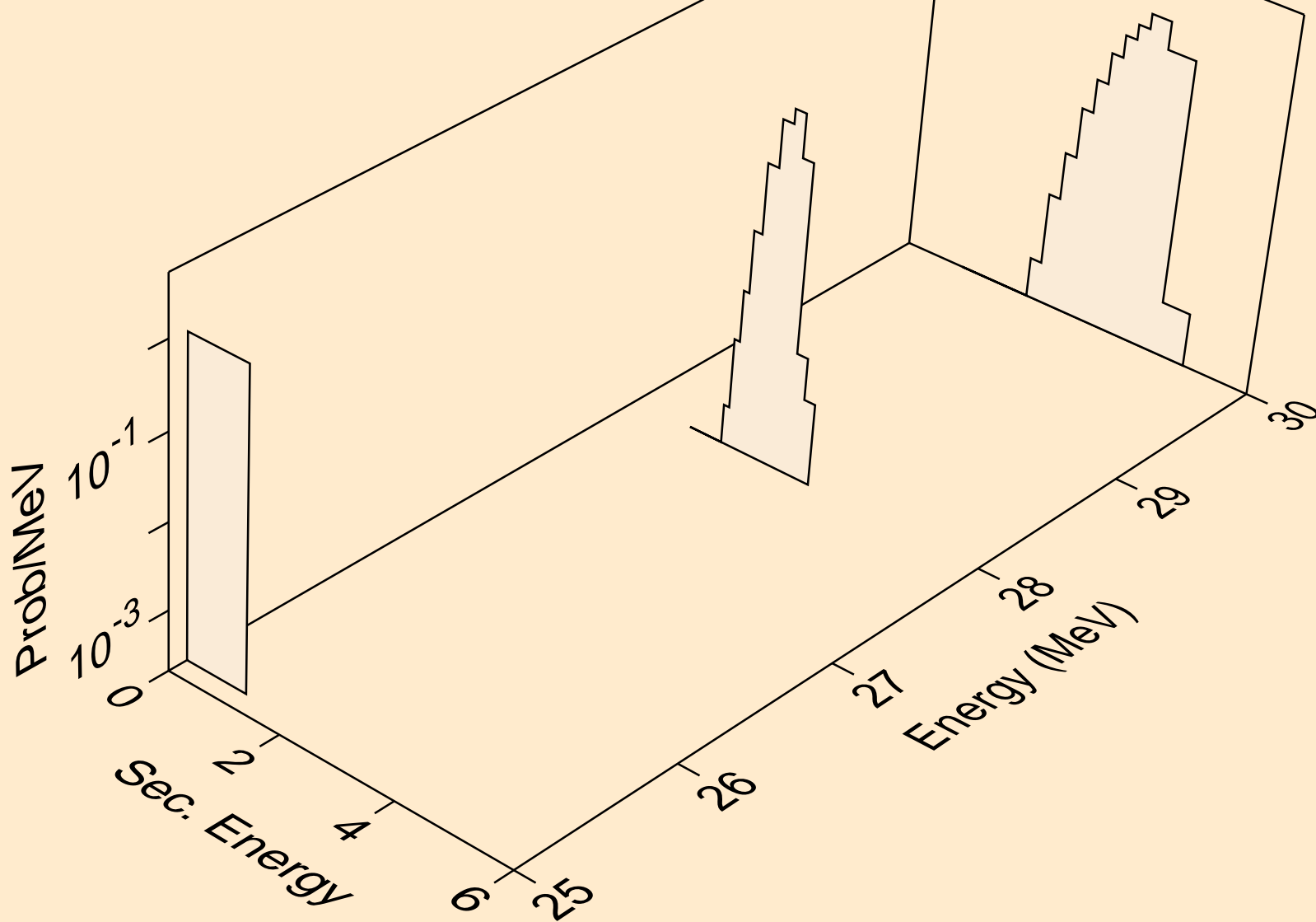

NI062 NEUTRON ACER TENDL-2023 LIBRARY; T=0.K
alphas from (n,n*)2a

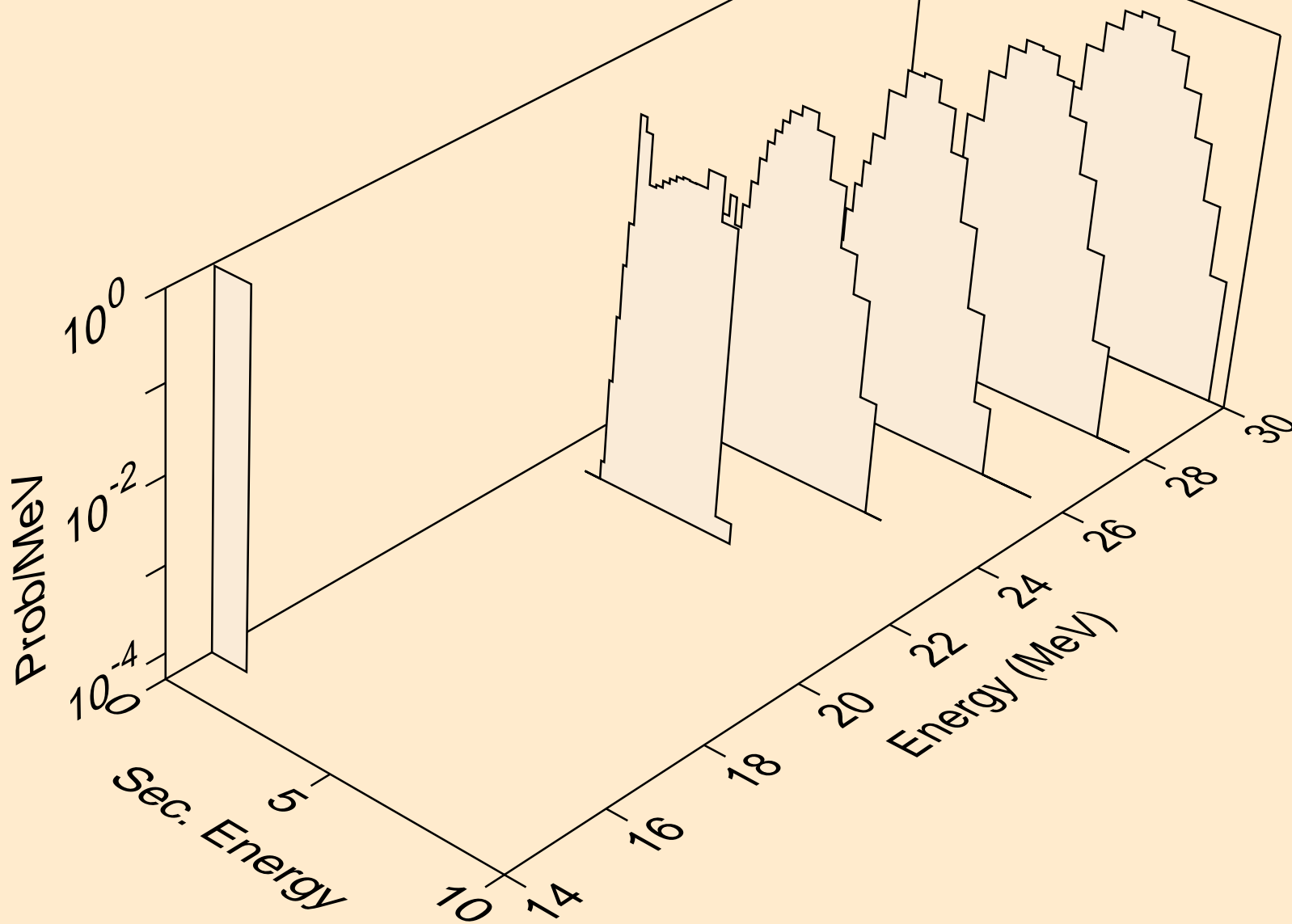

NI062 NEUTRON ACER TENDL-2023 LIBRARY; T=0.K
alphas from (n,npa)

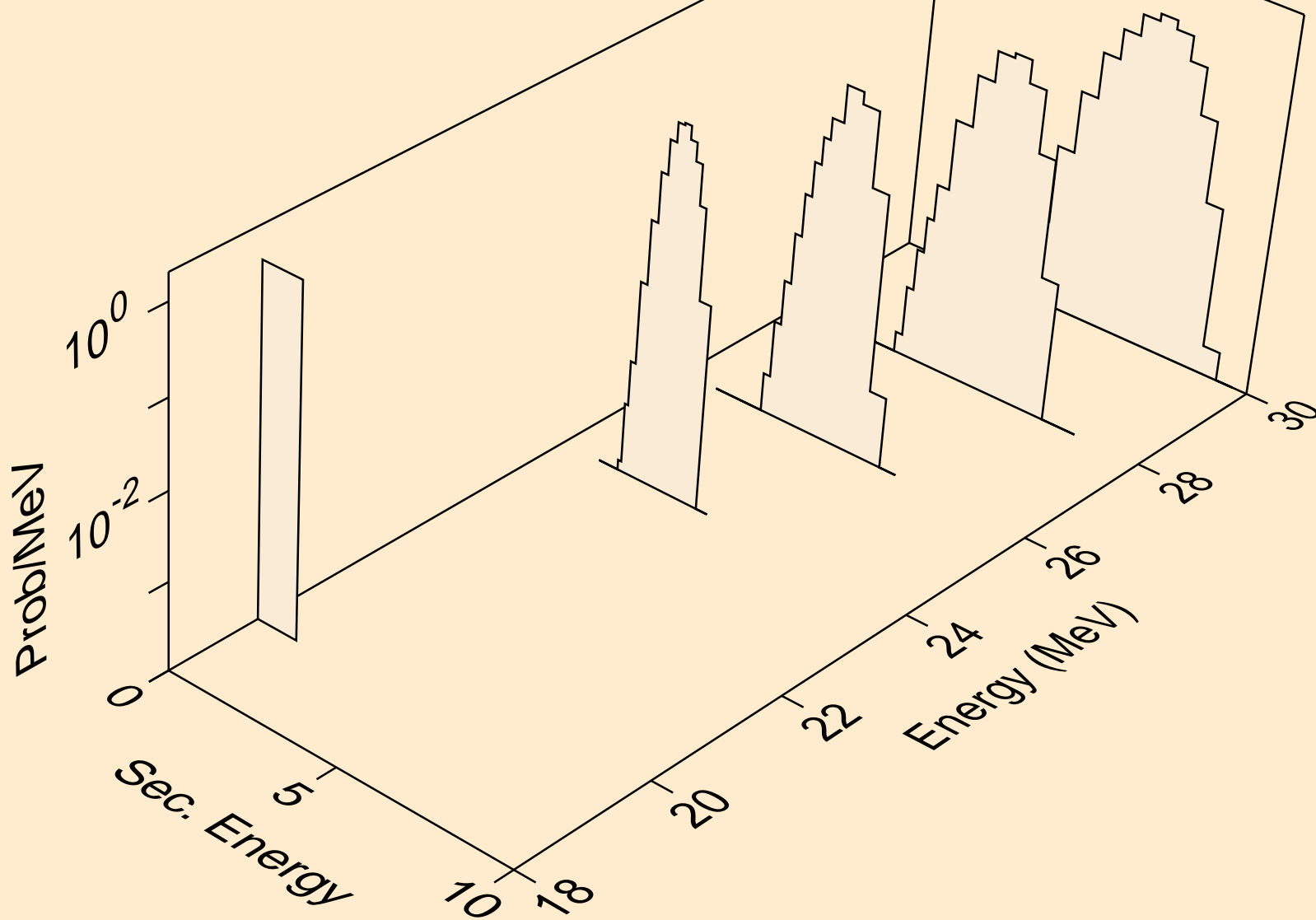

NI062 NEUTRON ACER TENDL-2023 LIBRARY; T=0.K
alphas from (n,a)

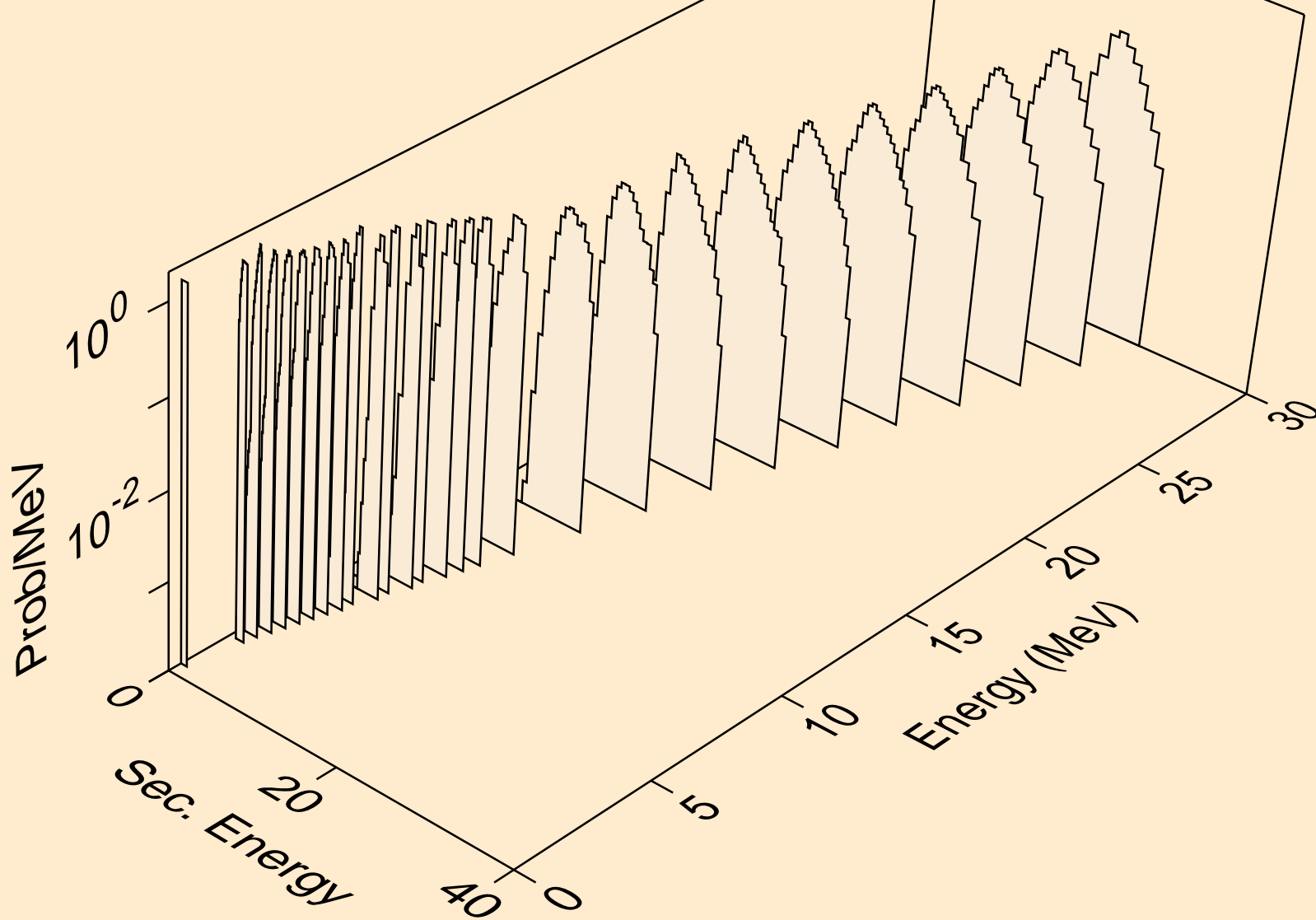

NI062 NEUTRON ACER TENDL-2023 LIBRARY; T=0.K
alphas from (n,2a)

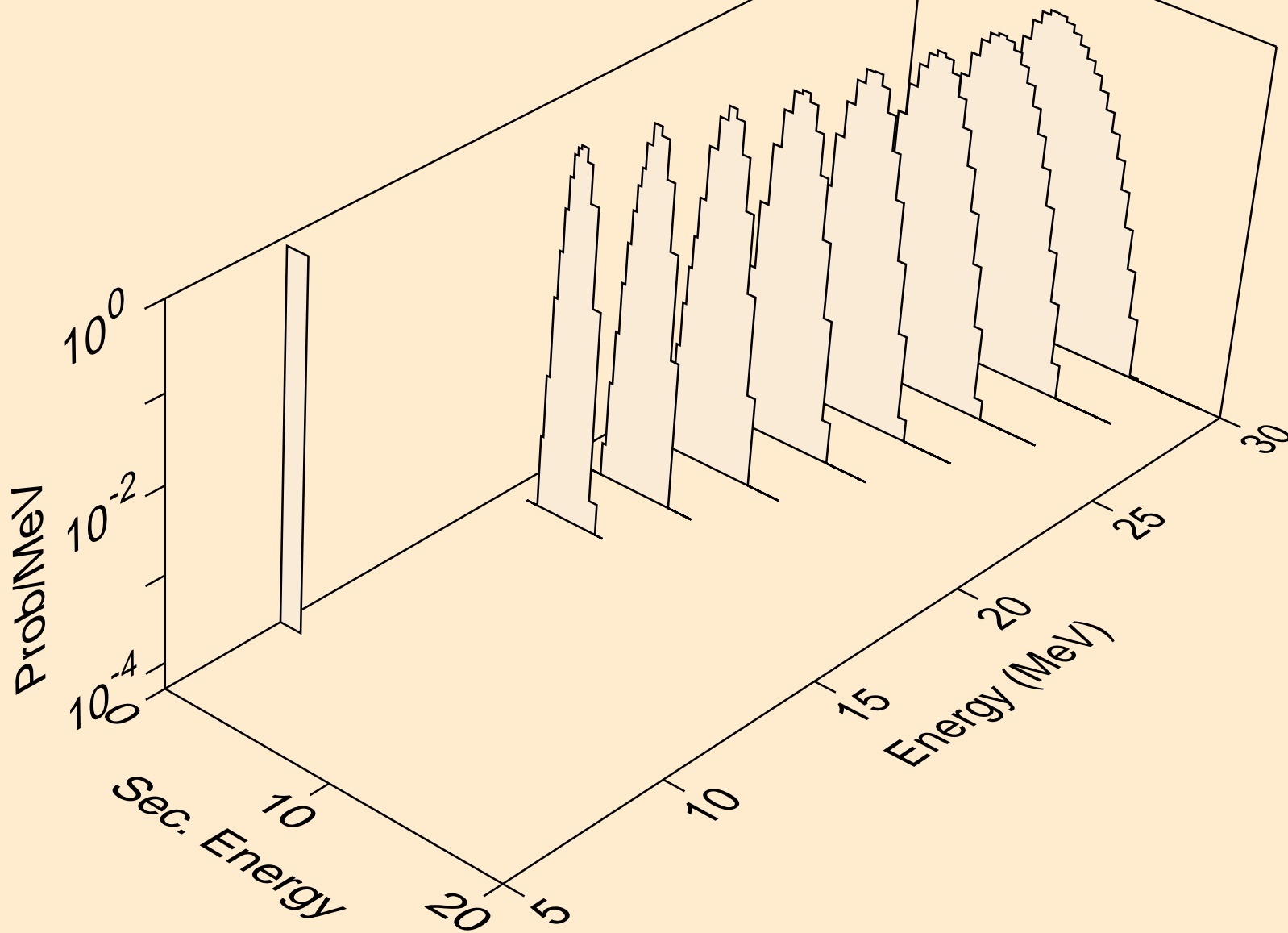

NI062 NEUTRON ACER TENDL-2023 LIBRARY; T=0.K
alphas from (n,pa)

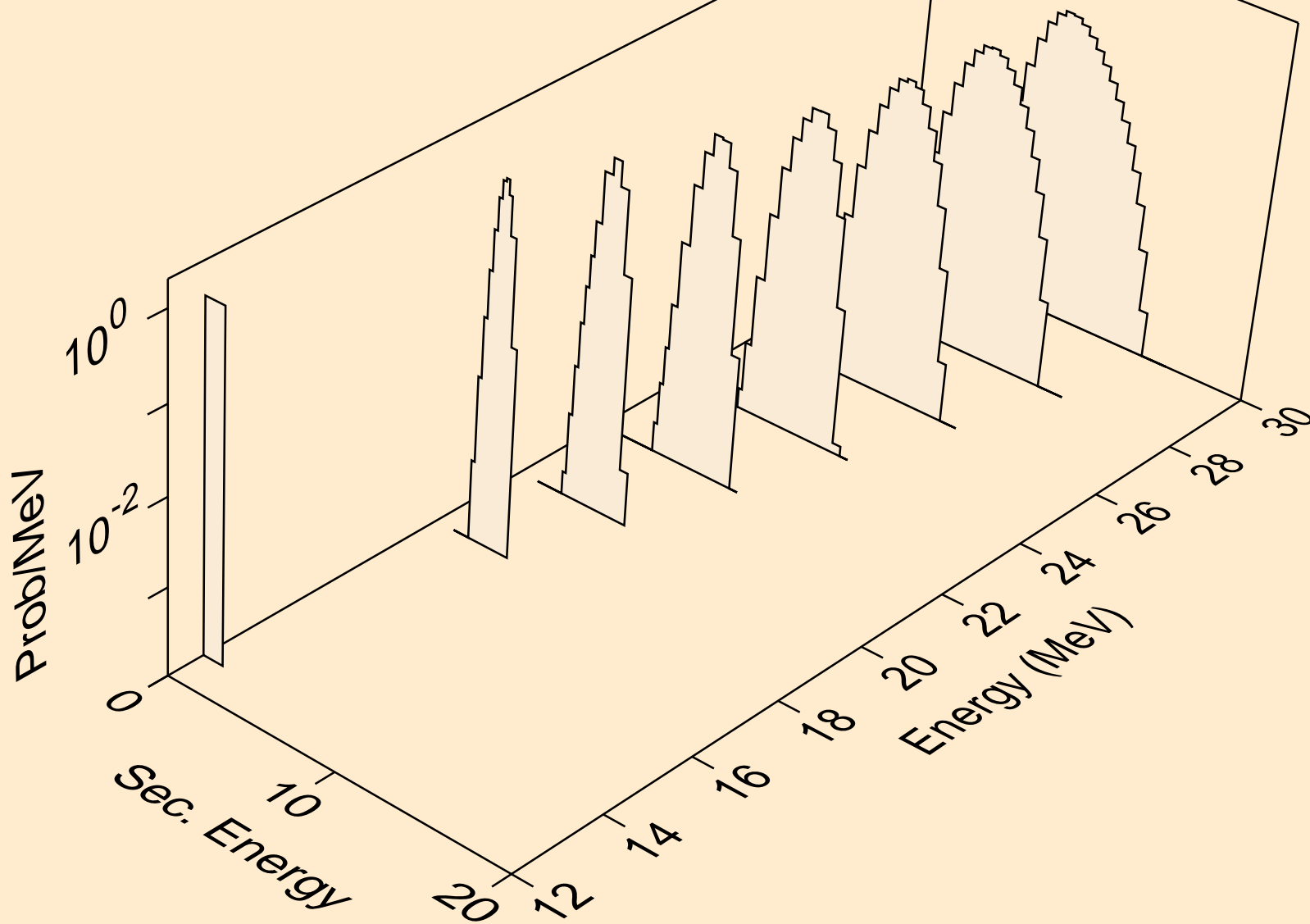

NI062 NEUTRON ACER TENDL-2023 LIBRARY; T=0.K
alphas from (n,da)

