

# NI068 NEUTRON ACER TENDL-2023 LIBRARY; T=0.K

## Principal cross sections

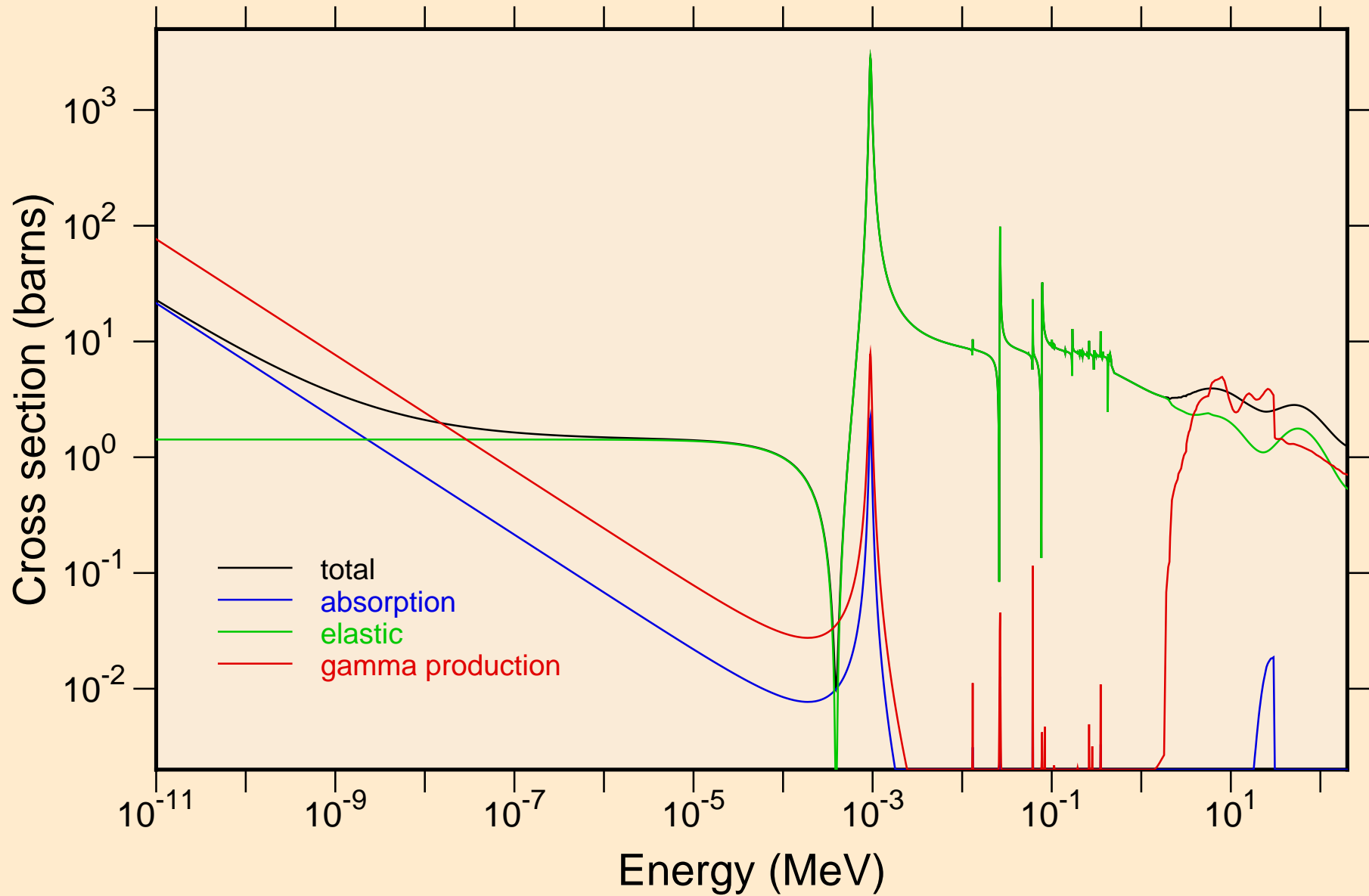

NI068 NEUTRON ACER TENDL-2023 LIBRARY; T=0.K  
resonance total cross section

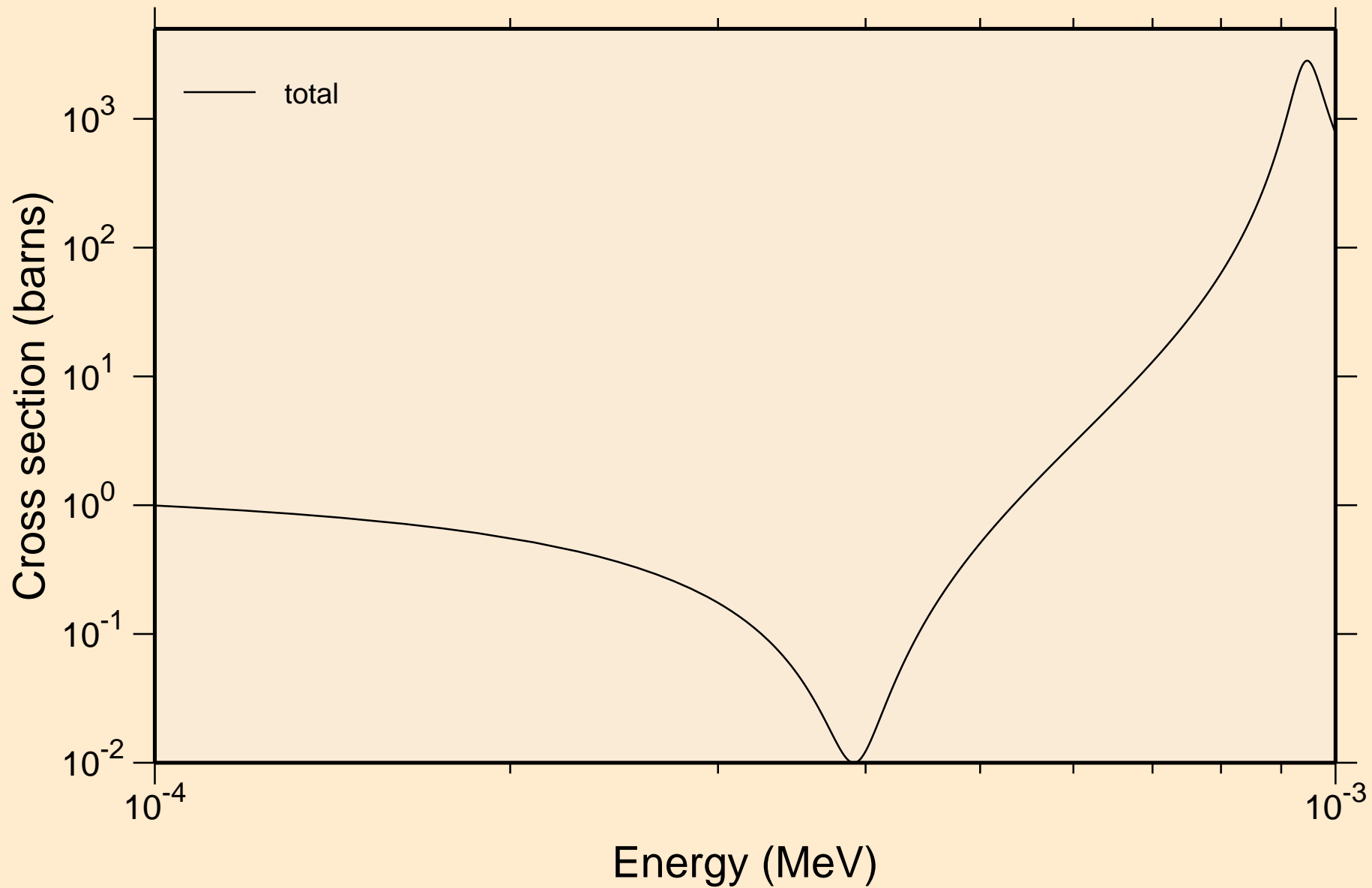

NI068 NEUTRON ACER TENDL-2023 LIBRARY; T=0.K  
resonance total cross section

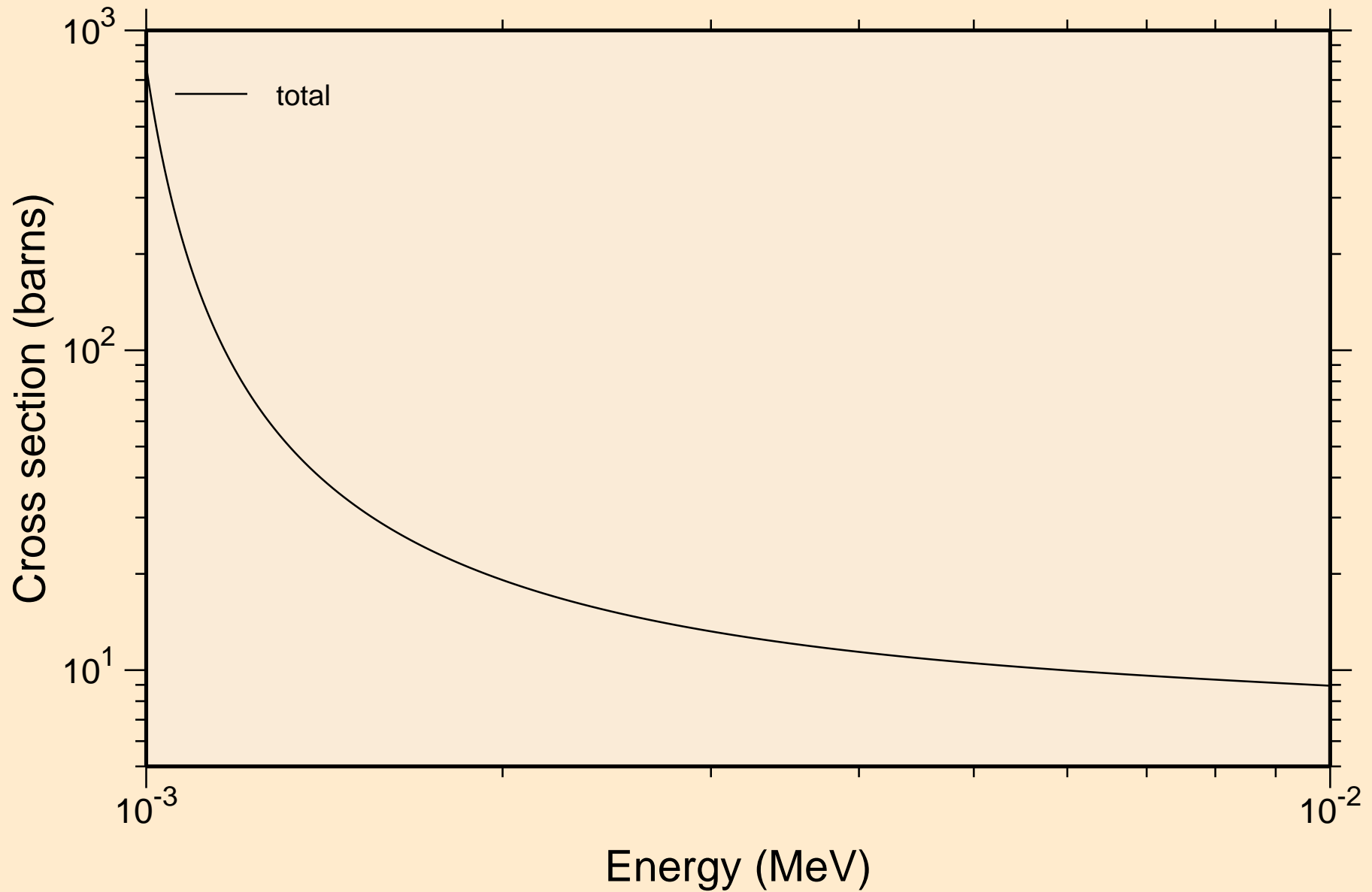



NI068 NEUTRON ACER TENDL-2023 LIBRARY; T=0.K  
resonance total cross section

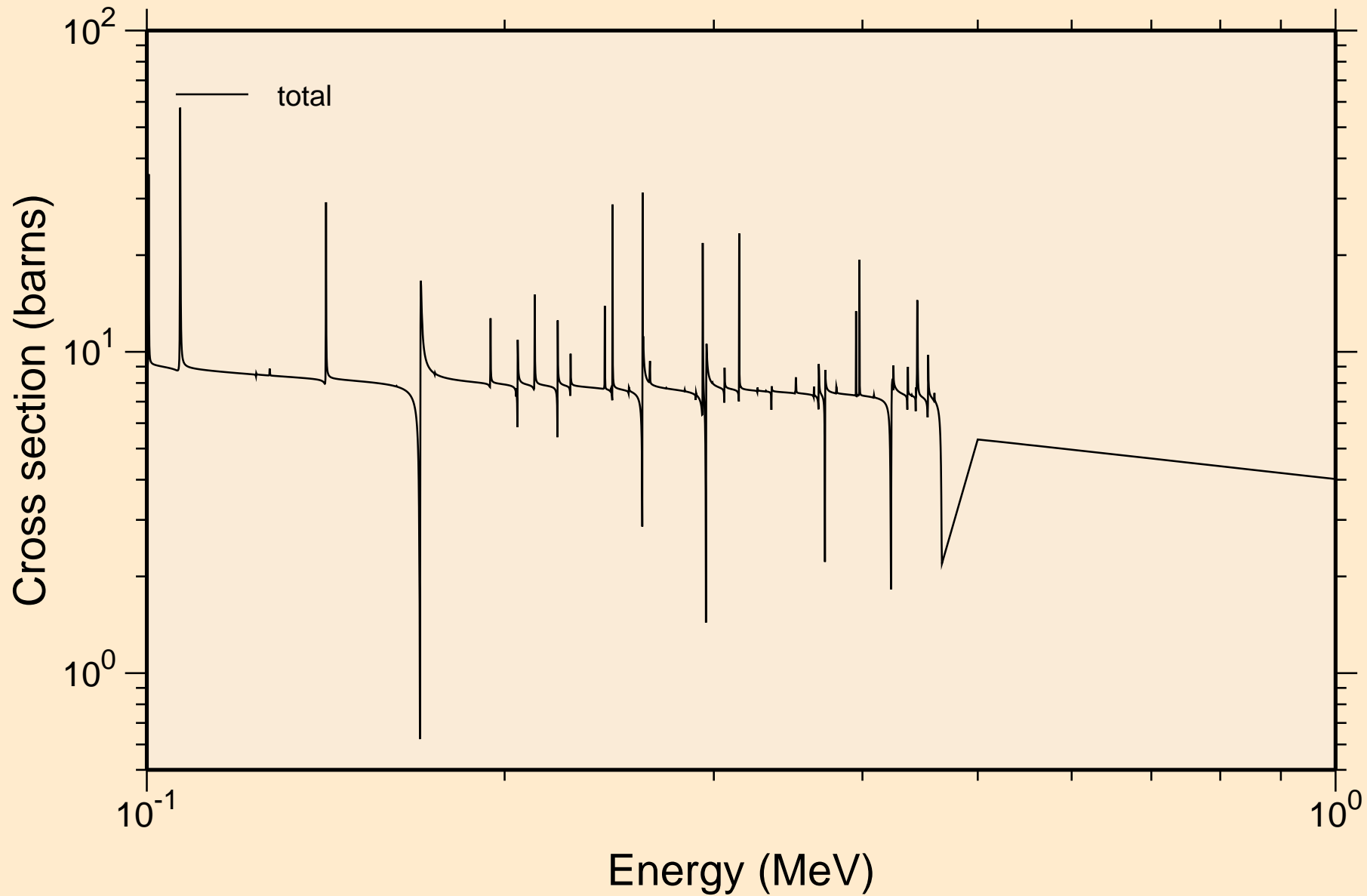

Ni068 NEUTRON ACER TENDL-2023 LIBRARY; T=0.K  
resonance total cross section

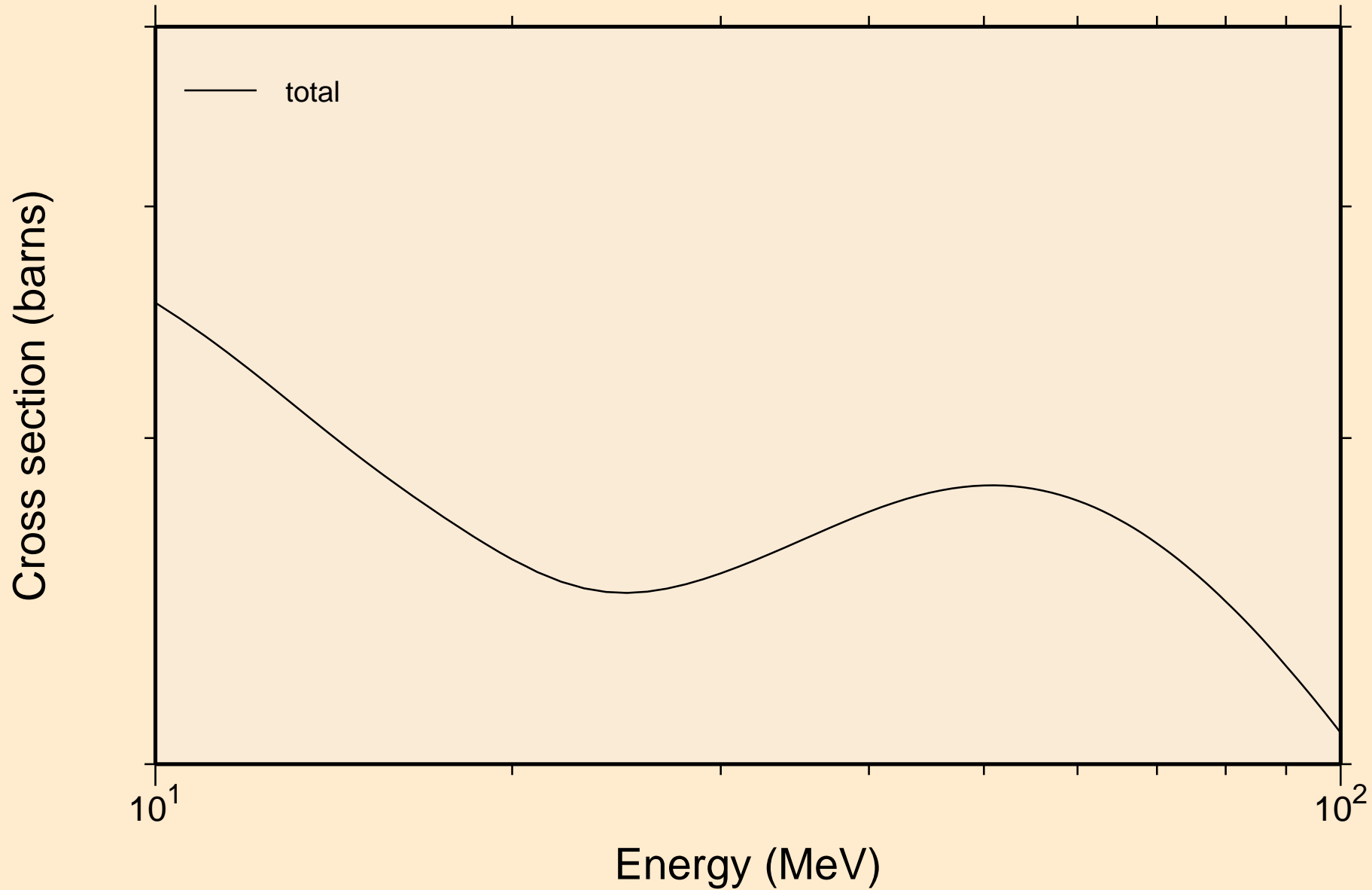

NI068 NEUTRON ACER TENDL-2023 LIBRARY; T=0.K  
resonance absorption cross sections

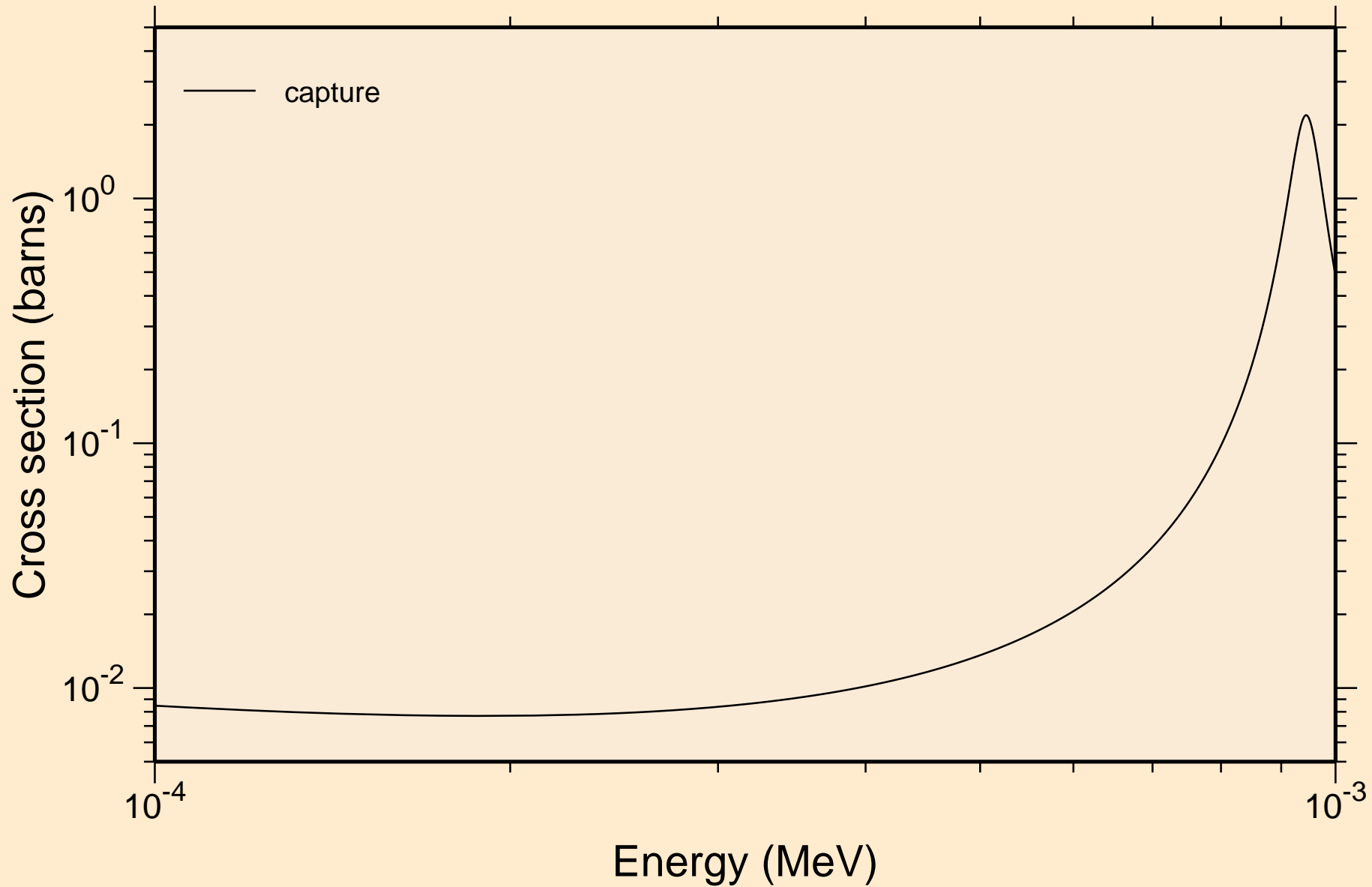

NI068 NEUTRON ACER TENDL-2023 LIBRARY; T=0.K  
resonance absorption cross sections

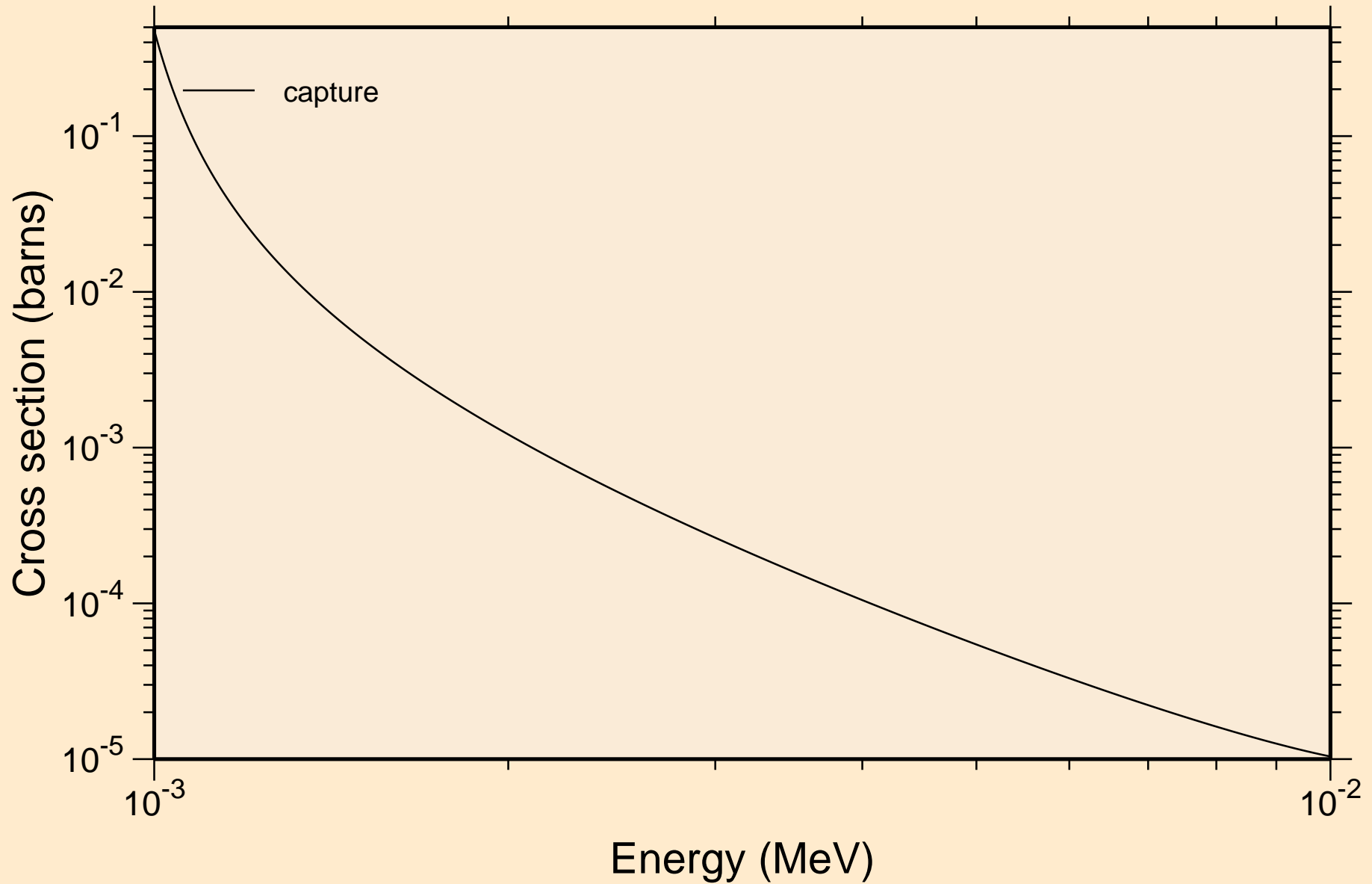



NI068 NEUTRON ACER TENDL-2023 LIBRARY; T=0.K  
resonance absorption cross sections

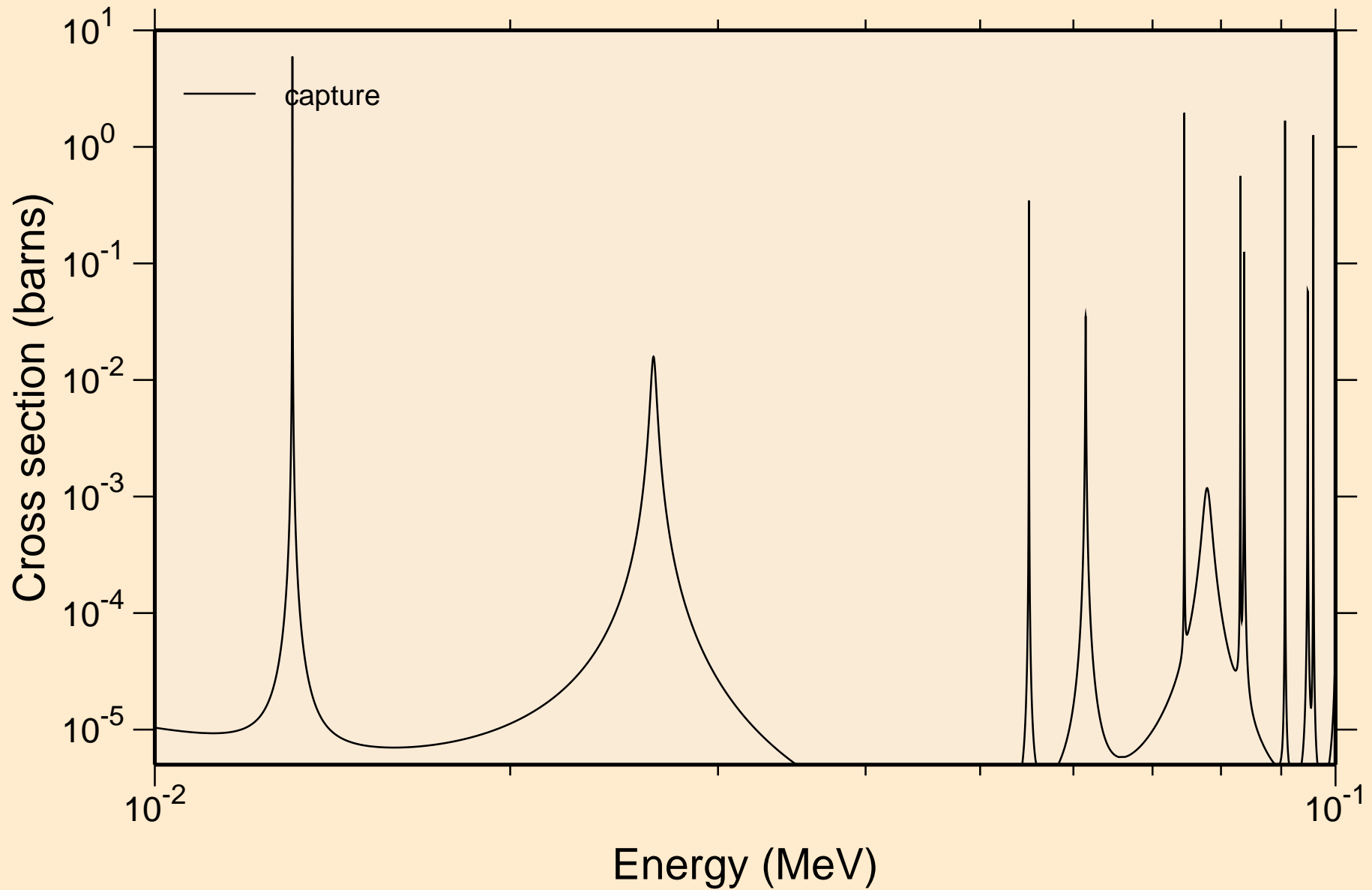

NI068 NEUTRON ACER TENDL-2023 LIBRARY; T=0.K  
resonance absorption cross sections

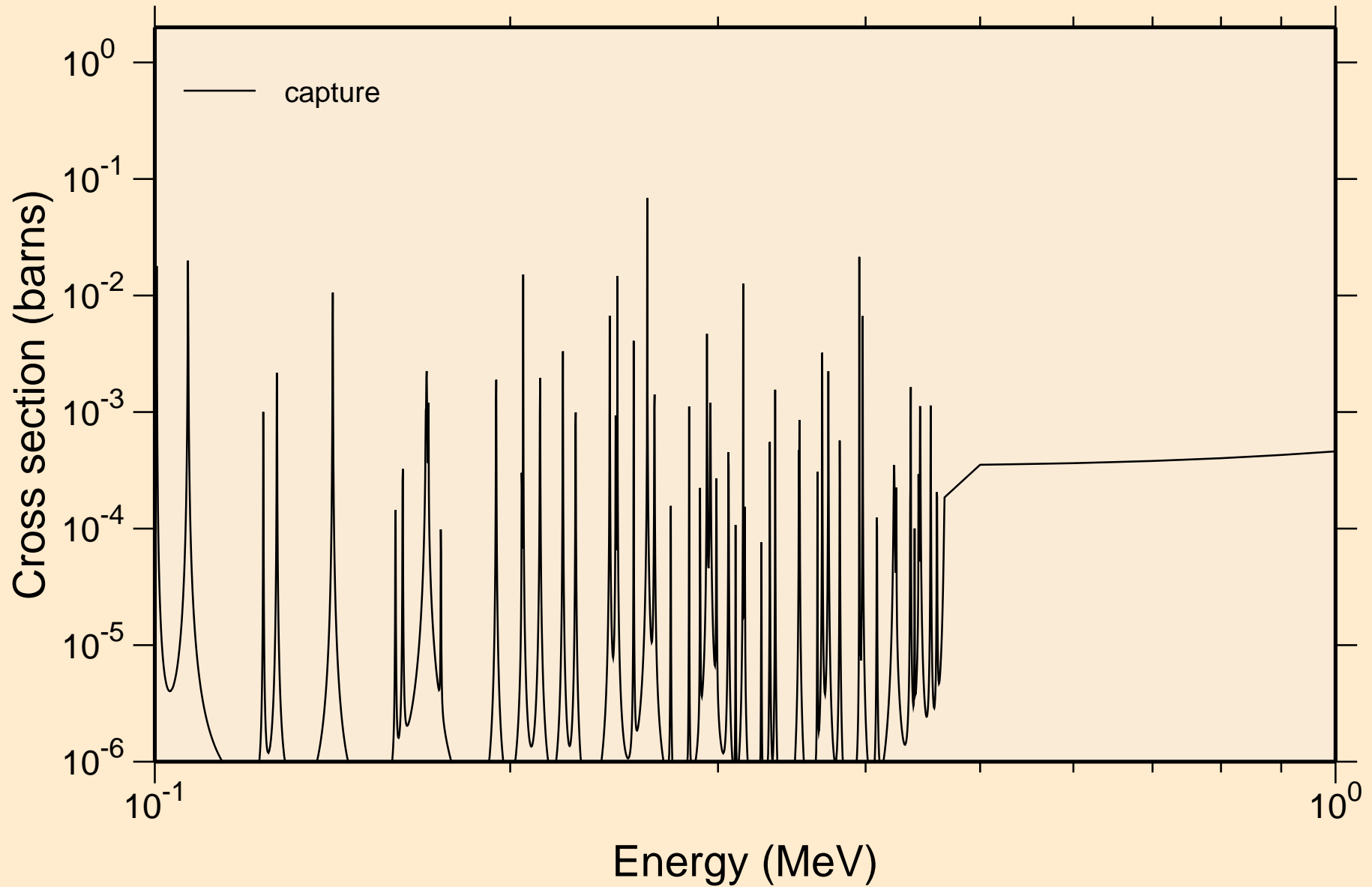

NI068 NEUTRON ACER TENDL-2023 LIBRARY; T=0.K  
resonance absorption cross sections

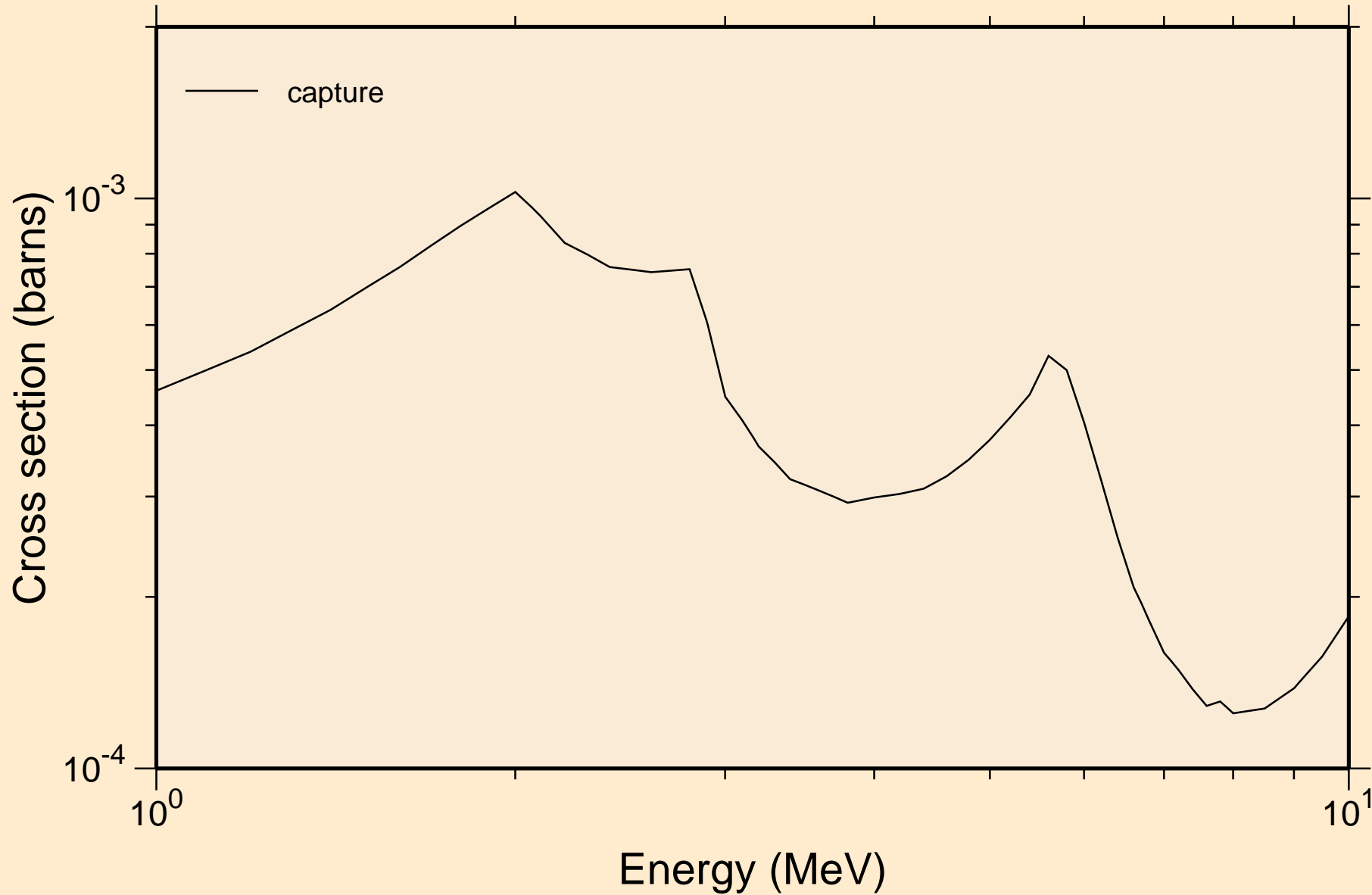

# NI068 NEUTRON ACER TENDL-2023 LIBRARY; T=0.K

## Heating

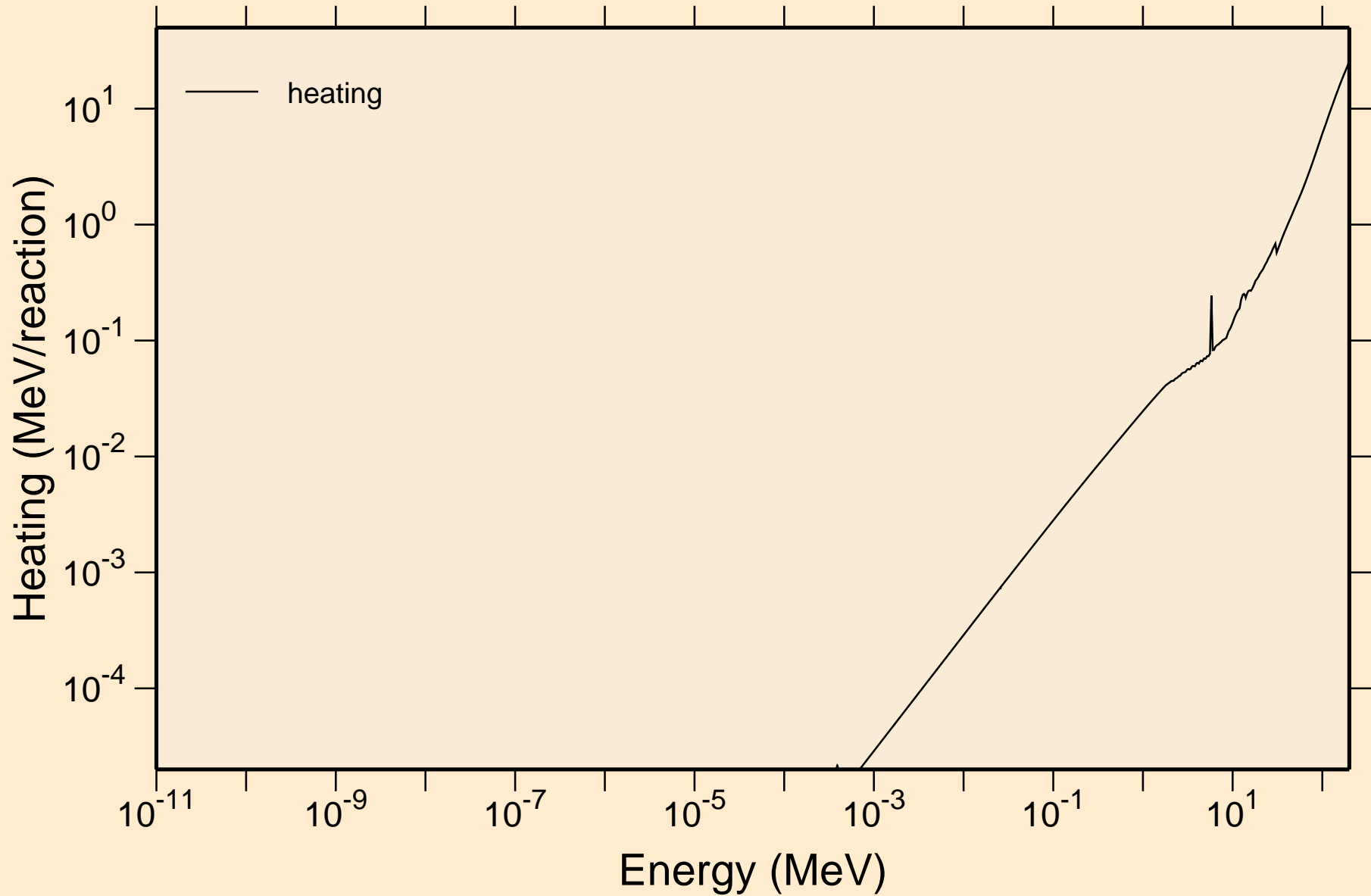

NI068 NEUTRON ACER TENDL-2023 LIBRARY; T=0.K  
Damage

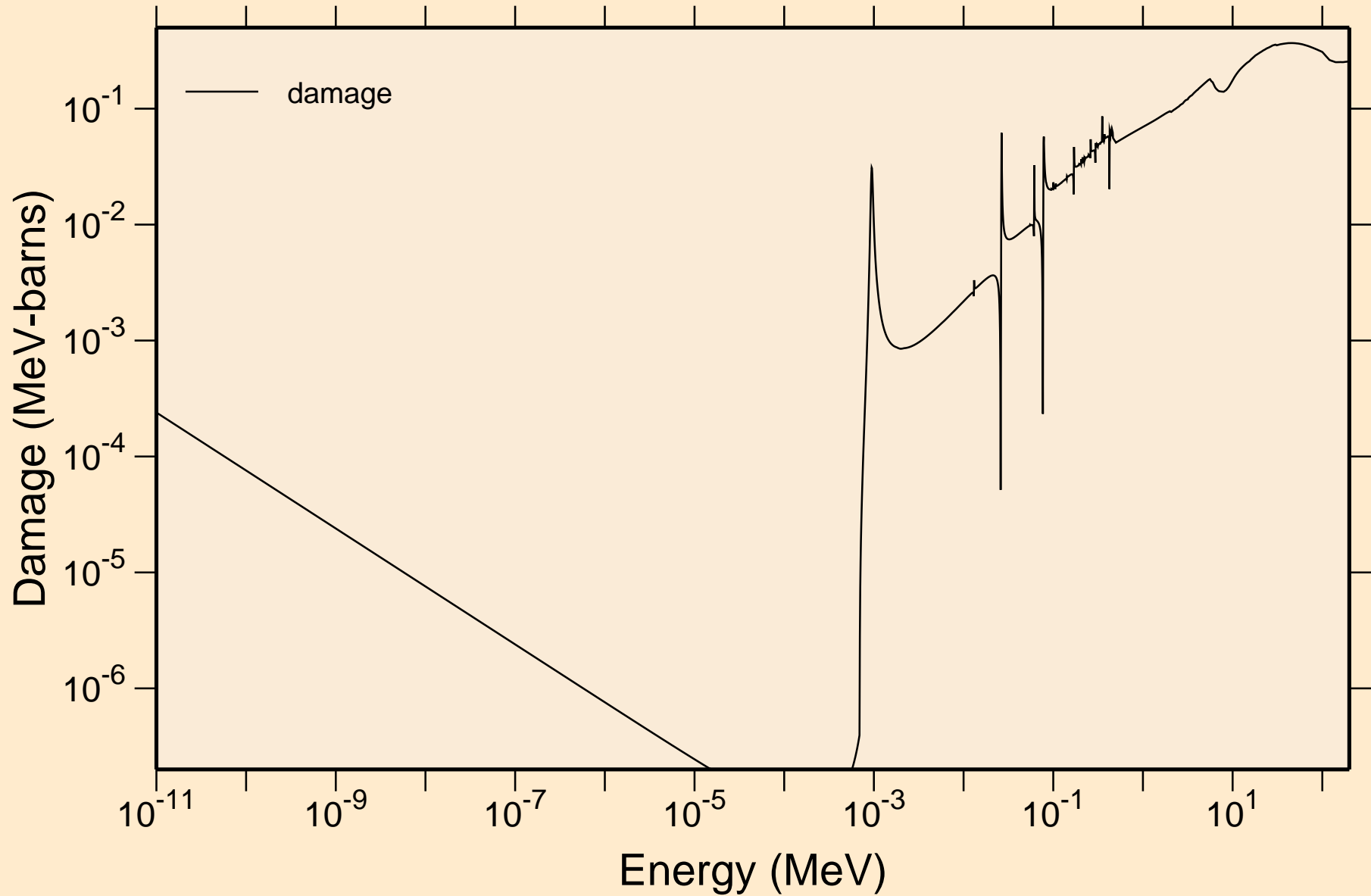

NI068 NEUTRON ACER TENDL-2023 LIBRARY; T=0.K  
Non-threshold reactions

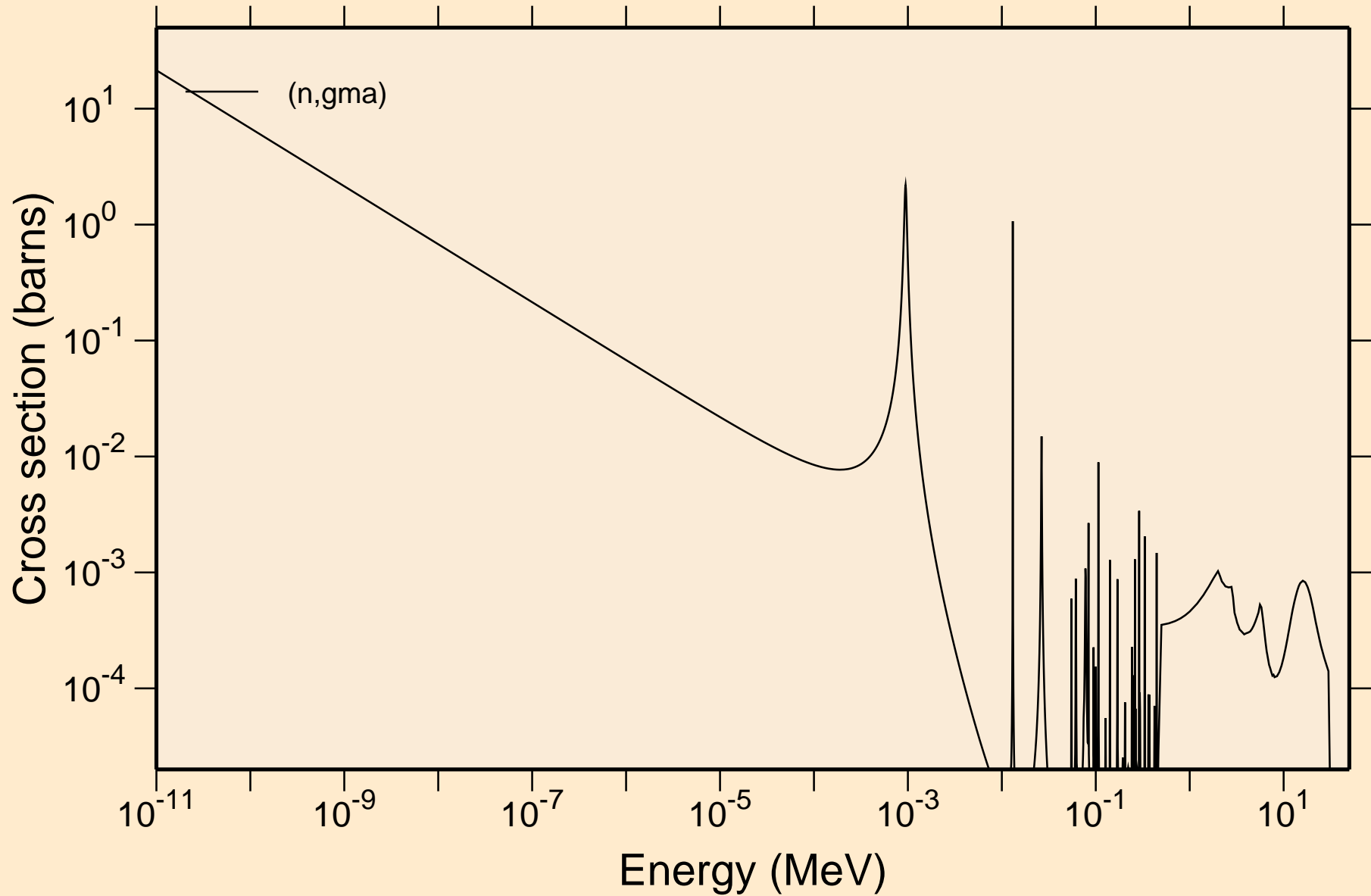

# NI068 NEUTRON ACER TENDL-2023 LIBRARY; T=0.K

## Principal cross sections

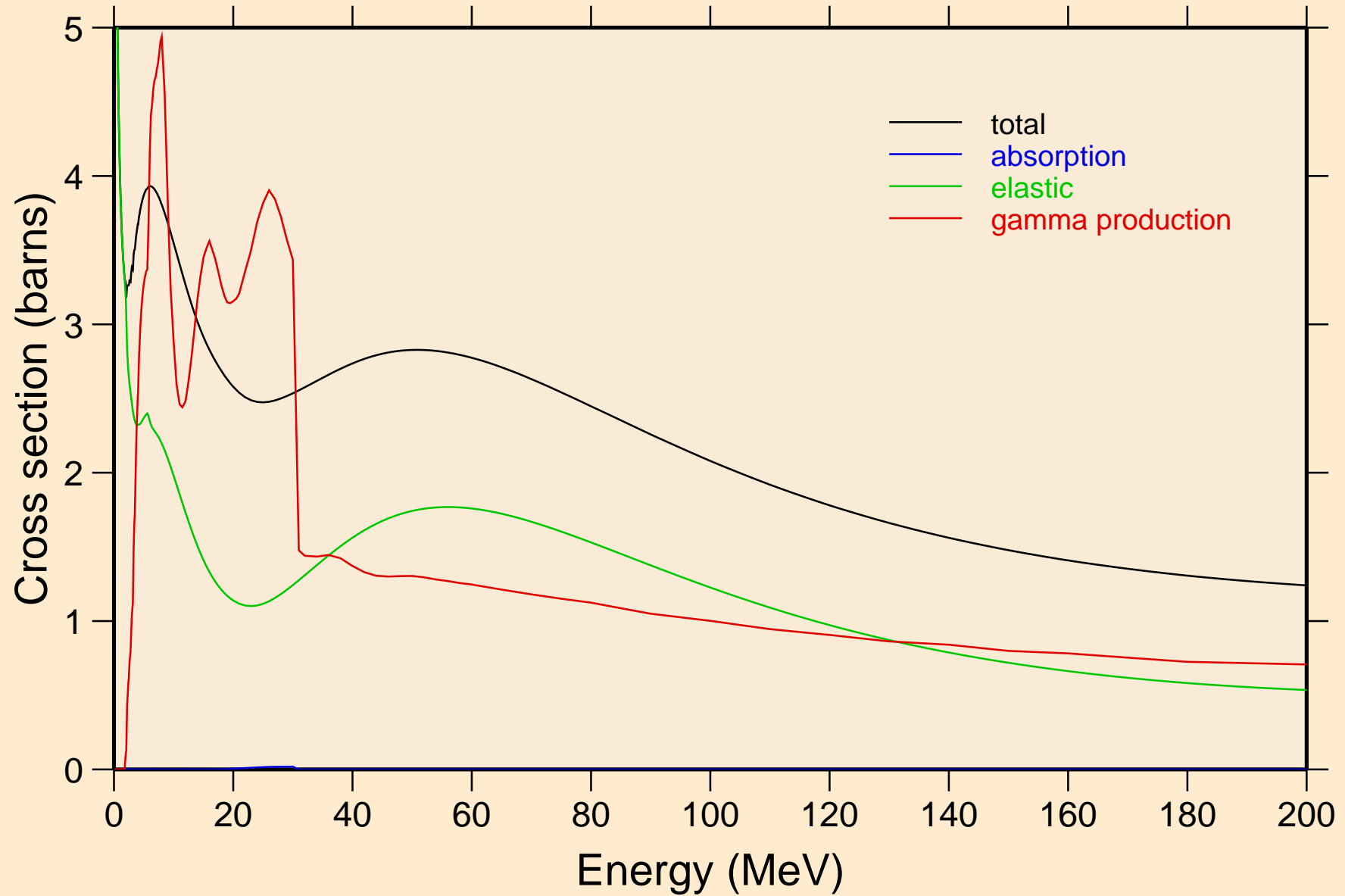

# NI068 NEUTRON ACER TENDL-2023 LIBRARY; T=0.K

## Heating

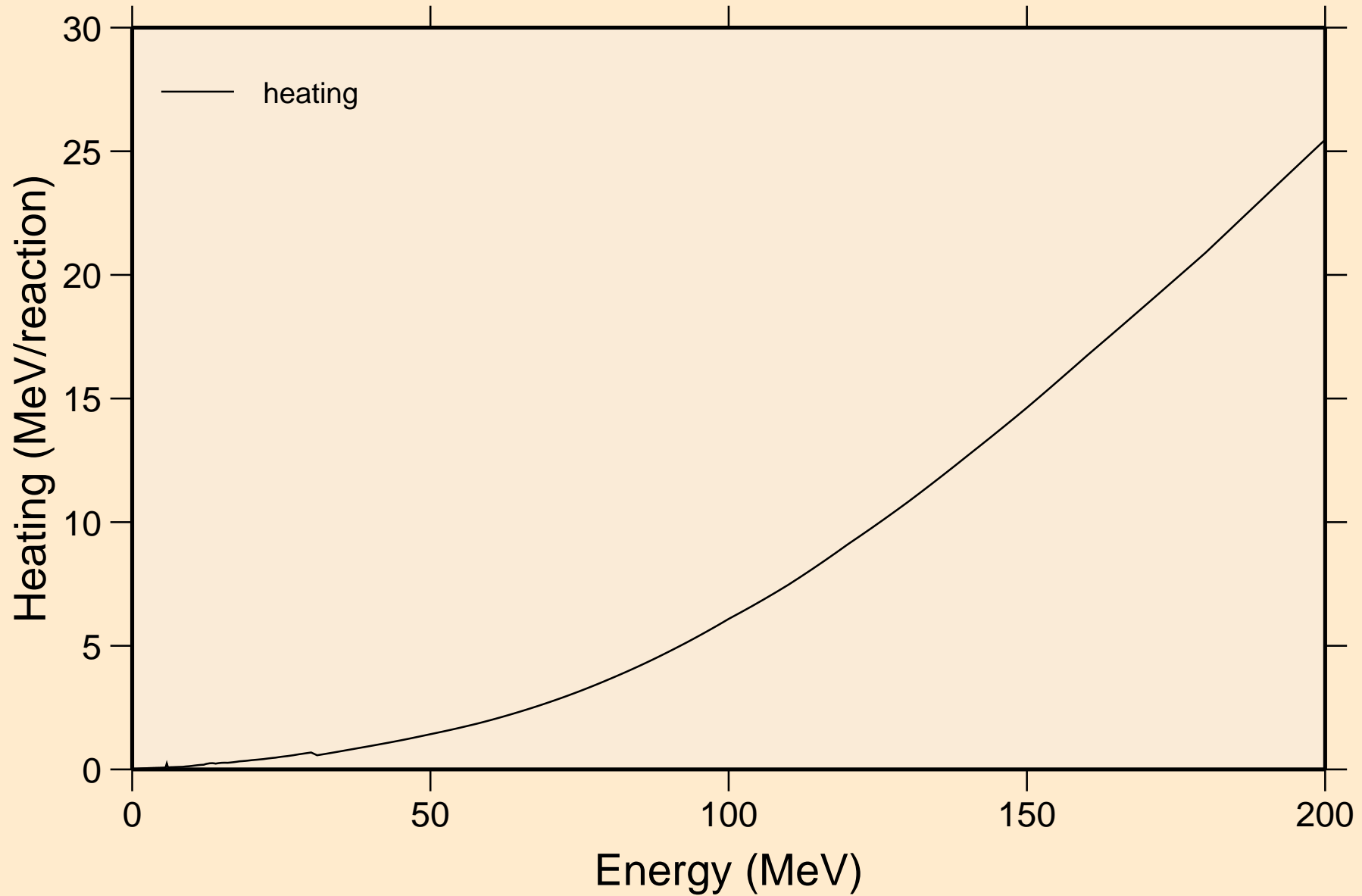



# NI068 NEUTRON ACER TENDL-2023 LIBRARY; T=0.K

## Damage

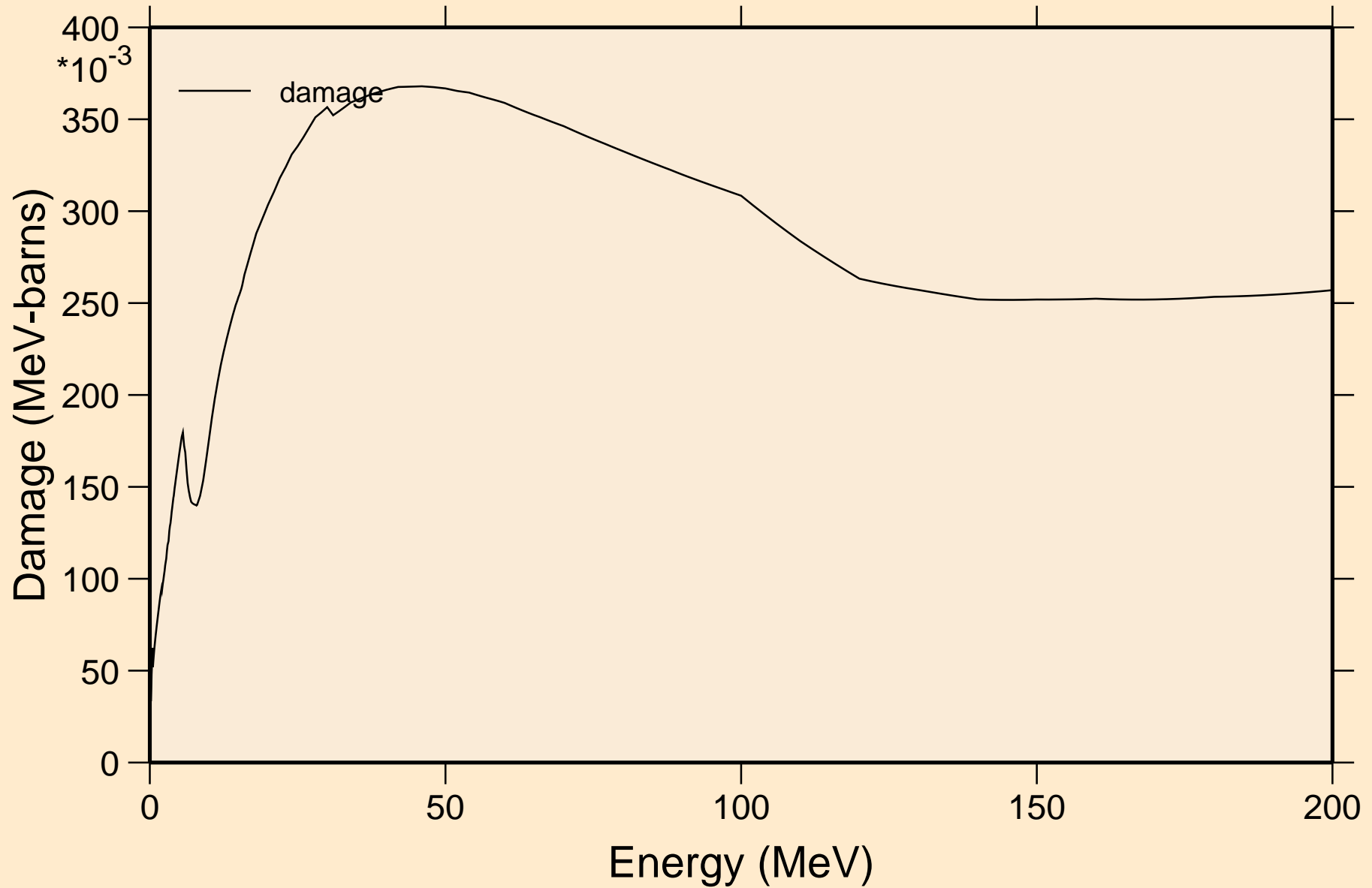

NI068 NEUTRON ACER TENDL-2023 LIBRARY; T=0.K  
Non-threshold reactions

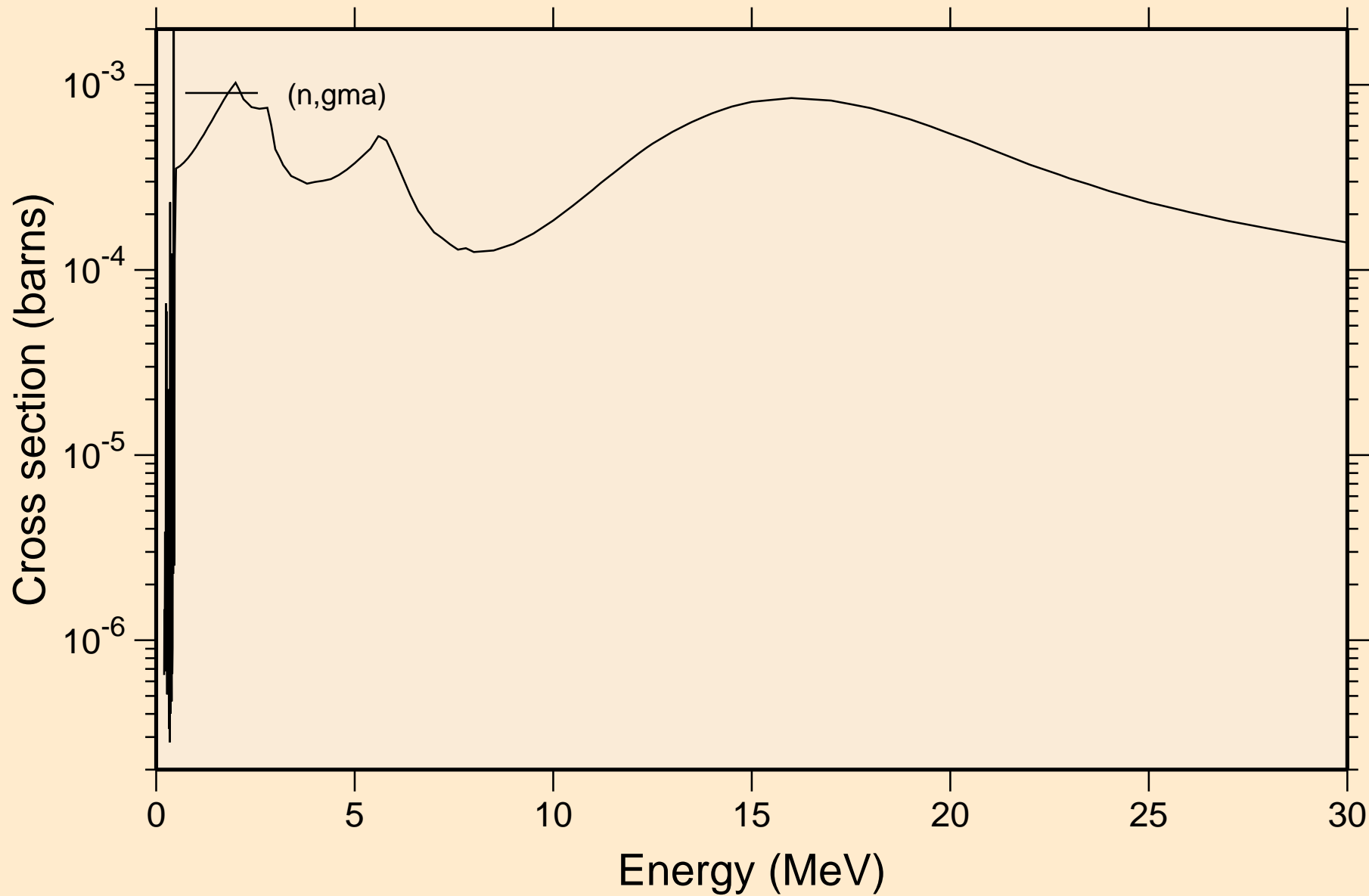

NI068 NEUTRON ACER TENDL-2023 LIBRARY; T=0.K  
Inelastic levels

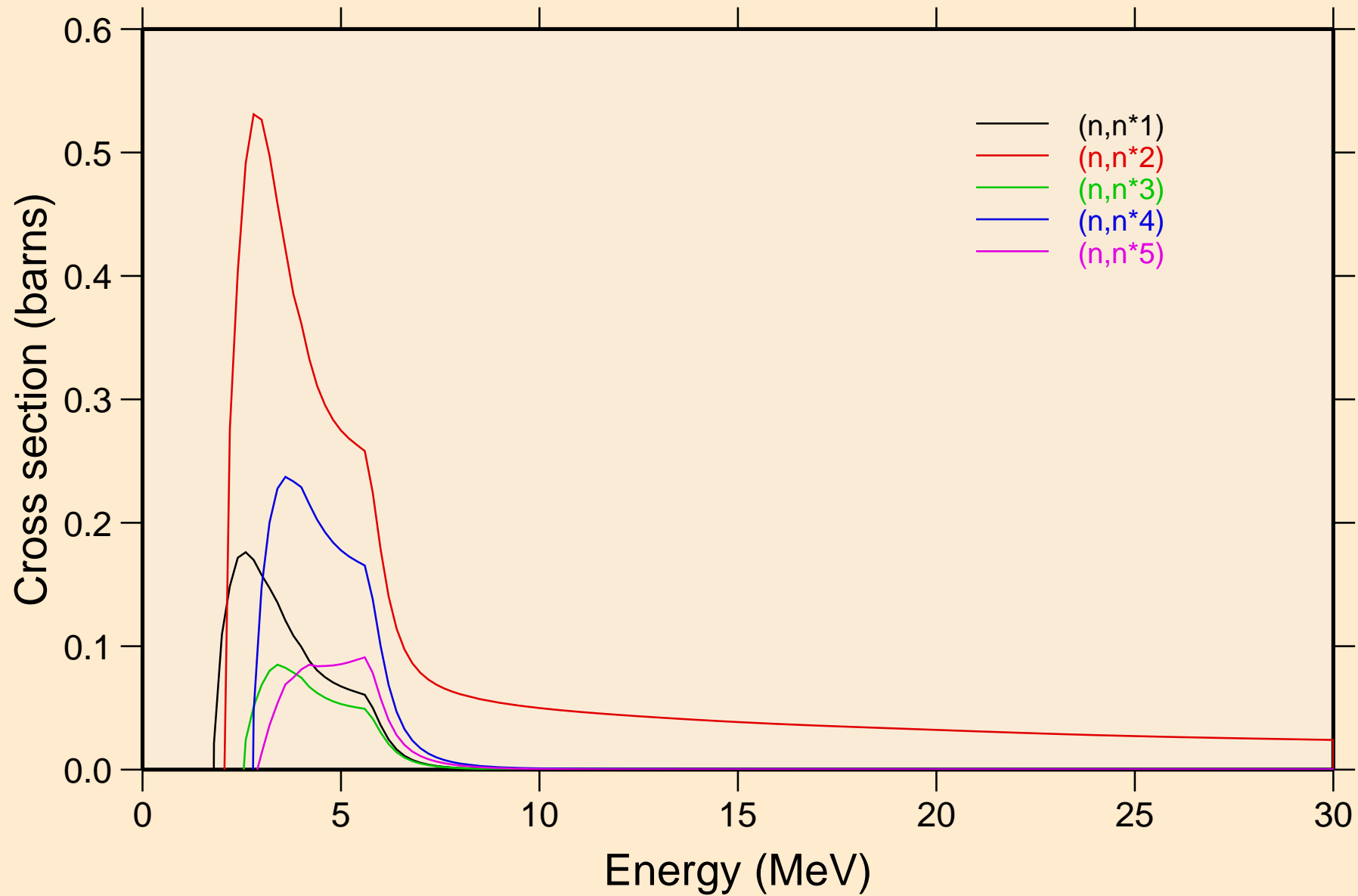

# NI068 NEUTRON ACER TENDL-2023 LIBRARY; T=0.K

## Inelastic levels

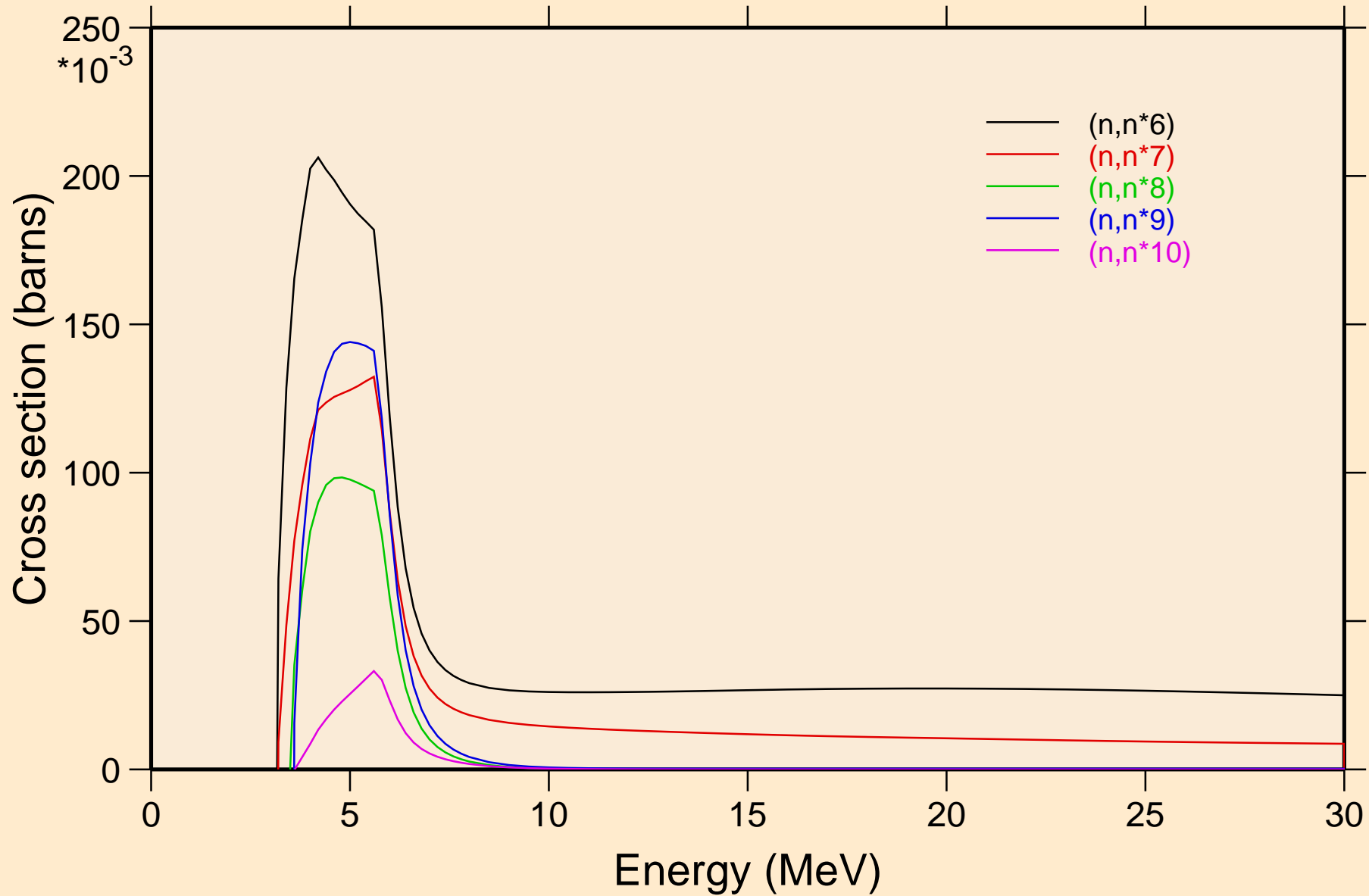

NI068 NEUTRON ACER TENDL-2023 LIBRARY; T=0.K  
Inelastic levels

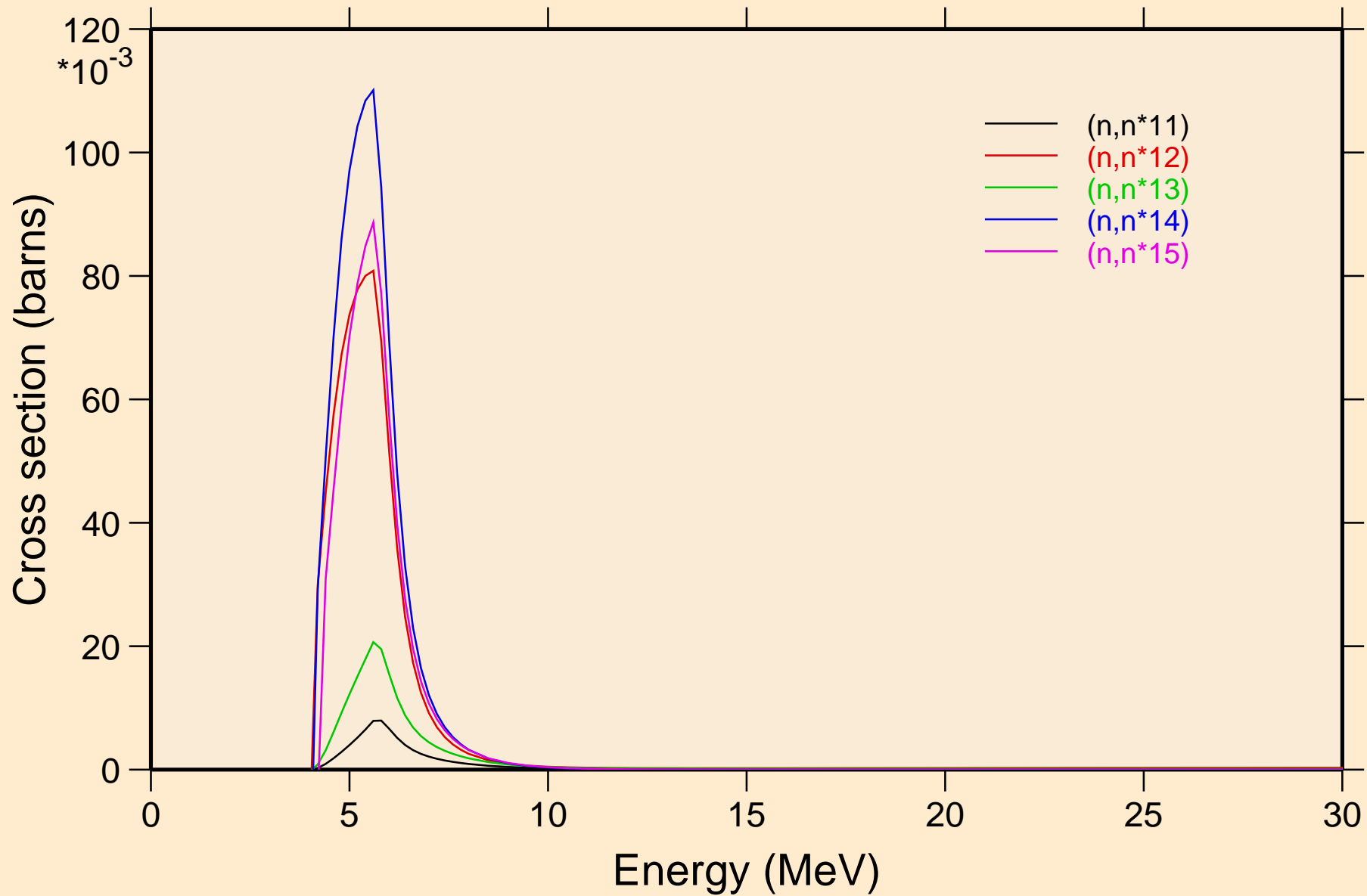

NI068 NEUTRON ACER TENDL-2023 LIBRARY; T=0.K  
Inelastic levels

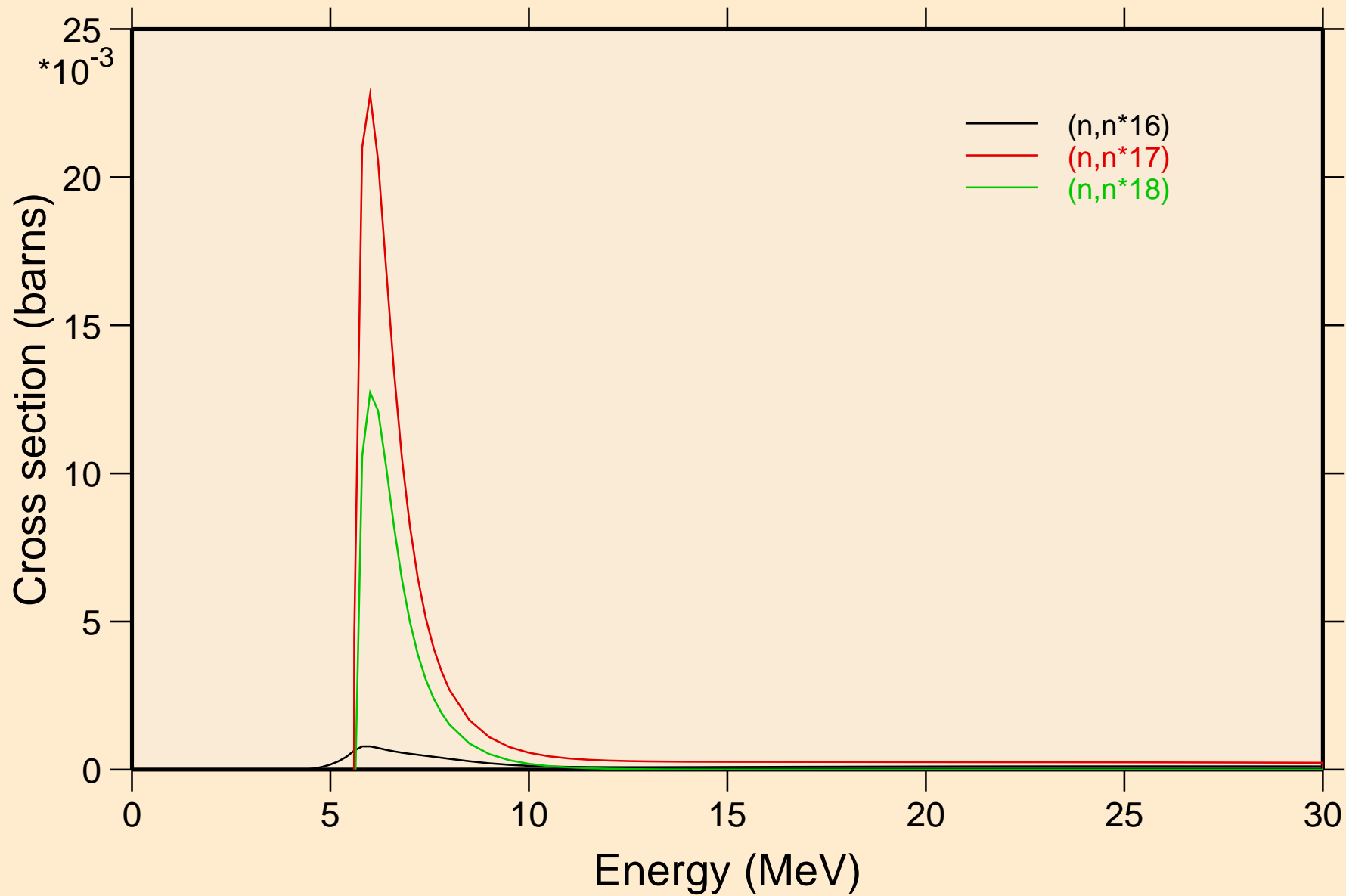

# NI068 NEUTRON ACER TENDL-2023 LIBRARY; T=0.K

## Threshold reactions

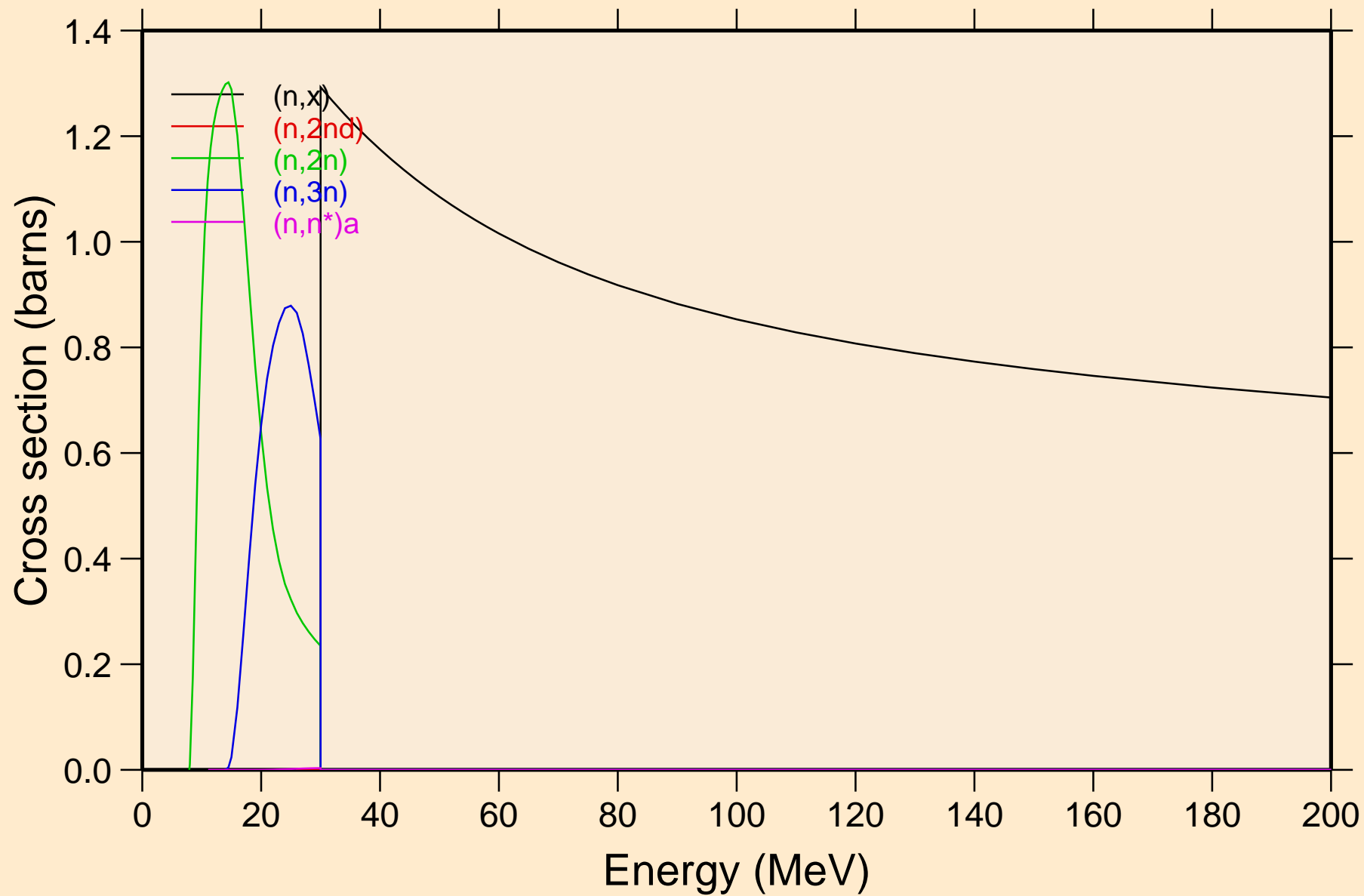

# NI068 NEUTRON ACER TENDL-2023 LIBRARY; T=0.K

## Threshold reactions

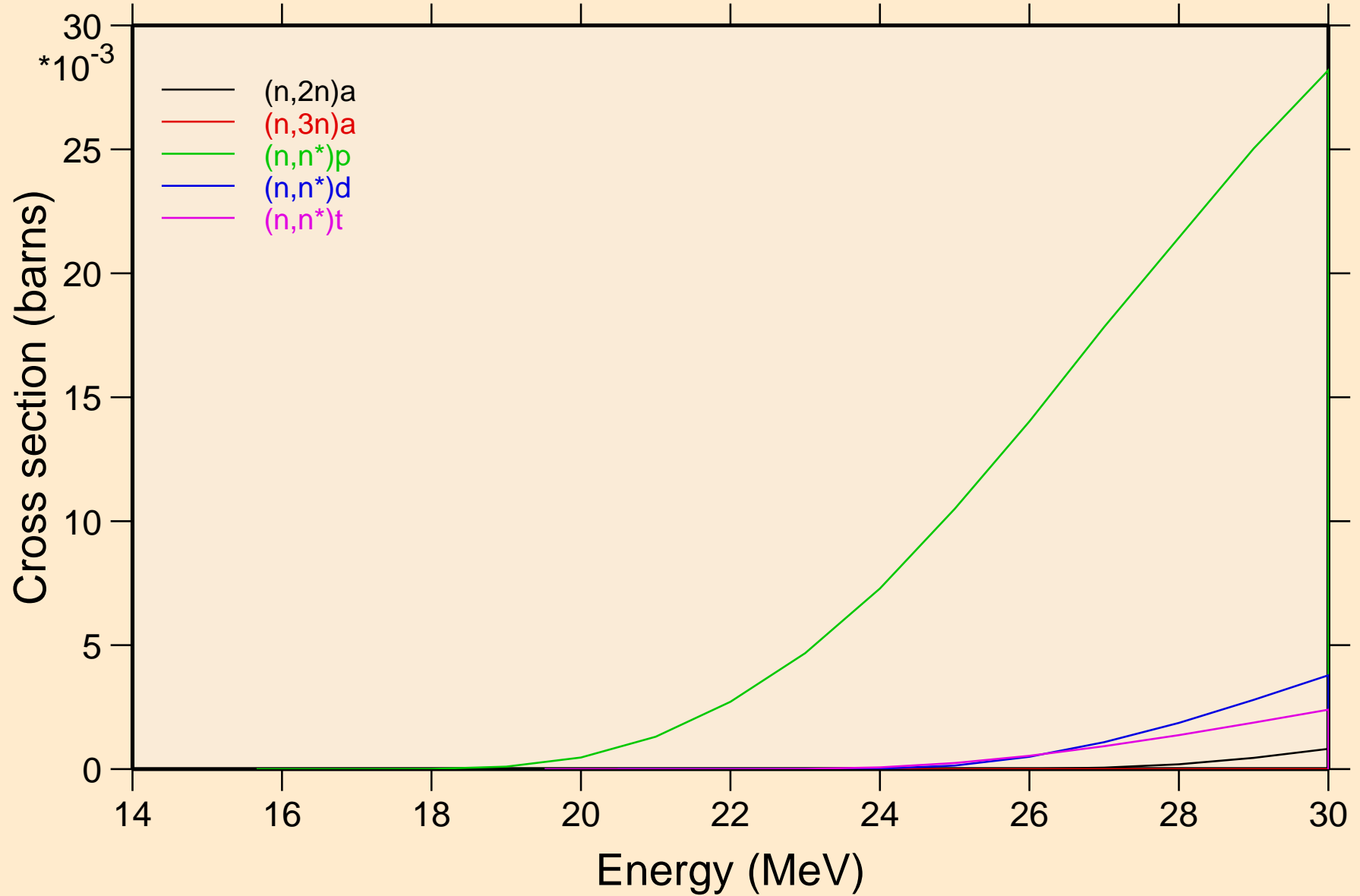



NI068 NEUTRON ACER TENDL-2023 LIBRARY; T=0.K  
Threshold reactions

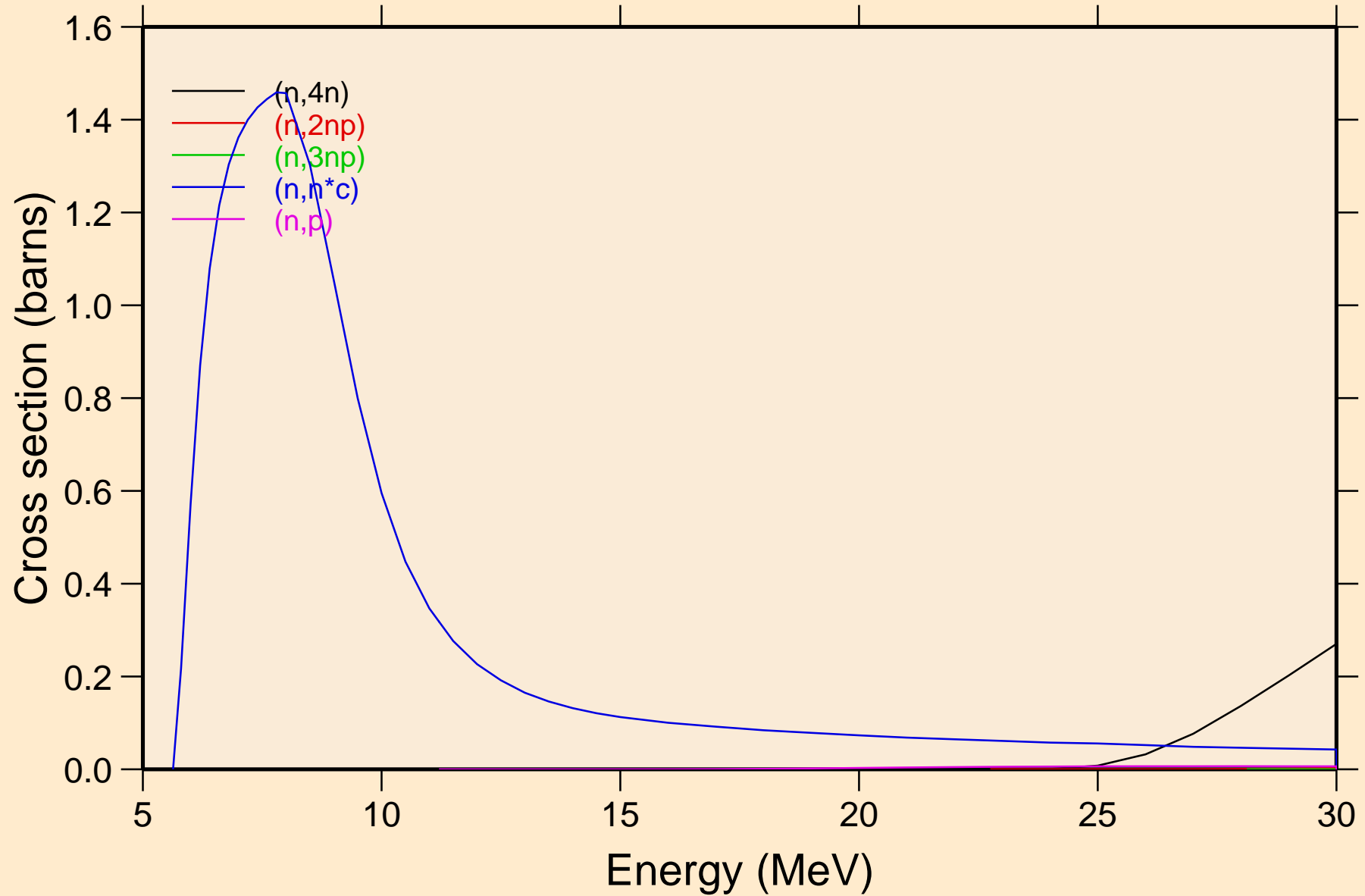

NI068 NEUTRON ACER TENDL-2023 LIBRARY; T=0.K  
Threshold reactions

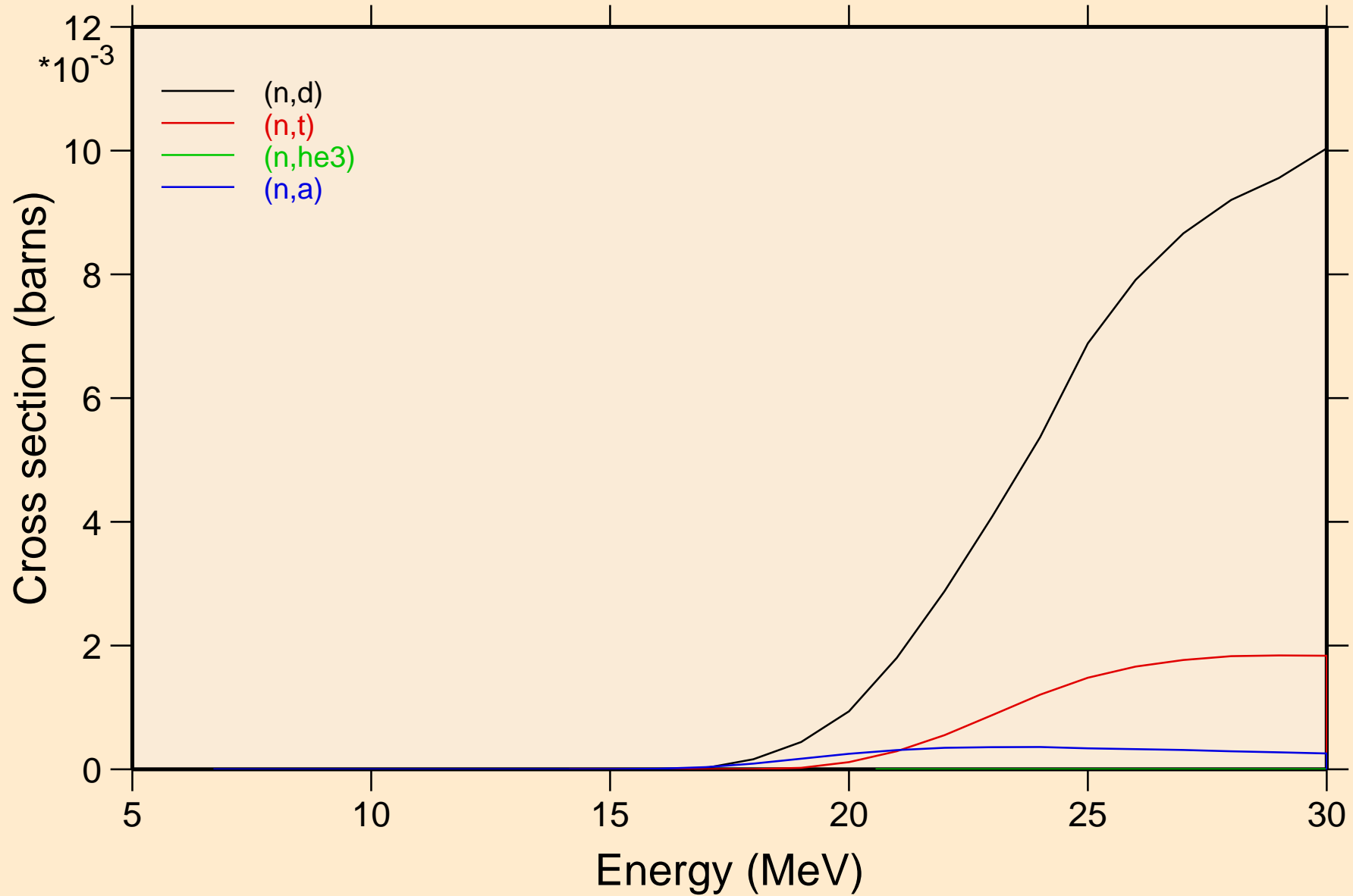

NI068 NEUTRON ACER TENDL-2023 LIBRARY; T=0.K  
Threshold reactions

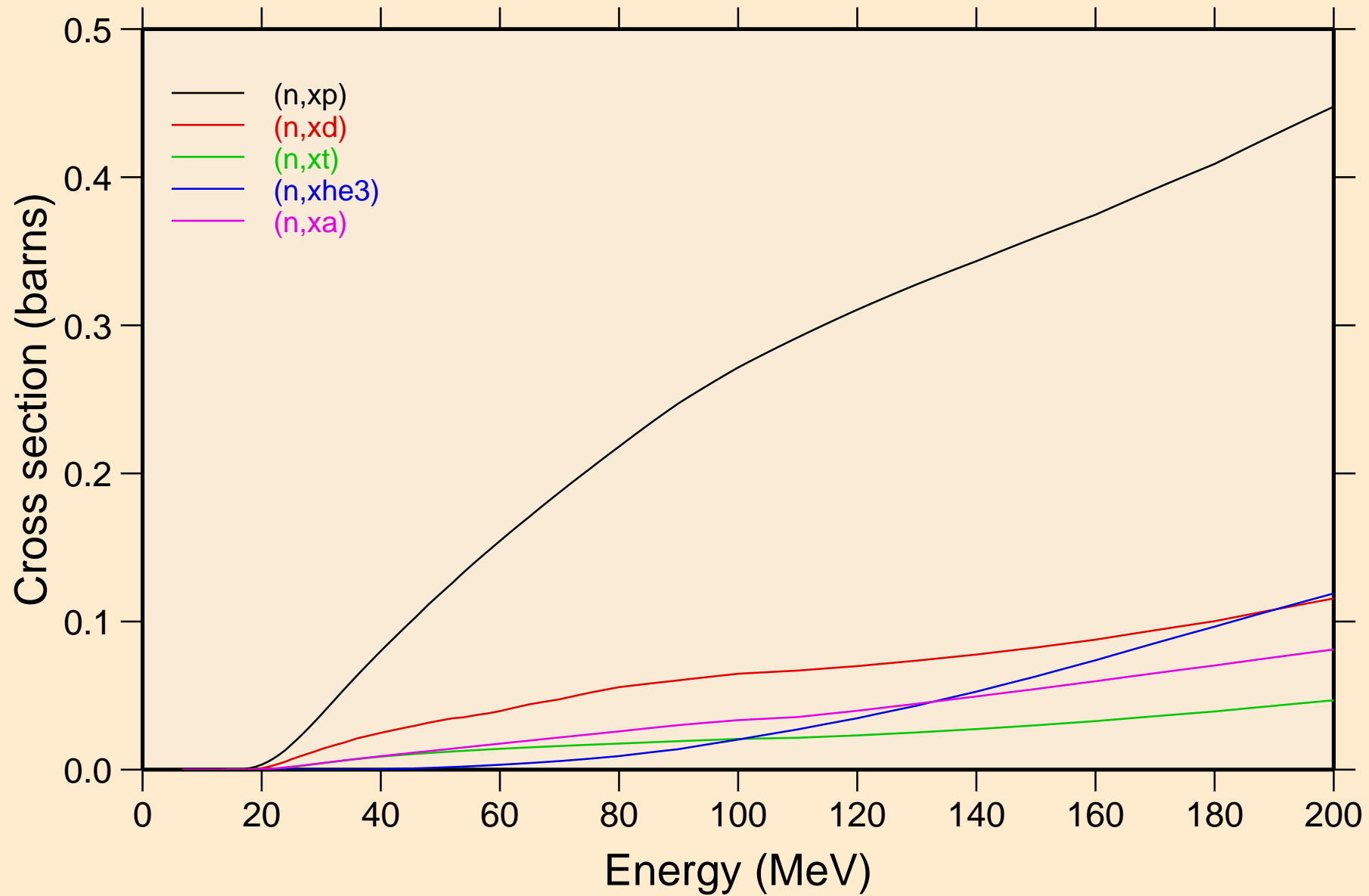

NI068 NEUTRON ACER TENDL-2023 LIBRARY; T=0.K  
angular distribution for elastic

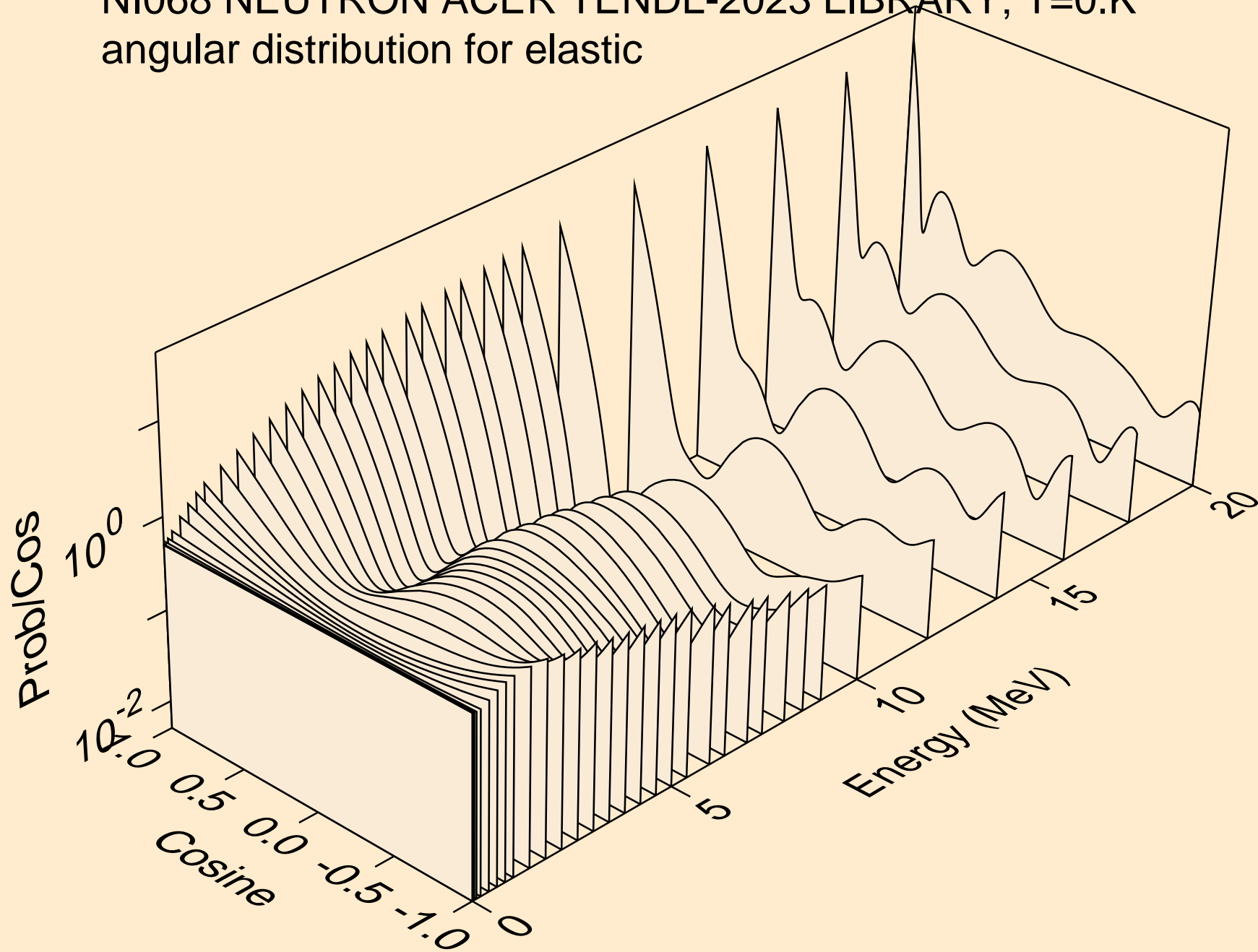

NI068 NEUTRON ACER TENDL-2023 LIBRARY; T=0.K  
angular distribution for elastic

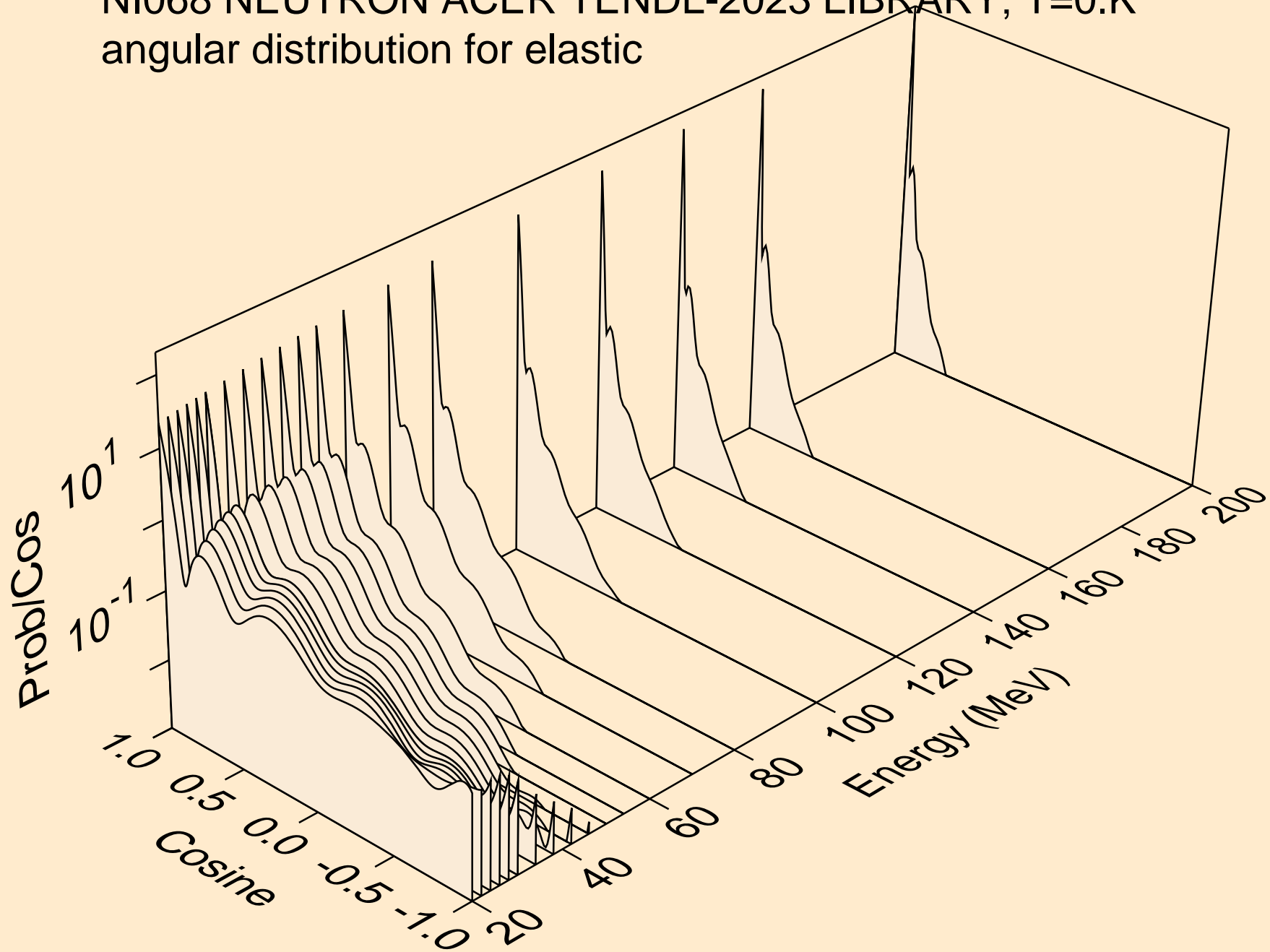

NI068 NEUTRON ACER TENDL-2023 LIBRARY; T=0.K  
angular distribution for (n,n\*1)

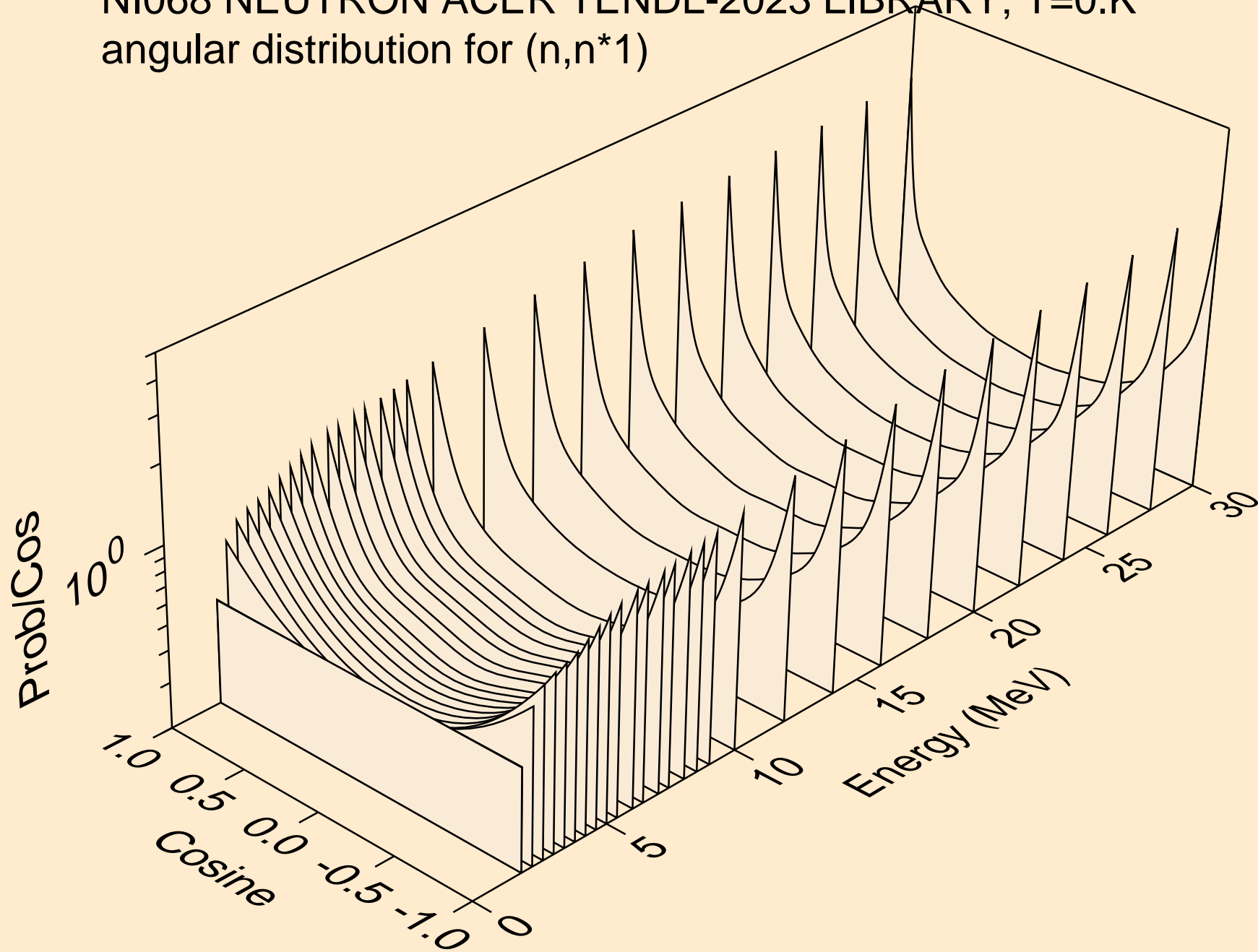

NI068 NEUTRON ACER TENDL-2023 LIBRARY; T=0.K  
angular distribution for (n,n\*2)

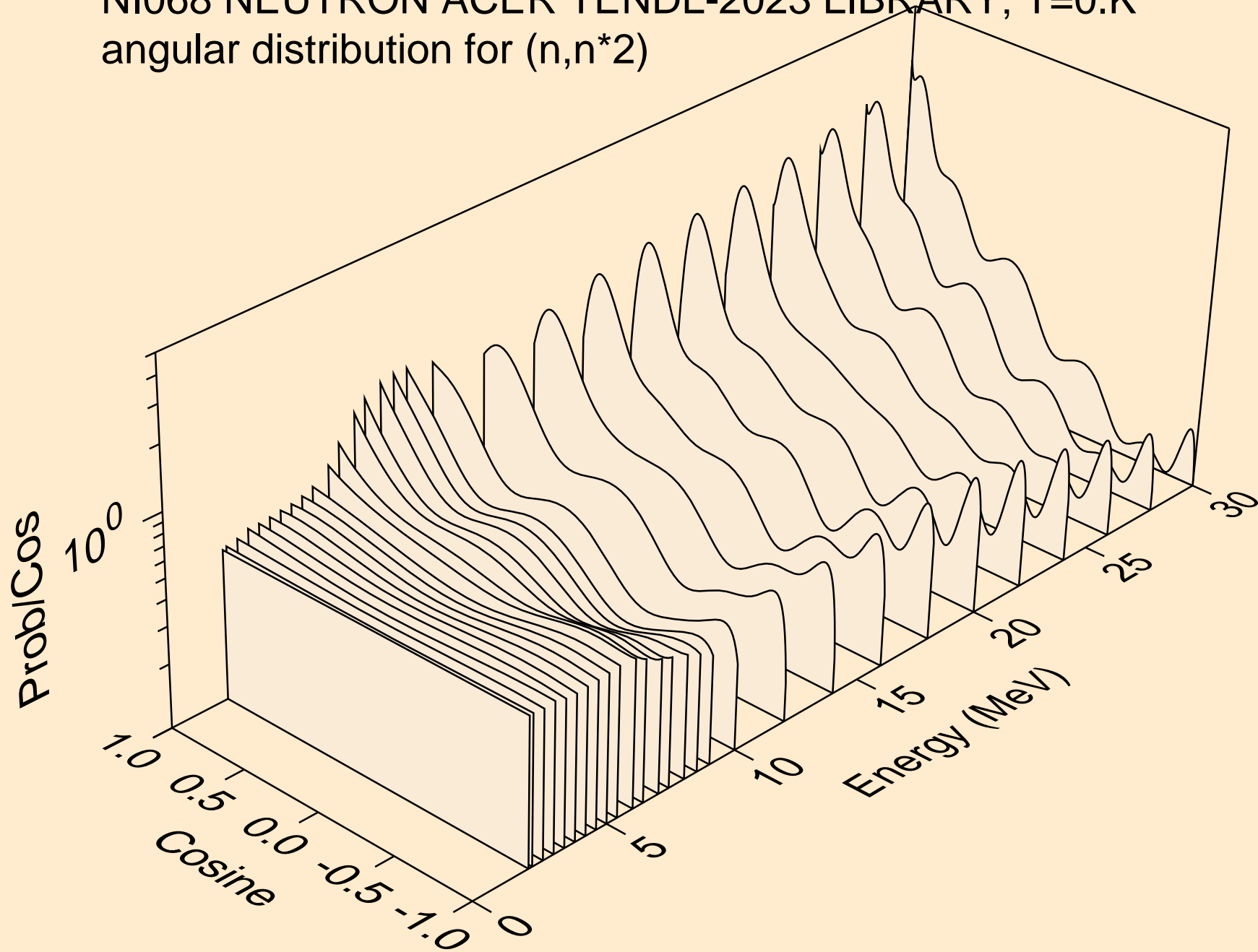

NI068 NEUTRON ACER TENDL-2023 LIBRARY; T=0.K  
angular distribution for (n,n\*3)

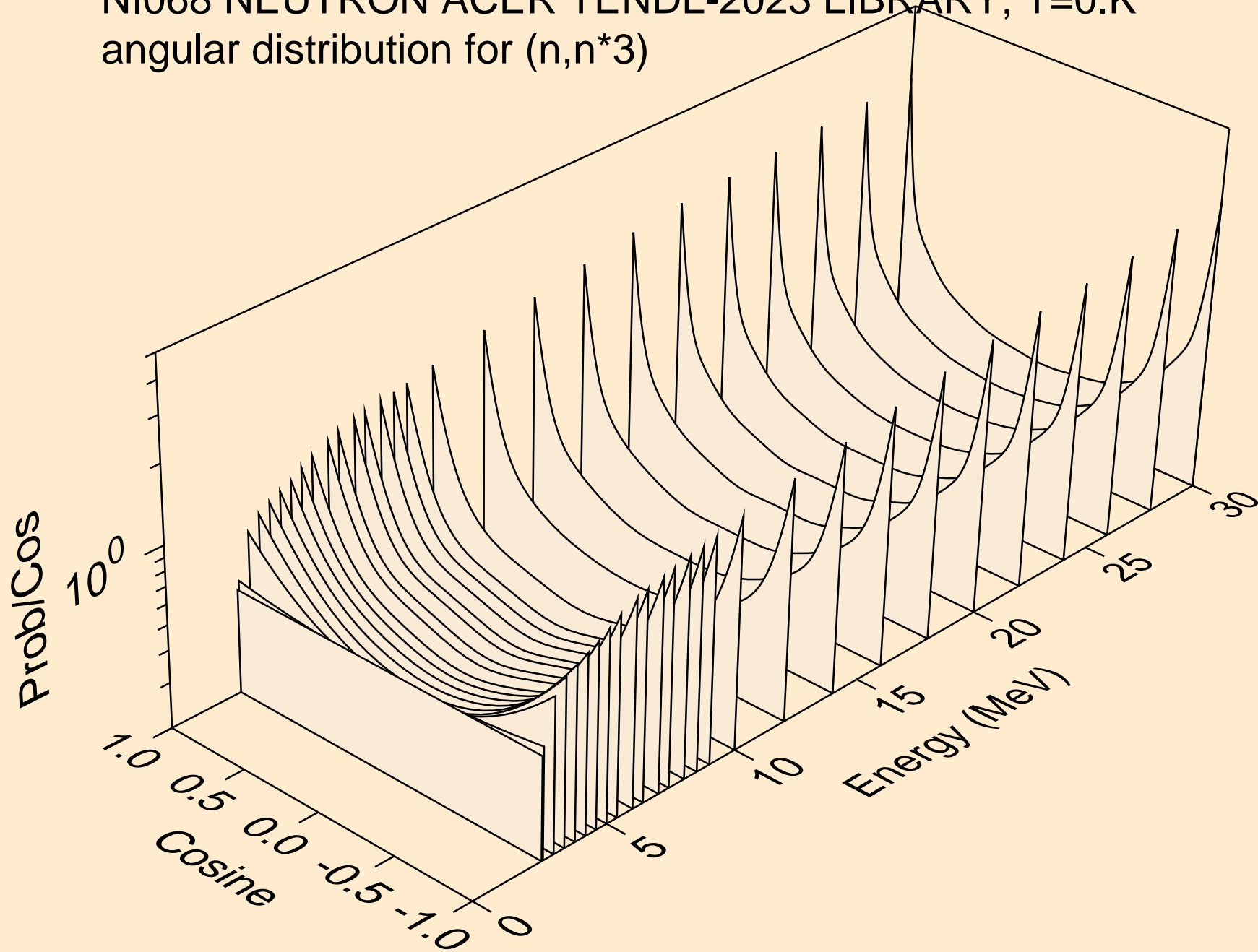



NI068 NEUTRON ACER TENDL-2023 LIBRARY; T=0.K  
angular distribution for (n,n\*4)

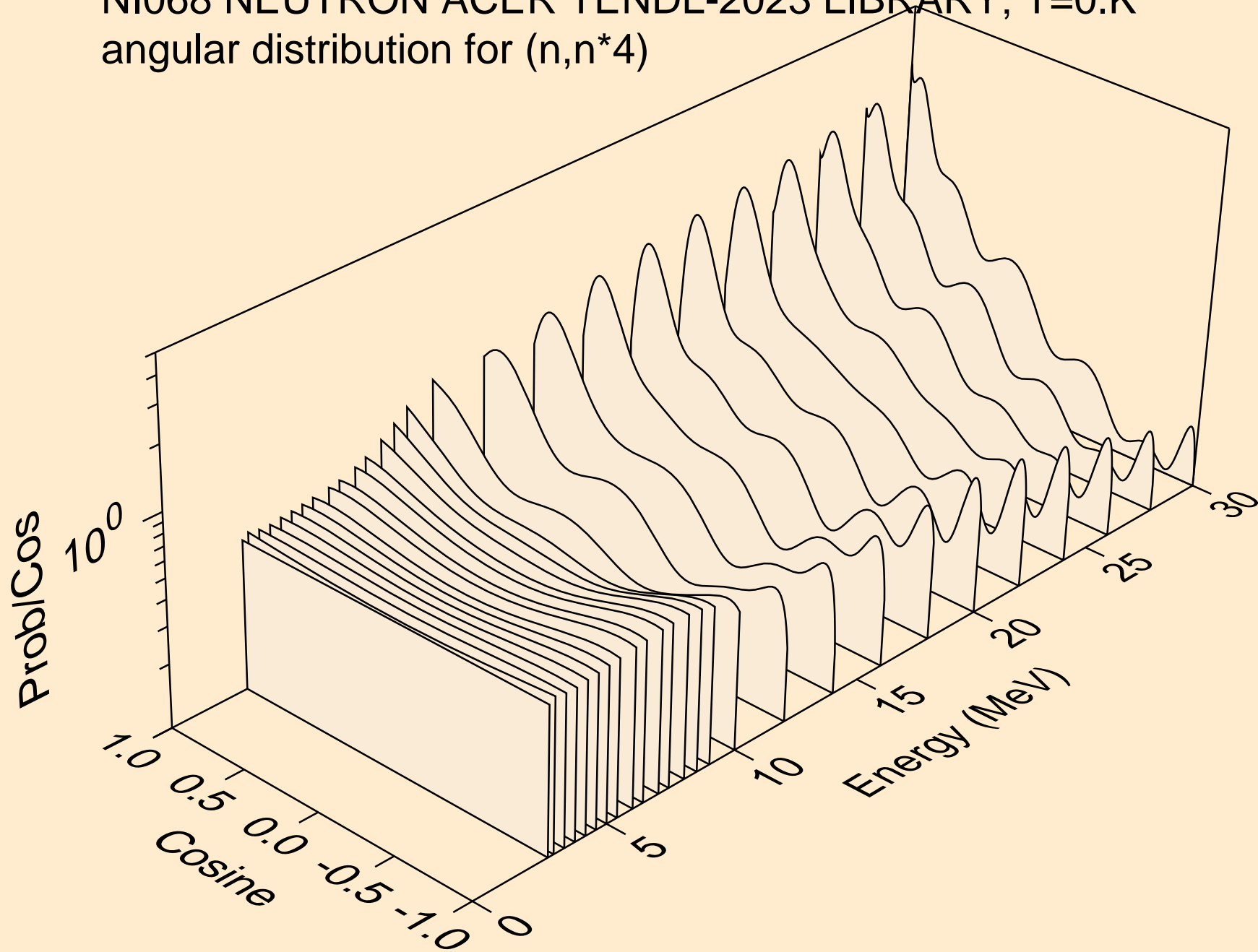

NI068 NEUTRON ACER TENDL-2023 LIBRARY; T=0.K  
angular distribution for (n,n\*5)

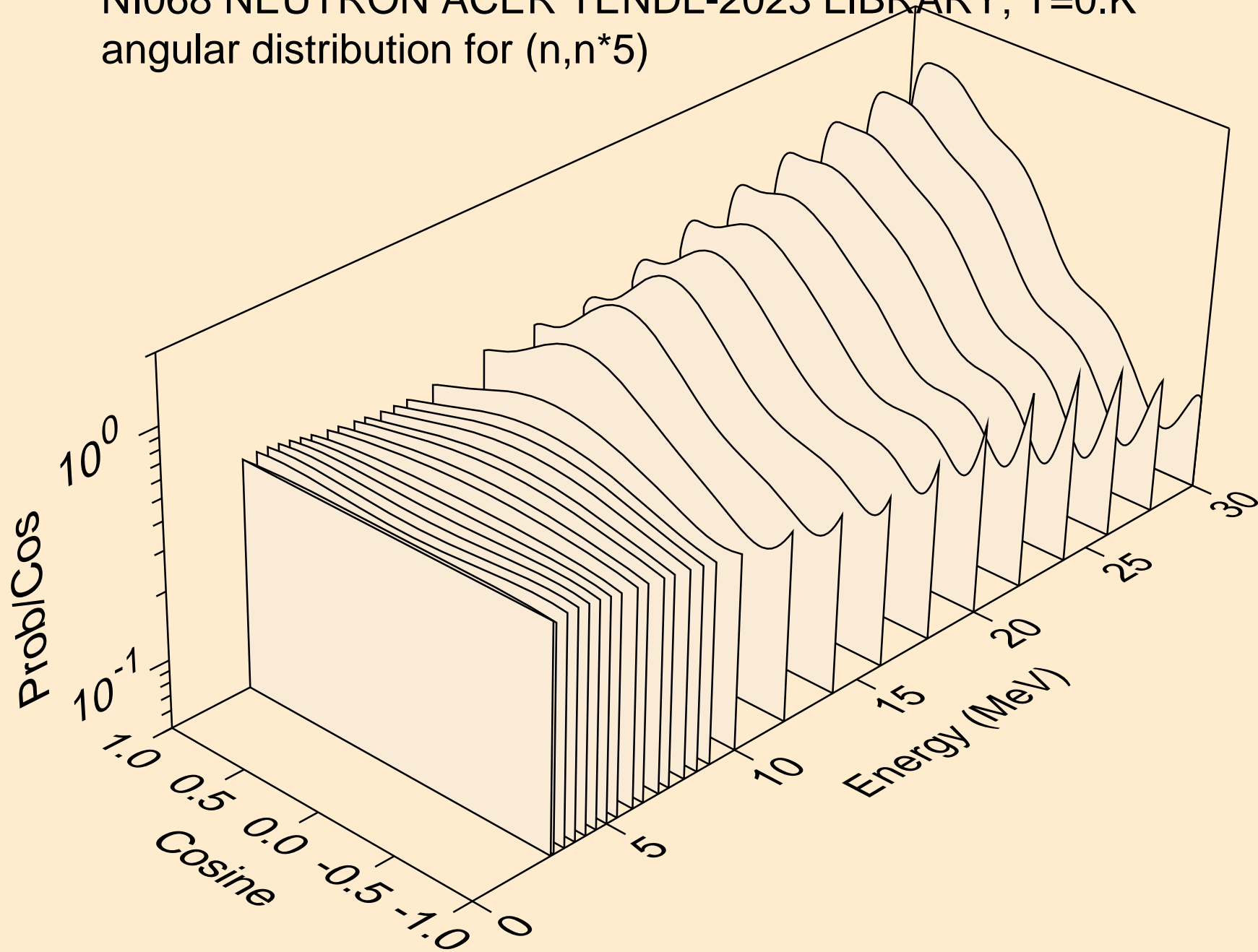

NI068 NEUTRON ACER TENDL-2023 LIBRARY; T=0.K  
angular distribution for (n,n\*6)

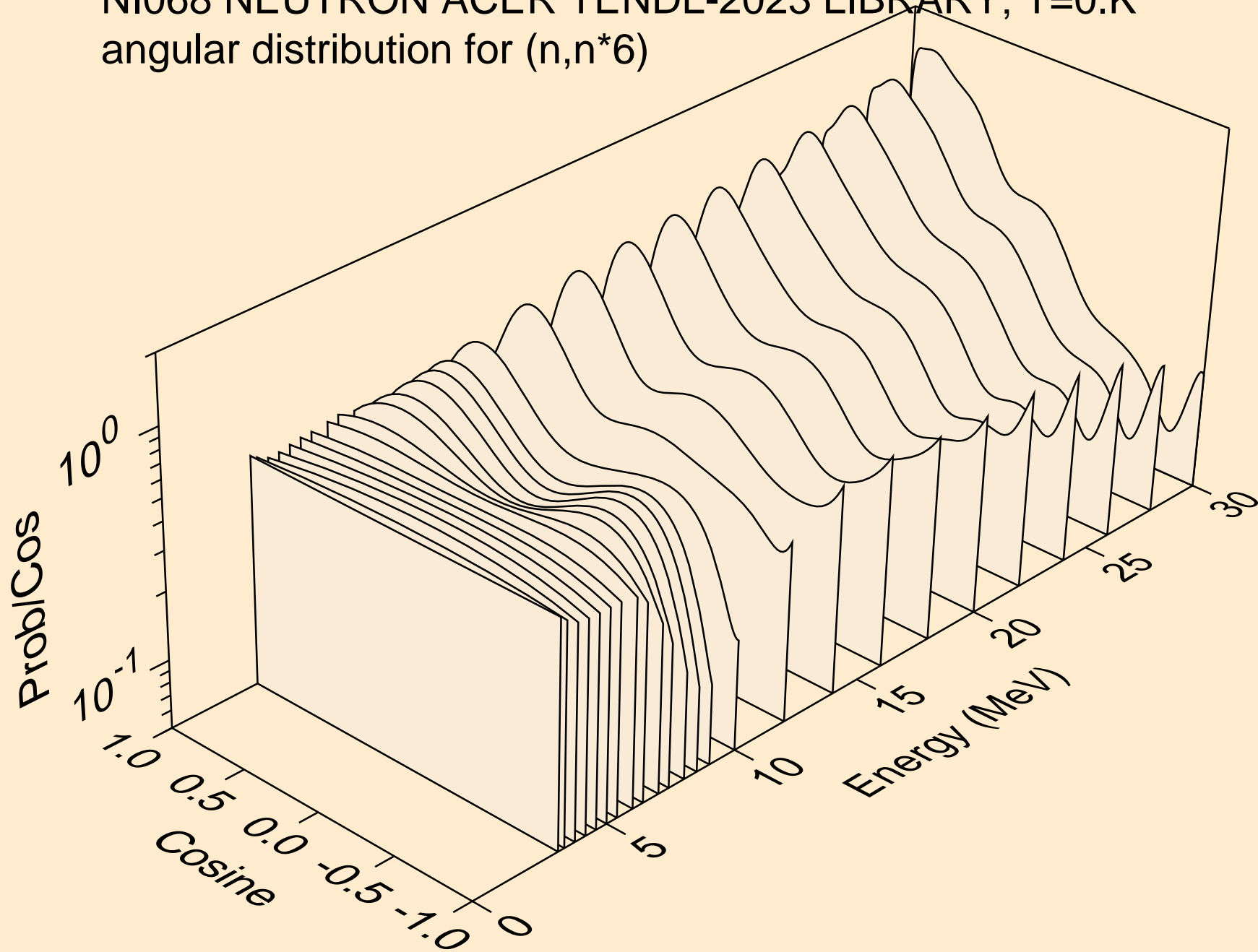

NI068 NEUTRON ACER TENDL-2023 LIBRARY; T=0.K  
angular distribution for (n,n\*7)

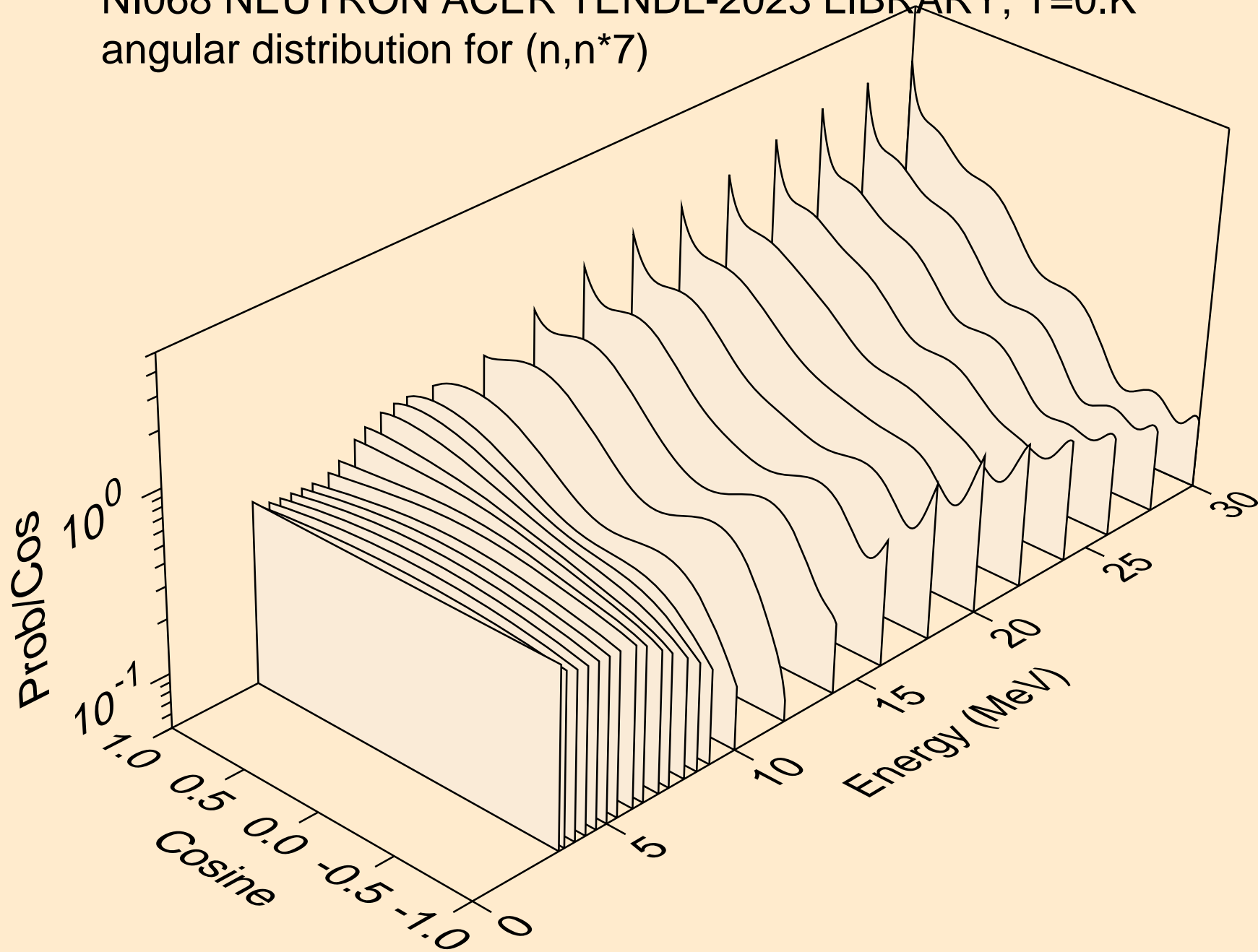

NI068 NEUTRON ACER TENDL-2023 LIBRARY; T=0.K  
angular distribution for (n,n\*8)

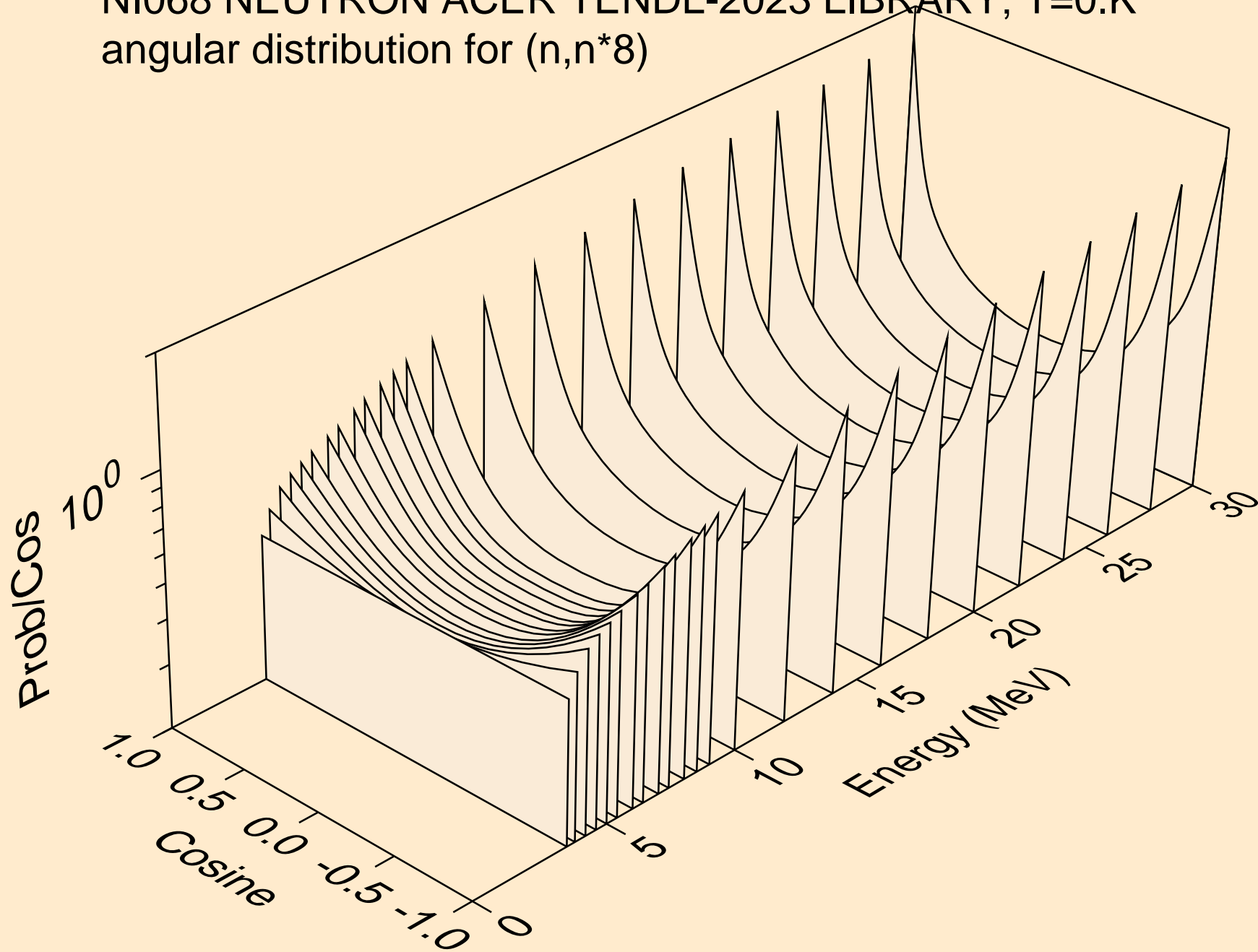

NI068 NEUTRON ACER TENDL-2023 LIBRARY; T=0.K  
angular distribution for (n,n\*9)

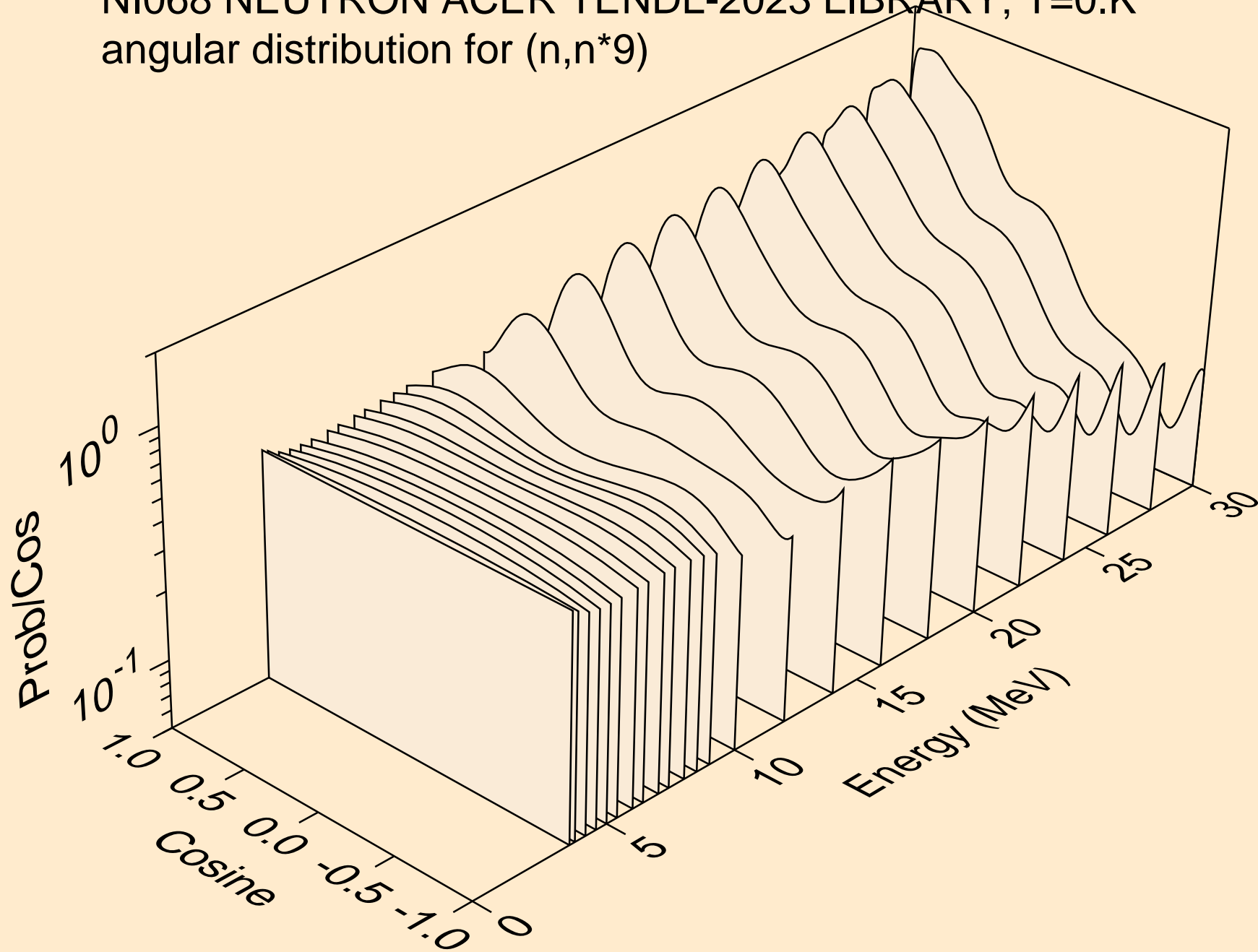

NI068 NEUTRON ACER TENDL-2023 LIBRARY; T=0.K  
angular distribution for (n,n\*10)

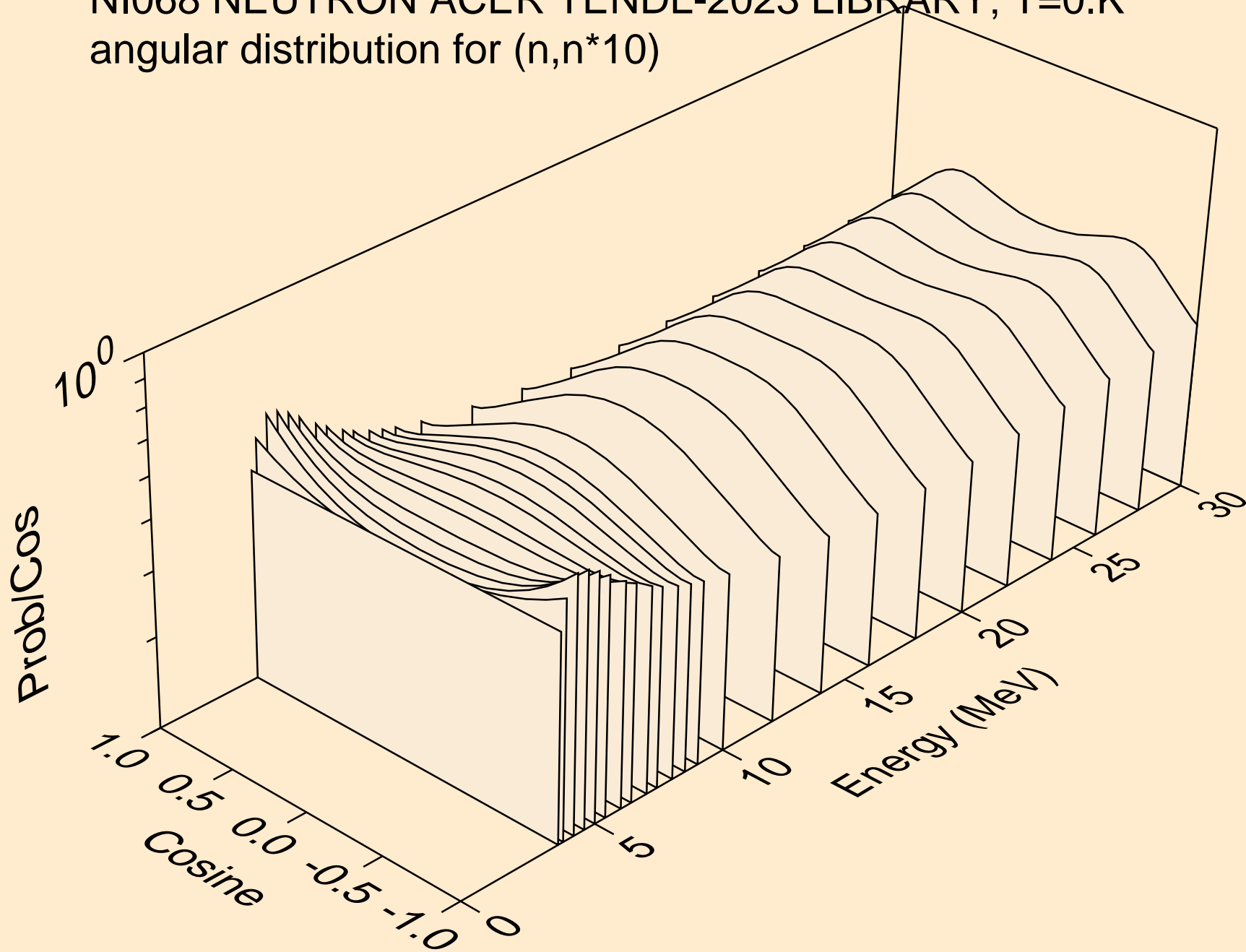

NI068 NEUTRON ACER TENDL-2023 LIBRARY; T=0.K  
angular distribution for (n,n\*11)

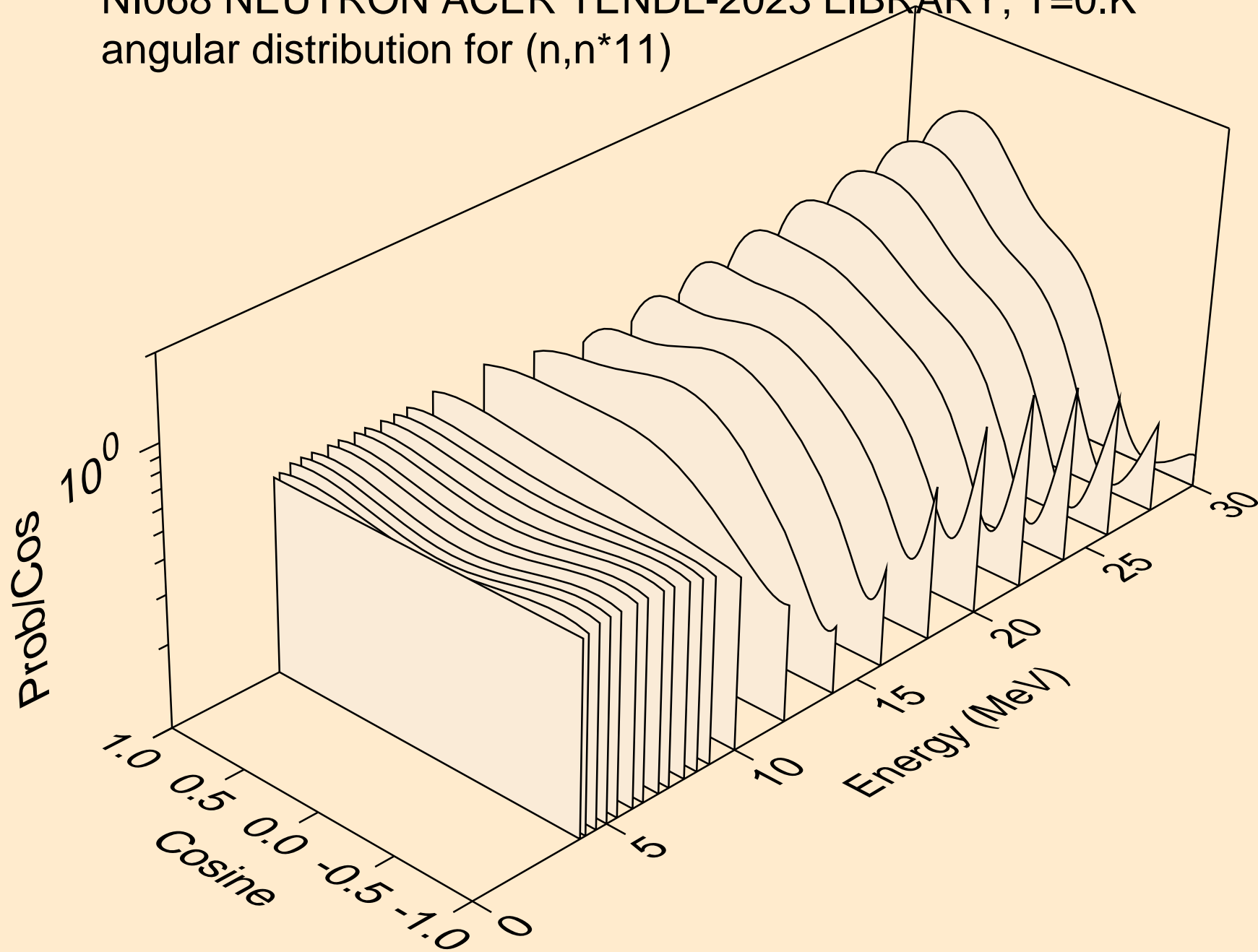



NI068 NEUTRON ACER TENDL-2023 LIBRARY; T=0.K  
angular distribution for (n,n\*12)

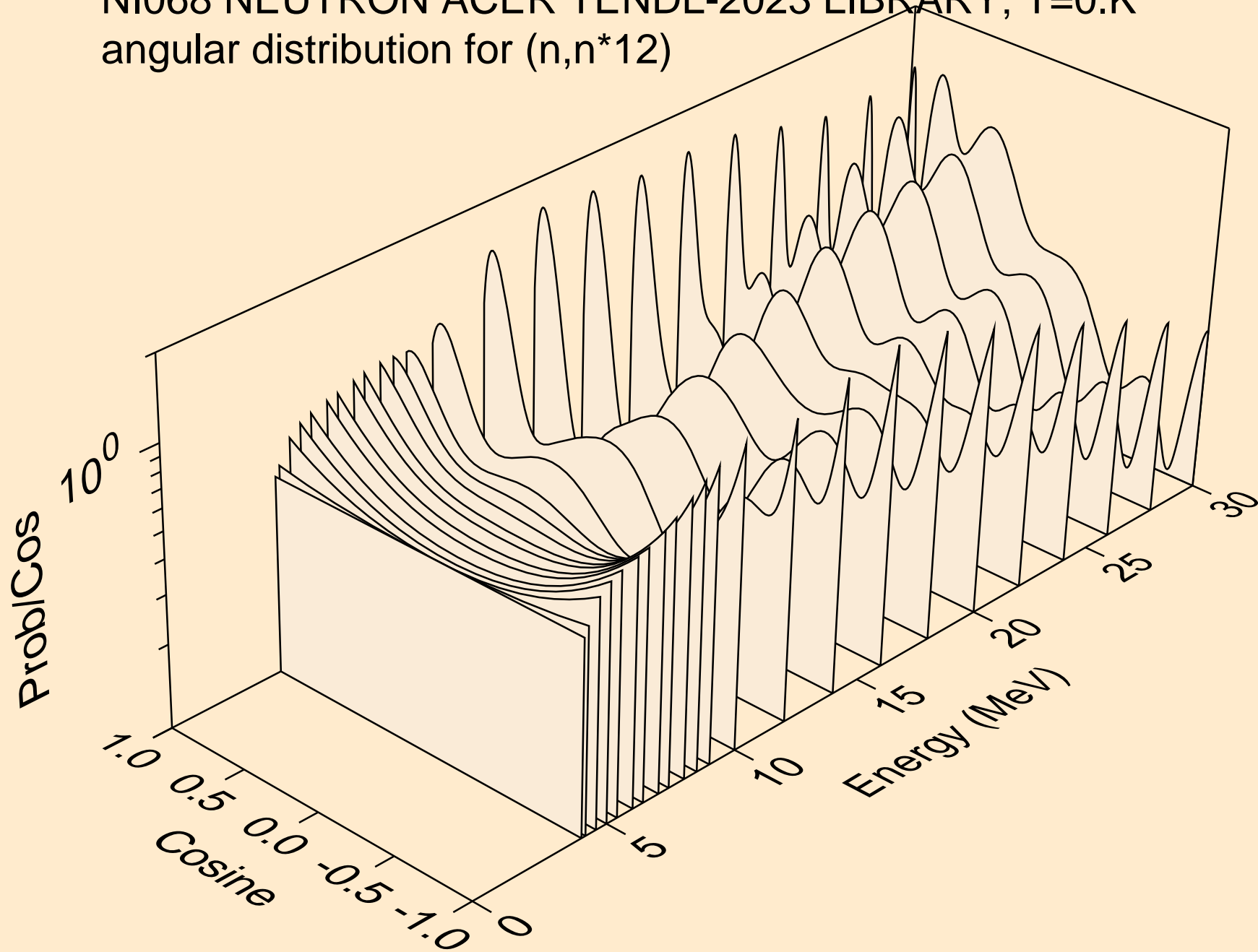

NI068 NEUTRON ACER TENDL-2023 LIBRARY; T=0.K  
angular distribution for (n,n\*13)

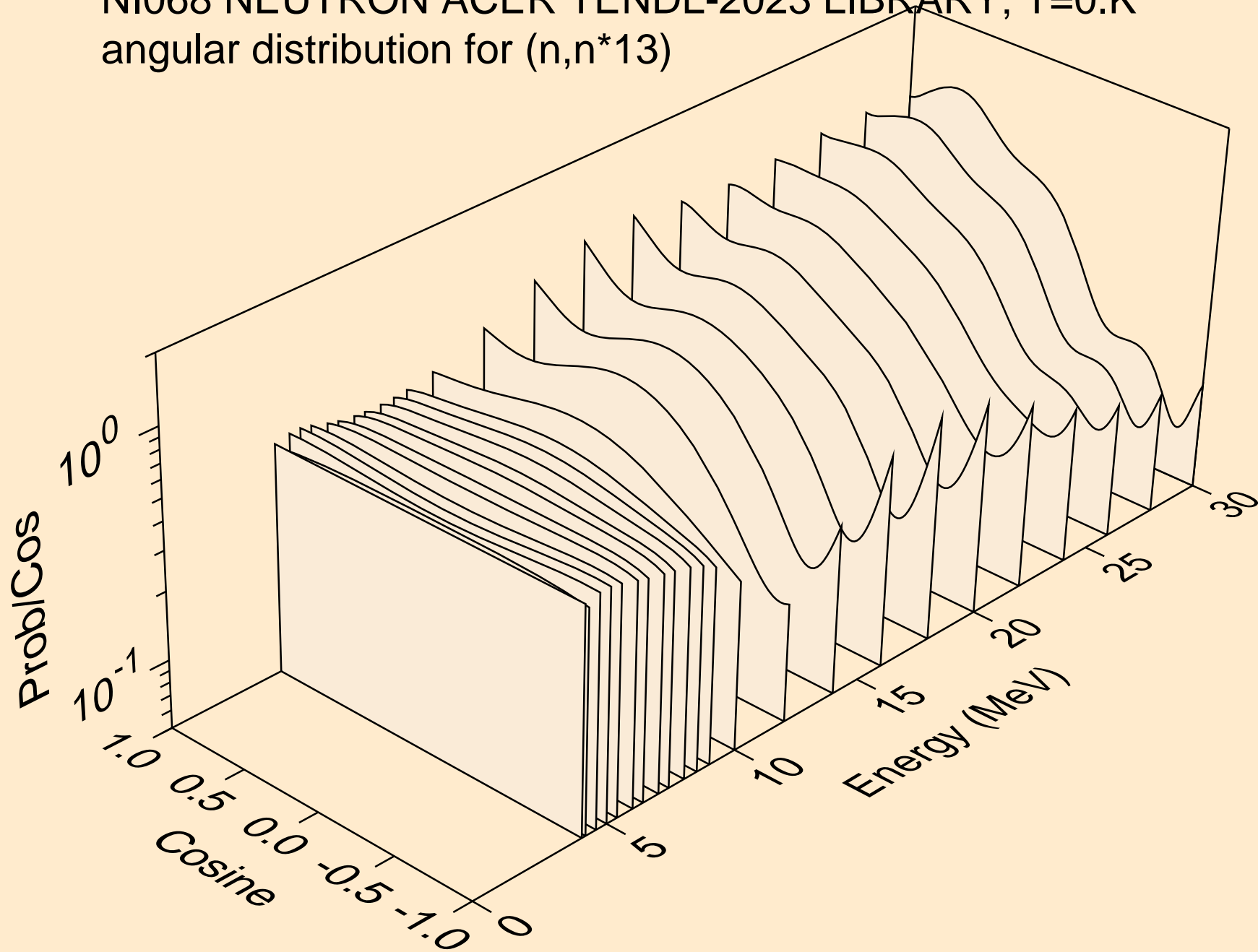

NI068 NEUTRON ACER TENDL-2023 LIBRARY; T=0.K  
angular distribution for (n,n\*14)

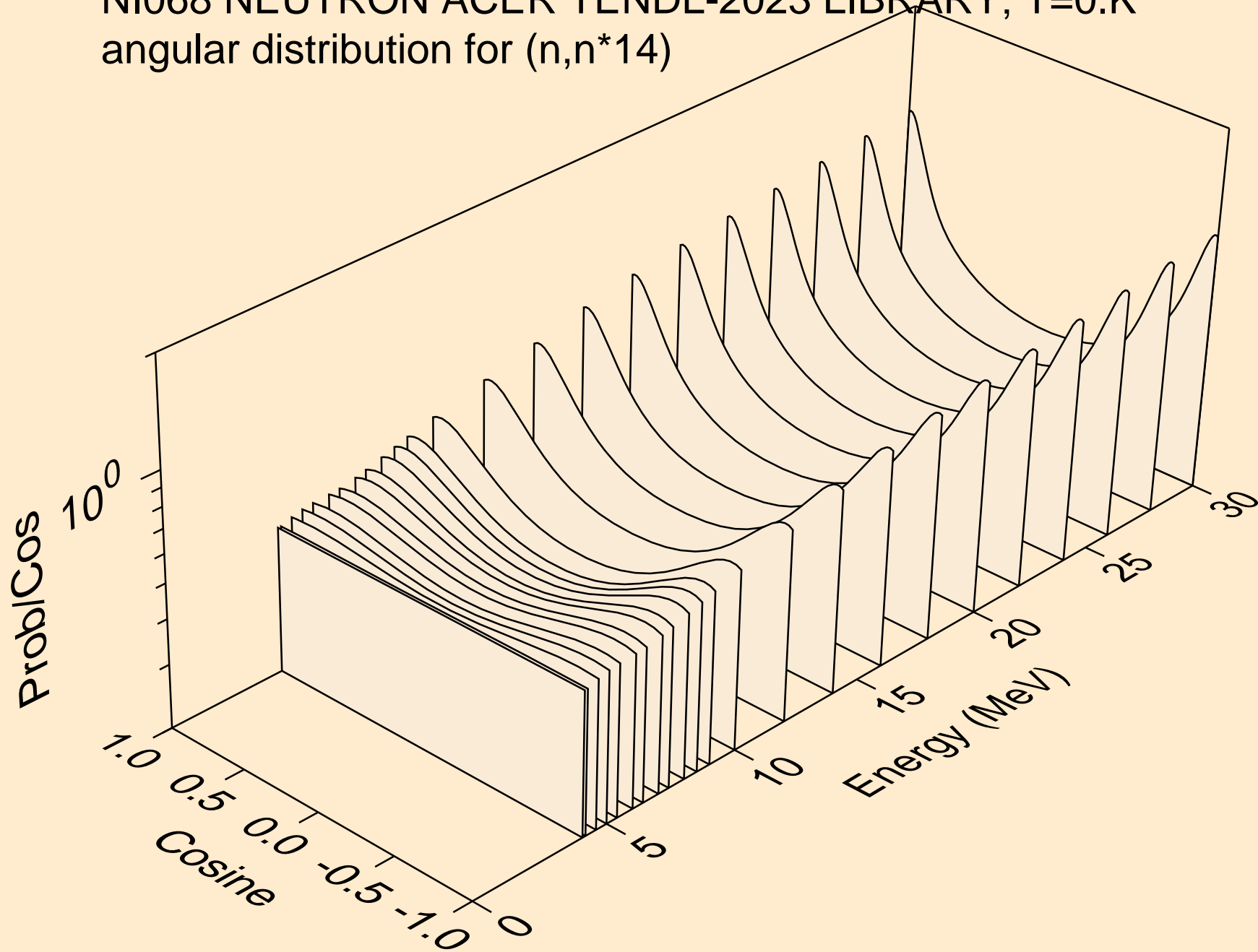

NI068 NEUTRON ACER TENDL-2023 LIBRARY; T=0.K  
angular distribution for (n,n\*15)

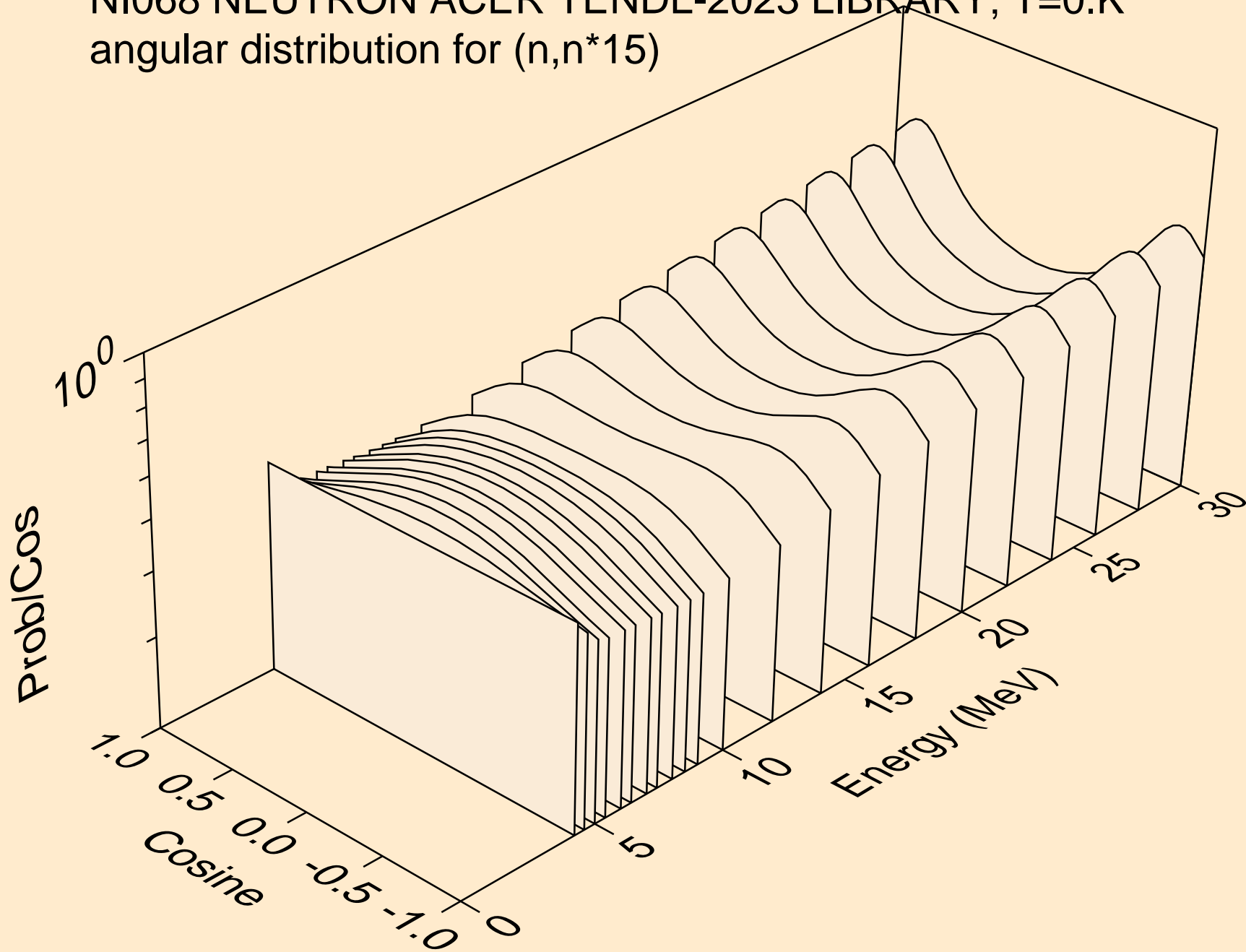

NI068 NEUTRON ACER TENDL-2023 LIBRARY; T=0.K  
angular distribution for (n,n\*16)

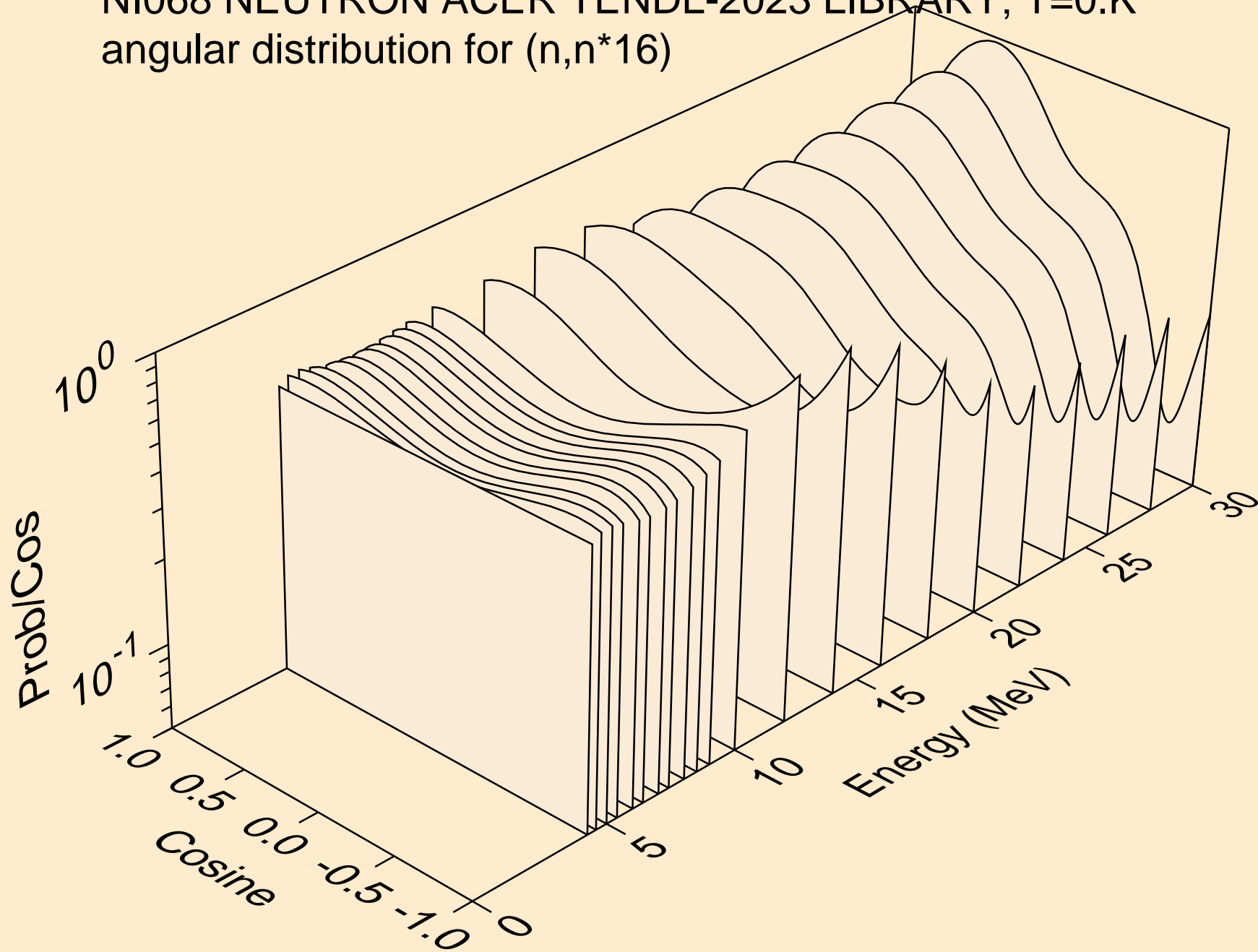

NI068 NEUTRON ACER TENDL-2023 LIBRARY; T=0.K  
angular distribution for (n,n\*17)

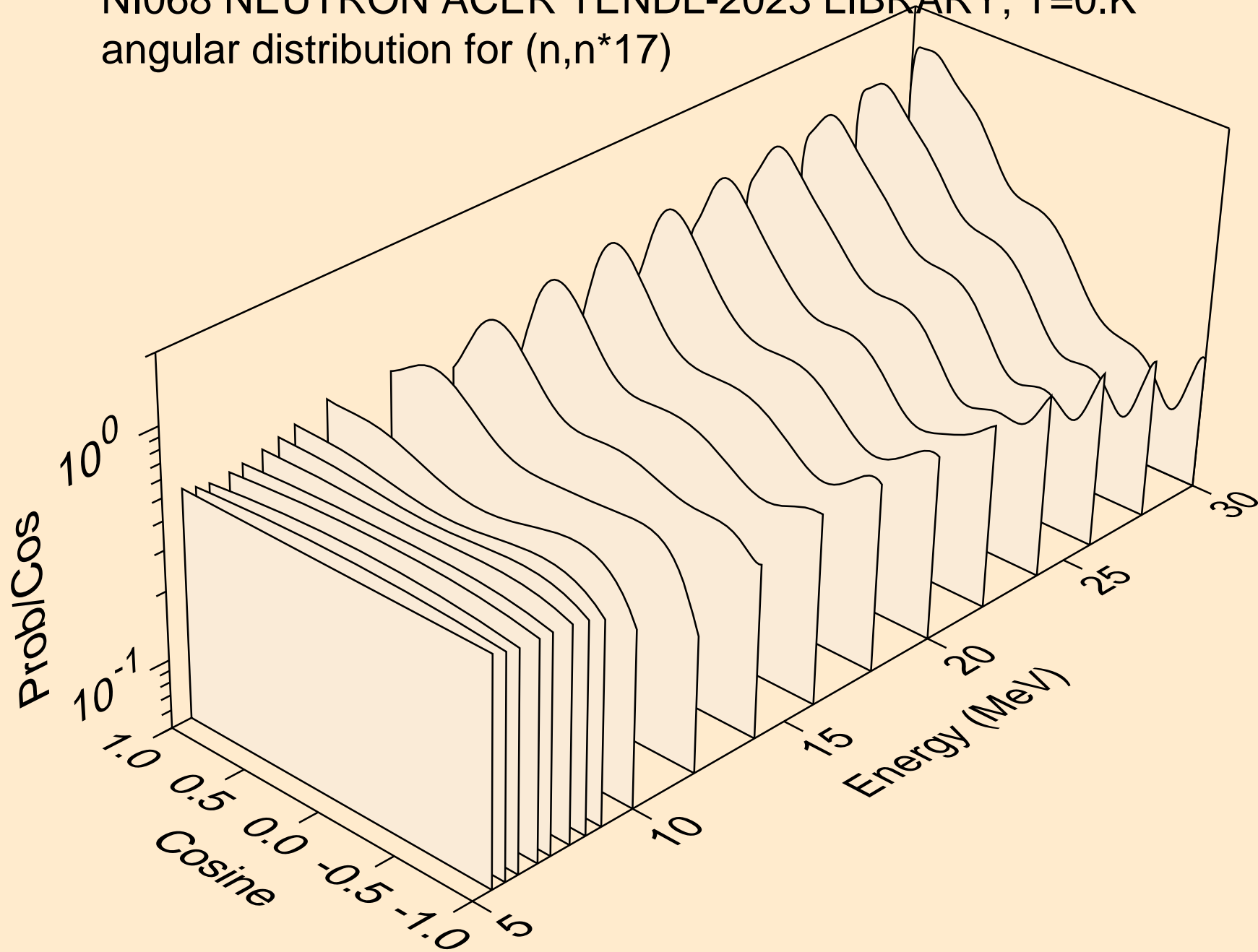

NI068 NEUTRON ACER TENDL-2023 LIBRARY; T=0.K  
angular distribution for (n,n\*18)

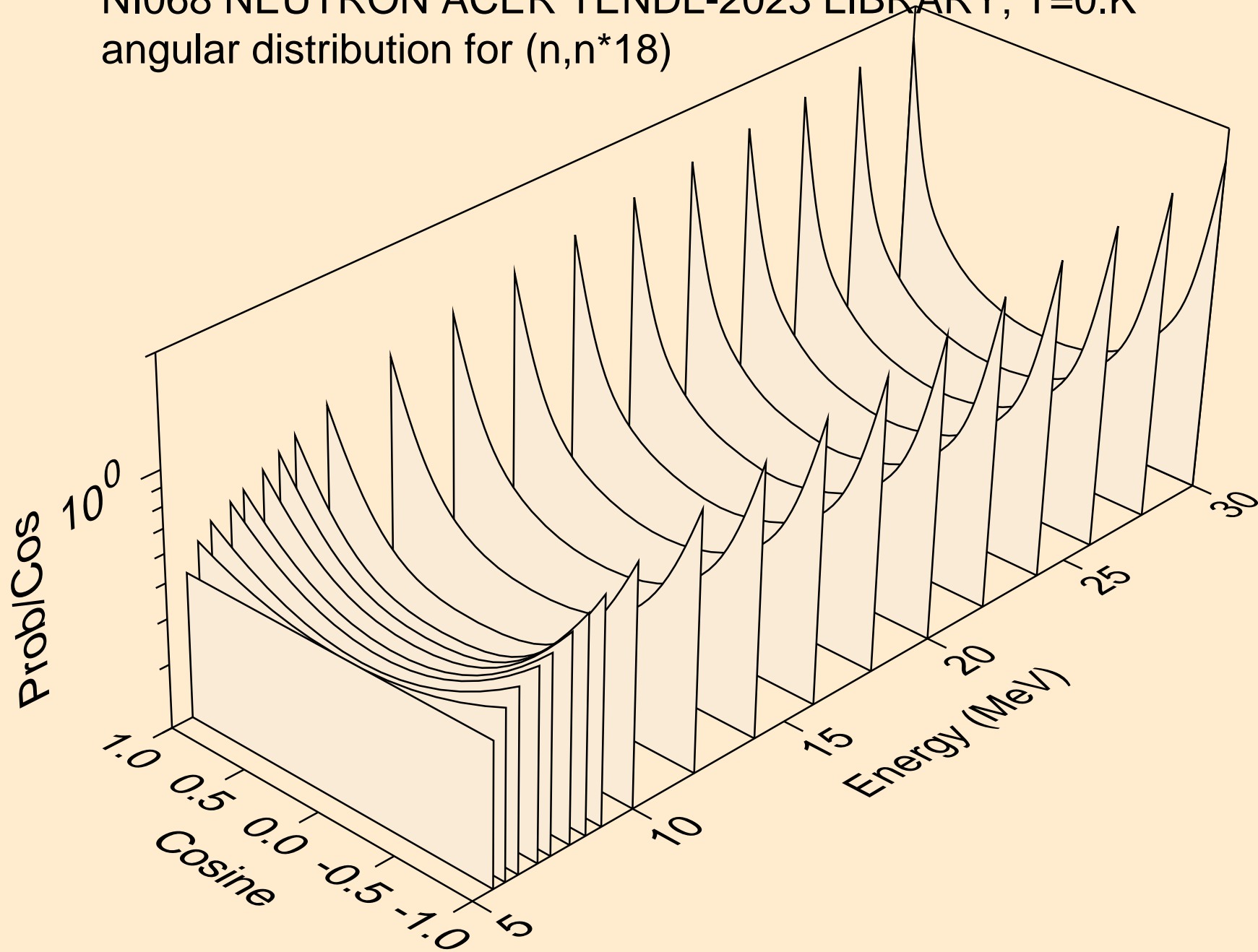

NI068 NEUTRON ACER TENDL-2023 LIBRARY; T=0.K  
Neutron emission for (n,x)

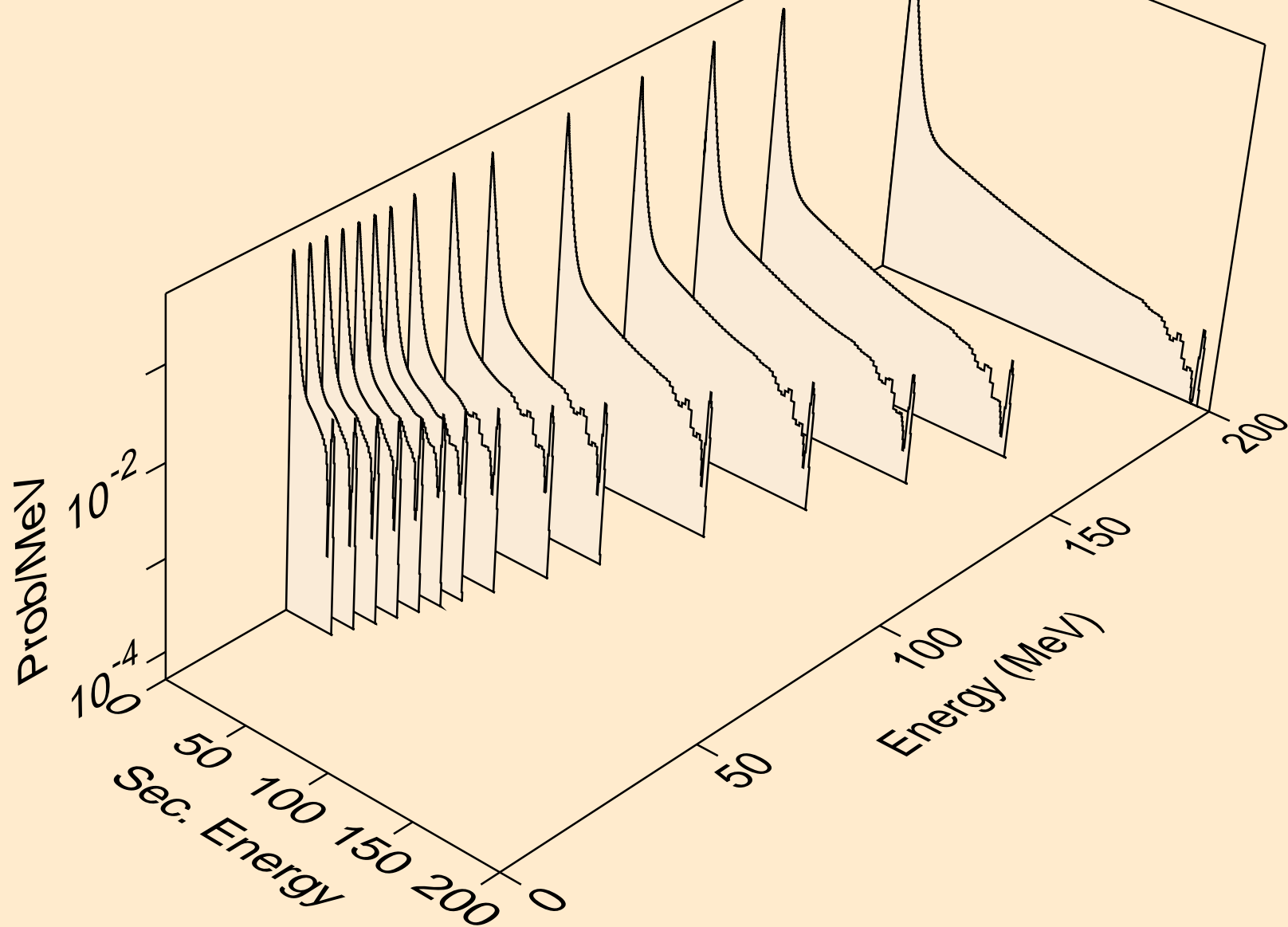



NI068 NEUTRON ACER TENDL-2023 LIBRARY; T=0.K  
Neutron emission for (n,2nd)

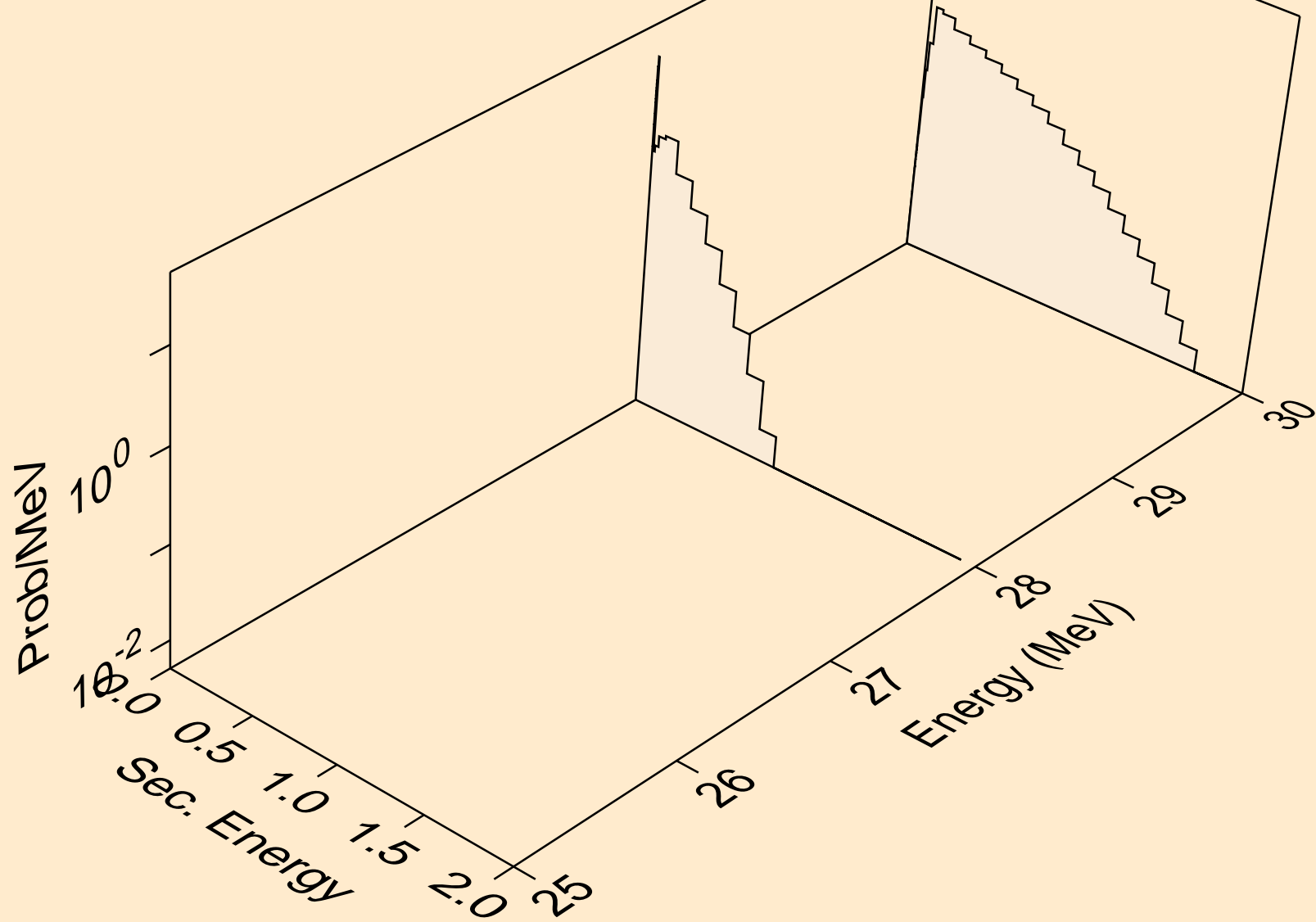

NI068 NEUTRON ACER TENDL-2023 LIBRARY; T=0.K  
Neutron emission for (n,2n)

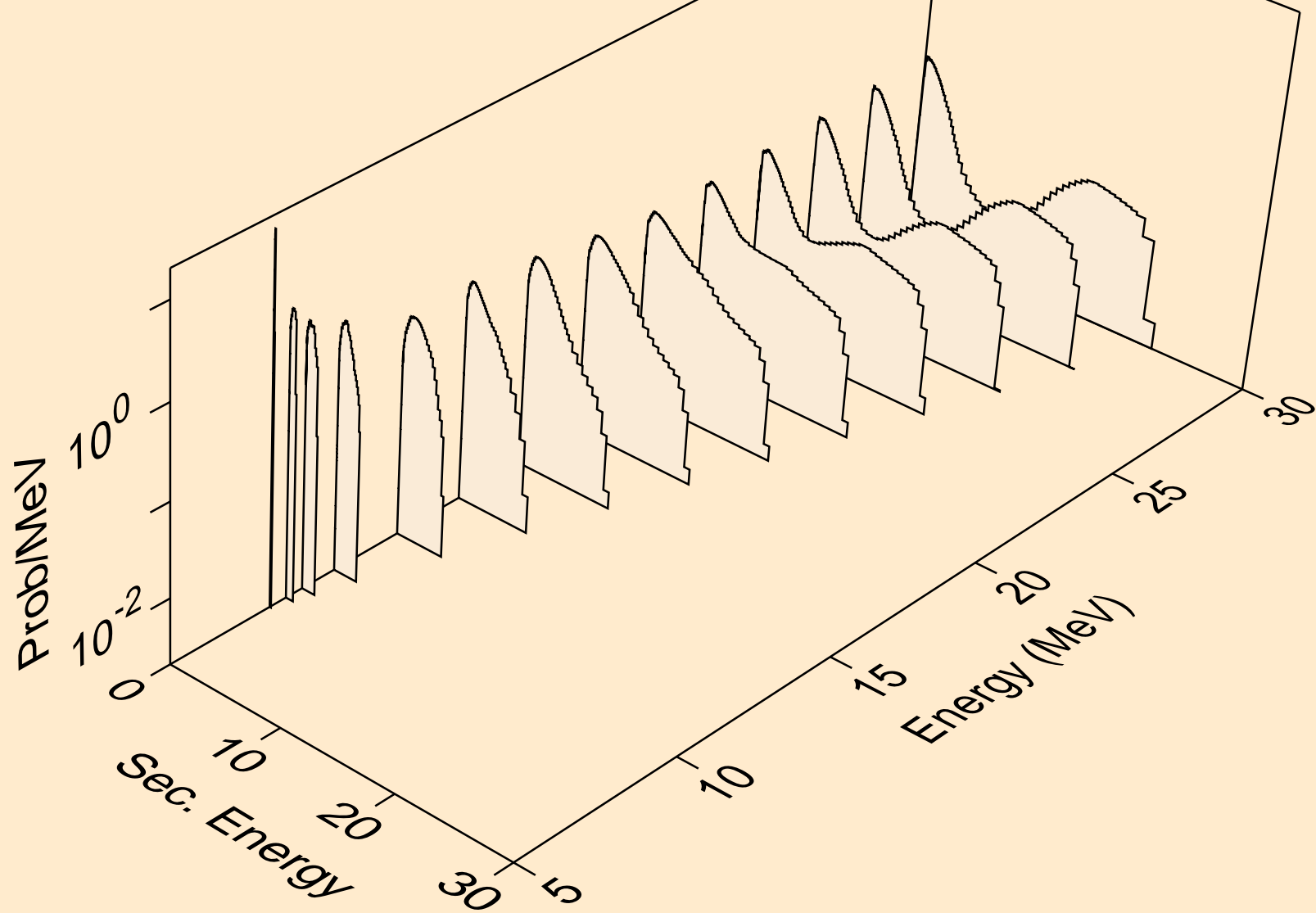

NI068 NEUTRON ACER TENDL-2023 LIBRARY; T=0.K  
Neutron emission for (n,3n)

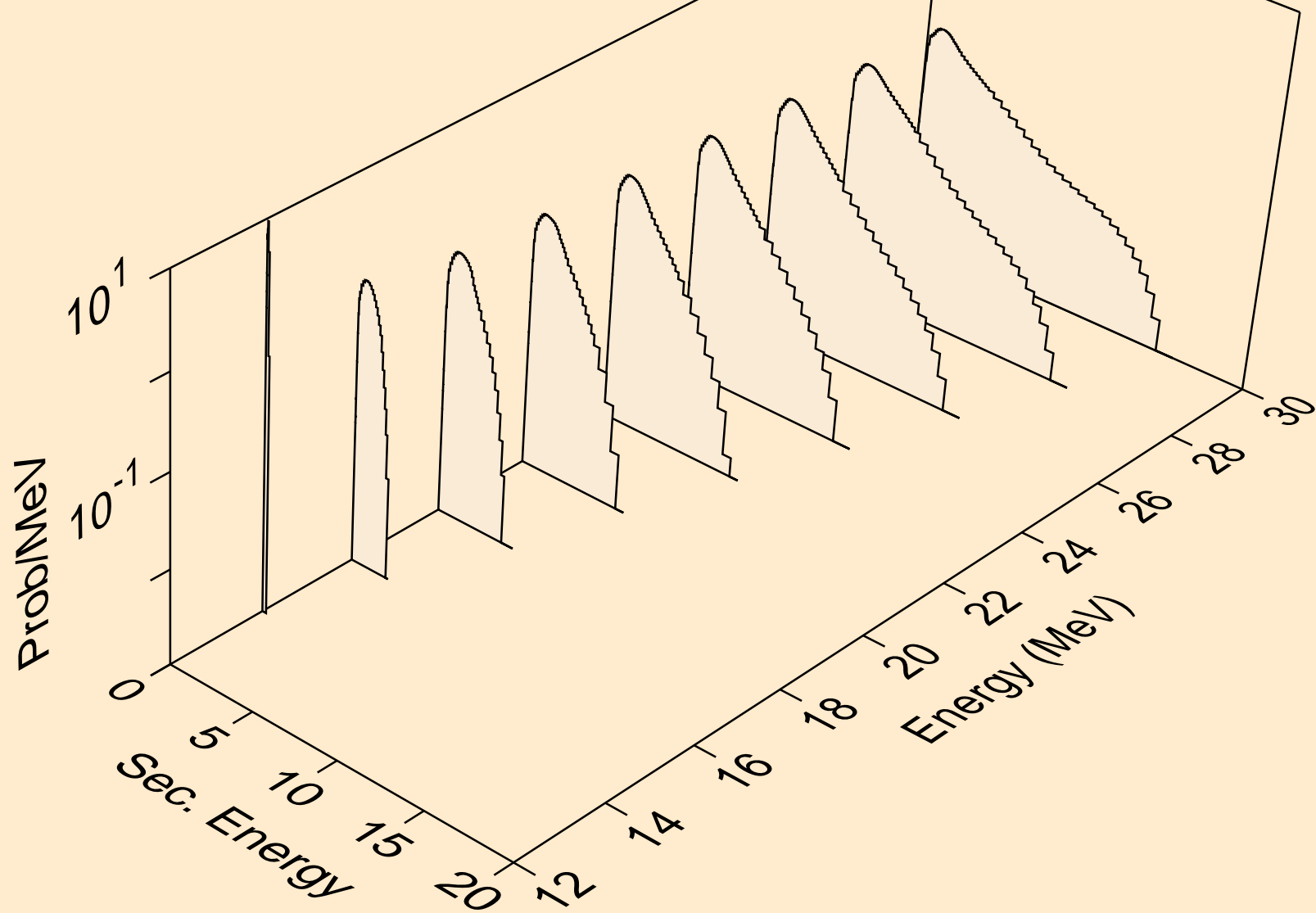

NI068 NEUTRON ACER TENDL-2023 LIBRARY; T=0.K  
Neutron emission for (n,n\*)a

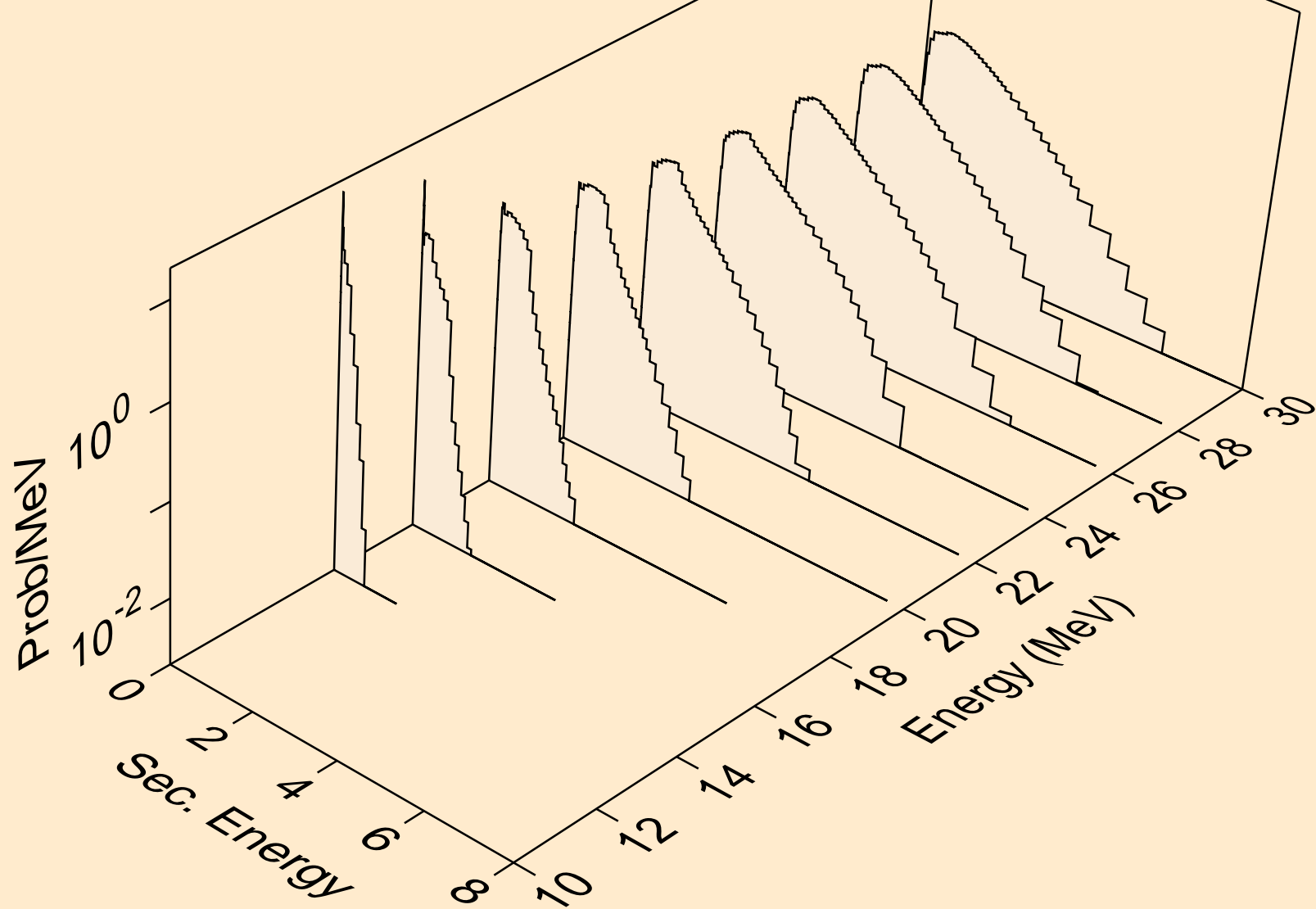

NI068 NEUTRON ACER TENDL-2023 LIBRARY; T=0.K  
Neutron emission for (n,2n)a

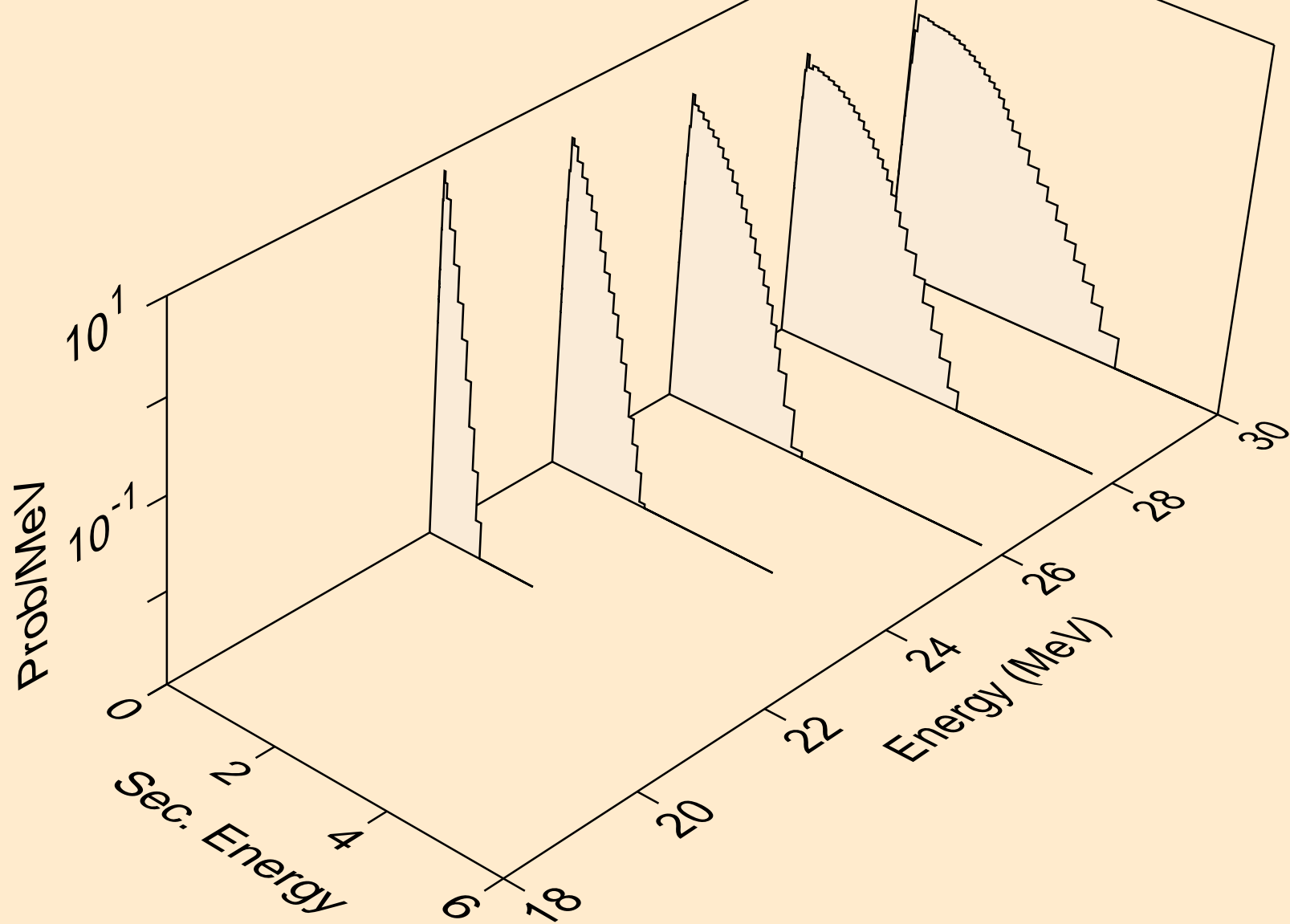

NI068 NEUTRON ACER TENDL-2023 LIBRARY; T=0.K  
Neutron emission for (n,3n)a

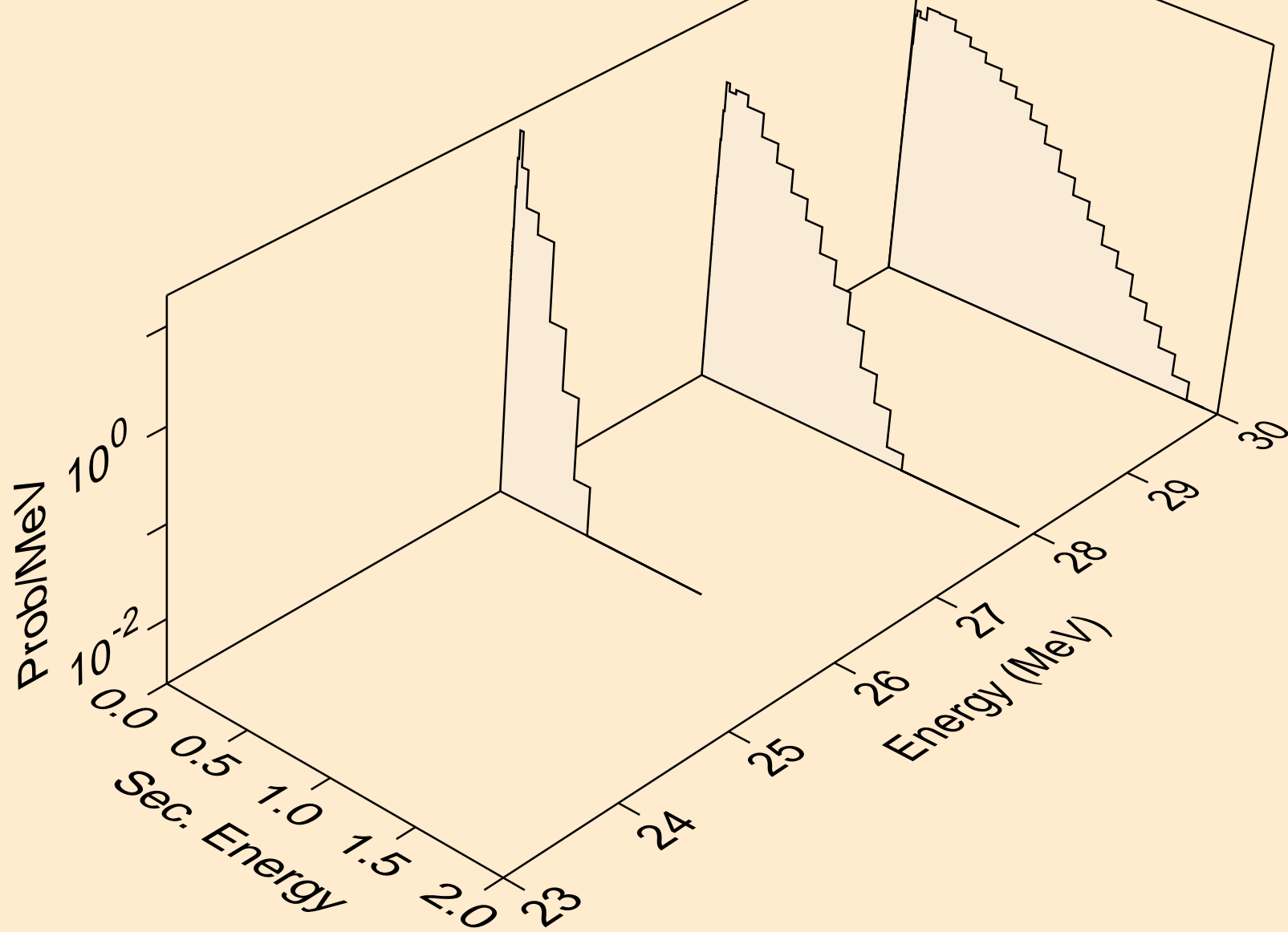

NI068 NEUTRON ACER TENDL-2023 LIBRARY; T=0.K  
Neutron emission for (n,n\*)p

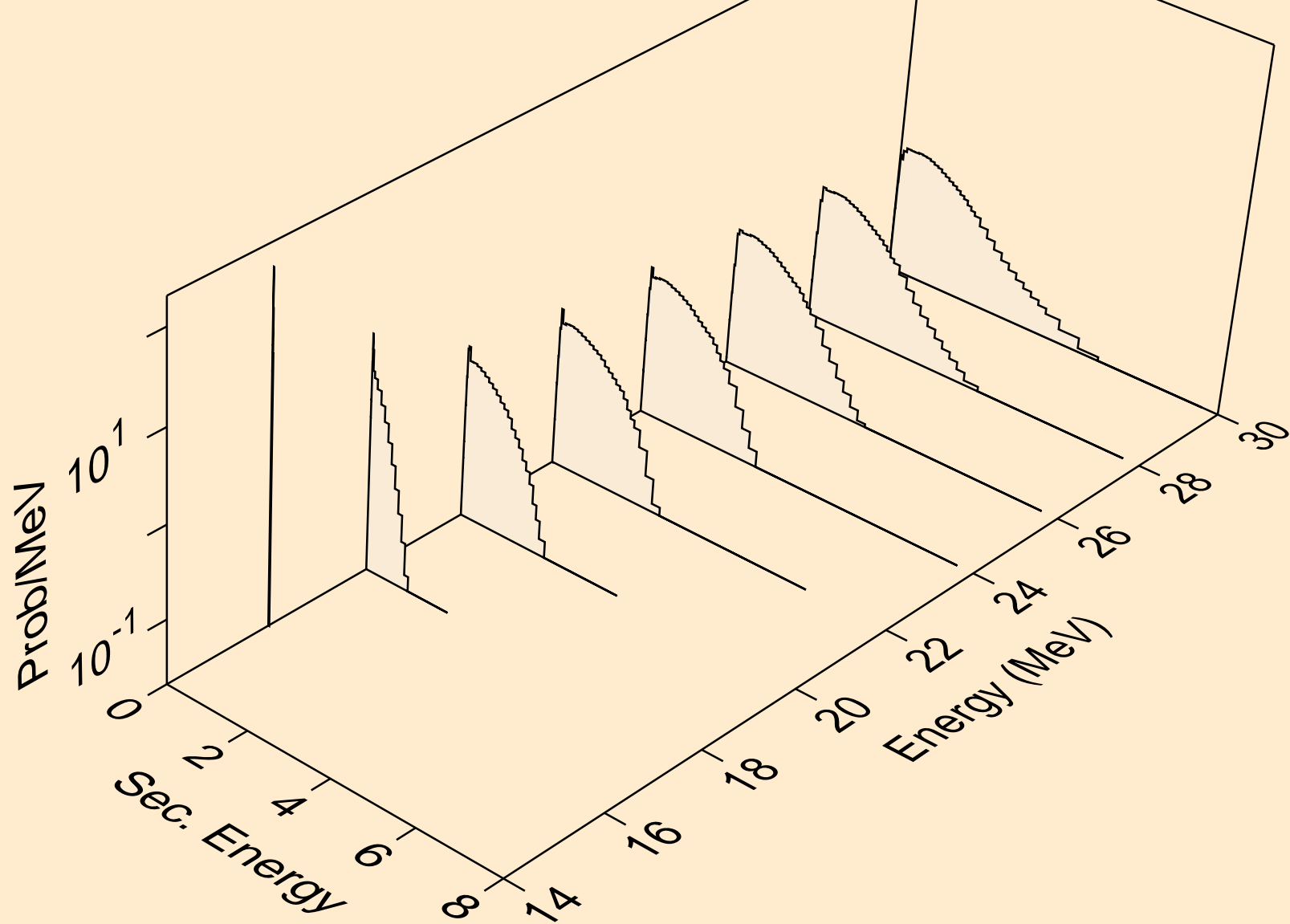

NI068 NEUTRON ACER TENDL-2023 LIBRARY; T=0.K  
Neutron emission for (n,n\*)d

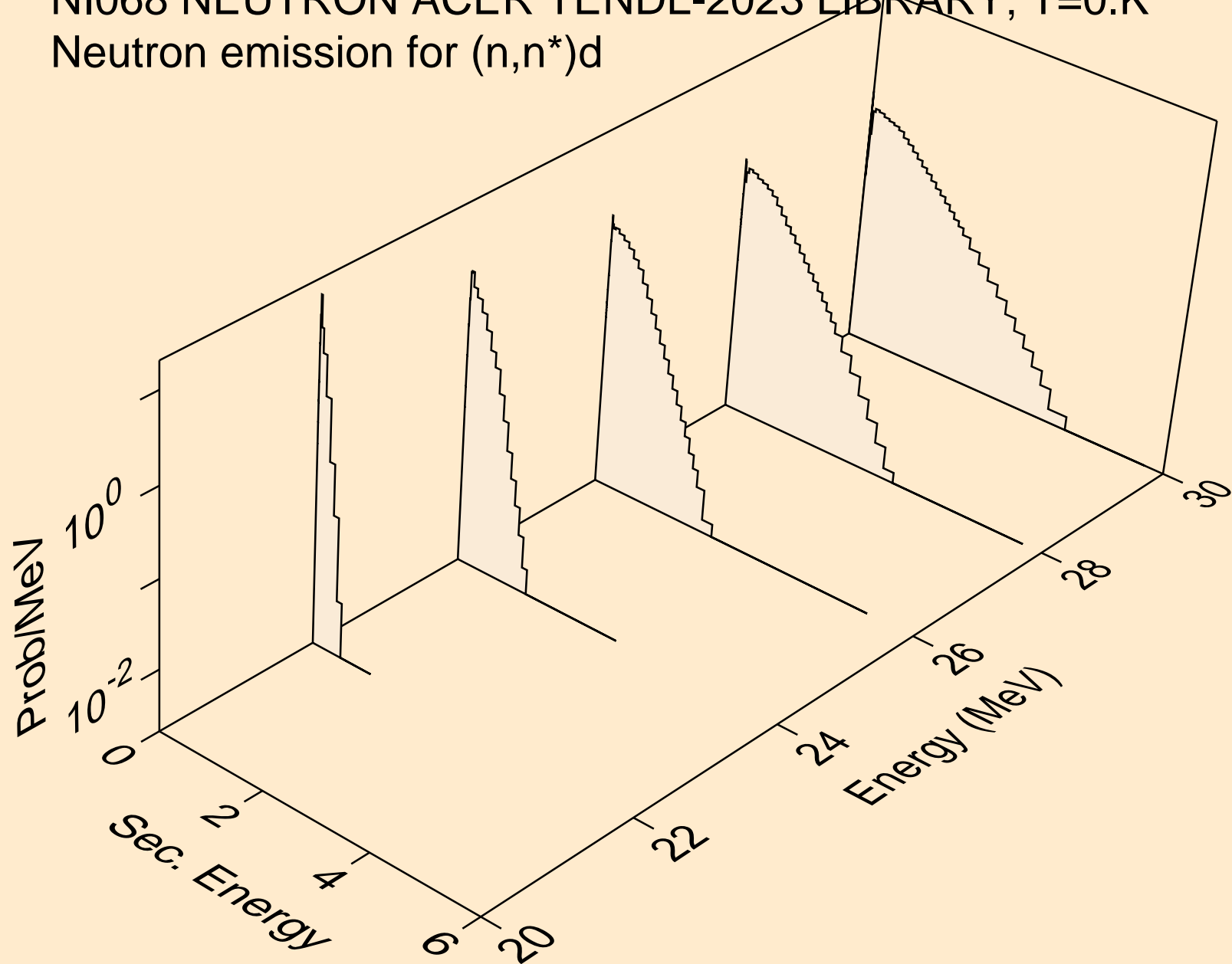



NI068 NEUTRON ACER TENDL-2023 LIBRARY; T=0.K  
Neutron emission for (n,n\*)t

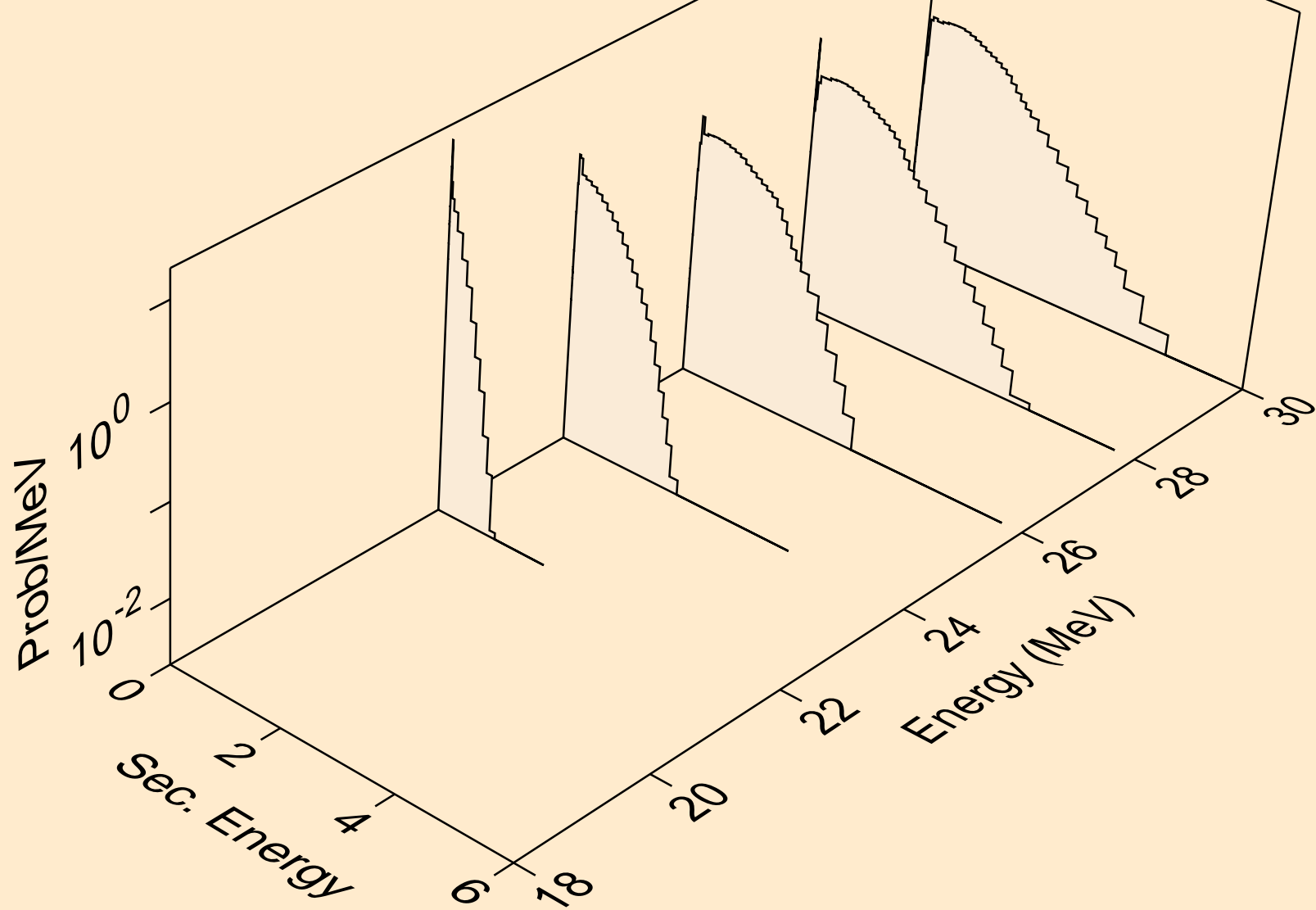

NI068 NEUTRON ACER TENDL-2023 LIBRARY; T=0.K  
Neutron emission for (n,4n)

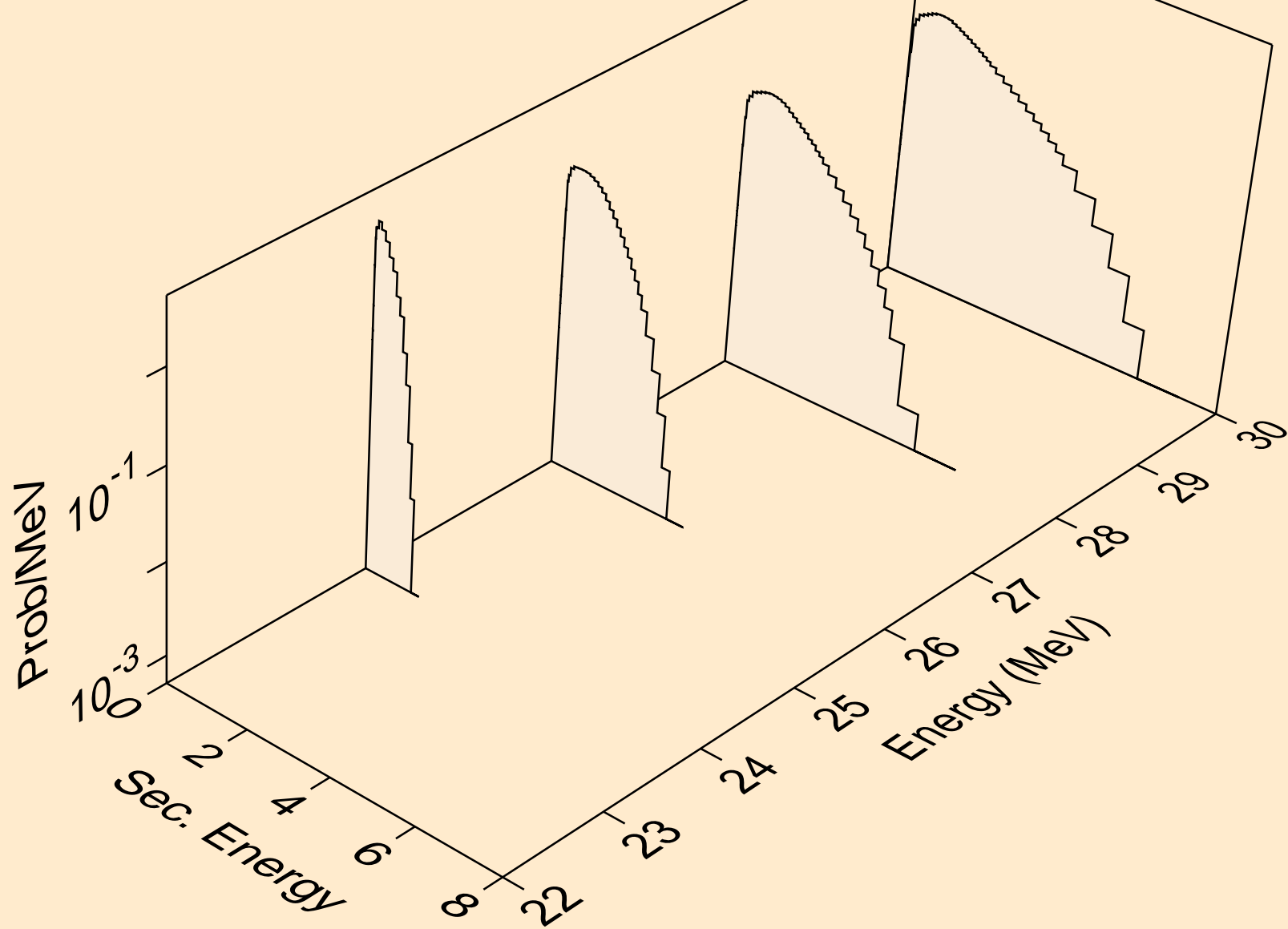

NI068 NEUTRON ACER TENDL-2023 LIBRARY; T=0.K  
Neutron emission for (n,2np)

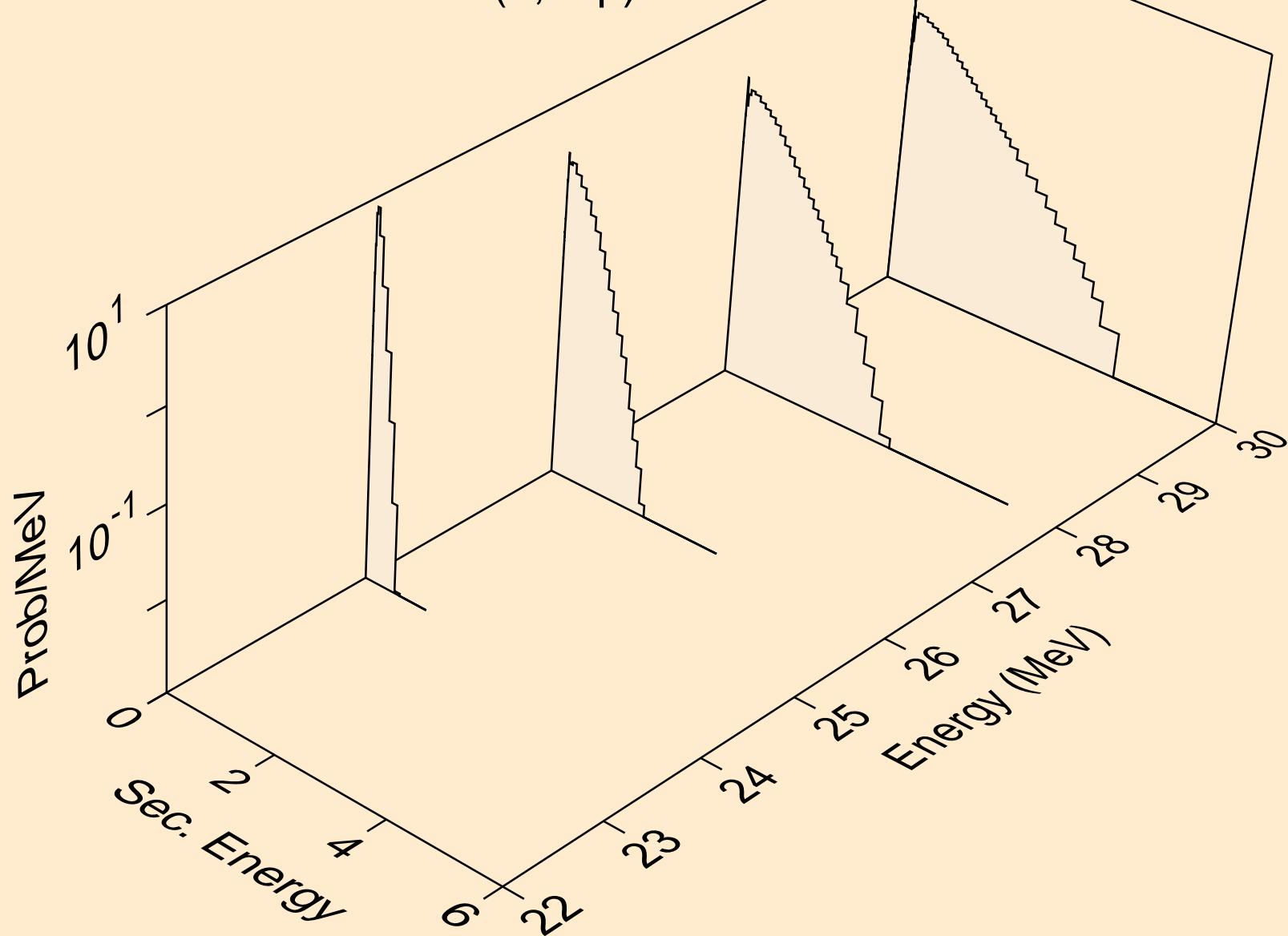

NI068 NEUTRON ACER TENDL-2023 LIBRARY; T=0.K  
Neutron emission for (n,3np)

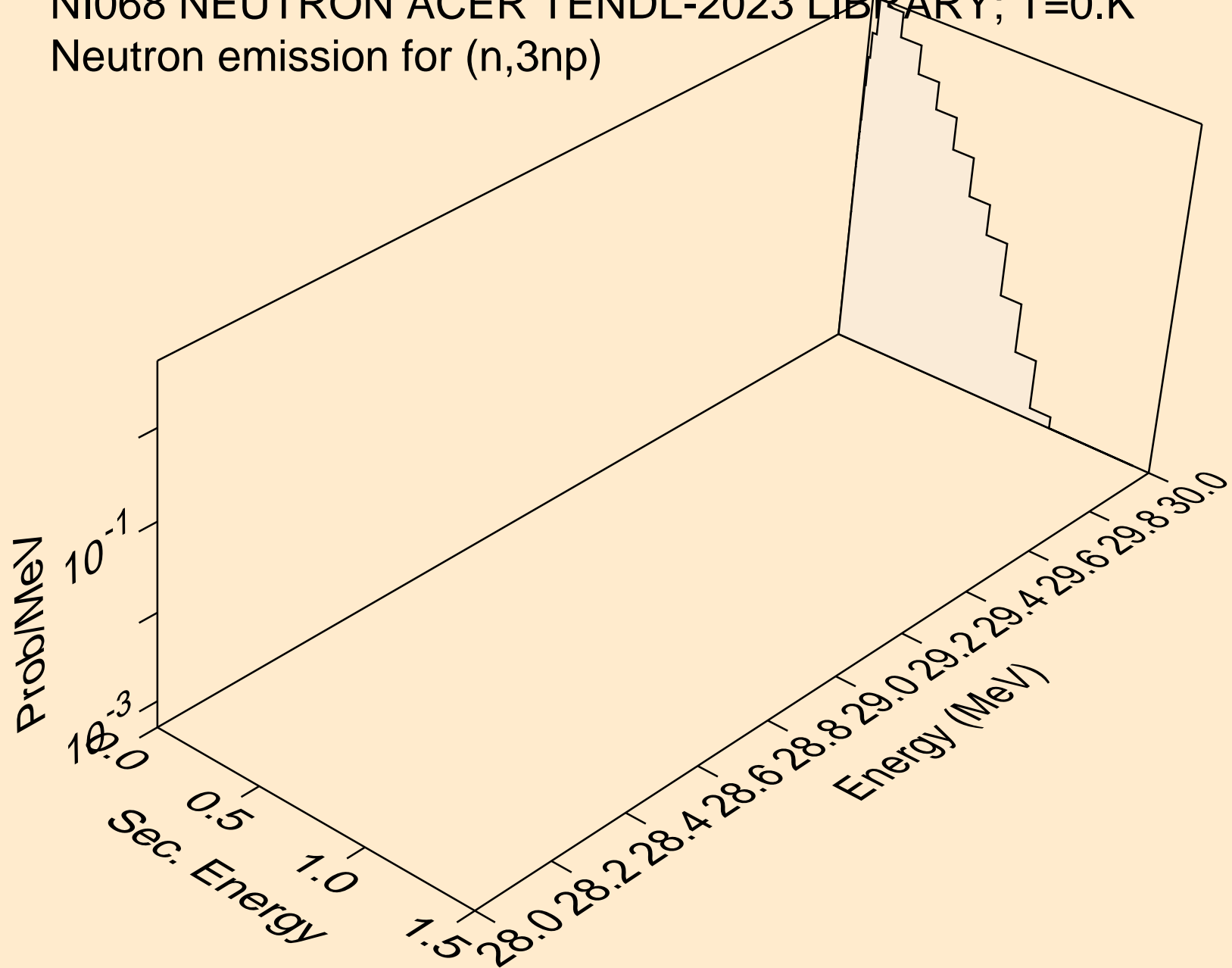

NI068 NEUTRON ACER TENDL-2023 LIBRARY; T=0.K  
Neutron emission for (n,n\*c)

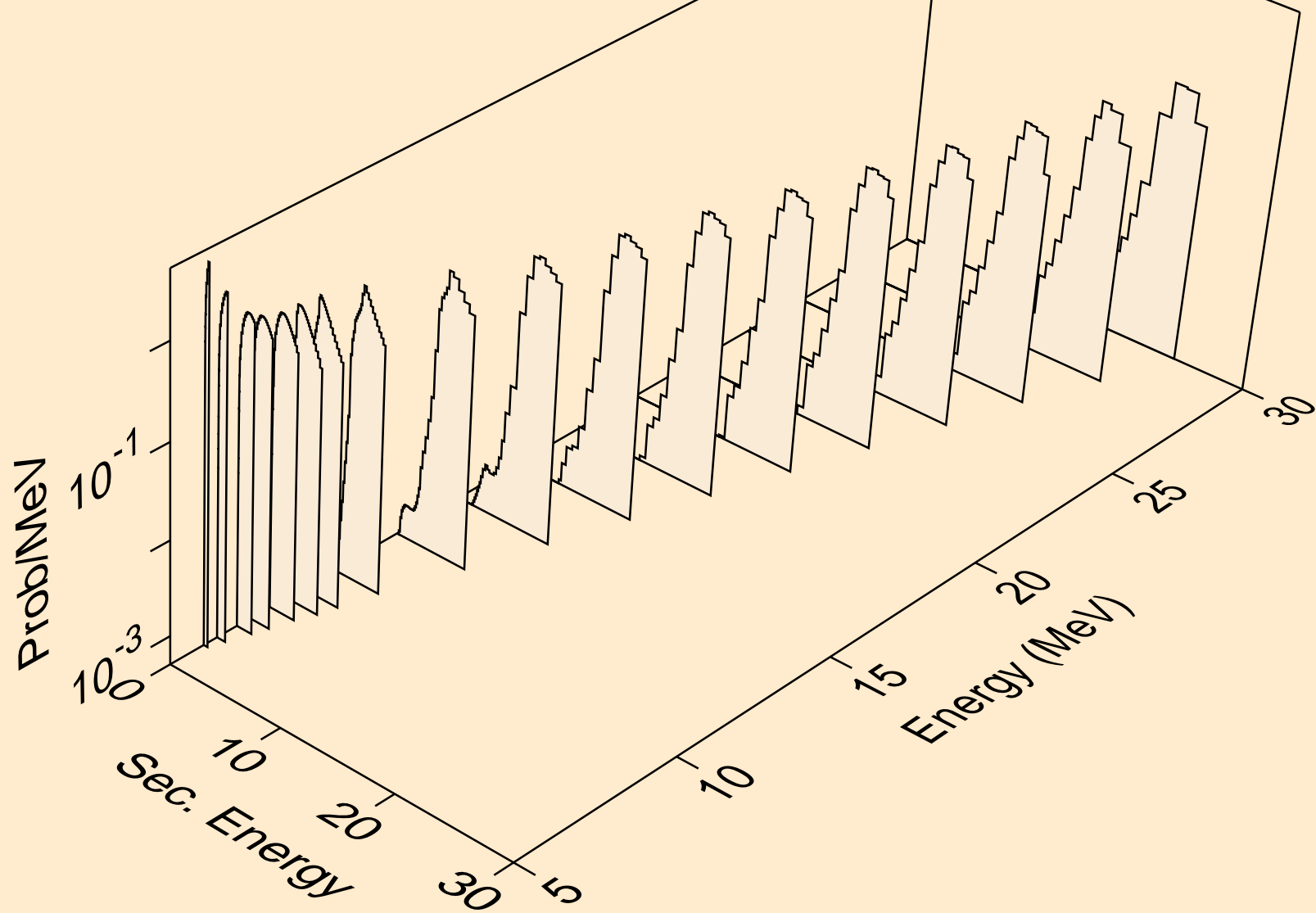

NI068 NEUTRON ACER TENDL-2023 LIBRARY; T=0.K  
Photon emission for (n,x)

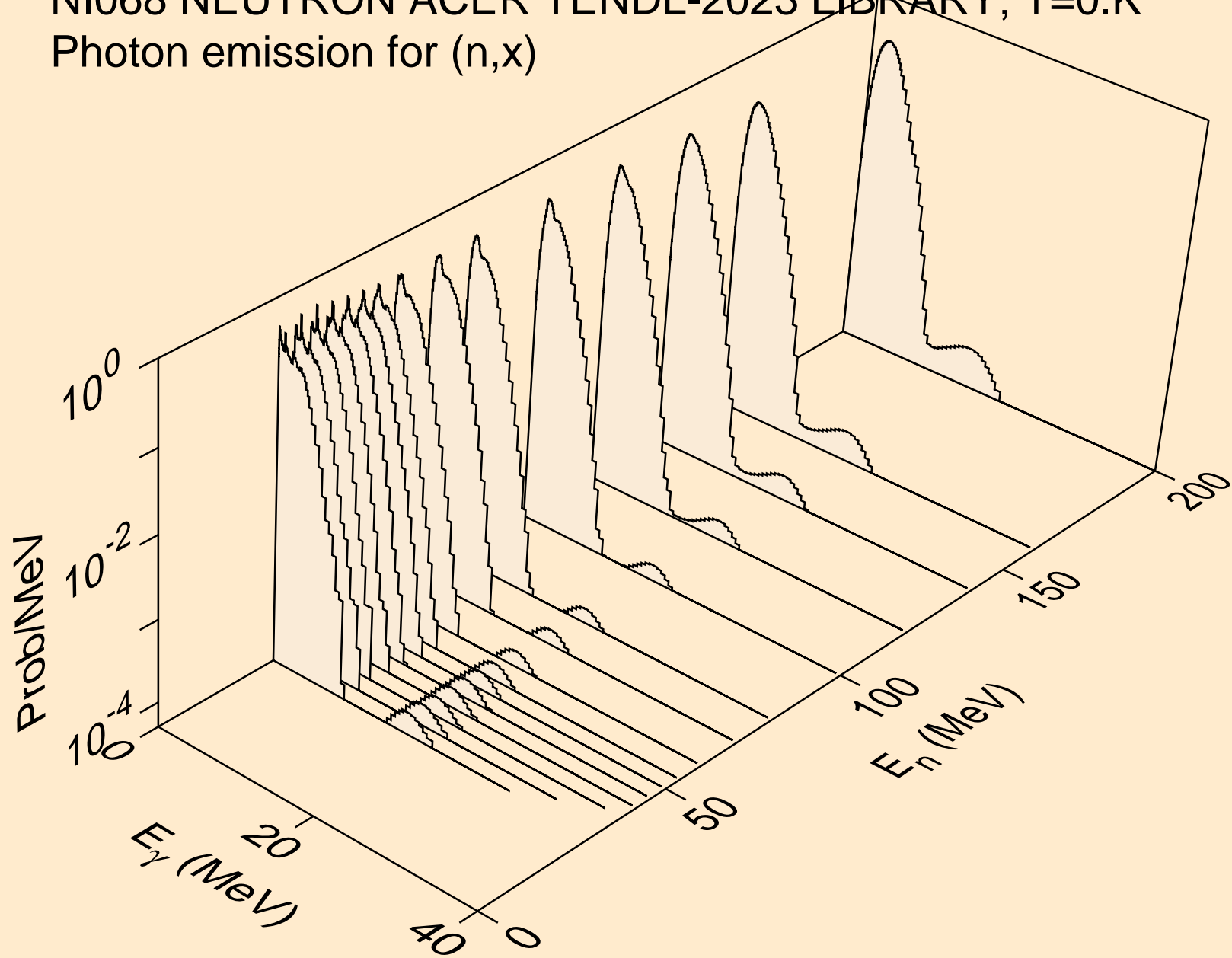

NI068 NEUTRON ACER TENDL-2023 LIBRARY; T=0.K  
Photon emission for (n,2nd)

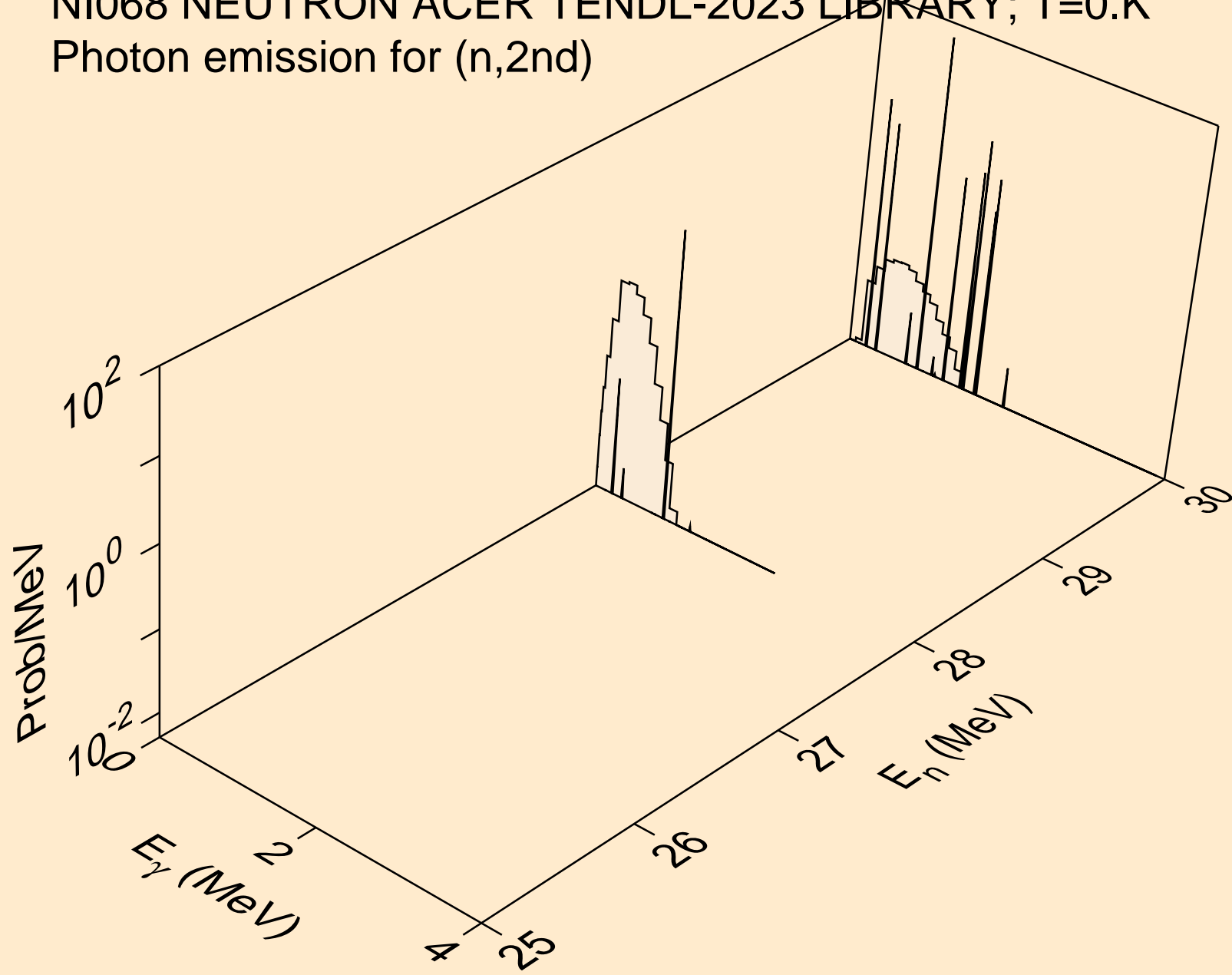

NI068 NEUTRON ACER TENDL-2023 LIBRARY; T=0.K  
Photon emission for (n,2n)

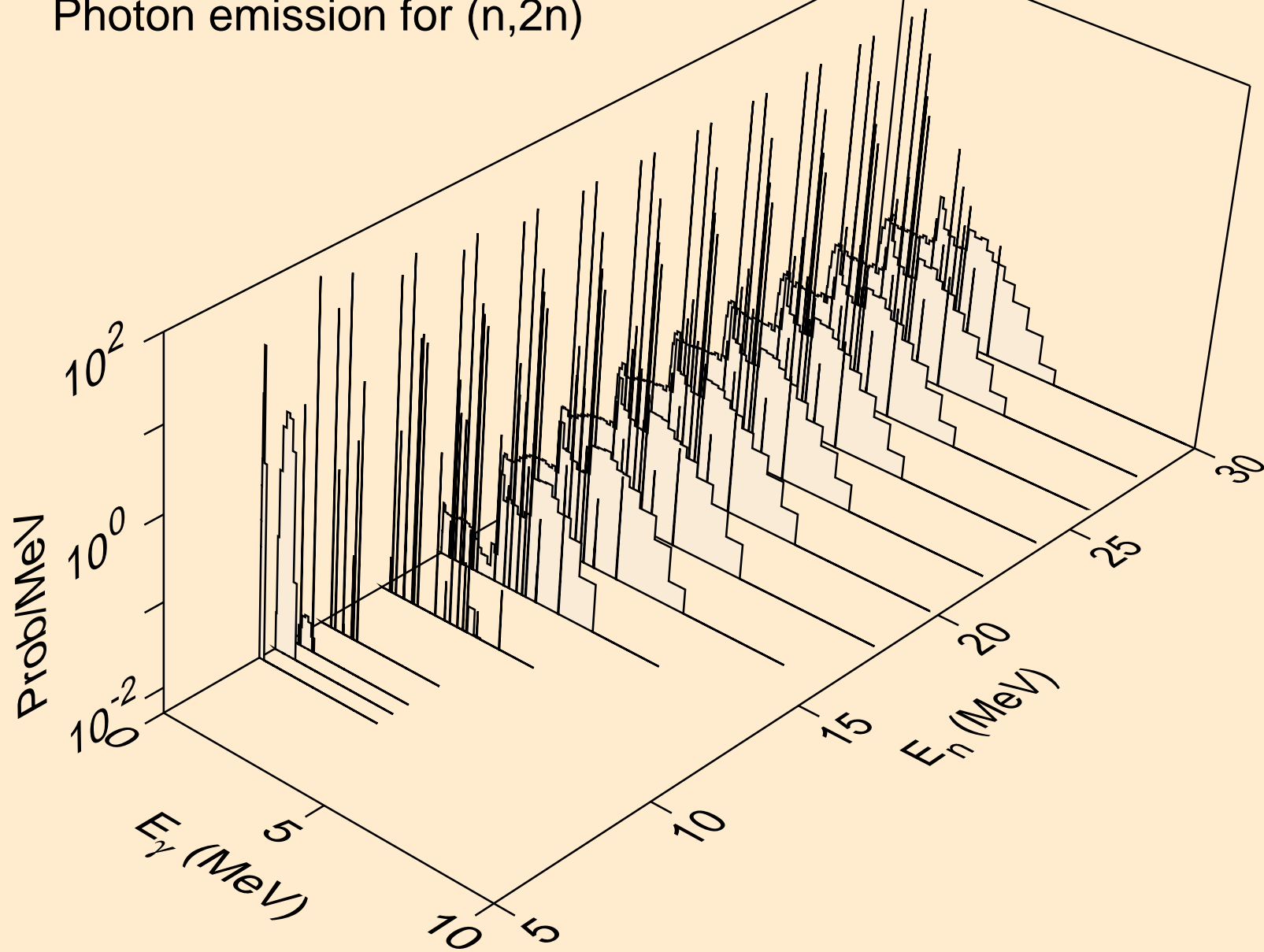



NI068 NEUTRON ACER TENDL-2023 LIBRARY; T=0.K  
Photon emission for (n,3n)

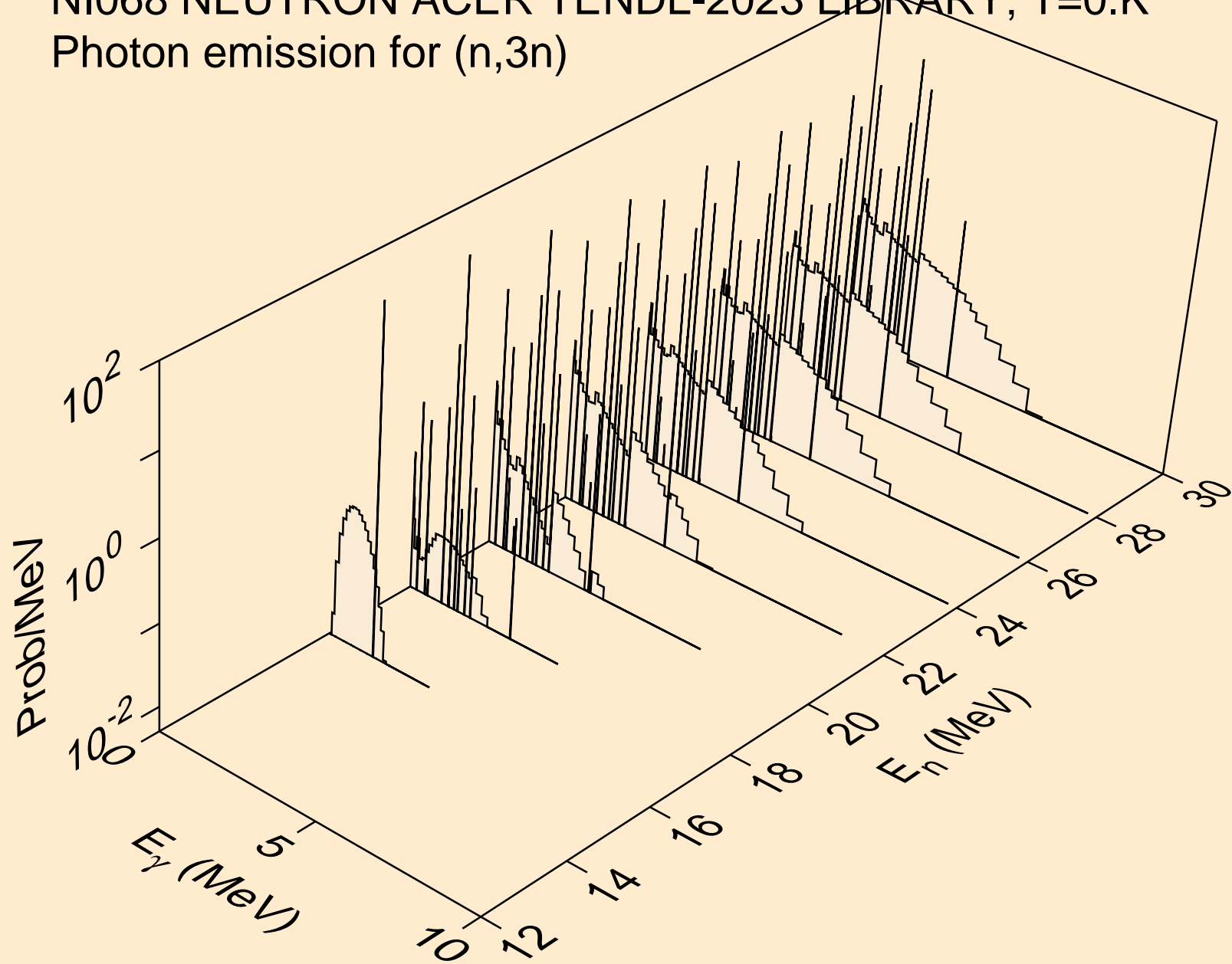

NI068 NEUTRON ACER TENDL-2023 LIBRARY; T=0.K  
Photon emission for (n,n\*)a

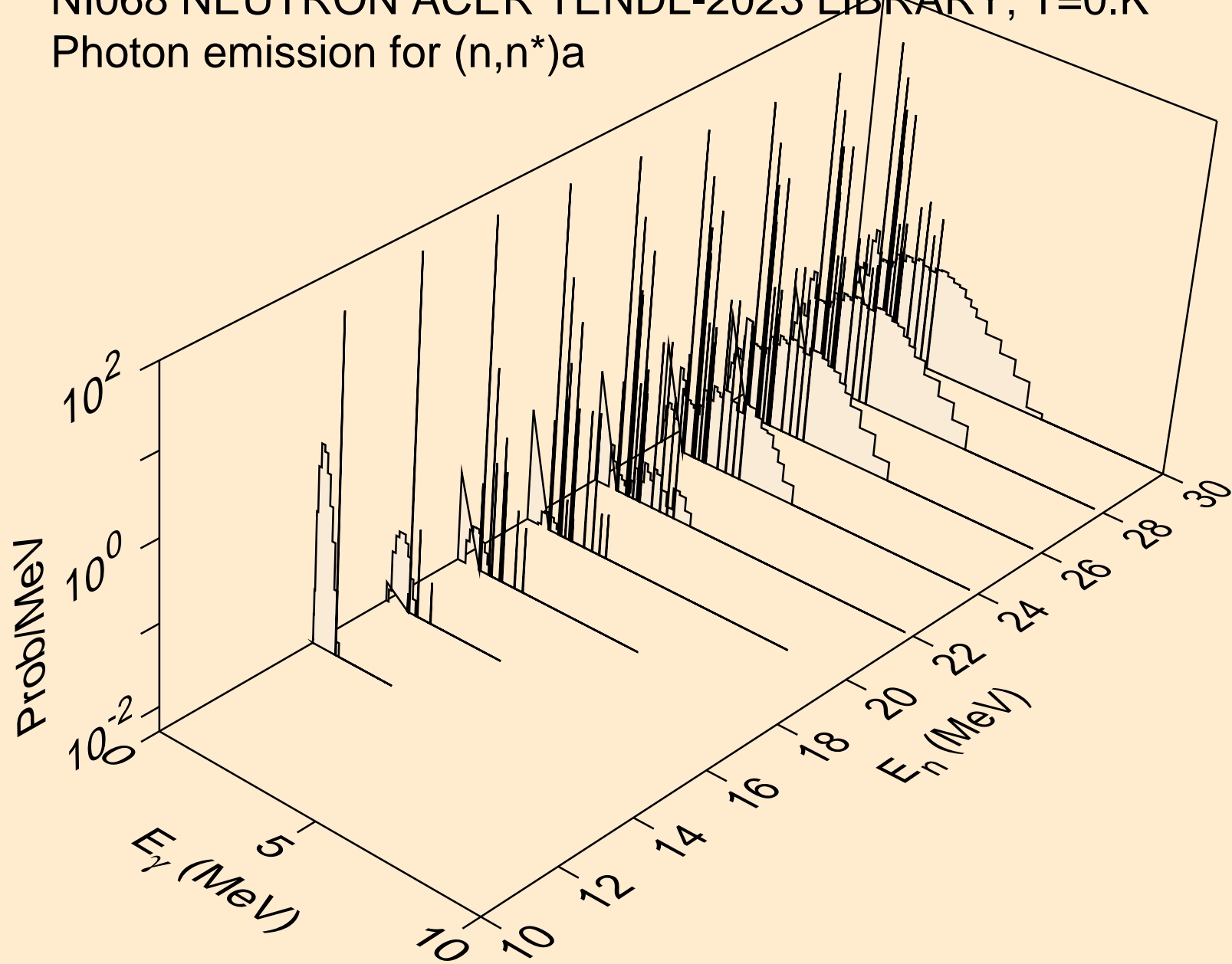

NI068 NEUTRON ACER TENDL-2023 LIBRARY; T=0.K  
Photon emission for (n,2n)a

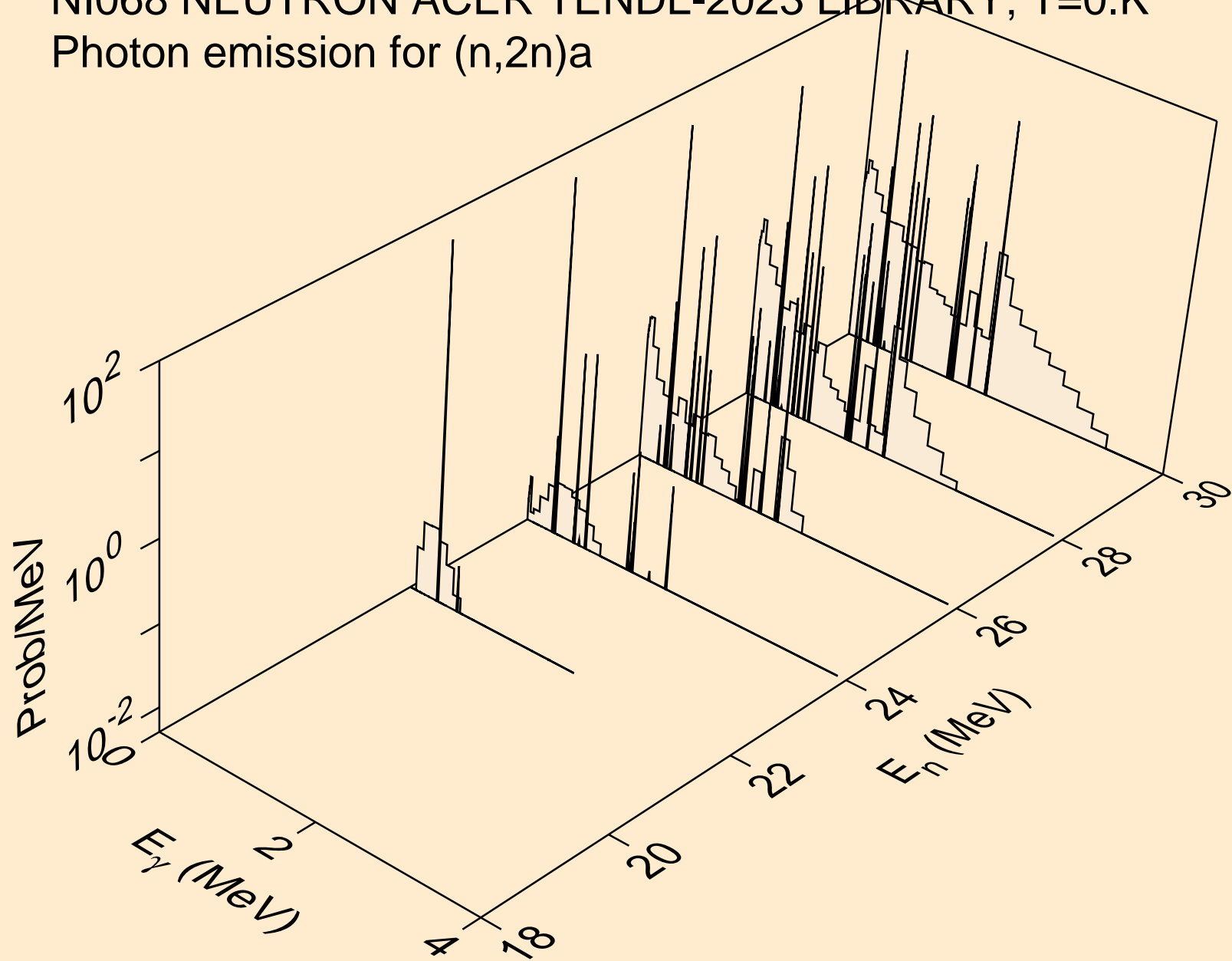

NI068 NEUTRON ACER TENDL-2023 LIBRARY; T=0.K  
Photon emission for (n,3n)a

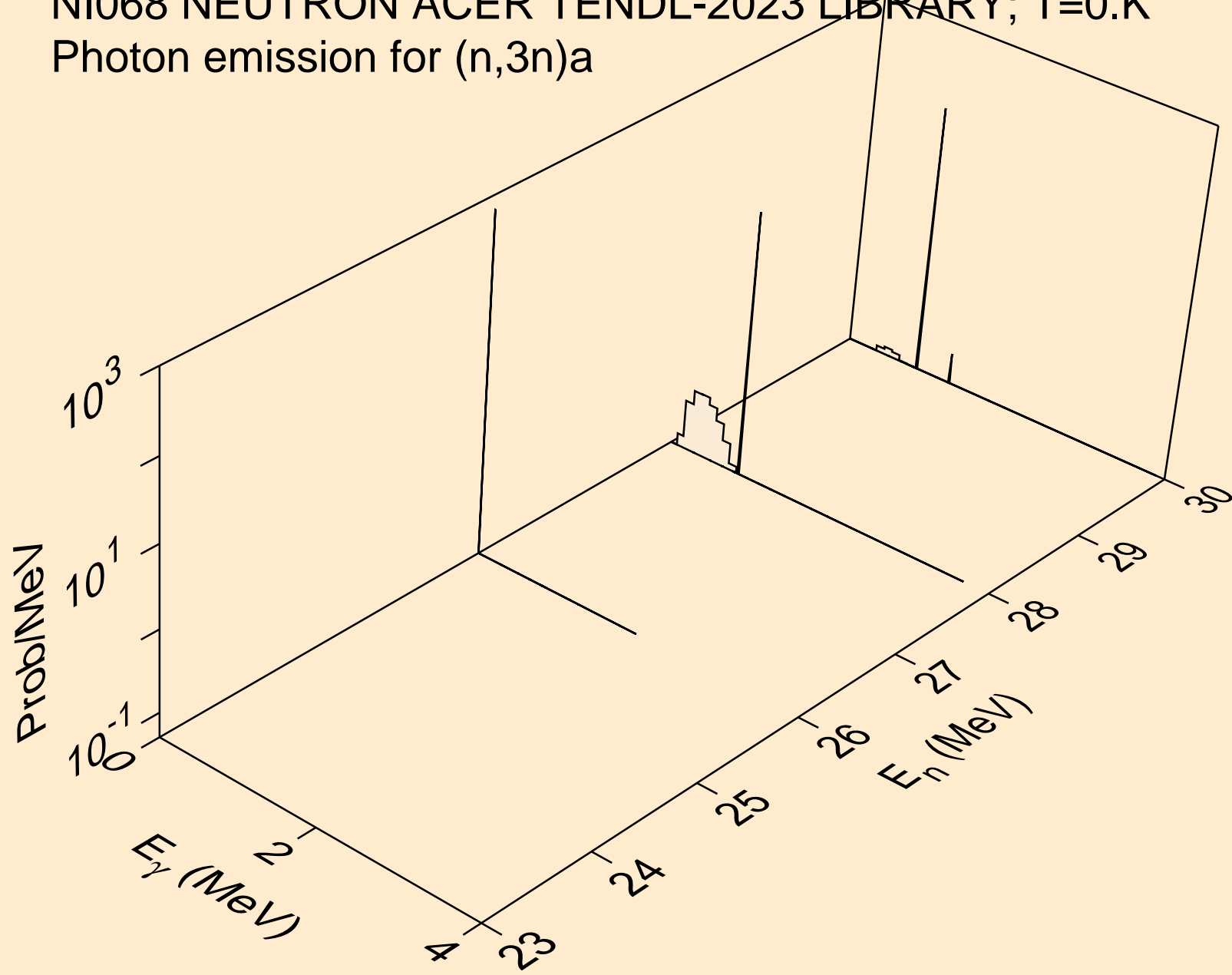

NI068 NEUTRON ACER TENDL-2023 LIBRARY; T=0.K  
Photon emission for (n,n\*)p

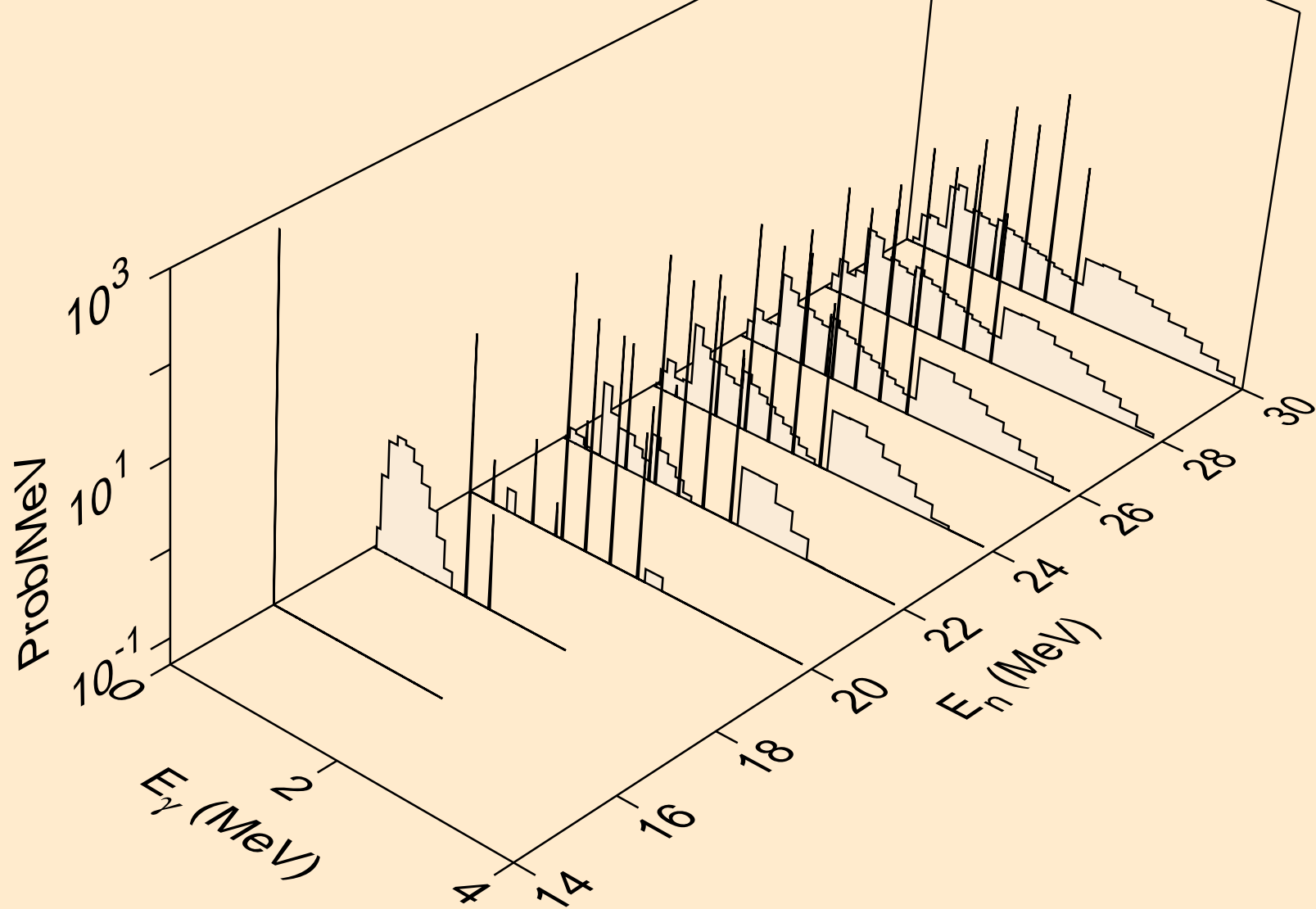

NI068 NEUTRON ACER TENDL-2023 LIBRARY; T=0.K  
Photon emission for (n,n\*)d

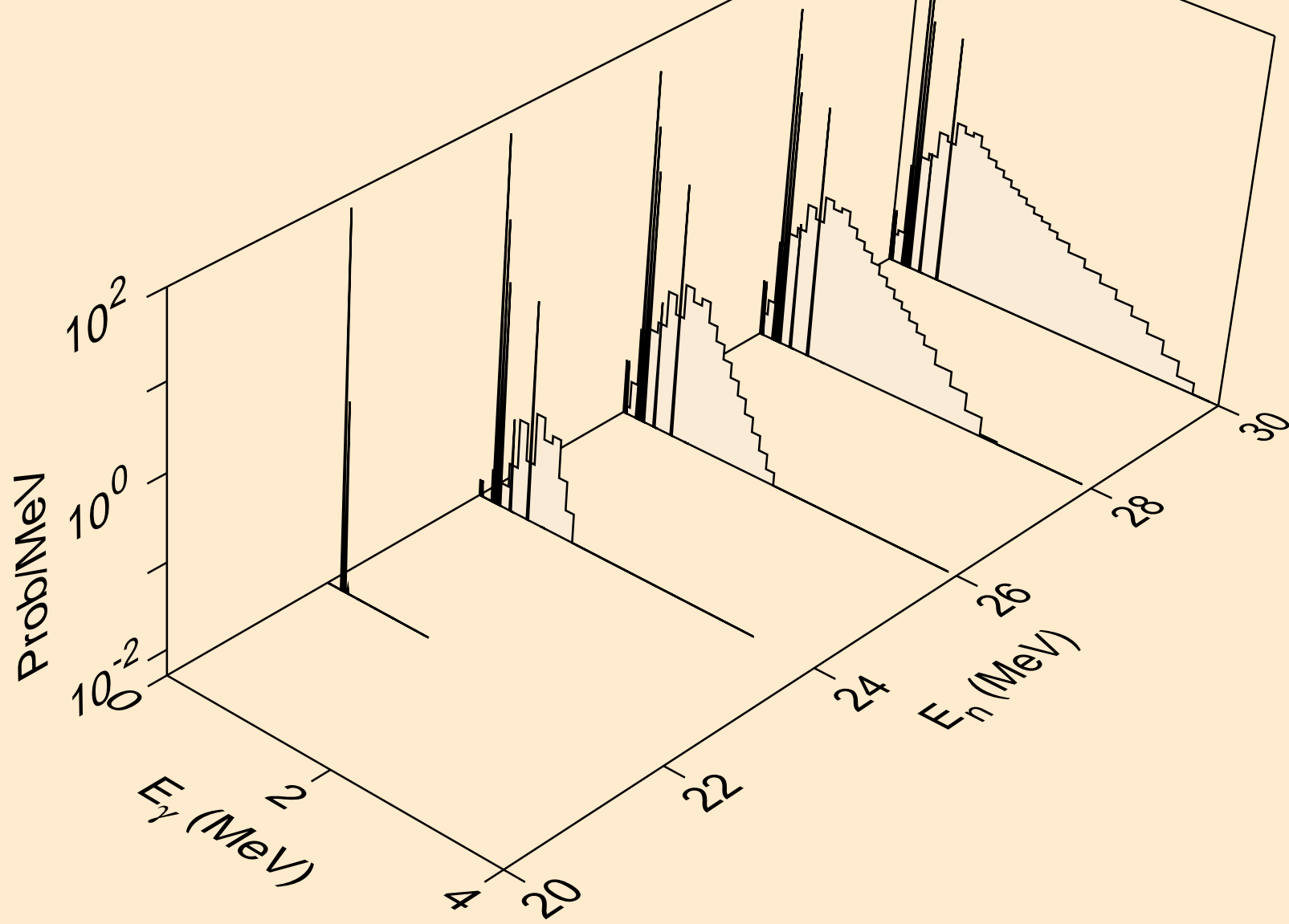

NI068 NEUTRON ACER TENDL-2023 LIBRARY; T=0.K  
Photon emission for (n,n\*)t

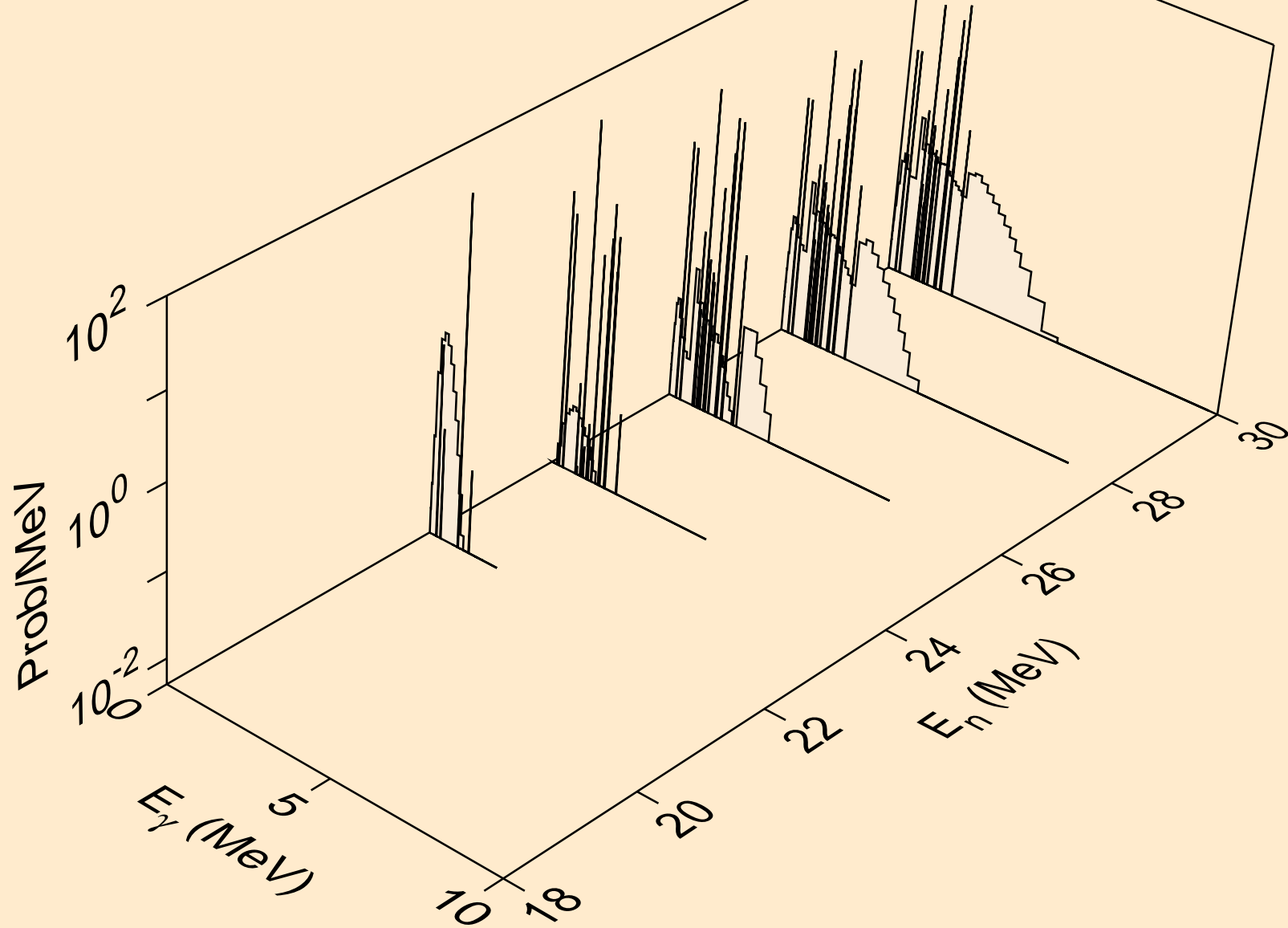

NI068 NEUTRON ACER TENDL-2023 LIBRARY; T=0.K  
Photon emission for (n,4n)

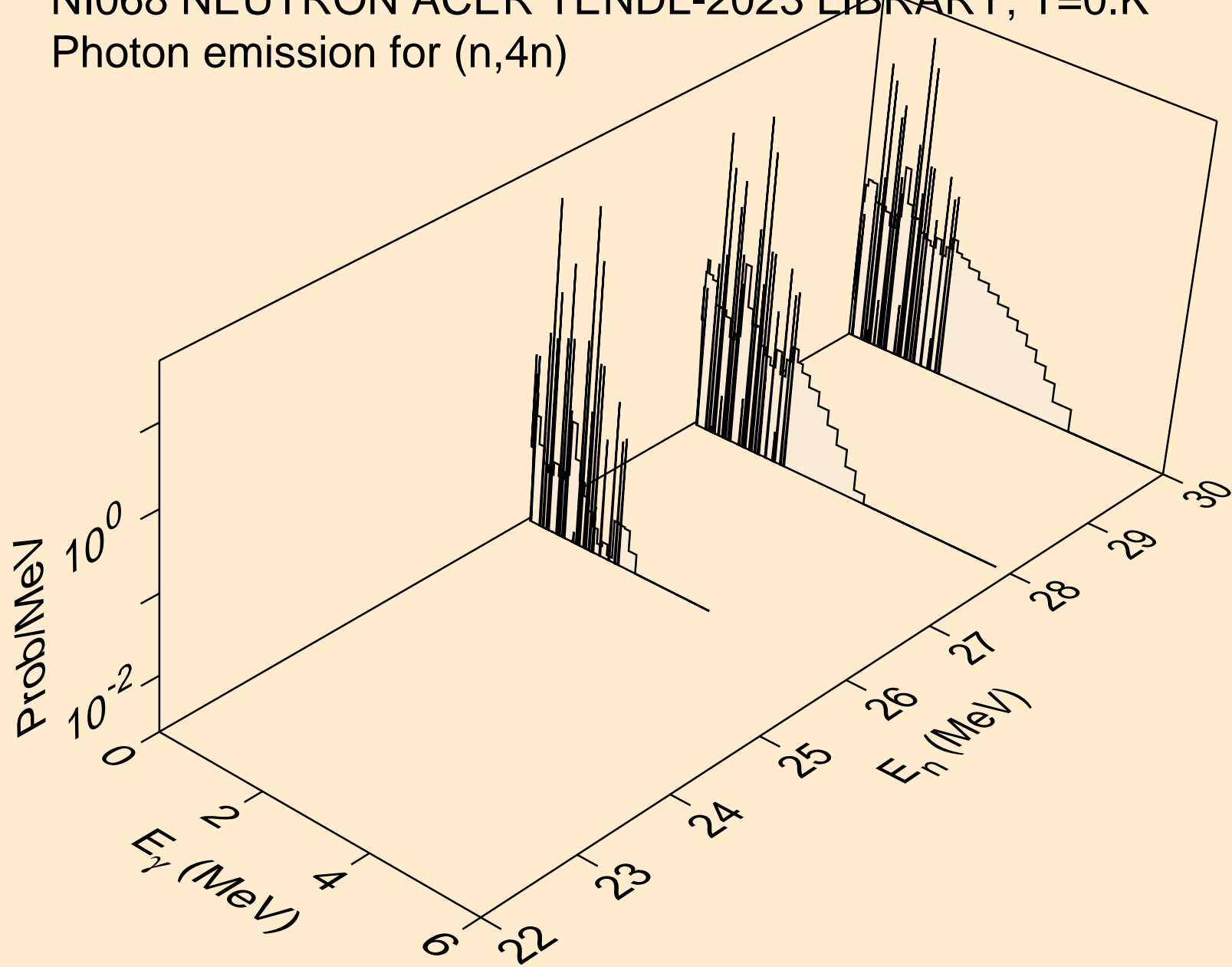



NI068 NEUTRON ACER TENDL-2023 LIBRARY; T=0.K  
Photon emission for (n,2np)

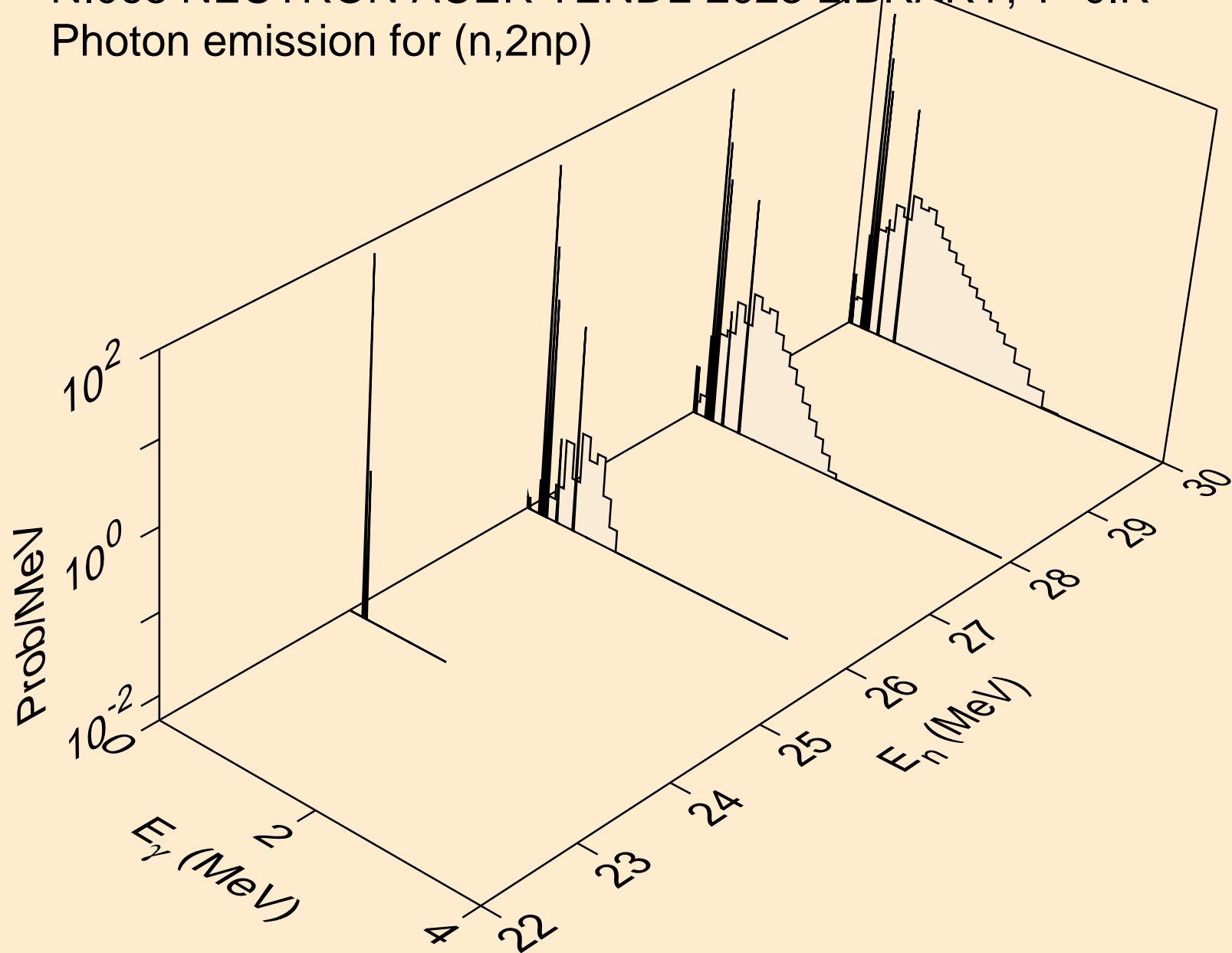

NI068 NEUTRON ACER TENDL-2023 LIBRARY; T=0.K  
Photon emission for (n,3np)

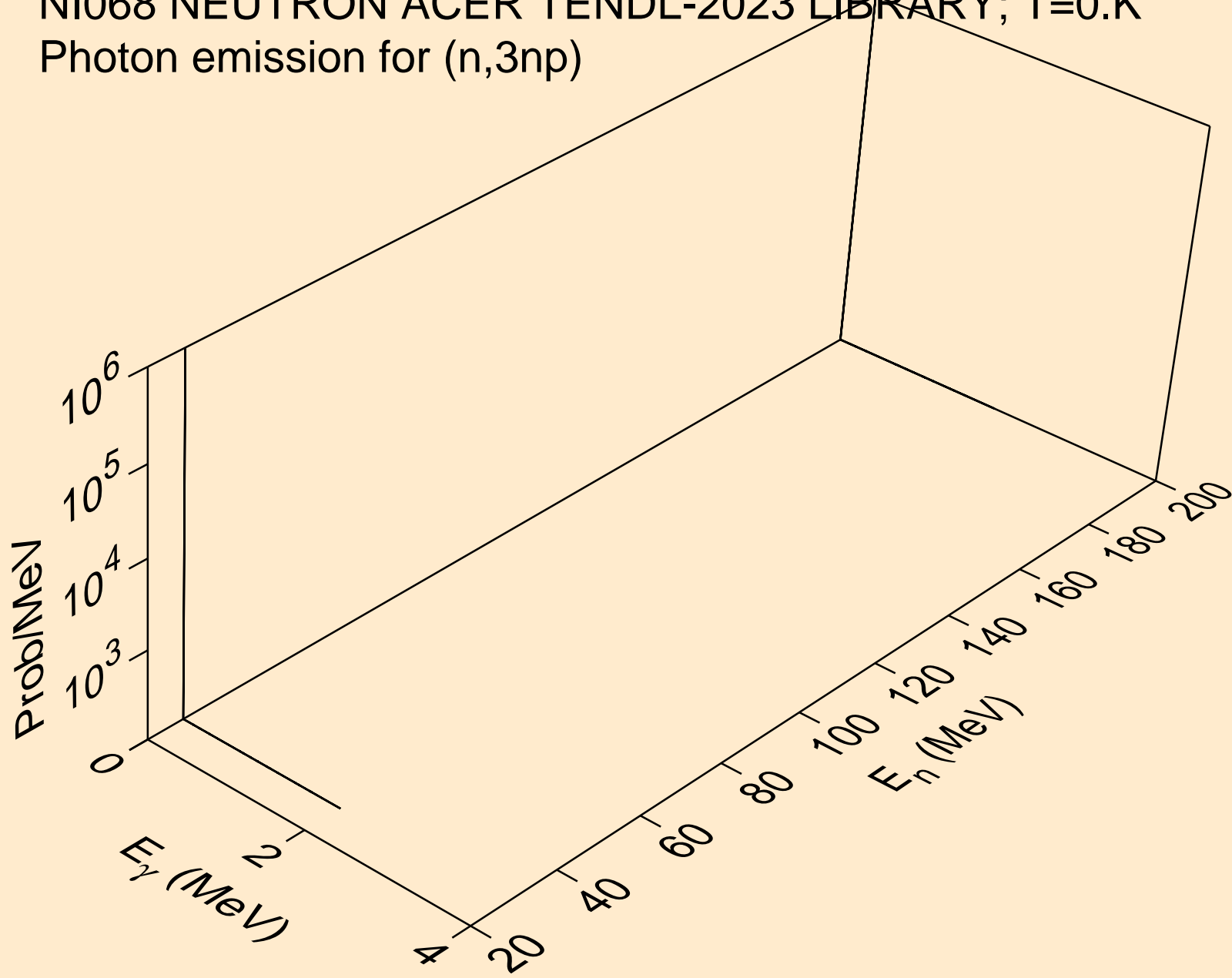

NI068 NEUTRON ACER TENDL-2023 LIBRARY; T=0.K  
Photon emission for (n,n\*c)

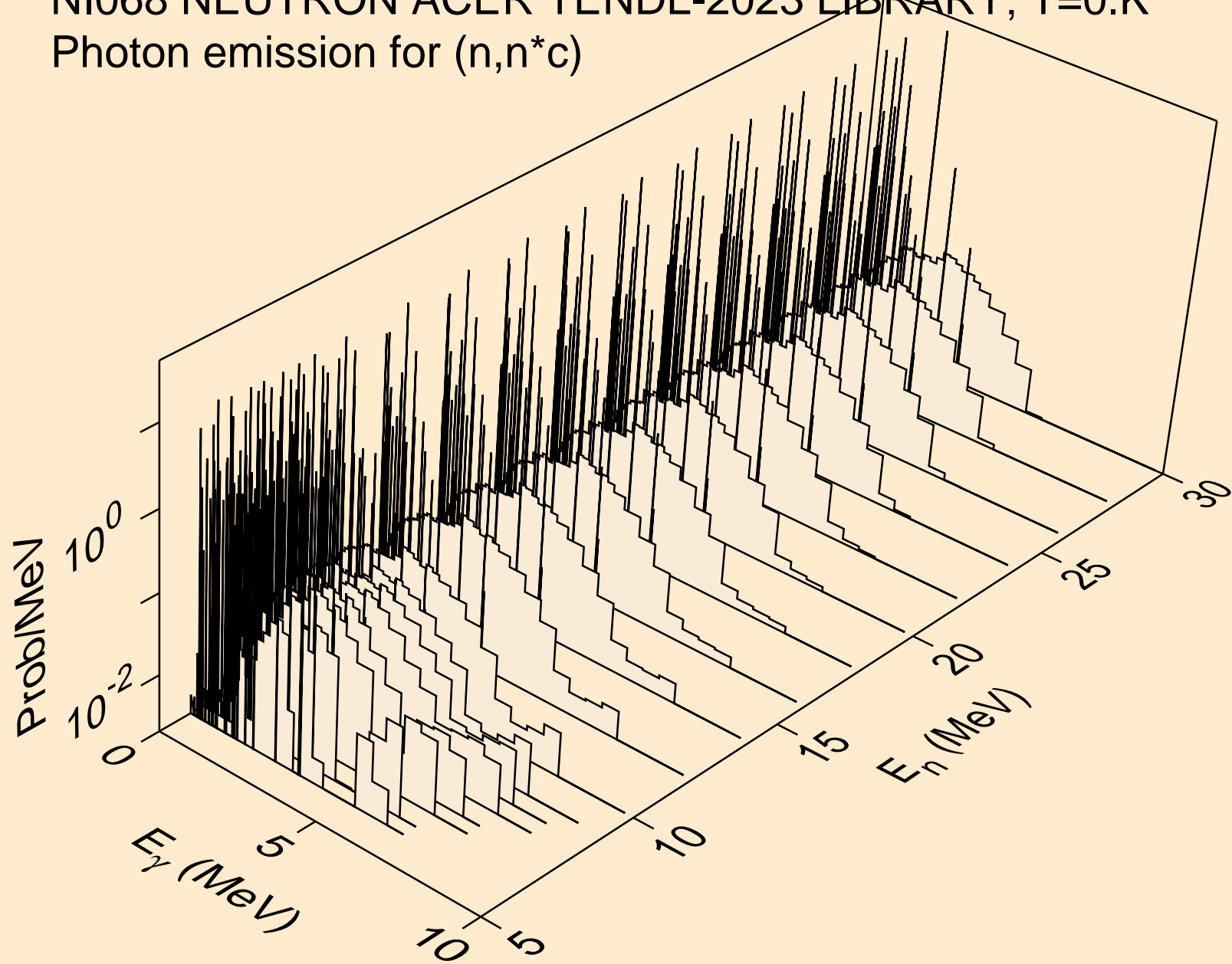

NI068 NEUTRON ACER TENDL-2023 LIBRARY; T=0.K  
Photon emission for (n,gma)

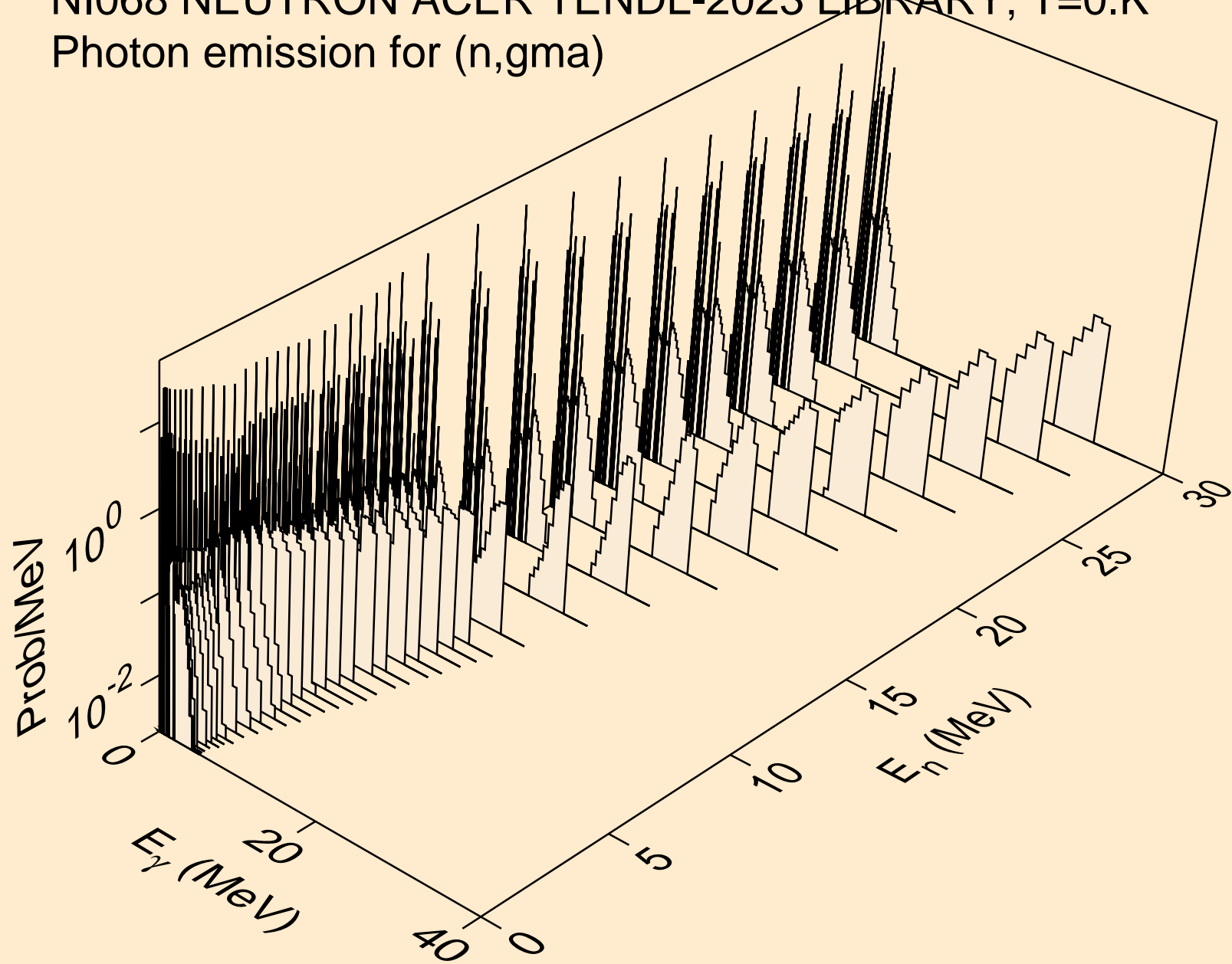

NI068 NEUTRON ACER TENDL-2023 LIBRARY; T=0.K  
Photon emission for (n,p)

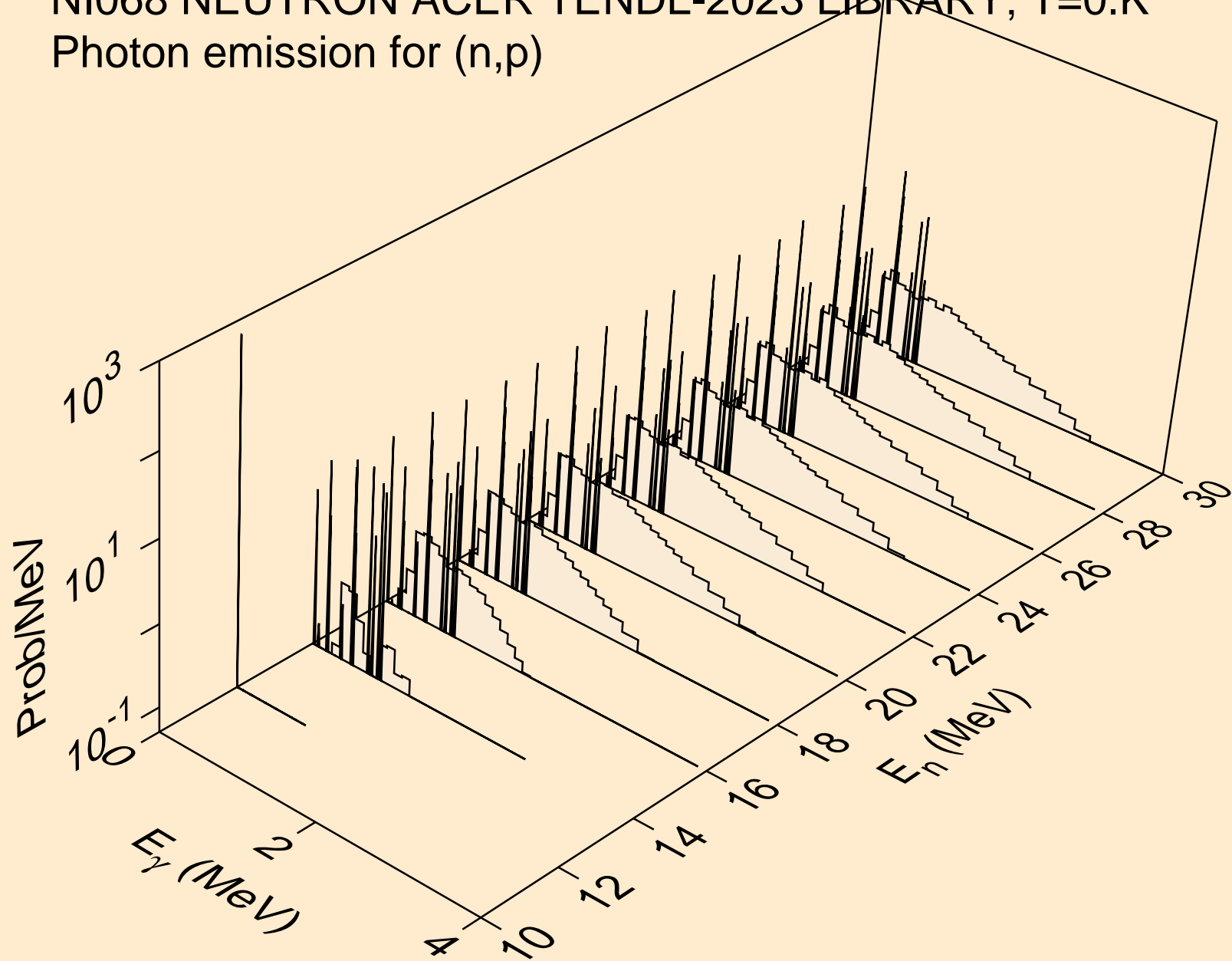

NI068 NEUTRON ACER TENDL-2023 LIBRARY; T=0.K  
Photon emission for (n,d)

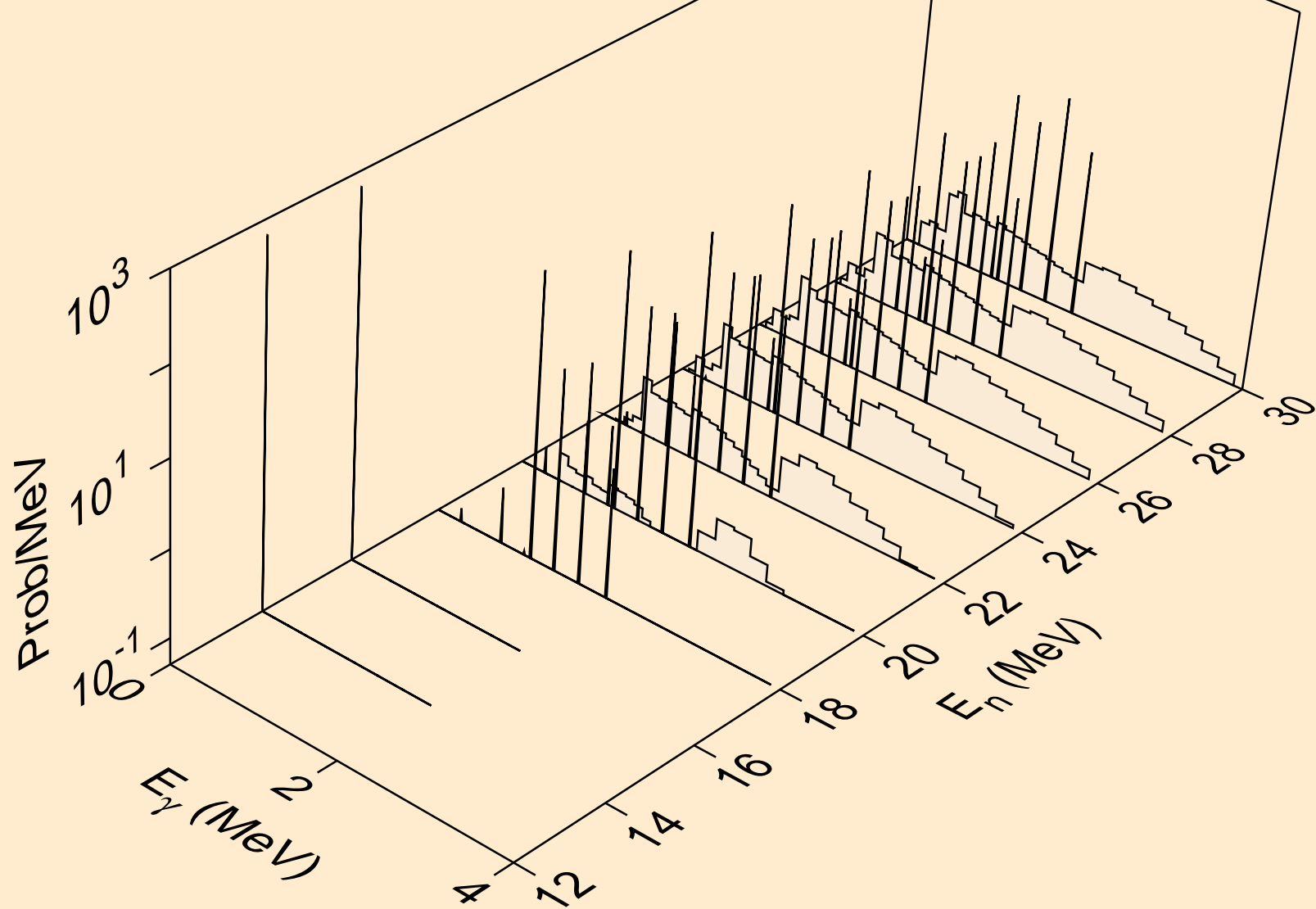

NI068 NEUTRON ACER TENDL-2023 LIBRARY; T=0.K  
Photon emission for (n,t)

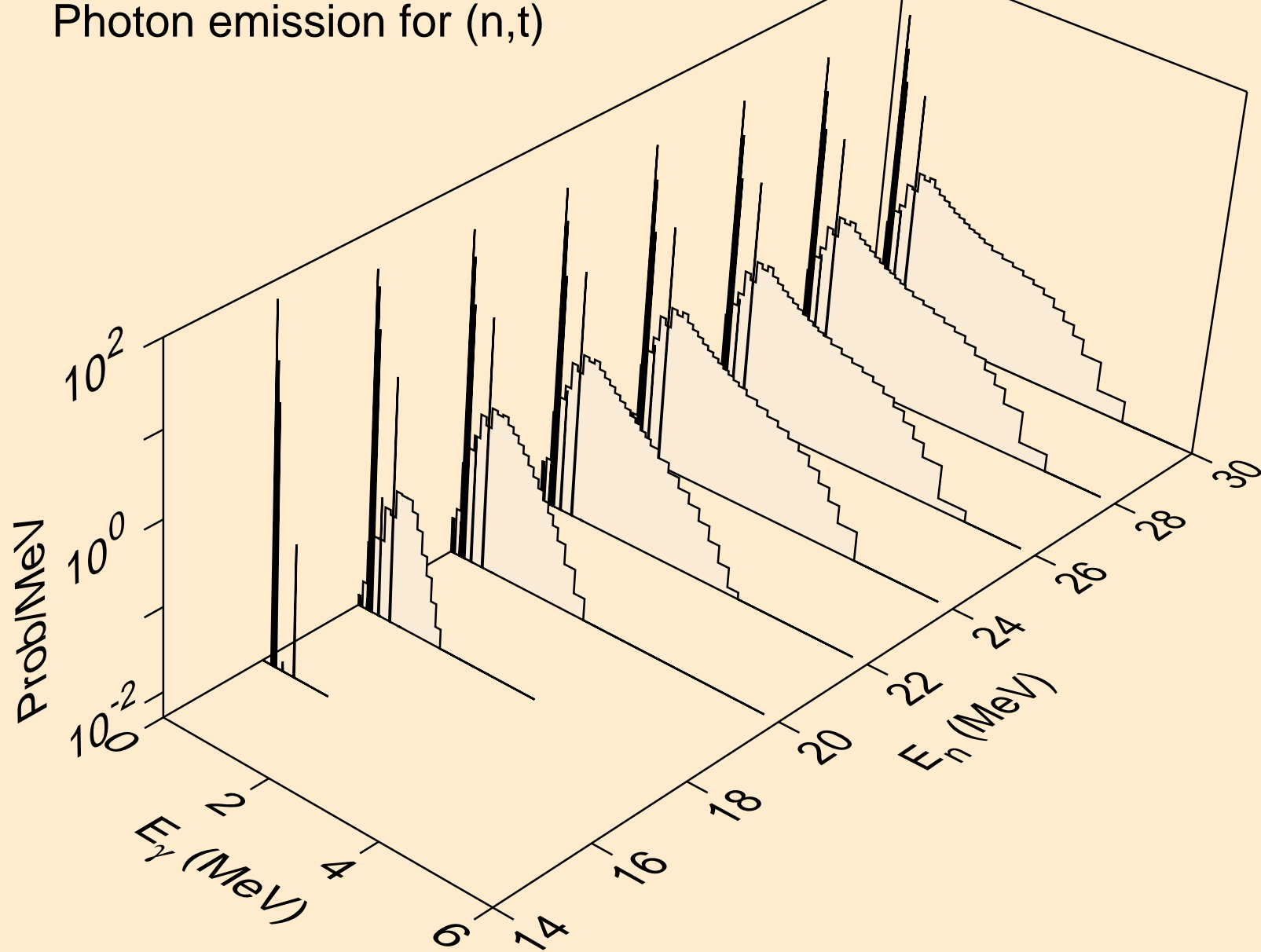

NI068 NEUTRON ACER TENDL-2023 LIBRARY; T=0.K  
Photon emission for (n,he3)

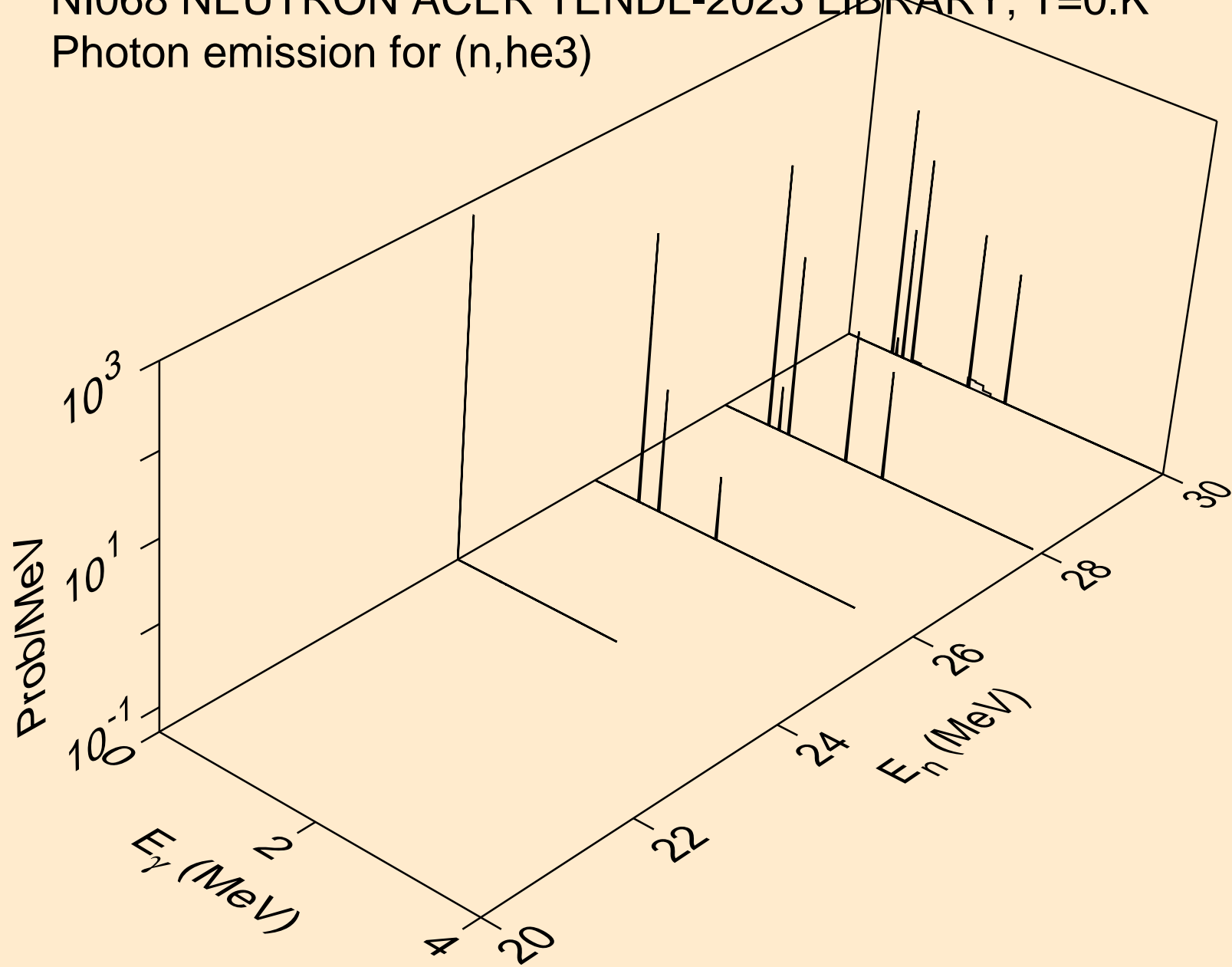



NI068 NEUTRON ACER TENDL-2023 LIBRARY; T=0.K  
Photon emission for (n,a)

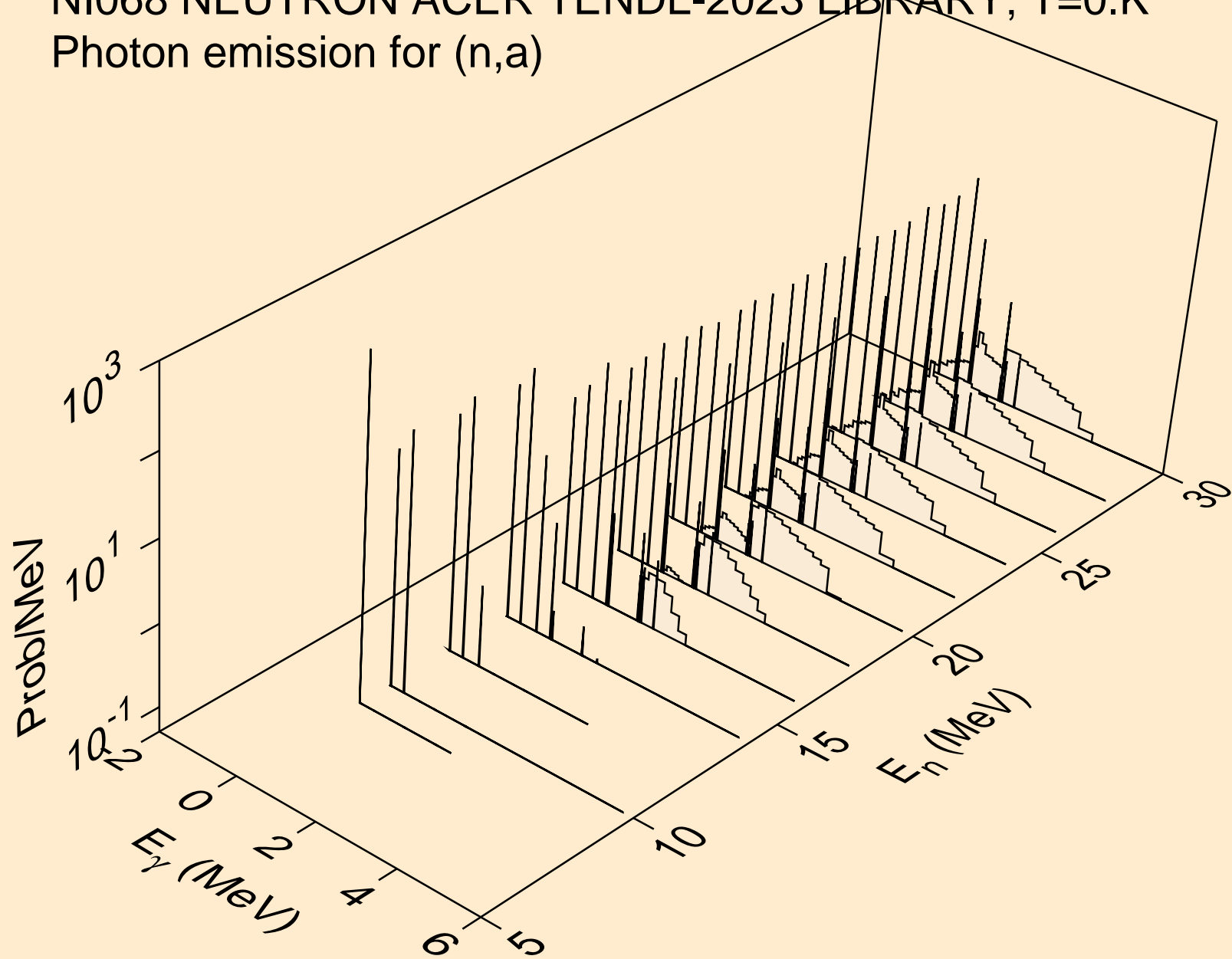

NI068 NEUTRON ACER TENDL-2023 LIBRARY; T=0.K  
thermal capture photon spectrum

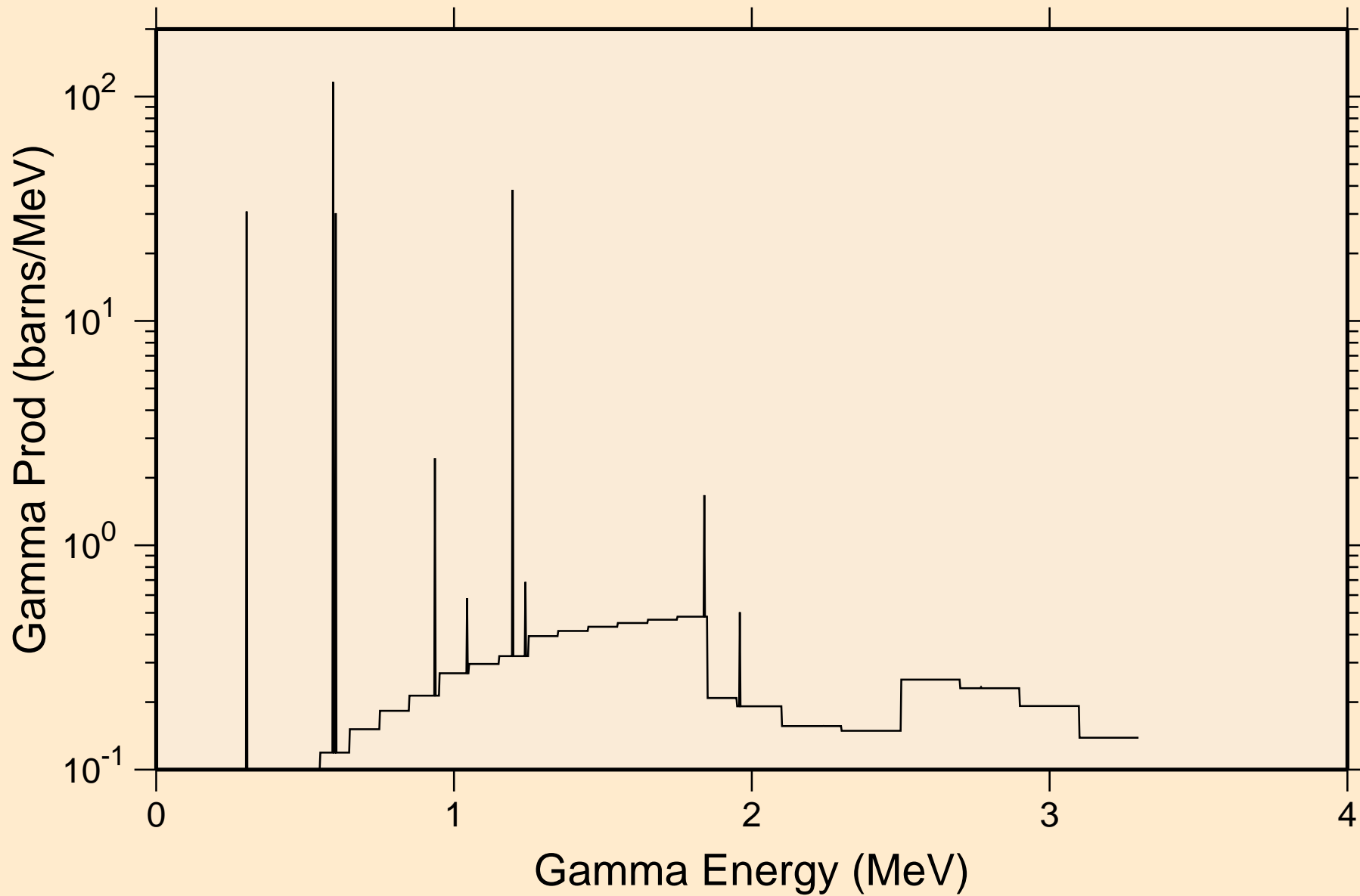

NI068 NEUTRON ACER TENDL-2023 LIBRARY; T=0.K  
14 MeV photon spectrum

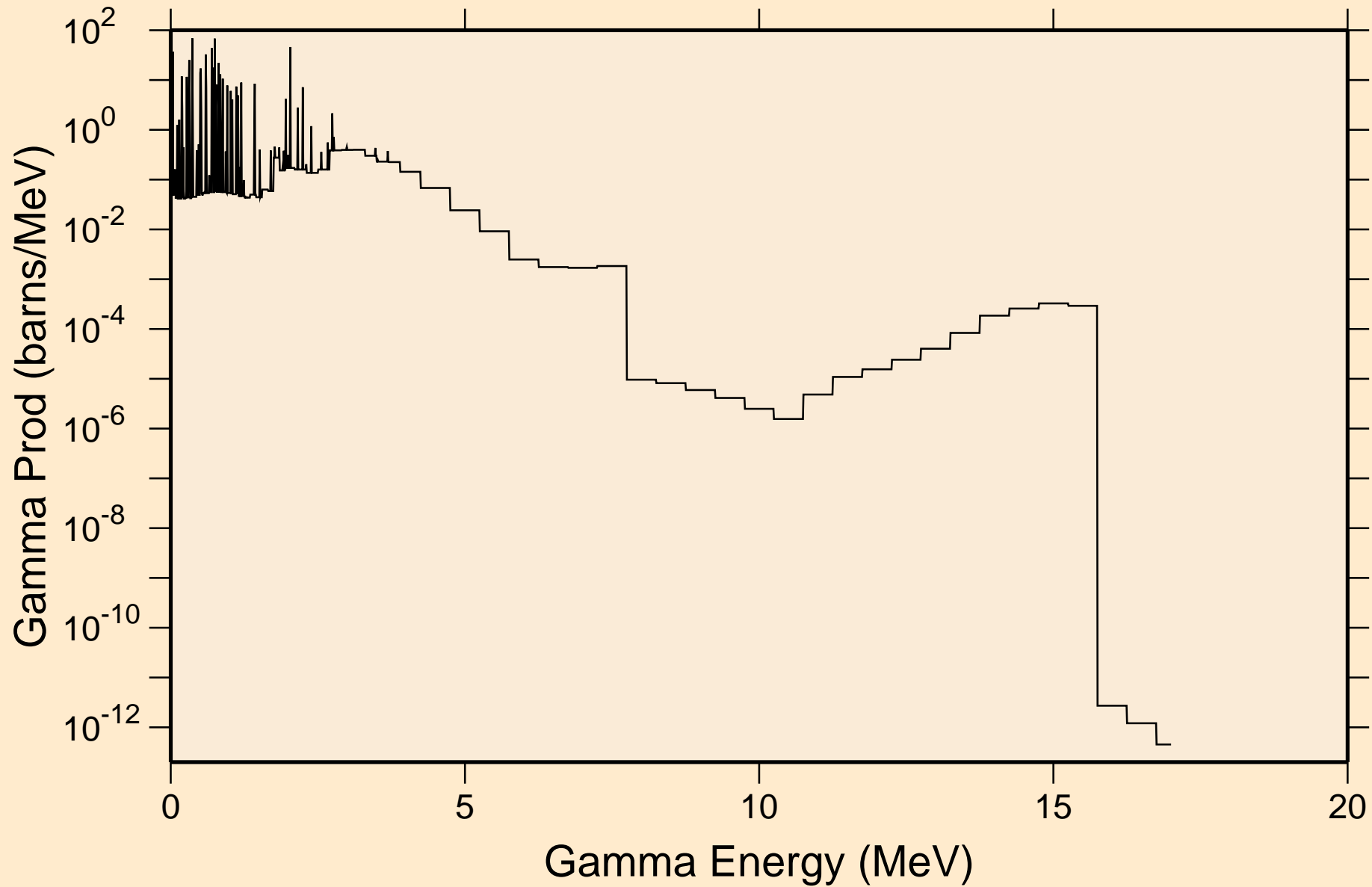

# NI068 NEUTRON ACER TENDL-2023 LIBRARY; T=0.K

## Particle heating contributions

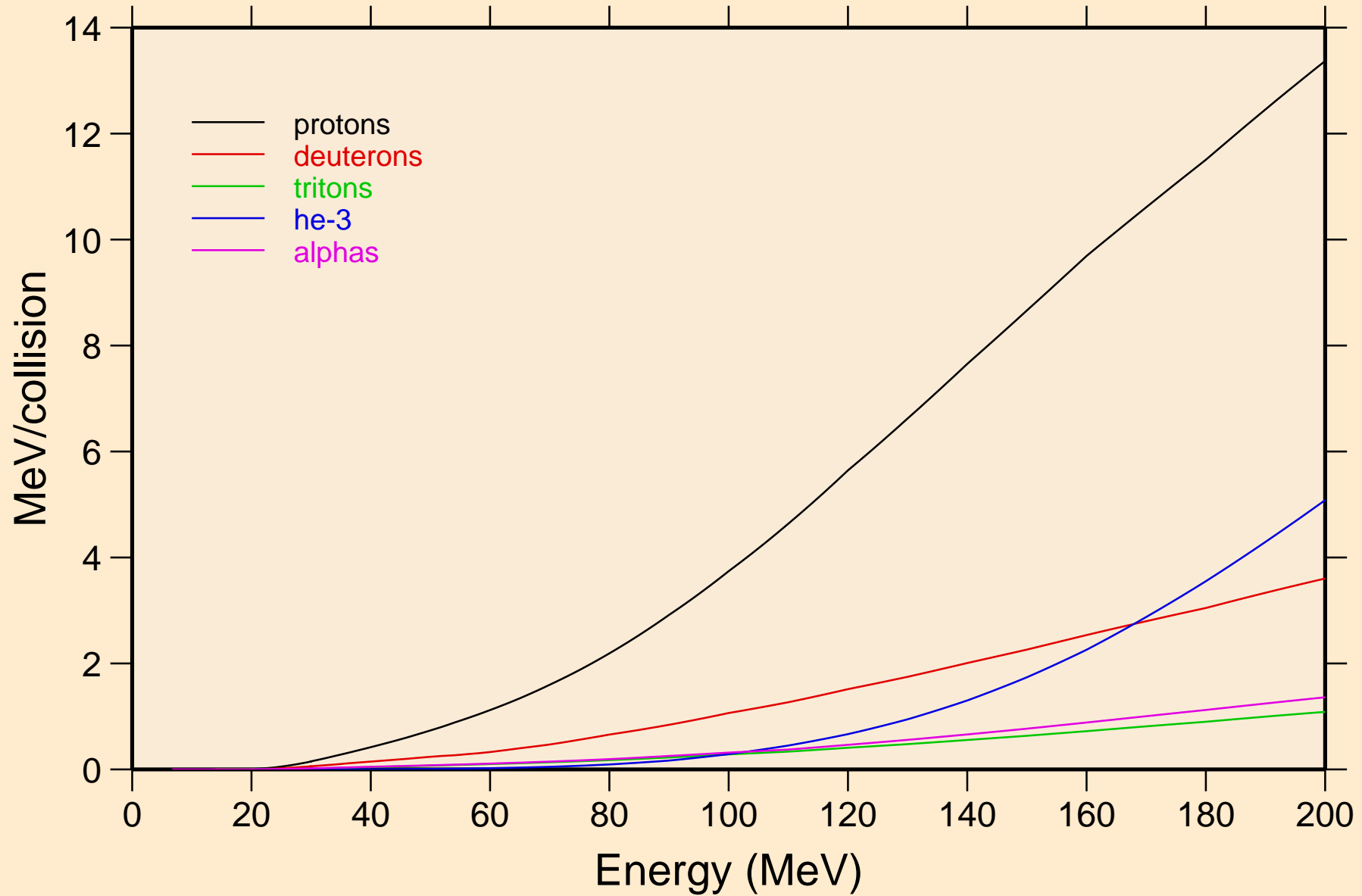

NI068 NEUTRON ACER TENDL-2023 LIBRARY; T=0.K  
Recoil Heating

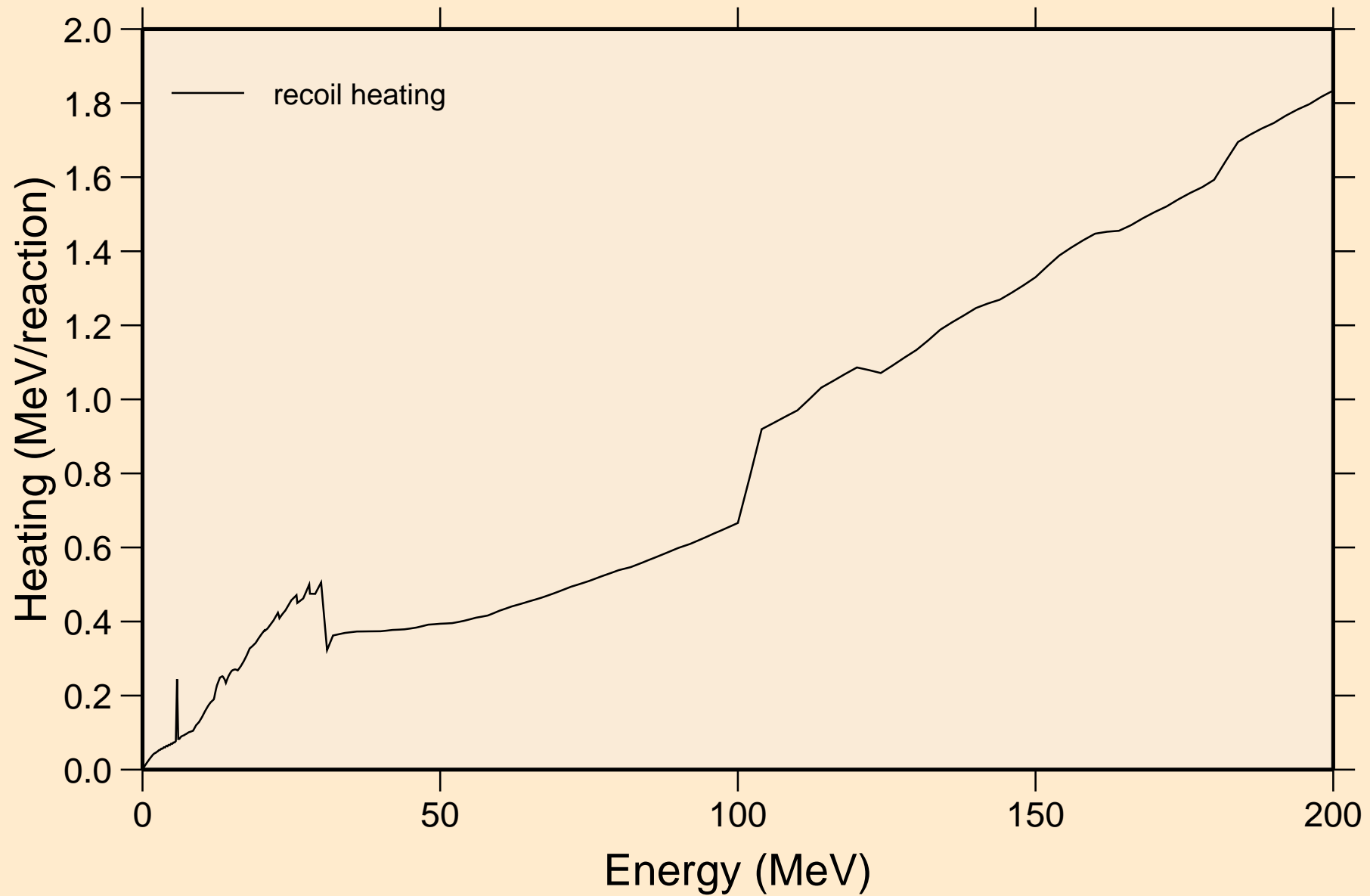

# NI068 NEUTRON ACER TENDL-2023 LIBRARY; T=0.K

## Particle production cross sections

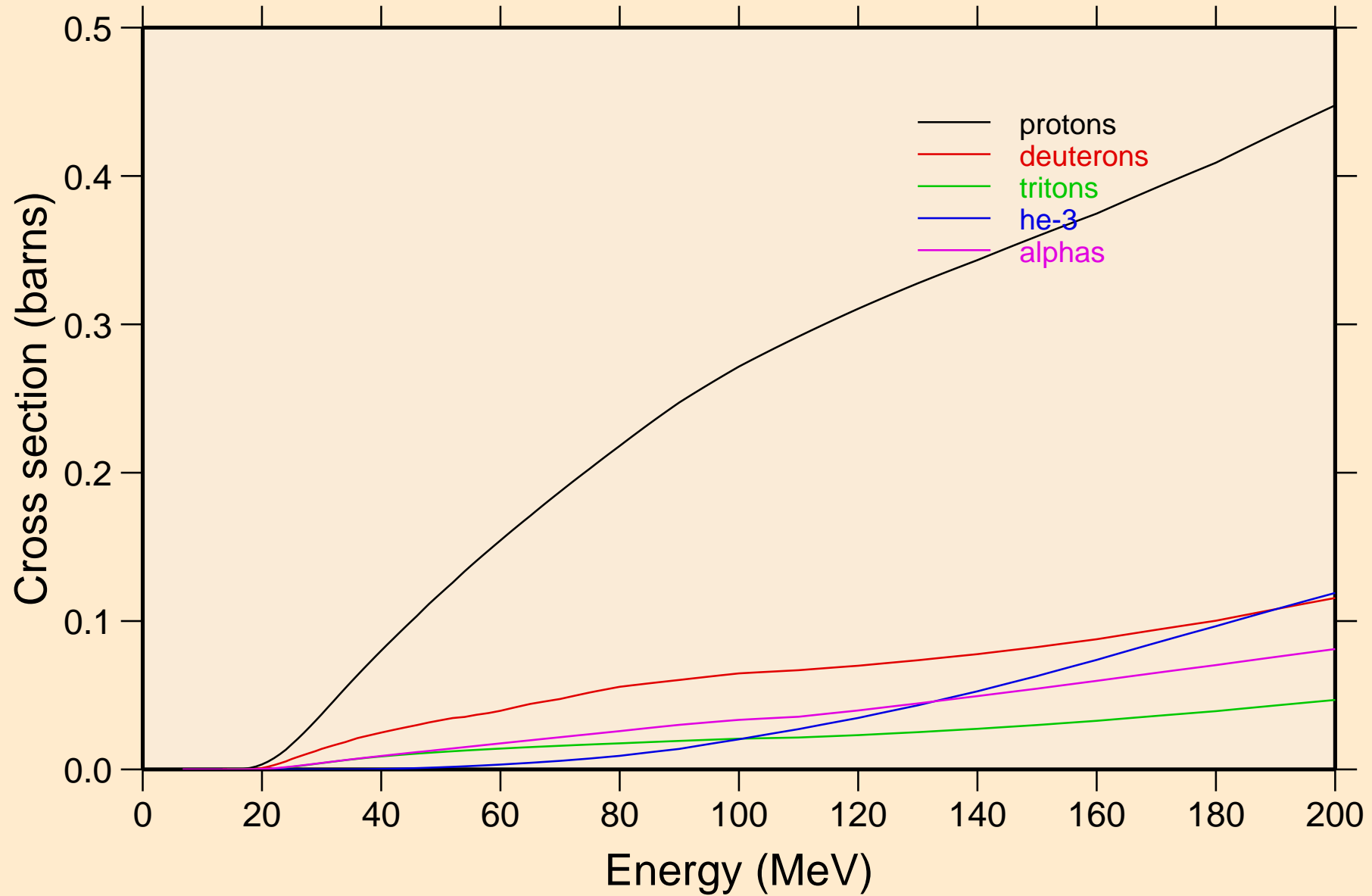

NI068 NEUTRON ACER TENDL-2023 LIBRARY; T=0.K  
protons from (n,x)

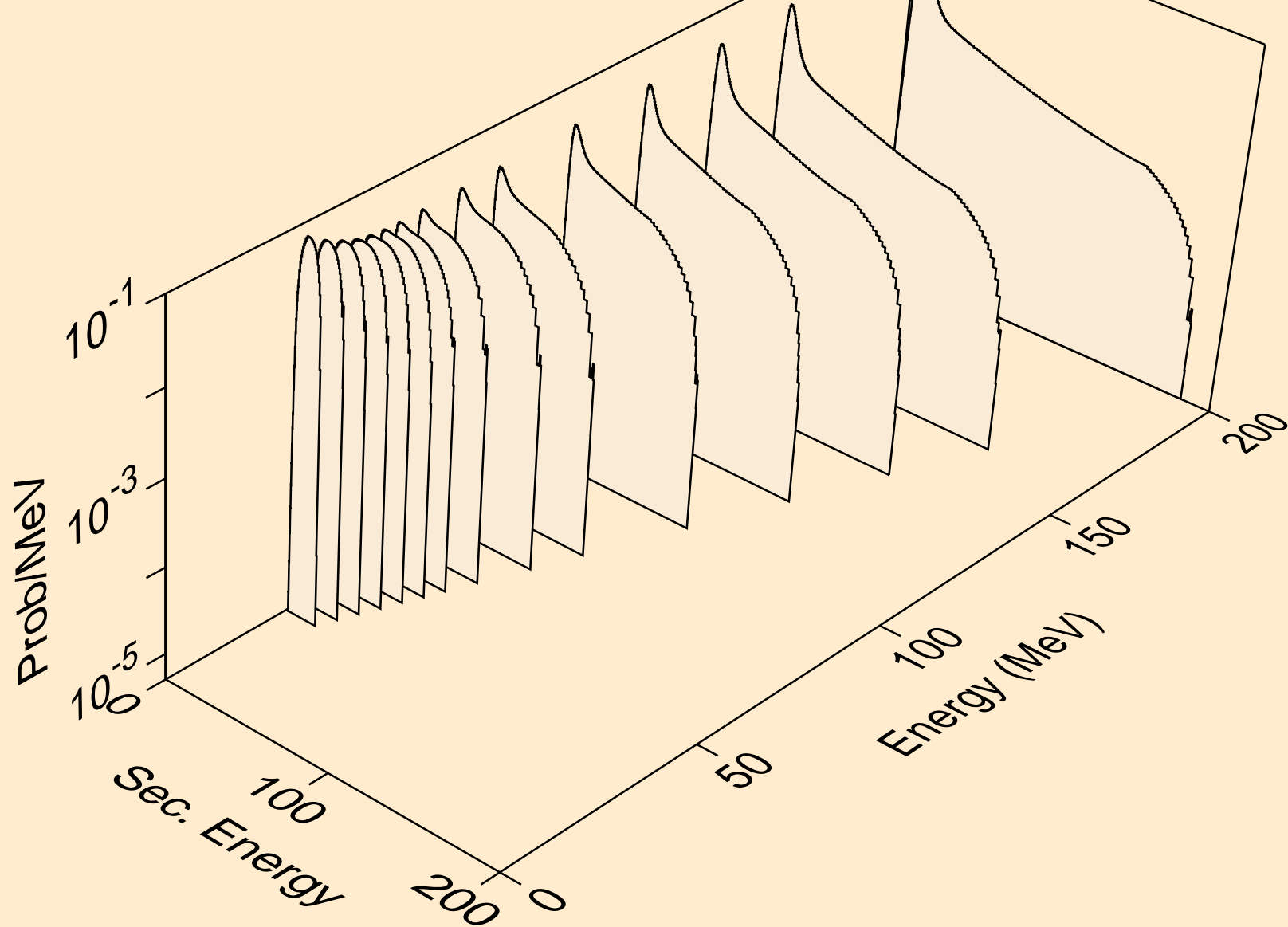

NI068 NEUTRON ACER TENDL-2023 LIBRARY; T=0.K  
protons from (n,n\*)p

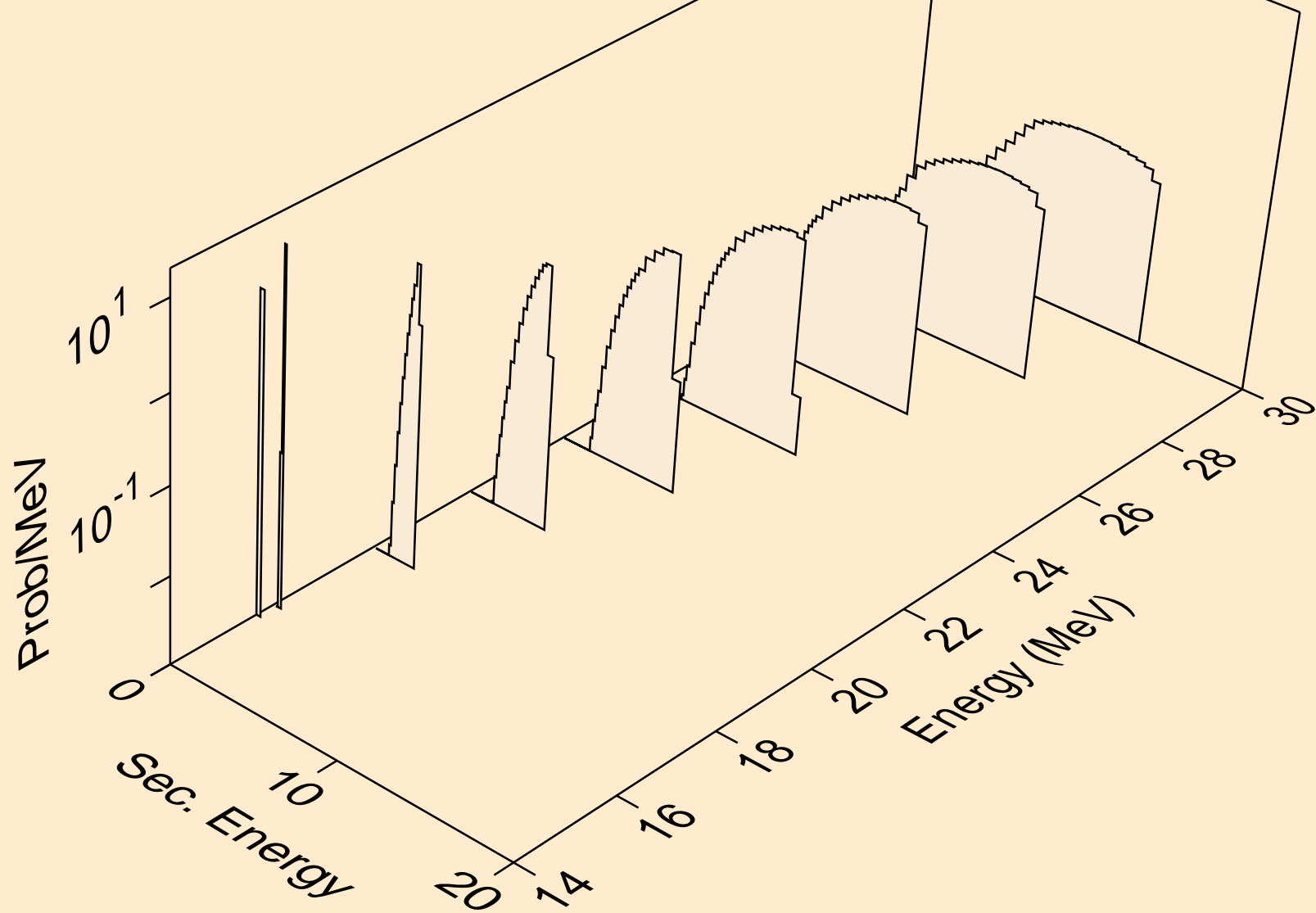



NI068 NEUTRON ACER TENDL-2023 LIBRARY; T=0.K  
protons from (n,2np)

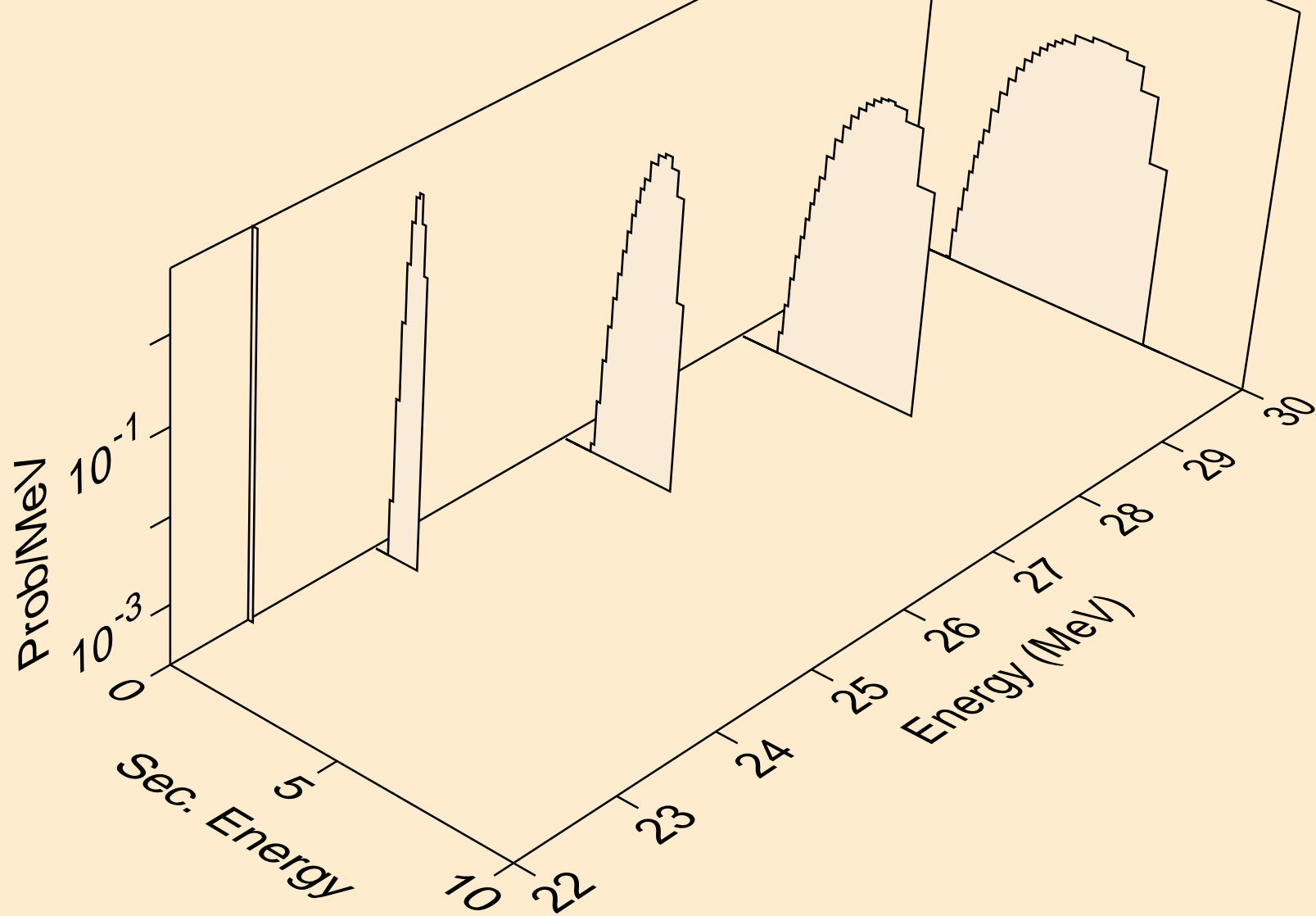

NI068 NEUTRON ACER TENDL-2023 LIBRARY; T=0.K  
protons from (n,3np)

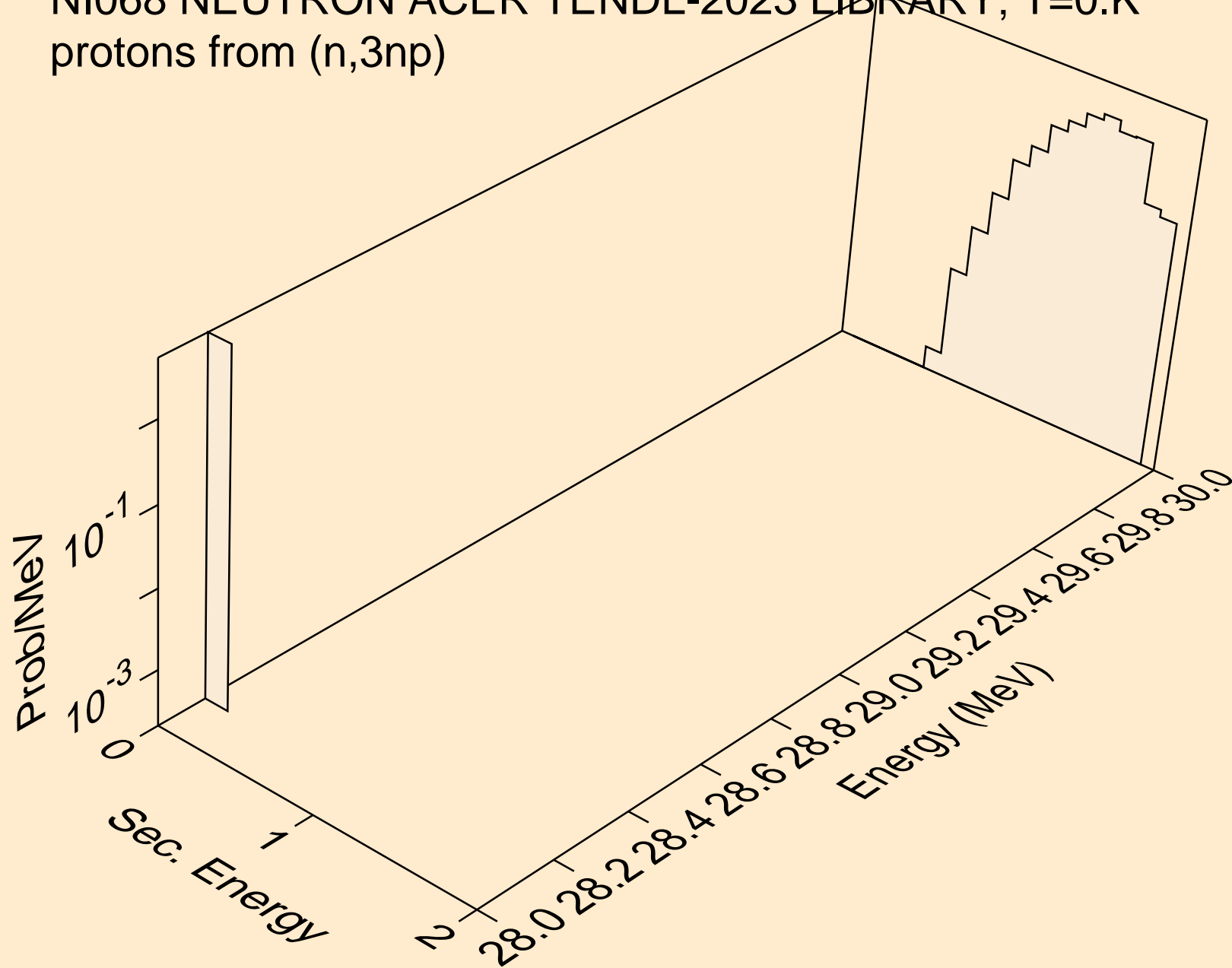

NI068 NEUTRON ACER TENDL-2023 LIBRARY; T=0.K  
protons from (n,p)

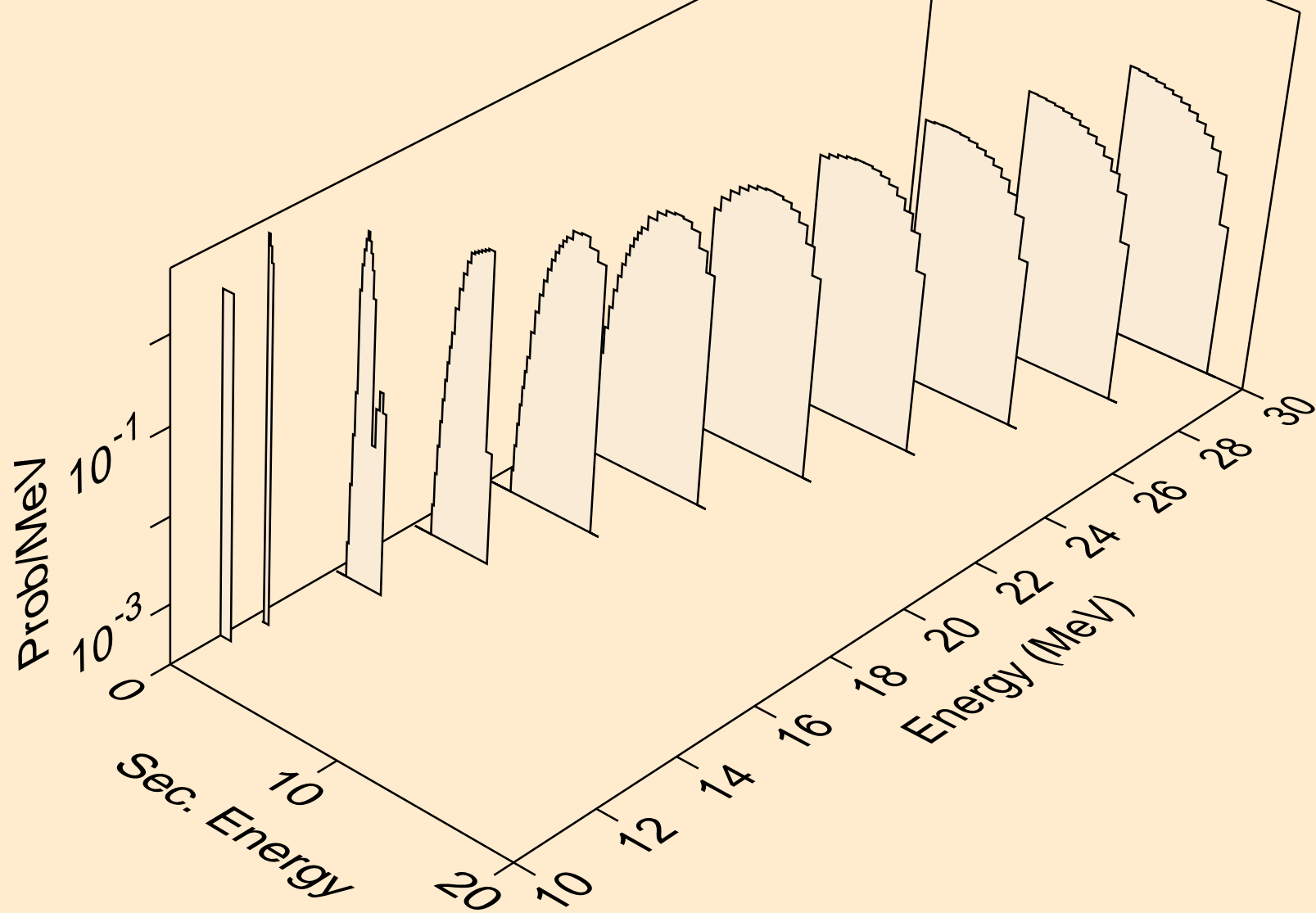

NI068 NEUTRON ACER TENDL-2023 LIBRARY; T=0.K  
deuterons from (n,x)

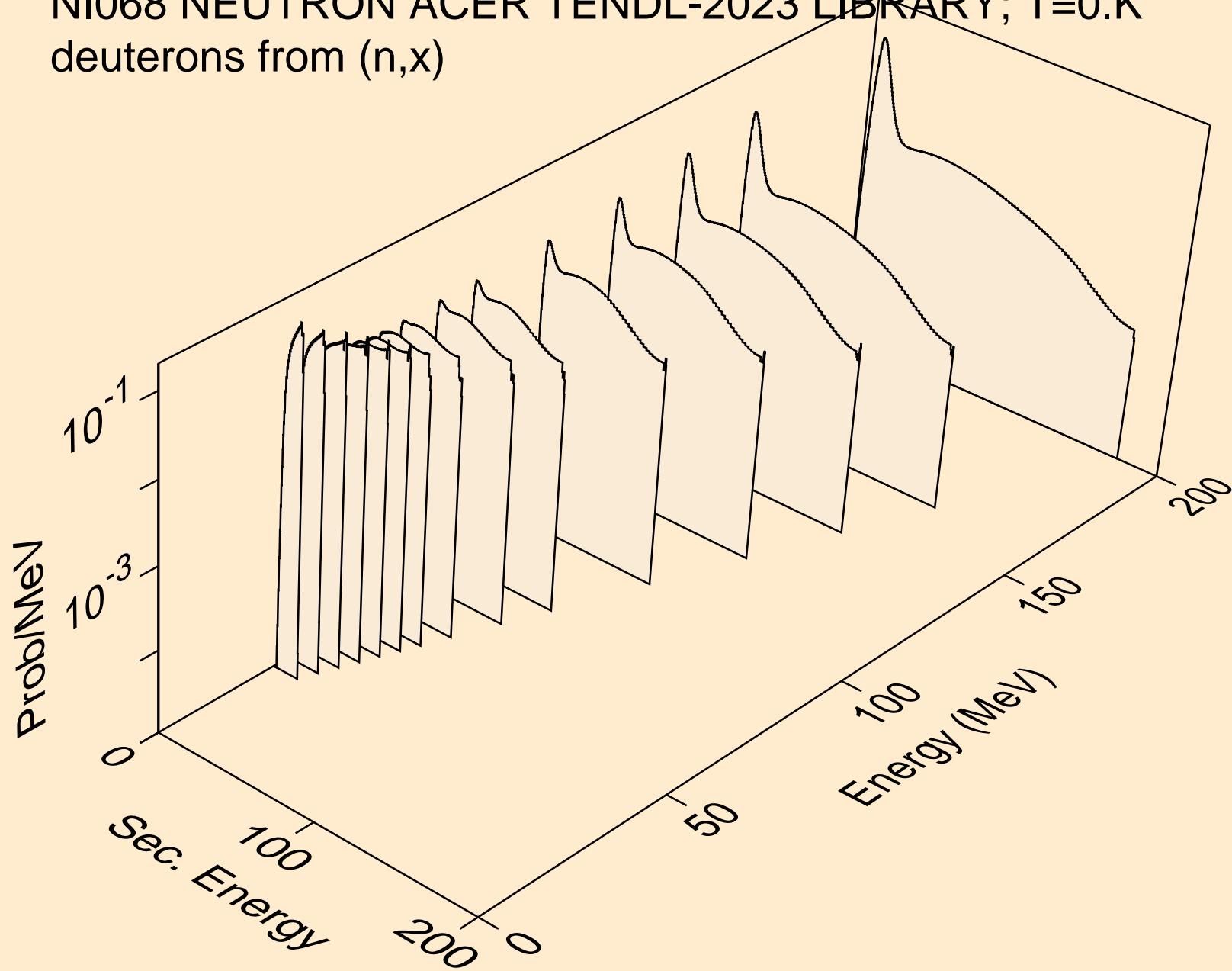

NI068 NEUTRON ACER TENDL-2023 LIBRARY; T=0.K  
deuterons from (n,2nd)

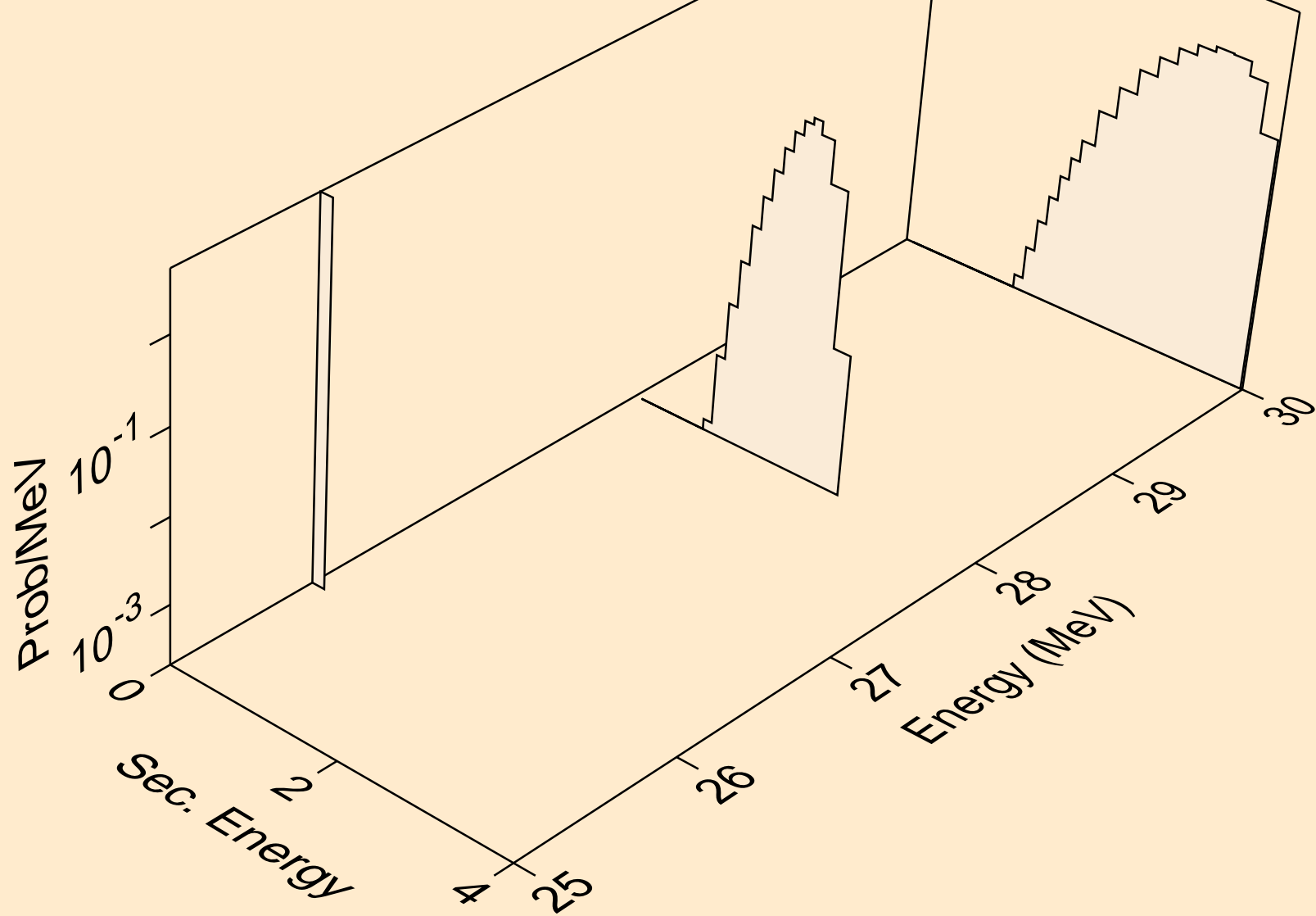

NI068 NEUTRON ACER TENDL-2023 LIBRARY; T=0.K  
deuterons from (n,n\*)d

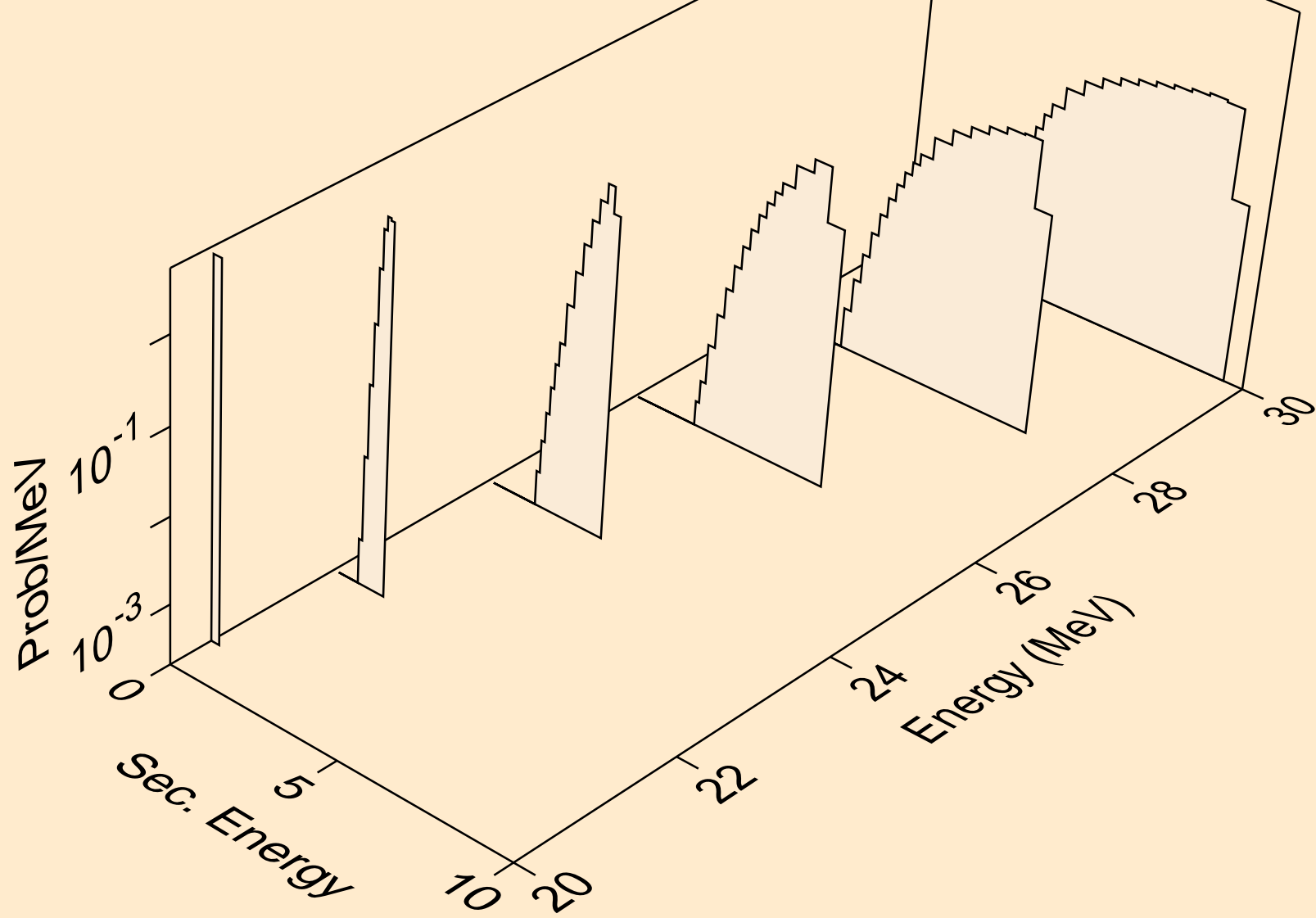

NI068 NEUTRON ACER TENDL-2023 LIBRARY; T=0.K  
deuterons from (n,d)

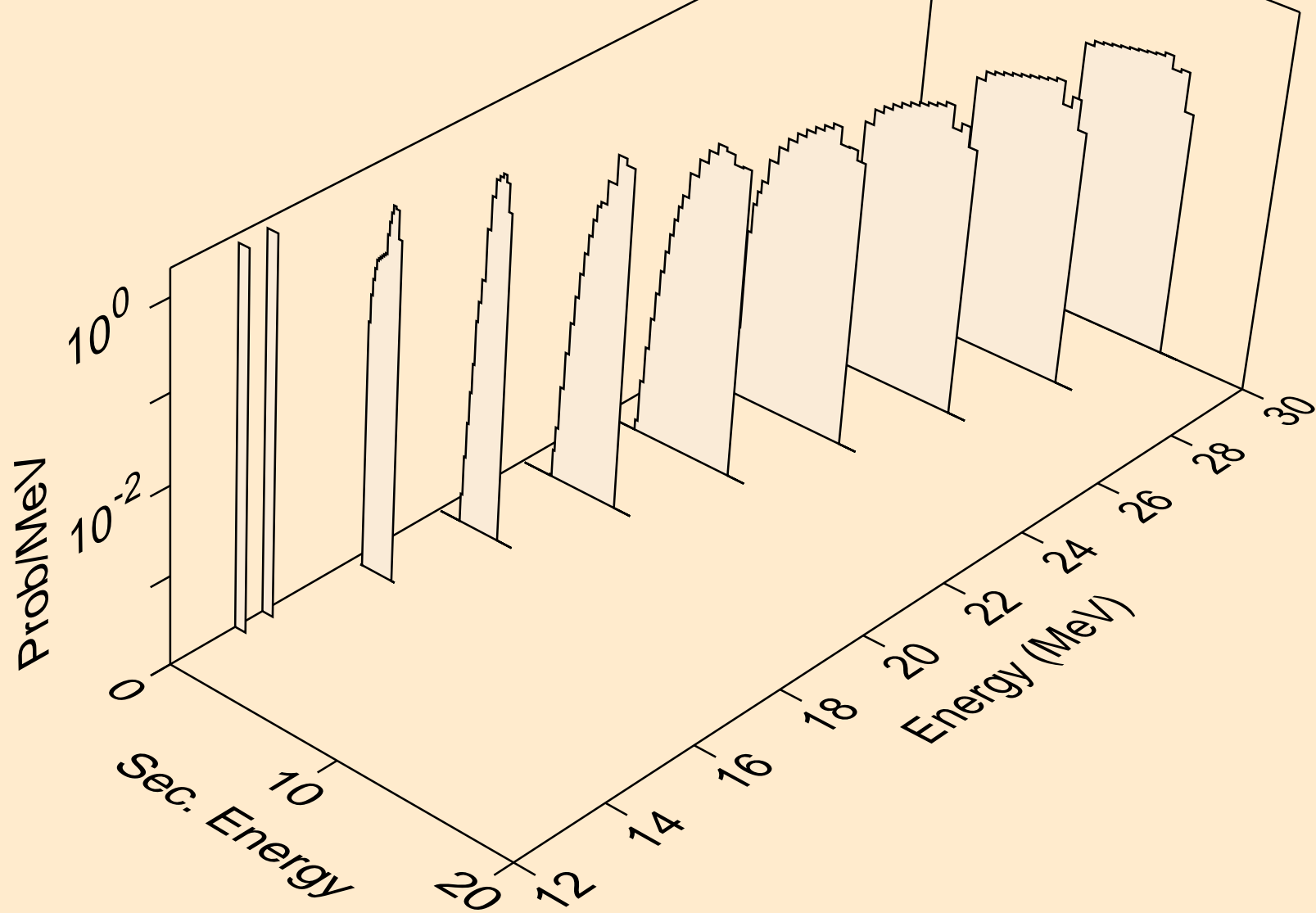

NI068 NEUTRON ACER TENDL-2023 LIBRARY; T=0.K  
tritons from (n,x)

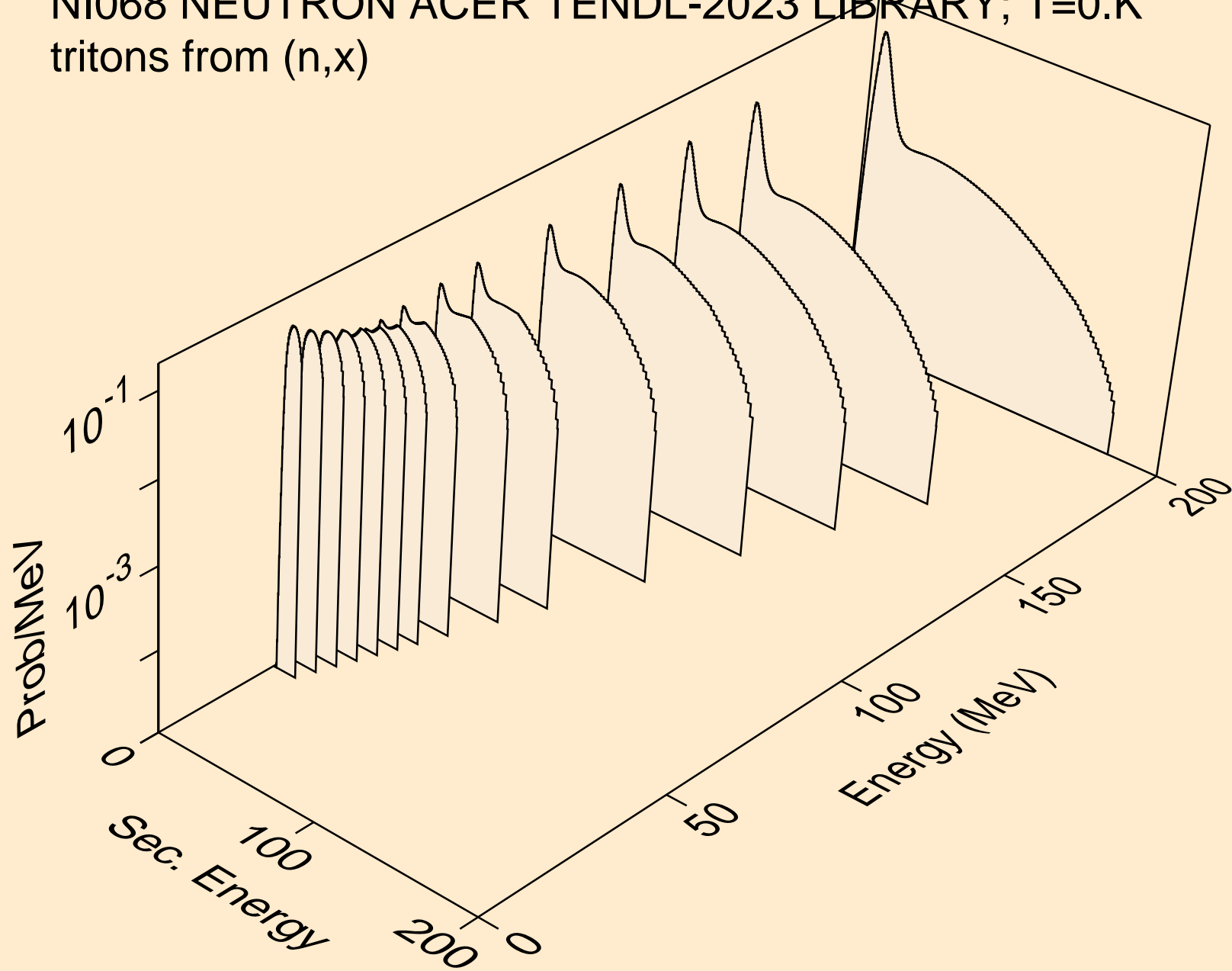



NI068 NEUTRON ACER TENDL-2023 LIBRARY; T=0.K  
tritons from (n,n\*)t

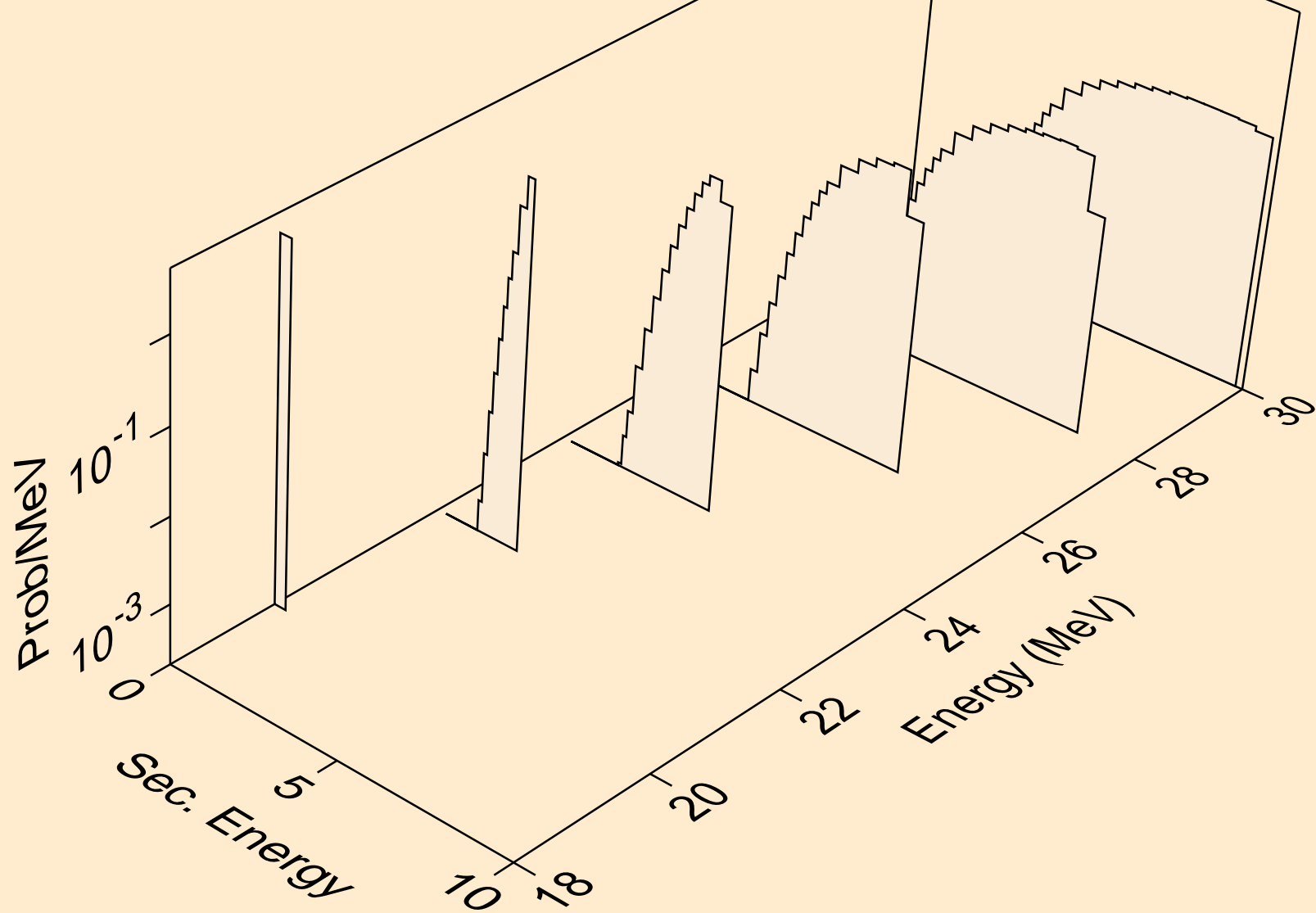

NI068 NEUTRON ACER TENDL-2023 LIBRARY; T=0.K  
tritons from (n,t)

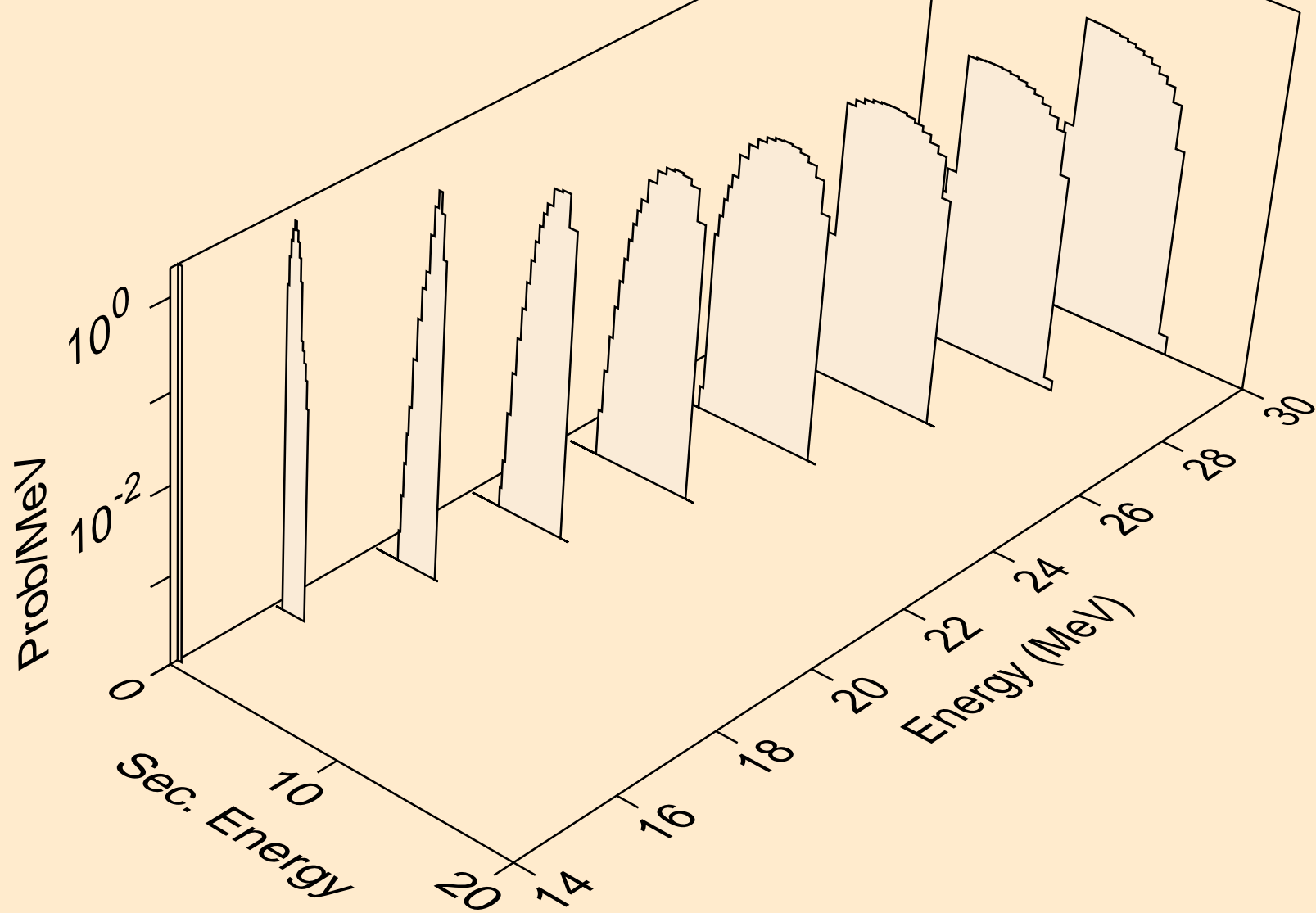

NI068 NEUTRON ACER TENDL-2023 LIBRARY; T=0.K  
he3s from (n,x)

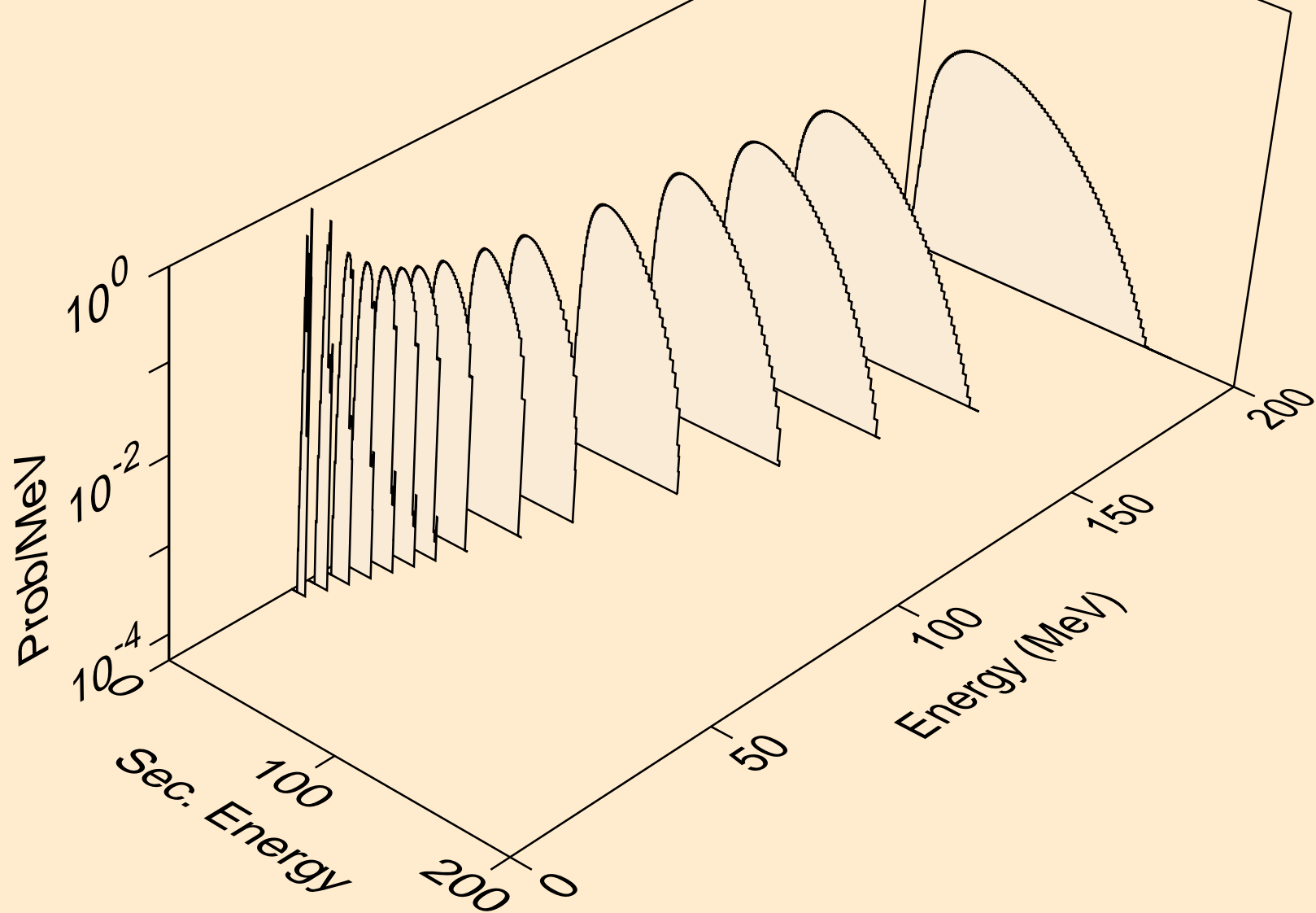

NI068 NEUTRON ACER TENDL-2023 LIBRARY; T=0.K  
he3s from (n,he3)

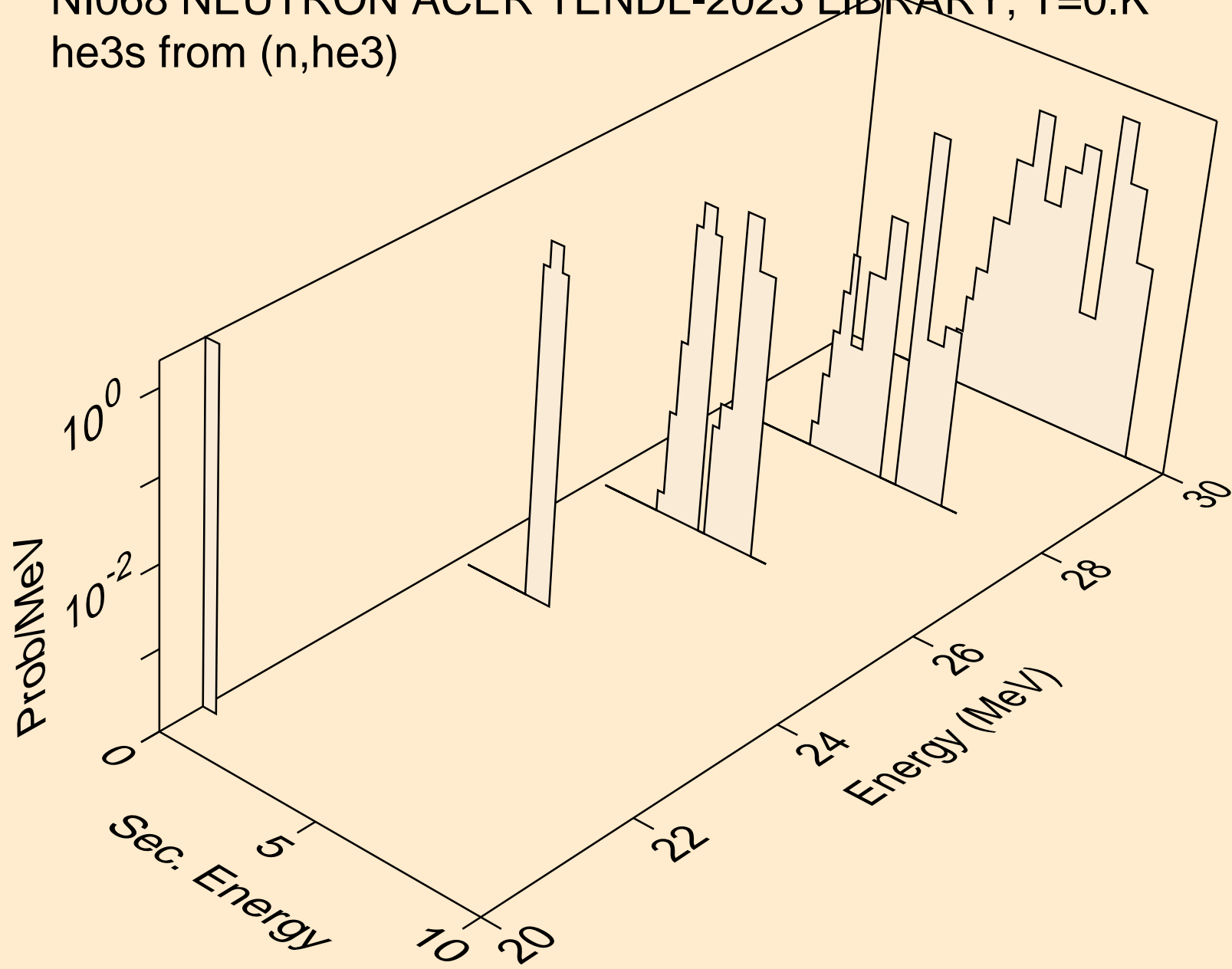

NI068 NEUTRON ACER TENDL-2023 LIBRARY; T=0.K  
alphas from (n,x)

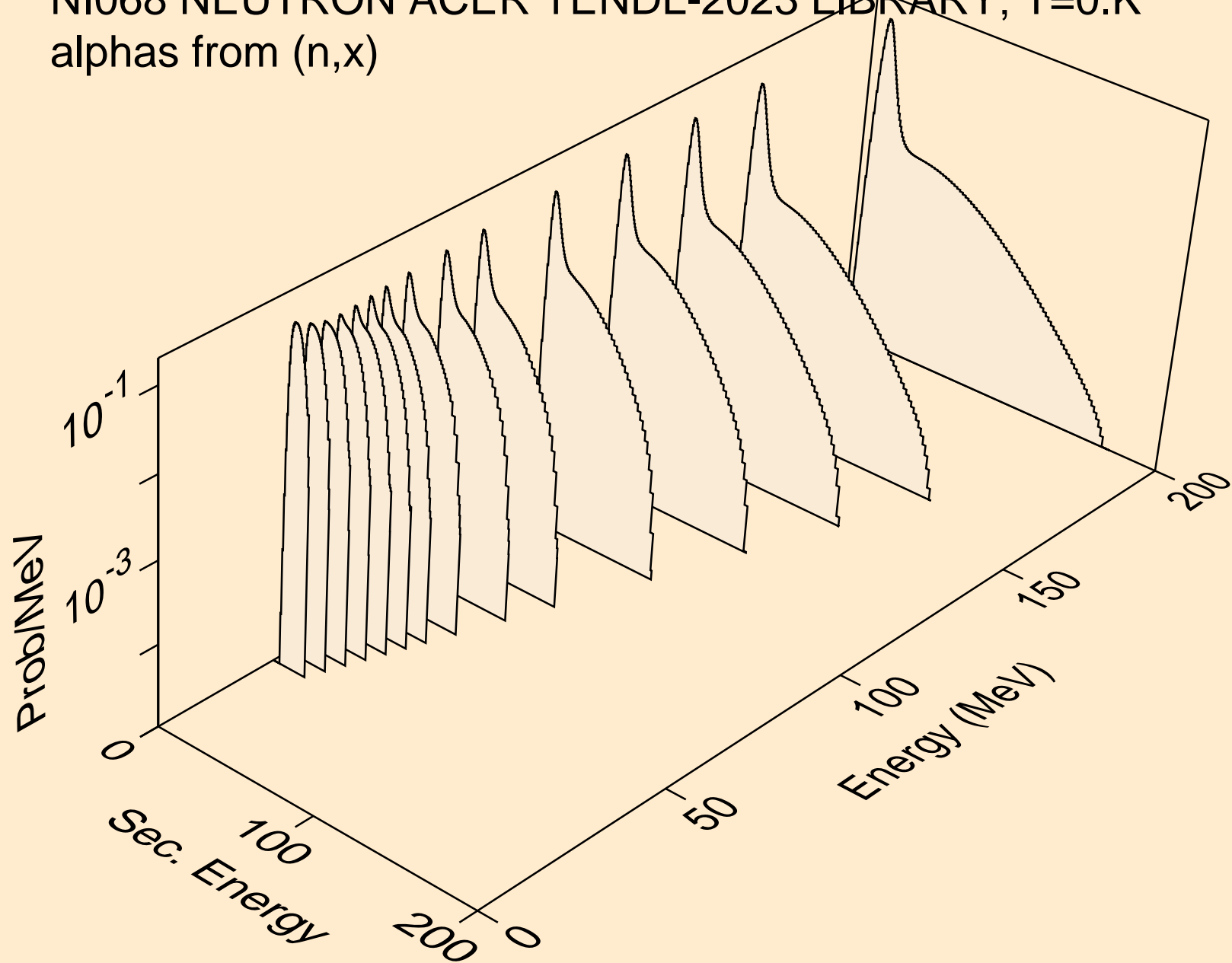

NI068 NEUTRON ACER TENDL-2023 LIBRARY; T=0.K  
alphas from (n,n\*)a

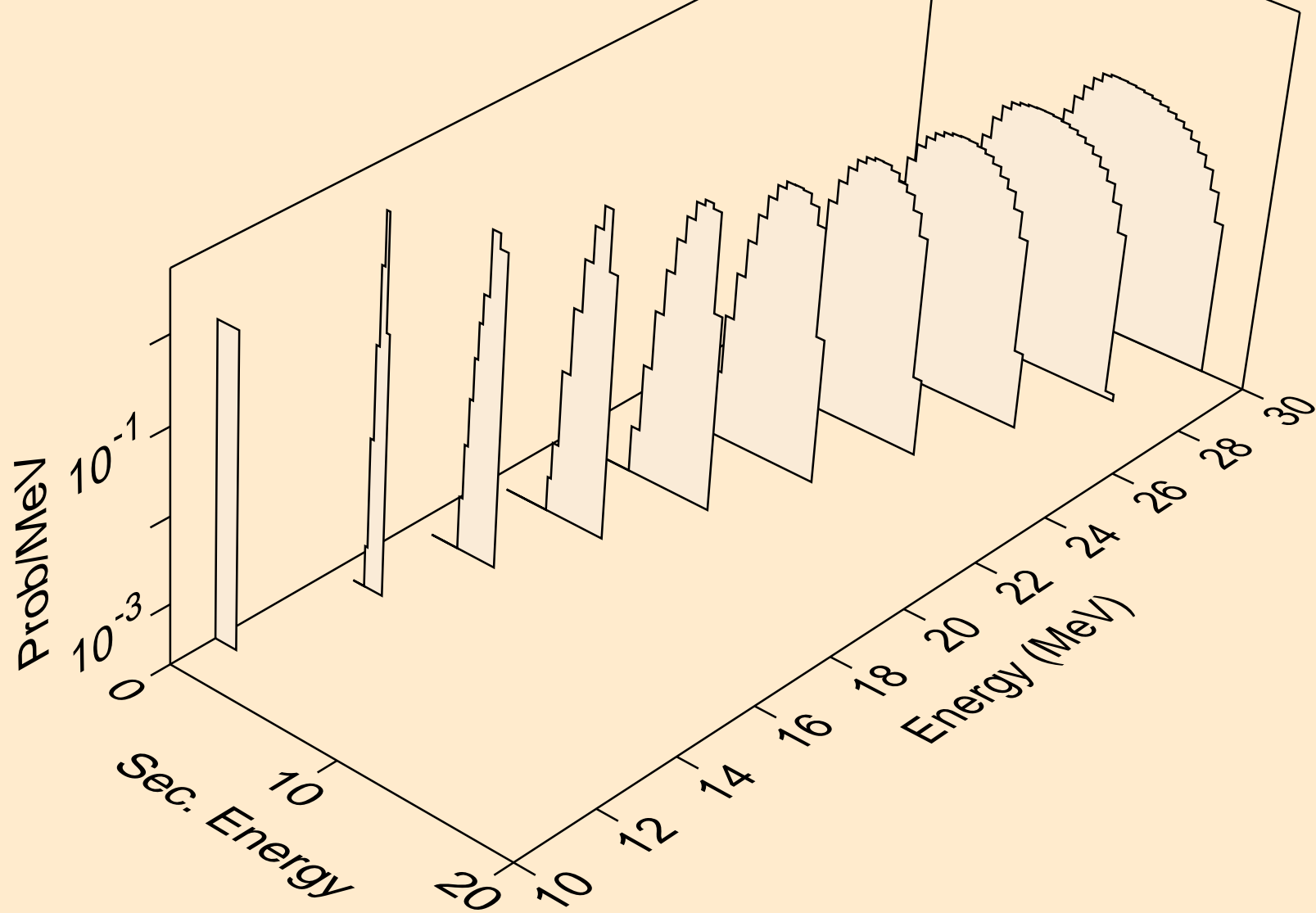

NI068 NEUTRON ACER TENDL-2023 LIBRARY; T=0.K  
alphas from (n,2n)a

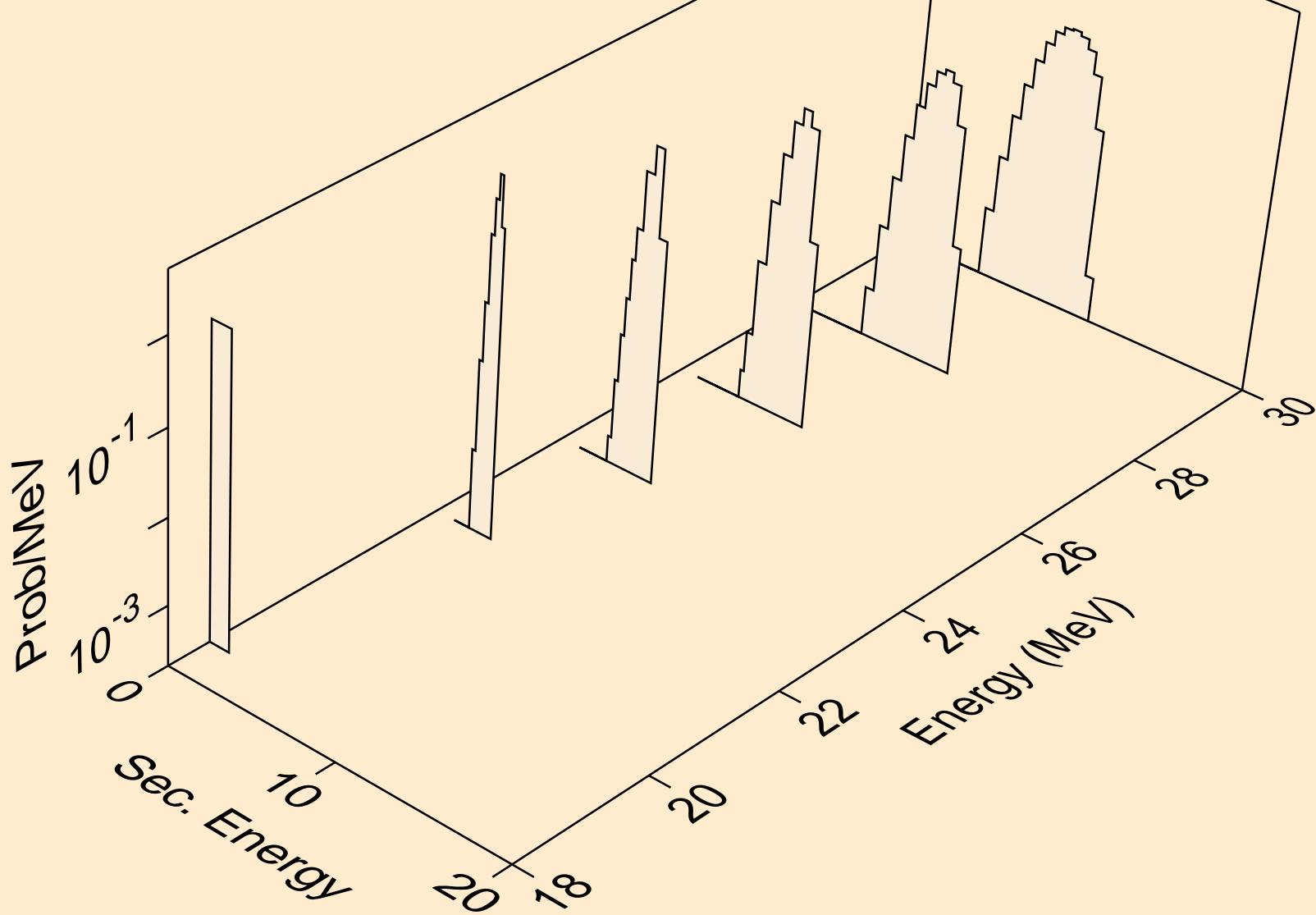

NI068 NEUTRON ACER TENDL-2023 LIBRARY; T=0.K  
alphas from (n,3n)a

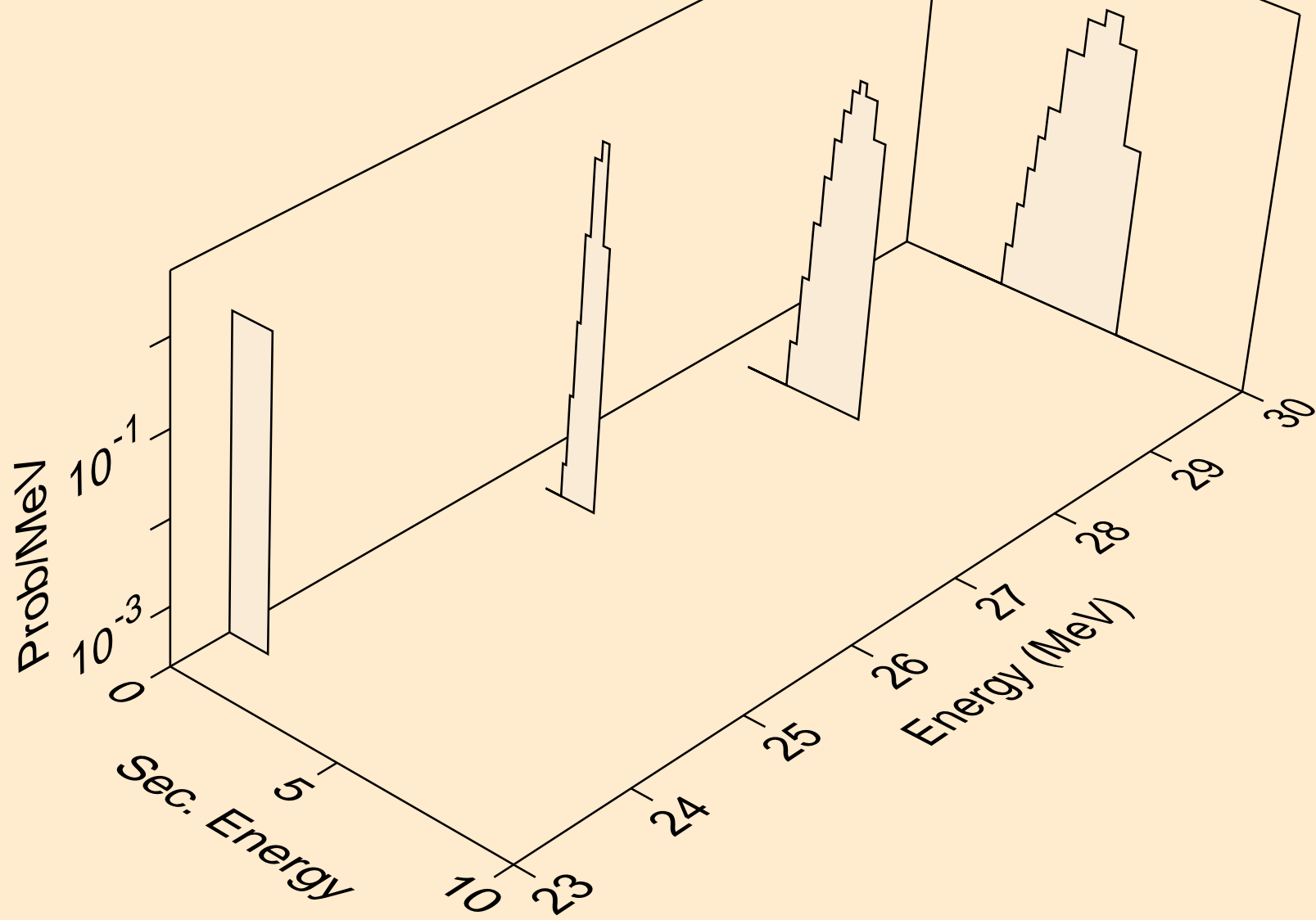



NI068 NEUTRON ACER TENDL-2023 LIBRARY; T=0.K  
alphas from (n,a)

