

NP238 NEUTRON ACER TENDL-2023 LIBRARY; T=0.K

Principal cross sections

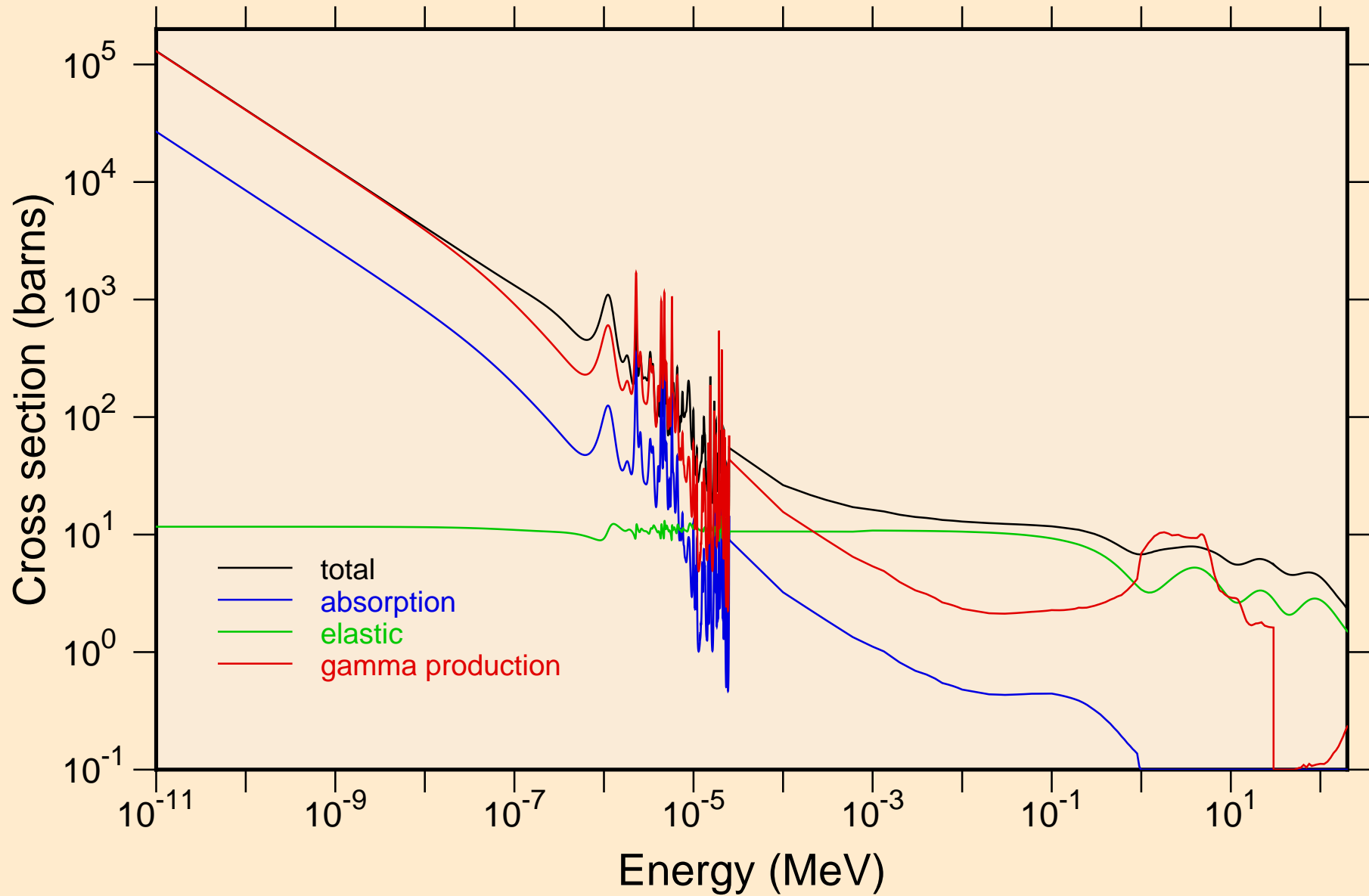

NP238 NEUTRON ACER TENDL-2023 LIBRARY; T=0.K
resonance total cross section

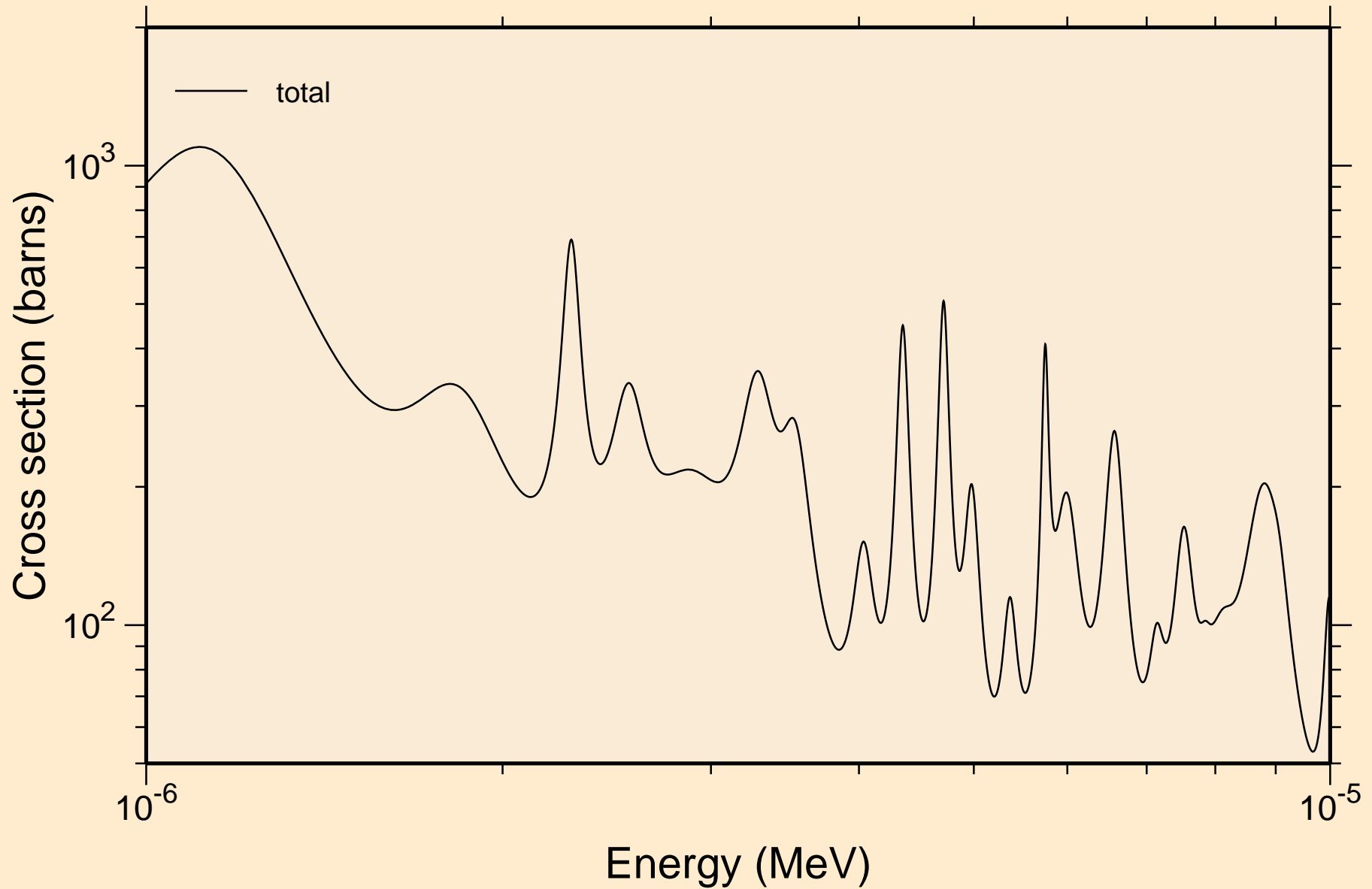

NP238 NEUTRON ACER TENDL-2023 LIBRARY; T=0.K
resonance total cross section

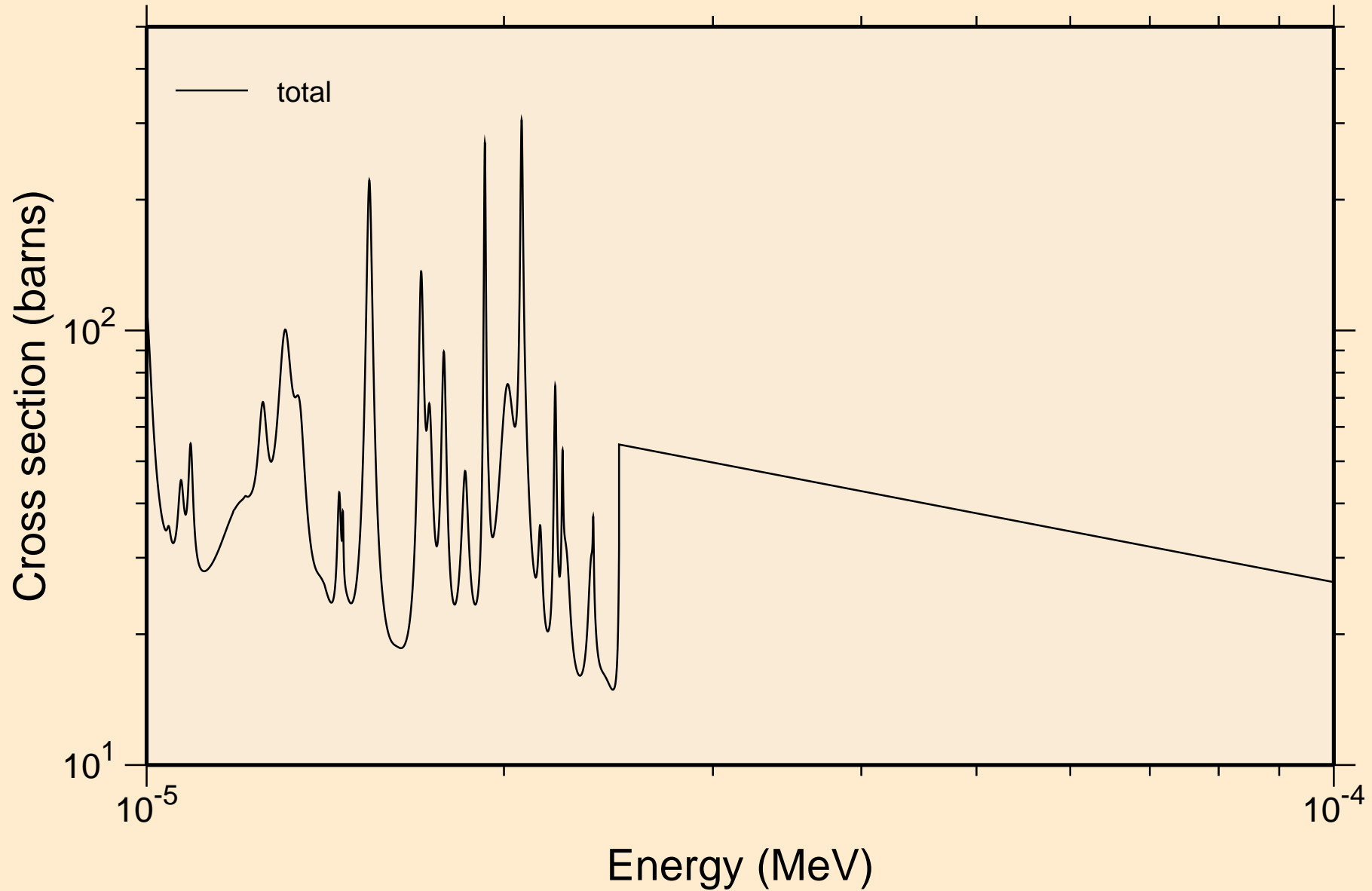

NP238 NEUTRON ACER TENDL-2023 LIBRARY; T=0.K
resonance total cross section

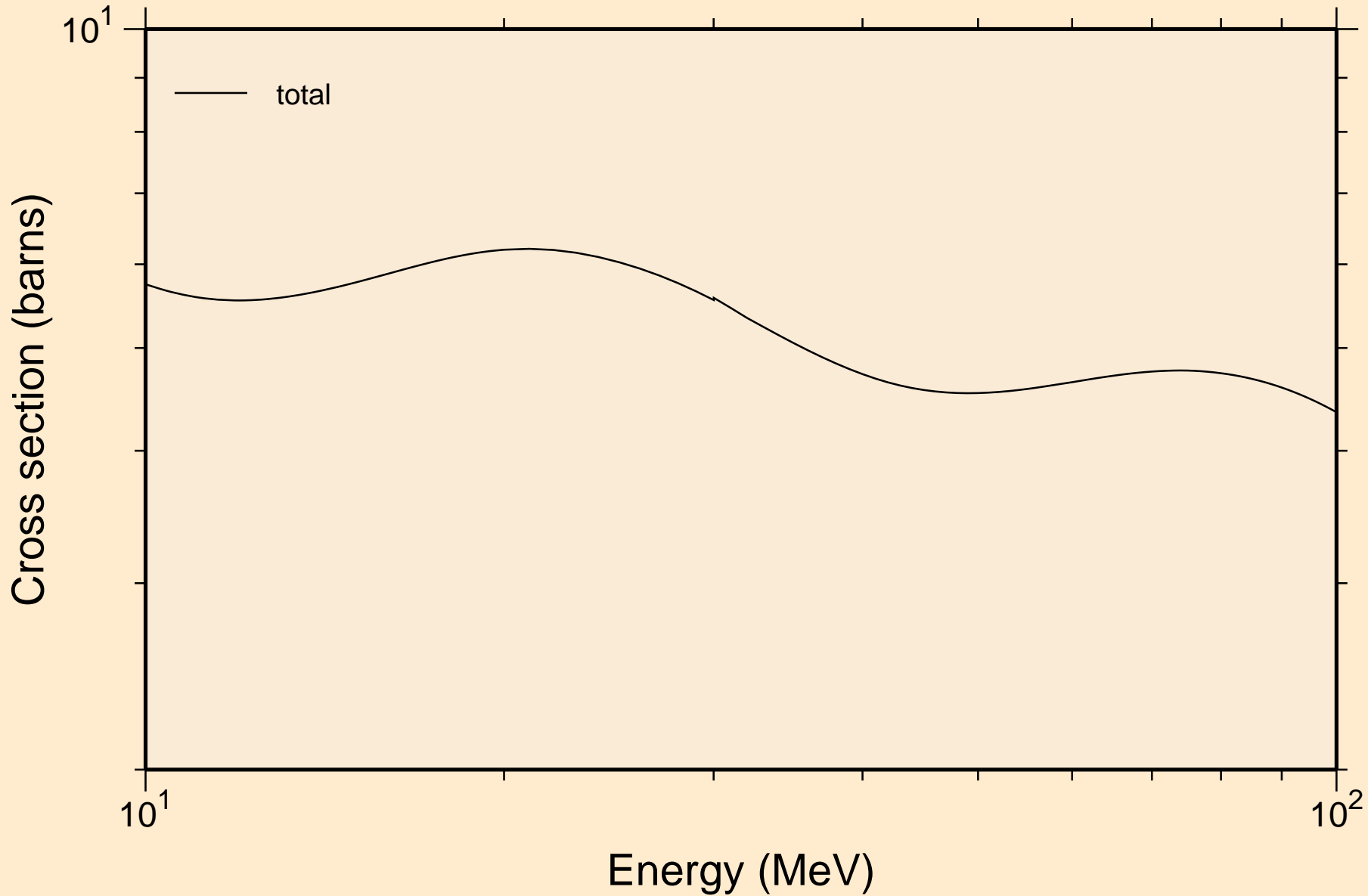

NP238 NEUTRON ACER TENDL-2023 LIBRARY; T=0.K
resonance absorption cross sections

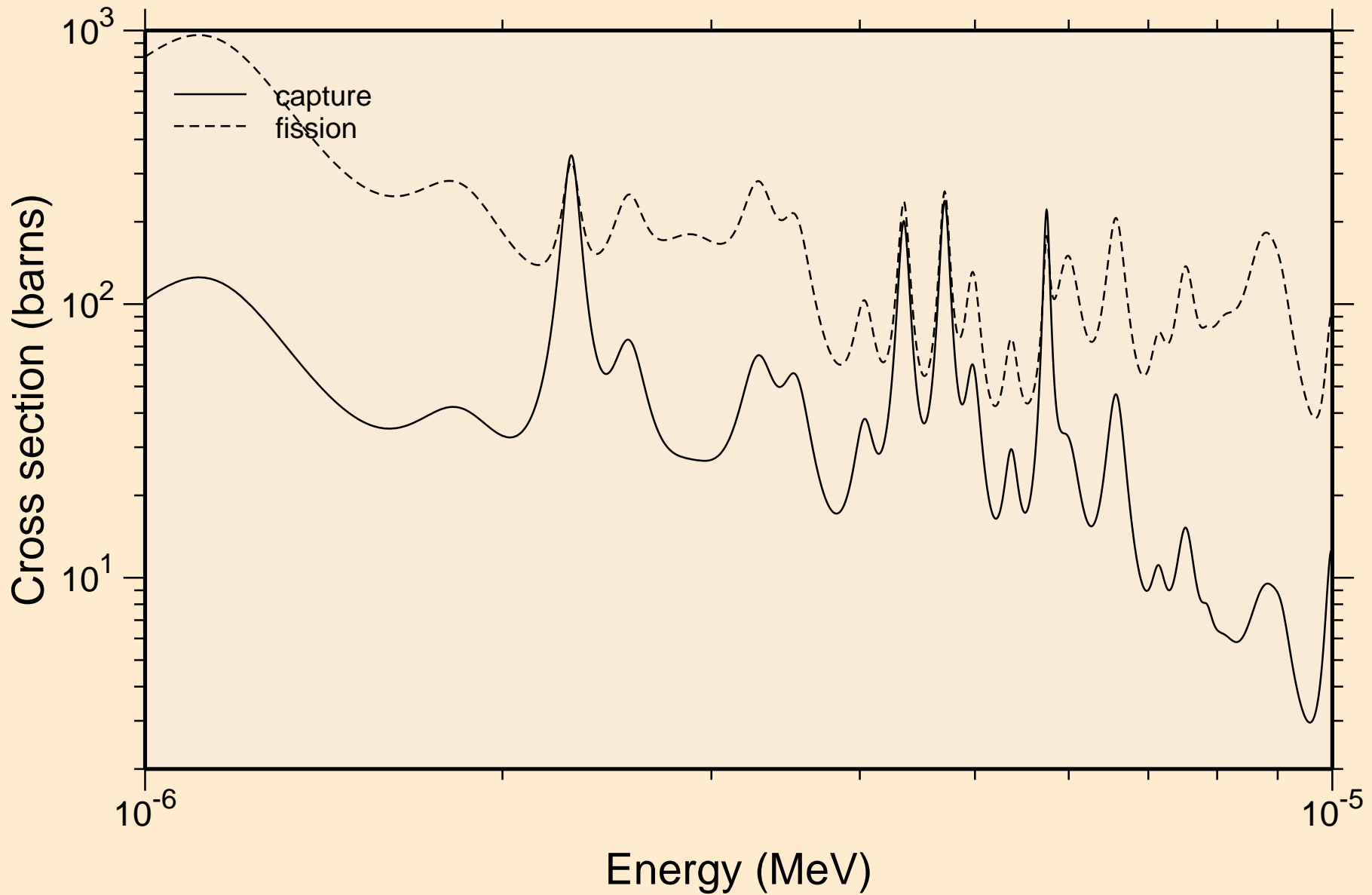

NP238 NEUTRON ACER TENDL-2023 LIBRARY; T=0.K
resonance absorption cross sections

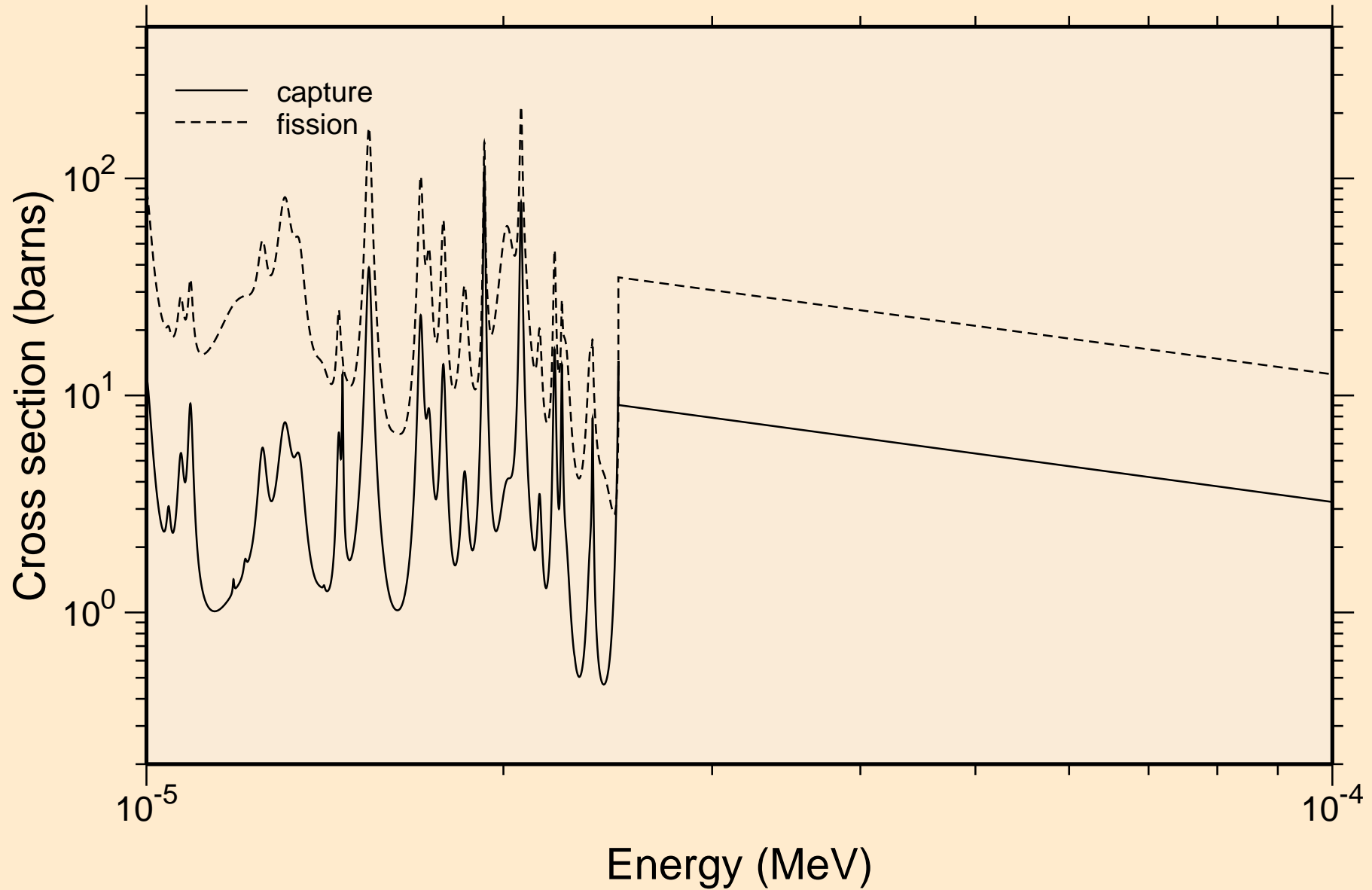

NP238 NEUTRON ACER TENDL-2023 LIBRARY; T=0.K
resonance absorption cross sections

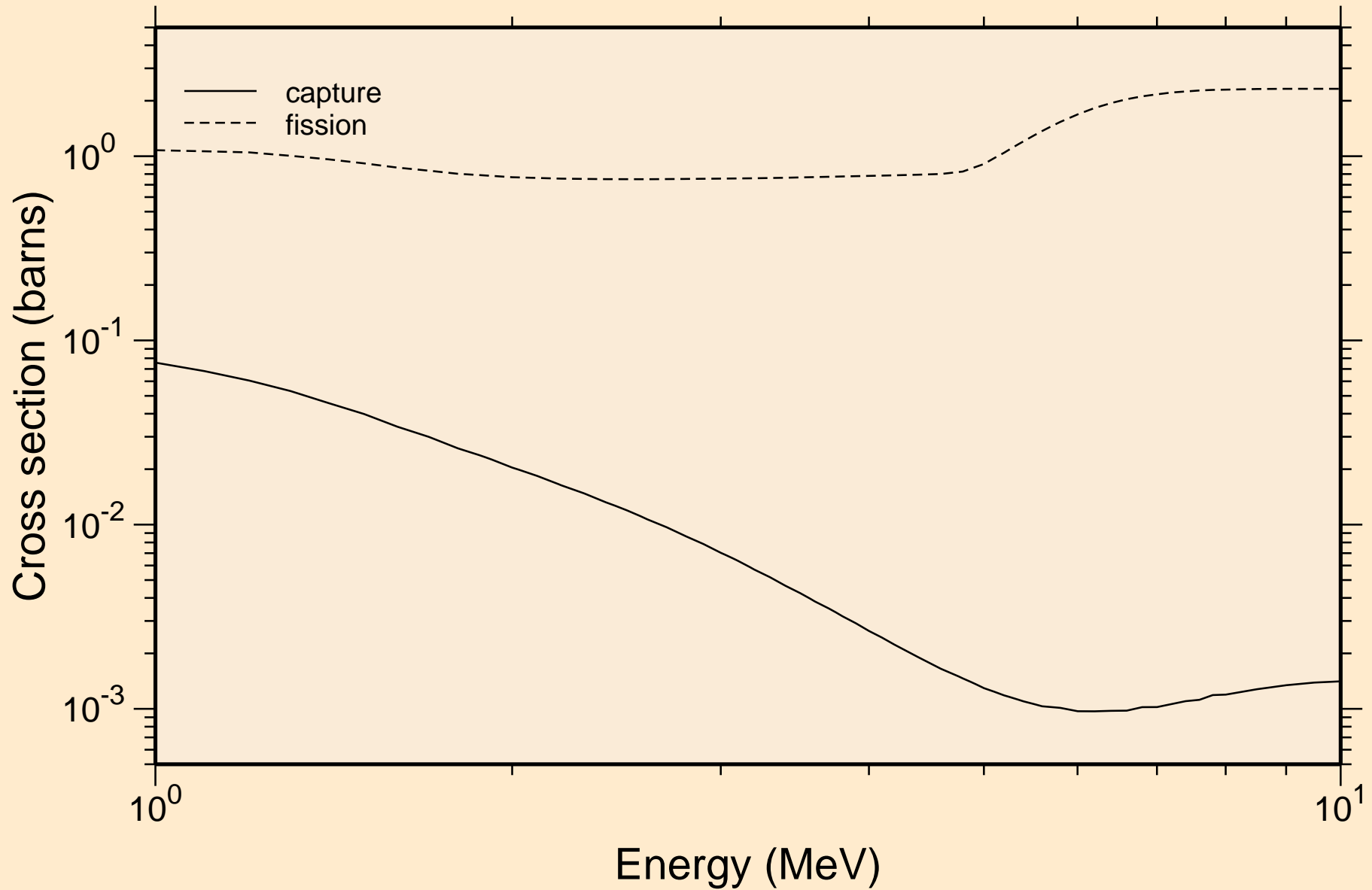

NP238 NEUTRON ACER TENDL-2023 LIBRARY; T=0.K

Heating

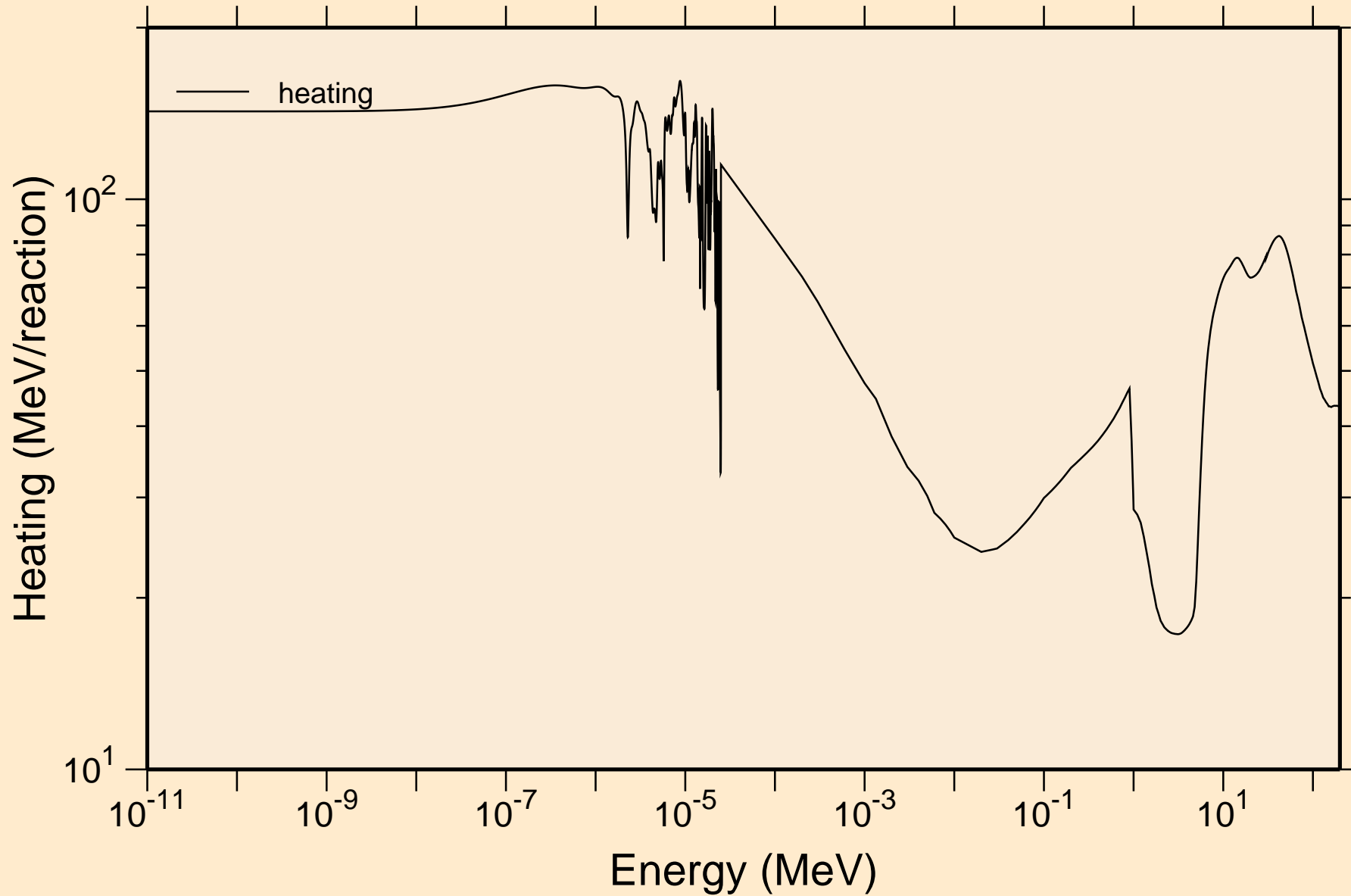

NP238 NEUTRON ACER TENDL-2023 LIBRARY; T=0.K

Damage

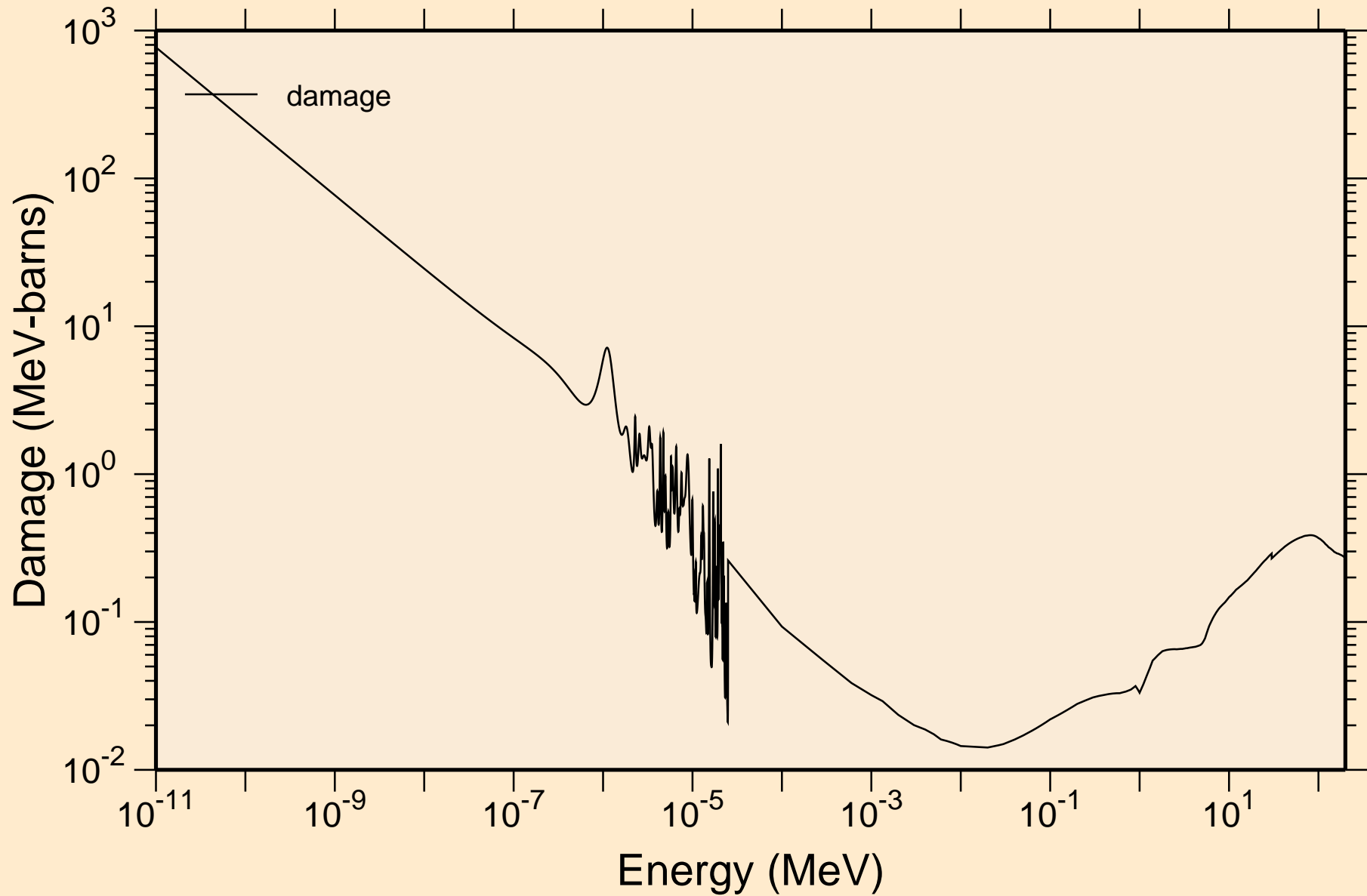

NP238 NEUTRON ACER TENDL-2023 LIBRARY; T=0.K

Non-threshold reactions

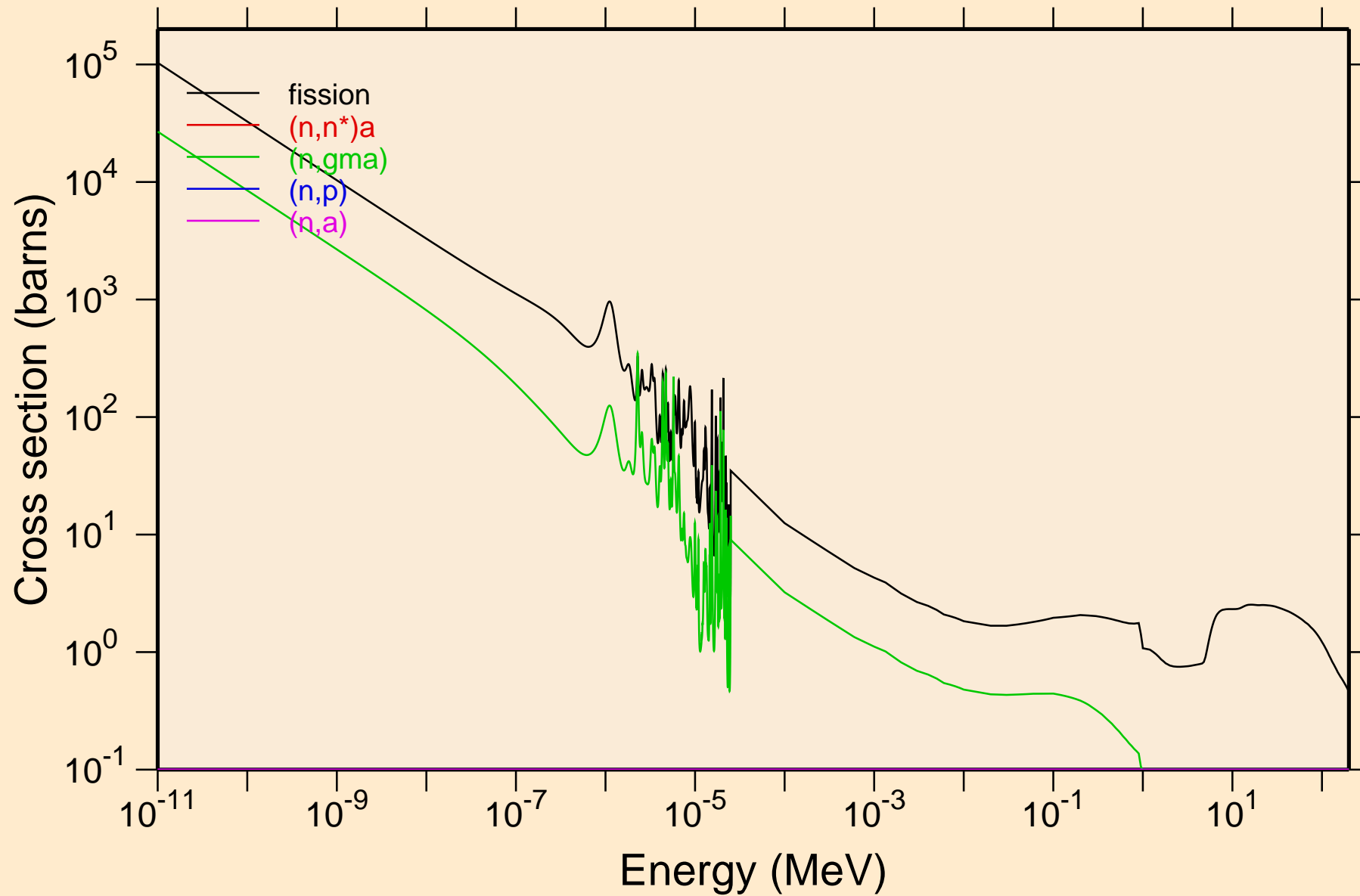

NP238 NEUTRON ACER TENDL-2023 LIBRARY; T=0.K

Non-threshold reactions

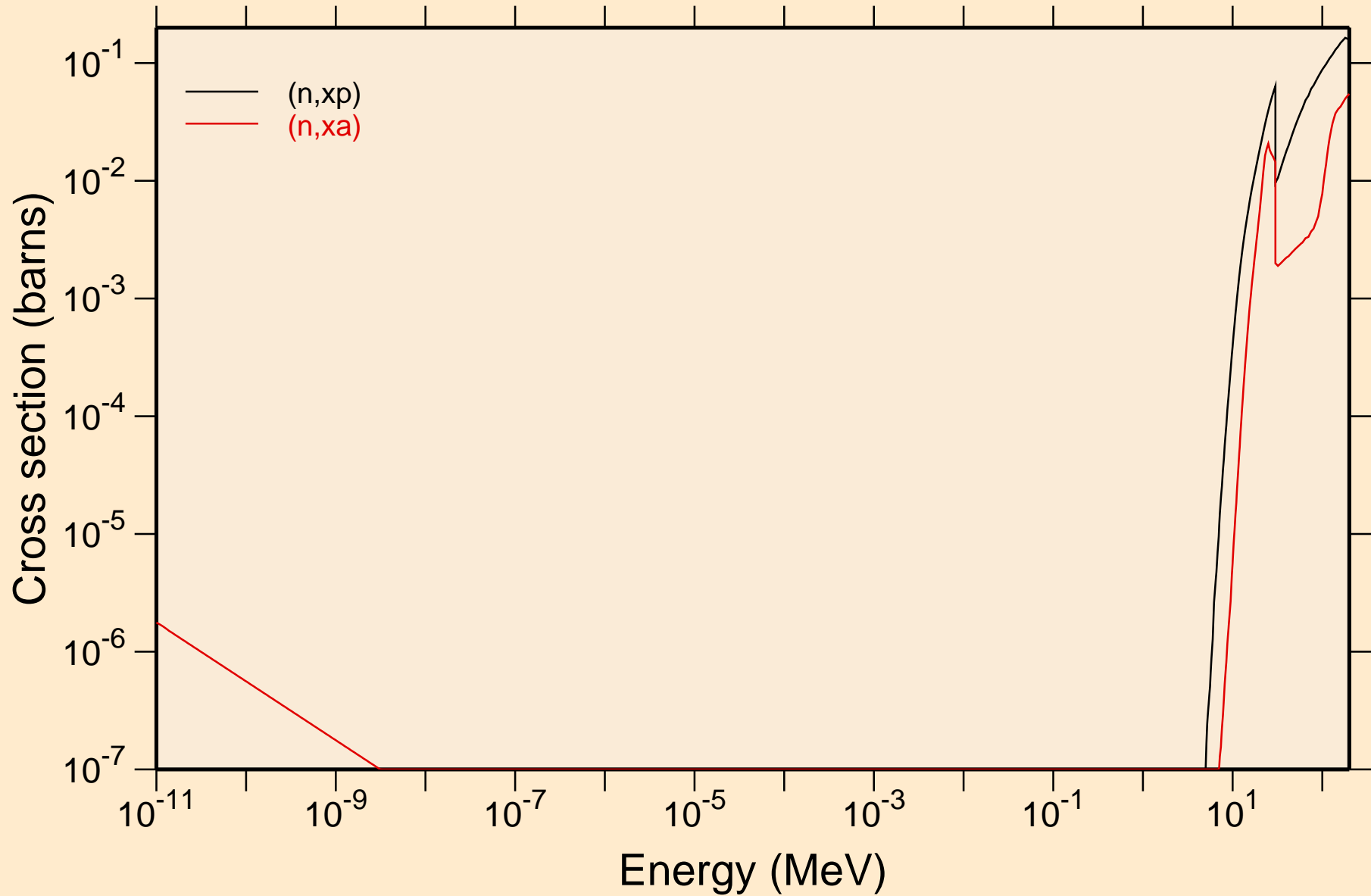

NP238 NEUTRON ACER TENDL-2023 LIBRARY; T=0.K

Principal cross sections

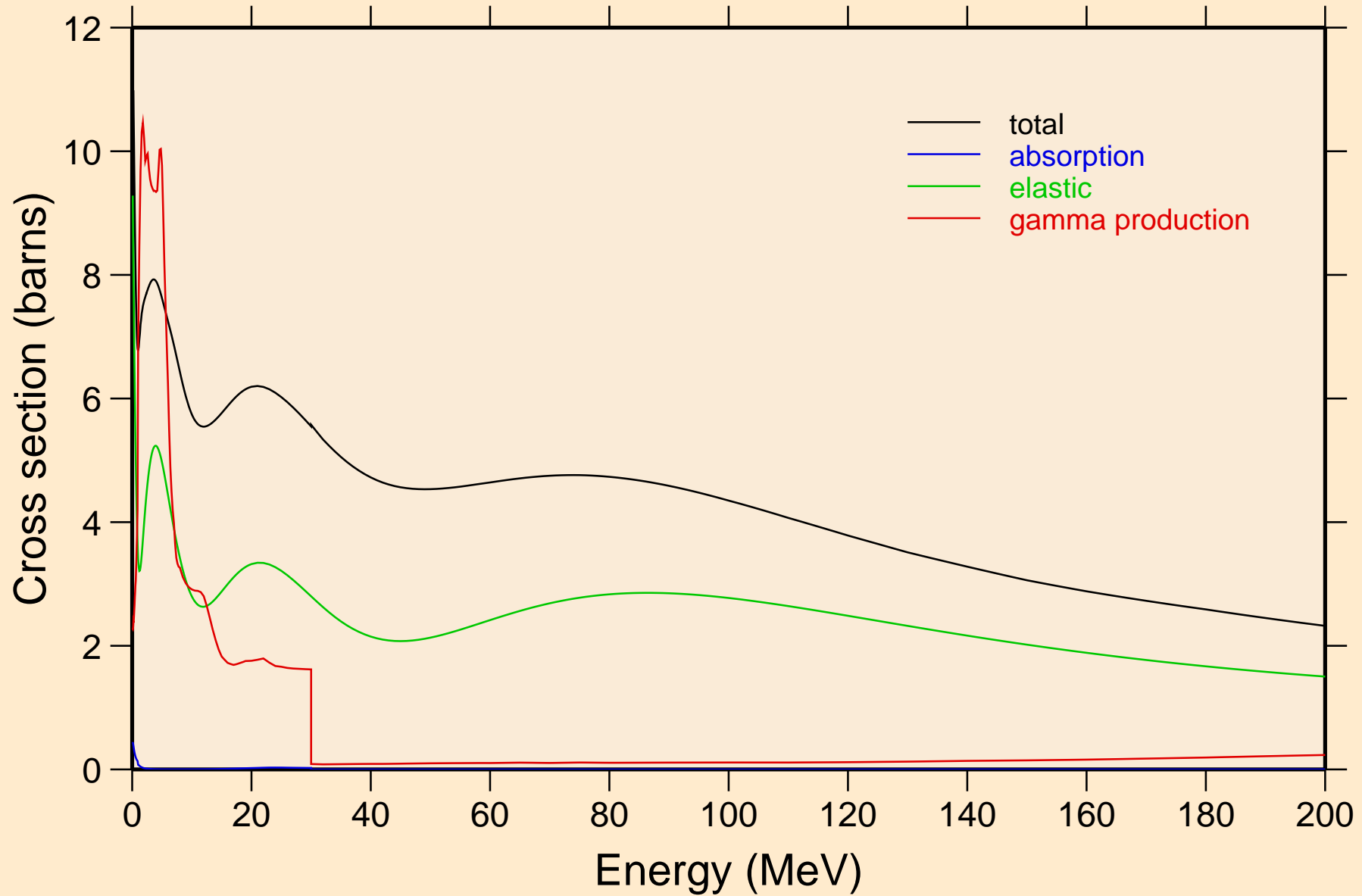

NP238 NEUTRON ACER TENDL-2023 LIBRARY; T=0.K

Heating

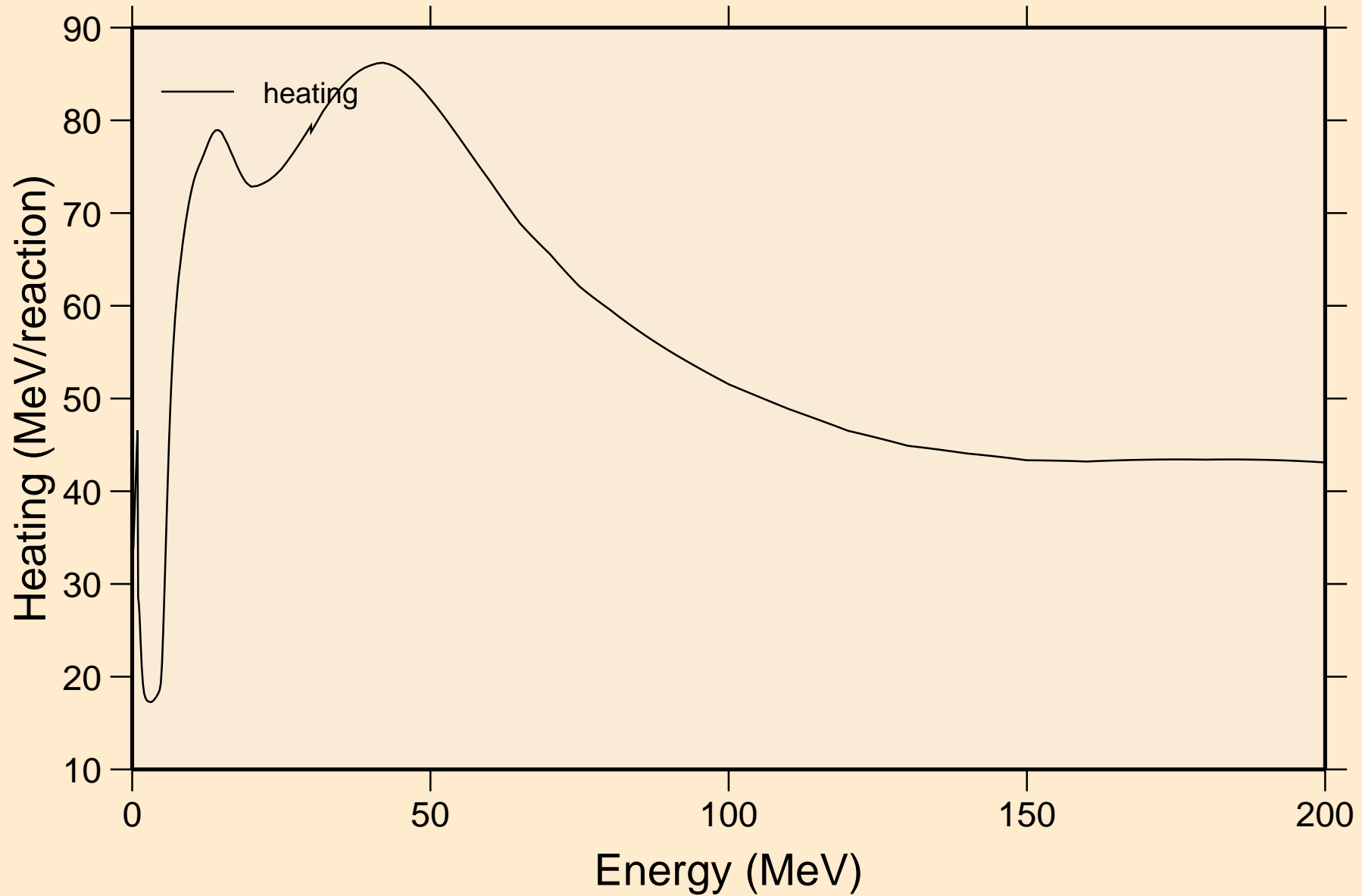

NP238 NEUTRON ACER TENDL-2023 LIBRARY; T=0.K

Damage

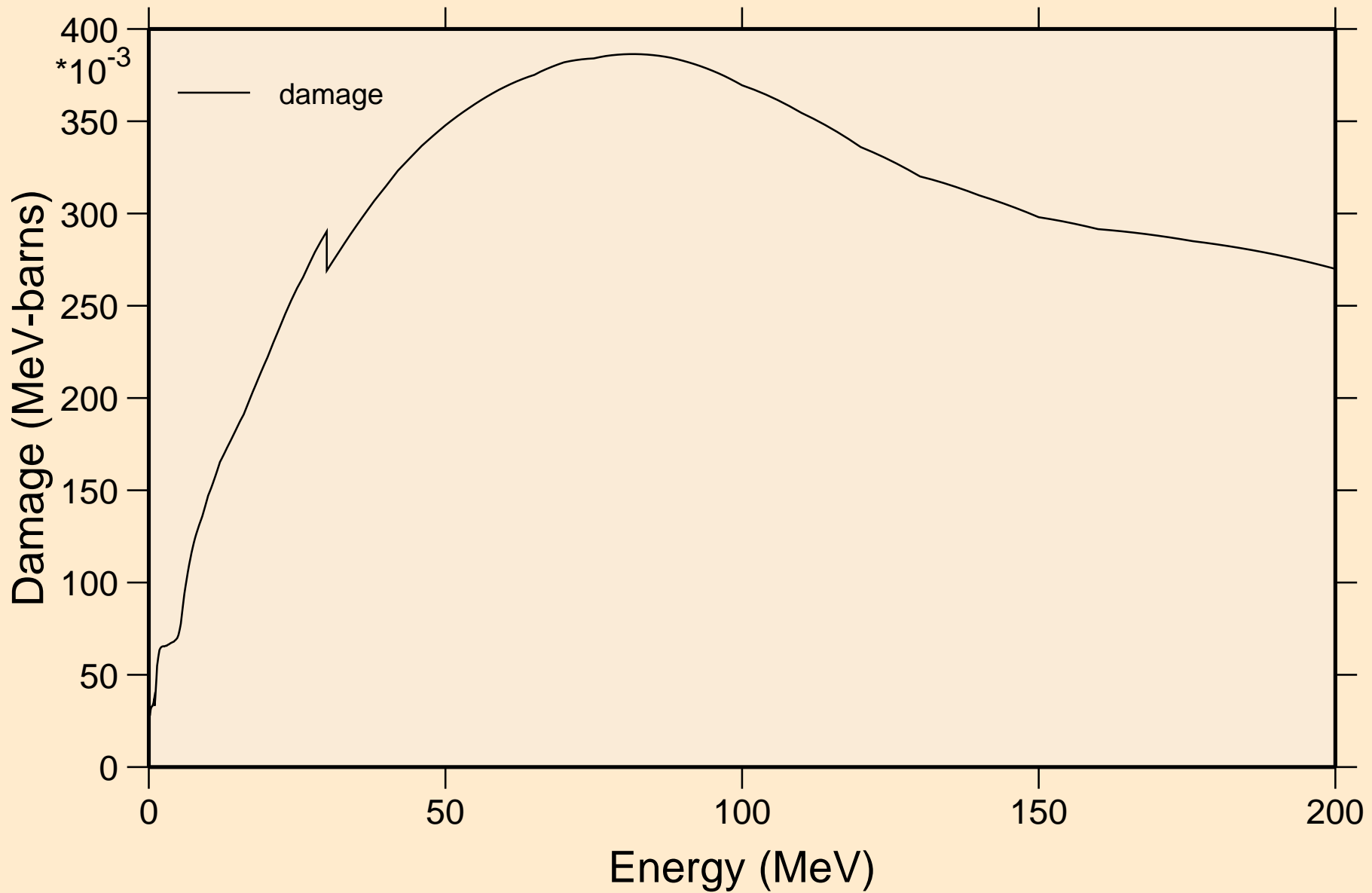

NP238 NEUTRON ACER TENDL-2023 LIBRARY; T=0.K

Non-threshold reactions

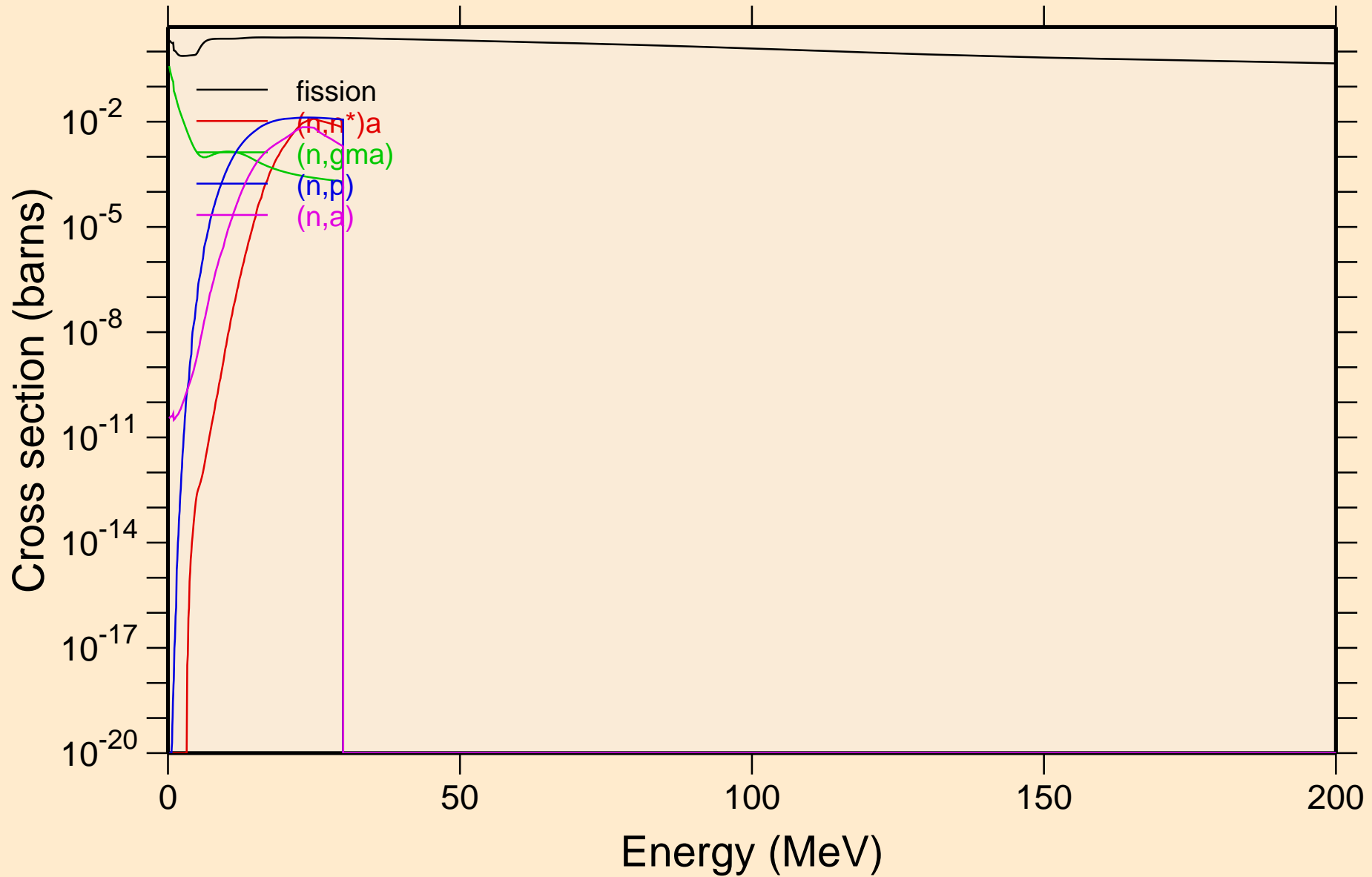

NP238 NEUTRON ACER TENDL-2023 LIBRARY; T=0.K
Non-threshold reactions

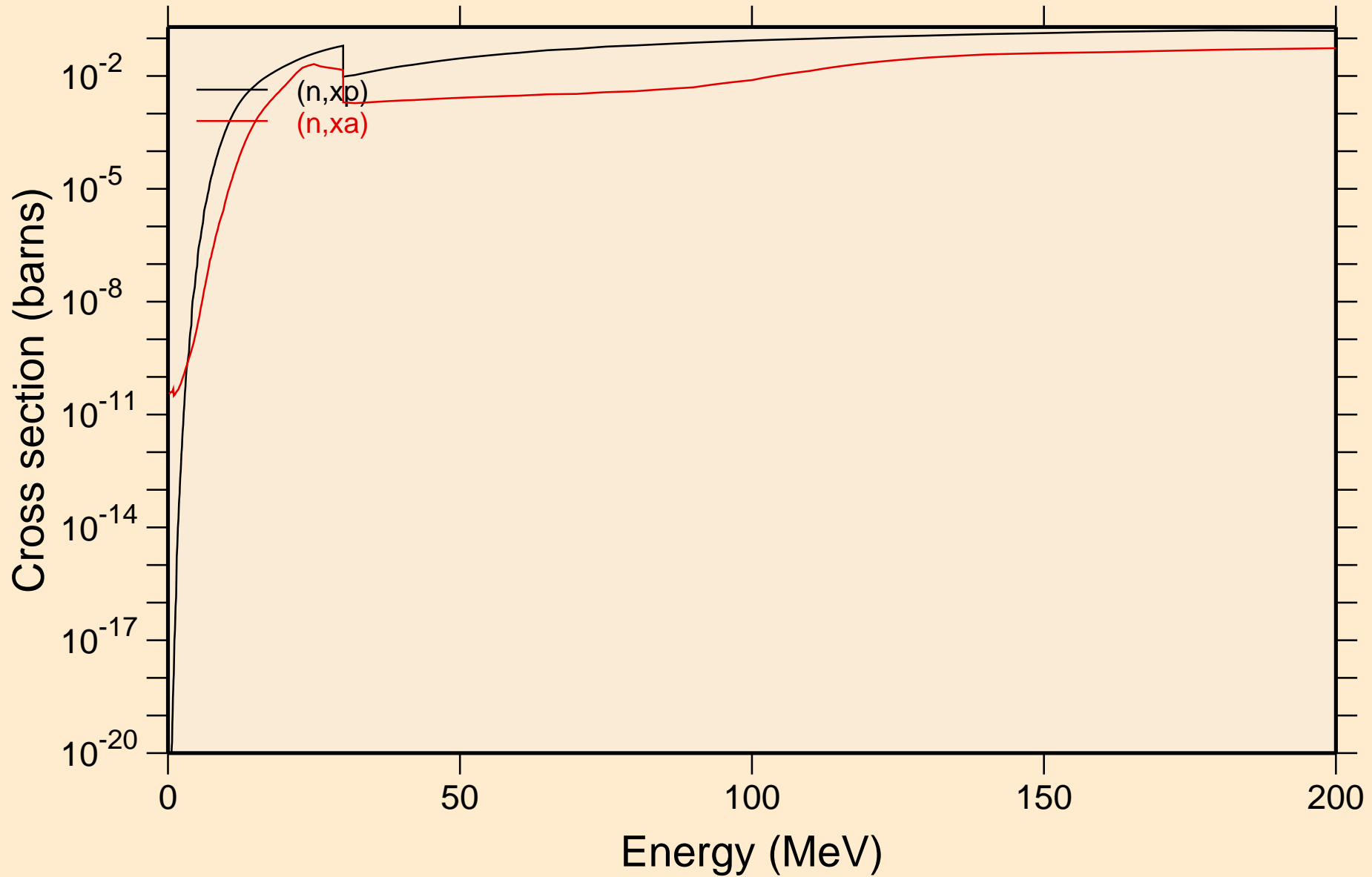

NP238 NEUTRON ACER TENDL-2023 LIBRARY; T=0.K
Inelastic levels

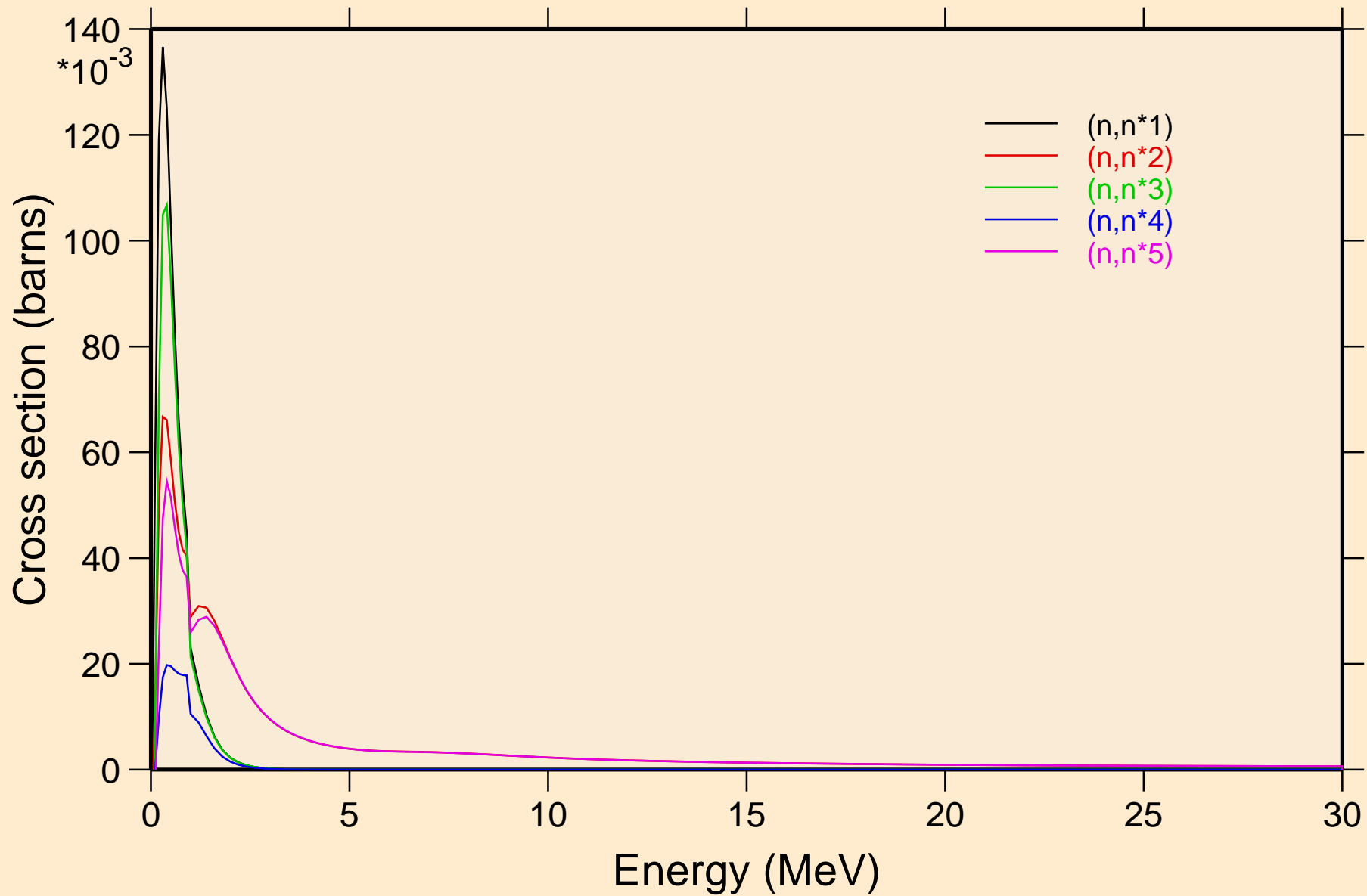

NP238 NEUTRON ACER TENDL-2023 LIBRARY; T=0.K
Inelastic levels

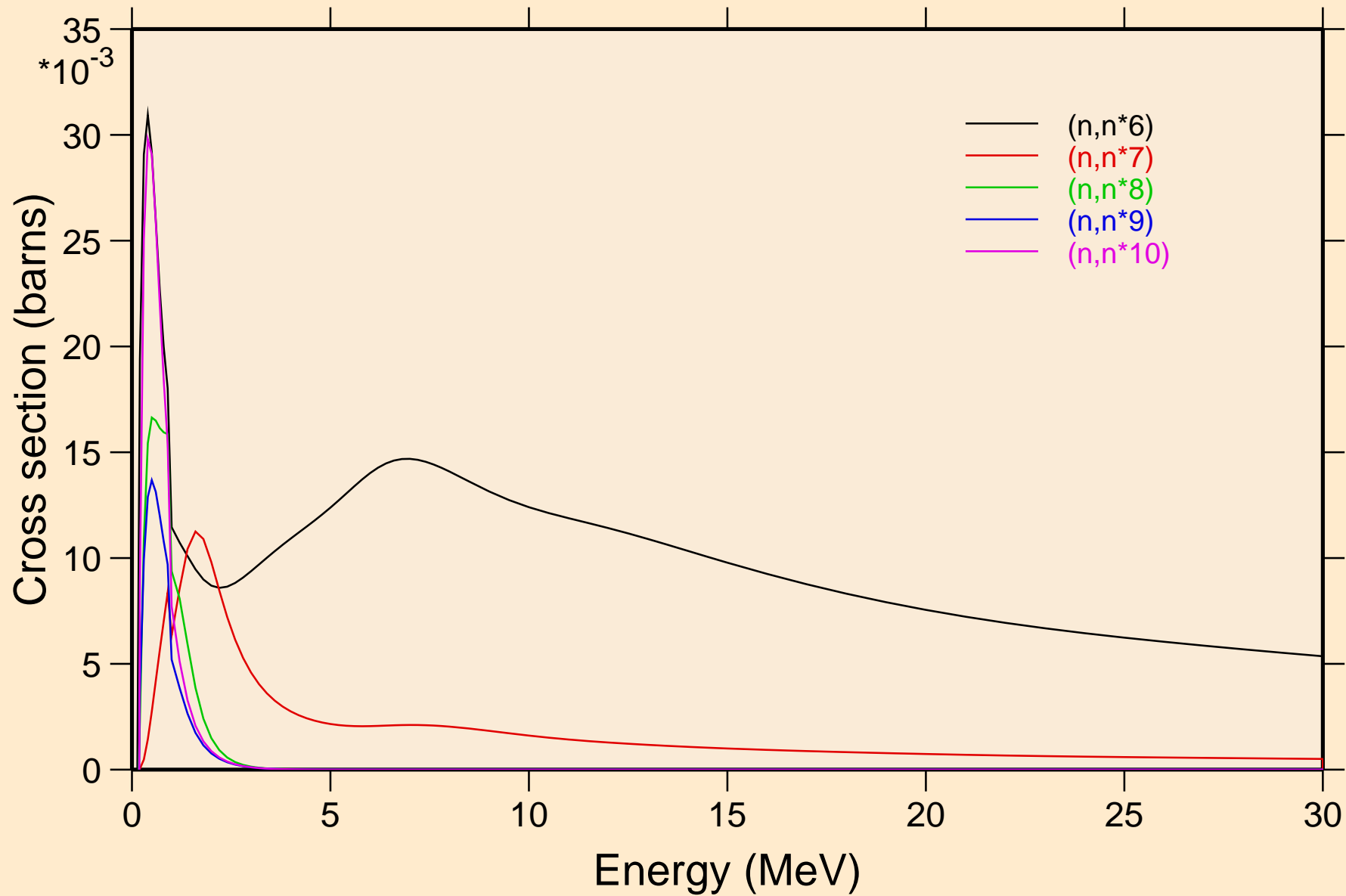

NP238 NEUTRON ACER TENDL-2023 LIBRARY; T=0.K
Inelastic levels

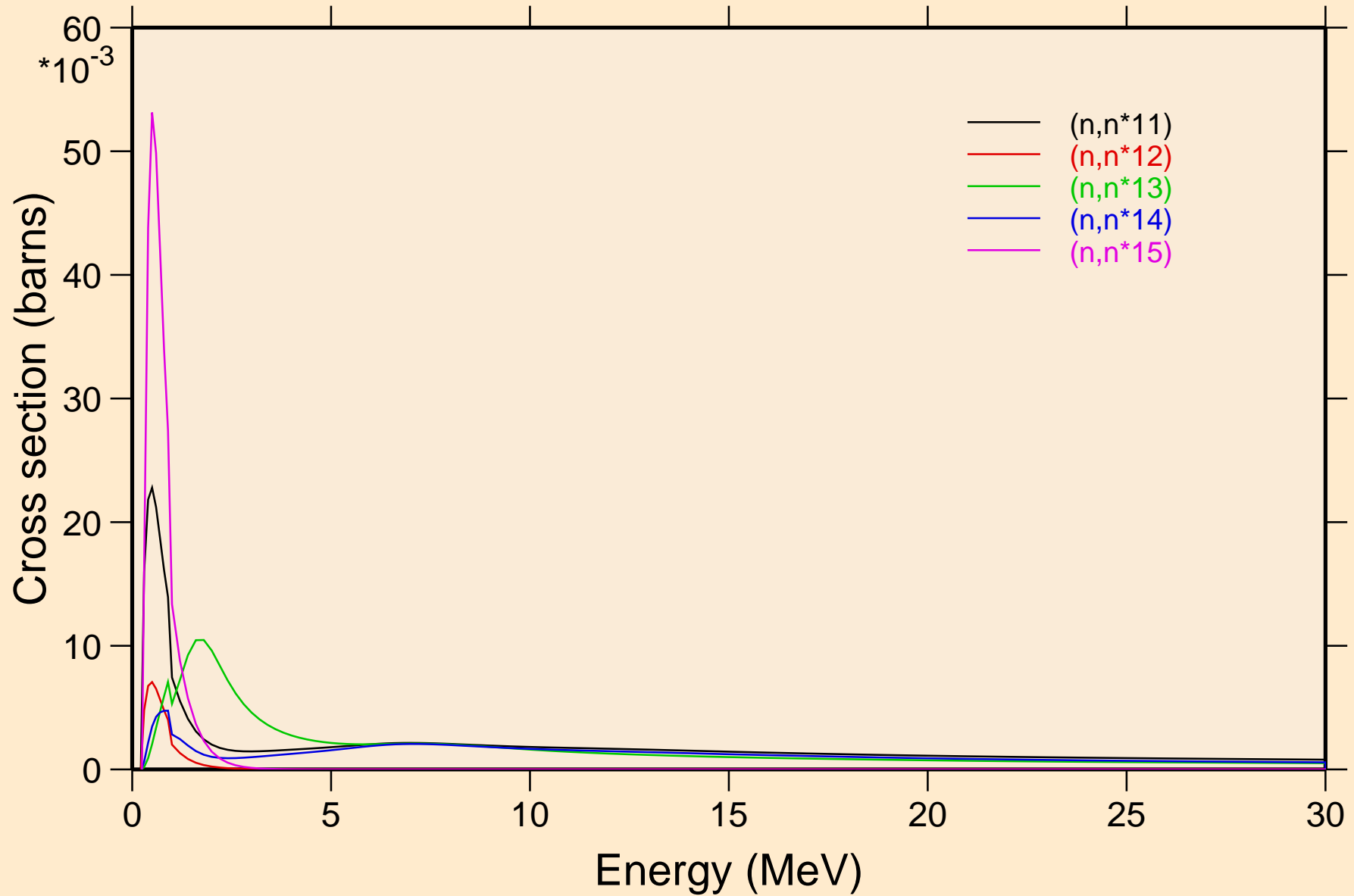

NP238 NEUTRON ACER TENDL-2023 LIBRARY; T=0.K

Threshold reactions

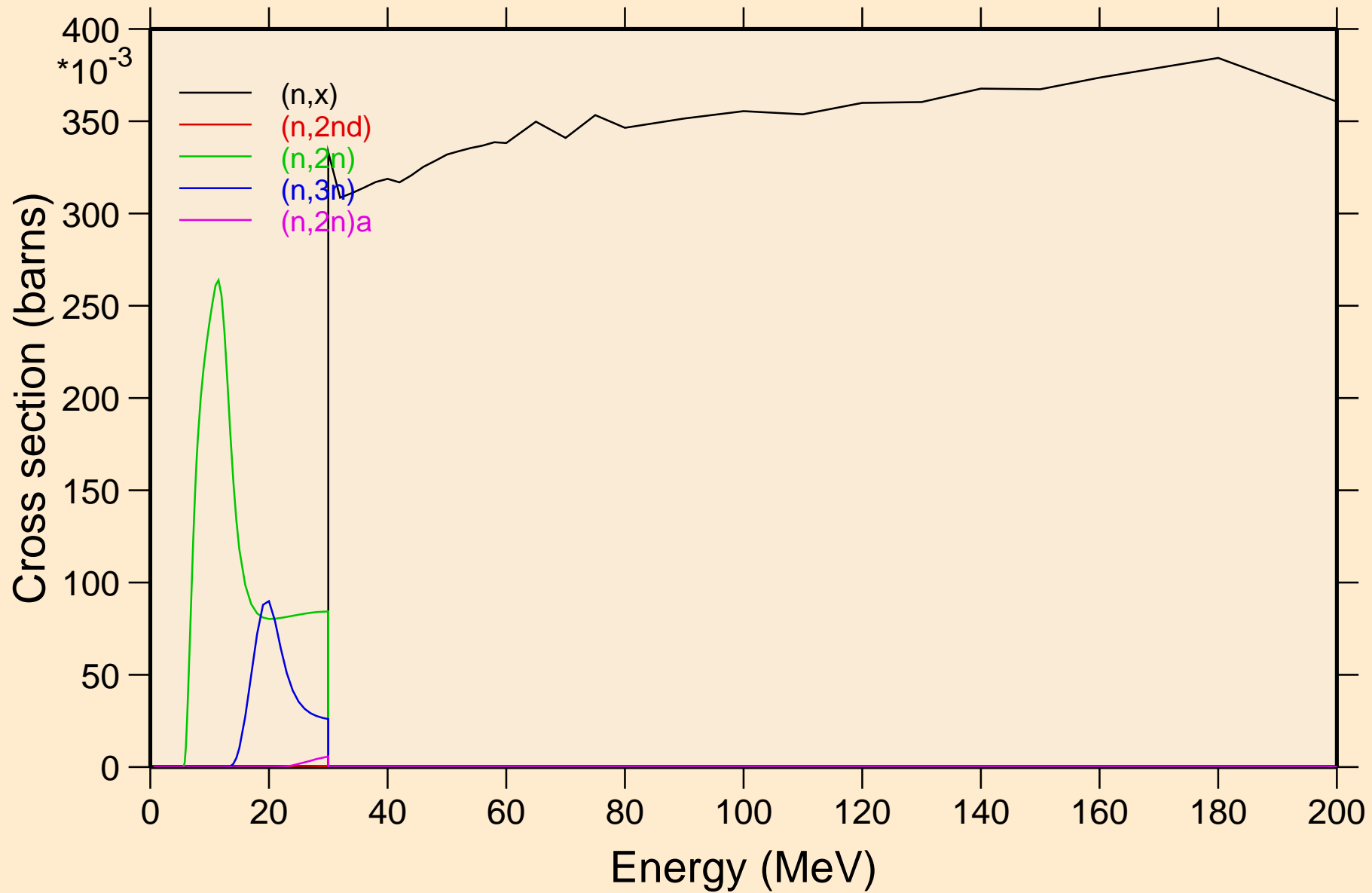

NP238 NEUTRON ACER TENDL-2023 LIBRARY; T=0.K

Threshold reactions

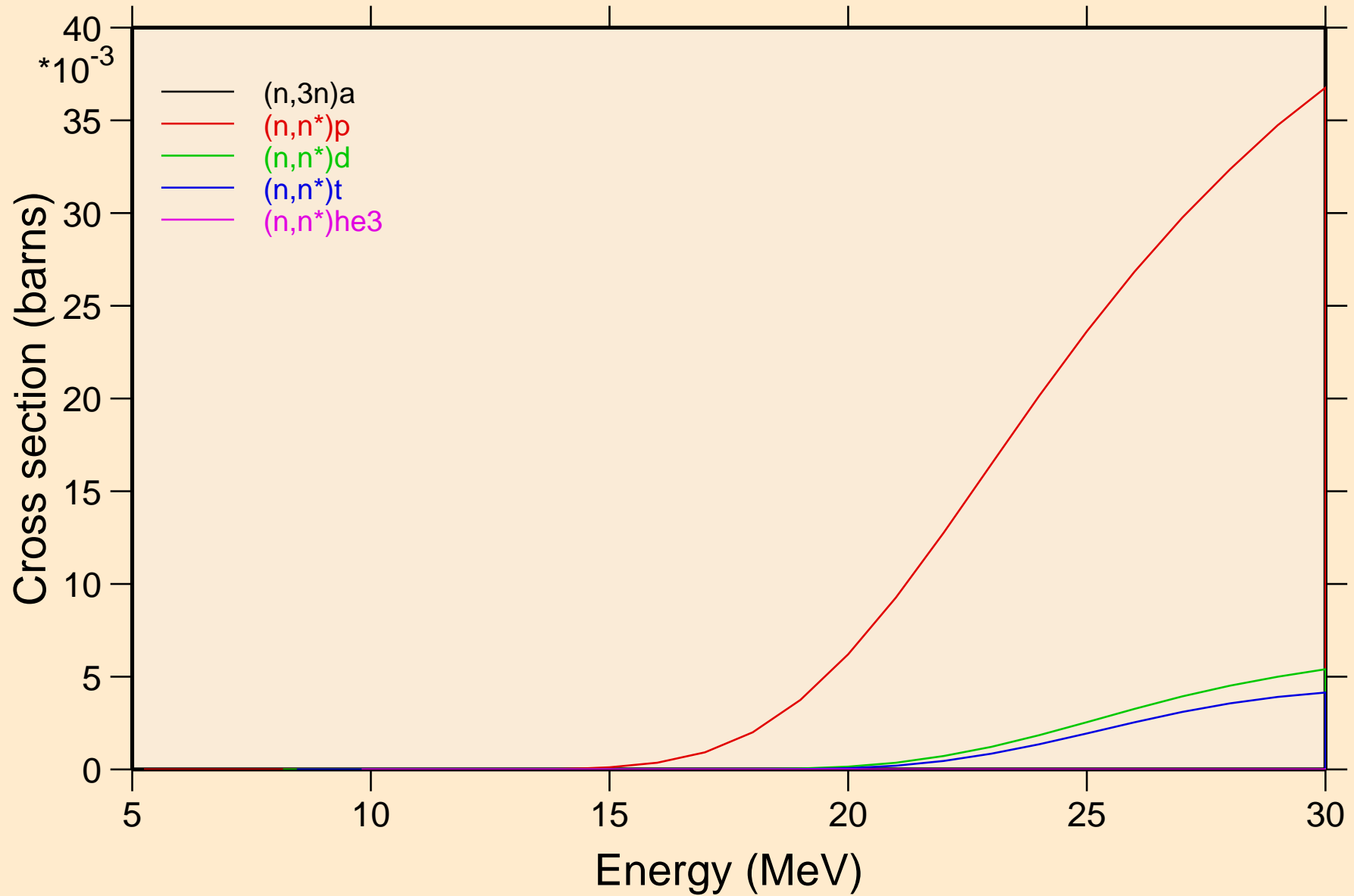

NP238 NEUTRON ACER TENDL-2023 LIBRARY; T=0.K

Threshold reactions

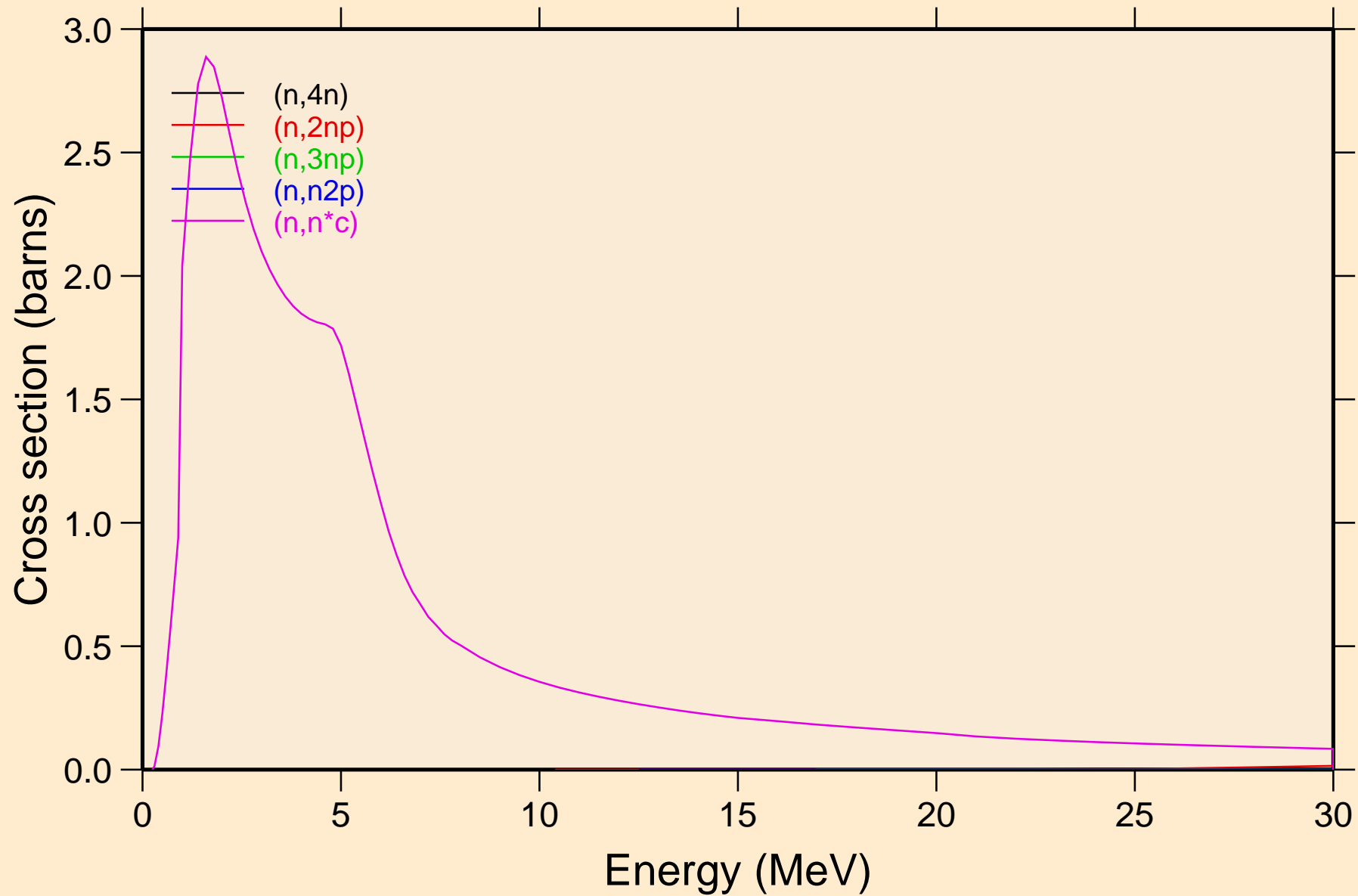

NP238 NEUTRON ACER TENDL-2023 LIBRARY; T=0.K
Threshold reactions

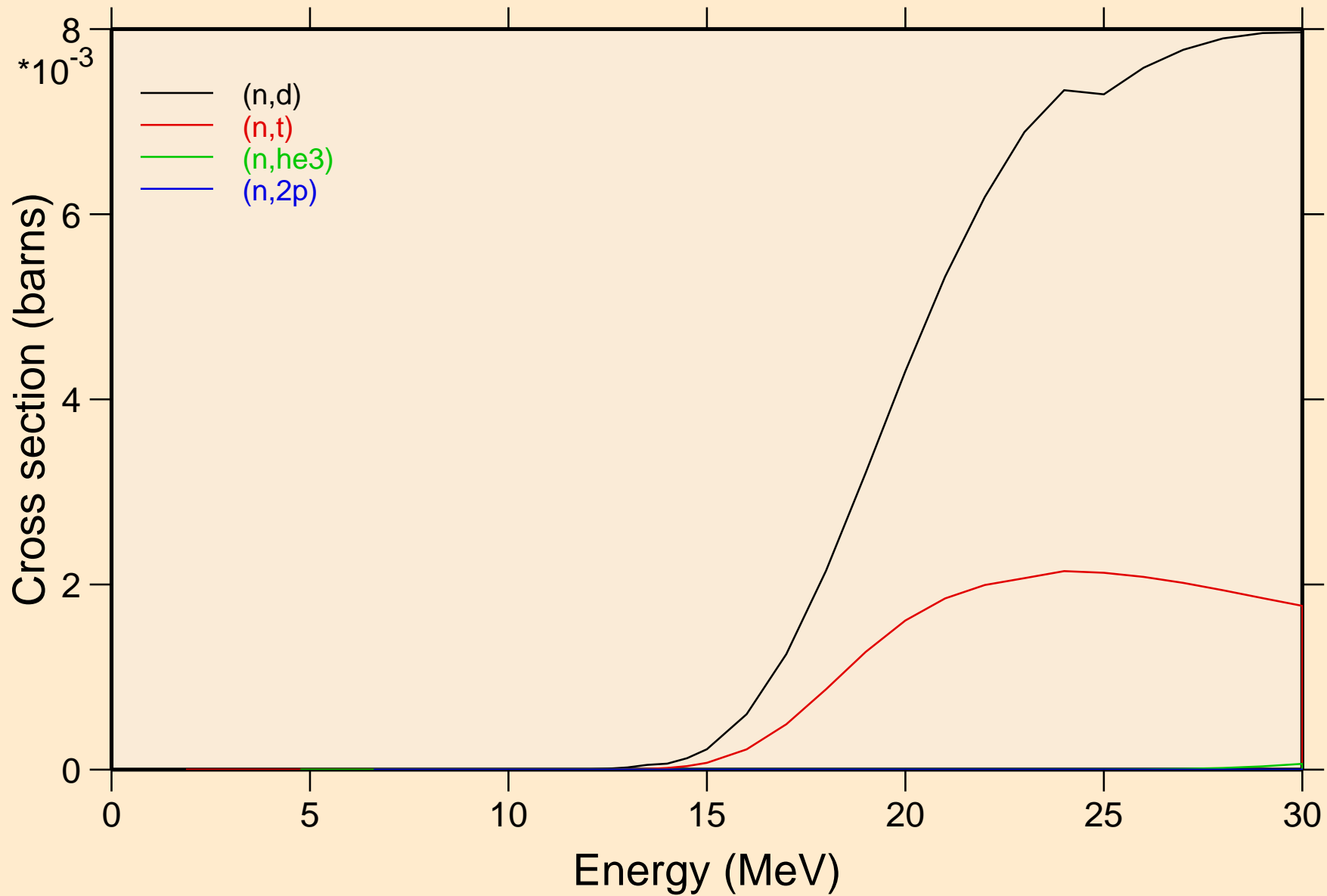

NP238 NEUTRON ACER TENDL-2023 LIBRARY; T=0.K

Threshold reactions

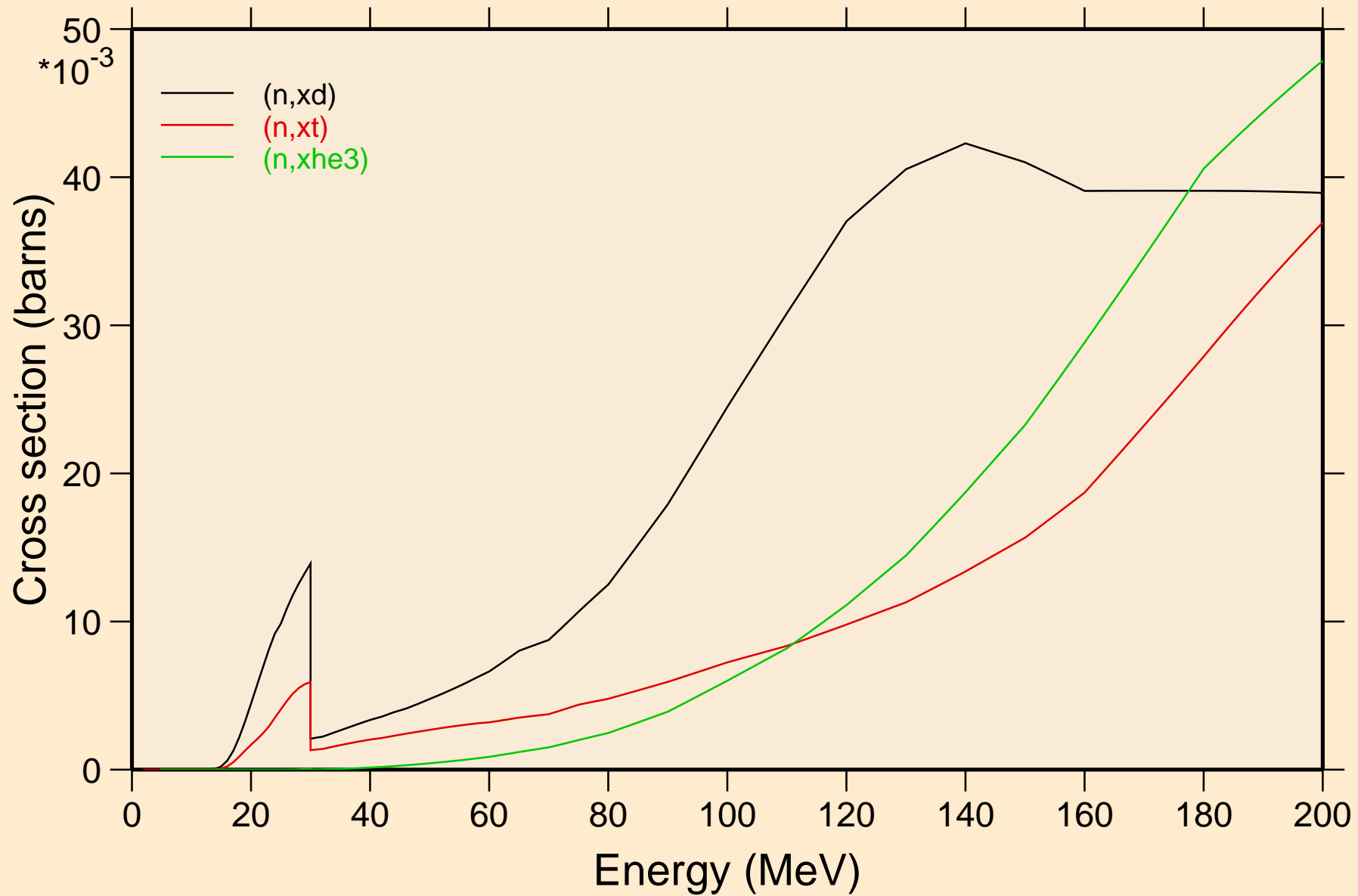

NP238 NEUTRON ACER TENDL-2023 LIBRARY; T=0.K
angular distribution for elastic

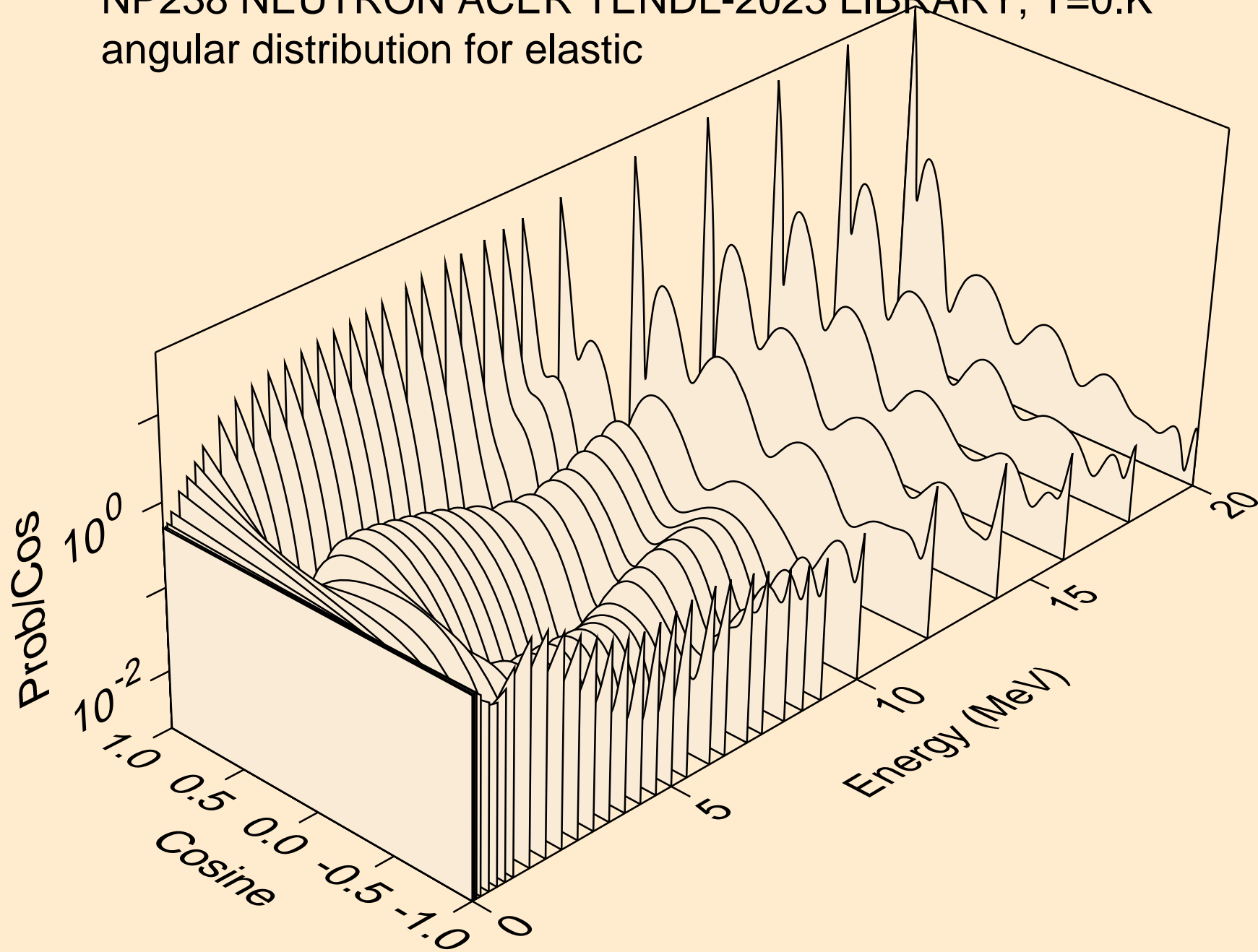

NP238 NEUTRON ACER TENDL-2023 LIBRARY; T=0.K
angular distribution for elastic

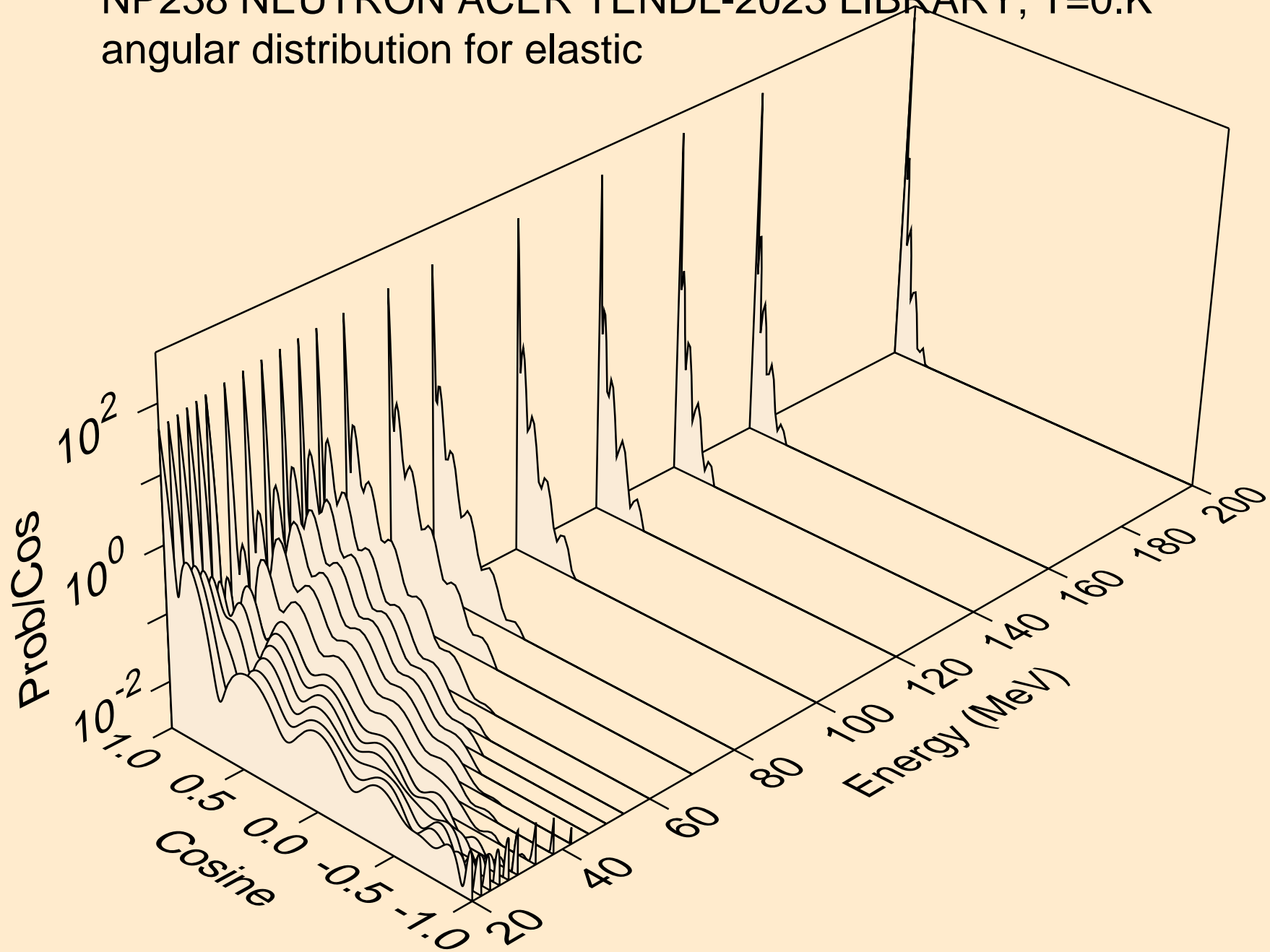

NP238 NEUTRON ACER TENDL-2023 LIBRARY; T=0.K
angular distribution for (n,n*1)

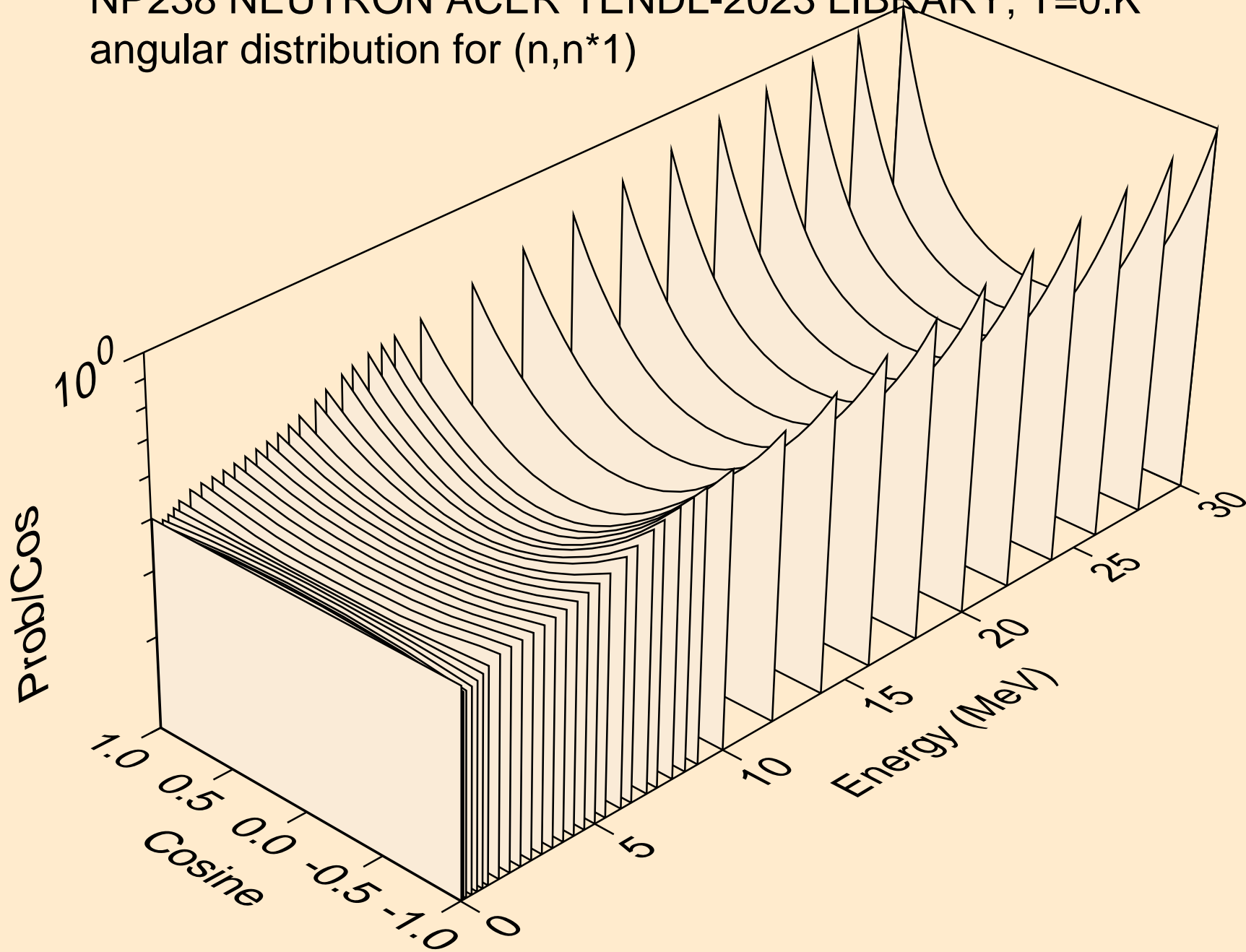

NP238 NEUTRON ACER TENDL-2023 LIBRARY; T=0.K
angular distribution for (n,n*2)

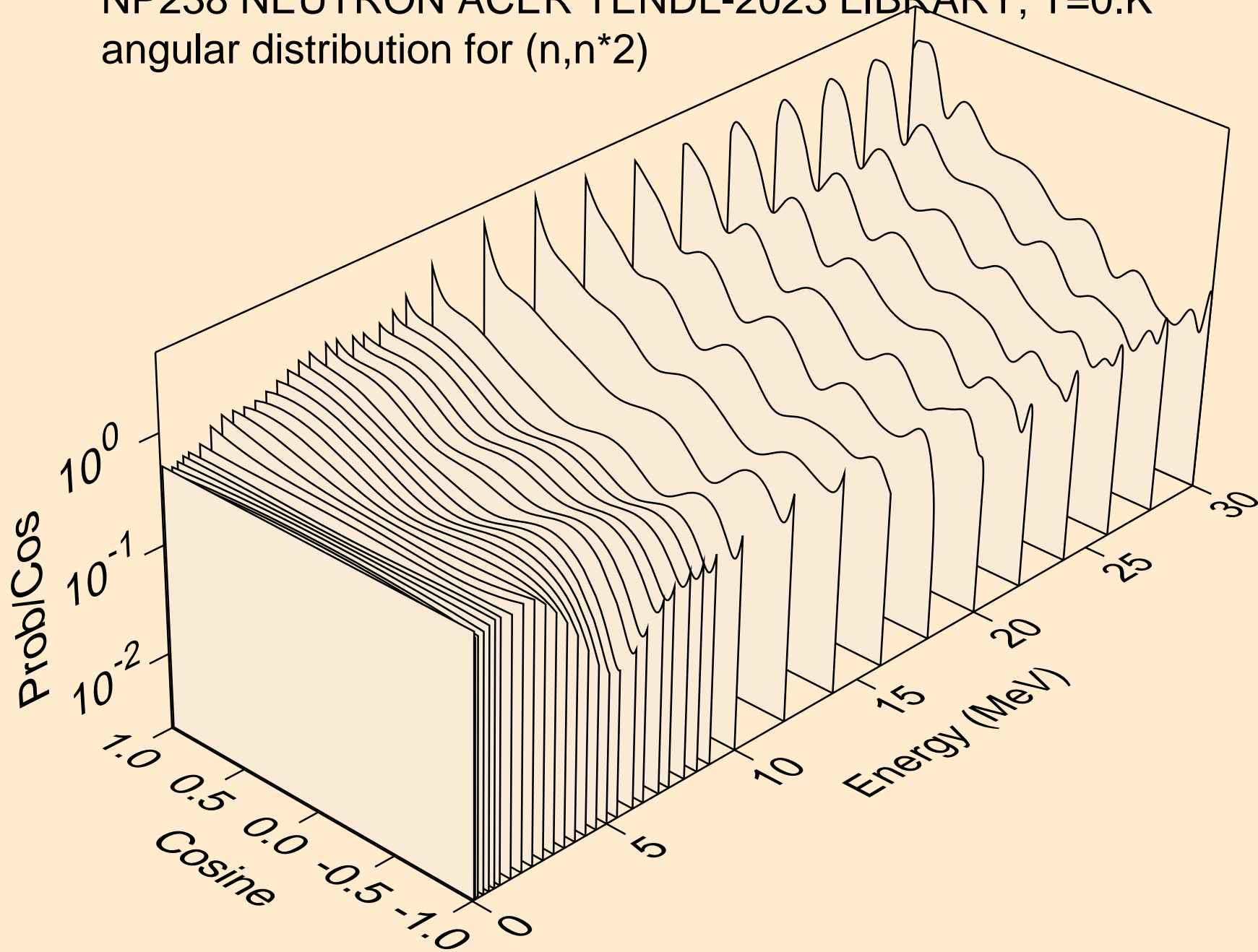

NP238 NEUTRON ACER TENDL-2023 LIBRARY; T=0.K
angular distribution for (n,n*3)

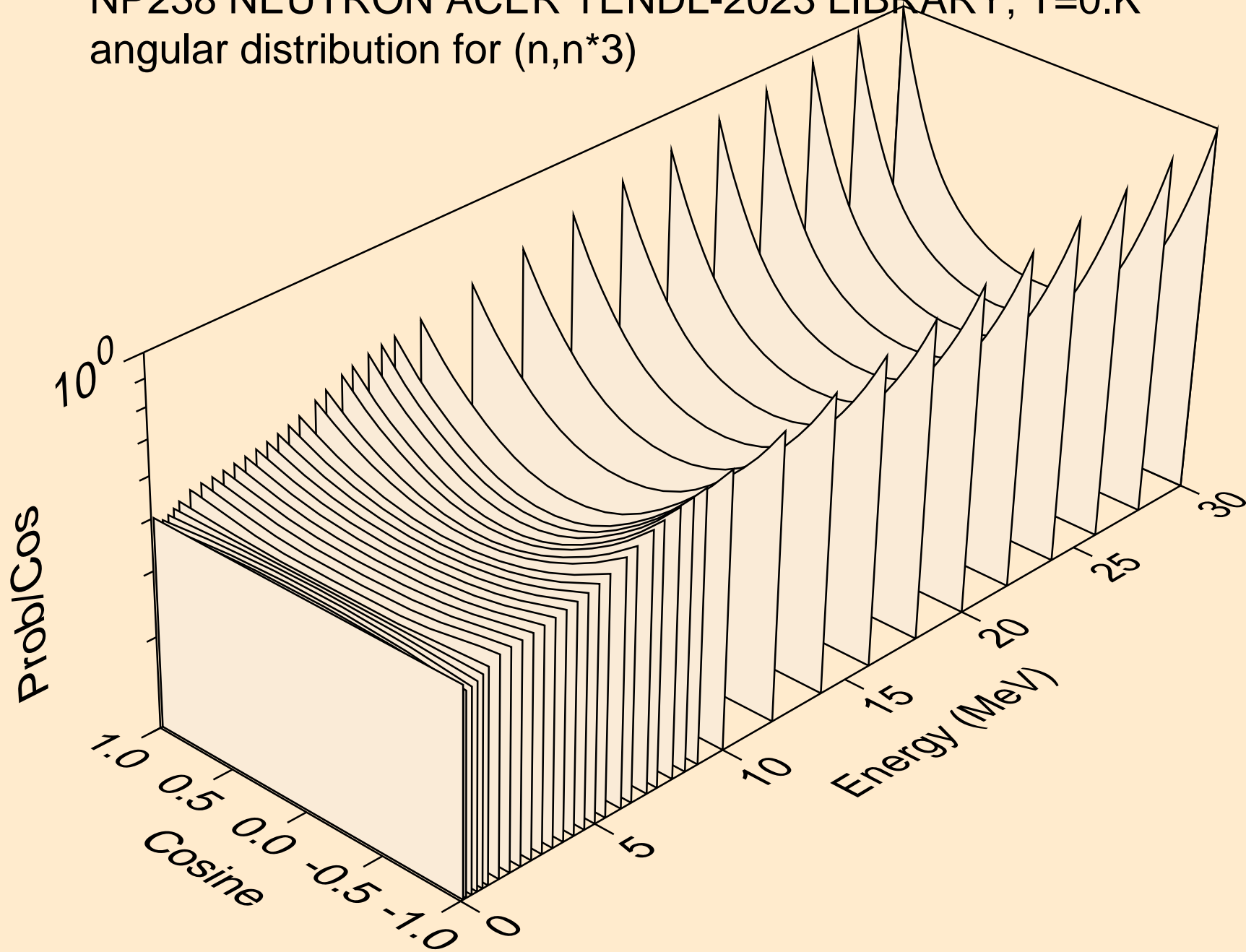

NP238 NEUTRON ACER TENDL-2023 LIBRARY; T=0.K
angular distribution for (n,n*4)

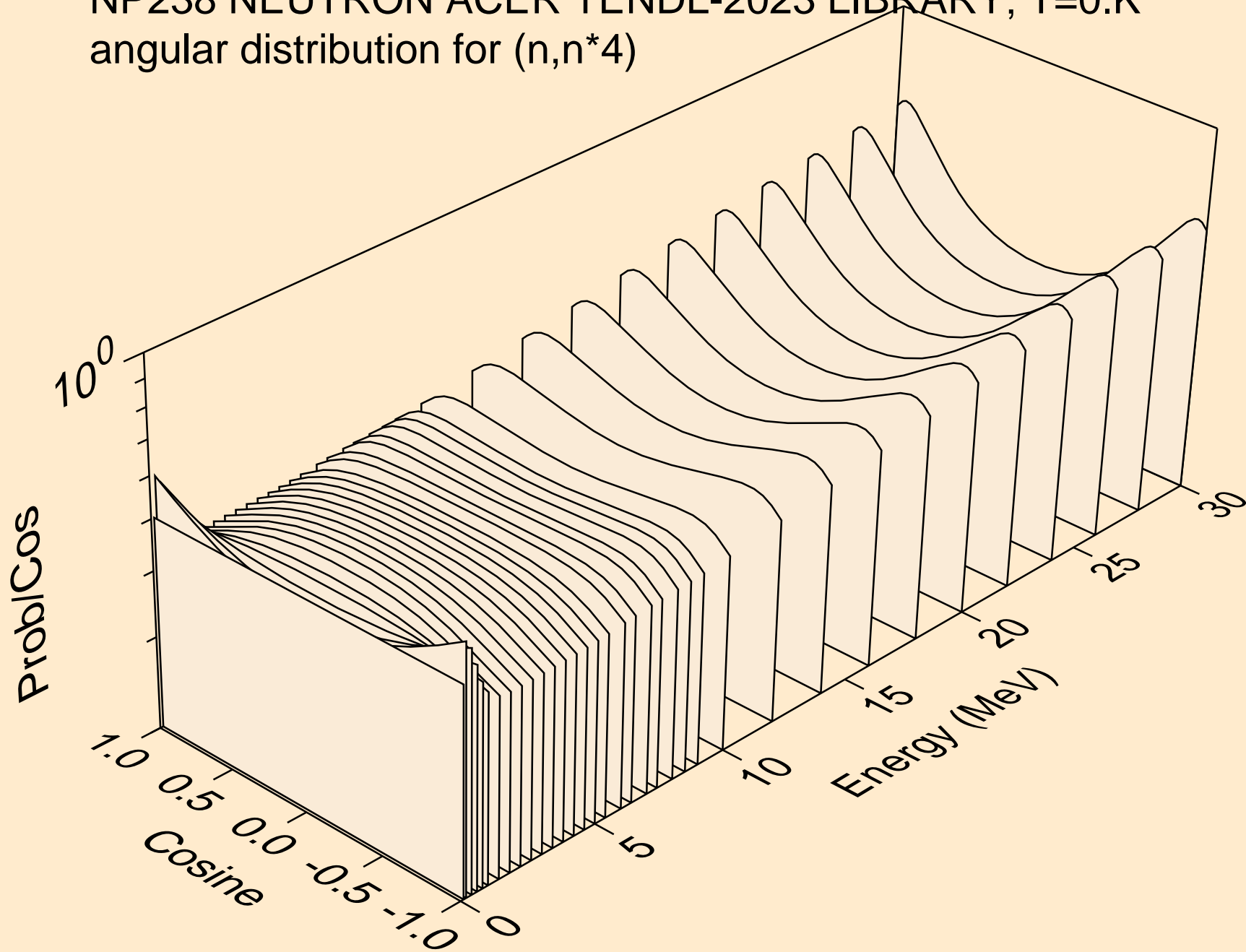

NP238 NEUTRON ACER TENDL-2023 LIBRARY; T=0.K
angular distribution for (n,n*5)

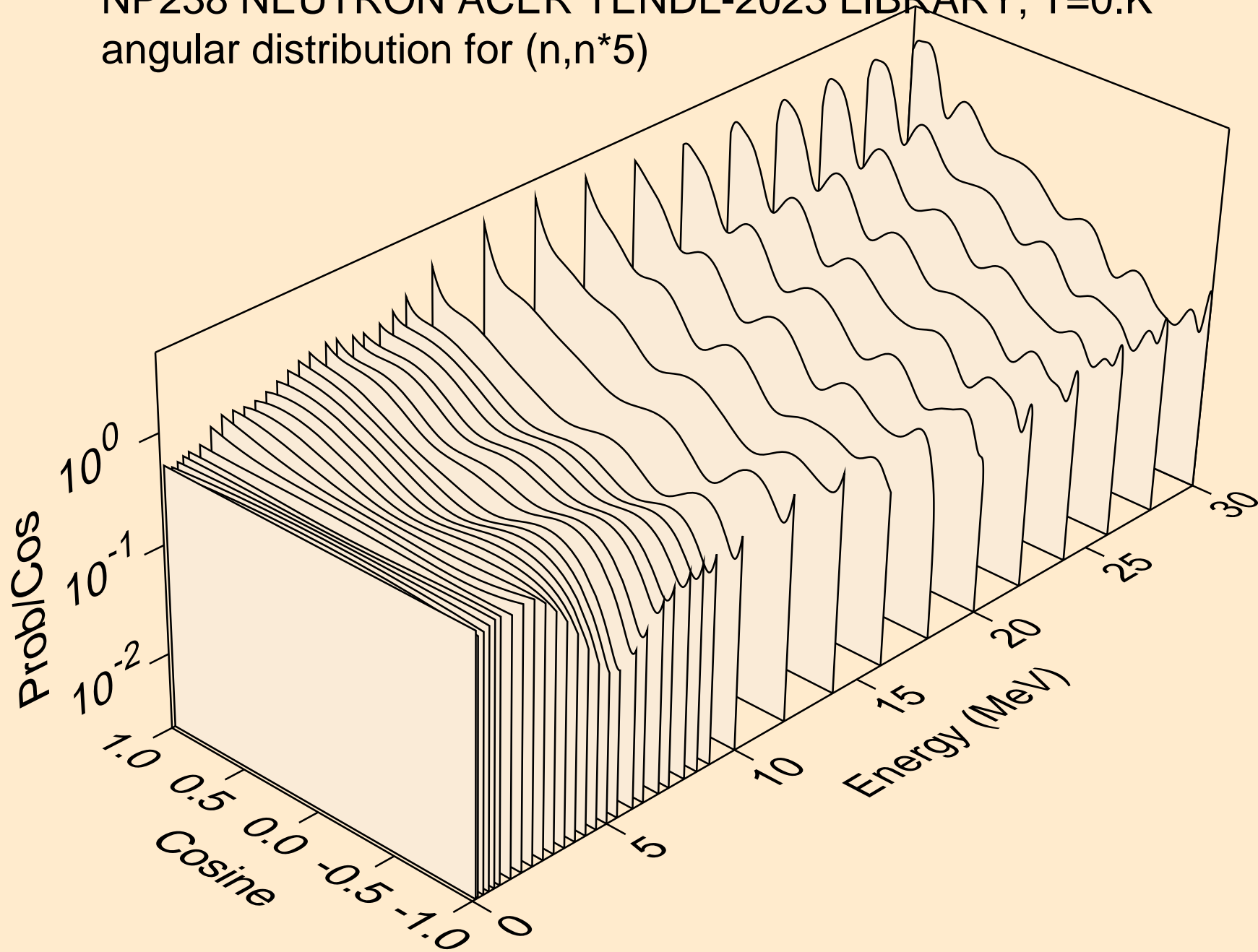

NP238 NEUTRON ACER TENDL-2023 LIBRARY; T=0.K
angular distribution for (n,n*6)

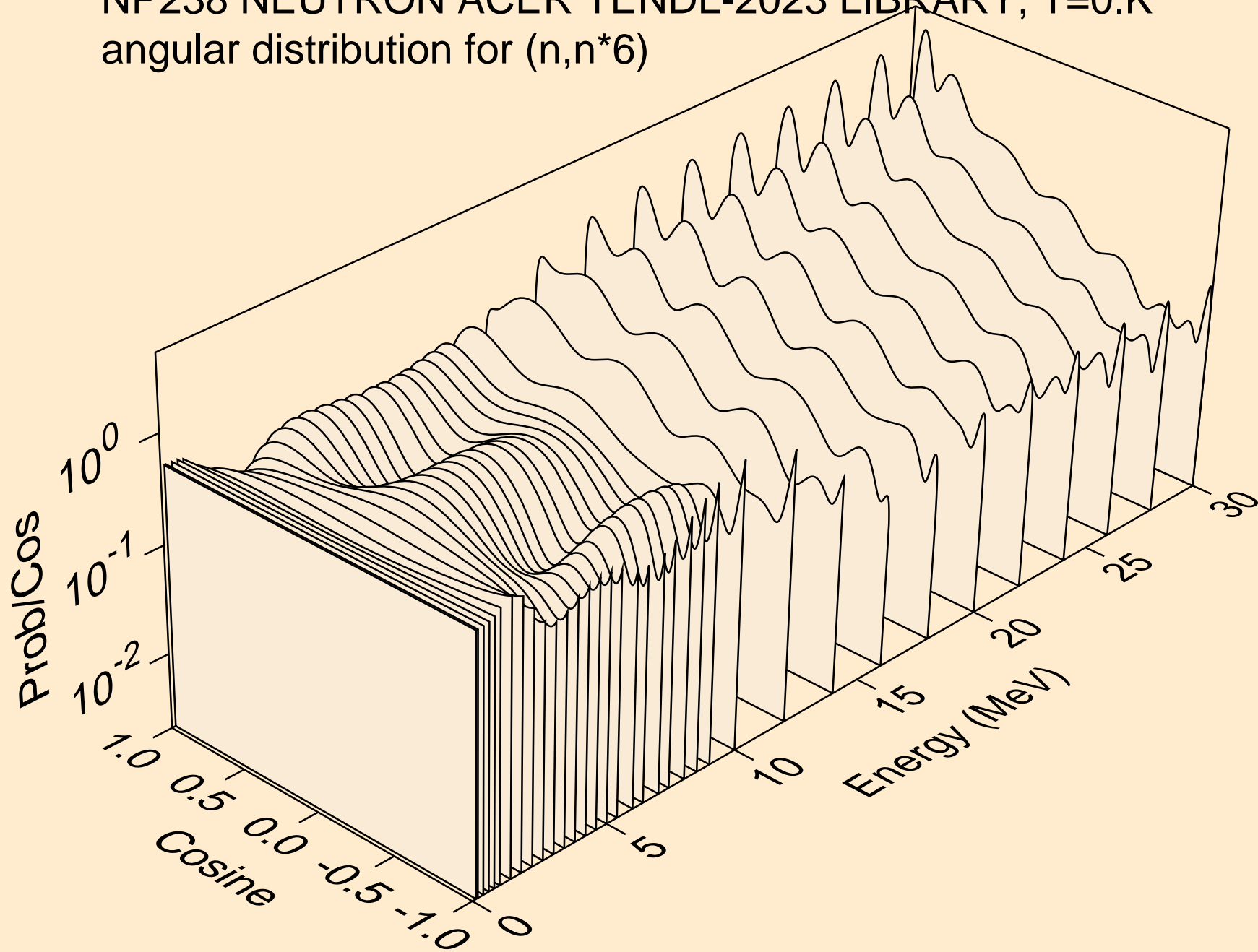

NP238 NEUTRON ACER TENDL-2023 LIBRARY; T=0.K
angular distribution for (n,n*7)

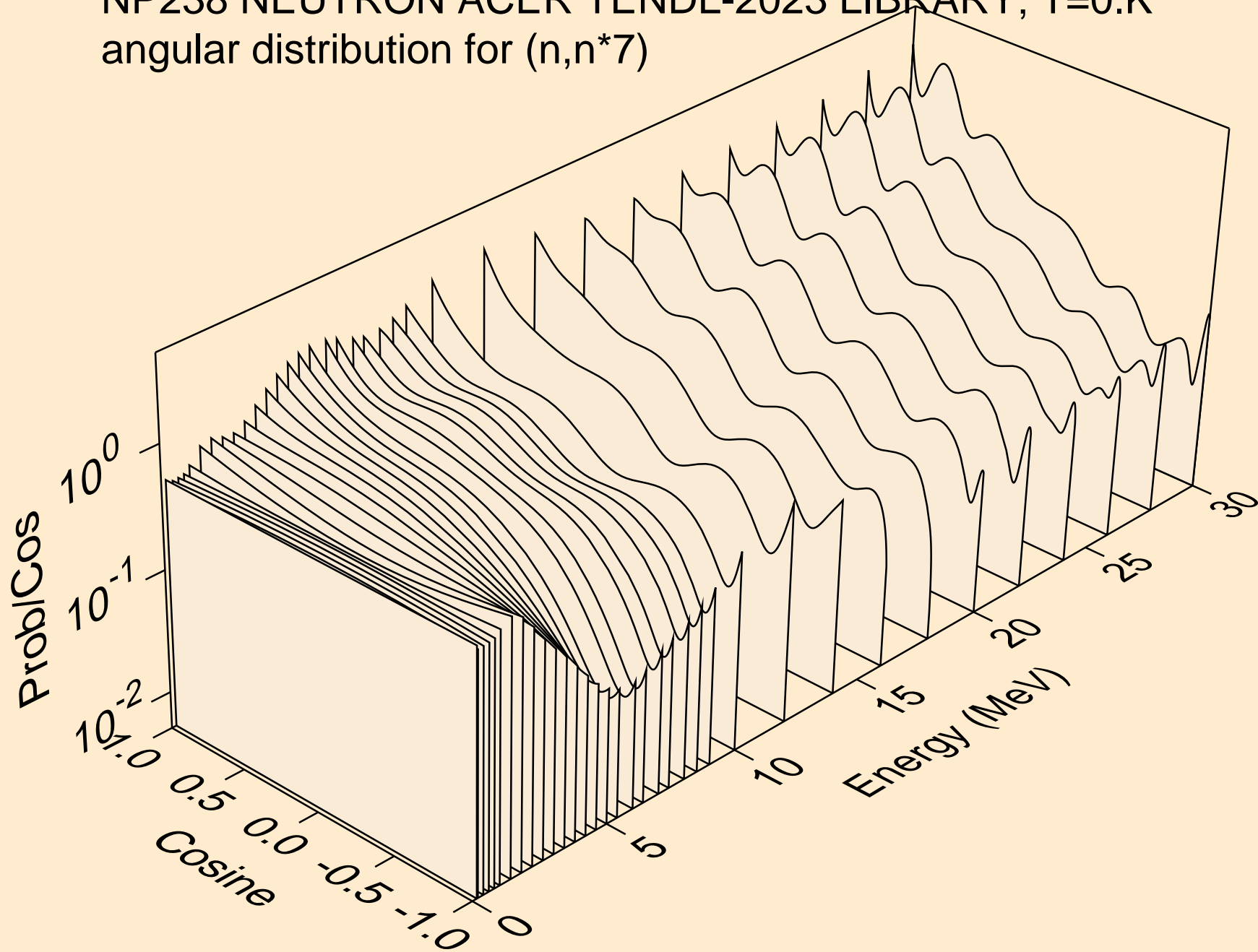

NP238 NEUTRON ACER TENDL-2023 LIBRARY; T=0.K
angular distribution for (n,n*8)

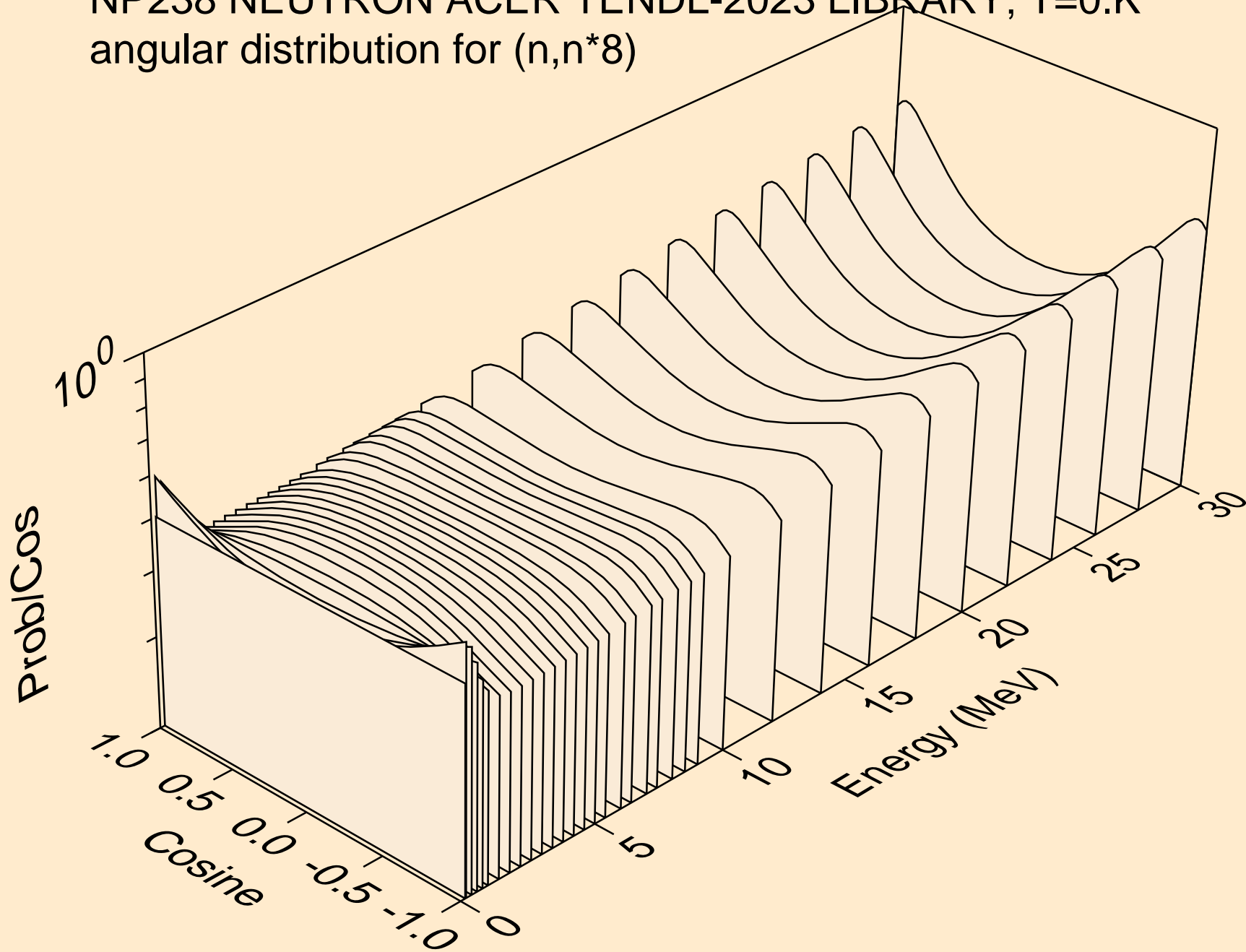

NP238 NEUTRON ACER TENDL-2023 LIBRARY; T=0.K
angular distribution for (n,n*9)

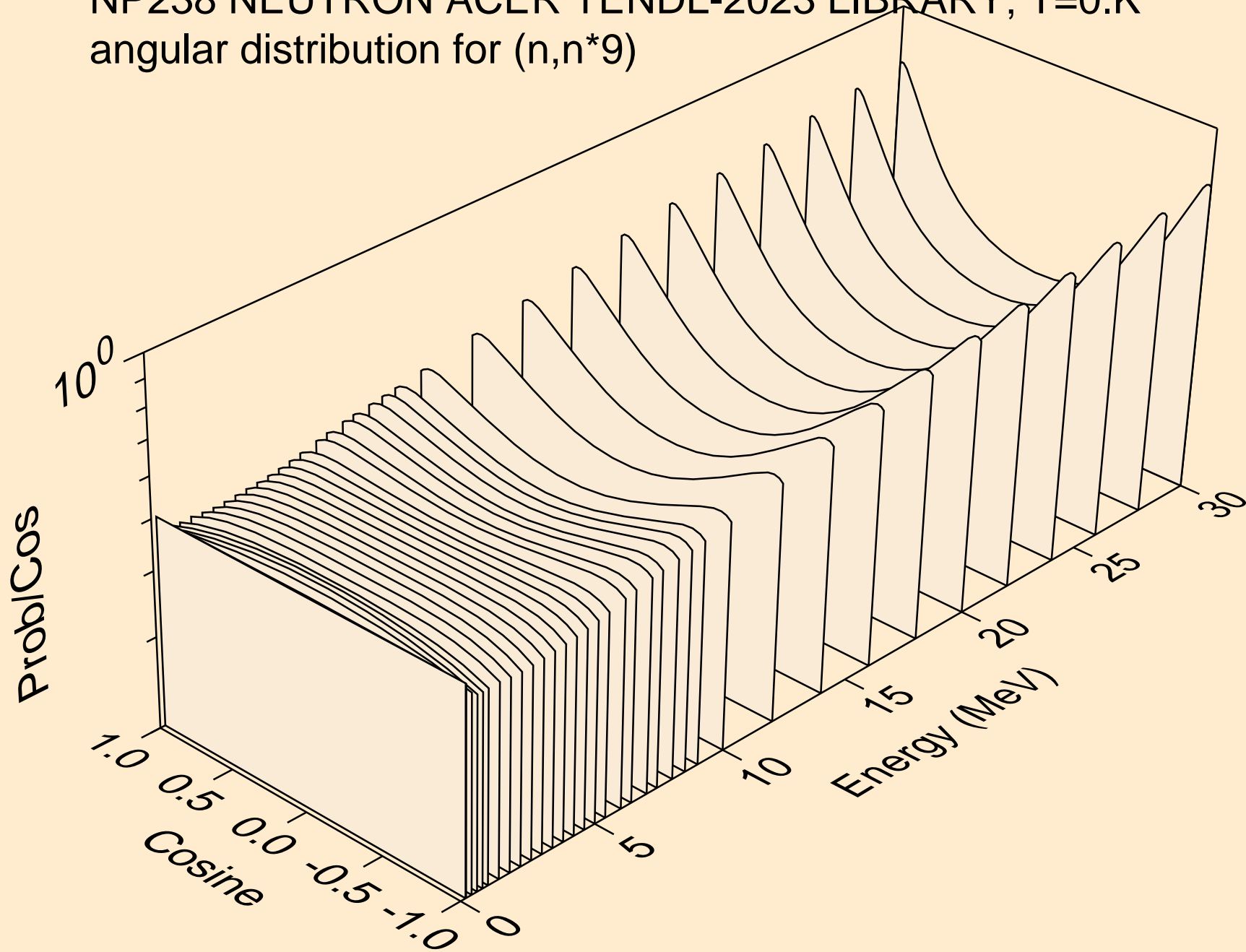

NP238 NEUTRON ACER TENDL-2023 LIBRARY; T=0.K
angular distribution for (n,n*10)

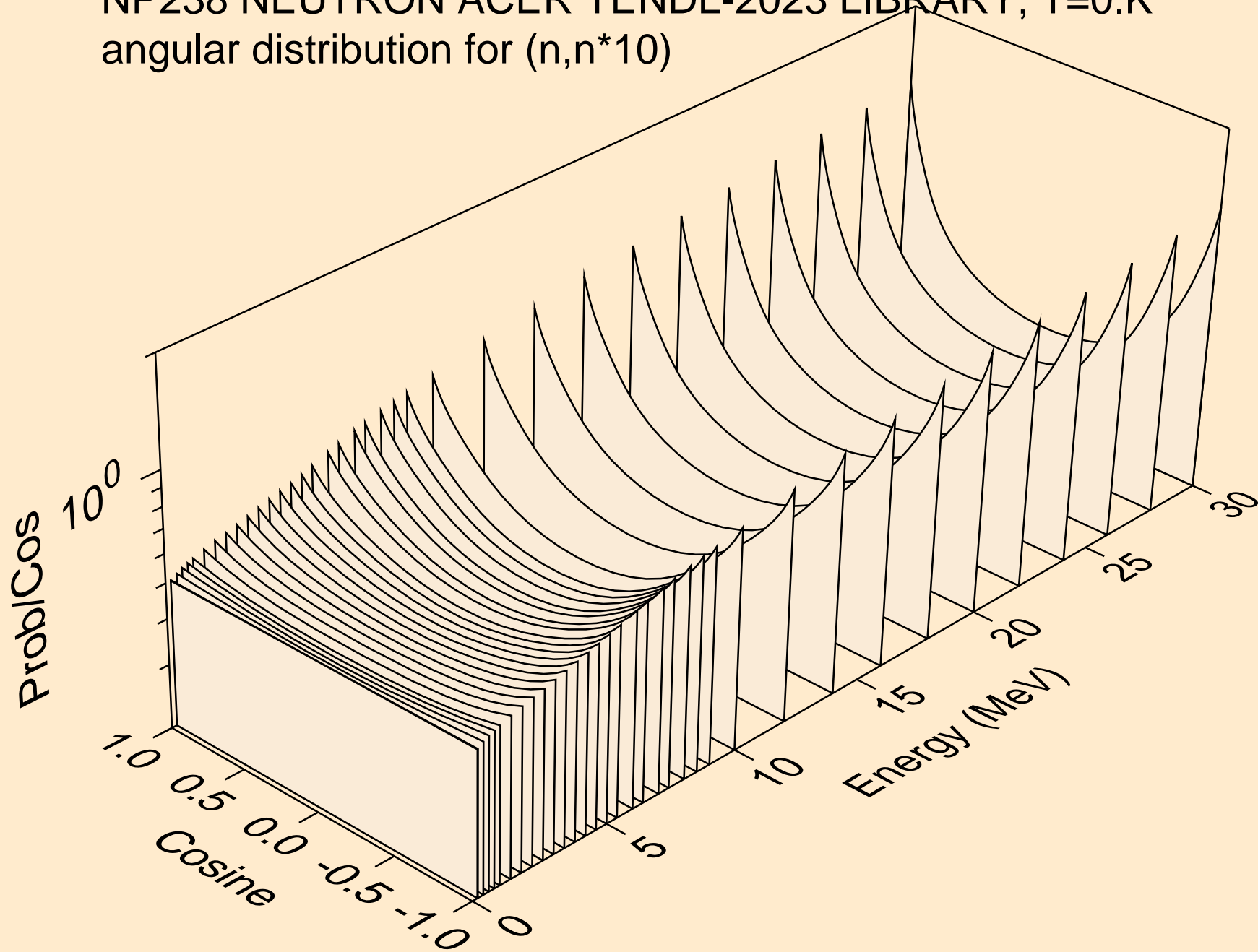

NP238 NEUTRON ACER TENDL-2023 LIBRARY; T=0.K
angular distribution for (n,n*11)

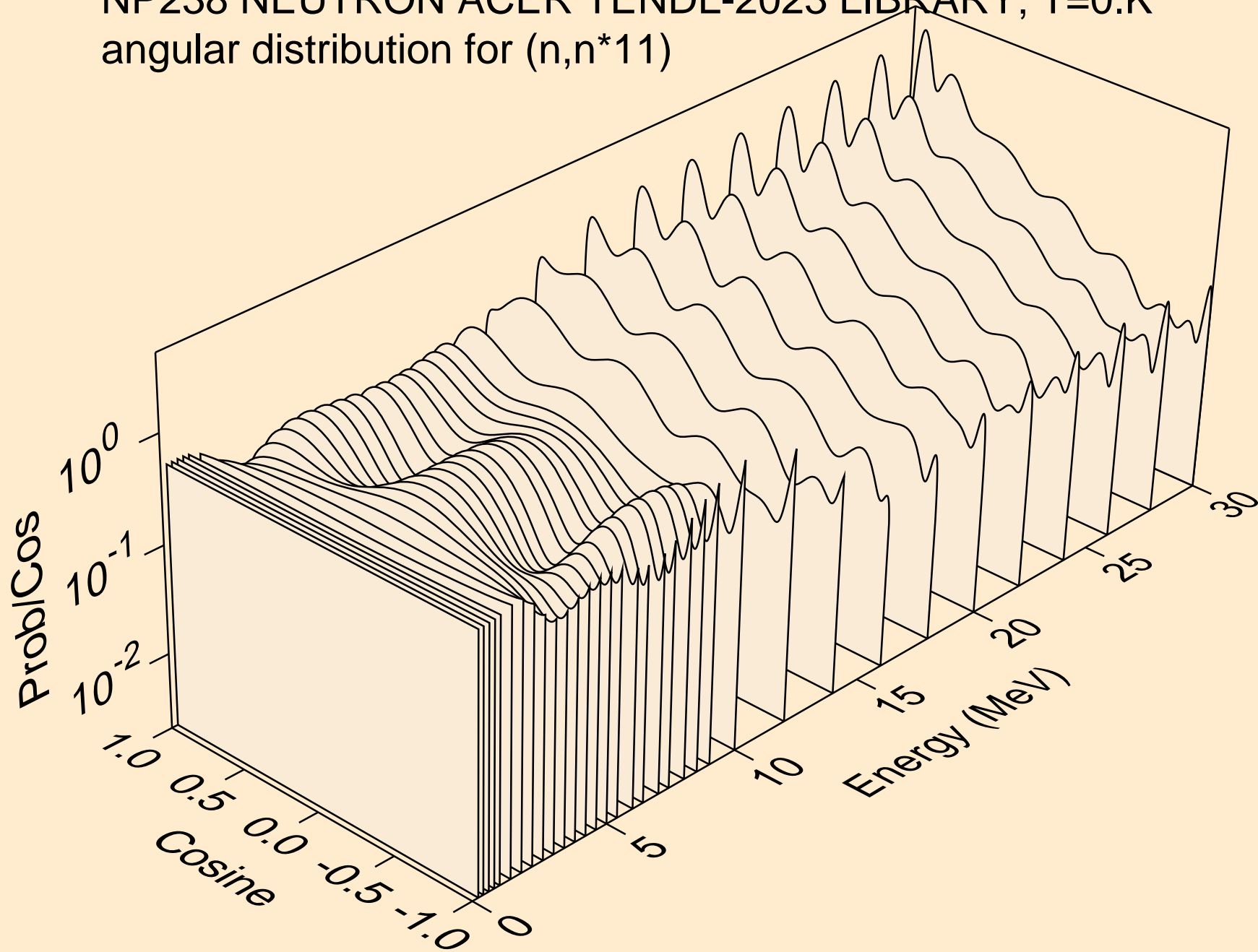

NP238 NEUTRON ACER TENDL-2023 LIBRARY; T=0.K
angular distribution for (n,n*12)

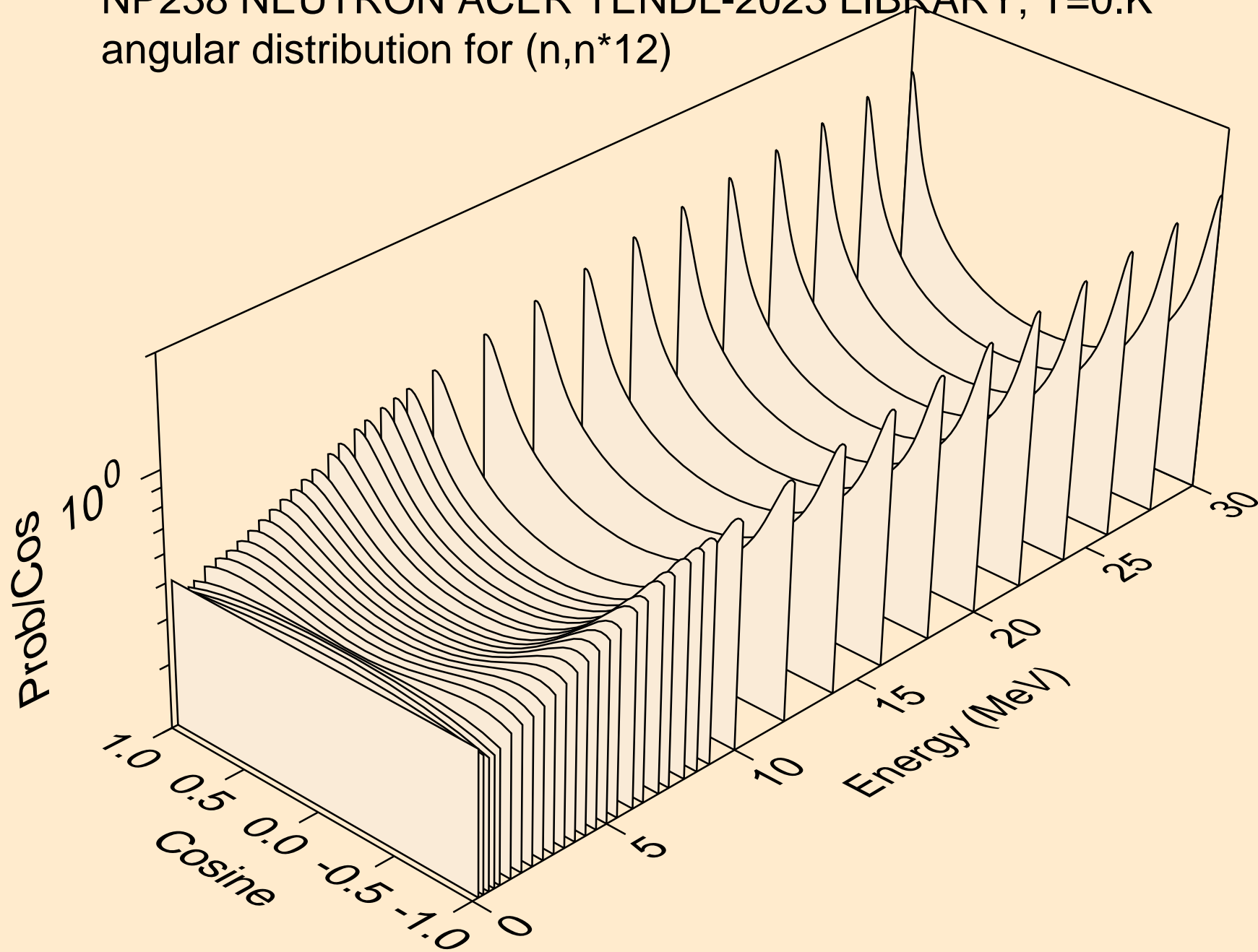

NP238 NEUTRON ACER TENDL-2023 LIBRARY; T=0.K
angular distribution for (n,n*13)

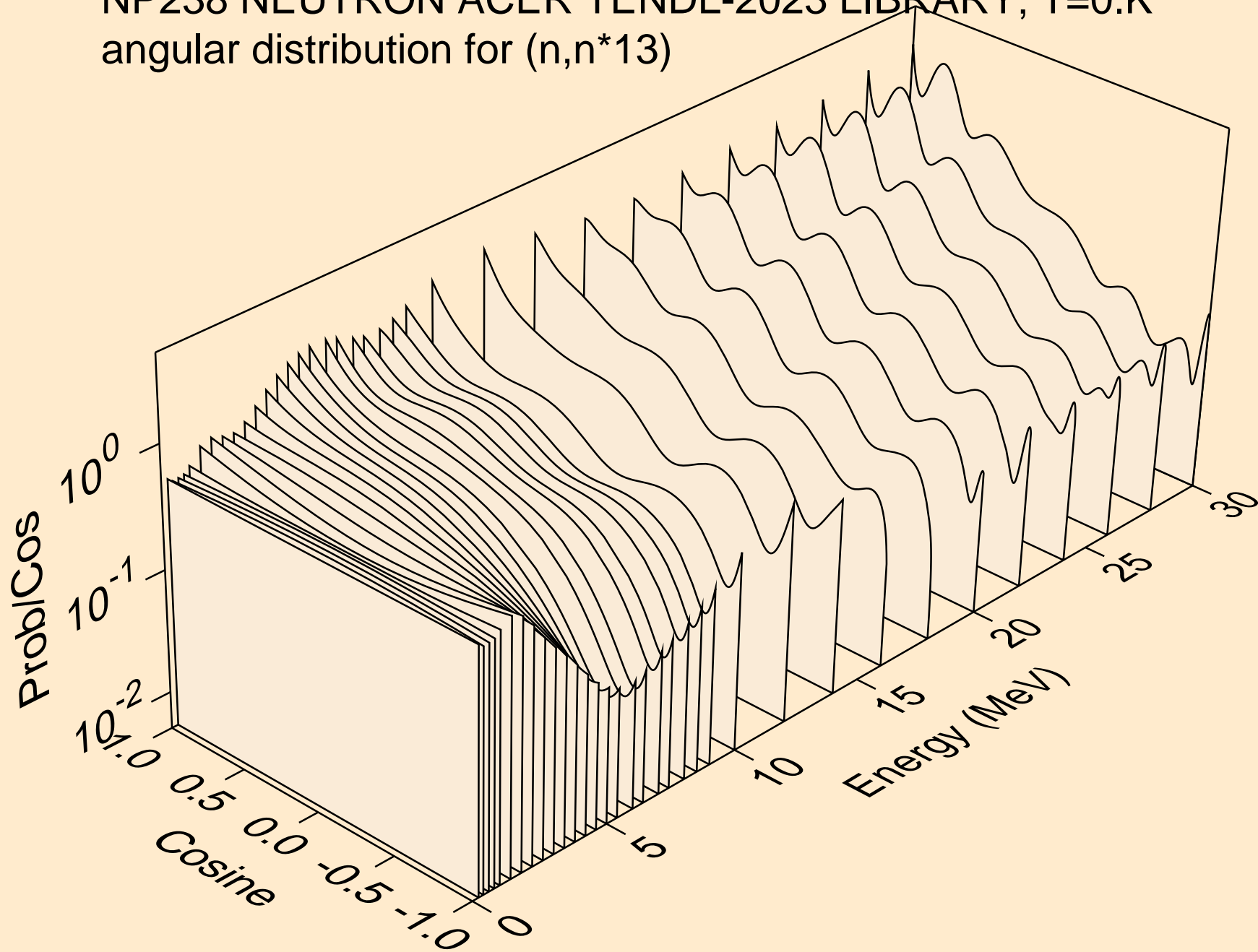

NP238 NEUTRON ACER TENDL-2023 LIBRARY; T=0.K
angular distribution for (n,n*14)

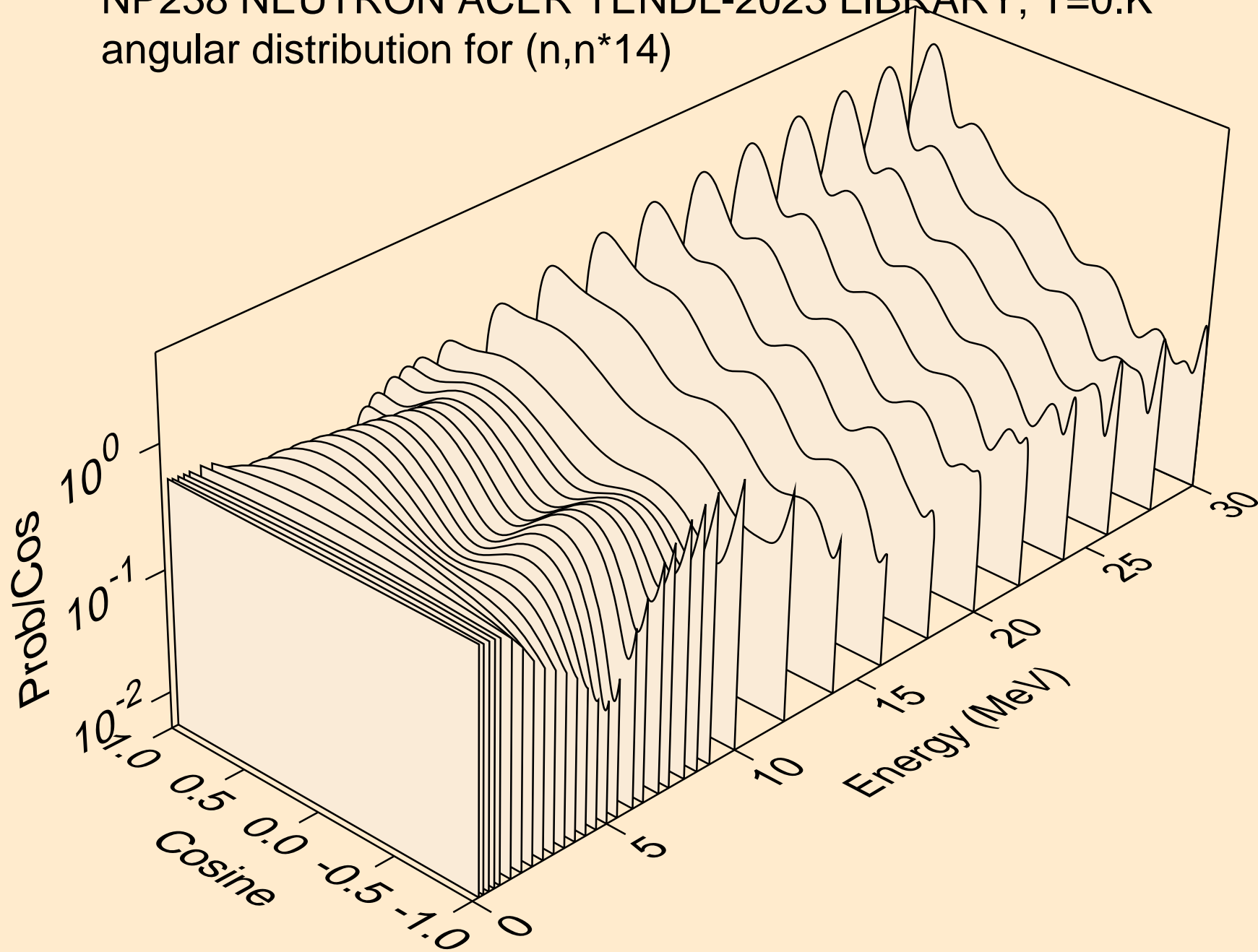

NP238 NEUTRON ACER TENDL-2023 LIBRARY; T=0.K
angular distribution for (n,n*15)

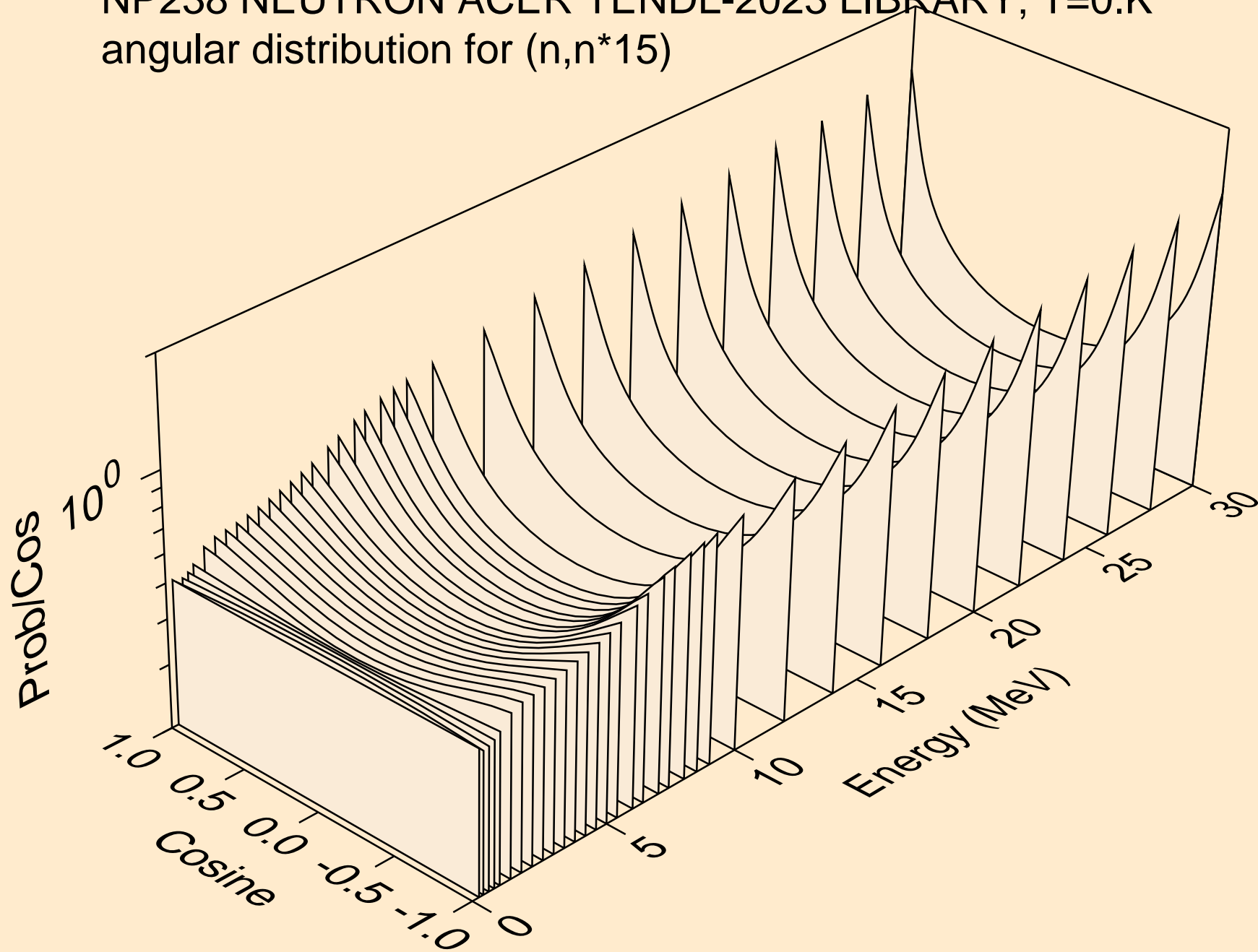

NP238 NEUTRON ACER TENDL-2023 LIBRARY; T=0.K

Total fission nubar

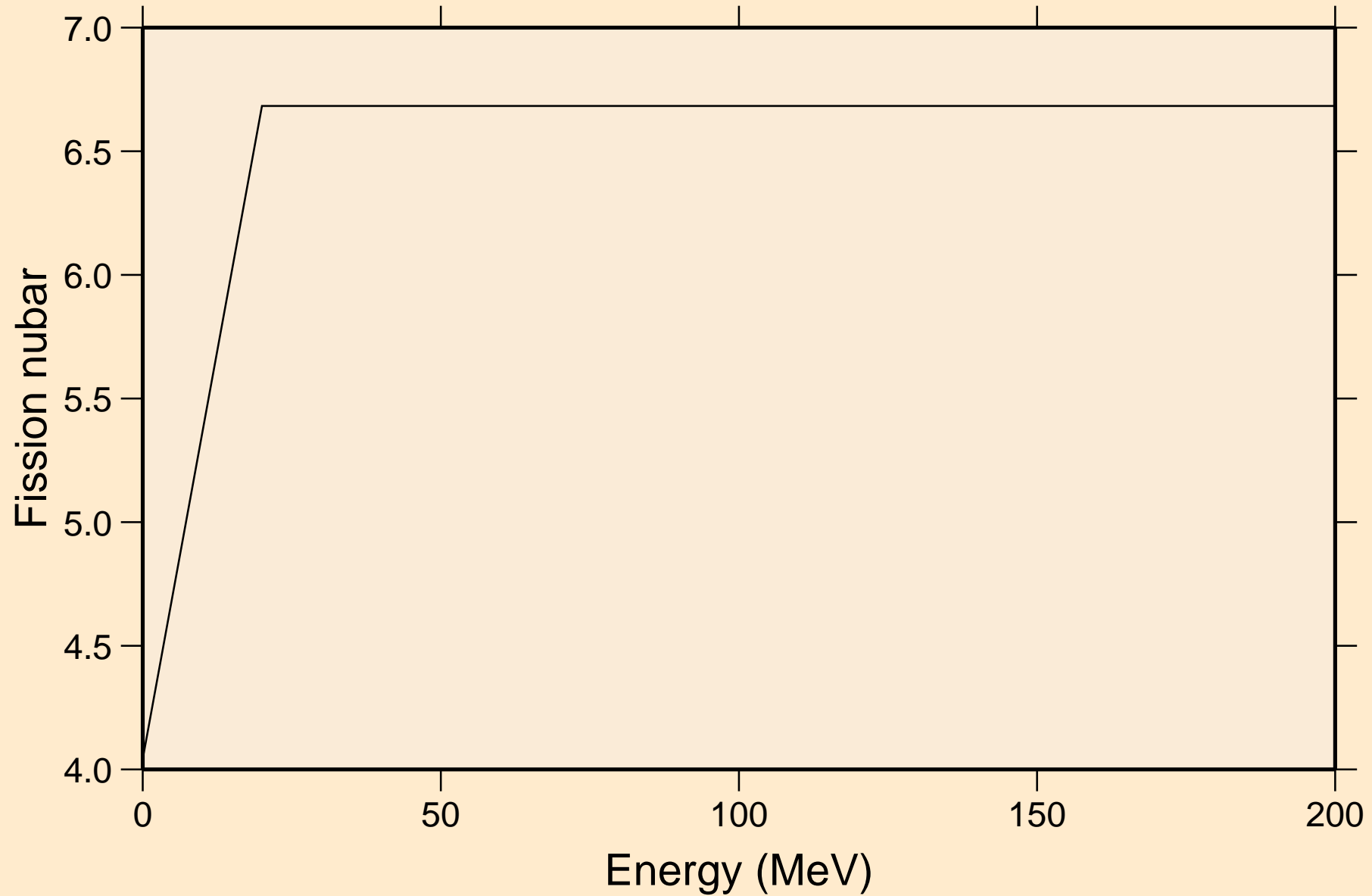

NP238 NEUTRON ACER TENDL-2023 LIBRARY; T=0.K
Neutron emission for (n,x)

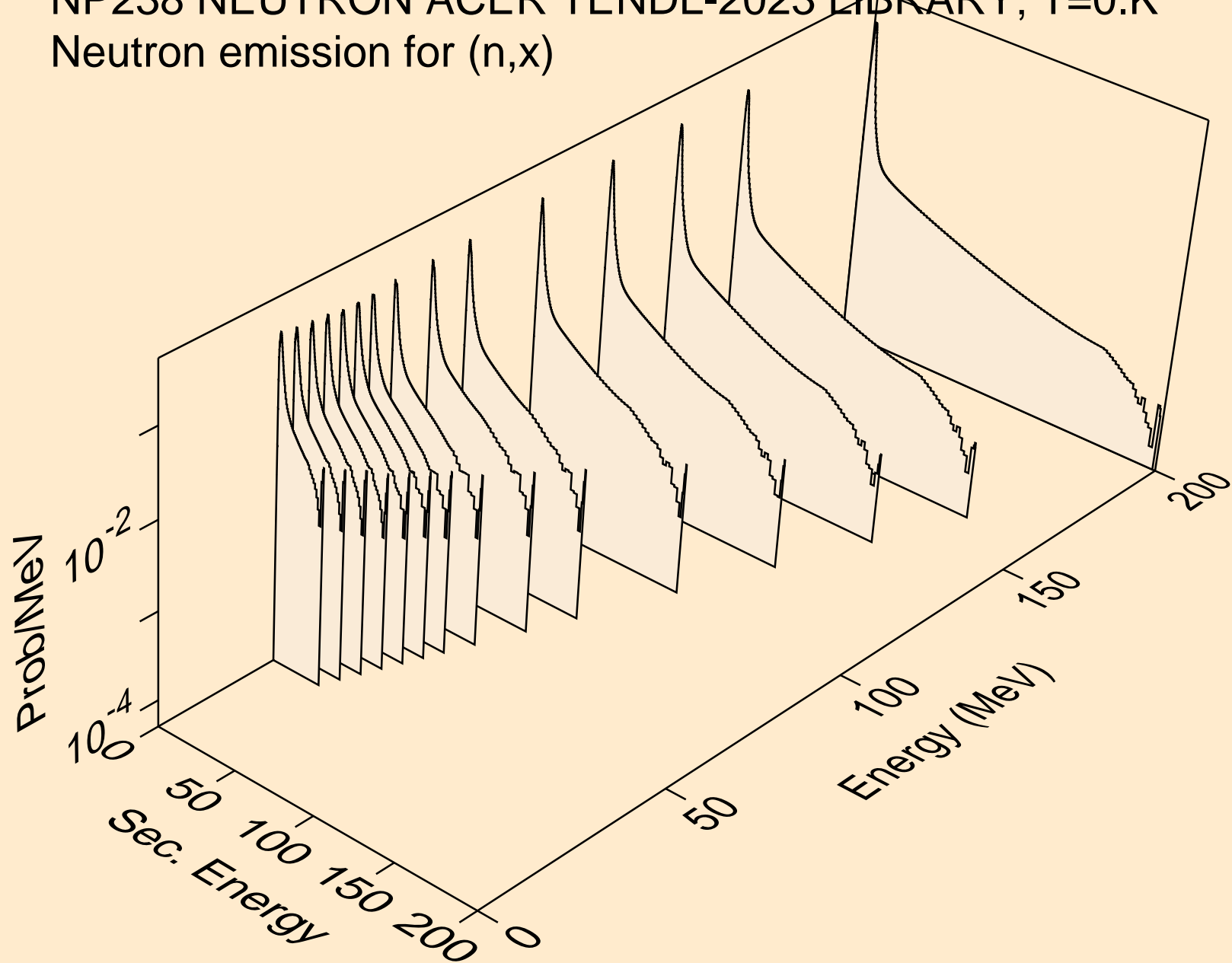

NP238 NEUTRON ACER TENDL-2023 LIBRARY; T=0.K
Neutron emission for (n,2nd)

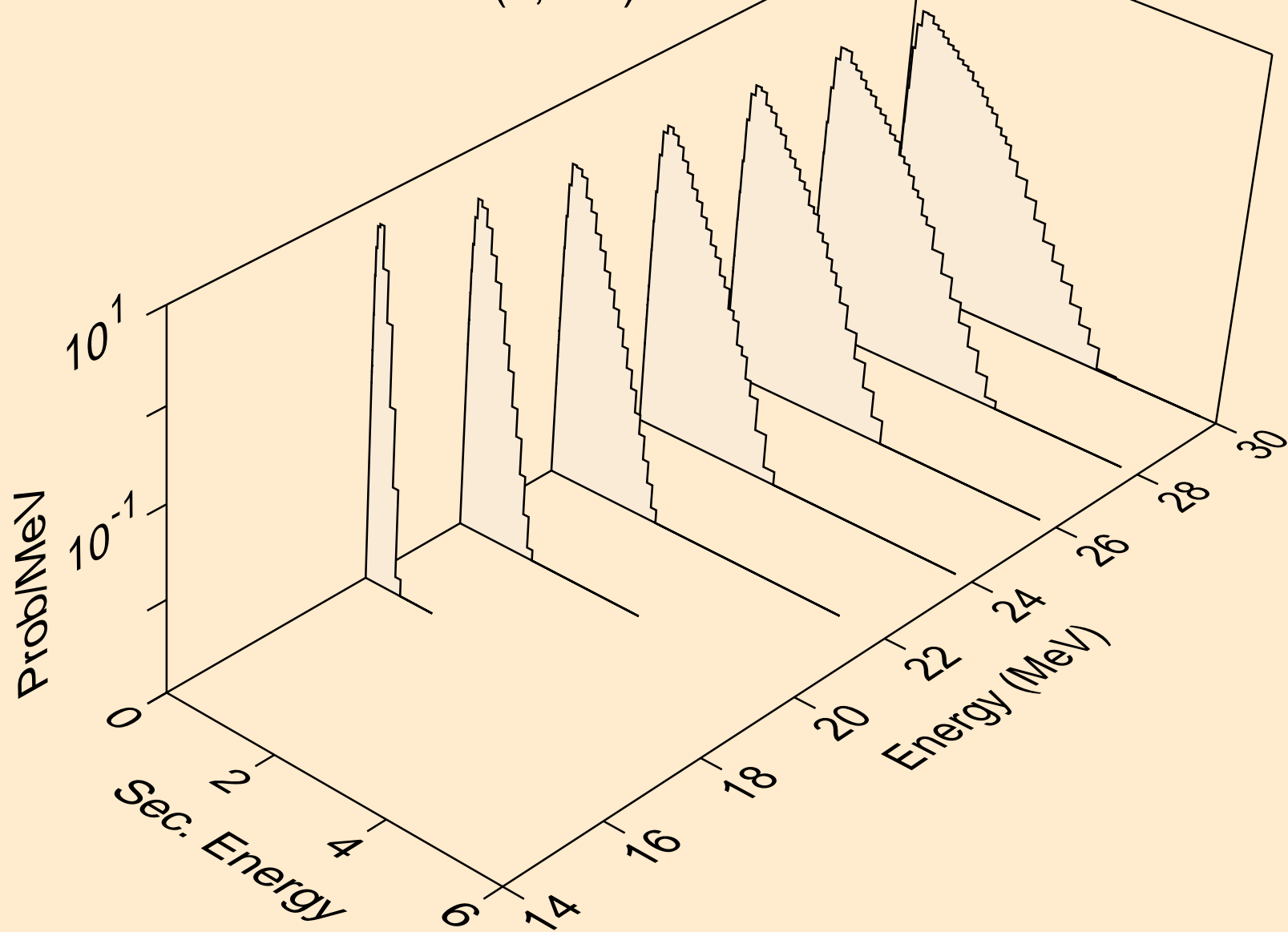

NP238 NEUTRON ACER TENDL-2023 LIBRARY; T=0.K
Neutron emission for (n,2n)

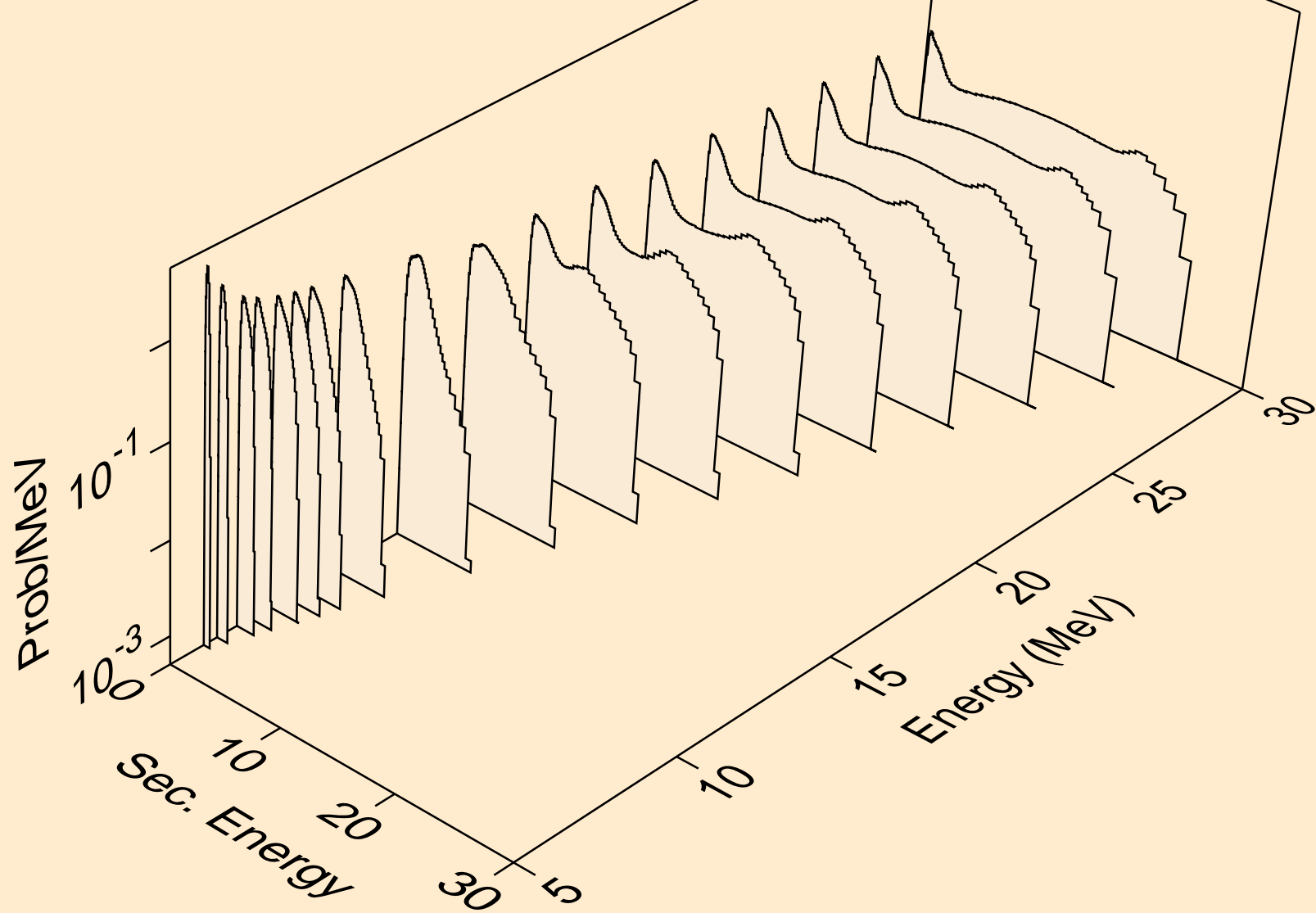

NP238 NEUTRON ACER TENDL-2023 LIBRARY; T=0.K
Neutron emission for (n,3n)

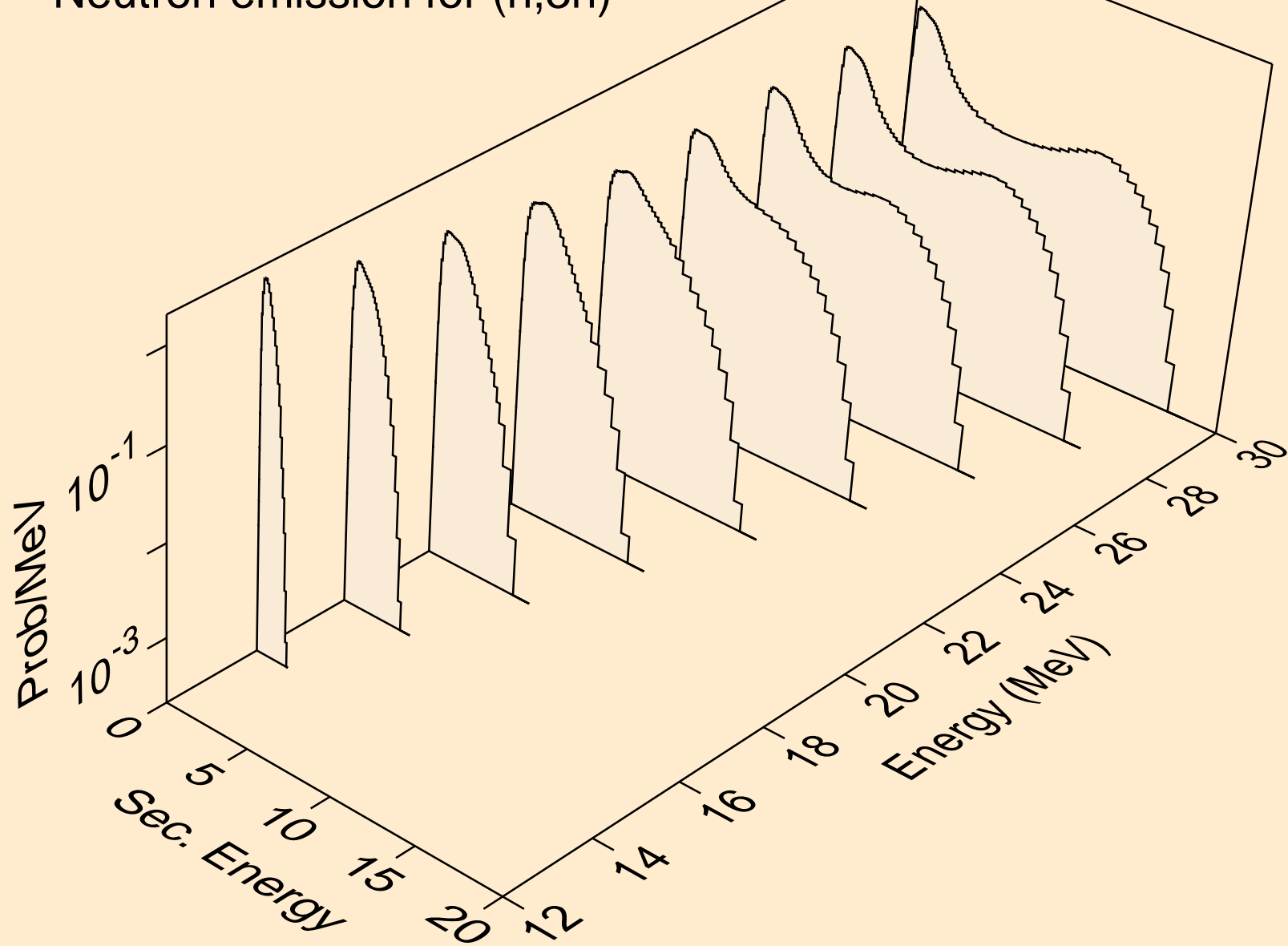

NP238 NEUTRON ACER TENDL-2023 LIBRARY; T=0.K
Neutron emission for fission

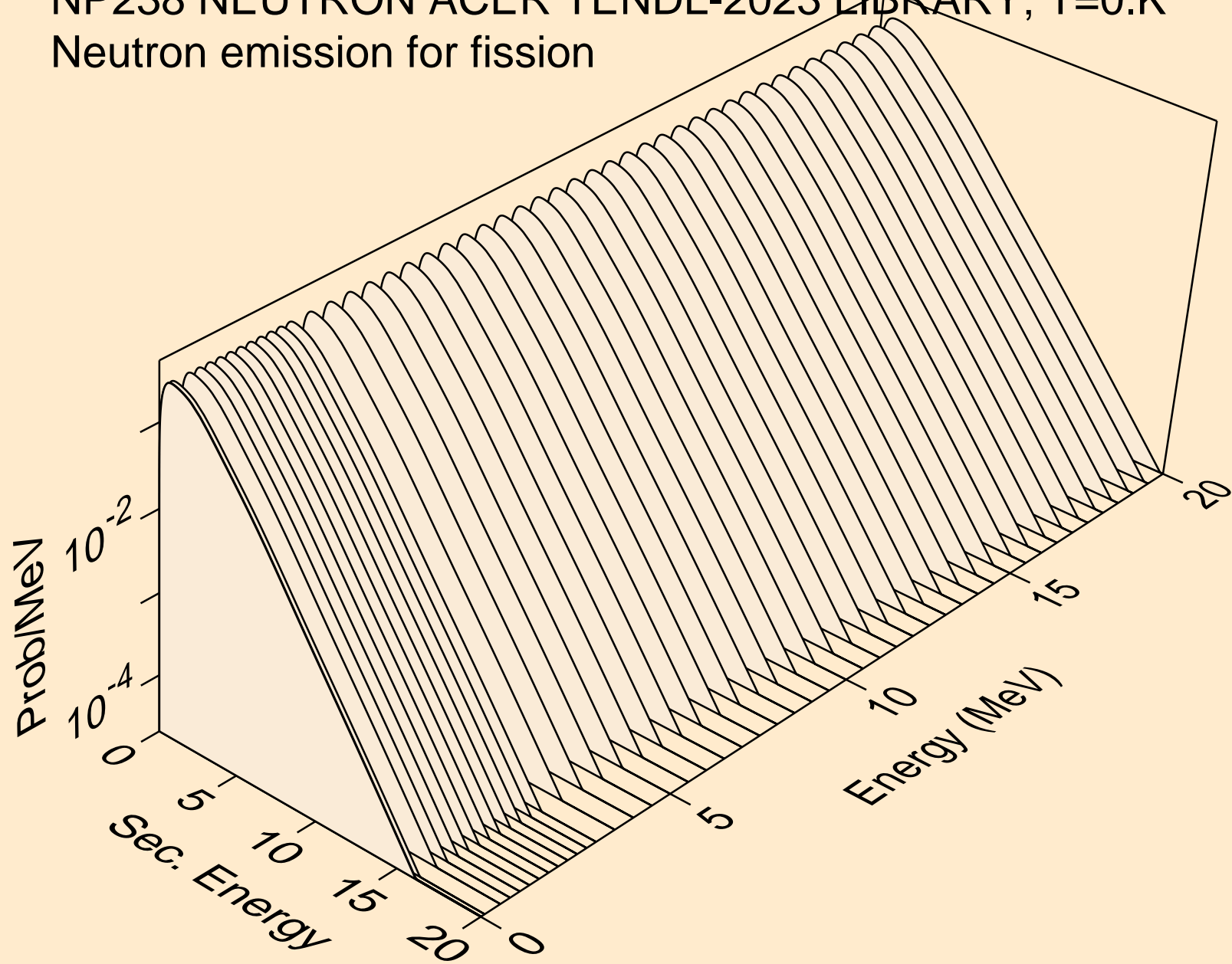

NP238 NEUTRON ACER TENDL-2023 LIBRARY; T=0.K
Neutron emission for (n,n*)a

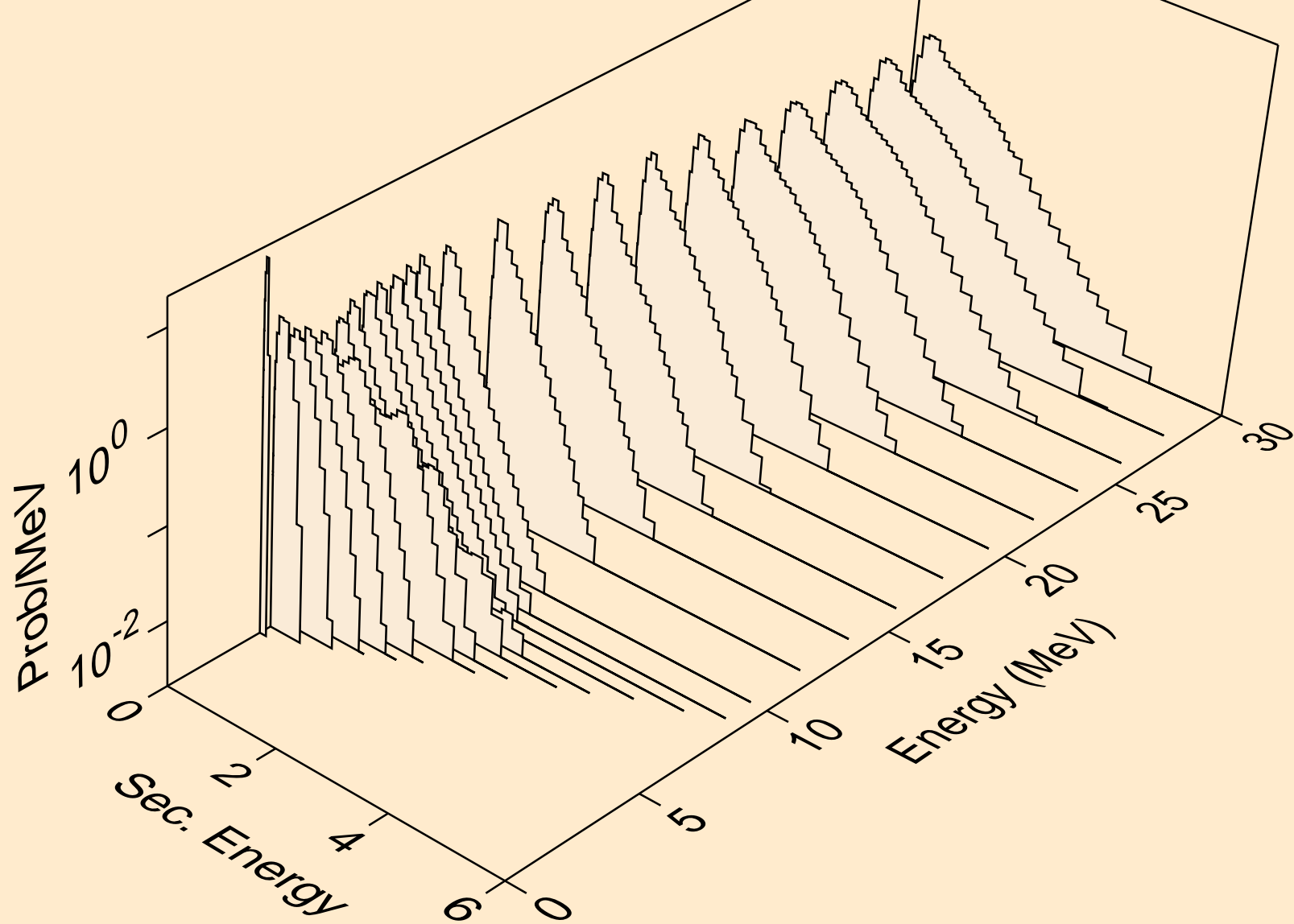

NP238 NEUTRON ACER TENDL-2023 LIBRARY; T=0.K
Neutron emission for (n,2n)a

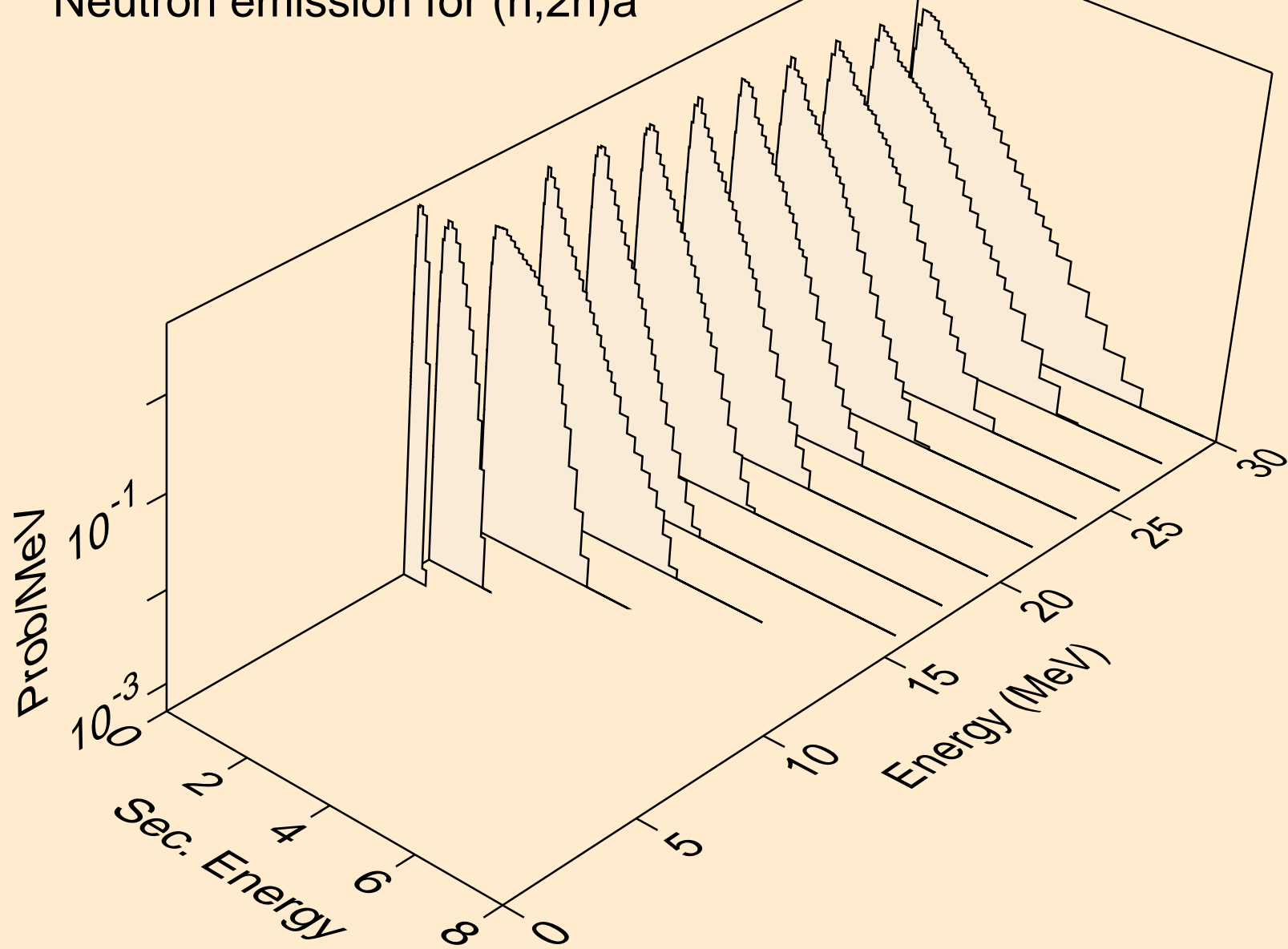

NP238 NEUTRON ACER TENDL-2023 LIBRARY; T=0.K
Neutron emission for (n,3n)a

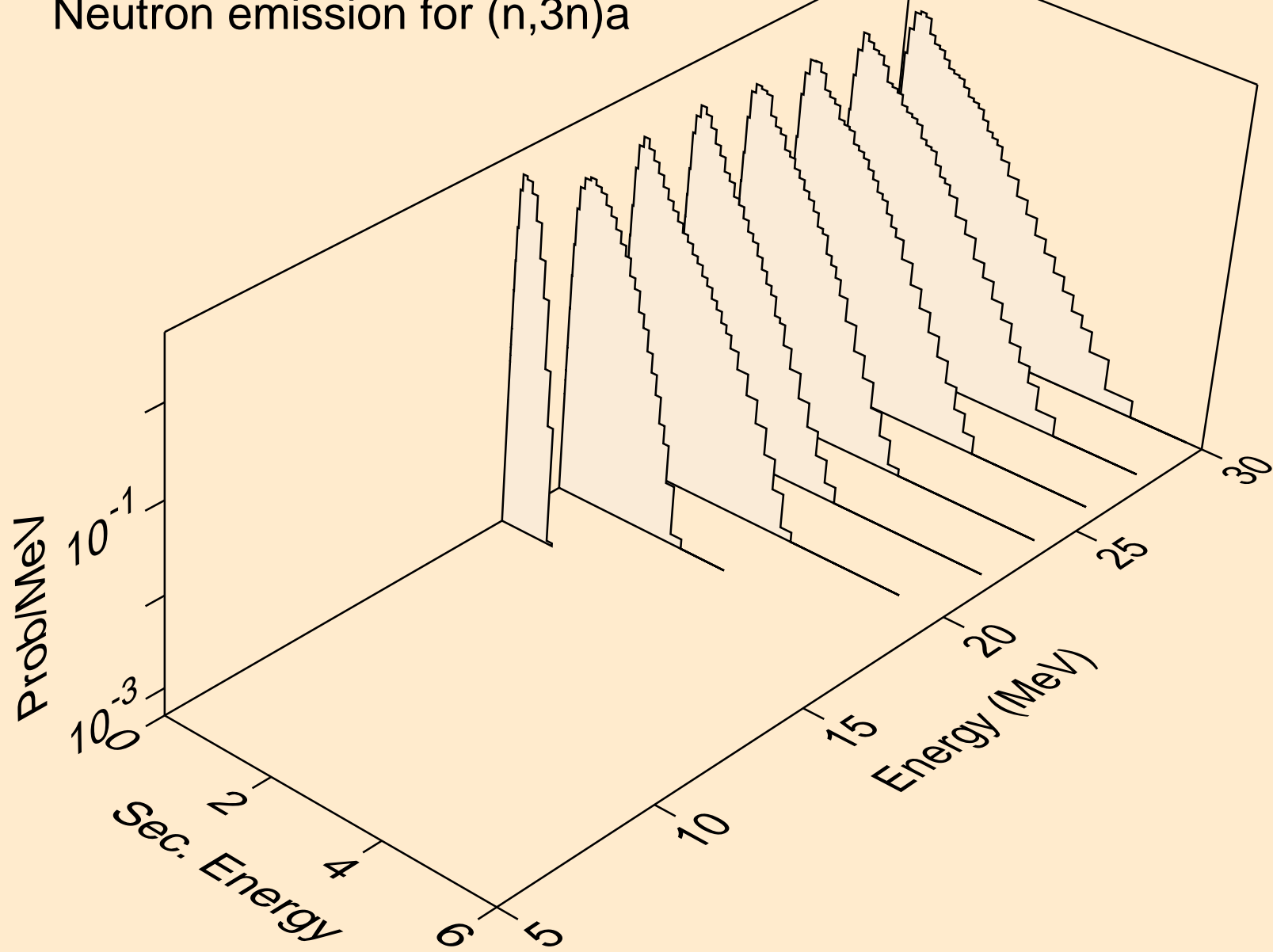

NP238 NEUTRON ACER TENDL-2023 LIBRARY; T=0.K
Neutron emission for (n,n*)p

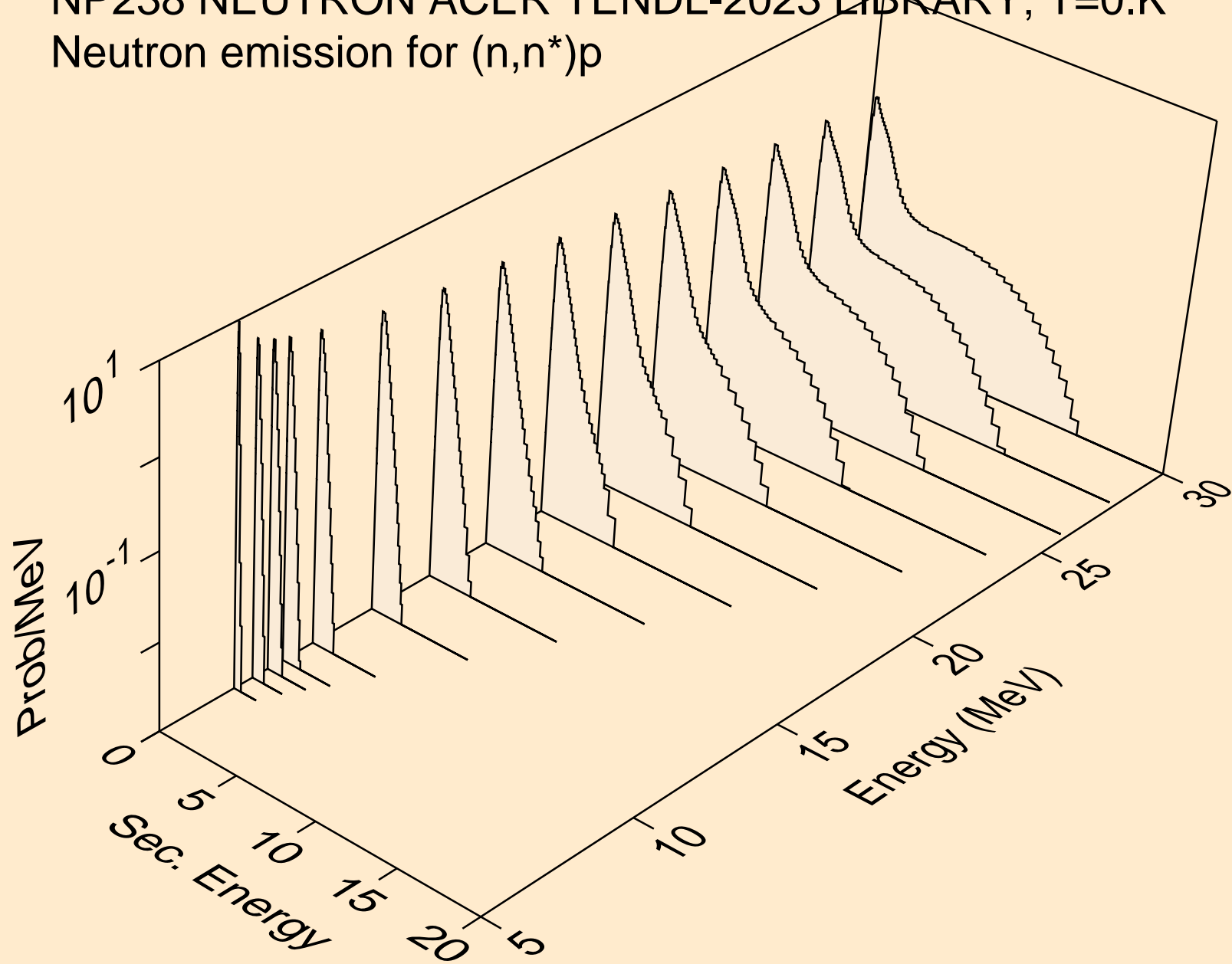

NP238 NEUTRON ACER TENDL-2023 LIBRARY; T=0.K
Neutron emission for (n,n*)d

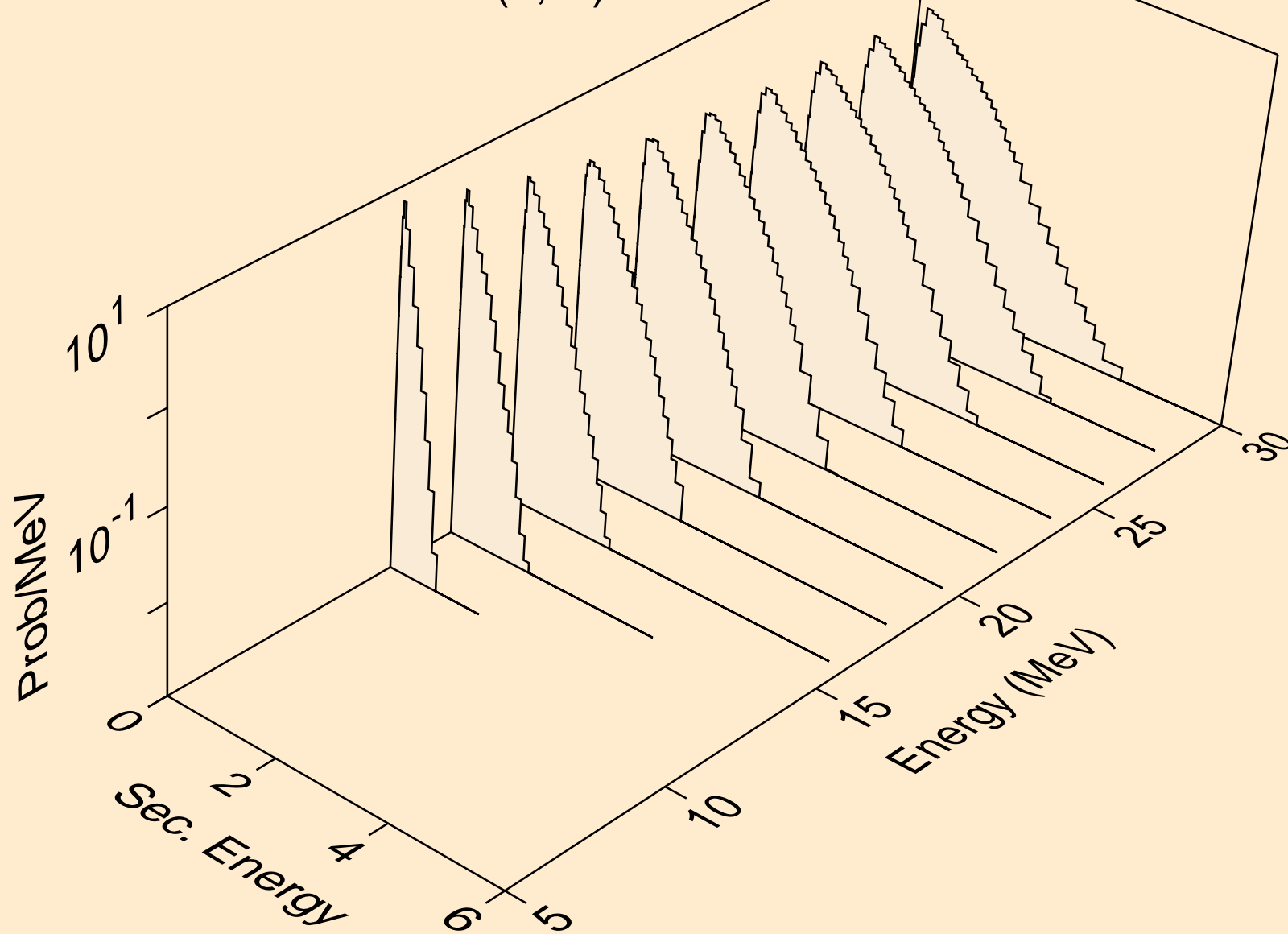

NP238 NEUTRON ACER TENDL-2023 LIBRARY; T=0.K
Neutron emission for (n,n*)t

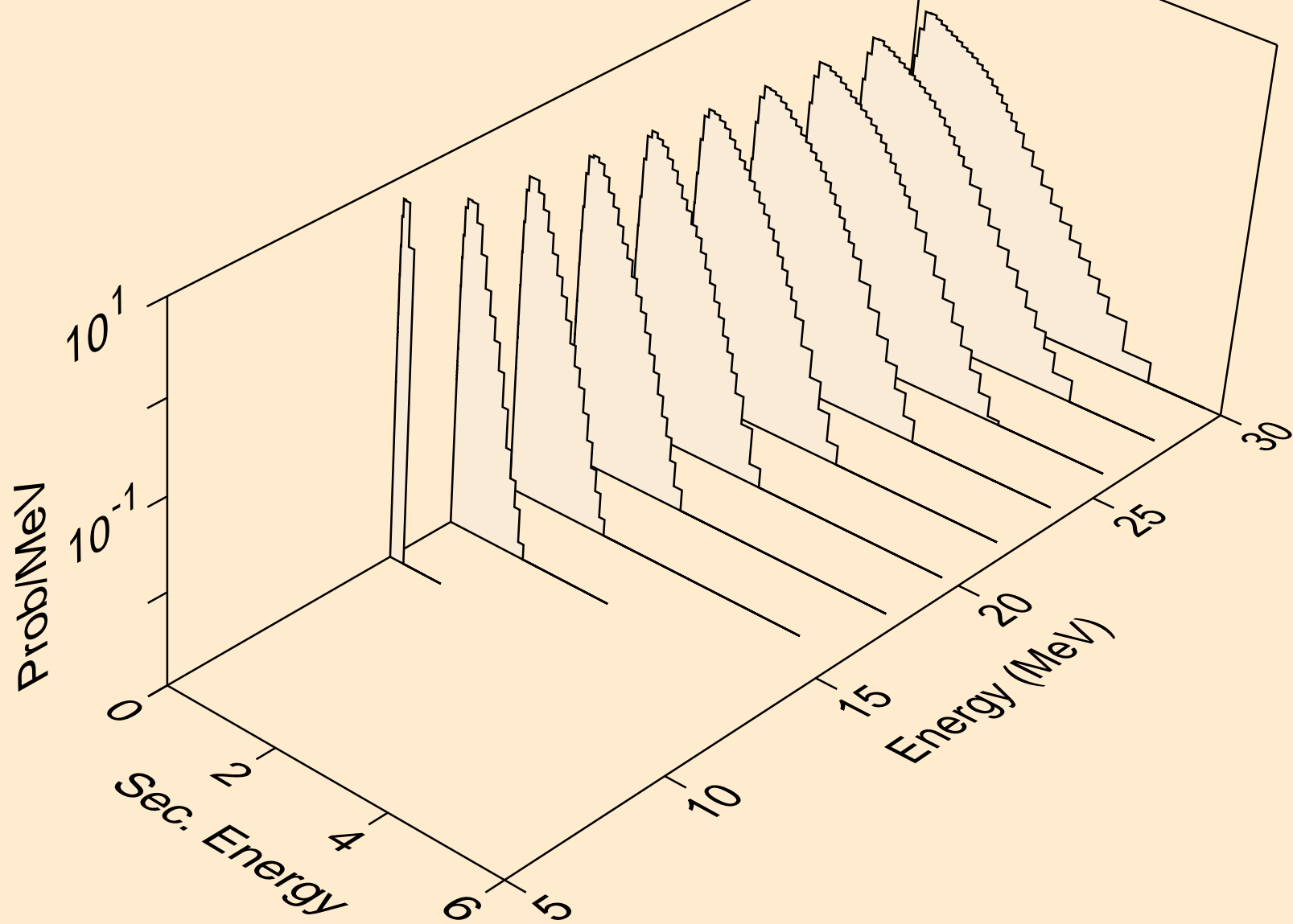

NP238 NEUTRON ACER TENDL-2023 LIBRARY; T=0.K
Neutron emission for (n,n*)he3

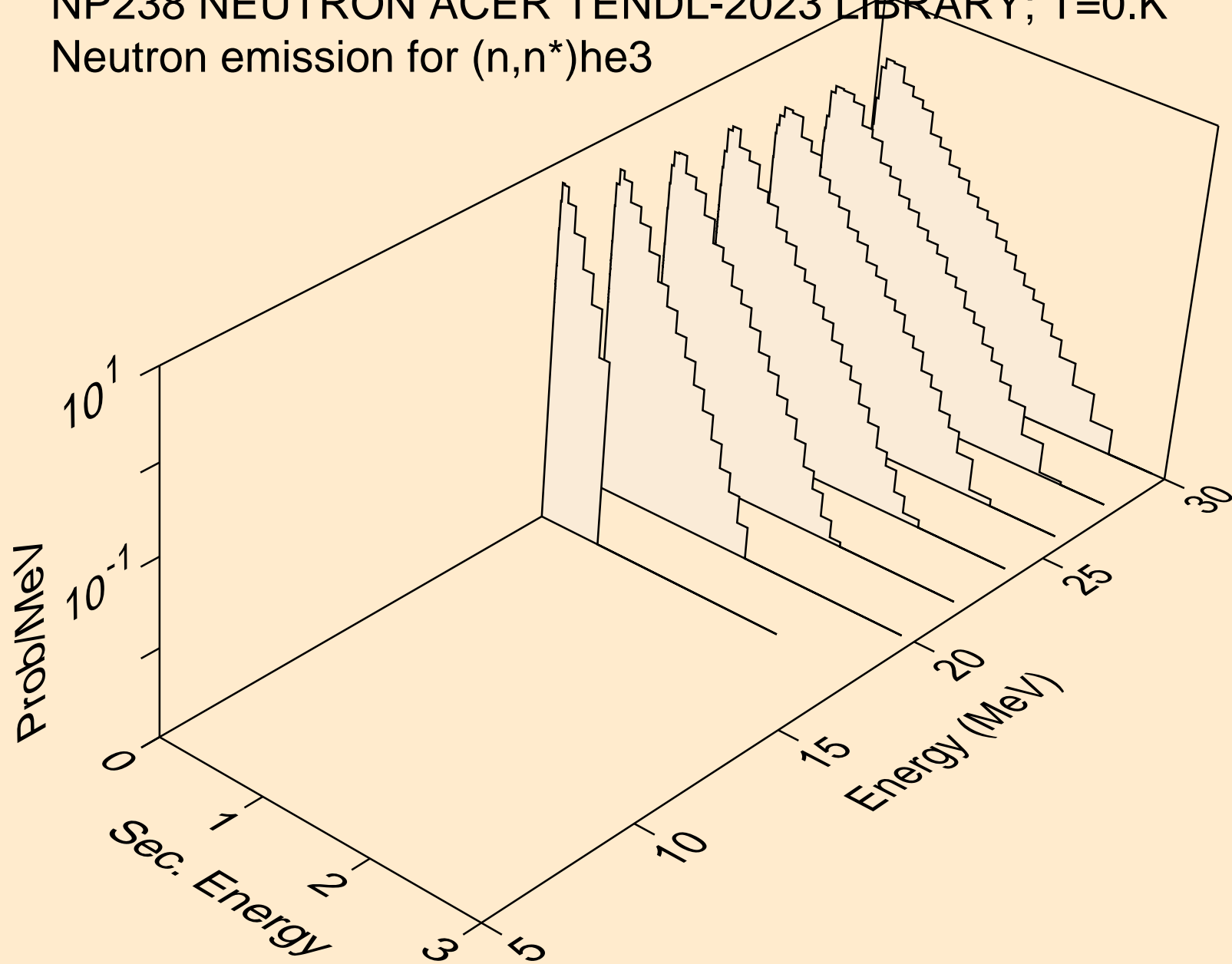

NP238 NEUTRON ACER TENDL-2023 LIBRARY; T=0.K
Neutron emission for (n,4n)

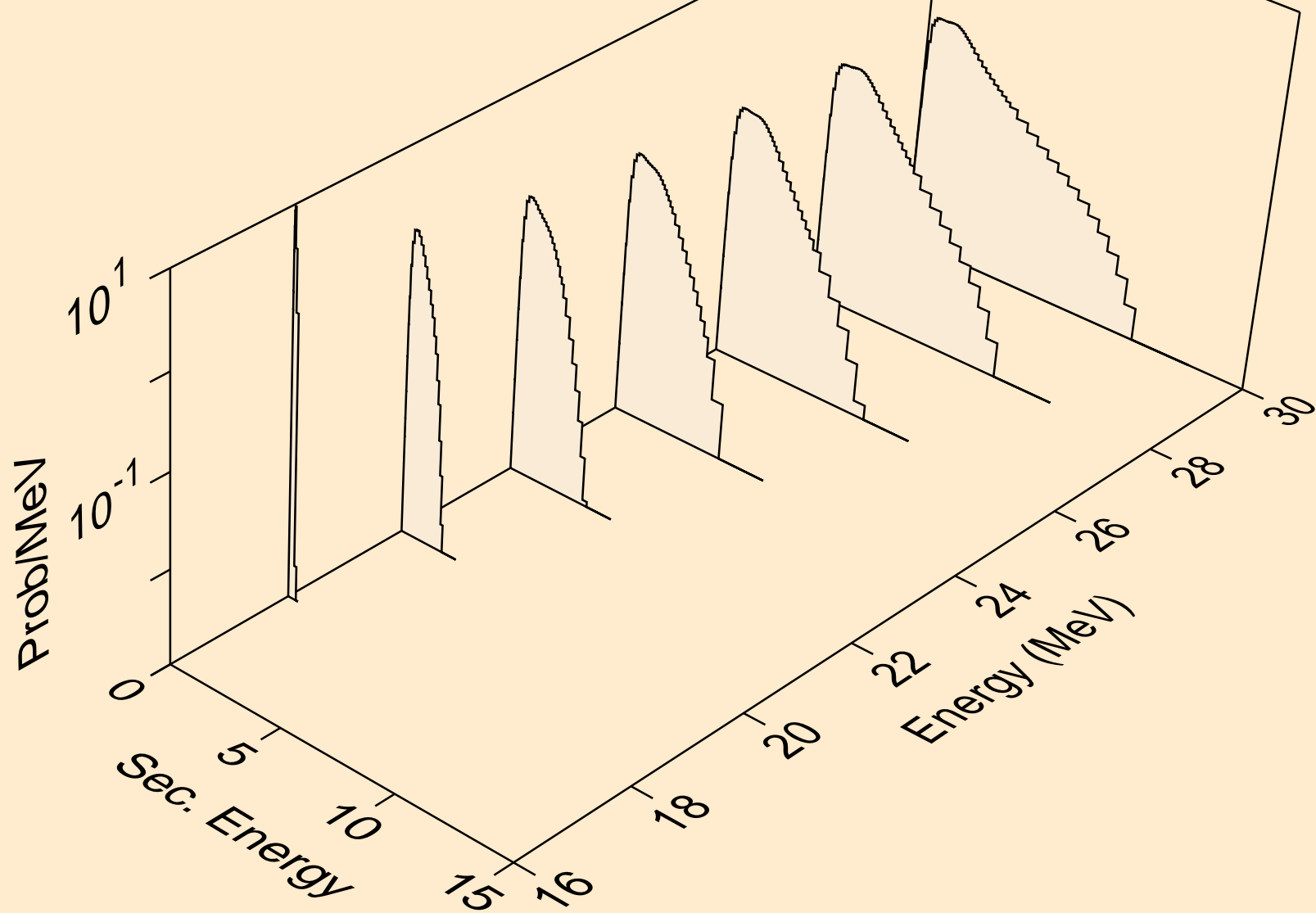

NP238 NEUTRON ACER TENDL-2023 LIBRARY; T=0.K
Neutron emission for (n,2np)

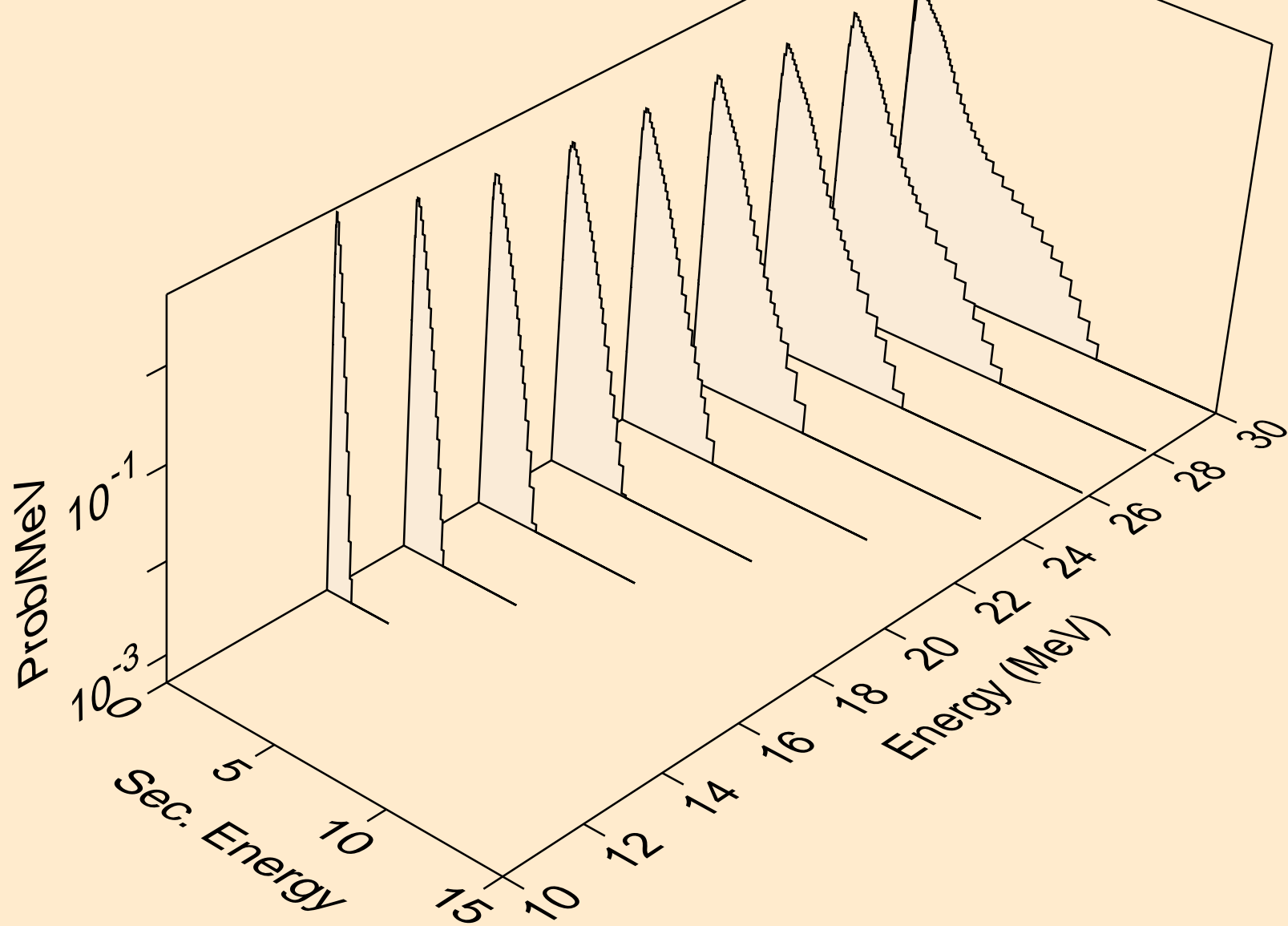

NP238 NEUTRON ACER TENDL-2023 LIBRARY; T=0.K
Neutron emission for (n,3np)

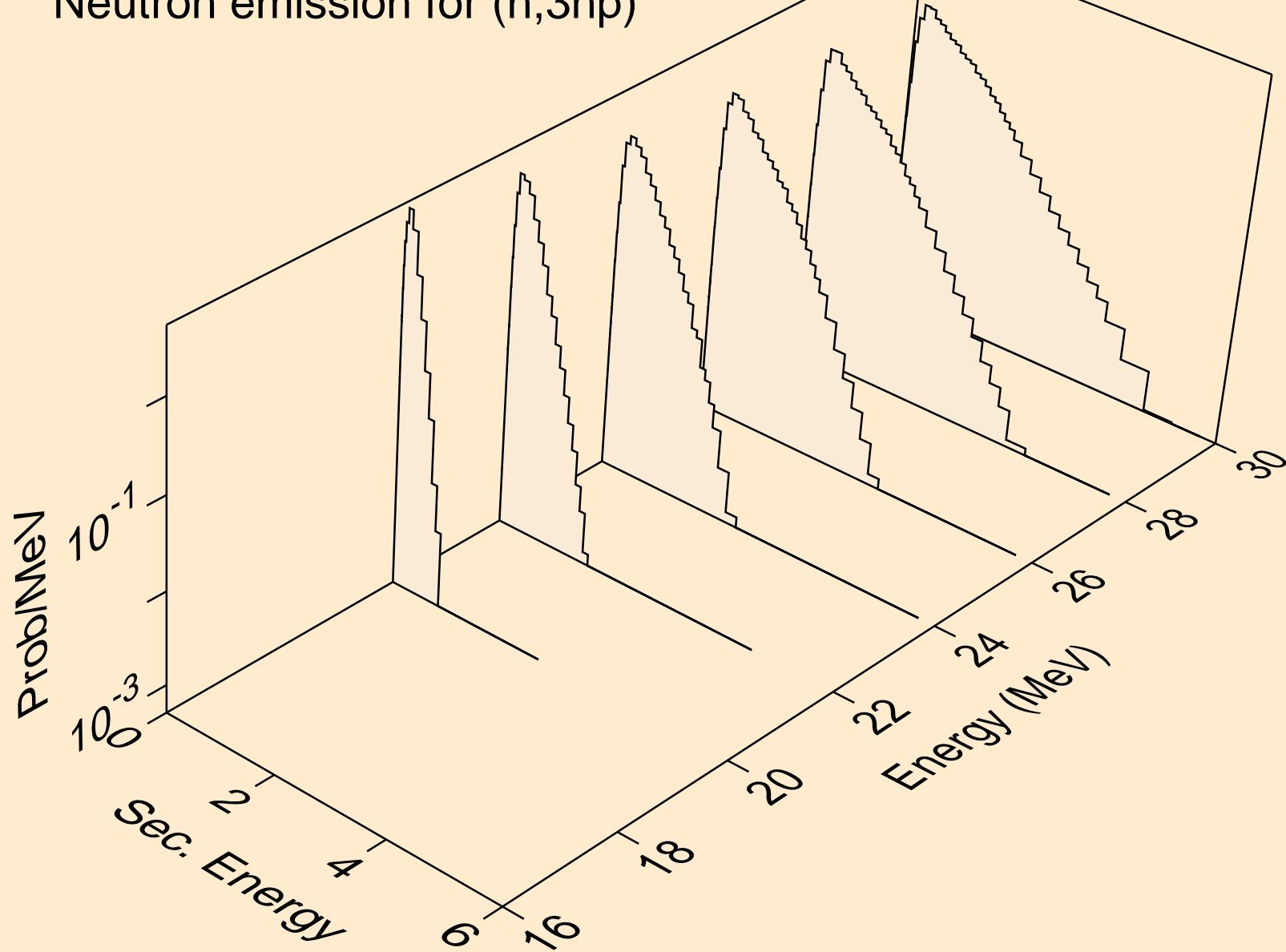

NP238 NEUTRON ACER TENDL-2023 LIBRARY; T=0.K
Neutron emission for (n,n2p)

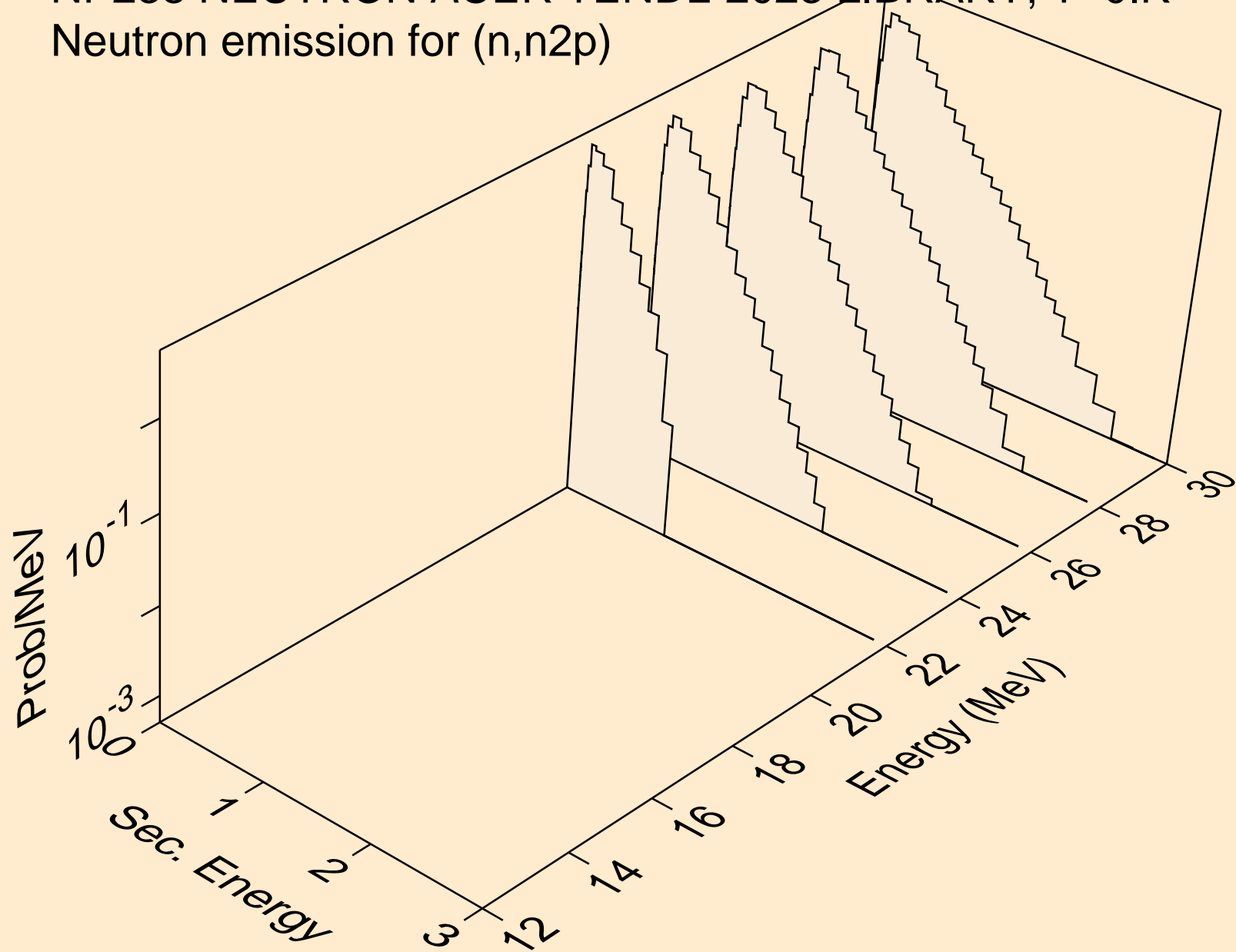

NP238 NEUTRON ACER TENDL-2023 LIBRARY; T=0.K
Neutron emission for (n,n*c)

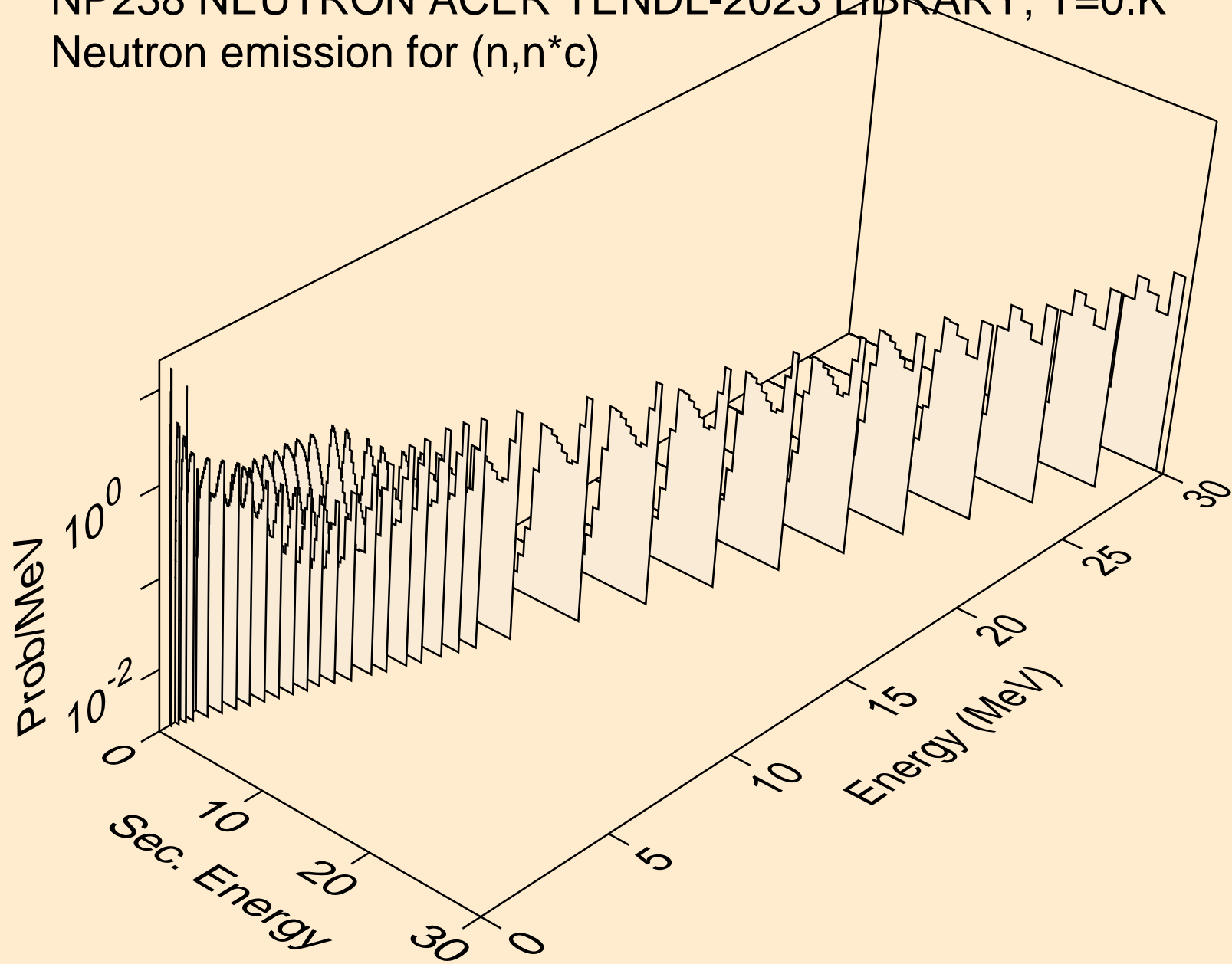

NP238 NEUTRON ACER TENDL-2023 LIBRARY; T=0.K

Delayed nubar

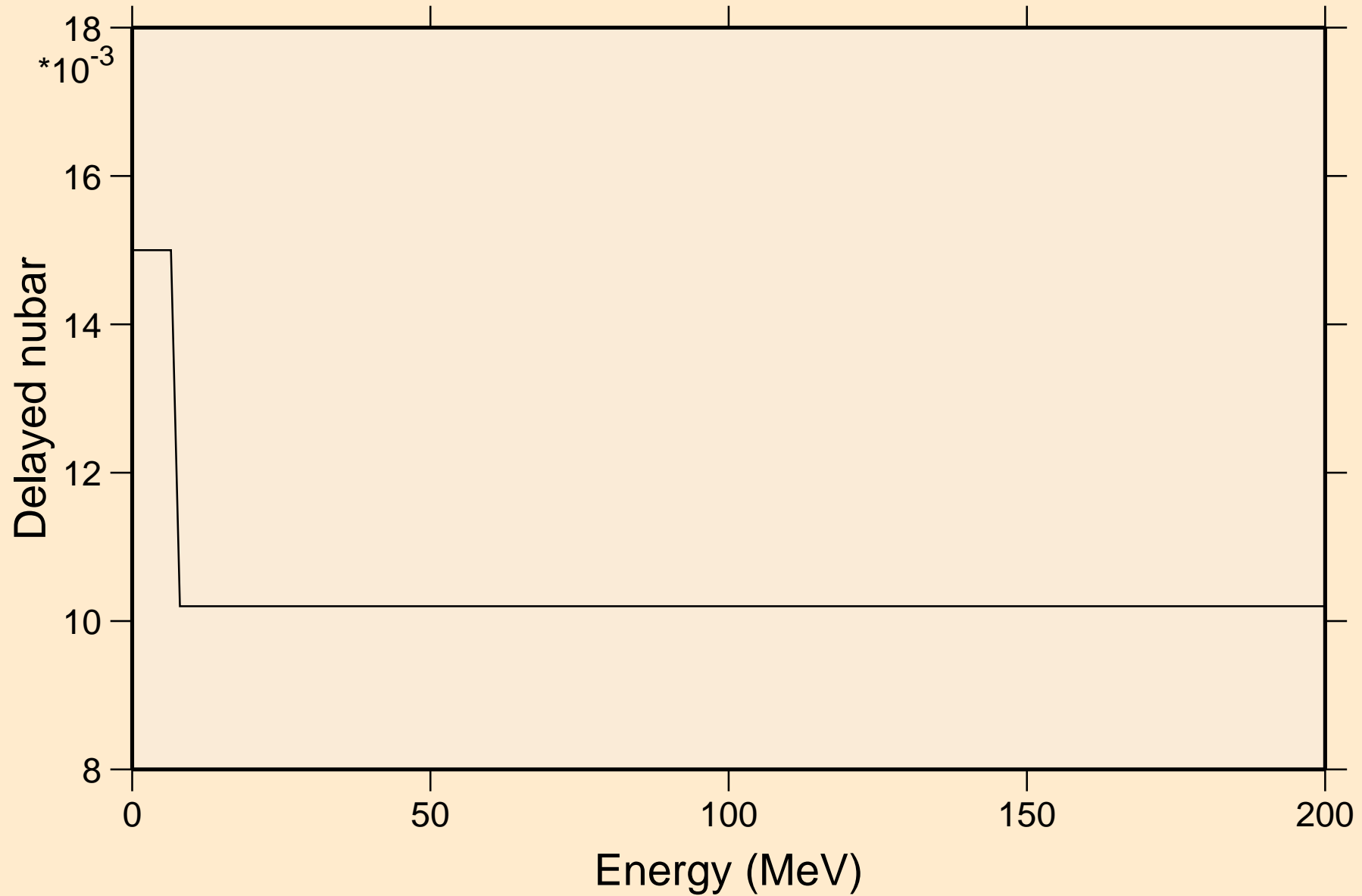

NP238 NEUTRON ACER TENDL-2023 LIBRARY; T=0.K

Delayed neutron spectra

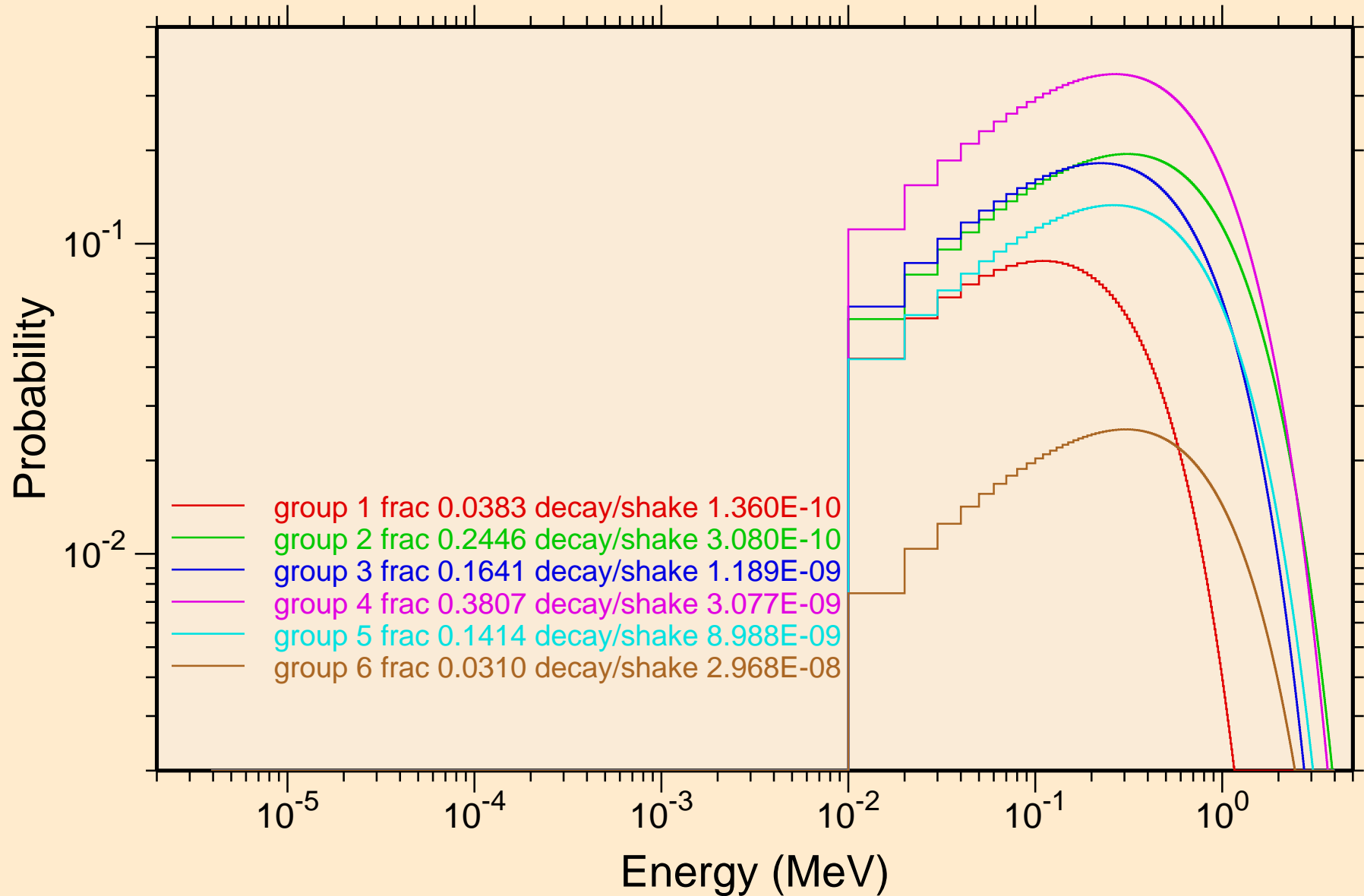

NP238 NEUTRON ACER TENDL-2023 LIBRARY; T=0.K
Photon emission for (n,x)

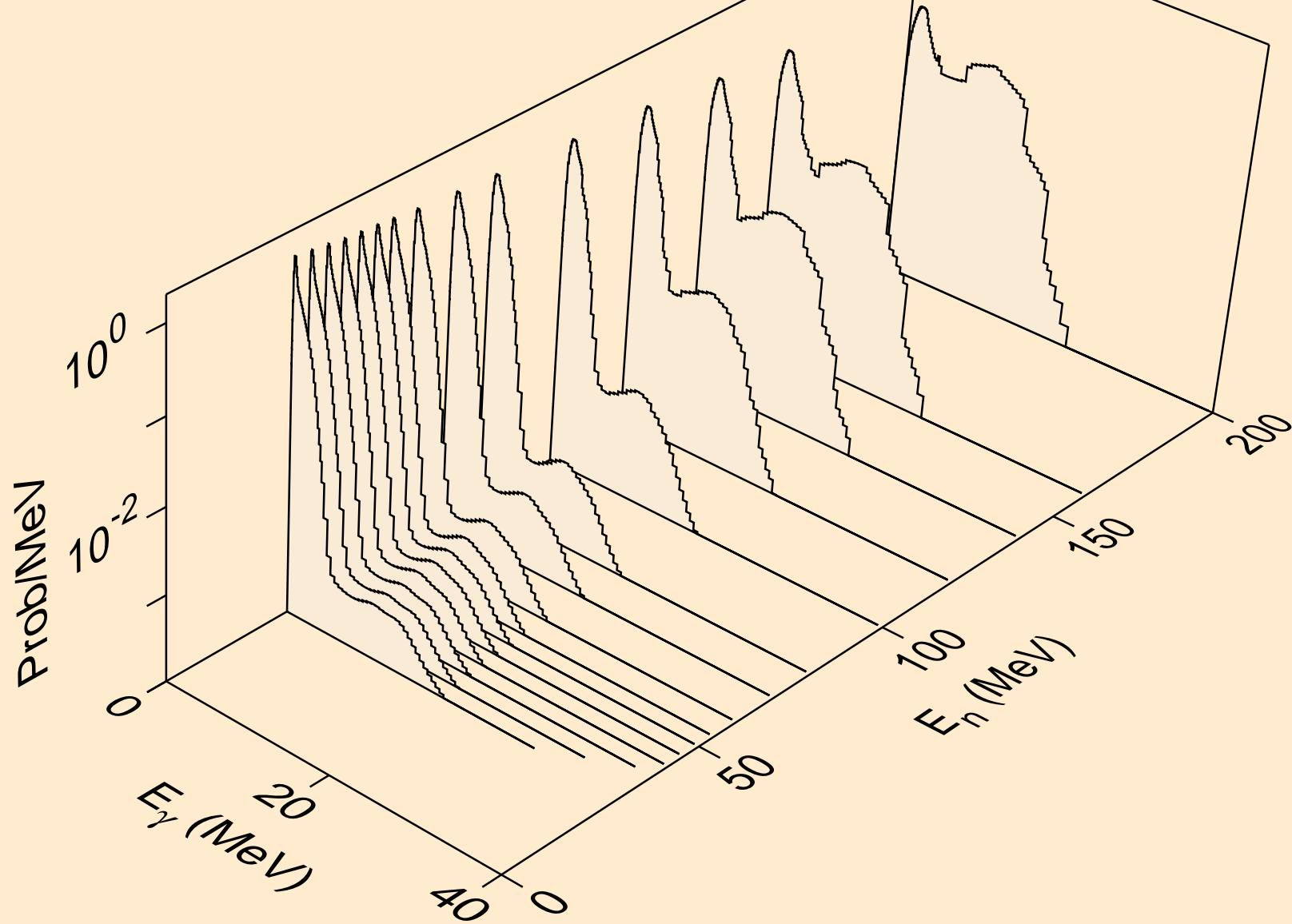

NP238 NEUTRON ACER TENDL-2023 LIBRARY; T=0.K
Photon emission for (n,2nd)

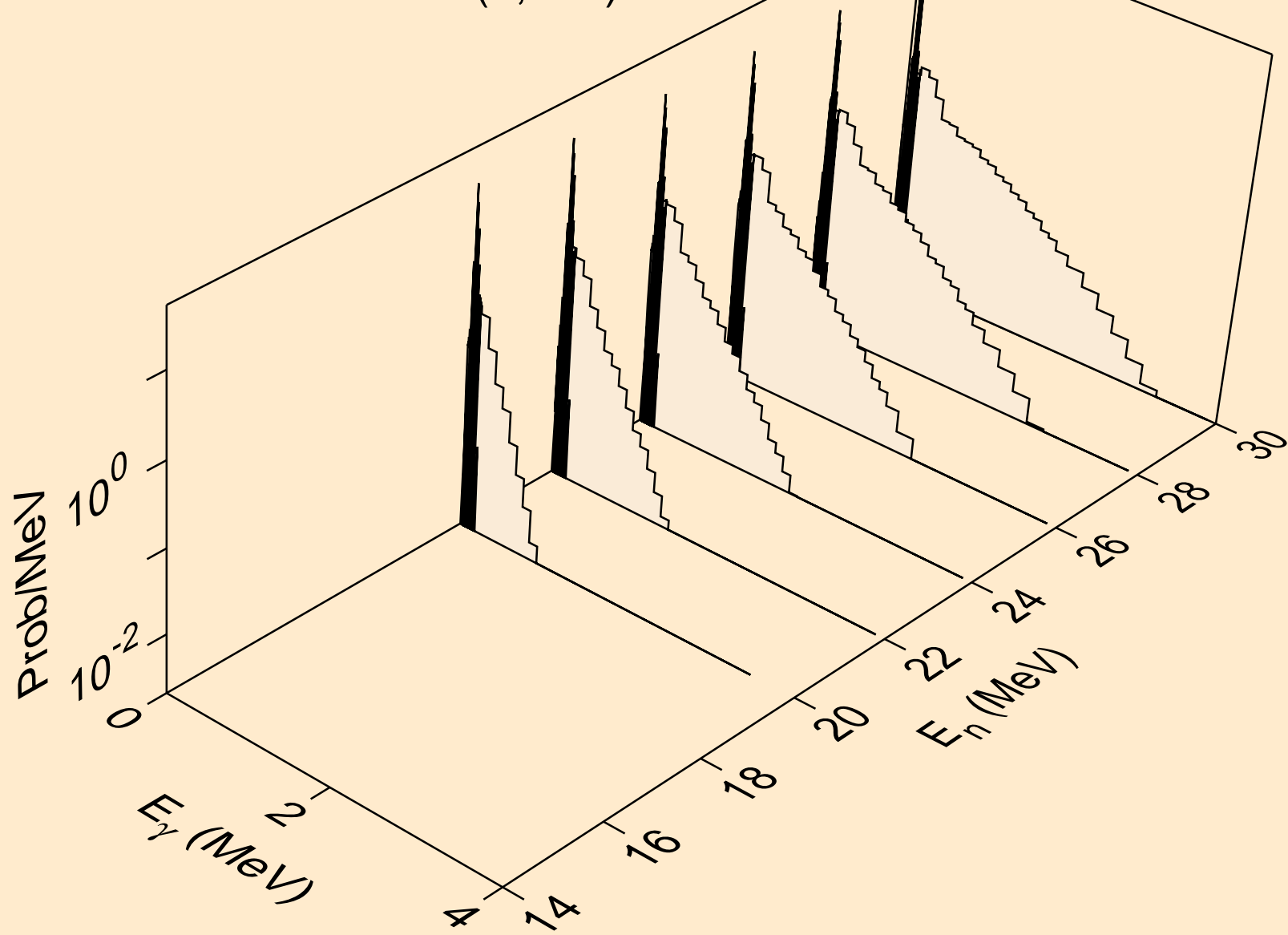

NP238 NEUTRON ACER TENDL-2023 LIBRARY; T=0.K
Photon emission for (n,2n)

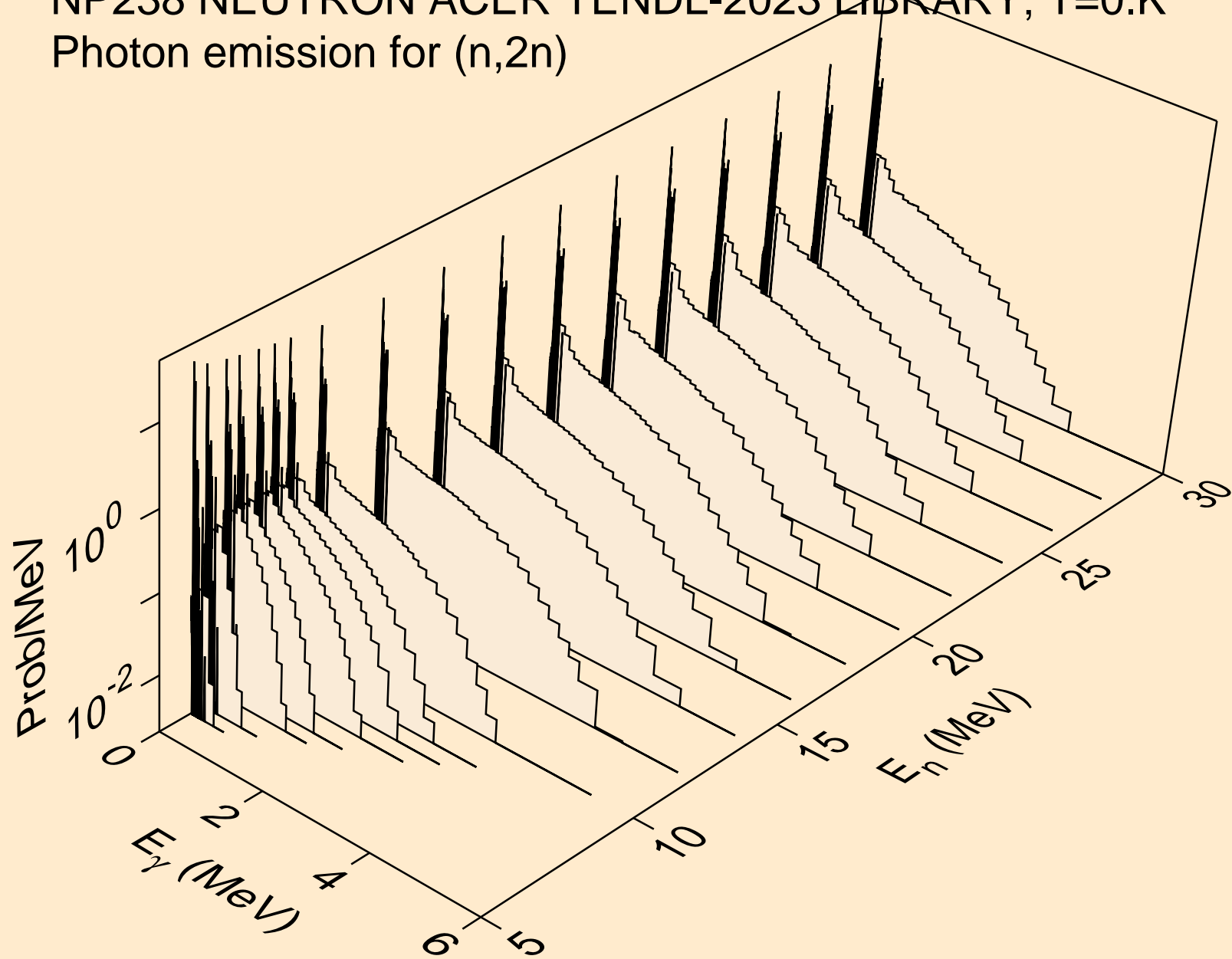

NP238 NEUTRON ACER TENDL-2023 LIBRARY; T=0.K
Photon emission for (n,3n)

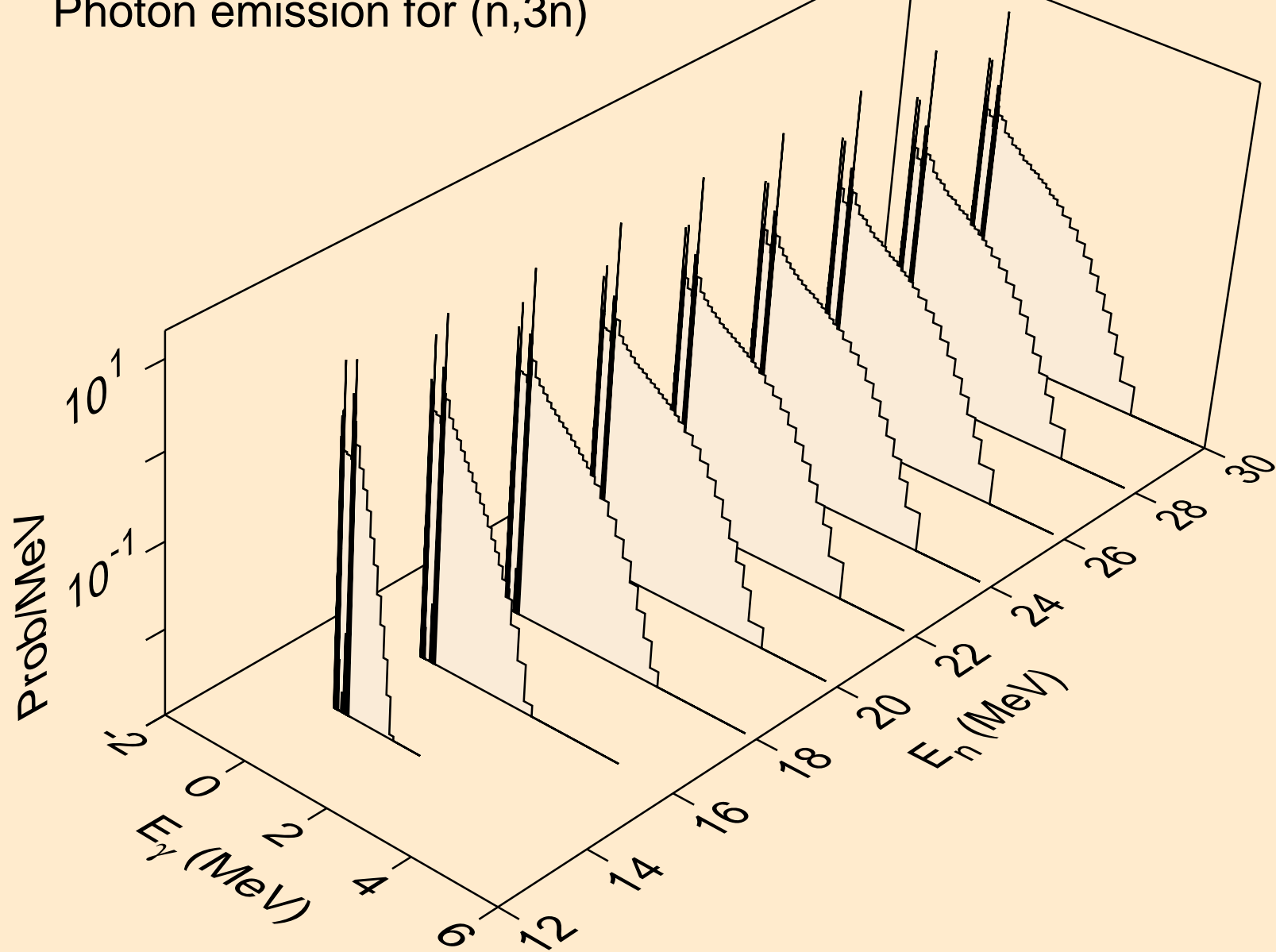

NP238 NEUTRON ACER TENDL-2023 LIBRARY; T=0.K
Photon emission for (n,n*)a

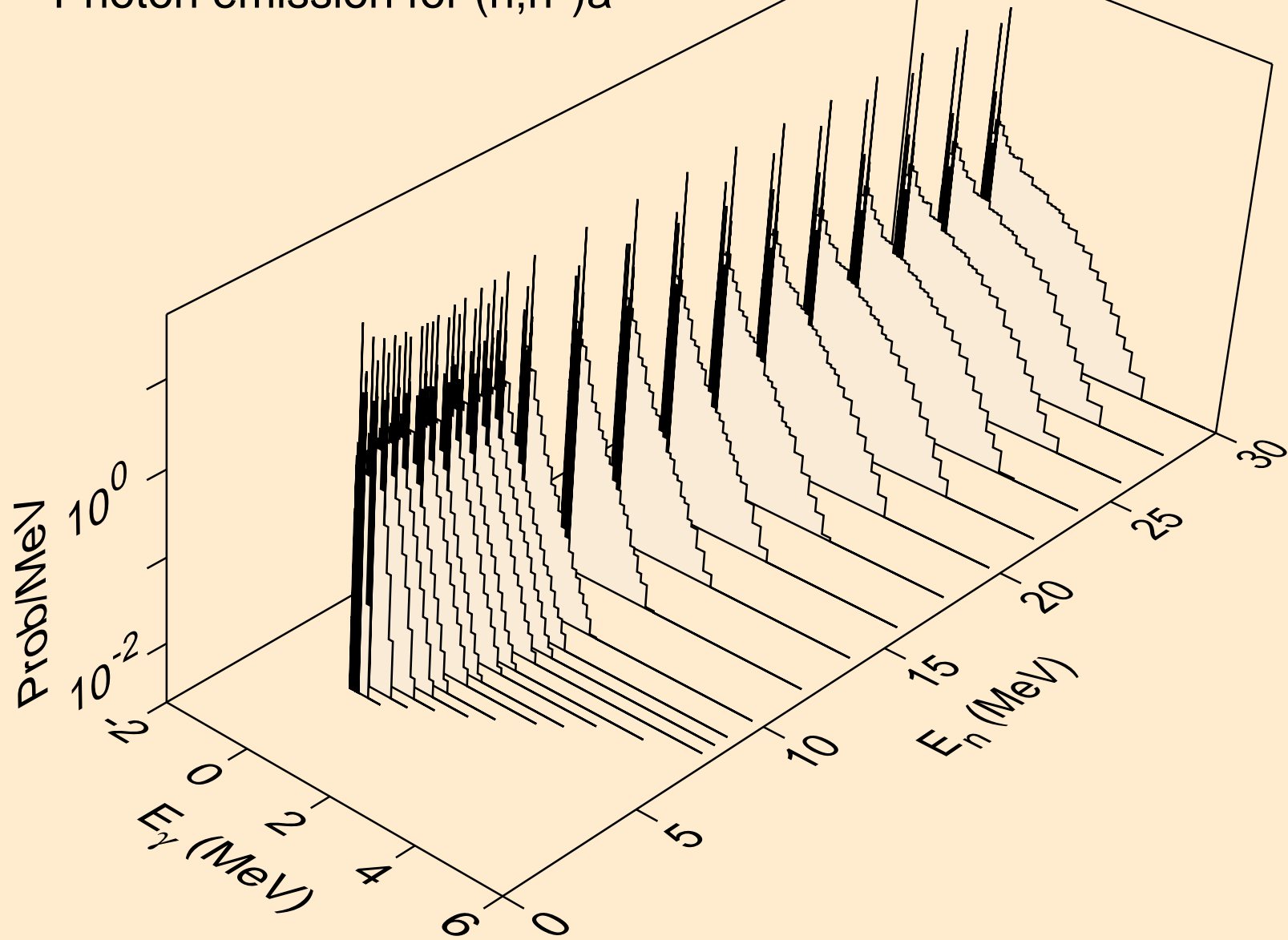

NP238 NEUTRON ACER TENDL-2023 LIBRARY; T=0.K
Photon emission for (n,2n)a

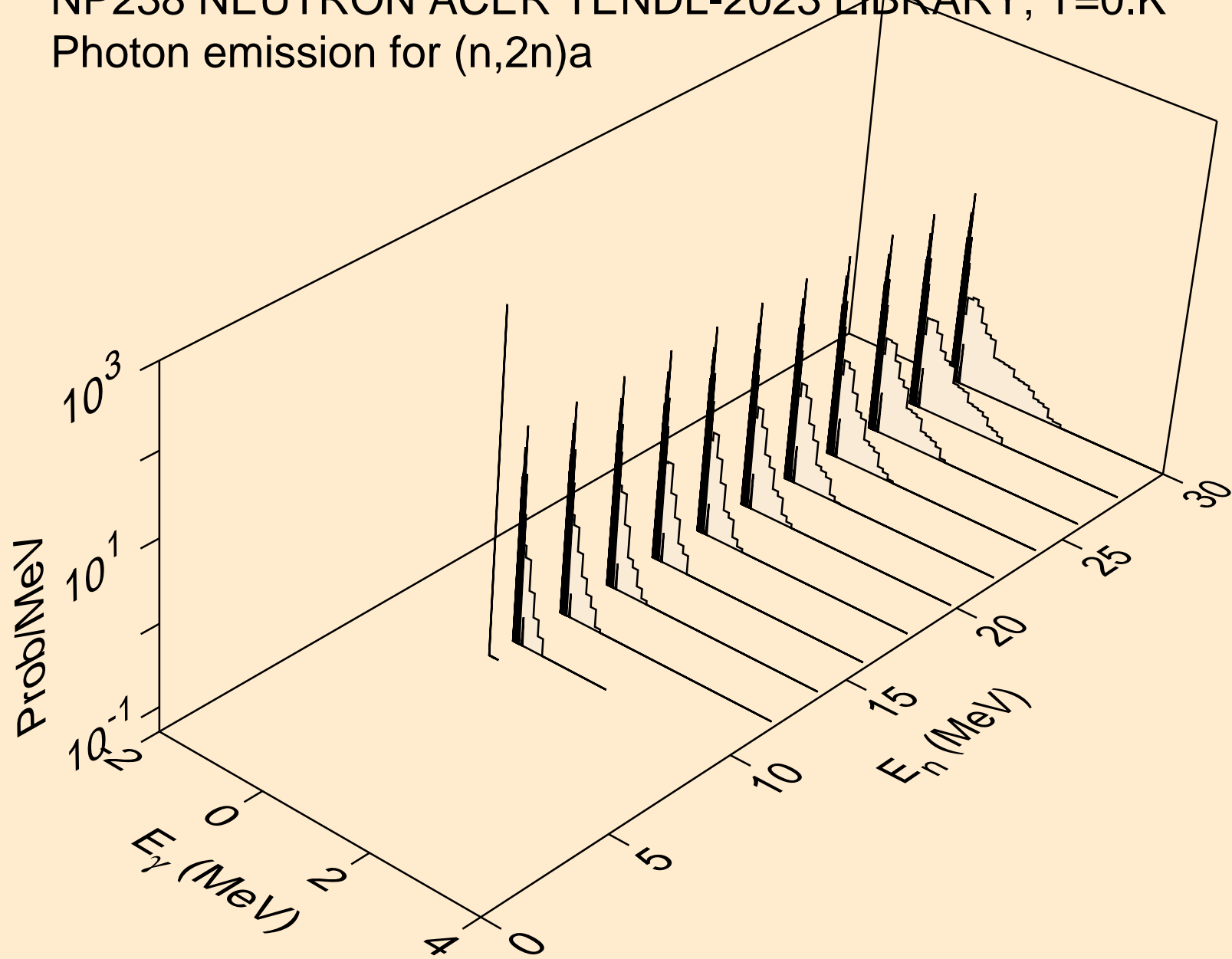

NP238 NEUTRON ACER TENDL-2023 LIBRARY; T=0.K
Photon emission for (n,3n)a

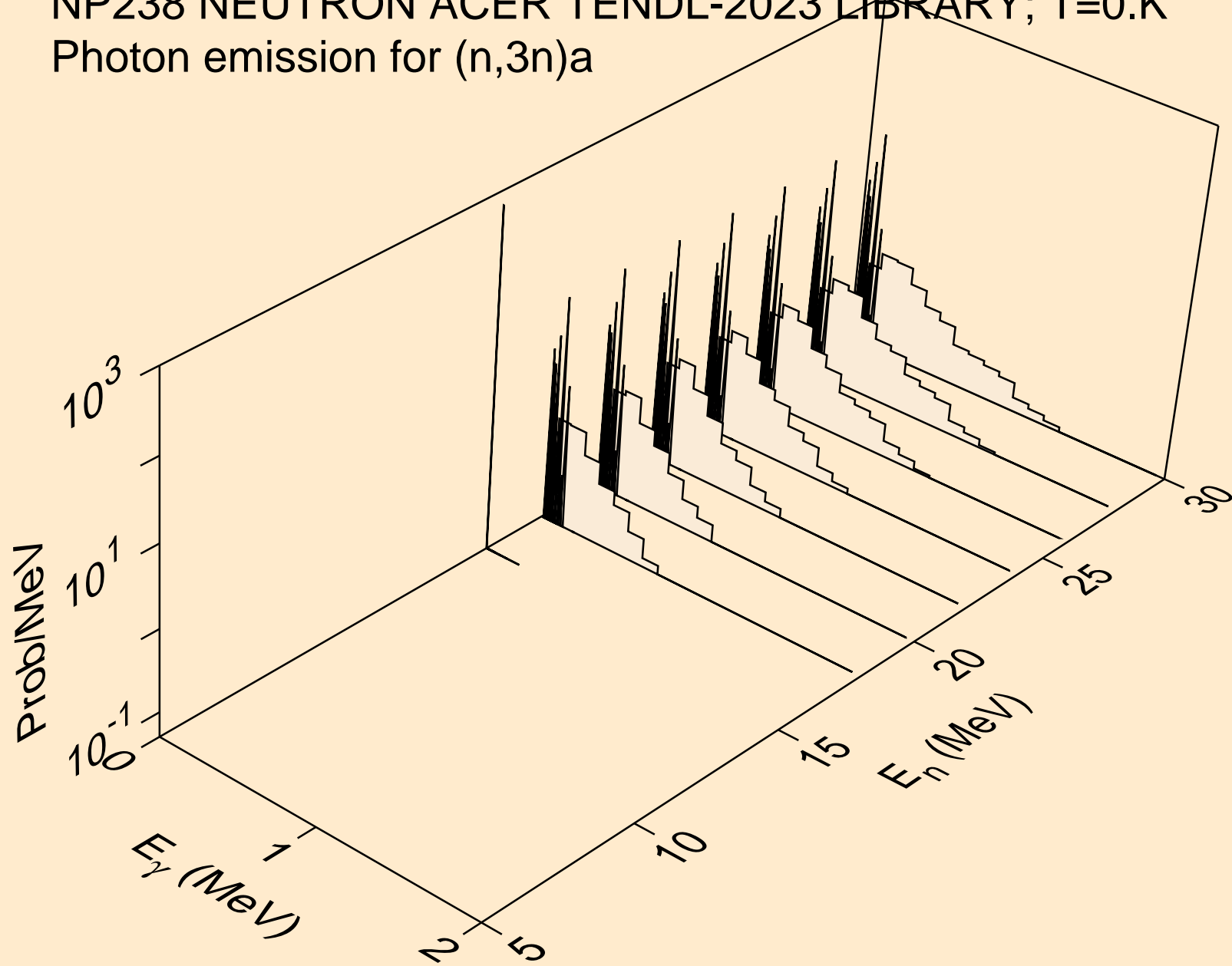

NP238 NEUTRON ACER TENDL-2023 LIBRARY; T=0.K
Photon emission for (n,n*)p

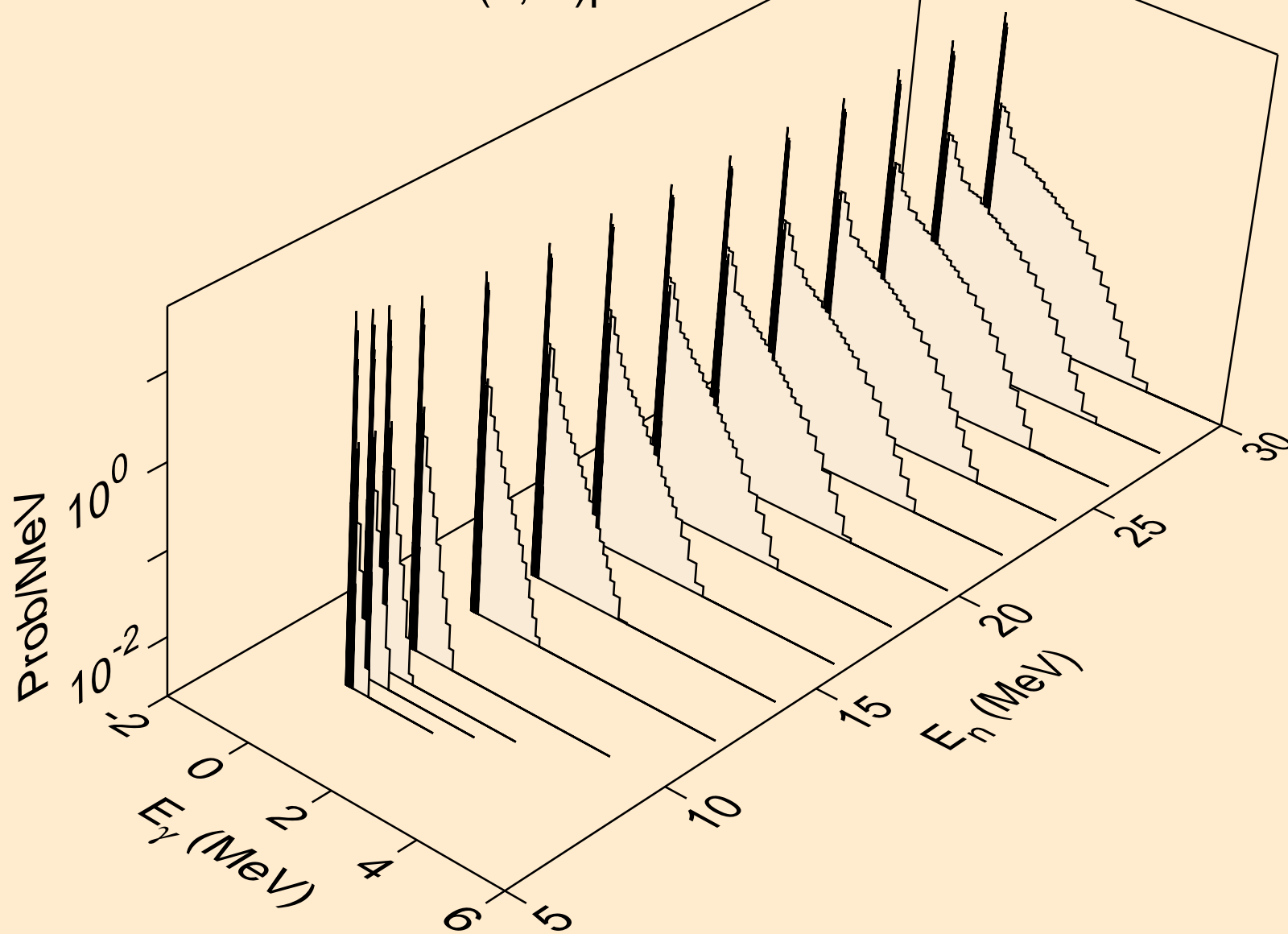

NP238 NEUTRON ACER TENDL-2023 LIBRARY; T=0.K
Photon emission for (n,n*)d

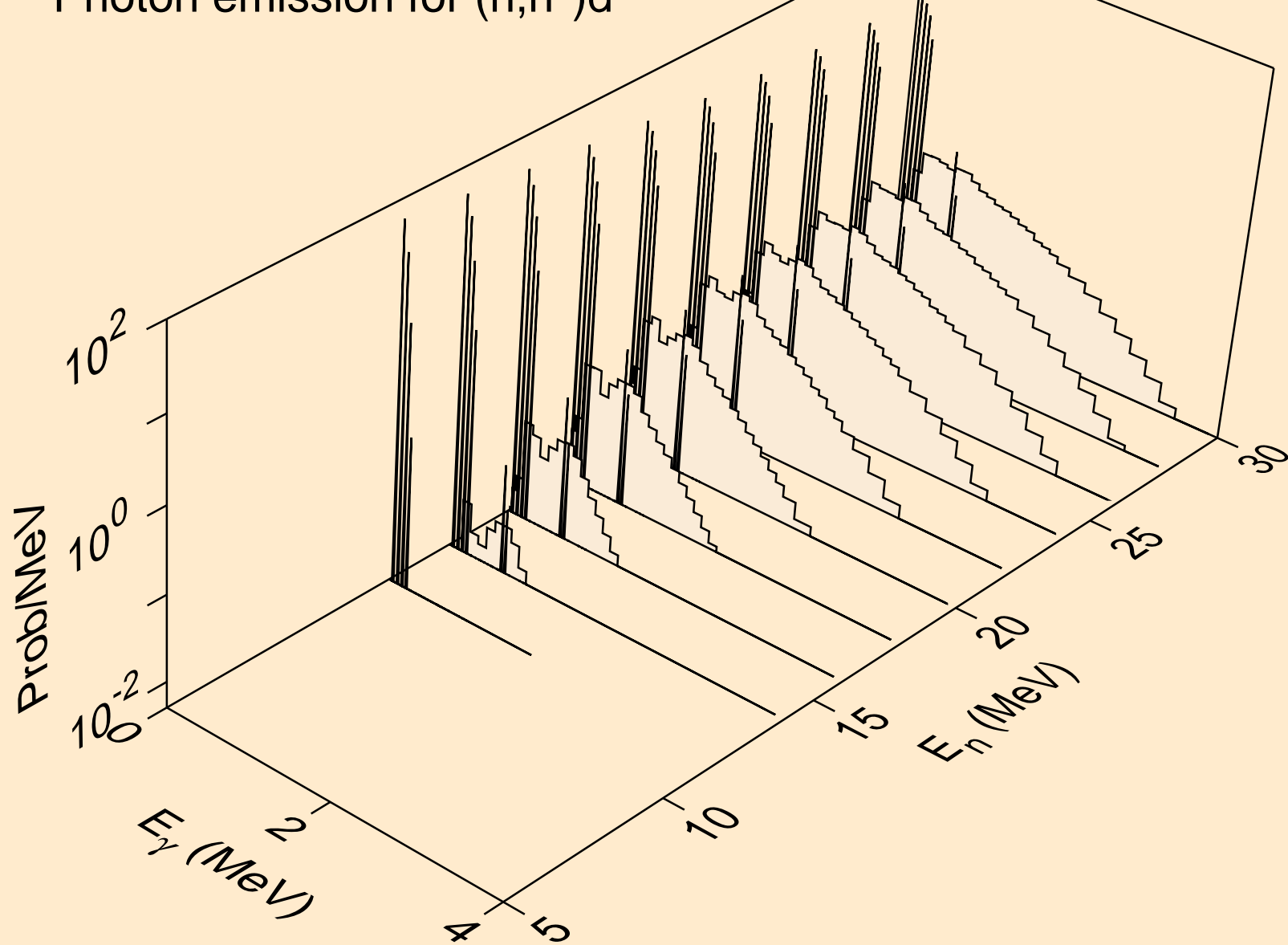

NP238 NEUTRON ACER TENDL-2023 LIBRARY; T=0.K
Photon emission for (n,n*)t

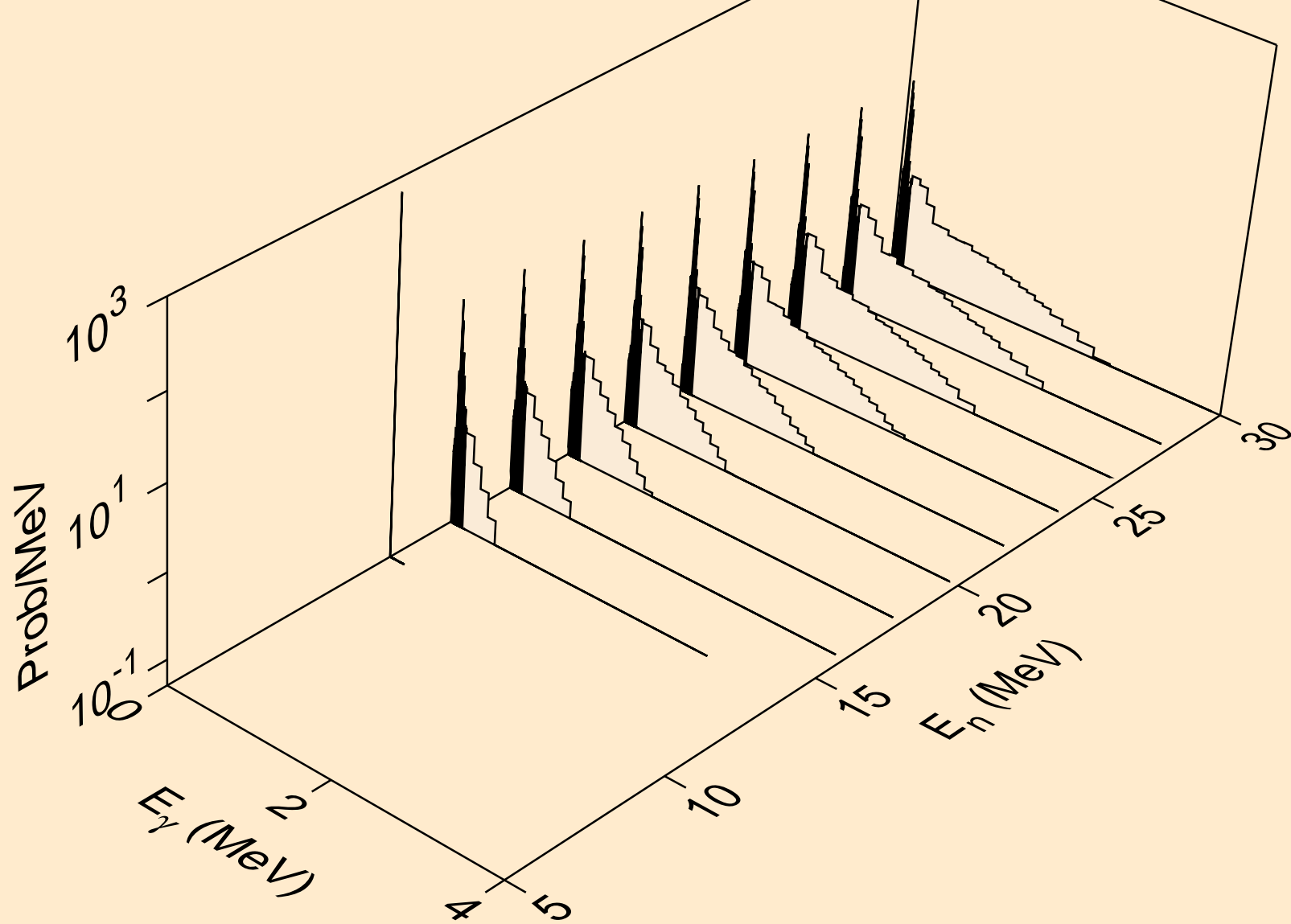

NP238 NEUTRON ACER TENDL-2023 LIBRARY; T=0.K
Photon emission for (n,n*)he3

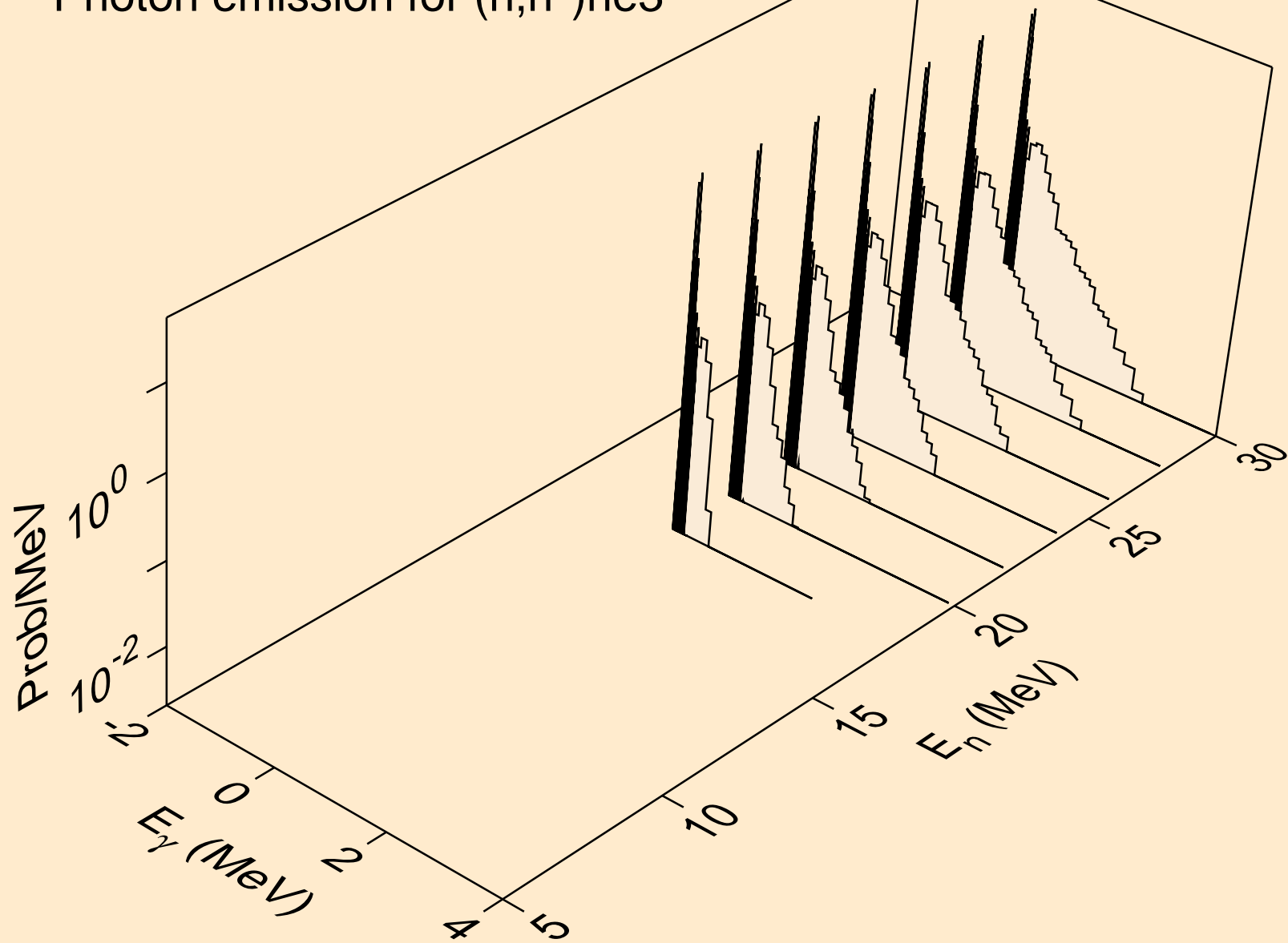

NP238 NEUTRON ACER TENDL-2023 LIBRARY; T=0.K
Photon emission for (n,4n)

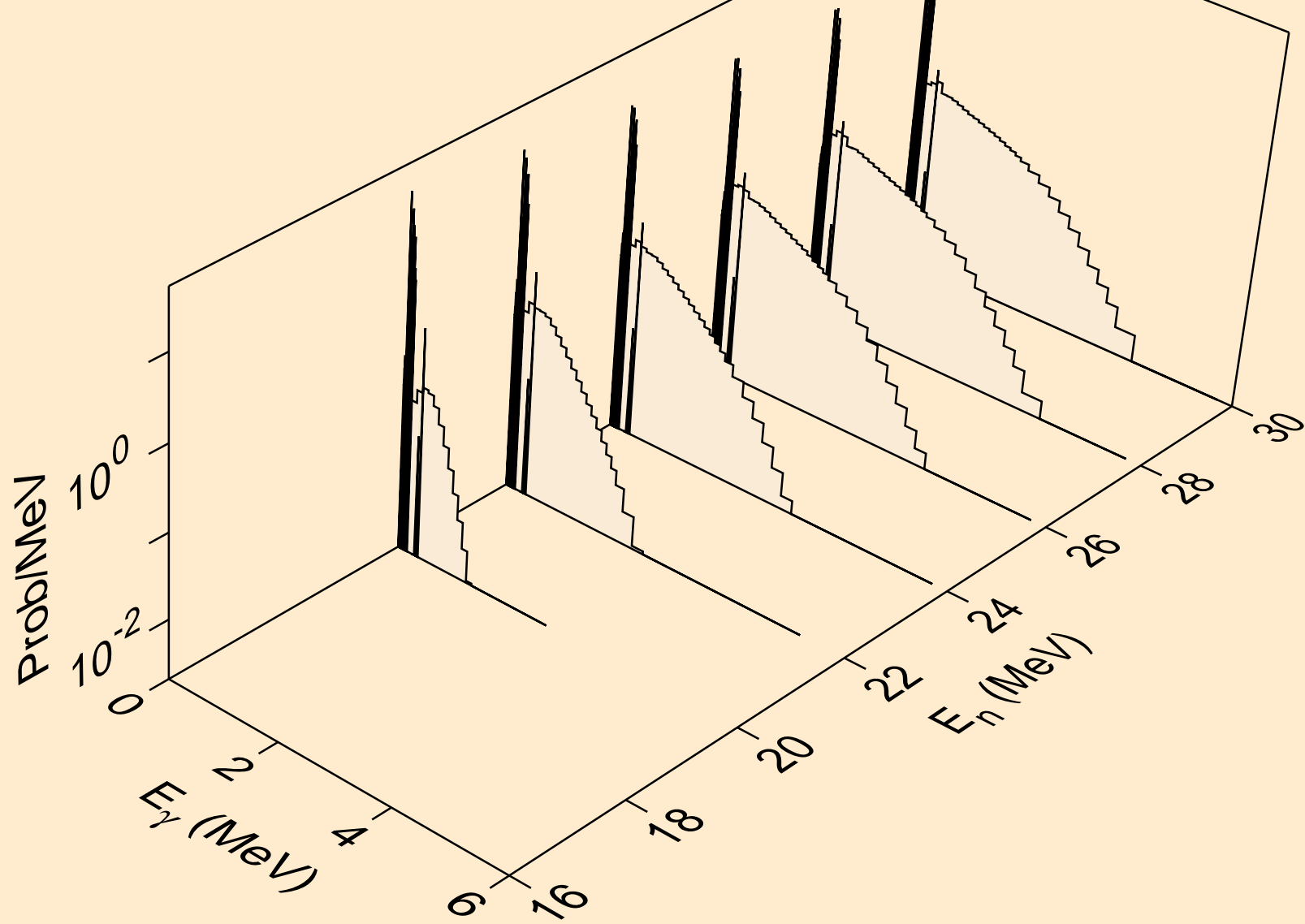

NP238 NEUTRON ACER TENDL-2023 LIBRARY; T=0.K
Photon emission for (n,2np)

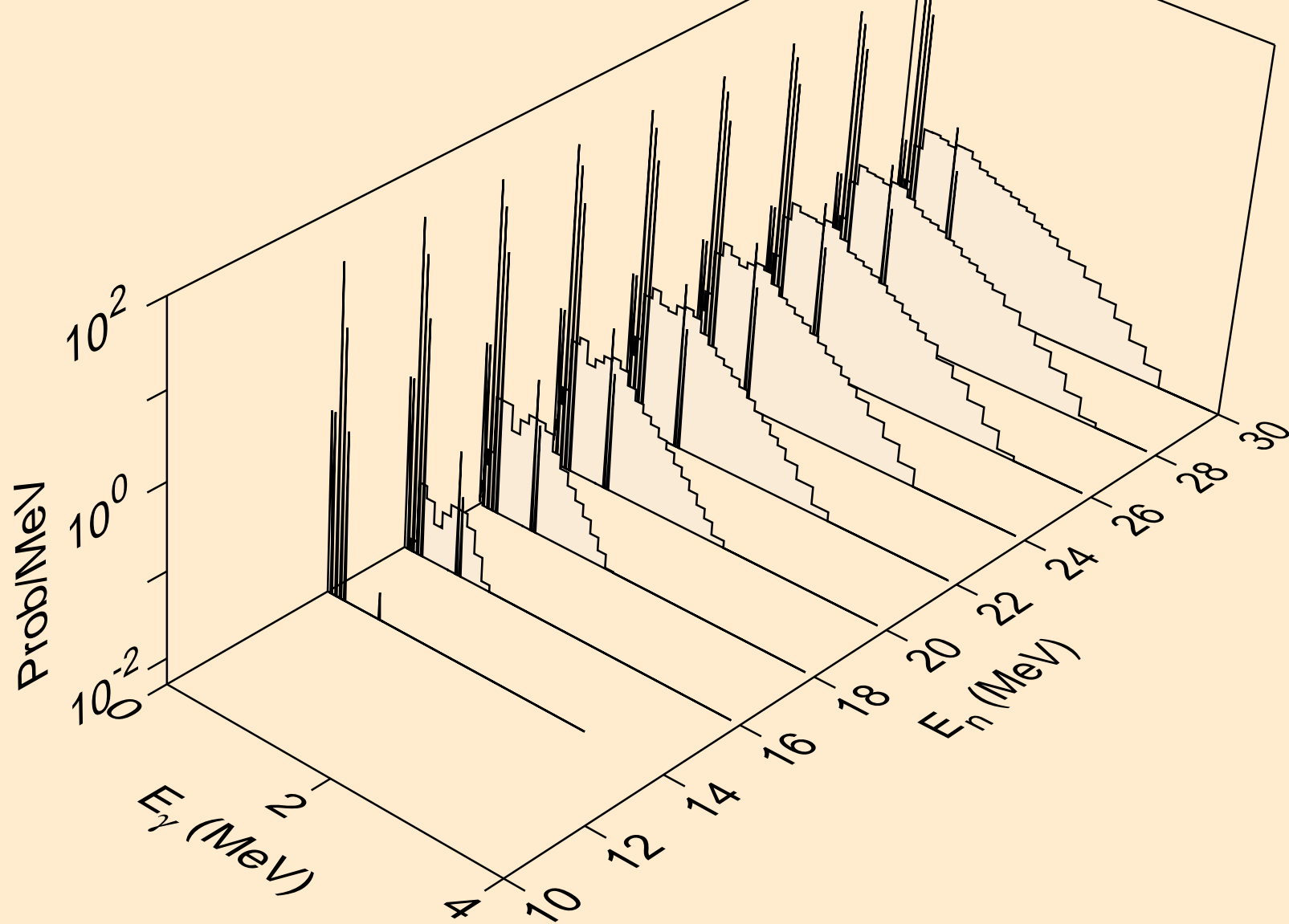

NP238 NEUTRON ACER TENDL-2023 LIBRARY; T=0.K
Photon emission for (n,3np)

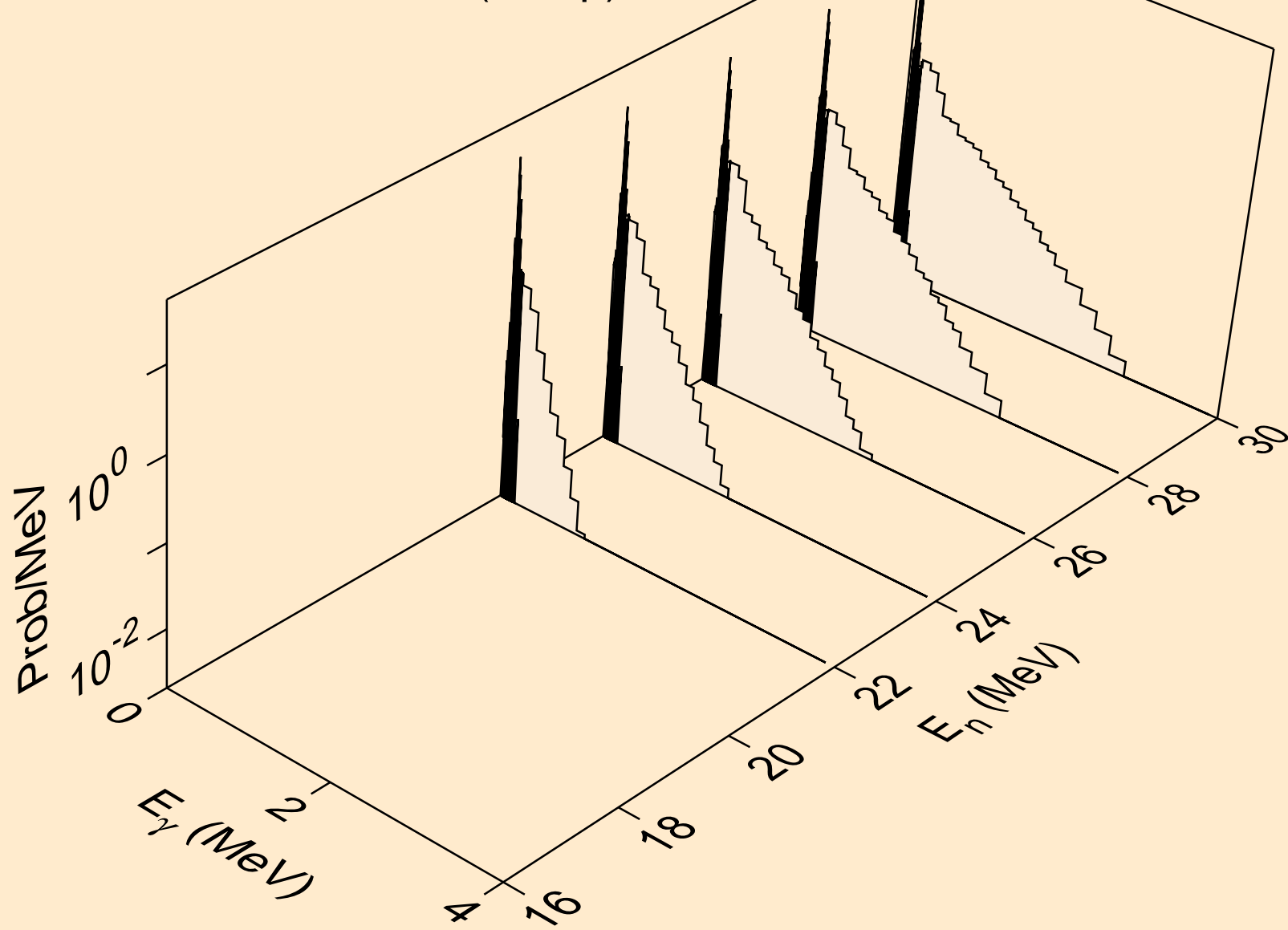

NP238 NEUTRON ACER TENDL-2023 LIBRARY; T=0.K
Photon emission for (n,n2p)

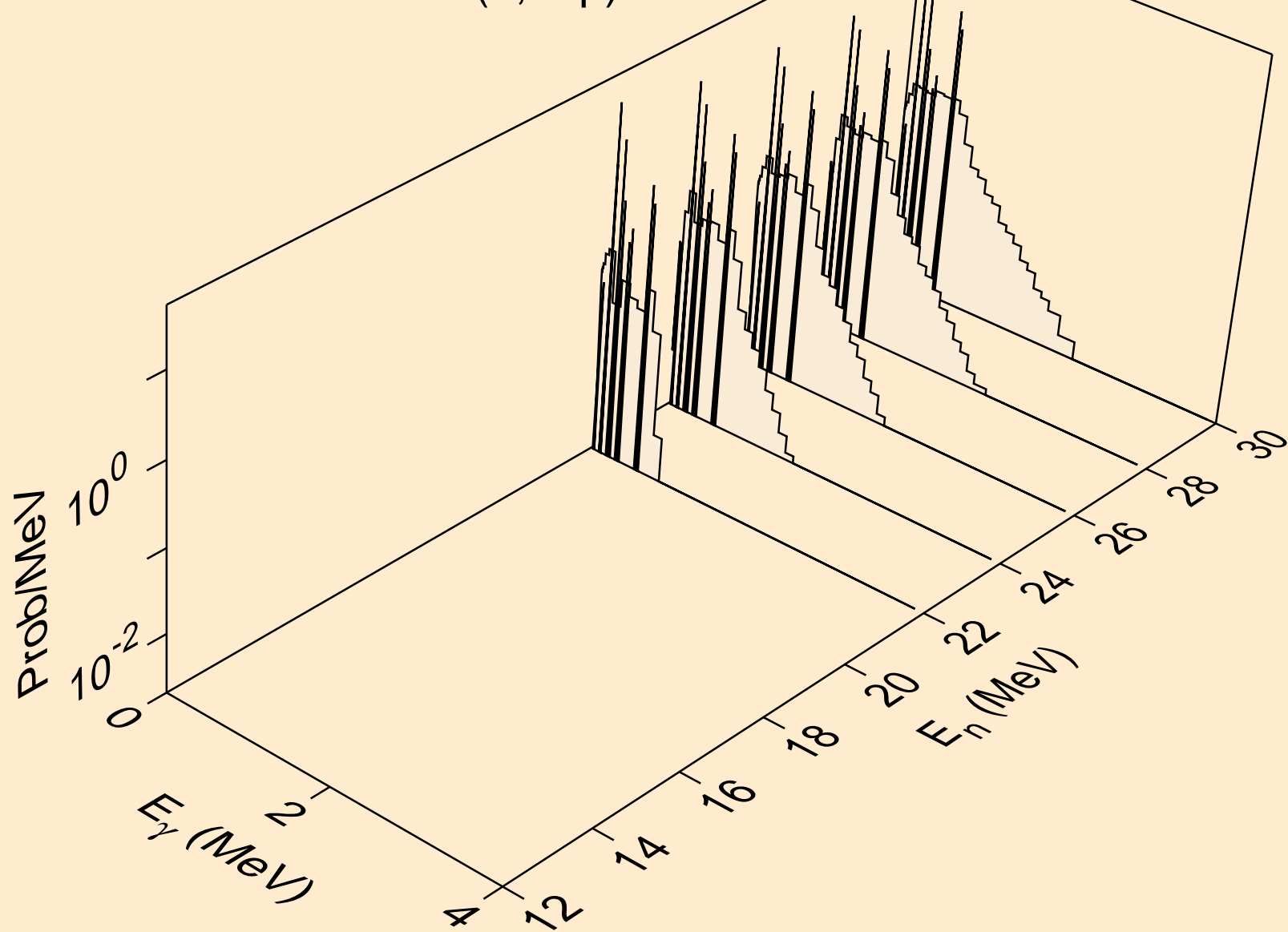

NP238 NEUTRON ACER TENDL-2023 LIBRARY; T=0.K
Photon emission for (n,n*c)

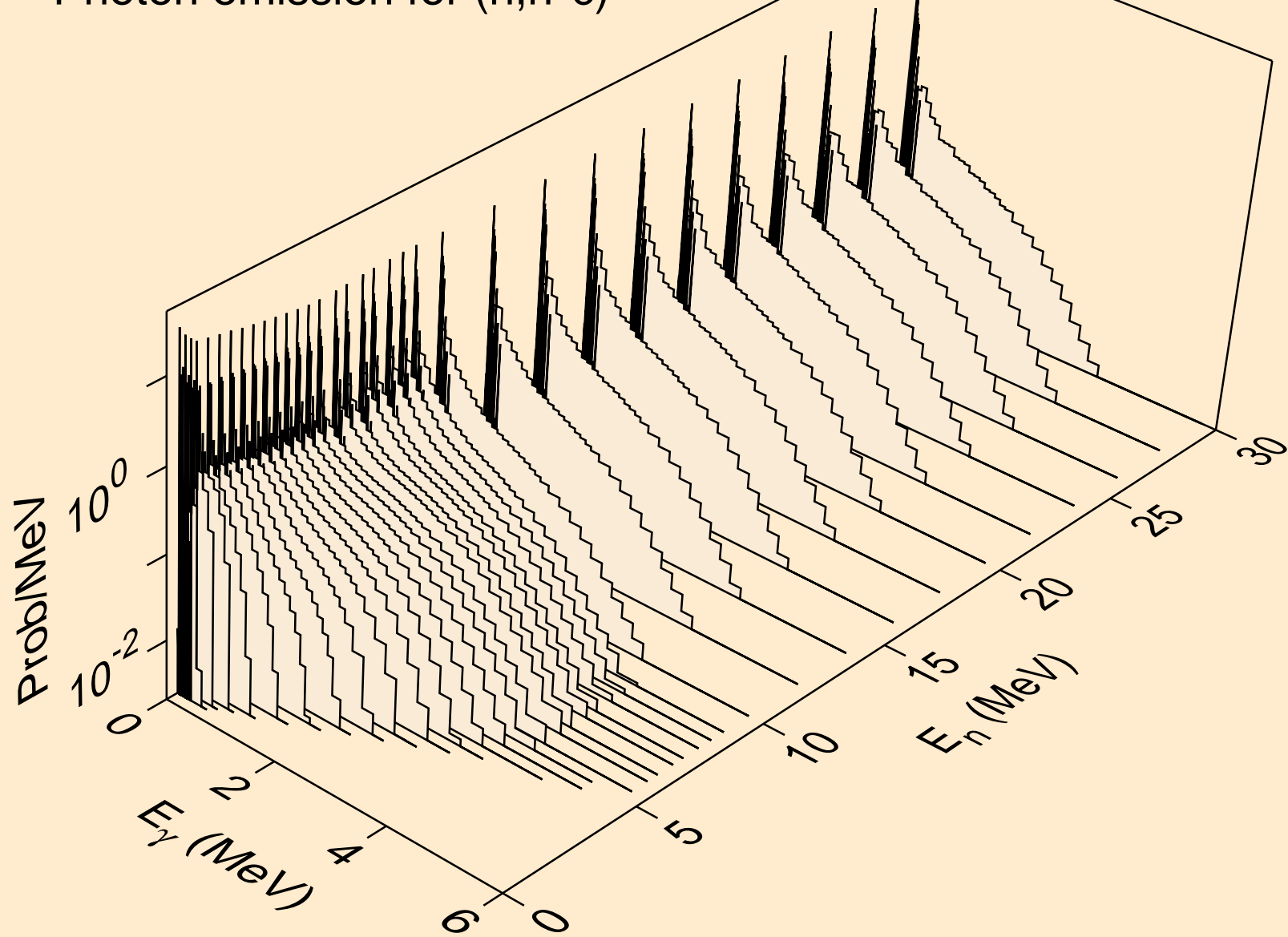

NP238 NEUTRON ACER TENDL-2023 LIBRARY; T=0.K
Photon emission for (n,gma)

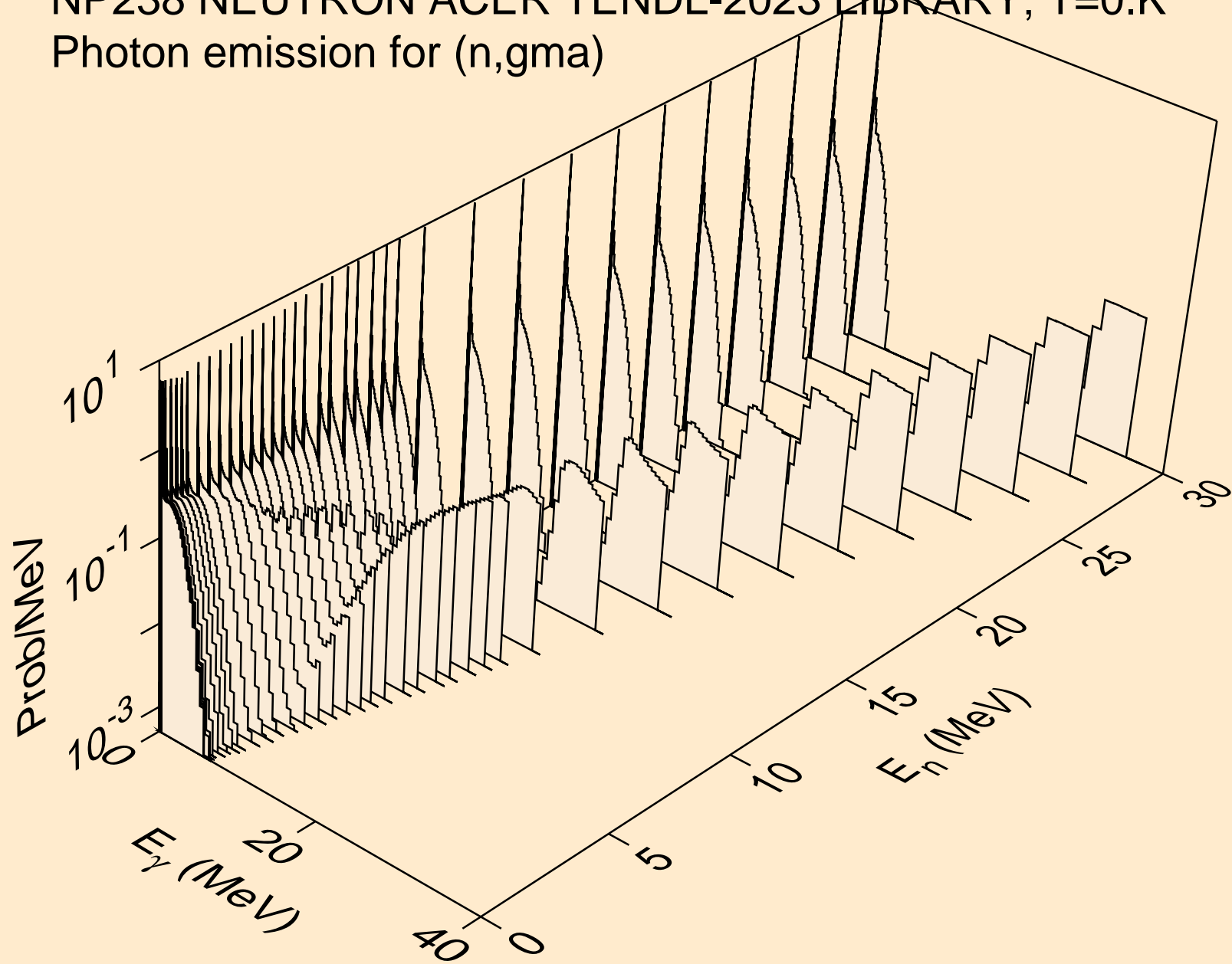

NP238 NEUTRON ACER TENDL-2023 LIBRARY; T=0.K
Photon emission for (n,p)

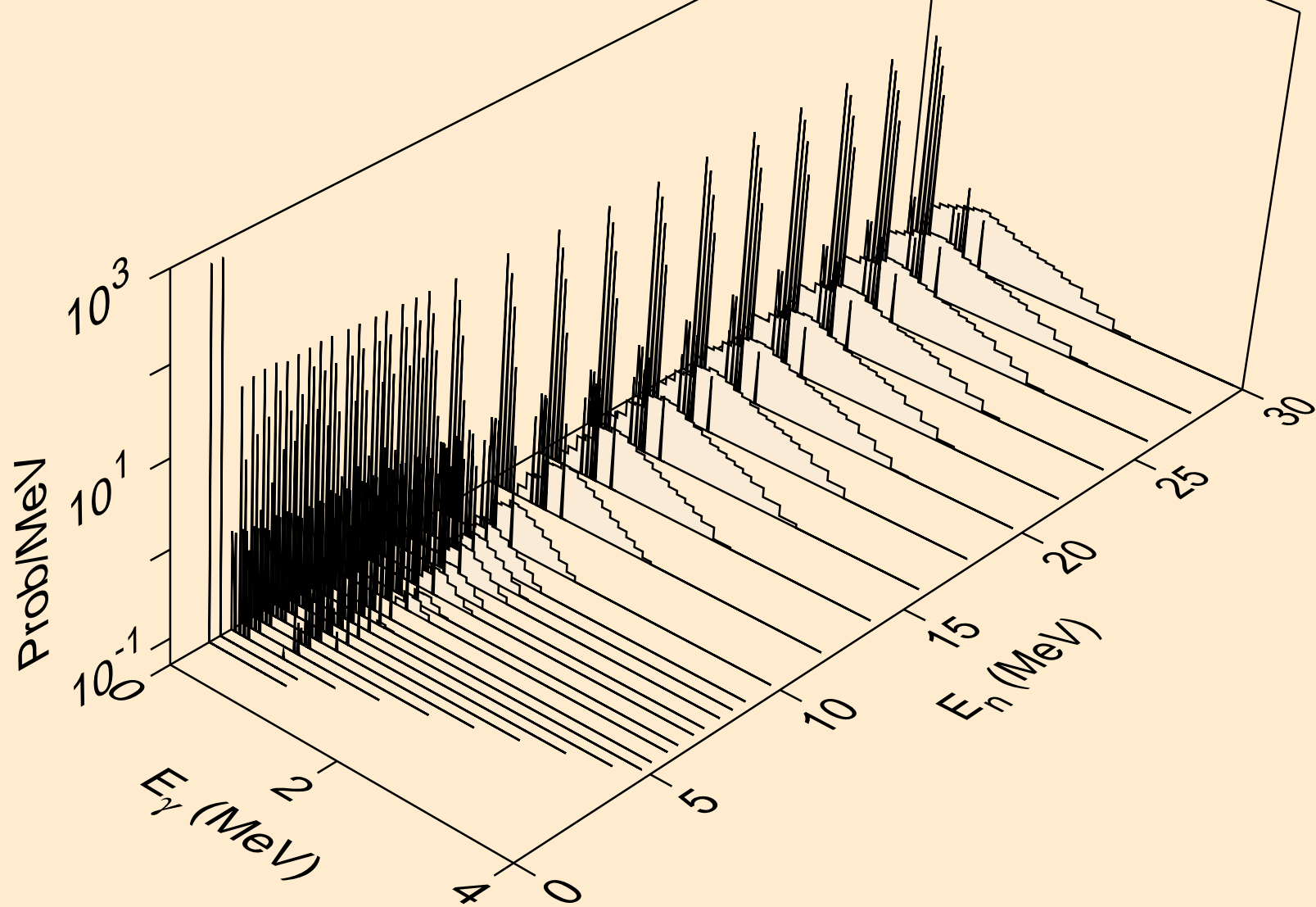

NP238 NEUTRON ACER TENDL-2023 LIBRARY; T=0.K
Photon emission for (n,d)

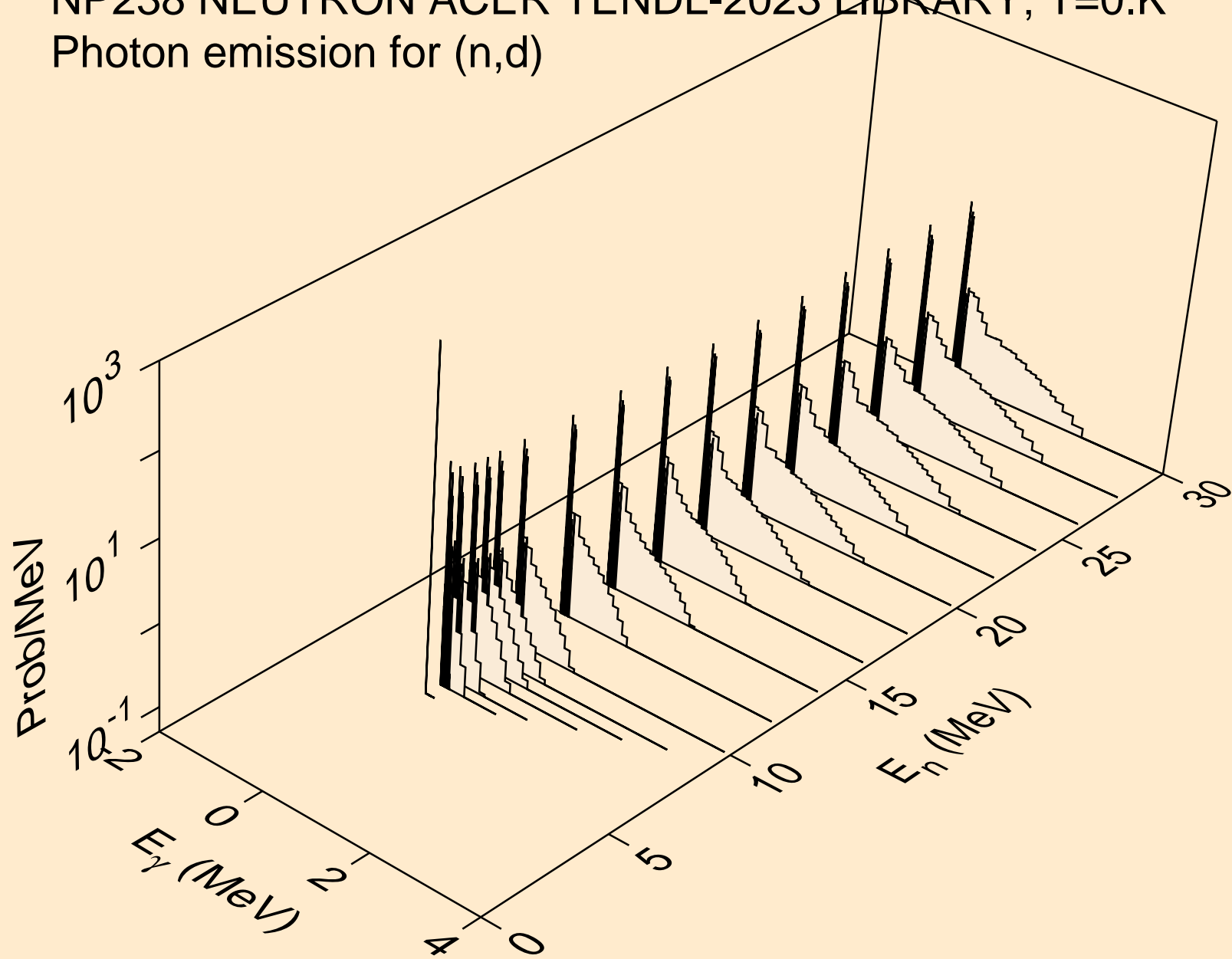

NP238 NEUTRON ACER TENDL-2023 LIBRARY; T=0.K
Photon emission for (n,t)

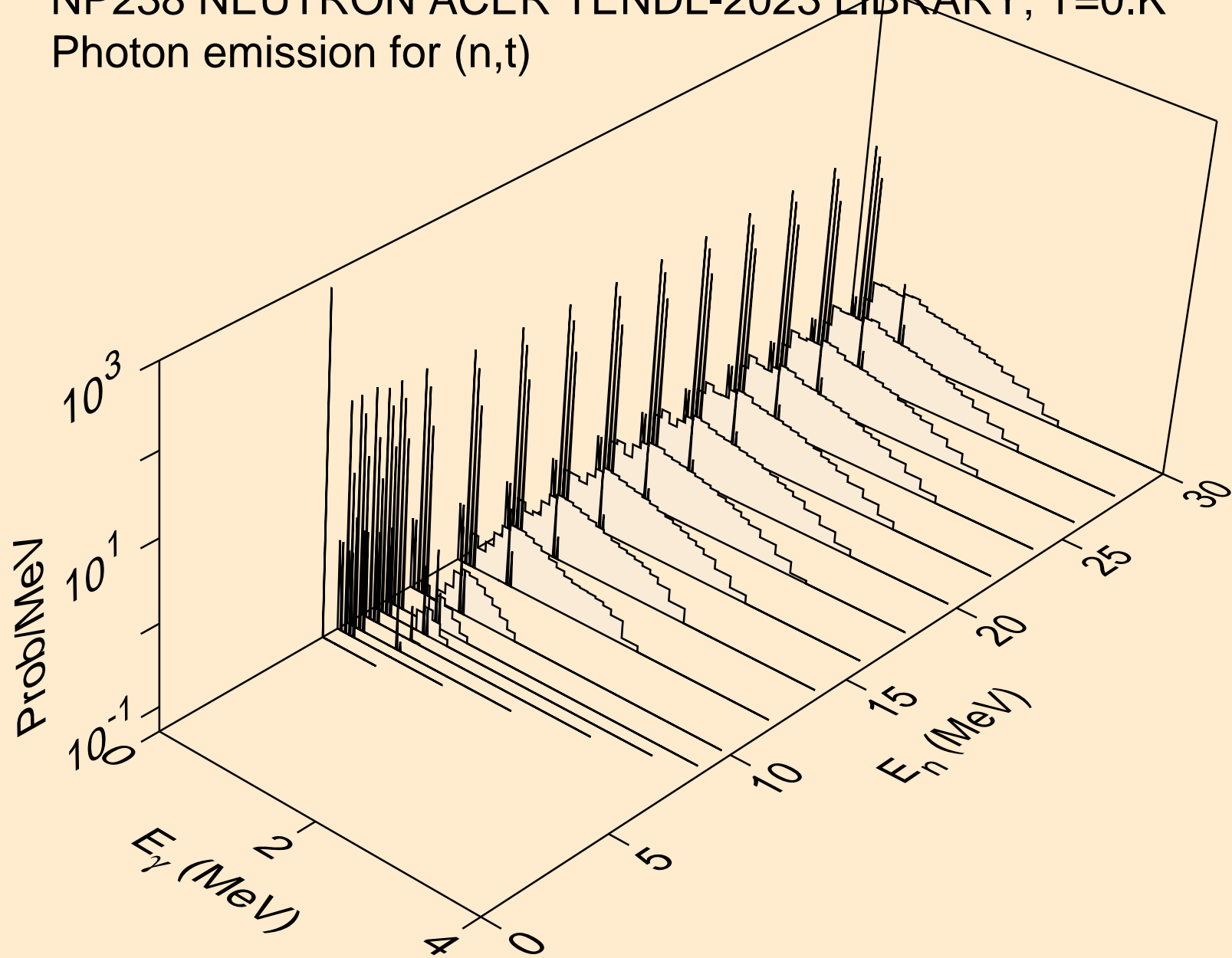

NP238 NEUTRON ACER TENDL-2023 LIBRARY; T=0.K
Photon emission for (n,he3)

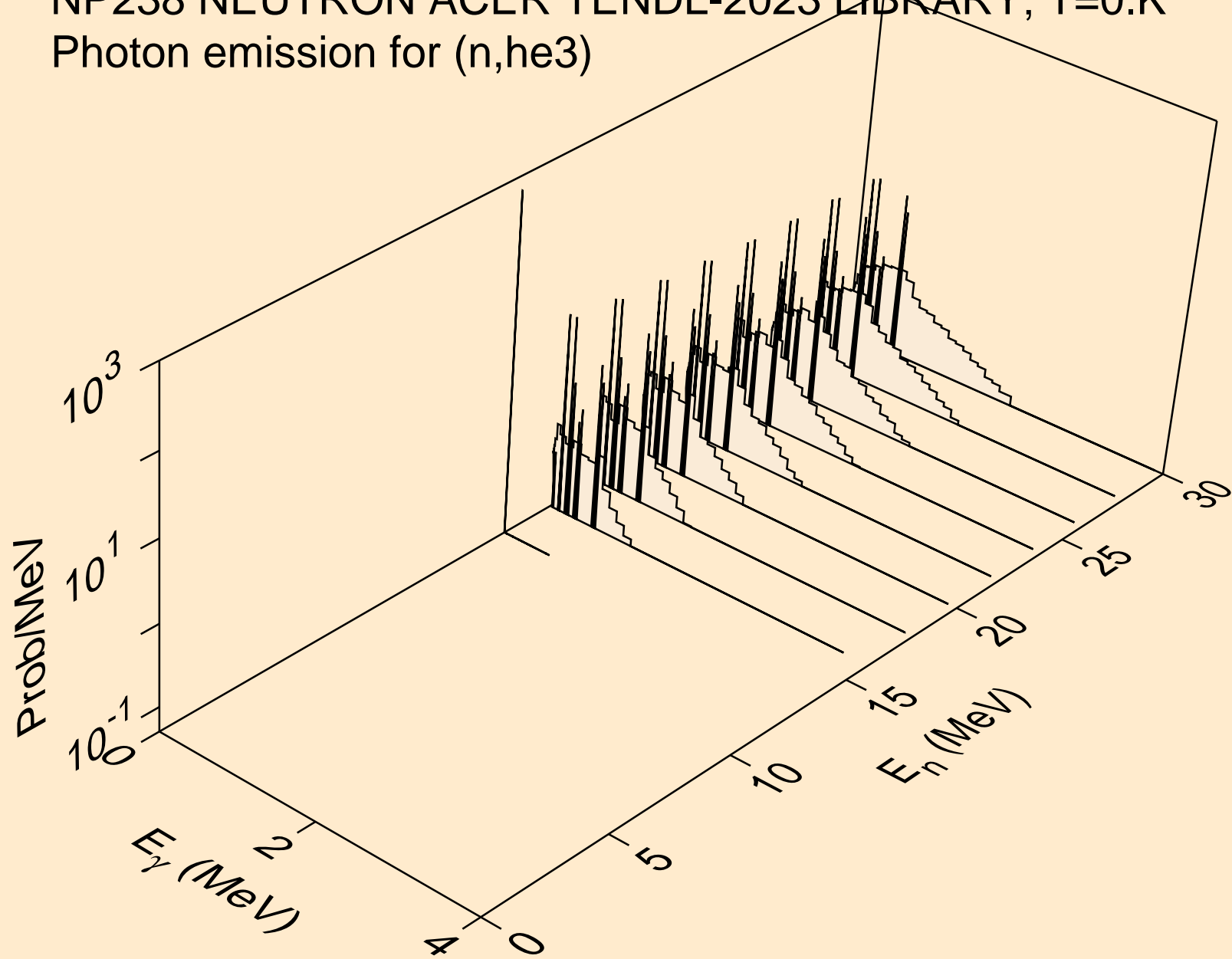

NP238 NEUTRON ACER TENDL-2023 LIBRARY; T=0.K
Photon emission for (n,a)

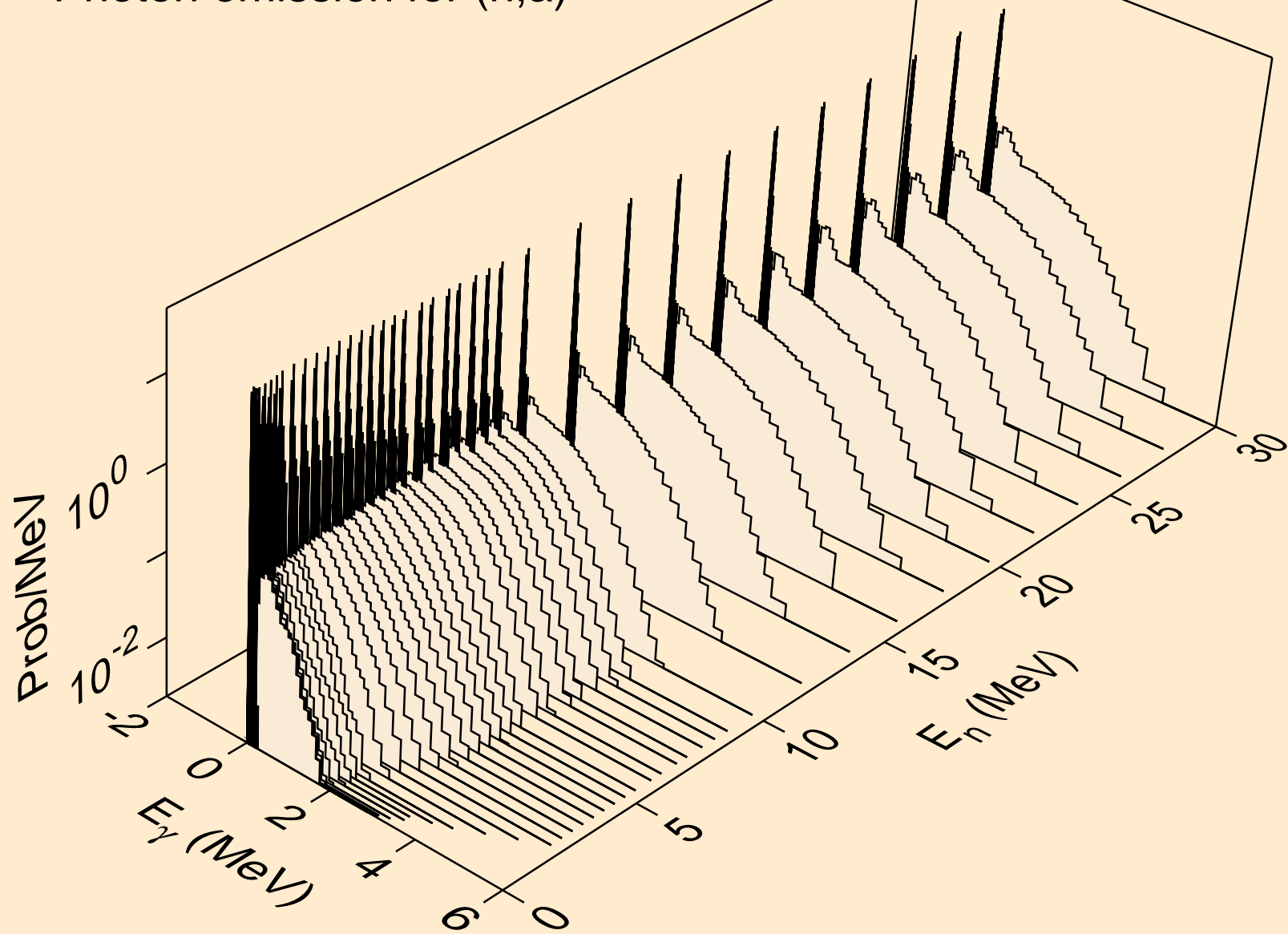

NP238 NEUTRON ACER TENDL-2023 LIBRARY; T=0.K
Photon emission for (n,2p)

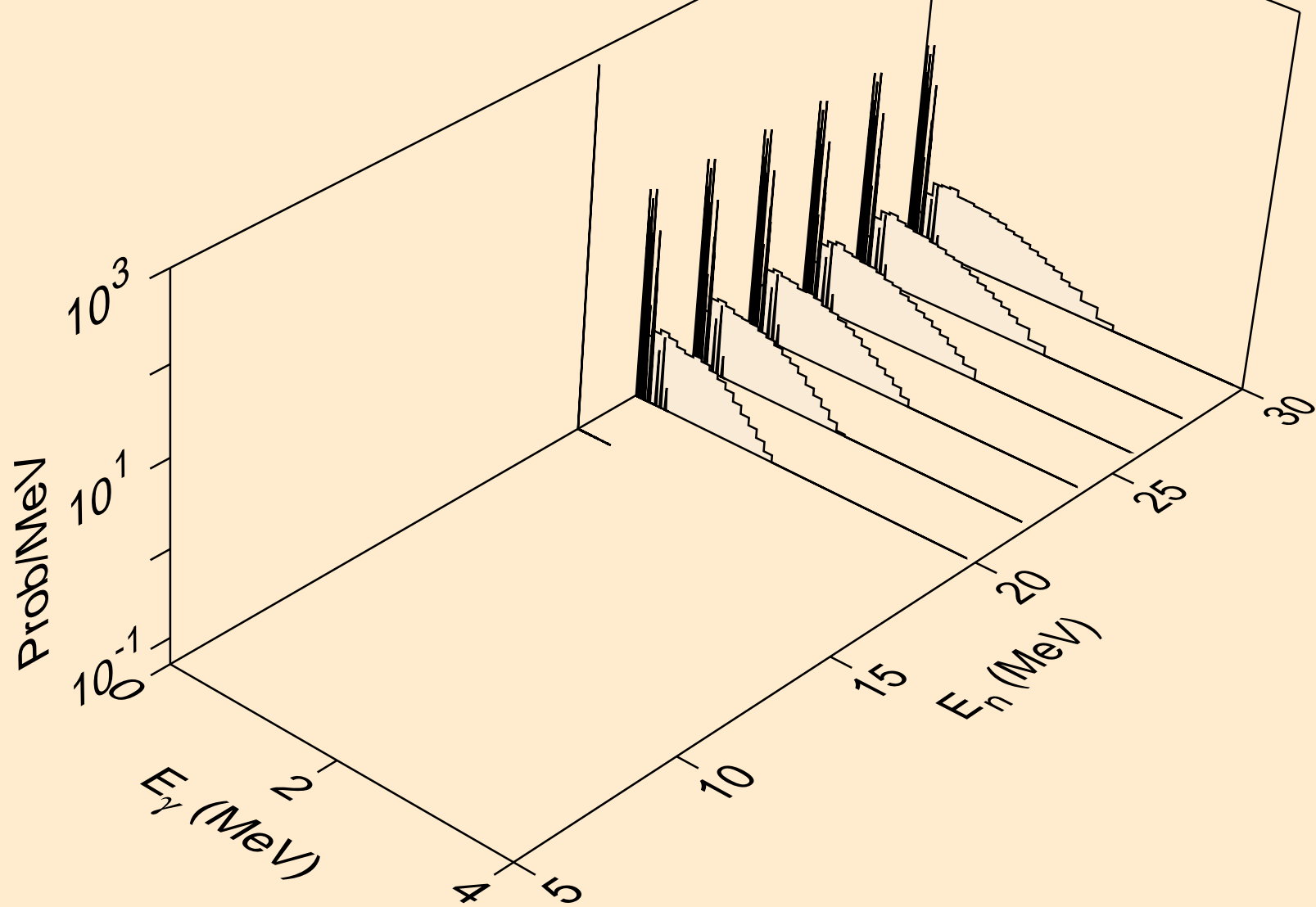

NP238 NEUTRON ACER TENDL-2023 LIBRARY; T=0.K
thermal capture photon spectrum

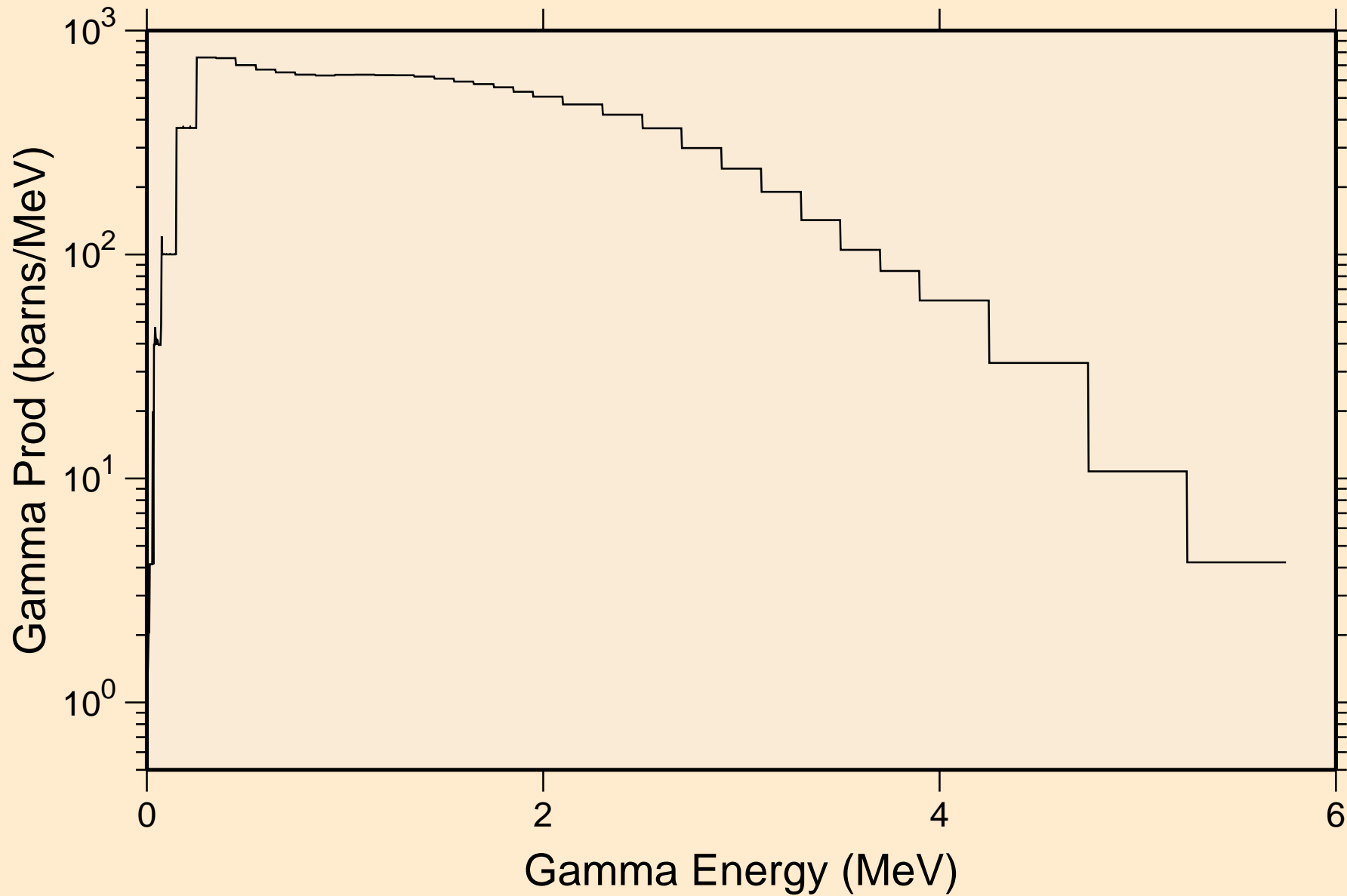

NP238 NEUTRON ACER TENDL-2023 LIBRARY; T=0.K
14 MeV photon spectrum

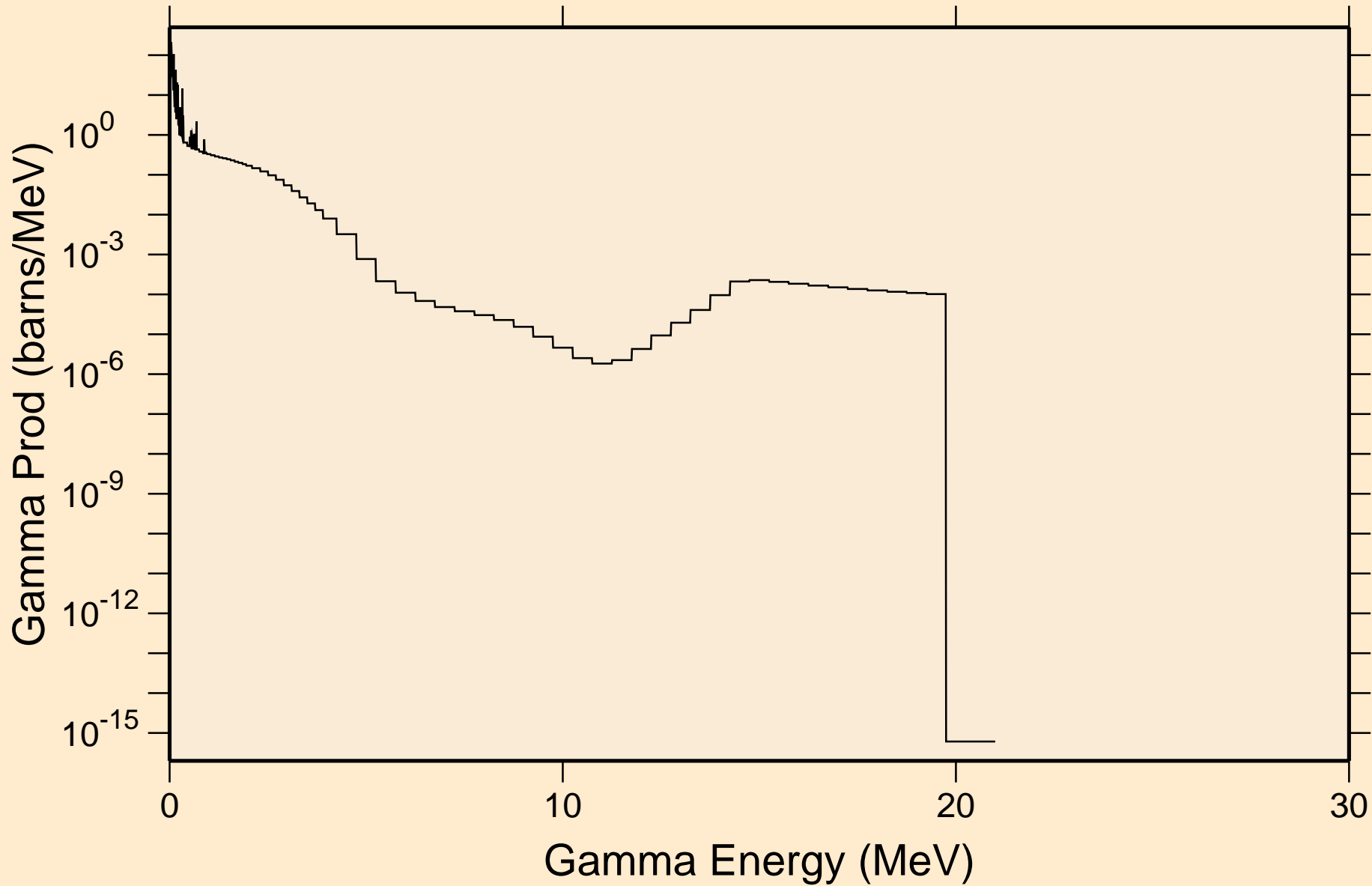

NP238 NEUTRON ACER TENDL-2023 LIBRARY; T=0.K

Particle heating contributions

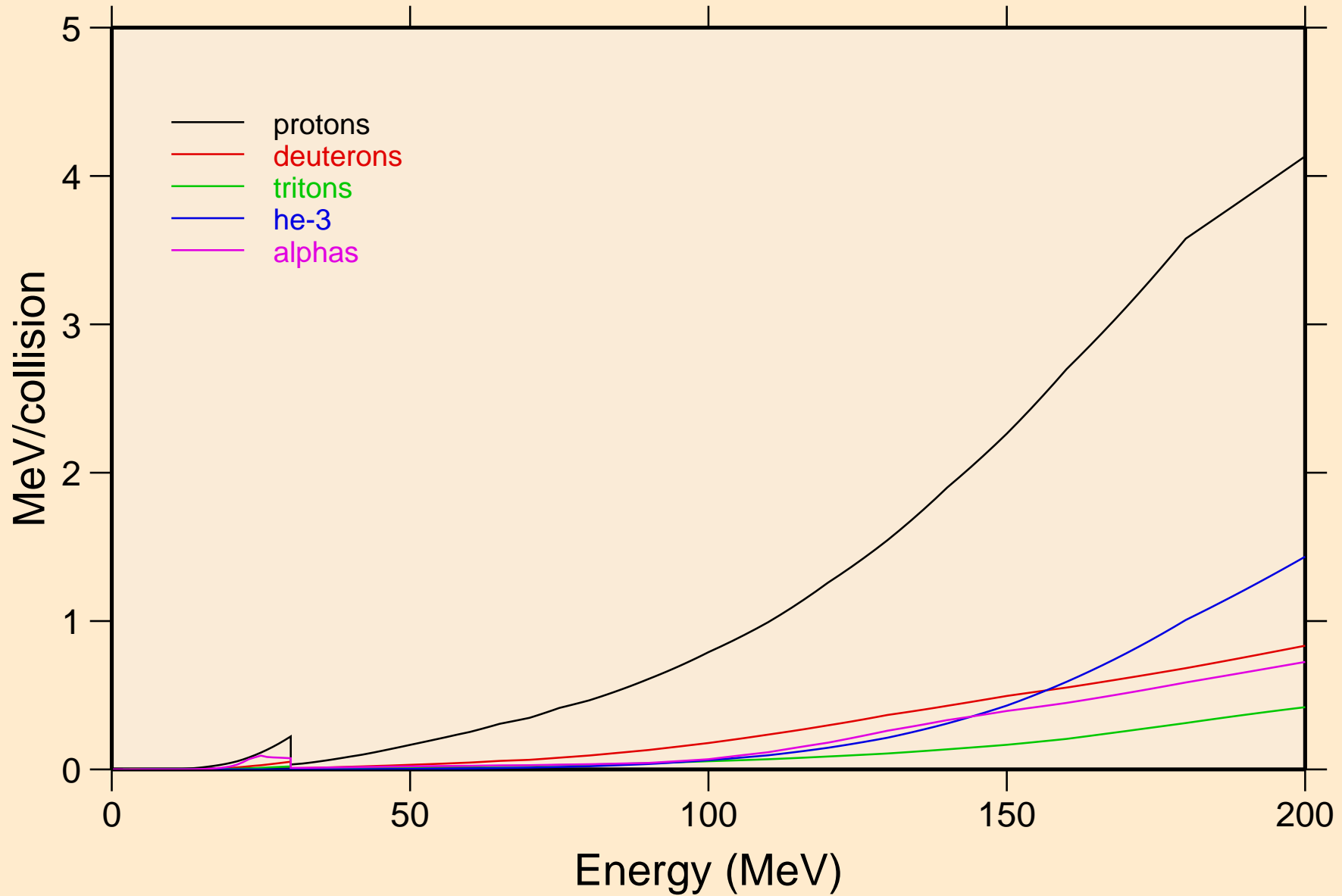

NP238 NEUTRON ACER TENDL-2023 LIBRARY; T=0.K
Recoil Heating

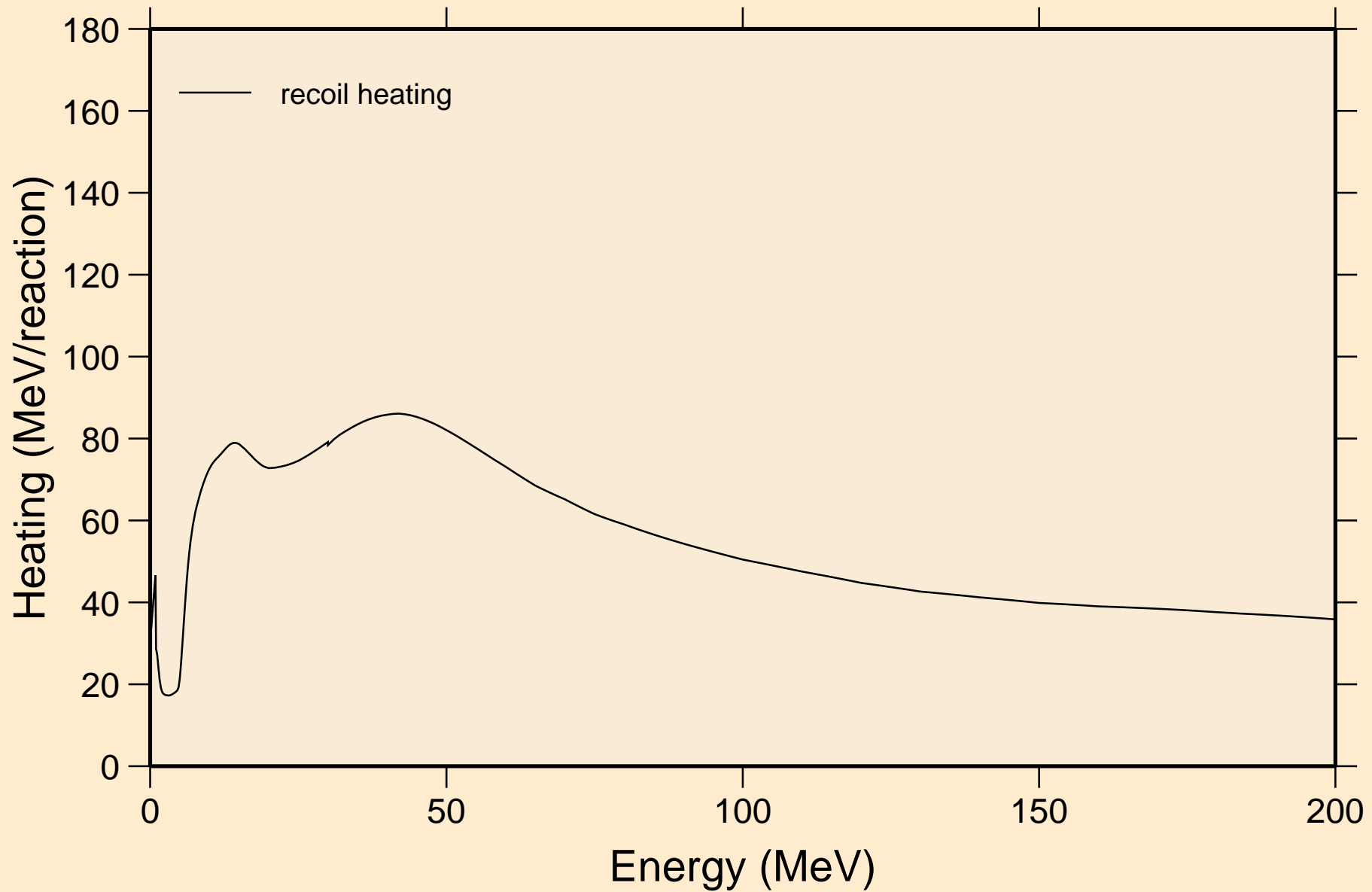

NP238 NEUTRON ACER TENDL-2023 LIBRARY; T=0.K

Particle production cross sections

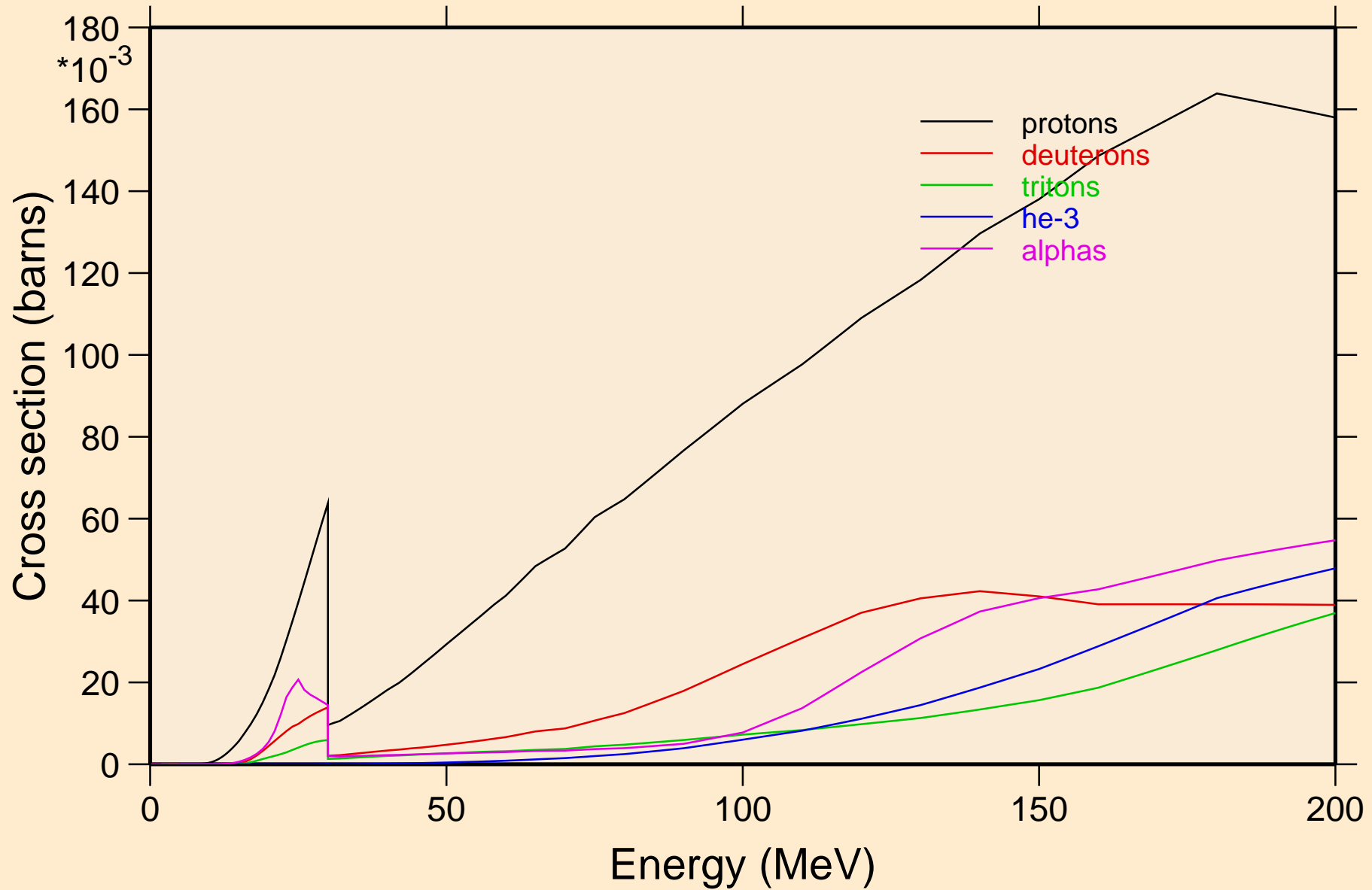

NP238 NEUTRON ACER TENDL-2023 LIBRARY; T=0.K
protons from (n,x)

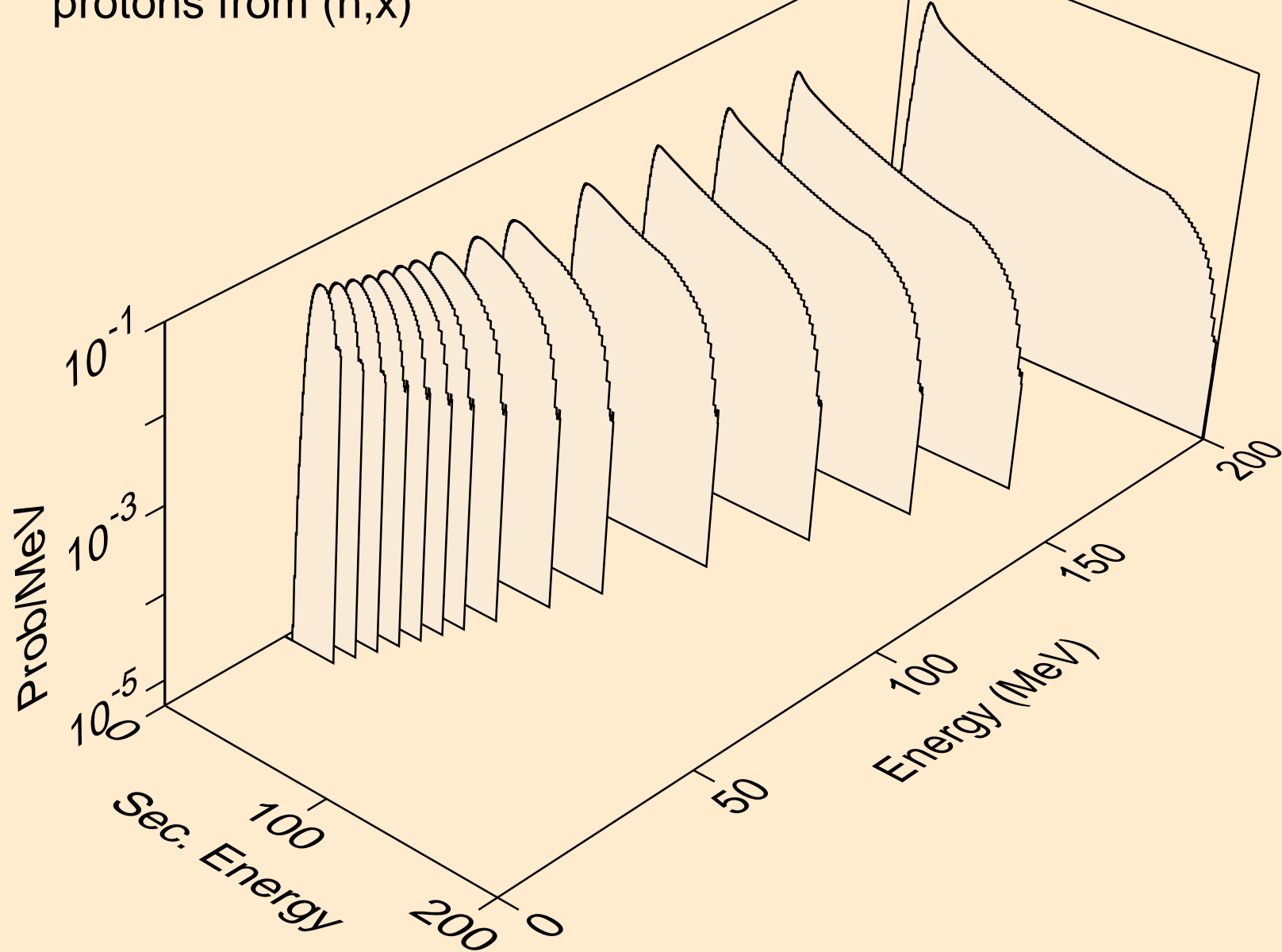

NP238 NEUTRON ACER TENDL-2023 LIBRARY; T=0.K
protons from (n,n*)p

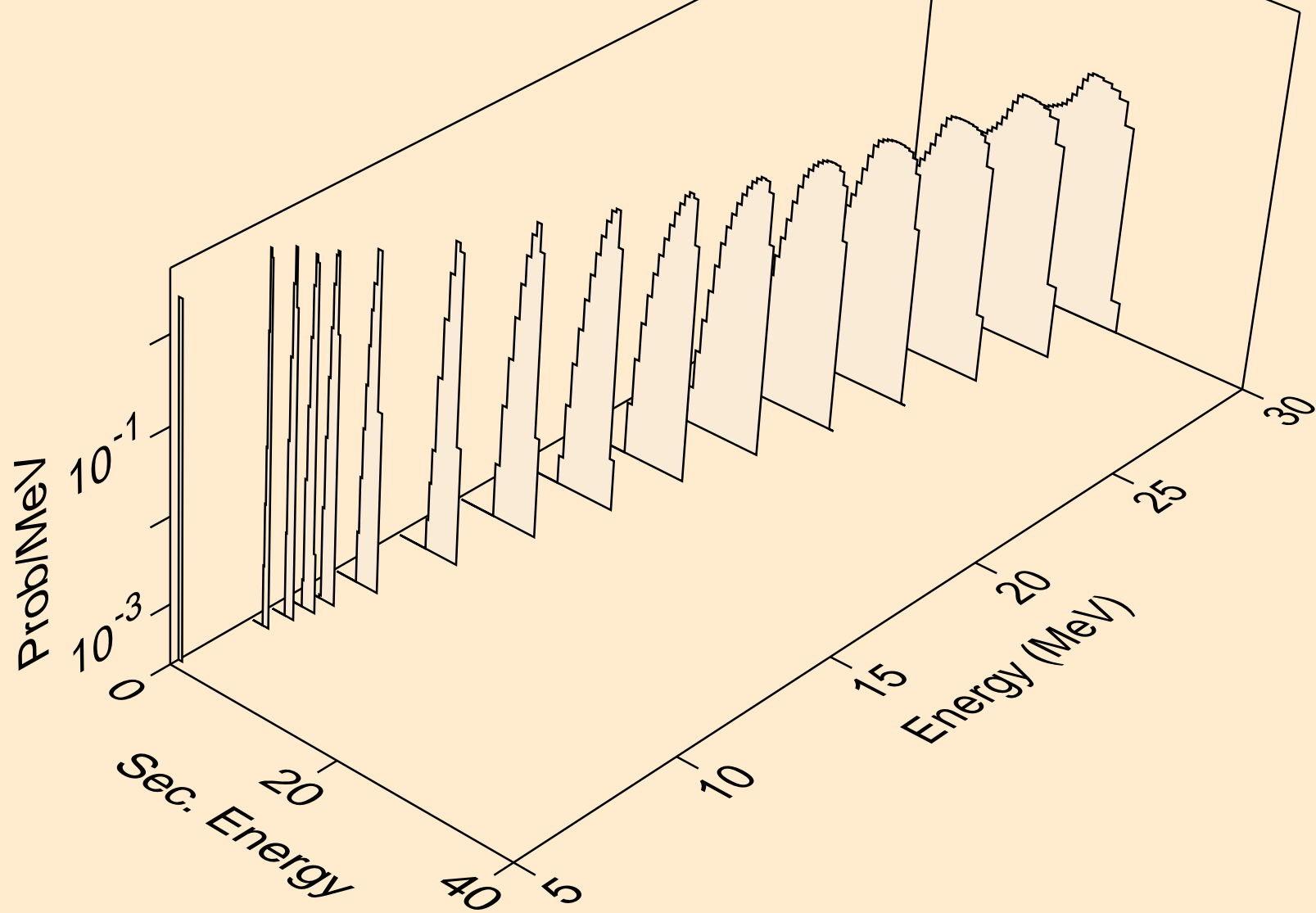

NP238 NEUTRON ACER TENDL-2023 LIBRARY; T=0.K
protons from (n,2np)

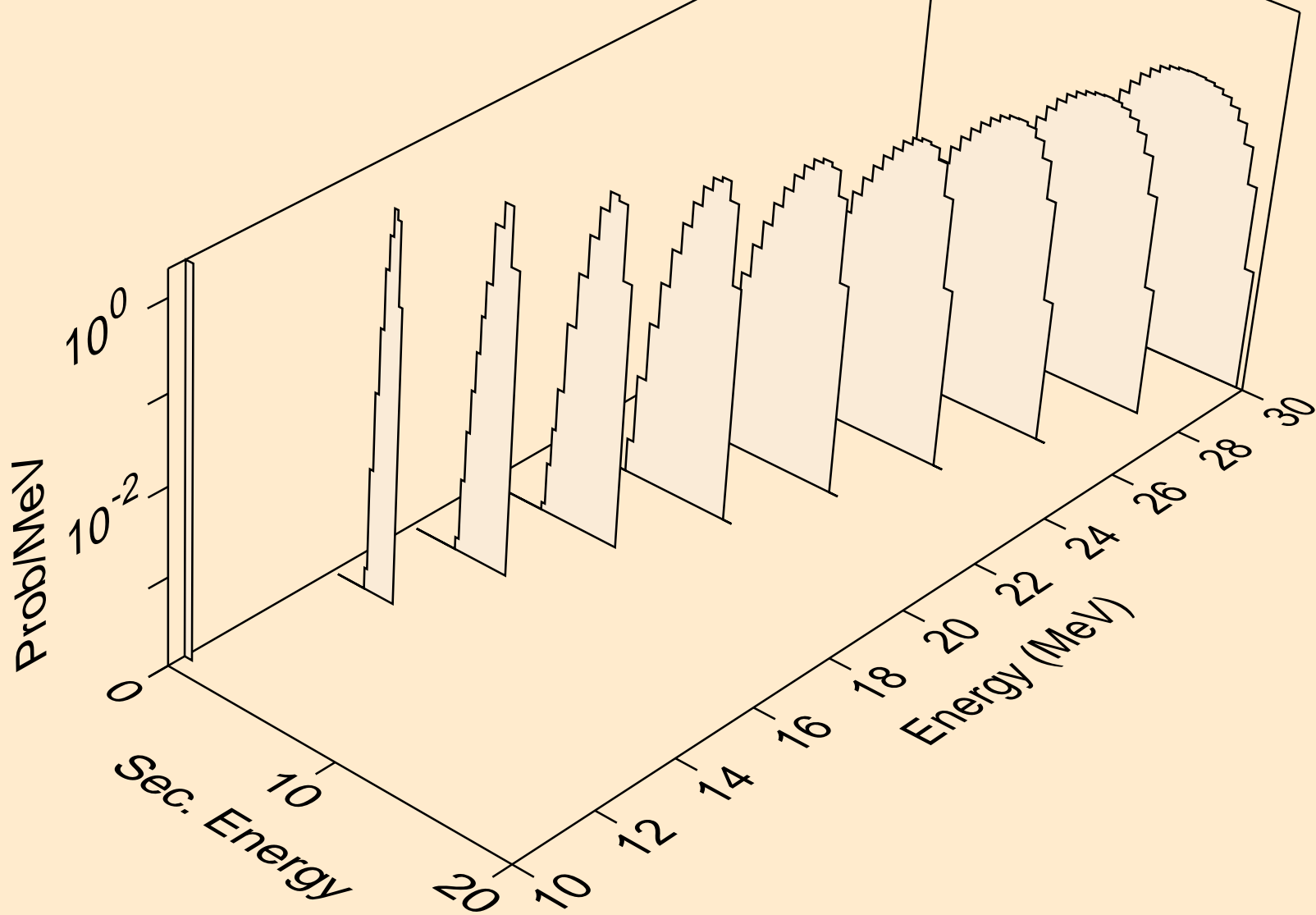

NP238 NEUTRON ACER TENDL-2023 LIBRARY; T=0.K
protons from (n,3np)

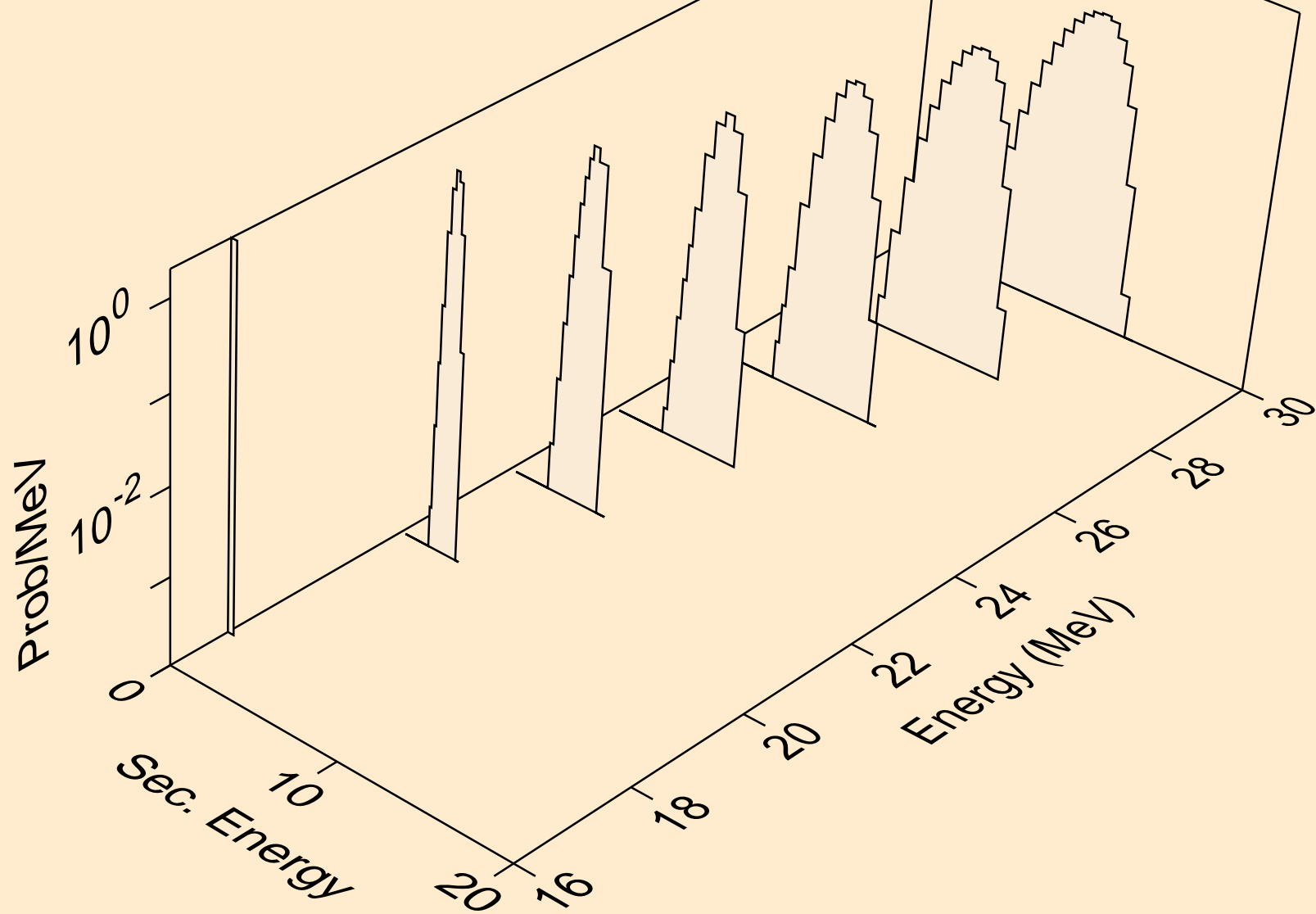

NP238 NEUTRON ACER TENDL-2023 LIBRARY; T=0.K
protons from (n,n2p)

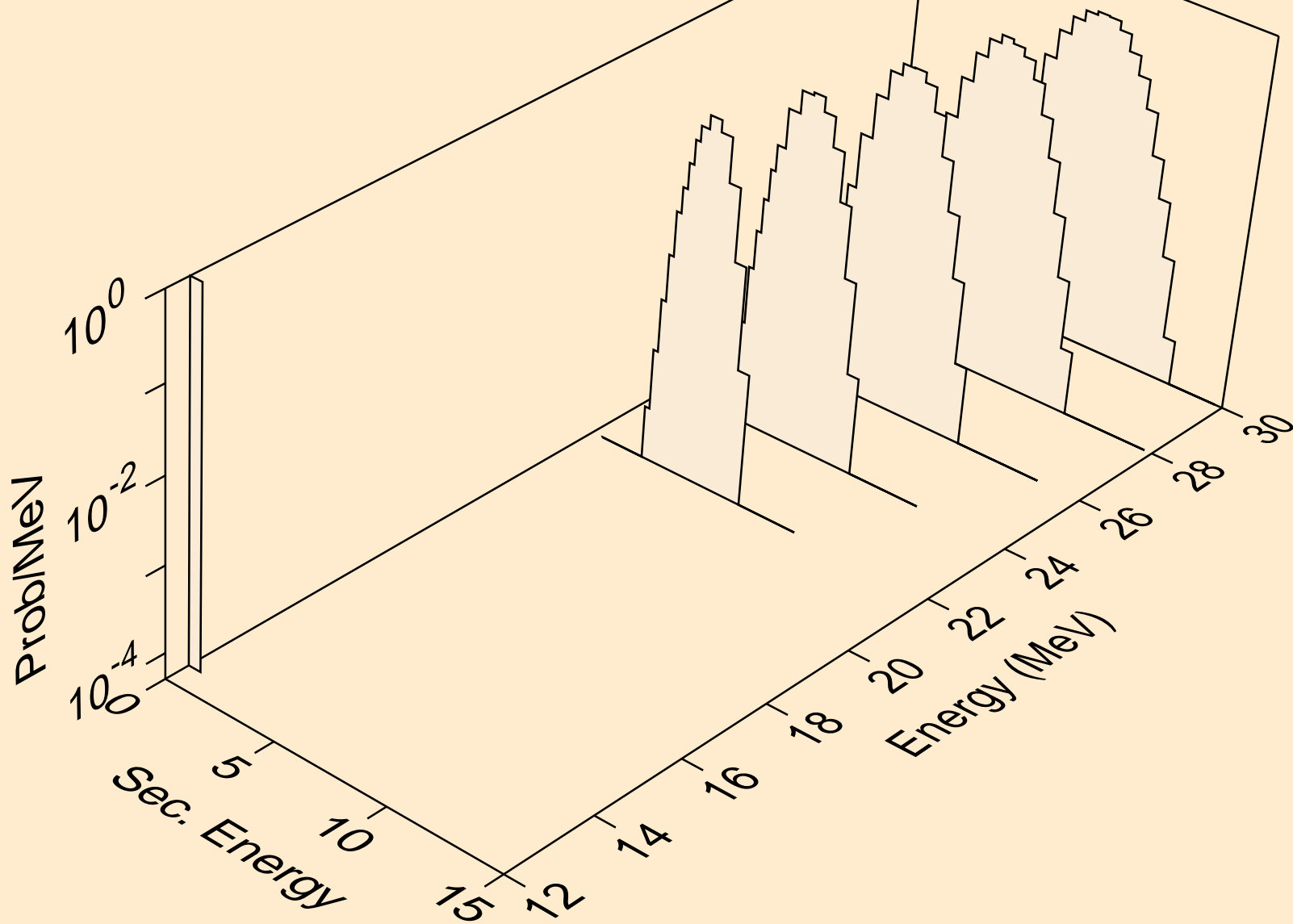

NP238 NEUTRON ACER TENDL-2023 LIBRARY; T=0.K
protons from (n,p)

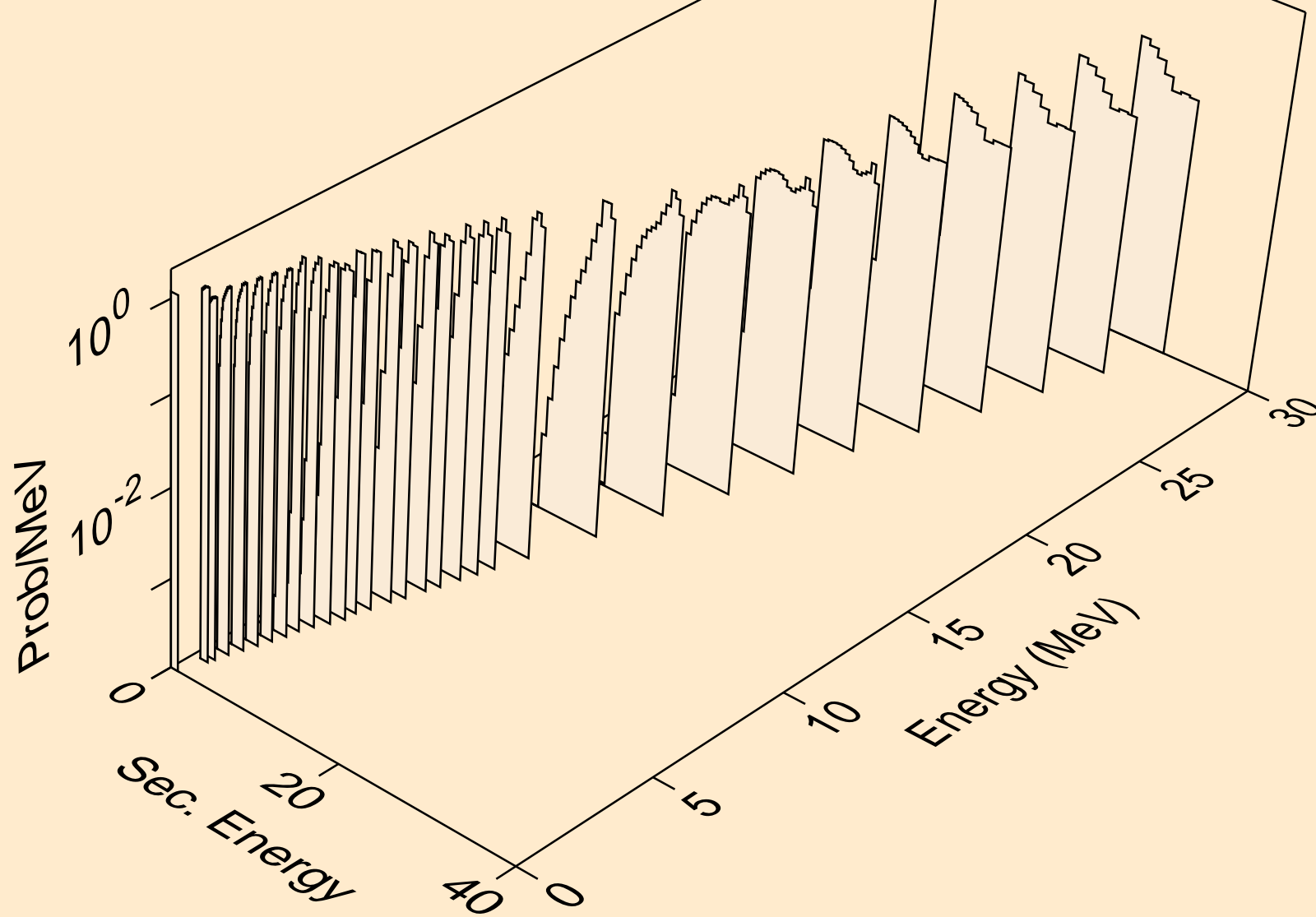

NP238 NEUTRON ACER TENDL-2023 LIBRARY; T=0.K
protons from (n,2p)

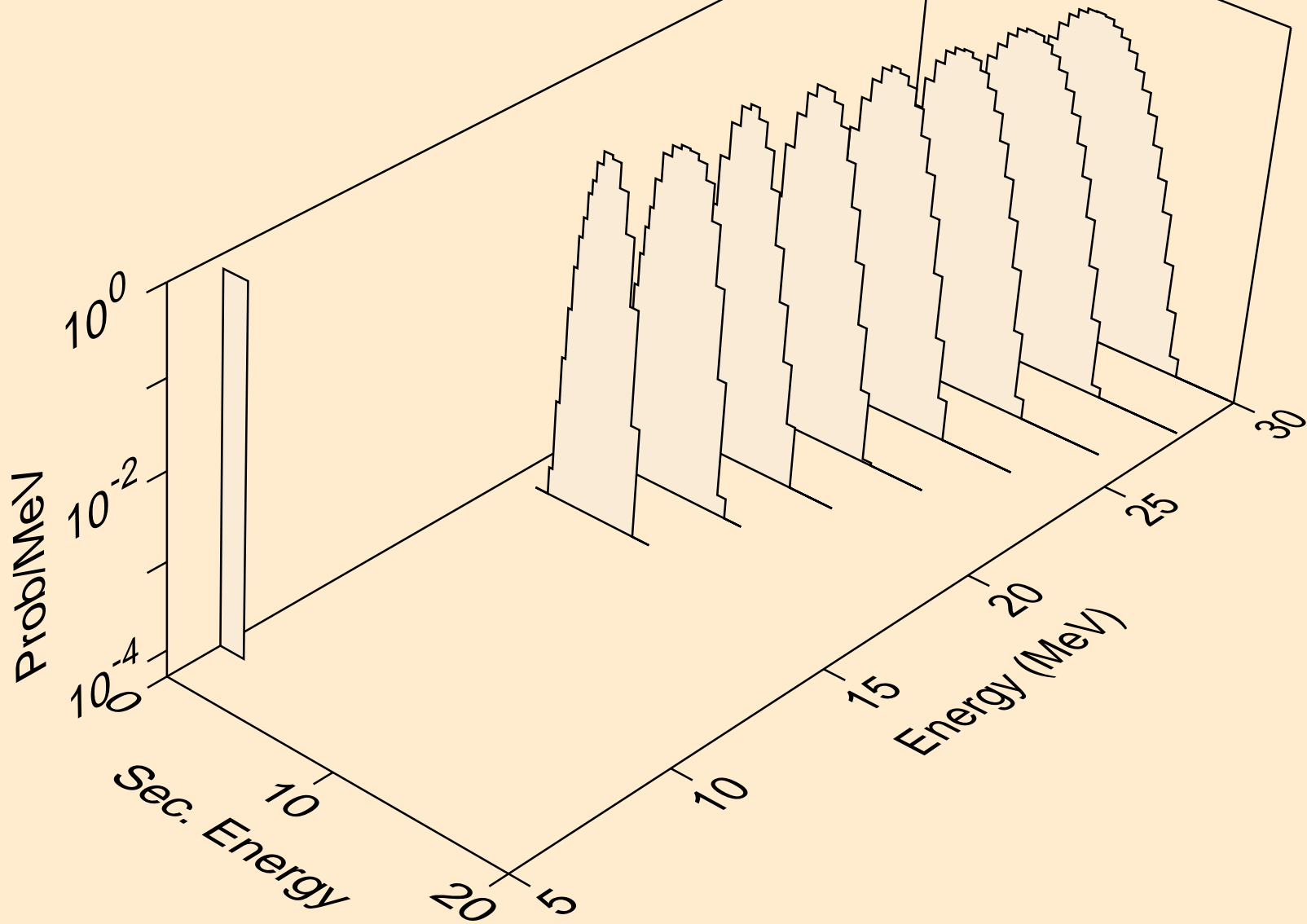

NP238 NEUTRON ACER TENDL-2023 LIBRARY; T=0.K
deuterons from (n,x)

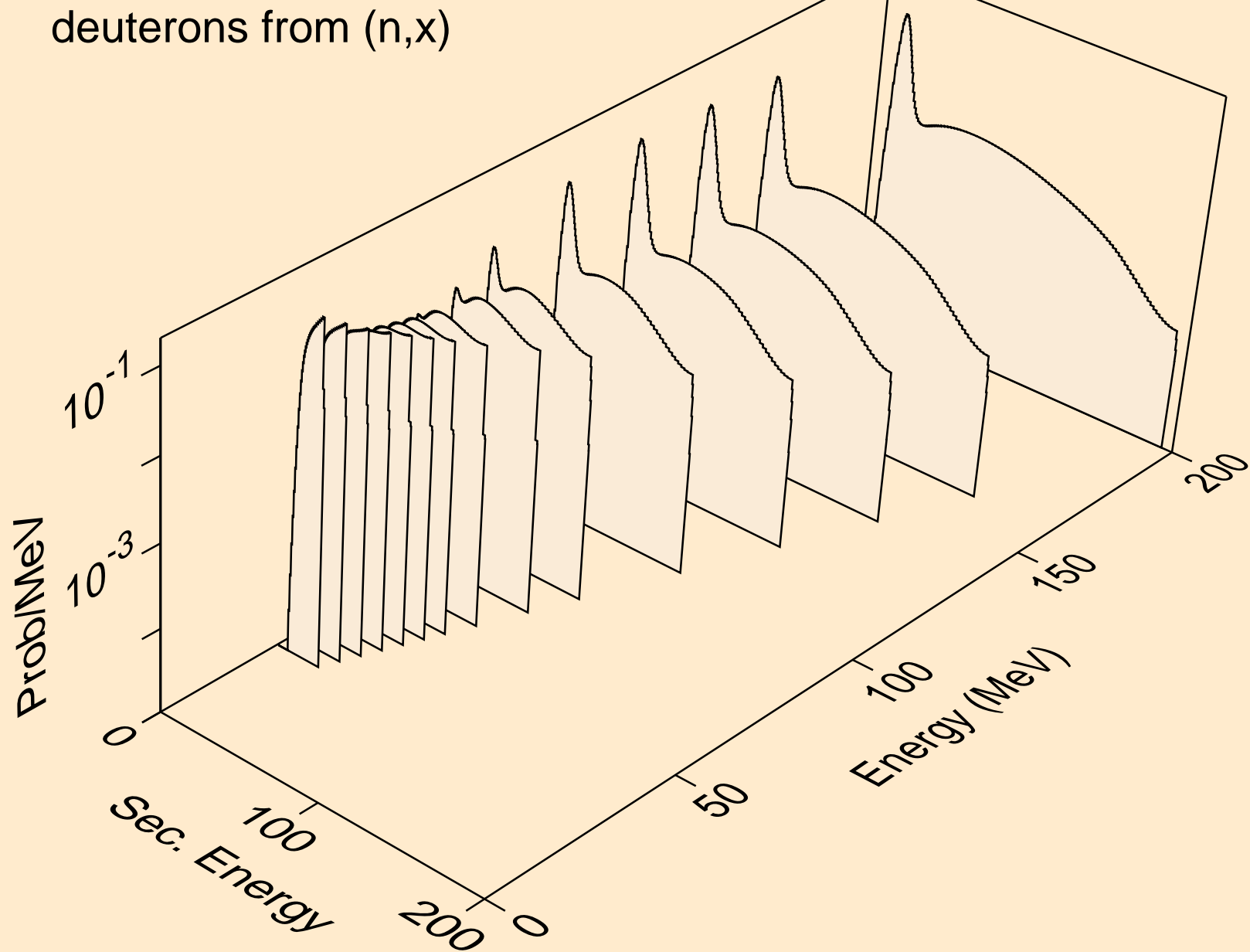

NP238 NEUTRON ACER TENDL-2023 LIBRARY; T=0.K
deuterons from (n,2nd)

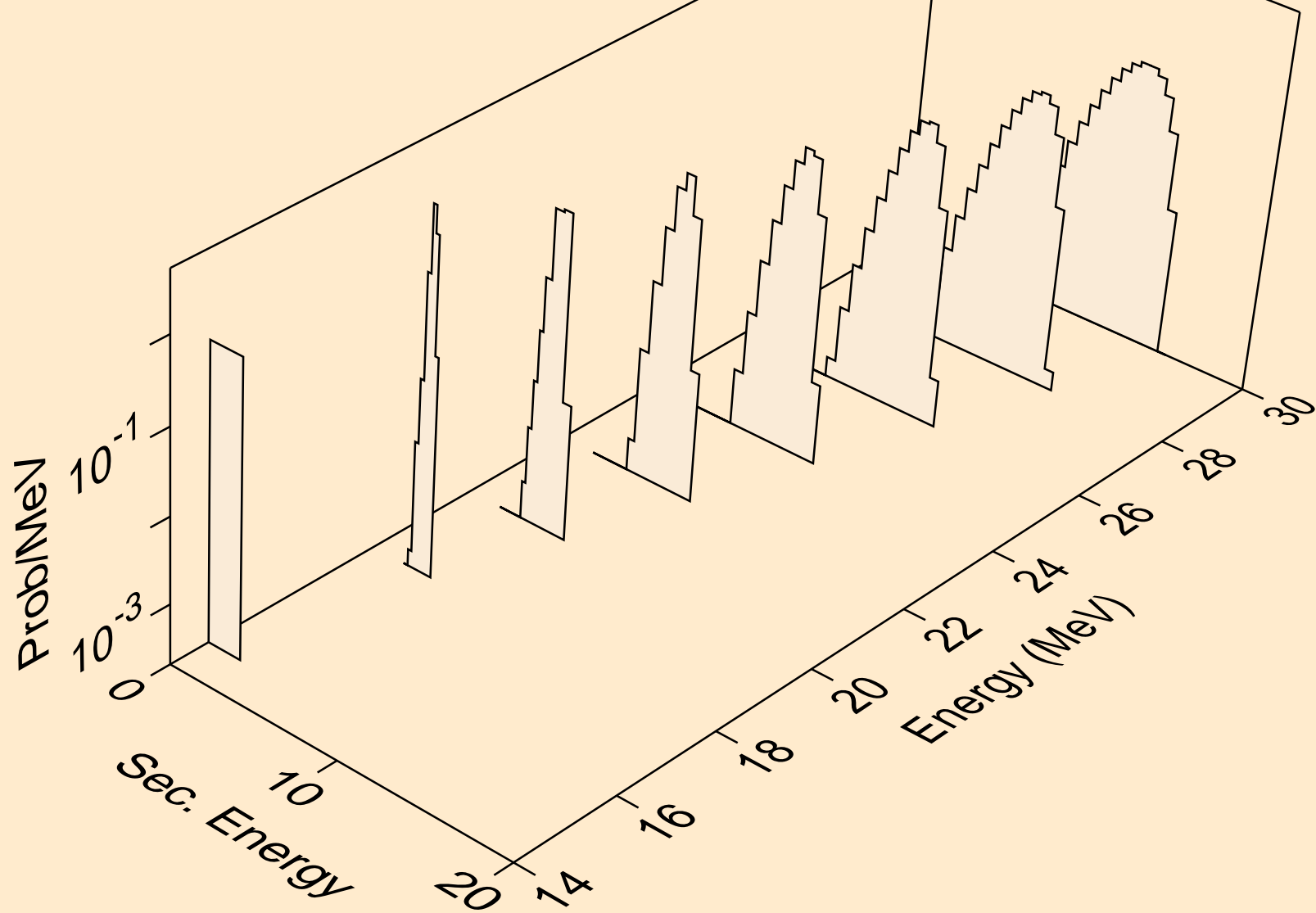

NP238 NEUTRON ACER TENDL-2023 LIBRARY; T=0.K
deuterons from (n,n*)d

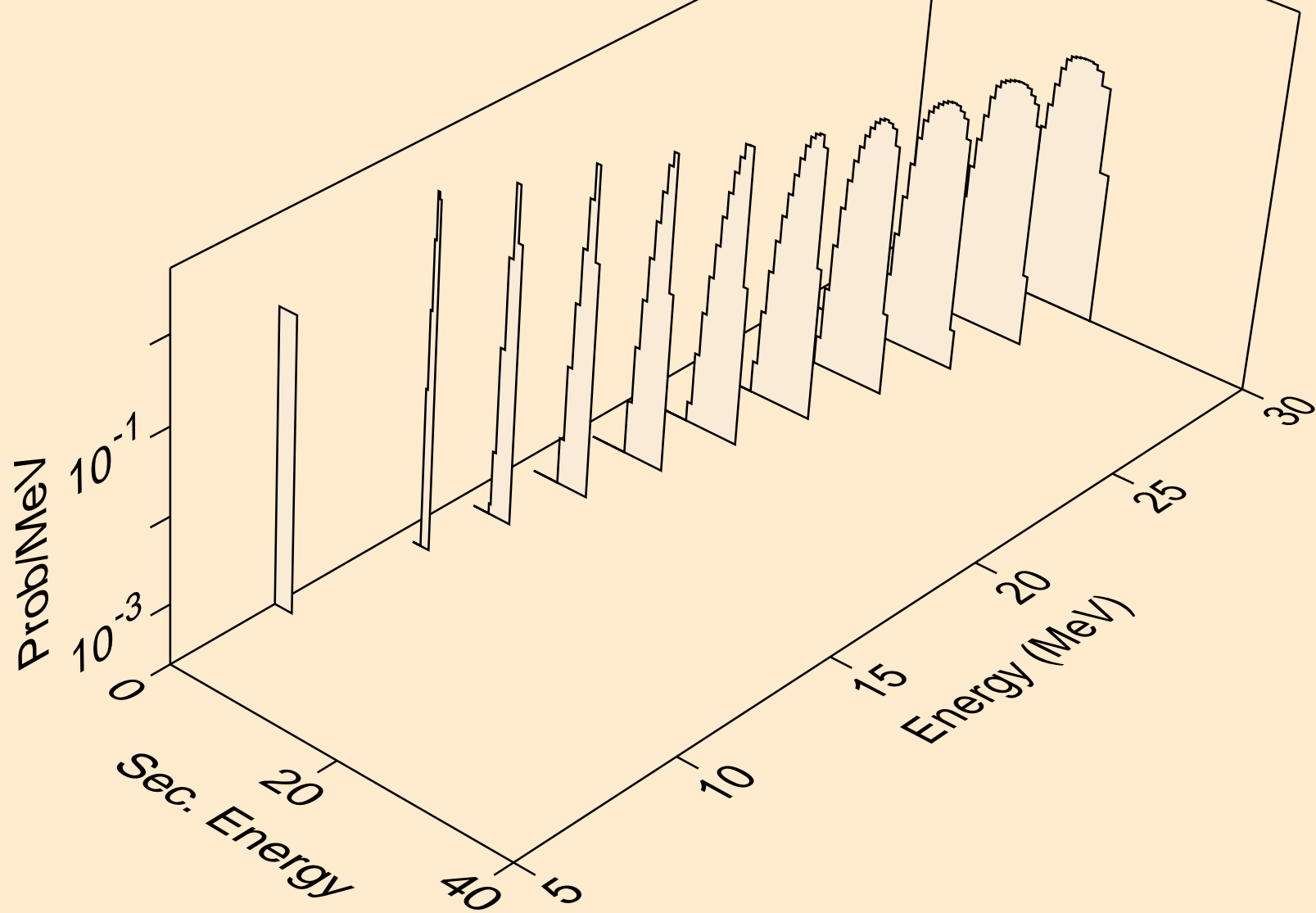

NP238 NEUTRON ACER TENDL-2023 LIBRARY; T=0.K
deuterons from (n,d)

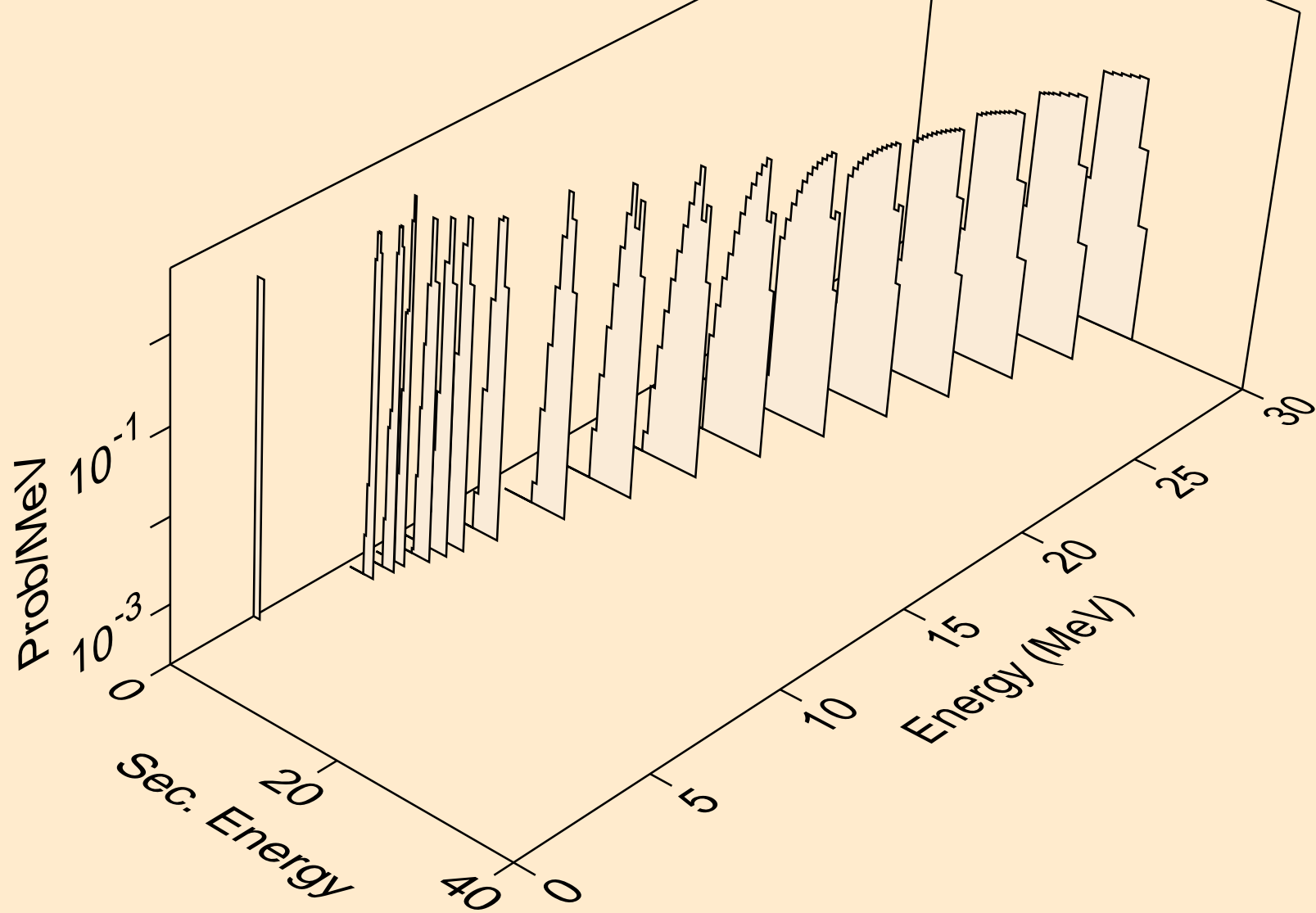

NP238 NEUTRON ACER TENDL-2023 LIBRARY; T=0.K
tritons from (n,x)

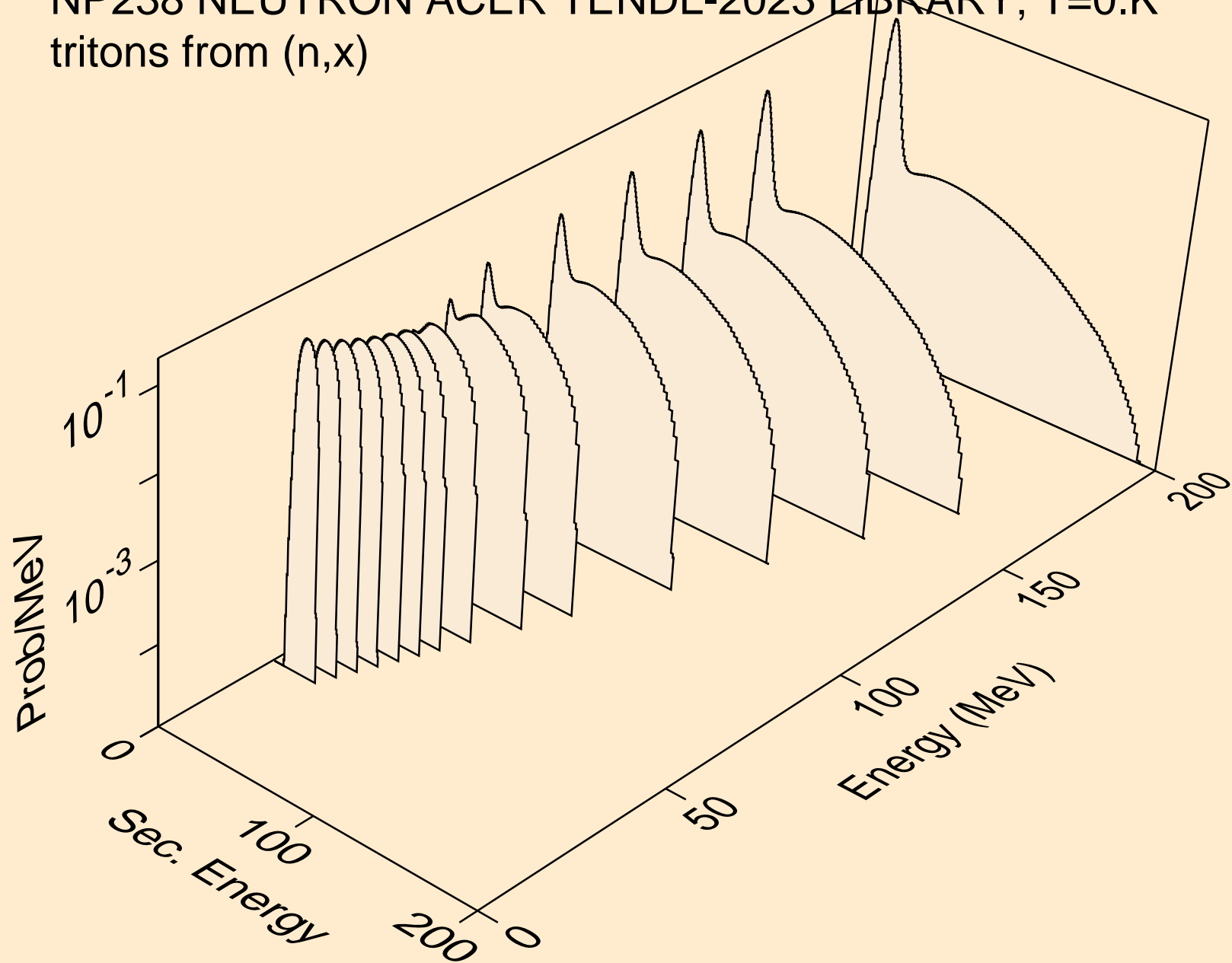

NP238 NEUTRON ACER TENDL-2023 LIBRARY; T=0.K
tritons from (n,n*)t

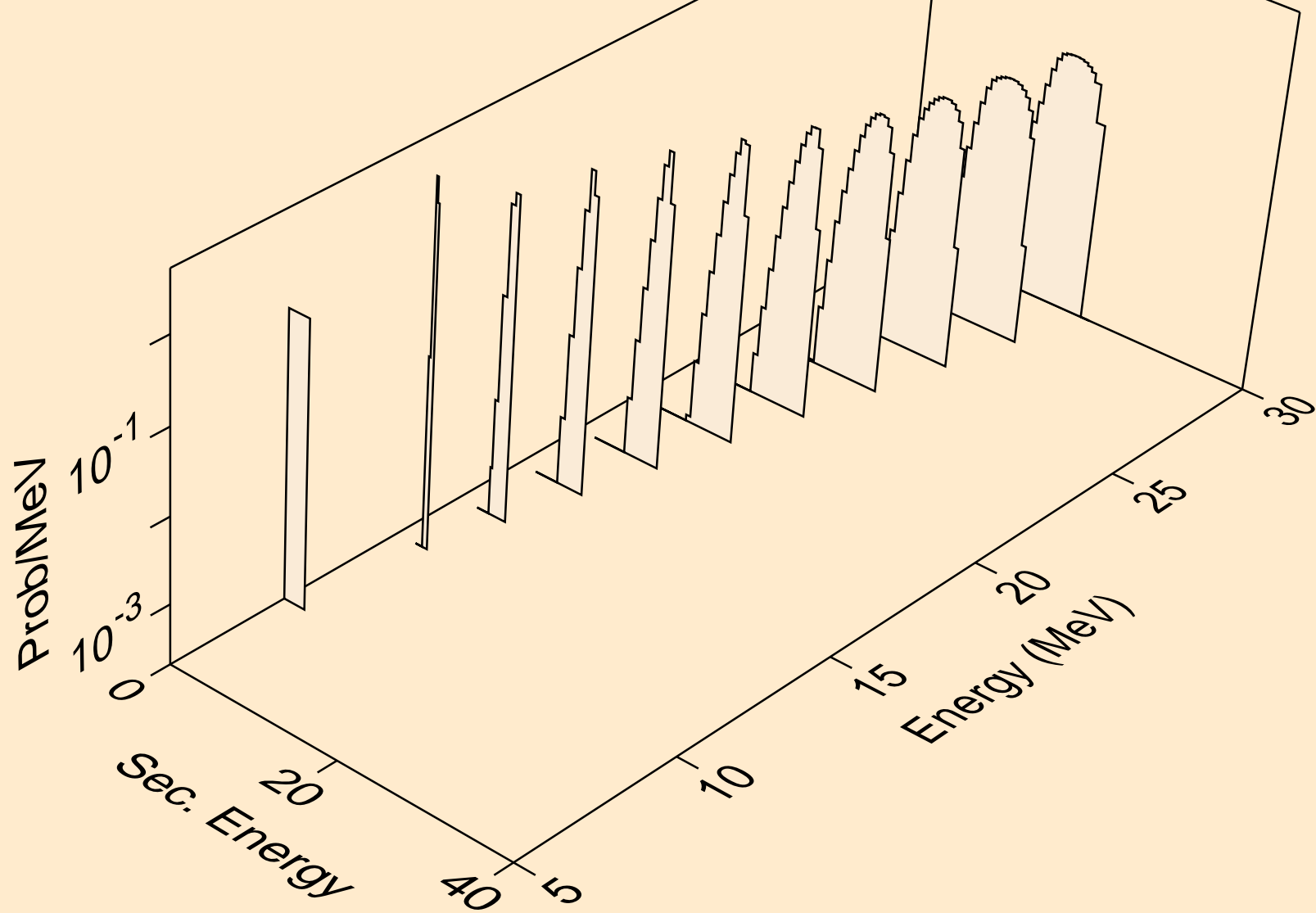

NP238 NEUTRON ACER TENDL-2023 LIBRARY; T=0.K
tritons from (n,t)

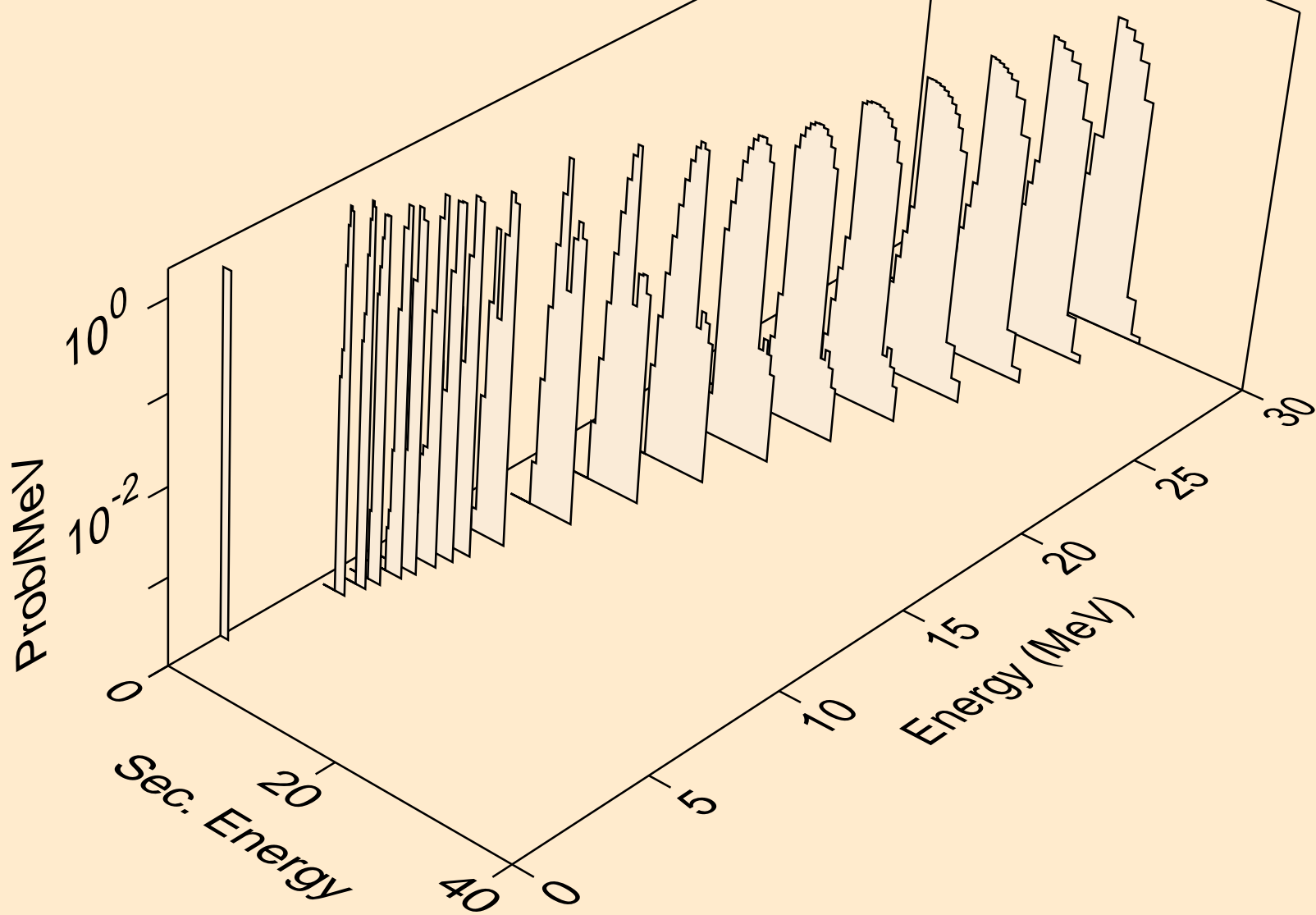

NP238 NEUTRON ACER TENDL-2023 LIBRARY; T=0.K
he3s from (n,x)

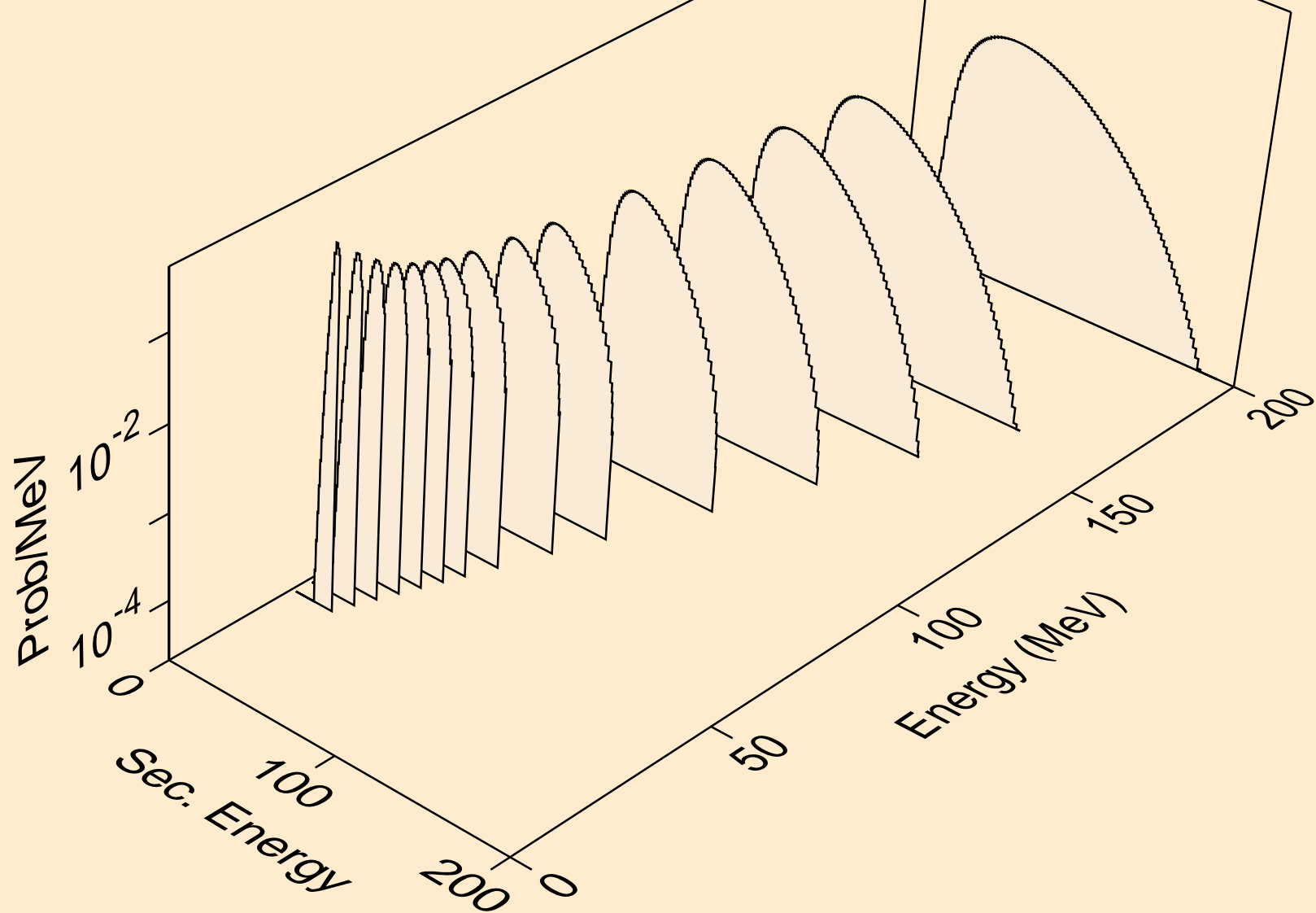

NP238 NEUTRON ACER TENDL-2023 LIBRARY; T=0.K
he3s from (n,n*)he3

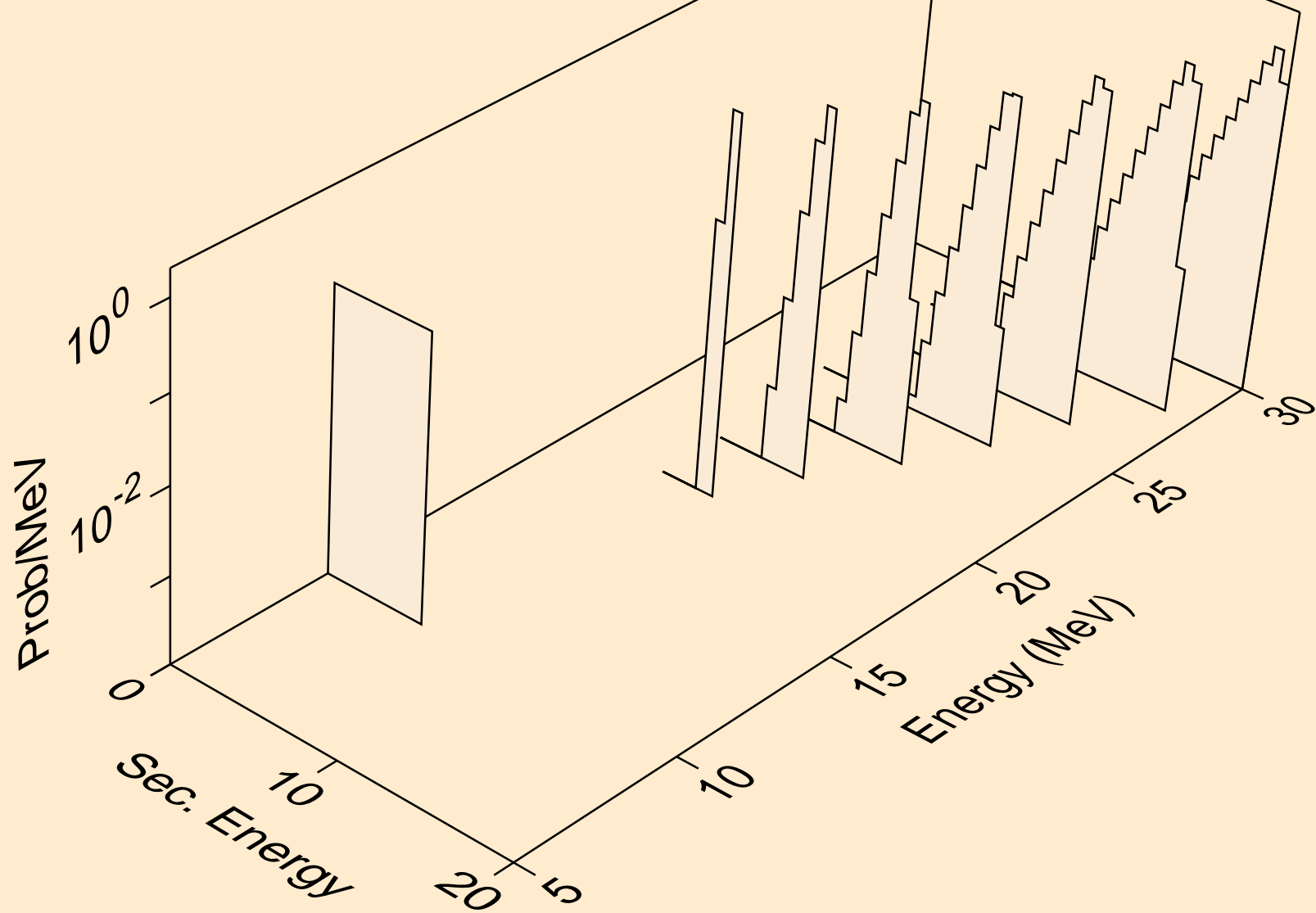

NP238 NEUTRON ACER TENDL-2023 LIBRARY; T=0.K
he3s from (n,he3)

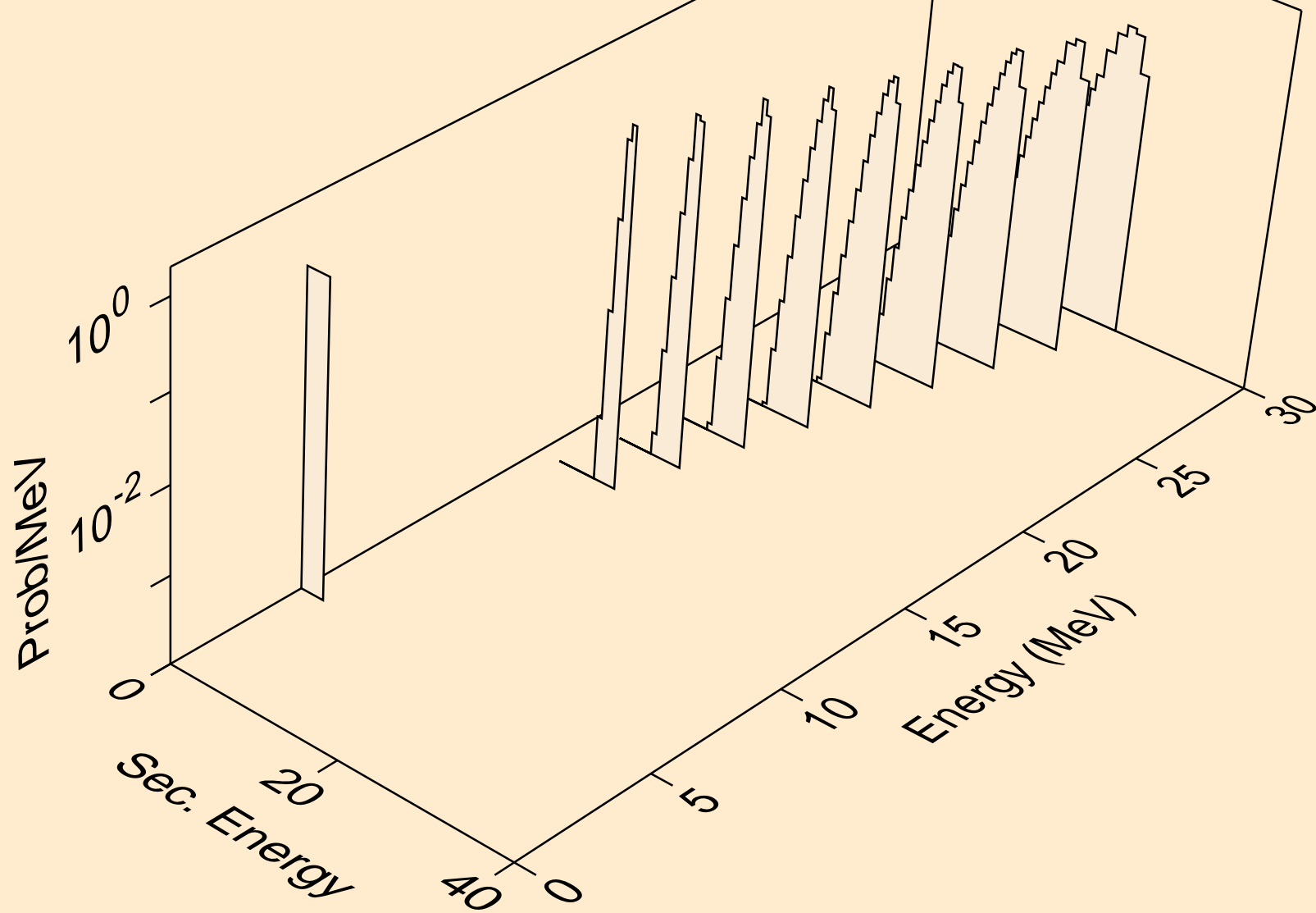

NP238 NEUTRON ACER TENDL-2023 LIBRARY; T=0.K
alphas from (n,x)

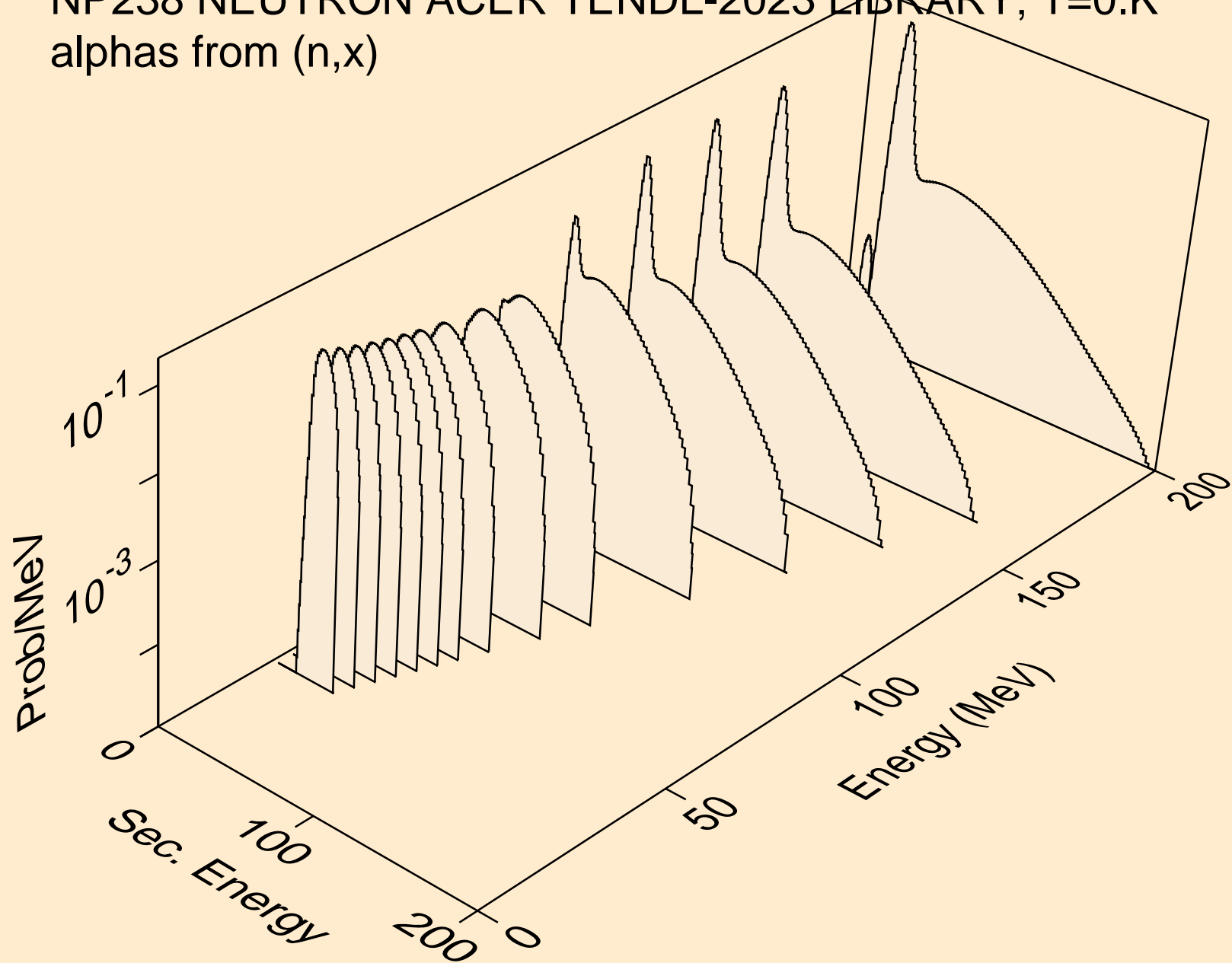

NP238 NEUTRON ACER TENDL-2023 LIBRARY; T=0.K
alphas from (n,n*)a

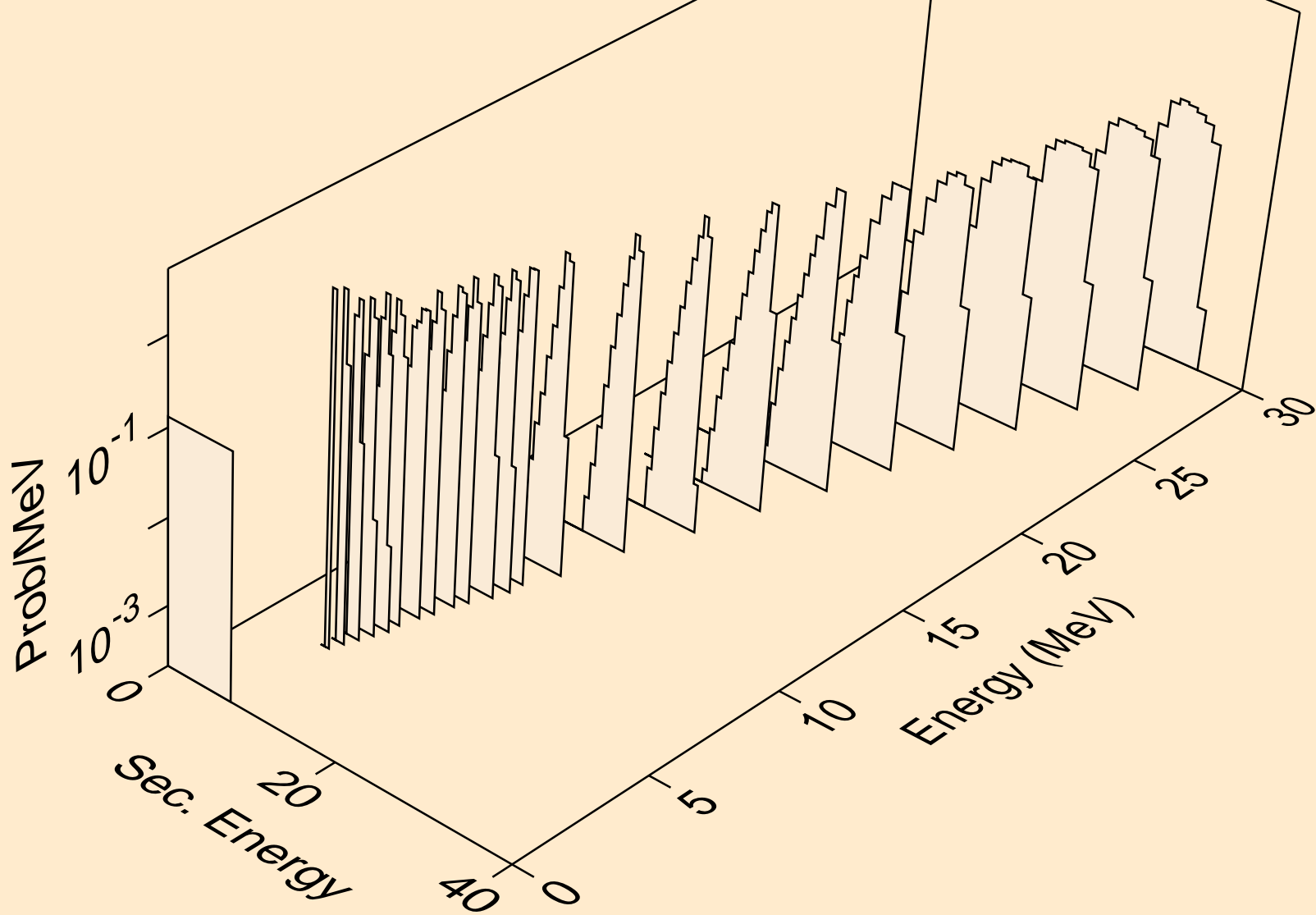

NP238 NEUTRON ACER TENDL-2023 LIBRARY; T=0.K
alphas from (n,2n)a

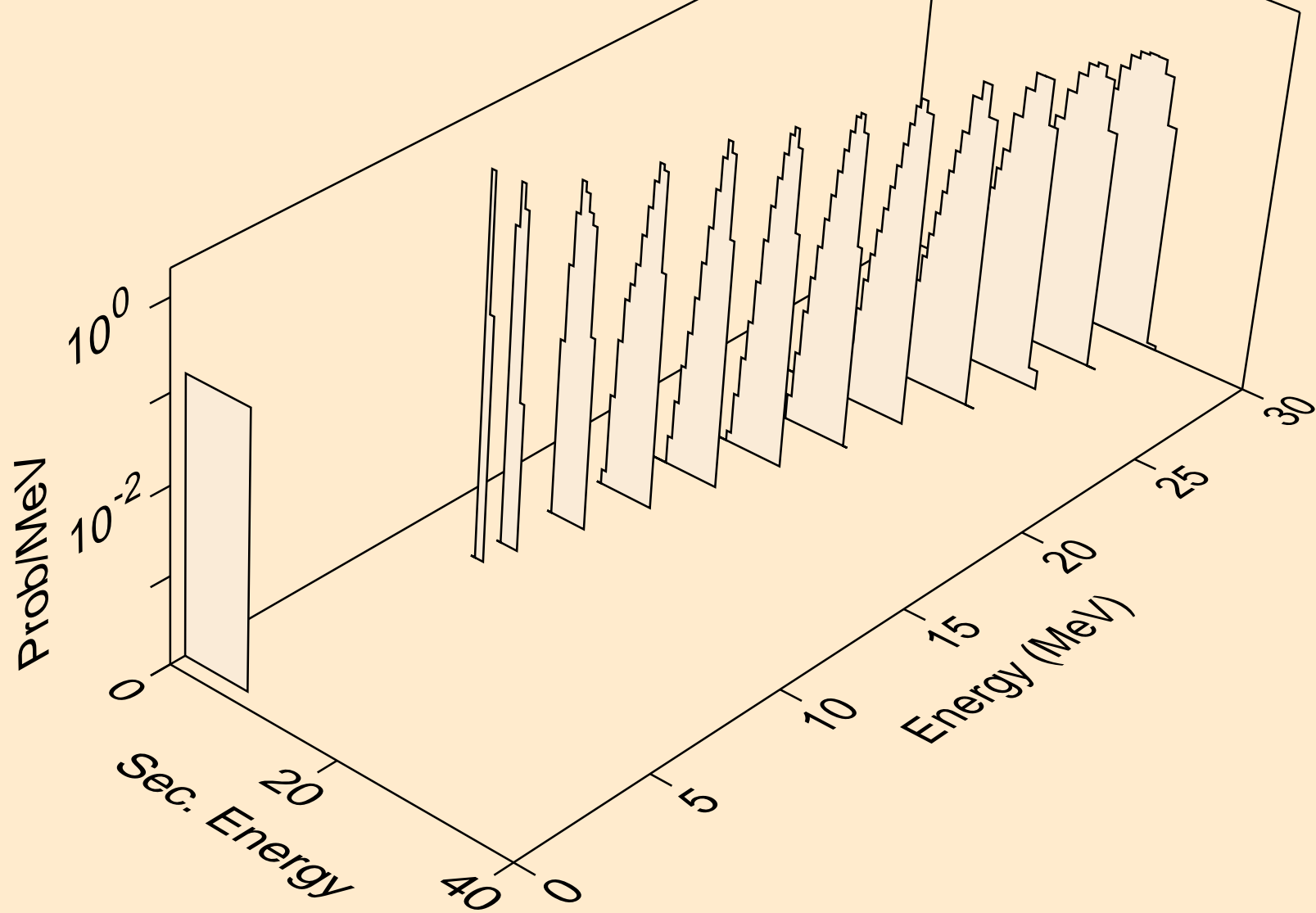

NP238 NEUTRON ACER TENDL-2023 LIBRARY; T=0.K
alphas from (n,3n)a

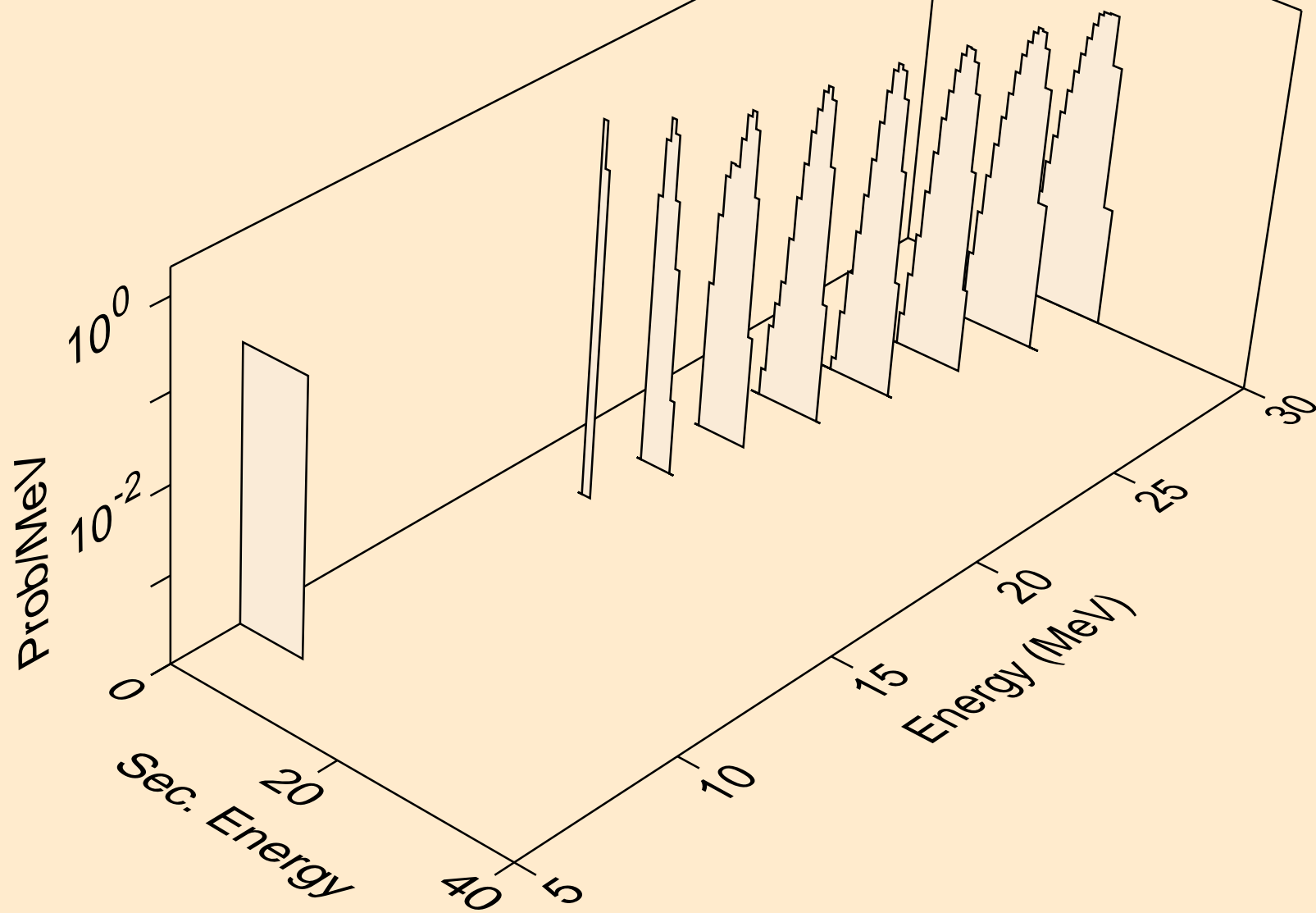

NP238 NEUTRON ACER TENDL-2023 LIBRARY; T=0.K
alphas from (n,a)

