

P036 NEUTRON ACER TENDL-2023 LIBRARY; T=0.K
Principal cross sections

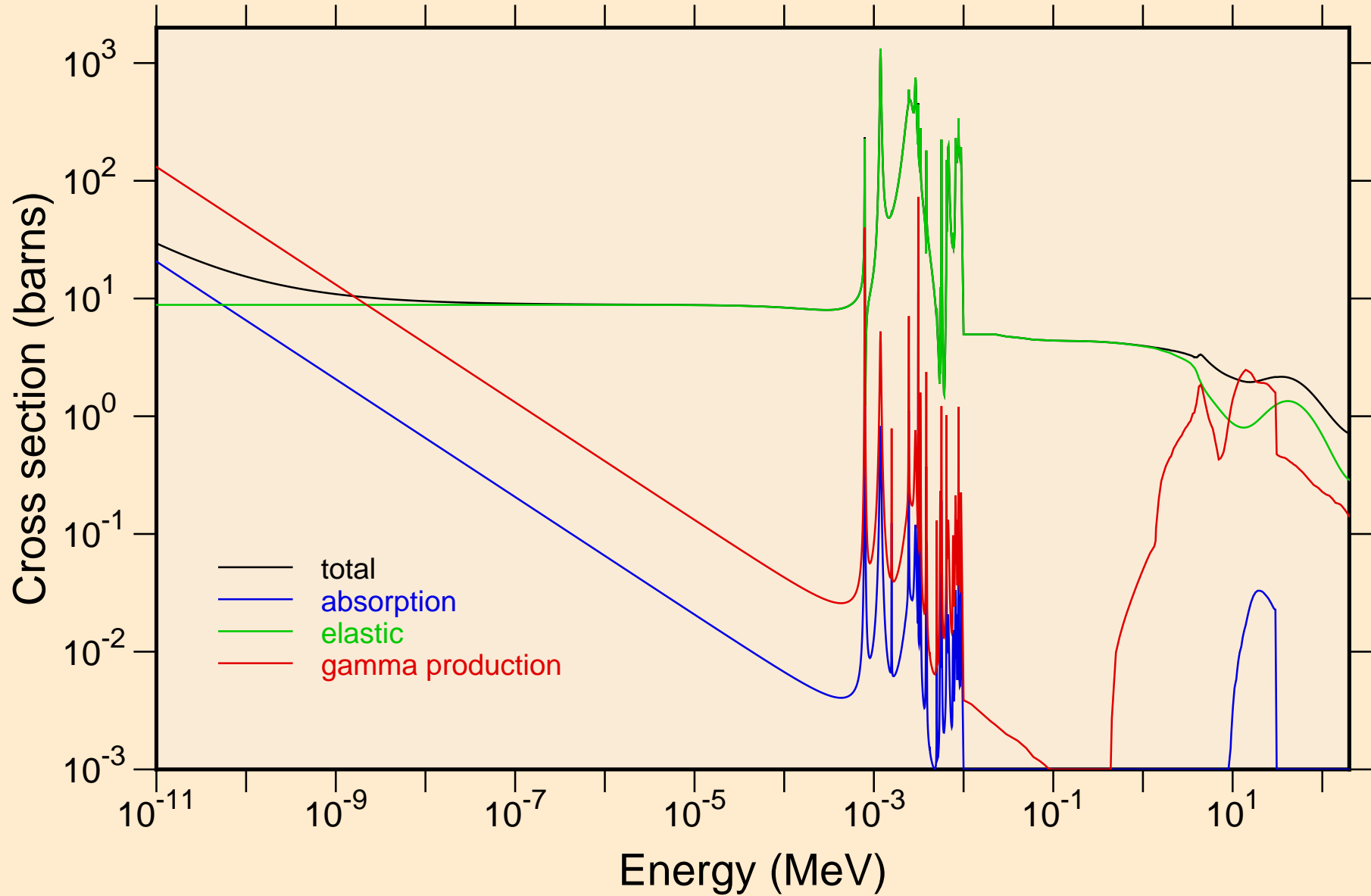

P036 NEUTRON ACER TENDL-2023 LIBRARY; T=0.K
resonance total cross section

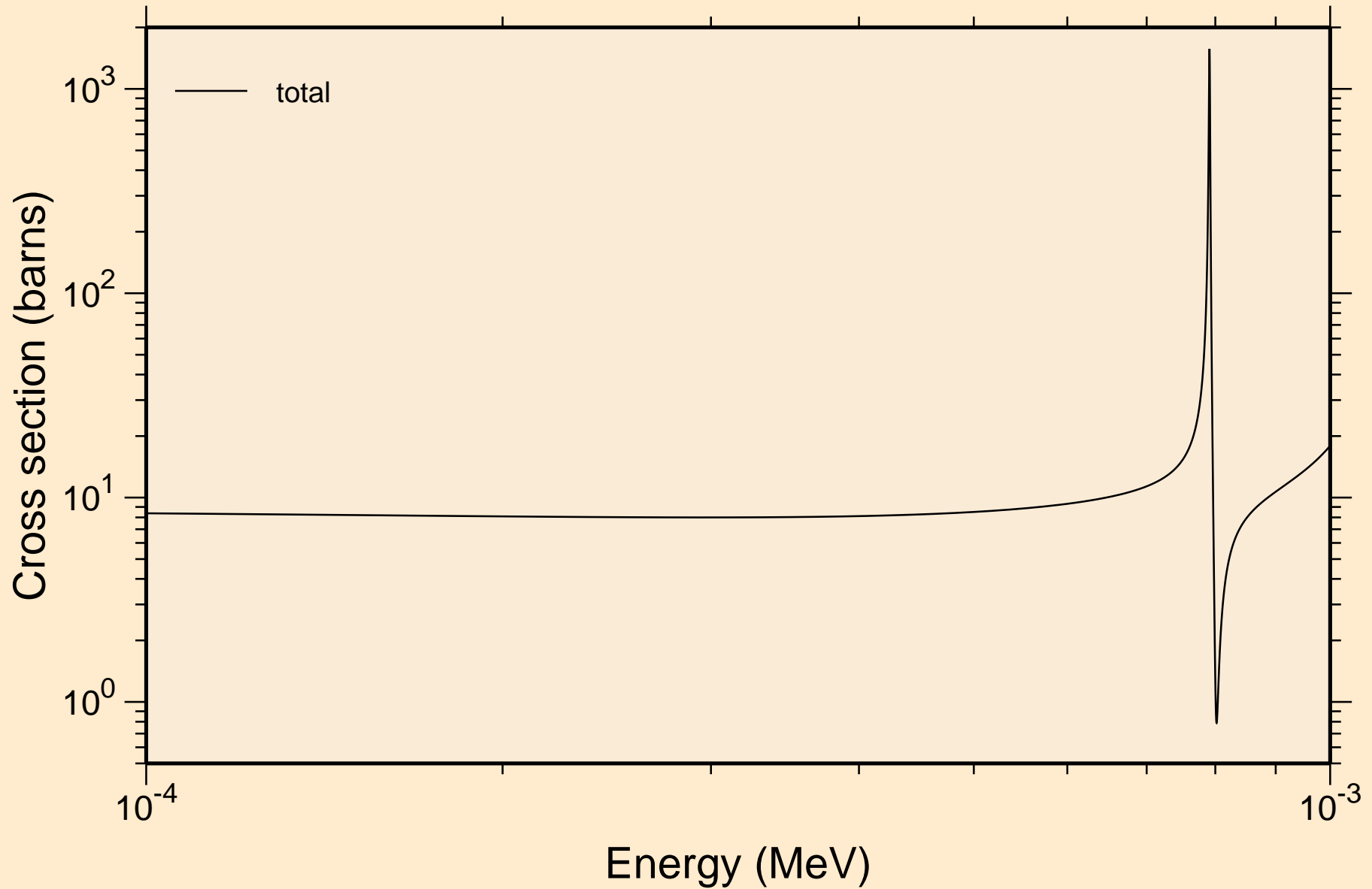

P036 NEUTRON ACER TENDL-2023 LIBRARY; T=0.K
resonance total cross section

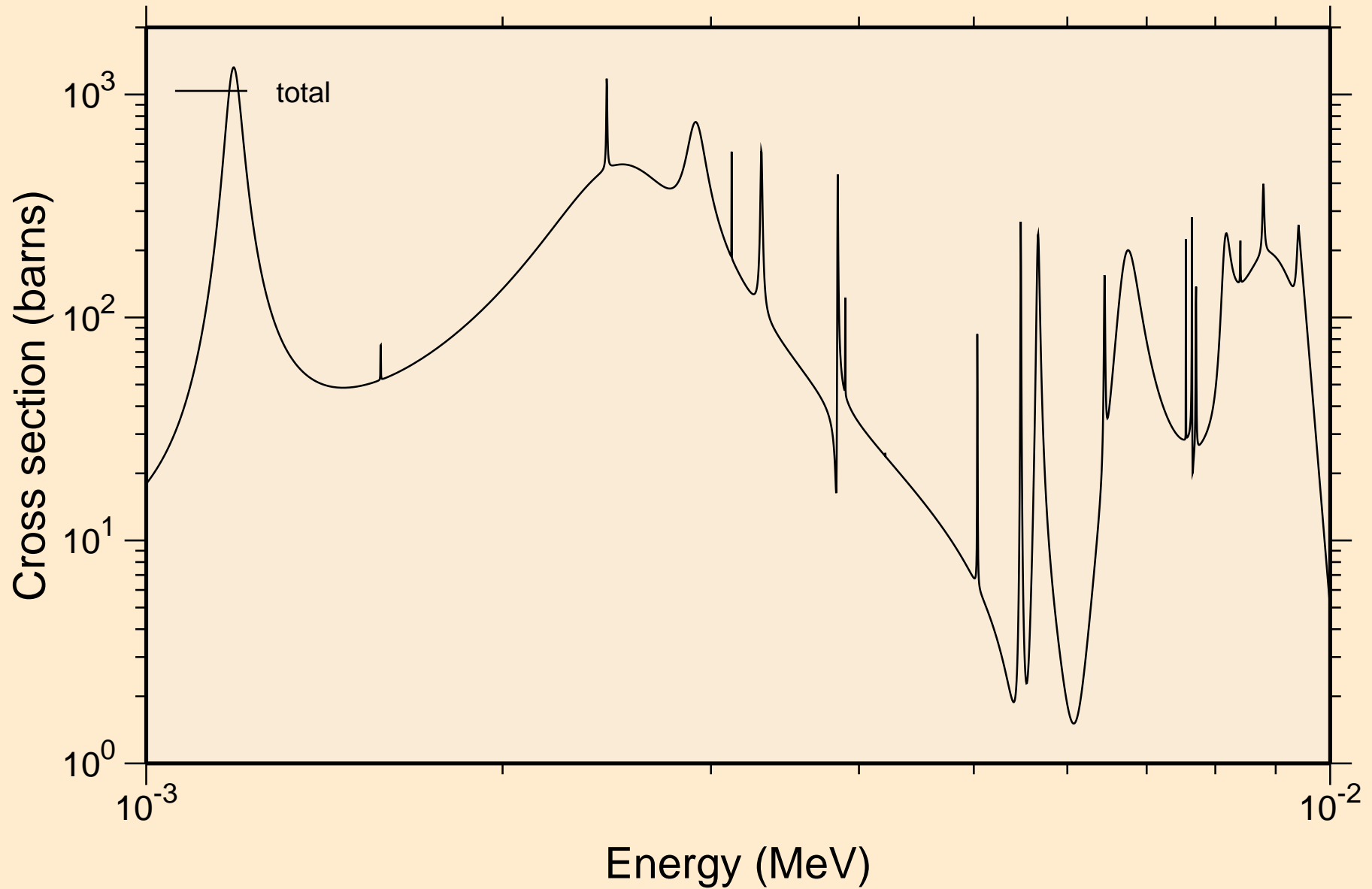

P036 NEUTRON ACER TENDL-2023 LIBRARY; T=0.K
resonance total cross section

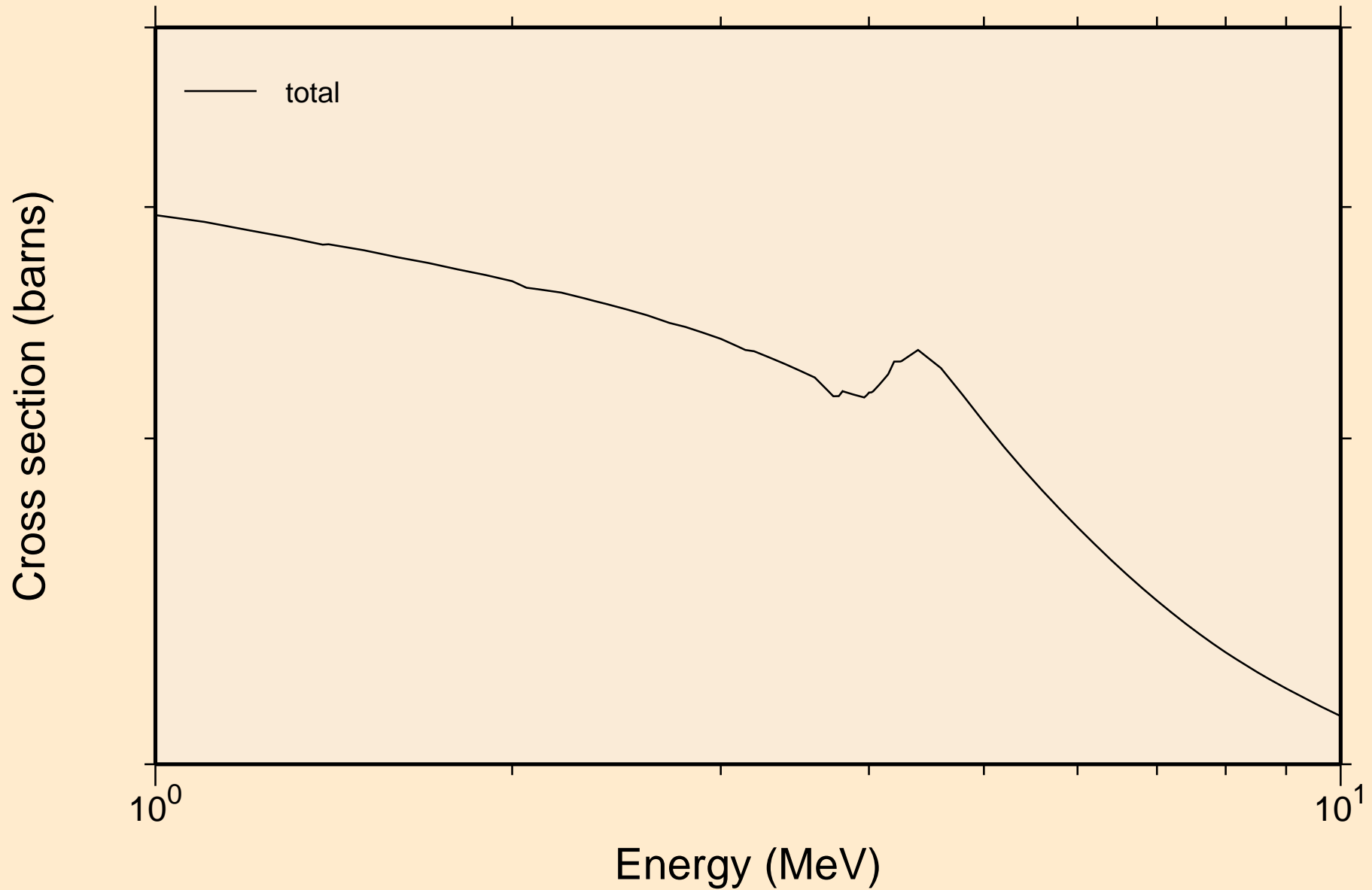

P036 NEUTRON ACER TENDL-2023 LIBRARY; T=0.K
resonance absorption cross sections

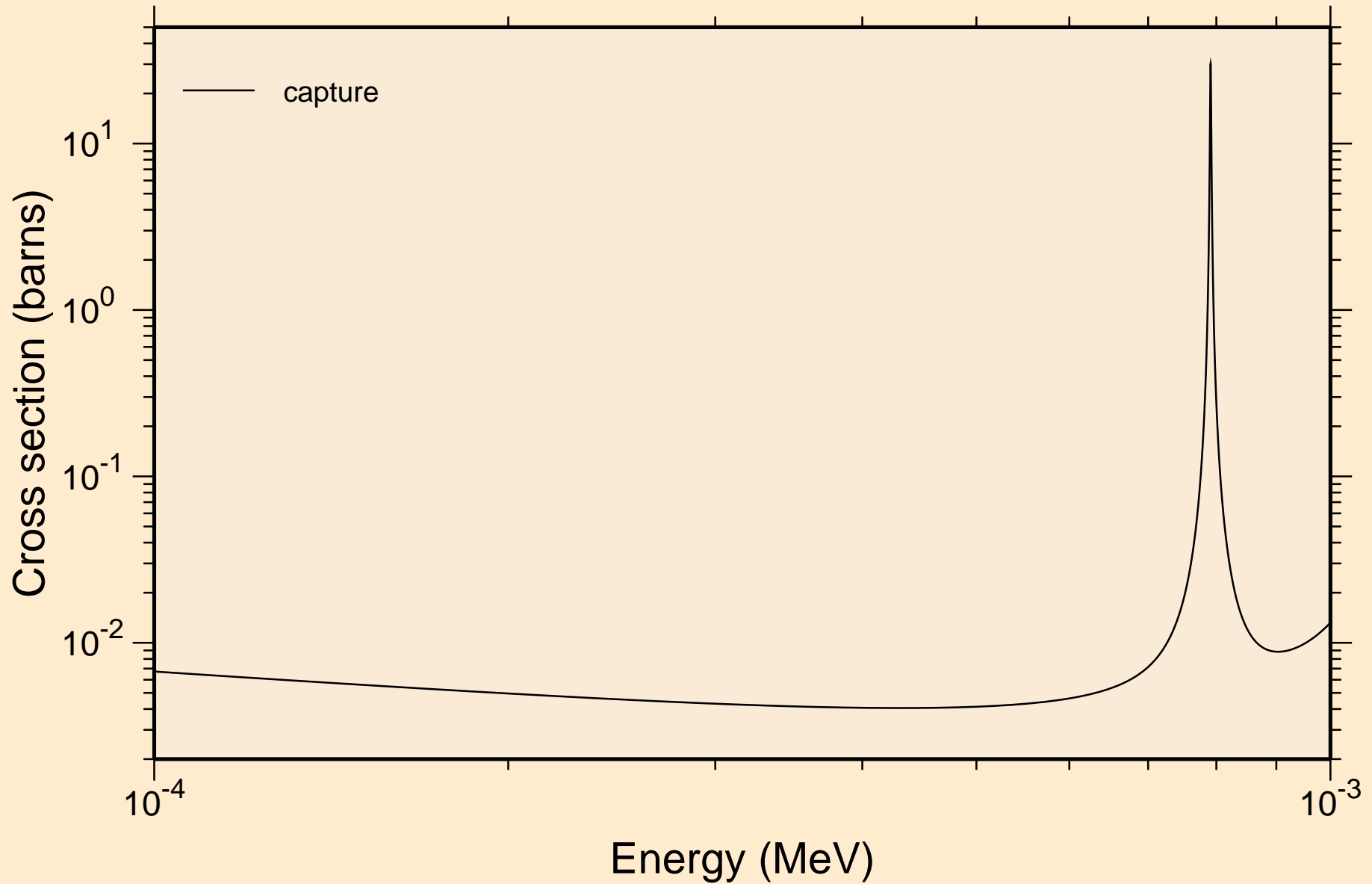

P036 NEUTRON ACER TENDL-2023 LIBRARY; T=0.K
resonance absorption cross sections

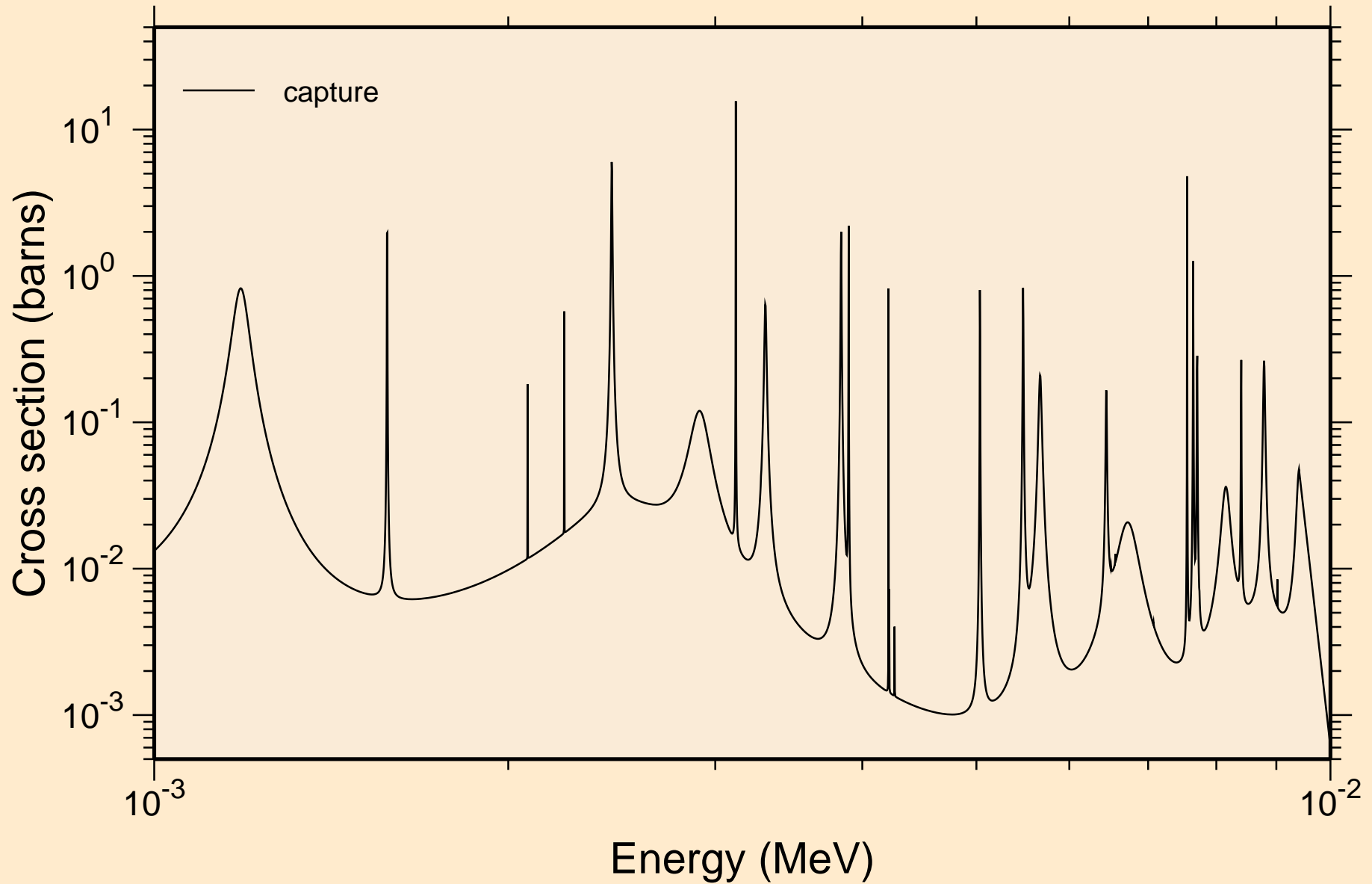

P036 NEUTRON ACER TENDL-2023 LIBRARY; T=0.K
resonance absorption cross sections

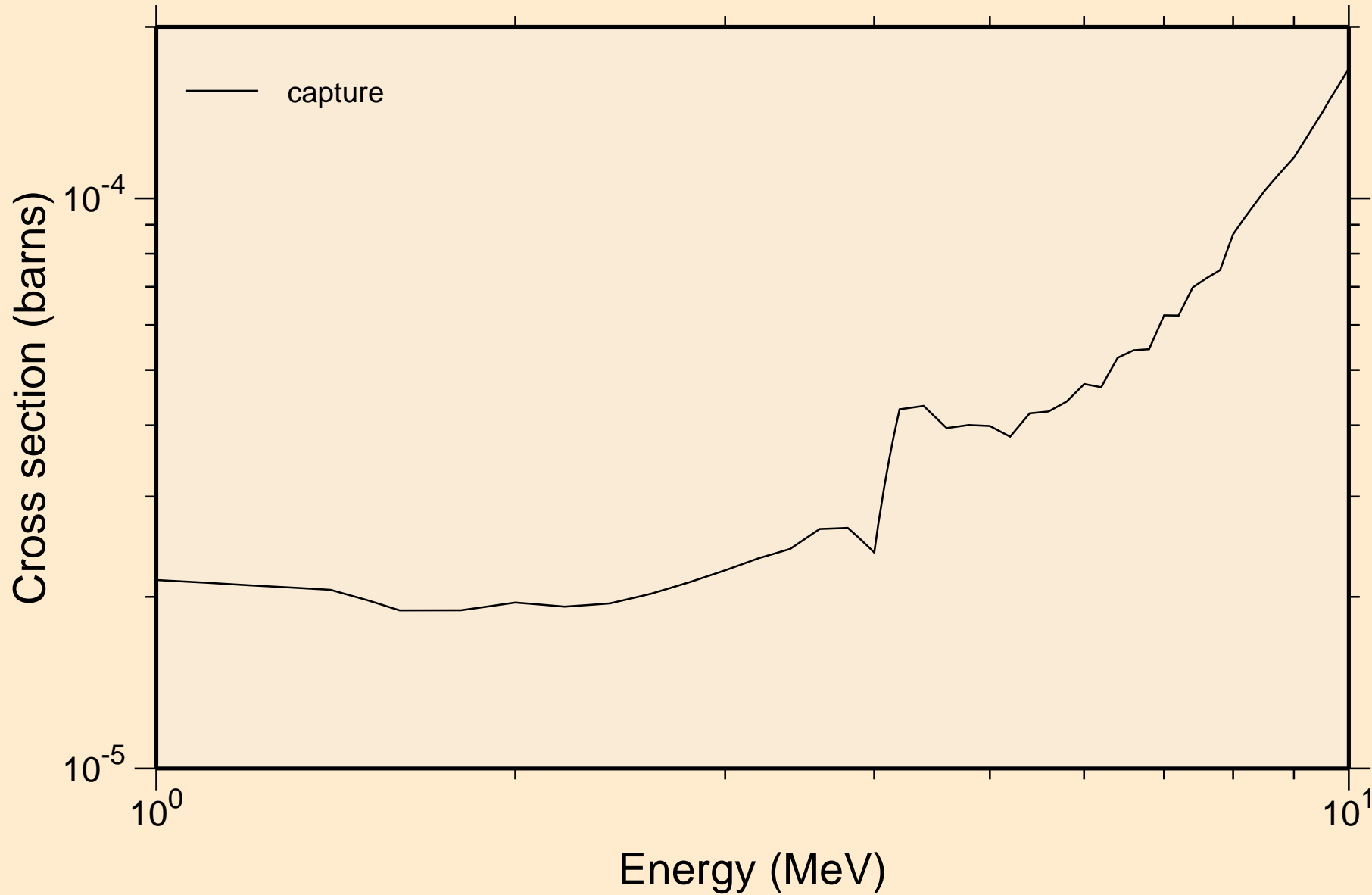

P036 NEUTRON ACER TENDL-2023 LIBRARY; T=0.K
Heating

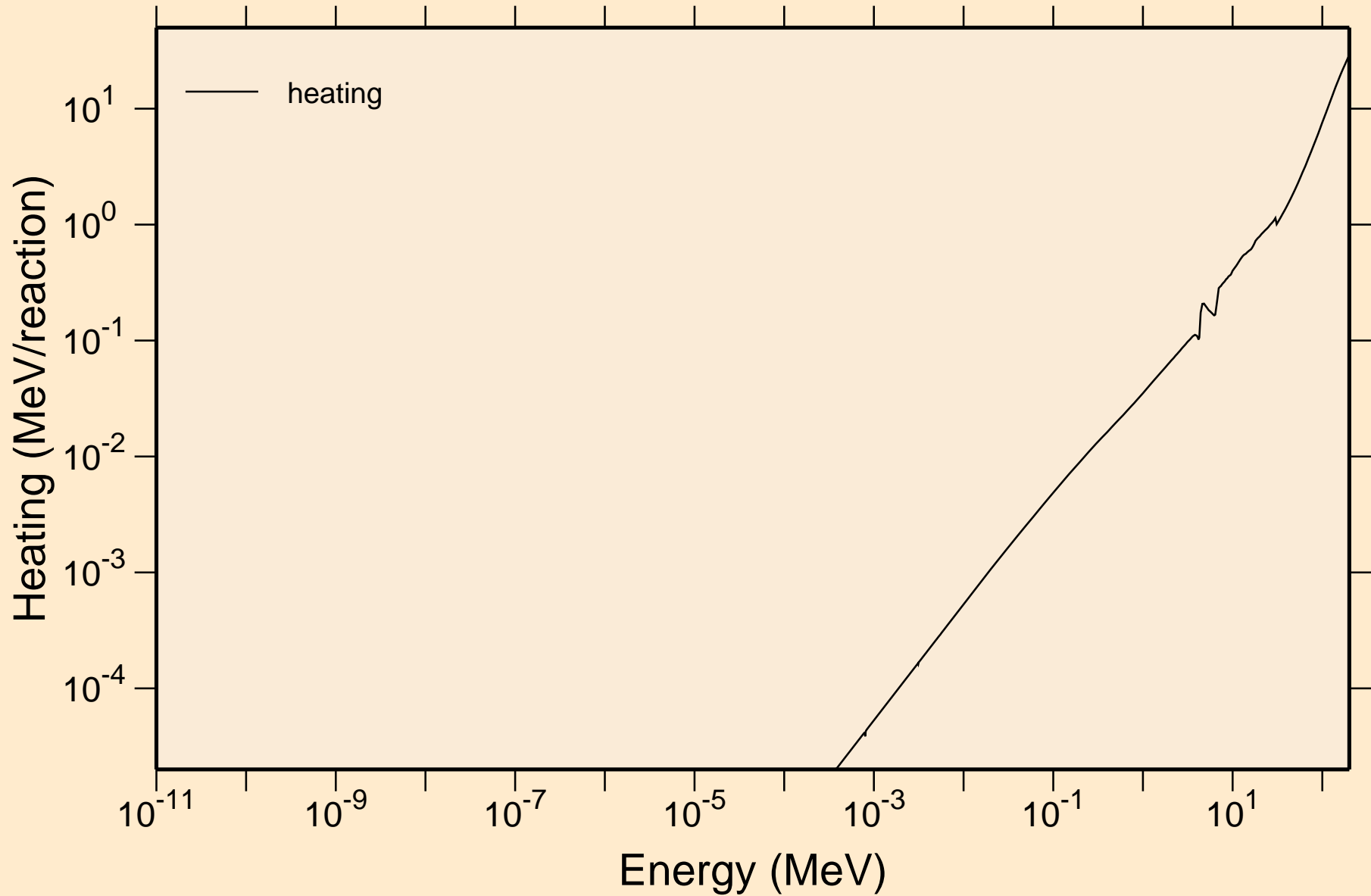

P036 NEUTRON ACER TENDL-2023 LIBRARY; T=0.K
Damage

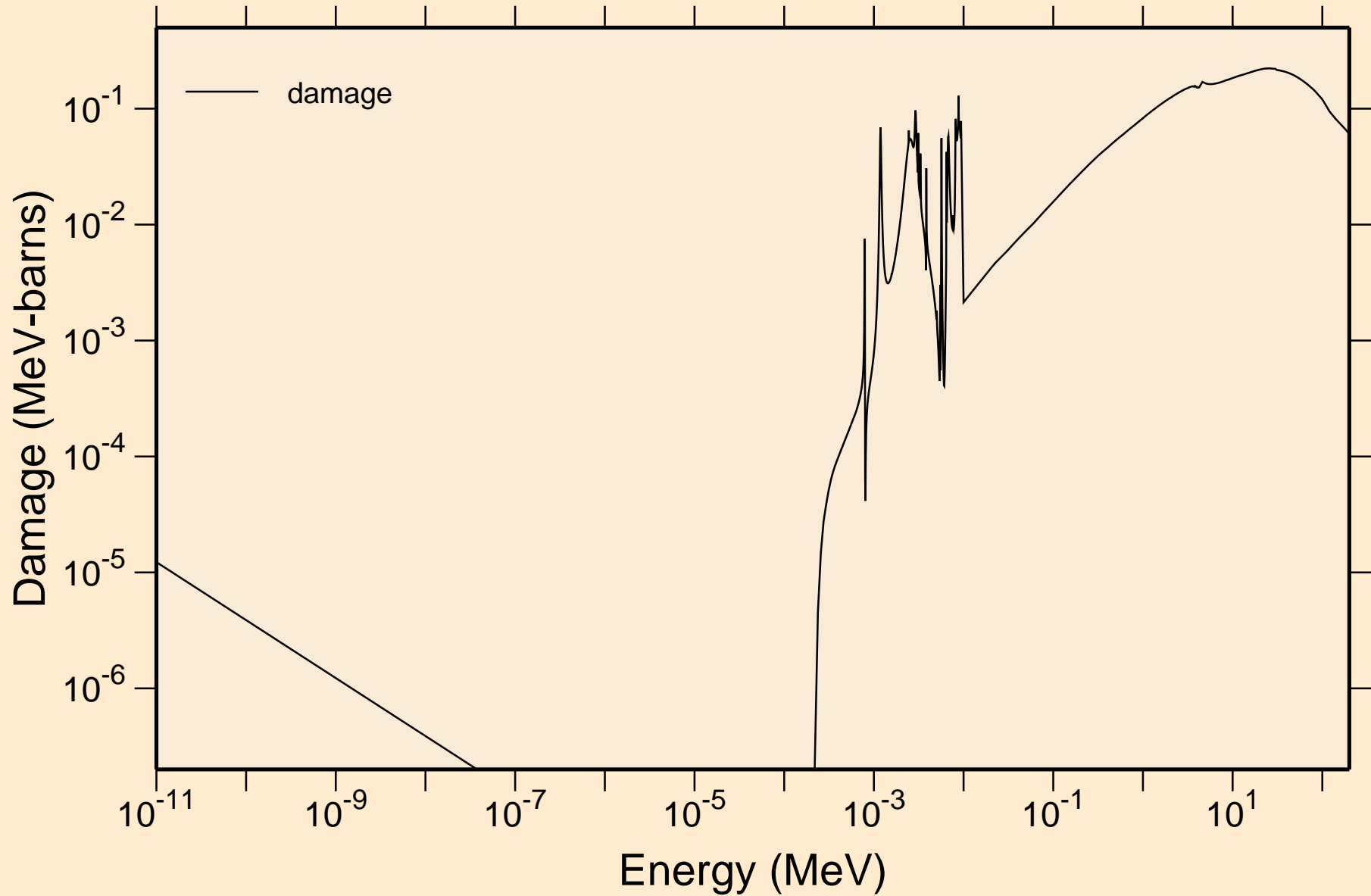

P036 NEUTRON ACER TENDL-2023 LIBRARY; T=0.K
Non-threshold reactions

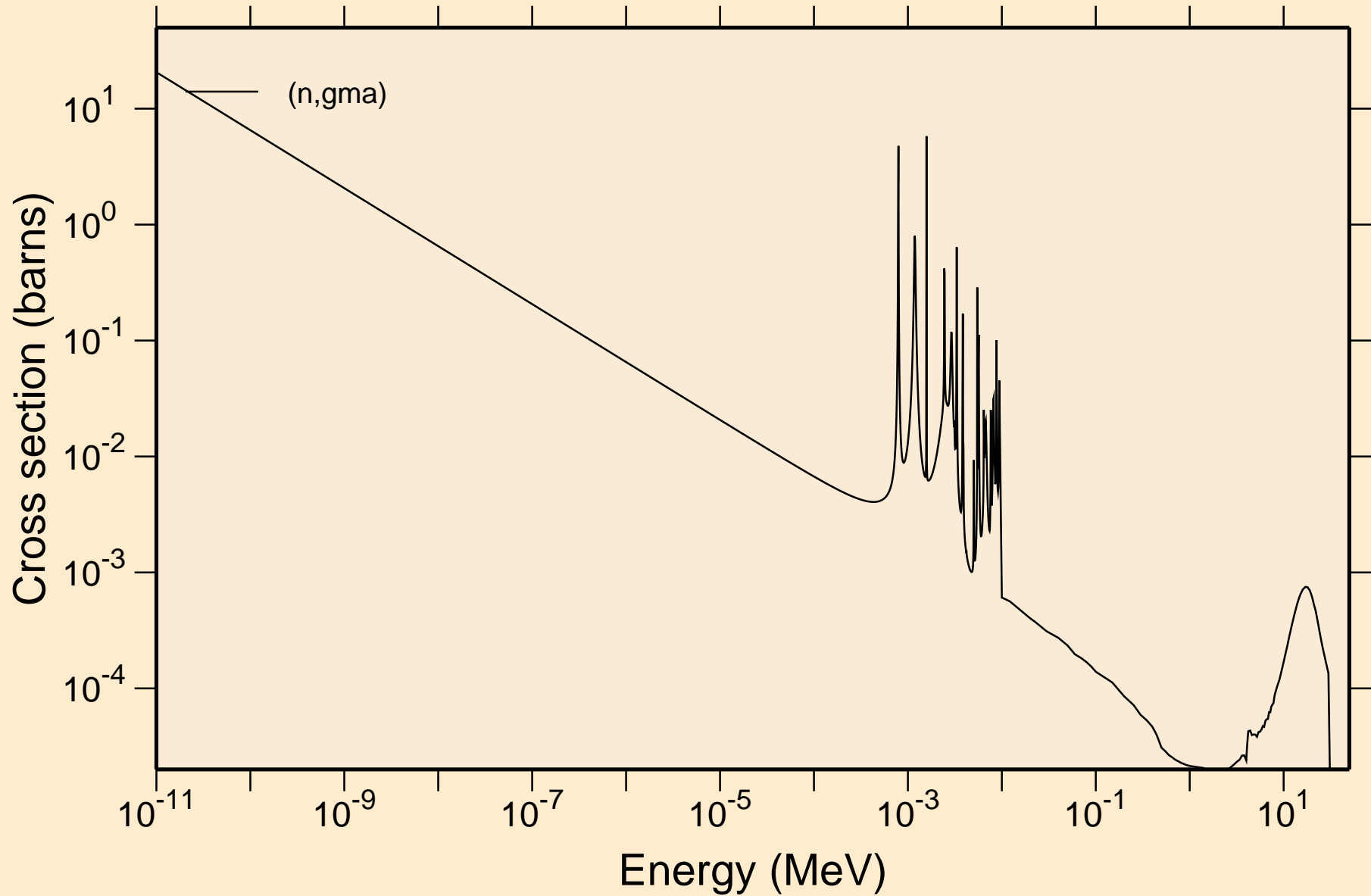

P036 NEUTRON ACER TENDL-2023 LIBRARY; T=0.K

Principal cross sections

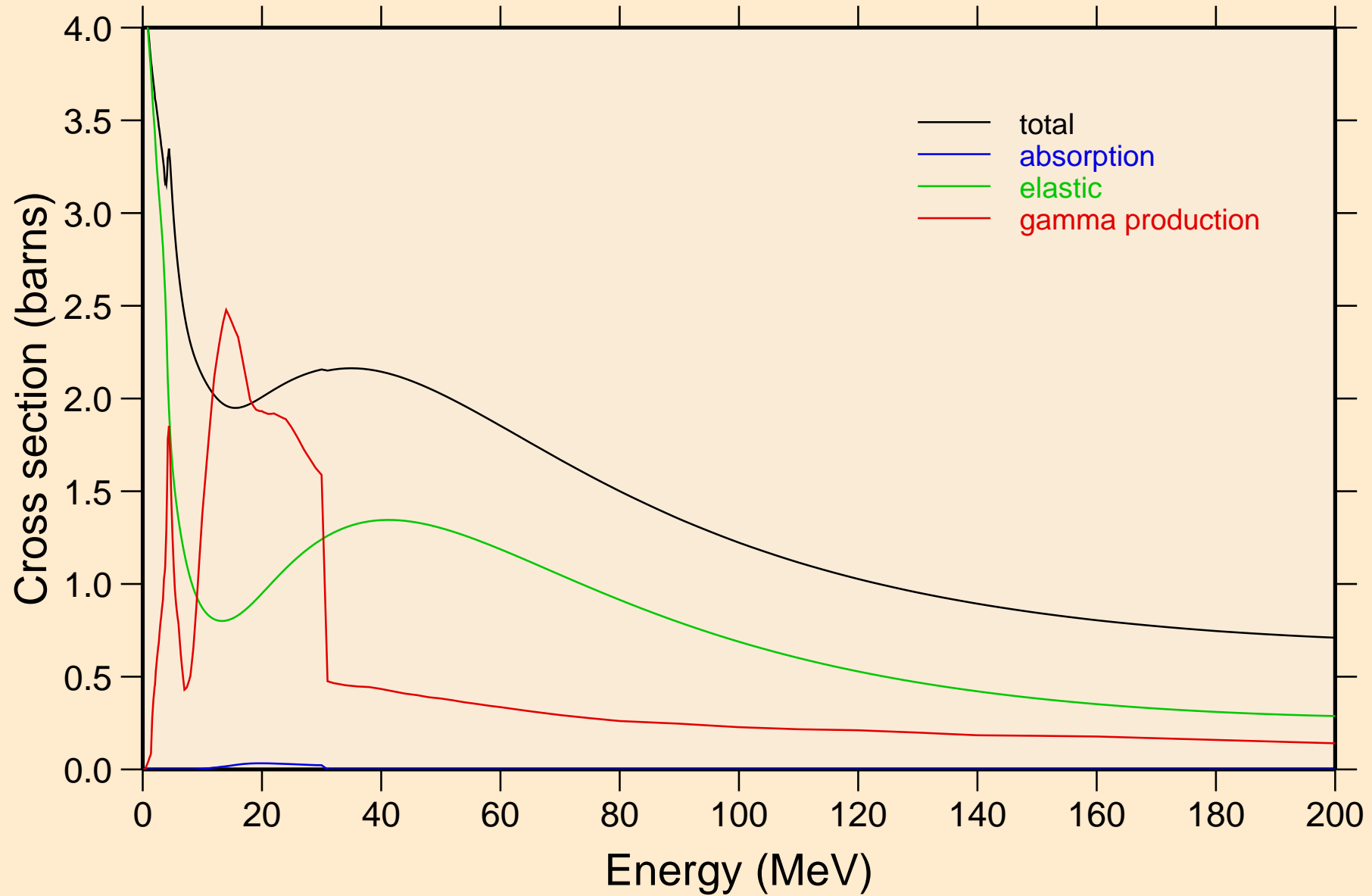

P036 NEUTRON ACER TENDL-2023 LIBRARY; T=0.K

Heating

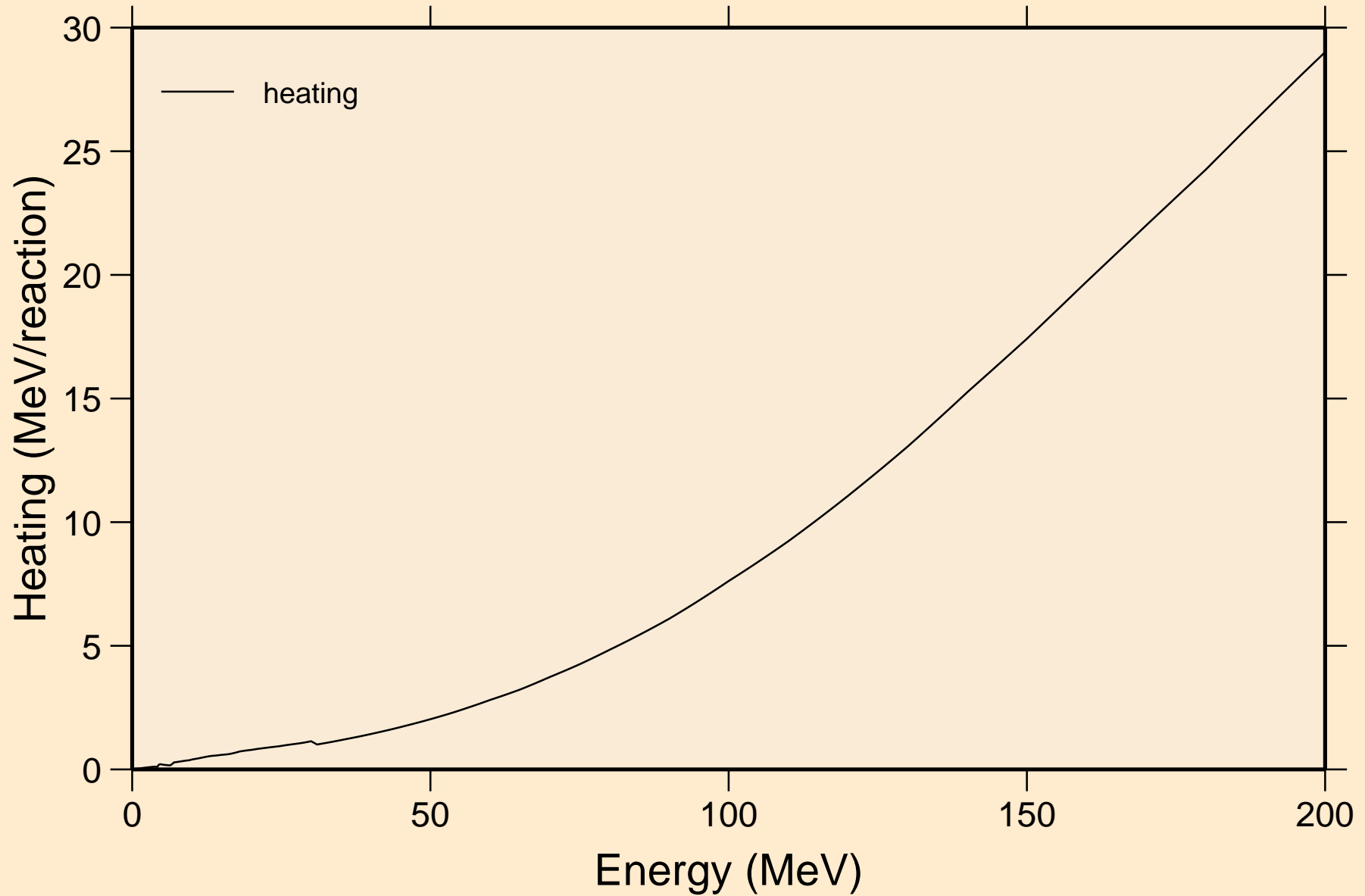

P036 NEUTRON ACER TENDL-2023 LIBRARY; T=0.K

Damage

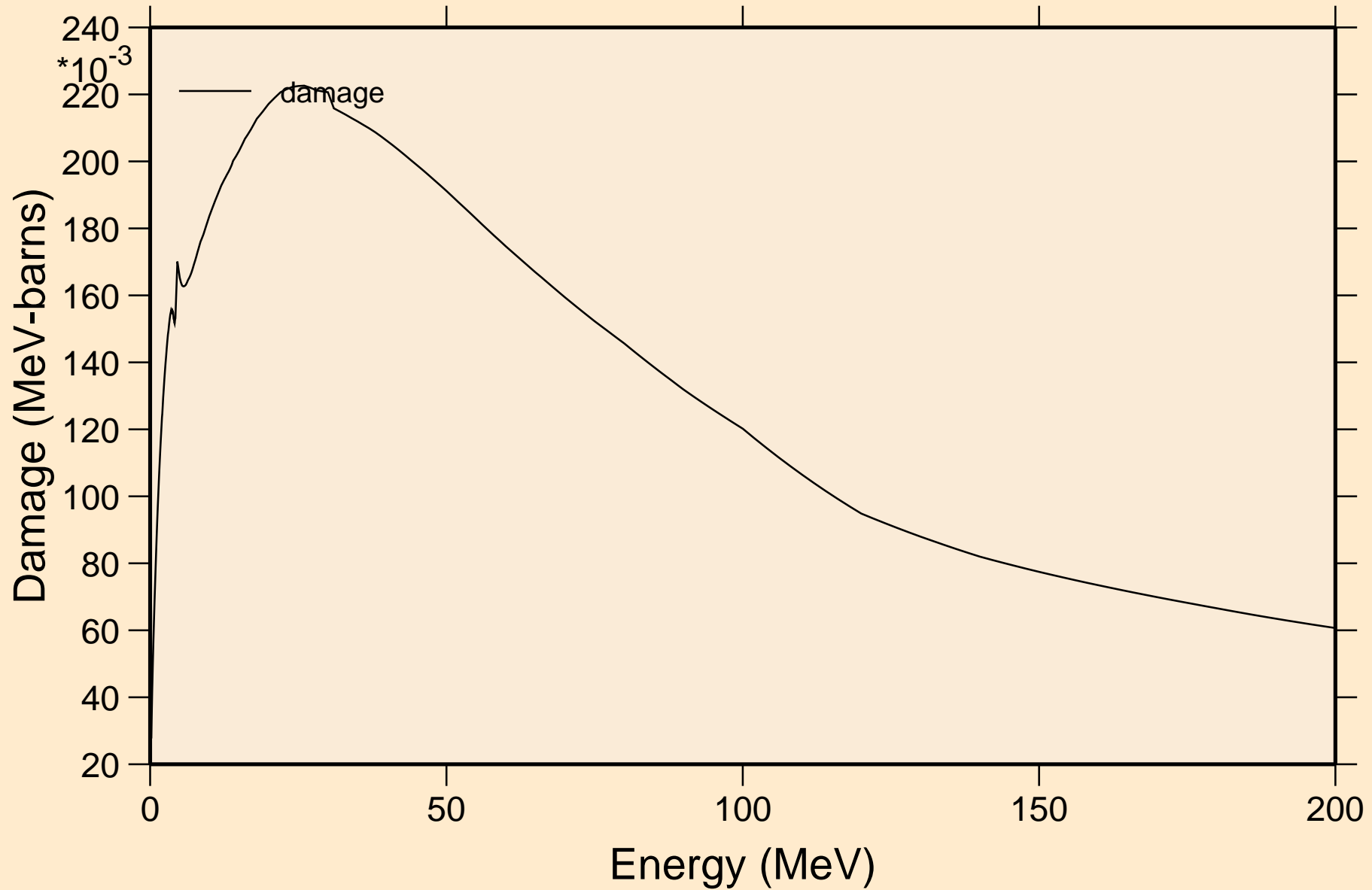

P036 NEUTRON ACER TENDL-2023 LIBRARY; T=0.K
Non-threshold reactions

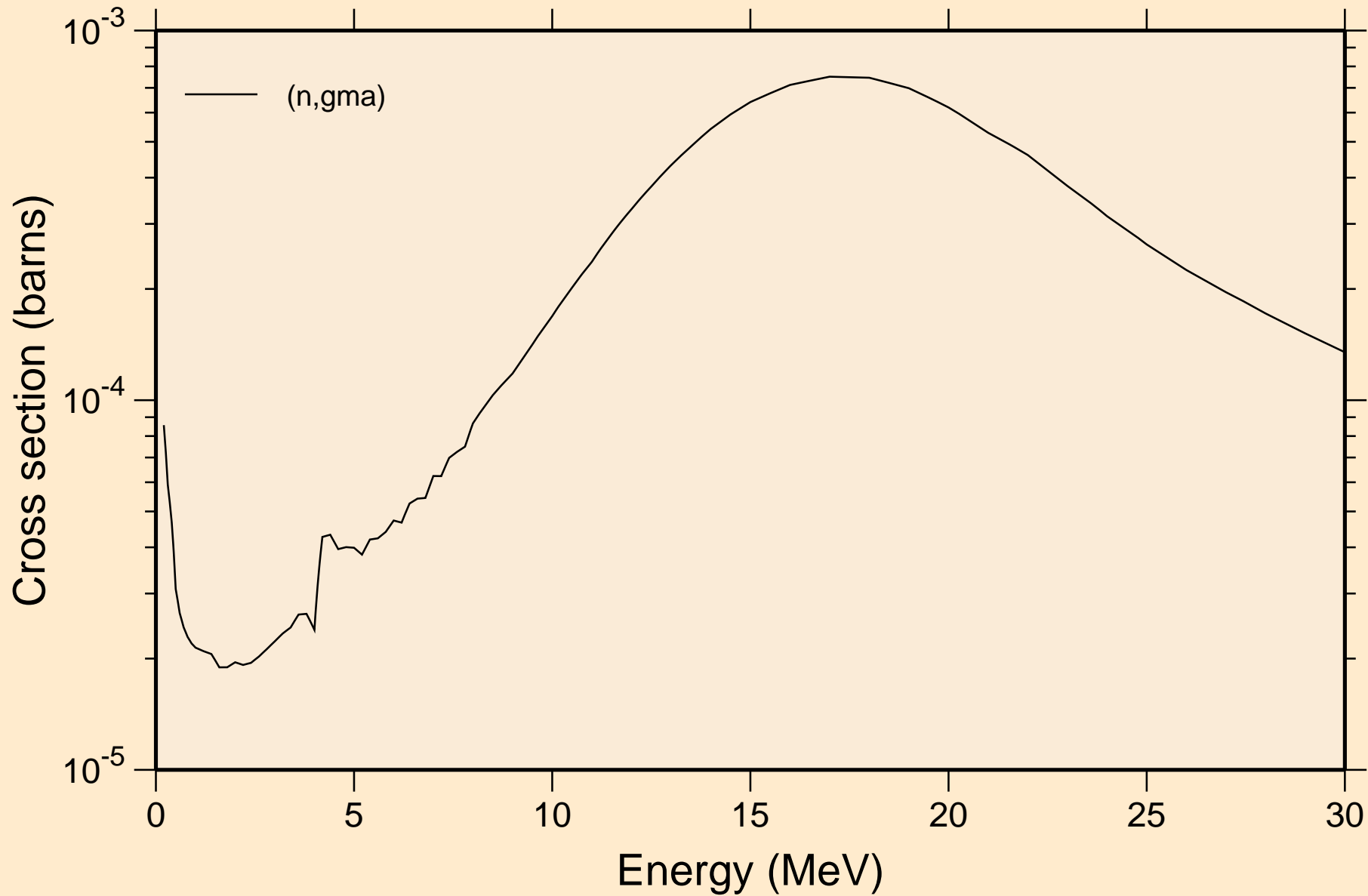

P036 NEUTRON ACER TENDL-2023 LIBRARY; T=0.K
Inelastic levels

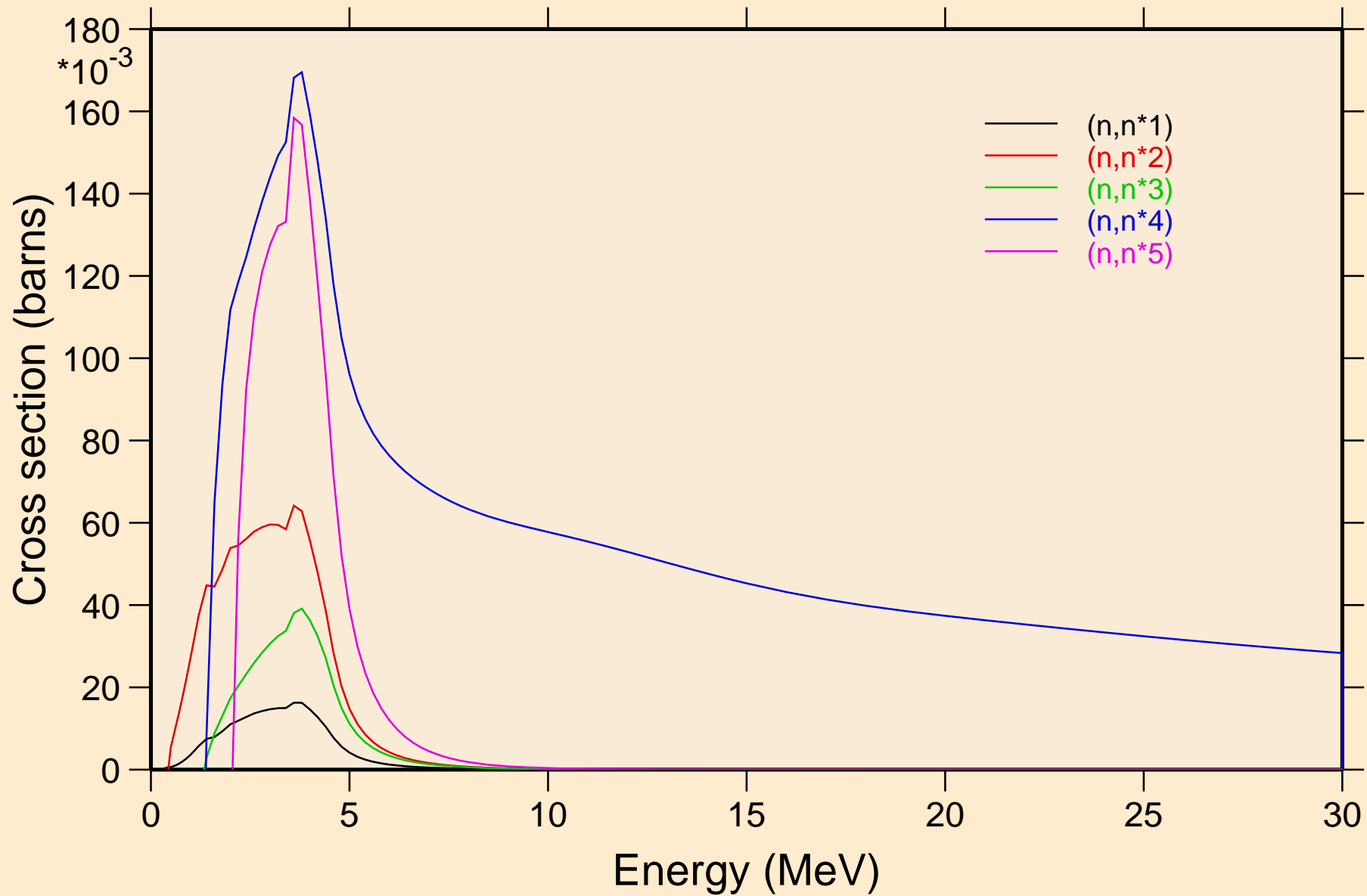

P036 NEUTRON ACER TENDL-2023 LIBRARY; T=0.K
Inelastic levels

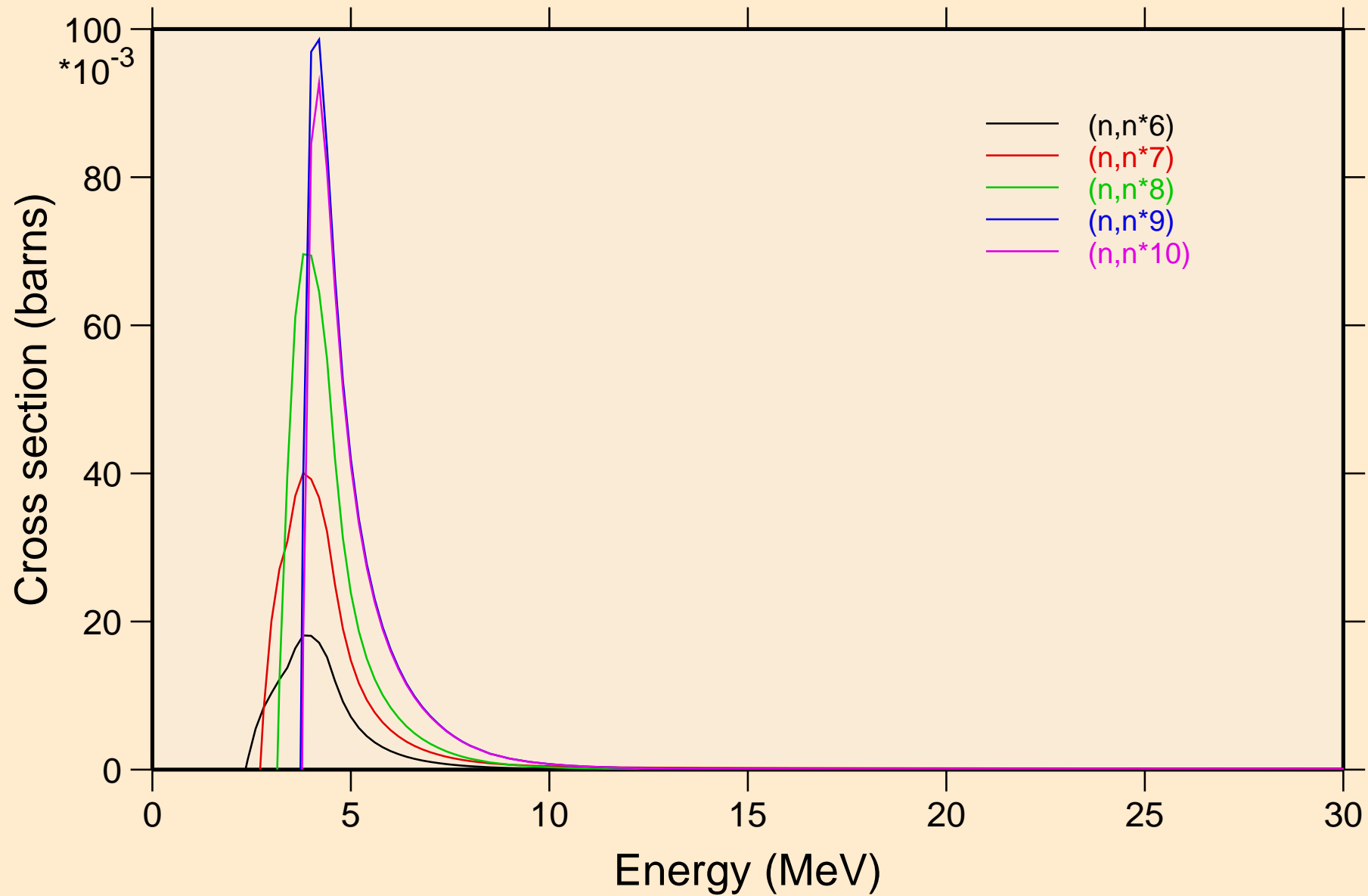

P036 NEUTRON ACER TENDL-2023 LIBRARY; T=0.K
Inelastic levels

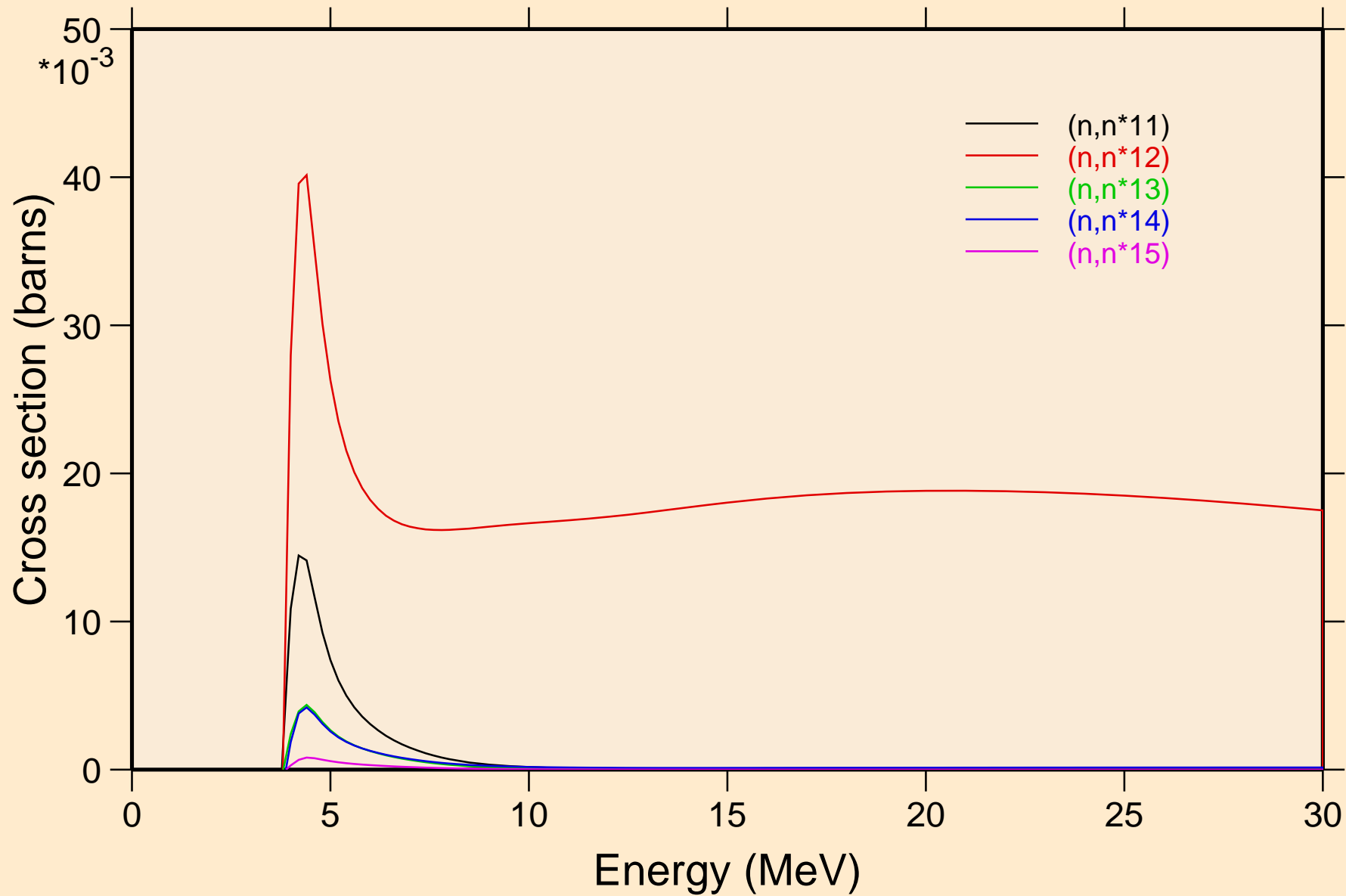

P036 NEUTRON ACER TENDL-2023 LIBRARY; T=0.K
Inelastic levels

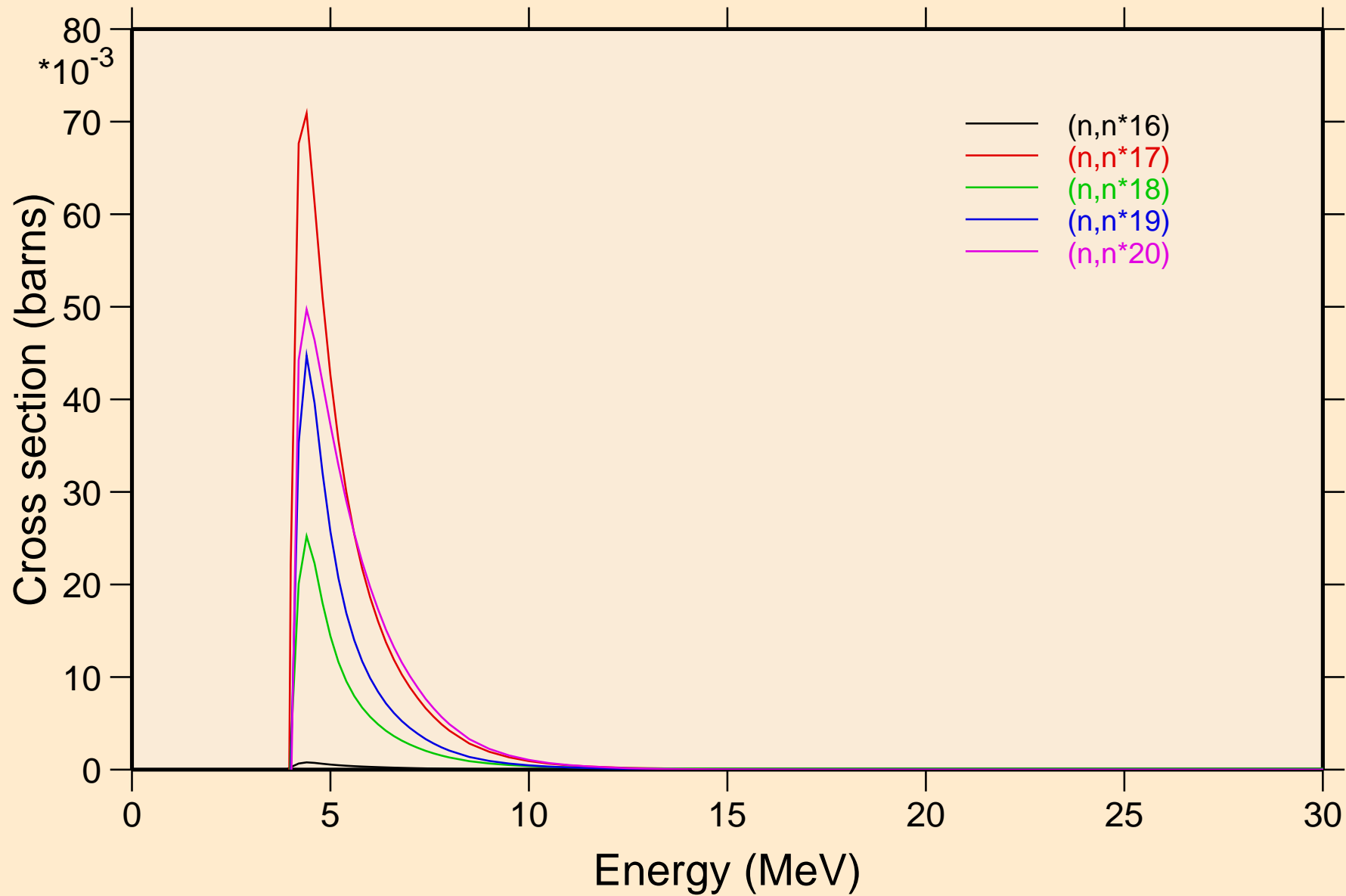

P036 NEUTRON ACER TENDL-2023 LIBRARY; T=0.K
Inelastic levels

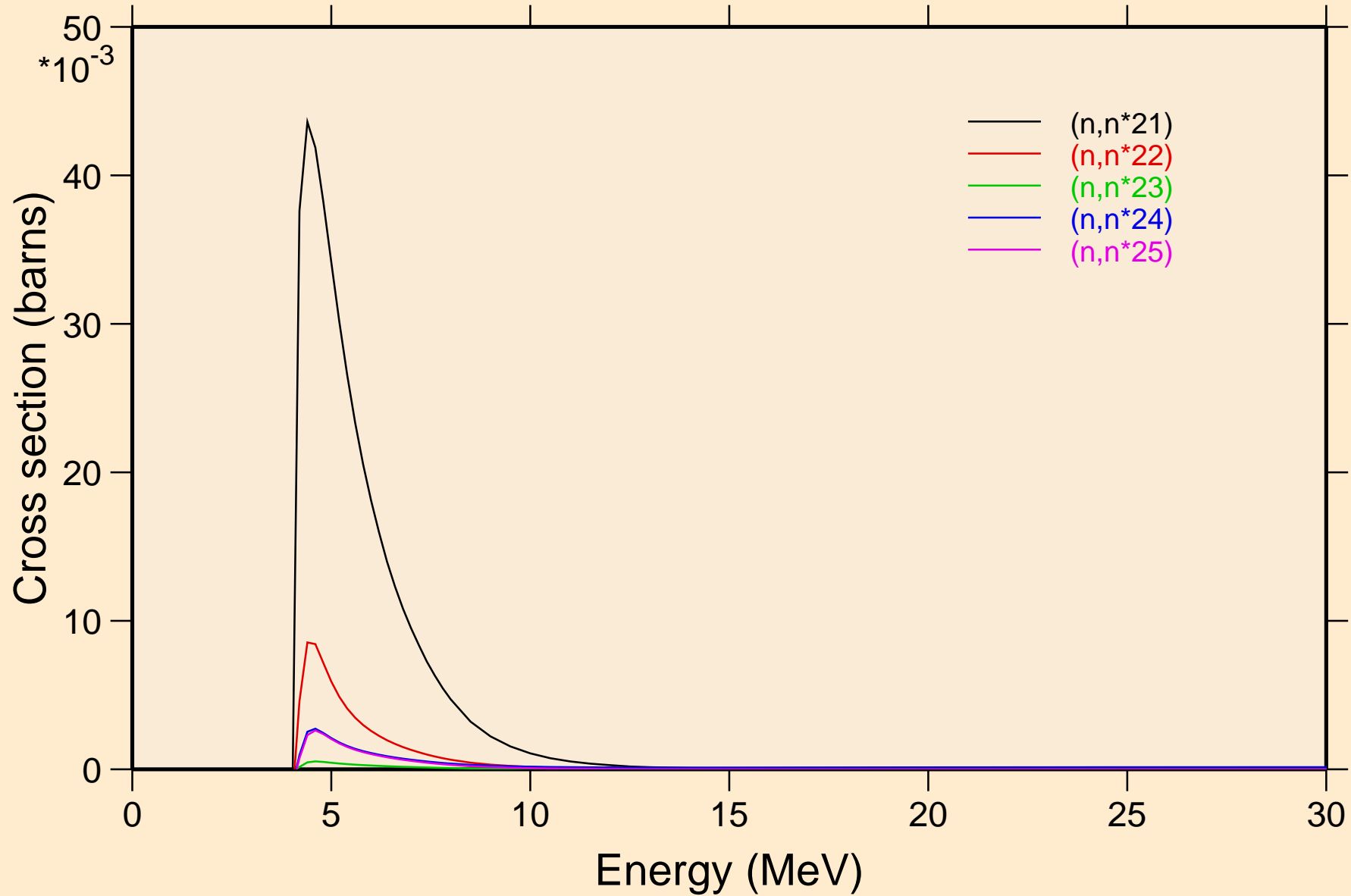

P036 NEUTRON ACER TENDL-2023 LIBRARY; T=0.K
Inelastic levels

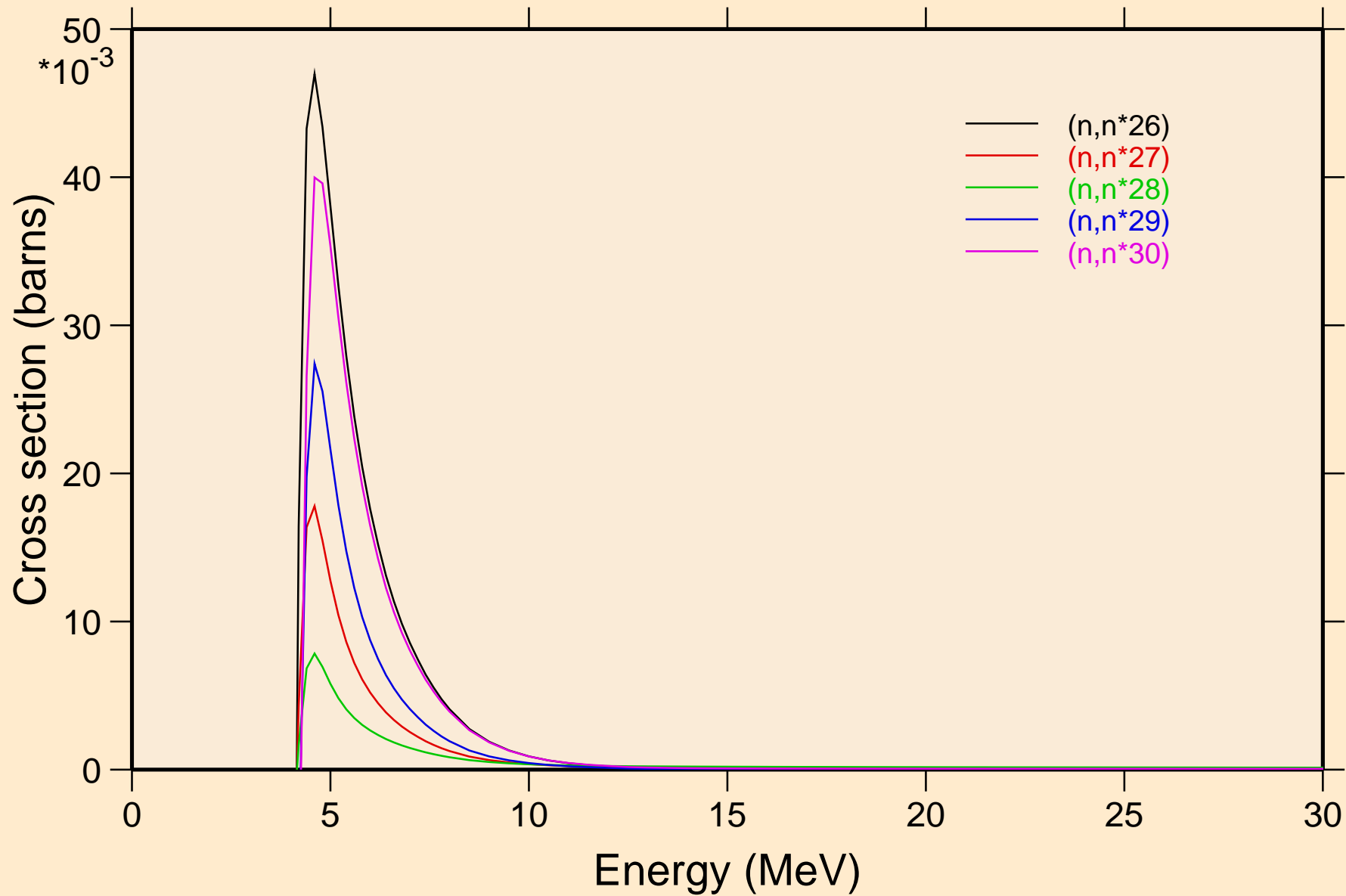

P036 NEUTRON ACER TENDL-2023 LIBRARY; T=0.K
Threshold reactions

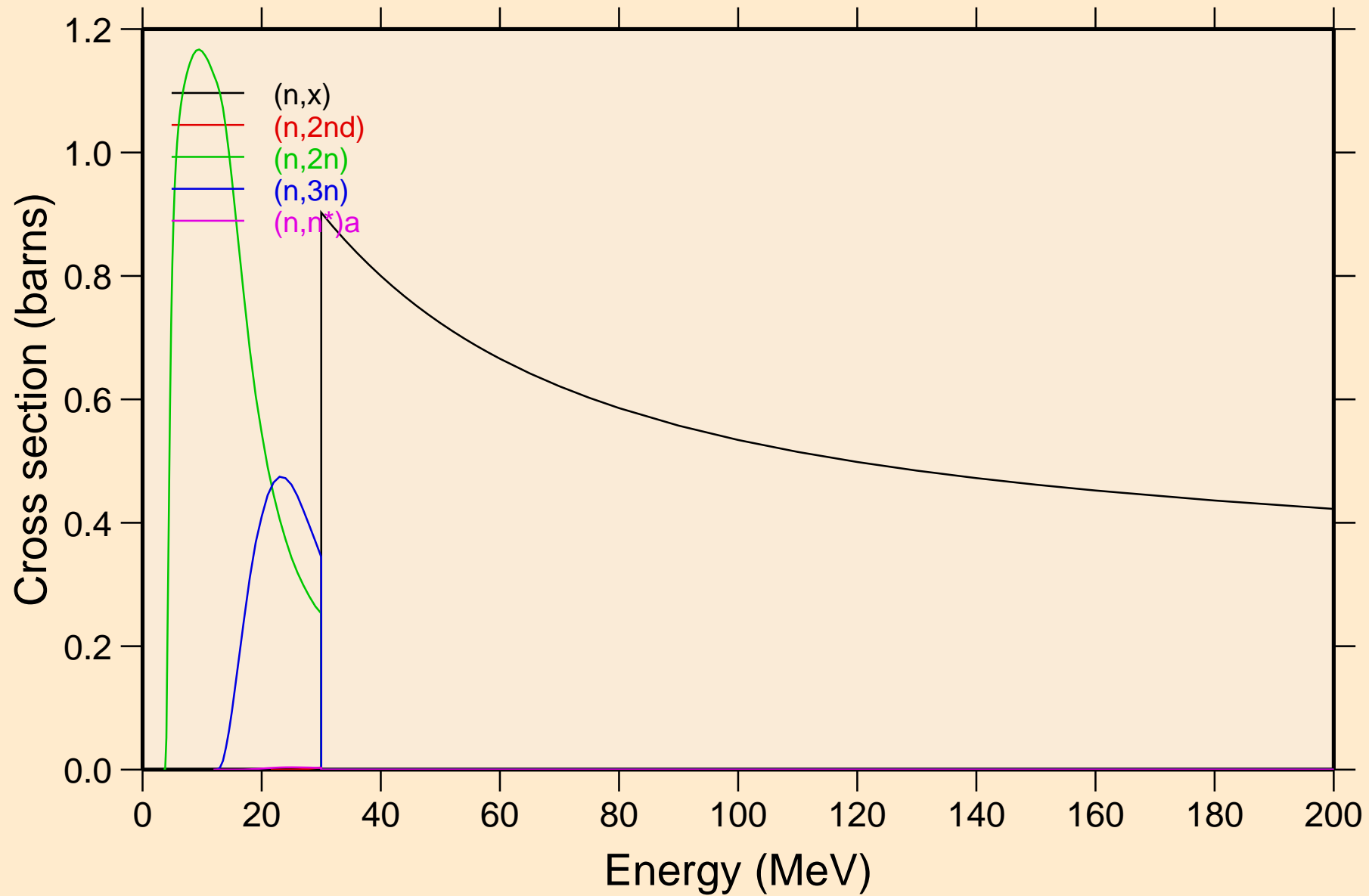

P036 NEUTRON ACER TENDL-2023 LIBRARY; T=0.K
Threshold reactions

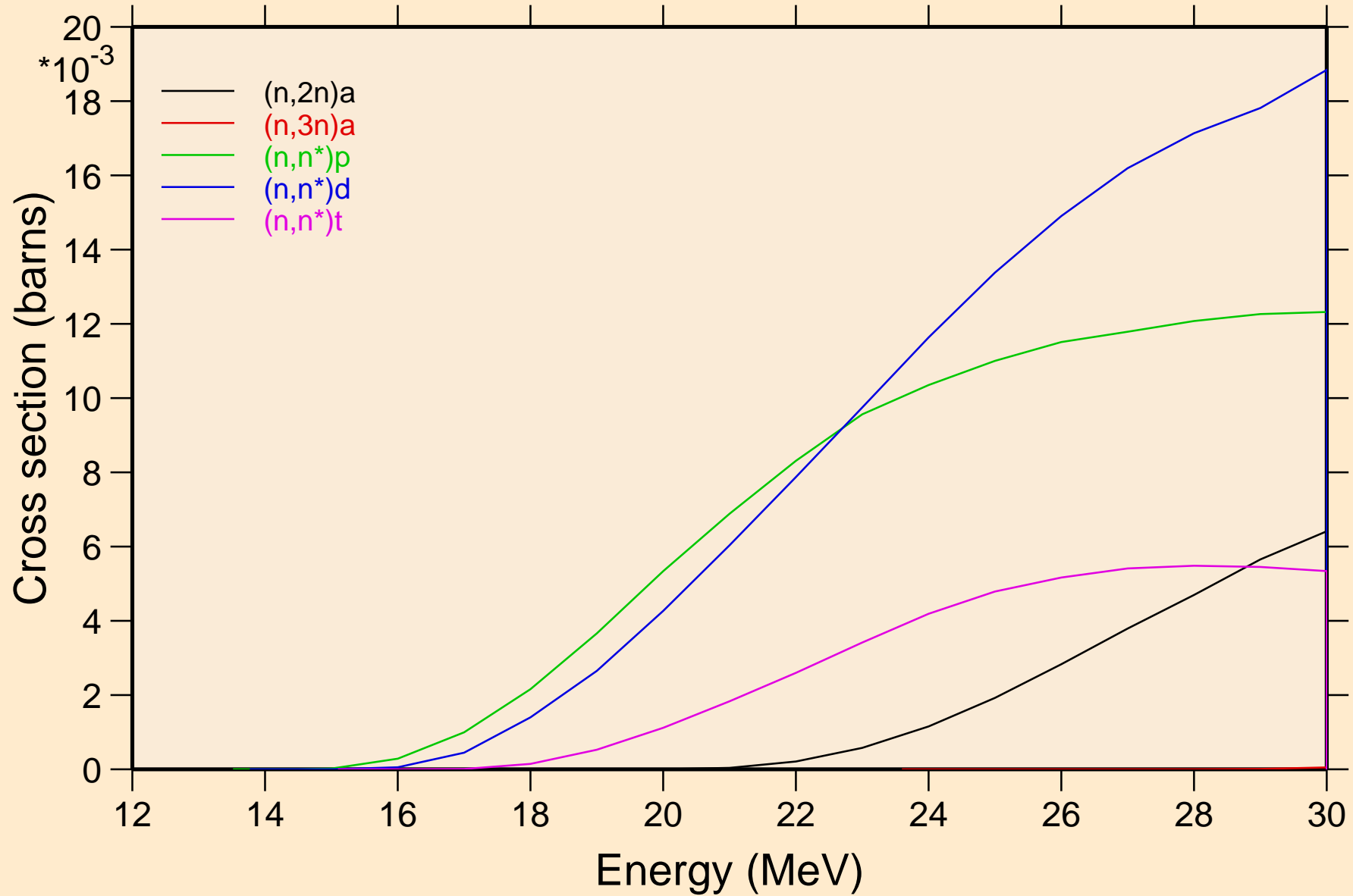

P036 NEUTRON ACER TENDL-2023 LIBRARY; T=0.K
Threshold reactions

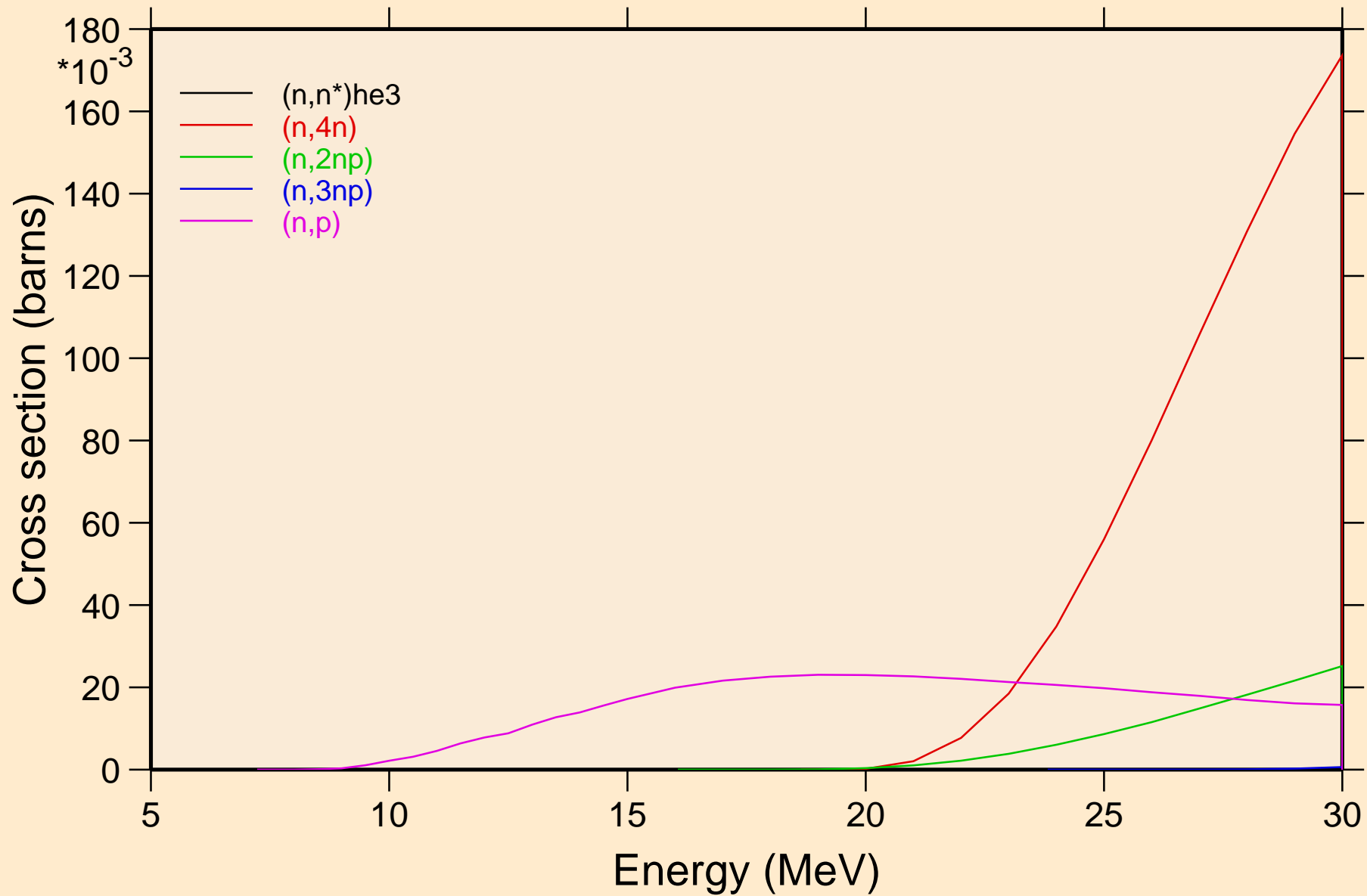

P036 NEUTRON ACER TENDL-2023 LIBRARY; T=0.K
Threshold reactions

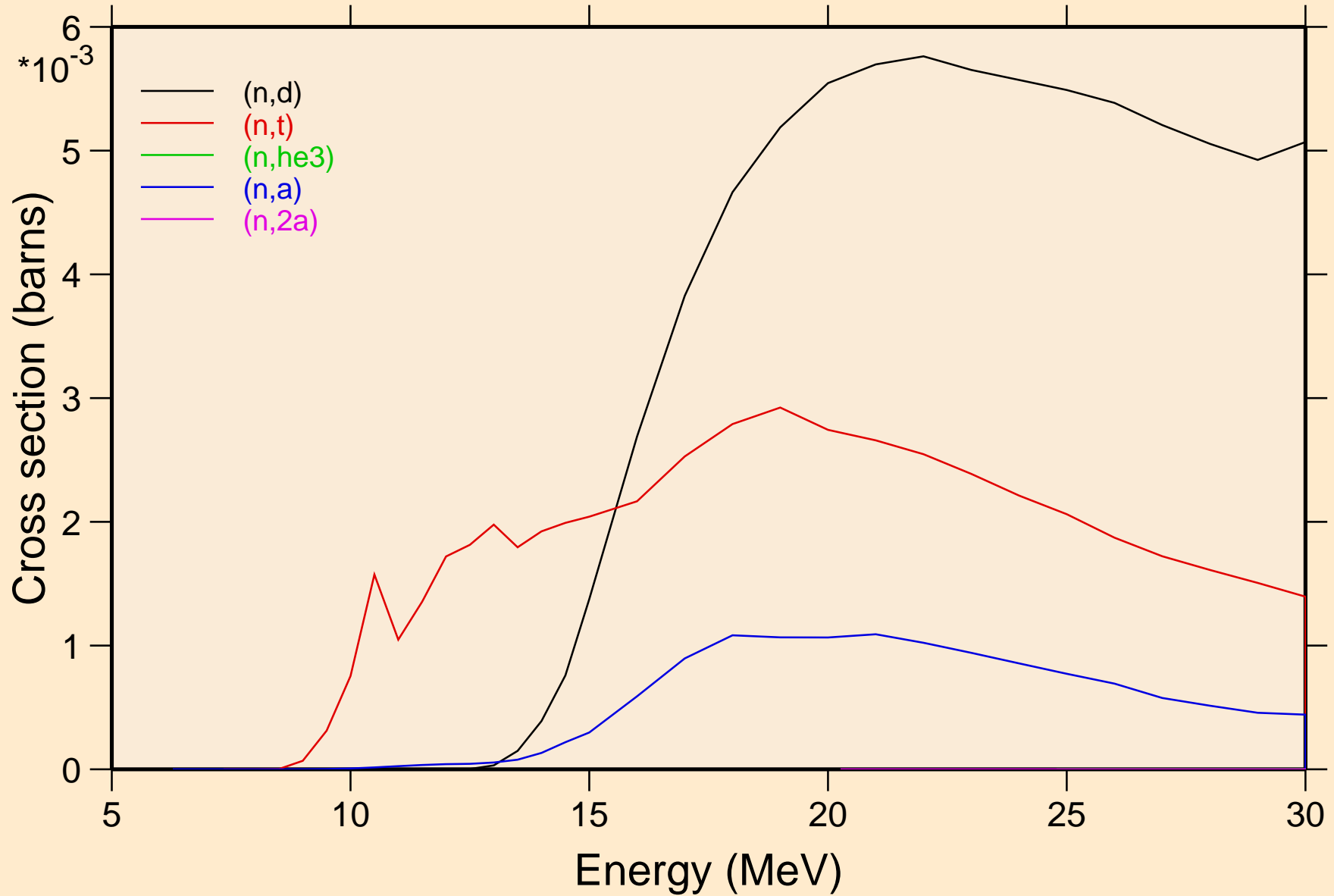

P036 NEUTRON ACER TENDL-2023 LIBRARY; T=0.K
Threshold reactions

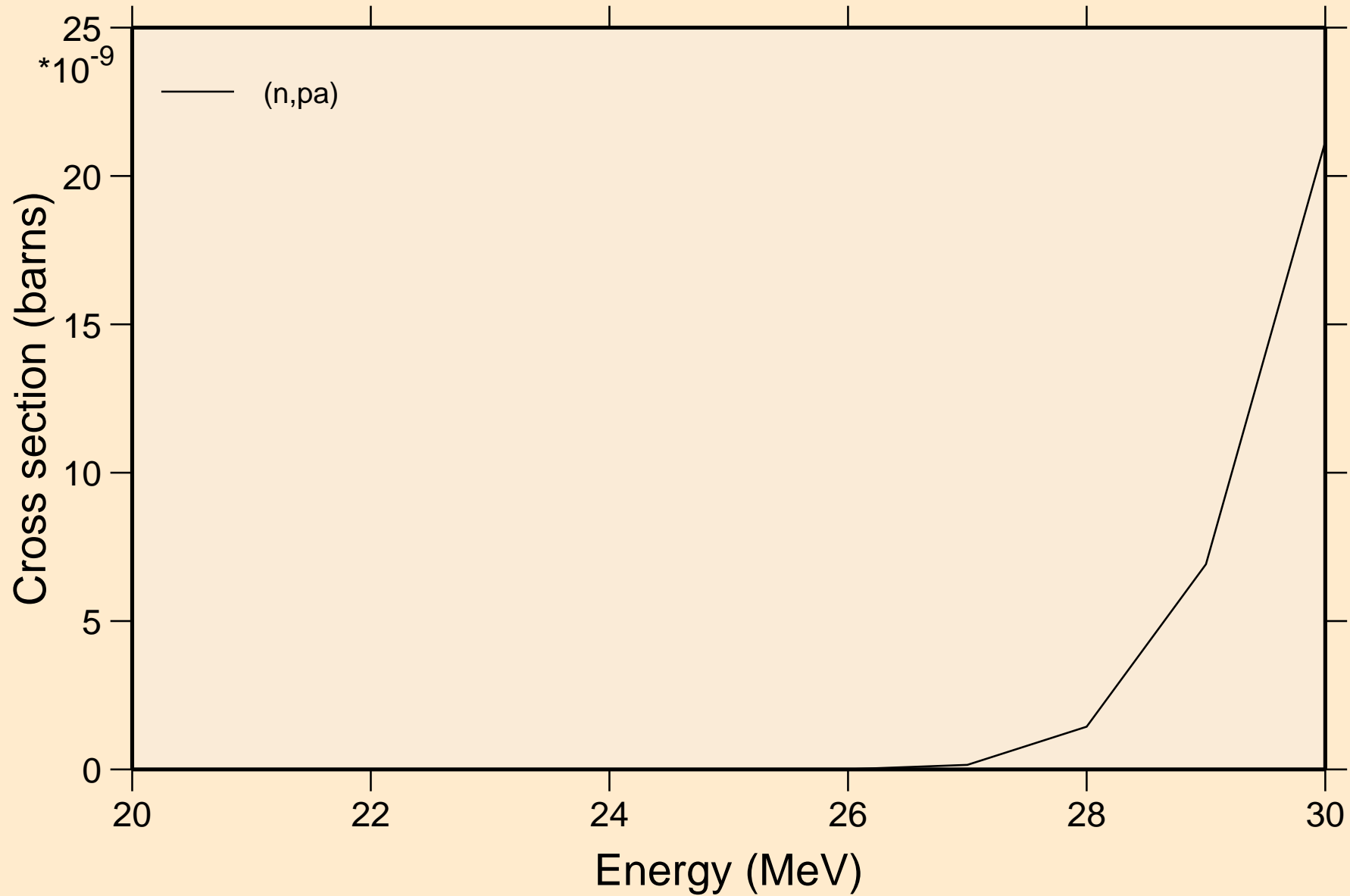

P036 NEUTRON ACER TENDL-2023 LIBRARY; T=0.K
Threshold reactions

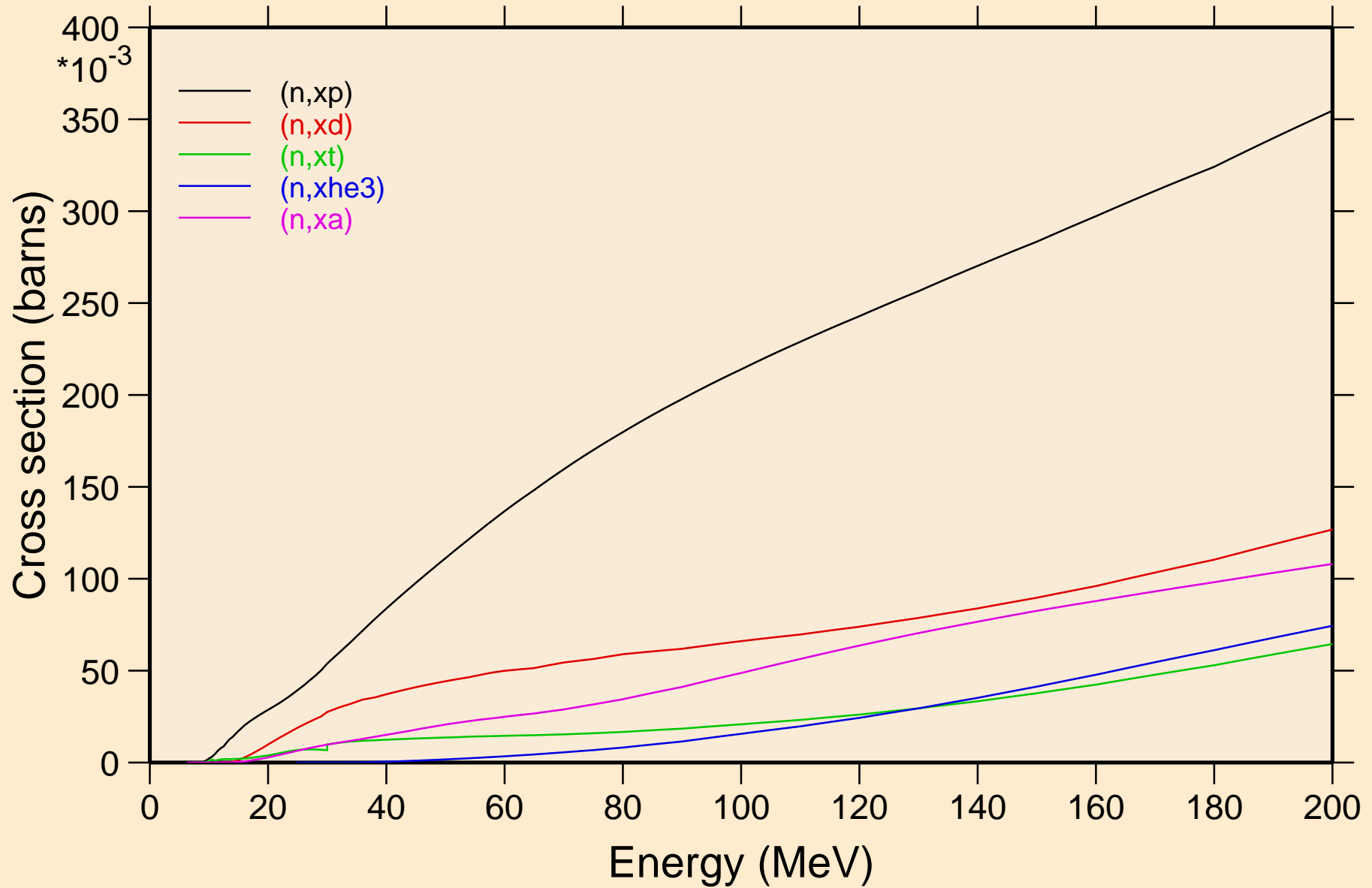

P036 NEUTRON ACER TENDL-2023 LIBRARY; T=0.K
angular distribution for elastic

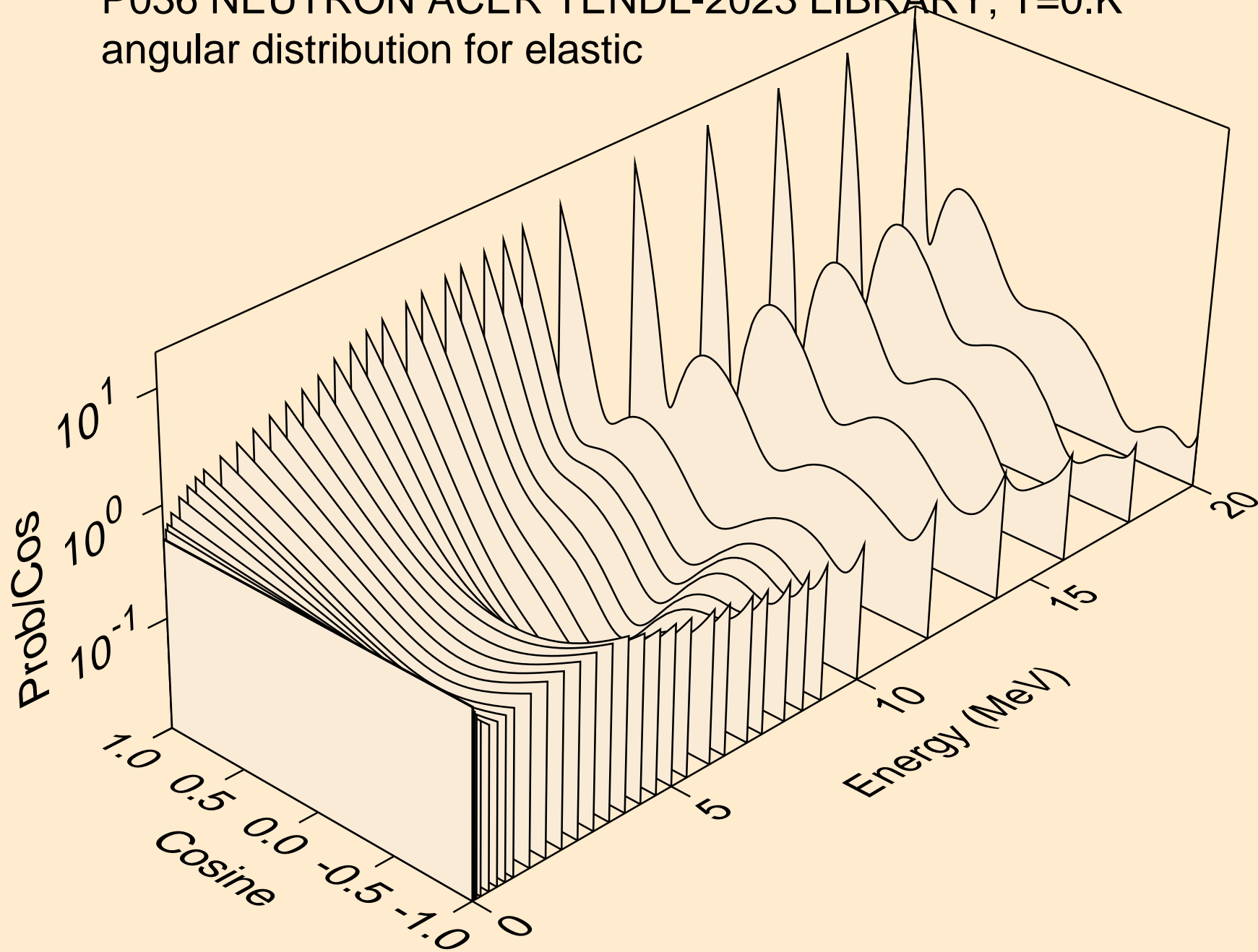

P036 NEUTRON ACER TENDL-2023 LIBRARY; T=0.K
angular distribution for elastic

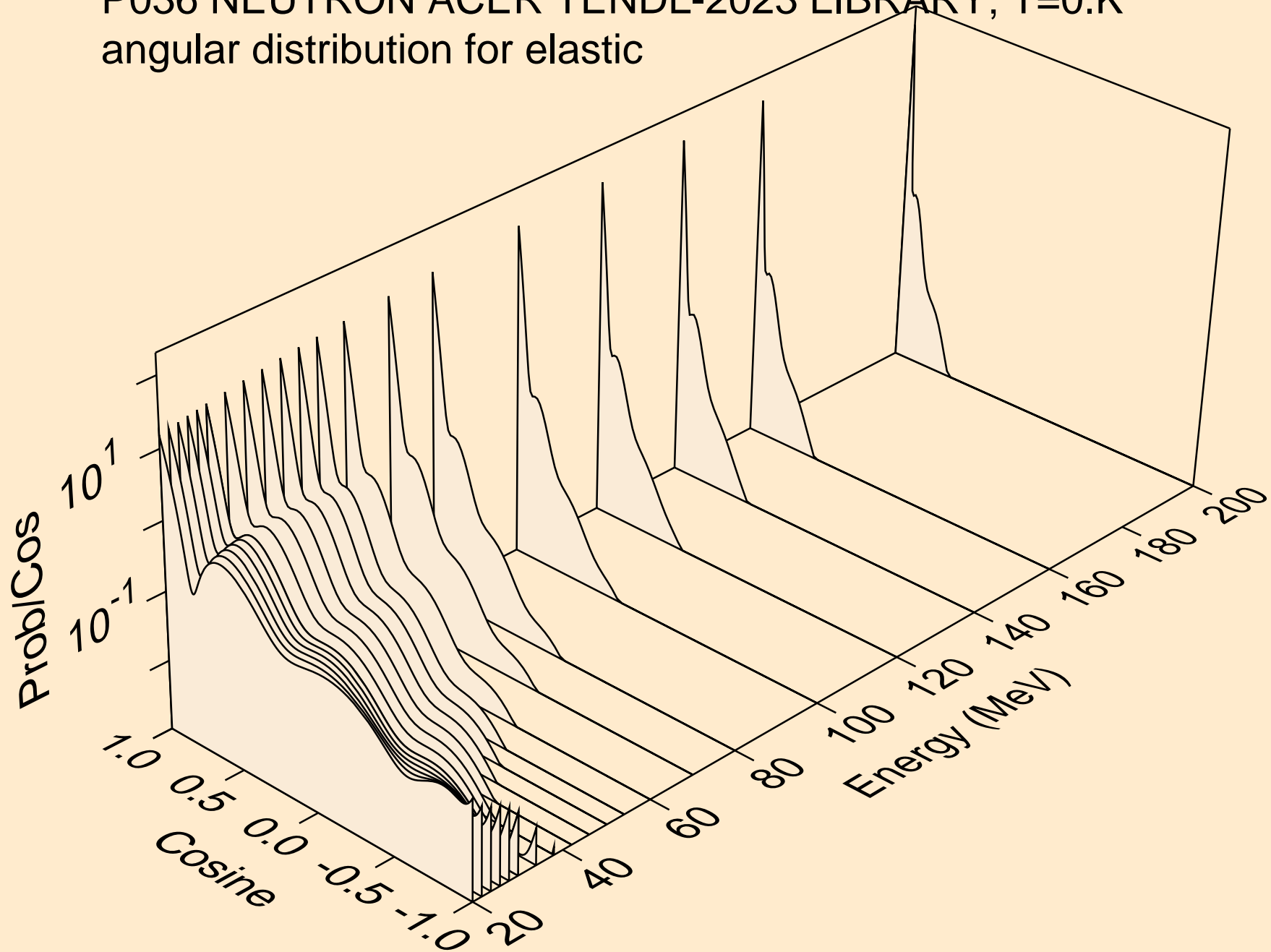

P036 NEUTRON ACER TENDL-2023 LIBRARY; T=0.K
angular distribution for (n,n*1)

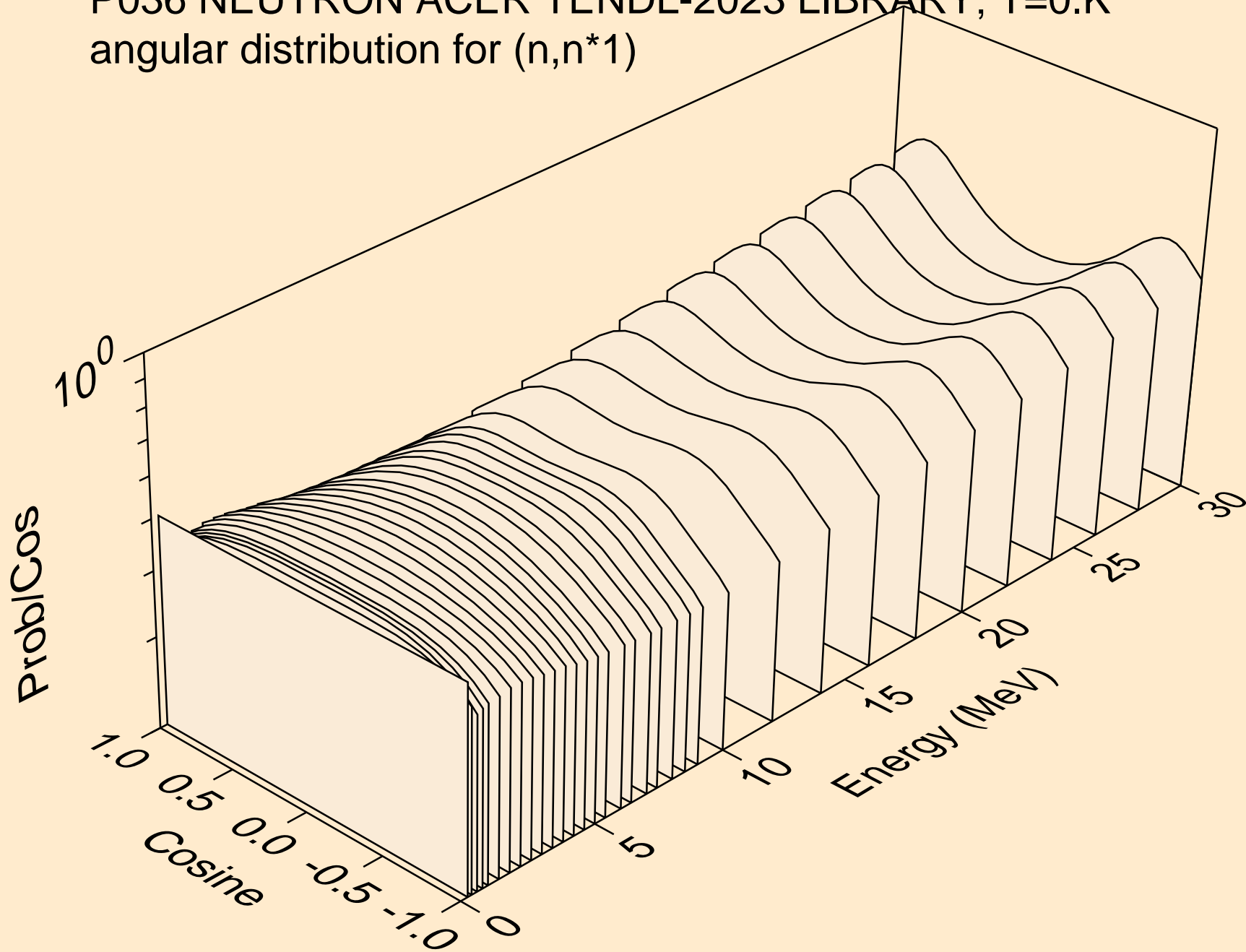

P036 NEUTRON ACER TENDL-2023 LIBRARY; T=0.K
angular distribution for (n,n*2)

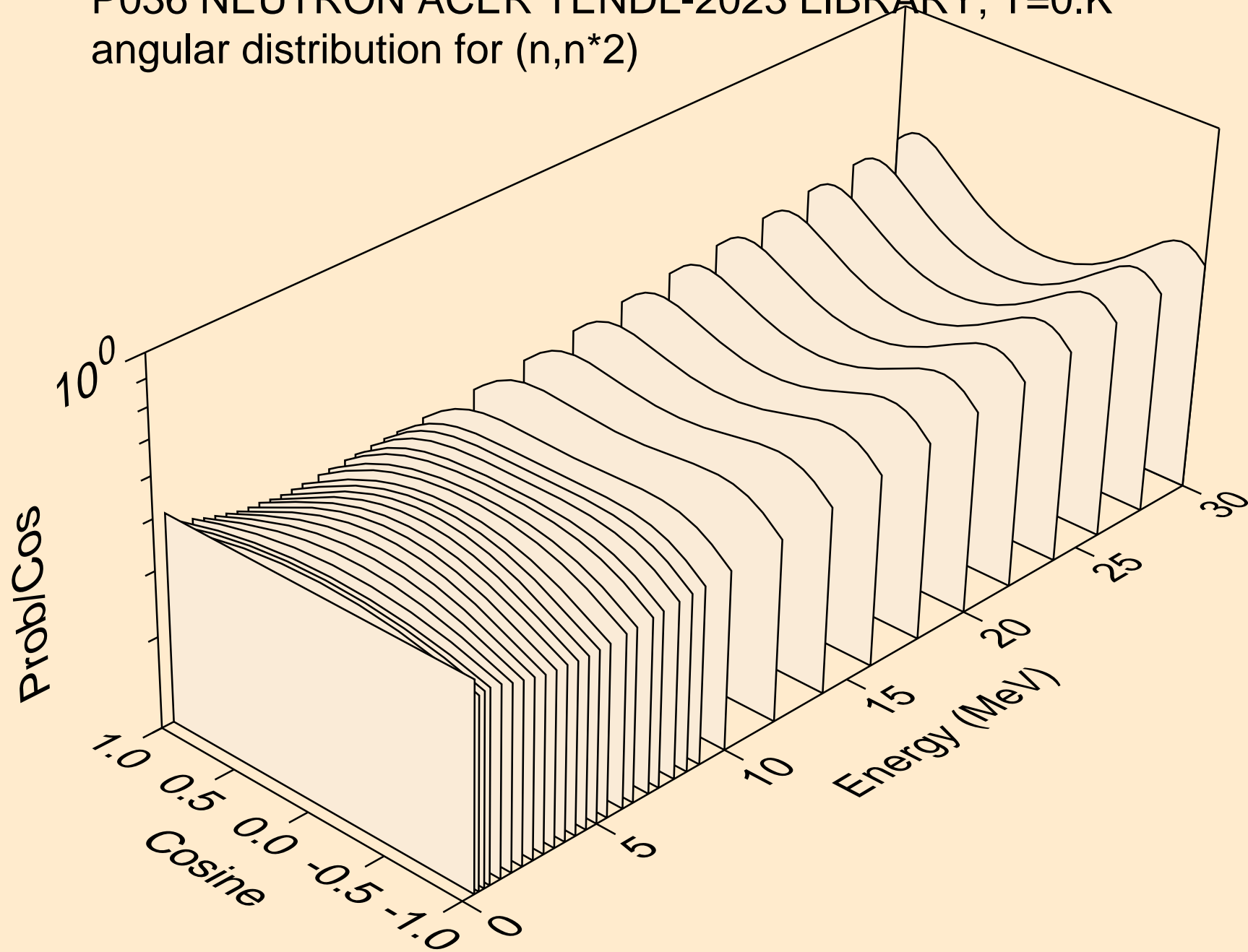

P036 NEUTRON ACER TENDL-2023 LIBRARY; T=0.K
angular distribution for (n,n*3)

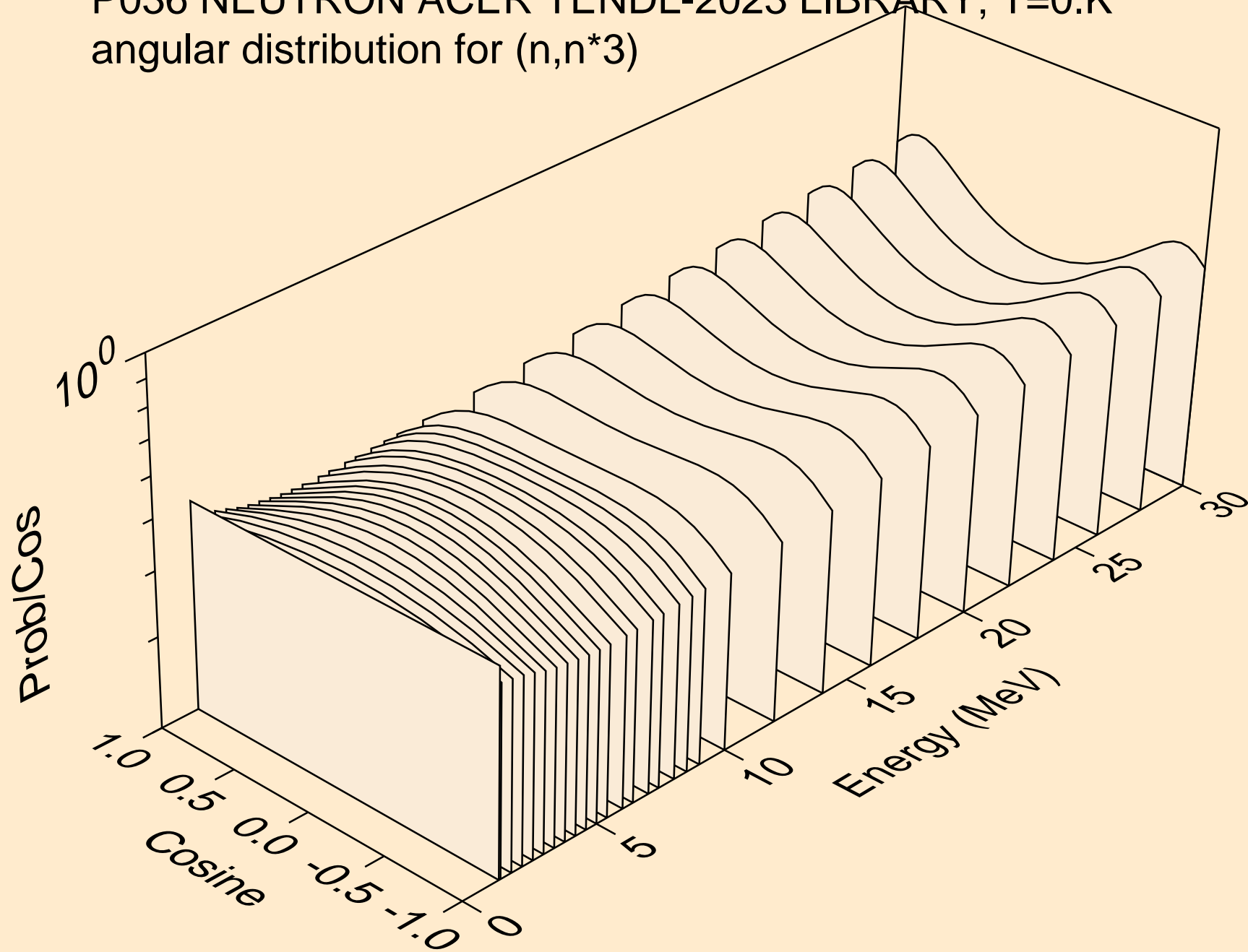

P036 NEUTRON ACER TENDL-2023 LIBRARY; T=0.K
angular distribution for (n,n*4)

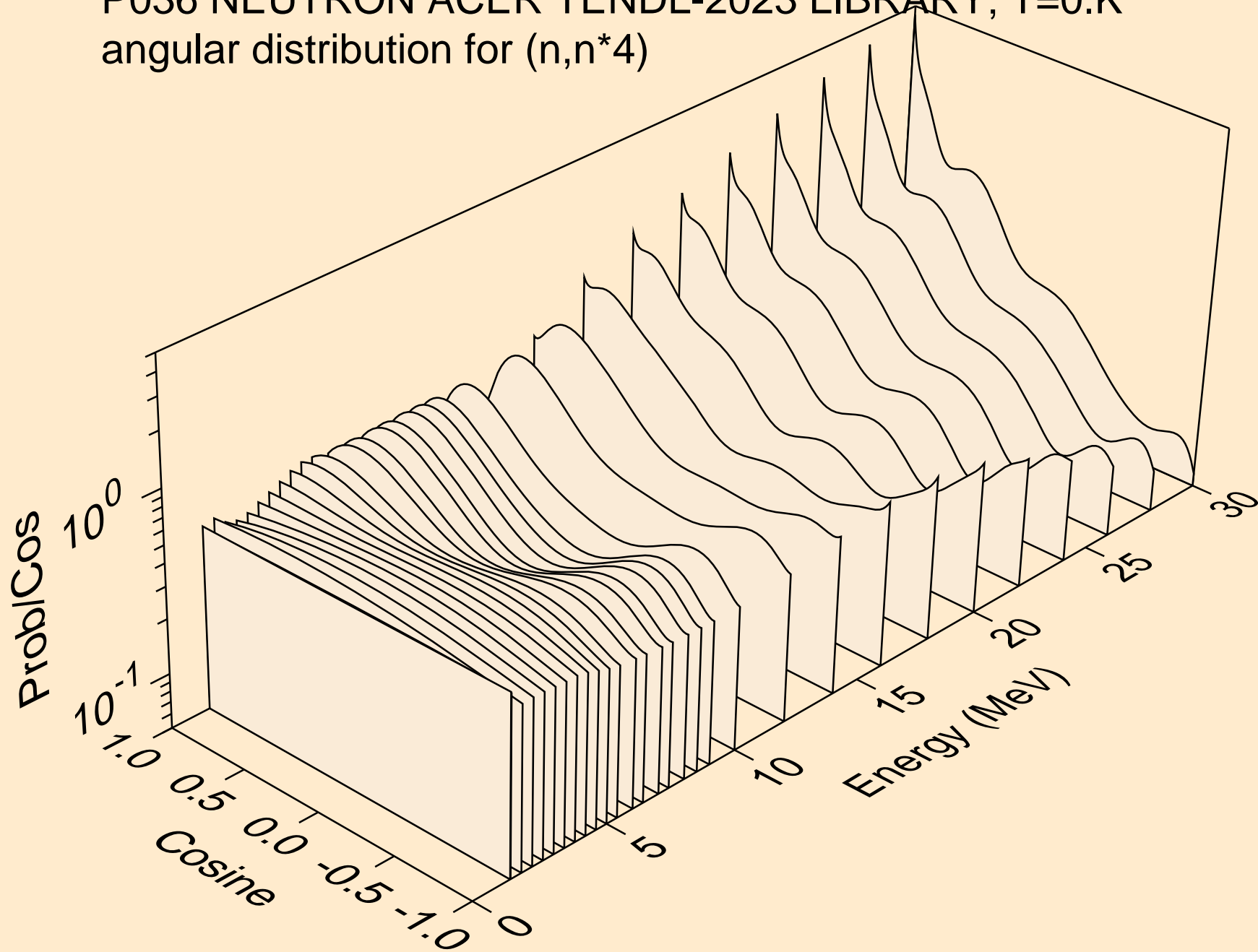

P036 NEUTRON ACER TENDL-2023 LIBRARY; T=0.K
angular distribution for (n,n*5)

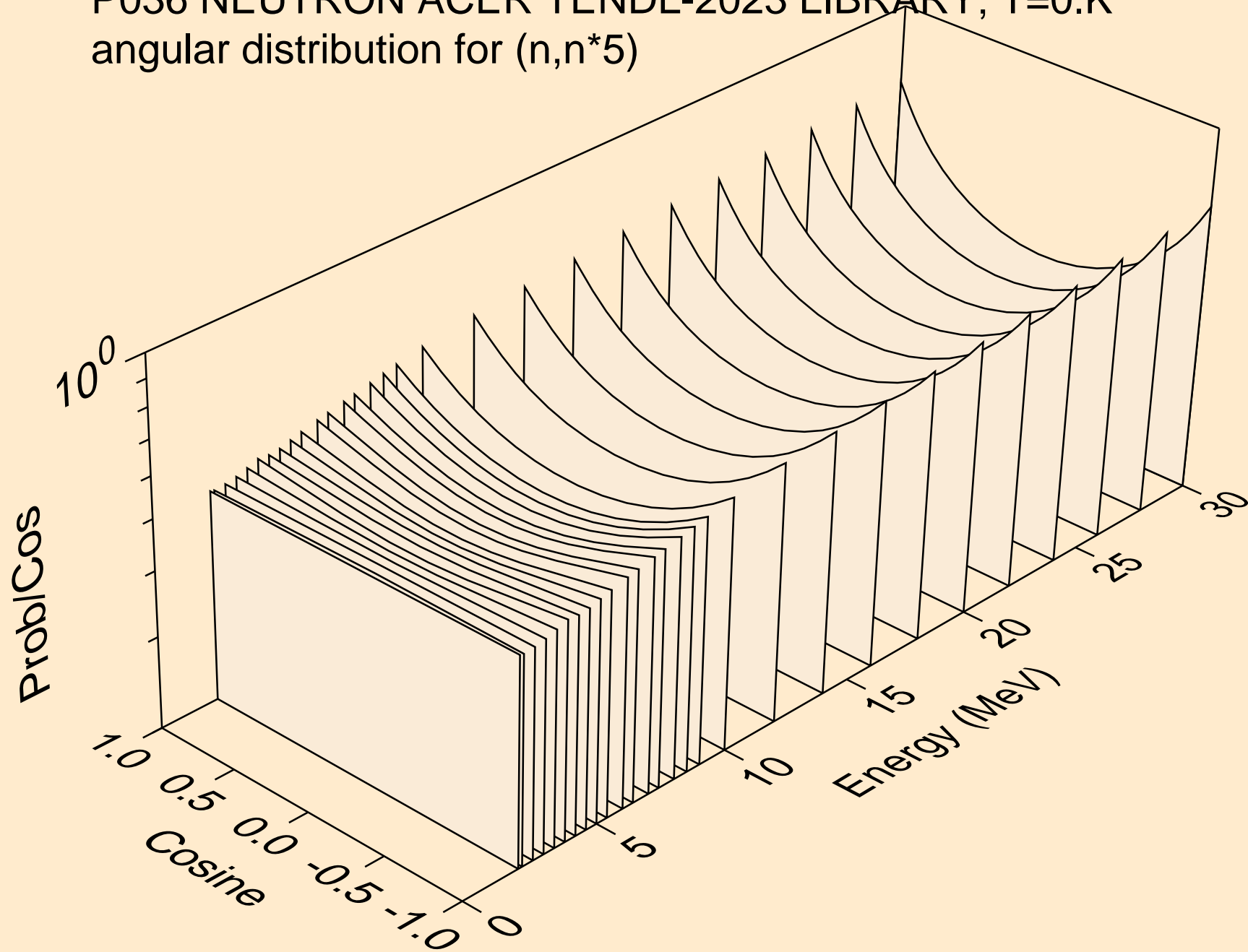

P036 NEUTRON ACER TENDL-2023 LIBRARY; T=0.K
angular distribution for (n,n*6)

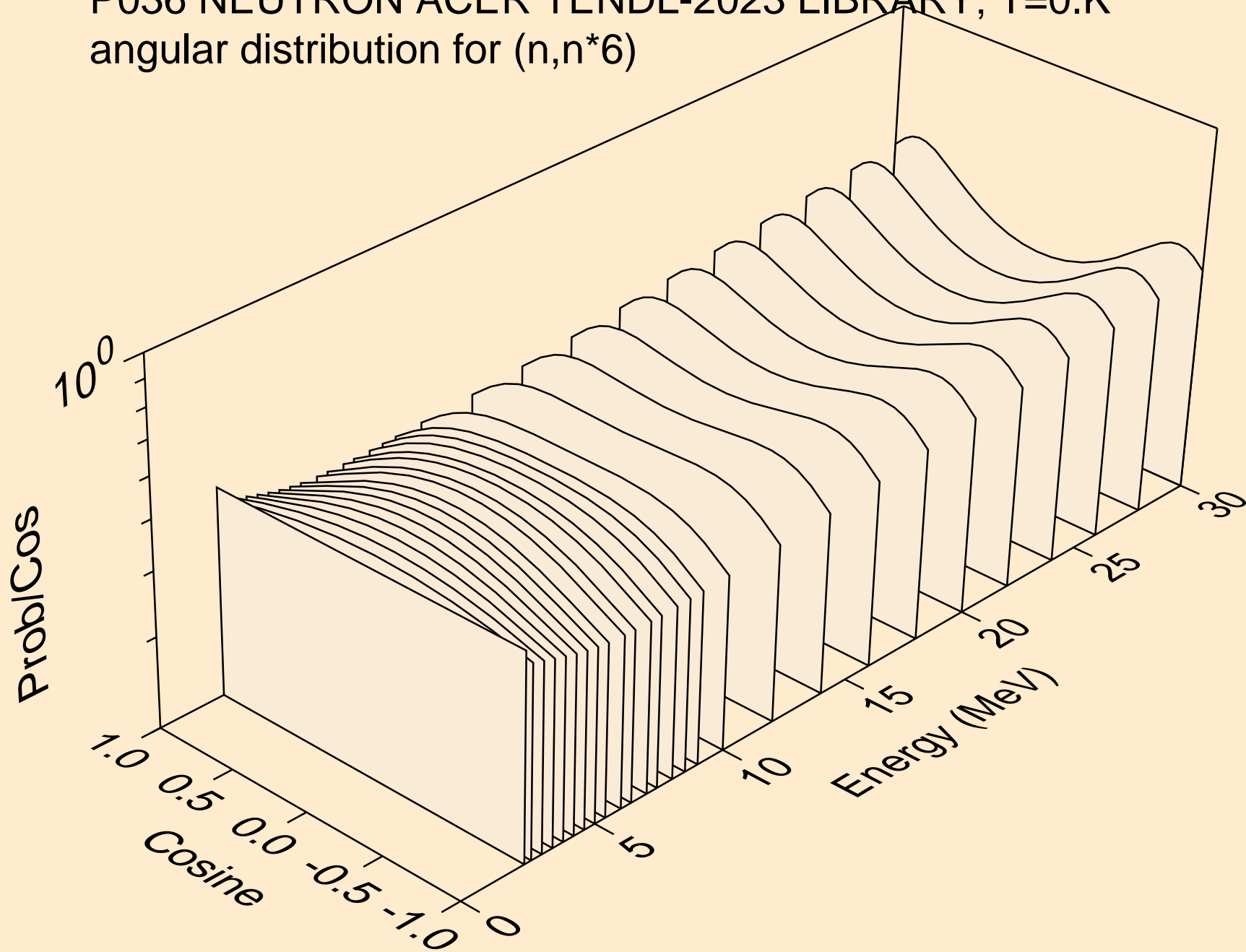

P036 NEUTRON ACER TENDL-2023 LIBRARY; T=0.K
angular distribution for (n,n*7)

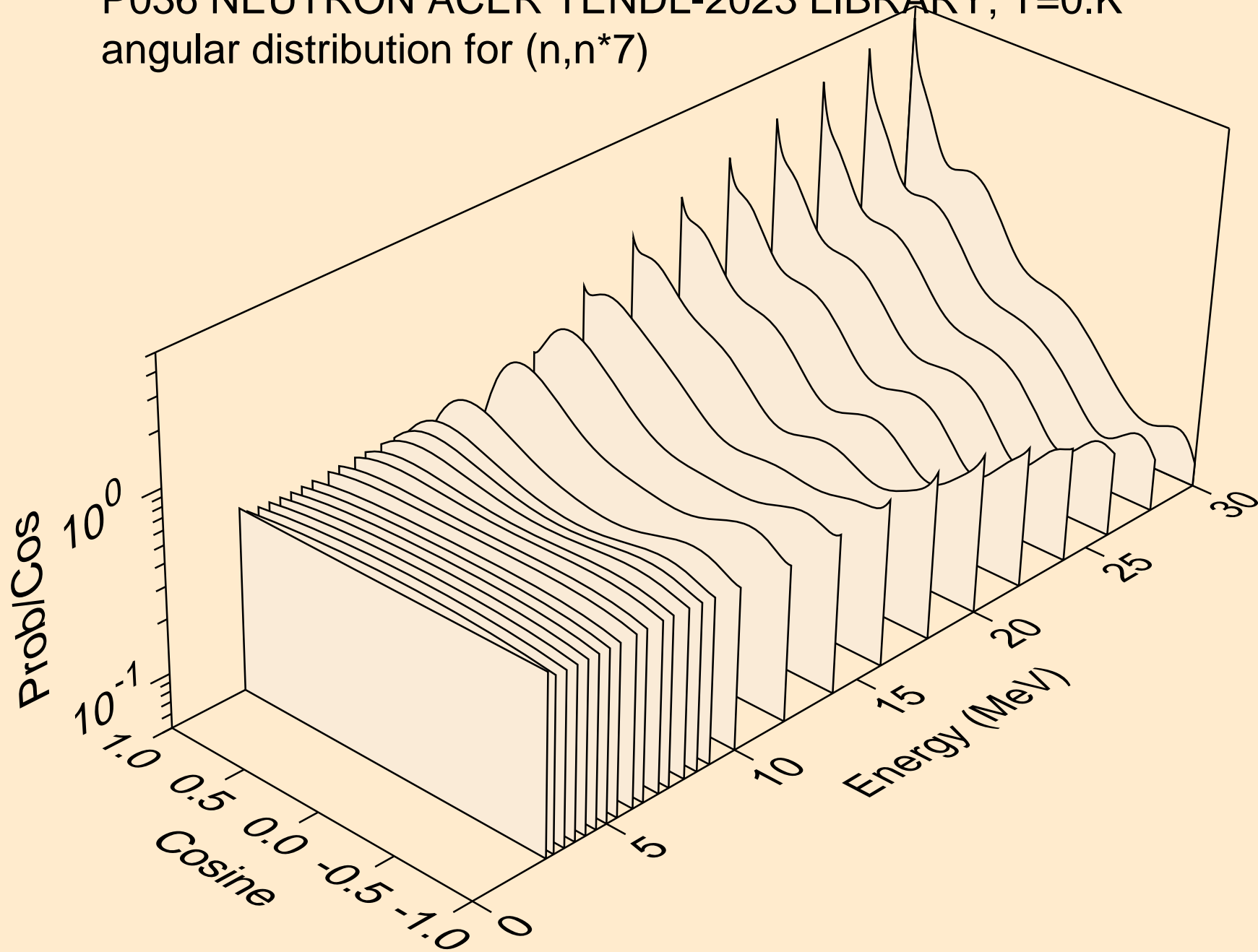

P036 NEUTRON ACER TENDL-2023 LIBRARY; T=0.K
angular distribution for (n,n*8)

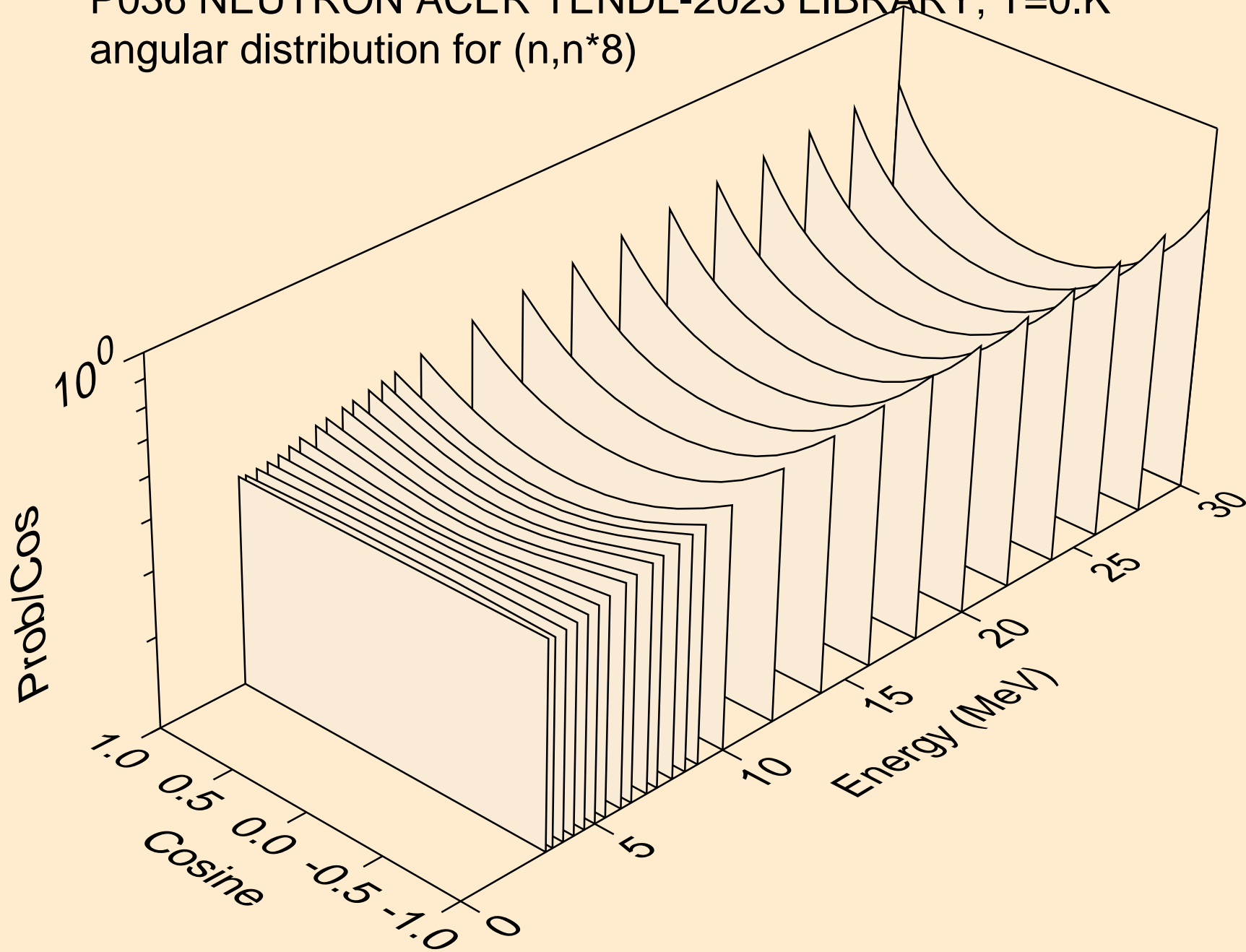

P036 NEUTRON ACER TENDL-2023 LIBRARY; T=0.K
angular distribution for (n,n*9)

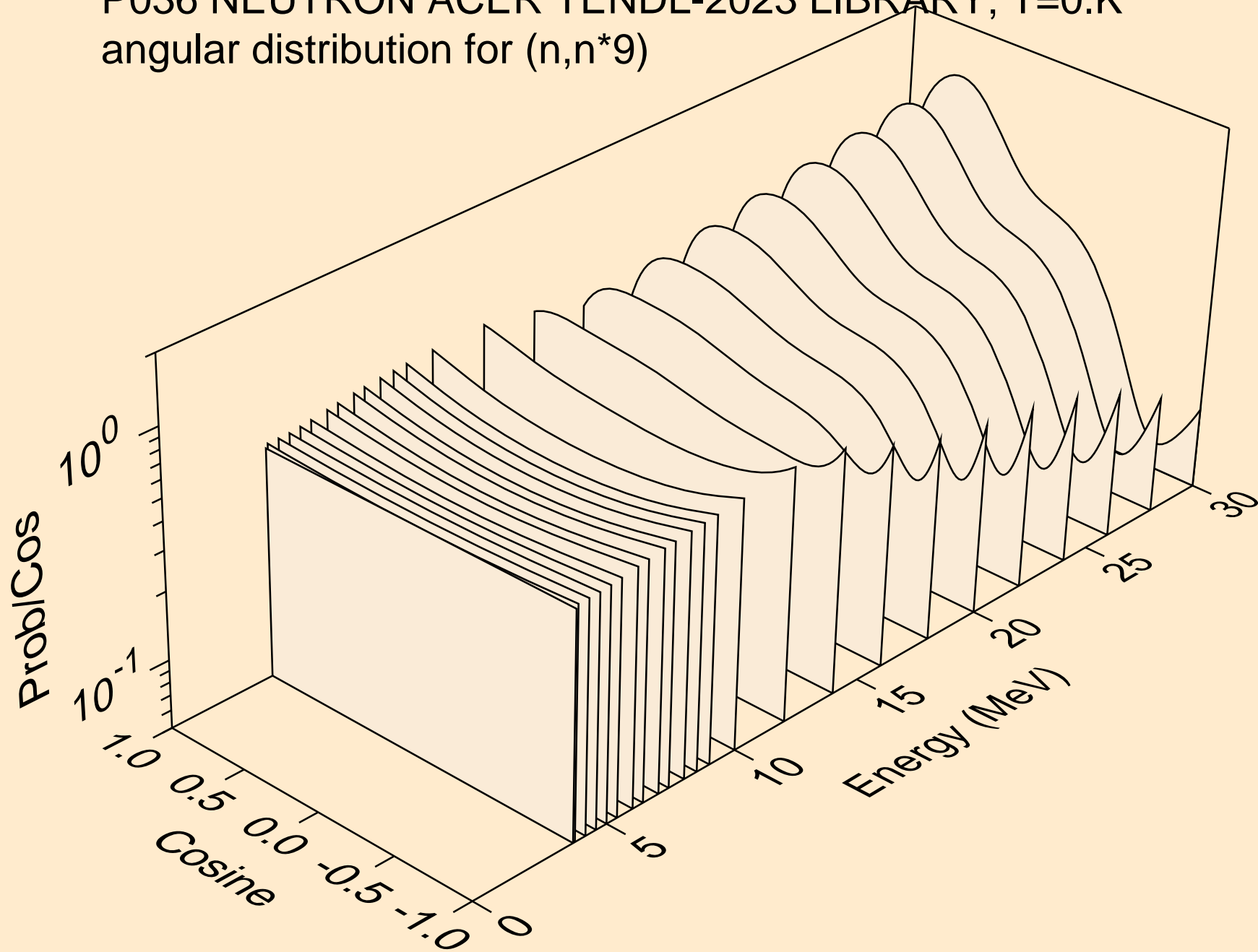

P036 NEUTRON ACER TENDL-2023 LIBRARY; T=0.K
angular distribution for (n,n*10)

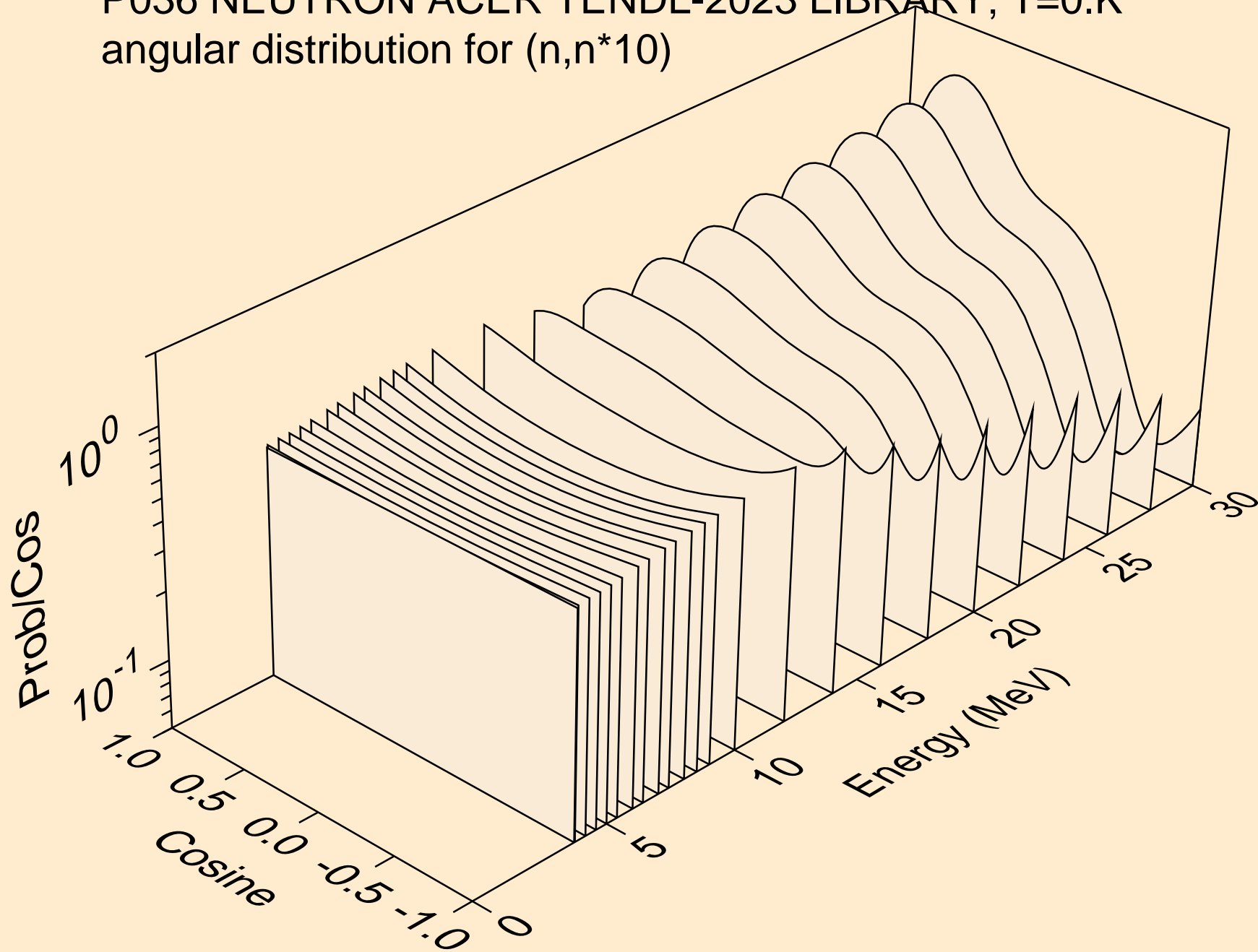

P036 NEUTRON ACER TENDL-2023 LIBRARY; T=0.K
angular distribution for (n,n*11)

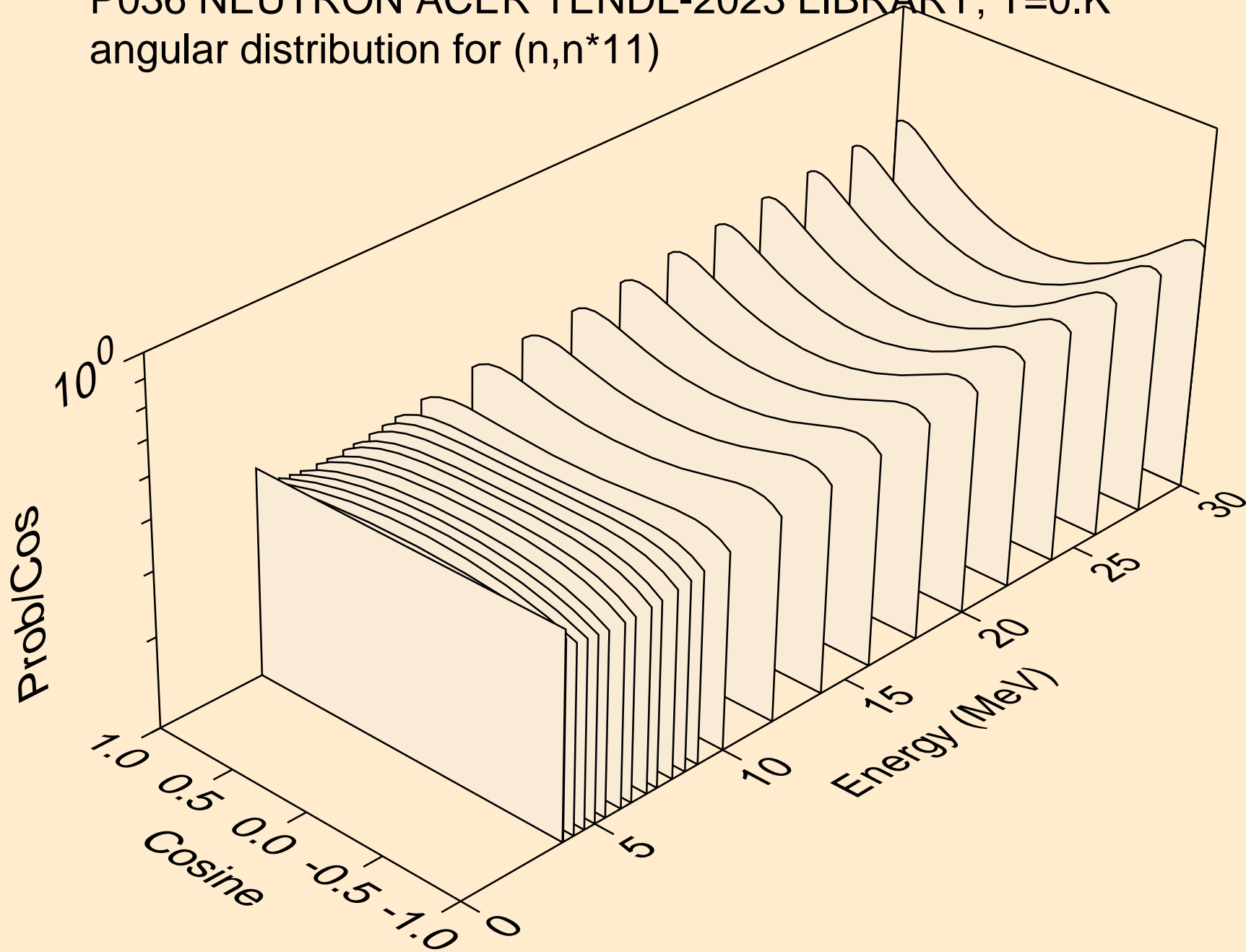

P036 NEUTRON ACER TENDL-2023 LIBRARY; T=0.K
angular distribution for (n,n*12)

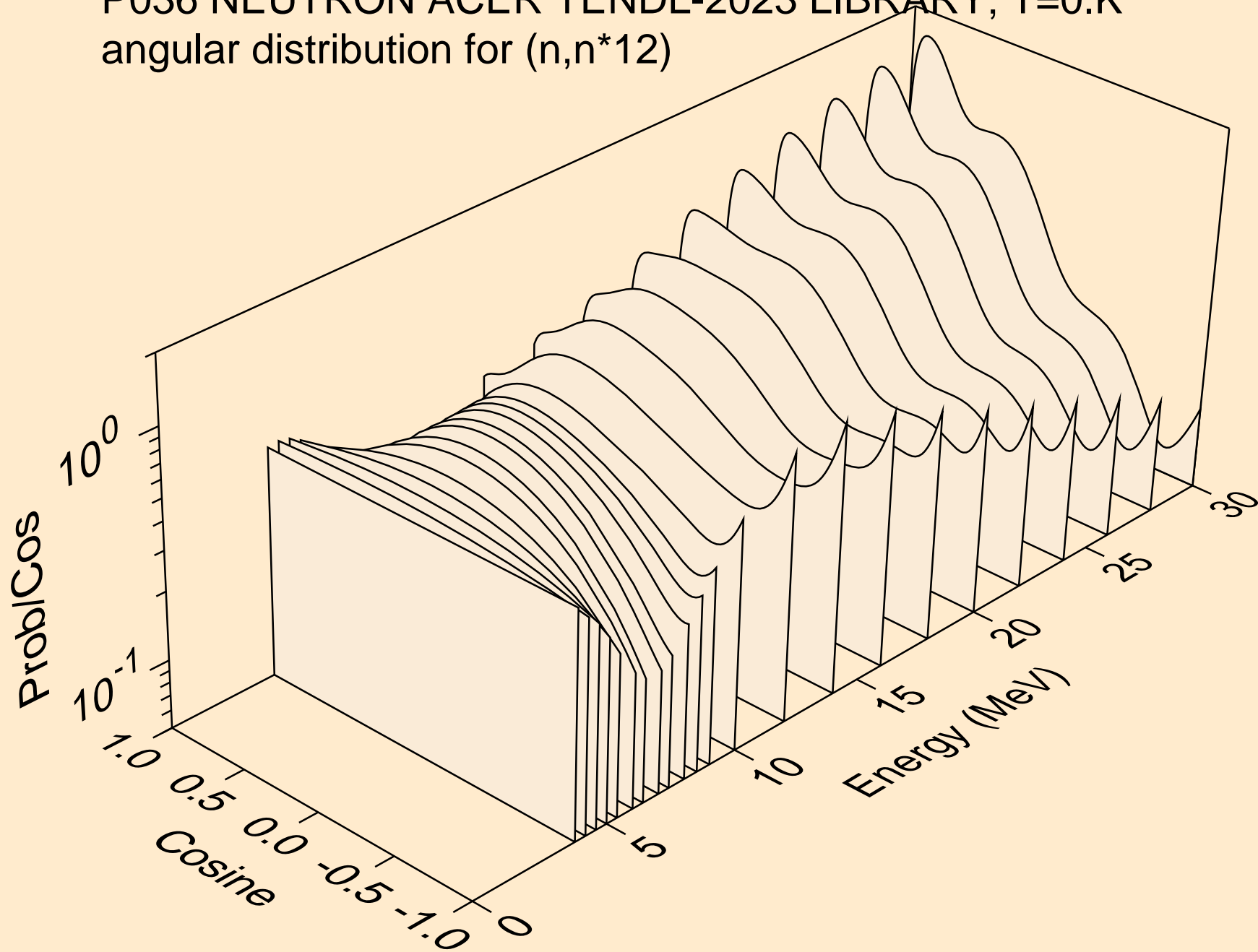

P036 NEUTRON ACER TENDL-2023 LIBRARY; T=0.K
angular distribution for (n,n*13)

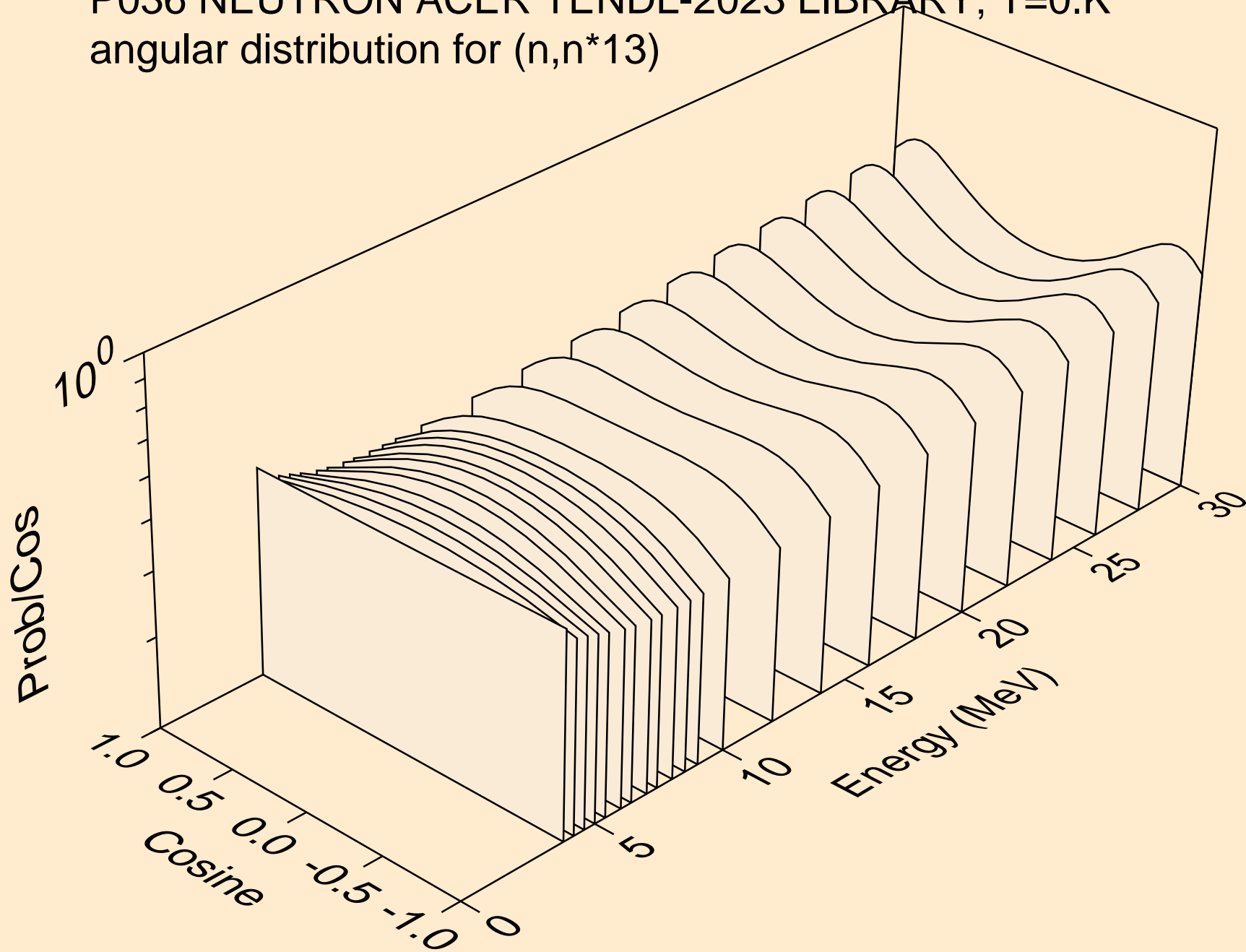

P036 NEUTRON ACER TENDL-2023 LIBRARY; T=0.K
angular distribution for (n,n*14)

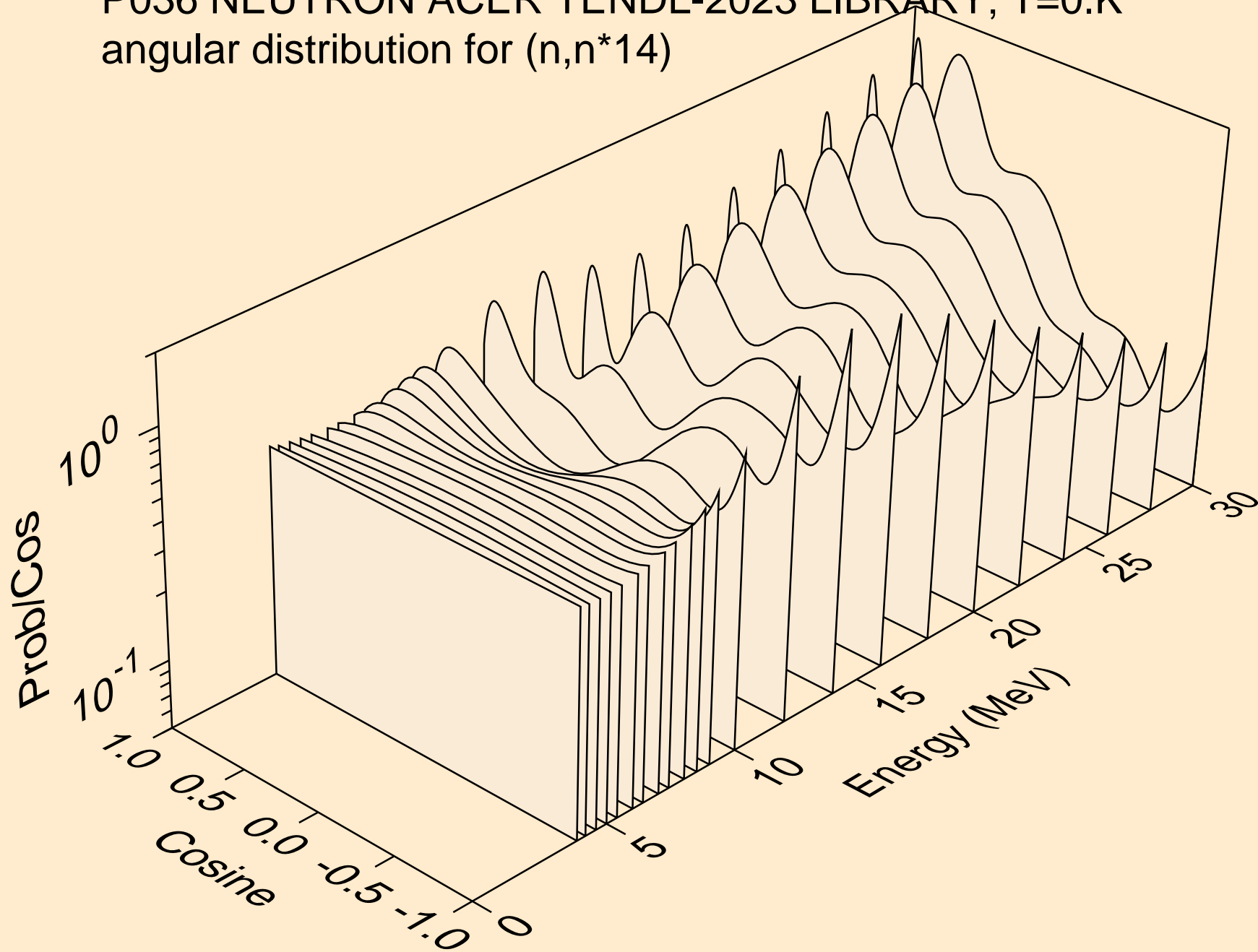

P036 NEUTRON ACER TENDL-2023 LIBRARY; T=0.K
angular distribution for (n,n*15)

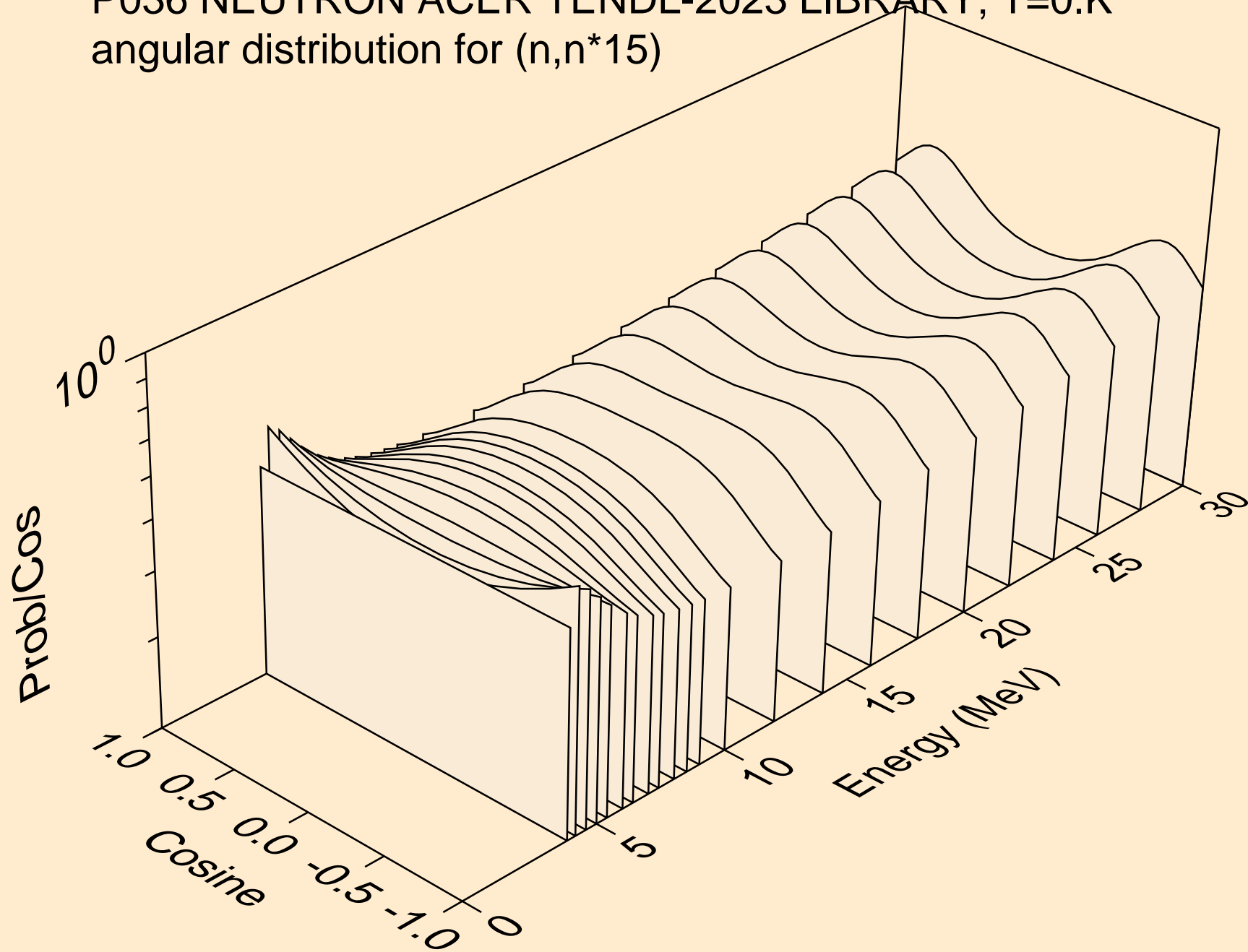

P036 NEUTRON ACER TENDL-2023 LIBRARY; T=0.K
angular distribution for (n,n*16)

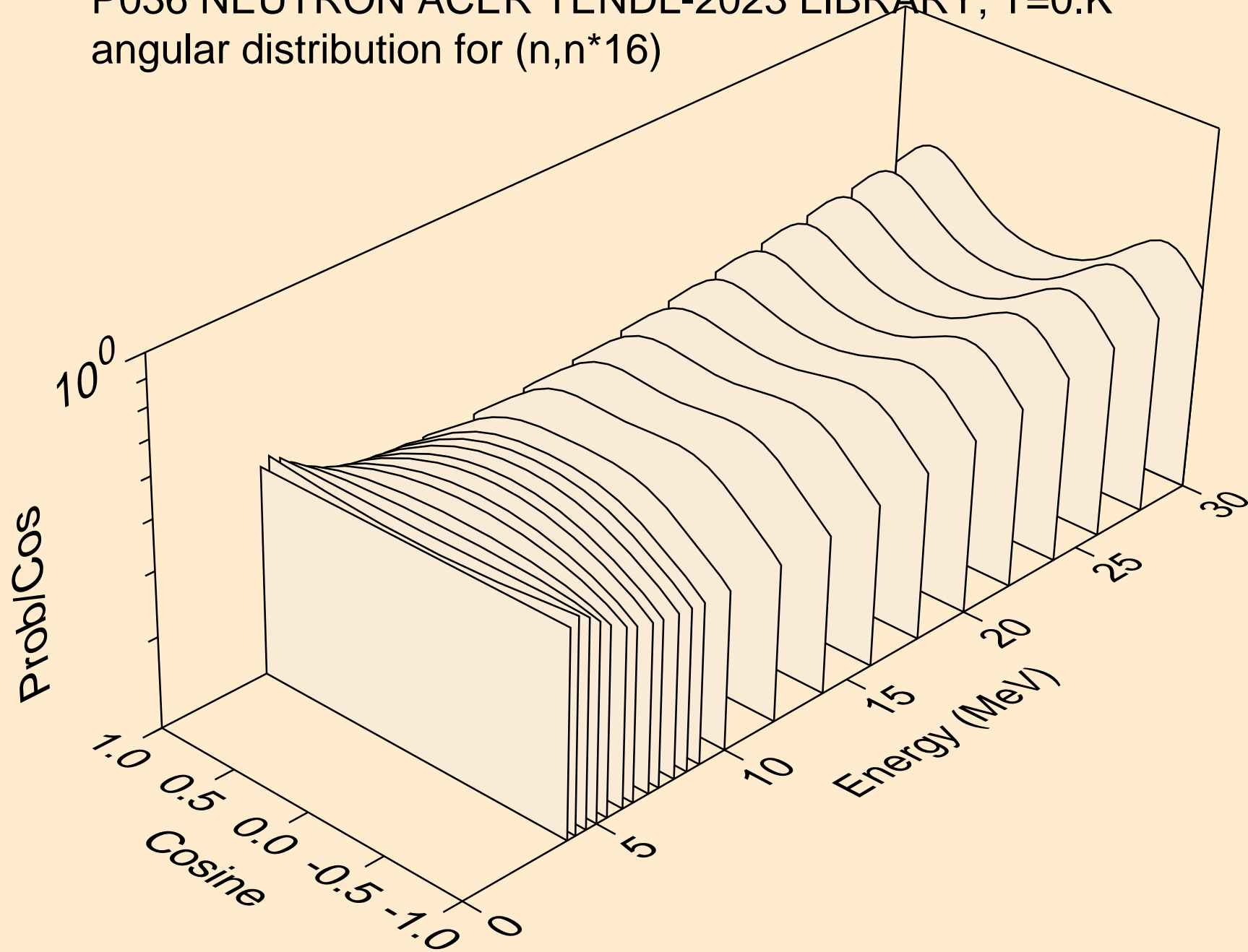

P036 NEUTRON ACER TENDL-2023 LIBRARY; T=0.K
angular distribution for (n,n*17)

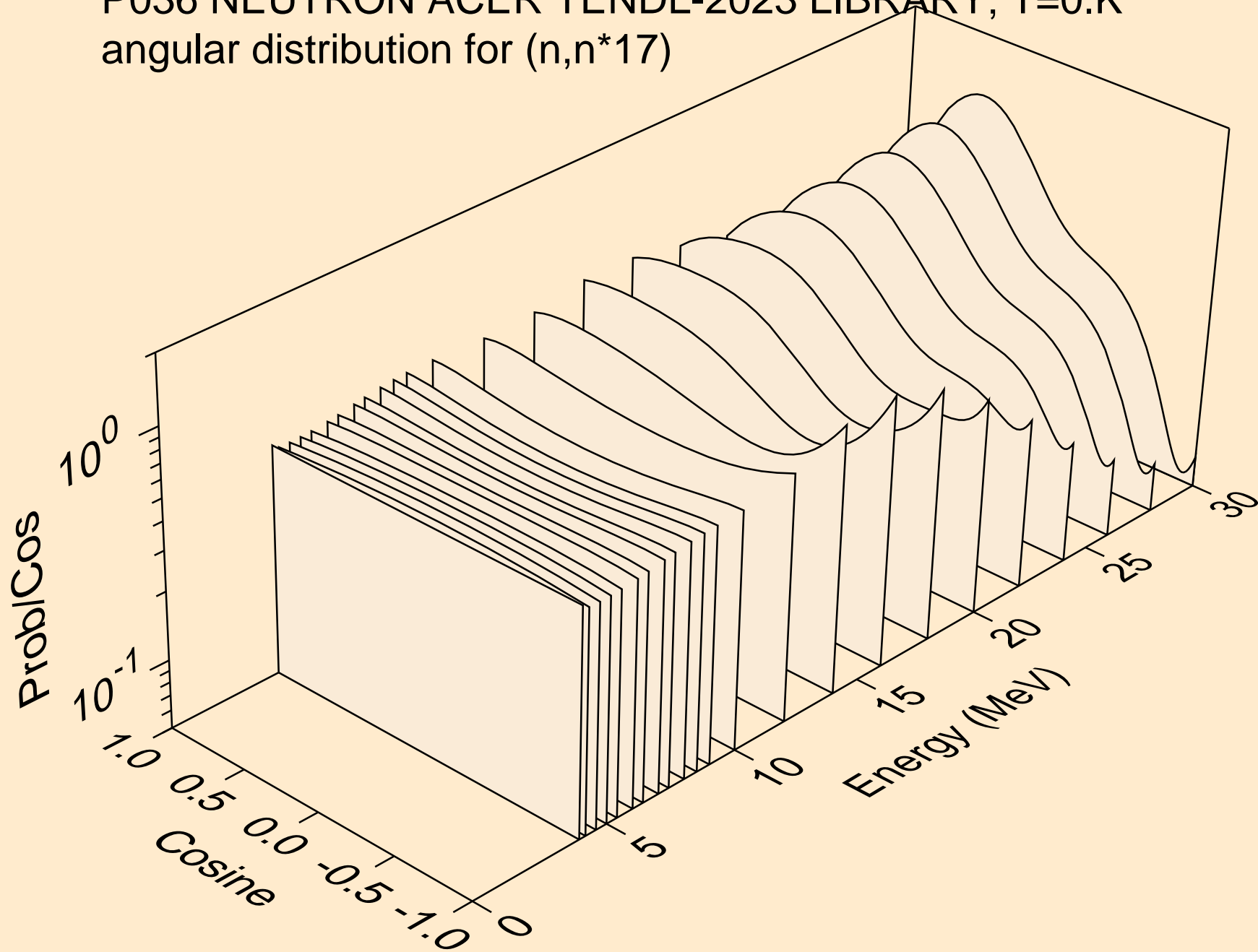

P036 NEUTRON ACER TENDL-2023 LIBRARY; T=0.K
angular distribution for (n,n*18)

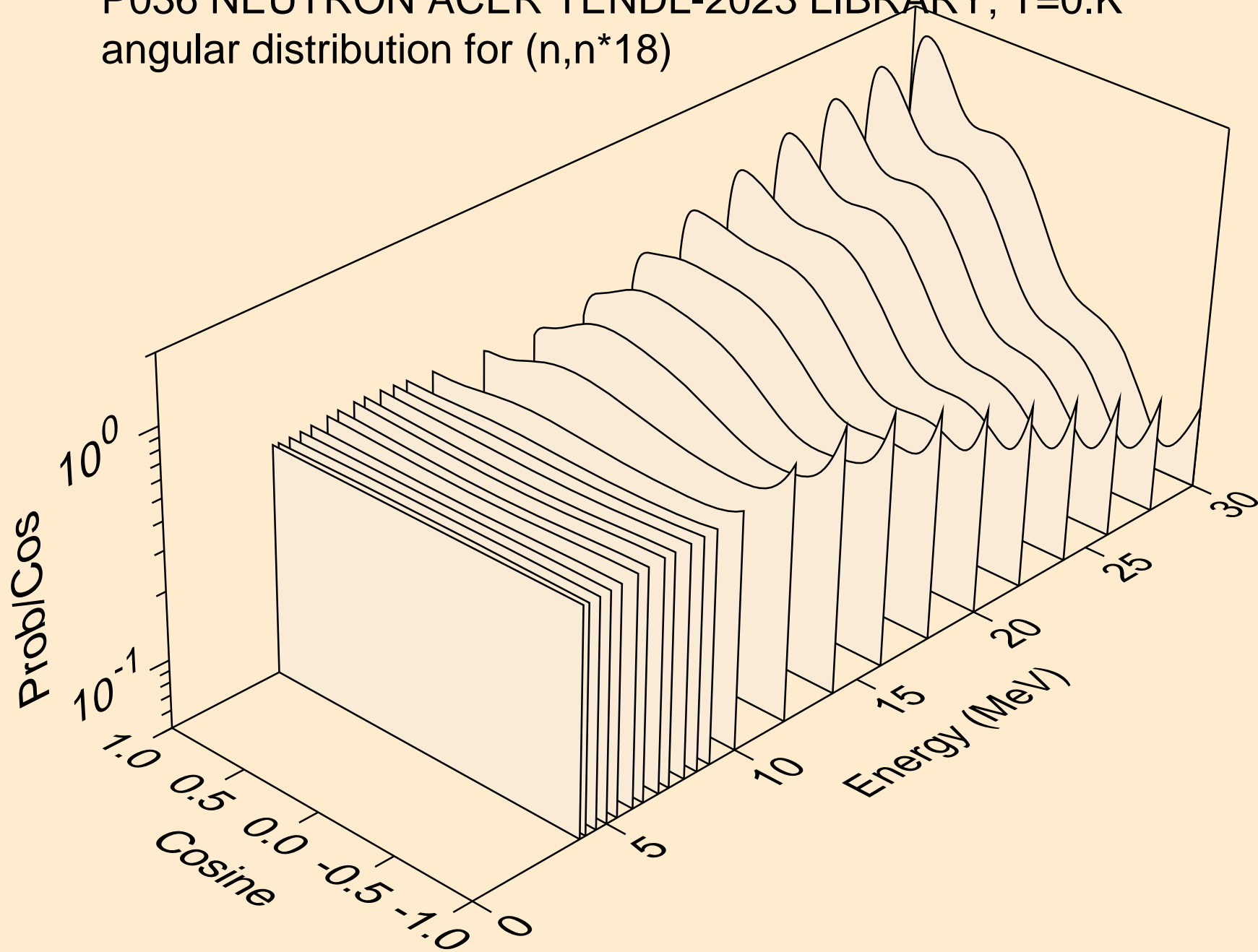

P036 NEUTRON ACER TENDL-2023 LIBRARY; T=0.K
angular distribution for (n,n*19)

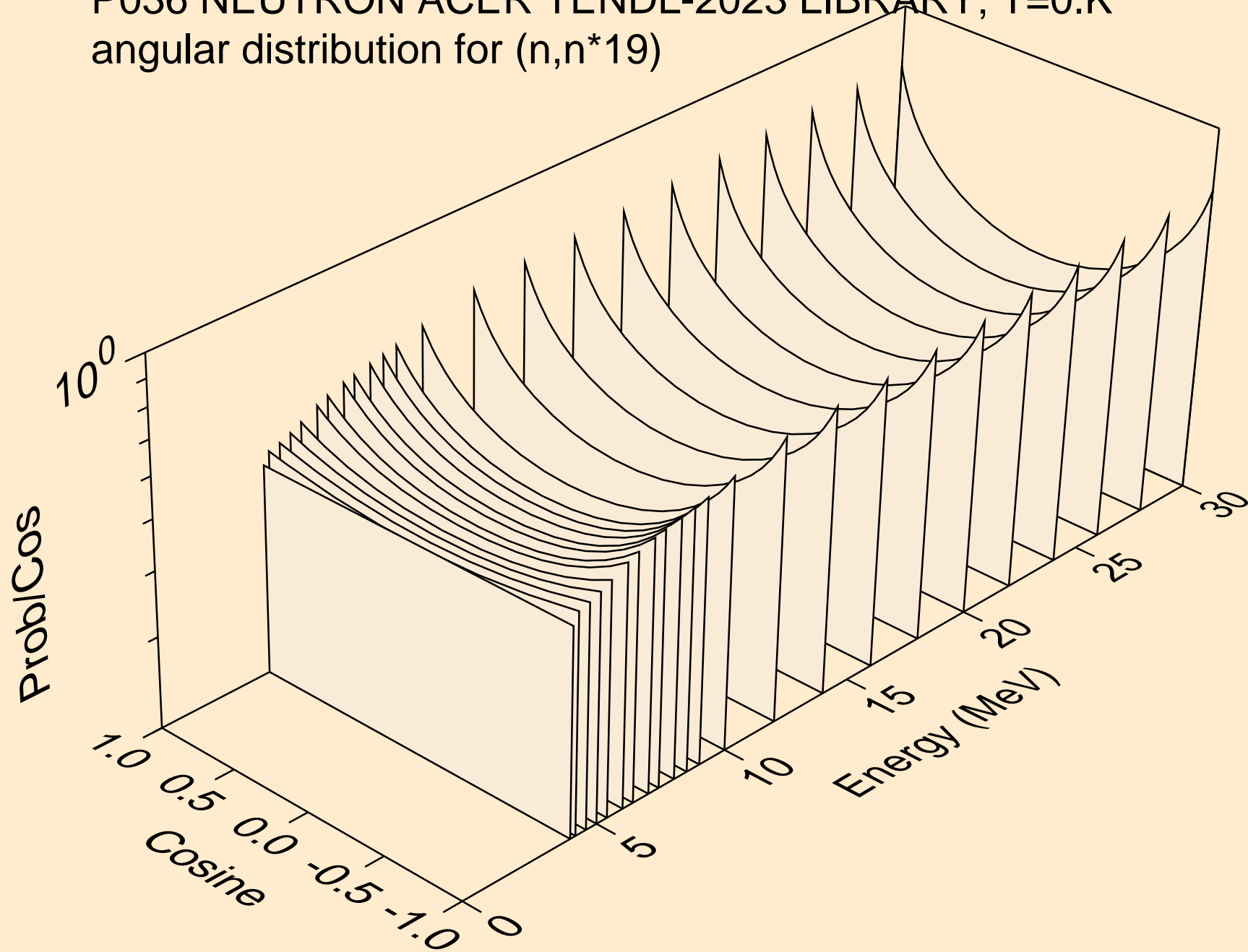

P036 NEUTRON ACER TENDL-2023 LIBRARY; T=0.K
angular distribution for (n,n*20)

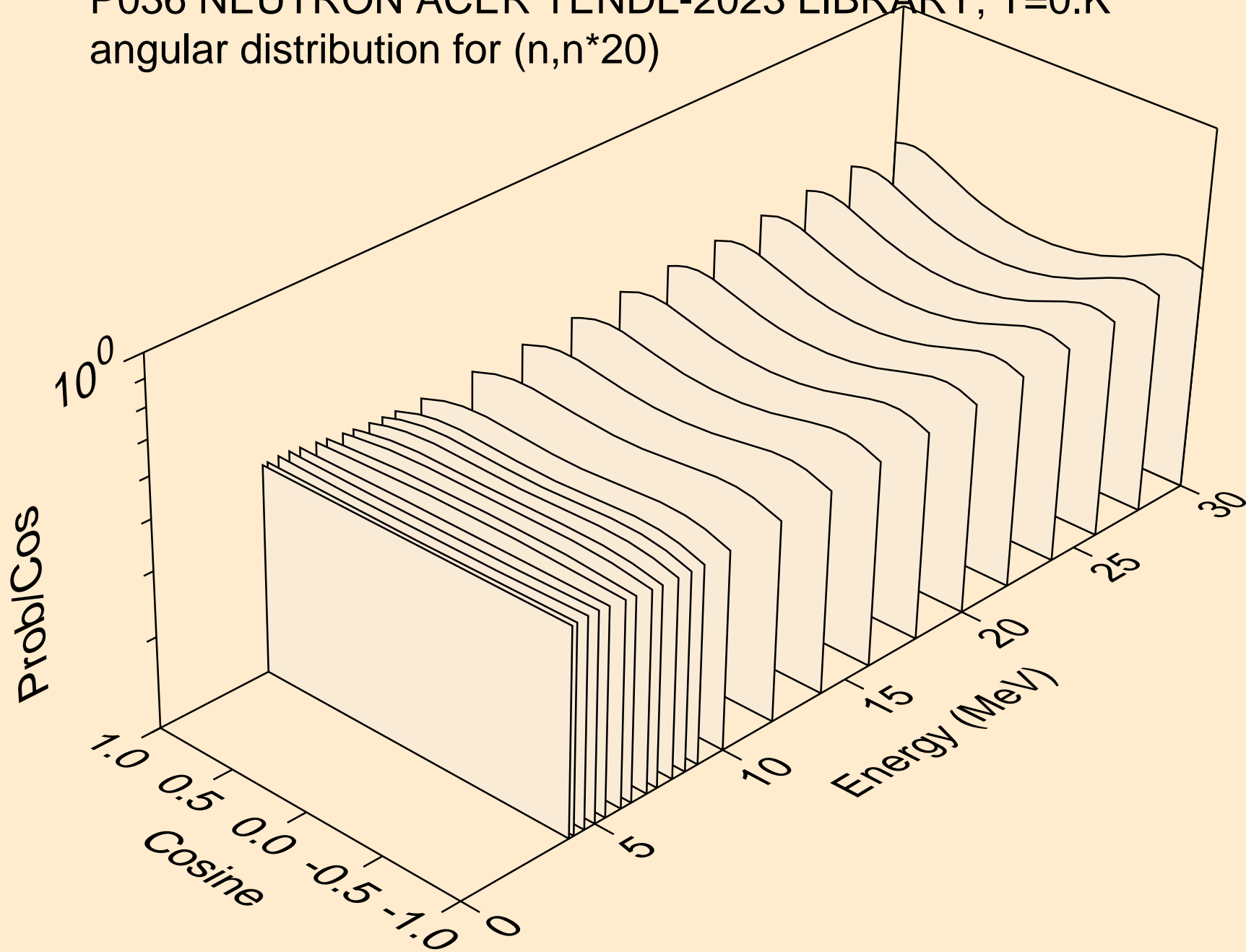

P036 NEUTRON ACER TENDL-2023 LIBRARY; T=0.K
angular distribution for (n,n*21)

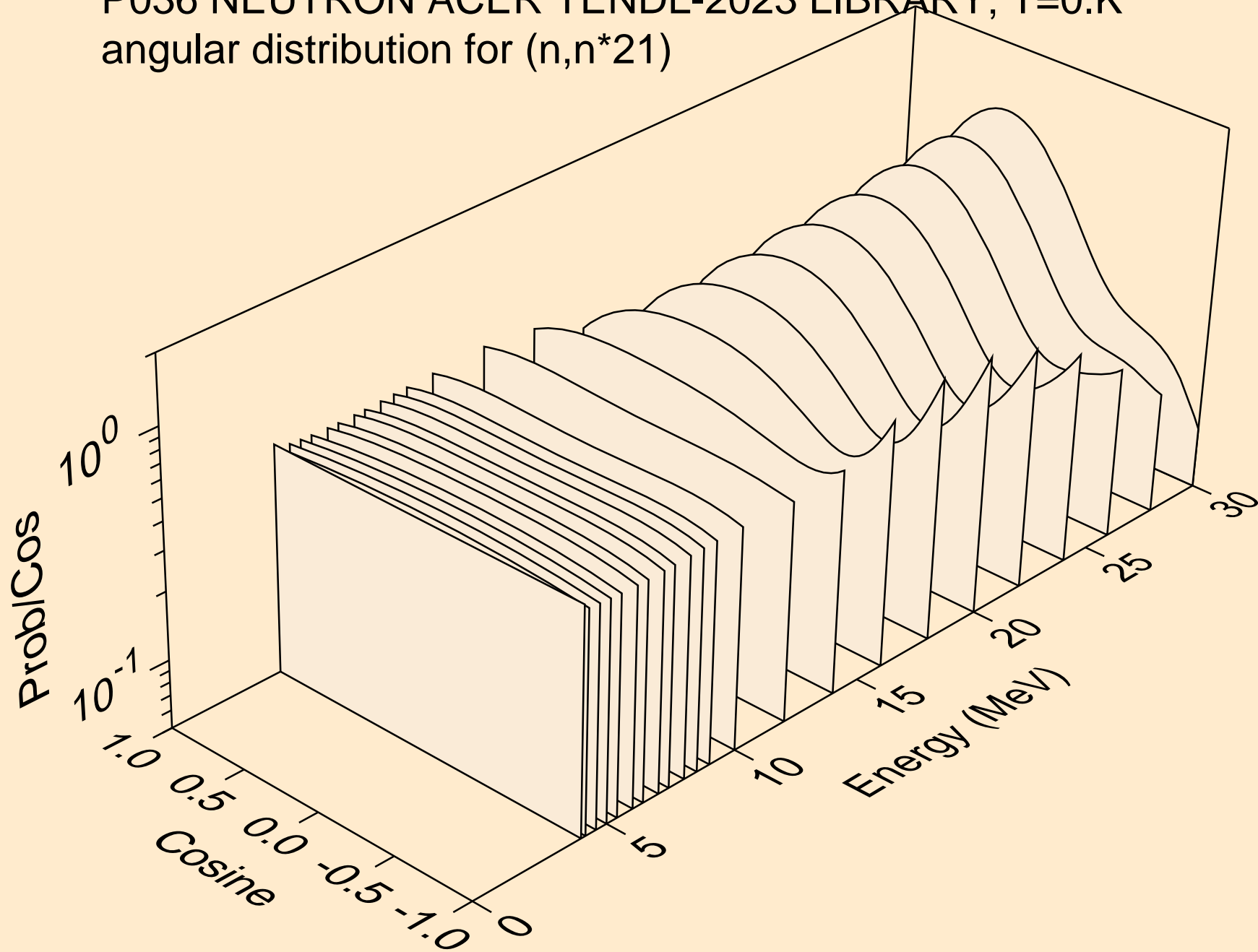

P036 NEUTRON ACER TENDL-2023 LIBRARY; T=0.K
angular distribution for (n,n*22)

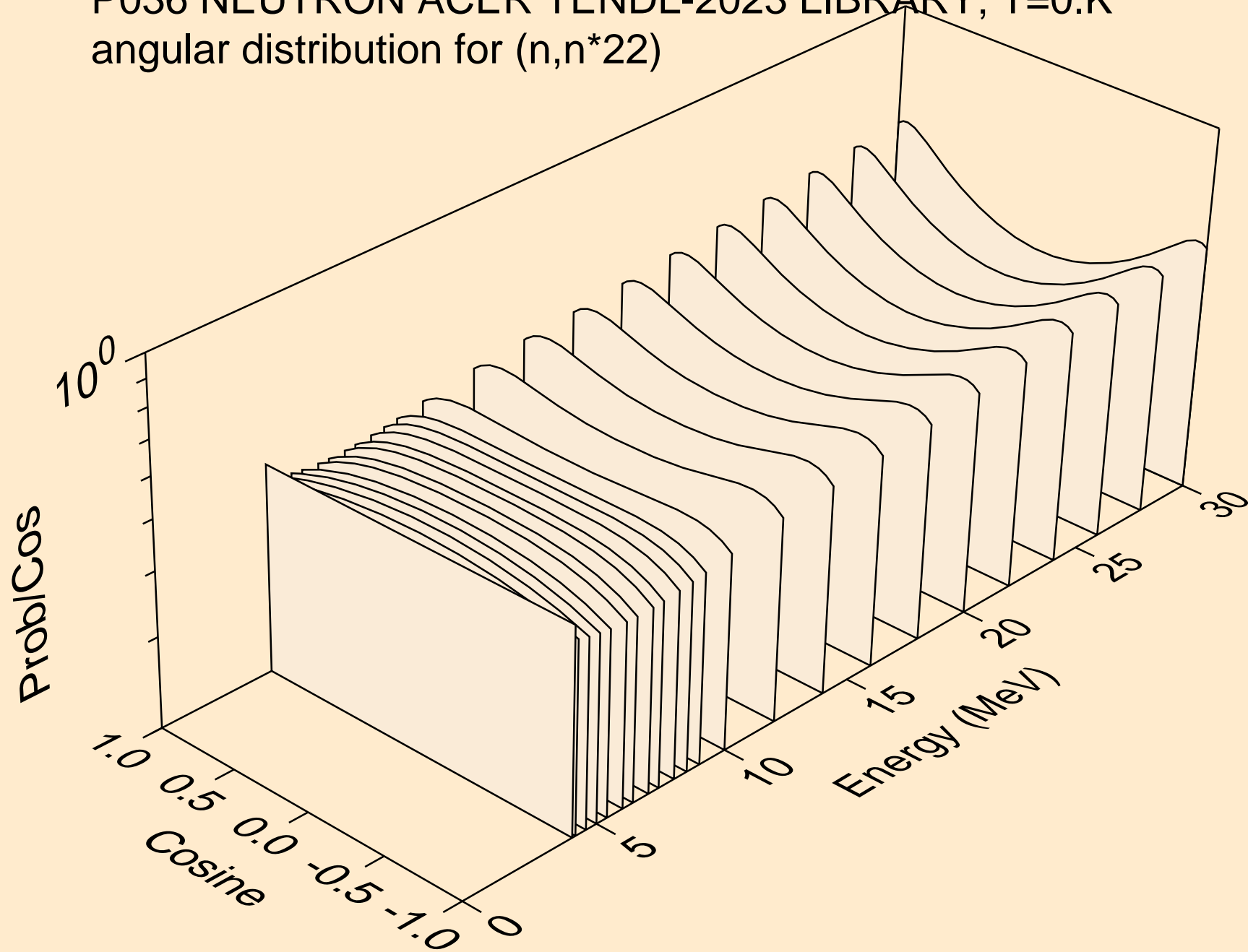

P036 NEUTRON ACER TENDL-2023 LIBRARY; T=0.K
angular distribution for (n,n*23)

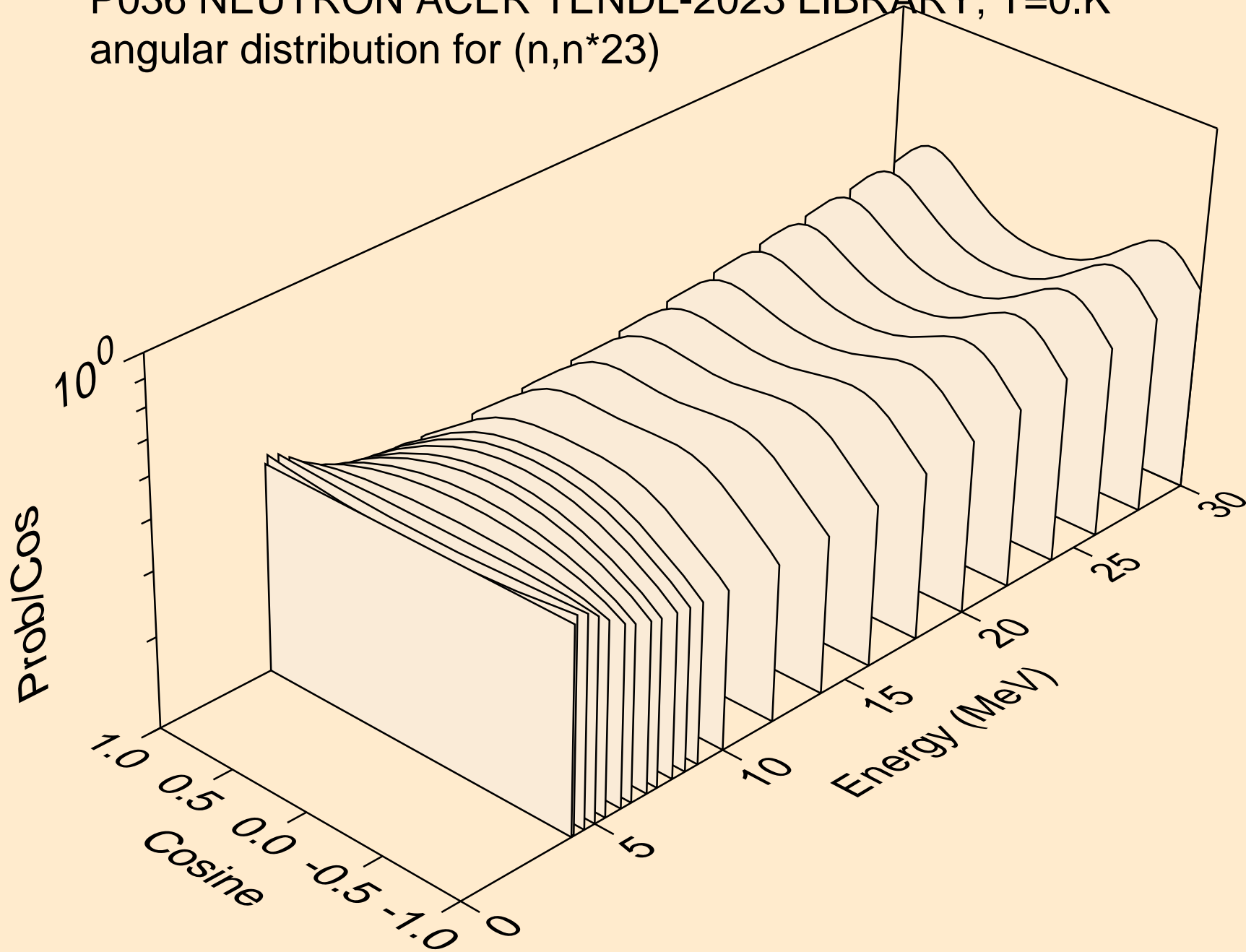

P036 NEUTRON ACER TENDL-2023 LIBRARY; T=0.K
angular distribution for (n,n*24)

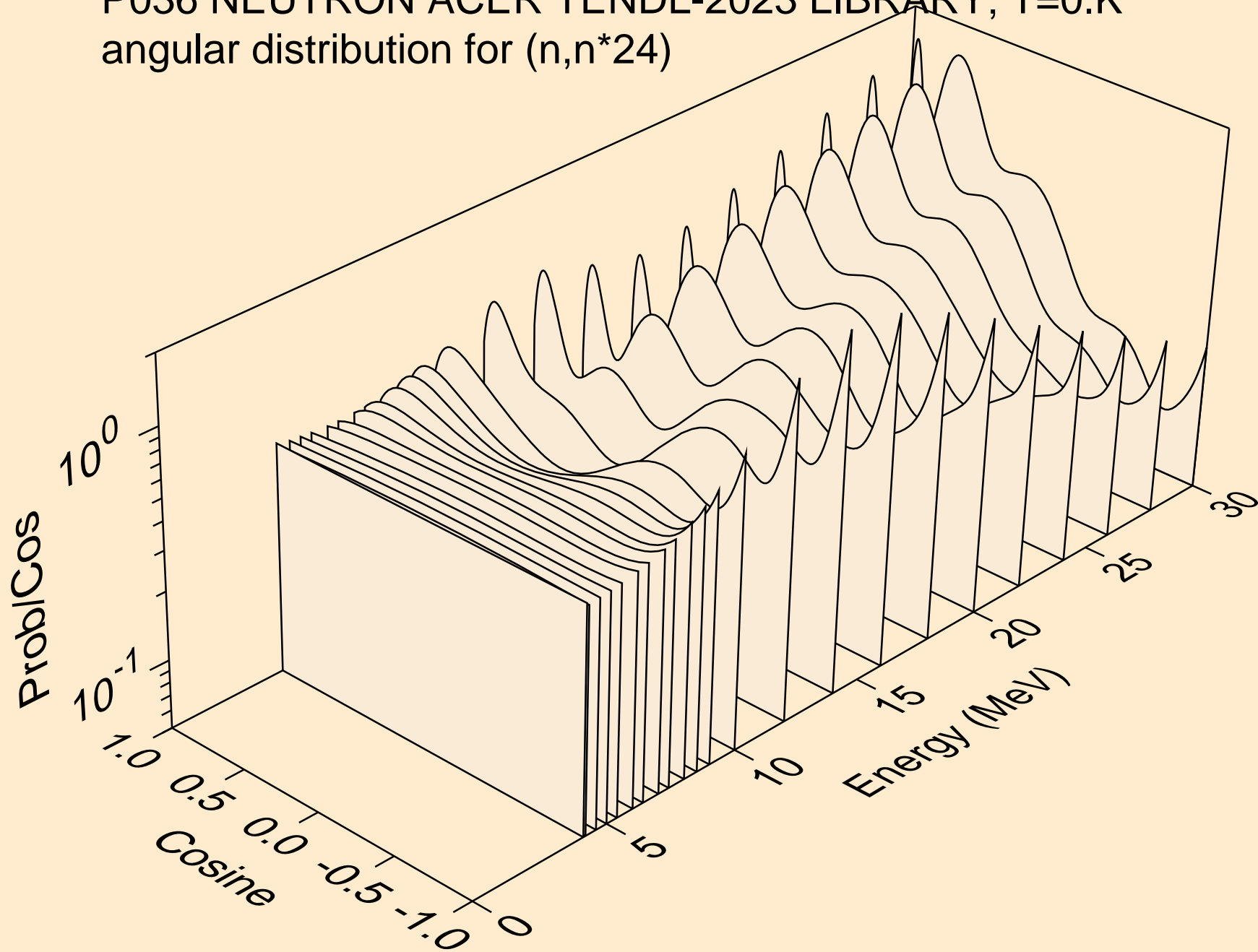

P036 NEUTRON ACER TENDL-2023 LIBRARY; T=0.K
angular distribution for (n,n*25)

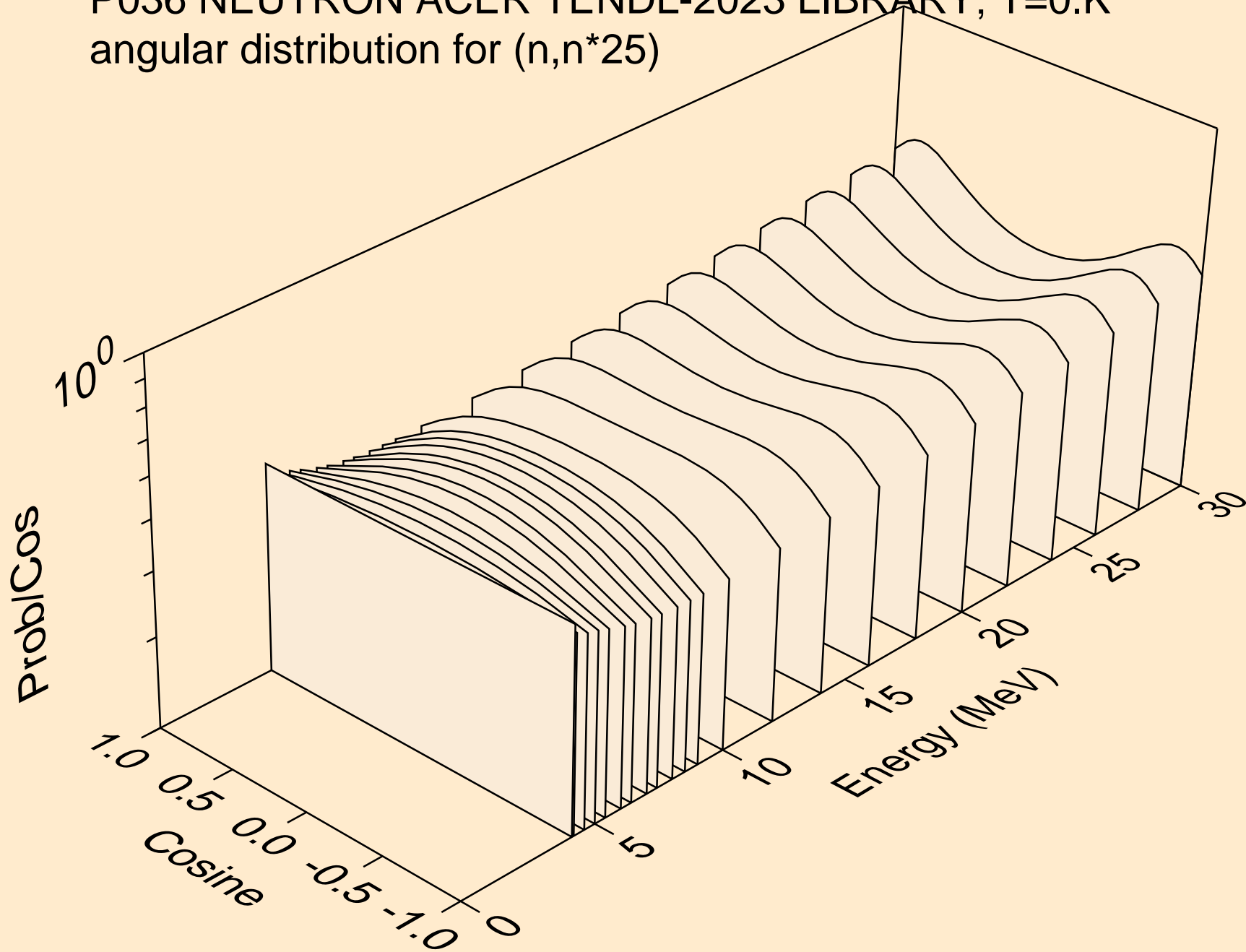

P036 NEUTRON ACER TENDL-2023 LIBRARY; T=0.K
angular distribution for (n,n*26)

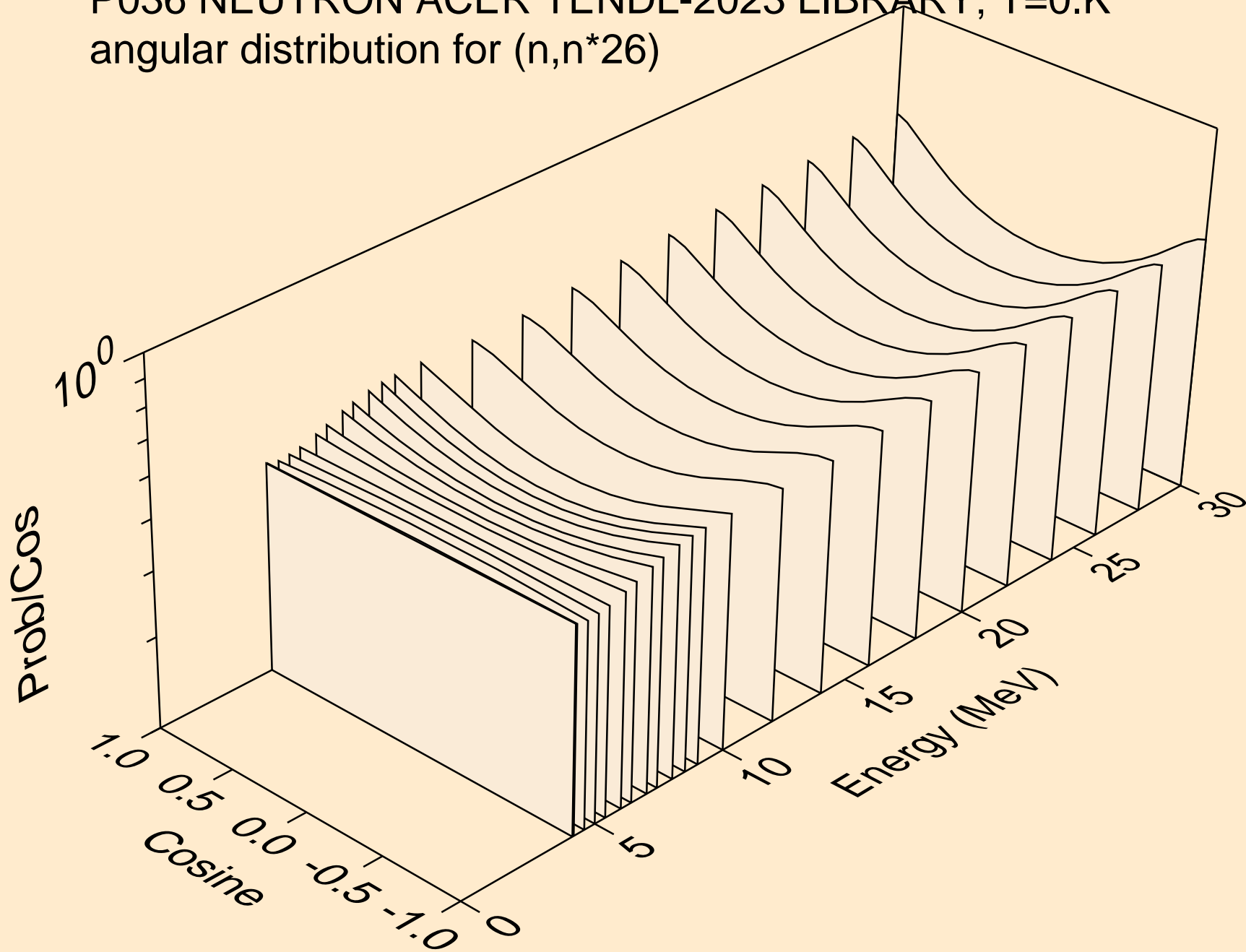

P036 NEUTRON ACER TENDL-2023 LIBRARY; T=0.K
angular distribution for (n,n*27)

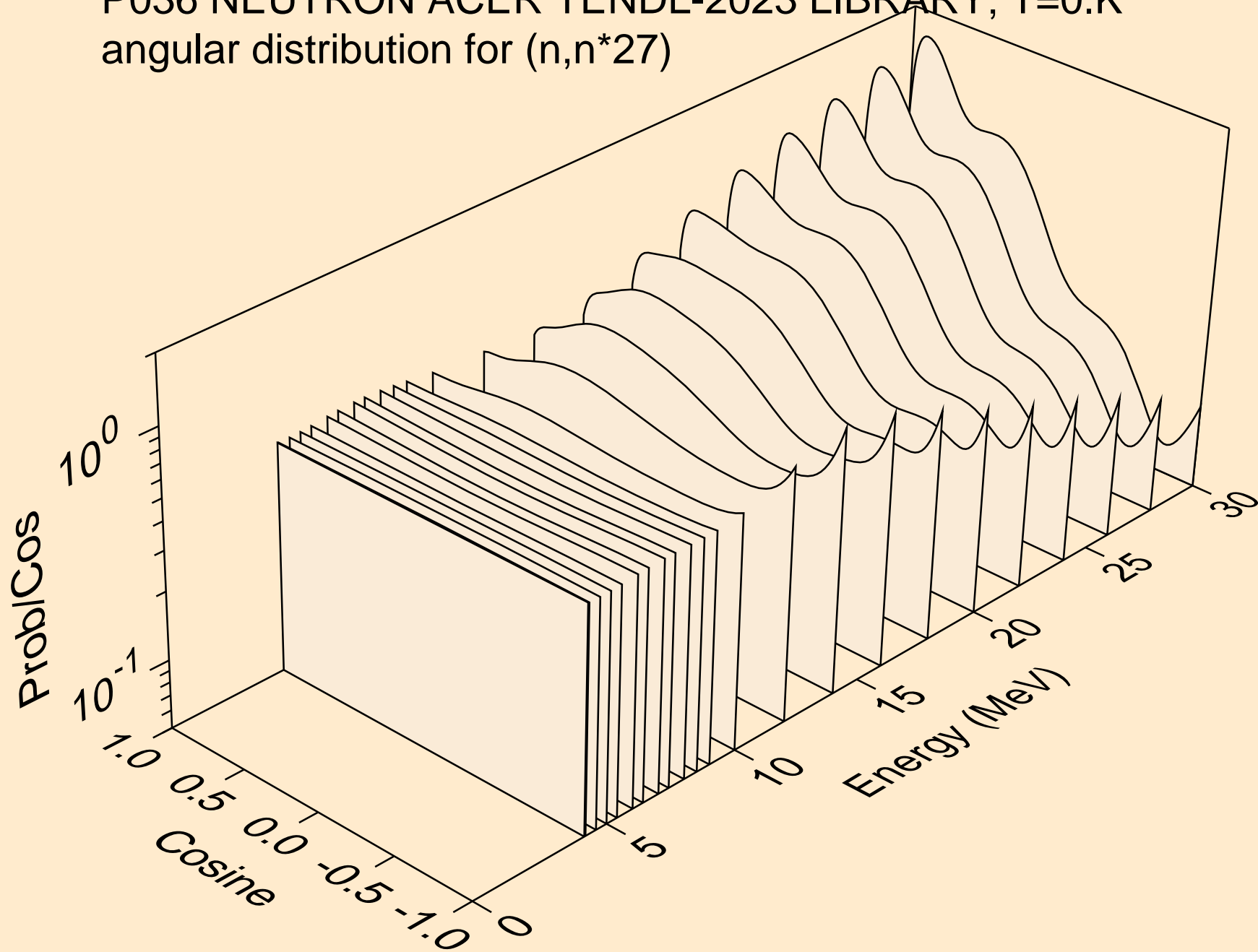

P036 NEUTRON ACER TENDL-2023 LIBRARY; T=0.K
angular distribution for (n,n*28)

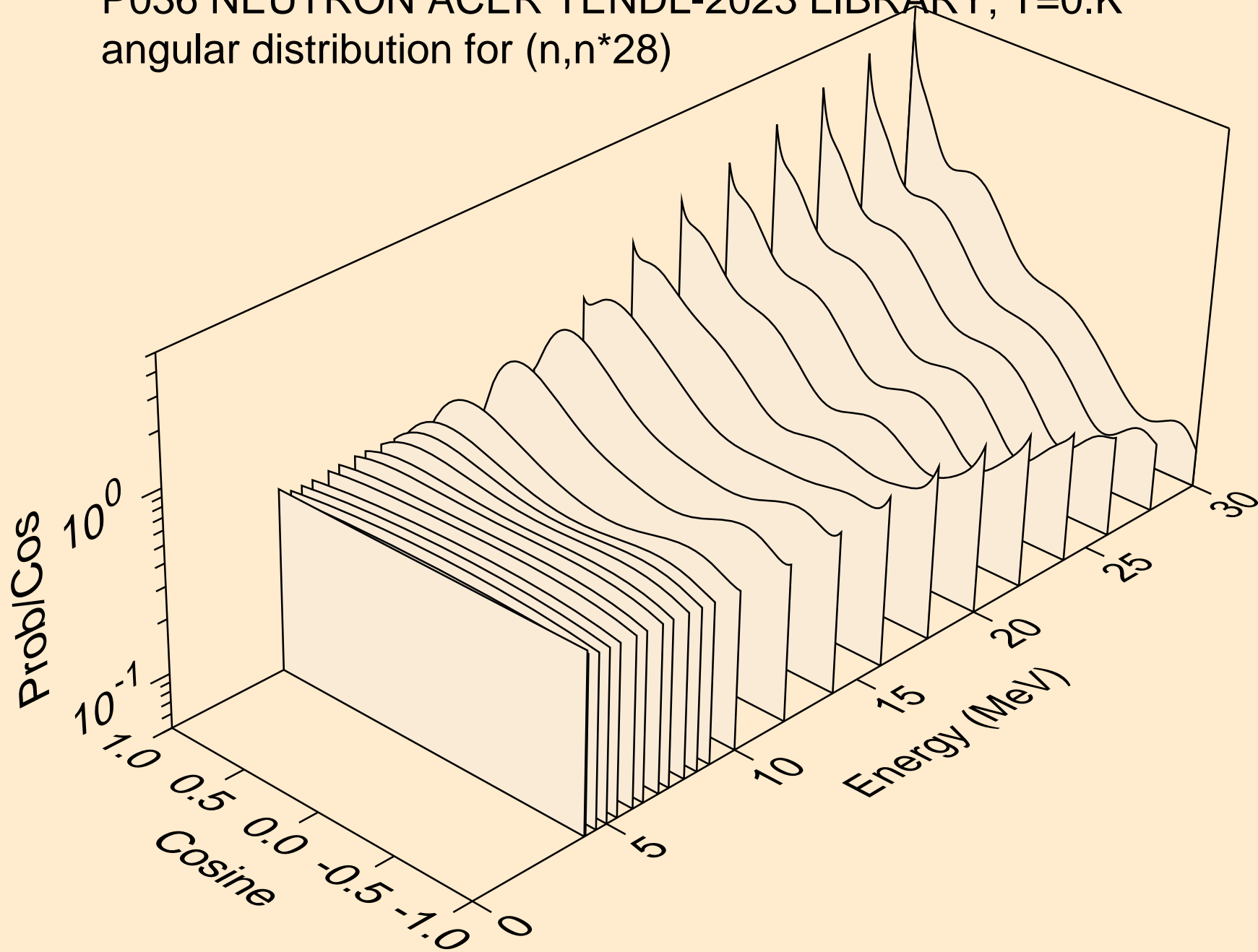

P036 NEUTRON ACER TENDL-2023 LIBRARY; T=0.K
angular distribution for (n,n*29)

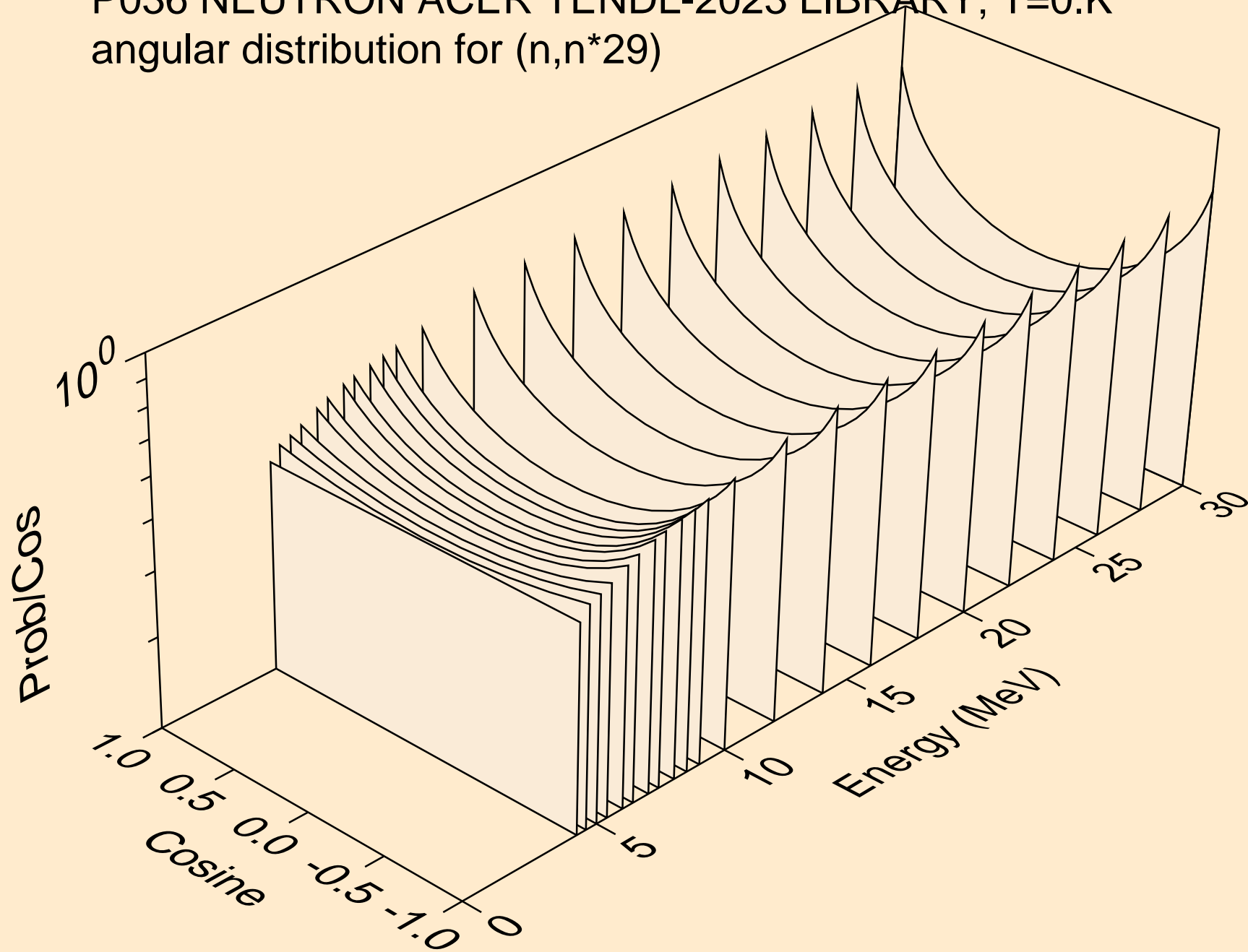

P036 NEUTRON ACER TENDL-2023 LIBRARY; T=0.K
angular distribution for (n,n*30)

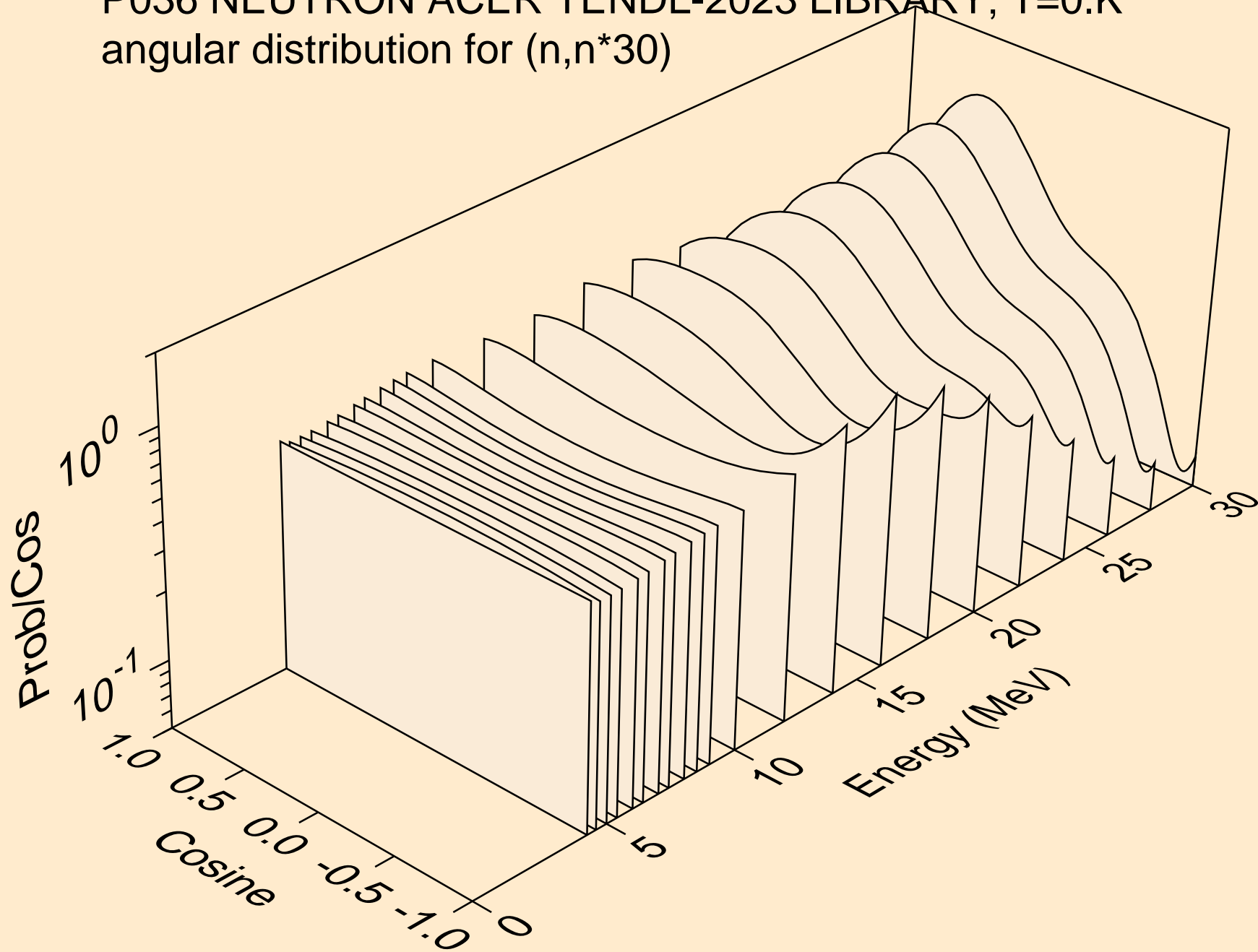

P036 NEUTRON ACER TENDL-2023 LIBRARY; T=0.K
Neutron emission for (n,x)

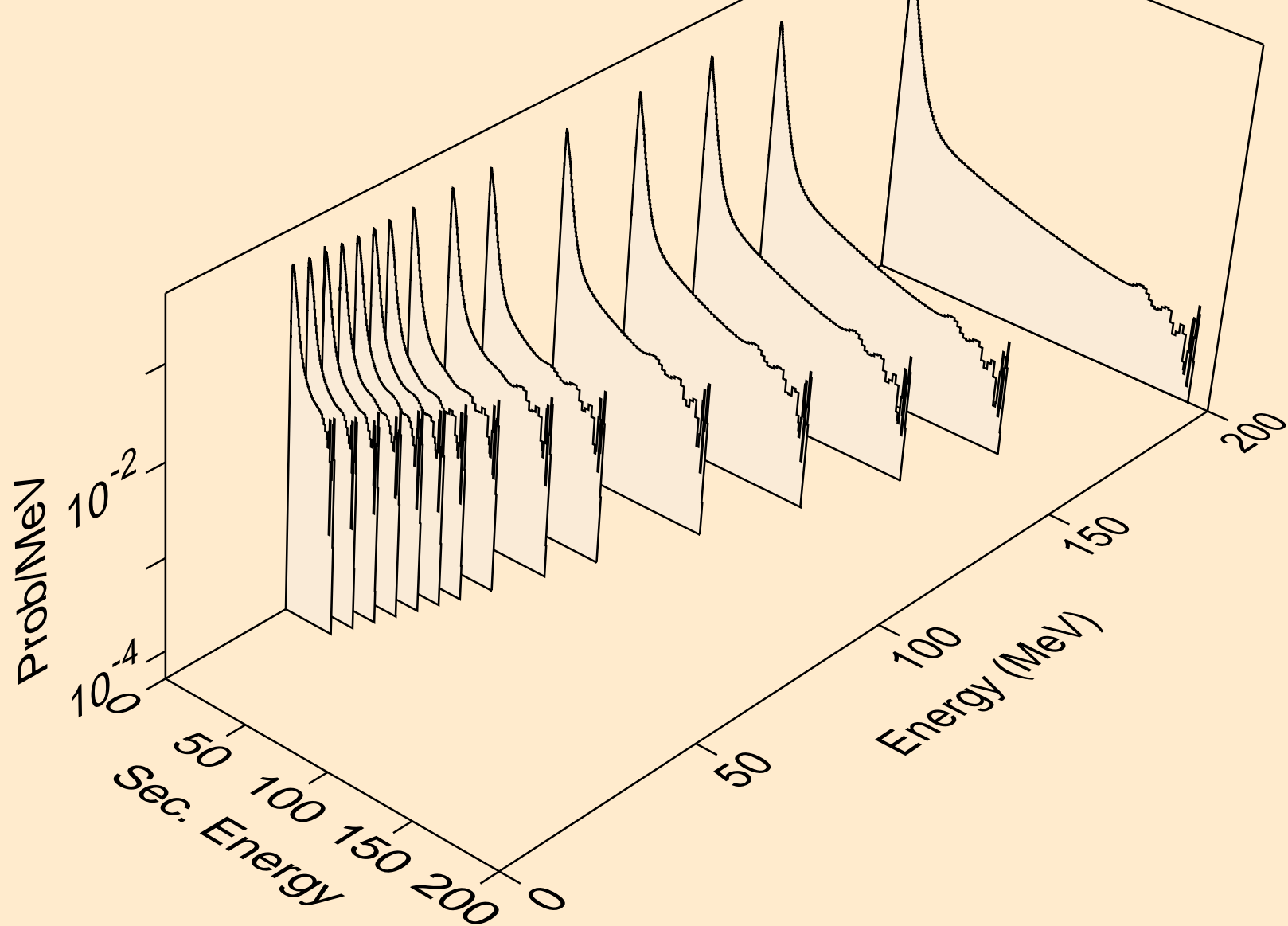

P036 NEUTRON ACER TENDL-2023 LIBRARY; T=0.K
Neutron emission for (n,2nd)

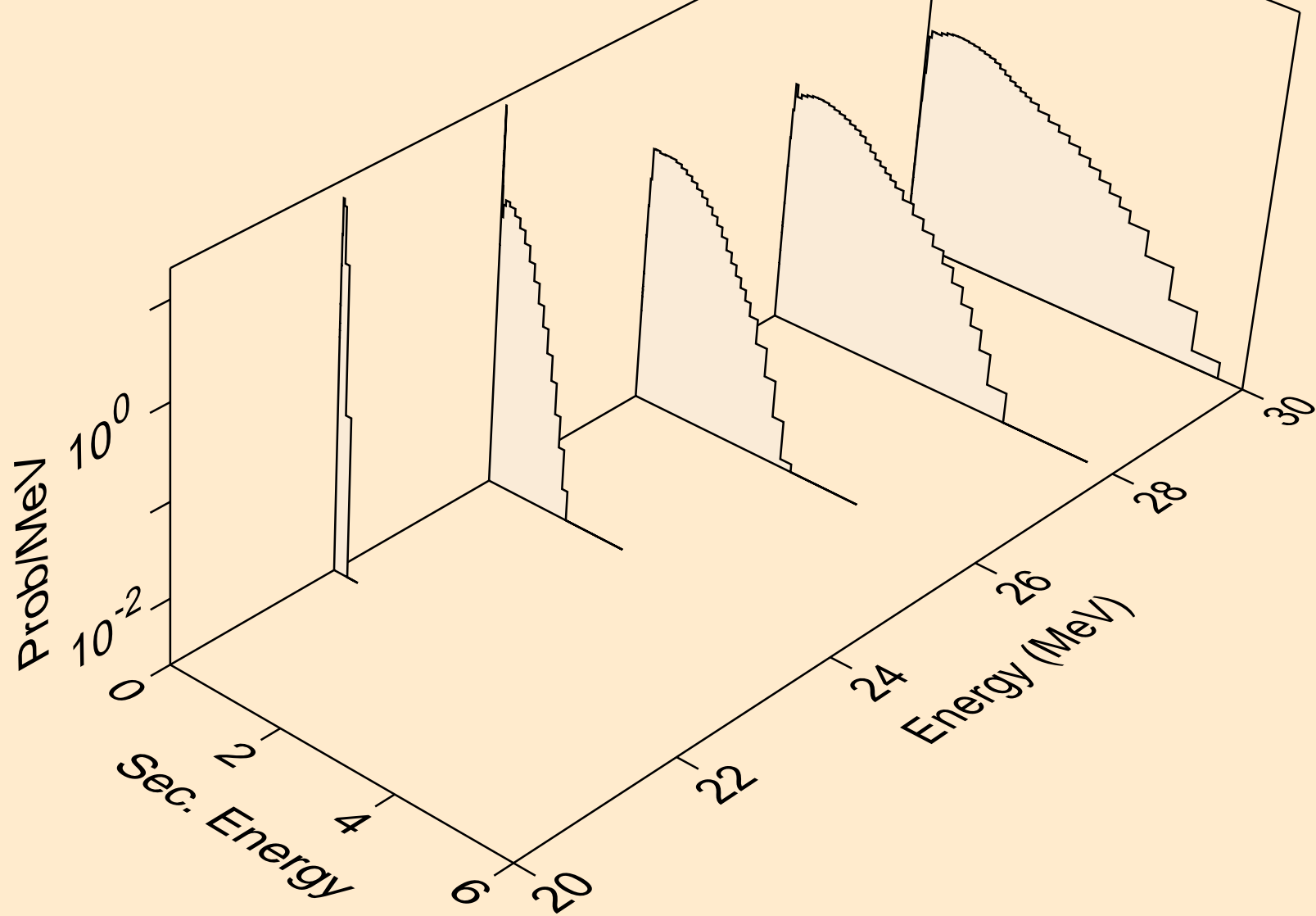

P036 NEUTRON ACER TENDL-2023 LIBRARY; T=0.K
Neutron emission for (n,2n)

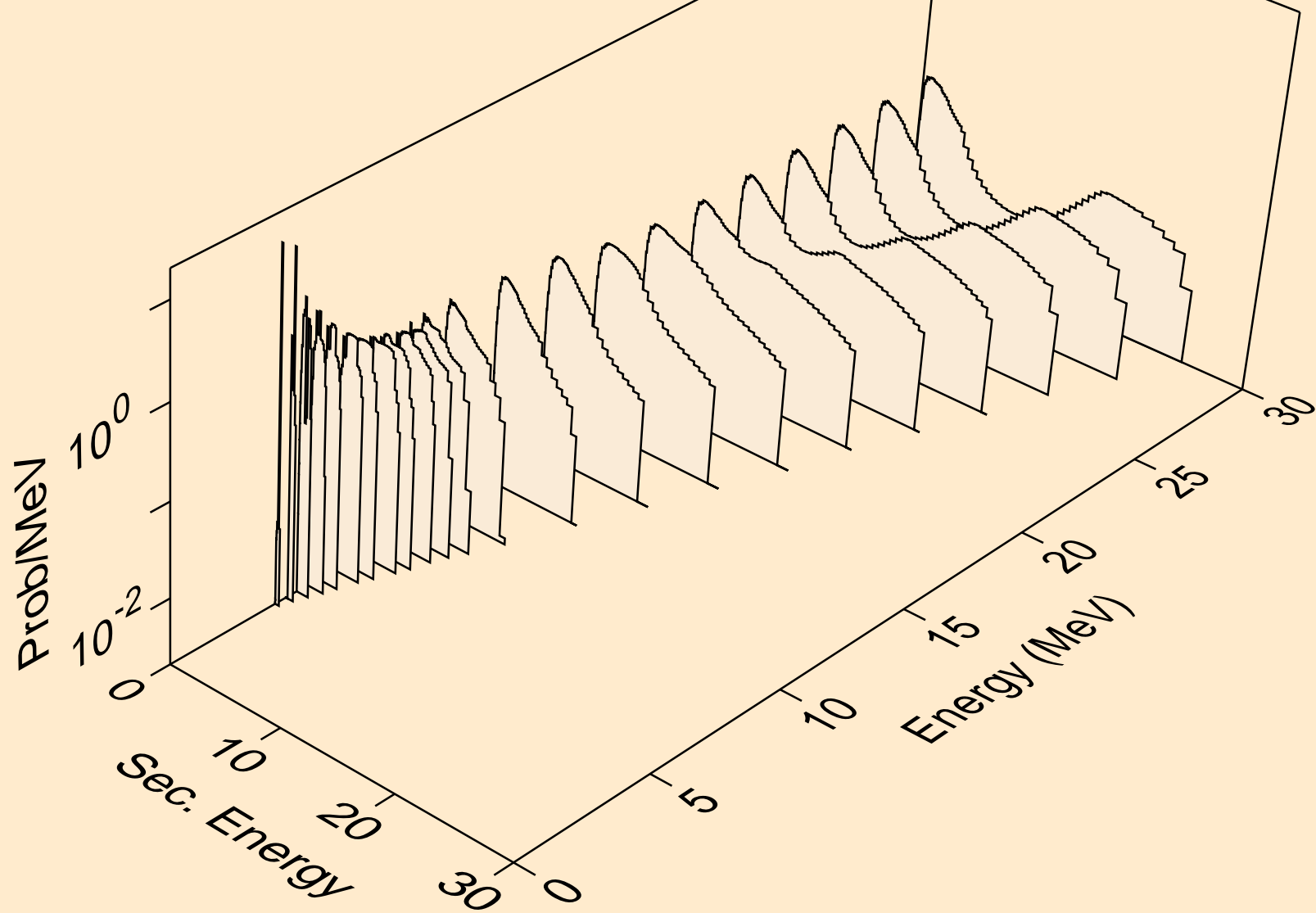

P036 NEUTRON ACER TENDL-2023 LIBRARY; T=0.K
Neutron emission for (n,3n)

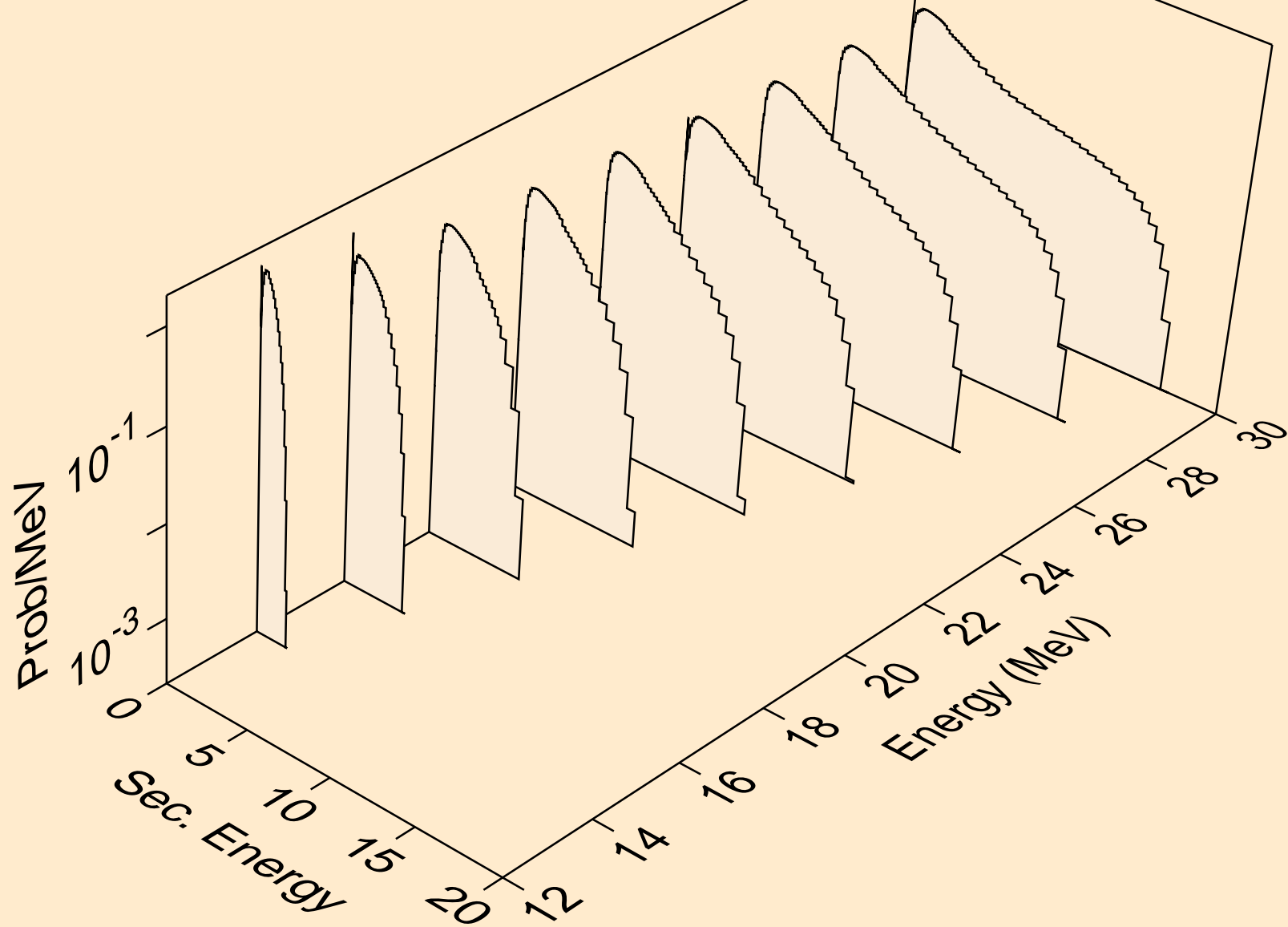

P036 NEUTRON ACER TENDL-2023 LIBRARY; T=0.K
Neutron emission for (n,n*)a

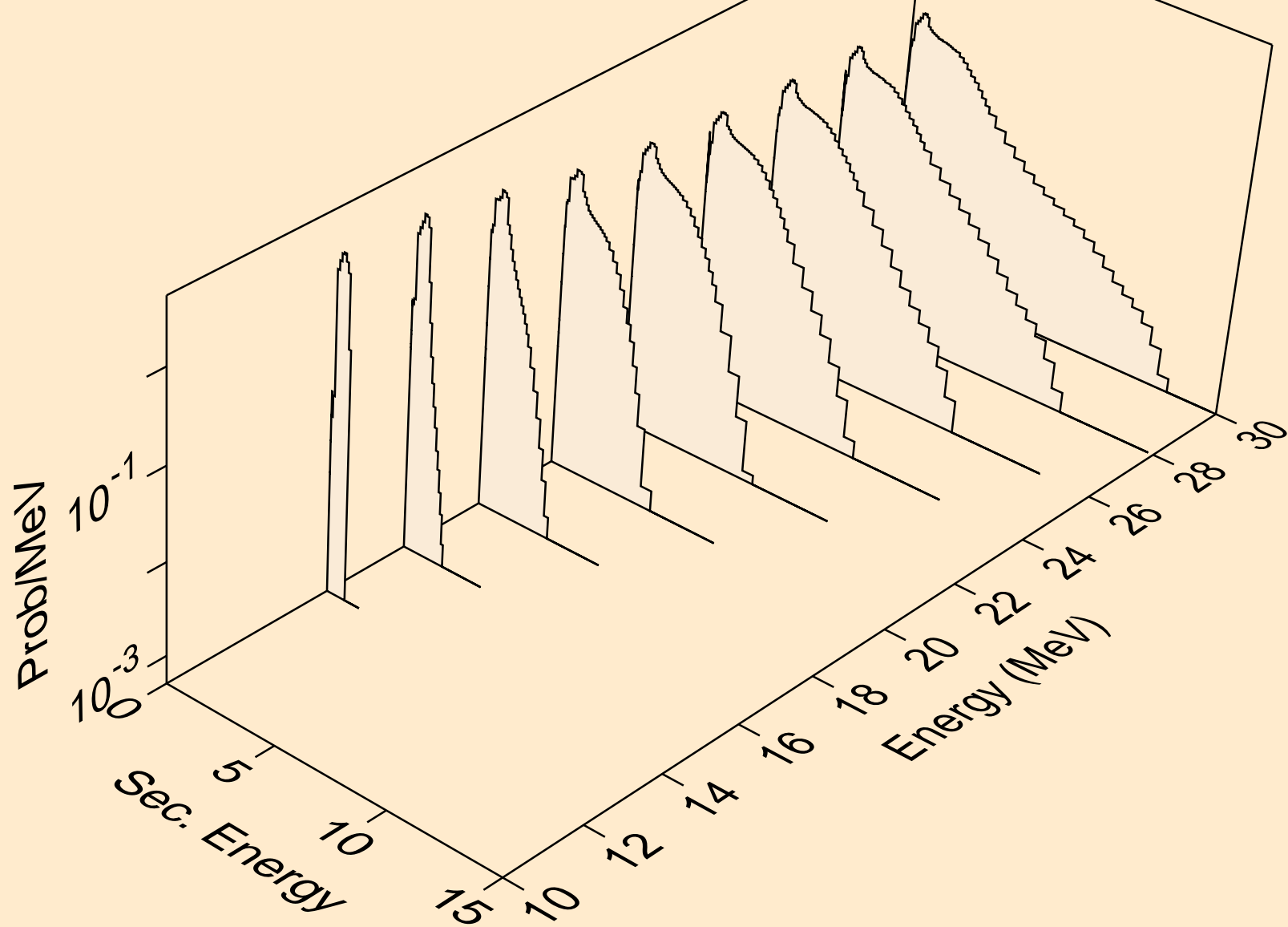

P036 NEUTRON ACER TENDL-2023 LIBRARY; T=0.K
Neutron emission for (n,2n)a

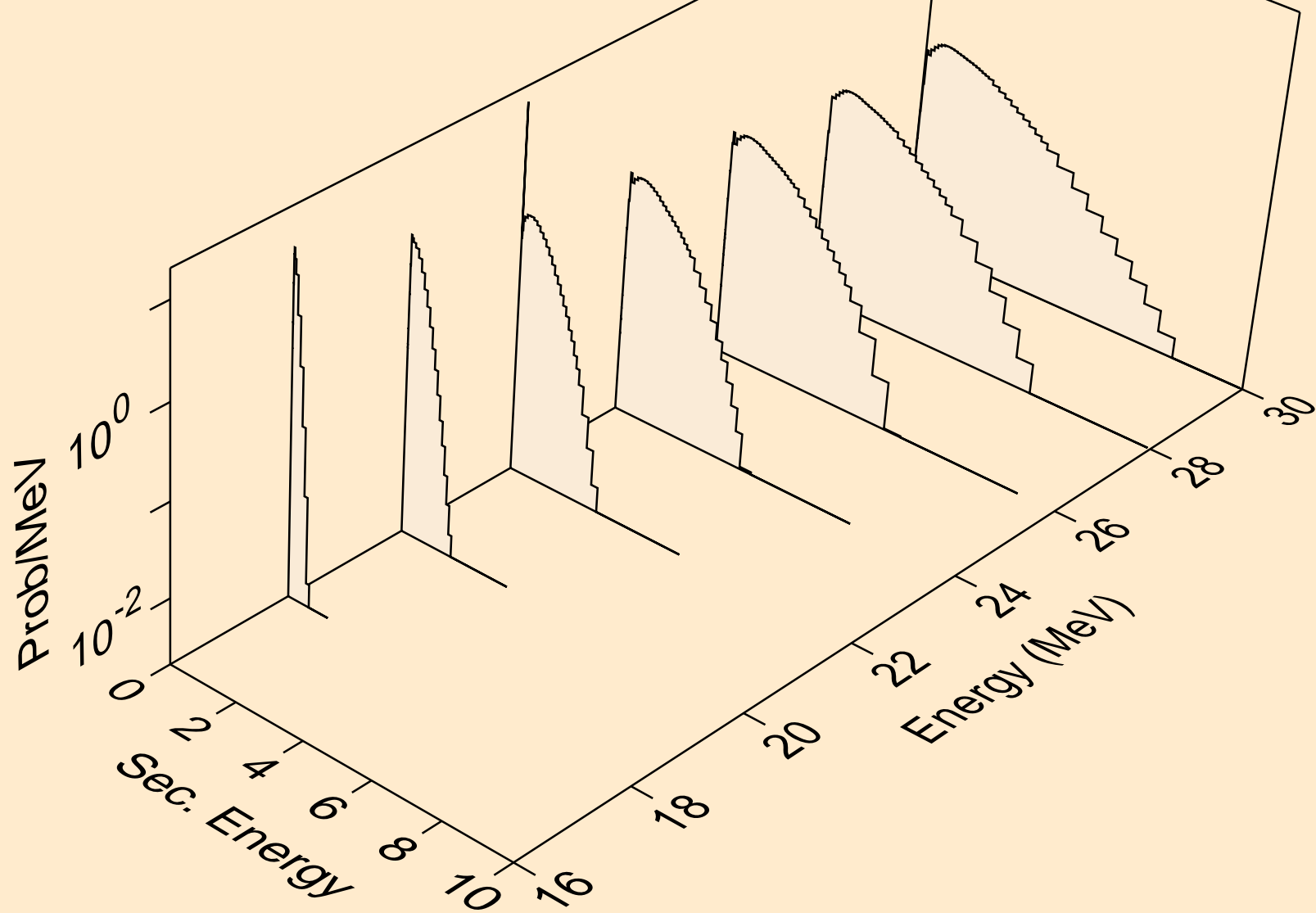

P036 NEUTRON ACER TENDL-2023 LIBRARY; T=0.K
Neutron emission for (n,3n)a

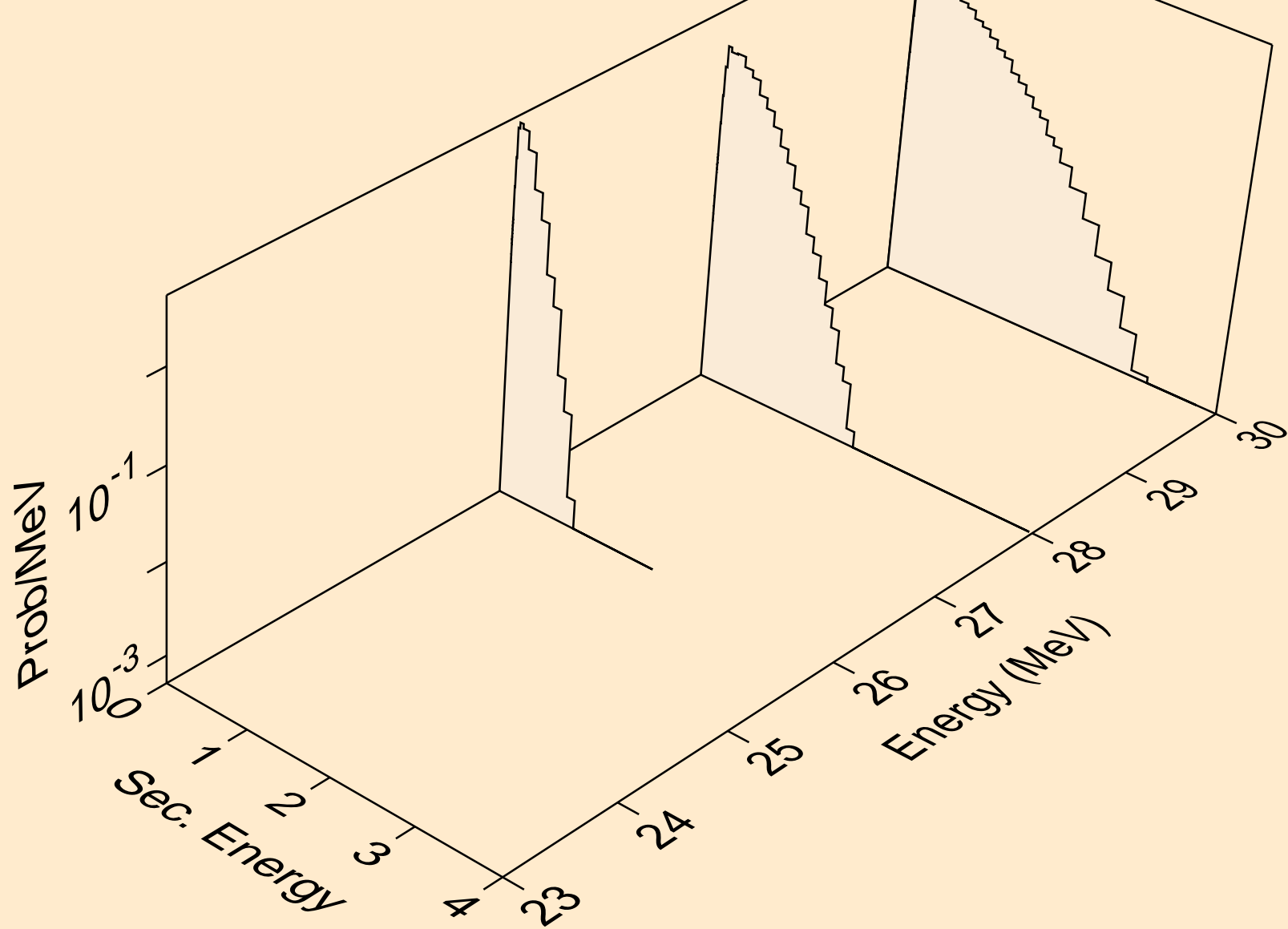

P036 NEUTRON ACER TENDL-2023 LIBRARY; T=0.K
Neutron emission for (n,n*)p

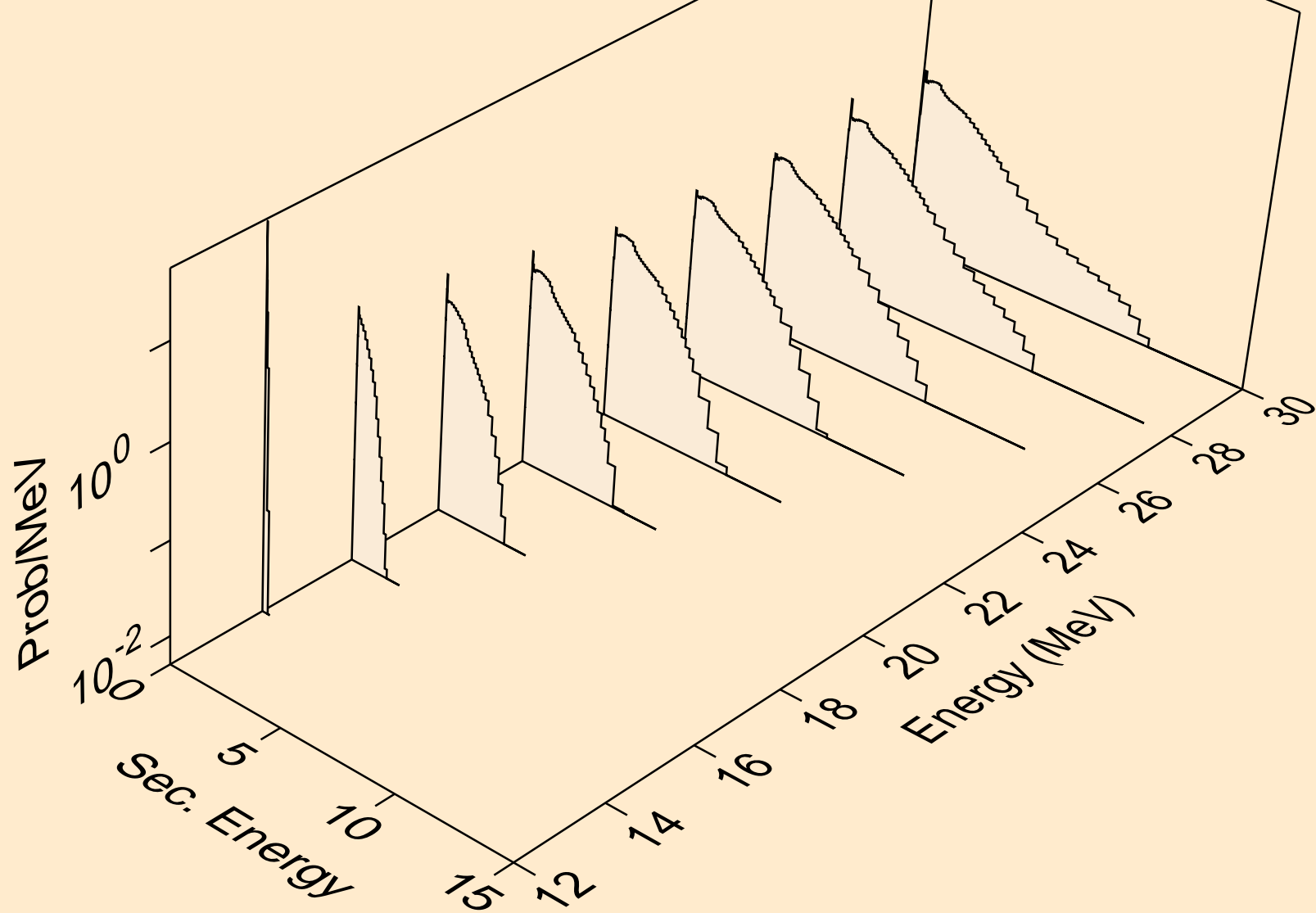

P036 NEUTRON ACER TENDL-2023 LIBRARY; T=0.K
Neutron emission for (n,n*)d

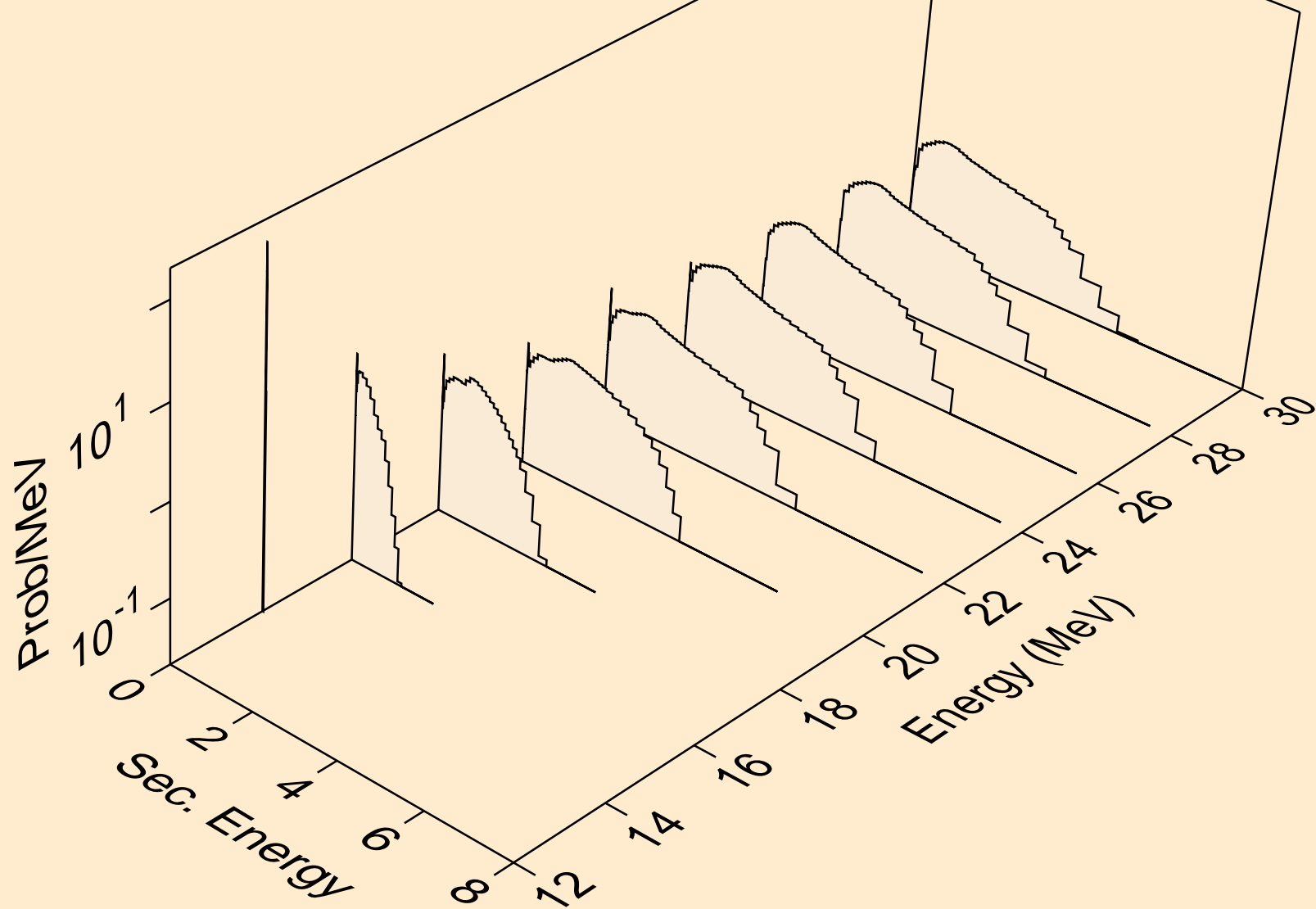

P036 NEUTRON ACER TENDL-2023 LIBRARY; T=0.K
Neutron emission for (n,n*)t

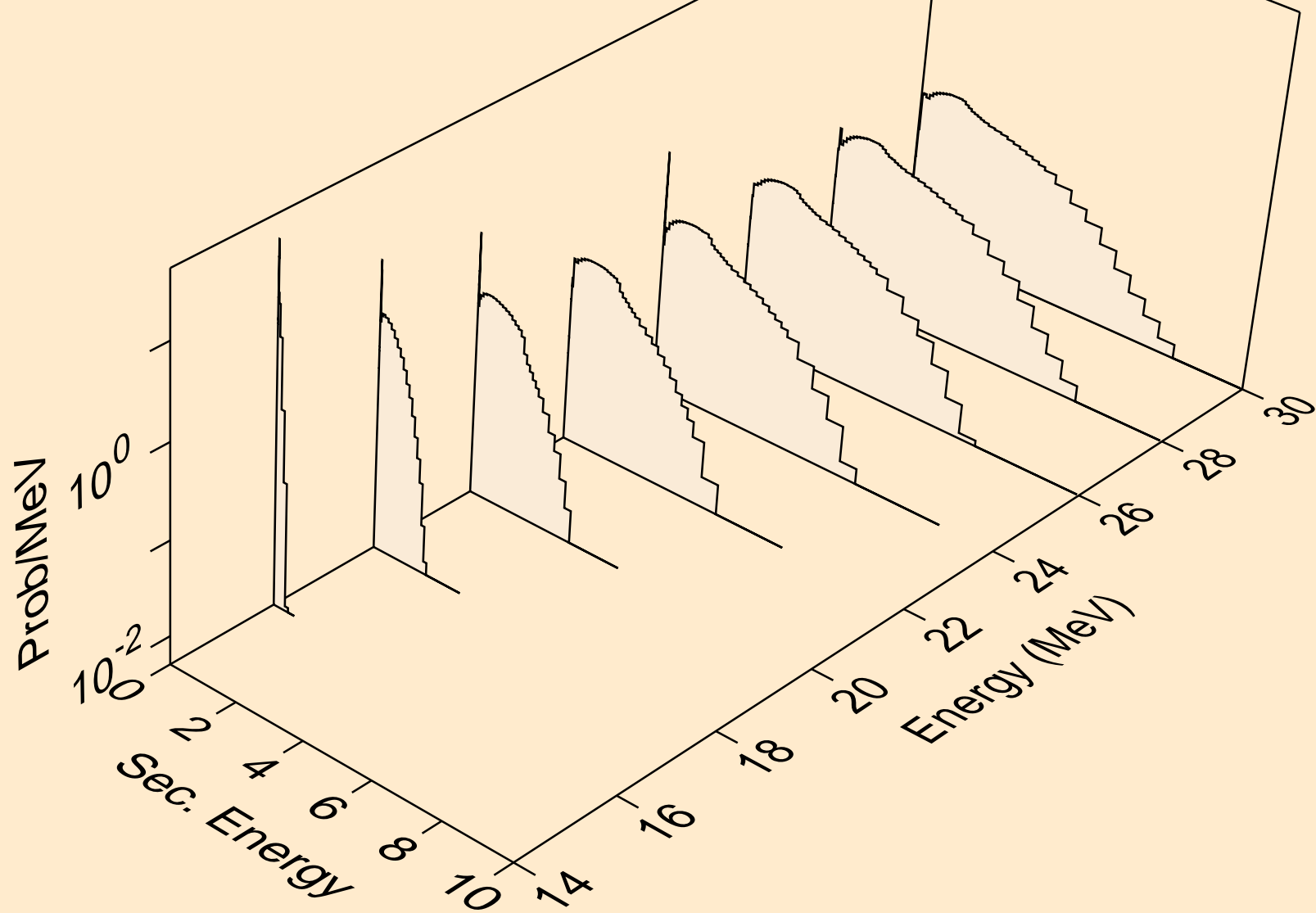

P036 NEUTRON ACER TENDL-2023 LIBRARY; T=0.K
Neutron emission for (n,n*)he3

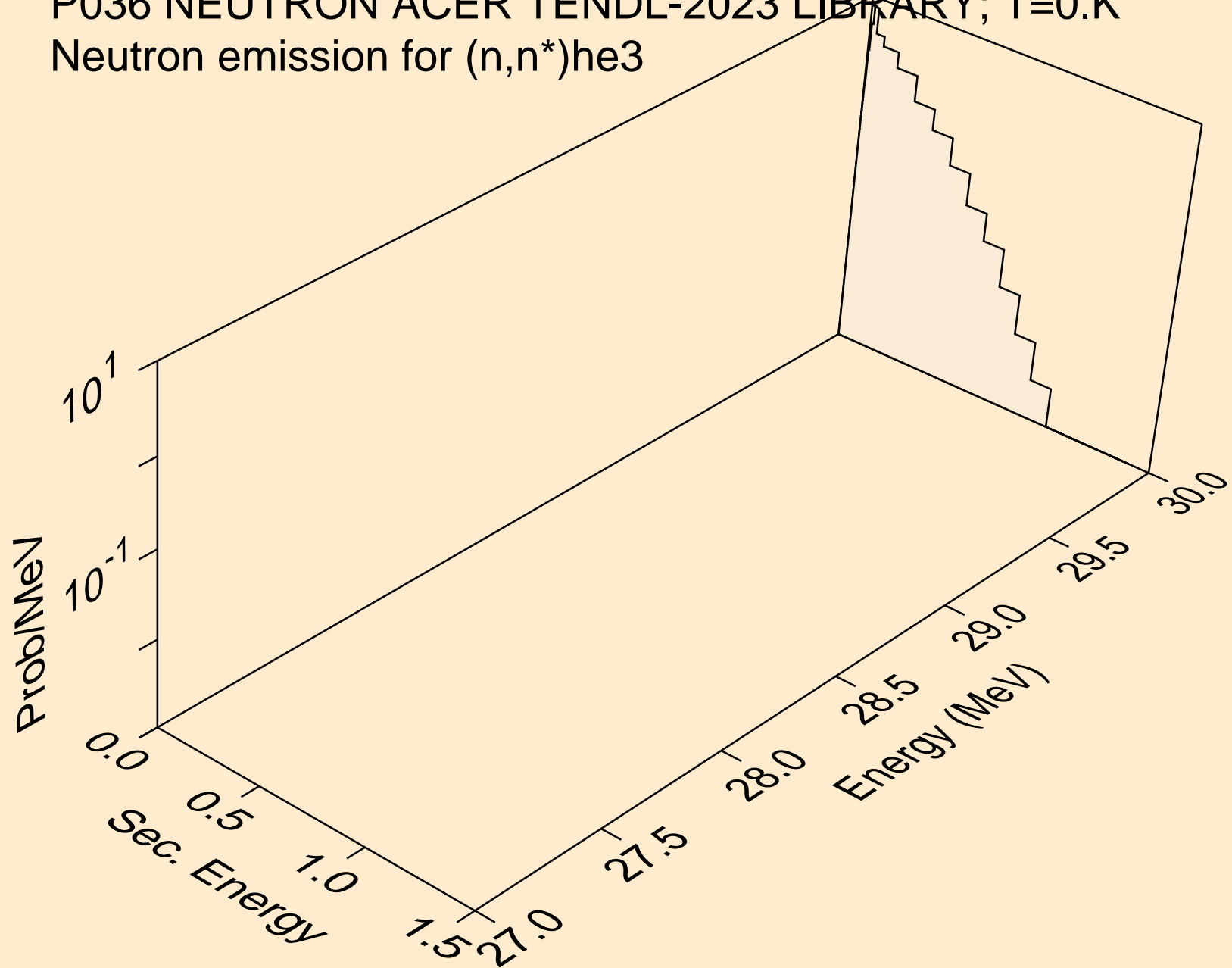

P036 NEUTRON ACER TENDL-2023 LIBRARY; T=0.K
Neutron emission for (n,4n)

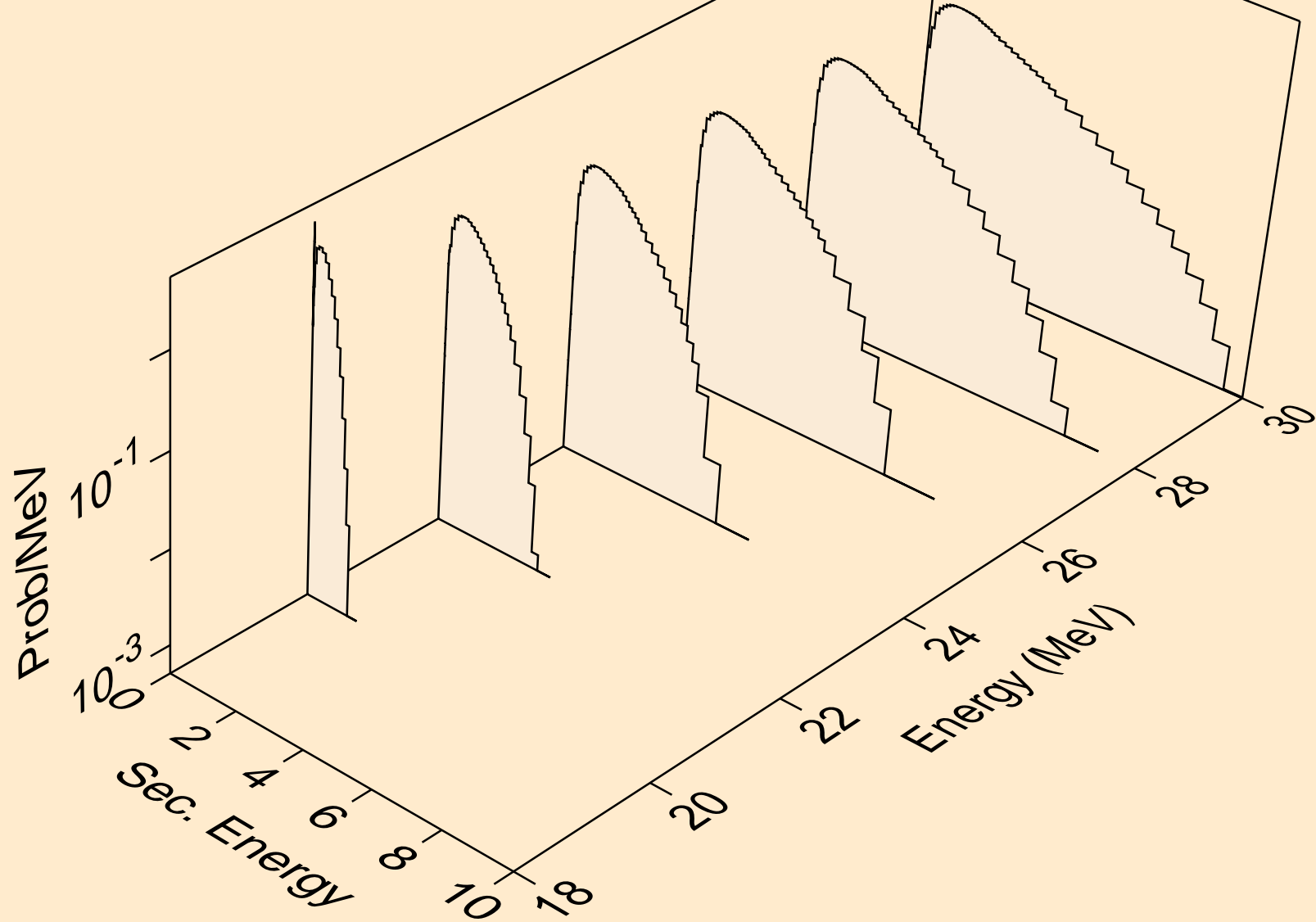

P036 NEUTRON ACER TENDL-2023 LIBRARY; T=0.K
Neutron emission for (n,2np)

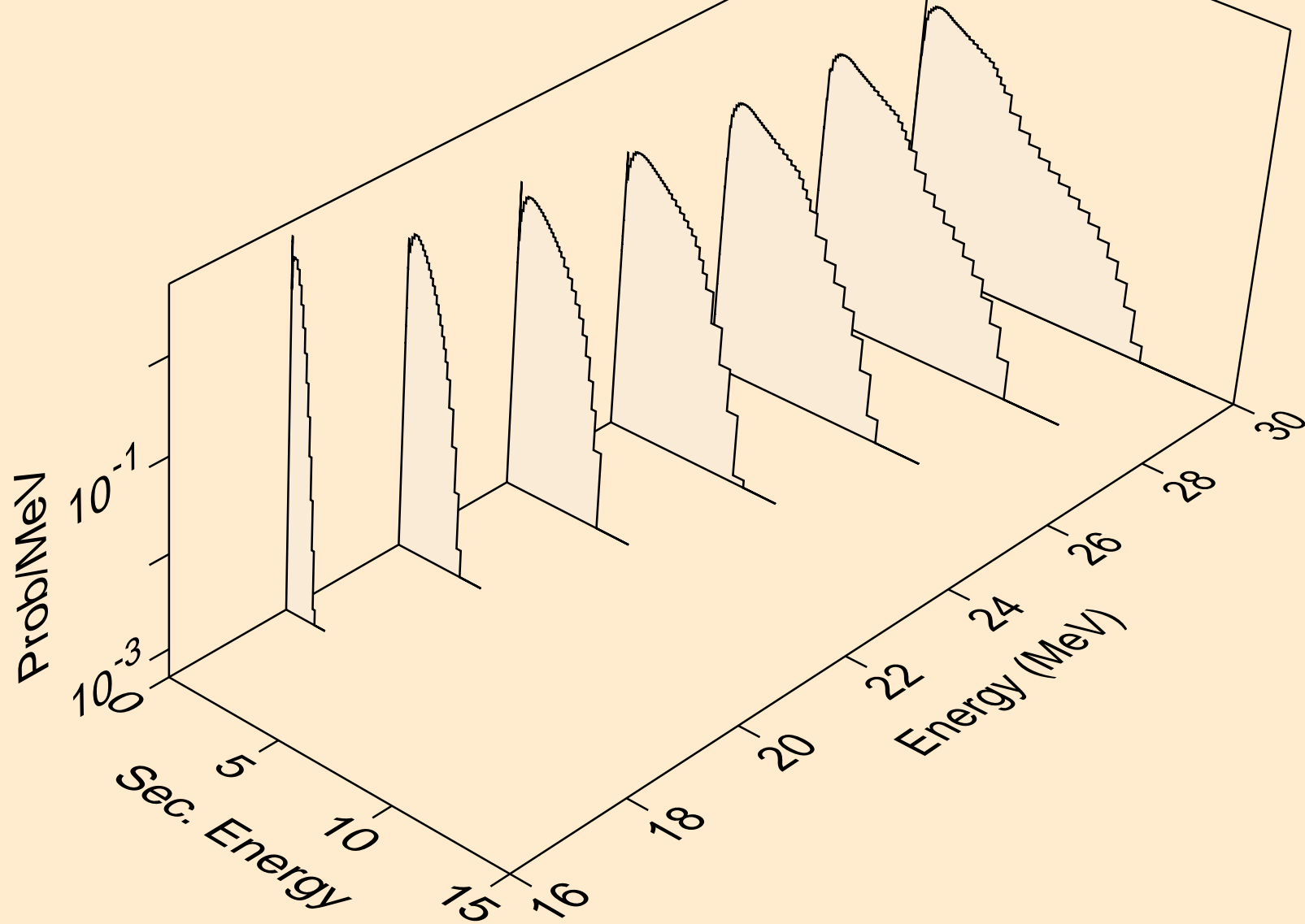

P036 NEUTRON ACER TENDL-2023 LIBRARY; T=0.K
Neutron emission for (n,3np)

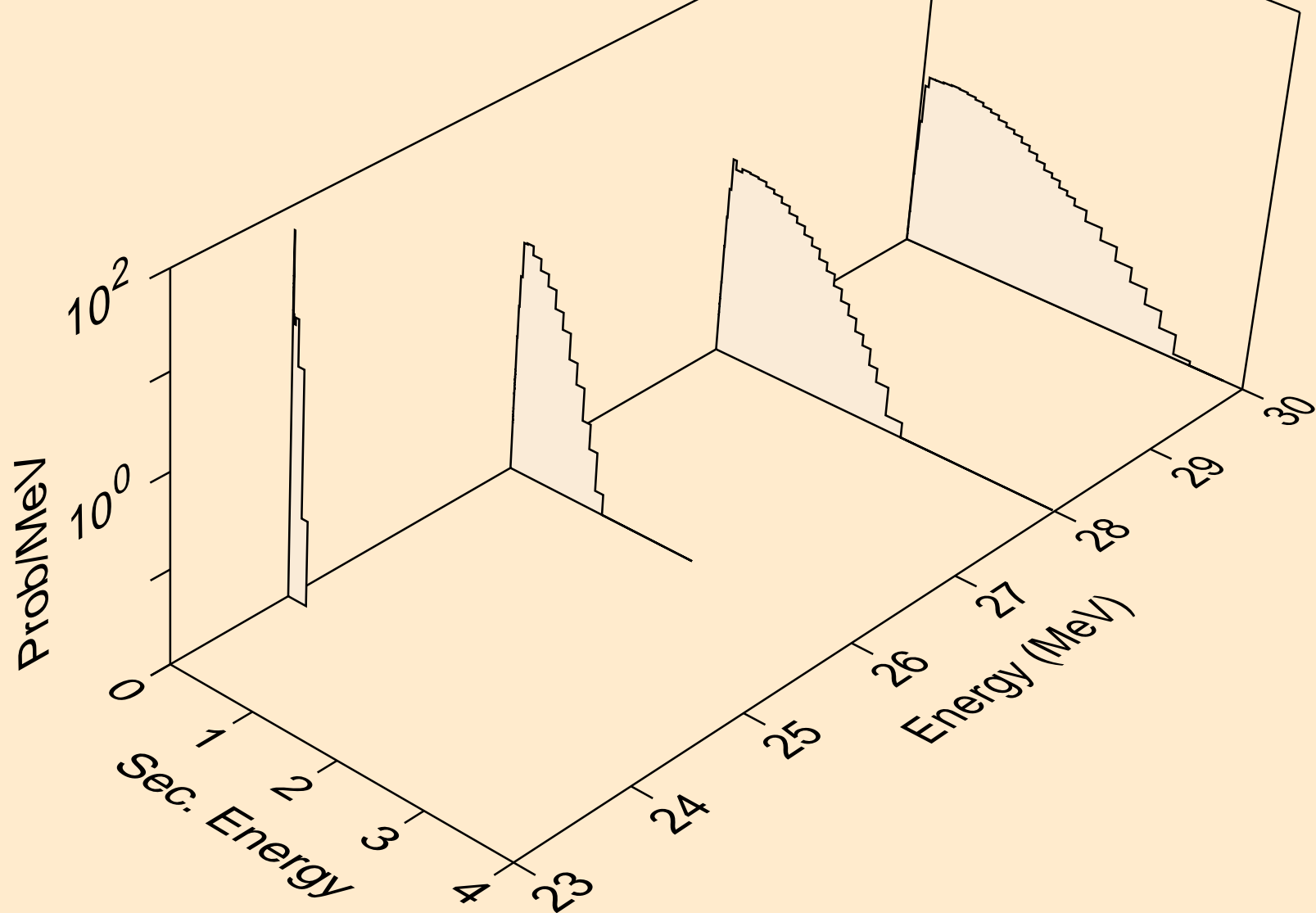

P036 NEUTRON ACER TENDL-2023 LIBRARY; T=0.K
Photon emission for (n,x)

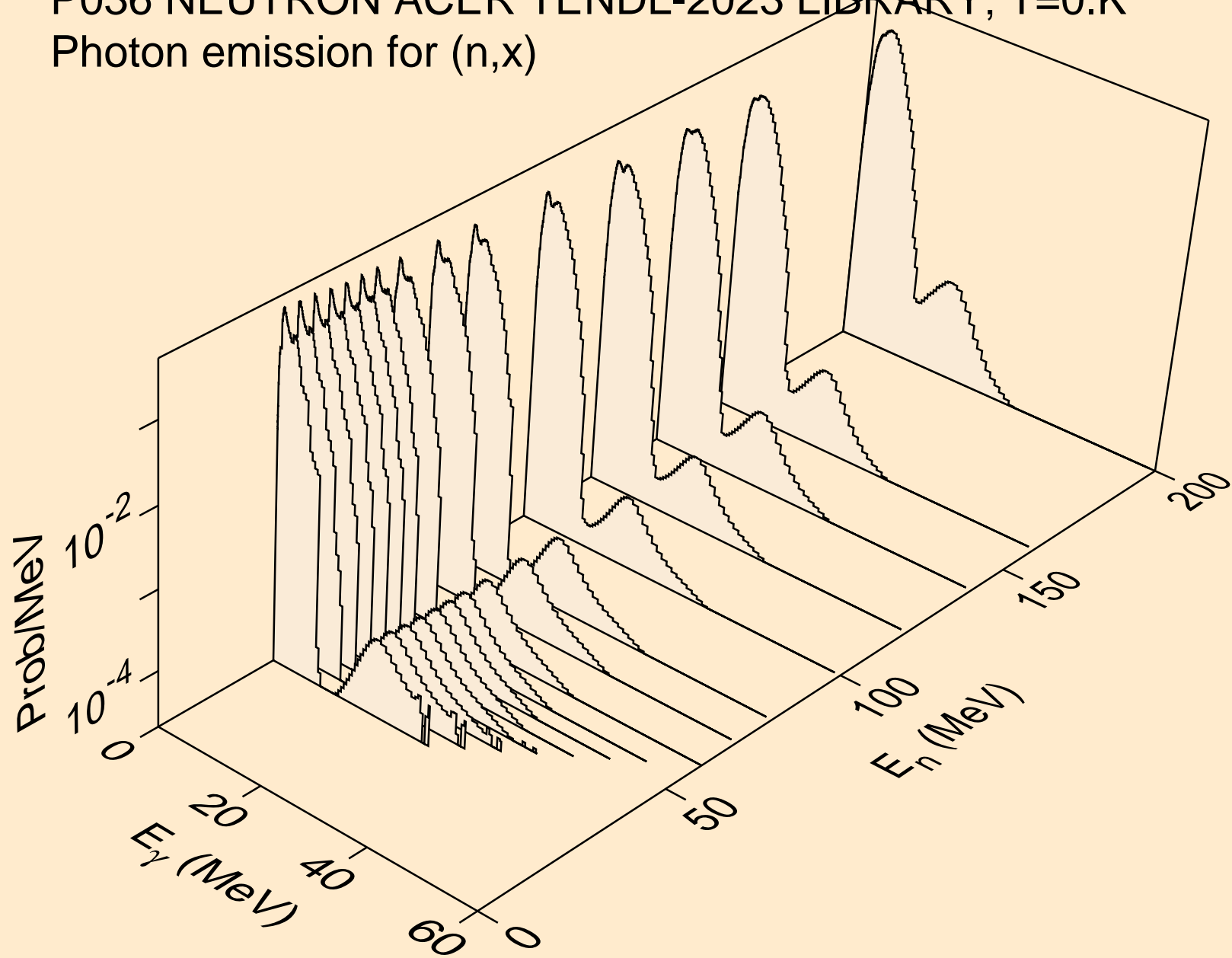

P036 NEUTRON ACER TENDL-2023 LIBRARY; T=0.K
Photon emission for (n,2nd)

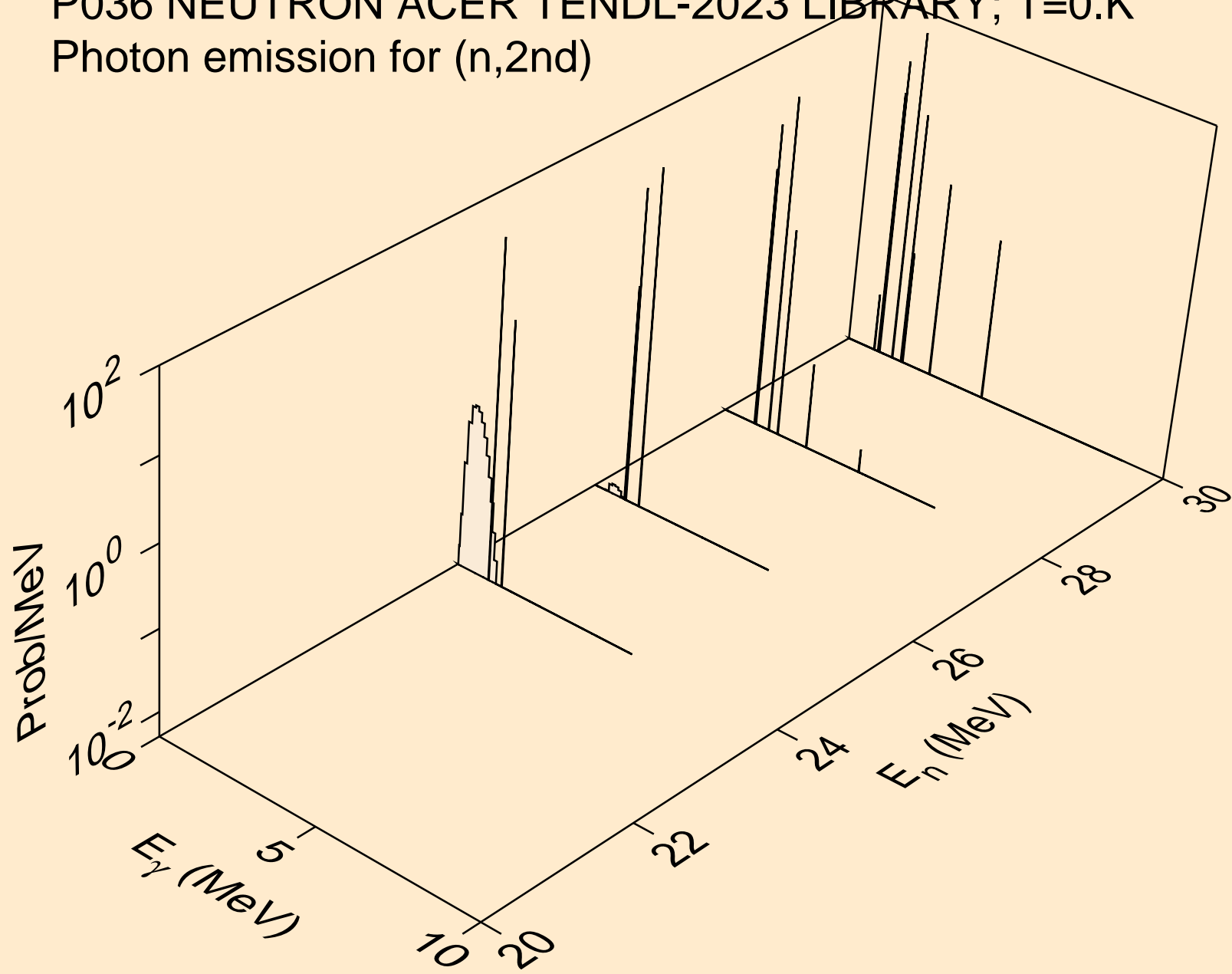

P036 NEUTRON ACER TENDL-2023 LIBRARY; T=0.K
Photon emission for (n,2n)

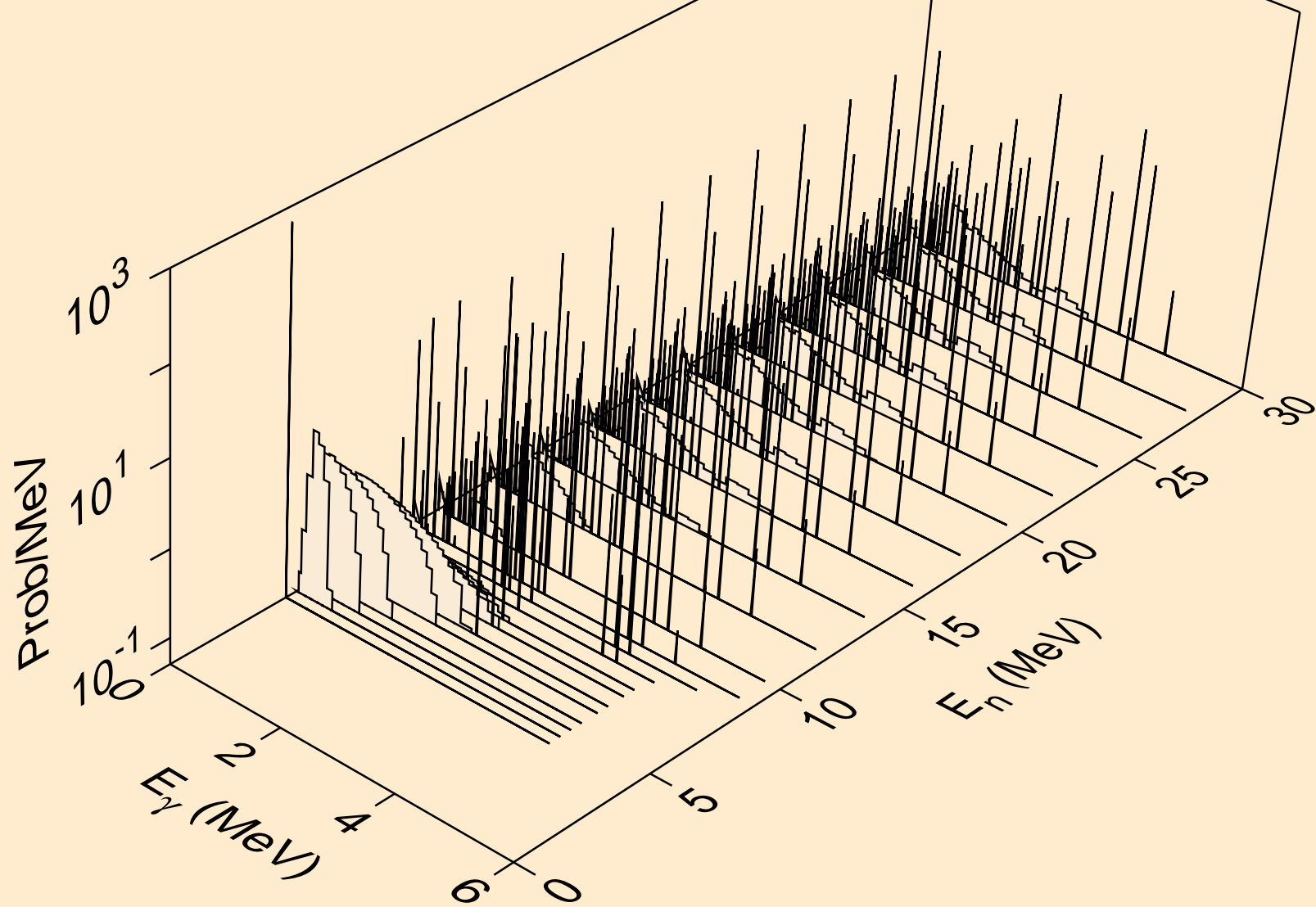

P036 NEUTRON ACER TENDL-2023 LIBRARY; T=0.K
Photon emission for (n,3n)

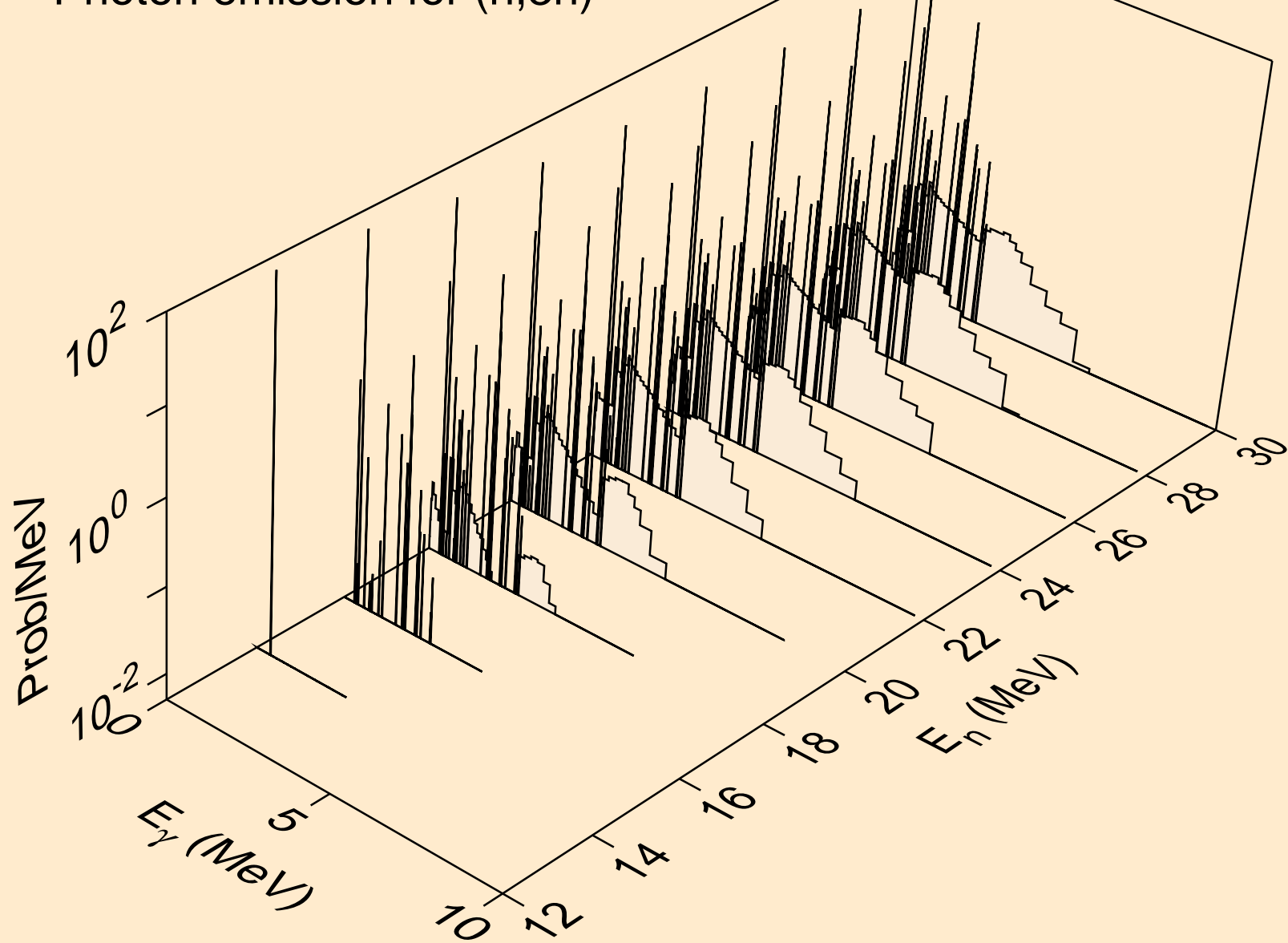

P036 NEUTRON ACER TENDL-2023 LIBRARY; T=0.K
Photon emission for (n,n*)a

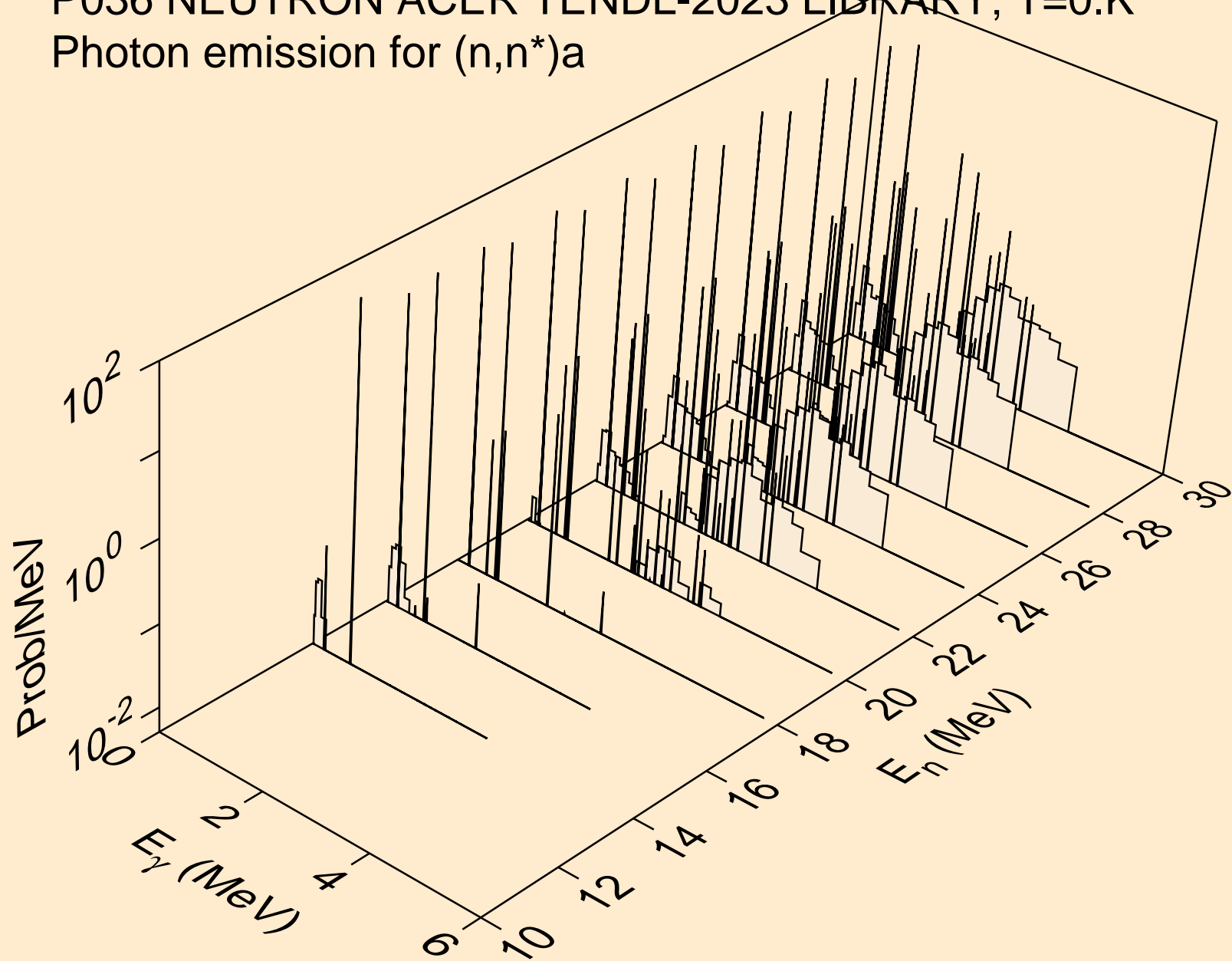

P036 NEUTRON ACER TENDL-2023 LIBRARY; T=0.K
Photon emission for (n,2n)a

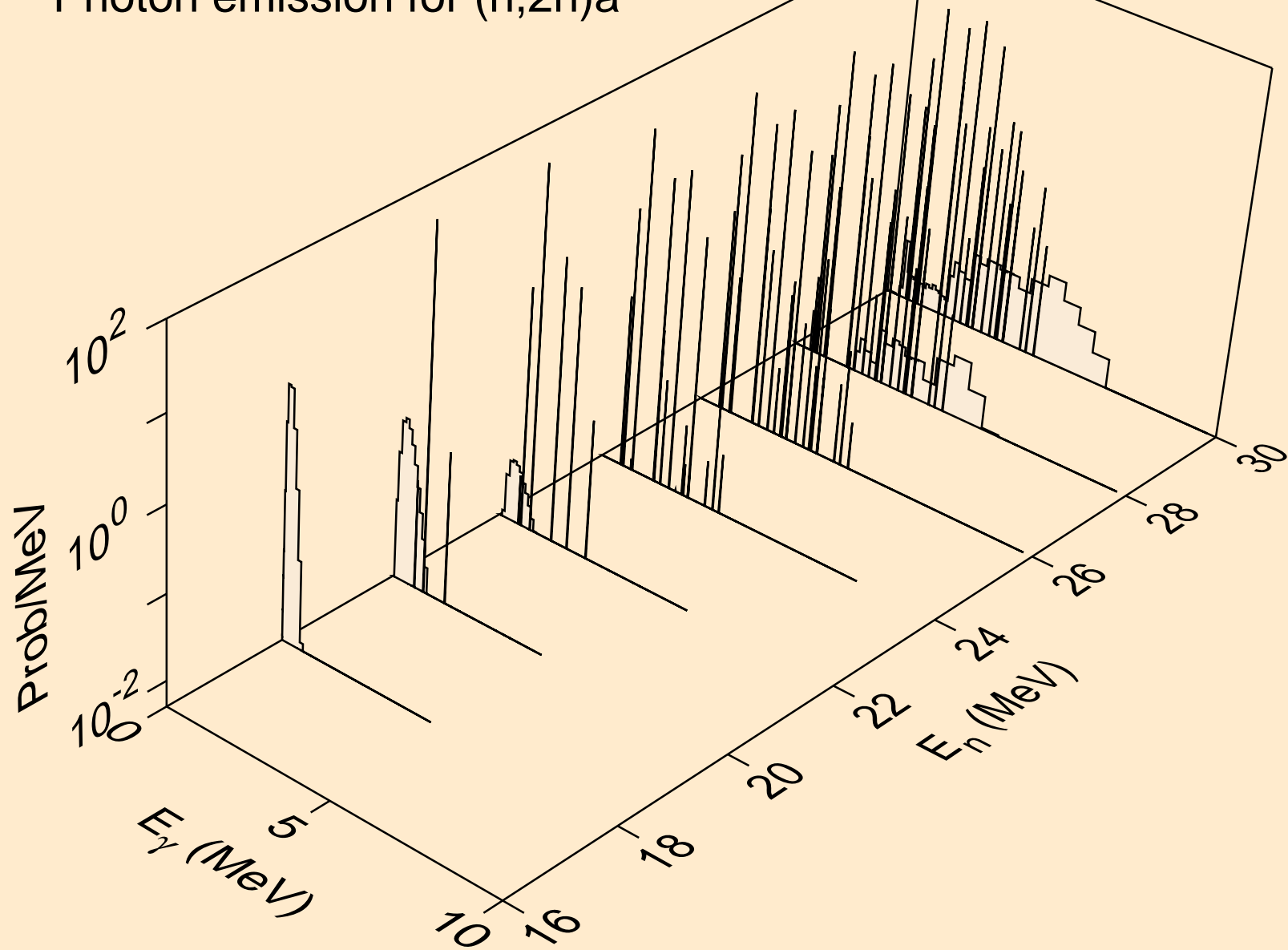

P036 NEUTRON ACER TENDL-2023 LIBRARY; T=0.K
Photon emission for (n,3n)a

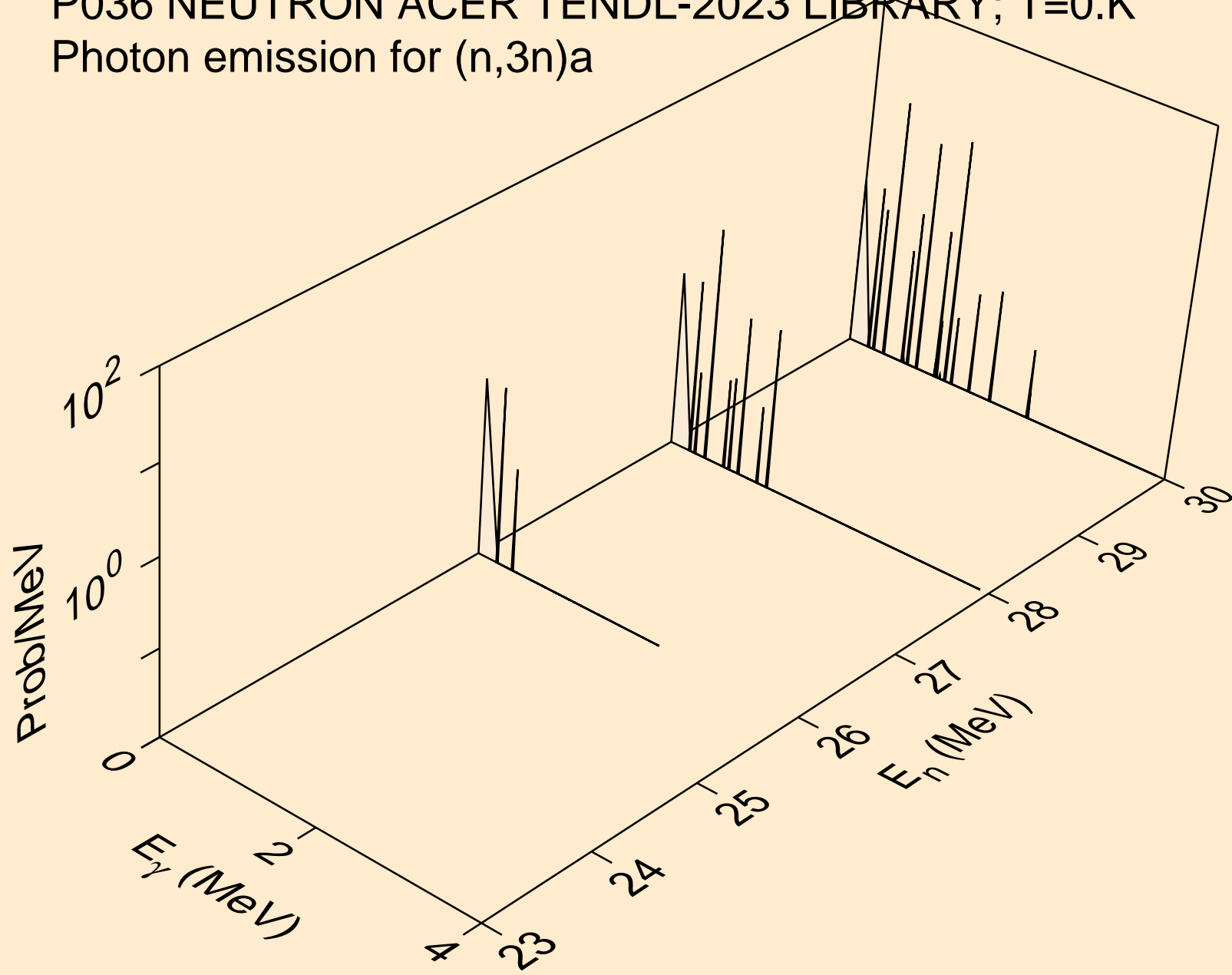

P036 NEUTRON ACER TENDL-2023 LIBRARY; T=0.K
Photon emission for (n,n*)p

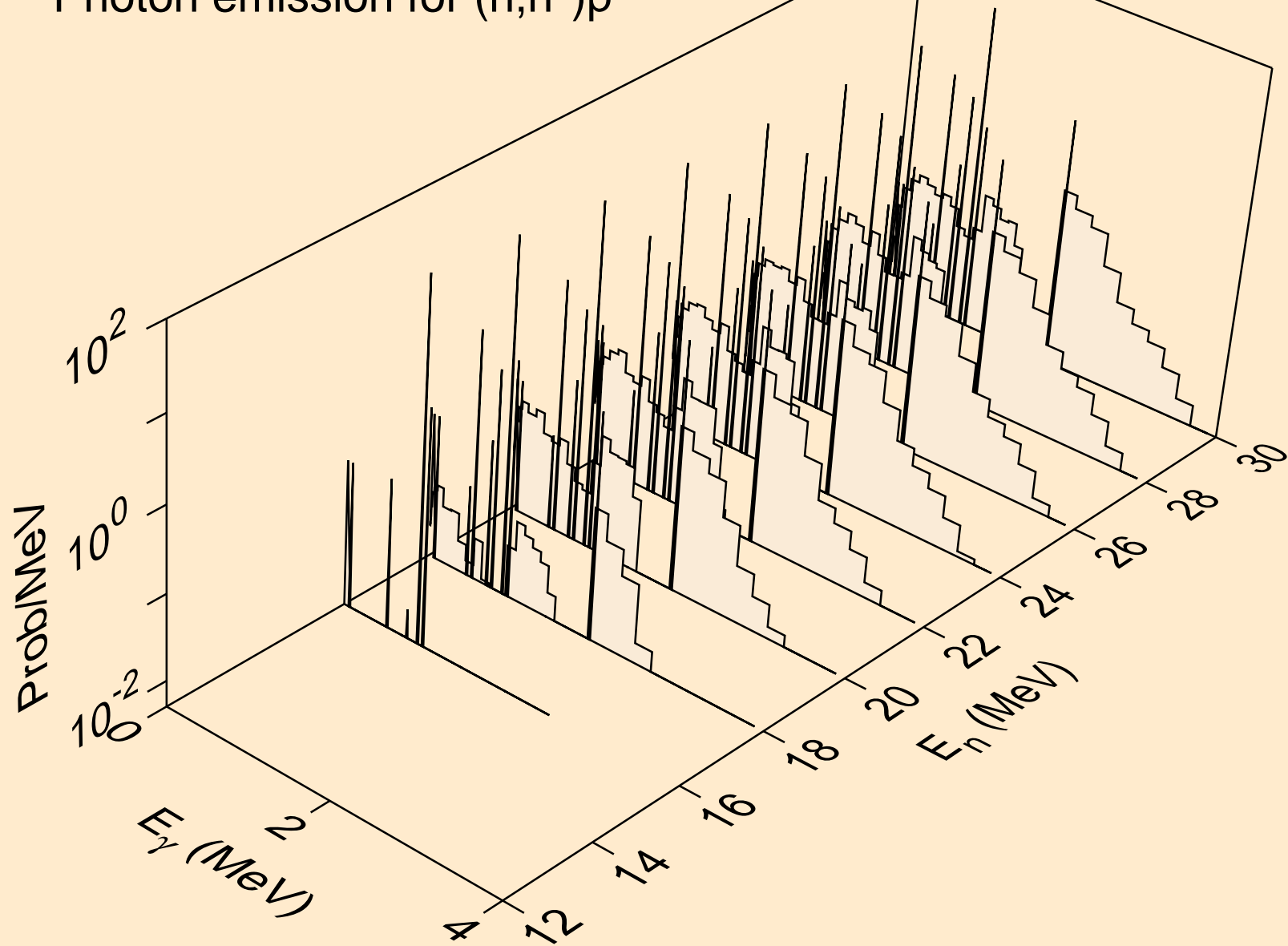

P036 NEUTRON ACER TENDL-2023 LIBRARY; T=0.K
Photon emission for (n,n*)d

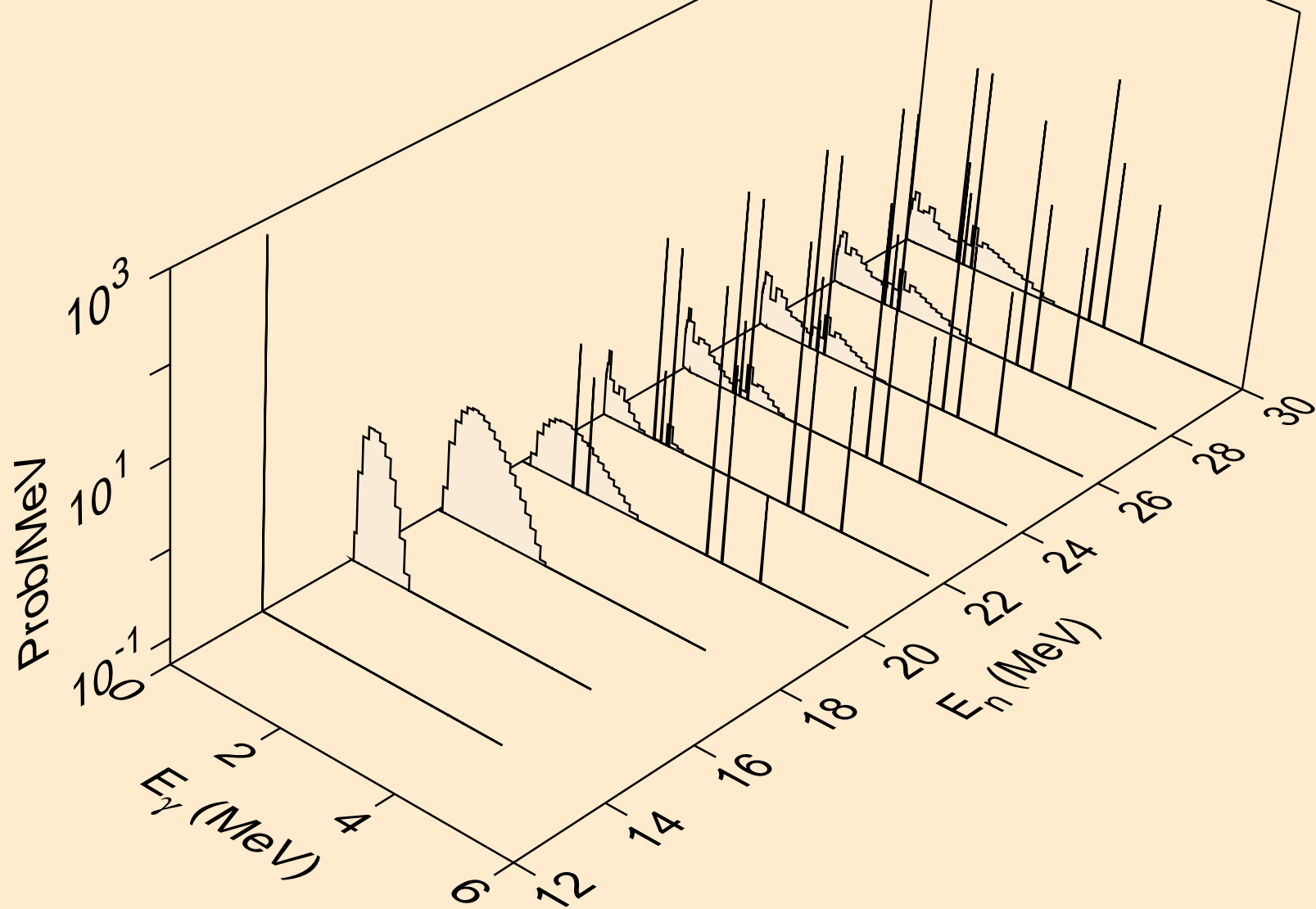

P036 NEUTRON ACER TENDL-2023 LIBRARY; T=0.K
Photon emission for (n,n*)t

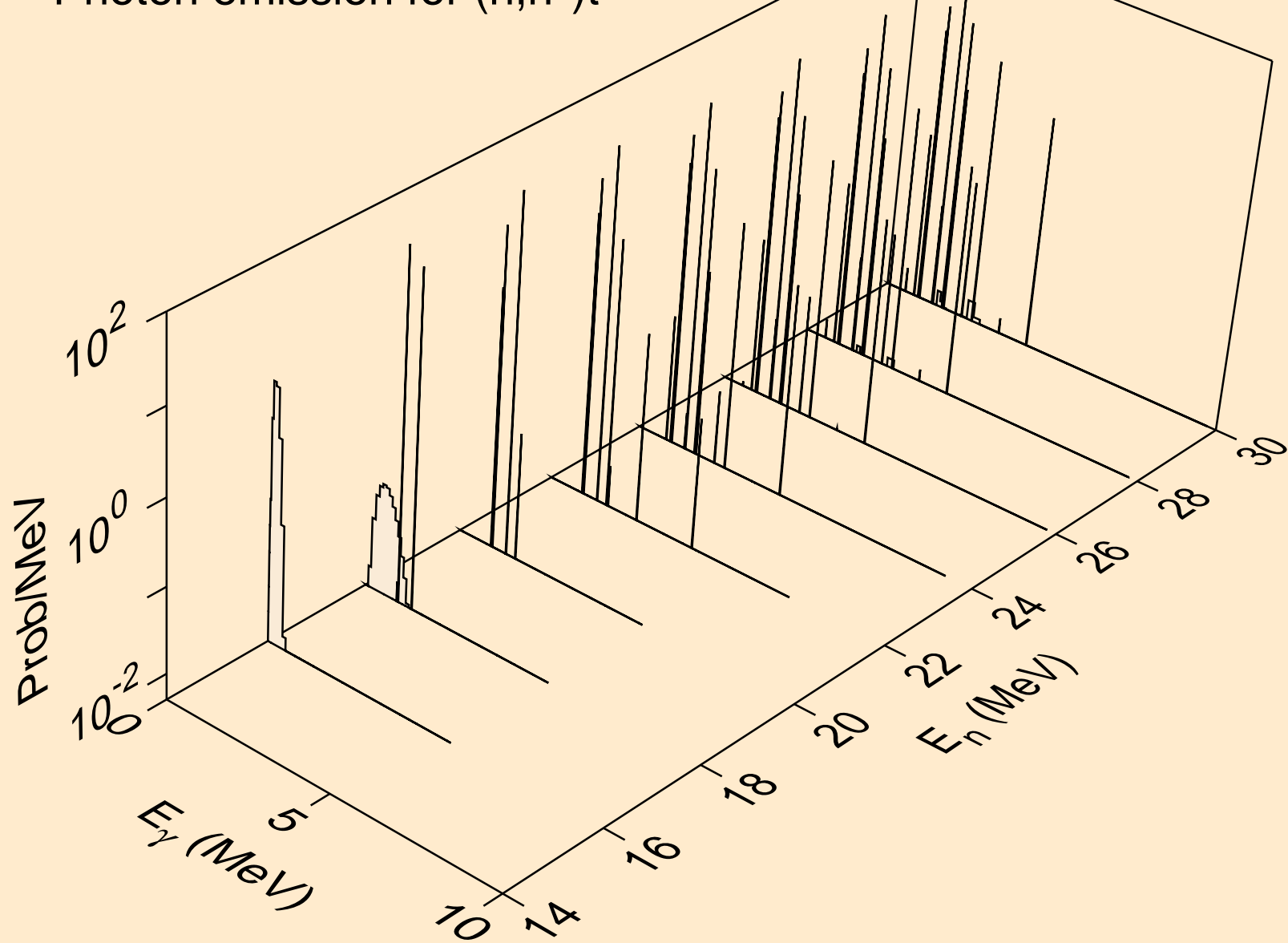

P036 NEUTRON ACER TENDL-2023 LIBRARY; T=0.K
Photon emission for (n,n*)he3

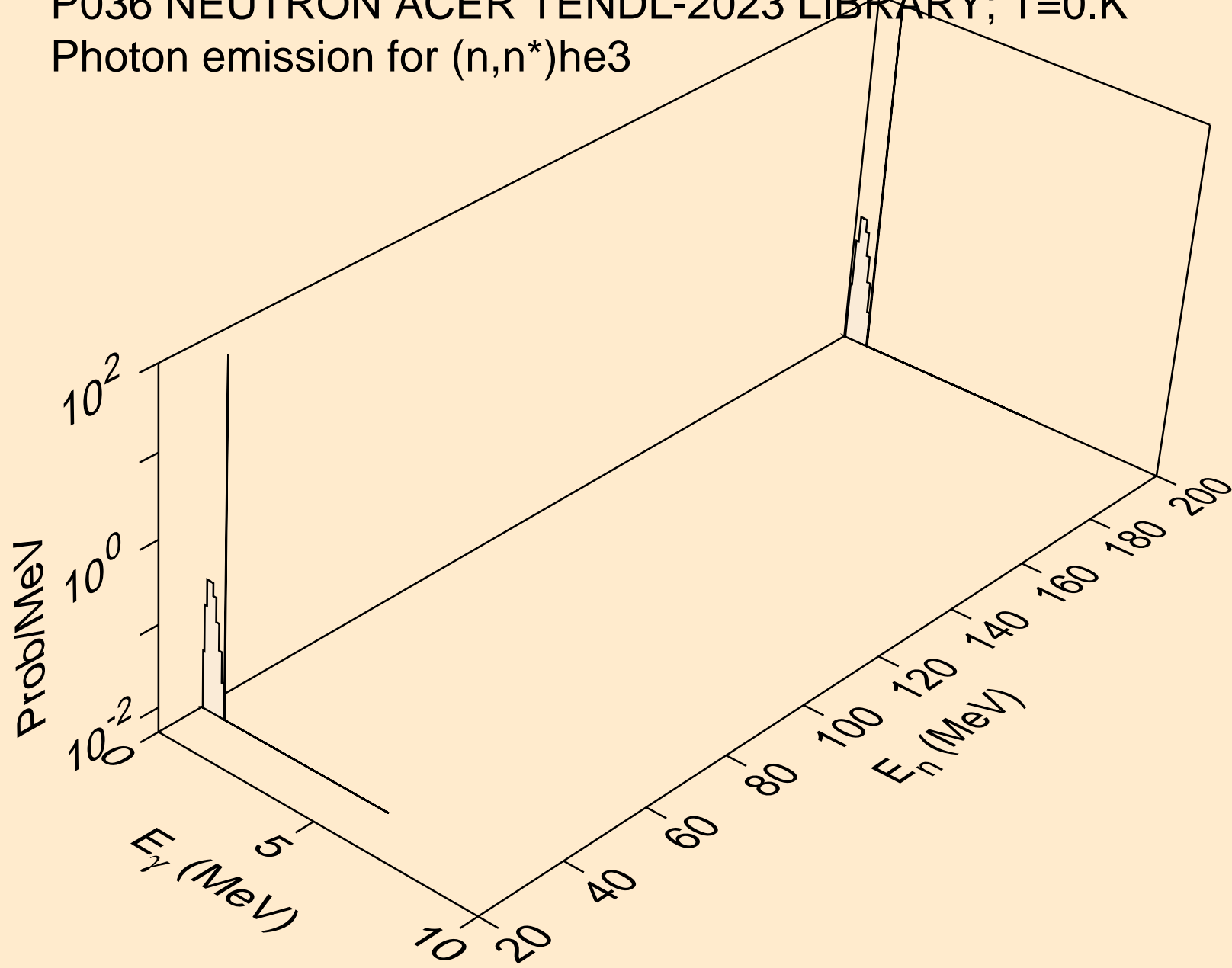

P036 NEUTRON ACER TENDL-2023 LIBRARY; T=0.K
Photon emission for (n,4n)

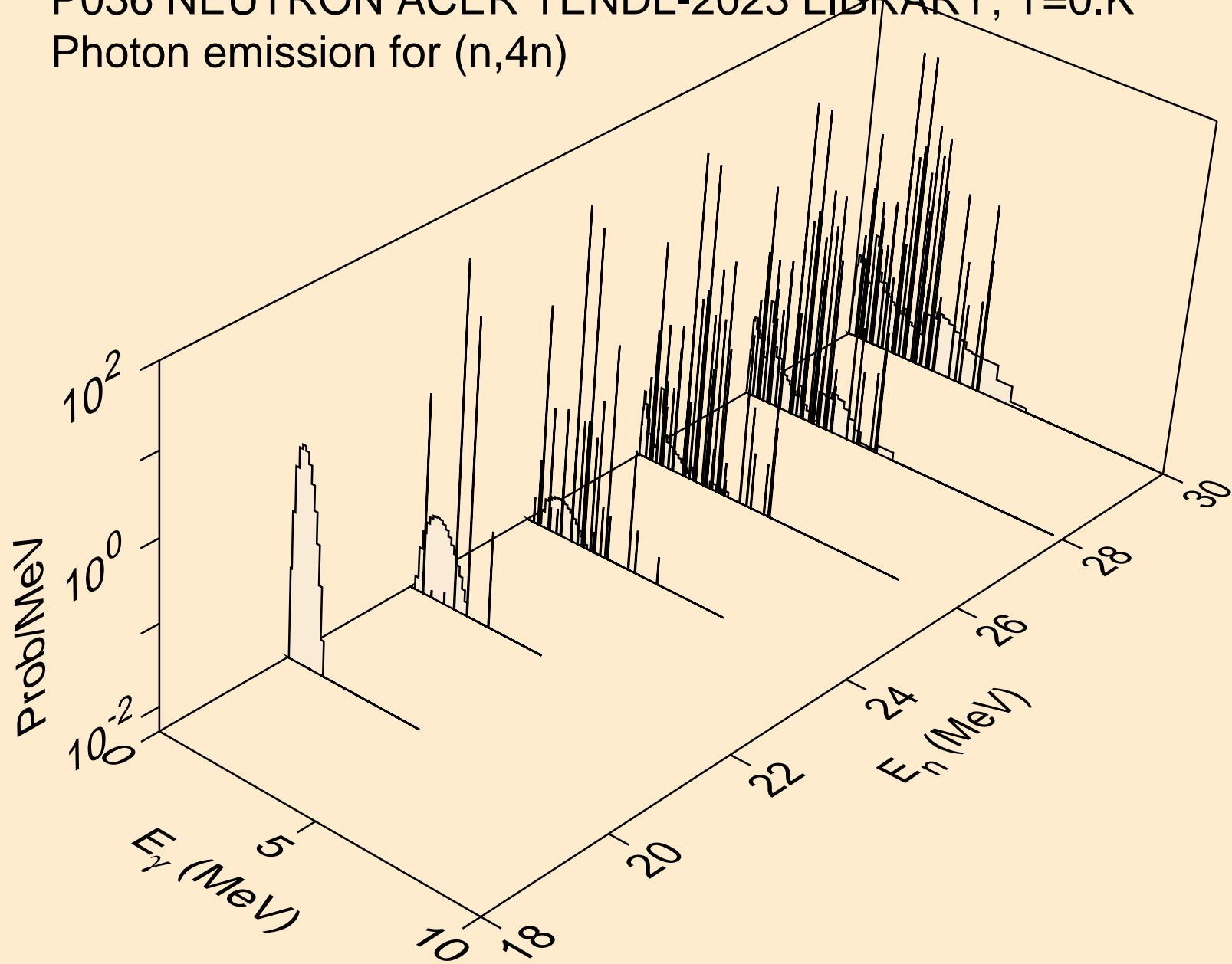

P036 NEUTRON ACER TENDL-2023 LIBRARY; T=0.K
Photon emission for (n,2np)

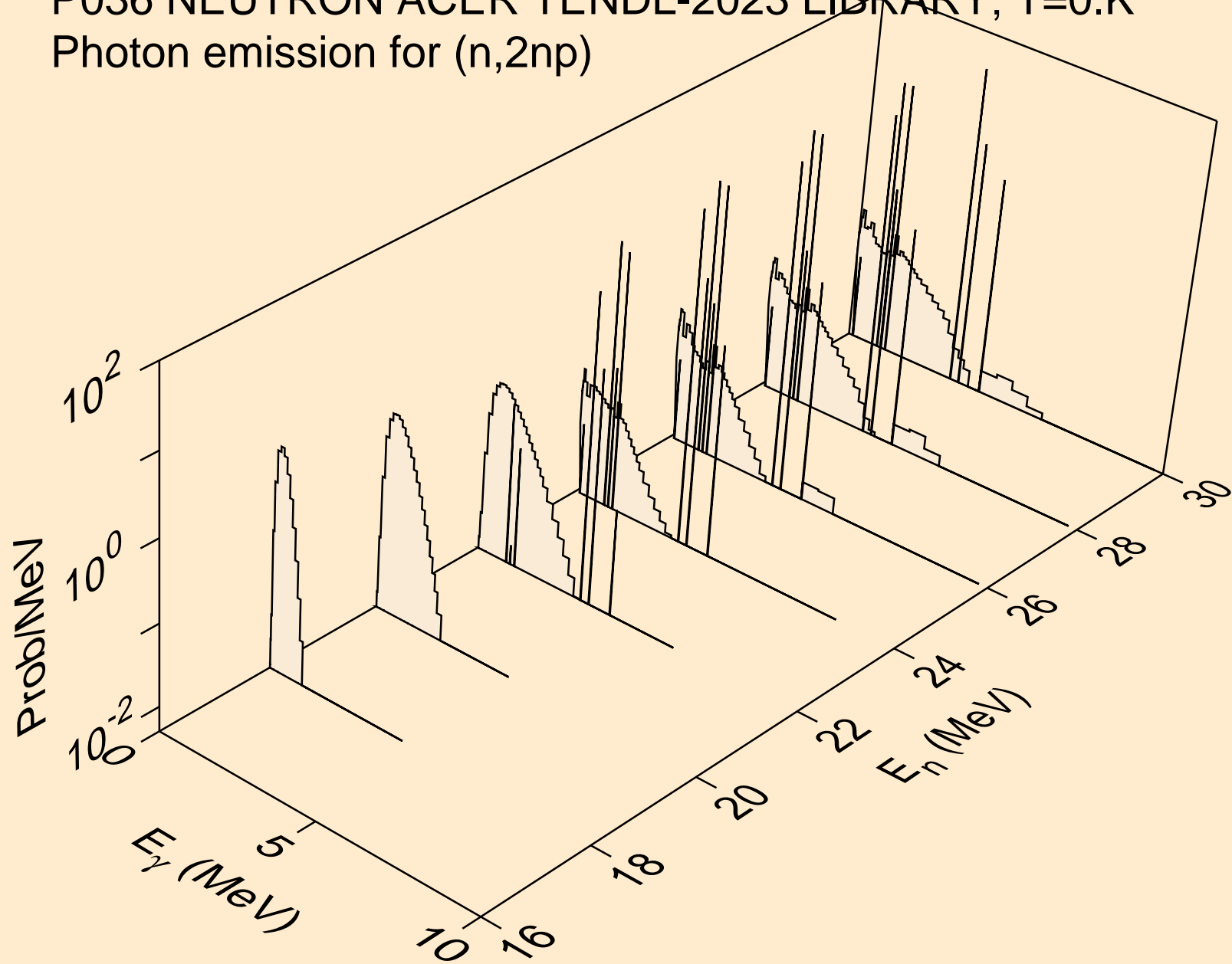

P036 NEUTRON ACER TENDL-2023 LIBRARY; T=0.K
Photon emission for (n,3np)

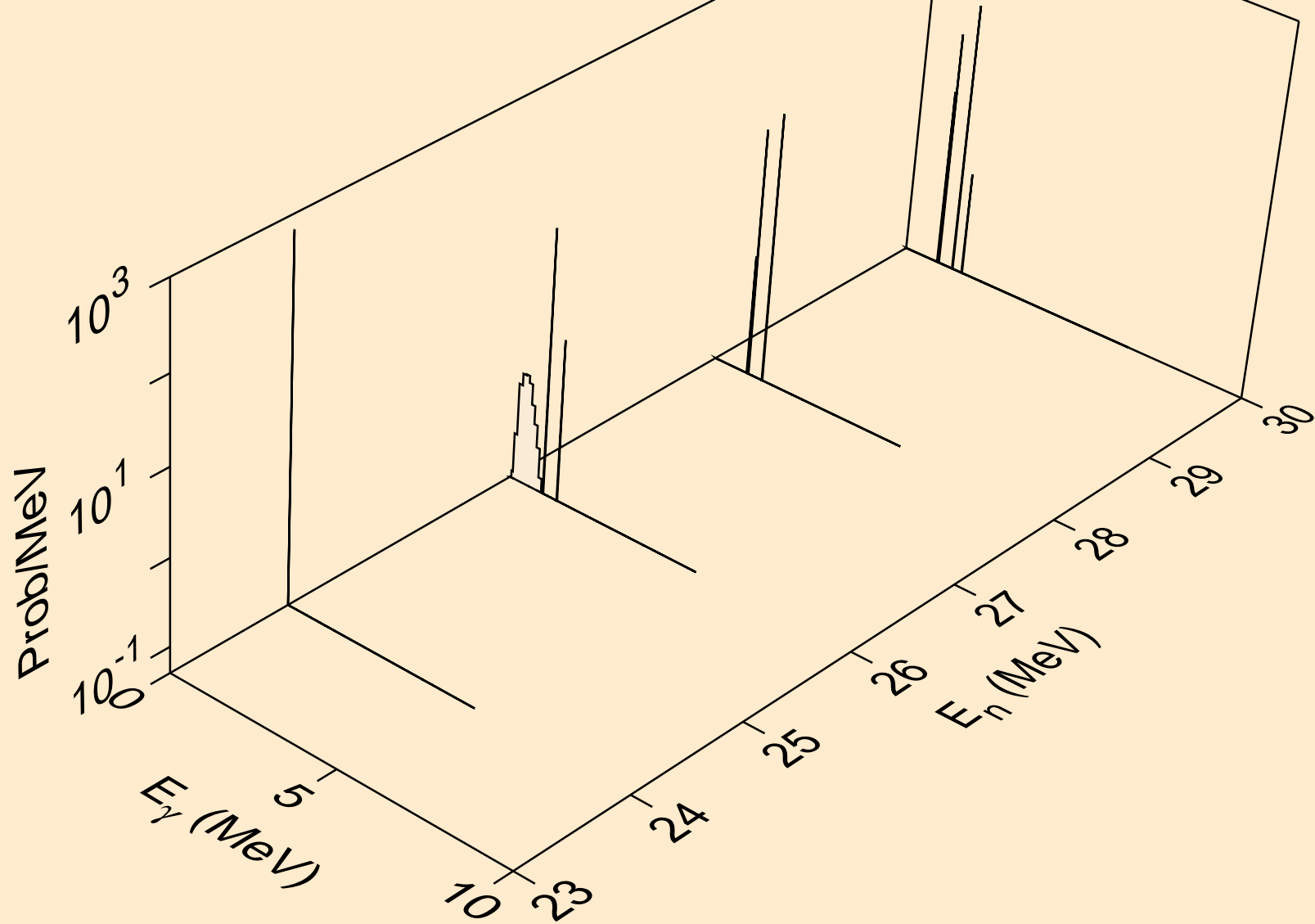

P036 NEUTRON ACER TENDL-2023 LIBRARY; T=0.K
Photon emission for (n,gma)

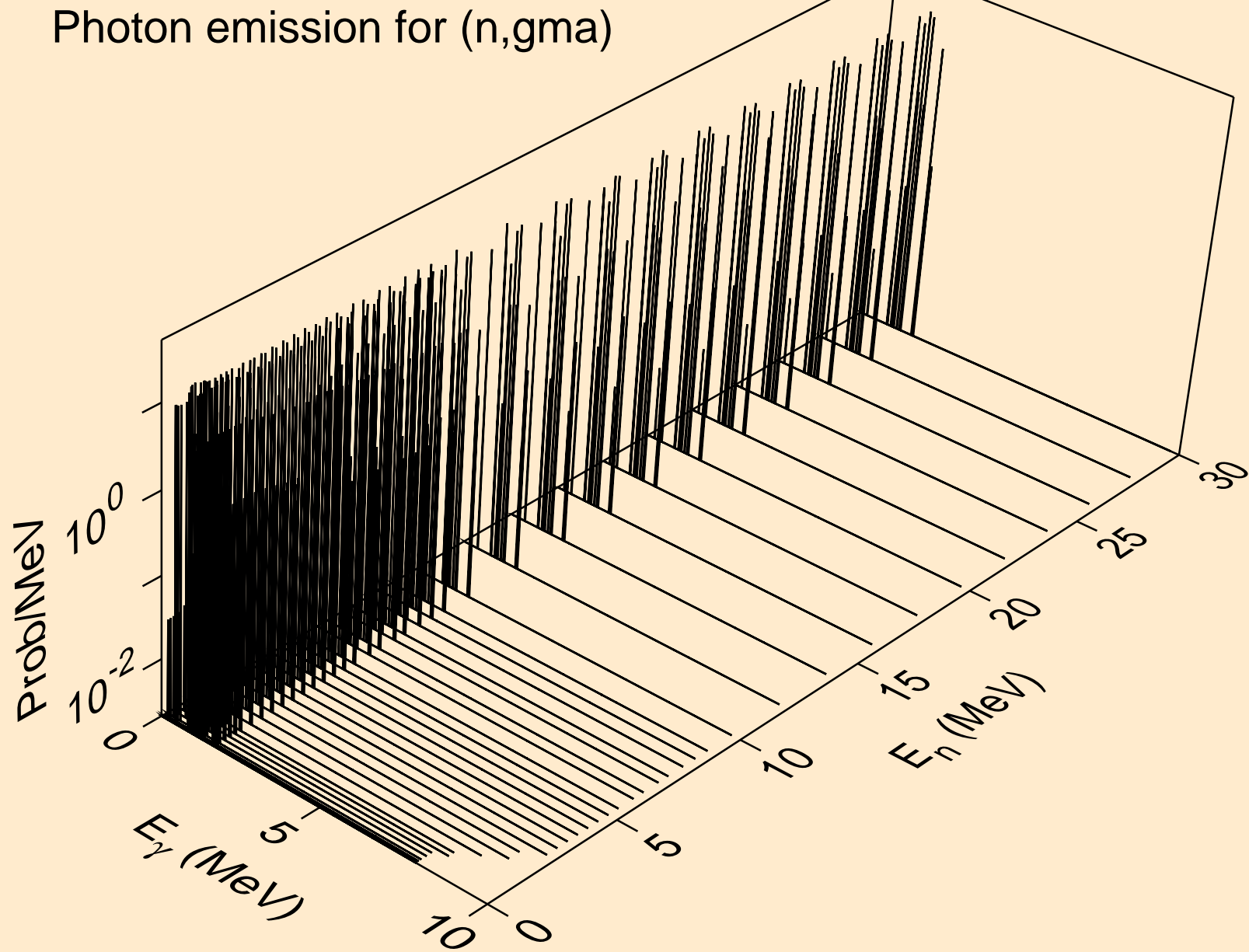

P036 NEUTRON ACER TENDL-2023 LIBRARY; T=0.K
Photon emission for (n,p)

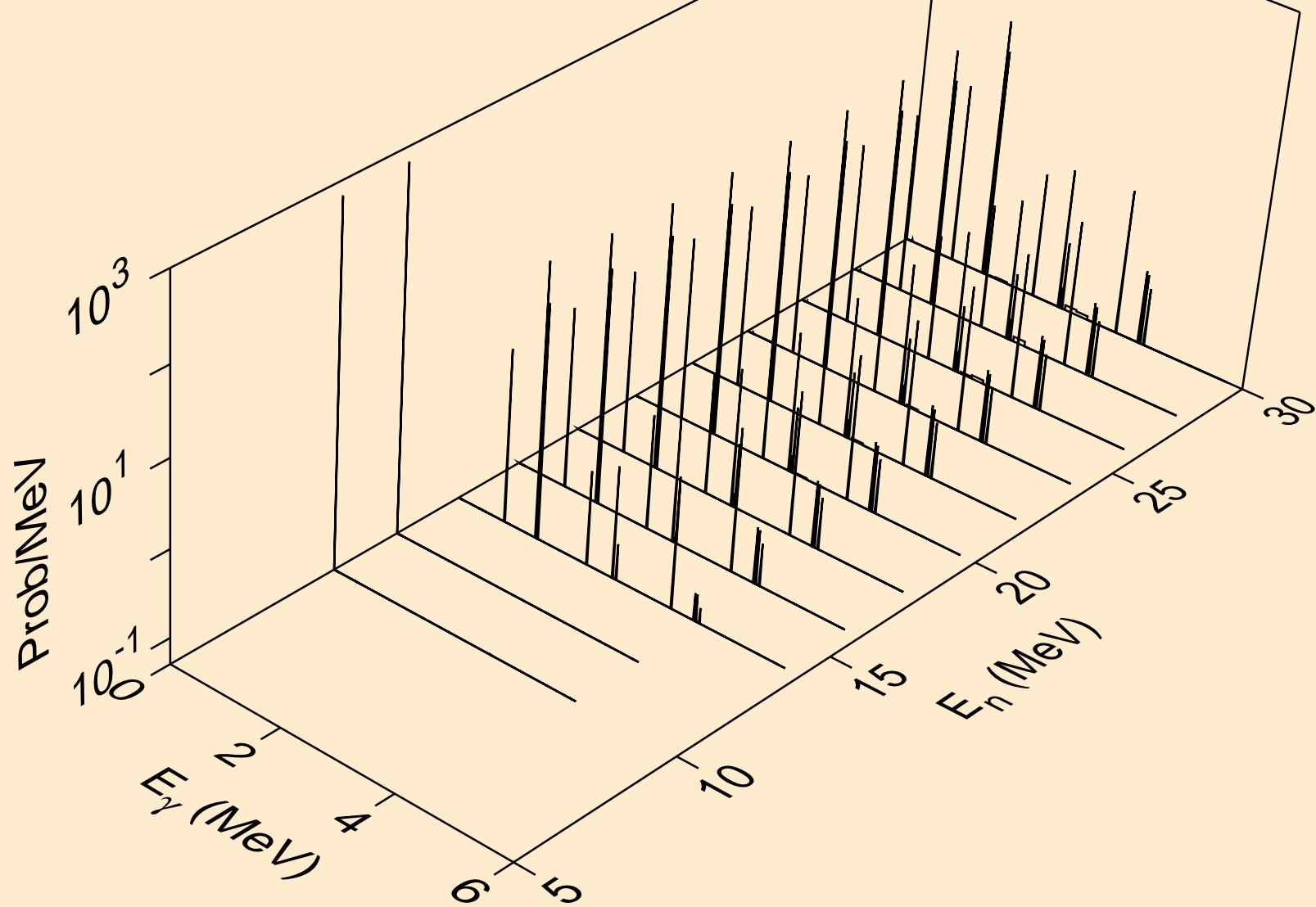

P036 NEUTRON ACER TENDL-2023 LIBRARY; T=0.K
Photon emission for (n,d)

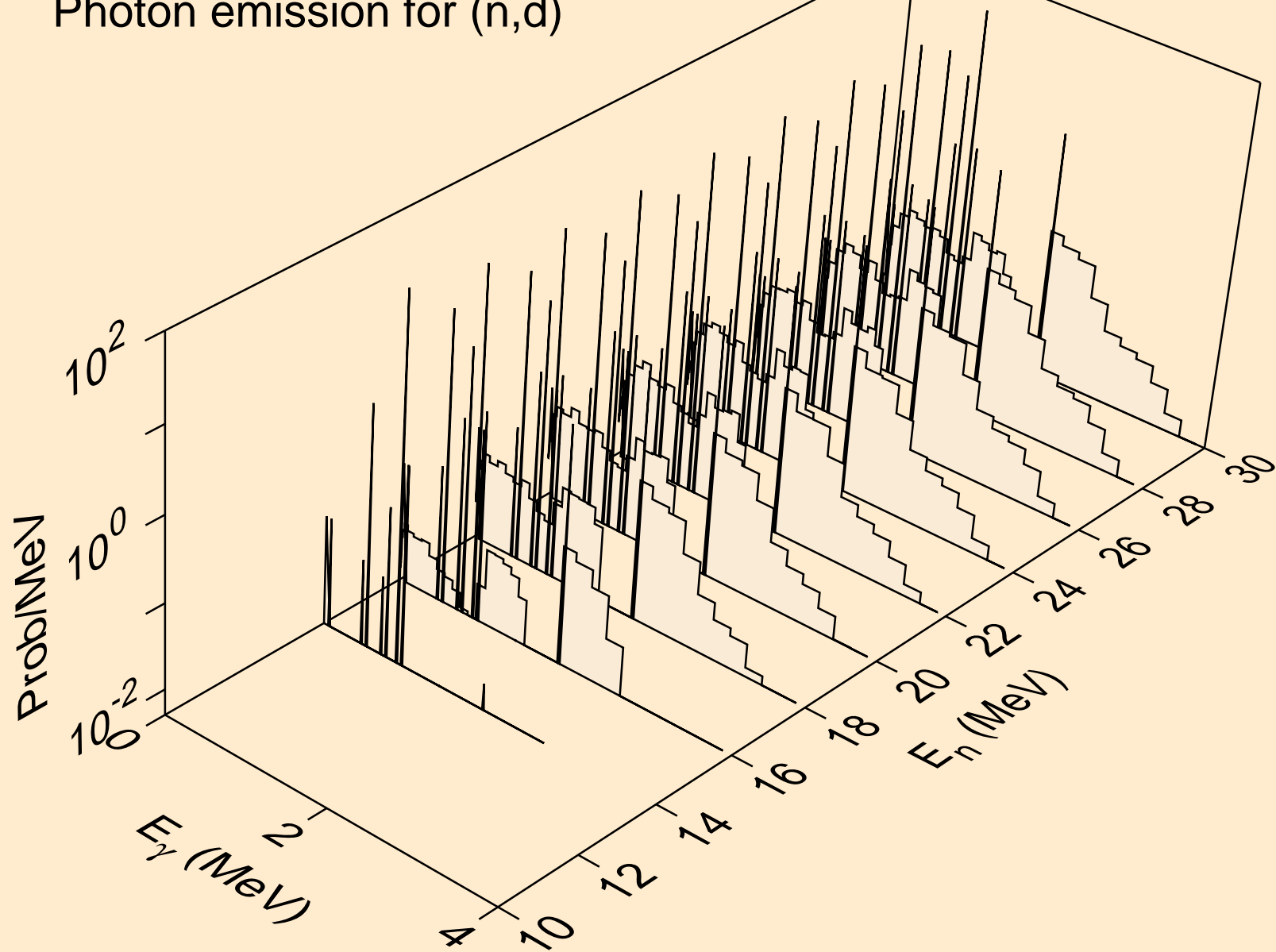

P036 NEUTRON ACER TENDL-2023 LIBRARY; T=0.K
Photon emission for (n,t)

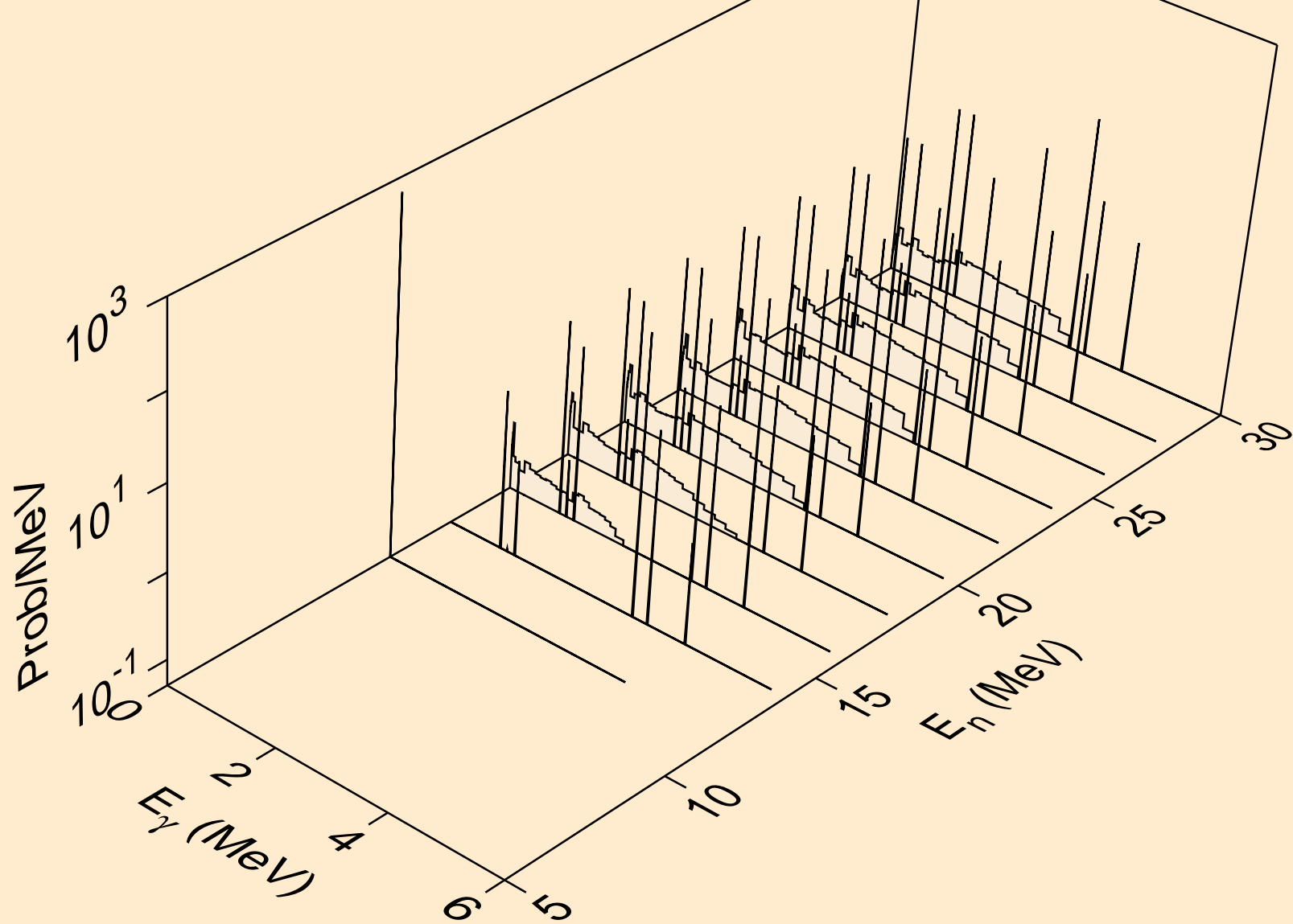

P036 NEUTRON ACER TENDL-2023 LIBRARY; T=0.K
Photon emission for (n,he3)

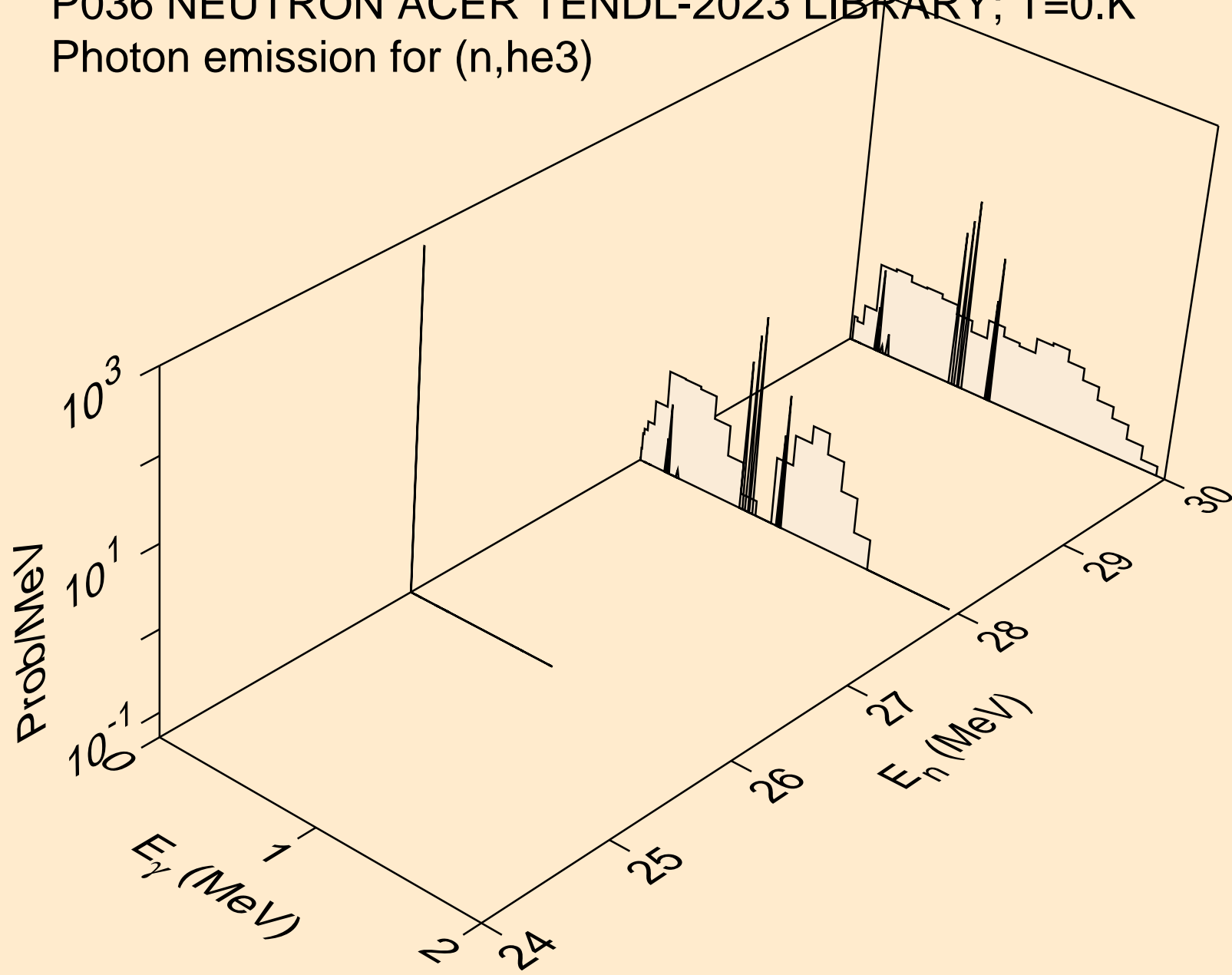

P036 NEUTRON ACER TENDL-2023 LIBRARY; T=0.K
Photon emission for (n,a)

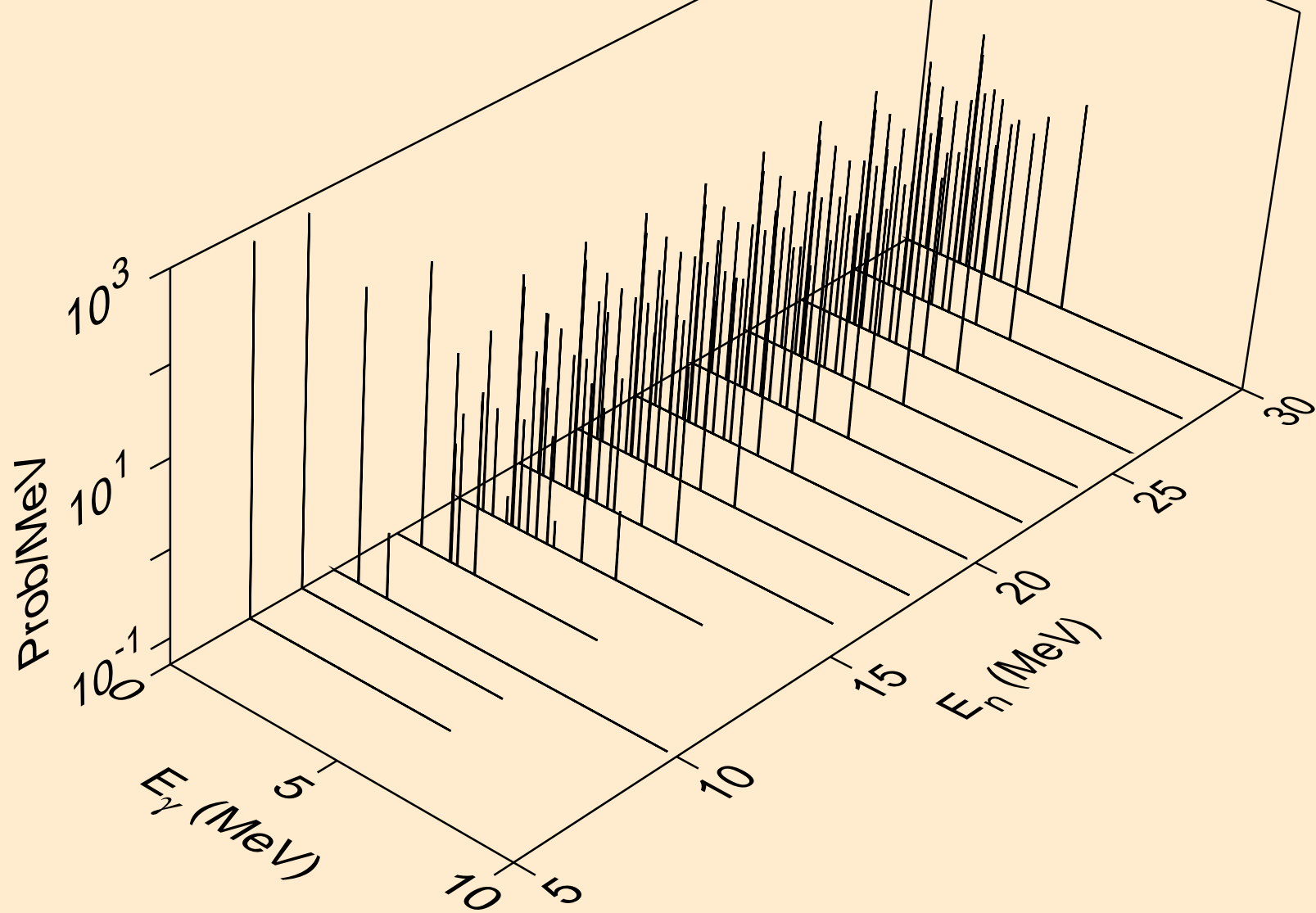

P036 NEUTRON ACER TENDL-2023 LIBRARY; T=0.K
Photon emission for (n,2a)

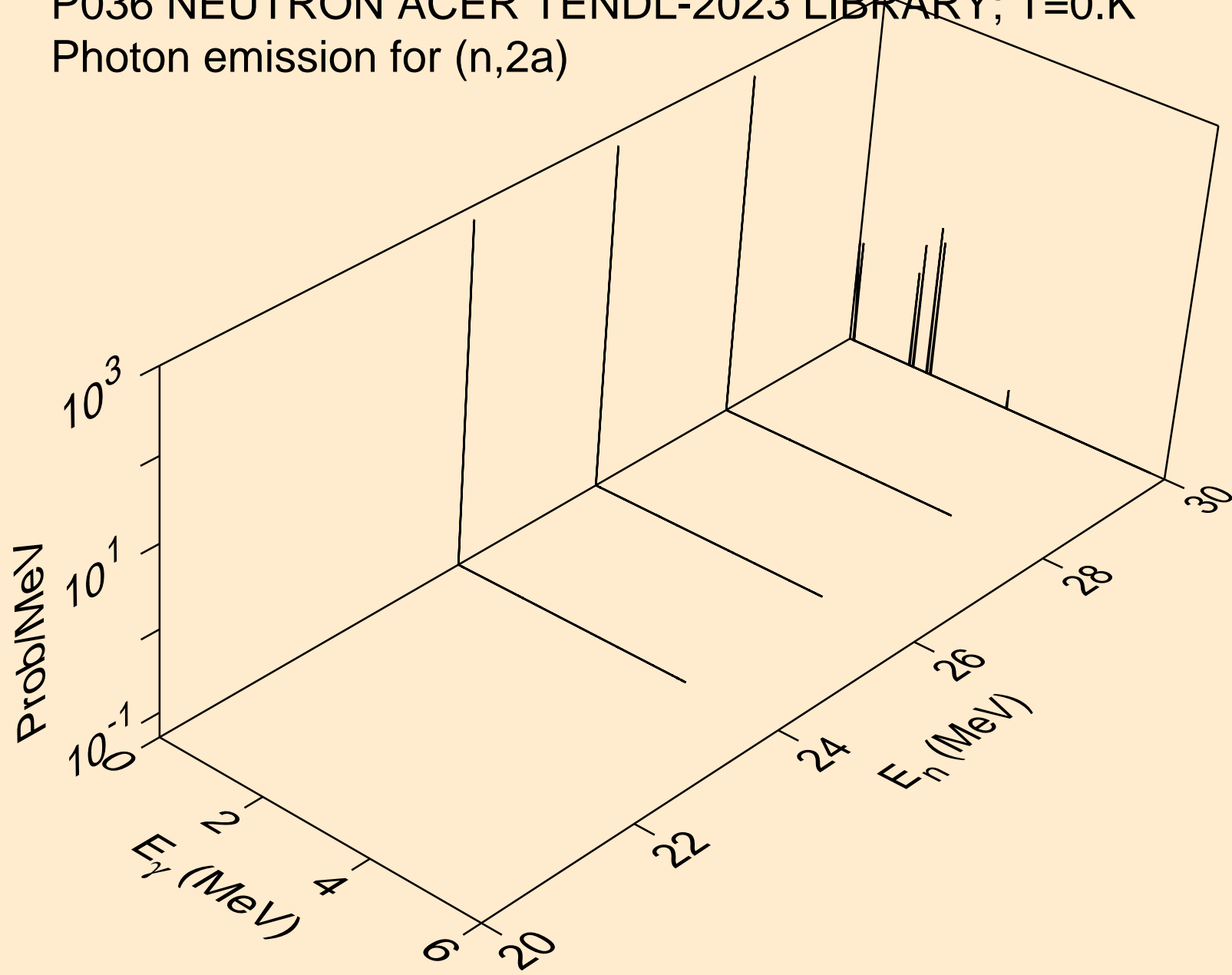

P036 NEUTRON ACER TENDL-2023 LIBRARY; T=0.K
Photon emission for (n,pa)

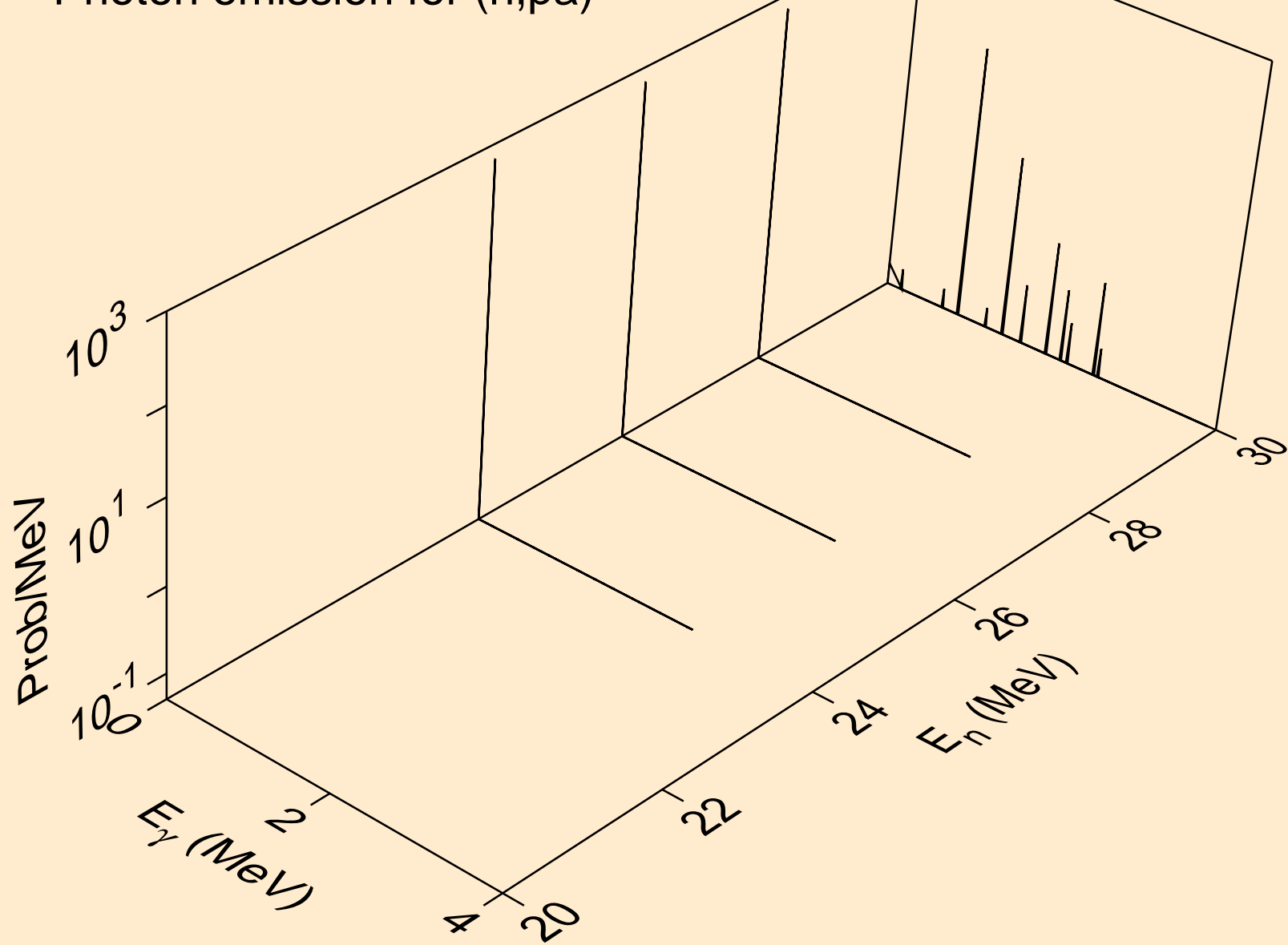

P036 NEUTRON ACER TENDL-2023 LIBRARY; T=0.K
thermal capture photon spectrum

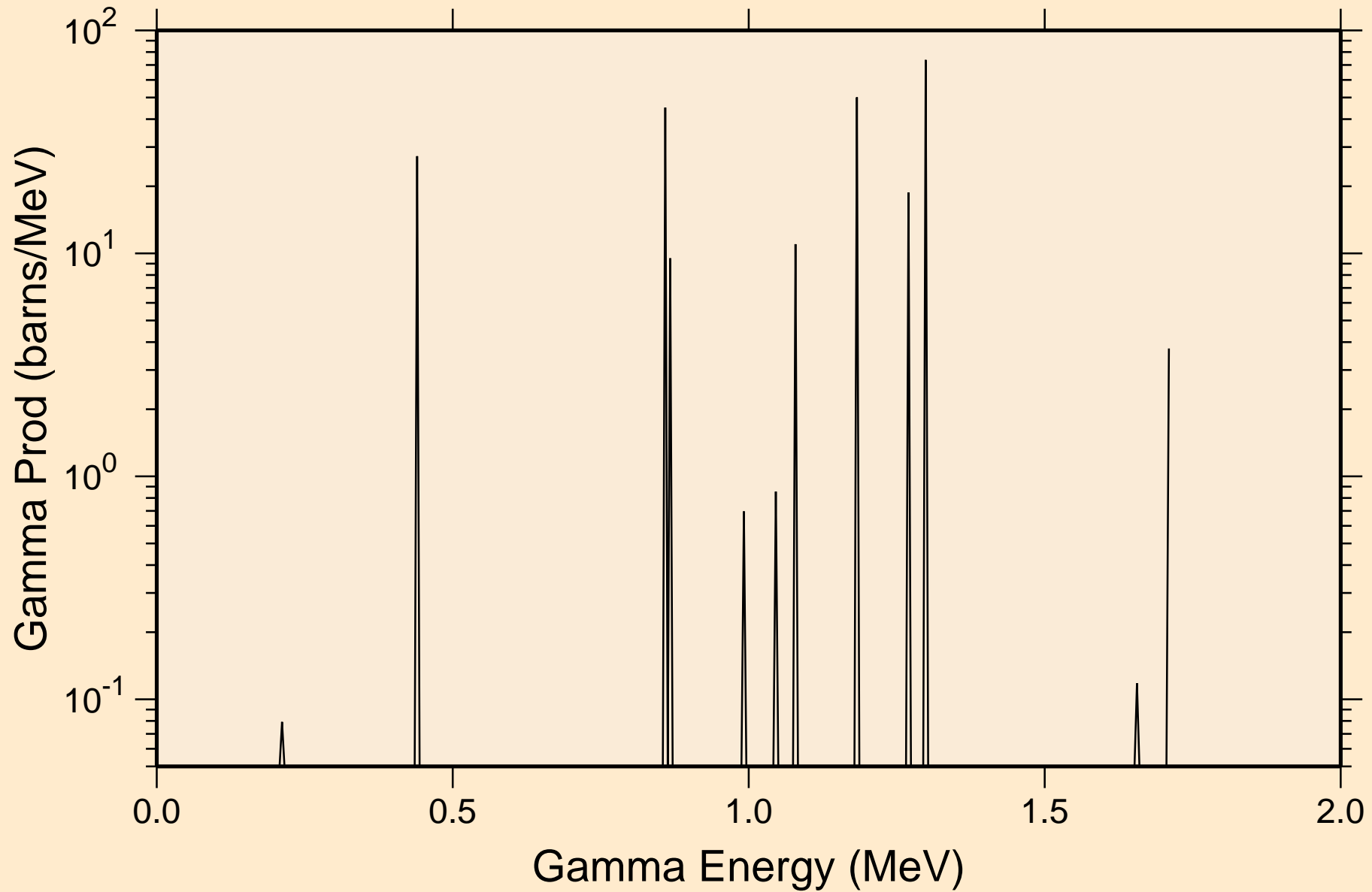

P036 NEUTRON ACER TENDL-2023 LIBRARY; T=0.K
14 MeV photon spectrum

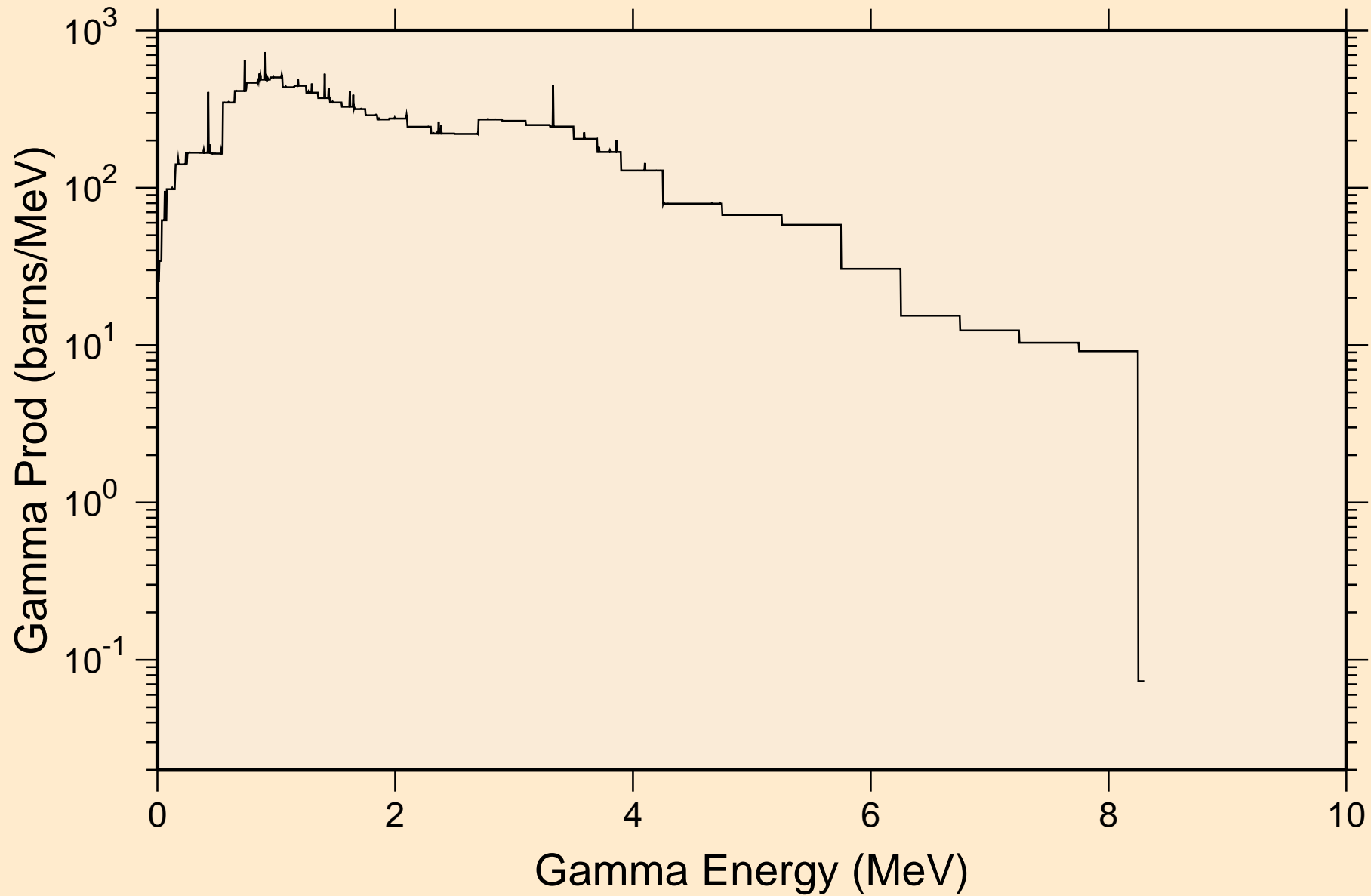

P036 NEUTRON ACER TENDL-2023 LIBRARY; T=0.K
Particle heating contributions

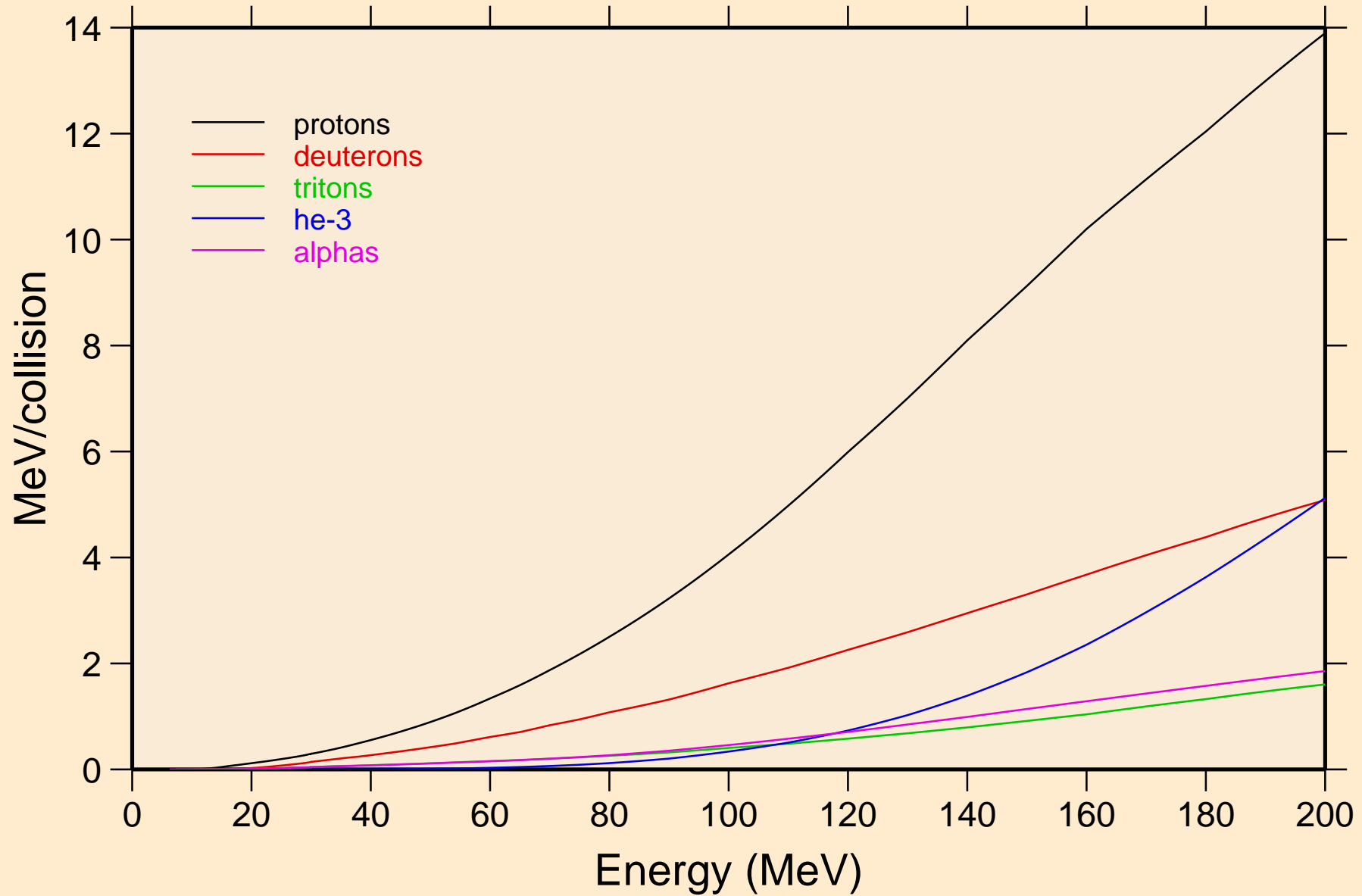

P036 NEUTRON ACER TENDL-2023 LIBRARY; T=0.K
Recoil Heating

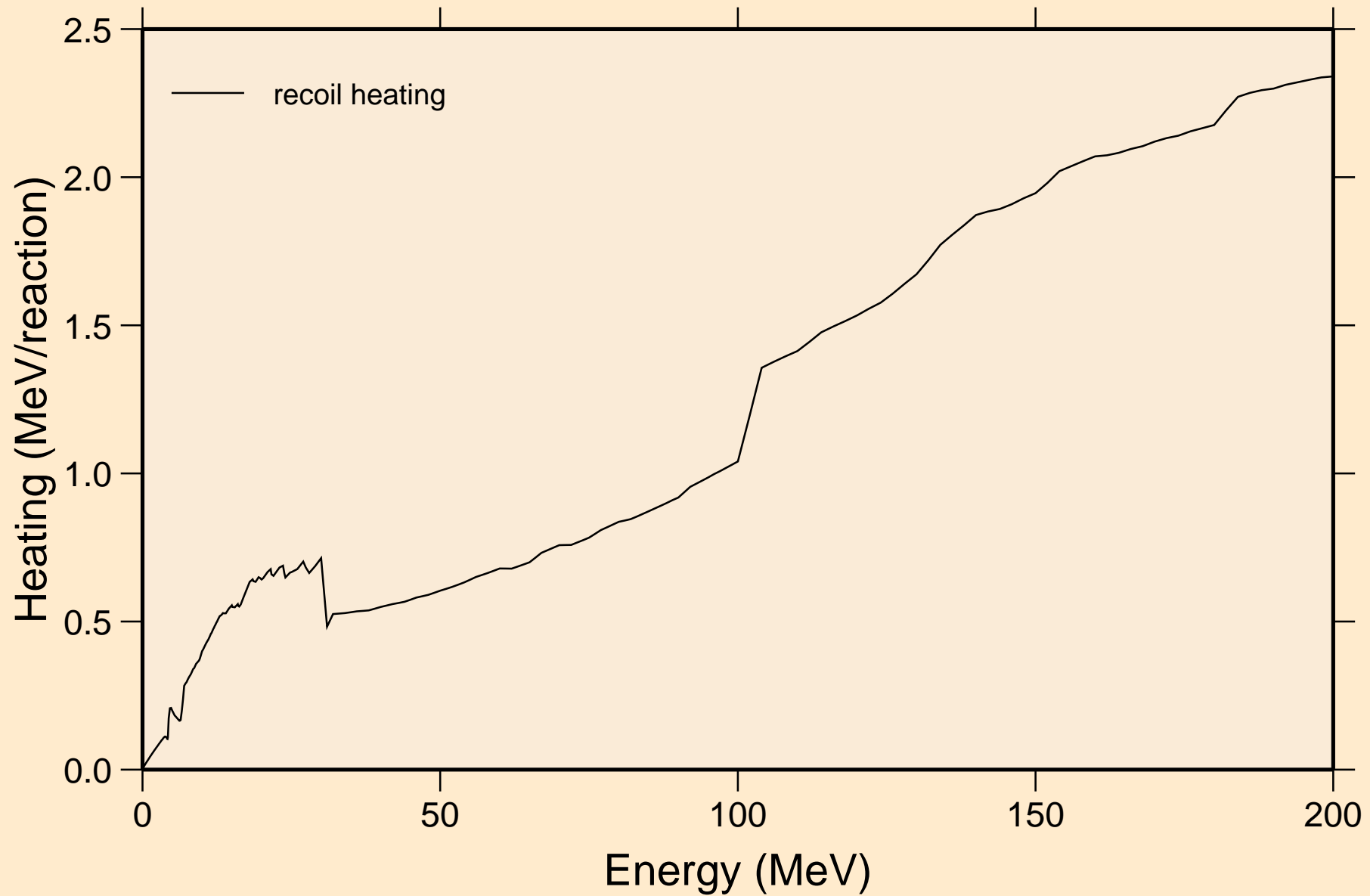

P036 NEUTRON ACER TENDL-2023 LIBRARY; T=0.K

Particle production cross sections

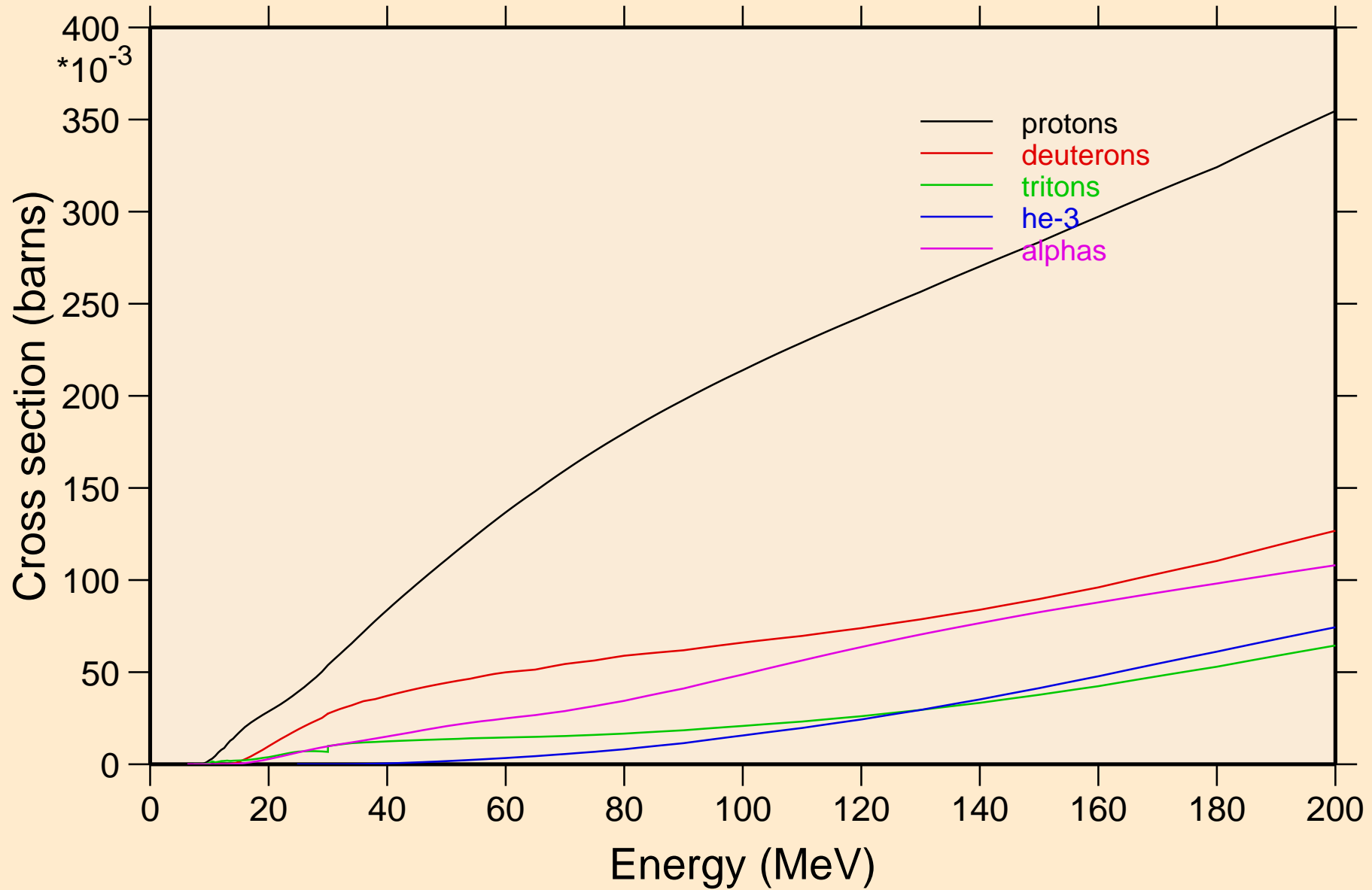

P036 NEUTRON ACER TENDL-2023 LIBRARY; T=0.K
protons from (n,x)

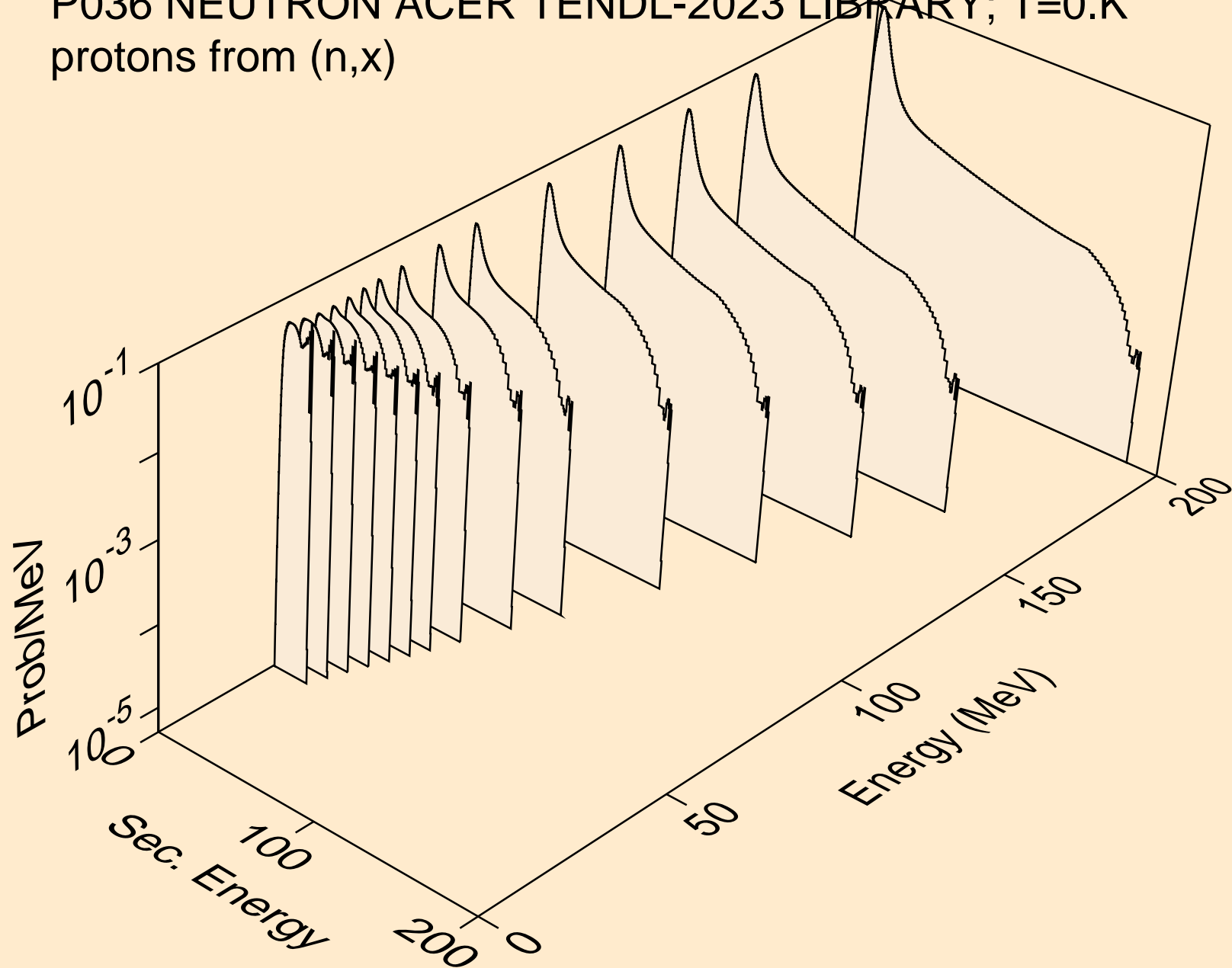

P036 NEUTRON ACER TENDL-2023 LIBRARY; T=0.K
protons from (n,n*)p

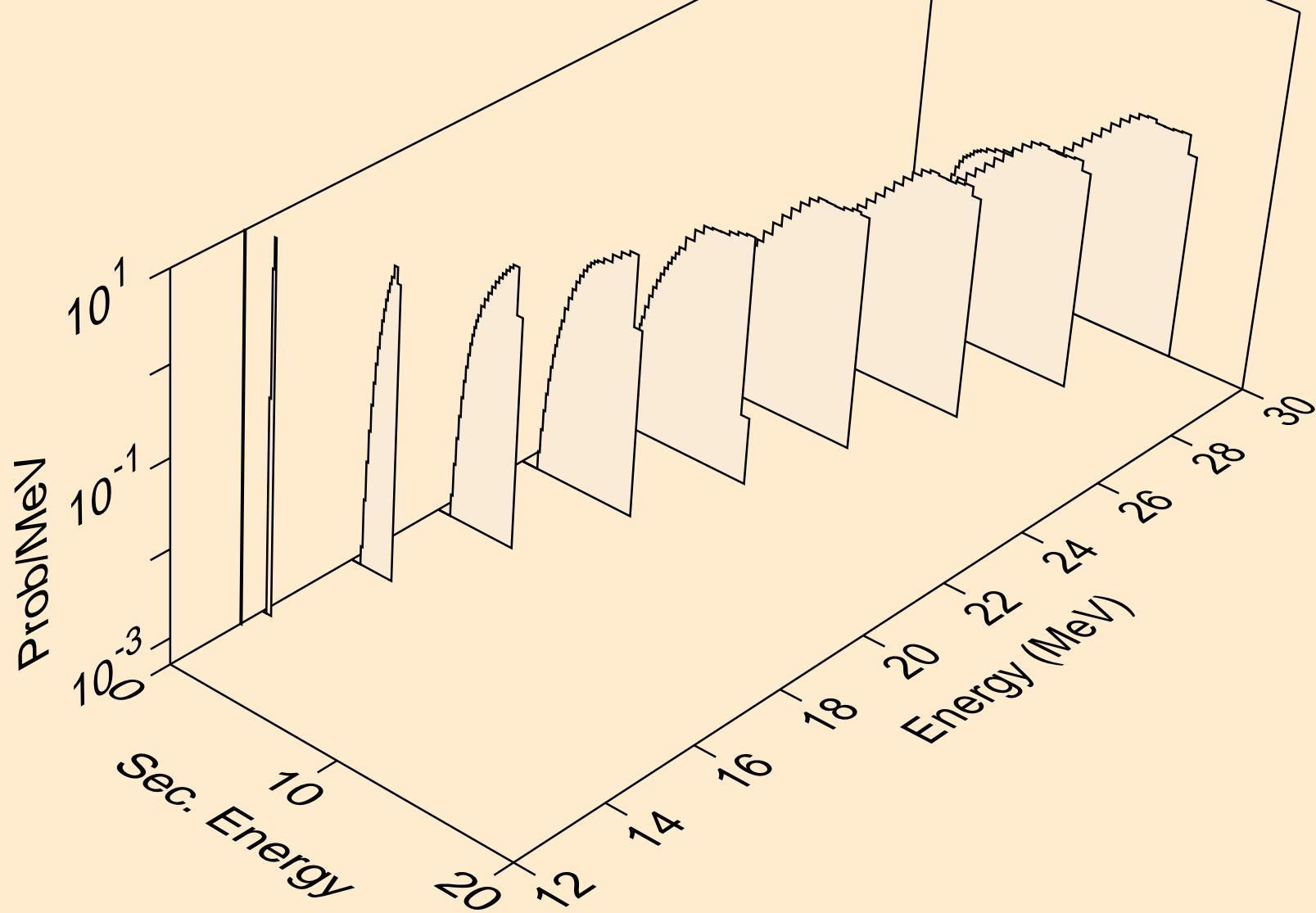

P036 NEUTRON ACER TENDL-2023 LIBRARY; T=0.K
protons from (n,2np)

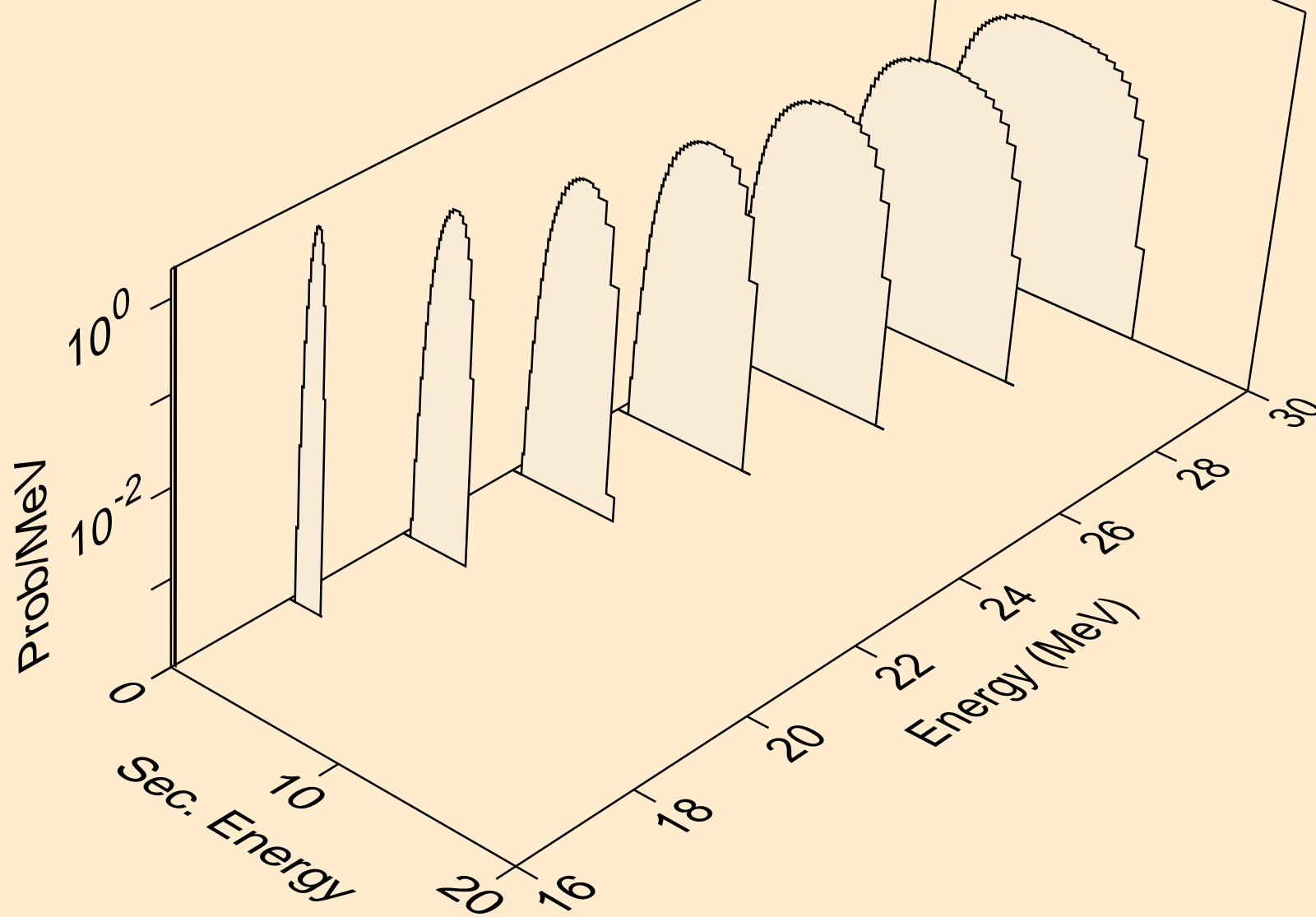

P036 NEUTRON ACER TENDL-2023 LIBRARY; T=0.K
protons from (n,3np)

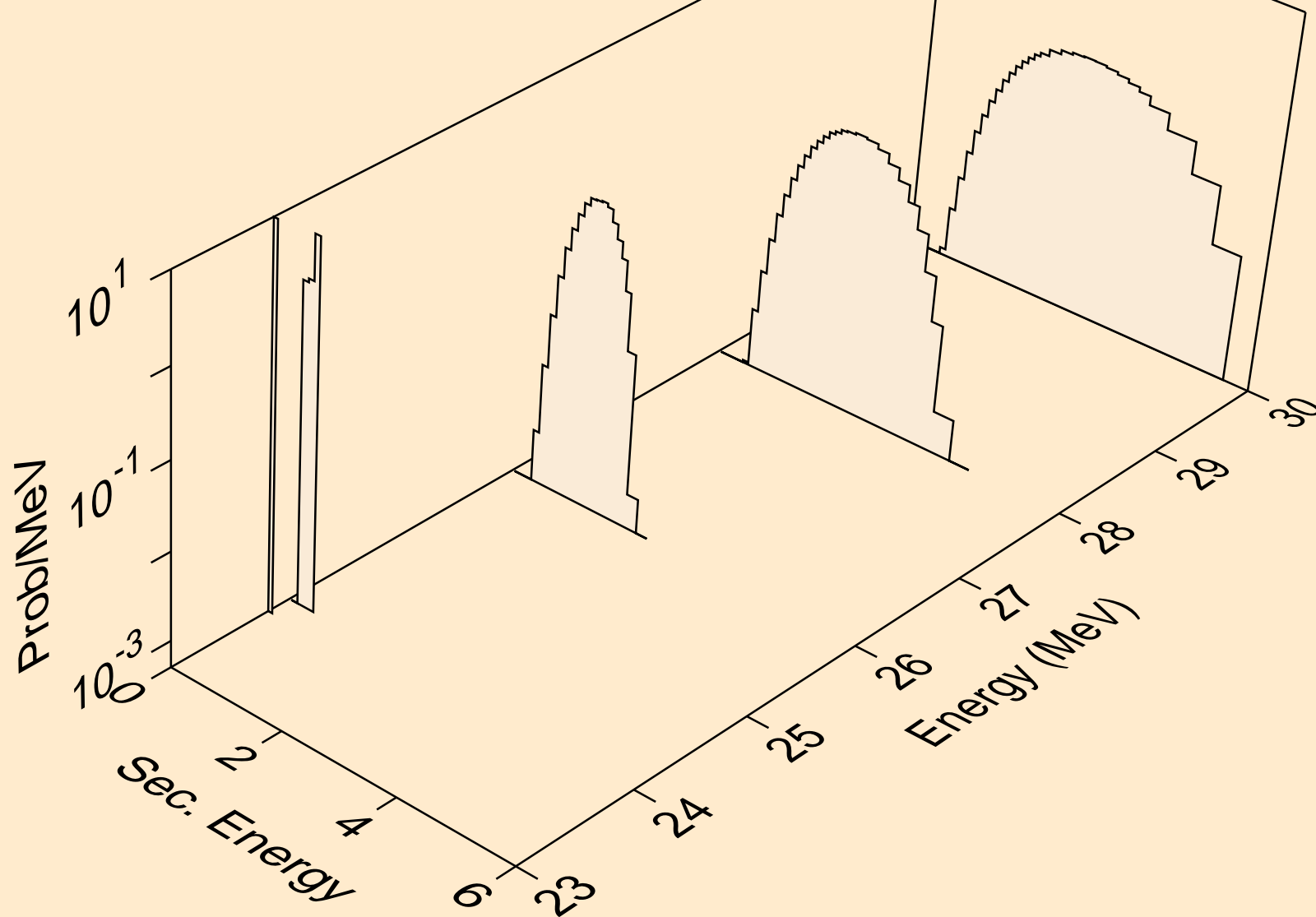

P036 NEUTRON ACER TENDL-2023 LIBRARY; T=0.K
protons from (n,p)

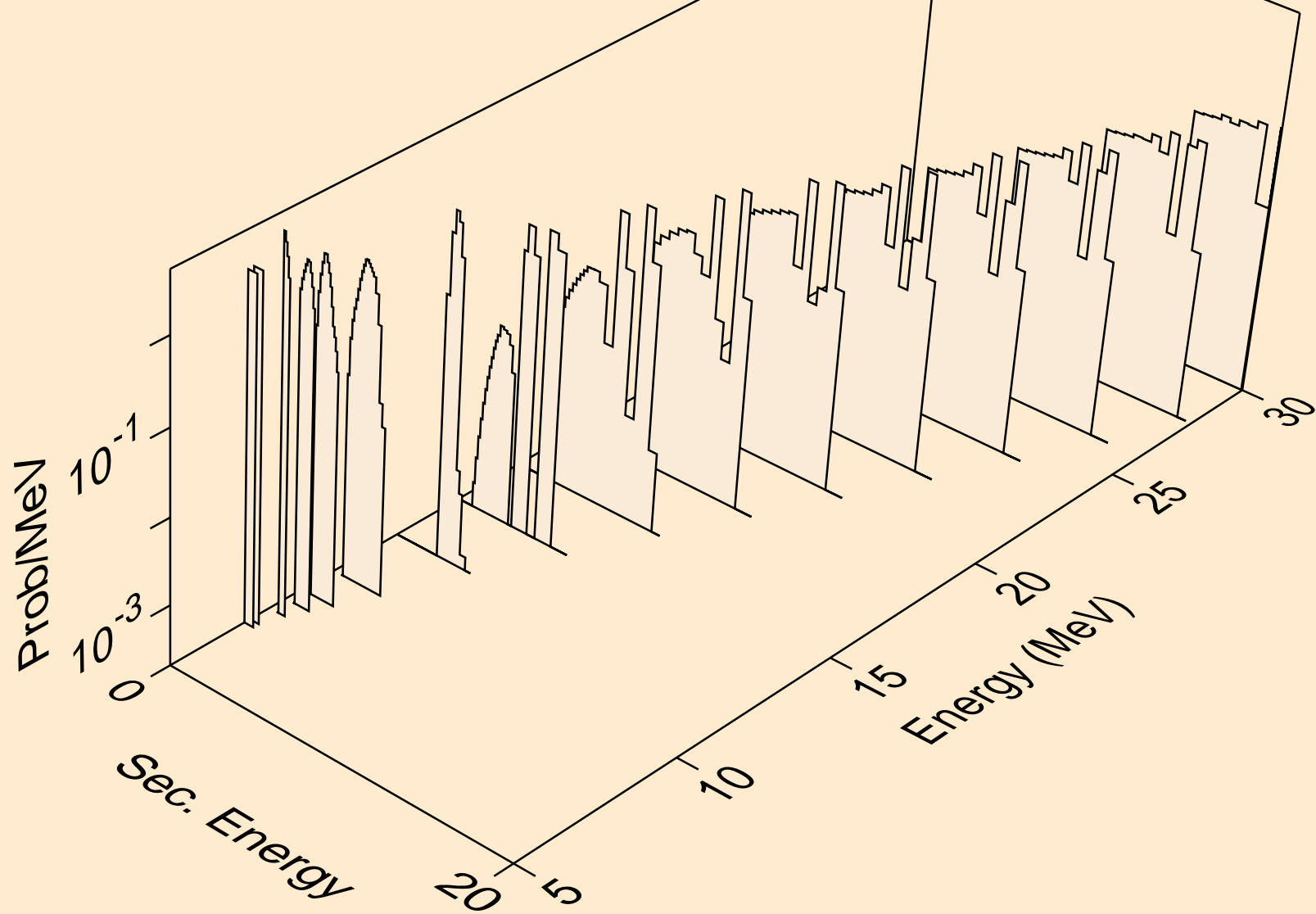

P036 NEUTRON ACER TENDL-2023 LIBRARY; T=0.K
protons from (n,p)

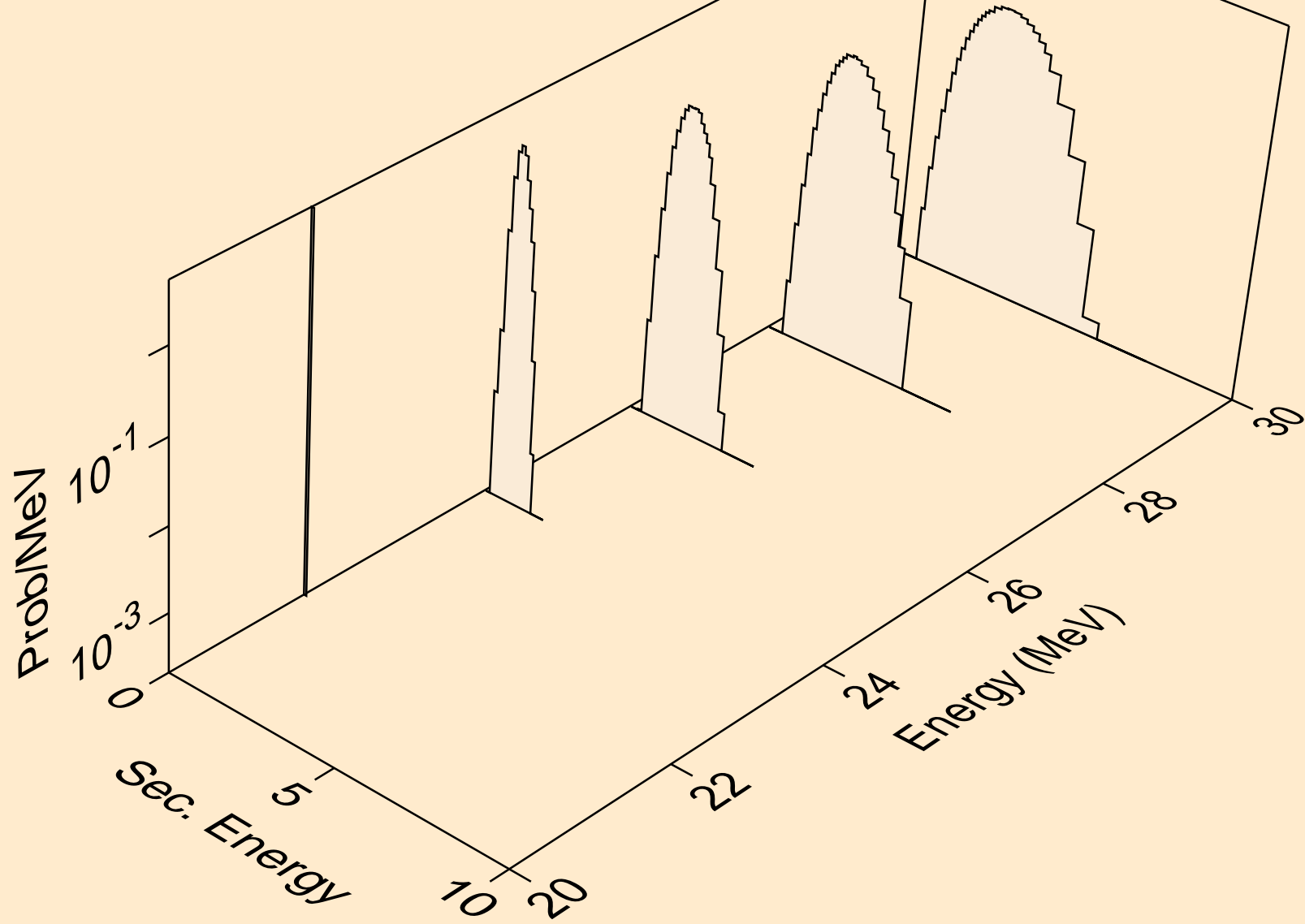

P036 NEUTRON ACER TENDL-2023 LIBRARY; T=0.K
deuterons from (n,x)

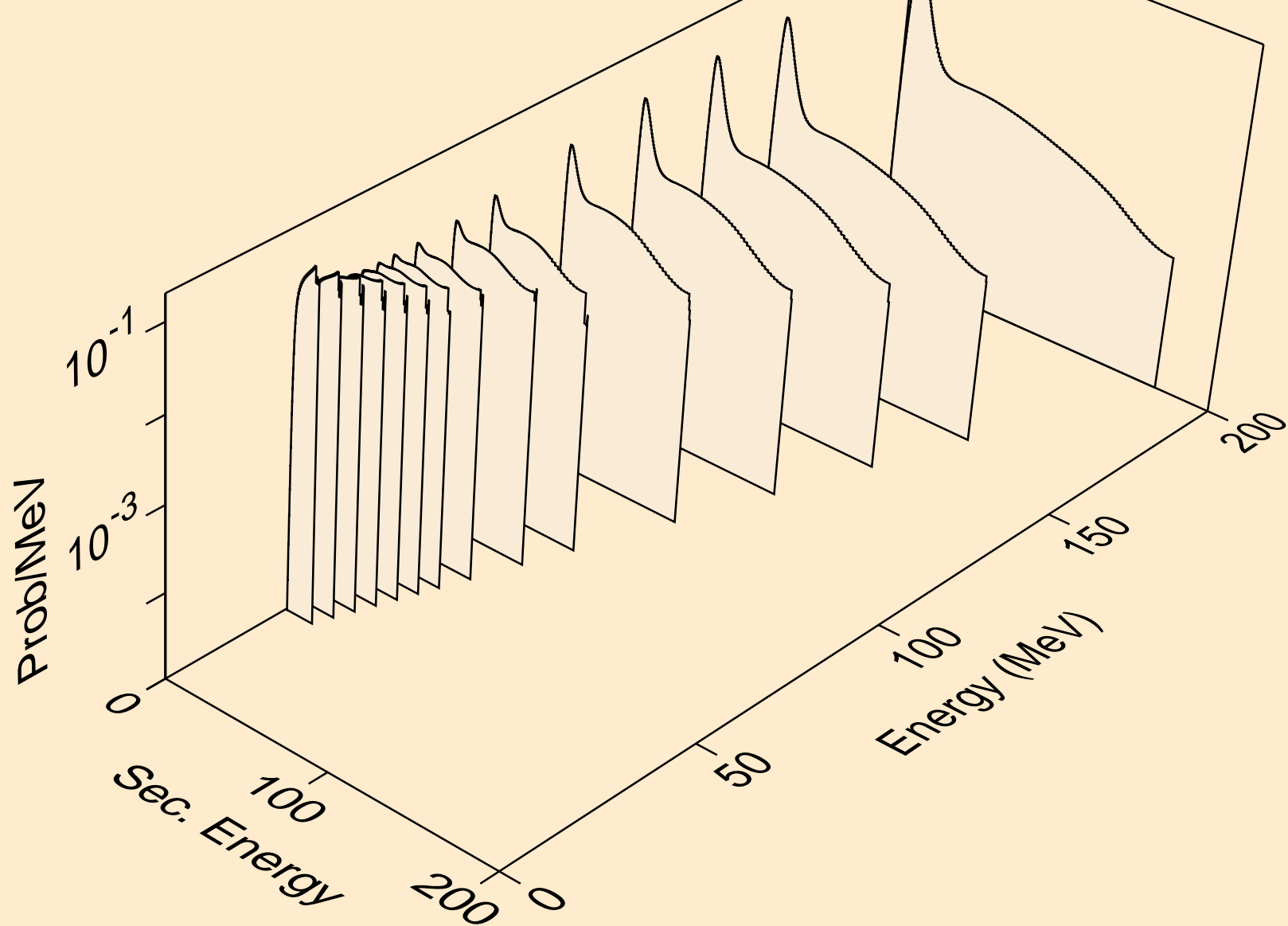

P036 NEUTRON ACER TENDL-2023 LIBRARY; T=0.K
deuterons from (n,2nd)

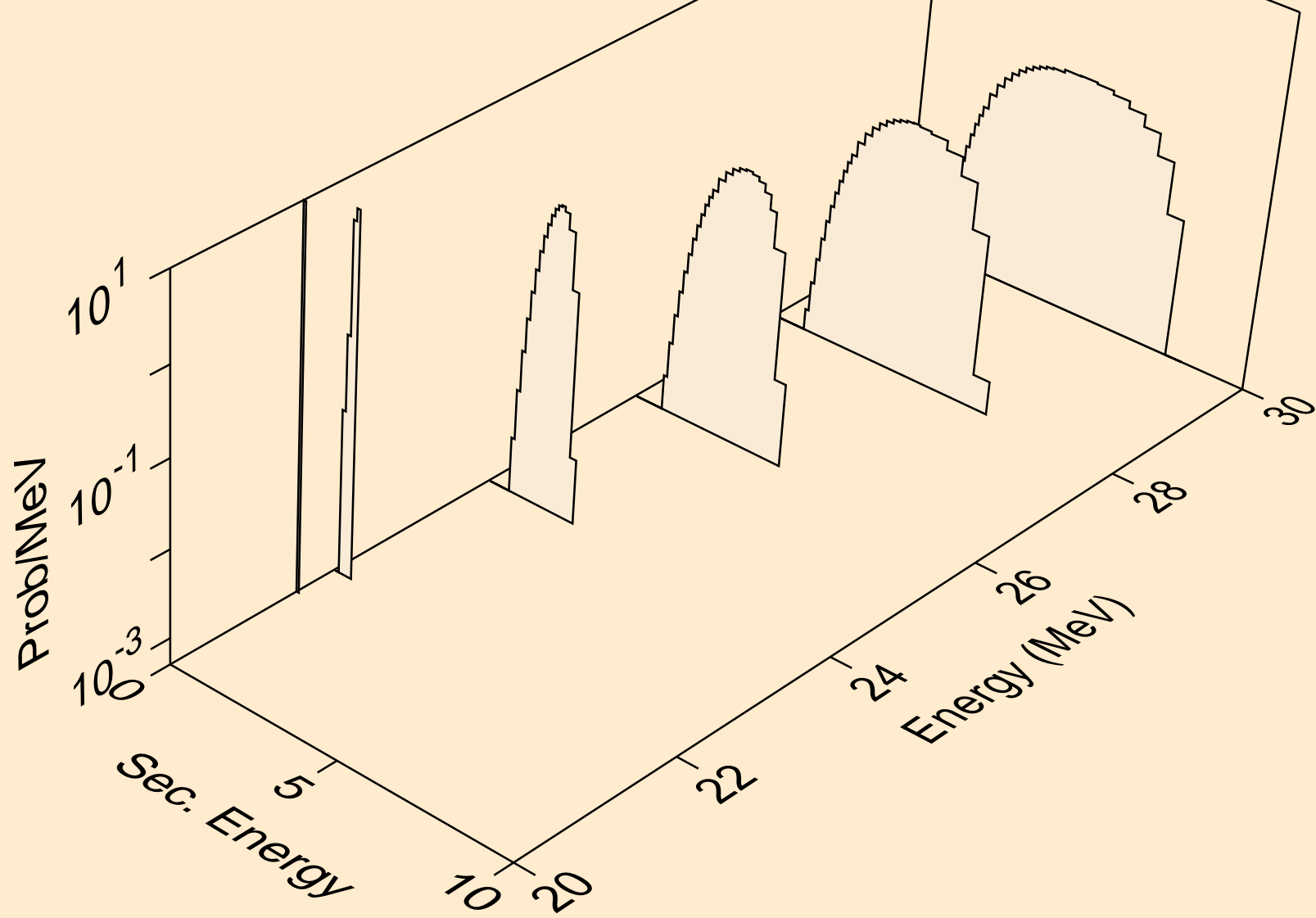

P036 NEUTRON ACER TENDL-2023 LIBRARY; T=0.K
deuterons from (n,n*)d

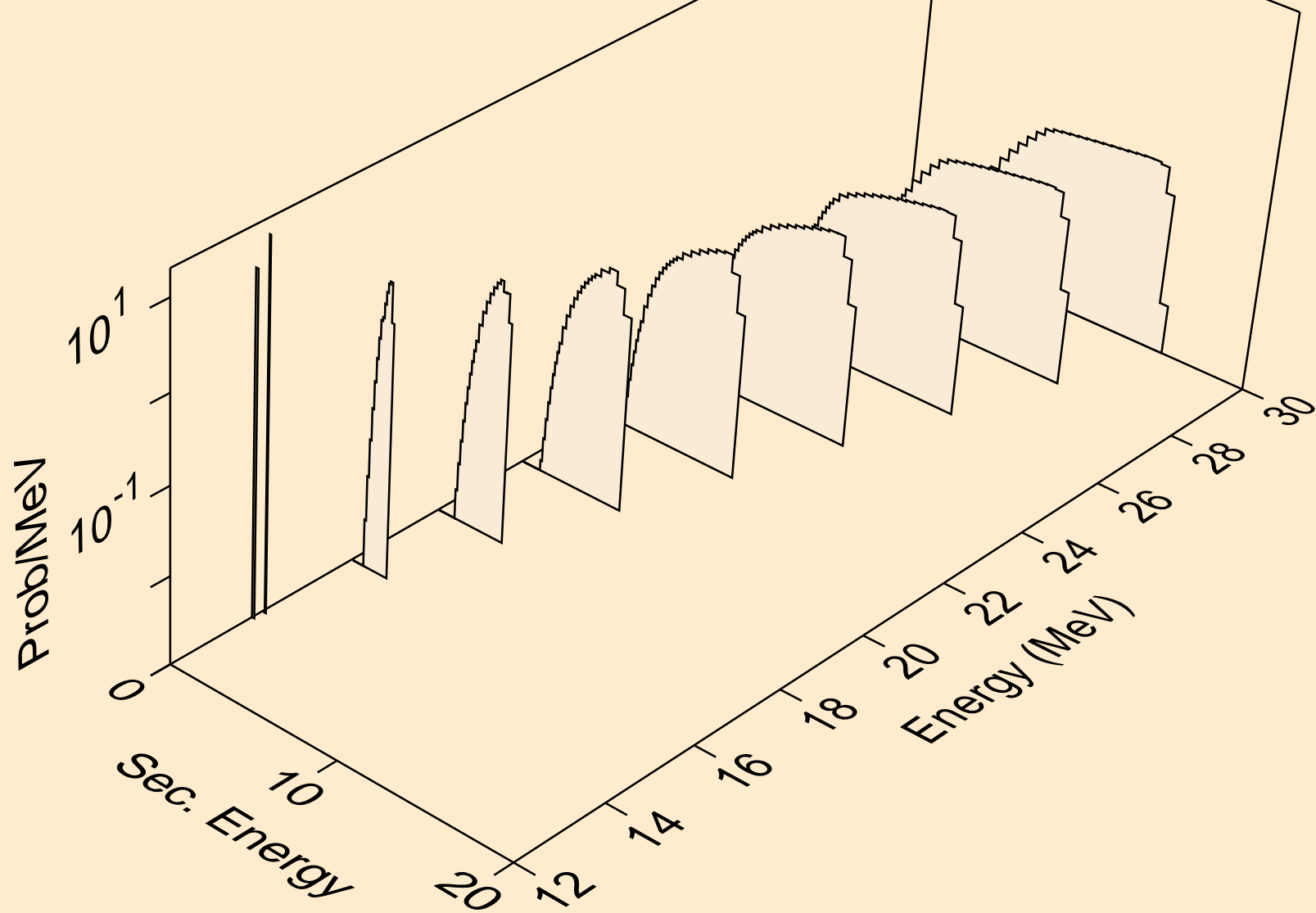

P036 NEUTRON ACER TENDL-2023 LIBRARY; T=0.K
deuterons from (n,d)

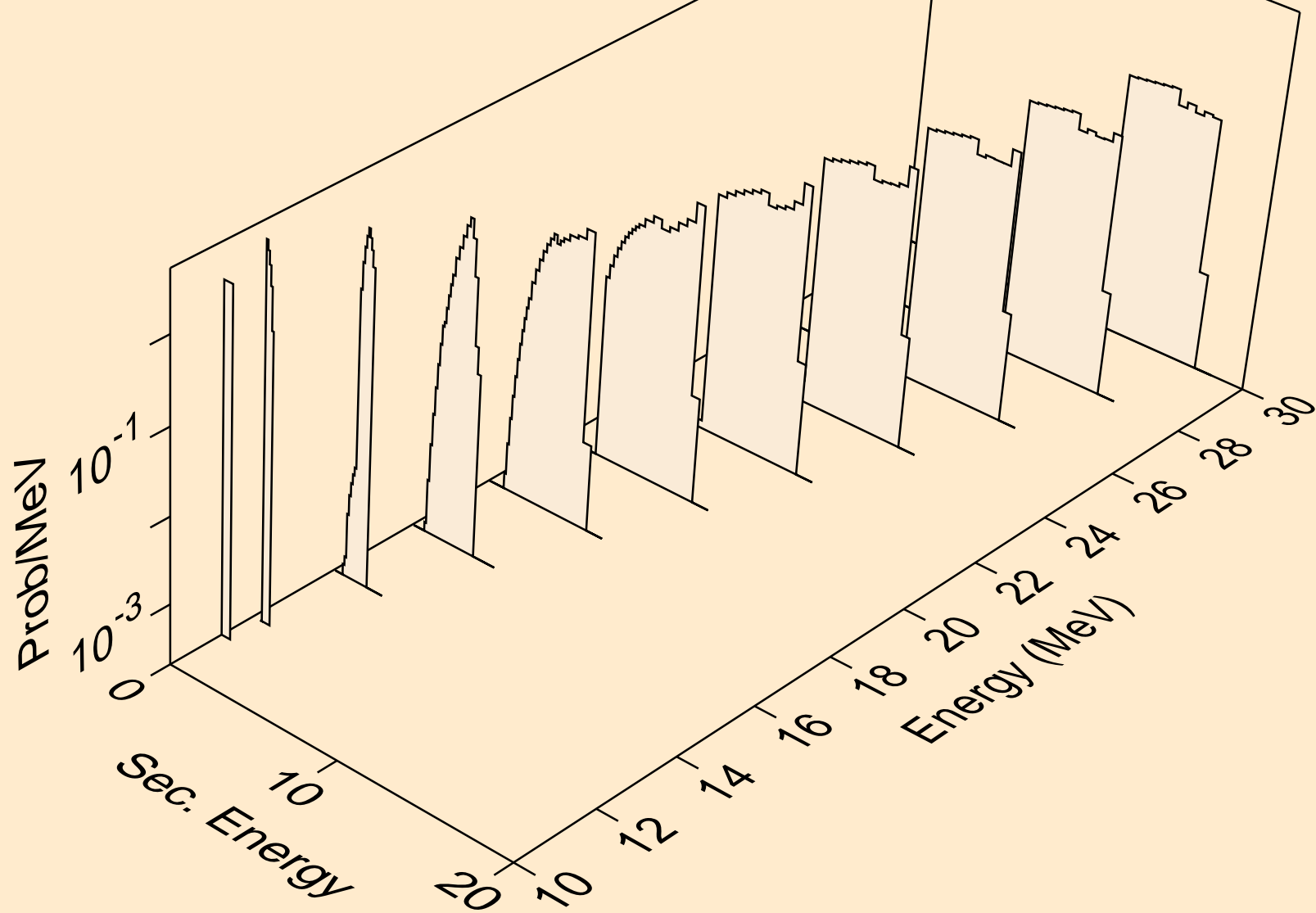

P036 NEUTRON ACER TENDL-2023 LIBRARY; T=0.K
tritons from (n,x)

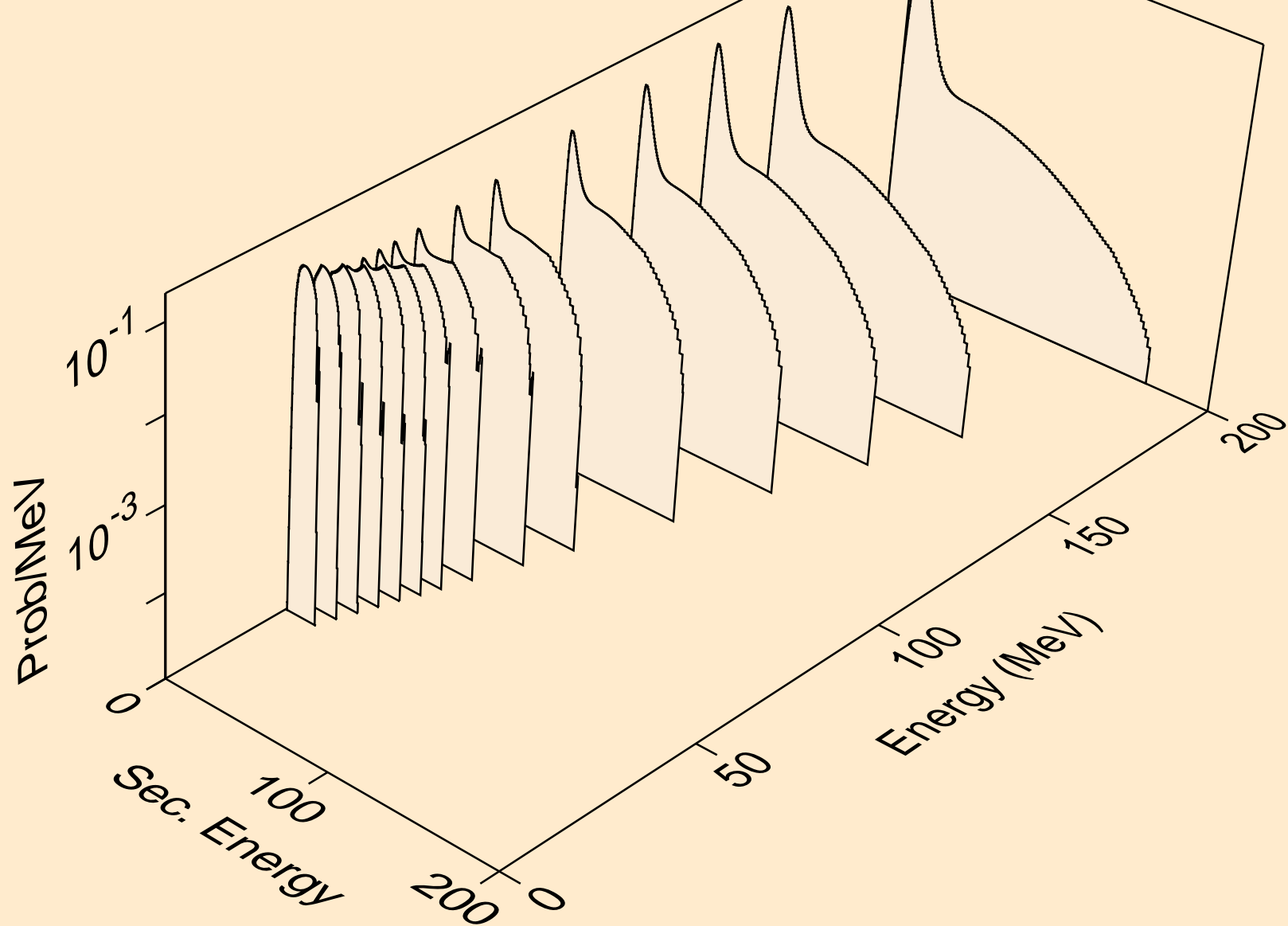

P036 NEUTRON ACER TENDL-2023 LIBRARY; T=0.K
tritons from (n,n*)t

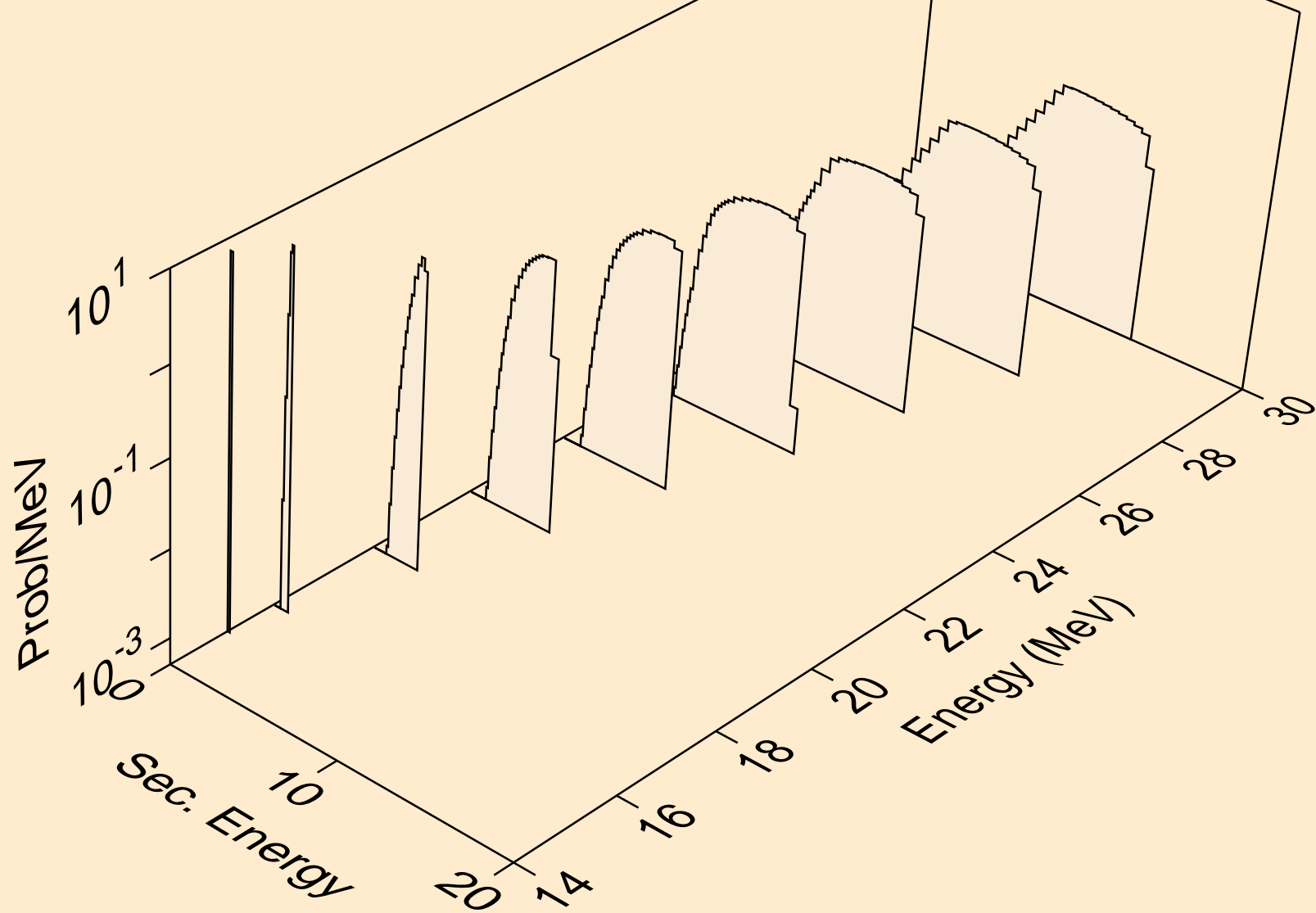

P036 NEUTRON ACER TENDL-2023 LIBRARY; T=0.K
tritons from (n,t)

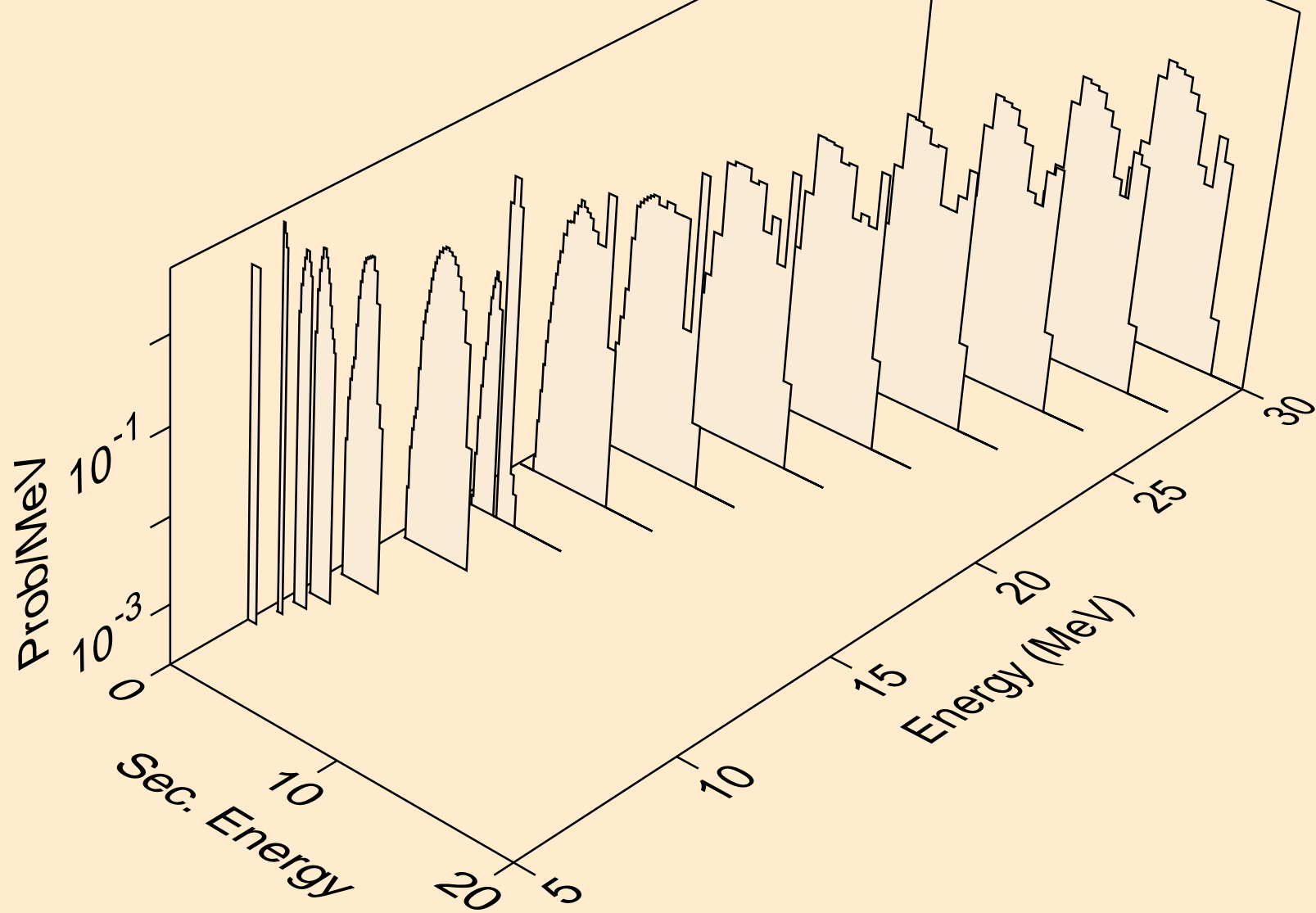

P036 NEUTRON ACER TENDL-2023 LIBRARY; T=0.K
he3s from (n,x)

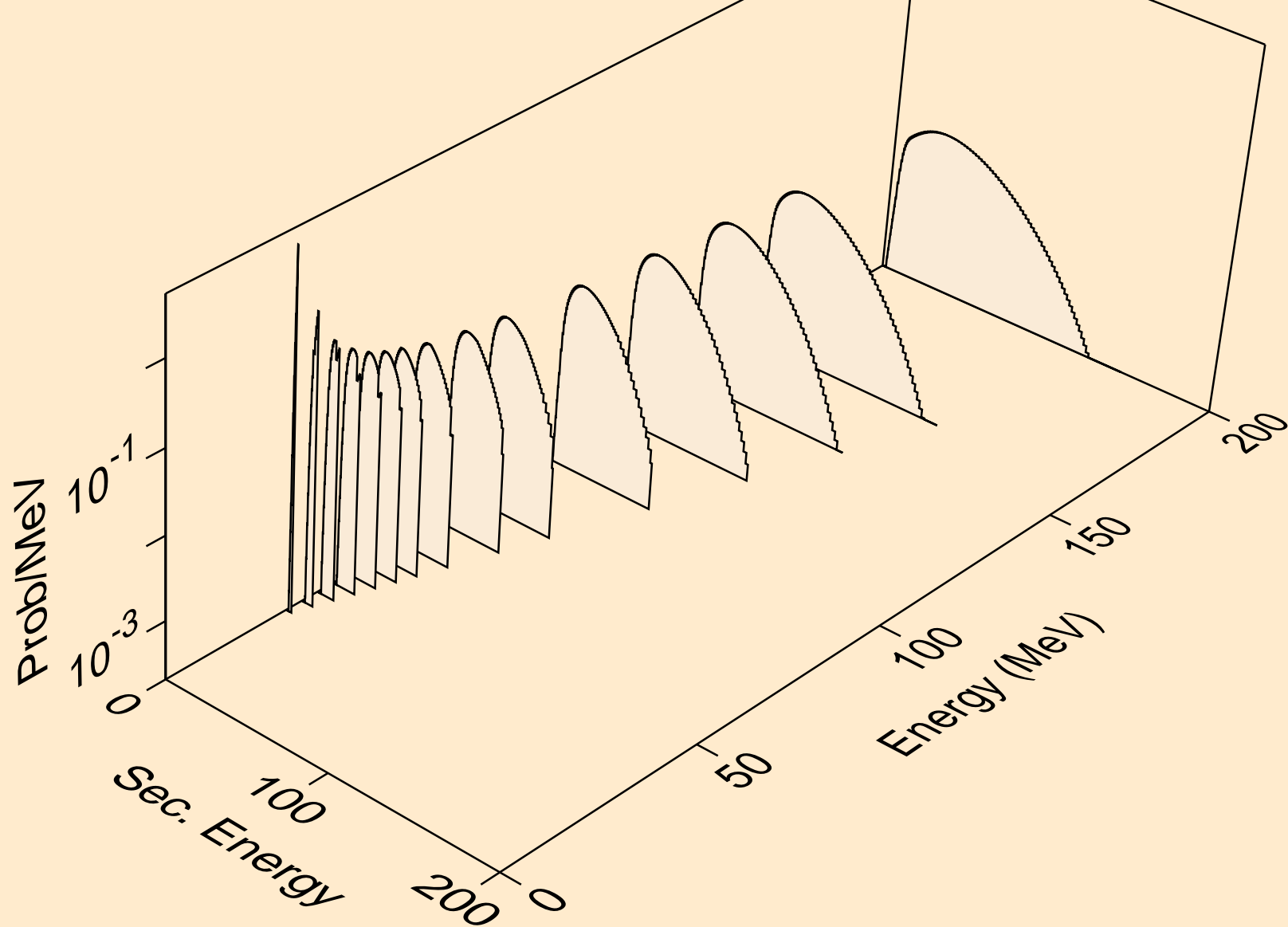

P036 NEUTRON ACER TENDL-2023 LIBRARY; T=0.K
he3s from (n,n*)he3

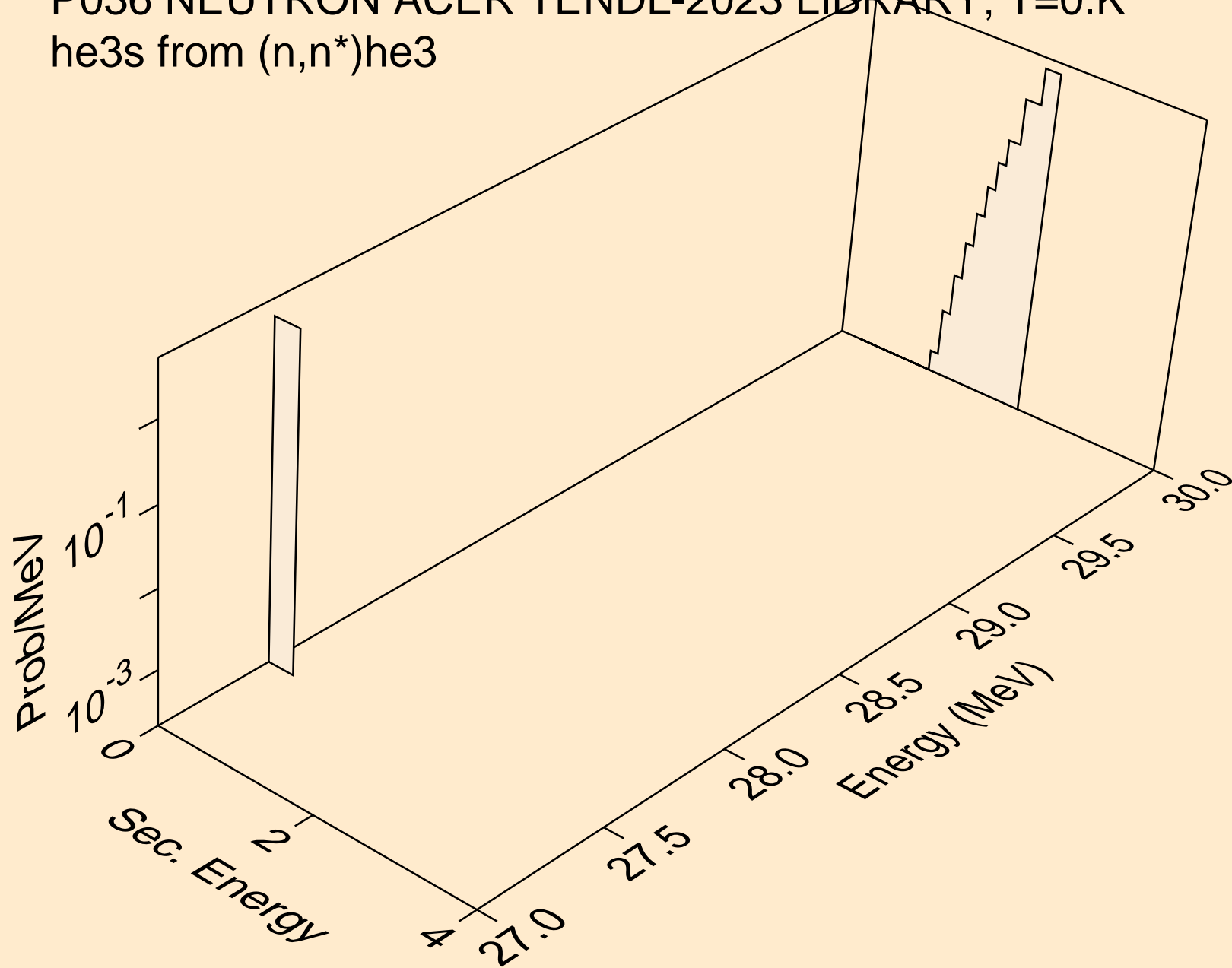

P036 NEUTRON ACER TENDL-2023 LIBRARY; T=0.K
he3s from (n,he3)

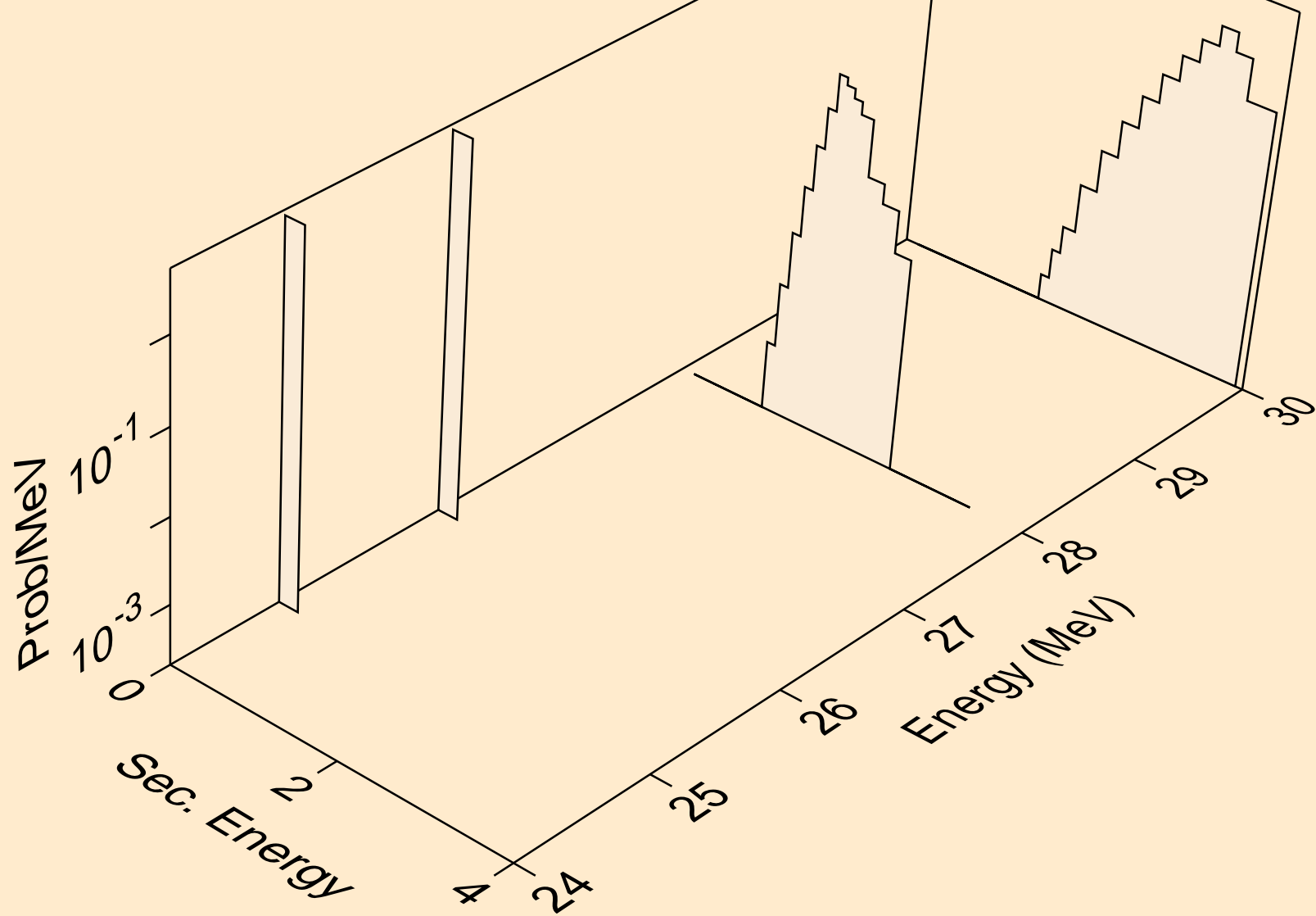

P036 NEUTRON ACER TENDL-2023 LIBRARY; T=0.K
alphas from (n,x)

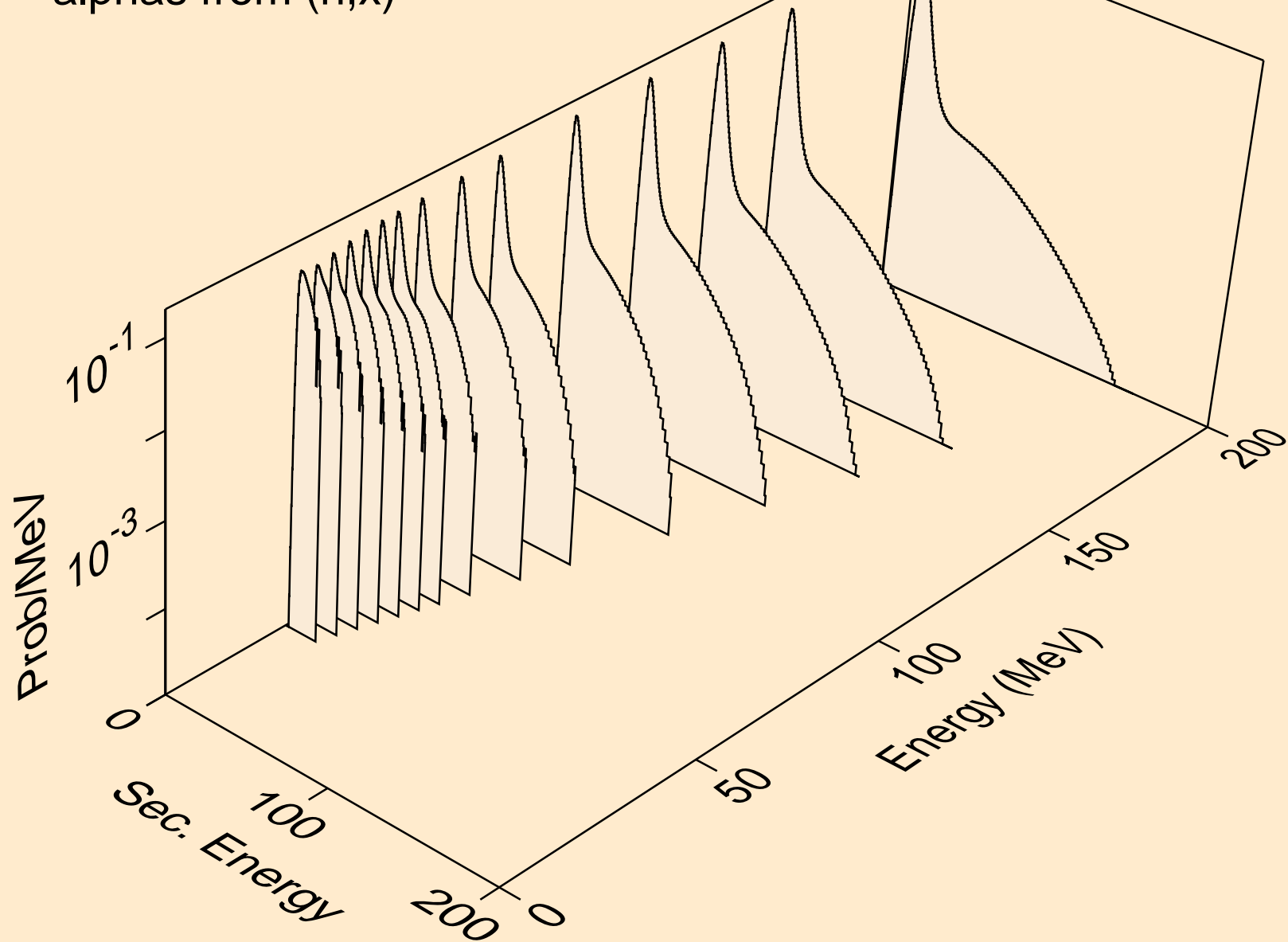

P036 NEUTRON ACER TENDL-2023 LIBRARY; T=0.K
alphas from (n,n*)a

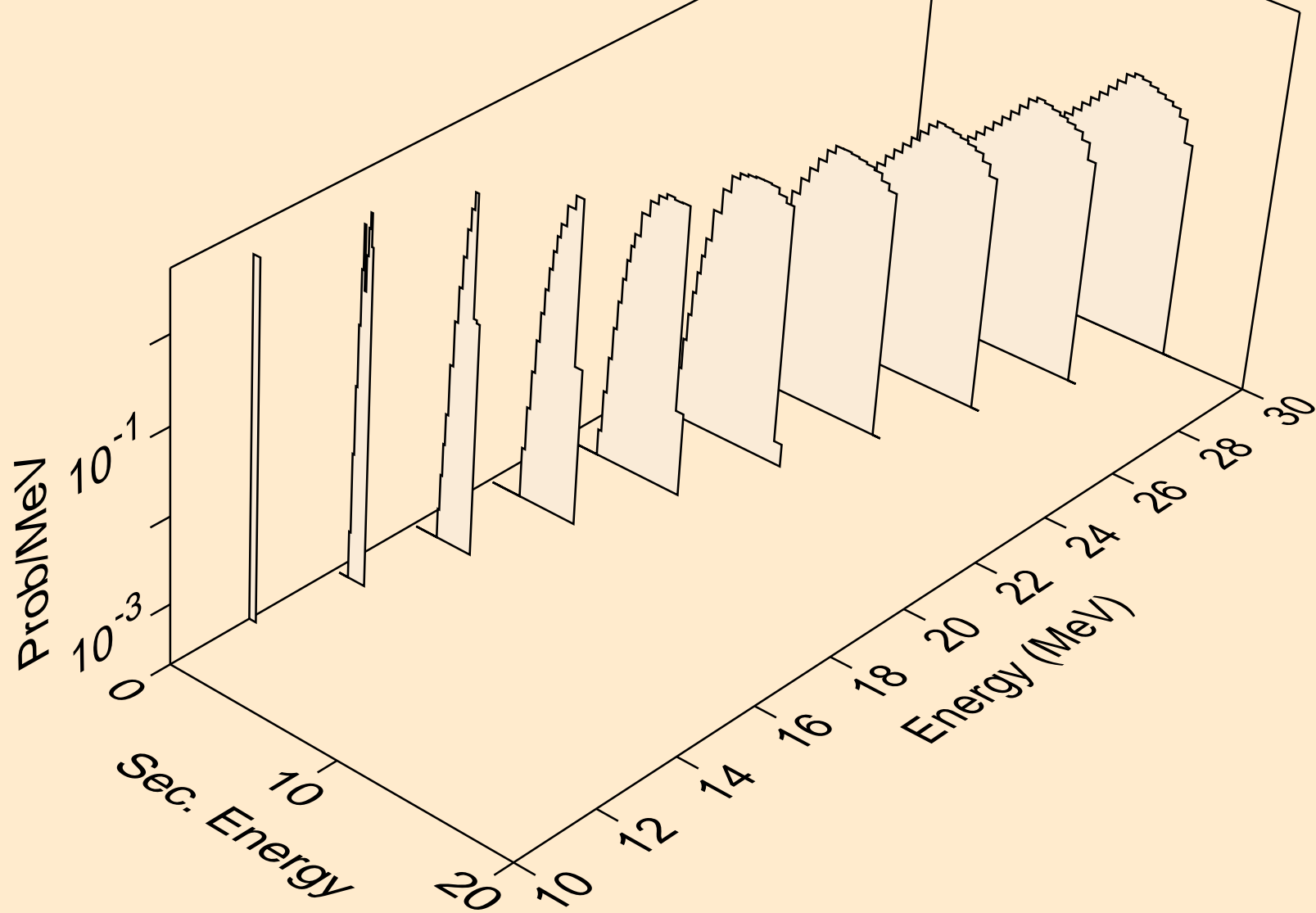

P036 NEUTRON ACER TENDL-2023 LIBRARY; T=0.K
alphas from (n,2n)a

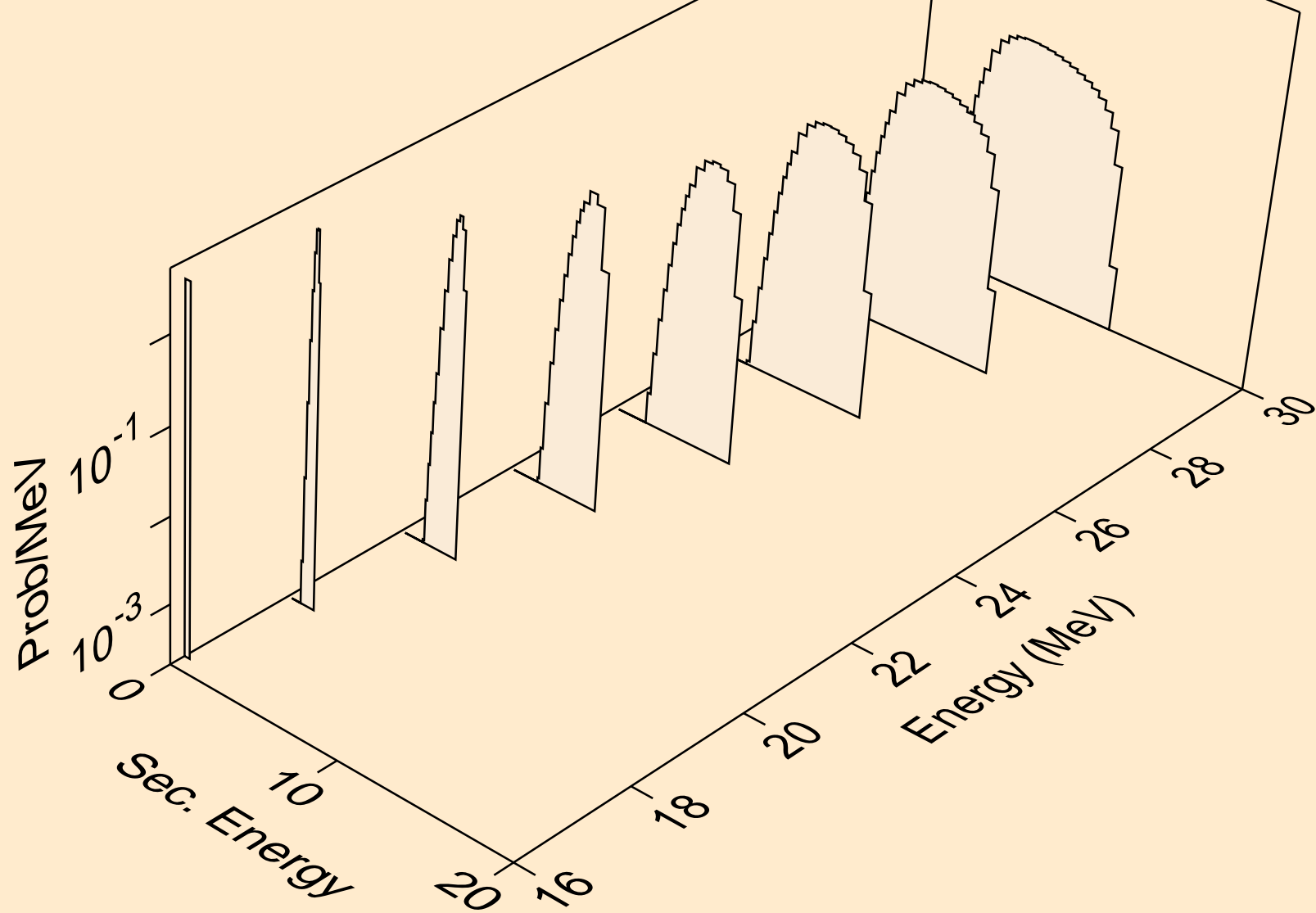

P036 NEUTRON ACER TENDL-2023 LIBRARY; T=0.K
alphas from (n,3n)a

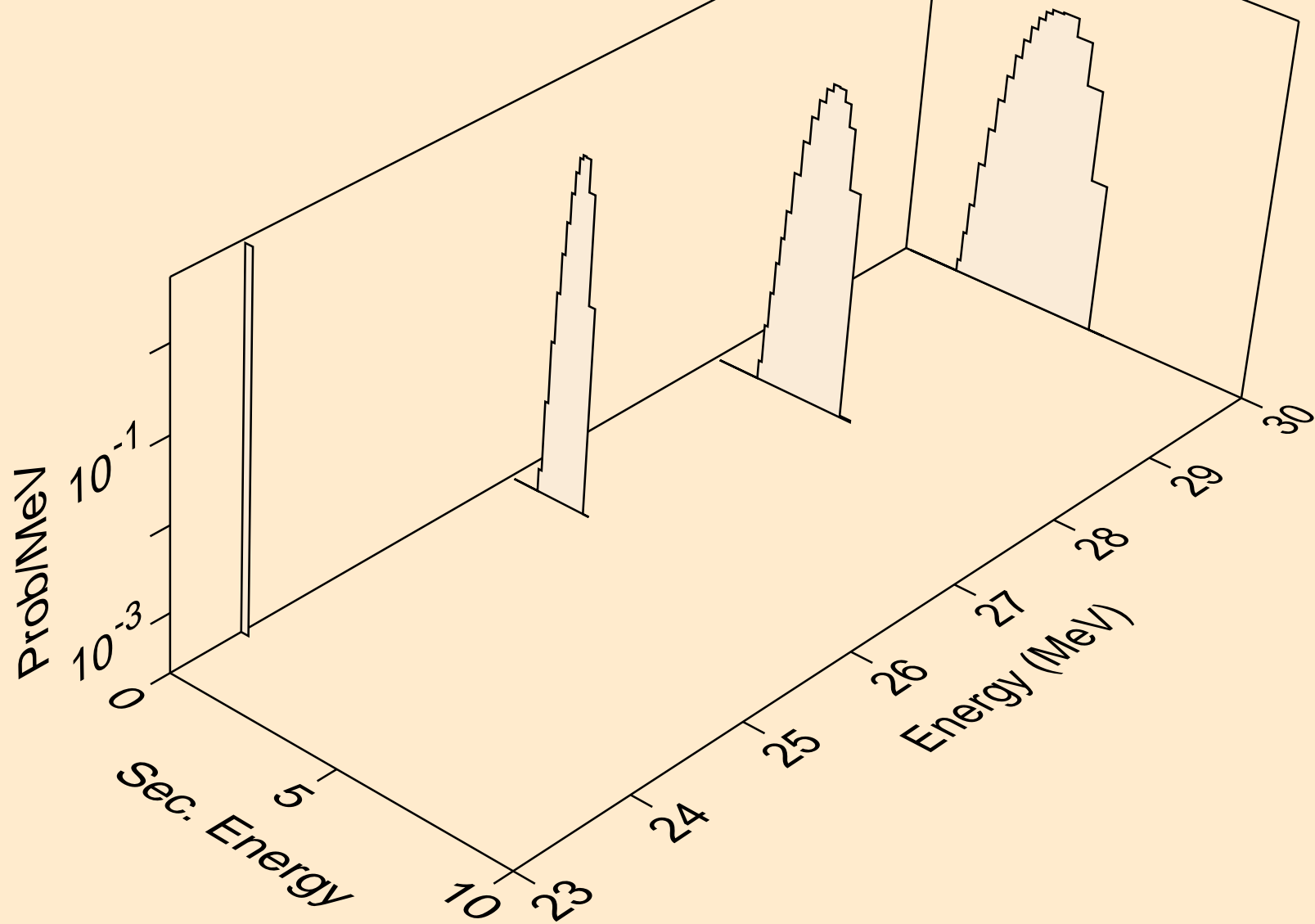

P036 NEUTRON ACER TENDL-2023 LIBRARY; T=0.K
alphas from (n,a)

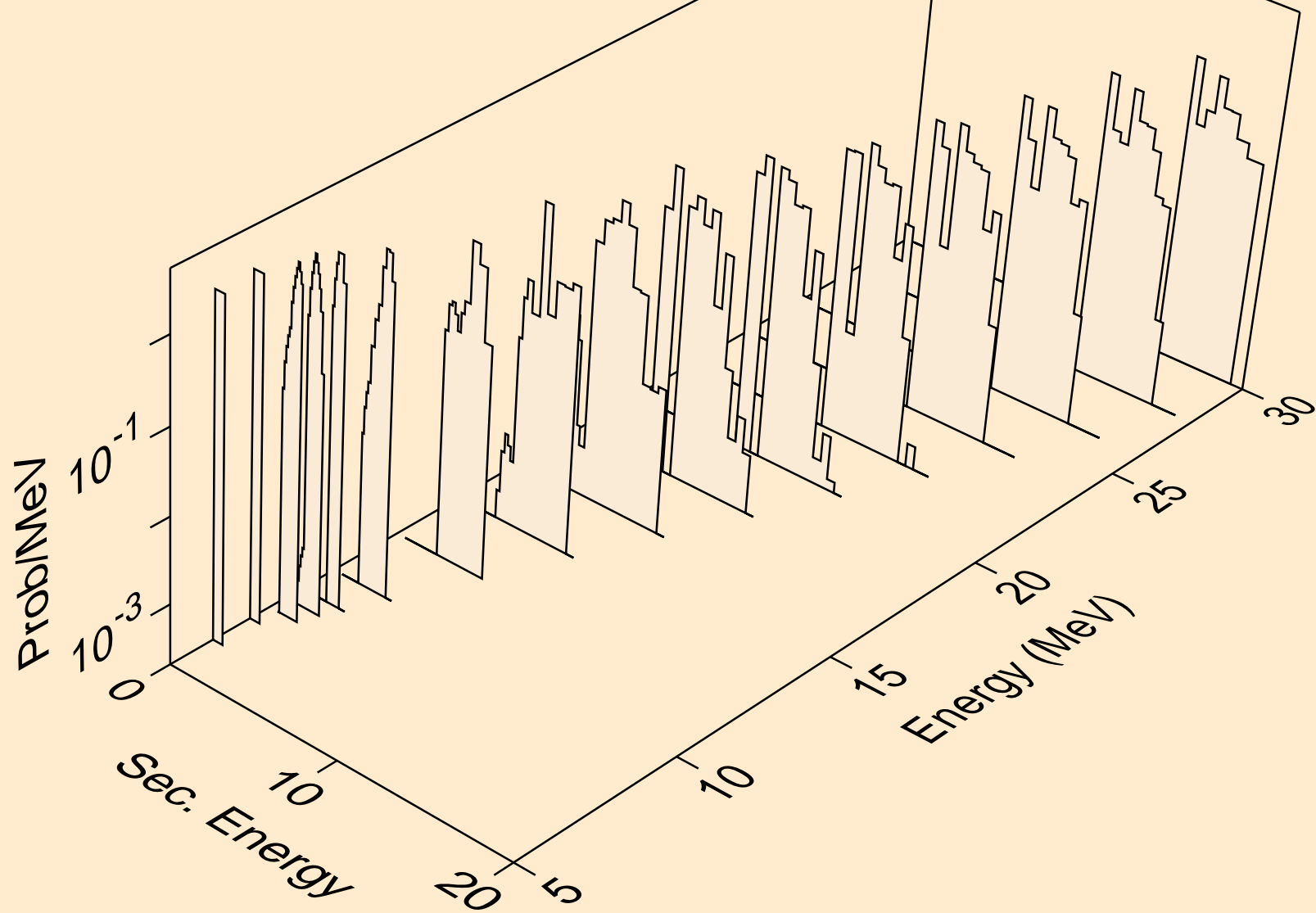

P036 NEUTRON ACER TENDL-2023 LIBRARY; T=0.K
alphas from (n,2a)

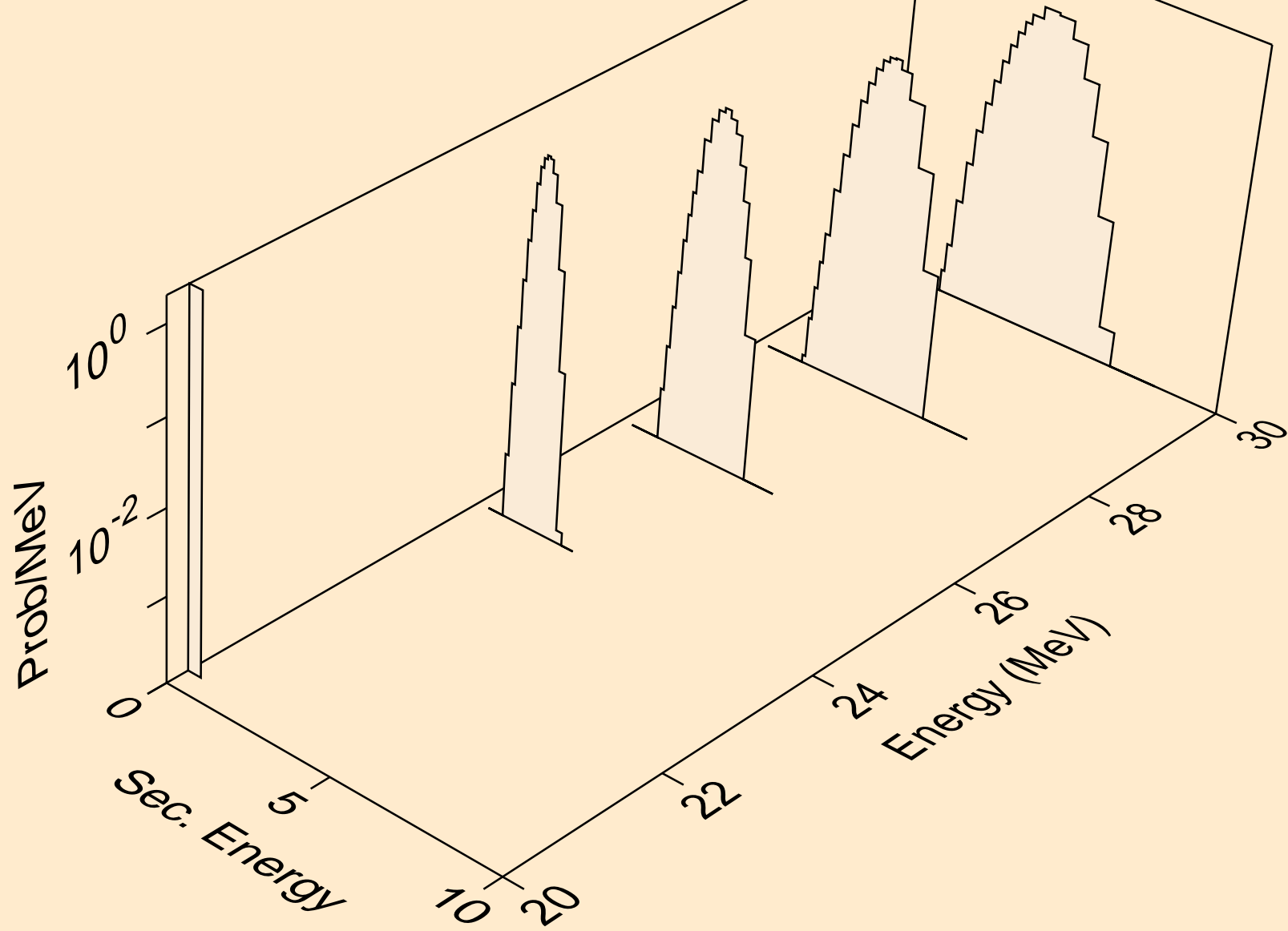

P036 NEUTRON ACER TENDL-2023 LIBRARY; T=0.K
alphas from (n,pa)

